

APPENDIX H1
PRELIMINARY WATER QUALITY MANAGEMENT PLAN

Project Specific Water Quality Management Plan

*A Template for Projects located within the **Santa Ana Watershed** Region of Riverside County*

Project Title: Penske Moreno Valley

Public Works No: PEN21-0025

Design Review/Case No: TBD

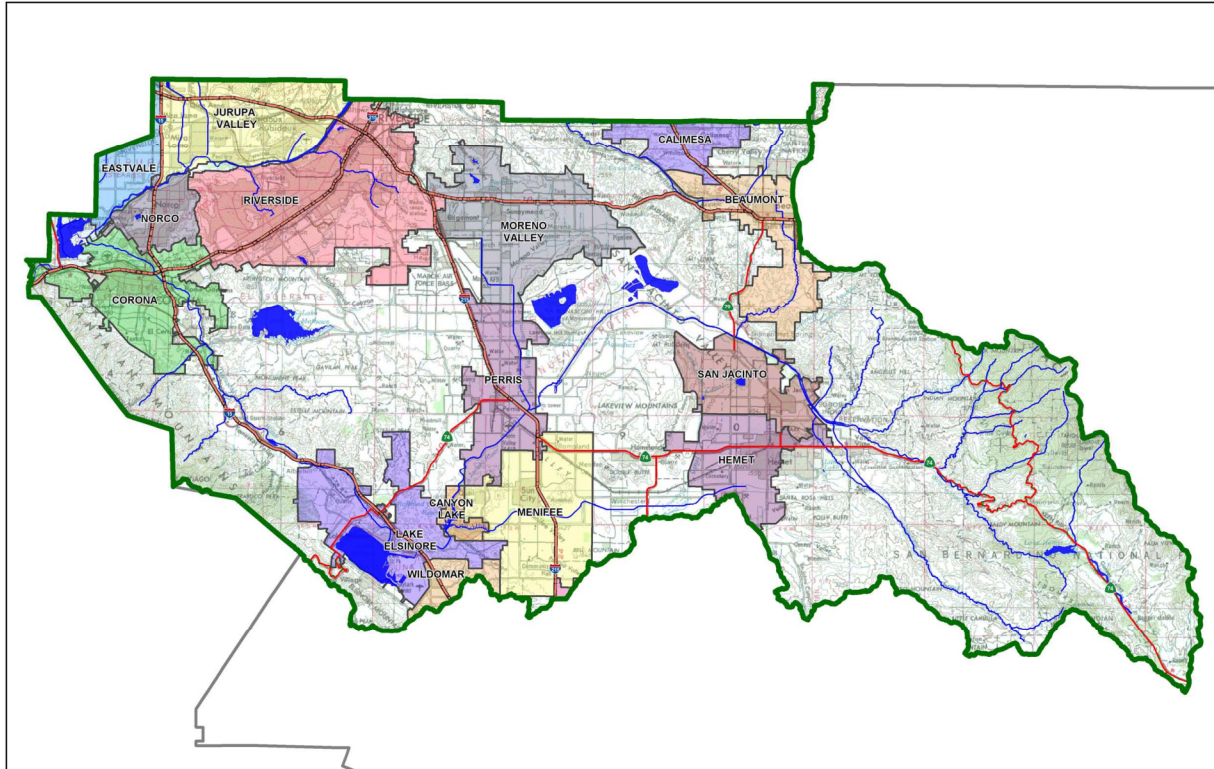

Preliminary

Final

Original Date Prepared: 11/10/2021

Revision Date(s):

*Prepared for Compliance with
Regional Board Order No. **R8-2010-0033***

Contact Information:

Prepared for:

Penske Truck Leasing
1711 W. Greentree Dr., Ste. 117
Tempe, AZ 85284

Prepared by:

Shea-Michael Anti, PE
Kimley-Horn and Associates
3880 Lemon Street Suite 420
Riverside, CA 92501
(951) 335-8272

A Brief Introduction

This Project-Specific WQMP Template for the **Santa Ana Region** has been prepared to help guide you in documenting compliance for your project. Because this document has been designed to specifically document compliance, you will need to utilize the WQMP Guidance Document as your “how-to” manual to help guide you through this process. Both the Template and Guidance Document go hand-in-hand, and will help facilitate a well prepared Project-Specific WQMP. Below is a flowchart for the layout of this Template that will provide the steps required to document compliance.

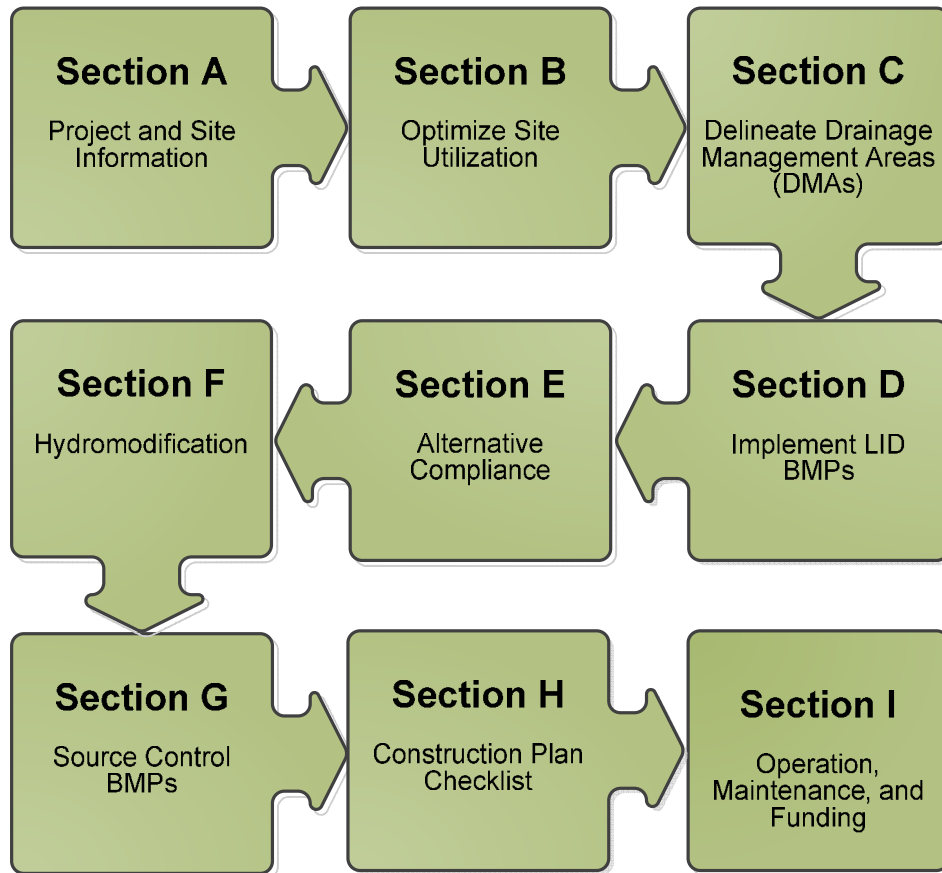

OWNER'S CERTIFICATION

This Project-Specific Water Quality Management Plan (WQMP) has been prepared for **Penske Truck Leasing** by **Kimley-Horn and Associates** for the **Penske Moreno Valley** project.

This WQMP is intended to comply with the requirements of the City of Moreno Valley for Ordinance No. 827, which includes the requirement for the preparation and implementation of a Project-Specific WQMP.

The undersigned, while owning the property/project described in the preceding paragraph, shall be responsible for the implementation and funding of this WQMP and will ensure that this WQMP is amended as appropriate to reflect up-to-date conditions on the site. In addition, the property owner accepts responsibility for interim operation and maintenance of Stormwater BMPs until such time as this responsibility is formally transferred to a subsequent owner. This WQMP will be reviewed with the facility operator, facility supervisors, employees, tenants, maintenance and service contractors, or any other party (or parties) having responsibility for implementing portions of this WQMP. At least one copy of this WQMP will be maintained at the project site or project office in perpetuity. The undersigned is authorized to certify and to approve implementation of this WQMP. The undersigned is aware that implementation of this WQMP is enforceable under the City of Moreno Valley Water Quality Ordinance (Municipal Code Section 8.10).

"I, the undersigned, certify under penalty of law that the provisions of this WQMP have been reviewed and accepted and that the WQMP will be transferred to future successors in interest."

TO BE PROVIDED IN FINAL REPORT

Owner's Signature

Date

Owner's Printed Name

Owner's Title/Position

PREPARER'S CERTIFICATION

"The selection, sizing and design of stormwater treatment and other stormwater quality and quantity control measures in this plan meet the requirements of Regional Water Quality Control Board Order No. **R8-2010-0033** and any subsequent amendments thereto."

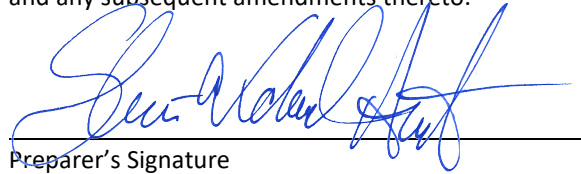

Preparer's Signature

11/10/21

Date

Shea-Michael Anti
Preparer's Printed Name

Senior Project Manager
Preparer's Title/Position

Preparer's Licensure: C78274



Table of Contents

| | |
|--|----|
| Section A: Project and Site Information..... | 6 |
| A.1 Maps and Site Plans..... | 6 |
| A.2 Identify Receiving Waters..... | 8 |
| A.3 Additional Permits/Approvals required for the Project: | 9 |
| Section B: Optimize Site Utilization (LID Principles) | 10 |
| Section C: Delineate Drainage Management Areas (DMAs)..... | 11 |
| Section D: Implement LID BMPs | 13 |
| D.1 Infiltration Applicability | 13 |
| D.2 Harvest and Use Assessment..... | 14 |
| D.3 Bioretention and Biotreatment Assessment | 17 |
| D.4 Feasibility Assessment Summaries | 18 |
| D.5 LID BMP Sizing | 19 |
| Section E: Alternative Compliance (LID Waiver Program) | 21 |
| E.1 Identify Pollutants of Concern | 22 |
| E.2 Stormwater Credits | 23 |
| E.3 Sizing Criteria..... | 23 |
| E.4 Treatment Control BMP Selection | 25 |
| Section F: Hydromodification | 26 |
| F.1 Hydrologic Conditions of Concern (HCOC) Analysis..... | 26 |
| F.2 HCOC Mitigation..... | 27 |
| Section G: Source Control BMPs..... | 28 |
| Section H: Construction Plan Checklist | 31 |
| Section I: Operation, Maintenance and Funding..... | 32 |

List of Tables

| | |
|---|----|
| Table A.1 Identification of Receiving Waters..... | 8 |
| Table A.2 Other Applicable Permits..... | 9 |
| Table C.1 DMA Classifications..... | 11 |
| Table C.2 Type 'A', Self-Treating Areas..... | 11 |
| Table C.3 Type 'B', Self-Retaining Areas..... | 11 |
| Table C.4 Type 'C', Areas that Drain to Self-Retaining Areas..... | 12 |
| Table C.5 Type 'D', Areas Draining to BMPs..... | 12 |
| Table D.1 Infiltration Feasibility..... | 13 |
| Table D.2 LID Prioritization Summary Matrix..... | 18 |
| Table D.3.1 DCV Calculations for LID BMPs..... | 19 |
| Table E.1 Potential Pollutants by Land Use Type..... | 22 |
| Table E.2 Water Quality Credits..... | 23 |
| Table E.3 Treatment Control BMP Sizing..... | 23 |
| Table E.4 Treatment Control BMP Selection..... | 25 |
| Table F.1 Hydrologic Conditions of Concern Summary..... | 26 |
| Table G.1 Permanent and Operational Source Control Measures..... | 29 |
| Table H.1 Construction Plan Cross-reference..... | 31 |

List of Appendices

| | |
|---|--------|
| Appendix 1: Maps and Site Plans..... | 33 |
| Appendix 2: Construction Plans..... | 34 |
| Appendix 3: Soils Information..... | 35 |
| Appendix 4: Historical Site Conditions..... | 36 |
| Appendix 5: LID Infeasibility..... | 37 |
| Appendix 6: BMP Design Details..... | 38 |
| Appendix 7: Hydromodification..... | 39 |
| Appendix 8: Source Control..... | 40 |
| Appendix 9: O&M..... | 41 |
| Appendix 10: Educational Materials..... | - 42 - |

Section A: Project and Site Information

| PROJECT INFORMATION | |
|---|--|
| Type of Project: | Commercial |
| Planning Area: | Community Commercial |
| Community Name: | n/a |
| Development Name: | Penske Moreno Valley |
| PROJECT LOCATION | |
| Latitude & Longitude (DMS): 33.915336°, -117.281606° | |
| Project Watershed and Sub-Watershed: Santa Ana Region Watershed, Santa Ana River Subwatershed | |
| APN(s): 297-100-067 (Portion), 297-100-073, 297-100-076, 297-120-002, 297-120-003, 297-120-017, 297-120-018, 297-120-016 (Portion) | |
| Map Book and Page No.: | |
| PROJECT CHARACTERISTICS | |
| Proposed or Potential Land Use(s) | Truck Leasing Center |
| Proposed or Potential SIC Code(s) | 7513 |
| Area of Impervious Project Footprint (SF) | 331,663 |
| Total Area of <u>proposed</u> Impervious Surfaces within the Project Limits (SF)/or Replacement | 331,663 |
| Does the project consist of offsite road improvements? | <input type="checkbox"/> Y <input checked="" type="checkbox"/> N |
| Does the project propose to construct unpaved roads? | <input type="checkbox"/> Y <input checked="" type="checkbox"/> N |
| Is the project part of a larger common plan of development (phased project)? | <input type="checkbox"/> Y <input checked="" type="checkbox"/> N |
| EXISTING SITE CHARACTERISTICS | |
| Total area of <u>existing</u> Impervious Surfaces within the project limits (SF) | 0 sf |
| Is the project located within any MSHCP Criteria Cell? | <input type="checkbox"/> Y <input checked="" type="checkbox"/> N |
| If so, identify the Cell number: | n/a |
| Are there any natural hydrologic features on the project site? | <input type="checkbox"/> Y <input checked="" type="checkbox"/> N |
| Is a Geotechnical Report attached? | <input type="checkbox"/> Y <input checked="" type="checkbox"/> N |
| If no Geotech. Report, list the NRCS soils type(s) present on the site (A, B, C and/or D) | Soils C |
| What is the Water Quality Design Storm Depth for the project? | 0.613 |

A.1 Maps and Site Plans

When completing your Project-Specific WQMP, include a map of the local vicinity and existing site. In addition, include all grading, drainage, landscape/plant palette and other pertinent construction plans in Appendix 2. At a **minimum**, your WQMP Site Plan should include the following:

- Drainage Management Areas
- Proposed Structural BMPs
- Drainage Path
- Drainage Infrastructure, Inlets, Overflows
- Source Control BMPs
- Buildings, Roof Lines, Downspouts
- Impervious Surfaces
- Standard Labeling

Use your discretion on whether or not you may need to create multiple sheets or can appropriately accommodate these features on one or two sheets. Keep in mind that the Co-Permittee plan reviewer must be able to easily analyze your project utilizing this template and its associated site plans and maps.

The existing vacant lot will be developed into the proposed Penske Truck Leasing Center. The proposed Penske Moreno Valley development will include the construction of a leasing center with associated commercial landscaping, concrete hardscape, and asphalt paving parking. Offsite street improvements are not proposed as part of the project scope. The project site is approximately 9.12 acres and is located in the southeast corner of Alessandro Boulevard and Old 215 Frontage Road in the City of Moreno Valley, within Riverside County. The existing site is approximately 0% impervious. Once the site is developed, the site will be approximately 83% impervious and 17% pervious.

The existing site is currently vacant and drains in a northwest direction. Under existing conditions, the site not only conveys onsite flows, but it also accepts offsite flows. The existing site currently accepts offsite flows from the east and northeast. Offsite flows sheet flow onsite and confluence with onsite flows. The combined onsite and offsite flows discharge northwest of the project site. The flows continue northwest and are eventually intercepted by existing catch basins near the intersection of Alessandro Boulevard and Old 215 Frontage Road. The existing site also includes an existing 24" RCP storm drain pipe that drains southwest and discharges to the offsite existing development across from the Old 215 Frontage Road. Although the existing grading for the site does not currently allow discharge into the existing 24" RCP, the existing pipe is intended to convey the flows tributary to the project site.

The proposed site grading intends to maintain the existing flow pattern by predominantly draining in a northwest direction. The post-development condition consists three (3) DMA's. The three onsite DMA's will drain into three proposed modular wetland systems. The proposed modular wetland systems are proposed for storm water quality treatment. The modular wetland systems will be sized to treat the design flow rate required for water quality purposes and bypass high flows. The treatment design flow rate was calculated using the Santa Ana Watershed - BMP Design Flow Rate Worksheet, which is based on the Riverside County Low Impact Development BMP Design Handbook. Runoff from the inlets is then conveyed into a proposed underground detention system for stormwater mitigation. The proposed detention system is proposed to outlet into the proposed pump that will be used to pump the flows up to the elevation of the existing 24" RCP storm drain pipe that is intended to convey the flows tributary to the project site.

Appendix 1 includes a map of the local vicinity and existing site. In addition, WQMP Site Plan, located in Appendix 1, includes the following:

- Drainage Management Areas
- Proposed Structural BMPs
- Drainage Path
- Drainage Infrastructure, Inlets, Overflows
- Source Control BMPs
- Buildings, Roof Lines, Downspouts
- Impervious Surfaces
- Standard Labeling

A.2 Identify Receiving Waters

Using Table A.1 below, list in order of upstream to downstream, the receiving waters that the project site is tributary to. Continue to fill each row with the Receiving Water's 303(d) listed impairments (if any), designated beneficial uses, and proximity, if any, to a RARE beneficial use. Include a map of the receiving waters in Appendix 1.

Table A.1 Identification of Receiving Waters

| Receiving Waters | EPA Approved 303(d) List Impairments | Designated Beneficial Uses | Proximity to RARE Beneficial Use |
|--|---|--|-------------------------------------|
| San Jacinto River (Reach 3) | None | AGR, GWR, REC1, REC2, WARM, WILD, MUN | Not a water body classified as RARE |
| Canyon Lake (Aka: San Jacinto River Reach 2) | Nutrients, Pathogens | MUN, AGR, GWR, REC1, REC2, WARM, WILD | Not a water body classified as RARE |
| San Jacinto River (Reach 1) | None | MUN, AGR, GWR, REC1, REC2, WARM, WILD | Not a water body classified as RARE |
| Lake Elsinore | Nutrients, Organic Enrichments, Low Dissolved Oxygen, PCBs, Sediment Toxicity, Unknown Toxicity | REC1, REC2, WARM, WILD, MUN | Not a water body classified as RARE |
| Temescal Creek (Reach 6) | Indicator Bacteria | GWR, REC1, REC2, WARM, WILD, MUN | Not a water body classified as RARE |
| Temescal Creek (Reach 5) | None | AGR, GWR, REC1, REC2, WARM, WILD, RARE, MUN | 22 miles |
| Temescal Creek (Reach 4) | None | AGR, GWR, REC1, REC2, WARM, WILD, RARE | 28 miles |
| Temescal Creek (Reach 3) – Lee Lake | None | AGR, IND, GWR, REC1, REC2, WARM, WILD, MUN | Not a water body classified as RARE |
| Temescal Creek (Reach 2) | None | AGR, IND, GWR, REC1, REC2, WARM, WILD, MUN | Not a water body classified as RARE |
| Temescal Creek (Reach 1) | None | REC1, REC2, WARM, WILD | Not a water body classified as RARE |
| Santa Ana River (Reach 3) | Copper, Lead, Pathogens | AGR, GWR, REC1, REC2, WARM, WILD, RARE, MUN | 47 miles |
| Prado Basin Management Zone | Pathogens, Nutrients | REC1, REC2, WARM, WILD, RARE, MUN | 49 miles |
| Santa Ana River (Reach 2) | Indicator Bacteria | AGR, GWR, REC1, REC2, WARM, WILD, RARE, MUN | 68 miles |
| Santa Ana River (Reach 1) | None | REC1, REC2, WARM, WILD, MUN | Not a water body classified as RARE |
| Tidal Prism of Santa Ana River (to within 1000' of Victoria Street) and Newport Slough | Enterococcus, Fecal Coliform, Total Coliform | REC1, REC2, COMM, WILD, RARE, MAR, MUN | 77 miles |
| Pacific Ocean Nearshore Zone | None | IND, NAV, REC1, REC2, COMM, WILD, RARE, SPWN, MAR, SHEL, MUN | 78 miles |
| Pacific Ocean Offshore Zone | None | IND, NAV, REC1, REC2, COMM, WILD, RARE, SPWN, MAR, MUN | 80 miles |

A.3 Additional Permits/Approvals required for the Project:

Table A.2 Other Applicable Permits

| Agency | Permit Required | |
|--|---------------------------------------|---------------------------------------|
| State Department of Fish and Game, 1602 Streambed Alteration Agreement | <input type="checkbox"/> Y | <input checked="" type="checkbox"/> N |
| State Water Resources Control Board, Clean Water Act (CWA) Section 401 Water Quality Cert. | <input type="checkbox"/> Y | <input checked="" type="checkbox"/> N |
| US Army Corps of Engineers, CWA Section 404 Permit | <input type="checkbox"/> Y | <input checked="" type="checkbox"/> N |
| US Fish and Wildlife, Endangered Species Act Section 7 Biological Opinion | <input type="checkbox"/> Y | <input checked="" type="checkbox"/> N |
| Statewide Construction General Permit Coverage: WDID # TBD prior to final approval | <input checked="" type="checkbox"/> Y | <input type="checkbox"/> N |
| Statewide Industrial General Permit Coverage | <input type="checkbox"/> Y | <input checked="" type="checkbox"/> N |
| Western Riverside MSHCP Consistency Approval (e.g., JPR, DBESP) | <input type="checkbox"/> Y | <input checked="" type="checkbox"/> N |
| Other <i>(please list in the space below as required)</i> | | |
| City of Moreno Valley Grading Permit | <input checked="" type="checkbox"/> Y | <input type="checkbox"/> N |
| City of Moreno Valley Building Permit | <input checked="" type="checkbox"/> Y | <input type="checkbox"/> N |

If yes is answered to any of the questions above, the Co-Permittee may require proof of approval/coverage from those agencies as applicable including documentation of any associated requirements that may affect this Project-Specific WQMP.

Section B: Optimize Site Utilization (LID Principles)

Review of the information collected in Section 'A' will aid in identifying the principal constraints on site design and selection of LID BMPs as well as opportunities to reduce imperviousness and incorporate LID Principles into the site and landscape design. For example, **constraints** might include impermeable soils, high groundwater, groundwater pollution or contaminated soils, steep slopes, geotechnical instability, high-intensity land use, heavy pedestrian or vehicular traffic, utility locations or safety concerns. **Opportunities** might include existing natural areas, low areas, oddly configured or otherwise unbuildable parcels, easements and landscape amenities including open space and buffers (which can double as locations for bioretention BMPs), and differences in elevation (which can provide hydraulic head). Prepare a brief narrative for each of the site optimization strategies described below. This narrative will help you as you proceed with your LID design and explain your design decisions to others.

The 2010 Santa Ana MS4 Permit further requires that LID Retention BMPs (Infiltration Only or Harvest and Use) be used unless it can be shown that those BMPs are infeasible. Therefore, it is important that your narrative identify and justify if there are any constraints that would prevent the use of those categories of LID BMPs. Similarly, you should also note opportunities that exist which will be utilized during project design. Upon completion of identifying Constraints and Opportunities, include these on your WQMP Site plan in Appendix 1.

Site Optimization

The following questions are based upon Section 3.2 of the WQMP Guidance Document. Review of the WQMP Guidance Document will help you determine how best to optimize your site and subsequently identify opportunities and/or constraints, and document compliance.

Does the project identify and preserve existing drainage patterns? If so, how? If not, why?

Yes. The proposed site grading intends to maintain the existing flow pattern by predominantly draining in the northwest direction.

Does the project identify and protect existing vegetation? If so, how? If not, why?

No. The existing site is currently vacant and does not have any existing vegetation, other than annual grass. The proposed development will add landscape throughout the site, making the proposed development approximately 17% pervious.

Does the project identify and preserve natural infiltration capacity? If so, how? If not, why?

Yes, natural infiltration capacity will be maintained to the maximum extent possible. Compaction of soils within proposed landscaped area will be kept to a minimum to preserve natural infiltration capacity.

Does the project identify and minimize impervious area? If so, how? If not, why?

Yes. The site plan was done with the intent of maximizing the pervious area on the site. This was accomplished by using landscape planters throughout the site and perimeter planter areas.

Does the project identify and disperse runoff to adjacent pervious areas? If so, how? If not, why?

Yes. Roof drains and site drainage will be routed to adjacent landscaping to the maximum extent possible.

Section C: Delineate Drainage Management Areas (DMAs)

Utilizing the procedure in Section 3.3 of the WQMP Guidance Document which discusses the methods of delineating and mapping your project site into individual DMAs, complete Table C.1 below to appropriately categorize the types of classification (e.g., Type A, Type B, etc.) per DMA for your project site. Upon completion of this table, this information will then be used to populate and tabulate the corresponding tables for their respective DMA classifications.

Table C.1 DMA Classifications

| DMA Name or ID | Surface Type(s) | Area (Sq. Ft.) | DMA Type |
|----------------|---|----------------|---|
| DMA-1 | Concrete/Asphalt/Landscape Areas | 145,084 | Type “D” – Area that drains to BMP |
| DMA-2 | Concrete/Asphalt/Landscape Areas | 173,200 | Type “D” – Area that drains to BMP |
| DMA-3 | Concrete/Asphalt/Landscape Areas | 78,952 | Type “D” – Area that drains to BMP |
| | | | |
| | | | |

Table C.2 Type ‘A’, Self-Treating Areas

| DMA Name or ID | Area (Sq. Ft.) | Stabilization Type | Irrigation Type (if any) |
|----------------|----------------|--------------------|--------------------------|
| N/A | | | |
| | | | |

Table C.3 Type ‘B’, Self-Retaining Areas

| Self-Retaining Area | | | | Type ‘C’ DMAs that are draining to the Self-Retaining Area | | |
|---------------------|---------------------------|--------------------|----------------------|--|----------------------|-----------------------------------|
| DMA Name/ ID | Post-project surface type | Area (square feet) | Storm Depth (inches) | DMA Name / ID | [C] from Table C.4 = | Required Retention Depth (inches) |
| | | [A] | [B] | | [C] | [D] |
| N/A | N/A | N/A | N/A | N/A | N/A | N/A |

$$[D] = [B] + \frac{[B] \cdot [C]}{[A]}$$

Table C.4 Type 'C', Areas that Drain to Self-Retaining Areas

| DMA | | | | | Receiving Self-Retaining DMA | | |
|---------------|--------------------|---------------------------|---------------|-----------------|------------------------------|--------------------|---------|
| DMA Name / ID | Area (square feet) | Post-project surface type | Runoff factor | Product | DMA name /ID | Area (square feet) | Ratio |
| | [A] | | [B] | [C] = [A] x [B] | | [D] | [C]/[D] |
| N/A | N/A | N/A | N/A | N/A | N/A | N/A | N/A |

Table C.5 Type 'D', Areas Draining to BMPs

| DMA Name or ID | BMP Name or ID |
|----------------|---------------------------------------|
| DMA-1 | Modular Wetland System (BMP-1) |
| DMA-2 | Modular Wetland System (BMP-2) |
| DMA-3 | Modular Wetland System (BMP-3) |

Note: More than one drainage management area can drain to a single LID BMP, however, one drainage management area may not drain to more than one BMP.

Section D: Implement LID BMPs

D.1 Infiltration Applicability

Is there an approved downstream ‘Highest and Best Use’ for stormwater runoff (see discussion in Chapter 2.4.4 of the WQMP Guidance Document for further details)? Y N

If yes has been checked, Infiltration BMPs shall not be used for the site. If no, continue working through this section to implement your LID BMPs. It is recommended that you contact your Co-Permittee to verify whether or not your project discharges to an approved downstream ‘Highest and Best Use’ feature.

Geotechnical Report

A Geotechnical Report or Phase I Environmental Site Assessment may be required by the Copermitttee to confirm present and past site characteristics that may affect the use of Infiltration BMPs. In addition, the Co-Permittee, at their discretion, may not require a geotechnical report for small projects as described in Chapter 2 of the WQMP Guidance Document. If a geotechnical report has been prepared, include it in Appendix 3. In addition, if a Phase I Environmental Site Assessment has been prepared, include it in Appendix 4.

Is this project classified as a small project consistent with the requirements of Chapter 2 of the WQMP Guidance Document? Y N

Infiltration Feasibility

Table D.1 below is meant to provide a simple means of assessing which DMAs on your site support Infiltration BMPs and is discussed in the WQMP Guidance Document in Chapter 2.4.5. Check the appropriate box for each question and then list affected DMAs as applicable. If additional space is needed, add a row below the corresponding answer.

Table D.1 Infiltration Feasibility

| Does the project site... | YES | NO |
|--|-----|----|
| ...have any DMAs with a seasonal high groundwater mark shallower than 10 feet? If Yes, list affected DMAs: | | X |
| ...have any DMAs located within 100 feet of a water supply well? If Yes, list affected DMAs: | | X |
| ...have any areas identified by the geotechnical report as posing a public safety risk where infiltration of stormwater could have a negative impact? If Yes, list affected DMAs: | | X |
| ...have measured in-situ infiltration rates of less than 1.6 inches / hour? If Yes, list affected DMAs: DMA 1, 2, 3 | X | |
| ...have significant cut and/or fill conditions that would preclude in-situ testing of infiltration rates at the final infiltration surface? If Yes, list affected DMAs: | | X |
| ...geotechnical report identify other site-specific factors that would preclude effective and safe infiltration? Describe here: | | X |

If you answered “Yes” to any of the questions above for any DMA, Infiltration BMPs should not be used for those DMAs.

D.2 Harvest and Use Assessment

Please check what applies:

- Reclaimed water will be used for the non-potable water demands for the project.
- Downstream water rights may be impacted by Harvest and Use as approved by the Regional Board (verify with the Copermittee).
- The Design Capture Volume will be addressed using Infiltration Only BMPs. In such a case, Harvest and Use BMPs are still encouraged, but it would not be required if the Design Capture Volume will be infiltrated or evapotranspired.

If any of the above boxes have been checked, Harvest and Use BMPs need not be assessed for the site. If neither of the above criteria applies, follow the steps below to assess the feasibility of irrigation use, toilet use and other non-potable uses (e.g., industrial use).

Irrigation Use Feasibility

Complete the following steps to determine the feasibility of harvesting stormwater runoff for Irrigation Use BMPs on your site:

Step 1: Identify the total area of irrigated landscape on the site, and the type of landscaping used.

Total Area of Irrigated Landscape: 1.51 acres

Type of Landscaping (Conservation Design or Active Turf): Conservation Design

Step 2: Identify the planned total of all impervious areas on the proposed project from which runoff might be feasibly captured and stored for irrigation use. Depending on the configuration of buildings and other impervious areas on the site, you may consider the site as a whole, or parts of the site, to evaluate reasonable scenarios for capturing and storing runoff and directing the stored runoff to the potential use(s) identified in Step 1 above.

Total Area of Impervious Surfaces: 7.61 acres

Step 3: Cross reference the Design Storm depth for the project site (see Exhibit A of the WQMP Guidance Document) with the left column of Table 2-3 in Chapter 2 to determine the minimum area of Effective Irrigated Area per Tributary Impervious Area (EIATIA).

The project EIATIA factor: 0.84

Step 4: Multiply the unit value obtained from Step 3 by the total of impervious areas from Step 2 to develop the minimum irrigated area that would be required.

Minimum required irrigated area: 7.11 acres x 0.84 = 5.97 acres

Step 5: Determine if harvesting stormwater runoff for irrigation use is feasible for the project by comparing the total area of irrigated landscape (Step 1) to the minimum required irrigated area (Step 4).

| Minimum required irrigated area (Step 4) | Available Irrigated Landscape (Step 1) |
|--|--|
| 5.97 acres | 1.51 acres |

The project is not feasible for harvesting stormwater runoff for irrigation use.

Toilet Use Feasibility

Complete the following steps to determine the feasibility of harvesting stormwater runoff for toilet flushing uses on your site:

Step 1: Identify the projected total number of daily toilet users during the wet season, and account for any periodic shutdowns or other lapses in occupancy:

Projected Number of Daily Toilet Users: 50

*Project Type: **Commercial***

Step 2: Identify the planned total of all impervious areas on the proposed project from which runoff might be feasibly captured and stored for toilet use. Depending on the configuration of buildings and other impervious areas on the site, you may consider the site as a whole, or parts of the site, to evaluate reasonable scenarios for capturing and storing runoff and directing the stored runoff to the potential use(s) identified in Step 1 above.

*Total Area of Impervious Surfaces: **7.61 acres***

Step 3: Enter the Design Storm depth for the project site (see Exhibit A) into the left column of Table 2-2 in Chapter 2 to determine the minimum number of toilet users per tributary impervious acre (TUTIA).

*The project TUTIA factor: **134***

Step 4: Multiply the unit value obtained from Step 3 by the total of impervious areas from Step 2 to develop the minimum number of toilet users that would be required.

*Minimum number of toilet users: **134 x 7.61 ac = 1020 toilet users***

Step 5: Determine if harvesting stormwater runoff for toilet flushing use is feasible for the project by comparing the Number of Daily Toilet Users (Step 1) to the minimum required number of toilet users (Step 4).

| Minimum required Toilet Users (Step 4) | Projected number of toilet users (Step 1) |
|---|--|
| 1020 | 50 |

The project is not feasible for harvesting stormwater runoff for toilet use.

Other Non-Potable Use Feasibility

Are there other non-potable uses for stormwater runoff on the site (e.g. industrial use)? See Chapter 2 of the Guidance for further information. If yes, describe below. If no, write N/A.

N/A

Step 1: Identify the projected average daily non-potable demand, in gallons per day, during the wet season and accounting for any periodic shut downs or other lapses in occupancy or operation.

Average Daily Demand: N/A

Step 2: Identify the planned total of all impervious areas on the proposed project from which runoff might be feasibly captured and stored for the identified non-potable use. Depending on the configuration of buildings and other impervious areas on the site, you may consider the site as a whole, or parts of the site, to evaluate reasonable scenarios for capturing and storing runoff and directing the stored runoff to the potential use(s) identified in Step 1 above.

Total Area of Impervious Surfaces: N/A

Step 3: Enter the Design Storm depth for the project site (see Exhibit A) into the left column of Table 2-3 in Chapter 2 to determine the minimum demand for non-potable uses per tributary impervious acre.

The project factor: N/A

Step 4: Multiply the unit value obtained from Step 4 by the total of impervious areas from Step 3 to develop the minimum number of gallons per day of non-potable use that would be required.

Minimum required use: N/A

Step 5: Determine if harvesting stormwater runoff for other non-potable use is feasible for the project by comparing the Average Daily non-potable demand (Step 1) to the minimum required non-potable use (Step 4).

| Minimum required non-potable use (Step 4) | Projected average daily use (Step 1) |
|--|---|
| N/A | N/A |

If Irrigation, Toilet and Other Use feasibility anticipated demands are less than the applicable minimum values, Harvest and Use BMPs are not required and you should proceed to utilize LID Bioretention and Biotreatment, unless a site-specific analysis has been completed that demonstrates technical infeasibility as noted in D.3 below.

D.3 Bioretention and Biotreatment Assessment

Other LID Bioretention and Biotreatment BMPs as described in Chapter 2.4.7 of the WQMP Guidance Document are feasible on nearly all development sites with sufficient advance planning.

Select one of the following:

LID Bioretention/Biotreatment BMPs will be used for some or all DMAs of the project as noted below in Section D.4 (note the requirements of Section 3.4.2 in the WQMP Guidance Document).

A site-specific analysis demonstrating the technical infeasibility of all LID BMPs has been performed and is included in Appendix 5. If you plan to submit an analysis demonstrating the technical infeasibility of LID BMPs, request a pre-submittal meeting with the Copermittee to discuss this option. Proceed to Section E to document your alternative compliance measures.

D.4 Feasibility Assessment Summaries

From the Infiltration, Harvest and Use, Bioretention and Biotreatment Sections above, complete Table D.2 below to summarize which LID BMPs are technically feasible, and which are not, based upon the established hierarchy.

Table D.2 LID Prioritization Summary Matrix

| DMA Name/ID | LID BMP Hierarchy | | | | No LID (Alternative Compliance) |
|-------------|--------------------------|--------------------------|--------------------------|-------------------------------------|---------------------------------|
| | 1. Infiltration | 2. Harvest and use | 3. Bioretention | 4. Biotreatment | |
| DMA-1 | <input type="checkbox"/> | <input type="checkbox"/> | <input type="checkbox"/> | <input checked="" type="checkbox"/> | <input type="checkbox"/> |
| DMA-2 | <input type="checkbox"/> | <input type="checkbox"/> | <input type="checkbox"/> | <input checked="" type="checkbox"/> | <input type="checkbox"/> |
| DMA-3 | <input type="checkbox"/> | <input type="checkbox"/> | <input type="checkbox"/> | <input checked="" type="checkbox"/> | <input type="checkbox"/> |
| | <input type="checkbox"/> | <input type="checkbox"/> | <input type="checkbox"/> | <input type="checkbox"/> | <input type="checkbox"/> |
| | <input type="checkbox"/> | <input type="checkbox"/> | <input type="checkbox"/> | <input type="checkbox"/> | <input type="checkbox"/> |

For those DMAs where LID BMPs are not feasible, provide a brief narrative below summarizing why they are not feasible, include your technical infeasibility criteria in Appendix 5, and proceed to Section E below to document Alternative Compliance measures for those DMAs. Recall that each proposed DMA must pass through the LID BMP hierarchy before alternative compliance measures may be considered.

D.5 LID BMP Sizing

Each LID BMP must be designed to ensure that the Design Capture Volume will be addressed by the selected BMPs. First, calculate the Design Capture Volume for each LID BMP using the V_{BMP} worksheet in Appendix F of the LID BMP Design Handbook. Second, design the LID BMP to meet the required V_{BMP} using a method approved by the Copermittee. Utilize the worksheets found in the LID BMP Design Handbook or consult with the Copermittee to assist you in correctly sizing your LID BMPs. Complete Table D.3 below to document the Design Capture Volume and the Proposed Volume for each LID BMP. Provide the completed design procedure sheets for each LID BMP in Appendix 6. You may add additional rows to the table below as needed.

Table D.3.1 Design Flow Rate Calculations for LID BMPs

| DMA Type/ID | DMA Area (square feet) | Post-Project Surface Type | Effective Impervious Fraction, I_f | DMA Runoff Factor | DMA Areas x Runoff Factor | Modular Wetland System BMP-1 | | |
|-------------|------------------------|---------------------------|--------------------------------------|-------------------|---------------------------|--|---|---|
| DMA-1 | [A] | | [B] | [C] | [A] x [C] | | | |
| 1A | 107,937 | Concrete or Asphalt | 1 | 0.89 | 96,279.8 | <i>Design Rainfall Intensity (in/hr)</i> | <i>Design Flowrate, Q_{BMP} (cubic feet/sec)</i> | <i>Proposed Flowrate (cubic feet/sec)</i> |
| 1B | 11,392 | Roofs | 1 | 0.89 | 10,161.7 | | | |
| 1C | 25,755 | Ornamental Landscaping | 0.1 | 0.11 | 2,844.8 | | | |
| | | | | | | | | |
| | A_T =145,084 | | | | 109,286.3 | 0.20 | 0.50 | 0.577 |

| DMA Type/ID | DMA Area (square feet) | Post-Project Surface Type | Effective Impervious Fraction, I_f | DMA Runoff Factor | DMA Areas x Runoff Factor | Modular Wetland System BMP-2 | | |
|-------------|------------------------|---------------------------|--------------------------------------|-------------------|---------------------------|--|---|---|
| DMA-2 | [A] | | [B] | [C] | [A] x [C] | | | |
| 2A | 146,809 | Concrete or Asphalt | 1 | 0.89 | 130,953.6 | <i>Design Rainfall Intensity (in/hr)</i> | <i>Design Flowrate, Q_{BMP} (cubic feet/sec)</i> | <i>Proposed Flowrate (cubic feet/sec)</i> |
| 2B | 9,600 | Roofs | 1 | 0.89 | 8,563.2 | | | |
| 2C | 16,791 | Ornamental Landscaping | 0.1 | 0.11 | 1,854.7 | | | |
| | | | | | | | | |
| | A_T =173,200 | | | | 141,371.5 | 0.20 | 0.60 | 0.693 |

| DMA Type/ID | DMA Area (square feet) | Post-Project Surface Type | Effective Impervious Fraction, I_f | DMA Runoff Factor | DMA Areas x Runoff Factor | Modular Wetland System BMP-3 | | |
|-------------|------------------------|---------------------------|--------------------------------------|-------------------|---------------------------|--|---|---|
| DMA-3 | [A] | | [B] | [C] | [A] x [C] | | | |
| 3A | 55,924 | Concrete or Asphalt | 1 | 0.89 | 49,884.2 | <i>Design Rainfall Intensity (in/hr)</i> | <i>Design Flowrate, Q_{BMP} (cubic feet/sec)</i> | <i>Proposed Flowrate (cubic feet/sec)</i> |
| 3B | 23,027 | Ornamental Landscaping | 0.1 | 0.11 | 2,543.2 | | | |
| | | | | | | | | |
| | | | | | | | | |
| | | | | | | | | |
| | A_T =78,951 | | | | 52,427.7 | 0.20 | 0.20 | 0.206 |

[B], [C] are obtained from Section 2.3.1 of the WQMP Guidance Document
[E] is obtained from Exhibit A of the WQMP Guidance Document
[G] is obtained from LID BMP design procedure sheet, placed in Appendix 6

Section E: Alternative Compliance (LID Waiver Program)

LID BMPs are expected to be feasible on virtually all projects. Where LID BMPs have been demonstrated to be infeasible as documented in Section D, other Treatment Control BMPs must be used (subject to LID waiver approval by the Copermittee). Check one of the following Boxes:

LID Principles and LID BMPs have been incorporated into the site design to fully address all Drainage Management Areas. No alternative compliance measures are required for this project and thus this Section is not required to be completed.

- Or -

The following Drainage Management Areas are unable to be addressed using LID BMPs. A site-specific analysis demonstrating technical infeasibility of LID BMPs has been approved by the Regional Board and included in Appendix 5. Additionally, no downstream regional and/or sub-regional LID BMPs exist or are available for use by the project. The alternative compliance measures on the following pages are being implemented to ensure that any pollutant loads expected to be discharged by not incorporating LID BMPs, are fully mitigated.

N/A

E.1 Identify Pollutants of Concern

Utilizing Table A.1 from Section A above which noted your project's receiving waters and their associated EPA approved 303(d) listed impairments, cross reference this information with that of your selected Priority Development Project Category in Table E.1 below. If the identified General Pollutant Categories are the same as those listed for your receiving waters, then these will be your Pollutants of Concern and the appropriate box or boxes will be checked on the last row. The purpose of this is to document compliance and to help you appropriately plan for mitigating your Pollutants of Concern in lieu of implementing LID BMPs.

Table E.1 Potential Pollutants by Land Use Type

| Priority Development Project Categories and/or Project Features (check those that apply) | General Pollutant Categories | | | | | | | |
|--|-------------------------------------|-------------------------------------|-------------------------------------|-------------------------------------|-------------------------------------|-------------------------------------|-------------------------------------|-------------------------------------|
| | Bacterial Indicators | Metals | Nutrients | Pesticides | Toxic Organic Compounds | Sediments | Trash & Debris | Oil & Grease |
| <input type="checkbox"/> Detached Residential Development | P | N | P | P | N | P | P | P |
| <input type="checkbox"/> Attached Residential Development | P | N | P | P | N | P | P | P ⁽²⁾ |
| <input checked="" type="checkbox"/> Commercial/Industrial Development | P ⁽³⁾ | P | P ⁽¹⁾ | P ⁽¹⁾ | P ⁽⁵⁾ | P ⁽¹⁾ | P | P |
| <input type="checkbox"/> Automotive Repair Shops | N | P | N | N | P ^(4, 5) | N | P | P |
| <input type="checkbox"/> Restaurants (>5,000 ft ²) | P | N | N | N | N | N | P | P |
| <input type="checkbox"/> Hillside Development (>5,000 ft ²) | P | N | P | P | N | P | P | P |
| <input checked="" type="checkbox"/> Parking Lots (>5,000 ft ²) | P ⁽⁶⁾ | P | P ⁽¹⁾ | P ⁽¹⁾ | P ⁽⁴⁾ | P ⁽¹⁾ | P | P |
| <input type="checkbox"/> Retail Gasoline Outlets | N | P | N | N | P | N | P | P |
| Project Priority Pollutant(s) of Concern | <input checked="" type="checkbox"/> | <input checked="" type="checkbox"/> | <input checked="" type="checkbox"/> | <input checked="" type="checkbox"/> | <input checked="" type="checkbox"/> | <input checked="" type="checkbox"/> | <input checked="" type="checkbox"/> | <input checked="" type="checkbox"/> |

P = Potential

N = Not Potential

⁽¹⁾ A potential Pollutant if non-native landscaping exists or is proposed onsite; otherwise not expected

⁽²⁾ A potential Pollutant if the project includes uncovered parking areas; otherwise not expected

⁽³⁾ A potential Pollutant is land use involving animal waste

⁽⁴⁾ Specifically, petroleum hydrocarbons

⁽⁵⁾ Specifically, solvents

⁽⁶⁾ Bacterial indicators are routinely detected in pavement runoff

E.2 Stormwater Credits

Projects that cannot implement LID BMPs but nevertheless implement smart growth principles are potentially eligible for Stormwater Credits. Utilize Table 3-8 within the WQMP Guidance Document to identify your Project Category and its associated Water Quality Credit. If not applicable, write N/A.

Table E.2 Water Quality Credits

| Qualifying Project Categories | Credit Percentage ² |
|--------------------------------------|--------------------------------|
| N/A | N/A |
| | |
| | |
| Total Credit Percentage ¹ | |

¹Cannot Exceed 50%

²Obtain corresponding data from Table 3-8 in the WQMP Guidance Document

E.3 Sizing Criteria

After you appropriately considered Stormwater Credits for your project, utilize Table E.3 below to appropriately size them to the DCV, or Design Flow Rate, as applicable. Please reference Chapter 3.5.2 of the WQMP Guidance Document for further information.

Table E.3 Treatment Control BMP Sizing

| DMA Type/ID | DMA Area (square feet) | Post-Project Surface Type | Effective Impervious Fraction, I _f | DMA Runoff Factor | DMA Areas x Runoff Factor | Modular Wetland System BMP-1 | | | |
|-------------|----------------------------|---------------------------|---|-------------------|---------------------------|-----------------------------------|--|--------------------------------------|------------------------------------|
| | | | | | | Design Rainfall Intensity (in/hr) | Design Flowrate, Q _{BMP} (cubic feet/sec) | Total Storm Water Credit % Reduction | Proposed Flowrate (cubic feet/sec) |
| | [A] | | [B] | [C] | [A] x [C] | | | | |
| 1A | 107,937 | Concrete or Asphalt | 1 | 0.89 | 96,279.8 | | | | |
| 1B | 11,392 | Roofs | 1 | 0.89 | 10,161.7 | | | | |
| 1C | 25,755 | Ornamental Landscaping | 0.1 | 0.11 | 2,844.8 | | | | |
| | A _T =145,084 | | | | 109,286.3 | 0.20 | 0.50 | N/A | 0.577 |

| DMA Type/ID | DMA Area (square feet) | Post-Project Surface Type | Effective Impervious Fraction, I _f | DMA Runoff Factor | DMA Areas x Runoff Factor | Modular Wetland System BMP-2 | | | |
|-------------|----------------------------|---------------------------|---|-------------------|---------------------------|-----------------------------------|--|--------------------------------------|------------------------------------|
| | | | | | | Design Rainfall Intensity (in/hr) | Design Flowrate, Q _{BMP} (cubic feet/sec) | Total Storm Water Credit % Reduction | Proposed Flowrate (cubic feet/sec) |
| | [A] | | [B] | [C] | [A] x [C] | | | | |
| 2A | 146,809 | Concrete or Asphalt | 1 | 0.89 | 130,953.6 | | | | |
| 2B | 9,600 | Roofs | 1 | 0.89 | 8,563.2 | | | | |
| 2C | 16,791 | Ornamental Landscaping | 0.1 | 0.11 | 1,854.7 | | | | |
| | A _T =173,200 | | | | 141,371.5 | 0.20 | 0.60 | N/A | 0.693 |

| DMA Type/ID | DMA Area (square feet) | Post-Project Surface Type | Effective Impervious Fraction, I _f | DMA Runoff Factor | DMA Areas x Runoff Factor | Modular Wetland System BMP-3 | | | |
|-------------|-------------------------|-------------------------------|---|-------------------|---------------------------|-----------------------------------|--|--------------------------------------|------------------------------------|
| | | | | | | Design Rainfall Intensity (in/hr) | Design Flowrate, Q _{BMP} (cubic feet/sec) | Total Storm Water Credit % Reduction | Proposed Flowrate (cubic feet/sec) |
| | [A] | | [B] | [C] | [A] x [C] | | | | |
| 3A | 55,924 | Concrete or Asphalt | 1 | 0.89 | 49,884.2 | | | | |
| 3B | 23,027 | Ornamental Landscaping | 0.1 | 0.11 | 2,543.2 | | | | |
| | | | | | | | | | |
| | A_T =78,951 | | | | 52,427.7 | 0.20 | 0.20 | N/A | 0.206 |

[B], [C] is obtained as described in Section 2.3.1 from the WQMP Guidance Document

[E] is obtained from Exhibit A in the WQMP Guidance Document

[G] is for Flow-Based Treatment Control BMPs [G] = 43,560, for Volume-Based Control Treatment BMPs, [G] = 12

[H] is from the Total Credit Percentage as Calculated from Table E.2 above

[I] as obtained from a design procedure sheet from the BMP manufacturer and should be included in Appendix 6

E.4 Treatment Control BMP Selection

Treatment Control BMPs typically provide proprietary treatment mechanisms to treat potential pollutants in runoff, but do not sustain significant biological processes. Treatment Control BMPs must have a removal efficiency of a medium or high effectiveness as quantified below:

- **High:** equal to or greater than 80% removal efficiency
- **Medium:** between 40% and 80% removal efficiency

Such removal efficiency documentation (e.g., studies, reports, etc.) as further discussed in Chapter 3.5.2 of the WQMP Guidance Document, must be included in Appendix 6. In addition, ensure that proposed Treatment Control BMPs are properly identified on the WQMP Site Plan in Appendix 1.

Table E.4 Treatment Control BMP Selection

| Selected Treatment Control BMP Name or ID ¹ | Priority Pollutant(s) of Concern to Mitigate ² | Removal Efficiency Percentage ³ |
|--|---|--|
| BMP-1: Modular Wetland System | | 80% of TSS and 90% hydrocarbons |
| BMP-2: Modular Wetland System | | 80% of TSS and 90% hydrocarbons |
| BMP-3: Modular Wetland System | | 80% of TSS and 90% hydrocarbons |
| | | |

¹ Treatment Control BMPs must not be constructed within Receiving Waters. In addition, a proposed Treatment Control BMP may be listed more than once if they possess more than one qualifying pollutant removal efficiency.

² Cross Reference Table E.1 above to populate this column.

³ As documented in a Co-Permittee Approved Study and provided in Appendix 6.

Section F: Hydromodification

F.1 Hydrologic Conditions of Concern (HCOC) Analysis

Once you have determined that the LID design is adequate to address water quality requirements, you will need to assess if the proposed LID Design may still create a HCOC. Review Chapters 2 and 3 (including Figure 3-7) of the WQMP Guidance Document to determine if your project must mitigate for Hydromodification impacts. If your project meets one of the following criteria which will be indicated by the check boxes below, you do not need to address Hydromodification at this time. However, if the project does not qualify for Exemptions 1, 2 or 3, then additional measures must be added to the design to comply with HCOC criteria. This is discussed in further detail below in Section F.2.

HCOC EXEMPTION 1: The Priority Development Project disturbs less than one acre. The City of Moreno Valley has the discretion to require a Project-Specific WQMP to address HCOCs on projects less than one acre on a case by case basis. The disturbed area calculation should include all disturbances associated with larger common plans of development.

Does the project qualify for this HCOC Exemption? Y N

If Yes, HCOC criteria do not apply.

HCOC EXEMPTION 2: The volume and time of concentration¹ of storm water runoff for the post-development condition is not significantly different from the pre-development condition for a 2-year return frequency storm (a difference of 5% or less is considered insignificant) using one of the following methods to calculate:

- Riverside County Hydrology Manual
- Technical Release 55 (TR-55): Urban Hydrology for Small Watersheds (NRCS 1986), or derivatives thereof, such as the Santa Barbara Urban Hydrograph Method
- Other methods acceptable to the City of Moreno Valley

Does the project qualify for this HCOC Exemption? Y N

If Yes, report results in Table F.1 below and provide your substantiated hydrologic analysis in Appendix 7.

Table F.1 Hydrologic Conditions of Concern Summary

| | 2 year – 24 hour | | |
|------------------------------|------------------|----------------|--------------|
| | Pre-condition | Post-condition | % Difference |
| Time of Concentration | | | |
| Flow (CFS) | | | |
| Volume (Cubic Feet) | | | |

¹ Time of concentration is defined as the time after the beginning of the rainfall when all portions of the drainage basin are contributing to flow at the outlet.

HCOC EXEMPTION 3: All downstream conveyance channels to an adequate sump (Prado Dam, Santa Ana River) that will receive runoff from the project are engineered and regularly maintained to ensure design flow capacity; no sensitive stream habitat areas will be adversely affected; or are not identified on the Co-Permittees Hydromodification Sensitivity Maps.

Does the project qualify for this HCOC Exemption? Y N

If Yes, HCOC criteria do not apply and note below which adequate sump applies to this HCOC qualifier:

F.2 HCOC Mitigation

If none of the above HCOC Exemption Criteria are applicable, HCOC criteria is considered mitigated if they meet one of the following conditions:

- a. Additional LID BMPS are implemented onsite or offsite to mitigate potential erosion or habitat impacts as a result of HCOCs. This can be conducted by an evaluation of site-specific conditions utilizing accepted professional methodologies published by entities such as the California Stormwater Quality Association (CASQA), the Southern California Coastal Water Research Project (SCCRWP), or other Co-Permittee approved methodologies for site-specific HCOC analysis.
- b. The project is developed consistent with an approved Watershed Action Plan that addresses HCOC in Receiving Waters.
- c. Mimicking the pre-development hydrograph with the post-development hydrograph, for a 2-year return frequency storm. Generally, the hydrologic conditions of concern are not significant if the post-development hydrograph is no more than 10% greater than pre-development hydrograph. In cases where excess volume cannot be infiltrated or captured and reused, discharge from the site must be limited to a flow rate no greater than 110% of the pre-development 2-year peak flow.

Be sure to include all pertinent documentation used in your analysis of the items a, b, or c in Appendix 7.

| | 2 year – 24 hour | | |
|-----------------------|------------------|----------------|--------------|
| | Pre-condition | Post-condition | % Difference |
| Time of Concentration | 19.90 | 9.63 | 52% |
| Flow (CFS) | 5.64 | 10.46 | 86% |
| Volume (Cubic Feet) | 6,281 | 46,540 | 641% |

The required retention volume was governed by the 2-year, 24-hour storm. To estimate the retention volume required for preliminary purposes, the pre-development volume was compared to the post-development volume to determine the increase in volume discharged from the project site. Since the detention system outlet riser structure will be sized in the Final Report, an additional 15% was added to the calculated difference in volume to account for the efficiency of the outlet structure. The resulting volume (46,298 cf) is the estimated retention volume for preliminary purposes. The proposed underground retention system will provide 49,401 cf of storage. Through the mitigation that the underground retention system will provide, the proposed development is expected to mitigate for HCOC criteria.

Section G: Source Control BMPs

Source control BMPs include permanent, structural features that may be required in your project plans — such as roofs over and berms around trash and recycling areas — and Operational BMPs, such as regular sweeping and “housekeeping”, that must be implemented by the site’s occupant or user. The MEP standard typically requires both types of BMPs. In general, Operational BMPs cannot be substituted for a feasible and effective permanent BMP. Using the Pollutant Sources/Source Control Checklist in Appendix 8, review the following procedure to specify Source Control BMPs for your site:

1. **Identify Pollutant Sources:** Review Column 1 in the Pollutant Sources/Source Control Checklist. Check off the potential sources of Pollutants that apply to your site.
2. **Note Locations on Project-Specific WQMP Exhibit:** Note the corresponding requirements listed in Column 2 of the Pollutant Sources/Source Control Checklist. Show the location of each Pollutant source and each permanent Source Control BMP in your Project-Specific WQMP Exhibit located in Appendix 1.
3. **Prepare a Table and Narrative:** Check off the corresponding requirements listed in Column 3 in the Pollutant Sources/Source Control Checklist. In the left column of Table G.1 below, list each potential source of runoff Pollutants on your site (from those that you checked in the Pollutant Sources/Source Control Checklist). In the middle column, list the corresponding permanent, Structural Source Control BMPs (from Columns 2 and 3 of the Pollutant Sources/Source Control Checklist) used to prevent Pollutants from entering runoff. **Add additional narrative** in this column that explains any special features, materials or methods of construction that will be used to implement these permanent, Structural Source Control BMPs.
4. **Identify Operational Source Control BMPs:** To complete your table, refer once again to the Pollutant Sources/Source Control Checklist. List in the right column of your table the Operational BMPs that should be implemented as long as the anticipated activities continue at the site. Copermittee stormwater ordinances require that applicable Source Control BMPs be implemented; the same BMPs may also be required as a condition of a use permit or other revocable Discretionary Approval for use of the site.

Table G.1 Permanent and Operational Source Control Measures

| Potential Sources of Runoff pollutants | Permanent Structural Source Control BMPs | Operational Source Control BMPs |
|--|--|---|
| Modular Wetlands | <p>Mark all modular wetlands with the words “Only Rain Down the Storm Drain” or similar. Markers may be available from the Riverside County Flood Control and Water Conservation District, call 951.955.1200 to verify stenciling.</p> <p>(CASQQ BMP SD-13, “Storm Drain Signage”)</p> | <p>Maintain and periodically repaint or replace stencil markings. Provide stormwater pollution prevention information to new site owners, lessees, or operators. See applicable operational BMPs in Fact Sheet SC-74 “Drainage System Maintenance” provided in Appendix 8 of this report.</p> |
| On-site storm drain inlets | <p>Stencil inlet structures per City of Moreno Valley Std. MVFE-300B-0, Note 13.</p> | <p>Maintain and periodically repaint or replace inlet markings. Provide stormwater pollution prevention information to new site owners, lessees, or operators. See applicable operational BMPs in Fact Sheet SC-44, “Drainage System Maintenance” provided in Appendix 10: Educational Materials. Include the following in lease agreements: “Tenant shall not allow anyone to discharge anything to storm drains or to store or deposit materials so as to</p> |
| Need for future indoor & structural pest control | <p>Incorporate building design features that discourage entry of pests:</p> <p>For Foundations and Slabs: use corrosion resistant, pest-resistant mesh on crawl space vents: foundation vents should be at least 6 inches above finish ground level; pour concrete patios as part of the main slabs to minimize entry of pests via joints; if slab joints are necessary, consider termite barriers; use epoxy sealants, or mesh barriers, or sand barriers for utility breaks.</p> <p>For Siding: use non-wood siding options; use high quality caulks and sealants; siding and stucco should begin at least six inches above soil level. For Lighting: use bird-resistant light fixtures. Use gutters with downspouts; use flap valves or mesh on downspouts to prevent rodents from entering downspouts.</p> <p>Use metal mesh to prevent animal access under sheds, decks, and porches.</p> | <p>Provide Integrated Pest Management information to owners, lessees, and operators. Provided “Pest Prevention by Design” Guidelines in Appendix 10.</p> |
| Landscape/ Outdoor Pesticide Use | <p>Final landscape plans will accomplish all of the following.</p> <p>Design landscaping to minimize irrigation and runoff, to promote surface infiltration where appropriate, and to minimize the use of fertilizers and pesticides that can contribute to stormwater pollution.</p> | <p>Maintain landscaping using minimum or no pesticides. See applicable operational BMPs in “What you should know for...Landscape and Gardening” provided in Appendix 10: Educational Materials.</p> <p>Provide IPM information to new owners, leases, and operators.</p> |

| | | |
|---|--|--|
| | <p>Where landscaped areas are used to retain or detain stormwater, specify plants that are tolerant of saturated soil conditions.</p> <p>Consider using pest-resistant plants, especially adjacent to hardscape.</p> <p>To ensure successful establishment, select plants appropriate to site soils, slopes, climate, sun, wind, rain, land use, air movement, ecological consistency, and plant interactions.</p> | |
| Pools, spas, ponds, decorative fountains, and other water features. | | n/a |
| Refuse area | <p>Outdoors Waste and Recycling enclosures with masonry walls and roofs will be constructed per City of Moreno Valley standards and architectural plans.</p> <p>Signs “Do not dump hazardous materials here” or similar will be posted on or near the bins.</p> <p>Outdoors trash receptacles will be provided at the common open space areas.</p> | <p>Provide adequate number of trash receptacles and bins. Inspect receptacles and bins regularly; repair or replace leaky receptacles and bins. Keep bins covered. Prohibit/ prevent dumping of liquid or hazardous waste. Post “no hazardous materials” signs. Inspect and pick up litter daily and clean up spills immediately. Keep spill control materials available on-site. See Fact Sheet SC-34, “Waste Handling and Disposal” provided in Appendix 10.</p> |
| Vehicle and equipment cleaning | Car wash area is not proposed on-site. Car washing shall be prohibited | n/a |
| Vehicle/Equipment Repair and Maintenance | Vehicle equipment repair and maintenance indoors and outdoors shall be prohibited. | n/a |
| Fire Sprinkler Test Water | Fire sprinkler water shall drain to the sanitary sewer. | See Fact Sheet SC-41, “Building and Grounds Maintenance” provided in Appendix 10. |
| Miscellaneous Drain Roofing, Gutters and Trim | Avoid roofing, gutters, and trim made of copper or other unprotected metals that may leach into runoff. | |
| Plazas, sidewalks, and parking lots. | | <p>Sweep sidewalks, and parking lots regularly to prevent accumulation of litter and debris. Collect debris from pressure washing to prevent entry into the storm drain system. Collect wash water containing any cleaning agent or degreaser and discharge to the sanitary sewer not to a storm drain.</p> |

Section H: Construction Plan Checklist

Populate Table H.1 below to assist the plan checker in an expeditious review of your project. The first two columns will contain information that was prepared in previous steps, while the last column will be populated with the corresponding plan sheets. This table is to be completed with the submittal of your final Project-Specific WQMP.

Table H.1 Construction Plan Cross-reference

| BMP No. or ID | BMP Identifier and Description | Plan Sheet Number(s) | Latitude / Longitude |
|---------------|--------------------------------|---------------------------------|----------------------|
| BMP-1 | Modular Wetland System | Preliminary Grading Plan | TBD |
| BMP-2 | Modular Wetland System | Preliminary Grading Plan | TBD |
| BMP-3 | Modular Wetland System | Preliminary Grading Plan | TBD |

Note that the updated table — or Construction Plan WQMP Checklist — is **only a reference tool** to facilitate an easy comparison of the construction plans to your Project-Specific WQMP. Co-Permittee staff can advise you regarding the process required to propose changes to the approved Project-Specific WQMP.

Section I: Operation, Maintenance and Funding

The Copermittee will periodically verify that Stormwater BMPs on your site are maintained and continue to operate as designed. To make this possible, your Copermittee will require that you include in Appendix 9 of this Project-Specific WQMP:

1. A means to finance and implement facility maintenance in perpetuity, including replacement cost.
2. Acceptance of responsibility for maintenance from the time the BMPs are constructed until responsibility for operation and maintenance is legally transferred.
3. An outline of general maintenance requirements for the Stormwater BMPs selected.
4. Figures delineating and designating pervious and impervious areas, location, and type of Stormwater BMP, and tables of pervious and impervious areas served by each facility.
5. A separate list and location of self-retaining areas or areas addressed by LID Principles that do not require specialized O&M or inspections but will require typical landscape maintenance as noted in Chapter 5, pages 85-86, in the WQMP Guidance. Include a brief description of typical landscape maintenance for these areas.

Your local Co-Permittee will also require that you prepare and submit a detailed Stormwater BMP Operation and Maintenance Plan that sets forth a maintenance schedule for each of the Stormwater BMPs built on your site. An agreement assigning responsibility for maintenance and providing for inspections and certification may also be required.

Details of these requirements and instructions for preparing a Stormwater BMP Operation and Maintenance Plan are in Chapter 5 of the WQMP Guidance Document.

Maintenance Mechanism: Pilot Travel Centers, LLC

Will the proposed BMPs be maintained by a Homeowners' Association (HOA) or Property Owners Association (POA)?

Y N

Operation and Maintenance Plan and Maintenance Mechanism is included in Appendix 9. Educational materials for those personnel that will be maintaining the proposed BMPs within this Project-Specific WQMP are included in Appendix 10.

Appendix 1: Maps and Site Plans

Location Map, WQMP Site Plan and Receiving Waters Map

Location Map

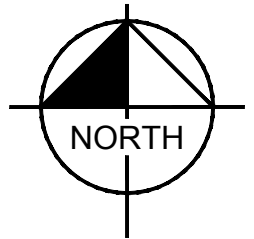
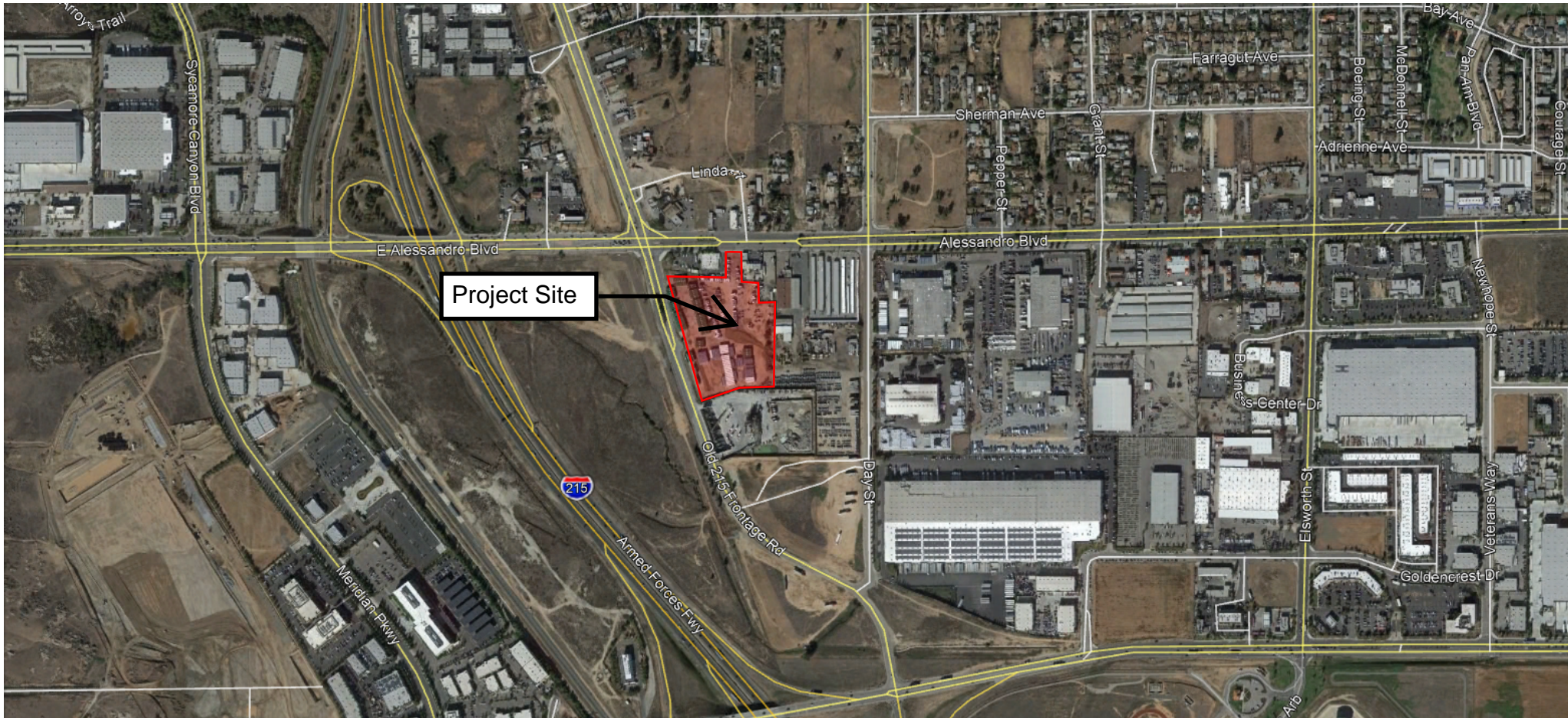

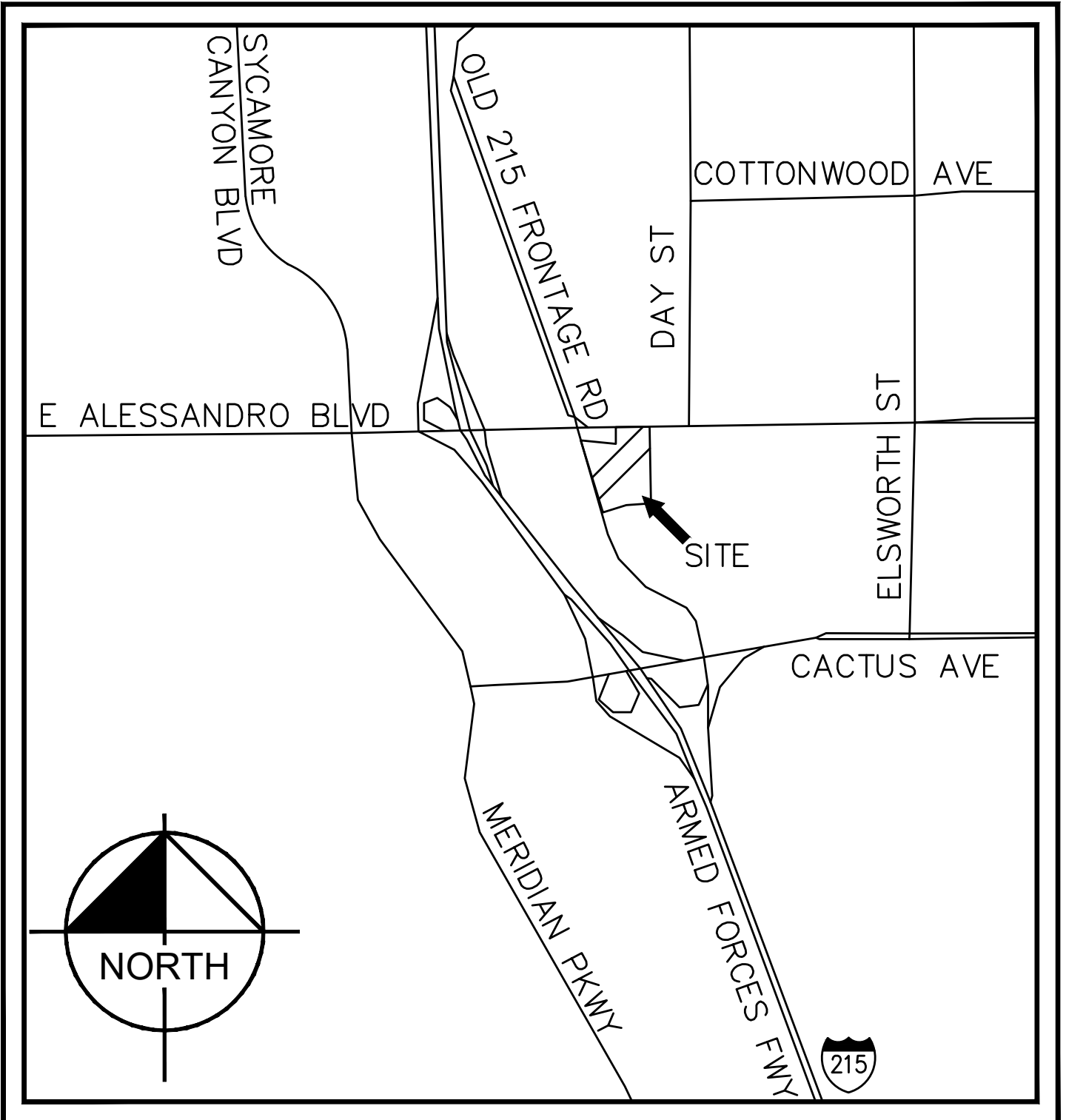

VICINITY MAP

NTS

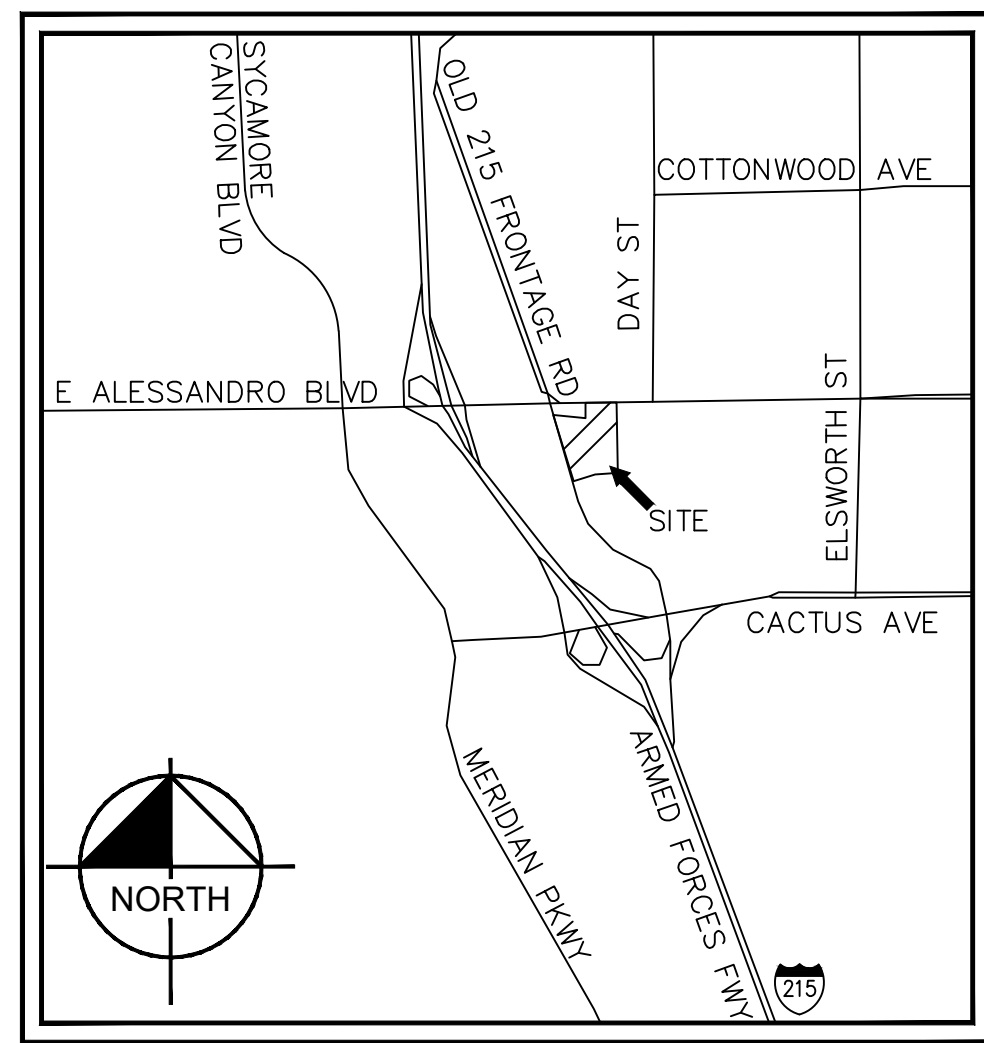

VICINITY MAP
NTS

LEGEND

- 1695 PROPOSED CONTOUR
- (1695) EXISTING CONTOUR
- PROPERTY LINE
- DMA BOUNDARY
- PROPOSED STORM DRAIN
- FLOW ARROW
- DA NAME
- DA AREA (IN ACRES)
- RIGHT OF WAY

LANDSCAPE NOTE:

FINISH GRADE OF LANDSCAPE AREAS IS TO BE DEPRESSED 1-2 INCHES (MIN.) BELOW TOP OF CURB, SIDEWALK OR PAVEMENT.

| TREATMENT CONTROL & SOURCE CONTROL BMP'S | |
|--|------------------------------------|
| BMP ID | BMP DESCRIPTION |
| SC-43 | PARKING AREA MAINTENANCE |
| SC-44 | DRAINAGE SYSTEM MAINTENANCE |
| SC-71 | PLAZA & SIDEWALK CLEANING |
| SC-73 | LANDSCAPE MAINTENANCE |
| SD-10 | SITE DESIGN AND LANDSCAPE PLANNING |
| SD-11 | ROOF RUNOFF CONTROL |
| SD-12 | EFFICIENT IRRIGATION |
| SD-13 | STORM DRAIN SIGNAGE |
| SD-32 | TRASH STORAGE AREAS |

| DMA | SURFACE TYPE | AREA (SF) | AREA (AC) | BMP ID | REQUIRED DESIGN FLOW RATE (CFS) | PROPOSED MODULAR WETLAND TREATMENT FLOW RATE (CFS) |
|------|------------------------|-----------|-----------|--------|---------------------------------|--|
| DA-1 | ROOFS | 11,392 | 3.33 | BMP-1 | 0.5 | 0.577 |
| | CONCRETE/ASPHALT | 107,937 | | | | |
| | ORNAMENTAL LANDSCAPING | 25,755 | | | | |
| DA-2 | ROOFS | 9,600 | 3.9800 | BMP-2 | 0.6 | 0.693 |
| | CONCRETE/ASPHALT | 146,809 | | | | |
| | ORNAMENTAL LANDSCAPING | 16,791 | | | | |
| DA-3 | CONCRETE/ASPHALT | 55,924 | 1.81 | BMP-3 | 0.2 | 0.206 |
| | ORNAMENTAL LANDSCAPING | 23,027 | | | | |

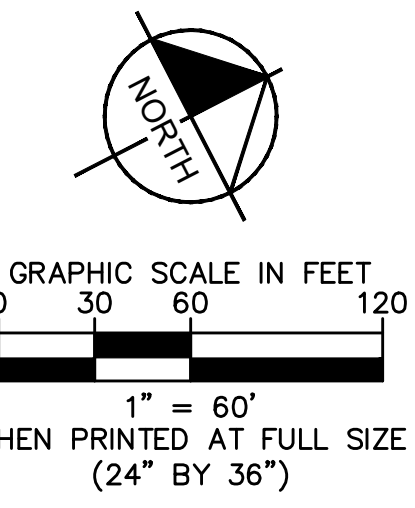
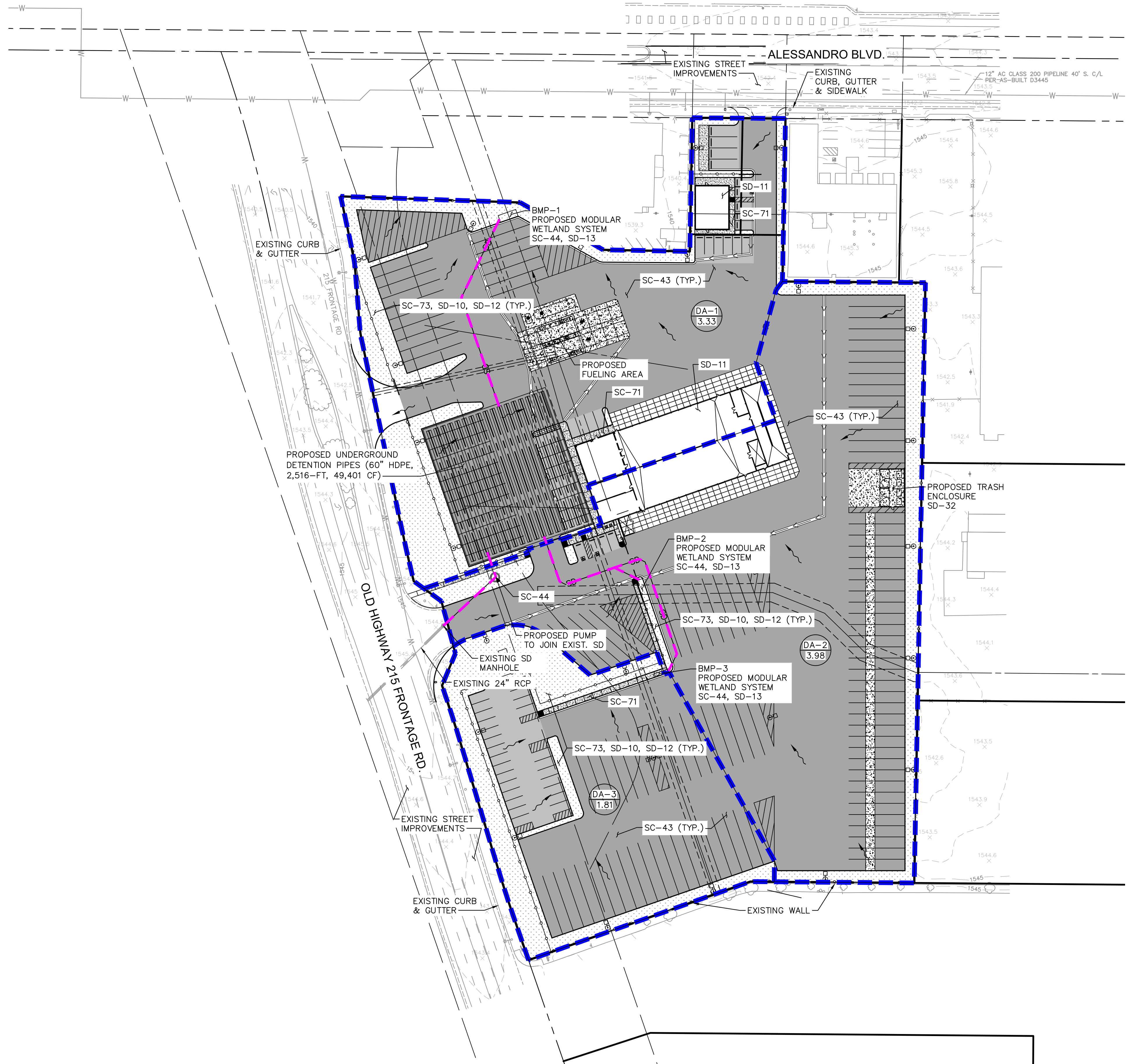

PROJECT SITE
 Penske Moreno
 Valley
 D85=0.613

| | | | | | |
|----|----|----|----|----|----|
| 06 | 05 | 04 | 03 | 02 | 01 |
| 07 | 08 | 09 | 10 | 11 | 12 |
| 18 | 17 | 16 | 15 | 14 | 13 |
| 19 | 20 | 21 | 22 | 23 | 24 |
| 30 | 29 | 28 | 27 | 26 | 25 |
| 31 | 32 | 33 | 34 | 35 | 36 |

● Rain Gage Locations

RIVERSIDE COUNTY FLOOD CONTROL AND WATER CONSERVATION DISTRICT

Isohyetal Map for the 85th Percentile 24 hour Storm Event

July 2011

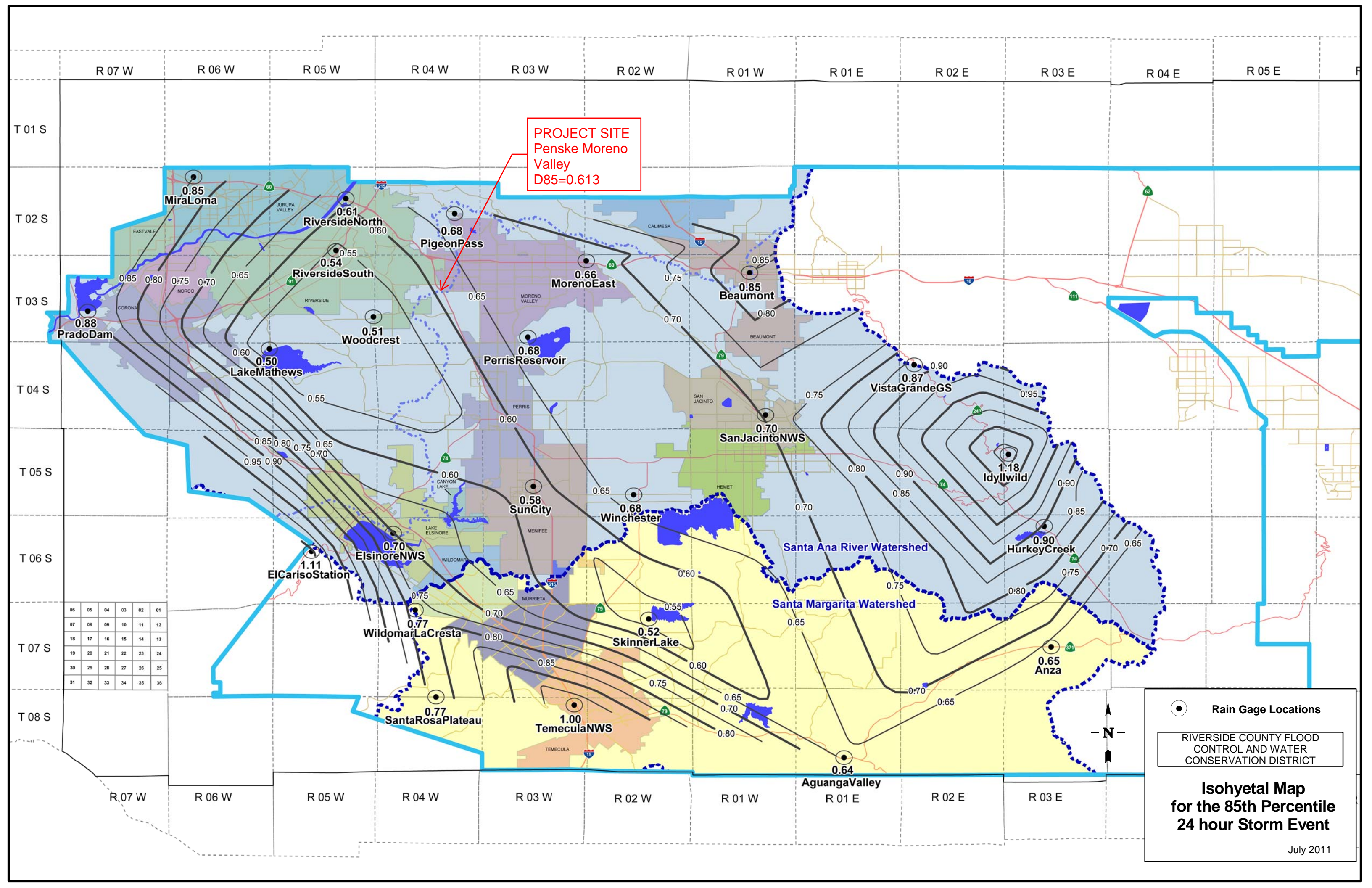

Appendix 2: Construction Plans

Grading and Drainage Plans, Landscape, Wet and Dry Utilities

LEGEND

- PROPERTY LINE CIVIL
- LIMITS OF WORK
- CENTER LINE
- SETBACKS
- EASEMENT LINE
- GRADE BREAK
- PROPOSED ELEVATION
- EXISTING ELEVATION
- SLOPE
- DETECTABLE WARNINGS
- STANDARD DUTY CONCRETE PAVEMENT
- HEAVY DUTY CONCRETE PAVEMENT
- HEAVY DUTY ASPHALT PAVEMENT
- STANDARD DUTY ASPHALT PAVEMENT
- LANDSCAPE/PLANTER AREA

ABBREVIATIONS:

EG EXISTING GROUND
 FF FINISHED FLOOR
 FS FINISH SURFACE
 FG FINISH GROUND
 FL FLOW LINE
 GB GRADE BREAK
 HP HIGH POINT
 LP LOW POINT
 N.A.P. NOT A PART
 TC TOP OF CURB
 TG TOP OF GRADE
 TP TOP OF PAVEMENT

SITE INFORMATION

PARCEL NUMBERS: 297-120-002, 297-120-003, 297-100-073, 297-100-076, 297-100-066 (PORTION), 297-120-017, 297-120-018, 297-120-016 (PORTION)

ADDRESS: 21839 AND 21921 ALESSANDRO BLVD., MORENO VALLEY, CA 92553

SITE AREA: ±9.1 ACRES

GRADING NOTES

- CONTRACTOR TO VERIFY ALL EXISTING TOPOGRAPHY AND STRUCTURES ON THE SITE AND IMMEDIATELY NOTIFY THE ENGINEER OF ANY DISCREPANCIES PRIOR TO STARTING WORK.
- ALL PAVEMENT SPOT GRADE ELEVATIONS AND RIM ELEVATIONS WITHIN OR ALONG CURB AND GUTTER REFER TO FLOW LINE ELEVATIONS UNLESS OTHERWISE NOTED.
- ALL ELEVATIONS SHOWN DEPICT FINISHED GRADE OR EDGE OF PAVEMENT UNLESS OTHERWISE NOTED. GENERAL CONTRACTOR TO COORDINATE WITH EXCAVATION, LANDSCAPE AND PAVING SUBCONTRACTORS REGARDING TOPSOIL THICKNESS FOR LANDSCAPE AREAS AND PAVEMENT SECTION THICKNESS FOR PAVED AREAS TO PROPERLY ENSURE ADEQUATE CUT TO ESTABLISH SUBGRADE ELEVATIONS.
- NO EARTHEN SLOPE SHALL BE GREATER THAN 2:1, UNLESS OTHERWISE NOTED.
- MAXIMUM SLOPE IN ACCESSIBLE PARKING SPACES AND LOADING ZONES SHALL NOT EXCEED 2.0% IN ALL DIRECTIONS.
- MAXIMUM RUNNING SLOPE SHALL NOT EXCEED 5% AND CROSS SLOPE SHALL NOT EXCEED 2% ON ALL SIDEWALKS AND ACCESSIBLE ROUTES.
- MATCH EXISTING ELEVATIONS AT THE PROPERTY LIMITS.
- REFER TO STORM DRAIN PLANS FOR INLET SIZE AND LOCATION.
- EARTHWORK AND PAVING SPECIFICATION PER GEOTECHNICAL REPORT.
- A GRADING PERMIT FROM THE CITY OF MORENO VALLEY WILL BE REQUIRED PRIOR TO COMMENCEMENT OF WORK.
- ALL WORK DETAILED ON THESE PLANS TO BE PERFORMED, EXCEPT AS OTHERWISE STATED OR PROVIDED HEREON, SHALL BE CONSTRUCTED IN ACCORDANCE WITH CITY OF MORENO VALLEY STANDARDS AND SPECIFICATIONS.

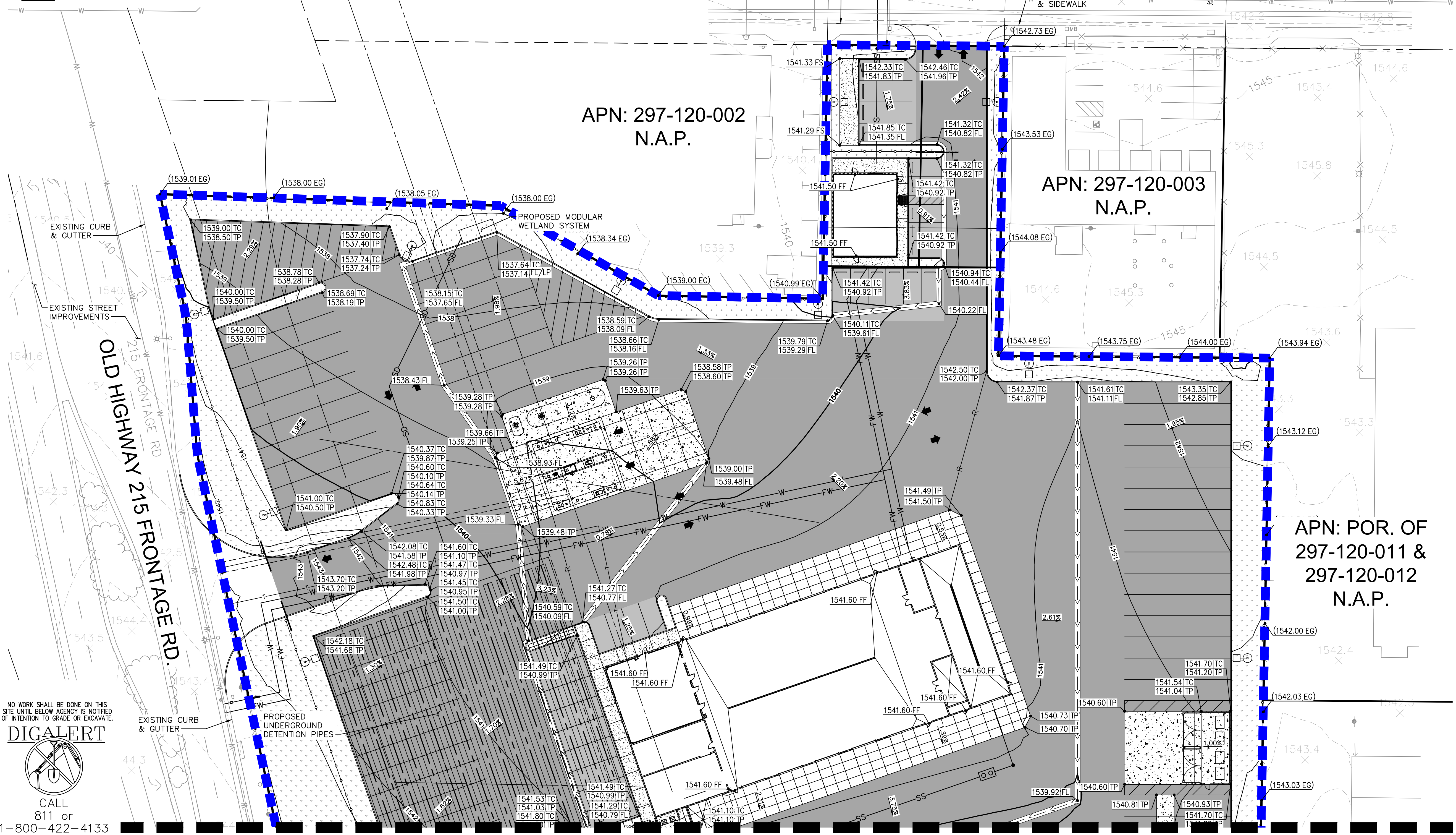

BASIS OF BEARINGS

THE BEARING OF NORTH 01°03'46" EAST BEING THE CENTERLINE OF DAY STREET, AS SHOWN ON PARCEL MAP NO. 33152-1, FILE IN BOOK 229, PAGES 39 THROUGH 41, OF PARCEL MAPS, RECORDS OF RIVERSIDE COUNTY, STATE OF CALIFORNIA, WAS USED AS THE BASIS OF BEARINGS FOR THIS MAP.

BENCHMARK

NATIONAL GEODETIC SURVEY BENCHMARK PID "DX3794"
 ELEVATION: 1669 (FEET) (DATUM: NAVD 88)
 DESCRIBED AS: CGS TRIANGULAR STATION DISK STAMPED "SYCAMORE 1964" CEMENTED IN A DRILL HOLE IN THE WESTERLY SIDE OF THE TOP OF A LARGE BOULDER THAT MEASURES 7 FEET BY 4 FEET AND PROJECTS 1-1/2 FEET ABOVE THE GROUND SURFACE. IT IS ABOUT 3 FEET HIGHER IN ELEVATION THAN THE STATION MARK.

LOCATION: TO REACH FROM THE INTERSECTION OF U.S. HIGHWAY 60 AND 395 WHICH IS 5 MILES SOUTHEAST OF RIVERSIDE, GO SOUTH ON U.S. HIGHWAY 395 FOR 1.0 MILE TO A SIDE ROAD RIGHT JUST AFTER PASSING A RAILROAD DEPOT, TURN RIGHT AND GO WEST ON A TRACK ROAD FOR 0.75 MILE TO A FORK, KEEP LEFT AND CONTINUE WESTERLY ON A TRACK ROAD FOR 0.3 MILE TO A CROSSROAD, CONTINUE WESTERLY ON THE TRACK ROAD FOR 0.3 MILE TO THE TOP OF A LOW HILL AND A SIDE ROAD RIGHT, TURN RIGHT AND GO NORTHERLY ON A WINDING TRACK ROAD FOR 0.4 MILE TO A SMALL WOODEN BUILDING ON THE LEFT, CONTINUE NORTH ACROSS COUNTRY 0.1 MILE TO THE AZIMUTH MARK ON THE LEFT IN A LARGE ROUND BOULDER. FROM HERE PICK WAY NORTH, WEST, NORTH AND EAST AROUND A CULTIVATED FIELD FOR 0.5 MILE TO A LOW ROCKY KNOLL AND THE STATION JUST NORTH OF THE HIGHEST POINT.

ESTIMATED EARTHWORK QUANTITIES

CUT: 6,338 CY
 FILL: 6,408 CY
 NET: 70 CY FILL

NOTE: THE ABOVE QUANTITIES ARE APPROXIMATE IN PLACE VOLUMES CALCULATED FROM THE EXISTING GROUND TO THE PROPOSED FINISHED GRADE. EXISTING GROUND IS DEFINED BY THE CONTOURS AND SPOT GRADES ON THE BASE SURVEY. PROPOSED FINISHED GRADE IS DEFINED AS THE FINAL GRADE AS INDICATED ON THE GRADING PLAN(S).

THE EARTHWORK QUANTITIES ABOVE ARE FOR PERMIT PURPOSES ONLY. THEY HAVE NOT BEEN FACTORED TO ACCOUNT FOR CHANGES IN VOLUME DUE TO BULKING, CLEARING AND GRUBBING, SHRINKAGE, OVER-EXCAVATION AND RE-COMPACTING, AND CONSTRUCTION METHODS, NOR DO THEY ACCOUNT FOR THE THICKNESS OF PAVEMENT SECTIONS, FOOTINGS, SLABS, REUSE OF PULVERIZED MATERIALS THAT WILL UNDERLIE NEW PAVEMENTS, ETC. THE CONTRACTOR SHALL RELY ON THEIR OWN EARTHWORK ESTIMATES FOR BIDDING PURPOSES.

NO WORK SHALL BE DONE ON THIS SITE UNTIL BELOW AGENCY IS NOTIFIED OF INTENTION TO GRADE OR EXCAVATE.

DIGALERT

CALL 811 or 1-800-422-4133 2 Working Days Before You Dig WWW.CALL811.COM

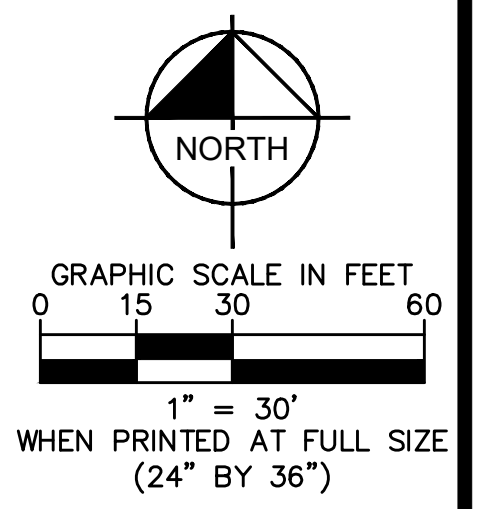

SEE SHEET 2

PEN21-0025

| | | | | | | | | | |
|--|---|------------------------------|---------|------|---------|---|--|---|---------------------------|
| BENCHMARK SEE SHEET 1 FOR BENCHMARK AND BASIS OF ELEVATION. | BASIS OF BEARING SEE SHEET 1 FOR BENCHMARK AND BASIS OF ELEVATION. | REVIEW BY CITY STAFF | | | | CITY OF MORENO VALLEY APPROVALS RECOMMENDED: MICHAEL D. LLOYD, PE ENGINEERING DIVISION MANAGER/ ASSISTANT CITY ENGINEER RCE 69563 APPROVED: MICHAEL L. WOLFE, PE PUBLIC WORKS DIRECTOR/CITY ENGINEER RCE 65623 | ENGINEER OF RECORD'S SEAL Kimley & Horn © 2019 KIMLEY-HORN AND ASSOCIATES, INC. 3880 LEMON STREET SUITE 420, RIVERSIDE, CA 92501 PHONE: 951-543-9868 UNDER THE SUPERVISION OF: SHEA-MICHAEL ANRI RCE C78274 | CITY OF MORENO VALLEY PRELIMINARY GRADING PLAN PENSKE MORENO VALLEY | SHEET 1 OF 2 |
| | | OFFICE | INITIAL | DATE | | | | | CITY ID No. LGRXX-XXXX |
| | | ENGINEERING DIVISION MANAGER | | | | | | | |
| | | LAND DEVELOPMENT | | | | | | | |
| | | PLANNING | | | | | | | |
| | | TRANSPORTATION | | | | | | | |
| | | PARKS AND COMMUNITY SERVICES | | | | | | | |
| | | SPECIAL DISTRICTS | | | | | | | |
| | | STORM WATER MANAGEMENT PRGM | | | | | | | |
| | | | MARK | DATE | INITIAL | DESCRIPTION | REC | APPR | DATE |
| | | | | | EOR | REVISION | | | |

SEE SHEET 1

LEGEND

| | | | |
|--|---------------------|--|---------------------------------|
| | PROPERTY LINE CIVIL | | STANDARD DUTY CONCRETE PAVEMENT |
| | LIMITS OF WORK | | HEAVY DUTY CONCRETE PAVEMENT |
| | CENTER LINE | | HEAVY DUTY ASPHALT PAVEMENT |
| | SETBACKS | | STANDARD DUTY ASPHALT PAVEMENT |
| | EASEMENT LINE | | LANDSCAPE/PLANTER AREA |
| | GRADE BREAK | | |
| | PROPOSED ELEVATION | | |
| | EXISTING ELEVATION | | |
| | SLOPE | | |
| | DETECTABLE WARNINGS | | |

ABBREVIATIONS:

| | |
|--------|---------------------------|
| EG | EXISTING GROUND ELEVATION |
| FF | FINISHED FLOOR ELEVATION |
| FS | FINISH SURFACE ELEVATION |
| FL | FLOW LINE |
| GB | GRADE BREAK |
| HP | HIGH POINT |
| LP | LOW POINT |
| N.A.P. | NOT A PART |
| TC | TOP OF CURB |
| TG | TOP OF GRATE |
| TP | TOP OF PAVEMENT |

APN: POR. OF
297-120-011,
297-120-012 &
297-100-066
N.A.P.

APN: POR. OF
297-100-066
N.A.P.

APN: 297-100-079
N.A.P.

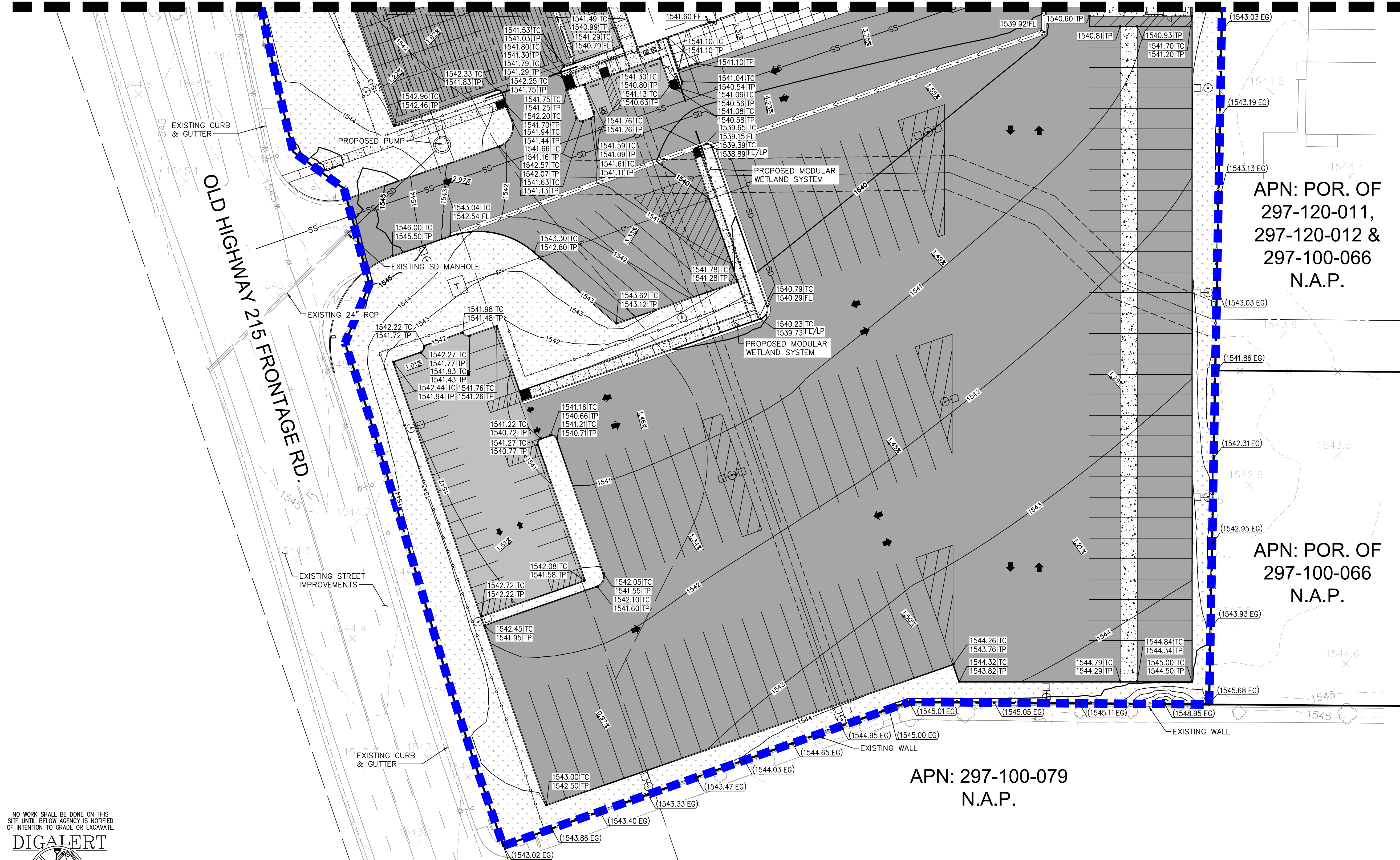

NO WORK SHALL BE DONE ON THIS SITE UNTIL BELOW AGENCY IS NOTIFIED OF INTENTION TO GRADE OR EXCAVATE.

DIGALERT

CALL 811 or 1-800-422-4133 2 Working Days Before You Dig WWW.CALL811.COM

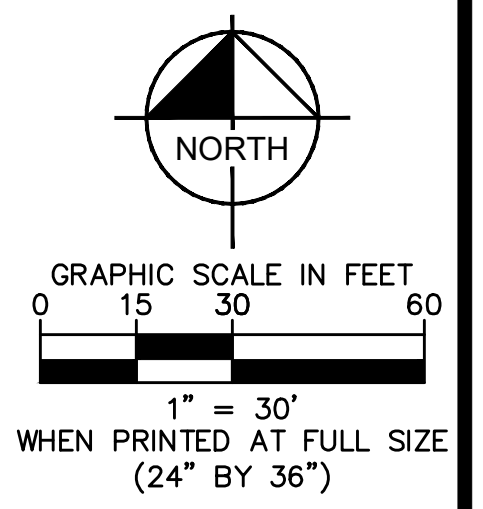

PEN21-0025

| | | | | | | | | | | |
|--|---|------------------------------|---------|------|--|--|--|--|---|------------------|
| BENCHMARK SEE SHEET 1 FOR BENCHMARK AND BASIS OF ELEVATION. | BASIS OF BEARING SEE SHEET 1 FOR BENCHMARK AND BASIS OF ELEVATION. | REVIEW BY CITY STAFF | | | | CITY OF MORENO VALLEY APPROVALS RECOMMENDED: MICHAEL D. LLOYD, PE ENGINEERING DIVISION MANAGER/ ASSISTANT CITY ENGINEER RCE 69563 | ENGINEER OF RECORD'S SEAL SHEA-MICHAEL ANRI REGISTERED PROFESSIONAL ENGINEER STATE OF CALIFORNIA CIVIL | © 2019 KIMLEY-HORN AND ASSOCIATES, INC. 3880 LEMON STREET SUITE 420, RIVERSIDE, CA 92501 PHONE: 951-543-9868 UNDER THE SUPERVISION OF: SHEA-MICHAEL ANRI RCE C78274 | CITY OF MORENO VALLEY | |
| | | OFFICE | INITIAL | DATE | | | | | APPROVED: MICHAEL L. WOLFE, PE PUBLIC WORKS DIRECTOR/CITY ENGINEER RCE 65623 | 11/10/21 DATE |
| | | LAND DEVELOPMENT | | | | | | | | |
| | | PLANNING | | | | | | | | |
| | | TRANSPORTATION | | | | | | | | |
| | | PARKS AND COMMUNITY SERVICES | | | | | | | | |
| | | SPECIAL DISTRICTS | | | | | | | | |
| | | STORM WATER MANAGEMENT PRGM | | | | | | | | |

Appendix 3: Soils Information

Geotechnical Study and Other Infiltration Testing Data



WQMP Project Report

County of Riverside Stormwater Program

Santa Ana River Watershed Geodatabase

Wednesday, August 11, 2021

Note: The information provided in this report and on the Stormwater Geodatabase for the County of Riverside Stormwater Program is intended to provide basic guidance in the preparation of the applicant's Water Quality Management Plan (WQMP) and should not be relied upon without independent verification.

Project Site Parcel Number(s): 297120015, 297120002, 297120003, 297120016, 297100066, RW, 297100076, 297120018, 297100073, RW, 297120017, 297120004, 297120001

Latitude/Longitude: 33.9154, -117.2817

Thomas Brothers Page:

Project Site Acreage: 8.84

Watershed(s): SANTA ANA

This Project Site Resides in the following Hydrologic Unit(s) (HUC): **HUC Name - HUC Number**
Tequesquite Arroyo - 180702030802

The HUCs Contribute stormwater to the following 303d listed water bodies and TMDLs which may include drainage from your proposed Project Site: **WBID Name - WBID Number**
Santa Ana River, Reach 3 - CAR8012100019990211140353

These 303d listed Water bodies and TMDLs have the following Pollutants of Concern (POC): **Bacterial Indicators - Pathogens**
Metals/Metalloids - Copper, Lead

Is the Site subject to Hydromodification: Yes

Limitations on Infiltration: **Project Site Onsite Soils Group(s) - C**
Known Groundwater Contamination Plumes within 1000' - No
Adjacent Water Supply Wells(s) - No information available please contact your local water agency for more information. Your local contact agency is EASTERN MUNICIPAL W.D.. Your local wholesaler contact agency is METROPOLITAN WATER DISTRICT.

Environmentally Sensitive Areas within 200'(Fish and Wildlife Habitat/Species): None

None

**Environmentally Sensitive Areas
within 200'(CVMSHCP):****Environmentally Sensitive Areas
within 200'(WRMSHCP):** Steven's Kangaroo Rat**Groundwater elevation from Mean
Sea Level:** No Data**85th Percentile Design Storm
Depth (in):** 0.613**Groundwater Basin:** No Data**MSHCP/CVMSHCP Criteria Cell
(s):** No Data**Retention Ordinance Information:** No Data**Studies and Reports Related to
Project Site:** [IBI Scores - Southern Cal
RiversideBasin
bulletin118_4-sc
water_fact_3_7.11
8039-SAR-Hydromodification
Comprehensive Bacteria Reduction Plan
Moreno Valley West End MDP
West San Jacinto GW Basin Management Plan
2012 Annual Report of Santa Ana River
Moreno Valley West End ADP Map
Moreno Valley West End ADP Report](#)



United States
Department of
Agriculture

NRCS

Natural
Resources
Conservation
Service

A product of the National
Cooperative Soil Survey,
a joint effort of the United
States Department of
Agriculture and other
Federal agencies, State
agencies including the
Agricultural Experiment
Stations, and local
participants

Custom Soil Resource Report for Western Riverside Area, California

Penske Moreno Valley



Preface

Soil surveys contain information that affects land use planning in survey areas. They highlight soil limitations that affect various land uses and provide information about the properties of the soils in the survey areas. Soil surveys are designed for many different users, including farmers, ranchers, foresters, agronomists, urban planners, community officials, engineers, developers, builders, and home buyers. Also, conservationists, teachers, students, and specialists in recreation, waste disposal, and pollution control can use the surveys to help them understand, protect, or enhance the environment.

Various land use regulations of Federal, State, and local governments may impose special restrictions on land use or land treatment. Soil surveys identify soil properties that are used in making various land use or land treatment decisions. The information is intended to help the land users identify and reduce the effects of soil limitations on various land uses. The landowner or user is responsible for identifying and complying with existing laws and regulations.

Although soil survey information can be used for general farm, local, and wider area planning, onsite investigation is needed to supplement this information in some cases. Examples include soil quality assessments (<http://www.nrcs.usda.gov/wps/portal/nrcs/main/soils/health/>) and certain conservation and engineering applications. For more detailed information, contact your local USDA Service Center (<https://offices.sc.egov.usda.gov/locator/app?agency=nrcs>) or your NRCS State Soil Scientist (http://www.nrcs.usda.gov/wps/portal/nrcs/detail/soils/contactus/?cid=nrcs142p2_053951).

Great differences in soil properties can occur within short distances. Some soils are seasonally wet or subject to flooding. Some are too unstable to be used as a foundation for buildings or roads. Clayey or wet soils are poorly suited to use as septic tank absorption fields. A high water table makes a soil poorly suited to basements or underground installations.

The National Cooperative Soil Survey is a joint effort of the United States Department of Agriculture and other Federal agencies, State agencies including the Agricultural Experiment Stations, and local agencies. The Natural Resources Conservation Service (NRCS) has leadership for the Federal part of the National Cooperative Soil Survey.

Information about soils is updated periodically. Updated information is available through the NRCS Web Soil Survey, the site for official soil survey information.

The U.S. Department of Agriculture (USDA) prohibits discrimination in all its programs and activities on the basis of race, color, national origin, age, disability, and where applicable, sex, marital status, familial status, parental status, religion, sexual orientation, genetic information, political beliefs, reprisal, or because all or a part of an individual's income is derived from any public assistance program. (Not all prohibited bases apply to all programs.) Persons with disabilities who require

alternative means for communication of program information (Braille, large print, audiotape, etc.) should contact USDA's TARGET Center at (202) 720-2600 (voice and TDD). To file a complaint of discrimination, write to USDA, Director, Office of Civil Rights, 1400 Independence Avenue, S.W., Washington, D.C. 20250-9410 or call (800) 795-3272 (voice) or (202) 720-6382 (TDD). USDA is an equal opportunity provider and employer.

Contents

| | |
|---|----|
| Preface | 2 |
| How Soil Surveys Are Made | 5 |
| Soil Map | 8 |
| Soil Map..... | 9 |
| Legend..... | 10 |
| Map Unit Legend..... | 11 |
| Map Unit Descriptions..... | 11 |
| Western Riverside Area, California..... | 13 |
| MmB—Monserate sandy loam, 0 to 5 percent slopes..... | 13 |
| MmC2—Monserate sandy loam, 5 to 8 percent slopes, eroded..... | 14 |
| References | 16 |

How Soil Surveys Are Made

Soil surveys are made to provide information about the soils and miscellaneous areas in a specific area. They include a description of the soils and miscellaneous areas and their location on the landscape and tables that show soil properties and limitations affecting various uses. Soil scientists observed the steepness, length, and shape of the slopes; the general pattern of drainage; the kinds of crops and native plants; and the kinds of bedrock. They observed and described many soil profiles. A soil profile is the sequence of natural layers, or horizons, in a soil. The profile extends from the surface down into the unconsolidated material in which the soil formed or from the surface down to bedrock. The unconsolidated material is devoid of roots and other living organisms and has not been changed by other biological activity.

Currently, soils are mapped according to the boundaries of major land resource areas (MLRAs). MLRAs are geographically associated land resource units that share common characteristics related to physiography, geology, climate, water resources, soils, biological resources, and land uses (USDA, 2006). Soil survey areas typically consist of parts of one or more MLRA.

The soils and miscellaneous areas in a survey area occur in an orderly pattern that is related to the geology, landforms, relief, climate, and natural vegetation of the area. Each kind of soil and miscellaneous area is associated with a particular kind of landform or with a segment of the landform. By observing the soils and miscellaneous areas in the survey area and relating their position to specific segments of the landform, a soil scientist develops a concept, or model, of how they were formed. Thus, during mapping, this model enables the soil scientist to predict with a considerable degree of accuracy the kind of soil or miscellaneous area at a specific location on the landscape.

Commonly, individual soils on the landscape merge into one another as their characteristics gradually change. To construct an accurate soil map, however, soil scientists must determine the boundaries between the soils. They can observe only a limited number of soil profiles. Nevertheless, these observations, supplemented by an understanding of the soil-vegetation-landscape relationship, are sufficient to verify predictions of the kinds of soil in an area and to determine the boundaries.

Soil scientists recorded the characteristics of the soil profiles that they studied. They noted soil color, texture, size and shape of soil aggregates, kind and amount of rock fragments, distribution of plant roots, reaction, and other features that enable them to identify soils. After describing the soils in the survey area and determining their properties, the soil scientists assigned the soils to taxonomic classes (units). Taxonomic classes are concepts. Each taxonomic class has a set of soil characteristics with precisely defined limits. The classes are used as a basis for comparison to classify soils systematically. Soil taxonomy, the system of taxonomic classification used in the United States, is based mainly on the kind and character of soil properties and the arrangement of horizons within the profile. After the soil

Custom Soil Resource Report

scientists classified and named the soils in the survey area, they compared the individual soils with similar soils in the same taxonomic class in other areas so that they could confirm data and assemble additional data based on experience and research.

The objective of soil mapping is not to delineate pure map unit components; the objective is to separate the landscape into landforms or landform segments that have similar use and management requirements. Each map unit is defined by a unique combination of soil components and/or miscellaneous areas in predictable proportions. Some components may be highly contrasting to the other components of the map unit. The presence of minor components in a map unit in no way diminishes the usefulness or accuracy of the data. The delineation of such landforms and landform segments on the map provides sufficient information for the development of resource plans. If intensive use of small areas is planned, onsite investigation is needed to define and locate the soils and miscellaneous areas.

Soil scientists make many field observations in the process of producing a soil map. The frequency of observation is dependent upon several factors, including scale of mapping, intensity of mapping, design of map units, complexity of the landscape, and experience of the soil scientist. Observations are made to test and refine the soil-landscape model and predictions and to verify the classification of the soils at specific locations. Once the soil-landscape model is refined, a significantly smaller number of measurements of individual soil properties are made and recorded. These measurements may include field measurements, such as those for color, depth to bedrock, and texture, and laboratory measurements, such as those for content of sand, silt, clay, salt, and other components. Properties of each soil typically vary from one point to another across the landscape.

Observations for map unit components are aggregated to develop ranges of characteristics for the components. The aggregated values are presented. Direct measurements do not exist for every property presented for every map unit component. Values for some properties are estimated from combinations of other properties.

While a soil survey is in progress, samples of some of the soils in the area generally are collected for laboratory analyses and for engineering tests. Soil scientists interpret the data from these analyses and tests as well as the field-observed characteristics and the soil properties to determine the expected behavior of the soils under different uses. Interpretations for all of the soils are field tested through observation of the soils in different uses and under different levels of management. Some interpretations are modified to fit local conditions, and some new interpretations are developed to meet local needs. Data are assembled from other sources, such as research information, production records, and field experience of specialists. For example, data on crop yields under defined levels of management are assembled from farm records and from field or plot experiments on the same kinds of soil.

Predictions about soil behavior are based not only on soil properties but also on such variables as climate and biological activity. Soil conditions are predictable over long periods of time, but they are not predictable from year to year. For example, soil scientists can predict with a fairly high degree of accuracy that a given soil will have a high water table within certain depths in most years, but they cannot predict that a high water table will always be at a specific level in the soil on a specific date.

After soil scientists located and identified the significant natural bodies of soil in the survey area, they drew the boundaries of these bodies on aerial photographs and

Custom Soil Resource Report

identified each as a specific map unit. Aerial photographs show trees, buildings, fields, roads, and rivers, all of which help in locating boundaries accurately.

Soil Map

The soil map section includes the soil map for the defined area of interest, a list of soil map units on the map and extent of each map unit, and cartographic symbols displayed on the map. Also presented are various metadata about data used to produce the map, and a description of each soil map unit.

Custom Soil Resource Report Soil Map



Soil Map may not be valid at this scale.

Map Scale: 1:1,620 if printed on A portrait (8.5" x 11") sheet.

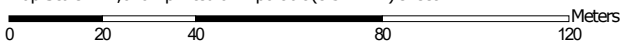

Map projection: Web Mercator Corner coordinates: WGS84 Edge tics: UTM Zone 11N WGS84

MAP LEGEND

Area of Interest (AOI)

 Area of Interest (AOI)



















Soils







 Soil Map Unit Polygons

 Soil Map Unit Lines

 Soil Map Unit Points

Special Point Features





-  Blowout
-  Borrow Pit
-  Clay Spot
-  Closed Depression
-  Gravel Pit
-  Gravelly Spot
-  Landfill
-  Lava Flow
-  Marsh or swamp
-  Mine or Quarry
-  Miscellaneous Water
-  Perennial Water
-  Rock Outcrop
-  Saline Spot
-  Sandy Spot
-  Severely Eroded Spot
-  Sinkhole
-  Slide or Slip
-  Sodic Spot

-  Spoil Area
-  Stony Spot
-  Very Stony Spot
-  Wet Spot
-  Other
-  Special Line Features

Water Features

 Streams and Canals

Transportation

-  Rails
-  Interstate Highways
-  US Routes
-  Major Roads
-  Local Roads

Background

 Aerial Photography

MAP INFORMATION

The soil surveys that comprise your AOI were mapped at 1:15,800.

Warning: Soil Map may not be valid at this scale.

Enlargement of maps beyond the scale of mapping can cause misunderstanding of the detail of mapping and accuracy of soil line placement. The maps do not show the small areas of contrasting soils that could have been shown at a more detailed scale.

Please rely on the bar scale on each map sheet for map measurements.

Source of Map: Natural Resources Conservation Service
 Web Soil Survey URL:
 Coordinate System: Web Mercator (EPSG:3857)

Maps from the Web Soil Survey are based on the Web Mercator projection, which preserves direction and shape but distorts distance and area. A projection that preserves area, such as the Albers equal-area conic projection, should be used if more accurate calculations of distance or area are required.

This product is generated from the USDA-NRCS certified data as of the version date(s) listed below.

Soil Survey Area: Western Riverside Area, California
 Survey Area Data: Version 13, May 27, 2020

Soil map units are labeled (as space allows) for map scales 1:50,000 or larger.

Date(s) aerial images were photographed: May 25, 2019—Jun 25, 2019

The orthophoto or other base map on which the soil lines were compiled and digitized probably differs from the background imagery displayed on these maps. As a result, some minor shifting of map unit boundaries may be evident.

Map Unit Legend

| Map Unit Symbol | Map Unit Name | Acres in AOI | Percent of AOI |
|------------------------------------|---|--------------|----------------|
| MmB | Monserate sandy loam, 0 to 5 percent slopes | 8.0 | 86.9% |
| MmC2 | Monserate sandy loam, 5 to 8 percent slopes, eroded | 1.2 | 13.1% |
| Totals for Area of Interest | | 9.2 | 100.0% |

Map Unit Descriptions

The map units delineated on the detailed soil maps in a soil survey represent the soils or miscellaneous areas in the survey area. The map unit descriptions, along with the maps, can be used to determine the composition and properties of a unit.

A map unit delineation on a soil map represents an area dominated by one or more major kinds of soil or miscellaneous areas. A map unit is identified and named according to the taxonomic classification of the dominant soils. Within a taxonomic class there are precisely defined limits for the properties of the soils. On the landscape, however, the soils are natural phenomena, and they have the characteristic variability of all natural phenomena. Thus, the range of some observed properties may extend beyond the limits defined for a taxonomic class. Areas of soils of a single taxonomic class rarely, if ever, can be mapped without including areas of other taxonomic classes. Consequently, every map unit is made up of the soils or miscellaneous areas for which it is named and some minor components that belong to taxonomic classes other than those of the major soils.

Most minor soils have properties similar to those of the dominant soil or soils in the map unit, and thus they do not affect use and management. These are called noncontrasting, or similar, components. They may or may not be mentioned in a particular map unit description. Other minor components, however, have properties and behavioral characteristics divergent enough to affect use or to require different management. These are called contrasting, or dissimilar, components. They generally are in small areas and could not be mapped separately because of the scale used. Some small areas of strongly contrasting soils or miscellaneous areas are identified by a special symbol on the maps. If included in the database for a given area, the contrasting minor components are identified in the map unit descriptions along with some characteristics of each. A few areas of minor components may not have been observed, and consequently they are not mentioned in the descriptions, especially where the pattern was so complex that it was impractical to make enough observations to identify all the soils and miscellaneous areas on the landscape.

The presence of minor components in a map unit in no way diminishes the usefulness or accuracy of the data. The objective of mapping is not to delineate pure taxonomic classes but rather to separate the landscape into landforms or landform segments that have similar use and management requirements. The delineation of such segments on the map provides sufficient information for the development of resource plans. If intensive use of small areas is planned, however,

Custom Soil Resource Report

onsite investigation is needed to define and locate the soils and miscellaneous areas.

An identifying symbol precedes the map unit name in the map unit descriptions. Each description includes general facts about the unit and gives important soil properties and qualities.

Soils that have profiles that are almost alike make up a *soil series*. Except for differences in texture of the surface layer, all the soils of a series have major horizons that are similar in composition, thickness, and arrangement.

Soils of one series can differ in texture of the surface layer, slope, stoniness, salinity, degree of erosion, and other characteristics that affect their use. On the basis of such differences, a soil series is divided into *soil phases*. Most of the areas shown on the detailed soil maps are phases of soil series. The name of a soil phase commonly indicates a feature that affects use or management. For example, Alpha silt loam, 0 to 2 percent slopes, is a phase of the Alpha series.

Some map units are made up of two or more major soils or miscellaneous areas. These map units are complexes, associations, or undifferentiated groups.

A *complex* consists of two or more soils or miscellaneous areas in such an intricate pattern or in such small areas that they cannot be shown separately on the maps. The pattern and proportion of the soils or miscellaneous areas are somewhat similar in all areas. Alpha-Beta complex, 0 to 6 percent slopes, is an example.

An *association* is made up of two or more geographically associated soils or miscellaneous areas that are shown as one unit on the maps. Because of present or anticipated uses of the map units in the survey area, it was not considered practical or necessary to map the soils or miscellaneous areas separately. The pattern and relative proportion of the soils or miscellaneous areas are somewhat similar. Alpha-Beta association, 0 to 2 percent slopes, is an example.

An *undifferentiated group* is made up of two or more soils or miscellaneous areas that could be mapped individually but are mapped as one unit because similar interpretations can be made for use and management. The pattern and proportion of the soils or miscellaneous areas in a mapped area are not uniform. An area can be made up of only one of the major soils or miscellaneous areas, or it can be made up of all of them. Alpha and Beta soils, 0 to 2 percent slopes, is an example.

Some surveys include *miscellaneous areas*. Such areas have little or no soil material and support little or no vegetation. Rock outcrop is an example.

Western Riverside Area, California

MmB—Monserate sandy loam, 0 to 5 percent slopes

Map Unit Setting

National map unit symbol: hcx4

Elevation: 700 to 2,500 feet

Mean annual precipitation: 10 to 18 inches

Mean annual air temperature: 63 to 64 degrees F

Frost-free period: 220 to 280 days

Farmland classification: Farmland of statewide importance

Map Unit Composition

Monserate and similar soils: 85 percent

Minor components: 15 percent

Estimates are based on observations, descriptions, and transects of the mapunit.

Description of Monserate

Setting

Landform: Alluvial fans

Landform position (three-dimensional): Tread

Down-slope shape: Linear

Across-slope shape: Linear

Parent material: Alluvium derived from granite

Typical profile

H1 - 0 to 10 inches: sandy loam

H2 - 10 to 28 inches: sandy clay loam

H3 - 28 to 45 inches: indurated

H4 - 45 to 57 inches: cemented

H5 - 57 to 70 inches: loamy coarse sand, coarse sandy loam

H5 - 57 to 70 inches:

Properties and qualities

Slope: 0 to 5 percent

Depth to restrictive feature: 20 to 39 inches to duripan

Drainage class: Well drained

Runoff class: Medium

Capacity of the most limiting layer to transmit water (Ksat): Very low (0.00 to 0.00 in/hr)

Depth to water table: More than 80 inches

Frequency of flooding: None

Frequency of ponding: None

Available water capacity: Low (about 4.1 inches)

Interpretive groups

Land capability classification (irrigated): 3e

Land capability classification (nonirrigated): 4e

Hydrologic Soil Group: C

Ecological site: R019XD029CA

Hydric soil rating: No

Minor Components

Greenfield

Percent of map unit: 5 percent
Hydric soil rating: No

Hanford

Percent of map unit: 5 percent
Hydric soil rating: No

Tujunga

Percent of map unit: 5 percent
Hydric soil rating: No

MmC2—Monserate sandy loam, 5 to 8 percent slopes, eroded

Map Unit Setting

National map unit symbol: hcx5
Elevation: 700 to 2,500 feet
Mean annual precipitation: 10 to 18 inches
Mean annual air temperature: 63 to 64 degrees F
Frost-free period: 220 to 280 days
Farmland classification: Farmland of statewide importance

Map Unit Composition

Monserate and similar soils: 85 percent
Minor components: 15 percent
Estimates are based on observations, descriptions, and transects of the mapunit.

Description of Monserate

Setting

Landform: Alluvial fans
Landform position (three-dimensional): Tread
Down-slope shape: Linear
Across-slope shape: Linear
Parent material: Alluvium derived from granite

Typical profile

H1 - 0 to 10 inches: sandy loam
H2 - 10 to 28 inches: sandy clay loam
H3 - 28 to 45 inches: indurated
H4 - 45 to 57 inches: cemented
H5 - 57 to 70 inches: loamy coarse sand, coarse sandy loam
H5 - 57 to 70 inches:

Properties and qualities

Slope: 5 to 8 percent
Depth to restrictive feature: 20 to 39 inches to duripan
Drainage class: Well drained
Runoff class: High

Custom Soil Resource Report

Capacity of the most limiting layer to transmit water (Ksat): Very low (0.00 to 0.00 in/hr)

Depth to water table: More than 80 inches

Frequency of flooding: None

Frequency of ponding: None

Available water capacity: Low (about 4.1 inches)

Interpretive groups

Land capability classification (irrigated): 3e

Land capability classification (nonirrigated): 4e

Hydrologic Soil Group: C

Ecological site: R019XD029CA

Hydric soil rating: No

Minor Components

Unnamed

Percent of map unit: 3 percent

Hydric soil rating: No

Ramona

Percent of map unit: 3 percent

Hydric soil rating: No

Hanford

Percent of map unit: 3 percent

Hydric soil rating: No

Greenfield

Percent of map unit: 3 percent

Hydric soil rating: No

Tujunga

Percent of map unit: 3 percent

Hydric soil rating: No

References

- American Association of State Highway and Transportation Officials (AASHTO). 2004. Standard specifications for transportation materials and methods of sampling and testing. 24th edition.
- American Society for Testing and Materials (ASTM). 2005. Standard classification of soils for engineering purposes. ASTM Standard D2487-00.
- Cowardin, L.M., V. Carter, F.C. Golet, and E.T. LaRoe. 1979. Classification of wetlands and deep-water habitats of the United States. U.S. Fish and Wildlife Service FWS/OBS-79/31.
- Federal Register. July 13, 1994. Changes in hydric soils of the United States.
- Federal Register. September 18, 2002. Hydric soils of the United States.
- Hurt, G.W., and L.M. Vasilas, editors. Version 6.0, 2006. Field indicators of hydric soils in the United States.
- National Research Council. 1995. Wetlands: Characteristics and boundaries.
- Soil Survey Division Staff. 1993. Soil survey manual. Soil Conservation Service. U.S. Department of Agriculture Handbook 18. http://www.nrcs.usda.gov/wps/portal/nrcs/detail/national/soils/?cid=nrcs142p2_054262
- Soil Survey Staff. 1999. Soil taxonomy: A basic system of soil classification for making and interpreting soil surveys. 2nd edition. Natural Resources Conservation Service, U.S. Department of Agriculture Handbook 436. http://www.nrcs.usda.gov/wps/portal/nrcs/detail/national/soils/?cid=nrcs142p2_053577
- Soil Survey Staff. 2010. Keys to soil taxonomy. 11th edition. U.S. Department of Agriculture, Natural Resources Conservation Service. http://www.nrcs.usda.gov/wps/portal/nrcs/detail/national/soils/?cid=nrcs142p2_053580
- Tiner, R.W., Jr. 1985. Wetlands of Delaware. U.S. Fish and Wildlife Service and Delaware Department of Natural Resources and Environmental Control, Wetlands Section.
- United States Army Corps of Engineers, Environmental Laboratory. 1987. Corps of Engineers wetlands delineation manual. Waterways Experiment Station Technical Report Y-87-1.
- United States Department of Agriculture, Natural Resources Conservation Service. National forestry manual. http://www.nrcs.usda.gov/wps/portal/nrcs/detail/soils/home/?cid=nrcs142p2_053374
- United States Department of Agriculture, Natural Resources Conservation Service. National range and pasture handbook. <http://www.nrcs.usda.gov/wps/portal/nrcs/detail/national/landuse/rangepasture/?cid=stelprdb1043084>

Custom Soil Resource Report

United States Department of Agriculture, Natural Resources Conservation Service. National soil survey handbook, title 430-VI. http://www.nrcs.usda.gov/wps/portal/nrcs/detail/soils/scientists/?cid=nrcs142p2_054242

United States Department of Agriculture, Natural Resources Conservation Service. 2006. Land resource regions and major land resource areas of the United States, the Caribbean, and the Pacific Basin. U.S. Department of Agriculture Handbook 296. http://www.nrcs.usda.gov/wps/portal/nrcs/detail/national/soils/?cid=nrcs142p2_053624

United States Department of Agriculture, Soil Conservation Service. 1961. Land capability classification. U.S. Department of Agriculture Handbook 210. http://www.nrcs.usda.gov/Internet/FSE_DOCUMENTS/nrcs142p2_052290.pdf

**GEOTECHNICAL ENGINEERING INVESTIGATION
PENSKE TRUCK LEASING FACILITY
HIGHWAY 215 FRONTAGE ROAD
MORENO VALLEY, CALIFORNIA**

**KA PROJECT NO. 112-21093
OCTOBER 22, 2021**

Prepared for:

**MR. MIKE BARNES, DIRECTOR OF CONSTRUCTION
PENSKE TRUCK LEASING
1541 W. BELL DEL MAR DRIVE
TEMPE, ARIZONA 85283**

Prepared by:

**KRAZAN & ASSOCIATES, INC.
GEOTECHNICAL ENGINEERING DIVISION
1100 OLYMPIC DRIVE, STE 103
CORONA, CALIFORNIA 92881
(951) 273-1011**

October 22, 2021

KA Project No. 112-21093

Mr. Mike Barnes, Director of Construction
Penske Truck Leasing
1541 W. Bell Del Mar Drive
Tempe, Arizona 85283 (480) 276-5888
Mike.barnes@penske.com

RE: Geotechnical Engineering Investigation
Proposed Penske Truck Leasing Facility
SEC of Alessandro Blvd. and Highway 215 Frontage Rd.
Moreno Valley, California

Dear Mr. Barnes:

In accordance with your request, we have completed a Geotechnical Engineering Investigation for the above-referenced site. The results of our investigation are presented in the attached report.

If you have any questions, or if we may be of further assistance, please do not hesitate to contact our office at (951) 273-1011.



Respectfully submitted,
KRAZAN & ASSOCIATES, INC.



Jorge A. Pelayo, PE
Project Engineer
RCE No. 91269

CLT:JAP

TABLE OF CONTENTS

INTRODUCTION 1

PURPOSE AND SCOPE..... 1

PROPOSED CONSTRUCTION..... 2

SITE LOCATION, SITE HISTORY AND SITE DESCRIPTION..... 2

GEOLOGIC SETTING 2

FIELD AND LABORATORY INVESTIGATIONS 3

SOIL PROFILE AND SUBSURFACE CONDITIONS 4

GROUNDWATER..... 4

SEISMICITY AND LIQUEFACTION POTENTIAL 4

FAULT RUPTURE HAZARD ZONES..... 5

SEISMIC HAZARDS ZONES..... 6

OTHER HAZARDS 6

 Expansive Soil..... 6

SOIL CORROSIVITY 7

INFILTRATION TESTING..... 7

CONCLUSIONS AND RECOMMENDATIONS..... 7

 Administrative Summary 7

 Groundwater Influence on Structures/Construction..... 8

 Site Preparation 9

 Engineered Fill..... 10

 Drainage and Landscaping..... 10

 Utility Trench Backfill 11

 Foundations - Conventional 11

 Floor Slabs and Exterior Flatwork 12

 Lateral Earth Pressures and Retaining Walls 13

 R-Value Test Results and Pavement Design 14

 Seismic Parameters – 2019 CBC..... 15

 Infiltration Testing..... 15

 Soil Cement Reactivity..... 16

 Compacted Material Acceptance..... 16

 Testing and Inspection 17



GEOTECHNICAL ENGINEERING • ENVIRONMENTAL ENGINEERING
CONSTRUCTION TESTING & INSPECTION

LIMITATIONS..... 17

FIGURES..... Following Text

LOGS OF BORINGS (1 TO 9)..... Appendix A

GENERAL EARTHWORK SPECIFICATIONS..... Appendix B

GENERAL PAVING SPECIFICATIONS..... Appendix C

With Offices Serving the Western United States

1100 Olympic Drive, Ste. 103 • Corona, Ca 92881 • (951) 273-1011 • Fax: (951) 273-1003

11221093 Penske Moreno Valley GEIR CLT JAP

October 22, 2021

KA Project No. 112-21093

**GEOTECHNICAL ENGINEERING INVESTIGATION
PROPOSED PENSKE TRUCK LEASING FACILITY
ALESSANDRO BLVD. AND HIGHWAY 215 FRONTAGE RD.
MORENO VALLEY, CALIFORNIA**

INTRODUCTION

This report presents the results of our Geotechnical Engineering Investigation for the proposed Penske Truck Leasing Facility to be located on Alessandro Boulevard and east of Highway 215 Frontage Road, in the City of Moreno Valley, California. Discussions regarding site conditions are presented herein, together with conclusions and recommendations pertaining to site preparation, Engineered Fill, utility trench backfill, drainage and landscaping, foundations, concrete floor slabs and exterior flatwork, retaining walls, soil cement reactivity, pavement design, and water infiltration rates.

A site plan showing the approximate boring locations is presented following the text of this report, the attached Site Map, Figure 1. A description of the field investigation, boring logs, and the boring log legend are presented in Appendix A. Appendix A contains a description of the laboratory testing phase of this study; along with the laboratory test results. Appendices B and C contain guides to earthwork and pavement specifications. When conflicts in the text of the report occur with the general specifications in the appendices, the recommendations in the text of the report have precedence.

PURPOSE AND SCOPE

This investigation was conducted to evaluate the soil and groundwater conditions at the subject site, to make geotechnical engineering recommendations for use in design of specific construction elements, and to provide criteria for site preparation and Engineered Fill construction.

Our scope of services was outlined in our proposal dated August 19, 2021 (KA Proposal No. G21100CAC) and included the following:

- A site reconnaissance by a member of our engineering staff to evaluate the surface conditions at the project site.
- A field investigation consisting of drilling a total of nine (9) borings to depths of approximately 10 to 50 feet below existing site grades for evaluation of the subsurface conditions at the project site.
- Performance of laboratory tests on representative soil samples obtained from the borings to evaluate the physical and index properties of the subsurface soils.

-
- Performance of two (2) water infiltration tests at the subject site in order to obtain approximate water infiltration rates for the near surface soil conditions.
 - Collection of a bulk sample for laboratory testing of R-value used in our pavement design recommendations.
 - Evaluation of the data obtained from the investigation and an engineering analysis to provide recommendations for use in the project design and preparation of construction specifications.
 - Preparation of this report summarizing the results, conclusions, recommendations, and findings of our investigation.

PROPOSED CONSTRUCTION

We have reviewed the Site Plan, prepared by K/G Architects for the proposed development. Building 1 is proposed as a new structure called, "Service Bays," that is a two-story semi-truck drive through building constructed of steel spans on concrete foundations and consisting of 19,158 square feet. Building 2 is proposed as a new single-story structure constructed of conventional wood frame with slab-on-grade floors and consisting of 1,192 square feet. The proposed development will include on-site parking and localized landscaped areas.

The anticipated finished grade elevation for the proposed structure is assumed to be relatively close to the existing site grades. As a result, only minor cuts and fills are anticipated at the site to account for site drainage. In the event these structural or grading details are inconsistent with the final design criteria, the Soils Engineer should be notified so that we may update this writing as applicable.

SITE LOCATION AND SITE DESCRIPTION

The subject site is roughly rectangular in shape and encompasses approximately 10 acres. The subject site is located on Alessandro Blvd. and east of the Highway 215 Frontage Rd. in the city of Moreno Valley, California, see the attached Vicinity Map, Figure 2. The site is bound to the south by Robertson's Ready Mix, to the west by the existing Highway 215 Frontage Rd., to the north by Alessandro Blvd., and to the east by Alessandro Self Storage (on Day St.).

The site is currently undeveloped and free of any above grade structures. Ground surface at the site consists of exposed soil and localized weed and brush growth. The site topography is relatively flat and level with no major changes in topography at an approximate elevation of 1545 feet above mean sea level. The site currently drains to the west side of the property.

GEOLOGIC SETTING

The subject site is located within the Peninsular Ranges Geomorphic Province (CGS Note 36). The Peninsular Ranges is a series of ranges is separated by northwest trending valleys, subparallel to faults branching from the San Andreas Fault. The trend of topography is similar to the Coast Ranges, but the geology is more like the Sierra Nevada, with granitic rock intruding the older metamorphic rocks. The

Peninsular Ranges extend into lower California and are bound on the east by the Colorado Desert. The Los Angeles Basin and the island group (Santa Catalina, Santa Barbara, and the distinctly terraced San Clemente and San Nicolas islands), together with the surrounding continental shelf (cut by deep submarine fault troughs), are included in this province.

Locally, the site is located in an inactive portion of the San Jacinto River floodplain, and central area of Moreno Valley. The Moreno Valley is bound to the south and west by the Santa Ana Mountains, to the north by the Box Springs Mountains, to the east by the San Jacinto Mountains.

The near-surface deposits in the vicinity of the subject site are indicated to be comprised of recent alluvium (Map Symbol Q) consisting of unconsolidated sands, silt, and clays derived from erosion of local mountain ranges. See the attached Geologic Map (Figure 3) and Boring Logs (Appendix A) for a description of the earth materials encountered during our investigation.

Numerous moderate to large earthquakes have affected the area of the subject site within historic time. Based on the proximity of several dominant active faults and seismogenic structures, as well as the historic seismic record, the area of the subject site is considered subject to relatively high seismicity. The nearest significant active faults are the San Jacinto (8 miles northeast), San Andreas (17 miles northeast), and Elsinore fault zone(s) (16 miles southwest), of the site. The area in consideration shows no mapped faults on-site according to maps prepared by the California Geologic Survey and published by the International Conference of Building Officials (ICBO). No evidence of surface faulting was observed on the property during our reconnaissance.

FIELD AND LABORATORY INVESTIGATIONS

Subsurface soil conditions were explored by drilling a total of eleven (9) borings (B-1 to B-9) to depths of approximately 10 to 50 feet below existing site grade, using a truck-mounted drill rig; in addition, two borings (IT-1 and IT-2) were advanced to a depth of ten feet for the purpose of infiltration testing. A bulk subgrade sample was obtained from the site for laboratory R-Value testing. The approximate boring and bulk sample locations are shown on the attached, Site Map, Figure 1. During drilling operations, penetration tests were performed at regular intervals to evaluate the soil consistency and to obtain information regarding the engineering properties of the subsurface soils. Soil samples were retained for laboratory testing. The soils encountered were continuously examined and visually classified in accordance with the Unified Soil Classification System. A more detailed description of the field investigation is presented in Appendix A.

Laboratory tests were performed on selected soil samples to evaluate their physical characteristics and engineering properties. The laboratory testing program was formulated with emphasis on the evaluation of natural moisture, density, gradation, shear strength, consolidation potential, R-Value, and moisture-density relationships of the materials encountered. In addition, chemical tests were performed to evaluate the corrosivity of the soils to buried concrete and metal. Details of the laboratory test program and results of the laboratory tests are summarized in Appendix A. This information, along with the field observations, was used to prepare the final boring logs in Appendix A.

SOIL PROFILE AND SUBSURFACE CONDITIONS

Based on our findings, the subsurface conditions encountered appear typical of those found in the geologic region of the site. In general, the surface soils consisted of approximately 6 to 12 inches of very loose silty sand or silty sand/sand. These soils are disturbed, have low strength characteristics and are highly compressible when saturated.

Beneath the loose surface soils, approximately 2 to 3 feet of loose to very dense silty sand or silty sand/sand was encountered. Field and laboratory tests suggest that these soils are moderately strong and slightly compressible. Penetration resistance ranged from 13 blows per foot to over 50 blows per 6 inches. Dry densities ranged from 110 to 129 pcf. A representative soil sample consolidated approximately 3¾ percent under a 2 ksf load when saturated. A representative soil sample had an angle of internal friction of 25 degrees.

Below 3 to 4 feet, predominately loose to very dense silty sand, silty sand/sand, silty sand/sandy silt or sand were encountered. Field and laboratory tests suggest that these soils are moderately strong and slightly compressible. Penetration resistance ranged from 14 blows per foot to over 50 blows per 6 inches. Dry densities ranged from 94 to 124 pcf. A representative soil sample consolidated approximately 4½ percent under a 2 ksf load when saturated. A representative soil sample had an internal angle of friction of 29 degrees. These soils had similar strength characteristics as the upper soils and extended to the termination depth of our borings.

For additional information about the soils encountered, please refer to the logs of borings in Appendix A.

GROUNDWATER

Test boring locations were checked for the presence of groundwater during and immediately following the drilling operations. Groundwater was encountered at a depth of approximately 14 feet below existing site grade in Boring Nos. B6, B7 and B8.

It should be recognized that water table elevations may fluctuate with time, being dependent upon seasonal precipitation, irrigation, land use, and climatic conditions, as well as other factors. Therefore, water level observations at the time of the field investigation may vary from those encountered during the construction phase of the project. The evaluation of such factors is beyond the scope of this report.

SEISMICITY AND LIQUEFACTION POTENTIAL

Seismicity is a general term relating to the abrupt release of accumulated strain energy in the rock materials of the earth's crust in a given geographical area. The recurrence of accumulation and subsequent release of strain have resulted in faults and fault systems. Fault patterns and density reflect relative degrees of regional stress through time, but do not necessarily indicate recent seismic activity; therefore, the degree of seismic risk must be determined or estimated by the seismic record in any given region.

Soil liquefaction is a state of soil particle suspension caused by a complete loss of strength when the effective stress drops to zero. Liquefaction normally occurs under saturated conditions in soils such as clean sand in which the strength is purely frictional. However, liquefaction has occurred in soils other than clean sand. Liquefaction usually occurs under vibratory conditions such as those induced by seismic events.

To evaluate the liquefaction potential of the site, the following items were evaluated:

- 1) Soil type
- 2) Groundwater depth
- 3) Relative density
- 4) Initial confining pressure
- 5) Intensity and duration of ground shaking

The site is located in an area designated by the County of Riverside Liquefaction Susceptibility Map as having Moderate Liquefaction Potential. Groundwater was encountered at the subject site at a depth of approximately 14 feet below current site grades.

The potential for soil liquefaction during a seismic event was evaluated using the LIQUEFYPRO computer program (version 5.8h) developed by CivilTech Software. For the analysis, a maximum earthquake magnitude of 7.0 was used. A peak horizontal ground surface acceleration of 0.620g was considered conservative and appropriate for the liquefaction analysis. An estimated high groundwater depth of fourteen (14) feet was used for our analysis. The computer analysis indicates that soil conditions encountered at the subject site are not subject to liquefaction under seismic shaking.

The computer analysis indicates that an estimated total and differential seismic induced settlement is not anticipated to exceed ½ inch and ¼ inch, respectively. Accordingly, the liquefaction potential at the site is not considered significant and measures to mitigate the liquefaction induced settlement are not warranted.

FAULT RUPTURE HAZARD ZONES

The Alquist-Priolo Geologic Hazards Zones Act went into effect in March, 1973. Since that time, the Act has been amended 11 times (Hart, 2007). The purpose of the Act, as provided in California Geologic Survey (CGS) Special Publication 42 (SP 42), is to prohibit the location of most structures for human occupancy across the traces of active faults and to mitigate thereby the hazard of fault-rupture." The Act was renamed the Alquist-Priolo Earthquake Fault Zoning Act in 1994, and at that time, the originally designated "Special Studies Zones" was renamed the "Earthquake Fault Zones." An Earthquake Fault Zones Map has not been prepared for the vicinity of the subject site to date.

SEISMIC HAZARDS ZONES

In 1990, the California State Legislature passed the Seismic Hazard Mapping Act to protect public safety from the effects of strong shaking, liquefaction, landslides, or other ground failure, and other hazards caused by earthquakes. The Act requires that the State Geologist delineate various seismic hazards zones on Seismic Hazards Zones Maps. Specifically, the maps identify areas where soil liquefaction and earthquake-induced landslides are most likely to occur. A site-specific geotechnical evaluation is required prior to permitting most urban developments within the mapped zones. The Act also requires sellers of real property within the zones to disclose this fact to potential buyers. A Seismic Hazard Zones Map has not been prepared for the vicinity of the subject site to date. Furthermore, the County of Riverside Liquefaction Susceptibility Map has identified the site as having Moderate Liquefaction Potential. It is our opinion that the site is not located in a Liquefaction Hazard Zone based on the absence of shallow groundwater in the upper 50 feet below existing site grades and the relatively dense soils encountered.

OTHER HAZARDS

Rockfall, Landslide, Slope Instability, and Debris Flow: The subject site is relatively flat and level. It is our understanding that there are no significant slopes proposed as part of the proposed development. Provided the recommendations presented in this report are implemented into the design and construction of the anticipated development, rockfalls, landslides, slope instability, and debris flows are not anticipated to pose a hazard to the subject site.

Seiches: Seiches are large waves generated within enclosed bodies of water. The site is not located in close proximity to any lakes or reservoirs. As such, seiches are not anticipated to pose a hazard to the subject site.

Tsunamis: Tsunamis are tidal waves generated by fault displacement or major ground movement. The site is several miles from the ocean. As such, tsunamis are not anticipated to pose a hazard to the subject site.

Hydroconsolidation: The near surface soils encountered at the subject site were found to be medium dense to dense. The underlying native soils were found to be dense to very dense. Provided the recommendations in this report are incorporated into the design and construction of the proposed development, hydroconsolidation is not anticipated to be a significant concern for the subject site.

Expansive Soil

The near-surface silty sand soils encountered at the site have been identified through laboratory testing as having a low expansion potential. Expansive soils have the potential to undergo volume change, or shrinkage and swelling, with changes in soil moisture. As expansive soils dry, the soil shrinks; when moisture is reintroduced into the soil, the soil swells.

SOIL CORROSIVITY

Corrosion tests were performed to evaluate the soil corrosivity to the buried structures. The tests consisted of sulfate content, chloride content, and resistivity and the results of the tests are included as follows:

| Parameter | Results | Test Method |
|------------------|----------------|--------------------|
| Resistivity | 1,900 ohms-cm | CA 643 |
| Sulfate | 296 ppm | CA 417 |
| Chloride | 71 ppm | CA 422 |
| pH | 8.0 | EPA 9045C |

INFILTRATION TESTING

Estimated infiltration rates were determined using the results of open borehole percolation testing performed at the subject site. The percolation testing indicated that the near surface dense silty sand soil was found to have infiltration rates of approximately 0.11 and 0.16 inch per hour in IT-1 and IT-2, respectively. The locations of these infiltration tests are presented on the attached Site Map, Figure 1.

The soil infiltration rates are based on tests conducted with clean water. The infiltration rates may vary with time as a result of soil clogging from water impurities. A factor of safety should be incorporated into the design of the infiltration system to compensate for these factors as determined appropriate by the designer. In addition, routine maintenance consisting of clearing the system of clogged soils and debris should be expected.

CONCLUSIONS AND RECOMMENDATIONS

Based on the findings of our field and laboratory investigations, along with previous geotechnical experience in the project area, the following is a summary of our evaluations, conclusions, and recommendations.

Administrative Summary

In brief, the subject site and soil conditions, with the exception of the loose surficial soils, appear to be conducive to the development of the project.

To reduce post-construction soil movement and provide uniform support for the buildings and other foundations, overexcavation and recompaction within the proposed building footprint areas should be performed to a minimum depth of at least four (4) feet below existing grades or three (3) feet below the bottom of the proposed foundation bearing grades. In addition, any fill soil present in the building area should be removed and re-placed as compacted Engineered Fill. The actual depth of the overexcavation and recompaction should be determined by our field representative during construction. The exposed subgrade at the base of the overexcavation should then be scarified, moisture-conditioned as necessary,

and compacted. The overexcavation and recompaction should also extend laterally five feet (5') beyond edges of the proposed footings or building limits. Any undocumented fill encountered during grading should be removed and replaced with Engineered Fill.

To reduce post-construction soil movement and provide uniform support for the proposed parking and drive areas, overexcavation and recompaction of the near surface soil in the proposed parking area should be performed to a minimum depth of at least twelve (12) inches below existing grades or proposed subgrade, whichever is deeper. The actual depth of the overexcavation and recompaction should be determined by our field representative during construction. The overexcavation and recompaction should also extend laterally at least three (3) feet beyond edges of the proposed paving limits or to the property boundary. Any undocumented fill encountered during grading should be removed and replaced with Engineered Fill.

Fill soils should be placed in lifts approximately 6 inches thick, moisture-conditioned to a minimum of 2 percent above optimum moisture content, and compacted to achieve at least 95 percent maximum density based on ASTM Test Method D1557. Additional lifts should not be placed if the previous lift did not meet the required density or if soil conditions are not stable.

Unless designed by the project structural engineer, concrete slabs-on-grade should be a minimum of five (5) inches thick. It is recommended that the concrete slab be reinforced to reduce crack separation and possible vertical offset at the cracks. We recommend at least No. 3 reinforcing bars placed on 18-inches on centers, be used for this purpose. Thicker floor slabs with increased concrete strength and reinforcement should be designed wherever heavy concentrated loads, heavy equipment, or machinery is anticipated.

The exterior floors should be poured separately in order to act independently of the walls and foundation system. Exterior finish grades should be sloped a minimum of 2 percent away from all interior slab areas to preclude ponding of water adjacent to the structures. All fills required to bring the building pads to grade should be Engineered Fills.

Groundwater Influence on Structures/Construction

During our recent field investigation groundwater was encountered at approximately 14 feet below existing site grade. Therefore, dewatering and/or waterproofing may be required should structures or excavations extend below this depth. If groundwater is encountered, our firm should be consulted prior to dewatering the site. Installation of a standpipe piezometer is suggested prior to construction should groundwater levels be a concern.

In addition to the groundwater level, if earthwork is performed during or soon after periods of precipitation, the subgrade soils may become saturated, "pump," or not respond to densification techniques. Typical remedial measures include: discing and aerating the soil during dry weather; mixing the soil with dryer materials; removing and replacing the soil with an approved fill material; or mixing the soil with an approved lime or cement product. Our firm should be consulted prior to implementing remedial measures to observe the unstable subgrade conditions and provide appropriate recommendations.

Site Preparation

General site clearing should include removal of vegetation; existing utilities; structures including foundations; existing stockpiled soil; trees and associated root systems; rubble; rubbish; and any loose and/or saturated materials. Site stripping should extend to a minimum depth of 2 to 4 inches, or until all organics in excess of 3 percent by volume are removed. Deeper stripping may be required in localized areas. These materials will not be suitable for use as Engineered Fill. However, stripped topsoil may be stockpiled and reused in landscape or non-structural areas.

Overexcavation and Recomaction – Building and Foundation Areas

To reduce post-construction soil movement and provide uniform support for the buildings and other foundations, overexcavation and recompaction within the proposed building footprint areas should be performed to a minimum depth of at least four (4) feet below existing grades or three (3) feet below the bottom of the proposed foundation bearing grades, whichever is greater. In addition, any fill soil present in the building area should be removed and re-placed as compacted Engineered Fill. The actual depth of the overexcavation and recompaction should be determined by our field representative during construction. The exposed subgrade at the base of the overexcavation should then be scarified, moisture-conditioned as necessary, and compacted. The overexcavation and recompaction should also extend laterally five feet (5') beyond edges of the proposed footings or building limits. Any undocumented fill encountered during grading should be removed and replaced with Engineered Fill.

Overexcavation and Recomaction – Proposed Parking Area

To reduce post-construction soil movement and provide uniform support for the proposed parking and drive areas, overexcavation and recompaction of the near surface soil in the proposed parking area should be performed to a minimum depth of at least twelve (12) inches below existing grades or proposed subgrade, whichever is deeper. The actual depth of the overexcavation and recompaction should be determined by our field representative during construction. The overexcavation and recompaction should also extend laterally at least three (3) feet beyond edges of the proposed paving limits or to the property boundary. Any undocumented fill encountered during grading should be removed and replaced with Engineered Fill.

Any buried structures encountered during construction should be properly removed and the resulting excavations backfilled with Engineered Fill, compacted to a minimum of 95 percent of the maximum dry density based on ASTM Test Method D1557. Excavations, depressions, or soft and pliant areas extending below planned finished subgrade levels should be cleaned to firm, undisturbed soil and backfilled with Engineered Fill. In general, any septic tanks, debris pits, cesspools, or similar structures should be entirely removed. Concrete footings should be removed to an equivalent depth of at least 3 feet below proposed footing elevations or as recommended by the Soils Engineer. Any other buried structures encountered, should be removed in accordance with the recommendations of the Soils Engineer. The resulting excavations should be backfilled with Engineered Fill.

The upper soils, during wet winter months become very moist due to the absorptive characteristics of the soil. Earthwork operations performed during winter months may encounter very moist unstable soils, which may require removal to grade a stable building foundation. Project site winterization consisting of placement of aggregate base and protecting exposed soils during the construction phase should be performed.

A representative of our firm should be present during all site clearing and grading operations to test and observe earthwork construction. This testing and observation is an integral part of our service as acceptance of earthwork construction is dependent upon compaction of the material and the stability of the material. The Soils Engineer may reject any material that does not meet compaction and stability requirements. Further recommendations of this report are predicated upon the assumption that earthwork construction will conform to recommendations set forth in this section and the Engineered Fill section.

Engineered Fill

The on-site upper native soils are predominately silty sand and silty sand/sand. These soils will be suitable for reuse as Engineered Fill, provided they are cleansed of excessive organics and debris.

The preferred materials specified for Engineered Fill are suitable for most applications with the exception of exposure to erosion. Project site winterization and protection of exposed soils during the construction phase should be the sole responsibility of the Contractor, since he has complete control of the project site at that time.

Imported Fill should consist of a well-graded, slightly cohesive, fine silty sand or sandy silt, with relatively impervious characteristics when compacted. This material should be approved by the Soils Engineer prior to use and should typically possess the following characteristics:

| | |
|-----------------------------------|------------|
| Percent Passing No. 200 Sieve | 20 to 50 |
| Plasticity Index | 10 maximum |
| UBC Standard 29-2 Expansion Index | 15 maximum |

Fill soils should be placed in lifts approximately 6 inches thick, moisture-conditioned to a minimum of 2 percent above optimum moisture content, and compacted to achieve at least 95 percent maximum dry density based on ASTM Test Method D1557. Additional lifts should not be placed if the previous lift did not meet the required density or if soil conditions are not stable.

Drainage and Landscaping

The ground surface should slope away from building pad and pavement areas toward appropriate drop inlets or other surface drainage devices. In accordance with Section 1804.4 of the 2019 California Building Code, it is recommended that the ground surface adjacent to foundations be sloped a minimum of 5 percent for a minimum distance of 10 feet away from structures, or to an approved alternative

means of drainage conveyance. Swales used for conveyance of drainage and located within 10 feet of foundations should be sloped a minimum of 2 percent. Impervious surfaces, such as pavement and exterior concrete flatwork, within 10 feet of building foundations should be sloped a minimum of 2 percent away from the structure. Drainage gradients should be maintained to carry all surface water to collection facilities and off-site. These grades should be maintained for the life of the project.

Utility Trench Backfill

Utility trenches should be excavated according to accepted engineering practice following OSHA (Occupational Safety and Health Administration) standards by a Contractor experienced in such work. The responsibility for the safety of open trenches should be borne by the Contractor. Traffic and vibration adjacent to trench walls should be reduced; cyclic wetting and drying of excavation side slopes should be avoided. Depending upon the location and depth of some utility trenches, groundwater flow into open excavations could be experienced, especially during or shortly following periods of precipitation.

Utility trench backfill placed in or adjacent to buildings and exterior slabs should be compacted to at least 95 percent of the maximum dry density based on ASTM Test Method D1557. Utility trench backfill placed in pavement areas should be compacted to at least 95 percent of the maximum dry density based on ASTM Test Method D1557. Pipe bedding should be in accordance with pipe manufacturer's recommendations.

Sandy soil conditions were encountered at the site. These cohesionless soils have a tendency to cave in trench wall excavations. Shoring or sloping back trench sidewalls may be required within these sandy and gravelly soils.

The Contractor is responsible for removing all water-sensitive soils from the trench regardless of the backfill location and compaction requirements. The Contractor should use appropriate equipment and methods to avoid damage to the utilities and/or structures during fill placement and compaction.

Foundations - Conventional

The proposed structures may be supported on a shallow foundation system bearing on a minimum of three (3) feet of Engineered Fill. Spread and continuous footings can be designed for the following maximum allowable soil bearing pressures:

| Load | Allowable Loading |
|---|--------------------------|
| Dead Load Only | 2,000 psf |
| Dead-Plus-Live Load | 2,600 psf |
| Total Load, including wind or seismic loads | 3,500 psf |

The footings should have a minimum depth of 18 inches below pad subgrade (soil grade) or adjacent exterior grade, whichever is lower. Footings should have a minimum width of 15 inches, regardless of load.

The total soil movement is not expected to exceed 1 inch. Differential movement measured across a horizontal distance of 30 feet should be less than ½ inch. Most of the settlement is expected to occur during construction as the loads are applied. However, additional post-construction settlement may occur if the foundation soils are flooded or saturated.

The footing excavations should not be allowed to dry out any time prior to pouring concrete. It is recommended that footings be reinforced by at least one No. 4 reinforcing bar in both top and bottom.

Resistance to lateral footing displacement can be computed using an allowable friction factor of 0.30 acting between the base of foundations and the supporting subgrade. Lateral resistance for footings can alternatively be developed using an allowable equivalent fluid passive pressure of 250 pounds per cubic foot acting against the appropriate vertical footing faces. The frictional and passive resistance of the soil may be combined without reduction in determining the total lateral resistance. A ⅓ increase in the above value may be used for short duration, wind, or seismic loads.

Floor Slabs and Exterior Flatwork

In areas where moisture-sensitive floor coverings will be utilized, concrete slab-on-grade floors should be underlain by a water vapor retarder. The water vapor retarder should be installed in accordance with accepted engineering practices. The water vapor retarder should consist of a vapor retarder sheeting underlain by a minimum of 3 inches of compacted, clean gravel of ¾-inch maximum size. To aid in concrete curing an optional 2 to 4 inches of granular fill may be placed on top of the vapor retarder. The granular fill should consist of damp clean sand with at least 10 to 30 percent of the sand passing the 100 sieve. The sand should be free of clay, silt, or organic material. Rock dust which is manufactured sand from rock crushing operations is typically suitable for the granular fill. This granular fill material should be compacted.

Unless designed by the project structural engineer, concrete slabs-on-grade should be a minimum of five (5) inches thick. It is recommended that the concrete slab be reinforced to reduce crack separation and possible vertical offset at the cracks. We recommend at least No. 3 reinforcing bars placed on 18-inch centers, be used for this purpose. Thicker floor slabs with increased concrete strength and reinforcement should be designed wherever heavy concentrated loads, heavy equipment, or machinery is anticipated.

The exterior floors should be poured separately in order to act independently of the walls and foundation system. Exterior finish grades should be sloped a minimum of 2 percent away from all interior slab areas to preclude ponding of water adjacent to the structures. All fills required to bring the building pads to grade should be Engineered Fills.

Moisture within the structure may be derived from water vapors, which were transformed from the moisture within the soils. This moisture vapor can travel through the vapor membrane and penetrate the slab-on-grade. This moisture vapor penetration can affect floor coverings and produce mold and mildew

in the structure. To reduce moisture vapor intrusion, it is recommended that a vapor retarder be installed. It is recommended that the utility trenches within the structure be compacted, as specified in our report, to reduce the transmission of moisture through the utility trench backfill. Special attention to the immediate drainage and irrigation around the building is recommended. Positive drainage should be established away from the structure and should be maintained throughout the life of the structure. Ponding of water should not be allowed adjacent to the structure. Over-irrigation within landscaped areas adjacent to the structure should not be performed. In addition, ventilation of the structure (i.e. ventilation fans) is recommended to reduce the accumulation of interior moisture.

Lateral Earth Pressures and Retaining Walls

Walls retaining horizontal backfill and capable of deflecting a minimum of 0.1 percent of its height at the top may be designed using an equivalent fluid active pressure of 44 pounds per square foot per foot of depth. Walls incapable of this deflection or are fully constrained walls against deflection may be designed for an equivalent fluid at-rest pressure of 64 pounds per square foot per foot of depth. Expansive soils should not be used for backfill against walls. The wedge of non-expansive backfill material should extend from the bottom of each retaining wall outward and upward at a slope of 2:1 (horizontal to vertical) or flatter. The stated lateral earth pressures do not include the effects of hydrostatic water pressures generated by infiltrating surface water that may accumulate behind the retaining walls; or loads imposed by construction equipment, foundations, or roadways.

During grading and backfilling operations adjacent to any walls, heavy equipment should not be allowed to operate within a lateral distance of 5 feet from the wall, or within a lateral distance equal to the wall height, whichever is greater, to avoid developing excessive lateral pressures. Within this zone, only hand-operated equipment (“whackers,” vibratory plates, or pneumatic compactors) should be used to compact the backfill soils.

Retaining and/or below grade walls should be drained with either perforated pipe encased in free-draining gravel or a prefabricated drainage system. The gravel zone should have a minimum width of 12 inches and should extend upward to within 12 inches of the top of the wall. The upper 12 inches of backfill should consist of native soils, concrete, asphaltic concrete, or other suitable backfill to reduce surface drainage into the wall drain system. The aggregate should conform to Class 2 permeable materials graded in accordance with CalTrans Standard Specifications (2018). Prefabricated drainage systems, such as Miradrain®, Enkadrain®, or an equivalent substitute, are acceptable alternatives in lieu of gravel provided they are installed in accordance with the manufacturer’s recommendations. If a prefabricated drainage system is proposed, our firm should review the system for final acceptance prior to installation.

Drainage pipes should be placed with perforations down and should discharge in a non-erosive manner away from foundations and other improvements. The pipes should be placed no higher than 6 inches above the heel of the wall, in the center line of the drainage blanket and should have a minimum diameter of four inches. Collector pipes may be either slotted or perforated. Slots should be no wider than 1/8 inch in diameter, while perforations should be no more than 1/4 inch in diameter. If retaining walls are less than 6 feet in height, the perforated pipe may be omitted in lieu of weep holes on 4 feet

maximum spacing. The weep holes should consist of 4-inch diameter holes (concrete walls) or unmortared head joints (masonry walls) and not be higher than 18 inches above the lowest adjacent grade. Two 8-inch square overlapping patches of geotextile fabric (conforming to CalTrans Standard Specifications for “edge drains”) should be affixed to the rear wall opening of each weep hole to retard soil piping.

R-Value Test Results and Pavement Design

One bulk soil sample was obtained from the project site for R-Value testing at the location shown on the attached site plan. The sample was tested in accordance with the State of California Materials Manual Test Designation 301. Results of the test are as follows:

| Sample | Depth | Description | R-Value at Equilibrium |
|---------------|--------------|--------------------|-------------------------------|
| B7/R1 | 0-36" | Silty Sand (SM) | 55 |

The test results are moderate and indicate good subgrade support characteristics under dynamic traffic loads. The following table shows the recommended pavement sections for various traffic indices.

| Traffic Index | Asphaltic Concrete | Class II Aggregate Base* | Compacted Subgrade** |
|----------------------|---------------------------|---------------------------------|-----------------------------|
| 4.0 | 2.0" | 4.0" | 6.0" |
| 4.5 | 2.5" | 4.0" | 6.0" |
| 5.0 | 2.5" | 4.0" | 6.0" |
| 5.5 | 3.0" | 4.0" | 6.0" |
| 6.0 | 3.0" | 4.0" | 6.0" |
| 6.5 | 3.5" | 4.0" | 6.0" |
| 7.0 | 4.0" | 4.0" | 6.0" |
| 7.5 | 4.0" | 4.0" | 6.0" |

* 95% compaction based on ASTM Test Method D1557 or CAL 216

** 95% compaction based on ASTM Test Method D1557 or CAL 216

If traffic indices are not available, an estimated (typical value) index of 4.5 may be used for light automobile traffic and an index of 7.0 may be used for light truck traffic. Following grading operations, it is recommended additional R-Value testing be performed to verify the design R-Value.

The following recommendations are for light-duty and heavy-duty Portland Cement Concrete pavement sections.

PORTLAND CEMENT PAVEMENT LIGHT DUTY

| Traffic Index | Portland Cement Concrete*** | Class II Aggregate Base* | Compacted Subgrade** |
|----------------------|------------------------------------|---------------------------------|-----------------------------|
| 4.5 | 5.0" | 4.0" | 12.0" |

HEAVY DUTY

| Traffic Index | Portland Cement Concrete*** | Class II Aggregate Base* | Compacted Subgrade** |
|---------------|-----------------------------|--------------------------|----------------------|
| 7.0 | 6.0" | 4.0" | 12.0" |

* 95% compaction based on ASTM Test Method D1557 or CAL 216

** 95% compaction based on ASTM Test Method D1557 or CAL 216

***Minimum compressive strength of 3000 psi

Seismic Parameters – 2019 California Building Code

The Site Class per Section 1613 of the 2019 California Building Code (2019 CBC) and ASCE 7-16, Chapter 20 is based upon the site soil conditions. It is our opinion that a Site Class D is most consistent with the subject site soil conditions. For seismic design of the structures based on the seismic provisions of the 2019 CBC, we recommend the following parameters:

| Seismic Item | Value | CBC Reference |
|------------------------|-------|--------------------|
| Site Class | D | Section 1613.2.2 |
| Site Coefficient F_a | 1.000 | Table 1613.2.3 (1) |
| S_s | 1.500 | Section 1613.2.1 |
| S_{MS} | 1.500 | Section 1613.2.3 |
| S_{DS} | 1.000 | Section 1613.2.4 |
| Site Coefficient F_v | 1.700 | Table 1613.2.3 (2) |
| S_1 | 0.600 | Section 1613.2.1 |
| S_{M1} | 1.020 | Section 1613.2.3 |
| S_{D1} | 0.670 | Section 1613.2.4 |
| T_s | 0.670 | Section 1613.2 |

* Based on Equivalent Lateral Force (ELF) Design Procedure being used.

Infiltration Testing

The shallow soil conditions present at the subject site were evaluated by drilling shallow borings in the vicinity of the infiltration test. The borings drilled at the site indicated the subsurface soil conditions consisted of medium dense to dense silty sand.

Infiltration rates were determined using the results of open borehole infiltration testing performed at the subject site. Infiltration testing performed on the near surface silty sand soil indicate infiltration rates of approximately 0.11 to 0.16 inches per hour. Based on the low infiltration rates, the subsurface conditions encountered at the site may not be conducive to infiltration. Detailed results of the percolation test and infiltration rate results are attached in tabular format.

The soil percolation rates are based on tests conducted with clean water. The infiltration rates may vary with time as a result of soil clogging from water impurities. A factor of safety should be incorporated into the design of the percolation system to compensate for these factors as determined appropriate by the designer. In addition, periodic maintenance consisting of clearing the bottom of the system of clogged soils should be expected.

It is recommended that the location of the infiltration systems not be closer than ten feet (10') as measured laterally from the edge of the adjacent property line, ten feet (10') from the outside edge of any foundation and five (5') from the edge of any right-of way to the outside edges of the infiltration system.

If the infiltration location is within ten feet (10') of the proposed foundation, it is recommended that this infiltration system should be impervious from the finished ground surface to a depth that will achieve a diagonal distance of a minimum of ten feet (10') below the bottom of the closest footing in the project.

Soil Cement Reactivity

Excessive sulfate in either the soil or native water may result in an adverse reaction between the cement in concrete (or stucco) and the soil. HUD/FHA and CBC have developed criteria for evaluation of sulfate levels and how they relate to cement reactivity with soil and/or water.

One soil sample was obtained from the site and tested in accordance with State of California Materials Manual Test Designation 417. The sulfate concentration detected from the soil sample indicated moderate sulfate exposure value as established by HUD/FHA and CBC. Therefore, it is recommended that concrete in contact with soil utilize Type II Cement and have a minimum compressive strength of 4,000 psi and a water to cement ratio of 0.50.

Electrical resistivity testing of the soil indicates that the onsite soils may have a severe potential for metal loss from electrochemical corrosion process. A qualified corrosion engineer should be consulted regarding the corrosion effects of the onsite soils on underground metal utilities.

Compacted Material Acceptance

Compaction specifications are not the only criteria for acceptance of the site grading or other such activities. However, the compaction test is the most universally recognized test method for assessing the performance of the Grading Contractor. The numerical test results from the compaction test cannot be used to predict the engineering performance of the compacted material. Therefore, the acceptance of compacted materials will also be dependent upon the stability of that material. The Soils Engineer has the option of rejecting any compacted material regardless of the degree of compaction if that material is considered to be unstable or if future instability is suspected. A specific example of rejection of fill material passing the required percent compaction is a fill which has been compacted with an in-situ moisture content significantly less than optimum moisture. This type of dry fill (brittle fill) is susceptible to future settlement if it becomes saturated or flooded.

Testing and Inspection

A representative of Krazan & Associates, Inc. should be present at the site during the earthwork activities to confirm that actual subsurface conditions are consistent with the exploratory fieldwork. This activity is an integral part of our service, as acceptance of earthwork construction is dependent upon compaction testing and stability of the material. This representative can also verify that the intent of these recommendations is incorporated into the project design and construction. Krazan & Associates, Inc. will not be responsible for grades or staking, since this is the responsibility of the Prime Contractor.

LIMITATIONS

Soils Engineering is one of the newest divisions of Civil Engineering. This branch of Civil Engineering is constantly improving as new technologies and understanding of earth sciences advance. Although your site was analyzed using the most appropriate and most current techniques and methods, undoubtedly there will be substantial future improvements in this branch of engineering. In addition to advancements in the field of Soils Engineering, physical changes in the site, either due to excavation or fill placement, new agency regulations, or possible changes in the proposed structure after the soils report is completed may require the soils report to be professionally reviewed. In light of this, the Owner should be aware that there is a practical limit to the usefulness of this report without critical review. Although the time limit for this review is strictly arbitrary, it is suggested that 2 years be considered a reasonable time for the usefulness of this report.

Foundation and earthwork construction are characterized by the presence of a calculated risk that soil and groundwater conditions have been fully revealed by the original foundation investigation. This risk is derived from the practical necessity of basing interpretations and design conclusions on limited sampling of the earth. The recommendations made in this report are based on the assumption that soil conditions do not vary significantly from those disclosed during our field investigation. If any variations or undesirable conditions are encountered during construction, the Soils Engineer should be notified so that supplemental recommendations may be made.

The conclusions of this report are based on the information provided regarding the proposed construction. If the proposed construction is relocated or redesigned, the conclusions in this report may not be valid. The Soils Engineer should be notified of any changes so the recommendations may be reviewed and re-evaluated.

This report is a Geotechnical Engineering Investigation with the purpose of evaluating the soil conditions in terms of foundation design. The scope of our services did not include any Environmental Site Assessment for the presence or absence of hazardous and/or toxic materials in the soil, groundwater, or atmosphere; or the presence of wetlands. Any statements, or absence of statements, in this report or on any boring log regarding odors, unusual or suspicious items, or conditions observed, are strictly for descriptive purposes and are not intended to convey engineering judgment regarding potential hazardous and/or toxic assessment.

The geotechnical engineering information presented herein is based upon professional interpretation utilizing standard engineering practices and a degree of conservatism deemed proper for this project. It is not warranted that such information and interpretation cannot be superseded by future geotechnical engineering developments. We emphasize that this report is valid for the project outlined above and should not be used for any other sites.

If you have any questions, or if we may be of further assistance, please do not hesitate to contact our office at (951) 273-1011.

Respectfully submitted,
KRAZAN & ASSOCIATES, INC.



Christopher L. Tomlin, MBA, CEG
Senior Engineering Geologist
PG No. 6296, CEG No. 2066



Jorge A. Pelayo, MS, PE
Project Engineer
RCE No. 91269

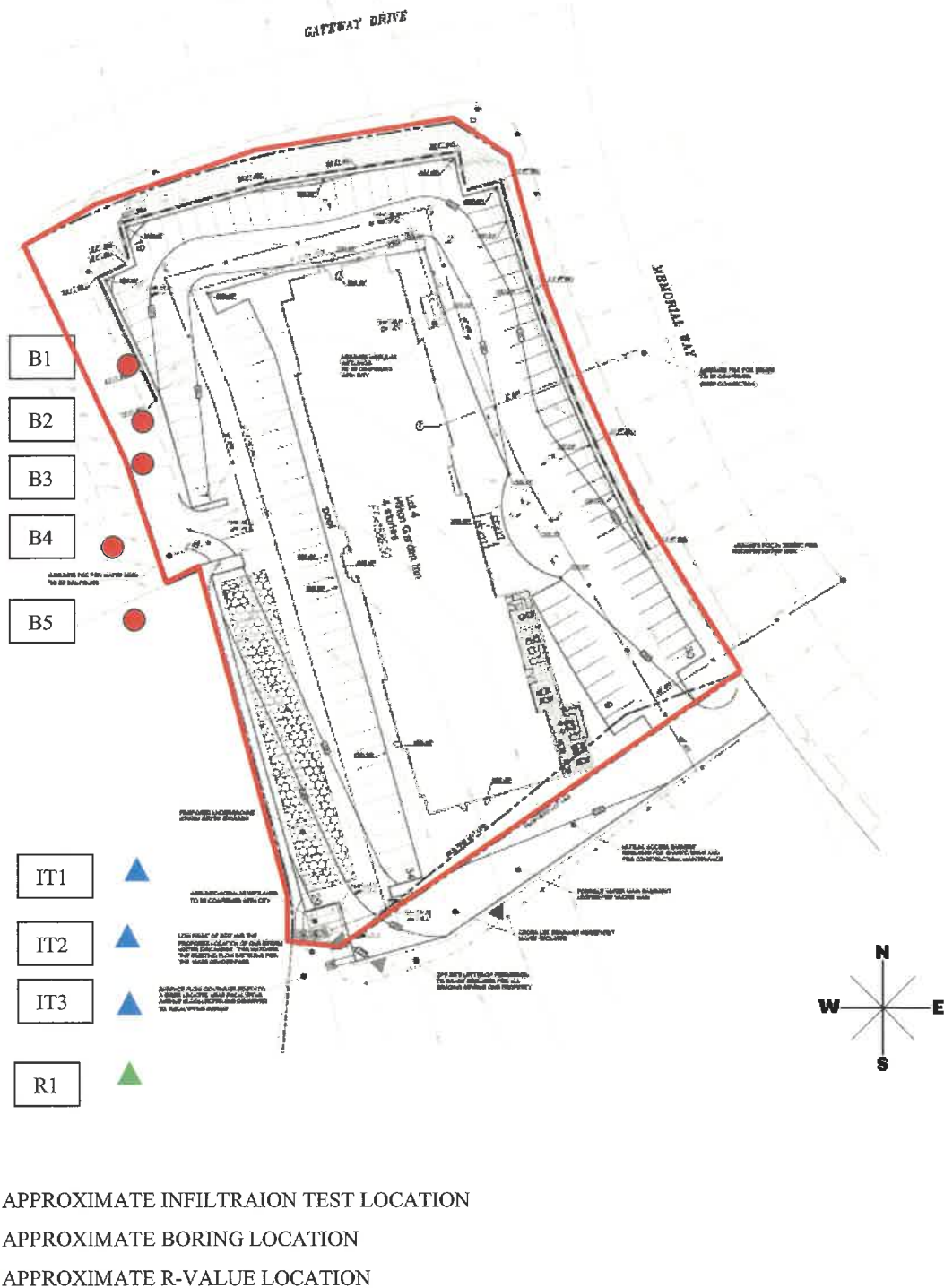

| | | | |
|--|--------------------------|---------------------|---|
| SITE MAP | Scale: NTS | Date: Oct, 2020 |  |
| | Drawn by: CLT | Approved by: JAP | |
| PROPOSED PENSKE MORENO VALLEY, CALIFORNIA | Project No. 112-21093 | Figure No. 1 | |



| | | | |
|---|--------------------------|---------------------|---|
| VICINITY MAP PROPOSED PENSKE MORENO VALLEY, CALIFORNIA | Scale: NTS | Date: Oct, 2021 |  |
| | Drawn by: CLT | Approved by: JAP | |
| | Project No. 112-21093 | Figure No. 2 | |

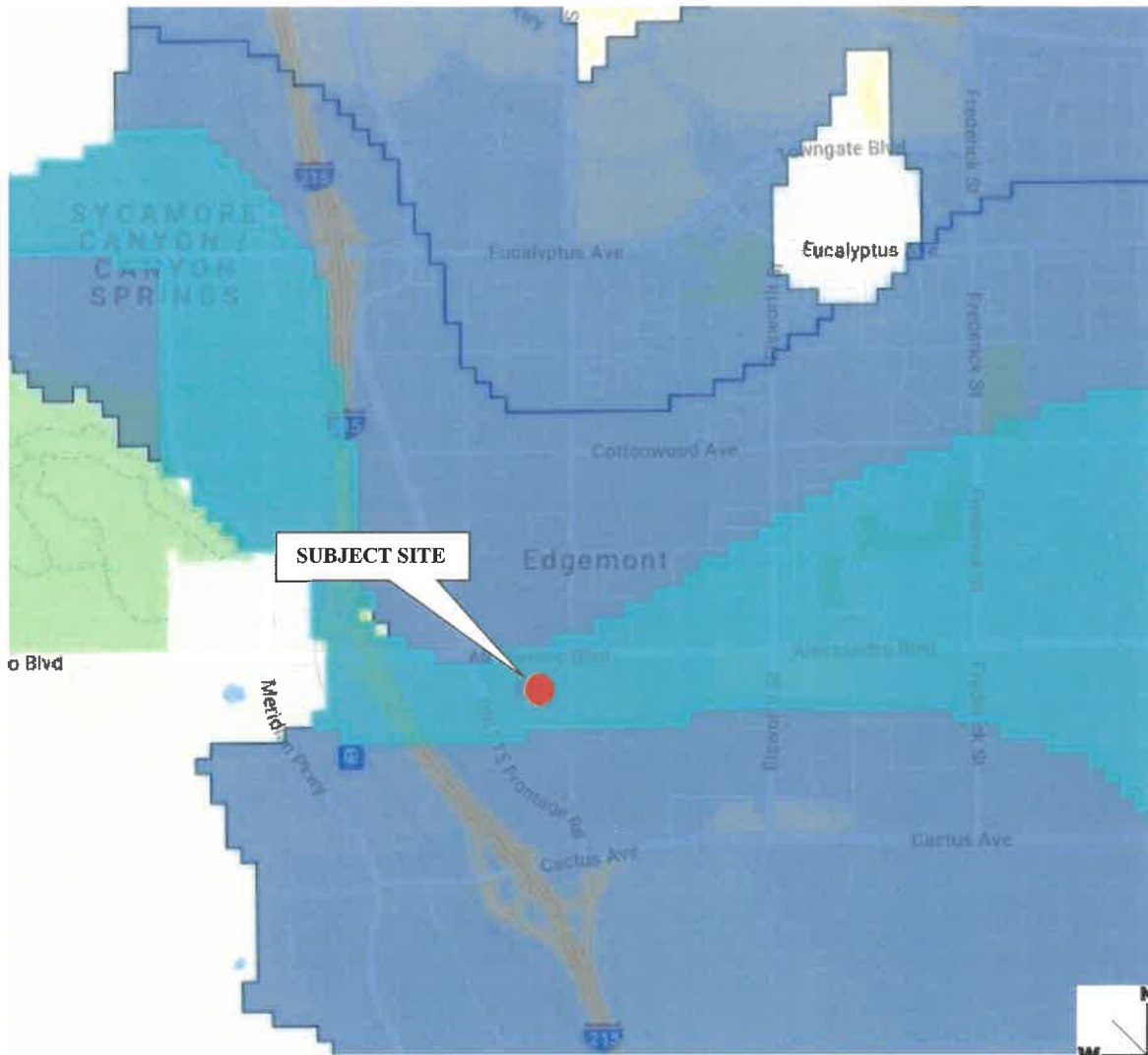

33.9156°N 117.2809°W

Riverside County, CA Liquefaction SUSCEPTIBILITY Moderate

0.0m

DEFINITION 4

50<GW<100 feet, Contains Etype:
 SED[TPHWClf, TPHUCac, PHUClf,
 PHUCaud, PHUCaf, PHMCAud, PHlf,
 PHMCAud, PHMCAf, PHMCAud, PHlf,

Source: Riverside County GIS Map: Liquefaction

| | | | |
|---|---------------------------------|----------------------------|--|
| COUNTY OF RIVERSIDE GIS MAP: LIQUEFACTION | Scale: NTS | Date: Oct, 2021 | |
| | Drawn by: CLT | Approved by: JAP | |
| PROPOSED PENSKE MORENO VALLEY, CALIFORNIA | Project No. 112-21093 | Figure No. 3 | |

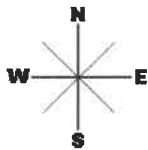
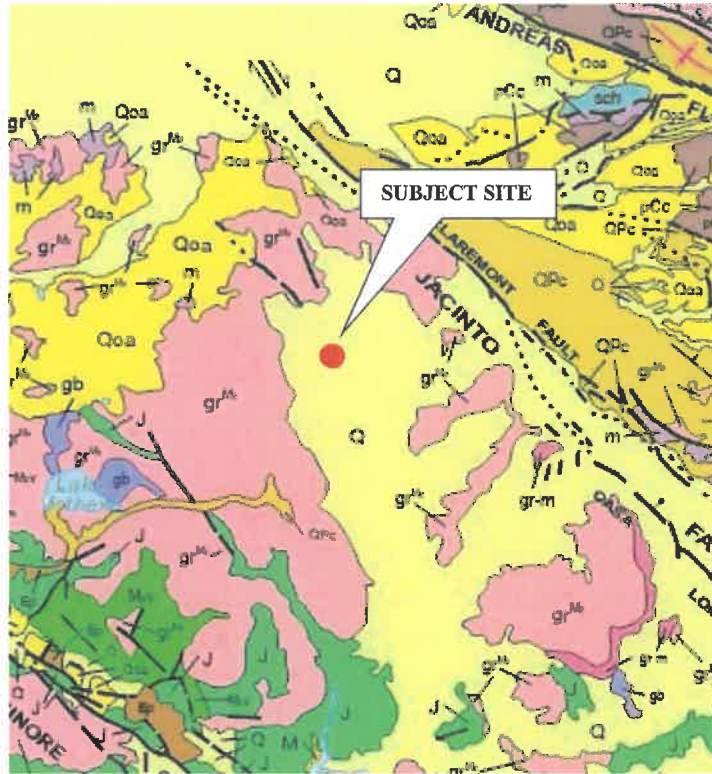

DESCRIPTION OF MAP UNITS

QUATERNARY DEPOSITS

- Qs** Extensive marine and nonmarine sand deposits, generally near the coast or desert playas
- Q** Alluvium, lake, playa, and terrace deposits; unconsolidated and semi-consolidated
- Qls** Selected large landslides
- Qg** Glacial till and moraines. Found at high elevations mostly in the Sierra Nevada and Klamath Mountains
- Qoa** Older alluvium, lake, playa, and terrace deposits
- QPc** Pleistocene and/or Pliocene sandstone, shale, and gravels deposits, mostly loosely consolidated

Source: Department of Conservation: Geologic Map of California, 2010

| | | | |
|--|--------------------------|---------------------|---|
| GEOLOGIC MAP | Scale: NTS | Date: Oct, 2021 |  |
| | Drawn by: CLT | Approved by: JAP | |
| PROPOSED PENSKE MORENO VALLEY, CALIFORNIA | Project No. 112-21093 | Figure No. 4 | |

APPENDIX A

FIELD AND LABORATORY INVESTIGATIONS

Field Investigation

The field investigation consisted of a surface reconnaissance and a subsurface exploratory program. Nine (9) 8½-inch diameter exploratory borings were advanced. The boring locations are shown on the attached Site Plan, Figure 1.

The soils encountered were logged in the field during the exploration and, with supplementary laboratory test data, are described in accordance with the Unified Soil Classification System.

Modified standard penetration tests and standard penetration tests were performed at selected depths. This test represents the resistance to driving a 2½-inch and 1½-inch diameter split barrel sampler, respectively. The driving energy was provided by a hammer weighing 140 pounds falling 30 inches. Relatively undisturbed soil samples were obtained while performing this test. Bag samples of the disturbed soil were obtained from the auger cuttings. The modified standard penetration tests are identified in the sample type on the boring logs with a full shaded in block. The standard penetration tests are identified in the sample type on the boring logs with one-half of the block shaded. All samples were returned to our Corona laboratory for evaluation.

Laboratory Investigation

The laboratory investigation was programmed to determine the physical and mechanical properties of the foundation soil underlying the site. Test results were used as criteria for determining the engineering suitability of the surface and subsurface materials encountered.

In-situ moisture content, dry density, consolidation, direct shear, and sieve analysis tests were completed for the undisturbed samples representative of the subsurface material. Expansion index and R-Value tests were completed for select bag samples obtained from the auger cuttings. These tests, supplemented by visual observation, comprised the basis for our evaluation of the site material.

UNIFIED SOIL CLASSIFICATION SYSTEM

| UNIFIED SOIL CLASSIFICATION AND SYMBOL CHART | | |
|---|---|--|
| COARSE-GRAINED SOILS (more than 50% of material is larger than No. 200 sieve size.) | | |
| GRAVELS More than 50% of coarse fraction larger than No. 4 sieve size | Clean Gravels (Less than 5% fines) | |
| | GW | Well-graded gravels, gravel-sand mixtures, little or no fines |
| | GP | Poorly-graded gravels, gravel-sand mixtures, little or no fines |
| | Gravels with fines (More than 12% fines) | |
| | GM | Silty gravels, gravel-sand-silt mixtures |
| | GC | Clayey gravels, gravel-sand-clay mixtures |
| SANDS 50% or more of coarse fraction smaller than No. 4 sieve size | Clean Sands (Less than 5% fines) | |
| | SW | Well-graded sands, gravelly sands, little or no fines |
| | SP | Poorly graded sands, gravelly sands, little or no fines |
| | Sands with fines (More than 12% fines) | |
| | SM | Silty sands, sand-silt mixtures |
| | SC | Clayey sands, sand-clay mixtures |
| FINE-GRAINED SOILS (50% or more of material is smaller than No. 200 sieve size.) | | |
| SILTS AND CLAYS Liquid limit less than 50% | ML | Inorganic silts and very fine sands, rock flour, silty or clayey fine sands or clayey silts with slight plasticity |
| | CL | Inorganic clays of low to medium plasticity, gravelly clays, sandy clays, silty clays, lean clays |
| | OL | Organic silts and organic silty clays of low plasticity |
| SILTS AND CLAYS Liquid limit 50% or greater | MH | Inorganic silts, micaceous or diatomaceous fine sandy or silty soils, elastic silts |
| | CH | Inorganic clays of high plasticity, fat clays |
| | OH | Organic clays of medium to high plasticity, organic silts |
| HIGHLY ORGANIC SOILS | PT | Peat and other highly organic soils |

| CONSISTENCY CLASSIFICATION | |
|-----------------------------------|----------------|
| Description | Blows per Foot |
| <i>Granular Soils</i> | |
| Very Loose | < 5 |
| Loose | 5 – 15 |
| Medium Dense | 16 – 40 |
| Dense | 41 – 65 |
| Very Dense | > 65 |
| <i>Cohesive Soils</i> | |
| Very Soft | < 3 |
| Soft | 3 – 5 |
| Firm | 6 – 10 |
| Stiff | 11 – 20 |
| Very Stiff | 21 – 40 |
| Hard | > 40 |

| GRAIN SIZE CLASSIFICATION | | | |
|----------------------------------|---------------------|---------------------------|----------------|
| Grain Type | Standard Sieve Size | Grain Size in Millimeters | |
| Boulders | Above 12 inches | Above 305 | |
| Cobbles | 12 to 13 inches | 305 to 76.2 | |
| Gravel | 3 inches to No. 4 | 76.2 to 4.76 | |
| | Coarse-grained | 3 to ¾ inches | 76.2 to 19.1 |
| | Fine-grained | ¾ inches to No. 4 | 19.1 to 4.76 |
| Sand | No. 4 to No. 200 | 4.76 to 0.074 | |
| | Coarse-grained | No. 4 to No. 10 | 4.76 to 2.00 |
| | Medium-grained | No. 10 to No. 40 | 2.00 to 0.042 |
| | Fine-grained | No. 40 to No. 200 | 0.042 to 0.074 |
| Silt and Clay | Below No. 200 | Below 0.074 | |

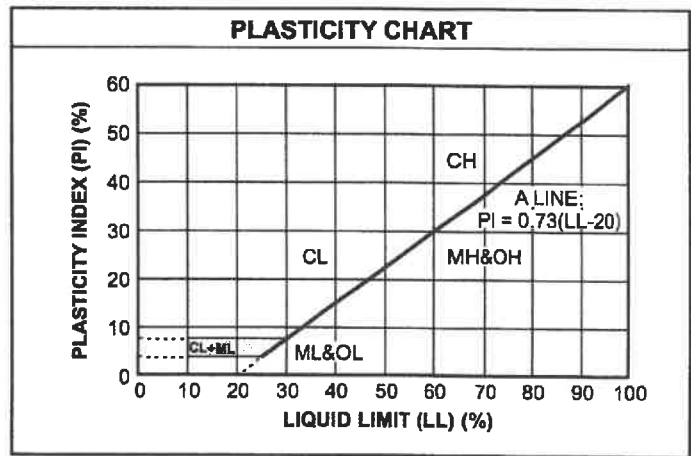

Log of Boring B1

Project: Penske Truck Leasing

Project No: 112-21093

Client: Penske Truck Leasing

Figure No.: A-1

Location: Highway 215 Frontage Road, Moreno Valley, California

Logged By: Angel Menchaca

Depth to Water: Not Encountered

Initial: N/A

At Completion: N/A

| SUBSURFACE PROFILE | | | SAMPLE | | | | Penetration Test blows/ft | | | Water Content (%) | | | | | | |
|---|--|---|-------------------|--------------|------|-----------|------------------------------|----|----|-------------------|----|----|----|--|--|---|
| Depth (ft) | Symbol | Description | Dry Density (pcf) | Moisture (%) | Type | Blows/ft. | | | | | | | | | | |
| | | | | | | | 20 | 40 | 60 | 10 | 20 | 30 | 40 | | | |
| Ground Surface | | | | | | | | | | | | | | | | |
| 0 |  | SILTY SAND (SM) Very loose, fine- to medium-grained; brown, moist, drills easily Loose below 12 inches Medium dense below 2 feet | | | | | | | | | | | | | | |
| 2 | | | | | | | | | | | | | | | | |
| 4 | | | | | | | | | | | | | | | | |
| 6 | | | | | 7.2 | ▲ | | 14 | | | | | | | | ■ |
| 8 | | | | | | | | | | | | | | | | |
| 10 | | | | | 10.1 | ▲ | | 28 | | | | | | | | ■ |
| 12 | | | | | | | | | | | | | | | | |
| 14 | | | | | | | | | | | | | | | | |
| 16 | | | | | | | | | | | | | | | | |
| 18 | | | | | | | | | | | | | | | | |
| 20 | | End of Borehole | | | | | | | | | | | | | | |
| Water not encountered Boring backfilled with soil cuttings | | | | | | | | | | | | | | | | |

Drill Method: Hollow Stem

Drill Date: 9-2-21

Drill Rig: CME 75

Krazan and Associates

Hole Size: 8½ Inches

Driller: Whitcomb Drilling, Inc.

Elevation: 10 Feet

Sheet: 1 of 1

Log of Boring B2

Project: Penske Truck Leasing

Project No: 112-21093

Client: Penske Truck Leasing

Figure No.: A-2

Location: Highway 215 Frontage Road, Moreno Valley, California

Logged By: Angel Menchaca

Depth to Water: Not Encountered

Initial: N/A

At Completion: N/A

| SUBSURFACE PROFILE | | | SAMPLE | | | | Penetration Test blows/ft | | | Water Content (%) | | | | | | | | | | |
|--------------------|--------|---|-------------------|--------------------------------------|-------|-----------|------------------------------|----|----|-------------------|----|----|----|--|--|--|--|--|--|--|
| Depth (ft) | Symbol | Description | Dry Density (pcf) | Moisture (%) | Type | Blows/ft. | Penetration Test | | | Water Content (%) | | | | | | | | | | |
| | | | | | | | 20 | 40 | 60 | 10 | 20 | 30 | 40 | | | | | | | |
| Ground Surface | | | | | | | | | | | | | | | | | | | | |
| 0 | | SILTY SAND (SM) Very loose, fine- to medium-grained; brown, moist, drills easily Loose below 12 inches Medium dense below 2 feet | | | | | | | | | | | | | | | | | | |
| 2 | | | 113.6 | 6.0 | | 29 | | | | | | | | | | | | | | |
| 4 | | | | | | | | | | | | | | | | | | | | |
| 6 | | | | Dense and drills firmly below 5 feet | 97.2 | 4.7 | | 42 | | | | | | | | | | | | |
| 10 | | | | | 106.7 | 6.1 | | 48 | | | | | | | | | | | | |
| 16 | | Medium dense and drills easily below 15 feet | | 11.4 | | 19 | | | | | | | | | | | | | | |
| 20 | | Water not encountered Boring backfilled with soil cuttings | | 16.6 | | 26 | | | | | | | | | | | | | | |

Drill Method: Hollow Stem

Drill Date: 9-2-21

Drill Rig: CME 75

Krazan and Associates

Hole Size: 8½ Inches

Driller: Whitcomb Drilling, Inc.

Elevation: 20 Feet

Sheet: 1 of 1

Log of Boring B3

Project: Penske Truck Leasing

Project No: 112-21093

Client: Penske Truck Leasing

Figure No.: A-3

Location: Highway 215 Frontage Road, Moreno Valley, California

Logged By: Angel Menchaca

Depth to Water: Not Encountered

Initial: N/A

At Completion: N/A

| SUBSURFACE PROFILE | | | SAMPLE | | | | Penetration Test blows/ft | Water Content (%) | | | | | | |
|--------------------|--------|--|-------------------|--------------|------|-----------|------------------------------|-------------------|----|----|----|----|----|----|
| Depth (ft) | Symbol | Description | Dry Density (pcf) | Moisture (%) | Type | Blows/ft. | | 20 | 40 | 60 | 10 | 20 | 30 | 40 |
| 0 | | Ground Surface | | | | | | | | | | | | |
| 0 | | SILTY SAND (SM) Very loose, fine- to medium-grained; brown, moist, drills easily | | | | | | | | | | | | |
| 2 | | Medium dense below 12 inches Very dense and drills firmly below 2 feet | 112.6 | 6.8 | | 50+ | | | | | | | | |
| 4 | | | | | | | | | | | | | | |
| 6 | | | 93.8 | 9.3 | | 50+ | | | | | | | | |
| 8 | | | | | | | | | | | | | | |
| 10 | | | 98.4 | 8.1 | | 50+ | | | | | | | | |
| 12 | | | | | | | | | | | | | | |
| 14 | | SILTY SAND/SAND (SM/SP) Dense, fine- to coarse-grained; brown, moist, drills firmly | | | | | | | | | | | | |
| 16 | | | | 16.5 | | 43 | | | | | | | | |
| 18 | | | | | | | | | | | | | | |
| 20 | | Water not encountered Boring backfilled with soil cuttings | | 15.4 | | 34 | | | | | | | | |

Drill Method: Hollow Stem

Drill Date: 9-2-21

Drill Rig: CME 75

Krazan and Associates

Hole Size: 8½ Inches

Driller: Whitcomb Drilling, Inc.

Elevation: 20 Feet

Sheet: 1 of 1

Log of Boring B4

Project: Penske Truck Leasing

Project No.: 112-21093

Client: Penske Truck Leasing

Figure No.: A-4

Location: Highway 215 Frontage Road, Moreno Valley, California

Logged By: Angel Menchaca

Depth to Water > Not Encountered

Initial: N/A

At Completion: N/A

| SUBSURFACE PROFILE | | | SAMPLE | | | | Penetration Test blows/ft | | | Water Content (%) | | | | |
|--------------------|--------|--|-------------------|--------------|------|-----------|---------------------------|----|----|-------------------|----|----|----|---|
| Depth (ft) | Symbol | Description | Dry Density (pcf) | Moisture (%) | Type | Blows/ft. | Penetration Test blows/ft | | | Water Content (%) | | | | |
| | | | | | | | 20 | 40 | 60 | 10 | 20 | 30 | 40 | |
| Ground Surface | | | | | | | | | | | | | | |
| 0 | | SILTY SAND (SM) Very loose, fine- to medium-grained; brown, moist, drills easily Loose below 12 inches Dense and drills firmly below 2 feet | | | | | | | | | | | | |
| 2 | | | | | | | | | | | | | | |
| 4 | | | | | | | | | | | | | | |
| 6 | | | | 6.4 | | 52 | | | | | | | | ■ |
| 8 | | | | | | | | | | | | | | |
| 10 | | SILTY SAND/SAND (SM/SP) Very dense, fine- to medium-grained; brown, damp, drills firmly | | 3.9 | | 50+ | | | | | | | | ■ |
| 10 | | | | | | | | | | | | | | |
| End of Borehole | | | | | | | | | | | | | | |
| 12 | | | | | | | | | | | | | | |
| 14 | | | | | | | | | | | | | | |
| 16 | | | | | | | | | | | | | | |
| 18 | | | | | | | | | | | | | | |
| 20 | | Water not encountered Boring backfilled with soil cuttings | | | | | | | | | | | | |

Drill Method: Hollow Stem

Drill Date: 9-2-21

Drill Rig: CME 75

Krazan and Associates

Hole Size: 8½ Inches

Driller: Whitcomb Drilling, Inc.

Elevation: 10 Feet

Sheet: 1 of 1

Log of Boring B5

Project: Penske Truck Leasing

Project No: 112-21093

Client: Penske Truck Leasing

Figure No.: A-5

Location: Highway 215 Frontage Road, Moreno Valley, California

Logged By: Angel Menchaca

Depth to Water: Not Encountered

Initial: N/A

At Completion: N/A

| SUBSURFACE PROFILE | | | SAMPLE | | | | Penetration Test blows/ft | | | Water Content (%) | | | | |
|--------------------|--------|---|-------------------|--------------|------|-----------|------------------------------|----|----|-------------------|----|----|----|--|
| Depth (ft) | Symbol | Description | Dry Density (pcf) | Moisture (%) | Type | Blows/ft. | Penetration Test | | | Water Content (%) | | | | |
| | | | | | | | 20 | 40 | 60 | 10 | 20 | 30 | 40 | |
| 0 | | Ground Surface | | | | | | | | | | | | |
| 0 - 2 | | SILTY SAND/SAND (SM/SP) Very loose, fine- to coarse-grained; brown, moist, drills easily Loose below 12 inches Very dense and drills firmly below 2 feet | | | | | | | | | | | | |
| 2 - 6 | | | | 8.2 | | 50+ | | | | | | | | |
| 6 - 10 | | SAND (SP) Very dense, fine- to coarse-grained; brown, damp, drills firmly | | 1.8 | | 50+ | | | | | | | | |
| 10 | | End of Borehole | | | | | | | | | | | | |
| 10 - 20 | | Water not encountered Boring backfilled with soil cuttings | | | | | | | | | | | | |

Drill Method: Hollow Stem

Drill Date: 9-2-21

Drill Rig: CME 75

Krazan and Associates

Hole Size: 8½ Inches

Driller: Whitcomb Drilling, Inc.

Elevation: 10 Feet

Sheet: 1 of 1

Log of Boring B6

Project: Penske Truck Leasing

Project No: 112-21093

Client: Penske Truck Leasing

Figure No.: A-6

Location: Highway 215 Frontage Road, Moreno Valley, California

Logged By: Angel Menchaca

Depth to Water > 14 Feet

Initial: 14 Feet

At Completion: 14 Feet

| SUBSURFACE PROFILE | | | SAMPLE | | | | Penetration Test blows/ft | Water Content (%) | | | | | | |
|--------------------|--------|--|-------------------|--------------|------|-----------|------------------------------|-------------------|----|----|----|----|----|----|
| Depth (ft) | Symbol | Description | Dry Density (pcf) | Moisture (%) | Type | Blows/ft. | | 20 | 40 | 60 | 10 | 20 | 30 | 40 |
| 0 | | Ground Surface | | | | | | | | | | | | |
| 0 - 2 | | SILTY SAND (SM) Very loose, fine- to medium-grained; brown, moist, drills easily Loose below 12 inches | 112.9 | 11.5 | | 13 | | | | | | | | |
| 2 - 6 | | | 118.8 | 9.3 | | 14 | | | | | | | | |
| 6 - 10 | | Dense and drills firmly below 10 feet | 120.0 | 10.1 | | 51 | | | | | | | | |
| 10 - 14 | | ▽ Saturated below 14 feet | | | | | | | | | | | | |
| 14 - 16 | | | | 10.5 | | 30 | | | | | | | | |
| 16 - 18 | | Medium dense below 18 feet | | | | | | | | | | | | |
| 18 - 20 | | Water encountered at 14 feet Boring backfilled with soil cuttings | | 16.2 | | 24 | | | | | | | | |

Drill Method: Hollow Stem

Drill Date: 9-2-21

Drill Rig: CME 75

Krazan and Associates

Hole Size: 8½ Inches

Driller: Whitcomb Drilling, Inc.

Elevation: 20 Feet

Sheet: 1 of 1

Log of Boring B7

Project: Penske Truck Leasing

Project No: 112-21093

Client: Penske Truck Leasing

Figure No.: A-7

Location: Highway 215 Frontage Road, Moreno Valley, California

Logged By: Angel Menchaca

Depth to Water > 14 Feet

Initial: 14 Feet

At Completion: 14 Feet

| SUBSURFACE PROFILE | | | SAMPLE | | | | Penetration Test blows/ft | Water Content (%) | | | | | |
|--------------------|--------|--|-------------------|--------------|------|-----------|------------------------------|-------------------|----|----|----|----|----|
| Depth (ft) | Symbol | Description | Dry Density (pcf) | Moisture (%) | Type | Blows/ft. | | | | | | | |
| | | | | | | | | 20 | 40 | 60 | 10 | 20 | 30 |
| Ground Surface | | | | | | | | | | | | | |
| 0 | | SILTY SAND (SM) Very loose, fine- to medium-grained; brown, moist, drills easily Loose below 12 inches Dense and drills firmly below 2 feet | | | | | | | | | | | |
| 2 | | | 129.4 | 9.5 | | 43 | | | | | | | |
| 4 | | | | | | | | | | | | | |
| 6 | | Very dense below 5½ feet | 115.9 | 3.1 | | 50+ | | | | | | | |
| 8 | | | | | | | | | | | | | |
| 10 | | | | 123.9 | 11.0 | | | 50+ | | | | | |
| 12 | | | | | | | | | | | | | |
| 14 | | Medium dense and saturated below 14 feet | | | | | | | | | | | |
| 16 | | | | 13.7 | | 20 | | | | | | | |
| 18 | | | | | | | | | | | | | |
| 20 | | Dense below 20 feet | | | | | | | | | | | |

Drill Method: Hollow Stem

Drill Date: 9-2-21

Drill Rig: CME 75

Krazan and Associates

Hole Size: 8½ Inches

Driller: Whitcomb Drilling, Inc.

Elevation: 50 Feet

Sheet: 1 of 3

Log of Boring B7

Project: Penske Truck Leasing

Project No: 112-21093

Client: Penske Truck Leasing

Figure No.: A-7

Location: Highway 215 Frontage Road, Moreno Valley, California

Logged By: Angel Menchaca

Depth to Water > 14 Feet

Initial: 14 Feet

At Completion: 14 Feet

| SUBSURFACE PROFILE | | | SAMPLE | | | | Penetration Test blows/ft | Water Content (%) | | | | | | | | | | |
|--------------------|---|--------------------------|-------------------|--------------|------|-----------|------------------------------|-------------------|----|----|----|----|----|----|--|--|--|--|
| Depth (ft) | Symbol | Description | Dry Density (pcf) | Moisture (%) | Type | Blows/ft. | | | | | | | | | | | | |
| | | | | | | | | 20 | 40 | 60 | 10 | 20 | 30 | 40 | | | | |
| 22 | | Very dense below 25 feet | | 17.8 | ▲ | 36 | ▲ | | | | | ■ | | | | | | |
| 24 | | | | | | | | | | | | | | | | | | |
| 26 | | | | | 14.0 | ▲ | 46 | ▲ | | | | | | ■ | | | | |
| 28 | | | | | | | | | | | | | | | | | | |
| 30 | SILTY SAND/SAND (SM/SP) Very dense, fine- to coarse-grained; brown, saturated, drills firmly | | | 13.6 | ▲ | 50+ | ▲ | | | | | ■ | | | | | | |
| 32 | | | | | | | | | | | | | | | | | | |
| 34 | SILTY SAND (SM) Very dense, fine- to coarse-grained; brown, saturated, drills firmly | | | 16.2 | ▲ | 45 | ▲ | | | | | ■ | | | | | | |
| 36 | | | | | | | | | | | | | | | | | | |
| 38 | | | | | | | | | | | | | | | | | | |
| 40 | | | | | | | | | | | | | | | | | | |

Drill Method: Hollow Stem

Drill Date: 9-2-21

Drill Rig: CME 75

Krazan and Associates

Hole Size: 8½ Inches

Driller: Whitcomb Drilling, Inc.

Elevation: 50 Feet

Sheet: 2 of 3

Log of Boring B7

Project: Penske Truck Leasing

Project No: 112-21093

Client: Penske Truck Leasing

Figure No.: A-7

Location: Highway 215 Frontage Road, Moreno Valley, California

Logged By: Angel Menchaca

Depth to Water > 14 Feet

Initial: 14 Feet

At Completion: 14 Feet

| SUBSURFACE PROFILE | | | SAMPLE | | | | Penetration Test blows/ft | | | Water Content (%) | | | | | | | |
|--------------------|--------------------------|---|-------------------|--------------|------|-----------|------------------------------|----|----|-------------------|----|----|----|--|--|--|--|
| Depth (ft) | Symbol | Description | Dry Density (pcf) | Moisture (%) | Type | Blows/ft. | Penetration Test | | | Water Content | | | | | | | |
| | | | | | | | 20 | 40 | 60 | 10 | 20 | 30 | 40 | | | | |
| 42 | [Symbol: Dotted pattern] | SILTY SAND/SANDY SILT (SM/ML) Dense, fine- to medium-grained; brown, saturated, drills firmly | | 18.7 | ▲ | 43 | | | | | | | ■ | | | | |
| 44 | | | | | | | | | | | | | | | | | |
| 46 | [Symbol: Dotted pattern] | SILTY SAND (SM) Very dense, fine- to coarse-grained; brown, saturated, drills firmly | | 14.1 | ▲ | 72 | | | | | | | ■ | | | | |
| 48 | | | | | | | | | | | | | | | | | |
| 50 | [Symbol: Dotted pattern] | SILTY SAND/SAND (SM/SP) Very dense, fine- to coarse-grained; brown, saturated, drills firmly | | 13.6 | ▲ | 50+ | | | | | | | ■ | | | | |
| 52 | | End of Borehole | | | | | | | | | | | | | | | |
| 54 | | | | | | | | | | | | | | | | | |
| 56 | | Water encountered at 14 feet Boring backfilled with soil cuttings | | | | | | | | | | | | | | | |
| 58 | | | | | | | | | | | | | | | | | |
| 60 | | | | | | | | | | | | | | | | | |

Drill Method: Hollow Stem

Drill Date: 9-2-21

Drill Rig: CME 75

Krazan and Associates

Hole Size: 8½ Inches

Driller: Whitcomb Drilling, Inc.

Elevation: 50 Feet

Sheet: 3 of 3

Log of Boring B8

Project: Penske Truck Leasing

Project No: 112-21093

Client: Penske Truck Leasing

Figure No.: A-8

Location: Highway 215 Frontage Road, Moreno Valley, California

Logged By: Angel Menchaca

Depth to Water > 14 Feet

Initial: 14 Feet

At Completion: 14 Feet

| SUBSURFACE PROFILE | | | SAMPLE | | | | Penetration Test blows/ft | Water Content (%) | | | | | | |
|--------------------|--------|---|-------------------|--------------|------|-----------|------------------------------|-------------------|----|----|----|----|----|----|
| Depth (ft) | Symbol | Description | Dry Density (pcf) | Moisture (%) | Type | Blows/ft. | | 20 | 40 | 60 | 10 | 20 | 30 | 40 |
| 0 | | Ground Surface | | | | | | | | | | | | |
| 0 | | SILTY SAND (SM) Very loose, fine- to medium-grained; brown, moist, drills easily | | | | | | | | | | | | |
| 2 | | Medium dense below 12 inches Very dense and drills firmly below 2 feet | 110.0 | 9.3 | | 50+ | | | | | | | | |
| 4 | | | | | | | | | | | | | | |
| 6 | | | 112.4 | 9.7 | | 50+ | | | | | | | | |
| 8 | | | | | | | | | | | | | | |
| 10 | | SILTY SAND/SAND (SM/SP) Very dense, fine- to coarse-grained; brown, moist, drills firmly | 110.8 | 11.3 | | 50+ | | | | | | | | |
| 12 | | | | | | | | | | | | | | |
| 14 | | ▽ Dense and saturated below 14 feet | | | | | | | | | | | | |
| 16 | | | | 3.4 | | 42 | | | | | | | | |
| 18 | | | | | | | | | | | | | | |
| 20 | | Water encountered at 14 feet Boring backfilled with soil cuttings | | 12.2 | | 41 | | | | | | | | |

Drill Method: Hollow Stem

Drill Date: 9-2-21

Drill Rig: CME 75

Krazan and Associates

Hole Size: 8½ Inches

Driller: Whitcomb Drilling, Inc.

Elevation: 20 Feet

Sheet: 1 of 1

Log of Boring B9

Project: Penske Truck Leasing

Project No: 112-21093

Client: Penske Truck Leasing

Figure No.: A-9

Location: Highway 215 Frontage Road, Moreno Valley, California

Logged By: Angel Menchaca

Depth to Water: Not Encountered

Initial: N/A

At Completion: N/A

| SUBSURFACE PROFILE | | | SAMPLE | | | | Penetration Test blows/ft | | | Water Content (%) | | | | |
|--------------------|--------|--|-------------------|--------------|------|-----------|------------------------------|----|----|-------------------|----|----|----|--|
| Depth (ft) | Symbol | Description | Dry Density (pcf) | Moisture (%) | Type | Blows/ft. | | | | | | | | |
| | | | | | | | 20 | 40 | 60 | 10 | 20 | 30 | 40 | |
| 0 | | Ground Surface | | | | | | | | | | | | |
| 0 | | SILTY SAND (SM) Very loose, fine- to medium-grained; brown, moist, drills easily Medium dense below 12 inches Very dense and drills firmly below 2 feet | | | | | | | | | | | | |
| 2 | | | | | | | | | | | | | | |
| 4 | | | | | | | | | | | | | | |
| 6 | | | | 6.0 | | 50+ | | | | | | | | |
| 8 | | | | | | | | | | | | | | |
| 10 | | Dense below 9 feet | | 7.3 | | 39 | | | | | | | | |
| 10 | | End of Borehole | | | | | | | | | | | | |
| 12 | | | | | | | | | | | | | | |
| 14 | | | | | | | | | | | | | | |
| 16 | | | | | | | | | | | | | | |
| 18 | | | | | | | | | | | | | | |
| 20 | | Water not encountered Boring backfilled with soil cuttings | | | | | | | | | | | | |

Drill Method: Hollow Stem

Drill Date: 9-2-21

Drill Rig: CME 75

Krazan and Associates

Hole Size: 8½ Inches

Driller: Whitcomb Drilling, Inc.

Elevation: 10 Feet

Sheet: 1 of 1

Consolidation Test

| Project No | Boring No. & Depth | Date | Soil Classification |
|------------|--------------------|------------|---------------------|
| 11221093 | B-2 @ 2' | 10/12/2021 | SM |

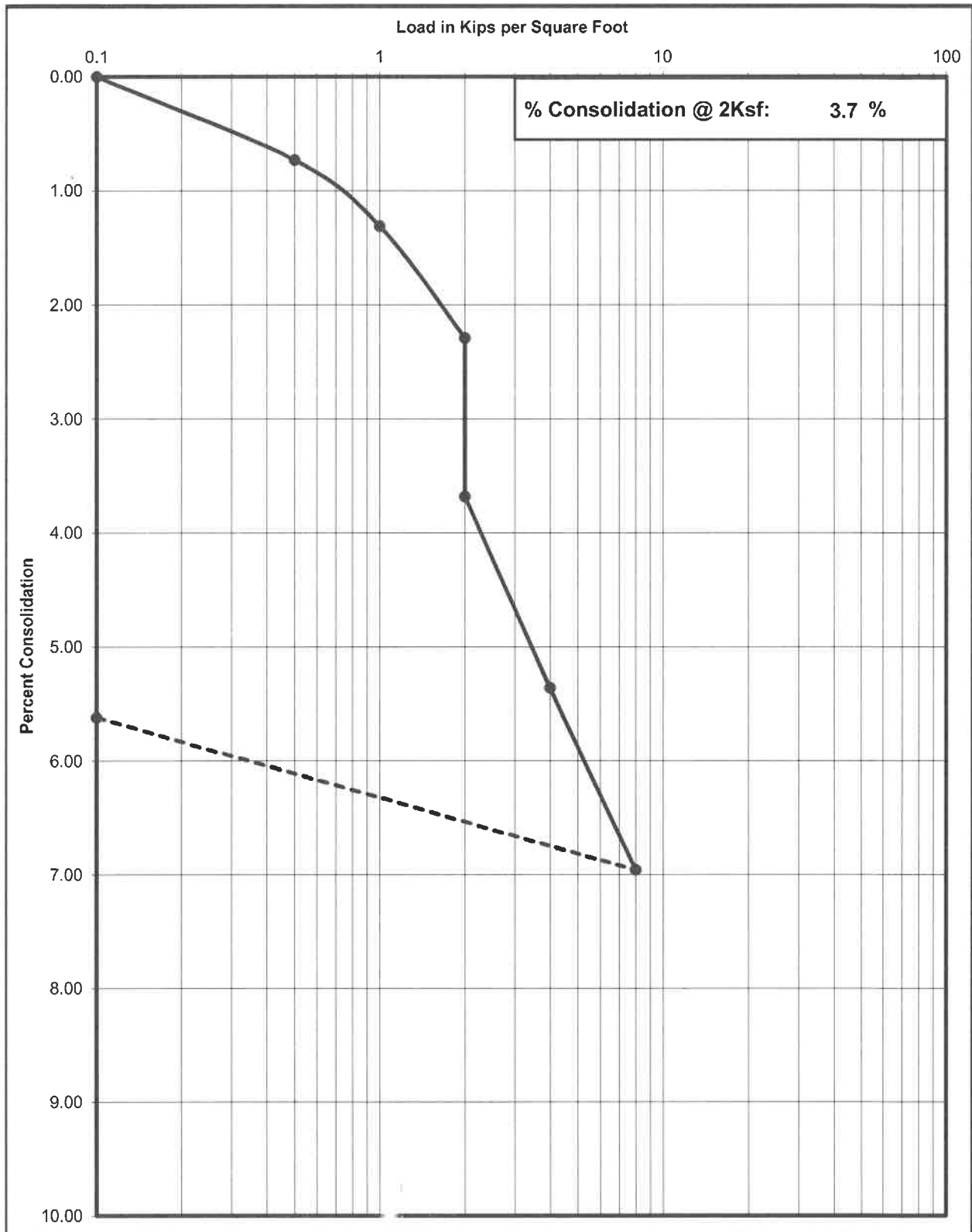

Consolidation Test

| Project No | Boring No. & Depth | Date | Soil Classification |
|------------|--------------------|------------|---------------------|
| 11221093 | B-7 @ 5' | 10/12/2021 | SM |

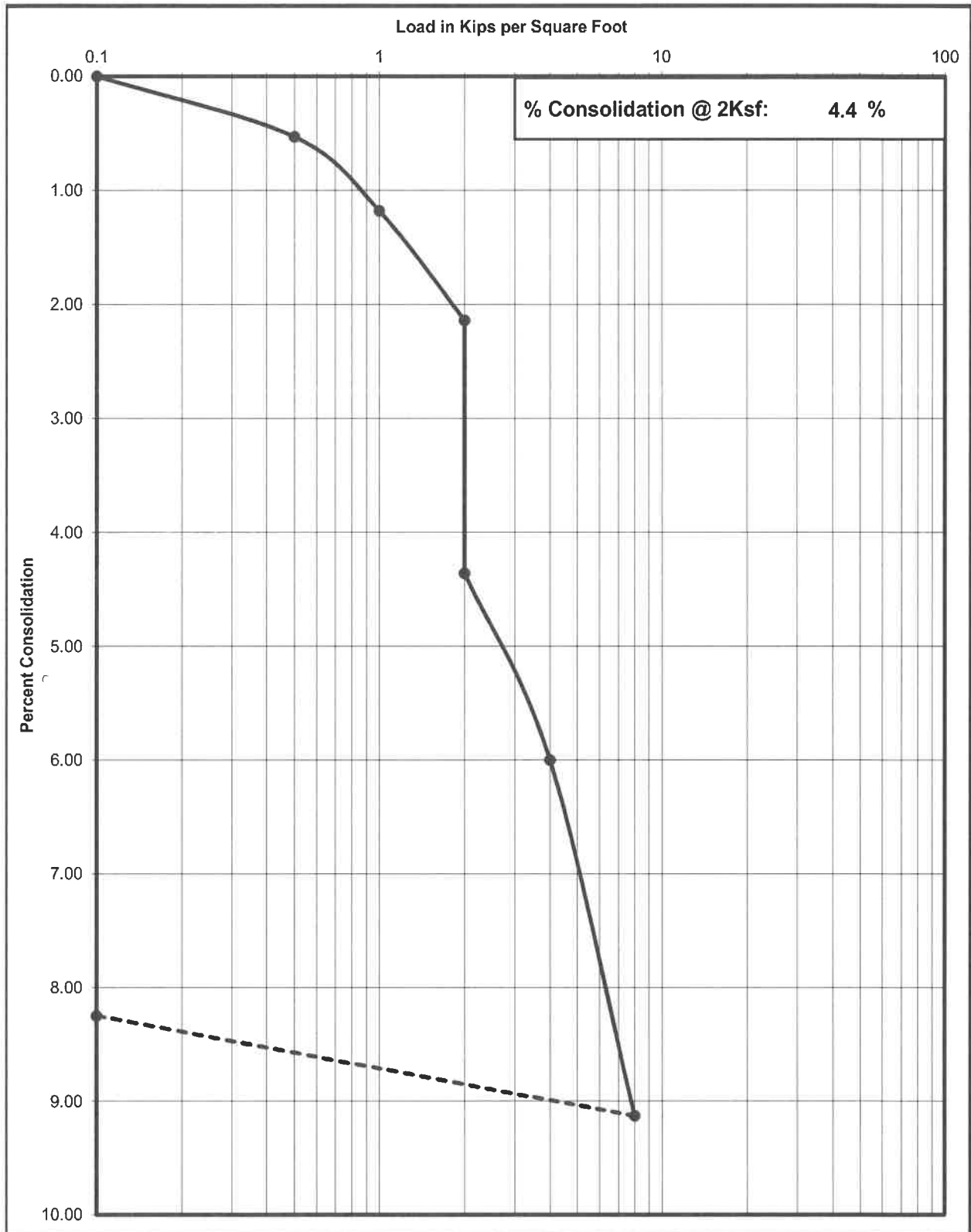

ASTM D - 3080 / AASHTO T - 236

| | | | |
|----------------|--------------------|-----------|------------|
| Project Number | Boring No. & Depth | Soil Type | Date |
| 11221093 | B-2 @ 2' | SM | 10/12/2021 |

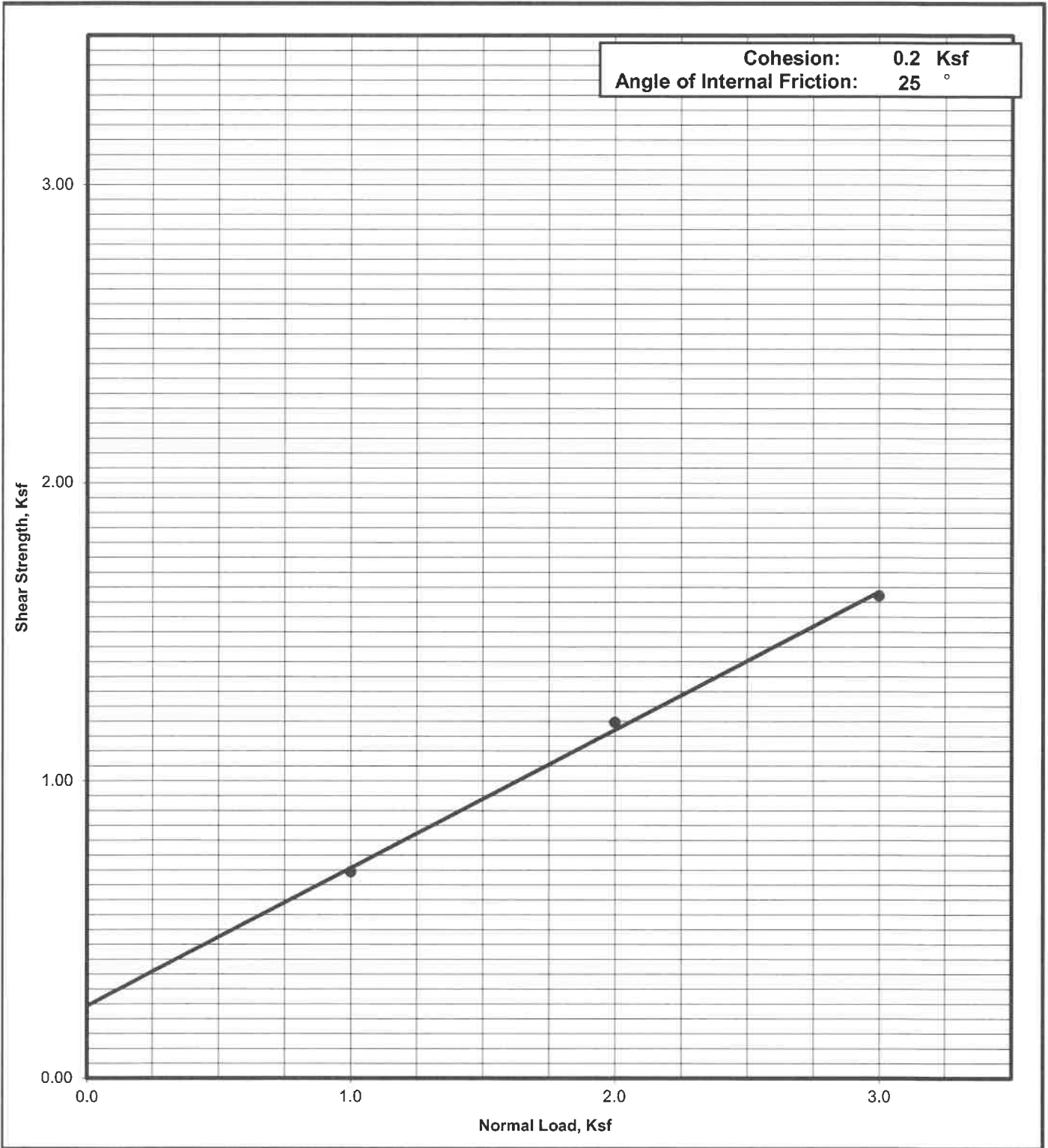

ASTM D - 3080 / AASHTO T - 236

| | | | |
|----------------|--------------------|-----------|------------|
| Project Number | Boring No. & Depth | Soil Type | Date |
| 11221093 | B-7 @ 5' | SM | 10/12/2021 |

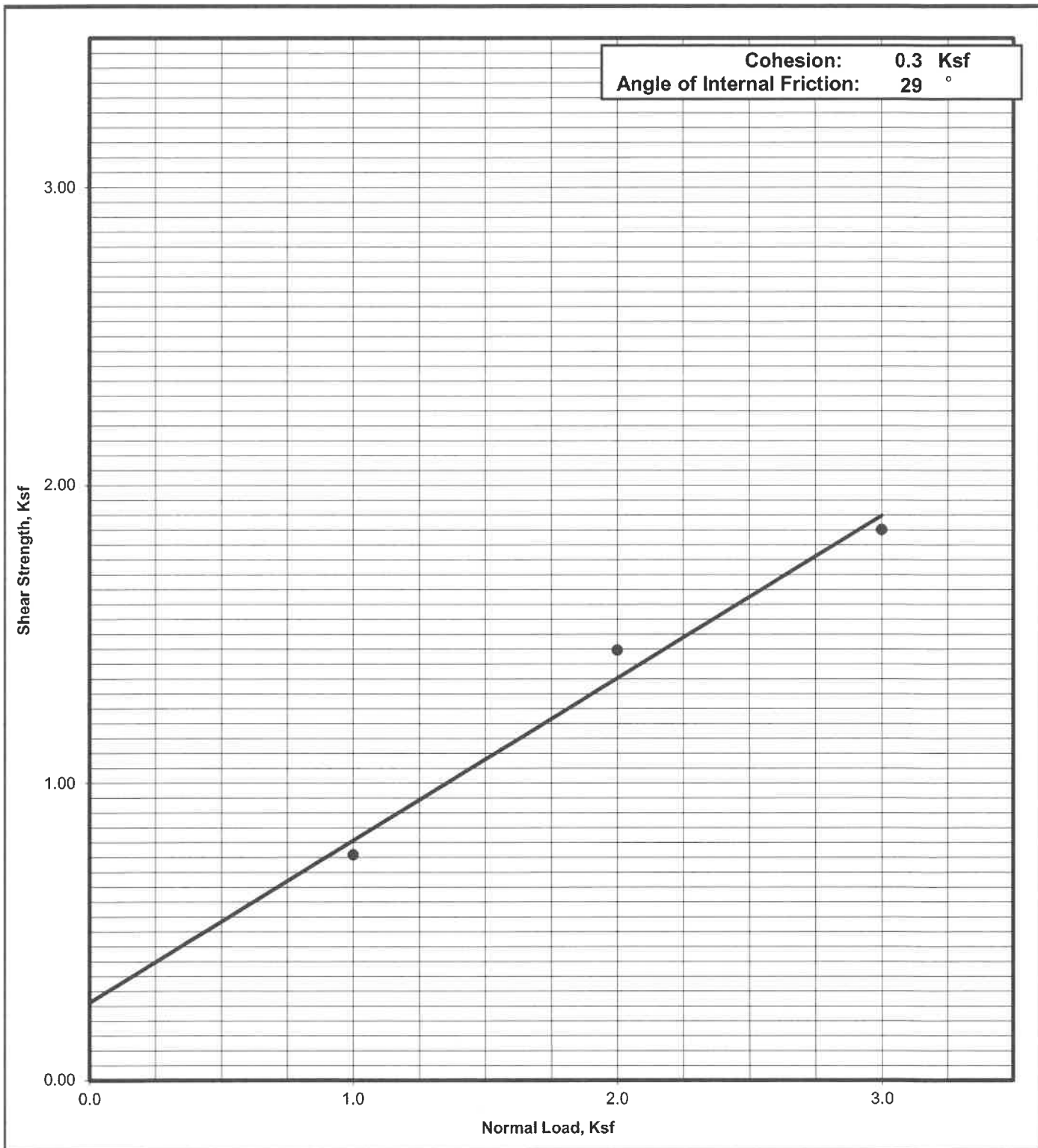

Grain Size Analysis

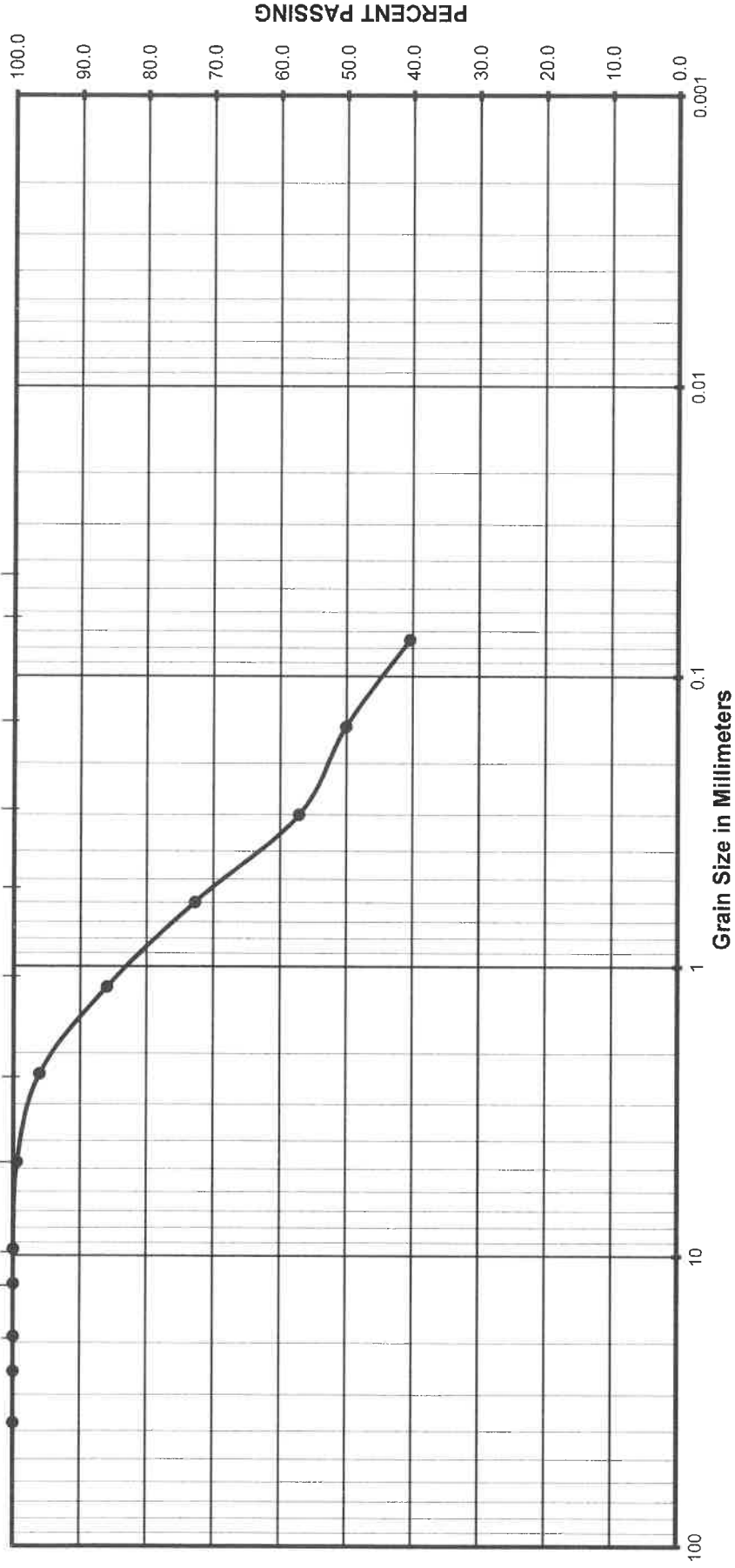

| | | | | |
|---------------|------|-------------|--------|---------------------|
| Gravel | | Sand | | Silt or Clay |
| Coarse | Fine | Coarse | Medium | Fine |

(Unified Soils Classification)

Project Name Penske Moreno Valley
 Project Number 11221093
 Soil Classification SM
 Sample Number B-7 @ 2'

Grain Size Analysis

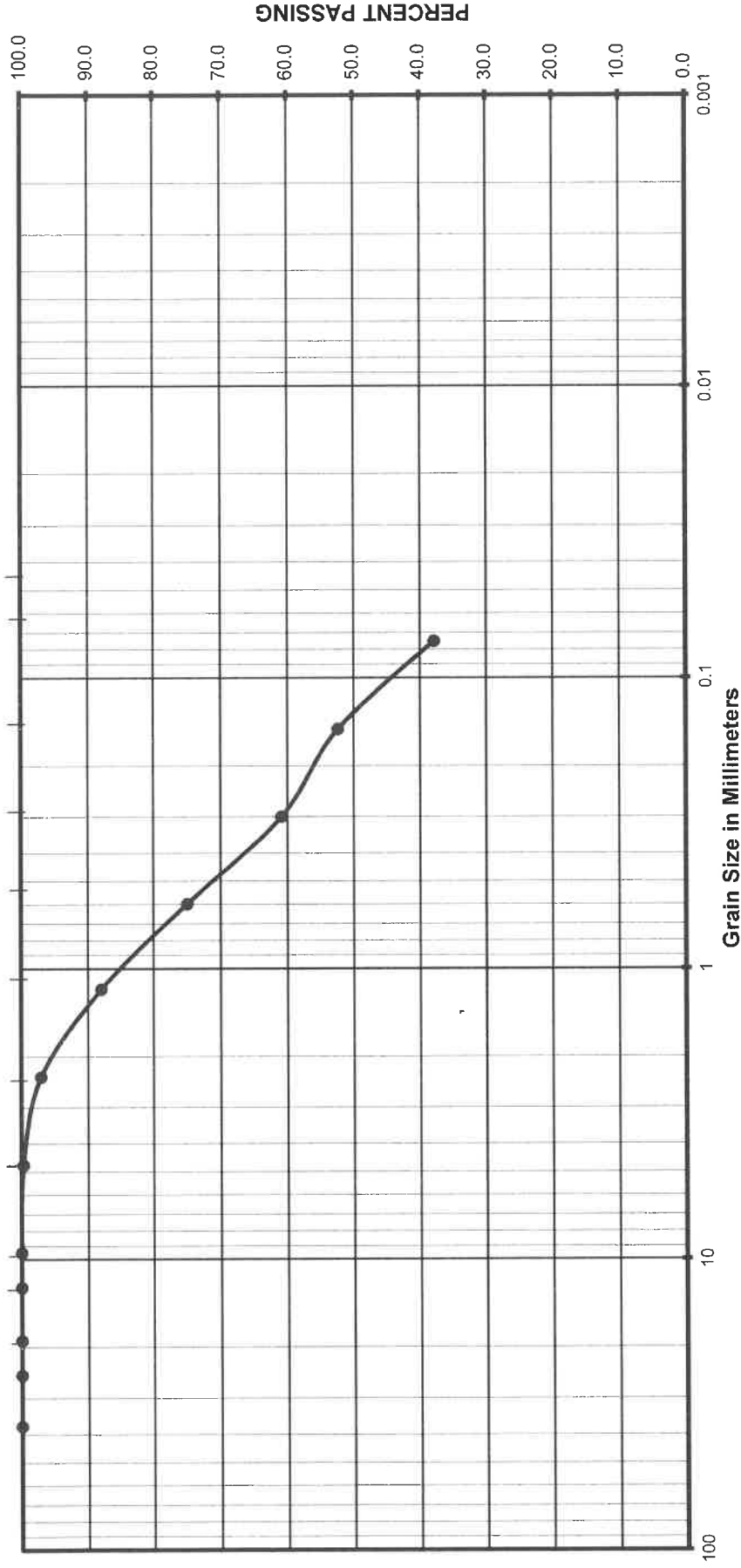

| | | | | | | |
|---------------|--|-------------|--------|--------|---------------------|--|
| Gravel | | Sand | | | Silt or Clay | |
| | | Fine | Coarse | Medium | | |

(Unified Soils Classification)

Project Name Penske Moreno Valley
 Project Number 11221093
 Soil Classification SM
 Sample Number B-7 @ 5'

Grain Size Analysis

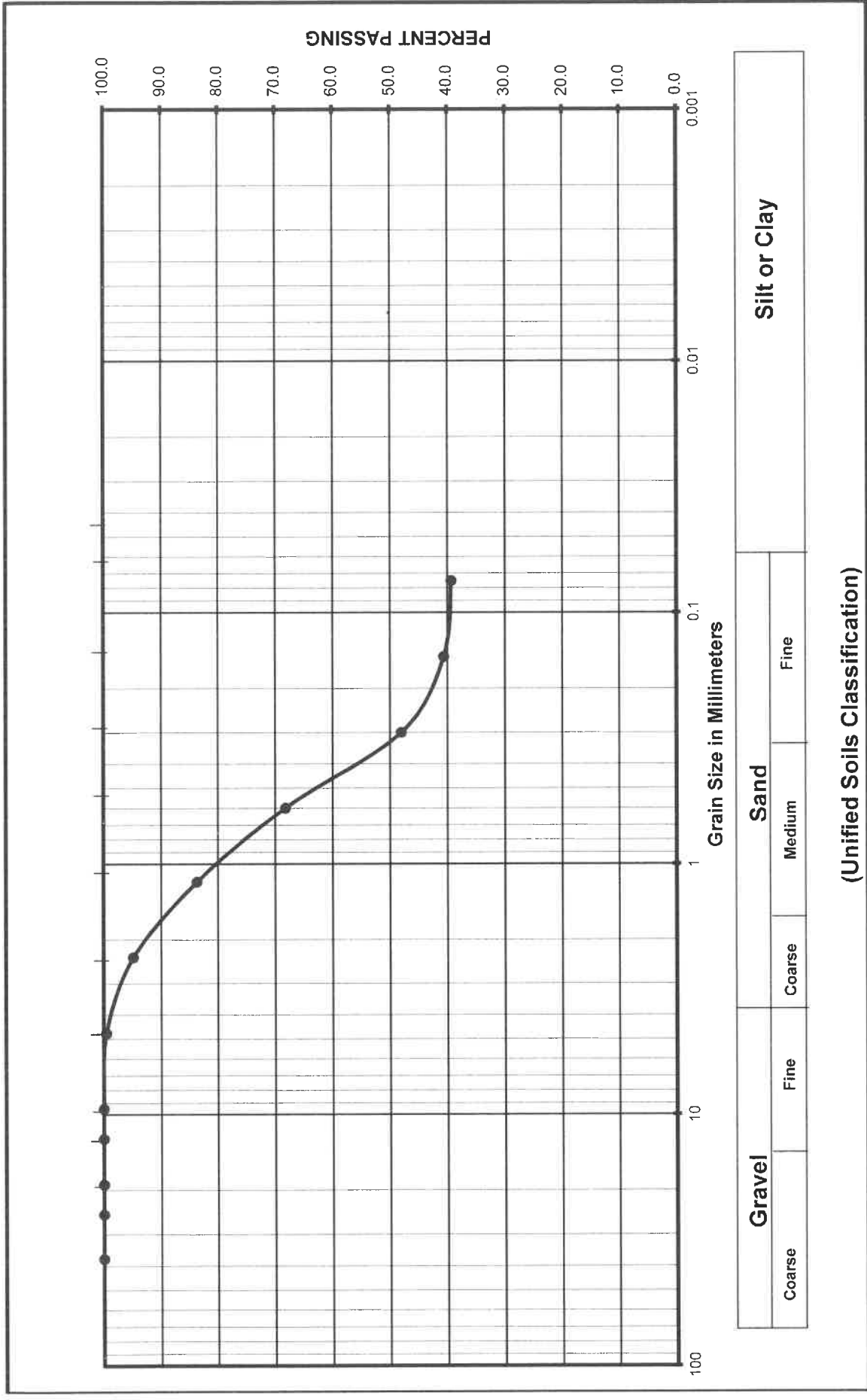

Project Name Penske Moreno Valley
Project Number 11221093
Soil Classification SM
Sample Number B-7 @ 10'

Grain Size Analysis

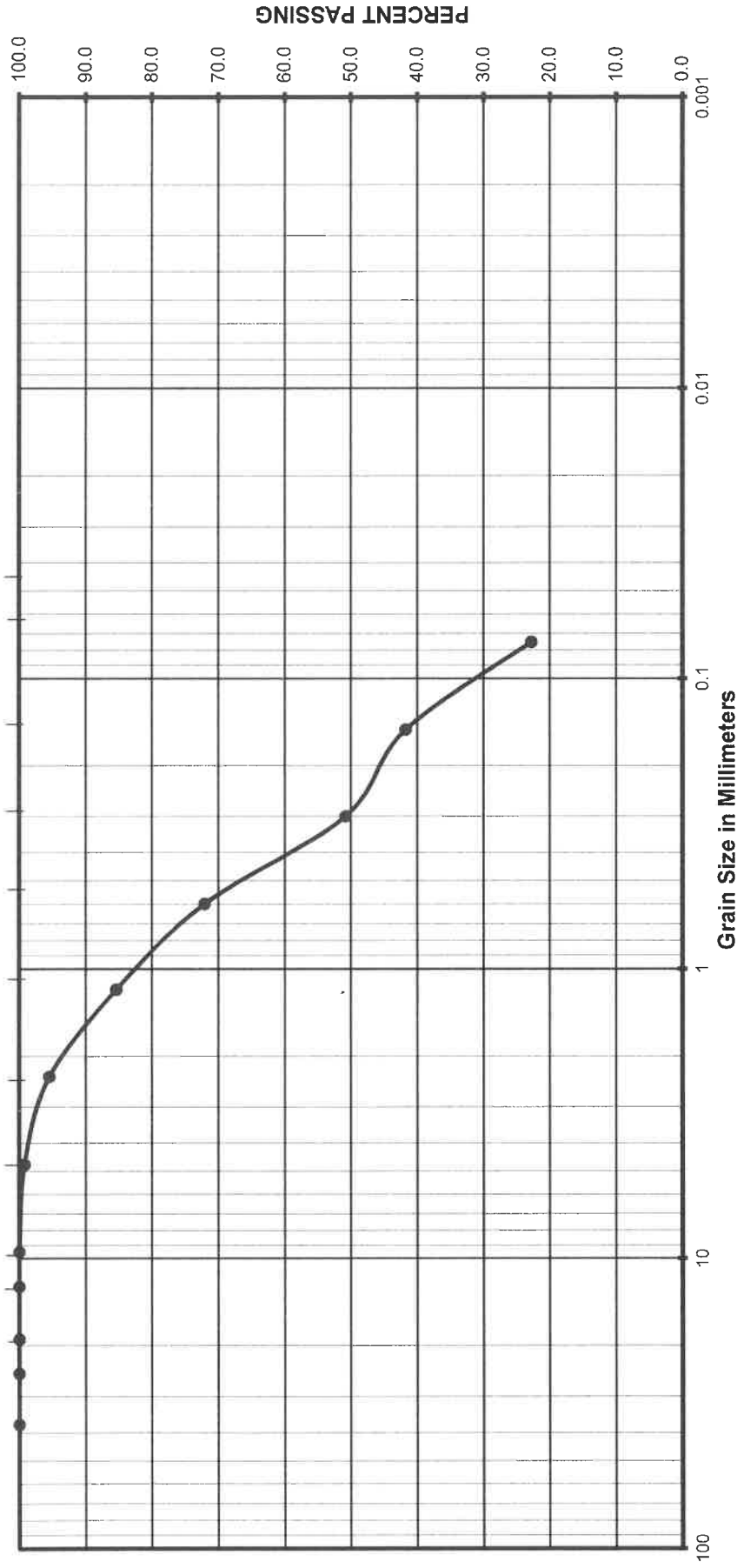

| | | | | | |
|---------------|------|-------------|--------|---------------------|--------------|
| Gravel | | Sand | | Silt or Clay | |
| Coarse | Fine | Coarse | Medium | Fine | Silt or Clay |

(Unified Soils Classification)

Project Name Penske Moreno Valley
 Project Number 11221093
 Soil Classification SM
 Sample Number B-7 @ 15'

Grain Size Analysis

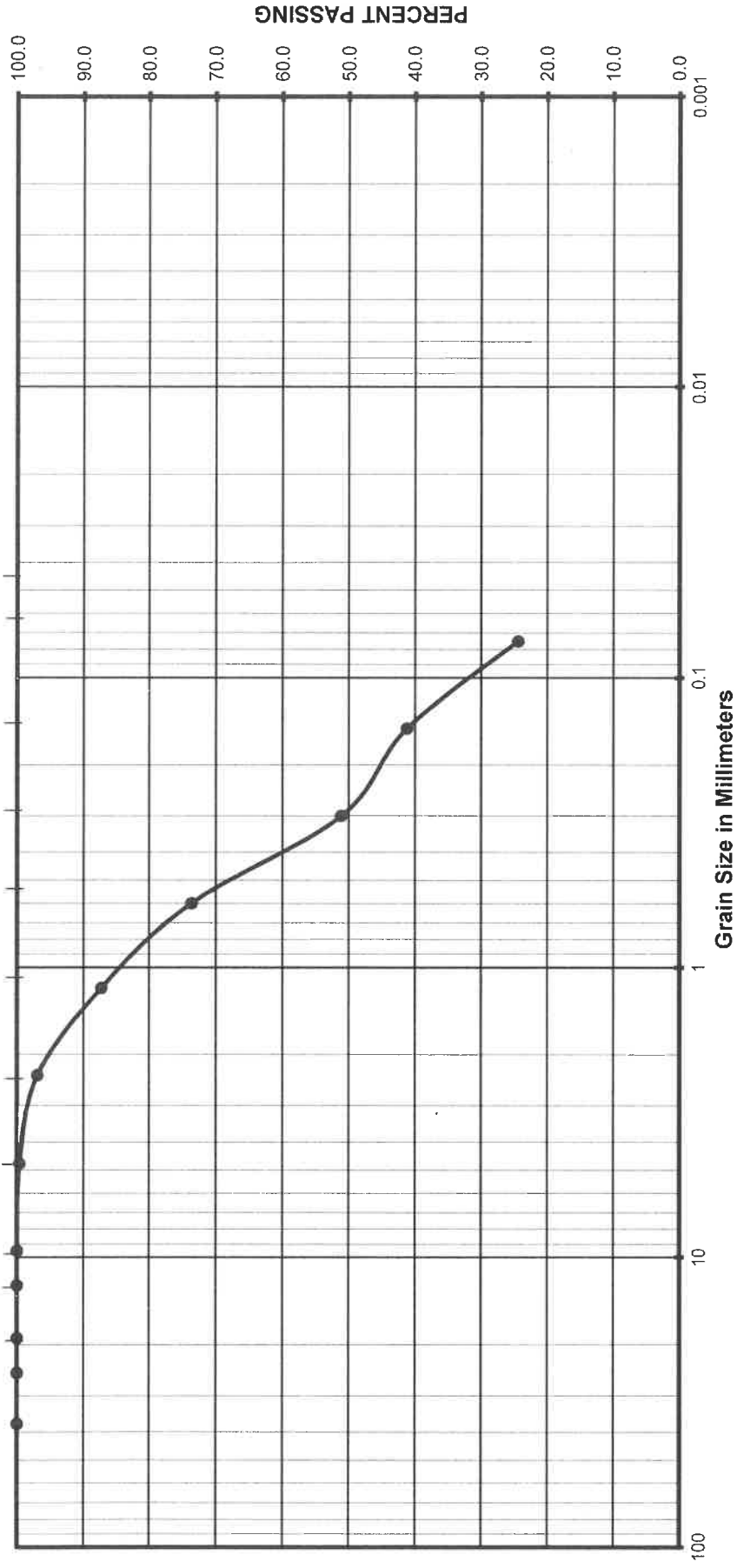

| | | | | | |
|---------------|--|-------------|--------|--|---------------------|
| Gravel | | Sand | | | Silt or Clay |
| | | Fine | Coarse | | |

(Unified Soils Classification)

Project Name: Penske Moreno Valley
 Project Number: 11221093
 Soil Classification: SM
 Sample Number: B-7 @ 20'

Grain Size Analysis

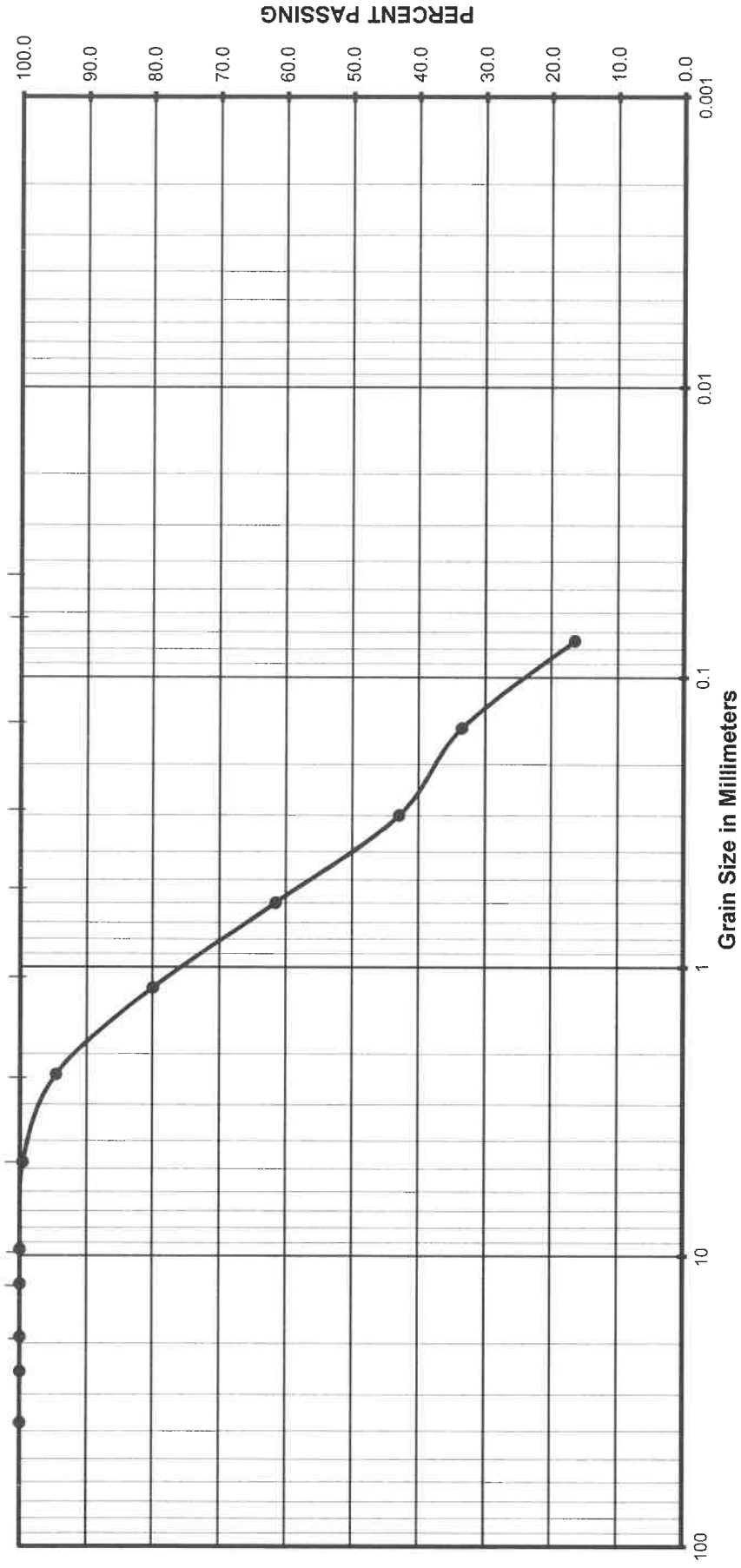

| | | | | |
|---------------|------|-------------|--------|---------------------|
| Gravel | | Sand | | Silt or Clay |
| Coarse | Fine | Coarse | Medium | Fine |

(Unified Soils Classification)

Project Name Penske Moreno Valley
 Project Number 11221093
 Soil Classification SM
 Sample Number B-7 @ 25'

Grain Size Analysis

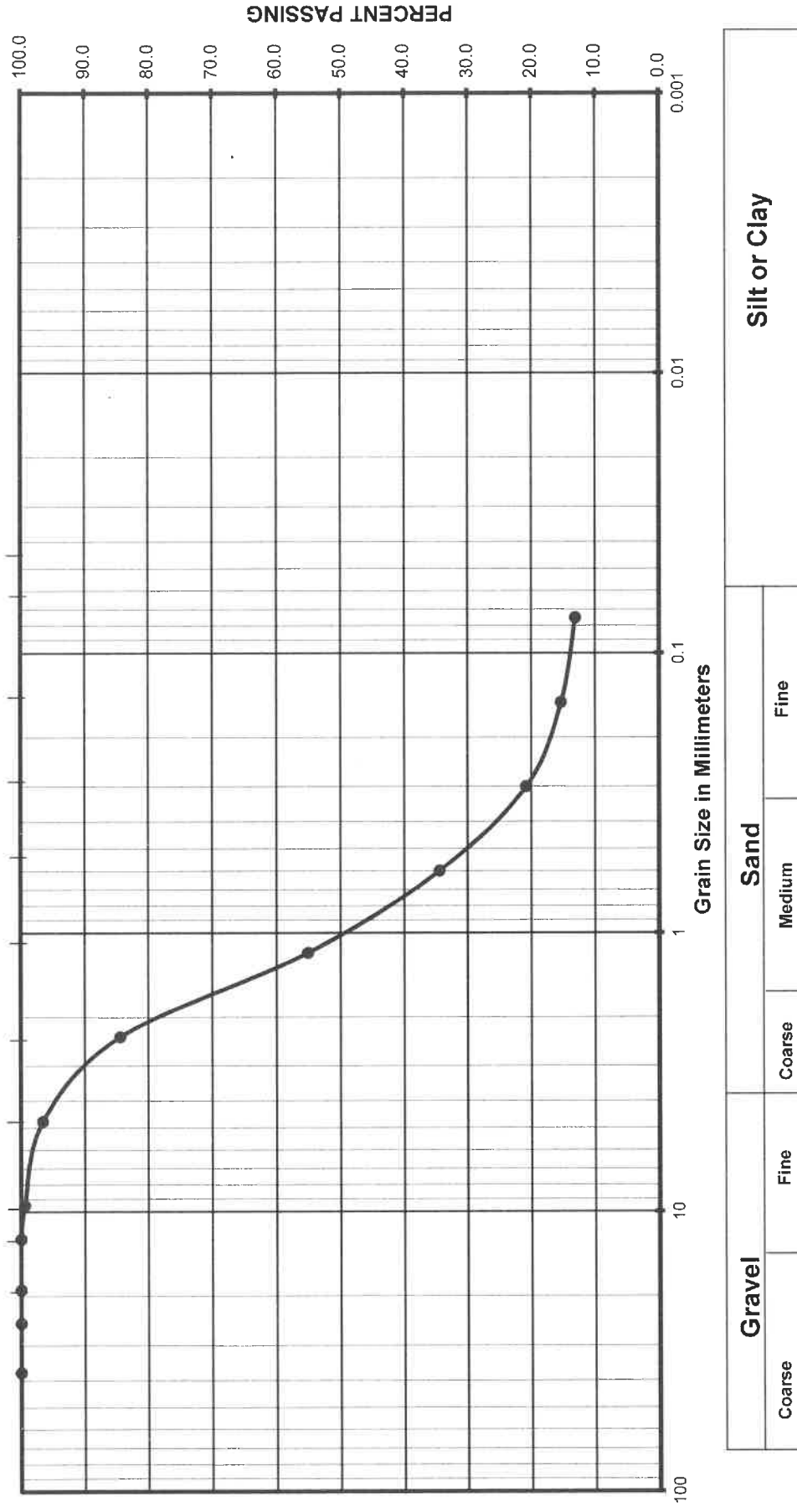

| | | | | | | |
|---------------|------|-------------|--------|------|---------------------|--|
| Gravel | | Sand | | | Silt or Clay | |
| Coarse | Fine | Coarse | Medium | Fine | | |

(Unified Soils Classification)

Project Name Penske Moreno Valley
 Project Number 11221093
 Soil Classification SM/SP
 Sample Number B-7 @ 30'

Grain Size Analysis

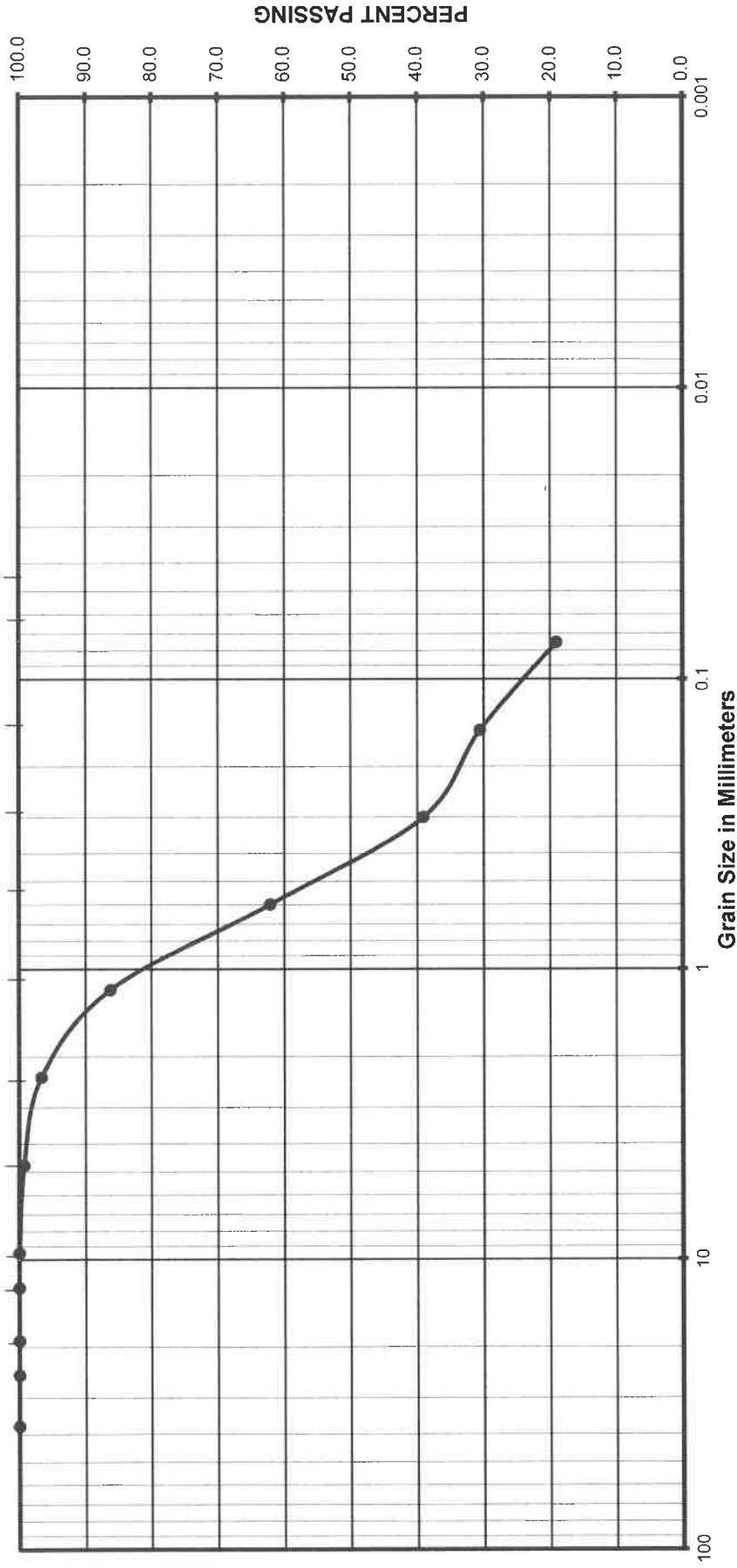

| | | | | | |
|---------------|------|-------------|--------|------|---------------------|
| Gravel | | Sand | | | Silt or Clay |
| Coarse | Fine | Coarse | Medium | Fine | |

(Unified Soils Classification)

Project Name Penske Moreno Valley
 Project Number 11221093
 Soil Classification SM
 Sample Number B-7 @ 35'

Grain Size Analysis

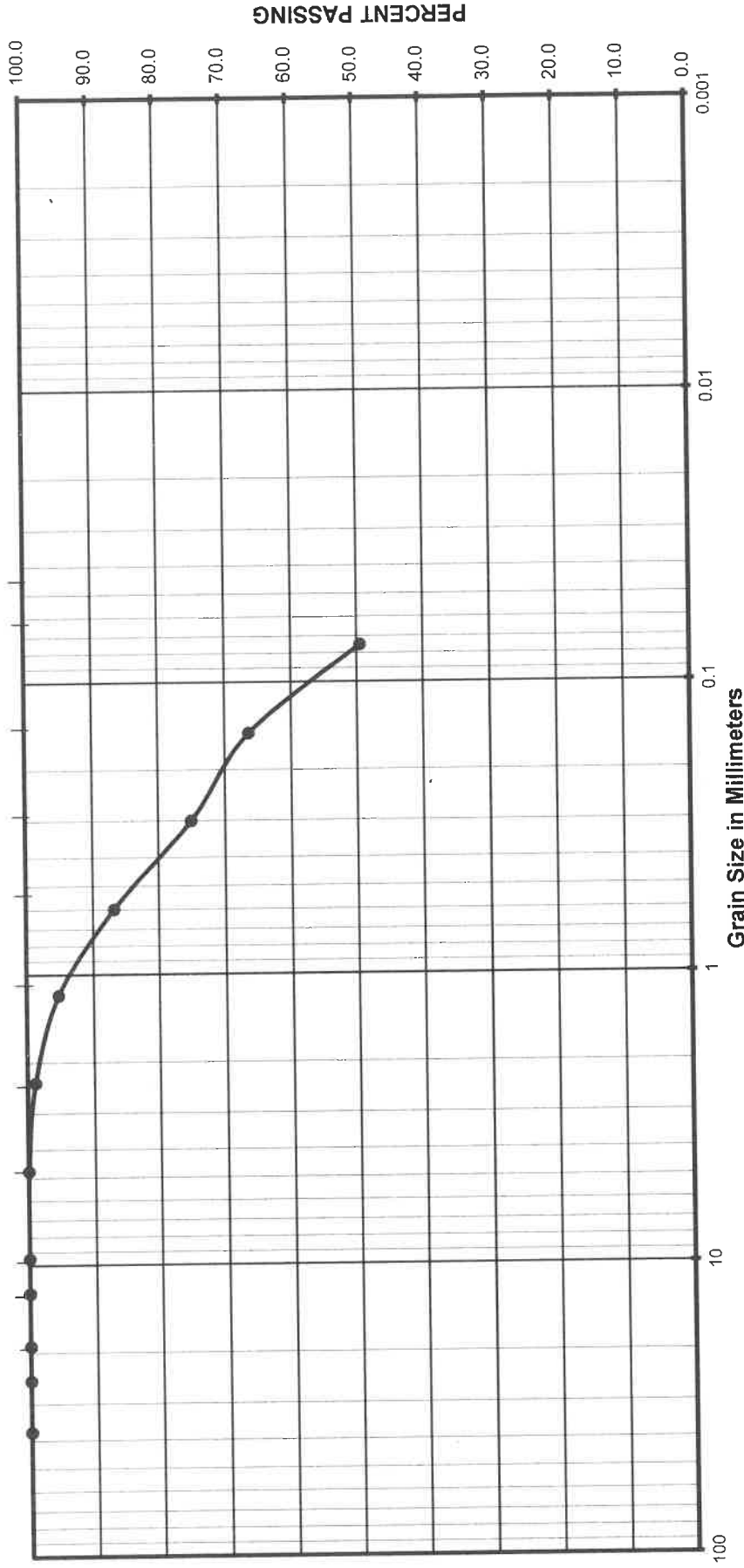

| | | | | | |
|--------|------|--------|--------|--------------|--|
| Gravel | | Sand | | Silt or Clay | |
| Coarse | Fine | Coarse | Medium | Fine | |

(Unified Soils Classification)

Project Name Penske Moreno Valley
 Project Number 11221093
 Soil Classification SM/ML
 Sample Number B-7 @ 40'

Grain Size Analysis

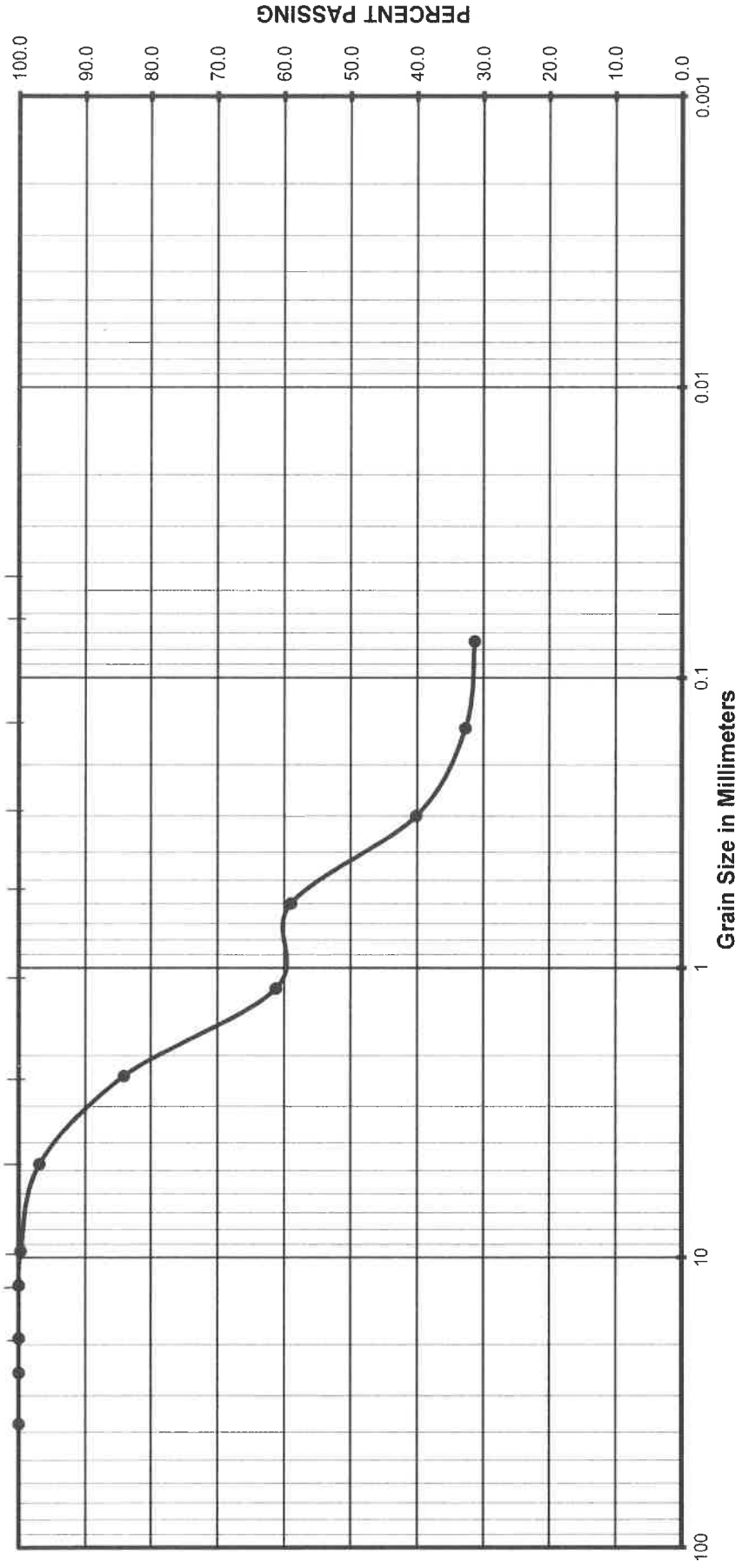

| | | | | | |
|---------------|--|-------------|--------|--|---------------------|
| Gravel | | Sand | | | Silt or Clay |
| | | Fine | Coarse | | |

(Unified Soils Classification)

Project Name: Peske Moreno Valley
 Project Number: 11221093
 Soil Classification: SM
 Sample Number: B-7 @ 45'

Grain Size Analysis

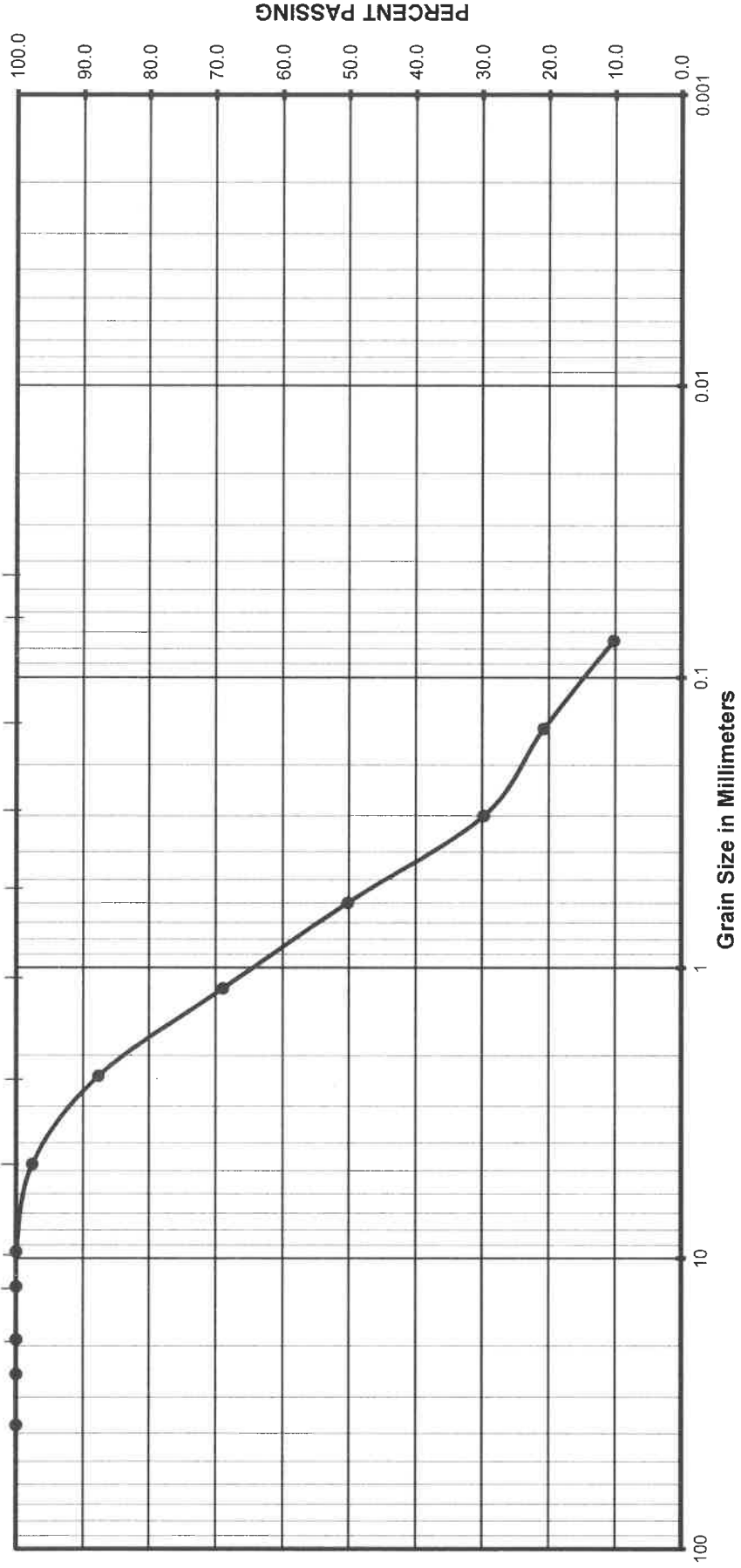

| | | | | |
|---------------|------|-------------|--------|---------------------|
| Gravel | | Sand | | Silt or Clay |
| Coarse | Fine | Coarse | Medium | Fine |

(Unified Soils Classification)

Project Name: Penske Moreno Valley
Project Number: 11221093
Soil Classification: SM-SP
Sample Number: B-7 @ 50'

R - VALUE TEST ASTM D - 2844 / CAL 301

Project Number : 11221093
 Project Name : Penske Truck Leasing Moreno Valley
 Date : 9/1/2021
 Sample Location/Curve Number : Bulk Sample
 Soil Classification : Silty Sand

| TEST | A | B | C |
|------------------------------------|-------|-------|-------|
| Percent Moisture @ Compaction, % | 13.4 | 14.2 | 16.0 |
| Dry Density, lbm/cu.ft. | 119.7 | 119.1 | 118.4 |
| Exudation Pressure, psi | 689 | 330 | 72 |
| Expansion Pressure, (Dial Reading) | 0 | 0 | 0 |
| Expansion Pressure, psf | 0 | 0 | 0 |
| Resistance Value R | 64 | 56 | 43 |

| | |
|---|------------------------|
| R Value at 300 PSI Exudation Pressure | 55 |
| R Value by Expansion Pressure (TI =): 5 | Expansion Pressure nil |

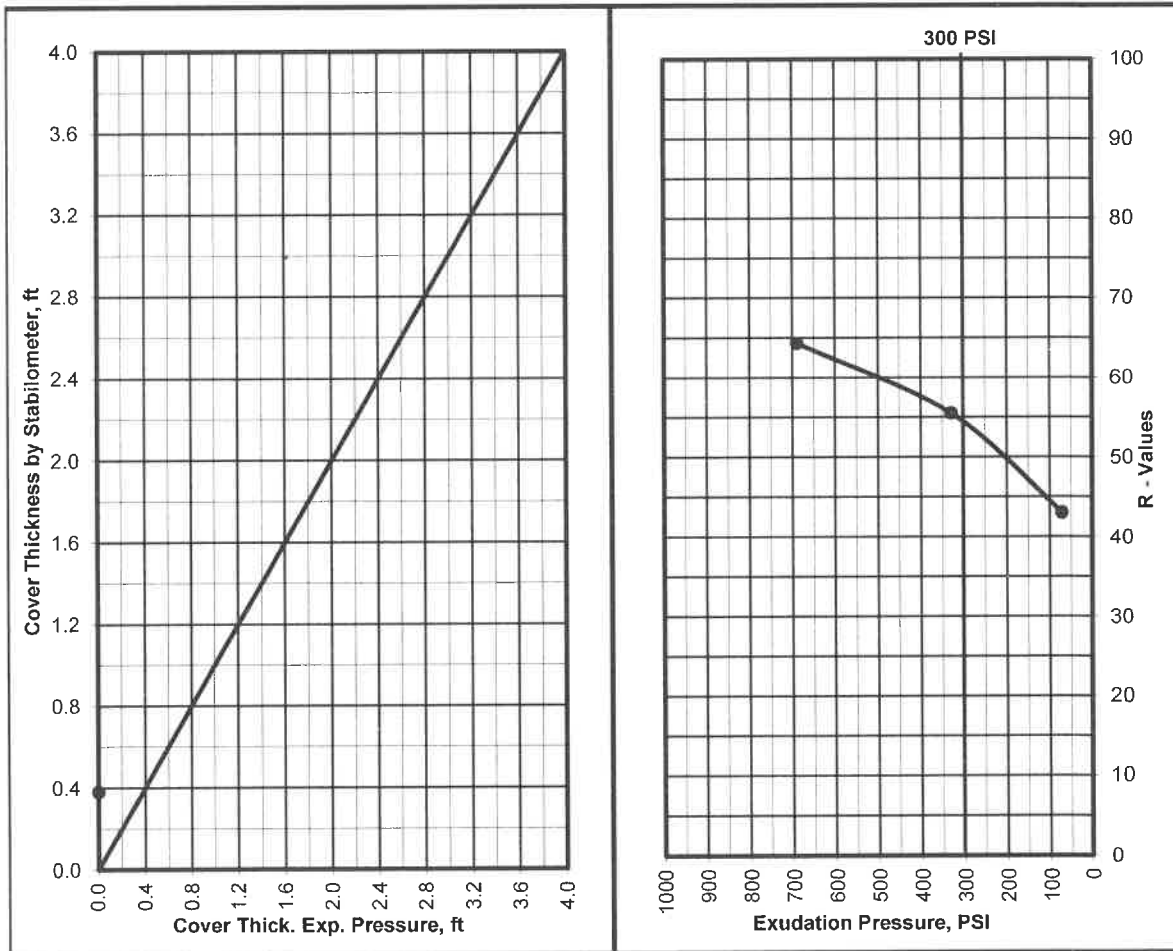

ANAHEIM TEST LAB, INC

196 Technology Drive, Unit D
Irvine, CA 92618
Phone (949)336-6544

Krazan & Associates, Inc.
1100 Olympic Drive, Ste. 103
Corona, CA 92881

DATE: 09/10/2021

P.O. NO: Verbal

LAB NO: C-5219

SPECIFICATION: CTM-643/417/422

MATERIAL: Soil

Project No: 11221093
Project Name: Penske Truck Leasing, Jurupa Valley
Sample ID: B-9 @ 0-5'

ANALYTICAL REPORT

CORROSION SERIES SUMMARY OF DATA

| pH | MIN. RESISTIVITY per CT. 643 ohm-cm | SOLUBLE SULFATES per CT. 417 ppm | SOLUBLE CHLORIDES per CT. 422 ppm |
|-----|---|--|---|
| 8.0 | 1,900 | 296 | 71 |

RESPECTFULLY SUBMITTED



WES BRIDGER LAB MANAGER

RESULTS OF INFILTRATION TESTS - REVERSE BOREHOLE

| | | | | | | |
|------------------------|------------------------------------|----------------------------|--|-------------|-----------------------|----|
| Project # | 11221093 | | | Date | 9/13/2021 | |
| Project Name | Penske Truck Leasing Moreno Valley | | | | | |
| Project Address | | | | | | |
| Test No: | IT-1 | Total Depth (in.) | | 120 | Test Size (in) | 10 |
| Depth To Water | >>50' | Soil Classification | | SM | | |

| Reading | Elapsed Time(min.) | Incremental Time (min.) | Initial Depth To Water(in.) | Final Depth To Water(in.) | Incremental Fall of Water(in.) | Incremental Infiltration Rate (in/hr) |
|---|--------------------|-------------------------|-----------------------------|---------------------------|--------------------------------|---------------------------------------|
| Start | 0 | 0.00 | | 45.00 | -- | -- |
| 1 | 20.00 | 20.00 | 45.00 | 52.00 | 7.00 | 0.71 |
| 2 | 40.00 | 20.00 | 52.00 | 55.00 | 3.00 | 0.33 |
| 3 | 60.00 | 20.00 | 55.00 | 56.00 | 1.00 | 0.11 |
| 4 | 80.00 | 20.00 | 56.00 | 57.00 | 1.00 | 0.11 |
| 5 | 100.00 | 20.00 | 57.00 | 59.00 | 2.00 | 0.23 |
| 6 | 120.00 | 20.00 | 59.00 | 60.00 | 1.00 | 0.12 |
| 7 | 140.00 | 20.00 | 60.00 | 62.00 | 2.00 | 0.24 |
| 8 | 160.00 | 20.00 | 62.00 | 63.00 | 1.00 | 0.13 |
| 9 | 180.00 | 20.00 | 63.00 | 64.00 | 1.00 | 0.13 |
| | | | | | | |
| | | | | | | |
| | | | | | | |
| | | | | | | |
| | | | | | | |
| | | | | | | |
| | | | | | | |
| | | | | | | |
| Infiltration Rate in Inches per Hour | | | | | | 0.11 |

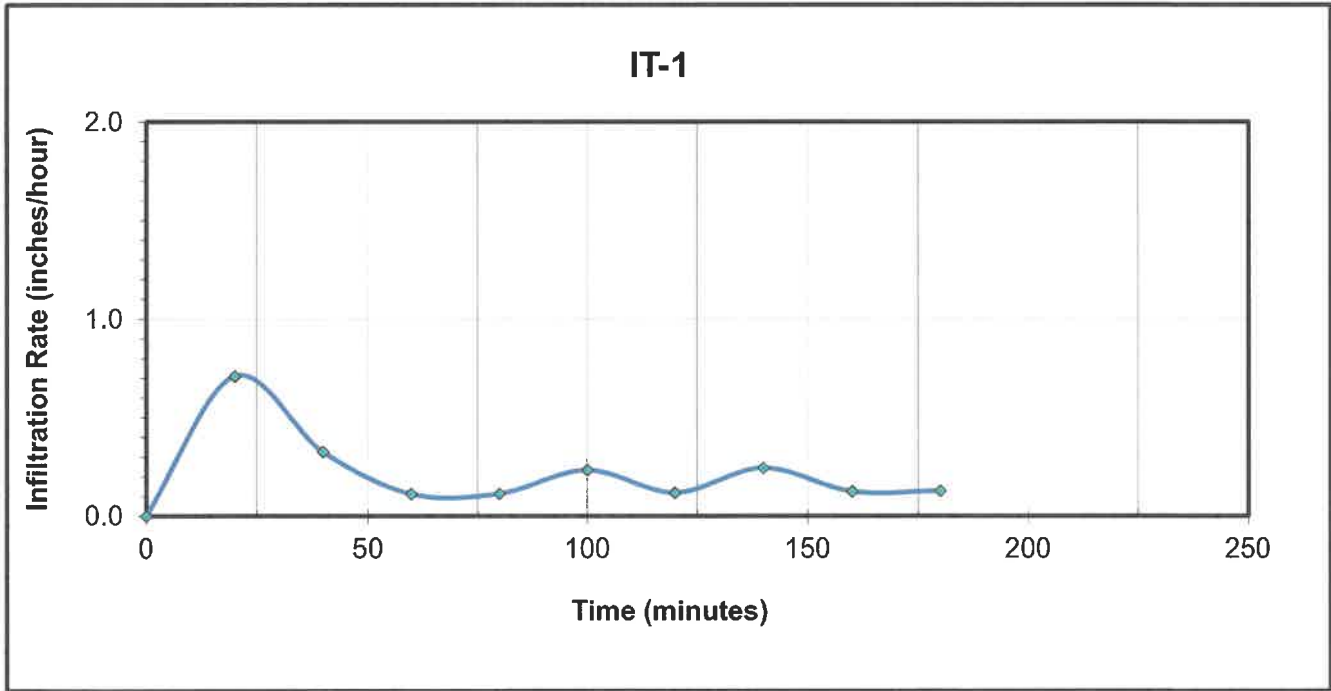

APPENDIX B

EARTHWORK SPECIFICATIONS

GENERAL

When the text of the report conflicts with the general specifications in this appendix, the recommendations in the report have precedence.

SCOPE OF WORK: These specifications and applicable plans pertain to and include all earthwork associated with the site rough grading, including but not limited to the furnishing of all labor, tools, and equipment necessary for site clearing and grubbing, stripping, preparation of foundation materials for receiving fill, excavation, processing, placement and compaction of fill and backfill materials to the lines and grades shown on the project grading plans, and disposal of excess materials.

PERFORMANCE: The Contractor shall be responsible for the satisfactory completion of all earthwork in accordance with the project plans and specifications. This work shall be inspected and tested by a representative of Krazan and Associates, Inc., hereinafter known as the Soils Engineer and/or Testing Agency. Attainment of design grades when achieved shall be certified by the project Civil Engineer. Both the Soils Engineer and the Civil Engineer are the Owner's representatives. If the Contractor should fail to meet the technical or design requirements embodied in this document and on the applicable plans, he shall make the necessary readjustments until all work is deemed satisfactory as determined by both the Soils Engineer and the Civil Engineer. No deviation from these specifications shall be made except upon written approval of the Soils Engineer, Civil Engineer or project Architect.

No earthwork shall be performed without the physical presence or approval of the Soils Engineer. The Contractor shall notify the Soils Engineer at least 2 working days prior to the commencement of any aspect of the site earthwork.

The Contractor agrees that he shall assume sole and complete responsibility for job site conditions during the course of construction of this project, including safety of all persons and property; that this requirement shall apply continuously and not be limited to normal working hours; and that the Contractor shall defend, indemnify and hold the Owner and the Engineers harmless from any and all liability, real or alleged, in connection with the performance of work on this project, except for liability arising from the sole negligence of the Owner or the Engineers.

TECHNICAL REQUIREMENTS: All compacted materials shall be densified to a density not less than 95 percent relative compaction based on ASTM Test Method D1557 or CAL-216, as specified in the technical portion of the Soil Engineer's report. The location and frequency of field density tests shall be as determined by the Soils Engineer. The results of these tests and compliance with these specifications shall be the basis upon which satisfactory completion of work will be judged by the Soils Engineer.

SOILS AND FOUNDATION CONDITIONS: The Contractor is presumed to have visited the site and to have familiarized himself with existing site conditions and the contents of the data presented in the soil report.

The Contractor shall make his own interpretation of the data contained in said report, and the Contractor shall not be relieved of liability under the Contract documents for any loss sustained as a result of any variance between conditions indicated by or deduced from said report and the actual conditions encountered during the progress of the work.

DUST CONTROL: The work includes dust control as required for the alleviation or prevention of any dust nuisance on or about the site or the borrow area, or off-site if caused by the Contractor's operation either during the performance of the earthwork or resulting from the conditions in which the Contractor leaves the site. The Contractor shall assume all liability, including court costs of codefendants, for all claims related to dust or windblown materials attributable to his work.

SITE PREPARATION

Site preparation shall consist of site clearing and grubbing and the preparations of foundation materials for receiving fill.

CLEARING AND GRUBBING: The Contractor shall accept the site in this present condition and shall demolish and/or remove from the area of designated project earthwork all structures, both surface and subsurface, trees, brush, roots, debris, organic matter, and all other matter determined by the Soils Engineer to be deleterious or otherwise unsuitable. Such materials shall become the property of the Contractor and shall be removed from the site.

Tree root systems in proposed building areas should be removed to a minimum depth of 3 feet and to such an extent which would permit removal of all roots larger than 1 inch. Tree roots removed in parking areas may be limited to the upper 1½ feet of the ground surface. Backfill of tree root excavations should not be permitted until all exposed surfaces have been inspected and the Soils Engineer is present for the proper control of backfill placement and compaction. Burning in areas which are to receive fill materials shall not be permitted.

SUBGRADE PREPARATION: Surfaces to receive Engineered Fill, building or slab loads shall be prepared as outlined above, excavated/scarified to a depth of 12 inches, moisture-conditioned as necessary, and compacted to 95 percent relative compaction.

Loose soil areas, areas of uncertified fill, and/or areas of disturbed soils shall be moisture-conditioned as necessary and recompacted to 95 percent relative compaction. All ruts, hummocks, or other uneven surface features shall be removed by surface grading prior to placement of any fill materials. All areas which are to receive fill materials shall be approved by the Soils Engineer prior to the placement of any of the fill material.

EXCAVATION: All excavation shall be accomplished to the tolerance normally defined by the Civil Engineer as shown on the project grading plans. All over-excavation below the grades specified shall be backfilled at the Contractor's expense and shall be compacted in accordance with the applicable technical requirements.

FILL AND BACKFILL MATERIAL: No material shall be moved or compacted without the presence of the Soils Engineer. Material from the required site excavation may be utilized for construction site fills provided prior approval is given by the Soils Engineer. All materials utilized for constructing site fills shall be free from vegetation or other deleterious matter as determined by the Soils Engineer.

PLACEMENT, SPREADING AND COMPACTION: The placement and spreading of approved fill materials and the processing and compaction of approved fill and native materials shall be the responsibility of the Contractor. However, compaction of fill materials by flooding, ponding, or jetting shall not be permitted unless specifically approved by local code, as well as the Soils Engineer.

Both cut and fill areas shall be surface-compacted to the satisfaction of the Soils Engineer prior to final acceptance.

SEASONAL LIMITS: No fill material shall be placed, spread, or rolled while it is frozen or thawing or during unfavorable wet weather conditions. When the work is interrupted by heavy rains, fill operations shall not be resumed until the Soils Engineer indicates that the moisture content and density of previously placed fill are as specified.

APPENDIX C

PAVEMENT SPECIFICATIONS

1. DEFINITIONS - The term "pavement" shall include asphaltic concrete surfacing, untreated aggregate base, and aggregate subbase. The term "subgrade" is that portion of the area on which surfacing, base, or subbase is to be placed.

The term "Standard Specifications": hereinafter referred to is the 2018 Standard Specifications of the State of California, Department of Transportation, and the "Materials Manual" is the Materials Manual of Testing and Control Procedures, State of California, Department of Public Works, Division of Highways. The term "relative compaction" refers to the field density expressed as a percentage of the maximum laboratory density as defined in the applicable tests outlined in the Materials Manual.

2. SCOPE OF WORK - This portion of the work shall include all labor, materials, tools, and equipment necessary for, and reasonably incidental to the completion of the pavement shown on the plans and as herein specified, except work specifically notes as "Work Not Included."

3. PREPARATION OF THE SUBGRADE - The Contractor shall prepare the surface of the various subgrades receiving subsequent pavement courses to the lines, grades, and dimensions given on the plans. The upper 12 inches of the soil subgrade beneath the pavement section shall be compacted to a minimum relative compaction of 90 percent. The finished subgrades shall be tested and approved by the Soils Engineer prior to the placement of additional pavement courses.

4. UNTREATED AGGREGATE BASE - The aggregate base material shall be spread and compacted on the prepared subgrade in conformity with the lines, grades, and dimensions shown on the plans. The aggregate base material shall conform to the requirements of Section 26 of the Standard Specifications for Class 2 material, 1½ inches maximum size. The aggregate base material shall be compacted to a minimum relative compaction of 95 percent. The aggregate base material shall be spread and compacted in accordance with Section 26 of the Standard Specifications. The aggregate base material shall be spread in layers not exceeding 6 inches and each layer of aggregate material course shall be tested and approved by the Soils Engineer prior to the placement of successive layers.

5. AGGREGATE SUBBASE - The aggregate subbase shall be spread and compacted on the prepared subgrade in conformity with the lines, grades, and dimensions shown on the plans. The aggregate subbase material shall conform to the requirements of Section 25 of the Standard Specifications for Class 2 material. The aggregate subbase material shall be compacted to a minimum relative compaction of 95 percent, and it shall be spread and compacted in accordance with Section 25 of the Standard Specifications. Each layer of aggregate subbase shall be tested and approved by the Soils Engineer prior to the placement of successive layers.

6. ASPHALTIC CONCRETE SURFACING - Asphaltic concrete surfacing shall consist of a mixture of mineral aggregate and paving grade asphalt, mixed at a central mixing plant and spread and compacted on a prepared base in conformity with the lines, grades, and dimensions shown on the plans. The viscosity grade of the asphalt shall be PG 64-10. The mineral aggregate shall be Type B, ½ inch maximum size, medium grading, and shall conform to the requirements set forth in Section 39 of the Standard Specifications. The drying, proportioning, and mixing of the materials shall conform to Section 39.

The prime coat, spreading and compacting equipment, and spreading and compacting the mixture shall conform to the applicable chapters of Section 39, with the exception that no surface course shall be placed when the atmospheric temperature is below 50 degrees F. The surfacing shall be rolled with a combination steel-wheel and pneumatic rollers, as described in Section 39-6. The surface course shall be placed with an approved self-propelled mechanical spreading and finishing machine.

7. FOG SEAL COAT - The fog seal (mixing type asphaltic emulsion) shall conform to and be applied in accordance with the requirements of Section 37.

Appendix 4: Historical Site Conditions

Phase I Environmental Site Assessment or Other Information on Past Site Use

Appendix 5: LID Infeasibility

LID Technical Infeasibility Analysis

N/A

Appendix 6: BMP Design Details

BMP Sizing, Design Details, and other Supporting Documentation

Santa Ana Watershed

V_{BMP} and Q_{BMP} worksheets

These worksheets are to be used to determine the required

Design Capture Volume (V_{BMP})

or the

Design Flow Rate (Q_{BMP})

for BMPs in the Santa Ana Watershed

To verify which watershed your project is located within, visit

www.rcflood.org/npdes

and use the 'Locate my Watershed' tool

If your project is not located in the Santa Ana Watershed,

Do not use these worksheets! Instead visit

www.rcflood.org/npdes/developers.aspx

To access worksheets applicable to your watershed

Use the **tabs across the bottom
to access the worksheets for the Santa Ana Watershed**

Santa Ana Watershed - BMP Design Flow Rate, Q_{BMP}

(Rev. 10-2011)

Legend:

Required Entries

Calculated Cells

*(Note this worksheet shall **only** be used in conjunction with BMP designs from the **LID BMP Design Handbook**)*

| | | | |
|-----------------------------|----------------------------|---------|-----------|
| Company Name | Kimley-Horn and Associates | Date | 11/9/2021 |
| Designed by | Leticia Alvarez | Case No | |
| Company Project Number/Name | Penske Moreno Valley | | |

BMP Identification

BMP NAME / ID **BMP 1**

Must match Name/ID used on BMP Design Calculation Sheet

Design Rainfall Depth

Design Rainfall Intensity I = **0.20** in/hr

Drainage Management Area Tabulation

Insert additional rows if needed to accommodate all DMAs draining to the BMP

| DMA Type/ID | DMA Area (square feet) | Post-Project Surface Type <i>(use pull-down menu)</i> | Effective Imperivous Fraction, I _f | DMA Runoff Factor | DMA Areas x Runoff Factor | Design Rainfall Intensity (in/hr) | Design Flow Rate (cfs) | Proposed Flow Rate (cfs) |
|-------------|------------------------|--|---|-------------------|---------------------------|-----------------------------------|------------------------|--------------------------|
| 1A | 107937 | Mixed Surface Types | 1 | 0.892 | 96279.8 | | | |
| 1B | 11392 | Roofs | 1 | 0.892 | 10161.7 | | | |
| 1C | 25755 | Ornamental Landscaping | 0.1 | 0.110 | 2844.8 | | | |
| | | | | | | | | |
| | | | | | | | | |
| | | | | | | | | |
| | | | | | | | | |
| | | | | | | | | |
| | | | | | | | | |
| | | | | | | | | |
| | | | | | | | | |
| | | | | | | | | |
| | | | | | | | | |
| | | | | | | | | |
| | | | | | | | | |
| | | | | | | | | |
| | | | | | | | | |
| | | 145084 | Total | | 109286.3 | 0.20 | 0.5 | 0.557 |

Notes:

Santa Ana Watershed - BMP Design Flow Rate, Q_{BMP}
(Rev. 10-2011)

Legend:

Required Entries
Calculated Cells

*(Note this worksheet shall **only** be used in conjunction with BMP designs from the **LID BMP Design Handbook**)*

| | | | |
|-----------------------------|----------------------------|---------|-----------|
| Company Name | Kimley-Horn and Associates | Date | 11/9/2021 |
| Designed by | Leticia Alvarez | Case No | |
| Company Project Number/Name | Penske Moreno Valley | | |

BMP Identification

BMP NAME / ID **BMP 3**
Must match Name/ID used on BMP Design Calculation Sheet

Design Rainfall Depth

Design Rainfall Intensity I = **0.20** in/hr

Drainage Management Area Tabulation

Insert additional rows if needed to accommodate all DMAs draining to the BMP

| DMA Type/ID | DMA Area (square feet) | Post-Project Surface Type <i>(use pull-down menu)</i> | Effective Imperivous Fraction, I_f | DMA Runoff Factor | DMA Areas x Runoff Factor | Design Rainfall Intensity (in/hr) | Design Flow Rate (cfs) | Proposed Flow Rate (cfs) | | |
|--------------|------------------------|--|--------------------------------------|-------------------|---------------------------|-----------------------------------|------------------------|--------------------------|------------|--------------|
| | | | | | | | | | | |
| 3A | 55924 | Mixed Surface Types | 1 | 0.892 | 49884.2 | 0.20 | 0.2 | 0.206 | | |
| 3C | 23027 | Ornamental Landscaping | 0.1 | 0.110 | 2543.5 | | | | | |
| | | | | | | | | | | |
| | | | | | | | | | | |
| | | | | | | | | | | |
| | | | | | | | | | | |
| | | | | | | | | | | |
| | | | | | | | | | | |
| | | | | | | | | | | |
| | | | | | | | | | | |
| | | | | | | | | | | |
| | | | | | | | | | | |
| | | | | | | | | | | |
| | | | | | | | | | | |
| | | | | | | | | | | |
| | | | | | | | | | | |
| | | | | | | | | | | |
| 78951 | | Total | | 52427.7 | 0.20 | | | | 0.2 | 0.206 |

Notes:

Effective Impervious Fraction

| Developed Cover Types | Effective Impervious Fraction |
|--|-------------------------------|
| Roofs | 1.00 |
| Concrete or Asphalt | 1.00 |
| Grouted or Gapless Paving Blocks | 1.00 |
| Compacted Soil (e.g. unpaved parking) | 0.40 |
| Decomposed Granite | 0.40 |
| Permeable Paving Blocks w/ Sand Filled Gap | 0.25 |
| Class 2 Base | 0.30 |
| Gravel or Class 2 Permeable Base | 0.10 |
| Pervious Concrete / Porous Asphalt | 0.10 |
| Open and Porous Pavers | 0.10 |
| Turf block | 0.10 |
| Ornamental Landscaping | 0.10 |
| Natural (A Soil) | 0.03 |
| Natural (B Soil) | 0.15 |
| Natural (C Soil) | 0.30 |
| Natural (D Soil) | 0.40 |

Mixed Surface Types

Use this table to determine the effective impervious fraction for the V_{BMP} and Q_{BMP} calculation sheets

Modular Wetlands System™ Linear

Biofiltration

Comprehensive Stormwater Solutions

Bio  Clean
A Forterra Company



OVERVIEW

The Bio Clean Modular Wetlands System™ Linear (MWS Linear) represents a pioneering breakthrough in stormwater technology as the only biofiltration system to utilize patented horizontal flow, allowing for a smaller footprint and higher treatment capacity. While most biofilters use little or no pretreatment, the MWS Linear incorporates an advanced pretreatment chamber that includes separation and pre-filter cartridges. In this chamber, sediment and hydrocarbons are removed from runoff before entering the biofiltration chamber, in turn reducing maintenance costs and improving performance.

The Urban Impact

For hundreds of years, natural wetlands surrounding our shores have played an integral role as nature's stormwater treatment

system. But as our cities grow and develop, these natural wetlands have perished under countless roads, rooftops, and parking lots.

Plant A Wetland

Without natural wetlands, our cities are deprived of water purification, flood control, and land stability. Modular Wetlands and the MWS Linear re-establish nature's presence and rejuvenate waterways in urban areas.

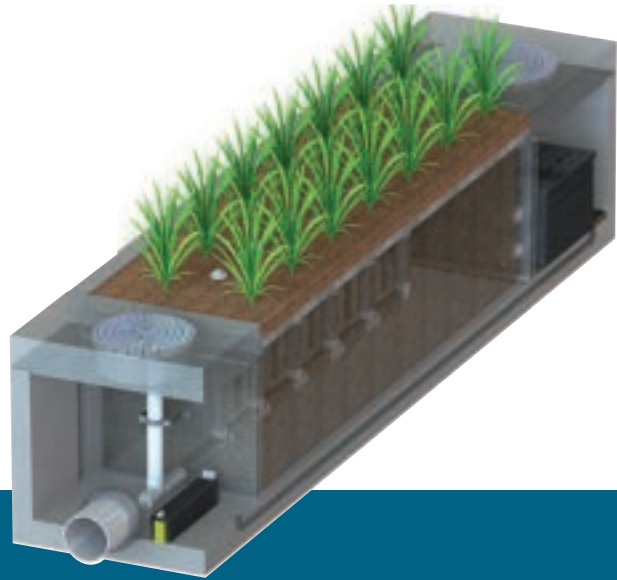

PERFORMANCE

The MWS Linear continues to outperform other treatment methods with superior pollutant removal for TSS, heavy metals, nutrients, hydrocarbons, and bacteria. Since 2007 the MWS Linear has been field tested on numerous sites across the country. With its advanced pretreatment chamber and innovative horizontal flow biofilter, the system is able to effectively remove pollutants through a combination of physical, chemical, and biological filtration processes. With the same biological processes found in natural wetlands, the MWS Linear harnesses nature's ability to process, transform, and remove even the most harmful pollutants.

66%
REMOVAL
OF
DISSOLVED
ZINC

69%
REMOVAL
OF TOTAL
ZINC

38%
REMOVAL
OF
DISSOLVED
COPPER

64%
REMOVAL
OF TOTAL
PHOSPHORUS

45%
REMOVAL
OF
NITROGEN

50%
REMOVAL
OF TOTAL
COPPER

95%
REMOVAL
OF MOTOR
OIL

67%
REMOVAL
OF ORTHO
PHOSPHORUS

85%
REMOVAL
OF TSS

APPROVALS

The MWS Linear has successfully met years of challenging technical reviews and testing from some of the most prestigious and demanding agencies in the nation and perhaps the world.



WASHINGTON STATE TAPE APPROVED

The MWS Linear is approved for General Use Level Designation (GULD) for Basic, Enhanced, and Phosphorus treatment at 1 gpm/ft² loading rate. The highest performing BMP on the market for all main pollutant categories.



DEQ ASSIGNMENT

The Virginia Department of Environmental Quality assigned the MWS Linear, the highest phosphorus removal rating for manufactured treatment devices to meet the new Virginia Stormwater Management Program (VSMP) Regulation technical criteria.



MARYLAND DEPARTMENT OF THE ENVIRONMENT APPROVED

Granted Environmental Site Design (ESD) status for new construction, redevelopment, and retrofitting when designed in accordance with the design manual.



MASTEP EVALUATION

The University of Massachusetts at Amherst - Water Resources Research Center issued a technical evaluation report noting removal rates up to 84% TSS, 70% total phosphorus, 68.5% total zinc, and more.



RHODE ISLAND DEM APPROVED

Approved as an authorized BMP and noted to achieve the following minimum removal efficiencies: 85% TSS, 60% pathogens, 30% total phosphorus, and 30% total nitrogen.

ADVANTAGES

- HORIZONTAL FLOW BIOFILTRATION
- GREATER FILTER SURFACE AREA
- PRETREATMENT CHAMBER
- PATENTED PERIMETER VOID AREA
- FLOW CONTROL
- NO DEPRESSED PLANTER AREA
- AUTO DRAINDOWN MEANS NO MOSQUITO VECTOR

OPERATION

The MWS Linear is the most efficient and versatile biofiltration system on the market, and it is the only system with horizontal flow which improves performance, reduces footprint, and minimizes maintenance. Figure 1 and Figure 2 illustrate the invaluable benefits of horizontal flow and the multiple treatment stages.

1 PRETREATMENT

SEPARATION

- Trash, sediment, and debris are separated before entering the pre-filter cartridges
- Designed for easy maintenance access

PRE-FILTER CARTRIDGES

- Over 25 sq. ft. of surface area per cartridge
- Utilizes BioMediaGREEN filter material
- Removes over 80% of TSS and 90% of hydrocarbons
- Prevents pollutants that cause clogging from migrating to the biofiltration chamber

Individual Media Filters

Pre-filter Cartridge

Curb Inlet

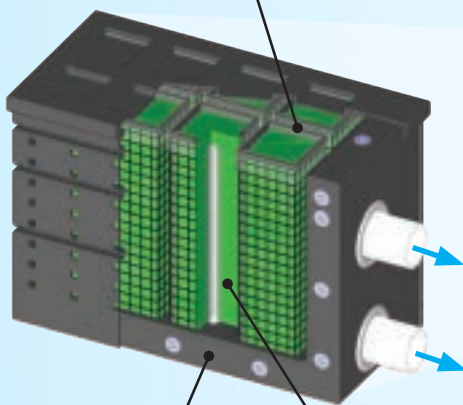

Cartridge Housing

BioMediaGREEN™

1
Vertical Underdrain
Manifold

2

WetlandMEDIA™

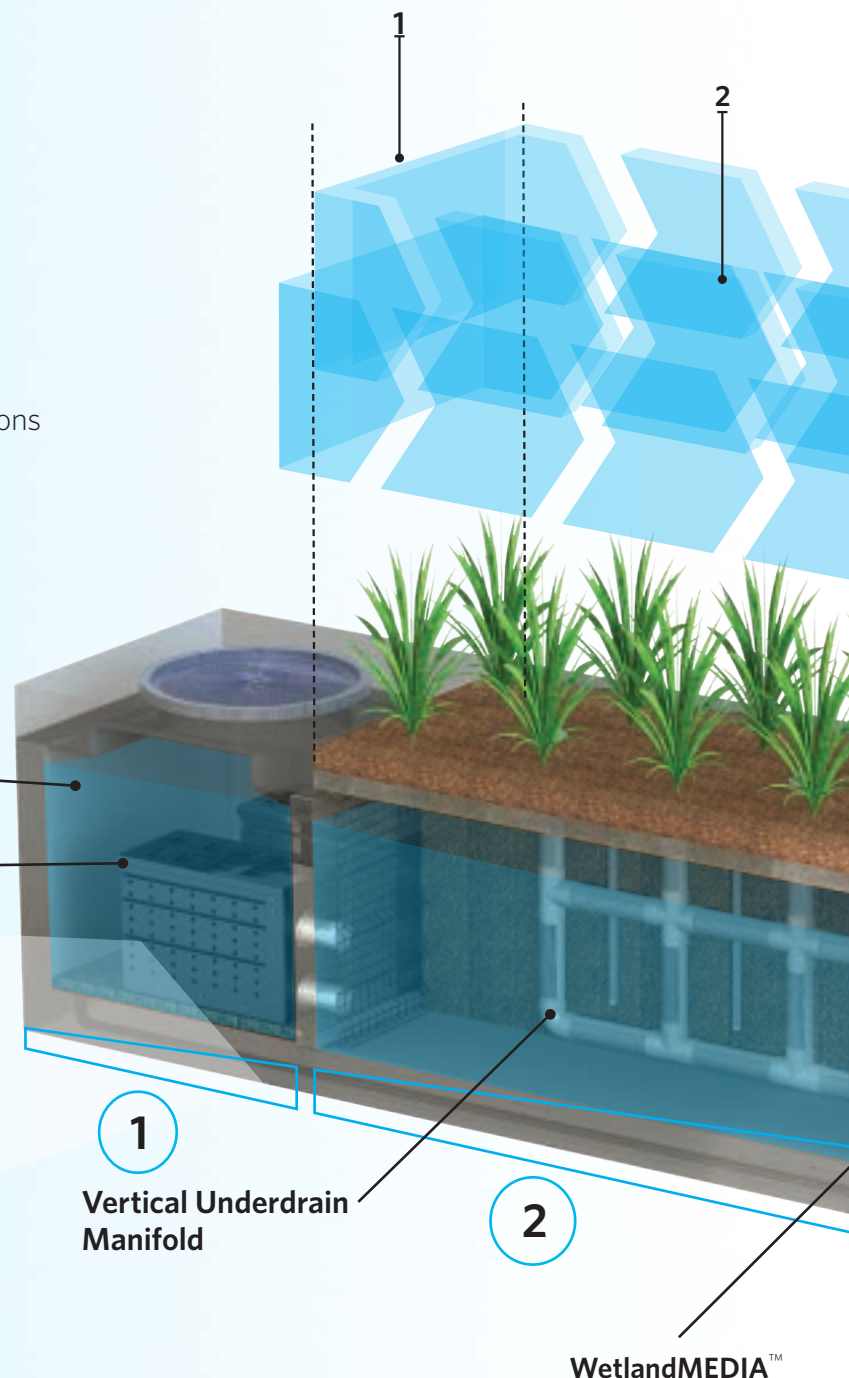

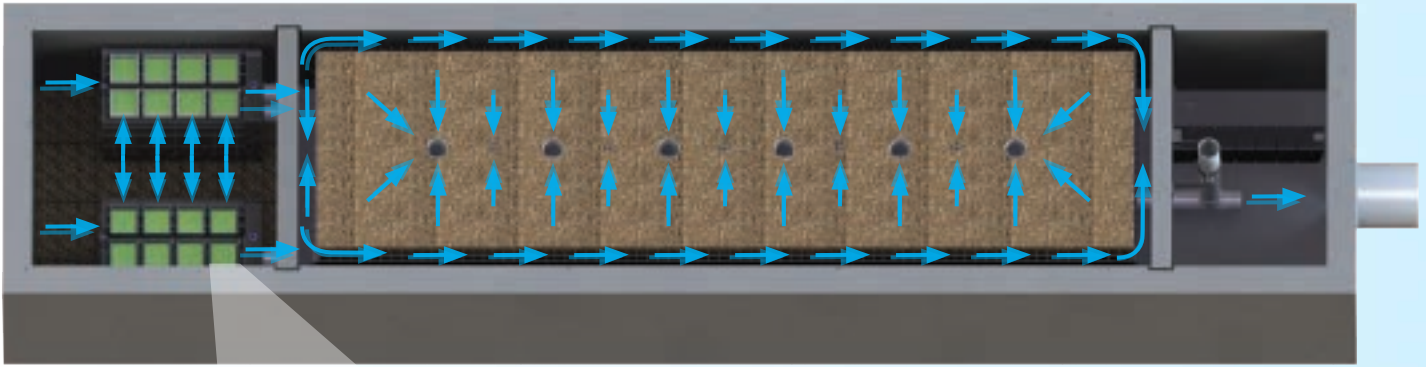

Figure 2,
Top View

2x to 3x more surface area than traditional downward flow bioretention systems.

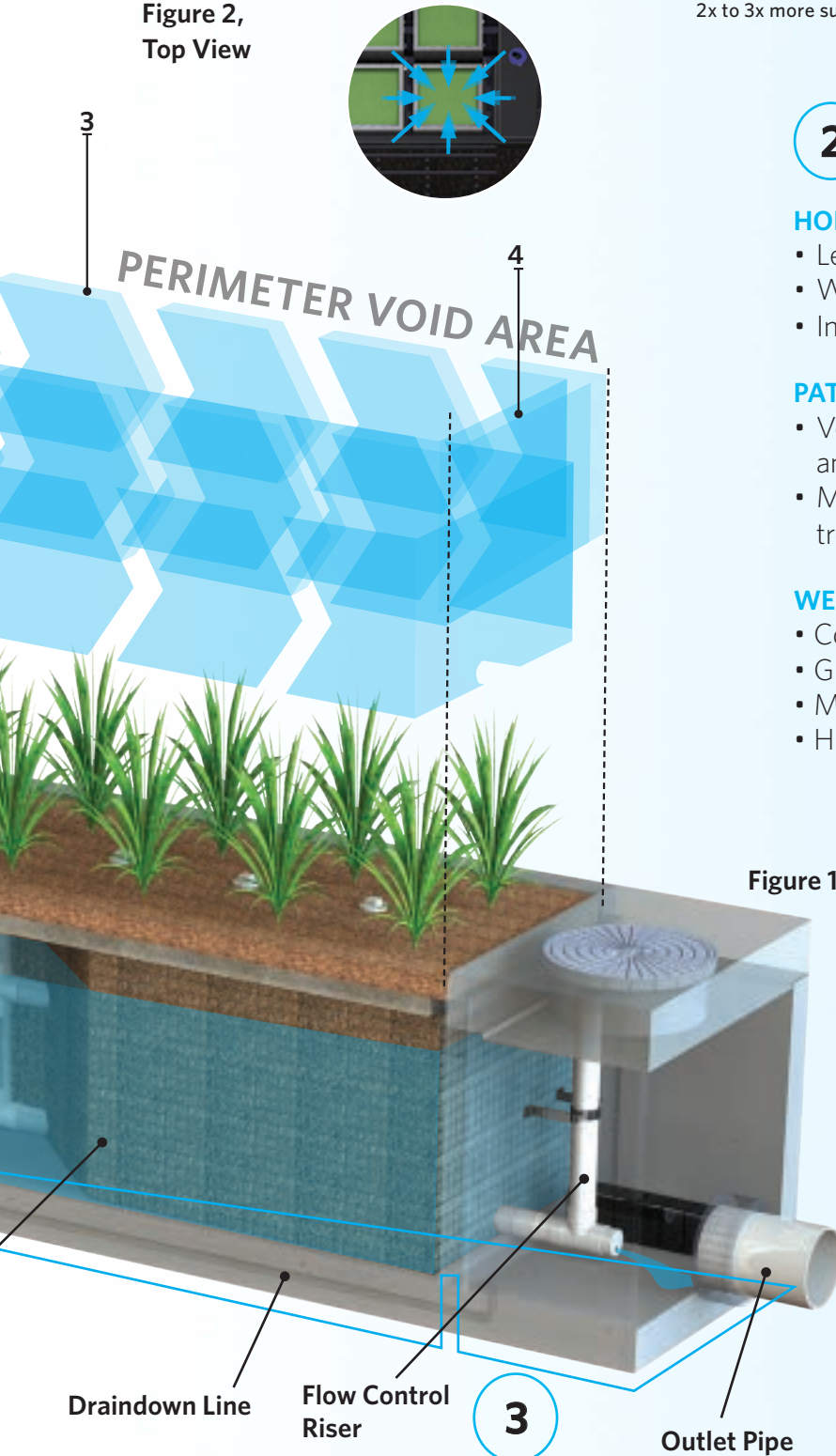

Figure 1

2 BIOFILTRATION

HORIZONTAL FLOW

- Less clogging than downward flow biofilters
- Water flow is subsurface
- Improves biological filtration

PATENTED PERIMETER VOID AREA

- Vertically extends void area between the walls and the WetlandMEDIA on all four sides
- Maximizes surface area of the media for higher treatment capacity

WETLANDMEDIA

- Contains no organics and removes phosphorus
- Greater surface area and 48% void space
- Maximum evapotranspiration
- High ion exchange capacity and lightweight

3 DISCHARGE

FLOW CONTROL

- Orifice plate controls flow of water through WetlandMEDIA to a level lower than the media's capacity
- Extends the life of the media and improves performance

DRAINDOWN FILTER

- The draindown is an optional feature that completely drains the pretreatment chamber
- Water that drains from the pretreatment chamber between storm events will be treated



CONFIGURATIONS

The MWS Linear is the preferred biofiltration system of civil engineers across the country due to its versatile design. This highly versatile system has available “pipe-in” options on most models, along with built-in curb or grated inlets for simple integration into your storm drain design.



CURB TYPE

The Curb Type configuration accepts sheet flow through a curb opening and is commonly used along roadways and parking lots. It can be used in sump or flow-by conditions. Length of curb opening varies based on model and size.

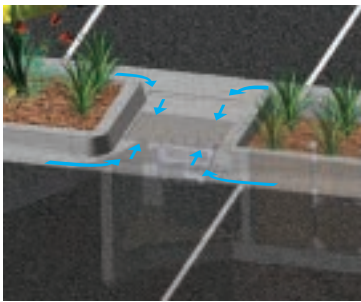

GRATE TYPE

The Grate Type configuration offers the same features and benefits as the Curb Type but with a grated/drop inlet above the systems pretreatment chamber. It has the added benefit of allowing pedestrian access over the inlet. ADA-compliant grates are available to assure easy and safe access. The Grate Type can also be used in scenarios where runoff needs to be intercepted on both sides of landscape islands.

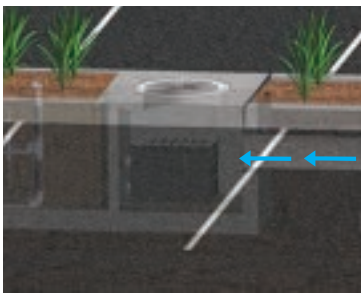

VAULT TYPE

The system’s patented horizontal flow biofilter is able to accept inflow pipes directly into the pretreatment chamber, meaning the MWS Linear can be used in end-of-the-line installations. This greatly improves feasibility over typical decentralized designs that are required with other biofiltration/bioretenion systems. Another benefit of the “pipe-in” design is the ability to install the system downstream of underground detention systems to meet water quality volume requirements.



DOWNSPOUT TYPE

The Downspout Type is a variation of the Vault Type and is designed to accept a vertical downspout pipe from rooftop and podium areas. Some models have the option of utilizing an internal bypass, simplifying the overall design. The system can be installed as a raised planter, and the exterior can be stuccoed or covered with other finishes to match the look of adjacent buildings.

ORIENTATIONS

SIDE-BY-SIDE

The Side-By-Side orientation places the pretreatment and discharge chamber adjacent to one another with the biofiltration chamber running parallel on either side. This minimizes the system length, providing a highly compact footprint. It has been proven useful in situations such as streets with directly adjacent sidewalks, as half of the system can be placed under that sidewalk. This orientation also offers internal bypass options as discussed below.



END-TO-END

The End-To-End orientation places the pretreatment and discharge chambers on opposite ends of the biofiltration chamber, therefore minimizing the width of the system to 5 ft. (outside dimension). This orientation is perfect for linear projects and street retrofits where existing utilities and sidewalks limit the amount of space available for installation. One limitation of this orientation is that bypass must be external.

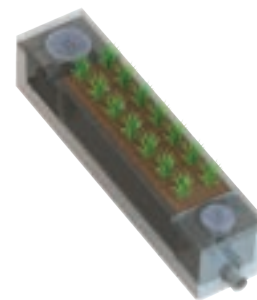

BYPASS

INTERNAL BYPASS WEIR (SIDE-BY-SIDE ONLY)

The Side-By-Side orientation places the pretreatment and discharge chambers adjacent to one another allowing for integration of internal bypass. The wall between these chambers can act as a bypass weir when flows exceed the system's treatment capacity, thus allowing bypass from the pretreatment chamber directly to the discharge chamber.

EXTERNAL DIVERSION WEIR STRUCTURE

This traditional offline diversion method can be used with the MWS Linear in scenarios where runoff is being piped to the system. These simple and effective structures are generally configured with two outflow pipes. The first is a smaller pipe on the upstream side of the diversion weir - to divert low flows over to the MWS Linear for treatment. The second is the main pipe that receives water once the system has exceeded treatment capacity and water flows over the weir.

FLOW-BY-DESIGN

This method is one in which the system is placed just upstream of a standard curb or grate inlet to intercept the first flush. Higher flows simply pass by the MWS Linear and into the standard inlet downstream.

DVERT LOW FLOW DIVERSION

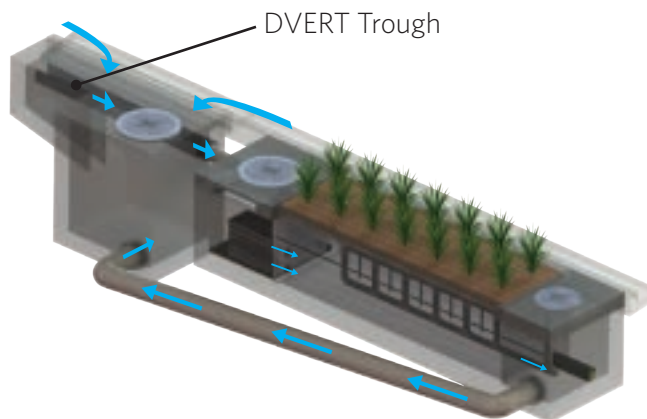

This simple yet innovative diversion trough can be installed in existing or new curb and grate inlets to divert the first flush to the MWS Linear via pipe. It works similar to a rain gutter and is installed just below the opening into the inlet. It captures the low flows and channels them over to a connecting pipe exiting out the wall of the inlet and leading to the MWS Linear. The DVERT is perfect for retrofit and green street applications that allow the MWS Linear to be installed anywhere space is available.

SPECIFICATIONS

FLOW-BASED

The MWS Linear can be used in stand-alone applications to meet treatment flow requirements. Since the MWS Linear is the only biofiltration system that can accept inflow pipes several feet below the surface, it can be used not only in decentralized design applications but also as a large central end-of-the-line application for maximum feasibility.

| MODEL # | DIMENSIONS | WETLAND MEDIA SURFACE AREA (sq.ft.) | TREATMENT FLOW RATE (cfs) |
|------------|------------|-------------------------------------|---------------------------|
| MWS-L-4-4 | 4' x 4' | 23 | 0.052 |
| MWS-L-4-6 | 4' x 6' | 32 | 0.073 |
| MWS-L-4-8 | 4' x 8' | 50 | 0.115 |
| MWS-L-4-13 | 4' x 13' | 63 | 0.144 |
| MWS-L-4-15 | 4' x 15' | 76 | 0.175 |
| MWS-L-4-17 | 4' x 17' | 90 | 0.206 |
| MWS-L-4-19 | 4' x 19' | 103 | 0.237 |
| MWS-L-4-21 | 4' x 21' | 117 | 0.268 |
| MWS-L-6-8 | 7' x 9' | 64 | 0.147 |
| MWS-L-8-8 | 8' x 8' | 100 | 0.230 |
| MWS-L-8-12 | 8' x 12' | 151 | 0.346 |
| MWS-L-8-16 | 8' x 16' | 201 | 0.462 |
| MWS-L-8-20 | 9' x 21' | 252 | 0.577 |
| MWS-L-8-24 | 9' x 25' | 302 | 0.693 |

SPECIFICATIONS

VOLUME-BASED

Many states require treatment of a water quality volume and do not offer the option of flow-based design. The MWS Linear and its unique horizontal flow makes it the only biofilter that can be used in volume-based design installed downstream of ponds, detention basins, and underground storage systems.

| MODEL # | TREATMENT CAPACITY (cu. ft.) @ 24-HOUR DRAINDOWN | TREATMENT CAPACITY (cu. ft.) @ 48-HOUR DRAINDOWN |
|------------|---|---|
| MWS-L-4-4 | 1140 | 2280 |
| MWS-L-4-6 | 1600 | 3200 |
| MWS-L-4-8 | 2518 | 5036 |
| MWS-L-4-13 | 3131 | 6261 |
| MWS-L-4-15 | 3811 | 7623 |
| MWS-L-4-17 | 4492 | 8984 |
| MWS-L-4-19 | 5172 | 10345 |
| MWS-L-4-21 | 5853 | 11706 |
| MWS-L-6-8 | 3191 | 6382 |
| MWS-L-8-8 | 5036 | 10072 |
| MWS-L-8-12 | 7554 | 15109 |
| MWS-L-8-16 | 10073 | 20145 |
| MWS-L-8-20 | 12560 | 25120 |
| MWS-L-8-24 | 15108 | 30216 |

APPLICATIONS

The MWS Linear has been successfully used on numerous new construction and retrofit projects. The system's superior versatility makes it beneficial for a wide range of stormwater and waste water applications - treating rooftops, streetscapes, parking lots, and industrial sites.



INDUSTRIAL

Many states enforce strict regulations for discharges from industrial sites. The MWS Linear has helped various sites meet difficult EPA-mandated effluent limits for dissolved metals and other pollutants.



RESIDENTIAL

Low to high density developments can benefit from the versatile design of the MWS Linear. The system can be used in both decentralized LID design and cost-effective end-of-the-line configurations.

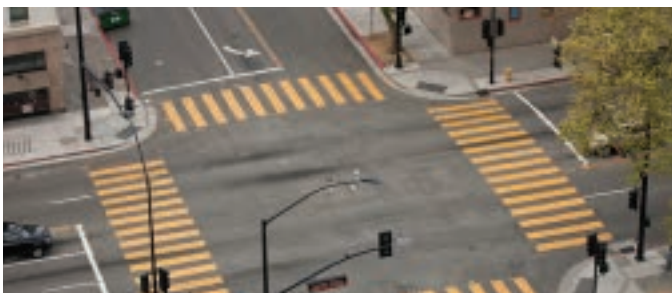

STREETS

Street applications can be challenging due to limited space. The MWS Linear is very adaptable, and it offers the smallest footprint to work around the constraints of existing utilities on retrofit projects.



PARKING LOTS

Parking lots are designed to maximize space and the MWS Linear's 4 ft. standard planter width allows for easy integration into parking lot islands and other landscape medians.



COMMERCIAL

Compared to bioretention systems, the MWS Linear can treat far more area in less space, meeting treatment and volume control requirements.



MIXED USE

The MWS Linear can be installed as a raised planter to treat runoff from rooftops or patios, making it perfect for sustainable "live-work" spaces.

More applications include:

- Agriculture
- Reuse
- Low Impact Development
- Waste Water

PLANT SELECTION

Abundant plants, trees, and grasses bring value and an aesthetic benefit to any urban setting, but those in the MWS Linear do even more - they increase pollutant removal. What's not seen, but very important, is that below grade, the stormwater runoff/flow is being subjected to nature's secret weapon: a dynamic physical, chemical, and biological process working to break down and remove non-point source pollutants. The flow rate is controlled in the MWS Linear, giving the plants more contact time so that pollutants are more successfully decomposed, volatilized, and incorporated into the biomass of the MWS Linear's micro/macro flora and fauna.



A wide range of plants are suitable for use in the MWS Linear, but selections vary by location and climate. View suitable plants by visiting biocleanenvironmental.com/plants.

INSTALLATION



The MWS Linear is simple, easy to install, and has a space-efficient design that offers lower excavation and installation costs compared to traditional tree-box type systems. The structure of the system resembles precast catch basin or utility vaults and is installed in a similar fashion.

The system is delivered fully assembled for quick installation. Generally, the structure can be unloaded and set in place in 15 minutes. Our experienced team of field technicians are available to supervise installations and provide technical support.

MAINTENANCE



Reduce your maintenance costs, man hours, and materials with the MWS Linear. Unlike other biofiltration systems that provide no pretreatment, the MWS Linear is a self-contained treatment train which incorporates simple and effective pretreatment.

Maintenance requirements for the biofilter itself are almost completely eliminated, as the pretreatment chamber removes and isolates trash, sediments, and hydrocarbons. What's left is the simple maintenance of an easily accessible pretreatment chamber that can be cleaned by hand or with a standard vac truck. Only periodic replacement of low-cost media in the pre-filter cartridges is required for long-term operation, and there is absolutely no need to replace expensive biofiltration media.



398 Via El Centro
Oceanside, CA 92058
855.566.3938
stormwater@forterrabp.com
biocleanenvironmental.com



Section [_____] Modular Subsurface Flow Wetland System

PART 1 – GENERAL

01.01.00 Purpose

The purpose of this specification is to establish generally acceptable criteria for Modular Subsurface Flow Wetland Systems used for biofiltration of stormwater runoff including dry weather flows and other contaminated water sources. It is intended to serve as a guide to producers, distributors, architects, engineers, contractors, plumbers, installers, inspectors, agencies and users; to promote understanding regarding materials, manufacture and installation; and to provide for identification of devices complying with this specification.

01.02.00 Description

Modular Subsurface Flow Wetland Systems (MSFWS) are used for filtration of stormwater runoff including dry weather flows. The MSFWS is a pre-engineered biofiltration system composed of a pretreatment chamber containing filtration cartridges, a horizontal flow biofiltration chamber with a peripheral void area and a centralized and vertically extending underdrain, the biofiltration chamber containing a sorptive media mix which does not contain any organic material and a layer of plant establishment media, and a discharge chamber containing an orifice control structure. Treated water flows horizontally in series through the pretreatment chamber cartridges, biofiltration chamber and orifice control structure.

01.03.00 Manufacturer

The manufacturer of the MSFWS shall be one that is regularly engaged in the engineering design and production of systems developed for the treatment of stormwater runoff for at least (10) years, and which have a history of successful production, acceptable to the engineer of work. In accordance with the drawings, the MSFWS(s) shall be a filter device Manufactured by Bio Clean Environmental Services, Inc., or Modular Wetland Systems, Inc., or assigned distributors or licensees. Bio Clean Environmental Services Inc., and Modular Wetland Systems, Inc., can be reached at:

Corporate Headquarters:
Bio Clean Environmental Service, Inc.
2972 San Luis Rey Road
Oceanside, CA 92058
Phone: (760) 433-7640
Fax: (760) 433-3176
www.biocleanenvironmental.net

Corporate Headquarters:
Modular Wetland Systems, Inc.
P.O. Box 869
Oceanside, CA 92049
Phone: (760) 433-7650
www.modularwetlands.net



01.04.00 Submittals

- 01.04.01 Shop drawings are to be submitted with each order to the contractor and consulting engineer.
- 01.04.02 Shop drawings are to detail the MSFWS and all components required and the sequence for installation, including:
 - System configuration with primary dimensions
 - Interior components
 - Any accessory equipment called out on shop drawings
- 01.04.03 Inspection and maintenance documentation submitted upon request.

01.05.00 Work Included

- 01.05.01 Specification requirements for installation of MSFWS.
- 01.05.02 Manufacturer to supply components of the MSFWS(s):
 - Pretreatment chamber components (pre-assembled)
 - Concrete Structure(s)
 - Biofiltration chamber components (pre-assembled)
 - Flow control discharge structure (pre-assembled)

01.06.00 Reference Standards

| | |
|----------------|---|
| ASTM C 29 | Standard Test Method for Unit Weight and Voids in Aggregate |
| ASTM C 88 | C 88 Standard Test Method for Soundness of Aggregates by Use of Sodium Sulfate or Magnesium Sulfate |
| ASTM C131 | C 131 Standard Test Method for Resistance to Degradation of Small-Size Coarse Aggregates by Abrasion and Impact in the Los Angeles Machine |
| ASTM C 136 | C 136 Standard Test Method for Sieve Analysis of Fine and Coarse Aggregates |
| ASTM C 330 | C 330 Standard Specification for Lightweight Aggregate for Structural Concrete |
| ASTM D 698 | Test Method for Laboratory Compaction Characteristics of Soil Using Standard Effort (12,400 ft.-lbf/ft ³ (600 kN-m/m ³)) |
| ASTM D 1621 | 10 Standard Test Method for Compressive Properties Of Rigid Cellular Plastics |
| ASTM D 1777 | ASTM D1777 - 96(2007) Standard Test Method for Thickness of Textile Materials |
| ASTM D 4716 | Standard Test Method for Determining the (In-plane) Flow Rate per Unit Width and Hydraulic Transmissivity of a Geosynthetic Using a Constant Head |
| AASHTO T 99-01 | Standard Method of Test for Moisture-Density Relations of Soils Using a 2.5-kg (5.5-lb) Rammer and a 305-mm (12-in) Drop |
| AASHTO T 104 | Standard Method of Test for Soundness of Aggregate by Use of Sodium Sulfate or Magnesium Sulfate |
| AASHTO T 260 | Standard Method of Test for Sampling and Testing for Chloride Ion in Concrete and Concrete Raw Materials. |
| AASHTO T 288 | Standard Method of Test for Determining Minimum Laboratory Soil Resistivity |
| AASHTO T 289 | Standard Method of Test for Determining ph of Soil for Use in Corrosion Testing |
| AASHTO T 291 | Standard Method of Test for Determining Water Soluble Chloride Ion Content in Soil |
| AASHTO T 290 | T 290 Standard Method of Test for Determining Water Soluble Sulfate Ion Content in Soil |



PART 2 – COMPONENTS

The Modular Subsurface Flow Wetland Systems (MSFWS) and all of its components shall be self-contained within a concrete structure constructed of concrete with a minimum 28 day compressive strength of 5,000 psi, with reinforcing per ASTM A 615, Grade 60, and supports and H2O loading as indicated by AASHTO. Each Chamber shall have appropriate access hatches for easy maintenance and sized to allow removal of all internal components without disassembly. All water transfer system components shall conform with the following;

- Filter netting shall be 100% Polyester with a number 16 sieve size, and strength tested per ASTM D 3787.
- Drainage cells shall be manufactured of lightweight injection-molded plastic and have a minimum compressive strength test of 6,000 psi and a void area along the surface making contact with the filter media of 75% or greater. The cells shall be at least 2" in thickness and allow water to freely flow in all four directions.

02.01.00 Pretreatment Chamber Components

- 02.01.01 Filter Cartridges shall operate at a loading rate not to exceed 3 gallons per minute per square foot surface area.
- 02.01.02 Drain Down System shall include a pervious floor that allows water to drain into the underdrain pipe that is connected to the discharge chamber.

02.02.00 Biofiltration Chamber Components

- 02.02.01 Media shall consist of ceramic material produced by expanding and vitrifying select material in a rotary kiln. Media must be produced to meet the requirements of ASTM C330, ASTM C331, and AASHTO M195. Aggregates must have a minimum 24-hour water absorption of 10.5% mass. Media shall not contain any organic material. Flow through media shall be horizontal from the outer perimeter of the chamber toward the centralized and vertically extending underdrain. The retention time in the media shall be at least 3 minutes. Downward flow filters are not acceptable alternatives. The thickness of the media shall be at least 19" from influent end to effluent end. The loading rate on the media shall not exceed 1.1 gallons per minute per square foot surface area. Media must be contained within structure that spaces the surface of the media at least 2" from all vertically extending walls of the concrete structure.
- 02.02.02 Planting shall be native, drought tolerant species recommend by manufacturer and/or landscape architect.
- 02.02.03 Plant Support Media shall be made of a 3" thick moisture retention cell that is inert and contains no chemicals or fertilizers, is not made of organic material and has an internal void percentage of 80%.

02.03.00 Discharge Chamber

The discharge device shall house a flow control orifice plate that restricts flows greater than designed treatment flow rate. All piping components shall be made of a high-density polyethylene. The discharge chamber shall also contain a drain down filter if specified on the drawing.



PART 3 – PERFORMANCE

03.01.00 General

- 03.01.01 Function - The MSFWS has no moving internal components and functions based on gravity flow, unless otherwise specified. The MSFWS is composed of a pretreatment chamber, a biofiltration chamber and a discharge chamber. The pretreatment device houses cartridge media filters, which consist of filter media housed in a perforated enclosure. The untreated runoff flows into the system via subsurface piping and or surface inlet. Water entering the system is forced through the filter cartridge enclosures by gravity flow. Then the flow contacts the filter media. The flow through the media is horizontal toward the center of each individual media filter. In the center of the media shall be a round slotted PVC pipe of no greater than 1.5” in diameter. The slotted PVC pipe shall extend downward into the water transfer cavity of the cartridge. The slotted PVC pipe shall be threaded on the bottom to connect to the water transfer cavity. After pollutants have been removed by the filter media the water discharges the pretreatment chamber and flows into the water transfer system and is conveyed to the biofiltration chamber. Once runoff has been filtered by the biofiltration chamber it is collected by the vertical underdrain and conveyed to a discharge chamber equipped with a flow control orifice plate. Finally the treated flow exits the system.
- 03.01.02 Pollutants - The MSFWS will remove and retain debris, sediments, TSS, dissolved and particulate metals and nutrients including nitrogen and phosphorus species, bacteria, BOD, oxygen demanding substances, organic compounds and hydrocarbons entering the filter during frequent storm events and continuous dry weather flows.
- 03.01.03 Treatment Flow Rate and Bypass - The MSFWS operates in-line. The MSFWS will treat 100% of the required water quality treatment flow based on a minimum filtration capacities listed in section 03.02.00. The size of the system must match those provided on the drawing to ensure proper performance and hydraulic residence time.

Minimum Treatment Capabilities

- System must be capable of treating flows to the specified treatment flow rate on the drawings. The flow rate shall be controlled by an orifice plate.

PART 4 - EXECUTION

04.01.00 General

The installation of the MSFWS shall conform to all applicable national, state, state highway, municipal and local specifications.

04.02.00 Installation

The Contractor shall furnish all labor, equipment, materials and incidentals required to install the (MSFWS) device(s) and appurtenances in accordance with the drawings and these specifications.

- 04.02.01 Grading and Excavation site shall be properly surveyed by a registered professional surveyor, and clearly marked with excavation limits and elevations. After site is marked it is the responsibility of the contractor to contact local utility companies and/or DigAlert to check for underground utilities. All grading permits shall be approved by governing agencies before commencement of grading and excavation. Soil conditions shall be tested in accordance with the governing agencies requirements. All earth removed shall be transported, disposed, stored, and handled per governing agencies standards. It is the responsibility of the contractor to install and maintain proper erosion control measures during grading and excavation operations.
- 04.02.02 Compaction – All soil shall be compacted per registered professional soils engineer’s recommendations prior to installation of MSFWS components.
- 04.02.03 Backfill shall be placed according to a registered professional soils engineer’s recommendations, and with a minimum of 6” of gravel under all concrete structures.
- 04.02.04 Concrete Structures – After backfill has been inspected by the governing agency and approved the concrete structures shall be lifted and placed in proper position per plans.
- 04.02.05 Subsurface Flow Wetland Media shall be carefully loaded into area so not to damage the Wetland Liner or Water Transfer Systems. The entire wetland area shall be filled to a level 9 inches below finished surface.
- 04.02.06 Planting layer shall be installed per manufacturer’s drawings and consist of a minimum 3” grow enhancement media that ensures greater than 95% plant survival rate, and 6” of wetland media. Planting shall consist of native plants recommended by manufacturer and/or landscape architect. Planting shall be drip irrigated for at least the first 3 months to insure long term plant growth. No chemical herbicides, pesticides, or fertilizers shall be used in the planting or care and maintenance of the planted area.

04.03.00 Shipping, Storage and Handling

- 04.03.01 Shipping – MSFWS shall be shipped to the contractor’s address or job site, and is the responsibility of the contractor to offload the unit(s) and place in the exact site of installation.
- 04.03.02 Storage and Handling– The contractor shall exercise care in the storage and handling of the MSFWS and all components prior to and during installation. Any repair or replacement costs associated with events occurring after delivery is accepted and unloading has commenced shall be born by the contractor. The MSFWS(s) and all components shall always be stored indoors and transported inside the original shipping container until the unit(s) are ready to be installed. The MSFWS shall always be handled with care and lifted according to OSHA and NIOSA lifting recommendations and/or contractor’s workplace safety professional recommendations.

04.04.00 Maintenance and Inspection

- 04.04.01 Inspection – After installation, the contractor shall demonstrate that the MSFWS has been properly installed at the correct location(s), elevations, and with appropriate components. All components associated with the MSFWS and its installation shall be subject to inspection by the engineer at the place of installation. In addition, the contractor shall demonstrate that the MSFWS has been installed per the manufacturer’s specifications and recommendations. All



- components shall be inspected by a qualified person once a year and results of inspection shall be kept in an inspection log.
- 04.04.02 Maintenance – The manufacturer recommends cleaning and debris removal maintenance of once a year and replacement of the Cartridge Filters as needed. The maintenance shall be performed by someone qualified. A Maintenance Manual is available upon request from the manufacturer. The manual has detailed information regarding the maintenance of the MSFWS. A Maintenance/Inspection record shall be kept by the maintenance operator. The record shall include any maintenance activities performed, amount and description of debris collected, and the condition of the filter.
- 04.04.03 Material Disposal - All debris, trash, organics, and sediments captured by the MSFWS shall be transported and disposed of at an approved facility for disposal in accordance with local and state requirements. Please refer to state and local regulations for the proper disposal of toxic and non-toxic material.

PART 5 – QUALITY ASSURNACE

05.01.00 Warranty

The Manufacturer shall guarantee the MSFWS against all manufacturing defects in materials and workmanship for a period of (5) years from the date of delivery to the _____. The manufacturer shall be notified of repair or replacement issues in writing within the warranty period. The MSFWS is limited to recommended application for which it was designed.

05.02.00 Performance Certification

The MSFWS manufacturer shall submit to the Engineer of Record a “Manufacturer’s Performance Certificate” certifying the MSFWS is capable of achieving the specified removal efficiency for suspended solids, phosphorous and dissolved metals.



Installation Guidelines for Modular Wetland System

Delivery & Unloading/Lifting

1. Modular Wetland Systems, Inc. shall deliver the unit(s) to the site in coordination with the Contractor.
2. The Contractor will require spreader bars and chains/cables to safely and securely lift the main structure, risers a set of suitable lifting hooks, knuckles, shackles and eye bolts.
3. The main structure and lid can be lifted together or separately.

Please see Modular Wetland Weights and Lifting Details. Contact Modular Wetlands for additional lifting details.

Inspection

1. Inspection of the Modular Wetland unit and all parts contained in or shipped outside of the unit shall be inspected at time of delivery by the site Engineer/Inspector and the Contractor. Any non-conformance to approved drawings or damage to any part of the system shall be documented on the Modular Wetland shipping ticket. Damage to the unit during and after unloading shall be corrected at the expense of the Contractor. Any necessary repairs to the Modular Wetland unit shall be made to the acceptance of the Engineer/Inspector.

Site Preparation

1. The Contractor is responsible for providing adequate and complete site/inlet protection when the Modular Wetland unit is installed prior to final site stabilization (full landscaping, grass cover, final paving, and street sweeping completed).
2. The Contractor shall adhere to all jurisdictional and/or OSHA safety rules in providing temporary shoring of the excavation.
3. The Contractor or Owner is responsible for appropriately barricading the Modular Wetland unit from traffic (in accordance with local codes).



Installation Guidelines for Modular Wetland System

Installation

1. Each unit shall be constructed at the locations and elevations according to the sizes shown on the approved drawings. Any modifications to the elevation or location shall be at the direction of and approved by the Engineer.
2. The unit shall be placed on the compacted sub-grade with a minimum 6-inch gravel base matching the final grade of the curb line in the area of the unit. The unit is to be placed such that the unit and top slab match the grade of the curb in the area of the unit. Compact undisturbed sub-grade materials to 95% of maximum density at +1% to 2% of the optimum moisture. Unsuitable material below sub-grade shall be replaced to site engineer's approval. Please see Modular Wetlands Weights and Lifting Details. Contact Modular Wetlands for guidance where slope exceeds 5%.
3. Once the unit is set, the internal wooden forms and protective silt fabric cover must be left intact (if WetlandMedia pre-installed). The top lid(s) should be sealed onto the box section before backfilling, using a non-shrink grout, butyl rubber or similar waterproof seal. The boards on the top of the lid and boards sealed in the unit's throat must NOT be removed. The Supplier will remove these sections at the time of activation.
4. Outlet connections shall be aligned and sealed to meet the approved drawings with modifications necessary to meet site conditions and local regulations. The correct outlet will be marked on the Modular Wetland unit.
5. Backfilling should be performed in a careful manner, bringing the appropriate fill material up in 6-inch lifts on all sides. Precast sections shall be set in a manner that will result in a watertight joint. In all instances, installation of the Modular Wetland unit shall conform to ASTM specification C891 "Standard Practice for Installation of Underground Precast Utility Structures" unless specified otherwise in contract documents.
6. It is the responsibility of the Contractor to provide curb and gutter and transition to the Modular Wetland unit for proper stormwater flow into the system through the throat, pipe or grate opening. A standard drawing of the throat and gutter detail is available in the following section; however the plans and contract documents supersede all standard drawings. Several variations of the standard design are available. Effective bypass for the Modular Wetland System is essential for correct operation (i.e. bypass to an overflow at lower elevation).

Installation Procedure

The contractor **MUST** provide all rigging and lifting apparatus, such as all cables, chains or straps and a set of lifting hooks, shackles, knuckles and eye bolts.



It is the contractor's responsibility to provide suitable lifting equipment to off-load the Modular Wetland unit.

Modular Wetland units are designed to be off-loaded using the contractor's spreader bar.



1. Apply Butyl Tape Seal

Apply butyl tape seal along the top of the box section. Butyl tape seal is provided with every unit.

Modular Wetland installed protective throat board and installed silt fabric must be left in place to protect the unit from construction sediment.



2. Unload and Set Box

Unload the Modular Wetland unit
the prepared hole with appropriate sub-grade.*

* Compacted sub-grade with a minimum
of six inches of gravel base which must match
the final grade of curb line the area of the unit.



3. Set Top On Box

Set the top slab on the box.

The Contractor is responsible for providing
adequate and complete site/inlet protection
when the Modular Wetland is installed prior
to final site stabilization (full landscaping,
grass cover, final paving, and street sweeping
completed).



4. Connect Outfall Pipe

The correct outlet will be marked on the
Modular Wetland.

Invert of outlet pipe **MUST** be even
with the floor of the system.



5. Install Curb & Gutter

It is the responsibility of the Contractor to provide curb and gutter and transition to the Modular Wetland for proper flow into the system through a 5" - 7" throat opening. A standard drawing of the throat and gutter detail in the following section. CONTRACTOR RESPONSIBLE FOR GROUTING IN ANY VISIBLE LIFTING POINTS.



6. Activation

Activation is performed **ONLY** by Modular Wetland personnel.

Activation can occur once the project site is fully stabilized (full landscaping, grass cover, final paving and street sweeping completed) and there is a 5" - 7" throat opening.

Call 760-433-7640 to schedule your activation.



NOTE: WetlandMedia Installation

For Larger models (MWS-L-4-13 and above) the system will be delivered without WetlandMedia pre-installed to minimize pick weight and prevent contamination of the media during construction. For these models the WetlandMedia will be delivered in bulk or in super sacks. It will be responsibility of the contractor to fill the system with the WetlandMedia during the installation process. Installation of the WetlandMedia can be done after the unit is fully installed to avoid contamination. See following pages for details.

WetlandMedia Install (if applicable)

1. Fill WetlandMedia

Position super sack of WetlandMedia over wetland chamber. Bottom of sack should not be more than 2' above top of system. Open sack and fill evenly*.

* One to several hundred cubic yards of WetlandMedia will be required based upon the model number and size of the system. For large scale jobs WetlandMedia will be delivered in bulk and will require a bobcat of similar to fill the system. All equipment is the responsibility of the contractor.



2. Install Plant Propagation Layer

Fill WetlandMedia up to 9" below the top of the wetland chamber. Level out the WetlandMedia as shown. Ensure that the level does not vary more than one inch or plant growth will be affected.



3. Install Plant Propagation Layer

Utilize plant propagation blocks provided by the manufacturer. Each block is approximately 40" by 6" by 3" thick. Blocks shall be placed side by side and end to end and cover the entire length and width of the wetland chamber unless specified.



4. Finish Filling WetlandMedia

After plant propagation blocks are installed repeat step 1 and fill the system to the top of the wetland chamber as shown. WetlandMedia must be filled within 2" of the top of the unit.



5. Planting

After system is filled with WetlandMedia planting of vegetation can begin. Utilizing 1 gallon plants dig down until The plant propagation blocks are reached. Remove plant and it's root ball from the container. Set the bottom of the root ball on the tops of the blocks. Fill hole back in with WetlandMedia. After planting a thorough watering of the plants is necessary. The plant propagation blocks must be saturated to provide a water source for the plants during the establishment phase. It is recommended that hand watering is done three times a week for the first two months. Hand water can be supplemented with drip or spray irrigation after the second week. Please call the manufacturer for more details on plants, planting arrangement and irrigation options.



NOTE: planting is required on all units, including units delivered with WetlandMedia pre-installed.



Curb and Gutter Details



Modular Wetland System, Inc.

P. 760.433-7640

F. 760-433-3176

E. Info@modularwetlands.com

www.modularwetlands.com

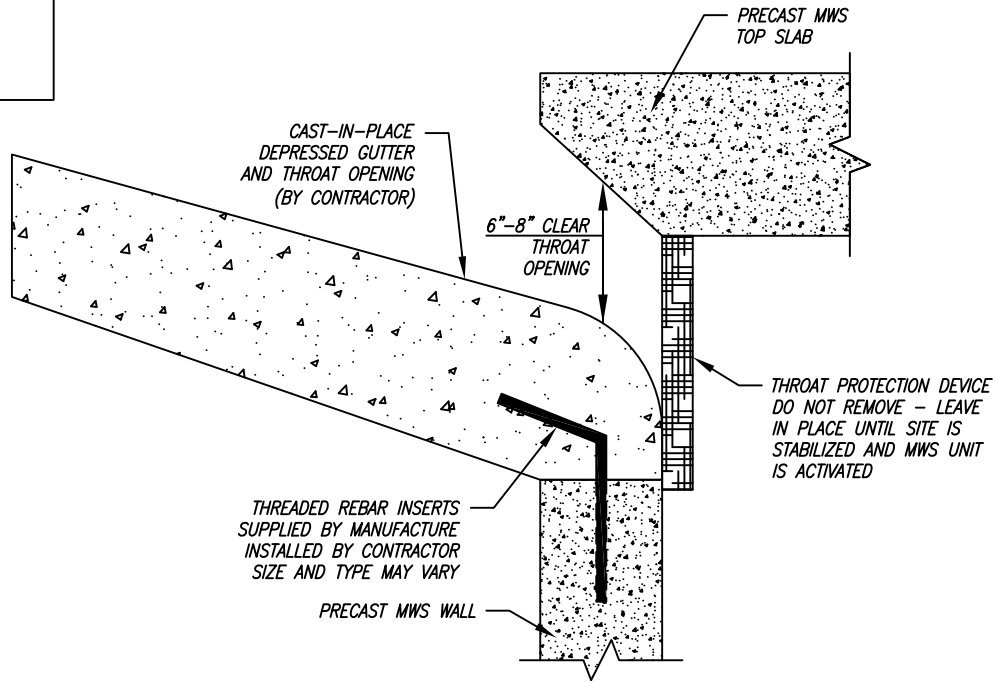

SECTION VIEW
STANDARD MODULAR WETLAND CURB OPENING

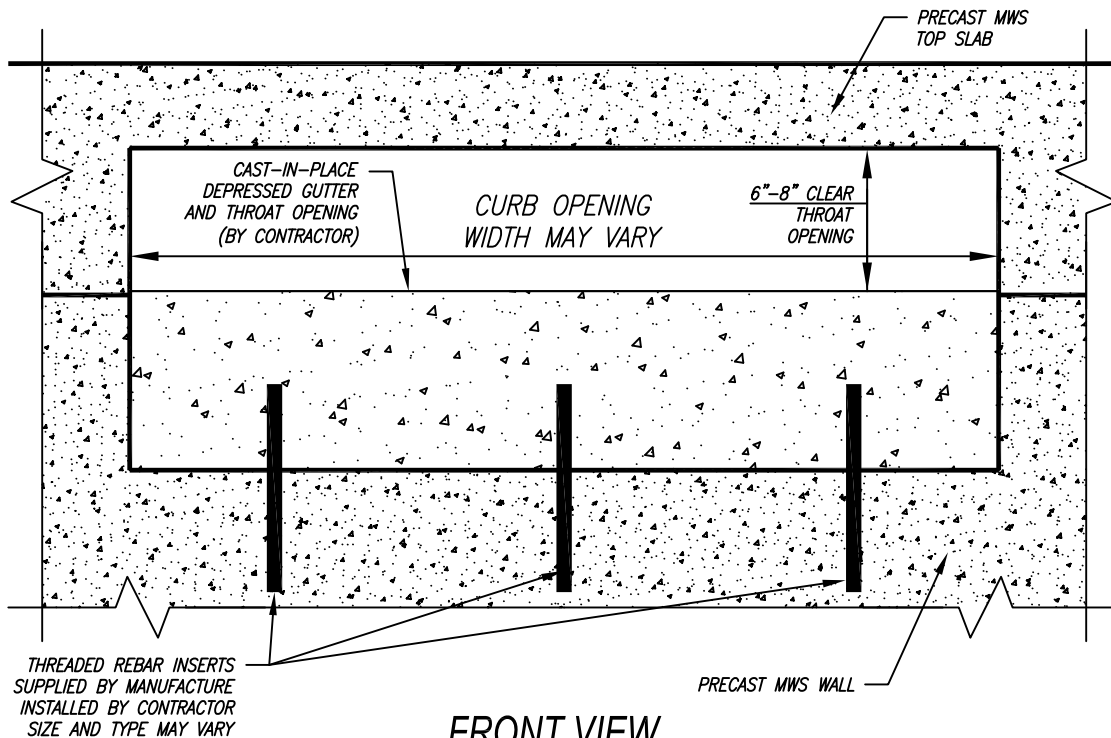

FRONT VIEW
STANDARD MODULAR WETLAND CURB OPENING

MODULAR WETLAND SYSTEMS INC.
P.O. BOX 869
OCEANSIDE, CA 92049
www.ModularWetlands.com

| | NAME | DATE |
|--------|------|--------|
| DRAWN | John | 5/3/13 |
| EDITED | | |

TITLE: *MWS LINEAR 2.0 CURB INLET DETAILS*

PROPRIETARY AND CONFIDENTIAL
THE INFORMATION CONTAINED IN THIS DRAWING IS THE SOLE PROPERTY OF MODULAR WETLAND SYSTEMS INC. ANY REPRODUCTION IN PART OR AS A WHOLE WITHOUT THE WRITTEN PERMISSION OF MODULAR WETLAND SYSTEMS INC. IS PROHIBITED.

COMMENTS:

| | | |
|-------|----------|----------------|
| SIZE | DWG. NO. | REV |
| SCALE | NTS | UNITS = INCHES |
| | | SHEET 1 OF 1 |

Weights and Lifting Details



Modular Wetland System, Inc.

P. 760.433-7640

F. 760-433-3176

E. Info@modularwetlands.com

www.modularwetlands.com

MWS-L 2.0 Max Pick Weights

| Model # | Size (O.D) | Size (I.D) | Unit Weight (lbs) | Media Weight (lbs) | Total Weight (lbs) |
|--------------------------|---------------------|----------------------|-------------------|--------------------|----------------------|
| MWS-L-4-4 | 5' x 5' | 4' x 4' | 7500.0 | 1607.7 | 9107.7 |
| MWS-L-4-6 MWS-L-4-6.5 | 5' x 7' 5 x 7.5' | 4' x 6' 4' x 6.5' | 11,000 11,500 | 1798.9 | 12,619.2 13,119.2 |
| MWS-L-4-8 | 5' x 9' | 8' x 4' | 12500 | 3966 | 16466 |
| MWS-L-4-13 | 5' x 14' | 13' x 4' | 21200 | 5895 | 27095 |
| MWS-L-4-15 | 5' x 16' | 15' x 4' | 23700 | 8039 | 31739 |
| MWS-L-4-17 | 5' x 18' | 17' x 4' | 26500 | 10182 | 36682 |
| MWS-L-4-19 | 5' x 20' | 19' x 4' | 28300 | 12326 | 40626 |
| MWS-L-4-21 | 5' x 22' | 21' x 4' | 30000 | 14470 | 44470 |
| MWS-L-6-8 | 7' x 9' | 6' x 8' | 24000 | 6109 | 30109 |
| MWS-L-8-8 | 9' x 9' | 8' x 8' | 32000 | 8253 | 40253 |
| MWS-L-8-12 | 9' x 13' | 8' x 12' | 44000 | 12540 | 56540 |
| MWS-L-8-16 | 9' x 17' | 8' x 16' | 47000 | 16828 | 63828 |

Max Pick Weight if Shipped
Without Media Installed

Max Pick Weight if Shipped
With Media Installed

Note: All weights listed hereon are standard max pick weights, actual pick weights may vary based upon state and local regulations and variation in concrete and rebar standards. For project specific pick weights contact the manufacturer prior to shipping of the unit(s). It is the contractor's responsibility to off-load the unit with an adequate size crane. Units are shipped with WetlandMEDIA in superbags and installed by contractor.

When Available see project contract terms, if lifting points are on the inside of the unit due to custom designs or installations requiring points to be on the inside the media will be shipped in bags and the contractor will be responsible to install after the unit is installed. For example, units placed against a wall.

For Questions or Comments Please Call 888-566-3938 or email: info@modularwetlands.com



Connection Details



Modular Wetland System, Inc.

P. 760.433-7640

F. 760-433-3176

E. Info@modularwetlands.com

www.modularwetlands.com

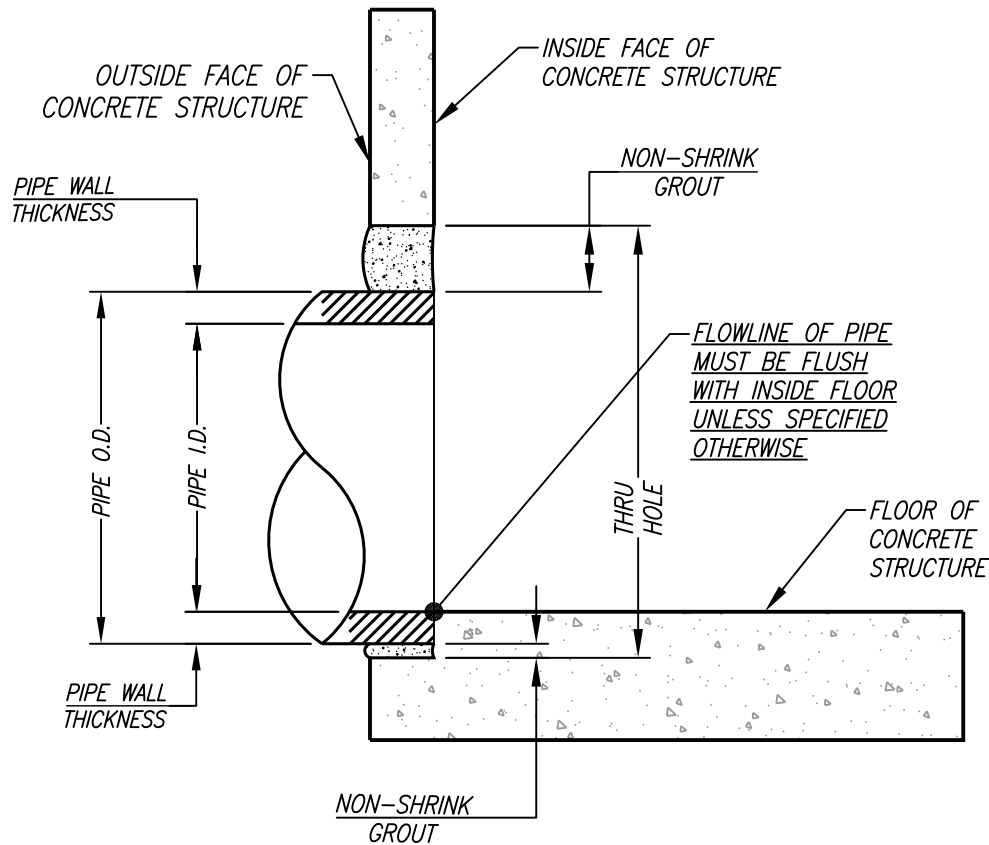

ELEVATION VIEW

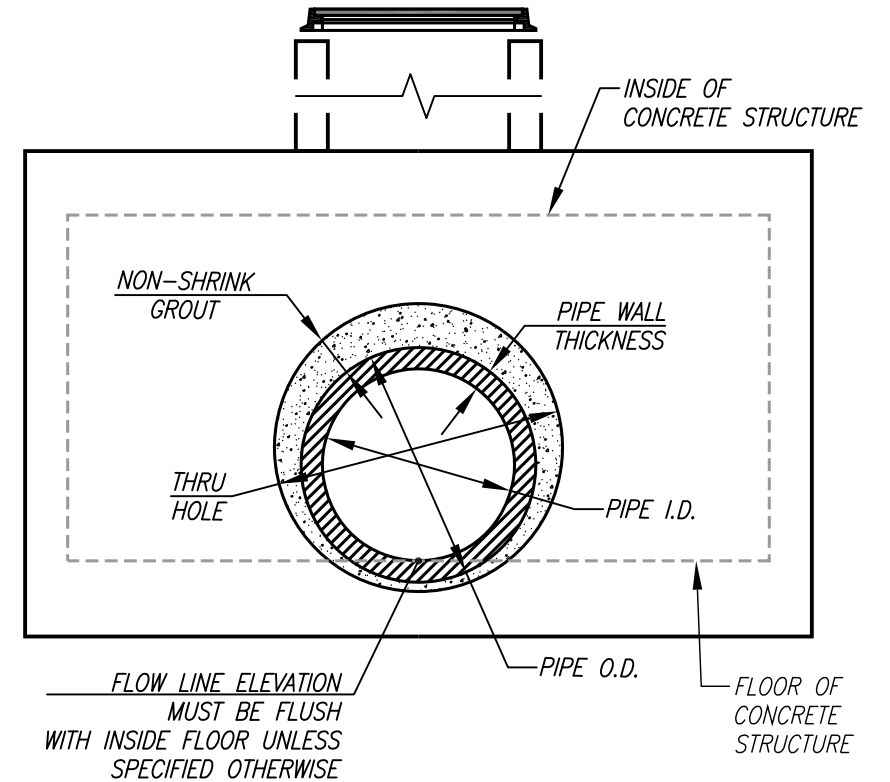

END VIEW

INSTALLATION NOTES

1. ALL CONNECTION PIPES SUPPLIED AND INSTALLED BY CONTRACTOR. MODULAR WETLAND UNIT WILL BE DELIVERED WITH A THRU HOLE AND ITS THE CONTRACTORS RESPONSIBILITY TO SUPPLY PIPE, AND ALL LABOR AND MATERIAL TO CONNECT PIPE AND SEAL UNIT WATER TIGHT INCLUDING BUT NOT LIMITED TO GROUT, CONCRETE LUG, REBAR, PLUG, ANCHORS, COUPLER, FITTINGS AND/OR ALL SUPPORT AND CONNECTING HARDWARE.
2. ALL CONNECTIONS ARE TO BE FLUSH WITH THE INSIDE SURFACE OF THE CONCRETE STRUCTURE. (CAN NOT INTRUDE BEYOND FLUSH) ALL PIPE FLOWLINES SHALL BE FLUSH WITH INSIDE FLOOR UNLESS SPECIFIED OTHERWISE.
3. ALL GROUT AND/OR CONCRETE SHALL BE NON-SHRINK AND MEET OR EXCEED LOCAL PIPE CONNECTION STANDARDS.
4. REFER TO AGENCY SPECIFICATIONS WHERE APPLICABLE.

THE PRODUCT DESCRIBED MAY BE PROTECTED BY ONE OR MORE OF THE FOLLOWING US PATENTS: 7,425,262; 7,470,362; 7,674,378; 8,303,816; RELATED FOREIGN PATENTS OR OTHER PATENTS PENDING

PROPRIETARY AND CONFIDENTIAL:

THE INFORMATION CONTAINED IN THIS DRAWING IS THE SOLE PROPERTY OF MODULAR WETLANDS SYSTEMS. ANY REPRODUCTION IN PART OR AS A WHOLE WITHOUT THE WRITTEN PERMISSION OF MODULAR WETLANDS SYSTEMS IS PROHIBITED.







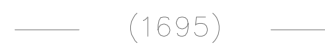

**PIPE CONNECTION
STANDARD DETAIL**

Appendix 7: Hydromodification

Supporting Detail Relating to Hydrologic Conditions of Concern

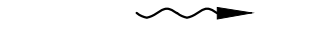
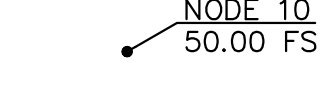
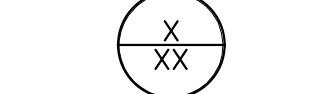
LEGEND



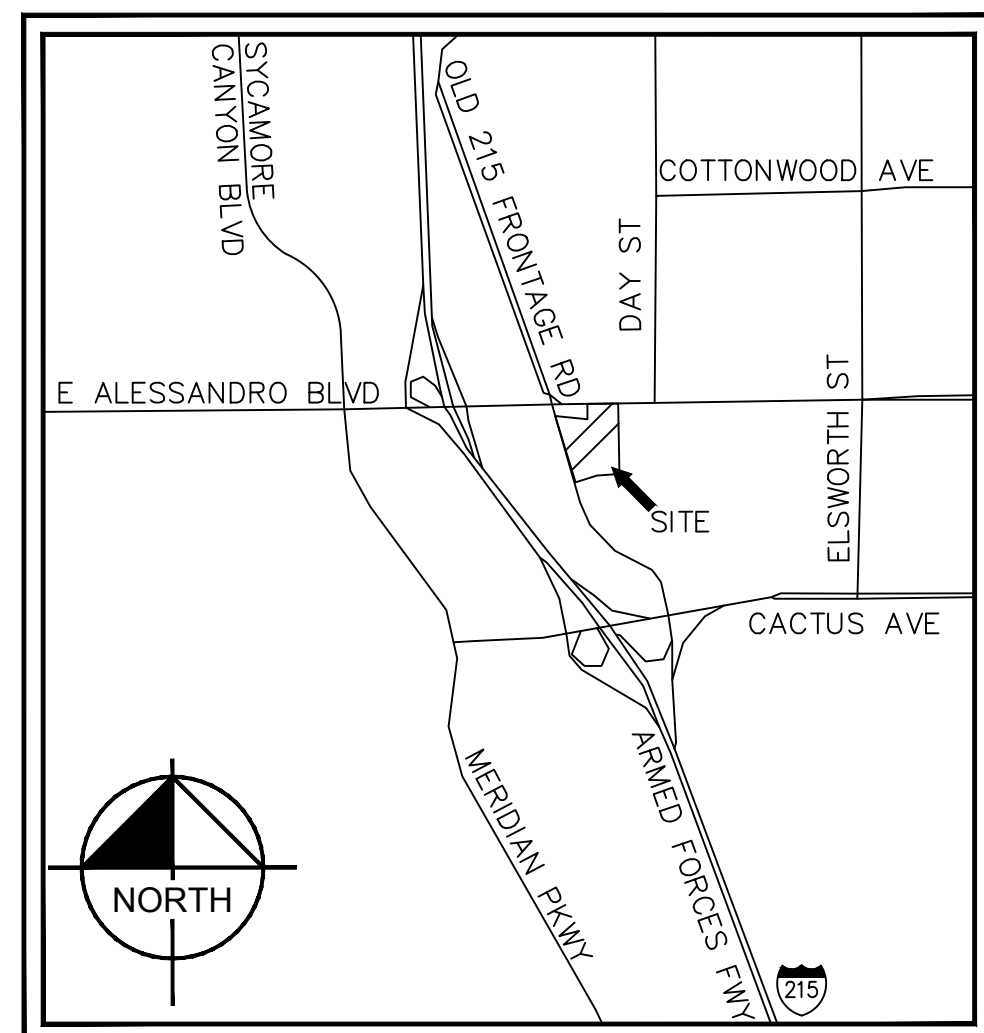
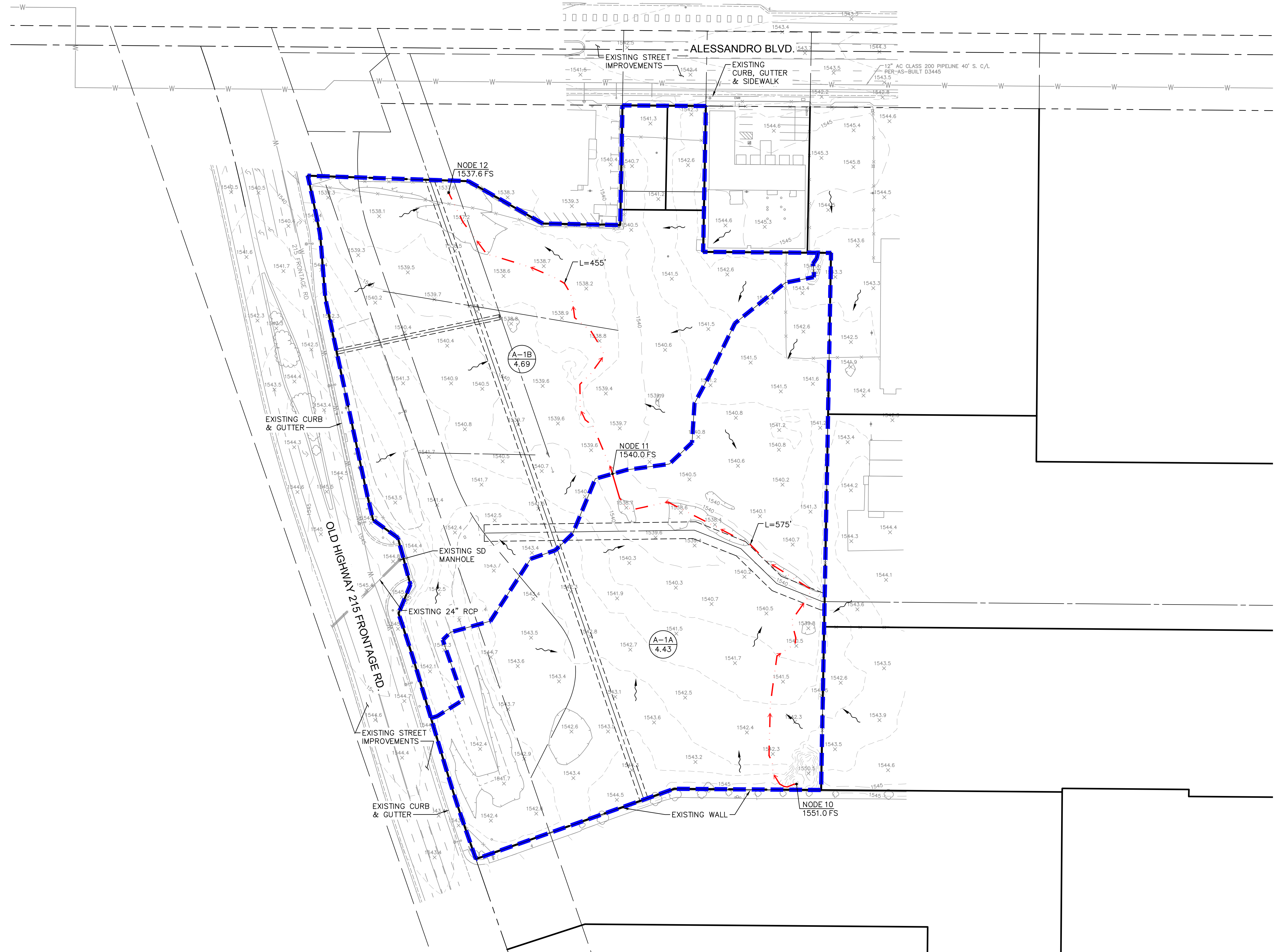



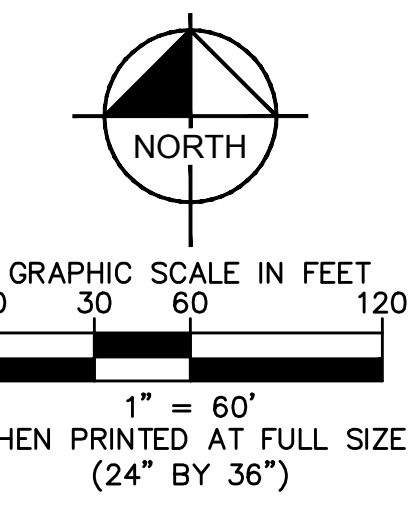

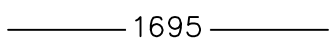
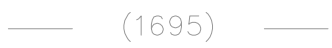

-  (1695) EXISTING CONTOUR
-  PROPERTY LINE
-  DMA BOUNDARY
-  FLOW PATH
-  FLOW ARROW
-  NODE 10
50.00 FS
-  DA NAME
DA AREA (IN ACRES)
-  RIGHT OF WAY



VICINITY MAP
NTS

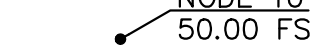

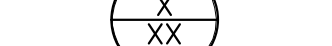
LEGEND

-  PROPOSED CONTOUR
-  EXISTING CONTOUR
-  PROPERTY LINE
-  DMA BOUNDARY
-  PROPOSED STORM DRAIN
-  FLOW PATH
-  FLOW ARROW
-  NODE ID AND ELEVATION
-  DA NAME
-  DA AREA (IN ACRES)
-  RIGHT OF WAY

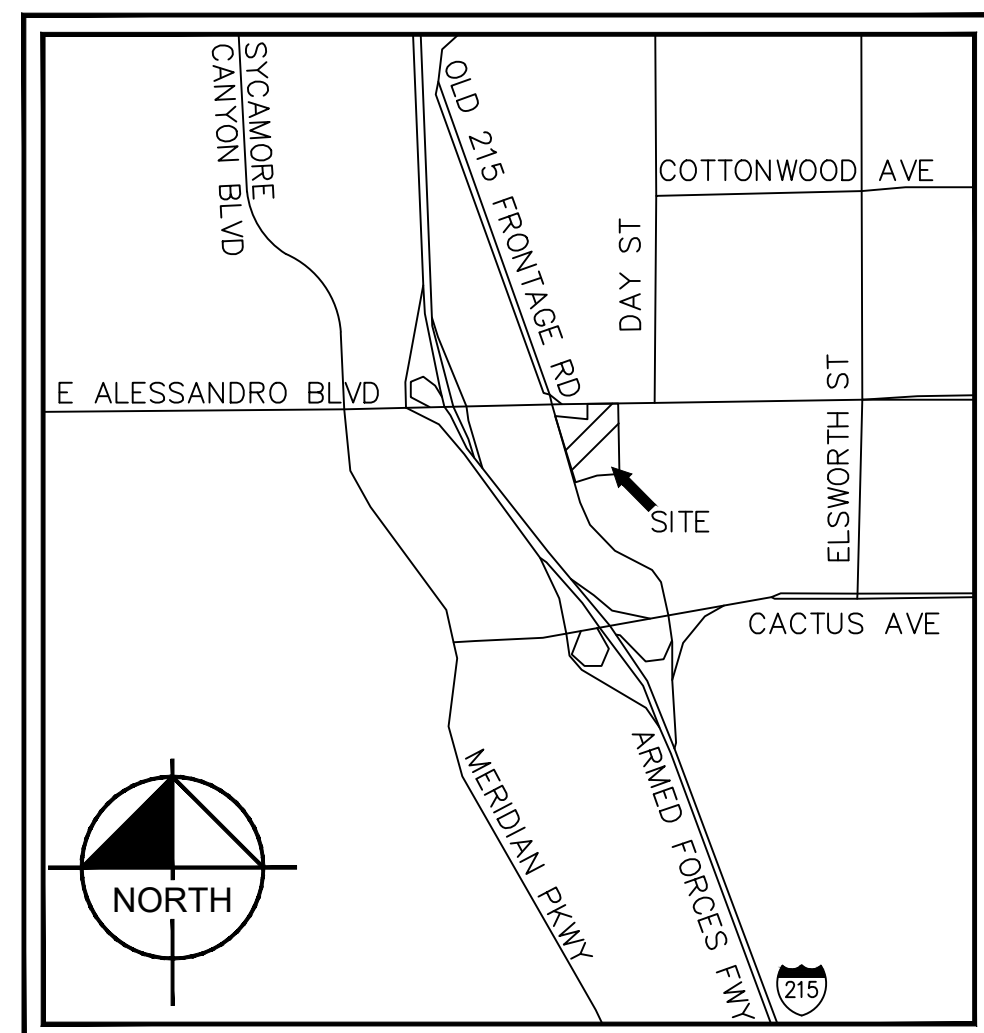
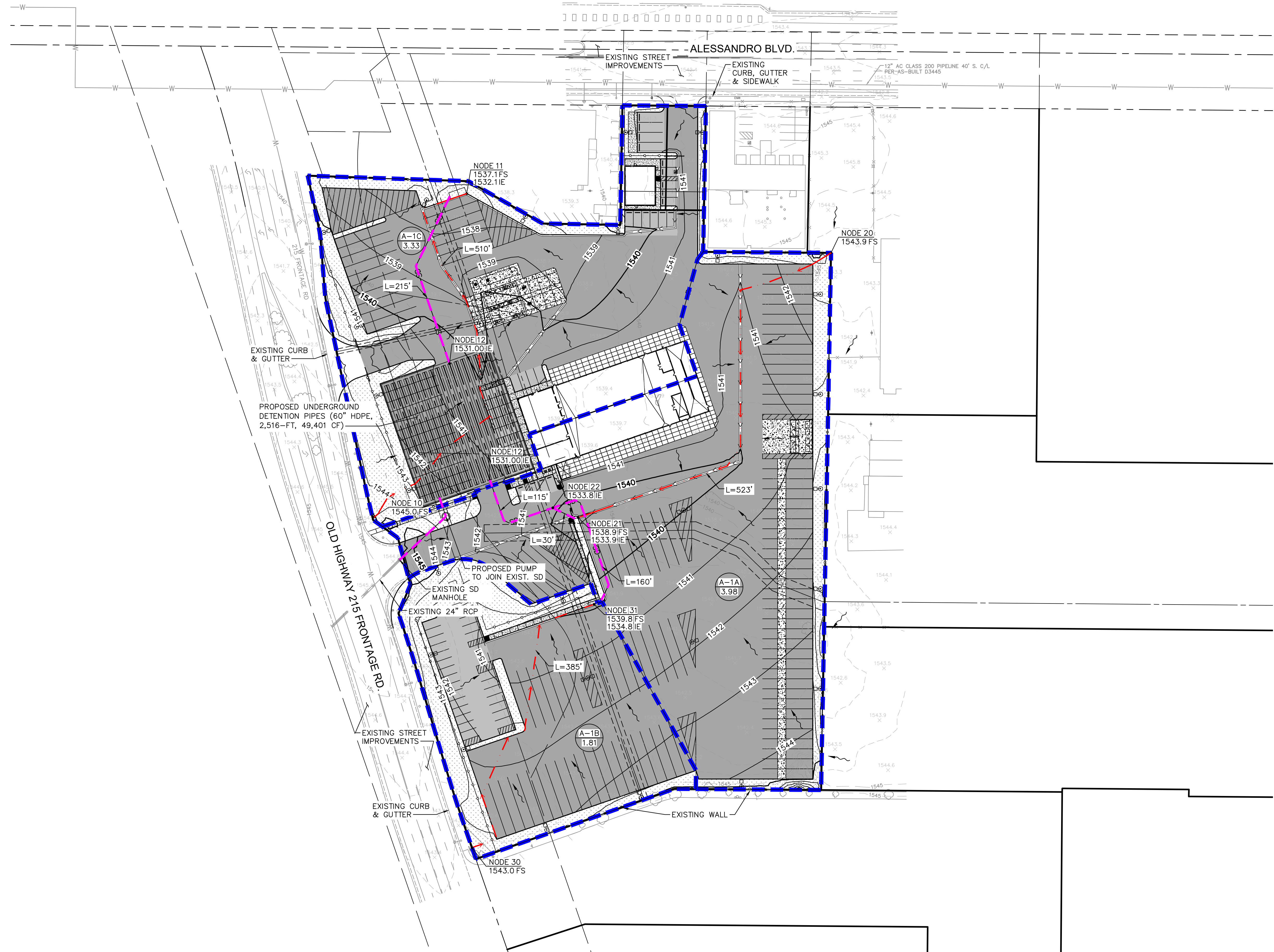

VICINITY MAP
NTS

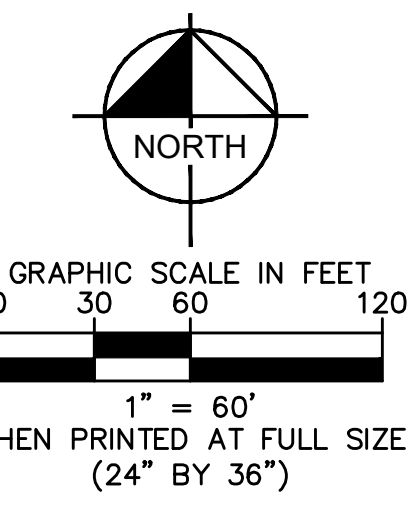

Riverside County Rational Hydrology Program

CIVILCADD/CIVILDESIGN Engineering Software, (c) 1989 - 2018 Version 9.0
Rational Hydrology Study Date: 11/10/21 File:P2E.out

PENSKE MORENO VALLEY
EXIST 2-YR
XO 11/10/21

***** Hydrology Study Control Information *****

English (in-lb) Units used in input data file

Program License Serial Number 6443

Rational Method Hydrology Program based on
Riverside County Flood Control & Water Conservation District
1978 hydrology manual

Storm event (year) = 2.00 Antecedent Moisture Condition = 1

Standard intensity-duration curves data (Plate D-4.1)
For the [Sunnymead-Moreno] area used.
10 year storm 10 minute intensity = 2.010(In/Hr)
10 year storm 60 minute intensity = 0.820(In/Hr)
100 year storm 10 minute intensity = 2.940(In/Hr)
100 year storm 60 minute intensity = 1.200(In/Hr)

Storm event year = 2.0
Calculated rainfall intensity data:
1 hour intensity = 0.554(In/Hr)
Slope of intensity duration curve = 0.5000

↑

Process from Point/Station 10.000 to Point/Station 11.000
**** INITIAL AREA EVALUATION ****

Initial area flow distance = 575.000(Ft.)
Top (of initial area) elevation = 51.000(Ft.)
Bottom (of initial area) elevation = 40.000(Ft.)
Difference in elevation = 11.000(Ft.)
Slope = 0.01913 s(percent)= 1.91
TC = $k(0.530)*[(length^3)/(elevation\ change)]^{0.2}$
Initial area time of concentration = 14.852 min.
Rainfall intensity = 1.114(In/Hr) for a 2.0 year storm
UNDEVELOPED (poor cover) subarea
Runoff Coefficient = 0.610
Decimal fraction soil group A = 0.000
Decimal fraction soil group B = 0.000
Decimal fraction soil group C = 1.000
Decimal fraction soil group D = 0.000
RI index for soil(AMC 1) = 71.60
Pervious area fraction = 1.000; Impervious fraction = 0.000
Initial subarea runoff = 3.013(CFS)
Total initial stream area = 4.430(Ac.)
Pervious area fraction = 1.000

↑

Process from Point/Station 11.000 to Point/Station 12.000
**** NATURAL CHANNEL TIME + SUBAREA FLOW ADDITION ****

Top of natural channel elevation = 40.000(Ft.)
End of natural channel elevation = 37.600(Ft.)
Length of natural channel = 455.000(Ft.)
Estimated mean flow rate at midpoint of channel = 4.607(CFS)

Natural valley channel type used
L.A. County flood control district formula for channel velocity:
Velocity(ft/s) = $(7 + 8(q(\text{English Units})^{.352})(\text{slope}^{.5}))$
Velocity using mean channel flow = 1.50(Ft/s)

Correction to map slope used on extremely rugged channels with
drops and waterfalls (Plate D-6.2)
Normal channel slope = 0.0053
Corrected/adjusted channel slope = 0.0053
Travel time = 5.04 min. TC = 19.90 min.

Adding area flow to channel
UNDEVELOPED (poor cover) subarea
Runoff Coefficient = 0.581
Decimal fraction soil group A = 0.000
Decimal fraction soil group B = 0.000
Decimal fraction soil group C = 1.000
Decimal fraction soil group D = 0.000
RI index for soil(AMC 1) = 71.60
Pervious area fraction = 1.000; Impervious fraction = 0.000
Rainfall intensity = 0.963(In/Hr) for a 2.0 year storm
Subarea runoff = 2.623(CFS) for 4.690(Ac.)
Total runoff = 5.635(CFS) Total area = 9.120(Ac.)
End of computations, total study area = 9.12 (Ac.)
The following figures may
be used for a unit hydrograph study of the same area.

Area averaged pervious area fraction(Ap) = 1.000
Area averaged RI index number = 86.0

Unit Hydrograph Analysis

Copyright (c) CIVILCADD/CIVILDESIGN, 1989 - 2018, Version 9.0
Study date 11/10/21 File: P2EUH242.out

Riverside County Synthetic Unit Hydrology Method
RCFC & WCD Manual date - April 1978

Program License Serial Number 6443

English (in-lb) Input Units Used
English Rainfall Data (Inches) Input Values Used

English Units used in output format

PENSKE MORENO VALLEY
EXIST. 2-YR
XO 11/10/21

Drainage Area = 9.12(Ac.) = 0.014 Sq. Mi.
Drainage Area for Depth-Area Areal Adjustment = 9.12(Ac.) = 0.014 Sq. Mi.
USER Entry of lag time in hours
Lag time = 0.265 Hr.
Lag time = 15.90 Min.
25% of lag time = 3.98 Min.
40% of lag time = 6.36 Min.
Unit time = 5.00 Min.
Duration of storm = 24 Hour(s)
User Entered Base Flow = 0.00(CFS)

2 YEAR Area rainfall data:

| Area(Ac.)[1] | Rainfall(In)[2] | Weighting[1*2] |
|--------------|-----------------|----------------|
| 9.12 | 1.84 | 16.78 |

100 YEAR Area rainfall data:

| Area(Ac.)[1] | Rainfall(In)[2] | Weighting[1*2] |
|--------------|-----------------|----------------|
| 9.12 | 4.52 | 41.22 |

STORM EVENT (YEAR) = 2.00
Area Averaged 2-Year Rainfall = 1.840(In)
Area Averaged 100-Year Rainfall = 4.520(In)

Point rain (area averaged) = 1.840(In)
Areal adjustment factor = 100.00 %
Adjusted average point rain = 1.840(In)

Sub-Area Data:
Area(Ac.) Runoff Index Impervious %
9.120 91.00 0.000
Total Area Entered = 9.12(Ac.)

| RI | RI | Infil. Rate | Impervious | Adj. Infil. Rate | Area% | F |
|------|-------|-------------|------------|------------------|--------|---------|
| AMC2 | AMC-1 | (In/Hr) | (Dec.%) | (In/Hr) | (Dec.) | (In/Hr) |

91.0 79.8 0.246 0.000 0.246 1.000 0.246
 Sum (F) = 0.246
 Area averaged mean soil loss (F) (In/Hr) = 0.246
 Minimum soil loss rate ((In/Hr)) = 0.123
 (for 24 hour storm duration)
 Soil low loss rate (decimal) = 0.900

U n i t H y d r o g r a p h
 VALLEY S-Curve

Unit Hydrograph Data

| Unit time period (hrs) | Time % of lag | Distribution Graph % | Unit Hydrograph (CFS) |
|------------------------|---------------|----------------------|-----------------------|
| 1 | 0.083 | 31.447 | 0.284 |
| 2 | 0.167 | 62.893 | 1.065 |
| 3 | 0.250 | 94.340 | 1.836 |
| 4 | 0.333 | 125.786 | 1.869 |
| 5 | 0.417 | 157.233 | 1.104 |
| 6 | 0.500 | 188.679 | 0.630 |
| 7 | 0.583 | 220.126 | 0.425 |
| 8 | 0.667 | 251.572 | 0.331 |
| 9 | 0.750 | 283.019 | 0.269 |
| 10 | 0.833 | 314.465 | 0.217 |
| 11 | 0.917 | 345.912 | 0.178 |
| 12 | 1.000 | 377.358 | 0.156 |
| 13 | 1.083 | 408.805 | 0.126 |
| 14 | 1.167 | 440.252 | 0.101 |
| 15 | 1.250 | 471.698 | 0.091 |
| 16 | 1.333 | 503.145 | 0.087 |
| 17 | 1.417 | 534.591 | 0.073 |
| 18 | 1.500 | 566.038 | 0.062 |
| 19 | 1.583 | 597.484 | 0.053 |
| 20 | 1.667 | 628.931 | 0.047 |
| 21 | 1.750 | 660.377 | 0.040 |
| 22 | 1.833 | 691.824 | 0.031 |
| 23 | 1.917 | 723.270 | 0.029 |
| 24 | 2.000 | 754.717 | 0.029 |
| 25 | 2.083 | 786.164 | 0.029 |
| 26 | 2.167 | 817.610 | 0.027 |
| | | Sum = 100.000 | Sum= 9.191 |

The following loss rate calculations reflect use of the minimum calculated loss rate subtracted from the Storm Rain to produce the maximum Effective Rain value

| Unit Time (Hr.) | Pattern Percent | Storm Rain (In/Hr) | Loss rate(In./Hr) Max Low | Effective (In/Hr) |
|-----------------|-----------------|--------------------|--------------------------------|-------------------|
| 1 | 0.07 | 0.015 | (0.437) 0.013 | 0.001 |
| 2 | 0.07 | 0.015 | (0.435) 0.013 | 0.001 |
| 3 | 0.07 | 0.015 | (0.433) 0.013 | 0.001 |
| 4 | 0.10 | 0.022 | (0.432) 0.020 | 0.002 |
| 5 | 0.10 | 0.022 | (0.430) 0.020 | 0.002 |
| 6 | 0.10 | 0.022 | (0.428) 0.020 | 0.002 |
| 7 | 0.10 | 0.022 | (0.427) 0.020 | 0.002 |
| 8 | 0.10 | 0.022 | (0.425) 0.020 | 0.002 |
| 9 | 0.10 | 0.022 | (0.423) 0.020 | 0.002 |
| 10 | 0.13 | 0.029 | (0.422) 0.026 | 0.003 |
| 11 | 0.13 | 0.029 | (0.420) 0.026 | 0.003 |
| 12 | 0.13 | 0.029 | (0.418) 0.026 | 0.003 |
| 13 | 0.10 | 0.022 | (0.417) 0.020 | 0.002 |
| 14 | 0.10 | 0.022 | (0.415) 0.020 | 0.002 |
| 15 | 0.10 | 0.022 | (0.413) 0.020 | 0.002 |
| 16 | 0.10 | 0.022 | (0.412) 0.020 | 0.002 |
| 17 | 0.10 | 0.022 | (0.410) 0.020 | 0.002 |
| 18 | 0.10 | 0.022 | (0.408) 0.020 | 0.002 |

| | | | | | | |
|----|------|------|-------|----------|-------|-------|
| 19 | 1.58 | 0.10 | 0.022 | (0.407) | 0.020 | 0.002 |
| 20 | 1.67 | 0.10 | 0.022 | (0.405) | 0.020 | 0.002 |
| 21 | 1.75 | 0.10 | 0.022 | (0.404) | 0.020 | 0.002 |
| 22 | 1.83 | 0.13 | 0.029 | (0.402) | 0.026 | 0.003 |
| 23 | 1.92 | 0.13 | 0.029 | (0.400) | 0.026 | 0.003 |
| 24 | 2.00 | 0.13 | 0.029 | (0.399) | 0.026 | 0.003 |
| 25 | 2.08 | 0.13 | 0.029 | (0.397) | 0.026 | 0.003 |
| 26 | 2.17 | 0.13 | 0.029 | (0.395) | 0.026 | 0.003 |
| 27 | 2.25 | 0.13 | 0.029 | (0.394) | 0.026 | 0.003 |
| 28 | 2.33 | 0.13 | 0.029 | (0.392) | 0.026 | 0.003 |
| 29 | 2.42 | 0.13 | 0.029 | (0.391) | 0.026 | 0.003 |
| 30 | 2.50 | 0.13 | 0.029 | (0.389) | 0.026 | 0.003 |
| 31 | 2.58 | 0.17 | 0.037 | (0.387) | 0.033 | 0.004 |
| 32 | 2.67 | 0.17 | 0.037 | (0.386) | 0.033 | 0.004 |
| 33 | 2.75 | 0.17 | 0.037 | (0.384) | 0.033 | 0.004 |
| 34 | 2.83 | 0.17 | 0.037 | (0.383) | 0.033 | 0.004 |
| 35 | 2.92 | 0.17 | 0.037 | (0.381) | 0.033 | 0.004 |
| 36 | 3.00 | 0.17 | 0.037 | (0.380) | 0.033 | 0.004 |
| 37 | 3.08 | 0.17 | 0.037 | (0.378) | 0.033 | 0.004 |
| 38 | 3.17 | 0.17 | 0.037 | (0.376) | 0.033 | 0.004 |
| 39 | 3.25 | 0.17 | 0.037 | (0.375) | 0.033 | 0.004 |
| 40 | 3.33 | 0.17 | 0.037 | (0.373) | 0.033 | 0.004 |
| 41 | 3.42 | 0.17 | 0.037 | (0.372) | 0.033 | 0.004 |
| 42 | 3.50 | 0.17 | 0.037 | (0.370) | 0.033 | 0.004 |
| 43 | 3.58 | 0.17 | 0.037 | (0.369) | 0.033 | 0.004 |
| 44 | 3.67 | 0.17 | 0.037 | (0.367) | 0.033 | 0.004 |
| 45 | 3.75 | 0.17 | 0.037 | (0.366) | 0.033 | 0.004 |
| 46 | 3.83 | 0.20 | 0.044 | (0.364) | 0.040 | 0.004 |
| 47 | 3.92 | 0.20 | 0.044 | (0.362) | 0.040 | 0.004 |
| 48 | 4.00 | 0.20 | 0.044 | (0.361) | 0.040 | 0.004 |
| 49 | 4.08 | 0.20 | 0.044 | (0.359) | 0.040 | 0.004 |
| 50 | 4.17 | 0.20 | 0.044 | (0.358) | 0.040 | 0.004 |
| 51 | 4.25 | 0.20 | 0.044 | (0.356) | 0.040 | 0.004 |
| 52 | 4.33 | 0.23 | 0.052 | (0.355) | 0.046 | 0.005 |
| 53 | 4.42 | 0.23 | 0.052 | (0.353) | 0.046 | 0.005 |
| 54 | 4.50 | 0.23 | 0.052 | (0.352) | 0.046 | 0.005 |
| 55 | 4.58 | 0.23 | 0.052 | (0.350) | 0.046 | 0.005 |
| 56 | 4.67 | 0.23 | 0.052 | (0.349) | 0.046 | 0.005 |
| 57 | 4.75 | 0.23 | 0.052 | (0.347) | 0.046 | 0.005 |
| 58 | 4.83 | 0.27 | 0.059 | (0.346) | 0.053 | 0.006 |
| 59 | 4.92 | 0.27 | 0.059 | (0.344) | 0.053 | 0.006 |
| 60 | 5.00 | 0.27 | 0.059 | (0.343) | 0.053 | 0.006 |
| 61 | 5.08 | 0.20 | 0.044 | (0.341) | 0.040 | 0.004 |
| 62 | 5.17 | 0.20 | 0.044 | (0.340) | 0.040 | 0.004 |
| 63 | 5.25 | 0.20 | 0.044 | (0.338) | 0.040 | 0.004 |
| 64 | 5.33 | 0.23 | 0.052 | (0.337) | 0.046 | 0.005 |
| 65 | 5.42 | 0.23 | 0.052 | (0.335) | 0.046 | 0.005 |
| 66 | 5.50 | 0.23 | 0.052 | (0.334) | 0.046 | 0.005 |
| 67 | 5.58 | 0.27 | 0.059 | (0.332) | 0.053 | 0.006 |
| 68 | 5.67 | 0.27 | 0.059 | (0.331) | 0.053 | 0.006 |
| 69 | 5.75 | 0.27 | 0.059 | (0.330) | 0.053 | 0.006 |
| 70 | 5.83 | 0.27 | 0.059 | (0.328) | 0.053 | 0.006 |
| 71 | 5.92 | 0.27 | 0.059 | (0.327) | 0.053 | 0.006 |
| 72 | 6.00 | 0.27 | 0.059 | (0.325) | 0.053 | 0.006 |
| 73 | 6.08 | 0.30 | 0.066 | (0.324) | 0.060 | 0.007 |
| 74 | 6.17 | 0.30 | 0.066 | (0.322) | 0.060 | 0.007 |
| 75 | 6.25 | 0.30 | 0.066 | (0.321) | 0.060 | 0.007 |
| 76 | 6.33 | 0.30 | 0.066 | (0.319) | 0.060 | 0.007 |
| 77 | 6.42 | 0.30 | 0.066 | (0.318) | 0.060 | 0.007 |
| 78 | 6.50 | 0.30 | 0.066 | (0.317) | 0.060 | 0.007 |
| 79 | 6.58 | 0.33 | 0.074 | (0.315) | 0.066 | 0.007 |
| 80 | 6.67 | 0.33 | 0.074 | (0.314) | 0.066 | 0.007 |
| 81 | 6.75 | 0.33 | 0.074 | (0.312) | 0.066 | 0.007 |
| 82 | 6.83 | 0.33 | 0.074 | (0.311) | 0.066 | 0.007 |
| 83 | 6.92 | 0.33 | 0.074 | (0.310) | 0.066 | 0.007 |
| 84 | 7.00 | 0.33 | 0.074 | (0.308) | 0.066 | 0.007 |
| 85 | 7.08 | 0.33 | 0.074 | (0.307) | 0.066 | 0.007 |
| 86 | 7.17 | 0.33 | 0.074 | (0.305) | 0.066 | 0.007 |
| 87 | 7.25 | 0.33 | 0.074 | (0.304) | 0.066 | 0.007 |

| | | | | | | |
|-----|-------|------|-------|----------|-------|-------|
| 88 | 7.33 | 0.37 | 0.081 | (0.303) | 0.073 | 0.008 |
| 89 | 7.42 | 0.37 | 0.081 | (0.301) | 0.073 | 0.008 |
| 90 | 7.50 | 0.37 | 0.081 | (0.300) | 0.073 | 0.008 |
| 91 | 7.58 | 0.40 | 0.088 | (0.298) | 0.079 | 0.009 |
| 92 | 7.67 | 0.40 | 0.088 | (0.297) | 0.079 | 0.009 |
| 93 | 7.75 | 0.40 | 0.088 | (0.296) | 0.079 | 0.009 |
| 94 | 7.83 | 0.43 | 0.096 | (0.294) | 0.086 | 0.010 |
| 95 | 7.92 | 0.43 | 0.096 | (0.293) | 0.086 | 0.010 |
| 96 | 8.00 | 0.43 | 0.096 | (0.292) | 0.086 | 0.010 |
| 97 | 8.08 | 0.50 | 0.110 | (0.290) | 0.099 | 0.011 |
| 98 | 8.17 | 0.50 | 0.110 | (0.289) | 0.099 | 0.011 |
| 99 | 8.25 | 0.50 | 0.110 | (0.288) | 0.099 | 0.011 |
| 100 | 8.33 | 0.50 | 0.110 | (0.286) | 0.099 | 0.011 |
| 101 | 8.42 | 0.50 | 0.110 | (0.285) | 0.099 | 0.011 |
| 102 | 8.50 | 0.50 | 0.110 | (0.283) | 0.099 | 0.011 |
| 103 | 8.58 | 0.53 | 0.118 | (0.282) | 0.106 | 0.012 |
| 104 | 8.67 | 0.53 | 0.118 | (0.281) | 0.106 | 0.012 |
| 105 | 8.75 | 0.53 | 0.118 | (0.280) | 0.106 | 0.012 |
| 106 | 8.83 | 0.57 | 0.125 | (0.278) | 0.113 | 0.013 |
| 107 | 8.92 | 0.57 | 0.125 | (0.277) | 0.113 | 0.013 |
| 108 | 9.00 | 0.57 | 0.125 | (0.276) | 0.113 | 0.013 |
| 109 | 9.08 | 0.63 | 0.140 | (0.274) | 0.126 | 0.014 |
| 110 | 9.17 | 0.63 | 0.140 | (0.273) | 0.126 | 0.014 |
| 111 | 9.25 | 0.63 | 0.140 | (0.272) | 0.126 | 0.014 |
| 112 | 9.33 | 0.67 | 0.147 | (0.270) | 0.132 | 0.015 |
| 113 | 9.42 | 0.67 | 0.147 | (0.269) | 0.132 | 0.015 |
| 114 | 9.50 | 0.67 | 0.147 | (0.268) | 0.132 | 0.015 |
| 115 | 9.58 | 0.70 | 0.155 | (0.267) | 0.139 | 0.015 |
| 116 | 9.67 | 0.70 | 0.155 | (0.265) | 0.139 | 0.015 |
| 117 | 9.75 | 0.70 | 0.155 | (0.264) | 0.139 | 0.015 |
| 118 | 9.83 | 0.73 | 0.162 | (0.263) | 0.146 | 0.016 |
| 119 | 9.92 | 0.73 | 0.162 | (0.261) | 0.146 | 0.016 |
| 120 | 10.00 | 0.73 | 0.162 | (0.260) | 0.146 | 0.016 |
| 121 | 10.08 | 0.50 | 0.110 | (0.259) | 0.099 | 0.011 |
| 122 | 10.17 | 0.50 | 0.110 | (0.258) | 0.099 | 0.011 |
| 123 | 10.25 | 0.50 | 0.110 | (0.256) | 0.099 | 0.011 |
| 124 | 10.33 | 0.50 | 0.110 | (0.255) | 0.099 | 0.011 |
| 125 | 10.42 | 0.50 | 0.110 | (0.254) | 0.099 | 0.011 |
| 126 | 10.50 | 0.50 | 0.110 | (0.253) | 0.099 | 0.011 |
| 127 | 10.58 | 0.67 | 0.147 | (0.251) | 0.132 | 0.015 |
| 128 | 10.67 | 0.67 | 0.147 | (0.250) | 0.132 | 0.015 |
| 129 | 10.75 | 0.67 | 0.147 | (0.249) | 0.132 | 0.015 |
| 130 | 10.83 | 0.67 | 0.147 | (0.248) | 0.132 | 0.015 |
| 131 | 10.92 | 0.67 | 0.147 | (0.247) | 0.132 | 0.015 |
| 132 | 11.00 | 0.67 | 0.147 | (0.245) | 0.132 | 0.015 |
| 133 | 11.08 | 0.63 | 0.140 | (0.244) | 0.126 | 0.014 |
| 134 | 11.17 | 0.63 | 0.140 | (0.243) | 0.126 | 0.014 |
| 135 | 11.25 | 0.63 | 0.140 | (0.242) | 0.126 | 0.014 |
| 136 | 11.33 | 0.63 | 0.140 | (0.241) | 0.126 | 0.014 |
| 137 | 11.42 | 0.63 | 0.140 | (0.239) | 0.126 | 0.014 |
| 138 | 11.50 | 0.63 | 0.140 | (0.238) | 0.126 | 0.014 |
| 139 | 11.58 | 0.57 | 0.125 | (0.237) | 0.113 | 0.013 |
| 140 | 11.67 | 0.57 | 0.125 | (0.236) | 0.113 | 0.013 |
| 141 | 11.75 | 0.57 | 0.125 | (0.235) | 0.113 | 0.013 |
| 142 | 11.83 | 0.60 | 0.132 | (0.233) | 0.119 | 0.013 |
| 143 | 11.92 | 0.60 | 0.132 | (0.232) | 0.119 | 0.013 |
| 144 | 12.00 | 0.60 | 0.132 | (0.231) | 0.119 | 0.013 |
| 145 | 12.08 | 0.83 | 0.184 | (0.230) | 0.166 | 0.018 |
| 146 | 12.17 | 0.83 | 0.184 | (0.229) | 0.166 | 0.018 |
| 147 | 12.25 | 0.83 | 0.184 | (0.228) | 0.166 | 0.018 |
| 148 | 12.33 | 0.87 | 0.191 | (0.227) | 0.172 | 0.019 |
| 149 | 12.42 | 0.87 | 0.191 | (0.225) | 0.172 | 0.019 |
| 150 | 12.50 | 0.87 | 0.191 | (0.224) | 0.172 | 0.019 |
| 151 | 12.58 | 0.93 | 0.206 | (0.223) | 0.185 | 0.021 |
| 152 | 12.67 | 0.93 | 0.206 | (0.222) | 0.185 | 0.021 |
| 153 | 12.75 | 0.93 | 0.206 | (0.221) | 0.185 | 0.021 |
| 154 | 12.83 | 0.97 | 0.213 | (0.220) | 0.192 | 0.021 |
| 155 | 12.92 | 0.97 | 0.213 | (0.219) | 0.192 | 0.021 |
| 156 | 13.00 | 0.97 | 0.213 | (0.218) | 0.192 | 0.021 |

| | | | | | | |
|-----|-------|------|-------|----------|----------|-------|
| 157 | 13.08 | 1.13 | 0.250 | 0.216 | (0.225) | 0.034 |
| 158 | 13.17 | 1.13 | 0.250 | 0.215 | (0.225) | 0.035 |
| 159 | 13.25 | 1.13 | 0.250 | 0.214 | (0.225) | 0.036 |
| 160 | 13.33 | 1.13 | 0.250 | 0.213 | (0.225) | 0.037 |
| 161 | 13.42 | 1.13 | 0.250 | 0.212 | (0.225) | 0.038 |
| 162 | 13.50 | 1.13 | 0.250 | 0.211 | (0.225) | 0.039 |
| 163 | 13.58 | 0.77 | 0.169 | (0.210) | 0.152 | 0.017 |
| 164 | 13.67 | 0.77 | 0.169 | (0.209) | 0.152 | 0.017 |
| 165 | 13.75 | 0.77 | 0.169 | (0.208) | 0.152 | 0.017 |
| 166 | 13.83 | 0.77 | 0.169 | (0.207) | 0.152 | 0.017 |
| 167 | 13.92 | 0.77 | 0.169 | (0.206) | 0.152 | 0.017 |
| 168 | 14.00 | 0.77 | 0.169 | (0.205) | 0.152 | 0.017 |
| 169 | 14.08 | 0.90 | 0.199 | (0.204) | 0.179 | 0.020 |
| 170 | 14.17 | 0.90 | 0.199 | (0.203) | 0.179 | 0.020 |
| 171 | 14.25 | 0.90 | 0.199 | (0.202) | 0.179 | 0.020 |
| 172 | 14.33 | 0.87 | 0.191 | (0.200) | 0.172 | 0.019 |
| 173 | 14.42 | 0.87 | 0.191 | (0.199) | 0.172 | 0.019 |
| 174 | 14.50 | 0.87 | 0.191 | (0.198) | 0.172 | 0.019 |
| 175 | 14.58 | 0.87 | 0.191 | (0.197) | 0.172 | 0.019 |
| 176 | 14.67 | 0.87 | 0.191 | (0.196) | 0.172 | 0.019 |
| 177 | 14.75 | 0.87 | 0.191 | (0.195) | 0.172 | 0.019 |
| 178 | 14.83 | 0.83 | 0.184 | (0.194) | 0.166 | 0.018 |
| 179 | 14.92 | 0.83 | 0.184 | (0.193) | 0.166 | 0.018 |
| 180 | 15.00 | 0.83 | 0.184 | (0.192) | 0.166 | 0.018 |
| 181 | 15.08 | 0.80 | 0.177 | (0.191) | 0.159 | 0.018 |
| 182 | 15.17 | 0.80 | 0.177 | (0.190) | 0.159 | 0.018 |
| 183 | 15.25 | 0.80 | 0.177 | (0.189) | 0.159 | 0.018 |
| 184 | 15.33 | 0.77 | 0.169 | (0.188) | 0.152 | 0.017 |
| 185 | 15.42 | 0.77 | 0.169 | (0.188) | 0.152 | 0.017 |
| 186 | 15.50 | 0.77 | 0.169 | (0.187) | 0.152 | 0.017 |
| 187 | 15.58 | 0.63 | 0.140 | (0.186) | 0.126 | 0.014 |
| 188 | 15.67 | 0.63 | 0.140 | (0.185) | 0.126 | 0.014 |
| 189 | 15.75 | 0.63 | 0.140 | (0.184) | 0.126 | 0.014 |
| 190 | 15.83 | 0.63 | 0.140 | (0.183) | 0.126 | 0.014 |
| 191 | 15.92 | 0.63 | 0.140 | (0.182) | 0.126 | 0.014 |
| 192 | 16.00 | 0.63 | 0.140 | (0.181) | 0.126 | 0.014 |
| 193 | 16.08 | 0.13 | 0.029 | (0.180) | 0.026 | 0.003 |
| 194 | 16.17 | 0.13 | 0.029 | (0.179) | 0.026 | 0.003 |
| 195 | 16.25 | 0.13 | 0.029 | (0.178) | 0.026 | 0.003 |
| 196 | 16.33 | 0.13 | 0.029 | (0.177) | 0.026 | 0.003 |
| 197 | 16.42 | 0.13 | 0.029 | (0.176) | 0.026 | 0.003 |
| 198 | 16.50 | 0.13 | 0.029 | (0.175) | 0.026 | 0.003 |
| 199 | 16.58 | 0.10 | 0.022 | (0.175) | 0.020 | 0.002 |
| 200 | 16.67 | 0.10 | 0.022 | (0.174) | 0.020 | 0.002 |
| 201 | 16.75 | 0.10 | 0.022 | (0.173) | 0.020 | 0.002 |
| 202 | 16.83 | 0.10 | 0.022 | (0.172) | 0.020 | 0.002 |
| 203 | 16.92 | 0.10 | 0.022 | (0.171) | 0.020 | 0.002 |
| 204 | 17.00 | 0.10 | 0.022 | (0.170) | 0.020 | 0.002 |
| 205 | 17.08 | 0.17 | 0.037 | (0.169) | 0.033 | 0.004 |
| 206 | 17.17 | 0.17 | 0.037 | (0.168) | 0.033 | 0.004 |
| 207 | 17.25 | 0.17 | 0.037 | (0.168) | 0.033 | 0.004 |
| 208 | 17.33 | 0.17 | 0.037 | (0.167) | 0.033 | 0.004 |
| 209 | 17.42 | 0.17 | 0.037 | (0.166) | 0.033 | 0.004 |
| 210 | 17.50 | 0.17 | 0.037 | (0.165) | 0.033 | 0.004 |
| 211 | 17.58 | 0.17 | 0.037 | (0.164) | 0.033 | 0.004 |
| 212 | 17.67 | 0.17 | 0.037 | (0.163) | 0.033 | 0.004 |
| 213 | 17.75 | 0.17 | 0.037 | (0.163) | 0.033 | 0.004 |
| 214 | 17.83 | 0.13 | 0.029 | (0.162) | 0.026 | 0.003 |
| 215 | 17.92 | 0.13 | 0.029 | (0.161) | 0.026 | 0.003 |
| 216 | 18.00 | 0.13 | 0.029 | (0.160) | 0.026 | 0.003 |
| 217 | 18.08 | 0.13 | 0.029 | (0.159) | 0.026 | 0.003 |
| 218 | 18.17 | 0.13 | 0.029 | (0.159) | 0.026 | 0.003 |
| 219 | 18.25 | 0.13 | 0.029 | (0.158) | 0.026 | 0.003 |
| 220 | 18.33 | 0.13 | 0.029 | (0.157) | 0.026 | 0.003 |
| 221 | 18.42 | 0.13 | 0.029 | (0.156) | 0.026 | 0.003 |
| 222 | 18.50 | 0.13 | 0.029 | (0.156) | 0.026 | 0.003 |
| 223 | 18.58 | 0.10 | 0.022 | (0.155) | 0.020 | 0.002 |
| 224 | 18.67 | 0.10 | 0.022 | (0.154) | 0.020 | 0.002 |
| 225 | 18.75 | 0.10 | 0.022 | (0.153) | 0.020 | 0.002 |

| | | | | | | |
|-----|-------|------|-------|----------|-------|-------|
| 226 | 18.83 | 0.07 | 0.015 | (0.153) | 0.013 | 0.001 |
| 227 | 18.92 | 0.07 | 0.015 | (0.152) | 0.013 | 0.001 |
| 228 | 19.00 | 0.07 | 0.015 | (0.151) | 0.013 | 0.001 |
| 229 | 19.08 | 0.10 | 0.022 | (0.150) | 0.020 | 0.002 |
| 230 | 19.17 | 0.10 | 0.022 | (0.150) | 0.020 | 0.002 |
| 231 | 19.25 | 0.10 | 0.022 | (0.149) | 0.020 | 0.002 |
| 232 | 19.33 | 0.13 | 0.029 | (0.148) | 0.026 | 0.003 |
| 233 | 19.42 | 0.13 | 0.029 | (0.148) | 0.026 | 0.003 |
| 234 | 19.50 | 0.13 | 0.029 | (0.147) | 0.026 | 0.003 |
| 235 | 19.58 | 0.10 | 0.022 | (0.146) | 0.020 | 0.002 |
| 236 | 19.67 | 0.10 | 0.022 | (0.146) | 0.020 | 0.002 |
| 237 | 19.75 | 0.10 | 0.022 | (0.145) | 0.020 | 0.002 |
| 238 | 19.83 | 0.07 | 0.015 | (0.144) | 0.013 | 0.001 |
| 239 | 19.92 | 0.07 | 0.015 | (0.144) | 0.013 | 0.001 |
| 240 | 20.00 | 0.07 | 0.015 | (0.143) | 0.013 | 0.001 |
| 241 | 20.08 | 0.10 | 0.022 | (0.142) | 0.020 | 0.002 |
| 242 | 20.17 | 0.10 | 0.022 | (0.142) | 0.020 | 0.002 |
| 243 | 20.25 | 0.10 | 0.022 | (0.141) | 0.020 | 0.002 |
| 244 | 20.33 | 0.10 | 0.022 | (0.141) | 0.020 | 0.002 |
| 245 | 20.42 | 0.10 | 0.022 | (0.140) | 0.020 | 0.002 |
| 246 | 20.50 | 0.10 | 0.022 | (0.139) | 0.020 | 0.002 |
| 247 | 20.58 | 0.10 | 0.022 | (0.139) | 0.020 | 0.002 |
| 248 | 20.67 | 0.10 | 0.022 | (0.138) | 0.020 | 0.002 |
| 249 | 20.75 | 0.10 | 0.022 | (0.138) | 0.020 | 0.002 |
| 250 | 20.83 | 0.07 | 0.015 | (0.137) | 0.013 | 0.001 |
| 251 | 20.92 | 0.07 | 0.015 | (0.137) | 0.013 | 0.001 |
| 252 | 21.00 | 0.07 | 0.015 | (0.136) | 0.013 | 0.001 |
| 253 | 21.08 | 0.10 | 0.022 | (0.135) | 0.020 | 0.002 |
| 254 | 21.17 | 0.10 | 0.022 | (0.135) | 0.020 | 0.002 |
| 255 | 21.25 | 0.10 | 0.022 | (0.134) | 0.020 | 0.002 |
| 256 | 21.33 | 0.07 | 0.015 | (0.134) | 0.013 | 0.001 |
| 257 | 21.42 | 0.07 | 0.015 | (0.133) | 0.013 | 0.001 |
| 258 | 21.50 | 0.07 | 0.015 | (0.133) | 0.013 | 0.001 |
| 259 | 21.58 | 0.10 | 0.022 | (0.132) | 0.020 | 0.002 |
| 260 | 21.67 | 0.10 | 0.022 | (0.132) | 0.020 | 0.002 |
| 261 | 21.75 | 0.10 | 0.022 | (0.131) | 0.020 | 0.002 |
| 262 | 21.83 | 0.07 | 0.015 | (0.131) | 0.013 | 0.001 |
| 263 | 21.92 | 0.07 | 0.015 | (0.131) | 0.013 | 0.001 |
| 264 | 22.00 | 0.07 | 0.015 | (0.130) | 0.013 | 0.001 |
| 265 | 22.08 | 0.10 | 0.022 | (0.130) | 0.020 | 0.002 |
| 266 | 22.17 | 0.10 | 0.022 | (0.129) | 0.020 | 0.002 |
| 267 | 22.25 | 0.10 | 0.022 | (0.129) | 0.020 | 0.002 |
| 268 | 22.33 | 0.07 | 0.015 | (0.128) | 0.013 | 0.001 |
| 269 | 22.42 | 0.07 | 0.015 | (0.128) | 0.013 | 0.001 |
| 270 | 22.50 | 0.07 | 0.015 | (0.128) | 0.013 | 0.001 |
| 271 | 22.58 | 0.07 | 0.015 | (0.127) | 0.013 | 0.001 |
| 272 | 22.67 | 0.07 | 0.015 | (0.127) | 0.013 | 0.001 |
| 273 | 22.75 | 0.07 | 0.015 | (0.127) | 0.013 | 0.001 |
| 274 | 22.83 | 0.07 | 0.015 | (0.126) | 0.013 | 0.001 |
| 275 | 22.92 | 0.07 | 0.015 | (0.126) | 0.013 | 0.001 |
| 276 | 23.00 | 0.07 | 0.015 | (0.126) | 0.013 | 0.001 |
| 277 | 23.08 | 0.07 | 0.015 | (0.125) | 0.013 | 0.001 |
| 278 | 23.17 | 0.07 | 0.015 | (0.125) | 0.013 | 0.001 |
| 279 | 23.25 | 0.07 | 0.015 | (0.125) | 0.013 | 0.001 |
| 280 | 23.33 | 0.07 | 0.015 | (0.125) | 0.013 | 0.001 |
| 281 | 23.42 | 0.07 | 0.015 | (0.124) | 0.013 | 0.001 |
| 282 | 23.50 | 0.07 | 0.015 | (0.124) | 0.013 | 0.001 |
| 283 | 23.58 | 0.07 | 0.015 | (0.124) | 0.013 | 0.001 |
| 284 | 23.67 | 0.07 | 0.015 | (0.124) | 0.013 | 0.001 |
| 285 | 23.75 | 0.07 | 0.015 | (0.124) | 0.013 | 0.001 |
| 286 | 23.83 | 0.07 | 0.015 | (0.123) | 0.013 | 0.001 |
| 287 | 23.92 | 0.07 | 0.015 | (0.123) | 0.013 | 0.001 |
| 288 | 24.00 | 0.07 | 0.015 | (0.123) | 0.013 | 0.001 |

(Loss Rate Not Used)

Sum = 100.0 Sum = 2.3

Flood volume = Effective rainfall 0.19(In)

times area 9.1(Ac.)/[(In)/(Ft.)] = 0.1(Ac.Ft)

Total soil loss = 1.65(In)

Total soil loss = 1.254(Ac.Ft)

Total rainfall = 1.84(In)
 Flood volume = 6281.5 Cubic Feet
 Total soil loss = 54631.7 Cubic Feet

 Peak flow rate of this hydrograph = 0.301(CFS)

+++++
 24 - H O U R S T O R M
 R u n o f f H y d r o g r a p h

Hydrograph in 5 Minute intervals ((CFS))

| Time(h+m) | Volume | Ac.Ft | Q(CFS) | 0 | 2.5 | 5.0 | 7.5 | 10.0 |
|-----------|--------|-------|--------|-----|-----|-----|-----|------|
| 0+ 5 | 0.0000 | | 0.00 | Q | | | | |
| 0+10 | 0.0000 | | 0.00 | Q | | | | |
| 0+15 | 0.0000 | | 0.00 | Q | | | | |
| 0+20 | 0.0001 | | 0.01 | Q | | | | |
| 0+25 | 0.0002 | | 0.01 | Q | | | | |
| 0+30 | 0.0003 | | 0.01 | Q | | | | |
| 0+35 | 0.0004 | | 0.01 | Q | | | | |
| 0+40 | 0.0005 | | 0.02 | Q | | | | |
| 0+45 | 0.0006 | | 0.02 | Q | | | | |
| 0+50 | 0.0007 | | 0.02 | Q | | | | |
| 0+55 | 0.0008 | | 0.02 | Q | | | | |
| 1+ 0 | 0.0010 | | 0.02 | Q | | | | |
| 1+ 5 | 0.0011 | | 0.02 | Q | | | | |
| 1+10 | 0.0013 | | 0.02 | Q | | | | |
| 1+15 | 0.0014 | | 0.02 | Q | | | | |
| 1+20 | 0.0016 | | 0.02 | Q | | | | |
| 1+25 | 0.0017 | | 0.02 | Q | | | | |
| 1+30 | 0.0018 | | 0.02 | Q | | | | |
| 1+35 | 0.0020 | | 0.02 | Q | | | | |
| 1+40 | 0.0021 | | 0.02 | Q | | | | |
| 1+45 | 0.0023 | | 0.02 | Q | | | | |
| 1+50 | 0.0024 | | 0.02 | Q | | | | |
| 1+55 | 0.0025 | | 0.02 | Q | | | | |
| 2+ 0 | 0.0027 | | 0.02 | Q | | | | |
| 2+ 5 | 0.0029 | | 0.02 | Q | | | | |
| 2+10 | 0.0030 | | 0.02 | Q | | | | |
| 2+15 | 0.0032 | | 0.03 | Q | | | | |
| 2+20 | 0.0034 | | 0.03 | Q | | | | |
| 2+25 | 0.0036 | | 0.03 | Q | | | | |
| 2+30 | 0.0038 | | 0.03 | QV | | | | |
| 2+35 | 0.0039 | | 0.03 | QV | | | | |
| 2+40 | 0.0041 | | 0.03 | QV | | | | |
| 2+45 | 0.0043 | | 0.03 | QV | | | | |
| 2+50 | 0.0045 | | 0.03 | QV | | | | |
| 2+55 | 0.0047 | | 0.03 | QV | | | | |
| 3+ 0 | 0.0050 | | 0.03 | QV | | | | |
| 3+ 5 | 0.0052 | | 0.03 | QV | | | | |
| 3+10 | 0.0054 | | 0.03 | QV | | | | |
| 3+15 | 0.0056 | | 0.03 | QV | | | | |
| 3+20 | 0.0059 | | 0.03 | QV | | | | |
| 3+25 | 0.0061 | | 0.03 | QV | | | | |
| 3+30 | 0.0063 | | 0.03 | QV | | | | |
| 3+35 | 0.0065 | | 0.03 | QV | | | | |
| 3+40 | 0.0068 | | 0.03 | QV | | | | |
| 3+45 | 0.0070 | | 0.03 | QV | | | | |
| 3+50 | 0.0072 | | 0.03 | Q V | | | | |
| 3+55 | 0.0075 | | 0.03 | Q V | | | | |
| 4+ 0 | 0.0077 | | 0.04 | Q V | | | | |
| 4+ 5 | 0.0080 | | 0.04 | Q V | | | | |
| 4+10 | 0.0082 | | 0.04 | Q V | | | | |
| 4+15 | 0.0085 | | 0.04 | Q V | | | | |
| 4+20 | 0.0088 | | 0.04 | Q V | | | | |
| 4+25 | 0.0091 | | 0.04 | Q V | | | | |
| 4+30 | 0.0093 | | 0.04 | Q V | | | | |

| | | | | | | | | |
|-------|--------|------|---|---|--|--|--|--|
| 4+35 | 0.0096 | 0.04 | Q | V | | | | |
| 4+40 | 0.0100 | 0.04 | Q | V | | | | |
| 4+45 | 0.0103 | 0.04 | Q | V | | | | |
| 4+50 | 0.0106 | 0.05 | Q | V | | | | |
| 4+55 | 0.0109 | 0.05 | Q | V | | | | |
| 5+ 0 | 0.0112 | 0.05 | Q | V | | | | |
| 5+ 5 | 0.0116 | 0.05 | Q | V | | | | |
| 5+10 | 0.0119 | 0.05 | Q | V | | | | |
| 5+15 | 0.0122 | 0.05 | Q | V | | | | |
| 5+20 | 0.0125 | 0.04 | Q | V | | | | |
| 5+25 | 0.0128 | 0.04 | Q | V | | | | |
| 5+30 | 0.0132 | 0.04 | Q | V | | | | |
| 5+35 | 0.0135 | 0.05 | Q | V | | | | |
| 5+40 | 0.0138 | 0.05 | Q | V | | | | |
| 5+45 | 0.0141 | 0.05 | Q | V | | | | |
| 5+50 | 0.0145 | 0.05 | Q | V | | | | |
| 5+55 | 0.0148 | 0.05 | Q | V | | | | |
| 6+ 0 | 0.0152 | 0.05 | Q | V | | | | |
| 6+ 5 | 0.0156 | 0.05 | Q | V | | | | |
| 6+10 | 0.0159 | 0.05 | Q | V | | | | |
| 6+15 | 0.0163 | 0.06 | Q | V | | | | |
| 6+20 | 0.0167 | 0.06 | Q | V | | | | |
| 6+25 | 0.0171 | 0.06 | Q | V | | | | |
| 6+30 | 0.0175 | 0.06 | Q | V | | | | |
| 6+35 | 0.0179 | 0.06 | Q | V | | | | |
| 6+40 | 0.0183 | 0.06 | Q | V | | | | |
| 6+45 | 0.0188 | 0.06 | Q | V | | | | |
| 6+50 | 0.0192 | 0.06 | Q | V | | | | |
| 6+55 | 0.0196 | 0.06 | Q | V | | | | |
| 7+ 0 | 0.0201 | 0.07 | Q | V | | | | |
| 7+ 5 | 0.0205 | 0.07 | Q | V | | | | |
| 7+10 | 0.0210 | 0.07 | Q | V | | | | |
| 7+15 | 0.0214 | 0.07 | Q | V | | | | |
| 7+20 | 0.0219 | 0.07 | Q | V | | | | |
| 7+25 | 0.0224 | 0.07 | Q | V | | | | |
| 7+30 | 0.0228 | 0.07 | Q | V | | | | |
| 7+35 | 0.0233 | 0.07 | Q | V | | | | |
| 7+40 | 0.0238 | 0.07 | Q | V | | | | |
| 7+45 | 0.0243 | 0.07 | Q | V | | | | |
| 7+50 | 0.0249 | 0.08 | Q | V | | | | |
| 7+55 | 0.0254 | 0.08 | Q | V | | | | |
| 8+ 0 | 0.0260 | 0.08 | Q | V | | | | |
| 8+ 5 | 0.0265 | 0.08 | Q | V | | | | |
| 8+10 | 0.0271 | 0.09 | Q | V | | | | |
| 8+15 | 0.0277 | 0.09 | Q | V | | | | |
| 8+20 | 0.0284 | 0.09 | Q | V | | | | |
| 8+25 | 0.0290 | 0.09 | Q | V | | | | |
| 8+30 | 0.0297 | 0.10 | Q | V | | | | |
| 8+35 | 0.0304 | 0.10 | Q | V | | | | |
| 8+40 | 0.0310 | 0.10 | Q | V | | | | |
| 8+45 | 0.0317 | 0.10 | Q | V | | | | |
| 8+50 | 0.0324 | 0.10 | Q | V | | | | |
| 8+55 | 0.0332 | 0.10 | Q | V | | | | |
| 9+ 0 | 0.0339 | 0.11 | Q | V | | | | |
| 9+ 5 | 0.0347 | 0.11 | Q | V | | | | |
| 9+10 | 0.0354 | 0.11 | Q | V | | | | |
| 9+15 | 0.0362 | 0.12 | Q | V | | | | |
| 9+20 | 0.0370 | 0.12 | Q | V | | | | |
| 9+25 | 0.0379 | 0.12 | Q | V | | | | |
| 9+30 | 0.0388 | 0.13 | Q | V | | | | |
| 9+35 | 0.0396 | 0.13 | Q | V | | | | |
| 9+40 | 0.0405 | 0.13 | Q | V | | | | |
| 9+45 | 0.0414 | 0.13 | Q | V | | | | |
| 9+50 | 0.0424 | 0.14 | Q | V | | | | |
| 9+55 | 0.0433 | 0.14 | Q | V | | | | |
| 10+ 0 | 0.0443 | 0.14 | Q | V | | | | |
| 10+ 5 | 0.0453 | 0.14 | Q | V | | | | |
| 10+10 | 0.0462 | 0.14 | Q | V | | | | |
| 10+15 | 0.0471 | 0.13 | Q | V | | | | |

| | | | | | | | |
|-------|--------|------|---|---|--|--|--|
| 10+20 | 0.0479 | 0.12 | Q | V | | | |
| 10+25 | 0.0487 | 0.11 | Q | V | | | |
| 10+30 | 0.0494 | 0.11 | Q | V | | | |
| 10+35 | 0.0502 | 0.11 | Q | V | | | |
| 10+40 | 0.0510 | 0.11 | Q | V | | | |
| 10+45 | 0.0518 | 0.12 | Q | V | | | |
| 10+50 | 0.0527 | 0.12 | Q | V | | | |
| 10+55 | 0.0536 | 0.13 | Q | V | | | |
| 11+ 0 | 0.0544 | 0.13 | Q | V | | | |
| 11+ 5 | 0.0553 | 0.13 | Q | V | | | |
| 11+10 | 0.0563 | 0.13 | Q | V | | | |
| 11+15 | 0.0571 | 0.13 | Q | V | | | |
| 11+20 | 0.0580 | 0.13 | Q | V | | | |
| 11+25 | 0.0589 | 0.13 | Q | V | | | |
| 11+30 | 0.0598 | 0.13 | Q | V | | | |
| 11+35 | 0.0607 | 0.13 | Q | V | | | |
| 11+40 | 0.0616 | 0.13 | Q | V | | | |
| 11+45 | 0.0624 | 0.12 | Q | V | | | |
| 11+50 | 0.0633 | 0.12 | Q | V | | | |
| 11+55 | 0.0641 | 0.12 | Q | V | | | |
| 12+ 0 | 0.0649 | 0.12 | Q | V | | | |
| 12+ 5 | 0.0658 | 0.12 | Q | V | | | |
| 12+10 | 0.0666 | 0.13 | Q | V | | | |
| 12+15 | 0.0676 | 0.14 | Q | V | | | |
| 12+20 | 0.0686 | 0.15 | Q | V | | | |
| 12+25 | 0.0697 | 0.15 | Q | V | | | |
| 12+30 | 0.0708 | 0.16 | Q | V | | | |
| 12+35 | 0.0719 | 0.16 | Q | V | | | |
| 12+40 | 0.0731 | 0.17 | Q | V | | | |
| 12+45 | 0.0742 | 0.17 | Q | V | | | |
| 12+50 | 0.0755 | 0.18 | Q | V | | | |
| 12+55 | 0.0767 | 0.18 | Q | V | | | |
| 13+ 0 | 0.0780 | 0.18 | Q | V | | | |
| 13+ 5 | 0.0793 | 0.19 | Q | V | | | |
| 13+10 | 0.0807 | 0.20 | Q | V | | | |
| 13+15 | 0.0823 | 0.23 | Q | V | | | |
| 13+20 | 0.0840 | 0.26 | Q | V | | | |
| 13+25 | 0.0860 | 0.28 | Q | V | | | |
| 13+30 | 0.0880 | 0.29 | Q | V | | | |
| 13+35 | 0.0901 | 0.30 | Q | V | | | |
| 13+40 | 0.0921 | 0.29 | Q | V | | | |
| 13+45 | 0.0938 | 0.26 | Q | V | | | |
| 13+50 | 0.0953 | 0.22 | Q | V | | | |
| 13+55 | 0.0967 | 0.20 | Q | V | | | |
| 14+ 0 | 0.0980 | 0.19 | Q | V | | | |
| 14+ 5 | 0.0993 | 0.18 | Q | V | | | |
| 14+10 | 0.1005 | 0.18 | Q | V | | | |
| 14+15 | 0.1018 | 0.18 | Q | V | | | |
| 14+20 | 0.1031 | 0.19 | Q | V | | | |
| 14+25 | 0.1044 | 0.19 | Q | V | | | |
| 14+30 | 0.1057 | 0.19 | Q | V | | | |
| 14+35 | 0.1069 | 0.18 | Q | V | | | |
| 14+40 | 0.1082 | 0.18 | Q | V | | | |
| 14+45 | 0.1094 | 0.18 | Q | V | | | |
| 14+50 | 0.1107 | 0.18 | Q | V | | | |
| 14+55 | 0.1119 | 0.18 | Q | V | | | |
| 15+ 0 | 0.1131 | 0.18 | Q | V | | | |
| 15+ 5 | 0.1143 | 0.18 | Q | V | | | |
| 15+10 | 0.1155 | 0.17 | Q | V | | | |
| 15+15 | 0.1167 | 0.17 | Q | V | | | |
| 15+20 | 0.1179 | 0.17 | Q | V | | | |
| 15+25 | 0.1190 | 0.17 | Q | V | | | |
| 15+30 | 0.1201 | 0.16 | Q | V | | | |
| 15+35 | 0.1212 | 0.16 | Q | V | | | |
| 15+40 | 0.1223 | 0.16 | Q | V | | | |
| 15+45 | 0.1233 | 0.15 | Q | V | | | |
| 15+50 | 0.1243 | 0.14 | Q | V | | | |
| 15+55 | 0.1253 | 0.14 | Q | V | | | |
| 16+ 0 | 0.1262 | 0.14 | Q | V | | | |

| | | | | |
|-------|--------|------|---|---|
| 16+ 5 | 0.1272 | 0.13 | Q | V |
| 16+10 | 0.1280 | 0.12 | Q | V |
| 16+15 | 0.1287 | 0.10 | Q | V |
| 16+20 | 0.1292 | 0.08 | Q | V |
| 16+25 | 0.1296 | 0.06 | Q | V |
| 16+30 | 0.1300 | 0.06 | Q | V |
| 16+35 | 0.1304 | 0.05 | Q | V |
| 16+40 | 0.1307 | 0.05 | Q | V |
| 16+45 | 0.1310 | 0.04 | Q | V |
| 16+50 | 0.1312 | 0.04 | Q | V |
| 16+55 | 0.1315 | 0.03 | Q | V |
| 17+ 0 | 0.1317 | 0.03 | Q | V |
| 17+ 5 | 0.1319 | 0.03 | Q | V |
| 17+10 | 0.1321 | 0.03 | Q | V |
| 17+15 | 0.1324 | 0.03 | Q | V |
| 17+20 | 0.1326 | 0.03 | Q | V |
| 17+25 | 0.1328 | 0.03 | Q | V |
| 17+30 | 0.1331 | 0.03 | Q | V |
| 17+35 | 0.1333 | 0.03 | Q | V |
| 17+40 | 0.1335 | 0.03 | Q | V |
| 17+45 | 0.1338 | 0.03 | Q | V |
| 17+50 | 0.1340 | 0.03 | Q | V |
| 17+55 | 0.1342 | 0.03 | Q | V |
| 18+ 0 | 0.1344 | 0.03 | Q | V |
| 18+ 5 | 0.1346 | 0.03 | Q | V |
| 18+10 | 0.1348 | 0.03 | Q | V |
| 18+15 | 0.1350 | 0.03 | Q | V |
| 18+20 | 0.1352 | 0.03 | Q | V |
| 18+25 | 0.1354 | 0.03 | Q | V |
| 18+30 | 0.1356 | 0.03 | Q | V |
| 18+35 | 0.1358 | 0.03 | Q | V |
| 18+40 | 0.1360 | 0.03 | Q | V |
| 18+45 | 0.1361 | 0.03 | Q | V |
| 18+50 | 0.1363 | 0.02 | Q | V |
| 18+55 | 0.1365 | 0.02 | Q | V |
| 19+ 0 | 0.1366 | 0.02 | Q | V |
| 19+ 5 | 0.1367 | 0.02 | Q | V |
| 19+10 | 0.1368 | 0.02 | Q | V |
| 19+15 | 0.1370 | 0.02 | Q | V |
| 19+20 | 0.1371 | 0.02 | Q | V |
| 19+25 | 0.1373 | 0.02 | Q | V |
| 19+30 | 0.1374 | 0.02 | Q | V |
| 19+35 | 0.1376 | 0.02 | Q | V |
| 19+40 | 0.1377 | 0.02 | Q | V |
| 19+45 | 0.1379 | 0.02 | Q | V |
| 19+50 | 0.1380 | 0.02 | Q | V |
| 19+55 | 0.1382 | 0.02 | Q | V |
| 20+ 0 | 0.1383 | 0.02 | Q | V |
| 20+ 5 | 0.1384 | 0.02 | Q | V |
| 20+10 | 0.1386 | 0.02 | Q | V |
| 20+15 | 0.1387 | 0.02 | Q | V |
| 20+20 | 0.1388 | 0.02 | Q | V |
| 20+25 | 0.1389 | 0.02 | Q | V |
| 20+30 | 0.1391 | 0.02 | Q | V |
| 20+35 | 0.1392 | 0.02 | Q | V |
| 20+40 | 0.1394 | 0.02 | Q | V |
| 20+45 | 0.1395 | 0.02 | Q | V |
| 20+50 | 0.1396 | 0.02 | Q | V |
| 20+55 | 0.1398 | 0.02 | Q | V |
| 21+ 0 | 0.1399 | 0.02 | Q | V |
| 21+ 5 | 0.1400 | 0.02 | Q | V |
| 21+10 | 0.1401 | 0.02 | Q | V |
| 21+15 | 0.1402 | 0.02 | Q | V |
| 21+20 | 0.1404 | 0.02 | Q | V |
| 21+25 | 0.1405 | 0.02 | Q | V |
| 21+30 | 0.1406 | 0.02 | Q | V |
| 21+35 | 0.1407 | 0.02 | Q | V |
| 21+40 | 0.1408 | 0.02 | Q | V |
| 21+45 | 0.1409 | 0.02 | Q | V |

| | | | | | | |
|-------|--------|------|---|--|--|---|
| 21+50 | 0.1411 | 0.02 | Q | | | V |
| 21+55 | 0.1412 | 0.02 | Q | | | V |
| 22+ 0 | 0.1413 | 0.02 | Q | | | V |
| 22+ 5 | 0.1414 | 0.02 | Q | | | V |
| 22+10 | 0.1415 | 0.02 | Q | | | V |
| 22+15 | 0.1416 | 0.02 | Q | | | V |
| 22+20 | 0.1418 | 0.02 | Q | | | V |
| 22+25 | 0.1419 | 0.02 | Q | | | V |
| 22+30 | 0.1420 | 0.02 | Q | | | V |
| 22+35 | 0.1421 | 0.02 | Q | | | V |
| 22+40 | 0.1422 | 0.02 | Q | | | V |
| 22+45 | 0.1423 | 0.01 | Q | | | V |
| 22+50 | 0.1424 | 0.01 | Q | | | V |
| 22+55 | 0.1425 | 0.01 | Q | | | V |
| 23+ 0 | 0.1426 | 0.01 | Q | | | V |
| 23+ 5 | 0.1427 | 0.01 | Q | | | V |
| 23+10 | 0.1428 | 0.01 | Q | | | V |
| 23+15 | 0.1429 | 0.01 | Q | | | V |
| 23+20 | 0.1430 | 0.01 | Q | | | V |
| 23+25 | 0.1431 | 0.01 | Q | | | V |
| 23+30 | 0.1432 | 0.01 | Q | | | V |
| 23+35 | 0.1433 | 0.01 | Q | | | V |
| 23+40 | 0.1434 | 0.01 | Q | | | V |
| 23+45 | 0.1435 | 0.01 | Q | | | V |
| 23+50 | 0.1436 | 0.01 | Q | | | V |
| 23+55 | 0.1437 | 0.01 | Q | | | V |
| 24+ 0 | 0.1438 | 0.01 | Q | | | V |
| 24+ 5 | 0.1438 | 0.01 | Q | | | V |
| 24+10 | 0.1439 | 0.01 | Q | | | V |
| 24+15 | 0.1440 | 0.01 | Q | | | V |
| 24+20 | 0.1440 | 0.01 | Q | | | V |
| 24+25 | 0.1441 | 0.00 | Q | | | V |
| 24+30 | 0.1441 | 0.00 | Q | | | V |
| 24+35 | 0.1441 | 0.00 | Q | | | V |
| 24+40 | 0.1441 | 0.00 | Q | | | V |
| 24+45 | 0.1441 | 0.00 | Q | | | V |
| 24+50 | 0.1441 | 0.00 | Q | | | V |
| 24+55 | 0.1442 | 0.00 | Q | | | V |
| 25+ 0 | 0.1442 | 0.00 | Q | | | V |
| 25+ 5 | 0.1442 | 0.00 | Q | | | V |
| 25+10 | 0.1442 | 0.00 | Q | | | V |
| 25+15 | 0.1442 | 0.00 | Q | | | V |
| 25+20 | 0.1442 | 0.00 | Q | | | V |
| 25+25 | 0.1442 | 0.00 | Q | | | V |
| 25+30 | 0.1442 | 0.00 | Q | | | V |
| 25+35 | 0.1442 | 0.00 | Q | | | V |
| 25+40 | 0.1442 | 0.00 | Q | | | V |
| 25+45 | 0.1442 | 0.00 | Q | | | V |
| 25+50 | 0.1442 | 0.00 | Q | | | V |
| 25+55 | 0.1442 | 0.00 | Q | | | V |
| 26+ 0 | 0.1442 | 0.00 | Q | | | V |
| 26+ 5 | 0.1442 | 0.00 | Q | | | V |

Riverside County Rational Hydrology Program

CIVILCADD/CIVILDESIGN Engineering Software,(c) 1989 - 2018 Version 9.0
Rational Hydrology Study Date: 11/10/21 File:P2P.out

PENSKE MORENO VALLEY
PROP 2-YR
XO 11/10/21

***** Hydrology Study Control Information *****

English (in-lb) Units used in input data file

Program License Serial Number 6443

Rational Method Hydrology Program based on
Riverside County Flood Control & Water Conservation District
1978 hydrology manual

Storm event (year) = 2.00 Antecedent Moisture Condition = 1

Standard intensity-duration curves data (Plate D-4.1)

For the [Sunnymead-Moreno] area used.

10 year storm 10 minute intensity = 2.010(In/Hr)

10 year storm 60 minute intensity = 0.820(In/Hr)

100 year storm 10 minute intensity = 2.940(In/Hr)

100 year storm 60 minute intensity = 1.200(In/Hr)

Storm event year = 2.0

Calculated rainfall intensity data:

1 hour intensity = 0.554(In/Hr)

Slope of intensity duration curve = 0.5000

↑

+++++
Process from Point/Station 10.000 to Point/Station 11.000
**** INITIAL AREA EVALUATION ****

Initial area flow distance = 510.000(Ft.)

Top (of initial area) elevation = 45.000(Ft.)

Bottom (of initial area) elevation = 37.100(Ft.)

Difference in elevation = 7.900(Ft.)

Slope = 0.01549 s(percent)= 1.55

TC = $k(0.323)*[(length^3)/(elevation\ change)]^{0.2}$

Initial area time of concentration = 9.000 min.

Rainfall intensity = 1.431(In/Hr) for a 2.0 year storm

APARTMENT subarea type

Runoff Coefficient = 0.813

Decimal fraction soil group A = 0.000

Decimal fraction soil group B = 0.000

Decimal fraction soil group C = 1.000

Decimal fraction soil group D = 0.000

RI index for soil(AMC 1) = 49.80

Pervious area fraction = 0.200; Impervious fraction = 0.800

Initial subarea runoff = 3.875(CFS)

Total initial stream area = 3.330(Ac.)

Pervious area fraction = 0.200

↑

Process from Point/Station 11.000 to Point/Station 12.000
**** PIPEFLOW TRAVEL TIME (Program estimated size) ****

Upstream point/station elevation = 32.100(Ft.)
Downstream point/station elevation = 31.000(Ft.)
Pipe length = 215.00(Ft.) Manning's N = 0.012
No. of pipes = 1 Required pipe flow = 3.875(CFS)
Nearest computed pipe diameter = 15.00(In.)
Calculated individual pipe flow = 3.875(CFS)
Normal flow depth in pipe = 9.91(In.)
Flow top width inside pipe = 14.20(In.)
Critical Depth = 9.55(In.)
Pipe flow velocity = 4.50(Ft/s)
Travel time through pipe = 0.80 min.
Time of concentration (TC) = 9.80 min.

↑

Process from Point/Station 12.000 to Point/Station 12.000
**** CONFLUENCE OF MAIN STREAMS ****

The following data inside Main Stream is listed:
In Main Stream number: 1
Stream flow area = 3.330(Ac.)
Runoff from this stream = 3.875(CFS)
Time of concentration = 9.80 min.
Rainfall intensity = 1.372(In/Hr)
Program is now starting with Main Stream No. 2

↑

Process from Point/Station 30.000 to Point/Station 31.000
**** INITIAL AREA EVALUATION ****

Initial area flow distance = 385.000(Ft.)
Top (of initial area) elevation = 43.000(Ft.)
Bottom (of initial area) elevation = 39.800(Ft.)
Difference in elevation = 3.200(Ft.)
Slope = 0.00831 s(percent)= 0.83
TC = $k(0.336)*[(length^3)/(elevation\ change)]^{0.2}$
Initial area time of concentration = 9.475 min.
Rainfall intensity = 1.395(In/Hr) for a 2.0 year storm
MOBILE HOME PARK subarea type
Runoff Coefficient = 0.790
Decimal fraction soil group A = 0.000
Decimal fraction soil group B = 0.000
Decimal fraction soil group C = 1.000
Decimal fraction soil group D = 0.000
RI index for soil(AMC 1) = 49.80
Pervious area fraction = 0.250; Impervious fraction = 0.750
Initial subarea runoff = 1.994(CFS)
Total initial stream area = 1.810(Ac.)
Pervious area fraction = 0.250

↑

Process from Point/Station 31.000 to Point/Station 22.000
**** PIPEFLOW TRAVEL TIME (Program estimated size) ****

Upstream point/station elevation = 34.800(Ft.)
Downstream point/station elevation = 33.800(Ft.)
Pipe length = 160.00(Ft.) Manning's N = 0.012
No. of pipes = 1 Required pipe flow = 1.994(CFS)
Nearest computed pipe diameter = 12.00(In.)

Calculated individual pipe flow = 1.994(CFS)
Normal flow depth in pipe = 7.07(In.)
Flow top width inside pipe = 11.81(In.)
Critical Depth = 7.23(In.)
Pipe flow velocity = 4.14(Ft/s)
Travel time through pipe = 0.64 min.
Time of concentration (TC) = 10.12 min.

↑

Process from Point/Station 22.000 to Point/Station 22.000
**** CONFLUENCE OF MINOR STREAMS ****

Along Main Stream number: 2 in normal stream number 1
Stream flow area = 1.810(Ac.)
Runoff from this stream = 1.994(CFS)
Time of concentration = 10.12 min.
Rainfall intensity = 1.350(In/Hr)

↑

Process from Point/Station 20.000 to Point/Station 21.000
**** INITIAL AREA EVALUATION ****

Initial area flow distance = 523.000(Ft.)
Top (of initial area) elevation = 43.900(Ft.)
Bottom (of initial area) elevation = 38.900(Ft.)
Difference in elevation = 5.000(Ft.)
Slope = 0.00956 s(percent)= 0.96
TC = $k(0.300)*[(length^3)/(elevation\ change)]^{0.2}$
Initial area time of concentration = 9.299 min.
Rainfall intensity = 1.408(In/Hr) for a 2.0 year storm
COMMERCIAL subarea type
Runoff Coefficient = 0.856
Decimal fraction soil group A = 0.000
Decimal fraction soil group B = 0.000
Decimal fraction soil group C = 1.000
Decimal fraction soil group D = 0.000
RI index for soil(AMC 1) = 49.80
Pervious area fraction = 0.100; Impervious fraction = 0.900
Initial subarea runoff = 4.798(CFS)
Total initial stream area = 3.980(Ac.)
Pervious area fraction = 0.100

↑

Process from Point/Station 21.000 to Point/Station 22.000
**** PIPEFLOW TRAVEL TIME (Program estimated size) ****

Upstream point/station elevation = 33.900(Ft.)
Downstream point/station elevation = 33.800(Ft.)
Pipe length = 30.00(Ft.) Manning's N = 0.012
No. of pipes = 1 Required pipe flow = 4.798(CFS)
Nearest computed pipe diameter = 18.00(In.)
Calculated individual pipe flow = 4.798(CFS)
Normal flow depth in pipe = 11.41(In.)
Flow top width inside pipe = 17.34(In.)
Critical Depth = 10.11(In.)
Pipe flow velocity = 4.06(Ft/s)
Travel time through pipe = 0.12 min.
Time of concentration (TC) = 9.42 min.

↑

Process from Point/Station 22.000 to Point/Station 22.000

**** CONFLUENCE OF MINOR STREAMS ****

Along Main Stream number: 2 in normal stream number 2
 Stream flow area = 3.980(Ac.)
 Runoff from this stream = 4.798(CFS)
 Time of concentration = 9.42 min.
 Rainfall intensity = 1.399(In/Hr)
 Summary of stream data:

| Stream No. | Flow rate (CFS) | TC (min) | Rainfall Intensity (In/Hr) |
|------------|-----------------|----------|----------------------------|
|------------|-----------------|----------|----------------------------|

| | | | |
|---|-------|-------|-------|
| 1 | 1.994 | 10.12 | 1.350 |
| 2 | 4.798 | 9.42 | 1.399 |

Largest stream flow has longer or shorter time of concentration

Qp = 4.798 + sum of
 Qa Tb/Ta
 1.994 * 0.931 = 1.856
 Qp = 6.654

Total of 2 streams to confluence:
 Flow rates before confluence point:
 1.994 4.798
 Area of streams before confluence:
 1.810 3.980

Results of confluence:
 Total flow rate = 6.654(CFS)
 Time of concentration = 9.422 min.
 Effective stream area after confluence = 5.790(Ac.)

↑

Process from Point/Station 22.000 to Point/Station 12.000
 **** PIPEFLOW TRAVEL TIME (Program estimated size) ****

Upstream point/station elevation = 33.800(Ft.)
 Downstream point/station elevation = 31.000(Ft.)
 Pipe length = 115.00(Ft.) Manning's N = 0.012
 No. of pipes = 1 Required pipe flow = 6.654(CFS)
 Nearest computed pipe diameter = 15.00(In.)
 Calculated individual pipe flow = 6.654(CFS)
 Normal flow depth in pipe = 8.46(In.)
 Flow top width inside pipe = 14.88(In.)
 Critical Depth = 12.46(In.)
 Pipe flow velocity = 9.34(Ft/s)
 Travel time through pipe = 0.21 min.
 Time of concentration (TC) = 9.63 min.

↑

Process from Point/Station 12.000 to Point/Station 12.000
 **** CONFLUENCE OF MAIN STREAMS ****

The following data inside Main Stream is listed:

In Main Stream number: 2
 Stream flow area = 5.790(Ac.)
 Runoff from this stream = 6.654(CFS)
 Time of concentration = 9.63 min.
 Rainfall intensity = 1.384(In/Hr)
 Summary of stream data:

| Stream No. | Flow rate (CFS) | TC (min) | Rainfall Intensity (In/Hr) |
|------------|-----------------|----------|----------------------------|
|------------|-----------------|----------|----------------------------|

| | | | |
|---|-------|------|-------|
| 1 | 3.875 | 9.80 | 1.372 |
|---|-------|------|-------|

2 6.654 9.63 1.384
 Largest stream flow has longer or shorter time of concentration
 $Q_p = 6.654 + \text{sum of}$
 Q_a T_b/T_a
 $3.875 * 0.983 = 3.808$
 $Q_p = 10.463$

Total of 2 main streams to confluence:
 Flow rates before confluence point:
 3.875 6.654
 Area of streams before confluence:
 3.330 5.790

Results of confluence:
 Total flow rate = 10.463(CFS)
 Time of concentration = 9.627 min.
 Effective stream area after confluence = 9.120(Ac.)
 End of computations, total study area = 9.12 (Ac.)
 The following figures may
 be used for a unit hydrograph study of the same area.

Area averaged pervious area fraction(A_p) = 0.166
 Area averaged RI index number = 69.0

Unit Hydrograph Analysis

Copyright (c) CIVILCADD/CIVILDESIGN, 1989 - 2018, Version 9.0
Study date 11/10/21 File: P2PUH242.out

Riverside County Synthetic Unit Hydrology Method
RCFC & WCD Manual date - April 1978

Program License Serial Number 6443

English (in-lb) Input Units Used
English Rainfall Data (Inches) Input Values Used

English Units used in output format

PENSKE MORENO VALLEY
PROP. 2-YR
XO 11/10/21

Drainage Area = 9.12(Ac.) = 0.014 Sq. Mi.
Drainage Area for Depth-Area Areal Adjustment = 9.12(Ac.) = 0.014 Sq. Mi.
USER Entry of lag time in hours
Lag time = 0.128 Hr.
Lag time = 7.70 Min.
25% of lag time = 1.93 Min.
40% of lag time = 3.08 Min.
Unit time = 5.00 Min.
Duration of storm = 24 Hour(s)
User Entered Base Flow = 0.00(CFS)

2 YEAR Area rainfall data:

| Area(Ac.)[1] | Rainfall(In)[2] | Weighting[1*2] |
|--------------|-----------------|----------------|
| 9.12 | 1.84 | 16.78 |

100 YEAR Area rainfall data:

| Area(Ac.)[1] | Rainfall(In)[2] | Weighting[1*2] |
|--------------|-----------------|----------------|
| 9.12 | 4.52 | 41.22 |

STORM EVENT (YEAR) = 2.00
Area Averaged 2-Year Rainfall = 1.840(In)
Area Averaged 100-Year Rainfall = 4.520(In)

Point rain (area averaged) = 1.840(In)
Areal adjustment factor = 100.00 %
Adjusted average point rain = 1.840(In)

Sub-Area Data:
Area(Ac.) Runoff Index Impervious %
9.120 69.00 0.830
Total Area Entered = 9.12(Ac.)

| RI | RI | Infil. Rate | Impervious | Adj. Infil. Rate | Area% | F |
|------|-------|-------------|------------|------------------|--------|---------|
| AMC2 | AMC-1 | (In/Hr) | (Dec.%) | (In/Hr) | (Dec.) | (In/Hr) |

69.0 49.8 0.574 0.830 0.145 1.000 0.145
 Sum (F) = 0.145
 Area averaged mean soil loss (F) (In/Hr) = 0.145
 Minimum soil loss rate ((In/Hr)) = 0.073
 (for 24 hour storm duration)
 Soil low loss rate (decimal) = 0.236

 U n i t H y d r o g r a p h
 VALLEY S-Curve

Unit Hydrograph Data

| Unit time period (hrs) | Time % of lag | Distribution Graph % | Unit Hydrograph (CFS) |
|------------------------|---------------|----------------------|-----------------------|
| 1 | 0.083 | 64.901 | 9.361 |
| 2 | 0.167 | 129.803 | 37.212 |
| 3 | 0.250 | 194.704 | 24.905 |
| 4 | 0.333 | 259.605 | 9.581 |
| 5 | 0.417 | 324.507 | 5.784 |
| 6 | 0.500 | 389.408 | 3.883 |
| 7 | 0.583 | 454.309 | 2.663 |
| 8 | 0.667 | 519.211 | 1.991 |
| 9 | 0.750 | 584.112 | 1.521 |
| 10 | 0.833 | 649.013 | 1.123 |
| 11 | 0.917 | 713.915 | 0.791 |
| 12 | 1.000 | 778.816 | 0.649 |
| 13 | 1.083 | 843.718 | 0.536 |
| Sum = 100.000 | | | Sum= 9.191 |

The following loss rate calculations reflect use of the minimum calculated loss rate subtracted from the Storm Rain to produce the maximum Effective Rain value

| Unit Time (Hr.) | Pattern Percent | Storm Rain (In/Hr) | Loss rate(In./Hr) | | Effective (In/Hr) |
|-----------------|-----------------|--------------------|-------------------|-------|-------------------|
| | | | Max | Low | |
| 1 | 0.08 | 0.07 | (0.257) | 0.003 | 0.011 |
| 2 | 0.17 | 0.07 | (0.256) | 0.003 | 0.011 |
| 3 | 0.25 | 0.07 | (0.255) | 0.003 | 0.011 |
| 4 | 0.33 | 0.10 | (0.254) | 0.005 | 0.017 |
| 5 | 0.42 | 0.10 | (0.253) | 0.005 | 0.017 |
| 6 | 0.50 | 0.10 | (0.252) | 0.005 | 0.017 |
| 7 | 0.58 | 0.10 | (0.251) | 0.005 | 0.017 |
| 8 | 0.67 | 0.10 | (0.250) | 0.005 | 0.017 |
| 9 | 0.75 | 0.10 | (0.250) | 0.005 | 0.017 |
| 10 | 0.83 | 0.13 | (0.249) | 0.007 | 0.022 |
| 11 | 0.92 | 0.13 | (0.248) | 0.007 | 0.022 |
| 12 | 1.00 | 0.13 | (0.247) | 0.007 | 0.022 |
| 13 | 1.08 | 0.10 | (0.246) | 0.005 | 0.017 |
| 14 | 1.17 | 0.10 | (0.245) | 0.005 | 0.017 |
| 15 | 1.25 | 0.10 | (0.244) | 0.005 | 0.017 |
| 16 | 1.33 | 0.10 | (0.243) | 0.005 | 0.017 |
| 17 | 1.42 | 0.10 | (0.242) | 0.005 | 0.017 |
| 18 | 1.50 | 0.10 | (0.241) | 0.005 | 0.017 |
| 19 | 1.58 | 0.10 | (0.240) | 0.005 | 0.017 |
| 20 | 1.67 | 0.10 | (0.239) | 0.005 | 0.017 |
| 21 | 1.75 | 0.10 | (0.238) | 0.005 | 0.017 |
| 22 | 1.83 | 0.13 | (0.237) | 0.007 | 0.022 |
| 23 | 1.92 | 0.13 | (0.236) | 0.007 | 0.022 |
| 24 | 2.00 | 0.13 | (0.235) | 0.007 | 0.022 |
| 25 | 2.08 | 0.13 | (0.234) | 0.007 | 0.022 |
| 26 | 2.17 | 0.13 | (0.233) | 0.007 | 0.022 |
| 27 | 2.25 | 0.13 | (0.232) | 0.007 | 0.022 |
| 28 | 2.33 | 0.13 | (0.231) | 0.007 | 0.022 |
| 29 | 2.42 | 0.13 | (0.230) | 0.007 | 0.022 |
| 30 | 2.50 | 0.13 | (0.229) | 0.007 | 0.022 |
| 31 | 2.58 | 0.17 | (0.228) | 0.009 | 0.028 |

| | | | | | | |
|-----|------|------|-------|----------|-------|-------|
| 32 | 2.67 | 0.17 | 0.037 | (0.227) | 0.009 | 0.028 |
| 33 | 2.75 | 0.17 | 0.037 | (0.227) | 0.009 | 0.028 |
| 34 | 2.83 | 0.17 | 0.037 | (0.226) | 0.009 | 0.028 |
| 35 | 2.92 | 0.17 | 0.037 | (0.225) | 0.009 | 0.028 |
| 36 | 3.00 | 0.17 | 0.037 | (0.224) | 0.009 | 0.028 |
| 37 | 3.08 | 0.17 | 0.037 | (0.223) | 0.009 | 0.028 |
| 38 | 3.17 | 0.17 | 0.037 | (0.222) | 0.009 | 0.028 |
| 39 | 3.25 | 0.17 | 0.037 | (0.221) | 0.009 | 0.028 |
| 40 | 3.33 | 0.17 | 0.037 | (0.220) | 0.009 | 0.028 |
| 41 | 3.42 | 0.17 | 0.037 | (0.219) | 0.009 | 0.028 |
| 42 | 3.50 | 0.17 | 0.037 | (0.218) | 0.009 | 0.028 |
| 43 | 3.58 | 0.17 | 0.037 | (0.217) | 0.009 | 0.028 |
| 44 | 3.67 | 0.17 | 0.037 | (0.216) | 0.009 | 0.028 |
| 45 | 3.75 | 0.17 | 0.037 | (0.215) | 0.009 | 0.028 |
| 46 | 3.83 | 0.20 | 0.044 | (0.215) | 0.010 | 0.034 |
| 47 | 3.92 | 0.20 | 0.044 | (0.214) | 0.010 | 0.034 |
| 48 | 4.00 | 0.20 | 0.044 | (0.213) | 0.010 | 0.034 |
| 49 | 4.08 | 0.20 | 0.044 | (0.212) | 0.010 | 0.034 |
| 50 | 4.17 | 0.20 | 0.044 | (0.211) | 0.010 | 0.034 |
| 51 | 4.25 | 0.20 | 0.044 | (0.210) | 0.010 | 0.034 |
| 52 | 4.33 | 0.23 | 0.052 | (0.209) | 0.012 | 0.039 |
| 53 | 4.42 | 0.23 | 0.052 | (0.208) | 0.012 | 0.039 |
| 54 | 4.50 | 0.23 | 0.052 | (0.207) | 0.012 | 0.039 |
| 55 | 4.58 | 0.23 | 0.052 | (0.206) | 0.012 | 0.039 |
| 56 | 4.67 | 0.23 | 0.052 | (0.206) | 0.012 | 0.039 |
| 57 | 4.75 | 0.23 | 0.052 | (0.205) | 0.012 | 0.039 |
| 58 | 4.83 | 0.27 | 0.059 | (0.204) | 0.014 | 0.045 |
| 59 | 4.92 | 0.27 | 0.059 | (0.203) | 0.014 | 0.045 |
| 60 | 5.00 | 0.27 | 0.059 | (0.202) | 0.014 | 0.045 |
| 61 | 5.08 | 0.20 | 0.044 | (0.201) | 0.010 | 0.034 |
| 62 | 5.17 | 0.20 | 0.044 | (0.200) | 0.010 | 0.034 |
| 63 | 5.25 | 0.20 | 0.044 | (0.199) | 0.010 | 0.034 |
| 64 | 5.33 | 0.23 | 0.052 | (0.199) | 0.012 | 0.039 |
| 65 | 5.42 | 0.23 | 0.052 | (0.198) | 0.012 | 0.039 |
| 66 | 5.50 | 0.23 | 0.052 | (0.197) | 0.012 | 0.039 |
| 67 | 5.58 | 0.27 | 0.059 | (0.196) | 0.014 | 0.045 |
| 68 | 5.67 | 0.27 | 0.059 | (0.195) | 0.014 | 0.045 |
| 69 | 5.75 | 0.27 | 0.059 | (0.194) | 0.014 | 0.045 |
| 70 | 5.83 | 0.27 | 0.059 | (0.193) | 0.014 | 0.045 |
| 71 | 5.92 | 0.27 | 0.059 | (0.193) | 0.014 | 0.045 |
| 72 | 6.00 | 0.27 | 0.059 | (0.192) | 0.014 | 0.045 |
| 73 | 6.08 | 0.30 | 0.066 | (0.191) | 0.016 | 0.051 |
| 74 | 6.17 | 0.30 | 0.066 | (0.190) | 0.016 | 0.051 |
| 75 | 6.25 | 0.30 | 0.066 | (0.189) | 0.016 | 0.051 |
| 76 | 6.33 | 0.30 | 0.066 | (0.188) | 0.016 | 0.051 |
| 77 | 6.42 | 0.30 | 0.066 | (0.187) | 0.016 | 0.051 |
| 78 | 6.50 | 0.30 | 0.066 | (0.187) | 0.016 | 0.051 |
| 79 | 6.58 | 0.33 | 0.074 | (0.186) | 0.017 | 0.056 |
| 80 | 6.67 | 0.33 | 0.074 | (0.185) | 0.017 | 0.056 |
| 81 | 6.75 | 0.33 | 0.074 | (0.184) | 0.017 | 0.056 |
| 82 | 6.83 | 0.33 | 0.074 | (0.183) | 0.017 | 0.056 |
| 83 | 6.92 | 0.33 | 0.074 | (0.182) | 0.017 | 0.056 |
| 84 | 7.00 | 0.33 | 0.074 | (0.182) | 0.017 | 0.056 |
| 85 | 7.08 | 0.33 | 0.074 | (0.181) | 0.017 | 0.056 |
| 86 | 7.17 | 0.33 | 0.074 | (0.180) | 0.017 | 0.056 |
| 87 | 7.25 | 0.33 | 0.074 | (0.179) | 0.017 | 0.056 |
| 88 | 7.33 | 0.37 | 0.081 | (0.178) | 0.019 | 0.062 |
| 89 | 7.42 | 0.37 | 0.081 | (0.178) | 0.019 | 0.062 |
| 90 | 7.50 | 0.37 | 0.081 | (0.177) | 0.019 | 0.062 |
| 91 | 7.58 | 0.40 | 0.088 | (0.176) | 0.021 | 0.067 |
| 92 | 7.67 | 0.40 | 0.088 | (0.175) | 0.021 | 0.067 |
| 93 | 7.75 | 0.40 | 0.088 | (0.174) | 0.021 | 0.067 |
| 94 | 7.83 | 0.43 | 0.096 | (0.173) | 0.023 | 0.073 |
| 95 | 7.92 | 0.43 | 0.096 | (0.173) | 0.023 | 0.073 |
| 96 | 8.00 | 0.43 | 0.096 | (0.172) | 0.023 | 0.073 |
| 97 | 8.08 | 0.50 | 0.110 | (0.171) | 0.026 | 0.084 |
| 98 | 8.17 | 0.50 | 0.110 | (0.170) | 0.026 | 0.084 |
| 99 | 8.25 | 0.50 | 0.110 | (0.169) | 0.026 | 0.084 |
| 100 | 8.33 | 0.50 | 0.110 | (0.169) | 0.026 | 0.084 |

| | | | | | | |
|-----|-------|------|-------|----------|-------|-------|
| 101 | 8.42 | 0.50 | 0.110 | (0.168) | 0.026 | 0.084 |
| 102 | 8.50 | 0.50 | 0.110 | (0.167) | 0.026 | 0.084 |
| 103 | 8.58 | 0.53 | 0.118 | (0.166) | 0.028 | 0.090 |
| 104 | 8.67 | 0.53 | 0.118 | (0.166) | 0.028 | 0.090 |
| 105 | 8.75 | 0.53 | 0.118 | (0.165) | 0.028 | 0.090 |
| 106 | 8.83 | 0.57 | 0.125 | (0.164) | 0.030 | 0.096 |
| 107 | 8.92 | 0.57 | 0.125 | (0.163) | 0.030 | 0.096 |
| 108 | 9.00 | 0.57 | 0.125 | (0.162) | 0.030 | 0.096 |
| 109 | 9.08 | 0.63 | 0.140 | (0.162) | 0.033 | 0.107 |
| 110 | 9.17 | 0.63 | 0.140 | (0.161) | 0.033 | 0.107 |
| 111 | 9.25 | 0.63 | 0.140 | (0.160) | 0.033 | 0.107 |
| 112 | 9.33 | 0.67 | 0.147 | (0.159) | 0.035 | 0.112 |
| 113 | 9.42 | 0.67 | 0.147 | (0.159) | 0.035 | 0.112 |
| 114 | 9.50 | 0.67 | 0.147 | (0.158) | 0.035 | 0.112 |
| 115 | 9.58 | 0.70 | 0.155 | (0.157) | 0.036 | 0.118 |
| 116 | 9.67 | 0.70 | 0.155 | (0.156) | 0.036 | 0.118 |
| 117 | 9.75 | 0.70 | 0.155 | (0.156) | 0.036 | 0.118 |
| 118 | 9.83 | 0.73 | 0.162 | (0.155) | 0.038 | 0.124 |
| 119 | 9.92 | 0.73 | 0.162 | (0.154) | 0.038 | 0.124 |
| 120 | 10.00 | 0.73 | 0.162 | (0.153) | 0.038 | 0.124 |
| 121 | 10.08 | 0.50 | 0.110 | (0.153) | 0.026 | 0.084 |
| 122 | 10.17 | 0.50 | 0.110 | (0.152) | 0.026 | 0.084 |
| 123 | 10.25 | 0.50 | 0.110 | (0.151) | 0.026 | 0.084 |
| 124 | 10.33 | 0.50 | 0.110 | (0.150) | 0.026 | 0.084 |
| 125 | 10.42 | 0.50 | 0.110 | (0.150) | 0.026 | 0.084 |
| 126 | 10.50 | 0.50 | 0.110 | (0.149) | 0.026 | 0.084 |
| 127 | 10.58 | 0.67 | 0.147 | (0.148) | 0.035 | 0.112 |
| 128 | 10.67 | 0.67 | 0.147 | (0.147) | 0.035 | 0.112 |
| 129 | 10.75 | 0.67 | 0.147 | (0.147) | 0.035 | 0.112 |
| 130 | 10.83 | 0.67 | 0.147 | (0.146) | 0.035 | 0.112 |
| 131 | 10.92 | 0.67 | 0.147 | (0.145) | 0.035 | 0.112 |
| 132 | 11.00 | 0.67 | 0.147 | (0.145) | 0.035 | 0.112 |
| 133 | 11.08 | 0.63 | 0.140 | (0.144) | 0.033 | 0.107 |
| 134 | 11.17 | 0.63 | 0.140 | (0.143) | 0.033 | 0.107 |
| 135 | 11.25 | 0.63 | 0.140 | (0.142) | 0.033 | 0.107 |
| 136 | 11.33 | 0.63 | 0.140 | (0.142) | 0.033 | 0.107 |
| 137 | 11.42 | 0.63 | 0.140 | (0.141) | 0.033 | 0.107 |
| 138 | 11.50 | 0.63 | 0.140 | (0.140) | 0.033 | 0.107 |
| 139 | 11.58 | 0.57 | 0.125 | (0.140) | 0.030 | 0.096 |
| 140 | 11.67 | 0.57 | 0.125 | (0.139) | 0.030 | 0.096 |
| 141 | 11.75 | 0.57 | 0.125 | (0.138) | 0.030 | 0.096 |
| 142 | 11.83 | 0.60 | 0.132 | (0.138) | 0.031 | 0.101 |
| 143 | 11.92 | 0.60 | 0.132 | (0.137) | 0.031 | 0.101 |
| 144 | 12.00 | 0.60 | 0.132 | (0.136) | 0.031 | 0.101 |
| 145 | 12.08 | 0.83 | 0.184 | (0.136) | 0.043 | 0.141 |
| 146 | 12.17 | 0.83 | 0.184 | (0.135) | 0.043 | 0.141 |
| 147 | 12.25 | 0.83 | 0.184 | (0.134) | 0.043 | 0.141 |
| 148 | 12.33 | 0.87 | 0.191 | (0.134) | 0.045 | 0.146 |
| 149 | 12.42 | 0.87 | 0.191 | (0.133) | 0.045 | 0.146 |
| 150 | 12.50 | 0.87 | 0.191 | (0.132) | 0.045 | 0.146 |
| 151 | 12.58 | 0.93 | 0.206 | (0.132) | 0.049 | 0.157 |
| 152 | 12.67 | 0.93 | 0.206 | (0.131) | 0.049 | 0.157 |
| 153 | 12.75 | 0.93 | 0.206 | (0.130) | 0.049 | 0.157 |
| 154 | 12.83 | 0.97 | 0.213 | (0.130) | 0.050 | 0.163 |
| 155 | 12.92 | 0.97 | 0.213 | (0.129) | 0.050 | 0.163 |
| 156 | 13.00 | 0.97 | 0.213 | (0.128) | 0.050 | 0.163 |
| 157 | 13.08 | 1.13 | 0.250 | (0.128) | 0.059 | 0.191 |
| 158 | 13.17 | 1.13 | 0.250 | (0.127) | 0.059 | 0.191 |
| 159 | 13.25 | 1.13 | 0.250 | (0.126) | 0.059 | 0.191 |
| 160 | 13.33 | 1.13 | 0.250 | (0.126) | 0.059 | 0.191 |
| 161 | 13.42 | 1.13 | 0.250 | (0.125) | 0.059 | 0.191 |
| 162 | 13.50 | 1.13 | 0.250 | (0.124) | 0.059 | 0.191 |
| 163 | 13.58 | 0.77 | 0.169 | (0.124) | 0.040 | 0.129 |
| 164 | 13.67 | 0.77 | 0.169 | (0.123) | 0.040 | 0.129 |
| 165 | 13.75 | 0.77 | 0.169 | (0.122) | 0.040 | 0.129 |
| 166 | 13.83 | 0.77 | 0.169 | (0.122) | 0.040 | 0.129 |
| 167 | 13.92 | 0.77 | 0.169 | (0.121) | 0.040 | 0.129 |
| 168 | 14.00 | 0.77 | 0.169 | (0.121) | 0.040 | 0.129 |
| 169 | 14.08 | 0.90 | 0.199 | (0.120) | 0.047 | 0.152 |

| | | | | | | |
|-----|-------|------|-------|----------|-------|-------|
| 170 | 14.17 | 0.90 | 0.199 | (0.119) | 0.047 | 0.152 |
| 171 | 14.25 | 0.90 | 0.199 | (0.119) | 0.047 | 0.152 |
| 172 | 14.33 | 0.87 | 0.191 | (0.118) | 0.045 | 0.146 |
| 173 | 14.42 | 0.87 | 0.191 | (0.118) | 0.045 | 0.146 |
| 174 | 14.50 | 0.87 | 0.191 | (0.117) | 0.045 | 0.146 |
| 175 | 14.58 | 0.87 | 0.191 | (0.116) | 0.045 | 0.146 |
| 176 | 14.67 | 0.87 | 0.191 | (0.116) | 0.045 | 0.146 |
| 177 | 14.75 | 0.87 | 0.191 | (0.115) | 0.045 | 0.146 |
| 178 | 14.83 | 0.83 | 0.184 | (0.115) | 0.043 | 0.141 |
| 179 | 14.92 | 0.83 | 0.184 | (0.114) | 0.043 | 0.141 |
| 180 | 15.00 | 0.83 | 0.184 | (0.113) | 0.043 | 0.141 |
| 181 | 15.08 | 0.80 | 0.177 | (0.113) | 0.042 | 0.135 |
| 182 | 15.17 | 0.80 | 0.177 | (0.112) | 0.042 | 0.135 |
| 183 | 15.25 | 0.80 | 0.177 | (0.112) | 0.042 | 0.135 |
| 184 | 15.33 | 0.77 | 0.169 | (0.111) | 0.040 | 0.129 |
| 185 | 15.42 | 0.77 | 0.169 | (0.111) | 0.040 | 0.129 |
| 186 | 15.50 | 0.77 | 0.169 | (0.110) | 0.040 | 0.129 |
| 187 | 15.58 | 0.63 | 0.140 | (0.109) | 0.033 | 0.107 |
| 188 | 15.67 | 0.63 | 0.140 | (0.109) | 0.033 | 0.107 |
| 189 | 15.75 | 0.63 | 0.140 | (0.108) | 0.033 | 0.107 |
| 190 | 15.83 | 0.63 | 0.140 | (0.108) | 0.033 | 0.107 |
| 191 | 15.92 | 0.63 | 0.140 | (0.107) | 0.033 | 0.107 |
| 192 | 16.00 | 0.63 | 0.140 | (0.107) | 0.033 | 0.107 |
| 193 | 16.08 | 0.13 | 0.029 | (0.106) | 0.007 | 0.022 |
| 194 | 16.17 | 0.13 | 0.029 | (0.106) | 0.007 | 0.022 |
| 195 | 16.25 | 0.13 | 0.029 | (0.105) | 0.007 | 0.022 |
| 196 | 16.33 | 0.13 | 0.029 | (0.104) | 0.007 | 0.022 |
| 197 | 16.42 | 0.13 | 0.029 | (0.104) | 0.007 | 0.022 |
| 198 | 16.50 | 0.13 | 0.029 | (0.103) | 0.007 | 0.022 |
| 199 | 16.58 | 0.10 | 0.022 | (0.103) | 0.005 | 0.017 |
| 200 | 16.67 | 0.10 | 0.022 | (0.102) | 0.005 | 0.017 |
| 201 | 16.75 | 0.10 | 0.022 | (0.102) | 0.005 | 0.017 |
| 202 | 16.83 | 0.10 | 0.022 | (0.101) | 0.005 | 0.017 |
| 203 | 16.92 | 0.10 | 0.022 | (0.101) | 0.005 | 0.017 |
| 204 | 17.00 | 0.10 | 0.022 | (0.100) | 0.005 | 0.017 |
| 205 | 17.08 | 0.17 | 0.037 | (0.100) | 0.009 | 0.028 |
| 206 | 17.17 | 0.17 | 0.037 | (0.099) | 0.009 | 0.028 |
| 207 | 17.25 | 0.17 | 0.037 | (0.099) | 0.009 | 0.028 |
| 208 | 17.33 | 0.17 | 0.037 | (0.098) | 0.009 | 0.028 |
| 209 | 17.42 | 0.17 | 0.037 | (0.098) | 0.009 | 0.028 |
| 210 | 17.50 | 0.17 | 0.037 | (0.097) | 0.009 | 0.028 |
| 211 | 17.58 | 0.17 | 0.037 | (0.097) | 0.009 | 0.028 |
| 212 | 17.67 | 0.17 | 0.037 | (0.096) | 0.009 | 0.028 |
| 213 | 17.75 | 0.17 | 0.037 | (0.096) | 0.009 | 0.028 |
| 214 | 17.83 | 0.13 | 0.029 | (0.095) | 0.007 | 0.022 |
| 215 | 17.92 | 0.13 | 0.029 | (0.095) | 0.007 | 0.022 |
| 216 | 18.00 | 0.13 | 0.029 | (0.094) | 0.007 | 0.022 |
| 217 | 18.08 | 0.13 | 0.029 | (0.094) | 0.007 | 0.022 |
| 218 | 18.17 | 0.13 | 0.029 | (0.094) | 0.007 | 0.022 |
| 219 | 18.25 | 0.13 | 0.029 | (0.093) | 0.007 | 0.022 |
| 220 | 18.33 | 0.13 | 0.029 | (0.093) | 0.007 | 0.022 |
| 221 | 18.42 | 0.13 | 0.029 | (0.092) | 0.007 | 0.022 |
| 222 | 18.50 | 0.13 | 0.029 | (0.092) | 0.007 | 0.022 |
| 223 | 18.58 | 0.10 | 0.022 | (0.091) | 0.005 | 0.017 |
| 224 | 18.67 | 0.10 | 0.022 | (0.091) | 0.005 | 0.017 |
| 225 | 18.75 | 0.10 | 0.022 | (0.090) | 0.005 | 0.017 |
| 226 | 18.83 | 0.07 | 0.015 | (0.090) | 0.003 | 0.011 |
| 227 | 18.92 | 0.07 | 0.015 | (0.090) | 0.003 | 0.011 |
| 228 | 19.00 | 0.07 | 0.015 | (0.089) | 0.003 | 0.011 |
| 229 | 19.08 | 0.10 | 0.022 | (0.089) | 0.005 | 0.017 |
| 230 | 19.17 | 0.10 | 0.022 | (0.088) | 0.005 | 0.017 |
| 231 | 19.25 | 0.10 | 0.022 | (0.088) | 0.005 | 0.017 |
| 232 | 19.33 | 0.13 | 0.029 | (0.087) | 0.007 | 0.022 |
| 233 | 19.42 | 0.13 | 0.029 | (0.087) | 0.007 | 0.022 |
| 234 | 19.50 | 0.13 | 0.029 | (0.087) | 0.007 | 0.022 |
| 235 | 19.58 | 0.10 | 0.022 | (0.086) | 0.005 | 0.017 |
| 236 | 19.67 | 0.10 | 0.022 | (0.086) | 0.005 | 0.017 |
| 237 | 19.75 | 0.10 | 0.022 | (0.085) | 0.005 | 0.017 |
| 238 | 19.83 | 0.07 | 0.015 | (0.085) | 0.003 | 0.011 |

| Time(h+m) | Volume | Ac.Ft | Q(CFS) | 0 | 2.5 | 5.0 | 7.5 | 10.0 |
|-----------|--------|-------|--------|---|-----|-----|-----|------|
| 0+ 5 | 0.0001 | 0.01 | Q | | | | | |
| 0+10 | 0.0004 | 0.05 | Q | | | | | |
| 0+15 | 0.0009 | 0.07 | Q | | | | | |
| 0+20 | 0.0015 | 0.09 | Q | | | | | |
| 0+25 | 0.0023 | 0.11 | Q | | | | | |
| 0+30 | 0.0032 | 0.13 | Q | | | | | |
| 0+35 | 0.0042 | 0.14 | Q | | | | | |
| 0+40 | 0.0051 | 0.14 | Q | | | | | |
| 0+45 | 0.0062 | 0.15 | Q | | | | | |
| 0+50 | 0.0072 | 0.15 | Q | | | | | |
| 0+55 | 0.0084 | 0.18 | Q | | | | | |
| 1+ 0 | 0.0097 | 0.19 | Q | | | | | |
| 1+ 5 | 0.0111 | 0.19 | Q | | | | | |
| 1+10 | 0.0123 | 0.18 | Q | | | | | |
| 1+15 | 0.0134 | 0.16 | Q | | | | | |
| 1+20 | 0.0145 | 0.16 | Q | | | | | |
| 1+25 | 0.0156 | 0.16 | Q | | | | | |
| 1+30 | 0.0167 | 0.16 | Q | | | | | |
| 1+35 | 0.0178 | 0.16 | Q | | | | | |
| 1+40 | 0.0189 | 0.16 | Q | | | | | |
| 1+45 | 0.0199 | 0.16 | Q | | | | | |
| 1+50 | 0.0211 | 0.16 | Q | | | | | |
| 1+55 | 0.0223 | 0.18 | Q | | | | | |
| 2+ 0 | 0.0236 | 0.19 | Q | | | | | |
| 2+ 5 | 0.0250 | 0.20 | Q | | | | | |
| 2+10 | 0.0264 | 0.20 | Q | | | | | |
| 2+15 | 0.0277 | 0.20 | QV | | | | | |
| 2+20 | 0.0291 | 0.20 | QV | | | | | |
| 2+25 | 0.0306 | 0.20 | QV | | | | | |
| 2+30 | 0.0320 | 0.21 | QV | | | | | |
| 2+35 | 0.0334 | 0.21 | QV | | | | | |
| 2+40 | 0.0350 | 0.23 | QV | | | | | |
| 2+45 | 0.0367 | 0.24 | QV | | | | | |
| 2+50 | 0.0384 | 0.25 | QV | | | | | |
| 2+55 | 0.0401 | 0.25 | Q | | | | | |
| 3+ 0 | 0.0419 | 0.25 | Q | | | | | |
| 3+ 5 | 0.0436 | 0.26 | Q | | | | | |
| 3+10 | 0.0454 | 0.26 | Q | | | | | |
| 3+15 | 0.0472 | 0.26 | Q | | | | | |
| 3+20 | 0.0489 | 0.26 | Q | | | | | |
| 3+25 | 0.0507 | 0.26 | Q | | | | | |
| 3+30 | 0.0525 | 0.26 | Q | | | | | |
| 3+35 | 0.0543 | 0.26 | QV | | | | | |
| 3+40 | 0.0561 | 0.26 | QV | | | | | |
| 3+45 | 0.0578 | 0.26 | QV | | | | | |
| 3+50 | 0.0596 | 0.26 | QV | | | | | |
| 3+55 | 0.0616 | 0.28 | QV | | | | | |
| 4+ 0 | 0.0636 | 0.30 | QV | | | | | |
| 4+ 5 | 0.0657 | 0.30 | QV | | | | | |
| 4+10 | 0.0678 | 0.30 | QV | | | | | |
| 4+15 | 0.0699 | 0.31 | QV | | | | | |
| 4+20 | 0.0720 | 0.31 | QV | | | | | |
| 4+25 | 0.0743 | 0.33 | QV | | | | | |
| 4+30 | 0.0767 | 0.35 | QV | | | | | |
| 4+35 | 0.0791 | 0.35 | QV | | | | | |
| 4+40 | 0.0816 | 0.35 | Q V | | | | | |
| 4+45 | 0.0840 | 0.36 | Q V | | | | | |
| 4+50 | 0.0865 | 0.36 | Q V | | | | | |
| 4+55 | 0.0892 | 0.38 | Q V | | | | | |
| 5+ 0 | 0.0919 | 0.40 | Q V | | | | | |
| 5+ 5 | 0.0946 | 0.39 | Q V | | | | | |
| 5+10 | 0.0971 | 0.36 | Q V | | | | | |
| 5+15 | 0.0994 | 0.33 | Q V | | | | | |
| 5+20 | 0.1017 | 0.33 | Q V | | | | | |
| 5+25 | 0.1040 | 0.35 | Q V | | | | | |
| 5+30 | 0.1065 | 0.36 | Q V | | | | | |
| 5+35 | 0.1090 | 0.36 | Q V | | | | | |

| | | | | | | | | | |
|-------|--------|------|---|---|--|--|--|--|--|
| 5+40 | 0.1116 | 0.38 | Q | V | | | | | |
| 5+45 | 0.1144 | 0.40 | Q | V | | | | | |
| 5+50 | 0.1171 | 0.40 | Q | V | | | | | |
| 5+55 | 0.1199 | 0.41 | Q | V | | | | | |
| 6+ 0 | 0.1227 | 0.41 | Q | V | | | | | |
| 6+ 5 | 0.1256 | 0.41 | Q | V | | | | | |
| 6+10 | 0.1286 | 0.43 | Q | V | | | | | |
| 6+15 | 0.1317 | 0.45 | Q | V | | | | | |
| 6+20 | 0.1348 | 0.45 | Q | V | | | | | |
| 6+25 | 0.1380 | 0.46 | Q | V | | | | | |
| 6+30 | 0.1411 | 0.46 | Q | V | | | | | |
| 6+35 | 0.1443 | 0.47 | Q | V | | | | | |
| 6+40 | 0.1477 | 0.49 | Q | V | | | | | |
| 6+45 | 0.1511 | 0.50 | Q | V | | | | | |
| 6+50 | 0.1546 | 0.51 | Q | V | | | | | |
| 6+55 | 0.1581 | 0.51 | Q | V | | | | | |
| 7+ 0 | 0.1617 | 0.51 | Q | V | | | | | |
| 7+ 5 | 0.1652 | 0.51 | Q | V | | | | | |
| 7+10 | 0.1688 | 0.51 | Q | V | | | | | |
| 7+15 | 0.1723 | 0.52 | Q | V | | | | | |
| 7+20 | 0.1759 | 0.52 | Q | V | | | | | |
| 7+25 | 0.1796 | 0.54 | Q | V | | | | | |
| 7+30 | 0.1834 | 0.55 | Q | V | | | | | |
| 7+35 | 0.1873 | 0.56 | Q | V | | | | | |
| 7+40 | 0.1913 | 0.59 | Q | V | | | | | |
| 7+45 | 0.1955 | 0.60 | Q | V | | | | | |
| 7+50 | 0.1997 | 0.61 | Q | V | | | | | |
| 7+55 | 0.2041 | 0.64 | Q | V | | | | | |
| 8+ 0 | 0.2086 | 0.65 | Q | V | | | | | |
| 8+ 5 | 0.2132 | 0.67 | Q | V | | | | | |
| 8+10 | 0.2181 | 0.71 | Q | V | | | | | |
| 8+15 | 0.2231 | 0.74 | Q | V | | | | | |
| 8+20 | 0.2283 | 0.75 | Q | V | | | | | |
| 8+25 | 0.2336 | 0.76 | Q | V | | | | | |
| 8+30 | 0.2388 | 0.76 | Q | V | | | | | |
| 8+35 | 0.2441 | 0.77 | Q | V | | | | | |
| 8+40 | 0.2496 | 0.79 | Q | V | | | | | |
| 8+45 | 0.2552 | 0.81 | Q | V | | | | | |
| 8+50 | 0.2608 | 0.82 | Q | V | | | | | |
| 8+55 | 0.2666 | 0.84 | Q | V | | | | | |
| 9+ 0 | 0.2726 | 0.86 | Q | V | | | | | |
| 9+ 5 | 0.2786 | 0.88 | Q | V | | | | | |
| 9+10 | 0.2849 | 0.92 | Q | V | | | | | |
| 9+15 | 0.2914 | 0.95 | Q | V | | | | | |
| 9+20 | 0.2981 | 0.96 | Q | V | | | | | |
| 9+25 | 0.3049 | 0.99 | Q | V | | | | | |
| 9+30 | 0.3118 | 1.01 | Q | V | | | | | |
| 9+35 | 0.3189 | 1.02 | Q | V | | | | | |
| 9+40 | 0.3261 | 1.05 | Q | V | | | | | |
| 9+45 | 0.3334 | 1.06 | Q | V | | | | | |
| 9+50 | 0.3408 | 1.08 | Q | V | | | | | |
| 9+55 | 0.3484 | 1.10 | Q | V | | | | | |
| 10+ 0 | 0.3560 | 1.12 | Q | V | | | | | |
| 10+ 5 | 0.3635 | 1.09 | Q | V | | | | | |
| 10+10 | 0.3701 | 0.96 | Q | V | | | | | |
| 10+15 | 0.3762 | 0.87 | Q | V | | | | | |
| 10+20 | 0.3819 | 0.84 | Q | V | | | | | |
| 10+25 | 0.3876 | 0.82 | Q | V | | | | | |
| 10+30 | 0.3931 | 0.81 | Q | V | | | | | |
| 10+35 | 0.3988 | 0.82 | Q | V | | | | | |
| 10+40 | 0.4051 | 0.91 | Q | V | | | | | |
| 10+45 | 0.4118 | 0.97 | Q | V | | | | | |
| 10+50 | 0.4186 | 0.99 | Q | V | | | | | |
| 10+55 | 0.4255 | 1.00 | Q | V | | | | | |
| 11+ 0 | 0.4325 | 1.01 | Q | V | | | | | |
| 11+ 5 | 0.4395 | 1.01 | Q | V | | | | | |
| 11+10 | 0.4464 | 1.00 | Q | V | | | | | |
| 11+15 | 0.4532 | 0.99 | Q | V | | | | | |
| 11+20 | 0.4600 | 0.99 | Q | V | | | | | |

| | | | | | | | |
|-------|--------|------|---|---|--|--|--|
| 11+25 | 0.4668 | 0.99 | Q | V | | | |
| 11+30 | 0.4735 | 0.99 | Q | V | | | |
| 11+35 | 0.4803 | 0.98 | Q | V | | | |
| 11+40 | 0.4867 | 0.94 | Q | V | | | |
| 11+45 | 0.4930 | 0.91 | Q | V | | | |
| 11+50 | 0.4992 | 0.90 | Q | V | | | |
| 11+55 | 0.5055 | 0.92 | Q | V | | | |
| 12+ 0 | 0.5119 | 0.93 | Q | V | | | |
| 12+ 5 | 0.5185 | 0.96 | Q | V | | | |
| 12+10 | 0.5261 | 1.10 | Q | V | | | |
| 12+15 | 0.5343 | 1.19 | Q | V | | | |
| 12+20 | 0.5427 | 1.23 | Q | V | | | |
| 12+25 | 0.5515 | 1.27 | Q | V | | | |
| 12+30 | 0.5604 | 1.30 | Q | V | | | |
| 12+35 | 0.5695 | 1.32 | Q | V | | | |
| 12+40 | 0.5789 | 1.37 | Q | V | | | |
| 12+45 | 0.5885 | 1.40 | Q | V | | | |
| 12+50 | 0.5983 | 1.42 | Q | V | | | |
| 12+55 | 0.6083 | 1.45 | Q | V | | | |
| 13+ 0 | 0.6185 | 1.47 | Q | V | | | |
| 13+ 5 | 0.6289 | 1.51 | Q | V | | | |
| 13+10 | 0.6399 | 1.61 | Q | V | | | |
| 13+15 | 0.6515 | 1.68 | Q | V | | | |
| 13+20 | 0.6632 | 1.70 | Q | V | | | |
| 13+25 | 0.6750 | 1.72 | Q | V | | | |
| 13+30 | 0.6870 | 1.73 | Q | V | | | |
| 13+35 | 0.6986 | 1.69 | Q | V | | | |
| 13+40 | 0.7088 | 1.48 | Q | V | | | |
| 13+45 | 0.7180 | 1.34 | Q | V | | | |
| 13+50 | 0.7269 | 1.29 | Q | V | | | |
| 13+55 | 0.7356 | 1.26 | Q | V | | | |
| 14+ 0 | 0.7442 | 1.24 | Q | V | | | |
| 14+ 5 | 0.7528 | 1.25 | Q | V | | | |
| 14+10 | 0.7618 | 1.31 | Q | V | | | |
| 14+15 | 0.7711 | 1.35 | Q | V | | | |
| 14+20 | 0.7805 | 1.36 | Q | V | | | |
| 14+25 | 0.7898 | 1.35 | Q | V | | | |
| 14+30 | 0.7991 | 1.34 | Q | V | | | |
| 14+35 | 0.8083 | 1.34 | Q | V | | | |
| 14+40 | 0.8175 | 1.34 | Q | V | | | |
| 14+45 | 0.8268 | 1.34 | Q | V | | | |
| 14+50 | 0.8360 | 1.34 | Q | V | | | |
| 14+55 | 0.8451 | 1.32 | Q | V | | | |
| 15+ 0 | 0.8541 | 1.31 | Q | V | | | |
| 15+ 5 | 0.8631 | 1.30 | Q | V | | | |
| 15+10 | 0.8718 | 1.28 | Q | V | | | |
| 15+15 | 0.8805 | 1.26 | Q | V | | | |
| 15+20 | 0.8891 | 1.25 | Q | V | | | |
| 15+25 | 0.8976 | 1.23 | Q | V | | | |
| 15+30 | 0.9059 | 1.21 | Q | V | | | |
| 15+35 | 0.9141 | 1.18 | Q | V | | | |
| 15+40 | 0.9217 | 1.10 | Q | V | | | |
| 15+45 | 0.9289 | 1.05 | Q | V | | | |
| 15+50 | 0.9359 | 1.03 | Q | V | | | |
| 15+55 | 0.9429 | 1.01 | Q | V | | | |
| 16+ 0 | 0.9498 | 1.00 | Q | V | | | |
| 16+ 5 | 0.9562 | 0.92 | Q | V | | | |
| 16+10 | 0.9605 | 0.63 | Q | V | | | |
| 16+15 | 0.9635 | 0.43 | Q | V | | | |
| 16+20 | 0.9660 | 0.36 | Q | V | | | |
| 16+25 | 0.9681 | 0.31 | Q | V | | | |
| 16+30 | 0.9701 | 0.28 | Q | V | | | |
| 16+35 | 0.9718 | 0.25 | Q | V | | | |
| 16+40 | 0.9733 | 0.22 | Q | V | | | |
| 16+45 | 0.9747 | 0.19 | Q | V | | | |
| 16+50 | 0.9759 | 0.18 | Q | V | | | |
| 16+55 | 0.9771 | 0.17 | Q | V | | | |
| 17+ 0 | 0.9782 | 0.16 | Q | V | | | |
| 17+ 5 | 0.9794 | 0.17 | Q | V | | | |

| | | | | |
|-------|--------|------|---|---|
| 17+10 | 0.9808 | 0.21 | Q | V |
| 17+15 | 0.9824 | 0.23 | Q | V |
| 17+20 | 0.9840 | 0.24 | Q | V |
| 17+25 | 0.9857 | 0.25 | Q | V |
| 17+30 | 0.9874 | 0.25 | Q | V |
| 17+35 | 0.9892 | 0.25 | Q | V |
| 17+40 | 0.9909 | 0.25 | Q | V |
| 17+45 | 0.9927 | 0.26 | Q | V |
| 17+50 | 0.9944 | 0.25 | Q | V |
| 17+55 | 0.9960 | 0.23 | Q | V |
| 18+ 0 | 0.9975 | 0.22 | Q | V |
| 18+ 5 | 0.9990 | 0.22 | Q | V |
| 18+10 | 1.0005 | 0.21 | Q | V |
| 18+15 | 1.0020 | 0.21 | Q | V |
| 18+20 | 1.0034 | 0.21 | Q | V |
| 18+25 | 1.0048 | 0.21 | Q | V |
| 18+30 | 1.0063 | 0.21 | Q | V |
| 18+35 | 1.0077 | 0.20 | Q | V |
| 18+40 | 1.0089 | 0.18 | Q | V |
| 18+45 | 1.0101 | 0.17 | Q | V |
| 18+50 | 1.0112 | 0.16 | Q | V |
| 18+55 | 1.0122 | 0.14 | Q | V |
| 19+ 0 | 1.0130 | 0.12 | Q | V |
| 19+ 5 | 1.0138 | 0.12 | Q | V |
| 19+10 | 1.0148 | 0.14 | Q | V |
| 19+15 | 1.0158 | 0.15 | Q | V |
| 19+20 | 1.0169 | 0.15 | Q | V |
| 19+25 | 1.0181 | 0.18 | Q | V |
| 19+30 | 1.0194 | 0.19 | Q | V |
| 19+35 | 1.0207 | 0.19 | Q | V |
| 19+40 | 1.0219 | 0.17 | Q | V |
| 19+45 | 1.0230 | 0.16 | Q | V |
| 19+50 | 1.0241 | 0.16 | Q | V |
| 19+55 | 1.0250 | 0.13 | Q | V |
| 20+ 0 | 1.0258 | 0.12 | Q | V |
| 20+ 5 | 1.0267 | 0.12 | Q | V |
| 20+10 | 1.0276 | 0.14 | Q | V |
| 20+15 | 1.0286 | 0.15 | Q | V |
| 20+20 | 1.0297 | 0.15 | Q | V |
| 20+25 | 1.0307 | 0.15 | Q | V |
| 20+30 | 1.0317 | 0.15 | Q | V |
| 20+35 | 1.0328 | 0.15 | Q | V |
| 20+40 | 1.0339 | 0.15 | Q | V |
| 20+45 | 1.0349 | 0.15 | Q | V |
| 20+50 | 1.0359 | 0.15 | Q | V |
| 20+55 | 1.0368 | 0.13 | Q | V |
| 21+ 0 | 1.0376 | 0.12 | Q | V |
| 21+ 5 | 1.0385 | 0.12 | Q | V |
| 21+10 | 1.0394 | 0.13 | Q | V |
| 21+15 | 1.0404 | 0.15 | Q | V |
| 21+20 | 1.0414 | 0.14 | Q | V |
| 21+25 | 1.0423 | 0.13 | Q | V |
| 21+30 | 1.0430 | 0.11 | Q | V |
| 21+35 | 1.0438 | 0.12 | Q | V |
| 21+40 | 1.0448 | 0.13 | Q | V |
| 21+45 | 1.0457 | 0.14 | Q | V |
| 21+50 | 1.0467 | 0.14 | Q | V |
| 21+55 | 1.0476 | 0.13 | Q | V |
| 22+ 0 | 1.0484 | 0.11 | Q | V |
| 22+ 5 | 1.0492 | 0.12 | Q | V |
| 22+10 | 1.0501 | 0.13 | Q | V |
| 22+15 | 1.0511 | 0.14 | Q | V |
| 22+20 | 1.0521 | 0.14 | Q | V |
| 22+25 | 1.0529 | 0.13 | Q | V |
| 22+30 | 1.0537 | 0.11 | Q | V |
| 22+35 | 1.0545 | 0.11 | Q | V |
| 22+40 | 1.0552 | 0.11 | Q | V |
| 22+45 | 1.0560 | 0.11 | Q | V |
| 22+50 | 1.0567 | 0.11 | Q | V |

| | | | | | | | |
|-------|--------|------|---|--|--|--|---|
| 22+55 | 1.0574 | 0.11 | Q | | | | V |
| 23+ 0 | 1.0581 | 0.10 | Q | | | | V |
| 23+ 5 | 1.0589 | 0.10 | Q | | | | V |
| 23+10 | 1.0596 | 0.10 | Q | | | | V |
| 23+15 | 1.0603 | 0.10 | Q | | | | V |
| 23+20 | 1.0610 | 0.10 | Q | | | | V |
| 23+25 | 1.0617 | 0.10 | Q | | | | V |
| 23+30 | 1.0624 | 0.10 | Q | | | | V |
| 23+35 | 1.0631 | 0.10 | Q | | | | V |
| 23+40 | 1.0639 | 0.10 | Q | | | | V |
| 23+45 | 1.0646 | 0.10 | Q | | | | V |
| 23+50 | 1.0653 | 0.10 | Q | | | | V |
| 23+55 | 1.0660 | 0.10 | Q | | | | V |
| 24+ 0 | 1.0667 | 0.10 | Q | | | | V |
| 24+ 5 | 1.0674 | 0.09 | Q | | | | V |
| 24+10 | 1.0677 | 0.06 | Q | | | | V |
| 24+15 | 1.0679 | 0.03 | Q | | | | V |
| 24+20 | 1.0681 | 0.02 | Q | | | | V |
| 24+25 | 1.0682 | 0.01 | Q | | | | V |
| 24+30 | 1.0682 | 0.01 | Q | | | | V |
| 24+35 | 1.0683 | 0.01 | Q | | | | V |
| 24+40 | 1.0683 | 0.00 | Q | | | | V |
| 24+45 | 1.0683 | 0.00 | Q | | | | V |
| 24+50 | 1.0683 | 0.00 | Q | | | | V |
| 24+55 | 1.0684 | 0.00 | Q | | | | V |
| 25+ 0 | 1.0684 | 0.00 | Q | | | | V |

Appendix 8: Source Control

Pollutant Sources/Source Control Checklist

STORMWATER POLLUTANT SOURCES/SOURCE CONTROL CHECKLIST

How to use this worksheet (also see instructions in Section G of the WQMP Template):

















1. Review Column 1 and identify which of these potential sources of stormwater pollutants apply to your site. Check each box that applies.
2. Review Column 2 and incorporate all of the corresponding applicable BMPs in your WQMP Exhibit.
3. Review Columns 3 and 4 and incorporate all of the corresponding applicable permanent controls and operational BMPs in your WQMP. Use the format shown in Table G.1 on page 23 of this WQMP Template. Describe your specific BMPs in an accompanying narrative, and explain any special conditions or situations that required omitting BMPs or substituting alternative BMPs for those shown here.

| IF THESE SOURCES WILL BE ON THE PROJECT SITE ... | ... THEN YOUR WQMP SHOULD INCLUDE THESE SOURCE CONTROL BMPs, AS APPLICABLE | | |
|---|--|---|---|
| 1 Potential Sources of Runoff Pollutants | 2 Permanent Controls—Show on WQMP Drawings | 3 Permanent Controls—List in WQMP Table and Narrative | 4 Operational BMPs—Include in WQMP Table and Narrative |
| <input checked="" type="checkbox"/> A. On-site storm drain inlets | <input checked="" type="checkbox"/> Locations of inlets. | <input checked="" type="checkbox"/> Mark all inlets with the words “Only Rain Down the Storm Drain” or similar. Catch Basin Markers may be available from the Riverside County Flood Control and Water Conservation District, call 951.955.1200 to verify. | <input checked="" type="checkbox"/> Maintain and periodically repaint or replace inlet markings. <input checked="" type="checkbox"/> Provide stormwater pollution prevention information to new site owners, lessees, or operators. <input checked="" type="checkbox"/> See applicable operational BMPs in Fact Sheet SC-44, “Drainage System Maintenance,” in the CASQA Stormwater Quality Handbooks at www.cabmphandbooks.com <input checked="" type="checkbox"/> Include the following in lease agreements: “Tenant shall not allow anyone to discharge anything to storm drains or to store or deposit materials so as to create a potential discharge to storm drains.” |
| <input checked="" type="checkbox"/> B. Interior floor drains and elevator shaft sump pumps | | <input checked="" type="checkbox"/> State that interior floor drains and elevator shaft sump pumps will be plumbed to sanitary sewer. | <input checked="" type="checkbox"/> Inspect and maintain drains to prevent blockages and overflow. |
| <input type="checkbox"/> C. Interior parking garages | | <input type="checkbox"/> State that parking garage floor drains will be plumbed to the sanitary sewer. | <input type="checkbox"/> Inspect and maintain drains to prevent blockages and overflow. |





STORMWATER POLLUTANT SOURCES/SOURCE CONTROL CHECKLIST

| IF THESE SOURCES WILL BE ON THE PROJECT SITE ... | ... THEN YOUR WQMP SHOULD INCLUDE THESE SOURCE CONTROL BMPs, AS APPLICABLE | | |
|--|---|--|--|
| 1 Potential Sources of Runoff Pollutants | 2 Permanent Controls—Show on WQMP Drawings | 3 Permanent Controls—List in WQMP Table and Narrative | 4 Operational BMPs—Include in WQMP Table and Narrative |
| <input checked="" type="checkbox"/> D1. Need for future indoor & structural pest control | | <input checked="" type="checkbox"/> Note building design features that discourage entry of pests. | <input checked="" type="checkbox"/> Provide Integrated Pest Management information to owners, lessees, and operators. |
| <input checked="" type="checkbox"/> D2. Landscape/ Outdoor Pesticide Use | <input checked="" type="checkbox"/> Show locations of native trees or areas of shrubs and ground cover to be undisturbed and retained. <input checked="" type="checkbox"/> Show self-retaining landscape areas, if any. <input checked="" type="checkbox"/> Show stormwater treatment and hydrograph modification management BMPs. (See instructions in Chapter 3, Step 5 and guidance in Chapter 5.) | State that final landscape plans will accomplish all of the following. <input checked="" type="checkbox"/> Preserve existing native trees, shrubs, and ground cover to the maximum extent possible. <input checked="" type="checkbox"/> Design landscaping to minimize irrigation and runoff, to promote surface infiltration where appropriate, and to minimize the use of fertilizers and pesticides that can contribute to stormwater pollution. <input checked="" type="checkbox"/> Where landscaped areas are used to retain or detain stormwater, specify plants that are tolerant of saturated soil conditions. <input checked="" type="checkbox"/> Consider using pest-resistant plants, especially adjacent to hardscape. To insure successful establishment, select plants appropriate to site soils, slopes, climate, sun, wind, rain, land use, air movement, ecological consistency, and plant interactions. | <input checked="" type="checkbox"/> Maintain landscaping using minimum or no pesticides. <input checked="" type="checkbox"/> See applicable operational BMPs in “What you should know for.....Landscape and Gardening” at http://rcflood.org/stormwater/Error! Hyperlink reference not valid. <input checked="" type="checkbox"/> Provide IPM information to new owners, lessees and operators. |

STORMWATER POLLUTANT SOURCES/SOURCE CONTROL CHECKLIST

| IF THESE SOURCES WILL BE ON THE PROJECT SITE ... | ... THEN YOUR WQMP SHOULD INCLUDE THESE SOURCE CONTROL BMPs, AS APPLICABLE | | |
|---|---|--|--|
| 1 Potential Sources of Runoff Pollutants | 2 Permanent Controls—Show on WQMP Drawings | 3 Permanent Controls—List in WQMP Table and Narrative | 4 Operational BMPs—Include in WQMP Table and Narrative |
| <p> E. Pools, spas, ponds, decorative fountains, and other water features.</p> | <p> Show location of water feature and a sanitary sewer cleanout in an accessible area within 10 feet. (Exception: Public pools must be plumbed according to County Department of Environmental Health Guidelines.)</p> | <p>If the Co-Permittee requires pools to be plumbed to the sanitary sewer, place a note on the plans and state in the narrative that this connection will be made according to local requirements.</p> | <p> See applicable operational BMPs in “Guidelines for Maintaining Your Swimming Pool, Jacuzzi and Garden Fountain” at http://rcflood.org/stormwater/</p> |
| <p> F. Food service</p> | <p> For restaurants, grocery stores, and other food service operations, show location (indoors or in a covered area outdoors) of a floor sink or other area for cleaning floor mats, containers, and equipment.</p> <p> On the drawing, show a note that this drain will be connected to a grease interceptor before discharging to the sanitary sewer.</p> | <p> Describe the location and features of the designated cleaning area.</p> <p> Describe the items to be cleaned in this facility and how it has been sized to insure that the largest items can be accommodated.</p> | <p> See the brochure, “The Food Service Industry Best Management Practices for: Restaurants, Grocery Stores, Delicatessens and Bakeries” at http://rcflood.org/stormwater/</p> <p>Provide this brochure to new site owners, lessees, and operators.</p> |
| <p> G. Refuse areas</p> | <p> Show where site refuse and recycled materials will be handled and stored for pickup. See local municipal requirements for sizes and other details of refuse areas.</p> <p> If dumpsters or other receptacles are outdoors, show how the designated area will be covered, graded, and paved to prevent run-on and show locations of berms to prevent runoff from the area.</p> <p> Any drains from dumpsters, compactors, and tallow bin areas shall be connected to a grease removal device before discharge to sanitary sewer.</p> | <p> State how site refuse will be handled and provide supporting detail to what is shown on plans.</p> <p> State that signs will be posted on or near dumpsters with the words “Do not dump hazardous materials here” or similar.</p> | <p> State how the following will be implemented:</p> <p>Provide adequate number of receptacles. Inspect receptacles regularly; repair or replace leaky receptacles. Keep receptacles covered. Prohibit/prevent dumping of liquid or hazardous wastes. Post “no hazardous materials” signs. Inspect and pick up litter daily and clean up spills immediately. Keep spill control materials available on-site. See Fact Sheet SC-34, “Waste Handling and Disposal” in the CASQA Stormwater Quality Handbooks at www.cabmphandbooks.com</p> |

STORMWATER POLLUTANT SOURCES/SOURCE CONTROL CHECKLIST

| IF THESE SOURCES WILL BE ON THE PROJECT SITE ... | ... THEN YOUR WQMP SHOULD INCLUDE THESE SOURCE CONTROL BMPs, AS APPLICABLE | | |
|---|---|--|---|
| 1 Potential Sources of Runoff Pollutants | 2 Permanent Controls—Show on WQMP Drawings | 3 Permanent Controls—List in WQMP Table and Narrative | 4 Operational BMPs—Include in WQMP Table and Narrative |
| <p> H. Industrial processes.</p> | <p> Show process area.</p> | <p> If industrial processes are to be located on site, state: “All process activities to be performed indoors. No processes to drain to exterior or to storm drain system.”</p> | <p> See Fact Sheet SC-10, “Non-Stormwater Discharges” in the CASQA Stormwater Quality Handbooks at www.cabmphandbooks.com</p> <p>See the brochure “Industrial & Commercial Facilities Best Management Practices for: Industrial, Commercial Facilities” at http://rcflood.org/stormwater/</p> |

STORMWATER POLLUTANT SOURCES/SOURCE CONTROL CHECKLIST

| IF THESE SOURCES WILL BE ON THE PROJECT SITE ... | ... THEN YOUR WQMP SHOULD INCLUDE THESE SOURCE CONTROL BMPs, AS APPLICABLE | | |
|---|--|--|--|
| 1 Potential Sources of Runoff Pollutants | 2 Permanent Controls—Show on WQMP Drawings | 3 Permanent Controls—List in WQMP Table and Narrative | 4 Operational BMPs—Include in WQMP Table and Narrative |
| <p>✗ I. Outdoor storage of equipment or materials. (See rows J and K for source control measures for vehicle cleaning, repair, and maintenance.)</p> | <p>✗ Show any outdoor storage areas, including how materials will be covered. Show how areas will be graded and bermed to prevent run-on or run-off from area.</p> <p>✗ Storage of non-hazardous liquids shall be covered by a roof and/or drain to the sanitary sewer system, and be contained by berms, dikes, liners, or vaults.</p> <p>✗ Storage of hazardous materials and wastes must be in compliance with the local hazardous materials ordinance and a Hazardous Materials Management Plan for the site.</p> | <p>✗ Include a detailed description of materials to be stored, storage areas, and structural features to prevent pollutants from entering storm drains.</p> <p>Where appropriate, reference documentation of compliance with the requirements of Hazardous Materials Programs for:</p> <ul style="list-style-type: none"> ▪ Hazardous Waste Generation ▪ Hazardous Materials Release Response and Inventory ▪ California Accidental Release (CalARP) ▪ Aboveground Storage Tank ▪ Uniform Fire Code Article 80 Section 103(b) & (c) 1991 ▪ Underground Storage Tank <p>www.cchealth.org/groups/hazmat/</p> | <p>✗ See the Fact Sheets SC-31, “Outdoor Liquid Container Storage” and SC-33, “Outdoor Storage of Raw Materials ” in the CASQA Stormwater Quality Handbooks at www.cabmphandbooks.com</p> |

STORMWATER POLLUTANT SOURCES/SOURCE CONTROL CHECKLIST

| IF THESE SOURCES WILL BE ON THE PROJECT SITE ... | ... THEN YOUR WQMP SHOULD INCLUDE THESE SOURCE CONTROL BMPs, AS APPLICABLE | | |
|---|---|--|---|
| 1 Potential Sources of Runoff Pollutants | 2 Permanent Controls—Show on WQMP Drawings | 3 Permanent Controls—List in WQMP Table and Narrative | 4 Operational BMPs—Include in WQMP Table and Narrative |
| <p><input checked="" type="checkbox"/> J. Vehicle and Equipment Cleaning</p> | <p><input checked="" type="checkbox"/> Show on drawings as appropriate:</p> <p>(1) Commercial/industrial facilities having vehicle/equipment cleaning needs shall either provide a covered, bermed area for washing activities or discourage vehicle/equipment washing by removing hose bibs and installing signs prohibiting such uses.</p> <p>(2) Multi-dwelling complexes shall have a paved, bermed, and covered car wash area (unless car washing is prohibited on-site and hoses are provided with an automatic shut-off to discourage such use).</p> <p>(3) Washing areas for cars, vehicles, and equipment shall be paved, designed to prevent run-on to or runoff from the area, and plumbed to drain to the sanitary sewer.</p> <p>(4) Commercial car wash facilities shall be designed such that no runoff from the facility is discharged to the storm drain system. Wastewater from the facility shall discharge to the sanitary sewer, or a wastewater reclamation system shall be installed.</p> | <p><input checked="" type="checkbox"/> If a car wash area is not provided, describe any measures taken to discourage on-site car washing and explain how these will be enforced.</p> | <p>Describe operational measures to implement the following (if applicable):</p> <p><input checked="" type="checkbox"/> Washwater from vehicle and equipment washing operations shall not be discharged to the storm drain system. Refer to “Outdoor Cleaning Activities and Professional Mobile Service Providers” for many of the Potential Sources of Runoff Pollutants categories below. Brochure can be found at http://rcflood.org/stormwater/</p> <p><input type="checkbox"/> Car dealerships and similar may rinse cars with water only.</p> |

STORMWATER POLLUTANT SOURCES/SOURCE CONTROL CHECKLIST

| IF THESE SOURCES WILL BE ON THE PROJECT SITE ... | ... THEN YOUR WQMP SHOULD INCLUDE THESE SOURCE CONTROL BMPs, AS APPLICABLE | | |
|---|---|--|---|
| 1 Potential Sources of Runoff Pollutants | 2 Permanent Controls—Show on WQMP Drawings | 3 Permanent Controls—List in WQMP Table and Narrative | 4 Operational BMPs—Include in WQMP Table and Narrative |
| <p>X K. Vehicle/Equipment Repair and Maintenance</p> | <p>X Accommodate all vehicle equipment repair and maintenance indoors. Or designate an outdoor work area and design the area to prevent run-on and runoff of stormwater.</p> <p>X Show secondary containment for exterior work areas where motor oil, brake fluid, gasoline, diesel fuel, radiator fluid, acid-containing batteries or other hazardous materials or hazardous wastes are used or stored. Drains shall not be installed within the secondary containment areas.</p> <p>X Add a note on the plans that states either (1) there are no floor drains, or (2) floor drains are connected to wastewater pretreatment systems prior to discharge to the sanitary sewer and an industrial waste discharge permit will be obtained.</p> | <p>X State that no vehicle repair or maintenance will be done outdoors, or else describe the required features of the outdoor work area.</p> <p>X State that there are no floor drains or if there are floor drains, note the agency from which an industrial waste discharge permit will be obtained and that the design meets that agency’s requirements.</p> <p>X State that there are no tanks, containers or sinks to be used for parts cleaning or rinsing or, if there are, note the agency from which an industrial waste discharge permit will be obtained and that the design meets that agency’s requirements.</p> | <p>In the Stormwater Control Plan, note that all of the following restrictions apply to use the site:</p> <p>X No person shall dispose of, nor permit the disposal, directly or indirectly of vehicle fluids, hazardous materials, or rinsewater from parts cleaning into storm drains.</p> <p>X No vehicle fluid removal shall be performed outside a building, nor on asphalt or ground surfaces, whether inside or outside a building, except in such a manner as to ensure that any spilled fluid will be in an area of secondary containment. Leaking vehicle fluids shall be contained or drained from the vehicle immediately.</p> <p>X No person shall leave unattended drip parts or other open containers containing vehicle fluid, unless such containers are in use or in an area of secondary containment.</p> <p>Refer to “Automotive Maintenance & Car Care Best Management Practices for Auto Body Shops, Auto Repair Shops, Car Dealerships, Gas Stations and Fleet Service Operations”. Brochure can be found at http://rcflood.org/stormwater/</p> <p>Refer to Outdoor Cleaning Activities and Professional Mobile Service Providers for many of the Potential Sources of Runoff Pollutants categories below. Brochure can be found at http://rcflood.org/stormwater/</p> |

STORMWATER POLLUTANT SOURCES/SOURCE CONTROL CHECKLIST

| IF THESE SOURCES WILL BE ON THE PROJECT SITE ... | ... THEN YOUR WQMP SHOULD INCLUDE THESE SOURCE CONTROL BMPs, AS APPLICABLE | | |
|--|---|--|---|
| 1 Potential Sources of Runoff Pollutants | 2 Permanent Controls—Show on WQMP Drawings | 3 Permanent Controls—List in WQMP Table and Narrative | 4 Operational BMPs—Include in WQMP Table and Narrative |
| <p>✓ L. Fuel Dispensing Areas</p> | <p>✓ Fueling areas⁶ shall have impermeable floors (i.e., portland cement concrete or equivalent smooth impervious surface) that are: a) graded at the minimum slope necessary to prevent ponding; and b) separated from the rest of the site by a grade break that prevents run-on of stormwater to the maximum extent practicable.</p> <p>✓ Fueling areas shall be covered by a canopy that extends a minimum of ten feet in each direction from each pump. [Alternative: The fueling area must be covered and the cover's minimum dimensions must be equal to or greater than the area within the grade break or fuel dispensing area¹.] The canopy [or cover] shall not drain onto the fueling area.</p> | | <p>✓ The property owner shall dry sweep the fueling area routinely.</p> <p>✓ See the Fact Sheet SD-30 , “Fueling Areas” in the CASQA Stormwater Quality Handbooks at www.cabmphandbooks.com</p> |

⁶ The fueling area shall be defined as the area extending a minimum of 6.5 feet from the corner of each fuel dispenser or the length at which the hose and nozzle assembly may be operated plus a minimum of one foot, whichever is greater.



STORMWATER POLLUTANT SOURCES/SOURCE CONTROL CHECKLIST

| IF THESE SOURCES WILL BE ON THE PROJECT SITE ... | ... THEN YOUR WQMP SHOULD INCLUDE THESE SOURCE CONTROL BMPs, AS APPLICABLE | | |
|--|--|--|--|
| 1 Potential Sources of Runoff Pollutants | 2 Permanent Controls—Show on WQMP Drawings | 3 Permanent Controls—List in WQMP Table and Narrative | 4 Operational BMPs—Include in WQMP Table and Narrative |
| <p>X M. Loading Docks</p> | <p>X Show a preliminary design for the loading dock area, including roofing and drainage. Loading docks shall be covered and/or graded to minimize run-on to and runoff from the loading area. Roof downspouts shall be positioned to direct stormwater away from the loading area. Water from loading dock areas shall be drained to the sanitary sewer, or diverted and collected for ultimate discharge to the sanitary sewer.</p> <p>X Loading dock areas draining directly to the sanitary sewer shall be equipped with a spill control valve or equivalent device, which shall be kept closed during periods of operation.</p> <p>X Provide a roof overhang over the loading area or install door skirts (cowling) at each bay that enclose the end of the trailer.</p> | | <p>X Move loaded and unloaded items indoors as soon as possible.</p> <p>X See Fact Sheet SC-30, “Outdoor Loading and Unloading,” in the CASQA Stormwater Quality Handbooks at www.cabmphandbooks.com</p> |

STORMWATER POLLUTANT SOURCES/SOURCE CONTROL CHECKLIST

| IF THESE SOURCES WILL BE ON THE PROJECT SITE ... | ... THEN YOUR WQMP SHOULD INCLUDE THESE SOURCE CONTROL BMPs, AS APPLICABLE | | |
|---|--|---|--|
| 1 Potential Sources of Runoff Pollutants | 2 Permanent Controls—Show on WQMP Drawings | 3 Permanent Controls—List in WQMP Table and Narrative | 4 Operational BMPs—Include in WQMP Table and Narrative |
| <p><input checked="" type="checkbox"/> N. Fire Sprinkler Test Water</p> | | <p><input checked="" type="checkbox"/> Provide a means to drain fire sprinkler test water to the sanitary sewer.</p> | <p><input checked="" type="checkbox"/> See the note in Fact Sheet SC-41, “Building and Grounds Maintenance,” in the CASQA Stormwater Quality Handbooks at www.cabmphandbooks.com</p> |
| <p>O. Miscellaneous Drain or Wash Water or Other Sources</p> <p><input checked="" type="checkbox"/> Boiler drain lines</p> <p><input checked="" type="checkbox"/> Condensate drain lines</p> <p><input checked="" type="checkbox"/> Rooftop equipment</p> <p><input checked="" type="checkbox"/> Drainage sumps</p> <p><input checked="" type="checkbox"/> Roofing, gutters, and trim.</p> <p><input checked="" type="checkbox"/> Other sources</p> | | <p><input checked="" type="checkbox"/> Boiler drain lines shall be directly or indirectly connected to the sanitary sewer system and may not discharge to the storm drain system.</p> <p><input checked="" type="checkbox"/> Condensate drain lines may discharge to landscaped areas if the flow is small enough that runoff will not occur. Condensate drain lines may not discharge to the storm drain system.</p> <p><input checked="" type="checkbox"/> Rooftop equipment with potential to produce pollutants shall be roofed and/or have secondary containment.</p> <p><input checked="" type="checkbox"/> Any drainage sumps on-site shall feature a sediment sump to reduce the quantity of sediment in pumped water.</p> <p><input checked="" type="checkbox"/> Avoid roofing, gutters, and trim made of copper or other unprotected metals that may leach into runoff.</p> <p>Include controls for other sources as specified by local reviewer.</p> | |

STORMWATER POLLUTANT SOURCES/SOURCE CONTROL CHECKLIST

| IF THESE SOURCES WILL BE ON THE PROJECT SITE ... | ... THEN YOUR WQMP SHOULD INCLUDE THESE SOURCE CONTROL BMPs, AS APPLICABLE | | |
|---|--|--|---|
| 1 Potential Sources of Runoff Pollutants | 2 Permanent Controls—Show on WQMP Drawings | 3 Permanent Controls—List in WQMP Table and Narrative | 4 Operational BMPs—Include in WQMP Table and Narrative |
|  P. Plazas, sidewalks, and parking lots. | | |  Sweep plazas, sidewalks, and parking lots regularly to prevent accumulation of litter and debris. Collect debris from pressure washing to prevent entry into the storm drain system. Collect washwater containing any cleaning agent or degreaser and discharge to the sanitary sewer not to a storm drain. |

Appendix 9: O&M

Operation and Maintenance Plan and Documentation of Finance, Maintenance and Recording Mechanisms

RECORDING REQUESTED BY
AND WHEN RECORDED MAIL TO:

LAND DEVELOPMENT DIV.
CITY OF MORENO VALLEY
PO BOX 88005
14177 FREDERICK STREET
MORENO VALLEY, CA 92552-0805

EXEMPT FROM FEE PER G.C. Section 6103

SPACE ABOVE THIS LINE FOR RECORDER'S USE
APN:

STORMWATER TREATMENT DEVICE AND CONTROL MEASURE ACCESS AND
MAINTENANCE COVENANT

THIS INSTRUMENT is made and entered into this _____ day of _____, by
and between Penske Truck Leasing, hereinafter referred to as "Owner," and the City of
Moreno Valley, a municipal corporation, hereinafter referred to as "City."

RECITALS

WHEREAS, the Owner owns real property ("Property") in the City specifically described
in Exhibit "A," which is attached hereto and incorporated herein by this reference; and

WHEREAS, at the time of approval of the development project known as
Penske Moreno Valley (the "Project") for the Property, the City required the Project to
employ on-site stormwater and non-stormwater control measures to mitigate the Project impacts
to water quality and minimize pollutants in urban stormwater runoff; and

WHEREAS, the City and [Owner](#), its successors, and assigns, agree that the health, safety and welfare of the residents of the City, require that on-site stormwater and non-stormwater management control measures be constructed and implemented and adequately maintained on the Property; and

WHEREAS, the [Owner](#) has chosen to install Modular Wetland Systems, hereinafter referred to as the "Device" and other control measures all as described in the Final Water Quality Management Plan (WQMP) to minimize pollutants in urban stormwater and non-stormwater runoff; and

WHEREAS, the Device and other control measures have been installed and/or implemented in accordance with the WQMP, project plans and specifications approved by the City; and

WHEREAS, the Device and other control measures, being installed on private property and draining only private property are private facilities with all maintenance or replacement therefore being the sole responsibility of the [Owner](#); and

WHEREAS, the [Owner](#) is aware that periodic and continuous maintenance including, but not necessarily limited to, filter material replacement and sediment removal is required to assure discharges from the Device, other control measures and the Project are in compliance with the City's Municipal Code for stormwater and non-stormwater discharges and that such maintenance activity will require compliance with all Federal, State and local laws and regulations, including

those pertaining to confined space and waste disposal methods in effect at the time such maintenance occurs;

NOW, THEREFORE, in consideration of City's approval of the Project and the foregoing premises, the mutual covenants contained herein, and the following terms and conditions, the City and [Owner](#) agree as follows:

1. The [Owner](#) hereby provides the City and its designees with full right of access to the Device and other control measures and the immediate vicinity of the property at any time, upon reasonable notice; or in the event of emergency, as determined by City's Public Works Director/City Engineer or designees, no advance notice; for the purpose of inspection, sampling and testing of the Device and other control measures, and in cases of emergency, where the public health, safety, or welfare is compromised, such emergency shall be declared a “nuisance” as defined in the Municipal Code. Such conditions that created the emergency shall be abated as provided for in the Municipal Code and at the [Owner's](#) expense as provided for in Section 3, below.
2. The [Owner](#) shall diligently maintain the Device and other control measures in a manner assuring all discharges from the Device, other control measures and the Project are in compliance with the Municipal Code for stormwater and non-stormwater discharges at all times. All reasonable precautions shall be exercised by the [Owner](#) and the [Owner's](#) representatives in the removal and extraction of materials from the Device and other control measures, and the ultimate disposal

of the materials in a manner consistent with all applicable laws. As may be requested from time to time by the City, the **Owner** shall provide the City with documentation identifying the materials removed, the quantity and the recycle or disposal destinations, as appropriate.

3. In the event the **Owner** fails to perform the necessary maintenance contemplated by this Instrument, within five (5) days of being given written notice by the City, the lack of maintenance shall be considered a public health and safety concern and declared a “nuisance”, the City shall take all necessary actions as provided in the Municipal Code, to abate the nuisance and charge the entire cost and expense to the **Owner**, including administrative costs, attorneys' fees and interest thereon at the maximum rate authorized by law from the date of the notice of expense until paid in full. Additionally, any discharge as a result from the lack of maintenance prescribed herein from the Device to the City’s maintained Municipal Separate Storm Sewer System shall be considered an illegal discharge and considered a violation of the Municipal Code and shall cease immediately. Such cessation may include a yellow or red tag issued to the Project.

4. This Instrument shall be recorded in the Official Records of the County of Riverside at the expense of the **Owner** and shall constitute notice to all successors and assigns to the title to the Property of the obligations herein set forth. This Instrument shall also constitute a lien against the Property in such amount as will fully reimburse the City, including interest as herein above set forth, subject to foreclosure in event of default in payment.

5. It is the intent of the **Owner** that the burdens and benefits herein undertaken shall constitute covenants that run with the Property and shall constitute a lien against the Property.
6. This covenant imposes no liability of any kind whatsoever on the City and the **Owner** agrees to hold the City harmless from any liability in the event the Device and other control measures fail to operate in accordance with the plans and specification submitted to the City.
7. The obligations herein undertaken shall be binding upon the heirs, successors, executors, administrators and assigns of the **Owner** hereto. The term “**Owner**” shall include not only the **Owner**, but also its heirs, successors, executors, administrators, lessees and assigns. The **Owner** shall notify any successor to title of all or part of the Property about the existence of this Instrument. The **Owner** shall provide such notice prior to such successor obtaining an interest in all or part of the Property. The **Owner** shall provide a copy of such notice to the City at the same time such notice is provided to the successor.
8. Time is of the essence in the performance of this Instrument.
9. Any notice to a party required or called for in this Instrument shall be served in person, or by deposit in the U.S. Mail, first class postage prepaid, to the address set forth below. Notice(s) shall be deemed effective upon receipt, or seventy-two

(72) hours after deposit in the U.S. Mail, whichever is earlier. A party may change notice address only by providing written notice thereof to the other party.

CITY:

Public Works Director/City Engineer
City of Moreno Valley
PO Box 88005
14177 Frederick Street
Moreno Valley, CA 92552-0805

OWNER:

Name: _____
Company: Penske Truck Leasing
Address: 1711 W. Greentree Dr., Ste. 117
City/State/ZIP: Tempe, AZ 85284

- 10. This Instrument represents the entire Covenant of the parties hereto as to the matters contained herein and supersedes any and all prior written or verbal agreements between the parties as to the subject matter hereof.
- 11. This Instrument shall be governed by and construed in accordance with the laws of the State of California.
- 12. No amendment to this Instrument shall be made without prior written approval by the City.

OWNER:

(Name, Title)

Penske Truck Leasing
(Name of company/partnership/corp./entity)

CITY:

CITY OF MORENO VALLEY

APPROVED AS TO FORM:

City Attorney

By: _____ Date: _____
City Manager

Attest:

By: _____ Date: _____
City Clerk

EXHIBIT “A”

Legal Description

PROPERTY DESCRIPTION

COUNTY OF RIVERSIDE, STATE OF CALIFORNIA, AND IS DESCRIBED AS FOLLOWS:

PARCEL A:

THAT PORTION OF LOT 3, BLOCK 12 OF ALESSANDRO TRACT, IN THE CITY OF MORENO VALLEY, COUNTY OF SAN BERNARDINO, STATE OF CALIFORNIA, AS PER MAP RECORDED IN BOOK 6, PAGE 13 OF MAPS, IN THE OFFICE OF THE COUNTY RECORDER OF SAN BERNARDINO COUNTY.

COMMENCING AT THE INTERSECTION OF THE SOUTHERLY LINE OF THAT CERTAIN ROAD AS CONVEYED TO THE COUNTY OF RIVERSIDE BY DEED RECORDED OCTOBER 04, 1915 IN BOOK 406, PAGE 382 DEEDS, KNOWN AS ALESSANDRO BOULEVARD, AND THE EASTERLY LINE OF THE ROAD AS CONVEYED TO THE SAID COUNTY OF RIVERSIDE, BY DEED RECORDED JUNE 13, 1914 IN BOOK 398, PAGE 364 DEEDS; THENCE EASTERLY ALONG SAID SOUTHERLY LINE OF ALESSANDRO BOULEVARD, 519.08 FEET TO THE TRUE POINT OF BEGINNING, SAID POINT BEING THE NORTHEASTERLY CORNER OF A PARCEL OF LAND CONVEYED TO D. K. BOALS, ET UX., IN A DEED RECORDED APRIL 13, 1946 IN BOOK 744, PAGE 102 OFFICIAL RECORDS; THENCE EASTERLY ALONG SAID SOUTHERLY LINE OF ALESSANDRO BOULEVARD, 100 FEET; THENCE SOUTH 00°30'30"EAST, 185 FEET; THENCE SOUTH 89°30'30"WEST, 100 FEET TO THE EASTERLY LINE OF BOAL'S LAND; THENCE ALONG THE EASTERLY LINE OF SAID BOAL'S LAND, NORTH 00°30'30"WEST TO THE TRUE POINT OF BEGINNING.

EXCEPTING THEREFROM THE EASTERLY 42 FEET THEREOF.

ALSO EXCEPTING THEREFROM THE NORTHERLY 60 FEET CONVEYED TO THE COUNTY RIVERSIDE, IN A DEED RECORDED AUGUST 21, 1972 AS INSTRUMENT NO. 1972-111332 OFFICIAL RECORDS. ALSO EXCEPTING THEREFROM ALL MINERALS, GAS, OIL, AND OTHER HYDROCARBON SUBSTANCES BEING IN AND UNDER SAID LAND, TOGETHER WITH THE RIGHT TO REMOVE SAME BY WELLS LOCATED ON THE SURFACE OF ADJACENT LAND AND DRILLED INTO THE ABOVE DESCRIBED LAND, WITHOUT THE RIGHT OF SURFACE ENTRY, AS RESERVED BY MARY H. TRAUTWEIN, ET AL., IN A DEED RECORDED MAY 25, 1954 IN BOOK 1591, PAGE 204 OFFICIAL RECORDS.

APN 297-120-002

PARCEL B:

THE EASTERLY 42 FEET OF THE FOLLOWING DESCRIBED PROPERTY:

THAT PORTION OF LOT 3, BLOCK 12 OF ALESSANDRO TRACT, IN THE CITY OF MORENO VALLEY, COUNTY OF RIVERSIDE, STATE OF CALIFORNIA, AS PER MAP RECORDED IN BOOK 6, PAGE 13 OF MAPS, IN THE OFFICE OF THE COUNTY RECORDER OF SAN BERNARDINO COUNTY.

COMMENCING AT THE INTERSECTION OF THE SOUTHERLY LINE OF THAT CERTAIN ROAD AS CONVEYED TO THE COUNTY OF RIVERSIDE, BY DEED RECORDED OCTOBER 04, 1915 IN BOOK 406, PAGE 382 DEEDS, RIVERSIDE COUNTY RECORDS, KNOWN AS ALESSANDRO BOULEVARD AND THE EASTERLY LINE OF THE ROAD AS CONVEYED TO THE SAID COUNTY OF RIVERSIDE BY DEED RECORDED JUNE 13, 1914 IN BOOK 398, PAGE 364 DEEDS, RIVERSIDE COUNTY RECORDS; THENCE EASTERLY ALONG SAID SOUTHERLY LINE OF ALESSANDRO BOULEVARD, 519.08 FEET TO THE TRUE POINT OF BEGINNING, SAID POINT BEING THE NORTHEASTERLY CORNER OF A PARCEL OF LAND CONVEYED TO D. K. BOALS, ET UX., IN A DEED RECORDED APRIL 13, 1946 IN BOOK 744, PAGE 102 OFFICIAL RECORDS, RIVERSIDE COUNTY RECORDS; THENCE EASTERLY ALONG SAID SOUTHERLY LINE OF ALESSANDRO BOULEVARD, 100 FEET; THENCE SOUTH 00°30'30"EAST, 185 FEET; THENCE SOUTH 89°30'30"WEST, 100 FEET TO THE EASTERLY LINE OF BOALS LAND; THENCE ALONG THE EASTERLY LINE OF SAID BOALS LAND, NORTH 00°30'30"WEST TO THE TRUE POINT OF BEGINNING.

EXCEPTING THEREFROM THE NORTHERLY 60 FEET THEREOF, AS CONVEYED TO THE COUNTY OF RIVERSIDE, IN A DEED RECORDED AUGUST 21, 1972 AS INSTRUMENT NO. 1972-111332 OFFICIAL RECORDS.

ALSO EXCEPTING THEREFROM ALL MINERALS, GAS, OIL, AND OTHER HYDROCARBON SUBSTANCES BEING IN AND UNDER SAID LAND, TOGETHER WITH THE RIGHT TO REMOVE SAME BY WELLS LOCATED ON THE SURFACE OF ADJACENT LAND AND DRILLED INTO THE ABOVE DESCRIBED LAND, WITHOUT THE RIGHT OF SURFACE ENTRY, AS RESERVED BY MARY H. TRAUTWEIN, ET AL., IN A DEED RECORDED MAY 25, 1954 IN BOOK 1591 PAGE 204 OFFICIAL RECORDS.

APN 297-120-003

PARCEL C:

THAT PORTION OF THE REMAINDER PARCEL OF PARCEL MAP 33152-1, IN THE CITY OF MORENO VALLEY, COUNTY OF RIVERSIDE, STATE OF CALIFORNIA, AS SHOWN ON THE MAP FILED IN BOOK 229, PAGES 39 THROUGH 41 INCLUSIVE OF PARCEL MAPS, RECORDS OF THE COUNTY RECORDER OF SAID COUNTY, LYING WITHIN THE LAND DESCRIBED IN THE DOCUMENT RECORDED NOVEMBER 08, 2007 AS INSTRUMENT NO. 2007-0681923 OFFICIAL RECORDS, TOGETHER WITH A PORTION OF PARCEL "A" AS DESCRIBED AND SHOWN ON LOT LINE ADJUSTMENT NO. 1053/CERTIFICATE OF COMPLIANCE, IN THE CITY OF MORENO VALLEY, COUNTY OF RIVERSIDE, STATE OF CALIFORNIA, RECORDED MARCH 30, 2020 AS INSTRUMENT NO. 2020-0144925 OFFICIAL RECORDS, MORE PARTICULARLY DESCRIBED AS FOLLOWS:

BEGINNING AT THE NORTHWESTERLY CORNER OF PARCEL 1 OF SAID PARCEL MAP 33152-1, SAID POINT ALSO BEING A POINT ON THE WESTERLY LINE OF THE PARCEL OF LAND DESCRIBED IN THE DOCUMENT RECORDED NOVEMBER 11, 2007 AS INSTRUMENT NO. 2007-0681923 OFFICIAL RECORDS, THENCE NORTHERLY ALONG SAID WESTERLY LINE THE FOLLOWING SIXTEEN COURSES:

NORTH 19°03'33" WEST 44.13 FEET TO THE BEGINNING OF A TANGENT CURVE CONCAVE EASTERLY HAVING A RADIUS OF 1554.00 FEET; NORTHERLY ALONG SAID CURVE AN ARC DISTANCE OF 67.69 FEET THROUGH A CENTRAL ANGLE OF 02°29'44"; NORTH 16°33'49" WEST 125.54 FEET TO THE BEGINNING OF A TANGENT CURVE CONCAVE WESTERLY HAVING A RADIUS OF 1646.00 FEET; NORTHERLY ALONG SAID CURVE AN ARC DISTANCE OF 71.65 FEET THROUGH A CENTRAL ANGLE OF 02°29'39", A RADIAL LINE TO SAID POINT BEARS NORTH 70°56'32" EAST; NORTH 22°31'56" EAST 37.41 FEET; NORTH 15°18'11" WEST 25.00 FEET TO THE BEGINNING OF A TANGENT CURVE CONCAVE SOUTHERLY HAVING A RADIUS OF 300.00 FEET; EASTERLY ALONG SAID CURVE AN ARC DISTANCE OF 0.29 FEET THROUGH A CENTRAL ANGLE OF 00°03'16"; NORTH 15°14'55" WEST 33.00 FEET; NORTH 54°05'00" WEST 36.67 FEET TO THE BEGINNING OF A TANGENT CURVE CONCAVE EASTERLY HAVING A RADIUS OF 1759.00 FEET, A RADIAL LINE TO SAID POINT BEARS NORTH 76°09'08" EAST; NORTHERLY ALONG SAID CURVE AN ARC DISTANCE OF 57.55 FEET THROUGH A CENTRAL ANGLE OF 01°52'28"; NORTH 11°58'24" WEST 209.12 FEET TO THE BEGINNING OF A TANGENT CURVE CONCAVE EASTERLY HAVING A RADIUS OF 88.00 FEET; NORTHERLY ALONG SAID CURVE AN ARC DISTANCE OF 11.35 FEET THROUGH A CENTRAL ANGLE OF 07°23'31"; NORTH 04°34'53" WEST 64.81 FEET TO THE BEGINNING OF A TANGENT CURVE CONCAVE WESTERLY HAVING A RADIUS OF 112.00 FEET; NORTHERLY ALONG SAID CURVE AN ARC DISTANCE OF 14.45 FEET THROUGH A CENTRAL ANGLE OF 07°23'31"; NORTH 11°58'24" WEST 42.91 FEET TO THE BEGINNING OF A TANGENT CURVE CONCAVE WESTERLY HAVING A RADIUS OF 1681.00 FEET; NORTHERLY ALONG SAID CURVE AN ARC DISTANCE OF 20.76 FEET THROUGH A CENTRAL ANGLE OF 00°42'27" TO A POINT OF INTERSECTION WITH THE WESTERLY PROLONGATION OF THE NORTHERLY LINE OF SAID PARCEL "A", A RADIAL LINE SAID POINT BEARS NORTH 77°19'10" WEST; THENCE EASTERLY ALONG SAID PROLONGATION AND SAID NORTHERLY LINE THE FOLLOWING SEVEN COURSES; SOUTH 88°03'08" EAST 192.77 FEET; SOUTH 60°18'11" EAST 102.54 FEET; SOUTH 88°54'38" EAST 93.00 FEET; SOUTH 01°03'52" EAST 18.46 FEET; SOUTH 89°32'17" EAST 100.01 FEET; SOUTH 01°03'46" WEST 49.93 FEET; NORTH 89°32'17" WEST 153.40 FEET; THENCE SOUTH 01°03'46" WEST 644.44 FEET TO A POINT ON THE SOUTHERLY LINE OF SAID PARCEL "A" AND THE NORTHERLY LINE OF SAID PARCEL 1; THENCE WESTERLY ALONG SAID SOUTHERLY LINE THE FOLLOWING TWO COURSES; NORTH 89°31'44" WEST 176.03 FEET; SOUTH 70°29'20" WEST 252.40 FEET TO THE POINT OF BEGINNING.

SAID LAND IS SHOWN AS PARCEL "A" OF LOT LINE ADJUSTMENT NO. 1067/CERTIFICATE OF COMPLIANCE RECORDED JULY 27, 2020.

APN 297-100-073, 297-100-076, APN 297-100-066 (PORTION)
APN 297-120-017, APN 297-120-018, APN 297-120-016 (PORTION)

EXHIBIT “A-1”

(Include 8.5x11 project site map and show location(s) of treatment control BMPs)

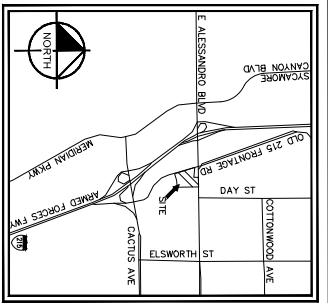

VICINITY MAP
N15

LEGEND

- 1895 PROPOSED CONTOUR
- (1895) EXISTING CONTOUR
- PROPERTY LINE
- DA BOUNDARY
- PROPOSED STORM DRAIN
- FLOW ARROW
- DA NAME
- DA AREA (IN ACRES)
- Right of Way

LANDSCAPE NOTE:

FINISH GRADE OF LANDSCAPE AREAS IS TO BE CURB SIDEWALK OR PARKLET.

| TREATMENT CONTROL & SOURCE CONTROL BMP'S |
|--|
| BMP ID |
| BMP DESCRIPTION |
| SC-43 |
| SC-44 |
| SC-71 |
| SC-73 |
| SC-10 |
| SC-11 |
| SC-12 |
| SC-13 |
| SC-32 |

| DMA | SURFACE TYPE | AREA (SF) | AREA (A0) | BMP ID | REQUIRED DESIGN FLOW RATE (CFS) | PROPOSED MODULAR WETLAND TREATMENT FLOW RATE (CFS) |
|------|------------------------|-----------|-----------|--------|---------------------------------|--|
| | ROOFS | 11,392 | | | | |
| DA-1 | CONCRETE/ASPHALT | 107,937 | 3.33 | BMP-1 | 0.5 | 0.577 |
| | ORNAMENTAL LANDSCAPING | 25,755 | | | | |
| | ROOFS | 9,600 | | | | |
| DA-2 | CONCRETE/ASPHALT | 146,809 | 3.9900 | BMP-2 | 0.6 | 0.693 |
| | ORNAMENTAL LANDSCAPING | 16,791 | | | | |
| | CONCRETE/ASPHALT | 55,924 | | | | |
| DA-3 | ORNAMENTAL LANDSCAPING | 23,027 | 1.81 | BMP-3 | 0.2 | 0.206 |

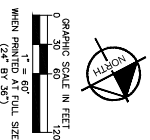

BMP Inspection and Maintenance Plan

| BMP | Responsible Party | Inspection/Maintenance Activities Required | Minimum Frequency of Activities |
|-----------------------------|-------------------|--|---|
| Parking Area Maintenance | Owner | Parking lots and private streets must be swept. | Quarterly (minimum), weekly during rainy season (oct-may) |
| Drainage System Maintenance | Owner | Inspect, clean and maintain drainage facilities. | Prior to rainy season and after every rain event greater than 0.5 inches. |
| Plaza and Sidewalk Cleaning | Owner | Litter shall be picked up. Sidewalk and plaza areas shall be swept. | Weekly |
| Landscape Maintenance | Owner | <p>Vegetated Areas Mowing and/or trimming of vegetation must be performed on a regular schedule based on specific site conditions.</p> <p>Vegetated areas must be inspected at least annually for erosion and scour. Vegetated areas should also be inspected at least annually for unwanted growth, which should be removed with minimum disruption to the planting soil bed and remaining vegetation. When establishing or restoring vegetation, biweekly inspections of vegetation health should be performed during the first growing season or until the vegetation is established. Once established, inspections of vegetation health, density, and diversity should be performed at least twice annually during both the growing and non-growing seasons.</p> <p>The vegetative cover should be maintained at 85 percent. If vegetation has greater than 50 percent damage, the area should be reestablished in accordance with the original specifications and the inspection requirements presented above.</p> <p>All use of fertilizers, mechanical treatments, pesticides and other means to assure optimum vegetation health should not compromise the intended purpose of the bioretention system. All vegetation deficiencies should be addressed without the use of fertilizers and pesticides whenever possible.</p> | Weekly |

BMP Inspection and Maintenance Plan

| BMP | Responsible Party | Inspection/Maintenance Activities Required | Minimum Frequency of Activities |
|-------------------------|-------------------|--|---------------------------------|
| Efficient Irrigation | Owner | Irrigation systems must be inspected to ensure proper functionality. Timers must be inspected to avoid overwatering and water cycle and duration shall be adjusted seasonally by landscape maintenance contractor. | Weekly |
| Storm Drain Signage | Owner | Maintain legibility of stenciling and signs. | Yearly |
| Trash Storage Areas | Owner | Trash and waste storage areas must be inspected to ensure receptacles are not collecting storm water. Trash enclosure areas shall be swept and cleaned, dumpsters shall be emptied. Lids must always be maintained closed. | Weekly |
| Modular Wetland Systems | Owner | Remove trash from screening device and sediment from separation chamber, replace cartridge filter media and drain down filter media; trim vegetation per manufacturer's guidelines. | Yearly |

Appendix 10: Educational Materials

BMP Fact Sheets, Maintenance Guidelines and Other End-User BMP Information



A Citizen's Guide to Understanding Stormwater



EPA United States Environmental Protection Agency

EPA 833-B-03-002

January 2003

Internet Address (URL): <http://www.epa.gov>
Recycled/Recyclable • Printed With Vegetable Oil Based Inks on 100% Postconsumer Process Chlorine Free Recycled Paper



After the Storm

For more information contact:
www.epa.gov/nps/stormwater
or visit
www.epa.gov/nps



What is stormwater runoff?



Stormwater runoff occurs when precipitation from rain or snowmelt flows over the ground. Impervious surfaces like driveways, sidewalks, and streets prevent stormwater from naturally soaking into the ground.

Why is stormwater runoff a problem?



Stormwater can pick up debris, chemicals, dirt, and other pollutants and flow into a storm sewer system or directly to a lake, stream, river, wetland, or coastal water. Anything that enters a storm sewer system is discharged untreated into the waterbodies we use for swimming, fishing, and providing drinking water.

The effects of pollution

Polluted stormwater runoff can have many adverse effects on plants, fish, animals, and people.

- ◆ Sediment can cloud the water and make it difficult or impossible for aquatic plants to grow. Sediment also can destroy aquatic habitats.
- ◆ Excess nutrients can cause algae blooms. When algae die, they sink to the bottom and decompose in a process that removes oxygen from the water. Fish and other aquatic organisms can't exist in water with low dissolved oxygen levels.
- ◆ Bacteria and other pathogens can wash into swimming areas and create health hazards, often making beach closures necessary.
- ◆ Debris—plastic bags, six-pack rings, bottles, and cigarette butts—washed into waterbodies can choke, suffocate, or disable aquatic life like ducks, fish, turtles, and birds.
- ◆ Household hazardous wastes like insecticides, pesticides, paint, solvents, used motor oil, and other auto fluids can poison aquatic life. Land animals and people can become sick or die from eating diseased fish and shellfish or ingesting polluted water.



- ◆ Polluted stormwater often affects drinking water sources. This, in turn, can affect human health and increase drinking water treatment costs.

Stormwater Pollution Solutions

Residential

Recycle or properly dispose of household products that contain chemicals, such as insecticides, pesticides, paint, solvents, and used motor oil and other auto fluids. Don't pour them onto the ground or into storm drains.

Lawn care

Excess fertilizers and pesticides applied to lawns and gardens wash off and pollute streams. In addition, yard clippings and leaves can wash into storm drains and contribute nutrients and organic matter to streams.



- ◆ Don't overwater your lawn. Consider using a soaker hose instead of a sprinkler.
- ◆ Use pesticides and fertilizers sparingly. When use is necessary, use these chemicals in the recommended amounts. Use organic mulch or safer pest control methods whenever possible.
- ◆ Compost or mulch yard waste. Don't leave it in the street or sweep it into storm drains or streams.
- ◆ Cover piles of dirt or mulch being used in landscaping projects.

Septic systems

Leaking and poorly maintained septic systems release nutrients and pathogens (bacteria and viruses) that can be picked up by stormwater and discharged into nearby waterbodies. Pathogens can cause public health problems and environmental concerns.



- ◆ Inspect your system every 3 years and pump your tank as necessary (every 3 to 5 years).
- ◆ Don't dispose of household hazardous waste in sinks or toilets.

Auto care

Washing your car and degreasing auto parts at home can send detergents and other contaminants through the storm sewer system. Dumping automotive fluids into storm drains has the same result as dumping the materials directly into a waterbody.



- ◆ Use a commercial car wash that treats or recycles its wastewater, or wash your car on your yard so the water infiltrates into the ground.
- ◆ Repair leaks and dispose of used auto fluids and batteries at designated drop-off or recycling locations.

Pet waste

Pet waste can be a major source of bacteria and excess nutrients in local waters.



- ◆ When walking your pet, remember to pick up the waste and dispose of it properly. Flushing pet waste is the best disposal method. Leaving pet waste on the ground increases public health risks by allowing harmful bacteria and nutrients to wash into the storm drain and eventually into local waterbodies.

Residential landscaping

Permeable Pavement—Traditional concrete and asphalt don't allow water to soak into the ground. Instead these surfaces rely on storm drains to divert unwanted water. Permeable pavement systems allow rain and snowmelt to soak through, decreasing stormwater runoff.

Rain Barrels—You can collect rainwater from rooftops in mosquito-proof containers. The water can be used later on lawn or garden areas.



Rain Gardens and Grassy Swales—Specially designed areas planted with native plants can provide natural places for



rainwater to collect and soak into the ground. Rain from rooftop areas or paved areas can be diverted into these areas rather than into storm drains.

Vegetated Filter Strips—Filter strips are areas of native grass or plants created along roadways or streams. They trap the pollutants stormwater picks up as it flows across driveways and streets.

Commercial

Dirt, oil, and debris that collect in parking lots and paved areas can be washed into the storm sewer system and eventually enter local waterbodies.

- ◆ Sweep up litter and debris from sidewalks, driveways and parking lots, especially around storm drains.
- ◆ Cover grease storage and dumpsters and keep them clean to avoid leaks.
- ◆ Report any chemical spill to the local hazardous waste cleanup team. They'll know the best way to keep spills from harming the environment.

Erosion controls that aren't maintained can cause excessive amounts of sediment and debris to be carried into the stormwater system. Construction vehicles can leak fuel, oil, and other harmful fluids that can be picked up by stormwater and deposited into local waterbodies.

- ◆ Divert stormwater away from disturbed or exposed areas of the construction site.
- ◆ Install silt fences, vehicle mud removal areas, vegetative cover, and other sediment and erosion controls and properly maintain them, especially after rainstorms.
- ◆ Prevent soil erosion by minimizing disturbed areas during construction projects, and seed and mulch bare areas as soon as possible.

Construction

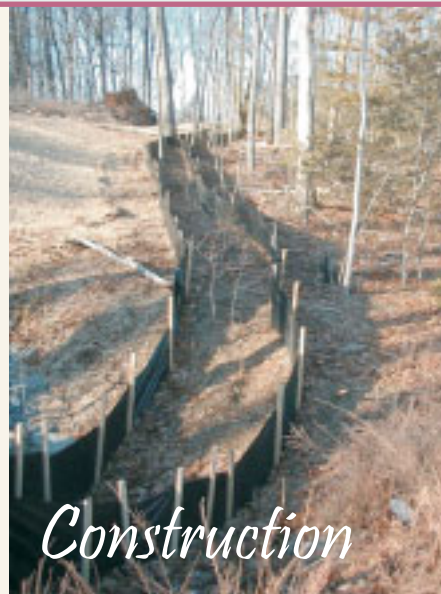

Agriculture

Lack of vegetation on streambanks can lead to erosion. Overgrazed pastures can also contribute excessive amounts of sediment to local waterbodies. Excess fertilizers and pesticides can poison aquatic animals and lead to destructive algae blooms. Livestock in streams can contaminate waterways with bacteria, making them unsafe for human contact.

- ◆ Keep livestock away from streambanks and provide them a water source away from waterbodies.
- ◆ Store and apply manure away from waterbodies and in accordance with a nutrient management plan.
- ◆ Vegetate riparian areas along waterways.
- ◆ Rotate animal grazing to prevent soil erosion in fields.
- ◆ Apply fertilizers and pesticides according to label instructions to save money and minimize pollution.



Forestry

Improperly managed logging operations can result in erosion and sedimentation.

- ◆ Conduct preharvest planning to prevent erosion and lower costs.
- ◆ Use logging methods and equipment that minimize soil disturbance.
- ◆ Plan and design skid trails, yard areas, and truck access roads to minimize stream crossings and avoid disturbing the forest floor.
- ◆ Construct stream crossings so that they minimize erosion and physical changes to streams.
- ◆ Expedite revegetation of cleared areas.

Automotive Facilities

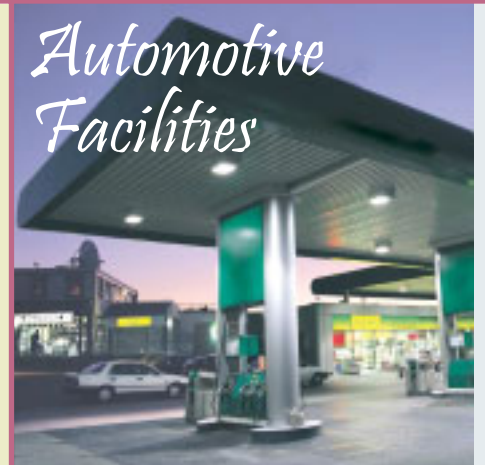

Uncovered fueling stations allow spills to be washed into storm drains. Cars waiting to be repaired can leak fuel, oil, and other harmful fluids that can be picked up by stormwater.

- ◆ Clean up spills immediately and properly dispose of cleanup materials.
- ◆ Provide cover over fueling stations and design or retrofit facilities for spill containment.
- ◆ Properly maintain fleet vehicles to prevent oil, gas, and other discharges from being washed into local waterbodies.
- ◆ Install and maintain oil/water separators.



Education is essential to changing people's behavior. Signs and markers near storm drains warn residents that pollutants entering the drains will be carried untreated into a local waterbody.



Landscaping and garden maintenance activities can be major contributors to water pollution. Soils, yard wastes, over-watering and garden chemicals become part of the urban runoff mix that winds its way through streets, gutters and storm drains before entering lakes, rivers, streams, etc. Urban runoff pollution contaminates water and harms aquatic life!

In Riverside County, report illegal discharges into the storm drain, call
1-800-506-2555
“Only Rain Down the Storm Drain”

Important Links:

Riverside County Household Hazardous Waste Collection Information
1-800-304-2226 or www.rivcwm.org

Riverside County Backyard Composting Program
1-800-366-SAVE

Integrated Pest Management (IPM) Solutions
www.ipm.ucdavis.edu

California Master Gardener Programs
www.mastergardeners.org
www.camastergardeners.ucdavis.edu

California Native Plant Society
www.cnps.org

The Riverside County “Only Rain Down the Storm Drain” Pollution Prevention Program gratefully acknowledges Orange County's Storm Water Program for their contribution to this brochure.



...Only Rain Down ...the Storm Drain

*What you should know for...
Landscape and Gardening*

Best Management tips for:

- Professionals
- Novices
- Landscapers
- Gardeners
- Cultivators



Tips for Landscape & Gardening

This brochure will help you to get the most of your lawn and gardening efforts and keep our waterways clean. Clean waterways provide recreation, establish thriving fish habitats, secure safe sanctuaries for wildlife, and add beauty to our communities. NEVER allow gardening products or waste water to enter the street, gutter or storm drain.

General Landscaping Tips

- Protect stockpiles and materials from wind and rain by storing them under tarps or secured plastic sheeting.
- Prevent erosion of slopes by planting fast-growing, dense ground covering plants. These will shield and bind the soil.
- Plant native vegetation to reduce the amount of water, fertilizers and pesticides applied to the landscape.
- Never apply pesticides or fertilizers when rain is predicted within the next 48 hours.



Garden & Lawn Maintenance

- Do not overwater. Use irrigation practices such as drip irrigation, soaker hoses or micro-spray systems. Periodically inspect and fix leaks and misdirected sprinklers.

- Do not rake or blow leaves, clippings or pruning waste into the street, gutter or storm drain. Instead, dispose of green waste by composting, hauling it to a permitted landfill, or recycling it through your city's program.



- Consider recycling your green waste and adding “nature’s own fertilizer” to your lawn or garden.
- Read labels and use only as directed. Do not over-apply pesticides or fertilizers. Apply to spots as needed, rather than blanketing an entire area.
- Store pesticides, fertilizers and other chemicals in a dry covered area to prevent exposure that may result in the deterioration of containers and packaging.
- Rinse empty pesticide containers and re-use rinse water as you would use the product. Do not dump rinse water down storm drains or sewers. Dispose of empty containers in the trash.
- When available, use non-toxic alternatives to traditional pesticides, and use pesticides specifically designed to control the pest you are targeting.

- Try natural long-term common sense solutions first. Integrated Pest Management (IPM) can provide landscaping guidance and solutions, such as:

- ◆ **Physical Controls** - Try hand picking, barriers, traps or caulking holes to control weeds and pests.
- ◆ **Biological Controls** - Use predatory insects to control harmful pests.
- ◆ **Chemical Controls** - Check out www.ipm.ucdavis.edu before using chemicals. Remember, all chemicals should be used cautiously and in moderation.

- If fertilizer is spilled, sweep up the spill before irrigating. If the spill is liquid, apply an absorbent material such as cat litter, and then sweep it up and dispose of it in the trash.
- Take unwanted pesticides to a Household Waste Collection Center to be recycled.
- *Dumping toxics into the street, gutter or storm drain is illegal!*

www.bewaterwise.com Great water conservation tips and drought tolerant garden designs.

www.ourwaterourworld.com Learn how to safely manage home and garden pests.

Additional information can also be found on the back of this brochure.

Helpful telephone numbers and links:

Riverside County Stormwater Protection Partners

| | |
|----------------------------|----------------|
| Flood Control District | (951) 955-1200 |
| County of Riverside | (951) 955-1000 |
| City of Banning | (951) 922-3105 |
| City of Beaumont | (951) 769-8520 |
| City of Calimesa | (909) 795-9801 |
| City of Canyon Lake | (951) 244-2955 |
| Cathedral City | (760) 770-0327 |
| City of Coachella | (760) 398-4978 |
| City of Corona | (951) 736-2447 |
| City of Desert Hot Springs | (760) 329-6411 |
| City of Eastvale | (951) 361-0900 |
| City of Hemet | (951) 765-2300 |
| City of Indian Wells | (760) 346-2489 |
| City of Indio | (760) 391-4000 |
| City of Lake Elsinore | (951) 674-3124 |
| City of La Quinta | (760) 777-7000 |
| City of Menifee | (951) 672-6777 |
| City of Moreno Valley | (951) 413-3000 |
| City of Murrieta | (951) 304-2489 |
| City of Norco | (951) 270-5607 |
| City of Palm Desert | (760) 346-0611 |
| City of Palm Springs | (760) 323-8299 |
| City of Perris | (951) 943-6100 |
| City of Rancho Mirage | (760) 324-4511 |
| City of Riverside | (951) 361-0900 |
| City of San Jacinto | (951) 654-7337 |
| City of Temecula | (951) 694-6444 |
| City of Wildomar | (951) 677-7751 |

REPORT ILLEGAL STORM DRAIN DISPOSAL

1-800-506-2555 or e-mail us at
fcnpdes@rcflood.org

- Riverside County Flood Control and Water Conservation District
www.rcflood.org

Online resources include:

- California Storm Water Quality Association
www.casqa.org
- State Water Resources Control Board
www.waterboards.ca.gov
- Power Washers of North America
www.thepwna.org

Stormwater Pollution

What you should know for...

Outdoor Cleaning Activities and Professional Mobile Service Providers



Storm drain pollution prevention information for:

- Car Washing / Mobile Detailers
- Window and Carpet Cleaners
- Power Washers
- Waterproofers / Street Sweepers
- Equipment cleaners or degreasers and all mobile service providers

Do you know where street flows actually go?

Storm drains are NOT connected to sanitary sewer systems and treatment plants!



The primary purpose of storm drains is to carry *rain* water away from developed areas to prevent flooding. Pollutants discharged to storm drains are transported directly into rivers, lakes and streams. Soaps, degreasers, automotive fluids, litter and a host of materials are washed off buildings, sidewalks, plazas and parking areas. Vehicles and equipment must be properly managed to prevent the pollution of local waterways.

Unintentional spills by mobile service operators can flow into storm drains and pollute our waterways. **Avoid mishaps.** Always have a **Spill Response Kit** on hand to clean up unintentional spills. Only emergency **Mechanical** repairs should be done in City streets, using drip pans for spills. **Plumbing** should be done on private property. Always store chemicals in a leak-proof container and keep covered when not in use. **Window/Power Washing** waste water shouldn't be released into the streets, but should be disposed of in a sanitary sewer, landscaped area or in the soil. Soiled **Carpet Cleaning** wash water should be filtered before being discharged into the sanitary sewer. Dispose of all filter debris properly. **Car Washing/Detailing** operators should wash cars on private property and use a regulated hose nozzle for water flow control and runoff prevention. Capture and dispose of waste water and chemicals properly. Remember, storm drains are for receiving rain water runoff only.

**REPORT ILLEGAL
STORM DRAIN
DISPOSAL
1-800-506-2555**

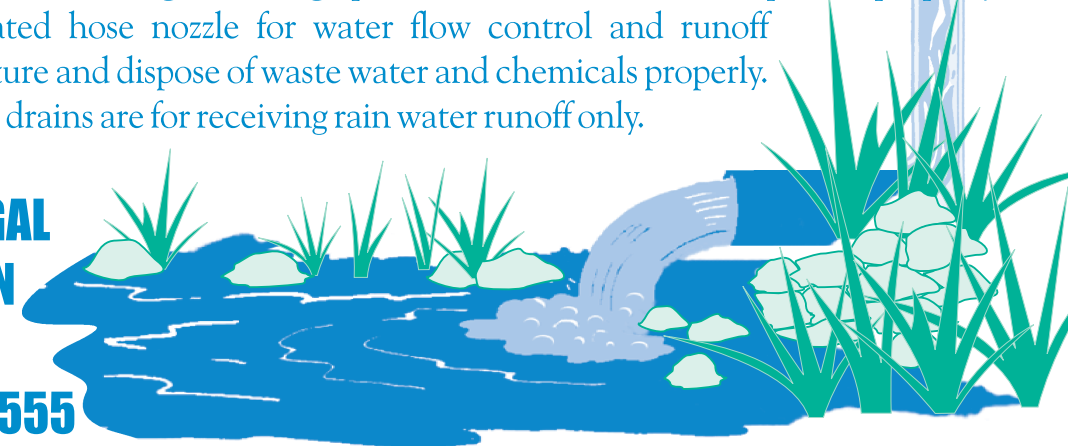

Help Protect Our Waterways!

Use these guidelines for Outdoor Cleaning Activities and Wash Water Disposal

Did you know that disposing of pollutants into the street, gutter, storm drain or body of water is **PROHIBITED** by law and can result in stiff penalties?

Best Management Practices

Waste wash water from Mechanics, Plumbers, Window/Power Washers, Carpet Cleaners, Car Washing and Mobile Detailing activities may contain significant quantities of motor oil, grease, chemicals, dirt, detergents, brake pad dust, litter and other materials.

Best Management Practices, or BMPs as they are known, are guides to prevent pollutants from entering the storm drains. *Each of us* can do our part to keep stormwater clean by using the suggested BMPs below:

Simple solutions for both light and heavy duty jobs:

Do...consider dry cleaning methods first such as a mop, broom, rag or wire brush. Always keep a spill response kit on site.

Do...prepare the work area before power cleaning by using sand bags, rubber mats, vacuum booms, containment pads or temporary berms to keep wash water away from the gutters and storm drains.

Do...use vacuums or other machines to remove and collect loose debris or litter before applying water.

Do...obtain the property owner's permission to dispose of *small amounts* of power washing waste water on to landscaped, gravel or unpaved surfaces.

Do...check your local sanitary sewer agency's policies on wash water disposal regulations before disposing of wash water into the sewer. (See list on reverse side)

Do...be aware that if discharging to landscape areas, soapy wash water may damage landscaping. Residual wash water may remain on paved surfaces to evaporate. Sweep up solid residuals and dispose of properly. Vacuum booms are another option for capturing and collecting wash water.

Do...check to see if local ordinances prevent certain activities.

Do not let...wash or waste water from sidewalk, plaza or building cleaning go into a street or storm drain.



Report illegal storm drain disposal
Call Toll Free
1-800-506-2555

Using Cleaning Agents

Try using biodegradable/phosphate-free products. They are easier on the environment, but don't confuse them with being toxic free. Soapy water entering the storm drain system can impact the delicate aquatic environment.



When cleaning surfaces with a *high-pressure washer* or *steam cleaner*, additional precautions should be taken to prevent the discharge of pollutants into the storm drain system. These two methods of surface cleaning can loosen additional material that can contaminate local waterways.

Think Water Conservation

Minimize water use by using high pressure, low volume nozzles. Be sure to check all hoses for leaks. Water is a precious resource, don't let it flow freely and be sure to shut it off in between uses.

Screening Wash Water

Conduct thorough dry cleanup before washing exterior surfaces, such as buildings and decks **with loose paint**, sidewalks or plaza areas. Keep debris from entering the storm drain after cleaning by first passing the wash water through a "20 mesh" or finer screen to catch the solid materials, then dispose of the mesh in a refuse container. Do not let the remaining wash water enter a street, gutter or storm drain.

Drain Inlet Protection & Collection of Wash Water

- Prior to any washing, block all storm drains with an impervious barrier such as sandbags or berms, or seal the storm drain with plugs or other appropriate materials.
- Create a containment area with berms and traps or take advantage of a low spot to keep wash water contained.
- Wash vehicles and equipment on grassy or gravel areas so that the wash water can seep into the ground.
- Pump or vacuum up all wash water in the contained area.

Concrete/Coring/Saw Cutting and Drilling Projects

Protect any down-gradient inlets by using dry activity techniques whenever possible. If water is used, minimize the amount of water used during the coring/drilling or saw cutting process. Place a barrier of sandbags and/or absorbent berms to protect the storm drain inlet or watercourse. Use a shovel or wet vacuum to remove the residue from the pavement. Do not wash residue or particulate matter into a storm drain inlet or watercourse.

Parking/Storage Area Maintenance SC-43



Description

Parking lots and storage areas can contribute a number of substances, such as trash, suspended solids, hydrocarbons, oil and grease, and heavy metals that can enter receiving waters through stormwater runoff or non-stormwater discharges. The following protocols are intended to prevent or reduce the discharge of pollutants from parking/storage areas and include using good housekeeping practices, following appropriate cleaning BMPs, and training employees.

Approach

Pollution Prevention

- Encourage alternative designs and maintenance strategies for impervious parking lots. (See New Development and Redevelopment BMP Handbook).
- Keep accurate maintenance logs to evaluate BMP implementation.

Suggested Protocols

General

- Keep the parking and storage areas clean and orderly. Remove debris in a timely fashion.
- Allow sheet runoff to flow into biofilters (vegetated strip and swale) and/or infiltration devices.
- Utilize sand filters or oleophilic collectors for oily waste in low concentrations.

Objectives

- Cover
- Contain
- Educate
- Reduce/Minimize
- Product Substitution

Targeted Constituents

| | |
|------------------|---|
| Sediment | ✓ |
| Nutrients | ✓ |
| Trash | ✓ |
| Metals | ✓ |
| Bacteria | ✓ |
| Oil and Grease | ✓ |
| Organics | ✓ |
| Oxygen Demanding | ✓ |



SC-43 Parking/Storage Area Maintenance

- Arrange rooftop drains to prevent drainage directly onto paved surfaces.
- Design lot to include semi-permeable hardscape.

Controlling Litter

- Post “No Littering” signs and enforce anti-litter laws.
- Provide an adequate number of litter receptacles.
- Clean out and cover litter receptacles frequently to prevent spillage.
- Provide trash receptacles in parking lots to discourage litter.
- Routinely sweep, shovel and dispose of litter in the trash.

Surface cleaning

- Use dry cleaning methods (e.g. sweeping or vacuuming) to prevent the discharge of pollutants into the stormwater conveyance system.
- Establish frequency of public parking lot sweeping based on usage and field observations of waste accumulation.
- Sweep all parking lots at least once before the onset of the wet season.
- If water is used follow the procedures below:
 - Block the storm drain or contain runoff.
 - Wash water should be collected and pumped to the sanitary sewer or discharged to a pervious surface, do not allow wash water to enter storm drains.
 - Dispose of parking lot sweeping debris and dirt at a landfill.
- When cleaning heavy oily deposits:
 - Use absorbent materials on oily spots prior to sweeping or washing.
 - Dispose of used absorbents appropriately.

Surface Repair

- Pre-heat, transfer or load hot bituminous material away from storm drain inlets.
- Apply concrete, asphalt, and seal coat during dry weather to prevent contamination from contacting stormwater runoff.
- Cover and seal nearby storm drain inlets (with waterproof material or mesh) and manholes before applying seal coat, slurry seal, etc., where applicable. Leave covers in place until job is complete and until all water from emulsified oil sealants has drained or evaporated. Clean any debris from these covered manholes and drains for proper disposal.

Parking/Storage Area Maintenance SC-43

- Use only as much water as necessary for dust control, to avoid runoff.
- Catch drips from paving equipment that is not in use with pans or absorbent material placed under the machines. Dispose of collected material and absorbents properly.

Inspection

- Have designated personnel conduct inspections of the parking facilities and stormwater conveyance systems associated with them on a regular basis.
- Inspect cleaning equipment/sweepers for leaks on a regular basis.

Training

- Provide regular training to field employees and/or contractors regarding cleaning of paved areas and proper operation of equipment.
- Train employees and contractors in proper techniques for spill containment and cleanup.

Spill Response and Prevention

- Refer to SC-11, Spill Prevention, Control & Cleanup.
- Keep your Spill Prevention Control and countermeasure (SPCC) plan up-to-date, and implement accordingly.
- Have spill cleanup materials readily available and in a known location.
- Cleanup spills immediately and use dry methods if possible.
- Properly dispose of spill cleanup material.

Other Considerations

- Limitations related to sweeping activities at large parking facilities may include high equipment costs, the need for sweeper operator training, and the inability of current sweeper technology to remove oil and grease.

Requirements

Costs

Cleaning/sweeping costs can be quite large, construction and maintenance of stormwater structural controls can be quite expensive as well.

Maintenance

- Sweep parking lot to minimize cleaning with water.
- Clean out oil/water/sand separators regularly, especially after heavy storms.
- Clean parking facilities on a regular basis to prevent accumulated wastes and pollutants from being discharged into conveyance systems during rainy conditions.

SC-43 Parking/Storage Area Maintenance

Supplemental Information

Further Detail of the BMP

Surface Repair

Apply concrete, asphalt, and seal coat during dry weather to prevent contamination from contacting stormwater runoff. Where applicable, cover and seal nearby storm drain inlets (with waterproof material or mesh) and manholes before applying seal coat, slurry seal, etc. Leave covers in place until job is complete and until all water from emulsified oil sealants has drained or evaporated. Clean any debris from these covered manholes and drains for proper disposal. Use only as much water as necessary for dust control, to avoid runoff.

References and Resources

<http://www.stormwatercenter.net/>

California's Nonpoint Source Program Plan <http://www.swrcb.ca.gov/nps/index.html>

Model Urban Runoff Program: A How-To Guide for Developing Urban Runoff Programs for Small Municipalities. Prepared by City of Monterey, City of Santa Cruz, California Coastal Commission, Monterey Bay National Marine Sanctuary, Association of Monterey Bay Area Governments, Woodward-Clyde, Central Coast Regional Water Quality Control Board. July 1998 (Revised February 2002 by the California Coastal Commission).

Orange County Stormwater Program

http://www.ocwatersheds.com/StormWater/swp_introduction.asp

Oregon Association of Clean Water Agencies. Oregon Municipal Stormwater Toolbox for Maintenance Practices. June 1998.

Pollution from Surface Cleaning Folder. 1996. Bay Area Stormwater Management Agencies Association (BASMAA) <http://www.basma.org>

San Diego Stormwater Co-permittees Jurisdictional Urban Runoff Management Program (URMP)

<http://www.projectcleanwater.org/pdf/Model%20Program%20Municipal%20Facilities.pdf>



Objectives

- Cover
- Contain
- Educate
- Reduce/Minimize

Description

As a consequence of its function, the stormwater conveyance system collects and transports urban runoff and stormwater that may contain certain pollutants. The protocols in this fact sheet are intended to reduce pollutants reaching receiving waters through proper conveyance system operation and maintenance.

Approach

Pollution Prevention

Maintain catch basins, stormwater inlets, and other stormwater conveyance structures on a regular basis to remove pollutants, reduce high pollutant concentrations during the first flush of storms, prevent clogging of the downstream conveyance system, restore catch basins' sediment trapping capacity, and ensure the system functions properly hydraulically to avoid flooding.

Suggested Protocols

Catch Basins/Inlet Structures

- Staff should regularly inspect facilities to ensure compliance with the following:
 - Immediate repair of any deterioration threatening structural integrity.
 - Cleaning before the sump is 40% full. Catch basins should be cleaned as frequently as needed to meet this standard.
 - Stenciling of catch basins and inlets (see SC34 Waste Handling and Disposal).

Targeted Constituents

| | |
|----------------|---|
| Sediment | ✓ |
| Nutrients | |
| Trash | ✓ |
| Metals | |
| Bacteria | ✓ |
| Oil and Grease | |
| Organics | |



SC-44 Drainage System Maintenance

- Clean catch basins, storm drain inlets, and other conveyance structures before the wet season to remove sediments and debris accumulated during the summer.
- Conduct inspections more frequently during the wet season for problem areas where sediment or trash accumulates more often. Clean and repair as needed.
- Keep accurate logs of the number of catch basins cleaned.
- Store wastes collected from cleaning activities of the drainage system in appropriate containers or temporary storage sites in a manner that prevents discharge to the storm drain.
- Dewater the wastes if necessary with outflow into the sanitary sewer if permitted. Water should be treated with an appropriate filtering device prior to discharge to the sanitary sewer. If discharge to the sanitary sewer is not allowed, water should be pumped or vacuumed to a tank and properly disposed. Do not dewater near a storm drain or stream.

Storm Drain Conveyance System

- Locate reaches of storm drain with deposit problems and develop a flushing schedule that keeps the pipe clear of excessive buildup.
- Collect and pump flushed effluent to the sanitary sewer for treatment whenever possible.

Pump Stations

- Clean all storm drain pump stations prior to the wet season to remove silt and trash.
- Do not allow discharge to reach the storm drain system when cleaning a storm drain pump station or other facility.
- Conduct routine maintenance at each pump station.
- Inspect, clean, and repair as necessary all outlet structures prior to the wet season.

Open Channel

- Modify storm channel characteristics to improve channel hydraulics, increase pollutant removals, and enhance channel/creek aesthetic and habitat value.
- Conduct channel modification/improvement in accordance with existing laws. Any person, government agency, or public utility proposing an activity that will change the natural (emphasis added) state of any river, stream, or lake in California, must enter into a Stream or Lake Alteration Agreement with the Department of Fish and Game. The developer-applicant should also contact local governments (city, county, special districts), other state agencies (SWRCB, RWQCB, Department of Forestry, Department of Water Resources), and Federal Corps of Engineers and USFWS.

Illicit Connections and Discharges

- Look for evidence of illegal discharges or illicit connections during routine maintenance of conveyance system and drainage structures:
 - Is there evidence of spills such as paints, discoloring, etc?

- Are there any odors associated with the drainage system?
- Record locations of apparent illegal discharges/illicit connections?
- Track flows back to potential dischargers and conduct aboveground inspections. This can be done through visual inspection of upgradient manholes or alternate techniques including zinc chloride smoke testing, fluorometric dye testing, physical inspection testing, or television camera inspection.
- Eliminate the discharge once the origin of flow is established.
- Stencil or demarcate storm drains, where applicable, to prevent illegal disposal of pollutants. Storm drain inlets should have messages such as “Dump No Waste Drains to Stream” stenciled next to them to warn against ignorant or intentional dumping of pollutants into the storm drainage system.
- Refer to fact sheet SC-10 Non-Stormwater Discharges.

Illegal Dumping

- Inspect and clean up hot spots and other storm drainage areas regularly where illegal dumping and disposal occurs.
- Establish a system for tracking incidents. The system should be designed to identify the following:
 - Illegal dumping hot spots
 - Types and quantities (in some cases) of wastes
 - Patterns in time of occurrence (time of day/night, month, or year)
 - Mode of dumping (abandoned containers, “midnight dumping” from moving vehicles, direct dumping of materials, accidents/spills)
 - Responsible parties
- Post “No Dumping” signs in problem areas with a phone number for reporting dumping and disposal. Signs should also indicate fines and penalties for illegal dumping.
- Refer to fact sheet SC-10 Non-Stormwater Discharges.

Training

- Train crews in proper maintenance activities, including record keeping and disposal.
- Allow only properly trained individuals to handle hazardous materials/wastes.
- Have staff involved in detection and removal of illicit connections trained in the following:
 - OSHA-required Health and Safety Training (29 CFR 1910.120) plus annual refresher training (as needed).

SC-44 Drainage System Maintenance

- OSHA Confined Space Entry training (Cal-OSHA Confined Space, Title 8 and Federal OSHA 29 CFR 1910.146).
- Procedural training (field screening, sampling, smoke/dye testing, TV inspection).

Spill Response and Prevention

- Investigate all reports of spills, leaks, and/or illegal dumping promptly.
- Clean up all spills and leaks using “dry” methods (with absorbent materials and/or rags) or dig up, remove, and properly dispose of contaminated soil.
- Refer to fact sheet SC-11 Spill Prevention, Control, and Cleanup.

Other Considerations (Limitations and Regulations)

- Clean-up activities may create a slight disturbance for local aquatic species. Access to items and material on private property may be limited. Trade-offs may exist between channel hydraulics and water quality/riparian habitat. If storm channels or basins are recognized as wetlands, many activities, including maintenance, may be subject to regulation and permitting.
- Storm drain flushing is most effective in small diameter pipes (36-inch diameter pipe or less, depending on water supply and sediment collection capacity). Other considerations associated with storm drain flushing may include the availability of a water source, finding a downstream area to collect sediments, liquid/sediment disposal, and prohibition against disposal of flushed effluent to sanitary sewer in some areas.
- Regulations may include adoption of substantial penalties for illegal dumping and disposal.
- Local municipal codes may include sections prohibiting discharge of soil, debris, refuse, hazardous wastes, and other pollutants into the storm drain system.

Requirements

Costs

- An aggressive catch basin cleaning program could require a significant capital and O&M budget.
- The elimination of illegal dumping is dependent on the availability, convenience, and cost of alternative means of disposal. The primary cost is for staff time. Cost depends on how aggressively a program is implemented. Other cost considerations for an illegal dumping program include:
 - Purchase and installation of signs.
 - Rental of vehicle(s) to haul illegally-disposed items and material to landfills.
 - Rental of heavy equipment to remove larger items (e.g., car bodies) from channels.
 - Purchase of landfill space to dispose of illegally-dumped items and material.

- Methods used for illicit connection detection (smoke testing, dye testing, visual inspection, and flow monitoring) can be costly and time-consuming. Site-specific factors, such as the level of impervious area, the density and ages of buildings, and type of land use will determine the level of investigation necessary.

Maintenance

- Two-person teams may be required to clean catch basins with vacuum trucks.
- Teams of at least two people plus administrative personnel are required to identify illicit discharges, depending on the complexity of the storm sewer system.
- Arrangements must be made for proper disposal of collected wastes.
- Technical staff are required to detect and investigate illegal dumping violations.

Supplemental Information

Further Detail of the BMP

Storm Drain Flushing

Flushing is a common maintenance activity used to improve pipe hydraulics and to remove pollutants in storm drainage systems. Flushing may be designed to hydraulically convey accumulated material to strategic locations, such as an open channel, another point where flushing will be initiated, or the sanitary sewer and the treatment facilities, thus preventing resuspension and overflow of a portion of the solids during storm events. Flushing prevents “plug flow” discharges of concentrated pollutant loadings and sediments. Deposits can hinder the designed conveyance capacity of the storm drain system and potentially cause backwater conditions in severe cases of clogging.

Storm drain flushing usually takes place along segments of pipe with grades that are too flat to maintain adequate velocity to keep particles in suspension. An upstream manhole is selected to place an inflatable device that temporarily plugs the pipe. Further upstream, water is pumped into the line to create a flushing wave. When the upstream reach of pipe is sufficiently full to cause a flushing wave, the inflated device is rapidly deflated with the assistance of a vacuum pump, thereby releasing the backed up water and resulting in the cleaning of the storm drain segment.

To further reduce impacts of stormwater pollution, a second inflatable device placed well downstream may be used to recollect the water after the force of the flushing wave has dissipated. A pump may then be used to transfer the water and accumulated material to the sanitary sewer for treatment. In some cases, an interceptor structure may be more practical or required to recollect the flushed waters.

It has been found that cleansing efficiency of periodic flush waves is dependent upon flush volume, flush discharge rate, sewer slope, sewer length, sewer flow rate, sewer diameter, and population density. As a rule of thumb, the length of line to be flushed should not exceed 700 feet. At this maximum recommended length, the percent removal efficiency ranges between 65-75% for organics and 55-65% for dry weather grit/inorganic material. The percent removal efficiency drops rapidly beyond that. Water is commonly supplied by a water truck, but fire hydrants can also supply water. To make the best use of water, it is recommended that reclaimed water be used or that fire hydrant line flushing coincide with storm sewer flushing.

SC-44 Drainage System Maintenance

References and Resources

California's Nonpoint Source Program Plan <http://www.swrcb.ca.gov/nps/index.html>

Clark County Storm Water Pollution Control Manual
<http://www.co.clark.wa.us/pubworks/bmpman.pdf>

Ferguson, B.K. 1991. Urban Stream Reclamation, p. 324-322, Journal of Soil and Water Conservation.

King County Storm Water Pollution Control Manual <http://dnr.metrokc.gov/wlr/dss/spcm.htm>

Oregon Association of Clean Water Agencies. Oregon Municipal Stormwater Toolbox for Maintenance Practices. June 1998.

Santa Clara Valley Urban Runoff Pollution Prevention Program <http://www.scvurppp.org>

The Storm Water Managers Resource Center <http://www.stormwatercenter.net>

United States Environmental Protection Agency (USEPA). 2002. Pollution Prevention/Good Housekeeping for Municipal Operations Storm Drain System Cleaning. On line:
http://www.epa.gov/npdes/menuofbmps/poll_16.htm



Objectives

- Cover
- Contain
- Educate
- Reduce/Minimize
- Product Substitution

Targeted Constituents

| | |
|------------------|-------------------------------------|
| Sediment | <input checked="" type="checkbox"/> |
| Nutrients | <input checked="" type="checkbox"/> |
| Trash | <input checked="" type="checkbox"/> |
| Metals | <input checked="" type="checkbox"/> |
| Bacteria | <input checked="" type="checkbox"/> |
| Oil and Grease | <input checked="" type="checkbox"/> |
| Organics | <input checked="" type="checkbox"/> |
| Oxygen Demanding | <input checked="" type="checkbox"/> |

Description

Pollutants on sidewalks and other pedestrian traffic areas and plazas are typically due to littering and vehicle use. This fact sheet describes good housekeeping practices that can be incorporated into the municipality's existing cleaning and maintenance program.

Approach

Pollution Prevention

- Use dry cleaning methods whenever practical for surface cleaning activities.
- Use the least toxic materials available (e.g. water based paints, gels or sprays for graffiti removal).

Suggested Protocols

Surface Cleaning

- Regularly broom (dry) sweep sidewalk, plaza and parking lot areas to minimize cleaning with water.
- Dry cleanup first (sweep, collect, and dispose of debris and trash) when cleaning sidewalks or plazas, then wash with or without soap.
- Block the storm drain or contain runoff when cleaning with water. Discharge wash water to landscaping or collect water and pump to a tank or discharge to sanitary sewer if allowed. (Permission may be required from local sanitation district.)



- Block the storm drain or contain runoff when washing parking areas, driveways or drive-throughs. Use absorbents to pick up oil; then dry sweep. Clean with or without soap. Collect water and pump to a tank or discharge to sanitary sewer if allowed. Street Repair and Maintenance.

Graffiti Removal

- Avoid graffiti abatement activities during rain events.
- Implement the procedures under Painting and Paint Removal in SC-70 Roads, Streets, and Highway Operation and Maintenance fact sheet when graffiti is removed by painting over.
- Direct runoff from sand blasting and high pressure washing (with no cleaning agents) into a dirt or landscaped area after treating with an appropriate filtering device.
- Plug nearby storm drain inlets and vacuum/pump wash water to the sanitary sewer if authorized to do so if a graffiti abatement method generates wash water containing a cleaning compound (such as high pressure washing with a cleaning compound). Ensure that a non-hazardous cleaning compound is used or dispose as hazardous waste, as appropriate.

Surface Removal and Repair

- Schedule surface removal activities for dry weather if possible.
- Avoid creating excess dust when breaking asphalt or concrete.
- Take measures to protect nearby storm drain inlets prior to breaking up asphalt or concrete (e.g. place hay bales or sand bags around inlets). Clean afterwards by sweeping up as much material as possible.
- Designate an area for clean up and proper disposal of excess materials.
- Remove and recycle as much of the broken pavement as possible to avoid contact with rainfall and stormwater runoff.
- When making saw cuts in pavement, use as little water as possible. Cover each storm drain inlet completely with filter fabric during the sawing operation and contain the slurry by placing straw bales, sandbags, or gravel dams around the inlets. After the liquid drains or evaporates, shovel or vacuum the slurry residue from the pavement or gutter and remove from site.
- Always dry sweep first to clean up tracked dirt. Use a street sweeper or vacuum truck. Do not dump vacuumed liquid in storm drains. Once dry sweeping is complete, the area may be hosed down if needed. Wash water should be directed to landscaping or collected and pumped to the sanitary sewer if allowed.

Concrete Installation and Repair

- Schedule asphalt and concrete activities for dry weather.

- Take measures to protect any nearby storm drain inlets and adjacent watercourses, prior to breaking up asphalt or concrete (e.g. place sand bags around inlets or work areas).
- Limit the amount of fresh concrete or cement mortar mixed, mix only what is needed for the job.
- Store concrete materials under cover, away from drainage areas. Secure bags of cement after they are open. Be sure to keep wind-blown cement powder away from streets, gutters, storm drains, rainfall, and runoff.
- Return leftover materials to the transit mixer. Dispose of small amounts of hardened excess concrete, grout, and mortar in the trash.
- Do not wash sweepings from exposed aggregate concrete into the street or storm drain. Collect and return sweepings to aggregate base stockpile, or dispose in the trash.
- Protect applications of fresh concrete from rainfall and runoff until the material has dried.
- Do not allow excess concrete to be dumped onsite, except in designated areas.
- Wash concrete trucks off site or in designated areas on site designed to preclude discharge of wash water to drainage system.

Controlling Litter

- Post “No Littering” signs and enforce anti-litter laws.
- Provide litter receptacles in busy, high pedestrian traffic areas of the community, at recreational facilities, and at community events.
- Cover litter receptacles and clean out frequently to prevent leaking/spillage or overflow.
- Clean parking lots on a regular basis with a street sweeper.

Training

- Provide regular training to field employees and/or contractors regarding surface cleaning and proper operation of equipment.
- Train employee and contractors in proper techniques for spill containment and cleanup.
- Use a training log or similar method to document training.

Spill Response and Prevention

- Refer to SC-11, Spill Prevention, Control & Cleanup.
- Have spill cleanup materials readily available and in a known location.
- Cleanup spills immediately and use dry methods if possible.
- Properly dispose of spill cleanup material.

Other Considerations

- Limitations related to sweeping activities at large parking facilities may include current sweeper technology to remove oil and grease.
- Surface cleaning activities that require discharges to the local sewerage agency will require coordination with the agency.
- Arrangements for disposal of the swept material collected must be made, as well as accurate tracking of the areas swept and the frequency of sweeping.

Requirements***Costs***

- The largest expenditures for sweeping and cleaning of sidewalks, plazas, and parking lots are in staffing and equipment. Sweeping of these areas should be incorporated into street sweeping programs to reduce costs.

Maintenance

Not applicable

Supplemental Information***Further Detail of the BMP***

Community education, such as informing residents about their options for recycling and waste disposal, as well as the consequences of littering, can instill a sense of citizen responsibility and potentially reduce the amount of maintenance required by the municipality.

Additional BMPs that should be considered for parking lot areas include:

- Allow sheet runoff to flow into biofilters (vegetated strip and swale) and infiltration devices.
- Utilize sand filters or oleophilic collectors for oily waste in low concentrations.
- Arrange rooftop drains to prevent drainage directly onto paved surfaces.
- Design lot to include semi-permeable hardscape.
- Structural BMPs such as storm drain inlet filters can be very effective in reducing the amount of pollutants discharged from parking facilities during periods of rain.

References and Resources

Bay Area Stormwater Management Agencies Association (BASMAA). 1996. Pollution From Surface Cleaning Folder <http://www.basmaa.org>

Model Urban Runoff Program: A How-To Guide for Developing Urban Runoff Programs for Small Municipalities. Prepared by City of Monterey, City of Santa Cruz, California Coastal Commission, Monterey Bay National Marine Sanctuary, Association of Monterey Bay Area Governments, Woodward-Clyde, Central Coast Regional Water Quality Control Board. July. 1998.

Oregon Association of Clean Water Agencies. Oregon Municipal Stormwater Toolbox for Maintenance Practices. June 1998.

Orange County Stormwater Program

http://www.ocwatersheds.com/stormwater/swp_introduction.asp

Santa Clara Valley Urban Runoff Pollution Prevention Program. 1997 Urban Runoff Management Plan. September 1997, updated October 2000.

Santa Clara Valley Urban Runoff Pollution Prevention Program. Maintenance Best Management Practices for the Construction Industry. Brochures: Landscaping, Gardening, and Pool; Roadwork and Paving; and Fresh Concrete and Mortar Application. June 2001.

San Diego Stormwater Co-permittees Jurisdictional Urban Runoff Management Plan. 2001. Municipal Activities Model Program Guidance. November.



Objectives

- Contain
- Educate
- Reduce/Minimize
- Product Substitution

Targeted Constituents

| | |
|------------------|-------------------------------------|
| Sediment | <input checked="" type="checkbox"/> |
| Nutrients | <input checked="" type="checkbox"/> |
| Trash | <input checked="" type="checkbox"/> |
| Metals | |
| Bacteria | |
| Oil and Grease | |
| Organics | |
| Oxygen Demanding | <input checked="" type="checkbox"/> |

Description

Landscape maintenance activities include vegetation removal; herbicide and insecticide application; fertilizer application; watering; and other gardening and lawn care practices. Vegetation control typically involves a combination of chemical (herbicide) application and mechanical methods. All of these maintenance practices have the potential to contribute pollutants to the storm drain system. The major objectives of this BMP are to minimize the discharge of pesticides, herbicides and fertilizers to the storm drain system and receiving waters; prevent the disposal of landscape waste into the storm drain system by collecting and properly disposing of clippings and cuttings, and educating employees and the public.

Approach

Pollution Prevention

- Implement an integrated pest management (IPM) program. IPM is a sustainable approach to managing pests by combining biological, cultural, physical, and chemical tools.
- Choose low water using flowers, trees, shrubs, and groundcover.
- Consider alternative landscaping techniques such as nativescaping and xeriscaping.
- Conduct appropriate maintenance (i.e. properly timed fertilizing, weeding, pest control, and pruning) to help preserve the landscapes water efficiency.



- Consider grass cycling (grass cycling is the natural recycling of grass by leaving the clippings on the lawn when mowing. Grass clippings decompose quickly and release valuable nutrients back into the lawn).

Suggested Protocols***Mowing, Trimming, and Weeding***

- Whenever possible use mechanical methods of vegetation removal (e.g mowing with tractor-type or push mowers, hand cutting with gas or electric powered weed trimmers) rather than applying herbicides. Use hand weeding where practical.
- Avoid loosening the soil when conducting mechanical or manual weed control, this could lead to erosion. Use mulch or other erosion control measures when soils are exposed.
- Performing mowing at optimal times. Mowing should not be performed if significant rain events are predicted.
- Mulching mowers may be recommended for certain flat areas. Other techniques may be employed to minimize mowing such as selective vegetative planting using low maintenance grasses and shrubs.
- Collect lawn and garden clippings, pruning waste, tree trimmings, and weeds. Chip if necessary, and compost or dispose of at a landfill (see waste management section of this fact sheet).
- Place temporarily stockpiled material away from watercourses, and berm or cover stockpiles to prevent material releases to storm drains.

Planting

- Determine existing native vegetation features (location, species, size, function, importance) and consider the feasibility of protecting them. Consider elements such as their effect on drainage and erosion, hardiness, maintenance requirements, and possible conflicts between preserving vegetation and the resulting maintenance needs.
- Retain and/or plant selected native vegetation whose features are determined to be beneficial, where feasible. Native vegetation usually requires less maintenance (e.g., irrigation, fertilizer) than planting new vegetation.
- Consider using low water use groundcovers when planting or replanting.

Waste Management

- Compost leaves, sticks, or other collected vegetation or dispose of at a permitted landfill. Do not dispose of collected vegetation into waterways or storm drainage systems.
- Place temporarily stockpiled material away from watercourses and storm drain inlets, and berm or cover stockpiles to prevent material releases to the storm drain system.
- Reduce the use of high nitrogen fertilizers that produce excess growth requiring more frequent mowing or trimming.

- Avoid landscape wastes in and around storm drain inlets by either using bagging equipment or by manually picking up the material.

Irrigation

- Where practical, use automatic timers to minimize runoff.
- Use popup sprinkler heads in areas with a lot of activity or where there is a chance the pipes may be broken. Consider the use of mechanisms that reduce water flow to sprinkler heads if broken.
- Ensure that there is no runoff from the landscaped area(s) if re-claimed water is used for irrigation.
- If bailing of muddy water is required (e.g. when repairing a water line leak), do not put it in the storm drain; pour over landscaped areas.
- Irrigate slowly or pulse irrigate to prevent runoff and then only irrigate as much as is needed.
- Apply water at rates that do not exceed the infiltration rate of the soil.

Fertilizer and Pesticide Management

- Utilize a comprehensive management system that incorporates integrated pest management (IPM) techniques. There are many methods and types of IPM, including the following:
 - Mulching can be used to prevent weeds where turf is absent, fencing installed to keep rodents out, and netting used to keep birds and insects away from leaves and fruit.
 - Visible insects can be removed by hand (with gloves or tweezers) and placed in soapy water or vegetable oil. Alternatively, insects can be sprayed off the plant with water or in some cases vacuumed off of larger plants.
 - Store-bought traps, such as species-specific, pheromone-based traps or colored sticky cards, can be used.
 - Slugs can be trapped in small cups filled with beer that are set in the ground so the slugs can get in easily.
 - In cases where microscopic parasites, such as bacteria and fungi, are causing damage to plants, the affected plant material can be removed and disposed of (pruning equipment should be disinfected with bleach to prevent spreading the disease organism).
 - Small mammals and birds can be excluded using fences, netting, tree trunk guards.
 - Beneficial organisms, such as bats, birds, green lacewings, ladybugs, praying mantis, ground beetles, parasitic nematodes, trichogramma wasps, seed head weevils, and spiders that prey on detrimental pest species can be promoted.
- Follow all federal, state, and local laws and regulations governing the use, storage, and disposal of fertilizers and pesticides and training of applicators and pest control advisors.

- Use pesticides only if there is an actual pest problem (not on a regular preventative schedule).
- Do not use pesticides if rain is expected. Apply pesticides only when wind speeds are low (less than 5 mph).
- Do not mix or prepare pesticides for application near storm drains.
- Prepare the minimum amount of pesticide needed for the job and use the lowest rate that will effectively control the pest.
- Employ techniques to minimize off-target application (e.g. spray drift) of pesticides, including consideration of alternative application techniques.
- Fertilizers should be worked into the soil rather than dumped or broadcast onto the surface.
- Calibrate fertilizer and pesticide application equipment to avoid excessive application.
- Periodically test soils for determining proper fertilizer use.
- Sweep pavement and sidewalk if fertilizer is spilled on these surfaces before applying irrigation water.
- Purchase only the amount of pesticide that you can reasonably use in a given time period (month or year depending on the product).
- Triple rinse containers, and use rinse water as product. Dispose of unused pesticide as hazardous waste.
- Dispose of empty pesticide containers according to the instructions on the container label.

Inspection

- Inspect irrigation system periodically to ensure that the right amount of water is being applied and that excessive runoff is not occurring. Minimize excess watering, and repair leaks in the irrigation system as soon as they are observed.
- Inspect pesticide/fertilizer equipment and transportation vehicles daily.

Training

- Educate and train employees on use of pesticides and in pesticide application techniques to prevent pollution. Pesticide application must be under the supervision of a California qualified pesticide applicator.
- Train/encourage municipal maintenance crews to use IPM techniques for managing public green areas.
- Annually train employees within departments responsible for pesticide application on the appropriate portions of the agency's IPM Policy, SOPs, and BMPs, and the latest IPM techniques.

- Employees who are not authorized and trained to apply pesticides should be periodically (at least annually) informed that they cannot use over-the-counter pesticides in or around the workplace.
- Use a training log or similar method to document training.

Spill Response and Prevention

- Refer to SC-11, Spill Prevention, Control & Cleanup
- Have spill cleanup materials readily available and in a known location
- Cleanup spills immediately and use dry methods if possible.
- Properly dispose of spill cleanup material.

Other Considerations

- The Federal Pesticide, Fungicide, and Rodenticide Act and California Title 3, Division 6, Pesticides and Pest Control Operations place strict controls over pesticide application and handling and specify training, annual refresher, and testing requirements. The regulations generally cover: a list of approved pesticides and selected uses, updated regularly; general application information; equipment use and maintenance procedures; and record keeping. The California Department of Pesticide Regulations and the County Agricultural Commission coordinate and maintain the licensing and certification programs. All public agency employees who apply pesticides and herbicides in “agricultural use” areas such as parks, golf courses, rights-of-way and recreation areas should be properly certified in accordance with state regulations. Contracts for landscape maintenance should include similar requirements.
- All employees who handle pesticides should be familiar with the most recent material safety data sheet (MSDS) files.
- Municipalities do not have the authority to regulate the use of pesticides by school districts, however the California Healthy Schools Act of 2000 (AB 2260) has imposed requirements on California school districts regarding pesticide use in schools. Posting of notification prior to the application of pesticides is now required, and IPM is stated as the preferred approach to pest management in schools.

Requirements

Costs

Additional training of municipal employees will be required to address IPM techniques and BMPs. IPM methods will likely increase labor cost for pest control which may be offset by lower chemical costs.

Maintenance

Not applicable

Supplemental Information***Further Detail of the BMP******Waste Management***

Composting is one of the better disposal alternatives if locally available. Most municipalities either have or are planning yard waste composting facilities as a means of reducing the amount of waste going to the landfill. Lawn clippings from municipal maintenance programs as well as private sources would probably be compatible with most composting facilities

Contractors and Other Pesticide Users

Municipal agencies should develop and implement a process to ensure that any contractor employed to conduct pest control and pesticide application on municipal property engages in pest control methods consistent with the IPM Policy adopted by the agency. Specifically, municipalities should require contractors to follow the agency's IPM policy, SOPs, and BMPs; provide evidence to the agency of having received training on current IPM techniques when feasible; provide documentation of pesticide use on agency property to the agency in a timely manner.

References and Resources

King County Stormwater Pollution Control Manual. Best Management Practices for Businesses. 1995. King County Surface Water Management. July. On-line:
<http://dnr.metrokc.gov/wlr/dss/spcm.htm>

Los Angeles County Stormwater Quality Model Programs. Public Agency Activities
http://ladpw.org/wmd/npdes/model_links.cfm

Model Urban Runoff Program: A How-To Guide for Developing Urban Runoff Programs for Small Municipalities. Prepared by City of Monterey, City of Santa Cruz, California Coastal Commission, Monterey Bay National Marine Sanctuary, Association of Monterey Bay Area Governments, Woodward-Clyde, Central Coast Regional Water Quality Control Board. July. 1998.

Orange County Stormwater Program

http://www.ocwatersheds.com/StormWater/swp_introduction.asp

Santa Clara Valley Urban Runoff Pollution Prevention Program. 1997 Urban Runoff Management Plan. September 1997, updated October 2000.

United States Environmental Protection Agency (USEPA). 2002. Pollution Prevention/Good Housekeeping for Municipal Operations Landscaping and Lawn Care. Office of Water. Office of Wastewater Management. On-line: http://www.epa.gov/npdes/menuofbmps/poll_8.htm

Site Design & Landscape Planning SD-10



Design Objectives

- Maximize Infiltration
 - Provide Retention
 - Slow Runoff
 - Minimize Impervious Land Coverage
 - Prohibit Dumping of Improper Materials
 - Contain Pollutants
 - Collect and Convey
-

Description

Each project site possesses unique topographic, hydrologic, and vegetative features, some of which are more suitable for development than others. Integrating and incorporating appropriate landscape planning methodologies into the project design is the most effective action that can be done to minimize surface and groundwater contamination from stormwater.

Approach

Landscape planning should couple consideration of land suitability for urban uses with consideration of community goals and projected growth. Project plan designs should conserve natural areas to the extent possible, maximize natural water storage and infiltration opportunities, and protect slopes and channels.

Suitable Applications

Appropriate applications include residential, commercial and industrial areas planned for development or redevelopment.

Design Considerations

Design requirements for site design and landscapes planning should conform to applicable standards and specifications of agencies with jurisdiction and be consistent with applicable General Plan and Local Area Plan policies.



SD-10 Site Design & Landscape Planning

Designing New Installations

Begin the development of a plan for the landscape unit with attention to the following general principles:

- Formulate the plan on the basis of clearly articulated community goals. Carefully identify conflicts and choices between retaining and protecting desired resources and community growth.
- Map and assess land suitability for urban uses. Include the following landscape features in the assessment: wooded land, open unwooded land, steep slopes, erosion-prone soils, foundation suitability, soil suitability for waste disposal, aquifers, aquifer recharge areas, wetlands, floodplains, surface waters, agricultural lands, and various categories of urban land use. When appropriate, the assessment can highlight outstanding local or regional resources that the community determines should be protected (e.g., a scenic area, recreational area, threatened species habitat, farmland, fish run). Mapping and assessment should recognize not only these resources but also additional areas needed for their sustenance.

Project plan designs should conserve natural areas to the extent possible, maximize natural water storage and infiltration opportunities, and protect slopes and channels.

Conserve Natural Areas during Landscape Planning

If applicable, the following items are required and must be implemented in the site layout during the subdivision design and approval process, consistent with applicable General Plan and Local Area Plan policies:

- Cluster development on least-sensitive portions of a site while leaving the remaining land in a natural undisturbed condition.
- Limit clearing and grading of native vegetation at a site to the minimum amount needed to build lots, allow access, and provide fire protection.
- Maximize trees and other vegetation at each site by planting additional vegetation, clustering tree areas, and promoting the use of native and/or drought tolerant plants.
- Promote natural vegetation by using parking lot islands and other landscaped areas.
- Preserve riparian areas and wetlands.

Maximize Natural Water Storage and Infiltration Opportunities Within the Landscape Unit

- Promote the conservation of forest cover. Building on land that is already deforested affects basin hydrology to a lesser extent than converting forested land. Loss of forest cover reduces interception storage, detention in the organic forest floor layer, and water losses by evapotranspiration, resulting in large peak runoff increases and either their negative effects or the expense of countering them with structural solutions.
- Maintain natural storage reservoirs and drainage corridors, including depressions, areas of permeable soils, swales, and intermittent streams. Develop and implement policies and

Site Design & Landscape Planning SD-10

regulations to discourage the clearing, filling, and channelization of these features. Utilize them in drainage networks in preference to pipes, culverts, and engineered ditches.

- Evaluating infiltration opportunities by referring to the stormwater management manual for the jurisdiction and pay particular attention to the selection criteria for avoiding groundwater contamination, poor soils, and hydrogeological conditions that cause these facilities to fail. If necessary, locate developments with large amounts of impervious surfaces or a potential to produce relatively contaminated runoff away from groundwater recharge areas.

Protection of Slopes and Channels during Landscape Design

- Convey runoff safely from the tops of slopes.
- Avoid disturbing steep or unstable slopes.
- Avoid disturbing natural channels.
- Stabilize disturbed slopes as quickly as possible.
- Vegetate slopes with native or drought tolerant vegetation.
- Control and treat flows in landscaping and/or other controls prior to reaching existing natural drainage systems.
- Stabilize temporary and permanent channel crossings as quickly as possible, and ensure that increases in run-off velocity and frequency caused by the project do not erode the channel.
- Install energy dissipaters, such as riprap, at the outlets of new storm drains, culverts, conduits, or channels that enter unlined channels in accordance with applicable specifications to minimize erosion. Energy dissipaters shall be installed in such a way as to minimize impacts to receiving waters.
- Line on-site conveyance channels where appropriate, to reduce erosion caused by increased flow velocity due to increases in tributary impervious area. The first choice for linings should be grass or some other vegetative surface, since these materials not only reduce runoff velocities, but also provide water quality benefits from filtration and infiltration. If velocities in the channel are high enough to erode grass or other vegetative linings, riprap, concrete, soil cement, or geo-grid stabilization are other alternatives.
- Consider other design principles that are comparable and equally effective.

Redeveloping Existing Installations

Various jurisdictional stormwater management and mitigation plans (SUSMP, WQMP, etc.) define “redevelopment” in terms of amounts of additional impervious area, increases in gross floor area and/or exterior construction, and land disturbing activities with structural or impervious surfaces. The definition of “redevelopment” must be consulted to determine whether or not the requirements for new development apply to areas intended for redevelopment. If the definition applies, the steps outlined under “designing new installations” above should be followed.

SD-10 Site Design & Landscape Planning

Redevelopment may present significant opportunity to add features which had not previously been implemented. Examples include incorporation of depressions, areas of permeable soils, and swales in newly redeveloped areas. While some site constraints may exist due to the status of already existing infrastructure, opportunities should not be missed to maximize infiltration, slow runoff, reduce impervious areas, disconnect directly connected impervious areas.

Other Resources

A Manual for the Standard Urban Stormwater Mitigation Plan (SUSMP), Los Angeles County Department of Public Works, May 2002.

Stormwater Management Manual for Western Washington, Washington State Department of Ecology, August 2001.

Model Standard Urban Storm Water Mitigation Plan (SUSMP) for San Diego County, Port of San Diego, and Cities in San Diego County, February 14, 2002.

Model Water Quality Management Plan (WQMP) for County of Orange, Orange County Flood Control District, and the Incorporated Cities of Orange County, Draft February 2003.

Ventura Countywide Technical Guidance Manual for Stormwater Quality Control Measures, July 2002.



Rain Garden

Design Objectives

- Maximize Infiltration
- Provide Retention
- Slow Runoff
- Minimize Impervious Land Coverage
- Prohibit Dumping of Improper Materials
- Contain Pollutants
- Collect and Convey

Description

Various roof runoff controls are available to address stormwater that drains off rooftops. The objective is to reduce the total volume and rate of runoff from individual lots, and retain the pollutants on site that may be picked up from roofing materials and atmospheric deposition. Roof runoff controls consist of directing the roof runoff away from paved areas and mitigating flow to the storm drain system through one of several general approaches: cisterns or rain barrels; dry wells or infiltration trenches; pop-up emitters, and foundation planting. The first three approaches require the roof runoff to be contained in a gutter and downspout system. Foundation planting provides a vegetated strip under the drip line of the roof.

Approach

Design of individual lots for single-family homes as well as lots for higher density residential and commercial structures should consider site design provisions for containing and infiltrating roof runoff or directing roof runoff to vegetative swales or buffer areas. Retained water can be reused for watering gardens, lawns, and trees. Benefits to the environment include reduced demand for potable water used for irrigation, improved stormwater quality, increased groundwater recharge, decreased runoff volume and peak flows, and decreased flooding potential.

Suitable Applications

Appropriate applications include residential, commercial and industrial areas planned for development or redevelopment.

Design Considerations

Designing New Installations

Cisterns or Rain Barrels

One method of addressing roof runoff is to direct roof downspouts to cisterns or rain barrels. A cistern is an above ground storage vessel with either a manually operated valve or a permanently open outlet. Roof runoff is temporarily stored and then released for irrigation or infiltration between storms. The number of rain



barrels needed is a function of the rooftop area. Some low impact developers recommend that every house have at least 2 rain barrels, with a minimum storage capacity of 1000 liters. Roof barrels serve several purposes including mitigating the first flush from the roof which has a high volume, amount of contaminants, and thermal load. Several types of rain barrels are commercially available. Consideration must be given to selecting rain barrels that are vector proof and childproof. In addition, some barrels are designed with a bypass valve that filters out grit and other contaminants and routes overflow to a soak-away pit or rain garden.

If the cistern has an operable valve, the valve can be closed to store stormwater for irrigation or infiltration between storms. This system requires continual monitoring by the resident or grounds crews, but provides greater flexibility in water storage and metering. If a cistern is provided with an operable valve and water is stored inside for long periods, the cistern must be covered to prevent mosquitoes from breeding.

A cistern system with a permanently open outlet can also provide for metering stormwater runoff. If the cistern outlet is significantly smaller than the size of the downspout inlet (say ¼ to ½ inch diameter), runoff will build up inside the cistern during storms, and will empty out slowly after peak intensities subside. This is a feasible way to mitigate the peak flow increases caused by rooftop impervious land coverage, especially for the frequent, small storms.

Dry wells and Infiltration Trenches

Roof downspouts can be directed to dry wells or infiltration trenches. A dry well is constructed by excavating a hole in the ground and filling it with an open graded aggregate, and allowing the water to fill the dry well and infiltrate after the storm event. An underground connection from the downspout conveys water into the dry well, allowing it to be stored in the voids. To minimize sedimentation from lateral soil movement, the sides and top of the stone storage matrix can be wrapped in a permeable filter fabric, though the bottom may remain open. A perforated observation pipe can be inserted vertically into the dry well to allow for inspection and maintenance.

In practice, dry wells receiving runoff from single roof downspouts have been successful over long periods because they contain very little sediment. They must be sized according to the amount of rooftop runoff received, but are typically 4 to 5 feet square, and 2 to 3 feet deep, with a minimum of 1-foot soil cover over the top (maximum depth of 10 feet).

To protect the foundation, dry wells must be set away from the building at least 10 feet. They must be installed in solids that accommodate infiltration. In poorly drained soils, dry wells have very limited feasibility.

Infiltration trenches function in a similar manner and would be particularly effective for larger roof areas. An infiltration trench is a long, narrow, rock-filled trench with no outlet that receives stormwater runoff. These are described under Treatment Controls.

Pop-up Drainage Emitter

Roof downspouts can be directed to an underground pipe that daylights some distance from the building foundation, releasing the roof runoff through a pop-up emitter. Similar to a pop-up irrigation head, the emitter only opens when there is flow from the roof. The emitter remains flush to the ground during dry periods, for ease of lawn or landscape maintenance.

Foundation Planting

Landscape planting can be provided around the base to allow increased opportunities for stormwater infiltration and protect the soil from erosion caused by concentrated sheet flow coming off the roof. Foundation plantings can reduce the physical impact of water on the soil and provide a subsurface matrix of roots that encourage infiltration. These plantings must be sturdy enough to tolerate the heavy runoff sheet flows, and periodic soil saturation.

Redeveloping Existing Installations

Various jurisdictional stormwater management and mitigation plans (SUSMP, WQMP, etc.) define “redevelopment” in terms of amounts of additional impervious area, increases in gross floor area and/or exterior construction, and land disturbing activities with structural or impervious surfaces. The definition of “redevelopment” must be consulted to determine whether or not the requirements for new development apply to areas intended for redevelopment. If the definition applies, the steps outlined under “designing new installations” above should be followed.

Supplemental Information

Examples

- City of Ottawa’s Water Links Surface –Water Quality Protection Program
- City of Toronto Downspout Disconnection Program
- City of Boston, MA, Rain Barrel Demonstration Program

Other Resources

Hager, Marty Catherine, Stormwater, “Low-Impact Development”, January/February 2003.
www.stormh2o.com

Low Impact Urban Design Tools, Low Impact Development Design Center, Beltsville, MD.
www.lid-stormwater.net

Start at the Source, Bay Area Stormwater Management Agencies Association, 1999 Edition



Design Objectives

- Maximize Infiltration
- Provide Retention
- Slow Runoff
- Minimize Impervious Land Coverage
- Prohibit Dumping of Improper Materials
- Contain Pollutants
- Collect and Convey

Description

Irrigation water provided to landscaped areas may result in excess irrigation water being conveyed into stormwater drainage systems.

Approach

Project plan designs for development and redevelopment should include application methods of irrigation water that minimize runoff of excess irrigation water into the stormwater conveyance system.

Suitable Applications

Appropriate applications include residential, commercial and industrial areas planned for development or redevelopment. (Detached residential single-family homes are typically excluded from this requirement.)

Design Considerations

Designing New Installations

The following methods to reduce excessive irrigation runoff should be considered, and incorporated and implemented where determined applicable and feasible by the Permittee:

- Employ rain-triggered shutoff devices to prevent irrigation after precipitation.
- Design irrigation systems to each landscape area's specific water requirements.
- Include design featuring flow reducers or shutoff valves triggered by a pressure drop to control water loss in the event of broken sprinkler heads or lines.
- Implement landscape plans consistent with County or City water conservation resolutions, which may include provision of water sensors, programmable irrigation times (for short cycles), etc.



- Design timing and application methods of irrigation water to minimize the runoff of excess irrigation water into the storm water drainage system.
- Group plants with similar water requirements in order to reduce excess irrigation runoff and promote surface filtration. Choose plants with low irrigation requirements (for example, native or drought tolerant species). Consider design features such as:
 - Using mulches (such as wood chips or bar) in planter areas without ground cover to minimize sediment in runoff
 - Installing appropriate plant materials for the location, in accordance with amount of sunlight and climate, and use native plant materials where possible and/or as recommended by the landscape architect
 - Leaving a vegetative barrier along the property boundary and interior watercourses, to act as a pollutant filter, where appropriate and feasible
 - Choosing plants that minimize or eliminate the use of fertilizer or pesticides to sustain growth
- Employ other comparable, equally effective methods to reduce irrigation water runoff.

Redeveloping Existing Installations

Various jurisdictional stormwater management and mitigation plans (SUSMP, WQMP, etc.) define “redevelopment” in terms of amounts of additional impervious area, increases in gross floor area and/or exterior construction, and land disturbing activities with structural or impervious surfaces. The definition of “redevelopment” must be consulted to determine whether or not the requirements for new development apply to areas intended for redevelopment. If the definition applies, the steps outlined under “designing new installations” above should be followed.

Other Resources

A Manual for the Standard Urban Stormwater Mitigation Plan (SUSMP), Los Angeles County Department of Public Works, May 2002.

Model Standard Urban Storm Water Mitigation Plan (SUSMP) for San Diego County, Port of San Diego, and Cities in San Diego County, February 14, 2002.

Model Water Quality Management Plan (WQMP) for County of Orange, Orange County Flood Control District, and the Incorporated Cities of Orange County, Draft February 2003.

Ventura Countywide Technical Guidance Manual for Stormwater Quality Control Measures, July 2002.



Design Objectives

- Maximize Infiltration
- Provide Retention
- Slow Runoff
- Minimize Impervious Land Coverage
- Prohibit Dumping of Improper Materials
- Contain Pollutants
- Collect and Convey

Description

Waste materials dumped into storm drain inlets can have severe impacts on receiving and ground waters. Posting notices regarding discharge prohibitions at storm drain inlets can prevent waste dumping. Storm drain signs and stencils are highly visible source controls that are typically placed directly adjacent to storm drain inlets.

Approach

The stencil or affixed sign contains a brief statement that prohibits dumping of improper materials into the urban runoff conveyance system. Storm drain messages have become a popular method of alerting the public about the effects of and the prohibitions against waste disposal.

Suitable Applications

Stencils and signs alert the public to the destination of pollutants discharged to the storm drain. Signs are appropriate in residential, commercial, and industrial areas, as well as any other area where contributions or dumping to storm drains is likely.

Design Considerations

Storm drain message markers or placards are recommended at all storm drain inlets within the boundary of a development project. The marker should be placed in clear sight facing toward anyone approaching the inlet from either side. All storm drain inlet locations should be identified on the development site map.

Designing New Installations

The following methods should be considered for inclusion in the project design and show on project plans:

- Provide stenciling or labeling of all storm drain inlets and catch basins, constructed or modified, within the project area with prohibitive language. Examples include “NO DUMPING



– DRAINS TO OCEAN” and/or other graphical icons to discourage illegal dumping.

- Post signs with prohibitive language and/or graphical icons, which prohibit illegal dumping at public access points along channels and creeks within the project area.

Note - Some local agencies have approved specific signage and/or storm drain message placards for use. Consult local agency stormwater staff to determine specific requirements for placard types and methods of application.

Redeveloping Existing Installations

Various jurisdictional stormwater management and mitigation plans (SUSMP, WQMP, etc.) define “redevelopment” in terms of amounts of additional impervious area, increases in gross floor area and/or exterior construction, and land disturbing activities with structural or impervious surfaces. If the project meets the definition of “redevelopment”, then the requirements stated under “designing new installations” above should be included in all project design plans.

Additional Information

Maintenance Considerations

- Legibility of markers and signs should be maintained. If required by the agency with jurisdiction over the project, the owner/operator or homeowner’s association should enter into a maintenance agreement with the agency or record a deed restriction upon the property title to maintain the legibility of placards or signs.

Placement

- Signage on top of curbs tends to weather and fade.
- Signage on face of curbs tends to be worn by contact with vehicle tires and sweeper brooms.

Supplemental Information

Examples

- Most MS4 programs have storm drain signage programs. Some MS4 programs will provide stencils, or arrange for volunteers to stencil storm drains as part of their outreach program.

Other Resources

A Manual for the Standard Urban Stormwater Mitigation Plan (SUSMP), Los Angeles County Department of Public Works, May 2002.

Model Standard Urban Storm Water Mitigation Plan (SUSMP) for San Diego County, Port of San Diego, and Cities in San Diego County, February 14, 2002.

Model Water Quality Management Plan (WQMP) for County of Orange, Orange County Flood Control District, and the Incorporated Cities of Orange County, Draft February 2003.

Ventura Countywide Technical Guidance Manual for Stormwater Quality Control Measures, July 2002.

Description

Trash storage areas are areas where a trash receptacle (s) are located for use as a repository for solid wastes. Stormwater runoff from areas where trash is stored or disposed of can be polluted. In addition, loose trash and debris can be easily transported by water or wind into nearby storm drain inlets, channels, and/or creeks. Waste handling operations that may be sources of stormwater pollution include dumpsters, litter control, and waste piles.

Approach

This fact sheet contains details on the specific measures required to prevent or reduce pollutants in stormwater runoff associated with trash storage and handling. Preventative measures including enclosures, containment structures, and impervious pavements to mitigate spills, should be used to reduce the likelihood of contamination.

Suitable Applications

Appropriate applications include residential, commercial and industrial areas planned for development or redevelopment. (Detached residential single-family homes are typically excluded from this requirement.)

Design Considerations

Design requirements for waste handling areas are governed by Building and Fire Codes, and by current local agency ordinances and zoning requirements. The design criteria described in this fact sheet are meant to enhance and be consistent with these code and ordinance requirements. Hazardous waste should be handled in accordance with legal requirements established in Title 22, California Code of Regulation.

Wastes from commercial and industrial sites are typically hauled by either public or commercial carriers that may have design or access requirements for waste storage areas. The design criteria in this fact sheet are recommendations and are not intended to be in conflict with requirements established by the waste hauler. The waste hauler should be contacted prior to the design of your site trash collection areas. Conflicts or issues should be discussed with the local agency.

Designing New Installations

Trash storage areas should be designed to consider the following structural or treatment control BMPs:

- Design trash container areas so that drainage from adjoining roofs and pavement is diverted around the area(s) to avoid run-on. This might include berming or grading the waste handling area to prevent run-on of stormwater.
- Make sure trash container areas are screened or walled to prevent off-site transport of trash.

Design Objectives

- Maximize Infiltration
- Provide Retention
- Slow Runoff
- Minimize Impervious Land Coverage
- Prohibit Dumping of Improper Materials
- Contain Pollutants
- Collect and Convey



- Use lined bins or dumpsters to reduce leaking of liquid waste.
- Provide roofs, awnings, or attached lids on all trash containers to minimize direct precipitation and prevent rainfall from entering containers.
- Pave trash storage areas with an impervious surface to mitigate spills.
- Do not locate storm drains in immediate vicinity of the trash storage area.
- Post signs on all dumpsters informing users that hazardous materials are not to be disposed of therein.

Redeveloping Existing Installations

Various jurisdictional stormwater management and mitigation plans (SUSMP, WQMP, etc.) define “redevelopment” in terms of amounts of additional impervious area, increases in gross floor area and/or exterior construction, and land disturbing activities with structural or impervious surfaces. The definition of “redevelopment” must be consulted to determine whether or not the requirements for new development apply to areas intended for redevelopment. If the definition applies, the steps outlined under “designing new installations” above should be followed.

Additional Information***Maintenance Considerations***

The integrity of structural elements that are subject to damage (i.e., screens, covers, and signs) must be maintained by the owner/operator. Maintenance agreements between the local agency and the owner/operator may be required. Some agencies will require maintenance deed restrictions to be recorded of the property title. If required by the local agency, maintenance agreements or deed restrictions must be executed by the owner/operator before improvement plans are approved.

Other Resources

A Manual for the Standard Urban Stormwater Mitigation Plan (SUSMP), Los Angeles County Department of Public Works, May 2002.

Model Standard Urban Storm Water Mitigation Plan (SUSMP) for San Diego County, Port of San Diego, and Cities in San Diego County, February 14, 2002.

Model Water Quality Management Plan (WQMP) for County of Orange, Orange County Flood Control District, and the Incorporated Cities of Orange County, Draft February 2003.

Ventura Countywide Technical Guidance Manual for Stormwater Quality Control Measures, July 2002.



The Food Handler's Manual



A Training Handbook for
Riverside County Food Handlers



Protecting People and the Environment





Table of Contents



Introduction

1



Inspection and Grade Posting

3



Foodborne Illness and Contamination Hazards

5



Food Protection

9



Personal Hygiene and Health

11



Handwashing

13



Time and Temperature

17



Cleaning and Sanitizing

23



Food Allergens

27



Waste and Pest Control

29



Facility Closure

31

Inspection and Grade Posting

Riverside County Department of Environmental Health employs approximately 50 trained inspectors, who are Registered Environmental Health Specialists. Since 1963, unannounced inspections have been conducted at restaurants, markets, schools, bakeries, bars, and all other food establishments throughout the county. These inspections are scored and graded. You have probably seen our public notice and grade placards posted.

The Public Notice Card tells the public that they have the right to see a copy of the last inspection report at any time. It is against the law for a facility to refuse to show the last inspection report when requested by the public. You can access a food facility's inspection history on our department website www.rivcoeh.org.

At each inspection, the facility will be graded on food safety and illness prevention on a 100 point scale with points being deducted for each violation observed. At the end of the inspection, the inspector will post a letter grade (A, B, or C) in a place that can be easily seen by the public. An "A" grade represents a passing score and should be the goal of every food establishment. Grades "B" or "C", also known as a "downgrade," indicates that the facility did not pass the inspection and has not met the minimum standards for food safety. In these cases, the food facility must correct the violations within a specified time period and be re-inspected to make sure their practices are safe to prepare food for the public. Failure to correct violations could result in further legal actions, including closure.

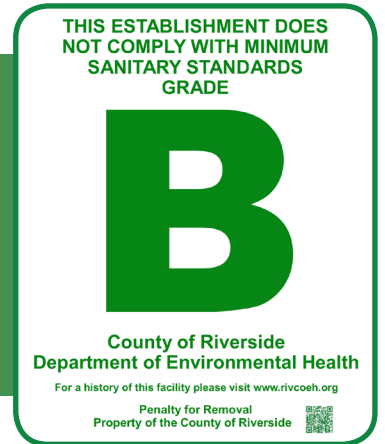
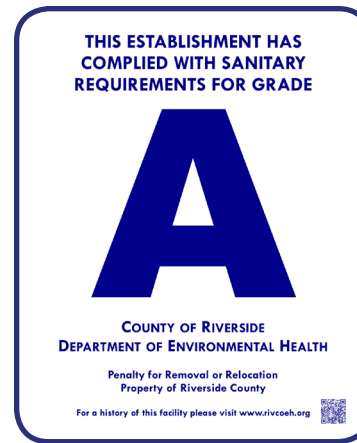
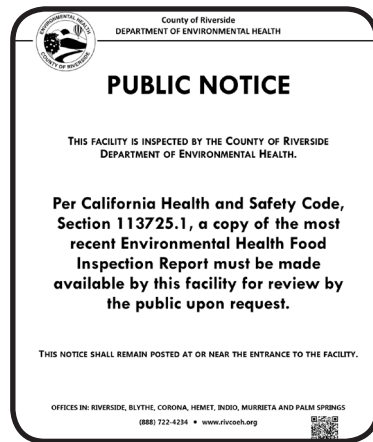

THE GRADE CARD MAY NOT BE MOVED, DAMAGED, OR COVERED UP. ONLY THE INSPECTOR IS ALLOWED TO MOVE OR RELOCATE THE GRADE CARD ONCE IT HAS BEEN POSTED.

Foodborne Illness and Contamination Hazards

Have you ever eaten something that possibly made you sick? Eating too many cheeseburgers is one thing, but you may have experienced actual foodborne illness by eating something contaminated. Contaminated food can make you sick with symptoms such as nausea, diarrhea, vomiting, fever, and chills. While most people will recover from the illness, in some cases the effects can be long-term and devastating, even resulting in death. Serious long-term consequences include kidney failure, chronic arthritis, even nerve and brain damage. While foodborne illness can affect just about everyone, certain people such as babies, small children, pregnant women, elderly, and people that are already sick are more susceptible.



EVEN THOUGH THE FOOD LOOKS, SMELLS AND TASTES NORMAL, IF NOT HANDLED CORRECTLY IT COULD MAKE SOMEONE VERY SICK.



Food becomes unsafe when it comes in contact with hazards. A food hazard is any item or substance that can make food dangerous to eat. Contaminated food may cause foodborne illness. There are three categories of contaminated food:

CHEMICAL CONTAMINATION



This can occur when chemicals like a cleaner, bug spray, or medication gets in or on a food item. This can happen when chemicals are stored in a food preparation area and spill or come in contact with food, possibly poisoning the person who eats that food. Always store chemicals in clearly labeled containers, in a designated area away from food storage and preparation. Avoid spraying or using chemicals near food.



BIOLOGICAL CONTAMINATION

This kind of contamination consists of tiny germs that can't be seen such as bacteria, viruses, fungi, and protozoa. While these are prevalent in our daily lives, those that cause illness are known as pathogens. Bacteria are common pathogens associated with foodborne illness as they are found naturally in soil and water. Bacteria's main goal is to replicate. Some can do this rapidly when actions to control the growth aren't followed. Bacteria like *Salmonella* can double their numbers in less than 20 minutes. So think about a piece of chicken that has 20 bacteria on it, in 10 hours, this piece of chicken could have over 20 million bacteria!

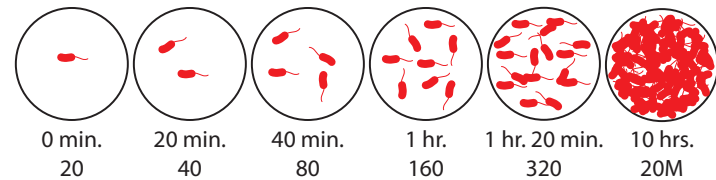

Even if pathogens are killed during the cooking process, they can still leave behind their toxins which can make someone very sick if ingested. For instance, *Bacillus cereus* which is often associated with cooked rice, produces toxins that are released when the bacteria is killed. The bacteria indirectly cause illness through the toxins they produce.

Viruses are also a common pathogen associated with foodborne illness. If you or your coworker come to work sick, you are probably carrying trillions of viruses which can easily spread to food or food-contact surfaces. These viruses can live for days or weeks on surfaces and eventually make their way into food where they are ingested. Some viruses only take a few hours before causing you to feel sick. Other pathogens may take a few days, or even a few weeks. Although you may not be experiencing symptoms, you can still carry around pathogens. That's why you should always follow safe food handling practices.



Foodborne Illness and Contamination Hazards



PHYSICAL CONTAMINATION

Have you ever had to pull a hair out of your food? If so, then you already know what physical contamination is. If something is in food that shouldn't be there such as a bandage, glass or metal fragments, fake fingernails, or even a fly, then it has been contaminated with a physical hazard and must be disposed. Physical contamination can cause injury such as cuts to the mouth, choking, or serious illness. Usually, physical hazards get into food accidentally; however, some can occur naturally like bones, fruit pits, or seeds. It's important to remove these items during preparation unless the physical hazard is obvious like the bone in a chicken leg.



SYMPTOMS OF FOODBORNE ILLNESS

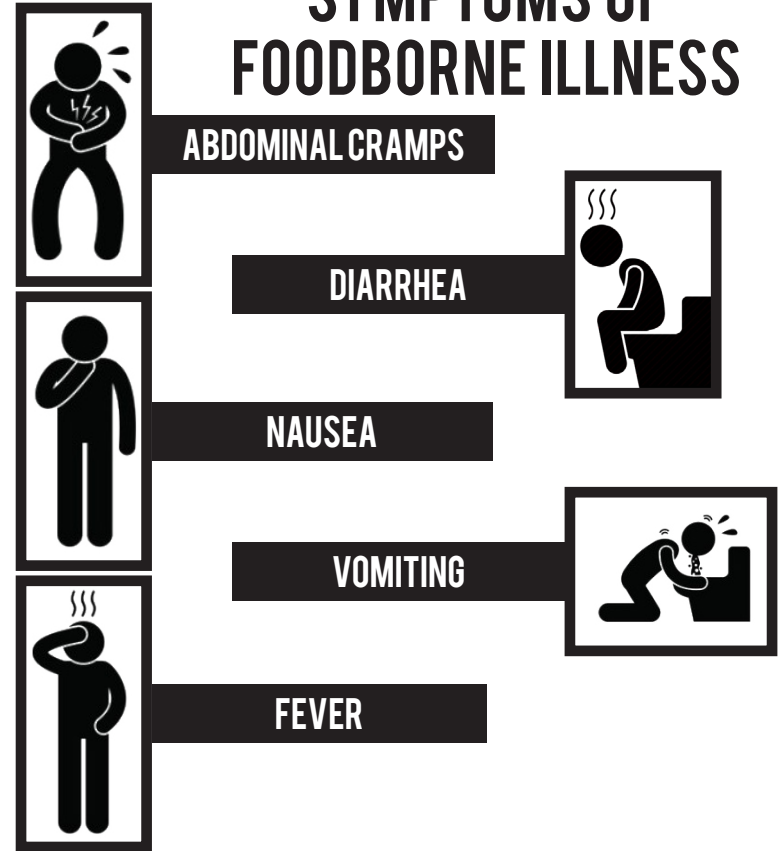

CONTRIBUTING FACTORS TO FOODBORNE ILLNESS

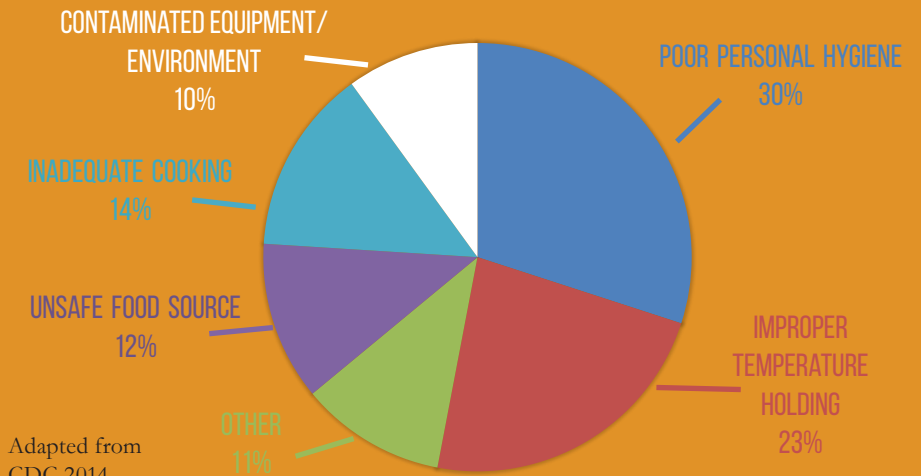

Food Protection

As a food handler, protecting food from potential contamination should be your first priority. Storing food properly is a way to protect it. Food should be stored inside the facility in approved storage areas. Food containers should also be covered, labeled, and stored at least 6 inches off the floor.



Don't forget that ice is also a food and should be protected from contamination as well. Never store food items in the same place as cleaners, chemicals, or personal items. Even utensils and dishes should have their own storage space.

Produce and ready-to-eat foods should be stored on top shelves of refrigerators. Different types of raw meats and raw shell eggs should always be stored separate from one another and on the bottom shelf in a refrigerator. If they happen to drip, they will not cross-contaminate the foods below them.

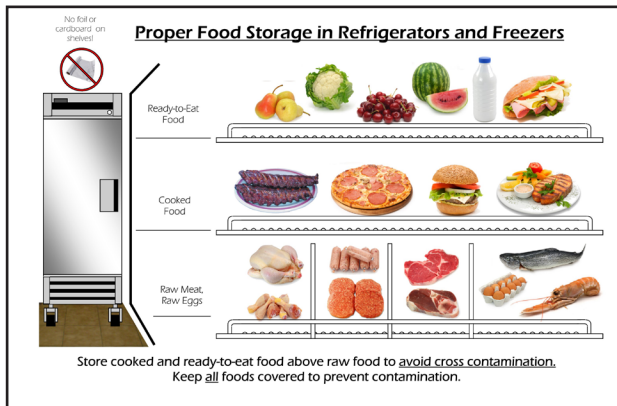

Cross-contamination refers to pathogens from one type of food coming into contact with another type of food. This can happen either by food-to-food (e.g., improper food storage), surface-to-food (e.g., contaminated utensils or surfaces), or person-to-food (e.g., hand contact) cross-contamination. For example, if you use a cutting board for raw chicken which is known for carrying harmful bacteria and then use that same cutting board to cut vegetables without properly cleaning it first, the bacteria from the raw chicken may be transferred to the vegetables. The vegetables are now contaminated. Food can also become cross-contaminated by food handlers themselves. For example, if the food handler doesn't properly wash their hands, they may cross contaminate foods through hand contact.



SEPARATE

DON'T CROSS CONTAMINATE

Another way to protect your customers and prevent foodborne illness is to verify the food obtained is from an approved source. All food must be received from a government regulated food supplier.



When food is delivered, look at it carefully and ensure that it is not damaged, contaminated, and has not been tampered with. Cold, potentially hazardous food should be delivered from a refrigerated



truck or packed in ice with an internal temperature of 45°F or below. If the food does not appear safe and in good condition, don't accept the order. Once the order has been accepted it should be promptly put away.

Personal Hygiene and Health

Practicing good hygiene will help protect food from biological and physical contamination. If a food worker has poor hygiene, they may be the source of food contamination.

- Shower daily and wear clean clothing. Try to limit the pathogens you bring to work.
- Remove jewelry and watches as they can trap food and pathogens and contaminate food or utensils you are handling.
- Properly restrain hair, by pulling it back or wearing a hat or hair/beard net to keep hair out of food.



- Do not eat, drink, smoke, or chew gum while working with food. Small droplets of saliva fall from your mouth and can contaminate food or surfaces.
- Keep fingernails neatly trimmed as dirt and pathogens can get trapped in the space under the fingernails.
- Never cough or sneeze into your hands or in the direction of food areas. You should turn away, and cough or sneeze into the bend of your arm.



- Do not touch the food-contact parts of utensils. For example, utilize the handle when scooping ice and handle silverware by handles only.



If you are sick, you can make everyone around you sick including those whose food you are handling. Some illnesses require you to stay home as they are so contagious you cannot go to work. If you are experiencing any of the following symptoms you must stay home: vomiting, diarrhea, sore throat with a fever, or yellowing of the skin or eyes. Contact your manager to inform them of your symptoms and they will let you know when it is safe for you to return to work. If you are diagnosed with any of the “Big 5” illnesses, you may be required to get a medical release by a doctor to return to work as these illnesses are so contagious they can be spread to food.

THE BIG 5

SHIGELLA SALMONELLA E. COLI NOROVIRUS HEPATITIS A

Handwashing

Your hands are covered with bacteria and viruses! While you cannot see or feel them, they are there. Washing your hands thoroughly, and often, can greatly reduce the spread of bacteria. Removing bacteria and viruses from your hands prevents them from getting into food and onto other surfaces where they can eventually lead to illness. Good personal hygiene, which includes hand washing, is vital when preparing food. In fact, it is required by law for you to wash your hands. Did you know that a food establishment must have a hand sink designated solely for hand washing? This sink should be supplied with both soap and paper towels in dispensers at all times and should never be blocked off or difficult to access. Do not use a food preparation sink or utensil washing sink to wash your hands as this can be a source of cross-contamination.



It is important to wash your hands frequently and whenever contamination may have occurred. You must wash your hands in the following instances:

After:

- using the restroom
- eating, drinking, or smoking
- sneezing or coughing
- handling chemicals or performing cleaning duties, including dish washing and touching wiping cloths
- taking out the trash
- touching your body, clothing, an animal, vermin, or any object
- any other activity that may contaminate hands



Before:

- starting work and when returning from a break
- putting on gloves or when changing gloves
- and after handling raw food

5 STEPS TO PROPERLY WASHED HANDS

1 Wet hands with warm water (at least 100°F) at the designated hand sink.



2 Apply liquid soap from a pump dispenser. Do not use bar soap, because it can harbor harmful germs.



3 Rub hands together vigorously for 10-15 seconds. Pay attention to areas between your fingers, under your nails, and your wrists.



4 Rinse hands thoroughly under warm, running water.



5 Dry your hands with paper towels or an air dryer. Use the paper towel to turn off the faucet. Do not use an apron or reusable towels to dry hands as this can be a source of cross-contamination.



WHAT ABOUT HAND SANITIZER?

Notice we haven't discussed hand sanitizer? Hand sanitizer cannot be used as a replacement for handwashing. Not all pathogens are killed with sanitizer. Some bacteria on your hands can produce toxins, which are not affected by hand sanitizer and can still be transferred to food or food contact surfaces causing foodborne illness.



Handwashing

If you have an injury such as a burn, cut, or open wound on your hand, wrist, or forearm, you must wear a bandage. In addition, you must wear either gloves or some kind of clothing/protection to cover the bandage entirely. This double barrier is required to keep the bacteria on your wound from spreading to food or surfaces. If your wound becomes infected, it can contain disease-causing bacteria which can be spread to food and cause foodborne illness. Notify your manager if your wound shows any of the following symptoms: red and swollen, hot to the touch, draining fluids, or pus-filled.

WASH HANDS PROPERLY BEFORE USING GLOVES



Single-use, disposable gloves can be used to enhance food safety when placed on washed hands and changed at appropriate times. If utensils, such as tongs, cannot be used to handle ready-to-eat foods, gloves should be used to limit bare hand contact with food.

FOLLOW THESE GUIDELINES WHEN USING GLOVES:

- Gloves are not a substitute for hand washing. They must be used in conjunction with a proper hand washing regimen.
- Properly wash your hands before you put on gloves.
- Gloves shall be used for only one task and must be discarded when damaged or soiled. Never re-use gloves.
- Gloves are required if you have artificial fingernails, or rings other than a plain band.
- Gloves must be changed as often as you would wash your hands.



Time and Temperature

For bacteria to survive and grow, they need a food source such as protein or sugar, moisture, and the right temperature. A food that can support the rapid growth of bacteria is known as a 'potentially hazardous food' (PHF). Here are some examples:



Meat and meat products, like chicken, beef, pork, and lamb



Fish and shellfish



Eggs, whether raw or cooked, or within a dish



Dairy products like milk, cream, custard, yogurt, and soft cheeses



Some cut fruits and vegetables, like melons and tomatoes



Vegetables and potatoes once they are cooked



Plants with protein such as cooked beans, rice, or soy products like tofu



Raw sprouts such as alfalfa or bean sprouts



Raw garlic-in-oil

You may notice that most of these foods are either rich in protein or sugar which bacteria use as a fuel source. They also have a moisture content, so at the right temperature, bacteria will thrive. Since you can't take the food source or moisture away, the only way to prohibit bacteria growth is to control the temperature. You can do this by either controlling the temperature or by controlling the time in which the food is at the suitable temperature.

Like yourself, bacteria do not like to be too cold or too hot. Bacteria known to cause foodborne illness grow best at warm temperatures. These temperatures are known as the temperature danger zone, which is between 41°F and 135°F.

When PHFs are held in the temperature danger zone, bacteria can multiply to levels which can cause foodborne illnesses in as little as four

hours. At temperatures of 41°F or below, bacteria will still grow, but not at a rapid rate that causes illness. At temperatures of 135°F or above, the bacteria will either die or be too hot to grow. So to keep the food safe, it must be kept out of the temperature danger zone.



THE GOAL IS TO REDUCE THE AMOUNT OF TIME PHFs ARE SPENT IN THE TEMPERATURE DANGER ZONE AND MINIMIZE THE TIME SPENT PREPARING, COOLING, AND REHEATING PHFs.

NEVER LEAVE FOOD OUT AT ROOM TEMPERATURE

Storing food in a properly functioning refrigeration system is a great way to ensure it does not enter the temperature danger zone. Remember, bacteria does not stop growing at cold temperatures, but rather their

growth only slows down. Be sure to utilize a system like labeling to ensure food is used no more than seven days after it was first thawed, opened, or prepared. Also, be sure the refrigerator has a properly functioning thermometer to ensure food is held at 41°F or below. If a refrigeration system is not available, ice can be used but requires frequent monitoring

to ensure the level of ice is maintained completely surrounding the food container and is being replenished as it melts.

Note: a thermometer reading of the refrigerator is not the most accurate way to tell if a food is at a safe temperature. The most accurate way to tell is by probing the actual food with a probe thermometer.

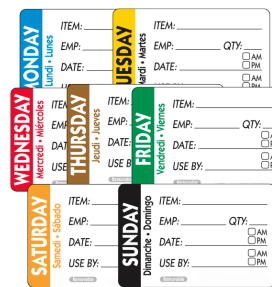

Time and Temperature

It is important to thaw food in approved ways to ensure the food does not enter into the temperature danger zone. You should always assume that bacteria is present in or on PHFs. For example, meat contains bacteria either from the animal's digestive track or through processing. This bacteria can survive even in a frozen state.

NEVER THAW FROZEN PHFs ON THE COUNTER OR IN STAGNANT WATER

Use one of these approved thawing methods:

- The safest way is to place the food in a refrigerator overnight. Large items such as a turkey or roast may require several days, so planning ahead is necessary.
- Directly cook the frozen food. For example, placing a frozen hamburger patty directly on the griddle will thaw it as part of the cooking process.
- Use a microwave on the defrost setting to thaw food. This method must be followed by immediate cooking. Also, be sure to rotate or stir the food throughout the process since microwaves do not heat evenly.
- Place the frozen food in the food preparation sink, completely submerged in water and let cool running water (70°F or below) flow over the food. Be sure the water is cool as warm water will allow the surface of the food to enter into the temperature danger zone, allowing bacteria to grow. Also, if the item is in a vacuum sealed package, remove the packaging before thawing process.



When a PHF is cooked, the harmful bacteria can be destroyed. For animal products, certain cooking temperatures are required. If these internal temperatures are not reached, the bacteria can survive and will be served along with the food, possibly causing foodborne illness.

Internal Cooking Temperatures

Use a Probe Thermometer to Take Internal Cooking Temperatures

| | | | | | | | |
|---|---|---|---|---|---|---|---|
|  |  |  |  |  |  |  |  |
| 135°F for 15 seconds | 145°F for 15 seconds | 145°F for 15 seconds | 145°F for 15 seconds | 155°F for 15 seconds | 155°F for 15 seconds | 165°F for 15 seconds | 165°F for 15 seconds |

Food temperature cannot be felt - use your probe thermometer!

Sometimes, your menu will contain an undercooked or raw animal product. You may serve this food as long as your customer is informed of the significantly increased risk of foodborne illness. This is done by a written disclosure statement and written reminder statement. The disclosure identifies the menu item, usually by an asterisk denoting a footnote that states the item is served raw or undercooked. The reminder follows with the phrase: "Consuming raw or undercooked meats, poultry, seafood, shellfish, or eggs may increase your risk of foodborne illness, especially if you have certain medical conditions".



Be sure to utilize your probe thermometer to check internal food temperatures when you are thawing, temperature-holding, cooking, or cooling PHF. Ensure the temperature is taken at the thickest portion of the food product and that liquids are stirred prior, to gain an accurate temperature. Always make sure the probe of the thermometer is washed, rinsed, and sanitized between uses, just like any other utensil. This is especially important when measuring the temperature of a ready-to-eat food after measuring a raw meat product. Your probe thermometer will require calibration to ensure it is accurate. Your manager can show you how to properly calibrate your thermometer.

One of the major causes of foodborne illness is improperly cooled foods because PHFs must enter the temperature danger zone when cooling. Foods must be rapidly cooled utilizing the two-step process to limit the time spent in the temperature danger zone.

2-STEP COOLING PROCESS

STEP 1: 135°F TO 70°F

IN 2 HOURS OR LESS

STEP 2: 70°F TO 41°F

IN 4 HOURS OR LESS

TOTAL COOLING TIME MUST

BE 6 HOURS OR LESS

Time and Temperature

You can utilize some of these methods to achieve proper rapid cooling:

- Using an ice bath with frequent stirring
- Pouring foods into shallow metal pans and placing in a walk-in cooler
- Using chill sticks or ice paddles
- Using a blast chiller or tumbler
- Portioning into smaller pieces



No matter which cooling method you use to rapidly cool your food, make sure to utilize your probe thermometer to take internal food temperatures to ensure you are meeting the temperature requirements.

Reheating food can also be a dangerous process because the food must enter the temperature danger zone. Foods that will be hot-held must be rapidly and evenly reheated to ensure all portions reach a minimum internal temperature of 165°F.

FOOD TO BE SERVED IMMEDIATELY



REHEAT TO ANY TEMPERATURE

FOOD THAT WILL BE HOT-HELD



REHEAT TO 165°F

ALL REHEATED FOOD MUST BE REHEATED IN 2 HOURS OR LESS

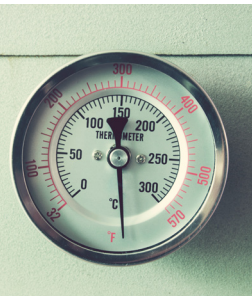

Only use equipment like stoves, ovens, or microwaves to reheat foods.



Never use a steam table or warmer drawer to heat up PHFs. These types of units will take too long as you only have two hours to reach proper temperature.



STEAM TABLES AND WARMERS SHOULD ONLY BE USED TO HOLD PHFs HOT, AT OR ABOVE 135°F

REMEMBER TO KEEP PHFs AT:

COLD FOOD

41°F OR BELOW



HOT FOOD

135°F OR ABOVE

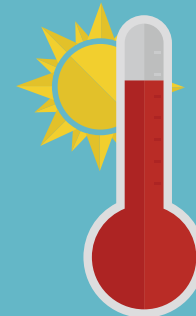

Cleaning and Sanitizing

Keeping the food facility, equipment, and utensils clean and sanitized is important in food safety. Disease-causing bacteria and viruses can survive on surfaces that have not been properly cleaned and sanitized. All utensils used in the food facility including plates, cups, cutlery, counters, and cutting boards must be properly washed and sanitized. Washing is the act of physically removing food and debris, while sanitizing is the act of killing any pathogens which may remain. Food facilities can accomplish this manually using a 3-compartment sink, or automatically in a commercial dish-washing machine.



THERE ARE 5 STEPS TO PROPERLY WASH DISHES AND UTENSILS USING A 3-COMPARTMENT SINK

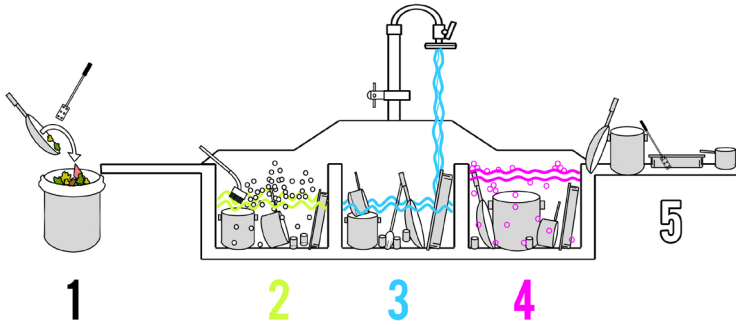

1 **SCRAPE** or pre-rinse items to remove large food particles.

2 **WASH** using a soap or detergent in warm water (minimum 100°F) in the first sink compartment to remove all food and debris including grease and grime.

3 **RINSE** items in clean water in the second compartment to completely remove the soap or detergent residue.



4 **SANITIZE** by completely submerging the item in a solution of water and sanitizer in the third compartment. Any of the following solutions are effective to kill pathogens:

- Chlorine (bleach) at 100 ppm for 30 seconds
- Quaternary ammonium at 200 ppm for 60 seconds
- Iodine at 25 ppm for 60 seconds
- Hot water immersion at 171°F for 30 seconds may also be used instead of chemical sanitizers

HAVE YOU CHECKED THE SANITIZER TODAY?

Always remember to check the sanitizer concentration after you have mixed the chemical in water. You do this by using a test strip specific to the type of chemical you are using.

5 **AIR DRY** the items on the clean drain board of the 3-compartment sink. Never towel or paper towel dry the item as you may contaminate it.

CLEANING AND SANITIZING USING AN AUTOMATIC DISH WASHING MACHINE

Commercial dish-washing machines are professionally installed equipment that wash and sanitize dishes automatically. They must be monitored and serviced to ensure they are working properly. Dish washing machines must be maintained according to the manufacturer's instructions. They use chlorine or hot water to sanitize utensils.



- If chlorine is used to sanitize, it must spray utensils with a concentration of 50 ppm during the final rinse.
- If hot water is used to sanitize, a minimum of 160°F hot water must reach the surface of the plate or utensil. This means the temperature gauge on the front of the machine will read much higher than 160°F. A temperature-sensing decal or a thermometer designed to test hot water in dish machines is required to verify utensils are being properly sanitized.

Cleaning and Sanitizing

Once the cycle is complete, allow the items to air dry. Don't forget to check the sanitizer concentration just as you would when manually cleaning and sanitizing.

Cleaning and sanitizing reduces food hazards and cross-contamination. All food contact surfaces must be cleaned and sanitized often.



SPECIFIC EXAMPLES OF WHEN FOOD CONTACT SURFACES WOULD NEED TO BE CLEANED AND SANITIZED:

- When switching between food types such as raw chicken to raw beef, or raw meat to food that is ready-to-eat.
- Every 4 hours after the utensil or surface comes in contact with PHFs.
- Any other time utensils may be contaminated, such as being dropped on the floor or contacting an unclean surface.
- Whenever a utensil has been used or comes in contact with customers, even if the plate, glass, or utensil was not used by the customer.



Dishes and utensils aren't the only things that need to be cleaned. Floors, walls, ceilings, equipment, counters, and shelving all need to be kept clean too. Food contact surfaces like counter tops and some equipment that need to be cleaned but are too large to wash in a standard

3-compartment sink or automatic dish-washing machine must be cleaned and sanitized in place.

Always refer to the equipment's manufacturer instructions for specifics and:

- Turn off and unplug the equipment.
- Remove any small parts that can be cleaned in the 3-compartment sink.
- Using a bucket with warm (100°F minimum) soapy water, thoroughly wash down all parts of the equipment. You may need to use a brush or cloth to reach all parts.
- Rinse the soap off of the equipment using a second clean cloth and clear water. If your facility is set up with an approved hose and floor drains, you can use that instead.
- Use a spray bottle of sanitizing solution to saturate the surface and all parts of the equipment.
- Let the equipment air dry and then reassemble.



As a food handler you will probably use wiping cloths to clean, wipe down counters, tables, or food prep surfaces. After a cloth has been used, it must be stored in a bucket with sanitizer solution or properly

laundered. The type and concentration of sanitizer should be the same as for manual sanitization. Be sure to change the sanitizer solution often to ensure the proper concentration is maintained to keep pathogens from growing.

**HAVE YOU CHECKED THE
SANITIZER TODAY?**



Food Allergens

Approximately 15 million Americans have a food allergy and the number keeps growing. A food allergy is caused when the body's immune system mistakenly thinks that a certain food, or substance within a food, is a threat to your body and triggers a protective response known as an allergic reaction. This can affect certain people even when the food could be safe for most other people. Reactions can range from mild to severe and potentially life-threatening. One of the more serious reactions is called anaphylaxis. This can cause a person to stop breathing.

COMMON SYMPTOMS OF AN ALLERGIC REACTION CAN INCLUDE:

- Hives
- Coughing or wheezing
- Rash or flushed skin
- Dizziness and/or lightheadedness
- Tingly or itchy sensation in the mouth
- Loss of consciousness
- Face, tongue, or lip swelling
- Difficulty breathing
- Vomiting and/or diarrhea
- Swelling of the throat and vocal chords

The eight most common food allergens, responsible for 90% of all documented allergic reactions, are:



As a food handler, it is important for you to take customer inquiries or statements regarding food allergies seriously. The severity of the allergy could mean the difference between life and death. If you are unsure about how the food is prepared or what is in a particular menu item, ask the cook. Do not just assume a food does not contain a certain ingredient. If you are uncertain, refer customers to your manager. The manager of a food facility must be knowledgeable of the eight major food allergens and the symptoms they may cause. You must also learn about allergens as it pertains to your job duties.



It is extremely important to prevent cross-contact when dealing with a food allergy. Cross-contact is when one food comes in contact with another food or equipment that contains the allergen. Even the smallest amount of the allergen can cause a reaction in people with food allergies.



Cross-contact is not the same as cross-contamination. For instance, if a customer orders a salad and is allergic to pine nuts, you cannot just remove the pine nuts from the salad. The salad has been compromised due to cross-contact. Another example, is using the same spatula to handle a cheeseburger and then hamburger to serve to a customer allergic to milk. Your facility might have a preparation area designated as allergen-free where storage and preparation of allergen-free meals is done. Inform the customer if you are unable to guarantee the food to be allergen-free.

Some people may not know they are allergic to a food. Be able to identify if a customer is experiencing an allergic reaction as symptoms may escalate quickly. Let your manager know and call 911.

Waste and Pest Control



Pests can spread illness to people by contaminating food and surfaces with the pathogens they carry in and on their bodies. Pests common to food establishments include rodents (mice and rats), cockroaches, and flying insects (flies).

COMMON SIGNS OF PESTS

- Brown capsule egg cases or strong oily odor
→ **cockroach infestation**
- Black pepper-like droppings
→ **cockroach infestation**
- Black pellets or droppings, signs of gnawing
→ **rat or mouse infestation**
- Black rub marks along the wall
→ **oil and filth from a rodent's body**



Pests only need a source of food and water and somewhere to hide to cause an infestation. The best way to keep pests out of your food establishment is making sure they cannot get in. Eliminate their food source by taking out the garbage often and maintaining a clean facility.



TO PREVENT RODENT AND INSECTS FROM ENTERING, YOU SHOULD:

- Have good seals and weather stripping around doors. Keep windows and doors closed.
- Fix plumbing leaks to keep water from puddling on the floor and remove any leftover mop water.
- Do not leave food debris on the floor; keep stored food in a container with a tight-fitting lid.
- Seal any cracks, crevices, or holes in the floors, walls, or ceiling.
- Keep floors, walls, and equipment clean. Remove unused equipment and excessive clutter so pests can't hide.
- Inspect food during deliveries for the presence of pests, and dispose of cardboard properly.
- Always use plastic liners in trash cans and tie the bag closed before putting in dumpster.
- Keep the dumpster area clean and tidy.
- Keep dumpster lids closed. Have dumpster replaced if damaged or leaking.
- Obtain routine professional pest control services.
- Immediately clean up droppings and report signs of pests to your manager.
- Keep air curtains clean and in good repair.

Many of the bug sprays that you find in stores are not only toxic to the insect or rodent, but also to you and your customers. Check the label to ensure it is safe to use around food or contact a professional pest control service to apply pesticide in a safe manner.



Facility Closure

There are times that a food facility is required to discontinue operation and close for the safety of the public. These include, but are not limited to:

- ▶ NO HOT OR COLD RUNNING WATER
- ▶ PLUMBING BACK-UP
- ▶ COCKROACH, RODENT, OR FLY INFESTATION
- ▶ NO ELECTRICITY
- ▶ INSUFFICIENT REFRIGERATION
- ▶ NO SANITIZER AVAILABLE
- ▶ ANY CONDITION THAT POSES AN IMMINENT HEALTH HAZARD TO THE PUBLIC

If you notice any of these conditions, inform your manager immediately, so the facility can close until these conditions are corrected.

FACILITY CLOSED

BY ORDER OF THE COUNTY OF RIVERSIDE
DEPARTMENT OF ENVIRONMENTAL HEALTH

PER CALIFORNIA HEALTH AND SAFETY CODE
SECTION 114409

DATE CLOSED: _____ INSPECTOR: _____

Property of the County of Riverside
For questions please call: _____



OFFICES IN: RIVERSIDE, BLYTHE, CORONA, HEMET, INDIO, MURRIETA AND PALM SPRINGS
For more information call (888)722-4234 • Department Web Site - www.rivcoeh.org



OFFICE LOCATIONS

WWW.RIVCOEH.ORG
(888)722-4234



1

CORONA

2275 MAIN ST, SUITE 204
CORONA, CA 92882
(951) 273-9140

2

RIVERSIDE - MAIN OFFICE

4065 COUNTY CIRCLE DR, SUITE 104
RIVERSIDE, CA 92503
(951) 358-5172

3

RIVERSIDE - DOWNTOWN

3880 LEMON ST, SUITE 200
RIVERSIDE, CA 92501
(951) 955-8980

4

MURRIETA

30135 TECHNOLOGY DR. SUITE 250,
MURRIETA, CA 92563
(951) 461-0284

5

HEMET

800 S. SANDERSON AVE, SUITE 200
HEMET, CA 92545
(951) 766-2824

6

PALM SPRINGS

554 S. PASEO DOROTEA
PALM SPRINGS, CA 92264
(760) 320-1048

7

INDIO

47-950 ARABIA ST, SUITE A
INDIO, CA 92201
(760) 863-8287

8

BLYTHE

260 N. BROADWAY
BLYTHE, CA 92225
SELF-SERVICE KIOSK ONLY