



**GEOTECHNICAL INVESTIGATION
THE PETALUMAN HOTEL
2 PETALUMA BOULEVARD SOUTH
PETALUMA, CALIFORNIA**

January 28, 2022

Project 1927.01

Prepared for:
EKN Development Group
220 Newport Center Drive, Suite 11-262
Newport Beach, California 92660

Attention: Mike Jolly

CERTIFICATION

This document is an instrument of service, prepared by or under the direction of the undersigned professionals, in accordance with the current ordinary standard of care. The service specifically excludes the investigation of radon, asbestos, toxic mold and other biological pollutants, and other hazardous materials. The document is for the sole use of the client and consultants on this project. Use by third parties or others is expressly prohibited without written permission. If the project changes, or more than two years have passed since issuance of this report, the findings and recommendations must be reviewed by the undersigned.

MILLER PACIFIC ENGINEERING GROUP
(a California corporation)

REVIEWED BY:

DRAFT

Daniel S. Caldwell
Geotechnical Engineer No. 2006
(Expires 9/30/23)

Nathan G. Klemin
Geotechnical Engineer No. 3168
(Expires 3/31/23)

**GEOTECHNICAL INVESTIGATION
THE PETALUMAN HOTEL
2 PETALUMA BOULEVARD SOUTH
PETALUMA, CALIFORNIA
TABLE OF CONTENTS**

1.0	INTRODUCTION.....	1
2.0	PROJECT DESCRIPTION.....	1
3.0	SITE CONDITIONS.....	1
3.1	Regional Geology.....	1
3.2	Surface Conditions.....	2
3.3	Field Exploration.....	2
3.4	Subsurface Conditions.....	3
3.5	Seismicity.....	3
3.5.1	Historic Fault Activity.....	3
3.5.2	Probability of Future Earthquakes.....	4
4.0	GEOLOGIC HAZARDS EVALUATION.....	4
4.1	General.....	4
4.2	Fault Surface Rupture.....	4
4.3	Seismic Shaking.....	5
4.3.1	Deterministic Seismic Hazard Analysis.....	5
4.3.2	Probabilistic Seismic Hazard Analysis.....	6
4.4	Liquefaction Potential and Related Impacts.....	7
4.4.1	Liquefaction Evaluation.....	7
4.4.2	Post Liquefaction Settlement.....	7
4.5	Seismically Induced Ground Settlement.....	8
4.6	Lurching and Ground Cracking.....	8
4.7	Erosion.....	8
4.8	Seiche and Tsunami.....	8
4.9	Flooding.....	9
4.10	Dam Failure Inundation.....	9
4.11	Expansive Soil.....	9
4.12	Settlement/Subsidence.....	9
4.13	Slope Instability/Landsliding.....	10
4.14	Radon-222 Gas.....	10
4.15	Volcanic Eruption.....	10
4.16	Naturally Occurring Asbestos (NOA).....	10
4.17	Hazardous Materials.....	11
5.0	CONCLUSIONS AND RECOMMENDATIONS.....	11
5.1	General.....	11
5.2	Seismic Design.....	11
5.3	Site Preparation and Grading.....	12
5.3.1	Site Preparation.....	12
5.3.2	Excavations.....	12
5.3.3	Fill Materials, Placement and Compaction.....	13
5.4	Foundation Design.....	13
5.5	Retaining Wall Design.....	14
5.7	Site and Foundation Drainage.....	15
5.8	Interior Concrete Slabs-On-Grade.....	15
5.9	Exterior Concrete Slabs.....	15
5.10	Underground Utilities.....	15
5.11	Wintertime Construction.....	16
6.0	SUPPLEMENTAL GEOTECHNICAL SERVICES.....	16
7.0	LIMITATIONS.....	17
8.0	LIST OF REFERENCES.....	18

FIGURES

Site Location Map	Figure 1
Site Plan	2
Regional Geologic Map	3
Active Fault Map	4
Historic Fault Map	5
Liquefaction Susceptibility Map	6
Liquefaction Analysis	7 through 10
FEMA Flood Map	11
Foundation and Retaining Wall Loads	12
Typical Retaining Wall Backdrain	13

APPENDIX A – SUBSURFACE EXPLORATION AND LABORATORY TESTING

Soil Classification Chart	Figure A-1
Rock Classification Chart	A-2
Boring Logs	A-3 through A-6
Sieve Analysis Test Results	A-7 through A-8

APPENDIX B – SUBSURFACE EXPLORATION (CPTS)

CPT Interpretation Chart and Diagram.....	Figure B-1
CPT Logs	B-2 through B-5

APPENDIX C – MCE_R GROUND MOTION HAZARD ANALYSIS

Site Specific MCE _R Data	C-1
Site Specific MCE _R Spectra Candidates	C-2
Site Specific MCE _R Spectra	C-3

**GEOTECHNICAL INVESTIGATION
THE PETALUMAN HOTEL
2 PETALUMA BOULEVARD SOUTH
PETALUMA, CALIFORNIA**

1.0 INTRODUCTION

This report summarizes Miller Pacific Engineering Group's (MPEG) Geotechnical Investigation for the planned Petaluman Hotel, located at 2 Petaluma Boulevard South in Petaluma, California. A Site Location Map is shown on Figure 1. The purpose of our Geotechnical Investigation is to explore the subsurface soil and groundwater conditions, evaluate geotechnical hazards that may affect the planned development, and provide geotechnical recommendations and design criteria for the project. In accordance with our proposal dated February 24, 2021, we are providing our geotechnical engineering services in three phases: 1) Geotechnical Investigation for the proposed improvements, 2) supplemental consultation and geotechnical design review, and 3) construction observation and testing. This report completes our Phase 1 services and includes the following:

- Review of readily available published geologic and geotechnical reference data;
- Exploration of subsurface conditions with one exploratory boring and four cone penetration tests (CPTs);
- Evaluation of geologic hazards and development of conceptual mitigation measures;
- Development of geotechnical recommendations and design criteria (i.e., site grading, seismic, foundation, etc.) for the project; and,
- Preparation of this report summarizing our findings.

2.0 PROJECT DESCRIPTION

As shown on the Site Plan, Figure 2, the project consists of developing the property with a five-story hotel with basement parking. We anticipate that the new building will be cast in place concrete at the basement and first floor level. The floors above the first-floor level will be post tensioned concrete slabs. The top of the basement floor will be approximately 15 feet below street level, and the top of the parking elevator pit slab will be approximately 21 feet below street level. Ancillary improvements are expected to include exterior hardscape/flatwork, new underground utilities, new site drainage, and other improvements "typical" of such developments. No detailed structural information is available at this time. However, preliminary estimates indicate the total building weight (dead load), including basement walls but not including basement mat slab floor, will be approximately 13,500 to 16,500 kips. The estimated total live load is 6,000 kips.

The project site is an approximately 0.3-acre parcel located in an area of nearly level terrain. The site has historically been used as a fuel/service station. We understand that environmental studies have been conducted at the property, and a clean-up of known areas of environmentally contaminated surface soil has been recently completed.

3.0 SITE CONDITIONS

3.1 Regional Geology

The project site lies within the Coast Ranges geomorphic province of California. Regional topography within the Coast Ranges province is characterized by northwest-southeast trending

mountain ridges and intervening valleys that parallel the major geologic structures, including the San Andreas Fault System. The province is also generally characterized by abundant landsliding and erosion, owing in part to its typically high levels of precipitation and seismic activity.

The oldest rocks in the region are the sedimentary, igneous, and metamorphic rocks of the Mesozoic-age (225- to 65-million years old) Franciscan Assemblage. Within Sonoma County, Franciscan rocks are in fault contact with marine sedimentary rocks of the Great Valley Sequence which are of similar age. Locally, a variety of younger sedimentary and volcanic rocks of Tertiary (1.8- to 65-million years old) and Quaternary (less than 1.8-million years old) age overlie the basement rocks of the Franciscan Assemblage and Great Valley Sequence. Within Sonoma County, Late Miocene to Pliocene-age (approximately 2.6- to 11.6-million years old) Sonoma Volcanics comprise the majority of these rocks.

Tectonic deformation and erosion during late Tertiary and Quaternary time (the last several million years) formed the prominent coastal ridges and intervening valleys typical of the Coast Ranges province. The youngest geologic units in the region are Quaternary-age (last 1.8 million years) sedimentary deposits, including alluvial deposits which partially fill most of the valleys and colluvial deposits which typically blanket the lower portions of surrounding slopes.

Regional geologic mapping (Bezore et al, 2002) indicates the site is underlain by Holocene fan deposits (map symbol Qhf), as shown on the Regional Geologic Map, Figure 3. These deposits typically consist of interbedded layers of unconsolidated gravel, sand, silt, and clay.

3.2 Surface Conditions

The project site is located on a rectangular 0.3-acre parcel in downtown Petaluma. The ground surface at the site is nearly level to slightly sloping. The site has been used as a fuel/service station. Properties east and south of the site are developed with commercial buildings. The existing Rex Ace Hardware Store south of the site is located very close to the property line of the subject site. The existing Bank of the West building east of the site is located about twenty feet or more from the property line. The site is bordered on the north by Petaluma Boulevard South and is bordered on the west by B Street.

3.3 Field Exploration

We explored subsurface conditions in the general vicinity of the planned improvements on August 25th, 2021, with four Cone Penetration Tests (CPTs) pushed to maximum depths between 13.7 and 27.7-feet below the ground surface. We also excavated one exploratory soil boring utilizing truck-mounted drilling equipment to 71.5-feet below the ground surface on October 29th, 2021. The approximate CPT and boring locations are shown on the Site Plan, Figure 2. Our Geologist logged the boring in the field and collected soil samples at select intervals for laboratory testing.

Brief descriptions of the terms and methodology used in classifying earth materials are provided on the Soil and Rock Classification Charts, Figures A-1 and A-2, and the exploratory Boring Log is shown on Figures A-3 through A-6. A description of the CPT instrument and exploratory CPT logs are presented on Figures B-1 through B-5. Our subsurface exploration program is discussed in more detail in Appendices A and B.

Laboratory testing of select soil samples recovered from our soil boring included determination of moisture content, dry density, unconfined compressive strength, and particle size distribution, in general accordance with ASTM, EPA, and/or other applicable standards. The results of the moisture

content, dry density, and unconfined compressive strength are presented on the Boring Log. The results of the particle size distribution tests are presented on Figures A-7 and A-8. The laboratory testing program is also discussed in further detail in Appendix A.

3.4 Subsurface Conditions

The subsurface exploration generally confirms the regionally mapped geologic conditions at the site. The project site is underlain by interbedded alluvial deposits variously composed of low to high plasticity, medium stiff to very stiff, silty to sandy clay and loose to dense silty and clayey sands and gravels of Holocene and likely Pleistocene age. Claystone bedrock was encountered approximately 43-feet below the ground surface.

Groundwater was encountered in Boring 1 at 6.9-feet below the ground surface. However, since the boring was not left open for an extended period, a stabilized depth to groundwater may not have been observed. Groundwater was encountered in the CPTs at a depth of between 5.0 and 11.0 feet below the ground surface. Typically, groundwater levels fluctuate seasonally, with higher levels expected during the wet winter months. For planning and design purposes, the groundwater should be assumed to be at the ground surface.

3.5 Seismicity

The project site is located within a seismically active region that includes the Central and Northern Coast Mountain Ranges. As shown on the Fault Map, Figure 4, several active faults are present in the area including Rodgers Creek, San Andreas, Hayward, Maacama, and West Napa Faults, among others. An “active” fault is defined as one that shows displacement within the last 11,000 years and, therefore, is considered more likely to generate a future earthquake than a fault that shows no evidence of recent rupture. The California Geologic Survey has mapped various active and inactive faults in the region (CDMG, 1972 and 2000). These faults are shown in relation to the project site on the attached Active Fault Map, Figure 4. The Rodgers Creek Fault is the nearest known active fault and is located approximately 8.7 kilometers (5.4-miles) east of the site (Google Earth, 2021).

3.5.1 Historic Fault Activity

Numerous earthquakes have occurred in the region within historic times. Earthquakes (magnitude 2.0 and greater) that have occurred in the San Francisco Bay Area since 1985 have been plotted on a map shown on Figure 5. Two significant earthquakes have struck the Petaluma area in recent history that have caused significant damage.

The first earthquake that caused significant damage was the 1906 San Francisco Earthquake (M7.9); which reportedly resulted in a Modified Mercalli Scale of IX (Lawson, 1908). The Modified Mercalli Intensity scale is based on observed damage and the public response during a seismic event. A Modified Mercalli Intensity of IX typically results in general public panic, damage to masonry buildings ranging from collapse to serious damage unless modern design, racked wood-framed structures, structures shifted off foundations; if not bolted to the foundation and broken underground utilities.” Reported damage included multiple structural collapses and structures sliding off foundations. Additionally, 60 to 65-lives were lost as a result of the earthquake.

The second earthquake that caused significant structural damage was the 1969 (M5.6) Santa Rosa Earthquake. This earthquake reportedly resulted in a Modified Mercalli Intensity of VIII (Cloud et. al., 1970). A Modified Mercalli Intensity of VIII typically results

in affected steering of cars, extensive damage to unreinforced masonry buildings, including partial collapse, fall of some masonry walls, twisting and falling of chimneys and monuments, structures shifted off foundations; if not bolted to the foundation; loose partition walls thrown out of plumb and broken tree branches. Reported damage included approximately 99-structures heavily damaged with many requiring abandonment. No deaths were associated with this earthquake.

3.5.2 Probability of Future Earthquakes

The site will likely experience moderate to strong ground shaking from future earthquakes originating on any of several active faults in the San Francisco Bay region. The historical records do not directly indicate either the maximum credible earthquake or the probability of such a future event. To evaluate earthquake probabilities in California, the USGS has assembled a group of researchers into the “Working Group on California Earthquake Probabilities” (USGS 2003, 2008; Field, et al 2015) to estimate the probabilities of earthquakes on active faults. These studies have been published cooperatively by the USGS, CGS, and Southern California Earthquake Center (SCEC) as the Uniform California Earthquake Rupture Forecast, Versions 1, 2, and 3.

In these studies, potential seismic sources were analyzed considering fault geometry, geologic slip rates, geodetic strain rates, historic activity, micro-seismicity, and other factors to arrive at estimates of earthquakes of various magnitudes on a variety of faults in California. The 2008 study specifically analyzed fault sources and earthquake probabilities for the seven major regional fault systems in the Bay Area region, and the entire state of California and updated some of the analytical methods and models. The most recent 2015 study (UCERF3) further expanded the database of faults considered and allowed for consideration of multi-fault ruptures, among other improvements.

Conclusions from the most recent UCERF3 and USGS’ 2016 Fact Sheet (Aagard et al, 2016) indicate there is a 72% chance of an M>6.7 earthquake in the San Francisco Bay Region between 2014 and 2043. The highest probability of an M>6.7 earthquake on any of the active faults in the San Francisco Bay region by 2043 is assigned to the Hayward/Rodgers Creek Fault system, located approximately 8.7-kilometers east of the site, at 33%. Additional studies by the USGS regarding the probability of large earthquakes in the Bay Area are ongoing. These current evaluations include data from additional active faults and updated geological data.

4.0 GEOLOGIC HAZARDS EVALUATION

4.1 General

The principal geologic hazards which could potentially affect the project site are strong seismic shaking from future earthquakes in the San Francisco Bay Region, liquefaction, and post-liquefaction settlement. Other hazards, such as fault rupture, tsunami inundation, slope instability, and others, are not considered significant at the site. More detailed discussion of each geologic hazard considered, their anticipated impacts, and recommended mitigation measures are discussed below.

4.2 Fault Surface Rupture

Under the Alquist-Priolo Earthquake Fault Zoning Act, the California Geological Survey (CDMG)/California Geologic Survey (CGS) (1972, 2000) produced 1:24,000 scale maps showing

all known active faults and defining zones within which special fault studies are required. Based on currently available published geologic information, the project site is not located within an Alquist-Priolo Earthquake Fault Zone (CGS, 2018) nor is within the City’s General Plan Fault Rupture Hazard Zone. The potential for fault surface rupture at the site is therefore considered to be low.

Evaluation: No significant impact.

Recommendation: No special engineering measures are required.

4.3 Seismic Shaking

The site will likely experience seismic ground shaking from future earthquakes in the San Francisco Bay Area. Earthquakes along several active faults in the region, as shown on Figure 4, could cause moderate to strong ground shaking at the site.

4.3.1 Deterministic Seismic Hazard Analysis

Deterministic Seismic Hazard Analysis (DSHA) predicts the intensity of earthquake ground motions by analyzing the characteristics of nearby faults, distance to the faults and rupture zones, earthquake magnitudes, earthquake durations, and site-specific geologic conditions. Empirical relations (Abrahamson, Silva & Kamai, Boore, Stewart, Seyhan & Atkinson, Campbell & Borzognia, and Chiou & Youngs, (2014)) for the stiff soil subsurface conditions were utilized to provide approximate estimates of median peak site accelerations. A summary of the principal active faults affecting the site, their closest distance, moment magnitude of characteristic earthquake, probable median accelerations and plus one standard deviation (+1σ), peak ground accelerations (PGA) for earthquakes on faults near the site are shown in Table A.

TABLE A
DETERMINISTIC PEAK GROUND ACCELERATION
The Petaluman Hotel
2 Petaluma Boulevard South
Petaluma, California

<u>Fault</u>	<u>Fault Distance</u> ¹	<u>Moment Magnitude</u> ¹	<u>Median PGA</u> ^{2,3}	<u>+1σ PGA</u> ^{2,3}
Rodgers Creek	8.7 km	7.58	0.37 g	0.62 g
San Andreas	23.7 km	8.04	0.26 g	0.44 g
Hayward	30.7 km	7.58	0.19 g	0.32 g
Maacama	34.1 km	7.55	0.17 g	0.30 g
West Napa	28.7 km	6.97	0.15 g	0.26 g

Reference:

1. Values estimated using Google Earth KML Files showing Quaternary Faults & Folds in the US obtained from USGS website January 24, 2022.
2. Values determined using Pacific Earthquake Engineering Research Center (PEER) NGA-West2 Excel Spreadsheet, <http://peer.berkeley.edu/ngawest2/databases/>
3. Values determined using $V_s^{30} = 260$ m/s for Site Class “D”. See Section 5.2 of this report for additional discussion regarding site classification.

4.3.2 Probabilistic Seismic Hazard Analysis

Probabilistic Seismic Hazard Analysis (PSHA) analyzes all possible earthquake scenarios while incorporating the probability of each individual event to occur. The probability is determined in the form of the recurrence interval, which is the average time for a specific earthquake acceleration to be exceeded. The design earthquake is not solely dependent on the fault with the closest distance to the site and/or the largest magnitude, but rather the probability of given seismic events occurring on both known and unknown faults.

We calculated the PGA for two separate probabilistic conditions, the 2% chance of exceedance in 50 years (2,475-year statistical return period) and the 10% chance of exceedance in 50 years (475-year statistical return period), utilizing the 2008 Interactive Deaggregation (USGS, 2008). The results of the probabilistic analyses are presented below in Table B.

TABLE B
PROBABILISTIC SEISMIC HAZARD ANALYSES
The Petaluman Hotel
2 Petaluma Boulevard South
Petaluma, California

	<u>Statistical Return Period</u>	<u>Magnitude</u>	<u>PGA</u>
2% in 50 years	2,475 years	7.2	0.79 g
10% in 50 years	475 years	7.1	0.48 g

Reference: USGS Unified Hazard Tool, accessed January 24, 2022.

The potential for strong seismic shaking at the project site is high. Due to its close proximity, the Rodgers Creek Fault (approximately 8.7 kilometers east) presents the highest potential for strong ground shaking. The most significant adverse impact associated with strong seismic shaking is potential damage to structures and improvements.

Evaluation: Less than significant with mitigation.
Recommendation: Minimum mitigation measures should include designing the structures and foundations in accordance with the most recent version of the California Building Code. Recommended seismic coefficients are provided in Section 5.2 of this report.

4.4 Liquefaction Potential and Related Impacts

Liquefaction refers to the sudden, temporary loss of soil shear strength during strong ground shaking. Liquefaction-related phenomena include liquefaction-induced settlement, flow failure, and lateral spreading. These phenomena can occur where there are saturated, loose, granular deposits. Recent advances in liquefaction studies indicate that liquefaction can occur in granular materials with a high, 35 to 50%, fines content (soil particles that pass the #200 sieve), provided the fines exhibit a plasticity less than 7. Saturated granular layers were observed during our subsurface exploration. Additionally, regional mapping indicates the site lies in a zone of “moderate liquefaction susceptibility”, as shown on Figure 6.

4.4.1 Liquefaction Evaluation

To evaluate soil liquefaction, the seismic energy from an earthquake is compared with the ability of the soil to resist pore pressure generation, known as the Cyclic Resistance Ratio (CRR). The earthquake energy is termed the cyclic stress ratio (CSR) and is a function of the maximum considered earthquake peak ground acceleration (PGA) and depth. Soil resistance to liquefaction is based on its relative density, and the amount and plasticity of the fines (silts and clays). The relative density of cohesionless soil is correlated with the Standard Penetration Test (SPT) blow count data measured in the field and corrected for hammer efficiency, overburden and percent fines to determine the $(N_1)_{60,CS}$ value. Cone Penetration Test data, corrected for overburden, can also be utilized to determine the relative density of a soils and subsequently its resistance to liquefaction.

We analyzed the potential for liquefaction utilizing the data from our borings and the procedures outlined by Idriss and Boulanger (2008 & 2010), considering a magnitude 7.58 earthquake producing a PGA of 0.72-g, which corresponds to the PGA_M value as defined in ASCE 7-10 Section 11.8.3. The liquefaction analysis software Cliq, developed by Geologismiki (2006), uses CPT data to evaluate liquefaction potential. The results of our liquefaction analyses, are presented on Figures 7 through 10 and indicate several localized soil layers, ranging from a few inches to a few feet thick, may liquefy under a strong seismic event.

4.4.2 Post Liquefaction Settlement

We predicted the amount of post liquefaction settlement utilizing the procedures outlined by Idriss and Boulanger (2008, 2010 & 2014), which indicate post liquefaction settlement can occur in soils that exhibit a factor of safety against liquefaction of 2.0 or less. Based on our analyses, we predict up to about 0.5-inch of total settlement and 0.25-inch of differential settlement may occur beneath the basement slab level (about 20 feet below street elevation), over a horizontal distance of 100-feet, during the design seismic event.

Additionally, we utilized the procedures outlined by Ozocak and Sert (2010) to calculate the Liquefaction Potential Index (LPI), which is a gauge to determine if liquefiable layers will impact the ground surface. LPI is a function of the thickness, depth, and factor of safety against liquefaction in the individual layers within a soil column. The resulting LPI value corresponds to a relative potential for surface deformation impacting the ground surface. Typically, an LPI value of zero indicates the liquefiable layer will not impact the ground surface; while a value less than 5 has a low probability, value between 5 and 15 have a moderate probability and an LPI value greater than 15 have a high probability of surface impact. The results of our liquefaction analyses indicate LPI values up to 4.3, suggesting a low probability of liquefaction effects at the ground surface.

Based on our calculations, as described above, it is our opinion that isolated layers within the sand/gravel deposits may liquefy during a strong seismic event. Therefore, liquefaction and related liquefaction induced settlement of the ground surface presents a low to moderate risk of damage to the planned improvements.

Evaluation: Less than significant with mitigation.

Recommendation: Foundation systems should be designed to withstand up to 0.5-inch of total and 0.25-inch of differential settlement, over 100-feet. Foundation design criteria to mitigate the effects of liquefaction are provided in Section 5.4 should be followed.

4.5 Seismically Induced Ground Settlement

Seismic ground shaking can induce settlement of unsaturated, loose, granular soils. Settlement occurs as the loose soil particles rearrange into a denser configuration when subjected to seismic ground shaking. Varying degrees of settlement can occur throughout a deposit, resulting in differential settlement of structures founded on such deposits. The proposed structure will be supported below the groundwater level. Therefore, in our opinion the risk of damage due to seismically induced ground settlement is low.

Evaluation: No significant impact.

Recommendation: No special engineering measures are required.

4.6 Lurching and Ground Cracking

Lurching and associated ground cracking can occur during strong ground shaking. The ground cracking generally occurs along the tops of slopes where stiff soils are underlain by soft deposits or along steep slopes or channel banks. These conditions do not exist at the site, therefore the risk of lurching and ground cracking at the project site is low.

Evaluation: No significant impact.

Recommendation: No special engineering measures are required.

4.7 Erosion

Sandy soils on moderate slopes or clayey soils on steep slopes are susceptible to erosion when exposed to concentrated water runoff. These conditions do not exist at the site. However, there is always some potential for localized erosion due to concentrated surface water flows.

Evaluation: Less than significant with mitigation.

Recommendation: Mitigation measures include designing a site drainage system to collect surface water and discharging it into an established storm drainage system. The project Civil Engineer of Architect is responsible for designing the site drainage system and, an erosion control plan could be developed prior to construction per the current guidelines of the California Stormwater Quality Association's Best Management Practice Handbook.

4.8 Seiche and Tsunami

Seiche and tsunamis are short duration, earthquake-generated water waves in large, enclosed bodies of water and the open ocean, respectively. The extent and severity of a seiche or tsunami

would be dependent upon ground motions and fault offset from nearby active faults. The project site is at an increased elevation and not located near a large body of water. Therefore, seiche and tsunami events are not considered significant geologic hazards at the site.

Evaluation: No significant impact.
Recommendation: No special engineering measures are required.

4.9 Flooding

The project site is mapped on the border of a FEMA 500-year flood zone (ABAG, 2021) as shown on Figure 11; therefore, large scale flooding does not present a significant hazard to the project. Localized flooding can occur during a strong rainfall due to adverse site grades and/or inadequate storm drainage system.

Evaluation: Less than significant with mitigation.
Recommendation: The project Civil Engineer should evaluate the risk localized flooding and provide appropriate finished floor elevations, site grading, and storm drain design.

4.10 Dam Failure Inundation

Based on the Sonoma County Hazard Mitigation Plan Map (County of Sonoma, 2011) the site is not mapped in a Dam Failure Inundation zone. Therefore, the threat of inundation of the site from dam failure is judged low.

Evaluation: No significant impact.
Recommendation: No special engineering measures are required.

4.11 Expansive Soil

Expansive soils will shrink and swell with fluctuations in moisture content and are capable of exerting significant expansion pressures on building foundations, interior floor slabs, and exterior flatwork. Distress from expansive soil movement can include cracking of brittle wall coverings (stucco, plaster, drywall, etc.), racked door and/or window frames, and uneven floors and cracked slabs. Flatwork, pavements, and concrete slabs-on-grade are particularly vulnerable to distress due to their low bearing pressures.

The near-surface soils in the borings are generally characterized as medium plasticity clays and clayey sands suggesting low to moderate expansion potential. Therefore, the risk of expansive soil affecting the proposed improvements is considered low.

Evaluation: Less than significant with mitigation.
Mitigation: Soils should be moisture conditioned to above the optimum moisture content during site grading and maintained at this moisture content until imported aggregate base and/or surface flatwork is completed to “seal” in the higher moisture content and therefore reduce future expansive potential.

4.12 Settlement/Subsidence

Significant settlement can occur when new loads are placed at sites due to consolidation of soft compressible clays (i.e., Bay Mud) or compression of loose granular soils. Significant deposits of soft compressible materials were not observed during our subsurface exploration. Therefore, the

risk of long-term static settlement to the proposed structures at the project site is low.

Evaluation: No significant impact.

Recommendation: No special engineering measures are required.

4.13 Slope Instability/Landsliding

Slope instability generally occurs on relatively steep slopes and/or on slopes underlain by weak materials. The site lies on nearly level terrain, therefore, slope instability/landsliding is not considered a geologic hazard at the project site.

Evaluation: No significant impact.

Recommendation: No special engineering measures are required.

4.14 Radon-222 Gas

Radon-222 is a product of the radioactive decay of uranium-238 and radium-226, which occur naturally in a variety of rock types, mainly phosphatic shales, but also in other igneous, metamorphic, and sedimentary rocks. While low levels of radon gas are common, very high levels, which are typically caused by a combination of poor ventilation and high concentrations of uranium and radium in the underlying geologic materials, can be hazardous to human health.

The project site is located in Sonoma County, California, which is mapped in radon gas Zone 3 by the United States Environmental Protection Agency (USEPA, 2019). Zone 3 is classified by the EPA as exhibiting a “low” potential for Radon-222 gas with average predicted indoor screening levels less than 2 pCi/L. Therefore, the potential for hazardous levels of radon at the project site is low.

Evaluation: No significant impact.

Recommendation: No special engineering measures are required.

4.15 Volcanic Eruption

Several active volcanoes with the potential for future eruptions exist within northern California, including Mount Shasta, Lassen Peak, and Medicine Lake in extreme northern California, the Mono Lake-Long Valley Caldera complex in east-central California, and the Clear Lake Volcanic Field, located in Lake County approximately 51 miles north of the project site. The most recent volcanic eruption in northern California was at Lassen Peak in 1917, while the most recent eruption at the nearest volcanic center to the project site, the Clear Lake Volcanic Field, was about 10,000 years ago. All of northern California’s volcanic centers are currently listed under “normal” volcanic alert levels by the USGS California Volcano Observatory (USGS, 2019a). While the aforementioned volcanic centers are considered “active” by the USGS, the likelihood of damage to the proposed improvements due to volcanic eruption is generally low.

Evaluation: No significant impact.

Recommendation: No special engineering measures are required.

4.16 Naturally Occurring Asbestos (NOA)

Naturally occurring asbestos is commonly found in association with serpentinite and associated ultramafic rock types. These rocks are a major constituent of the Franciscan Complex, which underlies vast portions of the greater San Francisco Bay Area. The site is underlain by relatively

thick native alluvial soils, and while it lies in a region dominated in part by Franciscan Complex bedrock, no evidence suggesting the presence of serpentinite or related rock types was observed during our exploration. Therefore, the likelihood that significant deposits of naturally occurring asbestos will be encountered at the site is low.

Evaluation: No significant impact.

Recommendation: No special engineering measures are required.

4.17 Hazardous Materials

Hazardous materials were not physically observed during our subsurface exploration. While environmental testing for hazardous materials was beyond the scope of our services, the site was previously used as a fuel/service station. We understand that environmental testing and clean-up of the site has already been completed. Therefore, we judge the potential for hazardous materials being present on the project site is low.

Evaluation: No significant impact.

Recommendation: No special engineering measures are required.

5.0 CONCLUSIONS AND RECOMMENDATIONS

5.1 General

Based on our experience with similar projects in the Petaluma area, we conclude that, from a geotechnical standpoint, the site is feasible for the planned improvements. The primary geotechnical issues to address in design of the project are providing adequate seismic design, lateral shoring and dewatering during construction to protect adjacent buildings and utilities, designing foundations to resist the effects of liquefaction-induced and static differential settlements and hydrostatic uplift and lateral forces, and providing moisture control measures for the basement. Specific recommendations and criteria to address these and other geotechnical project facets are presented in the following sections.

5.2 Seismic Design

The project site is located in a seismically active area. Therefore, structures should be designed in conformance to the seismic provisions of the California Building Code (CBC). However, since the goal of the building code is protection of life safety, some structural damage may still occur during strong ground shaking.

Due to the presence of sandy soil layers beneath the building site that are prone to liquefaction, we judge the site should be classified as “Site Class F” per the 2019 California Building Code. However, per section 20.3.1 of the ASCE 7-16, an equivalent linear site-specific response analysis (i.e., SHAKE, DeepSoil, etc.) is not required if the proposed structure has a fundamental period less than 0.5 seconds. We anticipate the proposed structure will have a fundamental period less than 0.5-seconds; therefore, based on the harmonic mean of the blow counts, we recommend classifying the site as a “Site Class D”.

Per ASCE 7-16 Section.11.4.8, a Site-Specific Ground Motion Hazard Analysis shall be performed in accordance with ASCE 7-16 Section 21.2 on sites classified as a “Site Class D” if the S_1 value is greater than or equal to 0.2 g. The S_1 value for the site conditions and location is 0.60 g; therefore, we performed a Site-Specific Ground Motion Hazard Analysis as presented in Appendix C, and the results are presented below on Table C.

TABLE C
ASCE 7-16 SEISMIC PARAMETERS
The Petaluman Hotel
2 Petaluma Boulevard South
Petaluma, California

<u>Factor Name</u>	<u>Coefficient</u>	<u>ASCE 7-16 Site Specific Value</u>
Site Class ¹	$S_{A,B,C,D,E, \text{ or } F}$	S_D
Spectral Acc. (short)	S_S	1.50 g
Spectral Acc. (1-sec)	S_1	0.60 g
Spectral Response (short)	SM_S	1.56 g
Spectral Response (1-sec)	SM_1	1.61 g
Design Spectral Response (short)	SD_S	1.04 g
Design Spectral Response (1-sec)	SD_1	1.07 g
MCE _G ² PGA adjusted for Site Class	PGA_M	0.72 g

Notes:

1. Site Class D Description: Stiff soil profile with shear wave velocities between 600 and 1,200 ft/sec, standard blow counts between 15 and 50 blows per foot, and undrained shear strength between 1,000 and 2,000 psf.
2. Maximum Considered Earthquake Geometric Mean

5.3 Site Preparation and Grading

Site grading and earthwork should be performed in accordance with the recommendations and criteria outlined in the following sections.

5.3.1 Site Preparation

Clear pavements, old foundations, over-sized debris, and organic material from areas to be graded. Debris, rocks larger than four inches, and vegetation are not suitable for structural fill and should be removed from the site. Existing foundations and utilities which are to be abandoned as part of the work should be removed from structural areas.

Where fills or other structural improvements are planned, any standing water or soft, saturated soils should be removed. The subgrade surface should then be scarified to a depth of eight inches, moisture conditioned to above the optimum moisture content, and compacted to at least 90 percent relative compaction. Relative compaction refers to the in-place dry density of soil expressed as a percentage of the maximum dry density, as determined by ASTM D1557. The subgrade should also be firm and unyielding when proof-rolled with heavy, rubber-tired construction equipment. If soft, wet, or otherwise unsuitable materials prevent compaction as described above, we will provide supplemental recommendations to address the specific condition.

5.3.2 Excavations

Site excavations for the new foundations and basement, utilities, and other improvements will generally encounter medium stiff to stiff clayey soils and medium dense clayey sand soils. Based on our subsurface exploration, we judge the majority of site excavations can be

reasonably performed with “traditional” grading equipment, such as medium-size dozers, excavators, and backhoes. Temporary (steeper) cut slopes may be required during construction and, for planning purposes, these cut slopes may be designed for an OSHA Type “C” soil profile. The Contractor is responsible for site safety during construction, including design of temporary cuts and shoring.

All excavations in excess of 5-feet deep will need to be sloped or braced in accordance with Cal/OSHA regulations. The onsite soils are considered “Type C” soil pursuant with OSHA classifications. Temporary support during new foundation construction or excavation for the new basement should be carefully considered and the shoring system should be monitored so if settlement or rotation occurs during the work, supplemental support can be added.

5.3.3 Fill Materials, Placement and Compaction

Fill materials should consist of non-expansive materials that are free of organic matter, have a Liquid Limit of less than 40 (ASTM D 4318), a Plasticity Index of less than 15 (ASTM D 4318), and a minimum R-value of 20 (California Test 301). The fill material should contain no more than 70 percent of particles passing a No. 200 sieve and should be well-graded with a maximum particle size of four inches. Onsite soils should be suitable for use as fill provided they meet the criteria generally specified above and are free of organic materials. Any imported fill material needs to be tested to determine its suitability.

Fill materials should be uniformly moisture conditioned to above the optimum moisture content prior to compaction. Properly moisture conditioned fill materials should subsequently be placed in loose, horizontal lifts of eight-inches-thick or less and uniformly compacted to at least 90 percent relative compaction. For fills thicker than four feet, the entire height of fill should be compacted to at least 92% to reduce the potential for settlement. In pavement areas subjected to vehicle loads, the upper 12 inches of fill or natural soil should be compacted to at least 95 percent relative compaction. The maximum dry density and optimum moisture content of fill materials should be determined in accordance with ASTM D1557.

5.4 Foundation Design

Based on discussions with the project Architect, the basement will be designed to resist full hydrostatic pressures. This would generally include using a combination of structure dead weight, a thickened concrete foundation slab, structural hold-downs such as helical piles, a structural “heel” around the perimeter of the building, or other measures to resist buoyancy and uplift forces. Since a waterproofing membrane will be used, we recommend that any skin friction on the vertical basement walls be neglected in calculating uplift resistance. We recommend a minimum factor of safety against buoyancy of 1.20. If structural hold-downs such as helical piles are used, we can coordinate with the design team to provide supplemental criteria for their design.

We recommend that the basement mat slab foundation should have a minimum thickness of 36 inches.

Waterproofing of the mat slab foundation and basement retaining walls will be critical because significant hydrostatic pressures are anticipated, and these pressures will occur over extended periods of time. A waterproofing consultant or the project Architect should determine an appropriate waterproofing system.

TABLE D
FOUNDATION DESIGN CRITERIA
The Petaluman Hotel
2 Petaluma Boulevard South
Petaluma, California

Mat Slab Foundation (Basement) – See Figure 12

Allowable bearing pressure (dead plus live loads) ¹ :	2,500 psf
Base friction coefficient:	0.30
Lateral passive resistance ^{2,3} :	300 pcf
Modulus of Subgrade Reaction, k:	150 psi per inch

Buoyancy Resisting Hold Downs

Minimum diameter:	6 inches
Minimum depth:	18 feet
Skin Friction (dead plus live loads) ^{4,5} :	500 psf
Hydrostatic Uplift:	62.4 x Hw psf

Notes:

1. May increase design values by 1/3 for total design loads including wind and seismic.
2. Equivalent Fluid Pressure, not to exceed 3,000 psf.
3. Ignore uppermost 12-inches unless concrete or asphalt surfacing exists adjacent to foundation.
4. Uniform pressure distribution.
5. Uplift resistance is equal to 80% of the vertical skin resistance.

5.5 Retaining Wall Design

New retaining walls, temporary and permanent, will be required to support cuts for the basement. Soil nails or tiebacks and shotcrete facing may be considered to provide temporary support of a vertical excavation for basement construction. Closely spaced “stitch” piers or a “secant” wall could also be considered. Retaining walls should be designed in accordance with the criteria presented on Figure 12.

Below grade structures that are designed for hydrostatic pressures and buoyancy will not need to be subdrained.

5.6 Existing Conditions Assessment and Settlement Monitoring During Construction

We recommend that a careful damage assessment should be conducted for all existing adjacent structures and improvements prior to the commencement of construction of the project. The damage assessment should document existing conditions of adjacent improvements, including foundation cracking, un-level floors, out of plumb walls and out of square door/window openings, etc.

We recommend that vertical and lateral control points should be established on all sides of the proposed basement excavation. The control points should be periodically measured and

monitored by a licensed surveyor to determine if any vertical or lateral movement is occurring adjacent to the excavation during construction. If any movement is observed/measured, steps can be taken to strengthen the excavation shoring to control settlements and lateral movements.

5.7 Site and Foundation Drainage

Careful consideration should be given to design of finished grades at the site. We recommend that the adjoining landscaped areas be sloped downward at least 0.25 feet for 5 feet (5 percent) from the perimeter of building foundations. Where hard surfaces, such as concrete or asphalt adjoin foundations, slope these surfaces at least 0.10 feet in the first 5 feet (2 percent). Roof gutter downspouts may discharge onto the pavements but should not discharge onto any landscaped areas. Provide area drains for landscape planters adjacent to buildings and parking areas and collect downspout discharges into a tight pipe collection system.

5.8 Interior Concrete Slabs-On-Grade

To reduce (i.e., improve) interior moisture conditions, a six-inch layer of clean, free draining, 3/4-inch angular gravel or crushed rock should be placed beneath (at grade) interior concrete slabs to form a capillary moisture break. The rock must be placed on a properly moisture conditioned and compacted subgrade that has been approved by the Geotechnical Engineer. A plastic membrane vapor barrier, 15 mils or thicker (e.g., 15-mil Stego Wrap Vapor Barrier), should be placed over the free draining gravel directly beneath the new slabs. The vapor barrier shall meet the ASTM E 1745 Class A requirements and be installed per ASTM 1643. Eliminating the capillary moisture break and/or plastic vapor barrier may result in excess moisture intrusion through the floor slabs resulting in poor performance of floor coverings, mold growth or other adverse conditions. The basement slab will be waterproofed, and the details of this system should be prepared by the project Architect or a waterproofing consultant.

5.9 Exterior Concrete Slabs

Exterior concrete walkway slabs and other concrete slabs that are not subjected to vehicle loads should be a minimum of five-inches-thick and underlain with four inches or more of Class 2 Aggregate Base. The aggregate base should be moisture conditioned to near optimum and compacted to at least 95 percent relative compaction. The upper eight inches of subgrade on which aggregate base is placed should be prepared as previously discussed under Section 5.2.

Where improved performance is desired (i.e., reduced risks of cracking or small movements), exterior slabs can be thickened to six inches and reinforced with steel reinforcing bars (not welded wire mesh). Driveways and slabs subject to vehicle loads should be a minimum of five-inches-thick with six inches of aggregate base and designed to resist traffic loading. We recommend crack control joints no farther than six feet apart in both directions and that the reinforcing bars extend through the control joints. Some movement or offset at sidewalk joints should be expected as the underlying soils expand and shrink from seasonal moisture changes.

5.10 Underground Utilities

Excavations for utilities will generally encounter stiff clayey soils and medium dense sandy soils. Groundwater may be encountered at shallow depths. Trench excavations having a depth of five feet or more must be excavated and shored in accordance with OSHA regulations, as discussed in Section 5.2.2.

Unless otherwise recommended by the pipe manufacturer, pipe bedding and embedment materials should consist of well-graded sand with 90 to 100 percent of particles passing the No. 4 sieve and no more than 5 percent finer than the No. 200 sieve. Crushed rock or pea gravel may also be considered for pipe bedding. Provide the minimum bedding thickness beneath the pipe in accordance with the manufacturer's recommendations (typically 3 to 6 inches). Trench backfill may consist of on-site soils, provided that the soils meet the fill criteria outlined in Section 5.2.3. Trench backfill should be moisture conditioned and placed in thin lifts and compacted to at least 90 percent. Use equipment and methods that are suitable for work in confined areas without damaging utility conduits.

5.11 Wintertime Construction

Wintertime/wet weather site work is feasible during the construction phase of this project, provided that weather conditions do not adversely impact the planned grading and proper erosion control measures are implemented to prevent excessive silt and mud from entering the storm drain system. High soil moisture contents and muddy site conditions may impact placing fills, compacting subgrades, and excavating foundation trenches. Several alternatives may be considered to improve the site conditions to allow site work to proceed in rainy conditions:

- Prior to the onset of winter rains, maintain a drier site by covering the work area and any stockpiled materials with plastic membrane sheeting or other impermeable membrane. Where asphalt pavements, other hardscape or drainage improvements currently exist in work areas, consider leaving these improvements in place until the last possible moment to maintain a drier subgrade condition.
- Lime treat the subgrade soils when site work commences to "weatherproof" the site. The disadvantage to this alternative is that future landscaping will likely require excavation and replacement of the treated soils for acceptable plant growth.
- Finally, imported, drier fill materials could be used to stabilize the site. Soft or wet on-site materials could be excavated to firm materials and drier (preferably granular) soils with good drainage characteristics would be imported to restore site grades. This alternative might also require future excavation and replacement of landscaping soils.

If construction occurs relatively early in the winter, we judge the first option (covering the site prior to winter rains) could be an effective method of maintaining a workable site. When the construction schedule and weather conditions are known, we can meet with the project team to further discuss alternatives to continuation of wintertime construction.

6.0 SUPPLEMENTAL GEOTECHNICAL SERVICES

We must review the plans and specifications for the project when they are nearing completion to confirm that the intent of our geotechnical recommendations has been incorporated and provide supplemental recommendations, if needed. During construction, we must observe and test site grading, and observe foundation excavations for the structures and associated improvements to confirm that the soil conditions encountered during construction are consistent with the design criteria presented in this report.

7.0 LIMITATIONS

This report has been prepared in accordance with generally accepted geotechnical engineering practices in the San Francisco Bay Area at the time the report was prepared. This report has been prepared for the exclusive use of EKN Development Group and/or its assignees specifically for this project. No other warranty, expressed or implied, is made. Our evaluations and recommendations are based on the data obtained during our subsurface exploration program and our experience with soil conditions in this geographic area.

Our approved scope of work did not include an environmental assessment of the site. Consequently, this report does not contain information regarding the presence or absence of toxic or hazardous wastes in the soil and groundwater at the site.

The evaluations and recommendations do not reflect variations in subsurface conditions that may exist between boring locations or in unexplored portions of the site. Should such variations become apparent during construction, the general recommendations contained within this report will not be considered valid unless MPEG is given the opportunity to review such variations and revise or modify our recommendations accordingly. No changes may be made to the general recommendations contained herein without the written consent of MPEG.

We recommend that this report, in its entirety, be made available to project team members, contractors, and subcontractors for informational purposes and discussion. We intend that the information presented within this report be interpreted only within the context of the report as a whole. No portion of this report should be separated from the rest of the information presented herein. No single portion of this report shall be considered valid unless it is presented with and as an integral part of the entire report.

8.0 LIST OF REFERENCES

American Society of Civil Engineers, “Minimum Design Loads for Buildings and Other Structures,” (ASCE 7), 2016.

American Society for Testing and Materials, “2018 Annual book of ASTM Standards, Section 4, Construction, Volume 4.08, Soil and Rock; Dimension Stone; Geosynthetics,” ASTM, Philadelphia, 2018.

Association of Bay Area Governments (ABAG), Geographic Information System, <http://quake.abag.ca.gov/mitigation/>, 2021.

Bezore, S., Randolph-Loar, C.E., and Witter, R.C., “Geologic Map of the Petaluma 7.5’ Quadrangle, Sonoma and Marin Counties, California: A Digital Database, Version 1.0”, California Department of Conservation, California Geological Survey, 2002.

California Building Code, 2019 Edition, California Building Standards Commission, Sacramento, California.

California Geologic Survey, CGS Regulatory Maps Geo Application, “Earthquake Zones of Required Investigation” <https://maps.conservation.ca.gov/cgs/EQZApp/app/>, 2018.

California Department of Transportation (Caltrans), “Corrosion Guidelines Version 1.0,” September 2018.

California Department of Transportation (Caltrans), “Standard Specifications,” 2015.

California Division of Mines and Geology, Special Publication 42, “Alquist-Priolo Special Studies Zone Act,” 1972 (Revised 1988).

Campbell, K., Bozorgnia, Y., “NGA Ground Motion Model for the Geometric Mean Horizontal Component of PGA, PGV, PGD and 5% Damped Linear Elastic Response Spectra for Periods Ranging from 0.01 to 10 s,” EERI Earthquakes Spectra, Volume 24, Number 1, February 2008.
Chiou, B. and Youngs, R., “An NGA Model for the Average Horizontal Component of Peak Ground Motion and Response Spectra,” EERI Earthquakes Spectra, Volume 24, Number 1, February 2008.

County of Los Angeles, “Review of Geotechnical Reports Addressing Liquefaction,” February 24, 2009.

County of Sonoma, “Sonoma County Hazard Mitigation Plan, Figure 8.7, Dam Failure Inundation Data” September 12, 2011.

Field, E.H., Biasi, G.P., Bird, P., Dawson, T.E., Felzer, K.R., Jackson, D.D., Johnson, K.M., Jordan, T.H., Madden, C., Michael, A.J., Milner, K.R., Page, M.T., Parsons, T., Powers, P.M., Shaw, B.E., Thatcher, W.R., Weldon, R.J., II, and Zeng, Y., 2013, Uniform California earthquake rupture forecast, version 3 (UCERF3) – The time-independent model: U.S. Open-File Report 2013–1165, 97 p., California Geological Survey Special Report 228, and Southern California Earthquake Center Publication 1792, <http://pubs.usgs.gov/of/2013/1165/>.

Huang, Y-N, Whittaker, A.S., and Luco, N., "Maximum Spectral Demands in the Near-Fault Region," Earthquake Engineering Research Institute, February 2008.

Idriss, I.M. & Boulanger, R.W. "Soil Liquefaction during Earthquakes", Earthquake Engineering Research Institute Monograph 12, 2008.

Idriss, I.M. & Boulanger, R.W. "SPT-Based Liquefaction Triggering Procedures" Department of Civil and Environmental Engineering, College of Engineering, University of California at Davis, UCD/GCM-10/02, December 2010.

Ozocak, A & Sert, S., "Evaluation of liquefaction risk by a revised LPI approach," 2nd International Symposium on Cone Penetration Testing, Huntington Beach, CA, USA. Volume 2&3: Technical Papers, Session 3: Applications, Paper No. 3-30, 2010.

SEAOC/OSHPD Seismic Design Maps, <https://seismicmaps.org/>, accessed 2022.

Southern California Earthquake Center (SCEC), "Recommended Procedures for Implementation of DMG Special Publication 117, Guidelines for Analyzing and Mitigating Liquefaction Hazards in California," University of Southern California, March 1999.

United States Geological Survey (USGS), "Earthquake Probabilities in the San Francisco Bay Region, 2002 to 2031 – A Summary of Finding," The Working Group on California Earthquake Probabilities, Open File Report 99-517, 2003.

United States Geological Survey (2018), "Unified Hazard Tool, Dynamic-Conterminous US 2014, v4.1.1" (interactive web-based probabilistic Deaggregation calculator tool), <https://earthquake.usgs.gov/hazards/interactive/index.php>, accessed 2022.

United States Geological Survey & SC/EC, "The Uniform California Earthquake Rupture Forecast, Version 2 (UCERF 2), 2007 Working Group on California Earthquake Probabilities, USGS Open File Report 2007-1437, CGS Special Report 203, SCEC Contribution #1138, 200



SITE COORDINATES

LAT. 38.2331°
LON. -122.6391°

SITE LOCATION

N.T.S.



REFERENCE: Google Earth, 2021



A CALIFORNIA CORPORATION, © 2020, ALL RIGHTS RESERVED
FILENAME: 1927.01 Figures.dwg

504 Redwood Blvd.
Suite 220
Novato, CA 94947
T 415 / 382-3444
F 415 / 382-3450
www.millerpac.com

SITE LOCATION MAP

The Petaluman Hotel
2 Petaluma Boulevard South
Petaluma, California

Drawn _____
Checked MMT

1
FIGURE

Project No. 1927.01

Date: 1/24/2022

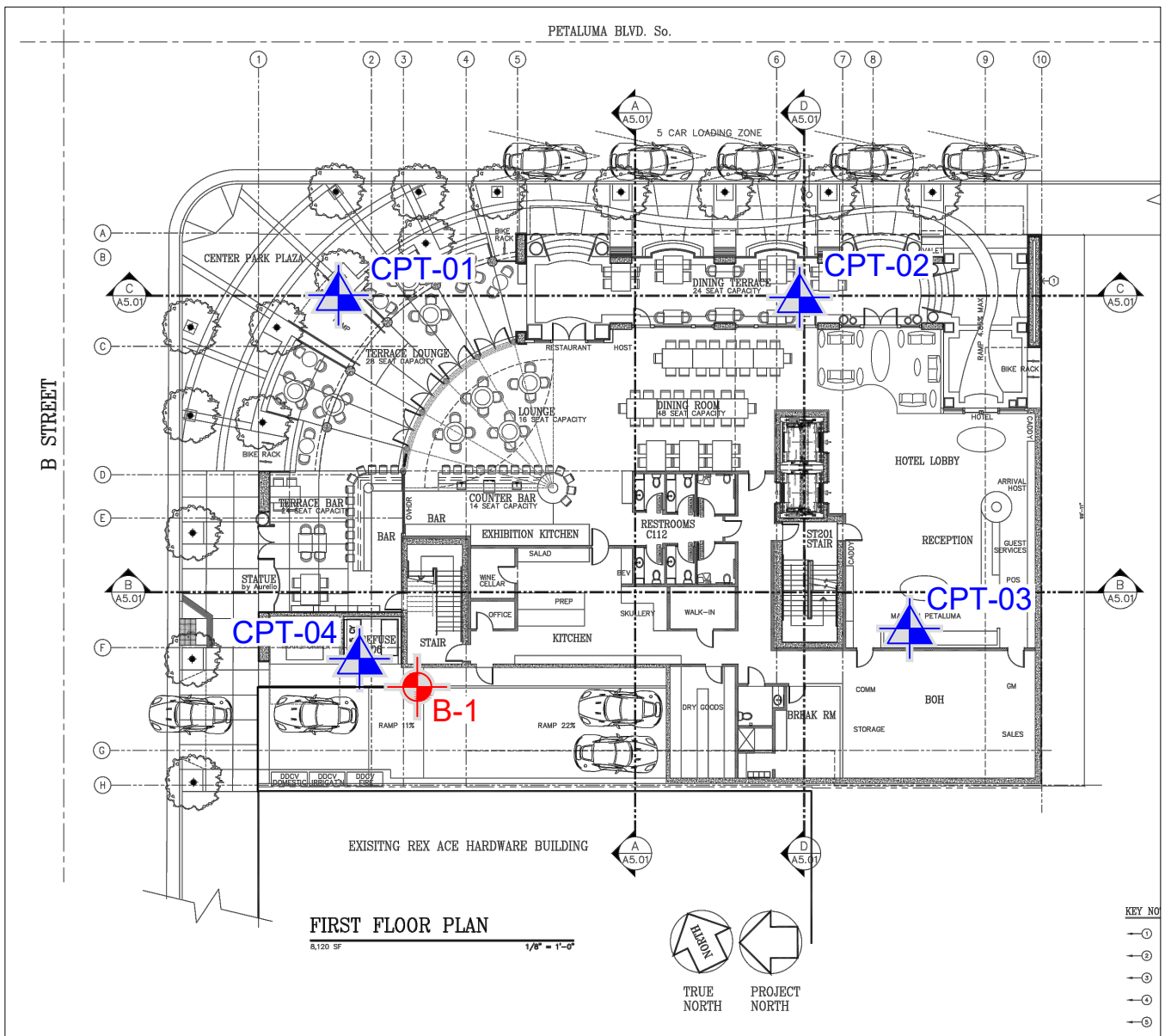



FIRST FLOOR PLAN

8,120 SF 1/8" = 1'-0"

SITE PLAN

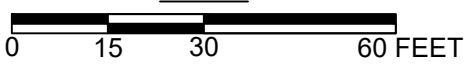
SCALE



-  Approximate location of boring completed by MPEG, 2021
-  Approximate location of CPT completed by MPEG, 2021

REFERENCE: Jones Architecture & Development, "The Petaluman, First Floor Plan" March 16, 2020.

MPEG
MILLER PACIFIC
ENGINEERING GROUP

A CALIFORNIA CORPORATION, © 2020. ALL RIGHTS RESERVED
 FILENAME: 1927.01 Figures.dwg

504 Redwood Blvd.
 Suite 220
 Novato, CA 94947
 T 415 / 382-3444
 F 415 / 382-3450
 www.millerpac.com

SITE PLAN

The Petaluman Hotel
 2 Petaluma Boulevard South
 Petaluma, California

Project No. 1927.01 Date: 1/24/2022

Drawn: MMT
 Checked: _____

2
FIGURE

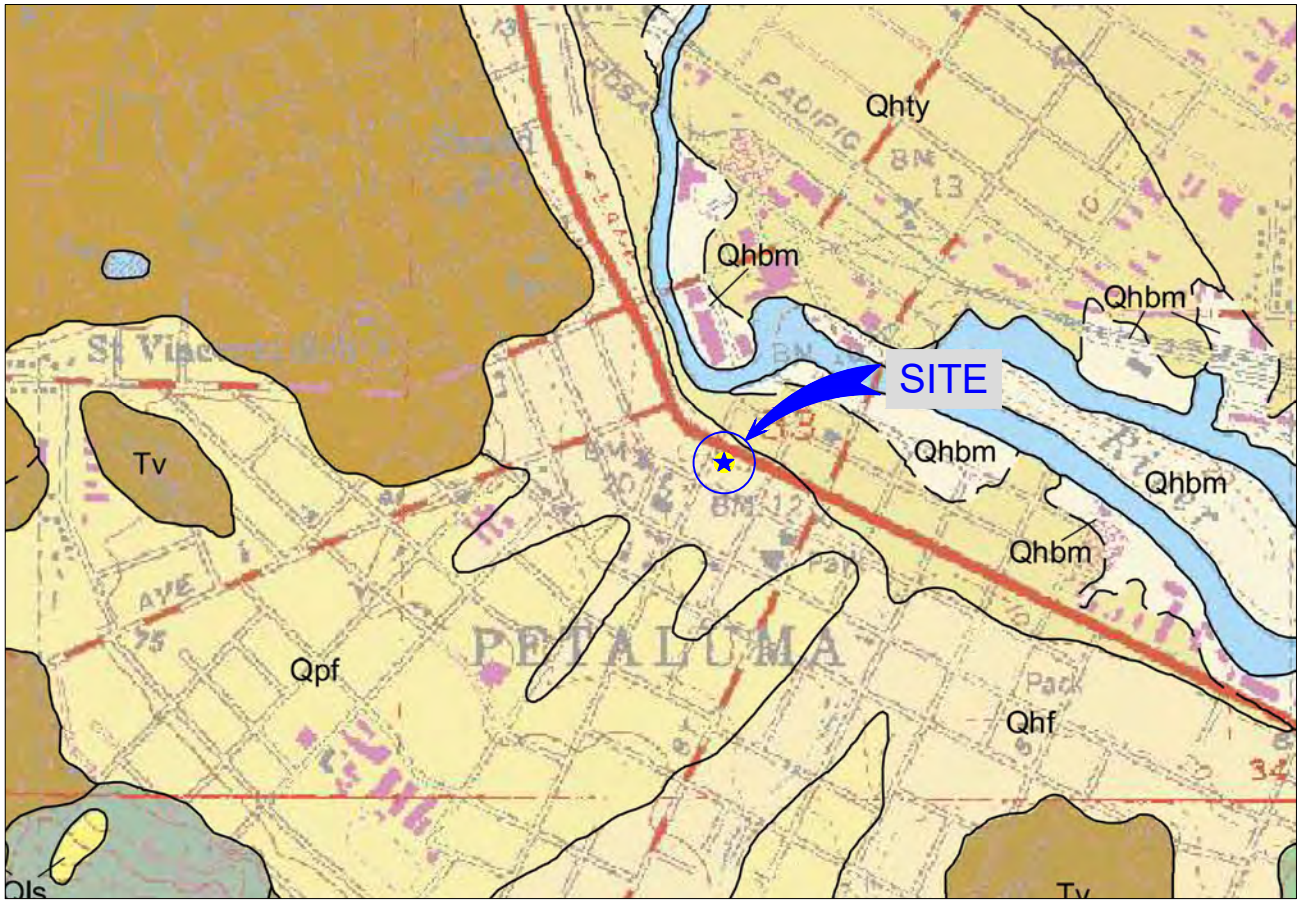

REGIONAL GEOLOGIC MAP



LEGEND:

Qhbm	Holocene estuarine deposits. Sediments are silts, fine sands, peat, and clays.
Qhf	Holocene fan deposits. Sediments include sand, gravel, silt, and clay.
Qhty	Latest Holocene terrace deposits. Sediments include sand, gravel, silt, with minor clay.
Qpf	Pleistocene fan deposits.
Tv	Tertiary volcanic rocks.

REFERENCE: Bezore, S., Randolph-Loar, C.E. and Witter, R.C. (2002), "Geologic Map of the Petaluma 7.5' Quadrangle Sonoma and Marin Counties, California: A Digital Database, Version 1.0", California Department of Conservation, California Geological Survey, Map Scale 1:24,000



A CALIFORNIA CORPORATION, © 2020, ALL RIGHTS RESERVED
 FILENAME: 1927.01 Figures.dwg

504 Redwood Blvd.
 Suite 220
 Novato, CA 94947
 T 415 / 382-3444
 F 415 / 382-3450
 www.millerpac.com

REGIONAL GEOLOGIC MAP

The Petaluman Hotel
 2 Petaluma Boulevard South
 Petaluma, California

Project No. 1927.01

Date: 1/24/2022

Drawn _____
 MMT
 Checked _____

3

FIGURE

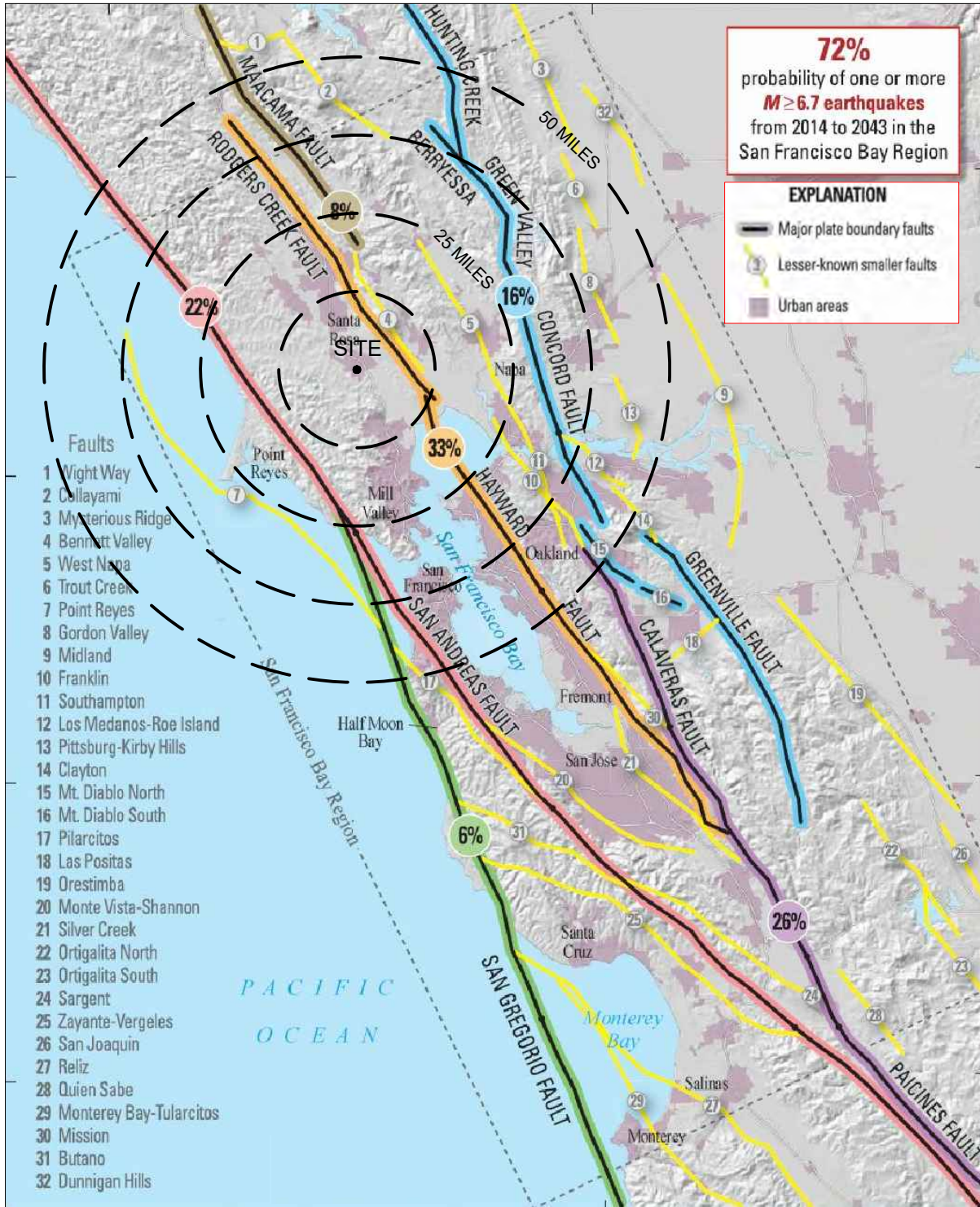

SITE COORDINATES
LAT. 38.2331°
LON. -122.6391°

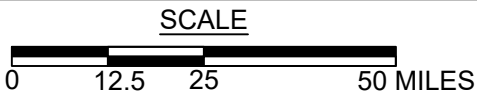

DATA SOURCE:

1) U.S. Geological Survey, U.S. Department of the Interior, "Earthquake Outlook for the San Francisco Bay Region 2014-2043", Map of Known Active Faults in the San Francisco Bay Region, Fact Sheet 2016-3020, Revised August 2016 (ver. 1.1).



A CALIFORNIA CORPORATION, © 2020, ALL RIGHTS RESERVED
FILENAME: 1927.01 Figures.dwg

504 Redwood Blvd.
Suite 220
Novato, CA 94947
T 415 / 382-3444
F 415 / 382-3450
www.millerpac.com

ACTIVE FAULT MAP

The Petaluman Hotel
2 Petaluma Boulevard South
Petaluma, California

Project No. 1927.01

Date: 1/24/2022

Drawn _____
MMT
Checked _____

4
FIGURE

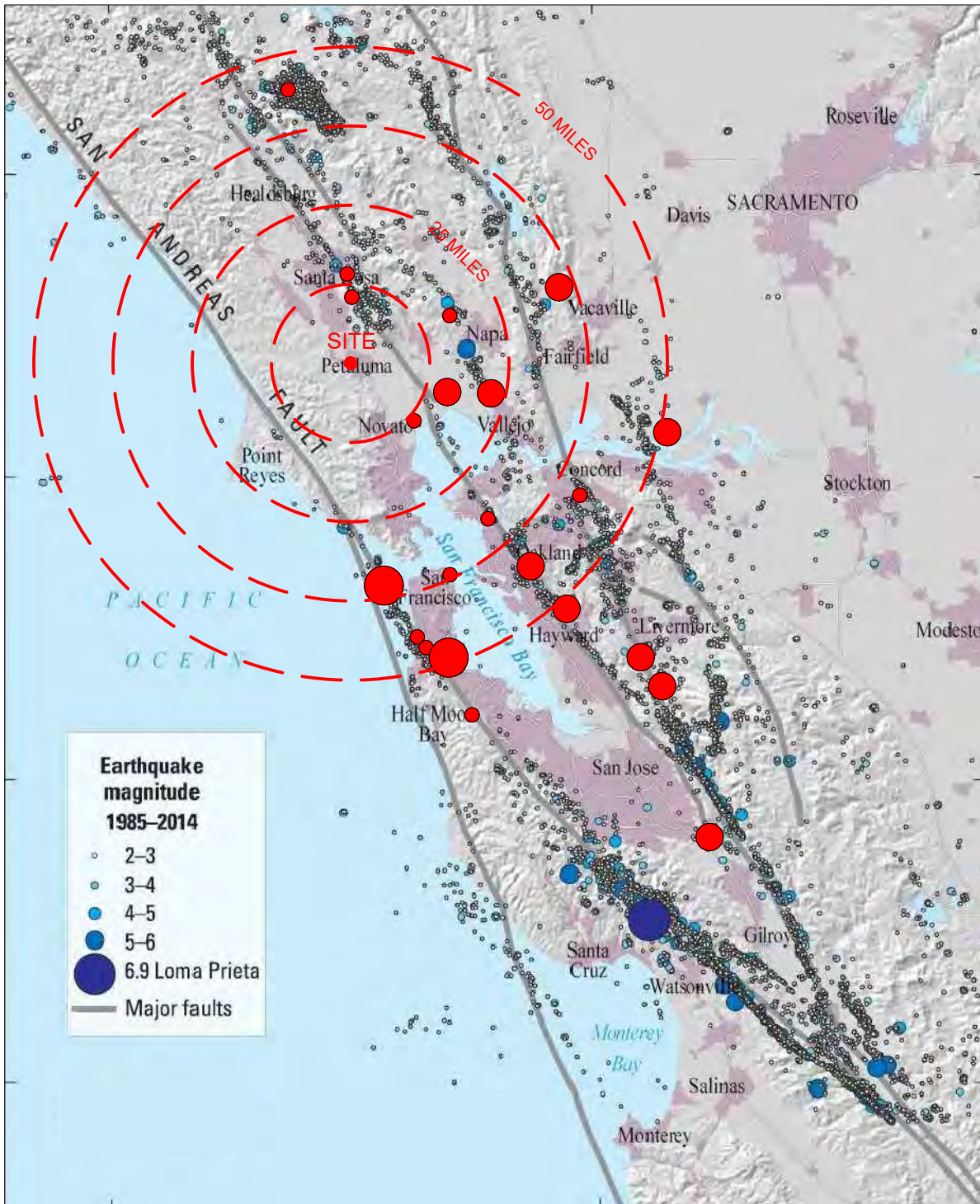

SITE COORDINATES

LAT. 38.2331°

LON. -122.6391°

SCALE

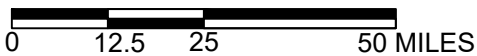

LEGEND & DATA SOURCE:

- See legend above. U.S. Geological Survey, U.S. Department of the Interior, "Earthquake Outlook for the San Francisco Bay Region 2014-2043", Map of Known Active Faults in the San Francisco Bay Region, Fact Sheet 2016-3020, Revised August 2016 (ver. 1.1).
- Large circles indicate earthquakes $M > 7.0$, medium circles indicate $6.0 < M < 7.0$ and small circles indicate $5.0 < M < 6.0$. U.S. Geological Survey, Earthquake Catalog Search, <https://earthquake.usgs.gov/earthquakes/search/>. Earthquakes between 1830 and 2021.



504 Redwood Blvd.
 Suite 220
 Novato, CA 94947
 T 415 / 382-3444
 F 415 / 382-3450
 www.millerpac.com

HISTORIC EARTHQUAKE MAP

The Petaluman Hotel
 2 Petaluma Boulevard South
 Petaluma, California

Drawn _____
 MMT
 Checked _____

5
 FIGURE

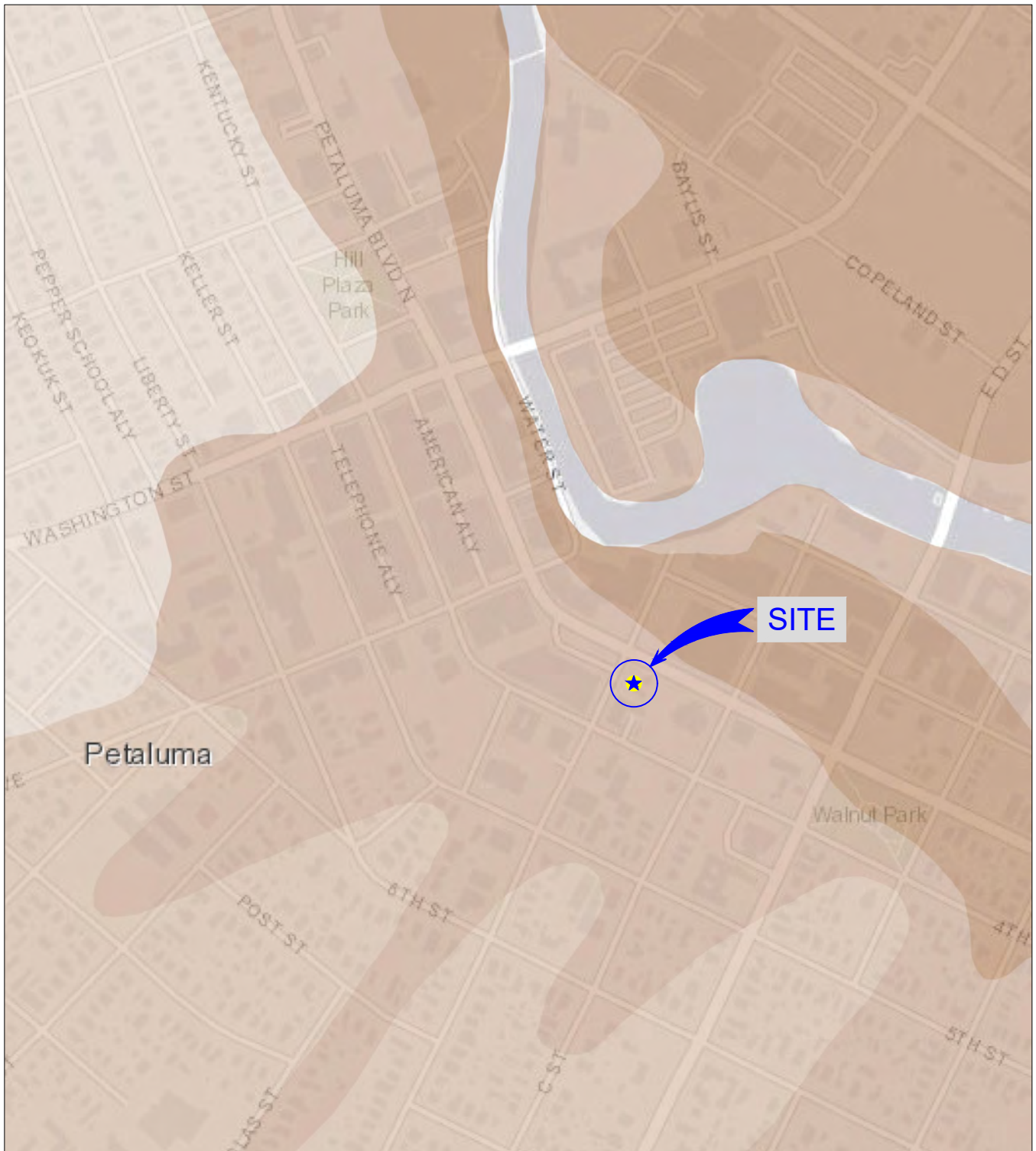

Susceptibility Level:

	Very High		Moderate		Very Low
	High		Low		

No Scale



Reference: ABAG Hazard Map Viewer.

A CALIFORNIA CORPORATION, © 2020, ALL RIGHTS RESERVED
 FILENAME: 1927.01 Figures.dwg

504 Redwood Blvd.
 Suite 220
 Novato, CA 94947
 T 415 / 382-3444
 F 415 / 382-3450
 www.millerpac.com

LIQUEFACTION SUSCEPTIBILITY MAP

The Petaluman Hotel
 2 Petaluma Boulevard South
 Petaluma, California

Drawn _____ Checked <u>MMT</u>	<table border="1" style="width: 100%; height: 100%;"> <tr> <td style="text-align: center; vertical-align: middle;">6</td> </tr> <tr> <td style="text-align: center;">FIGURE</td> </tr> </table>	6	FIGURE
6			
FIGURE			
Project No. 1927.01	Date: 1/24/2022		

6

FIGURE

This software is licensed to: Miller Pacific Engineering Group

CPT name: CPT-01

Liquefaction analysis overall plots

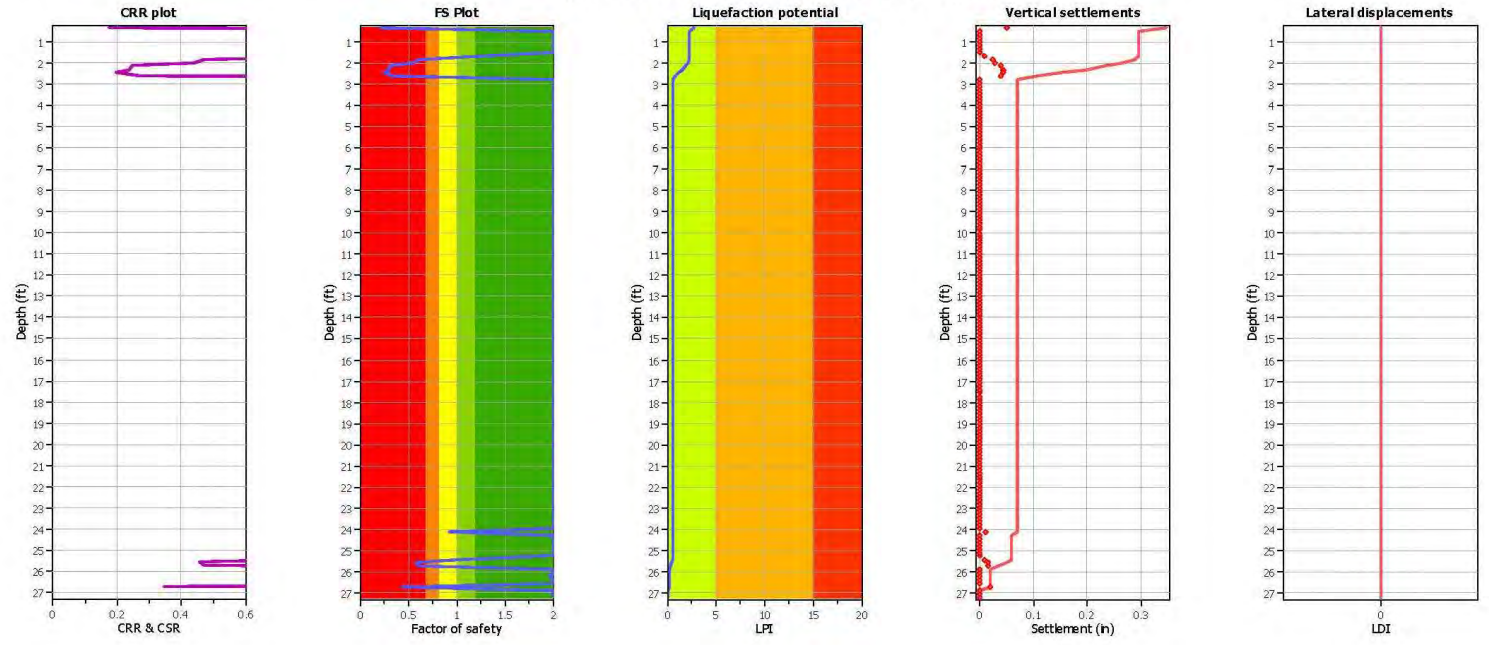

Input parameters and analysis data

Analysis method:	B&I (2014)	Depth to GWT (earthq.):	0.00 ft	Fill weight:	N/A
Fines correction method:	B&I (2014)	Average results interval:	3	Transition detect. applied:	Yes
Points to test:	Based on I _c value	I _c cut-off value:	2.50	K _v applied:	Yes
Earthquake magnitude M _w :	7.30	Unit weight calculation:	Based on SBT	Clay like behavior applied:	Sands only
Peak ground acceleration:	0.72	Use fill:	No	Limit depth applied:	No
Depth to water table (insitu):	5.00 ft	Fill height:	N/A	Limit depth:	N/A

F.S. color scheme

- Red: Almost certain it will liquefy
- Orange: Very likely to liquefy
- Yellow: Liquefaction and no liq. are equally likely
- Green: Unlike to liquefy
- Dark Green: Almost certain it will not liquefy

LPI color scheme

- Red: Very high risk
- Orange: High risk
- Green: Low risk

CLiq v.2.3.1.15 - CPT Liquefaction Assessment Software - Report created on: 9/16/2021, 11:03:36 AM
 Project file: H:\Jobs\1900-1999\1927.01 Hotel Petaluma\Analysis\1927.01 Liq Analysis.clg

This software is licensed to: Miller Pacific Engineering Group

CPT name: CPT-02

Liquefaction analysis overall plots

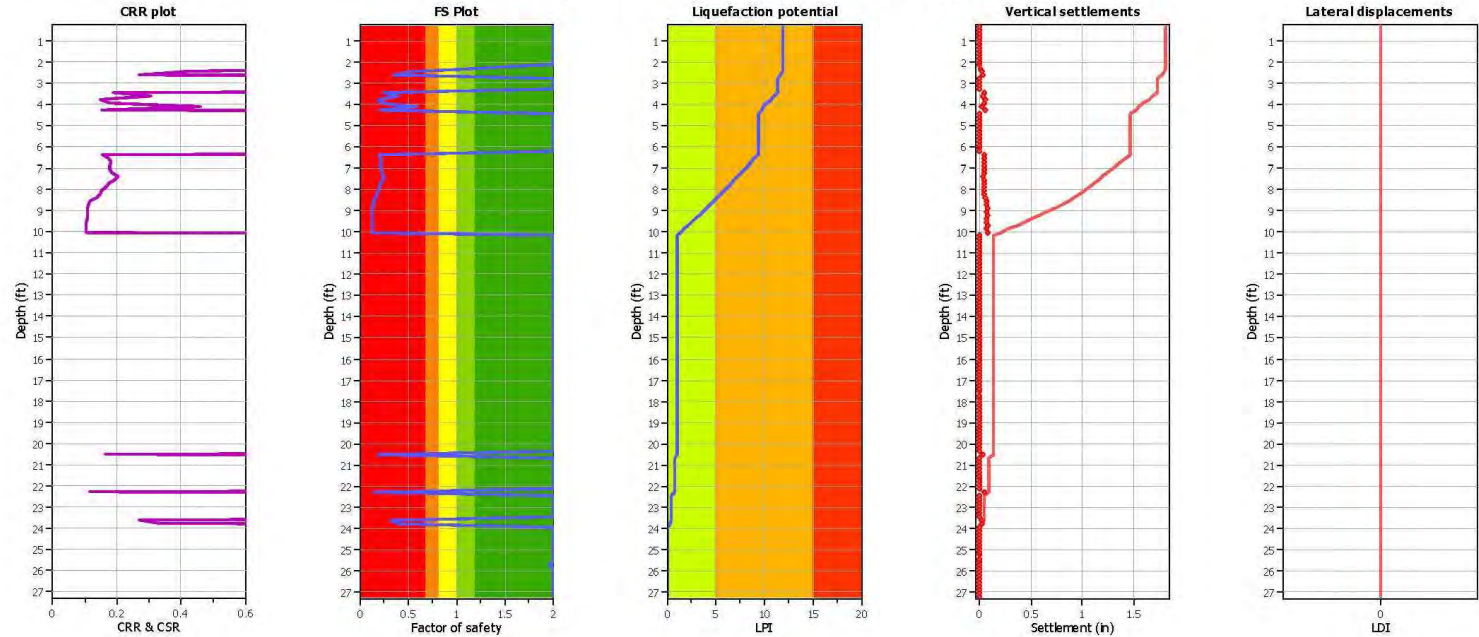

Input parameters and analysis data

Analysis method:	B&I (2014)	Depth to GWT (earthq.):	0.00 ft	Fill weight:	N/A
Fines correction method:	B&I (2014)	Average results interval:	3	Transition detect. applied:	Yes
Points to test:	Based on I _c value	I _c cut-off value:	2.50	K _σ applied:	Yes
Earthquake magnitude M _w :	7.30	Unit weight calculation:	Based on SBT	Clay like behavior applied:	Sands only
Peak ground acceleration:	0.72	Use fill:	No	Limit depth applied:	No
Depth to water table (insitu):	5.00 ft	Fill height:	N/A	Limit depth:	N/A

F.S. color scheme

- Almost certain it will liquefy
- Very likely to liquefy
- Liquefaction and no liq. are equally likely
- Unlike to liquefy
- Almost certain it will not liquefy

LPI color scheme

- Very high risk
- High risk
- Low risk

CLiq v.2.3.1.15 - CPT Liquefaction Assessment Software - Report created on: 9/16/2021, 11:03:37 AM
 Project file: H:\Jobs\1900-1999\1927.01 Hotel Petaluma\Analysis\1927.01 Liq Analysis.clx

This software is licensed to: Miller Pacific Engineering Group

CPT name: CPT-03

Liquefaction analysis overall plots

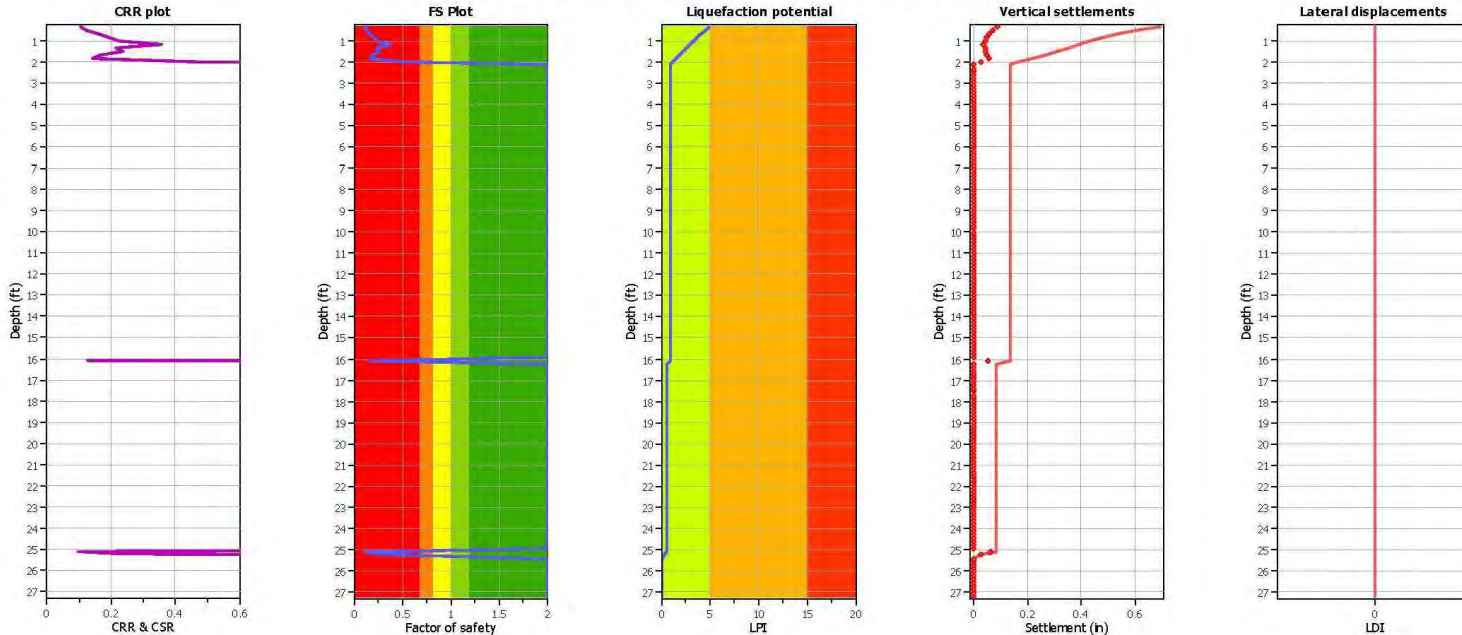

Input parameters and analysis data

Analysis method:	B&I (2014)	Depth to GWT (erthq.):	0.00 ft	Fill weight:	N/A
Fines correction method:	B&I (2014)	Average results interval:	3	Transition detect. applied:	Yes
Points to test:	Based on I _c value	I _c cut-off value:	2.50	K _r applied:	Yes
Earthquake magnitude M _w :	7.30	Unit weight calculation:	Based on SBT	Clay like behavior applied:	Sands only
Peak ground acceleration:	0.72	Use fill:	No	Limit depth applied:	No
Depth to water table (insitu):	11.00 ft	Fill height:	N/A	Limit depth:	N/A

F.S. color scheme

- Almost certain it will liquefy
- Very likely to liquefy
- Liquefaction and no liq. are equally likely
- Unlikely to liquefy
- Almost certain it will not liquefy

LPI color scheme

- Very high risk
- High risk
- Low risk

CLiq v.2.3.1.15 - CPT Liquefaction Assessment Software - Report created on: 9/16/2021, 11:03:38 AM
 Project file: H:\Jobs\1900-1999\1927.01 Hotel Petaluma\Analysis\1927.01 Liq Analysis.clg

This software is licensed to: Miller Pacific Engineering Group

CPT name: CPT-04

Liquefaction analysis overall plots

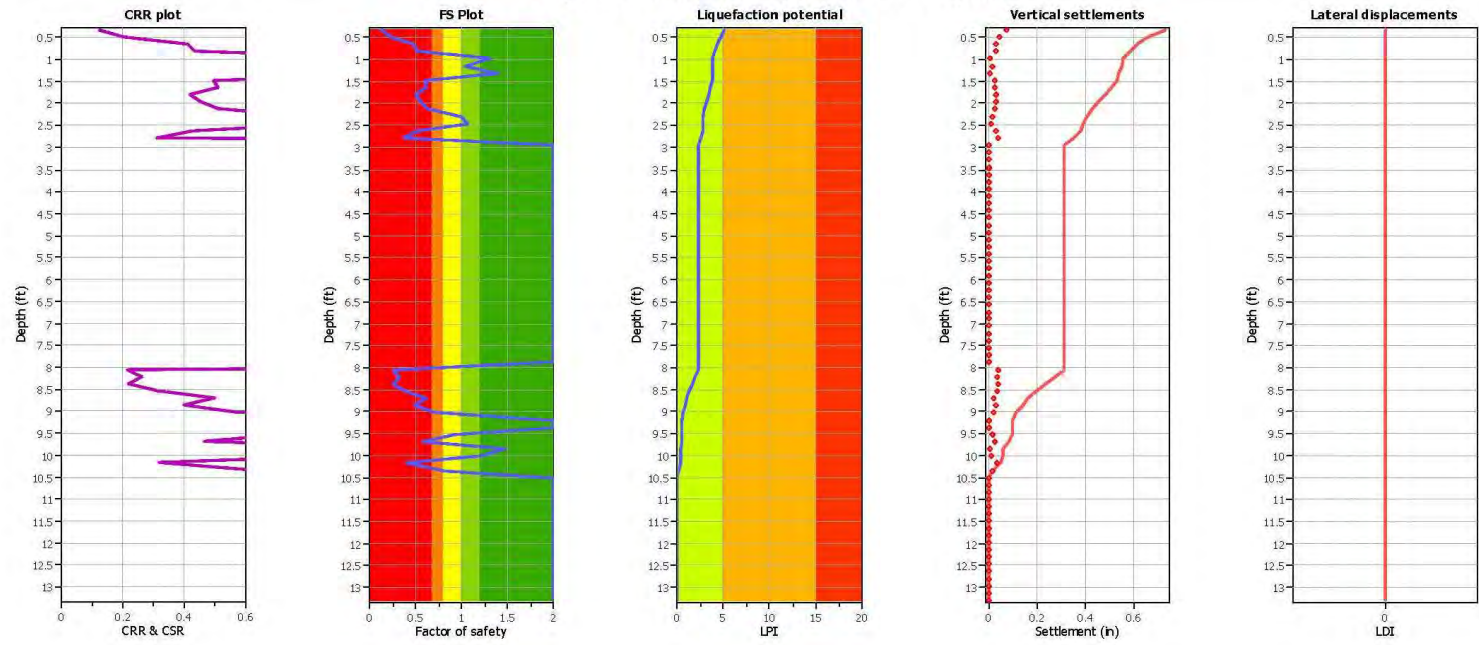

Input parameters and analysis data

Analysis method:	B&I (2014)	Depth to GWT (erthq.):	0.00 ft	Fill weight:	N/A
Fines correction method:	B&I (2014)	Average results interval:	3	Transition detect. applied:	Yes
Points to test:	Based on I _c value	I _c cut-off value:	2.50	K _σ applied:	Yes
Earthquake magnitude M _w :	7.30	Unit weight calculation:	Based on SBT	Clay like behavior applied:	Sands only
Peak ground acceleration:	0.72	Use fill:	No	Limit depth applied:	No
Depth to water table (insitu):	8.00 ft	Fill height:	N/A	Limit depth:	N/A

F.S. color scheme

- Red: Almost certain it will liquefy
- Orange: Very likely to liquefy
- Yellow: Liquefaction and no liq. are equally likely
- Light Green: Unlikely to liquefy
- Dark Green: Almost certain it will not liquefy

LPI color scheme

- Red: Very high risk
- Orange: High risk
- Yellow: Low risk

CLiq v.2.3.1.15 - CPT Liquefaction Assessment Software - Report created on: 9/16/2021, 11:03:38 AM
 Project file: H:\Jobs\1900-1999\1927.01 Hotel Petaluma\Analysis\1927.01 Liq Analysis.clg

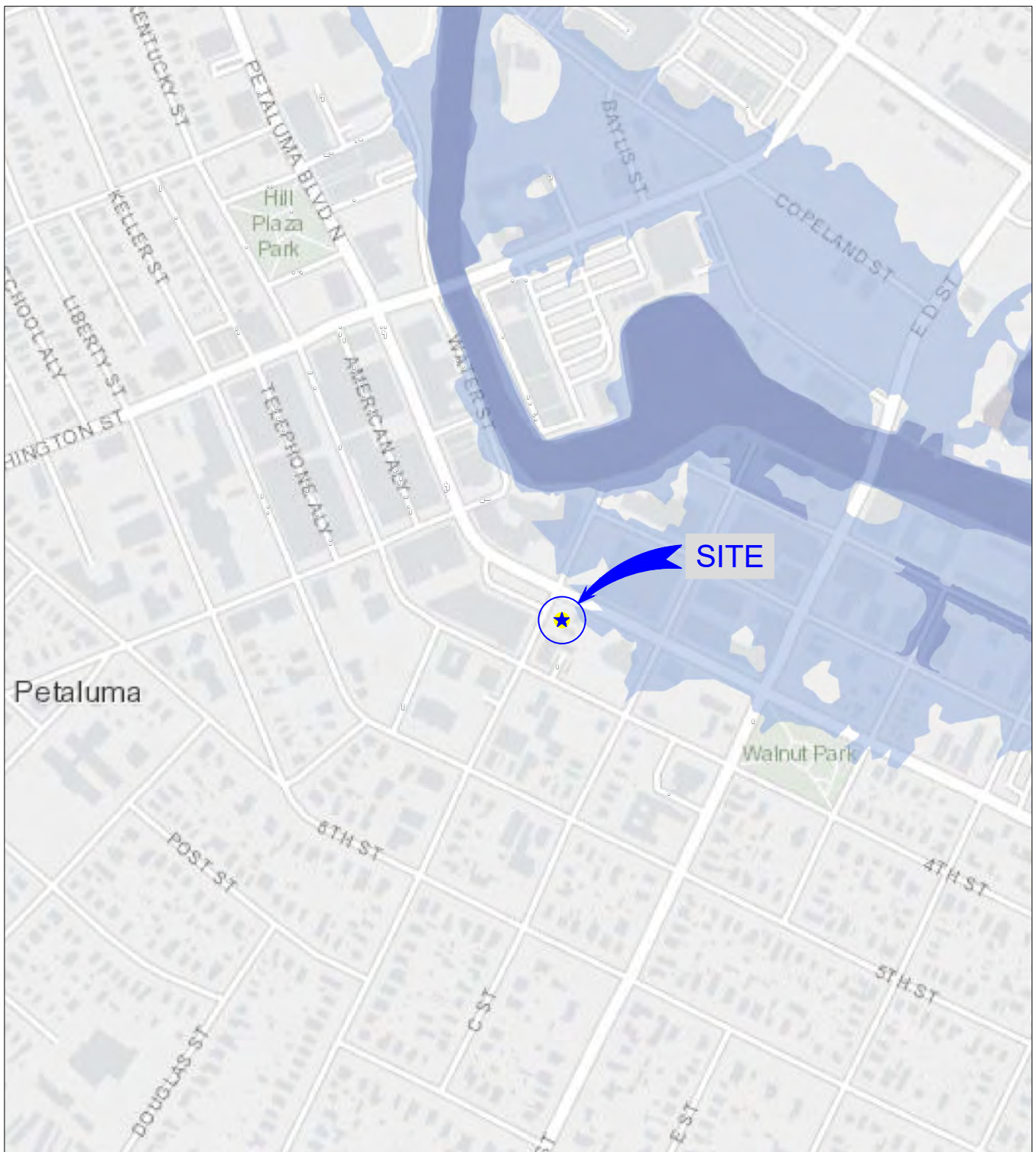

FEMA Flood Hazard:

- 100-Year
- 500-Year

No Scale



Reference: ABAG Hazard Map Viewer.



A CALIFORNIA CORPORATION, © 2020, ALL RIGHTS RESERVED
 FILENAME: 1927.01 Figures.dwg

504 Redwood Blvd.
 Suite 220
 Novato, CA 94947
 T 415 / 382-3444
 F 415 / 382-3450
 www.millerpac.com

FEMA FLOOD MAP

The Petaluman Hotel
 2 Petaluma Boulevard South
 Petaluma, California

Drawn: MMT
 Checked:

11
 FIGURE

Project No. 1927.01

Date: 1/24/2022

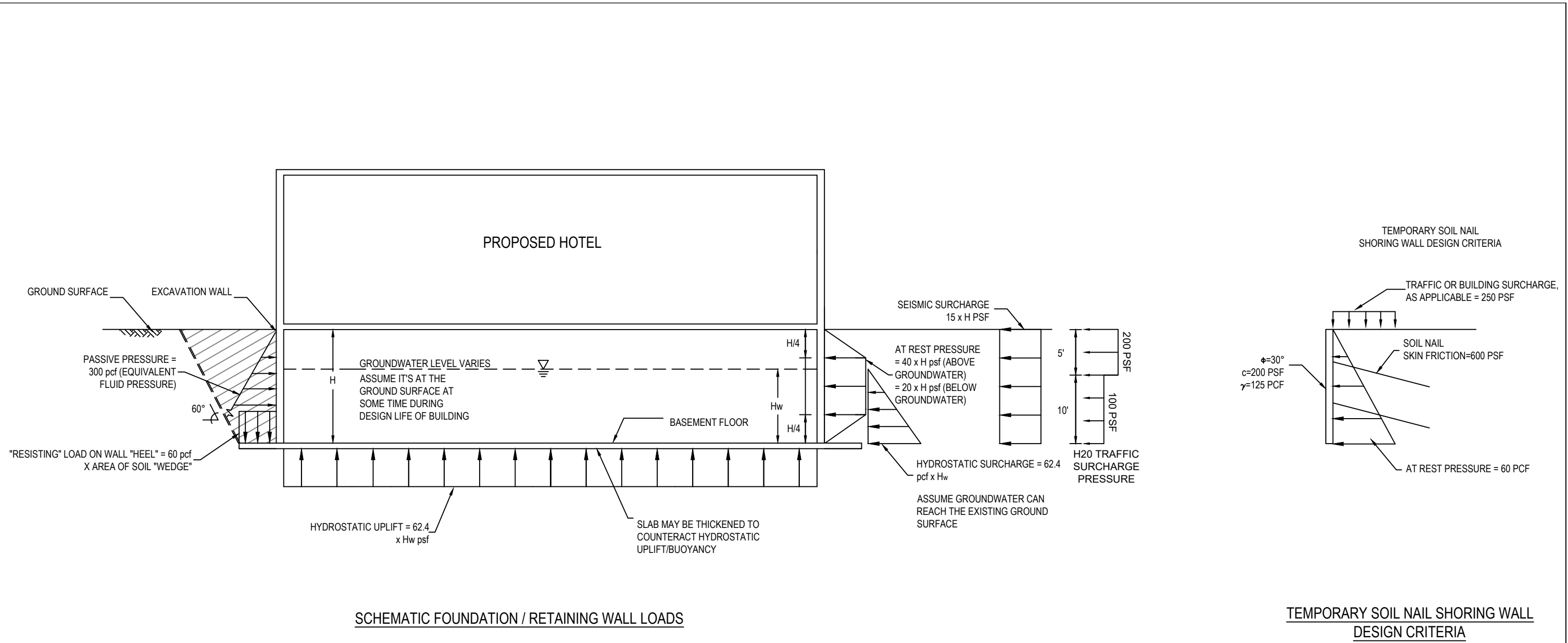

NOTES:

1. Assume groundwater is at the ground surface for design of permanent structures.
2. Surcharge pressures shown are based on H2O Traffic Loads. Other surcharge loads (e.g. due to construction traffic, soil stockpiles, structural loads, etc) may occur and should be applied by the designer as appropriate.

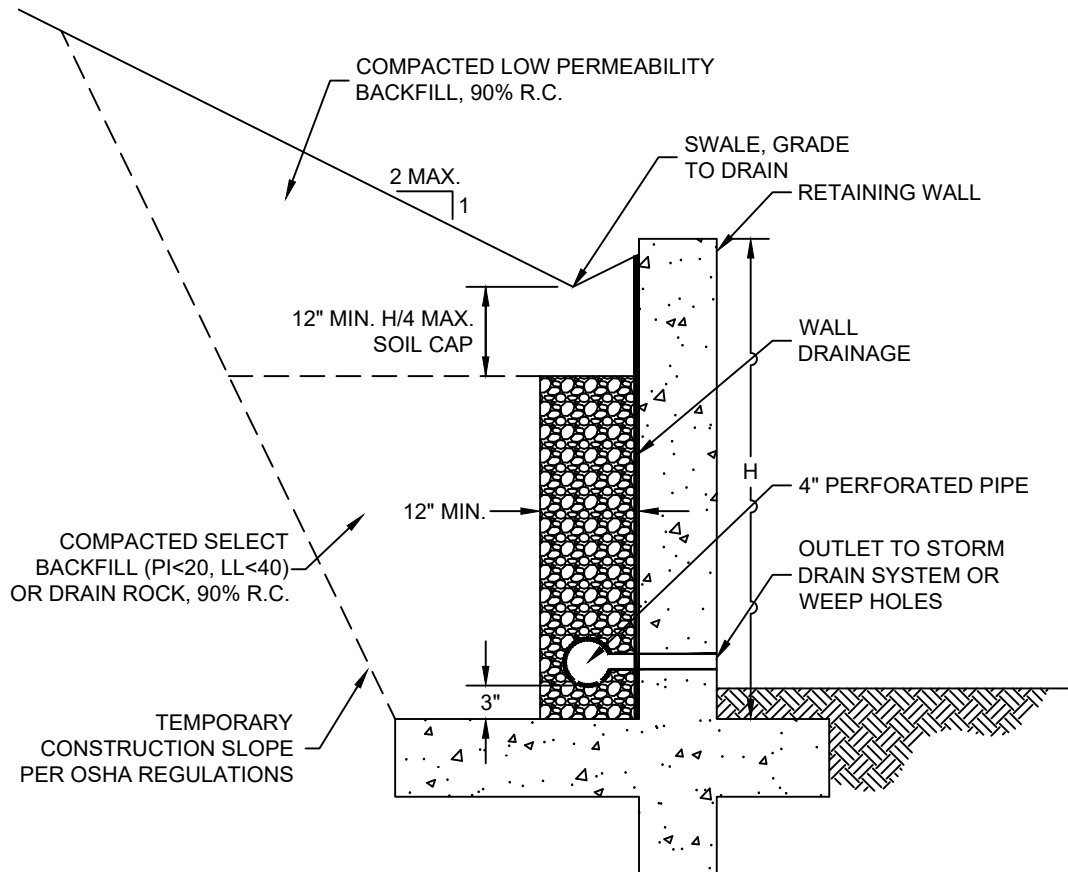

NOTES:

1. Wall drainage should consist of clean, free draining 3/4 inch crushed rock (Class 1B Permeable Material) wrapped in filter fabric (Mirafi 140N or equivalent) or Class 2 Permeable Material. Alternatively, pre-fabricated drainage panels (Miradrain G100N or equivalent), installed per the manufacturers recommendations, may be used in lieu of drain rock and fabric.
2. All retaining walls adjacent to interior living spaces shall be water/vapor proofed as specified by the project architect or structural engineer.
3. Perforated pipe shall be SCH 40 or SDR 35 for depths less than 20 feet. Use SCH 80 or SDR 23.5 perforated pipe for depths greater than 20 feet. Place pipe perforations down and slope at 1% to a gravity outlet. Alternatively, drainage can be outlet through 3" diameter weep holes spaced approximately 20' apart.
4. Clean outs should be installed at the upslope end and at significant direction changes of the perforated pipe. Additionally, all angled connectors shall be long bend sweep connections.
5. During compaction, the contractor should use appropriate methods (such as temporary bracing and/or light compaction equipment) to avoid over-stressing the walls. Walls shall be completely backfilled prior to construction in front of or above the retaining wall.
6. Refer to the geotechnical report for lateral soil pressures.
7. All work and materials shall conform with Section 68, of the latest edition of the Caltrans Standard Specifications.



A CALIFORNIA CORPORATION, © 2020, ALL RIGHTS RESERVED
 FILENAME: 1927.01 Figures.dwg

504 Redwood Blvd.
 Suite 220
 Novato, CA 94947
 T 415 / 382-3444
 F 415 / 382-3450
 www.millerpac.com

TYPICAL RETAINING WALL BACKDRAIN

The Petaluman Hotel
 2 Petaluma Boulevard South
 Petaluma, California

Project No. 1927.01

Date: 1/24/2022

Drawn _____
 MMT
 Checked _____

13
 FIGURE

APPENDIX A

SUBSURFACE EXPLORATION AND LABORATORY TESTING (BORINGS)

1.0 Subsurface Exploration

We explored subsurface conditions at the site by drilling one test boring utilizing truck mounted drilling equipment with 7-inch hollow stem augers on October 29th, 2021. The approximate boring location is shown on Figure 2. The boring was drilled to a maximum depth of 71.5-feet below the ground surface.

The soil conditions encountered were logged and identified in the field in general accordance with ASTM Standard D 2487, "Field Identification and Description of Soils (Visual-Manual Procedure)." These standards are briefly explained on Figures A-1 and A-2, Soil and Rock Classification Charts. The boring log is presented on Figures A-3 through A-6.

We obtained "undisturbed" samples using a 3-inch diameter, split-barrel modified California sampler with 2.5 by 6-inch brass tube liners or with a 2-inch diameter, split-barrel Standard Penetration Test (SPT) sampler. The sampler was driven with a 140-pound hammer falling 30 inches. The number of blows required to drive the samplers 18 inches was recorded and is reported on the boring logs as blows per foot for the last 12 inches of driving. The samples obtained were examined in the field, sealed to prevent moisture loss, and transported to our laboratory.

2.0 Laboratory Testing

We conducted laboratory tests on selected intact samples to verify field identifications and to evaluate engineering properties. The following laboratory tests were conducted in accordance with the ASTM standard test method cited:

- Laboratory Determination of Water (Moisture Content) of Soil, Rock, and Soil-Aggregate Mixtures, ASTM D 2216;
- Density of Soil in Place by the Drive-Cylinder Method, ASTM D 2937;
- Unconfined Compressive Strength of Cohesive Soil, ASTM D 2166; and
- Particle Size Distribution of Soils using Sieve Analysis, ASTM D6914.

The moisture content, dry density, and unconfined compressive strength results are shown on the exploratory Boring Log and the results of our particle size distribution tests are presented on Figures A-7 and A-8. The exploratory boring logs, description of soils encountered, and the laboratory test data reflect conditions only at the location of the boring at the time they were excavated or retrieved. Conditions may differ at other locations and may change with the passage of time due to a variety of causes including natural weathering, climate, and changes in surface and subsurface drainage.

MAJOR DIVISIONS		SYMBOL	DESCRIPTION
COARSE GRAINED SOILS over 50% sand and gravel	CLEAN GRAVEL	GW	Well-graded gravels or gravel-sand mixtures, little or no fines
		GP	Poorly-graded gravels or gravel-sand mixtures, little or no fines
	GRAVEL with fines	GM	Silty gravels, gravel-sand-silt mixtures
		GC	Clayey gravels, gravel-sand-clay mixtures
	CLEAN SAND	SW	Well-graded sands or gravelly sands, little or no fines
		SP	Poorly-graded sands or gravelly sands, little or no fines
	SAND with fines	SM	Silty sands, sand-silt mixtures
		SC	Clayey sands, sand-clay mixtures
FINE GRAINED SOILS over 50% silt and clay	SILT AND CLAY liquid limit <50%	ML	Inorganic silts and very fine sands, rock flour, silty or clayey fine sands or clayey silts with slight plasticity
		CL	Inorganic clays of low to medium plasticity, gravelly clays, sandy clays, silty clays, lean clays
		OL	Organic silts and organic silt-clays of low plasticity
	SILT AND CLAY liquid limit >50%	MH	Inorganic silts, micaceous or diatomaceous fine sands or silts, elastic silts
		CH	Inorganic clays of high plasticity, fat clays
		OH	Organic clays of medium to high plasticity
HIGHLY ORGANIC SOILS	PT	Peat, muck, and other highly organic soils	
ROCK		Undifferentiated as to type or composition	

KEY TO BORING AND TEST PIT SYMBOLS

CLASSIFICATION TESTS

PI	PLASTICITY INDEX
LL	LIQUID LIMIT
SA	SIEVE ANALYSIS
HYD	HYDROMETER ANALYSIS
P200	PERCENT PASSING NO. 200 SIEVE
P4	PERCENT PASSING NO. 4 SIEVE

STRENGTH TESTS

UC	LABORATORY UNCONFINED COMPRESSION
TXCU	CONSOLIDATED UNDRAINED TRIAXIAL
TXUU	UNCONSOLIDATED UNDRAINED TRIAXIAL
	UC, CU, UU = 1/2 Deviator Stress
DS (2.0)	DRAINED DIRECT SHEAR (NORMAL PRESSURE, ksf)

SAMPLER TYPE

	MODIFIED CALIFORNIA		HAND SAMPLER
	STANDARD PENETRATION TEST		ROCK CORE
	THIN-WALLED / FIXED PISTON		DISTURBED OR BULK SAMPLE

SAMPLER DRIVING RESISTANCE

Modified California and Standard Penetration Test samplers are driven 18 inches with a 140-pound hammer falling 30 inches per blow. Blows for the initial 6-inch drive seat the sampler. Blows for the final 12-inch drive are recorded onto the logs. Sampler refusal is defined as 50 blows during a 6-inch drive. Examples of blow records are as follows:

25 sampler driven 12 inches with 25 blows after initial 6-inch drive

85/7" sampler driven 7 inches with 85 blows after initial 6-inch drive

50/3" sampler driven 3 inches with 50 blows during initial 6-inch drive or beginning of final 12-inch drive

NOTE: Test boring and test pit logs are an interpretation of conditions encountered at the excavation location during the time of exploration. Subsurface rock, soil or water conditions may vary in different locations within the project site and with the passage of time. Boundaries between differing soil or rock descriptions are approximate and may indicate a gradual transition.



A CALIFORNIA CORPORATION, © 2021, ALL RIGHTS RESERVED
FILENAME: 1927.010 BL.dwg

504 Redwood Blvd.
Suite 220
Novato, CA 94947
T 415 / 382-3444
F 415 / 382-3450
www.millerpac.com

SOIL CLASSIFICATION CHART

The Petaluman Hotel
2 Petaluma Boulevard South
Petaluma, California

Project No. 1927.010

Date: 1/24/2022

Drawn _____
Checked EIC

A-1
FIGURE

FRACTURING AND BEDDING

Fracture Classification

Crushed
Intensely fractured
Closely fractured
Moderately fractured
Widely fractured
Very widely fractured

Spacing

less than 3/4 inch
3/4 to 2-1/2 inches
2-1/2 to 8 inches
8 to 24 inches
2 to 6 feet
greater than 6 feet

Bedding Classification

Laminated
Very thinly bedded
Thinly bedded
Medium bedded
Thickly bedded
Very thickly bedded

HARDNESS

Low
Moderate
Hard
Very hard

Carved or gouged with a knife
Easily scratched with a knife, friable
Difficult to scratch, knife scratch leaves dust trace
Rock scratches metal

STRENGTH

Friable
Weak
Moderate
Strong
Very strong

Crumbles by rubbing with fingers
Crumbles under light hammer blows
Indentations <1/8 inch with moderate blow with pick end of rock hammer
Withstands few heavy hammer blows, yields large fragments
Withstands many heavy hammer blows, yields dust, small fragments

WEATHERING

Complete	Minerals decomposed to soil, but fabric and structure preserved
High	Rock decomposition, thorough discoloration, all fractures are extensively coated with clay, oxides or carbonates
Moderate	Fracture surfaces coated with weathering minerals, moderate or localized discoloration
Slight	A few stained fractures, slight discoloration, no mineral decomposition, no affect on cementation
Fresh	Rock unaffected by weathering, no change with depth, rings under hammer impact

NOTE: Test boring and test pit logs are an interpretation of conditions encountered at the location and time of exploration. Subsurface rock, soil and water conditions may differ in other locations and with the passage of time.



**MILLER PACIFIC
ENGINEERING GROUP**

A CALIFORNIA CORPORATION, © 2021, ALL RIGHTS RESERVED
FILENAME: 1927.010 BL.dwg

504 Redwood Blvd.
Suite 220
Novato, CA 94947
T 415 / 382-3444
F 415 / 382-3450
www.millerpac.com

ROCK CLASSIFICATION CHART

The Petaluman Hotel
2 Petaluma Boulevard South
Petaluma, California

Project No. 1927.010

Date: 1/24/2022

Drawn _____
Checked EIC

A-2
FIGURE

DEPTH				BORING 1		BLOWS / FOOT (1)	DRY UNIT WEIGHT pcf (2)	MOISTURE CONTENT (%)	SHEAR STRENGTH psf (3)	OTHER TEST DATA	OTHER TEST DATA
meters	feet	SAMPLE	SYMBOL (4)	EQUIPMENT:	DATE:						
0	0			Truck-Mounted CME 75 Hydraulic Drill Rig with 7.0-inch Hollow Stem Auger	10/29/2021						
				ELEVATION: 18 - feet*							
				*REFERENCE: Google Earth, 2021							
0	0			Silty SAND with Gravel (SM) Medium brown, moist to wet, medium dense, fine to very coarse sand, ~20-30% angular gravels up to 3/4" Ø, ~15-20% low plasticity silt. [Fill]		25	106	18.2	UC 850		
1											
5											
2				GRAVEL with Sand and Silt (GP-GM) Black and medium brown, wet, medium dense, rounded gravels up to 1.5" Ø, ~10-15% fine to coarse sand, ~10-15% low plasticity silt. [Fill]		19					
3											
10				Sandy SILT (ML) Light to medium gray-tan, moist, very stiff, low plasticity, 40-45% very fine sand. [Alluvium]		45	98	27.6	UC 750	P200 57.5%	SA
4											
15				SAND with Silt (SP-SM) Medium brown, wet, very dense, medium to coarse sand, up to ~5-10% low plasticity silt. [Alluvium]		50/4"					
5											
6											
20											

▽ Water level encountered during drilling
 ▽ Water level measured after drilling

NOTES: (1) UNCORRECTED FIELD BLOW COUNTS
 (2) METRIC EQUIVALENT DRY UNIT WEIGHT $kN/m^3 = 0.1571 \times$ DRY UNIT WEIGHT (pcf)
 (3) METRIC EQUIVALENT STRENGTH (kPa) = 0.0479 x STRENGTH (psf)
 (4) GRAPHIC SYMBOLS ARE ILLUSTRATIVE ONLY



A CALIFORNIA CORPORATION, © 2021, ALL RIGHTS RESERVED
 FILENAME: 1927.010 BL.dwg

504 Redwood Blvd.
 Suite 220
 Novato, CA 94947
 T 415 / 382-3444
 F 415 / 382-3450
 www.millerpac.com

BORING LOG

The Petaluman Hotel
 2 Petaluma Boulevard South
 Petaluma, California



Project No. 1927.010

Date: 1/24/2022

Drawn _____
 EIC
 Checked _____

A-3
 FIGURE

DEPTH		BORING 1 (CONTINUED)		BLOWS / FOOT (1)	DRY UNIT WEIGHT pcf (2)	MOISTURE CONTENT (%)	SHEAR STRENGTH psf (3)	OTHER TEST DATA	OTHER TEST DATA
meters	feet	SAMPLE	SYMBOL (4)						
20									
			SAND with Silt (SP-SM) Medium brown, wet, dense, medium to coarse sand, up to ~5-10% low plasticity silt. [Alluvium]	58				P200 8.8%	SA
7			CLAY (CH) Gray, moist, stiff, medium plasticity, trace fines. [Alluvium]						
25			Silty SAND (SM) Medium brown, wet, very dense, medium to coarse sand, 15-20% low plasticity silt. [Alluvium] grades medium gray with predominately very fine to medium sand, ~20-25% low plasticity silt	50/5" 50/5"	99	25.2	UC 850	P200 16.5%	SA
8									
9			Sandy SILT (ML) Medium gray, moist, very stiff, low plasticity, 40-45% very fine to fine sand, trace gravel. [Alluvium]	50/6"				P200 57.4%	SA
30									
10									
35				50/4"					
11									
12				50/3"					
40									

 Water level encountered during drilling
 Water level measured after drilling

NOTES: (1) UNCORRECTED FIELD BLOW COUNTS
 (2) METRIC EQUIVALENT DRY UNIT WEIGHT $\text{KN/m}^3 = 0.1571 \times \text{DRY UNIT WEIGHT (pcf)}$
 (3) METRIC EQUIVALENT STRENGTH (kPa) = $0.0479 \times \text{STRENGTH (psf)}$
 (4) GRAPHIC SYMBOLS ARE ILLUSTRATIVE ONLY



A CALIFORNIA CORPORATION, © 2021, ALL RIGHTS RESERVED
 FILENAME: 1927.010 BL.dwg

504 Redwood Blvd.
 Suite 220
 Novato, CA 94947
 T 415 / 382-3444
 F 415 / 382-3450
 www.millerpac.com

BORING LOG

The Petaluman Hotel
 2 Petaluma Boulevard South
 Petaluma, California



Project No. 1927.010

Date: 1/24/2022

Drawn _____
 EIC
 Checked _____

A-4
 FIGURE

DEPTH		SAMPLE	SYMBOL (4)	BORING 1 (CONTINUED)		BLOWS / FOOT (1)	DRY UNIT WEIGHT pcf (2)	MOISTURE CONTENT (%)	SHEAR STRENGTH psf (3)	OTHER TEST DATA	OTHER TEST DATA
meters	feet										
40		☒		Sandy SILT (ML) Medium gray, moist, very stiff, low plasticity, 40-45% very fine to fine sand, trace gravel. [Alluvium]	50/3"						
13				Claystone Medium gray, low hardness, friable, completely weathered, some secondary veining present, blocky texture. [Bedrock]							
14		☒			36		35.1				
15		☒			39		35.1				
16											
17		☒			44		31.1				
18											
60		☒									

 Water level encountered during drilling
 Water level measured after drilling

NOTES: (1) UNCORRECTED FIELD BLOW COUNTS
 (2) METRIC EQUIVALENT DRY UNIT WEIGHT $\text{KN/m}^3 = 0.1571 \times \text{DRY UNIT WEIGHT (pcf)}$
 (3) METRIC EQUIVALENT STRENGTH (kPa) = $0.0479 \times \text{STRENGTH (psf)}$
 (4) GRAPHIC SYMBOLS ARE ILLUSTRATIVE ONLY



A CALIFORNIA CORPORATION, © 2021, ALL RIGHTS RESERVED
 FILENAME: 1927.010 BL.dwg

504 Redwood Blvd.
 Suite 220
 Novato, CA 94947
 T 415 / 382-3444
 F 415 / 382-3450
 www.millerpac.com

BORING LOG

The Petaluman Hotel
 2 Petaluma Boulevard South
 Petaluma, California



Project No. 1927.010

Date: 1/24/2022

Drawn _____
 EIC
 Checked _____

A-5
 FIGURE

DEPTH		BORING 1 (CONTINUED)			BLOWS / FOOT (1)	DRY UNIT WEIGHT pcf (2)	MOISTURE CONTENT (%)	SHEAR STRENGTH psf (3)	OTHER TEST DATA	OTHER TEST DATA
meters	feet	SAMPLE	SYMBOL (4)							
60				Claystone Medium gray, low hardness, friable, completely weathered, some secondary veining present, blocky texture. [Bedrock]	38		29.3			
13										
65				Boring terminated at 71-feet 6-inches. Groundwater measured at 6-feet 9-inches upon completion.	40		33.6			
14										
15	70									
16										
75										
17										
18										
80										

 Water level encountered during drilling
 Water level measured after drilling

NOTES: (1) UNCORRECTED FIELD BLOW COUNTS
 (2) METRIC EQUIVALENT DRY UNIT WEIGHT $\text{KN/m}^3 = 0.1571 \times \text{DRY UNIT WEIGHT (pcf)}$
 (3) METRIC EQUIVALENT STRENGTH (kPa) = $0.0479 \times \text{STRENGTH (psf)}$
 (4) GRAPHIC SYMBOLS ARE ILLUSTRATIVE ONLY



A CALIFORNIA CORPORATION, © 2021, ALL RIGHTS RESERVED
 FILENAME: 1927.010 BL.dwg

504 Redwood Blvd.
 Suite 220
 Novato, CA 94947
 T 415 / 382-3444
 F 415 / 382-3450
 www.millerpac.com

BORING LOG

The Petaluman Hotel
 2 Petaluma Boulevard South
 Petaluma, California

Project No. 1927.010

Date: 1/24/2022

Drawn _____
 EIC
 Checked _____

A-6
 FIGURE

MILLER PACIFIC ENGINEERING GROUP
 PARTICLE SIZE ANALYSIS - ASTM D 6913 & ASTM D 1140

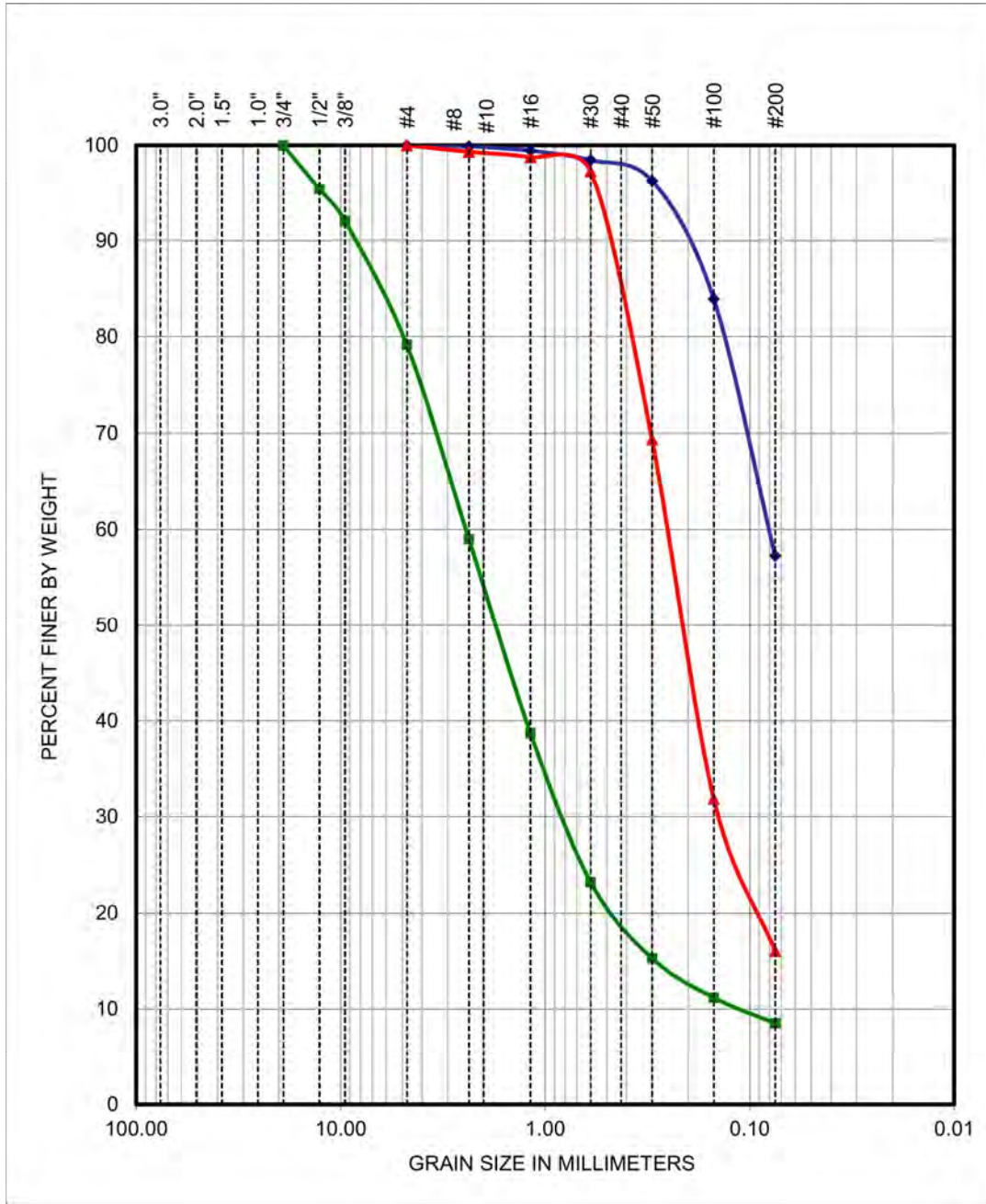

MILLER PACIFIC ENGINEERING GROUP
PARTICLE SIZE ANALYSIS - ASTM D 6913 & ASTM D 1140

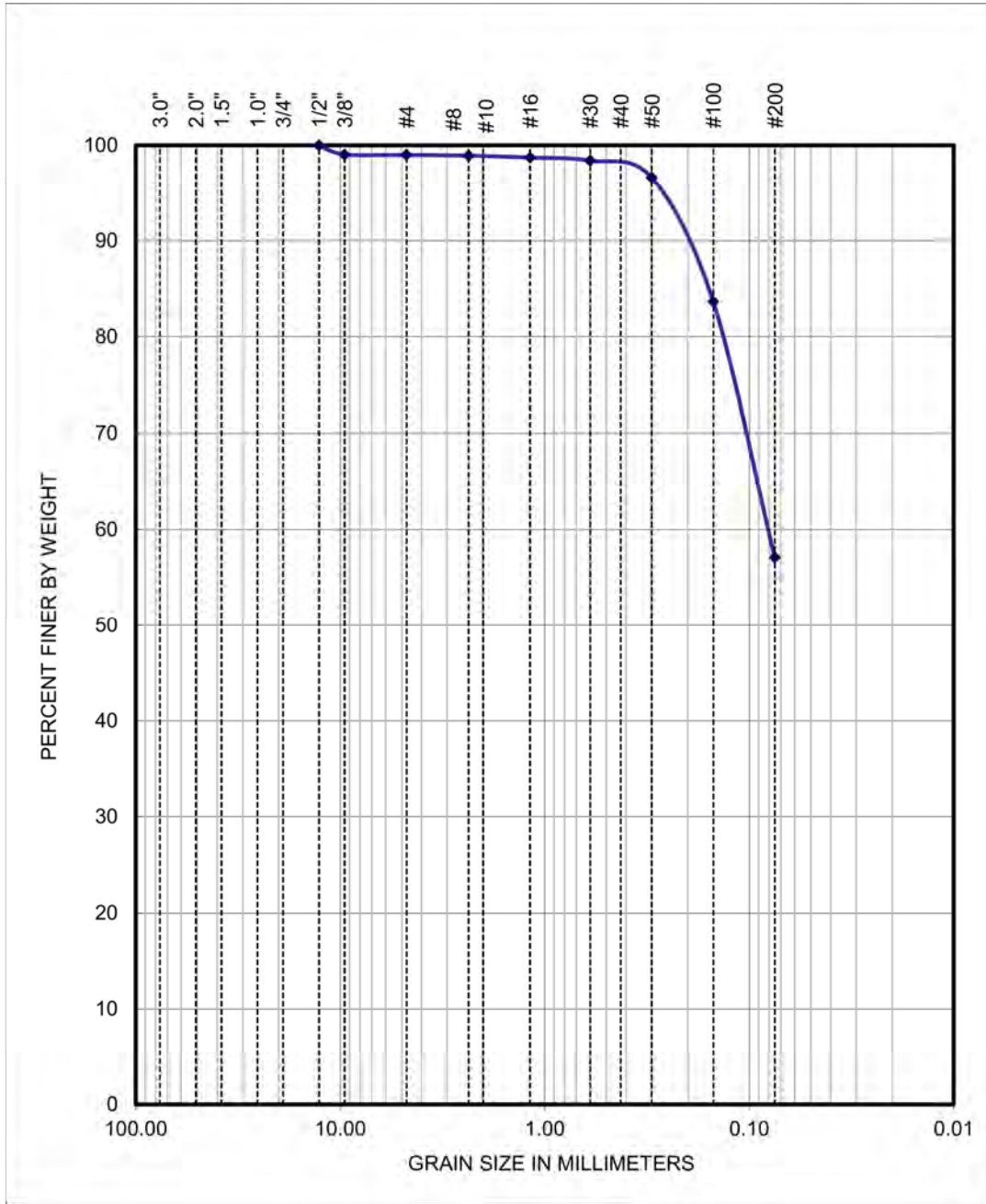

SYMBOL	SAMPLE SOURCE	CLASSIFICATION
—◆—	B1 @ 30.0'	Sandy SILT (ML)



**MILLER PACIFIC
ENGINEERING GROUP**

A CALIFORNIA CORPORATION, © 2021, ALL RIGHTS RESERVED
 FILENAME: 1927.010 BL.dwg

504 Redwood Blvd.
 Suite 220
 Novato, CA 94947
 T 415 / 382-3444
 F 415 / 382-3450
 www.millerpac.com

SIEVE ANALYSIS TEST RESULTS

The Petaluman Hotel
 2 Petaluma Boulevard South
 Petaluma, California

Project No. 1927.010 Date: 1/24/2022

Drawn _____	EIC
Checked _____	

A-8

FIGURE

**APPENDIX B
SUBSURFACE EXPLORATION AND LABORATORY TESTING (CPT)****1.0 Cone Penetration Testing**

We performed four Cone Penetration Tests (CPT) on August 25th, 2021, at the approximate locations shown on the Site Plan, Figure 2. The CPT is a special exploration technique that provides a continuous profile of data throughout the depth of exploration. It is particularly useful in defining stratigraphy, relative soil strength and in assessing liquefaction potential.

The CPT is a cylindrical probe, 35 mm in diameter, which is pushed into the ground at a constant rate of 2 cm/sec. The device is illustrated on Figure B-1. It is instrumented to obtain continuous measurements of cone bearing (tip resistance), sleeve friction and pore water pressure. The data is sensed by strain gages and load cells inside the instrument. Electronic signals from the instrument are continuously recorded by an on-board computer at the surface, which permits an initial evaluation of subsurface conditions during the exploration.

The recorded data is transferred to an in-office computer for reduction and analysis. The analysis of cone bearing and sleeve friction (i.e., friction ratio) indicates the soil type, the cone bearing alone indicates soil density or strength, and the pore pressure indicates the presence of clay. Variations in the data profile indicate changes in stratigraphy. This test method has been standardized and is described in detail by the ASTM Standard Test Method D3441 "Deep, Quasi-Static Cone and Friction Cone Penetration Tests of Soil." The interpretation of CPT data is illustrated on Figure B-1, and the CPT data logs are presented on Figures B-2 through B-5.

The exploratory CPT logs, description of soils encountered, and the laboratory test data reflect conditions only at the location of the CPT at the time they were excavated or retrieved. Conditions may differ at other locations and may change with the passage of time due to a variety of causes including natural weathering, climate, and changes in surface and subsurface drainage.

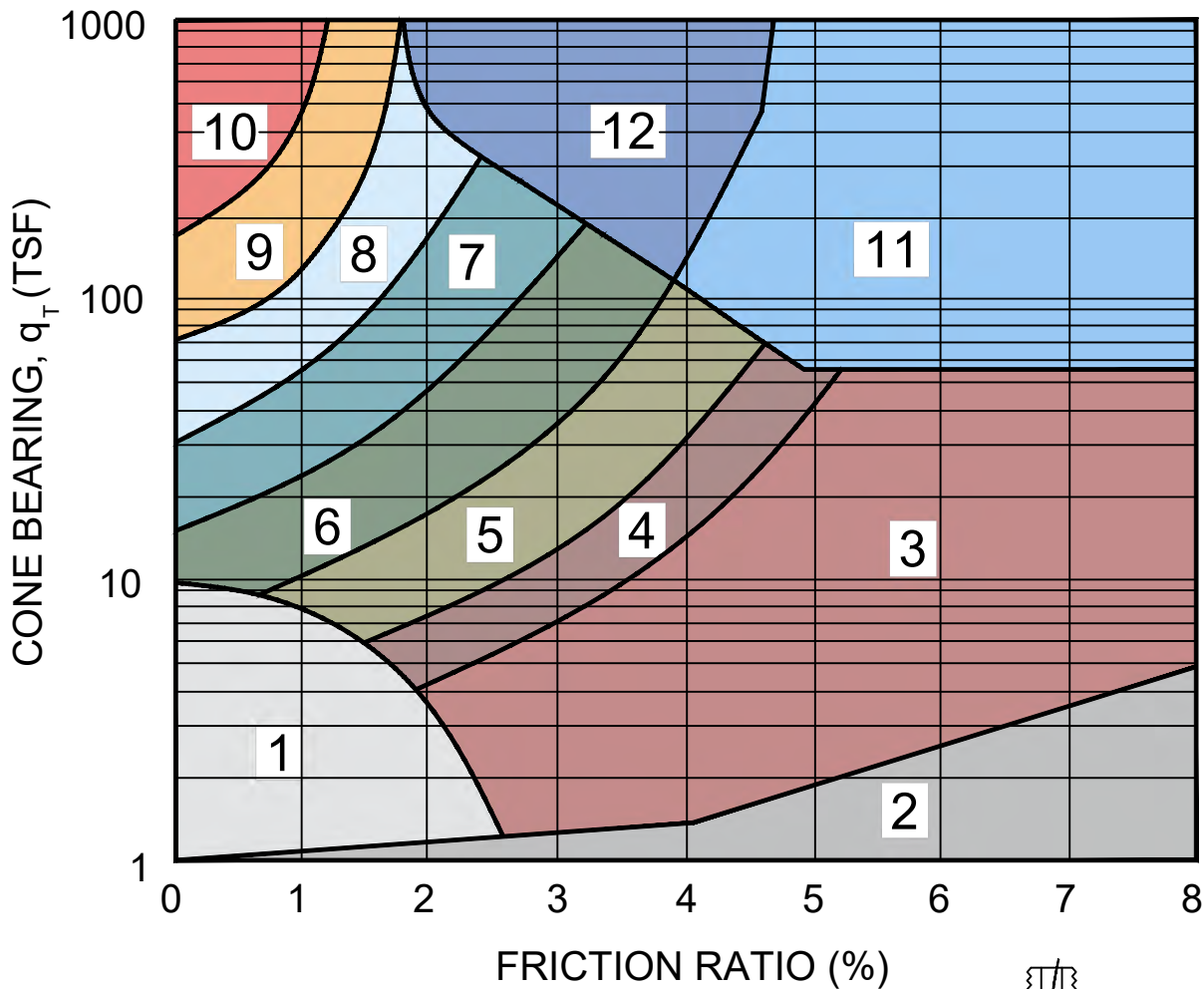

Zone:	Qc/N	Soil Behavior Type:
1)	2	Sensitive Fine Grained
2)	1	Organic Material
3)	1	Clay
4)	1.5	Silty Clay to Clay
5)	2	Clayey Silt to Silty Clay
6)	2.5	Sandy Silt to Clayey Silt
7)	3	Silty Sand to Sandy Silt
8)	4	Sand to Silty Sand
9)	5	Sand
10)	6	Gravelly Sand to Sand
11)	1	Very Stiff Fine Grained (*)
12)	2	Sand to Clayey Sand (*)

(*) Overconsolidated or Cemented

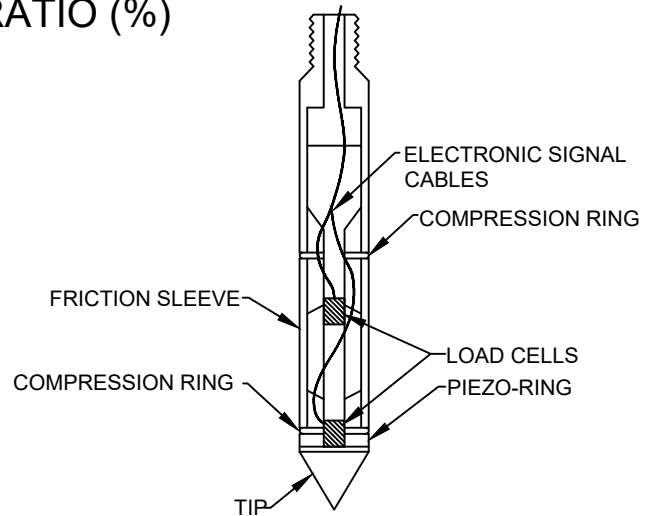

CONE PENETROMETER

(NO SCALE)

Reference: Robertson, P.K. (1986), "In-Situ Testing and Its Application to Geotechnical Engineering," Canadian Geotechnical Journal, Vol. 23; No. 23; No. 4, pp. 573-594

MILLER PACIFIC ENGINEERING GROUP

A CALIFORNIA CORPORATION, © 2016, ALL RIGHTS RESERVED
 FILENAME: 1927.001 CPTs.dwg

504 Redwood Blvd.
 Suite 220
 Novato, CA 94947
 T 415 / 382-3444
 F 415 / 382-3450
 www.millerpac.com

CPT SOIL INTERPRETATION CHART

The Petaluman Hotel
 2 Petaluma Boulevard South
 Petaluma, California

Project No. 1927.01 Date: 1/24/2022

Drawn _____
 Checked MMT

B-1
 FIGURE



Miller Pacific Engineering

Project Petaluma Hotel Operator AJ-00
 Job Number 1927.01 Cone Number DDG1596
 Hole Number CPT-01 Date and Time 8/25/2021 7:39:57 AM
 EST GW Depth During Test 5.00 ft

Filename SDF(872).cpt
 GPS _____
 Maximum Depth 27.72 ft

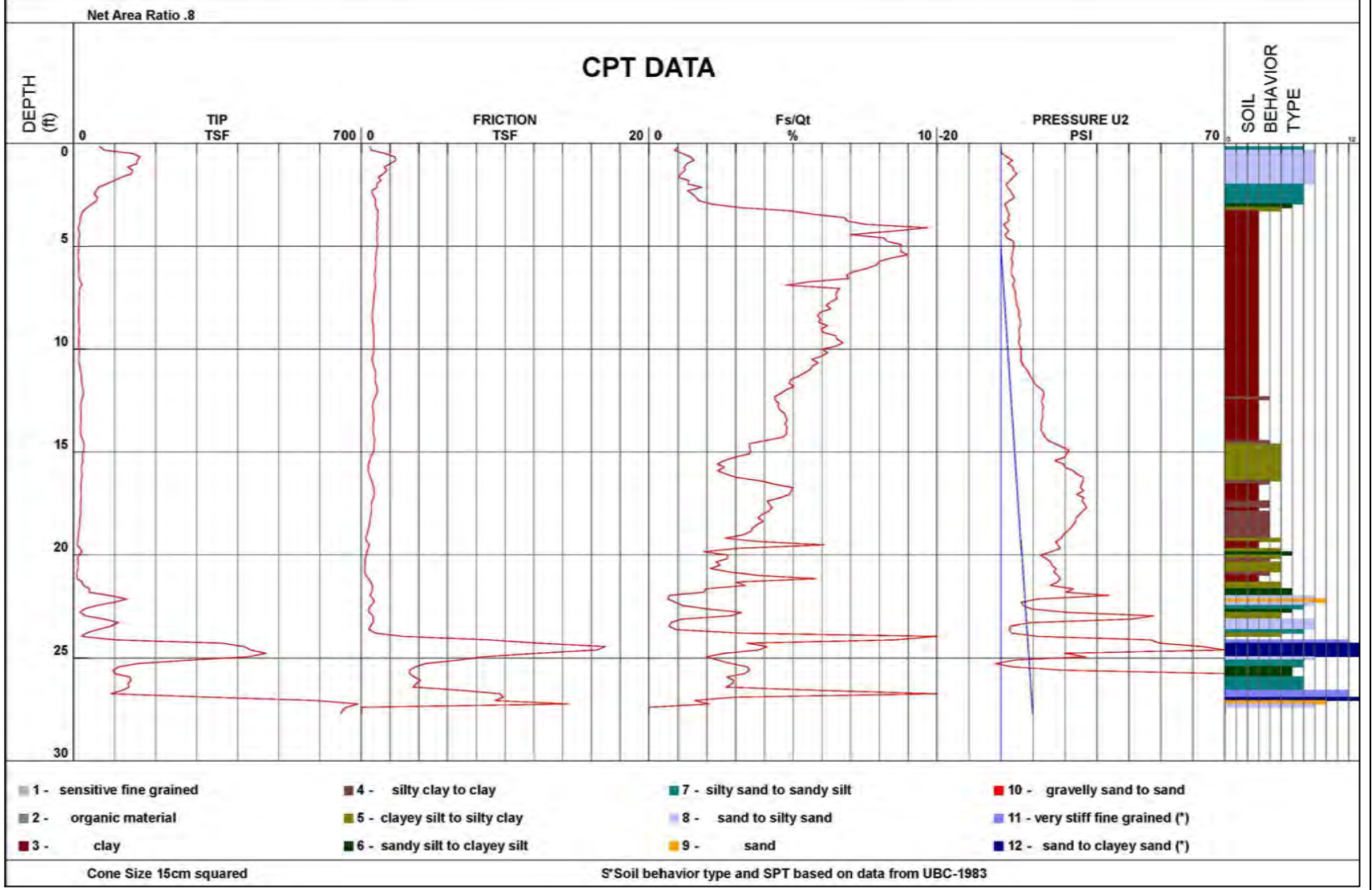



Miller Pacific Engineering

Project Petaluma Hotel Operator AJ-00
 Job Number 1927.01 Cone Number DDG1596
 Hole Number CPT-02 Date and Time 8/25/2021 8:14:49 AM
 EST GW Depth During Test 5.00 ft

Filename SDF(873).cpt
 GPS _____
 Maximum Depth 27.72 ft

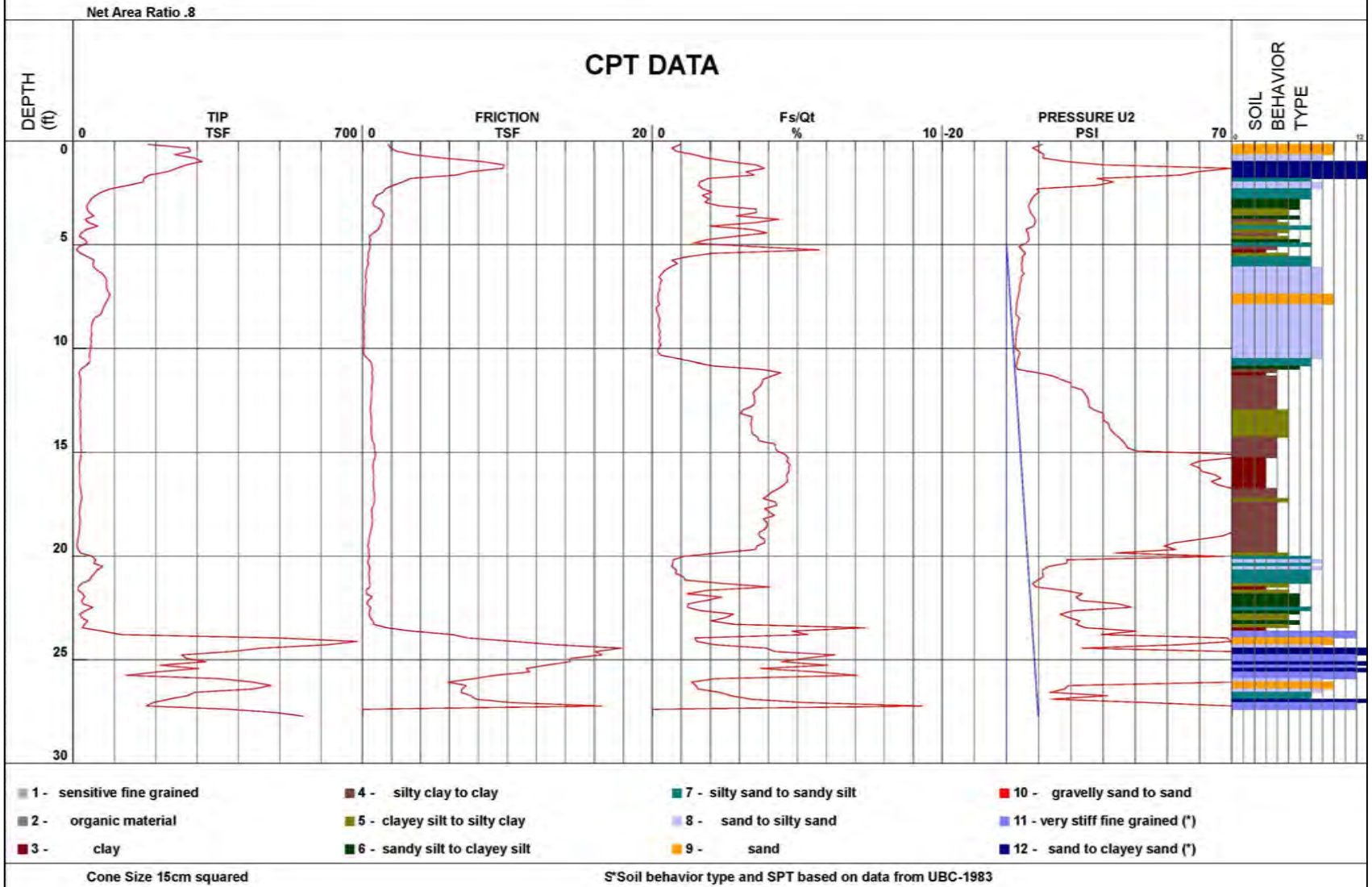



Miller Pacific Engineering

Project Petaluma Hotel Operator AJ-00
 Job Number 1927.01 Cone Number DDG1596
 Hole Number CPT-03 Date and Time 8/25/2021 9:03:58 AM
 EST GW Depth During Test 11.00 ft

Filename SDF(874).cpt
 GPS _____
 Maximum Depth 27.72 ft

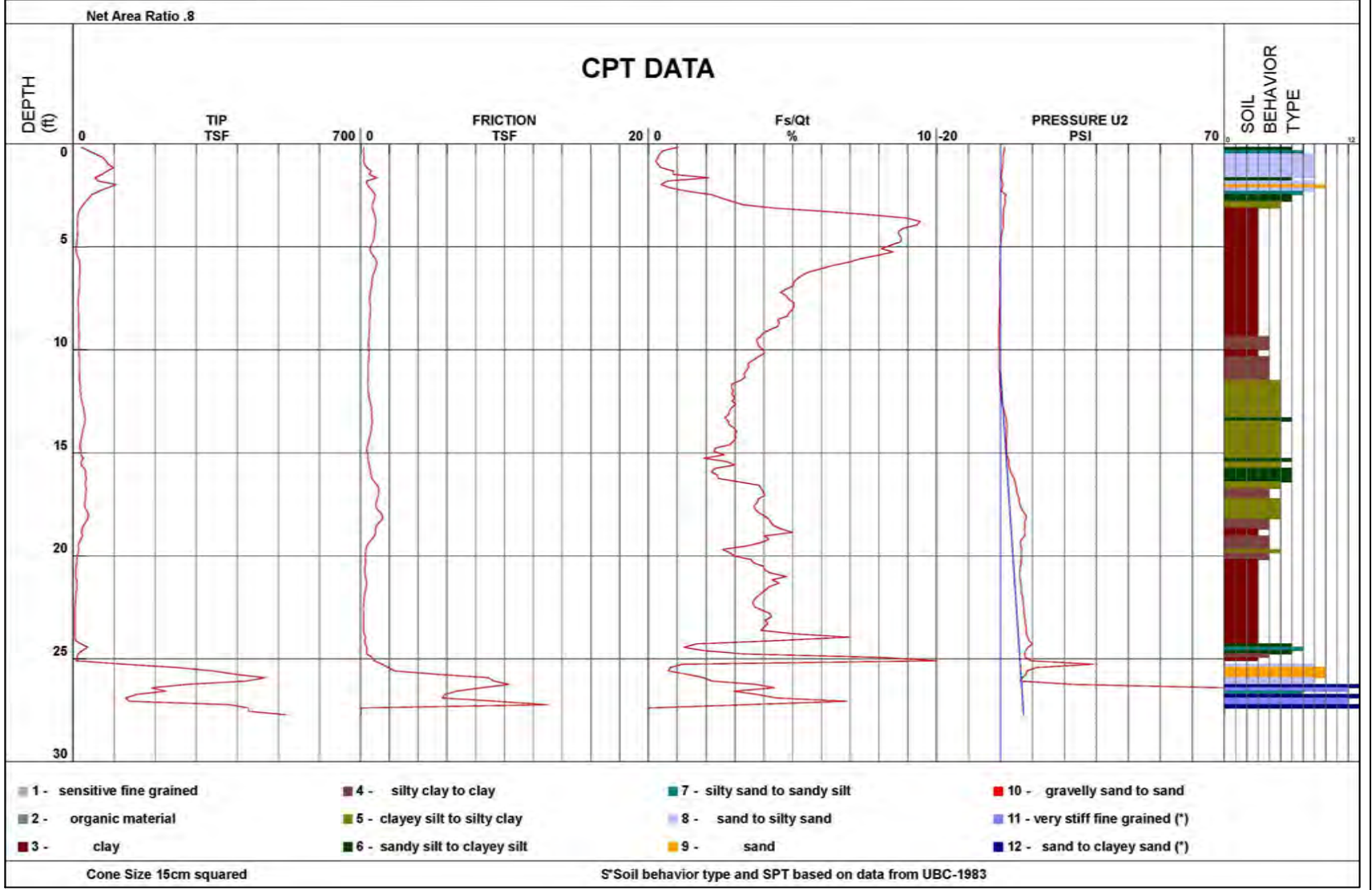



Miller Pacific Engineering

Project Petaluma Hotel Operator AJ-00
 Job Number 1927.01 Cone Number DDG1596
 Hole Number CPT-04 Date and Time 8/25/2021 9:31:22 AM
 EST GW Depth During Test 8.00 ft

Filename SDF(875).cpt
 GPS _____
 Maximum Depth 13.78 ft

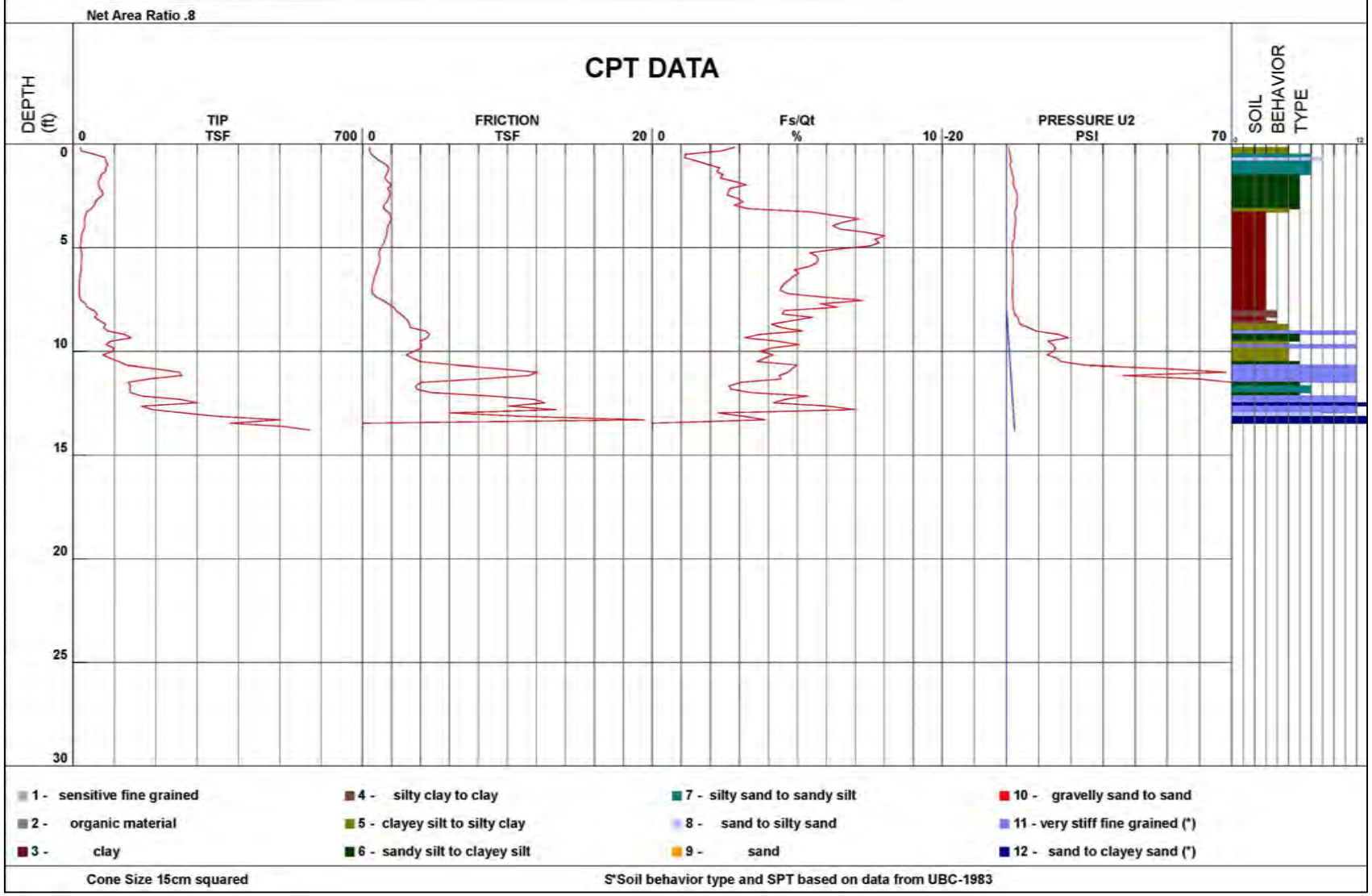

CPT-04 DATA

**APPENDIX C
RISK TARGETED MAXIMUM CONSIDERED
EARTHQUAKE (MCE_R) GROUND MOTION HAZARD ANALYSIS**

Due to the presence of sandy soil layers beneath the building site that are prone to liquefaction, we judge the site should be classified as “Site Class F” per the 2019 California Building Code. However, per section 20.3.1 of the ASCE 7-16, an equivalent linear site-specific response analysis (i.e., SHAKE, DeepSoil, etc.) is not required if the proposed structure has a fundamental period of less than 0.5 seconds. We anticipate the proposed structures will have fundamental periods less than 0.5-seconds; therefore, based on the harmonic mean of the blow counts we recommend classifying the site as a “Site Class D”.

The ASCE 7-16 mapped spectral acceleration parameters at a period of 0.2-second, S_s , and 1.0-second, S_1 , at the project site are 1.50 g and 0.60 g, respectively. Per ASCE 7-16 Table 11.4-1 a Site-Specific Ground Motion shall be developed per Section 11.4.8 for S_s values greater than 1.0 g for Site Class E sites and all cases for Site Class F sites. Additionally, a Site-Specific Ground Motion Hazard Analysis shall be performed per ASCE 7-16 Section 11.4.8 if the S_1 value is greater than 0.2 g for Site Class D, greater than 1.0 g for Site Class E, and all cases for Site Class F. Therefore, per ASCE 7-16 Section 11.4.8, we performed a Site-Specific Ground Motion Hazard Analysis per ASCE 7-16 Section 21.2, as described in the sections below.

Probabilistic (MCE_R) Ground Motions: Method 1

A probabilistic acceleration response spectrum, corresponding to a 2% chance of exceedance in 50-years (2,475 return period) was generated utilizing the United States Geologic Survey (USGS) online Unified Hazard Tool (<https://earthquake.usgs.gov/hazards/interactive/>, accessed 2022) for a Site Class D soil profile ($V_{S30} = 260$ m/s) and the Dynamic: Conterminous U.S. 2014 (v4.2.0) model. The accelerations given were modified by the risk coefficients C_{RS} and C_{R1} , 0.915 and 0.906, respectively. The accelerations were further converted to the probabilistic spectral response acceleration in the maximum horizontal response utilizing the procedures outlined by Shahi and Baker, 2013. These modifications to the probabilistic spectra correspond to a response with a risk targeted level of 1% probability of collapse within a 50-year period. The resulting probabilistic MCE_R values and spectra are presented on Figures C-1 and C-2, respectively.

Deterministic (MCE_R) Ground Motions

A deterministic acceleration response spectrum was generated utilizing the NGA attenuation models outlined by Abrahamson, Silva & Kamai (2014); Boore, Stewart, Seyhan & Atkinson (2014); Campbell & Borzognia (2014); and Chiou & Youngs (2014) NGA2 West models for a Site Class D ($V_{S30} = 270$ m/s). The geometric average of the 84th percentile spectral accelerations from the aforementioned attenuation relationships were modified for the probabilistic spectral response acceleration in the maximum horizontal direction, utilizing the procedures outlined by Shahi and Baker, 2013. The resulting deterministic MCE_R values and spectra are shown on Figures C-1 and C-2, respectively. The deterministic MCE_R spectra shall not be less than the Lower Limit Deterministic MCE_R Response Spectrum, as described in ASCE 7-16 Figure 21.2-1 which is tabulated and plotted on Figures C-1 and C-2, respectively.

Site Specific MCE_R

The site specific MCE_R spectral response acceleration at any period shall be taken as the lesser of the response accelerations from the probabilistic ground motions and the deterministic ground motions and is presented on Figure C-3. Additionally, per ASCE 7-16 Section 21.3, the design spectral response acceleration at any period is equal to $2/3^{\text{rds}}$ the MCE_R Response Spectrum, as shown on Figure C-3.

Per ASCE 7-16 Section 21.4, the MCE_R spectral response acceleration parameters shall be taken from the Site-Specific Spectrum defined as follows and are presented on Figure C-3:

- S_{DS} – The S_{DS} parameter shall be taken as 90% of the maximum spectral acceleration, S_a , obtained from the site-specific spectrum, at any period between 0.2 and 5.0-seconds. However, the values obtained shall not be less than 80% of the values determined in accordance with ASCE 7-16 Section 11.4.5.
- S_{D1} – The S_{D1} parameter shall be taken as the maximum value of the product, TS_a , for periods between 1.0 and 2.0-seconds for Site Class C and B sites; and periods between 1.0 and 5.0-seconds for Site Class D, E & F sites. However, the values obtained shall not be less than 80% of the values determined in accordance with ASCE 7-16 Section 11.4.5.
- S_{MS} – The S_{MS} parameter is equal to 1.5 times the S_{DS} value, but not less than 80% of the values determined in accordance with ASCE 7-16 Section 11.4.4.
- S_{M1} – The S_{M1} parameter is equal to 1.5 times the S_{D1} value, but not less than 80% of the values determined in accordance with ASCE 7-16 Section 11.4.4.

**ASCE 7-16
SITE SPECIFIC RISK-TARGETED
MAXIMUM CONSIDERED EARTHQUAKE (MCE_R)**

Project Name: Petaluman Hotel
Project Numb: 1927.01

Latitude: 38.2331
Longitude: -122.6391

General Seismic Parameters
ASCE 7-16 Section 11.4

Site Class: D
S_S (g): 1.50
S₁ (g): 0.80
F_v: 1.20
F_v: N/A
T_L (sec): 12.0
C_{RS}: 0.92
C_{RI}: 0.91

Minimum Design Spectra Parameters
ASCE 7-16 Section 21.3

Site Class: D
S_S (g): 1.50
S₁ (g): 0.60
F_v: 1.00
F_v: 2.50
S_{MS} (g): 1.50
S_{M1} (g): 1.50
S_{MS} (g): 1.00
S_{D1} (g): 1.00
T₀ (sec): 0.20
T_S (sec): 1.00

Deterministic MCE Screening
ASCE 7-16 (Sup #1) 21.2.3

F_a: 1.00
1.2 x F_a (g): 1.20
Max PSHA (g): 2.16
DSHA Rqd.: YES

Min. Deterministic MCE
ASCE 7-16 (Sup #1) 21.2.2

F_a: 1.00
1.5 x F_a (g): 1.50
Max DSHA (g): 1.73
Min MCE Rqd.: NO

Probabilistic MCE
ASCE 7-16 Section 21.2.1 - Method 1

Period (sec)	S _a Red100				C _R	S _a (g)
	S _a Red50 (g)	S _a Red100 (g)	S _a Red100 (g)	S _a Red100 (g)		
0.01	0.79	1.10	0.87	0.915	0.80	
0.10	1.33	1.10	1.46	0.915	1.34	
0.20	1.78	1.10	1.96	0.915	1.80	
0.30	2.05	1.13	2.30	0.914	2.10	
0.50	2.02	1.18	2.37	0.912	2.16	
0.75	1.66	1.24	2.05	0.909	1.86	
1.00	1.40	1.30	1.82	0.906	1.65	
2.00	0.78	1.35	1.05	0.906	0.95	
3.00	0.52	1.40	0.73	0.906	0.66	
4.00	0.38	1.45	0.55	0.906	0.50	
5.00	0.29	1.50	0.44	0.906	0.40	

Deterministic MCE
NGA West2 2014 - 84th Percentile

Period (sec)	S _a Red100		
	S _a Red50 (g)	S _a Red100 (g)	S _a Red100 (g)
0.01	0.59	1.10	0.65
0.02	0.59	1.10	0.65
0.03	0.60	1.10	0.66
0.05	0.66	1.10	0.72
0.08	0.78	1.10	0.86
0.10	0.91	1.10	1.00
0.15	1.12	1.10	1.23
0.20	1.26	1.10	1.39
0.25	1.37	1.11	1.53
0.30	1.46	1.13	1.64
0.40	1.50	1.15	1.73
0.50	1.46	1.18	1.72
0.75	1.22	1.24	1.51
1.00	1.04	1.30	1.35
1.50	0.76	1.33	1.00
2.00	0.58	1.35	0.78
3.00	0.38	1.40	0.54
4.00	0.27	1.45	0.39
5.00	0.19	1.50	0.29
7.50	0.09	1.50	0.14
10.00	0.05	1.50	0.08

Scaled Deterministic MCE
ASCE 7-16 (Sup #1) 21.2.2

Period (sec)	S _a (g)
0.01	0.57
0.02	0.57
0.03	0.57
0.05	0.63
0.08	0.75
0.10	0.87
0.15	1.07
0.20	1.21
0.25	1.33
0.30	1.42
0.40	1.50
0.50	1.49
0.75	1.31
1.00	1.17
1.50	0.87
2.00	0.68
3.00	0.47
4.00	0.33
5.00	0.25
7.50	0.12
10.00	0.07

Site Specific MCE_R
ASCE 7-16 Section 21.2.3

Period (sec)	S _a (g)
0.01	0.65
0.02	0.65
0.03	0.66
0.05	0.72
0.08	0.86
0.10	1.00
0.15	1.23
0.20	1.39
0.25	1.53
0.30	1.64
0.40	1.73
0.50	1.72
0.75	1.51
1.00	1.35
1.50	1.00
2.00	0.78
3.00	0.54
4.00	0.39
5.00	0.29
7.50	0.14
10.00	0.08

Site-Specific Design Spectrum
ASCE 7-16 Section 21.3

Period (sec)	S _a (g)
0.01	0.43
0.02	0.43
0.03	0.44
0.05	0.48
0.08	0.57
0.10	0.67
0.15	0.82
0.20	0.93
0.25	1.02
0.30	1.09
0.40	1.15
0.50	1.15
0.75	1.01
1.00	0.90
1.50	0.67
2.00	0.52
3.00	0.36
4.00	0.26
5.00	0.19
7.50	0.09
10.00	0.05

80% General Response Spectrum
ASCE 7-16 Section 21.3

Period (sec)	S _a (g)	80% S _a (g)
0.01	0.43	0.34
0.02	0.43	0.42
0.03	0.44	0.50
0.05	0.48	0.57
0.08	0.57	0.65
0.10	0.67	0.72
0.15	0.82	0.80
0.20	0.93	0.80
0.25	1.02	0.76
0.30	1.09	0.62
0.40	1.15	0.42
0.50	1.15	0.36
0.75	1.01	0.32
1.00	0.90	0.28
1.50	0.67	0.25
2.00	0.52	0.23
3.00	0.36	0.21
4.00	0.26	0.20
5.00	0.19	0.18
7.50	0.09	0.17
10.00	0.05	0.16

T₀ = 0.20
T_S = 1.00



A CALIFORNIA CORPORATION, © 2020, ALL RIGHTS RESERVED
FILE: 1927.01 Site Specific.dwg

504 Redwood Blvd.
Suite 220
Novato, CA 94947
T 415 / 382-3444
F 415 / 382-3450
www.millerpac.com

ASCE 7-16 MCE_R CALCULATIONS

The Petaluman Hotel
2 Petaluma Boulevard South
Petaluma, California

Project No. 1927.01

Date: 1/24/2022

Drawn _____
Checked MMT

C-1
FIGURE

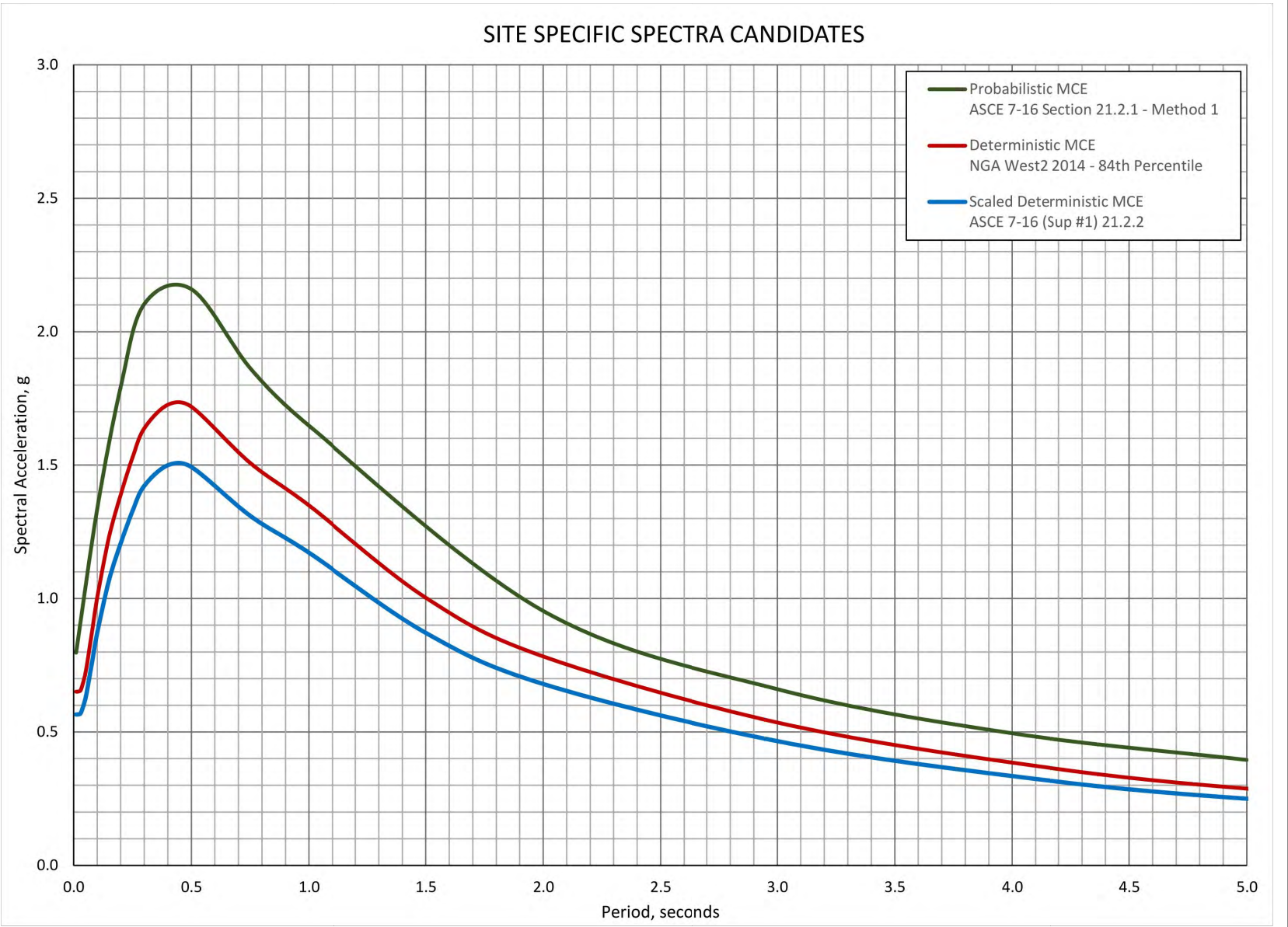

**MILLER PACIFIC
ENGINEERING GROUP**

A CALIFORNIA CORPORATION, © 2020, ALL RIGHTS RESERVED
FILE: 1927.01 Site Specific.dwg

504 Redwood Blvd.
Suite 220
Novato, CA 94947
T 415 / 382-3444
F 415 / 382-3450
www.millerpac.com

ASCE 7-16 MCE CANDIDATE SPECTRA

The Petalum Hotel
2 Petaluma Boulevard South
Petaluma, California
Project No. 1927.01 Date: 1/24/2022

Drawn
Checked
MMT

C-2

FIGURE



**MILLER PACIFIC
ENGINEERING GROUP**

A CALIFORNIA CORPORATION, © 2020, ALL RIGHTS RESERVED
FILE: 1927.01 Site Specific.dwg

504 Redwood Blvd.
Suite 220
Novato, CA 94947
T 415 / 382-3444
F 415 / 382-3450
www.millerpac.com

ASCE 7-16 MCER DESIGN SPECTRUM
The Petalumnan Hotel
2 Petaluma Boulevard South
Petaluma, California
Project No. 1927.01 Date: 1/24/2022

Drawn: MMT
Checked:

C-3
FIGURE

