

PROJECT REPORT

TO: ENVIRONMENTAL EVALUATION COMMITTEE

AGENDA DATE: April 25, 2024

FROM: PLANNING & DEVELOPMENT SERVICES

AGENDA TIME 1:30 PM / No.1

Maverik Inc

PROJECT TYPE: GPA #22-0002, ZC #22-0002, PM #02499 SUPERVISOR DIST #5

LOCATION: 407 E Ross Rd APN: 054-080-023-000

El Centro, CA 92243 PARCEL SIZE: 50 +/- acres

GENERAL PLAN (existing) Agriculture GENERAL PLAN (proposed) Urban Area

ZONE (existing) A-2 (General Agriculture) ZONE (proposed) C-3 (Heavy Commercial)

GENERAL PLAN FINDINGS CONSISTENT INCONSISTENT MAY BE/FINDINGS

PLANNING COMMISSION DECISION:

HEARING DATE: _____

APPROVED DENIED OTHER

PLANNING DIRECTORS DECISION:

HEARING DATE: _____

APPROVED DENIED OTHER

ENVIRONMENTAL EVALUATION COMMITTEE DECISION: HEARING DATE: 04/25/24

INITIAL STUDY: #22-0026

NEGATIVE DECLARATION MITIGATED NEG. DECLARATION EIR

DEPARTMENTAL REPORTS / APPROVALS:

PUBLIC WORKS	<input type="checkbox"/>	NONE	<input checked="" type="checkbox"/>	ATTACHED
AG	<input type="checkbox"/>	NONE	<input checked="" type="checkbox"/>	ATTACHED
APCD	<input type="checkbox"/>	NONE	<input checked="" type="checkbox"/>	ATTACHED
E.H.S.	<input type="checkbox"/>	NONE	<input checked="" type="checkbox"/>	ATTACHED
FIRE / OES	<input type="checkbox"/>	NONE	<input checked="" type="checkbox"/>	ATTACHED
SHERIFF	<input checked="" type="checkbox"/>	NONE	<input type="checkbox"/>	ATTACHED
OTHER				

IID, Caltrans

REQUESTED ACTION:

(See Attached)

Planning & Development Services

801 MAIN STREET, EL CENTRO, CA, 92243 442-265-1736

(Jim Minnick, Director)

EEC ORIGINAL PKG

NEGATIVE DECLARATION
 MITIGATED NEGATIVE DECLARATION

and
Initial Study & Environmental Analysis

For:

**Maverik Fueling Station and Convenience Store Project
General Plan Amendment #22-0002,
Zone Change #22-0002 and
Parcel Map #02499**



Prepared By:

COUNTY OF IMPERIAL

Planning & Development Services Department

801 Main Street
El Centro, CA 92243
(442) 265-1736
www.icpds.com

April 2024

EEC ORIGINAL PKG

This page intentionally left blank.

TABLE OF CONTENTS

SECTION	PAGE
SECTION I.	INTRODUCTION 1
A.	PURPOSE..... 1
B.	CEQA REQUIREMENTS AND THE IMPERIAL COUNTY “GUIDELINES AND REGULATIONS TO IMPLEMENT CEQA AS AMENDED” 1
C.	INTENDED USES OF INITIAL STUDY AND MITIGATED NEGATIVE DECLARATION .2
D.	CONTENTS OF INITIAL STUDY and MITIGATED NEGATIVE DECLARATION)2
E.	SCOPE OF ENVIRONMENTAL ANALYSIS..... 3
F.	POLICY-LEVEL or PROJECT LEVEL ENVIRONMENTAL ANALYSIS3
G.	TIERED DOCUMENTS AND INCORPORATION BY REFERENCE4
SECTION II.	ENVIRONMENTAL CHECKLIST 7
	ENVIRONMENTAL FACTORS POTENTIALLY AFFECTED: 12
	ENVIRONMENTAL EVALUATION COMMITTEE (EEC) DETERMINATION 12
	PROJECT SUMMARY 13
	<i>Site Characteristics</i> 13
	<i>Project Features</i> 13
	<i>Construction and Grading</i> 16
	<i>Operations</i> 16
	EVALUATION OF ENVIRONMENTAL IMPACTS: 35
	I. AESTHETICS. 36
	II. AGRICULTURAL AND FOREST RESOURCES..... 37
	III. AIR QUALITY. 41
	IV. BIOLOGICAL RESOURCES..... 53
	V. CULTURAL RESOURCES..... 61
	VI. ENERGY..... 67
	VII. GEOLOGY AND SOILS. 71
	VIII. GREENHOUSE GAS EMISSIONS..... 77
	IX. HAZARDS AND HAZARDOUS MATERIALS 79
	X. HYDROLOGY AND WATER QUALITY. 84
	XI. LAND USE AND PLANNING. 92
	XII. MINERAL RESOURCES. 93
	XIII. NOISE..... 94

	XIV. POPULATION AND HOUSING.....	104
	XV. PUBLIC SERVICES.....	104
	XVI. RECREATION.....	105
	XVII. TRANSPORTATION / TRAFFIC.....	106
	XVIII. TRIBAL CULTURAL RESOURCES.....	114
	XIX. UTILITIES AND SERVICE SYSTEMS.....	117
	XX. WILDFIRE.....	121
SECTION III.	MANDATORY FINDINGS OF SIGNIFICANCE.....	123
SECTION IV.	PERSONS & ORGANIZATIONS CONSULTED/ REFERENCES.....	124
	A. PERSONS & ORGANIZATIONS CONSULTED.....	124
	County Of Imperial.....	124
	Other Agencies/Organizations.....	124
	B. LIST OF PREPARERS.....	125
	Imperial County Planning & Development Services.....	125
	Willis Environmental Planning (Consultant to County).....	125
	McIntyre Environmental.....	125
SECTION V.	REFERENCES.....	125
SECTION VII.	FINDINGS.....	129
SECTION VIII.	RESPONSES TO COMMENTS.....	130
SECTION IX.	MITIGATION MONITORING AND REPORTING PROGRAM (MMRP).....	132

FIGURES

FIGURE		PAGE
Figure 1	Regional Location.....	17
Figure 2	Project Site.....	18
Figure 3	Proposed General Plan Amendment.....	19
Figure 4	Proposed Zone Change.....	20
Figure 5	Proposed Tentative Map.....	21
Figure 6	Site Plan.....	22
Figure 7	Floor Plan.....	23
Figure 8	Roof Plan.....	24
Figure 9	Building Perspectives (Front Left and Right).....	25
Figure 10a	Building Elevations – Left and Front.....	26
Figure 10b	Building Elevations - Right and Rear.....	27
Figure 11	Exterior Materials Board.....	28

Figure 12	Fuel Dispensing Canopies	29
Figure 13	Preliminary Landscaping Plan.....	30
Figure 14	Wastewater Treatment Plan Detail	31
Figure 15	Utility Plan	32
Figure 16	Grading Plan.....	33

TABLES

TABLE		PAGE
Table 1	Existing Land Uses, Zone Classification and General Plan Designation	8
Table 2	Potential Consultation and Permitting Requirements	8
Table 3	Proposed Ornamental Landscape Species	14
Table 4	Federal and State Ambient Air Quality Standards	42
Table 5	Screening Threshold for Criteria Pollutants	46
Table 6	Estimated Maximum Daily Construction Emissions	47
Table 7	Estimated Operational Emissions	48
Table 8	Special-Status Wildlife Species With Potential To Occur On Project Site.....	55
Table 9	Previously Recorded Cultural Resources within a half mile radius of the Project Area	62
Table 10	Electricity Consumption In IID Service Area (2022)	67
Table 11	Construction Worker Gasoline Demand	69
Table 12	Construction Equipment Diesel Demand	66
Table 13	Combined Annual Greenhouse Gas Emissions	77
Table 14	Ambient Noise Levels	95
Table 15	Property Line Noise Level Limits	96
Table 16	Human Reaction and Damage to Buildings for Continuous or Frequent Intermittent Vibration Levels	97
Table 17	Typical Maximum Construction Equipment Noise Levels	98
Table 18	Modeled Noise Levels	100
Table 19	Project Trip Generation	110

APPENDICES LIST

Appendix A	Air Quality/Greenhouse Gas Analysis Birdseye Planning Group, December 2023
Appendix B	Health Risk Assessment Entech Consulting Group, December 2023
Appendix C	Biological Resource Assessment Barret Biological Enterprises, December
Appendix D-1	Cultural and Paleontological Resources Assessment Cogstone Resource Management, January 10, 2024
Appendix D-2	Assembly Bill 52 Native American Consultation and Responses
Appendix D-3	Senate Bill 18 Native American Consultation and Responses
Appendix E	Energy Memo Birdseye Planning Group, January 2024
Appendix F	Geotechnical Engineering Study, CMT Engineering Laboratories, November 19, 2021
Appendix G	Phase I Environmental Site Assessment Cardno, October 22, 2021
Appendix H	Limited Phase II Environmental Site Assessment Cardno, November 3, 2021
Appendix I	Preliminary Drainage Study LC Engineering Consultants, Inc., November 14, 2023
Appendix J	Noise Analysis Birdseye Planning Group, March 2024
Appendix K	Traffic Study Mizuta Traffic Consulting, April 2024

SECTION I. INTRODUCTION

A. PURPOSE

This document is a policy-level; project level Initial Study for evaluation of potential environmental impacts resulting with the proposed Project.

B. CEQA REQUIREMENTS AND THE IMPERIAL COUNTY “GUIDELINES AND REGULATIONS TO IMPLEMENT CEQA AS AMENDED”

As defined by Section 15063 of the State California Environmental Quality Act (CEQA) Guidelines and Section 7 of the County’s “Guidelines for the Implementation of CEQA as Amended”, an Initial Study is prepared primarily to provide the Lead Agency with information to use as the basis for determining whether an Environmental Impact Report (EIR), Mitigated Negative Declaration, Negative Declaration, or other environmental document, would be appropriate for providing the necessary environmental documentation and clearance for any proposed project.

According to Section 15065, an **EIR** is deemed appropriate for a particular proposal if the following conditions occur:

- The proposal has the potential to substantially degrade quality of the environment.
- The proposal has the potential to achieve short-term environmental goals to the disadvantage of long-term environmental goals.
- The proposal has possible environmental effects that are individually limited but cumulatively considerable.
- The proposal could cause direct or indirect adverse effects on human beings.

According to Section 15070(a), a **Negative Declaration** is deemed appropriate if the proposal would not result in any significant effect on the environment.

According to Section 15070(b), a **Mitigated Negative Declaration** is deemed appropriate if it is determined that though a proposal could result in a significant effect, mitigation measures are available to reduce these significant effects to insignificant levels.

This Initial Study has determined that although the proposed Project has the potential results in potentially significant environmental impacts, mitigation measures are available to reduce these significant effects to insignificant levels, therefore quality of the environment and therefore, a Mitigated Negative Declaration is deemed as the appropriate document to provide necessary environmental evaluated and clearance as identified hereafter.

This Initial Study and Mitigated Negative Declaration are prepared in conformance with the California Environmental Quality Act of 1970, as amended (Public Resources Code, Section 21000 et. seq.); Section 15070 of the State & County of Imperial’s Guidelines for Implementation of the California Environmental Quality Act of 1970, as amended (California Code of Regulations, Title 14, Chapter 3, Section 15000, et. seq.); applicable requirements of the County of Imperial; and the regulations, requirements, and procedures of any other responsible public agency or an agency with jurisdiction by law.

Pursuant to the *County of Imperial Guidelines for Implementing CEQA*, depending on the project scope, the County of Imperial Board of Supervisors, Planning Commission and/or Planning Director is designated as the Lead Agency, in accordance with Section 15050 of the CEQA Guidelines. The Lead Agency is the public agency which has the principal responsibility for approving the necessary environmental clearances and analyses for any project in the County.

C. INTENDED USES OF INITIAL STUDY AND MITIGATED NEGATIVE DECLARATION

This Initial Study and Mitigated Negative Declaration (MND) are informational documents which are intended to inform County of Imperial decision-makers, other responsible or interested agencies, and the general public of potential environmental effects of the proposed applications. The environmental review process has been established to enable public agencies to evaluate environmental consequences and to examine and implement methods of eliminating or reducing any potentially adverse impacts. While CEQA requires that consideration be given to avoiding environmental damage, the Lead Agency and other responsible public agencies must balance adverse environmental effects against other public objectives, including economic and social goals.

The Initial Study and Mitigated Negative Declaration (MND), prepared for the project, will be circulated for a period of 35 days for public and agency review and comments. At the conclusion, if comments are received, the County Planning & Development Services Department will prepare a document entitled "Responses to Comments" which will be forwarded to any commenting entity and be made part of the record within 10-days of any project consideration.

D. CONTENTS OF INITIAL STUDY AND MITIGATED NEGATIVE DECLARATION)

This Initial Study is organized as described below to facilitate a basic understanding of the existing setting and environmental implications of the proposed applications.

SECTION I

INTRODUCTION presents an introduction to the entire report. This section discusses the environmental process, scope of environmental review, and incorporation by reference documents.

SECTION II

ENVIRONMENTAL CHECKLIST FORM contains the County's Environmental Checklist Form. The checklist form presents results of the environmental evaluation for the proposed applications and those issue areas that would have either a significant impact, potentially significant impact, or no impact.

PROJECT SUMMARY, LOCATION AND ENVIRONMENTAL SETTINGS describes the proposed project entitlements and required applications. A description of discretionary approvals and permits required for project implementation is also included. It also identifies the location of the project and a general description of the surrounding environmental settings.

ENVIRONMENTAL ANALYSIS evaluates each response provided in the environmental checklist form. Each response checked in the checklist form is discussed and supported with sufficient data and analysis as necessary.

As appropriate, each response discussion describes and identifies specific impacts anticipated with project implementation.

SECTION III

III. MANDATORY FINDINGS presents Mandatory Findings of Significance in accordance with Section 15065 of the CEQA Guidelines.

IV. PERSONS AND ORGANIZATION CONSULTED identifies those persons consulted and involved in preparation of this Initial Study.

V. REFERENCES lists bibliographical materials use in the preparation of this document.

VI. FINDINGS

SECTION 4

VIII. RESPONSE TO COMMENTS (IF ANY)

IX. MITIGATION MONITORING AND REPORTING PROGRAM (IF ANY)

E. SCOPE OF ENVIRONMENTAL ANALYSIS

For evaluation of environmental impacts, each question from the Environmental Checklist Form is summarized and responses are provided according to the analysis undertaken as part of the Initial Study. Impacts and effects will be evaluated and quantified, when appropriate. To each question, there are four possible responses, including:

1. **No Impact:** A “No Impact” response is adequately supported if the impact simply does not apply to the proposed applications.
2. **Less Than Significant Impact:** The proposed applications will have the potential to impact the environment. These impacts, however, will be less than significant; no additional analysis is required.
3. **Less Than Significant With Mitigation Incorporated:** This applies where incorporation of mitigation measures has reduced an effect from “Potentially Significant Impact” to a “Less Than Significant Impact.”
4. **Potentially Significant Impact:** The proposed applications could have impacts that are considered significant. Additional analyses and possibly an EIR could be required to identify mitigation measures that could reduce these impacts to less than significant levels.

F. POLICY-LEVEL OR PROJECT LEVEL ENVIRONMENTAL ANALYSIS

This Initial Study will be conducted under a policy-level, project level analysis. Regarding mitigation measures, it is not the intent of this document to “overlap” or restate conditions of approval that are commonly established for future known projects or the proposed applications. Additionally, those other standard requirements and regulations that any development must comply with, that are outside the County’s jurisdiction, are also not considered mitigation measures and therefore, will not be identified in this document.

G. TIERED DOCUMENTS AND INCORPORATION BY REFERENCE

Information, findings, and conclusions contained in this document are based on incorporation by reference of tiered documentation, which are discussed in the following section.

1. Tiered Documents

As permitted in Section 15152(a) of the CEQA Guidelines, information and discussions from other documents can be included into this document. Tiering is defined as follows:

“Tiering refers to using the analysis of general matters contained in a broader EIR (such as the one prepared for a general plan or policy statement) with later EIRs and negative declarations on narrower projects; incorporating by reference the general discussions from the broader EIR; and concentrating the later EIR or negative declaration solely on the issues specific to the later project.”

Tiering also allows this document to comply with Section 15152(b) of the CEQA Guidelines, which discourages redundant analyses, as follows:

“Agencies are encouraged to tier the environmental analyses which they prepare for separate but related projects including the general plans, zoning changes, and development projects. This approach can eliminate repetitive discussion of the same issues and focus the later EIR or [Negative Declaration] on the actual issues ripe for decision at each level of environmental review. Tiering is appropriate when the sequence of analysis is from an EIR prepared for a general plan, policy or program to an EIR or [Negative Declaration] for another plan, policy, or program of lesser scope, or to a site-specific EIR or [Negative Declaration].”

Further, Section 15152(d) of the CEQA Guidelines states:

“Where an EIR has been prepared and certified for a program, plan, policy, or ordinance consistent with the requirements of this section, any lead agency for a later project pursuant to or consistent with the program, plan, policy, or ordinance should limit the EIR or [Negative Declaration] on the later project to effects which:

- (1) Were not examined as significant effects on the environment in the prior EIR; or
- (2) Are susceptible to substantial reduction or avoidance by the choice of specific revisions in the project, by the imposition of conditions, or other means.”

2. Incorporation By Reference

Incorporation by reference is a procedure for reducing the size of EIRs/MND and is most appropriate for including long, descriptive, or technical materials that provide general background information, but do not contribute directly to the specific analysis of the project itself. This procedure is particularly useful when an EIR or Negative Declaration relies on a broadly-drafted EIR for its evaluation of cumulative impacts of related projects (*Las Virgenes Homeowners Federation v. County of Los Angeles* [1986, 177 Ca.3d 300]). If an EIR or Negative Declaration relies on information from a supporting study that is available to the public, the EIR or Negative

Declaration cannot be deemed unsupported by evidence or analysis (San Francisco Ecology Center v. City and County of San Francisco [1975, 48 Ca.3d 584, 595]).

When an EIR or Negative Declaration incorporates a document by reference, the incorporation must comply with Section 15150 of the CEQA Guidelines as follows:

- The incorporated document must be available to the public or be a matter of public record (CEQA Guidelines, Section 15150[a]). The General Plan EIR is available, along with this document, at the County of Imperial Planning & Development Services Department, 801 Main Street, El Centro, CA 92243, phone (442) 265-1736.
- This document must be available for inspection by the public at an office of the lead agency (CEQA Guidelines Section 15150[b]). These documents are available at the County of Imperial Planning & Development Services Department, 801 Main Street, El Centro, CA 92243; phone (442) 265-1736.
- These documents must summarize the portion of the document being incorporated by reference or briefly describe information that cannot be summarized. Furthermore, these documents must describe the relationship between the incorporated information and the analysis in the tiered documents (CEQA Guidelines Section 15150[c]). As discussed above, the tiered EIRs address the entire project site and provide background and inventory information and data which apply to the project site. Incorporated information and/or data will be cited in the appropriate sections.
- These documents must include the State identification number of the incorporated documents (CEQA Guidelines Section 15150[d]). The State Clearinghouse Number for the 1993 County of Imperial General Plan Final EIR is SCH #93011023.

The material to be incorporated in this document will include general background information (CEQA Guidelines Section 15150[f]).

This page intentionally left blank.

SECTION II. ENVIRONMENTAL CHECKLIST

1. **Project Title:** Maverik Fueling Station Project
General Plan Amendment #22-0002, Zone Change #22-0002
and Parcel Map #02499
2. **Lead Agency Name and Address:** Imperial County Planning & Development Services Department
3. **Contact Person and Phone Number:** Derek Newland, Planner III, 442-265-1736
4. **Address:** 801 Main Street, El Centro CA, 92243
5. **E-mail:** DerekNewland@co.imperial.ca.us
6. **Project Location:** Maverik™ (Applicant) is proposing to develop a fueling station and convenience store on a 10-acre portion of Assessor's Parcel Number (APN) 054-080-023 (Project or proposed Project). The Project would be located on 10 gross acres within unincorporated Imperial County (County), California, approximately 1.5 miles east of the City of El Centro (**Figure 1, Regional Location**). The Project site is located on the southeast corner of Hawes Road and Ross Road, immediately east of State Route 111 (SR-111/Imperial Valley Pioneers Expressway) and is bound by Ross Road on the north, Hawes Road and an Imperial Irrigation District (IID) drainage canal (Acacia Five Drain A) on the west (**Figure 2, Project Site**). The Project site is located within Section 11 of Township 16 South, Range 14 East, San Bernardino Base Meridian.
7. **Project Sponsor's Name and Address:** Maverik, Inc., 185 South State Street, Ste 800
Salt Lake City, UT 84111
8. **General Plan Designation:** Agriculture
9. **Zoning:** A-2 (General Agricultural)
10. **Description of Project:**
- The Maverik Fueling Station and Convenience Store Project (proposed Project or Project) includes up to 19 fuel pumps (38 fueling positions) under two separate canopies (totaling 9,000 square feet [SF]), and a 5,982 SF convenience store building. Additional improvements include three (3) underground storage tanks for fuel storage; two aboveground water storage tanks for potable water and for fire protection; on-site water treatment and wastewater treatment facilities; on-site parking, landscaping, and street improvements. The Maverik Fueling Station and Convenience store would operate 24 hours a day, 365 a year and would provide gasoline, diesel and biodiesel. The Project is anticipated to employ 15 employees.
- A General Plan Amendment to change the Project site's land use designation from "Agriculture" to "Urban Area"; as well as a Zone Change, to change zoning from A-2 (General Agricultural) to C-3 (Heavy Commercial) is also proposed (**See Figures 3 and 4**). The balance of the parcel will be separated from the Maverik Fueling Station site through a tentative parcel map (**Figure 5, Proposed Tentative Map**).

11. Surrounding Land Uses and Setting:

Existing land uses on and surrounding the Project site are presented on **Table 1**. As shown on **Table 1**, Surrounding land uses predominately include agricultural uses to the south and east immediately adjacent to the Project site. Agricultural uses are also located north of the Project site, across Ross Road, along with a single family residence, approximately. The Country Life RV Park is located west of the Project site, across SR-111.

TABLE 1. EXISTING LAND USES, ZONE CLASSIFICATION AND GENERAL PLAN DESIGNATION

Direction	Existing Land Uses	Zoning	General Plan
Site	Agriculture	A-2	Agriculture
North	Agriculture	A-2	Agriculture
South	Agriculture	A-2	Agriculture
East	Agriculture	A-2	Agriculture
West	Country Life Mobile Home & RV Park	C-2-U	Urban Areas

The sensitive receptors nearest the Project site include a single family residence located along the north side of Ross Road, approximately 180 feet north of the Project site. Additionally, mobile homes and recreational vehicles within the Country Life Mobil Home and RV Park. Those nearest to the Project site are located approximately 980 feet to the west, across SR-111. Booker T. Washington Elementary is the nearest school site and is located approximately 2.6 miles northeast of the Project site.

12. Other Public Agencies Whose Approval is Required (e.g., permits, financing approval, or participation agreement):

In addition to the General Plan Amendment and Zone Change previously identified, the federal, state and local permits and consultations that may be required for the proposed Project are listed on **Table 2**.

TABLE 2. POTENTIAL CONSULTATION AND PERMITTING REQUIREMENTS

Jurisdiction Level	Type of Permit/Approval	Agency	Purpose
State	Construction Stormwater General Permit (Order No. 2022-0057-DWQ NPDES No. CAS000002 as amended).	RWQCB	Discharges of storm water associated with construction activities
State	Transportation Permit - Oversize/Overweight Vehicles (California Vehicle Code, Division 15, Article 6, Section 35780	Caltrans	Required for oversized and/or overweight truckloads on highways under its jurisdiction that exceed legal load limits
Local	General Plan Amendment to change land use designation from "Agricultural" to "Commercial"	ICPDSD	Required for fueling station.

TABLE 2. POTENTIAL CONSULTATION AND PERMITTING REQUIREMENTS

Jurisdiction Level	Type of Permit/Approval	Agency	Purpose
Local	Change of Zone from A-2 (General Agriculture) to C-3 (Heavy Commercial)	ICPDSD	Required for fueling station.
Local	Conditional Use Permit	ICPDSD	Required underground fuel storage tanks ⁽¹⁾ .
Local	Tentative Parcel Map	ICPDSD	Required to subdivide Assessor's Parcel No. 054-080-023 to create Parcel 1
Local	Encroachment Permit	IID	<ul style="list-style-type: none"> ▪ Required for encroachment into IID canals, drains and electrical rights-of-way; including proposed water line connection to IID Acacia Lateral SA, Gate ACA-51 to obtain surface water. ▪ Required for potential relocation of an electrical pole south side of Ross Road. ▪ The Project must obtain approval from IID for water service from ID canals and electric service from IID's electrical distribution system.
Local	Authority to Construct, Permit to Operate, Permit for New Stationary Source (Rule 207 Review); Rule 403 Permit (Air Contaminants and Fugitive Dust) Rule 415 (Transfer and Storage of Gasoline) Rules 800, 801, 803, 805 (Fugitive Dust Rules)	ICAPCD	<ul style="list-style-type: none"> ▪ Authority to Construct - required prior to constructing any use which may emit air contaminants. ▪ Permit to Operate – required prior to operation of any machine or equipment that emits air contaminants.

(1) Imperial County Code of Ordinances, Title 9, Division 11, Chapter 3, §91103.00.

TABLE 2. POTENTIAL CONSULTATION AND PERMITTING REQUIREMENTS

Jurisdiction Level	Type of Permit/Approval	Agency	Purpose
Local	Building Permits	ICPDSD	<ul style="list-style-type: none"> ▪ New construction on the project site. ▪ Off-Site Noise barrier walls (MM NOI-5).
Local	Grading Permit	ICPDSD/DPW	Excavation or earthwork that involves over 2 feet in depth and/or fills over 1 foot in depth.
Local	Encroachment Permit (Public ROW)	DPW	Required any time work is performed within the public ROW (e.g., curb drains, lane closures, and utility trenches by utility agencies).
Local	Traffic Control Plan	DPW	Traffic management for potential lane closures during construction.
Local	Transportation Permit Overweight Vehicles and Load Permit (Imperial County Code of Ordinances, Chapter 10.12 -Overview Vehicles and Loads)	DPW	Required for oversized and/or overweight truckloads on roads and/or bridges under its jurisdiction that exceed legal load limits
State and Local	Non-Transient Non-Community Public Water System Permit	California Dept. of Public Health, Division of Drinking Water and ICPHD	For on-site potable water treatment system.
Local	On-site Wastewater Treatment System (OWTS) Permit	Imperial County Dept. of Public Health	For construction and operation of the OWTS.

Notes:

Caltrans = California Dept. of Transportation
 DPW = County of Imperial Dept. of Public Works
 ICAPCD = Imperia County Air Pollution Control Dist.

ICPDSD = Imperial County Planning & Development Services Dept.
 ICPHD = Imperial County Public Health Dept.
 IID = Imperial Irrigation District
 RWQCB - Regional Water Quality Control Board, Region 7

13. Native American Consultation: Have California Native American tribes traditionally and culturally affiliated with the project area requested consultation pursuant to Public Resources Code section 21080.3.1?

In compliance with Senate Bill 18 (SB-18; Government Code Section 65352.3), the Imperial County Planning & Development Services Department sent letters to 29 federally recognized California Native American Tribes and/or tribal representatives providing notification of the Project and an invitation to participate in consultation. By law, tribes have 90 days from the date of receipt of the notice to request consultation (Government Code 65352.3(a)(2)). As of the date of this Initial Study, one request for consultation under SB-18 has been received from the Aqua

Caliente Band of Cahuilla Indians. The Viejas Band of Kumeyaay Indians also responded to the County's letter, but did not request formal consultation.

In compliance with Assembly Bill 52 (Chapter 532, Statutes 2014), the Imperial County Planning & Development Services Department sent letters to those tribes who had previously requested notification of projects within their area of traditional and cultural affiliation. Specifically, the ICPDSD sent AB-52 consultation letters to the Campo Band of Mission Indians and the Quechan Indian Tribes on September 21, 2023, providing notification of the Project and an invitation to participate in consultation. Under AB-52, California Native American Tribes have 30 days from the date of receipt of the notice to request consultation. As of the date of this Initial Study, no requests for consultation under AB-52 have been received.

ENVIRONMENTAL FACTORS POTENTIALLY AFFECTED:

The environmental factors checked below would be potentially affected by this project, involving at least one impact that is a "Potentially Significant Impact" as indicated by the checklist on the following pages.

- | | | |
|---|--|--|
| <input type="checkbox"/> Aesthetics | <input checked="" type="checkbox"/> Agriculture and Forestry Resources | <input checked="" type="checkbox"/> Air Quality |
| <input checked="" type="checkbox"/> Biological Resources | <input checked="" type="checkbox"/> Cultural Resources | <input type="checkbox"/> Energy |
| <input checked="" type="checkbox"/> Geology /Soils | <input type="checkbox"/> Greenhouse Gas Emissions | <input type="checkbox"/> Hazards & Hazardous Materials |
| <input checked="" type="checkbox"/> Hydrology / Water Quality | <input type="checkbox"/> Land Use / Planning | <input type="checkbox"/> Mineral Resources |
| <input checked="" type="checkbox"/> Noise | <input type="checkbox"/> Population / Housing | <input type="checkbox"/> Public Services |
| <input type="checkbox"/> Recreation | <input checked="" type="checkbox"/> Transportation/Traffic | <input checked="" type="checkbox"/> Tribal Cultural Resources |
| <input checked="" type="checkbox"/> Utilities / Service Systems | <input type="checkbox"/> Wildfire | <input checked="" type="checkbox"/> Mandatory Findings of Significance |

ENVIRONMENTAL EVALUATION COMMITTEE (EEC) DETERMINATION

After Review of the Initial Study, the Environmental Evaluation Committee has:

- Found that the proposed project COULD NOT have a significant effect on the environment, and a NEGATIVE DECLARATION will be prepared.
- Found that although the proposed project could have a significant effect on the environment, there will not be a significant effect in this case because revisions in the project have been made by or agreed to by the project proponent. A MITIGATED NEGATIVE DECLARATION will be prepared.
- Found that the proposed project MAY have a significant effect on the environment, and an ENVIRONMENTAL IMPACT REPORT is required.
- Found that the proposed project MAY have a "potentially significant impact" or "potentially significant unless mitigation incorporated" impact on the environment, but at least one effect 1) has been adequately analyzed in an earlier document pursuant to applicable legal standards, and 2) has been addressed by mitigation measures based on the earlier analysis as described on attached sheets. An ENVIRONMENTAL IMPACT REPORT is required, but it must analyze only the effects that remain to be addressed.
- Found that although the proposed project could have a significant effect on the environment, because all potentially significant effects (a) have been analyzed adequately in an earlier Final EIR pursuant to applicable standards, and (b) have been avoided or mitigated pursuant to that earlier Final EIR, including revisions or mitigation measures that are imposed upon the proposed project, nothing further is required.

CALIFORNIA DEPARTMENT OF FISH AND WILDLIFE DE MINIMIS IMPACT FINDING: Yes No

EEC VOTES	YES	NO	ABSENT
PUBLIC WORKS	<input checked="" type="checkbox"/>	<input type="checkbox"/>	<input type="checkbox"/>
ENVIRONMENTAL HEALTH SVCS	<input checked="" type="checkbox"/>	<input type="checkbox"/>	<input type="checkbox"/>
OFFICE EMERGENCY SERVICES	<input checked="" type="checkbox"/>	<input type="checkbox"/>	<input type="checkbox"/>
APCD	<input checked="" type="checkbox"/>	<input type="checkbox"/>	<input type="checkbox"/>
AG	<input checked="" type="checkbox"/>	<input type="checkbox"/>	<input type="checkbox"/>
SHERIFF DEPARTMENT	<input checked="" type="checkbox"/>	<input type="checkbox"/>	<input type="checkbox"/>
ICPDS	<input checked="" type="checkbox"/>	<input type="checkbox"/>	<input type="checkbox"/>



 Jim Minnick, Director of Planning/EEC Chairman

4-25-2024

 Date:

PROJECT SUMMARY

Maverik™ (Applicant) is proposing to develop a fueling station and convenience store on 10 gross acres of an approximately 50-acre parcel within unincorporated Imperial County (County), California, approximately 1.5 miles east of the City of El Centro (**Figure 1, Regional Location**). The Maverik Fueling Station and Convenience Store Project (proposed Project or Project) site is located on the southeast corner of Hawes Road and Ross Road, east of State Route 111 (SR-111/Imperial Valley Pioneers Expressway) and is bound by Ross Road on the north, by Hawes Road and the Imperial Irrigation District's Acacia Five Drain A on the west (**Figure 2, Project Site**). The Project site is located on Assessor's Parcel Number (APN) 054-080-023 within Section 11 of Township 16 South, Range 14 East, San Bernardino Base Meridian. The westbound offramp of Interstate 8 at SR-111 is located approximately 0.25 miles south of the Project site.

The Project includes up to 19 fuel pumps (38 fueling positions) under two separate canopies (totaling 9,000 square feet [SF]), and a 5,982 SF convenience store building. Additional improvements include three (3) underground storage tanks (USTs) for fuel storage; two underground water storage tanks; on-site water and wastewater treatment facilities; parking, landscaping, drainage, and access improvements.

A General Plan Amendment to change the Project site's land use designation from "Agriculture" to "Urban Area"; as well as a Zone Change, to change zoning from A-2 (General Agricultural) to C-3 (Heavy Commercial) are also proposed (See **Figures 3 and 4**). A tentative parcel map is proposed to separate the Maverik Fueling Station and Convenience Store site from the balance of the parcel (**Figure 5, Proposed Tentative Map**).

Site Characteristics

The Project site is located at an elevation of approximately 36 feet below mean seal level (MSL) and slopes gently toward the west. The Project site has previously been used for agricultural purposes since at least 1937 and is currently an undeveloped alfalfa field (Cardno, 2021, Appendix H). According to the most recent California Department of Conservation Farmland Mapping and Monitoring Program (FMMP) the Project site is entirely comprised of Prime Farmland (P) and is not subject to a Williamson Act contract (California Dept. of Conservation., 2023a and 2023b). Surrounding uses include agricultural uses, with ancillary residential structures north and south of the Project site. Additionally, the Country Life RV and Mobile Home Park are located west of the Project, across SR-111.

Project Features

Gas Station and Convenience Store

The proposed Project would consist of the development of an 18-vehicle fueling position fueling station with two canopies that total 9,000 SF and a 5,982 SF convenience store. The fueling station would provide a combined maximum throughput of 8.5 million gallons of gasoline, diesel and biofuel annually. The Proposed Site Plan, Floor Plan and Roof Plan are shown on **Figures 6, Figure 7 and Figure 8**, respectively.

Fuel storage would be located between the Fuel Canopy A and the convenience store. Fuel tanks include a 40,000-gallon unleaded tank and a 40,000-gallon split tank that would contain 16,000-gallons of bio-diesel; 16,000-gallons of premium gasoline; and 8,000 gallons of DEF diesel additive. A 40,000-gallon diesel fuel tank would also be provided.

The proposed design of the convenience store is presented on **Figure 9, Building Perspectives**. The convenience store building would be 20' to the top of the parapet, and 29'1" to the top of the roof (See **Figures 10a and 10b, Building Elevations**). Roof top equipment would be screened by elevated and variable height parapets. The front elevation of the convenience store would face the fuel dispensing canopy, Hawes Road and SR-111 and contains the store's primary entrance. The architecture of the proposed building features clean lines and varied parapet heights with materials that include glass, fiber board and cultured stone (**Figure 11, Exterior Materials Board**).

The fueling station canopy will exhibit a clearance height of 16' and a maximum height of 19'3" above grade (**Figure 12, Fuel Dispensing Canopy Elevations**). Materials of the canopy are proposed to consist of textured cement, painted plaster and finished with neutral tones and colors.

Site Access and Parking

Vehicular access would be provided via three (3) ingress/egress drives along the south side of Ross Road. The westernmost access would be a 40-foot driveway that would allow for a left-and right-turn movements by vehicles accessing the fueling area and convenience store (Figure 6, Site Plan). This entrance would be located approximately 215 feet east of the Ross Road/SR-111 intersection. The second proposed entrance would be located approximately 150 feet east of the first and would provide a 60-foot inbound/outbound driveway leading directly to the proposed truck fueling stations. The third and easternmost driveway would be located 220 feet east of the second and would provide a 50-foot driveway that would permit the full range of left and right-turn movements, inbound and outbound. All driveways entrances would be constructed in accordance with the County's Road Standards. No direct access Hawes Road is proposed.

Parking would be provided in three (3) parking areas for a total of 45-parking spaces, including 2 accessible spaces. No overnight parking would be allowed and parking within the fueling area would be limited to 30 minutes.

Landscaping, Lighting and Signage

The Project would provide landscaping, including trees, shrubs and groundcover, throughout the site as shown on **Figure 13, Preliminary Landscape Plan**, to meet the requirements of Section 90302.04 of the Imperial County Code of Ordinances. The specific trees and shrubs proposed for the Project are listed in **Table 3**. All proposed landscaping would be irrigated with a drip irrigation system for maximum efficiency and the which would meet Model Water Efficient Landscape Ordinance (MWELo) standards in compliance with Section 8.72A.110 of the Imperial County Code of Ordinances. The proposed planting palette consists of low water use species.

TABLE 3. PROPOSED ORNAMENTAL LANDSCAPE SPECIES

Botanical Name	Common Name
Tree Species	
<i>Parkinsonia Aculeata</i>	Mexican Palo Verde Tree
<i>Chilopsis Linearis Spp</i>	Arts Seedless' - Desert Willow
Shrubs	
<i>Agave Americana 'Mediopicta</i>	Yellow Stripe (5 Gallon)
Hesperaloe Parviflora - Yellow Yucca	Purple Hopseed Bush
<i>Muhlenbergia Rigens</i>	Deer Grass

TABLE 3. PROPOSED ORNAMENTAL LANDSCAPE SPECIES

Botanical Name	Common Name
<i>Leucophyllum Frutescens</i> "Green Cloud"	Green Coud Texas Ranger (5 Gallon)
<i>Agave Parryi</i>	Pary's Agave (3 Gallon)
<i>Fouquieria Spondiensi</i>	Ocotillo (3 Gallon)
<i>Senna Nemophila</i>	Sienna (5 Gallon)

Source: Maverik, 2023.

The Project would provide lighting for security and safety throughout the site. Adequate lighting would be provided along the driveways, under the fuel canopies and outside the convenience store. On-site lighting would be designed in compliance with the County's standards for developments within commercial and industrial zones (Title 9 – Land Use Code, Division 3, Chapter 1, Section 908301.02). Light fixtures would be shielded to prevent spill over property lines, with heightened sensitivity at the residential-facing property lines.

Project signage would include a 24' pylon/pole sign with a maximum area of 200 SF per side (Imperial County Land Use Code, Division 4, Chapter 1, Section 90401.02); a 6' monument sign with a maximum area of 48 SF (Imperial County Land Use Code, Division 4, Chapter 1, Section 90401.01); and a freeway pylon/pole sign.

Wastewater Treatment

Sewer service is not available at the Project site, therefore, the Project includes installation of a onsite wastewater treatment system (OWTS). Specifically, the Project includes construction and operation of an on-site Advantex® "AX-Max" wastewater treatment system by Orenco or an approved equivalent. The proposed OWTS would have a design capacity to treat 3,500 gallons of wastewater per day ⁽²⁾. Details of the proposed wastewater treatment system are shown on **Figure 14, Wastewater Treatment Design Details**.

Water Treatment and Water Supply

Based on information supplied by Site Design Collaborative (SDC), the proposed Project is expected to require potable water at a rate of approximately 3,280.5 gallons per day (gpd) which equates to 3.677 acre-feet per year (AFY), including 4,448 gpd for landscaping (4.99 AFY) for a total of 8.67 AFY. The Applicant proposes to construct and operate a potable water treatment system to provide water solely for on-site use. Water would be obtained from IID's Acacia Lateral 5A (Gate ACA_51G); brought to the Project site via an underground pipeline beneath Ross Road; and, treated via a filtration, reverse osmosis (RO) or a comparable State-approved potable water treatment system meeting all the requirements of the Surface Water Treatment Rule (California Code of Regulations, Title 22, Division 4, Chapter 17, §64650 through §64666).

(2) Pursuant to Imperial County Code of Ordinances, Title 8, Chapter 8.8 Onsite Wastewater Treatment Systems, §8.80.040.D(1), the Imperial County Public Health Department has authority and approval over OWTS with design flows up to 5,000 gallons per day.

Treated water would be stored in a 25,000-gallon underground water tank (30' in diameter) located near the western edge of the Project site (**Figure 6, Proposed Site Plan**). A 180,000-gallon underground water tank (50' in diameter) would be installed in this same area for fire protection.

Storm Drainage

The Project would install a bioretention basin along the western border of the site, adjacent to the IID Acacia Drain and Hawes Road (**Figure 15, Utility Plan**). The approximately 18,500 SF bioretention basin would be designed to drain within 72 hours and would treat water before it is released into the IID's Acadia Drain. Storm drain catch basins, associated piping, and down spout connections to storm drain pipes would be installed throughout the site to route runoff to the bioretention basin.

Electrical and Natural Gas Services

Electric service would be provided to the Project site by the IID via the overhead electrical lines located along the south side of Ross Road. As shown on **Figure 15, Utility Plan**, a single power pole is located along the south side of Ross Road. This pole may be relocated approximately 40 feet to the east to facilitate installation of the Project's easternmost driveway; or electrical services may be provided to the Project site from the poles existing location.

Natural gas service is not available at the Project site and therefore the use of propane is proposed. The Project would contract with third party utility companies for other utilities like telecom, internet etc.

Solid Waste Disposal Services

The Project would construct a new trash enclosure that would be located within the center of the site, south of the convenience store. The Project site would be served by Republic Services which provides solid waste collection, disposal, recycling and yard waste services for businesses and residences in Imperial County. Solid waste from the Project would be taken to the Allied Imperial Landfill, which accepts Class III (municipal) waste at its facility located 5.25 mile northeast of the Project site.

Construction and Grading

Construction for the Project is anticipated to last approximately six (6) to eight (8) months. All construction staging would occur within the bounds of the Project site. Grading and excavation would be required to create level buildings pads, as well as for installation of canopy footings, USTs, product piping, stormwater improvements, and utilities (**Figure 16, Grading Plan**). USTs would require excavation to depths of approximately 18 feet and would be installed with 5 to 7 feet of cover.

Operations

The Maverik Fueling Station and Convenience store would operate 24 hours a day, 365 days a year. The fueling pumps will dispense unleaded, diesel and biodiesel fuels that will be available from multi-product fuel dispensers. The convenience store would be staffed with 15 staff persons across three (3) daily shifts.

Operation of the fuel station is anticipated to require daily delivery of fuel that would typically occur outside of peak hour traffic (in the early morning, late evening, or mid-day). Fuel delivery takes approximately 30 minutes. Truck idling would be limited to less than 5 minutes. The delivery truck would align parallel to the USTs to avoid conflict with fuel dispensing activity and not interfere with vehicle queuing.

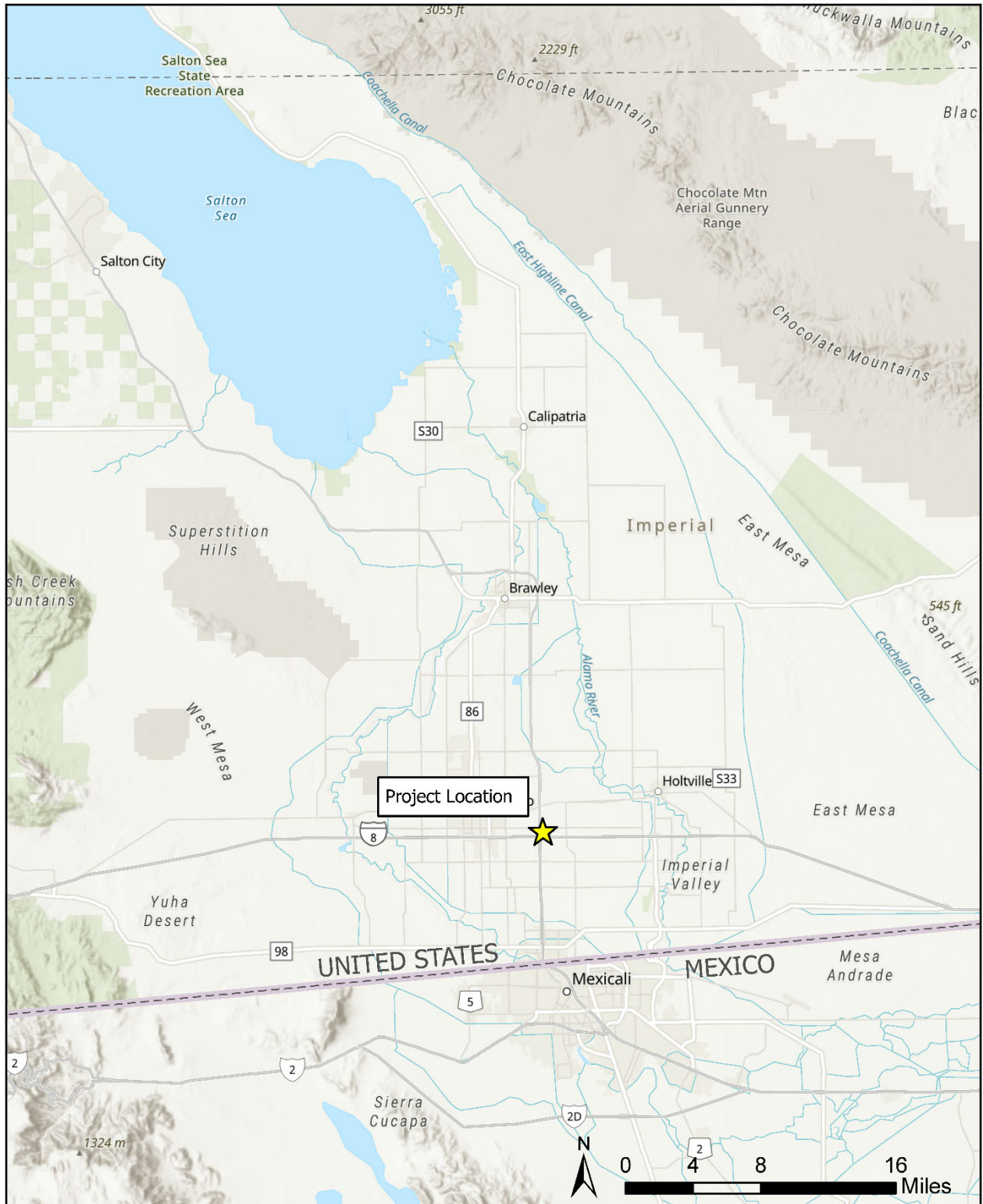

Source: Esri, 2023.



Regional Location
 Maverik Fueling Station Project GPA22-0002/ZC22-0002
 Figure 1

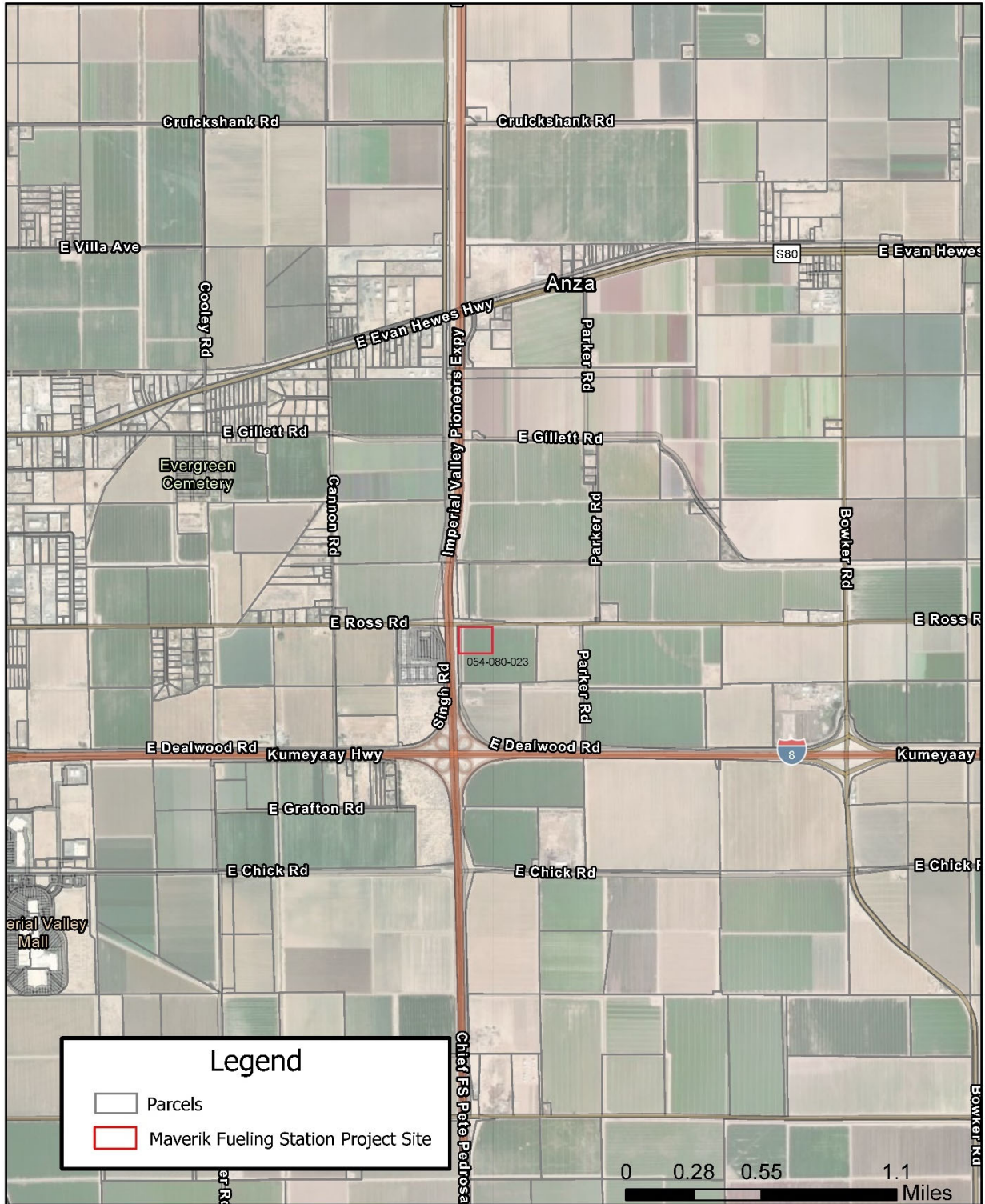

Source: Esri, 2023.



Project Site
 Maverik Fueling Station Project GPA22-0002/ZC22-0002
 Figure 2

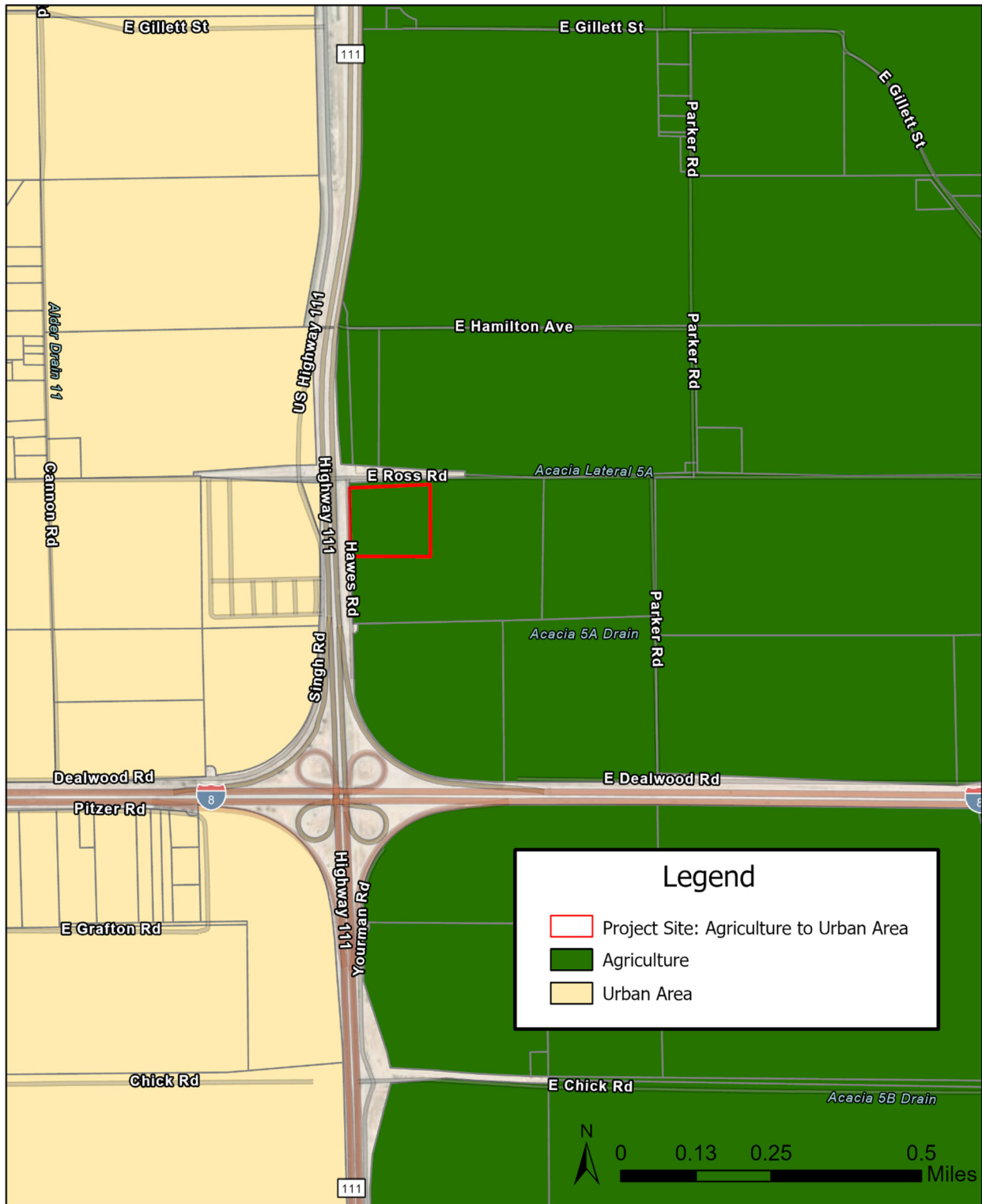

Proposed General Plan Amendment
 Maverik Fueling Station Project GPA22-0002/ZC22-0002
 Figure 3

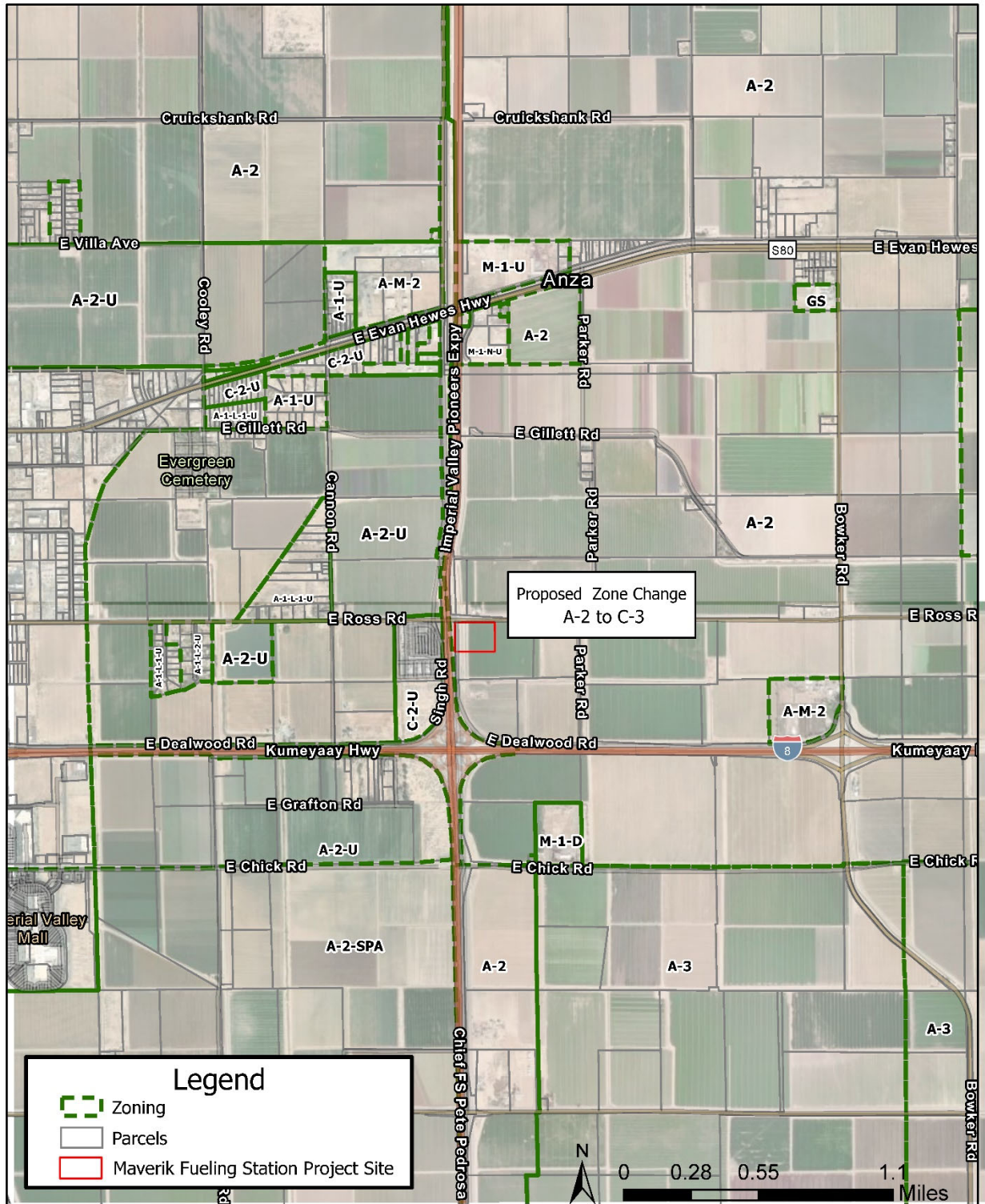

Source: Esri, 2023; Imperial County, 2023.



Proposed Zone Change
 Maverik Fueling Station Project GPA22-0002/ZC22-0002
 Figure 4

TENTATIVE PARCEL MAP NO. _____

PORTION OF LOT 3 OF SECTION 11, AND THE NE 1/4 OF THE NW 1/4 OF SECTION 11, T16S, R14E, S.B.M.
IN THE COUNTY OF IMPERIAL, CALIFORNIA

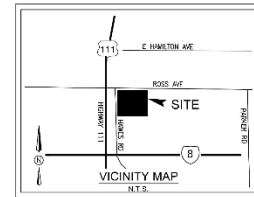
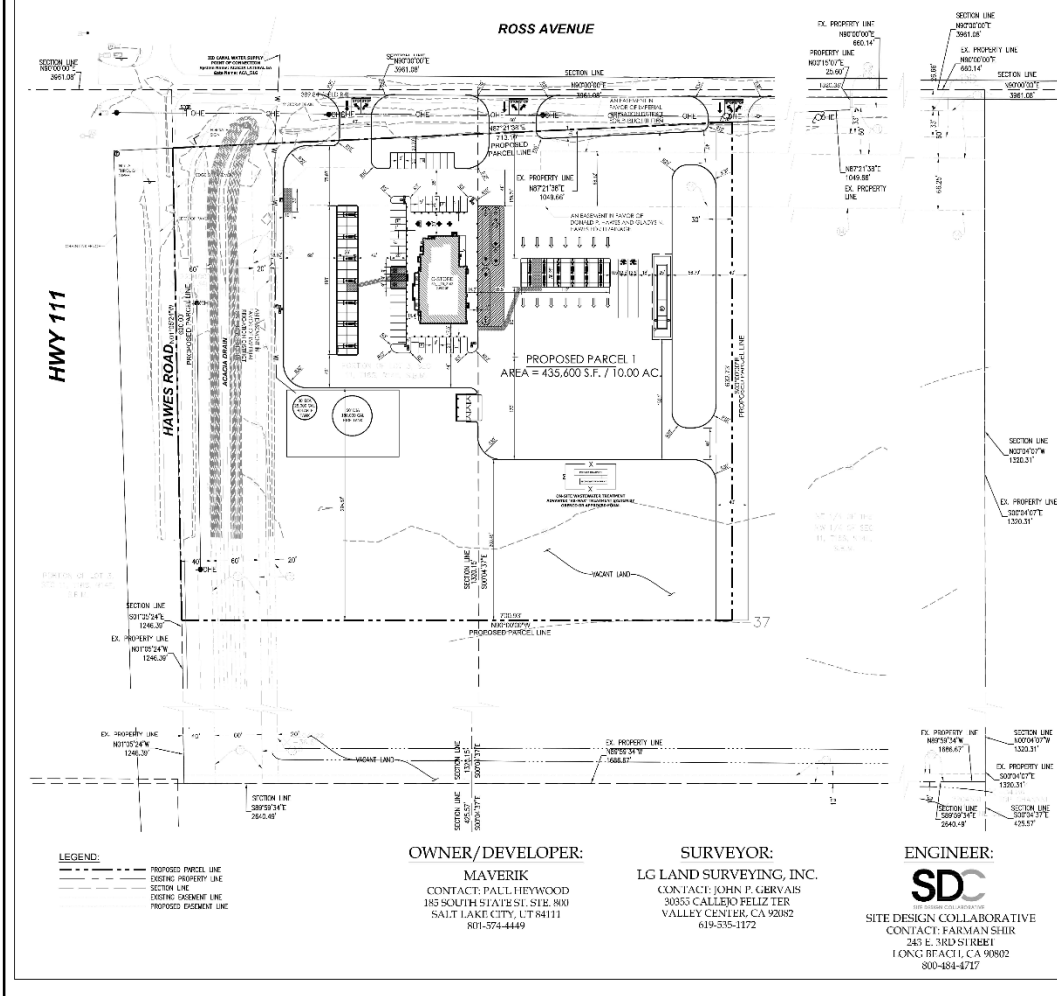

ASSESSOR PARCEL NO.:
054-080-023

LEGAL DESCRIPTION:
THE LAND REFERRED TO HEREIN BELOW IS SITUATED IN THE UNINCORPORATED AREA OF COUNTY OF IMPERIAL, STATE OF CALIFORNIA, AND IS DESCRIBED AS FOLLOWS:
PARCEL 1, THE NORTHWEST QUARTER OF THE NORTHWEST QUARTER OF SECTION 11, TOWNSHIP 16 SOUTH, RANGE 14 EAST, 3RD MERIDIAN (3RD AND 4TH) IN THE COUNTY OF IMPERIAL, STATE OF CALIFORNIA, ACCORDING TO THE OFFICIAL PLAT OF SURVEY APPROVED AND ON FILE IN THE U.S. LAND OFFICE, WASHINGTON, D.C., THAT PART OF LOT 3 IN SECTION 11, TOWNSHIP 16 SOUTH, RANGE 14 EAST, S.B.M., IN THE COUNTY OF IMPERIAL, STATE OF CALIFORNIA, ACCORDING TO THE UNITED STATES GOVERNMENT OFFICIAL PLAT OF SURVEY APPROVED AND ON FILE IN THE UNITED STATES LAND OFFICE, WASHINGTON, D.C., BEING EAST OF THE CENTER LINE IN THE COUNTY OF IMPERIAL.

UTILITY:
SEWER AND SANITATION: IMPERIAL COUNTY ENVIRONMENTAL HEALTH 701 MAIN ST., SUITE B EL CAHON, CA 92543 (442) 260-1888
PORTABLE & IRRIGATION WATER: IMPERIAL IRRIGATION DISTRICT 323 F BARON BLVD, IMPERIAL, CA 92251 (805) 360-7756
ELECTRIC: IMPERIAL IRRIGATION DISTRICT 1245 BRADWAY EL CAHON, CA 92543 (805) 333-7756
FIRE DEPARTMENT: IMPERIAL COUNTY FIRE DEPARTMENT 1018 EASTERN BLVD, SUITE 121 HOBOKA, CA 92544 (442) 260-8000

PUBLIC WORK:
125.5' TIE-TO 22' 22' 128' IN. OR 22243 (442) 260-1918

TITLE EXCEPTIONS/EXCLUSIONS:
9. A RIGHT OF WAY FOR STREETS AND CANALS AS RESERVED BY THE UNITED STATES OF AMERICA IN THE PLAT MAP RECORDED JANUARY 20, 1934 AS BOOK 576, PAGE 484 OF OFFICIAL RECORDS, BLANKET NOT PLOTTED HEREON.
10. AN EASEMENT IN FAVOR OF IMPERIAL IRRIGATION DISTRICT FOR PUBLIC UTILITIES AND INCIDENTAL PURPOSES, RECORDED OCTOBER 8, 1941 AS BOOK 576, PAGE 418 OF OFFICIAL RECORDS, NOT PLOTTED INFORMATION TO PLOT. APPROXIMATE LOCATION PER CALTRANS 10 MAP 75196 (14) PLOTTED HEREON.
11. AN EASEMENT IN FAVOR OF IMPERIAL IRRIGATION DISTRICT FOR PUBLIC UTILITIES AND INCIDENTAL PURPOSES, RECORDED JANUARY 20, 1934 AS BOOK 576, PAGE 484 OF OFFICIAL RECORDS, NOT PLOTTED INFORMATION TO PLOT. APPROXIMATE LOCATION PER CALTRANS 10 MAP 75196 (14) PLOTTED HEREON.
12. AN EASEMENT IN FAVOR OF IMPERIAL IRRIGATION DISTRICT FOR PUBLIC UTILITIES AND INCIDENTAL PURPOSES, RECORDED JANUARY 20, 1934 AS BOOK 576, PAGE 418 OF OFFICIAL RECORDS, NOT PLOTTED INFORMATION TO PLOT. APPROXIMATE LOCATION PER CALTRANS 10 MAP 75196 (14) PLOTTED HEREON.
13. AN EASEMENT IN FAVOR OF IMPERIAL IRRIGATION DISTRICT FOR PUBLIC UTILITIES AND INCIDENTAL PURPOSES, RECORDED JANUARY 20, 1934 AS BOOK 576, PAGE 418 OF OFFICIAL RECORDS, NOT PLOTTED INFORMATION TO PLOT. APPROXIMATE LOCATION PER CALTRANS 10 MAP 75196 (14) PLOTTED HEREON.
14. AN EASEMENT IN FAVOR OF DONALD P. HAYES AND GLADYS H. HAYES FOR DRAINAGE AND INCIDENTAL PURPOSES, RECORDED JULY 23, 1954 AS BOOK 890, PAGE 254 OF OFFICIAL RECORDS, PLOTTED HEREON.
15. THE TERMS AND PROVISIONS CONTAINED IN THE DOCUMENT ENTITLED "IMPERIAL COUNTY PROPERTY AGREEMENT" RECORDED MAY 4, 1976 AS BOOK 1386, PAGE 1428 OF OFFICIAL RECORDS, BLANKET NOT PLOTTED HEREON.
16. THE TERMS AND PROVISIONS CONTAINED IN THE DOCUMENT ENTITLED "PROPOSED JOINT VENTURE AGREEMENT BETWEEN BILL AND CAROL BROWNSHAW AND CHARLES AND FREDERICK GOSWOLD" RECORDED SEPTEMBER 24, 1993 AS INSTRUMENT NO. 1993-28262, IN BOOK 7143, PAGE 1761 OF OFFICIAL RECORDS, NOT A MATTER OF SURVEY.
17. THE TERMS AND PROVISIONS CONTAINED IN THE DOCUMENT ENTITLED "PROPOSED JOINT VENTURE AGREEMENT BETWEEN BILL AND CAROL BROWNSHAW AND CHARLES AND FREDERICK GOSWOLD" RECORDED SEPTEMBER 24, 1993 AS INSTRUMENT NO. 1993-28262, IN BOOK 7143, PAGE 1761 OF OFFICIAL RECORDS, NOT A MATTER OF SURVEY.
18. THE EFFECT OF A DOCUMENT ENTITLED "QUIT DEED 'JELLY'" RECORDED JULY 28, 2013 AS INSTRUMENT NO. 2013-014927 OF OFFICIAL RECORDS, NOT A MATTER OF SURVEY.
19. THE EFFECT OF A DOCUMENT ENTITLED "QUIT DEED 'JELLY'" RECORDED AUGUST 06, 2013 AS INSTRUMENT NO. 2013-014928 OF OFFICIAL RECORDS, NOT A MATTER OF SURVEY.

CURRENT ZONING:
A-2, AGRICULTURAL

FLOOD ZONE:
PROPERTY IS IN ZONE X, AREA OF MINIMAL FLOOD HAZARD PER FEMA MAPS 600251755C & SHEETS 755C; EFFECTIVE ON 03/29/2008.

LEGEND:
--- PROPOSED PARCEL LINE
- - - - - EXISTING PROPERTY LINE
- - - - - SECTION LINE
- - - - - EXISTING EASEMENT LINE
- - - - - PROPOSED EASEMENT LINE

OWNER/DEVELOPER:
MAVERIK
CONTACT: PAUL HEYWOOD
185 SOUTH STATE ST., STE. 400
SALT LAKE CITY, UT 84111
801-574-4449

SURVEYOR:
LG LAND SURVEYING, INC.
CONTACT: JOHN P. GARVAIS
30355 CALLEO FELIZ TER
VALLEY CENTER, CA 92082
619-535-1172

ENGINEER:
SDC
SITE DESIGN COLLABORATIVE
CONTACT: FARMAN SHIR
241 E. 3RD STREET
LONG BEACH, CA 90802
800-484-4717

FILED IN & COMMERCIAL CENTER	FILED IN & COMMERCIAL CENTER
ROSS AVENUE & INTERSTATE 8	ROSS AVENUE & INTERSTATE 8
SECTION 11	SECTION 11
COUNTY OF IMPERIAL	COUNTY OF IMPERIAL
TENTATIVE PARCEL MAP	TENTATIVE PARCEL MAP
NO.	NO.
SHEET NO.	SHEET NO.
1	1
DATE	DATE
PREPARED BY	PREPARED BY
2425 E. 3RD STREET	2425 E. 3RD STREET
LONG BEACH, CA 90802	LONG BEACH, CA 90802
PHONE: (562) 431-2000	PHONE: (562) 431-2000
FAX: (562) 431-2001	FAX: (562) 431-2001
WWW.SDC-ENGINEERS.COM	WWW.SDC-ENGINEERS.COM

Source: SDC, 2023

Proposed Tentative Map
Maverik Fueling Station Project GPA22-0002/ZC22-0002
Figure 5



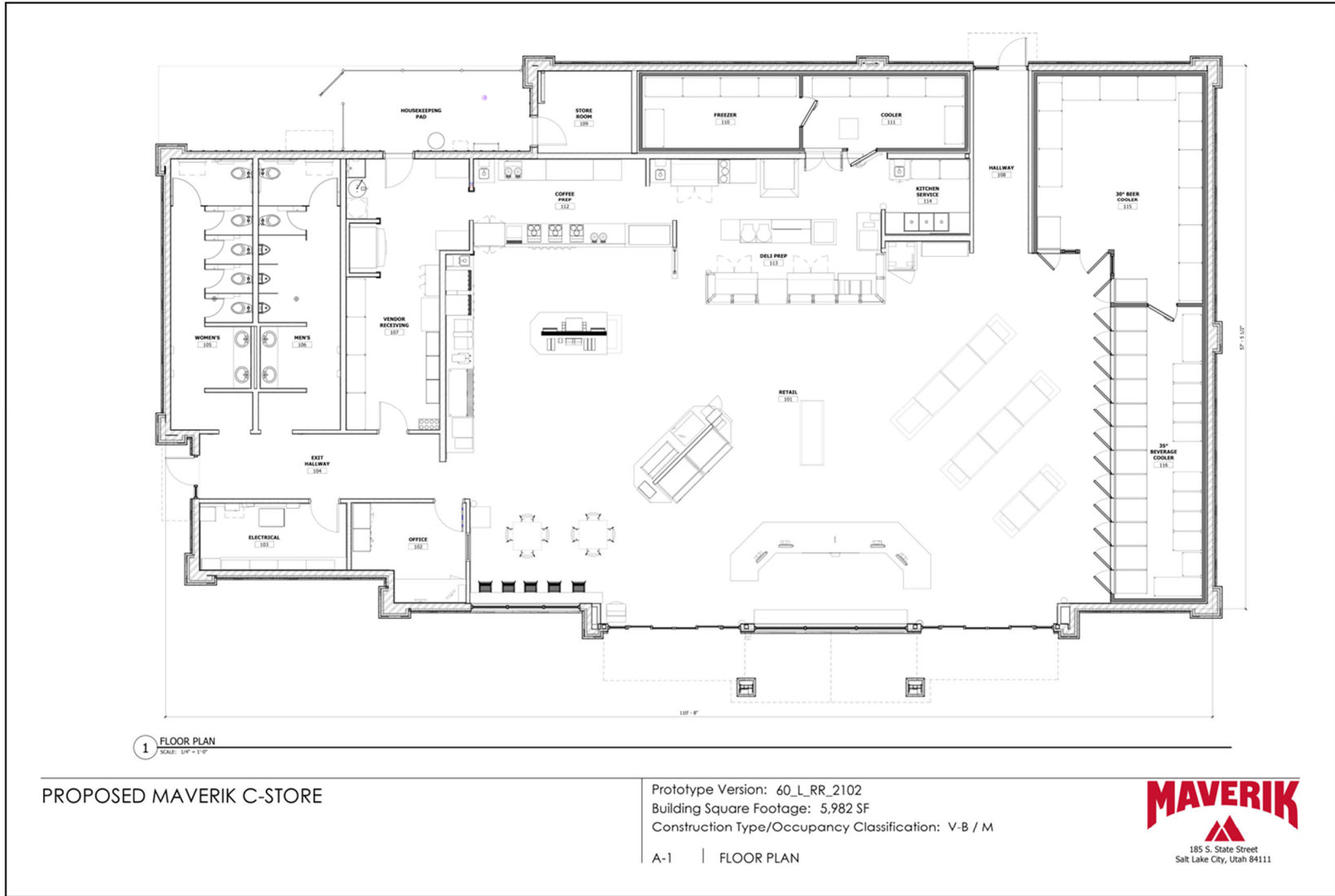

Source: Maverik, 2023



Floor Plan
Maverik Fueling Station Project GPA22-0002/ZC22-0002
Figure 7

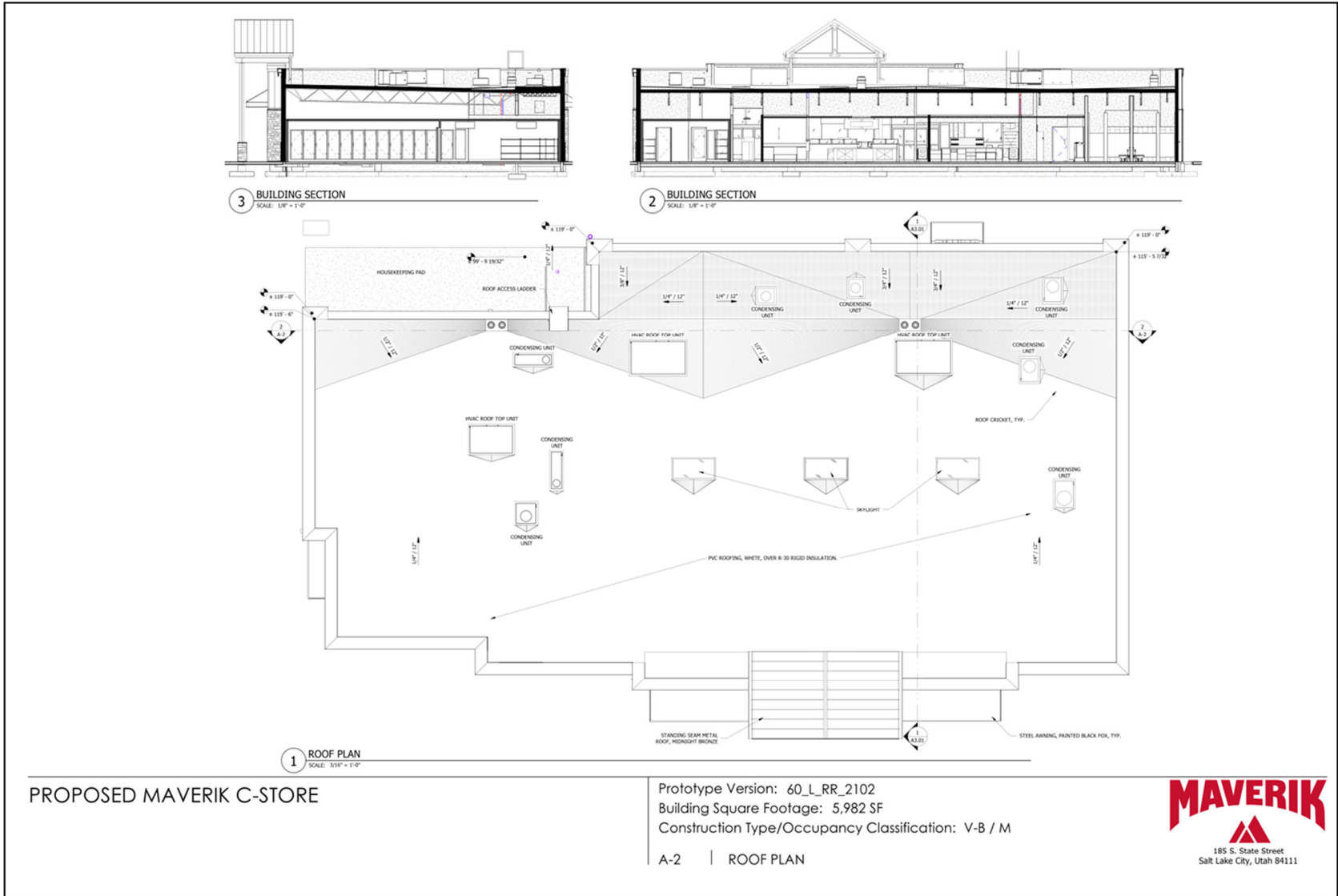

Source: Maverik, 2023



Floor Plan
 Maverik Fueling Station Project GPA22-0002/ZC22-0002
 Figure 8



2 FRONT PERSPECTIVE - FRONT LEFT
SCALE:



1 BUILDING PERSPECTIVE - FRONT RIGHT
SCALE:

PROPOSED MAVERIK C-STORE

Prototype Version: 60_L_RR_2102
 Building Square Footage: 5,982 SF
 Construction Type/Occupancy Classification: V-B / M
 A-3 | PERSPECTIVE VIEWS



Source: Maverik, 2023



Building Perspectives
 Maverik Fueling Station Project GPA22-0002/ZC22-0002
 Figure 9



Source: Maverik, 2023



Building Elevations—Left and Front
 Maverik Fueling Station Project GPA22-0002/ZC22-0002
 Figure 10a

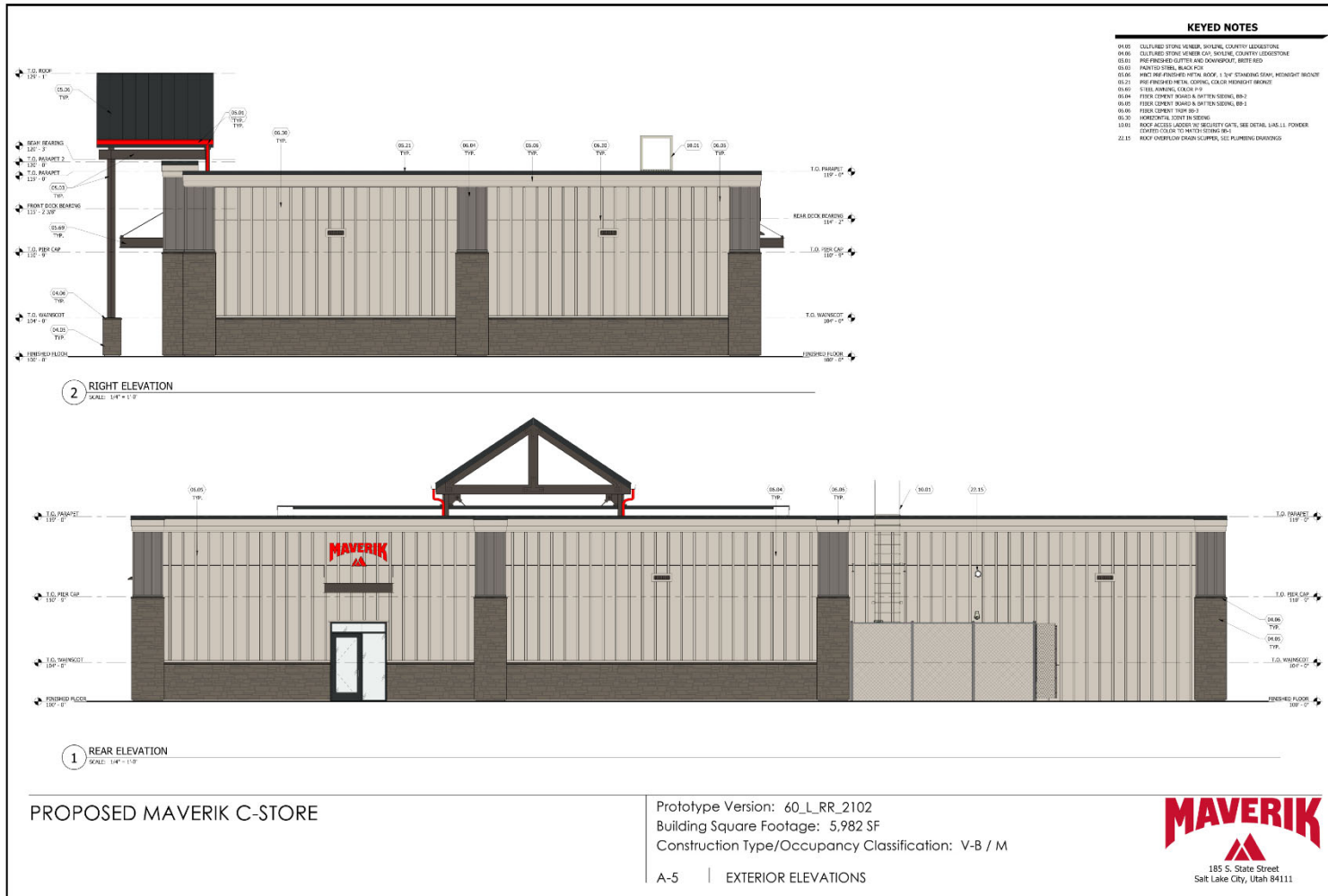

Source: Maverik, 2023



Building Elevations— Right and Rear
Maverik Fueling Station Project GPA22-0002/ZC22-0002
Figure 10b

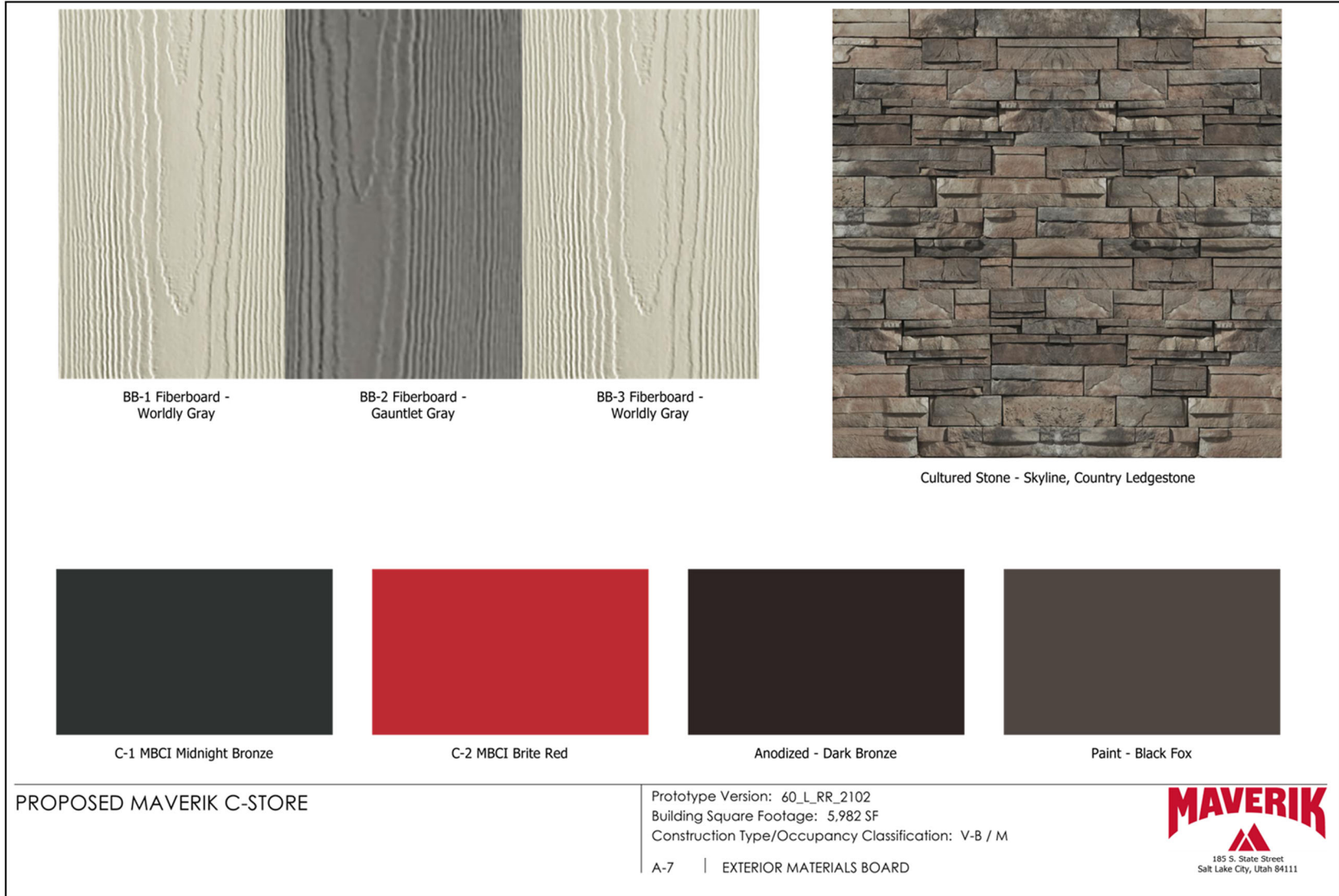

Source: Maverik, 2023



Exterior Material Board
 Maverik Fueling Station Project GPA22-0002/ZC22-0002
 Figure 11

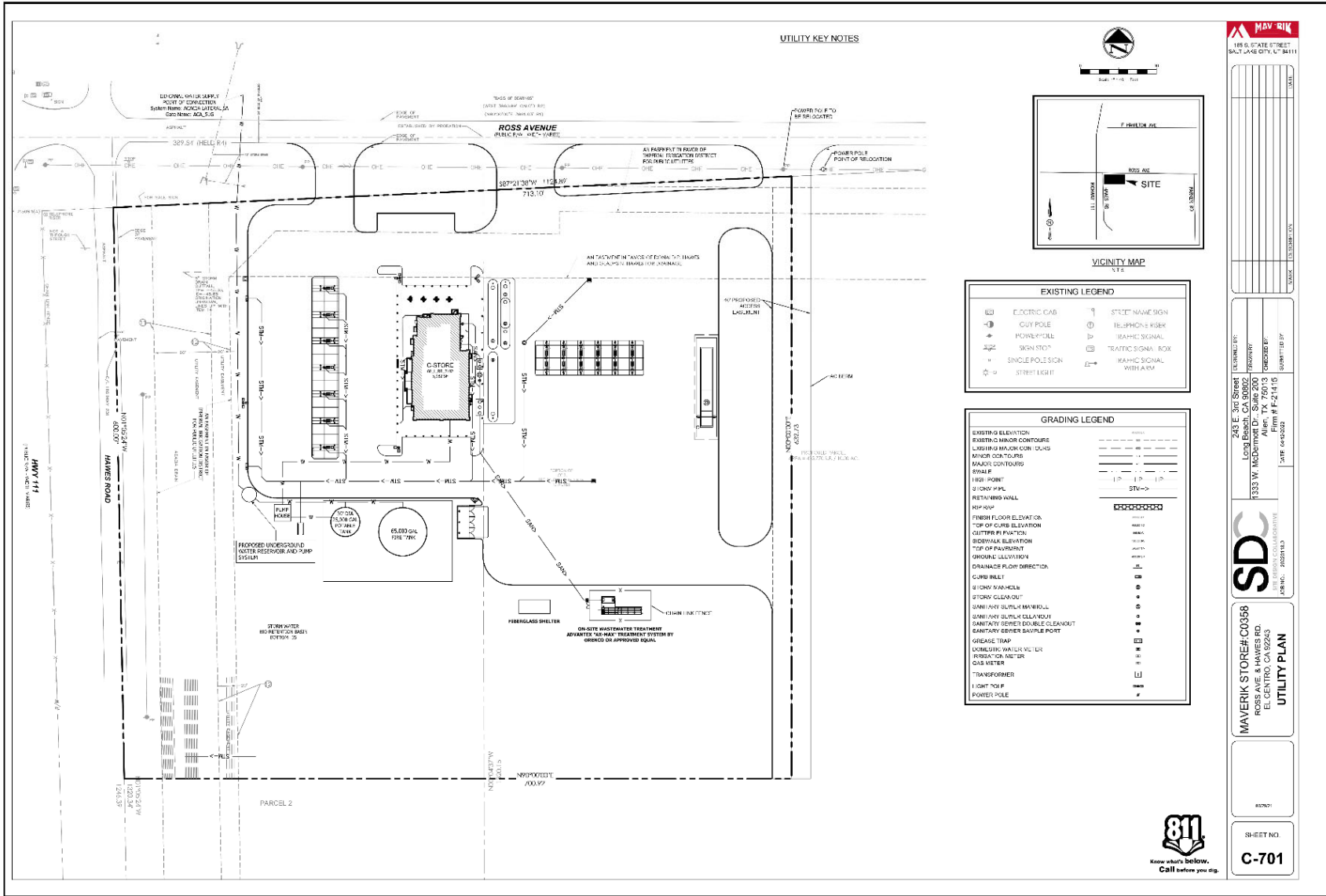

Source: SDC 12-30-23



Utility Plan
Maverik Fueling Station Project GPA22-0002/ZC22-0002
Figure 15

EEC ORIGINAL PKG

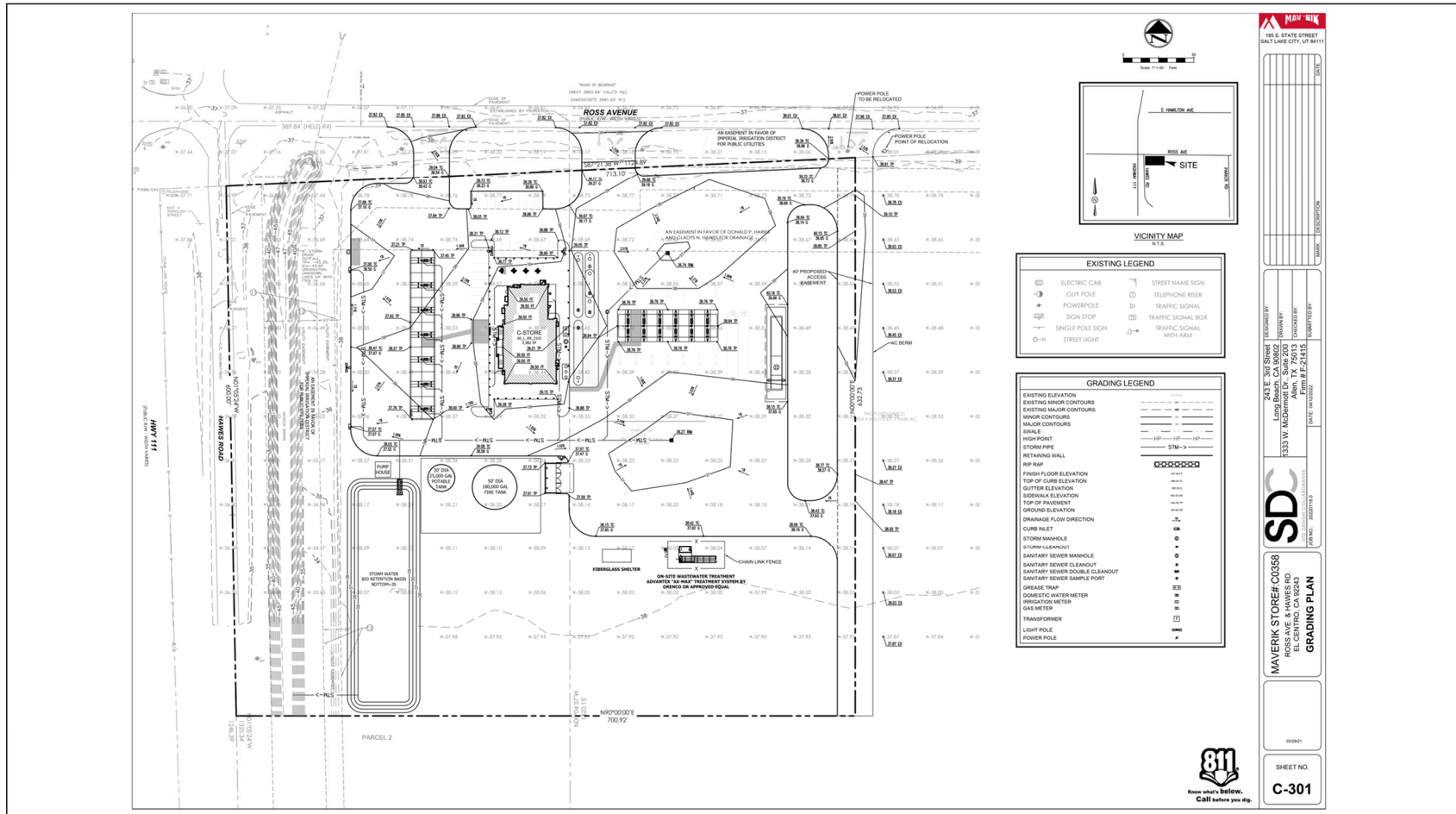

Source: Maverik, 2023



Preliminary Grading Plan
 Maverik Fueling Station Project GPA22-0002/ZC22-0002
 Figure 16

This page intentionally left blank.

EVALUATION OF ENVIRONMENTAL IMPACTS:

- 1) A brief explanation is required for all answers except "No Impact" answers that are adequately supported by the information sources a lead agency cites in the parentheses following each question. A "No Impact" answer is adequately supported if the referenced information sources show that the impact simply does not apply to projects like the one involved (e.g., the project falls outside a fault rupture zone). A "No Impact" answer should be explained where it is based on project-specific factors as well as general standards (e.g., the project will not expose sensitive receptors to pollutants, based on a project-specific screening analysis).
- 2) All answers must take account of the whole action involved, including off-site as well as on-site, cumulative as well as project-level, indirect as well as direct, and construction as well as operational impacts.
- 3) Once the lead agency has determined that a particular physical impact may occur, then the checklist answers must indicate whether the impact is potentially significant, less than significant with mitigation, or less than significant. "Potentially Significant Impact" is appropriate if there is substantial evidence that an effect may be significant. If there are one or more "Potentially Significant Impact" entries when the determination is made, an EIR is required.
- 4) "Negative Declaration: Less Than Significant With Mitigation Incorporated" applies where the incorporation of mitigation measures has reduced an effect from "Potentially Significant Impact" to a "Less Than Significant Impact." The lead agency must describe the mitigation measures, and briefly explain how they reduce the effect to a less than significant level (mitigation measures from "Earlier Analyses," as described in (5) below, may be cross-referenced).
- 5) Earlier analyses may be used where, pursuant to the tiering, program EIR, or other CEQA process, an effect has been adequately analyzed in an earlier EIR or [Negative Declaration]. Section 15063(c)(3)(D). In this case, a brief discussion should identify the following:
 - a) Earlier Analysis Used. Identify and state where they are available for review.
 - b) Impacts Adequately Addressed. Identify which effects from the above checklist were within the scope of and adequately analyzed in an earlier document pursuant to applicable legal standards, and state whether such effects were addressed by mitigation measures based on the earlier analysis.
 - c) Mitigation Measures. For effects that are "Less than Significant with Mitigation Measures Incorporated," describe the mitigation measures which were incorporated or refined from the earlier document and the extent to which they address site-specific conditions for the project.
- 6) Lead agencies are encouraged to incorporate into the checklist references to information sources for potential impacts (e.g., general plans, zoning ordinances). Reference to a previously prepared or outside document should, where appropriate, include a reference to the page or pages where the statement is substantiated.
- 7) Supporting Information Sources: A source list should be attached, and other sources used or individuals contacted should be cited in the discussion.
- 8) This is only a suggested form, and lead agencies are free to use different formats; however, lead agencies should normally address the questions from this checklist that are relevant to a project's environmental effects in whatever format is selected.
- 9) The explanation of each issue should identify:
 - a) The significance criteria or threshold, if any, used to evaluate each question; and
 - b) The mitigation measure identified, if any, to reduce the impact to less than significance.

Potentially Significant Impact (PSI)	Less Than Significant with Mitigation Incorporated (LTSWMI)	Less Than Significant Impact (LTSI)	No Impact (NI)
--------------------------------------	---	-------------------------------------	----------------

I. AESTHETICS.

Except as provided in Public Resources Code Section 21099, would the project:

- a) Have a substantial adverse effect on a scenic vista?

a) No Impact. Imperial County includes over 4,597 square miles between Riverside County to the north, Arizona to the east, Mexico to the south, and San Diego County to the west. The County’s visual character varies greatly and includes natural scenic visual resources such as deserts, sand dunes, mountains, and the Salton Sea. Visual character within Imperial County is defined as low, moderate, and high. Areas with a moderate to high value for maintenance of visual quality could represent opportunities for conservation and open space areas (County of Imperial, 2016). The County’s Conservation and Open Space Element identifies several areas within the County that contain scenic resources ; however none of these are located on or near the Project site.

For this reason, implementation of the Project would have no impact on a scenic vista.

- b) Substantially damage scenic resources, including, but not limited to trees, rock outcroppings, and historic buildings within a state scenic highway?

b) No Impact. The California Department of Transportation (Caltrans) manages the California Scenic Highway Program. The goal of the program is to preserve and protect scenic highway corridors from changes that would affect the aesthetic value of the land adjacent to the scenic corridor. No State scenic highways have been designated in Imperial County; therefore, no impact associated with a scenic highway would occur.

- c) Substantially degrade the existing visual character or quality of public views of the site and its surroundings? (Public views are those that are experienced from publicly accessible vantage point). If the Project is in an urbanized area, would the Project conflict with applicable zoning and other regulations governing scenic quality?

c) Less Than Significant Impact. The Project site is located at the intersection of SR-111 and Ross Road, between the Cities of El Centro and Holtville, directly east of (across SR-111) to the Country life RV and Motorhome Park. While the Proposed Project would result in a change in use from agricultural land to commercial, this change in and of itself would not degrade the existing visual character or quality of public views of the site.

With the proposed amendment to the General Plan to change the land use designation from “Agriculture” to “Urban Area,” as well as a Zone Change, to change zoning from A-2 (General Agricultural) to C-3 (Heavy Commercial), the Project, as designed, meets all development standards as identified in the Chapter 14 of the Land Use Code, including but not limited to permitted uses, minimum lot size, setbacks, building heights, off-street parking spaces, landscaping, and signage. Upon completion of the General Plan Amendment and Zone change, the proposed Project would be consistent with all applicable existing and planned land use policies and regulations of the County of Imperial Land Use

Potentially Significant Impact (PSI)	Less Than Significant With Mitigation Incorporated (LTSWMI)	Less Than Significant Impact (LTSI)	No Impact (NI)
--------------------------------------	---	-------------------------------------	----------------

Code and General Plan. It would not conflict with applicable zoning and would not substantially degrade the existing visual character or quality of public views of the site. Additionally, per **mitigation measure NOI-5** described in Section XII Noise of the IS/MND, two (2) concrete masonry walls, approximately six (6) feet in height, would be installed along the southern and western perimeter of the ancillary residential structures located immediately north of the Project site to ensure compliance with the County’s exterior noise standards. The noise barriers shall be solid masonry walls and are not out of character for the area. Therefore, impacts under this criteria would be less than significant and no mitigation would be required.

- d) Create a new source of substantial light or glare, which would adversely affect day or nighttime views in the area?

d) Less than Significant Impact. Implementation of the proposed Project is not expected to create a substantial new source of nighttime lighting or day-time glare and would provide external safety lighting for both normal and emergency conditions at the primary access points. The Project would include exterior lighting for the fuel canopies, convenience store and parking lot. Due to the proposed use of the site as a fueling station, it is anticipated lighting would be used 24 hours a day.

The Project would be conditioned to provide the minimum illumination needed to achieve safety and security and for lighting to be downward facing and shielded in order to focus the illumination in the immediate area. Additionally, the Project must adhere to the County design guidelines for monument signs (Title 9, Division 4, Section 90401.01), pole mounted signs (Title 9, Division 4, Section 90401.02) and signs attached to buildings (Title 9, Division 4, Section 90401.03), which require sign lighting to be arranged and installed so as not to produce glare on other properties in the vicinity or upon an adjacent highway.

With regard to glare, the proposed convenience store would include primarily cultured stone and fiberboard (See **Figure 11, Exterior Material Board**). Such architectural elements are not sources of glare. Glass would be limited to windows and doors on the convenience store building, typical of small-scale commercial retail construction and no other highly reflective surfaces would be provided (See **Building Elevation Figures 10a and 10b**). The extent and surface area of glass on the convenience store building would not be at a scale to generate adverse glare effects.

For these reasons light and glare impacts would be less than significant.

Mitigation Measures

No mitigation would be required.

II. AGRICULTURAL AND FOREST RESOURCES.

According to the most recent California Department of Conservation Farmland Mapping (2020) the Project site consists of Prime Farmland, which would be converted to non-agricultural uses. Additionally, the Project site is zoned A-2 (General Agricultural) which is intended primarily for agricultural uses (limited) and agricultural related compatible uses.

- a) Convert Prime Farmland, Unique Farmland, or Farmland of Statewide Importance (Farmland), as shown on the maps prepared pursuant to the Farmland Mapping and Monitoring Program of the

Potentially Significant Impact (PSI)	Less Than Significant With Mitigation Incorporated (LTSWMI)	Less Than Significant Impact (LTSI)	No Impact (NI)
--------------------------------------	---	-------------------------------------	----------------

California Resources Agency, to non-agricultural use?

a) **Less Than Significant With Mitigation Incorporated.** Implementation of the Project would result in the conversion of approximately 10-acres of Prime Farmland to a non-agricultural use. This impact is typically considered to be significant unless other mitigation is incorporated. This impact would be mitigated to below a level of significance with implementation of Mitigation Measure (MM) AG-1 and MM AG-2.

b) Conflict with existing zoning for agricultural use, or a Williamson Act contract?

b) Less Than Significant Impact.

Williamson Act Contract

The last of the active Williamson Act contracts within the county were due to expire on January 1, 2021; therefore, for the purposes of this assessment, it is assumed that no portion of the Project site is currently under a Williamson Act contract. Therefore, implementation of the Project would not conflict with a Williamson Act contract.

Agricultural Zoning

The Project site is zoned the Project site is zoned A-2 (General Agricultural) which is intended primarily for agricultural uses (limited) and agricultural related compatible uses. Fueling stations and convenience stores are not allowed within the A-2 Zone. For this reason, the Project includes a General Plan Amendment to change the Project site's land use designation from "Agriculture" to "Urban Area;" as well as a Zone Change, to change zoning from A-2 (General Agricultural) to C-3 (Heavy Commercial) are also proposed (See **Figures 3 and 4**).

Project implementation would result in the conversion of agricultural land to non-agricultural uses. However, with the approval of the proposed General Plan Amendment and Zone Change, the proposed use would be consistent with both the General Plan designation and zone classification. Additionally, operation of proposed fueling station and convenience store is not expected to inhibit or adversely affect adjacent agricultural operations through the placement of sensitive land uses or generation of excessive dust or shading. Based on these considerations, the Project would result in a less than significant impact under this criterion and no mitigation would be required.

c) Conflict with existing zoning for, or cause rezoning of, forest land (as defined in Public Resources Code section 12220(g)), timberland (as defined by Public Resources Code section 4526), or timberland zoned Timberland Production (as defined by Government Code section 51104(g))?

c) No Impact. The proposed Project would not conflict with existing zoning for, or cause rezoning of, forest land (as defined in Public Resources Code [PRC] Section 12220[g]), timberland (as defined by PRC Section 4526), or timberland zoned Timberland Production (as defined by Government Code Section 51104(g)). No forest or timber land is present in the Project site; therefore, no forest or timber land would be affected by the Project and there would be no impact. No mitigation would be required.

	Potentially Significant Impact (PSI)	Less Than Significant With Mitigation Incorporated (LTSWMI)	Less Than Significant Impact (LTSI)	No Impact (NI)
d) Result in the loss of forest land or conversion of forest land to non-forest use?	<input type="checkbox"/>	<input type="checkbox"/>	<input type="checkbox"/>	<input checked="" type="checkbox"/>

d) No Impact. The proposed Project would not result in the loss of forest land or conversion of forest land to non-forest use. As discussed in Impact II.c., no forest land is present at the Project site, and no forest land would be affected by the Project. Therefore, Project implementation would not result in the loss of forest land or conversion of forest land to non-forest use, No impacts would occur and mitigation would not be required.

e) Involve other changes in the existing environment, which, due to their location or nature, could result in conversion of Farmland, to non-agricultural use?	<input type="checkbox"/>	<input type="checkbox"/>	<input type="checkbox"/>	<input checked="" type="checkbox"/>
--	--------------------------	--------------------------	--------------------------	-------------------------------------

e) No Impact. As discussed under Impact II.a., the Project’s conversion of important farmlands to non-agricultural use would be significant. However, the Project does not include changes to the environment that would result in the conversion of surrounding farmland to non-agricultural uses nor the conversion of forest land to non-forest use.

The Project would not directly impact the movement of agricultural equipment on roads in the area and access to existing agriculture-serving roads would not be precluded or hindered. No modifications to roadways are proposed that would affect surrounding agricultural operations. Furthermore, existing agricultural-related nuisance issues such as noise, dust, and odors would have an impact on the Project given the general lack of associated sensitive uses (e.g., residences). Likewise, with mitigation measures proposed in other resource sections (e.g., air quality, noise, etc.), Project-related activities would not adversely affect adjacent agricultural operations.

Additionally, the Project would not develop infrastructure that would attract or encourage new development of adjacent farmlands. At the end of the Project’s useful life, disturbed lands on the site would be restored to suitability for agricultural use. Further, the provisions of the Imperial County Right-to-Farm Ordinance (No. 1031) and the State nuisance law (California Code Sub-Section 3482) would continue to be enforced. Based on these considerations, the Project would not result in the conversion of surrounding farmlands to non-agricultural uses and no impact would occur.

The following mitigation measures would ensure that impacts associated with the conversion of Important Farmlands to a non-agricultural use are reduced to below a level of significance.

Mitigation Measures

Implementation of the following mitigation measures would reduce impacts to below a level of significance.

MM-AG-1: Payment of Agricultural and Other Benefit Fees.

One of the following options included below shall be implemented prior to the issuance of a grading permit or building permit (whichever is issued first) for the Project:

Mitigation for Prime Farmland

- **Option 1: Provide Agricultural Conservation Easement(s).** The Permittee shall procure Agricultural Conservation Easements on a “2 to 1” basis on land of equal size, of equal quality farmland, outside the path of development. The conservation easement shall meet the

Potentially Significant Impact (PSI)	Less Than Significant With Mitigation Incorporated (LTSWMI)	Less Than Significant Impact (LTSI)	No Impact (NI)
--------------------------------------	---	-------------------------------------	----------------

State Department of Conservation's regulations and shall be recorded prior to issuance of any grading or building permits; or,

- Option 2: Pay Agricultural In-Lieu Mitigation Fee.** The Permittee shall pay an “Agricultural In-Lieu Mitigation Fee” in the amount of 30 percent of the fair market value per acre for the total acres of the proposed site based on five comparable sales of land used for agricultural purposes as of the effective date of the permit, including program costs on a cost recovery/time and material basis. The Agricultural In-Lieu Mitigation Fee, will be placed in a trust account administered by the Imperial County Agricultural Commissioner’s office and will be used for such purposes as the acquisition, stewardship, preservation and enhancement of agricultural lands within Imperial County; or,
- Option 3: Public Benefit Agreement.** The Permittee and County voluntarily enter into an enforceable Public Benefit Agreement or Development Agreement that includes an Agricultural Benefit Fee payment that is 1) consistent with Board Resolution 2012-005; 2) the Agricultural Benefit Fee must be held by the County in a restricted account to be used by the County only for such purposes as the stewardship, preservation and enhancement of agricultural lands within Imperial County and to implement the goals and objectives of the Agricultural Benefit program, as specified in the Development Agreement, including addressing the mitigation of agricultural job loss on the local economy; the Project and other recipients of the Project’s Agricultural Benefit Fee funds; or emphasis on creation of jobs in the agricultural sector of the local economy for the purpose of off-setting jobs displaced by this Project.

MM-AG-2: Pest Management Plan

Prior to the issuance of a grading permit or building permit (whichever occurs first), a Pest Management Plan shall be developed by the Project Applicant and submitted to/approved by the County of Imperial Agricultural Commissioner. The Plan shall provide the following:

- Monitoring, preventative, and management strategies for weed and pest control during construction activities at any portion of the Project (e.g., transmission line).
- Control and management of weeds and pests in areas temporarily disturbed during construction where native seed will aid in site revegetation as follows:
 - Monitor for all pests including insects, vertebrates, weeds, and pathogens. Promptly control or eradicate pests when found, or when notified by the Agricultural Commissioner’s office that a pest problem is present on the Project site. The assistance of a licensed pest control advisor is recommended. All treatments must be performed by a qualified applicator or a licensed pest control business.
 - All treatments must be performed by a qualified applicator or a licensed pest control operator.
 - “Control” means to reduce the population of common pests below economically damaging levels, and includes attempts to exclude pests before infestation, and effective control

Potentially Significant Impact (PSI)	Less Than Significant With Mitigation Incorporated (LTSWMI)	Less Than Significant Impact (LTSI)	No Impact (NI)
--------------------------------------	---	-------------------------------------	----------------

methods after infestation. Effective control methods may include physical/mechanical removal, bio control, cultural control, or chemical treatments.

- Use of “permanent” soil sterilants to control weeds or other pests is prohibited because this would interfere with reclamation.
- Notify the Agricultural Commissioner’s office immediately regarding any suspected exotic/invasive pest species as defined by the California Department of Food Agriculture and the USDA. Request a sample be taken by the Agricultural Commissioner’s Office of a suspected invasive species. Eradication of exotic pests shall be done under the direction of the Agricultural Commissioner’s Office and/or California Department of Food and Agriculture.
- Obey all pesticide use laws, regulations, and permit conditions.
- Allow access by Agricultural Commissioner staff for routine visual and trap pest surveys, compliance inspections, eradication of exotic pests, and other official duties.
- Ensure all Project employees that handle pest control issues are appropriately trained and certified, all required records are maintained and made available for inspection, and all required permits and other required legal documents are current.
- Maintain records of pests found and treatments or pest management methods used. Records should include the date, location/block, project name (current and previous if changed), and methods used. For pesticides include the chemical(s) used, U.S. Environmental Protection Agency (USEPA) Registration numbers, application rates, etc. A pesticide use report may be used for this.
- Submit a report of monitoring, pest finds, and treatments, or other pest management methods to the Agricultural Commissioner quarterly within 15 days after the end of the previous quarter, and upon request. The report is required even if no pests were found or treatment occurred. It may consist of a copy of all records for the previous quarter, or may be a summary letter/report as long as the original detailed records are available upon request.
- A long-term strategy for weed and pest control and management during the operation of the proposed Project. Such strategies may include, but are not limited to:
 - Use of specific types of herbicides and pesticides on a scheduled basis.
 - Maintenance and management of Project site conditions to reduce the potential for a significant increase in pest-related nuisance conditions on surrounding agricultural lands.
 - The Project shall reimburse the Agricultural Commissioner’s office for the actual cost of investigations, inspections, or other required non-routine responses to the site that are not funded by other sources.

III. AIR QUALITY.

Birdseye Planning Group (BPG) prepared an Air Quality and Greenhouse Gas Study for the Maverik Fueling Station and Convenience Store Project, which is included as Appendix A of this Initial Study (BPG, 2023; Appendix A). The Air

Potentially Significant Impact (PSI)	Less Than Significant With Mitigation Incorporated (LTSWMI)	Less Than Significant Impact (LTSI)	No Impact (NI)
--------------------------------------	---	-------------------------------------	----------------

Quality and Greenhouse Gas Study analyzed air quality and greenhouse gas (GHG) impacts that could result from construction and operation of the Project. Entech Consulting Group prepared a Health Risk Assessment (HRA) for the Maverik Fueling Station and Convenience Store Project, which is included as Appendix B (Entech, 2023; Appendix B) to evaluate whether Project-related diesel emissions would result in potential health risks. The analysis contained in this section is based on the findings of these technical reports.

Existing Setting

Sensitive Receptors

Ambient air quality standards have been established to represent the levels of air quality considered sufficient, with an adequate margin of safety, to protect public health and welfare. They are designed to protect that segment of the public most susceptible to respiratory distress, such as children under 14; the elderly over 65; persons engaged in strenuous work or exercise; and people with cardiovascular and chronic respiratory diseases. The nearest receptors are single-family residences located at 404 Ross Road and north of the Project site and at 1650 Hawes Road approximately 1,000 feet south of the site.

Attainment Status

Local control in air quality management is provided by the California Air Resources Board (CARB) through county-level or regional (multi-county) Air Pollution Control Districts (APCDs). The CARB establishes air quality standards and is responsible for control of mobile emission sources, while the local APCDs are responsible for enforcing standards and regulating stationary sources. The CARB has established 14 air basins statewide. The Project site is located within the Salton Sea Air Basin (SSAB), which includes all of Imperial County and a portion of central Riverside County. Air quality conditions in the Imperial County portion of the SSAB are under the jurisdiction of the Imperial County APCD (ICAPCD). The remainder of the SSAB in Riverside County is managed by the South Coast Air Quality Management District (SCAQMD). The ICAPCD is required to monitor air pollutant levels to ensure that air quality standards are met and, if they are not met, to develop strategies to meet the standards. Depending on whether the standards are met or exceeded, the local air basin is classified as being in “attainment” or “non-attainment.” The SSAB is designated as a non-attainment area for the federal and State standards for Ozone (O₃) and Respirable Particulate Matter (PM₁₀). The SSAB is in attainment or unclassified for the remaining criteria pollutants.

Regulatory Setting

The federal and state governments have been empowered by the federal and state Clean Air Acts (CAA) to regulate emissions of airborne pollutants and have established ambient air quality standards for the protection of public health. The U.S. Environmental Protection Agency (USEPA) is the federal agency designated to administer air quality regulation, while CARB is the state equivalent in California. Federal and state standards have been established for six criteria pollutants, including Ozone (O₃), Carbon Monoxide (CO), Nitrogen Dioxide (NO₂), Sulfur Dioxide (SO₂), particulates less than 10 and 2.5 microns in diameter (PM₁₀ and PM_{2.5}), and Lead (Pb). California has also set standards for sulfates, hydrogen sulfide, vinyl chloride, and visibility-reducing particles. **Table 4** lists the current federal and state standards for each of these pollutants.

TABLE 4. FEDERAL AND STATE AMBIENT AIR QUALITY STANDARDS

Pollutant	Averaging Time	NAAQS	CAAQS
		Concentration	
O ₃	8-hour	0.070 ppm (137 µg/m ³)	0.070 ppm (137 µg/m ³)

Potentially Significant Impact (PSI) Less Than Significant With Mitigation Incorporated (LTSWMI) Less Than Significant Impact (LTSI) No Impact (NI)

TABLE 4. FEDERAL AND STATE AMBIENT AIR QUALITY STANDARDS

Pollutant	Averaging Time	NAAQS	CAAQS
		Concentration	
	1-hour	-	0.09 ppm (180 µg/m ³)
CO	8-hour	9 ppm (10 µg/m ³)	9 ppm (10 µg/m ³)
	1-hour	35 ppm (40 µg/m ³)	20 ppm (23 µg/m ³)
NO ₂	Annual Average	53 ppb (100 µg/m ³)	0.030 ppm (57 µg/m ³)
	1-hour	100 ppb (188.68 µg/m ³)	0.18 ppm (339 µg/m ³)
SO ₂	3-hour	0.5 ppm (1,300 µg/m ³)	-
	24-hour	0.14 ppm (365 µg/m ³)	0.04 ppm (105µg/m ³)
	1-hour	75 ppb (196 µg/m ³)	0.25 ppm (655 µg/m ³)
PM ₁₀	Annual Arithmetic Mean	-	20 µg/m ³
	24-hour	150 µg/m ³	50 µg/m ³
PM _{2.5}	Annual Arithmetic Mean	12 µg/m ³	12 µg/m ³
	24-hour	35 µg/m ³	-
Sulfates	24-hour	-	25 µg/m ³
Pb	Rolling Three-Month Avg	0.15 µg/m ³	-
	30 Day Average	-	1.5 µg/m ³
H ₂ S	1-hour		0.03 ppm (42 µg/m ³)
Vinyl Chloride	24-hour		0.010 ppm (26 µg/m ³)
Visibility Reducing particles	8-hour (1000 to 1800 PST)		See Note 1

Source: BPG, 2023 (Appendix A).

Notes: ppm = parts per million ppb = parts per billion mg/m³ = milligrams per cubic meter µg/m³ = micrograms per cubic meter

(1) In 1989, CARB converted both the general statewide 10- mile visibility standards and the Lake Tahoe 30-mile visibility standard to instrumental equivalents.

Imperial County Air Pollution Control District

The ICAPCD is the agency responsible for monitoring air quality, as well as planning, implementing, and enforcing programs designed to attain and maintain state and federal ambient air quality standards in the district. The air district was formed by the Air Pollution Control Act of 1947.

The ICAPCD adopted its *CEQA Air Quality Handbook: Guidelines for the Implementation of the California Environmental Quality Act of 1970* in 2007, which was most recently amended in June 2022. The ICAPCD *CEQA Air Quality Handbook* provides guidance on how to determine the significance of impacts, including air pollutant emissions, related to the development of residential, commercial, and industrial projects. Where impacts are determined to be significant, the ICAPCD *CEQA Air Quality Handbook* provides guidance to mitigate adverse impacts to air quality from development projects. The ICAPCD is the agency principally responsible for comprehensive air pollution control in the region.

The ICAPCD has developed rules and regulations that regulate stationary sources, area sources, and certain mobile source emissions, and is responsible for establishing stationary source permitting requirements and for ensuring that new, modified, or relocated stationary sources do not create net emission increases.

Potentially Significant Impact (PSI)	Less Than Significant With Mitigation Incorporated (LTSWMI)	Less Than Significant Impact (LTSI)	No Impact (NI)
--------------------------------------	---	-------------------------------------	----------------

The following ICAPCD rules are applicable to the Project:

Rule 106 – Abatement. If the ICAPCD determines that any person is in violation of the Rules and Regulations for limiting the discharge of air contaminants into the atmosphere, the ICAPCD may issue an order for abatement.

Rule 107 – Land Use. The Air Pollution Control Officer has the responsibility to protect public health and property from the damaging effects of air pollution and will review and advise the appropriate land use authorities on all new construction or changes in land use which could become a source of air pollution problems.

Rule 310 – Operational Development Fee. Provides the ICAPCD with a sound method for mitigating emissions produced from operations of new commercial and residential development projects by requiring project proponents to pay fees based on the project’s emissions, type and size. The operational fees would assist in attaining the State and federal ambient air quality standards for PM₁₀ and O₃.

Rule 401 – Opacity of Emissions. Sets limits for release or discharge of emissions into the atmosphere, other than uncombined water vapor, that are dark or darker in shade as designated as No.1 on the Ringelmann Chart or obscure an observer’s view to a degree equal to or greater than smoke does as compared to No.1 on the Ringelmann Chart, for a period or aggregated period of more than three minutes in any hour.

Rule 403 – General Limitations on the Discharge of Air Contaminants. Rule 403 sets forth limitations on emissions of pollutants, including particulate matter, from individual sources.

Rule 407 – Nuisance. Rule 407 prohibits a person from discharging from any source whatsoever such quantities of air contaminants or other material which cause injury, detriment, nuisance or annoyance to any considerable number of persons or to the public, or which endanger the comfort, repose, health or safety of any such persons or the public, or which cause, or have a natural tendency to cause, injury or damage to business or property.

Stationary Sources

Rule 201 – Permits Required. The construction, installation, modification, replacement, use or operation of any equipment which may emit, or control, contaminants shall first obtain written authorization for such from the Air Pollution Control District Officer in the form of an Authority to Construct and a Permit to Operate.

Rule 207 – New and Modified Stationary Source Review. Establishes preconstruction review requirements for new and modified stationary sources to ensure the operations of equipment does not interfere with attainment or maintenance of AAQS.

Rule 208 – Permit to Operate. The ICAPCD shall inspect and evaluate the facility for which the permit is applied to ensure the facility has been constructed or installed and will operate so as to comply with the provisions of the Authority to Construct permit and comply with all applicable laws, rules, standards, and guidelines.

Potentially Significant Impact (PSI)	Less Than Significant With Mitigation Incorporated (LTSWMI)	Less Than Significant Impact (LTSI)	No Impact (NI)
--------------------------------------	---	-------------------------------------	----------------

Fugitive Dust Control

Regulation VIII – Fugitive Dust Rules. Regulation VIII sets forth rules regarding the control of fugitive dust, including fugitive dust from construction activities. The regulation requires actions to prevent, reduce, or mitigate PM₁₀ emissions from construction and earthmoving activities; handling, storage and transport of bulk materials; control of track-out/carry-out of bulk materials deposited onto a paved road; use of new or existing public or private Paved or Unpaved Road, road construction project, or road modification projects; and, agricultural operation sites. Regulation VIII includes the following specific rules:

- Rule 800–General Requirements for Control of Fine Particulate Matter (PM₁₀)
- Rule 801–Construction and Earthmoving Activities
- Rule 802–Bulk Materials
- Rule 803–Carry Out and Track Out
- Rule 804–Open Areas
- Rule 805–Paved and Unpaved Roads
- Rule 806–Conservation Management Practices

Additionally, ICAPCD’s standard design measures for construction equipment and fugitive PM₁₀ must be implemented at all construction sites. The implementation of design measures, as listed in the ICAPCD CEQA handbook, apply to those construction sites which are 5 acres or more for non- residential developments such as the proposed Project. Additionally, in an effort to reduce PM₁₀ or fugitive dust generation, the Project would be required to develop a dust management plan consistent with Regulation VIII of ICAPCD’s *Rules and Regulations*.

Air Quality Plans

The ICAPCD has also developed plans and strategies to achieve attainment for air quality ambient standards. The latest plans include the following:

- 2009 Imperial County Plan for PM₁₀
- 2012 Annual PM_{2.5} SIP
- 2013 Plan for 2006 24-hour PM_{2.5} for moderate nonattainment area
- 2017 Plan for 2008 8-hour O₃ standard
- 2018 Redesignation Request and Maintenance Plan for PM₁₀

Thresholds

The ICAPCD has established significance thresholds in its 2022 CEQA Air Quality Handbook for the preparation of Air Quality Impact Assessments (AQIA). The screening criteria within this handbook can be used to determine whether a project’s total emissions would result in a significant impact as defined by CEQA. Should emissions be found to exceed these thresholds, additional modeling is required to demonstrate that the project’s total air quality impacts are below the state and federal ambient air quality standards. These screening thresholds for construction and daily operations are shown in **Table 5**. The CEQA handbook further states that any proposed project with a potential to emit less than

Potentially Significant Impact (PSI)	Less Than Significant With Mitigation Incorporated (LTSWMI)	Less Than Significant Impact (LTSI)	No Impact (NI)
--------------------------------------	---	-------------------------------------	----------------

the Tier I thresholds during operations may potentially still have adverse impacts on the local air quality and would be required to develop an Initial Study to help the Lead Agency determine whether the project would have a less than significant impact.

On the other hand, if the proposed project's operational development fits within the Tier II classification, it is considered to have a significant impact on regional and local air quality. Therefore, Tier II projects are required to implement all standard design measures as well as all feasible discretionary design measures.

TABLE 5. SCREENING THRESHOLD FOR CRITERIA POLLUTANTS

Construction Emissions		
Pollutant	Pounds per Day	
Particulate Matter 10 (PM ₁₀)	150	
Reactive Organic Gases (ROG)	75	
Nitrogen Oxide (NOx)	100	
Carbon Monoxide (CO)	550	
Particulate Matter 2.5 (PM _{2.5})	N/A	
Sulfur Oxides	N/A	
Operational Emissions		
Pollutant	Tier I (Pounds per Day)	Tier II (Pounds per Day)
PM ₁₀ and Sulfur Oxide (SOx)	Less than 150 lbs/day	Greater than 150 lbs/day
NOx and ROG	Less than 137 lbs/day	Greater than 137 lbs/day
CO and PM _{2.5}	Less than 550 lbs/day	Greater than 550 lbs/day
Level of Significance:	Less Than Significant	Significant Impact
Level of Analysis:	Initial Study	Comprehensive Air Quality Analysis Report
Environmental Document:	Negative Declaration	Mitigated ND or EIR

Notes:
 ROG = reactive organic gas; NOx = oxides of nitrogen; CO = carbon monoxide;
 PM10 = particulate matter with an aerodynamic diameter 10 microns or less; lbs/day = pounds per day
 ND – Negative Declaration EIR = Environmental Impact Report.
 NA = Not Applicable.
 Source: BPG, 2023.

Methodology

Construction and operational emissions were estimated using the latest version of California Emissions Estimator Model (CalEEMod), version 2020.4.0. CalEEMod is a statewide land use emissions computer model designed to provide a uniform platform for government agencies, land use planners, and environmental professionals to quantify potential criteria pollutant and GHG emissions associated with both construction and operation of a variety of land use projects.

Potentially Significant Impact (PSI) Less Than Significant With Mitigation Incorporated (LTSWMI) Less Than Significant Impact (LTSI) No Impact (NI)

Construction Emissions

Project construction would generate temporary air pollutant emissions. These impacts are associated with fugitive dust (PM₁₀ and PM_{2.5}) and exhaust emissions from heavy construction vehicles. Construction would generally consist of site preparation, grading, excavation for the fuel tanks, construction of the buildings, application of architectural coating and paving. For modeling purposes, it was assumed that 500 cubic yards of export would be required. Construction emission estimates are shown in **Table 6**.

TABLE 6. ESTIMATED MAXIMUM DAILY CONSTRUCTION EMISSIONS

Construction Phase	Maximum Emissions (lbs/day)					
	ROG	NO _x	CO	SO _x	PM ₁₀	PM _{2.5}
Construction – 2024	3.76	37.1	34.4	0.05	9.7	5.5
Construction - 2025	1.1	10.4	13.2	0.02	0.4	0.4
ICAPCD Regional Thresholds	75	100	No Standard	550	150	No Standard
Threshold Exceeded?	No	No	No	No	No	No

Source: BPG, 2023.

The emissions shown in **Table 6** assume exposed soil areas would be watered twice daily to control fugitive dust emissions. While **Table 6** demonstrates that construction emissions would fall below the thresholds, the ICAPCD’s Rules 801 and 804 apply to any construction and earthmoving activities and open areas greater than 0.5 acres in urban areas and 3.0 or more acres within rural areas, respectively. Therefore, the Applicant will be required to implement fugitive dust control measures per ICAPCD Rules 801 and 804. The fugitive dust control plan and related requirements to reduce the amount of fine particulate matter (PM₁₀) entrained in the ambient air during construction and earth moving activities are assumed to be conditions of approval for the project and are identified in the IS/MND as “mitigation measures”.

Construction-Related Toxic Air Contaminant Impacts

The greatest potential for toxic air contaminant emissions would be related to diesel particulate emissions associated with heavy equipment operations during construction of the proposed project. Health effects from carcinogenic air toxics are usually described in terms of “individual cancer risk.” The California Office of Environmental Health Hazard Assessment (OEHHA) health risk guidance states that a residential receptor should be evaluated based on a 30-year exposure period. “Individual Cancer Risk” is the likelihood that a person exposed to concentrations of toxic air contaminants over a 70-year lifetime will contract cancer, based on the use of standard risk-assessment methodology.

Construction-Related Odor Impacts

Potential sources of odor during construction activities include equipment exhaust and activities such as paving. The objectionable odors that may be produced during the construction process would occur periodic and end when construction is completed.

Potentially Significant Impact (PSI)	Less Than Significant With Mitigation Incorporated (LTSWMI)	Less Than Significant Impact (LTSI)	No Impact (NI)
--------------------------------------	---	-------------------------------------	----------------

Operational Emissions

Regional Pollutant Emissions

An analysis of maximum daily emissions during operation was conducted to determine if emissions would exceed the daily thresholds for any pollutant of concern. The maximum daily operational emissions would occur at project buildout. Operational emissions were modeled for 2025, the projected first year of operations. Operational emissions include emissions from electricity consumption (energy sources), vehicle trips (mobile sources), and area sources including landscape equipment and architectural coating emissions as the structures are repainted over the life of the Project.

The majority of operational emissions are associated with vehicle trips to and from the Project site. Trip volumes were based on trip generation factors for a convenience store with a fueling facility for both light duty passenger vehicles and a truck stop use to calculate heavy truck trips. Multiple model runs were performed to quantify primary vehicle emissions associated with vehicles traveling to/from the site and heavy truck trips with the trip lengths and vehicle fleet mix adjusted to calculate emissions associated with the car/light truck separate from the heavy truck trips. The combined emissions reflect the total mobile emissions. Pass by trips (i.e., existing traffic) comprise the majority (approximately 76 percent) of project trips. These are not new trips generated by the Project; however, they were included in the emissions calculations for passenger cars/light duty vehicles.

Table 7 summarizes emissions associated with operation of the proposed Project. Emissions were calculated using two separate modeling runs. One run calculated operational emissions assuming only new passenger car trips were accessing the Project site. The heavy truck mobile emissions are shown separately assuming one mile of total distance to/from the site and on the site.

TABLE 7. ESTIMATED OPERATIONAL EMISSIONS

Proposed Project	Estimated Emissions (lbs/day)					
	ROG	NO _x	CO	SO _x	PM ₁₀	PM _{2.5}
Mobile, Area and Energy	13.2	3.7	51.7	0.05	4.7	1.2
Mobile (heavy trucks)	1.4	16.7	14.3	0.02	0.3	0.1
Total Daily Emissions	14.8	20.4	66.0	0.07	5.0	1.3
ICAPCD Thresholds	55	55	550	150	150	55
Threshold Exceeded?	No	No	No	No	No	No

Source: BPG 2023.

Potentially Significant Impact (PSI)	Less Than Significant With Mitigation Incorporated (LTSWMI)	Less Than Significant Impact (LTSI)	No Impact (NI)
--------------------------------------	---	-------------------------------------	----------------

Impact Analysis

Where available, the significance criteria established by the applicable air quality management district or air pollution control district may be relied upon to make the following determinations.

Would the project:

- a) Conflict with or obstruct implementation of the applicable air quality plan?

a) Less Than Significant. Less Than Significant. A project is conforming with applicable adopted plans if it complies with the applicable ICAPCD rules and regulations and emission control strategies in the applicable air quality attainment plans. The Project would comply with the applicable rules and regulations, including the use of standard mitigation measures for construction equipment and fugitive PM₁₀.

Consistency with air quality plans is typically based on a comparison of project-generated growth with growth projections in the AQMP generated by the Southern California Association of Governments. While the Project would contribute to the supply of available energy, which is one factor of population growth, the proposed Project would not significantly increase employment or growth within the region. Moreover, development of the proposed Project would increase the amount of renewable energy and help California meet its Renewable Portfolio Standard (RPS). Furthermore, the thresholds of significance adopted by ICAPCD determine compliance with the goals of attainment plans in the region. As such, emissions below the ICAPCD regional mass daily emissions thresholds presented in **Tables 6 and 7** would not conflict with or obstruct implementation of the applicable air quality plans.

Construction and Operations

As shown on **Tables 6 and 7**, construction and operation of the Project would not result in emission levels that would be below ICAPCD’s significance thresholds. Impacts would be less than significant. Nonetheless, in compliance with the ICAPCD requirements, all construction sites, regardless of size, must comply with the requirements contained within Regulation VIII – Fugitive Dust Control Measures. Compliance with these rules is included as **mitigation measures MM AQ-1** (Fugitive Dust Control), and **MM AQ-2** (Construction Equipment Control Measures).

Construction-related PM₁₀ generation would not exceed the ICAPCD’s thresholds and would be further reduced with implementation of the requirements contained within Regulation VIII, Operational emissions, which are presented on **Table 7**, would be below the thresholds of significance. Therefore, operation of the Project would not conflict with implementation of the ICAPCD applicable air quality plans.

Would the project:

- b) Result in a cumulatively considerable net increase of any criteria pollutant for which the project region is non-attainment under an applicable federal or state ambient air quality standard?

b) Less than Significant With Mitigation Incorporated. This discussion addresses whether the Proposed Project would result in a cumulatively considerable net increase of any criteria pollutant for which the project region is nonattainment. The Imperial Valley portion of the Salton Sea Air Basin (SSAB) is designated as a non-attainment area for the federal and State standards for Ozone (O3) and Respirable Particulate Matter (PM10).

Potentially Significant Impact (PSI)	Less Than Significant With Mitigation Incorporated (LTSWMI)	Less Than Significant Impact (LTSI)	No Impact (NI)
--------------------------------------	---	-------------------------------------	----------------

Within the SSAB, emissions which exceed quantitative thresholds for ozone precursors (NOx and ROG) or PM10, could represent a cumulatively considerable net increase by contributing to existing violations of the ambient air quality standards for ozone or particulate matter.

Tables 6 and 7, show that during construction and operation of the Project, the emissions generated would not exceed the applicable significance threshold levels for any air pollutants. Mitigation measures MM AQ-1 and MM AQ-2 would formalize the requirements for the Project to prepare a Dust Control Plan and to implement standard and enhanced measures to control dust and construction equipment emissions consistent with the ICAPCD’s rules adopted for the purpose of preventing violations of the ozone or PM10 ambient air quality standards.

With compliance of ICAPCD rules and measures MM AQ-1 and MM AQ-2, the Project would not result in a cumulatively considerable net increase of any criteria pollutants and would not violate any air quality standards. Accordingly, this impact would be less than significant with mitigation for dust control and construction equipment emissions reduction.

Would the project:

- c) Result in other emissions (such as those leading to odors adversely affecting a substantial number of people?

c) Less Than Significant. The occurrence and severity of potential odor impacts depends on numerous factors. The nature, frequency, and intensity of the source; the wind speeds and direction; and the sensitivity of receiving location each contribute to the intensity of the impact. Although offensive odors seldom cause physical harm, they can be annoying and cause distress among the public and generate citizen complaints. Odors would be potentially generated from vehicles and equipment exhaust emissions during construction of the project. Potential odors produced during construction would be attributable to exhaust emissions, architectural coatings, and asphalt pavement application. Such odors would disperse rapidly from the Project site and generally occur at magnitudes that would not affect substantial numbers of people. Therefore, impacts associated with other emissions (such as those leading to odors) adversely affecting a substantial number of people during construction would be less than significant. Land uses and industrial operations that are associated with odor complaints include agricultural uses, wastewater treatment plants, food processing plants, chemical plants, composting, refineries, landfills, dairies, and fiberglass molding facilities. The project would construct and operate a new travel center.

The on-site uses are not associated with emissions (such as those leading to odors) adversely affecting a substantial number of people that could rise to the level of significance. Additionally, the proposed OWTS’s compliance with the minimum design, construction, operation and maintenance standards required under the County’s OWTS Ordinance would ensure potential odor impacts from the onsite wastewater treatment system would be minimized. Therefore, impacts would be less than significant.

Would the project:

- d) Expose sensitive receptors to substantial pollutant concentrations?

d) Less Than Significant With Mitigation Incorporated. The nearest receptors are residences located approximately 180 feet north of the site at 404 Ross Road. As shown in Tables 6 and 7, project construction and operation would not exceed ICAPCD pollutant thresholds. Pollutants generated during operation would be negligible. The HRA determined

Potentially Significant Impact (PSI)	Less Than Significant With Mitigation Incorporated (LTSWMI)	Less Than Significant Impact (LTSI)	No Impact (NI)
--------------------------------------	---	-------------------------------------	----------------

that the maximum unmitigated carcinogenic health risk from construction (beginning 3rd trimester [-0.25 to 0.75 years] scenario) would be 14.47 in a million, which would result in a significant impact compared to the 10 in a million threshold. Therefore, implementation of **MM AQ-2**, requiring construction equipment to have engine ratings of Tier 4 Final, would be required and would reduce maximum construction impact to 1.87 in a million.

Mitigation Measures and Conditions of Approval

In compliance with ICAPCD rules, the following Conditions of Approval/Mitigation Measures have been identified.

MM AQ-1: Fugitive Dust Control

In compliance with the ICAPCD requirements, all construction sites, regardless of size, must comply with the requirements contained within Regulation VIII – Fugitive Dust Control Measures. Because these Regulation VIII measures are mandatory and are not considered project environmental mitigation measures, the standard and enhanced mitigation measures, required in the ICAPCD CEQA Handbook are listed below, and shall be implemented prior to and during construction.

Prior to commencing construction, the Applicant will be required to submit a Dust Control Plan to the ICAPCD for approval. The Dust Control Plan will identify the actual and potential sources of PM₁₀ emissions and the location of Bulk Material handling and storage areas, Paved and Unpaved Roads, entrances and exits where Track Out/Carry Out may occur, and Unpaved Traffic Areas. It shall also identify the dust suppressants to be applied; specific surface treatment(s) and/or control measures utilized to control Track Out/Carry Out and all associated measures to be implemented before, during, and after any dust generating activity (see Rule 801 F.2). Additionally, the Applicant shall submit a “Construction Notification Form” to ICAPCD 10 days prior to the commencement of any earthmoving or construction activities.

Standard Mitigation Measures for Construction Fugitive Dust (PM₁₀) Control

- All disturbed areas, including bulk material storage which is not being actively utilized, shall be effectively stabilized and visible emissions shall be limited to no greater than 20 percent opacity for dust emissions by using water, chemical stabilizers, dust suppressants, tarps or other suitable material such as vegetative ground cover.
- All on-site unpaved roads shall be effectively stabilized, and visible emissions shall be limited to no greater than 20 percent opacity for dust emissions by paving, chemical stabilizers, dust suppressants and/or watering.
- All unpaved traffic areas 1 acre or more with 75 or more average vehicle trips per day shall be effectively stabilized and visible emissions shall be limited to no greater than 20 percent opacity for dust emissions by paving, chemical stabilizers, dust suppressants and/or watering.
- The transport of bulk materials on public roads shall be completely covered unless 6 inches of freeboard space from the top of the container is maintained with no spillage and loss of bulk material. In addition, the cargo compartment of all haul trucks is to be cleaned and/or washed at delivery site after removal of bulk material.

Potentially Significant Impact (PSI)	Less Than Significant With Mitigation Incorporated (LTSWMI)	Less Than Significant Impact (LTSI)	No Impact (NI)
--------------------------------------	---	-------------------------------------	----------------

- All track-out or carry-out shall be cleaned at the end of each workday or immediately when mud or dirt extends a cumulative distance of 50 linear feet or more onto a paved road within an urban area.
- Movement of bulk material handling or transfer shall be stabilized prior to handling or at points of transfer with application of sufficient amounts of water, chemical stabilizers or by sheltering or enclosing the operation and transfer line.
- The construction of any new unpaved road is prohibited within any area with a population of 500 or more unless the road meets the definition of a temporary unpaved road. Any temporary unpaved road shall be effectively stabilized, and visible emissions shall be limited to no greater than 20 opacity for dust emission by paving, chemical stabilizers, dust suppressants and/or watering.

Discretionary Mitigation Measures for Fugitive Dust (PM₁₀) Control

For projects with construction sites of five (5) acres or more for non-residential developments, in order to provide a greater degree of PM₁₀ reductions above that required by Regulation VIII, the following measures shall be implemented:

- Water exposed soil with adequate frequency for continued moist soil.
- Replace ground cover in disturbed areas as quickly as possible.
- Use automatic sprinkler system installed on all soil piles.
- Limit vehicle speed for all construction vehicles to 15 miles per hour on any unpaved surface at the construction site.
- Develop a trip reduction plan to achieve a 1.5 average vehicle ridership for construction employees.
- Implement a shuttle service to and from retail services and food establishments during lunch hours.

Enhanced Dust Control Measures

To provide a greater degree of reduction of PM emissions from construction and earthmoving activities, the following enhanced measures shall be incorporated into the Project’s Dust Control Plan:

- Cessation of dust generating activities when wind speeds exceed 25 miles per hour (mph).
- Application of water or dust suppressants once per hour when wind speeds exceed 15mph.
- Application of water to maintain 12% soil moisture content when wind speed exceeds 15mph.
- Construct mesh construction fences 3-5 feet high with 50% or less porosity in conjunction with water application or dust suppressant when wind speeds exceed 15 mph.

Potentially Significant Impact (PSI)	Less Than Significant With Mitigation Incorporated (LTSWMI)	Less Than Significant Impact (LTSI)	No Impact (NI)
--------------------------------------	---	-------------------------------------	----------------

MM AQ-2: Construction Equipment Control Measures

Standard Mitigation Measures for Exhaust Equipment Emissions Control

- Use of equipment with alternative fueled or catalyst-equipped diesel engine, including for all off-road and portable diesel-powered equipment.
- Minimize idling time either by shutting equipment off when not in use or limit the idling time to a maximum of 5 minutes.
- Limit, to the extent feasible, the hours of operation of heavy-duty equipment and/or the number of equipment in use.
- Replace fossil fueled equipment with electrically driven equivalents (provided they are not run via a portable generator set).

Enhanced Mitigation Measures for Construction Equipment

To provide a greater degree of reduction of PM emissions from construction combustion equipment, the following enhanced measures shall be implemented.

- Curtail construction during periods of high ambient pollutant concentrations; this shall include ceasing of construction activity during the peak hour of vehicular traffic on adjacent roadways (insert peak hour from traffic report).
- Implement activity management (e.g., rescheduling activities to reduce short-term impacts).
- Require construction equipment to have engine ratings of Tier 4 Final.

IV. BIOLOGICAL RESOURCES.

Barrett Biological Enterprises prepared a Biological Resource Assessment for the Project in December 2023 (, which included a biological reconnaissance field survey of the Project site, a general habitat assessment and a discussion of potential biological resources (Barrett, 2023; Appendix C). The analysis contained in this section is based on the findings of these technical reports.

Existing Setting

The Project is located within Imperial County within in the unincorporated area of Imperial County, California. The Project site consists of an approximately 10-acre portion of a 50.28-acre parcel Assessor’s Parcel No. 054-080-023. An Imperial Irrigation District (IID) Acacia Drain is located along the western boundary of the Project site and the Acacia Canal is located across Ross Road north of the site which water to the property. Hawes Road abuts the Project site to the west, beyond which is SR-111. Land to the immediate south and east is used for agriculture and is undeveloped; Ross Road abuts the Project site to the north and a residence; beyond which is an IID water canal and agricultural land. SR-111, Country Life RV Park and agriculture is located west of the site, across Hawes Road. The Project site supports agricultural use, and was under alfalfa cultivation. The Biological Study Area (BSA) consisted of the Project site plus a mapping and habitat evaluation buffer.

No blue-line features (i.e., drainage, creek, streams, etc.) as identified by the U.S. Geological Service (USGS) topographic quadrangle map and/or U.S. Fish and Wildlife Service (USFWS) National Wetland Inventory (NWI) occur within the BSA. Additionally, no floodplain or floodway have been mapped within the BSA (Flood Insurance Rate Map Panels 06025C1750C and 0625C1725C).

Potentially Significant Impact (PSI)	Less Than Significant With Mitigation Incorporated (LTSWMI)	Less Than Significant Impact (LTSI)	No Impact (NI)
--------------------------------------	---	-------------------------------------	----------------

Biological Survey

A general biological survey was conducted within the biological study area (BSA) on November 3, 2023, to develop an inventory of species (plant and animal) present at the time of the surveys, map vegetative communities, if present and ascertain the potential for occurrence of sensitive, endangered or threatened species within the project area and vicinity.

Concurrent with the general biological survey, a directed survey/assessment for potentially present special status species (i.e. federally and state listed species; California Department of Fish and Wildlife (CDFW) Species of Special Concern (SSC) Fully Protected (FP), and Watch List (WL) species; and species designated as Special Plants or Special Animals recorded in the CNDDDB was performed. This included one focused western burrowing owl survey.

A review of the California Natural Diversity Database (CNDDDB), California Native Plant Society database (CNPS), United States Fish and Wildlife Service (USFWS)/Carlsbad Office Sensitive Species list, field guides and aerial photos was also conducted to identify special-status plant and wildlife species that could potentially occur inside the BSA.

Vegetation Communities

The entire 10 acre parcel site is under alfalfa cultivation. No native vegetation was present. Historic aerial photos of the Project area indicate the site has been under agricultural development since at least 1937 (Cardno, 2021a) thus eliminating any native species through cultivation practices which include disking, planing, rototilling, floating, harvesting and pesticide applications. Botanical species observed on or near the Project site included alfalfa (*megicago sativa*), Prostrate pigweed (*Tamarix spp.*), and ornamental landscape trees and vegetation.

Special Status Species

The special status species detected within the BSA and their potential for occurring is presented on **Table 8**. As shown on **Table 8**, no special status species other than burrowing owls were documented within the survey area. Wildlife species noted during the biological survey consisted of species commonly found in agricultural areas, such as ants, grasshoppers, aphids and beetles. No amphibians or lizards were observed on site and due to the lack of available water or vegetation, none would be expected.

Burrowing Owl

Burrowing owl (*Athene cunicularia*), also called western burrowing owl, is a CDFW Special-Status Species that occupies open areas of the desert and high desert and is frequently encountered in Imperial County. This small owl occurs in a wide range of mostly open habitats in California, including grasslands, shrub-steppe, deserts, pastures, and agricultural areas. No burrowing owls (BUOW) or burrows were found within the survey boundaries; however, signs of BUOW including one BUOW pellet, were found in a concrete pile 1,035 feet from southeast corner of Project site. The pellet was not within the area that would be disturbed by Project, but is evidence of BUOW presence within the vicinity.

Nesting Birds and Raptors

The field survey occurred outside of the nesting season (February 1 to August 31). There are no small trees on site that encourage bird nesting and no nesting bird activity was detected. However, ground nesting species, such as lesser nighthawk, black-necked stilt or killdeer could use the area. Additionally, large trees were found within 500 feet of the

Potentially Significant Impact (PSI) Less Than Significant With Mitigation Incorporated (LTSWMI) Less Than Significant Impact (LTSI) No Impact (NI)

Project site, across Ross Road to the north which could provide potential nesting habitat (outside areas of active agricultural land uses).

Bird species were detected during the biological survey. Commonly observed species observed on-site included black phoebe (*Sayornis nigricans*), mourning dove (*Zenaida macroura*), and northern mockingbird (*Mimus polyglottos*).

Signs of mammals were observed on the Project site, but were assumed to be canines and pocket gophers (See **Table 8**). Bats are not expected; roosting sites are not available.

TABLE 8. SPECIAL-STATUS WILDLIFE SPECIES WITH POTENTIAL TO OCCUR ON PROJECT SITE

Special-Status Species	Legal Status ⁽¹⁾	Found	Potential for Occurrence ⁽²⁾
Burrowing owl (BUOW) <i>Athene cunicularia</i>	Federal: None State: CSC	No BUOW but signs observed	<ul style="list-style-type: none"> ▪ Agricultural area that is very favorable BUOW habitat. ▪ One BUOW pellet was found in concrete pile 1,035 ft. west of Project site ▪ No active burrows were found onsite
Flat-tailed horned lizard (FTHL) <i>Phrynosoma mcallii</i>	Federal: None State: Protected, SC	No	<ul style="list-style-type: none"> ▪ Highly disturbed agricultural acreage. ▪ No loose soils occur on site. ▪ No FTHL, scat or tracks were identified in the general biological survey. ▪ Project site is not within a FTHL Management Area. ▪ Not expected
Le Conte's thrasher <i>Toxostoma lecontei</i>	Fed: None State: SC	No	<ul style="list-style-type: none"> ▪ Highly disturbed agricultural acreage with no available nesting opportunities; ▪ Not expected
Loggerhead shrike <i>Lanius ludovicianus</i>	Fed: None State: SC	No	<ul style="list-style-type: none"> ▪ Very low on site – Highly disturbed acreage with sparse available nesting opportunities. ▪ Lizards which are prey were not seen
Northern Harrier <i>Circus cyaneus</i>	Fed: None State: SC	No	<ul style="list-style-type: none"> ▪ Low populations of prey observed. ▪ Could be found hunting in area but not nesting
Yuma clapper rail (Ridgeway Rail) <i>Rallus longirostris yumanensis</i>	Fed: FE State: ST	No	<ul style="list-style-type: none"> ▪ None observed or heard; ▪ Cattails not found in dense stands. ▪ Not expected.

Source: Barrett, 2023.

Notes:

(1) FE = Federal endangered; SE = State endangered; ST = State threatened; SC = California species of special concern.

(2) Potential for occurrence ranking is based on the following criteria:

High = Recent or historical record of the species occurring within the Project site or within 1 mile of the Project sites and/or the habitat requirements for the species occur within Project site.

Moderate = either a recent or historical record exists of the species within 1 mile of the Project site or the habitat requirements for the species occur within the Project site.

Low = No recent or historical records exist of species occurring within the Project site or within 1 mile of Project site, and/or the habitats needed to support the species on the site are of poor quality.

Potentially Significant Impact (PSI)	Less Than Significant With Mitigation Incorporated (LTSWMI)	Less Than Significant Impact (LTSI)	No Impact (NI)
--------------------------------------	---	-------------------------------------	----------------

Impact Analysis

Would the project:

- a) Have a substantial adverse effect, either directly or through habitat modifications, on any species identified as a candidate, sensitive, or special status species in local or regional plans, policies, or regulations, or by the California Department of Fish and Wildlife or U.S. Fish and Wildlife Service?

<input type="checkbox"/>	<input checked="" type="checkbox"/>	<input type="checkbox"/>	<input type="checkbox"/>
--------------------------	-------------------------------------	--------------------------	--------------------------

a) Less Than Significant With Mitigation Incorporated. The Biology Report found that the Project has the potential to adversely affect burrowing owls, also called western burrowing owl, a CDFW Special-Status Species. During the field survey, a single burrowing owl pellet was observed in a concrete pile located 1,035 feet from the southeast corner of the Project site. While this area is outside the Project’s construction boundary, it indicates the presence of burrowing owls in the vicinity of the Project. Because a single focused burrowing owl survey was conducted, **MM BIO-1** requires the completion of the remaining three (3) protocol surveys by July and the identification of recommended impact minimization and mitigation measures. Additionally, **MM BIO-2** requires the completion of Pre-Construction Burrowing Owl Survey.

Indirect temporary impacts may occur on breeding birds, which can be significantly affected by short-term construction-related noise through the temporary disruption of foraging, nesting, and reproductive activities. There are no small trees on site that encourage bird nesting and no nesting bird activity was detected. However, ground nesting species, such as lesser nighthawk, black-necked stilt or killdeer could use the area. Additionally, large trees were found within 500 feet of the Project site, across Ross Road to the north which could provide potential nesting habitat (outside areas of active agricultural land uses). Indirect temporary impacts to active migratory bird nests, if present at the time of construction are prohibited under the federal Migratory Bird Treaty Act (MBTA) and California Fish and Game Code §3503 and §3513. Indirect impacts from construction-related noise may occur on breeding wildlife if construction occurs during the breeding season (i.e., February 15 through August 31 for most bird species and January 1 through August 31 for raptors). This would be considered a significant impact. Implementation of **MM BIO-3** would reduce this impact to less than significant.

Implementation of Mitigation Measures **MM BIO-1**, **MM BIO-2** and **MM BIO-3** would reduce impacts to below a level of significance.

Would the project:

- b) Have a substantial adverse effect on any riparian habitat or other sensitive natural community identified in local or regional plans, policies, regulations or by the California Department of Fish and Wildlife or U.S. Fish and Wildlife Service?

<input type="checkbox"/>	<input type="checkbox"/>	<input type="checkbox"/>	<input checked="" type="checkbox"/>
--------------------------	--------------------------	--------------------------	-------------------------------------

b) No Impact. The Project site is used for agricultural purposes and no riparian habitat or other sensitive natural community was found on site. Therefore no impacts would occur under this criteria and no mitigation would be required,

	Potentially Significant Impact (PSI)	Less Than Significant With Mitigation Incorporated (LTSWMI)	Less Than Significant Impact (LTSI)	No Impact (NI)
--	--------------------------------------	---	-------------------------------------	----------------

Would the project:

- | | | | | |
|--|--------------------------|--------------------------|--------------------------|-------------------------------------|
| c) Have a substantial adverse effect on federally protected wetlands as defined by Section 404 of the Clean Water Act (including, but not limited to, marsh, vernal pool, coastal, etc.) through direct removal, filling, hydrological interruption, or other means? | <input type="checkbox"/> | <input type="checkbox"/> | <input type="checkbox"/> | <input checked="" type="checkbox"/> |
|--|--------------------------|--------------------------|--------------------------|-------------------------------------|

c) No Impact. There are no federally protected wetlands or waters of the U.S. found on the Project site; therefore the Project will have no impact on federally protected wetlands as defined by Section 404 of the Clean Water Act (including, but not limited to, marsh, vernal pool, coastal, etc.) through direct removal, filling, hydrological interruption, or other means. No mitigation is required.

Would the project:

- | | | | | |
|--|--------------------------|-------------------------------------|--------------------------|--------------------------|
| d) Interfere substantially with the movement of any native resident or migratory fish or wildlife species or with established native resident or migratory wildlife corridors, or impede the use of native wildlife nursery sites? | <input type="checkbox"/> | <input checked="" type="checkbox"/> | <input type="checkbox"/> | <input type="checkbox"/> |
|--|--------------------------|-------------------------------------|--------------------------|--------------------------|

d) Less Than Significant With Mitigation Incorporated. Wildlife movement corridors are defined as areas that connect suitable wildlife habitat areas in a region otherwise fragmented by rugged terrain, changes in vegetation, or human disturbance. Natural features such as canyon drainages, ridgelines, or areas with vegetation cover provide corridors for wildlife travel. Wildlife movement corridors are important because they provide access to mates, food, and water; allow the dispersal of individuals away from high population density areas; and facilitate the exchange of genetic traits between populations.

The BSA does not support any of the above listed features. Additionally, the Project site is located within an agricultural area and is subjected to continuous disturbance from harvesting, cultivating, renovating, weeding, seeding, irrigation among other activities. It is bound by Ross Road on the north and by Hawes Road and SR-111 on the west. and as a result of these existing barriers, the Project is not expected to serve as a wildlife corridor, will not interfere substantially with the movement of any native resident or migratory fish or wildlife species or with established native resident.

While the habitat within the BSA likely provides foraging and breeding opportunities for urban tolerant species, the BSA is not expected to serve as a nurse site for special status species. Therefore, no impacts relating to interference with wildlife movement corridors or use as a nursery site are anticipated and no mitigation would be required.

Would the project:

- | | | | | |
|---|--------------------------|--------------------------|-------------------------------------|--------------------------|
| e) Conflict with any local policies or ordinances protecting biological resources, such as a tree preservation policy or ordinance? | <input type="checkbox"/> | <input type="checkbox"/> | <input checked="" type="checkbox"/> | <input type="checkbox"/> |
|---|--------------------------|--------------------------|-------------------------------------|--------------------------|

e) Less Than Significant Impact. The County of Imperial General Plan's Conservation and Open Space Element's Open space and Creation Conservation Policy requires detailed investigations to be conducted to determine the significance, location, extent, and condition of natural resources in the County (County of Imperial 2016). If any rare, sensitive, or

Potentially Significant Impact (PSI)	Less Than Significant With Mitigation Incorporated (LTSWMI)	Less Than Significant Impact (LTSI)	No Impact (NI)
--------------------------------------	---	-------------------------------------	----------------

unique plant or wildlife habitat would be impacted by a project, the County must notify the agency responsible for protecting plant and wildlife before approving the project.

Construction of the Project is not anticipated to conflict with any local policies or ordinances protecting biological resources during construction or operation. Consistent with the County's Open Space Conservation Policy, appropriate studies have been prepared for protecting potential impacted plant and wildlife

Additionally, implementation of mitigation measures **MM BIO-1, MM BIO-2, and MM BIO-3** would reduce any potential impacts to rare, sensitive, or unique plant or wildlife habitat to less than significant. Therefore, this impact would be less than significant and no further mitigation would be required.

Would the project:

- f) Conflict with the provisions of an adopted Habitat Conservation Plan, Natural Community Conservation Plan, or other approved local, regional, or state habitat conservation plan?

f) No Impact. The Project site is not located within an area that is subject to a Habitat Conservation Plan, Natural Community Conservation Plan, or other approved local, regional, or state habitat conservation plan. No impact would occur.

Mitigation Measures

Implementation of the following mitigation measures would reduce impacts to below a level of significance.

MM BIO-1: Burrowing Habitat Assessment

One BUOW protocol survey has been completed. In April, the remaining three (3) protocol surveys shall be started and completed by July; and a report prepared recommending avoidance, minimization and mitigation measures.

Since signs of BUOW have been located within the vicinity, construction foremen and workers and onsite employees be given worker training by a qualified biologist regarding burrowing owl that would include the following:

- Description of BUOW
- Biology
- Regulations (CDFW/USFWS)
- Wallet card with picture/guidelines for protecting owl and wildlife
- Notification procedures if owl (dead, alive, injured) is found on or near site

Sign-in sheets for the worker training program shall be maintained and copies of the sign-in sheets and training materials shall be submitted to ICPDSD and CDFW within 30 days of construction completion.

Potentially Significant Impact (PSI)	Less Than Significant With Mitigation Incorporated (LTSWMI)	Less Than Significant Impact (LTSI)	No Impact (NI)
--------------------------------------	---	-------------------------------------	----------------

MM BIO-2: Burrowing Owl Survey Pre-Construction Survey

No less than 14 days prior to the commencement of initial ground-disturbing activities (vegetation clearance, grading) and within 24 hours prior to the start of ground disturbance, pre-construction surveys for burrowing owls shall be conducted, in accordance with the Staff Report on Burrowing Owl Mitigation (2012 or most recent version). Surveys shall be conducted by a qualified biologist(s) (i.e., a wildlife biologist with previous burrowing owl survey experience), approved by Imperial County.

Surveys for burrowing owls shall be conducted in conformance with the 2012 CDFW Staff Report on Burrowing Owl Mitigation. Surveys shall be completed within all areas proposed for ground disturbance and vegetation clearing/trimming and within 200 meters (656 feet) of the construction zone to identify occupied breeding or wintering burrowing owl burrows.

If no burrowing owls are detected, a report documenting the burrowing owl survey results shall be prepared and submitted to the County of Imperial Planning and Development Services Department (ICPDSD) and the CDFW. No further mitigation is necessary.

Pre-Construction Survey during Non-breeding Season (September 1 – January 31):

- **Occupied Burrows:** If burrowing owls are detected on site during the non-breeding season (generally September 1 through January 31), a 50-foot buffer zone shall be maintained around the occupied burrow(s).
- **Unoccupied Burrows:** Once a burrow has been determined by a qualified wildlife biologist to be unoccupied by burrowing owls, the biologist shall excavate the burrow using hand tools. Sections of flexible plastic pipe or burlap bag shall be inserted into the tunnels during excavation to maintain an escape route for any animals inside the burrow. One-way doors shall be installed at the entrance to the active burrow and other potentially active burrows within 100 feet of the active burrow and monitored for at least 48 hours after installation.
- A report documenting the burrowing owl survey results shall be prepared and submitted to the ICPDSD and the CDFW.

Pre-Construction Survey during Breeding Season (February 1 – August 31):

The following avoidance measures shall be implemented for all burrows identified during surveys:

- Occupied burrows shall not be disturbed during the nesting season (February 1 through August 31) unless a qualified biologist verifies through non-invasive methods that either the birds have not begun egg-laying and incubation or that juveniles from the occupied burrows are foraging independently and are capable of independent survival. Burrowing owls present on-site after February 1 shall be assumed to be nesting unless evidence indicates otherwise.
- A 100-foot buffer shall be maintained between Project activities and nesting burrowing owls. No activity or entry by personnel or equipment will be allowed within the buffer area.

Potentially Significant Impact (PSI)	Less Than Significant With Mitigation Incorporated (LTSWMI)	Less Than Significant Impact (LTSI)	No Impact (NI)
--------------------------------------	---	-------------------------------------	----------------

- Physical (temporary fencing) and visual (hay bales or similar) barriers shall be installed to delineate the buffer zone. Installation of the exclusionary material will be completed by construction personnel under the supervision of a qualified biologist prior to initiation of construction activities.
- The buffer shall be maintained until August 31 or until the young owls are foraging independently or the nest is no longer active, based upon monitoring evidence.
- If there is danger that owls will be injured or killed as a result of construction activity, the birds may be passively relocated but only during the non-breeding season; relocation shall require coordination with and approval from the CDFW prior to relocation activities. Relocation of owls during the non-breeding season will be performed by a qualified biologist in coordination with the CDFW.
- Any damaged or collapsed active burrowing owl burrows will be replaced with artificial burrows in adjacent habitat at a 2:1 ratio.

Copies of the burrowing owl survey results report shall be submitted to the ICPDSD and the CDFW.

MM BIO-3: Pre-Construction General Nesting Bird Survey

Construction activities for the Project should commence outside of the bird breeding season (generally February 1 through August 31; January 1 for raptors). If activities associated with vegetation/tree removal, clearing, grubbing, demolition, grading, staging or other construction activities are planned to occur during the bird nesting/breeding season, the Applicant shall retain a qualified biologist to conduct a bird nesting survey no more than 72-hours prior to commencement of the construction activities to determine presence or absence of nesting birds or active nests within the proposed area of disturbance plus a 500-foot buffer and a 250-foot buffer for non-listed bird species. Inaccessible parts of the survey area shall be scanned using binoculars to ensure 100 percent visual coverage. The qualified biologist shall be familiar with the identification of bird species known to occur in southern California communities.

If no nesting birds or active nests are found, the Applicant shall submit the results of the Pre-Construction survey to the Development Services Department and wildlife agencies for review and approval prior to initiating any construction activities and no further mitigation would be required.

If active nests (those containing eggs, nestlings, or associated with dependent fledglings) of bird species covered by the Migratory Bird Treaty Act are detected within the proposed area of disturbance during the 10-day preconstruction survey:

- Construction activities shall stay outside a 250-foot avoidance buffer around the active nest. For raptor species, this buffer shall be expanded to 500 feet. A biological monitor shall delineate the boundaries of an avoidance buffer area with (highly visible construction fencing or other exclusionary material that would inhibit entry by personnel or equipment into the buffer zone) and monitor the active nest to ensure that nesting behavior is not adversely

Potentially Significant Impact (PSI)	Less Than Significant With Mitigation Incorporated (LTSWMI)	Less Than Significant Impact (LTSI)	No Impact (NI)
--------------------------------------	---	-------------------------------------	----------------

affected by construction activity. Once the young have fledged and the qualified biologist has determined the nest is inactive, normal construction activities can occur.

- The biologist and Project Applicant shall postpone construction activity within the buffer area(s) and contact the wildlife agencies and the City’s Development Services Department to discuss: 1) the best approach to avoid/minimize impacts to breeding/nesting birds (e.g., sound walls), and 2) a monitoring program acceptable to the wildlife agencies. Subsequent to these discussions, work may be initiated subject to implementation of the agreed-upon avoidance/minimization approach and monitoring program.
- Upon agreement as to the necessary revisions to the avoidance/minimization approach, work may resume subject to the revisions and continued monitoring. Success or failure of an active nest shall be established by regular and frequent trips to the site, as determined by the biologist and through a schedule approved by the wildlife agencies. Monitoring of an active nest shall continue until fledglings have dispersed or the nest has been determined to be a failure, as approved by the wildlife agencies.
- No project activity shall occur inside an avoidance buffer until the biologist determines that the nest is no longer active.

Reporting. Within 30 days of the completion of the monitoring efforts, the Project Applicant shall submit a Final Bird Survey Monitoring Report prepared by the project biologist to the wildlife agencies and City’s Development Services Department. The report shall include documentation of all bird survey, monitoring activities, coordination efforts with the wildlife agencies, as-built construction drawings with an overlay of any active nests in the survey areas, photographs of habitat areas during pre-construction and post-construction conditions, and other relevant summary information documenting that authorized impacts were not exceeded and that general compliance was achieved.

V. CULTURAL RESOURCES

Cogstone Resource Management prepared the *Cultural and Paleontological Resources Assessment For The Maverik Fueling Station and Convenience Store Project* (Cogstone, 2024). The Cultural and Paleontological Assessment, included as Appendix D-1 of this Initial Study, evaluates potential effects to cultural and paleontological resources that could result from implementation of the Project. The analysis contained in this section is based on the findings of this technical report.

Existing Setting

Potentially Significant Impact (PSI)	Less Than Significant With Mitigation Incorporated (LTSWMI)	Less Than Significant Impact (LTSI)	No Impact (NI)
---	---	--	----------------------

The Project's Area of Potential Effects (APE) ⁽³⁾ ⁽⁴⁾, consists of all areas of ground disturbance for the Project, including off-site improvements to Ross Road as well as a 1,225-foot long section of the Acacia Five A Drain For most Project components, the vertical depth of disturbance is expected be no more than 5 feet below the ground surface; however the USTs will require excavation to depths of approximately 18 feet and the wastewater treatment plant will be 6.5 feet below grade.

A records search of the California Historical Resources Information System (CHRIS) from the South Coastal Information Center (SCIC) located at San Diego State University was completed on November 8, 2023. A search of the Sacred Lands File held by the NAHC was requested on November 8, 2023. The search was undertaken to supplement the SCIC records search to inquire as to whether resources important to local Native American groups may exist within the project area. A response was received from the NAHC on December 3, 2023, which was positive for specific site information within the one-mile search radius. The NAHC provided a tribal consultation list that identified 29 Native American Tribes and tribal representatives (See Appendix D-2).

The record search indicated that eight (8) cultural resource studies have been conducted within a 0.5 mile radius of the Project site and that nine (9) cultural resources were previously recorded within the search area. No cultural resources were previously recorded within the Project site. **Table 9** summarizes the cultural resources sites recorded within 0.5 miles of the Project site and their eligibility for listing on the National Register of Historic Places (NRHP), and the California Register of Historic Resources (CRHR).

TABLE 9. PREVIOUSLY RECORDED CULTURAL RESOURCES WITHIN A HALF MILE RADIUS OF THE PROJECT AREA

Resource No. (Primary No.)	Resource Type	Description	Distance From Project Site (miles)	Eligibility Status
009016	Historic Built Environment	Two segments of transmission line that connect to IID's steam plant on Dogwood Road. The towers are metal A-frame.	0.25-0.5	Unevaluated
009068	Historic Built Environment	Two segments of unnamed canal. Poured concrete lining.	0.25-0.5	Unevaluated
009069	Historic Built Environment	Acacia Lateral 5A Canal. Poured concrete lining.	0-0.25	Unevaluated
009070	Historic Built Environment	Unnamed canal. Z Earthen lining.	0.25-0.5	Unevaluated

³ The "area of direct and indirect impacts" to cultural resources under CEQA is identical to the area referred to under Section 106 of the National Historic Preservation Act as the Area of Potential Effect (APE).

⁴ A project's APE is "the geographic area or areas within which an undertaking may cause changes to the cultural resources, as well as in the character or use of historic properties, if any such properties exist" (36 Code of Federal Regulations [CFR] 800.2(c)).

Potentially Significant Impact (PSI) Less Than Significant With Mitigation Incorporated (LTSWMI) Less Than Significant Impact (LTSI) No Impact (NI)

TABLE 9. PREVIOUSLY RECORDED CULTURAL RESOURCES WITHIN A HALF MILE RADIUS OF THE PROJECT AREA

Resource No. (Primary No.)	Resource Type	Description	Distance From Project Site (miles)	Eligibility Status
009071	Historic Built Environment	Unnamed canal. Poured concrete lining.	0.25-0.5	Unevaluated
009072	Historic Built Environment	Unnamed canal. Poured concrete lining.	0.25-0.5	Unevaluated
009081	Historic Built Environment	Segment of transmission line. Support poles are pine wood with single cross supporting 2 lines.	0.25-0.5	Unevaluated
009082	Historic Built Environment	Acacia 65 Canal. Earthen lined	0.25-0.5	Unevaluated
009083	Historic Built Environment	Acacia Lateral 6A Canal. Poured concrete lining.	0.25-0.5	Unevaluated

Source: Cogstone, 2024 (Appendix D-1)

A pedestrian field survey of the APE was conducted on November 21, 2023 to determine the presence of any previously undocumented cultural resources. The Project area, including a 1,225-foot long section of the Acacia Five A Drain, was documented during the surveyed. The Project Area supports agricultural use and had heavy ground cover with less than 10 percent visibility with the exception of the bare margins on the north and west sides. No archaeological materials were identified during the survey.

A 1,225-foot long section of the Acacia Five A Drain, the first 620 feet of which runs along the inside of the western boundary of the Project Area, was documented during the survey. The earthen-lined drain is approximately 40 feet wide at the surface, 20 feet deep, and varies between 0 and 10 feet wide at the bottom. The section of the Acacia Five A Drain was found to not be connected with important events in the past, important persons in the past, nor is it of unique construction. Recordation on Department of Parks and Recreation series 523 site forms has exhausted the potential of this resource to yield data important to the past. The resource is not considered significant and is recommended not eligible for listing in the California Register of Historical Resources under any criteria.

Impact Analysis

Would the project:

- a) Cause a substantial adverse change in the significance of a historical resource pursuant to §15064.5?

a) Less Than Significant With Mitigation Incorporated. For purposes of §15064.5 of the California Code of Regulation, the term “historical resource” includes a resource listed in, or determined to be eligible for listing in the California Register of Historical Resources; a resource included in a local register of historical resources or identified as significant in an historical resource survey meeting the requirements section 5024.1(g) of the Public Resources Code; or any object, building, structure, site, area, place, record, or manuscript which a lead agency determines to be historically significant. Generally, a resource shall be considered by the lead agency to be "historically significant" if the

Potentially Significant Impact (PSI)	Less Than Significant With Mitigation Incorporated (LTSWMI)	Less Than Significant Impact (LTSI)	No Impact (NI)
--------------------------------------	---	-------------------------------------	----------------

resource meets the criteria for listing on the California Register of Historical Resources (Pub. Res. Code, §5024.1, Title 14 CCR, Section 14 CCR, Section 4852)

To be considered historically significant, a resource must meet one of four criteria for listing outlined in the CRHR (CEQA Guidelines 15064.3 (a)(3)) and/or in the NRHP (36 CFR Part 60.4). In addition to meeting one of the criteria outlined the CRHR, a resource must retain enough intact and undisturbed deposits to make a meaningful data contribution to regional research issues (CCR Title 14, Chapter 1.5 Section 4852 [c]). Further, based on CEQA Guidelines Section 15064.5 (b), substantial adverse change would include physical demolition, destruction, relocation, or alteration of the resource or its immediate surroundings such that the significance of an historical resource is materially impaired. This can occur when a project:

- Demolishes or materially alters in an adverse manner those physical characteristics of an historical resource that convey its historical significance and that justify its inclusion in, or eligibility for, inclusion in the CRHR, NRHP, a local register, or historic resources.
- Demolishes or materially alters in an adverse manner those physical characteristics that account for its identification in an historical resources survey meeting the requirements of PRC §5024.1(g), unless the public agency establishes by a preponderance of the evidence that the resource is not historically or culturally significant.

Would the project:

- b) Cause a substantial adverse change in the significance of an archaeological resource pursuant to State CEQA Guidelines § 15064.5?

b). Less Than Significant With Mitigation Incorporated. The *Cultural And Paleontological Resources Assessment For The Maverik Fueling Station and Convenience Store Project* (Cogstone, 2024) identified 9 archaeological resources recorded within 0.5 miles of the Project site. No resources were observed during the pedestrian survey. Nevertheless, because prehistoric archaeological resources are extremely important to Native American tribes all prehistoric sites were considered eligible for the CRHR and the NRHP.

Direct effects on pre-historical (archaeological) resources in the APE could result from ground disturbing activities associated with the construction of the Project. Construction-related ground disturbing activities have the potential to cause substantial adverse changes to buried prehistoric and historic resources. If such resources are encountered during construction and those resources meet the eligibility criteria of the CRHR and/or the NRHP, the impact would cause a substantial adverse change in the significance of a historical or archaeological resource. This would be a potentially significant impact to historical resources. With implementation of mitigation measures **MM CUL-1** through **MM CUL-6**, impacts to significant historical resources would be less than significant.

Would the project:

- c) Disturb any human remains, including those interred outside of formal cemeteries?

c). Less Than Significant With Mitigation Incorporated. While no potential human remains have been identified in the project area, subsurface activities always have some potential to impact previously unknown remains. This potential impact is considered a significant impact. **MM CUL-3** will ensure that the potential impacts to previously unknown

Potentially Significant Impact (PSI)	Less Than Significant With Mitigation Incorporated (LTSWMI)	Less Than Significant Impact (LTSI)	No Impact (NI)
--------------------------------------	---	-------------------------------------	----------------

human remains do not rise to the level of significance pursuant to CEQA. Implementation of **MM CUL-3** will reduce the potential impact associated with inadvertent discovery of human remains to a level less than significant.

Mitigation Measures

Implementation of the following mitigation measures would reduce impacts to below a level of significance.

MM-CUL-1: Prepare and Implement a Cultural Resource Mitigation and Monitoring Plan.

Prior to issuance of a grading permit, the Applicant shall retain a qualified archaeologist⁵ to prepare a Cultural Resource Mitigation and Monitoring Plan (CRMMP), which shall be submitted to and approved by the County of Imperial Planning and Development Services. The purpose of the CRMMP is to document the actions and procedures to be followed to ensure avoidance or minimization of impacts to cultural resources consistent with CEQA Guidelines Section 15126.4(b), and to lay out a detailed program of mitigation for direct and indirect impacts on cultural resources during project implementation. The mitigation and monitoring plan shall identify procedures for monitoring and the implementation of a discovery plan in coordination with affected Tribal groups and include the following at a minimum:

- List of personnel involved in the monitoring activities;
- Inclusion of involvement of the Native American community, as appropriate;
- Description of the worker awareness program that shall be implemented;
- Description of how the monitoring shall occur;
- Description of frequency of monitoring (e.g., full-time, part time, spot checking);
- Description of resources expected to be encountered (if any);
- Description of circumstances that would result in the halting of work at the project site
- Description of procedures for halting work on the site and notification procedures including the notification of the Applicant, the ICPDSD, and tribal representatives within 24 hours of the inadvertent discovery of archaeological resources; and
- Description of monitoring reporting procedures.

The project’s grading and construction plans and specifications shall state that full-time monitoring by a qualified archaeologist shall be conducted during the initial grubbing and ground disturbance for the Project. In the event that archaeological resources are inadvertently discovered during ground-disturbing activities, work must be halted within 50 feet of the find until it can be evaluated by a qualified archaeologist. Construction activities could continue in other areas. If the discovery

⁵ Meeting the Secretary of the Interior’s Professional Standards published in Appendix A of 36 CFR Part 61.

Potentially Significant Impact (PSI)	Less Than Significant With Mitigation Incorporated (LTSWMI)	Less Than Significant Impact (LTSI)	No Impact (NI)
--------------------------------------	---	-------------------------------------	----------------

proves to be significant, additional work, such as data recovery excavation or fossil recovery, may be warranted and would be discussed in consultation with the appropriate regulatory agency(ies).

MM-CUL-2: Cultural Resources Construction Monitor.

The Applicant shall retain qualified archaeological monitors and a TCA (traditionally and culturally affiliated) Native American Monitor for all ground-disturbing activities associated with the Project. Native American tribes shall be given the opportunity to provide one or more certified cultural monitors for the Project during all excavation or earth-moving within the Project site in Holocene-aged deposits. The Construction Contractor shall give the tribe's Historic Preservation Officer (THPO) or other designated representative two weeks' advanced notice of the monitoring opportunity and shall provide a copy of such notice to the County.

If a significant cultural resource site is found during ground-disturbing activities the resource will be protected in place, or data recovery will be initiated, consistent with the mitigation and monitoring plan required by **MM-CUL-1**.

MM CUL-3: Human Remains.

Procedures of conduct following the discovery of human remains on non-federal lands have been mandated by California Health and Safety Code §7050.5, California Public Resources Code §5097.98, and California Code of Regulations (CCR) §15064.5(e). Should human remains be encountered, all work in the immediate vicinity of the burial must cease, and any necessary steps to ensure the integrity of the immediate area must be taken. The County Coroner will be immediately notified. The Coroner must then determine whether the remains are Native American. If the Coroner determines the remains are Native American, the Coroner has 24 hours to notify the NAHC, who will, in turn, notify the person they identify as the most likely descendent (MLD) of any human remains. Further actions will be determined, in part, by the desires of the MLD. The MLD has 48 hours to make recommendations regarding the disposition of the remains following notification from the NAHC of the discovery. If the MLD does not make recommendations within 48 hours, the owner shall, with appropriate dignity, reinter the remains in an area of the property secure from further disturbance. Alternatively, if the owner does not accept the MLD's recommendations, the owner or the descendent may request mediation by the NAHC.

MM CUL-4: Disposition of Tribal Cultural Resources.

The landowner shall relinquish ownership to the TCA tribe all tribal cultural resources collected during the cultural resource mitigation monitoring conducted for the Project site for respectful and dignified treatment and disposition, including reburial, in accordance with the Tribe's cultural and spiritual traditions. All cultural materials that are associated with burial and/or funerary goods will be repatriated to the Most Likely Descendant as determined by the Native American Heritage Commission per California Public Resources Code Section 5097.98.

Potentially Significant Impact (PSI)	Less Than Significant With Mitigation Incorporated (LTSWMI)	Less Than Significant Impact (LTSI)	No Impact (NI)
--------------------------------------	---	-------------------------------------	----------------

MM CUL-5: Unanticipated Discoveries Historic Properties Treatment Plan/Data Recovery Plan

Should an unanticipated discovery be made, avoidance is the preferred treatment (CEQA Guidelines, Section 15126.4(b)(3)(A)), but if the site cannot be avoided in place, then the site will be further evaluated. Immediately upon discovery of a find, a qualified archaeologist will evaluate the significance of the newly discovered site or unanticipated discovery along with attempted consultation with designated Native American representatives in order to provide proper management recommendations. If testing and evaluation of the site is recommended, the qualified archaeologist shall prepare a research design, schedule, and budget for review and approval by the County and the Applicant. During evaluation and testing, the appropriate Native American tribe shall be notified in advance so that a tribal monitor can be present and assist with the work being conducted. At the completion of the monitoring program, the qualified archaeologist shall prepare a monitoring report that describes the project, the personnel used, the dates of performance, and results. If cultural resources are recovered and cannot be preserved in place, they shall be cleaned, catalogued, analyzed, reburied in a nearby area, after consultation or curated at the California Historical Resources Regional Information Center.

MM CUL-6: Prepare Final Monitoring Report and/or Evaluation Report.

Prior to the release of the grading bond and no later than 90 days after monitoring has been completed, a Monitoring Report and/or Evaluation Report shall be completed. This report shall describe the results, analysis and conclusions of the cultural resource mitigation monitoring efforts such as, but not limited to, the Research Design and Data Recovery Program. It will also include a list of project personnel, a catalog of any cultural resources that were identified, any associated DPR 523 Forms and/or confidential maps, details of the location of the final disposition of cultural resources (if any), any issues or problems that occurred during monitoring, and any other pertinent information. The Monitoring Report shall be submitted by the project archaeologist, along with the notes and comments from the TCA Native American Monitor(s), to the County for review and approval. Upon approval by the Lead Agency, a complete final report shall be submitted to the appropriate Information Center, and TCA Tribes, any relevant curation facility, and the landowner/applicant.

VI. ENERGY.

Birdseye Planning Group (BPG) prepared an *Energy Calculation Memo for the Maverik Fueling Station and Convenience Store Project* (BPG, 2024). The *Energy Calculation Memo*, included as Appendix E of this Initial Study, quantified energy demand associated with the proposed Project. The analysis contained in this section is based on the findings of this technical report.

Energy relates directly to environmental quality as energy use can adversely affect air quality and other natural resources. The vast majority of California’s air pollution is caused by burning fossil fuels. Consumption of fossil fuels is linked to changes in global climate and depletion of stratospheric ozone. Transportation energy use is related to the fuel efficiency of cars, trucks, and public transportation; choice of different travel modes (e.g., auto, carpool, and public transit); vehicle speeds; and miles traveled by these modes. Construction and routine operation and maintenance of

Potentially Significant Impact (PSI)	Less Than Significant With Mitigation Incorporated (LTSWMI)	Less Than Significant Impact (LTSI)	No Impact (NI)
--------------------------------------	---	-------------------------------------	----------------

transportation infrastructure also consume energy. In addition, residential, commercial, and industrial land uses consume energy, typically through the usage of natural gas and electricity.

California relies on a regional power system comprised of a mix of natural gas, renewable, hydroelectric, and nuclear generation resources. Natural gas provides California with a majority of its electricity followed by renewables, large hydroelectric and nuclear (California Energy Commissions [CEC], 2018). The IID provides electricity to the Project area and generates or buys electricity from a variety of fossil fuel and renewable energy facilities. Close to 1,100 megawatts (MW) of energy are derived from a portfolio that includes its own generation, and long- and short-term power purchases (IID, 2023). Electricity consumption within the IID service area for 2022 ⁽⁶⁾ is outlined in **Table 10**.

TABLE 10. ELECTRICITY CONSUMPTION IN IID SERVICE AREA (2022)

Sector	Millions of kWh (GWh)
Ag & Water Pump	274.0384
Commercial Building	1,110.585
Commercial Other	178.1478
Industry	172.0324
Mining & Construction	75.37145
Residential	1,762.715
Streetlight	11.48198
Total	3,584.372

Source: California Energy Commission, 2024.

Natural gas is provided by SoCalGas (SoCalGas, 2023). SoCalGas gets most of its natural gas from natural gas production fields in New Mexico, west Texas, and Oklahoma, as well as in the Rocky Mountains and Canada. The remaining natural gas supply percentage is produced locally in Central and Southern California from onshore and offshore fields (SoCalGas, 2013).

According to the California Energy Commission’s Website on Natural Gas Consumption by Entity, the County of Imperial’s Non-Residential sector consumed 33.3 million therms (MMBtu) of natural gas in 2022; its Residential sector consumed 7.7 MMBtu in 2022, for a total consumption of 41 MMBtu (California Energy Commission, 2024).

Impact Analysis

Would the project:

- a) Result in potentially significant environmental impact due to wasteful, inefficient, or unnecessary consumption of energy resources, during project construction or operation?

⁶ 2022 is the most recent year that data is available.

Potentially Significant Impact (PSI) Less Than Significant With Mitigation Incorporated (LTSWMI) Less Than Significant Impact (LTSI) No Impact (NI)

a) Less Than Significant Impact. The Project would involve the use of energy during construction and operation. Energy use during the construction phase would be in the form of fuel consumption (e.g., gasoline and diesel fuel) to operate heavy equipment, light-duty vehicles, and machinery.

The long-term operation of the proposed includes electricity and natural gas service to power internal and exterior building lighting, and heating and cooling systems. In addition, the increase in vehicle trips associated with the project would increase fuel consumption within the County.

Energy Use

The following tables show estimated gasoline demand for construction workers (**Table 11**) and construction equipment by project phase and year (**Table 12**). All fuel calculations are based on the total Carbon Dioxide Equivalent (CO₂e) value calculated for each construction phase and vehicle miles traveled (VMT) using the California Emission Estimator Model (CalEEMod) version 2022.1. Data are reported in annual metric tons of CO₂e for the duration of each construction phase. Metric tons are converted to kilogram CO₂e and then divided by a conversion factor used by the U.S. Environmental Protection Agency to estimate gallons of gasoline (8.87) and diesel fuel (10.18) consumed based on carbon emissions.

Table 11 shows the gasoline demand for construction workers by project phase and year. **Table 12** shows the diesel fuel demand for equipment operation. For the purpose of determining fuel demand, it was assumed that all worker vehicles would be gasoline fueled and all construction equipment would diesel fueled.

TABLE 11. CONSTRUCTION WORKER GASOLINE DEMAND

Project Phase and Year	CO ₂ E MT	Kg CO ₂ e	Gallons
Demolition – 2024	1.97	1,002	113
Site Preparation – 2024	1.15	1,150	130
Grading – 2024	0.91	910	103
Grading - 2025	4.89	4,890	551
Building Construction - 2025	5.16	5,160	582
Architectural Coating - 2025	0.57	570	64
Paving - 2025	2.22	2,220	250
Total	16.87	15,902	1,793

Source: BPG, 2024.

TABLE 12. CONSTRUCTION EQUIPMENT DIESEL DEMAND

Project Phase and Year	CO ₂ E MT	Kg CO ₂ e	Gallons
Demolition – 2024	31.2	31,200	3,065
Site Preparation – 2024	24.1	24,100	2,367
Grading - 2024	13.2	13,200	1,297
Grading - 2025	71.7	71,700	7,043

Potentially Significant Impact (PSI) Less Than Significant With Mitigation Incorporated (LTSWMI) Less Than Significant Impact (LTSI) No Impact (NI)

TABLE 12. CONSTRUCTION EQUIPMENT DIESEL DEMAND

Project Phase and Year	CO ₂ E MT	Kg CO ₂ e	Gallons
Building Construction - 2025	210	210,000	20,629
Architectural Coating - 2025	15.8	15,800	1,552
Paving - 2025	2.31	2,310	227
Total	368.31	368,310	36,180

Source: BPG, 2024.

During operation, the Project would generate demand for 529,302 kilowatt hours (kWh) of electricity and 130,091 British Thermal Units (0.130091 MMBTU) of natural gas annually. The annual gasoline demand generated by passenger vehicles would be approximately 101,803 gallons. The annual diesel demand consumed by trucks entering and exiting the site for refueling would be approximately 49,804 gallons.

The construction and operation of the project would comply with all applicable federal, State, and local regulations regulating energy usage. The project will implement Title 24 Energy Efficiency Standards and CalGreen Code requirements for new construction that may include rooftop solar, double-pane windows, electric vehicle charging, LED lights, low-flow toilets, faucets drip irrigation, and the use of drought-tolerant landscaping to increase water conservation.

Energy-saving strategies will be implemented where possible to further reduce the project's energy consumption during the construction phase. Strategies being implemented include those recommended by the California Air Resources Board (CARB) that may reduce both the project's energy consumption, including diesel anti-idling measures, light-duty vehicle technology, usage of alternative fuels such as biodiesel blends and ethanol, and heavy-duty vehicle design measures to reduce energy consumption. As such, impacts would be less than significant and no mitigation would be required.

- b) Conflict with or obstruct a state or local plan for renewable energy or energy efficiency?

b) Less Than Significant Impact. The Project would be designed in a manner that is consistent with relevant energy conservation plans designed to encourage development that results in the efficient use of energy resources. The Project will be built to the *Energy Efficiency Standards for Residential and Nonresidential Buildings*, as specified in Title 24, Part 6, of the CCR (Title 24). Title 24 was established in 1978 in response to a legislative mandate to reduce California's energy consumption. Title 24 is updated approximately every three years; the 2016 standards became effective January 1, 2017. The 2019 Title 24 updates went into effect on January 1, 2020. The 2019 Energy Standards improve upon the 2016 Energy Standards for new construction of, and additions and alterations to, residential and nonresidential buildings. The 2019 update to the Energy Standards focuses on several key areas to improve the energy efficiency of newly constructed buildings and additions and alterations to existing buildings. The 2019 Energy Standards are a major step toward meeting Zero Net Energy. Buildings permitted on or after January 1, 2020, must comply with the 2019 Standards. Compliance with Title 24 is mandatory at the time new building permits are issued by city and county governments. Additionally, in January 2010, the State of California adopted the California Green Building Standards Code (CalGreen) that establishes mandatory green building standards for all buildings in California. The code was subsequently updated in 2013. The code covers five categories: planning and design, energy efficiency,

Potentially Significant Impact (PSI)	Less Than Significant With Mitigation Incorporated (LTSWMI)	Less Than Significant Impact (LTSI)	No Impact (NI)
--------------------------------------	---	-------------------------------------	----------------

water efficiency and conservation, material conservation and resource efficiency, and indoor environmental quality. Furthermore, the Project would also be consistent with the County's General Plan, which strives to promote development that is sustainable in its use of land and limits impacts on natural resources, energy, air and water.

Mitigation Measures

No mitigation would be required.

VII. GEOLOGY AND SOILS.

CMT Engineering Laboratories prepared a *Geotechnical Engineering Study for the Maverik Fueling Station and Convenience Store Project* in November 2021 (CMT, 2021). The Geotechnical Study, included as Appendix F of this Initial Study, evaluated the subsurface soil and groundwater conditions at the Project site, and made recommendations for foundation, earthwork, pavement and seismic considerations. Additionally, to define and evaluate the subsurface soil and groundwater conditions, 6 bore holes were drilled at the site to depths of approximately 6.5 to 71.5 feet below the existing ground surface. An infiltration test was also performed in bore hole B-3. The location of the bore holes (B-1 through B-6) is provided on Figure 1 of Appendix F.

Cogstone Resource Management prepared the *Cultural and Paleontological Resources Assessment For The Maverik Fueling Station and Convenience Store Project* (Cogstone, 2024). The Cultural and Paleontological Assessment, included as Appendix D-1 of this Initial Study, evaluate potential effects to cultural and paleontological resources that could result from implementation of the Project.

The analysis contained in this section is based on the findings of this technical report.

Impact Analysis

Would the project:

a) Directly or indirectly cause potential substantial adverse effects, including the risk of loss, injury or death involving:

- 1) Rupture of a known earthquake fault, as delineated on the most recent Alquist-Priolo Earthquake Fault Zoning Map issued by the State Geologist for the area or based on other substantial evidence of a known fault? Refer to Division of Mines and Geology Special Publication 42?

a.1) Less Than Significant Impact. In accordance with the Alquist-Priolo Special Studies Zone Act (Chapter 7.5, Division 2, Public Resources Code, State of California, effective May 4, 1975) the Office of State Geologist delineated Special Study Zones which encompass potentially and recently active traces of four major faults (San Andreas, Calaveras, Hayward and San Jacinto). The Alquist-Priolo Special Study Zone Act is enforced by the County to assure that homes, offices, hospitals, public buildings, and other structures for human occupancy which are built on or near active faults, or if built within special study areas, are designed and constructed in compliance with the County of Imperial Codified Ordinance.

Potentially Significant Impact (PSI)	Less Than Significant With Mitigation Incorporated (LTSWMI)	Less Than Significant Impact (LTSI)	No Impact (NI)
--------------------------------------	---	-------------------------------------	----------------

No fault traces were found, adjacent to, or projecting toward the subject site. The nearest mapped active (Holocene) fault is the Imperial Fault Zone approximately 2.6 miles to the northeast. The project site is not located within an Alquist-Priolo earthquake fault zone (California Department of Conservation, 2023). There are no active fault traces in the project vicinity. Accordingly, the project area is not within an earthquake fault zone.

The General Plan's Seismic and Public Safety Element (SPSE) contains a number of policies that would minimize impacts relating to the rupture of a known fault, including SPSE Policy 2, SPSE Policy 4 and SPSE Objective 4.2. Development of the proposed fueling station convenience store would adhere to all applicable policies of the General Plan and California Building Code for accepted structural standards and minimize the risk of loss, injury, or death. Therefore, impacts would be less than significant.

Would the project:

a) Directly or indirectly cause potential substantial adverse effects, including the risk of loss, injury or death involving:

2) Strong seismic ground shaking?

a.2) Less Than Significant Impact. The Project site has the potential to experience ground shaking during earthquakes along the Imperial Fault Zone , which is approximately 2.6 miles to the northeast. Based on the proximity of mapped strands of this known fault, the potential for ground shaking at the site resulting from seismic activity in the region is likely.

The geotechnical study calculated the site coefficients and adjusted the maximum considered earthquake spectral response acceleration parameters for the proposed Project (CMT 2021; Section 4.3.2). The site soils are classified as Site Class E (CMT, 2021). Because of the potential for structural damage to facilities, site structures will be designed in accordance with the latest edition of the California Building Code for Seismic Zone 4 for a "Maximum Considered Earthquake," as adopted by the County and with the appropriate site coefficients.

Additionally, the Project is required to design commercial buildings and associated infrastructure to withstand substantial ground shaking in accordance with all applicable State laws and applicable codes included in the California Building Code (CBC) Title 24 for earthquake construction standards and building standards code including those relating to soil characteristics (California Building Standards Commission, 2022). Adherence to these standards would ensure that the potential for structural damage to facilities and corollary indirect impacts associated with seismic-related ground shaking would be less than significant.

Would the project:

3) Seismic-related ground failure, including liquefaction?

a.3) Less Than Significant Impact. Liquefaction is defined as the condition when saturated, loose, sandy soils lose their support capabilities because of excessive pore water pressure which develops during a seismic event. Clayey soils, even if saturated, will generally not liquefy during a major seismic event. During drilling of the borings, increased soil moisture was noted at about 8 feet below the surface and groundwater was conservatively estimated to be at this level, but the subsurface soils consist predominately of clay, typically considered non-liquefiable (CMT, 2021). Based

Potentially Significant Impact (PSI)	Less Than Significant With Mitigation Incorporated (LTSWMI)	Less Than Significant Impact (LTSI)	No Impact (NI)
--------------------------------------	---	-------------------------------------	----------------

upon these conditions, the Geotechnical Study found the risk of seismically induced liquefaction impacts at the Project site to be “low.” For this reason, impacts under this criteria are considered less than significant.

Would the project:

- 4) Landslides?

a.4) No Impact. The Project site is relatively flat with no significant topological features. As such, there is no potential for rock falls and landslides to impact the project in the event of a major earthquake, as the area has no dramatic elevation changes. The site’s topography would not change substantially as a result of project development since the site is essentially flat in nature with no surrounding slopes, and it is not considered to be prone to landslides. No landslide deposits or features, including lateral spread deposits, are mapped on or adjacent to the Project (CMT, 2021) The site is not located within a known or mapped potential debris flow, stream flooding, or rock fall hazard area.

The Project would not expose people or structures to potential substantial adverse effects from landslides. Therefore, there would be no impact.

Would the project:

- b) Result in substantial soil erosion or the loss of topsoil?

b) Less Than Significant Impact. During the site grading and construction phases, large areas of unvegetated soil could be exposed to erosive forces by water for extended periods of time. Unvegetated soils are much more likely to erode from precipitation than vegetated areas because plants act to disperse, infiltrate, and retain water. Construction activities involving soil disturbance, excavation, cutting/filling, stockpiling, and grading activities could result in increased erosion and sedimentation to surface waters. Construction could produce sediment-laden stormwater runoff (nonpoint source pollution), a major contributor to the degradation of water quality. If precautions are not taken to contain contaminants, construction related erosion impacts are considered a significant impact.

The Project is not expected to result in substantial soil erosion or the loss of topsoil over the long-term. Project applicant would be required to implement on-site erosion control measures in accordance with County standards, which require the preparation, review, and approval of a grading plan by the County Engineer. Given these considerations the Project’s long-term impact in terms of soil erosion and loss of topsoil would be less than significant.

Would the project:

- c) Be located on a geologic unit or soil that is unstable, or that would become unstable as a result of the project, and potentially result in on- or off-site landslide, lateral spreading, subsidence, liquefaction or collapse?

c) No Impact. See discussion of Impact VII.a.4 above.

Would the project:

- d) Be located on expansive soil, as defined in Table 18-1-B of the Uniform Building Code (1994),

Potentially Significant Impact (PSI)	Less Than Significant With Mitigation Incorporated (LTSWMI)	Less Than Significant Impact (LTSI)	No Impact (NI)
--------------------------------------	---	-------------------------------------	----------------

creating substantial direct or indirect risks to life or property?

d) No Impact. The Geotechnical Engineering Study prepared by CMT Engineering Laboratories for the Proposed Maverik Store (CMT, 2021; Appendix F) did not identify the presence of expansive soils on the Project site. No impact under this criteria would be expected and no mitigation would be required,

Would the project:

- e) Have soils incapable of adequately supporting the use of septic tanks or alternative wastewater disposal systems where sewers are not available for the disposal of wastewater?

e) Less Than Significant. Portable chemical toilets would be provided on-site during construction and waste pumped and transported by licensed contractors to a sanitary water treatment plant.

Sanitary waste generated during operations would be discharged to a proposed on-site wastewater treatment system. Liquids generated by the onsite waste water treatment system would either be discharged a treatment basin or to an on-site leach field for percolation. The *Geotechnical Engineering Study for the Maverik Fueling Station and Convenience Store Project* did not identify on-site soils as being incapable of adequately supporting the proposed wastewater treatment plant. Therefore, this impact is considered less than significant.

Would the project:

- f) Directly or indirectly destroy a unique paleontological resource or site or unique geologic feature?

f) Less Than Significant With Mitigation Incorporated. To evaluate the Project’s potential impacts on significant paleontological resources, a paleontological records search was conducted at the San Diego Natural History Museum (SDNHM) to determine if any documented fossil collection localities occur within the study area or immediate surrounding area. This involved examination of the SDNHM paleontological database for any records of known fossil collection localities within a 5-mile radius of the study area. Additional records from the San Bernardino County Museum, the University of California Museum of Paleontology database, the PaleoBiology Database, and pertinent print sources were searched for records of fossils from the region. No recorded paleontological localities producing vertebrate fossils were found within one mile of the Project Area (Cogstone, 2024).

A paleontological field survey of the study area was conducted on November 21, 2023. The purpose of the field survey was to confirm the published geologic mapping, to field check the results of the literature and record searches, and to determine the paleontological potential of the strata present within the study area. No archaeological or paleontological materials were identified during the survey.

The Project is mapped entirely as the fossiliferous Lake Cahuilla beds, of latest Pleistocene to Holocene age. While the records searches revealed that no previously recorded paleontological localities occur within the Project Area, elsewhere the Lake Cahuilla Beds have yielded well-preserved fossilized remains of freshwater clams and snails, as well as freshwater fish. These fossils are significant in that they provide important paleoclimatic and palaeoecological

Potentially Significant Impact (PSI)	Less Than Significant With Mitigation Incorporated (LTSWMI)	Less Than Significant Impact (LTSI)	No Impact (NI)
--------------------------------------	---	-------------------------------------	----------------

data. The Lake Cahuilla beds are therefore assigned a moderate potential for fossils (PFYC 3) due to similar deposits elsewhere producing fossils with scientific significance.

Previously undisturbed Lake Cahuilla sediments underlie the entire Project area and contain proven and significant paleontological resources that could be negatively impacted by the Project's construction activities. Although the Project site has been tilled, potentially disturbing paleontological remains within the plow zone.

With USTs requiring excavation to depths of approximately 18 feet, construction of the Project would result in disturbances below the plow zone in some areas. Implementation of mitigation measures **MM PAL-1** and **MM PAL-2** would ensure that the unanticipated discovery of such fossils are assessed for significance and, if significant, salvaged and curated with an accredited repository. Thus, impacts to fossil resources would be reduced to a less-than-significant level.

Mitigation Measures

Implementation of the following mitigation measures would reduce impacts to below a level of significance.

MM PAL-1: Paleontological Construction Monitoring

A paleontological mitigation plan shall be prepared by a qualified paleontologist. The paleontological mitigation plan can be implemented before and/or during construction; however, the latter is more common on most construction projects. The paleontological mitigation plan shall include the following elements:

- A qualified paleontologist shall attend the pre-construction meeting to consult with the grading and excavation contractors concerning excavation schedules, paleontological field techniques, and safety issues. A qualified paleontologist is defined as an individual with an MS or Ph.D. in paleontology or geology that also is familiar with paleontological procedures and techniques, is knowledgeable in the geology and paleontology of the Project area, and has worked as a paleontological mitigation project supervisor in the area for at least one year.
- Ground-disturbing construction activities shall be monitored by a qualified paleontologist to assess, document, and recover unique fossils. A paleontological monitor shall be on-site on a full-time basis during the original cutting of previously undisturbed deposits of high paleontological resource potential (e.g., Lake Cahuilla sediments) to inspect exposures for contained fossils. A paleontological monitor is defined as an individual who has experience in the collection and salvage of fossil materials. The paleontological monitor should work under the direction of a qualified paleontologist.
- A professional repository shall be contracted by the project paleontologist prior to the start of earthwork to curate and store any discovered fossils. Such an institution shall be a recognized paleontological specimen repository with a permanent curator, such as an AAM-accredited museum or university (e.g., University of California Museum of Paleontology, or San Diego Natural History Museum). The repository shall be capable of storing fossils in a facility with adequate security against theft, loss, damage, fire, pests, and adverse climate conditions.

Potentially Significant Impact (PSI)	Less Than Significant With Mitigation Incorporated (LTSWMI)	Less Than Significant Impact (LTSI)	No Impact (NI)
--------------------------------------	---	-------------------------------------	----------------

- If paleontological resources are discovered during ground-disturbing activities, the qualified paleontologist (or paleontological monitor) shall have the authority to divert, direct, or temporarily halt ground disturbing activities in the area of discovery to allow for preliminary evaluation of potentially significant paleontological resources and to determine if additional measures (i.e., collection and curation) are required. The significance of the discovered paleontological resources will be determined by the Project Paleontologist. For significant paleontological resources, a fossil recovery program will be initiated.
- In most cases, the assessment and salvage of fossils can be completed in a short period of time; however, some fossil specimens (such as a complete large mammal skeleton or concentrations of vertebrate fossils) may require several days to weeks to complete. In these instances, project delays can be avoided or minimized by diverting earthwork operations to other areas of the project while fossil recovery work is under way.
- A temporary construction exclusion zone of at least 50 feet, consisting at a minimum of lath and flagging tape, will be erected around the discovery. The exclusion zone acts as a buffer around the discovery and is maintained for safety. The Applicant, through its qualified paleontological monitor will report the discovery to the County within 24 hours. Construction activities can occur outside the buffer if it is safe to do so. The size of the buffer may be increased or decreased once the monitor adequately explores the discovery to determine its size and significance. If indicators of potential microvertebrate fossils (e.g., small mammal, bird, reptile, amphibian, or fish remains) are found screening of a test sample shall be carried out as outlined in the Standard Procedures for the Assessment and Mitigation of Adverse Impacts to Paleontological Resources developed by the Society of Vertebrate Paleontology (SVP, 2010 (SVP, 2010). This procedure will be outlined in the Plan.
- In the event fossils are discovered and salvaged, the fossils will be prepared, identified, catalogued, and stored in the designated repository, and a final paleontological mitigation report written that summarizes the results and findings of paleontological monitoring. If no fossils are salvaged over the course of monitoring, an abbreviated final paleontological mitigation report will be prepared.

MM PAL-2: Worker’s Environmental Awareness Program (WEAP)

The Project Paleontologist shall develop a Worker’s Environmental Awareness Program (WEAP) to train the construction crew on the legal requirements for preserving fossil resources as well as procedures to follow in the event of a fossil discovery. This training program shall be given to the crew before ground-disturbing work commences and will include handouts to be given to new workers as needed.

At least 60 days prior to the start of ground-disturbing activities, the Applicant shall submit the WEAP presentation and associated materials to the County Department of Planning and Development Services Department for review and approval.

Potentially Significant Impact (PSI)	Less Than Significant With Mitigation Incorporated (LTSWMI)	Less Than Significant Impact (LTSI)	No Impact (NI)
--------------------------------------	---	-------------------------------------	----------------

MM PAL-3 Prepare Final Paleontological Monitoring Report.

Prior to the release of the Grading Bond and no later than 90 days after paleontological monitoring has been complete, a Final Paleontological Monitoring Report shall be completed that documents implementation of the WEAP and presents the results of the paleontological monitoring effort. In the event that fossils are recovered, the report will include discussions of the methods used, stratigraphic section(s) exposed, fossils collected, and significance of the recovered fossils relative to the research themes and questions. A complete inventory of salvaged, prepared, and curated fossils will be included. In the event that no fossils are recovered, an abbreviated report that summarizes the field methods used and stratigraphy exposed will be completed. The Final Paleontological Monitoring Report shall be submitted to the County Department of Planning and Development Services Department.

VIII. GREENHOUSE GAS EMISSIONS.

Birdseye Planning Group (BPG) has prepared an Air Quality and Greenhouse Gas Study for the Maverik Fueling Station and Convenience Store Project (BPG, 2023). The Air Quality and Greenhouse Gas Study, included as Appendix A of this Initial Study, analyzed potential air quality and greenhouse gas impacts associated with the proposed Maverik Fueling Station and Convenience Store Project in unincorporated Imperial County, California. The analysis contained in this section is based on the findings of this technical report.

Regulatory Setting

Significant legislative and regulatory activities directly and indirectly affect climate change and GHGs in California. The primary climate change legislation in California is Assembly Bill 32 (AB-32), the California Global Warming Solutions Act of 2006. AB-32 focuses on reducing greenhouse gas emissions in California, and AB 32 requires that GHGs emitted in California be reduced to 1990 levels by the year 2020. In addition to AB-32, Executive Order B-30-15 was issued on April 29, 2015 that aims to reduce California’s GHG emissions 40 percent below 1990 levels by 2030. In September 2016, AB-197 and Senate Bill (SB) 32 codified into statute the GHG emission reduction targets provided in Executive Order B-20-15.

The California Air Resources Board (CARB) is the state agency charged with monitoring and regulating sources of emissions of GHGs in California that contribute to global warming in order to reduce emissions of GHGs. The CARB Governing Board approved the 1990 GHG emissions level of 427 million tons of CO₂ equivalent (MtCO₂e) on December 6, 2007. Therefore, in 2020, annual emissions in California are required to be at or below 427 MtCO₂e. The CARB Board approved the Climate Change Scoping Plan (Scoping Plan) in December 2008, the First Update to the Scoping Plan in May 2014, and California’s 2017 Climate Change Scoping Plan in November 2017. The Scoping Plans define a range of programs and activities that will be implemented primarily by state agencies but also include actions by local government agencies. Primary strategies addressed in the Scoping Plans include new industrial and emission control technologies; alternative energy generation technologies; advanced energy conservation in lighting, heating, cooling, and ventilation; reduced-carbon fuels; hybrid and electric vehicles; and other methods of improving vehicle mileage. Local government will have a part in implementing some of these strategies. The Scoping Plans also call for reductions in vehicle-associated GHG emissions through smart growth that will result in reductions in vehicle miles traveled (CARB 2008, 2014, 2017).

Potentially Significant Impact (PSI) Less Than Significant With Mitigation Incorporated (LTSWMI) Less Than Significant Impact (LTSI) No Impact (NI)

Impact Analysis

Would the project:

- a) Generate greenhouse gas emissions, either directly or indirectly, that may have a significant impact on the environment?

a) Less Than Significant Impact. For the Project, the combined annual unmitigated emissions would total approximately 1,746 metric tons per year in CO₂E (Table 13). The proposed project is evaluated based on the threshold of 3,000 MT CO₂E annually. Project-related annual GHG emissions would not exceed the 3,000 metric ton screening threshold; thus, the project will not generate greenhouse gas emissions, either directly or indirectly, that may have a significant impact on the environment. Construction and operational project impacts from GHG emissions would be less than significant and no mitigation would be required.

TABLE 13. COMBINED ANNUAL GREENHOUSE GAS EMISSIONS

Emission Source	Annual Emissions (CO ₂ E)
Construction	11 metric tons
Operational	
Energy	117 metric tons
Solid Waste	2 metric tons
Water	0.3 metric tons
Area Sources	1 metric ton
Refrigerants	205 metric tons
Mobile	1,410 metric tons
TOTAL	1,746 metric tons

Source: BPG, 2023.

Would the project:

- b) Conflict with an applicable plan or policy or regulation adopted for the purpose of reducing the emissions of greenhouse gases?

b) Less Than Significant Impact. The Applicant would be required to implement California Energy Code Title 24 requirements that would address energy and water use reduction, promotion of green building measures, waste reduction and reduction in vehicle miles traveled. The proposed project would be required to implement all mandatory green building measures for new commercial/retail development under the CALGreen Code. This would require the project be designed to minimize water consumption, increase building system efficiencies, divert construction waste from landfills and maintain buildings systems. Implementation of these building and appliance standards would result in the efficient use of water and energy and reduce the volume of landfilled solid waste during both construction and operation.

Potentially Significant Impact (PSI)	Less Than Significant With Mitigation Incorporated (LTSWMI)	Less Than Significant Impact (LTSI)	No Impact (NI)
--------------------------------------	---	-------------------------------------	----------------

There are numerous State plans, policies, and regulations adopted for the purpose of reducing GHG emissions. The principal overall State plan and policy is AB-32, the California Global Warming Solutions Act of 2006. The quantitative goal of AB-32 is to reduce GHG emissions to 1990 levels by 2020. SB-32 would require further reductions of 40 percent below 1990 levels by 2030. Because the Project’s operational year is post-2020, the Project is being designed to reach the quantitative goals set by SB-32. Statewide plans and regulations such as GHG emissions standards for vehicles (AB-1493), the Low Carbon Fuel Standard, and regulations requiring an increasing fraction of electricity to be generated from renewable sources, are being implemented at the statewide level; as such, compliance at the Project level is not addressed. The proposed project would not conflict with statewide plans and regulations.

The project would not conflict with plans to integrate the transportation network and related strategies with an overall land use pattern that responds to projected growth, housing needs, changing demographics, and transportation demands. The project does not involve any improvements to the regional transportation system. The project would be consistent with or would not conflict with any of the goals identified in Connect SoCal.

Impacts related to consistency with the 2022 Scoping Plan would be less than significant. The Project would not conflict with the applicable plans and regulatory programs that are discussed above; and therefore, with respect to this particular threshold, the Project does not have a significant impact.

As discussed, the project would not exceed 3,000 MT of annual CO2e emissions and it would be consistent with Connect SoCal RTP/SCS and the 2017 CARB scoping plan and the 2022 Scoping Plan goals intended to reduce overall regional GHG emissions. The project will not impede or delay local or statewide initiatives to reduce GHG emissions. Impacts would be less than significant.

As stated, the project would not generate enough GHG emissions to cumulatively contribute to global climate change. Measures implemented by the project to reduce overall GHG emissions would also contribute to GHG reduction goals mandated by AB-32 and further address in EO S-3-05 and SB 32. Thus, the project would not conflict with an applicable plan, policy or regulation adopted for the purpose of reducing the emissions of greenhouse gases and impacts would be less than significant and no mitigation would be required.

Mitigation Measures

No mitigation would be required.

IX. HAZARDS AND HAZARDOUS MATERIALS.

Cardno, Inc. has prepared a Phase I and a Limited Phase II Environmental Site Assessment (ESA) for the Maverik Fueling Station and Convenience Store Project (Cardno, 2021a and 2021b, respectively). The Phase I ESA, included as Appendix G of this Initial Study, was prepared to identify Records of Environmental Consideration (RECs) and certain potential environmental conditions associated with the proposed Maverik Fueling Station and Convenience Store Project in unincorporated Imperial County, California. The Phase II ESA, included as Appendix H of this Initial Study, was prepared because of the historic agricultural use of the site and the possibility/potential for residuals of banned pesticides to be found in near surface soils. For this reason, a Limited Phase II ESA was conducted. that was associated with the proposed Maverik Fueling Station and Convenience Store Project in unincorporated Imperial County, California. No RECs were found by either ESA.

Potentially Significant Impact (PSI)	Less Than Significant With Mitigation Incorporated (LTSWMI)	Less Than Significant Impact (LTSI)	No Impact (NI)
--------------------------------------	---	-------------------------------------	----------------

A material is considered hazardous if it appears on a list of hazardous materials prepared by a federal, state, or local agency or if it has characteristics defined as hazardous by such an agency. A hazardous material is defined by the California Health and Safety Code, § 25501 as follows:

“Hazardous material” means any material that, because of its quantity, concentration, or physical or chemical characteristics, poses a significant present or potential hazard to human health and safety or to the environment if released into the workplace or the environment. "Hazardous materials" include, but are not limited to, hazardous substances, hazardous waste, and any material that a handler or the administering agency has a reasonable basis for believing that it would be injurious to the health and safety of persons or harmful to the environment if released into the workplace or the environment.

A hazardous material is defined in Title 22, § 662601.10, of the CCR as follows:

A substance or combination of substances which, because of its quantity, concentration, or physical, chemical or infectious characteristics, may either (1) cause, or significantly contribute to, an increase in mortality or an increase in serious irreversible, or incapacitating reversible, illness; or (2) pose a substantial present or potential hazard to human health or environment when improperly treated, stored, transported or disposed of or otherwise managed.

The release of hazardous materials into the environment could potentially contaminate soils, surface water, and groundwater supplies.

Under Government Code § 65962.5, both the Department of Toxic Substances Control (DTSC) and the SWRCB are required to maintain lists of sites known to have hazardous substances present in the environment. Both agencies maintain up-to-date lists on their websites. A search of the DTSC (2023) list and SWRCB (2023) lists identified no open cases of hazardous waste violations on, or within ½ mile of the Project site.

The USEPA maintains the Enforcement and Compliance History Online (ECHO) program. The ECHO website provides environmental regulatory compliance and enforcement information for approximately 800,000 regulated facilities nationwide. The ECHO website includes environmental permit, inspection, violation, enforcement action, and penalty information about USEPA-regulated facilities. Facilities included on the site are CAA stationary sources; Clean Water Act facilities with direct discharge permits under the National Pollutant Discharge Elimination System (NPDES); generators and handlers of hazardous waste regulated under the Resource Conservation and Recovery Act; and public drinking water systems regulated under the Safe Drinking Water Act. ECHO also includes information about USEPA cases under other environmental statutes. When available, information is provided on surrounding demographics, and ECHO includes other USEPA environmental data sets to provide additional context for analyses, such as Toxics Release Inventory data. According to the ECHO program, the Project site is not listed as having a hazardous materials violation (Cardno, 2021a, Appendix G).

Impact Analysis

Would the project:

- a) Create a significant hazard to the public or the environment through the routine transport, use, or disposal of hazardous materials?

Potentially Significant Impact (PSI)	Less Than Significant With Mitigation Incorporated (LTSWMI)	Less Than Significant Impact (LTSI)	No Impact (NI)
--------------------------------------	---	-------------------------------------	----------------

a) Less Than Significant Impact.

Construction

Project construction-related activities may involve the use and transport of hazardous materials. These materials may include fuels, oils, mechanical fluids, and other chemicals used during construction-related activities. As such, these materials could expose human health or the environment to undue risks associated with their use and no significant impacts will occur during construction activities.

Transportation, storage, use, and disposal of hazardous materials during construction activities will be required to comply with applicable federal, State, and local statutes and regulations. Transportation of hazardous materials is regulated by the U.S. Department of Transportation and the California Department of Transportation (Caltrans). Any hazardous waste or debris that is generated during the construction of the proposed Project would be collected and transported away from the site and disposed of at an approved offsite landfill or another such facility. In addition, sanitary waste generated during construction would be managed through the use of portable toilets, which would be located at reasonably accessible onsite locations.

Operations

Operation of the proposed Project would involve the routine use and storage of hazardous materials, which includes storage of gasoline in the project's underground fuel storage tanks (UST), as well as delivery of gasoline and subsequent refilling of the tanks. Gasoline is considered a hazardous waste, and therefore, the installation and operation of underground fuel storage tanks are regulated by a variety of State and local agencies.

Development of the Project facilities would include the installation of three (3) underground storage tanks (USTs) for fuel storage; two underground water storage tanks; and on-site water and wastewater treatment facilities which would be regulated by the State Water Resources Control Board (SWRCB) and the Imperial County Department of Public Health, which is the Certified Unified Program Agency (CUPA). The installation and operation of USTs would be in compliance with local and State regulations related to UST and hazardous materials. Therefore, the construction of the Project facilities would not create a hazard to the public or the environment through the routine transport, use, or disposal of hazardous materials.

The California Environmental Protection Agency (CalEPA) oversees the statewide implementation of the Hazardous Materials Business Plan (HMBP), which aims to prevent or minimize harm to public health and safety, and the environment from the release or threatened release of hazardous material. The minimum reporting quantities for hazardous materials is 55 gallons for liquids, 500 pounds for solids, or 200 cubic feet for compress gas.

If a business handles hazardous materials at or in excess of the minimum thresholds, a HMBP is required to be prepared and approved by the State and local jurisdictions. The project developer/operator will be required to submit information to the California Environmental Reporting System (CERS) and Imperial County Department of Public Health regarding the use and storage of hazardous materials. The Project facilities would be subject to the HMBP requirements if they handle hazardous materials in excess of minimum reporting quantities. Based on the analysis above, project construction and operation are not anticipated to result in significant impacts as a result of the transportation, use, or disposal of hazardous materials. Therefore, impacts would be less than significant.

	Potentially Significant Impact (PSI)	Less Than Significant With Mitigation Incorporated (LTSWMI)	Less Than Significant Impact (LTSI)	No Impact (NI)
--	--------------------------------------	---	-------------------------------------	----------------

Would the project:

- | | | | | |
|---|--------------------------|--------------------------|-------------------------------------|--------------------------|
| b) Create a significant hazard to the public or the environment through reasonably foreseeable upset and accident conditions involving the release of hazardous materials into the environment? | <input type="checkbox"/> | <input type="checkbox"/> | <input checked="" type="checkbox"/> | <input type="checkbox"/> |
|---|--------------------------|--------------------------|-------------------------------------|--------------------------|

b) Less Than Significant Impact. The proposed Project would not result in the routine transport, use, disposal, handling, or emission of any hazardous materials that would create a significant hazard to the public or the environment. Potential construction-related hazards could be created during the course of Project construction at the site, given that construction activities involve the use of heavy equipment, which uses small and incidental amounts of oils and fuels and other potentially flammable substances. The level of risk associated with the accidental release of hazardous substances is not considered significant due to the small volume and low concentration of hazardous materials used during construction. The construction contractor would be required to use standard construction controls and safety procedures that would avoid and minimize the potential for accidental release of such substances into the environment. Standard construction practices would be observed such that any materials released are appropriately contained and remediated as required by local, state, and federal law.

All hazardous materials on the Project site would be handled in accordance with city and state regulations. Long-term impacts associated with handling, storing, and disposing of hazardous materials from project operation would be less than significant because any hazardous materials used for operations would be in small quantities.

Would the project:

- | | | | | |
|---|--------------------------|--------------------------|--------------------------|-------------------------------------|
| c) Emit hazardous emissions or handle hazardous or acutely hazardous materials, substances, or waste within one-quarter mile of an existing or proposed school? | <input type="checkbox"/> | <input type="checkbox"/> | <input type="checkbox"/> | <input checked="" type="checkbox"/> |
|---|--------------------------|--------------------------|--------------------------|-------------------------------------|

c) No Impact. The nearest public school to the Project site is Meadows Union Elementary School, approximately 0.3 mile from the Project site. The Project would have no impact in this area.

Would the project:

- | | | | | |
|--|--------------------------|--------------------------|--------------------------|-------------------------------------|
| d) Be located on a site which is included on a list of hazardous materials sites compiled pursuant to Government Code Section 65962.5 and, as a result, would it create a significant hazard to the public or the environment? | <input type="checkbox"/> | <input type="checkbox"/> | <input type="checkbox"/> | <input checked="" type="checkbox"/> |
|--|--------------------------|--------------------------|--------------------------|-------------------------------------|

d) No Impact. Under Government Code § 65962.5, both the DTSC and the SWRCB are required to maintain lists of sites known to have hazardous substances present in the environment. Both agencies maintain up-to-date lists on their websites. A search of the DTSC and SWRCB lists verified that the Project site is not included on a list of hazardous materials sites compiled pursuant to Government Code Section 65962.5.

The Phase I ESA prepared for the Project did not identify any Recognized Environmental Conditions (RECs) and a subsequent Limited Phase II ESA to evaluate the potential presence of banned pesticides above regulatory cleanup levels showed that a de minimis condition currently exists.

Potentially Significant Impact (PSI)	Less Than Significant With Mitigation Incorporated (LTSWMI)	Less Than Significant Impact (LTSI)	No Impact (NI)
--------------------------------------	---	-------------------------------------	----------------

In summation, because the Project site is not included on a list of hazardous materials sites compiled pursuant to Government Code Section 65962.5 and the Phase I and Phase II ESAs did not identify any RECs, the Project would not create a significant hazard to the public or environment. No impacts would occur under this criteria and no mitigation would be required.

Would the project:

- e) For a project located within an airport land use plan or, where such a plan has not been adopted, within two miles of a public airport or public use airport, would the project result in a safety hazard or excessive noise for people residing or working in the project area?

e) No Impact. The Imperial County Airport, the nearest public airport, is approximately 5 miles northwest of the Project site. The Project site is not located within the Airport Land Use Compatibility Plan for Imperial County Airports (County of Imperial, 1996) or within two miles of a public airport or public use airport. Furthermore, the Project does not propose any new structures which may impede aircraft operations. Thus, no impact would occur.

Would the project:

- f) For a project within the vicinity of a private airstrip, would the project result in a safety hazard for people residing or working in the project area?

f) No Impact. The Project site is not in the vicinity of a private airstrip. As noted above, the nearest public airport is located approximately 5 miles northwest of the Project site.

Would the project:

- g) Impair implementation of or physically interfere with an adopted emergency response plan or emergency evacuation plan?

g) No Impact. Standard evacuation routes have not been designated in Imperial County. However, the Imperial County Office of Emergency Services has an Emergency Operations Plan (2016) stating that an Evacuation/Transportation plan should incorporate public transit, para-transit, school bus and private sector transportation resources and strategies for identifying and movement of people with disabilities and others with access and functional needs. An Animal Evacuation Plan was prepared in 2001.

It is likely that Caltrans facilities such as SR 111 and I-8 would be used to evacuate the community in an emergency.

The Project does not include any actions that would impair or physically interfere with an adopted emergency response plan or emergency evacuation plan. No construction activities would impede the use of surrounding roadways in an emergency evacuation. Similarly, operation of a fueling station and convenience store would not interfere with any emergency response or evacuation plans. Implementation of the Project would result in no impact in this area.

	Potentially Significant Impact (PSI)	Less Than Significant With Mitigation Incorporated (LTSWMI)	Less Than Significant Impact (LTSI)	No Impact (NI)
--	--------------------------------------	---	-------------------------------------	----------------

Would the project:

- | | | | | |
|---|--------------------------|--------------------------|--------------------------|-------------------------------------|
| h) Expose people or structures, either directly or indirectly, to a significant risk of loss, injury or death involving wildland fires? | <input type="checkbox"/> | <input type="checkbox"/> | <input type="checkbox"/> | <input checked="" type="checkbox"/> |
|---|--------------------------|--------------------------|--------------------------|-------------------------------------|

h) No Impact. The Project site is not in an area designated by California Department of Forestry and Fire Protection (CAL FIRE, 2007) as a Fire Hazard Severity Zone. Furthermore, no Very High Fire Hazard Severity Zones are located nearby. Finally, the location of the Project site makes it readily accessible by emergency personnel and vehicles in the event of a wildland fire. For these reasons, there would be no impact.

Mitigation Measures

No mitigation would be required.

X. HYDROLOGY AND WATER QUALITY.

LC Engineering Consultants prepared a *Preliminary Drainage Study for the Maverik Fueling Station and Convenience Store Project* in November 2023 (LC Engineering Consultants, 2023). The Preliminary Drainage Study, included as Appendix I of this Initial Study, presented on-site drainage conditions and provided recommendations for drainage and grading concepts for the Project. The analysis contained in this section is based on the findings of this technical report.

Existing Setting

Localized Drainage Conditions

The Project site lies at an elevation of approximately 36 feet below mean sea level (MSL) in the northeastern region of the Imperial Valley and slopes gently toward the west. The existing agricultural fields are graded such that the fields slope from east to west at slope percentage rates between 0.10% to 0.20%. The flat topography allows for the irrigation water to move slowly over the field and promote absorption in the existing clay soils (LC Engineering Consultants, 2023).

Hydrology on the Project site is manipulated via a system of manufactured canals and drains used for irrigation of croplands. The IID’s Acacia Drain 5A is located immediately west of the Project site, across Hawes Road. The Acacia Lateral 5A is located north of the site, across Ross Road. Irrigation tailwater outlet boxes and 12" diameter concrete pipes drain the excess irrigation tailwater and storm event runoff water to the IID drains at all low areas for each farm field. Elevated field roads or drain bank maintenance roads that are graded to about one foot above the adjacent farm field, are located at the low ends of each field. Based upon review of the existing topography, it is determined that off-site run off does not enter the project development areas due to the presence of physical features, including county roads, IID the Acacia 5A Drain and Acacia 5A Drain No. 1. and private field roads, presenting barriers to the off-site flow.

Flooding

The Federal Emergency Management Agency (FEMA) Flood Insurance Rate Maps (FIRM) for the Project Area (FIRM Panel 06025C1750C and 0625C1725C) show that the Project site is in unshaded Zone X, meaning that the area is outside of the 0.2 percent annual chance (500-year) floodplain and is not within a 100-year floodplain (FEMA, 2024).

Potentially Significant Impact (PSI)	Less Than Significant With Mitigation Incorporated (LTSWMI)	Less Than Significant Impact (LTSI)	No Impact (NI)
--------------------------------------	---	-------------------------------------	----------------

Groundwater

The Project site is located within the Imperial Vally Groundwater Basin (No. 7-030), which, according to the California Groundwater Bulletin 118, has a surface area of 1.2 million acres in size. Recharge is primarily from irrigation return (California Dept. of Water Resources, 2020). It should be noted however that the Project site is not within an identified area of special concern. During drilling conducted by CMT Engineering Laboratories' as part of the Maverik Fueling Station and Convenience Store Geotechnical Investigation, increased soil moisture was noted at about eight (8) feet below the surface and groundwater was conservatively estimated to be at this level (CMT, 2021).

Regulatory Setting

Local Agency Management Program / Advanced Protection Management Program for Onsite Wastewater Treatment Systems

The Imperial County Public Health Department, Division of Environmental Health (Division), is the local administering agency for permitting, inspections, and enforcement of onsite wastewater treatment systems with design flows up to five thousand (5,000) gallons per day within the County of Imperial. The Division is authorized, under Section 8.80.010 of the Imperial County Codified Ordinances and the Imperial County Ordinance 1516, to ensure all discharges from private sewage disposal systems adequately protect water quality and public health. While the State's regulatory authority extends to individual Onsite Wastewater Treatment Systems under Section 13260 of the California Water Code, the State Water Resources Control Board (SWRCB) and the regional boards have recognized the advantages and efficiencies of regulation of small dischargers by authorized and qualified local agencies.

The County prepared a Local Agency Management Program (LAMP) for Onsite Wastewater Treatment Systems, which consisted of a program for design, operation and maintenance of onsite wastewater treatment system. The Imperial County LAMP was approved/adopted by the Colorado River Basin Water Board on June 30, 2106 (Resolution R7-2016-0020). Since the adoption of the LAMP, all new or replacement OWTS have been governed by the Program's minimum site evaluation, siting standards, designs, construction and maintenance standards, which have been incorporated into Imperial County Ordinance No. 1516 and codified in Chapter 8.80 Onsite Wastewater Treatment Systems (OWTS) of the Imperial County Code of Ordinances.

All new OWTS, with design flows up to five thousand (5,000) gallons per day must be reviewed and approved by the Imperial County Public Health Department, Division of Environmental Health and obtain an OWTS permit.

Impact Analysis

Would the project:

- a) Violate any water quality standards or waste discharge requirements or otherwise substantially degrade surface or groundwater quality?

a) Less Than Significant With Mitigation Incorporated.

Construction

Construction activities would include site clearing, grading, utility connections, building construction, frontage improvements (e.g., sidewalk and driveway construction), and landscaping onsite. Construction activities would involve grading of the entire project site and the permanent disturbance of the site. These activities have the potential to

Potentially Significant Impact (PSI)	Less Than Significant With Mitigation Incorporated (LTSWMI)	Less Than Significant Impact (LTSI)	No Impact (NI)
--------------------------------------	---	-------------------------------------	----------------

generate stormwater runoff and to discharge pollutants, such as fuel, solvents, oil, paints, and trash, into the City's storm drain system. The proposed project would comply with the NPDES General Construction Permit. The NPDES General Construction Permit includes the preparation of a SWPPP and incorporation of BMPs

Mitigation Measure (MM) HWQ-1 would require the Project to obtain coverage under the State's General Stormwater Construction permit, prepare a SWPPP, and implement best management practices (BMPs), consistent with the California Stormwater Quality Association's Industrial/Commercial BMP Handbook or its equivalent, to control sedimentation, erosion, and hazardous materials from contacting stormwater, with the intent of keeping all products of erosion from moving offsite into receiving waters. Implementation of **MM HWQ-1** would reduce construction-related impacts to a level less than significant.

Hazardous materials associated with construction would be limited to substances associated with mechanized equipment, such as gasoline and diesel fuels, engine oil, and hydraulic fluids. If precautions are not taken to contain contaminants, accidental spills of these substances during construction could produce contaminated stormwater runoff (nonpoint source pollution), a major contributor to the degradation of water quality in surface waters. Without proper containment and incident response measures in place, the operation of construction equipment could result in significant direct and indirect impacts on water quality. Implementation of **MM HWQ-1** would reduce these impacts to a level less than significant.

Operation

Post-construction runoff from the constructed facilities would carry two main water quality impacts that could impact surface water drainages and drains. The first is caused by an increase in the type and quantity of pollutants in storm water runoff. As runoff flows over developed surfaces, water can entrain a variety of potential pollutants including, but not limited to, oil and grease, pesticides, trace metals, and nutrients. These pollutants can become suspended in runoff and carried to receiving waters. These effects are commonly referred to as non-point source water quality impacts.

Long-term operation of the fueling station and convenience store poses a limited threat to surface water quality after the completion of construction. The County regulates Project compliance with the General Permit of the SWRCB Phase II Small MS4 (Water Quality Water Order No. 2013-0001-DWQ), of which the County is one of the permittees. The Project would be subject to the requirements of the General Permit, which are met by applying the specifications for improvements of all drainage easements, culverts, drainage structures, and drainage channels in the *County's Engineering Design Guidelines Manual for the Preparation and Checking of Street Improvement, Drainage and Grading Plans, Department of Public Works, Engineering Division*, as amended in July 2022 (County of Imperial, 2022).

The Project would also be subject to the County's Grading Regulations as specified in Section 91010.02 of the Ordinance Code. Because the Project has the potential to result in both direct and indirect water quality impacts. Implementation of **MM HWQ-2** would reduce impacts to a level less than significant.

Long-term point discharges from the Project would be minimal; however, reductions in water quality could occur where the water released is of lower quality than ambient conditions. These discharges would be infrequent, but could include landscape irrigation, uncontaminated pumped ground water, and discharges of potable water during water tank cleaning [as defined in 40 CFR 35.2005(21)]. In this context, long-term water quality impacts from point sources would be less than significant.

Potentially Significant Impact (PSI)	Less Than Significant With Mitigation Incorporated (LTSWMI)	Less Than Significant Impact (LTSI)	No Impact (NI)
--------------------------------------	---	-------------------------------------	----------------

The second potential impact from post-construction runoff is a potential increase in the quantity of water delivered to adjacent or nearby water bodies during storms, referred to as hydromodification. Increased impervious surfaces from surfaces such as asphalt, concrete, and other compacted surfaces can interrupt the natural cycle of gradual percolation of water through vegetation and soil. Instead, large volumes of water runoff collect and are routed to drainage systems where it is discharged to the nearest receiving water. This process can contribute to stream bank scouring and downstream flooding, resulting in impacts on aquatic life and damage property. For these reasons, the Project could result in on- and off-site discharges that could indirectly impact downstream surface waters by increasing drain scour and/or sedimentation. Implementation of MMs **HWQ-1** and **HWQ-2** would reduce impacts to a level less than significant.

With regard to wastewater discharge requirements, the Project site is not located in an area served by public sewer services. For this reason, the Project includes construction and operation of an onsite wastewater treatment system with a design capacity to treat 3,500 gallons of domestic wastewater per day. Details of the proposed system are shown on **Figure 14, Wastewater Treatment Design Details**.

Domestic wastewater generated during operations of the proposed fueling station and convenience store would be discharged to the proposed OWTS. Liquids generated by the OWTS would either be discharged a treatment basin or to an on-site leach field for percolation.

In accordance with Imperial County Ordinance No. 1516 and Chapter 8.80 Onsite Wastewater Treatment Systems (OWTS) of the Imperial County Code of Ordinances, the design of the proposed OWTS must be reviewed and approved by the Imperial County Public Health Department, Division of Environmental Health and the Applicant must obtain an OWTS permit. This requirement is presented as **Mitigation Measure HWQ-4**.

Approval of an OWTS permit from the County (MM HWQ-4) would ensure compliance with the minimum site evaluation, siting standards, designs, construction and maintenance standards identified in the Local Agency Management Programs (LAMP) and would reduce potential impacts on water quality standards, waste discharge, or degradation of surface or groundwater quality to a less than significant level.

- b) Substantially decrease groundwater supplies or interfere substantially with groundwater recharge such that the Project may impede sustainable groundwater management of the basin?

b) Less Than Significant Impact. Water for construction and operation of the Project would be obtained from the Imperial Irrigation District and no groundwater would be used.

In terms of groundwater recharge, the Project site is located within the Imperial Vally Groundwater Basin (No. 7-030), which, according to the California Groundwater Bulletin 118, has a surface area of 1.2 million acres in size. Recharge is primarily from irrigation return (California Dept. of Water Resources, 2020).

While the Project would convert an existing agricultural area to a commercial use, groundwater recharge in the area will not be significantly affected because of the fact that the majority of the Project site would feature a pervious landscape (See Figure 13, Proposed Landscaping Plan). The design of the Project site includes a large retention basin that would also provide infiltration and groundwater recharge. Due to the depth of water encountered at the site and the fact the Project does not propose to use groundwater for its construction or operational water needs the Project

Potentially Significant Impact (PSI)	Less Than Significant With Mitigation Incorporated (LTSWMI)	Less Than Significant Impact (LTSI)	No Impact (NI)
--------------------------------------	---	-------------------------------------	----------------

would not interfere substantially with groundwater recharge. As a result, no significant impacts on groundwater levels would occur.

c) Substantially alter the existing drainage pattern of the site or area, including through the alteration of the course of a stream or river or through the addition of impervious surfaces in a manner which would:

1) Result in substantial erosion or siltation on- or off-site;	<input type="checkbox"/>	<input checked="" type="checkbox"/>	<input type="checkbox"/>	<input type="checkbox"/>
2) Substantially increase the rate or amount of surface runoff in a manner which would result in flooding on- or off-site;	<input type="checkbox"/>	<input checked="" type="checkbox"/>	<input type="checkbox"/>	<input type="checkbox"/>
3) Create or contribute runoff water which would exceed the capacity of existing or planned stormwater drainage systems or provide substantial additional resources of polluted runoff; or	<input type="checkbox"/>	<input checked="" type="checkbox"/>	<input type="checkbox"/>	<input type="checkbox"/>

c.1 and c.2) Less Than Significant With Mitigation Incorporated.

The rate and amount of surface runoff is determined by multiple factors, including the following: topography, the amount and intensity of precipitation, the amount of evaporation that occurs in the watershed, and the amount of precipitation and water that infiltrates to the groundwater. The Project would alter the existing drainage pattern of the site, which would have the potential to result in erosion or siltation on or offsite. The disturbance of soils onsite during construction could cause erosion, resulting in temporary construction impacts. In addition, the placement of permanent structures onsite could affect drainage in the long-term. Impacts from construction and operation are discussed below.

As discussed under Response to Impact X.a above, potential impacts on water quality arising from erosion and sedimentation are expected to be localized and temporary during construction. Construction-related erosion and sedimentation impacts as a result of soil disturbance would be less than significant after implementation of an SWPPP (see **Mitigation Measure HWQ-1**). No drainages or other water bodies are present on the Project site and therefore, the Project would not change the course of any such drainage.

Grading activities would occur over the entire Project site, including offsite improvements, to construct building foundations and to improve associated infrastructure systems (e.g. water and wastewater systems, site access). Such activities have the potential to result in erosion or sedimentation and/or discharge of construction debris from the site. The Project would not require grading on steep slopes, which are typically prone to erosion, as the Project site is flat. However, other earthmoving activities (e.g., excavation, creating building pads, installation of underground storage tanks, etc.) would have the potential to loosen soil, and the removal of any onsite vegetation could contribute to future soil loss and erosion by wind and stormwater runoff. The clearing of vegetation and grading activities, for example, could lead to exposed or stockpiled soils, which are susceptible to peak stormwater runoff flows and wind forces. In addition, the presence of large amounts of raw materials for construction may lead to stormwater runoff contamination.

Potentially Significant Impact (PSI)	Less Than Significant With Mitigation Incorporated (LTSWMI)	Less Than Significant Impact (LTSI)	No Impact (NI)
--------------------------------------	---	-------------------------------------	----------------

The Applicant would be required to obtain coverage under the NPDES General Permit, Order No. 2009-0009-DWQ, because the proposed Project would result in one or more acres of land disturbance. To conform to the requirements of the NPDES General Permit, a SWPPP shall be prepared (see **Mitigation Measure MM HWQ-1**). The SWPPP would specify BMPs to prevent construction pollutants, including eroded soils (such as topsoil), from moving offsite. Implementation of the permit and BMP requirements would mitigate the potential for erosion of soils or siltation during construction activities. With implementation of this mitigation measure, construction impacts would be reduced to less than significant.

Additionally, in accordance with §90804.05 (G) of the County of Imperial Code of Ordinances (Title 9, Division 8, Chapter 4 – Design Standards of Subdivisions) All subdivisions require drainage plans for the management and disposal of all surface drainage water originating on site which shall be approved by the Department of Public Works in coordination with the Imperial County Public Health Department, Imperial County Division of Environmental Health, as needed. Easements or rights-of-way deeds shall be granted to the County of Imperial for drainage purposes. This requirement is presented as **Mitigation Measure HWQ-3**. Implementation of **MM HWQ-3** would ensure that existing drainage patterns are maintained during operation and that operation of the Project would not result in substantial erosion or loss of topsoil. With implementation of this mitigation measure, impacts with regard to erosion during the operational phase would be less than significant.

c.3) Less Than Significant With Mitigation Incorporated. As described above, the proposed Project would not substantially alter the existing drainage pattern of the site or alter the course of a stream or river.

The Project would be graded to direct on-site drainage to the proposed retention basin by sheet flow or through a drainage system consisting of catch basins and drainage pipes. The Preliminary Drainage Study prepared by LC Engineering Consultations (Appendix I) included a drainage analysis, based on the amount of storm water that would be generated by the 100-year storm event (3 inches of rain), and assumed that 100% of the 100-year storm would be retained on site. The analysis also assumed that existing IID drain connections and a 12" diameter concrete discharge pipes would be utilized to drain the retention basin. The runoff volume resulting from 100-year storm (3 inches of rain).

The proposed stormwater retention basin would have a capacity to store 2.16 acre-feet of water would be sized to accommodate 3 inches of precipitation in a 24-hour period (a 100-year storm event). The Preliminary Drainage Study calculated that a total storage capacity of 2.08 acre-feet would be needed. In addition, the proposed retention basin would be surrounded by a berm to prevent overflow. Because the design size of the proposed retention basin (2.16-acre feet) exceeds stormwater storage requirements (2.08 acre feet), the Preliminary Drainage Study found that all stormwater generated during the 3-inch storm event would be contained on-site.

As previously noted, the Project will be required to prepare and implement a SWPPP (**MM HWQ-1**) during construction, along with best management practices to ensure that ground and surface waters would not be degraded and that water quality impacts resulting from construction activities are reduced to below a level of significance. After construction is complete, stormwater would be directed to the stormwater retention basin. A berm would be constructed around the basin to prevent overflow. Therefore, the Project would not create or contribute run-off volumes that would exceed the capacity of planned stormwater systems nor provide substantial additional sources of polluted water.

- d) In flood hazard, tsunami, or seiche zones, risk release of pollutants due to Project inundation?

Potentially Significant Impact (PSI)	Less Than Significant With Mitigation Incorporated (LTSWMI)	Less Than Significant Impact (LTSI)	No Impact (NI)
--------------------------------------	---	-------------------------------------	----------------

d) Less Than Significant Impact. The Project site is not located near the ocean or a steep topographic feature (i.e., mountain, hill, bluff, etc.). Additionally, there is no body of water within the vicinity of the Project site. The proposed project's inland location makes the risk of tsunami highly unlikely. The probability of a seiche occurring in the County is also considered negligible.

As previously noted, the Project is not located within a FEMA 100-year floodplain as mapped on a federal flood hazard boundary or flood insurance rate map, or other flood hazard delineation map.

The Project site is located approximately 60 miles from the Imperial Diversion Dam, which is managed by the U.S. Bureau of Reclamation. According to the Imperial County Seismic and Public Safety Element, in the case of dam failure, inundation of the community is considered unlikely (County of Imperial, 2008). There is no potential for inundation of the project site by seiche. Therefore, the Project would not contribute to inundation by seiche, tsunami, or mudflow. Impacts under this criteria would be less than significant and no mitigation would be required,

- e) Conflict with or obstruct implementation of a water quality control plan or sustainable groundwater management plan?

e) No Impact. The Project would not conflict with implementation of a water quality control plan or sustainable groundwater management plan. The proposed Project would not result in conditions that would alter or contribute to conflicts with an applicable water quality control plan or sustainable groundwater management plan. No impact would occur.

Mitigation Measures

Implementation of the following mitigation measures would reduce hydrology and water quality impacts to below a level of significance.

MM HWQ-1: Obtain coverage under Construction General Permit (SWRCB Order No. 2009-0009-DWQ and Associated Amendments)

The Project applicant or its contractor would obtain coverage under Construction General Permit (SWRCB Order No. 2009-0009-DWQ and Associated Amendments). Under this permit they would be required to prepare a SWPPP specific to the Project and be responsible for securing coverage under SWRCB's NPDES stormwater permit for general construction activity (Order 2009-0009-DWQ). The SWPPP shall identify specific actions and BMPs relating to the prevention of stormwater pollution from Project-related construction sources by identifying a practical sequence for site restoration, BMP implementation, contingency measures, responsible parties, and agency contacts. The SWPPP shall reflect localized surface hydrological conditions and shall be reviewed and approved by the Project applicant prior to commencement of work and shall be made conditions of the contract with the contractor selected to build and decommission the Project. The SWPPP(s) shall incorporate control measures in the following categories:

- Soil stabilization and erosion control practices (e.g., hydroseeding, erosion control blankets, mulching).
- Dewatering and/or flow diversion practices, if required (**MM HWQ-2**).

Potentially Significant Impact (PSI)	Less Than Significant With Mitigation Incorporated (LTSWMI)	Less Than Significant Impact (LTSI)	No Impact (NI)
--------------------------------------	---	-------------------------------------	----------------

- Sediment control practices (temporary sediment basins, fiber rolls).
- Temporary and post-construction on- and off-site runoff controls.
- Special considerations and BMPs for water crossings, wetlands, and drainages.
- Monitoring protocols for discharge(s) and receiving waters, with emphasis place on the following water quality objectives: dissolved oxygen, floating material, oil and grease, pH, and turbidity.
- Waste management, handling, and disposal control practices.
- Corrective action and spill contingency measures.
- Agency and responsible party contact information.
- Training procedures that shall be used to ensure that workers are aware of permit requirements and proper installation methods for BMPs specified in the SWPPP.

The SWPPP shall be prepared by a qualified SWPPP practitioner with BMPs selected to achieve maximum pollutant removal and that represent the best available technology that is economically achievable. Emphasis for BMPs shall be placed on controlling discharges of oxygen-depleting substances, floating material, oil and grease, acidic or caustic substances or compounds, and turbidity. BMPs for soil stabilization and erosion control practices and sediment control practices will also be required. Performance and effectiveness of these BMPs shall be determined either by visual means where applicable (i.e., observation of above-normal sediment release), or by actual water sampling in cases where verification of contaminant reduction or elimination, (inadvertent petroleum release) is required to determine adequacy of the measure.

MM HWQ-2: Incorporate Post-Construction Runoff BMPs into Project Drainage Plan

The Project Drainage Plan shall adhere to County guidelines to control and manage the on- and off-site discharge of stormwater to existing drainage systems. Infiltration basins will be integrated into the Drainage Plan to the maximum extent practical. The Drainage Plan shall provide both short- and long-term drainage solutions to ensure the proper sequencing of drainage facilities and management of runoff generated from Project impervious surfaces as necessary.

MM HWQ-3: Prepare Drainage Plan/Drainage Report

A Drainage Plan/Drainage Report shall be prepared for Project which shall adhere to guidelines in the County’s Engineering Guidelines Manual, or whatever regulations are in place at the time of project implementation, to control and manage the on- and off-site discharge of stormwater to existing drainage systems and shall include a project description, project setting including discussions of existing and proposed conditions, any drainage issues related to the site, summary of the findings or conclusions, off-site hydrology, onsite hydrology, hydraulic calculations and a hydrology map.

The drainage study and specifications for improvements of all drainage easements, culverts, drainage structures, and drainage channels shall be provided to the DPW for approval. Required

Potentially Significant Impact (PSI)	Less Than Significant With Mitigation Incorporated (LTSWMI)	Less Than Significant Impact (LTSI)	No Impact (NI)
--------------------------------------	---	-------------------------------------	----------------

plans and specifications shall provide a drainage system capable of handling and disposing of all surface waters originating within the subdivision and all surface waters that may flow onto the subdivision from adjacent lands. Said drainage system shall include any easements and structures required by the DPW or the affected Utility Agency to properly handle the drainage on site and off site. The report should detail any vegetation and trash/debris removal, as well as address any standing water.

Infiltration basins will be integrated into the Drainage Plan to the maximum extent practical. The Drainage Plan shall provide both short- and long-term drainage solutions to ensure the proper sequencing of drainage facilities and management of runoff generated from project impervious surfaces as necessary.

MM HWQ-4: Obtain On-site Water Treatment System (OWTS) Permit

Prior to the issuance of building permits for any portion of the project, the Applicant shall obtain an OWTS permit from the Imperial County Public Health Department, Division of Environmental Health.

The Applicant shall submit a detailed system design for the proposed OWTS which satisfies the requirements of Section 8.80.170 of the Imperial County Codified Ordinances. The detailed system design must include:

- (1) A scaled, dimensional drawing showing the proposed location of all OWTS components and replacement area;
- (2) Vertical cross-section drawing showing the depth of the drainfield, the vertical separation to groundwater, the depth of soil cover, and any other OWTS components to be constructed or installed at the site;
- (3) Calculations and assumptions supporting the proposed design, including the soil type; drainfield hydraulic loading rate; the design flow; and additional information as required by adopted technical standards.

The proposed design shall also demonstrate that the OWTS meets the minimum horizontal separations (i.e., setbacks) to water supplies, irrigation canals, surface waters and structures established in 8.80.100 of the Codified Ordinances and Table I of Imperial County Ordinance No. 1516.

A copy of the OWTS permit shall be provided to the ICPDSD staff.

XI. LAND USE AND PLANNING.

Would the project:

- a) Physically divide an established community?

Potentially Significant Impact (PSI)	Less Than Significant With Mitigation Incorporated (LTSWMI)	Less Than Significant Impact (LTSI)	No Impact (NI)
--------------------------------------	---	-------------------------------------	----------------

a) No Impact. The proposed fueling station and convenience store would not physically divide an established community, as no facilities are proposed that would prohibit travel throughout the project area. No impact would occur and mitigation would not be required.

Would the project:

- b) Cause a significant environmental impact due to a conflict with any land use plan, policy, or regulation adopted for the purpose of avoiding or mitigating an environmental effect?

b) Less Than Significant Impact. The General Plan Land Use designation of the Project site is Agriculture and the Project site is zoned General Agriculture (A-2). The Project includes a fueling station and convenience store as well as a General Plan Amendment to change the land use designation from “Agriculture” to “Urban Area” and a Zone Change to change the zone classification from General Agriculture (A-2) to Heavy Commercial (C-3).

The purpose of the C-3 (Heavy Commercial) zone is to designate areas for use and services normally associated with the traveling public or for the regional commercial convenience. The Project as designed meets all development standards as identified in the Chapter 14 of the Land Use Code, including but not limited to permitted uses, minimum lot size, setbacks, building heights, off-street parking spaces, landscaping, and signage. Upon completion of the General Plan Amendment and Zone change, the proposed Project would be consistent with all applicable existing and planned land use policies and regulations of the County of Imperial Land Use Code and General Plan. Therefore, potential impacts associated with conflict with a land use plan, policy or regulation would be less than significant and no mitigation would be required.

Mitigation Measures

No mitigation would be required.

XII. MINERAL RESOURCES.

Would the project:

- a) Result in the loss of availability of a known mineral resource that would be of value to the region and the residents of the state?

a) No Impact. A number of mineral resources in Imperial County are currently being extracted, including gold, gypsum, sand, gravel, lime, clay, stone, kyanite, limestone, sericite, mica, tuff, salt, potash, and manganese. Several issues influence the extraction of mineral deposits in Imperial County, including the location of geologic deposition, the potential for impacts to the environment, and land use conflicts. As a result, the extraction of mineral resources is limited to a relatively small number of sites throughout the County.

According to the Existing Mineral Resources Map (Figure 8) in the Conservation and Open Space Element of the County of Imperial General Plan (2016), no known mineral resources occur within the Project site itself or within the general vicinity (County of Imperial, 2016). Construction of the Project would not result in the loss of availability of a known mineral resource that would be of value to the region and the residents of the state, No impacts would occur under this criteria and no mitigation is required.

Potentially Significant Impact (PSI)	Less Than Significant With Mitigation Incorporated (LTSWMI)	Less Than Significant Impact (LTSI)	No Impact (NI)
--------------------------------------	---	-------------------------------------	----------------

Would the project:

b) Result in the loss of availability of a locally important mineral resource recovery site delineated on a local general plan, specific plan or other land use plan?	<input type="checkbox"/>	<input type="checkbox"/>	<input type="checkbox"/>	<input checked="" type="checkbox"/>
---	--------------------------	--------------------------	--------------------------	-------------------------------------

b) No Impact. As noted in Response to Impact XII. a) above, implementation of the Project would not result in any impacts to known mineral resources and therefore would not result in the loss of availability of a locally important mineral resource recovery site delineated on the local general plan. No impacts would occur under this criteria.

Mitigation Measures

No mitigation would be required.

XIII. NOISE.

Birdseye Planning Group (BPG) has prepared the Maverik Fueling Station and Convenience Store Project Noise Study (BPG, 2024). The Noise Study, included as Appendix J of this Initial Study, analyzed potential noise impacts associated with the proposed Maverik Fueling Station and Convenience Store Project in unincorporated Imperial County, California. The analysis contained in this section is based on the findings of this technical report.

Overview of Sound Measurement

Noise levels are generally measured in decibels (dB) using the A-weighted sound pressure level (SPL) (dBA). The A-weighting scale is an adjustment to the actual SPLs to be consistent with that of human hearing response, which is most sensitive to frequencies around 4,000 Hertz and less sensitive to low frequencies (below 100 Hertz). Based on the logarithmic scale, a doubling of sound energy is equivalent to an increase of 3 dBA, and a sound that is 10 dBA less than the ambient sound level has no effect on ambient noise. Because of the nature of the human ear, a sound must be about 10 dBA greater than the reference sound to be judged as twice as loud. In general, a 3 dBA change in community noise levels is noticeable, while 1-2 dB changes generally are not perceived.

Quiet suburban areas typically have noise levels in the range of 40-50 dBA, while arterial streets are in the 50-60+ dBA range. Normal conversational levels are in the 60-65 dBA range, and ambient noise levels greater than 65 dBA can interrupt conversations. Noise levels typically attenuate at a rate of 6 dBA per doubling of distance from point sources (i.e., industrial machinery). Noise from lightly traveled roads typically attenuates at a rate of about 4.5 dBA per doubling of distance. Noise from heavily traveled roads typically attenuates at about 3 dBA per doubling of distance. Noise levels may also be reduced by intervening structures; generally, a single row of buildings between the receptor and the noise source reduces the noise level by about 5 dBA. A solid wall or berm reduces noise levels by 5 to 10 dBA. The manner in which older (approximately 30 years plus) homes in California were constructed generally provides a reduction of exterior-to-interior noise levels of about 20 to 25 dBA with closed windows. The exterior-to-interior reduction of newer residential units and office buildings constructed to California Energy Code standards is generally 30 dBA or more.

In addition to the actual instantaneous measurement of sound levels, the duration of sound is important since sounds that occur over an extended period of time are more likely to be an annoyance. The Leq is defined as the single steady A-weighted level that is equivalent to the same amount of energy as that contained in the actual fluctuating levels over a period of time (essentially, the average noise level). Typically, Leq is summed over a one-hour period. Lmax is the

Potentially Significant Impact (PSI)	Less Than Significant With Mitigation Incorporated (LTSWMI)	Less Than Significant Impact (LTSI)	No Impact (NI)
---	---	--	----------------------

highest RMS (root mean squared) SPL within the measuring period, and Lmin is the lowest RMS SPL within the measuring period.

Noise that occurs at night tends to be more disturbing than that which occurs during the day. Community noise is usually measured using Day-Night Average Level (Ldn), which is the 24-hour average noise level with a 10-dBA penalty for noise occurring during nighttime (10 PM to 7 AM) hours, or Community Noise Equivalent Level (CNEL), which is the 24-hour average noise level with a 5 dBA penalty for noise occurring from 7 AM to 10 PM and a 10 dBA penalty for noise occurring from 10 PM to 7 AM. Daytime Leq levels are louder than Ldn or CNEL levels; thus, if the Leq meets noise standards, the Ldn and CNEL are also met.

Project Site Setting

The Project site is an urbanizing area within unincorporated Imperial County and is located northeast of the Interstate-8/ State Route 111 interchange east of the City of El Centro. The existing General Plan designation for the site is Agriculture. A General Plan Amendment is proposed to change the land use designation on the Project site from “Agriculture” to “Urban Area.” The Project site is zoned General Agriculture (A-2). A Zone Change to change the Project site’s zoning from General Agriculture (A-2) to Heavy Commercial (C-3) is also proposed. The most common and primary sources of noise in the Project site vicinity are motor vehicles (e.g., automobiles and trucks) operating on SR-111. Traffic on Ross Road, located along the northern site boundary, contributes negligibly to ambient conditions. Hawes Road borders the Project site to the west and provides access to one single-family residence located south of the Project site adjacent to the I-8 right of way (ROW). Motor vehicle noise is of concern because where a high number of individual events occur, it can create a sustained noise level.

Two weekday morning 15-minute noise measurements were taken on the Project site on October 19, 2023, using an ANSI Type II integrating sound level meter. The predominant noise source was traffic. The temperature during monitoring was 75° Fahrenheit with no cloud cover or perceptible wind. As shown on **Table 14**, ambient noise levels at the Project ranged from 61.9 dBA (Leq) to 62.5 dBA (Leq).

TABLE 14. AMBIENT NOISE LEVELS

Location No.	Measurement Location	Primary Noise Source	Sample Time	Leq (dBA)
Receiver 1	404 Ross Road (single-family residence, north of Project, adjacent to Ross Road)	Traffic	Weekday morning	62.5
Receiver 2	1750 Hawes Road (single-family residence, south of Project, near southern terminus of Hawes Road.	Traffic	Weekday morning	61.9

Notes: Ambient Noise Levels obtained during Field visit using ANSI Type II Integrating sound level meter.
Source: BPG, 2024.

Sensitive Receptors

Urban areas contain a variety of land use and development types that are noise sensitive including residences, schools, churches, hospitals and convalescent care facilities. The nearest sensitive receptors (two single family homes) are located north and south of the Project site. Specifically, Receiver 1 is located on the north side of Ross Road, approximately 180 feet north of the Project site. Receiver 2 is located at the south end of Hawes Road, approximately

Potentially Significant Impact (PSI)	Less Than Significant With Mitigation Incorporated (LTSWMI)	Less Than Significant Impact (LTSI)	No Impact (NI)
---	---	--	----------------------

980 feet south of the Project site. Additional residential uses at the Country Life RV and Mobile Home Park) are located west of the Project, across SR-111.

Regulatory Setting

In 1976, the California Department of Health, State Office of Noise Control published a recommended noise/land use compatibility matrix which many jurisdictions have adopted as a standard in their general plan noise elements. The California State Office of Planning and Research 2017 update to the *General Plan Guidelines, Appendix D Noise Element Guidelines*, Figure 2, shows that exterior noise levels up to 60 dBA (CNEL or Ldn) are normally compatible in rural residential areas. Noise levels up to 70 dBA (CNEL or Ldn) are conditionally compatible.

Imperial County Noise Ordinance

Operational Noise. The Property Line Noise Limits listed in Table 9 of the *County of Imperial General Plan Noise Element* (County of Imperial, 2015) and the County’s Code of Ordinances, Title 9, Division 7 (Noise Abatement and Control), Section 90702.00 (Sound Level Limits) provide acceptable sound level limits based on the property zoning.

Stationary Noise. The applicable property line sound level limits are provided in **Table 15** below and shall apply to noise generation from one property to an adjacent property. The standards imply the existence of a sensitive receptor on the adjacent, or receiving, property. In the absence of a sensitive receptor, an exception or variance to the standards may be appropriate. These standards do not apply to construction noise. Stationary sources associated with the Project (i.e., heating, ventilation and air conditioning [HVAC]) would have an adverse effect if they exceed baseline conditions at receiving properties. Truck movement on the Project site is considered a stationary source. The increase of noise levels generally results in an adverse impact to the noise environment. The Noise/Land Use Compatibility Guidelines are not intended to allow the increase of ambient noise levels up to the maximum without consideration of feasible noise reduction measures.

The following guidelines are established by the County of Imperial for the evaluation of significant noise impact.

- a. If the future noise level after the Project is completed will be within the "normally acceptable" noise levels shown in the Noise/Land Use Compatibility Guidelines but will result in an increase of 5 dB CNEL or greater, the Project will have a potentially significant noise impact and mitigation measures must be considered.
- b. If the future noise level after the Project is completed will be greater than the "normally acceptable" noise levels shown in the Noise/Land Use Compatibility Guidelines, a noise increase of 3 dB CNEL or greater shall be considered a potentially significant noise impact and mitigation measures must be considered.

TABLE 15. PROPERTY LINE NOISE LEVEL LIMITS

Zone	Time	Applicable Limit – One Hour Average Sound Level (decibels)
Residential Zones	7 AM to 10 PM	50
	10 PM to 7 AM	45
Multi-residential Zones	7 AM to 10 PM	55
	10 PM to 7 AM	50
Commercial Zones	7 AM to 10 PM	60
	10 PM to 7 AM	55

Potentially Significant Impact (PSI) Less Than Significant With Mitigation Incorporated (LTSWMI) Less Than Significant Impact (LTSI) No Impact (NI)

TABLE 15. PROPERTY LINE NOISE LEVEL LIMITS

Zone	Time	Applicable Limit – One Hour Average Sound Level (decibels)
Light Industrial/Industrial Park Zones	Anytime	70
General Industrial Zones, including agricultural uses	Anytime	75

Notes:

When the noise-generating property and the receiving property have different uses, the more restrictive standard shall apply. When the ambient noise level is equal to or exceeds the Property Line noise standard, the increase of the existing or proposed noise shall not exceed 3 dB Leq.

The sound level limit between two zoning districts (different land uses) shall be measured at the property line between the properties.

Fixed-location public utility distribution or transmission facilities located on or adjacent to a property line shall be subject to the noise level limits of subsection A of this section, measured at or beyond six feet from the boundary of the easement upon which the equipment is located.

This section does not apply to noise generated by helicopters at heliports or helistops authorized by a conditional use permit.

This section does not apply to noise generated by standard agricultural field operating practices such as planting and harvesting of crops. The County of Imperial has a Right to Farm Ordinance (1031) which serves as recognition to agricultural practices to new development. Agricultural/industrial operations shall comply with the noise levels prescribed under the general industrial zones.

Source: County of Imperial Ordinance, Title 9, Division 7 (Noise Abatement and Control)

Traffic Noise. Table 7 of the *Imperial County General Plan Noise Element* (Noise/Land Use Compatibility Guidelines) provides a range of land uses and compatibility criteria based on exterior noise levels (County of Imperial, 2015). This data shows that exterior noise levels up to 60 dBA (CNEL or Ldn) are normally compatible in rural residential areas. Noise levels up to 70 dBA (CNEL or Ldn) are conditionally compatible. For the purpose of identifying potential traffic-related impacts associated with the proposed Project, these standards are used. Because baseline conditions exceed 60 dBA, an impact is determined based on whether the project would cause a 3 dBA or greater increase in noise levels over baseline conditions.

Construction Noise. The *County of Imperial General Plan Noise Element* defines a construction noise impact as noise generated from a single piece of construction equipment or a combination of equipment that exceeds 75 dBA Leq when averaged over an 8-hour period (Leq[8]) and measured at the nearest sensitive receptor (e.g., homes, schools, hospitals, parks, and office buildings, and for certain non-human species, including riparian bird species). In cases of extended-length construction times, the standard may be reduced so as to not exceed 75 dB Leq when averaged over a one-hour period. The Noise Element also limits construction equipment operation to the hours of 7:00 AM to 7:00 PM, Monday through Friday, and 9:00 AM to 5:00 PM Saturday and Sunday.

Vibration Standards

Vibration is a unique form of noise as the energy is transmitted through buildings, structures and the ground whereas audible noise energy is transmitted through the air. Thus, vibration is generally felt rather than heard. The ground motion caused by vibration is measured as particle velocity in inches per second (PPV) and which is also referenced as vibration decibels (VdB). The vibration velocity level threshold of perception for humans is approximately 0.006-0.019 PPV or 65 VdB. There are no federal or state regulatory standards for ground-borne vibration. Caltrans has developed vibration criteria based on potential structural damage risks and human annoyance. **Table 16** shows various PPV and VdB levels and related human reactions and effects on buildings.

Potentially Significant Impact (PSI) Less Than Significant With Mitigation Incorporated (LTSWMI) Less Than Significant Impact (LTSI) No Impact (NI)

TABLE 16. HUMAN REACTION AND DAMAGE TO BUILDINGS FOR CONTINUOUS OR FREQUENT INTERMITTENT VIBRATION LEVELS

Peak Particle Velocity (inches/second)	Approximate Vibration Velocity Level (VdB)	Human Reaction	Effects on Buildings
0.006–0.019	64–74	Range of threshold of perception.	Vibrations unlikely to cause damage of any type.
0.08	87	Vibrations readily perceptible.	Recommended upper level to which ruins and ancient monuments should be subjected.
0.01	92	Level at which continuous vibrations may begin to annoy people, particularly those involved in vibration sensitive activities.	Virtually no risk of architectural damage to normal buildings.
0.2	94	Vibrations may begin to annoy people in buildings.	Threshold at which there is a risk of architectural damage to normal dwellings.
0.4–0.6	98-104	Vibrations considered unpleasant by people subjected to continuous vibrations and unacceptable to some people walking on bridges.	Architectural damage and possibly minor structural damage.

Source: Caltrans, April 2020.

For the protection of fragile, historic, and residential structures, Caltrans recommends a threshold of 0.2 inches per second PPV (94 VdB). This same threshold would represent the level at which vibrations would be potentially annoying to people in buildings. Construction activities such as blasting, pile driving, demolition, excavation and drilling have the potential to generate ground vibrations near structures.

No historic buildings occur on the site or are known to occur near the site; thus, 94 VdB is used to quantify potential vibration impacts to neighboring structures. Construction activities referenced above that would generate significant vibration levels are not proposed. However, to provide information for use in completing the CEQA evaluation, construction-related vibration impacts are evaluated using the above referenced criteria.

Impact Analysis

Would the project result in:

- a) Exposure of persons to or generation of noise levels in excess of standards established in the local general plan or noise ordinance, or applicable standards of other agencies?

a) Less Than Significant With Mitigation Incorporated.

Temporary Construction Noise

The primary source of noise during construction activities would be comprised of heavy machinery used during site preparation (i.e., clearing/grubbing), grading and clearing the site, as well as equipment used during building

Potentially Significant Impact (PSI) Less Than Significant With Mitigation Incorporated (LTSWMI) Less Than Significant Impact (LTSI) No Impact (NI)

construction and paving. **Table 17** shows the typical noise levels associated with heavy construction equipment. As shown in **Table 17**, average noise levels associated with the use of heavy equipment at construction sites can range from 81 to 91 dBA at 25 feet from the source, depending upon the types of equipment in operation at any given time and phase of construction (FTA 2018).

TABLE 17. TYPICAL MAXIMUM CONSTRUCTION EQUIPMENT NOISE LEVELS

Equipment Onsite	Typical Maximum Level (dBA) at Distance from the Source		
	25 Feet	50 Feet	100 Feet
Air Compressor	86	80	74
Backhoe	86	80	74
Bobcat Tractor	86	80	74
Concrete Mixer	91	85	79
Loader	86	80	74
Bulldozer	91	85	79
Jack Hammer	94	88	82
Pavement Roller	91	85	79
Street Sweeper	88	82	76
Man Lift	81	75	69
Dump Truck	90	84	78
Mobile Crane	89	83	77
Excavator/Scraper	91	85	79

Source: FTA *Transit Noise and Vibration Impact Assessment Manual* (September 2018), Table 7-1.

Project construction would occur over the entire project site. Construction activities will vary in distance from the nearest sensitive properties; thus, noise levels will vary over the workday. As previously stated, the closest receiver is located on the north side of Ross Road, north of the Project site, approximately 180 feet north of the northern property line. While construction noise would attenuate over the distance between the Project site and nearest receiver, noise would likely be audible. If during site preparation and grading several pieces of construction equipment were working simultaneously generally near the north side of Ross Road over an 8-hour work day, the 8-hour Leq could exceed the 75-dBA average at the sensitive receptor located north of the Project site. Because it is difficult to predict what equipment would be used on the site, where it would be used and for how long each day, construction of the project could result in minor adverse short-term noise impacts. Noise mitigation measures **NOI-1** through **NOI-3** would minimize temporary construction noise impacts to below a level of significance.

Potentially Significant Impact (PSI)	Less Than Significant With Mitigation Incorporated (LTSWMI)	Less Than Significant Impact (LTSI)	No Impact (NI)
--------------------------------------	---	-------------------------------------	----------------

Operation-Related Noise

Operation of the Project was evaluated for potential traffic related impacts on exterior and interior noise levels. The Project is considered a typical development that would not significantly contribute new vehicle trips to the existing road network. Traffic would primarily be comprised of existing pass by trips occurring on SR-111. The Project is expected to generate a total of 2,386 net new vehicle trips/day (See **Table 19**). However, for the purpose of estimating traffic noise, all peak hour trips were used because the majority of pass by traffic is concentrated on SR-111 rather than Ross Road.

Exterior Traffic Noise. Existing noise levels were measured at the Project site on October 19, 2023 and are presented on **Table 18**. The Leq during the 15-minute monitoring period was 62.5 dBA at the northwest corner of the site and 61.9 near the southern site boundary. Thus, whether a traffic-related noise impact would occur is based on whether Project traffic, when added to the existing traffic, would cause noise to noticeably increase over ambient conditions (i.e., +3 dBA) or exceed 65 dBA CNEL.

The roadway network adjacent to the Project site (i.e., SR-111, Ross Road and Hawes Road) was modeled using the Federal Highway Administration (FHWA) Traffic Noise Model (TNM) version 2.5 software. Traffic volumes and distribution are based on data from the *Maverik Fueling Station and Convenience Store Traffic Study* (See Appendix K of this IS/MND). To provide a conservative assessment of potential traffic noise, evening (PM) peak hour traffic volumes were used to calculate hourly average baseline noise levels (Leq) for the two sensitive receptor locations. The modeling results are shown in **Table 18**.

As shown on **Table 18**, baseline conditions exceed 60 dBA CNEL at both receivers. The Ldn/CNEL values associated with Project-related traffic are estimated by adding 1 dB to predicted peak-hour Leq traffic noise levels for comparison with the Imperial County General Plan Noise Element criteria for exterior (65 dBA) and interior (45 dBA) noise levels generated by traffic.

TABLE 18. MODELED EXTERIOR NOISE LEVELS

Receptor	Baseline Noise Levels		Project Noise Levels		Net Change (dBA)	Significant Impact	W. Noise Barrier Wall (MM NOI-5)	
	Existing Leq	Existing Ldn/CNEL	With Project Leq	With Project Ldn/CNEL			Mitigated Project Leq	Mitigated Project Ldn/CNEL
Receiver 1	62.2	63.2	65.8	66.8	+3.6	Yes	61.2	62.2
Receiver 2	61.4	62.4	61.5	62.5	+0.1	No	NA	NA

Note: NA = Not Applicable
Source: BPG, 2024.

Noise levels associated with the Project operations were calculated by distributing the 208 PM peak hour passenger cars/light trucks and heavy trucks onto Ross Road assuming 66 percent would come from SR-111 and the remainder would come to the site via Ross Road east of the site. As shown in **Table 18**, the Project would increase exterior noise levels at Receiver 1, by more than 3 dBA; thus, the Project would cause a significant impact at Receiver 1. The Project would not noticeably change exterior noise levels at Receiver 2.

Potentially Significant Impact (PSI)	Less Than Significant With Mitigation Incorporated (LTSWMI)	Less Than Significant Impact (LTSI)	No Impact (NI)
--------------------------------------	---	-------------------------------------	----------------

California Energy Code Title 24 standards specify construction methods and materials that result in energy efficient structures up to a 30 dBA reduction in exterior noise levels (assuming windows are closed). This includes operation of mechanical ventilation (e.g., HVAC), in combination with standard building construction that includes dual-glazed windows with a minimum Sound Transmission Class (STC) rating of 26 or higher. When windows are open, the insertion loss drops to about 10 dBA. Receiver 1 appears to have been constructed prior to Title 24. As stated, the manner in which older (approximately 30 years plus) homes in California were constructed generally provides a reduction of exterior-to-interior noise levels of about 20 to 25 dBA with closed windows. Assuming windows are closed and a 20 dBA insertion loss, interior noise levels at Receiver 1 would be approximately 46.8 dBA CNEL which would exceed 45 dBA CNEL standard. **Mitigation Measure NOI-4**, with the property owners approval, would retrofit Ross Road facing windows and doors of Receiver Location 1, such that interior noise levels meet or are less than the County's 45 dBA standard. Implementation of **Mitigation Measure NOI-4** would reduce interior noise impacts to the residence at 404 Ross Road to below a level of significance by ensuring interior noise levels meet or are less than the 45 dBA standard.

Mitigation Measure NOI-5 would replace the existing chain link fence along the southern and western exterior yard limit of Receiver 1 with a 6-foot concrete masonry unit wall. As shown on **Table 18**, the provision of off-site noise barrier walls between residential uses north of the Project site and traffic on Ross Road and SR-111 would reduce the "With-Project" exterior noise levels at Receiver 1 to 61.2 dBA Leq and to 62.2 dBA CNEL. This would be 1 dBA less than baseline conditions. The increase would be less than 3 dBA; and thus, less than significant. Thus, with implementation of **MM NOI-5**, exterior noise impacts would be reduced to less than significant.

On-Site Truck Movement. Trucks would move around the Project site entering and departing from Ross Road. Individual truck movement sound exposure level (SEL) is used to quantify noise exposure from on-site truck movements. The Traffic Study estimated that 1,568 truck trips would occur each day (See **Table 19**) and assumed that the movements would be evenly distributed over a 24-hour day.

Assuming 1,568 truck trips per day, the resulting noise exposure on-site would be approximately 60.7 dB Ldn. Noise associated with on-site truck movement would attenuate between the fueling area and Receiver 1, a distance of approximately 500 feet, to 40.6 dBA. This would be within the 60 dBA limit for residential uses and would not be significant.

Stationary Noise Sources

HVAC Systems. The proposed HVAC system has not been specified and noise levels vary depending on the size of the system. However, multiple HVAC systems will be installed on the roof-tops of the convenience store located along the east side of the Project site. Reference noise levels for the Project are based on noise measurements made at similar outdoor facilities.

HVAC noise levels can be expected to range from 60 to 70 dBA at 5 feet from the roof top equipment and ventilation openings. Assuming HVAC units are installed at the center of the roof top, a 70 dBA reference noise level would attenuate to 29 dBA and would be inaudible off-site (i.e. at Receiver 1). This would be within the 60 dBA limit for residential uses and would not be significant.

	Potentially Significant Impact (PSI)	Less Than Significant With Mitigation Incorporated (LTSWMI)	Less Than Significant Impact (LTSI)	No Impact (NI)
--	--------------------------------------	---	-------------------------------------	----------------

Would the project result in:

- | | | | | |
|---|--------------------------|--------------------------|-------------------------------------|--------------------------|
| b) Generation of excessive groundborne vibration or groundborne noise levels? | <input type="checkbox"/> | <input type="checkbox"/> | <input checked="" type="checkbox"/> | <input type="checkbox"/> |
|---|--------------------------|--------------------------|-------------------------------------|--------------------------|

b). Less Than Significant Impact.

Temporary Construction-Related Vibration

As referenced, the closest sensitive property to the site is 180 feet to the north at 404 Ross Road. The Noise Study found that vibration levels could be as high as 79 VdB at 100 feet from the source assuming operation of a large bulldozer. Vibration levels at the closest sensitive properties would be imperceptible because of the distance between the source and receiver. Thus, would not occur as a result of construction activities associated with the proposed project. Impacts from groundborne vibration would be less than significant and no mitigation would be required.

Operational Vibration

The proposed fueling station and convenience store do not involve heavy industrial activities or impact sources that would generate vibration detectable off-site. No operational related vibration impacts would occur and no mitigation would be required.

Would the project result in:

- | | | | | |
|---|--------------------------|--------------------------|--------------------------|-------------------------------------|
| c) For a project located within the vicinity of a private airstrip or an airport land use plan or, where such a plan has not been adopted, within two miles of a public airport or public use airport, would the project expose people residing or working in the project area to excessive noise levels? | <input type="checkbox"/> | <input type="checkbox"/> | <input type="checkbox"/> | <input checked="" type="checkbox"/> |
|---|--------------------------|--------------------------|--------------------------|-------------------------------------|

c) No Impact. The Project site is located approximately 6.0 miles southeast of the Imperial County Airport. The site is located outside the Airport Influence Area. Thus, the project site is located outside the 60 dB contour line for airport operations. Project employees would not be exposed to excessive airport noise levels. No impact would occur and no mitigation would be required.

Mitigation Measures

Implementation of the following mitigation measures would reduce impacts to below a level of significance.

NOI-1: Construction Equipment

Electrical power shall be used to run air compressors and similar power tools. Internal combustion engines should be equipped with a muffler of a type recommended by the manufacturer and in good repair. All diesel equipment should be operated with closed engine doors and should be equipped with factory-recommended mufflers. Construction equipment that continues to generate substantial noise at the project boundaries should be shielded with temporary noise barriers, such as barriers that meet a sound transmission class (STC) rating of 25, sound absorptive panels, or sound blankets on individual pieces of construction equipment. Stationary noise-generating equipment, such as generators and compressors, should be located as far as practically possible from the nearest residential property lines.

Potentially Significant Impact (PSI)	Less Than Significant With Mitigation Incorporated (LTSWMI)	Less Than Significant Impact (LTSI)	No Impact (NI)
--------------------------------------	---	-------------------------------------	----------------

NOI-2: Limit Operations Adjacent to Receivers.

Limit the number of large pieces of equipment (i.e., bulldozers or concrete mixers) operating adjacent to receivers to one at any given time to the extent feasible.

NOI-3: Neighbor Notification.

Construction Contractor shall provide notification to residential occupants nearest to the project site 7-14 days prior to initiation of construction activities that could result in noise levels exceeding 75 dBA at the property line adjacent to residences. This notification should include the anticipated hours and duration of construction and a description of noise reduction measures being implemented at the project site. The notification should include a telephone number for local residents to call to submit complaints associated with construction noise. The notification should be posted along Ross Road and Hawes Road and be visible.

NOI-4: Retrofit Windows and Doors of 404 Ross Road

Applicant shall, with approval from the property owner, retrofit the Ross Road facing windows and doors of the residential structure located 404 Ross Road, along with the existing heating, ventilation and air conditioning system to ensure a Sound Transmission Class (STC) rating of at least 30 dBA is achieved to ensure the 45 dBA interior noise standard is met. Prior to issuance of a grading permit, the Applicant shall provide the County with evidence of the property owner's approval of the recommended retrofits, along with evidence that said improvements have been installed to the property owner's satisfaction.

NOI-5: Off-site Noise Barrier Walls at 404 Ross Road

Prior to the issuance of the Building Permits for the proposed fueling station/convenience store, the Applicant shall construct a 6-foot concrete masonry unit (CMU) wall in place of the existing chain link fence along the southern and western exterior yard limits of APN 054-030-039. The southern wall segment shall be approximately 120 feet in length, gated to allow ingress/egress from the parking area and residence and connect with the existing chain link fence along the eastern yard area boundary. The western segment shall be approximately 65 feet in length and connect with the chain link fence segment along the northern yard area boundary.

In accordance with Section 90403.05 of the Imperial County Code of Ordinances, a building permit shall be obtained for the walls, which shall be sited outside of, and would not encroach into IID's ROWs for the Acacia Drain 6A and the Acacia Lateral 5A. Construction shall follow specifications from the 2019 California Building Code adopted by the county of Imperial, and the construction shall be designed by a registered professional civil engineer or architect, licensed in the state of California. Plans, calculations and a soils report may be required.

The ICPDSD shall verify the barriers have been constructed as required prior to issuance of the certificate of occupancy.

	Potentially Significant Impact (PSI)	Less Than Significant With Mitigation Incorporated (LTSWMI)	Less Than Significant Impact (LTSI)	No Impact (NI)
--	--------------------------------------	---	-------------------------------------	----------------

XIV. POPULATION AND HOUSING.

Would the project:

- | | | | | |
|--|--------------------------|--------------------------|-------------------------------------|--------------------------|
| a) Induce substantial unplanned population growth in an area, either directly (for example, by proposing new homes and businesses) or indirectly (for example, through extension of road or other infrastructure)? | <input type="checkbox"/> | <input type="checkbox"/> | <input checked="" type="checkbox"/> | <input type="checkbox"/> |
|--|--------------------------|--------------------------|-------------------------------------|--------------------------|

a) Less Than Significant Impact. The State of California Department of Finance estimated the County of Imperial population to be 179,476 persons as of January 2023 (California Dept. of Finance, 2023a). This population is projected to be 181,271 persons by 2025 and 192,383 persons by 2050 (California Dept. of Finance, 2023b)

The Project intends to develop a gas station and convenience store within an area that has generally been utilized for agricultural purposes. Construction of the Project would be of short duration and likely be completed by construction workers residing within the County or the surrounding area; they would not require new housing.

It is anticipated that the jobs created by these businesses will be filled by existing County residents and it is unlikely the jobs would attract new residents that would require increased County services. The Project would not induce substantial population growth in an area, either directly or indirectly. Impacts would be less than significant and no mitigation would be required.

Would the project:

- | | | | | |
|---|--------------------------|--------------------------|--------------------------|-------------------------------------|
| b) Displace substantial numbers of existing people or housing, necessitating the construction of replacement housing elsewhere? | <input type="checkbox"/> | <input type="checkbox"/> | <input type="checkbox"/> | <input checked="" type="checkbox"/> |
|---|--------------------------|--------------------------|--------------------------|-------------------------------------|

b) No Impact. The Project site is undeveloped with no structures and no displacement of existing housing would occur. Therefore there would be no impacts. The proposed Project would not require the demolition of any housing, as the project site is currently undeveloped. Therefore, there would be no need to construct replacement housing elsewhere. There would be no impact and no mitigation would be required.

Mitigation Measures

No mitigation would be required.

XV. PUBLIC SERVICES.

- a) Would the project result in substantial adverse physical impacts associated with the provision of new or physically altered governmental facilities, need for new or physically altered governmental facilities, the construction of which could cause significant environmental impacts, in order to maintain acceptable service ratios, response times or other performance objectives for any public services:

- | | | | | |
|--------------------|--------------------------|--------------------------|-------------------------------------|--------------------------|
| Fire protection? | <input type="checkbox"/> | <input type="checkbox"/> | <input checked="" type="checkbox"/> | <input type="checkbox"/> |
| Police protection? | <input type="checkbox"/> | <input type="checkbox"/> | <input checked="" type="checkbox"/> | <input type="checkbox"/> |
| Schools? | <input type="checkbox"/> | <input type="checkbox"/> | <input checked="" type="checkbox"/> | <input type="checkbox"/> |
| Parks? | <input type="checkbox"/> | <input type="checkbox"/> | <input checked="" type="checkbox"/> | <input type="checkbox"/> |

	Potentially Significant Impact (PSI)	Less Than Significant With Mitigation Incorporated (LTSWMI)	Less Than Significant Impact (LTSI)	No Impact (NI)
Other public facilities?	<input type="checkbox"/>	<input type="checkbox"/>	<input checked="" type="checkbox"/>	<input type="checkbox"/>

1 and 2) Fire and Police Protection. Less Than Significant Impact. The Imperial County fire station nearest the Project site is located at 1078 Dogwood Rd, Heber, CA 92249, approximately four miles southwest. The Project will comply with Title 24 of the California Building Code and local development standards. Additional provisions under the County's adopted Fire Code including an approved water system capable of supplying required fire flow for fire protection purposes may be required by the County. This provision is met by the Project's inclusion of an on-site water storage tank for firefighting purposes and the provision of fire suppression equipment.

Imperial County requires payment of impact fees for new development projects. Development Impact fees for Fire Services, Sherriff Services, General Government, Parks and Recreation, Public Works, and Library Services are imposed pursuant to Ordinance 1418 §2 (2006), which was drafted in accordance with the County's Tischler Bise Impact Fee Study. The ordinance has provisions for non-residential commercial projects based on square footage. The Project applicant will be required to pay development impact fees required under the ordinance. No new fire or stations/facilities would be required to serve the Project.

3, 4, 5) Schools, Parks, Other Public Facilities. Less Than Significant Impact. The Project site is located within the Meadows Union Elementary School District, which serves students in grades K-8, The Project site is also located within the Central Union High School District which serves students in grades 9 – 12.

The Project proposes to develop a new fueling station and convenience store development. The Project does not result in a change in population where the need for governmental facilities including school sites, parks or other public facilities would be necessary to maintain acceptable service ratios and response times. The Project will not result in the need for the provision of new or physically altered governmental facilities.

As previously noted, Imperial County requires new development projects to pay Development Impact fees for Fire Services, Sherriff Services, General Government, Parks and Recreation, Public Works, and Library Services pursuant to Ordinance 1418 §2 (2006). Additionally, all developments are required to pay School Impact Fees in compliance with Government Code Section 65995 to offset the new development impacts on school facilities. The payment of impact fees would offset any school impact related to increased enrollment associated with the Project. The Project is not expected to require the construction of new or expanded school facilities. The payment of required school development fees would reduce the potential increase in demand to less than significant.

Less than significant impacts would occur under this criteria and no mitigation would be required.

XVI. RECREATION.

Would the project:

- a) Increase the use of existing neighborhood and regional parks or other recreational facilities such that substantial physical deterioration of the facility would occur or be accelerated?

Potentially Significant Impact (PSI)	Less Than Significant With Mitigation Incorporated (LTSWMI)	Less Than Significant Impact (LTSI)	No Impact (NI)
--------------------------------------	---	-------------------------------------	----------------

a) Less Than Significant Impact. The Project would not increase the use of existing neighborhood and regional parks, which typically results from an increase in housing or population in an area. The Project would not result in an increase in housing or residents in the project vicinity and no increase in the use of existing neighborhood park, regional park or other recreational facility would occur. Impacts would be less than significant, and no mitigation measures would be required.

Would the project:

- b) Does the project include recreational facilities or require the construction or expansion of recreational facilities, which have an adverse physical effect on the environment?

b) Less Than Significant Impact. The number of new workers required for construction and operation of the fuel station and convenience store would be relatively low (approximately 15 local workers) and would not require construction or expansion of recreational facilities that might have an adverse effect on the environment. Therefore, impacts would be less than significant, and no mitigation measures would be required.

Mitigation Measures

No mitigation would be required.

VII. TRANSPORTATION / TRAFFIC.

Mizuta Traffic Consulting prepared a Traffic Study for the Project was prepared in December 2023 and updated in April 2024 (Mizuta, 2024). The *Maverik Fueling Station and Convenience Store Traffic Study*, included as Appendix K of this Initial Study, addressed potential operational impacts that could result from the addition of Project traffic to the local circulation system. The Traffic Study found that the Project would be expected to add 2,386 net new daily Project trips with 138 AM peak hour trips and 175 PM peak hour trips. The analysis contained in this section is based on the findings of this technical report.

Existing Setting

Roadway Network

The Maverik Fueling Station and Convenience Store Project site is located on the southeast corner of Hawes Road and Ross Road, east of State Route 111 (SR-111/Imperial Valley Pioneers Expressway) and is bound by Ross Road on the north, by Hawes Road and the Imperial Irrigation District's Acacia Five Drain A on the west.

Ross Road is an east-west roadway with one (1) lane of travel provided in each direction. The County's Circulation and Scenic Highway Element (CSHE) classifies Ross Road as a Minor Collector (Local Collector) (County of Imperial, 2008). Parking is prohibited on both sides of the roadway and the speed limit is posted at 55 mph.

State Highway 111 (SR-111/Imperial Valley Pioneers Expressway) is a north-south divided roadway with two (2) lanes of travel provided in each direction. The CSHE classifies SR-111 as an Expressway. Parking is prohibited on both sides of the roadway. The posted speed limit is 55 miles per hour (mph).

Potentially Significant Impact (PSI)	Less Than Significant With Mitigation Incorporated (LTSWMI)	Less Than Significant Impact (LTSI)	No Impact (NI)
--------------------------------------	---	-------------------------------------	----------------

Bicycle and Pedestrian Facilities

Bicycle lanes are not provided along Ross Road or SR-111 in the vicinity of the Project site. A portion of Ross Road, from Drew Road to Austin Road, is designated as a Class II bike route, approximately five (5) miles west of the Project site (County of Imperial, 2008).

There are no pedestrian facilities along Ross Road or SR-111 in the vicinity of the Project site. Pedestrian facilities on Ross Road end just east of Industry way, approximately 1.5 miles west of the Project site. Pedestrians are allowed to cross the SR-111 and Ross Road intersection, utilizing the west and east legs of the intersection. The traffic signals controlling the SR-111 and Ross Road intersection are provided with push buttons and signal faces for pedestrian traffic along these legs.

Transit Service

Public transportation service within Imperial County is provided chiefly by two providers: Imperial Valley Transit (IVT) and Yuma County Area Transit (YCAT). IVT offers fixed-route service as well as three on-demand programs (IVT Access, IVT Ride, and IVT MedTrans). YCAT, under a joint agreement between the Quechan Tribe, the Imperial County Transportation Commission (ICTC), and YCAT, operates two routes within Imperial County. No transit service is provided on Ross Road or on SR-111 in the vicinity of the Project site. Transit service nearest the Project site is provided by IVT on Old Highway 111, north of and Evan Hewes Highway, Route 3E has a weekday schedule with service approximately every half hour from about 8:00 AM to 7 PM (IVT, 2024). No transit service is provided along Ross Road or SR-111 in the vicinity of the Project. The nearest transit stop is located within the Imperial Valley college campus, approximately 3.25 miles to the north along SR-111.

Regulatory Framework

Senate Bill 743 (SB 743)

Senate Bill 743 (Steinberg, 2013), which was codified in Public Resources Code section 21099, required changes to the guidelines implementing CEQA (CEQA Guidelines) (Cal. Code Regs., Title 14, Div. 6, Ch. 3, § 15000 et seq.) regarding the analysis of transportation impacts. Previously, environmental review of transportation impacts was focused on the delay that vehicles experience at intersections and on roadway segments. That delay was measured using a metric known as “level of service,” or LOS. Under SB 743, the focus of transportation analysis shifted from “driver delay” to a reduction of greenhouse gas emissions, creation of multimodal networks and promotion of a mix of land uses. SB 743 required the Governor’s Office of Planning and Research (OPR) to amend the CEQA Guidelines to provide an alternative to level of service for evaluating transportation impacts.

To this end, OPR has certified and adopted changes to the CEQA Guidelines that identify vehicle miles traveled (VMT) as the most appropriate metric to evaluate a project’s transportation impacts. With the California Natural Resources Agency’s certification and adoption of the changes to the CEQA Guidelines in December 2018, automobile delay, as measured by “level of service” and other similar metrics, generally no longer constitutes a significant environmental effect under CEQA. (Pub. Resources Code, § 21099, subd. (b)(3).). The California OPR Technical Advisory developed guidance on implementing Senate Bill 743 (SB 743) that shifts the transportation impact measure of effectiveness from LOS to VMT. OPR’s *Technical Advisory on Evaluating Transportation Impacts in CEQA* states on page 8 “As noted above, lead agencies have the discretion to set or apply their own thresholds of significance” (LOS, 2023b).

Potentially Significant Impact (PSI)	Less Than Significant With Mitigation Incorporated (LTSWMI)	Less Than Significant Impact (LTSI)	No Impact (NI)
--------------------------------------	---	-------------------------------------	----------------

CEQA Guidelines Section 15064.3 – Determining the Significance of Transportation Impacts

State CEQA Guidelines Section 15064.3 was adopted in December 2018 to implement SB 743. Under SB 743, the focus of transportation analysis shifted from “driver delay” to a reduction of greenhouse gas emissions, creation of multimodal networks and promotion of a mix of land uses. In addition to establishing Vehicle Miles Traveled (VMT) as the most appropriate measure of transportation impacts, and shifting away from LOS, primary elements of this section:

- Reiterate that a project’s adverse effect on automobile delay, as described solely by level of service or similar measures of vehicle capacity or traffic congestion, shall not be considered a significant impact on the environment (Public Resources Code Section 21099(b)(2));
- Create a rebuttable presumption of no significant transportation impacts for (a) land use projects within 0.5-mile of either an existing major transit stop or a stop along an existing high-quality transit corridor, (b) land use projects that reduce VMT below existing conditions, and (c) transportation projects that reduce or have no impact on VMT;
- Allow a lead agency to qualitatively evaluate VMT if existing models are not available; and
- Give lead agencies discretion to select a methodology to evaluate a project’s VMT but requires disclosure of that methodology in the CEQA documentation. Lead agencies are required to comply with CEQA Guideline revisions no later than July 1, 2020. To assist lead agencies in this endeavor, the State Office of Planning and Research (OPR) has also published a Technical Advisory on Evaluating Transportation Impacts in CEQA (December 2018), which provides guidance in the calculation and application of VMT analyses within CEQA documents. Page 8 of the OPR’s Technical Advisory notes that lead agencies have the discretion to set or apply their own thresholds of significance.

County of Imperial Circulation and Scenic Highway Element

The County of Imperial Circulation and Scenic Highway Element (CSHE) of the General Plan identifies the transportation needs of the County and the various modes available to meet these needs. It provides a plan to accommodate a pattern of concentrated and coordinated growth. Additionally, the CSHE guides future circulation plans for the entire county in a manner that will provide a system of roads and streets that will operate at a level of service “C” (LOS “C”) or better.

The goals and objectives of CSHE along with policies to achieve them provide direction for private development as well as government actions and programs. The relevant CSHE goals and policies for the Project include:

Goal 1: The County will provide and require an integrated transportation system for the safe and efficient movement of people and goods within and through the County of Imperial with minimum disruption to the environment.

- Objective 1.2 Require a traffic analysis for any new development which may have a significant impact on County roads.
- Objective 1.12 Review new development proposals to ensure that the proposed development provides adequate parking and would not increase traffic on existing roadways and intersection to a level of service (LOS) worse than “C” without providing appropriate mitigations to existing infrastructure. This can include fair share contributions on the part of developers to mitigate traffic impacts caused by such proposed developments.

Potentially Significant Impact (PSI)	Less Than Significant With Mitigation Incorporated (LTSWMI)	Less Than Significant Impact (LTSI)	No Impact (NI)
--------------------------------------	---	-------------------------------------	----------------

Guidelines for Determination of Significance

According to Appendix G of the State CEQA Guidelines, a project would have a significant impact if it would:

- 1) Conflict with a program, plan, ordinance or policy addressing the circulation system, including transit, roadway, bicycle and pedestrian facilities.
- 2) Conflict or be inconsistent with CEQA Guidelines Section 15064.3, subdivision (b).
- 3) Substantially increase hazards due to a geometric design feature (e.g., sharp curves or dangerous intersections) or incompatible uses (e.g., farm equipment).
- 4) Result in inadequate emergency access.

Methodology

Vehicle Miles Traveled (V)MT Analysis

Pursuant to CEQA Guidelines Section 15064.3(c), beginning on July 1, 2020, the provisions of SB 743 apply statewide. A VMT Analysis was prepared for the Project, and is provided as Appendix K. Because the County of Imperial has yet to adopt the VMT guidelines, the VMT assessment was based on the criteria outlined in the Governor's Office of Planning and Research (OPR) Technical Advisory on Evaluating Transportation Impacts in CEQA (OPR's Technical Advisory)

LOS Analysis

With implementation of Senate Bill 743, automobile delay, as measured by level of service, is no longer considered a significant effect on the environment. Therefore for CEQA compliance purposes, the level of service analysis, prepared by Mizuta Traffic Consulting in 2023 (Mizuta, 2024; Appendix K) was conducted to determine whether the Project would conflict with the County Circulation and Scenic Highway Element Policy 1.12 for intersections in the project vicinity of the project and whether off-site roadway improvements would be necessary. This level of service (LOS) analysis is only addressed in this Initial Study as it relates to the Project's consistency with applicable Circulation and Scenic Highway Element policies.

The study area and scenarios evaluated the following six (6) intersections; three (3) street segments and three (3) scenarios:

STUDY AREA

Intersections	Street Segments	Traffic Scenarios
<ul style="list-style-type: none"> ▪ SR-111 & E Evan Hewes Highway ▪ SR-111 & Ross Road ▪ Bowker Road & Ross Road ▪ West Project Driveway & Ross Road (1) ▪ Middle Project Driveway & Ross Road(1) ▪ East Project Driveway & Ross Road (1) 	<ul style="list-style-type: none"> ▪ SR-111 north of Ross Road ▪ SR-111 south of Ross Road ▪ Ross Road, east of SR-111 	<ul style="list-style-type: none"> ▪ Existing Conditions ▪ Opening Year 2025 Baseline (2) ▪ Opening Year 2025 + Project

Notes: (1) Constructed as park of the Project. (2) Represents conditions at the anticipated year of project opening.

Potentially Significant Impact (PSI)	Less Than Significant With Mitigation Incorporated (LTSWMI)	Less Than Significant Impact (LTSI)	No Impact (NI)
--------------------------------------	---	-------------------------------------	----------------

Existing Traffic Volumes and LOS Analysis

To assess existing traffic operations, traffic counts were taken on November 9, 2023. Intersection counts were collected from 7:00 AM to 9:00 AM and from 4:00 PM to 6:00 PM to represent the AM and PM peak travel periods, respectively. Daily traffic counts (24 hour) were collected along SR-111, north and south of Ross Road; and along Ross Road, east and west of SR-111 on the same date.

Level of Service Approach

Level of Service (LOS) is the term used to denote the performance of roadways, intersections, and freeway entrances, under various traffic loads. LOS designations range from A to F, with LOS A representing the best operating conditions and LOS F representing the worst operating conditions.

The Traffic Study found that all existing study area intersections and street segments were operating at LOS or better under existing conditions (see Tables 3-1 and Table 3-2 of Appendix K, respectfully)

Project Traffic Generation

The Traffic Study estimated the vehicle and truck trips that would be generated by the Project as shown on **Table 19**. The Project would be expected to 2,386 net new daily Project trips with 138 AM peak hour trips and 175 PM peak hour trips.

TABLE 19. PROJECT TRIP GENERATION

TRIP GENERATION RATES ⁽¹⁾								
Land Use	ITE Code	Weekday Daily (trips/vfp)	AM PEAK			PM PEAK		
			Rate	In: Out Ratio		Rate	In: Out Ratio	
Convenience Store/Gas Station ⁽³⁾	945	345.75	31.60	0.50 : 0.50		26.90	0.50 : 0.50	
Truck Stop	950	224.00	13.97	0.49 : 0.51		15.42	0.53 : 0.47	
TRIP GENERATION CALCULATIONS								
Land Use	Amount	ADT	AM PEAK			PM PEAK		
			In	Out	Total	In	Out	Total
Convenience Store (3)	14 vfp	4,841	221	221	442	189	188	377
Less Pass by (76% AM, 75% PM & Daily) ⁽²⁾		-3,631	-166	-166	-322	-142	-141	-238
Truck Stop	7 vfp	1,568	48	50	98	57	51	108
Passenger Car Equivalent Factor (PCE) = 3.0		6,720	207	213	420	246	215	462
Less Pass by (76% AM, 75% PM & Daily) ⁽²⁾		-5,040	-156	-162	-316	-185	-162	-347
Proposed Driveway Trips (PCE)		9,545	365	371	736	360	341	701
Less Pass-by Trips		-7,159	-274	-279	-553	-270	-256	-526
Net New Traffic		2,386	91	92	183	90	85	175

Notes: vfp: vehicle fueling position

1. Trip and pass by rates for the project's land uses are based on the *Institute of Transportation Engineers (ITE) Trip Generation Manual, 11th Edition*.
2. Pass-by trip rate is based on the ITE Trip Generation Manual, 11th Edition.
- 3 – ITE Rate for convenience stores 5,500 to 10,000 SF in size.

Source: Mizuta Traffic Consulting, 2024; Appendix K.

Potentially Significant Impact (PSI)	Less Than Significant With Mitigation Incorporated (LTSWMI)	Less Than Significant Impact (LTSI)	No Impact (NI)
--------------------------------------	---	-------------------------------------	----------------

Analysis

Would the project:

- a) Conflict with a program, plan, ordinance or policy addressing the circulation system, including transit, roadway, bicycle and pedestrian facilities?

a) Less Than Significant.

Construction Phase Trip Generation

Short-term construction traffic would be generated with construction of the proposed Project. This would include traffic from construction workers and truck traffic for material removal (i.e., grading export and vegetation, demolition debris grading and soil remediation export) and material delivery (i.e., building materials, water, etc.), anticipated to be spread throughout the day.

The contribution of construction trips to the surrounding street system was not modeled because anticipated trip volumes would be temporary and are not expected to generate more than 50 peak hour trips, which is the threshold for modeling. Traffic generated by construction activities would be temporary and would not result in direct impacts on key intersections in the study area. Traffic impacts related to construction activities would be less than significant and no mitigation would be required.

Operations Phase – Trip Generation

In accordance with Objective 1.2 of the Circulation and Scenic Highway Element, Mizuta Traffic Consulting prepared the *Maverick Fueling Station and Convenience Store Traffic Study*, which included as Appendix K of this Initial Study. The Traffic Study estimated the trips that would be generated by the Project as shown on **Table 19**.

Project-related trips were then assigned and distributed to the surrounding circulation system to assess project impacts. The Traffic Study found that the addition of project-related trips to the local circulation system would not cause any of the study area intersections or street segments to operation below LOS C (see Tables 5-1 and 5-2 of Appendix K).

The Imperial County Circulation and Scenic Highway Element has an adopted level of service standard of LOS “C” or better. Objective 1.2 requires a traffic analysis for any new development which may have a significant impact on County Roads. Objective 1.12 requires a review of all new development proposals to ensure to ensure that the proposed development provides adequate parking and would not increase traffic on existing roadways and intersection to a level of service (LOS) worse than “C” without providing appropriate mitigations to existing infrastructure. This can include fair share contributions on the part of developers to mitigate traffic impacts caused by such proposed developments.

The proposed Project would not conflict with a program, plan, ordinance, or policy addressing the circulation system, including transit, roadway, bicycle, and pedestrian facilities. The Project does not propose any features that are inconsistent with applicable policies of the County’s General Plan Circulation and Scenic Highway Element and would not affect any transit, bicycle, or pedestrian facilities. Impacts under this criteria would be less than significant and no mitigation would be required.

Potentially Significant Impact (PSI)	Less Than Significant With Mitigation Incorporated (LTSWMI)	Less Than Significant Impact (LTSI)	No Impact (NI)
--------------------------------------	---	-------------------------------------	----------------

Would the project:

- | | | | | |
|---|--------------------------|--------------------------|-------------------------------------|--------------------------|
| b) Would the Project conflict or be inconsistent with CEQA Guidelines section 15064.3, subdivision (b)? | <input type="checkbox"/> | <input type="checkbox"/> | <input checked="" type="checkbox"/> | <input type="checkbox"/> |
|---|--------------------------|--------------------------|-------------------------------------|--------------------------|

b) Less Than Significant. According to the OPR's Technical Advisory, there are several screening criteria that can be applied to effectively screen projects from VMT project level assessments. The purpose is to screen out projects that are presumed to have a non-significant transportation impact based on facts of a project and to avoid unnecessary analysis and findings that would be inconsistent with the intent of SB 743. The following lists the various screening criteria:

1. Small Projects (Projects that generate or attract fewer than 110 trips per day)
2. Transit Priority Area (TPA)
3. Project Type - Locally Serving Retail

If the project meets any of the screening criteria above, they are presumed to not have a significant impact and are screened out from completing additional VMT analysis. Upon reviewing the screening criteria, the most appropriate and applicable criteria for the project was the Local Serving Retail use less than 50,000 SF criteria. According to OPR's Technical Advisory, a project that is a locally serving retail land use under 50,000 SF in size would be presumed to have a less than significant impact and can be successfully screened from further VMT analysis.

The Project's convenience store/gas station area is proposed to be 5,892 SF, which is much less than the 50,000 SF screening threshold. Additionally, even if the two canopies area for the fueling pumps are included in the total building square footage, it would only add another 9,000 SF, for a total of 14,892 SF. The sum of both of these areas are still well below the 50,000 SF threshold. The presence of other nine (9) other gas stations in the vicinity of the project (within two miles) also supports the conclusion that the Project would indeed function as local serving retail with most customers likely traveling from nearby areas within the County/neighboring cities and with little potential to draw longer trips from the wider region. Because the Project's total square footage is less than 50,000 SF and the screening threshold is met, the Project would not conflict or be inconsistent with CEQA Guidelines Section 15064.3, Subdivision (b). Impacts under this criteria would be less than significant and no mitigation would be required.

Would the project:

- | | | | | |
|--|--------------------------|-------------------------------------|--------------------------|--------------------------|
| c) Substantially increase hazards due to a geometric design feature (e.g., sharp curves or dangerous intersections) or incompatible uses (e.g., farm equipment)? | <input type="checkbox"/> | <input checked="" type="checkbox"/> | <input type="checkbox"/> | <input type="checkbox"/> |
|--|--------------------------|-------------------------------------|--------------------------|--------------------------|

c) Less Than Significant With Mitigation Incorporated. The proposed Project has the potential to generate pedestrian traffic from the Country Life Mobil Home and RV Park located west of the Project site across SR-111. As previously described, pedestrians are allowed to cross the SR-111 and Ross Road intersection, utilizing the west and east legs of the intersection. Additionally, the traffic signals controlling the SR-111 and Ross Road intersection are provided with push buttons and signal faces for pedestrian traffic along these legs. With approval of the proposed General Plan Amendment to change the Project site's land use designation from "Agriculture" to "Urban Area"; as well as a Zone Change, to change zoning from A-2 (General Agricultural) to C-3 (Heavy Commercial), the proposed fueling station and convenience store, would be a permitted use and would also be compatibility with surrounding uses. Given

Potentially Significant Impact (PSI)	Less Than Significant With Mitigation Incorporated (LTSWMI)	Less Than Significant Impact (LTSI)	No Impact (NI)
--------------------------------------	---	-------------------------------------	----------------

the existing pedestrian controls at the SR-111 and Ross Road intersection, the Project would not substantially increase hazards to pedestrians due to an incompatible use.

To ensure adequate vehicular access to the site, the Project includes three (3) ingress/egress drives along the south side of Ross Road. The westernmost access would be a 40-foot driveway that would allow for a left-and right-turn movements by vehicles accessing the fueling area and convenience store (**Figure 6, Site Plan**). This entrance would be located approximately 215 feet east of the Ross Road/SR-111 intersection. The second proposed entrance would be located approximately 150 feet east of the first and would provide a 60-foot inbound/outbound driveway leading directly to the proposed truck fueling stations. The third and easternmost driveway would be located 220 feet east of the second and would provide a 50-foot driveway that would permit the full range of left and right-turn movements, inbound and outbound. All driveways entrances would be constructed in accordance with the County’s Road Standards.

Turning movements at the proposed driveways were found to meet the ITE Traffic Engineering Handbook Warrants for left and right-turn lanes (Imperial County Department of Public Works, 2024). For this reason, the Project shall be conditioned to include the installation of left-turn and right-turn lanes on Ross Road that include deceleration lanes and storage per Caltrans Highway Design Manual.

Other than the proposed access driveways and conditioned improvements (i.e. installation of left- and right-turn lanes at project driveways on Ross Road including deceleration lanes and storage per Caltrans’ requirements), the proposed Project would not alter any roadway geometrics or install incompatible uses. With implementation of Condition of Approval TR-1, which requires the installation of left- and right-turn lanes at project driveways on Ross Road, potential hazards related to a design feature (e.g., sharp curves or dangerous intersections) or incompatible uses (e.g., farm equipment) would be reduced to below a level of significance and no additional mitigation is required.

Would the project:

- d) Result in inadequate emergency access?

d) Less Than Significant Impact. Access to the Project site would be provided via three (3) ingress/egress drives along the south side of Ross Road. These driveways would provide adequate emergency access to the site upon Project completion. A less than significant impact would occur.

Mitigation Measures and Conditions of Approval

In compliance with Imperial County Department of Public Works requirements, the following Condition of Approval has been identified:

TR-1 Installation of Left-Turn and Right-Turn Lanes at Project Driveways

Prior to the issuance of a Building Permit(s) for the proposed fueling station/convenience store, the Applicant shall prepare off-site circulation improvement plans for review and approval by the Imperial County Department of Public Works (DPW). The plans shall include the installation of left-turn and right-turn lanes on Ross Road at the Project Driveways that include deceleration lanes and storage per Caltrans Highway Design Manual. The Applicant shall also install curbs, gutters, and sidewalk sidewalks, along the south side of Ross Road, along the frontage of the property. The Improvement Plan(s) shall be submitted for approved by DPW prior to recordation of the Parcel Map. Prior to

Potentially Significant Impact (PSI)	Less Than Significant With Mitigation Incorporated (LTSWMI)	Less Than Significant Impact (LTSI)	No Impact (NI)
--------------------------------------	---	-------------------------------------	----------------

building occupancy for the Project, all improvements shall be completed to the satisfaction of DPW in accordance with the approved off-site circulation plans.

XVIII. TRIBAL CULTURAL RESOURCES.

Would the project cause a substantial adverse change in the significance of a tribal cultural resource, defined in Public Resources Code section 21074 as either a site, feature, place, cultural landscape that is geographically defined in terms of the size and scope of the landscape, sacred place, or object with cultural value to a California Native American tribe, and that is:

- | | | | | |
|--|--------------------------|-------------------------------------|--------------------------|--------------------------|
| a) Listed or eligible for listing in the California Register of Historical Resources, or in a local register of historical resources as defined in Public Resources Code section 5020.1(k), or | <input type="checkbox"/> | <input checked="" type="checkbox"/> | <input type="checkbox"/> | <input type="checkbox"/> |
| b) A resource determined by the lead agency, in its discretion and supported by substantial evidence, to be significant pursuant to criteria set forth in subdivision (c) of Public Resources Code Section 5024.1. In applying the criteria set forth in subdivision (c) of Public Resources Code Section 5024.1, the lead agency shall consider the significance of the resource to a California Native American tribe. | <input type="checkbox"/> | <input checked="" type="checkbox"/> | <input type="checkbox"/> | <input type="checkbox"/> |

Regulatory Framework

Assembly Bill 52 (AB-52)

California Assembly Bill 52 of 2014 (AB-52) was enacted on July 1, 2015 and expands CEQA by defining a new resource category, “tribal cultural resources.” AB-52 establishes that “A project with an effect that may cause a substantial adverse change in the significance of a tribal cultural resource is a project that may have a significant effect on the environment” (PRC Section 21084.2). It further states that the lead agency avoid impacts that would alter the significant characteristics of a tribal cultural resource, when feasible (PRC Section 21084.3). PRC Section 21074 (a)(1)(A) and (B) defines tribal cultural resources:

- 1) “Sites, features, places, cultural landscapes, sacred places and objects with cultural value to a California Native American tribe” and meets either of the following criteria: Listed or eligible for listing in the California Register of Historical Resources, or in a local register of historical resources as defined in Public Resources Code section 5020.1(k), or
- 2) A cultural resource determined by the lead agency, in its discretion and supported by substantial evidence, to be significant pursuant to criteria set forth in subdivision (c) of Public Resources Code Section 5024.1. In applying the criteria set forth in subdivision (c) of Public Resource Code Section 5024.1, the lead agency shall consider the significance of the resource to a California Native American tribe.

AB-52 also establishes a formal consultation process for California tribes regarding those resources. The consultation process must be completed before a CEQA document can be certified. AB-52 requires that lead agencies “begin consultation with a California Native American tribe that is traditionally and culturally affiliated with the geographic area

Potentially Significant Impact (PSI)	Less Than Significant With Mitigation Incorporated (LTSWMI)	Less Than Significant Impact (LTSI)	No Impact (NI)
--------------------------------------	---	-------------------------------------	----------------

of the proposed project.” Native American tribes to be included in the formal consultation process are those that have requested notice of projects proposed within the jurisdiction of the lead agency.

Senate Bill 18 (SB-18)

SB 18 (California Government Code §65352.3) requires local governments to contact, refer plans to and consult with tribal organizations prior to making a decision to adopt or amend a general or specific plan. Tribal organizations eligible to consult have traditional lands in a local government’s jurisdiction and are identified by the Native American Heritage Commission (NAHC). As noted in the California Office of Planning and Research’s Tribal Consultation Guidelines (2005), “The intent of SB 18 is to provide California Native American tribes an opportunity to participate in local land use decisions at an early planning stage, for the purpose of protecting, or mitigating impacts to, cultural places.”

a) and b) Less Than Significant With Mitigation Incorporated.

As required by Assembly Bill 52 (Chapter 532, Statutes 2014), the ICPDSD sent letters to those tribes who had previously requested notification of projects within their area of traditional and cultural affiliation. Specifically, the ICPDSD sent AB-52 consultation letters to the Campo Band of Mission Indians and the Quechan Indian Tribes on September 21, 2023, providing notification of the Project and an invitation to participate in consultation (see Appendix D-2). Under AB-52, California Native American Tribes have 30 days from the date of receipt of the notice to request consultation. As of the date of this initial Study, no responses, nor requests for consultation under AB-52 were received,

In compliance with Senate Bill 18 (SB-18; Government Code Section 65352.3), the Imperial County Planning & Development Services Department (ICPDSD) sent letters to 29 federally recognized California Native American Tribes and/or tribal representatives listed below providing notification of the Project and an invitation to participate in consultation (See Appendix D-3). By law, tribes have 90 days from the date of receipt of the notice to request consultation (Government Code 65352.3(a)(2)).

SB-18 Consultation List
▪ Agua Caliente Band of Cahuilla Indians, Patricia Garcia, Director of Historic Preservation
▪ Barona Group of the Capitan Grande, Art Bunce, Attorney
▪ Campo Band of Diegueno Mission Indians, Ralph Goff, Chairperson
▪ Ewiiapaayp Band of Kumeyaay Indians, Robert Pinto, Chairperson
▪ Ewiiapaayp Band of Kumeyaay Indians, Michael Garcia, Vice Chairperson
▪ Lipay Nation of Santa Ysabel, Clint Linton, Director of Cultural Resources
▪ Inaja-Cosmit Band of Indians, Rebecca Osuna, Chairperson
▪ Jamul Indian Village, Erica Pinto, Chairperson
▪ Jamul Indian Village, Lisa Cumper, Tribal Historic Preservation Officer
▪ Kwaaymii Laguna Band of Mission Indians, Carmen Lucas
▪ La Posta Band of Diegueno Mission Indians, Gwendolyn Parada, Chairperson
▪ Manzanita Band of Kumeyaay Nation, Angela Elliott Santos, Chairperson
▪ Mesa Grande Band of Diegueno Mission Indians, Michael Linton, Chairperson

Potentially Significant Impact (PSI)	Less Than Significant With Mitigation Incorporated (LTSWMI)	Less Than Significant Impact (LTSI)	No Impact (NI)
--------------------------------------	---	-------------------------------------	----------------

SB-18 Consultation List			
▪	Quechan Tribe of the Fort Yuma Reservation, Jill McCormick, Historic Preservation Officer		
▪	Quechan Tribe of the Fort Yuma Reservation, Manfred Scott, Acting Chairman		
▪	Quechan Tribe of the Fort Yuma Reservation, Jordan Joaquin, President, Quechan Tribal Council		
▪	San Pasqual Band of Diegueno Mission Indians, Allen Lawson, Chairperson		
▪	Santa Rosa Band of Cahuilla Indians, Lovina Redner, Tribal Chair		
▪	Soboba Band of Luiseno Indians, Jessica Valdez, Cultural Resource Specialist		
▪	Soboba Band of Luiseno Indians, Joseph Ontiveros, Tribal Historic Preservation Officer		
▪	Sycuan Band of the Kumeyaay Nation, Bernice Paipa, Cultural Resource Specialist		
▪	Sycuan Band of the Kumeyaay Nation, Cody Martinez, Chairman		
▪	Torres-Martinez Desert Cahuilla Indians, Mary Belardo, Cultural Committee Vice Chair		
▪	Torres-Martinez Desert Cahuilla Indians, Alesia Reed, Cultural Committee Chairwoman		
▪	Torres-Martinez Desert Cahuilla Indians, Thomas Tortez, Chairperson		
▪	Torres-Martinez Desert Cahuilla Indians, Abraham Becerra, Cultural Coordinator		
▪	Torres-Martinez Desert Cahuilla Indians, Gary Resvaloso, TM MLD		
▪	Viejas Band of Kumeyaay Indians, Ernest Pingleton, THPO		
▪	Viejas Band of Kumeyaay Indians, Ray Teran, Resource Management Director		

As of the date of this Initial Study, the County has not received any responses from Native American Tribes requesting consultation under AB-52. However a request for consultation under SB-18 was received from the Aqua Caliente Band of Cahuilla Indians (ACBCI). A copy of this letter is included in Appendix D-3. As requested by the ACBCI, a copy of the *Cultural and Paleontological Resources Assessment For The Maverik Fueling Station and Convenience Store Project* (Cogstone, 2024) was provided directly to the ACBCI's Tribal Historic Preservation Office on February 29, 2024. This transmittal also included copies of confidential records search materials, survey reports and site records obtained from the South Coastal Information Center during preparation of the *Cultural and Paleontological Resources Assessment*. The ACBCI's recommendations for cultural resource monitoring during construction, and the halting of construction activities should buried cultural deposits be found are incorporated into the Project as mitigation measures **MM-CUL-2** and **MM CUL-1**, respectively.

The Viejas Band of Kumeyaay Indians also responded to the County's SB-18 letter, but did not request formal consultation. Their letter, included in Appendix D-3, requests that a Kumeyaay cultural monitor be on site for ground disturbing activities and to be informed of any new developments such as the inadvertent discovery of cultural artifacts, cremation sites, or human remains. Mitigation measure MM CUL-2 includes the provision that "Native American tribes shall be given the opportunity to provide one or more certified cultural monitors for the Project during all excavation or earth-moving within the Project site in Holocene-aged deposits. The Construction Contractor shall give the tribe's Historic Preservation Officer (THPO) or other designated representative two weeks' advanced notice of the monitoring opportunity."

As discussed under Responses to Impact Va and Impact Vb, the Project could have potentially significant impacts to archaeological resources, which could be considered a significant resource to a California Native American tribe. With

Potentially Significant Impact (PSI)	Less Than Significant With Mitigation Incorporated (LTSWMI)	Less Than Significant Impact (LTSI)	No Impact (NI)
--------------------------------------	---	-------------------------------------	----------------

implementation of **MM CUL-1** through **MM CUL-6**, which include full-time construction monitoring by a Qualified Archaeological Monitor and a traditionally and culturally affiliated Native American Monitor during all ground-disturbing activities, potential impacts to tribal cultural resources would be less than significant.

Mitigation Measures

Implementation of **MM CUL-1** through **MM CUL-6** would reduce potentially significant impacts to Tribal Cultural Resources to below a level of significance.

XIX. UTILITIES AND SERVICE SYSTEMS.

Would the project:

- a) Require or result in the relocation or construction of new or expanded water, wastewater treatment or storm water drainage, electric power, natural gas, or telecommunications facilities, the construction or relocation of which could cause significant environmental effects?

a) Less Than Significant With Mitigation Incorporated. Implementation of the Project includes the construction of a new on-site water treatment system (OWTS)/treatment plant, a new wastewater treatment plant, on-site storm drainage and may include relocation of an electrical pole as described below.

Water Treatment and Water Supply

Based on information supplied by Site Design Collaborative (SDC), the proposed Project is expected to require potable water at a rate of approximately 3,280.5 gallons per day (gpd) which equates to 3.677 acre-feet per year (AFY), including 4,448 gpd for landscaping (4.99 AFY) for a total of 8.67 AFY. The Applicant proposes to construct and operate a potable water treatment system to provide water solely for on-site use. Raw water would be obtained from IID’s Acacia Lateral 5A (Gate ACA_51G); brought to the Project site via an underground pipeline beneath Ross Road; and, treated via a filtration, reverse osmosis (RO) or a comparable State-approved potable water treatment system meeting all the requirements of the Surface Water Treatment Rule (California Code of Regulations, Title 22, Division 4, Chapter 17, §64650 through §64666). Treated water would be stored in a 25,000-gallon underground water tank (30’ in diameter) located near the western edge of the Project site (**Figure 6, Proposed Site Plan**). A 180,000-gallon underground water tank (50’ in diameter) would be installed in this same area for fire protection.

The proposed water treatment plant would be sized to serve on-site uses only and would be considered a “Non-Transient Non-Community Public Water System.” A transient, non-community water system permit would be obtained from the California Department of Public Health, Division of Drinking Water and Environmental Management and the Imperial County Department of Environmental Health. All non-agricultural projects that require a raw water supply from IID must apply for a water service agreement pursuant to the IID’s s Interim Water Supply Policy (IWSP) for new Non-Agricultural Projects. Under the policy, 25,000 acre-feet of IID’s annual Colorado River water supply has been made available for these new projects. According to IID’s “Municipal, Industrial and Commercial Customer webpage (<https://www.iid.com/water/municipal-industrial-and-commercial-customers>), as of February 13, 2023, “IID has issued two Water Supply Agreements under the IWSP totaling 5,380 acre-feet per year, leaving a balance of 19,620 acre-feet

Potentially Significant Impact (PSI)	Less Than Significant With Mitigation Incorporated (LTSWMI)	Less Than Significant Impact (LTSI)	No Impact (NI)
--------------------------------------	---	-------------------------------------	----------------

per year of supply available for contracting under the IWSP. Additionally, any construction within an IID right-of-way will require an encroachment permit or encroachment agreement from IID.

Because the Project would not use municipal water treatment facilities, the Project would have no impact on the capacity of municipal water treatment providers. With implementation of the mitigation measures incorporated in the Project for air quality, biology, cultural resources, geology and soils (paleontological resources,) and hydrology/water quality, impacts associated with construction of the proposed water treatment system would be reduced to below a level of significance. No additional mitigation measures would be required.

Wastewater Treatment

Sewer service is not available at the Project site; therefore, the Project includes installation of a package wastewater treatment plant (WWTP). Specifically, the Project includes construction and operation of an on-site Advantex® "AX-Max" wastewater treatment system by Orenco or an approved equivalent. The proposed WWTP would have a design capacity to treat 3,500 gallons of wastewater per day. Details of the proposed wastewater treatment plant are shown on **Figure 14, Wastewater Treatment Design Details**. As discussed above in Section X. Hydrology and Water Quality, the design of the proposed OWTS must be consistent with Imperial County Ordinance No. 1516 and Chapter 8.80 Onsite Wastewater Treatment Systems (OWTS) of the Imperial County Code of Ordinances. The OWTS must also be reviewed and approved by the Imperial County Public Health Department, Division of Environmental Health and the Applicant must obtain an OWTS permit. This requirement is presented as **Mitigation Measure HWQ-4**. Approval of an OWTS permit (MM HWQ-4) would ensure potential impacts on water quality standards, waste discharge, or degradation of surface or groundwater quality would not be significant.

Portable restrooms would be maintained during construction and removed after the completion of construction.

Because the Project would not use municipal wastewater treatment facilities, the Project would have no impact on the capacity of municipal wastewater treatment providers. With implementation of the mitigation measures incorporated in the Project for air quality, biology, cultural resources, geology and soils (paleontological resources,) and hydrology/water quality, impacts associated with construction of the proposed wastewater treatment system would be reduced to below a level of significance. No additional mitigation measures would be required.

Stormwater

The Project would install a bioretention basin along the western border of the site, adjacent to the IID Accia Drian and Hawes Road (**Figure 15, Utility Plan**). The approximately 18,500 SF bioretention basin would be designed to drain within 72 hours and would treat water before it is released into the IID's Acadia Drain. Storm drain catch basins, associated piping, and down spout connections to storm drain pipes would be installed throughout the site to route runoff to the bioretention basin.

As part of the Project, the Applicant would construct a new bioretention basin. Stormwater runoff would be collected in the stormwater retention basin; therefore, no new or expanded municipal stormwater drainage facilities would be required for operation of the Project. With implementation of the mitigation measures incorporated in the Project for air quality, biology, cultural resources, geology and soils (paleontological resources,) and hydrology/water quality, impacts associated with construction of the proposed stormwater drainage system would be reduced to below a level of significance. No additional mitigation measures would be required.

Potentially Significant Impact (PSI)	Less Than Significant With Mitigation Incorporated (LTSWMI)	Less Than Significant Impact (LTSI)	No Impact (NI)
--------------------------------------	---	-------------------------------------	----------------

Electrical Power

Electric service would be provided to the Project site by the IID via the overhead electrical lines located along the south side of Ross Road. As shown on **Figure 15, Utility Plan**, a single power pole is located along the south side of Ross Road, just east of the Project site. This pole may be relocated approximately 40 feet to the east to facilitate installation of the Project’s easternmost driveway.

IID has indicated, in a letter dated October 4, 2023, that a circuit study may be required to identify system improvements that may be needed. Additionally, any construction within an IID right-of-way will require an encroachment permit or encroachment agreement from IID.

Natural gas service is not available at the Project site and therefore the use of propane is proposed. The Project would contract with third party utility companies for other utilities like telecom, internet etc.

With implementation of the mitigation measures incorporated in the Project for air quality, biology, cultural resources, geology and soils (paleontological resources) and hydrology/water quality, impacts associated with construction of the proposed water treatment system would be reduced to below a level of significance. No additional mitigation measures would be required.

Would the project:

- b) Have sufficient water supplies available to serve the project and reasonably foreseeable future development during normal, dry and multiple dry years?

b) Less Than Significant Impact. The Project would convert a site that supports agricultural uses to a non-agricultural use. Because water demands for certain non-agricultural projects are typically less than that required for agricultural use; this reduced demand allows additional water to be made available for other users under IID’s annual consumptive use cap.

Based on information supplied by Site Design Collaborative (SDC), the proposed Project is expected to require potable water at a rate of approximately 3,280.5 gallons per day (gpd) which equates to 3.677 acre-feet per year (AFY), including 4,448 gpd for landscaping (4.99 AFY) for a total of 8.67 AFY. Water would be obtained from the IID’s Acacia Lateral 5A (Gate ACA_51G) and brought to the Project site via an underground pipeline beneath Ross Road. IID has implemented a water allocation or allocation program pursuant to its revised Equitable Distribution Plan and is anticipated to have sufficient water supplies to serve the Project. Impacts under this criteria would be less than significant and no mitigation would be required.

Would the project:

- c) Result in a determination by the wastewater treatment provider, which serves or may serve the project that it has adequate capacity to serve the project’s projected demand in addition to the provider’s existing commitments?

Potentially Significant Impact (PSI)	Less Than Significant With Mitigation Incorporated (LTSWMI)	Less Than Significant Impact (LTSI)	No Impact (NI)
--------------------------------------	---	-------------------------------------	----------------

c) No Impact. Wastewater treatment service is not currently provided at the Project site. As noted under Response to Impact XIX.a above the Project includes construction and operation of an on-site wastewater treatment system and would not use municipal wastewater treatment facilities. Therefore, no impacts would occur under this criteria and no mitigation would be required,

Would the project:

- d) Generate solid waste in excess of State or local standards, or in excess of the capacity of local infrastructure, or otherwise impair the attainment of solid waste reduction goals?

d) Less Than Significant. Implementation of the Project would result in the generation of solid waste on the site, which would increase the demand for solid waste disposal. These materials, which are not anticipated to contain hazardous materials and a refuge/recycling storage area is provided onsite, as shown on **Figure 6** (Proposed Site Plan). Solid waste would be collected and disposed of in approved solid waste disposal sites in accordance with existing County, State and Federal regulations (Per Imperial County Code of Ordinances, Chapter 8.72). Non-hazardous waste and debris would be disposed of at local Class III landfills. Hazardous wastes would be recycled or managed and disposed of properly in a licensed Class I or II waste disposal facility authorized to accept the waste.

The Allied Imperial Landfill (13-AA-0019) receives municipal waste and is the Class III landfill nearest the Project site. Located at 104 East Robinson Road, it is approximately five (5) miles northwest of the Project site. According to CalRecycle’s Solid Waste Information System, this landfill can accept up to 1,700 cubic yards (CY) of municipal solid waste per day and has a remaining capacity of 12,027,900 CY (CalRecycle, 2024). The Imperial Landfill has sufficient capacity to accept solid waste generated by the Project.

Additionally, the Project shall comply with the requirements of the State’s Solid Waste Diversion Law (Assembly Bill 341); the State’s Mandatory Organic Waste Recycling Law (AB 1826 or Chapter 727, Statutes of 2014); and Section 8.72A of the Imperial County Code of Ordinances and Ordinance 1577 (Mandatory Organic Waste Disposal Reduction Program). These bills require commercial businesses to source separate organic waste [including landscape waste, wood waste, and food waste]; recyclable materials and garbage and to arrange for recycling services.

The Project shall also comply with CALGreen requirements and applicable law(s) related to management of construction and demolition debris (C&D), including diversion of organic waste in C&D from disposal; and all written and published county policies and/or administrative guidelines regarding the collection, recycling, diversion, tracking, and/or reporting of C&D.

In summation, the Project would comply with all applicable state and local ordinances regarding collection, diversion, and disposal of waste generated from construction and occupancy and would not impair the attainment of solid waste reduction goals. Similarly, the Project would not generate solid waste in excess of State or local standards. Therefore, the Project would have a less-than-significant impact.

	Potentially Significant Impact (PSI)	Less Than Significant With Mitigation Incorporated (LTSWMI)	Less Than Significant Impact (LTSI)	No Impact (NI)
--	--------------------------------------	---	-------------------------------------	----------------

Would the project:

- | | | | | |
|--|--------------------------|--------------------------|-------------------------------------|--------------------------|
| e) Comply with federal, state, and local management and reduction statutes and regulations related to solid waste? | <input type="checkbox"/> | <input type="checkbox"/> | <input checked="" type="checkbox"/> | <input type="checkbox"/> |
|--|--------------------------|--------------------------|-------------------------------------|--------------------------|

e) Less Than Significant Impact. See discussion for Impact XIX.d above.

Mitigation Measures

No mitigation would be required.

XX. WILDFIRE.

If located in or near state responsibility areas or lands classified as very high fire hazard severity zones, would the project:

- | | | | | |
|--|--------------------------|--------------------------|-------------------------------------|--------------------------|
| a) Substantially impair an adopted emergency response plan or emergency evacuation plan? | <input type="checkbox"/> | <input type="checkbox"/> | <input checked="" type="checkbox"/> | <input type="checkbox"/> |
|--|--------------------------|--------------------------|-------------------------------------|--------------------------|

a) Less Than Significant. The *Imperial County Area Emergency Operations Plan (EOP)* does not identify specific emergency roadway routes. The City of El Centro General Plan, Safety Element, includes a Safety Plan which identifies major access routes as I-8, State Route (SR) -111, SR-86, and SR-80. The Project site is located near two of these major access routes: I-8 and SR-111.

Vehicular access to the Project site would be provided via three (3) ingress/egress drives along the south side of Ross Road. During construction, materials would be “staged” within the Project site to avoid any access conflicts in case of emergency evacuations. Project construction would not result in closures along local roadways that may have an effect on emergency response or evacuation plans in the vicinity of the site. Access for emergency vehicles to the Project site and through the general area would be maintained throughout the construction period. The Project is not expected to impair the implementation of, or physically interfere with any adopted emergency response plans or emergency evacuation plans; therefore, a less than significant impact has been identified for this issue area.

- | | | | | |
|--|--------------------------|--------------------------|-------------------------------------|--------------------------|
| b) Due to slope, prevailing winds, and other factors, exacerbate wildfire risks, and thereby expose project occupants to, pollutant concentrations from a wildfire or the uncontrolled spread of a wildfire? | <input type="checkbox"/> | <input type="checkbox"/> | <input checked="" type="checkbox"/> | <input type="checkbox"/> |
|--|--------------------------|--------------------------|-------------------------------------|--------------------------|

b) Less Than Significant. The risk of wildfire is related to a variety of parameters, including fuel loading (vegetation), fire weather (winds, temperatures, humidity levels, and fuel moisture contents), and topography (degree of slope). Steep slopes contribute to fire hazards by intensifying the effects of wind and making fire suppression difficult. Fuels such as grass are highly flammable because they have a high surface area to mass ratio and require less heat to reach the ignition point.

Per the 2023 Fire Hazard Severity Zones in the LRA map, the Project site and surrounding area are not identified as being in a fire hazard severity zone (California Department of Forestry and Fire Protection, 2023). The site is located in an area that is predominately agricultural with some scattered residences, which is not considered a significant risk of wildfire. There are no other factors of the project or the surrounding area that would exacerbate wildfire risks, and thereby expose project occupants to pollutant concentrations.

Potentially Significant Impact (PSI)	Less Than Significant With Mitigation Incorporated (LTSWMI)	Less Than Significant Impact (LTSI)	No Impact (NI)
---	---	--	----------------------

As part of the plan check process, the Project Site plan would undergo a fire, life, and safety review by the City Fire Department to determine the specific fire requirements applicable to ensure compliance with these requirements. Therefore, impacts associated with wildland fires would be less than significant and no mitigation would be required.

- | | | | | |
|--|--------------------------|--------------------------|-------------------------------------|--------------------------|
| c) Require the installation or maintenance of associated infrastructure (such as roads, fuel breaks, emergency water sources, power lines or other utilities) that may exacerbate fire risk or that may result in temporary or ongoing impacts to the environment? | <input type="checkbox"/> | <input type="checkbox"/> | <input checked="" type="checkbox"/> | <input type="checkbox"/> |
|--|--------------------------|--------------------------|-------------------------------------|--------------------------|

c) Less Than Significant Impact. The Project includes connection of the gas station and convenience store to existing infrastructure electrical power lines and the installation of new storm drain, water and wastewater facilities and storm drain facilities require to support the proposed uses. The development of the gas station/mini-mart would be constructed in accordance with all local, State, and federal regulations regarding power lines and other related infrastructure, as well as fire suppression requirements. Therefore, the Project would not exacerbate fire risk or result in temporary or ongoing impacts to the environment, and impacts would be less than significant. No mitigation would be required.

- | | | | | |
|---|--------------------------|--------------------------|--------------------------|-------------------------------------|
| d) Expose people or structures to significant risks, including downslope or downstream flooding or landslides, as a result of runoff, post-fire slope instability, or drainage changes? | <input type="checkbox"/> | <input type="checkbox"/> | <input type="checkbox"/> | <input checked="" type="checkbox"/> |
|---|--------------------------|--------------------------|--------------------------|-------------------------------------|

d) No Impact. The Project site is located within an existing developed area would not involve development of structures of infrastructure that would introduce new populations to the proposed Project area that could result in impacts involving wildfires. The proposed Project area is generally flat, which would minimize any risk from downslope or downstream flooding or landslides. There would be no impact and no mitigation would be required.

Mitigation Measures

No mitigation would be required.

Note: Authority cited: Sections 21083 and 21083.05, Public Resources Code. Reference: Section 65088.4, Gov. Code; Sections 21080(c), 21080.1, 21080.3, 21083, 21083.05, 21083.3, 21093, 21094, 21095, and 21151, Public Resources Code; Sundstrom v. County of Mendocino, (1988) 202 Cal.App.3d 296; Leonoff v. Monterey Board of Supervisors, (1990) 222 Cal.App.3d 1337; Eureka Citizens for Responsible Govt. v. City of Eureka (2007) 147 Cal.App.4th 357; Protect the Historic Amador Waterways v. Amador Water Agency (2004) 116 Cal.App.4th at 1109; San Franciscans Upholding the Downtown Plan v. City and County of San Francisco (2002) 102 Cal.App.4th 656.

Revised 2009- CEQA
 Revised 2011- ICPDS
 Revised 2016 – ICPDS
 Revised 2017 – ICPDS
 Revised 2019 – CEQA

Potentially Significant Impact (PSI)	Less Than Significant With Mitigation Incorporated (LTSWMI)	Less Than Significant Impact (LTSI)	No Impact (NI)
---	---	--	----------------------

SECTION III. MANDATORY FINDINGS OF SIGNIFICANCE

The following are Mandatory Findings of Significance in accordance with Section 15065 of the CEQA Guidelines.

- | | | | | |
|--|--------------------------|-------------------------------------|--------------------------|--------------------------|
| a) Does the project have the potential to degrade the quality of the environment, substantially reduce the habitat of a fish or wildlife species, cause a fish or wildlife population to drop below self-sustaining levels, threaten to eliminate a plant or animal community, reduce the number or restrict the range of a rare or endangered plant or animal or eliminate important examples of the major periods of California history or prehistory? | <input type="checkbox"/> | <input checked="" type="checkbox"/> | <input type="checkbox"/> | <input type="checkbox"/> |
| b) Does the project have impacts that are individually limited, but cumulatively considerable? (“Cumulatively considerable” means that the incremental effects of a project are considerable when viewed in connection with the effects of past projects, the effects of other current project, and the effects of probable future projects.) | <input type="checkbox"/> | <input checked="" type="checkbox"/> | <input type="checkbox"/> | <input type="checkbox"/> |
| c) Does the project have environmental effects, which will cause substantial adverse effects on human beings, either directly or indirectly? | <input type="checkbox"/> | <input checked="" type="checkbox"/> | <input type="checkbox"/> | <input type="checkbox"/> |

SECTION IV. PERSONS & ORGANIZATIONS CONSULTED/ REFERENCES

A. PERSONS & ORGANIZATIONS CONSULTED

County Of Imperial

- Jim Minnick, Director of Planning & Development Services
- Michael Abraham, AICP, Assistant Director of Planning & Development Services
- Derek Newland, Planner III
- Imperial County Air Pollution Control District
- Department of Public Works
- Fire Department
- Agricultural Commissioner
- Environmental Health Services
- Sheriff's Office

Other Agencies/Organizations

- Native American Heritage Commission (NAHC)
- Agua Caliente Band of Cahuilla Indians
- Barona Group of the Capitan Grande
- Campo Band of Diegueno Mission Indians
- Ewiiapaayp Band of Kumeyaay Indians
- Iipay Nation of Santa Ysabel
- Inaja-Cosmit Band of Indians
- Jamul Indian Village
- Jamul Indian Village
- Kwaaymii Laguna Band of Mission Indians
- La Posta Band of Diegueno Mission Indians
- Manzanita Band of Kumeyaay Nation
- Mesa Grande Band of Diegueno Mission Indians
- Quechan Tribe of the Fort Yuma Reservation
- San Pasqual Band of Diegueno Mission Indians
- Santa Rosa Band of Cahuilla Indians
- Soboba Band of Luiseno Indians

- Sycuan Band of the Kumeyaay Nation
- Torres-Martinez Desert Cahuilla Indians
- Viejas Band of Kumeyaay Indians

B LIST OF PREPARERS

This Initial Study was prepared for the County of Imperial by Willis Environmental Planning, 238 Sychar Road, San Diego, CA 92114. The following professionals participated in its preparation:

Imperial County Planning & Development Services

Jim Minnick Director
 Michael Abraham Assistant Director
 David Black Planner IV
 Derek Newland Planner III

Willis Environmental Planning (Consultant to County)

Christina J. WillisPrincipal and Project Manager
 John AddenbrookeDocument Production/GIS Specialist

McIntyre Environmental

David McIntyre Principal Environmental Scientist

SECTION V. REFERENCES

Project Description

California Department of Conservation.2023a. California Important Farmland Finder. Available Online at: <https://maps.conservation.ca.gov/dlrp/ciff/>. Accessed September 26, 2023.

California Department of Conservation.2023b. California Williams Act Enrollment Finder. Available Online at: <https://maps.conservation.ca.gov/dlrp/WilliamsonAct/>. Accessed September 2023.

Cardno, 2021a. Phase I Environmental Site Assessment, Potential Maverik Acquisition, SEC of Ross Ave & Hawes Road, El Centro, October 22, 2021.

Aesthetics

County of Imperial, 2016. Imperial County Conservation and Open Space Element of the General Plan, March 8, 2016. Available at: <https://www.icpds.com/assets/planning/conservation-open-space-element-2016.pdf>

Agricultural And Forest Resources

California Department of Conservation.2023a. California Important Farmland Finder. Available Online at: <https://maps.conservation.ca.gov/dlrp/ciff/>. Accessed September 26, 2023.

California Department of Conservation.2023b. California Williams Act Enrollment Finder. Available Online at: <https://maps.conservation.ca.gov/dlrp/WilliamsonAct/>. Accessed September 2023.

Air Quality

Birdseye Planning Group, 2023. *Maverik Fueling Station and Convenience Store Project Air Quality and Greenhouse Gas Study* Imperial County, California. Prepared by Birdseye Planning Group, Dec, 2023 (Appendix A).

Biological Resources

Barrett, 2023. *Maverik Fueling Station And Convenience Store Biological Resources Assessment Report*. Prepared by Barret Biological Enterprises, December 2023 (Appendix B).

Cultural Resources

Cogstone, 2024 *Cultural and Paleontological Resources Assessment for the Maverik Fueling Station and Convenience Store Development Project*, Imperial County, California. Prepared by Cogstone Resource Management, January 2024 (Appendix C).

Energy

Birdseye Planning Group, 2024. *Maverik Fueling Station and Convenience Store Project Energy Memo* Imperial County, California. Prepared by Birdseye Planning Group, Dec, 2023 (Appendix E).

California Energy Commission, 2024. California Energy Commission Website “Electricity Use by Entity.” Available at: <http://www.ecdms.energy.ca.gov/elecbyutil.aspx>. Accessed January 3, 2024.

California Energy Commission. 2018. 2019 Building Energy Efficiency Standards: Frequently Asked Questions. http://www.energy.ca.gov/title24/2019standards/documents/2018_Title_24_2019_Building_Standards_FA_Q.pdf.

SoCal Gas 2023. SoCal Gas Service Area Maps and GIS. Available at <https://socalgas.maps.arcgis.com/apps/webappviewer/index.html?id=2f1c4c8e42f445c88b4e1d2344c580b3>. Accessed 12/19/23.

SoCalGas. 2013. Pipeline Basics.

Imperial Irrigation District (IID). 2023. *About IID Energy Webpage*. Available at: <https://www.iid.com/energy/about-iid-energy#:~:text=Located%20in%20a%20region%20with,%2C%20hydroelectric%2C%20solar%20and%20wind>. Accessed 12/19/2023.

Geology and Soils

CMT Engineering Laboratories, 2021. *Geotechnical Study for the Maverik Fueling Station Project*. Prepared by CMT Engineering Laboratories, November 2021 (Appendix F).

Cogstone, 2024 *Cultural and Paleontological Resources Assessment for the Maverik Fueling Station and Convenience Store Development Project*, Imperial County, California. Prepared by Cogstone Resource Management, January 2024 (Appendix D-1).

County of Imperial, 2008. *Seismic and Public Safety Element of the General Plan, 2008*.

SVP, 2010. *Standard Procedures for the Assessment and Mitigation of Adverse Impacts to Paleontological Resources*. Prepared by the Society of Vertebrate Paleontology, Impact and Mitigation Guidelines

Revision Committee, 2010. Available at: https://vertpaleo.org/wp-content/uploads/2021/01/SVP_Impact_Mitigation_Guidelines.pdf.

Greenhouse Gas Emissions

Birdseye Planning Group, 2023. *Maverik Fueling Station and Convenience Store Project Air Quality and Greenhouse Gas Study* Imperial County, California. Prepared by Birdseye Planning Group, Dec, 2023 (Appendix A).

Hazards And Hazardous Materials

DTSC, 2023. Department of Toxic Substances Control EnviroStor website; available at <https://www.envirostor.dtsc.ca.gov/public/>. Accessed December 20,2023.

SWRCB, 2023. State Water Resources Control Board GeoTracker website, available at: <https://geotracker.waterboards.ca.gov/>. Accessed December 20,2023.

Cardno, 2021a. Phase I Environmental Site Assessment Potential Maverik Acquisition. Prepared by Cardno, October 2021 (Appendix G).

Cardon, 2021b. Limited Phase II Environmental Site Assessment (ESA) Potential Maverik Acquisition. Prepared by Cardno, October 2021 (Appendix H).

Hydrology And Water Quality

California Dept. of Water Resources, 2020. California's Groundwater Update 2020. Prepared by the California Dept. of Water Resources. Available at: https://data.cnra.ca.gov/dataset/3f87088d-a2f9-4a46-a979-1120069db2c6/resource/d2b45d3c-52c0-45ba-b92a-fb3c90c1d4be/download/calqw2020_full_report.pdf

County of Imperial, 2022. County of Imperial Engineering Design Guidelines Manual for the Preparation and Checking of Street Improvement, Drainage and Grading Plans, Department of Public Works, Engineering Division, September 2008, as Amended July, 2022). Available at: <https://publicworks.imperialcounty.org/wp-content/uploads/2020/04/County-Procedure-Manual-September-2008.pdf>.

FEMA, 2024. Federal Emergency Management Agency Flood Map Service Center, Flood Insurance Rate Map Panels 06025C1750C and 0625C1725C. Available at <https://msc.fema.gov/portal/home>. Accessed January 2024.

LC Engineering Consultants, 2023. *Preliminary Drainage Study for Maverik Fueling Station and Convenience Store*. Prepared by LC Engineering Consultants, December 2023 (Appendix I).

Land Use and Planning

None.

Mineral Resources

County of Imperial, 2016. Conservation and Open Space Element of the County of Imperial General Plan, 2016.

Noise

Birdseye Planning Group, 2024. Noise Report for the Maverik Fueling Station and Convenience Center Project. Prepared by Birdseye Planning Group, December 2023 (Appendix J).

County of Imperial, 2015. Noise Element of the County of Imperial General Plan, 2015.

Federal Transit Administration (FTA), 2018. Transit Noise and Vibration Impact Assessment Manual. September 2018. Available at https://www.transit.dot.gov/sites/fta.dot.gov/files/docs/research-innovation/118131/transit-noise-and-vibration-impact-assessment-manual-fta-report-no-0123_0.pdf

Population And Housing

California Dept. of Finance, 2023a. Demographic Research Unit. Population and Housing Estimates for Cities, Counties, and the State, January 1, 2022 and 2023 (Report E-1 and H-1). Released May 1, 2023. Available at: <https://dof.ca.gov/forecasting/demographics/estimates-e1/>. Accessed January 4, 2024.

California Dept. of Finance, 2023b. Demographic Research Unit County Population Projections; Report P-2A: Total Population Projections, California Counties, 2020-2060 (Baseline 2019 Population Projections; Vintage 2023 Release). Sacramento: California. July 2023. Available at: <https://dof.ca.gov/forecasting/demographics/projections/>. Accessed January 4, 2024.

Public Services

CalRecycle, 2024. CalRecycle Solid Waste Information System for the Allied Imperial Landfill (13-AA-0019). Available at: <https://www2.calrecycle.ca.gov/SolidWaste/SiteActivity/Details/4191?siteID=603>. Accessed January 4, 2024.

Recreation

None.

Transportation/Traffic

County of Imperial, 2008. Circulation and Scenic Highway Element of the General Plan, 2008.

Imperial County Department of Public Works, 2024. Email from Carlos Yee, Permit Specialist, Imperial County Department of Public Works to Derek Newland, dated March 28, 2024.

Mizuta, 2024. *The Maverick Fueling Station and Convenience Store Traffic Study*. Prepared by Mizuta Traffic Consulting, December 2023 (Appendix K).

Tribal Cultural Resources

Cogstone, 2024. Cultural and Paleontological Resources Assessment for the Maverik Fueling Station and Convenience Store Development Project, Imperial County, California. Prepared by Cogstone Resource Management, January 2024 (Appendix D-1).

Utilities and Service Systems

None.

Wildfire

California Department of Forestry and Fire Protection (CalFire). 2023. Fire Hazard Severity Zones in SRA. Available Online at: <https://calfire-forestry.maps.arcgis.com/apps/webappviewer/index.html?id=988d431a42b242b29d89597ab693d008>

SECTION VII. FINDINGS

This is to advise that the County of Imperial, acting as the lead agency, has conducted an Initial Study to determine if the project may have a significant effect on the environmental and is proposing the attached environmental document based upon the following findings:

The Initial Study shows that there is no substantial evidence that the project may have a significant effect on the environment and a NEGATIVE DECLARATION will be prepared.

The Initial Study identifies potentially significant effects but:

- (1) Proposals made or agreed to by the applicant before this proposed Mitigated Negative Declaration was released for public review would avoid the effects or mitigate the effects to a point where clearly no significant effects would occur.
- (2) There is no substantial evidence before the agency that the project may have a significant effect on the environment.
- (3) Mitigation measures are required to ensure all potentially significant impacts are reduced to levels of insignificance. and a MITIGATED NEGATIVE DECLARATION will be prepared.

Based on the environmental analysis, a Mitigated Negative Declaration will be prepared.

If adopted, the Mitigated Negative Declaration means that an Environmental Impact Report will not be required. Reasons to support this finding are included in the attached Initial Study. The project file and all related documents are available for review at the County of Imperial, Planning & Development Services Department, 801 Main Street, El Centro, CA 92243 (442) 265-1736.

NOTICE

The public is invited to comment on the proposed Initial Study and Mitigated Mitigate Declaration during the review period.

11-25-2024 for [Signature]
Date of Determination Jim Minnick, Director of Planning & Development Services

The Applicant hereby acknowledges and accepts the results of the Environmental Evaluation Committee (EEC) and hereby agrees to implement all applicable Mitigation Measures, if applicable as outlined in the MM&RP.

Kevin Deis

Digitally signed by Kevin Deis
DN: C=US, E=kevin.deis@maverik.com,
O=Maverik, Inc., CN=Kevin Deis
Date: 2024.05.06 08:41:49-06'00'

05/06/2024

Applicant Signature

Date

SECTION VIII. RESPONSES TO COMMENTS

(Attachment documents, if any, here)

This page intentionally left blank.

SECTION IX. MITIGATION MONITORING AND REPORTING PROGRAM (MMRP)

MITIGATION MEASURES PURSUANT TO THE ENVIRONMENTAL EVALUATION COMMITTEE

**Maverik Fueling Station and Convenience Store Project
General Plan Amendment #22-0002,
Zone Change #22-0002 and
Parcel Map #02499**

**(APN 054-080-023)
(CEQA - Mitigated Negative Declaration)**

Pursuant to the review and recommendations of the Imperial County Environmental Evaluation Committee (EEC) on April 25, 2024), the following Mitigation Measures (MMs) and Conditions of Approval are hereby proposed for the Project:

AGRICULTURAL AND FOREST RESOURCES

MM-AG-1: Payment of Agricultural and Other Benefit Fees.

One of the following options included below shall be implemented prior to the issuance of a grading permit or building permit (whichever is issued first) for the Project:

Mitigation for Prime Farmland

- **Option 1: Provide Agricultural Conservation Easement(s).** The Permittee shall procure Agricultural Conservation Easements on a “2 to 1” basis on land of equal size, of equal quality farmland, outside the path of development. The conservation easement shall meet the State Department of Conservation’s regulations and shall be recorded prior to issuance of any grading or building permits; or,
- **Option 2: Pay Agricultural In-Lieu Mitigation Fee.** The Permittee shall pay an “Agricultural In-Lieu Mitigation Fee” in the amount of 30 percent of the fair market value per acre for the total acres of the proposed site based on five comparable sales of land used for agricultural purposes as of the effective date of the permit, including program costs on a cost recovery/time and material basis. The Agricultural In-Lieu Mitigation Fee, will be placed in a trust account administered by the Imperial County Agricultural Commissioner’s office and will be used for such purposes as the acquisition, stewardship, preservation and enhancement of agricultural lands within Imperial County; or,
- **Option 3: Public Benefit Agreement.** The Permittee and County voluntarily enter into an enforceable Public Benefit Agreement or Development Agreement that includes an Agricultural Benefit Fee payment that is 1) consistent with Board Resolution 2012-005; 2) the Agricultural Benefit Fee must be held by the County in a restricted account to be used by the County only for such purposes as the stewardship, preservation and enhancement of agricultural lands within Imperial County and to implement the goals and objectives of the Agricultural Benefit program, as specified in the Development Agreement, including addressing the mitigation of agricultural

job loss on the local economy; the Project and other recipients of the Project's Agricultural Benefit Fee funds; or emphasis on creation of jobs in the agricultural sector of the local economy for the purpose of off-setting jobs displaced by this Project.

MM-AG-2: Pest Management Plan

Prior to the issuance of a grading permit or building permit (whichever occurs first), a Pest Management Plan shall be developed by the Project Applicant and submitted to/approved by the County of Imperial Agricultural Commissioner. The Plan shall provide the following:

1. Monitoring, preventative, and management strategies for weed and pest control during construction activities at any portion of the Project (e.g., transmission line).
2. Control and management of weeds and pests in areas temporarily disturbed during construction where native seed will aid in site revegetation as follows:
 - Monitor for all pests including insects, vertebrates, weeds, and pathogens. Promptly control or eradicate pests when found, or when notified by the Agricultural Commissioner's office that a pest problem is present on the Project site. The assistance of a licensed pest control advisor is recommended. All treatments must be performed by a qualified applicator or a licensed pest control business.
 - All treatments must be performed by a qualified applicator or a licensed pest control operator.
 - "Control" means to reduce the population of common pests below economically damaging levels, and includes attempts to exclude pests before infestation, and effective control methods after infestation. Effective control methods may include physical/mechanical removal, bio control, cultural control, or chemical treatments.
 - Use of "permanent" soil sterilants to control weeds or other pests is prohibited because this would interfere with reclamation.
 - Notify the Agricultural Commissioner's office immediately regarding any suspected exotic/invasive pest species as defined by the California Department of Food Agriculture and the USDA. Request a sample be taken by the Agricultural Commissioner's Office of a suspected invasive species. Eradication of exotic pests shall be done under the direction of the Agricultural Commissioner's Office and/or California Department of Food and Agriculture.
 - Obey all pesticide use laws, regulations, and permit conditions.
 - Allow access by Agricultural Commissioner staff for routine visual and trap pest surveys, compliance inspections, eradication of exotic pests, and other official duties.
 - Ensure all Project employees that handle pest control issues are appropriately trained and certified, all required records are maintained and made available for inspection, and all required permits and other required legal documents are current.
 - Maintain records of pests found and treatments or pest management methods used. Records should include the date, location/block, project name (current and previous if changed), and methods used. For pesticides include the chemical(s) used, U.S.

Environmental Protection Agency (USEPA) Registration numbers, application rates, etc. A pesticide use report may be used for this.

- Submit a report of monitoring, pest finds, and treatments, or other pest management methods to the Agricultural Commissioner quarterly within 15 days after the end of the previous quarter, and upon request. The report is required even if no pests were found or treatment occurred. It may consist of a copy of all records for the previous quarter, or may be a summary letter/report as long as the original detailed records are available upon request.
- A long-term strategy for weed and pest control and management during the operation of the proposed Project. Such strategies may include, but are not limited to:
 - Use of specific types of herbicides and pesticides on a scheduled basis.
 - Maintenance and management of Project site conditions to reduce the potential for a significant increase in pest-related nuisance conditions on surrounding agricultural lands.
 - The Project shall reimburse the Agricultural Commissioner's office for the actual cost of investigations, inspections, or other required non-routine responses to the site that are not funded by other sources.

AIR QUALITY

MM AQ-1: Fugitive Dust Control

In compliance with the ICAPCD requirements, all construction sites, regardless of size, must comply with the requirements contained within Regulation VIII – Fugitive Dust Control Measures. Because these Regulation VIII measures are mandatory and are not considered project environmental mitigation measures, the standard and enhanced mitigation measures, required in the ICAPCD CEQA Handbook are listed below, and shall be implemented prior to and during construction.

Prior to commencing construction, the Applicant will be required to submit a Dust Control Plan to the ICAPCD for approval. The Dust Control Plan will identify the actual and potential sources of PM₁₀ emissions and the location of Bulk Material handling and storage areas, Paved and Unpaved Roads, entrances and exits where Track Out/Carry Out may occur, and Unpaved Traffic Areas. It shall also identify the dust suppressants to be applied; specific surface treatment(s) and/or control measures utilized to control Track Out/Carry Out and all associated measures to be implemented before, during, and after any dust generating activity (see Rule 801 F.2). Additionally, the Applicant shall submit a "Construction Notification Form" to ICAPCD 10 days prior to the commencement of any earthmoving or construction activities.

Standard Mitigation Measures for Construction Fugitive Dust (PM10) Control

- All disturbed areas, including bulk material storage which is not being actively utilized, shall be effectively stabilized and visible emissions shall be limited to no greater than 20 percent opacity for dust emissions by using water, chemical stabilizers, dust suppressants, tarps or other suitable material such as vegetative ground cover.

-
- All on-site unpaved roads shall be effectively stabilized, and visible emissions shall be limited to no greater than 20 percent opacity for dust emissions by paving, chemical stabilizers, dust suppressants and/or watering.
 - All unpaved traffic areas 1 acre or more with 75 or more average vehicle trips per day shall be effectively stabilized and visible emissions shall be limited to no greater than 20 percent opacity for dust emissions by paving, chemical stabilizers, dust suppressants and/or watering.
 - The transport of bulk materials on public roads shall be completely covered unless 6 inches of freeboard space from the top of the container is maintained with no spillage and loss of bulk material. In addition, the cargo compartment of all haul trucks is to be cleaned and/or washed at delivery site after removal of bulk material.
 - All track-out or carry-out shall be cleaned at the end of each workday or immediately when mud or dirt extends a cumulative distance of 50 linear feet or more onto a paved road within an urban area.
 - Movement of bulk material handling or transfer shall be stabilized prior to handling or at points of transfer with application of sufficient amounts of water, chemical stabilizers or by sheltering or enclosing the operation and transfer line.
 - The construction of any new unpaved road is prohibited within any area with a population of 500 or more unless the road meets the definition of a temporary unpaved road. Any temporary unpaved road shall be effectively stabilized, and visible emissions shall be limited to no greater than 20 opacity for dust emission by paving, chemical stabilizers, dust suppressants and/or watering.

Discretionary Mitigation Measures for Fugitive Dust (PM10) Control

- For projects with construction sites of five (5) acres or more for non-residential developments, in order to provide a greater degree of PM₁₀ reductions above that required by Regulation VIII, the following measures shall be implemented:
 - Water exposed soil with adequate frequency for continued moist soil.
 - Replace ground cover in disturbed areas as quickly as possible.
 - Use automatic sprinkler system installed on all soil piles.
 - Limit vehicle speed for all construction vehicles to 15 miles per hour on any unpaved surface at the construction site.
 - Develop a trip reduction plan to achieve a 1.5 average vehicle ridership for construction employees.
 - Implement a shuttle service to and from retail services and food establishments during lunch hours.

Enhanced Dust Control Measures

To provide a greater degree of reduction of PM emissions from construction and earthmoving activities, the following enhanced measures shall be incorporated into the Project's Dust Control Plan:

- Cessation of dust generating activities when wind speeds exceed 25 miles per hour (mph).
- Application of water or dust suppressants once per hour when wind speeds exceed 15mph.
- Application of water to maintain 12% soil moisture content when wind speed exceeds 15mph.
- Construct mesh construction fences 3-5 feet high with 50% or less porosity in conjunction with water application or dust suppressant when wind speeds exceed 15 mph.

MM AQ-2: Construction Equipment Control Measures

Standard Mitigation Measures for Exhaust Equipment Emissions Control

- Use of equipment with alternative fueled or catalyst-equipped diesel engine, including for all off-road and portable diesel-powered equipment.
- Minimize idling time either by shutting equipment off when not in use or limit the idling time to a maximum of 5 minutes.
- Limit, to the extent feasible, the hours of operation of heavy-duty equipment and/or the number of equipment in use.
- Replace fossil fueled equipment with electrically driven equivalents (provided they are not run via a portable generator set).

Enhanced Mitigation Measures for Construction Equipment

To provide a greater degree of reduction of PM emissions from construction combustion equipment, the following enhanced measures shall be implemented.

- Curtail construction during periods of high ambient pollutant concentrations; this shall include ceasing of construction activity during the peak hour of vehicular traffic on adjacent roadways (insert peak hour from traffic report).
- Implement activity management (e.g., rescheduling activities to reduce short-term impacts).
- Require construction equipment to have engine ratings of Tier 4 Final.

BIOLOGICAL RESOURCES

MM BIO-1: Burrowing Habitat Assessment

One BUOW protocol survey has been completed. In April, the remaining three (3) protocol surveys shall be started and completed by July; and a report prepared recommending avoidance, minimization and mitigation measures.

Since signs of BUOW have been located within the vicinity, construction foremen and workers and onsite employees be given worker training by a qualified biologist regarding burrowing owl that would include the following:

- Description of BUOW
- Biology
- Regulations (CDFW/USFWS)
- Wallet card with picture/guidelines for protecting owl and wildlife
- Notification procedures if owl (dead, alive, injured) is found on or near site

Sign-in sheets for the worker training program shall be maintained and copies of the sign-in sheets and training materials shall be submitted to ICPDSD and CDFW within 30 days of construction completion.

MM BIO-2: Burrowing Owl Survey Pre-Construction Survey

No less than 14 days prior to the commencement of initial ground-disturbing activities (vegetation clearance, grading) and within 24 hours prior to the start of ground disturbance, pre-construction surveys for burrowing owls shall be conducted, in accordance with the Staff Report on Burrowing Owl Mitigation (2012 or most recent version). Surveys shall be conducted by a qualified biologist(s) (i.e., a wildlife biologist with previous burrowing owl survey experience), approved by Imperial County.

Surveys for burrowing owls shall be conducted in conformance with the 2012 CDFW Staff Report on Burrowing Owl Mitigation. Surveys shall be completed within all areas proposed for ground disturbance and vegetation clearing/trimming and within 200 meters (656 feet) of the construction zone to identify occupied breeding or wintering burrowing owl burrows.

If no burrowing owls are detected, a report documenting the burrowing owl survey results shall be prepared and submitted to the County of Imperial Planning and Development Services Department (ICPDSD) and the CDFW. No further mitigation is necessary.

Pre-Construction Survey during Non-breeding Season (September 1 – January 31):

- **Occupied Burrows:** If burrowing owls are detected on site during the non-breeding season (generally September 1 through January 31), a 50-foot buffer zone shall be maintained around the occupied burrow(s).
- **Unoccupied Burrows:** Once a burrow has been determined by a qualified wildlife biologist to be unoccupied by burrowing owls, the biologist shall excavate the burrow using hand tools. Sections of flexible plastic pipe or burlap bag shall be inserted into the tunnels during excavation to maintain an escape route for any animals inside the burrow. One-way doors shall be installed at the entrance to the active burrow and other potentially active burrows within 100 feet of the active burrow and monitored for at least 48 hours after installation.
- A report documenting the burrowing owl survey results shall be prepared and submitted to the ICPDSD and the CDFW.

Pre-Construction Survey during Breeding Season (February 1 – August 31):

The following avoidance measures shall be implemented for all burrows identified during surveys:

- Occupied burrows shall not be disturbed during the nesting season (February 1 through August 31) unless a qualified biologist verifies through non-invasive methods that either the birds have not begun egg-laying and incubation or that juveniles from the occupied burrows are foraging independently and are capable of independent survival. Burrowing owls present on-site after February 1 shall be assumed to be nesting unless evidence indicates otherwise.
- A 100-foot buffer shall be maintained between Project activities and nesting burrowing owls. No activity or entry by personnel or equipment will be allowed within the buffer area.
- Physical (temporary fencing) and visual (hay bales or similar) barriers shall be installed to delineate the buffer zone. Installation of the exclusionary material will be completed by construction personnel under the supervision of a qualified biologist prior to initiation of construction activities.
- The buffer shall be maintained until August 31 or until the young owls are foraging independently or the nest is no longer active, based upon monitoring evidence.
- If there is danger that owls will be injured or killed as a result of construction activity, the birds may be passively relocated but only during the non-breeding season; relocation shall require coordination with and approval from the CDFW prior to relocation activities. Relocation of owls during the non-breeding season will be performed by a qualified biologist in coordination with the CDFW.
- Any damaged or collapsed active burrowing owl burrows will be replaced with artificial burrows in adjacent habitat at a 2:1 ratio.

Copies of the burrowing owl survey results report shall be submitted to the ICPDSD and the CDFW.

MM BIO-3: Pre-Construction General Nesting Bird Survey

Construction activities for the Project should commence outside of the bird breeding season (generally February 1 through August 31; January 1 for raptors). If activities associated with vegetation/tree removal, clearing, grubbing, demolition, grading, staging or other construction activities are planned to occur during the bird nesting/breeding season, the Applicant shall retain a qualified biologist to conduct a bird nesting survey no more than 72-hours prior to commencement of the construction activities to determine presence or absence of nesting birds or active nests within the proposed area of disturbance plus a 500-foot buffer and a 250-foot buffer for non-listed bird species. Inaccessible parts of the survey area shall be scanned using binoculars to ensure 100 percent visual coverage. The qualified biologist shall be familiar with the identification of bird species known to occur in southern California communities.

If no nesting birds or active nests are found, the Applicant shall submit the results of the Pre-Construction survey to the Development Services Department and wildlife agencies for review and approval prior to initiating any construction activities and no further mitigation would be required.

If active nests (those containing eggs, nestlings, or associated with dependent fledglings) of bird species covered by the Migratory Bird Treaty Act are detected within the proposed area of disturbance during the 10-day preconstruction survey:

- Construction activities shall stay outside a 250-foot avoidance buffer around the active nest. For raptor species, this buffer shall be expanded to 500 feet. A biological monitor shall delineate the boundaries of an avoidance buffer area with (highly visible construction fencing or other exclusionary material that would inhibit entry by personnel or equipment into the buffer zone) and monitor the active nest to ensure that nesting behavior is not adversely affected by construction activity. Once the young have fledged and the qualified biologist has determined the nest is inactive, normal construction activities can occur.
- The biologist and Project Applicant shall postpone construction activity within the buffer area(s) and contact the wildlife agencies and the City's Development Services Department to discuss: 1) the best approach to avoid/minimize impacts to breeding/nesting birds (e.g., sound walls), and 2) a monitoring program acceptable to the wildlife agencies. Subsequent to these discussions, work may be initiated subject to implementation of the agreed-upon avoidance/minimization approach and monitoring program.
- Upon agreement as to the necessary revisions to the avoidance/minimization approach, work may resume subject to the revisions and continued monitoring. Success or failure of an active nest shall be established by regular and frequent trips to the site, as determined by the biologist and through a schedule approved by the wildlife agencies. Monitoring of an active nest shall continue until fledglings have dispersed or the nest has been determined to be a failure, as approved by the wildlife agencies.
- No project activity shall occur inside an avoidance buffer until the biologist determines that the nest is no longer active.

Reporting. Within 30 days of the completion of the monitoring efforts, the Project Applicant shall submit a Final Bird Survey Monitoring Report prepared by the project biologist to the wildlife agencies and City's Development Services Department. The report shall include documentation of all bird survey, monitoring activities, coordination efforts with the wildlife agencies, as-built construction drawings with an overlay of any active nests in the survey areas, photographs of habitat areas during pre-construction and post-construction conditions, and other relevant summary information documenting that authorized impacts were not exceeded and that general compliance was achieved.

CULTURAL RESOURCES AND TRIBAL CULTURAL RESOURCES

Mitigation Measures

Implementation of the following mitigation measures would reduce impacts to below a level of significance.

MM-CUL-1: Prepare and Implement a Cultural Resource Mitigation and Monitoring Plan.

Prior to issuance of a grading permit, the Applicant shall retain a qualified archaeologist⁷ to prepare a Cultural Resource Mitigation and Monitoring Plan (CRMMP), which shall be submitted to and approved by the County of Imperial Planning and Development Services. The purpose of the CRMMP is to document the actions and procedures to be followed to ensure avoidance or minimization of impacts to cultural resources consistent with CEQA Guidelines Section 15126.4(b), and to lay out a detailed program of mitigation for direct and indirect impacts on cultural resources during project implementation. The mitigation and monitoring plan shall identify procedures for monitoring and the implementation of a discovery plan in coordination with affected Tribal groups and include the following at a minimum:

- List of personnel involved in the monitoring activities;
- Inclusion of involvement of the Native American community, as appropriate;
- Description of the worker awareness program that shall be implemented;
- Description of how the monitoring shall occur;
- Description of frequency of monitoring (e.g., full-time, part time, spot checking);
- Description of resources expected to be encountered (if any);
- Description of circumstances that would result in the halting of work at the project site
- Description of procedures for halting work on the site and notification procedures including the notification of the Applicant, the ICPDSD, and tribal representatives within 24 hours of the inadvertent discovery of archaeological resources; and
- Description of monitoring reporting procedures.

The project's grading and construction plans and specifications shall state that full-time monitoring by a qualified archaeologist shall be conducted during the initial grubbing and ground disturbance for the Project. In the event that archaeological resources are inadvertently discovered during ground-disturbing activities, work must be halted within 50 feet of the find until it can be evaluated by a qualified archaeologist. Construction activities could continue in other areas. If the discovery proves to be significant, additional work, such as data recovery excavation or fossil recovery, may be warranted and would be discussed in consultation with the appropriate regulatory agency(ies).

MM-CUL-2: Cultural Resources Construction Monitor.

The Applicant shall retain qualified archaeological monitors and a TCA (traditionally and culturally affiliated) Native American Monitor for all ground-disturbing activities associated with the Project. Native American tribes shall be given the opportunity to provide one or more certified cultural monitors for the Project during all excavation or earth-moving within the Project site in Holocene-aged deposits. The Construction Contractor shall give the tribe's Historic Preservation Officer (THPO) or

⁷ Meeting the Secretary of the Interior's Professional Standards published in Appendix A of 36 CFR Part 61.

other designated representative two weeks' advanced notice of the monitoring opportunity and shall provide a copy of such notice to the County.

If a significant cultural resource site is found during ground-disturbing activities the resource will be protected in place, or data recovery will be initiated, consistent with the mitigation and monitoring plan required by **MM-CUL-1**.

MM CUL-3: Human Remains.

Procedures of conduct following the discovery of human remains on non-federal lands have been mandated by California Health and Safety Code §7050.5, California Public Resources Code §5097.98, and California Code of Regulations (CCR) §15064.5(e). Should human remains be encountered, all work in the immediate vicinity of the burial must cease, and any necessary steps to ensure the integrity of the immediate area must be taken. The County Coroner will be immediately notified. The Coroner must then determine whether the remains are Native American. If the Coroner determines the remains are Native American, the Coroner has 24 hours to notify the NAHC, who will, in turn, notify the person they identify as the most likely descendent (MLD) of any human remains. Further actions will be determined, in part, by the desires of the MLD. The MLD has 48 hours to make recommendations regarding the disposition of the remains following notification from the NAHC of the discovery. If the MLD does not make recommendations within 48 hours, the owner shall, with appropriate dignity, reinter the remains in an area of the property secure from further disturbance. Alternatively, if the owner does not accept the MLD's recommendations, the owner or the descendent may request mediation by the NAHC.

MM CUL-4: Disposition of Tribal Cultural Resources.

The landowner shall relinquish ownership to the TCA tribe all tribal cultural resources collected during the cultural resource mitigation monitoring conducted for the Project site for respectful and dignified treatment and disposition, including reburial, in accordance with the Tribe's cultural and spiritual traditions. All cultural materials that are associated with burial and/or funerary goods will be repatriated to the Most Likely Descendant as determined by the Native American Heritage Commission per California Public Resources Code Section 5097.98.

MM CUL-5: Unanticipated Discoveries Historic Properties Treatment Plan/Data Recovery Plan

Should an unanticipated discovery be made, avoidance is the preferred treatment (CEQA Guidelines, Section 15126.4(b)(3)(A)), but if the site cannot be avoided in place, then the site will be further evaluated. Immediately upon discovery of a find, a qualified archaeologist will evaluate the significance of the newly discovered site or unanticipated discovery along with attempted consultation with designated Native American representatives in order to provide proper management recommendations. If testing and evaluation of the site is recommended, the qualified archaeologist shall prepare a research design, schedule, and budget for review and approval by the County and the Applicant. During evaluation and testing, the appropriate Native American tribe shall be notified in advance so that a tribal monitor can be present and assist with the work being conducted. At the completion of the monitoring program, the qualified archaeologist shall prepare a monitoring report that describes the project, the personnel used, the dates of performance, and results. If cultural resources are recovered and cannot be preserved in place, they shall be cleaned,

catalogued, analyzed, reburied in a nearby area, after consultation or curated at the California Historical Resources Regional Information Center.

MM CUL-6: Prepare Final Monitoring Report and/or Evaluation Report.

Prior to the release of the grading bond and no later than 90 days after monitoring has been completed, a Monitoring Report and/or Evaluation Report shall be completed. This report shall describe the results, analysis and conclusions of the cultural resource mitigation monitoring efforts such as, but not limited to, the Research Design and Data Recovery Program. It will also include a list of project personnel, a catalog of any cultural resources that were identified, any associated DPR 523 Forms and/or confidential maps, details of the location of the final disposition of cultural resources (if any), any issues or problems that occurred during monitoring, and any other pertinent information. The Monitoring Report shall be submitted by the project archaeologist, along with the notes and comments from the TCA Native American Monitor(s), to the County for review and approval. Upon approval by the Lead Agency, a complete final report shall be submitted to the appropriate Information Center, and TCA Tribes, any relevant curation facility, and the landowner/applicant.

GEOLOGY AND SOILS

MM PAL-1: Paleontological Construction Monitoring

A paleontological mitigation plan shall be prepared by a qualified paleontologist. The paleontological mitigation plan can be implemented before and/or during construction; however, the latter is more common on most construction projects. The paleontological mitigation plan shall include the following elements:

- A qualified paleontologist shall attend the pre-construction meeting to consult with the grading and excavation contractors concerning excavation schedules, paleontological field techniques, and safety issues. A qualified paleontologist is defined as an individual with an MS or Ph.D. in paleontology or geology that also is familiar with paleontological procedures and techniques, is knowledgeable in the geology and paleontology of the Project area, and has worked as a paleontological mitigation project supervisor in the area for at least one year.
- Ground-disturbing construction activities shall be monitored by a qualified paleontologist to assess, document, and recover unique fossils. A paleontological monitor shall be on-site on a full-time basis during the original cutting of previously undisturbed deposits of high paleontological resource potential (e.g., Lake Cahuilla sediments) to inspect exposures for contained fossils. A paleontological monitor is defined as an individual who has experience in the collection and salvage of fossil materials. The paleontological monitor should work under the direction of a qualified paleontologist.
- A professional repository shall be contracted by the project paleontologist prior to the start of earthwork to curate and store any discovered fossils. Such an institution shall be a recognized paleontological specimen repository with a permanent curator, such as an AAM-accredited museum or university (e.g., University of California Museum of Paleontology, or San Diego Natural History Museum). The repository shall be capable of storing fossils in a facility with adequate security against theft, loss, damage, fire, pests, and adverse climate conditions.

- If paleontological resources are discovered during ground-disturbing activities, the qualified paleontologist (or paleontological monitor) shall have the authority to divert, direct, or temporarily halt ground disturbing activities in the area of discovery to allow for preliminary evaluation of potentially significant paleontological resources and to determine if additional measures (i.e., collection and curation) are required. The significance of the discovered paleontological resources will be determined by the Project Paleontologist. For significant paleontological resources, a fossil recovery program will be initiated.
- In most cases, the assessment and salvage of fossils can be completed in a short period of time; however, some fossil specimens (such as a complete large mammal skeleton or concentrations of vertebrate fossils) may require several days to weeks to complete. In these instances, project delays can be avoided or minimized by diverting earthwork operations to other areas of the project while fossil recovery work is under way.
- A temporary construction exclusion zone of at least 50 feet, consisting at a minimum of lath and flagging tape, will be erected around the discovery. The exclusion zone acts as a buffer around the discovery and is maintained for safety. The Applicant, through its qualified paleontological monitor will report the discovery to the County within 24 hours. Construction activities can occur outside the buffer if it is safe to do so. The size of the buffer may be increased or decreased once the monitor adequately explores the discovery to determine its size and significance. If indicators of potential microvertebrate fossils (e.g., small mammal, bird, reptile, amphibian, or fish remains) are found screening of a test sample shall be carried out as outlined in the Standard Procedures for the Assessment and Mitigation of Adverse Impacts to Paleontological Resources developed by the Society of Vertebrate Paleontology (SVP, 2010 (SVP, 2010). This procedure will be outlined in the Plan.
- In the event fossils are discovered and salvaged, the fossils will be prepared, identified, catalogued, and stored in the designated repository, and a final paleontological mitigation report written that summarizes the results and findings of paleontological monitoring. If no fossils are salvaged over the course of monitoring, an abbreviated final paleontological mitigation report will be prepared.

MM PAL-2 Worker’s Environmental Awareness Program (WEAP)

The Project Paleontologist shall develop a Worker’s Environmental Awareness Program (WEAP) to train the construction crew on the legal requirements for preserving fossil resources as well as procedures to follow in the event of a fossil discovery. This training program shall be given to the crew before ground-disturbing work commences and will include handouts to be given to new workers as needed.

At least 60 days prior to the start of ground-disturbing activities, the Applicant shall submit the WEAP presentation and associated materials to the County Department of Planning and Development Services Department for review and approval.

MM PA:-3 Prepare Final Paleontological Monitoring Report.

Prior to the release of the Grading Bond and no later than 90 days after paleontological monitoring has been complete, a Final Paleontological Monitoring Report shall be completed that documents

implementation of the WEAP and presents the results of the paleontological monitoring effort. In the event that fossils are recovered, the report will include discussions of the methods used, stratigraphic section(s) exposed, fossils collected, and significance of the recovered fossils relative to the research themes and questions. A complete inventory of salvaged, prepared, and curated fossils will be included. In the event that no fossils are recovered, an abbreviated report that summarizes the field methods used and stratigraphy exposed will be completed. The Final Paleontological Monitoring Report shall be submitted to the County Department of Planning and Development Services Department.

HYDROLOGY AND WATER QUALITY

MM HWQ-1: Obtain coverage under Construction General Permit (SWRCB Order No. 2009-0009-DWQ and Associated Amendments)

The Project applicant or its contractor would obtain coverage under Construction General Permit (SWRCB Order No. 2009-0009-DWQ and Associated Amendments). Under this permit they would be required to prepare a SWPPP specific to the Project and be responsible for securing coverage under SWRCB's NPDES stormwater permit for general construction activity (Order 2009-0009-DWQ). The SWPPP shall identify specific actions and BMPs relating to the prevention of stormwater pollution from Project-related construction sources by identifying a practical sequence for site restoration, BMP implementation, contingency measures, responsible parties, and agency contacts. The SWPPP shall reflect localized surface hydrological conditions and shall be reviewed and approved by the Project applicant prior to commencement of work and shall be made conditions of the contract with the contractor selected to build and decommission the Project. The SWPPP(s) shall incorporate control measures in the following categories:

- Soil stabilization and erosion control practices (e.g., hydroseeding, erosion control blankets, mulching).
- Dewatering and/or flow diversion practices, if required (**MM HWQ-2**).
- Sediment control practices (temporary sediment basins, fiber rolls).
- Temporary and post-construction on- and off-site runoff controls.
- Special considerations and BMPs for water crossings, wetlands, and drainages.
- Monitoring protocols for discharge(s) and receiving waters, with emphasis place on the following water quality objectives: dissolved oxygen, floating material, oil and grease, pH, and turbidity.
- Waste management, handling, and disposal control practices.
- Corrective action and spill contingency measures.
- Agency and responsible party contact information.
- Training procedures that shall be used to ensure that workers are aware of permit requirements and proper installation methods for BMPs specified in the SWPPP.

The SWPPP shall be prepared by a qualified SWPPP practitioner with BMPs selected to achieve maximum pollutant removal and that represent the best available technology that is economically achievable. Emphasis for BMPs shall be placed on controlling discharges of oxygen-depleting

substances, floating material, oil and grease, acidic or caustic substances or compounds, and turbidity. BMPs for soil stabilization and erosion control practices and sediment control practices will also be required. Performance and effectiveness of these BMPs shall be determined either by visual means where applicable (i.e., observation of above-normal sediment release), or by actual water sampling in cases where verification of contaminant reduction or elimination, (inadvertent petroleum release) is required to determine adequacy of the measure.

MM HWQ-2 Incorporate Post-Construction Runoff BMPs into Project Drainage Plan

The Project Drainage Plan shall adhere to County guidelines to control and manage the on- and off-site discharge of stormwater to existing drainage systems. Infiltration basins will be integrated into the Drainage Plan to the maximum extent practical. The Drainage Plan shall provide both short- and long-term drainage solutions to ensure the proper sequencing of drainage facilities and management of runoff generated from Project impervious surfaces as necessary.

MM HWQ-3 Prepare Drainage Plan/Drainage Report

A Drainage Plan/Drainage Report shall be prepared for Project which shall adhere to guidelines in the County's Engineering Guidelines Manual, or whatever regulations are in place at the time of project implementation, to control and manage the on- and off-site discharge of stormwater to existing drainage systems and shall include a project description, project setting including discussions of existing and proposed conditions, any drainage issues related to the site, summary of the findings or conclusions, off-site hydrology, onsite hydrology, hydraulic calculations and a hydrology map.

The drainage study and specifications for improvements of all drainage easements, culverts, drainage structures, and drainage channels shall be provided to the DPW for approval. Required plans and specifications shall provide a drainage system capable of handling and disposing of all surface waters originating within the subdivision and all surface waters that may flow onto the subdivision from adjacent lands. Said drainage system shall include any easements and structures required by the DPW or the affected Utility Agency to properly handle the drainage on site and off site. The report should detail any vegetation and trash/debris removal, as well as address any standing water.

Infiltration basins will be integrated into the Drainage Plan to the maximum extent practical. The Drainage Plan shall provide both short- and long-term drainage solutions to ensure the proper sequencing of drainage facilities and management of runoff generated from project impervious surfaces as necessary.

MM HWQ-4 Obtain On-site Water Treatment System (OWTS) Permit

Prior to the issuance of building permits for any portion of the project, the Applicant shall obtain an OWTS permit from the Imperial County Public Health Department, Division of Environmental Health.

The Applicant shall submit a detailed system design for the proposed OWTS which satisfies the requirements of Section 8.80.170 of the Imperial County Codified Ordinances. The detailed system design must include:

(1) A scaled, dimensional drawing showing the proposed location of all OWTS components and replacement area;

(2) Vertical cross-section drawing showing the depth of the drainfield, the vertical separation to groundwater, the depth of soil cover, and any other OWTS components to be constructed or installed at the site;

(3) Calculations and assumptions supporting the proposed design, including the soil type; drainfield hydraulic loading rate; the design flow; and additional information as required by adopted technical standards.

The proposed design shall also demonstrate that the OWTS meets the minimum horizontal separations (i.e., setbacks) to water supplies, irrigation canals, surface waters and structures established in 8.80.100 of the Codified Ordinances and Table I of Imperial County Ordinance No. 1516.

A copy of the OWTS permit shall be provided to the ICPDSD staff.

NOISE

NOI-1: Construction Equipment

Electrical power shall be used to run air compressors and similar power tools. Internal combustion engines should be equipped with a muffler of a type recommended by the manufacturer and in good repair. All diesel equipment should be operated with closed engine doors and should be equipped with factory-recommended mufflers. Construction equipment that continues to generate substantial noise at the project boundaries should be shielded with temporary noise barriers, such as barriers that meet a sound transmission class (STC) rating of 25, sound absorptive panels, or sound blankets on individual pieces of construction equipment. Stationary noise-generating equipment, such as generators and compressors, should be located as far as practically possible from the nearest residential property lines.

NOI-2: Limit Operations Adjacent to Receivers.

Limit the number of large pieces of equipment (i.e., bulldozers or concrete mixers) operating adjacent to receivers to one at any given time to the extent feasible.

NOI-3: Neighbor Notification.

Construction Contractor shall provide notification to residential occupants nearest to the project site 7-14 days prior to initiation of construction activities that could result in noise levels exceeding 75 dBA at the property line adjacent to residences. This notification should include the anticipated hours and duration of construction and a description of noise reduction measures being implemented at the project site. The notification should include a telephone number for local residents to call to submit complaints associated with construction noise. The notification should be posted along Ross Road and Hawes Road and be visible.

NOI-4. Retrofit Windows and Doors of 404 Ross Road

Applicant shall, with approval from the property owner, retrofit the Ross Road facing windows and doors of the residential structure located 404 Ross Road, along with the existing heating, ventilation and air conditioning system to ensure a Sound Transmission Class (STC) rating of at least 30 dBA is achieved to ensure the 45 dBA interior noise standard is met. Prior to issuance of a grading permit, the Applicant shall provide the County with evidence of the property owner's approval of the recommended retrofits, along with evidence that said improvements have been installed to the property owner's satisfaction.

NOI-5 Off-site Noise Barrier Walls at 404 Ross Road

Prior to the issuance of the Building Permits for the proposed fueling station/convenience store, the Applicant shall construct a 6-foot concrete masonry unit (CMU) wall in place of the existing chain link fence along the southern and western exterior yard limits of APN 054-030-039. The southern wall segment shall be approximately 120 feet in length, gated to allow ingress/egress from the parking area and residence and connect with the existing chain link fence along the eastern yard area boundary. The western segment shall be approximately 65 feet in length and connect with the chain link fence segment along the northern yard area boundary.

In accordance with Section 90403.05 of the Imperial County Code of Ordinances, a building permit shall be obtained for the walls, which shall be sited outside of, and would not encroach into IID's ROWs for the Acacia Drain 6A and the Acacia Lateral 5A. Construction shall follow specifications from the 2019 California Building Code adopted by the county of Imperial, and the construction shall be designed by a registered professional civil engineer or architect, licensed in the state of California. Plans, calculations and a soils report may be required.

The ICPDSD shall verify the barriers have been constructed as required prior to issuance of the certificate of occupancy.

TRANSPORTATION/TRAFFIC

TR-1 Installation of Left-Turn and Right-Turn Lanes at Project Driveways

Prior to the issuance of a Building Permit(s) for the proposed fueling station/convenience store, the Applicant shall prepare off-site circulation improvement plans for review and approval by the Imperial County Department of Public Works (DPW). The plans shall include the installation of left-turn and right-turn lanes on Ross Road at the Project Driveways that include deceleration lanes and storage per Caltrans Highway Design Manual. The Applicant shall also install curbs, gutters, and sidewalk sidewalks, along the south side of Ross Road, along the frontage of the property.

The Improvement Plan(s) shall be submitted for approved by DPW prior to recordation of the Parcel Map. Prior to building occupancy for the Project, all improvements shall be completed to the satisfaction of DPW in accordance with the approved off-site circulation plans.

This page intentionally left blank.

APPENDICES

EEC ORIGINAL PKG



2 FRONT PERSPECTIVE - FRONT LEFT
SCALE:



INITIAL STUDY & MITIGATED NEGATIVE DECLARATION MAVERIK FUELING STATION PROJECT - GPA 22-0002/ZC22-0002

Volume I



**WILLIS
ENVIRONMENTAL**
PLANNING
238 Sychar Road
San Diego, CA 92114
619.925.2836
www.willisenvironmentalplanning.com

April 2024



EEC ORIGINAL PKG

This page intentionally left blank

NEGATIVE DECLARATION
 MITIGATED NEGATIVE DECLARATION

VOL. II: TECHNICAL APPENDICES

For:

**Maverik Fueling Station and Convenience Store Project
General Plan Amendment #22-0002,
Zone Change #22-0002 and
Parcel Map #02499**



Prepared By:

COUNTY OF IMPERIAL

Planning & Development Services Department
801 Main Street
El Centro, CA 92243
(442) 265-1736
www.icpds.com

April 2024

EEC ORIGINAL PKG

This page intentionally left blank.

VOLUME II: APPENDICES TO THE INITIAL STUDY

Appendix A	Air Quality/Greenhouse Gas Analysis Birdseye Planning Group, December 2023
Appendix B	Health Risk Assessment Entech Consulting Group, December 2023
Appendix C	Biological Resource Assessment Barret Biological Enterprises, December, 2023
Appendix D	Cultural and Paleontological Resources Assessment Cogstone Resource Management, January 10, 2024
Appendix E	Energy Memo Birdseye Planning Group, January 2024
Appendix F	Geotechnical Engineering Study, CMT Engineering Laboratories, November 19, 2021
Appendix G-1	Phase I Environmental Site Assessment Cardno, October 22, 2021
Appendix G-2	Limited Phase II Environmental Site Assessment Cardno, November 3, 2021
Appendix H	Preliminary Drainage Study LC Engineering Consultants, Inc., November 14, 2023
Appendix IA.	Noise Analysis Birdseye Planning Group, March 2024
Appendix J	Traffic Study Mizuta Traffic Consulting, April 2024

This page intentionally left blank.

A

**Air Quality and
Greenhouse Gas
Analysis**

This page intentionally left blank.

MAVERIK FUELING STATION AND CONVENIENCE STORE PROJECT

AIR QUALITY/GREENHOUSE GAS STUDY

Prepared for:

Christina Willis, President
Willis Environmental Planning
238 Sychar Road
San Diego, CA 92114

Prepared by:



December 2023

EEC ORIGINAL PKG

MAVERIK FUELING STATION AND CONVENIENCE STORE PROJECT IMPERIAL COUNTY, CALIFORNIA

AIR QUALITY and GREENHOUSE GAS STUDY

Table of Contents

	Page
PROJECT DESCRIPTION	1
SETTING	4
Air Pollution Regulation.....	4
Air Quality Management Plan.....	11
Sensitive Receptors	13
AIR QUALITY IMPACT ANALYSIS	13
Methodology and Significance Thresholds.....	13
Construction Emissions.....	15
Long-Term Regional Impacts.....	18
GREENHOUSE GAS EMISSIONS	21
CLIMATE CHANGE IMPACT ANALYSIS	33
REFERENCES	47
List of Figures	
Figure 1 Vicinity Map	2
Figure 2 Site Plan	3
List of Tables	
Table 1 State and Federal Ambient Air Quality Standards	4
Table 2 Imperial County Air Quality Standard Attainment Status.....	7
Table 3 Ambient Air Quality Data	11
Table 4 ICAPCD Tier I and Tier II Daily Operational Thresholds	15
Table 5 IPAPCD Daily Emission Thresholds.....	15

Table 6	Estimated Maximum Daily Construction Emissions.....	16
Table 7	Estimated Operational Emissions.....	20
Table 8	Estimated Construction Related GHG Emissions.....	35
Table 9	Estimated Annual Energy Related GHG Emissions.....	36
Table 10	Estimated Solid Waste and Water Use GHG Emissions.....	36
Table 11	Estimated Annual Mobile Emissions of Greenhouse Gases.....	36
Table 12	Combined Construction, Stationary and Mobile Source Emissions.....	37
Table 13	2017 Scoping Plan Consistency Summary.....	38

Appendices

Appendix A	CalEEMod Air Quality and Greenhouse Gas Emissions Model Results
------------	---

MAVERIK FUELING STATION AND CONVENIENCE STORE PROJECT IMPERIAL COUNTY, CALIFORNIA

AIR QUALITY and GREENHOUSE GAS STUDY

This report is an analysis of the potential air quality and greenhouse gas impacts associated with the proposed Maverik Fueling Station and Convenience Store Project in unincorporated Imperial County, California. This report has been prepared by Birdseye Planning Group (BPG) under contract to Willis Environmental Planning, Inc., to support preparation of the environmental documentation pursuant to the California Environmental Quality Act (CEQA).

PROJECT DESCRIPTION

Maverik is proposing to develop a fueling station and convenience store on a 10-acre site located on 10 gross acres of the approximately 50-acre parcel within unincorporated Imperial County (County), California, approximately 1.5 miles east of the City of El Centro (Figure 1 – Vicinity Map) (Assessor's Parcel Number 054-080-023). The Project site is located on the southeast corner of Hawes Road and Ross Avenue, east of State Route 111 (SR-111/Imperial Valley Pioneers Expressway) and is bound by Ross Avenue on the north, by Hawes Road and the Imperial Irrigation District's Acacia Five Drain A on the west (Figure 2 – Site Plan). The Project site is located within Section 11 of Township 16 South, Range 14 East, San Bernardino Base Meridian. The westbound offramp of Interstate 8 at SR-111 is located approximately 0.25 miles south of the Project site.

The Maverik Fueling Station and Convenience Store Project (Project) includes 21 fuel pumps under two separate canopies (totaling 9,0000 square feet (sf), and a 5,982 SF convenience store building. Additional improvements include three (3) underground storage tanks for fuel storage; two underground water storage tanks; on-site water and wastewater treatment facilities; parking, landscaping, drainage, and access improvements. Vehicular access would be provided via three (3) ingress/egress drives along the south side of Ross Avenue. The westernmost access would be a 40-foot driveway that would allow for left- and right-turn movements by vehicles accessing the fueling area and convenience store. This entrance would be located approximately 215 feet east of the Ross Avenue/SR-111 intersection. The second proposed entrance would be located approximately 150 feet east of the first and would provide a 60-foot inbound/outbound driveway leading directly to the proposed truck fueling stations. The third and easternmost driveway would be located 220 feet east of the second and would provide a 50-foot driveway that would permit the full range of left- and right-turn movements, inbound and outbound. Parking would be provided in three (3) parking areas for a total of 45-parking spaces, including two accessible spaces. No overnight parking would be allowed and parking within the fueling area would be limited to 30 minutes. Project construction is



Figure 1 — Vicinity Map

EEC ORIGINAL PKG

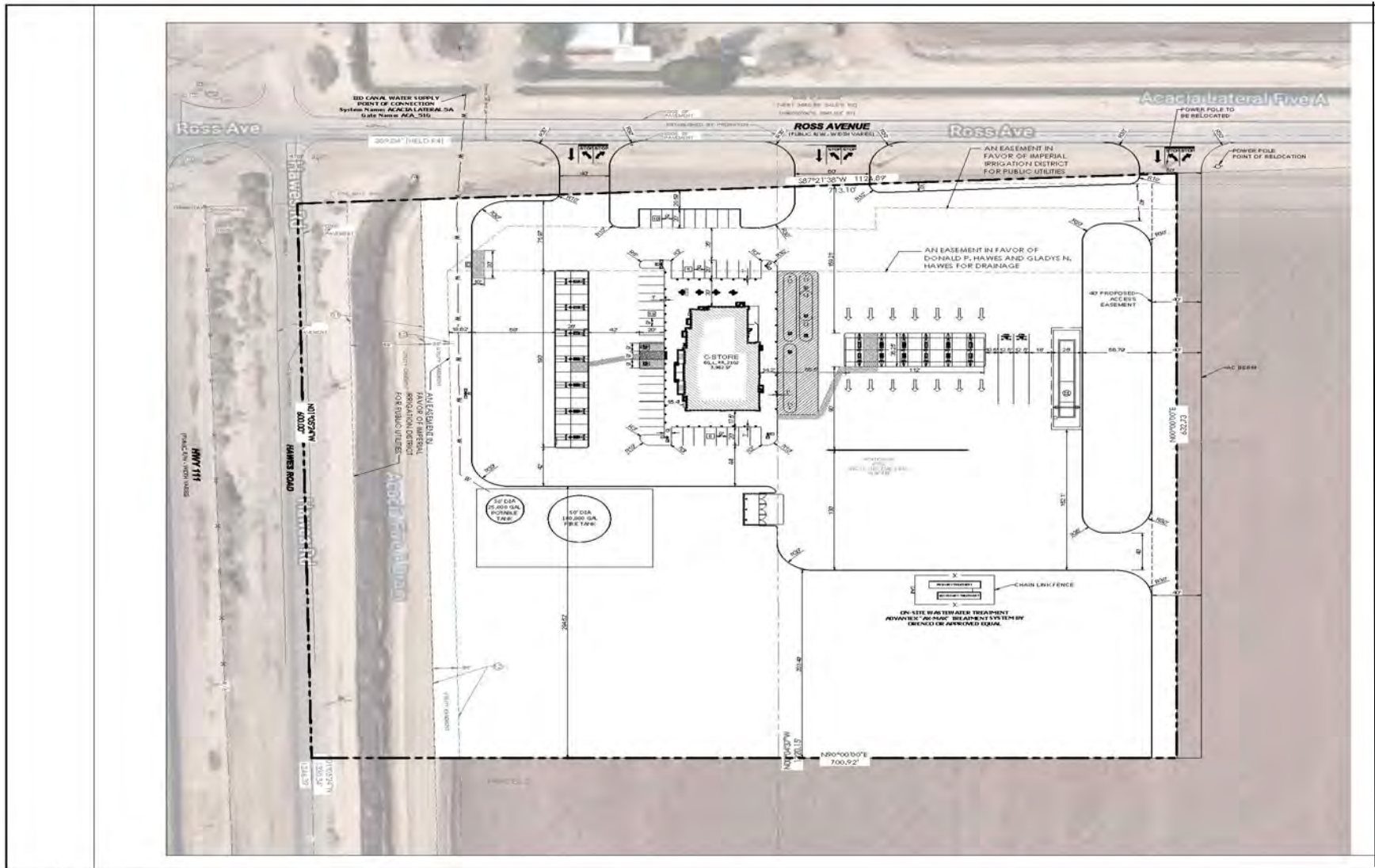

Source: SDC, 2023



Figure 2—Site Plan

EEC ORIGINAL PKG

anticipated to begin in late 2024 and be operational in late 2025. The project site is shown in Figure 1. The site plan is shown in Figure 2.

SETTING

Air Pollution Regulation

The federal and state governments have been empowered by the federal and state Clean Air Acts to regulate emissions of airborne pollutants and have established ambient air quality standards for the protection of public health. The EPA is the federal agency designated to administer air quality regulation, while the California Air Resources Board (ARB) is the state equivalent in California. Federal and state standards have been established for six criteria pollutants, including ozone (O₃), carbon monoxide (CO), nitrogen dioxide (NO₂), sulfur dioxide (SO₂), particulates less than 10 and 2.5 microns in diameter (PM₁₀ and PM_{2.5}), and lead (Pb). California has also set standards for sulfates, hydrogen sulfide, vinyl chloride, and visibility-reducing particles. Table 1 lists the current federal and state standards for each of these pollutants. Standards have been set at levels intended to be protective of public health. California standards are generally more restrictive than federal standards for each of these pollutants except lead and the eight-hour average for CO.

Table 1
State and Federal Ambient Air Quality Standards

POLLUTANT	AVERAGE TIME	CALIFORNIA STANDARDS ¹		NATIONAL STANDARDS ²		
		Concentration ³	Method ⁴	Primary ^{3,5}	Secondary ^{3,6}	Method ⁷
Ozone ⁸ (O ₃)	1 hour	0.09 ppm (180 µg/m ³)	Ultraviolet Photometry	—	Same as Primary Standard	Ultraviolet Photometry
	8 hours	0.070 ppm (137µg/m ³)		0.070 ppm (137 µg/m ³)		
Carbon Monoxide (CO)	8 hours	9.0 ppm (10 mg/m ³)	Non-Dispersive Infrared Spectroscopy (NDIR)	9 ppm (10 mg/m ³)	--	Non-Dispersive Infrared Spectroscopy (NDIR)
	1 hour	20 ppm (23 mg/m ³)		35 ppm (40 mg/m ³)		
Nitrogen Dioxide (NO ₂) ¹⁰	Annual Average	0.030 ppm (57 µg/m ³)	Gas Phase Chemiluminescence	0.053 ppm (100 µg/m ³)	Same as Primary Standard	Gas Phase Chemiluminescence
	1 hour	0.18 ppm (339 µg/m ³)		100 ppb (188 µg/m ³)		
Sulfur Dioxide (SO ₂) ¹¹	Annual Average	--	Ultraviolet Fluorescence	0.03 ppm (80 µg/m ³)	--	Pararosaniline
	24 hours	0.04 ppm (105 µg/m ³)		0.14 ppm (365 µg/m ³)		
	3 hours	--		--		

POLLUTANT	AVERAGE TIME	CALIFORNIA STANDARDS ¹		NATIONAL STANDARDS ²		
		Concentration ³	Method ⁴	Primary ^{3,5}	Secondary ^{3,6}	Method ⁷
	1 hour	0.25 ppm (655 µg/m ³)		75 ppb (196 µg/m ³)	--	
Respirable Particulate Matter (PM ₁₀) ⁹	24 hours	50 µg/m ³	Gravimetric or Beta Attenuation	150 µg/m ³	150 µg/m ³	Inertial Separation and Gravimetric Analysis
	Annual Arithmetic Mean	20 µg/m ³		--	--	
Fine Particulate Matter (PM _{2.5}) ⁹	Annual Arithmetic Mean	12 µg/m ³	Gravimetric or Beta Attenuation	12 µg/m ³	15 µg/m ³	Inertial Separation and Gravimetric Analysis
	24 hours	--		35 µg/m ³	Same as Primary Standard	
Sulfates	24 hours	25 µg/m ³	Ion Chromatography	--	--	--
Lead ^{12, 13} (Pb)	30-day Average	1.5 µg/m ³	Atomic Absorption	--	--	High Volume Sampler and Atomic Absorption
	Calendar Quarter	--		1.5 µg/m ³	Same as Primary Standard	
	3-month Rolling Average	--		0.15 µg/m ³		
Hydrogen Sulfide (H ₂ S)	1 hour	0.03 ppm (42 µg/m ³)	Ultraviolet Fluorescence	--	--	--
Vinyl Chloride ¹²	24 hours	0.010 ppm (26 µg/m ³)	Gas Chromatography	--	--	--

Notes:

ppm = parts per million

µg/m³ = micrograms per cubic meter

mg/m³ = milligrams per cubic meter

Source: California Air Resources Board 2017

1. California standards for ozone, carbon monoxide (except 8-hour Lake Tahoe), sulfur dioxide (1 and 24 hour), nitrogen dioxide, and particulate matter (PM₁₀, PM_{2.5}, and visibility reducing particles), are values that are not to be exceeded. All others are not to be equaled or exceeded. California ambient air quality standards are listed in the Table of Standards in Section 70200 of Title 17 of the California Code of Regulations.
2. National standards (other than ozone, particulate matter, and those based on annual arithmetic mean) are not to be exceeded more than once a year. The ozone standard is attained when the fourth highest 8-hour concentration measured at each site in a year, averaged over three years, is equal to or less than the standard. For PM₁₀, the 24-hour standard is attained when the expected number of days per calendar year with a 24-hour average concentration above 150 µg/m³ is equal to or less than one. For PM_{2.5}, the 24-hour standard is attained when 98 percent of the daily concentrations, averaged over three years, are equal to or less than the standard. Contact the U.S. EPA for further clarification and current national policies.

3. Concentration expressed first in units in which it was promulgated. Equivalent units given in parentheses are based upon a reference temperature of 25°C and a reference pressure of 760 torr. Most measurements of air quality are to be corrected to a reference temperature of 25°C and a reference pressure of 760 torr; ppm in this table refers to ppm by volume, or micromoles of pollutant per mole of gas.
4. Any equivalent measurement method which can be shown to the satisfaction of the CARB to give equivalent results at or near the level of the air quality standard may be used.
5. National Primary Standards: The levels of air quality necessary, with an adequate margin of safety to protect the public health.
6. National Secondary Standards: The levels of air quality necessary to protect the public welfare from any known or anticipated adverse effects of a pollutant.
7. Reference method as described by the U.S. EPA. An "equivalent method" of measurement may be used but must have a "consistent relationship to the reference method" and must be approved by the U.S. EPA.
8. On October 1, 2015, the national 8-hour ozone primary and secondary standards were lowered from 0.075 to 0.070 ppm.
9. On December 14, 2012, the national annual PM_{2.5} primary standard was lowered from 15 µg/ m³ to 12.0 µg/ m³. The existing national 24-hour PM_{2.5} standards (primary and secondary) were retained at 35 µg/ m³, as was the annual secondary standard of 15 µg/ m³. The existing 24-hour PM₁₀ standards (primary and secondary) of 150 µg/ m³ also were retained. The form of the annual primary and secondary standards is the annual mean, averaged over 3 years.
10. To attain the 1-hour national standard, the 3-year average of the annual 98th percentile of the 1-hour daily maximum concentrations at each site must not exceed 100 ppb. Note that the national 1-hour standard is in units of parts per billion (ppb). California standards are in units of parts per million (ppm). To directly compare the national 1-hour standard to the California standards the units can be converted from ppb to ppm. In this case, the national standard of 100 ppb is identical to 0.100 ppm.
11. On June 2, 2010, a new 1-hour SO₂ standard was established and the existing 24-hour and annual primary standards were revoked. To attain the 1-hour national standard, the 3-year average of the annual 99th percentile of the 1-hour daily maximum concentrations at each site must not exceed 75 ppb. The 1971 SO₂ national standards (24-hour and annual) remain in effect until one year after an area is designated for the 2010 standard, except that in areas designated nonattainment for the 1971 standards, the 1971 standards remain in effect until implementation plans to attain or maintain the 2010 standards are approved.

Note that the 1-hour national standard is in units of parts per billion (ppb). California standards are in units of parts per million (ppm). To directly compare the 1-hour national standard to the California standard the units can be converted to ppm. In this case, the national standard of 75 ppb is identical to 0.075 ppm.
12. The CARB has identified lead and vinyl chloride as 'toxic air contaminants' with no threshold level of exposure for adverse health effects determined. These actions allow for the implementation of control measures at levels below the ambient concentrations specified for these pollutants.
13. The national standard for lead was revised on October 15, 2008 to a rolling 3-month average. The 1978 lead standard (1.5 µg/ m³ as a quarterly average) remains in effect until one year after an area is designated for the 2008 standard, except that in areas designated nonattainment for the 1978 standard, the 1978 standard remains in effect until implementation plans to attain or maintain the 2008 standard are approved.
14. In 1989, the CARB converted both the general statewide 10-mile visibility standard and the Lake Tahoe 30-mile visibility standard to instrumental equivalents, which are "extinction of 0.23 per kilometer" and "extinction of 0.07 per kilometer" for the statewide and Lake Tahoe Air Basin standards, respectively.

Local control in air quality management is provided by the ARB through county-level or regional (multi-county) APCDs. The ARB establishes air quality standards and is responsible for control of mobile emission sources, while the local APCDs are responsible for enforcing

standards and regulating stationary sources. The ARB has established 14 air basins statewide. The project site is located within the Salton Sea Air Basin (Basin), which includes all of Imperial County and a portion of central Riverside County. Air quality conditions in the Imperial County portion of the Basin are under the jurisdiction of the Imperial County APCD (ICAPCD). The remainder in Riverside County is managed by the South Coast Air Quality Management District. The ICAPCD is required to monitor air pollutant levels to ensure that air quality standards are met and, if they are not met, to develop strategies to meet the standards. Depending on whether the standards are met or exceeded, the local air basin is classified as being in “attainment” or “non-attainment.” Table 2 shows the attainment status for the Salton Sea Air Basin.

Table 2
Imperial County Air Quality Standard Attainment Status

Pollutant	CAAQS	NAAQS
Ozone (O ₃)	Nonattainment	Nonattainment - Moderate
Carbon Monoxide (CO)	Attainment	Unclassified/Attainment
Respirable Particulate Matter (PM ₁₀)	Nonattainment	Nonattainment - Serious
Fine Particulate Matter (PM _{2.5}) ⁽¹⁾	Unclassified ⁽²⁾	Unclassified/Attainment
Nitrogen Dioxide (NO ₂)	Attainment	Unclassified/Attainment
Lead (Pb)	Attainment	Attainment
Sulfur Dioxide (SO ₂)	Attainment	Attainment
Sulfates	Attainment	No Federal Standards
Vinyl Chloride	Unclassified	
Hydrogen Sulfide (H ₂ S)	Attainment	
Visibility Reducing Particles	Unclassified	

Source: County of Imperial, September, 2013

¹ Part of Imperial County is designated nonattainment for the NAAQS; however, the nonattainment area does not include the project location

² Insufficient data to designate area or designations have yet to be made

The Basin in which the project area is located, is designated non-attainment area for the federal and state standards for ozone and PM₁₀. The Basin is in attainment or unclassified for the remaining pollutants. Characteristics of the pollutants referenced above are described below.

Ozone. Ozone is produced by a photochemical reaction (triggered by sunlight) between nitrogen oxides (NO_x) and reactive organic gases (ROG)¹. Nitrogen oxides are formed during the combustion of fuels, while reactive organic compounds are formed during combustion and evaporation of organic solvents. Because ozone requires sunlight to form, it mostly occurs in concentrations considered serious between the months of April and October. Ozone is a pungent, colorless, toxic gas with direct health effects on humans including respiratory and eye irritation and possible changes in lung functions. Groups most sensitive to ozone include children, the elderly, people with respiratory disorders, and people who exercise strenuously outdoors.

¹ Organic compound precursors of ozone are routinely described by a number of variations of three terms: hydrocarbons (HC), organic gases (OG), and organic compounds (OC). These terms are often modified by adjectives such as total, reactive, or volatile, and result in a rather confusing array of acronyms: HC, THC (total hydrocarbons), RHC (reactive hydrocarbons), TOG (total organic gases), ROG (reactive organic gases), TOC (total organic compounds), ROC (reactive organic compounds), and VOC (volatile organic compounds). While most of these differ in some significant way from a chemical perspective, from an air quality perspective two groups are important: non-photochemically reactive in the lower atmosphere, or photochemically reactive in the lower atmosphere (HC, RHC, ROG, ROC, and VOC).

Carbon Monoxide. Carbon monoxide is a local pollutant that is found in high concentrations only near the source. The major source of carbon monoxide, a colorless, odorless, poisonous gas, is automobile traffic. Elevated concentrations, therefore, are usually only found near areas of high traffic volumes. Carbon monoxide's health effects are related to its affinity for hemoglobin in the blood. At high concentrations, carbon monoxide reduces the amount of oxygen in the blood, causing heart difficulties in people with chronic diseases, reduced lung capacity and impaired mental abilities.

Nitrogen Dioxide. Nitrogen dioxide (NO₂) is a by-product of fuel combustion, with the primary source being motor vehicles and industrial boilers and furnaces. The principal form of nitrogen oxide produced by combustion is nitric oxide (NO), but NO reacts rapidly to form NO₂, creating the mixture of NO and NO₂ commonly called NO_x. Nitrogen dioxide is an acute irritant. A relationship between NO₂ and chronic pulmonary fibrosis may exist, and an increase in bronchitis in young children at concentrations below 0.3 parts per million (ppm) may occur. Nitrogen dioxide absorbs blue light and causes a reddish-brown cast to the atmosphere and reduced visibility. It can also contribute to the formation of PM₁₀ and acid rain.

Suspended Particulates. PM₁₀ is particulate matter measuring no more than 10 microns in diameter, while PM_{2.5} is fine particulate matter measuring no more than 2.5 microns in diameter. Suspended particulates are mostly dust particles, nitrates and sulfates. Both PM₁₀ and PM_{2.5} are by-products of fuel combustion and wind erosion of soil and unpaved roads, and are directly emitted into the atmosphere through these processes. Suspended particulates are also created in the atmosphere through chemical reactions. The characteristics, sources, and potential health effects associated with the small particulates (those between 2.5 and 10 microns in diameter) and fine particulates (PM_{2.5}) can be very different. The small particulates generally come from windblown dust and dust kicked up from mobile sources. The fine particulates are generally associated with combustion processes as well as being formed in the atmosphere as a secondary pollutant through chemical reactions. Fine particulate matter is more likely to penetrate deeply into the lungs and poses a health threat to all groups, but particularly to the elderly, children, and those with respiratory problems. More than half of the small and fine particulate matter that is inhaled into the lungs remains there. These materials can damage health by interfering with the body's mechanisms for clearing the respiratory tract or by acting as carriers of an absorbed toxic substance.

Lead (Pb). Lead is a naturally occurring metal used in a variety of industrial and commercial applications. Historically, the majority of lead emissions were attributed to automobiles using leaded gasoline. As leaded gasoline has been phased out of use, lead emissions have dropped dramatically, and current primary sources are ore processing and aircraft that use leaded aircraft fuel. Lead exposure has been associated with learning disabilities and behavioral problems in children, kidney damage, and negative effects on the nervous and cardiovascular systems.

Sulfur Dioxide (SO₂). SO₂ is one of several highly reactive gasses known as oxides of sulfur (SO_x) and is formed by burning fuel containing sulfur. Typical sources include emissions from

burning coal or oil at power plants and factories. Typical health effects associated with exposure to sulfur dioxide include respiratory illness and exacerbation of respiratory symptoms in people with asthma.

Sulfates. Sulfates are the fully oxidized ionic form of sulfur produced when sulfur dioxide is fully oxidized in the atmosphere. Sulfates are produced by emissions from automobiles, power plants, and industrial activity, and contribute to general atmospheric haziness. Typical health effects associated with exposure to sulfates include respiratory illness and an increased risk of cardio-pulmonary disease.

Vinyl Chloride. Vinyl chloride is an artificially created colorless gas with a mild, slightly sweet odor. The gas is used in the manufacture of vinyl products, including polyvinyl chloride (PVC) plastic. Vinyl chloride emissions are produced from the vinyl manufacturing process as well as from the breakdown of vinyl products in landfills and hazardous waste sites. The health effects associated with vinyl chloride include dizziness, headaches, and drowsiness from short-term exposure, and liver damage and cancer resulting from long-term exposure. In 1990, the California Air Resources Board (CARB) designated vinyl chloride as a toxic air contaminant.

Hydrogen Sulfide (H₂S). H₂S is a naturally occurring, colorless gas that, at low concentrations, produces a distinctive rotten egg odor. At higher concentrations, the gas produces a sweet odor. The gas is produced through the bacteriological breakdown of organic materials as well as some types of geothermal activity. Health effects associated with H₂S include exposure to a disagreeable odor, coughing, irritation to eyes, and impairment of the respiratory system.

Visibility Reducing Particles. Visibility reducing particles are particulate matter composed of many different substances that are suspended in the atmosphere and contribute to haze and diminished visibility.

Toxic Air Contaminants/Hazardous Air Pollutants. Toxic air contaminants (TACs), also known as hazardous air pollutants (HAPs), are a wide range of pollutants that may cause or contribute to an increase in deaths or in serious illness, or which may pose a present or potential hazard to human health (CARB 2010). Health effects associated with TACs, including cancer, are typically the result of acute or repeated exposure to these pollutants.

TACs are emitted from a number of different sources, including industrial sources (e.g., refining, manufacturing, utilities, and mining) commercial sources (e.g., gas stations and dry cleaners) and diesel-fueled vehicles. Currently, both the EPA and the State of California have recognized nearly 200 different contaminants as TACs/HAPs. CARB has identified 10 specific pollutants as posing the greatest risk to human health based on ambient background levels in the state. These pollutants include: acetaldehyde (CH₃CHO), benzene (C₆H₆), 1,3-butadiene (C₄H₆), carbon tetrachloride (CCl₄), hexavalent chromium, para-dichlorobenzene (C₆H₄Cl₂), formaldehyde (CH₂O), methylene chloride (CH₂Cl₂), perchloroethylene (C₂Cl₄), and diesel particulate matter (DPM). The potential TACs of most concern that are associated with the proposed project are benzene (C₆H₆) and diesel particulate matter (DPM).

Benzene (C₆H₆). Benzene is a colorless, flammable liquid with a pleasant, sweet odor that evaporates quickly when exposed to air. Benzene is produced naturally through geothermal processes, as a component of petroleum and natural gas, and as a byproduct of burning wood and other plant matter. Anthropomorphic sources of benzene include use as an ingredient in solvents and as an additive to gasoline.

Diesel Particulate Matter (DPM). DPM is produced by the combustion of diesel fuel and is composed of a mixture of various gases and fine particulate matter (i.e., soot). CARB recognized the particulate matter in DPM as a TAC in 1998 based on its potential to cause cancer and contribute to other adverse health effects (CARB 2011). This TAC is the most prevalent of the 10 specific pollutants identified by CARB and poses the greatest health risk.

Odors. Odors are generally considered a nuisance rather than a health hazard and can lead to discomfort and distress among the general public. However, as the human nose is the only means by which odors can be detected, the ability to identify and qualify odors is highly subjective. Some people have a greater ability to detect odors from minute emissions of odor causing substances and may take offense at certain odors that are unnoticeable or considered pleasant by others. In addition, regular exposure to odor may cause desensitization, resulting in “odor fatigue,” whereby once recognized odors go unnoticed unless there is a change in the odor’s intensity. Odors produced as a result of geothermal energy production can include the sulfurous, rotten egg smell characteristic of emissions of hydrogen sulfide (H₂S). Ammonia (NH₃) is also produced and has a sharp and irritating odor. The combustion of diesel fuel to power construction or operations related equipment can produce odors due to the sulfur content of diesel fuel.

Regional Climate and Local Air Quality

The proposed project is located in Imperial County, the southeastern most county in California. Imperial County is one of the hottest and driest parts of California and is located in a low latitude desert characterized by hot, dry summers and relatively mild winters. Average annual precipitation within Imperial County is less than 3 inches. The normal maximum temperature in January is approximately 70 degrees Fahrenheit (°F), and the normal minimum temperature is approximately 41°F. In July, the normal maximum temperature can exceed 107°F, while the normal minimum temperature is approximately 75°F. Relative humidity in the summer is low, averaging 30 to 50 percent in the early morning and 10 to 20 percent in the afternoon. During the hottest part of the day, the relative humidity can drop below 10 percent. However, the effect of extensive agricultural operations in the widely-irrigated Imperial Valley tends to increase local humidity. The prevailing weather conditions promote intense heating during the day in summer with cooling at night. During the fall, winter, and spring, regional winds tend to come from the northwest. During the summer, winds tend to come from the southeast.

The ICAPCD operates a network of 5 ambient air monitoring stations throughout Imperial County. The purpose of the monitoring stations is to measure ambient concentrations of the pollutants to determine whether the ambient air quality meets the California and federal

standards. The air quality monitoring station located nearest to the project site is located at 150 9th Street in El Centro, approximately 3.8 miles northwest of the project site. Table 3 provides a summary of monitoring data at the El Centro for ozone and PM₁₀. As referenced, the Salton Sea Basin is a nonattainment area for these two pollutants. PM_{2.5} data are also provided for reference purposes.

Both CARB and USEPA use this type of monitoring data to designate areas according to their attainment status for criteria air pollutants. The purpose of these designations is to identify the areas with air quality problems and thereby initiate planning efforts for improvement. The three basic designation categories are nonattainment, attainment, and unclassified. Unclassified is used in an area that cannot be classified on the basis of available information as meeting or not meeting the standards. If an area is redesignated from nonattainment to attainment, the CAA requires a revision to the SIP, called a maintenance plan, to demonstrate how the air quality standard will be maintained for 10 years.

Table 3
Ambient Air Quality Data

Pollutant	2020	2021	2022
Ozone, ppm - Worst Hour	0.077	0.083	0.078
Number of days of Federal exceedances (>0.070 ppm)*	2	6	10
Particulate Matter <10 microns, µg/m ³ Worst 24 Hours	197.5	194.5	554.6
Number of samples of State exceedances (>50 µg/m ³)	92	88	97
Number of samples of Federal exceedances (>150 µg/m ³)	2	1	2
Particulate Matter <2.5 microns, µg/m ³ Worst 24 Hours	28.5	19.1	30.6
Number of samples of State exceedances (>50 µg/m ³)	0	0	0
Number of samples of Federal exceedances (>150 µg/m ³)	0	0	0

*-indicates insufficient data available for reporting purposes.

Source: California Air Resources Board, 2020, 2021, 2022 Annual Air Quality Data Summaries available at <https://www.arb.ca.gov/adam/topfour/topfour2.php>

As shown, the state ozone standard was exceeded at the El Centro monitoring station ten times during 2022. The state PM₁₀ standard was exceeded 97 times in 2022 and 88 times in 2021. The federal PM₁₀ standard was exceeded twice in both 2020 and 2022. No PM_{2.5} exceedances were reported.

Air Quality Management Plan

ICAPCD is the local air pollution control agency for Imperial County and the southern portion of the Salton Sea Air Basin. The ICAPCD has primary responsibility for ensuring that state and federal air quality standards are attained and maintained within the ICAPCD's jurisdiction. Thus, the ICAPCD is responsible for preparing clean air plans, issuing construction and operation permits, monitoring ambient air quality, as well as developing and implementing rules and regulations that govern air quality within Imperial County. The ICAPCD meets its

regulatory responsibilities through the State of California State Implementation Plan (SIP). The ICAPCD adopted its first SIP in 1971 and has prepared updates to the SIP over the years. SIPs for controlling PM₁₀, ozone, and a reasonably available control technology SIP are in place for Imperial County and constitute the Air Quality Attainment Plan (AQAP) for Imperial County.

A SIP revision for revised rules under ICAPCD Regulation VIII for fugitive dust PM₁₀ was reviewed by EPA and the final rule was signed on March 27, 2013 and published in the Federal Register (Federal Register 2013). The ICAPCD adopted the rules on October 16, 2012 to regulate PM₁₀ emissions from sources of fugitive dust (e.g., unpaved roads and disturbed soils in open and agricultural areas). CARB submitted these rules to EPA for approval on November 7, 2012; EPA proposed approval of these revisions to the ICAPCD portion of the California SIP on January 7, 2013. The ICAPCD developed the 2018 PM₁₀ Plan and requested redesignation of Imperial County Planning Area as attainment. The 2018 SIP for PM₁₀ was approved by CARB on December 13, 2018 and received EPA approval on October 19, 2020.

Rules and regulations promulgated by the ICAPCD and in the SIP revision applicable to the proposed project include the following:

- ICAPCD Rule 207.C.1, New and Modified Stationary Source Review (best available control technologies [BACT]), requires that any new or modified emissions unit that has a potential to emit 25 pounds per day or more of any nonattainment pollutant or its precursors, or 55 pounds per day of H₂S, must include BACT as a part of the project.
- ICAPCD Rule 400, Nuisances, forbids the emission of air contaminants or other materials that would cause a nuisance to the public, including non-agricultural related odors.
- ICAPCD Rule 800 General Requirements for Control of Fine Particulate Matter (PM-10), requires actions to prevent, reduce, or mitigate PM-10 emissions from anthropogenic (man-made) Fugitive Dust (PM-10) sources generated within Imperial County.
- ICAPCD Regulation VIII, Rule 801 (Construction and Earthmoving Activities) establishes a 20 percent opacity limit, requires the implementation of a dust management control plan for all nonresidential projects of 5 acres or more, and requires compliance with other portions of Regulation VIII regarding bulk materials (Rule 802), carry-out and track-out (Rule 803), and paved and unpaved roads (Rule 805). The rule exempts single-family homes and waives the 20 percent opacity limit in winds over 25 miles per hour (mph) under certain conditions. To comply with this regulation, the applicant would implement Condition of Approval AQ-1 which requires preparation of a Fugitive Dust Suppression Plan to minimize dust generated during construction and ground disturbing activities.

- ICAPCD Rule 804 Open Areas, requires actions to prevent, reduce or mitigate the amount of fine Particulate Matter (PM-10) emissions generated from Open Areas. Open areas are defined as any open area having 0.5 acres or more within urban areas, or 3.0 acres or more within rural areas; and contains at least 1,000 square feet of disturbed surface area.

ICAPCD adopted the 2013 PM_{2.5} plan on December 2, 2014. The plan was transmitted to CARB on December 9, 2014. CARB reviewed and approved the plan on December 18, 2015, as a revision to the California State Implementation Plan for Imperial County. The plan was submitted to the U.S. EPA on January 9, 2015, and is pending approval.

Sensitive Receptors

Ambient air quality standards have been established to represent the levels of air quality considered sufficient, with an adequate margin of safety, to protect public health and welfare. They are designed to protect that segment of the public most susceptible to respiratory distress, such as children under 14; the elderly over 65; persons engaged in strenuous work or exercise; and people with cardiovascular and chronic respiratory diseases. The nearest receptor are single-family residences located at 498 Ross Avenue and north of the site and at 1650 Hawes Road approximately 1,000 feet south of the site.

AIR QUALITY IMPACT ANALYSIS

Methodology and Significance Thresholds

This air quality analysis conforms to the methodologies recommended in the ICAPCDs *CEQA Air Quality Handbook* (amended November 2007). The handbook includes thresholds for emissions associated with both construction and operation of proposed projects. All emissions associated with construction vehicle and equipment operations were calculated using the California Emissions Estimator Model (CalEEMod) software version 2022.1. As referenced, construction emissions would be associated with clearing, grading, excavation and construction of the buildings, paving and application of architectural coatings (i.e., paint). These emissions would consist of diesel exhaust and dust emissions. Construction equipment that would generate criteria air pollutants includes excavators, graders, dump trucks, and loaders. It was assumed that all construction equipment used would be diesel-powered. Construction emissions associated with development of the proposed project by estimating the types of equipment (including the number) that would be used on-site during each of the construction phases and scope of improvements required to implement the project as defined herein.

To determine whether construction of the project would cause a regional air quality impact. The increase in emissions would be compared with the ICAPCD's recommended regional thresholds for operational emissions.

Regional Thresholds. Based on Appendix G of the *CEQA Guidelines*, a project would have a significant air quality impact if it would:

- a) *Conflict with or obstruct implementation of the applicable air quality plan;*
- b) *Result in a cumulatively considerable net increase of any criteria pollutant for which the project region is non-attainment under an applicable federal or state ambient air quality standard?*
- c) *Expose sensitive receptors to substantial pollutant concentrations; or*
- d) *Result in other emissions (such as those leading to odors) adversely affecting a substantial number of people.*

a. *Conflict with or obstruct implementation of the applicable air quality plan;*

A project may be inconsistent with the SIP or related AQAP if it would generate population, housing, or employment growth exceeding forecasts used in the development of the AQAP. As referenced, the ICAPCD meets its regulatory responsibilities through the State of California SIP. The ICAPCD adopted its first SIP in 1971 and has prepared updates to the SIP over the years. SIPs for controlling PM₁₀, ozone, and a reasonably available control technology SIP are in place for Imperial County and constitute the AQAP for Imperial County.

The ICAPCD air quality plans aim to reduce emissions of criteria pollutants for which the region is in nonattainment by establishing a program of rules and regulations directed at reducing air pollutant emissions and achieving state and national air quality standards. The project proposes to amend the General Plan land use designation from Agriculture to Urban Area and a zone change from A-2 (General Agricultural) to C-3 (Heavy Commercial).

Because the proposed project is required to comply with applicable ICAPCD rules, regulations, and requirements for controlling emissions and because maximum daily pollutant emissions projected to result from the project would be below ICAPCD significance thresholds, the project would not conflict with or obstruct implementation of any air quality plans. Impacts would be less than significant.

b. *Result in a cumulatively considerable net increase of any criteria pollutant for which the project region is non-attainment under an applicable federal or state ambient air quality standard?*

New development with a potential to emit criteria pollutants below significance levels defined by the ICAPCD is referred to as a “Tier I project,” and is considered by the Imperial County APCD to have less than significant potential adverse impacts on local air quality. For Tier I projects, the project proponent should implement a set of feasible “standard” mitigation measures (determined by the Imperial County APCD) to reduce the air quality impacts to less than significant. A “Tier II project” is one whose emissions exceed any of the thresholds. Its impact is significant and the project proponent should select and implement all feasible

“discretionary” mitigation measures (as determined by the Imperial County APCD) in addition to the standard measures. Tier I and Tier II thresholds are shown in Table 4.

Table 4
ICAPCD Tier I and Tier II Daily Operational Thresholds

Pollutant	Tier I	Tier II
NOx and ROG	Less than 137 lbs/day	Greater than 137 lbs/day
PM ₁₀ and SOx	Less than 150 lbs/day	Greater than 150 lbs/day
CO and PM _{2.5}	Less than 550 lbs/day	Greater than 550 lbs/day
ROG = reactive organic gas; NOx = oxides of nitrogen; CO = carbon monoxide; PM ₁₀ = particulate matter with an aerodynamic diameter 10 microns or less; lbs/day = pounds per day SOURCE: Imperial County APCD 2017		

The ICAPCD has developed specific quantitative thresholds that apply to short-term construction activities and project operation. The thresholds are shown in Table 5.

Table 5
ICAPCD Daily Emission Thresholds

Pollutant	Construction (pounds/day)	Operation (pounds/day)
Reactive Organic Gases	75	55
Nitrogen Oxide	100	55
Carbon Monoxide	550	550
Particulate Matter 10	150	150
Particulate Matter 2.5	N/A	55*
Sulfur Oxides	N/A	150

Source: ICAPCD CEQA Handbook, 2007

Note: The ICAPCD has not adopted a significance threshold for operational or construction related emission of PM_{2.5} or construction related emissions of SOx. Recent projects in the ICAPCD have used a PM_{2.5} threshold for operation emissions of 55 pounds per day based on the SCAQMD’s Final Methodology to Calculate PM_{2.5} and PM_{2.5} Significance Thresholds (SCAQMD 2006).

NA = Construction thresholds for PM_{2.5} and SOx are not applicable.

Construction Emissions

Project construction would generate temporary air pollutant emissions. These impacts are associated with fugitive dust (PM₁₀ and PM_{2.5}) and exhaust emissions from heavy construction vehicles. Construction would generally consist of site preparation, grading, excavation for the fuel tanks, construction of the buildings, application of architectural coating and paving. For modeling purposes, it was assumed that 500 cubic yards of export would be required.

Construction emission estimates are shown in Table 6.

Table 6
Estimated Maximum Daily Construction Emissions

Construction Phase	Maximum Emissions (lbs/day)					
	ROG	NO _x	CO	SO _x	PM ₁₀	PM _{2.5}
Construction – 2024	3.7	37.1	34.4	0.05	9.7	5.5
Construction - 2025	1.1	10.4	13.2	0.02	0.4	0.4
ICAPCD Regional Thresholds	75	100	No Standard	550	150	No Standard
Threshold Exceeded	No	No	No	No	No	No

Note – Tire Repair and truck parking emissions shown for building construction, architectural coating and paving phases only.

The emissions shown in Table 6 assume exposed soil areas would be watered twice daily to control fugitive dust emissions. To minimize fugitive dust and general construction emissions, the applicant would be required to implement fugitive dust control measures per ICAPCD Rules 801 and 804 as referenced herein. The fugitive dust control plan and related requirements to control fugitive dust emissions during construction are addressed as follows and assumed to be conditions of approval for the project:

Condition of Approval AQ-1: Prior to commencing construction, the project applicant will be required to submit a Dust Control Plan to the ICAPCD for approval. The Dust Control Plan will identify all sources of PM₁₀ emissions and associated mitigation measures during the construction and operational phases (see Rule 801 F.2). The applicant shall submit a “Construction Notification Form” to the ICAPCD 10 days prior to the commencement of any earthmoving activity. The Dust Control Plan submitted to the ICAPCD shall meet all applicable requirements for control of fugitive dust emissions, including the following measures designed to achieve the no greater than 20-percent opacity performance standard for dust control and address the following parameters:

- All disturbed areas, including bulk material storage that is not being actively used, shall be effectively stabilized; and visible emissions shall be limited to no greater than 20-percent opacity for dust emissions by using water, chemical stabilizers, dust suppressants, tarps or other suitable material, such as vegetative groundcover. Bulk material is defined as earth, rock, silt, sediment, and other organic and/or inorganic material consisting of or containing particulate matter with 5 percent or greater silt content. For modeling purposes, it was assumed that watering would occur twice daily.
- All on-site unpaved roads segments or areas used for hauling materials shall be effectively stabilized. Visible emissions shall be limited to no greater than 20 percent opacity for dust emissions by restricting vehicle access, paving, application of chemical stabilizers, dust suppressants and/or watering.

- The transport of bulk materials on public roads shall be completely covered, unless 6 inches of freeboard space from the top of the container is maintained with no spillage and loss of bulk material. In addition, the cargo compartment of all haul trucks shall be cleaned and/or washed at the delivery site after removal of bulk material, prior to using the trucks to haul material on public roadways.
- All track-out or carry-out on paved public roads, which includes bulk materials that adhere to the exterior surfaces of motor vehicles and/or equipment (including tires) that may then fall onto the pavement, shall be cleaned at the end of each workday or immediately when mud or dirt extends a cumulative distance of 50 linear feet or more onto a paved road within an urban area.
- Movement of bulk material handling or transfer shall be stabilized prior to handling or at points of transfer with application of sufficient water, chemical stabilizers, or by sheltering or enclosing the operation and transfer line except where such material or activity is exempted from stabilization by the rules of ICAPCD.

Each project proponent shall implement all applicable standard measures for construction combustion equipment for the reduction of excess NO_x emissions as contained in the Imperial County CEQA Air Quality Handbook and associated regulations. These measures include:

- Use alternative-fueled or catalyst-equipped diesel construction equipment, including all off-road and portable diesel-powered equipment.
- Minimize idling time, either by shutting equipment off when not in use or reducing the time of idling to five minutes at a maximum.
- Limit the hours of operation of heavy-duty equipment and/or the amount of equipment in use. Replace fossil-fueled equipment with electrically driven equivalents (assuming powered by a portable generator set and are available, cost effective, and capable of performing the task in an effective, timely manner).
- Curtail construction during periods of high ambient pollutant concentrations; this may include ceasing construction activity during the peak hour of vehicular traffic on adjacent roadways.
- Implement activity management (e.g., rescheduling activities to avoid overlap of construction phases, which would reduce short-term impacts).

With implementation of condition of approval AQ-1, construction related impacts would be less than significant. No mitigation would be required.

Construction-Related Toxic Air Contaminant Impacts

The greatest potential for toxic air contaminant emissions would be related to diesel particulate emissions associated with heavy equipment operations during construction of the proposed project. Health effects from carcinogenic air toxics are usually described in terms of “individual cancer risk”. The California Office of Environmental Health Hazard Assessment (OEHHA) health risk guidance states that a residential receptor should be evaluated based on a 30-year exposure period. “Individual Cancer Risk” is the likelihood that a person exposed to concentrations of toxic air contaminants over a 70-year lifetime will contract cancer, based on the use of standard risk-assessment methodology. Given the short-term construction schedule, the proposed project would not result in a long-term (i.e., 30 or 70 year) exposure to a substantial source of toxic air contaminant emissions; and thus, would not be exposed to the related individual cancer risk. Therefore, no significant short-term toxic air contaminant impacts would occur during construction of the proposed project.

Construction-Related Odor Impacts

Potential sources of odor during construction activities include equipment exhaust and activities such as paving. The objectionable odors that may be produced during the construction process would occur periodically and end when construction is completed. No significant impact related to odors would occur during construction of the proposed project per threshold (d) referenced above.

Long-Term Regional Impacts

Regional Pollutant Emissions

An analysis of maximum daily emissions during operation was conducted to determine if emissions would exceed the daily thresholds for any pollutant of concern. The maximum daily operational emissions would occur at project buildout. Operational emissions were modeled for 2025, the projected first year of occupancy. Operational emissions include emissions from electricity consumption (energy sources), vehicle trips (mobile sources), and area sources including landscape equipment and architectural coating emissions as the structures are repainted over the life of the project.

The majority of operational emissions are associated with vehicle trips to and from the project site. Trip volumes were based on trip generation factors for a convenience store with a fueling facility for both light duty passenger vehicles and a truck stop use to calculate heavy truck trips. Multiple model runs were performed to quantify primary vehicle emissions associated with vehicles traveling to/from the site and heavy truck trips with the trip lengths and vehicle fleet mix adjusted to calculate emissions associated with the car/light truck separate from the heavy truck trips. The combined emissions reflect the total mobile emissions. Pass by trips (i.e., existing traffic) comprise the majority (approximately 76 percent) of project trips. These are not new trips generated by the project; however, they were included in the emissions calculations for passenger cars/light duty vehicles. Emissions sources addressed are summarized as follows:

Motor Vehicle Emissions. Motor vehicle emissions refer to exhaust and road dust emissions from the automobiles that would travel to and from the project site. Project trip generation rates were obtained from Mizuta Traffic Consulting, Inc. (November 2023). Highway commercial uses such as travel centers provide services primarily to those traveling by the site to other destinations. In this case, the trip rate was adjusted to calculate emissions from new trips. A pass-by trip accounts for vehicles already on the roadway network that stop at the project site as they pass-by. As stated, these emissions are not included in the total. With the removal of pass by trips, the project would generate approximately 2,386 new trips daily.

The vehicle fleet mix is defined as the mix of motor vehicle classes active during the operation of the project. Emission factors are assigned to the expected vehicle mix as a function of vehicle class, speed, and fuel use (gasoline and diesel-powered vehicles). As stated, the fleet mix was adjusted to calculate primary trips for passenger cars and other light duty vehicles. A separate modeling run was performed to calculate emissions associated with heavy truck trips.

Architectural Coatings (Painting). Paints release VOC emissions during application and drying. The buildings in the project would be repainted on occasion. The project is required to comply with the ICAPCD Rule 424—Architectural Coatings. The rule required flat paints to meet a standard of 100 g/l for non-flat coatings and 150 g/l for traffic/pavement markings.

Consumer Products. Consumer products are various solvents used in non-industrial applications, which emit VOCs during use. Consumer Products are generally defined as detergents; cleaning compounds; polishes; floor finishes; cosmetics; personal care products; home, lawn, and garden products; disinfectants; sanitizers; aerosol paints; and automotive specialty products. The default emission factor developed for CalEEMod was used.

Landscape Equipment. This category assumes use of equipment including lawnmowers/trimmers, blowers and related maintenance equipment. Default emission rates developed for CalEEMod were used for modeling purposes.

Electricity. Electricity used by the project (for lighting, etc.) would result in emissions from the power plants that would generate electricity distributed on the electrical power grid. Electricity emissions estimates are only used in the GHG analysis. CalEEMod was used to estimate these emissions from the project.

Natural Gas. The project would generate emissions from the combustion of natural gas for water heaters, heat, etc. CalEEMod has two categories for natural gas consumption - Title 24 and non-Title 24. CalEEMod defaults were used.

Water and Wastewater. GHG emissions are emitted from the use of electricity to pump water to the project and to treat wastewater. CalEEMod defaults were used.

Solid Waste. GHG emissions would be generated from the decomposition of solid waste generated by the project. CalEEMod was used to estimate the GHG emissions from this source.

Table 7 summarizes emissions associated with operation of the proposed project. Emissions were calculated using two separate modeling runs. One run calculated operational emissions assuming only new passenger car trips were accessing the site. The heavy truck mobile emissions are shown separately assuming one mile of total distance to/from the site and on the site. The ICAPCD thresholds for ROG, NO_x, CO, SO_x, PM₁₀ or PM_{2.5} would not be exceeded. Therefore, the project’s regional air quality impacts (including impacts related to criteria pollutants, sensitive receptors and violations of air quality standards) would be **less than significant**.

**Table 7
 Estimated Operational Emissions**

<i>Proposed Project</i>	Estimated Emissions (lbs/day)					
	ROG	NO_x	CO	SO_x	PM₁₀	PM_{2.5}
Mobile, Area and Energy	13.4	3.7	51.7	0.05	4.7	1.2
Mobile (heavy trucks)	1.4	16.7	14.3	0.02	0.3	0.1
Total Daily Emissions	14.8	20.4	66.0	0.07	5.0	1.3
<i>ICAPCD Thresholds</i>	55	55	550	150	150	55
Threshold Exceeded?	No	No	No	No	No	No

Summer emissions shown.

c. Expose sensitive receptors to substantial pollutant concentrations

Carbon Monoxide Hotspot. The nearest receptors are multifamily residences located approximately 130 feet north of the site at 498 Ross Avenue. As shown in Tables 6 and 7, project construction and operation would not exceed ICAPCD pollutant thresholds. Pollutants generated during operation would be negligible.

A CO hotspot analysis is performed if an intersection meets one of the following criteria: 1) the intersection is at Level of Service (LOS) D or worse and where the project increases the volume to capacity ratio by 2 percent, or 2) the project decreases LOS at an intersection to D or worse. A CO hotspot is a localized concentration of CO that is above the state or national 1-hour or 8-hour CO ambient air standards. Localized CO “hotspots” can occur at intersections with heavy peak hour traffic. Specifically, hotspots can be created at intersections where traffic levels are sufficiently high such that the local CO concentration exceeds the federal AAQS of 35.0 parts per million (ppm) or the state AAQS of 20.0 ppm.

As discussed in the Traffic Impact Analysis (Mizuta Traffic Consulting, Inc., December 2023), the project would add 2,386 new daily trips to cumulative conditions. The traffic analysis shows that with operation of the project in the cumulative condition, none of the intersections studied would be adversely affected. No adverse impact associated with CO hotspots would occur.

Health Risk Assessment. A Health Risk Assessment (HRA) was prepared by Entech Consulting Group, Inc. and provided under separate cover. In summary, the HRA determined that no adverse health effects associated with heavy truck operations would occur at the adjacent residence with the proposed project.

d. Result in other emissions (such as those leading to odors) adversely affecting a substantial number of people.

Objectionable Odor - Construction. Potential sources of odor during construction activities include equipment exhaust and activities such as paving. The objectionable odors that may be produced during the construction process would occur periodically and end when construction is completed.

Objectionable Odors – Operation. The occurrence and severity of potential odor impacts depends on numerous factors. The nature, frequency, and intensity of the source; the wind speeds and direction; and the sensitivity of receiving location each contribute to the intensity of the impact. Although offensive odors seldom cause physical harm, they can be annoying and cause distress among the public and generate citizen complaints. Odors would be potentially generated from vehicles and equipment exhaust emissions during construction of the project. Potential odors produced during construction would be attributable to exhaust emissions, architectural coatings, and asphalt pavement application. Such odors would disperse rapidly from the project site and generally occur at magnitudes that would not affect substantial numbers of people. Therefore, impacts associated with other emissions (such as those leading to odors) adversely affecting a substantial number of people during construction would be less than significant.

Land uses and industrial operations that are associated with odor complaints include agricultural uses, wastewater treatment plants, food processing plants, chemical plants, composting, refineries, landfills, dairies, and fiberglass molding facilities. The project would construct and operate a new travel center. The on-site uses are not associated with emissions (such as those leading to odors) adversely affecting a substantial number of people that could rise to the level of significance. Therefore, impacts would be **less than significant** per threshold (d).

GREENHOUSE GAS EMISSIONS

Gases that absorb and re-emit infrared radiation in the atmosphere are called greenhouse gases (GHGs). GHGs are present in the atmosphere naturally, are released by natural sources, or are formed from secondary reactions taking place in the atmosphere. The gases that are widely seen as the principal contributors to human-induced climate change include carbon dioxide (CO₂), methane (CH₄), nitrous oxides (N₂O), fluorinated gases such as hydrofluorocarbons (HFCs) and perfluorocarbons (PFCs), and sulfur hexafluoride (SF₆). Water vapor is excluded from the list of

GHGs because it is short-lived in the atmosphere and its atmospheric concentrations are largely determined by natural processes, such as oceanic evaporation.

GHGs are emitted by both natural processes and human activities. Of these gases, CO₂ and CH₄ are emitted in the greatest quantities from human activities. Emissions of CO₂ are largely by-products of fossil fuel combustion, whereas CH₄ results from off-gassing associated with agricultural practices and landfills. Man-made GHGs, many of which have greater heat-absorption potential than CO₂, include fluorinated gases and sulfur hexafluoride (SF₆) (California Environmental Protection Agency [CalEPA], 2006). Different types of GHGs have varying global warming potentials (GWPs). The GWP of a GHG is the potential of a gas or aerosol to trap heat in the atmosphere over a specified timescale (generally, 100 years). Because GHGs absorb different amounts of heat, a common reference gas (CO₂) is used to relate the amount of heat absorbed to the amount of the gas emissions, referred to as “carbon dioxide equivalent” (CO₂E), and is the amount of a GHG emitted multiplied by its GWP. Carbon dioxide has a GWP of one. By contrast, methane (CH₄) has a GWP of 28, meaning its global warming effect is 28 times greater than carbon dioxide on a molecule per molecule basis (IPCC, 2014).

The largest source of GHG in California is transportation, contributing 39.9 percent of the state’s total GHG emissions. The industrial sector is the second largest source, contributing 21 percent of the state’s GHG emissions. California emissions result in part to its geographic size and large population compared to other states. However, a factor that reduces California’s per capita fuel use and GHG emissions, as compared to other states, is its relatively mild climate. In July 2017, California’s state legislature passed Assembly Bill (AB) 398 to reauthorize and extend until 2030 the state’s economy-wide GHG reduction program. California has established a GHG target of at least 40% below the 1990 level of emissions by 2030.

California Regulations

In 2005, former Governor Schwarzenegger issued Executive Order (EO) S-3-05, establishing statewide GHG emissions reduction targets. EO S-3-05 states that by 2020, emissions shall be reduced to 1990 levels; and by 2050, emissions shall be reduced to 80 percent of 1990 levels (CalEPA, 2006). In response to EO S-3-05, CalEPA created the Climate Action Team (CAT), which in March 2006 published the Climate Action Team Report (the “2006 CAT Report”) (CalEPA, 2006). The 2006 CAT Report recommended various strategies that the state could pursue to reduce GHG emissions. These strategies could be implemented by various state agencies to ensure that the emission reduction targets in EO S-3-05 are met and can be met with existing authority of the state agencies. The strategies include the reduction of passenger and light duty truck emissions, the reduction of idling times for diesel trucks, an overhaul of shipping technology/infrastructure, increased use of alternative fuels, increased recycling, and landfill methane capture.

Assembly Bill 32 and CARB’s Scoping Plan

To further the goals established in EO S-3-05, the Legislature passed Assembly Bill (AB) 32, the California Global Warming Solutions Act of 2006. AB 32 requires California to reduce its GHG

emissions to 1990 levels by 2020. Under AB 32, CARB is responsible for and is recognized as having the expertise to carry out and develop the programs and requirements necessary to achieve the GHG emissions reduction mandate of AB 32. Under AB 32, CARB must adopt regulations requiring the reporting and verification of statewide GHG emissions from specified sources. This program is used to monitor and enforce compliance with established standards. CARB also is required to adopt rules and regulations to achieve the maximum technologically feasible and cost-effective GHG emission reductions. AB 32 authorized CARB to adopt market-based compliance mechanisms to meet the specified requirements. Finally, CARB is responsible for monitoring compliance and enforcing any rule, regulation, order, emission limitation, emission reduction measure, or market-based compliance mechanism adopted.

In 2007, CARB approved a limit on the statewide GHG emissions level for year 2020 consistent with the determined 1990 baseline (427 MMT CO₂E). CARB's adoption of this limit is in accordance with Health and Safety Code, Section 38550.

Further, in 2008, CARB adopted the Scoping Plan in accordance with Health and Safety Code Section 38561. The Scoping Plan establishes an overall framework for the measures that will be adopted to reduce California's GHG emissions for various emission sources/sectors to 1990 levels by 2020. The Scoping Plan evaluates opportunities for sector-specific reductions, integrates all CARB and Climate Action Team early actions and additional GHG reduction features by both entities, identifies additional measures to be pursued as regulations, and outlines the role of a cap-and-trade program. The key elements of the Scoping Plan include the following (CARB 2008):

1. Expanding and strengthening existing energy efficiency programs, as well as building and appliance standards;
2. Achieving a statewide renewable energy mix of 33%;
3. Developing a California cap-and-trade program that links with other Western Climate Initiative partner programs to create a regional market system and caps sources contributing 85% of California's GHG emissions;
2. Establishing targets for transportation-related GHG emissions for regions throughout California, and pursuing policies and incentives to achieve those targets;
3. Adopting and implementing measures pursuant to existing state laws and policies, including California's clean car standards, goods movement measures, and the Low Carbon Fuel Standard; and
4. Creating targeted fees, including a public goods charge on water use, fees on high GWP gases, and a fee to fund the administrative costs of the State of California's long-term commitment to AB 32 implementation.

In the Scoping Plan (CARB 2008), CARB determined that achieving the 1990 emissions level in 2020 would require a reduction in GHG emissions of approximately 28.5% from the otherwise projected 2020 emissions level (i.e., those emissions that would occur in 2020) absent GHG reducing laws and regulations (referred to as Business-As-Usual (BAU)). To calculate this percentage reduction, CARB assumed that all new electricity generation would be supplied by

natural gas plants, no further regulatory action would impact vehicle fuel efficiency, and building energy efficiency codes would be held at 2005 standards.

In the 2011 Final Supplement to the AB 32 Scoping Plan Functional Equivalent Document (CARB 2011a), CARB revised its estimates of the projected 2020 emissions level in light of the economic recession and the availability of updated information about GHG reduction regulations. Based on the new data, CARB determined that achieving the 1990 emissions level by 2020 would require a reduction in GHG emissions of 21.7% (down from 28.5%) from the BAU conditions. When the 2020 emissions level projection was updated to account for newly implemented regulatory measures, including Pavley I (model years 2009– 2016) and the Renewables Portfolio Standard (RPS) (12% to 20%), CARB determined that achieving the 1990 emissions level in 2020 would require a reduction in GHG emissions of 16% (down from 28.5%) from the BAU conditions.

In 2014, CARB adopted the First Update to the Climate Change Scoping Plan: Building on the Framework (First Update; CARB 2014). The stated purpose of the First Update is to “highlight California’s success to date in reducing its GHG emissions and lay the foundation for establishing a broad framework for continued emission reductions beyond 2020, on the path to 80% below 1990 levels by 2050” (CARB 2014). The First Update found that California is on track to meet the 2020 emissions reduction mandate established by AB 32 and noted that California could reduce emissions further by 2030 to levels needed to stay on track to reduce emissions to 80% below 1990 levels by 2050 if the state realizes the expected benefits of existing policy goals.

In conjunction with the First Update, CARB identified “six key focus areas comprising major components of the state’s economy to evaluate and describe the larger transformative actions that will be needed to meet the state’s more expansive emission reduction needs by 2050” (CARB 2014). Those six areas are (1) energy, (2) transportation (vehicles/equipment, sustainable communities, housing, fuels, and infrastructure), (3) agriculture, (4) water, (5) waste management, and (6) natural and working lands. The First Update identifies key recommended actions for each sector that will facilitate achievement of EO S-3-05’s 2050 reduction goal (CARB 2014).

Based on CARB’s research efforts presented in the First Update, it has a “strong sense of the mix of technologies needed to reduce emissions through 2050” (CARB 2014). Those technologies include energy demand reduction through efficiency and activity changes; large-scale electrification of on-road vehicles, buildings, and industrial machinery; decarbonizing electricity and fuel supplies; and the rapid market penetration of efficient and clean energy technologies. As part of the First Update, CARB recalculated the state’s 1990 emissions level using more recent GWPs identified by the IPCC. Using the recalculated 1990 emissions level (431 MMT CO₂E) and the revised 2020-emissions-level projection identified in the 2011 Final Supplement, CARB determined that achieving the 1990 emissions level by 2020 would require a reduction in GHG emissions of approximately 15% (instead of 28.5% or 16%) from the BAU conditions (CARB 2014).

In January 2017, CARB released, *The 2017 Climate Change Scoping Plan Update (Second Update; CARB 2017b)*, for public review and comment. This update proposes CARB's strategy for achieving the state's 2030 GHG target as established in Senate Bill (SB) 32 (discussed below), including continuing the Cap-and-Trade Program through 2030, and includes a new approach to reduce GHGs from refineries by 20%. The Second Update incorporates approaches to cutting short-lived climate pollutants (SLCPs) under the Short-Lived Climate Pollutant Reduction Strategy (a planning document that was adopted by CARB in March 2017), acknowledges the need for reducing emissions in agriculture, and highlights the work underway to ensure that California's natural and working lands increasingly sequester carbon. During development of the Second Update, CARB held a number of public workshops in the Natural and Working Lands, Agriculture, Energy, and Transportation sectors to inform development of the 2030 Scoping Plan Update (CARB 2016). The Second Update has not been considered by CARB's Governing Board at the time this analysis was prepared.

Executive Order S-01-07 was enacted on January 18, 2007. The order mandates that a Low Carbon Fuel Standard ("LCFS") for transportation fuels be established for California to reduce the carbon intensity of California's transportation fuels by at least 10 percent by 2020.

Other regulations affecting state and local GHG planning and policy development are summarized as follows:

Assembly Bill 939 and Senate Bill 1374

Assembly Bill 939 (AB 939) requires that each jurisdiction in California to divert at least 50 percent of its waste away from landfills, whether through waste reduction, recycling or other means. Senate Bill 1374 (SB 1374) requires the California Integrated Waste Management Board to adopt a model ordinance by March 1, 2004 suitable for adoption by any local agency to require 50 to 75 percent diversion of construction and demolition of waste materials from landfills.

Senate Bill 1368

SB 1368 required the California Public Utilities Commission (CPUC) to establish a performance standard for baseload generation of GHG emissions by investor-owned utilities by February 1, 2007 and for local publicly owned utilities by June 30, 2007. These standards could not exceed the GHG emissions rate from a baseload combined-cycle, natural gas-fired plant. Furthermore, the legislation states that all electricity provided to the State, including imported electricity, must be generated by plants that meet the standards set by CPUC and California Energy Commission (CEC).

Senate Bill 97

Senate Bill 97 (SB 97) was adopted August 2007 and acknowledges that climate change is an environmental issue that requires analysis under CEQA. SB 97 directed the Governor's Office of Planning and Research (OPR), which is part of the State Natural Resources Agency, to prepare, develop, and transmit to CARB guidelines for the feasible mitigation of GHG emissions or the effects of GHG emissions, as required by CEQA, by July 1, 2009. The Natural Resources Agency

was required to certify and adopt those guidelines by January 1, 2010. On December 30, 2009 the Natural Resources Agency adopted amendments to the CEQA guidelines that address GHG emissions. The CEQA Guidelines Amendments changed sections of the CEQA Guidelines and incorporated GHG language throughout the Guidelines. However, no GHG emissions thresholds of significance were provided and no specific mitigation measures were identified. The GHG emission reduction amendments went into effect on March 18, 2010 and are summarized below:

1. Climate action plans and other greenhouse gas reduction plans can be used to determine whether a project has significant impacts, based upon its compliance with the plan.
2. Local governments are encouraged to quantify the greenhouse gas emissions of proposed projects, noting that they have the freedom to select the models and methodologies that best meet their needs and circumstances. The section also recommends consideration of several qualitative factors that may be used in the determination of significance, such as the extent to which the given project complies with state, regional, or local GHG reduction plans and policies. OPR does not set or dictate specific thresholds of significance. Consistent with existing CEQA Guidelines, OPR encourages local governments to develop and publish their own thresholds of significance for GHG impacts assessment.
3. When creating their own thresholds of significance, local governments may consider the thresholds of significance adopted or recommended by other public agencies, or recommended by experts.
4. New amendments include guidelines for determining methods to mitigate the effects of greenhouse gas emissions in Appendix F of the CEQA Guidelines.
5. OPR is clear to state that “to qualify as mitigation, specific measures from an existing plan must be identified and incorporated into the project; general compliance with a plan, by itself, is not mitigation.”
6. OPR’s emphasizes the advantages of analyzing GHG impacts on an institutional, programmatic level. OPR therefore approves tiering of environmental analyses and highlights some benefits of such an approach.
7. Environmental impact reports (EIRs) must specifically consider a project's energy use and energy efficiency potential.

Senate Bills 1078, 107, and X1-2 and Executive Orders S-14-08 and S-21-09

Senate Bill 1078 (SB 1078) requires retail sellers of electricity, including investor-owned utilities and community choice aggregators, to provide at least 20 percent of their supply from renewable sources by 2017. Senate Bill 107 (SB 107) changed the target date to 2010. Executive

Order S-14-08 was signed on November 2008 and expands the State's Renewable Energy Standard to 33 percent renewable energy by 2020. Executive Order S-21-09 directed CARB to adopt regulations by July 31, 2010 to enforce S-14-08. Senate Bill X1-2 codifies the 33 percent renewable energy requirement by 2020.

California Code of Regulations (CCR) Title 24, Part 6

CCR Title 24, Part 6: California's Energy Efficiency Standards for Residential and Nonresidential Buildings (Title 24) were first established in 1978 in response to a legislative mandate to reduce California's energy consumption. The standards are updated periodically to allow consideration and possible incorporation of new energy efficiency technologies and methods. Although it was not originally intended to reduce GHG emissions, electricity production by fossil fuels results in GHG emissions and energy efficient buildings require less electricity. Therefore, increased energy efficiency results in decreased GHG emissions.

The 2022 Title 24 standards are the currently applicable building energy efficiency standards, and became effective on January 1, 2023. The 2022 Title 24 Building Energy Efficiency Standards will further reduce energy used and associated GHG emissions compared to prior standards.

On August 11, 2021, the CEC adopted the 2022 Energy Code. In December 2021, it was approved by the California Building Standards Commission for inclusion into the California Building Standards Code. The 2022 Energy Code encourages efficient electric heat pumps, establishes electric-ready requirements for new homes, expands solar photovoltaic and battery storage standards, strengthens ventilation standards, and more. Buildings whose permit applications are applied for on or after January 1, 2023, must comply with the 2022 Energy Code.

Senate Bill 375

SB 375 (2008) addresses GHG emissions associated with the transportation sector through regional transportation and sustainability plans. SB 375 required CARB to adopt regional GHG reduction targets for the automobile and light-truck sector for 2020 and 2035. Regional metropolitan planning organizations are then responsible for preparing a Sustainable Communities Strategy (SCS) within their Regional Transportation Plan (RTP). The goal of the SCS is to establish a forecasted development pattern for the region that, after considering transportation measures and policies, will achieve, if feasible, the GHG reduction targets. If an SCS is unable to achieve the GHG reduction target, a metropolitan planning organization must prepare an Alternative Planning Strategy demonstrating how the GHG reduction target would be achieved through alternative development patterns, infrastructure, or additional transportation measures or policies. Pursuant to California Government Code Section 65080(b)(2)(K), an SCS does not regulate the use of land; supersede the land use authority of cities and counties; or require that a city's or county's land use policies and regulations, including those in a general plan, be consistent with it. Nonetheless, SB 375 makes regional and local planning agencies responsible for developing those strategies as part of the federally required metropolitan transportation planning process and the state-mandated housing element process.

In 2010, CARB adopted the SB 375 targets for the regional metropolitan planning organizations. The targets adopted for SANDAG in 2010 are a 7% reduction in per-capita passenger-vehicle GHG emissions by 2020 and a 13% reduction by 2035, measured relative to 2005 GHG emissions. In 2018, CARB adopted the second round of SB 375 reduction targets, and increased SANDAG's 2020 target to a 15% reduction in per-capita passenger-vehicle GHG emissions, and the 2035 target to a 19% reduction using the same 2005 baseline.

Senate Bill X7-7

Senate Bill X7-7 (SB X7-7), enacted on November 9, 2009, mandates water conservation targets and efficiency improvements for urban and agricultural water suppliers. SB X7-7 requires the Department of Water Resources (DWR) to develop a task force and technical panel to develop alternative best management practices for the water sector. Additionally, SB X7-7 required the DWR to develop criteria for baseline uses for residential, commercial, and industrial uses for both indoor and landscaped area uses. The DWR was also required to develop targets and regulations that achieve a statewide 20 percent reduction in water usage.

California Green Building Standards

Title 24 of the California Code of Regulations was established in 1978 and serves to enhance and regulate California's building standards. While not initially promulgated to reduce GHG emissions, Part 6 of Title 24 specifically establishes Building Energy Efficiency Standards that are designed to ensure new and existing buildings in California achieve energy efficiency and preserve outdoor and indoor environmental quality. These energy efficiency standards are reviewed every few years by the Building Standards Commission and the California Energy Commission (CEC) (and revised if necessary) (California Public Resources Code, Section 25402(b)(1)). The regulations receive input from members of industry, as well as the public, with the goal of "reducing of wasteful, uneconomic, inefficient, or unnecessary consumption of energy" (California Public Resources Code, Section 25402). These regulations are carefully scrutinized and analyzed for technological and economic feasibility (California Public Resources Code, Section 25402(d)) and cost effectiveness (California Public Resources Code, Sections 25402(b)(2) and (b)(3)). These standards are updated to consider and incorporate new energy efficient technologies and construction methods. As a result, these standards save energy, increase electricity supply reliability, increase indoor comfort, avoid the need to construct new power plants, and help preserve the environment.

The 2019 Title 24 building energy efficiency standards and became effective on January 1, 2020 and addressed lighting, heating, cooling, ventilation, and water heating standards. The 2022 Energy Code encourages efficient electric heat pumps, establishes electric-ready requirements for new homes, expands solar photovoltaic and battery storage standards and strengthens ventilation standards.

Title 24, Part 11. In addition to the CEC's efforts, in 2008, the California Building Standards Commission adopted the nation's first green building standards. The California Green Building Standards Code (Part 11 of Title 24) is commonly referred to as "CALGreen," and establishes

minimum mandatory standards and voluntary standards pertaining to the planning and design of sustainable site development, energy efficiency (in excess of the California Energy Code requirements), water conservation, material conservation, and interior air quality. The CALGreen standards initially took effect in January 2011 and instituted mandatory minimum environmental performance standards for all ground-up, new construction of commercial, low-rise residential, and state-owned buildings and schools and hospitals. The CALGreen 2019 standards became effective on January 1, 2020. The CALGreen 2022 standards are the most current and became effective January, 2023. The mandatory standards require the following (24 CCR Part 11):

- Mandatory reduction in indoor water use through compliance with specified flow rates for plumbing fixtures and fittings;
- Mandatory reduction in outdoor water use through compliance with a local water efficient landscaping ordinance or the California Department of Water Resources' Model Water
- Efficient Landscape Ordinance;
- Diversion of 65% of construction and demolition waste from landfills;
- Mandatory inspections of energy systems to ensure optimal working efficiency;
- Inclusion of electric vehicle charging stations or designated spaces capable of supporting future charging stations; and
- Low-pollutant-emitting exterior and interior finish materials, such as paints, carpets, vinyl flooring, and particle board.

The CALGreen standards also include voluntary efficiency measures that are provided at two separate tiers and implemented at the discretion of local agencies and applicants. CALGreen's Tier 1 standards call for a 15% improvement in energy requirements, stricter water conservation, 65% diversion of construction and demolition waste, 10% recycled content in building materials, 20% permeable paving, 20% cement reduction, and cool/solar-reflective roofs. CALGreen's more rigorous Tier 2 standards call for a 30% improvement in energy requirements, stricter water conservation, 75% diversion of construction and demolition waste, 15% recycled content in building materials, 30% permeable paving, 25% cement reduction, and cool/solar-reflective roofs (24 CCR Part 11).

The California Public Utilities Commission, CEC, and CARB also have a shared, established goal of achieving zero net energy (ZNE) for new construction in California. The key policy timelines include the following: (1) all new residential construction in California will be ZNE by 2020, and (2) all new commercial construction in California will be ZNE by 2030 (CPUC 2013).² As most recently defined by the CEC in its 2015 Integrated Energy Policy Report., a ZNE code building is "one where the value of the energy produced by on-site renewable energy

² It is expected that achievement of the ZNE goal will occur through revisions to the Title 24 standards.

resources is equal to the value of the energy consumed annually by the building” using the CEC’s Time Dependent Valuation metric.

In November 2022, CARB released a proposal to set new targets for renewable energy, clean buildings, carbon removal, and clean fuels in the transportation sector. If adopted by CARB, this plan will implement actions to build out a 100% clean energy grid, achieve carbon neutrality by 2045.

Title 20

Title 20 of the California Code of Regulations requires manufacturers of appliances to meet state and federal standards for energy and water efficiency. Performance of appliances must be certified through the CEC to demonstrate compliance with standards. New appliances regulated under Title 20 include refrigerators, refrigerator-freezers, and freezers; room air conditioners and room air-conditioning heat pumps; central air conditioners; spot air conditioners; vented gas space heaters; gas pool heaters; plumbing fittings and plumbing fixtures; fluorescent lamp ballasts; lamps; emergency lighting; traffic signal modules; dishwaters; clothes washers and dryers; cooking products; electric motors; low voltage dry-type distribution transformers; power supplies; televisions and consumer audio and video equipment; and battery charger systems. Title 20 presents protocols for testing for each type of appliance covered under the regulations and appliances must meet the standards for energy performance, energy design, water performance, and water design. Title 20 contains three types of standards for appliances: federal and state standards for federally regulated appliances, state standards for federally regulated appliances, and state standards for non-federally regulated appliances.

Executive Order B-30-15

EO B-30-15 (April 2015) identified an interim GHG reduction target in support of targets previously identified under S-3-05 and AB 32. EO B-30-15 set an interim target goal of reducing statewide GHG emissions to 40% below 1990 levels by 2030 to keep California on its trajectory toward meeting or exceeding the long-term goal of reducing statewide GHG emissions to 80% below 1990 levels by 2050 as set forth in EO S-3-05. To facilitate achievement of this goal, EO B-30-15 calls for an update to CARB’s Scoping Plan to express the 2030 target in terms of MMT CO₂E. EO B-30-15 also calls for state agencies to continue to develop and implement GHG emission reduction programs in support of the reduction targets. EO B-30-15 does not require local agencies to take any action to meet the new interim GHG reduction target.

Senate Bill 32 and Assembly Bill 197

SB 32 and AB 197 (enacted in 2016) are companion bills that set new statewide GHG reduction targets, make changes to CARB’s membership, increase legislative oversight of CARB’s climate change-based activities, and expand dissemination of GHG and other air quality-related emissions data to enhance transparency and accountability. More specifically, SB 32 codified the 2030 emissions reduction goal of EO B-30-15 by requiring CARB to ensure that statewide GHG emissions are reduced to 40% below 1990 levels by 2030. AB 197 established the Joint Legislative Committee on Climate Change Policies, consisting of at least three members of the Senate and

three members of the Assembly, in order to provide ongoing oversight over implementation of the state's climate policies. AB 197 added two members of the Legislature to CARB as nonvoting members; requires CARB to make available and update (at least annually via its website) emissions data for GHGs, criteria air pollutants, and toxic air contaminants from reporting facilities; and requires CARB to identify specific information for GHG emissions reduction measures when updating the Scoping Plan.

SB 350— Clean Energy and Pollution Reduction Act of 2015

In October 2015, the legislature approved and the Governor signed SB 350, which reaffirms California's commitment to reducing its GHG emissions and addressing climate change. Key provisions include an increase in the renewables portfolio standard (RPS), higher energy efficiency requirements for buildings, initial strategies towards a regional electricity grid, and improved infrastructure for electric vehicle charging stations. Provisions for a 50 percent reduction in the use of petroleum statewide were removed from the Bill because of opposition and concern that it would prevent the Bill's passage. Specifically, SB 350 requires the following to reduce statewide GHG emissions:

8. Increase the amount of electricity procured from renewable energy sources from 33 percent to 50 percent by 2030, with interim targets of 40 percent by 2024, and 25 percent by 2027.
9. Double the energy efficiency in existing buildings by 2030. This target will be achieved through the CPUC, the CEC, and local publicly-owned utilities.
10. Reorganize the Independent System Operator (ISO) to develop more regional electrify transmission markets and to improve accessibility in these markets, which will facilitate the growth of renewable energy markets in the western United States.

SB 100

On September 10, 2018, Governor Brown signed SB 100, which raises California's RPS requirements to 60 percent by 2030, with interim targets, and 100 percent by 2045. The bill also establishes a state policy that eligible renewable energy resources and zero-carbon resources supply 100 percent of all retail sales of electricity to California end-use customers and 100 percent of electricity procured to serve all state agencies by December 31, 2045. Under the bill, the state cannot increase carbon emissions elsewhere in the western grid or allow resource shuffling to achieve the 100 percent carbon-free electricity target.

Executive Order B-55-18

On September 10, 2018, Governor Brown signed Executive Order B-55-2018 which established a new statewide goal to achieve carbon neutrality as soon as possible and no later than 2045. The executive order also states that California will achieve and maintain net negative emissions thereafter.

AB 2127

AB 2127 promotes better planning for EV infrastructure build-out across all vehicle classes. AB 2127 would help the state meet the goal of 5 million zero-emission vehicles (ZEV) on the road by 2030.

Local Regulations and CEQA Requirements

Pursuant to the requirements of SB 97, the Resources Agency has adopted amendments to the State CEQA Guidelines for the feasible mitigation of GHG emissions or the effects of GHG emissions. The adopted CEQA Guidelines provide general regulatory guidance on the analysis and mitigation of GHG emissions in CEQA documents but contain no suggested thresholds of significance for GHG emissions. Instead, lead agencies are given the discretion to set quantitative or qualitative thresholds for the assessment and mitigation of GHGs and climate change impacts. The general approach to developing a Threshold of Significance for GHG emissions is to identify the emissions level for which a project would not be expected to substantially conflict with existing California legislation adopted to reduce statewide GHG emissions needed to move the state towards climate stabilization. If a project would generate GHG emissions above the threshold level, its contribution to cumulative impacts would be considered significant.

The California Supreme Court addressed the issue of GHG emissions and the evaluation of potential impacts in CEQA documents, in the *Center for Biological Diversity v. California Department of Fish and Wildlife and Newhall Land and Farming* case, (2015) 224 Cal.App.4th 1105 (CBD vs. CDFW), also known as the “Newhall Ranch” case. The justices examined one of the most common approaches to GHG analyses for development projects which was evaluating the efficiency of a project’s emissions reduction in the context of the AB 32’s 2020 reduction goal, as presented in the statewide CARB Scoping Plan, using a comparison to an unregulated, “business as usual (BAU)” emissions scenario. As discussed in the Newhall Ranch decision, determining consistency with local GHG reduction plans or Climate Action Plans that qualify under Section 15183.5 of the CEQA Guidelines may be the most effective strategy for local governments to assess the significance of GHG emissions from proposed land development projects. Qualified CAPs also provide a workable option for addressing post-2020 GHG emissions and resolving issues that arise out of project-level GHG analyses raised in the Court’s decision.

The Imperial County Transportation Commission adopted a Climate Action Plan (June 2021); however, no specific quantitative thresholds are provided to evaluate whether specific projects would have adverse impacts with respect to GHG emissions. As stated in Section 15064.7(c) of the CEQA Guidelines, a lead agency may consider thresholds of significance previously adopted or recommended by other public agencies, or recommended by experts, provided the lead agency’s decision is supported by substantial evidence. Thus, in the absence of any GHG emissions significance thresholds, the projected emissions are compared to the SCAQMD numeric threshold of 3,000 metric tons of CO₂e (carbon dioxide equivalent) annually. This threshold is also appropriate as the SCAQMD GHG thresholds were formulated based on similar geography and climate patterns as found in Imperial County and are used for

determining the significance of GHG emissions in the Riverside County portion of the Salton Sea Air Basin, the air basin where the project is located.

Therefore, the 3,000 metric ton of CO₂e threshold is appropriate for analysis of the proposed project. The project is also evaluated for consistency with regulations or requirements adopted by the 2017 CARB Climate Change Scoping Plan and 2022 Scoping Plan Update. GHG emissions were modeled using CalEEMod 2022.1, the statewide land use emissions computer model designed to estimate air and GHG emissions associated with both construction and operations from land development projects.

CLIMATE CHANGE IMPACT ANALYSIS

Thresholds of Significance

Pursuant to the requirements of SB 97, the Resources Agency adopted amendments to the State CEQA Guidelines for the feasible mitigation of GHG emissions or the effects of GHG emissions in March 2010. These guidelines are used in evaluating the cumulative significance of GHG emissions from the proposed project. According to the adopted CEQA Guidelines, impacts related to GHG emissions from the proposed project would be significant if the project would:

- a. Generate greenhouse gas emissions, either directly or indirectly, that may have a significant impact on the environment; and/or*
- b. Conflict with an applicable plan, policy or regulation adopted for the purpose of reducing the emissions of greenhouse gases.*

The vast majority of individual projects do not generate sufficient GHG emissions to create a project-specific impact through a direct influence to climate change; therefore, the issue of climate change typically involves an analysis of whether a project's contribution towards an impact is cumulatively considerable. "Cumulatively considerable" means that the incremental effects of an individual project are significant when viewed in connection with the effects of past projects, other current projects, and probable future projects (CEQA Guidelines, Section 15355).

Methodology

GHG emissions associated with construction and operation of the proposed project and existing development have been estimated using California Emissions Estimator Model (CalEEMod) version 2022.1.

Construction Emissions

Construction of the proposed project would generate temporary GHG emissions primarily associated with the operation of construction equipment, worker trips and truck trips required for hauling excavation spoils, materials and equipment. Site preparation and grading typically generate the greatest emission quantities because the use of heavy equipment is greatest during

this phase of construction. Emissions associated with the construction period were estimated based on the projected maximum amount of equipment that would be used on-site at one time. Air districts such as the SDAPCD have recommended amortizing construction-related emissions over a 30-year period to calculate annual emissions. Complete CalEEMod results and assumptions can be viewed in the Appendix.

Operational Emissions

Default values used in CalEEMod version 2022.1 are based on the California Energy Commission (CEC) sponsored California Commercial End Use Survey (CEUS) and Residential Appliance Saturation Survey (RASS) studies. CalEEMod provides operational emissions of CO₂, N₂O and CH₄. This methodology has been subjected to peer review by numerous public and private stakeholders, and in particular by the CEC; and therefore, is considered reasonable and reliable for use in GHG impact analysis pursuant to CEQA. It is also recommended by CAPCOA (January 2008).

Emissions associated with area sources (i.e., consumer products, landscape maintenance, and architectural coating) were calculated in CalEEMod based on standard emission rates from CARB, USEPA, and district supplied emission factor values (CalEEMod User Guide, 2022). Emissions from waste generation were also calculated in CalEEMod and are based on the IPCC's methods for quantifying GHG emissions from solid waste using the degradable organic content of waste (CalEEMod User Guide, 2022). Waste disposal rates by land use and overall composition of municipal solid waste in California was primarily based on data provided by the California Department of Resources Recycling and Recovery (CalRecycle).

Emissions from water and wastewater usage calculated in CalEEMod were based on the default electricity intensity from the CEC's 2006 Refining Estimates of Water-Related Energy Use in California using the average values for Northern and Southern California. Emissions from mobile sources were quantified based on trip generation rates in Trip Generation Memorandum (June 2023).

a. Would the project generate greenhouse gas emissions, either directly or indirectly, that may have a significant impact on the environment?

Construction Emissions

Construction activity analysis is based on the anticipated construction period beginning in late 2024 with completion in 2025. Based on CalEEMod results, construction activity for the project would generate an estimated 329 metric tons of carbon dioxide equivalent (CO₂E), as shown in Table 8. Amortized over a 30-year period (the assumed life of the project), construction of the proposed project would generate 11 metric tons of CO₂E per year.

Table 8
Estimated Construction Related Greenhouse Gas Emissions

Year	Annual Emissions (metric tons CO₂E)
2024	77
2025	312
Total	329
Amortized over 30 years	11

See Appendix for CalEEMod software program output

Operational Indirect and Stationary Direct Emissions

Long-term emissions relate to energy use, solid waste, water use, and transportation. Each source is discussed below and includes the emissions associated with existing development and the anticipated emissions that would result from the proposed project.

Energy Use. Operation of onsite development would consume both electricity and natural gas (see Appendix for CalEEMod results). The generation of electricity through combustion of fossil fuels typically yields CO₂, and to a smaller extent, N₂O and CH₄. Natural gas emissions can be calculated using default values from the CEC sponsored CEUS and RASS studies which are built into CalEEMod. As shown in Table 9, the overall net increase in energy use at the project site would result in approximately 117 metric tons of CO₂E per year.

Water Use Emissions. The CalEEMod results indicate that the project would use approximately 207,811 gallons of water per year. Based on the amount of electricity generated to supply and convey this amount of water, as shown in Table 10, unmitigated, project would generate approximately 0.3 metric tons of CO₂E per year. Emissions related to water consumption would be reduced by 20% per Senate Bill X7-7, by implementing measures that include the installation of low flow plumbing fixtures (i.e., faucets, toilets, show heads) and water efficient irrigation systems.

Solid Waste Emissions. Implementation of a municipal recycling program that would achieve a 75% diversion rate statewide is required for residential uses per the California Integrated Waste Management Act of 1989 (AB 939). The unmitigated CalEEMod results indicate that the project would generate 5.9 tons of solid waste annually and 2 metric tons of provided 75% of solid waste is recycled.

**Table 9
 Estimated Annual Energy-Related Greenhouse Gas Emissions**

Emission Source	Annual Emissions (CO₂E)
<i>Proposed Project</i>	
Electricity/Natural Gas	117 metric tons
Total	117 metric tons

See Appendix for CalEEMod software program output.

**Table 10
 Estimated Annual
 Solid Waste and Water Use Greenhouse Gas Emissions**

Emission Source	Annual Emissions (CO₂E)
Water	0.3 metric tons
Solid Waste	2 metric tons
Total Water and Solid Waste	2.3 metric tons

See Appendix for CalEEMod software program output.

Transportation Emissions. Mobile source GHG emissions were estimated using modified trip generation rates from the Trip Generation Memorandum (December 2023). Table 11 shows the estimated mobile emissions of GHGs associated with new passenger vehicle trips and heavy trucks operating on the site. As shown in Table 11, the project would generate approximately 1,410 metric tons of CO₂E associated with vehicle trips.

**Table 11
 Estimated Annual Mobile Emissions of Greenhouse Gases**

Emission Source	Annual Emissions (CO₂E)
<i>Proposed Project</i>	
Mobile Emissions (CO ₂ & CH ₄)	903 passenger cars
	507 heavy trucks
Total	1,410 metric tons

See Appendix for CalEEMod software program output.

In addition to the sources referenced above, the project is expected to generate 205 metric tons per year in emissions associated with use of refrigerants and additional one metric ton associated with area sources.

Combined Construction, Stationary and Mobile Source Emissions

Table 12 combines construction, operational, and mobile GHG emissions associated with the proposed project. For the proposed project, the combined annual unmitigated emissions would total approximately 1,746 metric tons per year in CO₂E. The proposed project is evaluated based on the threshold of 3,000 MT CO₂E annually. Project-related annual GHG emissions would not exceed the 3,000 metric ton screening threshold; thus, the project will not generate greenhouse gas emissions, either directly or indirectly, that may have a significant impact on the environment. Construction and operational project impacts from GHG emissions would be **less than significant** per threshold a.

Table 12
Combined Annual Greenhouse Gas Emissions

Emission Source	Annual Emissions (CO₂E)
Construction	11 metric tons
Operational	
Energy	117 metric tons
Solid Waste	2 metric tons
Water	0.3 metric tons
Area Sources	1 metric ton
Refrigerants	205 metric tons
Mobile	1,410 metric tons
Total	1,746 metric tons

See Appendix for CalEEMod software program output.

b. Would the project conflict with an applicable plan, policy or regulation adopted for the purpose of reducing the emissions of greenhouse gases?

As stated, the County of Imperial does not have a Climate Action Plan and the Imperial County Transportation Commission June 2021 Climate Action Plan does not provide GHG emission thresholds for use in determining impacts for CEQA purpose. However, the applicant would be required to implement California Energy Code Title 24 requirements that would address energy and water use reduction, promotion of green building measures, waste reduction and reduction in vehicle miles traveled. Further, the proposed project would be required to implement all mandatory green building measures for new commercial/retail development under the CALGreen Code. This would require the project be designed to minimize water consumption, increase building system efficiencies, divert construction waste from landfills and maintain buildings systems. Implementation of these building and appliance standards would result in the efficient use of water and energy and reduce the volume of landfilled solid waste during both construction and operation.

There are numerous State plans, policies, and regulations adopted for the purpose of reducing GHG emissions. The principal overall State plan and policy is AB 32, the California Global Warming Solutions Act of 2006. The quantitative goal of AB 32 is to reduce GHG emissions to

1990 levels by 2020. SB 32 would require further reductions of 40 percent below 1990 levels by 2030. Because the Project’s operational year is post-2020, the Project is being designed to reach the quantitative goals set by SB 32. Statewide plans and regulations such as GHG emissions standards for vehicles (AB 1493), the Low Carbon Fuel Standard, and regulations requiring an increasing fraction of electricity to be generated from renewable sources, are being implemented at the statewide level; as such, compliance at the Project level is not addressed. The proposed project would not conflict with statewide plans and regulations. The following summarizes project consistency with Connect SoCal, the 2020-2045 Regional Transportation Plan/Sustainable Communities Strategy and the 2017 CARB scoping plan and 2022 Scoping Plan Update.

Connect SoCal 2020-2045 RTP/SCS Consistency. On September 3, 2020, SCAG’s Regional Council unanimously voted to approve and fully adopt Connect SoCal (2020–2045 Regional Transportation Plan/Sustainable Communities Strategy), and the addendum to the Connect SoCal Program Environmental Impact Report. Connect SoCal is a long-range visioning plan that builds upon and expands land use and transportation strategies established over several planning cycles to increase mobility options and achieve a more sustainable growth pattern. It charts a path toward a more mobile, sustainable and prosperous region by making connections between transportation networks, between planning strategies and between the people whose collaboration can improve the quality of life for Southern California residents within the counties of Imperial, Los Angeles, Orange, Riverside, San Bernardino and Ventura.

Further, Connect SoCal is supported by a combination of transportation and land use strategies that outline how the region can achieve California's GHG emission reduction goals and federal CAA requirements. The project would utilize the existing street network for primary access to the project site. The project would not conflict with plans to integrate the transportation network and related strategies with an overall land use pattern that responds to projected growth, housing needs, changing demographics, and transportation demands. The project does not involve any improvements to the regional transportation system. The project would be consistent with or would not conflict with any of the goals identified in Connect SoCal.

SB 32/2017 Scoping Plan Consistency. The 2017 Scoping Plan Update reflects the statewide 2030 target of a 40% reduction in GHG emissions below 1990 levels, set by EP B-30-15 and codified by SB 32. Table 13 summarizes the Project's consistency with applicable action elements of the 2017 Scoping Plan.

Table 13
2017 Scoping Plan Consistency Summary

ACTION	RESPONSIBLE PARTIES	CONSISTENCY
Implement SB 350 by 2030		
Increase the Renewables Portfolio Standard to 50% of retail sales by 2030 and ensure grid reliability.	California Public Utility Commission (CPUC), California Energy Commission (CEC) and	No Conflict. The Project would use energy from the Imperial Irrigation District (IID). IID has met or exceed the renewable

ACTION	RESPONSIBLE PARTIES	CONSISTENCY
	California Air Resources Board (CARB)	portfolio standard of 33% by 2020. The Project would not interfere with or obstruct IID's energy source diversification efforts.
Establish annual targets for statewide energy efficiency savings and demand reduction that will achieve a cumulative doubling of statewide energy efficiency savings in electricity and natural gas end uses by 2030.		No Conflict. The Project would be constructed in compliance with current CBC requirements including the 2019 Building and Energy Efficiency Standards and the 2022 California Green Building Standard requirements.
Reduce GHG emissions in the electricity sector through the implementation of the above measures and other actions as modeled in Integrated Resource Planning (IRP) to meet GHG emissions reductions planning targets in the IRP process. Load-serving entities and publicly-owned utilities meet GHG emissions reductions planning targets through a combination of measures as described in IRPs.		
Implement Mobile Source Strategy (Cleaner Technology and Fuels)		
At least 1.5 million zero emission and plugin hybrid light-duty EVs by 2025.	CARB, California State Transportation Agency (CalSTA), Strategic Growth Council (SGC), California Department of Transportation (Caltrans), CEC, Office of Planning and Research (OPR), Local Agencies	No Conflict. This is a CARB Mobile Source Strategy. The Project would not obstruct or interfere with CARB zero emission and plug-in hybrid light-duty EV 2025 targets. As this is a CARB enforced standard, vehicles that access the Project must comply with the standards as applicable; and thus, would comply with the strategy.
At least 4.2 million zero emission and plugin hybrid light-duty EVs by 2030.		No Conflict. This is a CARB Mobile Source Strategy. The Project would not obstruct or interfere with CARB zero emission and plug-in hybrid light-duty EV 2030 targets.

ACTION	RESPONSIBLE PARTIES	CONSISTENCY
Further increase GHG stringency on all light-duty vehicles beyond existing Advanced Clean cars regulations.	CARB, California State Transportation Agency (CalSTA), Strategic Growth Council (SGC), California Department of Transportation (Caltrans), CEC, Office of Planning and Research (OPR), Local Agencies	No Conflict. This is a CARB Mobile Source Strategy. The Project would not obstruct or interfere with CARB efforts to further increase GHG stringency on all light-duty vehicles beyond existing Advanced Clean cars regulations.
Medium- and Heavy-Duty GHG Phase 2.		No Conflict. This is a CARB Mobile Source Strategy. The Project would not obstruct or interfere with CARB efforts to implement Medium- and Heavy-Duty GHG Phase 2.
Innovative Clean Transit: Transition to a suite of to-be-determined innovative clean transit options. Assumed 20% of new urban buses purchased beginning in 2018 will be zero emission buses with the penetration of zero-emission technology ramped up to 100% of new sales in 2030. Also, new natural gas buses, starting in 2018, and diesel buses, starting in 2020, meet the optional heavy-duty low-NOX standard.		Not Applicable. This measure is not related to the project scope.
Last Mile Delivery: New regulation that would result in the use of low NOX or cleaner engines and the deployment of increasing numbers of zero-emission trucks primarily for class 3-7 last mile delivery trucks in California. This measure assumes ZEVs comprise 2.5% of new Class 3–7 truck sales in local fleets starting in 2020, increasing to 10% in 2025 and remaining flat through 2030.		No Conflict. This is a CARB Mobile Source Strategy. The Project would not obstruct or interfere with CARB efforts to improve last mile delivery emissions.
Further reduce VMT through continued implementation of SB 375 and regional Sustainable Communities Strategies; statewide		No Conflict. The majority of all project trips would be pass by rather than new trips. The project would not trigger a requirement

ACTION	RESPONSIBLE PARTIES	CONSISTENCY
implementation of SB 743; and potential additional VMT reduction strategies not specified in the Mobile Source Strategy but included in the document "Potential VMT Reduction Strategies for Discussion."		for VMT reduction strategy implementation.
Increase stringency of SB 375 Sustainable Communities Strategy (2035 targets).	CARB	No Conflict. The project would not exceed the SCAQMD GHG emission standards and would implement all applicable code requirements to reduce GHG emissions as conditions of approval. The project would not conflict with GHG reduction efforts.
Harmonize project performance with emissions reductions and increase competitiveness of transit and active transportation modes (e.g., via guideline documents, funding programs, project selection, etc.).	CalSTA, SGC, OPR, CARB, Governor's Office of Business and Economic Development (GOBiz), California Infrastructure and Economic Development Bank (IBank), Department of Finance (DOF), California Transportation Commission (CTC), Caltrans	No Conflict. The project would not conflict with use of adjacent streets by pedestrians, bicycles or transit service provided by Imperial Valley Transit.
By 2019, develop pricing policies to support low-GHG transportation (e.g., low emission vehicle zones for heavy duty, road user, parking pricing, transit discounts).	CalSTA, Caltrans, California Transportation Commission (CTC), OPR, SGC, CARB	Not Applicable. This measure is not related to the project scope.
Implement California Sustainable Freight Action Plan		
Improve freight system efficiency.	CalSTA, CalEPA, California Natural Resource Agency (CNRA), CARB, Caltrans, CEC, GO-Biz	No Conflict. This measure would apply to all trucks accessing the project site. It is presumed that these vehicles would be comprised primarily of heavy trucks operated as part of the statewide goods movement sector.
Deploy over 100,000 freight vehicles and equipment capable of zero emission operation and		Not applicable. This measure is unrelated to the project scope.

ACTION	RESPONSIBLE PARTIES	CONSISTENCY
maximize both zero and near zero emission freight vehicles and equipment powered by renewable energy by 2030.		
Adopt a Low Carbon Fuel Standard with a Carbon Intensity reduction of 18%.	CARB	No Conflict. When adopted, this measure would apply to all fuel sold on site and purchased for use in vehicles accessing the project site. The Project would not obstruct or interfere with agency efforts to adopt a Low Carbon Fuel Standard with a Carbon Intensity reduction of 18%.
Implement the Short-Lived Climate Pollutant Strategy (SLPS) by 2030		
40% reduction in methane and hydrofluorocarbon emissions below 2013 levels.	CARB, CalRecycle, California Department of Food and Agriculture (CDFA), California State Water Resource Control Board (SWRCB), Local Air Districts	No Conflict. The Project would be required to comply with this measure and reduce any Project-source SLPS emissions accordingly. The Project would not obstruct or interfere with agency efforts to reduce SLPS emissions.
Implement the post-2020 Cap-and-Trade Program with declining annual caps.	CARB	No Conflict. The Project would be required to comply with applicable Cap-and-Trade Program provisions. The Project would not obstruct or interfere agency efforts to implement the post-2020 Cap-and-Trade Program.
By 2018, develop Integrated Natural and Working Lands Implementation Plan to secure California's land base as a net carbon sink:		
Protect land from conversion through conservation easements and other incentives.	CNRA, Departments Within CDFA, CalEPA, CARB	Not applicable. The Project site is not an identified property that needs to be conserved.
Increase the long-term resilience of carbon storage in the land base and enhance sequestration capacity.		Not applicable. The entire site is planned for development.
Utilize wood and agricultural products to increase the amount of carbon stored in the natural and built environments.		No Conflict. To the extent appropriate for the proposed commercial buildings, wood products would be used in

ACTION	RESPONSIBLE PARTIES	CONSISTENCY
		construction, including roof structure. Additionally, the Project includes landscaping using native species.
Establish scenario projections to serve as the foundation for the Implementation Plan.		Not applicable. This measure is unrelated to the project scope.
Implement Forest Carbon Plan.	CNRA, California Department of Forestry and Fire Protection (CAL FIRE), CalEPA and Departments Within	Not applicable. This measure is unrelated to the project scope.
Identify and expand funding and financing mechanisms to support GHG reductions across all sectors.	State Agencies & Local Agencies	Not applicable. This measure is unrelated to the project scope.

2022 Scoping Plan Consistency

CARB’s 2022 Scoping Plan sets a path to achieve targets for carbon neutrality and reduce anthropogenic GHG emissions by 85 percent below 1990 levels by 2045 in accordance with AB 1279. The 2022 Scoping Plan focuses on zero-emission transportation; phasing out use of fossil gas use for heating homes and buildings; reducing chemical and refrigerants with high GWP; providing communities with sustainable options for walking, biking, and public transit; displacement of fossil-fuel fired electrical generation through use of renewable energy alternatives (e.g., solar arrays and wind turbines); and scaling up new options such as green hydrogen. Unlike the 2017 Scoping Plan, CARB no longer includes a numeric per capita threshold and instead advocates for compliance with a local GHG reduction strategy (i.e., Climate Action Plan) consistent with CEQA Guidelines Section 15183.5. Statewide strategies to reduce GHG emissions in the latest 2022 Scoping Plan include implementing SB 100, which would achieve 100 percent clean electricity by 2045; achieving 100 percent zero emission vehicle sales in 2035 through Advanced Clean Cars II; and implementing the Advanced Clean Fleets regulation to deploy ZEV buses and trucks. Additional transportation policies include the Off-Road Zero Emission Targeted Manufacturer rule, Clean Off-Road Fleet Recognition Program, In-use Off-Road Diesel Fueled Fleets Regulation, Clean Off-Road Fleet Recognition Program, and Amendments to the In-use Off-Road Diesel-Fueled Fleets Regulation.

The 2022 Scoping Plan would continue to implement SB 375. GHGs would be further reduced through the Cap-and-Trade Program carbon pricing and SB 905. SB 905 requires CARB to create the Carbon Capture, Removal, Utilization, and Storage Program to evaluate, demonstrate, and regulate carbon dioxide removal projects and technology. As indicated above, GHG reductions are also achieved as a result of State of California energy and water efficiency requirements for

new residential development. These efficiency improvements correspond to reductions in secondary GHG emissions. For example, in California, most of the electricity that powers homes is derived from natural gas combustion. Therefore, energy saving measures, such as Title 24, reduces GHG emissions from the power generation facilities by reducing load demand. The 2022 Scoping Plan Appendix D provides local jurisdictions with tools to reduce GHGs and assist the state in meeting the ambitious targets set forth in the 2022 Scoping Plan. The 2022 Scoping Plan Appendix D focuses on Residential and Mixed-Use Projects. The 2022 Scoping Plan Appendix D lists potential actions that support the State's climate goals. However, the 2022 Scoping Plan notes that the applicability and performance of the actions may vary across the regions. The document is organized into two categories (A) examples of plan-level GHG reduction actions that could be implemented by local governments and (B) examples of on-site project design features, mitigation measures, that could be required of individual projects under CEQA, if feasible, when the local jurisdiction is the lead agency. The Project would include a number of the Standard Conditions and mitigation measures for construction and operation. For example, the 2022 Scoping Plan's construction actions include enforcing idling time restrictions on construction vehicles and requiring construction vehicles to operate highest tier engines commercially available. The Project would include a majority of the feasible operational mitigation measures listed in the 2022 Scoping Plan Appendix D as design features. Some of the recommended operational measures would include providing bicycle parking, creating on- and off-site safety improvements for bike, pedestrian, and transit connections, requiring solar panels, drought-tolerant landscaping, and energy conserving appliances. As discussed above, the Project would be consistent with all applicable plan goals and applicable regulatory programs designed to reduce GHG emissions generated by land use projects. The Project would be subject to compliance with all building codes in effect at the time of construction, which include energy conservation measures mandated by California Building Standards Code Title 24 – Energy Efficiency Standards. Because Title 24 standards require energy conservation features in new construction (e.g., high- efficiency lighting, high-efficiency heating, ventilating, and air-conditioning (HVAC) systems, thermal insulation, double-glazed windows, water conserving plumbing fixtures), they indirectly regulate and reduce GHG emissions. California's Building Energy Efficiency Standards are updated on an approximately three-year cycle. As shown above, the majority of the Project's emissions are from energy and mobile sources, which would be further reduced by the 2022 Scoping Plan actions described above. The City has no control over vehicle emissions; however, these emissions would decline in the future because of Statewide measures as well as cleaner technology and fleet turnover. Many State plans and policies would contribute to a reduction in the Project's mobile source emissions, including the following:

CARB's Advanced Clean Truck Regulation: Adopted in June 2020, CARB's Advanced Clean Truck Regulation requires truck manufacturers to transition from diesel trucks and vans to electric zero-emission trucks beginning in 2024. By 2045, every new truck sold in California is required to be zero-emission. The Advanced Clean Truck Regulation accelerates the transition of zero-emission medium-and heavy-duty vehicles from Class 2b to Class 8.

Executive Order N-79-20: Executive Order N-79-20 establishes the goal for all new passenger cars and trucks, as well as all drayage/cargo trucks and off-road vehicles and equipment, sold in California, to be zero-emission by 2035 and all medium and heavy-duty vehicles to be zero-emission by 2045. It also directs CARB to develop and propose rulemaking for passenger vehicles and trucks, medium-and heavy-duty fleets where feasible, drayage trucks, and off-road vehicles and equipment “requiring increasing volumes” of new ZEVs “towards the target of 100 percent.”

CARB’s Mobile Source Strategy: CARB’s Mobile Source Strategy takes an integrated planning approach to identify the level of transition to cleaner mobile source technologies needed to achieve all of California’s targets by increasing the adoption of ZEV buses and trucks.

CARB’s Sustainable Freight Action Plan: The Sustainable Freight Action Plan which improves freight system efficiency, utilizes near-zero emissions technology, and deployment of ZEV trucks. This Plan applies to all trucks accessing the Project site and may include existing trucks or new trucks that are part of the Statewide goods movement sector.

CARB’s Emissions Reduction Plan for Ports and Goods Movement: CARB’s Emissions Reduction Plan for Ports and Goods Movement identifies measures to improve goods movement efficiencies such as advanced combustion strategies, friction reduction, waste heat recovery, and electrification of accessories. While these measures are not directly applicable to the Project, any commercial activity associated with goods movement would be required to comply with these measures as adopted.

The Project would not obstruct or interfere with efforts to increase ZEVs or State efforts to improve system efficiency. Compliance with applicable State standards (e.g., continuation of the Cap-and-Trade regulation; CARB’s Mobile Source Strategy, Sustainable Freight Action Plan, and Advanced Clean Truck Regulation; Executive Order N-79-20; SB 100/renewable electricity portfolio improvements that require 60 percent renewable electricity by 2030 and 100 percent renewable by 2045, etc.) would ensure consistency with State and regional GHG reduction planning efforts, including the 2022 Scoping Plan. It is also noted that the Project would not convert any Natural and Working Lands (NWL) and/or decrease the State’s urban forest carbon stock, which are areas of emphasis in the 2022 Scoping Plan.

Regarding goals for 2050 under Executive Order S-3-05, at this time it is not possible to quantify the emissions savings from future regulatory measures, as they have not yet been developed; nevertheless, it can be anticipated that Project operations would benefit from applicable measures enacted to meet State GHG reduction goals. The Project would not impede the State’s progress towards carbon neutrality by 2045 under the 2022 Scoping Plan. The Project would be required to comply with applicable current and future regulatory requirements promulgated through the 2022 Scoping Plan. Thus, impacts related to consistency with the 2022 Scoping Plan would be less than significant. The Project would not conflict with the applicable plans and regulatory programs that are discussed above; and therefore, with respect to this particular threshold, the Project does not have a significant impact.

As discussed, the project would not exceed 3,000 MT of annual CO₂e emissions and it would be consistent with Connect SoCal RTP/SCS and the 2017 CARB scoping plan and the 2022 Scoping Plan goals intended to reduce overall regional GHG emissions. The project will not impede or delay local or statewide initiatives to reduce GHG emissions. Impacts would be **less than significant**.

As stated, the project would not generate enough GHG emissions to cumulatively contribute to global climate change. Measures implemented by the project to reduce overall GHG emissions would also contribute to GHG reduction goals mandated by AB 32 and further address in EO S-3-05 and SB 32. Thus, the project would not conflict with an applicable plan, policy or regulation adopted for the purpose of reducing the emissions of greenhouse gases and impacts would be less than significant.

REFERENCES

- California Natural Resources Agency. *2023 California Environmental Quality Act (CEQA) Statute and Guidelines*. Association of Environmental Professionals. 2023
- California Air Pollution Control Officers Association. *CEQA and Climate Change: Addressing Climate Change through California Environmental Quality Act (CEQA)*. January 2008.
- California Air Pollution Control Officers Association. *California Emission Estimator Model version 2022.1.1.16*, May 2022.
- California Air Resources Board. *Ambient Air Quality Standards*. Updated February 2016.
<http://www.aqmd.gov/docs/default-source/clean-air-plans/air-quality-management-plans/naaqs-caaqs-feb2016.pdf>
- California Air Resources Board. 2020, 2021 & 2022 Annual Air Quality Data Summaries.
<http://www.arb.ca.gov/adam/topfour/topfour1.php>. Accessed November 2023.
- California Air Resources Board. June 2019. *Greenhouse Gas Inventory Data Inventory Program*. Available: <https://www.arb.ca.gov/cc/inventory/inventory.htm>
- California Air Resources Board. April 2012. *Greenhouse Gas Inventory Data – 2020 Emissions Forecast*. Available: <http://www.arb.ca.gov/cc/inventory/data/forecast.htm>
- California Air Resources Board. May 2014. *2020 Business As Usual Emission Projection, 2014 Edition*. Available:
http://www.arb.ca.gov/cc/inventory/data/tables/2020_bau_forecast_by_scoping_category_2014-05-22.pdf
- California Air Resources Board. April 2005. *Air Quality and Land Use Handbook, A Community Health Perspective*. <https://ww3.arb.ca.gov/ch/handbook.pdf>
- California Climate Action Registry General Reporting Protocol, *Reporting Entity-Wide Greenhouse Gas Emissions*, Version 3.1, January 2009.
- California Environmental Protection Agency, March 2006. *Climate Action Team Report to Governor Schwarzenegger and the Legislature*.
http://www.climatechange.ca.gov/climate_action_team/reports/2006-04-03_FINAL_CAT_REPORT_EXECSUMMARY.PDF
- Imperial County Air Pollution Control District, *State Implementation Plan*,
<https://ww2.arb.ca.gov/our-work/programs/california-state-implementation-plans/nonattainment-area-plans/imperial-county>

Imperial County Air Pollution Control District, *CEQA Air Quality Handbook*, November, 2007.
Intergovernmental Panel on Climate Change [IPCC]. *Revised 1996 IPCC Guidelines for National Greenhouse Gas Inventories*. [Kroeze, C.; Mosier, A.; Nevison, C.; Oenema, O.; Seitzinger, S.; Cleemput, O. van; Conrad, R.; Mitra, A.P.; H.U., Neue; Sass, R.]. Paris: OECD, 1997.

Mizuta Traffic Consulting, Inc., *Trip Generation Memorandum and Traffic Impact Analysis for the proposed Maverik Convenience Store and Fueling Station Project*, December 2023.

Office of the California Attorney General. *The California Environmental Quality Act, Addressing Global Warming Impacts at the Local Agency Level*. Updated May 21, 2008.
http://ag.ca.gov/globalwarming/pdf/GW_mitigation_measures.pdf

SCAQMD. *Air Quality Significance Threshold*, March 2023

United States Environmental Protection Agency (U.S. EPA). *Inventory of U.S. Greenhouse Gas Emissions and Sinks: 1990-2010*. U. S. EPA #430-R-11-005. April 2012.
<http://www.epa.gov/climatechange/emissions/usinventoryreport.html>

United States Environmental Protection Agency (U.S. EPA). *Inventory of U.S. Greenhouse Gas Emissions and Sinks: 1990-2015*. U. S. EPA #430-P-17-001. April 2017.
<https://www.epa.gov/ghgemissions/inventory-us-greenhouse-gas-emissions-and-sinks-1990-2015>

United States Environmental Protection Agency (U.S. EPA). *Inventory of U.S. Greenhouse Gas Emissions and Sinks: 1990-2019*, U. S. EPA #430-R-21-001. February 2021

Appendix A

CalEEMod Air Quality and Greenhouse Gas Emissions Report

Maverick Travel Center Detailed Report

Table of Contents

1. Basic Project Information
 - 1.1. Basic Project Information
 - 1.2. Land Use Types
 - 1.3. User-Selected Emission Reduction Measures by Emissions Sector
2. Emissions Summary
 - 2.1. Construction Emissions Compared Against Thresholds
 - 2.2. Construction Emissions by Year, Unmitigated
 - 2.3. Construction Emissions by Year, Mitigated
 - 2.4. Operations Emissions Compared Against Thresholds
 - 2.5. Operations Emissions by Sector, Unmitigated
 - 2.6. Operations Emissions by Sector, Mitigated
3. Construction Emissions Details
 - 3.1. Demolition (2024) - Unmitigated
 - 3.2. Demolition (2024) - Mitigated

3.3. Site Preparation (2024) - Unmitigated

3.4. Site Preparation (2024) - Mitigated

3.5. Grading (2024) - Unmitigated

3.6. Grading (2024) - Mitigated

3.7. Grading (2025) - Unmitigated

3.8. Grading (2025) - Mitigated

3.9. Building Construction (2025) - Unmitigated

3.10. Building Construction (2025) - Mitigated

3.11. Paving (2025) - Unmitigated

3.12. Paving (2025) - Mitigated

3.13. Architectural Coating (2025) - Unmitigated

3.14. Architectural Coating (2025) - Mitigated

4. Operations Emissions Details

4.1. Mobile Emissions by Land Use

4.1.1. Unmitigated

4.1.2. Mitigated

4.2. Energy

4.2.1. Electricity Emissions By Land Use - Unmitigated

4.2.2. Electricity Emissions By Land Use - Mitigated

4.2.3. Natural Gas Emissions By Land Use - Unmitigated

4.2.4. Natural Gas Emissions By Land Use - Mitigated

4.3. Area Emissions by Source

4.3.1. Unmitigated

4.3.2. Mitigated

4.4. Water Emissions by Land Use

4.4.1. Unmitigated

4.4.2. Mitigated

4.5. Waste Emissions by Land Use

4.5.1. Unmitigated

4.5.2. Mitigated

4.6. Refrigerant Emissions by Land Use

4.6.1. Unmitigated

4.6.2. Mitigated

4.7. Offroad Emissions By Equipment Type

4.7.1. Unmitigated

4.7.2. Mitigated

4.8. Stationary Emissions By Equipment Type

4.8.1. Unmitigated

4.8.2. Mitigated

4.9. User Defined Emissions By Equipment Type

4.9.1. Unmitigated

4.9.2. Mitigated

4.10. Soil Carbon Accumulation By Vegetation Type

4.10.1. Soil Carbon Accumulation By Vegetation Type - Unmitigated

4.10.2. Above and Belowground Carbon Accumulation by Land Use Type - Unmitigated

4.10.3. Avoided and Sequestered Emissions by Species - Unmitigated

4.10.4. Soil Carbon Accumulation By Vegetation Type - Mitigated

4.10.5. Above and Belowground Carbon Accumulation by Land Use Type - Mitigated

4.10.6. Avoided and Sequestered Emissions by Species - Mitigated

5. Activity Data

5.1. Construction Schedule

5.2. Off-Road Equipment

5.2.1. Unmitigated

5.2.2. Mitigated

5.3. Construction Vehicles

5.3.1. Unmitigated

5.3.2. Mitigated

5.4. Vehicles

5.4.1. Construction Vehicle Control Strategies

5.5. Architectural Coatings

5.6. Dust Mitigation

5.6.1. Construction Earthmoving Activities

5.6.2. Construction Earthmoving Control Strategies

5.7. Construction Paving

5.8. Construction Electricity Consumption and Emissions Factors

5.9. Operational Mobile Sources

5.9.1. Unmitigated

5.9.2. Mitigated

5.10. Operational Area Sources

5.10.1. Hearths

5.10.1.1. Unmitigated

5.10.1.2. Mitigated

5.10.2. Architectural Coatings

5.10.3. Landscape Equipment

5.10.4. Landscape Equipment - Mitigated

5.11. Operational Energy Consumption

5.11.1. Unmitigated

5.11.2. Mitigated

5.12. Operational Water and Wastewater Consumption

5.12.1. Unmitigated

5.12.2. Mitigated

5.13. Operational Waste Generation

5.13.1. Unmitigated

5.13.2. Mitigated

5.14. Operational Refrigeration and Air Conditioning Equipment

5.14.1. Unmitigated

5.14.2. Mitigated

5.15. Operational Off-Road Equipment

5.15.1. Unmitigated

5.15.2. Mitigated

5.16. Stationary Sources

5.16.1. Emergency Generators and Fire Pumps

5.16.2. Process Boilers

5.17. User Defined

5.18. Vegetation

5.18.1. Land Use Change

5.18.1.1. Unmitigated

5.18.1.2. Mitigated

5.18.1. Biomass Cover Type

5.18.1.1. Unmitigated

5.18.1.2. Mitigated

5.18.2. Sequestration

5.18.2.1. Unmitigated

5.18.2.2. Mitigated

6. Climate Risk Detailed Report

6.1. Climate Risk Summary

6.2. Initial Climate Risk Scores

6.3. Adjusted Climate Risk Scores

6.4. Climate Risk Reduction Measures

7. Health and Equity Details

7.1. CalEnviroScreen 4.0 Scores

7.2. Healthy Places Index Scores

7.3. Overall Health & Equity Scores

7.4. Health & Equity Measures

7.5. Evaluation Scorecard

7.6. Health & Equity Custom Measures

8. User Changes to Default Data

1. Basic Project Information

1.1. Basic Project Information

Data Field	Value
Project Name	Maverick Travel Center
Construction Start Date	11/5/2024
Operational Year	2025
Lead Agency	Imperial County
Land Use Scale	Project/site
Analysis Level for Defaults	County
Windspeed (m/s)	3.40
Precipitation (days)	4.80
Location	32.78141138061281, -115.50046938332159
County	Imperial
City	Unincorporated
Air District	Imperial County APCD
Air Basin	Salton Sea
TAZ	5606
EDFZ	19
Electric Utility	Imperial Irrigation District
Gas Utility	Southern California Gas
App Version	2022.1.1.21

1.2. Land Use Types

Land Use Subtype	Size	Unit	Lot Acreage	Building Area (sq ft)	Landscape Area (sq ft)	Special Landscape Area (sq ft)	Population	Description
------------------	------	------	-------------	-----------------------	------------------------	--------------------------------	------------	-------------

EEC ORIGINAL PKG

Convenience Market with Gas Pumps	14.0	Pump	0.05	5,982	2,000	—	—	—
Parking Lot	8.00	Acre	8.00	0.00	1,000	—	—	—

1.3. User-Selected Emission Reduction Measures by Emissions Sector

Sector	#	Measure Title
Water	W-7	Adopt a Water Conservation Strategy

2. Emissions Summary

2.1. Construction Emissions Compared Against Thresholds

Criteria Pollutants (lb/day for daily, ton/yr for annual) and GHGs (lb/day for daily, MT/yr for annual)

Un/Mit.	ROG	NOx	CO	SO2	PM10E	PM10D	PM10T	PM2.5E	PM2.5D	PM2.5T	BCO2	NBCO2	CO2T	CH4	N2O	R	CO2e
Daily, Summer (Max)	—	—	—	—	—	—	—	—	—	—	—	—	—	—	—	—	—
Unmit.	1.14	10.5	13.3	0.02	0.43	0.03	0.47	0.40	0.01	0.41	—	2,458	2,458	0.10	0.02	0.19	2,468
Daily, Winter (Max)	—	—	—	—	—	—	—	—	—	—	—	—	—	—	—	—	—
Unmit.	7.50	37.2	34.4	0.05	1.62	8.12	9.74	1.49	4.05	5.54	—	6,395	6,395	0.23	0.19	0.07	6,457
Average Daily (Max)	—	—	—	—	—	—	—	—	—	—	—	—	—	—	—	—	—
Unmit.	1.44	8.39	10.5	0.02	0.35	0.45	0.80	0.32	0.20	0.53	—	1,875	1,875	0.08	0.02	0.13	1,883
Annual (Max)	—	—	—	—	—	—	—	—	—	—	—	—	—	—	—	—	—
Unmit.	0.26	1.53	1.91	< 0.005	0.06	0.08	0.15	0.06	0.04	0.10	—	310	310	0.01	< 0.005	0.02	312

2.2. Construction Emissions by Year, Unmitigated

Criteria Pollutants (lb/day for daily, ton/yr for annual) and GHGs (lb/day for daily, MT/yr for annual)

Year	ROG	NOx	CO	SO2	PM10E	PM10D	PM10T	PM2.5E	PM2.5D	PM2.5T	BCO2	NBCO2	CO2T	CH4	N2O	R	CO2e
Daily - Summer (Max)	—	—	—	—	—	—	—	—	—	—	—	—	—	—	—	—	—
2025	1.14	10.5	13.3	0.02	0.43	0.03	0.47	0.40	0.01	0.41	—	2,458	2,458	0.10	0.02	0.19	2,468
Daily - Winter (Max)	—	—	—	—	—	—	—	—	—	—	—	—	—	—	—	—	—
2024	3.76	37.2	34.4	0.05	1.62	8.12	9.74	1.49	4.05	5.54	—	6,395	6,395	0.23	0.19	0.07	6,457
2025	7.50	18.9	25.3	0.04	0.81	3.00	3.72	0.74	1.39	2.06	—	4,299	4,299	0.18	0.05	0.03	4,317
Average Daily	—	—	—	—	—	—	—	—	—	—	—	—	—	—	—	—	—
2024	0.30	2.86	2.73	< 0.005	0.12	0.31	0.43	0.11	0.15	0.26	—	460	460	0.02	0.01	0.07	463
2025	1.44	8.39	10.5	0.02	0.35	0.45	0.80	0.32	0.20	0.53	—	1,875	1,875	0.08	0.02	0.13	1,883
Annual	—	—	—	—	—	—	—	—	—	—	—	—	—	—	—	—	—
2024	0.06	0.52	0.50	< 0.005	0.02	0.06	0.08	0.02	0.03	0.05	—	76.1	76.1	< 0.005	< 0.005	0.01	76.6
2025	0.26	1.53	1.91	< 0.005	0.06	0.08	0.15	0.06	0.04	0.10	—	310	310	0.01	< 0.005	0.02	312

2.3. Construction Emissions by Year, Mitigated

Criteria Pollutants (lb/day for daily, ton/yr for annual) and GHGs (lb/day for daily, MT/yr for annual)

Year	ROG	NOx	CO	SO2	PM10E	PM10D	PM10T	PM2.5E	PM2.5D	PM2.5T	BCO2	NBCO2	CO2T	CH4	N2O	R	CO2e
Daily - Summer (Max)	—	—	—	—	—	—	—	—	—	—	—	—	—	—	—	—	—
2025	1.14	10.5	13.3	0.02	0.43	0.03	0.47	0.40	0.01	0.41	—	2,458	2,458	0.10	0.02	0.19	2,468
Daily - Winter (Max)	—	—	—	—	—	—	—	—	—	—	—	—	—	—	—	—	—

EEC ORIGINAL PKG

2024	3.76	37.2	34.4	0.05	1.62	8.12	9.74	1.49	4.05	5.54	—	6,395	6,395	0.23	0.19	0.07	6,457
2025	7.50	18.9	25.3	0.04	0.81	3.00	3.72	0.74	1.39	2.06	—	4,299	4,299	0.18	0.05	0.03	4,317
Average Daily	—	—	—	—	—	—	—	—	—	—	—	—	—	—	—	—	—
2024	0.30	2.86	2.73	< 0.005	0.12	0.31	0.43	0.11	0.15	0.26	—	460	460	0.02	0.01	0.07	463
2025	1.44	8.39	10.5	0.02	0.35	0.45	0.80	0.32	0.20	0.53	—	1,875	1,875	0.08	0.02	0.13	1,883
Annual	—	—	—	—	—	—	—	—	—	—	—	—	—	—	—	—	—
2024	0.06	0.52	0.50	< 0.005	0.02	0.06	0.08	0.02	0.03	0.05	—	76.1	76.1	< 0.005	< 0.005	0.01	76.6
2025	0.26	1.53	1.91	< 0.005	0.06	0.08	0.15	0.06	0.04	0.10	—	310	310	0.01	< 0.005	0.02	312

2.4. Operations Emissions Compared Against Thresholds

Criteria Pollutants (lb/day for daily, ton/yr for annual) and GHGs (lb/day for daily, MT/yr for annual)

Un/Mit.	ROG	NOx	CO	SO2	PM10E	PM10D	PM10T	PM2.5E	PM2.5D	PM2.5T	BCO2	NBCO2	CO2T	CH4	N2O	R	CO2e
Daily, Summer (Max)	—	—	—	—	—	—	—	—	—	—	—	—	—	—	—	—	—
Unmit.	13.5	3.76	51.7	0.06	0.04	4.66	4.70	0.04	1.17	1.21	3.48	6,596	6,599	1.07	0.43	1,258	8,011
Mit.	13.5	3.76	51.7	0.06	0.04	4.66	4.70	0.04	1.17	1.21	3.42	6,596	6,599	1.06	0.42	1,258	8,011
% Reduced	—	—	—	—	—	—	—	—	—	—	2%	< 0.5%	< 0.5%	1%	—	—	< 0.5%
Daily, Winter (Max)	—	—	—	—	—	—	—	—	—	—	—	—	—	—	—	—	—
Unmit.	10.4	3.89	44.9	0.05	0.04	4.66	4.70	0.04	1.17	1.21	3.48	5,802	5,805	1.21	0.42	1,241	7,203
Mit.	10.4	3.89	44.9	0.05	0.04	4.66	4.70	0.04	1.17	1.21	3.42	5,802	5,805	1.20	0.42	1,241	7,202
% Reduced	—	—	—	—	—	—	—	—	—	—	2%	< 0.5%	< 0.5%	< 0.5%	—	—	< 0.5%
Average Daily (Max)	—	—	—	—	—	—	—	—	—	—	—	—	—	—	—	—	—

Unmit.	11.0	3.61	43.0	0.05	0.04	4.55	4.60	0.04	1.15	1.19	3.48	6,018	6,021	1.10	0.40	1,248	7,416
Mit.	11.0	3.61	43.0	0.05	0.04	4.55	4.60	0.04	1.15	1.19	3.42	6,018	6,021	1.09	0.40	1,248	7,416
% Reduced	—	—	—	—	—	—	—	—	—	—	2%	< 0.5%	< 0.5%	1%	—	—	< 0.5%
Annual (Max)	—	—	—	—	—	—	—	—	—	—	—	—	—	—	—	—	—
Unmit.	2.01	0.66	7.84	0.01	0.01	0.83	0.84	0.01	0.21	0.22	0.58	996	997	0.18	0.07	207	1,228
Mit.	2.01	0.66	7.84	0.01	0.01	0.83	0.84	0.01	0.21	0.22	0.57	996	997	0.18	0.07	207	1,228
% Reduced	—	—	—	—	—	—	—	—	—	—	2%	< 0.5%	< 0.5%	1%	< 0.5%	—	< 0.5%

2.5. Operations Emissions by Sector, Unmitigated

Criteria Pollutants (lb/day for daily, ton/yr for annual) and GHGs (lb/day for daily, MT/yr for annual)

Sector	ROG	NOx	CO	SO2	PM10E	PM10D	PM10T	PM2.5E	PM2.5D	PM2.5T	BCO2	NBCO2	CO2T	CH4	N2O	R	CO2e
Daily, Summer (Max)	—	—	—	—	—	—	—	—	—	—	—	—	—	—	—	—	—
Mobile	13.2	3.72	51.4	0.06	0.04	4.66	4.70	0.04	1.17	1.21	—	5,890	5,890	0.67	0.42	18.0	6,050
Area	0.26	< 0.005	0.26	< 0.005	< 0.005	—	< 0.005	< 0.005	—	< 0.005	—	1.07	1.07	< 0.005	< 0.005	—	1.07
Energy	< 0.005	0.03	0.03	< 0.005	< 0.005	—	< 0.005	< 0.005	—	< 0.005	—	704	704	0.05	0.01	—	707
Water	—	—	—	—	—	—	—	—	—	—	0.28	1.11	1.40	0.03	< 0.005	—	2.32
Waste	—	—	—	—	—	—	—	—	—	—	3.20	0.00	3.20	0.32	0.00	—	11.2
Refrig.	—	—	—	—	—	—	—	—	—	—	—	—	—	—	—	1,240	1,240
Total	13.5	3.76	51.7	0.06	0.04	4.66	4.70	0.04	1.17	1.21	3.48	6,596	6,599	1.07	0.43	1,258	8,011
Daily, Winter (Max)	—	—	—	—	—	—	—	—	—	—	—	—	—	—	—	—	—
Mobile	10.2	3.85	44.8	0.05	0.04	4.66	4.70	0.04	1.17	1.21	—	5,097	5,097	0.81	0.42	0.47	5,242
Area	0.22	—	—	—	—	—	—	—	—	—	—	—	—	—	—	—	—
Energy	< 0.005	0.03	0.03	< 0.005	< 0.005	—	< 0.005	< 0.005	—	< 0.005	—	704	704	0.05	0.01	—	707

EEC ORIGINAL PKG

Water	—	—	—	—	—	—	—	—	—	—	0.28	1.11	1.40	0.03	< 0.005	—	2.32
Waste	—	—	—	—	—	—	—	—	—	—	3.20	0.00	3.20	0.32	0.00	—	11.2
Refrig.	—	—	—	—	—	—	—	—	—	—	—	—	—	—	—	1,240	1,240
Total	10.4	3.89	44.9	0.05	0.04	4.66	4.70	0.04	1.17	1.21	3.48	5,802	5,805	1.21	0.42	1,241	7,203
Average Daily	—	—	—	—	—	—	—	—	—	—	—	—	—	—	—	—	—
Mobile	10.8	3.58	42.8	0.05	0.04	4.55	4.59	0.04	1.15	1.18	—	5,313	5,313	0.70	0.39	7.63	5,455
Area	0.24	< 0.005	0.13	< 0.005	< 0.005	—	< 0.005	< 0.005	—	< 0.005	—	0.53	0.53	< 0.005	< 0.005	—	0.53
Energy	< 0.005	0.03	0.03	< 0.005	< 0.005	—	< 0.005	< 0.005	—	< 0.005	—	704	704	0.05	0.01	—	707
Water	—	—	—	—	—	—	—	—	—	—	0.28	1.11	1.40	0.03	< 0.005	—	2.32
Waste	—	—	—	—	—	—	—	—	—	—	3.20	0.00	3.20	0.32	0.00	—	11.2
Refrig.	—	—	—	—	—	—	—	—	—	—	—	—	—	—	—	1,240	1,240
Total	11.0	3.61	43.0	0.05	0.04	4.55	4.60	0.04	1.15	1.19	3.48	6,018	6,021	1.10	0.40	1,248	7,416
Annual	—	—	—	—	—	—	—	—	—	—	—	—	—	—	—	—	—
Mobile	1.97	0.65	7.81	0.01	0.01	0.83	0.84	0.01	0.21	0.22	—	880	880	0.12	0.07	1.26	903
Area	0.04	< 0.005	0.02	< 0.005	< 0.005	—	< 0.005	< 0.005	—	< 0.005	—	0.09	0.09	< 0.005	< 0.005	—	0.09
Energy	< 0.005	0.01	0.01	< 0.005	< 0.005	—	< 0.005	< 0.005	—	< 0.005	—	117	117	0.01	< 0.005	—	117
Water	—	—	—	—	—	—	—	—	—	—	0.05	0.18	0.23	< 0.005	< 0.005	—	0.38
Waste	—	—	—	—	—	—	—	—	—	—	0.53	0.00	0.53	0.05	0.00	—	1.85
Refrig.	—	—	—	—	—	—	—	—	—	—	—	—	—	—	—	205	205
Total	2.01	0.66	7.84	0.01	0.01	0.83	0.84	0.01	0.21	0.22	0.58	996	997	0.18	0.07	207	1,228

2.6. Operations Emissions by Sector, Mitigated

Criteria Pollutants (lb/day for daily, ton/yr for annual) and GHGs (lb/day for daily, MT/yr for annual)

Sector	ROG	NOx	CO	SO2	PM10E	PM10D	PM10T	PM2.5E	PM2.5D	PM2.5T	BCO2	NBCO2	CO2T	CH4	N2O	R	CO2e
Daily, Summer (Max)	—	—	—	—	—	—	—	—	—	—	—	—	—	—	—	—	—

EEC ORIGINAL PKG

Mobile	13.2	3.72	51.4	0.06	0.04	4.66	4.70	0.04	1.17	1.21	—	5,890	5,890	0.67	0.42	18.0	6,050
Area	0.26	< 0.005	0.26	< 0.005	< 0.005	—	< 0.005	< 0.005	—	< 0.005	—	1.07	1.07	< 0.005	< 0.005	—	1.07
Energy	< 0.005	0.03	0.03	< 0.005	< 0.005	—	< 0.005	< 0.005	—	< 0.005	—	704	704	0.05	0.01	—	707
Water	—	—	—	—	—	—	—	—	—	—	0.22	0.89	1.12	0.02	< 0.005	—	1.86
Waste	—	—	—	—	—	—	—	—	—	—	3.20	0.00	3.20	0.32	0.00	—	11.2
Refrig.	—	—	—	—	—	—	—	—	—	—	—	—	—	—	—	1,240	1,240
Total	13.5	3.76	51.7	0.06	0.04	4.66	4.70	0.04	1.17	1.21	3.42	6,596	6,599	1.06	0.42	1,258	8,011
Daily, Winter (Max)	—	—	—	—	—	—	—	—	—	—	—	—	—	—	—	—	—
Mobile	10.2	3.85	44.8	0.05	0.04	4.66	4.70	0.04	1.17	1.21	—	5,097	5,097	0.81	0.42	0.47	5,242
Area	0.22	—	—	—	—	—	—	—	—	—	—	—	—	—	—	—	—
Energy	< 0.005	0.03	0.03	< 0.005	< 0.005	—	< 0.005	< 0.005	—	< 0.005	—	704	704	0.05	0.01	—	707
Water	—	—	—	—	—	—	—	—	—	—	0.22	0.89	1.12	0.02	< 0.005	—	1.86
Waste	—	—	—	—	—	—	—	—	—	—	3.20	0.00	3.20	0.32	0.00	—	11.2
Refrig.	—	—	—	—	—	—	—	—	—	—	—	—	—	—	—	1,240	1,240
Total	10.4	3.89	44.9	0.05	0.04	4.66	4.70	0.04	1.17	1.21	3.42	5,802	5,805	1.20	0.42	1,241	7,202
Average Daily	—	—	—	—	—	—	—	—	—	—	—	—	—	—	—	—	—
Mobile	10.8	3.58	42.8	0.05	0.04	4.55	4.59	0.04	1.15	1.18	—	5,313	5,313	0.70	0.39	7.63	5,455
Area	0.24	< 0.005	0.13	< 0.005	< 0.005	—	< 0.005	< 0.005	—	< 0.005	—	0.53	0.53	< 0.005	< 0.005	—	0.53
Energy	< 0.005	0.03	0.03	< 0.005	< 0.005	—	< 0.005	< 0.005	—	< 0.005	—	704	704	0.05	0.01	—	707
Water	—	—	—	—	—	—	—	—	—	—	0.22	0.89	1.12	0.02	< 0.005	—	1.86
Waste	—	—	—	—	—	—	—	—	—	—	3.20	0.00	3.20	0.32	0.00	—	11.2
Refrig.	—	—	—	—	—	—	—	—	—	—	—	—	—	—	—	1,240	1,240
Total	11.0	3.61	43.0	0.05	0.04	4.55	4.60	0.04	1.15	1.19	3.42	6,018	6,021	1.09	0.40	1,248	7,416
Annual	—	—	—	—	—	—	—	—	—	—	—	—	—	—	—	—	—
Mobile	1.97	0.65	7.81	0.01	0.01	0.83	0.84	0.01	0.21	0.22	—	880	880	0.12	0.07	1.26	903
Area	0.04	< 0.005	0.02	< 0.005	< 0.005	—	< 0.005	< 0.005	—	< 0.005	—	0.09	0.09	< 0.005	< 0.005	—	0.09

EEC ORIGINAL PKG

Energy	< 0.005	0.01	0.01	< 0.005	< 0.005	—	< 0.005	< 0.005	—	< 0.005	—	117	117	0.01	< 0.005	—	117
Water	—	—	—	—	—	—	—	—	—	—	0.04	0.15	0.18	< 0.005	< 0.005	—	0.31
Waste	—	—	—	—	—	—	—	—	—	—	0.53	0.00	0.53	0.05	0.00	—	1.85
Refrig.	—	—	—	—	—	—	—	—	—	—	—	—	—	—	—	205	205
Total	2.01	0.66	7.84	0.01	0.01	0.83	0.84	0.01	0.21	0.22	0.57	996	997	0.18	0.07	207	1,228

3. Construction Emissions Details

3.1. Demolition (2024) - Unmitigated

Criteria Pollutants (lb/day for daily, ton/yr for annual) and GHGs (lb/day for daily, MT/yr for annual)

Location	ROG	NOx	CO	SO2	PM10E	PM10D	PM10T	PM2.5E	PM2.5D	PM2.5T	BCO2	NBCO2	CO2T	CH4	N2O	R	CO2e
Onsite	—	—	—	—	—	—	—	—	—	—	—	—	—	—	—	—	—
Daily, Summer (Max)	—	—	—	—	—	—	—	—	—	—	—	—	—	—	—	—	—
Daily, Winter (Max)	—	—	—	—	—	—	—	—	—	—	—	—	—	—	—	—	—
Off-Road Equipment	2.62	24.9	21.7	0.03	1.06	—	1.06	0.98	—	0.98	—	3,425	3,425	0.14	0.03	—	3,437
Demolition	—	—	—	—	—	0.00	0.00	—	0.00	0.00	—	—	—	—	—	—	—
Onsite truck	0.00	0.00	0.00	0.00	0.00	0.00	0.00	0.00	0.00	0.00	—	0.00	0.00	0.00	0.00	0.00	0.00
Average Daily	—	—	—	—	—	—	—	—	—	—	—	—	—	—	—	—	—
Off-Road Equipment	0.14	1.36	1.19	< 0.005	0.06	—	0.06	0.05	—	0.05	—	188	188	0.01	< 0.005	—	188
Demolition	—	—	—	—	—	0.00	0.00	—	0.00	0.00	—	—	—	—	—	—	—

Onsite truck	0.00	0.00	0.00	0.00	0.00	0.00	0.00	0.00	0.00	0.00	0.00	—	0.00	0.00	0.00	0.00	0.00	0.00
Annual	—	—	—	—	—	—	—	—	—	—	—	—	—	—	—	—	—	—
Off-Road Equipment	0.03	0.25	0.22	< 0.005	0.01	—	0.01	0.01	—	0.01	—	31.1	31.1	< 0.005	< 0.005	—	31.2	
Demolition	—	—	—	—	—	0.00	0.00	—	0.00	0.00	—	—	—	—	—	—	—	
Onsite truck	0.00	0.00	0.00	0.00	0.00	0.00	0.00	0.00	0.00	0.00	—	0.00	0.00	0.00	0.00	0.00	0.00	
Offsite	—	—	—	—	—	—	—	—	—	—	—	—	—	—	—	—	—	
Daily, Summer (Max)	—	—	—	—	—	—	—	—	—	—	—	—	—	—	—	—	—	
Daily, Winter (Max)	—	—	—	—	—	—	—	—	—	—	—	—	—	—	—	—	—	
Worker	0.08	0.12	1.09	0.00	0.00	0.20	0.20	0.00	0.05	0.05	—	199	199	0.01	0.01	0.02	202	
Vendor	0.00	0.00	0.00	0.00	0.00	0.00	0.00	0.00	0.00	0.00	—	0.00	0.00	0.00	0.00	0.00	0.00	
Hauling	0.00	0.00	0.00	0.00	0.00	0.00	0.00	0.00	0.00	0.00	—	0.00	0.00	0.00	0.00	0.00	0.00	
Average Daily	—	—	—	—	—	—	—	—	—	—	—	—	—	—	—	—	—	
Worker	0.01	0.01	0.08	0.00	0.00	0.01	0.01	0.00	< 0.005	< 0.005	—	11.7	11.7	< 0.005	< 0.005	0.02	11.9	
Vendor	0.00	0.00	0.00	0.00	0.00	0.00	0.00	0.00	0.00	0.00	—	0.00	0.00	0.00	0.00	0.00	0.00	
Hauling	0.00	0.00	0.00	0.00	0.00	0.00	0.00	0.00	0.00	0.00	—	0.00	0.00	0.00	0.00	0.00	0.00	
Annual	—	—	—	—	—	—	—	—	—	—	—	—	—	—	—	—	—	
Worker	< 0.005	< 0.005	0.01	0.00	0.00	< 0.005	< 0.005	0.00	< 0.005	< 0.005	—	1.94	1.94	< 0.005	< 0.005	< 0.005	1.97	
Vendor	0.00	0.00	0.00	0.00	0.00	0.00	0.00	0.00	0.00	0.00	—	0.00	0.00	0.00	0.00	0.00	0.00	
Hauling	0.00	0.00	0.00	0.00	0.00	0.00	0.00	0.00	0.00	0.00	—	0.00	0.00	0.00	0.00	0.00	0.00	

3.2. Demolition (2024) - Mitigated

Criteria Pollutants (lb/day for daily, ton/yr for annual) and GHGs (lb/day for daily, MT/yr for annual)

Location	ROG	NOx	CO	SO2	PM10E	PM10D	PM10T	PM2.5E	PM2.5D	PM2.5T	BCO2	NBCO2	CO2T	CH4	N2O	R	CO2e
Onsite	—	—	—	—	—	—	—	—	—	—	—	—	—	—	—	—	—
Daily, Summer (Max)	—	—	—	—	—	—	—	—	—	—	—	—	—	—	—	—	—
Daily, Winter (Max)	—	—	—	—	—	—	—	—	—	—	—	—	—	—	—	—	—
Off-Road Equipment	2.62	24.9	21.7	0.03	1.06	—	1.06	0.98	—	0.98	—	3,425	3,425	0.14	0.03	—	3,437
Demolition	—	—	—	—	—	0.00	0.00	—	0.00	0.00	—	—	—	—	—	—	—
Onsite truck	0.00	0.00	0.00	0.00	0.00	0.00	0.00	0.00	0.00	0.00	—	0.00	0.00	0.00	0.00	0.00	0.00
Average Daily	—	—	—	—	—	—	—	—	—	—	—	—	—	—	—	—	—
Off-Road Equipment	0.14	1.36	1.19	< 0.005	0.06	—	0.06	0.05	—	0.05	—	188	188	0.01	< 0.005	—	188
Demolition	—	—	—	—	—	0.00	0.00	—	0.00	0.00	—	—	—	—	—	—	—
Onsite truck	0.00	0.00	0.00	0.00	0.00	0.00	0.00	0.00	0.00	0.00	—	0.00	0.00	0.00	0.00	0.00	0.00
Annual	—	—	—	—	—	—	—	—	—	—	—	—	—	—	—	—	—
Off-Road Equipment	0.03	0.25	0.22	< 0.005	0.01	—	0.01	0.01	—	0.01	—	31.1	31.1	< 0.005	< 0.005	—	31.2
Demolition	—	—	—	—	—	0.00	0.00	—	0.00	0.00	—	—	—	—	—	—	—
Onsite truck	0.00	0.00	0.00	0.00	0.00	0.00	0.00	0.00	0.00	0.00	—	0.00	0.00	0.00	0.00	0.00	0.00
Offsite	—	—	—	—	—	—	—	—	—	—	—	—	—	—	—	—	—
Daily, Summer (Max)	—	—	—	—	—	—	—	—	—	—	—	—	—	—	—	—	—

EEC ORIGINAL PKG

Daily, Winter (Max)	—	—	—	—	—	—	—	—	—	—	—	—	—	—	—	—	—
Worker	0.08	0.12	1.09	0.00	0.00	0.20	0.20	0.00	0.05	0.05	—	199	199	0.01	0.01	0.02	202
Vendor	0.00	0.00	0.00	0.00	0.00	0.00	0.00	0.00	0.00	0.00	—	0.00	0.00	0.00	0.00	0.00	0.00
Hauling	0.00	0.00	0.00	0.00	0.00	0.00	0.00	0.00	0.00	0.00	—	0.00	0.00	0.00	0.00	0.00	0.00
Average Daily	—	—	—	—	—	—	—	—	—	—	—	—	—	—	—	—	—
Worker	0.01	0.01	0.08	0.00	0.00	0.01	0.01	0.00	< 0.005	< 0.005	—	11.7	11.7	< 0.005	< 0.005	0.02	11.9
Vendor	0.00	0.00	0.00	0.00	0.00	0.00	0.00	0.00	0.00	0.00	—	0.00	0.00	0.00	0.00	0.00	0.00
Hauling	0.00	0.00	0.00	0.00	0.00	0.00	0.00	0.00	0.00	0.00	—	0.00	0.00	0.00	0.00	0.00	0.00
Annual	—	—	—	—	—	—	—	—	—	—	—	—	—	—	—	—	—
Worker	< 0.005	< 0.005	0.01	0.00	0.00	< 0.005	< 0.005	0.00	< 0.005	< 0.005	—	1.94	1.94	< 0.005	< 0.005	< 0.005	1.97
Vendor	0.00	0.00	0.00	0.00	0.00	0.00	0.00	0.00	0.00	0.00	—	0.00	0.00	0.00	0.00	0.00	0.00
Hauling	0.00	0.00	0.00	0.00	0.00	0.00	0.00	0.00	0.00	0.00	—	0.00	0.00	0.00	0.00	0.00	0.00

3.3. Site Preparation (2024) - Unmitigated

Criteria Pollutants (lb/day for daily, ton/yr for annual) and GHGs (lb/day for daily, MT/yr for annual)

Location	ROG	NOx	CO	SO2	PM10E	PM10D	PM10T	PM2.5E	PM2.5D	PM2.5T	BCO2	NBCO2	CO2T	CH4	N2O	R	CO2e
Onsite	—	—	—	—	—	—	—	—	—	—	—	—	—	—	—	—	—
Daily, Summer (Max)	—	—	—	—	—	—	—	—	—	—	—	—	—	—	—	—	—
Daily, Winter (Max)	—	—	—	—	—	—	—	—	—	—	—	—	—	—	—	—	—
Off-Road Equipment	3.65	36.0	32.9	0.05	1.60	—	1.60	1.47	—	1.47	—	5,296	5,296	0.21	0.04	—	5,314

Dust From Material Movement	—	—	—	—	—	7.67	7.67	—	3.94	3.94	—	—	—	—	—	—	—
Onsite truck	0.00	0.00	0.00	0.00	0.00	0.00	0.00	0.00	0.00	0.00	—	0.00	0.00	0.00	0.00	0.00	0.00
Average Daily	—	—	—	—	—	—	—	—	—	—	—	—	—	—	—	—	—
Off-Road Equipment	0.10	0.99	0.90	< 0.005	0.04	—	0.04	0.04	—	0.04	—	145	145	0.01	< 0.005	—	146
Dust From Material Movement	—	—	—	—	—	0.21	0.21	—	0.11	0.11	—	—	—	—	—	—	—
Onsite truck	0.00	0.00	0.00	0.00	0.00	0.00	0.00	0.00	0.00	0.00	—	0.00	0.00	0.00	0.00	0.00	0.00
Annual	—	—	—	—	—	—	—	—	—	—	—	—	—	—	—	—	—
Off-Road Equipment	0.02	0.18	0.16	< 0.005	0.01	—	0.01	0.01	—	0.01	—	24.0	24.0	< 0.005	< 0.005	—	24.1
Dust From Material Movement	—	—	—	—	—	0.04	0.04	—	0.02	0.02	—	—	—	—	—	—	—
Onsite truck	0.00	0.00	0.00	0.00	0.00	0.00	0.00	0.00	0.00	0.00	—	0.00	0.00	0.00	0.00	0.00	0.00
Offsite	—	—	—	—	—	—	—	—	—	—	—	—	—	—	—	—	—
Daily, Summer (Max)	—	—	—	—	—	—	—	—	—	—	—	—	—	—	—	—	—
Daily, Winter (Max)	—	—	—	—	—	—	—	—	—	—	—	—	—	—	—	—	—
Worker	0.09	0.14	1.27	0.00	0.00	0.23	0.23	0.00	0.05	0.05	—	233	233	0.01	0.01	0.03	235
Vendor	0.00	0.00	0.00	0.00	0.00	0.00	0.00	0.00	0.00	0.00	—	0.00	0.00	0.00	0.00	0.00	0.00
Hauling	0.02	1.08	0.25	0.01	0.02	0.23	0.24	0.02	0.06	0.07	—	867	867	0.01	0.01	0.05	908

Average Daily	—	—	—	—	—	—	—	—	—	—	—	—	—	—	—	—	—
Worker	< 0.005	< 0.005	0.04	0.00	0.00	0.01	0.01	0.00	< 0.005	< 0.005	—	6.85	6.85	< 0.005	< 0.005	0.01	6.94
Vendor	0.00	0.00	0.00	0.00	0.00	0.00	0.00	0.00	0.00	0.00	—	0.00	0.00	0.00	0.00	0.00	0.00
Hauling	< 0.005	0.03	0.01	< 0.005	< 0.005	0.01	0.01	< 0.005	< 0.005	< 0.005	—	23.7	23.7	< 0.005	< 0.005	0.02	24.9
Annual	—	—	—	—	—	—	—	—	—	—	—	—	—	—	—	—	—
Worker	< 0.005	< 0.005	0.01	0.00	0.00	< 0.005	< 0.005	0.00	< 0.005	< 0.005	—	1.13	1.13	< 0.005	< 0.005	< 0.005	1.15
Vendor	0.00	0.00	0.00	0.00	0.00	0.00	0.00	0.00	0.00	0.00	—	0.00	0.00	0.00	0.00	0.00	0.00
Hauling	< 0.005	0.01	< 0.005	< 0.005	< 0.005	< 0.005	< 0.005	< 0.005	< 0.005	< 0.005	—	3.93	3.93	< 0.005	< 0.005	< 0.005	4.12

3.4. Site Preparation (2024) - Mitigated

Criteria Pollutants (lb/day for daily, ton/yr for annual) and GHGs (lb/day for daily, MT/yr for annual)

Location	ROG	NOx	CO	SO2	PM10E	PM10D	PM10T	PM2.5E	PM2.5D	PM2.5T	BCO2	NBCO2	CO2T	CH4	N2O	R	CO2e
Onsite	—	—	—	—	—	—	—	—	—	—	—	—	—	—	—	—	—
Daily, Summer (Max)	—	—	—	—	—	—	—	—	—	—	—	—	—	—	—	—	—
Daily, Winter (Max)	—	—	—	—	—	—	—	—	—	—	—	—	—	—	—	—	—
Off-Road Equipment	3.65	36.0	32.9	0.05	1.60	—	1.60	1.47	—	1.47	—	5,296	5,296	0.21	0.04	—	5,314
Dust From Material Movement	—	—	—	—	—	7.67	7.67	—	3.94	3.94	—	—	—	—	—	—	—
Onsite truck	0.00	0.00	0.00	0.00	0.00	0.00	0.00	0.00	0.00	0.00	—	0.00	0.00	0.00	0.00	0.00	0.00
Average Daily	—	—	—	—	—	—	—	—	—	—	—	—	—	—	—	—	—
Off-Road Equipment	0.10	0.99	0.90	< 0.005	0.04	—	0.04	0.04	—	0.04	—	145	145	0.01	< 0.005	—	146

EEC ORIGINAL PKG

Dust From Material Movement	—	—	—	—	—	0.21	0.21	—	0.11	0.11	—	—	—	—	—	—	—
Onsite truck	0.00	0.00	0.00	0.00	0.00	0.00	0.00	0.00	0.00	0.00	—	0.00	0.00	0.00	0.00	0.00	0.00
Annual	—	—	—	—	—	—	—	—	—	—	—	—	—	—	—	—	—
Off-Road Equipment	0.02	0.18	0.16	< 0.005	0.01	—	0.01	0.01	—	0.01	—	24.0	24.0	< 0.005	< 0.005	—	24.1
Dust From Material Movement	—	—	—	—	—	0.04	0.04	—	0.02	0.02	—	—	—	—	—	—	—
Onsite truck	0.00	0.00	0.00	0.00	0.00	0.00	0.00	0.00	0.00	0.00	—	0.00	0.00	0.00	0.00	0.00	0.00
Offsite	—	—	—	—	—	—	—	—	—	—	—	—	—	—	—	—	—
Daily, Summer (Max)	—	—	—	—	—	—	—	—	—	—	—	—	—	—	—	—	—
Daily, Winter (Max)	—	—	—	—	—	—	—	—	—	—	—	—	—	—	—	—	—
Worker	0.09	0.14	1.27	0.00	0.00	0.23	0.23	0.00	0.05	0.05	—	233	233	0.01	0.01	0.03	235
Vendor	0.00	0.00	0.00	0.00	0.00	0.00	0.00	0.00	0.00	0.00	—	0.00	0.00	0.00	0.00	0.00	0.00
Hauling	0.02	1.08	0.25	0.01	0.02	0.23	0.24	0.02	0.06	0.07	—	867	867	0.01	0.14	0.05	908
Average Daily	—	—	—	—	—	—	—	—	—	—	—	—	—	—	—	—	—
Worker	< 0.005	< 0.005	0.04	0.00	0.00	0.01	0.01	0.00	< 0.005	< 0.005	—	6.85	6.85	< 0.005	< 0.005	0.01	6.94
Vendor	0.00	0.00	0.00	0.00	0.00	0.00	0.00	0.00	0.00	0.00	—	0.00	0.00	0.00	0.00	0.00	0.00
Hauling	< 0.005	0.03	0.01	< 0.005	< 0.005	0.01	0.01	< 0.005	< 0.005	< 0.005	—	23.7	23.7	< 0.005	< 0.005	0.02	24.9
Annual	—	—	—	—	—	—	—	—	—	—	—	—	—	—	—	—	—
Worker	< 0.005	< 0.005	0.01	0.00	0.00	< 0.005	< 0.005	0.00	< 0.005	< 0.005	—	1.13	1.13	< 0.005	< 0.005	< 0.005	1.15
Vendor	0.00	0.00	0.00	0.00	0.00	0.00	0.00	0.00	0.00	0.00	—	0.00	0.00	0.00	0.00	0.00	0.00

EEC ORIGINAL PKG

Hauling	< 0.005	0.01	< 0.005	< 0.005	< 0.005	< 0.005	< 0.005	< 0.005	< 0.005	< 0.005	—	3.93	3.93	< 0.005	< 0.005	< 0.005	4.12
---------	---------	------	---------	---------	---------	---------	---------	---------	---------	---------	---	------	------	---------	---------	---------	------

3.5. Grading (2024) - Unmitigated

Criteria Pollutants (lb/day for daily, ton/yr for annual) and GHGs (lb/day for daily, MT/yr for annual)

Location	ROG	NOx	CO	SO2	PM10E	PM10D	PM10T	PM2.5E	PM2.5D	PM2.5T	BCO2	NBCO2	CO2T	CH4	N2O	R	CO2e
Onsite	—	—	—	—	—	—	—	—	—	—	—	—	—	—	—	—	—
Daily, Summer (Max)	—	—	—	—	—	—	—	—	—	—	—	—	—	—	—	—	—
Daily, Winter (Max)	—	—	—	—	—	—	—	—	—	—	—	—	—	—	—	—	—
Off-Road Equipment	1.90	18.2	18.8	0.03	0.84	—	0.84	0.77	—	0.77	—	2,958	2,958	0.12	0.02	—	2,969
Dust From Material Movement	—	—	—	—	—	2.76	2.76	—	1.34	1.34	—	—	—	—	—	—	—
Onsite truck	0.00	0.00	0.00	0.00	0.00	0.00	0.00	0.00	0.00	0.00	—	0.00	0.00	0.00	0.00	0.00	0.00
Average Daily	—	—	—	—	—	—	—	—	—	—	—	—	—	—	—	—	—
Off-Road Equipment	0.05	0.46	0.48	< 0.005	0.02	—	0.02	0.02	—	0.02	—	75.3	75.3	< 0.005	< 0.005	—	75.5
Dust From Material Movement	—	—	—	—	—	0.07	0.07	—	0.03	0.03	—	—	—	—	—	—	—
Onsite truck	0.00	0.00	0.00	0.00	0.00	0.00	0.00	0.00	0.00	0.00	—	0.00	0.00	0.00	0.00	0.00	0.00
Annual	—	—	—	—	—	—	—	—	—	—	—	—	—	—	—	—	—
Off-Road Equipment	0.01	0.08	0.09	< 0.005	< 0.005	—	< 0.005	< 0.005	—	< 0.005	—	12.5	12.5	< 0.005	< 0.005	—	12.5

EEC ORIGINAL PKG

Dust From Material Movement	—	—	—	—	—	0.01	0.01	—	0.01	0.01	—	—	—	—	—	—	
Onsite truck	0.00	0.00	0.00	0.00	0.00	0.00	0.00	0.00	0.00	0.00	—	0.00	0.00	0.00	0.00	0.00	
Offsite	—	—	—	—	—	—	—	—	—	—	—	—	—	—	—	—	
Daily, Summer (Max)	—	—	—	—	—	—	—	—	—	—	—	—	—	—	—	—	
Daily, Winter (Max)	—	—	—	—	—	—	—	—	—	—	—	—	—	—	—	—	
Worker	0.08	0.12	1.09	0.00	0.00	0.20	0.20	0.00	0.05	0.05	—	199	199	0.01	0.01	0.02	202
Vendor	0.00	0.00	0.00	0.00	0.00	0.00	0.00	0.00	0.00	0.00	—	0.00	0.00	0.00	0.00	0.00	0.00
Hauling	< 0.005	0.18	0.04	< 0.005	< 0.005	0.04	0.04	< 0.005	0.01	0.01	—	145	145	< 0.005	0.02	0.01	151
Average Daily	—	—	—	—	—	—	—	—	—	—	—	—	—	—	—	—	—
Worker	< 0.005	< 0.005	0.03	0.00	0.00	< 0.005	< 0.005	0.00	< 0.005	< 0.005	—	5.45	5.45	< 0.005	< 0.005	0.01	5.53
Vendor	0.00	0.00	0.00	0.00	0.00	0.00	0.00	0.00	0.00	0.00	—	0.00	0.00	0.00	0.00	0.00	0.00
Hauling	< 0.005	< 0.005	< 0.005	< 0.005	< 0.005	< 0.005	< 0.005	< 0.005	< 0.005	< 0.005	—	3.68	3.68	< 0.005	< 0.005	< 0.005	3.85
Annual	—	—	—	—	—	—	—	—	—	—	—	—	—	—	—	—	—
Worker	< 0.005	< 0.005	0.01	0.00	0.00	< 0.005	< 0.005	0.00	< 0.005	< 0.005	—	0.90	0.90	< 0.005	< 0.005	< 0.005	0.91
Vendor	0.00	0.00	0.00	0.00	0.00	0.00	0.00	0.00	0.00	0.00	—	0.00	0.00	0.00	0.00	0.00	0.00
Hauling	< 0.005	< 0.005	< 0.005	< 0.005	< 0.005	< 0.005	< 0.005	< 0.005	< 0.005	< 0.005	—	0.61	0.61	< 0.005	< 0.005	< 0.005	0.64

3.6. Grading (2024) - Mitigated

Criteria Pollutants (lb/day for daily, ton/yr for annual) and GHGs (lb/day for daily, MT/yr for annual)

Location	ROG	NOx	CO	SO2	PM10E	PM10D	PM10T	PM2.5E	PM2.5D	PM2.5T	BCO2	NBCO2	CO2T	CH4	N2O	R	CO2e
Onsite	—	—	—	—	—	—	—	—	—	—	—	—	—	—	—	—	—

EEC ORIGINAL PKG

Daily, Summer (Max)	—	—	—	—	—	—	—	—	—	—	—	—	—	—	—	—	—
Daily, Winter (Max)	—	—	—	—	—	—	—	—	—	—	—	—	—	—	—	—	—
Off-Road Equipment	1.90	18.2	18.8	0.03	0.84	—	0.84	0.77	—	0.77	—	2,958	2,958	0.12	0.02	—	2,969
Dust From Material Movement	—	—	—	—	—	2.76	2.76	—	1.34	1.34	—	—	—	—	—	—	—
Onsite truck	0.00	0.00	0.00	0.00	0.00	0.00	0.00	0.00	0.00	0.00	—	0.00	0.00	0.00	0.00	0.00	0.00
Average Daily	—	—	—	—	—	—	—	—	—	—	—	—	—	—	—	—	—
Off-Road Equipment	0.05	0.46	0.48	< 0.005	0.02	—	0.02	0.02	—	0.02	—	75.3	75.3	< 0.005	< 0.005	—	75.5
Dust From Material Movement	—	—	—	—	—	0.07	0.07	—	0.03	0.03	—	—	—	—	—	—	—
Onsite truck	0.00	0.00	0.00	0.00	0.00	0.00	0.00	0.00	0.00	0.00	—	0.00	0.00	0.00	0.00	0.00	0.00
Annual	—	—	—	—	—	—	—	—	—	—	—	—	—	—	—	—	—
Off-Road Equipment	0.01	0.08	0.09	< 0.005	< 0.005	—	< 0.005	< 0.005	—	< 0.005	—	12.5	12.5	< 0.005	< 0.005	—	12.5
Dust From Material Movement	—	—	—	—	—	0.01	0.01	—	0.01	0.01	—	—	—	—	—	—	—
Onsite truck	0.00	0.00	0.00	0.00	0.00	0.00	0.00	0.00	0.00	0.00	—	0.00	0.00	0.00	0.00	0.00	0.00
Offsite	—	—	—	—	—	—	—	—	—	—	—	—	—	—	—	—	—

EEC ORIGINAL PKG

Daily, Summer (Max)	—	—	—	—	—	—	—	—	—	—	—	—	—	—	—	—	—
Daily, Winter (Max)	—	—	—	—	—	—	—	—	—	—	—	—	—	—	—	—	—
Worker	0.08	0.12	1.09	0.00	0.00	0.20	0.20	0.00	0.05	0.05	—	199	199	0.01	0.01	0.02	202
Vendor	0.00	0.00	0.00	0.00	0.00	0.00	0.00	0.00	0.00	0.00	—	0.00	0.00	0.00	0.00	0.00	0.00
Hauling	< 0.005	0.18	0.04	< 0.005	< 0.005	0.04	0.04	< 0.005	0.01	0.01	—	145	145	< 0.005	0.02	0.01	151
Average Daily	—	—	—	—	—	—	—	—	—	—	—	—	—	—	—	—	—
Worker	< 0.005	< 0.005	0.03	0.00	0.00	< 0.005	< 0.005	0.00	< 0.005	< 0.005	—	5.45	5.45	< 0.005	< 0.005	0.01	5.53
Vendor	0.00	0.00	0.00	0.00	0.00	0.00	0.00	0.00	0.00	0.00	—	0.00	0.00	0.00	0.00	0.00	0.00
Hauling	< 0.005	< 0.005	< 0.005	< 0.005	< 0.005	< 0.005	< 0.005	< 0.005	< 0.005	< 0.005	—	3.68	3.68	< 0.005	< 0.005	< 0.005	3.85
Annual	—	—	—	—	—	—	—	—	—	—	—	—	—	—	—	—	—
Worker	< 0.005	< 0.005	0.01	0.00	0.00	< 0.005	< 0.005	0.00	< 0.005	< 0.005	—	0.90	0.90	< 0.005	< 0.005	< 0.005	0.91
Vendor	0.00	0.00	0.00	0.00	0.00	0.00	0.00	0.00	0.00	0.00	—	0.00	0.00	0.00	0.00	0.00	0.00
Hauling	< 0.005	< 0.005	< 0.005	< 0.005	< 0.005	< 0.005	< 0.005	< 0.005	< 0.005	< 0.005	—	0.61	0.61	< 0.005	< 0.005	< 0.005	0.64

3.7. Grading (2025) - Unmitigated

Criteria Pollutants (lb/day for daily, ton/yr for annual) and GHGs (lb/day for daily, MT/yr for annual)

Location	ROG	NOx	CO	SO2	PM10E	PM10D	PM10T	PM2.5E	PM2.5D	PM2.5T	BCO2	NBCO2	CO2T	CH4	N2O	R	CO2e
Onsite	—	—	—	—	—	—	—	—	—	—	—	—	—	—	—	—	—
Daily, Summer (Max)	—	—	—	—	—	—	—	—	—	—	—	—	—	—	—	—	—
Daily, Winter (Max)	—	—	—	—	—	—	—	—	—	—	—	—	—	—	—	—	—
Off-Road Equipment	1.74	16.3	17.9	0.03	0.72	—	0.72	0.66	—	0.66	—	2,959	2,959	0.12	0.02	—	2,970

EEC ORIGINAL PKG

Dust From Material Movement	—	—	—	—	—	2.76	2.76	—	1.34	1.34	—	—	—	—	—	—	—
Onsite truck	0.00	0.00	0.00	0.00	0.00	0.00	0.00	0.00	0.00	0.00	—	0.00	0.00	0.00	0.00	0.00	0.00
Average Daily	—	—	—	—	—	—	—	—	—	—	—	—	—	—	—	—	—
Off-Road Equipment	0.24	2.26	2.49	< 0.005	0.10	—	0.10	0.09	—	0.09	—	411	411	0.02	< 0.005	—	413
Dust From Material Movement	—	—	—	—	—	0.38	0.38	—	0.19	0.19	—	—	—	—	—	—	—
Onsite truck	0.00	0.00	0.00	0.00	0.00	0.00	0.00	0.00	0.00	0.00	—	0.00	0.00	0.00	0.00	0.00	0.00
Annual	—	—	—	—	—	—	—	—	—	—	—	—	—	—	—	—	—
Off-Road Equipment	0.04	0.41	0.45	< 0.005	0.02	—	0.02	0.02	—	0.02	—	68.1	68.1	< 0.005	< 0.005	—	68.3
Dust From Material Movement	—	—	—	—	—	0.07	0.07	—	0.03	0.03	—	—	—	—	—	—	—
Onsite truck	0.00	0.00	0.00	0.00	0.00	0.00	0.00	0.00	0.00	0.00	—	0.00	0.00	0.00	0.00	0.00	0.00
Offsite	—	—	—	—	—	—	—	—	—	—	—	—	—	—	—	—	—
Daily, Summer (Max)	—	—	—	—	—	—	—	—	—	—	—	—	—	—	—	—	—
Daily, Winter (Max)	—	—	—	—	—	—	—	—	—	—	—	—	—	—	—	—	—
Worker	0.08	0.11	0.99	0.00	0.00	0.20	0.20	0.00	0.05	0.05	—	195	195	0.01	0.01	0.02	198
Vendor	0.00	0.00	0.00	0.00	0.00	0.00	0.00	0.00	0.00	0.00	—	0.00	0.00	0.00	0.00	0.00	0.00
Hauling	< 0.005	0.17	0.04	< 0.005	< 0.005	0.04	0.04	< 0.005	0.01	0.01	—	142	142	< 0.005	0.02	0.01	148

Average Daily	—	—	—	—	—	—	—	—	—	—	—	—	—	—	—	—	—
Worker	0.01	0.01	0.17	0.00	0.00	0.03	0.03	0.00	0.01	0.01	—	29.2	29.2	< 0.005	< 0.005	0.05	29.6
Vendor	0.00	0.00	0.00	0.00	0.00	0.00	0.00	0.00	0.00	0.00	—	0.00	0.00	0.00	0.00	0.00	0.00
Hauling	< 0.005	0.02	0.01	< 0.005	< 0.005	0.01	0.01	< 0.005	< 0.005	< 0.005	—	19.7	19.7	< 0.005	< 0.005	0.02	20.6
Annual	—	—	—	—	—	—	—	—	—	—	—	—	—	—	—	—	—
Worker	< 0.005	< 0.005	0.03	0.00	0.00	< 0.005	< 0.005	0.00	< 0.005	< 0.005	—	4.83	4.83	< 0.005	< 0.005	0.01	4.89
Vendor	0.00	0.00	0.00	0.00	0.00	0.00	0.00	0.00	0.00	0.00	—	0.00	0.00	0.00	0.00	0.00	0.00
Hauling	< 0.005	< 0.005	< 0.005	< 0.005	< 0.005	< 0.005	< 0.005	< 0.005	< 0.005	< 0.005	—	3.26	3.26	< 0.005	< 0.005	< 0.005	3.42

3.8. Grading (2025) - Mitigated

Criteria Pollutants (lb/day for daily, ton/yr for annual) and GHGs (lb/day for daily, MT/yr for annual)

Location	ROG	NOx	CO	SO2	PM10E	PM10D	PM10T	PM2.5E	PM2.5D	PM2.5T	BCO2	NBCO2	CO2T	CH4	N2O	R	CO2e
Onsite	—	—	—	—	—	—	—	—	—	—	—	—	—	—	—	—	—
Daily, Summer (Max)	—	—	—	—	—	—	—	—	—	—	—	—	—	—	—	—	—
Daily, Winter (Max)	—	—	—	—	—	—	—	—	—	—	—	—	—	—	—	—	—
Off-Road Equipment	1.74	16.3	17.9	0.03	0.72	—	0.72	0.66	—	0.66	—	2,959	2,959	0.12	0.02	—	2,970
Dust From Material Movement	—	—	—	—	—	2.76	2.76	—	1.34	1.34	—	—	—	—	—	—	—
Onsite truck	0.00	0.00	0.00	0.00	0.00	0.00	0.00	0.00	0.00	0.00	—	0.00	0.00	0.00	0.00	0.00	0.00
Average Daily	—	—	—	—	—	—	—	—	—	—	—	—	—	—	—	—	—
Off-Road Equipment	0.24	2.26	2.49	< 0.005	0.10	—	0.10	0.09	—	0.09	—	411	411	0.02	< 0.005	—	413

EEC ORIGINAL PKG

Dust From Material Movement	—	—	—	—	—	0.38	0.38	—	0.19	0.19	—	—	—	—	—	—	—
Onsite truck	0.00	0.00	0.00	0.00	0.00	0.00	0.00	0.00	0.00	0.00	—	0.00	0.00	0.00	0.00	0.00	0.00
Annual	—	—	—	—	—	—	—	—	—	—	—	—	—	—	—	—	—
Off-Road Equipment	0.04	0.41	0.45	< 0.005	0.02	—	0.02	0.02	—	0.02	—	68.1	68.1	< 0.005	< 0.005	—	68.3
Dust From Material Movement	—	—	—	—	—	0.07	0.07	—	0.03	0.03	—	—	—	—	—	—	—
Onsite truck	0.00	0.00	0.00	0.00	0.00	0.00	0.00	0.00	0.00	0.00	—	0.00	0.00	0.00	0.00	0.00	0.00
Offsite	—	—	—	—	—	—	—	—	—	—	—	—	—	—	—	—	—
Daily, Summer (Max)	—	—	—	—	—	—	—	—	—	—	—	—	—	—	—	—	—
Daily, Winter (Max)	—	—	—	—	—	—	—	—	—	—	—	—	—	—	—	—	—
Worker	0.08	0.11	0.99	0.00	0.00	0.20	0.20	0.00	0.05	0.05	—	195	195	0.01	0.01	0.02	198
Vendor	0.00	0.00	0.00	0.00	0.00	0.00	0.00	0.00	0.00	0.00	—	0.00	0.00	0.00	0.00	0.00	0.00
Hauling	< 0.005	0.17	0.04	< 0.005	< 0.005	0.04	0.04	< 0.005	0.01	0.01	—	142	142	< 0.005	0.02	0.01	148
Average Daily	—	—	—	—	—	—	—	—	—	—	—	—	—	—	—	—	—
Worker	0.01	0.01	0.17	0.00	0.00	0.03	0.03	0.00	0.01	0.01	—	29.2	29.2	< 0.005	< 0.005	0.05	29.6
Vendor	0.00	0.00	0.00	0.00	0.00	0.00	0.00	0.00	0.00	0.00	—	0.00	0.00	0.00	0.00	0.00	0.00
Hauling	< 0.005	0.02	0.01	< 0.005	< 0.005	0.01	0.01	< 0.005	< 0.005	< 0.005	—	19.7	19.7	< 0.005	< 0.005	0.02	20.6
Annual	—	—	—	—	—	—	—	—	—	—	—	—	—	—	—	—	—
Worker	< 0.005	< 0.005	0.03	0.00	0.00	< 0.005	< 0.005	0.00	< 0.005	< 0.005	—	4.83	4.83	< 0.005	< 0.005	0.01	4.89
Vendor	0.00	0.00	0.00	0.00	0.00	0.00	0.00	0.00	0.00	0.00	—	0.00	0.00	0.00	0.00	0.00	0.00

EEC ORIGINAL PKG

Hauling	< 0.005	< 0.005	< 0.005	< 0.005	< 0.005	< 0.005	< 0.005	< 0.005	< 0.005	< 0.005	< 0.005	—	3.26	3.26	< 0.005	< 0.005	< 0.005	3.42
---------	---------	---------	---------	---------	---------	---------	---------	---------	---------	---------	---------	---	------	------	---------	---------	---------	------

3.9. Building Construction (2025) - Unmitigated

Criteria Pollutants (lb/day for daily, ton/yr for annual) and GHGs (lb/day for daily, MT/yr for annual)

Location	ROG	NOx	CO	SO2	PM10E	PM10D	PM10T	PM2.5E	PM2.5D	PM2.5T	BCO2	NBCO2	CO2T	CH4	N2O	R	CO2e
Onsite	—	—	—	—	—	—	—	—	—	—	—	—	—	—	—	—	—
Daily, Summer (Max)	—	—	—	—	—	—	—	—	—	—	—	—	—	—	—	—	—
Off-Road Equipment	1.13	10.4	13.0	0.02	0.43	—	0.43	0.40	—	0.40	—	2,398	2,398	0.10	0.02	—	2,406
Onsite truck	0.00	0.00	0.00	0.00	0.00	0.00	0.00	0.00	0.00	0.00	—	0.00	0.00	0.00	0.00	0.00	0.00
Daily, Winter (Max)	—	—	—	—	—	—	—	—	—	—	—	—	—	—	—	—	—
Off-Road Equipment	1.13	10.4	13.0	0.02	0.43	—	0.43	0.40	—	0.40	—	2,398	2,398	0.10	0.02	—	2,406
Onsite truck	0.00	0.00	0.00	0.00	0.00	0.00	0.00	0.00	0.00	0.00	—	0.00	0.00	0.00	0.00	0.00	0.00
Average Daily	—	—	—	—	—	—	—	—	—	—	—	—	—	—	—	—	—
Off-Road Equipment	0.59	5.49	6.86	0.01	0.23	—	0.23	0.21	—	0.21	—	1,261	1,261	0.05	0.01	—	1,266
Onsite truck	0.00	0.00	0.00	0.00	0.00	0.00	0.00	0.00	0.00	0.00	—	0.00	0.00	0.00	0.00	0.00	0.00
Annual	—	—	—	—	—	—	—	—	—	—	—	—	—	—	—	—	—
Off-Road Equipment	0.11	1.00	1.25	< 0.005	0.04	—	0.04	0.04	—	0.04	—	209	209	0.01	< 0.005	—	210
Onsite truck	0.00	0.00	0.00	0.00	0.00	0.00	0.00	0.00	0.00	0.00	—	0.00	0.00	0.00	0.00	0.00	0.00
Offsite	—	—	—	—	—	—	—	—	—	—	—	—	—	—	—	—	—

EEC ORIGINAL PKG

Daily, Summer (Max)	—	—	—	—	—	—	—	—	—	—	—	—	—	—	—	—	—
Worker	0.01	0.01	0.22	0.00	0.00	0.03	0.03	0.00	0.01	0.01	—	29.5	29.5	< 0.005	< 0.005	0.10	29.9
Vendor	< 0.005	0.03	0.02	< 0.005	< 0.005	0.01	0.01	< 0.005	< 0.005	< 0.005	—	30.9	30.9	< 0.005	< 0.005	0.09	32.2
Hauling	0.00	0.00	0.00	0.00	0.00	0.00	0.00	0.00	0.00	0.00	—	0.00	0.00	0.00	0.00	0.00	0.00
Daily, Winter (Max)	—	—	—	—	—	—	—	—	—	—	—	—	—	—	—	—	—
Worker	0.01	0.01	0.13	0.00	0.00	0.03	0.03	0.00	0.01	0.01	—	24.9	24.9	< 0.005	< 0.005	< 0.005	25.2
Vendor	< 0.005	0.04	0.02	< 0.005	< 0.005	0.01	0.01	< 0.005	< 0.005	< 0.005	—	30.9	30.9	< 0.005	< 0.005	< 0.005	32.1
Hauling	0.00	0.00	0.00	0.00	0.00	0.00	0.00	0.00	0.00	0.00	—	0.00	0.00	0.00	0.00	0.00	0.00
Average Daily	—	—	—	—	—	—	—	—	—	—	—	—	—	—	—	—	—
Worker	0.01	0.01	0.08	0.00	0.00	0.01	0.01	0.00	< 0.005	< 0.005	—	14.1	14.1	< 0.005	< 0.005	0.02	14.3
Vendor	< 0.005	0.02	0.01	< 0.005	< 0.005	< 0.005	< 0.005	< 0.005	< 0.005	< 0.005	—	16.2	16.2	< 0.005	< 0.005	0.02	16.9
Hauling	0.00	0.00	0.00	0.00	0.00	0.00	0.00	0.00	0.00	0.00	—	0.00	0.00	0.00	0.00	0.00	0.00
Annual	—	—	—	—	—	—	—	—	—	—	—	—	—	—	—	—	—
Worker	< 0.005	< 0.005	0.02	0.00	0.00	< 0.005	< 0.005	0.00	< 0.005	< 0.005	—	2.33	2.33	< 0.005	< 0.005	< 0.005	2.36
Vendor	< 0.005	< 0.005	< 0.005	< 0.005	< 0.005	< 0.005	< 0.005	< 0.005	< 0.005	< 0.005	—	2.69	2.69	< 0.005	< 0.005	< 0.005	2.80
Hauling	0.00	0.00	0.00	0.00	0.00	0.00	0.00	0.00	0.00	0.00	—	0.00	0.00	0.00	0.00	0.00	0.00

3.10. Building Construction (2025) - Mitigated

Criteria Pollutants (lb/day for daily, ton/yr for annual) and GHGs (lb/day for daily, MT/yr for annual)

Location	ROG	NOx	CO	SO2	PM10E	PM10D	PM10T	PM2.5E	PM2.5D	PM2.5T	BCO2	NBCO2	CO2T	CH4	N2O	R	CO2e
Onsite	—	—	—	—	—	—	—	—	—	—	—	—	—	—	—	—	—
Daily, Summer (Max)	—	—	—	—	—	—	—	—	—	—	—	—	—	—	—	—	—

Off-Road Equipment	1.13	10.4	13.0	0.02	0.43	—	0.43	0.40	—	0.40	—	2,398	2,398	0.10	0.02	—	2,406
Onsite truck	0.00	0.00	0.00	0.00	0.00	0.00	0.00	0.00	0.00	0.00	—	0.00	0.00	0.00	0.00	0.00	0.00
Daily, Winter (Max)	—	—	—	—	—	—	—	—	—	—	—	—	—	—	—	—	—
Off-Road Equipment	1.13	10.4	13.0	0.02	0.43	—	0.43	0.40	—	0.40	—	2,398	2,398	0.10	0.02	—	2,406
Onsite truck	0.00	0.00	0.00	0.00	0.00	0.00	0.00	0.00	0.00	0.00	—	0.00	0.00	0.00	0.00	0.00	0.00
Average Daily	—	—	—	—	—	—	—	—	—	—	—	—	—	—	—	—	—
Off-Road Equipment	0.59	5.49	6.86	0.01	0.23	—	0.23	0.21	—	0.21	—	1,261	1,261	0.05	0.01	—	1,266
Onsite truck	0.00	0.00	0.00	0.00	0.00	0.00	0.00	0.00	0.00	0.00	—	0.00	0.00	0.00	0.00	0.00	0.00
Annual	—	—	—	—	—	—	—	—	—	—	—	—	—	—	—	—	—
Off-Road Equipment	0.11	1.00	1.25	< 0.005	0.04	—	0.04	0.04	—	0.04	—	209	209	0.01	< 0.005	—	210
Onsite truck	0.00	0.00	0.00	0.00	0.00	0.00	0.00	0.00	0.00	0.00	—	0.00	0.00	0.00	0.00	0.00	0.00
Offsite	—	—	—	—	—	—	—	—	—	—	—	—	—	—	—	—	—
Daily, Summer (Max)	—	—	—	—	—	—	—	—	—	—	—	—	—	—	—	—	—
Worker	0.01	0.01	0.22	0.00	0.00	0.03	0.03	0.00	0.01	0.01	—	29.5	29.5	< 0.005	< 0.005	0.10	29.9
Vendor	< 0.005	0.03	0.02	< 0.005	< 0.005	0.01	0.01	< 0.005	< 0.005	< 0.005	—	30.9	30.9	< 0.005	< 0.005	0.09	32.2
Hauling	0.00	0.00	0.00	0.00	0.00	0.00	0.00	0.00	0.00	0.00	—	0.00	0.00	0.00	0.00	0.00	0.00
Daily, Winter (Max)	—	—	—	—	—	—	—	—	—	—	—	—	—	—	—	—	—
Worker	0.01	0.01	0.13	0.00	0.00	0.03	0.03	0.00	0.01	0.01	—	24.9	24.9	< 0.005	< 0.005	< 0.005	25.2

EEC ORIGINAL PKG

Vendor	< 0.005	0.04	0.02	< 0.005	< 0.005	0.01	0.01	< 0.005	< 0.005	< 0.005	—	30.9	30.9	< 0.005	< 0.005	< 0.005	32.1
Hauling	0.00	0.00	0.00	0.00	0.00	0.00	0.00	0.00	0.00	0.00	—	0.00	0.00	0.00	0.00	0.00	0.00
Average Daily	—	—	—	—	—	—	—	—	—	—	—	—	—	—	—	—	—
Worker	0.01	0.01	0.08	0.00	0.00	0.01	0.01	0.00	< 0.005	< 0.005	—	14.1	14.1	< 0.005	< 0.005	0.02	14.3
Vendor	< 0.005	0.02	0.01	< 0.005	< 0.005	< 0.005	< 0.005	< 0.005	< 0.005	< 0.005	—	16.2	16.2	< 0.005	< 0.005	0.02	16.9
Hauling	0.00	0.00	0.00	0.00	0.00	0.00	0.00	0.00	0.00	0.00	—	0.00	0.00	0.00	0.00	0.00	0.00
Annual	—	—	—	—	—	—	—	—	—	—	—	—	—	—	—	—	—
Worker	< 0.005	< 0.005	0.02	0.00	0.00	< 0.005	< 0.005	0.00	< 0.005	< 0.005	—	2.33	2.33	< 0.005	< 0.005	< 0.005	2.36
Vendor	< 0.005	< 0.005	< 0.005	< 0.005	< 0.005	< 0.005	< 0.005	< 0.005	< 0.005	< 0.005	—	2.69	2.69	< 0.005	< 0.005	< 0.005	2.80
Hauling	0.00	0.00	0.00	0.00	0.00	0.00	0.00	0.00	0.00	0.00	—	0.00	0.00	0.00	0.00	0.00	0.00

3.11. Paving (2025) - Unmitigated

Criteria Pollutants (lb/day for daily, ton/yr for annual) and GHGs (lb/day for daily, MT/yr for annual)

Location	ROG	NOx	CO	SO2	PM10E	PM10D	PM10T	PM2.5E	PM2.5D	PM2.5T	BCO2	NBCO2	CO2T	CH4	N2O	R	CO2e
Onsite	—	—	—	—	—	—	—	—	—	—	—	—	—	—	—	—	—
Daily, Summer (Max)	—	—	—	—	—	—	—	—	—	—	—	—	—	—	—	—	—
Daily, Winter (Max)	—	—	—	—	—	—	—	—	—	—	—	—	—	—	—	—	—
Off-Road Equipment	0.80	7.45	9.98	0.01	0.35	—	0.35	0.32	—	0.32	—	1,511	1,511	0.06	0.01	—	1,517
Paving	0.91	—	—	—	—	—	—	—	—	—	—	—	—	—	—	—	—
Onsite truck	0.00	0.00	0.00	0.00	0.00	0.00	0.00	0.00	0.00	0.00	—	0.00	0.00	0.00	0.00	0.00	0.00
Average Daily	—	—	—	—	—	—	—	—	—	—	—	—	—	—	—	—	—

Off-Road Equipment	0.05	0.47	0.63	< 0.005	0.02	—	0.02	0.02	—	0.02	—	95.2	95.2	< 0.005	< 0.005	—	95.6
Paving	0.06	—	—	—	—	—	—	—	—	—	—	—	—	—	—	—	—
Onsite truck	0.00	0.00	0.00	0.00	0.00	0.00	0.00	0.00	0.00	0.00	—	0.00	0.00	0.00	0.00	0.00	0.00
Annual	—	—	—	—	—	—	—	—	—	—	—	—	—	—	—	—	—
Off-Road Equipment	0.01	0.09	0.11	< 0.005	< 0.005	—	< 0.005	< 0.005	—	< 0.005	—	15.8	15.8	< 0.005	< 0.005	—	15.8
Paving	0.01	—	—	—	—	—	—	—	—	—	—	—	—	—	—	—	—
Onsite truck	0.00	0.00	0.00	0.00	0.00	0.00	0.00	0.00	0.00	0.00	—	0.00	0.00	0.00	0.00	0.00	0.00
Offsite	—	—	—	—	—	—	—	—	—	—	—	—	—	—	—	—	—
Daily, Summer (Max)	—	—	—	—	—	—	—	—	—	—	—	—	—	—	—	—	—
Daily, Winter (Max)	—	—	—	—	—	—	—	—	—	—	—	—	—	—	—	—	—
Worker	0.08	0.11	0.99	0.00	0.00	0.20	0.20	0.00	0.05	0.05	—	195	195	0.01	0.01	0.02	198
Vendor	0.00	0.00	0.00	0.00	0.00	0.00	0.00	0.00	0.00	0.00	—	0.00	0.00	0.00	0.00	0.00	0.00
Hauling	0.00	0.00	0.00	0.00	0.00	0.00	0.00	0.00	0.00	0.00	—	0.00	0.00	0.00	0.00	0.00	0.00
Average Daily	—	—	—	—	—	—	—	—	—	—	—	—	—	—	—	—	—
Worker	0.01	0.01	0.08	0.00	0.00	0.01	0.01	0.00	< 0.005	< 0.005	—	13.2	13.2	< 0.005	< 0.005	0.02	13.4
Vendor	0.00	0.00	0.00	0.00	0.00	0.00	0.00	0.00	0.00	0.00	—	0.00	0.00	0.00	0.00	0.00	0.00
Hauling	0.00	0.00	0.00	0.00	0.00	0.00	0.00	0.00	0.00	0.00	—	0.00	0.00	0.00	0.00	0.00	0.00
Annual	—	—	—	—	—	—	—	—	—	—	—	—	—	—	—	—	—
Worker	< 0.005	< 0.005	0.01	0.00	0.00	< 0.005	< 0.005	0.00	< 0.005	< 0.005	—	2.19	2.19	< 0.005	< 0.005	< 0.005	2.22
Vendor	0.00	0.00	0.00	0.00	0.00	0.00	0.00	0.00	0.00	0.00	—	0.00	0.00	0.00	0.00	0.00	0.00
Hauling	0.00	0.00	0.00	0.00	0.00	0.00	0.00	0.00	0.00	0.00	—	0.00	0.00	0.00	0.00	0.00	0.00

3.12. Paving (2025) - Mitigated

Criteria Pollutants (lb/day for daily, ton/yr for annual) and GHGs (lb/day for daily, MT/yr for annual)

Location	ROG	NOx	CO	SO2	PM10E	PM10D	PM10T	PM2.5E	PM2.5D	PM2.5T	BCO2	NBCO2	CO2T	CH4	N2O	R	CO2e
Onsite	—	—	—	—	—	—	—	—	—	—	—	—	—	—	—	—	—
Daily, Summer (Max)	—	—	—	—	—	—	—	—	—	—	—	—	—	—	—	—	—
Daily, Winter (Max)	—	—	—	—	—	—	—	—	—	—	—	—	—	—	—	—	—
Off-Road Equipment	0.80	7.45	9.98	0.01	0.35	—	0.35	0.32	—	0.32	—	1,511	1,511	0.06	0.01	—	1,517
Paving	0.91	—	—	—	—	—	—	—	—	—	—	—	—	—	—	—	—
Onsite truck	0.00	0.00	0.00	0.00	0.00	0.00	0.00	0.00	0.00	0.00	—	0.00	0.00	0.00	0.00	0.00	0.00
Average Daily	—	—	—	—	—	—	—	—	—	—	—	—	—	—	—	—	—
Off-Road Equipment	0.05	0.47	0.63	< 0.005	0.02	—	0.02	0.02	—	0.02	—	95.2	95.2	< 0.005	< 0.005	—	95.6
Paving	0.06	—	—	—	—	—	—	—	—	—	—	—	—	—	—	—	—
Onsite truck	0.00	0.00	0.00	0.00	0.00	0.00	0.00	0.00	0.00	0.00	—	0.00	0.00	0.00	0.00	0.00	0.00
Annual	—	—	—	—	—	—	—	—	—	—	—	—	—	—	—	—	—
Off-Road Equipment	0.01	0.09	0.11	< 0.005	< 0.005	—	< 0.005	< 0.005	—	< 0.005	—	15.8	15.8	< 0.005	< 0.005	—	15.8
Paving	0.01	—	—	—	—	—	—	—	—	—	—	—	—	—	—	—	—
Onsite truck	0.00	0.00	0.00	0.00	0.00	0.00	0.00	0.00	0.00	0.00	—	0.00	0.00	0.00	0.00	0.00	0.00
Offsite	—	—	—	—	—	—	—	—	—	—	—	—	—	—	—	—	—
Daily, Summer (Max)	—	—	—	—	—	—	—	—	—	—	—	—	—	—	—	—	—

EEC ORIGINAL PKG

Daily, Winter (Max)	—	—	—	—	—	—	—	—	—	—	—	—	—	—	—	—	—
Worker	0.08	0.11	0.99	0.00	0.00	0.20	0.20	0.00	0.05	0.05	—	195	195	0.01	0.01	0.02	198
Vendor	0.00	0.00	0.00	0.00	0.00	0.00	0.00	0.00	0.00	0.00	—	0.00	0.00	0.00	0.00	0.00	0.00
Hauling	0.00	0.00	0.00	0.00	0.00	0.00	0.00	0.00	0.00	0.00	—	0.00	0.00	0.00	0.00	0.00	0.00
Average Daily	—	—	—	—	—	—	—	—	—	—	—	—	—	—	—	—	—
Worker	0.01	0.01	0.08	0.00	0.00	0.01	0.01	0.00	< 0.005	< 0.005	—	13.2	13.2	< 0.005	< 0.005	0.02	13.4
Vendor	0.00	0.00	0.00	0.00	0.00	0.00	0.00	0.00	0.00	0.00	—	0.00	0.00	0.00	0.00	0.00	0.00
Hauling	0.00	0.00	0.00	0.00	0.00	0.00	0.00	0.00	0.00	0.00	—	0.00	0.00	0.00	0.00	0.00	0.00
Annual	—	—	—	—	—	—	—	—	—	—	—	—	—	—	—	—	—
Worker	< 0.005	< 0.005	0.01	0.00	0.00	< 0.005	< 0.005	0.00	< 0.005	< 0.005	—	2.19	2.19	< 0.005	< 0.005	< 0.005	2.22
Vendor	0.00	0.00	0.00	0.00	0.00	0.00	0.00	0.00	0.00	0.00	—	0.00	0.00	0.00	0.00	0.00	0.00
Hauling	0.00	0.00	0.00	0.00	0.00	0.00	0.00	0.00	0.00	0.00	—	0.00	0.00	0.00	0.00	0.00	0.00

3.13. Architectural Coating (2025) - Unmitigated

Criteria Pollutants (lb/day for daily, ton/yr for annual) and GHGs (lb/day for daily, MT/yr for annual)

Location	ROG	NOx	CO	SO2	PM10E	PM10D	PM10T	PM2.5E	PM2.5D	PM2.5T	BCO2	NBCO2	CO2T	CH4	N2O	R	CO2e
Onsite	—	—	—	—	—	—	—	—	—	—	—	—	—	—	—	—	—
Daily, Summer (Max)	—	—	—	—	—	—	—	—	—	—	—	—	—	—	—	—	—
Daily, Winter (Max)	—	—	—	—	—	—	—	—	—	—	—	—	—	—	—	—	—
Off-Road Equipment	0.13	0.88	1.14	< 0.005	0.03	—	0.03	0.03	—	0.03	—	134	134	0.01	< 0.005	—	134
Architectural Coatings	4.45	—	—	—	—	—	—	—	—	—	—	—	—	—	—	—	—

EEC ORIGINAL PKG

Onsite truck	0.00	0.00	0.00	0.00	0.00	0.00	0.00	0.00	0.00	0.00	0.00	—	0.00	0.00	0.00	0.00	0.00	0.00
Average Daily	—	—	—	—	—	—	—	—	—	—	—	—	—	—	—	—	—	—
Off-Road Equipment	0.01	0.09	0.12	< 0.005	< 0.005	—	< 0.005	< 0.005	—	< 0.005	—	13.9	13.9	< 0.005	< 0.005	—	13.9	
Architectural Coatings	0.46	—	—	—	—	—	—	—	—	—	—	—	—	—	—	—	—	
Onsite truck	0.00	0.00	0.00	0.00	0.00	0.00	0.00	0.00	0.00	0.00	—	0.00	0.00	0.00	0.00	0.00	0.00	
Annual	—	—	—	—	—	—	—	—	—	—	—	—	—	—	—	—	—	
Off-Road Equipment	< 0.005	0.02	0.02	< 0.005	< 0.005	—	< 0.005	< 0.005	—	< 0.005	—	2.30	2.30	< 0.005	< 0.005	—	2.31	
Architectural Coatings	0.08	—	—	—	—	—	—	—	—	—	—	—	—	—	—	—	—	
Onsite truck	0.00	0.00	0.00	0.00	0.00	0.00	0.00	0.00	0.00	0.00	—	0.00	0.00	0.00	0.00	0.00	0.00	
Offsite	—	—	—	—	—	—	—	—	—	—	—	—	—	—	—	—	—	
Daily, Summer (Max)	—	—	—	—	—	—	—	—	—	—	—	—	—	—	—	—	—	
Daily, Winter (Max)	—	—	—	—	—	—	—	—	—	—	—	—	—	—	—	—	—	
Worker	< 0.005	< 0.005	0.03	0.00	0.00	0.01	0.01	0.00	< 0.005	< 0.005	—	4.98	4.98	< 0.005	< 0.005	< 0.005	5.05	
Vendor	0.00	0.00	0.00	0.00	0.00	0.00	0.00	0.00	0.00	0.00	—	0.00	0.00	0.00	0.00	0.00	0.00	
Hauling	0.00	0.00	0.00	0.00	0.00	0.00	0.00	0.00	0.00	0.00	—	0.00	0.00	0.00	0.00	0.00	0.00	
Average Daily	—	—	—	—	—	—	—	—	—	—	—	—	—	—	—	—	—	
Worker	< 0.005	< 0.005	< 0.005	0.00	0.00	< 0.005	< 0.005	0.00	< 0.005	< 0.005	—	0.56	0.56	< 0.005	< 0.005	< 0.005	0.57	
Vendor	0.00	0.00	0.00	0.00	0.00	0.00	0.00	0.00	0.00	0.00	—	0.00	0.00	0.00	0.00	0.00	0.00	

EEC ORIGINAL PKG

Hauling	0.00	0.00	0.00	0.00	0.00	0.00	0.00	0.00	0.00	0.00	—	0.00	0.00	0.00	0.00	0.00	0.00
Annual	—	—	—	—	—	—	—	—	—	—	—	—	—	—	—	—	—
Worker	< 0.005	< 0.005	< 0.005	0.00	0.00	< 0.005	< 0.005	0.00	< 0.005	< 0.005	—	0.09	0.09	< 0.005	< 0.005	< 0.005	0.09
Vendor	0.00	0.00	0.00	0.00	0.00	0.00	0.00	0.00	0.00	0.00	—	0.00	0.00	0.00	0.00	0.00	0.00
Hauling	0.00	0.00	0.00	0.00	0.00	0.00	0.00	0.00	0.00	0.00	—	0.00	0.00	0.00	0.00	0.00	0.00

3.14. Architectural Coating (2025) - Mitigated

Criteria Pollutants (lb/day for daily, ton/yr for annual) and GHGs (lb/day for daily, MT/yr for annual)

Location	ROG	NOx	CO	SO2	PM10E	PM10D	PM10T	PM2.5E	PM2.5D	PM2.5T	BCO2	NBCO2	CO2T	CH4	N2O	R	CO2e
Onsite	—	—	—	—	—	—	—	—	—	—	—	—	—	—	—	—	—
Daily, Summer (Max)	—	—	—	—	—	—	—	—	—	—	—	—	—	—	—	—	—
Daily, Winter (Max)	—	—	—	—	—	—	—	—	—	—	—	—	—	—	—	—	—
Off-Road Equipment	0.13	0.88	1.14	< 0.005	0.03	—	0.03	0.03	—	0.03	—	134	134	0.01	< 0.005	—	134
Architectural Coatings	4.45	—	—	—	—	—	—	—	—	—	—	—	—	—	—	—	—
Onsite truck	0.00	0.00	0.00	0.00	0.00	0.00	0.00	0.00	0.00	0.00	—	0.00	0.00	0.00	0.00	0.00	0.00
Average Daily	—	—	—	—	—	—	—	—	—	—	—	—	—	—	—	—	—
Off-Road Equipment	0.01	0.09	0.12	< 0.005	< 0.005	—	< 0.005	< 0.005	—	< 0.005	—	13.9	13.9	< 0.005	< 0.005	—	13.9
Architectural Coatings	0.46	—	—	—	—	—	—	—	—	—	—	—	—	—	—	—	—
Onsite truck	0.00	0.00	0.00	0.00	0.00	0.00	0.00	0.00	0.00	0.00	—	0.00	0.00	0.00	0.00	0.00	0.00

EEC ORIGINAL PKG

Annual	—	—	—	—	—	—	—	—	—	—	—	—	—	—	—	—	—
Off-Road Equipment	< 0.005	0.02	0.02	< 0.005	< 0.005	—	< 0.005	< 0.005	—	< 0.005	—	2.30	2.30	< 0.005	< 0.005	—	2.31
Architectural Coatings	0.08	—	—	—	—	—	—	—	—	—	—	—	—	—	—	—	—
Onsite truck	0.00	0.00	0.00	0.00	0.00	0.00	0.00	0.00	0.00	0.00	—	0.00	0.00	0.00	0.00	0.00	0.00
Offsite	—	—	—	—	—	—	—	—	—	—	—	—	—	—	—	—	—
Daily, Summer (Max)	—	—	—	—	—	—	—	—	—	—	—	—	—	—	—	—	—
Daily, Winter (Max)	—	—	—	—	—	—	—	—	—	—	—	—	—	—	—	—	—
Worker	< 0.005	< 0.005	0.03	0.00	0.00	0.01	0.01	0.00	< 0.005	< 0.005	—	4.98	4.98	< 0.005	< 0.005	< 0.005	5.05
Vendor	0.00	0.00	0.00	0.00	0.00	0.00	0.00	0.00	0.00	0.00	—	0.00	0.00	0.00	0.00	0.00	0.00
Hauling	0.00	0.00	0.00	0.00	0.00	0.00	0.00	0.00	0.00	0.00	—	0.00	0.00	0.00	0.00	0.00	0.00
Average Daily	—	—	—	—	—	—	—	—	—	—	—	—	—	—	—	—	—
Worker	< 0.005	< 0.005	< 0.005	0.00	0.00	< 0.005	< 0.005	0.00	< 0.005	< 0.005	—	0.56	0.56	< 0.005	< 0.005	< 0.005	0.57
Vendor	0.00	0.00	0.00	0.00	0.00	0.00	0.00	0.00	0.00	0.00	—	0.00	0.00	0.00	0.00	0.00	0.00
Hauling	0.00	0.00	0.00	0.00	0.00	0.00	0.00	0.00	0.00	0.00	—	0.00	0.00	0.00	0.00	0.00	0.00
Annual	—	—	—	—	—	—	—	—	—	—	—	—	—	—	—	—	—
Worker	< 0.005	< 0.005	< 0.005	0.00	0.00	< 0.005	< 0.005	0.00	< 0.005	< 0.005	—	0.09	0.09	< 0.005	< 0.005	< 0.005	0.09
Vendor	0.00	0.00	0.00	0.00	0.00	0.00	0.00	0.00	0.00	0.00	—	0.00	0.00	0.00	0.00	0.00	0.00
Hauling	0.00	0.00	0.00	0.00	0.00	0.00	0.00	0.00	0.00	0.00	—	0.00	0.00	0.00	0.00	0.00	0.00

4. Operations Emissions Details

4.1. Mobile Emissions by Land Use

4.1.1. Unmitigated

Criteria Pollutants (lb/day for daily, ton/yr for annual) and GHGs (lb/day for daily, MT/yr for annual)

Land Use	ROG	NOx	CO	SO2	PM10E	PM10D	PM10T	PM2.5E	PM2.5D	PM2.5T	BCO2	NBCO2	CO2T	CH4	N2O	R	CO2e
Daily, Summer (Max)	—	—	—	—	—	—	—	—	—	—	—	—	—	—	—	—	—
Convenience Market with Gas Pumps	13.2	3.72	51.4	0.06	0.04	4.66	4.70	0.04	1.17	1.21	—	5,890	5,890	0.67	0.42	18.0	6,050
Parking Lot	0.00	0.00	0.00	0.00	0.00	0.00	0.00	0.00	0.00	0.00	—	0.00	0.00	0.00	0.00	0.00	0.00
Total	13.2	3.72	51.4	0.06	0.04	4.66	4.70	0.04	1.17	1.21	—	5,890	5,890	0.67	0.42	18.0	6,050
Daily, Winter (Max)	—	—	—	—	—	—	—	—	—	—	—	—	—	—	—	—	—
Convenience Market with Gas Pumps	10.2	3.85	44.8	0.05	0.04	4.66	4.70	0.04	1.17	1.21	—	5,097	5,097	0.81	0.42	0.47	5,242
Parking Lot	0.00	0.00	0.00	0.00	0.00	0.00	0.00	0.00	0.00	0.00	—	0.00	0.00	0.00	0.00	0.00	0.00
Total	10.2	3.85	44.8	0.05	0.04	4.66	4.70	0.04	1.17	1.21	—	5,097	5,097	0.81	0.42	0.47	5,242
Annual	—	—	—	—	—	—	—	—	—	—	—	—	—	—	—	—	—
Convenience Market with Gas Pumps	1.97	0.65	7.81	0.01	0.01	0.83	0.84	0.01	0.21	0.22	—	880	880	0.12	0.07	1.26	903

Parking Lot	0.00	0.00	0.00	0.00	0.00	0.00	0.00	0.00	0.00	0.00	—	0.00	0.00	0.00	0.00	0.00	0.00
Total	1.97	0.65	7.81	0.01	0.01	0.83	0.84	0.01	0.21	0.22	—	880	880	0.12	0.07	1.26	903

4.1.2. Mitigated

Criteria Pollutants (lb/day for daily, ton/yr for annual) and GHGs (lb/day for daily, MT/yr for annual)

Land Use	ROG	NOx	CO	SO2	PM10E	PM10D	PM10T	PM2.5E	PM2.5D	PM2.5T	BCO2	NBCO2	CO2T	CH4	N2O	R	CO2e
Daily, Summer (Max)	—	—	—	—	—	—	—	—	—	—	—	—	—	—	—	—	—
Convenience Market with Gas Pumps	13.2	3.72	51.4	0.06	0.04	4.66	4.70	0.04	1.17	1.21	—	5,890	5,890	0.67	0.42	18.0	6,050
Parking Lot	0.00	0.00	0.00	0.00	0.00	0.00	0.00	0.00	0.00	0.00	—	0.00	0.00	0.00	0.00	0.00	0.00
Total	13.2	3.72	51.4	0.06	0.04	4.66	4.70	0.04	1.17	1.21	—	5,890	5,890	0.67	0.42	18.0	6,050
Daily, Winter (Max)	—	—	—	—	—	—	—	—	—	—	—	—	—	—	—	—	—
Convenience Market with Gas Pumps	10.2	3.85	44.8	0.05	0.04	4.66	4.70	0.04	1.17	1.21	—	5,097	5,097	0.81	0.42	0.47	5,242
Parking Lot	0.00	0.00	0.00	0.00	0.00	0.00	0.00	0.00	0.00	0.00	—	0.00	0.00	0.00	0.00	0.00	0.00
Total	10.2	3.85	44.8	0.05	0.04	4.66	4.70	0.04	1.17	1.21	—	5,097	5,097	0.81	0.42	0.47	5,242
Annual	—	—	—	—	—	—	—	—	—	—	—	—	—	—	—	—	—

Convenience Market with Gas Pumps	1.97	0.65	7.81	0.01	0.01	0.83	0.84	0.01	0.21	0.22	—	880	880	0.12	0.07	1.26	903
Parking Lot	0.00	0.00	0.00	0.00	0.00	0.00	0.00	0.00	0.00	0.00	—	0.00	0.00	0.00	0.00	0.00	0.00
Total	1.97	0.65	7.81	0.01	0.01	0.83	0.84	0.01	0.21	0.22	—	880	880	0.12	0.07	1.26	903

4.2. Energy

4.2.1. Electricity Emissions By Land Use - Unmitigated

Criteria Pollutants (lb/day for daily, ton/yr for annual) and GHGs (lb/day for daily, MT/yr for annual)

Land Use	ROG	NOx	CO	SO2	PM10E	PM10D	PM10T	PM2.5E	PM2.5D	PM2.5T	BCO2	NBCO2	CO2T	CH4	N2O	R	CO2e
Daily, Summer (Max)	—	—	—	—	—	—	—	—	—	—	—	—	—	—	—	—	—
Convenience Market with Gas Pumps	—	—	—	—	—	—	—	—	—	—	—	280	280	0.02	< 0.005	—	281
Parking Lot	—	—	—	—	—	—	—	—	—	—	—	382	382	0.03	< 0.005	—	384
Total	—	—	—	—	—	—	—	—	—	—	—	662	662	0.05	0.01	—	665
Daily, Winter (Max)	—	—	—	—	—	—	—	—	—	—	—	—	—	—	—	—	—
Convenience Market with Gas Pumps	—	—	—	—	—	—	—	—	—	—	—	280	280	0.02	< 0.005	—	281
Parking Lot	—	—	—	—	—	—	—	—	—	—	—	382	382	0.03	< 0.005	—	384

EEC ORIGINAL PKG

Total	—	—	—	—	—	—	—	—	—	—	—	662	662	0.05	0.01	—	665
Annual	—	—	—	—	—	—	—	—	—	—	—	—	—	—	—	—	—
Convenience Market with Gas Pumps	—	—	—	—	—	—	—	—	—	—	—	46.4	46.4	< 0.005	< 0.005	—	46.6
Parking Lot	—	—	—	—	—	—	—	—	—	—	—	63.2	63.2	< 0.005	< 0.005	—	63.5
Total	—	—	—	—	—	—	—	—	—	—	—	110	110	0.01	< 0.005	—	110

4.2.2. Electricity Emissions By Land Use - Mitigated

Criteria Pollutants (lb/day for daily, ton/yr for annual) and GHGs (lb/day for daily, MT/yr for annual)

Land Use	ROG	NOx	CO	SO2	PM10E	PM10D	PM10T	PM2.5E	PM2.5D	PM2.5T	BCO2	NBCO2	CO2T	CH4	N2O	R	CO2e
Daily, Summer (Max)	—	—	—	—	—	—	—	—	—	—	—	—	—	—	—	—	—
Convenience Market with Gas Pumps	—	—	—	—	—	—	—	—	—	—	—	280	280	0.02	< 0.005	—	281
Parking Lot	—	—	—	—	—	—	—	—	—	—	—	382	382	0.03	< 0.005	—	384
Total	—	—	—	—	—	—	—	—	—	—	—	662	662	0.05	0.01	—	665
Daily, Winter (Max)	—	—	—	—	—	—	—	—	—	—	—	—	—	—	—	—	—
Convenience Market with Gas Pumps	—	—	—	—	—	—	—	—	—	—	—	280	280	0.02	< 0.005	—	281

Parking Lot	—	—	—	—	—	—	—	—	—	—	—	382	382	0.03	< 0.005	—	384
Total	—	—	—	—	—	—	—	—	—	—	—	662	662	0.05	0.01	—	665
Annual	—	—	—	—	—	—	—	—	—	—	—	—	—	—	—	—	—
Convenience Market with Gas Pumps	—	—	—	—	—	—	—	—	—	—	—	46.4	46.4	< 0.005	< 0.005	—	46.6
Parking Lot	—	—	—	—	—	—	—	—	—	—	—	63.2	63.2	< 0.005	< 0.005	—	63.5
Total	—	—	—	—	—	—	—	—	—	—	—	110	110	0.01	< 0.005	—	110

4.2.3. Natural Gas Emissions By Land Use - Unmitigated

Criteria Pollutants (lb/day for daily, ton/yr for annual) and GHGs (lb/day for daily, MT/yr for annual)

Land Use	ROG	NOx	CO	SO2	PM10E	PM10D	PM10T	PM2.5E	PM2.5D	PM2.5T	BCO2	NBCO2	CO2T	CH4	N2O	R	CO2e
Daily, Summer (Max)	—	—	—	—	—	—	—	—	—	—	—	—	—	—	—	—	—
Convenience Market with Gas Pumps	< 0.005	0.03	0.03	< 0.005	< 0.005	—	< 0.005	< 0.005	—	< 0.005	—	41.7	41.7	< 0.005	< 0.005	—	41.8
Parking Lot	0.00	0.00	0.00	0.00	0.00	—	0.00	0.00	—	0.00	—	0.00	0.00	0.00	0.00	—	0.00
Total	< 0.005	0.03	0.03	< 0.005	< 0.005	—	< 0.005	< 0.005	—	< 0.005	—	41.7	41.7	< 0.005	< 0.005	—	41.8
Daily, Winter (Max)	—	—	—	—	—	—	—	—	—	—	—	—	—	—	—	—	—

Convenience Market with Gas Pumps	< 0.005	0.03	0.03	< 0.005	< 0.005	—	< 0.005	< 0.005	—	< 0.005	—	41.7	41.7	< 0.005	< 0.005	—	41.8
Parking Lot	0.00	0.00	0.00	0.00	0.00	—	0.00	0.00	—	0.00	—	0.00	0.00	0.00	0.00	—	0.00
Total	< 0.005	0.03	0.03	< 0.005	< 0.005	—	< 0.005	< 0.005	—	< 0.005	—	41.7	41.7	< 0.005	< 0.005	—	41.8
Annual	—	—	—	—	—	—	—	—	—	—	—	—	—	—	—	—	—
Convenience Market with Gas Pumps	< 0.005	0.01	0.01	< 0.005	< 0.005	—	< 0.005	< 0.005	—	< 0.005	—	6.90	6.90	< 0.005	< 0.005	—	6.92
Parking Lot	0.00	0.00	0.00	0.00	0.00	—	0.00	0.00	—	0.00	—	0.00	0.00	0.00	0.00	—	0.00
Total	< 0.005	0.01	0.01	< 0.005	< 0.005	—	< 0.005	< 0.005	—	< 0.005	—	6.90	6.90	< 0.005	< 0.005	—	6.92

4.2.4. Natural Gas Emissions By Land Use - Mitigated

Criteria Pollutants (lb/day for daily, ton/yr for annual) and GHGs (lb/day for daily, MT/yr for annual)

Land Use	ROG	NOx	CO	SO2	PM10E	PM10D	PM10T	PM2.5E	PM2.5D	PM2.5T	BCO2	NBCO2	CO2T	CH4	N2O	R	CO2e
Daily, Summer (Max)	—	—	—	—	—	—	—	—	—	—	—	—	—	—	—	—	—
Convenience Market with Gas Pumps	< 0.005	0.03	0.03	< 0.005	< 0.005	—	< 0.005	< 0.005	—	< 0.005	—	41.7	41.7	< 0.005	< 0.005	—	41.8
Parking Lot	0.00	0.00	0.00	0.00	0.00	—	0.00	0.00	—	0.00	—	0.00	0.00	0.00	0.00	—	0.00
Total	< 0.005	0.03	0.03	< 0.005	< 0.005	—	< 0.005	< 0.005	—	< 0.005	—	41.7	41.7	< 0.005	< 0.005	—	41.8

Daily, Winter (Max)	—	—	—	—	—	—	—	—	—	—	—	—	—	—	—	—	—
Convenience Market with Gas Pumps	< 0.005	0.03	0.03	< 0.005	< 0.005	—	< 0.005	< 0.005	—	< 0.005	—	41.7	41.7	< 0.005	< 0.005	—	41.8
Parking Lot	0.00	0.00	0.00	0.00	0.00	—	0.00	0.00	—	0.00	—	0.00	0.00	0.00	0.00	—	0.00
Total	< 0.005	0.03	0.03	< 0.005	< 0.005	—	< 0.005	< 0.005	—	< 0.005	—	41.7	41.7	< 0.005	< 0.005	—	41.8
Annual	—	—	—	—	—	—	—	—	—	—	—	—	—	—	—	—	—
Convenience Market with Gas Pumps	< 0.005	0.01	0.01	< 0.005	< 0.005	—	< 0.005	< 0.005	—	< 0.005	—	6.90	6.90	< 0.005	< 0.005	—	6.92
Parking Lot	0.00	0.00	0.00	0.00	0.00	—	0.00	0.00	—	0.00	—	0.00	0.00	0.00	0.00	—	0.00
Total	< 0.005	0.01	0.01	< 0.005	< 0.005	—	< 0.005	< 0.005	—	< 0.005	—	6.90	6.90	< 0.005	< 0.005	—	6.92

4.3. Area Emissions by Source

4.3.1. Unmitigated

Criteria Pollutants (lb/day for daily, ton/yr for annual) and GHGs (lb/day for daily, MT/yr for annual)

Source	ROG	NOx	CO	SO2	PM10E	PM10D	PM10T	PM2.5E	PM2.5D	PM2.5T	BCO2	NBCO2	CO2T	CH4	N2O	R	CO2e
Daily, Summer (Max)	—	—	—	—	—	—	—	—	—	—	—	—	—	—	—	—	—
Consumer Products	0.16	—	—	—	—	—	—	—	—	—	—	—	—	—	—	—	—

Architectural Coatings	0.06	—	—	—	—	—	—	—	—	—	—	—	—	—	—	—	—
Landscape Equipment	0.04	< 0.005	0.26	< 0.005	< 0.005	—	< 0.005	< 0.005	—	< 0.005	—	1.07	1.07	< 0.005	< 0.005	—	1.07
Total	0.26	< 0.005	0.26	< 0.005	< 0.005	—	< 0.005	< 0.005	—	< 0.005	—	1.07	1.07	< 0.005	< 0.005	—	1.07
Daily, Winter (Max)	—	—	—	—	—	—	—	—	—	—	—	—	—	—	—	—	—
Consumer Products	0.16	—	—	—	—	—	—	—	—	—	—	—	—	—	—	—	—
Architectural Coatings	0.06	—	—	—	—	—	—	—	—	—	—	—	—	—	—	—	—
Total	0.22	—	—	—	—	—	—	—	—	—	—	—	—	—	—	—	—
Annual	—	—	—	—	—	—	—	—	—	—	—	—	—	—	—	—	—
Consumer Products	0.03	—	—	—	—	—	—	—	—	—	—	—	—	—	—	—	—
Architectural Coatings	0.01	—	—	—	—	—	—	—	—	—	—	—	—	—	—	—	—
Landscape Equipment	< 0.005	< 0.005	0.02	< 0.005	< 0.005	—	< 0.005	< 0.005	—	< 0.005	—	0.09	0.09	< 0.005	< 0.005	—	0.09
Total	0.04	< 0.005	0.02	< 0.005	< 0.005	—	< 0.005	< 0.005	—	< 0.005	—	0.09	0.09	< 0.005	< 0.005	—	0.09

4.3.2. Mitigated

Criteria Pollutants (lb/day for daily, ton/yr for annual) and GHGs (lb/day for daily, MT/yr for annual)

Source	ROG	NOx	CO	SO2	PM10E	PM10D	PM10T	PM2.5E	PM2.5D	PM2.5T	BCO2	NBCO2	CO2T	CH4	N2O	R	CO2e
--------	-----	-----	----	-----	-------	-------	-------	--------	--------	--------	------	-------	------	-----	-----	---	------

EEC ORIGINAL PKG

Daily, Summer (Max)	—	—	—	—	—	—	—	—	—	—	—	—	—	—	—	—	—
Consumer Products	0.16	—	—	—	—	—	—	—	—	—	—	—	—	—	—	—	—
Architectural Coatings	0.06	—	—	—	—	—	—	—	—	—	—	—	—	—	—	—	—
Landscape Equipment	0.04	< 0.005	0.26	< 0.005	< 0.005	—	< 0.005	< 0.005	—	< 0.005	—	1.07	1.07	< 0.005	< 0.005	—	1.07
Total	0.26	< 0.005	0.26	< 0.005	< 0.005	—	< 0.005	< 0.005	—	< 0.005	—	1.07	1.07	< 0.005	< 0.005	—	1.07
Daily, Winter (Max)	—	—	—	—	—	—	—	—	—	—	—	—	—	—	—	—	—
Consumer Products	0.16	—	—	—	—	—	—	—	—	—	—	—	—	—	—	—	—
Architectural Coatings	0.06	—	—	—	—	—	—	—	—	—	—	—	—	—	—	—	—
Total	0.22	—	—	—	—	—	—	—	—	—	—	—	—	—	—	—	—
Annual	—	—	—	—	—	—	—	—	—	—	—	—	—	—	—	—	—
Consumer Products	0.03	—	—	—	—	—	—	—	—	—	—	—	—	—	—	—	—
Architectural Coatings	0.01	—	—	—	—	—	—	—	—	—	—	—	—	—	—	—	—
Landscape Equipment	< 0.005	< 0.005	0.02	< 0.005	< 0.005	—	< 0.005	< 0.005	—	< 0.005	—	0.09	0.09	< 0.005	< 0.005	—	0.09
Total	0.04	< 0.005	0.02	< 0.005	< 0.005	—	< 0.005	< 0.005	—	< 0.005	—	0.09	0.09	< 0.005	< 0.005	—	0.09

EEC ORIGINAL PKG

4.4. Water Emissions by Land Use

4.4.1. Unmitigated

Criteria Pollutants (lb/day for daily, ton/yr for annual) and GHGs (lb/day for daily, MT/yr for annual)

Land Use	ROG	NOx	CO	SO2	PM10E	PM10D	PM10T	PM2.5E	PM2.5D	PM2.5T	BCO2	NBCO2	CO2T	CH4	N2O	R	CO2e
Daily, Summer (Max)	—	—	—	—	—	—	—	—	—	—	—	—	—	—	—	—	—
Convenience Market with Gas Pumps	—	—	—	—	—	—	—	—	—	—	0.28	1.03	1.31	0.03	< 0.005	—	2.24
Parking Lot	—	—	—	—	—	—	—	—	—	—	0.00	0.08	0.08	< 0.005	< 0.005	—	0.08
Total	—	—	—	—	—	—	—	—	—	—	0.28	1.11	1.40	0.03	< 0.005	—	2.32
Daily, Winter (Max)	—	—	—	—	—	—	—	—	—	—	—	—	—	—	—	—	—
Convenience Market with Gas Pumps	—	—	—	—	—	—	—	—	—	—	0.28	1.03	1.31	0.03	< 0.005	—	2.24
Parking Lot	—	—	—	—	—	—	—	—	—	—	0.00	0.08	0.08	< 0.005	< 0.005	—	0.08
Total	—	—	—	—	—	—	—	—	—	—	0.28	1.11	1.40	0.03	< 0.005	—	2.32
Annual	—	—	—	—	—	—	—	—	—	—	—	—	—	—	—	—	—
Convenience Market with Gas Pumps	—	—	—	—	—	—	—	—	—	—	0.05	0.17	0.22	< 0.005	< 0.005	—	0.37

Parking Lot	—	—	—	—	—	—	—	—	—	—	0.00	0.01	0.01	< 0.005	< 0.005	—	0.01
Total	—	—	—	—	—	—	—	—	—	—	0.05	0.18	0.23	< 0.005	< 0.005	—	0.38

4.4.2. Mitigated

Criteria Pollutants (lb/day for daily, ton/yr for annual) and GHGs (lb/day for daily, MT/yr for annual)

Land Use	ROG	NOx	CO	SO2	PM10E	PM10D	PM10T	PM2.5E	PM2.5D	PM2.5T	BCO2	NBCO2	CO2T	CH4	N2O	R	CO2e
Daily, Summer (Max)	—	—	—	—	—	—	—	—	—	—	—	—	—	—	—	—	—
Convenience Market with Gas Pumps	—	—	—	—	—	—	—	—	—	—	0.22	0.83	1.05	0.02	< 0.005	—	1.79
Parking Lot	—	—	—	—	—	—	—	—	—	—	0.00	0.07	0.07	< 0.005	< 0.005	—	0.07
Total	—	—	—	—	—	—	—	—	—	—	0.22	0.89	1.12	0.02	< 0.005	—	1.86
Daily, Winter (Max)	—	—	—	—	—	—	—	—	—	—	—	—	—	—	—	—	—
Convenience Market with Gas Pumps	—	—	—	—	—	—	—	—	—	—	0.22	0.83	1.05	0.02	< 0.005	—	1.79
Parking Lot	—	—	—	—	—	—	—	—	—	—	0.00	0.07	0.07	< 0.005	< 0.005	—	0.07
Total	—	—	—	—	—	—	—	—	—	—	0.22	0.89	1.12	0.02	< 0.005	—	1.86
Annual	—	—	—	—	—	—	—	—	—	—	—	—	—	—	—	—	—

Convenience Market with Gas Pumps	—	—	—	—	—	—	—	—	—	—	0.04	0.14	0.17	< 0.005	< 0.005	—	0.30
Parking Lot	—	—	—	—	—	—	—	—	—	—	0.00	0.01	0.01	< 0.005	< 0.005	—	0.01
Total	—	—	—	—	—	—	—	—	—	—	0.04	0.15	0.18	< 0.005	< 0.005	—	0.31

4.5. Waste Emissions by Land Use

4.5.1. Unmitigated

Criteria Pollutants (lb/day for daily, ton/yr for annual) and GHGs (lb/day for daily, MT/yr for annual)

Land Use	ROG	NOx	CO	SO2	PM10E	PM10D	PM10T	PM2.5E	PM2.5D	PM2.5T	BCO2	NBCO2	CO2T	CH4	N2O	R	CO2e
Daily, Summer (Max)	—	—	—	—	—	—	—	—	—	—	—	—	—	—	—	—	—
Convenience Market with Gas Pumps	—	—	—	—	—	—	—	—	—	—	3.20	0.00	3.20	0.32	0.00	—	11.2
Parking Lot	—	—	—	—	—	—	—	—	—	—	0.00	0.00	0.00	0.00	0.00	—	0.00
Total	—	—	—	—	—	—	—	—	—	—	3.20	0.00	3.20	0.32	0.00	—	11.2
Daily, Winter (Max)	—	—	—	—	—	—	—	—	—	—	—	—	—	—	—	—	—
Convenience Market with Gas Pumps	—	—	—	—	—	—	—	—	—	—	3.20	0.00	3.20	0.32	0.00	—	11.2
Parking Lot	—	—	—	—	—	—	—	—	—	—	0.00	0.00	0.00	0.00	0.00	—	0.00

EEC ORIGINAL PKG

Total	—	—	—	—	—	—	—	—	—	—	3.20	0.00	3.20	0.32	0.00	—	11.2
Annual	—	—	—	—	—	—	—	—	—	—	—	—	—	—	—	—	—
Convenience Market with Gas Pumps	—	—	—	—	—	—	—	—	—	—	0.53	0.00	0.53	0.05	0.00	—	1.85
Parking Lot	—	—	—	—	—	—	—	—	—	—	0.00	0.00	0.00	0.00	0.00	—	0.00
Total	—	—	—	—	—	—	—	—	—	—	0.53	0.00	0.53	0.05	0.00	—	1.85

4.5.2. Mitigated

Criteria Pollutants (lb/day for daily, ton/yr for annual) and GHGs (lb/day for daily, MT/yr for annual)

Land Use	ROG	NOx	CO	SO2	PM10E	PM10D	PM10T	PM2.5E	PM2.5D	PM2.5T	BCO2	NBCO2	CO2T	CH4	N2O	R	CO2e
Daily, Summer (Max)	—	—	—	—	—	—	—	—	—	—	—	—	—	—	—	—	—
Convenience Market with Gas Pumps	—	—	—	—	—	—	—	—	—	—	3.20	0.00	3.20	0.32	0.00	—	11.2
Parking Lot	—	—	—	—	—	—	—	—	—	—	0.00	0.00	0.00	0.00	0.00	—	0.00
Total	—	—	—	—	—	—	—	—	—	—	3.20	0.00	3.20	0.32	0.00	—	11.2
Daily, Winter (Max)	—	—	—	—	—	—	—	—	—	—	—	—	—	—	—	—	—
Convenience Market with Gas Pumps	—	—	—	—	—	—	—	—	—	—	3.20	0.00	3.20	0.32	0.00	—	11.2

Parking Lot	—	—	—	—	—	—	—	—	—	—	0.00	0.00	0.00	0.00	0.00	—	0.00
Total	—	—	—	—	—	—	—	—	—	—	3.20	0.00	3.20	0.32	0.00	—	11.2
Annual	—	—	—	—	—	—	—	—	—	—	—	—	—	—	—	—	—
Convenience Market with Gas Pumps	—	—	—	—	—	—	—	—	—	—	0.53	0.00	0.53	0.05	0.00	—	1.85
Parking Lot	—	—	—	—	—	—	—	—	—	—	0.00	0.00	0.00	0.00	0.00	—	0.00
Total	—	—	—	—	—	—	—	—	—	—	0.53	0.00	0.53	0.05	0.00	—	1.85

4.6. Refrigerant Emissions by Land Use

4.6.1. Unmitigated

Criteria Pollutants (lb/day for daily, ton/yr for annual) and GHGs (lb/day for daily, MT/yr for annual)

Land Use	ROG	NOx	CO	SO2	PM10E	PM10D	PM10T	PM2.5E	PM2.5D	PM2.5T	BCO2	NBCO2	CO2T	CH4	N2O	R	CO2e
Daily, Summer (Max)	—	—	—	—	—	—	—	—	—	—	—	—	—	—	—	—	—
Convenience Market with Gas Pumps	—	—	—	—	—	—	—	—	—	—	—	—	—	—	—	1,240	1,240
Total	—	—	—	—	—	—	—	—	—	—	—	—	—	—	—	1,240	1,240
Daily, Winter (Max)	—	—	—	—	—	—	—	—	—	—	—	—	—	—	—	—	—

Convenience Market with Gas Pumps	—	—	—	—	—	—	—	—	—	—	—	—	—	—	—	1,240	1,240
Total	—	—	—	—	—	—	—	—	—	—	—	—	—	—	—	1,240	1,240
Annual	—	—	—	—	—	—	—	—	—	—	—	—	—	—	—	—	—
Convenience Market with Gas Pumps	—	—	—	—	—	—	—	—	—	—	—	—	—	—	—	205	205
Total	—	—	—	—	—	—	—	—	—	—	—	—	—	—	—	205	205

4.6.2. Mitigated

Criteria Pollutants (lb/day for daily, ton/yr for annual) and GHGs (lb/day for daily, MT/yr for annual)

Land Use	ROG	NOx	CO	SO2	PM10E	PM10D	PM10T	PM2.5E	PM2.5D	PM2.5T	BCO2	NBCO2	CO2T	CH4	N2O	R	CO2e
Daily, Summer (Max)	—	—	—	—	—	—	—	—	—	—	—	—	—	—	—	—	—
Convenience Market with Gas Pumps	—	—	—	—	—	—	—	—	—	—	—	—	—	—	—	1,240	1,240
Total	—	—	—	—	—	—	—	—	—	—	—	—	—	—	—	1,240	1,240
Daily, Winter (Max)	—	—	—	—	—	—	—	—	—	—	—	—	—	—	—	—	—
Convenience Market with Gas Pumps	—	—	—	—	—	—	—	—	—	—	—	—	—	—	—	1,240	1,240
Total	—	—	—	—	—	—	—	—	—	—	—	—	—	—	—	1,240	1,240

EEC ORIGINAL PKG

Annual	—	—	—	—	—	—	—	—	—	—	—	—	—	—	—	—	—	
Convenience Market with Gas Pumps	—	—	—	—	—	—	—	—	—	—	—	—	—	—	—	—	205	205
Total	—	—	—	—	—	—	—	—	—	—	—	—	—	—	—	—	205	205

4.7. Offroad Emissions By Equipment Type

4.7.1. Unmitigated

Criteria Pollutants (lb/day for daily, ton/yr for annual) and GHGs (lb/day for daily, MT/yr for annual)

Equipment Type	ROG	NOx	CO	SO2	PM10E	PM10D	PM10T	PM2.5E	PM2.5D	PM2.5T	BCO2	NBCO2	CO2T	CH4	N2O	R	CO2e
Daily, Summer (Max)	—	—	—	—	—	—	—	—	—	—	—	—	—	—	—	—	—
Total	—	—	—	—	—	—	—	—	—	—	—	—	—	—	—	—	—
Daily, Winter (Max)	—	—	—	—	—	—	—	—	—	—	—	—	—	—	—	—	—
Total	—	—	—	—	—	—	—	—	—	—	—	—	—	—	—	—	—
Annual	—	—	—	—	—	—	—	—	—	—	—	—	—	—	—	—	—
Total	—	—	—	—	—	—	—	—	—	—	—	—	—	—	—	—	—

4.7.2. Mitigated

Criteria Pollutants (lb/day for daily, ton/yr for annual) and GHGs (lb/day for daily, MT/yr for annual)

Equipment Type	ROG	NOx	CO	SO2	PM10E	PM10D	PM10T	PM2.5E	PM2.5D	PM2.5T	BCO2	NBCO2	CO2T	CH4	N2O	R	CO2e
----------------	-----	-----	----	-----	-------	-------	-------	--------	--------	--------	------	-------	------	-----	-----	---	------

Daily, Summer (Max)	—	—	—	—	—	—	—	—	—	—	—	—	—	—	—	—	—
Total	—	—	—	—	—	—	—	—	—	—	—	—	—	—	—	—	—
Daily, Winter (Max)	—	—	—	—	—	—	—	—	—	—	—	—	—	—	—	—	—
Total	—	—	—	—	—	—	—	—	—	—	—	—	—	—	—	—	—
Annual	—	—	—	—	—	—	—	—	—	—	—	—	—	—	—	—	—
Total	—	—	—	—	—	—	—	—	—	—	—	—	—	—	—	—	—

4.8. Stationary Emissions By Equipment Type

4.8.1. Unmitigated

Criteria Pollutants (lb/day for daily, ton/yr for annual) and GHGs (lb/day for daily, MT/yr for annual)

Equipment Type	ROG	NOx	CO	SO2	PM10E	PM10D	PM10T	PM2.5E	PM2.5D	PM2.5T	BCO2	NBCO2	CO2T	CH4	N2O	R	CO2e
Daily, Summer (Max)	—	—	—	—	—	—	—	—	—	—	—	—	—	—	—	—	—
Total	—	—	—	—	—	—	—	—	—	—	—	—	—	—	—	—	—
Daily, Winter (Max)	—	—	—	—	—	—	—	—	—	—	—	—	—	—	—	—	—
Total	—	—	—	—	—	—	—	—	—	—	—	—	—	—	—	—	—
Annual	—	—	—	—	—	—	—	—	—	—	—	—	—	—	—	—	—
Total	—	—	—	—	—	—	—	—	—	—	—	—	—	—	—	—	—

4.8.2. Mitigated

Criteria Pollutants (lb/day for daily, ton/yr for annual) and GHGs (lb/day for daily, MT/yr for annual)

EEC ORIGINAL PKG

Equipme Type	ROG	NOx	CO	SO2	PM10E	PM10D	PM10T	PM2.5E	PM2.5D	PM2.5T	BCO2	NBCO2	CO2T	CH4	N2O	R	CO2e
Daily, Summer (Max)	—	—	—	—	—	—	—	—	—	—	—	—	—	—	—	—	—
Total	—	—	—	—	—	—	—	—	—	—	—	—	—	—	—	—	—
Daily, Winter (Max)	—	—	—	—	—	—	—	—	—	—	—	—	—	—	—	—	—
Total	—	—	—	—	—	—	—	—	—	—	—	—	—	—	—	—	—
Annual	—	—	—	—	—	—	—	—	—	—	—	—	—	—	—	—	—
Total	—	—	—	—	—	—	—	—	—	—	—	—	—	—	—	—	—

4.9. User Defined Emissions By Equipment Type

4.9.1. Unmitigated

Criteria Pollutants (lb/day for daily, ton/yr for annual) and GHGs (lb/day for daily, MT/yr for annual)

Equipme nt Type	ROG	NOx	CO	SO2	PM10E	PM10D	PM10T	PM2.5E	PM2.5D	PM2.5T	BCO2	NBCO2	CO2T	CH4	N2O	R	CO2e
Daily, Summer (Max)	—	—	—	—	—	—	—	—	—	—	—	—	—	—	—	—	—
Total	—	—	—	—	—	—	—	—	—	—	—	—	—	—	—	—	—
Daily, Winter (Max)	—	—	—	—	—	—	—	—	—	—	—	—	—	—	—	—	—
Total	—	—	—	—	—	—	—	—	—	—	—	—	—	—	—	—	—
Annual	—	—	—	—	—	—	—	—	—	—	—	—	—	—	—	—	—
Total	—	—	—	—	—	—	—	—	—	—	—	—	—	—	—	—	—

4.9.2. Mitigated

Criteria Pollutants (lb/day for daily, ton/yr for annual) and GHGs (lb/day for daily, MT/yr for annual)

Equipment Type	ROG	NOx	CO	SO2	PM10E	PM10D	PM10T	PM2.5E	PM2.5D	PM2.5T	BCO2	NBCO2	CO2T	CH4	N2O	R	CO2e
Daily, Summer (Max)	—	—	—	—	—	—	—	—	—	—	—	—	—	—	—	—	—
Total	—	—	—	—	—	—	—	—	—	—	—	—	—	—	—	—	—
Daily, Winter (Max)	—	—	—	—	—	—	—	—	—	—	—	—	—	—	—	—	—
Total	—	—	—	—	—	—	—	—	—	—	—	—	—	—	—	—	—
Annual	—	—	—	—	—	—	—	—	—	—	—	—	—	—	—	—	—
Total	—	—	—	—	—	—	—	—	—	—	—	—	—	—	—	—	—

4.10. Soil Carbon Accumulation By Vegetation Type

4.10.1. Soil Carbon Accumulation By Vegetation Type - Unmitigated

Criteria Pollutants (lb/day for daily, ton/yr for annual) and GHGs (lb/day for daily, MT/yr for annual)

Vegetation	ROG	NOx	CO	SO2	PM10E	PM10D	PM10T	PM2.5E	PM2.5D	PM2.5T	BCO2	NBCO2	CO2T	CH4	N2O	R	CO2e
Daily, Summer (Max)	—	—	—	—	—	—	—	—	—	—	—	—	—	—	—	—	—
Total	—	—	—	—	—	—	—	—	—	—	—	—	—	—	—	—	—
Daily, Winter (Max)	—	—	—	—	—	—	—	—	—	—	—	—	—	—	—	—	—
Total	—	—	—	—	—	—	—	—	—	—	—	—	—	—	—	—	—
Annual	—	—	—	—	—	—	—	—	—	—	—	—	—	—	—	—	—

EEC ORIGINAL PKG

Total	—	—	—	—	—	—	—	—	—	—	—	—	—	—	—	—	—
-------	---	---	---	---	---	---	---	---	---	---	---	---	---	---	---	---	---

4.10.2. Above and Belowground Carbon Accumulation by Land Use Type - Unmitigated

Criteria Pollutants (lb/day for daily, ton/yr for annual) and GHGs (lb/day for daily, MT/yr for annual)

Land Use	ROG	NOx	CO	SO2	PM10E	PM10D	PM10T	PM2.5E	PM2.5D	PM2.5T	BCO2	NBCO2	CO2T	CH4	N2O	R	CO2e
Daily, Summer (Max)	—	—	—	—	—	—	—	—	—	—	—	—	—	—	—	—	—
Total	—	—	—	—	—	—	—	—	—	—	—	—	—	—	—	—	—
Daily, Winter (Max)	—	—	—	—	—	—	—	—	—	—	—	—	—	—	—	—	—
Total	—	—	—	—	—	—	—	—	—	—	—	—	—	—	—	—	—
Annual	—	—	—	—	—	—	—	—	—	—	—	—	—	—	—	—	—
Total	—	—	—	—	—	—	—	—	—	—	—	—	—	—	—	—	—

4.10.3. Avoided and Sequestered Emissions by Species - Unmitigated

Criteria Pollutants (lb/day for daily, ton/yr for annual) and GHGs (lb/day for daily, MT/yr for annual)

Species	ROG	NOx	CO	SO2	PM10E	PM10D	PM10T	PM2.5E	PM2.5D	PM2.5T	BCO2	NBCO2	CO2T	CH4	N2O	R	CO2e
Daily, Summer (Max)	—	—	—	—	—	—	—	—	—	—	—	—	—	—	—	—	—
Avoided	—	—	—	—	—	—	—	—	—	—	—	—	—	—	—	—	—
Subtotal	—	—	—	—	—	—	—	—	—	—	—	—	—	—	—	—	—
Sequestered	—	—	—	—	—	—	—	—	—	—	—	—	—	—	—	—	—
Subtotal	—	—	—	—	—	—	—	—	—	—	—	—	—	—	—	—	—
Removed	—	—	—	—	—	—	—	—	—	—	—	—	—	—	—	—	—
Subtotal	—	—	—	—	—	—	—	—	—	—	—	—	—	—	—	—	—
—	—	—	—	—	—	—	—	—	—	—	—	—	—	—	—	—	—

EEC ORIGINAL PKG

Daily, Winter (Max)	—	—	—	—	—	—	—	—	—	—	—	—	—	—	—	—	—
Avoided	—	—	—	—	—	—	—	—	—	—	—	—	—	—	—	—	—
Subtotal	—	—	—	—	—	—	—	—	—	—	—	—	—	—	—	—	—
Sequestered	—	—	—	—	—	—	—	—	—	—	—	—	—	—	—	—	—
Subtotal	—	—	—	—	—	—	—	—	—	—	—	—	—	—	—	—	—
Removed	—	—	—	—	—	—	—	—	—	—	—	—	—	—	—	—	—
Subtotal	—	—	—	—	—	—	—	—	—	—	—	—	—	—	—	—	—
—	—	—	—	—	—	—	—	—	—	—	—	—	—	—	—	—	—
Annual	—	—	—	—	—	—	—	—	—	—	—	—	—	—	—	—	—
Avoided	—	—	—	—	—	—	—	—	—	—	—	—	—	—	—	—	—
Subtotal	—	—	—	—	—	—	—	—	—	—	—	—	—	—	—	—	—
Sequestered	—	—	—	—	—	—	—	—	—	—	—	—	—	—	—	—	—
Subtotal	—	—	—	—	—	—	—	—	—	—	—	—	—	—	—	—	—
Removed	—	—	—	—	—	—	—	—	—	—	—	—	—	—	—	—	—
Subtotal	—	—	—	—	—	—	—	—	—	—	—	—	—	—	—	—	—
—	—	—	—	—	—	—	—	—	—	—	—	—	—	—	—	—	—

4.10.4. Soil Carbon Accumulation By Vegetation Type - Mitigated

Criteria Pollutants (lb/day for daily, ton/yr for annual) and GHGs (lb/day for daily, MT/yr for annual)

Vegetation	ROG	NOx	CO	SO2	PM10E	PM10D	PM10T	PM2.5E	PM2.5D	PM2.5T	BCO2	NBCO2	CO2T	CH4	N2O	R	CO2e
Daily, Summer (Max)	—	—	—	—	—	—	—	—	—	—	—	—	—	—	—	—	—
Total	—	—	—	—	—	—	—	—	—	—	—	—	—	—	—	—	—

Daily, Winter (Max)	—	—	—	—	—	—	—	—	—	—	—	—	—	—	—	—	—
Total	—	—	—	—	—	—	—	—	—	—	—	—	—	—	—	—	—
Annual	—	—	—	—	—	—	—	—	—	—	—	—	—	—	—	—	—
Total	—	—	—	—	—	—	—	—	—	—	—	—	—	—	—	—	—

4.10.5. Above and Belowground Carbon Accumulation by Land Use Type - Mitigated

Criteria Pollutants (lb/day for daily, ton/yr for annual) and GHGs (lb/day for daily, MT/yr for annual)

Land Use	ROG	NOx	CO	SO2	PM10E	PM10D	PM10T	PM2.5E	PM2.5D	PM2.5T	BCO2	NBCO2	CO2T	CH4	N2O	R	CO2e
Daily, Summer (Max)	—	—	—	—	—	—	—	—	—	—	—	—	—	—	—	—	—
Total	—	—	—	—	—	—	—	—	—	—	—	—	—	—	—	—	—
Daily, Winter (Max)	—	—	—	—	—	—	—	—	—	—	—	—	—	—	—	—	—
Total	—	—	—	—	—	—	—	—	—	—	—	—	—	—	—	—	—
Annual	—	—	—	—	—	—	—	—	—	—	—	—	—	—	—	—	—
Total	—	—	—	—	—	—	—	—	—	—	—	—	—	—	—	—	—

4.10.6. Avoided and Sequestered Emissions by Species - Mitigated

Criteria Pollutants (lb/day for daily, ton/yr for annual) and GHGs (lb/day for daily, MT/yr for annual)

Species	ROG	NOx	CO	SO2	PM10E	PM10D	PM10T	PM2.5E	PM2.5D	PM2.5T	BCO2	NBCO2	CO2T	CH4	N2O	R	CO2e
Daily, Summer (Max)	—	—	—	—	—	—	—	—	—	—	—	—	—	—	—	—	—
Avoided	—	—	—	—	—	—	—	—	—	—	—	—	—	—	—	—	—
Subtotal	—	—	—	—	—	—	—	—	—	—	—	—	—	—	—	—	—

Sequestered	—	—	—	—	—	—	—	—	—	—	—	—	—	—	—	—	—
Subtotal	—	—	—	—	—	—	—	—	—	—	—	—	—	—	—	—	—
Removed	—	—	—	—	—	—	—	—	—	—	—	—	—	—	—	—	—
Subtotal	—	—	—	—	—	—	—	—	—	—	—	—	—	—	—	—	—
—	—	—	—	—	—	—	—	—	—	—	—	—	—	—	—	—	—
Daily, Winter (Max)	—	—	—	—	—	—	—	—	—	—	—	—	—	—	—	—	—
Avoided	—	—	—	—	—	—	—	—	—	—	—	—	—	—	—	—	—
Subtotal	—	—	—	—	—	—	—	—	—	—	—	—	—	—	—	—	—
Sequestered	—	—	—	—	—	—	—	—	—	—	—	—	—	—	—	—	—
Subtotal	—	—	—	—	—	—	—	—	—	—	—	—	—	—	—	—	—
Removed	—	—	—	—	—	—	—	—	—	—	—	—	—	—	—	—	—
Subtotal	—	—	—	—	—	—	—	—	—	—	—	—	—	—	—	—	—
—	—	—	—	—	—	—	—	—	—	—	—	—	—	—	—	—	—
Annual	—	—	—	—	—	—	—	—	—	—	—	—	—	—	—	—	—
Avoided	—	—	—	—	—	—	—	—	—	—	—	—	—	—	—	—	—
Subtotal	—	—	—	—	—	—	—	—	—	—	—	—	—	—	—	—	—
Sequestered	—	—	—	—	—	—	—	—	—	—	—	—	—	—	—	—	—
Subtotal	—	—	—	—	—	—	—	—	—	—	—	—	—	—	—	—	—
Removed	—	—	—	—	—	—	—	—	—	—	—	—	—	—	—	—	—
Subtotal	—	—	—	—	—	—	—	—	—	—	—	—	—	—	—	—	—
—	—	—	—	—	—	—	—	—	—	—	—	—	—	—	—	—	—

5. Activity Data

5.1. Construction Schedule

Phase Name	Phase Type	Start Date	End Date	Days Per Week	Work Days per Phase	Phase Description
Demolition	Demolition	11/5/2024	12/3/2024	5.00	20.0	—
Site Preparation	Site Preparation	12/4/2024	12/18/2024	5.00	10.0	—
Grading	Grading	12/19/2024	3/12/2025	5.00	60.0	—
Building Construction	Building Construction	3/13/2025	12/5/2025	5.00	192	—
Paving	Paving	12/1/2025	12/31/2025	5.00	23.0	—
Architectural Coating	Architectural Coating	10/15/2025	12/5/2025	5.00	38.0	—

5.2. Off-Road Equipment

5.2.1. Unmitigated

Phase Name	Equipment Type	Fuel Type	Engine Tier	Number per Day	Hours Per Day	Horsepower	Load Factor
Demolition	Rubber Tired Dozers	Diesel	Average	2.00	8.00	367	0.40
Demolition	Excavators	Diesel	Average	3.00	8.00	36.0	0.38
Demolition	Concrete/Industrial Saws	Diesel	Average	1.00	8.00	33.0	0.73
Site Preparation	Rubber Tired Dozers	Diesel	Average	3.00	8.00	367	0.40
Site Preparation	Tractors/Loaders/Backhoes	Diesel	Average	4.00	8.00	84.0	0.37
Grading	Graders	Diesel	Average	1.00	8.00	148	0.41
Grading	Excavators	Diesel	Average	1.00	8.00	36.0	0.38
Grading	Tractors/Loaders/Backhoes	Diesel	Average	3.00	8.00	84.0	0.37
Grading	Rubber Tired Dozers	Diesel	Average	1.00	8.00	367	0.40
Building Construction	Forklifts	Diesel	Average	3.00	8.00	82.0	0.20
Building Construction	Generator Sets	Diesel	Average	1.00	8.00	14.0	0.74
Building Construction	Cranes	Diesel	Average	1.00	7.00	367	0.29

EEC ORIGINAL PKG

Building Construction	Welders	Diesel	Average	1.00	8.00	46.0	0.45
Building Construction	Tractors/Loaders/Backhoes	Diesel	Average	3.00	7.00	84.0	0.37
Paving	Pavers	Diesel	Average	2.00	8.00	81.0	0.42
Paving	Paving Equipment	Diesel	Average	2.00	8.00	89.0	0.36
Paving	Rollers	Diesel	Average	2.00	8.00	36.0	0.38
Architectural Coating	Air Compressors	Diesel	Average	1.00	6.00	37.0	0.48

5.2.2. Mitigated

Phase Name	Equipment Type	Fuel Type	Engine Tier	Number per Day	Hours Per Day	Horsepower	Load Factor
Demolition	Rubber Tired Dozers	Diesel	Average	2.00	8.00	367	0.40
Demolition	Excavators	Diesel	Average	3.00	8.00	36.0	0.38
Demolition	Concrete/Industrial Saws	Diesel	Average	1.00	8.00	33.0	0.73
Site Preparation	Rubber Tired Dozers	Diesel	Average	3.00	8.00	367	0.40
Site Preparation	Tractors/Loaders/Backhoes	Diesel	Average	4.00	8.00	84.0	0.37
Grading	Graders	Diesel	Average	1.00	8.00	148	0.41
Grading	Excavators	Diesel	Average	1.00	8.00	36.0	0.38
Grading	Tractors/Loaders/Backhoes	Diesel	Average	3.00	8.00	84.0	0.37
Grading	Rubber Tired Dozers	Diesel	Average	1.00	8.00	367	0.40
Building Construction	Forklifts	Diesel	Average	3.00	8.00	82.0	0.20
Building Construction	Generator Sets	Diesel	Average	1.00	8.00	14.0	0.74
Building Construction	Cranes	Diesel	Average	1.00	7.00	367	0.29
Building Construction	Welders	Diesel	Average	1.00	8.00	46.0	0.45
Building Construction	Tractors/Loaders/Backhoes	Diesel	Average	3.00	7.00	84.0	0.37
Paving	Pavers	Diesel	Average	2.00	8.00	81.0	0.42

EEC ORIGINAL PKG

Paving	Paving Equipment	Diesel	Average	2.00	8.00	89.0	0.36
Paving	Rollers	Diesel	Average	2.00	8.00	36.0	0.38
Architectural Coating	Air Compressors	Diesel	Average	1.00	6.00	37.0	0.48

5.3. Construction Vehicles

5.3.1. Unmitigated

Phase Name	Trip Type	One-Way Trips per Day	Miles per Trip	Vehicle Mix
Demolition	—	—	—	—
Demolition	Worker	15.0	18.5	LDA,LDT1,LDT2
Demolition	Vendor	—	10.2	HHDT,MHDT
Demolition	Hauling	0.00	20.0	HHDT
Demolition	Onsite truck	—	—	HHDT
Site Preparation	—	—	—	—
Site Preparation	Worker	17.5	18.5	LDA,LDT1,LDT2
Site Preparation	Vendor	—	10.2	HHDT,MHDT
Site Preparation	Hauling	12.5	20.0	HHDT
Site Preparation	Onsite truck	—	—	HHDT
Grading	—	—	—	—
Grading	Worker	15.0	18.5	LDA,LDT1,LDT2
Grading	Vendor	—	10.2	HHDT,MHDT
Grading	Hauling	2.08	20.0	HHDT
Grading	Onsite truck	—	—	HHDT
Building Construction	—	—	—	—
Building Construction	Worker	1.91	18.5	LDA,LDT1,LDT2
Building Construction	Vendor	0.98	10.2	HHDT,MHDT
Building Construction	Hauling	0.00	20.0	HHDT

EEC ORIGINAL PKG

Building Construction	Onsite truck	—	—	HHDT
Paving	—	—	—	—
Paving	Worker	15.0	18.5	LDA,LDT1,LDT2
Paving	Vendor	—	10.2	HHDT,MHDT
Paving	Hauling	0.00	20.0	HHDT
Paving	Onsite truck	—	—	HHDT
Architectural Coating	—	—	—	—
Architectural Coating	Worker	0.38	18.5	LDA,LDT1,LDT2
Architectural Coating	Vendor	—	10.2	HHDT,MHDT
Architectural Coating	Hauling	0.00	20.0	HHDT
Architectural Coating	Onsite truck	—	—	HHDT

5.3.2. Mitigated

Phase Name	Trip Type	One-Way Trips per Day	Miles per Trip	Vehicle Mix
Demolition	—	—	—	—
Demolition	Worker	15.0	18.5	LDA,LDT1,LDT2
Demolition	Vendor	—	10.2	HHDT,MHDT
Demolition	Hauling	0.00	20.0	HHDT
Demolition	Onsite truck	—	—	HHDT
Site Preparation	—	—	—	—
Site Preparation	Worker	17.5	18.5	LDA,LDT1,LDT2
Site Preparation	Vendor	—	10.2	HHDT,MHDT
Site Preparation	Hauling	12.5	20.0	HHDT
Site Preparation	Onsite truck	—	—	HHDT
Grading	—	—	—	—
Grading	Worker	15.0	18.5	LDA,LDT1,LDT2
Grading	Vendor	—	10.2	HHDT,MHDT

EEC ORIGINAL PKG

Grading	Hauling	2.08	20.0	HHDT
Grading	Onsite truck	—	—	HHDT
Building Construction	—	—	—	—
Building Construction	Worker	1.91	18.5	LDA,LDT1,LDT2
Building Construction	Vendor	0.98	10.2	HHDT,MHDT
Building Construction	Hauling	0.00	20.0	HHDT
Building Construction	Onsite truck	—	—	HHDT
Paving	—	—	—	—
Paving	Worker	15.0	18.5	LDA,LDT1,LDT2
Paving	Vendor	—	10.2	HHDT,MHDT
Paving	Hauling	0.00	20.0	HHDT
Paving	Onsite truck	—	—	HHDT
Architectural Coating	—	—	—	—
Architectural Coating	Worker	0.38	18.5	LDA,LDT1,LDT2
Architectural Coating	Vendor	—	10.2	HHDT,MHDT
Architectural Coating	Hauling	0.00	20.0	HHDT
Architectural Coating	Onsite truck	—	—	HHDT

5.4. Vehicles

5.4.1. Construction Vehicle Control Strategies

Control Strategies Applied	PM10 Reduction	PM2.5 Reduction
Water unpaved roads twice daily	55%	55%

5.5. Architectural Coatings

Phase Name	Residential Interior Area Coated (sq ft)	Residential Exterior Area Coated (sq ft)	Non-Residential Interior Area Coated (sq ft)	Non-Residential Exterior Area Coated (sq ft)	Parking Area Coated (sq ft)
------------	--	--	--	--	-----------------------------

EEC ORIGINAL PKG

Architectural Coating	0.00	0.00	3,812	1,271	20,909
-----------------------	------	------	-------	-------	--------

5.6. Dust Mitigation

5.6.1. Construction Earthmoving Activities

Phase Name	Material Imported (Cubic Yards)	Material Exported (Cubic Yards)	Acres Graded (acres)	Material Demolished (sq. ft.)	Acres Paved (acres)
Demolition	0.00	0.00	0.00	—	—
Site Preparation	—	1,000	15.0	0.00	—
Grading	—	1,000	60.0	0.00	—
Paving	0.00	0.00	0.00	0.00	8.00

5.6.2. Construction Earthmoving Control Strategies

Control Strategies Applied	Frequency (per day)	PM10 Reduction	PM2.5 Reduction
Water Exposed Area	2	61%	61%

5.7. Construction Paving

Land Use	Area Paved (acres)	% Asphalt
Convenience Market with Gas Pumps	0.00	0%
Parking Lot	8.00	100%

5.8. Construction Electricity Consumption and Emissions Factors

kWh per Year and Emission Factor (lb/MWh)

Year	kWh per Year	CO2	CH4	N2O
2024	0.00	457	0.03	< 0.005
2025	0.00	457	0.03	< 0.005

5.9. Operational Mobile Sources

5.9.1. Unmitigated

Land Use Type	Trips/Weekday	Trips/Saturday	Trips/Sunday	Trips/Year	VMT/Weekday	VMT/Saturday	VMT/Sunday	VMT/Year
Convenience Market with Gas Pumps	4,356	4,064	4,064	1,559,554	6,721	6,269	6,269	2,406,206
Parking Lot	0.00	0.00	0.00	0.00	0.00	0.00	0.00	0.00

5.9.2. Mitigated

Land Use Type	Trips/Weekday	Trips/Saturday	Trips/Sunday	Trips/Year	VMT/Weekday	VMT/Saturday	VMT/Sunday	VMT/Year
Convenience Market with Gas Pumps	4,356	4,064	4,064	1,559,554	6,721	6,269	6,269	2,406,206
Parking Lot	0.00	0.00	0.00	0.00	0.00	0.00	0.00	0.00

5.10. Operational Area Sources

5.10.1. Hearths

5.10.1.1. Unmitigated

5.10.1.2. Mitigated

5.10.2. Architectural Coatings

Residential Interior Area Coated (sq ft)	Residential Exterior Area Coated (sq ft)	Non-Residential Interior Area Coated (sq ft)	Non-Residential Exterior Area Coated (sq ft)	Parking Area Coated (sq ft)
0	0.00	8,973	2,991	20,909

5.10.3. Landscape Equipment

Season	Unit	Value
Snow Days	day/yr	0.00
Summer Days	day/yr	180

5.10.4. Landscape Equipment - Mitigated

Season	Unit	Value
Snow Days	day/yr	0.00
Summer Days	day/yr	180

5.11. Operational Energy Consumption

5.11.1. Unmitigated

Electricity (kWh/yr) and CO2 and CH4 and N2O and Natural Gas (kBTU/yr)

Land Use	Electricity (kWh/yr)	CO2	CH4	N2O	Natural Gas (kBTU/yr)
Convenience Market with Gas Pumps	224,034	457	0.0330	0.0040	130,091
Parking Lot	305,268	457	0.0330	0.0040	0.00

5.11.2. Mitigated

Electricity (kWh/yr) and CO2 and CH4 and N2O and Natural Gas (kBTU/yr)

Land Use	Electricity (kWh/yr)	CO2	CH4	N2O	Natural Gas (kBTU/yr)
Convenience Market with Gas Pumps	224,034	457	0.0330	0.0040	130,091
Parking Lot	305,268	457	0.0330	0.0040	0.00

5.12. Operational Water and Wastewater Consumption

5.12.1. Unmitigated

Land Use	Indoor Water (gal/year)	Outdoor Water (gal/year)
Convenience Market with Gas Pumps	146,401	40,940
Parking Lot	0.00	20,470

5.12.2. Mitigated

Land Use	Indoor Water (gal/year)	Outdoor Water (gal/year)
Convenience Market with Gas Pumps	117,120	32,752
Parking Lot	0.00	16,376

5.13. Operational Waste Generation

5.13.1. Unmitigated

Land Use	Waste (ton/year)	Cogeneration (kWh/year)
Convenience Market with Gas Pumps	5.93	—
Parking Lot	0.00	—

5.13.2. Mitigated

Land Use	Waste (ton/year)	Cogeneration (kWh/year)
Convenience Market with Gas Pumps	5.93	—
Parking Lot	0.00	—

5.14. Operational Refrigeration and Air Conditioning Equipment

5.14.1. Unmitigated

Land Use Type	Equipment Type	Refrigerant	GWP	Quantity (kg)	Operations Leak Rate	Service Leak Rate	Times Serviced
---------------	----------------	-------------	-----	---------------	----------------------	-------------------	----------------

ECC ORIGINAL PKG

Convenience Market with Gas Pumps	Other commercial A/C and heat pumps	R-410A	2,088	< 0.005	4.00	4.00	18.0
Convenience Market with Gas Pumps	Supermarket refrigeration and condensing units	R-404A	3,922	26.5	16.5	16.5	18.0

5.14.2. Mitigated

Land Use Type	Equipment Type	Refrigerant	GWP	Quantity (kg)	Operations Leak Rate	Service Leak Rate	Times Serviced
Convenience Market with Gas Pumps	Other commercial A/C and heat pumps	R-410A	2,088	< 0.005	4.00	4.00	18.0
Convenience Market with Gas Pumps	Supermarket refrigeration and condensing units	R-404A	3,922	26.5	16.5	16.5	18.0

5.15. Operational Off-Road Equipment

5.15.1. Unmitigated

Equipment Type	Fuel Type	Engine Tier	Number per Day	Hours Per Day	Horsepower	Load Factor
----------------	-----------	-------------	----------------	---------------	------------	-------------

5.15.2. Mitigated

Equipment Type	Fuel Type	Engine Tier	Number per Day	Hours Per Day	Horsepower	Load Factor
----------------	-----------	-------------	----------------	---------------	------------	-------------

5.16. Stationary Sources

5.16.1. Emergency Generators and Fire Pumps

Equipment Type	Fuel Type	Number per Day	Hours per Day	Hours per Year	Horsepower	Load Factor
----------------	-----------	----------------	---------------	----------------	------------	-------------

5.16.2. Process Boilers

Equipment Type	Fuel Type	Number	Boiler Rating (MMBtu/hr)	Daily Heat Input (MMBtu/day)	Annual Heat Input (MMBtu/yr)
----------------	-----------	--------	--------------------------	------------------------------	------------------------------

5.17. User Defined

Equipment Type	Fuel Type
----------------	-----------

5.18. Vegetation

5.18.1. Land Use Change

5.18.1.1. Unmitigated

Vegetation Land Use Type	Vegetation Soil Type	Initial Acres	Final Acres
--------------------------	----------------------	---------------	-------------

5.18.1.2. Mitigated

Vegetation Land Use Type	Vegetation Soil Type	Initial Acres	Final Acres
--------------------------	----------------------	---------------	-------------

5.18.1. Biomass Cover Type

5.18.1.1. Unmitigated

Biomass Cover Type	Initial Acres	Final Acres
--------------------	---------------	-------------

5.18.1.2. Mitigated

Biomass Cover Type	Initial Acres	Final Acres
--------------------	---------------	-------------

5.18.2. Sequestration

5.18.2.1. Unmitigated

Tree Type	Number	Electricity Saved (kWh/year)	Natural Gas Saved (btu/year)
-----------	--------	------------------------------	------------------------------

5.18.2.2. Mitigated

Tree Type	Number	Electricity Saved (kWh/year)	Natural Gas Saved (btu/year)
-----------	--------	------------------------------	------------------------------

6. Climate Risk Detailed Report

6.1. Climate Risk Summary

Cal-Adapt midcentury 2040–2059 average projections for four hazards are reported below for your project location. These are under Representation Concentration Pathway (RCP) 8.5 which assumes GHG emissions will continue to rise strongly through 2050 and then plateau around 2100.

Climate Hazard	Result for Project Location	Unit
Temperature and Extreme Heat	27.1	annual days of extreme heat
Extreme Precipitation	0.10	annual days with precipitation above 20 mm
Sea Level Rise	—	meters of inundation depth
Wildfire	0.00	annual hectares burned

Temperature and Extreme Heat data are for grid cell in which your project are located. The projection is based on the 98th historical percentile of daily maximum/minimum temperatures from observed historical data (32 climate model ensemble from Cal-Adapt, 2040–2059 average under RCP 8.5). Each grid cell is 6 kilometers (km) by 6 km, or 3.7 miles (mi) by 3.7 mi.

Extreme Precipitation data are for the grid cell in which your project are located. The threshold of 20 mm is equivalent to about ¾ an inch of rain, which would be light to moderate rainfall if received over a full day or heavy rain if received over a period of 2 to 4 hours. Each grid cell is 6 kilometers (km) by 6 km, or 3.7 miles (mi) by 3.7 mi.

Sea Level Rise data are for the grid cell in which your project are located. The projections are from Radke et al. (2017), as reported in Cal-Adapt (Radke et al., 2017, CEC-500-2017-008), and consider inundation location and depth for the San Francisco Bay, the Sacramento-San Joaquin River Delta and California coast resulting different increments of sea level rise coupled with extreme storm events.

Users may select from four scenarios to view the range in potential inundation depth for the grid cell. The four scenarios are: No rise, 0.5 meter, 1.0 meter, 1.41 meters

Wildfire data are for the grid cell in which your project are located. The projections are from UC Davis, as reported in Cal-Adapt (2040–2059 average under RCP 8.5), and consider historical data of climate, vegetation, population density, and large (> 400 ha) fire history. Users may select from four model simulations to view the range in potential wildfire probabilities for the grid cell. The four simulations make different assumptions about expected rainfall and temperature are: Warmer/drier (HadGEM2-ES), Cooler/wetter (CNRM-CM5), Average conditions (CanESM2), Range of different rainfall and temperature possibilities (MIROC5). Each grid cell is 6 kilometers (km) by 6 km, or 3.7 miles (mi) by 3.7 mi.

6.2. Initial Climate Risk Scores

Climate Hazard	Exposure Score	Sensitivity Score	Adaptive Capacity Score	Vulnerability Score
Temperature and Extreme Heat	N/A	N/A	N/A	N/A
Extreme Precipitation	N/A	N/A	N/A	N/A

EEC ORIGINAL PKG

Sea Level Rise	N/A	N/A	N/A	N/A
Wildfire	N/A	N/A	N/A	N/A
Flooding	N/A	N/A	N/A	N/A
Drought	N/A	N/A	N/A	N/A
Snowpack Reduction	N/A	N/A	N/A	N/A
Air Quality Degradation	N/A	N/A	N/A	N/A

The sensitivity score reflects the extent to which a project would be adversely affected by exposure to a climate hazard. Exposure is rated on a scale of 1 to 5, with a score of 5 representing the greatest exposure.

The adaptive capacity of a project refers to its ability to manage and reduce vulnerabilities from projected climate hazards. Adaptive capacity is rated on a scale of 1 to 5, with a score of 5 representing the greatest ability to adapt.

The overall vulnerability scores are calculated based on the potential impacts and adaptive capacity assessments for each hazard. Scores do not include implementation of climate risk reduction measures.

6.3. Adjusted Climate Risk Scores

Climate Hazard	Exposure Score	Sensitivity Score	Adaptive Capacity Score	Vulnerability Score
Temperature and Extreme Heat	N/A	N/A	N/A	N/A
Extreme Precipitation	N/A	N/A	N/A	N/A
Sea Level Rise	N/A	N/A	N/A	N/A
Wildfire	N/A	N/A	N/A	N/A
Flooding	N/A	N/A	N/A	N/A
Drought	N/A	N/A	N/A	N/A
Snowpack Reduction	N/A	N/A	N/A	N/A
Air Quality Degradation	N/A	N/A	N/A	N/A

The sensitivity score reflects the extent to which a project would be adversely affected by exposure to a climate hazard. Exposure is rated on a scale of 1 to 5, with a score of 5 representing the greatest exposure.

The adaptive capacity of a project refers to its ability to manage and reduce vulnerabilities from projected climate hazards. Adaptive capacity is rated on a scale of 1 to 5, with a score of 5 representing the greatest ability to adapt.

The overall vulnerability scores are calculated based on the potential impacts and adaptive capacity assessments for each hazard. Scores include implementation of climate risk reduction measures.

6.4. Climate Risk Reduction Measures

7. Health and Equity Details

7.1. CalEnviroScreen 4.0 Scores

The maximum CalEnviroScreen score is 100. A high score (i.e., greater than 50) reflects a higher pollution burden compared to other census tracts in the state.

Indicator	Result for Project Census Tract
Exposure Indicators	—
AQ-Ozone	62.7
AQ-PM	43.4
AQ-DPM	29.3
Drinking Water	58.3
Lead Risk Housing	38.3
Pesticides	92.1
Toxic Releases	32.1
Traffic	25.3
Effect Indicators	—
CleanUp Sites	25.6
Groundwater	65.7
Haz Waste Facilities/Generators	84.5
Impaired Water Bodies	99.5
Solid Waste	98.9
Sensitive Population	—
Asthma	77.6
Cardio-vascular	83.7
Low Birth Weights	38.7
Socioeconomic Factor Indicators	—
Education	84.9
Housing	40.3

EEC ORIGINAL PKG

Linguistic	94.6
Poverty	80.3
Unemployment	73.4

7.2. Healthy Places Index Scores

The maximum Health Places Index score is 100. A high score (i.e., greater than 50) reflects healthier community conditions compared to other census tracts in the state.

Indicator	Result for Project Census Tract
Economic	—
Above Poverty	28.25612729
Employed	3.939432824
Median HI	30.21942769
Education	—
Bachelor's or higher	23.23880405
High school enrollment	100
Preschool enrollment	46.22096753
Transportation	—
Auto Access	59.70742974
Active commuting	21.17284743
Social	—
2-parent households	57.11535994
Voting	19.06839471
Neighborhood	—
Alcohol availability	78.28820737
Park access	20.21044527
Retail density	14.35904016
Supermarket access	7.981521879
Tree canopy	4.042089054

Housing	—
Homeownership	64.04465546
Housing habitability	62.23533941
Low-inc homeowner severe housing cost burden	34.69780572
Low-inc renter severe housing cost burden	68.75401001
Uncrowded housing	35.32657513
Health Outcomes	—
Insured adults	34.04337226
Arthritis	0.0
Asthma ER Admissions	38.7
High Blood Pressure	0.0
Cancer (excluding skin)	0.0
Asthma	0.0
Coronary Heart Disease	0.0
Chronic Obstructive Pulmonary Disease	0.0
Diagnosed Diabetes	0.0
Life Expectancy at Birth	75.8
Cognitively Disabled	50.3
Physically Disabled	34.8
Heart Attack ER Admissions	20.4
Mental Health Not Good	0.0
Chronic Kidney Disease	0.0
Obesity	0.0
Pedestrian Injuries	50.2
Physical Health Not Good	0.0
Stroke	0.0
Health Risk Behaviors	—

EEC ORIGINAL PKG

Binge Drinking	0.0
Current Smoker	0.0
No Leisure Time for Physical Activity	0.0
Climate Change Exposures	—
Wildfire Risk	0.0
SLR Inundation Area	0.0
Children	4.5
Elderly	74.7
English Speaking	3.6
Foreign-born	75.9
Outdoor Workers	8.1
Climate Change Adaptive Capacity	—
Impervious Surface Cover	83.4
Traffic Density	37.5
Traffic Access	23.0
Other Indices	—
Hardship	79.0
Other Decision Support	—
2016 Voting	0.0

7.3. Overall Health & Equity Scores

Metric	Result for Project Census Tract
CalEnviroScreen 4.0 Score for Project Location (a)	89.0
Healthy Places Index Score for Project Location (b)	22.0
Project Located in a Designated Disadvantaged Community (Senate Bill 535)	Yes
Project Located in a Low-Income Community (Assembly Bill 1550)	Yes
Project Located in a Community Air Protection Program Community (Assembly Bill 617)	El Centro Corridor

EEC ORIGINAL PKG

a: The maximum CalEnviroScreen score is 100. A high score (i.e., greater than 50) reflects a higher pollution burden compared to other census tracts in the state.
 b: The maximum Health Places Index score is 100. A high score (i.e., greater than 50) reflects healthier community conditions compared to other census tracts in the state.

7.4. Health & Equity Measures

No Health & Equity Measures selected.

7.5. Evaluation Scorecard

Health & Equity Evaluation Scorecard not completed.

7.6. Health & Equity Custom Measures

No Health & Equity Custom Measures created.

8. User Changes to Default Data

Screen	Justification
Construction: Construction Phases	Grading phase adjusted for tank excavation. Architectural coating phase overlapped with building construction to reflect anticipated construction phasing.
Construction: On-Road Fugitive Dust	All haul roads are paved.
Construction: Architectural Coatings	VOC modified for consistency with ICAPCD requirements.
Operations: Vehicle Data	Trip generation rate modified to match Trip Generation Table (Mizuta Traffic Consulting, Inc. November 2023).
Operations: Fleet Mix	Fleet mix changed to calculate only passenger car and light truck emissions.
Operations: Road Dust	All haul roads are paved.
Land Use	Building size is proposed to be 5,982 feet.
Operations: Water and Waste Water	—

B

**Health Risk
Assessment**

This page intentionally left blank.

Maverik Fuel Station
Health Risk Assessment
Imperial County, CA

Prepared for:
Wills Environmental Planning
San Diego, CA

Prepared by:
Entech Consulting Group
Temecula, CA
951-506-0055

December 2023

EEC ORIGINAL PKG

TABLE OF CONTENTS

1.0	Introduction	1
1.1	Purpose of Analysis and Study Objectives	1
1.2	Project Summary	1
1.2.1	Site Location	1
1.2.2	Project Description	1
1.2.3	Sensitive Receptors	1
1.3	Executive Summary of Findings and Mitigation Measures	1
2.0	Regulatory Framework and Background	3
2.1	Health Risk Regulatory Setting	3
3.0	Thresholds of Significance	3
3.1	Toxic Air Contaminants	3
4.0	Health Risk Assessment	4
4.1	Diesel Emissions Health Risk Assessment	4
5.0	References	19

LIST OF APPENDICES

- Appendix A:**
AERMOD Input Calculations
- Appendix B:**
AERMOD Model Printouts

LIST OF EXHIBITS

Exhibit A	10
AERMOD Model Source and Receptor Placement - Construction	10
Exhibit B	11
AERMOD Model Source and Receptor Placement - Operation	11
Exhibit C	16
Mitigated Annual DPM Emissions - Construction	16
Exhibit D	17
Unmitigated Annual Fueling Emissions – Operations	17
Exhibit E	18
Unmitigated Annual DPM Emissions – Operations	18

LIST OF TABLES

Table 1: DPM Emissions Factors.....	6
Table 2: Summary of Emission Configurations.....	8
Table 3: General Modeling Assumptions – AERMOD Model.....	9
Table 4: Cumulative Carcinogenic Risk, 30-Year Exposure Scenario.....	13
Table 5: Cumulative Carcinogenic Risk, 29-Year Fueling Operations Exposure Scenario	14
Table 6: Cumulative Carcinogenic Risk, 29-Year DPM Operations Exposure Scenario	14
Table 7: Cumulative Carcinogenic Risk, 30-Year Combined Construction and Operations Exposure Scenario.....	15

GLOSSARY OF TERMS

CAAQS	California Ambient Air Quality Standards
CARB	California Air Resources Board
CEQA	California Environmental Quality Act
CFCs	Chlorofluorocarbons
CH ₄	Methane
CNG	Compressed natural gas
CO	Carbon monoxide
CO ₂	Carbon dioxide
CO ₂ e	Carbon dioxide equivalent
DPM	Diesel particulate matter
GHG	Greenhouse gas
ICAPCD	Imperial County Air Pollution Control District
HFCs	Hydrofluorocarbons
MTCO ₂ e	Metric tons of carbon dioxide equivalent
MMTCO ₂ e	Million metric tons of carbon dioxide equivalent
NAAQS	National Ambient Air Quality Standards
NO _x	Nitrogen Oxides
NO ₂	Nitrogen dioxide
N ₂ O	Nitrous oxide
O ₃	Ozone
PFCs	Perfluorocarbons
PM	Particle matter
PM10	Particles that are less than 10 micrometers in diameter
PM2.5	Particles that are less than 2.5 micrometers in diameter
PMI	Point of maximum impact
PPM	Parts per million
PPB	Parts per billion
RTIP	Regional Transportation Improvement Plan
RTP	Regional Transportation Plan
SF ₆	Sulfur hexafluoride
SIP	State Implementation Plan
SO _x	Sulfur Oxides
SRA	Source/Receptor Area
TAC	Toxic air contaminants
VOC	Volatile organic compounds
WRCC	Western Regional Climate Center

1.0 Introduction

1.1 Purpose of Analysis and Study Objectives

This health risk analysis was prepared to evaluate whether the diesel air emissions generated by the construction and operation of the project would cause a significant impact to the air resources in the project area. This assessment was conducted within the context of the California Environmental Quality Act (CEQA, California Public Resources Code Sections 21000, et seq.). The assessment is consistent with the methodology and emission factors endorsed by the Imperial County Air Pollution control district (ICAPCD), California Air Resource Board (CARB), and the United States Environmental Protection Agency (US EPA).

1.2 Project Summary

1.2.1 Site Location

The project site is located at the southeast corner of E Ross Rd & Hawes Rd, in Imperial County, CA. The site is bordered by vacant land to the east and south, Ross Avenue to the north with a single-family residence further north, and CA-111 to the west with an RV park further west.

1.2.2 Project Description

The project proposes to develop the approximately 16.14-acre project site with a 5,982-square foot convenience store, gas station with 14 vehicle fueling positions, and a truck stop with 7 vehicle fueling positions.

1.2.3 Sensitive Receptors

Sensitive receptors are considered land uses or other types of population groups that are more sensitive to air pollution than others due to their exposure. As identified by the California Air Resources Board (CARB), sensitive population groups include children, the elderly, the acutely and chronically ill, and those with cardio-respiratory diseases. For CEQA purposes, a sensitive receptor would be a location where a sensitive individual could remain for 24-hours or longer, such as residencies, hospitals, and schools (etc).

The closest existing sensitive receptors (to the site area) are the single-family residence approximately 160 feet to the north and the mobile home park located approximately 450 feet to the west, as shown in Exhibit A.

1.3 Executive Summary of Findings and Mitigation Measures

The following is a summary of the analysis results:

The analysis shows that the nearby sensitive receptors would not be exposed to elevated cancer risk from project operation-related diesel emissions in excess of 10 in a million, with implementation of mitigation measure 1, and therefore impacts are less than significant with mitigation. The operational

related health risk impacts for non-cancer related impacts are less than 1.0; therefore, they are also considered to be less than significant.

Mitigation Measures

A. Construction Measures

Mitigation Measure 1: Construction equipment shall be required to have an engine rating of Tier 4 Final.

B. Operational Measures to Reduce Emissions

No operational mitigation required.

2.0 Regulatory Framework and Background

2.1 Health Risk Regulatory Setting

Health Risk Assessments for Proposed Land Use Projects CAPCOA Guidance Document. This guidance was adopted July 2009 to ensure consistency in assessing the health risk impacts from and to proposed land use projects. This CAPCOA guidance document focuses on the acute, chronic, and cancer impacts of sources affected by CEQA. It also outlines the recommended procedures to identify when a project should undergo further risk evaluation, how to conduct the health risk assessment (HRA), how to engage the public, what to do with the results from the HRA, and what mitigation measures may be appropriate for various land use projects. With respect to health risks associated with locating sensitive land uses in proximity to freeways and other high traffic roadways, HRA modeling may not thoroughly characterize all the health risk associated with nearby exposure to traffic generated pollutants.

California Code of Regulations (CCR) Title 13 Section 2485. The Airborne Toxic Control Measure to Limit Diesel-Fueled Commercial Motor Vehicle Idling applies to diesel-fueled commercial motor vehicles that operate in the State of California with gross vehicle weight ratings of greater than 10,000 pounds that are or must be licensed for operation on highways. It limits applicable vehicles from idling more than five consecutive minutes at any location.

3.0 Thresholds of Significance

3.1 Toxic Air Contaminants

Non criteria pollutants such as Hazardous Air Pollutants (HAPs) or Toxic Air Contaminants (TACs) are also regulated by the ICAPCD. ICAPCD requires evaluation of potential health risks for any new, relocated, or modified emission unit which may increase emissions of one or more toxic air contaminants.¹ As ICAPCD has not established a threshold for health risk, the project shall be compared to the thresholds of the San Diego APCD, which are a maximum incremental cancer risk of 10 per million and a non-cancer (acute and chronic) hazard index of 1.0 or greater. An exceedance to these values would be considered a significant impact.

¹ ICAPCD CEQA Handbook. December 17, 2017. <https://apcd.imperialcounty.org/wp-content/uploads/2020/01/CEQAHandbk.pdf>.

4.0 Health Risk Assessment

4.1 Diesel Emissions Health Risk Assessment

The construction and on-going operation of the proposed project would generate toxic air contaminant emissions from diesel truck emissions, off-road equipment, and fueling operations. According to OEHHA methodology, health effects from carcinogenic air toxics are usually described in terms of individual cancer risk. "Individual Cancer Risk" is the likelihood that a person exposed to concentrations of toxic air contaminants over a 30-year lifetime will contract cancer, based on the use of revised Office of Environmental Health Hazard Assessment (OEHHA) risk-assessment methodology.

A health risk assessment requires the completion and interaction of four general steps:

1. Quantify project-generated TAC emissions.
2. Identify nearby ground-level receptor locations that may be affected by the emissions (including any special sensitive receptor locations such as residences, schools, hospitals, convalescent homes, and daycare centers).
3. Perform air dispersion modeling analyses to estimate ambient pollutant concentrations at each receptor location using project TAC emissions and representative meteorological data to define the transport and dispersion of those emissions in the atmosphere.
4. Characterize and compare the calculated health risks with the applicable health risk significance thresholds.

4.1.1 Health Risk Assessment Assumptions

Important issues that affect the dispersion modeling include the following: (1) Model Selection, (2) Source Treatment, (3) Meteorological Data, and (4) Receptor Grid. Each of these issues is addressed below.

Construction-Generated Air Toxics

Construction-related activities would result in temporary, short-term project-generated emissions of diesel particulate matter (DPM) from the exhaust of off-road, heavy-duty diesel equipment for site grading; soil hauling truck traffic; vertical building construction; paving; application of architectural coatings; and other miscellaneous activities. For construction activity, DPM is the primary air toxic of concern. Particulate exhaust emissions from diesel-fueled engines (i.e., DPM) were identified as a toxic air contaminant (TAC) by the California Air Resources Board (CARB) in 1998.

The construction HRA evaluated DPM (represented as exhaust PM10 from CalEEMod) emissions generated during construction of the proposed project and the related health risk impacts for sensitive receptors located within 1,000 feet of the project boundary. A project would result in a significant impact if it would individually expose sensitive receptors to TACs resulting in an increased cancer risk greater than 10 in one million or an increased non-cancer risk of greater than 1.0 on the hazard index.

The project site is located within 1,000 feet from existing sensitive receptors that could be exposed to diesel emission exhaust during the construction period. To estimate the potential cancer risk associated with construction of the proposed project from equipment exhaust (including DPM), a dispersion model was used to translate an emission rate from the source location to concentrations at the receptor locations of interest (i.e., receptors at nearby residences).

Emission Source Estimates – DPM for Motor Vehicles

DPM emissions from the various sources were calculated using information derived from the project description, and mobile source emission factors from the CARB EMFAC2021 emissions factor model. Four pieces of information are required to generate the mobile source emissions from the proposed project:

- Number of vehicle trips for each component of the proposed project;
- Types of vehicles that access the proposed project (passenger car vs. heavy-duty truck and gasoline vs. diesel);
- The allocation of the vehicle trips to each building that comprises the proposed project; and
- Estimate of the vehicle emission factors for estimating exhaust and idling emissions.

Estimate of Vehicle Trips and Vehicle Types

The provided trip generation information showed the project is expected to generate approximately a total of 1,568 truck trips per day.

Estimate of Emission Factors

The DPM emission factors for the various vehicle types were derived from the CARB EMFAC2021 mobile source emission model. The emissions factors were derived for Imperial County. Third trimester exposure used opening year (2023) emissions factors, 2-year factors (for infant exposure) reflect years 2023 and 2024, 14-year average factors (for child exposure during years 2-16) reflect emissions during the first 14 years of operation (2025 to 2038), the second 14 years of exposure (years 2039-2052) were used for assessment of exposure during years 16 to 30.

Emissions factors were estimated to establish the emissions generated while the vehicles travel off-site, along travel links from the entrance to the loading docks, and while idling at the loading dock during loading or unloading materials. All vehicles were assumed to travel on-site at a speed of 10 miles per hour. Off-site, the speeds along the roads were anticipated to average 30 miles per hour. Delivery vehicles were assumed to idle for a maximum of 15 minutes per vehicle per day (5 minutes per location: at loading and truck parking areas), in keeping with the CARB Air Toxic Control Measure (ATCM), which regulates truck idling time (CARB 2005). The four different sets of emissions factors used in this assessment are detailed in Table 1. It should be noted that the DPM emissions on both the gram per mile and gram per idle hour bases decline beyond 2023 for all vehicle classes and in particular the heavy-heavy-duty truck class (the 4+ axle “big rig” trucks). This is due to the CARB emissions’ requirements on

heavy-duty trucks that call for either the replacement of older trucks with cleaner trucks or the installation of diesel particulate matter filters on the truck fleet.

Emission Source Characterization

Each of the emission source types described above also requires geometrical and emission release specifications for use in the air dispersion model. Table 1 provides a summary of the assumptions used to configure the various emission sources. The following definitions are used to characterize the emission source geometrical configurations referred to in Table 1:

- Line source: A series of volume sources along a path, for example, vehicular traffic volumes along a roadway.
- Area source: A series of sources contained to a specific area, for example construction equipment operating throughout a project site.

Exhibit A provides the location of the project buildings, emission source locations, and the locations of the nearest sensitive receptors (single-family detached residential dwelling units located to the north of property line and RV park to the west). Residential receptors are labeled 1 through 6. The direction of on-site and off-site truck travel were obtained from either the site plan and/or based on City truck routes and location of nearest freeways.

Table 1: DPM Emissions Factors¹

Vehicle Class	30-Year Average (2024-2050)		
	Idling (g/sec)	On-Site Travel (g/sec)	Off-Site Travel (g/sec)
Light-Heavy Duty Truck 1	1.12E-07	1.44E-05	1.42E-05
Light-Heavy Duty Truck 1	2.17E-08	3.15E-06	2.85E-06
Medium-Heavy Duty Truck	2.22E-09	2.12E-07	1.57E-07
Heavy-Heavy Duty Truck	4.53E-07	8.89E-06	7.90E-06

¹ Source: EMFAC2021.

Gasoline Dispensing TAC

Benzene, Ethylbenzene, and Naphthalene

Out of the toxic compounds emitted from the gasoline stations, benzene, ethylbenzene, and naphthalene have cancer toxicity values. However, benzene is the toxic air contaminant (TAC) which drives the risk, accounting for 87 percent of cancer risk from gasoline vapors (SCAQMD 2015). Furthermore, benzene constitutes more than three to four times the weight of gasoline than ethylbenzene and naphthalene, respectively (SCAQMD 2015). Additionally, there are substances emitted from gasoline stations, such as toluene and xylene which possess acute adverse health effects (though not cancer risk). However, it is not until the benzene concentrations are more than two orders of magnitude above 10 in one million that the emissions of toluene and xylene begin to cause adverse health effects (SCAQMD 2007, CAPCOA 1997). Therefore, toluene and xylene emissions have not been

modeled and are instead considered significant in the case that benzene concentrations are identified at two orders of magnitude above 10 in one million cancer risk.

Emissions sources in the model include proposed on-site fuel storage tanks and fuel dispensers. The specific processes associated with fuel storage tanks and fuel dispensers that emit air toxics include loading, breathing, refueling, and spillage, as described below:

- Loading – Emissions occur when a fuel tanker truck unloads gasoline into the storage tanks. The storage tank vapors, displaced during loading, are emitted through its vent pipe. (A required pressure/vacuum valve installed on the tank vent pipe significantly reduces these emissions.)
- Breathing – Emissions occur through the storage tank vent pipe as a result of temperature and pressure changes in the tank vapor space.
- Refueling – Emissions occur during motor vehicle refueling when gasoline vapors escape through the vehicle/nozzle interface.
- Spillage – Emissions occur from evaporating gasoline that spills during vehicle refueling.
- Hose Permeation - Emissions occur when liquid gasoline or gasoline vapors diffuse through the dispensing hose outer surface to the atmosphere.

Loading and breathing emissions exit the underground storage tank vent pipe and are thus treated as a point source. The height and diameter of the vent are assumed to be 3.66 meters and 0.05 meters, respectively. Refueling and spillage emissions are modeled as volume sources with a vertical dimension of 5 meters to correspond to the height of the canopy. For refueling and hose permeation, the release height is assumed to be 1 meter to approximate the height of a vehicle fuel tank inlet, whereas spillage emissions are assumed to be released at ground level since nearly all the gasoline from spillage reaches the ground.

The model was run to obtain the peak 24-hour and annual average concentration in micrograms per cubic meter [$\mu\text{g}/\text{m}^3$] at nearby sensitive receptors.

The chronic and carcinogenic health risk calculations are based on the standardized equations contained in the U.S. EPA Human Health Evaluation Manual (1991) and the Office of Environmental Health Hazard Assessment (OEHHA) Guidance Manual.

An annual throughput of 8.5 million gallons of gasoline was assumed in the analysis based on project-specific information provided by the project applicant.

4.1.2 Receptor Network

The assessment requires that a network of receptors be specified where the impacts can be computed at the various locations surrounding the project. Discrete receptors were located at existing sensitive residential receptors surrounding the proposed project (as detailed above). In addition, the identified sensitive receptor's locations were supplemented by the specification of a modeling grid that extended around the proposed project to identify other potential locations of impact. See Exhibit A for details.

4.1.3 Dispersion Modeling

The next step in the assessment process utilizes the emissions inventory along with a mathematical air dispersion model and representative meteorological data to calculate impacts at the various receptor locations. The dispersion model used in this assessment is described below.

Model Selection

The assessment of air quality and health risk impacts from pollutant emissions from this project applied the USEPA AERMOD Model, which is an air dispersion model accepted by the ICAPCD for performing health risk assessment analyses. AERMOD predicts pollutant concentrations from point, area, volume, line, and flare sources with variable emissions in terrain from flat to complex with the inclusion of building downwash effects from buildings on pollutant dispersion (as applicable). It captures the essential atmospheric physical processes and provides reasonable estimates over a wide range of meteorological conditions and modeling scenarios.

General Model Assumptions

A summary of Emission Configurations is shown in Table 2. The basic options used in the dispersion modeling are summarized in Table 3.

As indicated in Table 3, the analysis takes into account the effects of building downwash on the dispersion of emissions from the various sources located on the project's property. Building downwash occurs when the aerodynamic turbulence, induced by nearby buildings, causes pollutants emitted from an elevated source to be mixed rapidly toward the ground (downwash), resulting in potentially higher ground-level concentrations than if the buildings were not present. The AERMOD dispersion model contains algorithms to account for building downwash effects. The required information includes the location of the emission source; the location of adjacent buildings; and the building geometry in terms of length, width, and height. For purposes of this analysis, the emission source and building locations were taken from the project site plan. The proposed building geometries were estimated from the project plans, assuming a building height of 40 feet. Calculations for model inputs can be found in Appendix A.

<Tables 2 & 3, next page>

Table 2: Summary of Emission Configurations

Emission Source Type	Geometric Configuration	Relevant Assumptions
Off-Site Diesel Truck Traffic	Line Sources	Stack release height: 12 feet
		Vehicle speed: 30 mph
		Length of the line source (Ross Avenue from project to CA-111, CA-111 from Ross Ave toward I-8)
		Vehicle types: heavy-heavy-duty diesel delivery trucks
		Emission factor: CARB EMFAC2021
On-Site Diesel Truck Traffic	Line Sources	Stack release height: 12 feet
		Vehicle speed: 5 mph
		Length of the line source (distance from the facility entrance to the loading docks)
		Vehicle types: heavy-heavy-duty diesel delivery trucks
		Emission factor: CARB EMFAC2021
On-Site Diesel Truck Idling	Area Sources at fueling positions and tanks	Stack release height: 12 feet
		Stack release characteristics
		Idle time: 15 minutes per truck per day
		Vehicle types: light-heavy-duty, medium-heavy-duty, and heavy-heavy-duty diesel delivery trucks
		Emission factor: CARB EMFAC2021

Table 3: General Modeling Assumptions – AERMOD Model

Feature	Option Selected
Terrain processing	AERMAP-generated NED GEOTIFF 30 m
Regulatory dispersion options	See Table 1
Land use	Urban
Coordinate system	UTM Zone 11 North
Building downwash	Included in calculations
Receptor height	0 meters above ground (per OEHHA methodology)
Meteorological data	Desert Hot Springs Meteorological Data

4.1.4 Estimation of Health Risks

Health risks from diesel particulate matter are twofold. First, diesel particulate matter, benzene, ethylbenzene, and naphthalene are carcinogens according to the State of California. Second, long-term chronic exposure to these pollutants can cause health effects to the respiratory system. Each of these health risks is discussed below. Health risk calculations were based on the most-recent Office of Environmental Health Hazard Assessment guidance as detailed below.

Exhibit A

AERMOD Model Source and Receptor Placement - Construction

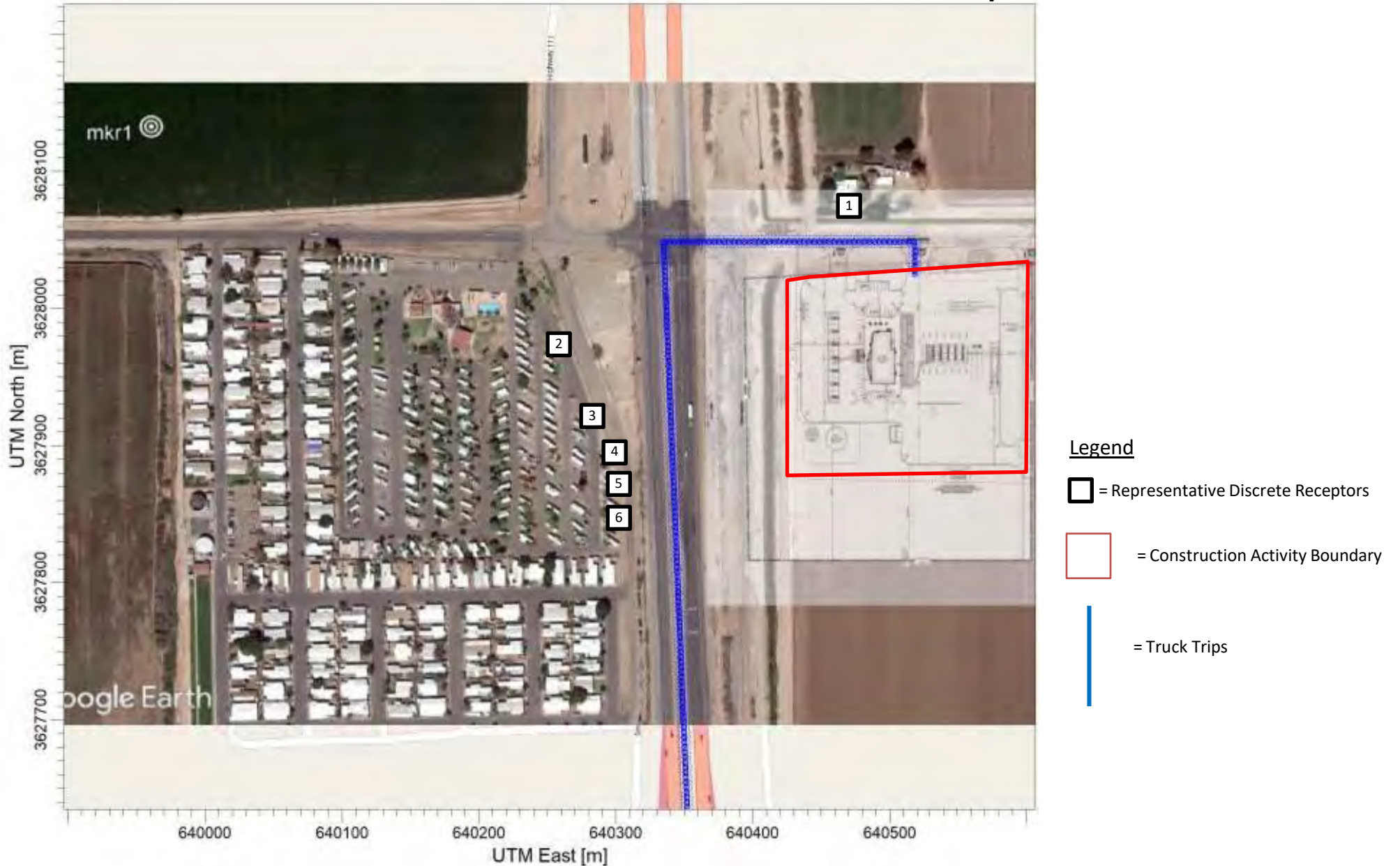

Exhibit B

AERMOD Model Source and Receptor Placement - Construction



Legend

□ = Representative Discrete Receptors

□ = Idling Activity and Fueling Operations

— = Truck Trips

Cancer Risks

According to the *Risk Assessment Guidelines: Guidance Manual for Preparation of Health Risk Assessments*, released by the Office of Environmental Health Hazard Assessment (OEHHA) in February 2015 and formally adopted in March 2015, the residential inhalation dose for long-term cancer risk assessment should be calculated using the following formula:

$$[\text{Dose-air (mg)/(Kg-day)}] * \text{Cancer Potency} * [1 \times 10^{-6}] = \text{Potential Cancer Risk}$$

Where:

Cancer Potency Factor = 1.1

$$\text{Dose-inh} = (\text{C-air} * \text{DBR} * \text{A} * \text{EF} * \text{ED} * \text{ASF} * \text{FAH} * 10^{-6}) / \text{AT}$$

Where:

DBR [Daily breathing rate (L/kg body weight – day)] = 261 for adults, 572 for children, and 1,090 for infants, and 361 for 3rd trimester per OEHHA guidance.

A [Inhalation absorption factor] = 1

EF [Exposure frequency (days/year)] = 350

ED [Exposure duration (years)] = 30 for adults (for an individual who is an adult at opening year), 14 for children (from 2-16 years), 14 for adults (from 16-30 years), 2 for infants, and 1 for 3rd Trimester

ASF [Age sensitivity factor] = 10 for 3rd trimester to 2 years of age, 3 for 2 to 16 years of age, and 1 for 16 to 30 years of age

FAH [Fraction of time spent at home] = 1 for 3rd trimester to 2 years of age, 1 for 2 to 16 years of age, and 0.73 for 16 to 30 years of age

10^6 [Micrograms to milligrams conversion]

AT [Average time period over which exposure is averaged in days] = 25,550

The model run results are shown in Appendix B. HARP2 (Hotspots Analysis and Report Program) from CARB was used to calculate risk. Exhibit B shows the DPM dispersion from construction of the project and Exhibit C shows the dispersion from operation of the project.

Estimated cancer risk was based on a conservative maximum duration that a long-term resident might live on the property, i.e. 30 years. Construction was estimated as occurring in one year. Based on these conservative assumptions, the maximum unmitigated carcinogenic health risk from construction (beginning 3rd trimester [-0.25 to 0.75 years] scenario) would be 14.47 in a million, which would result in a significant impact compared to the 10 in a million threshold. Therefore, implementation of **Mitigation Measure 1**, requiring construction equipment to have engine ratings of Tier 4 Final, would be required and would reduce maximum construction impact to 1.87 in a million.

Table 4: Cumulative Carcinogenic Risk, 30-Year Exposure Scenario

Receptor ID	Construction (1 year)				Noncarcinogenic Hazards Index
	Average Annual Unmitigated Concentration (ug/m3)	Unmitigated Cumulative RISK (per million)	Average Annual Mitigated Concentration (ug/m3)	Mitigated Cumulative RISK (per million)	
1	0.0814	14.47	0.0193	1.87	0.0660
2	0.0116	2.06	0.0248	0.27	0.1020
3	0.0118	2.10	0.0280	0.27	0.0609
4	0.0131	2.34	0.0305	0.31	0.0923
5	0.0126	2.25	0.0311	0.29	0.0109
6	0.0124	2.21	0.0317	0.29	0.0073
ICAPCD Threshold	-	10	-	10	1

The maximum unmitigated 29-year operational cumulative carcinogenic health risk (infant [0.75-2 years] + child [2-16 years] + adult [16-30 years]) to an individual born during the opening year of the project, and located in the project vicinity for the entire 29-year duration, is a maximum of 1.64 in a million from fueling operations and 2.34 from operational DPM, both at receptor 1, as shown in Tables 5 and 6 respectively. The maximum combined 30-year cumulative risk would be 5.86 in a million at receptor 1, as shown in Table 7.

<Tables 5-7, next pages>

Table 5: Cumulative Carcinogenic Risk, 29-Year Fueling Operations Exposure Scenario

Receptor ID	Operations (29 year)						
	Average Annual Concentration Benzene (ug/m3)	Unmitigated Cumulative Benzene RISK (per million)	Average Annual Concentration Ethylbenzene (ug/m3)	Unmitigated Cumulative Ethylbenzene RISK (per million)	Average Annual Concentration Naphthalene (ug/m3)	Unmitigated Cumulative Naphthalene RISK (per million)	Unmitigated Cumulative Total RISK (per million)
1	2.248E-02	1.40	1.744E-02	0.09	1.890E-03	0.14	1.64
2	2.490E-03	0.16	2.120E-03	0.01	2.400E-04	0.02	0.19
3	2.620E-03	0.16	2.250E-03	0.01	2.500E-04	0.02	0.19
4	2.900E-03	0.18	2.500E-03	0.01	2.800E-04	0.02	0.22
5	2.780E-03	0.17	2.380E-03	0.01	2.700E-04	0.02	0.21
6	2.740E-03	0.17	2.340E-03	0.01	2.600E-04	0.02	0.20

Table 6: Cumulative Carcinogenic Risk, 29-Year DPM Operations Exposure Scenario

Receptor ID	Operations (29 year)	
	Average Annual Concentration DPM (ug/m3)	Unmitigated Cumulative DPM RISK (per million)
1	3.410E-03	2.34
2	8.300E-04	0.57
3	1.140E-03	0.78
4	1.720E-03	1.18
5	1.740E-03	1.20
6	1.760E-03	1.21

Table 7: Cumulative Carcinogenic Risk, 30-Year Combined Construction and Operations Exposure Scenario

Receptor ID	Mitigated Cumulative Construction DPM RISK (per million)	Unmitigated Cumulative Fueling Operation RISK (per million)	Unmitigated Cumulative DPM Operation RISK (per million)	Total Combined 30-year RISK (per million)	Noncarcinogenic Hazards Index
1	1.87	1.64	2.34	5.86	0.0045
2	0.27	0.19	0.57	1.02	0.0050
3	0.27	0.19	0.78	1.25	0.0056
4	0.31	0.22	1.18	1.70	0.0061
5	0.29	0.21	1.20	1.70	0.0062
6	0.29	0.20	1.21	1.70	0.0063

Therefore, as the residential cancer risk is below 10 in a million, the construction and on-going operations of the proposed project would result in a less than significant impact due to the cancer risk from diesel emissions created by the proposed project.

Non-Cancer Risks

The relationship for non-cancer health effects is given by the equation:

$$HIDPM = CDPM/RELDPM$$

Where,

HIDPM = Hazard Index; an expression of the potential for non-cancer health effects.

CDPM = Annual average diesel particulate matter concentration in µg/m³.

RELDPM = Reference Exposure Level (REL) for diesel particulate matter; the diesel particulate matter concentration at which no adverse health effects are anticipated.

The non-carcinogenic hazards are also detailed in Table 4. The RELDPM is 5 µg/m³. The Office of Environmental Health Hazard Assessment as protective for the respiratory system has established this concentration. Using the maximum DPM concentration from years 2024-2052, the resulting Hazard Index is:

$$HIDPM = 0.02248/5 = 0.0045$$

The criterion for significance is a Hazard Index increase of 1.0 or greater. Therefore, the proposed project would have a less than significant impact due to the non-cancer risk from diesel emissions created by the proposed project.

Exhibit C

Mitigated Annual DPM Emissions - Construction

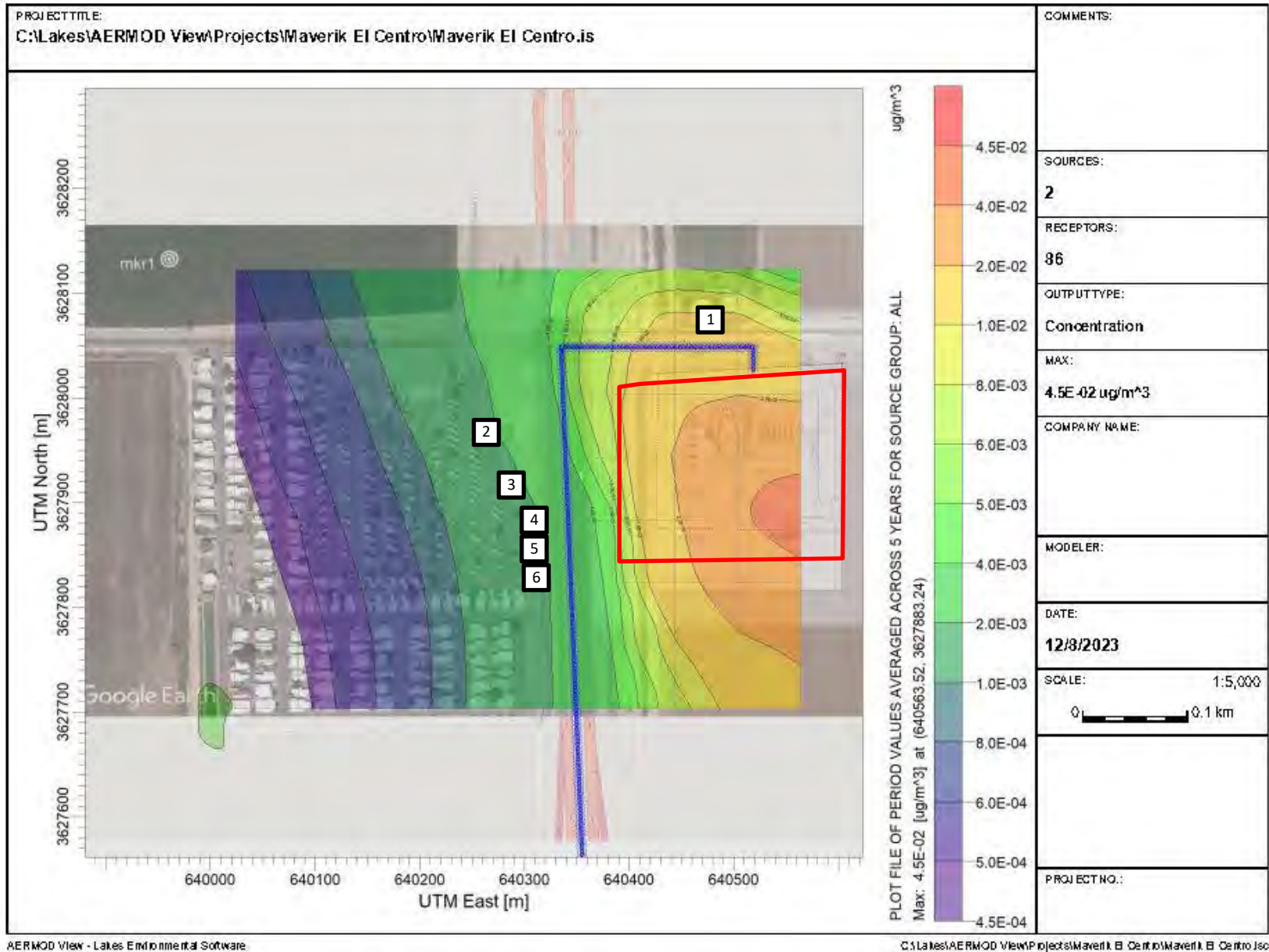

AERMOD View - Lakes Environmental Software

C:\Lakes\AERMOD View\Projects\Maverik El Centro\Maverik El Centro.is

Exhibit D

Unmitigated Annual Fueling Emissions - Operations

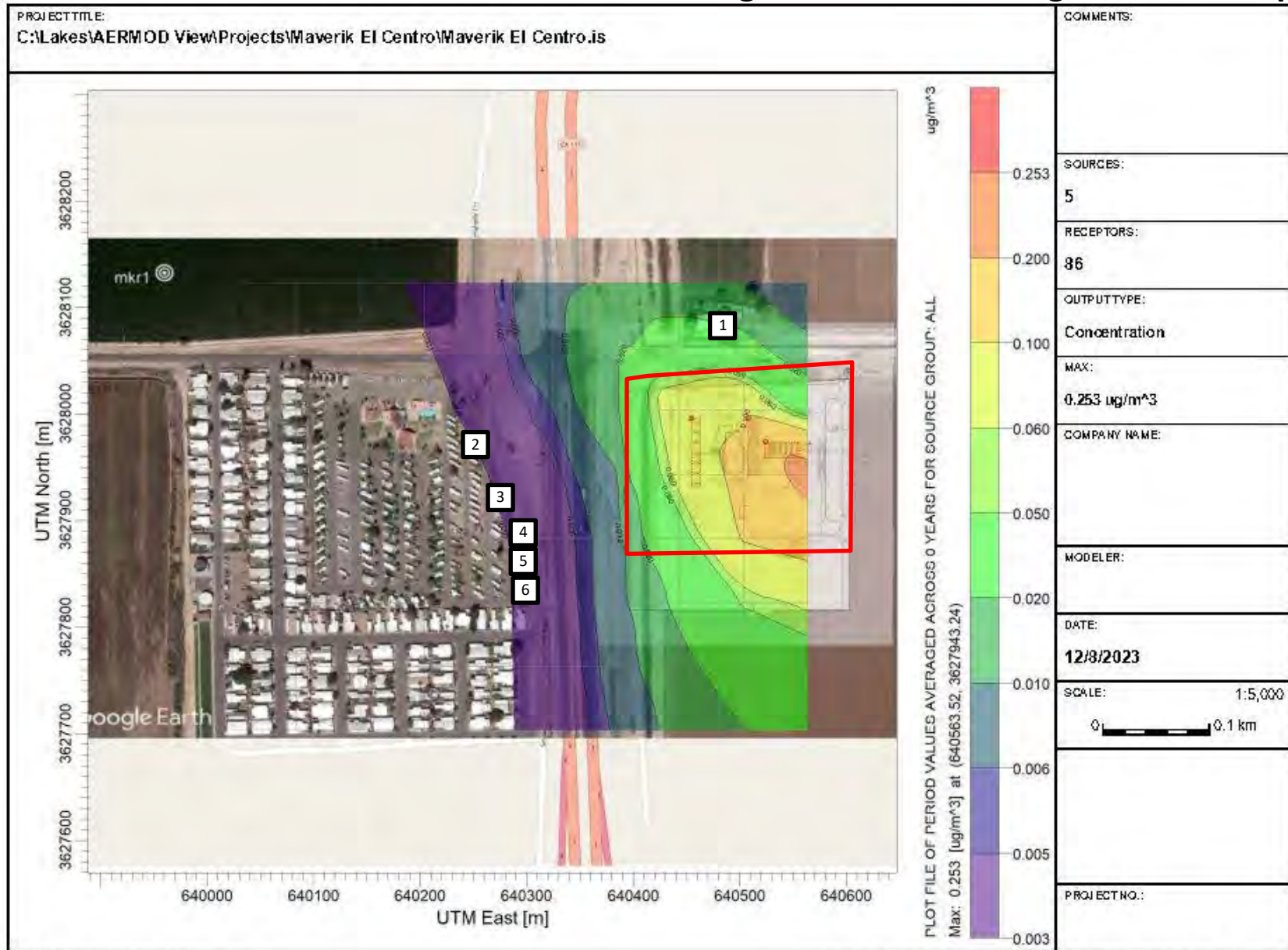

Unmitigated Annual DPM Emissions - Operations

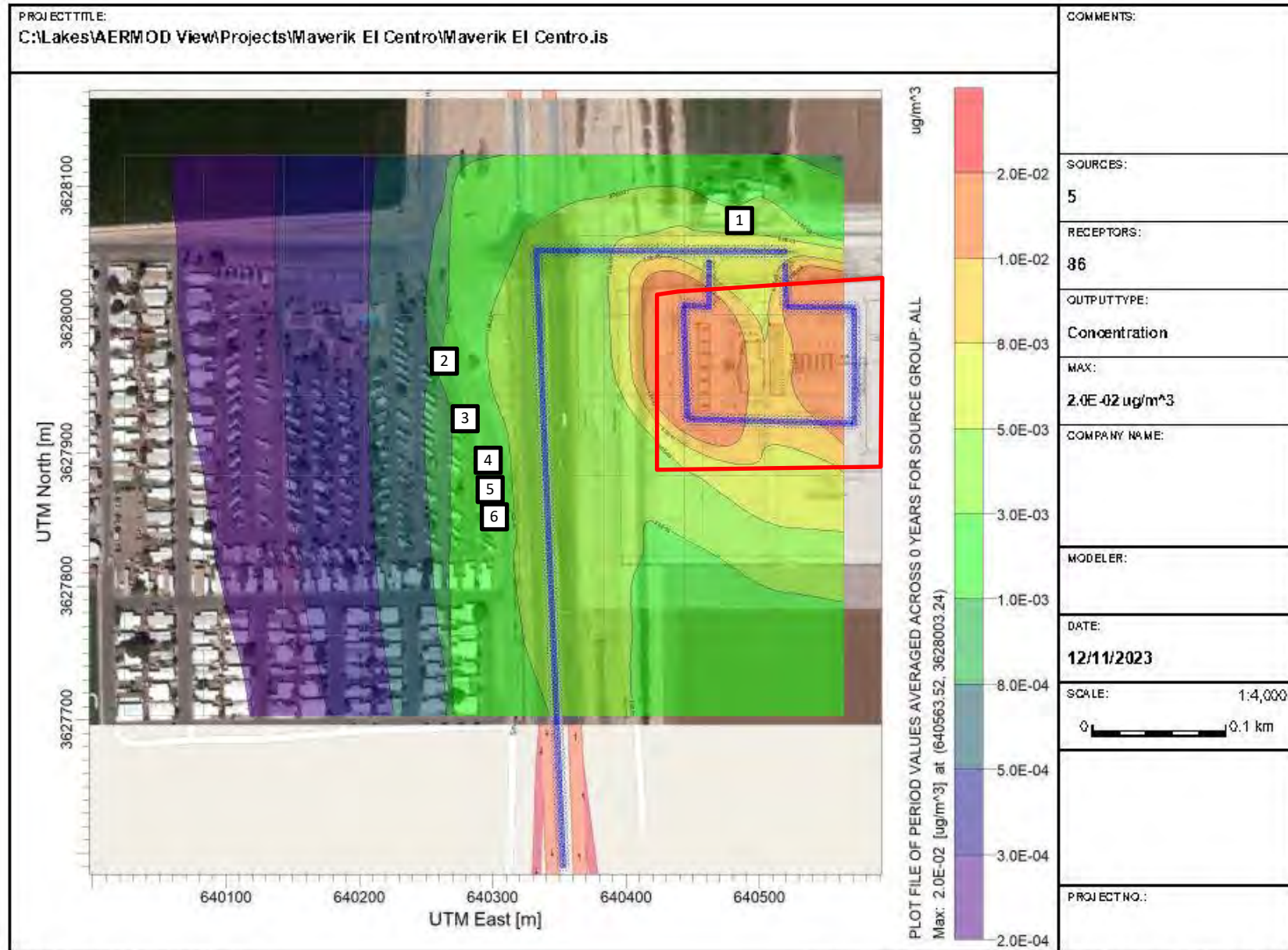

5.0 References

The following references were used in the preparing this analysis.

Birdseye Planning Group, LLC

2023 CALEEMOD Model Runs for Maverick Operations & Construction

California Air Pollution Control Officers Association

2009 Health Risk Assessments for Proposed Land Use Projects

California Air Resources Board

2005 Air Quality and Land Use Handbook: A Community Health Perspective. April.

2008 Resolution 08-43

2008 ARB Recommended Interim Risk Management Policy for Inhalation-Based Residential Cancer Risk – Frequently Asked Questions

Governor’s Office of Planning and Research

2008 CEQA and Climate: Addressing Climate Change Through California Environmental Quality Act (CEQA) Review

2009 CEQA Guideline Sections to be Added or Amended

Mizuta Traffic Consulting

2023 Trip Generation Rates & Calculations

Office of Environmental Health Hazard Assessment

2015 Air Toxics Hot Spots Program Risk Assessment Guidelines

Office of Environmental Health Hazard Assessment

2015 Air Toxics Hot Spots Program Risk Assessment Guidelines

Office of Environmental Health Hazard Assessment

2015 Air Toxics Hot Spots Program Risk Assessment Guidelines

Appendix A:

AERMOD Input Calculations

Maverik El Centro - Construction DPM

Start of Construction 11/5/2024
 End of Construction 12/5/2025
 Number of Days 360
 Number of Hours 8640

On-site Construction Activity	Unmitigated On-site DPM (tons)	Mitigated
Demolition	0.00980	0.0006
Site Preparation	0.00740	0.0005
Grading	0.02040	0.0017
Building Construction	0.03810	0.0072
Paving	0.00370	0.0003
Architectural Coating	0.00050	< 0.00005
Total	0.07990 tons 72,484.06 grams	0.01030 tons 9,344.00 grams
Average Emission	0.00233 grams/sec	0.0003004 grams/sec

Construction Trip Type	Site Preparation	Grading	Building Construction	Building Construction	Paving	Architectural Coating
Haul Truck	0.0001	0.0001	0	0	0	0
Vendor Truck	0	0	0	0	0	0
Worker	0	0	0	0	0	0
Total	0.0001	0.0001	0	0	0	0

	Haul Truck (tons)	Vendor Truck (tons)	Worker (tons)	Total (tons)
Total DPM	0.0002	0	0	0.0002

Average Emissions			
Grams	181.436948	0	0
Grams/sec	5.83324E-06	0	0
Default Distance*	20	6.9	14.7

*Default Vehicle Travel Distance in CalEEMod

Vehicle Travel Distance in the Construction HRA (miles)			
Road Segment 1	0.5	0.5	0.5

Total Average Offsite Vehicle Emissions Along Travel Distance (g/sec)			Total
Road Segment 1	5.83324E-07	0	0 5.83324E-07

Maverik El Centro - Gasoline Dispensing Emission Calculations

Total Capacity (gallons) 120,000 (3 x 40,000 gallon underground storage tanks)
 Maximum Permitted Total Annual Throughput (gallons) 8,500,000 (Annual permitted throughput value in gallons)

Gasoline Dispensing Emissions Calculations (Based on 24-hr, 7-days per week Operations)

Underground Storage Tanks

Pollutant	Underground Storage Tanks (Area 1 of 2)	Total Capacity (gallons)	Annual Throughput (gallons)	Emission Factor (lbs/1,000 gallons)	Daily Fuel Movement (gallons)	lbs/day	g/day	g/sec
Benzene	Loading	120,000	8,500,000	6.83E-04	23,288	0.0159	7.21460412	8.35024E-05
	Breathing			1.09E-04	120,000	0.0131	5.9329882	6.86688E-05
Ethylbenzene	Loading			1.61E-04	23,288	0.0037	1.70066071	1.96836E-05
	Breathing			2.57E-05	120,000	0.0031	1.39887887	1.61907E-05
Naphthalene	Loading			6.00E-07	23,288	0.0000	0.00633787	7.33549E-08
	Breathing			9.60E-08	120,000	0.0000	0.00522538	6.0479E-08

Fuel Dispensers

Pollutant	Fuel Dispensers (Total)	Annual Throuput (gallons)	Emission Factor (lbs/1,000 gallons)	Daily Fuel Movement (gallons)	lbs/day	g/day	g/sec
Benzene	Refueling	8,500,000	1.46E-03	23,288	3.40E-02	15.4221406	1.78E-04
	Spillage		1.70E-03	23,288	3.96E-02	17.957287	2.08E-04
	Hose Permeation		4.10E-05	23,288	9.55E-04	0.43308751	5.01E-06
Ethylbenzene	Refueling		3.42E-04	23,288	7.96E-03	3.61258362	4.18E-05
	Spillage		3.10E-03	23,288	7.22E-02	32.745641	3.79E-04
	Hose Permeation		9.63E-06	23,288	2.24E-04	0.10172275	1.18E-06
Naphthalene	Refueling		1.28E-06	23,288	2.98E-05	0.01352078	1.56E-07
	Spillage		4.18E-04	23,288	9.73E-03	4.41537997	5.11E-05
	Hose Permeation		3.60E-08	23,288	8.38E-07	0.00038027	4.40E-09

Gasoline Dispensing Input Summary

Parameter	Location	Source	Height (m)	Diameter (m)	Vertical Dimension (m)	Release Height (m)
Loading	Storage Tanks	Point	3.66	0.05	-	-
Breathing	Storage Tanks	Point	3.66	0.05	-	-
Refueling	Canopy	Area	-	-	5	1
Spillage	Canopy	Area	-	-	5	0
Hose Permeation	Canopy	Area	-	-	5	1

Maverik El Centro - Operational DPM

Roadway Links Modeled

Link	Truck Type	Average Speed (mph)	Emission Factor (g/mi)	Daily Trips (in & out)	Link Length (m)	Link Length (mi)	Ave	Ave	Average	Emissions
							Emissions Over Link (g/day)	Emissions (lbs/day)	Emissions (g/sec)	for All Vehicles (g/sec)
OnTruck1	LHDT1	5	0.0461	101.9	425	2.64E-01	1.24E+00	2.74E-03	1.44E-05	
	LHDT2	5	0.0526	19.6	425	2.64E-01	2.72E-01	6.00E-04	3.15E-06	
	MHDT	5	0.0088	7.8	425	2.64E-01	1.83E-02	4.03E-05	2.12E-07	
	HHDT	5	0.0111	262.6	425	2.64E-01	7.68E-01	1.69E-03	8.89E-06	2.66E-05
OnTruck2	LHDT1	30	0.0246	101.9	790	4.91E-01	1.23E+00	2.71E-03	1.42E-05	
	LHDT2	30	0.0256	19.6	790	4.91E-01	2.46E-01	5.42E-04	2.85E-06	
	MHDT	30	0.0035	7.8	790	4.91E-01	1.35E-02	2.99E-05	1.57E-07	
	HHDT	30	0.0053	262.6	790	4.91E-01	6.83E-01	1.50E-03	7.90E-06	2.51E-05

Diesel Truck Idling Emissions

Onsite Vehicle Travel Segments	Truck Type	DPM Emission Factor (grams/trip)	Idling Time (min)	Number Idling		Emissions (lb/day)	Average	Emissions
				Vehicle Trips/day	Emissions (g/day)		Emissions (g/sec)	for All Vehicles (g/sec)
Idle(1-3)	LHDT1	2.85E-04	15	34.0	9.70E-03	2.14E-05	1.12E-07	
	LHDT2	2.87E-04	15	6.5	1.87E-03	4.13E-06	2.17E-08	
	MHDT	7.34E-05	15	2.6	1.92E-04	4.23E-07	2.22E-09	
	HHDT	4.47E-04	15	87.5	3.92E-02	8.64E-05	4.53E-07	5.90E-07

Appendix B:

AERMOD Model Printouts

```

**
*****
**
** AERMOD Input Produced by:
** AERMOD View Ver. 10.0.1
** Lakes Environmental Software Inc.
** Date: 12/8/2023
** File: C:\Lakes\AERMOD View\Projects\Maverik El Centro\Maverik El Centro.ADI
**
*****
**
**
*****
** AERMOD Control Pathway
*****
**
**
CO STARTING
  TITLEONE C:\Lakes\AERMOD View\Projects\Maverik El Centro\Maverik El Centro.is
  MODELOPT DFAULT CONC
  AVERTIME 1 PERIOD
  POLLUTID SO2
  RUNORNOT RUN
  ERRORFIL "Maverik El Centro.err"
CO FINISHED
**
*****
** AERMOD Source Pathway
*****
**
**
SO STARTING
** Source Location **
** Source ID - Type - X Coord. - Y Coord. **
  LOCATION PAREAL      AREAPOLY    640603.267  3628032.763      -11.280
** DESCRSRC Constructio Equipment
** -----

```



```

** Line Source Represented by Adjacent Volume Sources
** LINE VOLUME Source ID = SLINE1
** DESCRSRC Truck Trips
** PREFIX
** Length of Side = 3.66
** Configuration = Adjacent
** Emission Rate = 5.833E-07
** Vertical Dimension = 3.66
** SZINIT = 1.70
** Nodes = 4
** 640518.391, 3628025.345, -11.28, 0.00, 1.70
** 640518.391, 3628048.816, -11.28, 0.00, 1.70
** 640334.858, 3628048.816, -11.28, 0.00, 1.70
** 640356.361, 3627532.608, -10.97, 0.00, 1.70

```

```

** -----
LOCATION L0000001      VOLUME  640518.391 3628027.173 -11.28
LOCATION L0000002      VOLUME  640518.391 3628030.831 -11.28
LOCATION L0000003      VOLUME  640518.391 3628034.489 -11.28
LOCATION L0000004      VOLUME  640518.391 3628038.146 -11.28
LOCATION L0000005      VOLUME  640518.391 3628041.804 -11.28
LOCATION L0000006      VOLUME  640518.391 3628045.461 -11.28
LOCATION L0000007      VOLUME  640518.088 3628048.816 -11.28
LOCATION L0000008      VOLUME  640514.431 3628048.816 -11.28
LOCATION L0000009      VOLUME  640510.773 3628048.816 -11.28
LOCATION L0000010      VOLUME  640507.116 3628048.816 -11.28
LOCATION L0000011      VOLUME  640503.458 3628048.816 -11.28
LOCATION L0000012      VOLUME  640499.800 3628048.816 -11.28
LOCATION L0000013      VOLUME  640496.143 3628048.816 -11.28
LOCATION L0000014      VOLUME  640492.485 3628048.816 -11.28
LOCATION L0000015      VOLUME  640488.828 3628048.816 -11.28
LOCATION L0000016      VOLUME  640485.170 3628048.816 -11.28
LOCATION L0000017      VOLUME  640481.512 3628048.816 -11.28
LOCATION L0000018      VOLUME  640477.855 3628048.816 -11.28
LOCATION L0000019      VOLUME  640474.197 3628048.816 -11.28
LOCATION L0000020      VOLUME  640470.540 3628048.816 -11.28
LOCATION L0000021      VOLUME  640466.882 3628048.816 -11.28
LOCATION L0000022      VOLUME  640463.224 3628048.816 -11.28

```

LOCATION	L0000023	VOLUME	640459.567	3628048.816	-11.28
LOCATION	L0000024	VOLUME	640455.909	3628048.816	-11.28
LOCATION	L0000025	VOLUME	640452.252	3628048.816	-11.28
LOCATION	L0000026	VOLUME	640448.594	3628048.816	-11.28
LOCATION	L0000027	VOLUME	640444.936	3628048.816	-11.28
LOCATION	L0000028	VOLUME	640441.279	3628048.816	-11.28
LOCATION	L0000029	VOLUME	640437.621	3628048.816	-11.28
LOCATION	L0000030	VOLUME	640433.964	3628048.816	-11.28
LOCATION	L0000031	VOLUME	640430.306	3628048.816	-11.28
LOCATION	L0000032	VOLUME	640426.648	3628048.816	-11.28
LOCATION	L0000033	VOLUME	640422.991	3628048.816	-11.28
LOCATION	L0000034	VOLUME	640419.333	3628048.816	-11.28
LOCATION	L0000035	VOLUME	640415.676	3628048.816	-11.28
LOCATION	L0000036	VOLUME	640412.018	3628048.816	-11.28
LOCATION	L0000037	VOLUME	640408.360	3628048.816	-11.28
LOCATION	L0000038	VOLUME	640404.703	3628048.816	-11.28
LOCATION	L0000039	VOLUME	640401.045	3628048.816	-11.28
LOCATION	L0000040	VOLUME	640397.388	3628048.816	-11.28
LOCATION	L0000041	VOLUME	640393.730	3628048.816	-11.28
LOCATION	L0000042	VOLUME	640390.072	3628048.816	-11.28
LOCATION	L0000043	VOLUME	640386.415	3628048.816	-11.28
LOCATION	L0000044	VOLUME	640382.757	3628048.816	-11.28
LOCATION	L0000045	VOLUME	640379.100	3628048.816	-11.28
LOCATION	L0000046	VOLUME	640375.442	3628048.816	-11.28
LOCATION	L0000047	VOLUME	640371.784	3628048.816	-11.28
LOCATION	L0000048	VOLUME	640368.127	3628048.816	-11.28
LOCATION	L0000049	VOLUME	640364.469	3628048.816	-11.28
LOCATION	L0000050	VOLUME	640360.812	3628048.816	-11.28
LOCATION	L0000051	VOLUME	640357.154	3628048.816	-11.28
LOCATION	L0000052	VOLUME	640353.496	3628048.816	-11.28
LOCATION	L0000053	VOLUME	640349.839	3628048.816	-11.28
LOCATION	L0000054	VOLUME	640346.181	3628048.816	-11.28
LOCATION	L0000055	VOLUME	640342.524	3628048.816	-11.28
LOCATION	L0000056	VOLUME	640338.866	3628048.816	-11.28
LOCATION	L0000057	VOLUME	640335.208	3628048.816	-11.28
LOCATION	L0000058	VOLUME	640334.996	3628045.512	-11.28
LOCATION	L0000059	VOLUME	640335.148	3628041.857	-11.28

LOCATION	L0000060	VOLUME	640335.300	3628038.203	-11.28
LOCATION	L0000061	VOLUME	640335.452	3628034.548	-11.28
LOCATION	L0000062	VOLUME	640335.604	3628030.894	-11.28
LOCATION	L0000063	VOLUME	640335.757	3628027.240	-11.28
LOCATION	L0000064	VOLUME	640335.909	3628023.585	-11.28
LOCATION	L0000065	VOLUME	640336.061	3628019.931	-11.28
LOCATION	L0000066	VOLUME	640336.213	3628016.276	-11.28
LOCATION	L0000067	VOLUME	640336.366	3628012.622	-11.28
LOCATION	L0000068	VOLUME	640336.518	3628008.967	-11.28
LOCATION	L0000069	VOLUME	640336.670	3628005.313	-11.28
LOCATION	L0000070	VOLUME	640336.822	3628001.659	-11.28
LOCATION	L0000071	VOLUME	640336.975	3627998.004	-11.28
LOCATION	L0000072	VOLUME	640337.127	3627994.350	-11.28
LOCATION	L0000073	VOLUME	640337.279	3627990.695	-11.28
LOCATION	L0000074	VOLUME	640337.431	3627987.041	-11.28
LOCATION	L0000075	VOLUME	640337.583	3627983.386	-11.28
LOCATION	L0000076	VOLUME	640337.736	3627979.732	-11.28
LOCATION	L0000077	VOLUME	640337.888	3627976.078	-11.28
LOCATION	L0000078	VOLUME	640338.040	3627972.423	-11.28
LOCATION	L0000079	VOLUME	640338.192	3627968.769	-11.28
LOCATION	L0000080	VOLUME	640338.345	3627965.114	-11.28
LOCATION	L0000081	VOLUME	640338.497	3627961.460	-11.28
LOCATION	L0000082	VOLUME	640338.649	3627957.805	-11.28
LOCATION	L0000083	VOLUME	640338.801	3627954.151	-11.28
LOCATION	L0000084	VOLUME	640338.954	3627950.497	-11.28
LOCATION	L0000085	VOLUME	640339.106	3627946.842	-11.28
LOCATION	L0000086	VOLUME	640339.258	3627943.188	-11.28
LOCATION	L0000087	VOLUME	640339.410	3627939.533	-11.28
LOCATION	L0000088	VOLUME	640339.562	3627935.879	-11.28
LOCATION	L0000089	VOLUME	640339.715	3627932.224	-11.28
LOCATION	L0000090	VOLUME	640339.867	3627928.570	-11.28
LOCATION	L0000091	VOLUME	640340.019	3627924.916	-11.28
LOCATION	L0000092	VOLUME	640340.171	3627921.261	-11.28
LOCATION	L0000093	VOLUME	640340.324	3627917.607	-11.28
LOCATION	L0000094	VOLUME	640340.476	3627913.952	-11.27
LOCATION	L0000095	VOLUME	640340.628	3627910.298	-11.26
LOCATION	L0000096	VOLUME	640340.780	3627906.643	-11.24

LOCATION	L0000097	VOLUME	640340.933	3627902.989	-11.23
LOCATION	L0000098	VOLUME	640341.085	3627899.335	-11.21
LOCATION	L0000099	VOLUME	640341.237	3627895.680	-11.20
LOCATION	L0000100	VOLUME	640341.389	3627892.026	-11.18
LOCATION	L0000101	VOLUME	640341.541	3627888.371	-11.17
LOCATION	L0000102	VOLUME	640341.694	3627884.717	-11.15
LOCATION	L0000103	VOLUME	640341.846	3627881.062	-11.14
LOCATION	L0000104	VOLUME	640341.998	3627877.408	-11.14
LOCATION	L0000105	VOLUME	640342.150	3627873.754	-11.13
LOCATION	L0000106	VOLUME	640342.303	3627870.099	-11.12
LOCATION	L0000107	VOLUME	640342.455	3627866.445	-11.12
LOCATION	L0000108	VOLUME	640342.607	3627862.790	-11.12
LOCATION	L0000109	VOLUME	640342.759	3627859.136	-11.11
LOCATION	L0000110	VOLUME	640342.912	3627855.481	-11.11
LOCATION	L0000111	VOLUME	640343.064	3627851.827	-11.13
LOCATION	L0000112	VOLUME	640343.216	3627848.173	-11.15
LOCATION	L0000113	VOLUME	640343.368	3627844.518	-11.17
LOCATION	L0000114	VOLUME	640343.520	3627840.864	-11.19
LOCATION	L0000115	VOLUME	640343.673	3627837.209	-11.21
LOCATION	L0000116	VOLUME	640343.825	3627833.555	-11.23
LOCATION	L0000117	VOLUME	640343.977	3627829.900	-11.25
LOCATION	L0000118	VOLUME	640344.129	3627826.246	-11.27
LOCATION	L0000119	VOLUME	640344.282	3627822.592	-11.28
LOCATION	L0000120	VOLUME	640344.434	3627818.937	-11.28
LOCATION	L0000121	VOLUME	640344.586	3627815.283	-11.28
LOCATION	L0000122	VOLUME	640344.738	3627811.628	-11.28
LOCATION	L0000123	VOLUME	640344.891	3627807.974	-11.28
LOCATION	L0000124	VOLUME	640345.043	3627804.319	-11.28
LOCATION	L0000125	VOLUME	640345.195	3627800.665	-11.28
LOCATION	L0000126	VOLUME	640345.347	3627797.010	-11.28
LOCATION	L0000127	VOLUME	640345.499	3627793.356	-11.28
LOCATION	L0000128	VOLUME	640345.652	3627789.702	-11.28
LOCATION	L0000129	VOLUME	640345.804	3627786.047	-11.28
LOCATION	L0000130	VOLUME	640345.956	3627782.393	-11.28
LOCATION	L0000131	VOLUME	640346.108	3627778.738	-11.28
LOCATION	L0000132	VOLUME	640346.261	3627775.084	-11.28
LOCATION	L0000133	VOLUME	640346.413	3627771.429	-11.28

LOCATION	L0000134	VOLUME	640346.565	3627767.775	-11.28
LOCATION	L0000135	VOLUME	640346.717	3627764.121	-11.28
LOCATION	L0000136	VOLUME	640346.870	3627760.466	-11.28
LOCATION	L0000137	VOLUME	640347.022	3627756.812	-11.28
LOCATION	L0000138	VOLUME	640347.174	3627753.157	-11.28
LOCATION	L0000139	VOLUME	640347.326	3627749.503	-11.28
LOCATION	L0000140	VOLUME	640347.478	3627745.848	-11.28
LOCATION	L0000141	VOLUME	640347.631	3627742.194	-11.28
LOCATION	L0000142	VOLUME	640347.783	3627738.540	-11.28
LOCATION	L0000143	VOLUME	640347.935	3627734.885	-11.27
LOCATION	L0000144	VOLUME	640348.087	3627731.231	-11.24
LOCATION	L0000145	VOLUME	640348.240	3627727.576	-11.20
LOCATION	L0000146	VOLUME	640348.392	3627723.922	-11.16
LOCATION	L0000147	VOLUME	640348.544	3627720.267	-11.12
LOCATION	L0000148	VOLUME	640348.696	3627716.613	-11.09
LOCATION	L0000149	VOLUME	640348.849	3627712.959	-11.05
LOCATION	L0000150	VOLUME	640349.001	3627709.304	-11.01
LOCATION	L0000151	VOLUME	640349.153	3627705.650	-10.98
LOCATION	L0000152	VOLUME	640349.305	3627701.995	-10.97
LOCATION	L0000153	VOLUME	640349.457	3627698.341	-10.97
LOCATION	L0000154	VOLUME	640349.610	3627694.686	-10.97
LOCATION	L0000155	VOLUME	640349.762	3627691.032	-10.97
LOCATION	L0000156	VOLUME	640349.914	3627687.378	-10.97
LOCATION	L0000157	VOLUME	640350.066	3627683.723	-10.97
LOCATION	L0000158	VOLUME	640350.219	3627680.069	-10.97
LOCATION	L0000159	VOLUME	640350.371	3627676.414	-10.97
LOCATION	L0000160	VOLUME	640350.523	3627672.760	-10.97
LOCATION	L0000161	VOLUME	640350.675	3627669.105	-10.97
LOCATION	L0000162	VOLUME	640350.828	3627665.451	-10.97
LOCATION	L0000163	VOLUME	640350.980	3627661.797	-10.97
LOCATION	L0000164	VOLUME	640351.132	3627658.142	-10.97
LOCATION	L0000165	VOLUME	640351.284	3627654.488	-10.97
LOCATION	L0000166	VOLUME	640351.437	3627650.833	-10.97
LOCATION	L0000167	VOLUME	640351.589	3627647.179	-10.97
LOCATION	L0000168	VOLUME	640351.741	3627643.524	-10.97
LOCATION	L0000169	VOLUME	640351.893	3627639.870	-10.97
LOCATION	L0000170	VOLUME	640352.045	3627636.216	-10.97

LOCATION	L0000171	VOLUME	640352.198	3627632.561	-10.97
LOCATION	L0000172	VOLUME	640352.350	3627628.907	-10.97
LOCATION	L0000173	VOLUME	640352.502	3627625.252	-10.97
LOCATION	L0000174	VOLUME	640352.654	3627621.598	-10.97
LOCATION	L0000175	VOLUME	640352.807	3627617.943	-10.97
LOCATION	L0000176	VOLUME	640352.959	3627614.289	-10.97
LOCATION	L0000177	VOLUME	640353.111	3627610.635	-10.97
LOCATION	L0000178	VOLUME	640353.263	3627606.980	-10.97
LOCATION	L0000179	VOLUME	640353.416	3627603.326	-10.97
LOCATION	L0000180	VOLUME	640353.568	3627599.671	-10.97
LOCATION	L0000181	VOLUME	640353.720	3627596.017	-10.97
LOCATION	L0000182	VOLUME	640353.872	3627592.362	-10.97
LOCATION	L0000183	VOLUME	640354.024	3627588.708	-10.97
LOCATION	L0000184	VOLUME	640354.177	3627585.054	-10.97
LOCATION	L0000185	VOLUME	640354.329	3627581.399	-10.97
LOCATION	L0000186	VOLUME	640354.481	3627577.745	-10.97
LOCATION	L0000187	VOLUME	640354.633	3627574.090	-10.97
LOCATION	L0000188	VOLUME	640354.786	3627570.436	-10.97
LOCATION	L0000189	VOLUME	640354.938	3627566.781	-10.97
LOCATION	L0000190	VOLUME	640355.090	3627563.127	-10.97
LOCATION	L0000191	VOLUME	640355.242	3627559.473	-10.97
LOCATION	L0000192	VOLUME	640355.395	3627555.818	-10.97
LOCATION	L0000193	VOLUME	640355.547	3627552.164	-10.97
LOCATION	L0000194	VOLUME	640355.699	3627548.509	-10.97
LOCATION	L0000195	VOLUME	640355.851	3627544.855	-10.97
LOCATION	L0000196	VOLUME	640356.003	3627541.200	-10.97
LOCATION	L0000197	VOLUME	640356.156	3627537.546	-10.97
LOCATION	L0000198	VOLUME	640356.308	3627533.891	-10.97

** End of LINE VOLUME Source ID = SLINE1

** Source Parameters **

SRCPARAM	PAREAL	1.0971E-08	5.000	5	
AREAVERT	PAREAL	640603.267	3628032.763	640432.221	3628023.559
AREAVERT	PAREAL	640427.619	3628023.559	640425.702	3627875.908
AREAVERT	PAREAL	640605.952	3627872.456		

** LINE VOLUME Source ID = SLINE1

SRCPARAM	L0000001	0.000000002946	0.00	1.70	1.70
SRCPARAM	L0000002	0.000000002946	0.00	1.70	1.70

SRCPARAM	L0000003	0.000000002946	0.00	1.70	1.70
SRCPARAM	L0000004	0.000000002946	0.00	1.70	1.70
SRCPARAM	L0000005	0.000000002946	0.00	1.70	1.70
SRCPARAM	L0000006	0.000000002946	0.00	1.70	1.70
SRCPARAM	L0000007	0.000000002946	0.00	1.70	1.70
SRCPARAM	L0000008	0.000000002946	0.00	1.70	1.70
SRCPARAM	L0000009	0.000000002946	0.00	1.70	1.70
SRCPARAM	L0000010	0.000000002946	0.00	1.70	1.70
SRCPARAM	L0000011	0.000000002946	0.00	1.70	1.70
SRCPARAM	L0000012	0.000000002946	0.00	1.70	1.70
SRCPARAM	L0000013	0.000000002946	0.00	1.70	1.70
SRCPARAM	L0000014	0.000000002946	0.00	1.70	1.70
SRCPARAM	L0000015	0.000000002946	0.00	1.70	1.70
SRCPARAM	L0000016	0.000000002946	0.00	1.70	1.70
SRCPARAM	L0000017	0.000000002946	0.00	1.70	1.70
SRCPARAM	L0000018	0.000000002946	0.00	1.70	1.70
SRCPARAM	L0000019	0.000000002946	0.00	1.70	1.70
SRCPARAM	L0000020	0.000000002946	0.00	1.70	1.70
SRCPARAM	L0000021	0.000000002946	0.00	1.70	1.70
SRCPARAM	L0000022	0.000000002946	0.00	1.70	1.70
SRCPARAM	L0000023	0.000000002946	0.00	1.70	1.70
SRCPARAM	L0000024	0.000000002946	0.00	1.70	1.70
SRCPARAM	L0000025	0.000000002946	0.00	1.70	1.70
SRCPARAM	L0000026	0.000000002946	0.00	1.70	1.70
SRCPARAM	L0000027	0.000000002946	0.00	1.70	1.70
SRCPARAM	L0000028	0.000000002946	0.00	1.70	1.70
SRCPARAM	L0000029	0.000000002946	0.00	1.70	1.70
SRCPARAM	L0000030	0.000000002946	0.00	1.70	1.70
SRCPARAM	L0000031	0.000000002946	0.00	1.70	1.70
SRCPARAM	L0000032	0.000000002946	0.00	1.70	1.70
SRCPARAM	L0000033	0.000000002946	0.00	1.70	1.70
SRCPARAM	L0000034	0.000000002946	0.00	1.70	1.70
SRCPARAM	L0000035	0.000000002946	0.00	1.70	1.70
SRCPARAM	L0000036	0.000000002946	0.00	1.70	1.70
SRCPARAM	L0000037	0.000000002946	0.00	1.70	1.70
SRCPARAM	L0000038	0.000000002946	0.00	1.70	1.70
SRCPARAM	L0000039	0.000000002946	0.00	1.70	1.70

SRCPARAM	L0000040	0.000000002946	0.00	1.70	1.70
SRCPARAM	L0000041	0.000000002946	0.00	1.70	1.70
SRCPARAM	L0000042	0.000000002946	0.00	1.70	1.70
SRCPARAM	L0000043	0.000000002946	0.00	1.70	1.70
SRCPARAM	L0000044	0.000000002946	0.00	1.70	1.70
SRCPARAM	L0000045	0.000000002946	0.00	1.70	1.70
SRCPARAM	L0000046	0.000000002946	0.00	1.70	1.70
SRCPARAM	L0000047	0.000000002946	0.00	1.70	1.70
SRCPARAM	L0000048	0.000000002946	0.00	1.70	1.70
SRCPARAM	L0000049	0.000000002946	0.00	1.70	1.70
SRCPARAM	L0000050	0.000000002946	0.00	1.70	1.70
SRCPARAM	L0000051	0.000000002946	0.00	1.70	1.70
SRCPARAM	L0000052	0.000000002946	0.00	1.70	1.70
SRCPARAM	L0000053	0.000000002946	0.00	1.70	1.70
SRCPARAM	L0000054	0.000000002946	0.00	1.70	1.70
SRCPARAM	L0000055	0.000000002946	0.00	1.70	1.70
SRCPARAM	L0000056	0.000000002946	0.00	1.70	1.70
SRCPARAM	L0000057	0.000000002946	0.00	1.70	1.70
SRCPARAM	L0000058	0.000000002946	0.00	1.70	1.70
SRCPARAM	L0000059	0.000000002946	0.00	1.70	1.70
SRCPARAM	L0000060	0.000000002946	0.00	1.70	1.70
SRCPARAM	L0000061	0.000000002946	0.00	1.70	1.70
SRCPARAM	L0000062	0.000000002946	0.00	1.70	1.70
SRCPARAM	L0000063	0.000000002946	0.00	1.70	1.70
SRCPARAM	L0000064	0.000000002946	0.00	1.70	1.70
SRCPARAM	L0000065	0.000000002946	0.00	1.70	1.70
SRCPARAM	L0000066	0.000000002946	0.00	1.70	1.70
SRCPARAM	L0000067	0.000000002946	0.00	1.70	1.70
SRCPARAM	L0000068	0.000000002946	0.00	1.70	1.70
SRCPARAM	L0000069	0.000000002946	0.00	1.70	1.70
SRCPARAM	L0000070	0.000000002946	0.00	1.70	1.70
SRCPARAM	L0000071	0.000000002946	0.00	1.70	1.70
SRCPARAM	L0000072	0.000000002946	0.00	1.70	1.70
SRCPARAM	L0000073	0.000000002946	0.00	1.70	1.70
SRCPARAM	L0000074	0.000000002946	0.00	1.70	1.70
SRCPARAM	L0000075	0.000000002946	0.00	1.70	1.70
SRCPARAM	L0000076	0.000000002946	0.00	1.70	1.70

SRCPARAM	L0000077	0.000000002946	0.00	1.70	1.70
SRCPARAM	L0000078	0.000000002946	0.00	1.70	1.70
SRCPARAM	L0000079	0.000000002946	0.00	1.70	1.70
SRCPARAM	L0000080	0.000000002946	0.00	1.70	1.70
SRCPARAM	L0000081	0.000000002946	0.00	1.70	1.70
SRCPARAM	L0000082	0.000000002946	0.00	1.70	1.70
SRCPARAM	L0000083	0.000000002946	0.00	1.70	1.70
SRCPARAM	L0000084	0.000000002946	0.00	1.70	1.70
SRCPARAM	L0000085	0.000000002946	0.00	1.70	1.70
SRCPARAM	L0000086	0.000000002946	0.00	1.70	1.70
SRCPARAM	L0000087	0.000000002946	0.00	1.70	1.70
SRCPARAM	L0000088	0.000000002946	0.00	1.70	1.70
SRCPARAM	L0000089	0.000000002946	0.00	1.70	1.70
SRCPARAM	L0000090	0.000000002946	0.00	1.70	1.70
SRCPARAM	L0000091	0.000000002946	0.00	1.70	1.70
SRCPARAM	L0000092	0.000000002946	0.00	1.70	1.70
SRCPARAM	L0000093	0.000000002946	0.00	1.70	1.70
SRCPARAM	L0000094	0.000000002946	0.00	1.70	1.70
SRCPARAM	L0000095	0.000000002946	0.00	1.70	1.70
SRCPARAM	L0000096	0.000000002946	0.00	1.70	1.70
SRCPARAM	L0000097	0.000000002946	0.00	1.70	1.70
SRCPARAM	L0000098	0.000000002946	0.00	1.70	1.70
SRCPARAM	L0000099	0.000000002946	0.00	1.70	1.70
SRCPARAM	L0000100	0.000000002946	0.00	1.70	1.70
SRCPARAM	L0000101	0.000000002946	0.00	1.70	1.70
SRCPARAM	L0000102	0.000000002946	0.00	1.70	1.70
SRCPARAM	L0000103	0.000000002946	0.00	1.70	1.70
SRCPARAM	L0000104	0.000000002946	0.00	1.70	1.70
SRCPARAM	L0000105	0.000000002946	0.00	1.70	1.70
SRCPARAM	L0000106	0.000000002946	0.00	1.70	1.70
SRCPARAM	L0000107	0.000000002946	0.00	1.70	1.70
SRCPARAM	L0000108	0.000000002946	0.00	1.70	1.70
SRCPARAM	L0000109	0.000000002946	0.00	1.70	1.70
SRCPARAM	L0000110	0.000000002946	0.00	1.70	1.70
SRCPARAM	L0000111	0.000000002946	0.00	1.70	1.70
SRCPARAM	L0000112	0.000000002946	0.00	1.70	1.70
SRCPARAM	L0000113	0.000000002946	0.00	1.70	1.70

SRCPARAM	L0000114	0.000000002946	0.00	1.70	1.70
SRCPARAM	L0000115	0.000000002946	0.00	1.70	1.70
SRCPARAM	L0000116	0.000000002946	0.00	1.70	1.70
SRCPARAM	L0000117	0.000000002946	0.00	1.70	1.70
SRCPARAM	L0000118	0.000000002946	0.00	1.70	1.70
SRCPARAM	L0000119	0.000000002946	0.00	1.70	1.70
SRCPARAM	L0000120	0.000000002946	0.00	1.70	1.70
SRCPARAM	L0000121	0.000000002946	0.00	1.70	1.70
SRCPARAM	L0000122	0.000000002946	0.00	1.70	1.70
SRCPARAM	L0000123	0.000000002946	0.00	1.70	1.70
SRCPARAM	L0000124	0.000000002946	0.00	1.70	1.70
SRCPARAM	L0000125	0.000000002946	0.00	1.70	1.70
SRCPARAM	L0000126	0.000000002946	0.00	1.70	1.70
SRCPARAM	L0000127	0.000000002946	0.00	1.70	1.70
SRCPARAM	L0000128	0.000000002946	0.00	1.70	1.70
SRCPARAM	L0000129	0.000000002946	0.00	1.70	1.70
SRCPARAM	L0000130	0.000000002946	0.00	1.70	1.70
SRCPARAM	L0000131	0.000000002946	0.00	1.70	1.70
SRCPARAM	L0000132	0.000000002946	0.00	1.70	1.70
SRCPARAM	L0000133	0.000000002946	0.00	1.70	1.70
SRCPARAM	L0000134	0.000000002946	0.00	1.70	1.70
SRCPARAM	L0000135	0.000000002946	0.00	1.70	1.70
SRCPARAM	L0000136	0.000000002946	0.00	1.70	1.70
SRCPARAM	L0000137	0.000000002946	0.00	1.70	1.70
SRCPARAM	L0000138	0.000000002946	0.00	1.70	1.70
SRCPARAM	L0000139	0.000000002946	0.00	1.70	1.70
SRCPARAM	L0000140	0.000000002946	0.00	1.70	1.70
SRCPARAM	L0000141	0.000000002946	0.00	1.70	1.70
SRCPARAM	L0000142	0.000000002946	0.00	1.70	1.70
SRCPARAM	L0000143	0.000000002946	0.00	1.70	1.70
SRCPARAM	L0000144	0.000000002946	0.00	1.70	1.70
SRCPARAM	L0000145	0.000000002946	0.00	1.70	1.70
SRCPARAM	L0000146	0.000000002946	0.00	1.70	1.70
SRCPARAM	L0000147	0.000000002946	0.00	1.70	1.70
SRCPARAM	L0000148	0.000000002946	0.00	1.70	1.70
SRCPARAM	L0000149	0.000000002946	0.00	1.70	1.70
SRCPARAM	L0000150	0.000000002946	0.00	1.70	1.70

SRCPARAM	L0000151	0.000000002946	0.00	1.70	1.70
SRCPARAM	L0000152	0.000000002946	0.00	1.70	1.70
SRCPARAM	L0000153	0.000000002946	0.00	1.70	1.70
SRCPARAM	L0000154	0.000000002946	0.00	1.70	1.70
SRCPARAM	L0000155	0.000000002946	0.00	1.70	1.70
SRCPARAM	L0000156	0.000000002946	0.00	1.70	1.70
SRCPARAM	L0000157	0.000000002946	0.00	1.70	1.70
SRCPARAM	L0000158	0.000000002946	0.00	1.70	1.70
SRCPARAM	L0000159	0.000000002946	0.00	1.70	1.70
SRCPARAM	L0000160	0.000000002946	0.00	1.70	1.70
SRCPARAM	L0000161	0.000000002946	0.00	1.70	1.70
SRCPARAM	L0000162	0.000000002946	0.00	1.70	1.70
SRCPARAM	L0000163	0.000000002946	0.00	1.70	1.70
SRCPARAM	L0000164	0.000000002946	0.00	1.70	1.70
SRCPARAM	L0000165	0.000000002946	0.00	1.70	1.70
SRCPARAM	L0000166	0.000000002946	0.00	1.70	1.70
SRCPARAM	L0000167	0.000000002946	0.00	1.70	1.70
SRCPARAM	L0000168	0.000000002946	0.00	1.70	1.70
SRCPARAM	L0000169	0.000000002946	0.00	1.70	1.70
SRCPARAM	L0000170	0.000000002946	0.00	1.70	1.70
SRCPARAM	L0000171	0.000000002946	0.00	1.70	1.70
SRCPARAM	L0000172	0.000000002946	0.00	1.70	1.70
SRCPARAM	L0000173	0.000000002946	0.00	1.70	1.70
SRCPARAM	L0000174	0.000000002946	0.00	1.70	1.70
SRCPARAM	L0000175	0.000000002946	0.00	1.70	1.70
SRCPARAM	L0000176	0.000000002946	0.00	1.70	1.70
SRCPARAM	L0000177	0.000000002946	0.00	1.70	1.70
SRCPARAM	L0000178	0.000000002946	0.00	1.70	1.70
SRCPARAM	L0000179	0.000000002946	0.00	1.70	1.70
SRCPARAM	L0000180	0.000000002946	0.00	1.70	1.70
SRCPARAM	L0000181	0.000000002946	0.00	1.70	1.70
SRCPARAM	L0000182	0.000000002946	0.00	1.70	1.70
SRCPARAM	L0000183	0.000000002946	0.00	1.70	1.70
SRCPARAM	L0000184	0.000000002946	0.00	1.70	1.70
SRCPARAM	L0000185	0.000000002946	0.00	1.70	1.70
SRCPARAM	L0000186	0.000000002946	0.00	1.70	1.70
SRCPARAM	L0000187	0.000000002946	0.00	1.70	1.70

SRCPARAM	L0000188	0.000000002946	0.00	1.70	1.70
SRCPARAM	L0000189	0.000000002946	0.00	1.70	1.70
SRCPARAM	L0000190	0.000000002946	0.00	1.70	1.70
SRCPARAM	L0000191	0.000000002946	0.00	1.70	1.70
SRCPARAM	L0000192	0.000000002946	0.00	1.70	1.70
SRCPARAM	L0000193	0.000000002946	0.00	1.70	1.70
SRCPARAM	L0000194	0.000000002946	0.00	1.70	1.70
SRCPARAM	L0000195	0.000000002946	0.00	1.70	1.70
SRCPARAM	L0000196	0.000000002946	0.00	1.70	1.70
SRCPARAM	L0000197	0.000000002946	0.00	1.70	1.70
SRCPARAM	L0000198	0.000000002946	0.00	1.70	1.70

**

SRCGROUP ALL

SO FINISHED

**

** AERMOD Receptor Pathway

**

**

RE STARTING

INCLUDED "Maverik El Centro.rou"

RE FINISHED

**

** AERMOD Meteorology Pathway

**

**

ME STARTING

SURFFILE DesertHotSpringsAirportADJU\KTRM_V9_ADJU\KTRM_v9.SFC

PROFFILE DesertHotSpringsAirportADJU\KTRM_V9_ADJU\KTRM_v9.PFL

SURFDATA 3104 2012

UAIRDATA 3190 2012

PROFBASE 0.0 METERS

ME FINISHED

**

```

*****
** AERMOD Output Pathway
*****
**
**
OU STARTING
  RECTABLE ALLAVE 1ST
  RECTABLE 1 1ST
** Auto-Generated Plotfiles
  PLOTFILE 1 ALL 1ST "Maverik El Centro.AD\01H1GALL.PLT" 31
  PLOTFILE PERIOD ALL "Maverik El Centro.AD\PE00GALL.PLT" 32
  SUMMFILE "Maverik El Centro.sum"
OU FINISHED

```

*** Message Summary For AERMOD Model Setup ***

----- Summary of Total Messages -----

```

A Total of          0 Fatal Error Message(s)
A Total of          3 Warning Message(s)
A Total of          0 Informational Message(s)

```

***** FATAL ERROR MESSAGES *****
 *** NONE ***

```

***** WARNING MESSAGES *****
CO W361      25      COCARD: Multiyear PERIOD/ANNUAL values for NO2/SO2 require MULTYEAR
Opt
ME W186     480      MEOPEN: THRESH_1MIN 1-min ASOS wind speed threshold used
0.50
ME W187     480      MEOPEN: ADJ_U* Option for Stable Low Winds used in AERMET

```

 *** SETUP Finishes Successfully ***

*** AERMOD - VERSION 21112 *** *** C:\Lakes\AERMOD View\Projects\Maverik El Centro
\Maverik El Centro.is *** 12/08/23
*** AERMET - VERSION 16216 *** ***
*** 09:45:50

PAGE 1

*** MODELOPTs: RegDEFAULT CONC ELEV RURAL ADJ_U*

*** MODEL SETUP OPTIONS SUMMARY ***

**Model Is Setup For Calculation of Average CONCentration Values.

-- DEPOSITION LOGIC --

**NO GAS DEPOSITION Data Provided.

**NO PARTICLE DEPOSITION Data Provided.

**Model Uses NO DRY DEPLETION. DRYDPLT = F

**Model Uses NO WET DEPLETION. WETDPLT = F

**Model Uses RURAL Dispersion Only.

**Model Uses Regulatory DEFAULT Options:

1. Stack-tip Downwash.
2. Model Accounts for ELEVated Terrain Effects.
3. Use Calms Processing Routine.
4. Use Missing Data Processing Routine.
5. No Exponential Decay.

**Other Options Specified:

ADJ_U* - Use ADJ_U* option for SBL in AERMET
CCVR_Sub - Meteorological data includes CCVR substitutions
TEMP_Sub - Meteorological data includes TEMP substitutions

**Model Assumes No FLAGPOLE Receptor Heights.

**The User Specified a Pollutant Type of: SO2

**Note that special processing requirements apply for the 1-hour SO2 NAAQS - check available guidance.

Model will process user-specified ranks of daily maximum 1-hour values averaged across the number of years modeled.

**Model Calculates 1 Short Term Average(s) of: 1-HR
and Calculates PERIOD Averages

**This Run Includes: 199 Source(s); 1 Source Group(s); and 86 Receptor(s)
with: 0 POINT(s), including
0 POINTCAP(s) and 0 POINTHOR(s)
and: 198 VOLUME source(s)
and: 1 AREA type source(s)
and: 0 LINE source(s)
and: 0 RLINE/RLINEEXT source(s)
and: 0 OPENPIT source(s)
and: 0 BUOYANT LINE source(s) with a total of 0 line(s)

**Model Set To Continue RUNNING After the Setup Testing.

**The AERMET Input Meteorological Data Version Date: 16216

**Output Options Selected:

Model Outputs Tables of PERIOD Averages by Receptor
Model Outputs Tables of Highest Short Term Values by Receptor (RECTABLE Keyword)
Model Outputs External File(s) of High Values for Plotting (PLOTFILE Keyword)
Model Outputs Separate Summary File of High Ranked Values (SUMMFILE Keyword)

**NOTE: The Following Flags May Appear Following CONC Values: c for Calm Hours
m for Missing Hours
b for Both Calm and Missing

Hours

**Misc. Inputs: Base Elev. for Pot. Temp. Profile (m MSL) = 0.00 ; Decay Coef. =

```
0.000      ; Rot. Angle =      0.0
            Emission Units = GRAMS/SEC          ; Emission Rate
Unit Factor = 0.10000E+07
            Output Units   = MICROGRAMS/M**3

**Approximate Storage Requirements of Model =      3.7 MB of RAM.

**Input Runstream File:      aermod.inp
**Output Print File:        aermod.out

**Detailed Error/Message File:  Maverik El Centro.err
**File for Summary of Results:  Maverik El Centro.sum
```

*** AERMOD - VERSION 21112 *** *** C:\Lakes\AERMOD View\Projects\Maverik El Centro
 \Maverik El Centro.is *** 12/08/23
 *** AERMET - VERSION 16216 *** ***
 *** 09:45:50

PAGE 2

*** MODELOPTs: RegDFAULT CONC ELEV RURAL ADJ_U*

*** VOLUME SOURCE DATA ***

URBAN	EMISSION RATE	NUMBER	EMISSION RATE			BASE	RELEASE	INIT.	INIT.
SOURCE	PART.	(GRAMS/SEC)	X	Y	ELEV.	HEIGHT	SY	SZ	
SOURCE SCALAR VARY			(METERS)	(METERS)	(METERS)	(METERS)	(METERS)	(METERS)	(METERS)
ID	CATS.								
L0000001	0	0.29460E-08	640518.4	3628027.2	-11.3	0.00	1.70	1.70	
NO									
L0000002	0	0.29460E-08	640518.4	3628030.8	-11.3	0.00	1.70	1.70	
NO									
L0000003	0	0.29460E-08	640518.4	3628034.5	-11.3	0.00	1.70	1.70	
NO									
L0000004	0	0.29460E-08	640518.4	3628038.1	-11.3	0.00	1.70	1.70	
NO									
L0000005	0	0.29460E-08	640518.4	3628041.8	-11.3	0.00	1.70	1.70	
NO									
L0000006	0	0.29460E-08	640518.4	3628045.5	-11.3	0.00	1.70	1.70	
NO									
L0000007	0	0.29460E-08	640518.1	3628048.8	-11.3	0.00	1.70	1.70	
NO									
L0000008	0	0.29460E-08	640514.4	3628048.8	-11.3	0.00	1.70	1.70	
NO									
L0000009	0	0.29460E-08	640510.8	3628048.8	-11.3	0.00	1.70	1.70	

NO								
L0000010	0	0.29460E-08	640507.1	3628048.8	-11.3	0.00	1.70	1.70
NO								
L0000011	0	0.29460E-08	640503.5	3628048.8	-11.3	0.00	1.70	1.70
NO								
L0000012	0	0.29460E-08	640499.8	3628048.8	-11.3	0.00	1.70	1.70
NO								
L0000013	0	0.29460E-08	640496.1	3628048.8	-11.3	0.00	1.70	1.70
NO								
L0000014	0	0.29460E-08	640492.5	3628048.8	-11.3	0.00	1.70	1.70
NO								
L0000015	0	0.29460E-08	640488.8	3628048.8	-11.3	0.00	1.70	1.70
NO								
L0000016	0	0.29460E-08	640485.2	3628048.8	-11.3	0.00	1.70	1.70
NO								
L0000017	0	0.29460E-08	640481.5	3628048.8	-11.3	0.00	1.70	1.70
NO								
L0000018	0	0.29460E-08	640477.9	3628048.8	-11.3	0.00	1.70	1.70
NO								
L0000019	0	0.29460E-08	640474.2	3628048.8	-11.3	0.00	1.70	1.70
NO								
L0000020	0	0.29460E-08	640470.5	3628048.8	-11.3	0.00	1.70	1.70
NO								
L0000021	0	0.29460E-08	640466.9	3628048.8	-11.3	0.00	1.70	1.70
NO								
L0000022	0	0.29460E-08	640463.2	3628048.8	-11.3	0.00	1.70	1.70
NO								
L0000023	0	0.29460E-08	640459.6	3628048.8	-11.3	0.00	1.70	1.70
NO								
L0000024	0	0.29460E-08	640455.9	3628048.8	-11.3	0.00	1.70	1.70
NO								
L0000025	0	0.29460E-08	640452.3	3628048.8	-11.3	0.00	1.70	1.70
NO								
L0000026	0	0.29460E-08	640448.6	3628048.8	-11.3	0.00	1.70	1.70
NO								
L0000027	0	0.29460E-08	640444.9	3628048.8	-11.3	0.00	1.70	1.70
NO								

L0000028	0	0.29460E-08	640441.3	3628048.8	-11.3	0.00	1.70	1.70
NO								
L0000029	0	0.29460E-08	640437.6	3628048.8	-11.3	0.00	1.70	1.70
NO								
L0000030	0	0.29460E-08	640434.0	3628048.8	-11.3	0.00	1.70	1.70
NO								
L0000031	0	0.29460E-08	640430.3	3628048.8	-11.3	0.00	1.70	1.70
NO								
L0000032	0	0.29460E-08	640426.6	3628048.8	-11.3	0.00	1.70	1.70
NO								
L0000033	0	0.29460E-08	640423.0	3628048.8	-11.3	0.00	1.70	1.70
NO								
L0000034	0	0.29460E-08	640419.3	3628048.8	-11.3	0.00	1.70	1.70
NO								
L0000035	0	0.29460E-08	640415.7	3628048.8	-11.3	0.00	1.70	1.70
NO								
L0000036	0	0.29460E-08	640412.0	3628048.8	-11.3	0.00	1.70	1.70
NO								
L0000037	0	0.29460E-08	640408.4	3628048.8	-11.3	0.00	1.70	1.70
NO								
L0000038	0	0.29460E-08	640404.7	3628048.8	-11.3	0.00	1.70	1.70
NO								
L0000039	0	0.29460E-08	640401.0	3628048.8	-11.3	0.00	1.70	1.70
NO								
L0000040	0	0.29460E-08	640397.4	3628048.8	-11.3	0.00	1.70	1.70
NO								

```

*** AERMOD - VERSION 21112 ***      *** C:\Lakes\AERMOD View\Projects\Maverik El Centro
\Maverik El Centro.is ***          12/08/23
*** AERMET - VERSION 16216 ***      ***
***                                09:45:50

```

PAGE 3

*** MODELOPTs: RegDFault CONC ELEV RURAL ADJ_U*

*** VOLUME SOURCE DATA ***

URBAN	EMISSION RATE	NUMBER	EMISSION RATE			BASE	RELEASE	INIT.	INIT.
SOURCE	PART.	(GRAMS/SEC)	X	Y	ELEV.	HEIGHT	SY	SZ	
SOURCE SCALAR VARY			(METERS)	(METERS)	(METERS)	(METERS)	(METERS)	(METERS)	(METERS)
ID	CATS.								
L0000041	0	0.29460E-08	640393.7	3628048.8	-11.3	0.00	1.70	1.70	
NO									
L0000042	0	0.29460E-08	640390.1	3628048.8	-11.3	0.00	1.70	1.70	
NO									
L0000043	0	0.29460E-08	640386.4	3628048.8	-11.3	0.00	1.70	1.70	
NO									
L0000044	0	0.29460E-08	640382.8	3628048.8	-11.3	0.00	1.70	1.70	
NO									
L0000045	0	0.29460E-08	640379.1	3628048.8	-11.3	0.00	1.70	1.70	
NO									
L0000046	0	0.29460E-08	640375.4	3628048.8	-11.3	0.00	1.70	1.70	
NO									
L0000047	0	0.29460E-08	640371.8	3628048.8	-11.3	0.00	1.70	1.70	
NO									
L0000048	0	0.29460E-08	640368.1	3628048.8	-11.3	0.00	1.70	1.70	
NO									
L0000049	0	0.29460E-08	640364.5	3628048.8	-11.3	0.00	1.70	1.70	

NO								
L0000050	0	0.29460E-08	640360.8	3628048.8	-11.3	0.00	1.70	1.70
NO								
L0000051	0	0.29460E-08	640357.2	3628048.8	-11.3	0.00	1.70	1.70
NO								
L0000052	0	0.29460E-08	640353.5	3628048.8	-11.3	0.00	1.70	1.70
NO								
L0000053	0	0.29460E-08	640349.8	3628048.8	-11.3	0.00	1.70	1.70
NO								
L0000054	0	0.29460E-08	640346.2	3628048.8	-11.3	0.00	1.70	1.70
NO								
L0000055	0	0.29460E-08	640342.5	3628048.8	-11.3	0.00	1.70	1.70
NO								
L0000056	0	0.29460E-08	640338.9	3628048.8	-11.3	0.00	1.70	1.70
NO								
L0000057	0	0.29460E-08	640335.2	3628048.8	-11.3	0.00	1.70	1.70
NO								
L0000058	0	0.29460E-08	640335.0	3628045.5	-11.3	0.00	1.70	1.70
NO								
L0000059	0	0.29460E-08	640335.1	3628041.9	-11.3	0.00	1.70	1.70
NO								
L0000060	0	0.29460E-08	640335.3	3628038.2	-11.3	0.00	1.70	1.70
NO								
L0000061	0	0.29460E-08	640335.5	3628034.5	-11.3	0.00	1.70	1.70
NO								
L0000062	0	0.29460E-08	640335.6	3628030.9	-11.3	0.00	1.70	1.70
NO								
L0000063	0	0.29460E-08	640335.8	3628027.2	-11.3	0.00	1.70	1.70
NO								
L0000064	0	0.29460E-08	640335.9	3628023.6	-11.3	0.00	1.70	1.70
NO								
L0000065	0	0.29460E-08	640336.1	3628019.9	-11.3	0.00	1.70	1.70
NO								
L0000066	0	0.29460E-08	640336.2	3628016.3	-11.3	0.00	1.70	1.70
NO								
L0000067	0	0.29460E-08	640336.4	3628012.6	-11.3	0.00	1.70	1.70
NO								

L0000068	0	0.29460E-08	640336.5	3628009.0	-11.3	0.00	1.70	1.70
NO								
L0000069	0	0.29460E-08	640336.7	3628005.3	-11.3	0.00	1.70	1.70
NO								
L0000070	0	0.29460E-08	640336.8	3628001.7	-11.3	0.00	1.70	1.70
NO								
L0000071	0	0.29460E-08	640337.0	3627998.0	-11.3	0.00	1.70	1.70
NO								
L0000072	0	0.29460E-08	640337.1	3627994.3	-11.3	0.00	1.70	1.70
NO								
L0000073	0	0.29460E-08	640337.3	3627990.7	-11.3	0.00	1.70	1.70
NO								
L0000074	0	0.29460E-08	640337.4	3627987.0	-11.3	0.00	1.70	1.70
NO								
L0000075	0	0.29460E-08	640337.6	3627983.4	-11.3	0.00	1.70	1.70
NO								
L0000076	0	0.29460E-08	640337.7	3627979.7	-11.3	0.00	1.70	1.70
NO								
L0000077	0	0.29460E-08	640337.9	3627976.1	-11.3	0.00	1.70	1.70
NO								
L0000078	0	0.29460E-08	640338.0	3627972.4	-11.3	0.00	1.70	1.70
NO								
L0000079	0	0.29460E-08	640338.2	3627968.8	-11.3	0.00	1.70	1.70
NO								
L0000080	0	0.29460E-08	640338.3	3627965.1	-11.3	0.00	1.70	1.70
NO								

*** AERMOD - VERSION 21112 *** *** C:\Lakes\AERMOD View\Projects\Maverik El Centro
 \Maverik El Centro.is *** 12/08/23
 *** AERMET - VERSION 16216 *** ***
 *** 09:45:50

PAGE 4

*** MODELOPTs: RegDFAULT CONC ELEV RURAL ADJ_U*

*** VOLUME SOURCE DATA ***

URBAN	EMISSION RATE	NUMBER	EMISSION RATE			BASE	RELEASE	INIT.	INIT.
SOURCE	PART.	(GRAMS/SEC)	X	Y	ELEV.	HEIGHT	SY	SZ	
SOURCE SCALAR VARY			(METERS)	(METERS)	(METERS)	(METERS)	(METERS)	(METERS)	(METERS)
ID	CATS.								
BY									
L0000081	0	0.29460E-08	640338.5	3627961.5	-11.3	0.00	1.70	1.70	
NO									
L0000082	0	0.29460E-08	640338.6	3627957.8	-11.3	0.00	1.70	1.70	
NO									
L0000083	0	0.29460E-08	640338.8	3627954.2	-11.3	0.00	1.70	1.70	
NO									
L0000084	0	0.29460E-08	640339.0	3627950.5	-11.3	0.00	1.70	1.70	
NO									
L0000085	0	0.29460E-08	640339.1	3627946.8	-11.3	0.00	1.70	1.70	
NO									
L0000086	0	0.29460E-08	640339.3	3627943.2	-11.3	0.00	1.70	1.70	
NO									
L0000087	0	0.29460E-08	640339.4	3627939.5	-11.3	0.00	1.70	1.70	
NO									
L0000088	0	0.29460E-08	640339.6	3627935.9	-11.3	0.00	1.70	1.70	
NO									
L0000089	0	0.29460E-08	640339.7	3627932.2	-11.3	0.00	1.70	1.70	

NO								
L0000090	0	0.29460E-08	640339.9	3627928.6	-11.3	0.00	1.70	1.70
NO								
L0000091	0	0.29460E-08	640340.0	3627924.9	-11.3	0.00	1.70	1.70
NO								
L0000092	0	0.29460E-08	640340.2	3627921.3	-11.3	0.00	1.70	1.70
NO								
L0000093	0	0.29460E-08	640340.3	3627917.6	-11.3	0.00	1.70	1.70
NO								
L0000094	0	0.29460E-08	640340.5	3627914.0	-11.3	0.00	1.70	1.70
NO								
L0000095	0	0.29460E-08	640340.6	3627910.3	-11.3	0.00	1.70	1.70
NO								
L0000096	0	0.29460E-08	640340.8	3627906.6	-11.2	0.00	1.70	1.70
NO								
L0000097	0	0.29460E-08	640340.9	3627903.0	-11.2	0.00	1.70	1.70
NO								
L0000098	0	0.29460E-08	640341.1	3627899.3	-11.2	0.00	1.70	1.70
NO								
L0000099	0	0.29460E-08	640341.2	3627895.7	-11.2	0.00	1.70	1.70
NO								
L0000100	0	0.29460E-08	640341.4	3627892.0	-11.2	0.00	1.70	1.70
NO								
L0000101	0	0.29460E-08	640341.5	3627888.4	-11.2	0.00	1.70	1.70
NO								
L0000102	0	0.29460E-08	640341.7	3627884.7	-11.2	0.00	1.70	1.70
NO								
L0000103	0	0.29460E-08	640341.8	3627881.1	-11.1	0.00	1.70	1.70
NO								
L0000104	0	0.29460E-08	640342.0	3627877.4	-11.1	0.00	1.70	1.70
NO								
L0000105	0	0.29460E-08	640342.2	3627873.8	-11.1	0.00	1.70	1.70
NO								
L0000106	0	0.29460E-08	640342.3	3627870.1	-11.1	0.00	1.70	1.70
NO								
L0000107	0	0.29460E-08	640342.5	3627866.4	-11.1	0.00	1.70	1.70
NO								

L0000108	0	0.29460E-08	640342.6	3627862.8	-11.1	0.00	1.70	1.70
NO								
L0000109	0	0.29460E-08	640342.8	3627859.1	-11.1	0.00	1.70	1.70
NO								
L0000110	0	0.29460E-08	640342.9	3627855.5	-11.1	0.00	1.70	1.70
NO								
L0000111	0	0.29460E-08	640343.1	3627851.8	-11.1	0.00	1.70	1.70
NO								
L0000112	0	0.29460E-08	640343.2	3627848.2	-11.2	0.00	1.70	1.70
NO								
L0000113	0	0.29460E-08	640343.4	3627844.5	-11.2	0.00	1.70	1.70
NO								
L0000114	0	0.29460E-08	640343.5	3627840.9	-11.2	0.00	1.70	1.70
NO								
L0000115	0	0.29460E-08	640343.7	3627837.2	-11.2	0.00	1.70	1.70
NO								
L0000116	0	0.29460E-08	640343.8	3627833.6	-11.2	0.00	1.70	1.70
NO								
L0000117	0	0.29460E-08	640344.0	3627829.9	-11.2	0.00	1.70	1.70
NO								
L0000118	0	0.29460E-08	640344.1	3627826.2	-11.3	0.00	1.70	1.70
NO								
L0000119	0	0.29460E-08	640344.3	3627822.6	-11.3	0.00	1.70	1.70
NO								
L0000120	0	0.29460E-08	640344.4	3627818.9	-11.3	0.00	1.70	1.70
NO								

*** AERMOD - VERSION 21112 *** *** C:\Lakes\AERMOD View\Projects\Maverik El Centro
 \Maverik El Centro.is *** 12/08/23
 *** AERMET - VERSION 16216 *** ***
 *** 09:45:50

PAGE 5

*** MODELOPTs: RegDFAULT CONC ELEV RURAL ADJ_U*

*** VOLUME SOURCE DATA ***

URBAN	EMISSION RATE	NUMBER	EMISSION RATE			BASE	RELEASE	INIT.	INIT.
SOURCE	PART.	(GRAMS/SEC)	X	Y	ELEV.	HEIGHT	SY	SZ	
SOURCE SCALAR VARY			(METERS)	(METERS)	(METERS)	(METERS)	(METERS)	(METERS)	(METERS)
ID	CATS.								
L0000121	0	0.29460E-08	640344.6	3627815.3	-11.3	0.00	1.70	1.70	
NO									
L0000122	0	0.29460E-08	640344.7	3627811.6	-11.3	0.00	1.70	1.70	
NO									
L0000123	0	0.29460E-08	640344.9	3627808.0	-11.3	0.00	1.70	1.70	
NO									
L0000124	0	0.29460E-08	640345.0	3627804.3	-11.3	0.00	1.70	1.70	
NO									
L0000125	0	0.29460E-08	640345.2	3627800.7	-11.3	0.00	1.70	1.70	
NO									
L0000126	0	0.29460E-08	640345.3	3627797.0	-11.3	0.00	1.70	1.70	
NO									
L0000127	0	0.29460E-08	640345.5	3627793.4	-11.3	0.00	1.70	1.70	
NO									
L0000128	0	0.29460E-08	640345.7	3627789.7	-11.3	0.00	1.70	1.70	
NO									
L0000129	0	0.29460E-08	640345.8	3627786.0	-11.3	0.00	1.70	1.70	

NO								
L0000130	0	0.29460E-08	640346.0	3627782.4	-11.3	0.00	1.70	1.70
NO								
L0000131	0	0.29460E-08	640346.1	3627778.7	-11.3	0.00	1.70	1.70
NO								
L0000132	0	0.29460E-08	640346.3	3627775.1	-11.3	0.00	1.70	1.70
NO								
L0000133	0	0.29460E-08	640346.4	3627771.4	-11.3	0.00	1.70	1.70
NO								
L0000134	0	0.29460E-08	640346.6	3627767.8	-11.3	0.00	1.70	1.70
NO								
L0000135	0	0.29460E-08	640346.7	3627764.1	-11.3	0.00	1.70	1.70
NO								
L0000136	0	0.29460E-08	640346.9	3627760.5	-11.3	0.00	1.70	1.70
NO								
L0000137	0	0.29460E-08	640347.0	3627756.8	-11.3	0.00	1.70	1.70
NO								
L0000138	0	0.29460E-08	640347.2	3627753.2	-11.3	0.00	1.70	1.70
NO								
L0000139	0	0.29460E-08	640347.3	3627749.5	-11.3	0.00	1.70	1.70
NO								
L0000140	0	0.29460E-08	640347.5	3627745.8	-11.3	0.00	1.70	1.70
NO								
L0000141	0	0.29460E-08	640347.6	3627742.2	-11.3	0.00	1.70	1.70
NO								
L0000142	0	0.29460E-08	640347.8	3627738.5	-11.3	0.00	1.70	1.70
NO								
L0000143	0	0.29460E-08	640347.9	3627734.9	-11.3	0.00	1.70	1.70
NO								
L0000144	0	0.29460E-08	640348.1	3627731.2	-11.2	0.00	1.70	1.70
NO								
L0000145	0	0.29460E-08	640348.2	3627727.6	-11.2	0.00	1.70	1.70
NO								
L0000146	0	0.29460E-08	640348.4	3627723.9	-11.2	0.00	1.70	1.70
NO								
L0000147	0	0.29460E-08	640348.5	3627720.3	-11.1	0.00	1.70	1.70
NO								

L0000148	0	0.29460E-08	640348.7	3627716.6	-11.1	0.00	1.70	1.70
NO								
L0000149	0	0.29460E-08	640348.8	3627713.0	-11.1	0.00	1.70	1.70
NO								
L0000150	0	0.29460E-08	640349.0	3627709.3	-11.0	0.00	1.70	1.70
NO								
L0000151	0	0.29460E-08	640349.2	3627705.6	-11.0	0.00	1.70	1.70
NO								
L0000152	0	0.29460E-08	640349.3	3627702.0	-11.0	0.00	1.70	1.70
NO								
L0000153	0	0.29460E-08	640349.5	3627698.3	-11.0	0.00	1.70	1.70
NO								
L0000154	0	0.29460E-08	640349.6	3627694.7	-11.0	0.00	1.70	1.70
NO								
L0000155	0	0.29460E-08	640349.8	3627691.0	-11.0	0.00	1.70	1.70
NO								
L0000156	0	0.29460E-08	640349.9	3627687.4	-11.0	0.00	1.70	1.70
NO								
L0000157	0	0.29460E-08	640350.1	3627683.7	-11.0	0.00	1.70	1.70
NO								
L0000158	0	0.29460E-08	640350.2	3627680.1	-11.0	0.00	1.70	1.70
NO								
L0000159	0	0.29460E-08	640350.4	3627676.4	-11.0	0.00	1.70	1.70
NO								
L0000160	0	0.29460E-08	640350.5	3627672.8	-11.0	0.00	1.70	1.70
NO								

*** AERMOD - VERSION 21112 *** *** C:\Lakes\AERMOD View\Projects\Maverik El Centro
 \Maverik El Centro.is *** 12/08/23
 *** AERMET - VERSION 16216 *** ***
 *** 09:45:50

PAGE 6

*** MODELOPTs: RegDFAULT CONC ELEV RURAL ADJ_U*

*** VOLUME SOURCE DATA ***

URBAN	EMISSION RATE	NUMBER	EMISSION RATE			BASE	RELEASE	INIT.	INIT.
SOURCE	PART.	(GRAMS/SEC)	X	Y	ELEV.	HEIGHT	SY	SZ	
SOURCE SCALAR VARY			(METERS)	(METERS)	(METERS)	(METERS)	(METERS)	(METERS)	(METERS)
ID	CATS.								
BY									
L0000161	0	0.29460E-08	640350.7	3627669.1	-11.0	0.00	1.70	1.70	
NO									
L0000162	0	0.29460E-08	640350.8	3627665.5	-11.0	0.00	1.70	1.70	
NO									
L0000163	0	0.29460E-08	640351.0	3627661.8	-11.0	0.00	1.70	1.70	
NO									
L0000164	0	0.29460E-08	640351.1	3627658.1	-11.0	0.00	1.70	1.70	
NO									
L0000165	0	0.29460E-08	640351.3	3627654.5	-11.0	0.00	1.70	1.70	
NO									
L0000166	0	0.29460E-08	640351.4	3627650.8	-11.0	0.00	1.70	1.70	
NO									
L0000167	0	0.29460E-08	640351.6	3627647.2	-11.0	0.00	1.70	1.70	
NO									
L0000168	0	0.29460E-08	640351.7	3627643.5	-11.0	0.00	1.70	1.70	
NO									
L0000169	0	0.29460E-08	640351.9	3627639.9	-11.0	0.00	1.70	1.70	

NO								
L0000170	0	0.29460E-08	640352.0	3627636.2	-11.0	0.00	1.70	1.70
NO								
L0000171	0	0.29460E-08	640352.2	3627632.6	-11.0	0.00	1.70	1.70
NO								
L0000172	0	0.29460E-08	640352.4	3627628.9	-11.0	0.00	1.70	1.70
NO								
L0000173	0	0.29460E-08	640352.5	3627625.3	-11.0	0.00	1.70	1.70
NO								
L0000174	0	0.29460E-08	640352.7	3627621.6	-11.0	0.00	1.70	1.70
NO								
L0000175	0	0.29460E-08	640352.8	3627617.9	-11.0	0.00	1.70	1.70
NO								
L0000176	0	0.29460E-08	640353.0	3627614.3	-11.0	0.00	1.70	1.70
NO								
L0000177	0	0.29460E-08	640353.1	3627610.6	-11.0	0.00	1.70	1.70
NO								
L0000178	0	0.29460E-08	640353.3	3627607.0	-11.0	0.00	1.70	1.70
NO								
L0000179	0	0.29460E-08	640353.4	3627603.3	-11.0	0.00	1.70	1.70
NO								
L0000180	0	0.29460E-08	640353.6	3627599.7	-11.0	0.00	1.70	1.70
NO								
L0000181	0	0.29460E-08	640353.7	3627596.0	-11.0	0.00	1.70	1.70
NO								
L0000182	0	0.29460E-08	640353.9	3627592.4	-11.0	0.00	1.70	1.70
NO								
L0000183	0	0.29460E-08	640354.0	3627588.7	-11.0	0.00	1.70	1.70
NO								
L0000184	0	0.29460E-08	640354.2	3627585.1	-11.0	0.00	1.70	1.70
NO								
L0000185	0	0.29460E-08	640354.3	3627581.4	-11.0	0.00	1.70	1.70
NO								
L0000186	0	0.29460E-08	640354.5	3627577.7	-11.0	0.00	1.70	1.70
NO								
L0000187	0	0.29460E-08	640354.6	3627574.1	-11.0	0.00	1.70	1.70
NO								

L0000188	0	0.29460E-08	640354.8	3627570.4	-11.0	0.00	1.70	1.70
NO								
L0000189	0	0.29460E-08	640354.9	3627566.8	-11.0	0.00	1.70	1.70
NO								
L0000190	0	0.29460E-08	640355.1	3627563.1	-11.0	0.00	1.70	1.70
NO								
L0000191	0	0.29460E-08	640355.2	3627559.5	-11.0	0.00	1.70	1.70
NO								
L0000192	0	0.29460E-08	640355.4	3627555.8	-11.0	0.00	1.70	1.70
NO								
L0000193	0	0.29460E-08	640355.5	3627552.2	-11.0	0.00	1.70	1.70
NO								
L0000194	0	0.29460E-08	640355.7	3627548.5	-11.0	0.00	1.70	1.70
NO								
L0000195	0	0.29460E-08	640355.9	3627544.9	-11.0	0.00	1.70	1.70
NO								
L0000196	0	0.29460E-08	640356.0	3627541.2	-11.0	0.00	1.70	1.70
NO								
L0000197	0	0.29460E-08	640356.2	3627537.5	-11.0	0.00	1.70	1.70
NO								
L0000198	0	0.29460E-08	640356.3	3627533.9	-11.0	0.00	1.70	1.70
NO								

*** AERMOD - VERSION 21112 *** *** C:\Lakes\AERMOD View\Projects\Maverik El Centro
 \Maverik El Centro.is *** 12/08/23
 *** AERMET - VERSION 16216 *** ***
 *** 09:45:50

PAGE 34

*** MODELOPTs: RegDFAULT CONC ELEV RURAL ADJ_U*

*** AREAPOLY SOURCE DATA ***

URBAN EMISSION RATE	NUMBER	EMISSION RATE	LOCATION OF AREA		BASE	RELEASE	NUMBER	INIT.
SOURCE	PART.	(GRAMS/SEC	X	Y	ELEV.	HEIGHT	OF VERTS.	SZ
SOURCE SCALAR VARY		/METER**2)	(METERS)	(METERS)	(METERS)	(METERS)		(METERS)
ID	CATS.							
PAREAL	0	0.10971E-07	640603.3	3628032.8	-11.3	5.00	5	0.00
NO								

```

*** AERMOD - VERSION 21112 ***      *** C:\Lakes\AERMOD View\Projects\Maverik El Centro
\Maverik El Centro.is ***          12/08/23
*** AERMET - VERSION 16216 ***      ***
***          09:45:50

```

PAGE 35

*** MODELOPTs: RegDEFAULT CONC ELEV RURAL ADJ_U*

*** SOURCE IDs DEFINING SOURCE GROUPS ***

SRCGROUP ID	SOURCE IDs					
-----	-----					
ALL	PAREA1	, L0000001	, L0000002	, L0000003	, L0000004	,
L0000005	, L0000006	, L0000007	,			
	L0000008	, L0000009	, L0000010	, L0000011	, L0000012	,
L0000013	, L0000014	, L0000015	,			
	L0000016	, L0000017	, L0000018	, L0000019	, L0000020	,
L0000021	, L0000022	, L0000023	,			
	L0000024	, L0000025	, L0000026	, L0000027	, L0000028	,
L0000029	, L0000030	, L0000031	,			
	L0000032	, L0000033	, L0000034	, L0000035	, L0000036	,
L0000037	, L0000038	, L0000039	,			
	L0000040	, L0000041	, L0000042	, L0000043	, L0000044	,
L0000045	, L0000046	, L0000047	,			
	L0000048	, L0000049	, L0000050	, L0000051	, L0000052	,
L0000053	, L0000054	, L0000055	,			
	L0000056	, L0000057	, L0000058	, L0000059	, L0000060	,

L0000061	,	L0000062	,	L0000063	,		
L0000069	,	L0000064 , L0000070	,	L0000065 , L0000071	,	L0000066 , L0000067	, L0000068
L0000077	,	L0000072 , L0000078	,	L0000073 , L0000079	,	L0000074 , L0000075	, L0000076
L0000085	,	L0000080 , L0000086	,	L0000081 , L0000087	,	L0000082 , L0000083	, L0000084
L0000093	,	L0000088 , L0000094	,	L0000089 , L0000095	,	L0000090 , L0000091	, L0000092
L0000101	,	L0000096 , L0000102	,	L0000097 , L0000103	,	L0000098 , L0000099	, L0000100
L0000109	,	L0000104 , L0000110	,	L0000105 , L0000111	,	L0000106 , L0000107	, L0000108
L0000117	,	L0000112 , L0000118	,	L0000113 , L0000119	,	L0000114 , L0000115	, L0000116
L0000125	,	L0000120 , L0000126	,	L0000121 , L0000127	,	L0000122 , L0000123	, L0000124
L0000133	,	L0000128 , L0000134	,	L0000129 , L0000135	,	L0000130 , L0000131	, L0000132
L0000141	,	L0000136 , L0000142	,	L0000137 , L0000143	,	L0000138 , L0000139	, L0000140
L0000149	,	L0000144 , L0000150	,	L0000145 , L0000151	,	L0000146 , L0000147	, L0000148
L0000157	,	L0000152 , L0000158	,	L0000153 , L0000159	,	L0000154 , L0000155	, L0000156

```

*** AERMOD - VERSION 21112 ***      *** C:\Lakes\AERMOD View\Projects\Maverik El Centro
\Maverik El Centro.is ***          12/08/23
*** AERMET - VERSION 16216 ***      ***
***          09:45:50

```

PAGE 38

*** MODELOPTs: RegDEFAULT CONC ELEV RURAL ADJ_U*

*** SOURCE IDs DEFINING SOURCE GROUPS ***

SRCGROUP ID	SOURCE IDs					
-----	-----					
L0000165	L0000160	, L0000161	, L0000162	, L0000163	, L0000164	,
	, L0000166	, L0000167	,			
L0000173	L0000168	, L0000169	, L0000170	, L0000171	, L0000172	,
	, L0000174	, L0000175	,			
L0000181	L0000176	, L0000177	, L0000178	, L0000179	, L0000180	,
	, L0000182	, L0000183	,			
L0000189	L0000184	, L0000185	, L0000186	, L0000187	, L0000188	,
	, L0000190	, L0000191	,			
L0000197	L0000192	, L0000193	, L0000194	, L0000195	, L0000196	,
	, L0000198	,				

*** AERMOD - VERSION 21112 *** *** C:\Lakes\AERMOD View\Projects\Maverik El Centro
\Maverik El Centro.is *** 12/08/23
*** AERMET - VERSION 16216 *** ***
*** 09:45:50

PAGE 39

*** MODELOPTs: RegDEFAULT CONC ELEV RURAL ADJ_U*

*** GRIDDED RECEPTOR NETWORK SUMMARY ***

*** NETWORK ID: UCART ; NETWORK TYPE: GRIDCART ***

*** X-COORDINATES OF GRID ***
(METERS)

640023.5, 640083.5, 640143.5, 640203.5, 640263.5, 640323.5, 640383.5,
640443.5, 640503.5, 640563.5,

*** Y-COORDINATES OF GRID ***
(METERS)

3627703.2, 3627763.2, 3627823.2, 3627883.2, 3627943.2, 3628003.2, 3628063.2,
3628123.2,

```

*** AERMOD - VERSION 21112 ***      *** C:\Lakes\AERMOD View\Projects\Maverik El Centro
\Maverik El Centro.is ***          12/08/23
*** AERMET - VERSION 16216 ***      ***
***                                09:45:50

```

PAGE 40

*** MODELOPTs: RegDFault CONC ELEV RURAL ADJ_U*

*** NETWORK ID: UCART ; NETWORK TYPE: GRIDCART ***

* ELEVATION HEIGHTS IN METERS *

Y-COORD (METERS)	640023.52	640083.52	640143.52	640203.52	640263.52	
640323.52	640383.52	640443.52	640503.52			
3628123.24						
	-11.60	-11.60	-11.60	-11.30	-11.30	-11.30
0	-11.30	-11.30				-11.3
3628063.24						
	-11.60	-11.60	-11.60	-11.30	-11.30	-11.30
0	-11.30	-11.30				-11.3
3628003.24						
	-11.60	-11.60	-11.30	-11.30	-11.30	-11.30
0	-11.30	-11.30				-11.3
3627943.24						
	-11.30	-11.30	-11.30	-11.30	-11.30	-11.30
0	-11.30	-11.30				-11.3
3627883.24						
	-11.30	-11.30	-11.30	-11.30	-11.30	-11.30
0	-11.30	-11.30				-11.2
3627823.24						
	-11.30	-11.30	-11.30	-11.00	-11.00	-11.20
0	-11.20	-11.30				-11.3
3627763.24						

	-11.00	-10.90	-11.00	-11.00	-11.00	-11.30	-11.0
0	-11.00	-11.00					
	3627703.24						
	-10.00	-10.90	-11.00	-11.00	-11.00	-11.00	-11.0
0	-11.00	-11.00					

```

*** AERMOD - VERSION 21112 ***      *** C:\Lakes\AERMOD View\Projects\Maverik El Centro
\Maverik El Centro.is ***          12/08/23
*** AERMET - VERSION 16216 ***      ***
***                                09:45:50

```

PAGE 42

```

*** MODELOPTs:      RegDFault  CONC  ELEV  RURAL  ADJ_U*

```

```

*** NETWORK ID: UCART      ; NETWORK TYPE: GRIDCART ***

```

* ELEVATION HEIGHTS IN METERS *

Y-COORD (METERS)	X-COORD (METERS)
640563.52	
3628123.24	-11.30
3628063.24	-11.30
3628003.24	-11.30
3627943.24	-11.30
3627883.24	-11.30
3627823.24	-11.00
3627763.24	-11.00
3627703.24	-11.00

```

*** AERMOD - VERSION 21112 ***      *** C:\Lakes\AERMOD View\Projects\Maverik El Centro
\Maverik El Centro.is ***          12/08/23
*** AERMET - VERSION 16216 ***      ***
***                                09:45:50

```

PAGE 43

*** MODELOPTs: RegDFault CONC ELEV RURAL ADJ_U*

*** NETWORK ID: UCART ; NETWORK TYPE: GRIDCART ***

* HILL HEIGHT SCALES IN METERS *

Y-COORD (METERS)	640023.52	640083.52	640143.52	640203.52	640263.52	
640323.52	640383.52	640443.52	640503.52			
3628123.24						
	-11.60	-11.60	-11.60	-11.30	-11.30	-11.30
0	-11.30	-11.30				-11.3
3628063.24						
	-11.60	-11.60	-11.60	-11.30	-11.30	-11.30
0	-11.30	-11.30				-11.3
3628003.24						
	-11.60	-11.60	-11.30	-11.30	-11.30	-11.30
0	-11.30	-11.30				-11.3
3627943.24						
	-11.30	-11.30	-11.30	-11.30	-11.30	-11.30
0	-11.30	-11.30				-11.3
3627883.24						
	-11.30	-11.30	-11.30	-11.30	-11.30	-11.30
0	-11.30	-11.30				-11.2
3627823.24						
	-11.30	-11.30	-11.30	-11.00	-11.00	-11.20
0	-11.20	-11.30				-11.3
3627763.24						

	-11.00	-10.90	-11.00	-11.00	-11.00	-11.30	-11.0
0	-11.00	-11.00					
	3627703.24						
	-10.00	-10.90	-11.00	-11.00	-11.00	-11.00	-11.0
0	-11.00	-11.00					

*** AERMOD - VERSION 21112 *** *** C:\Lakes\AERMOD View\Projects\Maverik El Centro
\Maverik El Centro.is *** 12/08/23
*** AERMET - VERSION 16216 *** ***
*** 09:45:50

PAGE 45

*** MODELOPTs: RegDEFAULT CONC ELEV RURAL ADJ_U*

*** NETWORK ID: UCART ; NETWORK TYPE: GRIDCART ***

* HILL HEIGHT SCALES IN METERS *

Y-COORD (METERS)		X-COORD (METERS)
	640563.52	

3628123.24	-11.30
3628063.24	-11.30
3628003.24	-11.30
3627943.24	-11.30
3627883.24	-11.30
3627823.24	-11.00
3627763.24	-11.00
3627703.24	-11.00

```
*** AERMOD - VERSION 21112 ***      *** C:\Lakes\AERMOD View\Projects\Maverik El Centro
\Maverik El Centro.is ***          12/08/23
*** AERMET - VERSION 16216 ***      ***
***          09:45:50
```

PAGE 46

```
*** MODELOPTs:      RegDEFAULT  CONC  ELEV  RURAL  ADJ_U*
```

```
*** DISCRETE CARTESIAN RECEPTORS ***
(X-COORD, Y-COORD, ZELEV, ZHILL, ZFLAG)
(METERS)
```

```
( 640477.2, 3628075.7, -11.3, -11.3, 0.0); ( 640256.6,
3627956.3, -11.3, -11.3, 0.0);
( 640278.4, 3627913.0, -11.3, -11.3, 0.0); ( 640299.1,
3627891.2, -11.3, -11.3, 0.0);
( 640300.3, 3627870.2, -11.1, -11.1, 0.0); ( 640301.1,
3627857.0, -11.0, -11.0, 0.0);
```

1.54, 3.09, 5.14, 8.23, 10.80,

```

*** AERMOD - VERSION 21112 ***      *** C:\Lakes\AERMOD View\Projects\Maverik El Centro
\Maverik El Centro.is ***          12/08/23
*** AERMET - VERSION 16216 ***      ***
***                                09:45:50

```

PAGE 17

```

*** MODELOPTs:      RegDFault  CONC  ELEV  RURAL  ADJ_U*

```

*** UP TO THE FIRST 24 HOURS OF METEOROLOGICAL DATA ***

```

Surface file:  DesertHotSpringsAirportADJU\KTRM_V9_ADJU\KTRM_v9.SFC
Met Version:  16216
Profile file:  DesertHotSpringsAirportADJU\KTRM_V9_ADJU\KTRM_v9.PFL
Surface format: FREE
Profile format: FREE
Surface station no.: 3104                               Upper air station no.: 3190
                  Name: UNKNOWN                          Name: UNKNOWN
                  Year: 2012                             Year: 2012

```

First 24 hours of scalar data

YR	MO	DY	JDY	HR	H0	U*	W*	DT/DZ	ZICNV	ZIMCH	M-O	LEN	Z0	BOWEN	ALBEDO	REF
WS	WD	HT	REF	TA	HT											
12	01	01	1	01	-7.8	0.118	-9.000	-9.000	-999.	98.	19.4	0.08	1.91	1.00		
1.59	77.	10.1	278.8	2.0												
12	01	01	1	02	-15.8	0.171	-9.000	-9.000	-999.	169.	32.1	0.08	1.91	1.00		
2.23	288.	10.1	277.5	2.0												
12	01	01	1	03	-16.9	0.177	-9.000	-9.000	-999.	178.	34.3	0.08	1.91	1.00		
2.30	325.	10.1	278.8	2.0												
12	01	01	1	04	-3.0	0.076	-9.000	-9.000	-999.	56.	13.4	0.08	1.91	1.00		
0.94	321.	10.1	275.4	2.0												
12	01	01	1	05	-4.7	0.092	-9.000	-9.000	-999.	67.	15.0	0.08	1.91	1.00		
1.23	342.	10.1	274.2	2.0												
12	01	01	1	06	-10.7	0.139	-9.000	-9.000	-999.	124.	22.8	0.08	1.91	1.00		
1.84	309.	10.1	274.9	2.0												
12	01	01	1	07	-18.8	0.186	-9.000	-9.000	-999.	193.	38.2	0.08	1.91	1.00		

2.42	338.	10.1	277.0	2.0								
12 01 01	1 08	-11.5	0.179	-9.000	-9.000	-999.	182.	45.7	0.08	1.91	0.49	
2.30	343.	10.1	282.5	2.0								
12 01 01	1 09	44.9	0.190	0.372	0.007	42.	198.	-13.9	0.08	1.91	0.30	
1.86	334.	10.1	288.8	2.0								
12 01 01	1 10	109.3	0.237	0.720	0.006	125.	278.	-11.2	0.08	1.91	0.23	
2.27	333.	10.1	293.8	2.0								
12 01 01	1 11	153.1	0.246	1.122	0.005	338.	293.	-8.9	0.08	1.91	0.21	
2.28	348.	10.1	297.0	2.0								
12 01 01	1 12	173.2	0.204	1.424	0.005	612.	222.	-4.5	0.08	1.91	0.20	
1.72	322.	10.1	298.8	2.0								
12 01 01	1 13	169.9	0.156	1.670	0.005	1005.	148.	-2.0	0.08	1.91	0.20	
1.14	351.	10.1	300.4	2.0								
12 01 01	1 14	142.4	0.144	1.714	0.005	1296.	131.	-1.9	0.08	1.91	0.22	
1.04	329.	10.1	300.9	2.0								
12 01 01	1 15	92.8	0.142	1.542	0.005	1447.	129.	-2.8	0.08	1.91	0.25	
1.11	316.	10.1	301.4	2.0								
12 01 01	1 16	24.5	0.122	0.995	0.005	1469.	102.	-6.8	0.08	1.91	0.35	
1.09	301.	10.1	300.4	2.0								
12 01 01	1 17	-3.0	0.077	-9.000	-9.000	-999.	51.	13.7	0.08	1.91	0.65	
0.99	209.	10.1	292.0	2.0								
12 01 01	1 18	-11.9	0.149	-9.000	-9.000	-999.	138.	25.2	0.08	1.91	1.00	
1.96	149.	10.1	286.4	2.0								
12 01 01	1 19	-6.4	0.107	-9.000	-9.000	-999.	85.	17.7	0.08	1.91	1.00	
1.45	31.	10.1	284.9	2.0								
12 01 01	1 20	-15.7	0.171	-9.000	-9.000	-999.	169.	32.1	0.08	1.91	1.00	
2.23	327.	10.1	283.1	2.0								
12 01 01	1 21	-8.3	0.122	-9.000	-9.000	-999.	103.	20.2	0.08	1.91	1.00	
1.64	347.	10.1	282.0	2.0								
12 01 01	1 22	-7.9	0.119	-9.000	-9.000	-999.	99.	19.6	0.08	1.91	1.00	
1.60	316.	10.1	279.2	2.0								
12 01 01	1 23	-5.3	0.097	-9.000	-9.000	-999.	73.	15.9	0.08	1.91	1.00	
1.31	325.	10.1	278.1	2.0								
12 01 01	1 24	-9.4	0.130	-9.000	-9.000	-999.	113.	21.5	0.08	1.91	1.00	
1.74	304.	10.1	278.8	2.0								

First hour of profile data

YR	MO	DY	HR	HEIGHT	F	WDIR	WSPD	AMB_TMP	sigmaA	sigmaW	sigmaV
12	01	01	01	10.1	1	77.	1.59	278.8	99.0	-99.00	-99.00

F indicates top of profile (=1) or below (=0)

*** AERMOD - VERSION 21112 *** *** C:\Lakes\AERMOD View\Projects\Maverik El Centro
 \Maverik El Centro.is *** 12/08/23
 *** AERMET - VERSION 16216 *** ***
 *** 09:45:50

PAGE 18

*** MODELOPTs: RegDEFAULT CONC ELEV RURAL ADJ_U*

*** THE PERIOD (43848 HRS) AVERAGE CONCENTRATION VALUES FOR
 SOURCE GROUP: ALL ***
 INCLUDING SOURCE(S): PAREA1 , L0000001 ,
 L0000002 , L0000003 , L0000004 ,
 L0000005 , L0000006 , L0000007 , L0000008 , L0000009 ,
 L0000010 , L0000011 , L0000012 ,
 L0000013 , L0000014 , L0000015 , L0000016 , L0000017 ,
 L0000018 , L0000019 , L0000020 ,
 L0000021 , L0000022 , L0000023 , L0000024 , L0000025 ,
 L0000026 , L0000027 , . . . ,

*** NETWORK ID: UCART ; NETWORK TYPE: GRIDCART ***

** CONC OF SO2 IN MICROGRAMS/M**3

**

Y-COORD (METERS)	X-COORD (METERS)					
640323.52	640383.52	640443.52	640503.52	640203.52	640263.52	
3628123.24	0.00057	0.00076	0.00106	0.00155	0.00238	
0.00369	0.00530	0.00615	0.00559			
3628063.24	0.00052	0.00068	0.00094	0.00139	0.00225	
0.00405	0.00777	0.01181	0.01204			
3628003.24	0.00047	0.00061	0.00082	0.00118	0.00189	
0.00361	0.00838	0.01585	0.01985			
3627943.24	0.00044	0.00055	0.00072	0.00100	0.00151	

0.00273	0.00675	0.02076	0.03670			
3627883.24		0.00041	0.00050	0.00065	0.00087	0.00127
0.00214	0.00466	0.01824	0.03945			
3627823.24		0.00038	0.00047	0.00060	0.00080	0.00116
0.00197	0.00433	0.01452	0.03019			
3627763.24		0.00036	0.00044	0.00056	0.00076	0.00112
0.00193	0.00404	0.00941	0.01739			
3627703.24		0.00034	0.00042	0.00055	0.00075	0.00112
0.00190	0.00360	0.00682	0.01124			

*** AERMOD - VERSION 21112 *** *** C:\Lakes\AERMOD View\Projects\Maverik El Centro
 \Maverik El Centro.is *** 12/08/23
 *** AERMET - VERSION 16216 *** ***
 *** 09:45:50

PAGE 54

*** MODELOPTs: RegDEFAULT CONC ELEV RURAL ADJ_U*

*** THE PERIOD (43848 HRS) AVERAGE CONCENTRATION VALUES FOR
 SOURCE GROUP: ALL ***
 INCLUDING SOURCE(S): PAREA1 , L0000001 ,
 L0000002 , L0000003 , L0000004 ,
 L0000005 , L0000006 , L0000007 , L0000008 , L0000009 ,
 L0000010 , L0000011 , L0000012 ,
 L0000013 , L0000014 , L0000015 , L0000016 , L0000017 ,
 L0000018 , L0000019 , L0000020 ,
 L0000021 , L0000022 , L0000023 , L0000024 , L0000025 ,
 L0000026 , L0000027 , . . . ,

*** NETWORK ID: UCART ; NETWORK TYPE: GRIDCART ***

** CONC OF SO2 IN MICROGRAMS/M**3

**

Y-COORD
(METERS)

640563.52

X-COORD (METERS)

 3628123.24 | 0.00393
 3628063.24 | 0.00877
 3628003.24 | 0.01762
 3627943.24 | 0.03819
 3627883.24 | 0.04517
 3627823.24 | 0.03696
 3627763.24 | 0.02241
 3627703.24 | 0.01454

*** AERMOD - VERSION 21112 *** *** C:\Lakes\AERMOD View\Projects\Maverik El Centro
 \Maverik El Centro.is *** 12/08/23
 *** AERMET - VERSION 16216 *** ***
 *** 09:45:50

PAGE 56

*** MODELOPTs: RegDEFAULT CONC ELEV RURAL ADJ_U*

*** THE PERIOD (43848 HRS) AVERAGE CONCENTRATION VALUES FOR
 SOURCE GROUP: ALL ***
 INCLUDING SOURCE(S): PAREA1 , L0000001 ,
 L0000002 , L0000003 , L0000004 ,
 L0000005 , L0000006 , L0000007 , L0000008 , L0000009 ,
 L0000010 , L0000011 , L0000012 ,
 L0000013 , L0000014 , L0000015 , L0000016 , L0000017 ,
 L0000018 , L0000019 , L0000020 ,
 L0000021 , L0000022 , L0000023 , L0000024 , L0000025 ,
 L0000026 , L0000027 , . . . ,

*** DISCRETE CARTESIAN RECEPTOR POINTS ***

** ** CONC OF SO2 IN MICROGRAMS/M**3
 **
 X-COORD (M) Y-COORD (M) CONC X-COORD (M) Y-COORD (M)
 CONC

 640477.17 3628075.66 0.01052 640256.60 3627956.34
 0.00150
 640278.36 3627913.01 0.00154 640299.14 3627891.23
 0.00172
 640300.34 3627870.21 0.00165 640301.14 3627857.00
 0.00163

```

*** AERMOD - VERSION 21112 ***      *** C:\Lakes\AERMOD View\Projects\Maverik El Centro
\Maverik El Centro.is ***          12/08/23
*** AERMET - VERSION 16216 ***      ***
***          09:45:50

```

PAGE 57

*** MODELOPTs: RegDEFAULT CONC ELEV RURAL ADJ_U*

*** THE 1ST-HIGHEST MAX DAILY 1-HR AVERAGE CONCENTRATION VALUES AVERAGED OVER 5
YEARS FOR SOURCE GROUP: ALL ***

```

          INCLUDING SOURCE(S):      PAREA1      , L0000001      ,
L0000002      , L0000003      , L0000004      ,
          L0000005      , L0000006      , L0000007      , L0000008      , L0000009      ,
L0000010      , L0000011      , L0000012      ,
          L0000013      , L0000014      , L0000015      , L0000016      , L0000017      ,
L0000018      , L0000019      , L0000020      ,
          L0000021      , L0000022      , L0000023      , L0000024      , L0000025      ,
L0000026      , L0000027      , . . .      ,

```

*** NETWORK ID: UCART ; NETWORK TYPE: GRIDCART ***

** CONC OF SO2 IN MICROGRAMS/M**3

**

Y-COORD (METERS)	640023.52	640083.52	640143.52	640203.52	640263.52
640323.52	640383.52	640443.52	640503.52		
3628123.24	0.10752	0.12136	0.13347	0.16648	0.19381
0.21127	0.25320	0.27749	0.27748		
3628063.24	0.10742	0.12601	0.14901	0.17577	0.20886
0.27024	0.31664	0.35317	0.36325		
3628003.24	0.11384	0.13169	0.15549	0.18721	0.23193
0.29062	0.37504	0.34926	0.29014		
3627943.24	0.11420	0.13199	0.15469	0.18449	0.22526

0.28359	0.36178	0.31853	0.22283			
3627883.24		0.10851	0.12773	0.15106	0.18110	0.22369
0.27872	0.35881	0.37098	0.32067			
3627823.24		0.10883	0.12669	0.14631	0.16907	0.20103
0.25609	0.32243	0.33957	0.34308			
3627763.24		0.10381	0.11459	0.12984	0.16027	0.18652
0.22539	0.25313	0.26954	0.26731			
3627703.24		0.09226	0.11035	0.12907	0.14455	0.16942
0.19063	0.19437	0.21895	0.21527			

```

*** AERMOD - VERSION 21112 ***      *** C:\Lakes\AERMOD View\Projects\Maverik El Centro
\Maverik El Centro.is ***          12/08/23
*** AERMET - VERSION 16216 ***      ***
***          09:45:50

```

PAGE 22

*** MODELOPTs: RegDEFAULT CONC ELEV RURAL ADJ_U*

*** THE 1ST-HIGHEST MAX DAILY 1-HR AVERAGE CONCENTRATION VALUES AVERAGED OVER 5
YEARS FOR SOURCE GROUP: ALL ***

```

          INCLUDING SOURCE(S):      PAREAL      , L0000001      ,
L0000002      , L0000003      , L0000004      ,
          L0000005      , L0000006      , L0000007      , L0000008      , L0000009      ,
L0000010      , L0000011      , L0000012      ,
          L0000013      , L0000014      , L0000015      , L0000016      , L0000017      ,
L0000018      , L0000019      , L0000020      ,
          L0000021      , L0000022      , L0000023      , L0000024      , L0000025      ,
L0000026      , L0000027      , . . .      ,

```

*** NETWORK ID: UCART ; NETWORK TYPE: GRIDCART ***

** CONC OF SO2 IN MICROGRAMS/M**3

**

Y-COORD
(METERS)

640563.52

X-COORD (METERS)

```

-----
-----
3628123.24 | 0.27084
3628063.24 | 0.33474
3628003.24 | 0.31372
3627943.24 | 0.29976
3627883.24 | 0.36710
3627823.24 | 0.35581
3627763.24 | 0.27042
3627703.24 | 0.21288

```



```

*** AERMOD - VERSION 21112 ***   *** C:\Lakes\AERMOD View\Projects\Maverik El Centro
\Maverik El Centro.is ***      12/08/23
*** AERMET - VERSION 16216 ***   ***
***      09:45:50

```

PAGE 61

```

*** MODELOPTs:      RegDEFAULT CONC ELEV RURAL ADJ_U*

```

```

*** THE 1ST-HIGHEST MAX DAILY 1-HR AVERAGE CONCENTRATION VALUES AVERAGED OVER 5
YEARS FOR SOURCE GROUP: ALL ***

```

```

          INCLUDING SOURCE(S):      PAREA1      , L0000001      ,
L0000002      , L0000003      , L0000004      ,
          L0000005      , L0000006      , L0000007      , L0000008      , L0000009      ,
L0000010      , L0000011      , L0000012      ,
          L0000013      , L0000014      , L0000015      , L0000016      , L0000017      ,
L0000018      , L0000019      , L0000020      ,
          L0000021      , L0000022      , L0000023      , L0000024      , L0000025      ,
L0000026      , L0000027      , . . .      ,

```

```

*** DISCRETE CARTESIAN RECEPTOR POINTS ***

```

```

** CONC OF SO2          IN MICROGRAMS/M**3

**
      X-COORD (M)      Y-COORD (M)          CONC          X-COORD (M)      Y-COORD (M)
CONC
-----
          640477.17      3628075.66          0.34722          640256.60      3627956.34
0.22440
          640278.36      3627913.01          0.24160          640299.14      3627891.23
0.25724
          640300.34      3627870.21          0.24982          640301.14      3627857.00
0.24371

```

*** AERMOD - VERSION 21112 *** *** C:\Lakes\AERMOD View\Projects\Maverik El Centro
 \Maverik El Centro.is *** 12/08/23
 *** AERMET - VERSION 16216 *** ***
 *** 09:45:50

PAGE 62

*** MODELOPTs: RegDFault CONC ELEV RURAL ADJ_U*

*** THE SUMMARY OF MAXIMUM PERIOD (43848 HRS)

RESULTS ***

** CONC OF SO2 IN MICROGRAMS/M**3

**

NETWORK

GROUP ID	ZFLAG)	OF TYPE	GRID-ID	AVERAGE CONC	RECEPTOR (XR, YR, ZELEV, ZHILL,
----------	--------	---------	---------	--------------	---------------------------------

ALL				0.04517 AT (640563.52,	
3627883.24,				0.00) GC UCART	
				0.03945 AT (640503.52,	
3627883.24,				0.00) GC UCART	
				0.03819 AT (640563.52,	
3627943.24,				0.00) GC UCART	
				0.03696 AT (640563.52,	
3627823.24,				0.00) GC UCART	
				0.03670 AT (640503.52,	
3627943.24,				0.00) GC UCART	
				0.03019 AT (640503.52,	
3627823.24,				0.00) GC UCART	
				0.02241 AT (640563.52,	
3627763.24,				0.00) GC UCART	
				0.02076 AT (640443.52,	

```
3627943.24,  -11.30,  -11.30,  0.00)  GC  UCART
      9TH HIGHEST VALUE IS      0.01985 AT ( 640503.52,
3628003.24,  -11.30,  -11.30,  0.00)  GC  UCART
      10TH HIGHEST VALUE IS     0.01824 AT ( 640443.52,
3627883.24,  -11.30,  -11.30,  0.00)  GC  UCART
```

```
*** RECEPTOR TYPES:  GC = GRIDCART
                       GP = GRIDPOLR
                       DC = DISCCART
                       DP = DISCPOLR
```

*** AERMOD - VERSION 21112 *** *** C:\Lakes\AERMOD View\Projects\Maverik El Centro
\Maverik El Centro.is *** 12/08/23
*** AERMET - VERSION 16216 *** ***
*** 09:45:50

PAGE 25

*** MODELOPTs: RegDFAULT CONC ELEV RURAL ADJ_U*

 *** THE SUMMARY OF MAXIMUM 1ST-HIGHEST MAX DAILY 1-HR RESULTS
AVERAGED OVER 5 YEARS ***

** CONC OF SO2 IN MICROGRAMS/M**3

**

NETWORK

GROUP ID	AVERAGE CONC	RECEPTOR (XR, YR, ZELEV, ZHILL,
ZFLAG) OF TYPE GRID-ID		

ALL	1ST HIGHEST VALUE IS	0.37504 AT (640383.52,
3628003.24,	-11.30, -11.30,	0.00) GC UCART
	2ND HIGHEST VALUE IS	0.37098 AT (640443.52,
3627883.24,	-11.30, -11.30,	0.00) GC UCART
	3RD HIGHEST VALUE IS	0.36710 AT (640563.52,
3627883.24,	-11.30, -11.30,	0.00) GC UCART
	4TH HIGHEST VALUE IS	0.36325 AT (640503.52,
3628063.24,	-11.30, -11.30,	0.00) GC UCART
	5TH HIGHEST VALUE IS	0.36178 AT (640383.52,
3627943.24,	-11.30, -11.30,	0.00) GC UCART
	6TH HIGHEST VALUE IS	0.35881 AT (640383.52,
3627883.24,	-11.20, -11.20,	0.00) GC UCART
	7TH HIGHEST VALUE IS	0.35581 AT (640563.52,
3627823.24,	-11.00, -11.00,	0.00) GC UCART
	8TH HIGHEST VALUE IS	0.35317 AT (640443.52,

```
3628063.24,  -11.30,  -11.30,  0.00)  GC  UCART
      9TH HIGHEST VALUE IS      0.34926 AT ( 640443.52,
3628003.24,  -11.30,  -11.30,  0.00)  GC  UCART
      10TH HIGHEST VALUE IS     0.34722 AT ( 640477.17,
3628075.66,  -11.28,  -11.28,  0.00)  DC
```

```
*** RECEPTOR TYPES:  GC = GRIDCART
                        GP = GRIDPOLR
                        DC = DISCCART
                        DP = DISCPOLR
```

*** AERMOD - VERSION 21112 *** *** C:\Lakes\AERMOD View\Projects\Maverik El Centro
\Maverik El Centro.is *** 12/08/23
*** AERMET - VERSION 16216 *** ***
*** 09:45:50

PAGE 26

*** MODELOPTs: RegDEFAULT CONC ELEV RURAL ADJ_U*

*** Message Summary : AERMOD Model Execution ***

----- Summary of Total Messages -----

A Total of 0 Fatal Error Message(s)
A Total of 3 Warning Message(s)
A Total of 1124 Informational Message(s)

A Total of 43848 Hours Were Processed

A Total of 595 Calm Hours Identified

A Total of 529 Missing Hours Identified (1.21 Percent)

***** FATAL ERROR MESSAGES *****
*** NONE ***

***** WARNING MESSAGES *****
CO W361 25 COCARD: Multiyear PERIOD/ANNUAL values for NO2/SO2 require MULTYEAR
Opt
ME W186 480 MEOPEN: THRESH_1MIN 1-min ASOS wind speed threshold used
0.50
ME W187 480 MEOPEN: ADJ_U* Option for Stable Low Winds used in AERMET

*** AERMOD Finishes Successfully ***

```

**
*****
**
** AERMOD Input Produced by:
** AERMOD View Ver. 10.0.1
** Lakes Environmental Software Inc.
** Date: 12/8/2023
** File: C:\Lakes\AERMOD View\Projects\Maverik El Centro - Benzene\Maverik El Centro -
Benzene.ADI
**
*****
**
**
*****
** AERMOD Control Pathway
*****
**
**
CO STARTING
  TITLEONE C:\Lakes\AERMOD View\Projects\Maverik El Centro\Maverik El Centro.is
  MODELOPT DFAULT CONC
  AVERTIME 1 PERIOD
  POLLUTID BENZENE
  RUNORNOT RUN
  ERRORFIL "Maverik El Centro - Benzene.err"
CO FINISHED
**
*****
** AERMOD Source Pathway
*****
**
**
SO STARTING
** Source Location **
** Source ID - Type - X Coord. - Y Coord. **
  LOCATION PAREAL      AREAPOLY    640508.076  3627996.212      -11.280
** DESCRSRC Storage Tanks

```

```

LOCATION PAREA2      AREAPOLY  640454.922  3627995.703      -11.280
** DESCRSRC Refueling and Breathing Trucks
LOCATION PAREA3      AREAPOLY  640523.995  3627973.965      -11.280
** DESCRSRC Refueling and Breathing Cars
LOCATION PAREA4      AREAPOLY  640454.572  3627996.054      -11.280
** DESCRSRC Spillage Trucks
LOCATION PAREA5      AREAPOLY  640523.995  3627974.316      -11.280
** DESCRSRC Spillage Passenger Vehicles
** Source Parameters **
SRCPARAM PAREA1      2.6576E-07      3.660           5           0.050
AREAVERT PAREA1      640508.076  3627996.212  640518.209  3627996.510
AREAVERT PAREA1      640517.911  3627942.269  640507.182  3627942.269
AREAVERT PAREA1      640507.778  3627997.106
SRCPARAM PAREA2      1.8133E-07      1.000           4           5.000
AREAVERT PAREA2      640454.922  3627995.703  640462.636  3627996.755
AREAVERT PAREA2      640462.987  3627931.890  640454.922  3627932.241
SRCPARAM PAREA3      1.8876E-07      1.000           4           5.000
AREAVERT PAREA3      640523.995  3627973.965  640523.644  3627958.888
AREAVERT PAREA3      640556.252  3627958.888  640555.902  3627973.965
SRCPARAM PAREA4      1.8974E-07      0.000           4           5.000
AREAVERT PAREA4      640454.572  3627996.054  640462.636  3627996.054
AREAVERT PAREA4      640463.337  3627931.890  640454.221  3627932.591
SRCPARAM PAREA5      2.175E-07      0.000           4           5.000
AREAVERT PAREA5      640523.995  3627974.316  640523.294  3627958.537
AREAVERT PAREA5      640555.551  3627959.239  640555.902  3627973.264
SRCGROUP ALL
SO FINISHED
**
*****
** AERMOD Receptor Pathway
*****
**
**
RE STARTING
  INCLUDED "Maverik El Centro - Benzene.rou"
RE FINISHED
**

```

```

*****
** AERMOD Meteorology Pathway
*****
**
**
ME STARTING
  SURFFILE DesertHotSpringsAirportADJU\KTRM_V9_ADJU\KTRM_v9.SFC
  PROFFILE DesertHotSpringsAirportADJU\KTRM_V9_ADJU\KTRM_v9.PFL
  SURFDATA 3104 2012
  UAIRDATA 3190 2012
  PROFBASE 0.0 METERS
ME FINISHED
**
*****
** AERMOD Output Pathway
*****
**
**
OU STARTING
  RECTABLE ALLAVE 1ST
  RECTABLE 1 1ST
** Auto-Generated Plotfiles
  PLOTFILE 1 ALL 1ST "MAVERIK EL CENTRO - BENZENE.AD\01H1GALL.PLT" 31
  PLOTFILE PERIOD ALL "MAVERIK EL CENTRO - BENZENE.AD\PE00GALL.PLT" 32
  SUMMFILE "Maverik El Centro - Benzene.sum"
OU FINISHED

```

*** Message Summary For AERMOD Model Setup ***

----- Summary of Total Messages -----

A Total of	0 Fatal Error Message(s)
A Total of	2 Warning Message(s)
A Total of	0 Informational Message(s)

```
***** FATAL ERROR MESSAGES *****  
*** NONE ***
```

```
***** WARNING MESSAGES *****  
ME W186      85      MEOPEN: THRESH_1MIN 1-min ASOS wind speed threshold used  
0.50  
ME W187      85      MEOPEN: ADJ_U* Option for Stable Low Winds used in AERMET
```

```
*****  
*** SETUP Finishes Successfully ***  
*****
```

*** AERMOD - VERSION 21112 *** *** C:\Lakes\AERMOD View\Projects\Maverik El Centro
\Maverik El Centro.is *** 12/08/23
*** AERMET - VERSION 16216 *** ***
*** 10:35:10

PAGE 1

*** MODELOPTs: RegDEFAULT CONC ELEV RURAL ADJ_U*

*** MODEL SETUP OPTIONS SUMMARY ***

**Model Is Setup For Calculation of Average CONCentration Values.

-- DEPOSITION LOGIC --

**NO GAS DEPOSITION Data Provided.

**NO PARTICLE DEPOSITION Data Provided.

**Model Uses NO DRY DEPLETION. DRYDPLT = F

**Model Uses NO WET DEPLETION. WETDPLT = F

**Model Uses RURAL Dispersion Only.

**Model Uses Regulatory DEFAULT Options:

1. Stack-tip Downwash.
2. Model Accounts for ELEVated Terrain Effects.
3. Use Calms Processing Routine.
4. Use Missing Data Processing Routine.
5. No Exponential Decay.

**Other Options Specified:

ADJ_U* - Use ADJ_U* option for SBL in AERMET
CCVR_Sub - Meteorological data includes CCVR substitutions
TEMP_Sub - Meteorological data includes TEMP substitutions

**Model Assumes No FLAGPOLE Receptor Heights.

**The User Specified a Pollutant Type of: BENZENE

**Model Calculates 1 Short Term Average(s) of: 1-HR
and Calculates PERIOD Averages

**This Run Includes: 5 Source(s); 1 Source Group(s); and 6 Receptor(s)
with: 0 POINT(s), including
0 POINTCAP(s) and 0 POINTHOR(s)
and: 0 VOLUME source(s)
and: 5 AREA type source(s)
and: 0 LINE source(s)
and: 0 RLINE/RLINEXT source(s)
and: 0 OPENPIT source(s)
and: 0 BUOYANT LINE source(s) with a total of 0 line(s)

**Model Set To Continue RUNNING After the Setup Testing.

**The AERMET Input Meteorological Data Version Date: 16216

**Output Options Selected:

Model Outputs Tables of PERIOD Averages by Receptor
Model Outputs Tables of Highest Short Term Values by Receptor (RECTABLE Keyword)
Model Outputs External File(s) of High Values for Plotting (PLOTFILE Keyword)
Model Outputs Separate Summary File of High Ranked Values (SUMMFILE Keyword)

**NOTE: The Following Flags May Appear Following CONC Values: c for Calm Hours
m for Missing Hours
b for Both Calm and Missing

Hours

**Misc. Inputs: Base Elev. for Pot. Temp. Profile (m MSL) = 0.00 ; Decay Coef. =
0.000 ; Rot. Angle = 0.0
Emission Units = GRAMS/SEC ; Emission Rate
Unit Factor = 0.10000E+07
Output Units = MICROGRAMS/M**3

**Approximate Storage Requirements of Model = 3.5 MB of RAM.

**Input Runstream File: aermod.inp

**Output Print File: aermod.out

**Detailed Error/Message File: Maverik El Centro - Benzene.err

**File for Summary of Results: Maverik El Centro - Benzene.sum

*** AERMOD - VERSION 21112 *** *** C:\Lakes\AERMOD View\Projects\Maverik El Centro
 \Maverik El Centro.is *** 12/08/23
 *** AERMET - VERSION 16216 *** ***
 *** 10:35:10

PAGE 8

*** MODELOPTs: RegDEFAULT CONC ELEV RURAL ADJ_U*

*** AREAPOLY SOURCE DATA ***

URBAN	EMISSION RATE	NUMBER	EMISSION RATE	LOCATION OF AREA		BASE	RELEASE	NUMBER	INIT.
SOURCE	PART.	(GRAMS/SEC	X	Y	ELEV.	HEIGHT	OF VERTS.	SZ	
SOURCE	SCALAR VARY		(METERS)	(METERS)	(METERS)	(METERS)		(METERS)	
ID	CATS.	/METER**2)							
BY									
PAREA1	0	0.26576E-06	640508.1	3627996.2	-11.3	3.66	5	0.05	
NO									
PAREA2	0	0.18133E-06	640454.9	3627995.7	-11.3	1.00	4	5.00	
NO									
PAREA3	0	0.18876E-06	640524.0	3627974.0	-11.3	1.00	4	5.00	
NO									
PAREA4	0	0.18974E-06	640454.6	3627996.1	-11.3	0.00	4	5.00	
NO									
PAREA5	0	0.21750E-06	640524.0	3627974.3	-11.3	0.00	4	5.00	
NO									

*** AERMOD - VERSION 21112 *** *** C:\Lakes\AERMOD View\Projects\Maverik El Centro
\Maverik El Centro.is *** 12/08/23
*** AERMET - VERSION 16216 *** ***
*** 10:35:10

PAGE 9

*** MODELOPTs: RegDEFAULT CONC ELEV RURAL ADJ_U*

*** SOURCE IDs DEFINING SOURCE GROUPS ***

SRCGROUP ID

SOURCE IDs

ALL PAREA1 , PAREA2 , PAREA3 , PAREA4 , PAREA5 ,

*** AERMOD - VERSION 21112 *** *** C:\Lakes\AERMOD View\Projects\Maverik El Centro
\Maverik El Centro.is *** 12/08/23
*** AERMET - VERSION 16216 *** ***
*** 10:35:10

PAGE 10

*** MODELOPTs: RegDEFAULT CONC ELEV RURAL ADJ_U*

*** DISCRETE CARTESIAN RECEPTORS ***
(X-COORD, Y-COORD, ZELEV, ZHILL, ZFLAG)
(METERS)

(640477.2, 3628075.7,	-11.3,	-11.3,	0.0);	(640256.6,
3627956.3,	-11.3,	-11.3,	0.0);	
(640278.4, 3627913.0,	-11.3,	-11.3,	0.0);	(640299.1,
3627891.2,	-11.3,	-11.3,	0.0);	
(640300.3, 3627870.2,	-11.1,	-11.1,	0.0);	(640301.1,
3627857.0,	-11.0,	-11.0,	0.0);	

```

*** AERMOD - VERSION 21112 ***      *** C:\Lakes\AERMOD View\Projects\Maverik El Centro
\Maverik El Centro.is ***          12/08/23
*** AERMET - VERSION 16216 ***      ***
***                                  10:35:10

```

```

PAGE      11
*** MODELOPTs:      RegDFault  CONC  ELEV  RURAL  ADJ_U*

```

*** METEOROLOGICAL DAYS SELECTED FOR PROCESSING

(1=YES; 0=NO)

```

      1 1 1 1 1 1 1 1 1 1 1 1 1 1 1 1 1 1 1 1 1 1 1 1 1 1 1 1 1 1 1 1 1
1 1 1   1 1 1 1 1 1 1 1 1 1 1 1 1 1 1 1 1 1 1 1 1 1 1 1 1 1 1 1 1 1 1 1
      1 1 1 1 1 1 1 1 1 1 1 1 1 1 1 1 1 1 1 1 1 1 1 1 1 1 1 1 1 1 1 1 1
1 1 1   1 1 1 1 1 1 1 1 1 1 1 1 1 1 1 1 1 1 1 1 1 1 1 1 1 1 1 1 1 1 1 1
      1 1 1 1 1 1 1 1 1 1 1 1 1 1 1 1 1 1 1 1 1 1 1 1 1 1 1 1 1 1 1 1 1
1 1 1   1 1 1 1 1 1 1 1 1 1 1 1 1 1 1 1 1 1 1 1 1 1 1 1 1 1 1 1 1 1 1 1
      1 1 1 1 1 1 1 1 1 1 1 1 1 1 1 1 1 1 1 1 1 1 1 1 1 1 1 1 1 1 1 1 1
1 1 1   1 1 1 1 1 1 1 1 1 1 1 1 1 1 1 1 1 1 1 1 1 1 1 1 1 1 1 1 1 1 1 1
      1 1 1 1 1 1 1 1 1 1 1 1 1 1 1 1 1 1 1 1 1 1 1 1 1 1 1 1 1 1 1 1 1
1 1 1   1 1 1 1 1 1 1 1 1 1 1 1 1 1 1 1 1 1 1 1 1 1 1 1 1 1 1 1 1 1 1 1
      1 1 1 1 1 1 1 1 1 1 1 1 1 1 1 1 1 1 1 1 1 1 1 1 1 1 1 1 1 1 1 1 1
1 1 1   1 1 1 1 1 1 1 1 1 1 1 1 1 1 1 1 1 1 1 1 1 1 1 1 1 1 1 1 1 1 1 1

```

NOTE: METEOROLOGICAL DATA ACTUALLY PROCESSED WILL ALSO DEPEND ON WHAT IS INCLUDED IN THE DATA FILE.

*** UPPER BOUND OF FIRST THROUGH FIFTH WIND SPEED

CATEGORIES ***

(METERS/SEC)

1.54, 3.09, 5.14, 8.23, 10.80,

*** AERMOD - VERSION 21112 *** *** C:\Lakes\AERMOD View\Projects\Maverik El Centro
 \Maverik El Centro.is *** 12/08/23
 *** AERMET - VERSION 16216 *** ***
 *** 10:35:10

PAGE 6

*** MODELOPTs: RegDEFAULT CONC ELEV RURAL ADJ_U*

*** UP TO THE FIRST 24 HOURS OF METEOROLOGICAL DATA ***

Surface file: DesertHotSpringsAirportADJU\KTRM_V9_ADJU\KTRM_v9.SFC
 Met Version: 16216
 Profile file: DesertHotSpringsAirportADJU\KTRM_V9_ADJU\KTRM_v9.PFL
 Surface format: FREE
 Profile format: FREE
 Surface station no.: 3104 Upper air station no.: 3190
 Name: UNKNOWN Name: UNKNOWN
 Year: 2012 Year: 2012

First 24 hours of scalar data

YR	MO	DY	JDY	HR	H0	U*	W*	DT/DZ	ZICNV	ZIMCH	M-O	LEN	Z0	BOWEN	ALBEDO	REF
WS	WD	HT	REF	TA	HT											
12	01	01	1	01	-7.8	0.118	-9.000	-9.000	-999.	98.		19.4	0.08	1.91	1.00	
1.59	77.			10.1	278.8	2.0										
12	01	01	1	02	-15.8	0.171	-9.000	-9.000	-999.	169.		32.1	0.08	1.91	1.00	
2.23	288.			10.1	277.5	2.0										
12	01	01	1	03	-16.9	0.177	-9.000	-9.000	-999.	178.		34.3	0.08	1.91	1.00	
2.30	325.			10.1	278.8	2.0										
12	01	01	1	04	-3.0	0.076	-9.000	-9.000	-999.	56.		13.4	0.08	1.91	1.00	
0.94	321.			10.1	275.4	2.0										
12	01	01	1	05	-4.7	0.092	-9.000	-9.000	-999.	67.		15.0	0.08	1.91	1.00	
1.23	342.			10.1	274.2	2.0										
12	01	01	1	06	-10.7	0.139	-9.000	-9.000	-999.	124.		22.8	0.08	1.91	1.00	
1.84	309.			10.1	274.9	2.0										
12	01	01	1	07	-18.8	0.186	-9.000	-9.000	-999.	193.		38.2	0.08	1.91	1.00	

2.42	338.	10.1	277.0	2.0									
12 01 01	1 08	-11.5	0.179	-9.000	-9.000	-999.	182.	45.7	0.08	1.91	0.49		
2.30	343.	10.1	282.5	2.0									
12 01 01	1 09	44.9	0.190	0.372	0.007	42.	198.	-13.9	0.08	1.91	0.30		
1.86	334.	10.1	288.8	2.0									
12 01 01	1 10	109.3	0.237	0.720	0.006	125.	278.	-11.2	0.08	1.91	0.23		
2.27	333.	10.1	293.8	2.0									
12 01 01	1 11	153.1	0.246	1.122	0.005	338.	293.	-8.9	0.08	1.91	0.21		
2.28	348.	10.1	297.0	2.0									
12 01 01	1 12	173.2	0.204	1.424	0.005	612.	222.	-4.5	0.08	1.91	0.20		
1.72	322.	10.1	298.8	2.0									
12 01 01	1 13	169.9	0.156	1.670	0.005	1005.	148.	-2.0	0.08	1.91	0.20		
1.14	351.	10.1	300.4	2.0									
12 01 01	1 14	142.4	0.144	1.714	0.005	1296.	131.	-1.9	0.08	1.91	0.22		
1.04	329.	10.1	300.9	2.0									
12 01 01	1 15	92.8	0.142	1.542	0.005	1447.	129.	-2.8	0.08	1.91	0.25		
1.11	316.	10.1	301.4	2.0									
12 01 01	1 16	24.5	0.122	0.995	0.005	1469.	102.	-6.8	0.08	1.91	0.35		
1.09	301.	10.1	300.4	2.0									
12 01 01	1 17	-3.0	0.077	-9.000	-9.000	-999.	51.	13.7	0.08	1.91	0.65		
0.99	209.	10.1	292.0	2.0									
12 01 01	1 18	-11.9	0.149	-9.000	-9.000	-999.	138.	25.2	0.08	1.91	1.00		
1.96	149.	10.1	286.4	2.0									
12 01 01	1 19	-6.4	0.107	-9.000	-9.000	-999.	85.	17.7	0.08	1.91	1.00		
1.45	31.	10.1	284.9	2.0									
12 01 01	1 20	-15.7	0.171	-9.000	-9.000	-999.	169.	32.1	0.08	1.91	1.00		
2.23	327.	10.1	283.1	2.0									
12 01 01	1 21	-8.3	0.122	-9.000	-9.000	-999.	103.	20.2	0.08	1.91	1.00		
1.64	347.	10.1	282.0	2.0									
12 01 01	1 22	-7.9	0.119	-9.000	-9.000	-999.	99.	19.6	0.08	1.91	1.00		
1.60	316.	10.1	279.2	2.0									
12 01 01	1 23	-5.3	0.097	-9.000	-9.000	-999.	73.	15.9	0.08	1.91	1.00		
1.31	325.	10.1	278.1	2.0									
12 01 01	1 24	-9.4	0.130	-9.000	-9.000	-999.	113.	21.5	0.08	1.91	1.00		
1.74	304.	10.1	278.8	2.0									

First hour of profile data

YR	MO	DY	HR	HEIGHT	F	WDIR	WSPD	AMB_TMP	sigmaA	sigmaW	sigmaV
12	01	01	01	10.1	1	77.	1.59	278.8	99.0	-99.00	-99.00

F indicates top of profile (=1) or below (=0)

```

*** AERMOD - VERSION 21112 ***      *** C:\Lakes\AERMOD View\Projects\Maverik El Centro
\Maverik El Centro.is ***          12/08/23
*** AERMET - VERSION 16216 ***      ***
***          10:35:10

```

```

PAGE 16
*** MODELOPTs:      RegDFault  CONC  ELEV  RURAL  ADJ_U*

```

```

*** THE PERIOD ( 43848 HRS) AVERAGE CONCENTRATION  VALUES FOR
SOURCE GROUP: ALL      ***
                        INCLUDING SOURCE(S):      PAREA1      , PAREA2      ,
PAREA3      , PAREA4      , PAREA5      ,

```

*** DISCRETE CARTESIAN RECEPTOR POINTS ***

** CONC OF BENZENE IN MICROGRAMS/M**3

**

CONC	X-COORD (M)	Y-COORD (M)	CONC	X-COORD (M)	Y-COORD (M)
0.00249	640477.17	3628075.66	0.02248	640256.60	3627956.34
0.00290	640278.36	3627913.01	0.00262	640299.14	3627891.23
0.00274	640300.34	3627870.21	0.00278	640301.14	3627857.00

```

*** AERMOD - VERSION 21112 ***      *** C:\Lakes\AERMOD View\Projects\Maverik El Centro
\Maverik El Centro.is ***          12/08/23
*** AERMET - VERSION 16216 ***      ***
***          10:35:10

```

PAGE 17

*** MODELOPTs: RegDFault CONC ELEV RURAL ADJ_U*

```

*** THE 1ST HIGHEST 1-HR AVERAGE CONCENTRATION VALUES FOR
SOURCE GROUP: ALL ***
INCLUDING SOURCE(S): PAREA1 , PAREA2 ,
PAREA3 , PAREA4 , PAREA5 ,

```

*** DISCRETE CARTESIAN RECEPTOR POINTS ***

** CONC OF BENZENE IN MICROGRAMS/M**3

**

X-COORD (M) (M)	Y-COORD (M) (YYMMDDHH)	CONC	(YYMMDDHH)	X-COORD (M)	Y-COORD
640477.17	3628075.66	1.27102	(15092206)	640256.60	
3627956.34	0.84013 (14012621)				
640278.36	3627913.01	0.93048	(16122304)	640299.14	
3627891.23	0.95626 (12121507)				
640300.34	3627870.21	0.85417	(13112306)	640301.14	
3627857.00	0.81996 (13112306)				

*** AERMOD - VERSION 21112 *** *** C:\Lakes\AERMOD View\Projects\Maverik El Centro
 \Maverik El Centro.is *** 12/08/23
 *** AERMET - VERSION 16216 *** ***
 *** 10:35:10

PAGE 18
 *** MODELOPTs: RegDEFAULT CONC ELEV RURAL ADJ_U*

*** THE SUMMARY OF MAXIMUM PERIOD (43848 HRS)

RESULTS ***

** CONC OF BENZENE IN MICROGRAMS/M**3

**

NETWORK

GROUP ID	ZFLAG)	OF TYPE	GRID-ID	AVERAGE CONC	RECEPTOR (XR, YR, ZELEV, ZHILL,
ALL		1ST HIGHEST VALUE IS		0.02248 AT (640477.17,	
3628075.66,		-11.28, -11.28,		0.00) DC	
		2ND HIGHEST VALUE IS		0.00290 AT (640299.14,	
3627891.23,		-11.28, -11.28,		0.00) DC	
		3RD HIGHEST VALUE IS		0.00278 AT (640300.34,	
3627870.21,		-11.12, -11.12,		0.00) DC	
		4TH HIGHEST VALUE IS		0.00274 AT (640301.14,	
3627857.00,		-10.99, -10.99,		0.00) DC	
		5TH HIGHEST VALUE IS		0.00262 AT (640278.36,	
3627913.01,		-11.28, -11.28,		0.00) DC	
		6TH HIGHEST VALUE IS		0.00249 AT (640256.60,	
3627956.34,		-11.28, -11.28,		0.00) DC	
		7TH HIGHEST VALUE IS		0.00000 AT (0.00,	0.00, 0.00,
0.00,		0.00)			
		8TH HIGHEST VALUE IS		0.00000 AT (0.00,	0.00, 0.00,

0.00, 0.00)
9TH HIGHEST VALUE IS 0.00000 AT (0.00, 0.00, 0.00,
0.00, 0.00)
10TH HIGHEST VALUE IS 0.00000 AT (0.00, 0.00, 0.00,
0.00, 0.00)

*** RECEPTOR TYPES: GC = GRIDCART
GP = GRIDPOLR
DC = DISCCART
DP = DISCPOLR

```

*** AERMOD - VERSION 21112 ***      *** C:\Lakes\AERMOD View\Projects\Maverik El Centro
\Maverik El Centro.is ***          12/08/23
*** AERMET - VERSION 16216 ***      ***
***          10:35:10

```

PAGE 10

```

*** MODELOPTs:      RegDFault  CONC  ELEV  RURAL  ADJ_U*

```

*** THE SUMMARY OF HIGHEST 1-HR RESULTS ***

** CONC OF BENZENE IN MICROGRAMS/M**3

**

NETWORK	DATE
GROUP ID ZELEV, ZHILL, ZFLAG)	RECEPTOR (XR, YR,
AVERAGE CONC OF TYPE GRID-ID	(YYMMDDHH)
ALL HIGH 1ST HIGH VALUE IS	1.27102 ON 15092206: AT (640477.17,
3628075.66, -11.28, -11.28, 0.00) DC	

```

*** RECEPTOR TYPES:  GC = GRIDCART
                        GP = GRIDPOLR
                        DC = DISCCART
                        DP = DISCPOLR

```

```
*** AERMOD - VERSION 21112 ***      *** C:\Lakes\AERMOD View\Projects\Maverik El Centro
\Maverik El Centro.is ***          12/08/23
*** AERMET - VERSION 16216 ***      ***
***          10:35:10
```

PAGE 11

```
*** MODELOPTs:      RegDFault  CONC  ELEV  RURAL  ADJ_U*
```

```
*** Message Summary : AERMOD Model Execution ***
```

```
----- Summary of Total Messages -----
```

```
A Total of          0 Fatal Error Message(s)
A Total of          2 Warning Message(s)
A Total of        1124 Informational Message(s)

A Total of        43848 Hours Were Processed

A Total of          595 Calm Hours Identified

A Total of          529 Missing Hours Identified (  1.21 Percent)
```

```
***** FATAL ERROR MESSAGES *****
```

```
*** NONE ***
```

```
***** WARNING MESSAGES *****
```

```
ME W186      85      MEOPEN: THRESH_1MIN 1-min ASOS wind speed threshold used
0.50
```

```
ME W187      85      MEOPEN: ADJ_U* Option for Stable Low Winds used in AERMET
```

```
*****
```

```
*** AERMOD Finishes Successfully ***
```

```
*****
```

```

**
*****
**
** AERMOD Input Produced by:
** AERMOD View Ver. 10.0.1
** Lakes Environmental Software Inc.
** Date: 12/11/2023
** File: C:\Lakes\AERMOD View\Projects\Maverik El Centro - Ops DPM\Maverik El Centro - Ops
DPM.ADI
**
*****
**
**
*****
** AERMOD Control Pathway
*****
**
**
CO STARTING
  TITLEONE C:\Lakes\AERMOD View\Projects\Maverik El Centro\Maverik El Centro.is
  MODELOPT DFAULT CONC
  AVERTIME 1 PERIOD
  POLLUTID DPM
  RUNORNOT RUN
  ERRORFIL "Maverik El Centro - Ops DPM.err"
CO FINISHED
**
*****
** AERMOD Source Pathway
*****
**
**
SO STARTING
** Source Location **
** Source ID - Type - X Coord. - Y Coord. **
  LOCATION PAREAL      AREAPOLY      640454.056  3627996.875      -11.280
** DESCRSRC Idle1

```



```

LOCATION PAREA2          AREAPOLY   640507.431  3627996.535    -11.280
** DESCRSRC Idle2
LOCATION PAREA3          AREAPOLY   640524.089  3627973.417    -11.280
** DESCRSRC Idle 3
** -----
** Line Source Represented by Adjacent Volume Sources
** LINE VOLUME Source ID = SLINE1
** DESCRSRC Onsite Trucks
** PREFIX
** Length of Side = 3.66
** Configuration = Adjacent
** Emission Rate = 0.0000266
** Vertical Dimension = 3.66
** SZINIT = 1.70
** Nodes = 8
** 640462.152, 3628044.269, -11.28, 0.00, 1.70
** 640462.152, 3628009.443, -11.28, 0.00, 1.70
** 640442.998, 3628010.749, -11.28, 0.00, 1.70
** 640446.045, 3627925.426, -11.28, 0.00, 1.70
** 640571.419, 3627921.943, -11.28, 0.00, 1.70
** 640570.983, 3628009.008, -11.28, 0.00, 1.70
** 640520.051, 3628009.443, -11.28, 0.00, 1.70
** 640519.180, 3628043.399, -11.28, 0.00, 1.70
** -----
LOCATION L0000001        VOLUME   640462.152  3628042.440  -11.28
LOCATION L0000002        VOLUME   640462.152  3628038.783  -11.28
LOCATION L0000003        VOLUME   640462.152  3628035.125  -11.28
LOCATION L0000004        VOLUME   640462.152  3628031.468  -11.28
LOCATION L0000005        VOLUME   640462.152  3628027.810  -11.28
LOCATION L0000006        VOLUME   640462.152  3628024.152  -11.28
LOCATION L0000007        VOLUME   640462.152  3628020.495  -11.28
LOCATION L0000008        VOLUME   640462.152  3628016.837  -11.28
LOCATION L0000009        VOLUME   640462.152  3628013.180  -11.28
LOCATION L0000010        VOLUME   640462.152  3628009.522  -11.28
LOCATION L0000011        VOLUME   640458.582  3628009.687  -11.28
LOCATION L0000012        VOLUME   640454.933  3628009.935  -11.28
LOCATION L0000013        VOLUME   640451.284  3628010.184  -11.28

```

LOCATION	L0000014	VOLUME	640447.634	3628010.433	-11.28
LOCATION	L0000015	VOLUME	640443.985	3628010.682	-11.28
LOCATION	L0000016	VOLUME	640443.093	3628008.083	-11.28
LOCATION	L0000017	VOLUME	640443.224	3628004.428	-11.28
LOCATION	L0000018	VOLUME	640443.354	3628000.772	-11.28
LOCATION	L0000019	VOLUME	640443.485	3627997.117	-11.28
LOCATION	L0000020	VOLUME	640443.616	3627993.462	-11.28
LOCATION	L0000021	VOLUME	640443.746	3627989.806	-11.28
LOCATION	L0000022	VOLUME	640443.877	3627986.151	-11.28
LOCATION	L0000023	VOLUME	640444.007	3627982.496	-11.28
LOCATION	L0000024	VOLUME	640444.138	3627978.841	-11.28
LOCATION	L0000025	VOLUME	640444.268	3627975.185	-11.28
LOCATION	L0000026	VOLUME	640444.399	3627971.530	-11.28
LOCATION	L0000027	VOLUME	640444.529	3627967.875	-11.28
LOCATION	L0000028	VOLUME	640444.660	3627964.220	-11.28
LOCATION	L0000029	VOLUME	640444.790	3627960.564	-11.28
LOCATION	L0000030	VOLUME	640444.921	3627956.909	-11.28
LOCATION	L0000031	VOLUME	640445.052	3627953.254	-11.28
LOCATION	L0000032	VOLUME	640445.182	3627949.598	-11.28
LOCATION	L0000033	VOLUME	640445.313	3627945.943	-11.28
LOCATION	L0000034	VOLUME	640445.443	3627942.288	-11.28
LOCATION	L0000035	VOLUME	640445.574	3627938.633	-11.28
LOCATION	L0000036	VOLUME	640445.704	3627934.977	-11.28
LOCATION	L0000037	VOLUME	640445.835	3627931.322	-11.28
LOCATION	L0000038	VOLUME	640445.965	3627927.667	-11.28
LOCATION	L0000039	VOLUME	640447.460	3627925.386	-11.28
LOCATION	L0000040	VOLUME	640451.116	3627925.285	-11.28
LOCATION	L0000041	VOLUME	640454.772	3627925.183	-11.28
LOCATION	L0000042	VOLUME	640458.428	3627925.082	-11.28
LOCATION	L0000043	VOLUME	640462.085	3627924.980	-11.28
LOCATION	L0000044	VOLUME	640465.741	3627924.879	-11.28
LOCATION	L0000045	VOLUME	640469.397	3627924.777	-11.28
LOCATION	L0000046	VOLUME	640473.053	3627924.675	-11.28
LOCATION	L0000047	VOLUME	640476.709	3627924.574	-11.28
LOCATION	L0000048	VOLUME	640480.365	3627924.472	-11.28
LOCATION	L0000049	VOLUME	640484.022	3627924.371	-11.28
LOCATION	L0000050	VOLUME	640487.678	3627924.269	-11.28

LOCATION	L0000051	VOLUME	640491.334	3627924.168	-11.28
LOCATION	L0000052	VOLUME	640494.990	3627924.066	-11.28
LOCATION	L0000053	VOLUME	640498.646	3627923.965	-11.28
LOCATION	L0000054	VOLUME	640502.303	3627923.863	-11.28
LOCATION	L0000055	VOLUME	640505.959	3627923.761	-11.28
LOCATION	L0000056	VOLUME	640509.615	3627923.660	-11.28
LOCATION	L0000057	VOLUME	640513.271	3627923.558	-11.28
LOCATION	L0000058	VOLUME	640516.927	3627923.457	-11.28
LOCATION	L0000059	VOLUME	640520.584	3627923.355	-11.28
LOCATION	L0000060	VOLUME	640524.240	3627923.254	-11.28
LOCATION	L0000061	VOLUME	640527.896	3627923.152	-11.28
LOCATION	L0000062	VOLUME	640531.552	3627923.050	-11.28
LOCATION	L0000063	VOLUME	640535.208	3627922.949	-11.28
LOCATION	L0000064	VOLUME	640538.865	3627922.847	-11.28
LOCATION	L0000065	VOLUME	640542.521	3627922.746	-11.28
LOCATION	L0000066	VOLUME	640546.177	3627922.644	-11.28
LOCATION	L0000067	VOLUME	640549.833	3627922.543	-11.28
LOCATION	L0000068	VOLUME	640553.489	3627922.441	-11.28
LOCATION	L0000069	VOLUME	640557.145	3627922.340	-11.28
LOCATION	L0000070	VOLUME	640560.802	3627922.238	-11.28
LOCATION	L0000071	VOLUME	640564.458	3627922.136	-11.28
LOCATION	L0000072	VOLUME	640568.114	3627922.035	-11.28
LOCATION	L0000073	VOLUME	640571.417	3627922.295	-11.28
LOCATION	L0000074	VOLUME	640571.399	3627925.952	-11.28
LOCATION	L0000075	VOLUME	640571.380	3627929.610	-11.28
LOCATION	L0000076	VOLUME	640571.362	3627933.267	-11.28
LOCATION	L0000077	VOLUME	640571.344	3627936.925	-11.28
LOCATION	L0000078	VOLUME	640571.326	3627940.582	-11.28
LOCATION	L0000079	VOLUME	640571.307	3627944.240	-11.28
LOCATION	L0000080	VOLUME	640571.289	3627947.897	-11.28
LOCATION	L0000081	VOLUME	640571.271	3627951.555	-11.28
LOCATION	L0000082	VOLUME	640571.252	3627955.213	-11.28
LOCATION	L0000083	VOLUME	640571.234	3627958.870	-11.28
LOCATION	L0000084	VOLUME	640571.216	3627962.528	-11.28
LOCATION	L0000085	VOLUME	640571.198	3627966.185	-11.28
LOCATION	L0000086	VOLUME	640571.179	3627969.843	-11.28
LOCATION	L0000087	VOLUME	640571.161	3627973.500	-11.28

LOCATION	L0000088	VOLUME	640571.143	3627977.158	-11.28
LOCATION	L0000089	VOLUME	640571.124	3627980.815	-11.28
LOCATION	L0000090	VOLUME	640571.106	3627984.473	-11.28
LOCATION	L0000091	VOLUME	640571.088	3627988.131	-11.28
LOCATION	L0000092	VOLUME	640571.070	3627991.788	-11.28
LOCATION	L0000093	VOLUME	640571.051	3627995.446	-11.28
LOCATION	L0000094	VOLUME	640571.033	3627999.103	-11.28
LOCATION	L0000095	VOLUME	640571.015	3628002.761	-11.28
LOCATION	L0000096	VOLUME	640570.996	3628006.418	-11.28
LOCATION	L0000097	VOLUME	640569.916	3628009.017	-11.28
LOCATION	L0000098	VOLUME	640566.258	3628009.048	-11.28
LOCATION	L0000099	VOLUME	640562.601	3628009.080	-11.28
LOCATION	L0000100	VOLUME	640558.943	3628009.111	-11.28
LOCATION	L0000101	VOLUME	640555.286	3628009.142	-11.28
LOCATION	L0000102	VOLUME	640551.628	3628009.173	-11.28
LOCATION	L0000103	VOLUME	640547.971	3628009.205	-11.28
LOCATION	L0000104	VOLUME	640544.313	3628009.236	-11.28
LOCATION	L0000105	VOLUME	640540.656	3628009.267	-11.28
LOCATION	L0000106	VOLUME	640536.998	3628009.298	-11.28
LOCATION	L0000107	VOLUME	640533.341	3628009.330	-11.28
LOCATION	L0000108	VOLUME	640529.683	3628009.361	-11.28
LOCATION	L0000109	VOLUME	640526.026	3628009.392	-11.28
LOCATION	L0000110	VOLUME	640522.368	3628009.423	-11.28
LOCATION	L0000111	VOLUME	640520.016	3628010.782	-11.28
LOCATION	L0000112	VOLUME	640519.922	3628014.439	-11.28
LOCATION	L0000113	VOLUME	640519.829	3628018.095	-11.28
LOCATION	L0000114	VOLUME	640519.735	3628021.752	-11.28
LOCATION	L0000115	VOLUME	640519.641	3628025.408	-11.28
LOCATION	L0000116	VOLUME	640519.547	3628029.064	-11.28
LOCATION	L0000117	VOLUME	640519.454	3628032.721	-11.28
LOCATION	L0000118	VOLUME	640519.360	3628036.377	-11.28
LOCATION	L0000119	VOLUME	640519.266	3628040.034	-11.28

** End of LINE VOLUME Source ID = SLINE1

**

** Line Source Represented by Adjacent Volume Sources

** LINE VOLUME Source ID = SLINE2

** DESCRSRC Offsite Trucks

```

** PREFIX
** Length of Side = 3.66
** Configuration = Adjacent
** Emission Rate = 0.0000251
** Vertical Dimension = 3.66
** SZINIT = 1.70
** Nodes = 3
** 640520.486, 3628050.799, -11.28, 0.00, 1.70
** 640332.426, 3628051.670, -11.28, 0.00, 1.70
** 640352.926, 3627588.790, -10.97, 0.00, 1.70
** -----
LOCATION L0001752      VOLUME  640518.657 3628050.808 -11.28
LOCATION L0001753      VOLUME  640515.000 3628050.824 -11.28
LOCATION L0001754      VOLUME  640511.342 3628050.841 -11.28
LOCATION L0001755      VOLUME  640507.684 3628050.858 -11.28
LOCATION L0001756      VOLUME  640504.027 3628050.875 -11.28
LOCATION L0001757      VOLUME  640500.369 3628050.892 -11.28
LOCATION L0001758      VOLUME  640496.712 3628050.909 -11.28
LOCATION L0001759      VOLUME  640493.054 3628050.926 -11.28
LOCATION L0001760      VOLUME  640489.397 3628050.943 -11.28
LOCATION L0001761      VOLUME  640485.739 3628050.960 -11.28
LOCATION L0001762      VOLUME  640482.081 3628050.977 -11.28
LOCATION L0001763      VOLUME  640478.424 3628050.994 -11.28
LOCATION L0001764      VOLUME  640474.766 3628051.011 -11.28
LOCATION L0001765      VOLUME  640471.109 3628051.028 -11.28
LOCATION L0001766      VOLUME  640467.451 3628051.045 -11.28
LOCATION L0001767      VOLUME  640463.794 3628051.062 -11.28
LOCATION L0001768      VOLUME  640460.136 3628051.078 -11.28
LOCATION L0001769      VOLUME  640456.479 3628051.095 -11.28
LOCATION L0001770      VOLUME  640452.821 3628051.112 -11.28
LOCATION L0001771      VOLUME  640449.163 3628051.129 -11.28
LOCATION L0001772      VOLUME  640445.506 3628051.146 -11.28
LOCATION L0001773      VOLUME  640441.848 3628051.163 -11.28
LOCATION L0001774      VOLUME  640438.191 3628051.180 -11.28
LOCATION L0001775      VOLUME  640434.533 3628051.197 -11.28
LOCATION L0001776      VOLUME  640430.876 3628051.214 -11.28
LOCATION L0001777      VOLUME  640427.218 3628051.231 -11.28

```

LOCATION	L0001778	VOLUME	640423.560	3628051.248	-11.28
LOCATION	L0001779	VOLUME	640419.903	3628051.265	-11.28
LOCATION	L0001780	VOLUME	640416.245	3628051.282	-11.28
LOCATION	L0001781	VOLUME	640412.588	3628051.299	-11.28
LOCATION	L0001782	VOLUME	640408.930	3628051.316	-11.28
LOCATION	L0001783	VOLUME	640405.273	3628051.332	-11.28
LOCATION	L0001784	VOLUME	640401.615	3628051.349	-11.28
LOCATION	L0001785	VOLUME	640397.958	3628051.366	-11.28
LOCATION	L0001786	VOLUME	640394.300	3628051.383	-11.28
LOCATION	L0001787	VOLUME	640390.642	3628051.400	-11.28
LOCATION	L0001788	VOLUME	640386.985	3628051.417	-11.28
LOCATION	L0001789	VOLUME	640383.327	3628051.434	-11.28
LOCATION	L0001790	VOLUME	640379.670	3628051.451	-11.28
LOCATION	L0001791	VOLUME	640376.012	3628051.468	-11.28
LOCATION	L0001792	VOLUME	640372.355	3628051.485	-11.28
LOCATION	L0001793	VOLUME	640368.697	3628051.502	-11.28
LOCATION	L0001794	VOLUME	640365.040	3628051.519	-11.28
LOCATION	L0001795	VOLUME	640361.382	3628051.536	-11.28
LOCATION	L0001796	VOLUME	640357.724	3628051.553	-11.28
LOCATION	L0001797	VOLUME	640354.067	3628051.570	-11.28
LOCATION	L0001798	VOLUME	640350.409	3628051.586	-11.28
LOCATION	L0001799	VOLUME	640346.752	3628051.603	-11.28
LOCATION	L0001800	VOLUME	640343.094	3628051.620	-11.28
LOCATION	L0001801	VOLUME	640339.437	3628051.637	-11.28
LOCATION	L0001802	VOLUME	640335.779	3628051.654	-11.28
LOCATION	L0001803	VOLUME	640332.439	3628051.366	-11.28
LOCATION	L0001804	VOLUME	640332.601	3628047.712	-11.28
LOCATION	L0001805	VOLUME	640332.763	3628044.058	-11.28
LOCATION	L0001806	VOLUME	640332.925	3628040.404	-11.28
LOCATION	L0001807	VOLUME	640333.087	3628036.750	-11.28
LOCATION	L0001808	VOLUME	640333.248	3628033.096	-11.28
LOCATION	L0001809	VOLUME	640333.410	3628029.442	-11.28
LOCATION	L0001810	VOLUME	640333.572	3628025.788	-11.28
LOCATION	L0001811	VOLUME	640333.734	3628022.134	-11.28
LOCATION	L0001812	VOLUME	640333.896	3628018.480	-11.28
LOCATION	L0001813	VOLUME	640334.058	3628014.826	-11.28
LOCATION	L0001814	VOLUME	640334.219	3628011.172	-11.28

LOCATION	L0001815	VOLUME	640334.381	3628007.518	-11.28
LOCATION	L0001816	VOLUME	640334.543	3628003.864	-11.28
LOCATION	L0001817	VOLUME	640334.705	3628000.210	-11.28
LOCATION	L0001818	VOLUME	640334.867	3627996.555	-11.28
LOCATION	L0001819	VOLUME	640335.029	3627992.901	-11.28
LOCATION	L0001820	VOLUME	640335.190	3627989.247	-11.28
LOCATION	L0001821	VOLUME	640335.352	3627985.593	-11.28
LOCATION	L0001822	VOLUME	640335.514	3627981.939	-11.28
LOCATION	L0001823	VOLUME	640335.676	3627978.285	-11.28
LOCATION	L0001824	VOLUME	640335.838	3627974.631	-11.28
LOCATION	L0001825	VOLUME	640336.000	3627970.977	-11.28
LOCATION	L0001826	VOLUME	640336.161	3627967.323	-11.28
LOCATION	L0001827	VOLUME	640336.323	3627963.669	-11.28
LOCATION	L0001828	VOLUME	640336.485	3627960.015	-11.28
LOCATION	L0001829	VOLUME	640336.647	3627956.361	-11.28
LOCATION	L0001830	VOLUME	640336.809	3627952.707	-11.28
LOCATION	L0001831	VOLUME	640336.971	3627949.053	-11.28
LOCATION	L0001832	VOLUME	640337.132	3627945.399	-11.28
LOCATION	L0001833	VOLUME	640337.294	3627941.745	-11.28
LOCATION	L0001834	VOLUME	640337.456	3627938.091	-11.28
LOCATION	L0001835	VOLUME	640337.618	3627934.437	-11.28
LOCATION	L0001836	VOLUME	640337.780	3627930.783	-11.28
LOCATION	L0001837	VOLUME	640337.942	3627927.129	-11.28
LOCATION	L0001838	VOLUME	640338.103	3627923.475	-11.28
LOCATION	L0001839	VOLUME	640338.265	3627919.821	-11.28
LOCATION	L0001840	VOLUME	640338.427	3627916.167	-11.28
LOCATION	L0001841	VOLUME	640338.589	3627912.513	-11.27
LOCATION	L0001842	VOLUME	640338.751	3627908.859	-11.26
LOCATION	L0001843	VOLUME	640338.913	3627905.205	-11.24
LOCATION	L0001844	VOLUME	640339.074	3627901.551	-11.23
LOCATION	L0001845	VOLUME	640339.236	3627897.897	-11.22
LOCATION	L0001846	VOLUME	640339.398	3627894.243	-11.21
LOCATION	L0001847	VOLUME	640339.560	3627890.589	-11.19
LOCATION	L0001848	VOLUME	640339.722	3627886.935	-11.18
LOCATION	L0001849	VOLUME	640339.884	3627883.281	-11.16
LOCATION	L0001850	VOLUME	640340.045	3627879.627	-11.15
LOCATION	L0001851	VOLUME	640340.207	3627875.973	-11.14

LOCATION	L0001852	VOLUME	640340.369	3627872.319	-11.13
LOCATION	L0001853	VOLUME	640340.531	3627868.665	-11.12
LOCATION	L0001854	VOLUME	640340.693	3627865.011	-11.11
LOCATION	L0001855	VOLUME	640340.855	3627861.357	-11.10
LOCATION	L0001856	VOLUME	640341.016	3627857.703	-11.10
LOCATION	L0001857	VOLUME	640341.178	3627854.049	-11.10
LOCATION	L0001858	VOLUME	640341.340	3627850.395	-11.12
LOCATION	L0001859	VOLUME	640341.502	3627846.741	-11.15
LOCATION	L0001860	VOLUME	640341.664	3627843.087	-11.17
LOCATION	L0001861	VOLUME	640341.826	3627839.433	-11.19
LOCATION	L0001862	VOLUME	640341.987	3627835.779	-11.22
LOCATION	L0001863	VOLUME	640342.149	3627832.125	-11.24
LOCATION	L0001864	VOLUME	640342.311	3627828.471	-11.26
LOCATION	L0001865	VOLUME	640342.473	3627824.817	-11.28
LOCATION	L0001866	VOLUME	640342.635	3627821.163	-11.28
LOCATION	L0001867	VOLUME	640342.797	3627817.509	-11.28
LOCATION	L0001868	VOLUME	640342.958	3627813.855	-11.28
LOCATION	L0001869	VOLUME	640343.120	3627810.201	-11.28
LOCATION	L0001870	VOLUME	640343.282	3627806.547	-11.28
LOCATION	L0001871	VOLUME	640343.444	3627802.893	-11.28
LOCATION	L0001872	VOLUME	640343.606	3627799.239	-11.28
LOCATION	L0001873	VOLUME	640343.768	3627795.584	-11.28
LOCATION	L0001874	VOLUME	640343.929	3627791.930	-11.28
LOCATION	L0001875	VOLUME	640344.091	3627788.276	-11.28
LOCATION	L0001876	VOLUME	640344.253	3627784.622	-11.28
LOCATION	L0001877	VOLUME	640344.415	3627780.968	-11.28
LOCATION	L0001878	VOLUME	640344.577	3627777.314	-11.28
LOCATION	L0001879	VOLUME	640344.739	3627773.660	-11.28
LOCATION	L0001880	VOLUME	640344.900	3627770.006	-11.28
LOCATION	L0001881	VOLUME	640345.062	3627766.352	-11.28
LOCATION	L0001882	VOLUME	640345.224	3627762.698	-11.28
LOCATION	L0001883	VOLUME	640345.386	3627759.044	-11.28
LOCATION	L0001884	VOLUME	640345.548	3627755.390	-11.28
LOCATION	L0001885	VOLUME	640345.710	3627751.736	-11.28
LOCATION	L0001886	VOLUME	640345.871	3627748.082	-11.28
LOCATION	L0001887	VOLUME	640346.033	3627744.428	-11.28
LOCATION	L0001888	VOLUME	640346.195	3627740.774	-11.28

LOCATION	L0001889	VOLUME	640346.357	3627737.120	-11.28
LOCATION	L0001890	VOLUME	640346.519	3627733.466	-11.26
LOCATION	L0001891	VOLUME	640346.681	3627729.812	-11.22
LOCATION	L0001892	VOLUME	640346.842	3627726.158	-11.18
LOCATION	L0001893	VOLUME	640347.004	3627722.504	-11.15
LOCATION	L0001894	VOLUME	640347.166	3627718.850	-11.11
LOCATION	L0001895	VOLUME	640347.328	3627715.196	-11.07
LOCATION	L0001896	VOLUME	640347.490	3627711.542	-11.04
LOCATION	L0001897	VOLUME	640347.652	3627707.888	-11.00
LOCATION	L0001898	VOLUME	640347.813	3627704.234	-10.97
LOCATION	L0001899	VOLUME	640347.975	3627700.580	-10.97
LOCATION	L0001900	VOLUME	640348.137	3627696.926	-10.97
LOCATION	L0001901	VOLUME	640348.299	3627693.272	-10.97
LOCATION	L0001902	VOLUME	640348.461	3627689.618	-10.97
LOCATION	L0001903	VOLUME	640348.622	3627685.964	-10.97
LOCATION	L0001904	VOLUME	640348.784	3627682.310	-10.97
LOCATION	L0001905	VOLUME	640348.946	3627678.656	-10.97
LOCATION	L0001906	VOLUME	640349.108	3627675.002	-10.97
LOCATION	L0001907	VOLUME	640349.270	3627671.348	-10.97
LOCATION	L0001908	VOLUME	640349.432	3627667.694	-10.97
LOCATION	L0001909	VOLUME	640349.593	3627664.040	-10.97
LOCATION	L0001910	VOLUME	640349.755	3627660.386	-10.97
LOCATION	L0001911	VOLUME	640349.917	3627656.732	-10.97
LOCATION	L0001912	VOLUME	640350.079	3627653.078	-10.97
LOCATION	L0001913	VOLUME	640350.241	3627649.424	-10.97
LOCATION	L0001914	VOLUME	640350.403	3627645.770	-10.97
LOCATION	L0001915	VOLUME	640350.564	3627642.116	-10.97
LOCATION	L0001916	VOLUME	640350.726	3627638.462	-10.97
LOCATION	L0001917	VOLUME	640350.888	3627634.808	-10.97
LOCATION	L0001918	VOLUME	640351.050	3627631.154	-10.97
LOCATION	L0001919	VOLUME	640351.212	3627627.500	-10.97
LOCATION	L0001920	VOLUME	640351.374	3627623.846	-10.97
LOCATION	L0001921	VOLUME	640351.535	3627620.192	-10.97
LOCATION	L0001922	VOLUME	640351.697	3627616.538	-10.97
LOCATION	L0001923	VOLUME	640351.859	3627612.884	-10.97
LOCATION	L0001924	VOLUME	640352.021	3627609.230	-10.97
LOCATION	L0001925	VOLUME	640352.183	3627605.576	-10.97

LOCATION	L0001926	VOLUME	640352.345	3627601.922	-10.97
LOCATION	L0001927	VOLUME	640352.506	3627598.268	-10.97
LOCATION	L0001928	VOLUME	640352.668	3627594.614	-10.97
LOCATION	L0001929	VOLUME	640352.830	3627590.959	-10.97

** End of LINE VOLUME Source ID = SLINE2

** Source Parameters **

SRCPARAM	PAREA1	1.0226E-09	1.000	4	
AREAVERT	PAREA1	640454.056	3627996.875	640462.555	3627996.875
AREAVERT	PAREA1	640462.895	3627931.601	640453.716	3627931.601
SRCPARAM	PAREA2	1.1251E-09	1.000	4	
AREAVERT	PAREA2	640507.431	3627996.535	640517.290	3627996.195
AREAVERT	PAREA2	640517.630	3627942.820	640507.771	3627943.499
SRCPARAM	PAREA3	1.2842E-09	1.000	4	
AREAVERT	PAREA3	640524.089	3627973.417	640556.386	3627974.097
AREAVERT	PAREA3	640556.386	3627959.818	640522.729	3627959.818

** LINE VOLUME Source ID = SLINE1

SRCPARAM	L0000001	0.0000002235	0.00	1.70	1.70
SRCPARAM	L0000002	0.0000002235	0.00	1.70	1.70
SRCPARAM	L0000003	0.0000002235	0.00	1.70	1.70
SRCPARAM	L0000004	0.0000002235	0.00	1.70	1.70
SRCPARAM	L0000005	0.0000002235	0.00	1.70	1.70
SRCPARAM	L0000006	0.0000002235	0.00	1.70	1.70
SRCPARAM	L0000007	0.0000002235	0.00	1.70	1.70
SRCPARAM	L0000008	0.0000002235	0.00	1.70	1.70
SRCPARAM	L0000009	0.0000002235	0.00	1.70	1.70
SRCPARAM	L0000010	0.0000002235	0.00	1.70	1.70
SRCPARAM	L0000011	0.0000002235	0.00	1.70	1.70
SRCPARAM	L0000012	0.0000002235	0.00	1.70	1.70
SRCPARAM	L0000013	0.0000002235	0.00	1.70	1.70
SRCPARAM	L0000014	0.0000002235	0.00	1.70	1.70
SRCPARAM	L0000015	0.0000002235	0.00	1.70	1.70
SRCPARAM	L0000016	0.0000002235	0.00	1.70	1.70
SRCPARAM	L0000017	0.0000002235	0.00	1.70	1.70
SRCPARAM	L0000018	0.0000002235	0.00	1.70	1.70
SRCPARAM	L0000019	0.0000002235	0.00	1.70	1.70
SRCPARAM	L0000020	0.0000002235	0.00	1.70	1.70
SRCPARAM	L0000021	0.0000002235	0.00	1.70	1.70

SRCPARAM	L0000022	0.0000002235	0.00	1.70	1.70
SRCPARAM	L0000023	0.0000002235	0.00	1.70	1.70
SRCPARAM	L0000024	0.0000002235	0.00	1.70	1.70
SRCPARAM	L0000025	0.0000002235	0.00	1.70	1.70
SRCPARAM	L0000026	0.0000002235	0.00	1.70	1.70
SRCPARAM	L0000027	0.0000002235	0.00	1.70	1.70
SRCPARAM	L0000028	0.0000002235	0.00	1.70	1.70
SRCPARAM	L0000029	0.0000002235	0.00	1.70	1.70
SRCPARAM	L0000030	0.0000002235	0.00	1.70	1.70
SRCPARAM	L0000031	0.0000002235	0.00	1.70	1.70
SRCPARAM	L0000032	0.0000002235	0.00	1.70	1.70
SRCPARAM	L0000033	0.0000002235	0.00	1.70	1.70
SRCPARAM	L0000034	0.0000002235	0.00	1.70	1.70
SRCPARAM	L0000035	0.0000002235	0.00	1.70	1.70
SRCPARAM	L0000036	0.0000002235	0.00	1.70	1.70
SRCPARAM	L0000037	0.0000002235	0.00	1.70	1.70
SRCPARAM	L0000038	0.0000002235	0.00	1.70	1.70
SRCPARAM	L0000039	0.0000002235	0.00	1.70	1.70
SRCPARAM	L0000040	0.0000002235	0.00	1.70	1.70
SRCPARAM	L0000041	0.0000002235	0.00	1.70	1.70
SRCPARAM	L0000042	0.0000002235	0.00	1.70	1.70
SRCPARAM	L0000043	0.0000002235	0.00	1.70	1.70
SRCPARAM	L0000044	0.0000002235	0.00	1.70	1.70
SRCPARAM	L0000045	0.0000002235	0.00	1.70	1.70
SRCPARAM	L0000046	0.0000002235	0.00	1.70	1.70
SRCPARAM	L0000047	0.0000002235	0.00	1.70	1.70
SRCPARAM	L0000048	0.0000002235	0.00	1.70	1.70
SRCPARAM	L0000049	0.0000002235	0.00	1.70	1.70
SRCPARAM	L0000050	0.0000002235	0.00	1.70	1.70
SRCPARAM	L0000051	0.0000002235	0.00	1.70	1.70
SRCPARAM	L0000052	0.0000002235	0.00	1.70	1.70
SRCPARAM	L0000053	0.0000002235	0.00	1.70	1.70
SRCPARAM	L0000054	0.0000002235	0.00	1.70	1.70
SRCPARAM	L0000055	0.0000002235	0.00	1.70	1.70
SRCPARAM	L0000056	0.0000002235	0.00	1.70	1.70
SRCPARAM	L0000057	0.0000002235	0.00	1.70	1.70
SRCPARAM	L0000058	0.0000002235	0.00	1.70	1.70

SRCPARAM	L0000059	0.0000002235	0.00	1.70	1.70
SRCPARAM	L0000060	0.0000002235	0.00	1.70	1.70
SRCPARAM	L0000061	0.0000002235	0.00	1.70	1.70
SRCPARAM	L0000062	0.0000002235	0.00	1.70	1.70
SRCPARAM	L0000063	0.0000002235	0.00	1.70	1.70
SRCPARAM	L0000064	0.0000002235	0.00	1.70	1.70
SRCPARAM	L0000065	0.0000002235	0.00	1.70	1.70
SRCPARAM	L0000066	0.0000002235	0.00	1.70	1.70
SRCPARAM	L0000067	0.0000002235	0.00	1.70	1.70
SRCPARAM	L0000068	0.0000002235	0.00	1.70	1.70
SRCPARAM	L0000069	0.0000002235	0.00	1.70	1.70
SRCPARAM	L0000070	0.0000002235	0.00	1.70	1.70
SRCPARAM	L0000071	0.0000002235	0.00	1.70	1.70
SRCPARAM	L0000072	0.0000002235	0.00	1.70	1.70
SRCPARAM	L0000073	0.0000002235	0.00	1.70	1.70
SRCPARAM	L0000074	0.0000002235	0.00	1.70	1.70
SRCPARAM	L0000075	0.0000002235	0.00	1.70	1.70
SRCPARAM	L0000076	0.0000002235	0.00	1.70	1.70
SRCPARAM	L0000077	0.0000002235	0.00	1.70	1.70
SRCPARAM	L0000078	0.0000002235	0.00	1.70	1.70
SRCPARAM	L0000079	0.0000002235	0.00	1.70	1.70
SRCPARAM	L0000080	0.0000002235	0.00	1.70	1.70
SRCPARAM	L0000081	0.0000002235	0.00	1.70	1.70
SRCPARAM	L0000082	0.0000002235	0.00	1.70	1.70
SRCPARAM	L0000083	0.0000002235	0.00	1.70	1.70
SRCPARAM	L0000084	0.0000002235	0.00	1.70	1.70
SRCPARAM	L0000085	0.0000002235	0.00	1.70	1.70
SRCPARAM	L0000086	0.0000002235	0.00	1.70	1.70
SRCPARAM	L0000087	0.0000002235	0.00	1.70	1.70
SRCPARAM	L0000088	0.0000002235	0.00	1.70	1.70
SRCPARAM	L0000089	0.0000002235	0.00	1.70	1.70
SRCPARAM	L0000090	0.0000002235	0.00	1.70	1.70
SRCPARAM	L0000091	0.0000002235	0.00	1.70	1.70
SRCPARAM	L0000092	0.0000002235	0.00	1.70	1.70
SRCPARAM	L0000093	0.0000002235	0.00	1.70	1.70
SRCPARAM	L0000094	0.0000002235	0.00	1.70	1.70
SRCPARAM	L0000095	0.0000002235	0.00	1.70	1.70

SRCPARAM	L0000096	0.0000002235	0.00	1.70	1.70
SRCPARAM	L0000097	0.0000002235	0.00	1.70	1.70
SRCPARAM	L0000098	0.0000002235	0.00	1.70	1.70
SRCPARAM	L0000099	0.0000002235	0.00	1.70	1.70
SRCPARAM	L0000100	0.0000002235	0.00	1.70	1.70
SRCPARAM	L0000101	0.0000002235	0.00	1.70	1.70
SRCPARAM	L0000102	0.0000002235	0.00	1.70	1.70
SRCPARAM	L0000103	0.0000002235	0.00	1.70	1.70
SRCPARAM	L0000104	0.0000002235	0.00	1.70	1.70
SRCPARAM	L0000105	0.0000002235	0.00	1.70	1.70
SRCPARAM	L0000106	0.0000002235	0.00	1.70	1.70
SRCPARAM	L0000107	0.0000002235	0.00	1.70	1.70
SRCPARAM	L0000108	0.0000002235	0.00	1.70	1.70
SRCPARAM	L0000109	0.0000002235	0.00	1.70	1.70
SRCPARAM	L0000110	0.0000002235	0.00	1.70	1.70
SRCPARAM	L0000111	0.0000002235	0.00	1.70	1.70
SRCPARAM	L0000112	0.0000002235	0.00	1.70	1.70
SRCPARAM	L0000113	0.0000002235	0.00	1.70	1.70
SRCPARAM	L0000114	0.0000002235	0.00	1.70	1.70
SRCPARAM	L0000115	0.0000002235	0.00	1.70	1.70
SRCPARAM	L0000116	0.0000002235	0.00	1.70	1.70
SRCPARAM	L0000117	0.0000002235	0.00	1.70	1.70
SRCPARAM	L0000118	0.0000002235	0.00	1.70	1.70
SRCPARAM	L0000119	0.0000002235	0.00	1.70	1.70

**

** LINE VOLUME Source ID = SLINE2

SRCPARAM	L0001752	0.000000141	0.00	1.70	1.70
SRCPARAM	L0001753	0.000000141	0.00	1.70	1.70
SRCPARAM	L0001754	0.000000141	0.00	1.70	1.70
SRCPARAM	L0001755	0.000000141	0.00	1.70	1.70
SRCPARAM	L0001756	0.000000141	0.00	1.70	1.70
SRCPARAM	L0001757	0.000000141	0.00	1.70	1.70
SRCPARAM	L0001758	0.000000141	0.00	1.70	1.70
SRCPARAM	L0001759	0.000000141	0.00	1.70	1.70
SRCPARAM	L0001760	0.000000141	0.00	1.70	1.70
SRCPARAM	L0001761	0.000000141	0.00	1.70	1.70
SRCPARAM	L0001762	0.000000141	0.00	1.70	1.70

SRCPARAM	L0001763	0.000000141	0.00	1.70	1.70
SRCPARAM	L0001764	0.000000141	0.00	1.70	1.70
SRCPARAM	L0001765	0.000000141	0.00	1.70	1.70
SRCPARAM	L0001766	0.000000141	0.00	1.70	1.70
SRCPARAM	L0001767	0.000000141	0.00	1.70	1.70
SRCPARAM	L0001768	0.000000141	0.00	1.70	1.70
SRCPARAM	L0001769	0.000000141	0.00	1.70	1.70
SRCPARAM	L0001770	0.000000141	0.00	1.70	1.70
SRCPARAM	L0001771	0.000000141	0.00	1.70	1.70
SRCPARAM	L0001772	0.000000141	0.00	1.70	1.70
SRCPARAM	L0001773	0.000000141	0.00	1.70	1.70
SRCPARAM	L0001774	0.000000141	0.00	1.70	1.70
SRCPARAM	L0001775	0.000000141	0.00	1.70	1.70
SRCPARAM	L0001776	0.000000141	0.00	1.70	1.70
SRCPARAM	L0001777	0.000000141	0.00	1.70	1.70
SRCPARAM	L0001778	0.000000141	0.00	1.70	1.70
SRCPARAM	L0001779	0.000000141	0.00	1.70	1.70
SRCPARAM	L0001780	0.000000141	0.00	1.70	1.70
SRCPARAM	L0001781	0.000000141	0.00	1.70	1.70
SRCPARAM	L0001782	0.000000141	0.00	1.70	1.70
SRCPARAM	L0001783	0.000000141	0.00	1.70	1.70
SRCPARAM	L0001784	0.000000141	0.00	1.70	1.70
SRCPARAM	L0001785	0.000000141	0.00	1.70	1.70
SRCPARAM	L0001786	0.000000141	0.00	1.70	1.70
SRCPARAM	L0001787	0.000000141	0.00	1.70	1.70
SRCPARAM	L0001788	0.000000141	0.00	1.70	1.70
SRCPARAM	L0001789	0.000000141	0.00	1.70	1.70
SRCPARAM	L0001790	0.000000141	0.00	1.70	1.70
SRCPARAM	L0001791	0.000000141	0.00	1.70	1.70
SRCPARAM	L0001792	0.000000141	0.00	1.70	1.70
SRCPARAM	L0001793	0.000000141	0.00	1.70	1.70
SRCPARAM	L0001794	0.000000141	0.00	1.70	1.70
SRCPARAM	L0001795	0.000000141	0.00	1.70	1.70
SRCPARAM	L0001796	0.000000141	0.00	1.70	1.70
SRCPARAM	L0001797	0.000000141	0.00	1.70	1.70
SRCPARAM	L0001798	0.000000141	0.00	1.70	1.70
SRCPARAM	L0001799	0.000000141	0.00	1.70	1.70

SRCPARAM	L0001800	0.000000141	0.00	1.70	1.70
SRCPARAM	L0001801	0.000000141	0.00	1.70	1.70
SRCPARAM	L0001802	0.000000141	0.00	1.70	1.70
SRCPARAM	L0001803	0.000000141	0.00	1.70	1.70
SRCPARAM	L0001804	0.000000141	0.00	1.70	1.70
SRCPARAM	L0001805	0.000000141	0.00	1.70	1.70
SRCPARAM	L0001806	0.000000141	0.00	1.70	1.70
SRCPARAM	L0001807	0.000000141	0.00	1.70	1.70
SRCPARAM	L0001808	0.000000141	0.00	1.70	1.70
SRCPARAM	L0001809	0.000000141	0.00	1.70	1.70
SRCPARAM	L0001810	0.000000141	0.00	1.70	1.70
SRCPARAM	L0001811	0.000000141	0.00	1.70	1.70
SRCPARAM	L0001812	0.000000141	0.00	1.70	1.70
SRCPARAM	L0001813	0.000000141	0.00	1.70	1.70
SRCPARAM	L0001814	0.000000141	0.00	1.70	1.70
SRCPARAM	L0001815	0.000000141	0.00	1.70	1.70
SRCPARAM	L0001816	0.000000141	0.00	1.70	1.70
SRCPARAM	L0001817	0.000000141	0.00	1.70	1.70
SRCPARAM	L0001818	0.000000141	0.00	1.70	1.70
SRCPARAM	L0001819	0.000000141	0.00	1.70	1.70
SRCPARAM	L0001820	0.000000141	0.00	1.70	1.70
SRCPARAM	L0001821	0.000000141	0.00	1.70	1.70
SRCPARAM	L0001822	0.000000141	0.00	1.70	1.70
SRCPARAM	L0001823	0.000000141	0.00	1.70	1.70
SRCPARAM	L0001824	0.000000141	0.00	1.70	1.70
SRCPARAM	L0001825	0.000000141	0.00	1.70	1.70
SRCPARAM	L0001826	0.000000141	0.00	1.70	1.70
SRCPARAM	L0001827	0.000000141	0.00	1.70	1.70
SRCPARAM	L0001828	0.000000141	0.00	1.70	1.70
SRCPARAM	L0001829	0.000000141	0.00	1.70	1.70
SRCPARAM	L0001830	0.000000141	0.00	1.70	1.70
SRCPARAM	L0001831	0.000000141	0.00	1.70	1.70
SRCPARAM	L0001832	0.000000141	0.00	1.70	1.70
SRCPARAM	L0001833	0.000000141	0.00	1.70	1.70
SRCPARAM	L0001834	0.000000141	0.00	1.70	1.70
SRCPARAM	L0001835	0.000000141	0.00	1.70	1.70
SRCPARAM	L0001836	0.000000141	0.00	1.70	1.70

SRCPARAM	L0001837	0.000000141	0.00	1.70	1.70
SRCPARAM	L0001838	0.000000141	0.00	1.70	1.70
SRCPARAM	L0001839	0.000000141	0.00	1.70	1.70
SRCPARAM	L0001840	0.000000141	0.00	1.70	1.70
SRCPARAM	L0001841	0.000000141	0.00	1.70	1.70
SRCPARAM	L0001842	0.000000141	0.00	1.70	1.70
SRCPARAM	L0001843	0.000000141	0.00	1.70	1.70
SRCPARAM	L0001844	0.000000141	0.00	1.70	1.70
SRCPARAM	L0001845	0.000000141	0.00	1.70	1.70
SRCPARAM	L0001846	0.000000141	0.00	1.70	1.70
SRCPARAM	L0001847	0.000000141	0.00	1.70	1.70
SRCPARAM	L0001848	0.000000141	0.00	1.70	1.70
SRCPARAM	L0001849	0.000000141	0.00	1.70	1.70
SRCPARAM	L0001850	0.000000141	0.00	1.70	1.70
SRCPARAM	L0001851	0.000000141	0.00	1.70	1.70
SRCPARAM	L0001852	0.000000141	0.00	1.70	1.70
SRCPARAM	L0001853	0.000000141	0.00	1.70	1.70
SRCPARAM	L0001854	0.000000141	0.00	1.70	1.70
SRCPARAM	L0001855	0.000000141	0.00	1.70	1.70
SRCPARAM	L0001856	0.000000141	0.00	1.70	1.70
SRCPARAM	L0001857	0.000000141	0.00	1.70	1.70
SRCPARAM	L0001858	0.000000141	0.00	1.70	1.70
SRCPARAM	L0001859	0.000000141	0.00	1.70	1.70
SRCPARAM	L0001860	0.000000141	0.00	1.70	1.70
SRCPARAM	L0001861	0.000000141	0.00	1.70	1.70
SRCPARAM	L0001862	0.000000141	0.00	1.70	1.70
SRCPARAM	L0001863	0.000000141	0.00	1.70	1.70
SRCPARAM	L0001864	0.000000141	0.00	1.70	1.70
SRCPARAM	L0001865	0.000000141	0.00	1.70	1.70
SRCPARAM	L0001866	0.000000141	0.00	1.70	1.70
SRCPARAM	L0001867	0.000000141	0.00	1.70	1.70
SRCPARAM	L0001868	0.000000141	0.00	1.70	1.70
SRCPARAM	L0001869	0.000000141	0.00	1.70	1.70
SRCPARAM	L0001870	0.000000141	0.00	1.70	1.70
SRCPARAM	L0001871	0.000000141	0.00	1.70	1.70
SRCPARAM	L0001872	0.000000141	0.00	1.70	1.70
SRCPARAM	L0001873	0.000000141	0.00	1.70	1.70

SRCPARAM	L0001874	0.000000141	0.00	1.70	1.70
SRCPARAM	L0001875	0.000000141	0.00	1.70	1.70
SRCPARAM	L0001876	0.000000141	0.00	1.70	1.70
SRCPARAM	L0001877	0.000000141	0.00	1.70	1.70
SRCPARAM	L0001878	0.000000141	0.00	1.70	1.70
SRCPARAM	L0001879	0.000000141	0.00	1.70	1.70
SRCPARAM	L0001880	0.000000141	0.00	1.70	1.70
SRCPARAM	L0001881	0.000000141	0.00	1.70	1.70
SRCPARAM	L0001882	0.000000141	0.00	1.70	1.70
SRCPARAM	L0001883	0.000000141	0.00	1.70	1.70
SRCPARAM	L0001884	0.000000141	0.00	1.70	1.70
SRCPARAM	L0001885	0.000000141	0.00	1.70	1.70
SRCPARAM	L0001886	0.000000141	0.00	1.70	1.70
SRCPARAM	L0001887	0.000000141	0.00	1.70	1.70
SRCPARAM	L0001888	0.000000141	0.00	1.70	1.70
SRCPARAM	L0001889	0.000000141	0.00	1.70	1.70
SRCPARAM	L0001890	0.000000141	0.00	1.70	1.70
SRCPARAM	L0001891	0.000000141	0.00	1.70	1.70
SRCPARAM	L0001892	0.000000141	0.00	1.70	1.70
SRCPARAM	L0001893	0.000000141	0.00	1.70	1.70
SRCPARAM	L0001894	0.000000141	0.00	1.70	1.70
SRCPARAM	L0001895	0.000000141	0.00	1.70	1.70
SRCPARAM	L0001896	0.000000141	0.00	1.70	1.70
SRCPARAM	L0001897	0.000000141	0.00	1.70	1.70
SRCPARAM	L0001898	0.000000141	0.00	1.70	1.70
SRCPARAM	L0001899	0.000000141	0.00	1.70	1.70
SRCPARAM	L0001900	0.000000141	0.00	1.70	1.70
SRCPARAM	L0001901	0.000000141	0.00	1.70	1.70
SRCPARAM	L0001902	0.000000141	0.00	1.70	1.70
SRCPARAM	L0001903	0.000000141	0.00	1.70	1.70
SRCPARAM	L0001904	0.000000141	0.00	1.70	1.70
SRCPARAM	L0001905	0.000000141	0.00	1.70	1.70
SRCPARAM	L0001906	0.000000141	0.00	1.70	1.70
SRCPARAM	L0001907	0.000000141	0.00	1.70	1.70
SRCPARAM	L0001908	0.000000141	0.00	1.70	1.70
SRCPARAM	L0001909	0.000000141	0.00	1.70	1.70
SRCPARAM	L0001910	0.000000141	0.00	1.70	1.70

SRCPARAM	L0001911	0.000000141	0.00	1.70	1.70
SRCPARAM	L0001912	0.000000141	0.00	1.70	1.70
SRCPARAM	L0001913	0.000000141	0.00	1.70	1.70
SRCPARAM	L0001914	0.000000141	0.00	1.70	1.70
SRCPARAM	L0001915	0.000000141	0.00	1.70	1.70
SRCPARAM	L0001916	0.000000141	0.00	1.70	1.70
SRCPARAM	L0001917	0.000000141	0.00	1.70	1.70
SRCPARAM	L0001918	0.000000141	0.00	1.70	1.70
SRCPARAM	L0001919	0.000000141	0.00	1.70	1.70
SRCPARAM	L0001920	0.000000141	0.00	1.70	1.70
SRCPARAM	L0001921	0.000000141	0.00	1.70	1.70
SRCPARAM	L0001922	0.000000141	0.00	1.70	1.70
SRCPARAM	L0001923	0.000000141	0.00	1.70	1.70
SRCPARAM	L0001924	0.000000141	0.00	1.70	1.70
SRCPARAM	L0001925	0.000000141	0.00	1.70	1.70
SRCPARAM	L0001926	0.000000141	0.00	1.70	1.70
SRCPARAM	L0001927	0.000000141	0.00	1.70	1.70
SRCPARAM	L0001928	0.000000141	0.00	1.70	1.70
SRCPARAM	L0001929	0.000000141	0.00	1.70	1.70

```

** -----
SRCGROUP ALL
SO FINISHED
**
*****
** AERMOD Receptor Pathway
*****
**
**
RE STARTING
  INCLUDED "Maverik El Centro - Ops DPM.rou"
RE FINISHED
**
*****
** AERMOD Meteorology Pathway
*****
**
**

```

```

ME STARTING
SURFFILE DesertHotSpringsAirportADJU\KTRM_V9_ADJU\KTRM_v9.SFC
PROFFILE DesertHotSpringsAirportADJU\KTRM_V9_ADJU\KTRM_v9.PFL
SURFDATA 3104 2012
UAIRDATA 3190 2012
PROFBASE 0.0 METERS
ME FINISHED
**
*****
** AERMOD Output Pathway
*****
**
**
OU STARTING
RECTABLE ALLAVE 1ST
RECTABLE 1 1ST
** Auto-Generated Plotfiles
PLOTFILE 1 ALL 1ST "MAVERIK EL CENTRO - OPS DPM.AD\01H1GALL.PLT" 31
PLOTFILE PERIOD ALL "MAVERIK EL CENTRO - OPS DPM.AD\PE00GALL.PLT" 32
SUMMFILE "Maverik El Centro - Ops DPM.sum"
OU FINISHED

```

*** Message Summary For AERMOD Model Setup ***

----- Summary of Total Messages -----

```

A Total of          0 Fatal Error Message(s)
A Total of          2 Warning Message(s)
A Total of          0 Informational Message(s)

```

```

***** FATAL ERROR MESSAGES *****
          *** NONE ***

```

```

***** WARNING MESSAGES *****

```

ME W186 709 MEOPEN: THRESH_1MIN 1-min ASOS wind speed threshold used
0.50

ME W187 709 MEOPEN: ADJ_U* Option for Stable Low Winds used in AERMET

*** SETUP Finishes Successfully ***

*** AERMOD - VERSION 21112 *** *** C:\Lakes\AERMOD View\Projects\Maverik El Centro
\Maverik El Centro.is *** 12/11/23
*** AERMET - VERSION 16216 *** ***
*** 13:17:55

PAGE 1

*** MODELOPTs: RegDEFAULT CONC ELEV RURAL ADJ_U*

*** MODEL SETUP OPTIONS SUMMARY ***

**Model Is Setup For Calculation of Average CONCentration Values.

-- DEPOSITION LOGIC --

**NO GAS DEPOSITION Data Provided.

**NO PARTICLE DEPOSITION Data Provided.

**Model Uses NO DRY DEPLETION. DRYDPLT = F

**Model Uses NO WET DEPLETION. WETDPLT = F

**Model Uses RURAL Dispersion Only.

**Model Uses Regulatory DEFAULT Options:

1. Stack-tip Downwash.
2. Model Accounts for ELEVated Terrain Effects.
3. Use Calms Processing Routine.
4. Use Missing Data Processing Routine.
5. No Exponential Decay.

**Other Options Specified:

ADJ_U* - Use ADJ_U* option for SBL in AERMET
CCVR_Sub - Meteorological data includes CCVR substitutions
TEMP_Sub - Meteorological data includes TEMP substitutions

**Model Assumes No FLAGPOLE Receptor Heights.

**The User Specified a Pollutant Type of: DPM

**Model Calculates 1 Short Term Average(s) of: 1-HR
and Calculates PERIOD Averages

**This Run Includes: 300 Source(s); 1 Source Group(s); and 6 Receptor(s)
with: 0 POINT(s), including
0 POINTCAP(s) and 0 POINTHOR(s)
and: 297 VOLUME source(s)
and: 3 AREA type source(s)
and: 0 LINE source(s)
and: 0 RLINE/RLINEXT source(s)
and: 0 OPENPIT source(s)
and: 0 BUOYANT LINE source(s) with a total of 0 line(s)

**Model Set To Continue RUNNING After the Setup Testing.

**The AERMET Input Meteorological Data Version Date: 16216

**Output Options Selected:

Model Outputs Tables of PERIOD Averages by Receptor
Model Outputs Tables of Highest Short Term Values by Receptor (RECTABLE Keyword)
Model Outputs External File(s) of High Values for Plotting (PLOTFILE Keyword)
Model Outputs Separate Summary File of High Ranked Values (SUMMFILE Keyword)

**NOTE: The Following Flags May Appear Following CONC Values: c for Calm Hours
m for Missing Hours
b for Both Calm and Missing

Hours

**Misc. Inputs: Base Elev. for Pot. Temp. Profile (m MSL) = 0.00 ; Decay Coef. =
0.000 ; Rot. Angle = 0.0
Emission Units = GRAMS/SEC ; Emission Rate
Unit Factor = 0.10000E+07
Output Units = MICROGRAMS/M**3

**Approximate Storage Requirements of Model = 3.7 MB of RAM.

**Input Runstream File: aermod.inp

**Output Print File: aermod.out

**Detailed Error/Message File: Maverik El Centro - Ops DPM.err

**File for Summary of Results: Maverik El Centro - Ops DPM.sum

```

*** AERMOD - VERSION 21112 ***      *** C:\Lakes\AERMOD View\Projects\Maverik El Centro
\Maverik El Centro.is ***          12/11/23
*** AERMET - VERSION 16216 ***      ***
***          13:17:55

```

PAGE 2

*** MODELOPTs: RegDFault CONC ELEV RURAL ADJ_U*

*** VOLUME SOURCE DATA ***

URBAN	EMISSION RATE	NUMBER	EMISSION RATE			BASE	RELEASE	INIT.	INIT.
SOURCE	PART.	(GRAMS/SEC)	X	Y	ELEV.	HEIGHT	SY	SZ	
SOURCE SCALAR VARY			(METERS)	(METERS)	(METERS)	(METERS)	(METERS)	(METERS)	(METERS)
ID	CATS.								
L0000001	0	0.22350E-06	640462.2	3628042.4	-11.3	0.00	1.70	1.70	
NO									
L0000002	0	0.22350E-06	640462.2	3628038.8	-11.3	0.00	1.70	1.70	
NO									
L0000003	0	0.22350E-06	640462.2	3628035.1	-11.3	0.00	1.70	1.70	
NO									
L0000004	0	0.22350E-06	640462.2	3628031.5	-11.3	0.00	1.70	1.70	
NO									
L0000005	0	0.22350E-06	640462.2	3628027.8	-11.3	0.00	1.70	1.70	
NO									
L0000006	0	0.22350E-06	640462.2	3628024.2	-11.3	0.00	1.70	1.70	
NO									
L0000007	0	0.22350E-06	640462.2	3628020.5	-11.3	0.00	1.70	1.70	
NO									
L0000008	0	0.22350E-06	640462.2	3628016.8	-11.3	0.00	1.70	1.70	
NO									
L0000009	0	0.22350E-06	640462.2	3628013.2	-11.3	0.00	1.70	1.70	

NO								
L0000010	0	0.22350E-06	640462.2	3628009.5	-11.3	0.00	1.70	1.70
NO								
L0000011	0	0.22350E-06	640458.6	3628009.7	-11.3	0.00	1.70	1.70
NO								
L0000012	0	0.22350E-06	640454.9	3628009.9	-11.3	0.00	1.70	1.70
NO								
L0000013	0	0.22350E-06	640451.3	3628010.2	-11.3	0.00	1.70	1.70
NO								
L0000014	0	0.22350E-06	640447.6	3628010.4	-11.3	0.00	1.70	1.70
NO								
L0000015	0	0.22350E-06	640444.0	3628010.7	-11.3	0.00	1.70	1.70
NO								
L0000016	0	0.22350E-06	640443.1	3628008.1	-11.3	0.00	1.70	1.70
NO								
L0000017	0	0.22350E-06	640443.2	3628004.4	-11.3	0.00	1.70	1.70
NO								
L0000018	0	0.22350E-06	640443.4	3628000.8	-11.3	0.00	1.70	1.70
NO								
L0000019	0	0.22350E-06	640443.5	3627997.1	-11.3	0.00	1.70	1.70
NO								
L0000020	0	0.22350E-06	640443.6	3627993.5	-11.3	0.00	1.70	1.70
NO								
L0000021	0	0.22350E-06	640443.7	3627989.8	-11.3	0.00	1.70	1.70
NO								
L0000022	0	0.22350E-06	640443.9	3627986.2	-11.3	0.00	1.70	1.70
NO								
L0000023	0	0.22350E-06	640444.0	3627982.5	-11.3	0.00	1.70	1.70
NO								
L0000024	0	0.22350E-06	640444.1	3627978.8	-11.3	0.00	1.70	1.70
NO								
L0000025	0	0.22350E-06	640444.3	3627975.2	-11.3	0.00	1.70	1.70
NO								
L0000026	0	0.22350E-06	640444.4	3627971.5	-11.3	0.00	1.70	1.70
NO								
L0000027	0	0.22350E-06	640444.5	3627967.9	-11.3	0.00	1.70	1.70
NO								

L0000028	0	0.22350E-06	640444.7	3627964.2	-11.3	0.00	1.70	1.70
NO								
L0000029	0	0.22350E-06	640444.8	3627960.6	-11.3	0.00	1.70	1.70
NO								
L0000030	0	0.22350E-06	640444.9	3627956.9	-11.3	0.00	1.70	1.70
NO								
L0000031	0	0.22350E-06	640445.1	3627953.3	-11.3	0.00	1.70	1.70
NO								
L0000032	0	0.22350E-06	640445.2	3627949.6	-11.3	0.00	1.70	1.70
NO								
L0000033	0	0.22350E-06	640445.3	3627945.9	-11.3	0.00	1.70	1.70
NO								
L0000034	0	0.22350E-06	640445.4	3627942.3	-11.3	0.00	1.70	1.70
NO								
L0000035	0	0.22350E-06	640445.6	3627938.6	-11.3	0.00	1.70	1.70
NO								
L0000036	0	0.22350E-06	640445.7	3627935.0	-11.3	0.00	1.70	1.70
NO								
L0000037	0	0.22350E-06	640445.8	3627931.3	-11.3	0.00	1.70	1.70
NO								
L0000038	0	0.22350E-06	640446.0	3627927.7	-11.3	0.00	1.70	1.70
NO								
L0000039	0	0.22350E-06	640447.5	3627925.4	-11.3	0.00	1.70	1.70
NO								
L0000040	0	0.22350E-06	640451.1	3627925.3	-11.3	0.00	1.70	1.70
NO								

*** AERMOD - VERSION 21112 *** *** C:\Lakes\AERMOD View\Projects\Maverik El Centro
 \Maverik El Centro.is *** 12/11/23
 *** AERMET - VERSION 16216 *** ***
 *** 13:17:55

PAGE 3

*** MODELOPTs: RegDFault CONC ELEV RURAL ADJ_U*

*** VOLUME SOURCE DATA ***

URBAN	EMISSION RATE	NUMBER	EMISSION RATE			BASE	RELEASE	INIT.	INIT.
SOURCE	PART.	(GRAMS/SEC)	X	Y	ELEV.	HEIGHT	SY	SZ	
SOURCE SCALAR VARY			(METERS)	(METERS)	(METERS)	(METERS)	(METERS)	(METERS)	(METERS)
ID	CATS.								
L0000041	0	0.22350E-06	640454.8	3627925.2	-11.3	0.00	1.70	1.70	
NO									
L0000042	0	0.22350E-06	640458.4	3627925.1	-11.3	0.00	1.70	1.70	
NO									
L0000043	0	0.22350E-06	640462.1	3627925.0	-11.3	0.00	1.70	1.70	
NO									
L0000044	0	0.22350E-06	640465.7	3627924.9	-11.3	0.00	1.70	1.70	
NO									
L0000045	0	0.22350E-06	640469.4	3627924.8	-11.3	0.00	1.70	1.70	
NO									
L0000046	0	0.22350E-06	640473.1	3627924.7	-11.3	0.00	1.70	1.70	
NO									
L0000047	0	0.22350E-06	640476.7	3627924.6	-11.3	0.00	1.70	1.70	
NO									
L0000048	0	0.22350E-06	640480.4	3627924.5	-11.3	0.00	1.70	1.70	
NO									
L0000049	0	0.22350E-06	640484.0	3627924.4	-11.3	0.00	1.70	1.70	

NO								
L0000050	0	0.22350E-06	640487.7	3627924.3	-11.3	0.00	1.70	1.70
NO								
L0000051	0	0.22350E-06	640491.3	3627924.2	-11.3	0.00	1.70	1.70
NO								
L0000052	0	0.22350E-06	640495.0	3627924.1	-11.3	0.00	1.70	1.70
NO								
L0000053	0	0.22350E-06	640498.6	3627924.0	-11.3	0.00	1.70	1.70
NO								
L0000054	0	0.22350E-06	640502.3	3627923.9	-11.3	0.00	1.70	1.70
NO								
L0000055	0	0.22350E-06	640506.0	3627923.8	-11.3	0.00	1.70	1.70
NO								
L0000056	0	0.22350E-06	640509.6	3627923.7	-11.3	0.00	1.70	1.70
NO								
L0000057	0	0.22350E-06	640513.3	3627923.6	-11.3	0.00	1.70	1.70
NO								
L0000058	0	0.22350E-06	640516.9	3627923.5	-11.3	0.00	1.70	1.70
NO								
L0000059	0	0.22350E-06	640520.6	3627923.4	-11.3	0.00	1.70	1.70
NO								
L0000060	0	0.22350E-06	640524.2	3627923.3	-11.3	0.00	1.70	1.70
NO								
L0000061	0	0.22350E-06	640527.9	3627923.2	-11.3	0.00	1.70	1.70
NO								
L0000062	0	0.22350E-06	640531.6	3627923.0	-11.3	0.00	1.70	1.70
NO								
L0000063	0	0.22350E-06	640535.2	3627922.9	-11.3	0.00	1.70	1.70
NO								
L0000064	0	0.22350E-06	640538.9	3627922.8	-11.3	0.00	1.70	1.70
NO								
L0000065	0	0.22350E-06	640542.5	3627922.7	-11.3	0.00	1.70	1.70
NO								
L0000066	0	0.22350E-06	640546.2	3627922.6	-11.3	0.00	1.70	1.70
NO								
L0000067	0	0.22350E-06	640549.8	3627922.5	-11.3	0.00	1.70	1.70
NO								

L0000068	0	0.22350E-06	640553.5	3627922.4	-11.3	0.00	1.70	1.70
NO								
L0000069	0	0.22350E-06	640557.1	3627922.3	-11.3	0.00	1.70	1.70
NO								
L0000070	0	0.22350E-06	640560.8	3627922.2	-11.3	0.00	1.70	1.70
NO								
L0000071	0	0.22350E-06	640564.5	3627922.1	-11.3	0.00	1.70	1.70
NO								
L0000072	0	0.22350E-06	640568.1	3627922.0	-11.3	0.00	1.70	1.70
NO								
L0000073	0	0.22350E-06	640571.4	3627922.3	-11.3	0.00	1.70	1.70
NO								
L0000074	0	0.22350E-06	640571.4	3627926.0	-11.3	0.00	1.70	1.70
NO								
L0000075	0	0.22350E-06	640571.4	3627929.6	-11.3	0.00	1.70	1.70
NO								
L0000076	0	0.22350E-06	640571.4	3627933.3	-11.3	0.00	1.70	1.70
NO								
L0000077	0	0.22350E-06	640571.3	3627936.9	-11.3	0.00	1.70	1.70
NO								
L0000078	0	0.22350E-06	640571.3	3627940.6	-11.3	0.00	1.70	1.70
NO								
L0000079	0	0.22350E-06	640571.3	3627944.2	-11.3	0.00	1.70	1.70
NO								
L0000080	0	0.22350E-06	640571.3	3627947.9	-11.3	0.00	1.70	1.70
NO								

*** AERMOD - VERSION 21112 *** *** C:\Lakes\AERMOD View\Projects\Maverik El Centro
 \Maverik El Centro.is *** 12/11/23
 *** AERMET - VERSION 16216 *** ***
 *** 13:17:55

PAGE 4

*** MODELOPTs: RegDFAULT CONC ELEV RURAL ADJ_U*

*** VOLUME SOURCE DATA ***

URBAN	EMISSION RATE	NUMBER	EMISSION RATE			BASE	RELEASE	INIT.	INIT.
SOURCE	PART.	(GRAMS/SEC)	X	Y	ELEV.	HEIGHT	SY	SZ	
SOURCE SCALAR VARY			(METERS)	(METERS)	(METERS)	(METERS)	(METERS)	(METERS)	(METERS)
ID	CATS.								
BY									
L0000081	0	0.22350E-06	640571.3	3627951.6	-11.3	0.00	1.70	1.70	
NO									
L0000082	0	0.22350E-06	640571.3	3627955.2	-11.3	0.00	1.70	1.70	
NO									
L0000083	0	0.22350E-06	640571.2	3627958.9	-11.3	0.00	1.70	1.70	
NO									
L0000084	0	0.22350E-06	640571.2	3627962.5	-11.3	0.00	1.70	1.70	
NO									
L0000085	0	0.22350E-06	640571.2	3627966.2	-11.3	0.00	1.70	1.70	
NO									
L0000086	0	0.22350E-06	640571.2	3627969.8	-11.3	0.00	1.70	1.70	
NO									
L0000087	0	0.22350E-06	640571.2	3627973.5	-11.3	0.00	1.70	1.70	
NO									
L0000088	0	0.22350E-06	640571.1	3627977.2	-11.3	0.00	1.70	1.70	
NO									
L0000089	0	0.22350E-06	640571.1	3627980.8	-11.3	0.00	1.70	1.70	

NO								
L0000090	0	0.22350E-06	640571.1	3627984.5	-11.3	0.00	1.70	1.70
NO								
L0000091	0	0.22350E-06	640571.1	3627988.1	-11.3	0.00	1.70	1.70
NO								
L0000092	0	0.22350E-06	640571.1	3627991.8	-11.3	0.00	1.70	1.70
NO								
L0000093	0	0.22350E-06	640571.1	3627995.4	-11.3	0.00	1.70	1.70
NO								
L0000094	0	0.22350E-06	640571.0	3627999.1	-11.3	0.00	1.70	1.70
NO								
L0000095	0	0.22350E-06	640571.0	3628002.8	-11.3	0.00	1.70	1.70
NO								
L0000096	0	0.22350E-06	640571.0	3628006.4	-11.3	0.00	1.70	1.70
NO								
L0000097	0	0.22350E-06	640569.9	3628009.0	-11.3	0.00	1.70	1.70
NO								
L0000098	0	0.22350E-06	640566.3	3628009.0	-11.3	0.00	1.70	1.70
NO								
L0000099	0	0.22350E-06	640562.6	3628009.1	-11.3	0.00	1.70	1.70
NO								
L0000100	0	0.22350E-06	640558.9	3628009.1	-11.3	0.00	1.70	1.70
NO								
L0000101	0	0.22350E-06	640555.3	3628009.1	-11.3	0.00	1.70	1.70
NO								
L0000102	0	0.22350E-06	640551.6	3628009.2	-11.3	0.00	1.70	1.70
NO								
L0000103	0	0.22350E-06	640548.0	3628009.2	-11.3	0.00	1.70	1.70
NO								
L0000104	0	0.22350E-06	640544.3	3628009.2	-11.3	0.00	1.70	1.70
NO								
L0000105	0	0.22350E-06	640540.7	3628009.3	-11.3	0.00	1.70	1.70
NO								
L0000106	0	0.22350E-06	640537.0	3628009.3	-11.3	0.00	1.70	1.70
NO								
L0000107	0	0.22350E-06	640533.3	3628009.3	-11.3	0.00	1.70	1.70
NO								

L0000108	0	0.22350E-06	640529.7	3628009.4	-11.3	0.00	1.70	1.70
NO								
L0000109	0	0.22350E-06	640526.0	3628009.4	-11.3	0.00	1.70	1.70
NO								
L0000110	0	0.22350E-06	640522.4	3628009.4	-11.3	0.00	1.70	1.70
NO								
L0000111	0	0.22350E-06	640520.0	3628010.8	-11.3	0.00	1.70	1.70
NO								
L0000112	0	0.22350E-06	640519.9	3628014.4	-11.3	0.00	1.70	1.70
NO								
L0000113	0	0.22350E-06	640519.8	3628018.1	-11.3	0.00	1.70	1.70
NO								
L0000114	0	0.22350E-06	640519.7	3628021.8	-11.3	0.00	1.70	1.70
NO								
L0000115	0	0.22350E-06	640519.6	3628025.4	-11.3	0.00	1.70	1.70
NO								
L0000116	0	0.22350E-06	640519.5	3628029.1	-11.3	0.00	1.70	1.70
NO								
L0000117	0	0.22350E-06	640519.5	3628032.7	-11.3	0.00	1.70	1.70
NO								
L0000118	0	0.22350E-06	640519.4	3628036.4	-11.3	0.00	1.70	1.70
NO								
L0000119	0	0.22350E-06	640519.3	3628040.0	-11.3	0.00	1.70	1.70
NO								
L0001752	0	0.14100E-06	640518.7	3628050.8	-11.3	0.00	1.70	1.70
NO								

*** AERMOD - VERSION 21112 *** *** C:\Lakes\AERMOD View\Projects\Maverik El Centro
 \Maverik El Centro.is *** 12/11/23
 *** AERMET - VERSION 16216 *** ***
 *** 13:17:55

PAGE 5

*** MODELOPTs: RegDFAULT CONC ELEV RURAL ADJ_U*

*** VOLUME SOURCE DATA ***

URBAN	EMISSION RATE	NUMBER	EMISSION RATE			BASE	RELEASE	INIT.	INIT.
SOURCE	PART.	(GRAMS/SEC)	X	Y	ELEV.	HEIGHT	SY	SZ	
SOURCE SCALAR VARY			(METERS)	(METERS)	(METERS)	(METERS)	(METERS)	(METERS)	(METERS)
ID	CATS.								
BY									
L0001753	0	0.14100E-06	640515.0	3628050.8	-11.3	0.00	1.70	1.70	
NO									
L0001754	0	0.14100E-06	640511.3	3628050.8	-11.3	0.00	1.70	1.70	
NO									
L0001755	0	0.14100E-06	640507.7	3628050.9	-11.3	0.00	1.70	1.70	
NO									
L0001756	0	0.14100E-06	640504.0	3628050.9	-11.3	0.00	1.70	1.70	
NO									
L0001757	0	0.14100E-06	640500.4	3628050.9	-11.3	0.00	1.70	1.70	
NO									
L0001758	0	0.14100E-06	640496.7	3628050.9	-11.3	0.00	1.70	1.70	
NO									
L0001759	0	0.14100E-06	640493.1	3628050.9	-11.3	0.00	1.70	1.70	
NO									
L0001760	0	0.14100E-06	640489.4	3628050.9	-11.3	0.00	1.70	1.70	
NO									
L0001761	0	0.14100E-06	640485.7	3628051.0	-11.3	0.00	1.70	1.70	

NO								
L0001762	0	0.14100E-06	640482.1	3628051.0	-11.3	0.00	1.70	1.70
NO								
L0001763	0	0.14100E-06	640478.4	3628051.0	-11.3	0.00	1.70	1.70
NO								
L0001764	0	0.14100E-06	640474.8	3628051.0	-11.3	0.00	1.70	1.70
NO								
L0001765	0	0.14100E-06	640471.1	3628051.0	-11.3	0.00	1.70	1.70
NO								
L0001766	0	0.14100E-06	640467.5	3628051.0	-11.3	0.00	1.70	1.70
NO								
L0001767	0	0.14100E-06	640463.8	3628051.1	-11.3	0.00	1.70	1.70
NO								
L0001768	0	0.14100E-06	640460.1	3628051.1	-11.3	0.00	1.70	1.70
NO								
L0001769	0	0.14100E-06	640456.5	3628051.1	-11.3	0.00	1.70	1.70
NO								
L0001770	0	0.14100E-06	640452.8	3628051.1	-11.3	0.00	1.70	1.70
NO								
L0001771	0	0.14100E-06	640449.2	3628051.1	-11.3	0.00	1.70	1.70
NO								
L0001772	0	0.14100E-06	640445.5	3628051.1	-11.3	0.00	1.70	1.70
NO								
L0001773	0	0.14100E-06	640441.8	3628051.2	-11.3	0.00	1.70	1.70
NO								
L0001774	0	0.14100E-06	640438.2	3628051.2	-11.3	0.00	1.70	1.70
NO								
L0001775	0	0.14100E-06	640434.5	3628051.2	-11.3	0.00	1.70	1.70
NO								
L0001776	0	0.14100E-06	640430.9	3628051.2	-11.3	0.00	1.70	1.70
NO								
L0001777	0	0.14100E-06	640427.2	3628051.2	-11.3	0.00	1.70	1.70
NO								
L0001778	0	0.14100E-06	640423.6	3628051.2	-11.3	0.00	1.70	1.70
NO								
L0001779	0	0.14100E-06	640419.9	3628051.3	-11.3	0.00	1.70	1.70
NO								

L0001780	0	0.14100E-06	640416.2	3628051.3	-11.3	0.00	1.70	1.70
NO								
L0001781	0	0.14100E-06	640412.6	3628051.3	-11.3	0.00	1.70	1.70
NO								
L0001782	0	0.14100E-06	640408.9	3628051.3	-11.3	0.00	1.70	1.70
NO								
L0001783	0	0.14100E-06	640405.3	3628051.3	-11.3	0.00	1.70	1.70
NO								
L0001784	0	0.14100E-06	640401.6	3628051.3	-11.3	0.00	1.70	1.70
NO								
L0001785	0	0.14100E-06	640398.0	3628051.4	-11.3	0.00	1.70	1.70
NO								
L0001786	0	0.14100E-06	640394.3	3628051.4	-11.3	0.00	1.70	1.70
NO								
L0001787	0	0.14100E-06	640390.6	3628051.4	-11.3	0.00	1.70	1.70
NO								
L0001788	0	0.14100E-06	640387.0	3628051.4	-11.3	0.00	1.70	1.70
NO								
L0001789	0	0.14100E-06	640383.3	3628051.4	-11.3	0.00	1.70	1.70
NO								
L0001790	0	0.14100E-06	640379.7	3628051.5	-11.3	0.00	1.70	1.70
NO								
L0001791	0	0.14100E-06	640376.0	3628051.5	-11.3	0.00	1.70	1.70
NO								
L0001792	0	0.14100E-06	640372.4	3628051.5	-11.3	0.00	1.70	1.70
NO								

*** AERMOD - VERSION 21112 *** *** C:\Lakes\AERMOD View\Projects\Maverik El Centro
 \Maverik El Centro.is *** 12/11/23
 *** AERMET - VERSION 16216 *** ***
 *** 13:17:55

PAGE 6

*** MODELOPTs: RegDFAULT CONC ELEV RURAL ADJ_U*

*** VOLUME SOURCE DATA ***

URBAN	EMISSION RATE	NUMBER	EMISSION RATE			BASE	RELEASE	INIT.	INIT.
SOURCE	PART.	(GRAMS/SEC)	X	Y	ELEV.	HEIGHT	SY	SZ	
SOURCE SCALAR VARY			(METERS)	(METERS)	(METERS)	(METERS)	(METERS)	(METERS)	(METERS)
ID	CATS.								
BY									
L0001793	0	0.14100E-06	640368.7	3628051.5	-11.3	0.00	1.70	1.70	
NO									
L0001794	0	0.14100E-06	640365.0	3628051.5	-11.3	0.00	1.70	1.70	
NO									
L0001795	0	0.14100E-06	640361.4	3628051.5	-11.3	0.00	1.70	1.70	
NO									
L0001796	0	0.14100E-06	640357.7	3628051.6	-11.3	0.00	1.70	1.70	
NO									
L0001797	0	0.14100E-06	640354.1	3628051.6	-11.3	0.00	1.70	1.70	
NO									
L0001798	0	0.14100E-06	640350.4	3628051.6	-11.3	0.00	1.70	1.70	
NO									
L0001799	0	0.14100E-06	640346.8	3628051.6	-11.3	0.00	1.70	1.70	
NO									
L0001800	0	0.14100E-06	640343.1	3628051.6	-11.3	0.00	1.70	1.70	
NO									
L0001801	0	0.14100E-06	640339.4	3628051.6	-11.3	0.00	1.70	1.70	

NO								
L0001802	0	0.14100E-06	640335.8	3628051.7	-11.3	0.00	1.70	1.70
NO								
L0001803	0	0.14100E-06	640332.4	3628051.4	-11.3	0.00	1.70	1.70
NO								
L0001804	0	0.14100E-06	640332.6	3628047.7	-11.3	0.00	1.70	1.70
NO								
L0001805	0	0.14100E-06	640332.8	3628044.1	-11.3	0.00	1.70	1.70
NO								
L0001806	0	0.14100E-06	640332.9	3628040.4	-11.3	0.00	1.70	1.70
NO								
L0001807	0	0.14100E-06	640333.1	3628036.8	-11.3	0.00	1.70	1.70
NO								
L0001808	0	0.14100E-06	640333.2	3628033.1	-11.3	0.00	1.70	1.70
NO								
L0001809	0	0.14100E-06	640333.4	3628029.4	-11.3	0.00	1.70	1.70
NO								
L0001810	0	0.14100E-06	640333.6	3628025.8	-11.3	0.00	1.70	1.70
NO								
L0001811	0	0.14100E-06	640333.7	3628022.1	-11.3	0.00	1.70	1.70
NO								
L0001812	0	0.14100E-06	640333.9	3628018.5	-11.3	0.00	1.70	1.70
NO								
L0001813	0	0.14100E-06	640334.1	3628014.8	-11.3	0.00	1.70	1.70
NO								
L0001814	0	0.14100E-06	640334.2	3628011.2	-11.3	0.00	1.70	1.70
NO								
L0001815	0	0.14100E-06	640334.4	3628007.5	-11.3	0.00	1.70	1.70
NO								
L0001816	0	0.14100E-06	640334.5	3628003.9	-11.3	0.00	1.70	1.70
NO								
L0001817	0	0.14100E-06	640334.7	3628000.2	-11.3	0.00	1.70	1.70
NO								
L0001818	0	0.14100E-06	640334.9	3627996.6	-11.3	0.00	1.70	1.70
NO								
L0001819	0	0.14100E-06	640335.0	3627992.9	-11.3	0.00	1.70	1.70
NO								

L0001820	0	0.14100E-06	640335.2	3627989.2	-11.3	0.00	1.70	1.70
NO								
L0001821	0	0.14100E-06	640335.4	3627985.6	-11.3	0.00	1.70	1.70
NO								
L0001822	0	0.14100E-06	640335.5	3627981.9	-11.3	0.00	1.70	1.70
NO								
L0001823	0	0.14100E-06	640335.7	3627978.3	-11.3	0.00	1.70	1.70
NO								
L0001824	0	0.14100E-06	640335.8	3627974.6	-11.3	0.00	1.70	1.70
NO								
L0001825	0	0.14100E-06	640336.0	3627971.0	-11.3	0.00	1.70	1.70
NO								
L0001826	0	0.14100E-06	640336.2	3627967.3	-11.3	0.00	1.70	1.70
NO								
L0001827	0	0.14100E-06	640336.3	3627963.7	-11.3	0.00	1.70	1.70
NO								
L0001828	0	0.14100E-06	640336.5	3627960.0	-11.3	0.00	1.70	1.70
NO								
L0001829	0	0.14100E-06	640336.6	3627956.4	-11.3	0.00	1.70	1.70
NO								
L0001830	0	0.14100E-06	640336.8	3627952.7	-11.3	0.00	1.70	1.70
NO								
L0001831	0	0.14100E-06	640337.0	3627949.1	-11.3	0.00	1.70	1.70
NO								
L0001832	0	0.14100E-06	640337.1	3627945.4	-11.3	0.00	1.70	1.70
NO								

```

*** AERMOD - VERSION 21112 ***      *** C:\Lakes\AERMOD View\Projects\Maverik El Centro
\Maverik El Centro.is ***          12/11/23
*** AERMET - VERSION 16216 ***      ***
***          13:17:55

```

PAGE 7

*** MODELOPTs: RegDEFAULT CONC ELEV RURAL ADJ_U*

*** VOLUME SOURCE DATA ***

URBAN	EMISSION RATE	NUMBER	EMISSION RATE			BASE	RELEASE	INIT.	INIT.
SOURCE	PART.	(GRAMS/SEC)	X	Y	ELEV.	HEIGHT	SY	SZ	
SOURCE SCALAR VARY			(METERS)	(METERS)	(METERS)	(METERS)	(METERS)	(METERS)	(METERS)
ID	CATS.								
L0001833	0	0.14100E-06	640337.3	3627941.7	-11.3	0.00	1.70	1.70	
NO									
L0001834	0	0.14100E-06	640337.5	3627938.1	-11.3	0.00	1.70	1.70	
NO									
L0001835	0	0.14100E-06	640337.6	3627934.4	-11.3	0.00	1.70	1.70	
NO									
L0001836	0	0.14100E-06	640337.8	3627930.8	-11.3	0.00	1.70	1.70	
NO									
L0001837	0	0.14100E-06	640337.9	3627927.1	-11.3	0.00	1.70	1.70	
NO									
L0001838	0	0.14100E-06	640338.1	3627923.5	-11.3	0.00	1.70	1.70	
NO									
L0001839	0	0.14100E-06	640338.3	3627919.8	-11.3	0.00	1.70	1.70	
NO									
L0001840	0	0.14100E-06	640338.4	3627916.2	-11.3	0.00	1.70	1.70	
NO									
L0001841	0	0.14100E-06	640338.6	3627912.5	-11.3	0.00	1.70	1.70	

NO								
L0001842	0	0.14100E-06	640338.8	3627908.9	-11.3	0.00	1.70	1.70
NO								
L0001843	0	0.14100E-06	640338.9	3627905.2	-11.2	0.00	1.70	1.70
NO								
L0001844	0	0.14100E-06	640339.1	3627901.6	-11.2	0.00	1.70	1.70
NO								
L0001845	0	0.14100E-06	640339.2	3627897.9	-11.2	0.00	1.70	1.70
NO								
L0001846	0	0.14100E-06	640339.4	3627894.2	-11.2	0.00	1.70	1.70
NO								
L0001847	0	0.14100E-06	640339.6	3627890.6	-11.2	0.00	1.70	1.70
NO								
L0001848	0	0.14100E-06	640339.7	3627886.9	-11.2	0.00	1.70	1.70
NO								
L0001849	0	0.14100E-06	640339.9	3627883.3	-11.2	0.00	1.70	1.70
NO								
L0001850	0	0.14100E-06	640340.0	3627879.6	-11.2	0.00	1.70	1.70
NO								
L0001851	0	0.14100E-06	640340.2	3627876.0	-11.1	0.00	1.70	1.70
NO								
L0001852	0	0.14100E-06	640340.4	3627872.3	-11.1	0.00	1.70	1.70
NO								
L0001853	0	0.14100E-06	640340.5	3627868.7	-11.1	0.00	1.70	1.70
NO								
L0001854	0	0.14100E-06	640340.7	3627865.0	-11.1	0.00	1.70	1.70
NO								
L0001855	0	0.14100E-06	640340.9	3627861.4	-11.1	0.00	1.70	1.70
NO								
L0001856	0	0.14100E-06	640341.0	3627857.7	-11.1	0.00	1.70	1.70
NO								
L0001857	0	0.14100E-06	640341.2	3627854.0	-11.1	0.00	1.70	1.70
NO								
L0001858	0	0.14100E-06	640341.3	3627850.4	-11.1	0.00	1.70	1.70
NO								
L0001859	0	0.14100E-06	640341.5	3627846.7	-11.2	0.00	1.70	1.70
NO								

L0001860	0	0.14100E-06	640341.7	3627843.1	-11.2	0.00	1.70	1.70
NO								
L0001861	0	0.14100E-06	640341.8	3627839.4	-11.2	0.00	1.70	1.70
NO								
L0001862	0	0.14100E-06	640342.0	3627835.8	-11.2	0.00	1.70	1.70
NO								
L0001863	0	0.14100E-06	640342.1	3627832.1	-11.2	0.00	1.70	1.70
NO								
L0001864	0	0.14100E-06	640342.3	3627828.5	-11.3	0.00	1.70	1.70
NO								
L0001865	0	0.14100E-06	640342.5	3627824.8	-11.3	0.00	1.70	1.70
NO								
L0001866	0	0.14100E-06	640342.6	3627821.2	-11.3	0.00	1.70	1.70
NO								
L0001867	0	0.14100E-06	640342.8	3627817.5	-11.3	0.00	1.70	1.70
NO								
L0001868	0	0.14100E-06	640343.0	3627813.9	-11.3	0.00	1.70	1.70
NO								
L0001869	0	0.14100E-06	640343.1	3627810.2	-11.3	0.00	1.70	1.70
NO								
L0001870	0	0.14100E-06	640343.3	3627806.5	-11.3	0.00	1.70	1.70
NO								
L0001871	0	0.14100E-06	640343.4	3627802.9	-11.3	0.00	1.70	1.70
NO								
L0001872	0	0.14100E-06	640343.6	3627799.2	-11.3	0.00	1.70	1.70
NO								

```

*** AERMOD - VERSION 21112 ***      *** C:\Lakes\AERMOD View\Projects\Maverik El Centro
\Maverik El Centro.is ***          12/11/23
*** AERMET - VERSION 16216 ***      ***
***          13:17:55

```

PAGE 8

*** MODELOPTs: RegDFAULT CONC ELEV RURAL ADJ_U*

*** VOLUME SOURCE DATA ***

URBAN	EMISSION RATE	NUMBER	EMISSION RATE			BASE	RELEASE	INIT.	INIT.
SOURCE	PART.	(GRAMS/SEC)	X	Y	ELEV.	HEIGHT	SY	SZ	
SOURCE SCALAR VARY			(METERS)	(METERS)	(METERS)	(METERS)	(METERS)	(METERS)	(METERS)
ID	CATS.								
BY									
L0001873	0	0.14100E-06	640343.8	3627795.6	-11.3	0.00	1.70	1.70	
NO									
L0001874	0	0.14100E-06	640343.9	3627791.9	-11.3	0.00	1.70	1.70	
NO									
L0001875	0	0.14100E-06	640344.1	3627788.3	-11.3	0.00	1.70	1.70	
NO									
L0001876	0	0.14100E-06	640344.3	3627784.6	-11.3	0.00	1.70	1.70	
NO									
L0001877	0	0.14100E-06	640344.4	3627781.0	-11.3	0.00	1.70	1.70	
NO									
L0001878	0	0.14100E-06	640344.6	3627777.3	-11.3	0.00	1.70	1.70	
NO									
L0001879	0	0.14100E-06	640344.7	3627773.7	-11.3	0.00	1.70	1.70	
NO									
L0001880	0	0.14100E-06	640344.9	3627770.0	-11.3	0.00	1.70	1.70	
NO									
L0001881	0	0.14100E-06	640345.1	3627766.4	-11.3	0.00	1.70	1.70	

NO								
L0001882	0	0.14100E-06	640345.2	3627762.7	-11.3	0.00	1.70	1.70
NO								
L0001883	0	0.14100E-06	640345.4	3627759.0	-11.3	0.00	1.70	1.70
NO								
L0001884	0	0.14100E-06	640345.5	3627755.4	-11.3	0.00	1.70	1.70
NO								
L0001885	0	0.14100E-06	640345.7	3627751.7	-11.3	0.00	1.70	1.70
NO								
L0001886	0	0.14100E-06	640345.9	3627748.1	-11.3	0.00	1.70	1.70
NO								
L0001887	0	0.14100E-06	640346.0	3627744.4	-11.3	0.00	1.70	1.70
NO								
L0001888	0	0.14100E-06	640346.2	3627740.8	-11.3	0.00	1.70	1.70
NO								
L0001889	0	0.14100E-06	640346.4	3627737.1	-11.3	0.00	1.70	1.70
NO								
L0001890	0	0.14100E-06	640346.5	3627733.5	-11.3	0.00	1.70	1.70
NO								
L0001891	0	0.14100E-06	640346.7	3627729.8	-11.2	0.00	1.70	1.70
NO								
L0001892	0	0.14100E-06	640346.8	3627726.2	-11.2	0.00	1.70	1.70
NO								
L0001893	0	0.14100E-06	640347.0	3627722.5	-11.2	0.00	1.70	1.70
NO								
L0001894	0	0.14100E-06	640347.2	3627718.8	-11.1	0.00	1.70	1.70
NO								
L0001895	0	0.14100E-06	640347.3	3627715.2	-11.1	0.00	1.70	1.70
NO								
L0001896	0	0.14100E-06	640347.5	3627711.5	-11.0	0.00	1.70	1.70
NO								
L0001897	0	0.14100E-06	640347.7	3627707.9	-11.0	0.00	1.70	1.70
NO								
L0001898	0	0.14100E-06	640347.8	3627704.2	-11.0	0.00	1.70	1.70
NO								
L0001899	0	0.14100E-06	640348.0	3627700.6	-11.0	0.00	1.70	1.70
NO								

L0001900	0	0.14100E-06	640348.1	3627696.9	-11.0	0.00	1.70	1.70
NO								
L0001901	0	0.14100E-06	640348.3	3627693.3	-11.0	0.00	1.70	1.70
NO								
L0001902	0	0.14100E-06	640348.5	3627689.6	-11.0	0.00	1.70	1.70
NO								
L0001903	0	0.14100E-06	640348.6	3627686.0	-11.0	0.00	1.70	1.70
NO								
L0001904	0	0.14100E-06	640348.8	3627682.3	-11.0	0.00	1.70	1.70
NO								
L0001905	0	0.14100E-06	640348.9	3627678.7	-11.0	0.00	1.70	1.70
NO								
L0001906	0	0.14100E-06	640349.1	3627675.0	-11.0	0.00	1.70	1.70
NO								
L0001907	0	0.14100E-06	640349.3	3627671.3	-11.0	0.00	1.70	1.70
NO								
L0001908	0	0.14100E-06	640349.4	3627667.7	-11.0	0.00	1.70	1.70
NO								
L0001909	0	0.14100E-06	640349.6	3627664.0	-11.0	0.00	1.70	1.70
NO								
L0001910	0	0.14100E-06	640349.8	3627660.4	-11.0	0.00	1.70	1.70
NO								
L0001911	0	0.14100E-06	640349.9	3627656.7	-11.0	0.00	1.70	1.70
NO								
L0001912	0	0.14100E-06	640350.1	3627653.1	-11.0	0.00	1.70	1.70
NO								

```

*** AERMOD - VERSION 21112 ***      *** C:\Lakes\AERMOD View\Projects\Maverik El Centro
\Maverik El Centro.is ***          12/11/23
*** AERMET - VERSION 16216 ***      ***
***          13:17:55

```

PAGE 9

*** MODELOPTs: RegDFAULT CONC ELEV RURAL ADJ_U*

*** VOLUME SOURCE DATA ***

URBAN	EMISSION RATE	NUMBER	EMISSION RATE			BASE	RELEASE	INIT.	INIT.
SOURCE	PART.	(GRAMS/SEC)	X	Y	ELEV.	HEIGHT	SY	SZ	
SOURCE SCALAR VARY			(METERS)	(METERS)	(METERS)	(METERS)	(METERS)	(METERS)	(METERS)
ID	CATS.								
L0001913	0	0.14100E-06	640350.2	3627649.4	-11.0	0.00	1.70	1.70	
NO									
L0001914	0	0.14100E-06	640350.4	3627645.8	-11.0	0.00	1.70	1.70	
NO									
L0001915	0	0.14100E-06	640350.6	3627642.1	-11.0	0.00	1.70	1.70	
NO									
L0001916	0	0.14100E-06	640350.7	3627638.5	-11.0	0.00	1.70	1.70	
NO									
L0001917	0	0.14100E-06	640350.9	3627634.8	-11.0	0.00	1.70	1.70	
NO									
L0001918	0	0.14100E-06	640351.1	3627631.2	-11.0	0.00	1.70	1.70	
NO									
L0001919	0	0.14100E-06	640351.2	3627627.5	-11.0	0.00	1.70	1.70	
NO									
L0001920	0	0.14100E-06	640351.4	3627623.8	-11.0	0.00	1.70	1.70	
NO									
L0001921	0	0.14100E-06	640351.5	3627620.2	-11.0	0.00	1.70	1.70	

NO								
L0001922	0	0.14100E-06	640351.7	3627616.5	-11.0	0.00	1.70	1.70
NO								
L0001923	0	0.14100E-06	640351.9	3627612.9	-11.0	0.00	1.70	1.70
NO								
L0001924	0	0.14100E-06	640352.0	3627609.2	-11.0	0.00	1.70	1.70
NO								
L0001925	0	0.14100E-06	640352.2	3627605.6	-11.0	0.00	1.70	1.70
NO								
L0001926	0	0.14100E-06	640352.3	3627601.9	-11.0	0.00	1.70	1.70
NO								
L0001927	0	0.14100E-06	640352.5	3627598.3	-11.0	0.00	1.70	1.70
NO								
L0001928	0	0.14100E-06	640352.7	3627594.6	-11.0	0.00	1.70	1.70
NO								
L0001929	0	0.14100E-06	640352.8	3627591.0	-11.0	0.00	1.70	1.70
NO								

```

*** AERMOD - VERSION 21112 ***      *** C:\Lakes\AERMOD View\Projects\Maverik El Centro
\Maverik El Centro.is ***          12/11/23
*** AERMET - VERSION 16216 ***      ***
***          13:17:55

```

PAGE 48

*** MODELOPTs: RegDFault CONC ELEV RURAL ADJ_U*

*** AREAPOLY SOURCE DATA ***

URBAN	EMISSION RATE	NUMBER	EMISSION RATE	LOCATION OF AREA	BASE	RELEASE	NUMBER	INIT.
SOURCE	PART.	(GRAMS/SEC	X	Y	ELEV.	HEIGHT	OF VERTS.	SZ
SOURCE	SCALAR VARY		(METERS)	(METERS)	(METERS)	(METERS)		(METERS)
ID	CATS.	/METER**2)						
BY								
PAREA1	0	0.10226E-08	640454.1	3627996.9	-11.3	1.00	4	0.00
NO								
PAREA2	0	0.11251E-08	640507.4	3627996.5	-11.3	1.00	4	0.00
NO								
PAREA3	0	0.12842E-08	640524.1	3627973.4	-11.3	1.00	4	0.00
NO								

```

*** AERMOD - VERSION 21112 ***      *** C:\Lakes\AERMOD View\Projects\Maverik El Centro
\Maverik El Centro.is ***          12/11/23
*** AERMET - VERSION 16216 ***      ***
***          13:17:55

```

PAGE 49

```

*** MODELOPTs:      RegDEFAULT CONC ELEV RURAL ADJ_U*

```

*** SOURCE IDs DEFINING SOURCE GROUPS ***

SRCGROUP ID	SOURCE IDs					
-----	-----					
ALL	PAREA1	, PAREA2	, PAREA3	, L0000001	, L0000002	,
L0000003	, L0000004	, L0000005	,			
	L0000006	, L0000007	, L0000008	, L0000009	, L0000010	,
L0000011	, L0000012	, L0000013	,			
	L0000014	, L0000015	, L0000016	, L0000017	, L0000018	,
L0000019	, L0000020	, L0000021	,			
	L0000022	, L0000023	, L0000024	, L0000025	, L0000026	,
L0000027	, L0000028	, L0000029	,			
	L0000030	, L0000031	, L0000032	, L0000033	, L0000034	,
L0000035	, L0000036	, L0000037	,			
	L0000038	, L0000039	, L0000040	, L0000041	, L0000042	,
L0000043	, L0000044	, L0000045	,			
	L0000046	, L0000047	, L0000048	, L0000049	, L0000050	,
L0000051	, L0000052	, L0000053	,			
	L0000054	, L0000055	, L0000056	, L0000057	, L0000058	,

L0000059	,	L0000060	,	L0000061	,			
		L0000062	,	L0000063	,	L0000064	,	L0000065
L0000067	,	L0000068	,	L0000069	,			
		L0000070	,	L0000071	,	L0000072	,	L0000073
L0000075	,	L0000076	,	L0000077	,			
		L0000078	,	L0000079	,	L0000080	,	L0000081
L0000083	,	L0000084	,	L0000085	,			
		L0000086	,	L0000087	,	L0000088	,	L0000089
L0000091	,	L0000092	,	L0000093	,			
		L0000094	,	L0000095	,	L0000096	,	L0000097
L0000099	,	L0000100	,	L0000101	,			
		L0000102	,	L0000103	,	L0000104	,	L0000105
L0000107	,	L0000108	,	L0000109	,			
		L0000110	,	L0000111	,	L0000112	,	L0000113
L0000115	,	L0000116	,	L0000117	,			
		L0000118	,	L0000119	,	L0001752	,	L0001753
L0001755	,	L0001756	,	L0001757	,			
		L0001758	,	L0001759	,	L0001760	,	L0001761
L0001763	,	L0001764	,	L0001765	,			
		L0001766	,	L0001767	,	L0001768	,	L0001769
L0001771	,	L0001772	,	L0001773	,			
		L0001774	,	L0001775	,	L0001776	,	L0001777
L0001779	,	L0001780	,	L0001781	,			
		L0001782	,	L0001783	,	L0001784	,	L0001785
L0001787	,	L0001788	,	L0001789	,			

```

*** AERMOD - VERSION 21112 ***      *** C:\Lakes\AERMOD View\Projects\Maverik El Centro
\Maverik El Centro.is ***          12/11/23
*** AERMET - VERSION 16216 ***      ***
***          13:17:55

```

PAGE 12

*** MODELOPTs: RegDEFAULT CONC ELEV RURAL ADJ_U*

*** SOURCE IDs DEFINING SOURCE GROUPS ***

SRCGROUP ID	SOURCE IDs									
-----	-----									
L0001795	L0001790	,	L0001791	,	L0001792	,	L0001793	,	L0001794	,
	, L0001796		, L0001797		,					
L0001803	L0001798	,	L0001799	,	L0001800	,	L0001801	,	L0001802	,
	, L0001804		, L0001805		,					
L0001811	L0001806	,	L0001807	,	L0001808	,	L0001809	,	L0001810	,
	, L0001812		, L0001813		,					
L0001819	L0001814	,	L0001815	,	L0001816	,	L0001817	,	L0001818	,
	, L0001820		, L0001821		,					
L0001827	L0001822	,	L0001823	,	L0001824	,	L0001825	,	L0001826	,
	, L0001828		, L0001829		,					
L0001835	L0001830	,	L0001831	,	L0001832	,	L0001833	,	L0001834	,
	, L0001836		, L0001837		,					
L0001843	L0001838	,	L0001839	,	L0001840	,	L0001841	,	L0001842	,
	, L0001844		, L0001845		,					
	L0001846	,	L0001847	,	L0001848	,	L0001849	,	L0001850	,

L0001851 , L0001852 , L0001853 ,
 L0001859 L0001854 , L0001855 , L0001856 , L0001857 , L0001858 ,
 , L0001860 , L0001861 ,
 L0001867 L0001862 , L0001863 , L0001864 , L0001865 , L0001866 ,
 , L0001868 , L0001869 ,
 L0001875 L0001870 , L0001871 , L0001872 , L0001873 , L0001874 ,
 , L0001876 , L0001877 ,
 L0001883 L0001878 , L0001879 , L0001880 , L0001881 , L0001882 ,
 , L0001884 , L0001885 ,
 L0001891 L0001886 , L0001887 , L0001888 , L0001889 , L0001890 ,
 , L0001892 , L0001893 ,
 L0001899 L0001894 , L0001895 , L0001896 , L0001897 , L0001898 ,
 , L0001900 , L0001901 ,
 L0001907 L0001902 , L0001903 , L0001904 , L0001905 , L0001906 ,
 , L0001908 , L0001909 ,
 L0001915 L0001910 , L0001911 , L0001912 , L0001913 , L0001914 ,
 , L0001916 , L0001917 ,
 L0001923 L0001918 , L0001919 , L0001920 , L0001921 , L0001922 ,
 , L0001924 , L0001925 ,
 L0001926 , L0001927 , L0001928 , L0001929 ,

```
*** AERMOD - VERSION 21112 ***      *** C:\Lakes\AERMOD View\Projects\Maverik El Centro
\Maverik El Centro.is ***          12/11/23
*** AERMET - VERSION 16216 ***      ***
***          13:17:55
```

PAGE 54

```
*** MODELOPTs:      RegDEFAULT  CONC  ELEV  RURAL  ADJ_U*
```

```
*** DISCRETE CARTESIAN RECEPTORS ***
(X-COORD, Y-COORD, ZELEV, ZHILL, ZFLAG)
(METERS)
```

```
( 640477.2, 3628075.7, -11.3, -11.3, 0.0); ( 640256.6,
3627956.3, -11.3, -11.3, 0.0);
( 640278.4, 3627913.0, -11.3, -11.3, 0.0); ( 640299.1,
3627891.2, -11.3, -11.3, 0.0);
( 640300.3, 3627870.2, -11.1, -11.1, 0.0); ( 640301.1,
3627857.0, -11.0, -11.0, 0.0);
```

```

*** AERMOD - VERSION 21112 *** *** C:\Lakes\AERMOD View\Projects\Maverik El Centro
\Maverik El Centro.is *** 12/11/23
*** AERMET - VERSION 16216 *** ***
*** 13:17:55

```

PAGE 55

```

*** MODELOPTs: RegDEFAULT CONC ELEV RURAL ADJ_U*

```

```

*** METEOROLOGICAL DAYS SELECTED FOR PROCESSING

```

```

***

```

```

(1=YES; 0=NO)

```

1 1 1	1 1 1	1 1 1	1 1 1	1 1 1	1 1 1	1 1 1	1 1 1	1 1 1	1 1 1	1 1 1	1 1 1	1 1 1	1 1 1	1 1 1	1 1 1	1 1 1	1 1 1	1 1 1	1 1 1
1 1 1	1 1 1	1 1 1	1 1 1	1 1 1	1 1 1	1 1 1	1 1 1	1 1 1	1 1 1	1 1 1	1 1 1	1 1 1	1 1 1	1 1 1	1 1 1	1 1 1	1 1 1	1 1 1	1 1 1
1 1 1	1 1 1	1 1 1	1 1 1	1 1 1	1 1 1	1 1 1	1 1 1	1 1 1	1 1 1	1 1 1	1 1 1	1 1 1	1 1 1	1 1 1	1 1 1	1 1 1	1 1 1	1 1 1	1 1 1
1 1 1	1 1 1	1 1 1	1 1 1	1 1 1	1 1 1	1 1 1	1 1 1	1 1 1	1 1 1	1 1 1	1 1 1	1 1 1	1 1 1	1 1 1	1 1 1	1 1 1	1 1 1	1 1 1	1 1 1
1 1 1	1 1 1	1 1 1	1 1 1	1 1 1	1 1 1	1 1 1	1 1 1	1 1 1	1 1 1	1 1 1	1 1 1	1 1 1	1 1 1	1 1 1	1 1 1	1 1 1	1 1 1	1 1 1	1 1 1
1 1 1	1 1 1	1 1 1	1 1 1	1 1 1	1 1 1	1 1 1	1 1 1	1 1 1	1 1 1	1 1 1	1 1 1	1 1 1	1 1 1	1 1 1	1 1 1	1 1 1	1 1 1	1 1 1	1 1 1
1 1 1	1 1 1	1 1 1	1 1 1	1 1 1	1 1 1	1 1 1	1 1 1	1 1 1	1 1 1	1 1 1	1 1 1	1 1 1	1 1 1	1 1 1	1 1 1	1 1 1	1 1 1	1 1 1	1 1 1
1 1 1	1 1 1	1 1 1	1 1 1	1 1 1	1 1 1	1 1 1	1 1 1	1 1 1	1 1 1	1 1 1	1 1 1	1 1 1	1 1 1	1 1 1	1 1 1	1 1 1	1 1 1	1 1 1	1 1 1
1 1 1	1 1 1	1 1 1	1 1 1	1 1 1	1 1 1	1 1 1	1 1 1	1 1 1	1 1 1	1 1 1	1 1 1	1 1 1	1 1 1	1 1 1	1 1 1	1 1 1	1 1 1	1 1 1	1 1 1
1 1 1	1 1 1	1 1 1	1 1 1	1 1 1	1 1 1	1 1 1	1 1 1	1 1 1	1 1 1	1 1 1	1 1 1	1 1 1	1 1 1	1 1 1	1 1 1	1 1 1	1 1 1	1 1 1	1 1 1
1 1 1	1 1 1	1 1 1	1 1 1	1 1 1	1 1 1	1 1 1	1 1 1	1 1 1	1 1 1	1 1 1	1 1 1	1 1 1	1 1 1	1 1 1	1 1 1	1 1 1	1 1 1	1 1 1	1 1 1

NOTE: METEOROLOGICAL DATA ACTUALLY PROCESSED WILL ALSO DEPEND ON WHAT IS INCLUDED IN THE DATA FILE.

```

*** UPPER BOUND OF FIRST THROUGH FIFTH WIND SPEED

```

```

CATEGORIES ***

```

```

(METERS/SEC)

```

1.54, 3.09, 5.14, 8.23, 10.80,

```

*** AERMOD - VERSION 21112 ***   *** C:\Lakes\AERMOD View\Projects\Maverik El Centro
\Maverik El Centro.is ***       12/11/23
*** AERMET - VERSION 16216 ***   ***
***                               13:17:55

```

PAGE 15

*** MODELOPTs: RegDFault CONC ELEV RURAL ADJ_U*

*** UP TO THE FIRST 24 HOURS OF METEOROLOGICAL DATA ***

```

Surface file: DesertHotSpringsAirportADJU\KTRM_V9_ADJU\KTRM_v9.SFC
Met Version: 16216
Profile file: DesertHotSpringsAirportADJU\KTRM_V9_ADJU\KTRM_v9.PFL
Surface format: FREE
Profile format: FREE
Surface station no.: 3104           Upper air station no.: 3190
                        Name: UNKNOWN           Name: UNKNOWN
                        Year: 2012             Year: 2012

```

First 24 hours of scalar data

YR	MO	DY	JDY	HR	H0	U*	W*	DT/DZ	ZICNV	ZIMCH	M-O	LEN	Z0	BOWEN	ALBEDO	REF
WS	WD	HT	REF	TA	HT											
12	01	01	1	01	-7.8	0.118	-9.000	-9.000	-999.	98.		19.4	0.08	1.91	1.00	
1.59	77.			10.1	278.8	2.0										
12	01	01	1	02	-15.8	0.171	-9.000	-9.000	-999.	169.		32.1	0.08	1.91	1.00	
2.23	288.			10.1	277.5	2.0										
12	01	01	1	03	-16.9	0.177	-9.000	-9.000	-999.	178.		34.3	0.08	1.91	1.00	
2.30	325.			10.1	278.8	2.0										
12	01	01	1	04	-3.0	0.076	-9.000	-9.000	-999.	56.		13.4	0.08	1.91	1.00	
0.94	321.			10.1	275.4	2.0										
12	01	01	1	05	-4.7	0.092	-9.000	-9.000	-999.	67.		15.0	0.08	1.91	1.00	
1.23	342.			10.1	274.2	2.0										
12	01	01	1	06	-10.7	0.139	-9.000	-9.000	-999.	124.		22.8	0.08	1.91	1.00	
1.84	309.			10.1	274.9	2.0										
12	01	01	1	07	-18.8	0.186	-9.000	-9.000	-999.	193.		38.2	0.08	1.91	1.00	

2.42	338.	10.1	277.0	2.0								
12 01 01	1 08	-11.5	0.179	-9.000	-9.000	-999.	182.	45.7	0.08	1.91	0.49	
2.30	343.	10.1	282.5	2.0								
12 01 01	1 09	44.9	0.190	0.372	0.007	42.	198.	-13.9	0.08	1.91	0.30	
1.86	334.	10.1	288.8	2.0								
12 01 01	1 10	109.3	0.237	0.720	0.006	125.	278.	-11.2	0.08	1.91	0.23	
2.27	333.	10.1	293.8	2.0								
12 01 01	1 11	153.1	0.246	1.122	0.005	338.	293.	-8.9	0.08	1.91	0.21	
2.28	348.	10.1	297.0	2.0								
12 01 01	1 12	173.2	0.204	1.424	0.005	612.	222.	-4.5	0.08	1.91	0.20	
1.72	322.	10.1	298.8	2.0								
12 01 01	1 13	169.9	0.156	1.670	0.005	1005.	148.	-2.0	0.08	1.91	0.20	
1.14	351.	10.1	300.4	2.0								
12 01 01	1 14	142.4	0.144	1.714	0.005	1296.	131.	-1.9	0.08	1.91	0.22	
1.04	329.	10.1	300.9	2.0								
12 01 01	1 15	92.8	0.142	1.542	0.005	1447.	129.	-2.8	0.08	1.91	0.25	
1.11	316.	10.1	301.4	2.0								
12 01 01	1 16	24.5	0.122	0.995	0.005	1469.	102.	-6.8	0.08	1.91	0.35	
1.09	301.	10.1	300.4	2.0								
12 01 01	1 17	-3.0	0.077	-9.000	-9.000	-999.	51.	13.7	0.08	1.91	0.65	
0.99	209.	10.1	292.0	2.0								
12 01 01	1 18	-11.9	0.149	-9.000	-9.000	-999.	138.	25.2	0.08	1.91	1.00	
1.96	149.	10.1	286.4	2.0								
12 01 01	1 19	-6.4	0.107	-9.000	-9.000	-999.	85.	17.7	0.08	1.91	1.00	
1.45	31.	10.1	284.9	2.0								
12 01 01	1 20	-15.7	0.171	-9.000	-9.000	-999.	169.	32.1	0.08	1.91	1.00	
2.23	327.	10.1	283.1	2.0								
12 01 01	1 21	-8.3	0.122	-9.000	-9.000	-999.	103.	20.2	0.08	1.91	1.00	
1.64	347.	10.1	282.0	2.0								
12 01 01	1 22	-7.9	0.119	-9.000	-9.000	-999.	99.	19.6	0.08	1.91	1.00	
1.60	316.	10.1	279.2	2.0								
12 01 01	1 23	-5.3	0.097	-9.000	-9.000	-999.	73.	15.9	0.08	1.91	1.00	
1.31	325.	10.1	278.1	2.0								
12 01 01	1 24	-9.4	0.130	-9.000	-9.000	-999.	113.	21.5	0.08	1.91	1.00	
1.74	304.	10.1	278.8	2.0								

First hour of profile data

YR	MO	DY	HR	HEIGHT	F	WDIR	WSPD	AMB_TMP	sigmaA	sigmaW	sigmaV
12	01	01	01	10.1	1	77.	1.59	278.8	99.0	-99.00	-99.00

F indicates top of profile (=1) or below (=0)

*** AERMOD - VERSION 21112 *** *** C:\Lakes\AERMOD View\Projects\Maverik El Centro
 \Maverik El Centro.is *** 12/11/23
 *** AERMET - VERSION 16216 *** ***
 *** 13:17:55

PAGE 60

*** MODELOPTs: RegDEFAULT CONC ELEV RURAL ADJ_U*

*** THE PERIOD (43848 HRS) AVERAGE CONCENTRATION VALUES FOR
 SOURCE GROUP: ALL ***
 INCLUDING SOURCE(S): PAREA1 , PAREA2 ,
 PAREA3 , L0000001 , L0000002 ,
 L0000003 , L0000004 , L0000005 , L0000006 , L0000007 ,
 L0000008 , L0000009 , L0000010 ,
 L0000011 , L0000012 , L0000013 , L0000014 , L0000015 ,
 L0000016 , L0000017 , L0000018 ,
 L0000019 , L0000020 , L0000021 , L0000022 , L0000023 ,
 L0000024 , L0000025 , . . . ,

*** DISCRETE CARTESIAN RECEPTOR POINTS ***

** ** CONC OF DPM IN MICROGRAMS/M**3
 **
 X-COORD (M) Y-COORD (M) CONC X-COORD (M) Y-COORD (M)
 CONC

 640477.17 3628075.66 0.00341 640256.60 3627956.34
 0.00083
 640278.36 3627913.01 0.00114 640299.14 3627891.23
 0.00172
 640300.34 3627870.21 0.00174 640301.14 3627857.00
 0.00176

*** AERMOD - VERSION 21112 *** *** C:\Lakes\AERMOD View\Projects\Maverik El Centro
 \Maverik El Centro.is *** 12/11/23
 *** AERMET - VERSION 16216 *** ***
 *** 13:17:55

PAGE 61

*** MODELOPTs: RegDEFAULT CONC ELEV RURAL ADJ_U*

*** THE 1ST HIGHEST 1-HR AVERAGE CONCENTRATION VALUES FOR
 SOURCE GROUP: ALL ***
 INCLUDING SOURCE(S): PAREA1 , PAREA2 ,
 PAREA3 , L0000001 , L0000002 ,
 L0000003 , L0000004 , L0000005 , L0000006 , L0000007 ,
 L0000008 , L0000009 , L0000010 ,
 L0000011 , L0000012 , L0000013 , L0000014 , L0000015 ,
 L0000016 , L0000017 , L0000018 ,
 L0000019 , L0000020 , L0000021 , L0000022 , L0000023 ,
 L0000024 , L0000025 , . . . ,

*** DISCRETE CARTESIAN RECEPTOR POINTS ***

** CONC OF DPM IN MICROGRAMS/M**3

**

X-COORD (M) (M)	Y-COORD (M) (YMMDDHH)	CONC	(YMMDDHH)	X-COORD (M)	Y-COORD
640477.17	3628075.66	0.08697	(13121318)	640256.60	
3627956.34	0.02967 (13053101)				
640278.36	3627913.01	0.03416	(14082306)	640299.14	
3627891.23	0.03736 (13110619)				
640300.34	3627870.21	0.03670	(13032605)	640301.14	
3627857.00	0.03573 (16120917)				

*** AERMOD - VERSION 21112 *** *** C:\Lakes\AERMOD View\Projects\Maverik El Centro
\Maverik El Centro.is *** 12/11/23
*** AERMET - VERSION 16216 *** ***
*** 13:17:55

PAGE 62

*** MODELOPTs: RegDFault CONC ELEV RURAL ADJ_U*

*** THE SUMMARY OF MAXIMUM PERIOD (43848 HRS)

RESULTS ***

** CONC OF DPM IN MICROGRAMS/M**3

**

NETWORK

GROUP ID	ZFLAG)	OF TYPE	GRID-ID	AVERAGE CONC	RECEPTOR (XR, YR, ZELEV, ZHILL,
----------	--------	---------	---------	--------------	---------------------------------

ALL	1ST HIGHEST VALUE IS	0.00341	AT (640477.17,	
3628075.66,	-11.28, -11.28,	0.00)	DC		
	2ND HIGHEST VALUE IS	0.00176	AT (640301.14,	
3627857.00,	-10.99, -10.99,	0.00)	DC		
	3RD HIGHEST VALUE IS	0.00174	AT (640300.34,	
3627870.21,	-11.12, -11.12,	0.00)	DC		
	4TH HIGHEST VALUE IS	0.00172	AT (640299.14,	
3627891.23,	-11.28, -11.28,	0.00)	DC		
	5TH HIGHEST VALUE IS	0.00114	AT (640278.36,	
3627913.01,	-11.28, -11.28,	0.00)	DC		
	6TH HIGHEST VALUE IS	0.00083	AT (640256.60,	
3627956.34,	-11.28, -11.28,	0.00)	DC		
0.00,	7TH HIGHEST VALUE IS	0.00000	AT (0.00,	0.00, 0.00,
0.00)					
	8TH HIGHEST VALUE IS	0.00000	AT (0.00,	0.00, 0.00,

0.00, 0.00)
9TH HIGHEST VALUE IS 0.00000 AT (0.00, 0.00, 0.00,
0.00, 0.00)
10TH HIGHEST VALUE IS 0.00000 AT (0.00, 0.00, 0.00,
0.00, 0.00)

*** RECEPTOR TYPES: GC = GRIDCART
GP = GRIDPOLR
DC = DISCCART
DP = DISCPOLR

```

*** AERMOD - VERSION 21112 ***      *** C:\Lakes\AERMOD View\Projects\Maverik El Centro
\Maverik El Centro.is ***          12/11/23
*** AERMET - VERSION 16216 ***      ***
***          13:17:55

```

PAGE 19

```

*** MODELOPTs:      RegDEFAULT  CONC  ELEV  RURAL  ADJ_U*

```

*** THE SUMMARY OF HIGHEST 1-HR RESULTS ***

** CONC OF DPM IN MICROGRAMS/M**3

**

```

                                DATE
NETWORK
GROUP ID                        AVERAGE CONC      (YYMMDDHH)      RECEPTOR (XR, YR,
ZELEV, ZHILL, ZFLAG)          OF TYPE GRID-ID
-----
ALL      HIGH      1ST HIGH VALUE IS      0.08697 ON 13121318: AT ( 640477.17,
3628075.66, -11.28, -11.28, 0.00) DC

```

```

*** RECEPTOR TYPES:  GC = GRIDCART
                       GP = GRIDPOLR
                       DC = DISCCART
                       DP = DISCPOLR

```

\Maverik El Centro.is *** 12/11/23
*** AERMET - VERSION 16216 *** ***
*** 13:17:55

PAGE 20

*** MODELOPTs: RegDEFAULT CONC ELEV RURAL ADJ_U*

*** Message Summary : AERMOD Model Execution ***

----- Summary of Total Messages -----

A Total of 0 Fatal Error Message(s)
A Total of 2 Warning Message(s)
A Total of 1124 Informational Message(s)

A Total of 43848 Hours Were Processed

A Total of 595 Calm Hours Identified

A Total of 529 Missing Hours Identified (1.21 Percent)

***** FATAL ERROR MESSAGES *****

*** NONE ***

***** WARNING MESSAGES *****

ME W186 709 MEOPEN: THRESH_1MIN 1-min ASOS wind speed threshold used
0.50

ME W187 709 MEOPEN: ADJ_U* Option for Stable Low Winds used in AERMET

*** AERMOD Finishes Successfully ***

This page intentionally left blank.

B-2 **Energy Memo**

This page intentionally left blank.



January 2, 2024

Christina Willis, President
Willis Environmental Planning
238 Sychar Road
San Diego, CA 92114

SUBJECT: Energy Calculation Memorandum for the Maverik Travel Center Project

Dear Ms. Willis;

Birdseye Planning Group (BPG) is pleased to submit this memorandum quantifying energy demand associated with the proposed Maverik Travel Center project near the City of El Centro in unincorporated Imperial County, California. The information contained herein will assist with the preparation of an Initial Study and Mitigated Negative Declaration (MND) that identifies project-specific impacts associated with developing the proposed project.

Project Description

Maverik is proposing to develop a fueling station and convenience store on a 10-acre site located on 10 gross acres of the approximately 50-acre parcel within unincorporated Imperial County (County), California, approximately 1.5 miles east of the City of El Centro (Assessor's Parcel Number 054-080-023). The Project site is located on the southeast corner of Hawes Road and Ross Avenue, east of State Route 111 (SR-111/Imperial Valley Pioneers Expressway) and is bound by Ross Avenue on the north, by Hawes Road and the Imperial Irrigation District's Acacia Five Drain A on the west.

The Maverik Fueling Station and Convenience Store Project (Project) includes 19 fuel pumps (38 fueling positions) under two separate canopies (totaling 9,0000 square feet (sf), and a 5,982 SF convenience store building. Additional improvements include three (3) underground storage tanks for fuel storage; two underground water storage tanks; on-site water and wastewater treatment facilities; parking, landscaping, drainage, and access improvements. Vehicular access would be provided via three (3) ingress/egress drives along the south side of Ross Avenue. The westernmost access would be a 40-foot driveway that would allow for left- and right-turn movements by vehicles accessing the fueling area and convenience store. This entrance would be located approximately 215 feet east of the Ross Avenue/SR-111 intersection. The second proposed entrance would be located approximately 150 feet east of the first and would provide a 60-foot inbound/outbound driveway leading directly to the proposed truck fueling stations. The third and easternmost driveway would be

located 220 feet east of the second and would provide a 50-foot driveway that would permit the full range of left- and right-turn movements, inbound and outbound. Parking would be provided in three (3) parking areas for a total of 45 parking spaces, including two accessible spaces. No overnight parking would be allowed and parking within the fueling area would be limited to 30 minutes. Project construction is anticipated to begin in late 2024 and be operational in late 2025.

Energy Demand

The following tables show estimated gasoline demand for construction workers (Table 1) and construction equipment (Table 2). All fuel calculations are based on the total Carbon Dioxide Equivalent (CO₂e) value calculated for each construction phase and vehicle miles traveled (VMT) using the California Emission Estimator Model (CalEEMod) version 2022.1. Data are reported in annual metric tons of CO₂e for the duration of each construction phase. Metric tons are converted to kilogram CO₂e and then divided by a conversion factor used by the U.S. Environmental Protection Agency to estimate gallons of gasoline (8.87) and diesel fuel (10.18) consumed based on carbon emissions.

Table 1 shows the gasoline demand for construction workers by project phase. Table 2 shows the diesel fuel demand for equipment operation. For the purpose of determining fuel demand, it was assumed that all worker vehicles would be gasoline fueled and all construction equipment would diesel fueled.

Table 1
Construction Worker Gasoline Demand

	CO ₂ E MT	Kg CO ₂ e	Gallons
Demolition – 2024	1.97	1,002	113
Site Preparation – 2024	1.15	1,150	130
Grading – 2024	0.91	910	103
Grading - 2025	4.89	4,890	551
Building Construction - 2025	5.16	5,160	582
Architectural Coating - 2025	0.57	570	64
Paving - 2025	2.22	2,220	250
Total	16.87	15,902	1,793

During operation, the project would generate demand for 529,302 kilowatt hours (kWh) of electricity and 130,091 British Thermal Units (BTU) of natural gas annually. The annual gasoline demand generated by passenger vehicles would be approximately 101,803 gallons. The annual diesel demand consumed by trucks entering and exiting the site for refueling would be approximately 49,804 gallons.

Table 2
Construction Equipment Diesel Demand

2021	CO2E MT	Kg CO2e	Gallons
Demolition – 2024	31.2	31,200	3,065
Site Preparation – 2024	24.1	24,100	2,367
Grading - 2024	13.2	13,200	1,297
Grading - 2025	71.7	71,700	7,043
Building Construction - 2025	210	210,000	20,629
Architectural Coating - 2025	15.8	15,800	1,552
Paving - 2025	2.31	2,310	227
Total	368.31	368,310	36,180

Please let me know if you have questions. You can reach me via e-mail at 760-712-2199 or via e-mail ryan@birdseyeplanninggroup.com.

Regards,



Ryan Birdseye
Principal

This page intentionally left blank.

C

**Biological
Resource Study**

This page intentionally left blank.

MAVERIK/FUELING STATION AND CONVENIENCE STORE PROJECT
BIOLOGICAL RESOURCES
ASSESSMENT REPORT
EL CENTRO, CALIFORNIA

December, 2023

Prepared for:

WILLIS ENVIRONMENTAL PLANNING

238 Sychar Road

San Diego, CA 92114

619.925.2836 (mobile)

christina@willisenvironmentalplanning.com

Prepared by:

Barrett Biological Enterprises, Inc

Certified as performed in accordance with
established biological practices by:



Marie S. Barrett, Biologist

2035 Forrester Road

El Centro, Ca 92243

760.352.4159

TABLE OF CONTENTS

MAVERICK/EVC PROJECT	1
Biological Resources	1
Assessment Report	1
El Centro, California	1
Executive Summary	4
1.0 Introduction.....	5
1.1 Location.....	5
1.2 Project Description	5
1.3 Possible Applicable Environmental Regulations	6
1.3.1 State of California	6
1.3.1 Federal.....	6
2.0 BIOLOGICAL SURVEY METHODOLOGIES.....	7
2.1 Field Surveys	7
2.1.1 General Biological Survey.....	7
2.1.2 Jurisdictional Delineation	8
2.2 Literature Review	8
3.0 Existing Conditions	9
3.1 Topography and Soils	9
3.2 Vegetation.....	9
3.2.1 Vegetation Community.....	9
3.2.2 Agriculture	9
3.2.3 Vegetation.....	9
3.3 Wildlife.....	10
3.3.1 Invertebrates.....	10
3.3.2 Amphibians.....	10
3.3.3 REPTILES	10
3.3.4 BIRDS.....	10
3.3.5 Mammals.....	10
3.3.6 Fish	10
3.4 Sensitive Biological Resources	11
3.4.1 Special Status Species.....	11
Table 3. Special-Status Wildlife Species with Potential to Occur on Project Site	11

3.4.2	Riparian Habitat or Sensitive Natural Communities.....	11
3.4.3	Jurisdictional Waters.....	12
3.4.4	Habitat Connectivity and Wildlife Corridors	12
3.4.5	California Desert Conservation Area (CDCA)	12
4.0	Proposed Project Impact	12
4.1	Impact to Special Status Species	12
4.1.1	Biological Resources.....	12
	Table 4 BIOLOGICAL Resources.....	12
4.1.2	Sensitive Wildlife.....	13
4.2	Impact to Riparian Habitat or Sensitive Natural Communities.....	13
4.3	Impact to Jurisdictional Waters	13
4.4	Impact to Wildlife Movement and Nursery Sites.....	14
4.5	Impact to Airports.....	14
4.6	CEQA Impacts	14
	Table 5: Expected Impacts.....	14
5.0	Recommended Avoidance, Minimization and Mitigation Measures.....	14
5.1	Sensitive Wildlife.....	14
5.1.1	Burrowing Owl	14
5.1.2	Migratory Birds and Non-migratory Bird Species.....	16
5.1.2	Invasive Plants.....	16
6.0	Works Referenced	17

APPENDICES

Appendix A Sensitive Botanical and Zoological Species (CNDDDB/CNPS)

Appendix B Photographs

Appendix C Species Found Onsite and Vicinity

Appendix D Qualifications

FIGURES

Figure 1 Regional Location Map

Figure 2 Project Location Maps

Figure 3 Biological Resources Map

EXECUTIVE SUMMARY

General biological surveys were conducted on November 3, 2023 within the proposed site. The approximately 10 acres of the project site is located within Imperial County, CA.

No federal or state botanical endangered or threatened species were found within the project site areas or buffer survey zone during this survey.

Burrowing owls, a California Species of Special Concern, were not found on project site but could be expected. Migratory Bird Treaty Act bird nests were not found on site but could be expected.

1.0 INTRODUCTION

1.1 LOCATION

The proposed project is located on the southeast corner of Hawes Road and Ross Avenue, immediately east of State Route 111 (SR-111), in the unincorporated area of Imperial County, California.

The site is a +/- 50.28 **-acre with Assessor's Parcel No. 054-080-023**. An Imperial Irrigation District (IID) Acacia Drain is located along the western boundary of the proposed parcel and the Acacia Canal is located across Ross Road on the northern side of the site and provides water to the property. Hawes Road abuts the project site to the west, beyond which is SR-111. Land to the immediate south and east is used for agriculture and undeveloped; Ross Avenue abuts the project site to the north and a residence; beyond which is an IID water canal and agricultural land. Found to the west is SR 111, Country Life RV Park and agriculture. The project will be developed in multiple phases. This phase consists of +/- 10 acres to be developed by Maverik; the other phase consists of the remaining +/- 40 -acres to be developed by EVC Partners LLC.

1.2 PROJECT DESCRIPTION

This biological survey was done to inventory existing environmental status on the project site. This information will guide plans related to the preparation of an Environmental Impact Report (EIR).

During the initial development phase, Maverik is proposing the construction of a new fueling station consisting of 18 fuel pumps, and a 5,982 square foot convenience store building. The applicant also proposes associated site improvements, including parking, landscaping, street improvements, and utilities.

Vehicular access to the project site is provided via three full access driveways located along Ross Avenue. Ross Avenue is a two-lane undivided roadway.

Electric service would be provided to the project site by the Imperial Irrigation District. Water service will be provided from an existing service at an Imperial Irrigation District canal. A water treatment system will be required in conjunction with the project. Sewer service is not available at the project site. A package Wastewater Treatment Plant will be required due to existing soil conditions in the area. Natural gas service is not available at the project site.

The project will require the following approvals from Imperial County for the proposed use:

- A General Plan Amendment from an Agriculture use to a Commercial use
- Change of Zone from A-2 (General Agricultural) to C-3 (Heavy Commercial)
- Tentative Map & Final (to create the +/- 10-acre parcel)

- Conditional Use Permit for three (3) Underground Fuel Storage Tanks
- Site Plan Review

1.3 POSSIBLE APPLICABLE ENVIRONMENTAL REGULATIONS

1.3.1 STATE OF CALIFORNIA

California Environmental Quality Act (CEQA) Title 14 CA Code of Regulations 15380 requires that endangered, rare or threatened species or subspecies of animals or plants be identified within the influence of the project. If any such species are found, appropriate measures should be identified to avoid, minimize or mitigate to the extent possible the effects of the project.

Native Plant Protection Act CDFG Code Section 1900-1913 prohibits the taking, possessing, or sale within the state of any plant listed by CDFG as rare, threatened, or endangered. Landowners may be allowed to take these species if CDFG is notified at least 10 days prior to plant removal or if these plants are found within public right of ways.

CA Fish and Game Codes 3503, 3503.5, 3513 protect migratory birds, bird nests and eggs including raptors (birds of prey) and raptor nests from take unless authorized by CDFW.

CA Fish and Game Code Section 1600, as amended regulates activities that substantially diverts or obstructs the natural flow of any river, stream or lake or uses materials from a streambed. This can include riparian habitat associated with watercourses.

State of CA Fully Protected Species identifies and provides additional protection to species that are rare or face possible extinction. These species may not be taken or possessed at any time except for scientific research or relocation for protection of livestock.

California Endangered Species Act (CESA) protects all native species of fishes, amphibians, reptiles, birds, mammals, invertebrates, and plants, and their habitats, threatened with extinction and those experiencing a significant decline which, if not halted, would lead to a threatened or endangered designation, will be protected or preserved.

Porter-Cologne Water Quality Control Act, as amended is administered by the State Water Resource Control Board (SWRCB) to protect water quality and is an avenue to implement CA responsibilities under the federal Clean Water Act. This act regulates discharge of waste into a water resource.

1.3.1 FEDERAL

National Environmental Policy Act (NEPA: 42 United States Code (U.S.C.) 4321 et seq) established national environmental policy and goals for the protection, maintenance and enhancement of the environment. A process is available for implementation goals within federal agencies. NEPA requires federal agencies to consider the environment in processing proposed actions.

Endangered Species Act (ESA) of 1973 (16 U.S.C. 1531-1544) protects federal listed threatened and endangered species from unlawful take (harass, harm, pursue, hunt, shoot, kill, wound, collect, capture, trap or attempt to do so) or significantly modify habitat. If a proposed project would jeopardize a threatened or endangered species, then a Section 7 consultation with a federal agency could be required.

Migratory Bird Treaty Act (50 Code Federal Regulations (CFR) 10.13) is a federal statute with several foreign countries to protect species that migrate between countries. Over 850 species are listed and may not be disrupted during nesting activities. It is illegal to collect any part (nest, feather, eggs, etc.) of a listed species, disturb species while nesting or offer for trade or barter any listed species or parts thereof.

Bald and Golden Eagle Protection Act (16 U.S.C. 668-668c) protects bald and golden eagles from take (harass, harm, pursue, hunt, shoot, kill, wound, collect, capture, trap or attempt to do so) or interference with breeding, feeding or sheltering activities.

Clean Water Act, 1972 (CWA 33 U.S.C. 1251 et seq.) regulates discharges into waters of the U.S. EPA is given the responsibility to implement programs to prevent pollution.

2.0 BIOLOGICAL SURVEY METHODOLOGIES

The purpose of the survey was to determine the inventory of biological resources at the time of the survey; the possibility of the existence of endangered, threatened, sensitive or species of concern within project area; map habitats, and ascertain the probability of the presence of sensitive species on site.

2.1 FIELD SURVEYS

2.1.1 GENERAL BIOLOGICAL SURVEY

The survey was intended to assess presence or the potential for species to occur based on habitat suitability.

California Natural Diversity Database (CNDDDB), California Native Plant Society database (CNPS), United States Fish and Wildlife Service (USFWS)/Carlsbad office Sensitive Species List, field guides, personal contacts and other methods were utilized to ascertain potential for sensitive species on the site.

Pedestrian biological survey of the approximately 10-acre project area and buffer zones, where possible, to document vegetation and animals was conducted by biologists Marie Barrett and Glenna Barrett, as indicated in Table 1: Field Survey Schedule. The surveys were conducted to develop an inventory of species (plant and animal) present at the time of the surveys, map vegetative communities, if present and ascertain the potential for occurrence of sensitive, endangered or threatened species within the project area and vicinity.

TABLE 1: FIELD SURVEY SCHEDULE

Date/Conditions	Surveyors	Survey Time
11/03/23 53-57°F clear, 0-5 mph	Marie Barrett/Glenna Barrett	0715-0830
Total all surveyors		2.5 hrs.

Garmin GPS, binoculars, thermometer, anemometer and digital cameras were used.

2.1.2 JURISDICTIONAL DELINEATION

FEMA Map 06025C1725C rates the area as Zone X: (No screen on Map): Area of Minimal Flood Hazard Zone X.

There are no blue line waterways on the map (Quadrangle Map: Holtville West).

There are drainage ditches and canals that would not meet the criteria for wetlands by either USACE or CDFW; the habitat should not be considered jurisdictional by either agency. This project will not adversely affect either water conveyance systems. Agricultural exemptions exist for activities associated with ongoing agricultural operations. The drainage ditches and canal adjacent to the project are operated by the IID. The system will remain in an IID easement following completion of the proposed project. These drainage ditches and canal connect upgradient and downgradient to offsite properties with agricultural activities that would continue to operate following implementation of the proposed project. The project will not terminate their operation or function for agricultural purposes. Therefore, these drainage ditches, canal, would still be covered per the USACE Section 404(f) exemptions.

The site has an existing water connection to the Acacia Canal.

2.2 LITERATURE REVIEW

Potential occurrence for endangered, threatened, sensitive, species of concern and noxious weeds was determined by perusal of appropriate data bases which included:

- CA Natural Diversity Database (CNDDDB)
- CA Native Plant Society (CNPS) Rare Plant Program
- USFWS Bird Species of Conservation Concern
- UFWS Critical Habitat for Threatened & Endangered Species Website
- CA Food and Agriculture Department Noxious Weed Information Project

3.0 EXISTING CONDITIONS

3.1 TOPOGRAPHY AND SOILS

This site is located in Imperial County and is found in the central part of the county. Landforms are alluvial fans derived from igneous rock and are typically sand to fine sand. The soil type is Meloland very fine sandy loam, wet (122). 0-2% slope and moderately well drained; does not flood or pond. Depth to water table is typically greater than 80 inches. This soil is considered prime farmland if irrigated and drained.

The elevation on this site varies from approximately -37 to -39 feet (below mean sea level).

3.2 VEGETATION

3.2.1 VEGETATION COMMUNITY

Vegetation has been divided into communities that are groups of plants that usually coexist within the same area. This area is considered the Colorado Desert. No native vegetation is present as this area has been converted into agricultural property.

TABLE 2: VEGETATIVE COMMUNITIES

Parcels	Acreage	Description	Vegetative Communities
054-080-023	10	Agricultural crop	Agricultural (Alfalfa)

3.2.2 AGRICULTURE

Site is used for agricultural cultivation.

3.2.3 VEGETATION

The site is under cultivation and alfalfa is being grown. Protocols for Surveying and Evaluating Impacts to Special Status Native Plant Populations and Sensitive Natural Communities (California Department of Fish and Wildlife) states that it is appropriate to conduct a botanical field survey when:

Natural (or naturalized) vegetation occurs in an area that may be directly or indirectly affected by a project (project area), and it is unknown whether or not special status plants or sensitive natural communities occur in the project area.

No natural or naturalized vegetation occurs in this agricultural cultivated property. This property has been dedicated to agricultural production for decades thus eliminating any native species through cultivation practices which include disking, planing, rototilling, floating, harvesting and pesticide applications.

3.3 WILDLIFE

3.3.1 INVERTEBRATES

The project site is an agricultural field. Typical agricultural pests such as ants, grasshoppers, aphids, beetles would be expected; identified in Appendix C.

3.3.2 AMPHIBIANS

Reliable moisture is a requirement for a portion of amphibian life cycle. The project site is an agricultural field. No amphibians were observed on site. Due to the lack of reliable, available water, none would be expected.

3.3.3 REPTILES

The project site is an agricultural field. Reptiles utilize habitat dependent upon their dietary requirements. Some species diet includes vegetation while others consume insects. All require vegetation for shelter. No lizards were found and would not be expected.

3.3.4 BIRDS

Bird species diversity varies with seasons, variety and quality of vegetative communities.

Birds were observed in the vicinity. List of species observed is found in Appendix C.

3.3.5 MAMMALS

Signs of mammals were observed on sites but were assumed to be canines and pocket gophers. Bats are not expected; roosting sites are not available. The mammals that were found are identified in Appendix C.

3.3.6 FISH

The project site is an agricultural field. There are no permanent water sources observed on site; no fish would be expected.

3.4 SENSITIVE BIOLOGICAL RESOURCES

3.4.1 SPECIAL STATUS SPECIES

TABLE 3. SPECIAL-STATUS WILDLIFE SPECIES WITH POTENTIAL TO OCCUR ON PROJECT SITE

Special-Status Species	Legal Status	Found	Potential for Occurrence
Burrowing owl (BUOW) <i>Athene cunicularia</i>	Federal: None State: CSC	No BUOW but signs observed	Agricultural area that is very favorable BUOW habitat. One BUOW pellet was found in concrete pile. No active burrows were found onsite
Flat-tailed horned lizard (FTHL) <i>Phrynosoma mcallii</i>	Federal: None State: Protected, Species of Special Concern	No	Highly disturbed agricultural acreage. No loose soils occur on site. No FTHL, scat or tracks were identified in the general biological survey. This area is not within a FTHL Management Area. Not expected
Le Conte's thrasher <i>Toxostoma lecontei</i>	CDFW: Species of Concern	No	Highly disturbed agricultural acreage with no available nesting opportunities; not expected
Loggerhead shrike <i>Lanius ludovicianus</i>	CDFW: Species of Concern	No	Very low on site - Highly disturbed acreage with sparse available nesting opportunities. Lizards which are prey were not seen
Northern Harrier <i>Circus cyaneus</i>	CDFW: SC Species of Concern	No	Low populations of prey observed but could be found hunting in area but not nesting
Yuma clapper rail (Ridgeway Rail) <i>Rallus longirostris yumanensis</i>	Fed: Endangered Ca: Threatened	No	None observed or heard; Cattails not found in dense stands. Not expected.

3.4.2 RIPARIAN HABITAT OR SENSITIVE NATURAL COMMUNITIES

Based upon the level of disturbance or habitat conversion within adjacent areas, vegetative communities are considered rare or sensitive. Rare vegetation types that are converted and degraded can disrupt the integrity of the ecological functions of natural environments. This can lead to the loss of sensitive plant species and a resulting decrease in biodiversity. Wetland or riparian habitat communities are considered sensitive by CDFW.

3.4.3 Jurisdictional Waters

Wetlands and other “waters of the United States” that are subject to Section 404 of the Clean Water Act and/or Section 10 of the Rivers and Harbors Act are under the jurisdiction of the U.S. Army Corp of Engineers (ACOE).

3.4.4 Habitat Connectivity and Wildlife Corridors

The ability for wildlife to freely move about an area and not become isolated is considered connectivity and is important to allow dispersal of a species to maintain exchange genetic characteristics; forage (food and water) and escape from predation.

3.4.5 California Desert Conservation Area (CDCA)

This project is not within or immediately adjacent to an Area of Critical Environmental Concern (ACEC) of the CDCA.

4.0 PROPOSED PROJECT IMPACT

The proposed impacts are summarized in this section.

4.1 IMPACT TO SPECIAL STATUS SPECIES

If this project has a substantial adverse effect, either directly or through habitat modification or elimination, on any plant or animal species that is considered endangered, threatened, candidate for listing or special status species either through federal or state regulations, this project would be considered to have a significant impact.

4.1.1 BIOLOGICAL RESOURCES

No special status and priority plants or animals were observed. The approximately 10 acres are highly disturbed due to agricultural cultivation and no adverse impact is expected directly on any species identified as a candidate, sensitive, or special status species in local or regional plans, policies, or regulations, or by the California Department of Fish and Wildlife (CDFW) or U.S. Fish and Wildlife Service when avoidance, minimization and mitigation recommendations are followed. Habitat modification will remove 10 acres of forage for BUOW.

Biological resources found are listed in Table 4 and Figure 4 Biological Resources Map.

TABLE 4 BIOLOGICAL RESOURCES

Location	Description	Recommendations
1. 32°46'41.88"/115°29'43.37.4"	BUOW pellet in concrete pile 1035 feet from southeast corner of site. Not within construction influence but	Complete 3 additional BUOW CDFW Protocol Surveys

	evidence of BUOW presence within vicinity.	
2. Various	Meadowlark, mourning dove, black phoebe sightings (Appendix C)	Preconstruction surveys

4.1.2 SENSITIVE WILDLIFE

4.1.2.1 MBTA NESTING

Construction Impact

There are no small trees on site that encourage bird nesting. Ground nesting species, such as lesser nighthawk, black-necked stilt or killdeer could use the area. Large trees do exist to the north of the site across Ross Road within 500 feet of project and should be monitored.

If construction is planned to begin during nesting season (generally February 1 through August 31 dependent upon weather factors), the project area and a 500-foot buffer area should be surveyed to determine presence/absence of nesting. If nests are found, an appropriate buffer zone for the species should be maintained during construction until juveniles have fledged.

There will be no impacts to nesting raptors on site due to the absence of suitable large trees for nesting. The residential trees to the north could support raptor nesting and should be surveyed and monitored.

Operations and Maintenance Indirect Impact

ELECTROCUTION

The construction of a new fueling station consisting of 18 fuel pumps, and a 5,982 square foot convenience store building and associated site improvements, including parking, landscaping, street improvements, and utilities would involve electrical components but will be installed underground to minimize avian exposure.

4.2 IMPACT TO RIPARIAN HABITAT OR SENSITIVE NATURAL COMMUNITIES

The distribution of riparian plant species is largely driven by hydrological and soil variables and riparian plant communities frequently occur in relatively distinct zones along streamside elevational and soil textural gradients.

There is no riparian vegetation found on site, therefore this project should not have a substantial adverse effect on any riparian habitat.

4.3 IMPACT TO JURISDICTIONAL WATERS

There are no wetlands or waters of the U.S. found on site; therefore this project will have no impact on federally protected wetlands as defined by Section 404 of the Clean Water Act

(including, but not limited to, marsh, vernal pool, coastal, etc.) through direct removal, filling, hydrological interruption, or other means.

4.4 IMPACT TO WILDLIFE MOVEMENT AND NURSERY SITES

This project site is in an agricultural community and subjected to continuous disturbance such as harvesting, cultivating, renovating, weeding, seeding, irrigation among other activities. Site is located to the east of SR 111, south of East Ross Road and as a result of these existing barriers, the project will not interfere substantially with the currently restricted movement of any native resident or migratory fish or wildlife species or with established native resident or migratory wildlife corridors, or impede the use of native wildlife nursery sites.

4.5 IMPACT TO AIRPORTS

This project has no components that will attract avian populations that would impact airports. It is approximately 5.35 miles from Imperial Airport, CA, which is the closest airport. No impact upon airports is expected.

4.6 CEQA IMPACTS

Possible CEQA significant impacts that could include the following within the parameters of this project:

TABLE 5: EXPECTED IMPACTS

Area	Endangered/threatened/ Species of Concern Habitat	Riparian Habitat	Wetlands	Wildlife Corridors	Local Ordinances	Waters of the U.S.
10 acres	None with avoidance/minimization/mitigation measures listed	No	No	No	No	No

5.0 RECOMMENDED AVOIDANCE, MINIMIZATION AND MITIGATION MEASURES

5.1 SENSITIVE WILDLIFE

5.1.1 BURROWING OWL

One BUOW protocol survey has been completed. In April the remaining 3 protocol surveys should be started and completed by July; and a report prepared recommending avoidance, minimization and mitigation measures. A preconstruction survey should be performed 14-30

days and 24 hours prior to initiating ground disturbance. Report should be submitted to the appropriate agency.

Since signs of BUOW have been located within the vicinity, it is recommended that construction foremen and workers and onsite employees be given worker training by a qualified biologist regarding burrowing owl that would include the following:

- Description of BUOW
- Biology
- Regulations (CDFW/USFWS)
- Wallet card with picture/guidelines for protecting owl and wildlife
- Notification procedures if owl (dead, alive, injured) is found on or near site

A sign in should be obtained and the training materials and sign in sheet should be submitted to appropriate agency.

Minimization Measures

To avoid direct or indirect impacts to BUOW, surveys for this species should be conducted to determine if this species is present within the survey area. If BUOW is present, mitigation will be required. Minimization measures could include preconstruction surveys within 14-30 days and 24 hours of start of ground breaking activities and worker training.

Mitigation Measures

1. If occupied burrows are found on site, and if necessary, the burrows shall be passively relocated by a qualified biologist outside of nesting season and an appropriate number of artificial burrows shall be installed. If possible, these burrows shall be installed as close as possible to the passively relocated burrows. A Burrowing Owl Plan should be prepared to address activities and conservation efforts and submitted to CDFW.
2. If not in the active construction areas, the occupied burrows can be sheltered in place with appropriate materials under the supervision of a qualified biologist and consultation with CDFW.
3. If occupied burrows are sheltered, a biological monitor shall monitor areas of active construction; schedule to be determined by qualified biologist. This biologist will ensure that the project complies with these mitigation measures and will have the authority to halt activities if they are not in compliance. The biologist will inspect the construction areas periodically for the presence of BUOWs.
4. If work is stopped for longer than 14 days, area will be resurveyed prior to restart of construction.

5.1.2 MIGRATORY BIRDS AND NON-MIGRATORY BIRD SPECIES

If construction is scheduled to begin during nesting season, generally considered to be between February and August dependent upon weather conditions, a survey for nesting birds should be performed within 3-7 days of groundbreaking activities on project site. Dependent upon species found, appropriate buffer zones will be established by a qualified biologist. If construction is delayed or halted for over 2 weeks during nesting season, a nesting bird survey should be conducted with 3-7 days of resumption of construction.

Presence of nesting birds should be monitored throughout the year.

It is recommended that construction foremen and workers and onsite employees be given worker training by a qualified biologist regarding nesting birds that would include the following:

- Description of BUOW and birds covered under MBTA and likely to be found on project
- Biology
- Regulations (CDFW/USFWS)
- Notification procedures if bird (dead, alive, injured) is found on or near site

A sign should be obtained and the training materials and sign in sheet should be submitted to appropriate agency.

A biologist should be consulted immediately if a dead or injured bird is found on site.

5.1.2 INVASIVE PLANTS

Any saltcedar found on site should be removed in a manner that will not distribute plant seeds or plant material as overseen by project biologist prior to construction. Use of covered trailers to remove invasive species to an approved landfill is recommended.

Equipment brought onsite should be clean to prevent importing invasive species to site.

6.0 WORKS REFERENCED

- Alonso, Juan C., Javier A. Alonso, Rodrigo Munoz-Palido, *Mitigation of Bird Collisions with Transmission Lines through Groundwire Marking*, Biological Conservation, 1994.
- Association of Environmental Professionals, *California Environmental Quality Act 2014 Statutes and Guidelines*, AEP, Palm Desert, CA, 2014.
- Baldwin, Bruce G., et al, *The Jepson Desert Manual*, Los Angeles, University of California Press, 2002.
- Behler, Jack L., and F. Wayne King, *Natural Audubon Society Field Guide to North American Reptiles & Amphibians*, New York, Chanticleer Press, 1996.
- Borror, Donald J. and Richard E. White, *Insects*, The Easton Press, Norwalk, Ct. 1970.
- Bowers, Nora, Rick Bowers, Kenn Kaufman, *Mammals of North America*, Houghton Mifflin Company, Singapore, 2004.
- California Department of Fish and Game, *Staff Report on Burrowing Owl Mitigation, California Department of Fish and Game, Oct 17, 1995*
- California Department of Fish and Game, *Staff Report on Burrowing Owl Mitigation, California Department of Fish and Game, March 7, 2012.*
- California Native Plant Society, *CNPS Inventory of Rare and Endangered Plants*, online: www.northcoast.com, November, 2023
- California Natural Diversity Database, November, 2023. Sacramento, Ca California Department of Fish and Wildlife.
- Coulombe, Harry N., *Behavior and Population Ecology of the Burrowing Owl, Speotyto Cunicularia, in the Imperial Valley of California*, The Condor, 73:163-176, 1971.
- Department of the Army, *Corps of Engineers Wetlands Delineation Manual*, January, 1987. U.S. Department of Commerce.
- Flat-tailed Horned Lizard Interagency Coordinating Committee 2003. Flat-tailed horned lizard rangewide management strategy, 2003 revision. 788 pp. plus appendices.
- Griggs, Jack, ***American Bird Conservancy's Field Guide***, *All the Birds of North America*, New York HarpersCollinsPublishers, Inc. 1997.
- Grinnell, J., and A. H. Miller. 1944. The distribution of the birds of California. Pac. Coast Avifauna no. 27. Cooper Ornith. Society. 608pp
- https://www.cnps.org/wp-content/uploads/2019/10/Bot-Cert_2018-CDFW-Plant-and-Vegetation-Survey-Protocols-LR.pdf

<https://www.google.com/maps/place/Imperial+County,+CA/@33.0211899,-116.4057862,8z/data=!3m1!4b1!4m5!3m4!1s0x80d754222493d885:0xe9d06a1b18608580!8m2!3d33.0113694!4d-115.4733554>

<https://msc.fema.gov/portal/search?AddressQuery=375%20East%20Ross%20Road%20E!%20Centro%2C%20Ca%20>

<http://viewer.nationalmap.gov/viewer>

<https://store.usgs.gov/map-locator>

<http://websoilsurvey.nrcs.usda.gov/app/WebSoilSurvey.aspx>

Jameson, E.W., Hans J. Peeters, *Mammals of California*, Los Angeles, University of California, 2004.

Rosenberg, Daniel K. and Katherin Haley, *The Ecology of Burrowing Owl in the Agroecosystem of the Imperial Valley, California*, Studies in Avian Biology, No. , 27:120-135, 2004.

Sawyer, John O. and Todd Keeler-Wolf, *A Manual of California Vegetation*, California Natural Plant Society, 2009.

Sibley, David Allen, *The Sibley Guide To Birds*, Alfred A. Knopf, New York, 2000.

Shuford W. D., and Gardali, T., editors, *California Bird Species of Special Concern: A ranked assessment of species, subspecies, and distinct populations of birds of immediate conservation concern in California*. Studies of Western Birds 1. Western Field Ornithologists, Camarillo, California and California Department of Fish and Game, Sacramento, CA

Tibbitts, T.J., M.K. Sogge, and S.J. Sferra. 1994. A survey protocol for the southwestern willow flycatcher (*Empidonax traillii extimus*). Technical Report NPS/NAUCPRS/NRTR-94/04. National Park Service Colorado Plateau Research Station, Flagstaff, Arizona. 24 p

United States Fish and Wildlife Service, *Birds of Conservation Concern*

United States Fish and Wildlife Service, *Status Assessment and Conservation Plan for the Western Burrowing Owl in the United States BTP-R6001-2003*.

York, Melissa A., Daniel K. Rosenberg, and Ken A. Sturm, *Diet and Food-Niche Breadth of Burrowing Owl (*Athene Cunicularia*) in the Imperial Valley, California*, Western North American Naturalist 62(3), 2002. 280-287.

APPENDIX A
SENSITIVE BOTANICAL AND
ZOOLOGICAL SPECIES
(CNDDDB/CNPS) SPECIES

APPENDIX A
SENSITIVE BOTANICAL AND ZOOLOGICAL SPECIES (CNDDDB/CNPS)
Holtville West Quadrangle (One Quad)
November 2023

BOTANICAL SPECIES	STATUS¹	DESCRIPTION OF SPECIES	HABITAT	OBSERVATION/SITE POTENTIAL
Sand Food <i>Pholisma sonorae</i>	State: S1.2 (threatened); CNPS list: 1B.2	Parasite on species such as <i>Erigonus</i> , <i>/tiqulia</i> , <i>ambrosia</i> , <i>pluchea</i> . White to brown color. Corolla pink to purple.	Sonoran Desert Dunes; loose deep sand	L No deep loose sand available habitat; none observed
Ribbed cryptantha <i>Johnstonella costata</i>	State: 4.3	An annual herb that is native to California, and also found in Baja California and Arizona.	an annual herb that is native to California, and also found in Baja California and Arizona.	L No desert habitat; none observed
ZOOLOGICAL SPECIES	STATUS¹	DESCRIPTION OF SPECIES	HABITAT	OBSERVATION/ SITE POTENTIAL
Yuma clapper rail (Ridgeway Rail) <i>Rallus longirostris yumanensis</i>	Fed: Endangered Ca: Threatened	A chickenlike marsh bird with a long, slightly drooping bill and an often upturned tail. Light brownish with dark streaks above. Rust-colored breast; bold, vertical gray and white bars on the flanks; white undertail coverts	Lives in freshwater and brackish marshes. Prefers dense cattails, bulrushes, and other aquatic vegetation. Nests in riverine wetlands near upland, in shallow sites dominated by mature vegetation, often in the base of a shrub. Prefers denser cover in winter than in summer. Very shy.	L None observed or heard; Cattails not found in dense stands
Burrowing Owl <i>Athene cunicularia</i>	CDFW: SC Species of Concern	Small raptors that nest in burrows that have been borrowed from other species in open grassland areas. Have adapted well in Imperial County using canals/drains/ditches to establish burrows and foraging for insects in agricultural fields	Open, dry annual or perennial grasslands; deserts & scrublands	H No owls or active burrows found; habitat. BUOW pellet found in concrete pile. Survey results included in this report

Summer tanager <i>Piranga rubra</i>	CDFW: SC Species of Concern	Adults have stout pointed bills and measure 17 cm (6.7 in) in length and 29 g (1.0 oz) in weight. Adult males are rose red and similar in appearance to the hepatic tanager, although the latter has a dark bill; females are orangish on the underparts and olive on top, with olive-brown wings and tail.	Their breeding habitat is open wooded areas, especially with oaks, across the southern United States, extending as far north as Iowa. These birds migrate to Mexico, Central America and northern South America.	L No habitat present on site.
Northern Harrier <i>Circus cyaneus</i>	CDFW: SC Species of Concern	Long-winged, long tailed hawk. Habitually flies low over open fields and marshes watching and listening for prey such as rodents and birds. (I observed Harrier with a white faced ibis as prey). Perches low or on ground. Low slow flight. Nests in reeds. Grey with black wingtips.	Marshes, open fields. Nests in reeds	M Could be found hunting in area but not nesting
Sonoran desert toad <i>Incillius alvarius</i>	CDFW: SC	Large: 7.5 inches or more in length. smooth, typically olive-green/brown skin, cranial crests, and prominent, elongated glands on both sides of the back of the head (parotoid glands) and on the hind legs. Young toads have small dark, orange-tipped spots on the back. Larger tadpoles are gray or brown with a rounded tail tip, and grow to about 2.25 inches.	<u>Sonoran Desert scrub</u> , semi-desert grasslands. Can be tied to permanent water, such as major rivers or the edges of agriculture. May be found many miles from water, particularly during the summer monsoons. Most Sonoran Desert toads are found at night during the monsoon season, but they may emerge a month or more before the summer rains begin, particularly in areas of permanent water. Can be found in rodent burrows or underground retreats.	L No habitat present on site. Not on edge of desert. Canals/drains will not be affected.

Western Yellow bat <i>Lasiurus xanthinus</i>	CDFW: Species of Concern	Consumes small to medium-sized, night flying insects. Yellow color/short ears.	Roosts in leafy vegetation in the deserts of the southwestern United States. Roosts among the dead fronds of palm trees and cottonwoods	L No palm trees for roosting; not expected
Pocketed free-tailed bat <i>Nyctinomops femorosaccus</i>	CDFW: SC	Bat has a free-tail which extends beyond the edge of the interfemoral membrane. With a forearm of 45-49 mm, it is smaller than all other North American molossid species except <i>Tadarida brasiliensis</i> . The body length measures 3 7/8 to 4 5/8", with a wingspan of 14". The fur is dark gray or brown above and below and nearly white at base.	Lives in rocky areas of desert scrub or coniferous forests. During day roosts in crevices on cliff faces.	L Not expected; no cliff crevice habitat.
Mountain plover <i>Charadrius montanus</i>	CDFW: Species of Concern	a medium-sized ground bird in the plover family. it's height is in the range of 5-9 inches (12.7-22.8 cm), and it's length is in the range of 8-10 inches (20.3 -25.4 cm), and it wrights around 102 grams.	It prefers dry habitat with short grass (usually due to grazing) and bare ground.	L If crop is bermuda or alfalfa on site and has sheep grazing or is burned off, could have foraging in area
Flat-tailed horned lizard <i>Phrynosoma mcallii</i>	CDFW: Species of Concern	A medium-sized flat-bodied lizard with a wide oval-shaped body and scattered enlarged pointed scales on the upper body and tail. The back skin is smooth with small spines. 8 horns extend from the back of the head. The two central horns are long, slender and sharp. Long and narrow	It is found in Mexico and the United States. A species of reptile, it is endemic to the Sonoran desert of the southwestern United States and northwestern Mexico.	L No habitat present on site. Site not near edge of desert.

		spines on the lower jaw and two rows of fringe scales on the sides of the body, the bottom row scales smaller than the upper		
Yuma hispid cotton rat <i>Sigmodon hispidus eremicus</i>	CDFW: Species of Concern	Dark brown or blackish rat (head to tail length: 224-365 mm; weight: 100-225 grams grizzled fur. Shorter tail than roof rat (<i>Rattus rattus</i>). Diet of vegetation and is active both day and night.	Favored habitat is wetlands with dense grass and herbaceous plants; travels on runways through vegetation.	L None observed; no habitat and no runways seen.

Special Status Species that Occur in Imperial County (USFWS)

Common Name <i>Scientific Name</i>	Status ¹ Federal/CD FW / CNPS	DESCRIPTION OF SPECIES	Habitat	Suitability Of Habitat In Survey Area
Plants				
Peirson's milk-vetch <i>Astragalus magdalenae</i> var. <i>peirsonii</i>	T/E/1B	Silvery, short-lived perennial plant that is somewhat broom like in appearance. A member of the pea and bean family, it can grow to 2.5 feet tall and is notable among milkvetches for its greatly reduced leaves. Peirson's milkvetch produces attractive, small purple flowers, generally in March or April, with 10 to 17 flowers per stalk. It yields inflated fruit similar to yellow-green pea pods with triangular beaks.	Desert dune habitats. In California, known from sand dunes in the Algodones Dunes system of Imperial County. Was known historically from Borrego Valley in San Diego County and at a site southwest of the Salton Sea in Imperial County	L None observed. No dune habitat
Birds				
California brown pelican <i>Pelecanus occidentalis</i> No longer endangered	E/E/-	Large size and brown color. Adults weigh approximately 9 pounds, and have a wingspan of over 6 feet. They have long, dark bills with big pouches for catching and holding fish. Pelicans breed in nesting colonies on islands without mammal predators. Roosting and loafing sites provide important resting	Open water, estuaries, beaches; roosts on various structures, such as pilings, boat docks, breakwaters, and mudflats	L None observed. No open water

Common Name <i>Scientific Name</i>	Status ¹ Federal/CD FW / CNPS	DESCRIPTION OF SPECIES	Habitat	Suitability Of Habitat In Survey Area
		habitat for breeding and non-breeding birds.		
Southwestern willow flycatcher <i>Empidonax traillii extimus</i>	E/-/-	Small; usually a little less than 6 inches in length, including tail. Conspicuous light-colored wingbars. Lacks the conspicuous pale eye-ring of many similar <i>Empidonax</i> species. Overall, body brownish-olive to gray-green above. Throat whitish, breast pale olive, and belly yellowish. Bill relatively large; lower mandible completely pale. The breeding range of <i>extimus</i> includes Arizona and adjacent states.	At low elevations, breeds principally in dense willow, cottonwood, and tamarisk thickets and in woodlands, along streams and rivers. Migrants may occur more widely. Prefers riparian willow/cottonwood but will use salt cedar thickets	L None Observed No habitat
Yuma clapper rail (Ridgeway Rail) <i>Rallus longirostris yumanensis</i>	E/T/-	A chickenlike marsh bird with a long, slightly drooping bill and an often upturned tail. Light brownish with dark streaks above. Rust-colored breast; bold, vertical gray and white bars on the flanks; white undertail coverts. Very shy.	Lives in freshwater and brackish marshes. Prefers dense cattails, bulrushes, and other aquatic vegetation. Nests in riverine wetlands near upland, in shallow sites dominated by mature vegetation, often in the base of a shrub. Prefers denser cover in	L None observed or heard; Cattails not found in dense stands

Common Name Scientific Name	Status ¹ Federal/CD FW / CNPS	DESCRIPTION OF SPECIES	Habitat	Suitability Of Habitat In Survey Area
			winter than in summer..	
Yellow-billed cuckoo <i>Coccyzus americanus</i>	C/E/-	Medium-sized cuckoo with gray-brown upperparts and white underparts. Eye-rings are pale yellow. Bill is mostly yellow. Wings are gray-brown with rufous primaries. Tail is long and has white-spotted black edges. Sexes are similar.	Found in forest and open woodlands, especially in areas with dense undergrowth, such as parks, riparian woodlands, and thickets	L None observed; no habitat on site. Canals/drains will not be affected.
Bald eagle <i>Haliaeetus leucocephalus</i>	T, PD/E/-	The distinctive white head and tail feathers Beak and eyes yellow. Bald Eagles are about 29 to 42 inches long, can weigh 7 to 15 pounds, and have a wing span of 6 to 8 feet.	Found on shores, lake margins, and near large rivers. Nests in large trees. Winters at lakes, reservoirs, river systems, and some rangelands and coastal wetlands (breeding range is mainly in mountainous habitats near reservoirs, lakes and rivers, mainly in the northern two-thirds of California)	L None observed; no habitat. Canals/drains will not be affected.
Least tern <i>Sterna antillarum</i>	E/E/-	Small tern. During breeding, black cap ending at white forehead. Short white eyestripe. Bill yellow with black tip. Back light gray.	Shallow areas of estuaries, lagoons, and at the joining points between rivers and estuaries	L None observed; no habitat

Common Name <i>Scientific Name</i>	Status ¹ Federal/CD FW / CNPS	DESCRIPTION OF SPECIES	Habitat	Suitability Of Habitat In Survey Area
		Underside white. Black leading edge to wing. In nonbreeding plumage has black eyestripe extending to back of head, white top of head, and black bill. Size: 21-23 cm (8-9 in) Wingspan: 48-53 cm (19-21 in) Weight: 30-45 g (1.06-1.59 ounces)		
Least Bell's Vireo <i>Vireo bellii pusillus</i>	E/E/-	Drab gray to green above and white to yellow below. It has a faint white eyering and two pale wingbars; has pale whitish cheeks and forehead and greenish wings and tail. longer tail and subtle wingbars. The song is a varied sequence of sharp, slurred phrases that typically end with an ascending or descending note.	Formerly a common and widespread summer resident below about 2,000 feet in western Sierra Nevada. Also was common in coastal southern California, from Santa Barbara County south, below about 4,000 feet east of the Sierra Nevada. Prefers thickets of willow, and other low shrubs afford nesting and roosting cover	L None observed; no habitat on site. Canals/drains will not be affected.
Mountain plover <i>Charadrius montanus</i>	FPT/SC/-	Medium-sized plover with pale brown upperparts, white underparts, and brown sides. Head has brown cap, white	Avoids high and dense cover. Uses open grass plains, plowed fields with little	L If crop is bermuda or alfalfa on site and has

Common Name <i>Scientific Name</i>	Status ¹ Federal/CD FW / CNPS	DESCRIPTION OF SPECIES	Habitat	Suitability Of Habitat In Survey Area
		face, and dark eyestripe. Upperwings are brown with black edges and white bars; underwings are white. Tail is brown-black with white edges. Sexes are similar.	vegetation, and open sagebrush areas. Likes to follow livestock grazing or burned off fields.	sheep grazing or is burned off, could have foraging in area
Black rail <i>Laterallus jamaicensis coturniculus</i>	-T/-	The smallest of all rails, the black rail is slate-colored, with a black bill, red eyes and a white-speckled back. The legs are moderately long and the toes are unwebbed. The sexes are similar.	Most commonly occurs in tidal emergent wetlands dominated by pickleweed or in brackish marshes with bulrushes in association with pickleweed. In freshwater, usually found in bulrushes, cattails, and saltgrass and in immediate vicinity of tidal sloughs. Typically occurs in the high wetland zones near upper limit of tidal flooding, not in low wetland areas with considerable annual or daily fluctuations in water levels. Nests are concealed in dense vegetation, often pickleweed, near upper limits of tidal flooding	L None observed; no habitat

Common Name <i>Scientific Name</i>	Status ¹ Federal/CD FW / CNPS	DESCRIPTION OF SPECIES	Habitat	Suitability Of Habitat In Survey Area
Raptors Peregrine Falcon <i>Falco peregrinus</i> Northern Harrier <i>Circus cyaneus</i> Sharp-shinned Hawk <i>Accipiter striatus</i>	D/E/-	Large, powerful falcon; pointed winged falcon silhouette. Strong shallow wingbeats may dive at speeds up to 100 mph. Dark with dark hooded effect. Blue gray below with narrow bars	Most often found along coastlines or marshy habitats. Nest in cliffs and have been known to nest in tall buildings	L None observed; rare visitors to area outside of the Salton Sea. No waterfowl for prey or cliffs/tall buildings for nesting
	-/SC/-	Long-winged, long tailed hawk. Habitually flies low over open fields and marshes watching and listening for prey such as rodents and birds. (I observed Harrier with a white faced ibis as prey). Perches low or on ground. Low slow flight. Nests in reeds. Grey with black wingtips.	Marshes, open fields. Nests in reeds	M Could be found hunting in area but not nesting
	-/SC/-	Blue gray above pale reddish below; small size. Tip of tail squared off. Nesting occurs in dense	Sharp-shinned hawks may appear in woodland habitats	L Low rodent, rabbit populations. Not observed

Common Name <i>Scientific Name</i>	Status ¹ Federal/CD FW / CNPS	DESCRIPTION OF SPECIES	Habitat	Suitability Of Habitat In Survey Area
White tailed Kite <i>Elanus leucurus</i>	/E/	<p>tree stands which are cool, moist, well shaded and usually near water. Hunt in openings at the edges of woodlands and also brushy pastures.</p> <p>Gray and white with black on shoulders and under bend of wing. Graceful flyer. Adults have bright red eyes. Medium size hawk; about 15 inches long and about 12 ounces.</p>	<p>during winter and migration periods and are often common in southern California in the coastal lowlands and desert areas; winters in woodlands and other habitats except alpine, open prairie and bare desert</p> <p>Found in open country; like to perch on treetop. May be seen hovering prior to attack of a rodent.</p>	<p>L</p> <p>Low rodent, rabbit populations; None observed</p>
Ferruginous hawk <i>Buteo regalis</i>	/SC/	<p>Males pale with with rufous shoulders and thigh feathers. White tail washed with rufous. Wide head wings in shallow v when soaring.</p>	<p>Found in arid to semiarid regions, as well as grasslands and agricultural areas in southwestern Canada, western United States, and northern Mexico.</p>	<p>L</p> <p>Low rodent, rabbit populations; None observed</p>

Common Name <i>Scientific Name</i>	Status ¹ Federal/CD FW / CNPS	DESCRIPTION OF SPECIES	Habitat	Suitability Of Habitat In Survey Area
Mammals				
Bighorn sheep <i>Ovis canadensis</i>	E/E/-	Sheep have short hair which is light gray to grayish brown, except around their stomachs and rump, where it is creamy white. Their tails are about four inches long. Full-grown rams weigh between 180 and 240 pounds,	Desert Bighorn sheep occupy a variety of plant communities, ranging from mixed-grass hillsides, shrubs. Avoids dense vegetation	L None observed; no habitat
Jaguar <i>Panthera onca</i>	-/-/-	Typically yellow-brown with black spots, called rosettes, but they can also be black with black spots. They are nocturnal and have a keen sense of smell and hearing. Excellent swimmers, tree climbers, and move easily on the ground.	Occurs in tropical rainforests, arid scrub, and wet grasslands. Prefers dense forests or swamps with a ready supply of water	L None observed; no habitat
Reptiles and Amphibians				
Desert tortoise <i>Gopherus agassizii</i>	T/T/-	A herbivore that may attain a length of 9 to 15 inches in upper shell (carapace) length. The tortoise is able to live	Dry, flat, and gravelly or sandy ground in desert shrub communities where	L None observed; habitat not favorable; no desert shrub

Common Name <i>Scientific Name</i>	Status ¹ Federal/CD FW / CNPS	DESCRIPTION OF SPECIES	Habitat	Suitability Of Habitat In Survey Area
		where ground temperature may exceed 140 degrees F because of its ability to dig underground burrows and escape the heat. At least 95% of its life is spent in burrows. Their shells are high-domed, and greenish-tan to dark brown in color. Desert tortoises can grow from 4–6" in height and weigh 8–15 lb (4–7 kg) when fully grown. The front limbs have heavy, claw-like scales and are flattened for digging. Back legs are more stumpy and elephantine	annual and perennial grasses are abundant. Frequent habitats with a mix of shrubs, forbs, and grasses	
Flat-tailed horn lizard <i>Phrynosoma mcallii</i>	PT/-/-	Closely related to Desert horned lizard (scat indistinguishable); only found in Imperial, Riverside County, Ca and Yuma area, Az. Small round lizard with distinguishing round spots on back. Diet of ants; needs sandy soil, shade bushes to survive.	Desert washes/sandy areas with vegetative cover. Diet of ants	L No habitat; none observed; no sandy areas available

Common Name <i>Scientific Name</i>	Status ¹ Federal/CD FW / CNPS	DESCRIPTION OF SPECIES	Habitat	Suitability Of Habitat In Survey Area
Fish				
Desert pupfish <i>Cyprinodon macularius</i>	E/E/-	<p>Small, silvery-colored fish with 6 to 9 dark bands on its sides. Grows to a full average length of only 2.5 inches; develop quickly, sometimes reaching full maturity within 2 to 3 months. Although their average life span is 6 to 9 months, some survive more than one year.</p> <p>Pupfish have a short, scaled head with an upturned mouth. The anal and dorsal fins are rounded with the dorsal sometimes exhibiting a dark blotch. The caudal fin is convex at the rear.</p>	Springs, seeps, and slow-moving streams in Salton Sink basin and backwaters and sloughs of the Colorado River	L None observed; no habitat
Razorback Sucker <i>Xyrauchen texanus</i>	Fed/CA: Endanger ed	One of the largest suckers in North America, can grow to up to 13 pounds and lengths exceeding 3 feet. The razorback is brownish-green with a yellow to white-colored belly and has an abrupt, bony hump on its back shaped like an upside-down boat keel	Colorado River	L None observed; no habitat

Sources: CDFW/CNDDDB July, 2023, California Wildlife 2023; CNPS 2023; USFWS, 2023

¹Status: Federal:

E = Listed as an endangered species

T = Listed as a threatened species

C = Candidate for listing

D = Delisted

PD = Proposed for delisting/PT = Proposed for threatened status

State/CDFG:

E = Listed as an endangered species; or previously known as "rare, fully protected"

T = Listed as a threatened species

SC = species of special concern (designation intended for use as a management tool and for information; species of special concern have no legal status (www.dfg.ca.gov/wildlife/species/ssc/birds.html))

CNPS (California Native Plant Society):

1 = Rare, threatened, or endangered in California or elsewhere

2 = Plants rare, threatened, or endangered in Ca, but more common elsewhere

3 = Plants about which more information is needed

0.1 Seriously threatened in Ca (high degree/immediacy of threat)

0.2 Fairly threatened in Ca (moderate degree/immediacy of threat)

0.3 Not very threatened in Ca (low degree/immediacy of threats or no current threats known)

Habitat Suitability Codes: H = Habitat is of high suitability for this species M = Habitat is of moderate suitability for this species L = Habitat is of low suitability for this species

USFWS BIRDS OF CONSERVATION CONCERN 2023

Common Name	Species Name	Region 8 Imperial County	National Rating	Habitat	Potential Onsite
-------------	--------------	--------------------------------	--------------------	---------	------------------

Bald Eagle	<i>Haliaeetus leucocephalus</i>	X	X	Nests on tall trees or on cliffs in forested areas near large bodies of water. Winters in coastal areas, along large rivers, and large unfrozen lakes.	Low Not expected. No tall trees; not observed in area
------------	---------------------------------	---	---	--	--

Barrett Biological Enterprises, Inc.

Maverick Project

November 2023

Swainson's Hawk	<i>Buteo swainsoni</i>		X	Breeds in open country such as grassland, shrubland, and agricultural areas. Usually migrates in large flocks often with Broad-winged Hawks. Winters in open grasslands and agricultural areas of Southern America.	Low Not expected on site; may migrate through. Not observed in area
Peregrine Falcon	<i>Falco peregrinus</i>	X	X	Inhabits open wetlands near cliffs for nesting. Also uses large cities and nests on buildings.	Low No open wetlands or nesting area.
Black Rail	<i>Laterallus jamaicensis</i>	X	X	Nests in high portions of salt marshes, shallow freshwater marshes, wet meadows, and flooded grassy vegetation.	Low No salt or freshwater marshes; no or sparse vegetation
Snowy Plover	<i>Charadrius alexandrinus</i>	X	X	Barren to sparsely vegetated sand beaches, dry salt flats in lagoons, dredge spoils deposited on beach or dune habitat, levees and flats at salt-evaporation ponds, river bars, along alkaline or saline lakes, reservoirs, and ponds.	Low No habitat; not observed
Mountain Plover	<i>Charadrius montanus</i>	X	X	Breeds on open plains at moderate elevations. Winters in short-grass plains and fields, plowed fields, and sandy deserts.	L If crop is bermuda or alfalfa on site and has sheep grazing or is burned off, could have foraging in area
Black Oystercatcher	<i>Haematopus bachmani</i>	X	X	Rocky seacoasts and islands, less commonly sandy beaches.	Low No habitat; not observed

Solitary Sandpiper	<i>Tringa solitaria</i>		X	Breeds in taiga, nesting in trees in deserted songbird nests. In migration and winter found along freshwater ponds, stream edges, temporary ponds, flooded ditches and fields, more commonly in wooded regions, less frequently on mudflats and open marshes.	Low No habitat; not observed
Lesser Yellowlegs	<i>Tringa flavipes</i>		X	Breeds in open boreal forest with scattered shallow wetlands. Winters in wide variety of shallow fresh and saltwater habitats.	Low No habitat; not observed
Upland Sandpiper	<i>Bartramia longicauda</i>		X	Native prairie and other dry grasslands, including airports and some croplands.	Low No habitat; not observed
Whimbrel	<i>Numenius phaeopus</i>	X	X	Breeds in various tundra habitat, from wet lowlands to dry heath. In migration, frequents various coastal and inland habitats, including fields and beaches. Winters in tidal flats and shorelines, occasionally visiting inland habitats.	Low Not observed Could forage in project site if forage is present
Long-billed Curlew	<i>Numenius americanus</i>	X	X	Nests in wet and dry uplands. In migration and winter found on wetlands, grain fields, lake and river shores, marshes, and	Low Not observed. Could forage in project site if forage is present

				beaches.	
Short-billed Dowitcher	<i>Limnodromus griseus</i>	X	X	Breeds in muskegs of taiga to timberline, and barely into subarctic tundra. Winters on coastal mud flats and brackish lagoons. In migration prefers saltwater tidal flats, beaches, and salt marshes. Also found in freshwater mud flats and flooded agricultural fields.	Low Not observed Could forage in project site if forage is present.
Aleutian Tern	<i>Sterna aleutica</i>		X	Nest on flat vegetated islands on or near the coast. Vegetation includes dwarf-shrub tundra, grass and sedgemeanows, and coastal marsh. Migration and winter habitat not known, probably pelagic.	Low No habitat; not observed
Least Tern	<i>Sterna antillarum</i>		X	Seacoasts, beaches, bays, estuaries, lagoons, lakes and rivers, breeding on sandy or gravelly beaches and banks of rivers or lakes, rarely on flat rooftops of buildings.	Low No habitat; not observed
Gull-billed Turn	<i>Sterna nilotica</i>		X	Breeds on gravelly or sandy beaches. Inters in salt marshes, estuaries, lagoons and plowed fields, along rivers, around lakes and in freshwater marshes.	Low No habitat; not observed

Black Skimmer	<i>Rynchops niger</i>	X	X	Breeds in large colonies on sandbars and beaches. Forages in shallow bays, inlets, and estuaries.	Low No habitat; not observed
Yellow-billed Cuckoo	<i>Coccyzus americanus</i>	X	X	Open woodlands with clearings, orchards, dense scrubby vegetation, mainly cottonwood, willow, and adler, often along water.	Low No habitat; not observed
Black Swift	<i>Cypseloides niger</i>	X	X	Nests on steep ledges on cliffs or canyons. Migrates and winters over coastal lowlands.	Low No habitat; no swifts observed in area
Costa's Hummingbird	<i>Calypte costae</i>	X	X	Primarily low deserts and arid brushy foothills, but also chaparral and coastal sage scrub closer to the coast. Often visits ornamental plantings and feeders in desert communities. In migration and winter frequents a wider variety of habitats, occasionally ranging into pine-oak woodlands in adjacent mountains.	Low No habitat; not observed – no feeders or nectar sources in area
Calliope Hummingbird	<i>Stellula calliope</i>	X	X	Open montane forest, mountain meadows, and thickets of willow and alder. In migration and winter also in chaparral, oak and pine-oak woodlands, deserts, and gardens.	Low No habitat; not observed

Rufous Hummingbird	<i>Selasphorus rufus</i>		X	Breeds in a variety of forested habitats where flowers are found. Frequents montane meadows and just about anywhere else with flowers or feeders during migration. Winters primarily in pine and pine-oak forests in Mexico, but most birds wintering farther north are attracted either to flowers or feeders in gardens.	Low No habitat; not observed – no feeders or nectar in area.
Allen's Hummingbird	<i>Selasphorus sasin</i>	X	X	Breeds in coastal sage scrub, chaparral, and riparian corridors within coastal forests. In Mexico winters in forest edge and scrub clearings with flowers. The resident population on the mainland of southern California is largely restricted to suburban neighborhoods where feeders and flowers are plentiful.	Low No habitat; not observed. No feeders or nectar in area
Lewis's Woodpecker	<i>Melanerpes lewis</i>	X	X	Breeds in open arid conifer, oak, and riparian woodlands: rare in coastal areas. Winters in breeding habitat, and oak savannas, orchards, and even in towns.	Low No habitat; not observed

Olive-sided Flycatcher	<i>Contopus cooperi</i>	X	X	Montane and northern coniferous forests, at forest edges and openings such as meadows, and at ponds and bogs. Winters at forest edges and clearings where tall trees or snags are present.	Low No habitat; not observed
Willow Flycatcher	<i>Empidonax trailii</i>	X	X	Breeds in moist, shrubby areas, often with standing or running water. Winters in shrubby clearings and early successional growth.	Low No habitat; not observed
Loggerhead Shrike	<i>Lanius ludovicianus</i>	X	X	Open or brushy areas.	Low No habitat; not observed.
Bell's Vireo	<i>Vireo bellii</i>	X	X	Dense, low, shrubby vegetation generally early successional stages in riparian areas, brushy fields, young second-growth forest or woodland, scrub oak, coastal chaparral, and mesquite brushlands, often near water in arid regions.	Low No habitat; not observed
Gray Vireo	<i>Vireo vicinior</i>	X	X	Found in desert scrub, mixed oak-juniper and pinyon-juniper woodlands, dry chaparral, and thorn scrub in hot, arid mountains and high-plains.	Low No habitat; not observed
LeConte's Thrasher	<i>Toxostoma lecontei</i>	X	X	Desert scrub, mesquite, tall riparian brush and, locally, chaparral.	Low No habitat; not observed

Yellow Warbler	<i>Dendroica petechia</i>	X		Breeds in wet, deciduous thickets, especially in willows and adler. Also in shrubby areas, old fields, gardens and orchards. In southern Florida and farther south, found in mangroves.	Low No habitat; not observed
Common Yellowthroat	<i>Geothlypis trichas</i>	X		Thick vegetation from wetlands to prairies to pine forests. Frequently near water.	Low No habitat; not observed
Rufous-winged Sparrow	<i>Aimophila carpalis</i>		X	Found in flat areas of tall desert grass mixed with brush and cactus, and thorn scrub.	Low No habitat; not observed
Brewer's Sparrow	<i>Euphagus cyanocephalus</i>	X	X	Found in a variety of habitats, but prefers open, human-modified areas, such as farmland, fields, residential lawns, and urban parks.	Low Not observed
Black-chinned Sparrow	<i>Spizella atrogularis</i>	X	X	Arid brushland, commonly in tall and fairly dense sagebrush, and dry chaparral. Often in rocky, rugged country from sea level to around 8,900 ft (2700m).	Low No habitat; not observed

Tricolored Blackbird	<i>Agelaius tricolor</i>	X	X	Breeds in marsh vegetation, particularly cattails, near grain fields, riparian scrubland, and forests, but always near water. Dairies and feedlots also commonly used for foraging. Urban and suburban areas occasionally utilized, particularly park lawns. Cultivated lands also suitable for foraging. Large night-time roosts form during nonbreeding season in cattail marshes near foraging grounds.	Low No cattails; not observed
Lawrence's Goldfinch	<i>Carduelis lawrencei</i>	X	X	Prefers dry interior foothills, mountain valleys, open woodlands, chaparral, and weedy fields. Often found near isolated water sources such as springs and cattle troughs.	Low No habitat; not observed

APPENDIX B PHOTOGRAPHS

PHOTOGRAPHS

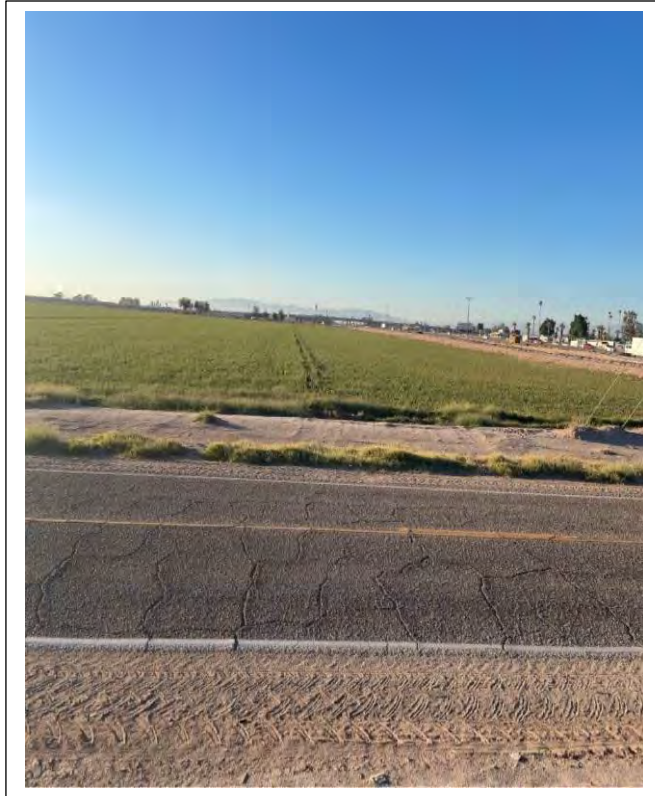

1. Project site looking south; SR 111 and RV Park to right; Ross Rd



2. Field road between two agricultural fields; rubbish and concrete pile to left; looking south



3. BUOW pellet found in concrete pile adjacent to site

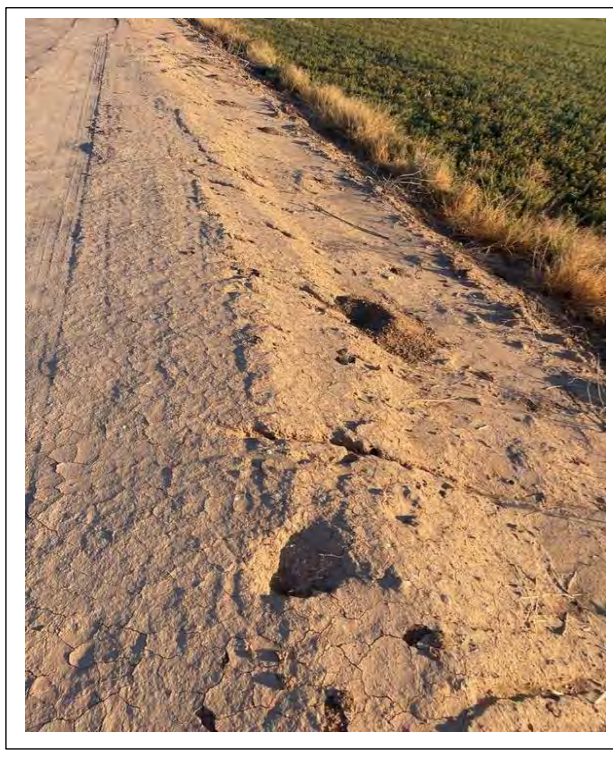

4. Pocket gopher mound found on east berm
EEC ORIGINAL PKG

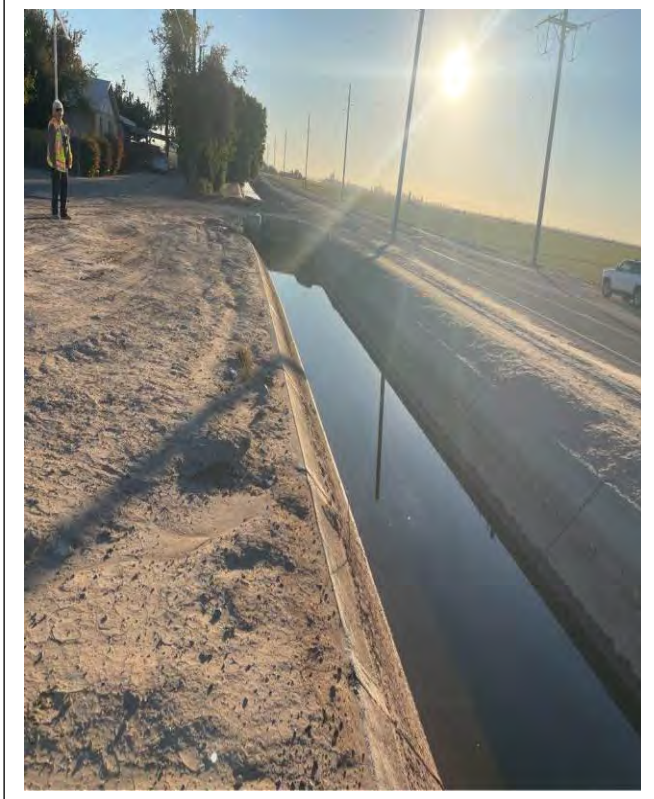

5. Residential area to north with tall trees; Acacia Canal; site to right

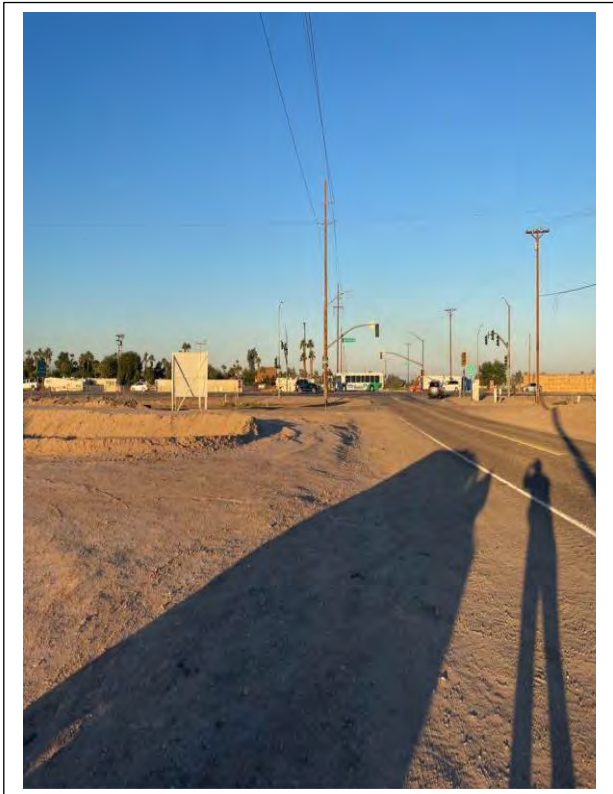

6. Facing west at intersection of SR 111 and Ross Road; Acacia drain and RV Park. Site to left

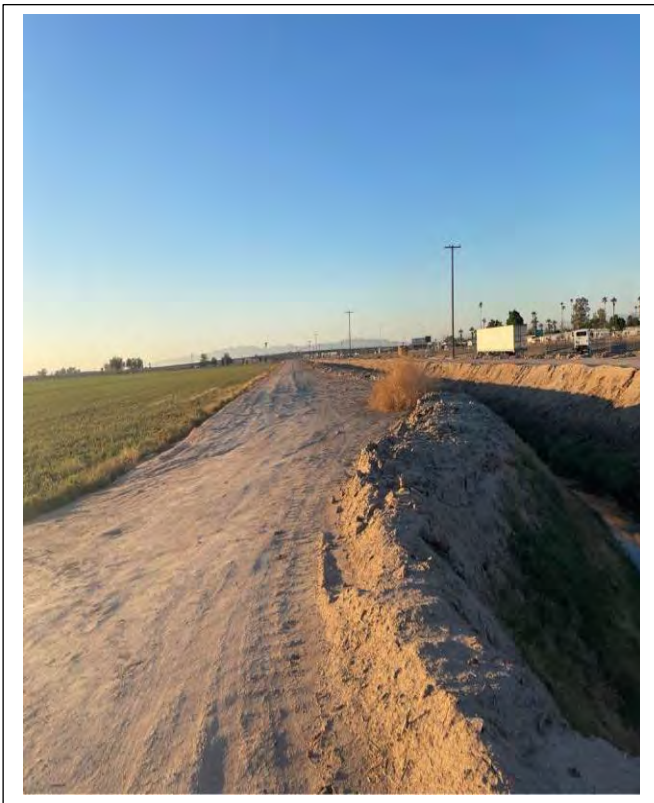

7. Site and drain road to left; Acacia Drain and Hawes Road to right.

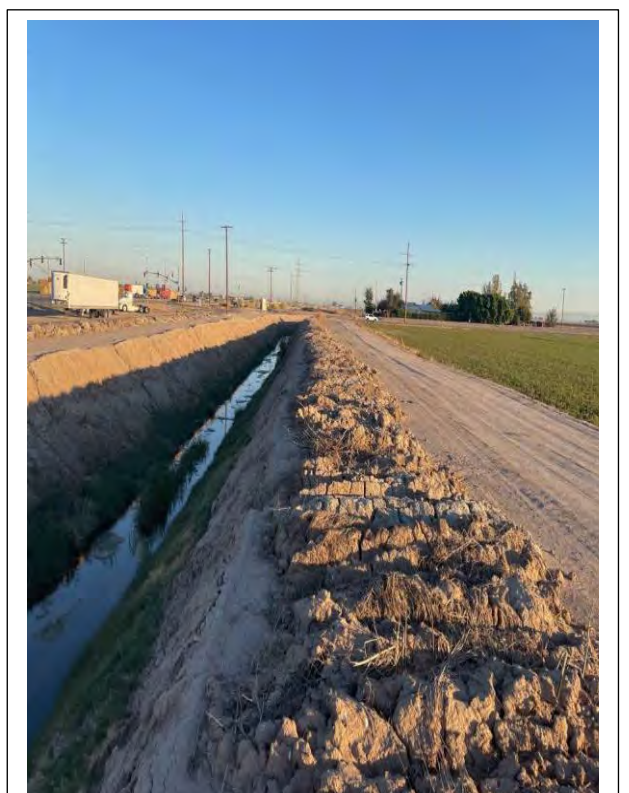

8. Looking north from south boundary; recently dredged Acacia Drain, Hawes Road to left and site to right; residential area and Ross Road top of picture



9. Southwest corner of project facing east

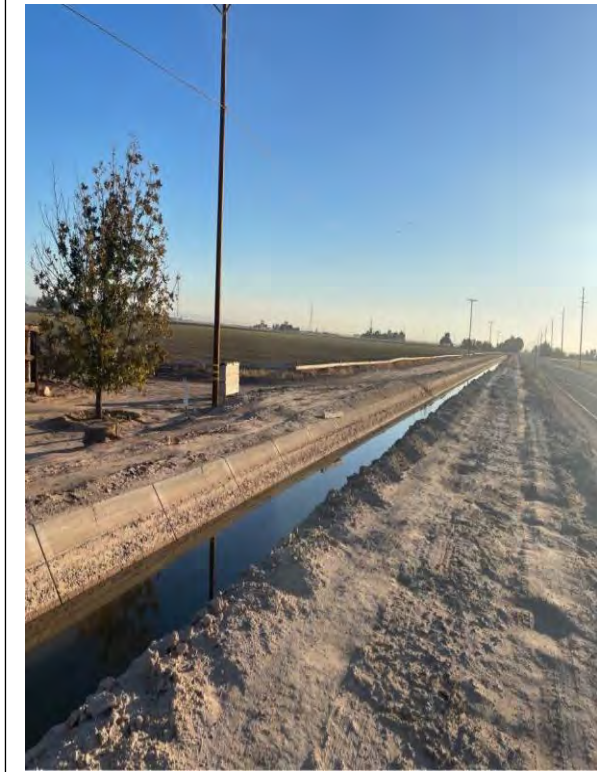

10. Agricultural field to north of site; Ross Road to right



11 Northeast corner of project looking south

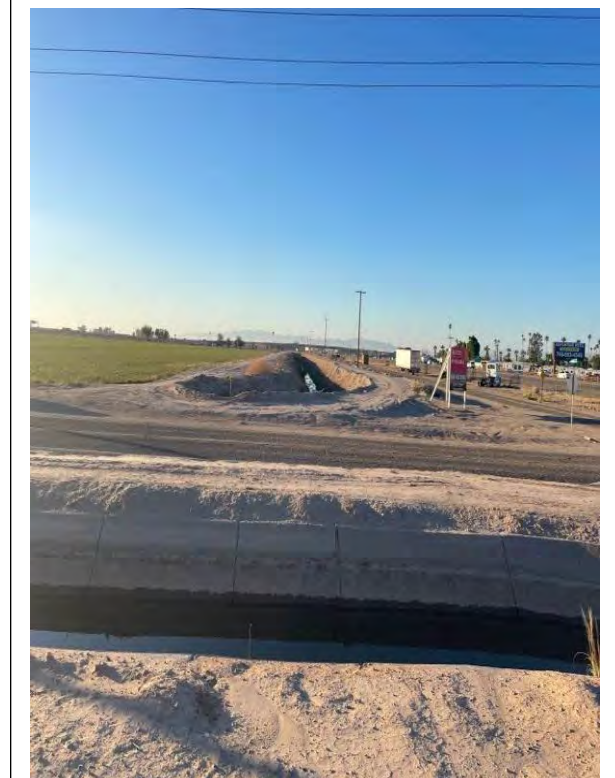

12. Acacia Canal, Ross Road, site, Acacia Drain, Hawes Road, SR 111 and RV Park looking south

APPENDIX C
SPECIES FOUND ONSITE
AND VICINITY

ZOOLOGICAL SPECIES OBSERVED ON OR NEAR SITE		
Common name	Scientific name	
Birds		Onsite/offsite
Black phoebe	<i>Sayornis nigricans</i>	Onsite
Mourning dove	<i>Zenaida macroura</i>	Onsite
Northern mockingbird	<i>Mimus polyglottos</i>	Onsite
Insects		
Ants	<i>Various</i>	Onsite
Mammals		Onsite/offsite
Canine tracks	<i>various</i>	Both
Gopher	<i>Thomomys bottae</i>	Onsite

BOTANICAL SPECIES OBSERVED ON OR NEAR SITE		
Common name	Scientific name	CNPS Classification
Alfalfa	<i>Medicago sativa</i>	None
Prostrate pigweed	<i>Amaranthus albus</i>	None
Saltcedar	<i>Tamarix spp.</i>	Ca Noxious Weed Cal-IPC rating: High *
Residential trees/vegetation (offsite)	<i>various</i>	None

*High – These species have severe ecological impacts on physical processes, plant and animal communities, and vegetation structure. Their reproductive biology and other attributes are conducive to moderate to high rates of dispersal and establishment. Most are widely distributed ecologically.

APPENDIX D QUALIFICATIONS

GLENNA MARIE BARRETT

PO Box 636 Imperial, California 92251 (760) 425-0688
glennabarrett@outlook.com

PROFILE

Organized and focused individual, adept at implementing multifaceted projects while working alone or as an integral part of a team. Skilled in client/employee communications, report preparation, program analyses and development. Cost conscious, safety oriented and empathetic. A strong communicator with excellent interpersonal skills, which allows development of rapport with individuals on all levels. A sound professional attitude, strong work ethic and pride in personal performance.

WORK EXPERIENCE

Senior Biologist Barrett's Biological Surveys, Imperial County, CA April 2016-currently.

Principal Biological Consultant, Barrett Enterprises. Imperial, CA December 2001 - currently. Compile information and complete local, state, and federal government forms; such as conditional use permits, reclamation plan applications, Financial Assurance Cost Estimates, zone changes, CEQA, Environmental Evaluation Committee responses, and 501 (c)(3) tax exemption applications. Act as liaison between local businesses and local, state, and federal government agencies. Certified to survey for Flat-Tailed Horned Lizards in California and Arizona. Certified to survey for the Desert Tortoise.

Kruger- Environmental Compliance Coordinator (ECC) for Seville Solar Complex for a 626-acre solar farm in Imperial County, CA. Compiled and submitted data and reports for APCD such as equipment lists and man hours, water hours for dust suppression; Planning reports such as weekly monitoring reports and scheduling with the third party monitor for work on BLM land; Assisted in writing the Emergency Response Action Plan; CDFW quarterly reports for the Incidental Take Permit for the Flat Tail Horned Lizard (FTHL), CNDDDB reports, FTHL Observation Data Sheets, site tours and any other information required by CDFW; Agriculture Commissioner's Office quarterly reports; provided the hazardous reporting information for the CERS online reporting system; assisted writing the FTHL ITP; trained new hires; contacted various local businesses for different on-call services; also provided any updates for plans and schedules necessary throughout the life of the project; etc. (January 2015- March 2016).

Grant writing experience: Awarded two grants for BUOW educational programs for \$15,000 each from Imperial Valley Community Foundation. Awarded \$35,700 for a total of \$75,000 with matching funds to establish the Imperial Valley Small Business Development Center with the Imperial Regional Alliance. Awarded \$450,000 from the California Public Utilities Commission for a broadband connectivity initiative in Imperial County with Imperial Regional Alliance and Imperial Valley Economic Development Corporation (IVEDC).

FIELD EXPERIENCE

Ms. Barrett has done the field work and contributed to the required reports for the following projects:

- **8ME-Burrowing Owl/MBTA/Avian Mortality Monitoring and training for the Mount Signal Solar Projects** in Calexico, CA (April 2010-2022)
- **Salton Sea Species Conservation Habitat Project** - Imperial County, CA: Nov 2020 -July 2022 monitoring construction for desert pupfish, Ridgway Rails and other species. Found both species on site and consulted with agencies for protective measures.
- **Burrtec- FTHL/MBTA Surveys** in Salton City, CA: Team leader for eight people to complete a pre-construction site sweep for 320 acres in Imperial County. 2014-2022
- **Applied Biological Consulting- Approved Biological Monitor on DPV2:** The 500kV transmission line traverses approximately 153 mi from Bythe, CA to Menifee in Riverside County, CA. Crossing private, state and Federal lands, such as the Bureau of Land Management [BLM],

U.S. Forest Service [USFS]. Desert tortoise, nesting birds, fringe toed lizard, flat tailed lizard (November 2011 to May 31, 2013)

- **Chandi Group**, Conduct Habitat Assessment Survey (as outlined in Western Riverside Multispecies Habitat Conservation Plan: Burrowing Owl/Narrow Endemic Species) within the City of Jurupa Valley, Riverside County, 2015

EDUCATION AND TRAINING

Received Bachelor of Science in Business Administration with a focus on Management, along with Economics and Leadership minors, December 2000. Humboldt State University, Arcata, CA.

Special Status/listed species observed/ identified, surveyed, monitored and/or relocated: Mohave desert tortoise, Coachella valley milkvetch, Desert kit fox, Mountain lion, Coachella valley fringe toed lizard, Mohave fringe toed lizard, Stephen's kangaroo rat, Mohave ground squirrel, Coast horned lizard, Flat-Tail Horned lizard, Burrowing Owl.

Extensive knowledge in southwestern United States, non-migratory and migratory avian biology and ecology. Strong knowledge of common Flora and Fauna communities associated with Southern California and surrounding environs. CEQA, NEPA, California Endangered Species Act (CESA) and Federal Endangered Species Act (ESA) knowledge gained through work experience. I have excellent analytical skills, multi-tasking and writing abilities. My past work experience has provided me with many years of hands on experience working with and managing others to find practical solutions to solve problems and achieve common goals.

CERTIFICATIONS/ WORKSHOPS

- Desert Pupfish Training CA Department of Fish and Wildlife Sharon Keeney, Summer/Fall 2019-21
- Introduction to Plant Identification CA Native Plant Society June. 2019
- FTHL Workshop, 2008 El Centro BLM office.
- Yuma Clapper Rail Training Colorado River Yuma Bird Festival AZ Game and Fish 2008
- USFW Desert Tortoise Egg Handling Desert Tortoise Council Survey Techniques Workshop Certificate, 2008 and 2010.
- Anza Borrego State Park Wildflower Identification Workshop, 2010.
- Southwest Willow Flycatcher Workshop Kernville, CA, 2010.
- SCE TRTP Construction Monitoring Training Class and WEAP Redlands, CA 2011.
- DPV2 Construction Monitoring Training Class and WEAP Santa Ana, CA 2011.
- Helicopter flight trained on DPV2, 2012.
- Certified to handle/ move venomous snakes on DPV2, 2012.
- Bat monitoring with Ms. Pat Brown BLM El Centro, CA Office, 2010.
- Salton Sea International Bird Festival 2007 Coordinator
- Mountain Plover/ Long-billed Curlew surveys, L.A. Museum of Natural History
- Presented at the Fourth Annual BUOW Symposium in Pasco, Washington, 2014.
- Board Member- Colorado River Citizens Forum, 2014-2016.
- BUOW Educational outreach grantee from IVCF, interacting with IID, IVROP, ICFB, Ag Commissioner's Office, 2015.
- Friends of the Sonny Bono National Wildlife Refuge, Member 2015

MARIE S. BARRETT
mariebarrett@roadrunner.com

2035 Forrester Road, El Centro, CA 92243 (760) 352 4159

LICENSES/CERTIFICATES/TRAINING

Flat Tailed Horn Lizard Surveyor CDFW/BLM

Burrowing Owl Surveyor (CDFW/USFWS)

USFW Desert Tortoise Egg Handling Desert Tortoise Council Survey Techniques Workshop
Certificate

BCI Bat Conservation and Management Workshop (Acoustic) Certificate

Southwestern Willow Flycatcher Workshop Kernville, CA 2010

Yuma Clapper Rail Training Colorado River Yuma Bird Festival AZ Game and Fish 2008

CAREER HISTORY

Barrett's Biological Surveys, El Centro, California *BIOLOGIST* 3/95 -present

Have performed numerous (over 40,000 acres) surveys involving varied wildlife including burrowing owl and plant species and written reports and biological assessments. Certified to perform Flat Tailed Horned Lizard Surveys; completed Desert Tortoise workshops; approved to handle desert tortoise (American Girl Mine/BLM project, 1/2013). Work closely with governmental agencies such as Bureau of Land Management, State Office of Mining Reclamation, California Department of Fish and Wildlife. **Biological:** Over 150 days spent in field monitoring/surveying for FTHL; 98 days in field monitoring/surveying for desert tortoise and 40,000 acres surveyed for burrowing owl; 3 IID Burrowing owl surveys with AECOM (2011/12- 275 hrs). Wrote Imperial Irrigation District (IID) Artificial Burrow Installation Manual (2009). Over 25 active burrowing owl burrows passively relocated and 50 artificial burrows installed. Volunteered for desert tortoise work (20 hrs) with Dr. Jeff Lovich. Projects: 8Minute Mt. Signal Solar 4500 acres. Preconstruction surveys/construction monitoring and BUOW Post construction monitoring; Biological reports. 2010-2020 Black Mt. MetTower Installation: desert tortoise survey and monitoring approved by BLM, El Centro office. **Monitoring:** Salton Sea Species Conservation Habitat Project Nov 21 -7/22: preconstruction surveys and monitoring; 8ME-Burrowing Owl/MBTA/Avian Mortality Monitoring and training for the Mount Signal Solar Projects in Calexico, CA (April 2010-currently); Salton City Burrtec Landfill FTHL/MBTA monitoring/clearance 2010-2022; Superior Redi Mix: FTHL surveys, Oat Pit Environmental Assessment/surveying/monitoring, El Centro, 2009-21. SDG&E La Rosite Pole Replacement FTHL Monitoring 2012-2013(410 hrs); Imperial County Department of Public Works: 6 Bridge biological assessments/reports and applicable permitting (2018-present)/Brawley Solid Waste Site Reclamation Mitigation 2015-16/Gateway of Americas Lift Station 32: Biological Assessment/Report 2016/On Call Environmental Services:2011-16; All American Aggregates, FTHL surveys, 8Minute USFWS Authorized desert tortoise biologist: American Girl Mine and Mesquite Mine. **Wetlands and Vegetation:** Participated as member of the Citizens's Congressional Task Force on New River to develop constructed wetlands criteria for 4 constructed wetlands. Performed biological/vegetative habitat surveys on each wetlands; cooperated with developing water quality and habitat criteria. Wrote a grant and obtained monies for outreach to over 2000 local students. Developed signage for the Shank Road Wetlands to explain and demonstrate the actions of wetlands. Performed Bombay Beach habitat assessment for ECORP , Sept 2021 for proposed habitat enhancements in the Bombay Beach area.

Citizens' Congressional Task Force on the New River, Brawley, Ca PROGRAM

COORDINATOR 1/98 - present

Assisted with design, construction, planting and monitoring of four constructed wetlands in Imperial County. Responsible for coordinating activities relating to student and public outreach education to promote the water quality and habitat opportunities of constructed wetlands systems on New River and Alamo River.

Imperial Valley College, Imperial, California ENVIRONMENTAL MANAGEMENT PROJECT COORDINATOR 9/95-12/99

Responsible for establishing an Environmental Technology curriculum, presenting public forums, short courses and certificate courses in hazardous materials and safety areas. In conjunction with Division Chairman, established a budget for 96-98 program and obtained funding of \$131,000 based on 95-96 program performance. Established short courses that trained over 700 people in hazardous materials safety programs. Compiled a survey of employers, which provided direction for the program.

VOLUNTEER ORGANIZATIONS

CALIFORNIA NATIVE PLANT SOCIETY: Imperial Valley Coordinator, 2006-2022.

SALTON SEA INTERNATIONAL BIRD FESTIVAL: Coordinator: 2001-2010. Organized bird festival in the Imperial Valley that attracted over 300 birders.

COLORADO RIVER WATER QUALITY CONTROL BOARD: Board member Dec 05-Sept 06.

DESERT WILDLIFE UNLIMITED: Lifetime member; serve on Citizens Congressional Task on New River

EDUCATION

University of Arizona, Tucson, Arizona

Masters of Science Degree – AGRICULTURAL EDUCATION

Thesis: Survey and training protocol for documenting burrowing owls and habitat in Imperial County, California

California State Polytechnic College, Kellogg-Voorhis Campus, Pomona, California

Bachelor of Science Degree.- AGRICULTURAL BIOLOGY, Entomology option

Imperial Valley College, Imperial, California *Associate of Science Degree. AGRICULTURE*

FIGURE 1
REGIONAL LOCATION MAP

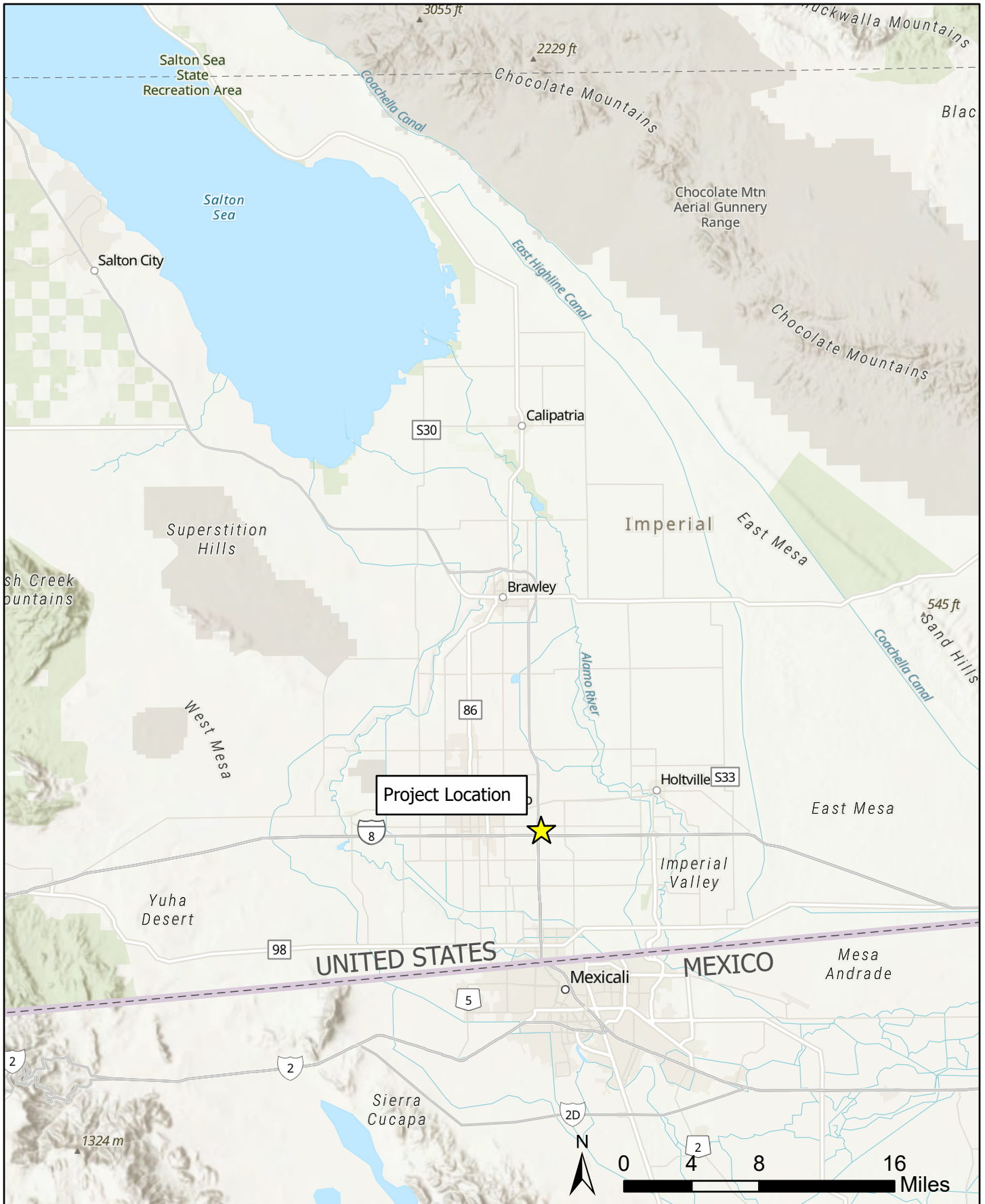

Source: Esri, 2023.



Regional Location
 Maverik Fueling Station Project GPA22-0002/ZC22-0002
 Figure 1

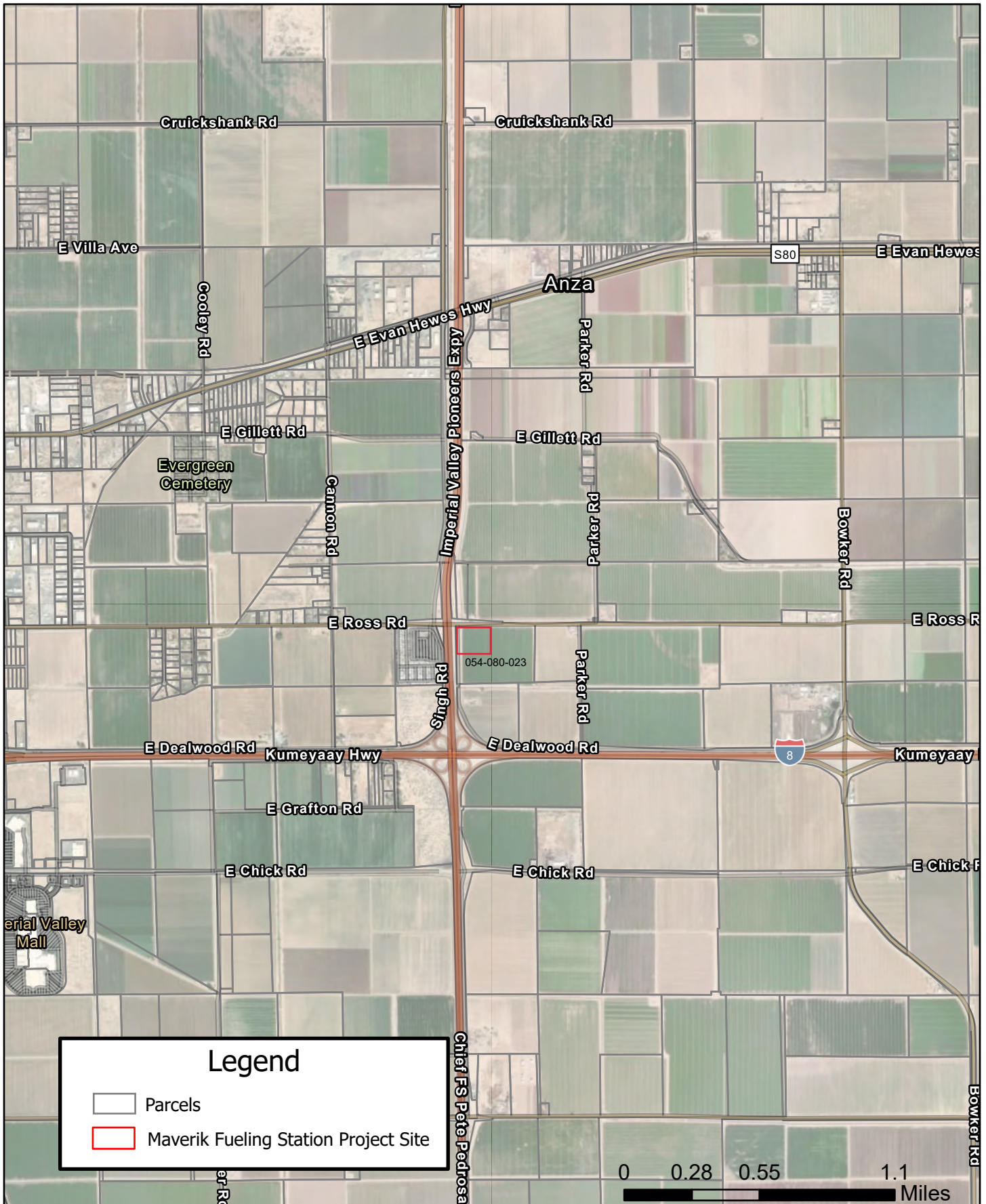

Source: Esri, 2023.



Project Site
 Maverik Fueling Station Project GPA22-0002/ZC22-0002
 Figure 2



Alfalfa field

Alfalfa

Residence with trees

Acacia Lateral 5A

DVC solar maintenance services

Country Life RV Park

Country Life Mobile Home/RV

Alfalfa

Alfalfa

1035 feet from SE corner of site

Maverick Site
Biological Resource Map

BUOW pellet

Vacant lot

Acacia Five A Drain

Acacia Five A Drain



This page intentionally left blank.

D

**Cultural
Resources**

This page intentionally left blank.

D-1

**Cultural and
Paleontological
Resource Report**

This page intentionally left blank.

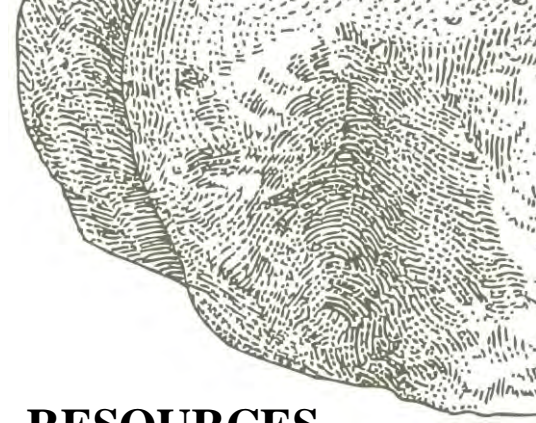

**CULTURAL AND PALEONTOLOGICAL RESOURCES
ASSESSMENT FOR THE MAVERIK FUELING
STATION AND CONVENIENCE STORE
DEVELOPMENT PROJECT, IMPERIAL COUNTY,
CALIFORNIA**

Prepared for:

Christina Willis, President
Willis Environmental Planning,
238 Sychar Road
San Diego, CA 92114

Authors:

John Gust, Ph.D.
Eric Scott, M.A.

Principal Investigator:

John Gust, Ph.D
Km Scott, M.S.

January 2024

Cogstone Project Number: 5434-01

Type of Study: Cultural and Paleontological Resources Assessment

Archaeological Sites: None within the Project Area

Historic Built Environment Resources: Acacia Five A Drain

7.5' USGS Quadrangle: El Centro (1979), Holtville West (1979)

Area: 10 acres

Key Words: Negative for significant cultural resources, Positive for historic built environment resources, Negative for paleontological resources, Imperial Valley, Cultural and paleontological resources assessment

TABLE OF CONTENTS

SUMMARY OF FINDINGS	V
INTRODUCTION	1
PURPOSE OF STUDY	1
PROJECT LOCATION AND DESCRIPTION	1
PROJECT PERSONNEL	5
REGULATORY ENVIRONMENT	5
STATE LAWS AND REGULATIONS.....	5
<i>CALIFORNIA ENVIRONMENTAL QUALITY ACT.....</i>	<i>5</i>
<i>TRIBAL CULTURAL RESOURCES</i>	<i>6</i>
<i>PUBLIC RESOURCES CODE.....</i>	<i>6</i>
<i>CALIFORNIA REGISTER OF HISTORICAL RESOURCES.....</i>	<i>7</i>
<i>NATIVE AMERICAN HUMAN REMAINS.....</i>	<i>8</i>
<i>CALIFORNIA ADMINISTRATIVE CODE, TITLE 14, SECTION 4307</i>	<i>8</i>
IMPERIAL COUNTY GENERAL PLAN	8
<i>OPEN SPACE AND CONSERVATION ELEMENT.....</i>	<i>8</i>
DEFINITION OF SIGNIFICANCE FOR PALEONTOLOGICAL RESOURCES.....	9
BACKGROUND	10
NATURAL SETTING	10
<i>GEOLOGICAL SETTING</i>	<i>10</i>
<i>PALEONTOLOGICAL SETTING.....</i>	<i>11</i>
PREHISTORIC SETTING.....	11
<i>EARLY HOLOCENE PERIOD (10,000 TO 9,000 B.P.)</i>	<i>11</i>
<i>MIDDLE TO EARLY LATE HOLOCENE PERIOD (9000 TO 1500 B.P.)</i>	<i>11</i>
<i>LATE PREHISTORIC PERIOD (AFTER 1500 B.P.)</i>	<i>12</i>
ETHNOGRAPHIC AND ETHNOHISTORIC CONTEXT	12
HISTORIC SETTING.....	14
<i>PROJECT AREA HISTORY</i>	<i>15</i>
RECORDS SEARCH.....	16
PALEONTOLOGICAL RECORD SEARCH	16
CALIFORNIA HISTORIC RESOURCES INFORMATION SYSTEM.....	16
OTHER SOURCES	18
SACRED LANDS FILE SEARCH.....	19
SURVEY.....	19
METHODS.....	19
RESULTS	19
STUDY FINDINGS AND CONCLUSIONS	27
PALEONTOLOGICAL RESOURCES SENSITIVITY	27
CULTURAL RESOURCES SENSITIVITY	28
RECOMMENDATIONS	28
PALEONTOLOGICAL RESOURCES RECOMMENDATIONS	28
CULTURAL RESOURCES RECCOMENDATIONS.....	28
REFERENCES CITED.....	30
APPENDIX A. QUALIFICATIONS.....	34

APPENDIX B. PALEONTOLOGICAL RECORD SEARCH39
APPENDIX C. HISTORICAL SOCIETIES CONSULTATION.....43
APPENDIX D. SACRED LANDS FILE SEARCH46
APPENDIX E. PALEONTOLOGICAL SENSITIVITY RANKING CRITERIA52
APPENDIX F. DPR 523 FORMS.....54

LIST OF FIGURES

FIGURE 1. PROJECT VICINITY MAP2
FIGURE 2. PROJECT LOCATION3
FIGURE 3. PROJECT AERIAL MAP4
FIGURE 4. TRIBAL BOUNDARIES MAP13
FIGURE 5. OVERVIEW FROM NORTHEAST CORNER OF PROJECT AREA, FACING SOUTHWEST20
FIGURE 6. OVERVIEW CENTER OF NORTHERN END OF PROJECT AREA, FACING SOUTH21
FIGURE 7. OVERVIEW FROM NORTHWEST CORNER OF PROJECT AREA, FACING EAST21
FIGURE 8. TYPICAL SEDIMENTS IN THE PROJECT AREA22
FIGURE 9. SURVEY RESULTS MAP.....23
FIGURE 10. ACACIA FIVE A DRAIN FROM SOUTH OF PROJECT AREA, FACING NORTH24
FIGURE 11. NORTHERN PORTION OF ACACIA FIVE A DRAIN IN PROJECT AREA, FACING SOUTH24
FIGURE 12. SIDE WALL OF ACACIA FIVE A DRAIN, FACING WEST25

LIST OF TABLES

TABLE 1. PREVIOUS STUDIES WITHIN A HALF-MILE RADIUS OF THE PROJECT AREA16
TABLE 2. PREVIOUSLY RECORDED CULTURAL RESOURCES WITHIN A HALF MILE RADIUS OF THE PROJECT AREA
.....17
TABLE 3. ADDITIONAL SOURCES CONSULTED.....18

SUMMARY OF FINDINGS

The purpose of this study is to determine the potential effects to cultural and paleontological resources resulting from the Maverik Fueling Station and Convenience Store Project, unincorporated Imperial County, California (Project). Imperial County is the lead agency under the California Environmental Quality Act (CEQA).

Maverik is proposing to develop a fueling station and convenience store on 10 gross acres of an approximately 50-acre parcel within unincorporated Imperial County (County), California, approximately 1.5 miles east of the City of El Centro. The Project site is located on the southeast corner of Hawes Road and Ross Avenue, east of State Route 111 (SR-111/Imperial Valley Pioneers Expressway) and is bound by Ross Avenue on the north, by Hawes Road and the Imperial Irrigation District's Acacia Five Drain A on the west. The Project site is located on Assessor's Parcel Number (APN) 054-080-023 within Section 11 of Township 16 South, Range 14 East, San Bernardino Base Meridian on the United States Geological Survey (USGS) El Centro and Holtville West 7.5-minute topographic quadrangle maps. The westbound offramp of Interstate 8 at SR-111 is located approximately 0.25 miles south of the Project site.

The Project includes 19 fuel pumps (38 fueling positions) under two separate canopies (totaling 9,000 square feet), and a 5,982 square-foot convenience store building. Additional improvements include three (3) underground storage tanks (USTs) for fuel storage; two underground water storage tanks; on-site water and wastewater treatment facilities; parking, landscaping, drainage, and access improvements.

A General Plan Amendment to change the Project site's land use designation from "Agriculture" to "Urban Area"; as well as a Zone Change, to change zoning from A-2 (General Agricultural) to C-3 (Heavy Commercial) are also proposed.

The USTs will require excavation to depths of approximately 18 feet and the wastewater treatment plant will be 6.5 feet below grade.

A paleontological record search for the Project was obtained from the San Diego Natural History Museum; additional records from the San Bernardino County Museum, the University of California Museum of Paleontology database, the PaleoBiology Database, and pertinent print sources were also consulted for records of fossils from the region. Results confirm that the Project is situated entirely upon sediments of the fossiliferous Lake Cahuilla Beds, which have yielded well-preserved remains of latest Pleistocene and Holocene freshwater clams and snails as well as freshwater fish. No recorded paleontological localities producing vertebrate fossils were found within one mile of the Project Area.

Cogstone requested a search of the California Historical Resources Information System (CHRIS) from the South Coastal Information Center (SCIC) located at San Diego State University on November 8, 2023 which included the entire proposed Project Area as well as a half-mile radius. Results of the record search indicate that one previous study has been completed within the

Project Area while an additional seven studies have been completed previously within a half-mile radius of the Project Area.

No cultural resources have been recorded within the Project Area. Outside of the Project area a total of nine cultural resources have been previously documented within the half-mile search radius from the Project area. These consist of one cultural resource within a quarter-mile of the Project Area and eight cultural resources within a quarter- to half-mile of the Project Area.

Cogstone requested a Sacred Lands File (SLF) search from the Native American Heritage Commission (NAHC) on November 8, 2023. The NAHC responded on December 3, 2023, with a positive SLF search result and 21 tribes or individuals that the NAHC suggested be contacted concerning information about the Project Area.

Cogstone archaeologist and cross-trained paleontologist Stephen Egenberger conducted the pedestrian survey on November 21, 2023 using two three-meter transects. The Project Area is currently forage land for sheep and has heavy ground cover with less than 10 percent visibility with the exception of the bare margins on the north and west sides. No archaeological or paleontological materials were identified during the survey.

A 1,225-foot long section of the Acacia Five A Drain, the first 620 feet of which runs along the inside of the western boundary of the Project Area, was documented during the survey. The earthen-lined drain is approximately 40 feet wide at the surface, 20 feet deep, and varies between 0 and 10 feet wide at the bottom.

The section of this resource was found to not be connected with important events in the past, important persons in the past, nor is it of unique construction. Recordation on Department of Parks and Recreation series 523 site forms has exhausted the potential of this resource to yield data important to the past. The resource is not considered significant and is recommended not eligible for listing in the California Register of Historical Resources under any criteria.

Sediments of the latest Pleistocene and Holocene Lake Cahuilla Beds have been demonstrated to have moderate paleontological sensitivity. A qualified paleontologist should be retained to develop and implement a Paleontological Resources Impact Mitigation Plan, which should include development of a paleontology Worker Environmental Awareness Program (WEAP) and full-time paleontological monitoring.

Based on a review of the SCIC record search results, historic USGS topographic quadrangle maps, and USDA aerial photographs, the Project Area is assessed to have a low sensitivity for buried historic-aged cultural deposits. Based on these data sources alone the Project Area is also assessed to have low sensitivity for buried prehistoric archaeological resources. However, the positive SLF search result may indicate that there are tribal cultural resources present that are unknown to the SCIC that elevate the cultural sensitivity of the Project Area.

With respect to cultural resources, Cogstone recommends that this Project proceed as planned, but that full-time cultural resources and Native American monitoring be required by Imperial

County should the cultural sensitivity of the Project Area be enhanced by the results of government to government Native American consultation.

INTRODUCTION

PURPOSE OF STUDY

The purpose of this study is to determine the potential effects to cultural and paleontological resources resulting from the Maverik Fueling Station and Convenience Store Project, unincorporated Imperial County, California (Project; Figure 1). Imperial County is the lead agency under the California Environmental Quality Act (CEQA).

PROJECT LOCATION AND DESCRIPTION

Maverik is proposing to develop a fueling station and convenience store on 10 gross acres of an approximately 50-acre parcel within unincorporated Imperial County (County), California, approximately 1.5 miles east of the City of El Centro (see Figure 1). The Project site is located on the southeast corner of Hawes Road and Ross Avenue, east of State Route 111 (SR-111/Imperial Valley Pioneers Expressway) and is bound by Ross Avenue on the north, by Hawes Road and the Imperial Irrigation District's Acacia Five A Drain on the west (Figures 2 and 3). The Project site is located on Assessor's Parcel Number (APN) 054-080-023 within Section 11 of Township 16 South, Range 14 East, San Bernardino Base Meridian on the United States Geological Survey (USGS) El Centro and Holtville West 7.5-minute topographic quadrangle maps. The westbound offramp of Interstate 8 at SR-111 is located approximately 0.25 miles south of the Project site.

The Project includes 19 fuel pumps (38 fueling positions) under two separate canopies (totaling 9,000 square feet), and a 5,982 square feet convenience store building. Additional improvements include three (3) underground storage tanks (USTs) for fuel storage; two underground water storage tanks; on-site water and wastewater treatment facilities; parking, landscaping, drainage, and access improvements.

A General Plan Amendment to change the Project site's land use designation from "Agriculture" to "Urban Area"; as well as a Zone Change, to change zoning from A-2 (General Agricultural) to C-3 (Heavy Commercial) are also proposed.

The USTs will require excavation to depths of approximately 18 feet and the wastewater treatment plant will be 6.5 feet below grade.

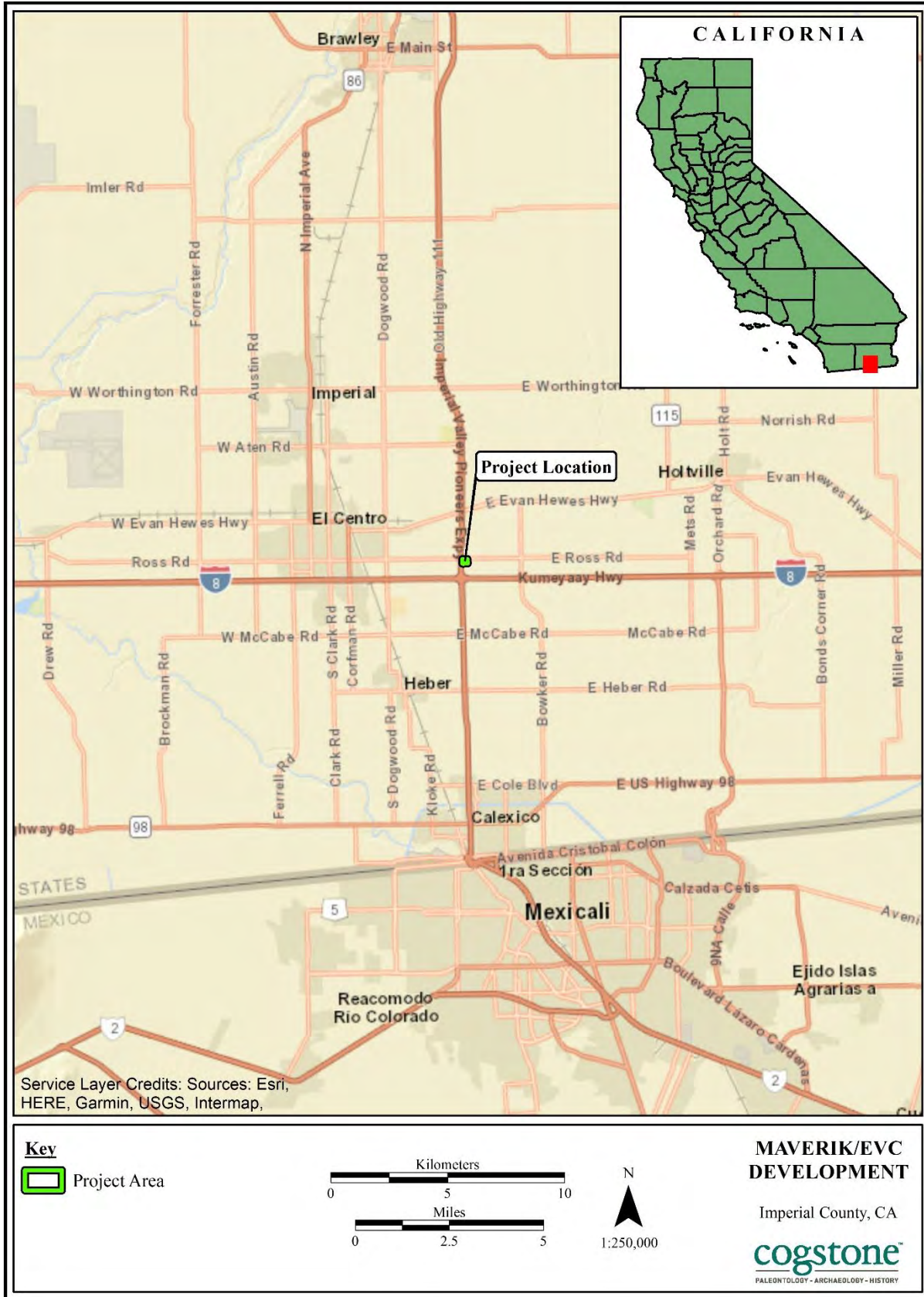

Figure 1. Project vicinity map

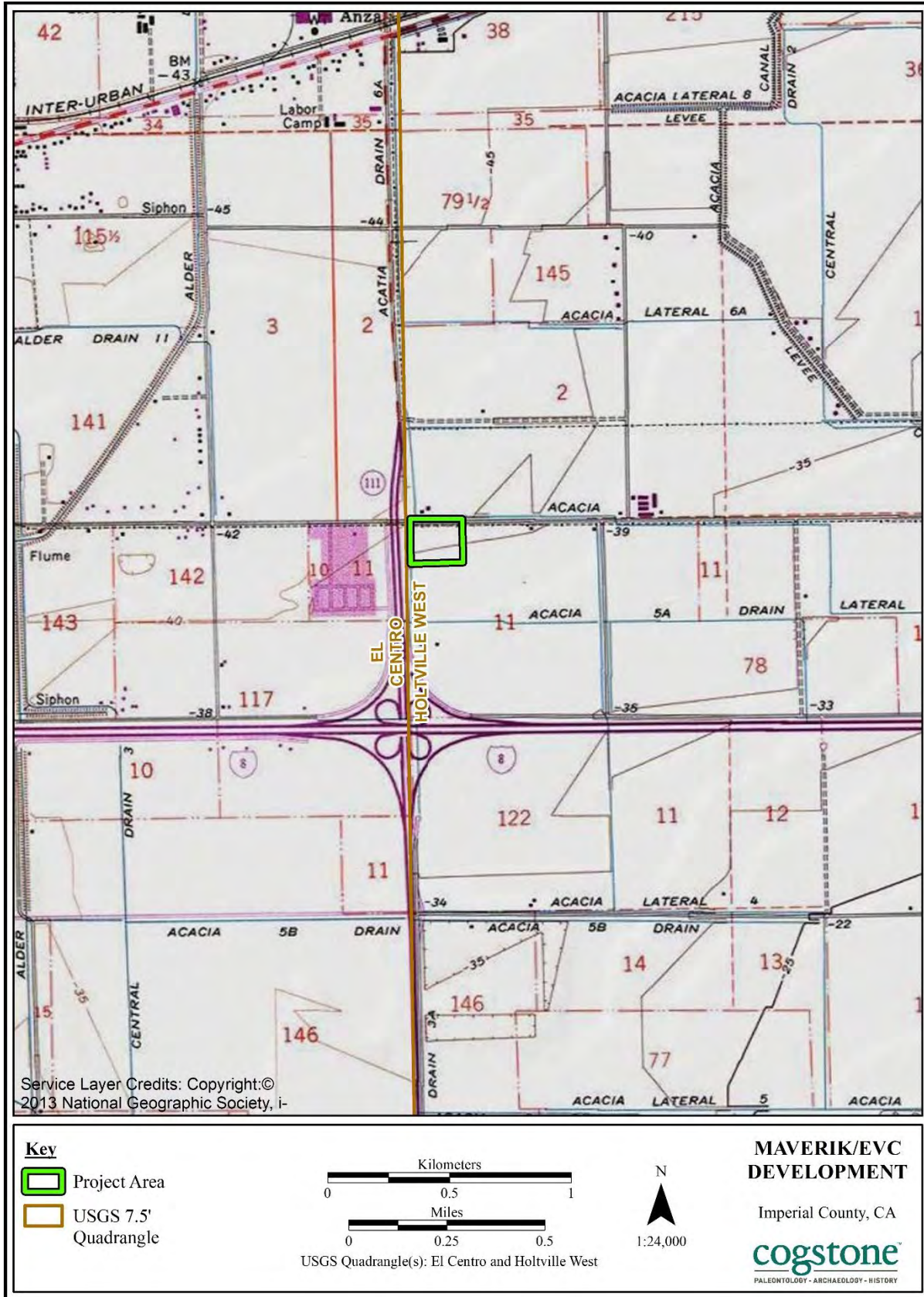

Figure 2. Project location



Figure 3. Project aerial map

PROJECT PERSONNEL

Cogstone Resource Management (Cogstone) conducted the cultural and paleontological resources assessment and authored this report. Resumes of key personnel are provided in Appendix A.

John Gust, Registered Professional Archaeologist (RPA), served as the Task Manager and Principal Investigator for Archaeology for the Project, and co-authored this report. Dr. Gust has a Ph.D. in Anthropology from the University of California (UC), Riverside, and over 11 years of experience in archaeology.

Kim Scott served as the Principal Investigator for Paleontology for the Project and is an Orange County certified paleontologist. Ms. Scott has an M.S. in Biology with a paleontology emphasis from California State University (CSU), San Bernardino, and over 28 years of experience in California paleontology and geology.

Eric Scott coauthored this report as well as providing QA/QC of the paleontology and geology sections. Mr. Scott is a member of the Society of Vertebrate Paleontology, has an M.A. in Anthropology, with an emphasis in biological paleoanthropology, from the University of California, Los Angeles (UCLA), and more than 39 years of experience in California paleontology.

Logan Freeberg prepared the Geographic Information System (GIS) maps throughout this report. Mr. Freeberg has a B.A. in Anthropology from UC Santa Barbara and a GIS certification from CSU Fullerton and over 20 years of experience in California archaeology.

Molly Valasik, RPA, provided Quality Assurance and Quality Control (QA/QC) for the Project and reviewed this report. Ms. Valasik has an M.A. in Anthropology from Kent State University in Ohio and over 14 years of experience in California archaeology.

REGULATORY ENVIRONMENT

STATE LAWS AND REGULATIONS

CALIFORNIA ENVIRONMENTAL QUALITY ACT

CEQA states that: It is the policy of the state that public agencies should not approve projects as proposed if there are feasible alternatives or feasible mitigation measures available which would substantially lessen the significant environmental effects of such projects, and that the procedures required are intended to assist public agencies in systematically identifying both the

significant effects of proposed project and the feasible alternatives or feasible mitigation measures which will avoid or substantially lessen such significant effects.

CEQA declares that it is state policy to: “take all action necessary to provide the people of this state with...historic environmental qualities.” It further states that public or private projects financed or approved by the state are subject to environmental review by the state. All such projects, unless entitled to an exemption, may proceed only after this requirement has been satisfied. CEQA requires detailed studies that analyze the environmental effects of a proposed project. In the event that a project is determined to have a potential significant environmental effect, the act requires that alternative plans and mitigation measures be considered.

TRIBAL CULTURAL RESOURCES

As of 2015, CEQA established that “[a] project with an effect that may cause a substantial adverse change in the significance of a tribal cultural resource is a project that may have a significant effect on the environment” (Public Resources Code, § 21084.2). In order to be considered a “tribal cultural resource,” a resource must be either:

- (1) listed, or determined to be eligible for listing, on the national, state, or local register of historic resources, or
- (2) a resource that the lead agency chooses, in its discretion, to treat as a tribal cultural resource.

To help determine whether a project may have such an effect, the lead agency must consult with any California Native American tribe that requests consultation and is traditionally and culturally affiliated with the geographic area of a proposed project. If a lead agency determines that a project may cause a substantial adverse change to tribal cultural resources, the lead agency must consider measures to mitigate that impact. Public Resources Code §20184.3 (b)(2) provides examples of mitigation measures that lead agencies may consider to avoid or minimize impacts to tribal cultural resources.

PUBLIC RESOURCES CODE

Section 5097.5: No person shall knowingly and willfully excavate upon, or remove, destroy, injure or deface any historic or prehistoric ruins, burial grounds, archaeological or vertebrate paleontological site, including fossilized footprints, inscriptions made by human agency, or any other archaeological, paleontological or historical feature, situated on public lands (lands under state, county, city, district or public authority jurisdiction, or the jurisdiction of a public corporation), except with the express permission of the public agency having jurisdiction over such lands. Violation of this section is a misdemeanor. As used in this section, “public lands” means lands owned by, or under the jurisdiction of, the state, or any city, county, district, authority, or public corporation, or any agency thereof.

CALIFORNIA REGISTER OF HISTORICAL RESOURCES

The California Register of Historical Resources (CRHR) is a listing of all properties considered to be significant historical resources in the state. The California Register includes all properties listed or determined eligible for listing on the National Register, including properties evaluated under Section 106, and State Historical Landmarks No. 770 and above. The California Register statute specifically provides that historical resources listed, determined eligible for listing on the California Register by the State Historical Resources Commission, or resources that meet the California Register criteria are resources which must be given consideration under CEQA (see above). Other resources, such as resources listed on local registers of historic resources or in local surveys, may be listed if they are determined by the State Historic Resources Commission to be significant in accordance with criteria and procedures to be adopted by the Commission and are nominated; their listing in the California Register is not automatic.

Resources eligible for listing include buildings, sites, structures, objects, or historic districts that retain historical integrity and are historically significant at the local, state or national level under one or more of the following four criteria:

- 1) It is associated with events that have made a significant contribution to the broad patterns of local or regional history, or the cultural heritage of California or the United States;
- 2) It is associated with the lives of persons important to local, California, or national history;
- 3) It embodies the distinctive characteristics of a type, period, region, or method of construction, or represents the work of a master or possesses high artistic values; or
- 4) It has yielded, or has the potential to yield, information important to the prehistory or history of the local area, California, or the nation.

In addition to having significance, resources must have integrity for the period of significance. The period of significance is the date or span of time within which significant events transpired, or significant individuals made their important contributions. Integrity is the authenticity of a historical resource's physical identity as evidenced by the survival of characteristics or historic fabric that existed during the resource's period of significance.

Alterations to a resource or changes in its use over time may have historical, cultural, or architectural significance. Simply, resources must retain enough of their historic character or appearance to be recognizable as historical resources and to convey the reasons for their significance. A resource that has lost its historic character or appearance may still have sufficient integrity for the California Register, if, under Criterion 4, it maintains the potential to yield significant scientific or historical information or specific data.

NATIVE AMERICAN HUMAN REMAINS

Sites that may contain human remains important to Native Americans must be identified and treated in a sensitive manner, consistent with state law (i.e., Health and Safety Code §7050.5 and Public Resources Code §5097.98), as reviewed below:

In the event that human remains are encountered during project development and in accordance with the Health and Safety Code Section 7050.5, the County Coroner must be notified if potentially human bone is discovered. The Coroner will then determine within two working days of being notified if the remains are subject to his or her authority. If the Coroner recognizes the remains to be Native American, he or she shall contact the Native American Heritage Commission (NAHC) by phone within 24 hours, in accordance with Public Resources Code Section 5097.98. The NAHC will then designate a Most Likely Descendant (MLD) with respect to the human remains. The MLD then has the opportunity to recommend to the property owner or the person responsible for the excavation work means for treating or disposing, with appropriate dignity, the human remains and associated grave goods.

CALIFORNIA ADMINISTRATIVE CODE, TITLE 14, SECTION 4307

This section states that “No person shall remove, injure, deface or destroy any object of paleontological, archeological or historical interest or value.”

IMPERIAL COUNTY GENERAL PLAN

OPEN SPACE AND CONSERVATION ELEMENT

Conservation of Environmental Resources for Future Generations

Goal 1: Environmental resources shall be conserved for future generations by minimizing environmental impacts in all land use decisions and educating the public on their value.

Objective 1.1: Encourage uses and activities that are compatible with the fragile desert environment and foster conservation.

Objective 1.2: Coordinate the acquisition, designation, and management of important natural and cultural resource areas in Imperial County with other governmental agencies as appropriate.

Objective 1.3: Develop standards to protect significant natural and cultural resource areas for the purpose of enhancing both the planning and decision-making process.

Objective 1.4: Ensure the conservation and management of the County's natural and cultural resources.

Objective 1.5: Provide opportunities for enjoyment of a quality natural experience to present and future generations.

Objective 1.6: Promote the conservation of ecological sites and preservation of cultural resource sites through scientific investigation and public education.

Preservation of Cultural Resources

Goal 3: Preserve the spiritual and cultural heritage of the diverse communities of Imperial County.

Objective 3.1: Protect and preserve sites of archaeological, ecological, historical, and scientific value, and/or cultural significance.

Objective 3.2: Develop management strategies to preserve the memory of important historic periods, including Spanish, Mexican, and early American settlements of Imperial County.

Objective 3.3: Engage all local Native American Tribes in the protection of tribal cultural resources, including prehistoric trails and burial sites.

DEFINITION OF SIGNIFICANCE FOR PALEONTOLOGICAL RESOURCES

Only qualified, trained paleontologists with specific expertise in the type of fossils being evaluated can determine the scientific significance of paleontological resources. Fossils are considered to be significant if one or more of the following criteria apply:

1. The fossils provide information on the evolutionary relationships and developmental trends among organisms, living or extinct;
2. The fossils provide data useful in determining the age(s) of the rock unit or sedimentary stratum, including data important in determining the depositional history of the region and the timing of geologic events therein;
3. The fossils provide data regarding the development of biological communities or interaction between paleobotanical and paleozoological biotas;
4. The fossils demonstrate unusual or spectacular circumstances in the history of life;
5. The fossils are in short supply and/or in danger of being depleted or destroyed by the elements, vandalism, or commercial exploitation, and are not found in other geographic locations.

As so defined, significant paleontological resources are determined to be fossils or assemblages of fossils that are unique, unusual, rare, uncommon, or diagnostically important. Significant fossils can include remains of large to very small aquatic and terrestrial vertebrates or remains of plants and animals previously not represented in certain portions of the stratigraphy.

Assemblages of fossils that might aid stratigraphic correlation, particularly those offering data for the interpretation of tectonic events, geomorphologic evolution, and paleoclimatology are also critically important (Scott and Springer 2003; Scott et al. 2004).

BACKGROUND

NATURAL SETTING

The area of the Project location is within the relatively flat region of the Imperial Valley, south of the Salton Sea. The Chocolate Mountains bound the area to the east and the Colorado River Basin is located to the south. Elevation in the Imperial Valley ranges from -71 below mean sea level (msl) at the Salton Sea to +781 msl at the Mexico Border.

The Imperial Valley experiences an arid, desert climate because of its location in a basin between mountain ranges. Most months are characterized by high temperatures, low humidity, and sunny days. Temperatures can reach 120 degrees in the summer and drop as low as 25 degrees in the winter. Average annual precipitation is approximately 2.6 inches, with the most rainfall occurring in late summer through winter and early spring. Some freezing rain and snow occurs during the winter months in the surrounding hills with higher elevations.

Today the Project Area is irrigated using water brought by canal from the Colorado River Basin. Prior to development of the area for agriculture, natural vegetation in the study area consisted of creosote (*Larrea tridentata*) and bursage (*Ambrosia dumosa*), on alluvial sand and gravel. Larger washes host plants of the woodland wash community (Cleland and Apple 2003). Fauna common to the environments in the study area include desert mammals such as the coyote (*Canis latrans*), black-tailed jackrabbit (*Lepus californicus*), cottontail rabbit (*Sylvilagus audubonii*), and various deer mice (*Peromyscus* spp.). Larger mammals, such as the Sonoran pronghorn (*Antilocapra americana sonorensis*) and mule deer (*Odocoileus hemionus*) are occasionally found in areas. Reptiles such as the desert tortoise (*Gopherus agassizii*), western diamondback (*Crotalus atrox*), desert rosy boa (*Lichanura trivirgata*), and various lizards and horned lizards are common in creosote-dominated habitats (Jaeger 1965).

GEOLOGICAL SETTING

The study area lies within the Salton Trough, a northward extension of the Sea of Cortez (McKibben 1993). The Salton Trough lies below sea level and is an active continental rift underlain by the landward extension of the East Pacific Rise; it is surrounded on three sides by mountains and bounded to the southeast by the Colorado River delta. Since the beginning of the Holocene Epoch [\pm 11,000 years before present (ybp)], the Colorado River delta has blocked marine water from entering the Salton Trough from the Sea of Cortez. Freshwater lakes have

existed intermittently in the deeper parts of the basin that developed landward of the Colorado River delta (Maloney 1986; Van de Kamp 1973; Waters 1983; Whistler et al. 1995).

PALEONTOLOGICAL SETTING

Previous geologic mapping (Dibblee and Minch 2008; Jennings et al. 2010) indicates that the study area is located upon Quaternary lake sediments (= unit Qc of Dibblee and Minch 2008) deposited below the 12-meter high shoreline of ancient Lake Cahuilla, which is thought to have existed intermittently from 470 ybp to at least $\pm 6,000$ ybp (Van de Kamp 1973; Waters 1983; Whistler et al. 1995). The subsurface lacustrine sediments were deposited during each of at least seven high stands of Lake Cahuilla, each high stand resulting from flooding of the Salton Trough by inflow from the Colorado River (Waters 1983). Fluvial sediments in the area were laid down during intervening lake low stands when the lakebed was dry. These alternating lacustrine and fluvial sediments, termed the Lake Cahuilla beds, have previously yielded fossil remains representing diverse freshwater diatoms, land plants, sponges, ostracods, molluscs, fish, and small terrestrial vertebrates. As these remains are not associated with any evidence of human activity, they are considered paleontological rather than archaeological.

PREHISTORIC SETTING

EARLY HOLOCENE PERIOD (10,000 TO 9,000 B.P.)

The San Dieguito Period in the Colorado is dated from 10,000 to approximately 8,000 years before present (Cleland 1999). It is characterized by aceramic lithic assemblages, rock features, and cleared circles. Rogers (1929, 1939, 1966) proposed three phases of the San Dieguito complex in the area of the Colorado and Mojave deserts and the western Great Basin. Each successive phase is characterized by the addition of new, more sophisticated tool types to the preexisting tool kit (Rogers 1929, 1939, 1966). The variations noted by Rogers may also have been contemporaneous functional or ecological characteristics. The phases have not been confirmed in research since Roger's work. The San Dieguito complex is characterized by a high degree of residential mobility in the Colorado Desert (Cleland 1999). The sites indicate a hunter-gatherer adaptation consisting of small, mobile groups exploiting small and large game and collecting seasonally available wild plants. The largest aggregations of San Dieguito sites are situated on mesas and terraces overlooking major washes. Lake Mojave type sites are located around lake shores.

MIDDLE TO EARLY LATE HOLOCENE PERIOD (9000 TO 1500 B.P.)

The Middle Holocene period contains two complexes, the Pinto complex during the Early Archaic from 8,000 to 4,000 B.P. and the Late Archaic Amargosa complex characterized by Elko and Gypsum series points dating from 4,000 to 1,500 B.P. Millingstones are present at sites throughout this period but are more common during the Late Archaic (Cleland 1999). Little is known about this period due to the dearth of sites in the Colorado Desert.

LATE PREHISTORIC PERIOD (AFTER 1500 B.P.)

The Late Prehistoric period, 1500 to approximately 500 B.P., began with the introduction of the bow and arrow. This Patayan Period is also characterized by the introduction of ceramics 1200 years before present. Flood plain horticulture along the Colorado River was introduced during this period and use of the Colorado Desert by prehistoric groups increased substantially (Cleland 1999). The sites consist mainly of trails, shrines and ceramic scatters.

ETHNOGRAPHIC AND ETHNOHISTORIC CONTEXT

The Native American tribes of western Arizona and southeastern California were speakers of related languages of the Yuman family. The economy during this time was based on floodplain agriculture, fishing, and harvesting wild plant foods. The construction of a regional trail system was a key component of the cultural system. Intertribal warfare throughout the lower Colorado River caused shifting tribal boundaries in ethnohistoric times (Forbes 1965). The first Spanish visit to the area occurred in 1540 when Alarcón sailed up the lower Colorado River. He described a situation of incessant warfare between the local tribes at this time. In the 1770s the Franciscan missionary-explorer Francisco Garcés and the soldier Juan Bautista de Anza established a strong east-west travel link across the Salton Basin (Bolton 1930).

ETHNOGRAPHY

The Project Area is ethnohistorically known to have been part of the Ipai (Kumeyaay) territory (Figure 4). The Kumeyaay were referred to as Diegueño by the Spanish. The Kumeyaay are Yuman-speaking people of Hokan stock and have lived in this area for more than 10,000 years with territorial boundaries that once extended from the Pacific Ocean, south to Ensenada in Baja Norte, Mexico, east to the sand dunes of the Colorado River in Imperial Valley and north to Warner Springs Valley.

The Kumeyaay lived in *Sh'mulq* (clan) territories and typically resided in summer and winter villages (Connolly 2013). Although different *Sh'mulqs* gathered for social activities such as singing, games, and “spouse seeking”, taking up settlement in another’s territory was not allowed (Connolly 2013). These clan groups seem to have been considered a local kin group and the names, when translatable, are names of localities or at the least reference a locality (Kroeber 1971). The Kumeyaay have only six names for months and these six names are repeated the other half of the year to balance it, with the solstices being the pivotal point (Kroeber 1971).

Although many plants had an extended harvest time they were considered best if harvested during certain periods of their development, such as Yucca, which becomes bitter after blooming (Connolly 2013). The staple of the Kumeyaay diet was *Sha-wee*, a meal made from grinding acorns into a meal (Connolly 2013). Evidence of the importance of this resource can be seen in archaeological sites in the Santa Maria Valley (see Cooley and Barrie 2004). Opening up the

chaparral through burning also attracted game.

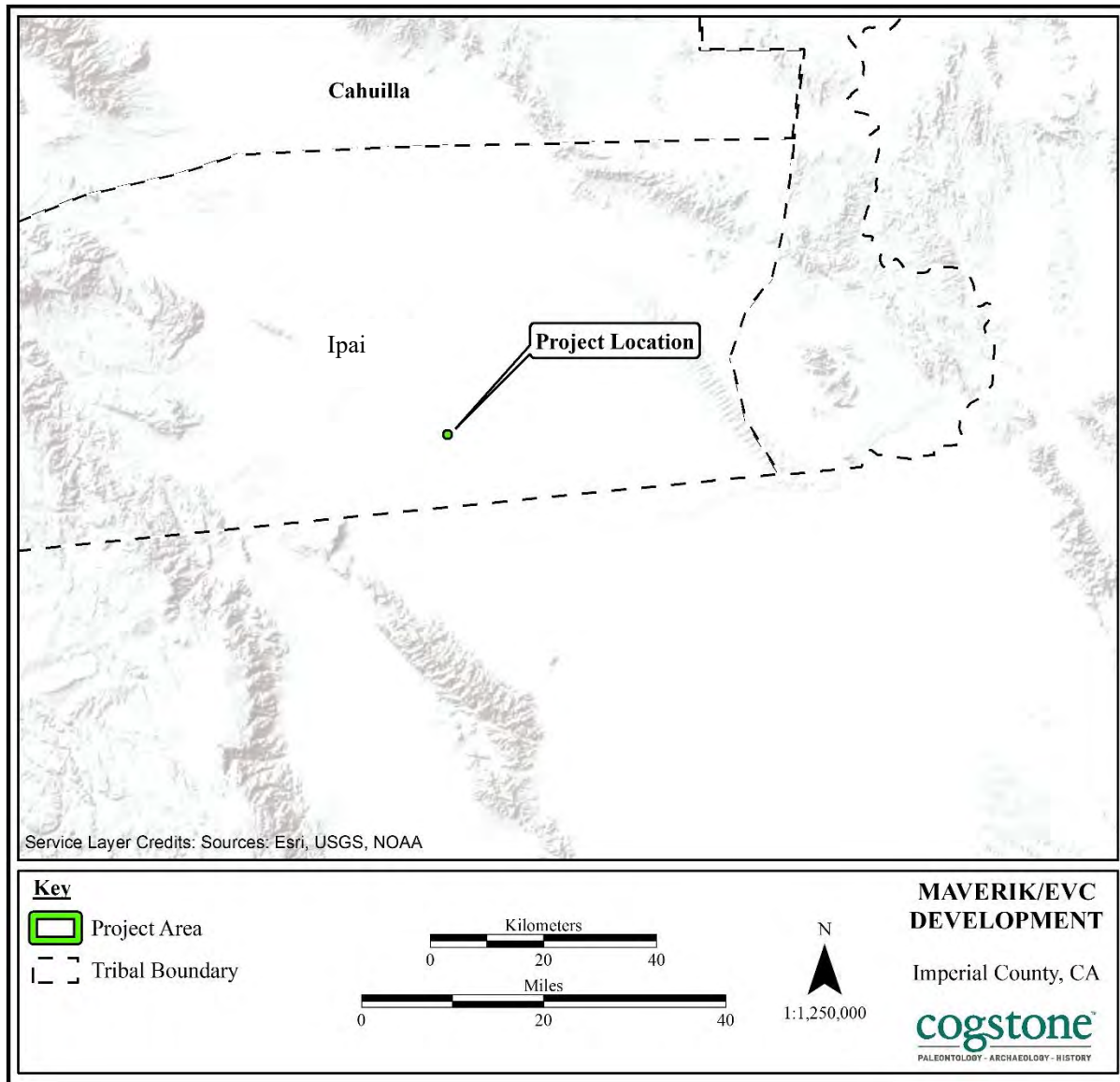

Figure 4. Tribal boundaries map

Trade routes between the coastal and inland Sh’mulqs brought marine shell into the Santa Maria Valley. Trade routes were used for exchange of resources as well as communication. Runners could relay important information over great distances in a relatively short time. When the Quechan at Yuma rebelled against the Spanish in 1780, the news reached the Kumeyaay at the Mission in San Diego that same evening, a distance of 120 miles (Connolly 2013).

The Kumeyaay, as with other California tribes, used fire as an important environmental management tool, burning off the dense chaparral and allowing plants used for food and medicine to increase (Connolly 2013). In the coastal plains there was a type of grain described

in Spanish accounts as being half the size of a wheat grain. This grain became extinct after the Kumeyaay practice of controlled burns and traditional hand-broadcast reseeding were discontinued under European influence (Connolly 2013). As chronicled by anthropologist Florence Shippek, "Kumeyaay erosion control systems...included complex techniques of controlled burning. These systems were combined with several methods of water management to maintain ground waters close to valley surfaces and to keep the many springs and surface streams at usable levels for the complex Kumeyaay plant husbandry-corn agriculture systems..."

The Kumeyaay home was a willow framed structure overlain by brush, tules, or tree branches (Connolly 2013). Willow poles were set into the ground with Yucca twine tying the poles together (Connolly 2013). The exterior was then thatched, and stones placed around the base of the house to help deter crawling animals from entering (Connolly 2013). Pottery was made from clay and fired in open pits. Large pots were capped and used for long term storage of acorns or acorn flour. Baskets were made from grasses or willows depending on the need. Coiled grass baskets were made by the women, some made to be waterproof and others with a looser weave for leaching the tannic acids from acorns (Connolly 2013). The Kumeyaay used only their woven baskets for leeching acorns (Gifford 1971). Three materials were used to make the baskets: a grass (*Epicampes*) was used for the foundation and for wrapping wither a reed (*Juncus*) or sumach (*Rhus*) (Kroeber 1971).

HISTORIC SETTING

SPANISH EXPLORATION

The earliest explorations of the San Diego area began in 1542, when Juan Rodríguez Cabrillo and his party landed near Point Loma. Cabrillo had been tasked with the exploration of the interior of the western U.S. by the Spanish monarch. Interaction with the Kumeyaay was initiated, but overall little attention was given to California until the 1700s.

Spanish settlement of the San Diego area began in 1769 when the Spanish developed plans to build four presidios (forts), and three towns along the California coastline stretching from San Diego northward to Monterey. The town sites, established between 1777 and 1797, included present-day Los Angeles, San Jose, and a small town near Santa Cruz named Branciforte; while the presidios were established at San Diego, Santa Barbara, Monterey, and San Francisco. Under Spain, the "borderlands were colonized as defenses against the intrusion of the English, French, Dutch, and Russians, with the Manila trade an important item for protection in California. They were held by two typical institutions: the mission and the presidio" (Bolton 1913, 1921, 1930 as cited in Aviña 1976).

Mission San Diego Alcalá was also founded in 1769, the first of 21 Franciscan missions built along the coast on the El Camino Real, from San Diego to Sonoma. The goals of the missions were tri-fold: they helped establish a Spanish presence on the west coast, allowed for a means to

Christianize the native peoples, and served to exploit the native population as laborers. The missionaries, or padres, would essentially serve as a mayor, or head of the town. The Kumeyaay socio-political structure was severely disrupted by the Mission, especially those living closest to the grounds (Loumala 1978).

THE SPANISH (1776-1820) AND MEXICAN RANCHO ERA (1821-1847)

The arrival of the Spanish missionaries brought about prevailing changes for the Native Americans, including high mortality rates and social changes due to the introduction of European diseases and customs (e.g., European farming methods; Dobyns 1983; Walker and Hudson 1993). Due to the high mortality rates, many Native American villages were abandoned, with inhabitants recruited for the missions.

The Kumeyaay population decreased due to disease, revolts, and changes to their traditional ways of life. The San Diego Mission however, was unique in that it allowed neophytes to move freely between the mission and traditional villages in order to hunt and gather food for the struggling mission. This allowed the Kumeyaay to experience a smaller population decline than Native Americans at other California missions.

Mexico gained independence from Spain in 1821, taking control of the lands Spain once held. The Secularization Act of 1833 transferred much of the mission lands to political appointees. Between 1840 and 1846, the Governors of California, Juan B. Alvarado, Manuel Micheltoarena and Pio Pico, made a series of land grants, transferring Mission properties to private ownership (Cowan 1977; Ohles 1997).

STATEHOOD

In 1846, the Mexican-American war broke out in part because of American excursions into California. In 1847, General Andrés Pico and John C. Frémont signed the Articles of Capitulation, ending hostilities between the U.S. and Mexico. The U.S. and Mexico signed the Treaty of Guadalupe Hidalgo, which resulted in Mexico ceding the lands of present-day California, New Mexico, and Texas to the U.S. for \$15 million (Fogelson 1993:10). Within two years of the Treaty of Guadalupe Hidalgo, California applied for admission as a state.

PROJECT AREA HISTORY

The 1907 Holtville (1:125000) USGS topographic quadrangle map, the earliest map available, shows the Project Area and vicinity as undeveloped. Roads are in place adjacent to the Project Area in the 1940 Almorio (1:62500) USGS topographic quadrangle map; the 1954 El Centro (1:25000000) topographic map has California state Highway 111 in place directly west of the Project Area. USDA aerial photographs from 1953 to 2020 depict the Project Area in agricultural use as it is today, with the Acacia Five A Drain in place in the earliest photograph while Highway 111 expands to the west (NETROnline 1953, 1984, 1996, 2005, 2010, 2016, 2020). Throughout this period there is a strip of bare earth between the Acacia Five A Drain and

Highway 111 that is now designated Hawes Road. This road is not formally marked on any USGA map or USDA photograph.

RECORDS SEARCH

PALEONTOLOGICAL RECORD SEARCH

A record search of the Project was obtained from the San Diego Natural History Museum (Mueller 2023; Appendix B). Additional records from the San Bernardino County Museum, the University of California Museum of Paleontology database, the PaleoBiology Database, and pertinent print sources were searched for records of fossils from the region.

No recorded paleontological localities producing vertebrate fossils were found within one mile of the Project Area. Elsewhere the Lake Cahuilla Beds have yielded well-preserved fossilized remains of freshwater clams and snails, as well as sparse remains of freshwater fish (Mueller 2023; Appendix B). The paleontological resources of the Lake Cahuilla Beds are interpreted to be scientifically significant because they provide valuable information on ancient paleoclimatic and paleoecological processes.

CALIFORNIA HISTORIC RESOURCES INFORMATION SYSTEM

Cogstone requested a search of the California Historical Resources Information System (CHRIS) from the South Coastal Information Center (SCIC) located at San Diego State University on November 8, 2023 which included the entire proposed Project Area as well as a half-mile radius. Results of the record search indicate that one previous study has been completed within the Project Area while an additional seven studies have been completed previously within a half-mile radius of the Project Area (Table 1).

Table 1. Previous Studies within a half-mile radius of the Project Area

Report No. (IM-)	Author(s)	Title	Year	Distance (miles) from Project Area
00570	Dominici, Debra A., and Karen Crafts	Negative Archaeological Survey Report for the Proposed Imperial 111 Highway Project	1993	0-0.25
00670	Dominici, Debra	Historic Property Survey for the Imperial 111 Highway Project Imperial County, California	1994	0-0.25
00831	Boghosian, Paula	Historic Architectural Survey Report for Road Widening Project and Construction of Two Frontage Roads	1994	0.25-0.5

Report No. (IM-)	Author(s)	Title	Year	Distance (miles) from Project Area
01182	Yost, Stephen W., Michael Mirro, Lori Rhodes, J. David Ing, and Howard Higgins	Final Report on Cultural Resource Monitoring Along the Level (3) Long Haul Fiber Optic Running Line, San Diego, California to Yuma, Arizona, San Diego and Imperial Counties	2001	Within
01242	Bureau of Land Management	Final Environmental Impact Statement/Environmental Impact Report and Proposed Land Use Plan Amendment - Volume I and II - North Baja Pipeline Expansion Project	2007	0-0.25
01243	Bureau of Land Management	Draft Environmental Impact Statement/Environmental Impact Report and Draft Land Use Plan Amendment - Volumes I and II - North Baja Pipeline Expansion Project	2006	0-0.25
01306	Wirth Associates, Inc.	APS/SDG&E Interconnection Project Environmental Study Phase II Corridor Studies - Native American Cultural Resources Appendices	1980	0-0.25
01698	Unknown	Cultural Resource Assessment - Cingular's Site Sd-774-01, 371 E. Ross Road, El Centro, California	2002	0-0.25

No cultural resources have been recorded within the Project Area (Table 2). Outside of the Project Area a total of nine cultural resources have been previously documented within the half-mile search radius from the Project Area (Table 2). These consist of one cultural resource within a quarter-mile of the Project Area and eight cultural resources within a quarter- to half-mile of the Project Area.

Table 2. Previously Recorded Cultural Resources within a half mile radius of the Project Area

Primary No. (P-13-)	Trinomial No. (CA-IMP-)	Resource Type	Resource Description	Year Recorded	Distance (miles) From Project SArea	NRHP/CRHR Status
009016		Historic Built Environment	Two segments of transmission line that connect to the Imperial Irrigation District's steam plant on Dogwood Road. The towers are metal A-frame.	2012; 2005	0.25-0.5	Unevaluated
009068		Historic Built Environment	Two segments of unnamed canal. Poured concrete lining.	2009	0.25-0.5	Unevaluated
009069		Historic Built Environment	Acacia Lateral 5A Canal. Poured concrete lining.	2009	0-0.25	Unevaluated
009070		Historic Built Environment	Unnamed canal. Earthen lining.	2009	0.25-0.5	Unevaluated

Primary No. (P-13-)	Trinomial No. (CA-IMP-)	Resource Type	Resource Description	Year Recorded	Distance (miles) From Project SArea	NRHP/CRHR Status
009071		Historic Built Environment	Unnamed canal. Poured concrete lining.	2009	0.25-0.5	Unevaluated
009072		Historic Built Environment	Unnamed canal. Poured concrete lining.	2009	0.25-0.5	Unevaluated
009081		Historic Built Environment	Segment of transmission line. Support poles are pine wood with single cross supporting 2 lines.	2009	0.25-0.5	Unevaluated
009082		Historic Built Environment	Acacia 65 Canal. Earthen lined	2009	0.25-0.5	Unevaluated
009083		Historic Built Environment	Acacia Lateral 6A Canal. Poured concrete lining.	2009	0.25-0.5	Unevaluated

OTHER SOURCES

In addition to the SCIC records search, a variety of sources were consulted in December 2023 to obtain information regarding the cultural context of the Project vicinity (Table 3). Sources included the National Register of Historic Places (NRHP), California Register of Historical Resources (CRHR), Built Environment Resource Directory (BERD), California Historical Landmarks (CHL), and California Points of Historical Interest (CPHI). Specific information about the Project Area, obtained from historic-era maps and aerial photographs, is presented in the Project Area History section.

Table 3. Additional Sources Consulted

Source	Results
National Register of Historic Places (NRHP)	Negative
Historic USGS Topographic Maps	See Project Area History section
Historic US Department of Agriculture Aerial Photographs	See Project Area History section
California Register of Historical Resources (CRHR)	Negative
Built Environment Resource Directory (BERD)	Negative
California Historical Landmarks (CHL)	Negative
California Points of Historical Interest (CPHI)	Negative
Bureau of Land Management (BLM) General Land Office Records	Negative

Source	Results
Local Registers (Historical Societies/Archives)	The Imperial County Historical Society was contacted via United States Postal Service certified mail on November 2, 2023, regarding any additional information it may have about the history of the Project Area. No response has been received (Appendix C).

SACRED LANDS FILE SEARCH

Cogstone requested a Sacred Lands File (SLF) search from the Native American Heritage Commission (NAHC) on November 8, 2023. The NAHC responded on December 3, 2023, with a positive SLF search result (Appendix D) and 21 tribes or individuals that the NAHC suggested be contacted concerning information about the Project Area. The results letter have been forward to the Project Proponent’s agent so it may be sent to the County for use during government to government tribal consultations.

SURVEY

METHODS

The survey stage is important in a Project’s environmental assessment phase to verify the exact location of each identified cultural resource, the condition or integrity of the resource, and the proximity of the resource to areas of cultural resources sensitivity. All undeveloped ground surface areas within the ground disturbance portion of the Project Area were examined for artifacts (e.g., flaked stone tools, tool-making debris, stone milling tools or fire-affected rock), soil discoloration that might indicate the presence of a cultural midden, soil depressions and features indicative of the former presence of structures or buildings (e.g., postholes, foundations), or historic-era debris (e.g., metal, glass, ceramics). Existing ground disturbances (e.g., cutbanks, ditches, animal burrows, etc.) were visually inspected. Photographs of the Project Area, including ground surface visibility and items of interest, were taken with a digital camera.

RESULTS

Cogstone archaeologist and cross-trained paleontologist Stephen Egenberger conducted the pedestrian survey on November 21, 2023 using two to three-meter transects. The Project Area is currently forage land for sheep and has heavy ground cover with less than 10 percent visibility with the exception of the bare margins on the north and west sides (Figures 5 to 8). No archaeological or paleontological materials were identified during the survey.

A 1,225-foot long section of the Acacia Five A Drain, the first 620 feet of which with runs along the inside of the western boundary of the Project Area, was documented during the survey (Figures 9 to 12). The earthen-lined drain is approximately 40 feet wide at the surface, 20 feet deep, and varies between 0 and ten 10 feet wide at the bottom. Department of Parks and Recreation (DPR) 523 series forms were prepared for this resource and are located in Appendix F.



Figure 5. Overview from northeast corner of Project Area, facing southwest



Figure 6. Overview center of northern end of Project Area, facing south



Figure 7. Overview from northwest corner of Project Area, facing east



Figure 8. Typical sediments in the Project Area



Figure 9. Survey results map



Figure 10. Acacia Five A Drain from south of Project Area, facing north



Figure 11. Northern portion of Acacia Five A Drain in Project Area, facing south



Figure 12. Side wall of Acacia Five A Drain, facing west

HISTORIC RESOURCE EVALUATION

To be eligible for the CRHR a resource must:

1. be associated with events that have made a significant contribution to the broad patterns of history;
2. be associated with the lives of significant persons of the past;
3. embody distinctive characteristics of type, period, or method of construction or represent the work of a master, or possess high artistic value, or represent a significant and distinguishable entity those components may lack individual distinction; or
4. yielded or may likely yield information important in history or prehistory.

In addition to having significance using the above criteria, resources must have “integrity of location, design, setting, materials, workmanship, feeling, and association” to the period. The period of significance is the date or span of time within which significant events transpired, or significant individuals made their important contributions.

Integrity is the authenticity of a historical resource’s physical identity as evidenced by the survival of characteristics or historic fabric that existed during the resource’s period of significance. Alterations to a resource or changes in its use over time may have historical,

cultural, or architectural significance. Simply, resources must retain enough of their historic character or appearance to be recognizable as historical resources and to convey the reasons for their significance.

Acacia Five A Drain

Theme: Agriculture

Period of Significance: ca. 1891-1950

Criterion 1

Is this resource associated with events that have made a significant contribution to the broad patterns of our history?

Despite a search of historic newspapers, no information could be found that connects this canal to any event significant to local, state, or national history. Therefore, this canal is recommended not eligible for listing on the CRHR under Criterion 1.

Criterion 2

Is this resource associated with the lives of significant persons in our past?

Despite a search of historic newspapers, no information could be found that connects this canal to any person or persons significant to local, state, or national history. Therefore, this canal is recommended not eligible for listing on the CRHR under Criterion 2.

Criterion 3

Does this resource embody the distinctive characteristics of a type, period, or method of construction, or that represent the work of a master, or that possess high artistic values, or that represent a significant and distinguishable entity whose components may lack individual distinction?

This canal is a standard dirt lined drainage canal and is not an exemplary representation of a type, style, or work of a master craftsman. Due to a lack of significance, this canal is recommended not eligible for listing in the CRHR under Criterion 3.

Criterion 4

Has this building yielded or is it likely to yield, information important in history or prehistory?

Criterion 4 is most often applied to archaeological sites and districts but can also apply to buildings, structures, and/or objects. This canal does not exhibit a local variation of a standard design or construction technique that can yield important information (such as construction expertise or availability of local materials). Due to a lack of significance, this canal is recommended not eligible for listing in the CRHR under Criterion 4.

The resource is not considered significant and is recommended not eligible for listing in the CRHR under any criteria. This lack of significance makes questions of integrity moot.

STUDY FINDINGS AND CONCLUSIONS

PALEONTOLOGICAL RESOURCES SENSITIVITY

A multilevel ranking system was developed by professional resource managers within the Bureau of Land Management (BLM) as a practical tool to assess the sensitivity of sediments for fossils. The Potential Fossil Yield Classification (PFYC) system (BLM 2016; Appendix E) has a multi-level scale based on demonstrated yield of fossils. The PFYC system provides additional guidance regarding assessment and management for different fossil yield rankings.

Fossil resources occur in geologic units (e.g., formations or members). The probability for finding significant fossils in a Project Area can be broadly predicted from previous records of fossils recovered from the geologic units present in and/or adjacent to the study area. The geological setting and the number of known fossil localities help determine the paleontological sensitivity according to PFYC criteria

All alluvial deposits may increase or decrease in fossiliferous potential depending on how coarse the sediments are. Sediments that are close to their basement rock source are typically coarse; those farther from the basement rock source are finer. The chance of fossils being preserved greatly increases once the average size of the sediment particles is reduced to 5 mm or less in diameter. Moreover, fossil preservation also greatly increases with rapid burial in flood-plains, rivers, lakes, oceans, etc. Remains left on the ground surface become weathered by the sun or consumed by scavengers and bacterial activity, usually within 20 years or less. So the sands, silts, and clays of flood-plains, rivers, lakes, and oceans are the most likely sediments to contain fossils.

Using the PFYC system, geologic units are classified according to the relative abundance of vertebrate fossils or scientifically significant invertebrate or plant fossils and their sensitivity to adverse impacts within the known extent of the geological unit. Although significant localities may occasionally occur in a geologic unit, a few widely scattered important fossils or localities do not necessarily indicate a higher PFYC value; instead, the relative abundance of localities is intended to be the major determinant for the value assignment.

The Project is mapped entirely as the fossiliferous Lake Cahuilla beds, of latest Pleistocene to Holocene age. A records search revealed that no previously recorded paleontological localities occur within the Project Area. Elsewhere the Lake Cahuilla Beds have yielded well-preserved fossilized remains of freshwater clams and snails, as well as freshwater fish, which are significant in that they provide important paleoclimatic and paleoecological data. The Lake

Cahuilla beds are therefore assigned a moderate potential for fossils (PFYC 3) due to similar deposits elsewhere producing fossils with scientific significance.

CULTURAL RESOURCES SENSITIVITY

Based on a review of the SCIC record search results, review of historic USGS topographic quadrangle maps, and USDA aerial photographs the Project Area is assessed to have a low sensitivity for buried historic-aged cultural deposits. Based on these data sources alone the Project Area is also assessed to have low sensitivity for buried prehistoric archaeological resources. However, positive SLF search result may indicate that there are tribal cultural resources present that are unknown to the SCIC that elevate the cultural sensitivity of the Project Area.

A section of the Acacia 5A Drain is the only historic built environment resource within or adjacent to the Project Area. This resource is recommended not eligible for listing in the CRHR. The DPR 523 series forms are located in Appendix F.

RECOMMENDATIONS

PALEONTOLOGICAL RESOURCES RECOMMENDATIONS

Based upon recorded fossil locality data near the Project Area, sediments of the Lake Cahuilla beds exposed at the surface are assigned moderate sensitivity (PFYC 3). A qualified paleontologist should be retained to develop and implement a Paleontological Resources Impact Mitigation Plan, which should include development of a paleontology Worker Environmental Awareness Program (WEAP) and full-time paleontological monitoring.

In the event of an unanticipated discovery, all work must be suspended within 50 feet of the find until a qualified paleontologist can evaluate the find and make recommendations.

CULTURAL RESOURCES RECCOMENDATIONS

With respect to cultural resources, Cogstone recommends that this Project proceed as planned, but that full-time cultural resources and Native American monitoring be required should the cultural sensitivity of the Project Area be enhanced by the results of government to government Native American consultation.

In the event of an unanticipated discovery, all work must be suspended within 50 feet of the find until a qualified archaeologist evaluates it. In the unlikely event that human remains are encountered during project development, all work must cease near the find immediately.

In accordance with California Health and Safety Code Section 7050.5, the County Coroner must be notified if potentially human bone is discovered. The Coroner will then determine within two working days of being notified if the remains are subject to his or her authority. If the Coroner recognizes the remains to be Native American, he or she shall contact the Native American Heritage Commission (NAHC) by phone within 24 hours, in accordance with Public Resources Code Section 5097.98. The NAHC will then designate a Most Likely Descendant (MLD) with respect to the human remains. The MLD then has the opportunity to recommend to the property owner or the person responsible for the excavation work means for treating or disposing, with appropriate dignity, the human remains and associated grave goods. Work may not resume in the vicinity of the find until all requirements of the health and safety code have been met.

REFERENCES CITED

- Aviña, Rose Hollenbaugh
1976 *Spanish and Mexican Land Grants in California*. Arno Press, New York.
- Bureau of Land Management (BLM)
2016 *Potential Fossil Yield Classification (PFYC) System*. <https://www.blm.gov/policy/im-2016-124>.
- Bolton, Herbert Eugene
1930 *Anza's California Expeditions*. 5 vols. University of California Press, Berkeley.
- Cleland, James H.
1999 From Paleoindian to protohistoric: the chronology of human occupation of Salton Sea Test Base, *Proceedings of the Society for California Archaeology* 12:10-19.
- Cleland, James H., and Rebecca McCorkle Apple
2003 A View across the Cultural Landscape of the Lower Colorado Desert: Cultural Resource Investigations for the North Baja Pipeline Project. EDAW, San Diego.
- Connolly, Mike
2013 Campo. <http://www.kumeyaay.com/kumeyaay-history/2-articles/articles/38-precontact-culture.html>, last accessed May 21, 2013.
- Cooley, Theodore G., and Laura J. Barrie
2004 Archaeological Excavation at Village of Pa'Mu, Ramona Valley, California. *Proceedings of the Society for California Archaeology*, Vol. 17, pp. 43-57.
- Cowan, Robert G.
1977 *Ranchos of California: A List of Spanish Concessions, 1775-1882 and Mexican Grants, 1822-1846*. Historical Society of Southern California.
- Dibblee, T.W., and J.A. Minch
2008 Geologic map of the Plaster City & Brawley 15-minute quadrangles, Imperial County, California. Dibblee Geological Foundation Map DF-406, scale 1:62,500.
- Dobyns, Henry F.
1983 *Their Number Become Thinned: Native American Population Dynamics in Eastern North America*. University of Tennessee, Knoxville.
- Fogelson, Robert M.
1993 *The Fragmented Metropolis: Los Angeles, 1850-1930*. University of California Press, Berkeley.

Forbes, Jack D.

1965 *Warriors of the Colorado: The Yumas of the Quechan Nation and Their Neighbors*. University of Oklahoma Press, Norman.

Gifford, E.W.

1971 California Balanophogy. *The California Indians, A Source Book*, eds. R.E. Heizer and M.A. Whipple, Pages 301-305. University of California Press. Berkeley.

Jaeger, Edmund C.

1965 *The California Deserts*. 4th ed. Stanford University Press, Palo Alto, California.

Jennings, C.W., C. Gutierrez, W. Bryant, G. Saucedo, and C. Wills

2010 Geologic Map of California: California Geological Survey California Geologic Data Map Series Map No. 2, scale 1:750,000.

Kroeber, A.L.

1971 California Basketry and the Pomo. *The California Indians, A Source Book*, eds. R.E. Heizer and M.A. Whipple, Pages 319-331. University of California Press, Berkeley.

Luomala, Katherine

1978 Tipai and Ipai. In *California*, edited by Robert F. Heizer, pp. 592–609. *Handbook of North American Indians*, Vol. 8, William G. Sturtevant, general editor, Smithsonian Institution, Washington, D.C.

Maloney, N.J.

1986 Coastal landforms of Holocene Lake Cahuilla, northeastern Salton Basin, California. In P.D. Guptil, E.M. Gath and R.W. Ruff (eds.), *Geology of the Imperial Valley, California*. South Coast Geological Society, Santa Ana, California 14: 151-158.

McKibben, M.A.

1993 The Salton Trough rift. In R.E. and J. Reynolds (eds.), *Ashes, faults and basins*. San Bernardino County Museum Association Special Publication 93-1: 76-80.

Mueller, K.

2023 Paleontological Records Search, Maverik/EVC Development. San Diego Natural History Museum. 3 p.

NETROnline

1953 *Historic Aerials*. Available at <https://www.historicaerials.com/viewer#>, accessed December 11, 2023.

1984 *Historic Aerials*. Available at <https://www.historicaerials.com/viewer#>, accessed December 11, 2023.

1996 *Historic Aerials*. Available at <https://www.historicaerials.com/viewer#>, accessed December 11, 2023.

- 2005 *Historic Aerials*. Available at <https://www.historicaerials.com/viewer#>, accessed December 11, 2023.
- 2010 *Historic Aerials*. Available at <https://www.historicaerials.com/viewer#>, accessed December 11, 2023.
- 2016 *Historic Aerials*. Available at <https://www.historicaerials.com/viewer#>, accessed December 11, 2023.
- 2020 *Historic Aerials*. Available at <https://www.historicaerials.com/viewer#>, accessed December 11, 2023.

Ohles, Wallace V.

- 1997 *Mission San Miguel Property and Padres*. The Friends of the Adobes, Inc., San Miguel, California.

Rogers, Malcolm J.

- 1929 The Stone Art of the San Dieguito Plateau. *American Anthropologist* 31:454-467.
- 1939 Early Lithic Industries of the Lower Basin of the Colorado River and Adjacent Desert Areas. San Diego Museum Papers No. 3.
- 1966 *Ancient Hunters of the Far West*. Union-Tribune Publishing, San Diego.

Scott, E., and K. Springer

- 2003 CEQA and fossil preservation in southern California. *The Environmental Monitor*, Fall 2003, p. 4-10, 17.

Scott, E., K. Springer, and J.C. Sagebiel

- 2004 Vertebrate paleontology in the Mojave Desert: the continuing importance of “follow-through” in preserving paleontologic resources. In M.W. Allen and J. Reed (eds.) *The human journey and ancient life in California’s deserts: Proceedings from the 2001 Millennium Conference*. Ridgecrest: Maturango Museum Publication No. 15, p. 65-70.

United States Geological Survey (USGS)

- 1907 *Holtville*. [map]. U.S. Geological Survey. 1:125000. Topographic Quadrangle Map. El Centro, CA.
- 1940 *Alomorito*. [map]. U.S. Geological Survey. 1:62500. Topographic Quadrangle Map. El Centro, CA.
- 1954 *El Centro*. [map]. U.S. Geological Survey. 1:250000. Topographic Quadrangle Map. El Centro, CA. 1954.

Van de Kamp, P.C.

- 1973 Holocene continental sedimentation in the Salton Basin, California: a reconnaissance. *Geological Society of America Bulletin* 84: 827-848.

Walker, Phillip L. and Travis Hudson

- 1989 *Chumash Healing: Changing Health and Medical Practices in an American Indian Society*. Malki Museum Press, California.

Waters, M.R.

1983 Late Holocene lacustrine chronology and archaeology of ancient Lake Cahuilla, California. *Quaternary Research* 19: 373-387.

Whistler, D.P., E.B. Lander and M.A. Roeder

1995 A diverse record of microfossils and fossil plants, invertebrates, and small vertebrates from the late Holocene Lake Cahuilla beds, Riverside County, California. *In* P. Remeika and A. Sturz (eds.), *Paleontology and Geology of the Western Salton Trough Detachment, Anza-Borrego Desert State Park, California*, p. 109-118.

APPENDIX A. QUALIFICATIONS

EDUCATION

2009 M.A., Anthropology, Kent State University, Kent, Ohio
2006 B.A., Anthropology, Ohio State University, Columbus, Ohio

SUMMARY OF QUALIFICATIONS

Ms. Valasik is a Registered Professional Archaeologist (RPA) with 14 years of experience. She is a skilled professional who is well-versed in the compliance procedures of the California Environmental Quality Act (CEQA) and Section 106 of the National Historic Preservation Act (NHPA) and regularly prepares cultural resources assessment reports for a variety of federal, state, and local agencies throughout California. She meets the qualifications required by the Secretary of the Interior's *Standards and Guidelines for Archaeology and Historic Preservation*. She is listed as a principal investigator on Cogstone's Bureau of Land Management (BLM) cultural resources permit and has completed several projects involving surveys and monitoring on BLM lands. She is accepted as a principal investigator for prehistoric archaeology by the State Office of Historic Preservation. Ms. Valasik is a member of the Society for California Archaeology.

SELECTED EXPERIENCE

BLM El Centro Recreation Project, City of Imperial, Imperial County, CA. The BLM El Centro Field Office requested Class III Cultural Resources Inventory Surveys and archaeological site assessments to prevent potential adverse effects to cultural resources within BLM-managed lands identified for temporary or permanent disturbance due to implementation of recreation program projects on 47 acres in the Superstition and Plaster City Open Areas. Cogstone completed this work to satisfy BLM's responsibilities for compliance under Section 106 of the NHPA. Cogstone's services included a records search for known cultural resources, an intensive pedestrian survey, and prepared a Cultural Resources Assessment Report. Although the records search did not identify any previously recorded cultural resources in the proposed Area of Potential Effects (APE), 41 previously recorded cultural resources were identified within a one-mile radius, some of which may have subsurface potential. Prime. Project Manager. 2022-2023

New Cuyama Dump Sites 1, 2, and 3, BLM Bakersfield Office, Santa Barbara County, CA. The project involved identifying archaeological and historical resources present within three illegal dump sites on BLM land. This study included an assessment of the historic potential of dump refuse and National Register of Historic Places (NRHP) eligibility recommendations for debris demonstrating affirmative evidence for an age greater than 45 years. A Class III Cultural Resources survey was conducted and included an intensive-level pedestrian survey of the APE with no larger than ten-meter-wide transects. Smaller transects were used in narrower areas of the APE and during investigations of newly identified archaeological sites and isolates. A total of three historic trash scatters were identified during the survey and four historic isolates were identified. These resources were recorded on California Department of Parks and Recreation 523 (DPR 523) forms. No archaeological sites or isolates were identified. No artifacts were collected. The deliverables were accepted by BLM without revisions. Prime. Task Manager. 2020-2021

Priest Valley Very High Frequency Omni-Directional Range Project, Priest Valley, Monterey and Fresno Counties, CA. Cogstone conducted a cultural resources assessment to identify potential impacts to cultural resources from the Priest Valley Very High Frequency Omni-Directional Range Project which will consist of the demolition, removal, and disposal of the facility (recorded as the Charley Mountain Radio Facility P-10-007062/P-27-003635). The United States Department of Transportation (USDOT) Volpe National Transportation System Center provided environmental compliance support for the Federal Aviation Administration to meet their obligations for historic properties identification requirements under 36 CFR 800.4 in Section 106 of the NHPA. Cogstone's assessment was conducted under BLM CRUP number CA-19-07 and BLM Fieldwork Authorization No. FWA# CA-19-07-2022-190/01. Cogstone's assessment included a cultural records search, a Sacred Lands File search from the Native American Heritage Commission, an intensive pedestrian and built environment survey, and updated the evaluation and site record for one historic facility on DPR 523 forms. Cogstone prepared separate Archaeological and Historical Resources Assessment Reports documenting the findings of the study due to changes in scope during the Project. Prime. Task Manager and Principal Investigator for Archaeology. 2021

EDUCATION

- 2016 Ph.D., Anthropology, University of California, Riverside (UCR)
- 2011 M.A., Anthropology, UCR
- 2007 M.A., Applied Geography, University of Colorado, Colorado Springs (UCCS)
- 2002 B.A., Anthropology, minor in Geography/Environmental Studies, UCCS

SUMMARY OF QUALIFICATIONS

Dr. Gust is a Registered Professional Archaeologist (RPA) with 11 years of experience in field archaeology. He meets the qualifications required by the Secretary of the Interior's *Standards and Guidelines for Archaeology and Historic Preservation* and his field expertise includes pedestrian surveys, excavation monitoring, resource recording, and historic artifact analysis. He has managed a variety of projects at Cogstone in the water, development, residential, transportation, telecommunications, and public works sectors. He is listed as a principal investigator on Cogstone's Bureau of Land Management (BLM) cultural resources permit. Dr. Gust is a member of the Society for California Archaeology, Society for American Archaeology, and the American Anthropological Association.

SELECTED EXPERIENCE

BLM El Centro Recreation Project, City of Imperial, Imperial County, CA. The BLM El Centro Field Office requested Class III Cultural Resources Inventory Surveys and archaeological site assessments to prevent potential adverse effects to cultural resources within BLM-managed lands identified for temporary or permanent disturbance due to implementation of recreation program projects on 47 acres in the Superstition and Plaster City Open Areas. Cogstone completed this work to satisfy BLM's responsibilities for compliance under Section 106 of the National Historic Preservation Act (NHPA). Cogstone's services included a records search for known cultural resources, an intensive pedestrian survey, and prepared a Cultural Resources Assessment Report. Although the records search did not identify any previously recorded cultural resources in the proposed Area of Potential Effects (APE), 41 previously recorded cultural resources were identified within a one-mile radius, some of which may have subsurface potential. Cultural resources monitoring was recommended due to the sensitivity for buried cultural resources. Prime. Principal Investigator for Archaeology. 2022-2023

Priest Valley Very High Frequency Omni-Directional Range Project, Priest Valley, Monterey and Fresno Counties, CA. Cogstone conducted a cultural resources assessment to identify potential impacts to cultural resources from the Priest Valley Very High Frequency Omni-Directional Range Project which will consist of the demolition, removal, and disposal of the facility (recorded as the Charley Mountain Radio Facility P-10-007062/P-27-003635). The United States Department of Transportation (USDOT) Volpe National Transportation System Center provided environmental compliance support for the Federal Aviation Administration to meet their obligations for historic properties identification requirements under 36 CFR 800.4 in Section 106 of the NHPA. Cogstone's assessment was conducted under the BLM Cultural Resources Use Permit number CA-19-07 and BLM Fieldwork Authorization No. FWA# CA-19-07-2022-190/01. Cogstone's assessment included a cultural records search, a Sacred Lands File search from the Native American Heritage Commission, an intensive pedestrian and built environment survey, and updated the evaluation and site record for one historic facility on California Department of Parks and Recreation 523 forms. Cogstone prepared separate Archaeological and Historical Resources Assessment Reports documenting the findings of the study due to changes in scope during the Project. Prime. Report Author. 2021

Goffs Butte 3 Cell Tower Project, Community of Essex, San Bernardino County, CA. Cogstone conducted a cultural resources assessment to determine potential impacts to cultural resources resulting from improvements to an existing cell tower on BLM land. Improvements consisted of removal and disposal of an existing generator and installation of an optional standby generator system, automatic transfer switch, generator auxiliary power distribution, and remote monitoring communications circuitry. Cogstone's services included a cultural resources record search, and an intensive pedestrian survey. A previously recorded historic site was relocated during the survey and was evaluated for inclusion in the National Register of Historic Places (NRHP) and the California Register of Historical Resources (CRHP). A Cultural Resources Assessment letter report was prepared at the conclusion of the survey. Sub to Partner Engineering and Science, Inc. Project Manager. 2020

EDUCATION

1990 M.A., Anthropology (Biological), University of California, Los Angeles
1985 B.A., Anthropology (Physical), California State University, Northridge

SUMMARY QUALIFICATIONS

Mr. Scott is a professional vertebrate paleontologist with over four decades of experience in paleontological mitigation, fieldwork, curation, and research. He is emeritus paleontology curator at the San Bernardino County Museum, an adjunct instructor at California State University, San Bernardino, and a research associate of the Natural History Museum of Los Angeles County and the La Brea Tar Pits and Museum. He is a 30+ year member of the Society of Vertebrate Paleontology, an international society of professional scientists where he currently serves on the Government Affairs Committee, and also holds membership in the Geological Society of America and other professional societies. Eric has published over 40 research articles in professional scientific journals.

SELECTED PROJECTS

Purple Line Extension (Westside Subway), Section 1, Metropolitan Transit Authority (METRO), Los Angeles, CA. The project involves construction of seven stations from the existing Purple Line at Wilshire/Western Avenue along Wilshire Boulevard to the Veterans Administration Hospital in Westwood for 8.6 miles. Supervises paleontological monitoring, fossil recovery, and fossil preparation in the lab. Contributes to monthly reporting. Sub to JV West. Paleontologist. 2017-ongoing

Irvine General Plan Update - Phase II, City of Irvine, Orange County, CA. Cogstone conducted a study to review and summarize available information regarding known paleontological, archaeological, and historical resources within the boundaries of the City of Irvine to support the Phase II update of the City's General Plan. A general analysis of impacts of future projects within the City of Irvine that may adversely affect paleontological, archaeological, or historic resources was provided along with mitigation recommendations. Sub to PlaceWorks. Paleontology QA/QC. 2018-2019

Victorville Fleet Service Center Project, City of Victorville, San Bernardino County, CA. Cogstone was retained by the County of San Bernardino Department of Public Works to provide paleontological monitoring and mitigation during excavation conducted in conjunction with construction of the 4.8 acre project. Upon completion of monitoring, a Paleontological Resources Monitoring Compliance Report was submitted. Principal Investigator for Paleontology. 2018

SR 14 / Avenue N Operational Interchange Improvements Project, Caltrans District 7, City of Palmdale, Los Angeles County, CA. The purpose of this study was to identify and evaluate paleontological resources during the proposed upgrades and improvements to transportation facilities. Cogstone conducted a ground truthing survey and requested a record search from the Natural History Museum of Los Angeles County. Online records from the University of California Museum of Paleontology database and the Paleobiology Database were searched for fossil records as well as print sources. Ultimately, a combined PIR/PER were submitted and accepted with minimal comments. Sub to ECORP Consulting. Principal Investigator for Paleontology. 2018

I-10/Grove Avenue Corridor Project, Caltrans District 8, City of Ontario, San Bernardino County, CA. Cogstone produced a combined Paleontological Identification and Evaluation Report (PIR/PER) and Paleontological Mitigation Plan (PMP) to assess and plan for the potential for impacting fossil resources during proposed improvements to Grove Avenue south of Interstate 10. The proposed improvements included the widening of Grove Avenue from a four-lane roadway to a six-lane roadway from 4th Street to State Street/Airport Drive. The City of Ontario acted as the lead agency under CEQA and NEPA. Sub to Parsons. Paleontology QA/QC. 2017

EDUCATION

2018 Geographic Information Systems (GIS) Certificate, California State University, Fullerton
2003 B.A., Anthropology, University of California, Santa Barbara

SUMMARY OF QUALIFICATIONS

Mr. Freeberg has over 20 years of experience in cultural resource management and has extensive experience in field surveying, data recovery, monitoring, and excavation of archaeological and paleontological resources associated with land development projects in the private and public sectors. He has conducted all phases of archaeological work, including fieldwork, laboratory analysis, research, and reporting. Mr. Freeberg also has a strong grounding in conventional field and laboratory methods and is skilled in the use of ArcGIS.

SELECTED EXPERIENCE

New Cuyama Dump Sites 1, 2, and 3, BLM Bakersfield Office, Santa Barbara County, CA. The Project involved identifying archaeological and historical resources present within three illegal dump sites on BLM land. This study included an assessment of the historic potential of dump refuse and NRHP eligibility recommendations for debris demonstrating affirmative evidence for an age greater than 45 years. A Class III Cultural Resources survey was conducted and included an intensive-level pedestrian survey of the APE with no larger than ten-meter-wide transects when used. Smaller transects were used in narrower areas of the APE and during investigations of newly identified archaeological sites and isolates. A total of three historic trash scatters were identified during the survey and a total of four historic isolates were identified. These resources were recorded on Department of Parks and Recreation 523 (DPR 523) forms. No archaeological sites or isolates were identified. No artifacts were collected. The deliverables were accepted by the BLM without revisions. Archaeologist and GIS Supervisor. 2020-2021

San Gabriel River Commuter Bikeway and Big Dalton Wash Commuter Bikeway, City of Baldwin Park, Los Angeles County, CA. Cogstone conducted a cultural and historic built environment resources assessment to determine the potential impacts to cultural and historical resources for the proposed construction of approximately five miles of new bikeway/pedestrian pathway. Services included pedestrian surveys, records searches, a Sacred Lands File search from the NAHC, preparation of DPR 523 forms, NRHP eligibility assessments, and reporting. The project required a Section 408 permit from the USACE due to the proximity of the federally managed San Gabriel River and tributaries. All work performed complied with Section 106 of the NHPA. The City of Baldwin Park acted as lead agency under CEQA. Sub to Infrastructure Engineering Corporation. GIS Supervisor. 2020-2021

State Route 108/Highway 49 and Mackey Ranch Road Intersection Improvements Project, Caltrans District 10, Tuolumne County, CA. The Chicken Ranch Rancheria of Me-Wuk Indians of California, in partnership with Caltrans, proposed to replace an intersection and convert to a roundabout designed to accommodate forecasted future traffic volumes and provide an alternative access route to the Chicken Ranch Rancheria. Cogstone completed intensive-level pedestrian survey, records search, sacred lands file search from the NAHC, Native American consultation, consulted with local history societies and preservation groups, and prepared a Historical Resources Compliance Report (HRCR) and Archaeological Survey Report (ASR). Sub to Foothill Associates. GIS Supervisor. 2019-2020

Jack Ranch San Luis Obispo Agricultural Cluster Project, City of San Luis Obispo, San Luis Obispo County, CA. Cogstone prepared a cultural and paleontological assessment to propose effective mitigation of potential adverse impacts to paleontological resources resulting from a proposed subdivision of a 299-acre property into 13 residential lots as well as a Conditional Use Permit to allow for a Major Agricultural Cluster project. Cogstone provided archaeological and paleontological monitoring and submitted a Cultural and Paleontological Resources Monitoring Compliance Report upon completion. Sub to Jack Ranch SLO, LLC. GIS Supervisor. 2020

APPENDIX B. PALEONTOLOGICAL RECORD SEARCH

SAN DIEGO NATURAL HISTORY MUSEUM

18 November 2023

Logan Freeberg
Cogstone Resource Management
1518 W Taft Avenue
Orange, California 92865

RE: Paleontological Records Search – Maverik/EVC Development

Dear Mr. Freeberg:

This letter presents the results of a paleontological records search conducted for the Maverik/EVC Development project (“Project”) located in the southern portion of Imperial County, California. The Project site is located east of State Route (SR-) 111 and north of Interstate (I-) 8, east of the City of El Centro (Figure 1). The Project is bordered to the north by Ross Avenue, to the east by agricultural development, to the south by Acacia 5-A Drain, and to the west by Acacia 5-A Drain and Hawes Road.

Methods

A review of published geological maps covering the Project site and surrounding area was conducted to determine the specific geologic units underlying the Project site. Each geologic unit was subsequently assigned a paleontological resource potential following guidelines developed by the Society of Vertebrate Paleontology (SVP, 2010). In addition, a search of the paleontological collection records housed at the San Diego Natural History Museum (SDNHM) was conducted in order to determine if any documented fossil collection localities occur at the Project site or within the immediate surrounding area.

Results

Published geological reports (e.g., Jennings, 2010) covering the Project area indicate that the proposed Project has the potential to impact the late Pleistocene- to Holocene-age Lake Cahuilla Beds. This geologic unit and its paleontological potential are summarized below.

The SDNHM does not have any recorded fossil localities that lie within one mile of the Project site.

Lake Cahuilla Beds – Lake Cahuilla was a former freshwater lake that periodically occupied a major portion of the Salton Trough during late Pleistocene to Holocene time (approximately 37,000 to 240 years ago), depositing sediments that underlie the majority of the Project site (mapped as Quaternary lake deposits by Jennings, 2010). Generally, Lake Cahuilla sediments consist of an interbedded sequence of both freshwater lacustrine (lake) and fluvial (river/stream) deposits. There are no recorded SDNHM fossil collection localities from these deposits within a one-mile radius of the Project site. The Lake Cahuilla Beds have yielded well-preserved subfossil remains of freshwater clams and snails, as well as sparse remains of freshwater fish (Deméré and Walsh, 1993). The paleontological resources of the Lake Cahuilla Beds are considered significant because of the paleoclimatic and



P.O. BOX 121390, SAN DIEGO, CA 92112-1390
SDNAT.ORG P 619.232.3821 F 619.232.0248

paleoecological information they can provide, and these deposits are therefore assigned a high paleontological potential.

Summary and Recommendations

The high paleontological potential of the Lake Cahuilla Beds (SVP, 2010) suggests that construction of the proposed Project could result in impacts to paleontological resources. Any proposed excavation activities that extend deep enough to encounter previously undisturbed deposits of this geologic unit have the potential to impact the paleontological resources preserved therein. For these reasons, implementation of a complete paleontological resource mitigation program during ground-disturbing activities is recommended. The mitigation program must include, at a minimum, measures for construction monitoring, fossil salvage and data recovery, laboratory preparation and curation of the fossils into the collections of an appropriate regional repository, and submission of a final paleontological mitigation report.

If you have any questions concerning these findings please feel free to contact me at kmueller@sdnhm.org.

Sincerely,



Kirstin Mueller
Assistant Report Writer
San Diego Natural History Museum

Enc: Figure 1: Records search map.

Literature Cited

- Deméré, T.A., and S.L. Walsh. 1993. Paleontological Resources, County of San Diego. Unpublished technical report prepared for the San Diego County Department of Public Works: 1–68.
- Jennings, C.W., C. Gutierrez, W. Bryant, G. Saucedo, and C. Wills. 2010. Geologic Map of California: California Geological Survey California Geologic Data Map Series Map No. 2, scale 1:750,000.
- SDNHM unpublished paleontological collections data.
- SVP. 2010. Standard Procedures for the Assessment and Mitigation of Adverse Impacts to Paleontological Resources. Society of Vertebrate Paleontology: 1–11.



APPENDIX C. HISTORICAL SOCIETIES CONSULTATION



November 29, 2023

Imperial County Historical Society
373 E Aten Rd,
Imperial, CA. 92251

RE: Cultural Resources Assessment for the Maverik\EVC Development Project, Imperial County, California.

To Whom It May Concern:

As a sub-consultant to Willis Environmental Planning, Cogstone Resource Management, Inc. (Cogstone) is conducting a cultural and paleontological resources assessment for the Maverik\EVC Development Project (Project) located on approximately 10 acres in the northwest corner of Assessor Parcel Number (APN) 054-080-023 located at the southeast corner of Hawes Road and Ross Avenue in El Centro, Imperial County, California.

The initial Project development involves the construction of a new fueling station with 18 fuel pumps and a 5,892 square foot convenience store building with associated site improvements such as landscaping, parking, street improvements, and utilities. In addition, a 16.14-acre electric vehicle charging hub with ancillary uses for medium and heavy-duty trucks and light duty/passenger vehicles. The Project area is currently developed for agricultural purposes and has been disced and graded.

We are contacting you because we would like to invite members of the Imperial County Historical Society to provide input regarding the redevelopment of the Project area. We appreciate any information regarding the history of the Project area that you may have as well as any comments, issues, and/or concerns relating to the history of the Project area. Please contact me at slopez@cogstone.com. Thank you for your attention to this matter.

Sincerely,

Shannon Lopez, M.A.
Architectural Historian
(714) 974-8300 x.108
slopez@cogstone.com

1818 West Taft Avenue
Orange, CA 92665
Office (714) 974-8300

Branch Offices
San Diego - Riverside - Morro Bay - Sacramento

cogstone.com
Toll free (888) 323-3212

Federal Certifications EDWOSB, SDB
State Certifications DBE, WBE, UDBE



Figure 1. Project Location Map

cogstone.com

APPENDIX D. SACRED LANDS FILE SEARCH

Sacred Lands File & Native American Contacts List Request

NATIVE AMERICAN HERITAGE COMMISSION

1550 Harbor Blvd, Suite 100
West Sacramento, CA 95691
(916) 373-3710
(916) 373-5471 – Fax
nahc@nahc.ca.gov

Information Below is Required for a Sacred Lands File Search

Project: Maverik EVC Development
County: Imperial

USGS Quadrangle
Name: El Centro and Holtville West
Township: 16S Range: 14E Section(s): 11

Company/Firm/Agency:
Cogstone Resource Management

Contact Person: _____
Street Address: 1518 W. Taft Avenue
City: Orange Zip: 92865
Phone: (714) 974-8300 Extension: _____
Fax: (714) 974-8303
Email: cogstoneconsult@cogstone.com

Project Description:

During the initial development phase, Maverik is proposing the construction of a new fueling station consisting of 18 fuel pumps, and a 5,982 square foot convenience store building. The applicant also proposes associated site improvements, including parking, landscaping, street improvements, and utilities. During the subsequent phase, EVCPartners LLC is proposing to entitle this site for a) an approximately 16.14-acre electric vehicle charging hub, with related ancillary uses for medium and heavy-duty trucks and light duty/passenger vehicles, and b) commercial/hospitality land uses appropriate for this site and location on the remaining approximately 24.14 acres of the site.

Project Location Map is attached

SLP&ContactsForm: rev: 05/07/14

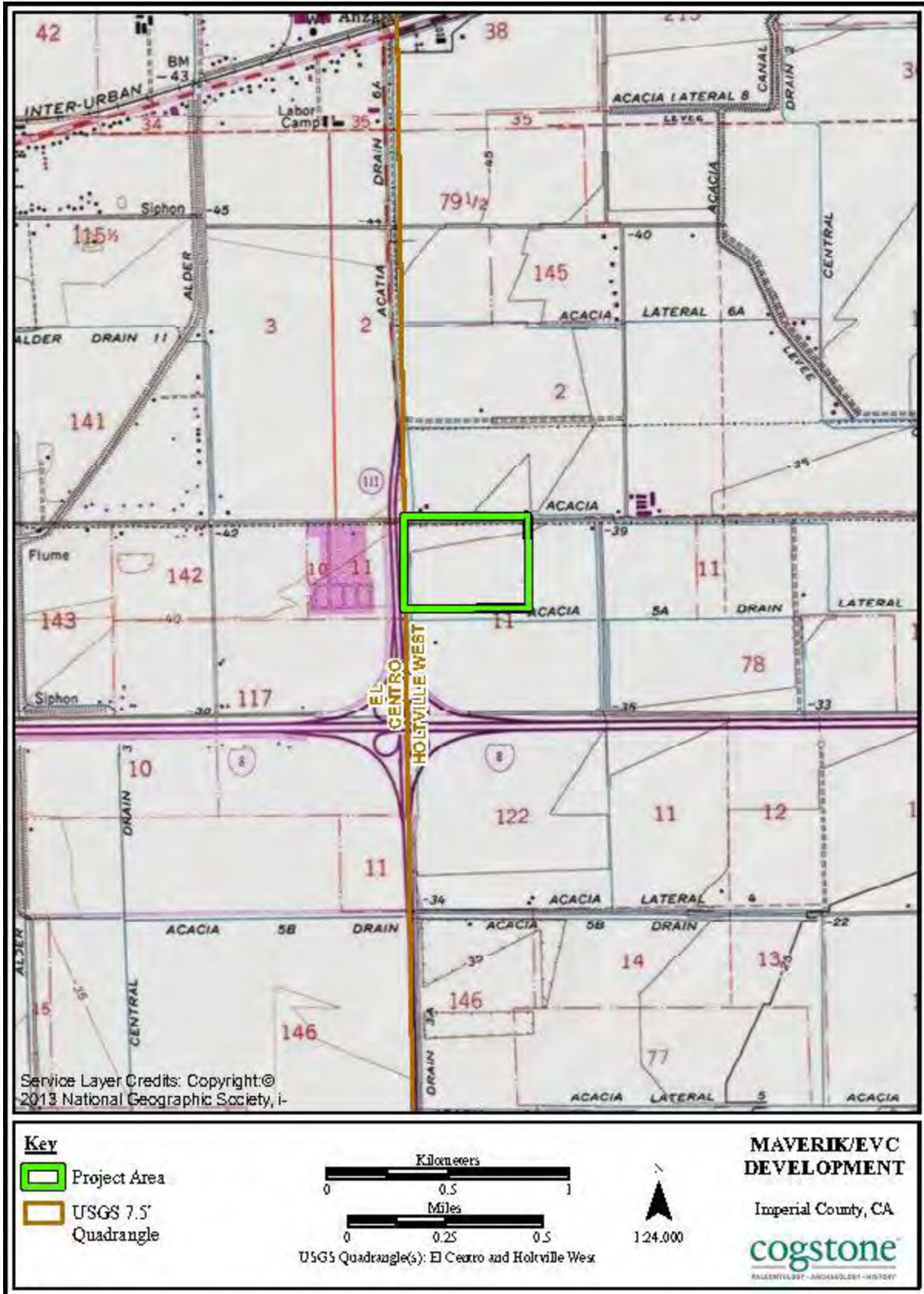



STATE OF CALIFORNIA

Govin Newsom, Governor

NATIVE AMERICAN HERITAGE COMMISSION

December 1, 2023

Cogstone Resource Management

Via Email to: cogstoneconsult@cogstone.com

CHAIRPERSON
Reginald Pagaling
Chumash

VICE-CHAIRPERSON
Buffy McQuillen
Yakaya Pomo, Yuki,
Nimlaku

SECRETARY
Sara Dutschke
Miwok

PARLIAMENTARIAN
Wayne Nelson
Luiseño

COMMISSIONER
Isaac Bojorquez
Chilone-Costanoan

COMMISSIONER
Stanley Rodriguez
Kumeyaay

COMMISSIONER
Laurena Bolden
Serrano

COMMISSIONER
Reid Milanovich
Cahuilla

COMMISSIONER
Vacant

EXECUTIVE SECRETARY
Raymond C.
Hitchcock
Miwok, Nisenan

NAHC HEADQUARTERS
1550 Harbor Boulevard
Suite 100
West Sacramento,
California 95691
(916) 379-3710

Re: Maverik EVC Development Project, Imperial County

Dear Cogstone Resource Management:

A record search of the Native American Heritage Commission (NAHC) Sacred Lands File (SLF) was completed for the information you have submitted for the above referenced project. The results were positive. Please contact the tribes on the attached list for more information. Other sources of cultural resources should also be contacted for information regarding known and recorded sites.

Attached is a list of Native American tribes who may also have knowledge of cultural resources in the project area. This list should provide a starting place in locating areas of potential adverse impact within the proposed project area. I suggest you contact all of those indicated; if they cannot supply information, they might recommend others with specific knowledge. By contacting all those listed, your organization will be better able to respond to claims of failure to consult with the appropriate tribe. If a response has not been received within two weeks of notification, the Commission requests that you follow-up with a telephone call or email to ensure that the project information has been received.

If you receive notification of change of addresses and phone numbers from tribes, please notify me. With your assistance, we can assure that our lists contain current information.

If you have any questions or need additional information, please contact me at my email address: Pricilla.Torres-Fuentes@nahc.ca.gov.

Sincerely,

Pricilla Torres-Fuentes

Pricilla Torres-Fuentes
Cultural Resources Analyst

Attachment

Native American Heritage Commission Native American Contact List Imperial County 12/1/2023				
Tribe Name	Contact Person	Cultural Affiliation	Counties	Last Updated
Barona Group of the Capitan Grande	Art Bunce, Attorney	Diegueno	Imperial, San Diego	7/25/2023
Campo Band of Diegueno Mission Indians	Ralph Goff, Chairperson	Diegueno	Imperial, Orange, Riverside, S an Diego	
Ewiiapaayp Band of Kumeyaay Indians	Michael Garcia, Vice Chairperson	Diegueno	Imperial, Orange, Riverside, San Diego	
Ewiiapaayp Band of Kumeyaay Indians	Robert Pinto, Chairperson	Diegueno	Imperial, Orange, Riverside, San Diego	
Iipay Nation of Santa Ysabel	Clint Linton, Director of Cultural Resources	Diegueno	Imperial, San Diego	11/30/2023
Inaja-Cosmit Band of Indians	Rebecca Osuna, Chairperson	Diegueno	Imperial, San Diego	
Jamul Indian Village	Lisa Cumper, Tribal Historic Preservation Officer	Diegueno	Imperial, San Diego	9/5/2018
Jamul Indian Village	Erica Pinto, Chairperson	Diegueno	Imperial, San Diego	
Kwaaymii Laguna Band of Mission Indians	Carmen Lucas,	Kwaaymii Diegueno	Imperial, San Diego	6/20/2023
La Posta Band of Diegueno Mission Indians	Gwendolyn Parada, Chairperson	Diegueno	Imperial, Orange, R iverside, S an Diego	
Manzanita Band of Kumeyaay Nation	Angela Elliott Santos, Chairperson	Diegueno	Imperial, Orange, Riverside, San Diego	
Mesa Grande Band of Diegueno Mission Indians	Michael Linton, Chairperson	Diegueno	Imperial, Orange, Riverside, San Diego	
Quechan Tribe of the Fort Yuma Reservation	Jill McCormick, Historic Preservation Officer	Quechan	Imperial, Kern, Los Angeles, Riverside, San Bernardino, San Diego	5/16/2023

Native American Heritage Commission Native American Contact List Imperial County 12/1/2023				
Tribe Name	Contact Person	Cultural Affiliation	Counties	Last Updated
Quechan Tribe of the Fort Yuma Reservation	Jordan Joaquin, President, Quechan Tribal Council	Quechan	Imperial, Kern, Los Angeles, Riverside, San Bernardino, San Diego	5/16/2023
Quechan Tribe of the Fort Yuma Reservation	Manfred Scott, Acting Chairman - Kw'ts'an Cultural Committee	Quechan	Imperial, Kern, Los Angeles, Riverside, San Bernardino, San Diego	5/16/2023
San Pasqual Band of Diegueno Mission Indians	Allen Lawson, Chairperson	Diegueno	Imperial, San Diego	
San Pasqual Band of Diegueno Mission Indians	John Flores, Environmental Coordinator	Diegueno	Imperial, San Diego	8/16/2016
Sycuan Band of the Kumeyaay Nation	Cody Martinez, Chairman	Kumeyaay	Imperial, San Diego	8/7/2023
Sycuan Band of the Kumeyaay Nation	Bernice Paipa, Cultural Resource Specialist	Kumeyaay	Imperial, San Diego	8/7/2023
Viejas Band of Kumeyaay Indians	Ray Teran, Resource Management Director	Kumeyaay	Imperial, San Diego	6/29/2023
Viejas Band of Kumeyaay Indians	Ernest Pingleton, THPO	Kumeyaay	Imperial, San Diego	6/29/2023
<p>This list is current only as of the date of this document. Distribution of this list does not relieve any person of statutory responsibility as defined in Section 7050.5 of the Health and Safety Code, Section 5097.94 of the Public Resource Section 5097.98 of the Public Resources Code.</p> <p>This list is only applicable for contacting local Native Americans with regard to cultural resources assessment for the proposed Maverik EVC Development Project, Imperial County.</p>				

**APPENDIX E. PALEONTOLOGICAL SENSITIVITY RANKING
CRITERIA**

PFYC Description Summary (BLM 2016)	PFYC Rank
<p>Very Low. The occurrence of significant fossils is non-existent or extremely rare. Includes igneous (excluding air-fall and reworked volcanic ash units), metamorphic, or Precambrian rocks. Assessment or mitigation of paleontological resources is usually unnecessary except in very rare or isolated circumstances that result in the unanticipated presence of fossils.</p>	1
<p>Low. Sedimentary geologic units that are unlikely to contain vertebrate or scientifically significant nonvertebrate fossils. Includes rock units less than 10,000 years old and sediments with significant physical and chemical changes (e.g., diagenetic alteration) which decrease the potential for fossil preservation. Assessment or mitigation of paleontological resources is not likely to be necessary.</p>	2
<p>Moderate. Units are known to contain vertebrate or scientifically significant nonvertebrate fossils, but these occurrences are widely scattered and/or of low abundance. Common invertebrate or plant fossils may be found and opportunities may exist for casual collecting. Paleontological mitigation strategies will be based on the nature of the proposed activity. Management considerations cover a broad range of options that may include record searches, pre-disturbance surveys, monitoring, mitigation, or avoidance. Surface-disturbing activities may require assessment by a qualified paleontologist to determine whether significant paleontological resources occur in the area of a proposed action, and whether the action could affect the paleontological resources.</p>	3
<p>High. Geologic units containing a high occurrence of significant fossils. Fossils must be abundant per locality. Vertebrates or scientifically significant invertebrate or plant fossils are known to occur and have been documented, but may vary in occurrence and predictability. Mitigation plans must consider the nature of the proposed disturbance, such as removal or penetration of protective surface alluvium or soils, potential for future accelerated erosion, or increased ease of access that could result in looting. Detailed field assessment is normally required and on-site monitoring or spot-checking may be necessary during land disturbing activities. In some cases avoidance of known paleontological resources may be necessary.</p>	4
<p>Very High. Highly fossiliferous geologic units that consistently and predictably produce vertebrate or scientifically significant invertebrate or plant fossils. Vertebrate fossils or scientifically significant invertebrate fossils are known or can reasonably be expected to occur in the impacted area. Paleontological resources are highly susceptible to adverse impacts from surface disturbing activities. Paleontological mitigation may be necessary before or during surface disturbing activities. The area should be assessed prior to land tenure adjustments. Pre-work surveys are usually needed and on-site monitoring may be necessary during land use activities. Avoidance or resource preservation through controlled access, designation of areas of avoidance, or special management designations should be considered.</p>	5
<p>Unknown. An assignment of “Unknown” may indicate the unit or area is poorly studied and field studies are needed to verify the presence or absence of paleontological resources. The unit may exhibit features or preservational conditions that suggest significant fossils could be present, but little information about the actual unit or area is known. Literature searches or consultation with professional colleagues may allow an unknown unit to be provisionally assigned to another Class, but the geological unit should be formally assigned to a Class after adequate survey and research is performed to make an informed determination.</p>	U
<p>Water or Ice. Typically used only for areas which have been covered thus preventing an examination of the underlying geology.</p>	W, I

APPENDIX F. DPR 523 FORMS

PRIMARY RECORD

Primary #
HRI #
Trinomial
NRHP Status Code

Other Listings
Review Code

Reviewer

Date

Page 1 of 5

*Resource Name or #: Acacia Five A Drain (canal)

P1. Other Identifier:

P2. Location: Not for Publication Unrestricted

a. County: Imperial

b. USGS 7.5' Quad: Holtville West Date: T 16 South; R 14 East; NW ¼ of Sec 11; S.B.B.M.

c. Address: Ross Ave. and Hawes Rd. City: El Centro Zip: 92243

d. UTM: Zone: 11S; 640420mE/3627850 mN

e. Other Locational Data: APN 054-080-023

Elevation: 35 feet amsl

P3a. Description:

The canal is an exposed dirt-lined linear feature built ca 1950. This canal section is 1,200 feet long by 20 feet deep by 40 feet wide. Its purpose is to provide drainage to the adjacent field and it is one segment of a vast network of various agricultural canal systems in the area (USGS, *El Centro* 1954). It is directly associated with 13-009069 the Acacia 5A Drain.

P3b. Resource Attributes: HP20. Canal

P4. Resources Present: Building Structure Object Site District Element of District Other



P5b. Description of Photo:

Canal overview, view facing north (photo taken November 21, 2023).

P6. Date Constructed/Age

and Sources: Historic
 Prehistoric Both
Ca. 1950 (per USDA Historic Aerials; NETROnline 1953).

P7. Owner and Address:

Charles T. Ciruolo and Frances C. Ciruolo
Ciralo Family Partners L.P.
1666 Kimberly Woods Dr.
El Cajon, CA 92020

P8. Recorded by:

Cogstone Resource Management; 1518 W. Taft Ave., Orange, CA 92865

P9. Date Recorded:

November 21, 2023

P10. Survey Type: Intensive Pedestrian

P11. Report Citation: *Draft Cultural Resources Assessment Report for Maverik Fuel Station and Convenience Store Development Project, Imperial County, California.* Prepared for Wills Environmental Planning. Prepared by Cogstone. January 2024.

Attachments: NONE Location Map Sketch Map Continuation Sheet Building, Structure, and Object Record Archaeological Record District Record Linear Feature Record Milling Station Record Rock Art Record Artifact Record Photograph Record Other

BUILDING, STRUCTURE, AND OBJECT RECORD

- B1. **Historic Name:** None
- B2. **Common Name:** Acacia Five A Drain
- B3. **Original Use:** Drainage canal
- B4. **Present Use:** Drainage canal
- *B5. **Architectural Style:** None
- *B6. **Construction History:** Due to a data gap, it is unclear when this canal was constructed. Therefore, it is estimated that the canal was built in ca. 1950 following a review of 1953 USDA aerial photograph (NETROnline 1953).

- *B7. **Moved?** No Yes Unknown **Date:** **Original Location:**
- *B8. **Related Features:** Adjacent agricultural field.

- B9a. **Architect:** None
- B9b. **Builder:** Unknown
- *B10. **Significance:** None
- Theme:** Agriculture
- Area:** Imperial County
- Period of Significance:** ca. 1950-1978
- Property Type:** Canal
- Applicable Criteria:** None

Criteria A/1

Is this resource associated with events that have made a significant contribution to the broad patterns of our history?

Despite a search of historic newspapers, no information could be found that connects this this canal to any event significant to local, state, or national history. Therefore, this canal is recommended not eligible for listing on the National Register of Historic Places (NRHP) under Criterion A and the California Register of Historical Resources (CRHR) under Criterion 1.

Criteria B/2

Is this resource associated with the lives of significant persons in our past?

Despite a search of historic newspapers, no information could be found that connects this this canal to any person or persons significant to local, state, or national history. Therefore, this canal is recommended not eligible for listing on the NRHP under Criterion B and the CRHR under Criterion 2.

- B11. **Additional Resource Attributes:** HP33. Farm
- *B12. **References:**

B13. **Remarks:**

- *B14. **Evaluator:** Shannon Lopez
- ***Date of Evaluation:** December 11, 2023

LINEAR FEATURE RECORD

L1. **Historic and/or Common Name:** Acacia Five a Drain

L2a. **Portion Described:** Entire Resource Segment Point Observation **Designation:**

b. **Location of point or segment:** Located along the western boundary of APN 054-080-023.

L3. **Description:** The canal segment is an exposed dirt-lined linear feature built ca 1950. This canal is 1200 feet long, approximately 20 feet deep, and approximately 40 feet wide. Its purpose is to provide drainage to the adjacent field and is one segment of a vast network of various agricultural canal systems in the area (USGS, El Centro 1954).

L4. **Dimensions:**

a. **Top Width** 40 feet

b. **Bottom Width** 0 to 10 feet

c. **Height or Depth** 20 feet

d. **Length of Segment** 1200 feet

L5. **Associated Resources:** Adjacent agricultural field.

L6. **Setting:** Large agricultural fields to the north, west, and south. Highway and trailer park to the west.

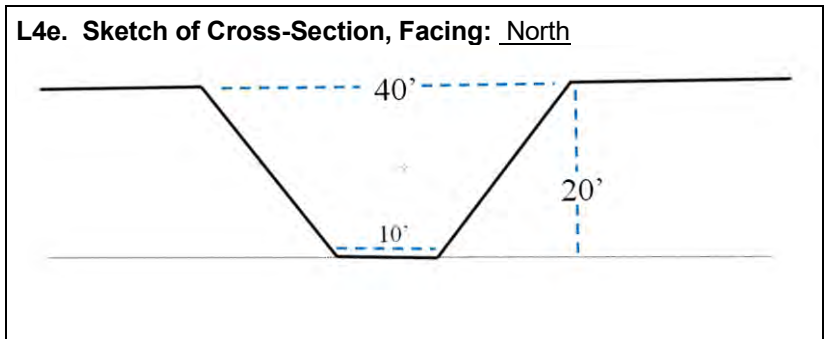

L7. **Integrity Considerations:**

This resource maintains its original alignment and appearance as seen in a 1953 USDA aerial photograph (NETROnline 1953). This segment of canal retains its integrity of location, design, setting, materials, feeling, workmanship, and association.

L8b. **Description of Photo, Map, or Drawing:** Overhead view of the drain section (photograph courtesy of Google Earth).

L8a.

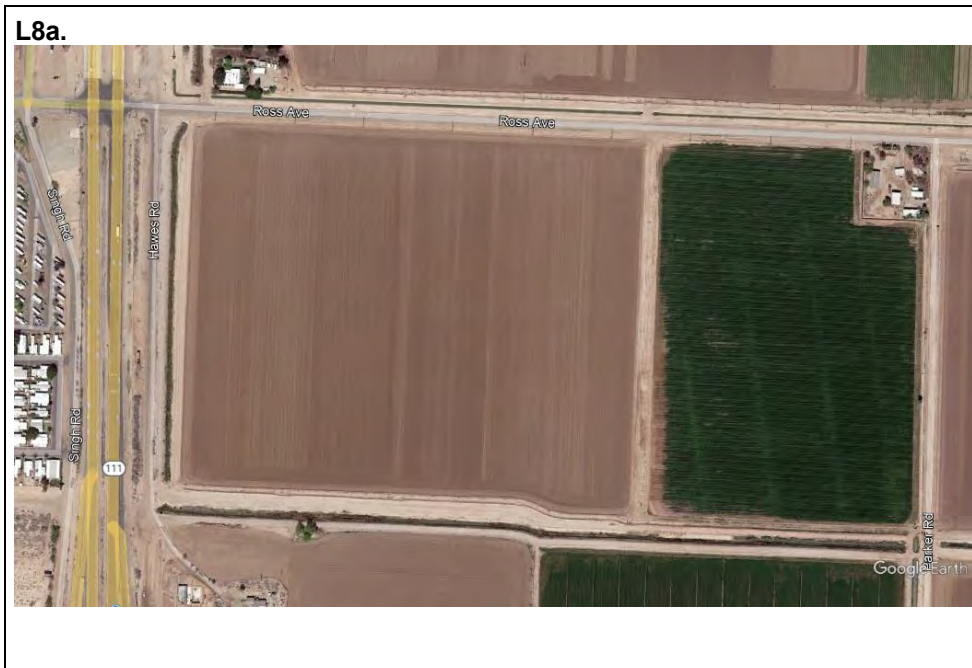





L9. **Remarks:**

L10. **Form Prepared by:**
Shannon Lopez
Cogstone Resource
Management, 1518 W. Taft
Ave.
Orange, CA 92865

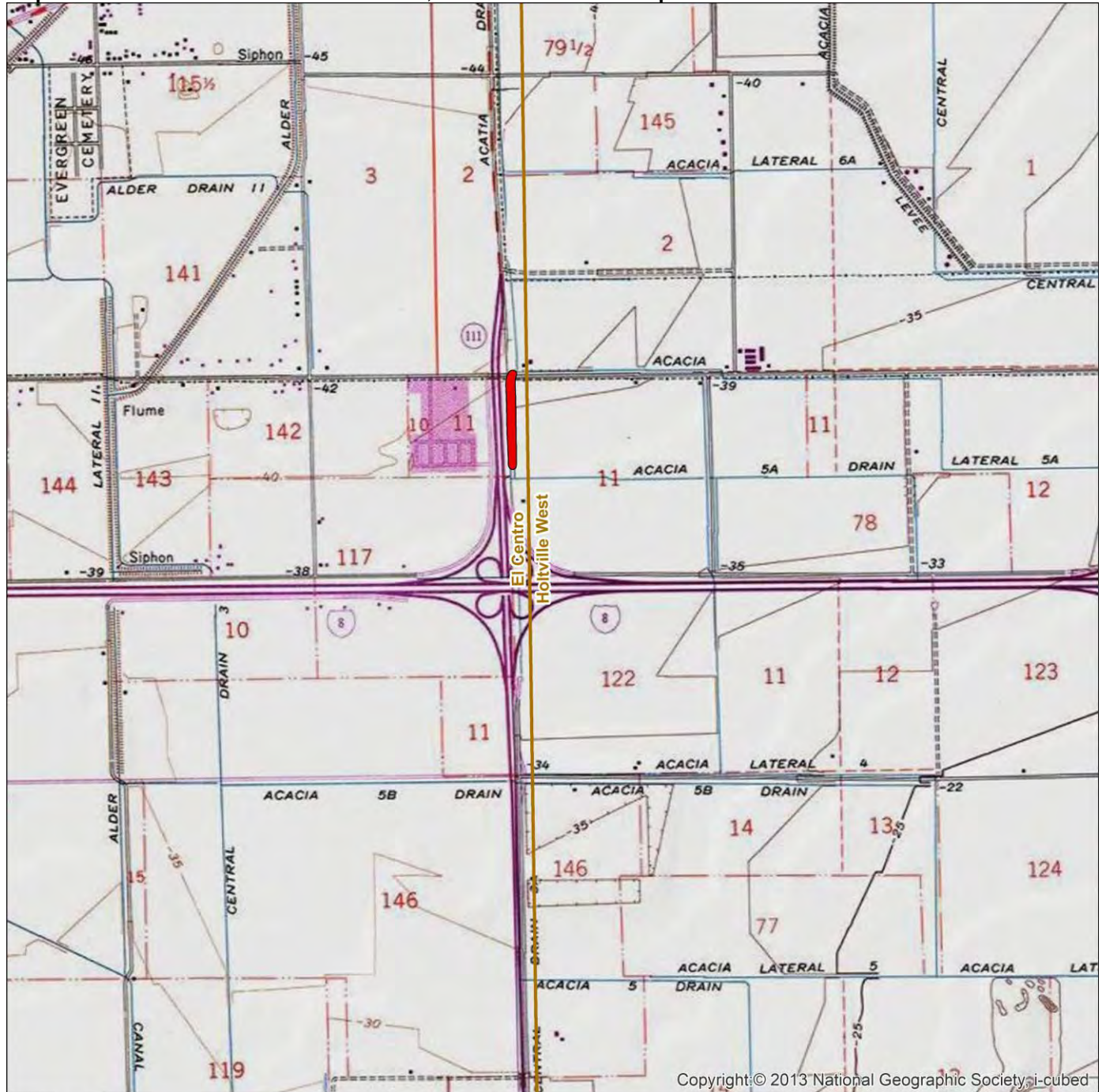
L11. **Date:** December 11,
2023

LOCATION MAP

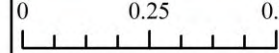
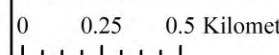

<p>Acacia 5A Drain Imperial County, CA</p>	<p> Acacia 5A Drain  USGS 7.5' Quadrangle</p>	<p>USGS 7.5' Quads: EL CENTRO HOLTVILLE WEST</p>	<p>0 0.25 0.5 Miles  N 0 0.25 0.5 Kilometers  1:24,000 1 in = 2,000 ft </p>
---	--	--	--

CONTINUATION SHEET

EVALUATION

Criteria C/3

Does this resource embody the distinctive characteristics of a type, period, or method of construction, or that represent the work of a master, or that possess high artistic values, or that represent a significant and distinguishable entity whose components may lack individual distinction?

This canal is a standard dirt-lined drainage canal and is not an exemplary representation of a type, style, or work of a master craftsman. Due to a lack of significance, this canal is recommended not eligible for listing in the NRHP under Criterion C and the CRHR under Criterion 3.

Criteria D/4

Has this building yielded or is it likely to yield, information important in history or prehistory?

Criterion D/4 is most often applied to archaeological sites and districts but can also apply to buildings, structures, and/or objects. This canal does not exhibit a local variation of a standard design or construction technique that can yield important information (such as construction expertise or availability of local materials). Due to a lack of significance, this canal is recommended not eligible for listing in the NRHP under Criterion D and the CRHR under Criterion 4.

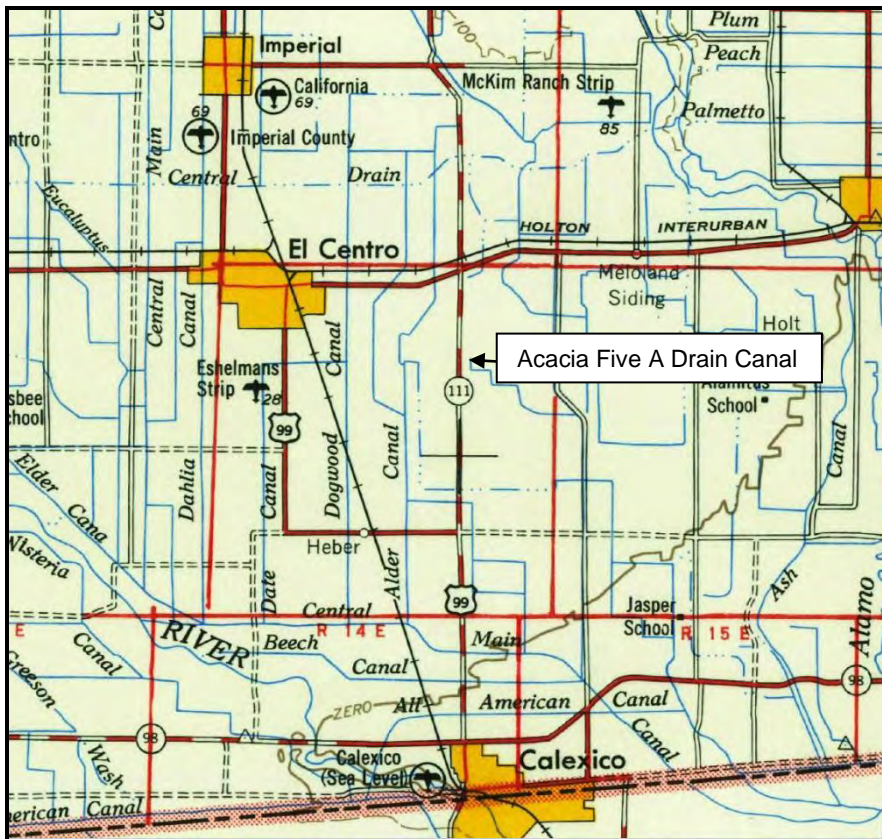

1954 canal map (USGS, *El Centro*, 1954).

REFERENCES

NETROnline

1953 *Historic Aerials*. Available at <https://www.historicaerials.com/viewer#>, accessed December 11, 2023.

United States Geological Survey (USGS)

1954 *El Centro*. [map]. U.S. Geological Survey. 1:250000. Topographic Quadrangle Map. El Centro, CA. 1954.

D-2

**AB-52 Consultation &
Responses**

This page intentionally left blank.



Imperial County Planning & Development Services Planning / Building

September 21, 2023

Jim Minnick
DIRECTOR

CERTIFIED MAIL NO. 7016 2140 0000 2120 4587

Marcus Cuero, Chairperson
Campo Band of Mission Indians
36190 Church Road, Suite 1
Campo, CA 91906

Subject: Tribal Culture Resources under the California Environmental Quality Act, AB 52 (Gatto, 2014). Formal Notification of Determination that a Project Application is Complete or Decision to undertake a Project, and Notification of Consultation Opportunity, pursuant to Public Resources Code Section 21080.3.1(d).

Dear Mr. Cuero:

The Imperial County Planning & Development Services Department has determined that project application is complete for General Plan Amendment #22-0002, Zone Change #22-00015 and Parcel Map #02499. The applicant is proposing a General Plan Amendment from Agriculture to Commercial, Zone Change from A-2 (General Agriculture) to C-3 (Heavy Commercial and Parcel Map proposing a 40 acres parcel and a 10 acres parcel for a fueling station and convenience store.

The location of the proposed project is at southeast corner of Highway 111 and Ross Road, El Centro, California (APN 054-080-023). Attached for your use, please find a copy of Imperial County Assessor Plat Map (Book 54, Page 08), an Aerial Vicinity Map and the Tentative Parcel Map of the subject area.

Pursuant to Public Resources Code, Section 21080.3.1(b), you have thirty (30) days from the receipt of this letter to request consultation, in writing, with the Imperial County Planning & Development Services Department. Your response is expected by October 20, 2023.

The contact person for this project is Derek Newland, Planner III, and can be reached at 442-265-1736, extension 1756, or via-email at dereknewland@co.imperial.ca.us.

Very Respectfully,

JIM MINNICK, Director
Planning & Development Services

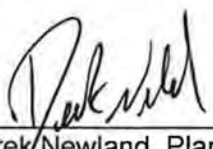
By: 
Derek Newland, Planner III

ATTACHMENTS:

Copy of Assessor Plat
Aerial Vicinity Map
Tentative Parcel Map
Site Plan

CC: Johnathan Mesa, Tribal Secretary / Cultural Monitor Project Manager (Mail and Email)

Jim Minnick, ICPDS Director
Michael Abraham, AICP, Assistant ICPDS Director
Diana Robinson, Planning Division Manager
File:10.102; 10.101; 10.104; 10.103
DNATIS\W\...

Band of Mission Indians GPA22-0002.docx

CALIFORNIA PRODUCER'S TRACT 1,2 & TRACT 78,122, SEC. 11, 12 & POR. SEC. 10, 11, 12, T.16S., R.14E.

Tax Area Code
75-001

54-08

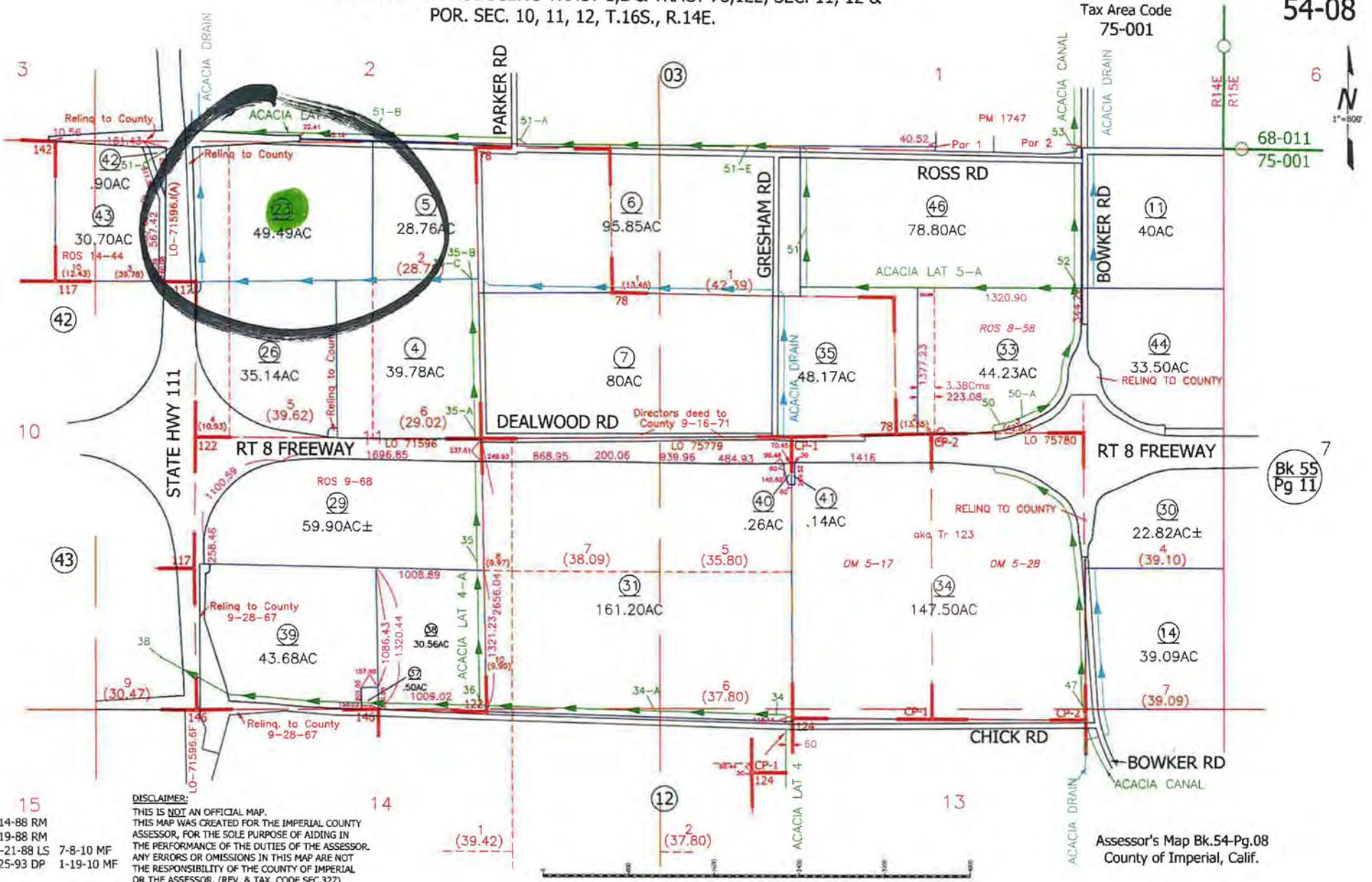

- 15
- 6-14-88 RM
- 2-19-88 RM
- 11-21-88 LS
- 3-25-93 DP
- 7-8-10 MF
- 1-19-10 MF

DISCLAIMER:
THIS IS NOT AN OFFICIAL MAP.
THIS MAP WAS CREATED FOR THE IMPERIAL COUNTY ASSESSOR, FOR THE SOLE PURPOSE OF AIDING IN THE PERFORMANCE OF THE DUTIES OF THE ASSESSOR. ANY ERRORS OR OMISSIONS IN THIS MAP ARE NOT THE RESPONSIBILITY OF THE COUNTY OF IMPERIAL OR THE ASSESSOR. (REV. & TAX. CODE SEC.327)



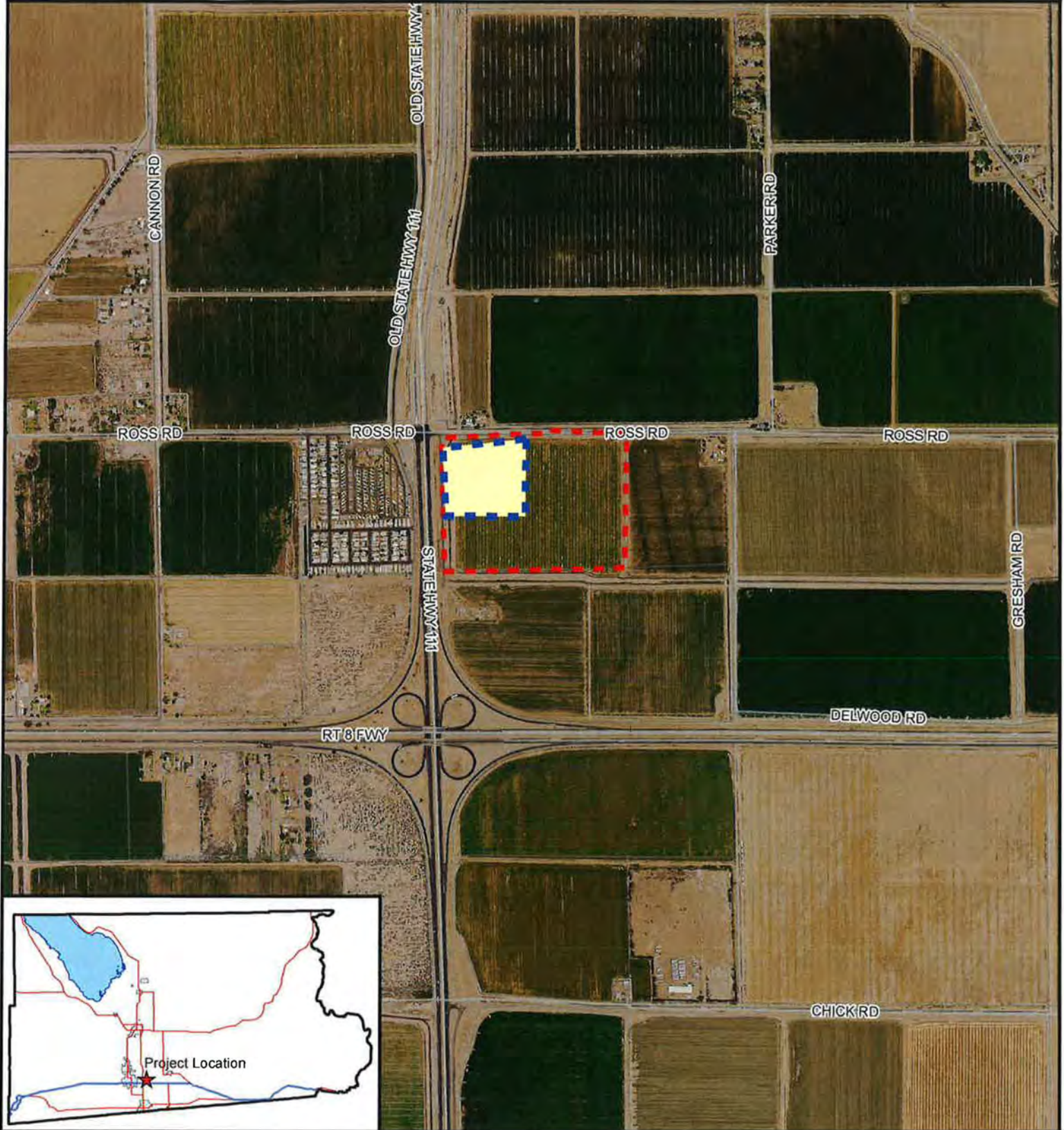

Assessor's Map Bk.54-Pg.08
County of Imperial, Calif.

EEC ORIGINAL PKG

PROJECT LOCATION MAP



MAVERIK INC.
GPA #22-0002 / ZC #22-0002 /
PM #02499
APN #054-080-023-000

-  Zone Change #22-0022
-  Project Location
-  Centerline
-  Parcels



EEC ORIGINAL PKG

TENTATIVE PARCEL MAP NO.

PORTION OF LOT 3 OF SECTION 11, AND THE NE 1/4 OF THE NW 1/4 OF SECTION 11, T16S, R14E, S.B.M.
IN THE COUNTY OF IMPERIAL, CALIFORNIA

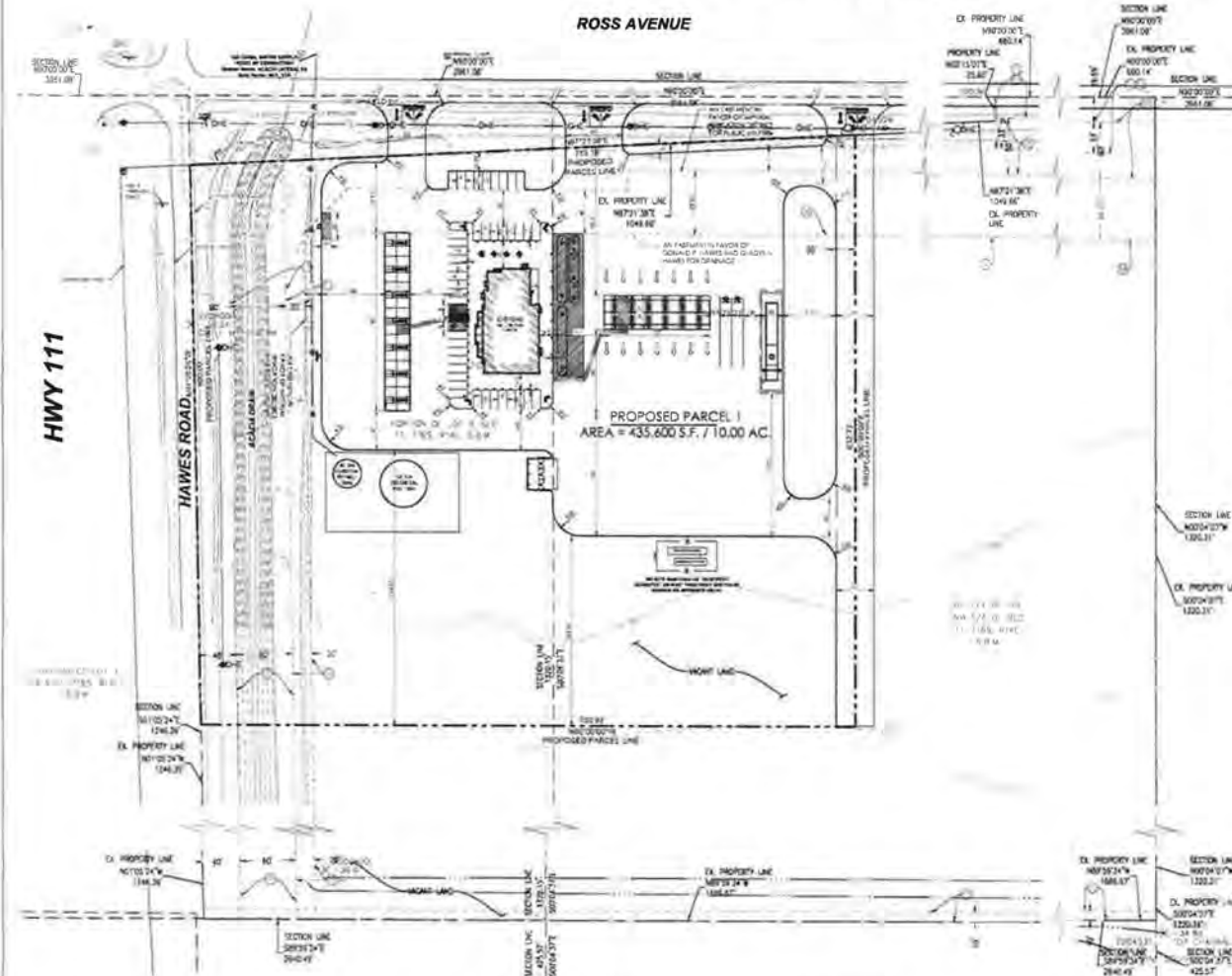

PROPOSED PARCEL 1
AREA = 435,800 S.F. / 10.00 AC.

ASSESSOR PARCEL NO.
054-080-022

LEGAL DESCRIPTION
THE LAND REFERRED TO HEREIN BELOW IS SITUATED IN THE UNINCORPORATED AREA OF , COUNTY OF IMPERIAL, STATE OF CALIFORNIA AND IS DESCRIBED AS FOLLOWS:

PARCEL 1, THE NORTHEAST QUARTER OF THE NORTHEAST QUARTER OF SECTION 11, TOWNSHIP 16 SOUTH, RANGE 14 EAST, COUNTY OF IMPERIAL, STATE OF CALIFORNIA, ACCORDING TO THE OFFICIAL PLAT OF SURVEY APPROVED AND ON FILE IN THE U.S. LAND OFFICE, PARCEL 2, THAT PART OF LOT 3 IN SECTION 11, TOWNSHIP 16 SOUTH, RANGE 14 EAST, S.B.M., IN THE COUNTY OF IMPERIAL, STATE OF CALIFORNIA, ACCORDING TO THE UNITED STATES GOVERNMENT OFFICIAL PLAT OF SURVEY APPROVED AND ON FILE IN THE UNITED STATES LAND OFFICE, 1/16E EAST OF THE CENTER LINE IN THE COUNTY ROAD.

UTILITY
SEWER AND SANITATION:
IMPERIAL COUNTY ENVIRONMENTAL HEALTH: 797 MAIN ST., SUITE B EL CENTRO, CA 92542 (442) 242-1888
POTABLE & IRRIGATION WATER:
IMPERIAL IRRIGATION DISTRICT: 333 E BARNUM BLVD, IMPERIAL, CA 92251 (805) 343-7756

ELECTRIC:
IMPERIAL REGISTRATION DISTRICT: 1252 BROADWAY EL CENTRO, CA 92524 (805) 343-7756

FIRE DEPARTMENT:
IMPERIAL COUNTY FIRE DEPARTMENT: 1678 DOUGLASS, SUITE 101 HELEN, CA 92248 (442) 242-6500

PUBLIC WORKS:
154 S 11TH ST EL CENTRO, CA 92543 (442) 242-1918

TITLE EXCEPTIONS/EXCLUSIONS

- A RIGHT OF WAY FOR DITCHES AND CANALS AS PROVIDED BY THE UNITED STATES OF AMERICA IN THE PATENT RECORDED MARCH 20, 1914 IN BOOK 33 OF PATENTS, PAGE 287, BLANKET IN NATURE, NOT PLOTTED HERETO.
- AN EASEMENT IN FAVOR OF IMPERIAL IRRIGATION DISTRICT FOR PUBLIC UTILITIES AND INCIDENTAL PURPOSES, RECORDED JANUARY 20, 1938 AS BOOK 148, PAGE 429 OF OFFICIAL RECORDS, BLANKET IN NATURE, NOT PLOTTED HERETO.
- AN EASEMENT IN FAVOR OF IMPERIAL IRRIGATION DISTRICT FOR PUBLIC UTILITIES AND INCIDENTAL PURPOSES, RECORDED APRIL 26, 1938 AS BOOK 463, PAGE 484 OF OFFICIAL RECORDS, NOT ENOUGH INFORMATION TO PLOT, APPROXIMATE LOCATION FOR CULTURS LG MAP 71586 (A) PLOTTED HERETO.
- AN EASEMENT IN FAVOR OF IMPERIAL IRRIGATION DISTRICT FOR PUBLIC UTILITIES AND INCIDENTAL PURPOSES, RECORDED OCTOBER 8, 1941 AS BOOK 516, PAGE 418 OF OFFICIAL RECORDS, NOT ENOUGH INFORMATION TO PLOT, APPROXIMATE LOCATION FOR CULTURS LG MAP 71586 (A) PLOTTED HERETO.
- AN EASEMENT IN FAVOR OF DONALD P. HAMES AND CLAYVA H. HAMES FOR GRANCE AND INCIDENTAL PURPOSES, RECORDED JULY 23, 1964 AS BOOK 696, PAGE 234 OF OFFICIAL RECORDS, PLOTTED HERETO.
- THE TERMS AND PROVISIONS CONTAINED IN THE DOCUMENT ENTITLED "AGREEMENT FOR PEE HERVO" RECORDED NOVEMBER 18, 1979 AS BOOK 1284, PAGE 381 OF OFFICAL RECORDS, BLANKET IN NATURE, NOT PLOTTED HERETO.
- THE TERMS AND PROVISIONS CONTAINED IN THE DOCUMENT ENTITLED "IMPERIAL COUNTY PROPERTY AGREEMENT" RECORDED MAY 4, 1976 AS BOOK 1286, PAGE 1426 OF OFFICAL RECORDS, BLANKET IN NATURE, NOT PLOTTED HERETO.
- THE TERMS AND PROVISIONS CONTAINED IN THE DOCUMENT ENTITLED "TRIMPOVED JOINT VENTURE AGREEMENT BETWEEN TRILL AND CAROL SHOFER AND CHARLES AND FRANCES OSBORN" RECORDED SEPTEMBER 24, 1993 AS INSTRUMENT NO. 1893-22923, IN BOOK 1746, PAGE 1781 OF OFFICAL RECORDS, NOT A MATTER OF SURVEY.
- THE EFFECT OF A DOCUMENT ENTITLED "QUOTIUM DEED", RECORDED JULY 02, 2013 AS INSTRUMENT NO. 2013-01407 OF OFFICAL RECORDS, NOT A MATTER OF SURVEY.
- THE EFFECT OF A DOCUMENT ENTITLED "QUOTIUM DEED", RECORDED AUGUST 06, 2013 AS INSTRUMENT NO. 2013-01848 OF OFFICAL RECORDS, NOT A MATTER OF SURVEY.

CURRENT ZONING:
A-2, AGRICULTURAL

FLOOD ZONE:
RESERVED TO FLOOD & AREA OF MINIMAL FLOOD HAZARD PER FEMA MAPS 050201725C & 050201750C, EFFECTIVE ON 06/24/2003.

OWNER/DEVELOPER:
MAVERIK
CONTACT: PAUL HEYWOOD
185 SOUTH STATE ST. STE. 800
SALT LAKE CITY, UT 84111
801-574-4449

SURVEYOR:
LG LAND SURVEYING, INC.
CONTACT: JOHN P. GERVAIS
30355 CALLEJO BELIZ TER.
VALLEY CENTER, CA 92082
619-535-1172

ENGINEER:
SDC
SITE DESIGN COLLABORATIVE
CONTACT: FARMAN SHIR
243 E 3RD STREET
LONG BEACH, CA 90802
800-484-4717

DATE	
REVISION	
NO.	

RECORDED BY:
243 E 3rd Street
Long Beach, CA 90802
1333 W. McWhorter St.
Alhambra, TX 76013
FORM # F-21415
EXPIRES 12/31/16



FUELING & COMMERCIAL CENTER
ROSS AVE. & INTERSTATE 8
IMPERIAL COUNTY OF IMPERIAL
TENTATIVE PARCEL MAP
NO.

SHEET NO.
1
OF 1

EEC ORIGINAL PKG



Imperial County Planning & Development Services Planning / Building

September 21, 2023

Jim Minnick
DIRECTOR

CERTIFIED MAIL NO. 7016 2140 0000 2120 4594

President Jordan D. Joaquin
Quechan Indian Tribe
Fort Yuma-Quechan Indian Tribe
P.O. Box 1899
Yuma, AZ 85366

Subject: Tribal Culture Resources under the California Environmental Quality Act, AB 52 (Gatto, 2014). Formal Notification of Determination that a Project Application is Complete or Decision to undertake a Project, and Notification of Consultation Opportunity, pursuant to Public Resources Code Section 21080.3.1(d).

Dear Mr. Joaquin:

The Imperial County Planning & Development Services Department has determined that project application is complete for General Plan Amendment #22-0002, Zone Change #22-00015 and Parcel Map #02499. The applicant is proposing a General Plan Amendment from Agriculture to Commercial, Zone Change from A-2 (General Agriculture) to C-3 (Heavy Commercial and Parcel Map proposing a 40 acre parcel and a 10 acre parcel for a fueling station and convenience store.

The location of the proposed project is at southeast corner of Highway 111 and Ross Road, El Centro, California (APN 054-080-023). Attached for your use, please find a copy of Imperial County Assessor Plat Map (Book 54, Page 08), an Aerial Vicinity Map and the Tentative Parcel Map of the subject area.

Pursuant to Public Resources Code, Section 21080.3.1(b), you have thirty (30) days from the receipt of this letter to request consultation, in writing, with the Imperial County Planning & Development Services Department. Your response is expected by October 20, 2023.

The contact person for this project is Derek Newland, Planner III, and can be reached at 442-265-1736, extension 1756, or via-email at dereknewland@co.imperial.ca.us.

Very Respectfully,

JIM MINNICK, Director
Planning & Development Services

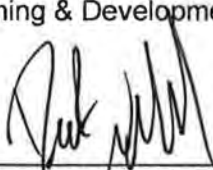
By: 
Derek Newland, Planner III

ATTACHMENTS:

Copy of Assessor Plat
Aerial Vicinity Map
Tentative Parcel Map
Site Plan

CC: H. Jill McCormick, Tribal Historic Preservation Officer (Mail and Email)
Jim Minnick, ICPDS Director
Michael Abraham, AICP, Assistant ICPDS Director
Diana Robinson, Planning Division Manager
File: 10_102; 10_101; 10_103; 10_111
DNATS: \\l:\tr\p\10_102; 10_101; 10_103; 10_111

09 Letter Quechan.docx

CALIFORNIA PRODUCER'S TRACT 1,2 & TRACT 78,122, SEC. 11, 12 & POR. SEC. 10, 11, 12, T.16S., R.14E.

Tax Area Code
75-001

54-08

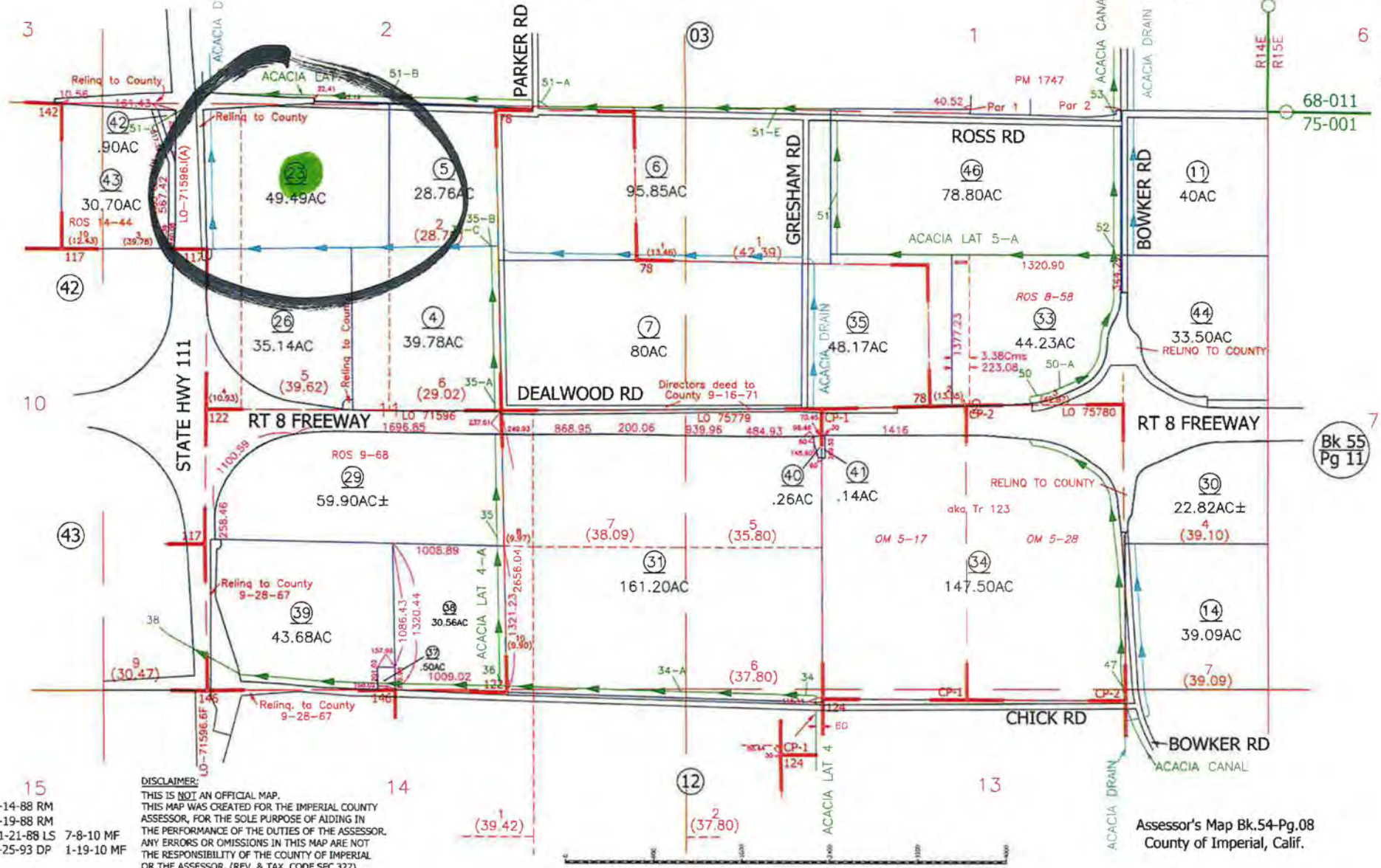
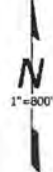

15
6-14-88 RM
2-19-88 RM
11-21-88 LS 7-8-10 MF
3-25-93 DP 1-19-10 MF

DISCLAIMER:
THIS IS NOT AN OFFICIAL MAP.
THIS MAP WAS CREATED FOR THE IMPERIAL COUNTY
ASSESSOR, FOR THE SOLE PURPOSE OF AIDING IN
THE PERFORMANCE OF THE DUTIES OF THE ASSESSOR.
ANY ERRORS OR OMISSIONS IN THIS MAP ARE NOT
THE RESPONSIBILITY OF THE COUNTY OF IMPERIAL
OR THE ASSESSOR. (REV. & TAX. CODE SEC.327)

Bk 55
Pg 11

Assessor's Map Bk.54-Pg.08
County of Imperial, Calif.

EEC ORIGINAL PKG

PROJECT LOCATION MAP

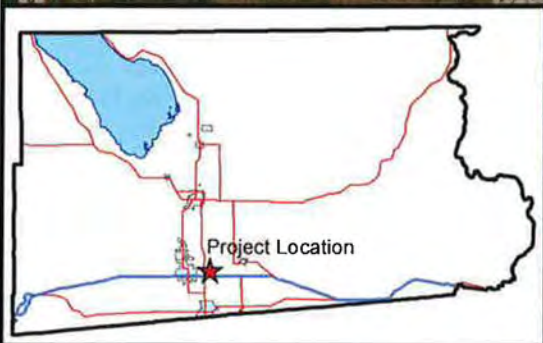
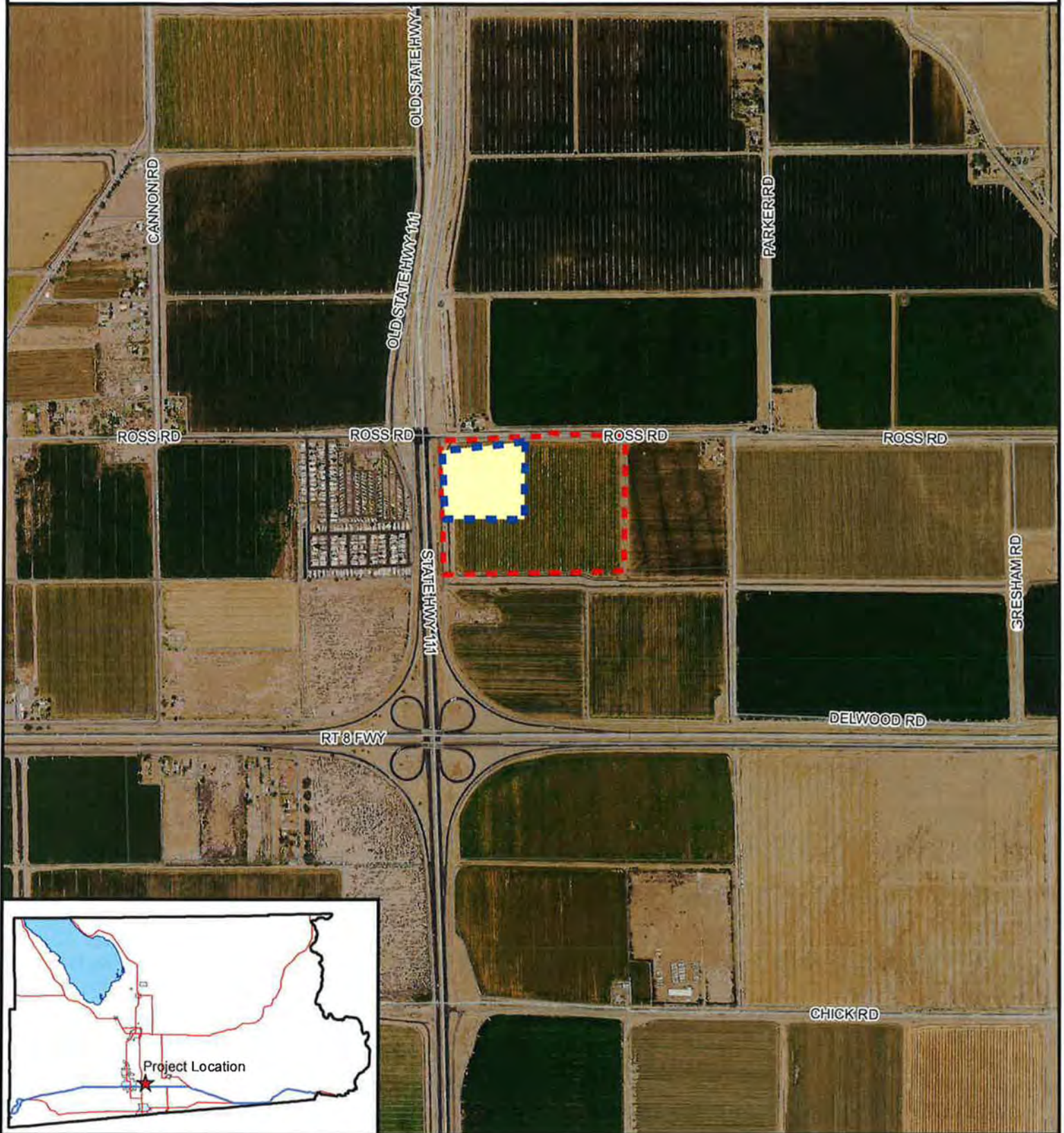

MAVERIK INC.
GPA #22-0002 / ZC #22-0002 /
PM #02499
APN #054-080-023-000

- Zone Change #22-0022
- Project Location
- Centerline
- Parcels



EEO ORIGINAL PKG

TENTATIVE PARCEL MAP NO.

PORTION OF LOT 3 OF SECTION 11, AND THE NE 1/4 OF THE NW 1/4 OF SECTION 11, T16S, R14E, S.B.M.
IN THE COUNTY OF IMPERIAL, CALIFORNIA

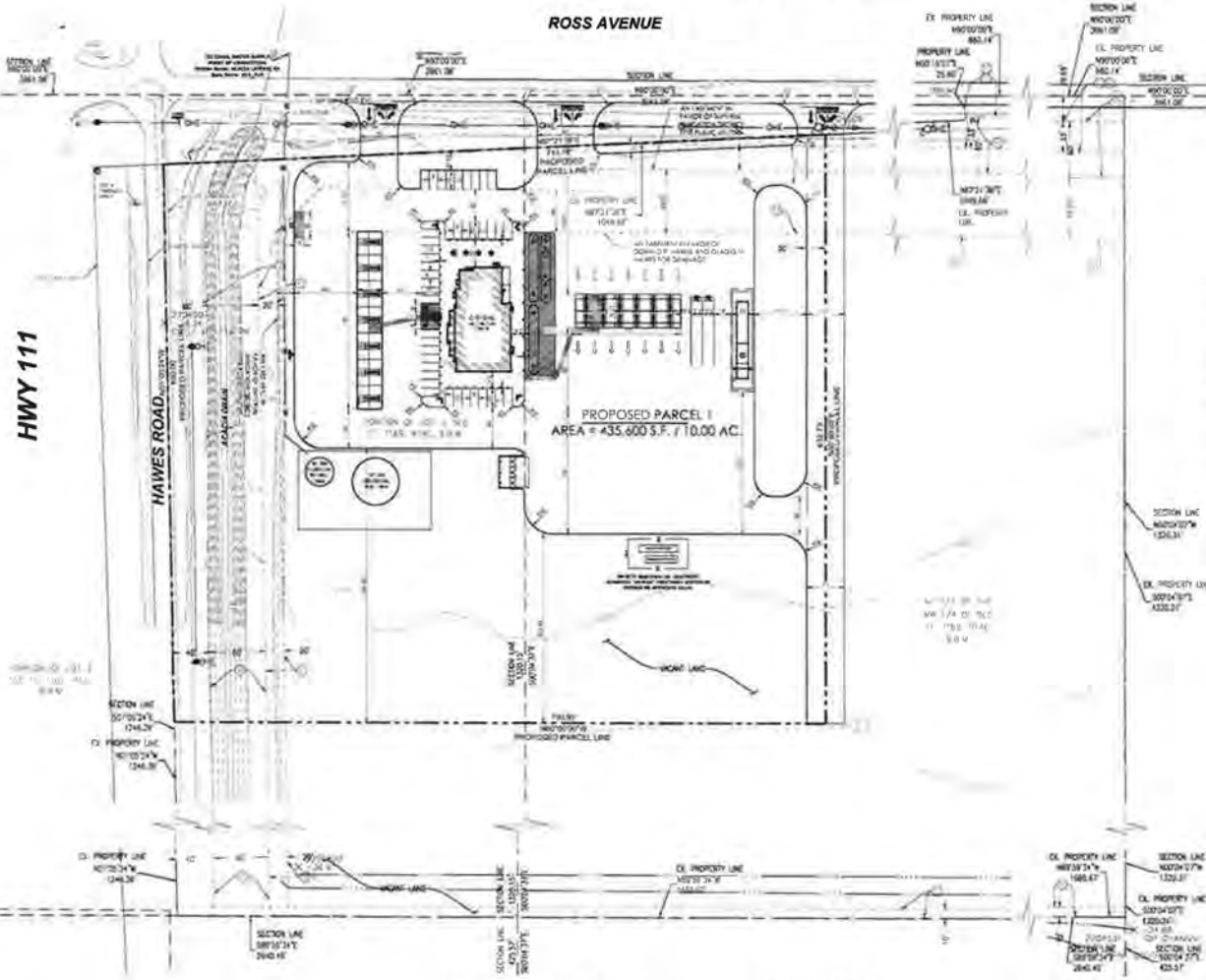

ROSS AVENUE

HWY 111

PROPOSED PARCEL II
AREA = 435,600 S.F. 710.00 AC.

- UTILITY:**
- SEWER AND SANITATION:**
IMPERIAL COUNTY ENVIRONMENTAL HEALTH
787 MAIN ST., SUITE B
ESCONDIDO, CA 92529
(760) 265-1800
 - POTABLE & IRRIGATION WATER:**
IMPERIAL IRRIGATION DISTRICT
333 E BARDEN BLVD, IMPERIAL, CA 92211
(604) 343-7758
 - ELECTRIC:**
IMPERIAL IRRIGATION DISTRICT
1285 BROADWAY
EL CENTRO, CA 92524
(604) 343-7758
 - FIRE DEPARTMENT:**
IMPERIAL COUNTY FIRE DEPARTMENT
426 OGDON RD, SUITE 10
HEBER, CA 92549
(760) 265-6555
 - PUBLIC WORKS:**
155 S 17th ST
EL CENTRO, CA 92524
(760) 265-1818

ASSESSOR PARCEL NO.
054-080-023

LEGAL DESCRIPTION
THE LAND HEREIN TO BE DIVIDED IS SITUATED IN THE UNINCORPORATED AREA OF _____, COUNTY OF IMPERIAL, STATE OF CALIFORNIA, AND IS DESCRIBED AS FOLLOWS:

TRACT 11, THE NORTHEAST QUARTER OF SECTION 11, TOWNSHIP 16 SOUTH, RANGE 14 EAST, SAN BERNARDINO BASIN AND MOUNTAIN, IN THE COUNTY OF IMPERIAL, STATE OF CALIFORNIA, ACCORDING TO THE OFFICIAL PLAT OF SURVEY APPROVED AND ON FILE IN THE U.S. LAND OFFICE, BUREAU OF LAND MANAGEMENT, BUREAU OF LAND SURVEY, IN THE COUNTY OF IMPERIAL, STATE OF CALIFORNIA, ACCORDING TO THE UNITED STATES GOVERNMENT OFFICIAL PLAT OF SURVEY APPROVED AND ON FILE IN THE UNITED STATES LAND OFFICE, THE EAST 1/2 OF THE CENTER LINE IN THE COUNTY ROAD.

EXCEPTING THEREFROM THE INTEREST OF SANDWICH E. HODGES, A SINGLE MALE, IN AN TO ONE-HALF INTEREST IN ALL GAS AND OIL IN AND UNDER SAID LAND, AS RESERVED IN THE DEED RECORDED DECEMBER 15, 1981 IN BOOK 838A AS PAGE 104 OF OFFICIAL RECORDS.

EXCEPTING FROM PARCELS ONE AND TWO HEREIN THAT PORTION THEREOF DECEDED TO THE STATE OF CALIFORNIA BY DEED RECORDED MARCH 8, 1962 IN BOOK 1000, PAGE 606 OF OFFICIAL RECORDS FOR CONTINGENT PURPOSES ONLY. WPA 054-080-023-002.

BASIS OF BEARINGS:
THE BASIS OF BEARINGS FOR THIS SURVEY IS THE NORTH-SECTION LINE OF SECTION 11 & LOT 3 OF SECTION 11, T16S, R14E, S3M FOR NE 1/4-1/4, U.S. G.S.

BASIS OF ELEVATIONS:
THE BASIS OF ELEVATIONS FOR THIS SURVEY IS THE U.S. COAST & GEODETIC SURVEY BENCHMARK STATIONED 81224 1917 LOCATED BY NATIONAL GEODETIC SURVEY 1971, 5.4 IN 2E FROM EL CENTRO, 2.30 MILES EAST ALONG THE HOLDEN RITCHIE-HIGHWAY VALLEY FROM THE SOUTHWEST PACIFIC STATION AT EL CENTRO, THENCE 2.4 MILES SOUTH ALONG STATE HIGHWAY 111, 0.15 MILE SOUTH OF THE JUNCTION OF DUCK ROAD, IN THE TOP AND 5.6 FEET NORTH OF THE SOUTH END OF THE EAST CONDUITE ROAD WALL OF AN 18-INCH PIPE CULVERT UNDER THE HIGHWAY, 33 1/2 FEET EAST OF THE CENTER LINE OF THE EAST END OF THE HIGHWAY, 25 1/2 FEET WEST OF THE CENTER LINE OF THE EAST FRONTRIDGE ROAD, 0.6 FOOT WEST OF THE EAST RIGHT-OF-WAY TONGUE AND ABOUT 1/2 FOOT LOWER THAN THE HIGHWAY, SECTION 14, T. 16S, R. 14E, S. 33E BENCHMARK.

TITLE EXCEPTIONS/EXCLUSIONS

- A RIGHT OF WAY FOR DITCHES AND CANALS AS RESERVED BY THE UNITED STATES OF AMERICA IN THE PATENT RECORDED MARCH 28, 1914 IN BOOK 51 OF PATENTS, PAGE 293, BUREAU OF LAND MANAGEMENT, NOT PLATTED HEREIN.
- AN EASEMENT IN FAVOR OF IMPERIAL IRRIGATION DISTRICT FOR PUBLIC UTILITIES AND INCIDENTAL PURPOSES, RECORDED JANUARY 20, 1938 AS BOOK 476, PAGE 408 OF OFFICIAL RECORDS, BUREAU OF LAND MANAGEMENT, NOT PLATTED HEREIN.
- AN EASEMENT IN FAVOR OF IMPERIAL IRRIGATION DISTRICT FOR PUBLIC UTILITIES AND INCIDENTAL PURPOSES, RECORDED APRIL 26, 1938 AS BOOK 482, PAGE 484 OF OFFICIAL RECORDS, NOT DULOUGH INFORMATION TO PLOT, APPROXIMATE LOCATION FOR CALTRANS US MAP 71568 (A) PLATTED HEREIN.
- AN EASEMENT IN FAVOR OF IMPERIAL IRRIGATION DISTRICT FOR PUBLIC UTILITIES AND INCIDENTAL PURPOSES, RECORDED OCTOBER 8, 1941 AS BOOK 576, PAGE 418 OF OFFICIAL RECORDS, NOT DULOUGH INFORMATION TO PLOT, APPROXIMATE LOCATION FOR CALTRANS US MAP 71568 (A) PLATTED HEREIN.
- AN EASEMENT IN FAVOR OF IMPERIAL IRRIGATION DISTRICT FOR PUBLIC UTILITIES AND INCIDENTAL PURPOSES, RECORDED JUNE 20, 1944 AS BOOK 623, PAGE 28 OF OFFICIAL RECORDS, NOT DULOUGH INFORMATION TO PLOT, APPROXIMATE LOCATION FOR CALTRANS US MAP 71568 (A) PLATTED HEREIN.
- AN EASEMENT IN FAVOR OF DONALD P. FAMES AND GLADYS H. FAMES FIVE THIRDS AND INCIDENTAL PURPOSES, RECORDED JULY 23, 1924 AS BOOK 585, PAGE 234 OF OFFICIAL RECORDS, BUREAU OF LAND MANAGEMENT, NOT PLATTED HEREIN.
- THE TERMS AND PROVISIONS CONTAINED IN THE DOCUMENT ENTITLED "IMPERIAL COUNTY PROPERTY INDEMNITY" RECORDED MAY 4, 1978 AS BOOK 1386, PAGE 1425 OF OFFICIAL RECORDS, BUREAU OF LAND MANAGEMENT, NOT PLATTED HEREIN.
- THE TERMS AND PROVISIONS CONTAINED IN THE DOCUMENT ENTITLED "PROPOSED JOINT VENTURE AGREEMENT BETWEEN BELL AND SANDWICH, BERNARDINO AND CHARLES AND FRANCES CHAMBERLAIN" RECORDED SEPTEMBER 24, 1983 AS INSTRUMENT NO. 1983-229318, IN BOOK 1743, PAGE 1787 OF OFFICIAL RECORDS NOT A MATTER OF SURVEY.
- THE EFFECT OF A DOCUMENT ENTITLED "OUTLINE DEED", RECORDED JULY 01, 2013 AS INSTRUMENT NO. 2013-01907 OF OFFICIAL RECORDS NOT A MATTER OF SURVEY.
- THE EFFECT OF A DOCUMENT ENTITLED "OUTLINE DEED", RECORDED ABOUT 04, 2013 AS INSTRUMENT NO. 2013-01848 OF OFFICIAL RECORDS NOT A MATTER OF SURVEY.

CURRENT ZONING
A-2, AGRICULTURAL

FLOOD ZONE
HEREIN IS IN ZONE 1, AREA OF MINIMAL FLOOD HAZARD FOR FEMA MAPS 05220C1255C & 062301-750C, EFFECTIVE ON 04/24/2008.

LEGEND

- PROPOSED PARCEL LINE
- EXISTING PROPERTY LINE
- SECTION LINE
- EXISTING EASEMENT LINE
- PROPOSED EASEMENT LINE

OWNER/DEVELOPER:
MAVERIK
CONTACT: PAUL HEYWOOD
165 SOUTH STATE ST., STE. 800
SALT LAKE CITY, UT 84111
801-574-4449

SURVEYOR:
LG LAND SURVEYING, INC.
CONTACT: JOHN P. GERVAIS
3035 CALLEJO FELIZ TER
VALLEY CENTER, CA 92282
619-535-1172

ENGINEER:
SDC
SITE DESIGN COLLABORATIVE
CONTACT: FARMAN SHIR
243 E. 38th STREET
LONG BEACH, CA 90802
800-484-4717

<p>243 E. 3rd Street Long Beach, CA 90802 1333 W. McDaniel Dr., Suite 200 Allen, TX 75013 STATE OF CALIFORNIA STATE SURVEYOR</p>	
<p>SD FUELING & COMMERCIAL CENTER EL CENTRO, CA 92524 COUNTY OF IMPERIAL TENTATIVE PARCEL MAP NO.</p>	
<p>SHEET NO. 1 OF 1</p>	

EEC ORIGINAL PKG

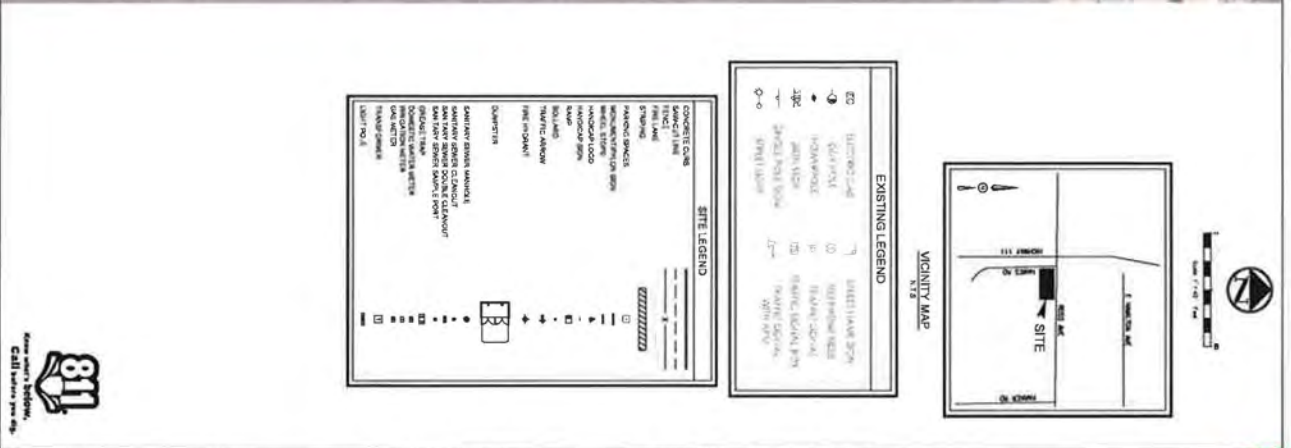
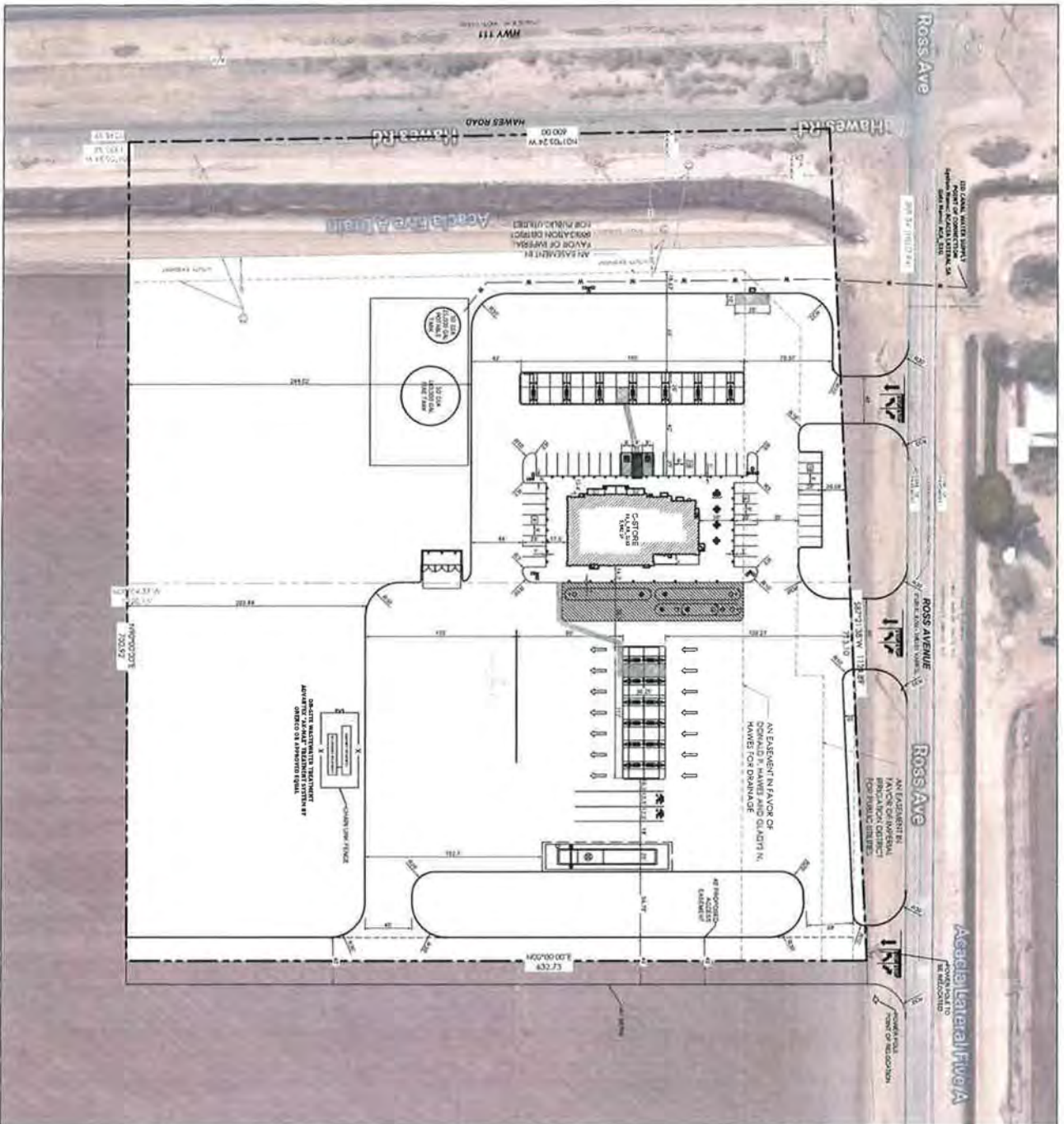

EXISTING LEGEND

EQ	EXISTING EASEMENT	SHEET HAVE SITE
○	EXISTING TREE	EXISTING TREE
□	EXISTING CONCRETE	EXISTING CONCRETE
+	EXISTING CURB	EXISTING CURB
—	EXISTING DRIVE	EXISTING DRIVE
—	EXISTING SIDEWALK	EXISTING SIDEWALK
—	EXISTING UTILITY	EXISTING UTILITY
—	EXISTING FENCE	EXISTING FENCE
—	EXISTING WALL	EXISTING WALL
—	EXISTING SIGN	EXISTING SIGN
—	EXISTING LIGHT	EXISTING LIGHT
—	EXISTING SIGNAGE	EXISTING SIGNAGE
—	EXISTING LANDSCAPE	EXISTING LANDSCAPE
—	EXISTING SITE	EXISTING SITE

SITE LEGEND

—	CONCRETE CURB	CONCRETE CURB
—	CONCRETE DRIVE	CONCRETE DRIVE
—	CONCRETE SIDEWALK	CONCRETE SIDEWALK
—	CONCRETE UTILITY	CONCRETE UTILITY
—	CONCRETE WALL	CONCRETE WALL
—	CONCRETE SIGN	CONCRETE SIGN
—	CONCRETE LIGHT	CONCRETE LIGHT
—	CONCRETE SIGNAGE	CONCRETE SIGNAGE
—	CONCRETE LANDSCAPE	CONCRETE LANDSCAPE
—	CONCRETE SITE	CONCRETE SITE



SHEET NO. C-1	MAVERIK STORE#: C0358 ROSS AVE. & INTERSTATE 8 EL CENTRO, CA 92243 SITE PLAN		243 E. 3rd Street Long Beach, CA 90802 1333 W. McDermott Dr., Suite 200 Allen, TX 75013 Firm # F-21415	DESIGNED BY CHECKED BY CREDITED BY SUBMITTED BY	DATE: 04/20/2022 JOB NO: 2022114
				MAVERIK	MARCH 2022

EEC ORIGINAL PKG

D-3

**SB-18 Consultation &
Responses**

This page intentionally left blank.



Imperial County Planning & Development Services Planning / Building

Jim Minnick
DIRECTOR

February 1, 2024

CERTIFIED NO. 7018 1830 0000 2357 3503

Abraham Becerra, Cultural Coordinator
Torres-Martinez Desert Cahuilla Indians
P.O. Box 1160 Thermal, CA, 92274

RE: Notice of Opportunity to Consult under SB-18 for the Maverik Fueling Station and Convenience Store Project (General Plan Amendment #22-0002, Zone Change #22-00015 and Parcel Map #02499) APN 054-080-023

Dear Abraham Becerra, Cultural Coordinator,

This letter formally invites you to request consultation pursuant to Senate Bill 18 (SB 18; Government Code Section 65352.3) regarding the proposed Maverik Fueling Station and Convenience Store Project. As you may know, SB 18 became effective on March 1, 2005 and requires local governments to consult with California Native American Tribes about proposed local land use planning decisions for the purpose of protecting traditional tribal cultural places and sacred sites. The intent of SB 18 is to provide an opportunity for interested tribes and local governments to work together toward the protection of tribal cultural places that might not appear on cultural resource registries. To this end, the County is contacting you to consult on this project.

The County of Imperial is committed to fulfilling the goals of SB 18 and believes that tribal participation in the planning process is crucial for the success of the proposed project. The Imperial County Planning and Development Services Department has contacted the Native American Heritage Commission (NAHC) in order to obtain a list of tribes who should be included in the planning consultation process regarding the proposed project and your name was included in the NAHC's response.

The Maverik Fueling Station and Convenience Store Project includes a fueling station and convenience store on 10 acres of an approximately 50-acre parcel within unincorporated Imperial County (County), California, approximately 1.5 miles east of the City of El Centro (Figure 1, Regional Location). The Project site is located on the southeast corner of Hawes Road and Ross Avenue, east of State Route 111 and is bound by Ross Avenue on the north and by Hawes Road and the Imperial Irrigation District's Acacia Five Drain A on the west (Figure 2, Project Site). The Project site is also located within the USGS Geologic Survey 7.5' quadrangle for Holtville West on Assessor's Parcel Number (APN) 054-080-023 within Section 11 of Township 16 South, Range 14 East, San Bernardino Base Meridian. The westbound offramp of Interstate 8 at SR-111 is located approximately 0.25 miles south of the Project site.

The Project includes 19 fuel pumps (38 fueling positions) under two separate canopies (totaling 9,000 square feet [SF]), and a 5,982 SF convenience store building. Additional improvements include three (3) underground storage tanks (USTs) for fuel storage; two underground water storage tanks; on-site water and wastewater treatment facilities; parking, landscaping, drainage, and access improvements. A General Plan Amendment (#22-0002), to change the Project site's land use designation from "Agriculture" to "Urban Area"; as well as a Zone Change (#22-00015), to change zoning from A-2 (General Agricultural) to C-3 (Heavy Commercial) are also proposed (See Figures 3 and 4). A tentative parcel map (Parcel Map #02499) is proposed to separate Maverik Fueling Station and Convenience Store site from the balance of the parcel (Figure 5, Proposed Tentative Map).

If your tribe would like to consult with the County of Imperial regarding this project, please respond within ninety (90) days of the date of this letter. Under SB 18, any sensitive information shared with the County regarding cultural places and/or sacred sites will be kept strictly confidential and will not be divulged to the public.

Please send your written response before April 2, 2024 to Derek Newland, Planner III or by email to CommentLetters@co.imperial.ca.us. If the County does not receive a response within 90 days, the County will proceed with the project. Thank you and we look forward to your response.

Sincerely,

JIM MINNICK, DIRECTOR
Imperial County Planning & Development Services

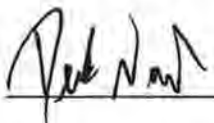
BY:  _____

Derek Newland, Planner III

Attachments: Figure 1 – Regional Location Map
Figure 2 – Project Site
Figure 3 – Proposed General Plan Amendment
Figure 4 – Proposed Zone Change
Figure 5 – Proposed Tentative Map

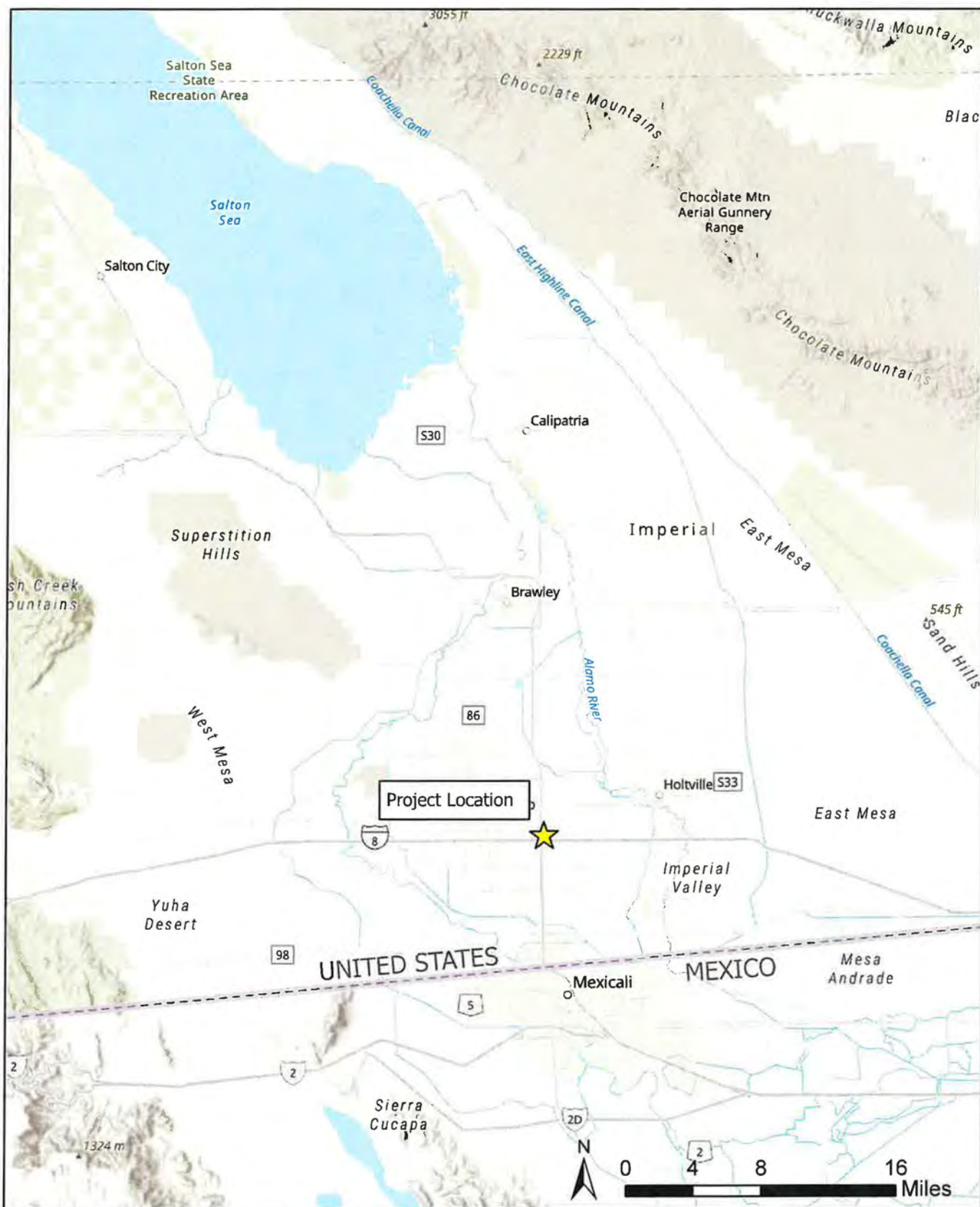

Source: Esri, 2023.



Regional Location
 Maverik Fueling Station Project GPA22-0002/ZC22-0002
 Figure 1

EEC ORIGINAL PKG

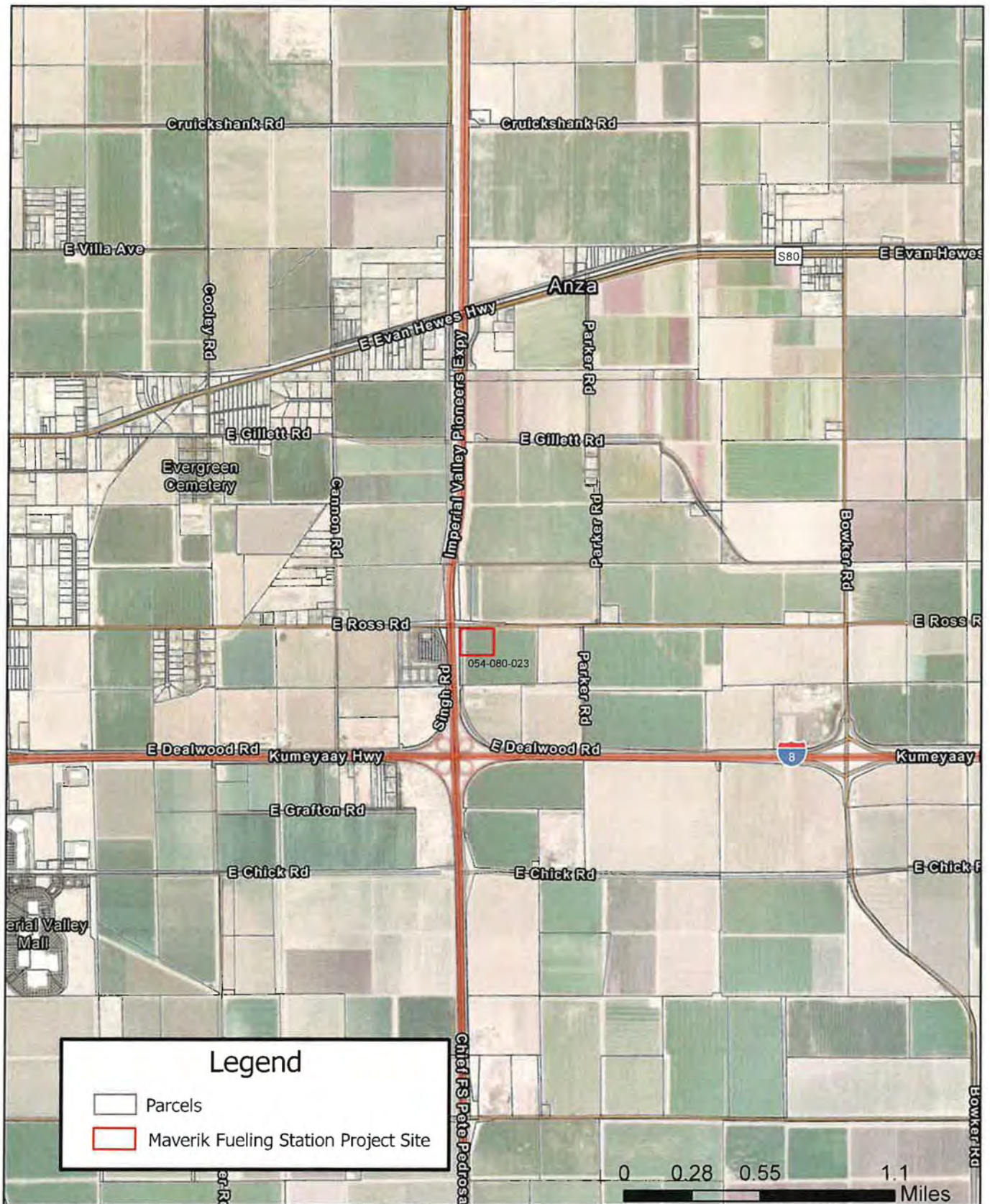

Source: Esri, 2023.



Project Site
 Maverik Fueling Station Project GPA22-0002/ZC22-0002
 Figure 2

EEC ORIGINAL PKG



Source: Esri, 2023. Imperial County, 2023



Proposed General Plan Amendment
 Maverik Fueling Station Project GPA22-0002/ZC22-0002
 Figure 3

EEC ORIGINAL PKG

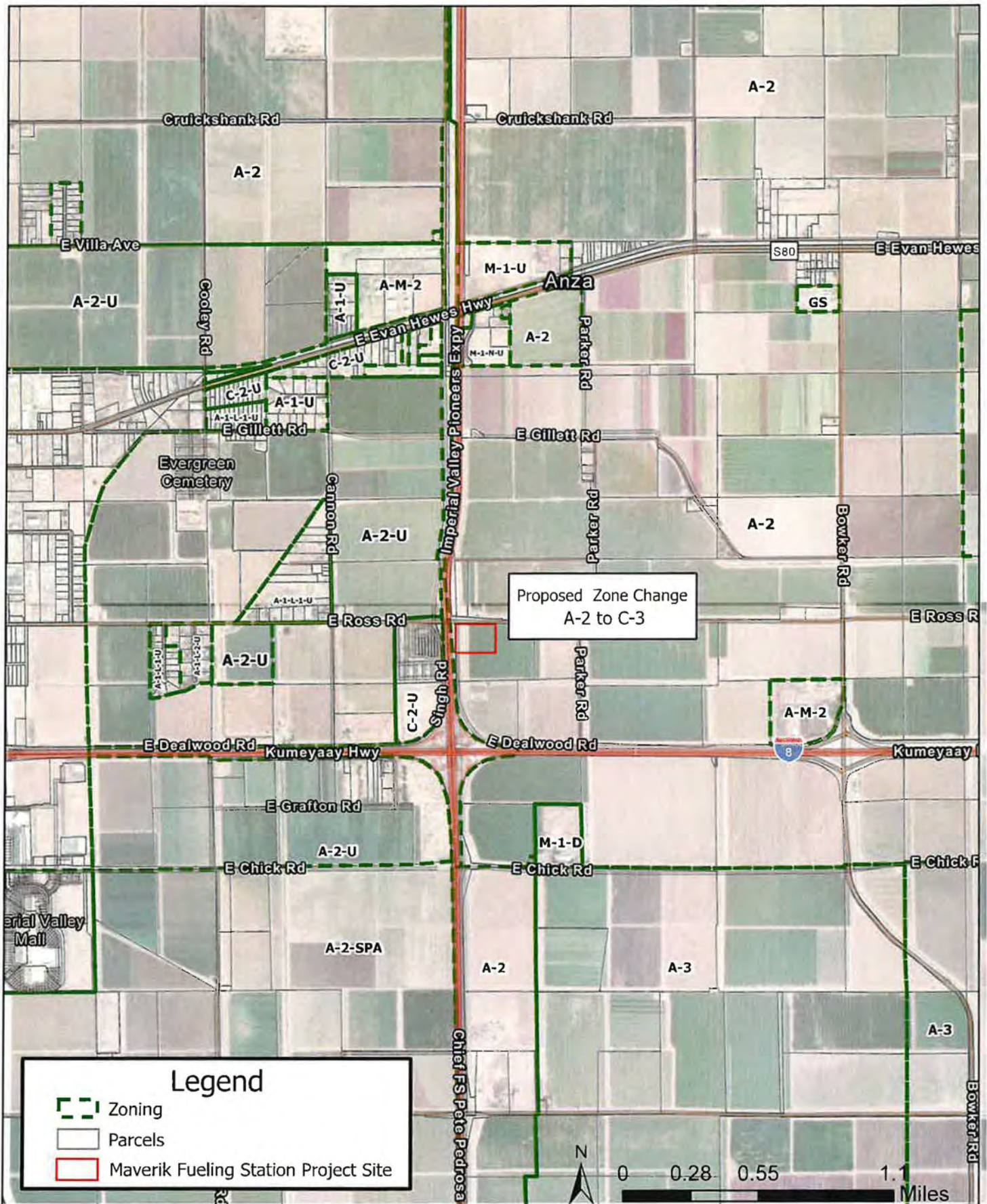

Source: Esri, 2023; Imperial County, 2023.



Proposed Zone Change
Maverik Fueling Station Project GPA22-0002/ZC22-0002
Figure 4

EEC ORIGINAL PKG

TENTATIVE PARCEL MAP NO.
 PORTION OF LOT 3 OF SECTION 11, AND THE NE 1/4 OF THE NW 1/4 OF SECTION 11, T16S, R14E, S.B.M.
 IN THE COUNTY OF IMPERIAL, CALIFORNIA

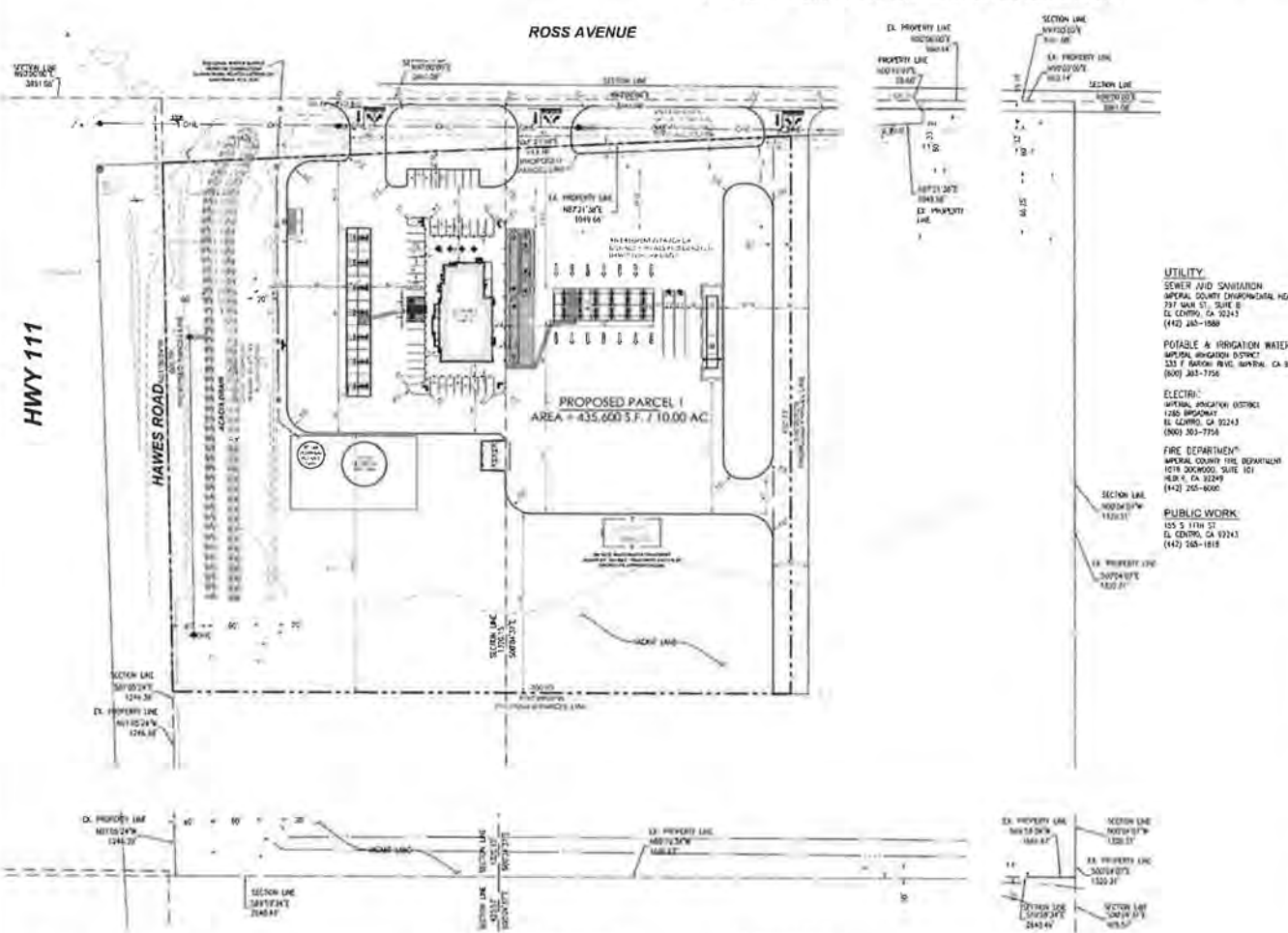

ASSESSOR PARCEL NO.
054-680-023

LEGAL DESCRIPTION
THE LAND REFERRED TO HEREIN BEING AS SHOWN IN THE UNINCORPORATED AREA OF COUNTY OF IMPERIAL, STATE OF CALIFORNIA, AND IS DESCRIBED AS FOLLOWS:

PARCEL 1, THE NORTHWEST QUARTER OF SECTION 11, T16S, R14E, S.B.M. PARCEL 2, THE SOUTHWEST QUARTER OF SECTION 11, T16S, R14E, S.B.M. PARCEL 3, THE SOUTHWEST QUARTER OF SECTION 11, T16S, R14E, S.B.M. PARCEL 4, THE SOUTHWEST QUARTER OF SECTION 11, T16S, R14E, S.B.M. PARCEL 5, THE SOUTHWEST QUARTER OF SECTION 11, T16S, R14E, S.B.M. PARCEL 6, THE SOUTHWEST QUARTER OF SECTION 11, T16S, R14E, S.B.M. PARCEL 7, THE SOUTHWEST QUARTER OF SECTION 11, T16S, R14E, S.B.M. PARCEL 8, THE SOUTHWEST QUARTER OF SECTION 11, T16S, R14E, S.B.M. PARCEL 9, THE SOUTHWEST QUARTER OF SECTION 11, T16S, R14E, S.B.M. PARCEL 10, THE SOUTHWEST QUARTER OF SECTION 11, T16S, R14E, S.B.M. PARCEL 11, THE SOUTHWEST QUARTER OF SECTION 11, T16S, R14E, S.B.M. PARCEL 12, THE SOUTHWEST QUARTER OF SECTION 11, T16S, R14E, S.B.M. PARCEL 13, THE SOUTHWEST QUARTER OF SECTION 11, T16S, R14E, S.B.M. PARCEL 14, THE SOUTHWEST QUARTER OF SECTION 11, T16S, R14E, S.B.M. PARCEL 15, THE SOUTHWEST QUARTER OF SECTION 11, T16S, R14E, S.B.M. PARCEL 16, THE SOUTHWEST QUARTER OF SECTION 11, T16S, R14E, S.B.M. PARCEL 17, THE SOUTHWEST QUARTER OF SECTION 11, T16S, R14E, S.B.M. PARCEL 18, THE SOUTHWEST QUARTER OF SECTION 11, T16S, R14E, S.B.M. PARCEL 19, THE SOUTHWEST QUARTER OF SECTION 11, T16S, R14E, S.B.M. PARCEL 20, THE SOUTHWEST QUARTER OF SECTION 11, T16S, R14E, S.B.M. PARCEL 21, THE SOUTHWEST QUARTER OF SECTION 11, T16S, R14E, S.B.M. PARCEL 22, THE SOUTHWEST QUARTER OF SECTION 11, T16S, R14E, S.B.M. PARCEL 23, THE SOUTHWEST QUARTER OF SECTION 11, T16S, R14E, S.B.M. PARCEL 24, THE SOUTHWEST QUARTER OF SECTION 11, T16S, R14E, S.B.M. PARCEL 25, THE SOUTHWEST QUARTER OF SECTION 11, T16S, R14E, S.B.M. PARCEL 26, THE SOUTHWEST QUARTER OF SECTION 11, T16S, R14E, S.B.M. PARCEL 27, THE SOUTHWEST QUARTER OF SECTION 11, T16S, R14E, S.B.M. PARCEL 28, THE SOUTHWEST QUARTER OF SECTION 11, T16S, R14E, S.B.M. PARCEL 29, THE SOUTHWEST QUARTER OF SECTION 11, T16S, R14E, S.B.M. PARCEL 30, THE SOUTHWEST QUARTER OF SECTION 11, T16S, R14E, S.B.M. PARCEL 31, THE SOUTHWEST QUARTER OF SECTION 11, T16S, R14E, S.B.M. PARCEL 32, THE SOUTHWEST QUARTER OF SECTION 11, T16S, R14E, S.B.M. PARCEL 33, THE SOUTHWEST QUARTER OF SECTION 11, T16S, R14E, S.B.M. PARCEL 34, THE SOUTHWEST QUARTER OF SECTION 11, T16S, R14E, S.B.M. PARCEL 35, THE SOUTHWEST QUARTER OF SECTION 11, T16S, R14E, S.B.M. PARCEL 36, THE SOUTHWEST QUARTER OF SECTION 11, T16S, R14E, S.B.M. PARCEL 37, THE SOUTHWEST QUARTER OF SECTION 11, T16S, R14E, S.B.M. PARCEL 38, THE SOUTHWEST QUARTER OF SECTION 11, T16S, R14E, S.B.M. PARCEL 39, THE SOUTHWEST QUARTER OF SECTION 11, T16S, R14E, S.B.M. PARCEL 40, THE SOUTHWEST QUARTER OF SECTION 11, T16S, R14E, S.B.M. PARCEL 41, THE SOUTHWEST QUARTER OF SECTION 11, T16S, R14E, S.B.M. PARCEL 42, THE SOUTHWEST QUARTER OF SECTION 11, T16S, R14E, S.B.M. PARCEL 43, THE SOUTHWEST QUARTER OF SECTION 11, T16S, R14E, S.B.M. PARCEL 44, THE SOUTHWEST QUARTER OF SECTION 11, T16S, R14E, S.B.M. PARCEL 45, THE SOUTHWEST QUARTER OF SECTION 11, T16S, R14E, S.B.M. PARCEL 46, THE SOUTHWEST QUARTER OF SECTION 11, T16S, R14E, S.B.M. PARCEL 47, THE SOUTHWEST QUARTER OF SECTION 11, T16S, R14E, S.B.M. PARCEL 48, THE SOUTHWEST QUARTER OF SECTION 11, T16S, R14E, S.B.M. PARCEL 49, THE SOUTHWEST QUARTER OF SECTION 11, T16S, R14E, S.B.M. PARCEL 50, THE SOUTHWEST QUARTER OF SECTION 11, T16S, R14E, S.B.M. PARCEL 51, THE SOUTHWEST QUARTER OF SECTION 11, T16S, R14E, S.B.M. PARCEL 52, THE SOUTHWEST QUARTER OF SECTION 11, T16S, R14E, S.B.M. PARCEL 53, THE SOUTHWEST QUARTER OF SECTION 11, T16S, R14E, S.B.M. PARCEL 54, THE SOUTHWEST QUARTER OF SECTION 11, T16S, R14E, S.B.M. PARCEL 55, THE SOUTHWEST QUARTER OF SECTION 11, T16S, R14E, S.B.M. PARCEL 56, THE SOUTHWEST QUARTER OF SECTION 11, T16S, R14E, S.B.M. PARCEL 57, THE SOUTHWEST QUARTER OF SECTION 11, T16S, R14E, S.B.M. PARCEL 58, THE SOUTHWEST QUARTER OF SECTION 11, T16S, R14E, S.B.M. PARCEL 59, THE SOUTHWEST QUARTER OF SECTION 11, T16S, R14E, S.B.M. PARCEL 60, THE SOUTHWEST QUARTER OF SECTION 11, T16S, R14E, S.B.M. PARCEL 61, THE SOUTHWEST QUARTER OF SECTION 11, T16S, R14E, S.B.M. PARCEL 62, THE SOUTHWEST QUARTER OF SECTION 11, T16S, R14E, S.B.M. PARCEL 63, THE SOUTHWEST QUARTER OF SECTION 11, T16S, R14E, S.B.M. PARCEL 64, THE SOUTHWEST QUARTER OF SECTION 11, T16S, R14E, S.B.M. PARCEL 65, THE SOUTHWEST QUARTER OF SECTION 11, T16S, R14E, S.B.M. PARCEL 66, THE SOUTHWEST QUARTER OF SECTION 11, T16S, R14E, S.B.M. PARCEL 67, THE SOUTHWEST QUARTER OF SECTION 11, T16S, R14E, S.B.M. PARCEL 68, THE SOUTHWEST QUARTER OF SECTION 11, T16S, R14E, S.B.M. PARCEL 69, THE SOUTHWEST QUARTER OF SECTION 11, T16S, R14E, S.B.M. PARCEL 70, THE SOUTHWEST QUARTER OF SECTION 11, T16S, R14E, S.B.M. PARCEL 71, THE SOUTHWEST QUARTER OF SECTION 11, T16S, R14E, S.B.M. PARCEL 72, THE SOUTHWEST QUARTER OF SECTION 11, T16S, R14E, S.B.M. PARCEL 73, THE SOUTHWEST QUARTER OF SECTION 11, T16S, R14E, S.B.M. PARCEL 74, THE SOUTHWEST QUARTER OF SECTION 11, T16S, R14E, S.B.M. PARCEL 75, THE SOUTHWEST QUARTER OF SECTION 11, T16S, R14E, S.B.M. PARCEL 76, THE SOUTHWEST QUARTER OF SECTION 11, T16S, R14E, S.B.M. PARCEL 77, THE SOUTHWEST QUARTER OF SECTION 11, T16S, R14E, S.B.M. PARCEL 78, THE SOUTHWEST QUARTER OF SECTION 11, T16S, R14E, S.B.M. PARCEL 79, THE SOUTHWEST QUARTER OF SECTION 11, T16S, R14E, S.B.M. PARCEL 80, THE SOUTHWEST QUARTER OF SECTION 11, T16S, R14E, S.B.M. PARCEL 81, THE SOUTHWEST QUARTER OF SECTION 11, T16S, R14E, S.B.M. PARCEL 82, THE SOUTHWEST QUARTER OF SECTION 11, T16S, R14E, S.B.M. PARCEL 83, THE SOUTHWEST QUARTER OF SECTION 11, T16S, R14E, S.B.M. PARCEL 84, THE SOUTHWEST QUARTER OF SECTION 11, T16S, R14E, S.B.M. PARCEL 85, THE SOUTHWEST QUARTER OF SECTION 11, T16S, R14E, S.B.M. PARCEL 86, THE SOUTHWEST QUARTER OF SECTION 11, T16S, R14E, S.B.M. PARCEL 87, THE SOUTHWEST QUARTER OF SECTION 11, T16S, R14E, S.B.M. PARCEL 88, THE SOUTHWEST QUARTER OF SECTION 11, T16S, R14E, S.B.M. PARCEL 89, THE SOUTHWEST QUARTER OF SECTION 11, T16S, R14E, S.B.M. PARCEL 90, THE SOUTHWEST QUARTER OF SECTION 11, T16S, R14E, S.B.M. PARCEL 91, THE SOUTHWEST QUARTER OF SECTION 11, T16S, R14E, S.B.M. PARCEL 92, THE SOUTHWEST QUARTER OF SECTION 11, T16S, R14E, S.B.M. PARCEL 93, THE SOUTHWEST QUARTER OF SECTION 11, T16S, R14E, S.B.M. PARCEL 94, THE SOUTHWEST QUARTER OF SECTION 11, T16S, R14E, S.B.M. PARCEL 95, THE SOUTHWEST QUARTER OF SECTION 11, T16S, R14E, S.B.M. PARCEL 96, THE SOUTHWEST QUARTER OF SECTION 11, T16S, R14E, S.B.M. PARCEL 97, THE SOUTHWEST QUARTER OF SECTION 11, T16S, R14E, S.B.M. PARCEL 98, THE SOUTHWEST QUARTER OF SECTION 11, T16S, R14E, S.B.M. PARCEL 99, THE SOUTHWEST QUARTER OF SECTION 11, T16S, R14E, S.B.M. PARCEL 100, THE SOUTHWEST QUARTER OF SECTION 11, T16S, R14E, S.B.M.

UTILITY
SEWER AND SANITATION
IMPERIAL COUNTY COMMUNITY DEVELOPMENT
217 SAN JOE, SUITE B
EL CENTRO, CA 92543
(941) 245-1880

POTABLE & IRRIGATION WATER:
IMPERIAL IRRIGATION DISTRICT
333 F. SUTTON AVENUE, WAREHOUSING, CA 92581
(941) 245-1756

ELECTRIC:
IMPERIAL IRRIGATION DISTRICT
1200 BROADWAY
EL CENTRO, CA 92543
(941) 245-1756

FIRE DEPARTMENT:
IMPERIAL COUNTY FIRE DEPARTMENT
1618 DOUGLASS, SUITE 101
EL CENTRO, CA 92543
(941) 245-1800

PUBLIC WORKS:
105 S. 11TH ST.
EL CENTRO, CA 92543
(941) 245-1818

- TITLE EXCEPTIONS/EXCLUSIONS**
- A RIGHT OF WAY FOR STREETS AND CANALS AS REQUIRED BY THE UNITED STATES OF AMERICA IN THE PATENT RECORDED MARCH 20, 1914 IN BOOK 5 OF PATENTS PAGE 207 BLANKET IN NATURE, NOT PLOTTED HEREIN.
 - AN EASEMENT IN FAVOR OF IMPERIAL IRRIGATION DISTRICT FOR PUBLIC UTILITIES AND INCIDENTAL PURPOSES RECORDED JANUARY 20, 1938 AS BOOK 478, PAGE 439 OF OFFICIAL RECORDS BLANKET IN NATURE, NOT PLOTTED HEREIN.
 - AN EASEMENT IN FAVOR OF IMPERIAL IRRIGATION DISTRICT FOR PUBLIC UTILITIES AND INCIDENTAL PURPOSES RECORDED APRIL 23, 1938 AS BOOK 480, PAGE 444 OF OFFICIAL RECORDS, NOT ENOUGH INFORMATION TO PLOT APPROPRIATE LOCATION PER CALTRANS LID MAP 71596 (M) PLOTTED HEREIN.
 - AN EASEMENT IN FAVOR OF IMPERIAL IRRIGATION DISTRICT FOR PUBLIC UTILITIES AND INCIDENTAL PURPOSES RECORDED DECEMBER 8, 1941 AS BOOK 578, PAGE 478 OF OFFICIAL RECORDS, NOT ENOUGH INFORMATION TO PLOT APPROPRIATE LOCATION PER CALTRANS LID MAP 71596 (M) PLOTTED HEREIN.
 - AN EASEMENT IN FAVOR OF IMPERIAL IRRIGATION DISTRICT FOR PUBLIC UTILITIES AND INCIDENTAL PURPOSES RECORDED JUNE 25, 1944 AS BOOK 111, PAGE 28 OF OFFICIAL RECORDS, NOT ENOUGH INFORMATION TO PLOT APPROPRIATE LOCATION PER CALTRANS LID MAP 71596 (M) PLOTTED HEREIN.
 - AN EASEMENT IN FAVOR OF (VARIOUS) BANKS AND CREDITORS IN FAVOR OF IMPERIAL AND INCIDENTAL PURPOSES RECORDED JULY 23, 1958 AS BOOK 698, PAGE 474 OF OFFICIAL RECORDS PLOTTED HEREIN.
 - THE TERMS AND PROVISIONS CONTAINED IN THE DOCUMENT ENTITLED "AGREEMENT FOR PIPE SERVICE" RECORDED NOVEMBER 12, 1975 AS BOOK 1381, PAGE 567 OF OFFICIAL RECORDS, BLANKET IN NATURE, NOT PLOTTED HEREIN.
 - THE TERMS AND PROVISIONS CONTAINED IN THE DOCUMENT ENTITLED "IMPERIAL COUNTY PROPERTY AGREEMENT" RECORDED MAY 4, 1976 AS BOOK 1386, PAGE 163 OF OFFICIAL RECORDS, BLANKET IN NATURE, NOT PLOTTED HEREIN.
 - THE TERMS AND PROVISIONS CONTAINED IN THE DOCUMENT ENTITLED "AGREEMENT FOR PIPE SERVICE" RECORDED SEPTEMBER 24, 1982 AS INSTRUMENT NO. 1982-2233, IN BOOK 1190, PAGE 1781 OF OFFICIAL RECORDS, NOT A MATTER OF SURVEY.
 - THE EFFECT OF A DOCUMENT ENTITLED "OUT-OF-STATE DEED" RECORDED JULY 09, 2013 AS INSTRUMENT NO. 2013-014897 OF OFFICIAL RECORDS, NOT A MATTER OF SURVEY.
 - THE EFFECT OF A DOCUMENT ENTITLED "OUT-OF-STATE DEED" RECORDED AUGUST 08, 2012 AS INSTRUMENT NO. 2012-02848 OF OFFICIAL RECORDS, NOT A MATTER OF SURVEY.
- CURRENT ZONING:**
A-2, AGRICULTURAL
- FLOOD ZONE:**
PROPERTY IS IN ZONE V, AREA OF MINIMAL FLOOD HAZARD PER FEMA MAP 060220125C & 06015750C, EFFECTIVE ON 09/26/2008

LEGEND:
 - - - - - PROPOSED PARCEL LINE
 - - - - - EXISTING PROPERTY LINE
 - - - - - SECTION LINE
 - - - - - EXISTING EASEMENT LINE
 - - - - - PROPOSED EASEMENT LINE

OWNER/DEVELOPER:
MAVERIK
 CONTACT: PAUL HEYWOOD
 185 SOUTH STATE ST., STE. 100
 SALT LAKE CITY, UT 84111
 801-574-4449

SURVEYOR:
LG LAND SURVEYING, INC.
 CONTACT: JOHN J. GERVAYS
 3035 CALLEJO FELIZ 11 R.
 VALLEY CENTER, CA 92682
 949-515-1172

ENGINEER:
SD
 SITE DESIGN COLLABORATIVE
 CONTACT: FARMAN SUIR
 243 E. 3RD STREET
 LONG BEACH, CA 90802
 562-494-4717

**243 E. 3rd Street
 Long Beach, CA 90802
 562-494-4717
 3333 W. McQuinn Avenue
 Alhambra, CA 91803
 626-271-1215**

**FUELING & COMMERCIAL CENTER
 ROSS AVENUE & INTERSTATE 8
 COUNTY OF IMPERIAL
 TENTATIVE PARCEL MAP
 NO.**

**SHEET NO.
 1
 OF 1**

Source: SDC, 2023



Proposed Tentative Map
 Maverik Fueling Station Project GPA22-0002/ZC22-0002
 Figure 5

This page intentionally left blank.



Imperial County Planning & Development Services Planning / Building

Jim Minnick
DIRECTOR

February 1, 2024

CERTIFIED NO. 7018 1830 0000 2357 3480

Alesia Reed, Cultural Committee Chairwoman
Torres-Martinez Desert Cahuilla Indians
P.O. Box 1160 Thermal, CA, 92274

RE: Notice of Opportunity to Consult under SB-18 for the Maverik Fueling Station and Convenience Store Project (General Plan Amendment #22-0002, Zone Change #22-00015 and Parcel Map #02499) APN 054-080-023

Dear Alesia Reed, Cultural Committee Chairwoman,

This letter formally invites you to request consultation pursuant to Senate Bill 18 (SB 18; Government Code Section 65352.3) regarding the proposed Maverik Fueling Station and Convenience Store Project. As you may know, SB 18 became effective on March 1, 2005 and requires local governments to consult with California Native American Tribes about proposed local land use planning decisions for the purpose of protecting traditional tribal cultural places and sacred sites. The intent of SB 18 is to provide an opportunity for interested tribes and local governments to work together toward the protection of tribal cultural places that might not appear on cultural resource registries. To this end, the County is contacting you to consult on this project.

The County of Imperial is committed to fulfilling the goals of SB 18 and believes that tribal participation in the planning process is crucial for the success of the proposed project. The Imperial County Planning and Development Services Department has contacted the Native American Heritage Commission (NAHC) in order to obtain a list of tribes who should be included in the planning consultation process regarding the proposed project and your name was included in the NAHC's response.

The Maverik Fueling Station and Convenience Store Project includes a fueling station and convenience store on 10 acres of an approximately 50-acre parcel within unincorporated Imperial County (County), California, approximately 1.5 miles east of the City of El Centro (Figure 1, Regional Location). The Project site is located on the southeast corner of Hawes Road and Ross Avenue, east of State Route 111 and is bound by Ross Avenue on the north and by Hawes Road and the Imperial Irrigation District's Acacia Five Drain A on the west (Figure 2, Project Site). The Project site is also located within the USGS Geologic Survey 7.5' quadrangle for Holtville West on Assessor's Parcel Number (APN) 054-080-023 within Section 11 of Township 16 South, Range 14 East, San Bernardino Base Meridian. The westbound offramp of Interstate 8 at SR-111 is located approximately 0.25 miles south of the Project site.

The Project includes 19 fuel pumps (38 fueling positions) under two separate canopies (totaling 9,0000 square feet [SF]), and a 5,982 SF convenience store building. Additional improvements include three (3) underground storage tanks (USTs) for fuel storage; two underground water storage tanks; on-site water and wastewater treatment facilities; parking, landscaping, drainage, and access improvements. A General Plan Amendment (#22-0002), to change the Project site's land use designation from "Agriculture" to "Urban Area"; as well as a Zone Change (#22-00015), to change zoning from A-2 (General Agricultural) to C-3 (Heavy Commercial) are also proposed (See Figures 3 and 4). A tentative parcel map (Parcel Map #02499) is proposed to separate Maverik Fueling Station and Convenience Store site from the balance of the parcel (Figure 5, Proposed Tentative Map).

If your tribe would like to consult with the County of Imperial regarding this project, please respond within ninety (90) days of the date of this letter. Under SB 18, any sensitive information shared with the County regarding cultural places and/or sacred sites will be kept strictly confidential and will not be divulged to the public.

Please send your written response before April 2, 2024 to Derek Newland, Planner III or by email to CommentLetters@co.imperial.ca.us. If the County does not receive a response within 90 days, the County will proceed with the project. Thank you and we look forward to your response.

Sincerely,

JIM MINNICK, DIRECTOR
Imperial County Planning & Development Services

BY:  _____

Derek Newland, Planner III

Attachments: Figure 1 – Regional Location Map
Figure 2 – Project Site
Figure 3 – Proposed General Plan Amendment
Figure 4 – Proposed Zone Change
Figure 5 – Proposed Tentative Map



Imperial County Planning & Development Services Planning / Building

Jim Minnick
DIRECTOR

February 1, 2024

CERTIFIED NO. 7018 1830 0000 2357 3411

Allen Lawson, Chairperson
San Pasqual Band of Diegueno Mission Indians
P.O. Box 365 Valley Center, CA, 92082

RE: Notice of Opportunity to Consult under SB-18 for the Maverik Fueling Station and Convenience Store Project (General Plan Amendment #22-0002, Zone Change #22-00015 and Parcel Map #02499) APN 054-080-023

Dear Allen Lawson, Chairperson,

This letter formally invites you to request consultation pursuant to Senate Bill 18 (SB 18; Government Code Section 65352.3) regarding the proposed Maverik Fueling Station and Convenience Store Project. As you may know, SB 18 became effective on March 1, 2005 and requires local governments to consult with California Native American Tribes about proposed local land use planning decisions for the purpose of protecting traditional tribal cultural places and sacred sites. The intent of SB 18 is to provide an opportunity for interested tribes and local governments to work together toward the protection of tribal cultural places that might not appear on cultural resource registries. To this end, the County is contacting you to consult on this project.

The County of Imperial is committed to fulfilling the goals of SB 18 and believes that tribal participation in the planning process is crucial for the success of the proposed project. The Imperial County Planning and Development Services Department has contacted the Native American Heritage Commission (NAHC) in order to obtain a list of tribes who should be included in the planning consultation process regarding the proposed project and your name was included in the NAHC's response.

The Maverik Fueling Station and Convenience Store Project includes a fueling station and convenience store on 10 acres of an approximately 50-acre parcel within unincorporated Imperial County (County), California, approximately 1.5 miles east of the City of El Centro (Figure 1, Regional Location). The Project site is located on the southeast corner of Hawes Road and Ross Avenue, east of State Route 111 and is bound by Ross Avenue on the north and by Hawes Road and the Imperial Irrigation District's Acacia Five Drain A on the west (Figure 2, Project Site). The Project site is also located within the USGS Geologic Survey 7.5' quadrangle for Holtville West on Assessor's Parcel Number (APN) 054-080-023 within Section 11 of Township 16 South, Range 14 East, San Bernardino Base Meridian. The westbound offramp of Interstate 8 at SR-111 is located approximately 0.25 miles south of the Project site.

The Project includes 19 fuel pumps (38 fueling positions) under two separate canopies (totaling 9,000 square feet [SF]), and a 5,982 SF convenience store building. Additional improvements include three (3) underground storage tanks (USTs) for fuel storage; two underground water storage tanks; on-site water and wastewater treatment facilities; parking, landscaping, drainage, and access improvements. A General Plan Amendment (#22-0002), to change the Project site's land use designation from "Agriculture" to "Urban Area"; as well as a Zone Change (#22-00015), to change zoning from A-2 (General Agricultural) to C-3 (Heavy Commercial) are also proposed (See Figures 3 and 4). A tentative parcel map (Parcel Map #02499) is proposed to separate Maverik Fueling Station and Convenience Store site from the balance of the parcel (Figure 5, Proposed Tentative Map).

If your tribe would like to consult with the County of Imperial regarding this project, please respond within ninety (90) days of the date of this letter. Under SB 18, any sensitive information shared with the County regarding cultural places and/or sacred sites will be kept strictly confidential and will not be divulged to the public.

Please send your written response before April 2, 2024 to Derek Newland, Planner III or by email to CommentLetters@co.imperial.ca.us. If the County does not receive a response within 90 days, the County will proceed with the project. Thank you and we look forward to your response.

Sincerely,

JIM MINNICK, DIRECTOR
Imperial County Planning & Development Services

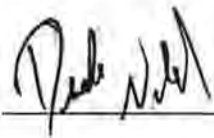
BY:  _____

Derek Newland, Planner III

Attachments: Figure 1 – Regional Location Map
Figure 2 – Project Site
Figure 3 – Proposed General Plan Amendment
Figure 4 – Proposed Zone Change
Figure 5 – Proposed Tentative Map

EEC ORIGINAL PKG



Imperial County Planning & Development Services Planning / Building

February 1, 2024

Jim Minnick
DIRECTOR

CERTIFIED NO. 7018 1830 0000 2357 3367

Angela Elliott Santos, Chairperson
Manzanita Band of Kumeyaay Nation
P.O. Box 1302 Boulevard, CA, 91905

RE: Notice of Opportunity to Consult under SB-18 for the Maverik Fueling Station and Convenience Store Project (General Plan Amendment #22-0002, Zone Change #22-00015 and Parcel Map #02499) APN 054-080-023

Dear Angela Elliott Santos, Chairperson,

This letter formally invites you to request consultation pursuant to Senate Bill 18 (SB 18; Government Code Section 65352.3) regarding the proposed Maverik Fueling Station and Convenience Store Project. As you may know, SB 18 became effective on March 1, 2005 and requires local governments to consult with California Native American Tribes about proposed local land use planning decisions for the purpose of protecting traditional tribal cultural places and sacred sites. The intent of SB 18 is to provide an opportunity for interested tribes and local governments to work together toward the protection of tribal cultural places that might not appear on cultural resource registries. To this end, the County is contacting you to consult on this project.

The County of Imperial is committed to fulfilling the goals of SB 18 and believes that tribal participation in the planning process is crucial for the success of the proposed project. The Imperial County Planning and Development Services Department has contacted the Native American Heritage Commission (NAHC) in order to obtain a list of tribes who should be included in the planning consultation process regarding the proposed project and your name was included in the NAHC's response.

The Maverik Fueling Station and Convenience Store Project includes a fueling station and convenience store on 10 acres of an approximately 50-acre parcel within unincorporated Imperial County (County), California, approximately 1.5 miles east of the City of El Centro (Figure 1, Regional Location). The Project site is located on the southeast corner of Hawes Road and Ross Avenue, east of State Route 111 and is bound by Ross Avenue on the north and by Hawes Road and the Imperial Irrigation District's Acacia Five Drain A on the west (Figure 2, Project Site). The Project site is also located within the USGS Geologic Survey 7.5' quadrangle for Holtville West on Assessor's Parcel Number (APN) 054-080-023 within Section 11 of Township 16 South, Range 14 East, San Bernardino Base Meridian. The westbound offramp of Interstate 8 at SR-111 is located approximately 0.25 miles south of the Project site.

The Project includes 19 fuel pumps (38 fueling positions) under two separate canopies (totaling 9,000 square feet [SF]), and a 5,982 SF convenience store building. Additional improvements include three (3) underground storage tanks (USTs) for fuel storage; two underground water storage tanks; on-site water and wastewater treatment facilities; parking, landscaping, drainage, and access improvements. A General Plan Amendment (#22-0002), to change the Project site's land use designation from "Agriculture" to "Urban Area"; as well as a Zone Change (#22-00015), to change zoning from A-2 (General Agricultural) to C-3 (Heavy Commercial) are also proposed (See Figures 3 and 4). A tentative parcel map (Parcel Map #02499) is proposed to separate Maverik Fueling Station and Convenience Store site from the balance of the parcel (Figure 5, Proposed Tentative Map).

If your tribe would like to consult with the County of Imperial regarding this project, please respond within ninety (90) days of the date of this letter. Under SB 18, any sensitive information shared with the County regarding cultural places and/or sacred sites will be kept strictly confidential and will not be divulged to the public.

Please send your written response before April 2, 2024 to Derek Newland, Planner III or by email to CommentLetters@co.imperial.ca.us. If the County does not receive a response within 90 days, the County will proceed with the project. Thank you and we look forward to your response.

Sincerely,

JIM MINNICK, DIRECTOR
Imperial County Planning & Development Services

BY: 

Derek Newland, Planner III

Attachments: Figure 1 – Regional Location Map
Figure 2 – Project Site
Figure 3 – Proposed General Plan Amendment
Figure 4 – Proposed Zone Change
Figure 5 – Proposed Tentative Map

EEC ORIGINAL PKG



Imperial County Planning & Development Services Planning / Building

Jim Minnick
DIRECTOR

February 1, 2024

CERTIFIED NO. 7018 1830 0000 2357 3268

Art Bunce, Attorney
Barona Group of the Capitan Grande

RE: Notice of Opportunity to Consult under SB-18 for the Maverik Fueling Station and Convenience Store Project (General Plan Amendment #22-0002, Zone Change #22-00015 and Parcel Map #02499) APN 054-080-023

Dear Art Bunce, Attorney,

This letter formally invites you to request consultation pursuant to Senate Bill 18 (SB 18; Government Code Section 65352.3) regarding the proposed Maverik Fueling Station and Convenience Store Project. As you may know, SB 18 became effective on March 1, 2005 and requires local governments to consult with California Native American Tribes about proposed local land use planning decisions for the purpose of protecting traditional tribal cultural places and sacred sites. The intent of SB 18 is to provide an opportunity for interested tribes and local governments to work together toward the protection of tribal cultural places that might not appear on cultural resource registries. To this end, the County is contacting you to consult on this project.

The County of Imperial is committed to fulfilling the goals of SB 18 and believes that tribal participation in the planning process is crucial for the success of the proposed project. The Imperial County Planning and Development Services Department has contacted the Native American Heritage Commission (NAHC) in order to obtain a list of tribes who should be included in the planning consultation process regarding the proposed project and your name was included in the NAHC's response.

The Maverik Fueling Station and Convenience Store Project includes a fueling station and convenience store on 10 acres of an approximately 50-acre parcel within unincorporated Imperial County (County), California, approximately 1.5 miles east of the City of El Centro (Figure 1, Regional Location). The Project site is located on the southeast corner of Hawes Road and Ross Avenue, east of State Route 111 and is bound by Ross Avenue on the north and by Hawes Road and the Imperial Irrigation District's Acacia Five Drain A on the west (Figure 2, Project Site). The Project site is also located within the USGS Geologic Survey 7.5' quadrangle for Holtville West on Assessor's Parcel Number (APN) 054-080-023 within Section 11 of Township 16 South, Range 14 East, San Bernardino Base Meridian. The westbound offramp of Interstate 8 at SR-111 is located approximately 0.25 miles south of the Project site.

The Project includes 19 fuel pumps (38 fueling positions) under two separate canopies (totaling 9,000 square feet [SF]), and a 5,982 SF convenience store building. Additional improvements include three (3) underground storage tanks (USTs) for fuel storage; two underground water storage tanks; on-site water and wastewater treatment facilities; parking, landscaping, drainage, and access improvements. A General Plan Amendment (#22-0002), to change the Project site's land use designation from "Agriculture" to "Urban Area"; as well as a Zone Change (#22-00015), to change zoning from A-2 (General Agricultural) to C-3 (Heavy Commercial) are also proposed (See Figures 3 and 4). A tentative parcel map (Parcel Map #02499) is proposed to separate Maverik Fueling Station and Convenience Store site from the balance of the parcel (Figure 5, Proposed Tentative Map).

If your tribe would like to consult with the County of Imperial regarding this project, please respond within ninety (90) days of the date of this letter. Under SB 18, any sensitive information shared with the County regarding cultural places and/or sacred sites will be kept strictly confidential and will not be divulged to the public.

Please send your written response before April 2, 2024 to Derek Newland, Planner III or by email to CommentLetters@co.imperial.ca.us. If the County does not receive a response within 90 days, the County will proceed with the project. Thank you and we look forward to your response.

Sincerely,

JIM MINNICK, DIRECTOR
Imperial County Planning & Development Services

BY:



Derek Newland, Planner III

Attachments: Figure 1 – Regional Location Map
Figure 2 – Project Site
Figure 3 – Proposed General Plan Amendment
Figure 4 – Proposed Zone Change
Figure 5 – Proposed Tentative Map

EEC ORIGINAL PKG



Imperial County Planning & Development Services Planning / Building

Jim Minnick
DIRECTOR

February 1, 2024

CERTIFIED NO. 7018 1830 0000 2357 3459

Bernice Paipa, Cultural Resource Specialist
Sycuan Band of the Kumeyaay Nation
Sycuan Cultural Center: 910 Willow Glen Drive El Cajon, CA, 92019

RE: Notice of Opportunity to Consult under SB-18 for the Maverik Fueling Station and Convenience Store Project (General Plan Amendment #22-0002, Zone Change #22-00015 and Parcel Map #02499) APN 054-080-023

Dear Bernice Paipa, Cultural Resource Specialist,

This letter formally invites you to request consultation pursuant to Senate Bill 18 (SB 18; Government Code Section 65352.3) regarding the proposed Maverik Fueling Station and Convenience Store Project. As you may know, SB 18 became effective on March 1, 2005 and requires local governments to consult with California Native American Tribes about proposed local land use planning decisions for the purpose of protecting traditional tribal cultural places and sacred sites. The intent of SB 18 is to provide an opportunity for interested tribes and local governments to work together toward the protection of tribal cultural places that might not appear on cultural resource registries. To this end, the County is contacting you to consult on this project.

The County of Imperial is committed to fulfilling the goals of SB 18 and believes that tribal participation in the planning process is crucial for the success of the proposed project. The Imperial County Planning and Development Services Department has contacted the Native American Heritage Commission (NAHC) in order to obtain a list of tribes who should be included in the planning consultation process regarding the proposed project and your name was included in the NAHC's response.

The Maverik Fueling Station and Convenience Store Project includes a fueling station and convenience store on 10 acres of an approximately 50-acre parcel within unincorporated Imperial County (County), California, approximately 1.5 miles east of the City of El Centro (Figure 1, Regional Location). The Project site is located on the southeast corner of Hawes Road and Ross Avenue, east of State Route 111 and is bound by Ross Avenue on the north and by Hawes Road and the Imperial Irrigation District's Acacia Five Drain A on the west (Figure 2, Project Site). The Project site is also located within the USGS Geologic Survey 7.5' quadrangle for Holtville West on Assessor's Parcel Number (APN) 054-080-023 within Section 11 of Township 16 South, Range 14 East, San Bernardino Base Meridian. The westbound offramp of Interstate 8 at SR-111 is located approximately 0.25 miles south of the Project site.

The Project includes 19 fuel pumps (38 fueling positions) under two separate canopies (totaling 9,000 square feet [SF]), and a 5,982 SF convenience store building. Additional improvements include three (3) underground storage tanks (USTs) for fuel storage; two underground water storage tanks; on-site water and wastewater treatment facilities; parking, landscaping, drainage, and access improvements. A General Plan Amendment (#22-0002), to change the Project site's land use designation from "Agriculture" to "Urban Area"; as well as a Zone Change (#22-00015), to change zoning from A-2 (General Agricultural) to C-3 (Heavy Commercial) are also proposed (See Figures 3 and 4). A tentative parcel map (Parcel Map #02499) is proposed to separate Maverik Fueling Station and Convenience Store site from the balance of the parcel (Figure 5, Proposed Tentative Map).

If your tribe would like to consult with the County of Imperial regarding this project, please respond within ninety (90) days of the date of this letter. Under SB 18, any sensitive information shared with the County regarding cultural places and/or sacred sites will be kept strictly confidential and will not be divulged to the public.

Please send your written response before April 2, 2024 to Derek Newland, Planner III or by email to CommentLetters@co.imperial.ca.us. If the County does not receive a response within 90 days, the County will proceed with the project. Thank you and we look forward to your response.

Sincerely,

JIM MINNICK, DIRECTOR
Imperial County Planning & Development Services

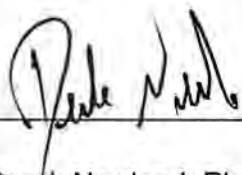
BY: 
Derek Newland, Planner III

Attachments: Figure 1 – Regional Location Map
Figure 2 – Project Site
Figure 3 – Proposed General Plan Amendment
Figure 4 – Proposed Zone Change
Figure 5 – Proposed Tentative Map



Imperial County Planning & Development Services Planning / Building

Jim Minnick
DIRECTOR

CERTIFIED NO. 7018 1830 0000 2357 3343

February 1, 2024

Carmen Lucas,
Kwaaymii Laguna Band of Mission Indians
P.O. Box 775 Pine Valley, CA, 91962

RE: Notice of Opportunity to Consult under SB-18 for the Maverik Fueling Station and Convenience Store Project (General Plan Amendment #22-0002, Zone Change #22-00015 and Parcel Map #02499) APN 054-080-023

Dear Carmen Lucas, ,

This letter formally invites you to request consultation pursuant to Senate Bill 18 (SB 18; Government Code Section 65352.3) regarding the proposed Maverik Fueling Station and Convenience Store Project. As you may know, SB 18 became effective on March 1, 2005 and requires local governments to consult with California Native American Tribes about proposed local land use planning decisions for the purpose of protecting traditional tribal cultural places and sacred sites. The intent of SB 18 is to provide an opportunity for interested tribes and local governments to work together toward the protection of tribal cultural places that might not appear on cultural resource registries. To this end, the County is contacting you to consult on this project.

The County of Imperial is committed to fulfilling the goals of SB 18 and believes that tribal participation in the planning process is crucial for the success of the proposed project. The Imperial County Planning and Development Services Department has contacted the Native American Heritage Commission (NAHC) in order to obtain a list of tribes who should be included in the planning consultation process regarding the proposed project and your name was included in the NAHC's response.

The Maverik Fueling Station and Convenience Store Project includes a fueling station and convenience store on 10 acres of an approximately 50-acre parcel within unincorporated Imperial County (County), California, approximately 1.5 miles east of the City of El Centro (Figure 1, Regional Location). The Project site is located on the southeast corner of Hawes Road and Ross Avenue, east of State Route 111 and is bound by Ross Avenue on the north and by Hawes Road and the Imperial Irrigation District's Acacia Five Drain A on the west (Figure 2, Project Site). The Project site is also located within the USGS Geologic Survey 7.5' quadrangle for Holtville West on Assessor's Parcel Number (APN) 054-080-023 within Section 11 of Township 16 South, Range 14 East, San Bernardino Base Meridian. The westbound offramp of Interstate 8 at SR-111 is located approximately 0.25 miles south of the Project site.

The Project includes 19 fuel pumps (38 fueling positions) under two separate canopies (totaling 9,000 square feet [SF]), and a 5,982 SF convenience store building. Additional improvements include three (3) underground storage tanks (USTs) for fuel storage; two underground water storage tanks; on-site water and wastewater treatment facilities; parking, landscaping, drainage, and access improvements. A General Plan Amendment (#22-0002), to change the Project site's land use designation from "Agriculture" to "Urban Area"; as well as a Zone Change (#22-00015), to change zoning from A-2 (General Agricultural) to C-3 (Heavy Commercial) are also proposed (See Figures 3 and 4). A tentative parcel map (Parcel Map #02499) is proposed to separate Maverik Fueling Station and Convenience Store site from the balance of the parcel (Figure 5, Proposed Tentative Map).

If your tribe would like to consult with the County of Imperial regarding this project, please respond within ninety (90) days of the date of this letter. Under SB 18, any sensitive information shared with the County regarding cultural places and/or sacred sites will be kept strictly confidential and will not be divulged to the public.

Please send your written response before April 2, 2024 to Derek Newland, Planner III or by email to CommentLetters@co.imperial.ca.us. If the County does not receive a response within 90 days, the County will proceed with the project. Thank you and we look forward to your response.

Sincerely,

JIM MINNICK, DIRECTOR
Imperial County Planning & Development Services

BY:  _____

· Derek Newland, Planner III

Attachments: Figure 1 – Regional Location Map
Figure 2 – Project Site
Figure 3 – Proposed General Plan Amendment
Figure 4 – Proposed Zone Change
Figure 5 – Proposed Tentative Map

EEC ORIGINAL PKG



Imperial County Planning & Development Services Planning / Building

February 1, 2024

Jim Minnick
DIRECTOR

CERTIFIED NO. 7018 1830 0000 2357 3305

Clint Linton, Director of Cultural Resources
Iipay Nation of Santa Ysabel
P.O. Box 507 Santa Ysabel, CA, 92070

RE: Notice of Opportunity to Consult under SB-18 for the Maverik Fueling Station and Convenience Store Project (General Plan Amendment #22-0002, Zone Change #22-00015 and Parcel Map #02499) APN 054-080-023

Dear Clint Linton, Director of Cultural Resources,

This letter formally invites you to request consultation pursuant to Senate Bill 18 (SB 18; Government Code Section 65352.3) regarding the proposed Maverik Fueling Station and Convenience Store Project. As you may know, SB 18 became effective on March 1, 2005 and requires local governments to consult with California Native American Tribes about proposed local land use planning decisions for the purpose of protecting traditional tribal cultural places and sacred sites. The intent of SB 18 is to provide an opportunity for interested tribes and local governments to work together toward the protection of tribal cultural places that might not appear on cultural resource registries. To this end, the County is contacting you to consult on this project.

The County of Imperial is committed to fulfilling the goals of SB 18 and believes that tribal participation in the planning process is crucial for the success of the proposed project. The Imperial County Planning and Development Services Department has contacted the Native American Heritage Commission (NAHC) in order to obtain a list of tribes who should be included in the planning consultation process regarding the proposed project and your name was included in the NAHC's response.

The Maverik Fueling Station and Convenience Store Project includes a fueling station and convenience store on 10 acres of an approximately 50-acre parcel within unincorporated Imperial County (County), California, approximately 1.5 miles east of the City of El Centro (Figure 1, Regional Location). The Project site is located on the southeast corner of Hawes Road and Ross Avenue, east of State Route 111 and is bound by Ross Avenue on the north and by Hawes Road and the Imperial Irrigation District's Acacia Five Drain A on the west (Figure 2, Project Site). The Project site is also located within the USGS Geologic Survey 7.5' quadrangle for Holtville West on Assessor's Parcel Number (APN) 054-080-023 within Section 11 of Township 16 South, Range 14 East, San Bernardino Base Meridian. The westbound offramp of Interstate 8 at SR-111 is located approximately 0.25 miles south of the Project site.

The Project includes 19 fuel pumps (38 fueling positions) under two separate canopies (totaling 9,000 square feet [SF]), and a 5,982 SF convenience store building. Additional improvements include three (3) underground storage tanks (USTs) for fuel storage; two underground water storage tanks; on-site water and wastewater treatment facilities; parking, landscaping, drainage, and access improvements. A General Plan Amendment (#22-0002), to change the Project site's land use designation from "Agriculture" to "Urban Area"; as well as a Zone Change (#22-00015), to change zoning from A-2 (General Agricultural) to C-3 (Heavy Commercial) are also proposed (See Figures 3 and 4). A tentative parcel map (Parcel Map #02499) is proposed to separate Maverik Fueling Station and Convenience Store site from the balance of the parcel (Figure 5, Proposed Tentative Map).

If your tribe would like to consult with the County of Imperial regarding this project, please respond within ninety (90) days of the date of this letter. Under SB 18, any sensitive information shared with the County regarding cultural places and/or sacred sites will be kept strictly confidential and will not be divulged to the public.

Please send your written response before April 2, 2024 to Derek Newland, Planner III or by email to CommentLetters@co.imperial.ca.us. If the County does not receive a response within 90 days, the County will proceed with the project. Thank you and we look forward to your response.

Sincerely,

JIM MINNICK, DIRECTOR
Imperial County Planning & Development Services

BY:



Derek Newland, Planner III

Attachments: Figure 1 – Regional Location Map
Figure 2 – Project Site
Figure 3 – Proposed General Plan Amendment
Figure 4 – Proposed Zone Change
Figure 5 – Proposed Tentative Map



Imperial County Planning & Development Services Planning / Building

Jim Minnick
DIRECTOR

February 1, 2024

CERTIFIED NO. 7018 1830 0000 2357 3466

Cody Martinez, Chairman
Sycuan Band of the Kumeyaay Nation
Sycuan Tribal Office: 1 Kwaaypaay Court El Cajon, CA, 92019

RE: Notice of Opportunity to Consult under SB-18 for the Maverik Fueling Station and Convenience Store Project (General Plan Amendment #22-0002, Zone Change #22-00015 and Parcel Map #02499) APN 054-080-023

Dear Cody Martinez, Chairman,

This letter formally invites you to request consultation pursuant to Senate Bill 18 (SB 18; Government Code Section 65352.3) regarding the proposed Maverik Fueling Station and Convenience Store Project. As you may know, SB 18 became effective on March 1, 2005 and requires local governments to consult with California Native American Tribes about proposed local land use planning decisions for the purpose of protecting traditional tribal cultural places and sacred sites. The intent of SB 18 is to provide an opportunity for interested tribes and local governments to work together toward the protection of tribal cultural places that might not appear on cultural resource registries. To this end, the County is contacting you to consult on this project.

The County of Imperial is committed to fulfilling the goals of SB 18 and believes that tribal participation in the planning process is crucial for the success of the proposed project. The Imperial County Planning and Development Services Department has contacted the Native American Heritage Commission (NAHC) in order to obtain a list of tribes who should be included in the planning consultation process regarding the proposed project and your name was included in the NAHC's response.

The Maverik Fueling Station and Convenience Store Project includes a fueling station and convenience store on 10 acres of an approximately 50-acre parcel within unincorporated Imperial County (County), California, approximately 1.5 miles east of the City of El Centro (Figure 1, Regional Location). The Project site is located on the southeast corner of Hawes Road and Ross Avenue, east of State Route 111 and is bound by Ross Avenue on the north and by Hawes Road and the Imperial Irrigation District's Acacia Five Drain A on the west (Figure 2, Project Site). The Project site is also located within the USGS Geologic Survey 7.5' quadrangle for Holtville West on Assessor's Parcel Number (APN) 054-080-023 within Section 11 of Township 16 South, Range 14 East, San Bernardino Base Meridian. The westbound offramp of Interstate 8 at SR-111 is located approximately 0.25 miles south of the Project site.

The Project includes 19 fuel pumps (38 fueling positions) under two separate canopies (totaling 9,000 square feet [SF]), and a 5,982 SF convenience store building. Additional improvements include three (3) underground storage tanks (USTs) for fuel storage; two underground water storage tanks; on-site water and wastewater treatment facilities; parking, landscaping, drainage, and access improvements. A General Plan Amendment (#22-0002), to change the Project site's land use designation from "Agriculture" to "Urban Area"; as well as a Zone Change (#22-00015), to change zoning from A-2 (General Agricultural) to C-3 (Heavy Commercial) are also proposed (See Figures 3 and 4). A tentative parcel map (Parcel Map #02499) is proposed to separate Maverik Fueling Station and Convenience Store site from the balance of the parcel (Figure 5, Proposed Tentative Map).

If your tribe would like to consult with the County of Imperial regarding this project, please respond within ninety (90) days of the date of this letter. Under SB 18, any sensitive information shared with the County regarding cultural places and/or sacred sites will be kept strictly confidential and will not be divulged to the public.

Please send your written response before April 2, 2024 to Derek Newland, Planner III or by email to CommentLetters@co.imperial.ca.us. If the County does not receive a response within 90 days, the County will proceed with the project. Thank you and we look forward to your response.

Sincerely,

JIM MINNICK, DIRECTOR
Imperial County Planning & Development Services

BY: 
Derek Newland, Planner III

- Attachments: Figure 1 – Regional Location Map
Figure 2 – Project Site
Figure 3 – Proposed General Plan Amendment
Figure 4 – Proposed Zone Change
Figure 5 – Proposed Tentative Map



Imperial County Planning & Development Services Planning / Building

February 1, 2024

Jim Minnick
DIRECTOR

CERTIFIED NO. 7018 1830 0000 2357 3329

Erica Pinto, Chairperson
Jamul Indian Village
P.O. Box 612 Jamul, CA, 91935

RE: Notice of Opportunity to Consult under SB-18 for the Maverik Fueling Station and Convenience Store Project (General Plan Amendment #22-0002, Zone Change #22-00015 and Parcel Map #02499) APN 054-080-023

Dear Erica Pinto, Chairperson,

This letter formally invites you to request consultation pursuant to Senate Bill 18 (SB 18; Government Code Section 65352.3) regarding the proposed Maverik Fueling Station and Convenience Store Project. As you may know, SB 18 became effective on March 1, 2005 and requires local governments to consult with California Native American Tribes about proposed local land use planning decisions for the purpose of protecting traditional tribal cultural places and sacred sites. The intent of SB 18 is to provide an opportunity for interested tribes and local governments to work together toward the protection of tribal cultural places that might not appear on cultural resource registries. To this end, the County is contacting you to consult on this project.

The County of Imperial is committed to fulfilling the goals of SB 18 and believes that tribal participation in the planning process is crucial for the success of the proposed project. The Imperial County Planning and Development Services Department has contacted the Native American Heritage Commission (NAHC) in order to obtain a list of tribes who should be included in the planning consultation process regarding the proposed project and your name was included in the NAHC's response.

The Maverik Fueling Station and Convenience Store Project includes a fueling station and convenience store on 10 acres of an approximately 50-acre parcel within unincorporated Imperial County (County), California, approximately 1.5 miles east of the City of El Centro (Figure 1, Regional Location). The Project site is located on the southeast corner of Hawes Road and Ross Avenue, east of State Route 111 and is bound by Ross Avenue on the north and by Hawes Road and the Imperial Irrigation District's Acacia Five Drain A on the west (Figure 2, Project Site). The Project site is also located within the USGS Geologic Survey 7.5' quadrangle for Holtville West on Assessor's Parcel Number (APN) 054-080-023 within Section 11 of Township 16 South, Range 14 East, San Bernardino Base Meridian. The westbound offramp of Interstate 8 at SR-111 is located approximately 0.25 miles south of the Project site.

The Project includes 19 fuel pumps (38 fueling positions) under two separate canopies (totaling 9,000 square feet [SF]), and a 5,982 SF convenience store building. Additional improvements include three (3) underground storage tanks (USTs) for fuel storage; two underground water storage tanks; on-site water and wastewater treatment facilities; parking, landscaping, drainage, and access improvements. A General Plan Amendment (#22-0002), to change the Project site's land use designation from "Agriculture" to "Urban Area"; as well as a Zone Change (#22-00015), to change zoning from A-2 (General Agricultural) to C-3 (Heavy Commercial) are also proposed (See Figures 3 and 4). A tentative parcel map (Parcel Map #02499) is proposed to separate Maverik Fueling Station and Convenience Store site from the balance of the parcel (Figure 5, Proposed Tentative Map).

If your tribe would like to consult with the County of Imperial regarding this project, please respond within ninety (90) days of the date of this letter. Under SB 18, any sensitive information shared with the County regarding cultural places and/or sacred sites will be kept strictly confidential and will not be divulged to the public.

Please send your written response before April 2, 2024 to Derek Newland, Planner III or by email to CommentLetters@co.imperial.ca.us. If the County does not receive a response within 90 days, the County will proceed with the project. Thank you and we look forward to your response.

Sincerely,

JIM MINNICK, DIRECTOR
Imperial County Planning & Development Services

BY: 
Derek Newland, Planner III

Attachments: Figure 1 – Regional Location Map
Figure 2 – Project Site
Figure 3 – Proposed General Plan Amendment
Figure 4 – Proposed Zone Change
Figure 5 – Proposed Tentative Map

EEC ORIGINAL PKG



Imperial County Planning & Development Services Planning / Building

Jim Minnick
DIRECTOR

February 1, 2024

CERTIFIED NO. 7018 1830 0000 2357 3527

Ernest Pingleton, THPO
Viejas Band of Kumeyaay Indians
1 Viejas Grade Road Alpine, CA, 91901

RE: Notice of Opportunity to Consult under SB-18 for the Maverik Fueling Station and Convenience Store Project (General Plan Amendment #22-0002, Zone Change #22-00015 and Parcel Map #02499) APN 054-080-023

Dear Ernest Pingleton, THPO,

This letter formally invites you to request consultation pursuant to Senate Bill 18 (SB 18; Government Code Section 65352.3) regarding the proposed Maverik Fueling Station and Convenience Store Project. As you may know, SB 18 became effective on March 1, 2005 and requires local governments to consult with California Native American Tribes about proposed local land use planning decisions for the purpose of protecting traditional tribal cultural places and sacred sites. The intent of SB 18 is to provide an opportunity for interested tribes and local governments to work together toward the protection of tribal cultural places that might not appear on cultural resource registries. To this end, the County is contacting you to consult on this project.

The County of Imperial is committed to fulfilling the goals of SB 18 and believes that tribal participation in the planning process is crucial for the success of the proposed project. The Imperial County Planning and Development Services Department has contacted the Native American Heritage Commission (NAHC) in order to obtain a list of tribes who should be included in the planning consultation process regarding the proposed project and your name was included in the NAHC's response.

The Maverik Fueling Station and Convenience Store Project includes a fueling station and convenience store on 10 acres of an approximately 50-acre parcel within unincorporated Imperial County (County), California, approximately 1.5 miles east of the City of El Centro (Figure 1, Regional Location). The Project site is located on the southeast corner of Hawes Road and Ross Avenue, east of State Route 111 and is bound by Ross Avenue on the north and by Hawes Road and the Imperial Irrigation District's Acacia Five Drain A on the west (Figure 2, Project Site). The Project site is also located within the USGS Geologic Survey 7.5' quadrangle for Holtville West on Assessor's Parcel Number (APN) 054-080-023 within Section 11 of Township 16 South, Range 14 East, San Bernardino Base Meridian. The westbound offramp of Interstate 8 at SR-111 is located approximately 0.25 miles south of the Project site.

The Project includes 19 fuel pumps (38 fueling positions) under two separate canopies (totaling 9,000 square feet [SF]), and a 5,982 SF convenience store building. Additional improvements include three (3) underground storage tanks (USTs) for fuel storage; two underground water storage tanks; on-site water and wastewater treatment facilities; parking, landscaping, drainage, and access improvements. A General Plan Amendment (#22-0002), to change the Project site's land use designation from "Agriculture" to "Urban Area"; as well as a Zone Change (#22-00015), to change zoning from A-2 (General Agricultural) to C-3 (Heavy Commercial) are also proposed (See Figures 3 and 4). A tentative parcel map (Parcel Map #02499) is proposed to separate Maverik Fueling Station and Convenience Store site from the balance of the parcel (Figure 5, Proposed Tentative Map).

If your tribe would like to consult with the County of Imperial regarding this project, please respond within ninety (90) days of the date of this letter. Under SB 18, any sensitive information shared with the County regarding cultural places and/or sacred sites will be kept strictly confidential and will not be divulged to the public.

Please send your written response before April 2, 2024 to Derek Newland, Planner III or by email to CommentLetters@co.imperial.ca.us. If the County does not receive a response within 90 days, the County will proceed with the project. Thank you and we look forward to your response.

Sincerely,

JIM MINNICK, DIRECTOR
Imperial County Planning & Development Services

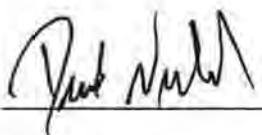
BY: 
Derek Newland, Planner III

- Attachments: Figure 1 – Regional Location Map
Figure 2 – Project Site
Figure 3 – Proposed General Plan Amendment
Figure 4 – Proposed Zone Change
Figure 5 – Proposed Tentative Map



Imperial County Planning & Development Services Planning / Building

Jim Minnick
DIRECTOR

February 1, 2024

CERTIFIED NO. 7018 1830 0000 2357 3510

Gary Resvaloso, TM MLD
Torres-Martinez Desert Cahuilla Indians
P.O. Box 1160 Thermal, CA, 92274

RE: Notice of Opportunity to Consult under SB-18 for the Maverik Fueling Station and Convenience Store Project (General Plan Amendment #22-0002, Zone Change #22-00015 and Parcel Map #02499) APN 054-080-023

Dear Gary Resvaloso, TM MLD,

This letter formally invites you to request consultation pursuant to Senate Bill 18 (SB 18; Government Code Section 65352.3) regarding the proposed Maverik Fueling Station and Convenience Store Project. As you may know, SB 18 became effective on March 1, 2005 and requires local governments to consult with California Native American Tribes about proposed local land use planning decisions for the purpose of protecting traditional tribal cultural places and sacred sites. The intent of SB 18 is to provide an opportunity for interested tribes and local governments to work together toward the protection of tribal cultural places that might not appear on cultural resource registries. To this end, the County is contacting you to consult on this project.

The County of Imperial is committed to fulfilling the goals of SB 18 and believes that tribal participation in the planning process is crucial for the success of the proposed project. The Imperial County Planning and Development Services Department has contacted the Native American Heritage Commission (NAHC) in order to obtain a list of tribes who should be included in the planning consultation process regarding the proposed project and your name was included in the NAHC's response.

The Maverik Fueling Station and Convenience Store Project includes a fueling station and convenience store on 10 acres of an approximately 50-acre parcel within unincorporated Imperial County (County), California, approximately 1.5 miles east of the City of El Centro (Figure 1, Regional Location). The Project site is located on the southeast corner of Hawes Road and Ross Avenue, east of State Route 111 and is bound by Ross Avenue on the north and by Hawes Road and the Imperial Irrigation District's Acacia Five Drain A on the west (Figure 2, Project Site). The Project site is also located within the USGS Geologic Survey 7.5' quadrangle for Holtville West on Assessor's Parcel Number (APN) 054-080-023 within Section 11 of Township 16 South, Range 14 East, San Bernardino Base Meridian. The westbound offramp of Interstate 8 at SR-111 is located approximately 0.25 miles south of the Project site.

The Project includes 19 fuel pumps (38 fueling positions) under two separate canopies (totaling 9,0000 square feet [SF]), and a 5,982 SF convenience store building. Additional improvements include three (3) underground storage tanks (USTs) for fuel storage; two underground water storage tanks; on-site water and wastewater treatment facilities; parking, landscaping, drainage, and access improvements. A General Plan Amendment (#22-0002), to change the Project site's land use designation from "Agriculture" to "Urban Area"; as well as a Zone Change (#22-00015), to change zoning from A-2 (General Agricultural) to C-3 (Heavy Commercial) are also proposed (See Figures 3 and 4). A tentative parcel map (Parcel Map #02499) is proposed to separate Maverik Fueling Station and Convenience Store site from the balance of the parcel (Figure 5, Proposed Tentative Map).

If your tribe would like to consult with the County of Imperial regarding this project, please respond within ninety (90) days of the date of this letter. Under SB 18, any sensitive information shared with the County regarding cultural places and/or sacred sites will be kept strictly confidential and will not be divulged to the public.

Please send your written response before April 2, 2024 to Derek Newland, Planner III or by email to CommentLetters@co.imperial.ca.us. If the County does not receive a response within 90 days, the County will proceed with the project. Thank you and we look forward to your response.

Sincerely,

JIM MINNICK, DIRECTOR
Imperial County Planning & Development Services

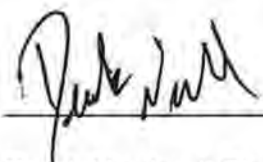
BY: 
Derek Newland, Planner III

Attachments: Figure 1 – Regional Location Map
Figure 2 – Project Site
Figure 3 – Proposed General Plan Amendment
Figure 4 – Proposed Zone Change
Figure 5 – Proposed Tentative Map

EEC ORIGINAL PKG



Imperial County Planning & Development Services Planning / Building

February 1, 2024

Jim Minnick
DIRECTOR

CERTIFIED NO. 7018 1830 0000 2357 3350

Gwendolyn Parada, Chairperson
La Posta Band of Diegueno Mission Indians
8 Crestwood Road Boulevard, CA, 91905

RE: Notice of Opportunity to Consult under SB-18 for the Maverik Fueling Station and Convenience Store Project (General Plan Amendment #22-0002, Zone Change #22-00015 and Parcel Map #02499) APN 054-080-023

Dear Gwendolyn Parada, Chairperson,

This letter formally invites you to request consultation pursuant to Senate Bill 18 (SB 18; Government Code Section 65352.3) regarding the proposed Maverik Fueling Station and Convenience Store Project. As you may know, SB 18 became effective on March 1, 2005 and requires local governments to consult with California Native American Tribes about proposed local land use planning decisions for the purpose of protecting traditional tribal cultural places and sacred sites. The intent of SB 18 is to provide an opportunity for interested tribes and local governments to work together toward the protection of tribal cultural places that might not appear on cultural resource registries. To this end, the County is contacting you to consult on this project.

The County of Imperial is committed to fulfilling the goals of SB 18 and believes that tribal participation in the planning process is crucial for the success of the proposed project. The Imperial County Planning and Development Services Department has contacted the Native American Heritage Commission (NAHC) in order to obtain a list of tribes who should be included in the planning consultation process regarding the proposed project and your name was included in the NAHC's response.

The Maverik Fueling Station and Convenience Store Project includes a fueling station and convenience store on 10 acres of an approximately 50-acre parcel within unincorporated Imperial County (County), California, approximately 1.5 miles east of the City of El Centro (Figure 1, Regional Location). The Project site is located on the southeast corner of Hawes Road and Ross Avenue, east of State Route 111 and is bound by Ross Avenue on the north and by Hawes Road and the Imperial Irrigation District's Acacia Five Drain A on the west (Figure 2, Project Site). The Project site is also located within the USGS Geologic Survey 7.5' quadrangle for Holtville West on Assessor's Parcel Number (APN) 054-080-023 within Section 11 of Township 16 South, Range 14 East, San Bernardino Base Meridian. The westbound offramp of Interstate 8 at SR-111 is located approximately 0.25 miles south of the Project site.

The Project includes 19 fuel pumps (38 fueling positions) under two separate canopies (totaling 9,000 square feet [SF]), and a 5,982 SF convenience store building. Additional improvements include three (3) underground storage tanks (USTs) for fuel storage; two underground water storage tanks; on-site water and wastewater treatment facilities; parking, landscaping, drainage, and access improvements. A General Plan Amendment (#22-0002), to change the Project site's land use designation from "Agriculture" to "Urban Area"; as well as a Zone Change (#22-00015), to change zoning from A-2 (General Agricultural) to C-3 (Heavy Commercial) are also proposed (See Figures 3 and 4). A tentative parcel map (Parcel Map #02499) is proposed to separate Maverik Fueling Station and Convenience Store site from the balance of the parcel (Figure 5, Proposed Tentative Map).

If your tribe would like to consult with the County of Imperial regarding this project, please respond within ninety (90) days of the date of this letter. Under SB 18, any sensitive information shared with the County regarding cultural places and/or sacred sites will be kept strictly confidential and will not be divulged to the public.

Please send your written response before April 2, 2024 to Derek Newland, Planner III or by email to CommentLetters@co.imperial.ca.us. If the County does not receive a response within 90 days, the County will proceed with the project. Thank you and we look forward to your response.

Sincerely,

JIM MINNICK, DIRECTOR
Imperial County Planning & Development Services

BY:  _____

Derek Newland, Planner III

Attachments: Figure 1 – Regional Location Map
Figure 2 – Project Site
Figure 3 – Proposed General Plan Amendment
Figure 4 – Proposed Zone Change
Figure 5 – Proposed Tentative Map



Imperial County Planning & Development Services Planning / Building

Jim Minnick
DIRECTOR

February 1, 2024

CERTIFIED NO. 7018 1830 0000 2357 3435

Jessica Valdez, Cultural Resource Specialist
Soboba Band of Luiseno Indians
P.O. Box 487 San Jacinto, CA, 92581

RE: Notice of Opportunity to Consult under SB-18 for the Maverik Fueling Station and Convenience Store Project (General Plan Amendment #22-0002, Zone Change #22-00015 and Parcel Map #02499) APN 054-080-023

Dear Jessica Valdez, Cultural Resource Specialist,

This letter formally invites you to request consultation pursuant to Senate Bill 18 (SB 18; Government Code Section 65352.3) regarding the proposed Maverik Fueling Station and Convenience Store Project. As you may know, SB 18 became effective on March 1, 2005 and requires local governments to consult with California Native American Tribes about proposed local land use planning decisions for the purpose of protecting traditional tribal cultural places and sacred sites. The intent of SB 18 is to provide an opportunity for interested tribes and local governments to work together toward the protection of tribal cultural places that might not appear on cultural resource registries. To this end, the County is contacting you to consult on this project.

The County of Imperial is committed to fulfilling the goals of SB 18 and believes that tribal participation in the planning process is crucial for the success of the proposed project. The Imperial County Planning and Development Services Department has contacted the Native American Heritage Commission (NAHC) in order to obtain a list of tribes who should be included in the planning consultation process regarding the proposed project and your name was included in the NAHC's response.

The Maverik Fueling Station and Convenience Store Project includes a fueling station and convenience store on 10 acres of an approximately 50-acre parcel within unincorporated Imperial County (County), California, approximately 1.5 miles east of the City of El Centro (Figure 1, Regional Location). The Project site is located on the southeast corner of Hawes Road and Ross Avenue, east of State Route 111 and is bound by Ross Avenue on the north and by Hawes Road and the Imperial Irrigation District's Acacia Five Drain A on the west (Figure 2, Project Site). The Project site is also located within the USGS Geologic Survey 7.5' quadrangle for Holtville West on Assessor's Parcel Number (APN) 054-080-023 within Section 11 of Township 16 South, Range 14 East, San Bernardino Base Meridian. The westbound offramp of Interstate 8 at SR-111 is located approximately 0.25 miles south of the Project site.

The Project includes 19 fuel pumps (38 fueling positions) under two separate canopies (totaling 9,0000 square feet [SF]), and a 5,982 SF convenience store building. Additional improvements include three (3) underground storage tanks (USTs) for fuel storage; two underground water storage tanks; on-site water and wastewater treatment facilities; parking, landscaping, drainage, and access improvements. A General Plan Amendment (#22-0002), to change the Project site's land use designation from "Agriculture" to "Urban Area"; as well as a Zone Change (#22-00015), to change zoning from A-2 (General Agricultural) to C-3 (Heavy Commercial) are also proposed (See Figures 3 and 4). A tentative parcel map (Parcel Map #02499) is proposed to separate Maverik Fueling Station and Convenience Store site from the balance of the parcel (Figure 5, Proposed Tentative Map).

If your tribe would like to consult with the County of Imperial regarding this project, please respond within ninety (90) days of the date of this letter. Under SB 18, any sensitive information shared with the County regarding cultural places and/or sacred sites will be kept strictly confidential and will not be divulged to the public.

Please send your written response before April 2, 2024 to Derek Newland, Planner III or by email to CommentLetters@co.imperial.ca.us. If the County does not receive a response within 90 days, the County will proceed with the project. Thank you and we look forward to your response.

Sincerely,

JIM MINNICK, DIRECTOR
Imperial County Planning & Development Services

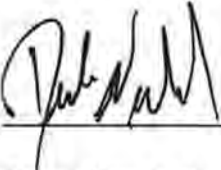
BY: 
Derek Newland, Planner III

Attachments: Figure 1 – Regional Location Map
Figure 2 – Project Site
Figure 3 – Proposed General Plan Amendment
Figure 4 – Proposed Zone Change
Figure 5 – Proposed Tentative Map



Imperial County Planning & Development Services Planning / Building

February 1, 2024

Jim Minnick
DIRECTOR

CERTIFIED NO. 7018 1830 0000 2357 3381

Jill McCormick, Historic Preservation Officer
Quechan Tribe of the Fort Yuma Reservation
P.O. Box 1899 Yuma, AZ, 85366

RE: Notice of Opportunity to Consult under SB-18 for the Maverik Fueling Station and Convenience Store Project (General Plan Amendment #22-0002, Zone Change #22-00015 and Parcel Map #02499) APN 054-080-023

Dear Jill McCormick, Historic Preservation Officer,

This letter formally invites you to request consultation pursuant to Senate Bill 18 (SB 18; Government Code Section 65352.3) regarding the proposed Maverik Fueling Station and Convenience Store Project. As you may know, SB 18 became effective on March 1, 2005 and requires local governments to consult with California Native American Tribes about proposed local land use planning decisions for the purpose of protecting traditional tribal cultural places and sacred sites. The intent of SB 18 is to provide an opportunity for interested tribes and local governments to work together toward the protection of tribal cultural places that might not appear on cultural resource registries. To this end, the County is contacting you to consult on this project.

The County of Imperial is committed to fulfilling the goals of SB 18 and believes that tribal participation in the planning process is crucial for the success of the proposed project. The Imperial County Planning and Development Services Department has contacted the Native American Heritage Commission (NAHC) in order to obtain a list of tribes who should be included in the planning consultation process regarding the proposed project and your name was included in the NAHC's response.

The Maverik Fueling Station and Convenience Store Project includes a fueling station and convenience store on 10 acres of an approximately 50-acre parcel within unincorporated Imperial County (County), California, approximately 1.5 miles east of the City of El Centro (Figure 1, Regional Location). The Project site is located on the southeast corner of Hawes Road and Ross Avenue, east of State Route 111 and is bound by Ross Avenue on the north and by Hawes Road and the Imperial Irrigation District's Acacia Five Drain A on the west (Figure 2, Project Site). The Project site is also located within the USGS Geologic Survey 7.5' quadrangle for Holtville West on Assessor's Parcel Number (APN) 054-080-023 within Section 11 of Township 16 South, Range 14 East, San Bernardino Base Meridian. The westbound offramp of Interstate 8 at SR-111 is located approximately 0.25 miles south of the Project site.

The Project includes 19 fuel pumps (38 fueling positions) under two separate canopies (totaling 9,000 square feet [SF]), and a 5,982 SF convenience store building. Additional improvements include three (3) underground storage tanks (USTs) for fuel storage; two underground water storage tanks; on-site water and wastewater treatment facilities; parking, landscaping, drainage, and access improvements. A General Plan Amendment (#22-0002), to change the Project site's land use designation from "Agriculture" to "Urban Area"; as well as a Zone Change (#22-00015), to change zoning from A-2 (General Agricultural) to C-3 (Heavy Commercial) are also proposed (See Figures 3 and 4). A tentative parcel map (Parcel Map #02499) is proposed to separate Maverik Fueling Station and Convenience Store site from the balance of the parcel (Figure 5, Proposed Tentative Map).

If your tribe would like to consult with the County of Imperial regarding this project, please respond within ninety (90) days of the date of this letter. Under SB 18, any sensitive information shared with the County regarding cultural places and/or sacred sites will be kept strictly confidential and will not be divulged to the public.

Please send your written response before April 2, 2024 to Derek Newland, Planner III or by email to CommentLetters@co.imperial.ca.us. If the County does not receive a response within 90 days, the County will proceed with the project. Thank you and we look forward to your response.

Sincerely,

JIM MINNICK, DIRECTOR
Imperial County Planning & Development Services

BY: 
Derek Newland, Planner III

Attachments: Figure 1 – Regional Location Map
Figure 2 – Project Site
Figure 3 – Proposed General Plan Amendment
Figure 4 – Proposed Zone Change
Figure 5 – Proposed Tentative Map

EEC ORIGINAL PKG



Imperial County Planning & Development Services Planning / Building

Jim Minnick
DIRECTOR

February 1, 2024

CERTIFIED NO. 7018 1830 0000 2357 3404

Jordan Joaquin, President, Quechan Tribal Council
Quechan Tribe of the Fort Yuma Reservation
P.O.Box 1899 Yuma, AZ, 85366

RE: Notice of Opportunity to Consult under SB-18 for the Maverik Fueling Station and Convenience Store Project (General Plan Amendment #22-0002, Zone Change #22-00015 and Parcel Map #02499) APN 054-080-023

Dear Jordan Joaquin, President, Quechan Tribal Council,

This letter formally invites you to request consultation pursuant to Senate Bill 18 (SB 18; Government Code Section 65352.3) regarding the proposed Maverik Fueling Station and Convenience Store Project. As you may know, SB 18 became effective on March 1, 2005 and requires local governments to consult with California Native American Tribes about proposed local land use planning decisions for the purpose of protecting traditional tribal cultural places and sacred sites. The intent of SB 18 is to provide an opportunity for interested tribes and local governments to work together toward the protection of tribal cultural places that might not appear on cultural resource registries. To this end, the County is contacting you to consult on this project.

The County of Imperial is committed to fulfilling the goals of SB 18 and believes that tribal participation in the planning process is crucial for the success of the proposed project. The Imperial County Planning and Development Services Department has contacted the Native American Heritage Commission (NAHC) in order to obtain a list of tribes who should be included in the planning consultation process regarding the proposed project and your name was included in the NAHC's response.

The Maverik Fueling Station and Convenience Store Project includes a fueling station and convenience store on 10 acres of an approximately 50-acre parcel within unincorporated Imperial County (County), California, approximately 1.5 miles east of the City of El Centro (Figure 1, Regional Location). The Project site is located on the southeast corner of Hawes Road and Ross Avenue, east of State Route 111 and is bound by Ross Avenue on the north and by Hawes Road and the Imperial Irrigation District's Acacia Five Drain A on the west (Figure 2, Project Site). The Project site is also located within the USGS Geologic Survey 7.5' quadrangle for Holtville West on Assessor's Parcel Number (APN) 054-080-023 within Section 11 of Township 16 South, Range 14 East, San Bernardino Base Meridian. The westbound offramp of Interstate 8 at SR-111 is located approximately 0.25 miles south of the Project site.

The Project includes 19 fuel pumps (38 fueling positions) under two separate canopies (totaling 9,000 square feet [SF]), and a 5,982 SF convenience store building. Additional improvements include three (3) underground storage tanks (USTs) for fuel storage; two underground water storage tanks; on-site water and wastewater treatment facilities; parking, landscaping, drainage, and access improvements. A General Plan Amendment (#22-0002), to change the Project site's land use designation from "Agriculture" to "Urban Area"; as well as a Zone Change (#22-00015), to change zoning from A-2 (General Agricultural) to C-3 (Heavy Commercial) are also proposed (See Figures 3 and 4). A tentative parcel map (Parcel Map #02499) is proposed to separate Maverik Fueling Station and Convenience Store site from the balance of the parcel (Figure 5, Proposed Tentative Map).

If your tribe would like to consult with the County of Imperial regarding this project, please respond within ninety (90) days of the date of this letter. Under SB 18, any sensitive information shared with the County regarding cultural places and/or sacred sites will be kept strictly confidential and will not be divulged to the public.

Please send your written response before April 2, 2024 to Derek Newland, Planner III or by email to CommentLetters@co.imperial.ca.us. If the County does not receive a response within 90 days, the County will proceed with the project. Thank you and we look forward to your response.

Sincerely,

JIM MINNICK, DIRECTOR
Imperial County Planning & Development Services

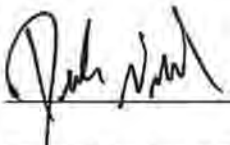
BY: 
Derek Newland, Planner III

Attachments: Figure 1 – Regional Location Map
Figure 2 – Project Site
Figure 3 – Proposed General Plan Amendment
Figure 4 – Proposed Zone Change
Figure 5 – Proposed Tentative Map

EEC ORIGINAL PKG



Imperial County Planning & Development Services Planning / Building

Jim Minnick
DIRECTOR

February 1, 2024

CERTIFIED NO. 7018 1830 0000 2357 3442

Joseph Ontiveros, Tribal Historic Preservation Officer
Soboba Band of Luiseno Indians
P.O. Box 487 San Jacinto, CA, 92581

RE: Notice of Opportunity to Consult under SB-18 for the Maverik Fueling Station and Convenience Store Project (General Plan Amendment #22-0002, Zone Change #22-00015 and Parcel Map #02499) APN 054-080-023

Dear Joseph Ontiveros, Tribal Historic Preservation Officer,

This letter formally invites you to request consultation pursuant to Senate Bill 18 (SB 18; Government Code Section 65352.3) regarding the proposed Maverik Fueling Station and Convenience Store Project. As you may know, SB 18 became effective on March 1, 2005 and requires local governments to consult with California Native American Tribes about proposed local land use planning decisions for the purpose of protecting traditional tribal cultural places and sacred sites. The intent of SB 18 is to provide an opportunity for interested tribes and local governments to work together toward the protection of tribal cultural places that might not appear on cultural resource registries. To this end, the County is contacting you to consult on this project.

The County of Imperial is committed to fulfilling the goals of SB 18 and believes that tribal participation in the planning process is crucial for the success of the proposed project. The Imperial County Planning and Development Services Department has contacted the Native American Heritage Commission (NAHC) in order to obtain a list of tribes who should be included in the planning consultation process regarding the proposed project and your name was included in the NAHC's response.

The Maverik Fueling Station and Convenience Store Project includes a fueling station and convenience store on 10 acres of an approximately 50-acre parcel within unincorporated Imperial County (County), California, approximately 1.5 miles east of the City of El Centro (Figure 1, Regional Location). The Project site is located on the southeast corner of Hawes Road and Ross Avenue, east of State Route 111 and is bound by Ross Avenue on the north and by Hawes Road and the Imperial Irrigation District's Acacia Five Drain A on the west (Figure 2, Project Site). The Project site is also located within the USGS Geologic Survey 7.5' quadrangle for Holtville West on Assessor's Parcel Number (APN) 054-080-023 within Section 11 of Township 16 South, Range 14 East, San Bernardino Base Meridian. The westbound offramp of Interstate 8 at SR-111 is located approximately 0.25 miles south of the Project site.

The Project includes 19 fuel pumps (38 fueling positions) under two separate canopies (totaling 9,000 square feet [SF]), and a 5,982 SF convenience store building. Additional improvements include three (3) underground storage tanks (USTs) for fuel storage; two underground water storage tanks; on-site water and wastewater treatment facilities; parking, landscaping, drainage, and access improvements. A General Plan Amendment (#22-0002), to change the Project site's land use designation from "Agriculture" to "Urban Area"; as well as a Zone Change (#22-00015), to change zoning from A-2 (General Agricultural) to C-3 (Heavy Commercial) are also proposed (See Figures 3 and 4). A tentative parcel map (Parcel Map #02499) is proposed to separate Maverik Fueling Station and Convenience Store site from the balance of the parcel (Figure 5, Proposed Tentative Map).

If your tribe would like to consult with the County of Imperial regarding this project, please respond within ninety (90) days of the date of this letter. Under SB 18, any sensitive information shared with the County regarding cultural places and/or sacred sites will be kept strictly confidential and will not be divulged to the public.

Please send your written response before April 2, 2024 to Derek Newland, Planner III or by email to CommentLetters@co.imperial.ca.us. If the County does not receive a response within 90 days, the County will proceed with the project. Thank you and we look forward to your response.

Sincerely,

JIM MINNICK, DIRECTOR
Imperial County Planning & Development Services

BY: 
Derek Newland, Planner III

Attachments: Figure 1 – Regional Location Map
Figure 2 – Project Site
Figure 3 – Proposed General Plan Amendment
Figure 4 – Proposed Zone Change
Figure 5 – Proposed Tentative Map

EEC ORIGINAL PKG



Imperial County Planning & Development Services Planning / Building

February 1, 2024

Jim Minnick
DIRECTOR

CERTIFIED NO. 7018 1830 0000 2357 3336

Lisa Cumper, Tribal Historic Preservation Officer
Jamul Indian Village
P.O. Box 612 Jamul, CA, 91935

RE: Notice of Opportunity to Consult under SB-18 for the Maverik Fueling Station and Convenience Store Project (General Plan Amendment #22-0002, Zone Change #22-00015 and Parcel Map #02499) APN 054-080-023

Dear Lisa Cumper, Tribal Historic Preservation Officer,

This letter formally invites you to request consultation pursuant to Senate Bill 18 (SB 18; Government Code Section 65352.3) regarding the proposed Maverik Fueling Station and Convenience Store Project. As you may know, SB 18 became effective on March 1, 2005 and requires local governments to consult with California Native American Tribes about proposed local land use planning decisions for the purpose of protecting traditional tribal cultural places and sacred sites. The intent of SB 18 is to provide an opportunity for interested tribes and local governments to work together toward the protection of tribal cultural places that might not appear on cultural resource registries. To this end, the County is contacting you to consult on this project.

The County of Imperial is committed to fulfilling the goals of SB 18 and believes that tribal participation in the planning process is crucial for the success of the proposed project. The Imperial County Planning and Development Services Department has contacted the Native American Heritage Commission (NAHC) in order to obtain a list of tribes who should be included in the planning consultation process regarding the proposed project and your name was included in the NAHC's response.

The Maverik Fueling Station and Convenience Store Project includes a fueling station and convenience store on 10 acres of an approximately 50-acre parcel within unincorporated Imperial County (County), California, approximately 1.5 miles east of the City of El Centro (Figure 1, Regional Location). The Project site is located on the southeast corner of Hawes Road and Ross Avenue, east of State Route 111 and is bound by Ross Avenue on the north and by Hawes Road and the Imperial Irrigation District's Acacia Five Drain A on the west (Figure 2, Project Site). The Project site is also located within the USGS Geologic Survey 7.5' quadrangle for Holtville West on Assessor's Parcel Number (APN) 054-080-023 within Section 11 of Township 16 South, Range 14 East, San Bernardino Base Meridian. The westbound offramp of Interstate 8 at SR-111 is located approximately 0.25 miles south of the Project site.

The Project includes 19 fuel pumps (38 fueling positions) under two separate canopies (totaling 9,000 square feet [SF]), and a 5,982 SF convenience store building. Additional improvements include three (3) underground storage tanks (USTs) for fuel storage; two underground water storage tanks; on-site water and wastewater treatment facilities; parking, landscaping, drainage, and access improvements. A General Plan Amendment (#22-0002), to change the Project site's land use designation from "Agriculture" to "Urban Area"; as well as a Zone Change (#22-00015), to change zoning from A-2 (General Agricultural) to C-3 (Heavy Commercial) are also proposed (See Figures 3 and 4). A tentative parcel map (Parcel Map #02499) is proposed to separate Maverik Fueling Station and Convenience Store site from the balance of the parcel (Figure 5, Proposed Tentative Map).

If your tribe would like to consult with the County of Imperial regarding this project, please respond within ninety (90) days of the date of this letter. Under SB 18, any sensitive information shared with the County regarding cultural places and/or sacred sites will be kept strictly confidential and will not be divulged to the public.

Please send your written response before April 2, 2024 to Derek Newland, Planner III or by email to CommentLetters@co.imperial.ca.us. If the County does not receive a response within 90 days, the County will proceed with the project. Thank you and we look forward to your response.

Sincerely,

JIM MINNICK, DIRECTOR
Imperial County Planning & Development Services

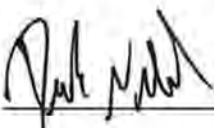
BY: 

Derek Newland, Planner III

Attachments: Figure 1 – Regional Location Map
Figure 2 – Project Site
Figure 3 – Proposed General Plan Amendment
Figure 4 – Proposed Zone Change
Figure 5 – Proposed Tentative Map



Imperial County Planning & Development Services Planning / Building

February 1, 2024

Jim Minnick
DIRECTOR

CERTIFIED NO. 7018 1830 0000 2357 3428

Lovina Redner, Tribal Chair
Santa Rosa Band of Cahuilla Indians
P.O. Box 391820 Anza, CA, 92539

RE: Notice of Opportunity to Consult under SB-18 for the Maverik Fueling Station and Convenience Store Project (General Plan Amendment #22-0002, Zone Change #22-00015 and Parcel Map #02499) APN 054-080-023

Dear Lovina Redner, Tribal Chair,

This letter formally invites you to request consultation pursuant to Senate Bill 18 (SB 18; Government Code Section 65352.3) regarding the proposed Maverik Fueling Station and Convenience Store Project. As you may know, SB 18 became effective on March 1, 2005 and requires local governments to consult with California Native American Tribes about proposed local land use planning decisions for the purpose of protecting traditional tribal cultural places and sacred sites. The intent of SB 18 is to provide an opportunity for interested tribes and local governments to work together toward the protection of tribal cultural places that might not appear on cultural resource registries. To this end, the County is contacting you to consult on this project.

The County of Imperial is committed to fulfilling the goals of SB 18 and believes that tribal participation in the planning process is crucial for the success of the proposed project. The Imperial County Planning and Development Services Department has contacted the Native American Heritage Commission (NAHC) in order to obtain a list of tribes who should be included in the planning consultation process regarding the proposed project and your name was included in the NAHC's response.

The Maverik Fueling Station and Convenience Store Project includes a fueling station and convenience store on 10 acres of an approximately 50-acre parcel within unincorporated Imperial County (County), California, approximately 1.5 miles east of the City of El Centro (Figure 1, Regional Location). The Project site is located on the southeast corner of Hawes Road and Ross Avenue, east of State Route 111 and is bound by Ross Avenue on the north and by Hawes Road and the Imperial Irrigation District's Acacia Five Drain A on the west (Figure 2, Project Site). The Project site is also located within the USGS Geologic Survey 7.5' quadrangle for Holtville West on Assessor's Parcel Number (APN) 054-080-023 within Section 11 of Township 16 South, Range 14 East, San Bernardino Base Meridian. The westbound offramp of Interstate 8 at SR-111 is located approximately 0.25 miles south of the Project site.

The Project includes 19 fuel pumps (38 fueling positions) under two separate canopies (totaling 9,000 square feet [SF]), and a 5,982 SF convenience store building. Additional improvements include three (3) underground storage tanks (USTs) for fuel storage; two underground water storage tanks; on-site water and wastewater treatment facilities; parking, landscaping, drainage, and access improvements. A General Plan Amendment (#22-0002), to change the Project site's land use designation from "Agriculture" to "Urban Area"; as well as a Zone Change (#22-00015), to change zoning from A-2 (General Agricultural) to C-3 (Heavy Commercial) are also proposed (See Figures 3 and 4). A tentative parcel map (Parcel Map #02499) is proposed to separate Maverik Fueling Station and Convenience Store site from the balance of the parcel (Figure 5, Proposed Tentative Map).

If your tribe would like to consult with the County of Imperial regarding this project, please respond within ninety (90) days of the date of this letter. Under SB 18, any sensitive information shared with the County regarding cultural places and/or sacred sites will be kept strictly confidential and will not be divulged to the public.

Please send your written response before April 2, 2024 to Derek Newland, Planner III or by email to CommentLetters@co.imperial.ca.us. If the County does not receive a response within 90 days, the County will proceed with the project. Thank you and we look forward to your response.

Sincerely,

JIM MINNICK, DIRECTOR
Imperial County Planning & Development Services

BY: 
Derek Newland, Planner III

Attachments: Figure 1 – Regional Location Map
Figure 2 – Project Site
Figure 3 – Proposed General Plan Amendment
Figure 4 – Proposed Zone Change
Figure 5 – Proposed Tentative Map



Imperial County Planning & Development Services Planning / Building

February 1, 2024

Jim Minnick
DIRECTOR

CERTIFIED NO. 7018 1830 0000 2357 3398

Manfred Scott, Acting Chairman - Kw'ts'an Cultural Committee
Quechan Tribe of the Fort Yuma Reservation
P.O. Box 1899 Yuma, AZ, 85366

RE: Notice of Opportunity to Consult under SB-18 for the Maverik Fueling Station and Convenience Store Project (General Plan Amendment #22-0002, Zone Change #22-00015 and Parcel Map #02499) APN 054-080-023

Dear Manfred Scott, Acting Chairman - Kw'ts'an Cultural Committee,

This letter formally invites you to request consultation pursuant to Senate Bill 18 (SB 18; Government Code Section 65352.3) regarding the proposed Maverik Fueling Station and Convenience Store Project. As you may know, SB 18 became effective on March 1, 2005 and requires local governments to consult with California Native American Tribes about proposed local land use planning decisions for the purpose of protecting traditional tribal cultural places and sacred sites. The intent of SB 18 is to provide an opportunity for interested tribes and local governments to work together toward the protection of tribal cultural places that might not appear on cultural resource registries. To this end, the County is contacting you to consult on this project.

The County of Imperial is committed to fulfilling the goals of SB 18 and believes that tribal participation in the planning process is crucial for the success of the proposed project. The Imperial County Planning and Development Services Department has contacted the Native American Heritage Commission (NAHC) in order to obtain a list of tribes who should be included in the planning consultation process regarding the proposed project and your name was included in the NAHC's response.

The Maverik Fueling Station and Convenience Store Project includes a fueling station and convenience store on 10 acres of an approximately 50-acre parcel within unincorporated Imperial County (County), California, approximately 1.5 miles east of the City of El Centro (Figure 1, Regional Location). The Project site is located on the southeast corner of Hawes Road and Ross Avenue, east of State Route 111 and is bound by Ross Avenue on the north and by Hawes Road and the Imperial Irrigation District's Acacia Five Drain A on the west (Figure 2, Project Site). The Project site is also located within the USGS Geologic Survey 7.5' quadrangle for Holtville West on Assessor's Parcel Number (APN) 054-080-023 within Section 11 of Township 16 South, Range 14 East, San Bernardino Base Meridian. The westbound offramp of Interstate 8 at SR-111 is located approximately 0.25 miles south of the Project site.

The Project includes 19 fuel pumps (38 fueling positions) under two separate canopies (totaling 9,000 square feet [SF]), and a 5,982 SF convenience store building. Additional improvements include three (3) underground storage tanks (USTs) for fuel storage; two underground water storage tanks; on-site water and wastewater treatment facilities; parking, landscaping, drainage, and access improvements. A General Plan Amendment (#22-0002), to change the Project site's land use designation from "Agriculture" to "Urban Area"; as well as a Zone Change (#22-00015), to change zoning from A-2 (General Agricultural) to C-3 (Heavy Commercial) are also proposed (See Figures 3 and 4). A tentative parcel map (Parcel Map #02499) is proposed to separate Maverik Fueling Station and Convenience Store site from the balance of the parcel (Figure 5, Proposed Tentative Map).

If your tribe would like to consult with the County of Imperial regarding this project, please respond within ninety (90) days of the date of this letter. Under SB 18, any sensitive information shared with the County regarding cultural places and/or sacred sites will be kept strictly confidential and will not be divulged to the public.

Please send your written response before April 2, 2024 to Derek Newland, Planner III or by email to CommentLetters@co.imperial.ca.us. If the County does not receive a response within 90 days, the County will proceed with the project. Thank you and we look forward to your response.

Sincerely,

JIM MINNICK, DIRECTOR
Imperial County Planning & Development Services

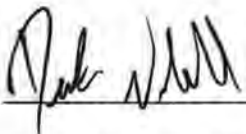
BY:  _____

Derek Newland, Planner III

Attachments: Figure 1 – Regional Location Map
Figure 2 – Project Site
Figure 3 – Proposed General Plan Amendment
Figure 4 – Proposed Zone Change
Figure 5 – Proposed Tentative Map



Imperial County Planning & Development Services Planning / Building

Jim Minnick
DIRECTOR

February 1, 2024

CERTIFIED NO. 7018 1830 0000 2357 3473

Mary Belardo, Cultural Committee Vice Chair
Torres-Martinez Desert Cahuilla Indians
P.O. Box 1160 Thermal, CA, 92274

RE: Notice of Opportunity to Consult under SB-18 for the Maverik Fueling Station and Convenience Store Project (General Plan Amendment #22-0002, Zone Change #22-00015 and Parcel Map #02499) APN 054-080-023

Dear Mary Belardo, Cultural Committee Vice Chair,

This letter formally invites you to request consultation pursuant to Senate Bill 18 (SB 18; Government Code Section 65352.3) regarding the proposed Maverik Fueling Station and Convenience Store Project. As you may know, SB 18 became effective on March 1, 2005 and requires local governments to consult with California Native American Tribes about proposed local land use planning decisions for the purpose of protecting traditional tribal cultural places and sacred sites. The intent of SB 18 is to provide an opportunity for interested tribes and local governments to work together toward the protection of tribal cultural places that might not appear on cultural resource registries. To this end, the County is contacting you to consult on this project.

The County of Imperial is committed to fulfilling the goals of SB 18 and believes that tribal participation in the planning process is crucial for the success of the proposed project. The Imperial County Planning and Development Services Department has contacted the Native American Heritage Commission (NAHC) in order to obtain a list of tribes who should be included in the planning consultation process regarding the proposed project and your name was included in the NAHC's response.

The Maverik Fueling Station and Convenience Store Project includes a fueling station and convenience store on 10 acres of an approximately 50-acre parcel within unincorporated Imperial County (County), California, approximately 1.5 miles east of the City of El Centro (Figure 1, Regional Location). The Project site is located on the southeast corner of Hawes Road and Ross Avenue, east of State Route 111 and is bound by Ross Avenue on the north and by Hawes Road and the Imperial Irrigation District's Acacia Five Drain A on the west (Figure 2, Project Site). The Project site is also located within the USGS Geologic Survey 7.5' quadrangle for Holtville West on Assessor's Parcel Number (APN) 054-080-023 within Section 11 of Township 16 South, Range 14 East, San Bernardino Base Meridian. The westbound offramp of Interstate 8 at SR-111 is located approximately 0.25 miles south of the Project site.

The Project includes 19 fuel pumps (38 fueling positions) under two separate canopies (totaling 9,0000 square feet [SF]), and a 5,982 SF convenience store building. Additional improvements include three (3) underground storage tanks (USTs) for fuel storage; two underground water storage tanks; on-site water and wastewater treatment facilities; parking, landscaping, drainage, and access improvements. A General Plan Amendment (#22-0002), to change the Project site's land use designation from "Agriculture" to "Urban Area"; as well as a Zone Change (#22-00015), to change zoning from A-2 (General Agricultural) to C-3 (Heavy Commercial) are also proposed (See Figures 3 and 4). A tentative parcel map (Parcel Map #02499) is proposed to separate Maverik Fueling Station and Convenience Store site from the balance of the parcel (Figure 5, Proposed Tentative Map).

If your tribe would like to consult with the County of Imperial regarding this project, please respond within ninety (90) days of the date of this letter. Under SB 18, any sensitive information shared with the County regarding cultural places and/or sacred sites will be kept strictly confidential and will not be divulged to the public.

Please send your written response before April 2, 2024 to Derek Newland, Planner III or by email to CommentLetters@co.imperial.ca.us. If the County does not receive a response within 90 days, the County will proceed with the project. Thank you and we look forward to your response.

Sincerely,

JIM MINNICK, DIRECTOR
Imperial County Planning & Development Services

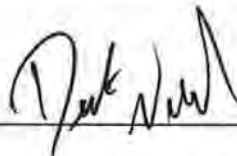
BY: 
Derek Newland, Planner III

Attachments: Figure 1 – Regional Location Map
Figure 2 – Project Site
Figure 3 – Proposed General Plan Amendment
Figure 4 – Proposed Zone Change
Figure 5 – Proposed Tentative Map

EEC ORIGINAL PKG



Imperial County Planning & Development Services Planning / Building

Jim Minnick
DIRECTOR

February 1, 2024

CERTIFIED NO. 7018 1830 0000 2357 3299

Michael Garcia, Vice Chairperson
Ewiiapaayp Band of Kumeyaay Indians
4054 Willows Road Alpine, CA, 91901

RE: Notice of Opportunity to Consult under SB-18 for the Maverik Fueling Station and Convenience Store Project (General Plan Amendment #22-0002, Zone Change #22-00015 and Parcel Map #02499) APN 054-080-023

Dear Michael Garcia, Vice Chairperson,

This letter formally invites you to request consultation pursuant to Senate Bill 18 (SB 18; Government Code Section 65352.3) regarding the proposed Maverik Fueling Station and Convenience Store Project. As you may know, SB 18 became effective on March 1, 2005 and requires local governments to consult with California Native American Tribes about proposed local land use planning decisions for the purpose of protecting traditional tribal cultural places and sacred sites. The intent of SB 18 is to provide an opportunity for interested tribes and local governments to work together toward the protection of tribal cultural places that might not appear on cultural resource registries. To this end, the County is contacting you to consult on this project.

The County of Imperial is committed to fulfilling the goals of SB 18 and believes that tribal participation in the planning process is crucial for the success of the proposed project. The Imperial County Planning and Development Services Department has contacted the Native American Heritage Commission (NAHC) in order to obtain a list of tribes who should be included in the planning consultation process regarding the proposed project and your name was included in the NAHC's response.

The Maverik Fueling Station and Convenience Store Project includes a fueling station and convenience store on 10 acres of an approximately 50-acre parcel within unincorporated Imperial County (County), California, approximately 1.5 miles east of the City of El Centro (Figure 1, Regional Location). The Project site is located on the southeast corner of Hawes Road and Ross Avenue, east of State Route 111 and is bound by Ross Avenue on the north and by Hawes Road and the Imperial Irrigation District's Acacia Five Drain A on the west (Figure 2, Project Site). The Project site is also located within the USGS Geologic Survey 7.5' quadrangle for Holtville West on Assessor's Parcel Number (APN) 054-080-023 within Section 11 of Township 16 South, Range 14 East, San Bernardino Base Meridian. The westbound offramp of Interstate 8 at SR-111 is located approximately 0.25 miles south of the Project site.

The Project includes 19 fuel pumps (38 fueling positions) under two separate canopies (totaling 9,000 square feet [SF]), and a 5,982 SF convenience store building. Additional improvements include three (3) underground storage tanks (USTs) for fuel storage; two underground water storage tanks; on-site water and wastewater treatment facilities; parking, landscaping, drainage, and access improvements. A General Plan Amendment (#22-0002), to change the Project site's land use designation from "Agriculture" to "Urban Area"; as well as a Zone Change (#22-00015), to change zoning from A-2 (General Agricultural) to C-3 (Heavy Commercial) are also proposed (See Figures 3 and 4). A tentative parcel map (Parcel Map #02499) is proposed to separate Maverik Fueling Station and Convenience Store site from the balance of the parcel (Figure 5, Proposed Tentative Map).

If your tribe would like to consult with the County of Imperial regarding this project, please respond within ninety (90) days of the date of this letter. Under SB 18, any sensitive information shared with the County regarding cultural places and/or sacred sites will be kept strictly confidential and will not be divulged to the public.

Please send your written response before April 2, 2024 to Derek Newland, Planner III or by email to CommentLetters@co.imperial.ca.us. If the County does not receive a response within 90 days, the County will proceed with the project. Thank you and we look forward to your response.

Sincerely,

JIM MINNICK, DIRECTOR
Imperial County Planning & Development Services

BY: 
Derek Newland, Planner III

Attachments: Figure 1 – Regional Location Map
Figure 2 – Project Site
Figure 3 – Proposed General Plan Amendment
Figure 4 – Proposed Zone Change
Figure 5 – Proposed Tentative Map



Imperial County Planning & Development Services Planning / Building

February 1, 2024

Jim Minnick
DIRECTOR

CERTIFIED NO. 7018 1830 0000 2357 3374

Michael Linton, Chairperson
Mesa Grande Band of Diegueno Mission Indians
P.O Box 270 Santa Ysabel, CA, 92070

RE: Notice of Opportunity to Consult under SB-18 for the Maverik Fueling Station and Convenience Store Project (General Plan Amendment #22-0002, Zone Change #22-00015 and Parcel Map #02499) APN 054-080-023

Dear Michael Linton, Chairperson,

This letter formally invites you to request consultation pursuant to Senate Bill 18 (SB 18; Government Code Section 65352.3) regarding the proposed Maverik Fueling Station and Convenience Store Project. As you may know, SB 18 became effective on March 1, 2005 and requires local governments to consult with California Native American Tribes about proposed local land use planning decisions for the purpose of protecting traditional tribal cultural places and sacred sites. The intent of SB 18 is to provide an opportunity for interested tribes and local governments to work together toward the protection of tribal cultural places that might not appear on cultural resource registries. To this end, the County is contacting you to consult on this project.

The County of Imperial is committed to fulfilling the goals of SB 18 and believes that tribal participation in the planning process is crucial for the success of the proposed project. The Imperial County Planning and Development Services Department has contacted the Native American Heritage Commission (NAHC) in order to obtain a list of tribes who should be included in the planning consultation process regarding the proposed project and your name was included in the NAHC's response.

The Maverik Fueling Station and Convenience Store Project includes a fueling station and convenience store on 10 acres of an approximately 50-acre parcel within unincorporated Imperial County (County), California, approximately 1.5 miles east of the City of El Centro (Figure 1, Regional Location). The Project site is located on the southeast corner of Hawes Road and Ross Avenue, east of State Route 111 and is bound by Ross Avenue on the north and by Hawes Road and the Imperial Irrigation District's Acacia Five Drain A on the west (Figure 2, Project Site). The Project site is also located within the USGS Geologic Survey 7.5' quadrangle for Holtville West on Assessor's Parcel Number (APN) 054-080-023 within Section 11 of Township 16 South, Range 14 East, San Bernardino Base Meridian. The westbound offramp of Interstate 8 at SR-111 is located approximately 0.25 miles south of the Project site.

The Project includes 19 fuel pumps (38 fueling positions) under two separate canopies (totaling 9,000 square feet [SF]), and a 5,982 SF convenience store building. Additional improvements include three (3) underground storage tanks (USTs) for fuel storage; two underground water storage tanks; on-site water and wastewater treatment facilities; parking, landscaping, drainage, and access improvements. A General Plan Amendment (#22-0002), to change the Project site's land use designation from "Agriculture" to "Urban Area"; as well as a Zone Change (#22-00015), to change zoning from A-2 (General Agricultural) to C-3 (Heavy Commercial) are also proposed (See Figures 3 and 4). A tentative parcel map (Parcel Map #02499) is proposed to separate Maverik Fueling Station and Convenience Store site from the balance of the parcel (Figure 5, Proposed Tentative Map).

If your tribe would like to consult with the County of Imperial regarding this project, please respond within ninety (90) days of the date of this letter. Under SB 18, any sensitive information shared with the County regarding cultural places and/or sacred sites will be kept strictly confidential and will not be divulged to the public.

Please send your written response before April 2, 2024 to Derek Newland, Planner III or by email to CommentLetters@co.imperial.ca.us. If the County does not receive a response within 90 days, the County will proceed with the project. Thank you and we look forward to your response.

Sincerely,

JIM MINNICK, DIRECTOR
Imperial County Planning & Development Services

BY:  _____

Derek Newland, Planner III

Attachments: Figure 1 – Regional Location Map
Figure 2 – Project Site
Figure 3 – Proposed General Plan Amendment
Figure 4 – Proposed Zone Change
Figure 5 – Proposed Tentative Map



Imperial County Planning & Development Services Planning / Building

February 1, 2024

Jim Minnick
DIRECTOR

CERTIFIED NO. 7018 1830 0000 2357 3251

Patricia Garcia, Director of Historic Preservation
Agua Caliente Band of Cahuilla Indians
5401 Dinah Shore Drive
Palm Springs, CA, 92264

RE: Notice of Opportunity to Consult under SB-18 for the Maverik Fueling Station and Convenience Store Project (General Plan Amendment #22-0002, Zone Change #22-00015 and Parcel Map #02499) APN 054-080-023

Dear Patricia Garcia, Director of Historic Preservation,

This letter formally invites you to request consultation pursuant to Senate Bill 18 (SB 18; Government Code Section 65352.3) regarding the proposed Maverik Fueling Station and Convenience Store Project. As you may know, SB 18 became effective on March 1, 2005 and requires local governments to consult with California Native American Tribes about proposed local land use planning decisions for the purpose of protecting traditional tribal cultural places and sacred sites. The intent of SB 18 is to provide an opportunity for interested tribes and local governments to work together toward the protection of tribal cultural places that might not appear on cultural resource registries. To this end, the County is contacting you to consult on this project.

The County of Imperial is committed to fulfilling the goals of SB 18 and believes that tribal participation in the planning process is crucial for the success of the proposed project. The Imperial County Planning and Development Services Department has contacted the Native American Heritage Commission (NAHC) in order to obtain a list of tribes who should be included in the planning consultation process regarding the proposed project and your name was included in the NAHC's response.

The Maverik Fueling Station and Convenience Store Project includes a fueling station and convenience store on 10 acres of an approximately 50-acre parcel within unincorporated Imperial County (County), California, approximately 1.5 miles east of the City of El Centro (Figure 1, Regional Location). The Project site is located on the southeast corner of Hawes Road and Ross Avenue, east of State Route 111 and is bound by Ross Avenue on the north and by Hawes Road and the Imperial Irrigation District's Acacia Five Drain A on the west (Figure 2, Project Site). The Project site is also located within the USGS Geologic Survey 7.5' quadrangle for Holtville West on Assessor's Parcel Number (APN) 054-080-023 within Section 11 of Township 16 South, Range 14 East, San Bernardino Base Meridian. The westbound offramp of Interstate 8 at SR-111 is located approximately 0.25 miles south of the Project site.

The Project includes 19 fuel pumps (38 fueling positions) under two separate canopies (totaling 9,000 square feet [SF]), and a 5,982 SF convenience store building. Additional improvements include three (3) underground storage tanks (USTs) for fuel storage; two underground water storage tanks; on-site water and wastewater treatment facilities; parking, landscaping, drainage, and access improvements. A General Plan Amendment (#22-0002), to change the Project site's land use designation from "Agriculture" to "Urban Area"; as well as a Zone Change (#22-00015), to change zoning from A-2 (General Agricultural) to C-3 (Heavy Commercial) are also proposed (See Figures 3 and 4). A tentative parcel map (Parcel Map #02499) is proposed to separate Maverik Fueling Station and Convenience Store site from the balance of the parcel (Figure 5, Proposed Tentative Map).

If your tribe would like to consult with the County of Imperial regarding this project, please respond within ninety (90) days of the date of this letter. Under SB 18, any sensitive information shared with the County regarding cultural places and/or sacred sites will be kept strictly confidential and will not be divulged to the public.

Please send your written response before April 2, 2024 to Derek Newland, Planner III or by email to CommentLetters@co.imperial.ca.us. If the County does not receive a response within 90 days, the County will proceed with the project. Thank you and we look forward to your response.

Sincerely,

JIM MINNICK, DIRECTOR
Imperial County Planning & Development Services

BY: 
Derek Newland, Planner III

Attachments: Figure 1 – Regional Location Map
Figure 2 – Project Site
Figure 3 – Proposed General Plan Amendment
Figure 4 – Proposed Zone Change
Figure 5 – Proposed Tentative Map



Imperial County Planning & Development Services Planning / Building

Jim Minnick
DIRECTOR

February 1, 2024

CERTIFIED NO. 7018 1830 0000 2357 3275

Ralph Goff, Chairperson
Campo Band of Diegueno Mission Indians
36190 Church Road, Suite 1 Campo, CA, 91906

RE: Notice of Opportunity to Consult under SB-18 for the Maverik Fueling Station and Convenience Store Project (General Plan Amendment #22-0002, Zone Change #22-00015 and Parcel Map #02499) APN 054-080-023

Dear Ralph Goff, Chairperson,

This letter formally invites you to request consultation pursuant to Senate Bill 18 (SB 18; Government Code Section 65352.3) regarding the proposed Maverik Fueling Station and Convenience Store Project. As you may know, SB 18 became effective on March 1, 2005 and requires local governments to consult with California Native American Tribes about proposed local land use planning decisions for the purpose of protecting traditional tribal cultural places and sacred sites. The intent of SB 18 is to provide an opportunity for interested tribes and local governments to work together toward the protection of tribal cultural places that might not appear on cultural resource registries. To this end, the County is contacting you to consult on this project.

The County of Imperial is committed to fulfilling the goals of SB 18 and believes that tribal participation in the planning process is crucial for the success of the proposed project. The Imperial County Planning and Development Services Department has contacted the Native American Heritage Commission (NAHC) in order to obtain a list of tribes who should be included in the planning consultation process regarding the proposed project and your name was included in the NAHC's response.

The Maverik Fueling Station and Convenience Store Project includes a fueling station and convenience store on 10 acres of an approximately 50-acre parcel within unincorporated Imperial County (County), California, approximately 1.5 miles east of the City of El Centro (Figure 1, Regional Location). The Project site is located on the southeast corner of Hawes Road and Ross Avenue, east of State Route 111 and is bound by Ross Avenue on the north and by Hawes Road and the Imperial Irrigation District's Acacia Five Drain A on the west (Figure 2, Project Site). The Project site is also located within the USGS Geologic Survey 7.5' quadrangle for Holtville West on Assessor's Parcel Number (APN) 054-080-023 within Section 11 of Township 16 South, Range 14 East, San Bernardino Base Meridian. The westbound offramp of Interstate 8 at SR-111 is located approximately 0.25 miles south of the Project site.

The Project includes 19 fuel pumps (38 fueling positions) under two separate canopies (totaling 9,000 square feet [SF]), and a 5,982 SF convenience store building. Additional improvements include three (3) underground storage tanks (USTs) for fuel storage; two underground water storage tanks; on-site water and wastewater treatment facilities; parking, landscaping, drainage, and access improvements. A General Plan Amendment (#22-0002), to change the Project site's land use designation from "Agriculture" to "Urban Area"; as well as a Zone Change (#22-00015), to change zoning from A-2 (General Agricultural) to C-3 (Heavy Commercial) are also proposed (See Figures 3 and 4). A tentative parcel map (Parcel Map #02499) is proposed to separate Maverik Fueling Station and Convenience Store site from the balance of the parcel (Figure 5, Proposed Tentative Map).

If your tribe would like to consult with the County of Imperial regarding this project, please respond within ninety (90) days of the date of this letter. Under SB 18, any sensitive information shared with the County regarding cultural places and/or sacred sites will be kept strictly confidential and will not be divulged to the public.

Please send your written response before April 2, 2024 to Derek Newland, Planner III or by email to CommentLetters@co.imperial.ca.us. If the County does not receive a response within 90 days, the County will proceed with the project. Thank you and we look forward to your response.

Sincerely,

JIM MINNICK, DIRECTOR
Imperial County Planning & Development Services

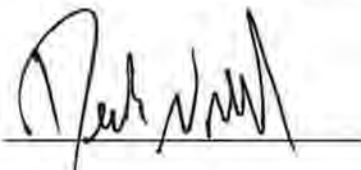
BY: 

Derek Newland, Planner III

- Attachments: Figure 1 – Regional Location Map
Figure 2 – Project Site
Figure 3 – Proposed General Plan Amendment
Figure 4 – Proposed Zone Change
Figure 5 – Proposed Tentative Map



Imperial County Planning & Development Services Planning / Building

Jim Minnick
DIRECTOR

February 1, 2024

CERTIFIED NO. 7018 1830 0000 2357 3534

Ray Teran, Resource Management Director
Viejas Band of Kumeyaay Indians
1 Viejas Grade Road Alpine, CA, 91901

RE: Notice of Opportunity to Consult under SB-18 for the Maverik Fueling Station and Convenience Store Project (General Plan Amendment #22-0002, Zone Change #22-00015 and Parcel Map #02499) APN 054-080-023

Dear Ray Teran, Resource Management Director,

This letter formally invites you to request consultation pursuant to Senate Bill 18 (SB 18; Government Code Section 65352.3) regarding the proposed Maverik Fueling Station and Convenience Store Project. As you may know, SB 18 became effective on March 1, 2005 and requires local governments to consult with California Native American Tribes about proposed local land use planning decisions for the purpose of protecting traditional tribal cultural places and sacred sites. The intent of SB 18 is to provide an opportunity for interested tribes and local governments to work together toward the protection of tribal cultural places that might not appear on cultural resource registries. To this end, the County is contacting you to consult on this project.

The County of Imperial is committed to fulfilling the goals of SB 18 and believes that tribal participation in the planning process is crucial for the success of the proposed project. The Imperial County Planning and Development Services Department has contacted the Native American Heritage Commission (NAHC) in order to obtain a list of tribes who should be included in the planning consultation process regarding the proposed project and your name was included in the NAHC's response.

The Maverik Fueling Station and Convenience Store Project includes a fueling station and convenience store on 10 acres of an approximately 50-acre parcel within unincorporated Imperial County (County), California, approximately 1.5 miles east of the City of El Centro (Figure 1, Regional Location). The Project site is located on the southeast corner of Hawes Road and Ross Avenue, east of State Route 111 and is bound by Ross Avenue on the north and by Hawes Road and the Imperial Irrigation District's Acacia Five Drain A on the west (Figure 2, Project Site). The Project site is also located within the USGS Geologic Survey 7.5' quadrangle for Holtville West on Assessor's Parcel Number (APN) 054-080-023 within Section 11 of Township 16 South, Range 14 East, San Bernardino Base Meridian. The westbound offramp of Interstate 8 at SR-111 is located approximately 0.25 miles south of the Project site.

The Project includes 19 fuel pumps (38 fueling positions) under two separate canopies (totaling 9,000 square feet [SF]), and a 5,982 SF convenience store building. Additional improvements include three (3) underground storage tanks (USTs) for fuel storage; two underground water storage tanks; on-site water and wastewater treatment facilities; parking, landscaping, drainage, and access improvements. A General Plan Amendment (#22-0002), to change the Project site's land use designation from "Agriculture" to "Urban Area"; as well as a Zone Change (#22-00015), to change zoning from A-2 (General Agricultural) to C-3 (Heavy Commercial) are also proposed (See Figures 3 and 4). A tentative parcel map (Parcel Map #02499) is proposed to separate Maverik Fueling Station and Convenience Store site from the balance of the parcel (Figure 5, Proposed Tentative Map).

If your tribe would like to consult with the County of Imperial regarding this project, please respond within ninety (90) days of the date of this letter. Under SB 18, any sensitive information shared with the County regarding cultural places and/or sacred sites will be kept strictly confidential and will not be divulged to the public.

Please send your written response before April 2, 2024 to Derek Newland, Planner III or by email to CommentLetters@co.imperial.ca.us. If the County does not receive a response within 90 days, the County will proceed with the project. Thank you and we look forward to your response.

Sincerely,

JIM MINNICK, DIRECTOR
Imperial County Planning & Development Services

BY:  _____

Derek Newland, Planner III

- Attachments:
- Figure 1 – Regional Location Map
 - Figure 2 – Project Site
 - Figure 3 – Proposed General Plan Amendment
 - Figure 4 – Proposed Zone Change
 - Figure 5 – Proposed Tentative Map



Imperial County Planning & Development Services Planning / Building

Jim Minnick
DIRECTOR

CERTIFIED NO. 7018 1830 0000 2357 3312

February 1, 2024

Rebecca Osuna, Chairperson
Inaja-Cosmit Band of Indians
2005 S. Escondido Blvd. Escondido, CA, 92025

RE: Notice of Opportunity to Consult under SB-18 for the Maverik Fueling Station and Convenience Store Project (General Plan Amendment #22-0002, Zone Change #22-00015 and Parcel Map #02499) APN 054-080-023

Dear Rebecca Osuna, Chairperson,

This letter formally invites you to request consultation pursuant to Senate Bill 18 (SB 18; Government Code Section 65352.3) regarding the proposed Maverik Fueling Station and Convenience Store Project. As you may know, SB 18 became effective on March 1, 2005 and requires local governments to consult with California Native American Tribes about proposed local land use planning decisions for the purpose of protecting traditional tribal cultural places and sacred sites. The intent of SB 18 is to provide an opportunity for interested tribes and local governments to work together toward the protection of tribal cultural places that might not appear on cultural resource registries. To this end, the County is contacting you to consult on this project.

The County of Imperial is committed to fulfilling the goals of SB 18 and believes that tribal participation in the planning process is crucial for the success of the proposed project. The Imperial County Planning and Development Services Department has contacted the Native American Heritage Commission (NAHC) in order to obtain a list of tribes who should be included in the planning consultation process regarding the proposed project and your name was included in the NAHC's response.

The Maverik Fueling Station and Convenience Store Project includes a fueling station and convenience store on 10 acres of an approximately 50-acre parcel within unincorporated Imperial County (County), California, approximately 1.5 miles east of the City of El Centro (Figure 1, Regional Location). The Project site is located on the southeast corner of Hawes Road and Ross Avenue, east of State Route 111 and is bound by Ross Avenue on the north and by Hawes Road and the Imperial Irrigation District's Acacia Five Drain A on the west (Figure 2, Project Site). The Project site is also located within the USGS Geologic Survey 7.5' quadrangle for Holtville West on Assessor's Parcel Number (APN) 054-080-023 within Section 11 of Township 16 South, Range 14 East, San Bernardino Base Meridian. The westbound offramp of Interstate 8 at SR-111 is located approximately 0.25 miles south of the Project site.

The Project includes 19 fuel pumps (38 fueling positions) under two separate canopies (totaling 9,000 square feet [SF]), and a 5,982 SF convenience store building. Additional improvements include three (3) underground storage tanks (USTs) for fuel storage; two underground water storage tanks; on-site water and wastewater treatment facilities; parking, landscaping, drainage, and access improvements. A General Plan Amendment (#22-0002), to change the Project site's land use designation from "Agriculture" to "Urban Area"; as well as a Zone Change (#22-00015), to change zoning from A-2 (General Agricultural) to C-3 (Heavy Commercial) are also proposed (See Figures 3 and 4). A tentative parcel map (Parcel Map #02499) is proposed to separate Maverik Fueling Station and Convenience Store site from the balance of the parcel (Figure 5, Proposed Tentative Map).

If your tribe would like to consult with the County of Imperial regarding this project, please respond within ninety (90) days of the date of this letter. Under SB 18, any sensitive information shared with the County regarding cultural places and/or sacred sites will be kept strictly confidential and will not be divulged to the public.

Please send your written response before April 2, 2024 to Derek Newland, Planner III or by email to CommentLetters@co.imperial.ca.us. If the County does not receive a response within 90 days, the County will proceed with the project. Thank you and we look forward to your response.

Sincerely,

JIM MINNICK, DIRECTOR
Imperial County Planning & Development Services

BY: 

Derek Newland, Planner III

Attachments: Figure 1 – Regional Location Map
Figure 2 – Project Site
Figure 3 – Proposed General Plan Amendment
Figure 4 – Proposed Zone Change
Figure 5 – Proposed Tentative Map



Imperial County Planning & Development Services Planning / Building

February 1, 2024

Jim Minnick
DIRECTOR

CERTIFIED NO. 7018 1830 0000 2357 3282

Robert Pinto, Chairperson
Ewiiapaayp Band of Kumeyaay Indians
4054 Willows Road Alpine, CA, 91901

RE: Notice of Opportunity to Consult under SB-18 for the Maverik Fueling Station and Convenience Store Project (General Plan Amendment #22-0002, Zone Change #22-00015 and Parcel Map #02499) APN 054-080-023

Dear Robert Pinto, Chairperson,

This letter formally invites you to request consultation pursuant to Senate Bill 18 (SB 18; Government Code Section 65352.3) regarding the proposed Maverik Fueling Station and Convenience Store Project. As you may know, SB 18 became effective on March 1, 2005 and requires local governments to consult with California Native American Tribes about proposed local land use planning decisions for the purpose of protecting traditional tribal cultural places and sacred sites. The intent of SB 18 is to provide an opportunity for interested tribes and local governments to work together toward the protection of tribal cultural places that might not appear on cultural resource registries. To this end, the County is contacting you to consult on this project.

The County of Imperial is committed to fulfilling the goals of SB 18 and believes that tribal participation in the planning process is crucial for the success of the proposed project. The Imperial County Planning and Development Services Department has contacted the Native American Heritage Commission (NAHC) in order to obtain a list of tribes who should be included in the planning consultation process regarding the proposed project and your name was included in the NAHC's response.

The Maverik Fueling Station and Convenience Store Project includes a fueling station and convenience store on 10 acres of an approximately 50-acre parcel within unincorporated Imperial County (County), California, approximately 1.5 miles east of the City of El Centro (Figure 1, Regional Location). The Project site is located on the southeast corner of Hawes Road and Ross Avenue, east of State Route 111 and is bound by Ross Avenue on the north and by Hawes Road and the Imperial Irrigation District's Acacia Five Drain A on the west (Figure 2, Project Site). The Project site is also located within the USGS Geologic Survey 7.5' quadrangle for Holtville West on Assessor's Parcel Number (APN) 054-080-023 within Section 11 of Township 16 South, Range 14 East, San Bernardino Base Meridian. The westbound offramp of Interstate 8 at SR-111 is located approximately 0.25 miles south of the Project site.

The Project includes 19 fuel pumps (38 fueling positions) under two separate canopies (totaling 9,000 square feet [SF]), and a 5,982 SF convenience store building. Additional improvements include three (3) underground storage tanks (USTs) for fuel storage; two underground water storage tanks; on-site water and wastewater treatment facilities; parking, landscaping, drainage, and access improvements. A General Plan Amendment (#22-0002), to change the Project site's land use designation from "Agriculture" to "Urban Area"; as well as a Zone Change (#22-00015), to change zoning from A-2 (General Agricultural) to C-3 (Heavy Commercial) are also proposed (See Figures 3 and 4). A tentative parcel map (Parcel Map #02499) is proposed to separate Maverik Fueling Station and Convenience Store site from the balance of the parcel (Figure 5, Proposed Tentative Map).

If your tribe would like to consult with the County of Imperial regarding this project, please respond within ninety (90) days of the date of this letter. Under SB 18, any sensitive information shared with the County regarding cultural places and/or sacred sites will be kept strictly confidential and will not be divulged to the public.

Please send your written response before April 2, 2024 to Derek Newland, Planner III or by email to CommentLetters@co.imperial.ca.us. If the County does not receive a response within 90 days, the County will proceed with the project. Thank you and we look forward to your response.

Sincerely,

JIM MINNICK, DIRECTOR
Imperial County Planning & Development Services

BY:



Derek Newland, Planner III

Attachments: Figure 1 – Regional Location Map
Figure 2 – Project Site
Figure 3 – Proposed General Plan Amendment
Figure 4 – Proposed Zone Change
Figure 5 – Proposed Tentative Map



Imperial County Planning & Development Services Planning / Building

Jim Minnick
DIRECTOR

February 1, 2024

CERTIFIED NO. 7018 1830 0000 2357 3497

Thomas Tortez, Chairperson
Torres-Martinez Desert Cahuilla Indians
P.O. Box 1160 Thermal, CA, 92274

RE: Notice of Opportunity to Consult under SB-18 for the Maverik Fueling Station and Convenience Store Project (General Plan Amendment #22-0002, Zone Change #22-00015 and Parcel Map #02499) APN 054-080-023

Dear Thomas Tortez, Chairperson,

This letter formally invites you to request consultation pursuant to Senate Bill 18 (SB 18; Government Code Section 65352.3) regarding the proposed Maverik Fueling Station and Convenience Store Project. As you may know, SB 18 became effective on March 1, 2005 and requires local governments to consult with California Native American Tribes about proposed local land use planning decisions for the purpose of protecting traditional tribal cultural places and sacred sites. The intent of SB 18 is to provide an opportunity for interested tribes and local governments to work together toward the protection of tribal cultural places that might not appear on cultural resource registries. To this end, the County is contacting you to consult on this project.

The County of Imperial is committed to fulfilling the goals of SB 18 and believes that tribal participation in the planning process is crucial for the success of the proposed project. The Imperial County Planning and Development Services Department has contacted the Native American Heritage Commission (NAHC) in order to obtain a list of tribes who should be included in the planning consultation process regarding the proposed project and your name was included in the NAHC's response.

The Maverik Fueling Station and Convenience Store Project includes a fueling station and convenience store on 10 acres of an approximately 50-acre parcel within unincorporated Imperial County (County), California, approximately 1.5 miles east of the City of El Centro (Figure 1, Regional Location). The Project site is located on the southeast corner of Hawes Road and Ross Avenue, east of State Route 111 and is bound by Ross Avenue on the north and by Hawes Road and the Imperial Irrigation District's Acacia Five Drain A on the west (Figure 2, Project Site). The Project site is also located within the USGS Geologic Survey 7.5' quadrangle for Holtville West on Assessor's Parcel Number (APN) 054-080-023 within Section 11 of Township 16 South, Range 14 East, San Bernardino Base Meridian. The westbound offramp of Interstate 8 at SR-111 is located approximately 0.25 miles south of the Project site.

The Project includes 19 fuel pumps (38 fueling positions) under two separate canopies (totaling 9,000 square feet [SF]), and a 5,982 SF convenience store building. Additional improvements include three (3) underground storage tanks (USTs) for fuel storage; two underground water storage tanks; on-site water and wastewater treatment facilities; parking, landscaping, drainage, and access improvements. A General Plan Amendment (#22-0002), to change the Project site's land use designation from "Agriculture" to "Urban Area"; as well as a Zone Change (#22-00015), to change zoning from A-2 (General Agricultural) to C-3 (Heavy Commercial) are also proposed (See Figures 3 and 4). A tentative parcel map (Parcel Map #02499) is proposed to separate Maverik Fueling Station and Convenience Store site from the balance of the parcel (Figure 5, Proposed Tentative Map).

If your tribe would like to consult with the County of Imperial regarding this project, please respond within ninety (90) days of the date of this letter. Under SB 18, any sensitive information shared with the County regarding cultural places and/or sacred sites will be kept strictly confidential and will not be divulged to the public.

Please send your written response before April 2, 2024 to Derek Newland, Planner III or by email to CommentLetters@co.imperial.ca.us. If the County does not receive a response within 90 days, the County will proceed with the project. Thank you and we look forward to your response.

Sincerely,

JIM MINNICK, DIRECTOR
Imperial County Planning & Development Services

BY: 
Derek Newland, Planner III

Attachments: Figure 1 – Regional Location Map
Figure 2 – Project Site
Figure 3 – Proposed General Plan Amendment
Figure 4 – Proposed Zone Change
Figure 5 – Proposed Tentative Map

EEC ORIGINAL PKG

SB-18 Responses

This page intentionally left blank.



03-015-2024-004

February 12, 2024

[VIA EMAIL TO:dereknewland@co.imperial.ca.us]
Imperial County
Derek Newland
801 Main St.
El Centro, CA 92243

Re: Maverik Fueling Station

Dear Derek Newland,

The Agua Caliente Band of Cahuilla Indians (ACBCI) appreciates your efforts to include the Tribal Historic Preservation Office (THPO) in the Maverik Fueling Station project. The project area is not located within the boundaries of the ACBCI Reservation. However, it is within the Tribe's Traditional Use Area. For this reason, the ACBCI THPO requests the following:

*Formal government to government consultation under California Senate Bill 18 (SB-18).

*A cultural resources inventory of the project area by a qualified archaeologist prior to any development activities in this area.

*The presence of an approved Cultural Resource Monitor(s) during any ground disturbing activities (including archaeological testing and surveys). Should buried cultural deposits be encountered, the Monitor may request that destructive construction halt and the Monitor shall notify a Qualified Archaeologist (Secretary of the Interior's Standards and Guidelines) to investigate and, if necessary, prepare a mitigation plan for submission to the State Historic Preservation Officer.

*A copy of the records search with associated survey reports and site records from the information center.

*Copies of any cultural resource documentation (report and site records) generated in connection with this project.

Again, the Agua Caliente appreciates your interest in our cultural heritage. If you have questions or require additional information, please call me at (760) 423-3485. You may also email me at ACBCI-THPO@aguacaliente.net.

Cordially,

AGUA CALIENTE BAND OF CAHUILLA INDIANS



Xitlaly Madrigal
Cultural Resources Analyst
Tribal Historic Preservation Office
AGUA CALIENTE BAND
OF CAHUILLA INDIANS

Maverik Fueling Station Record Search results

John Gust <jgust@cogstone.com>

Thu 2/29/2024 8:29 AM

To:THPO Consulting <ACBCI-THPO@aguacaliente.net>

Good morning Ms. Padilla,

The SCIC cultural record search results for the Maverik Fueling Station Project are too large to mail but can be securely downloaded using the link below. Let me know if you have any questions. Please cc Christina Willis (christina@willisenvironmentalplanning.com) on any communication.

 [Maverik - RS to ABCI THPO](#)

John Gust

John Gust, PhD, RPA

Vice President of Learning and Development

Principal Investigator for Archaeology III/Project Manager III

Cogstone Resource Management

P.O. Box 7366, Orange, CA, 92863

714-974-8300 office x 127 | 951-315-6033 cell

jgust@cogstone.com www.cogstone.com

Offices in San Diego, Riverside, Morro Bay, Sacramento

Uncover the past. Build the future.

Check out our new website at www.cogstone.com !

EEC ORIGINAL PKG

From: Ray Teran <rteran@viejas-nsn.gov>

Sent: Thursday, February 1, 2024 2:33 PM

To: John Robb <JohnRobb@co.imperial.ca.us>; Ernest Pingleton <epingleton@viejas-nsn.gov>; alan hatcher <Hatchera77@hotmail.com>

Cc: Jim Minnick <JimMinnick@co.imperial.ca.us>; Michael Abraham <MichaelAbraham@co.imperial.ca.us>; Diana Robinson <DianaRobinson@co.imperial.ca.us>; Derek Newland <DerekNewland@co.imperial.ca.us>; Laryssa Alvarado <laryssaalvarado@co.imperial.ca.us>; Rosa Soto <RosaSoto@co.imperial.ca.us>; Aimee Trujillo <aimeetrujillo@co.imperial.ca.us>; Jenyssa Gutierrez <jenyssagutierrez@co.imperial.ca.us>; Kamika Mitchell <kamikamitchell@co.imperial.ca.us>; Olivia Lopez <olivialopez@co.imperial.ca.us>

Subject: RE: SB-18 Maverik Fueling Station and Convenience Store Project (GPA22-0002/ZC22-0015/PM02499)

CAUTION: This email originated outside your organization; please use caution.

The Viejas Band of Kumeyaay Indians (“Viejas”) has reviewed the proposed project and at this time we have determined that the project site has cultural significance or ties to Viejas. Cultural resources have been located within or adjacent to the APE-DE of the proposed project.

Viejas Band requests that a Kumeyaay cultural monitor be on site for ground disturbing activities and to inform us of any new developments such as inadvertent discovery of cultural artifacts, cremation sites, or human remains.

If you wish to utilize Viejas cultural monitors (Viejas rate is \$54.15 an hour plus GSA mileage), please call Ernest Pingleton at 619-655-0410 or e-mail, epingleton@viejas-nsn.gov, for contracting and scheduling thank you.

If a Tribe, having a closer proximity to the project, requests to perform cultural monitoring, Viejas will defer to them.

EEC ORIGINAL PKG

E

Energy Memo

This page intentionally left blank.



January 2, 2024

Christina Willis, President
Willis Environmental Planning
238 Sychar Road
San Diego, CA 92114

SUBJECT: Energy Calculation Memorandum for the Maverik Travel Center Project

Dear Ms. Willis;

Birdseye Planning Group (BPG) is pleased to submit this memorandum quantifying energy demand associated with the proposed Maverik Travel Center project near the City of El Centro in unincorporated Imperial County, California. The information contained herein will assist with the preparation of an Initial Study and Mitigated Negative Declaration (MND) that identifies project-specific impacts associated with developing the proposed project.

Project Description

Maverik is proposing to develop a fueling station and convenience store on a 10-acre site located on 10 gross acres of the approximately 50-acre parcel within unincorporated Imperial County (County), California, approximately 1.5 miles east of the City of El Centro (Assessor's Parcel Number 054-080-023). The Project site is located on the southeast corner of Hawes Road and Ross Avenue, east of State Route 111 (SR-111/Imperial Valley Pioneers Expressway) and is bound by Ross Avenue on the north, by Hawes Road and the Imperial Irrigation District's Acacia Five Drain A on the west.

The Maverik Fueling Station and Convenience Store Project (Project) includes 19 fuel pumps (38 fueling positions) under two separate canopies (totaling 9,0000 square feet (sf), and a 5,982 SF convenience store building. Additional improvements include three (3) underground storage tanks for fuel storage; two underground water storage tanks; on-site water and wastewater treatment facilities; parking, landscaping, drainage, and access improvements. Vehicular access would be provided via three (3) ingress/egress drives along the south side of Ross Avenue. The westernmost access would be a 40-foot driveway that would allow for left- and right-turn movements by vehicles accessing the fueling area and convenience store. This entrance would be located approximately 215 feet east of the Ross Avenue/SR-111 intersection. The second proposed entrance would be located approximately 150 feet east of the first and would provide a 60-foot inbound/outbound driveway leading directly to the proposed truck fueling stations. The third and easternmost driveway would be

located 220 feet east of the second and would provide a 50-foot driveway that would permit the full range of left- and right-turn movements, inbound and outbound. Parking would be provided in three (3) parking areas for a total of 45 parking spaces, including two accessible spaces. No overnight parking would be allowed and parking within the fueling area would be limited to 30 minutes. Project construction is anticipated to begin in late 2024 and be operational in late 2025.

Energy Demand

The following tables show estimated gasoline demand for construction workers (Table 1) and construction equipment (Table 2). All fuel calculations are based on the total Carbon Dioxide Equivalent (CO₂e) value calculated for each construction phase and vehicle miles traveled (VMT) using the California Emission Estimator Model (CalEEMod) version 2022.1. Data are reported in annual metric tons of CO₂e for the duration of each construction phase. Metric tons are converted to kilogram CO₂e and then divided by a conversion factor used by the U.S. Environmental Protection Agency to estimate gallons of gasoline (8.87) and diesel fuel (10.18) consumed based on carbon emissions.

Table 1 shows the gasoline demand for construction workers by project phase. Table 2 shows the diesel fuel demand for equipment operation. For the purpose of determining fuel demand, it was assumed that all worker vehicles would be gasoline fueled and all construction equipment would diesel fueled.

Table 1
Construction Worker Gasoline Demand

	CO ₂ E MT	Kg CO ₂ e	Gallons
Demolition – 2024	1.97	1,002	113
Site Preparation – 2024	1.15	1,150	130
Grading – 2024	0.91	910	103
Grading - 2025	4.89	4,890	551
Building Construction - 2025	5.16	5,160	582
Architectural Coating - 2025	0.57	570	64
Paving - 2025	2.22	2,220	250
Total	16.87	15,902	1,793

During operation, the project would generate demand for 529,302 kilowatt hours (kWh) of electricity and 130,091 British Thermal Units (BTU) of natural gas annually. The annual gasoline demand generated by passenger vehicles would be approximately 101,803 gallons. The annual diesel demand consumed by trucks entering and exiting the site for refueling would be approximately 49,804 gallons.

Table 2
Construction Equipment Diesel Demand

2021	CO2E MT	Kg CO2e	Gallons
Demolition – 2024	31.2	31,200	3,065
Site Preparation – 2024	24.1	24,100	2,367
Grading - 2024	13.2	13,200	1,297
Grading - 2025	71.7	71,700	7,043
Building Construction - 2025	210	210,000	20,629
Architectural Coating - 2025	15.8	15,800	1,552
Paving - 2025	2.31	2,310	227
Total	368.31	368,310	36,180

Please let me know if you have questions. You can reach me via e-mail at 760-712-2199 or via e-mail ryan@birdseyeplanninggroup.com.

Regards,



Ryan Birdseye
Principal

This page intentionally left blank.



ENGINEERING • GEOTECHNICAL • ENVIRONMENTAL (ESA I & II) •
MATERIALS TESTING • SPECIAL INSPECTIONS •
ORGANIC CHEMISTRY • PAVEMENT
DESIGN • GEOLOGY

GEOTECHNICAL ENGINEERING STUDY

Proposed Maverik Store

SEC of Ross Avenue & Interstate 8
El Centro, California

CMT PROJECT NO. 17436

FOR:

Cardno, Inc.

1142 West 2320 South, Suite A
West Valley City, Utah 84119

November 19, 2021

EEC ORIGINAL PKG

November 19, 2021

Mr. Russ Hamblin
Cardno, Inc.
1142 West 2320 South, Suite A
West Valley City, Utah 84119

Subject: Geotechnical Engineering Study
Proposed Maverik Store
SEC of Ross Avenue & Interstate 8
El Centro, California
CMT Project Number: 17436

Mr. Hamblin:

Submitted herewith is the report of our geotechnical engineering study for the subject site. This report contains the results of our findings and an engineering interpretation of the results with respect to the available project characteristics. It also contains recommendations to aid in the design and construction of the earth-related phases of this project.

On October 20, 2021 Cardno personnel were onsite and supervised the drilling of 6 bore holes extending to depths of 6.5 to 71.5 feet below the existing site grades. Samples of the subsurface soils encountered in the bore holes were collected for laboratory testing. Groundwater was encountered at about 37 feet below the surface. Based upon the results of our explorations, the proposed structures may be supported on conventional strip and spread footings founded on suitable, undisturbed, natural soils or structural fill placed on suitable, undisturbed natural soils. A detailed discussion of design and construction criteria is presented in this report.

We appreciate the opportunity to work with you at this stage of the project. CMT offers a full range of Geotechnical Engineering, Geological, Material Testing, Special Inspection services, and Phase I and II Environmental Site Assessments. With offices throughout Utah, Idaho, and Arizona, our staff is capable of efficiently serving your project needs. If we can be of further assistance or if you have any questions regarding this project, please do not hesitate to contact us at (801) 492-4132.

Sincerely,
CMT Engineering Laboratories



Jeffrey J. Egbert, P.E., LEED A.P., M. ASCE
Senior Geotechnical Engineer

Reviewed By:



William G. Turner, P.E.
Senior Geotechnical Engineer

TABLE OF CONTENTS

1.0 INTRODUCTION	1
<u>1.1 General</u>	1
<u>1.2 Objectives, Scope and Authorization</u>	1
<u>1.3 Description of Proposed Construction</u>	2
<u>1.4 Executive Summary</u>	2
2.0 FIELD EXPLORATION	3
<u>2.1 General</u>	3
<u>2.2 Infiltration Testing</u>	3
3.0 LABORATORY TESTING	4
4.0 GEOLOGIC & SEISMIC CONDITIONS	5
<u>4.1 Geologic Setting</u>	5
<u>4.2 Faulting</u>	6
<u>4.3 Seismicity</u>	6
4.3.1 Site Class	6
4.3.2 Ground Motions.....	6
4.3.3 Liquefaction	7
<u>4.4 Other Geologic Hazards</u>	7
5.0 SITE CONDITIONS	7
<u>5.1 Surface Conditions</u>	7
<u>5.2 Subsurface Soils</u>	7
<u>5.3 Groundwater</u>	8
<u>5.4 Site Subsurface Variations</u>	8
6.0 SITE PREPARATION AND GRADING	8
<u>6.1 General</u>	8
<u>6.2 Temporary Excavations</u>	9
<u>6.3 Fill Material</u>	9
<u>6.4 Fill Placement and Compaction</u>	10
<u>6.5 Utility Trenches</u>	10
<u>6.6 Stabilization</u>	11
7.0 FOUNDATION RECOMMENDATIONS	11
<u>7.1 Foundation Recommendations</u>	11
<u>7.2 Installation</u>	11
<u>7.3 Estimated Settlement</u>	12
<u>7.4 Lateral Resistance</u>	12
<u>7.5 Uplift Loads</u>	12
8.0 LATERAL EARTH PRESSURES	12
9.0 BOUYANT FORCES	13
10.0 FLOOR SLABS	13
11.0 DRAINAGE RECOMMENDATIONS	13
12.0 PAVEMENTS	14
13.0 QUALITY CONTROL	15
<u>13.1 Field Observations</u>	15
<u>13.2 Fill Compaction</u>	15
<u>13.3 Excavations</u>	15
14.0 LIMITATIONS	15

APPENDIX

Figure 1: Site Plan

Figures 2 - 7: Bore Hole Logs

Figure 8: Key to Symbols

Figures 9-11: DCP Test Results

1.0 INTRODUCTION

1.1 General

CMT Engineering Laboratories (CMT) was retained to conduct a geotechnical subsurface study for a proposed Maverik Store. The site for the proposed development is situated at the southeast corner of Highway 111 and Ross Avenue in El Centro, California as shown on the **Vicinity Map** below.



VICINITY MAP

1.2 Objectives, Scope and Authorization

The objectives and scope of our study were planned in communications between Mr. Russ Hamblin of Cardno, Inc., and Mr. Jeffrey Egbert of CMT Engineering Laboratories (CMT). In general, the objectives of this study were to define and evaluate the subsurface soil and groundwater conditions at the site, and provide appropriate foundation, earthwork, pavement and seismic recommendations to be utilized in the design and construction of the proposed development.

In accomplishing these objectives, subsurface explorations, consisting of the drilling/logging/sampling of 6 bore holes, an infiltration test in one of the bore holes, and Dynamic Cone Penetration (DCP) tests, were performed by Cardno personnel. Our scope of work included laboratory testing of samples of the subsurface soils from the

site as provided to us, and conducting an office program which included correlating available data, performing engineering analyses, and preparing this summary report.

1.3 Description of Proposed Construction

We understand that construction of a new Maverik convenience store and fuel station with accompanying fuel islands and canopies, a truck scale, and underground fuel storage tanks, is planned for the site. We project that wall loads for the store building will not exceed 4,000 pounds per linear foot. Floor slab loads are anticipated to be relatively light, with an average uniform loading not exceeding 150 pounds per square foot.

The fuel island canopies will be supported by steel frames and columns extending to the foundation system. It is projected that the maximum canopy downward column loads will be on the order of 60,000 pounds. In addition, uplift and lateral loads will be imposed upon these foundations.

If the structural loading conditions are different than we have projected, please notify us so that any appropriate modifications to our conclusions and recommendations contained herein can be made.

Parking/drive paved areas will utilize both asphalt and concrete pavement. Concrete pavement will likely be installed in front of the proposed store structure, as well as in the canopy fuel islands and over the underground storage tank area. In other areas, asphalt concrete sections will likely be used. It appears that there will be 7 hi-flow lanes for the project. Traffic for the medium duty pavement areas (store front and automobile pump island) is projected to consist of 1,100 automobiles and light trucks per day, and a daily medium-weight delivery truck. For the heavy duty section (drive lane and hi-flow lanes), a daily fuel delivery truck, 200 semi-trucks per day, a weekly garbage truck, and an occasional fire truck are estimated.

1.4 Executive Summary

The most significant geotechnical aspects regarding site development include the following:

1. Vegetation and topsoil on the surface to be removed.
2. Subsurface natural soils within the depths explored consisted of predominately of CLAY (CL, CH) and a few SILT (ML) layers;
3. Increased moisture was noted about 8 feet below the surface, with a more pronounced groundwater level at about 15 feet below the surface, which will likely affect the tank excavations;
4. Foundations and floor slabs may be constructed on suitable undisturbed, natural soils or on structural/engineered fill which extends to natural soils.

A qualified geotechnical engineer must assess that undocumented fill, topsoil, debris, disturbed or unsuitable soils have been removed and that suitable soils have been encountered prior to placing structural/site grading fills, footings, slabs, and pavements.

In the following sections, detailed discussions pertaining to the site and subsurface descriptions, geologic/seismic setting, earthwork, foundations, lateral resistance, lateral pressure, floor slabs, and pavements are provided.

2.0 FIELD EXPLORATION

2.1 General

In order to define and evaluate the subsurface soil and groundwater conditions, 6 bore holes were drilled at the site to depths of approximately 6.5 to 71.5 feet below the existing ground surface. Supervision of the drilling, logging and sampling of the bore holes was performed by Cardo personnel. Approximate locations of the bore holes are presented on **Figure 1** in the Appendix.

Samples of the subsurface soils encountered in the bore holes were collected at varying depths through the hollow stem drill augers. Relatively undisturbed samples were obtained by driving a split-spoon sampler with 2.5-inch outside diameter rings/liners into the undisturbed soils below the drill augers. Disturbed samples were collected utilizing a standard split spoon sampler. This standard split spoon sampler was driven 18 inches into the soils below the drill augers using a 140-pound hammer free-falling a distance of 30 inches. The number of hammer blows needed for each 6-inch interval was recorded. The sum of the hammer blows for the final 12 inches of penetration is known as a standard penetration test and this 'blow count' was recorded on the bore hole logs. The blow count provides a reasonable approximation of the relative density of granular soils, but only a limited indication of the relative consistency of fine-grained soils because the consistency of these soils is significantly influenced by the moisture content.

The subsurface soil samples retrieved from the bore holes were classified in the field based upon visual examination in general accordance with ASTM¹ D-2488. Graphic logs of the bore holes, including a description of the soil strata encountered, are presented on the **Bore Hole Logs, Figures 2 through 7**, included in the Appendix. Sampling information and other pertinent data and observations are also included on the logs. In addition, a **Key to Symbols** defining the terms and symbols used on the logs is provided as **Figure 8** in the Appendix.

2.2 Infiltration Testing

An infiltration test was performed in bore hole B-3 by drilling to the depth shown on the log, withdrawing the auger, filling the hole with water, and measuring the rate the water level dropped with time. The test was monitored for approximately 2 hours and the water level dropped approximately 10 inches in that time (12 minutes per inch). This rate will likely slow over time due to siltation and an appropriate factor of safety should be applied. We recommend visual observation of soils at proposed sump locations.

¹American Society for Testing and Materials

3.0 LABORATORY TESTING

Of the samples collected from the bore holes representative samples were selected for laboratory testing. Various laboratory tests were performed to refine field classifications and assess pertinent engineering properties, as follows:

1. Moisture Content, ASTM D-2216, Percent moisture representative of field conditions
2. Dry Density, ASTM D-2937, Dry unit weight representing field conditions
3. Atterberg Limits, ASTM D-4318, Plasticity and workability
4. Gradation Analysis, ASTM D-1140, C-136/C-117, Grain Size Analysis
5. One Dimension Consolidation, ASTM D-2435, Consolidation properties

To provide data for an analysis of potential settlement from structural loading, a one-dimensional consolidation test was performed on 3 relatively undisturbed samples of the subsurface soils collected in bore holes. Based upon data obtained from the consolidation testing, the clay soils at this site are moderately over-consolidated and moderately compressible under additional loading. Detailed results of the consolidation tests are maintained within our files and can be transmitted to you, if so desired.

Laboratory test results are presented on the exploration logs (**Figures 2 through 7**) and in the following Lab Summary Table:

LAB SUMMARY TABLE

BORE HOLE	DEPTH (feet)	SAMPLE TYPE	SOIL CLASS	MOISTURE CONTENT(%)	DRY DENSITY (pcf)	GRADATION			ATTERBERG LIMITS			COLLAPSE (-)/ EXPANSION(+)
						GRAV.	SAND	FINES	LL	PL	PI	
B-1	5	Rings	CL	23	102				46	21	25	
	10	Rings	CL	25	98				42	21	21	
	25	SPT	CL	25				89				
	35	SPT	CH	23					60	24	36	
	55	SPT	CL	23					39	20	19	
	70	SPT	ML	28				98				
B-2	7.5	Rings	CL	24	98							
B-3	2.5	SPT	CH	16					57	22	35	
B-4	10	SPT	CH	36					52	19	33	
B-5	5	SPT	CL	21					37	20	17	
B-6	2.5	SPT	CL	16					45	20	25	

4.0 GEOLOGIC & SEISMIC CONDITIONS

4.1 Geologic Setting

The subject site is located in the Imperial Valley of south-central California. The Imperial Valley is deep sediment filled basin formed by extensional and transverse tectonism. The sediment is largely derived from ancient Lake Coahuila. The site sits at an elevation of approximately 35 feet below sea level.

The geology at the location of the subject site is depicted on an interactive map provided by the California Geological Survey². The geology at the location of the site and adjacent properties is mapped as “Quaternary Lake Deposits” (Map Unit Q1) dated upper Pleistocene. Unit Q1 is described in the referenced map as “Lake Coahuila deposits and Playa deposits.” Refer to the **Geologic Map**, shown below.

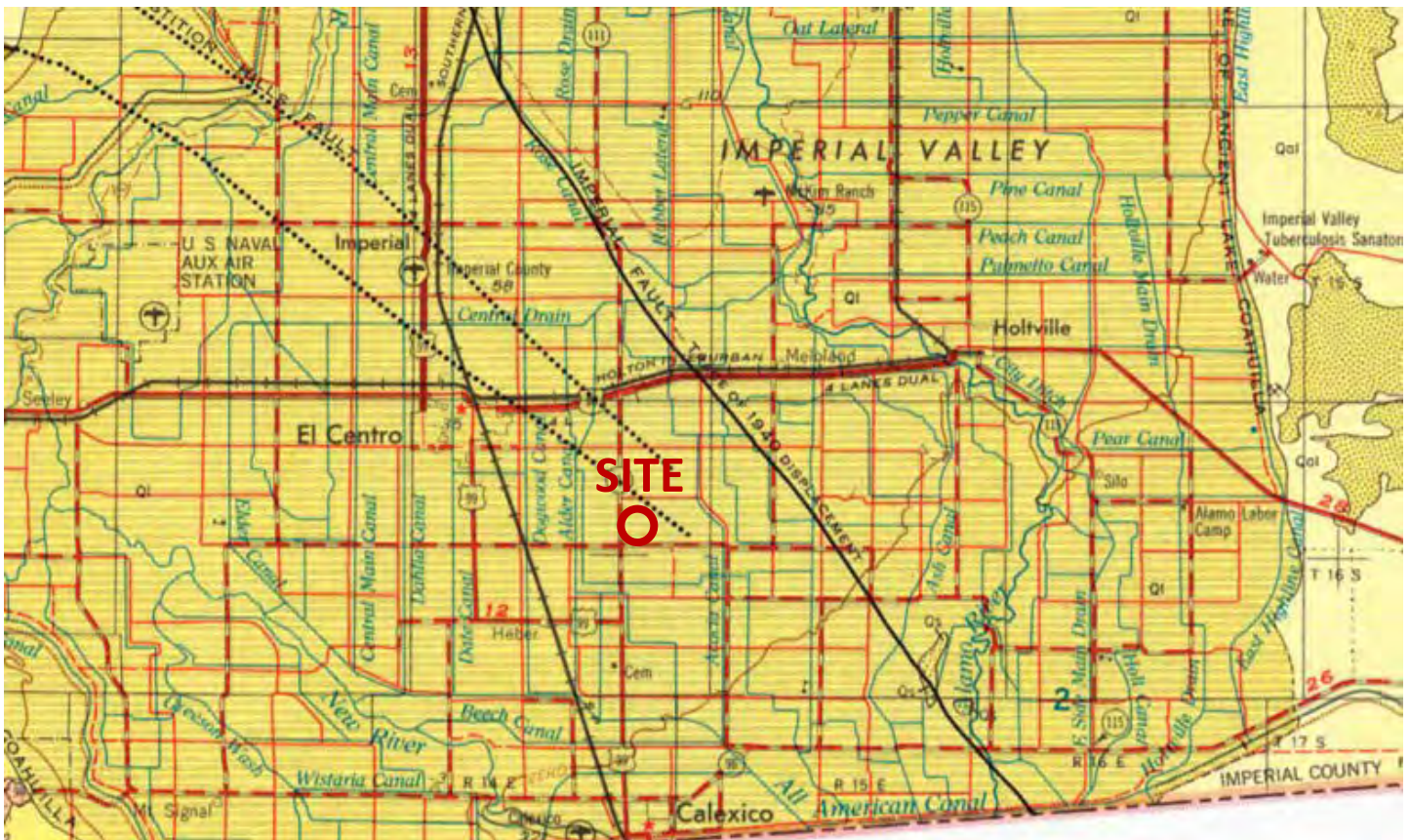

GEOLOGIC MAP

² <https://maps.conservation.ca.gov/cgs/qsd/app/>

4.2 Faulting

An interactive hazards map from the California Geological Survey³ was reviewed. No fault traces are shown on the referenced geologic map crossing, adjacent to, or projecting toward the subject site. The nearest mapped active (Holocene) fault is the Imperial Fault Zone approximately 2.6 miles to the northeast.

4.3 Seismicity

4.3.1 Site Class

We understand that the State of California Building Code (SCBC) 2019 was adopted on January 1, 2020, which we anticipate will be the code for design of the structures at this site. SCBC 2019 refers to Chapter 20, Site Classification Procedure for Seismic Design, of ASCE⁴ 7-16, which stipulates that the average values of shear wave velocity, blow count and/or shear strength within the upper 100 feet (30 meters) be utilized to determine seismic site class.

The blow counts in bore hole B-1, which extended to approximately 71.5 feet below the surface, average less than 15. These conditions indicate a Site Class E – Soft Clay profile for the site, which we recommend for seismic structural design.

4.3.2 Ground Motions

The seismic mapping utilized by the California Building Code provides values of peak ground, short period and long period spectral accelerations for the Site Class B/C boundary and the Risk-Targeted Maximum Considered Earthquake (MCE_R). This Site Class B/C boundary represents average bedrock values for the Western United States and must be corrected for local soil conditions. The following table summarizes the peak ground, short period and long period accelerations for the MCE_R event, and incorporates appropriate soil correction factors for a Site Class E soil profile at site grid coordinates of 39.1323 degrees north latitude and -122.1335 degrees west longitude:

SPECTRAL ACCELERATION PERIOD, T	SITE CLASS B/C BOUNDARY [mapped values] (g)	SITE COEFFICIENT	SITE CLASS E [adjusted for site class effects] (g)	MULTI-PLIER	DESIGN VALUES (g)
Peak Ground Acceleration	PGA = 1.100	F _{pga} = 1.100	PGA _M = 1.210	1.000	PGA _M = 1.210
0.2 Seconds (Long Period Acceleration)	S _s = 1.846	F _a = N/A	S _{MS} = N/A	0.667	S _{DS} = N/A
	(Exception 1:)	F _a = (1.200)	S _{MS} = (2.215)	0.667	S _{DS} = (1.477)
1.0 Second (Long Period Acceleration)	S ₁ = 0.650	F _v = N/A	S _{M1} = N/A	0.667	S _{D1} = N/A
	(Exception 3:)	F _v = (2.000)	S _{M1} = (1.300)	0.667	S _{D1} = (0.867)

NOTES: 1. TL (seconds): **8**

2. Site Class: **E**

3. Have data to verify? **yes**

4. ASCE 7-16 Requires Site-Specific Ground Motion Hazard Analysis (Since S_s ≥ 1.0 & S₁ ≥ 0.2 sec) - OR Can Use Exceptions 1 & 3 up to T=0.59sec (per §11.4.8)

³ <https://maps.conservation.ca.gov/cgs/DataViewer/>

⁴ American Society of Civil Engineers

As indicated in the above table, if the period of the proposed building is greater than 0.59 seconds, a site-specific ground motion hazard analysis (GMHA) is required for the site. If this situation applies, please contact CMT for a proposal to perform the GMHA. Otherwise, the higher exception values may be used for design a site-specific ground motion hazard analysis (GMHA) is required for the site. If a site-specific GMHA is desired instead of using the higher exception values, please contact CMT for a proposal to perform the GMHA.

4.3.3 Liquefaction

Liquefaction is defined as the condition when saturated, loose, sandy soils lose their support capabilities because of excessive pore water pressure which develops during a seismic event. Clayey soils, even if saturated, will generally not liquefy during a major seismic event.

Groundwater possibly as shallow as 8 feet was encountered in several of the bore holes, but the subsurface soils consist predominately of clay, typically considered non-liquefiable. Based upon these conditions, we estimate a low liquefaction potential for this site.

4.4 Other Geologic Hazards

No landslide deposits or features, including lateral spread deposits, are mapped on or adjacent to the site. The site is not located within a known or mapped potential debris flow, stream flooding⁵, or rock fall hazard area.

5.0 SITE CONDITIONS

5.1 Surface Conditions

At the time the subsurface explorations were performed the site consisted of undeveloped land vegetated with alfalfa. Site grades slope slightly downward to the south. Based on aerial photos readily available on the internet dating back to 1985, it appears the site has been used for agricultural purposes since that time. The site is bordered on the north by Ross Avenue, on the south and east by fields, and on the west by Highway 111 (see **Vicinity Map** in **Section 1.1** above).

5.2 Subsurface Soils

Topsoil was noted on the surface which extended about 12 inches in depth. Natural soils encountered consisted predominately of CLAY (CL), with some layers of Fat CLAY (CH), and a few layers of SILT (ML), all with varying amounts of sand and/or sand seams, extending to the maximum depth explored of 71.5 feet below the existing surface.

The clay and silt layers were brown in color, dry to wet, and of soft to stiff consistency based upon the SPT blow counts in the bore holes.

⁵<https://msc.fema.gov/portal/search?AddressQuery=Highway%20111%20%26%20Ross%20Ave.%2C%20El%20Centro%2C%20CA#searchresultsanchor>

For a more descriptive interpretation of subsurface conditions, please refer to the bore hole logs, **Figures 2 through 7**, which graphically represent the subsurface conditions encountered. The lines designating the interface between soil types on the logs generally represent approximate boundaries; in situ, the transition between soil types may be gradual.

5.3 Groundwater

During drilling increased soil moisture was noted at about 8 feet below the surface and groundwater was conservatively estimated to be at this level, however a measurable water surface was found to be at about 15 feet below the surface. We anticipate that groundwater will be encountered in underground tank excavations, and possibly in utility excavations.

Groundwater levels can fluctuate seasonally and in response to numerous factors such as heavy precipitation, irrigation of neighboring land, and other unforeseen factor. The detailed evaluation of these and other factors, which may be responsible for ground water fluctuations, and the magnitude of potential fluctuations, is beyond the scope of this study.

5.4 Site Subsurface Variations

Based on the results of the subsurface explorations and our experience, variations in the continuity and nature of subsurface conditions should be anticipated. Due to the heterogeneous characteristics of natural soils, care should be taken in interpolating or extrapolating subsurface conditions between or beyond the exploratory locations.

6.0 SITE PREPARATION AND GRADING

6.1 General

All deleterious materials should be stripped from the site prior to commencement of construction activities. This includes vegetation, topsoil, loose and disturbed soils, undocumented fill, etc. When stripping and grubbing, topsoil should be distinguished by the apparent organic content and not solely by color. Due to past cultivation of the site it is possible that loose and/or disturbed soils could be encountered as deep as 15 to 18 inches. Alfalfa roots can extend to significant depths, we recommend that roots larger than about ½ inch in diameter be removed.

The site should be observed by a qualified geotechnical engineer to assess that suitable natural soils have been exposed and any deleterious materials, loose and/or disturbed soils have been removed, prior to placing site grading fills, footings, slabs, and pavements.

Fill placed over large areas to raise overall site grades can induce settlements in the underlying natural soils. If more than 3 feet of site grading fill is anticipated over the existing ground surface, we should be notified to assess potential settlements and provide additional recommendations as needed. These recommendations may

include placement of the site grading fill far in advance to allow potential settlements to occur prior to construction.

6.2 Temporary Excavations

Excavations up to 16 feet deep for underground fuel storage tanks are anticipated at the site.

In clayey (cohesive) soils, temporary construction excavations not exceeding 4 feet in depth may be constructed with near-vertical side slopes. Temporary excavations up to 16 feet deep, above or below groundwater, may be constructed with side slopes no steeper than one-half horizontal to one vertical (0.5H:1V).

For sandy/gravelly (cohesionless) soils, temporary construction excavations not exceeding 4 feet in depth should be no steeper than one-half horizontal to one vertical (0.5H:1V). For excavations up to 16 feet and above groundwater, side slopes should be no steeper than one and one half horizontal to one vertical (1.5H:1V). Excavations encountering saturated cohesionless soils, though not anticipated, will be very difficult to maintain, and will require very flat side slopes and/or shoring, bracing and dewatering.

All excavations must be inspected periodically by qualified personnel. If any signs of instability or excessive sloughing are noted, immediate remedial action must be initiated. All excavations should be made following OSHA safety guidelines.

6.3 Fill Material

The table below contains our recommendations for the various fill types we anticipate will be used at this site:

FILL MATERIAL TYPE	DESCRIPTION RECOMMENDED SPECIFICATION
Structural Fill	Placed below structures, flatwork and pavement. Well-graded sand/gravel mixture, with maximum particle size of 4 inches, a minimum 70% passing 3/4-inch sieve, a maximum 20% passing the No. 200 sieve, and a maximum Plasticity Index of 10.
Site Grading Fill	Placed over larger areas to raise the site grade. Sandy to gravelly soil, with a maximum particle size of 6 inches, a minimum 70% passing 3/4-inch sieve, a maximum 50% passing No. 200 sieve and a maximum Plasticity Index of 15.
Non-Structural Fill	Placed below non-structural areas, such as landscaping. On-site soils or imported soils, with a maximum particle size of 8 inches, including silt/clay soils not containing excessive amounts of degradable/organic material (see discussion below).
Stabilization Fill	Placed to stabilize soft areas prior to placing structural fill and/or site grading fill. Coarse angular gravels and cobbles 1 inch to 8 inches in size. May also use 1.5- to 2.0-inch gravel placed on stabilization fabric, such as Mirafi RS280i or equivalent (see Section 6.6).

Natural clay soils are not suitable for use as structural fill or site grading fill, but could be used as non-structural (landscape) fill. All fill material proposed for structural and pavement areas should be approved by a CMT geotechnical engineer prior to placement.

6.4 Fill Placement and Compaction

The various types of compaction equipment available have their limitations as to the maximum lift thickness that can be compacted. For example, hand operated equipment is limited to lifts of about 4 inches and most “trench compactors” have a maximum, consistent compaction depth of about 6 inches. Large rollers, depending on soil and moisture conditions, can achieve compaction at 8 to 12 inches. The full thickness of each lift should be compacted to at least the following percentages of the maximum dry density as determined by ASTM D-698 (or AASHTO⁶ T-99) in accordance with the following recommendations:

LOCATION	TOTAL FILL THICKNESS (FEET)	MINIMUM PERCENTAGE OF MAXIMUM DRY DENSITY
Beneath an area extending at least 4 feet beyond the perimeter of structures, and below flatwork and pavement (applies to structural fill and site grading fill) extending at least 2 feet beyond the perimeter	0 to 5	95
	5 to 8	100
Site grading fill outside area defined above	0 to 5	90
	5 to 8	95
Utility trenches within structural areas	--	95
Roadbase and subbase	-	95
Non-structural fill	0 to 5	85
	5 to 8	90

Structural fills greater than 8 feet thick are not anticipated at the site. For best compaction results, we recommend that the moisture content for structural fill/backfill be within 2% of optimum. Field density tests should be performed on each lift as necessary to verify that proper compaction is being achieved.

6.5 Utility Trenches

For the bedding zone around the utility, we recommend utilizing sand bedding fill material that meets current local or APWA⁷ requirements.

All utility trench backfill material below structurally loaded facilities (foundations, floor slabs, flatwork, parking lots/drive areas, etc.) should be placed at the same density requirements established for structural fill in the previous section. Above the bedding zone, we recommend that utility trench backfill have a minimum 20% fines, to reduce permeability.

Most utility companies and local governments are requiring Type A-1a or A-1b (AASHTO Designation) soils (sand/gravel soils with limited fines) be used as backfill over utilities within public rights of way, and the backfill be compacted over the full depth above the bedding zone to at least 95% of the maximum dry density as determined by AASHTO T-99 (ASTM D-698).

⁶ American Association of State Highway and Transportation Officials

⁷ American Public Works Association

6.6 Stabilization

The natural clay soils at this site will likely be susceptible to rutting and pumping. The likelihood of disturbance or rutting and/or pumping of the existing natural soils is a function of the soil moisture content, the load applied to the surface, as well as the frequency of the load. To stabilize soft subgrade conditions, if encountered, a mixture of coarse, clean, angular gravels and cobbles and/or 1.5- to 2.0-inch clean gravel should be utilized. Often the amount of gravelly material can be reduced with the use of a geotextile fabric such as Mirafi RS280i, or equivalent. Its use will also help avoid mixing of the subgrade soils with the gravelly material. After excavating the soft/disturbed soils, the fabric should be spread across the bottom of the excavation and up the sides a minimum of 18 inches. Otherwise, it should be placed in accordance with the manufacturer's recommendation, including proper overlaps. The gravel material can then be placed over the fabric in compacted lifts as described above.

7.0 FOUNDATION RECOMMENDATIONS

The following recommendations have been developed on the basis of the previously described project characteristics, the subsurface conditions observed in the field and the laboratory test data, as well as common geotechnical engineering practice.

7.1 Foundation Recommendations

Based on our geotechnical engineering analyses, the proposed structures may be supported upon conventional spread and/or continuous wall foundations placed on suitable, undisturbed, natural soils and/or on structural fill extending to suitable natural soils. Footings may be designed using a net bearing pressure of 2,000 psf if placed on suitable, undisturbed, natural soils, or designed using a net bearing pressure of 2,500 psf if bearing on a minimum of 18 inches of structural fill. The term "net bearing pressure" refers to the pressure imposed by the portion of the structure located above lowest adjacent final grade, thus the weight of the footing and backfill to lowest adjacent final grade need not be considered. The allowable bearing pressure may be increased by 1/3 for temporary loads such as wind and seismic forces.

We also recommend the following:

1. Exterior footings subject to frost should be placed at least 18 inches below final grade.
2. Continuous footing widths should be maintained at a minimum of 18 inches.
3. Spot footings should be a minimum of 24 inches wide.

7.2 Installation

Under no circumstances shall foundations be placed on undocumented fill, topsoil with organics, sod, rubbish, construction debris, other deleterious materials, frozen soils, or within ponded water. If unsuitable soils are encountered, they must be completely removed and replaced with properly compacted structural fill. The base

of footing excavations and floor slab subgrades should be observed by a qualified geotechnical engineer to confirm that suitable bearing soils have been exposed.

All structural fill should meet the requirements for such, and should be placed and compacted in accordance with **Section 6** above. The width of structural replacement fill below footings should be equal to the width of the footing plus 1 foot for each foot of fill thickness. For instance, if the footing width is 2 feet and the structural fill depth beneath the footing is 4 feet, the fill replacement width should be 6 feet, centered beneath the footing.

The minimum thickness of structural fill below footings should be equivalent to one-third the thickness of structural fill below any other portion of the foundations. For example, if the maximum depth of structural fill is 6 feet, all footings for the new structure should be underlain by a minimum 2 feet of structural fill.

7.3 Estimated Settlement

Foundations designed and constructed in accordance with our recommendations could experience some settlement, but we anticipate that total settlements of footings founded as recommended above will not exceed 1 inch, with differential settlements on the order of 0.5 inches over a distance of 25 feet. We expect approximately 50% of the total settlement to initially take place during construction.

7.4 Lateral Resistance

Lateral loads imposed upon foundations due to wind or seismic forces may be resisted by the development of passive earth pressures and friction between the base of the footings and the supporting soils. In determining frictional resistance, a coefficient of 0.30 for natural clay soils, or 0.40 for structural fill may be utilized for design. Passive resistance provided by properly placed and compacted existing clay soils above the water table may be considered equivalent to a fluid with a density of 300 pcf. A combination of passive earth resistance and friction may be utilized if the passive pressure component of the total is divided by 1.5.

7.5 Uplift Loads

Uplift loads may be resisted by the weight of the foundation and the backfill wedge above the top of the foundation within the area defined by an imaginary line extending outward from the outside top edge of the footing 10 degrees from vertical, up to final grade. A unit weight of 125 pounds per square foot can be used for sand and gravel backfill over the footings.

8.0 LATERAL EARTH PRESSURES

We anticipate that below-grade walls up to 4 feet high may be constructed at this site. The lateral earth pressure values given in the table below are for a backfill material that will consist of existing clay soils placed and compacted in accordance with the recommendations presented herein. If other soil types will be used as backfill, we should be notified so that appropriate modifications to these values can be provided, as needed.

The lateral pressures imposed upon subgrade facilities will depend upon the relative rigidity and movement of the backfilled structure. The following table presents the recommended lateral pressure values, which also assume that the soil surface behind the wall is horizontal and that the backfill within 3 feet of the wall will be compacted with hand-operated compacting equipment.

CONDITION	STATIC (psf/ft)*	SEISMIC (psf)**
Active Pressure (wall is allowed to yield, i.e. move away from the soil, with a minimum 0.001H movement/rotation at the top of the wall, where “H” is the total height of the wall)	42	72
At-Rest Pressure (wall is not allowed to yield)	61	--
Passive Pressure (wall moves into the soil)	300	25

*Equivalent Fluid Pressure (applied at 1/3 Height of 4-foot High Wall)

**Uniform Pressure, Seismic Only (applied at 1/2 Height of 4-foot High Wall)

9.0 BOUYANT FORCES

Groundwater was encountered in the bore holes possibly as shallow as 8 feet. Therefore underground tanks will likely need to be designed to resist buoyant forces.

10.0 FLOOR SLABS

Floor slabs may be established upon suitable, undisturbed, natural soils and/or on structural fill extending to suitable, undisturbed natural soils (same as for foundations). Under no circumstances shall floor slabs be established directly on any topsoil, undocumented fills, loose or disturbed soils, sod, rubbish, construction debris, other deleterious materials, frozen soils, or within ponded water.

In order to facilitate curing of the concrete, we recommend that floor slabs be directly underlain by at least 4 inches of “free-draining” fill, such as “pea” gravel or 3/4-inch quarters to 1-inch minus, clean, gap-graded gravel. To help control normal shrinkage and stress cracking, the floor slabs should have the following features:

1. Adequate reinforcement for the anticipated floor loads with the reinforcement continuous through interior floor joints;
2. Frequent crack control joints; and
3. Non-rigid attachment of the slabs to foundation walls and bearing slabs.

11.0 DRAINAGE RECOMMENDATIONS

It is important to the long-term performance of foundations and floor slabs that water not be allowed to collect near the foundation walls and infiltrate into the underlying soils. We recommend the following:

1. All areas around the structures should be sloped to provide drainage away from the foundations. We recommend a minimum slope of 6 inches in the first 10 feet away from the structure. This slope should be maintained throughout the lifetime of the structure.
2. All roof drainage should be collected in rain gutters with downspouts designed to discharge at least 10 feet from the foundation walls or well beyond the backfill limits, whichever is greater.
3. Adequate compaction of the foundation backfill should be provided. We suggest a minimum of 90% of the maximum laboratory density as determined by ASTM D-698. Water consolidation methods should not be used under any circumstances.
4. Landscape sprinklers should be aimed away from the foundation walls. The sprinkling systems should be designed with proper drainage and be well-maintained. Over watering should be avoided.
5. Other precautions that may become evident during construction.

12.0 PAVEMENTS

All pavement areas must be prepared as discussed above in **Section 6.1**. Under no circumstances shall pavements be established over topsoil, unprepared undocumented fills, loose or disturbed soils, sod, rubbish, construction debris, other deleterious materials, frozen soils, or within ponded water.

In pavement areas, subsequent to stripping and prior to the placement of pavement materials, the exposed subgrade must be proof rolled by passing moderate-weight rubber tire-mounted construction equipment over the surface at least twice. If excessively soft or otherwise unsuitable soils are encountered, we recommend they be removed to a minimum of 18 inches below the subgrade level and replaced with structural fill.

To assess the subgrade soil for pavement support Dynamic Cone Penetration (DCP) tests were performed at three locations on the site in pavement areas. The DCP data was correlated to the California Bearing Ratio (CBR), which indicated CBR values in the range of about 6.9 to 10.2. Clay soils are expected to exhibit poor pavement support characteristics when saturated or nearly saturated. We therefore have utilized a CBR value of 6 for our pavement design recommendations. Given the projected traffic as discussed above in **Section 1.3**, the following pavement sections are recommended for the given ESAL's (18-kip equivalent single-axle loads) per day:

MATERIAL	PAVEMENT SECTION THICKNESS (inches)				
	PARKING AREAS (Moderate Duty) (4 ESAL'S per day)		HI-FLOW AREAS (Heavy Duty) (391 ESAL'S per day)		
Asphalt	4	---	5	5	---
Concrete	---	4	---	---	6
Road-Base	8	6	23	10	8
Subbase	0	0	0	17	0
Total Thickness	12	10	28	32	15

Untreated base course (UTBC) should conform to city specifications, or Caltrans specifications, and have a minimum CBR value of 70%. Material meeting our specification for structural fill can be used for subbase, as long as the fines content (percent passing No. 200 sieve) does not exceed 15%. Roadbase and subbase material should be compacted as recommended above in **Section 6.4**. Asphalt material generally should conform to APWA requirements.

Concrete pavement should typically have a minimum 28-day strength of 4,000 psi, contain 6 percent ± 1 percent air-entrainment and should be saw-cut at appropriate intervals and at the proper time to control the locations of shrinkage cracking. This generally means maximum saw-cut intervals of twice the pavement thickness, in feet (i.e. a 10-foot maximum interval for 5 inches thick concrete), and performing the saw cutting within 24 hours of placement.

13.0 QUALITY CONTROL

We recommend that a comprehensive quality control testing and observation program. Without such a program CMT cannot be responsible for application of our recommendations to subsurface conditions which may vary from those described herein. This program may include, but not necessarily be limited to, the following:

13.1 Field Observations

Observations should be completed during all phases of construction such as site preparation, foundation excavation, structural fill placement and concrete placement.

13.2 Fill Compaction

Compaction testing is required for all structural supporting fill materials. Maximum Dry Density (Modified Proctor, ASTM D-1557) tests should be requested by the contractor immediately after delivery of any fill materials. The maximum density information should then be used for field density tests on each lift as necessary to ensure that the required compaction is being achieved.

13.3 Excavations

All excavation procedures and processes should be observed by a geotechnical engineer their representative. In addition, for the recommendations in this report to be valid, all backfill and structural fill placed in trenches and all pavements should be density tested by CMT. We recommend that freshly mixed concrete be tested by CMT in accordance with ASTM designations.

14.0 LIMITATIONS

The recommendations provided herein were developed by evaluating the information obtained from the subsurface explorations and soils encountered therein. The exploration logs reflect the subsurface conditions only

at the specific location at the particular time designated on the logs. Soil and ground water conditions may differ from conditions encountered at the actual exploration locations. The nature and extent of any variation in the explorations may not become evident until during the course of construction. If variations do appear, it may become necessary to re-evaluate the recommendations of this report after we have observed the variation.

Our professional services have been performed, our findings obtained, and our recommendations prepared in accordance with generally accepted geotechnical engineering principles and practices. This warranty is in lieu of all other warranties, either expressed or implied.

We appreciate the opportunity to be of service to you on this project. If we can be of further assistance or if you have any questions regarding this project, please do not hesitate to contact us at (801) 492-4132.

APPENDIX

SUPPORTING
DOCUMENTATION

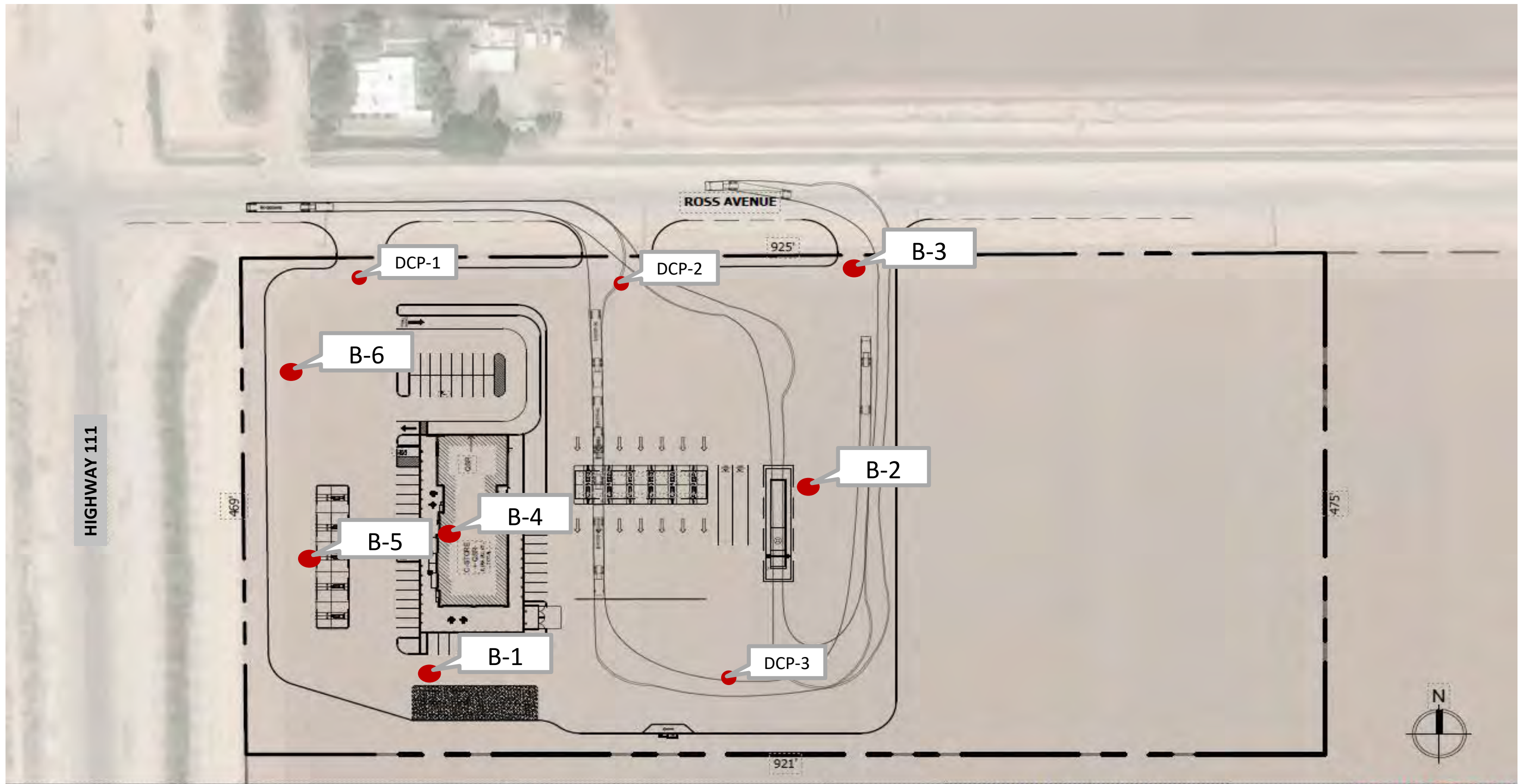

SITE DATA		
PARKING:	APPROX. 51 STALLS PROVIDED	
PARCEL AREA:	435,598 SQ. FT.	10.00 ACRES
BUILDING AREA:	9,084 SQ. FT.	0.21 ACRES

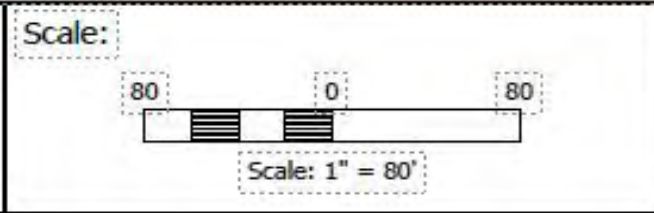

QUICK FIT STUDY		
ROSS AVENUE & INTERSTATE 8 EL CENTRO, CALIFORNIA		
Date: 2021/09/27	BY: WO	Project number: 21-170

185 S. State Street
Salt Lake City, Utah 84111

Maverik Store
SEC of Hwy 111 and Ross Ave, El Centro, CA

SITE PLAN

Date:	20-Oct-2021
CMT No.:	17436

Figure:
1

EEC ORIGINAL PKG

Maverik Store

SEC of Hwy 111 and Ross Ave, El Centro, CA

Bore Hole Log

B-1

Total Depth: 71.5'

Date: 10/20/21

Water Depth: 8.5'

Job #: 17436

Depth (ft)	GRAPHIC LOG	Soil Description	Sample Type	Sample #	Blows (N)			Moisture (%)	Dry Density(pcf)	Gradation			Atterberg		
					Total					Gravel %	Sand %	Fines %	LL	PL	PI
0		Topsoil: Alfalfa field													
		CLAY (CL) brown, moist	stiff	1	3 4 4	8									
4		Clayey Fine SAND (SC) light brown, moist	medium dense	2	4 5 11	16	23	102				46	21	25	
		CLAY (CL) brown, moist													
8		grades with 6" layer of clayey fine sand		3	2 3 2	5									
			stiff	4	4 6 8	14	25	98				42	21	21	
12															
16		grades with frequent fine sand seams and layers up to 1" brown, wet	stiff	5	2 4 6	10									
20				6	4 2 2	4									
24		grades with frequent fine sand layers up to 3" thick	medium stiff												
			stiff	7	5 6 9	15	25					89			
28															

Remarks: Groundwater encountered during drilling at depth of 8.5 feet.

Coordinates: 32.7803°, -115.499986°

Surface Elev. (approx): Not Given

Equipment: Hollow-Stem Auger

Automatic Hammer, Wt=140 lbs, Drop=30"

Excavated By: Southland Engineering

Logged By: Michelle Bostrom

Figure:

2

Maverik Store

SEC of Hwy 111 and Ross Ave, El Centro, CA

Bore Hole Log

B-1

Total Depth: 71.5'

Water Depth: 8.5'

Date: 10/20/21

Job #: 17436

Depth (ft)	GRAPHIC LOG	Soil Description	Sample Type	Sample #	Blows (N)			Moisture (%)	Dry Density(pcf)	Gradation			Atterberg																
					Total					Gravel %	Sand %	Fines %	LL	PL	PI														
28		CLAY (CL) with sand seams, brown, moist	stiff	8	4	10																							
32					5																								
					5																								
36																Fat CLAY (CH) with sand seams, moist, brown	stiff	9	4	13	23						60	24	36
																			5										
	8																												
40		CLAY (CL), moist, brown		10	3	13																							
44					5																								
					8																								
48																		11	3	13									
52																			5										
	8																												
56					12	4	5	7	12																				
					13			23					39	20	19														

Remarks: Groundwater encountered during drilling at depth of 8.5 feet.

Coordinates: 32.7803°, -115.499986°

Surface Elev. (approx): Not Given

Equipment: Hollow-Stem Auger

Automatic Hammer, Wt=140 lbs, Drop=30"

Excavated By: Southland Engineering

Logged By: Michelle Bostrom

Figure:

2

Maverik Store

SEC of Hwy 111 and Ross Ave, El Centro, CA

Bore Hole Log

B-1

Total Depth: 71.5'

Water Depth: 8.5'

Date: 10/20/21

Job #: 17436

Depth (ft)	GRAPHIC LOG	Soil Description	Sample Type	Blows (N)			Moisture (%)	Dry Density(pcf)	Gradation			Atterberg		
				Sample #	Total				Gravel %	Sand %	Fines %	LL	PL	PI
56			stiff											
60			soft	14	3 1 1	2								
64														
68		Clayey SILT (ML) brown, wet	very stiff	15	7 9 7	16								
72		grades with trace fine sand, oxidation staining	stiff	16	5 5 6	11	28			98				
72		END AT 71.5'												
76														
80														
84														

Remarks: Groundwater encountered during drilling at depth of 8.5 feet.

Coordinates: 32.7803°, -115.499986°

Surface Elev. (approx): Not Given

Equipment: Hollow-Stem Auger

Automatic Hammer, Wt=140 lbs, Drop=30"

Excavated By: Southland Engineering

Logged By: Michelle Bostrom

Figure:

2

Maverik Store

SEC of Hwy 111 and Ross Ave, El Centro, CA

Bore Hole Log

B-2

Total Depth: 16.5'

Date: 10/20/21

Water Depth: 8'

Job #: 17436

Depth (ft)	GRAPHIC LOG	Soil Description	Sample Type	Sample #	Blows (N)		Moisture (%)	Dry Density(pcf)	Gradation			Atterberg		
						Total			Gravel %	Sand %	Fines %	LL	PL	PI
0		Topsoil: Alfalfa field												
		CLAY (CL) with oxidation staining, trace calcification, brown, moist												
4			stiff	17	4 5 5	10								
			medium stiff	18	3 2 5	7								
			soft	19	2 1 2	3	24	98						
		grades with frequent layers of silty fine sand and silt		20	2 2 2	4								
16		SILT (ML) with fine sand, some clay, brown	wet medium stiff	21	3 3 4	7								
		END AT 16.5'												
20														
24														
28														

Remarks: Groundwater encountered during drilling at depth of 8 feet.

Coordinates: 32.780776°, -115.49894°

Surface Elev. (approx): Not Given

Equipment: Hollow-Stem Auger

Automatic Hammer, Wt=140 lbs, Drop=30"

Excavated By: Southland Engineering

Logged By: Michelle Bostrom

Page: ORIGINAL PKG

Figure:

3

Maverik Store

SEC of Hwy 111 and Ross Ave, El Centro, CA

Bore Hole Log



B-3

Total Depth: 6.5'

Date: 10/20/21

Water Depth: (see Remarks)

Job #: 17436

Depth (ft)	GRAPHIC LOG	Soil Description	Sample Type	Sample #	Blows (N)		Moisture (%)	Dry Density(pcf)	Gradation			Atterberg		
						Total			Gravel %	Sand %	Fines %	LL	PL	PI
0		Topsoil: Alfalfa field												
		Fat CLAY (CH) with heavy oxidation staining, brown, moist												
4				22	4 5 5	10	16					57	22	35
				23	3 3 3	6								
		END AT 6.5'												
8														
12														
16														
20														
24														
28														

Remarks: Groundwater not encountered during drilling.

Coordinates: 32.781323°, -115.49881°

Surface Elev. (approx): Not Given

Equipment: Hollow-Stem Auger

Automatic Hammer, Wt=140 lbs, Drop=30"

Excavated By: Southland Engineering

Logged By: Michelle Bostrom

Page: **EEC ORIGINAL PKG**

Figure:

4

Maverik Store

SEC of Hwy 111 and Ross Ave, El Centro, CA

Bore Hole Log

B-4

Total Depth: 11.5'

Date: 10/20/21

Water Depth: (see Remarks)

Job #: 17436

Depth (ft)	GRAPHIC LOG	Soil Description	Sample Type	Sample #	Blows (N)		Moisture (%)	Dry Density(pcf)	Gradation			Atterberg		
						Total			Gravel %	Sand %	Fines %	LL	PL	PI
0		Topsoil: Alfalfa field												
		CLAY (CL) brown, slightly moist												
4		grades with trace oxidation staining	stiff	24	4 7 8	15								
		grades with fine sand layers 2-3" thick		25	3 3 6	9								
8		grades with fine sand seams	medium stiff	26	2 2 3	5								
		Fat CLAY (CH) with sand seams, moist, brown grades with oxidation staining		27			35					52	19	33
12		END AT 11.5'												
16														
20														
24														
28														

Remarks: Groundwater not encountered during drilling.

Coordinates: 32.780668°, -115.499945°

Surface Elev. (approx): Not Given

Equipment: Hollow-Stem Auger

Automatic Hammer, Wt=140 lbs, Drop=30"

Excavated By: Southland Engineering

Logged By: Michelle Bostrom

Figure:

5

Maverik Store

SEC of Hwy 111 and Ross Ave, El Centro, CA

Bore Hole Log

B-5

Total Depth: 16.5'

Date: 10/20/21

Water Depth: 8'

Job #: 17436

Depth (ft)	GRAPHIC LOG	Soil Description	Sample Type	Sample #	Blows (N)		Moisture (%)	Dry Density(pcf)	Gradation			Atterberg		
						Total			Gravel %	Sand %	Fines %	LL	PL	PI
0		Topsoil: Alfalfa field												
		CLAY (CL) with fine sand, brown, slightly moist to dry												
4		very stiff		28	4 7 11	18								
		stiff		29	3 4 6	10	21					37	20	17
8		grades with frequent sand layers 1-2" thick, more moisture		30	2 2 4	6								
		medium stiff		31										
12														
16		wet		32	4 5 12	17								
		END AT 16.5'												
20														
24														
28														

Remarks: Groundwater encountered during drilling at depth of 8 feet.

Coordinates: °, °
Surface Elev. (approx): Not Given

Equipment: Hollow-Stem Auger
Automatic Hammer, Wt=140 lbs, Drop=30"
Excavated By: Southland Engineering
Logged By: Michelle Bostrom

Figure:

6

Maverik Store

SEC of Hwy 111 and Ross Ave, El Centro, CA

Bore Hole Log

B-6

Total Depth: 6.5'

Date: 10/20/21

Water Depth: (see Remarks)

Job #: 17436

Depth (ft)	GRAPHIC LOG	Soil Description	Sample Type	Sample #	Blows (N)		Moisture (%)	Dry Density(pcf)	Gradation			Atterberg		
						Total			Gravel %	Sand %	Fines %	LL	PL	PI
0		Topsoil: Alfalfa field												
		Fine Sandy CLAY (CL) brown, dry												
4			very stiff	33	5 7 9	16	16					45	20	25
			stiff	34	5 6 3	9								
		END AT 6.5'												
8														
12														
16														
20														
24														
28														

Remarks: Groundwater not encountered during drilling.

Coordinates: 32.781079°, -115.50039°

Surface Elev. (approx): Not Given

Equipment: Hollow-Stem Auger

Automatic Hammer, Wt=140 lbs, Drop=30"

Excavated By: Southland Engineering

Logged By: Michelle Bostrom

Page: **EEC ORIGINAL PKG**

Figure:

7

①	②	③ Soil Description	④	⑤	Blows(N)	⑥	⑦	⑧	⑨	Gradation	Atterberg		
Depth (ft)	GRAPHIC LOG		Sample Type	Sample #	Total	Moisture (%)	Dry Density(pcf)	Gravel %	Sand %	Fines %	LL	PL	PI

COLUMN DESCRIPTIONS

- ① **Depth (ft.):** Depth (feet) below the ground surface (including groundwater depth - see water symbol below).
- ② **Graphic Log:** Graphic depicting type of soil encountered (see ② below).
- ③ **Soil Description:** Description of soils encountered, including Unified Soil Classification Symbol (see below).
Sample Type: Type of soil sample collected at depth interval shown; sampler symbols are explained below-right
- ④ **Sample #:** Consecutive numbering of soil samples collected during field exploration.
- ⑤ **Blows:** Number of blows to advance sampler in 6" increments, using a 140-lb hammer with 30" drop.
- ⑥ **Total Blows:** Number of blows to advance sampler the 2nd and 3rd 6" increments.
- ⑦ **Moisture (%):** Water content of soil sample measured in laboratory (percentage of dry weight of sample).
- ⑧ **Dry Density (pcf):** The dry density of a soil measured in laboratory (pounds per cubic foot).
- ⑩ **Gradation:** Percentages of Gravel, Sand and Fines (Silt/Clay), obtained from lab test results of soil passing the No. 4 and No. 200 sieves.
- ⑪ **Atterberg:** Individual descriptions of Atterberg Tests are as follows:
 - LL = Liquid Limit (%):** Water content at which a soil changes from plastic to liquid behavior.
 - PL = Plastic Limit (%):** Water content at which a soil changes from liquid to plastic behavior.
 - PI = Plasticity Index (%):** Range of water content at which a soil exhibits plastic properties (= Liquid Limit - Plastic Limit).

STRATIFICATION		MODIFIERS	MOISTURE CONTENT
Description	Thickness	Trace	Dry: Absence of moisture, dusty, dry to the touch.
Seam	Up to ½ inch	<5%	Moist: Damp / moist to the touch, but no visible water.
Lense	Up to 12 inches	Some	
Layer	Greater than 12 in.	5-12%	Saturated: Visible water, usually soil below groundwater.
Occasional	1 or less per foot	With	
Frequent	More than 1 per foot	> 12%	

UNIFIED SOIL CLASSIFICATION SYSTEM (USCS)	MAJOR DIVISIONS		USCS SYMBOLS	②	TYPICAL DESCRIPTIONS
	COARSE-GRAINED SOILS More than 50% of material is larger than No. 200 sieve size.	GRAVELS The coarse fraction retained on No. 4 sieve.	CLEAN GRAVELS (< 5% fines)	GW	
GRAVELS WITH FINES (≥ 12% fines)			GP		Poorly-Graded Gravels, Gravel-Sand Mixtures, Little or No Fines
			GM		Silty Gravels, Gravel-Sand-Silt Mixtures
SANDS The coarse fraction passing through No. 4 sieve.			CLEAN SANDS (< 5% fines)	SW	
		SANDS WITH FINES (≥ 12% fines)	SP		Poorly-Graded Sands, Gravelly Sands, Little or No Fines
SM				Silty Sands, Sand-Silt Mixtures	
SC				Clayey Sands, Sand-Clay Mixtures	
FINE-GRAINED SOILS More than 50% of material is smaller than No. 200 sieve size.		SILTS AND CLAYS Liquid Limit less than 50%	ML		Inorganic Silts and Very Fine Sands, Silty or Clayey Fine Sands or Clayey Silts with Slight
			CL		Inorganic Clays of Low to Medium Plasticity, Gravelly Clays, Sandy Clays, Silty Clays, Lean
	OL			Organic Silts and Organic Silty Clays of Low Plasticity	
	SILTS AND CLAYS Liquid Limit greater than 50%	MH		Inorganic Silts, Micaceous or Diatomaceous Fine Sand or Silty Soils with Plasticity (Elastic Silts)	
		CH		Inorganic Clays of High Plasticity, Fat Clays	
		OH		Organic Silts and Organic Clays of Medium to High Plasticity	
HIGHLY ORGANIC SOILS	PT		Peat, Humus, Swamp Soils with High Organic Contents		

SAMPLER SYMBOLS

- Block Sample
- Bulk/Bag Sample
- Modified California Sampler
3.5" OD, 2.42" ID
- D&M Sampler
- Rock Core
- Standard Penetration Split Spoon Sampler
- Thin Wall (Shelby Tube)

WATER SYMBOL

- Encountered Water Level
 - Measured Water Level
- (see Remarks on Logs)

Note: Dual Symbols are used to indicate borderline soil classifications (i.e. GP-GM, SC-SM, etc.).

- The results of laboratory tests on the samples collected are shown on the logs at the respective sample depths.
- The subsurface conditions represented on the logs are for the locations specified. Caution should be exercised if interpolating between or extrapolating beyond the exploration locations.
- The information presented on each log is subject to the limitations, conclusions, and recommendations presented in this report.

Figure:

8

DCP TEST DATA

Project: Maverik-El Centro, CA
Location: DCP-1
Hammer: 17.6 lb
Soil Type(s): CLAY (CL)

Date: 10/21/2021

No. of Blows	Individual Penetration (mm)	Type of Hammer
1	0	2
1	28	2
1	15	2
1	15	2
1	14	2
1	19	2
1	18	2
1	13	2
1	15	2
1	12	2
1	9	2
1	9	2
1	8	2
1	12	2
1	8	2
1	7	2
1	8	2
1	9	2
1	7	2
1	6	2
1	8	2
1	8	2
1	10	2
1	9	2
1	9	2
1	9	2
1	11	2
1	10	2
1	9	2
1	10	2
1	10	2
1	10	2
1	11	2
1	9	2
1	11	2
1	7	2
1	9	2
1	9	2
1	10	2
1	11	2
1	11	2
1	11	2

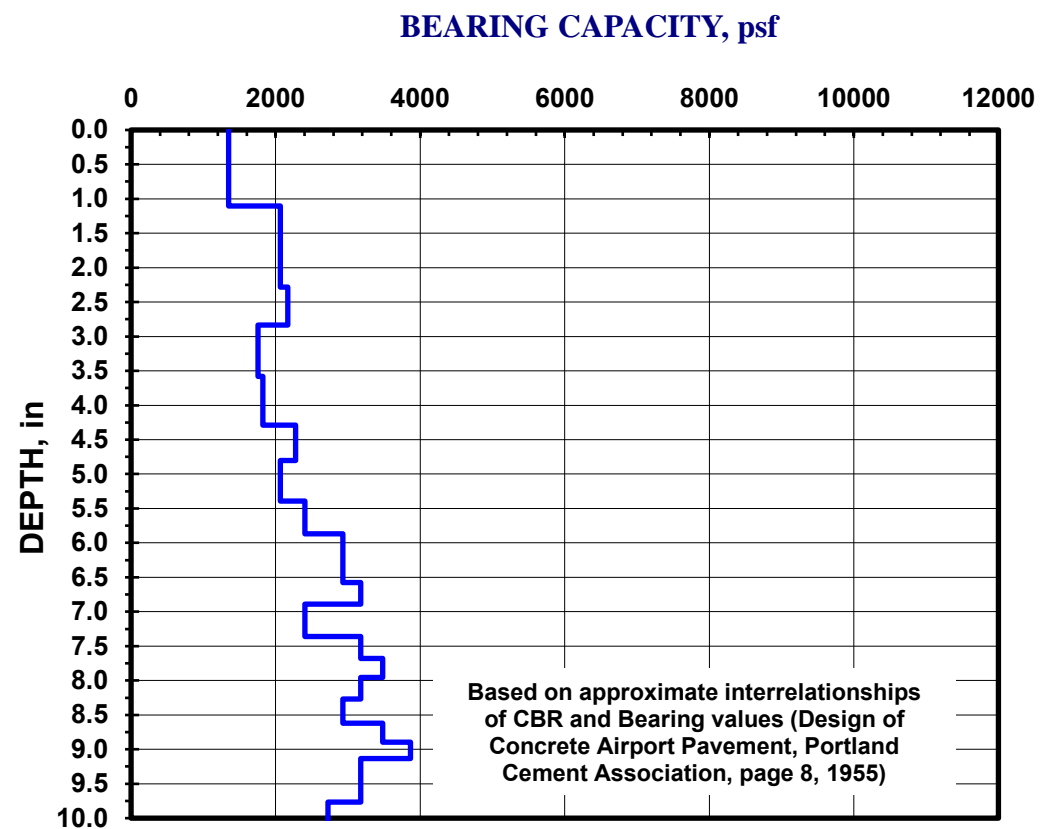
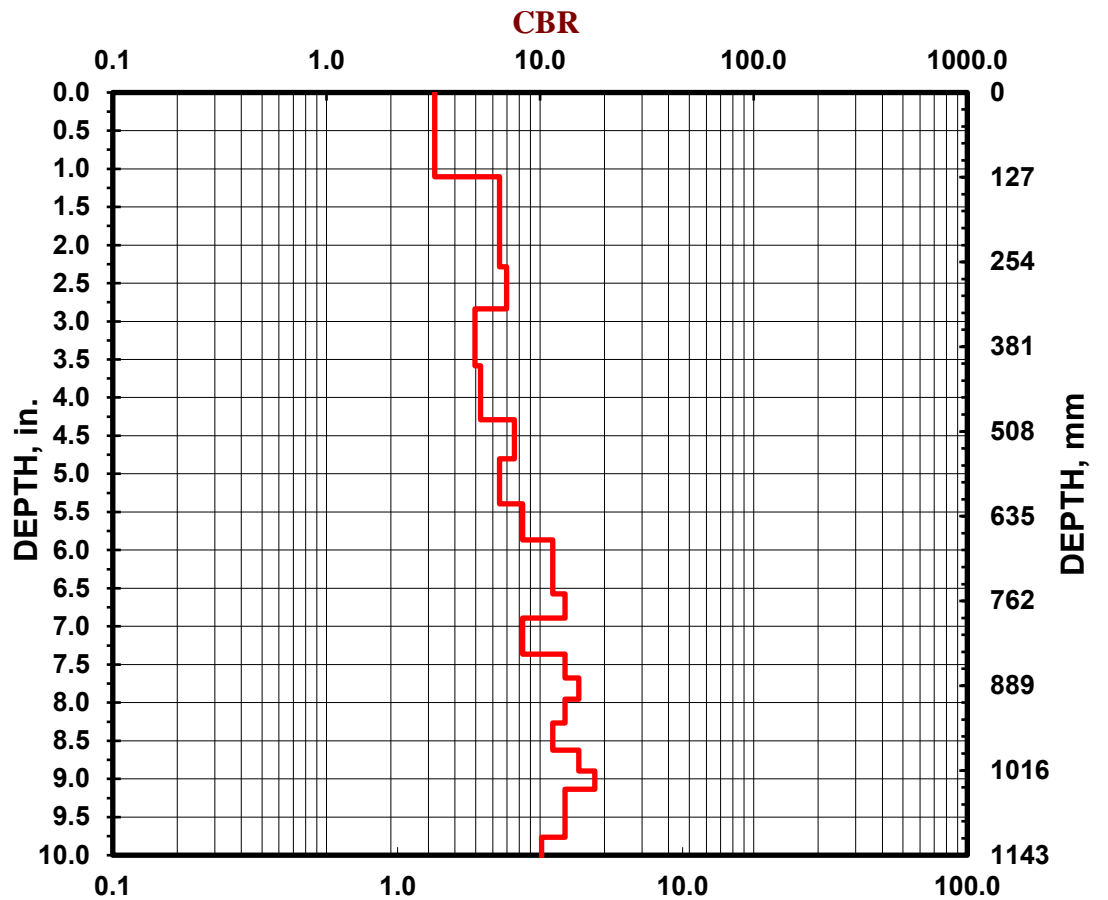

Maverik Store

Husted Rd & I-5, Williams, CA

CMT ENGINEERING
LABORATORIES

DCP Data

Date: 17-Sep-21

Job # 17329

Figure:

9

EEC ORIGINAL PKG

Phase I Environmental Site Assessment

Potential Maverik Acquisition -
SEC of Ross Ave & Hawes Rd,
El Centro, CA

821AR00978.0001

Prepared by
Cardno, Inc.
1142 West 2320 South, Suite
A
Salt Lake City, Utah 84119
Phone: (801) 256-3800
Fax: (801) 973-1095

Prepared for
Maverik, Inc

October 22, 2021



EEC ORIGINAL PKG

Table of Contents

1	Executive Summary	1
1.1	General Information	1
1.2	Findings and Conclusions Summary	2
1.3	Significant Data Gap Summary	3
1.4	Findings	3
	1.4.1 Recognized Environmental Condition	3
	1.4.2 Controlled Recognized Environmental Condition	3
	1.4.3 Historical Recognized Environmental Condition	3
	1.4.4 Environmental Issue	3
1.5	Conclusions, Opinions and Recommendations	4
2	Introduction	5
2.1	Purpose	5
2.2	Scope	5
2.3	Significant Assumption	6
2.4	Limitations and Exceptions	6
2.5	Special Terms and Conditions (User Reliance)	8
3	Site Description	9
3.1	Local and Legal Description	9
3.2	Surrounding Area General Characteristics	9
3.3	Current Use of the Property	9
3.4	Description of Property Improvements	9
3.5	Current Uses of Adjoining Properties	10
4	User-Provided Information	11
4.1	Title Records	11
4.2	Environmental Liens or Activity and Use Limitations	11
4.3	Specialized Knowledge	11
4.4	Significant Valuation Reduction for Environmental Issues	11
4.5	Owner, Property Manager and Occupant Information	11
4.6	Reason for Performing Phase I ESA	11
4.7	Other User Provided Documents	11
5	Records Review	12
5.1	Standard Environmental Records	12
	5.1.1 Subject Property Listings	15
	5.1.2 Adjacent Property Listings	15
	5.1.3 Sites of Concern Listings	15
	5.1.4 Orphan Listings	15
	5.1.5 Local Environmental Records Search	15
	5.1.6 Health Department	16
	5.1.7 Fire Department	16
	5.1.8 Planning Department	16
	5.1.9 Oil & Gas Exploration	17
	5.1.10 Assessor's Office	17

5.1.11	Utilities	17
5.1.12	Other Local Environmental Records Sources	17
5.2	Physical Setting Sources	18
5.2.1	Topography	18
5.2.2	Geology/Soils	18
5.2.3	Hydrology	18
5.2.4	Other Physical Setting Sources	18
5.3	Historical Records Sources	18
5.3.1	Aerial Photographs	19
5.3.2	Fire Insurance Maps	20
5.3.3	Property Tax Files	20
5.3.4	Recorded Land Title Records and AULs	20
5.3.5	Historical USGS Topographic Quadrangles	20
5.3.6	City Directories	21
5.3.7	Building Department Records	21
5.3.8	Zoning/Land Use Records	21
5.3.9	Prior Reports	21
5.3.10	Other Historical Sources	21
6	Site Reconnaissance	22
6.1	Methodology and Limiting Conditions	22
6.2	Hazardous Substance Use, Storage, and Disposal	22
6.3	Aboveground and Underground Hazardous Substance or Petroleum Product Storage Tanks	22
6.4	Polychlorinated Biphenyls	22
6.5	Unidentified Substance Containers	22
6.6	Non-hazardous Solid Waste	22
6.7	Wastewater	22
6.8	Waste Pits, Ponds and Lagoons	22
6.9	Sumps	22
6.10	Septic Systems	23
6.11	Storm water Management System	23
6.12	Wells	23
7	Interviews	24
8	Other Environmental Conditions	25
8.1	Asbestos-Containing Material	25
8.2	Radon	25
8.3	Lead in Drinking Water	25
8.4	Lead-Based Paint	26
8.5	Mold Screening	26
8.6	Vapor Encroachment	26
9	References	27

Appendices

Appendix A	Site Vicinity Map
Appendix B	Site Plan
Appendix C	Subject Property Photographs
Appendix D	User Provided Documentation
Appendix E	Regulatory Database Report
Appendix F	Aerial Photographs
Appendix G	Historical Research Documentation
Appendix H	Prior Reports
Appendix I	Resumes
Appendix J	Laboratory Reports
Appendix K	Other Supporting Documentation
Appendix L	Terminology

1 Executive Summary

1.1 General Information

Project Information	Approximate 10-acre parcel
Site Information	Potential Maverik Acquisition SEC of Ross Avenue & Hawes Road El Centro, Imperial County California
Site Access Contact	Charles Ciraolo, Owner (619) 787-2329
Client Information	Maverik, Inc. 185 South State Street, Suite 800 Salt Lake City, UT 84111 Paul Heywood
Consultant Information	Cardno, Inc. 1142 West 2320 South, Suite A Salt Lake City, Utah 84119 Phone: (801) 256-3800 Fax: (801) 973-1095
Reconnaissance Date	October 15, 2021
Site Assessor	Russell D. Hamblin, P.G
Report Writer	Alisha Harper
Environmental Professional	Russell D. Hamblin, P.G.

Environmental Professional Statement

I declare that, to the best of my professional knowledge and belief, I meet the definition of Environmental Professional as defined in § 312.10 part of 40 CFR 312. We have the specific qualifications based on education, training, and experience to assess a property of the nature, history, and setting of the Subject Property. We have developed and performed the all appropriate inquiries in conformance with the standards and practices set forth in 40 CFR Part 312.



Russell D. Hamblin, P.G.
National Client Manager
Environmental Professional

1.2 Findings and Conclusions Summary

Cardno Inc. (Cardno) performed this Phase I Environmental Site Assessment (ESA) in conformance with the scope and limitations of American Society of Testing and Material (ASTM) Standard Practice E 1527-13. Any exceptions to, or deletions from, this practice are described in Section 2.0 of this report. This assessment did not reveal evidence of *recognized environmental conditions* (RECs) in connection with the Subject Property. Information regarding this finding is detailed in the following table.

Findings and Conclusions Summary

Report Section	Further Action	<i>De Minimis</i> Condition	REC	Historical REC	Controlled REC	ASTM Non-Scope Condition	Description
4.0	User Provided Information	No					
5.1.1	Federal Database Findings	No					
5.1.2	State and Tribal Database Findings	No					
5.1.3	Local Environmental Record Sources	No					
5.3	Historical Records Sources	No					
6.2	Hazardous Substance Use, Storage and Disposal	No					
6.3	Underground Storage Tanks	No					
6.4	Aboveground Storage Tanks	No					
6.5	Other Petroleum Products	No					
6.6	Polychlorinated Biphenyls	No					
6.7	Unidentified Substance Containers	No					
6.8	Nonhazardous Solid Waste	No					
6.9	Wastewater	No					
6.10	Waste Pits, Ponds and Lagoons	No					
6.11	Sumps	No					
6.12	Septic Systems	No					
6.13	Storm water Management System	No					
6.14	Wells	No					
7.0	Interviews	No					
8.1	Asbestos-Containing Material	No					
8.2	Radon	No					
8.3	Lead in Drinking Water	No					
8.4	Lead-Based Paint	No					
8.5	Mold Screening	No					
8.6	Vapor Encroachment	No					

1.3 Significant Data Gap Summary

Data gaps may have been encountered during the performance of this Phase I ESA and are discussed within the section of the report where they were encountered. According to ASTM Standard Practice E 1527-13, *data gaps* are only significant if "other information and/or professional experience raise reasonable concerns involving the *data gap*." The following is a list of common sources of *significant data gaps* and Cardno's experience with them on this Phase I ESA.

Significant Data Gap Summary

Report Section	Description	
3.5	Current Uses of Adjoining Properties	No significant data gap identified.
4.2	Environmental Liens or Activity and Use Limitations	No significant data gap identified.
5.1	Standard Environmental Records	No significant data gap identified.
5.2	Physical Setting Sources	No significant data gap identified.
5.3	Historical Records Sources	No significant data gap identified.
6.1	Methodology and Limiting Conditions	No significant data gap identified.
7.0	Interviews	No significant data gap identified.

1.4 Findings

1.4.1 Recognized Environmental Condition

A REC refers to the presence or likely presence of any hazardous substances or petroleum products in, on, or at a property due to release to the environment, under conditions indicative of a release to the environment, or under conditions that pose a material threat of a future release to the environment.

Cardno did not identify any RECs at the Subject Property during the course of this assessment.

1.4.2 Controlled Recognized Environmental Condition

A *controlled recognized environmental condition* (CREC) refers to a REC resulting from a past release of hazardous substances or petroleum products that has been addressed to the satisfaction of the applicable regulatory authority, with hazardous substances or petroleum products allowed to remain in place subject to the implementation of required controls.

Cardno did not identify any CRECs at the Subject Property during the course of this assessment.

1.4.3 Historical Recognized Environmental Condition

An *historical recognized environmental condition* (HREC) refers to a past release of any hazardous substances or petroleum products that occurred in connection with the Subject Property and has been addressed to the satisfaction of the applicable regulatory authority or meeting unrestricted use criteria established by a regulatory authority, without subjecting the Subject Property to any required controls.

Cardno did not identify any HRECs at the Subject Property during the course of this assessment.

1.4.4 Environmental Issue

An *environmental issue* refers to environmental concerns identified by Cardno that warrant further discussion, but that do not qualify as RECs.

Cardno did not identify any environmental issues during the course of this assessment.

1.5 Conclusions, Opinions and Recommendations

Cardno performed a Phase I ESA in conformance with the scope and limitations of ASTM Practice E1527-13 of SEC of Ross Avenue & Hawes Road in the City of El Centro, Imperial County, California (the "Subject Property"). Any exceptions to, or deletions from, are described in Section 1.3 of this report.

This assessment did not reveal evidence of RECs or environmental issues in connection with the Subject Property. Based on the conclusions of this assessment no further investigation of the Subject Property is warranted at this time.

2 Introduction

2.1 Purpose

The purpose of this Phase I ESA was to identify RECs and certain potential environmental conditions outside the scope of ASTM Standard Practice E 1527-13 in connection with the Subject Property at the time of the site reconnaissance. This report documents the findings, opinions, and conclusions of the Phase I ESA.

2.2 Scope

This Phase I ESA was conducted in general accordance with the ASTM Standard Practice E 1527-13, consistent with a level of care and skill ordinarily practiced by the environmental consulting profession currently providing similar services under similar circumstances. Significant additions, deletions, or exceptions to ASTM Standard Practice E 1527-13 are noted below or in the corresponding sections of this report. The scope of this assessment included an evaluation of the following:

- Physical setting characteristics of the Subject Property through a review of referenced sources such as topographic maps and geologic, soils, and hydrologic reports.
- Usage of the Subject Property, adjoining properties, and surrounding area through a review of referenced historical sources such as land title records, fire insurance maps, city directories, aerial photographs, prior reports, and interviews.
- Observations and interviews regarding current Subject Property usage and conditions including the use, treatment, storage, disposal, or generation of hazardous substances, petroleum products, hazardous wastes, non-hazardous solid wastes, and wastewater.
- Usage of adjoining and surrounding properties and the likely impact of known or suspected releases of hazardous substances or petroleum products on the Subject Property.
- Information referenced in environmental agency databases and local environmental records within the specified approximate minimum search distance from the Subject Property.

The scope of the assessment also included consideration of the following environmental issues or conditions that are beyond the scope of ASTM Standard Practice E 1527-13:

- Mold screening to report the findings of a baseline survey of readily observable mold and conditions conducive to mold on the Subject Property identified by limited interview, document review, and physical observation and to provide an opinion on whether an identified condition warrants further action. The scope of work for the mold screening was intended to be consistent with ASTM Standard Practice E 2418-06: *Standard Guide for Readily Observable Mold and Conditions Conducive to Mold in Commercial Buildings: Baseline Survey Process*. The scope of work, including potential deviations from the Standard Guide, is described as follows. The interview was limited to one knowledgeable person from property management or engineering staff. The document review was limited to only those relevant documents made readily available to Cardno in a timely manner. The physical observations were limited to certain heating, ventilation, and air conditioning (HVAC) system areas and other readily accessible building areas likely to become subject to water damage, plumbing leaks, and flooding. Unless noted otherwise herein, Cardno observed the HVAC equipment room(s) and readily accessible mechanical rooms and, in buildings with package units in the ceiling, at least one unit per floor. Also, unless noted otherwise, Cardno observed readily accessible areas of the basement (or lowest level), the top floor, the roof and at least one mid-level floor (if applicable). For multi-story buildings, the total number of floors observed (inclusive of those already mentioned) was intended to be up to 10% of the total number of floors (if readily accessible). For hotel and multi-family buildings, Cardno targeted the lowest and highest levels and roof as described above and up to 10% of units, including one per floor if readily accessible.

The mold screening did not include destructive methods of observation. No sampling or laboratory analyses were conducted. The mold screening service as described herein was limited in scope and by the time and cost considerations typically associated with performing a Phase I ESA. No method can guarantee that a hazard will be discovered if evidence of the hazard is not encountered within the performance of the mold screening as authorized and that opinions and conclusions must, out of necessity, be extrapolated from limited information and discrete, non-continuous data points. Unidentified mold or other microbial conditions may exist on the Subject Property.

- Visual observation and limited sampling of suspect asbestos-containing material (ACM) at the Subject Property. The visual observation consists of providing an opinion on the condition of suspect ACM on the Subject Property, based upon visual observation during the site reconnaissance. The limited sampling, if conducted, consists of the submission of bulk material samples to an accredited laboratory for determination of asbestos concentrations. The sampling was “limited” in that it was not intended to comply with the sampling requirements described in 40 CFR Part 763 or 40 CFR Part 61. Limited surveys are performed to identify the presence of readily accessible suspect ACM and to develop recommendations as to the need for a more thorough survey and/or an operations and maintenance (O&M) program.
- Radon document review, consisting of the review of published radon data with regard to the potential for elevated levels of radon gas in the surrounding area of the Subject Property.
- Lead in drinking water data review, consisting of contacting the water supplier for information regarding whether or not the potable water provided to the Subject Property meets or exceeds drinking water standards for lead.
- Visual observation of lead-based paint (LBP), consisting of providing an opinion on the potential for LBP based on the construction date of buildings on the Subject Property and visual observation of the condition of suspect LBP.
- Wetlands document review, consisting of a review of a current National Wetlands Inventory map of the surrounding area to note if the Subject Property is identified as having a wetland.
- Flood plain document review, consisting of a review of a reasonably ascertainable flood plain map of the surrounding area to note if the Subject Property is identified as being located within a flood plain.

2.3 Significant Assumption

Any assumptions in this report were not considered as having significant impact on the determination of RECs associated with the Subject Property.

2.4 Limitations and Exceptions

Cardno prepared this Phase I ESA report using reasonable efforts to identify RECs associated with hazardous substances or petroleum products at the Subject Property. Findings contained within this report are based on information collected from observations made on the day(s) of the site reconnaissance and from reasonably ascertainable information obtained from certain public agencies and other referenced sources.

The ASTM Standard Practice E 1527-13 recognizes inherent limitations for Phase I ESAs, including, but not limited to:

- *Uncertainty Not Eliminated* – A Phase I ESA cannot completely eliminate uncertainty regarding the potential for RECs in connection with any property.
- *Not Exhaustive* – A Phase I ESA is not an exhaustive investigation of the Subject Property and environmental conditions on such property.

- *Past Uses of the Property* – Phase I requirements only require review of standard historical sources at five year intervals; therefore, past uses of the Subject Property at less than five year intervals may not be discovered.

Users of this report may refer to ASTM Standard Practice E 1527-13 for further information regarding these and other limitations. This report is not definitive and should not be assumed to be a complete and/or specific definition of all conditions above or below grade. Current subsurface conditions may differ from the conditions determined by surface observations, interviews, and reviews of historical sources. The most reliable method of evaluating subsurface conditions is through intrusive techniques, which are beyond the scope of this report. Information in this report is not intended to be used as a construction document and should not be used for demolition, renovation, or other property construction purposes. Any use of this report by any party, beyond the scope and intent of the original parties, shall be at the sole risk and expense of such user.

Cardno makes no representation or warranty that the past or current operations at the Subject Property are, or have been, in compliance with all applicable federal, state, and local laws, regulations, and codes. This report does not warrant against future operations or conditions, nor does it warrant against operations or conditions present of a type or at a location not investigated. Regardless of the findings stated in this report, Cardno is not responsible for consequences or conditions arising from facts not fully disclosed to Cardno during the assessment.

An independent data research company provided the government agency database referenced in this report. Information on surrounding area properties was requested for approximate minimum search distances and is assumed to be correct and complete unless obviously contradicted by Cardno's observations or other credible referenced sources reviewed during the assessment. Cardno shall not be liable for any such database firm's failure to make relevant files or documents properly available, to properly index files, or otherwise to fail to maintain or produce accurate or complete records.

Cardno used reasonable efforts to identify evidence of aboveground and underground storage tanks (USTs) and ancillary equipment on the Subject Property during the assessment. "Reasonable efforts" were limited to observation of accessible areas, review of referenced public records and interviews. These reasonable efforts may not identify subsurface equipment or evidence hidden from view by things including, but not limited to, snow cover, paving, construction activities, stored materials and landscaping.

Any estimates of costs or quantities in this report are approximations for commercial real estate transaction due diligence purposes and are based on the findings, opinions, and conclusions of this assessment, which are limited by the scope of the assessment, schedule demands, cost constraints, accessibility limitations, and other factors associated with performing the Phase I ESA. Subsequent determinations of costs or quantities may vary from the estimates in this report. The estimated costs or quantities in this report are not intended to be used for financial disclosure related to the Financial Accounting Standards Board (FASB) Statement No. 143, FASB Interpretation No. 47, Sarbanes/Oxley Act or any United States Securities and Exchange Commission reporting obligations, and may not be used for such purposes in any form without the express written permission of Cardno.

Cardno is not a professional title insurance or land surveyor firm and makes no guarantee, express or implied, that any land title records acquired or reviewed in this report, or any physical descriptions or depictions of the Subject Property in this report, represent a comprehensive definition or precise delineation of property ownership or boundaries.

The Environmental Professional Statement in Section 1.1 of this report does not "certify" the findings contained in this report and is not a legal opinion of the Environmental Professional. The Environmental Professional Statement is intended to document Cardno's opinion that an individual meeting the qualifications of an Environmental Professional was involved in the performance of the assessment and that the activities performed by, or under the supervision of, the Environmental Professional were performed in conformance with the standards and practices set forth in 40 CFR Part 312 per the methodology in ASTM Standard Practice E 1527-13 and the scope of work for this assessment.

Per ASTM Standard Practice E 1527-13, Section 6, User Responsibilities, the user of this assessment has specific obligations for performing tasks during this assessment that will help identify the possibility of RECs in connection with the Subject Property. Failure by the user to fully comply with the requirements may impact their ability to use this report to help qualify for Landowner Liability Protections (LLPs) under the Comprehensive Environmental Response, Compensation, and Liability Act (CERCLA). Cardno makes no representations or warranties regarding a user's qualification for protection under any federal, state, or local laws, rules, or regulations.

In accordance with the ASTM Standard Practice E 1527-13, this report is presumed to be valid for a six-month period. If the report is older than six months, the following information must be updated for the report to be valid: (1) regulatory review, (2) site visit, (3) interviews, (4) specialized knowledge, and (5) environmental liens search. Reports older than one year may not meet the ASTM Standard Practice 1527-13 and, therefore, the entire report must be updated to reflect current conditions and property-specific information.

Other limitations and exceptions that are specific to the scope of this report may be found in corresponding sections.

2.5 Special Terms and Conditions (User Reliance)

This report is for the use and benefit of, and may be relied upon by the Maverik, Inc., its affiliates, and third parties authorized in writing by the client and Cardno, including the lender(s) in connection with a secured financing of the Subject Property, and their respective successors and assigns. Any third party agrees by accepting this report that any use or reliance on this report shall be limited by the exceptions and limitations in this report, and with the acknowledgment that actual Subject Property conditions may change with time, and that hidden conditions may exist at the Subject Property that were not discovered within the authorized scope of the assessment. Any use by or distribution of this report to third parties, without the express written consent of Cardno, is at the sole risk and expense of such third party.

Cardno makes no other representation to any third party except that it has used the degree of care and skill ordinarily exercised by environmental consultants in the preparation of the report and in the assembling of data and information related thereto. No other warranties are made to any third party, either expressed or implied. Unless otherwise agreed upon in writing by Cardno and a third party, Cardno's liability to any third party authorized to use or rely on this report with respect to any acts or omissions shall be limited to a total maximum amount of \$50,000.

3 Site Description

3.1 Local and Legal Description

The Subject Property at SEC of Ross Avenue & Hawes Road in El Centro, California is located on the south side of Ross Avenue and the east side of Hawes Road. According to the county assessor the Subject Property ownership has been vested in Ross Road Project LLC.

A Site Vicinity Map is located in Appendix A, a Site Plan is included in Appendix B, and Subject Property photographs are provided in Appendix C.

3.2 Surrounding Area General Characteristics

The surrounding area is primarily characterized by agricultural properties. The Subject Property can be accessed from Ross Avenue. Elevation at the Subject Property is at 36 feet below mean sea level (msl). The topography of the Subject Property is generally flat. The Subject Property topography is discussed in detail in Section 5.2.1 of this report.

Specific adjoining property information is further discussed in Section 3.5.

3.3 Current Use of the Property

The Subject Property is currently an undeveloped alfalfa field.

Vehicular access to the Subject Property is provided from Ross Avenue along the northern perimeter of the Subject Property.

The Subject Property is designated for agricultural use by Imperial County and is considered a legal use in its current configuration.

The Subject Property was not identified in the regulatory database report of Section 5.1.

Subject Property photographs are provided in Appendix C.

3.4 Description of Property Improvements

The following table provides general descriptions of the Subject Property improvements.

Property Improvements

Size of Property (approximate)	Approximate 10-acre parcel
General Topography of Property	Generally flat
Adjoining and/or Access/Egress Roads	North: Ross Ave West: Hawes Rd
Approximate % Paved or Concrete Areas	<input type="checkbox"/> Asphalt 0% <input type="checkbox"/> Concrete 0%
Approximate % Unimproved Areas	100%
Approximate % Landscaped Areas	0%%
Approximate % Surface Water	0%
Potable Water Source	NA
Sanitary Sewer Utility	NA
Storm Sewer Utility	NA

Electrical Utility	NA
Natural Gas Utility	NA
Current Occupancy Status	Unoccupied
Unoccupied Buildings/Spaces/Structures	0
Number of Occupied Buildings	0

3.5 Current Uses of Adjoining Properties

The Subject Property is located within a mixed agricultural area of Imperial County. During the vicinity reconnaissance, Cardno observed land use in the immediate vicinity of the Subject Property as detailed in the following table.

Adjacent Properties

Direction	Street or Address	Across street (address if applicable)
North	Ross Ave	Residential (404 Ross Ave)
South	Agricultural land	N/A
East	Agricultural land	N/A
West	Hawes Rd & Interstate 111	Trailer Park (375 Ross Rd)

The adjacent property to the west was identified as a LUST and UST SWEEPS site in the regulatory database report of Section 5.1.2.

4 User-Provided Information

The following section summarizes information (if any) provided by Maverik, Inc. (User) with regard to the Phase I ESA. Documentation may be found where referenced in this report.

4.1 Title Records

User did not provide title record information for the Subject Property.

4.2 Environmental Liens or Activity and Use Limitations

User did not provide information regarding property environmental liens or activity and use limitations (AULs). Cardno attempted to identify environmental liens and AULs through client-supplied data. No liens or AULs were identified on the Subject Property.

4.3 Specialized Knowledge

User did not provide specialized knowledge regarding RECs associated with the Subject Property.

4.4 Significant Valuation Reduction for Environmental Issues

User did not provide information regarding a significant valuation reduction for environmental issues associated with the Subject Property.

4.5 Owner, Property Manager and Occupant Information

User provided Cardno with a site access contact indicating the Subject Property was currently unoccupied and an escort would not be needed.

4.6 Reason for Performing Phase I ESA

User indicated that the Phase I ESA was being completed prior to a financial transaction regarding the Subject Property.

4.7 Other User Provided Documents

The User was provided an environmental questionnaire concerning the Subject Property. Cardno had not received the completed document by October 22, 2021. A site map was provided by the User. This information can be reviewed in Appendix D. No other documents were supplied to Cardno as described in the ASTM Standard Practice E 1527-13.

5 Records Review

5.1 Standard Environmental Records

The regulatory agency database report discussed in this section, provided by Environmental Data Resources, Inc. (EDR), of Shelton, Connecticut, was reviewed for information regarding reported releases of hazardous substances and petroleum products on or near the Subject Property. Cardno also reviewed the “unmappable” (also referred to as “orphan”) listings within the database report, cross-referencing available address information and facility names. Unmappable sites are listings that could not be plotted with confidence, but are potentially in the general area of the Subject Property based on the partial street address, city, or zip code. Any unmappable site that was identified by Cardno as a being within the approximate minimum search distance from the Subject Property based on the site reconnaissance and/or cross-referencing to mapped listings, is included in the discussion within this section. The complete regulatory agency database report may be found in Appendix E. The following table is a summary of the findings of the database review.

Summary of Federal, State, and Tribal Database Findings

Regulatory Database	Approx. Minimum Search Distance	Property Listed?	Additional Sites Listed
Federal			
DOE FUSRAP	1 mile	No	No
NPL	1 mile	No	No
PROPOSED NPL	1 mile	No	No
DELETED NPL	½ mile	No	No
SEMS	½ mile	No	No
ODI	½ mile	No	No
SEMS ARCHIVE	½ mile	No	No
CERCLIS	½ mile	No	No
IODI	½ mile	No	No
CERCLIS NFRAP	½ mile	No	No
CERCLIS LIENS	Property	No	No
RCRA CORRACTS	1 mile	No	No
RCRA TSD	½ mile	No	No
RCRA LQG	¼ mile	No	No
RCRA SQG	¼ mile	No	No
RCRA VSQG	¼ mile	No	No
RCRA NON GEN	¼ mile	No	No
FED ENG	½ mile	No	No
FED INST	½ mile	No	No
LUCIS	½ mile	No	No
ERNS 1982 TO 1986	Property	No	No
ERNS 1987 TO 1989	Property	No	No
ERNS	Property	No	No
FED BROWNFIELDS	½ mile	No	No
FEMA UST	¼ mile	No	No
FRP	¼ mile	No	No
HIST GAS STATION	¼ mile	No	No
REFN	¼ mile	No	No
BULK TERMINAL	¼ mile	No	No
SEMS LIEN	Property	No	No

Regulatory Database	Approx. Minimum Search Distance	Property Listed?	Additional Sites Listed
State			
RESPONSE	1 mile	No	No
ENVIROSTOR	1 mile	No	No
DELISTED ENVIS	1 mile	No	No
SWF/LF	½ mile	No	No
SWRCB SWF	½ mile	No	No
HWP	1 mile	No	No
SWAT	½ mile	No	No
C&D DEBRIS RECY	½ mile	No	No
RECYCLING	½ mile	No	No
PROCESSORS	½ mile	No	No
CONTAINER RECY	½ mile	No	No
LDS	½ mile	No	No
LUST	½ mile	No	Yes (1)
DELISTED LST	½ mile	No	No
UST	¼ mile	No	No
UST CLOSURE	½ mile	No	No
HHSS	¼ mile	No	No
UST SWEEPS	¼ mile	No	Yes (1)
AST	¼ mile	No	No
AST SWRCB	¼ mile	No	No
TANKS OIL GAS	¼ mile	No	No
DELISTED TNK	¼ mile	No	No
CERS TANK	¼ mile	No	No
DELISTED CTNK	¼ mile	No	No
HIST TANK	¼ mile	No	No
LUR	½ mile	No	No
CALSITES	½ mile	No	No
HLUR	½ mile	No	No
DEED	½ mile	No	No
VCP	½ mile	No	No
CLEANUP SITES	½ mile	No	No
DELISTED COUNTY	¼ mile	No	No
Tribal			
INDIAN LUST	½ mile	No	No
INDIAN UST	¼ mile	No	No
DELISTED ILST	½ mile	No	No
DELISTED IUST	¼ mile	No	No
County			
CUPA IMPERIAL	¼ mile	No	No
Additional Environmental Records			
Federal			
PFAS NPL	½ mile	No	No
FINDS/FRS	Property	No	No
TRIS	Property	No	No
PRAS TI	½ mile	No	No

Regulatory Database	Approx. Minimum Search Distance	Property Listed?	Additional Sites Listed
PFAS WATER	½ mile	No	No
HMIRS	1/8 mile	No	No
NCDL	1/8 mile	No	No
TSCA	1/8 mile	No	No
HIST TSCA	1/8 mile	No	No
FTTS ADMIN	Property	No	No
FTTS INSP	Property	No	No
PRP	Property	No	No
SCRD DRYCLEANER	½ mile	No	No
ICIS	Property	No	No
FED DRYCLEANERS	¼ mile	No	No
DELISTED FED DRY	¼ mile	No	No
FUDS	1 mile	No	No
FORMER NIKE	1 mile	No	No
PIPELINE INCIDENT	Property	No	No
MLTS	Property	No	No
HIST MLTS	Property	No	No
MINES	¼ mile	No	No
SMCRA	1 mile	No	No
MRDS	1 mile	No	No
URANIUM	1 mile	No	No
ALT FUELS	¼ mile	No	No
SSTS	¼ mile	No	No
PCB	½ mile	No	No
State			
DRYCLEANERS	¼ mile	No	No
DELISTED DRYCLEANERS	¼ mile	No	No
DRYC GRANT	¼ mile	No	No
PFAS	½ mile	No	No
PFAS GW	½ mile	No	No
HWSS CLEANUP	½ mile	No	No
DTSC HWF	½ mile	No	No
INSP COMP ENF	1 mile	No	No
SCH	1 mile	No	No
CHMIRS	Property	No	No
HIST CHMIRS	Property	No	No
HAZNET	Property	No	No
HIST MANIFEST	Property	No	No
HW TRANSPORT	1/8 mile	No	No
WASTE TIRE	Property	No	No
MEDICAL WASTE	¼ mile	No	No
HIST CORTESE	½ mile	No	No
CDO/CAO	½ mile	No	No
CERS HAZ	1/8 mile	No	No
DELISTED HAZ	½ mile	No	No
GEOTRACKER	1/8 mile	No	No
MINE	1 mile	No	No

Regulatory Database	Approx. Minimum Search Distance	Property Listed?	Additional Sites Listed
LIEN	Property	No	No
WASTE DISCHG	¼ mile	No	No
EMISSIONS	¼ mile	No	No
CDL	1/8 mile	No	No

5.1.1 Subject Property Listings

The Subject Property is not identified in the regulatory database report.

5.1.2 Adjacent Property Listings

The adjacent properties are identified in the regulatory database report:

- The adjacent property, identified as KOA Campground at 375 Ross Road, El Centro, CA, is located adjacent to the west of the Subject Property. This site reported a release of gasoline on September 6, 1994, which reportedly was closed on June 27, 1996. Based on the closure of this site and the site being down gradient of the Subject Property, this listing is not expected to represent a significant environmental concern and it is unlikely that a regulatory file review for this site would alter the findings of this assessment.

5.1.3 Sites of Concern Listings

No sites of concern are identified in the regulatory database report.

Based on the findings, vapor migration is not expected to represent a significant environmental concern at this time.

5.1.4 Orphan Listings

No orphan listings are identified in the regulatory database report.

5.1.5 Local Environmental Records Search

Name of Agency: California Environmental Protection Agency

Point of Contact: ERIS Xplorer

Agency Address: 1001 I Street, Sacramento, CA 95814

Agency Phone Number: (916) 232-2514

Date of Contact: October 18, 2021

Method of Communication: Online

Communication Summary: No records regarding hazardous substance use, storage or releases, or the presence of USTs and AULs on the Subject Property were on file with the agency.

A copy of pertinent documents is included in Appendix E of this report.

5.1.6 Health Department

Name of Agency: Imperial County Environmental Health
Point of Contact: Admin
Agency Address: 797 Main Street, Suite B, El Centro, CA 92243
Agency Phone Number: (442) 265-1888
Date of Contact: October 18, 2021
Method of Communication: Telephone
Communication Summary: As of the date of this report, Cardno has not received a response from this agency for inclusion in this report.

5.1.7 Fire Department

Name of Agency: El Centro Fire Department
Point of Contact: Website
Agency Address: 1910 N Waterman Ave, El Centro, CA 92243
Agency Phone Number: (760) 337-4530
Date of Contact: October 18, 2021
Method of Communication: Online
Communication Summary: As of the date of this report, Cardno has not received a response from this agency for inclusion in this report.

5.1.8 Planning Department

Name of Agency: Department of Planning & Zoning
Point of Contact: Website
Agency Address: 1275 Main Street, El Centro, CA 92243
Agency Phone Number: (760) 337-4545
Date of Contact: October 18, 2021
Method of Communication: Online
Communication Summary: According to records reviewed, the Subject Property is zoned for agricultural use by Imperial County.

A copy of pertinent documents is included in Appendix G of this report.

5.1.9 Oil & Gas Exploration

Name of Agency: Division of Oil, Gas, and Geothermal Resources
Point of Contact: ERIS Xplorer
Agency Address: 4800 Stockdale Hwy #100, Bakersfield, CA 93309
Agency Phone Number: (661) 322-4031
Date of Contact: October 18, 2021
Method of Communication: Online
Communication Summary: According to the agency, no oil or gas wells are located on or adjacent to the Subject Property.

5.1.10 Assessor's Office

Name of Agency: Imperial County Assessor
Point of Contact: Website
Agency Address: 940 Main Street #115, El Centro, CA 92243
Agency Phone Number: (442) 265-1300
Date of Contact: October 18, 2021
Method of Communication: Online
Communication Summary: According to records reviewed, the Subject property is identified as a portion of Assessor Parcel Number (APN) 054080023 and is currently owned by Ross Road Project LLC.

5.1.11 Utilities

Utility providers for the Subject Property are detailed in the following table.

Utility Providers

Utility	Provider
Electrical Utility Company	NA
Water Utility	NA
Sewer Utility	NA
Natural Gas Utility	NA

5.1.12 Other Local Environmental Records Sources

No additional local environmental records sources were reviewed for this assessment.

5.2 Physical Setting Sources

5.2.1 Topography

The United States Geological Survey (USGS) *El Centro & Holtville West*, California Quadrangle 7.5-minute series topographic map was reviewed for this ESA. According to the contour lines on the topographic map, the Subject Property is located at approximately 36 feet below msl. The contour lines in the area of the Subject Property indicate the area is sloping gently toward the west. The Subject Property is depicted on the 2015 map as undeveloped.

5.2.2 Geology/Soils

The Subject Property is situated within the Quaternary alluvium and marine deposits in the Pliocene to Holocene epochs.

Based on information obtained from the USDA Natural Resources Conservation Service Web Soil Survey online database, the Subject Property is mapped as Melolo and very fine sandy loam. The soils have a high runoff potential when thoroughly wet. Water movement through the soil is restricted or very restricted. Slopes range from 0 to 2 percent.

5.2.3 Hydrology

According to topographic map interpretation, the direction of groundwater in the vicinity of the Subject Property is inferred to flow toward the west. The nearest surface water in the vicinity of the Subject Property is the Acacia Five A Drain, located along the western perimeter of the Subject Property. No settling ponds, lagoons, surface impoundments, wetlands, or natural catch basins were observed at the Subject Property during this assessment.

According to available information, a public water system operated by the El Centro Water Department serves the Subject Property vicinity. According to the Consumer Confidence Report, shallow groundwater beneath the Subject Property is not used for domestic purposes. The sources of public water for the City of El Centro are surface water from the Colorado River via the All American Canal.

Information specific to the Subject Property regarding the depth to groundwater and direction of groundwater flow was not available for the subject area.

5.2.4 Other Physical Setting Sources

5.2.4.1 *Flood Plain Map*

Cardno performed a review of the Flood Insurance Rate Map, published by the Federal Emergency Management Agency (FEMA). According to Community Panel Number 06025C1725C, September 26, 2008, the Subject Property appears to be located in Zone X, an area of minimal flood hazard.

A copy of the FEMA Map is included in Appendix G.

5.2.4.2 *Wetlands Map*

According to the U.S. Fish and Wildlife Service, National Wetlands Inventory, wetlands *are not* located on the Subject Property. A copy of the Wetland Map is included in Appendix G. It is noted that this investigation did not include a formal determination relating to the presence of possible wetlands areas on the Subject Property.

5.3 Historical Records Sources

The following table summarizes the findings of the research presented in the following subsections pertaining to historical property and surrounding area uses.

Historical Use Information

Period / Date	Source	Description / Use
1937 - present	Aerial Photographs, Interviews, Topographic Maps, On-site Observations	Agricultural land

Potential environmental concerns were not identified in association with the current or former use of the Subject Property.

Data gaps were encountered; however, based on the historical research conducted, *significant data gaps* were not identified during this Phase I ESA. As such, the requirements of ASTM Standard Practice E 1527-13 §8.3.2.1 and §8.3.2.2 have been satisfied and the historical research is considered complete.

5.3.1 Aerial Photographs

Cardno obtained available aerial photographs of the Subject Property and surrounding area from ERIS on October 7, 2021. The observations in the following tables were noted to be visible on the Subject Property and adjacent properties during the aerial photograph review.

Aerial Photographs (1937)

	Description	Scale: 1"=500'
Subject Property	Appears to be agricultural land	
North	Appears to be agricultural land across a road	
South	Appears to be developed with a structure and agricultural land	
East	Appears to be agricultural land	
West	Appears to be agricultural land across a road	

Aerial Photographs (1953)

	Description	Scale: 1"=500'
Subject Property	Appears to be agricultural land	
North	Appears to be developed with a structure and agricultural land across a road	
South	Appears to be agricultural land	
East	Appears to be agricultural land	
West	Appears to be developed with a structure and agricultural land across a road	

Aerial Photographs (1956, 1969)

	Description	Scale: 1"=500'
Subject Property	Appears to be agricultural land	
North	Appears to be developed with a structure and agricultural land across a road	
South	Appears to be agricultural land	
East	Appears to be agricultural land	
West	Appears to be agricultural land across a road	

Aerial Photographs (1976, 1984, 1996, 2002, 2005, 2006, 2010, 2012, 2014, 2016, 2018, 2020)

	Description	Scale: 1"=500'
Subject Property	Appears to be agricultural land	
North	Appears to be developed with a structure and agricultural land across a road	
South	Appears to be agricultural land	
East	Appears to be agricultural land	

West	Appears to be developed with a camp ground across a interstate
------	--

Copies of select aerial photographs are included in Appendix F of this report.

5.3.2 Fire Insurance Maps

Cardno reviewed the collection of Sanborn Fire insurance maps from ERIS on October 6, 2021. Sanborn map coverage was not available for the Subject Property.

Copies of reviewed Sanborn Maps are included in Appendix G of this report.

5.3.3 Property Tax Files

According to information obtained from the Imperial County Assessor’s office, the Subject Property is made up of a portion of 1 parcel of land. This is parcel 054080023. According to the Imperial County Assessor’s online data, all parcels are owned by Ross Road Project LLC.

Additional historical ownership information was not available. The review of tax files did not identify past uses indicating RECs at the Subject Property.

5.3.4 Recorded Land Title Records and AULs

The acquisition of recorded land title records was not required by the scope of work for this ESA; however, Cardno did conduct a search for environmental liens and/or AULs using client-supplied information. No environmental liens or AULs were identified from the client-supplied information.

5.3.5 Historical USGS Topographic Quadrangles

Cardno reviewed historical topographic maps obtained from ERIS on October 6, 2021. The observations of the Subject Property and adjacent properties made during the topographic map review are as follows.

Historic USGS Topographic Quadrangles (1940, 1945)

	Description
Subject Property	Appears to be undeveloped vacant land
North	Appears to be undeveloped vacant land across a road
South	Appears to be undeveloped vacant land
East	Appears to be undeveloped vacant land
West	Appears to be developed with a structure across a road

Historic USGS Topographic Quadrangles (1956, 1957)

	Description
Subject Property	Appears to be undeveloped vacant land
North	Appears to be developed with a structure across a road
South	Appears to be undeveloped vacant land
East	Appears to be undeveloped vacant land
West	Appears to be undeveloped vacant land across a road

Historic USGS Topographic Quadrangles (1979, 2015)

	Description
Subject Property	Appears to be undeveloped vacant land
North	Appears to be developed with a structure across a road

South	Appears to be undeveloped vacant land
East	Appears to be undeveloped vacant land
West	Appears to be developed with a structure across a road

Copies of reviewed topographic maps are included in Appendix G of this report.

5.3.6 City Directories

Cardno reviewed historical city directories obtained from ERIS on October 8, 2021 for past names and businesses that were listed for the Subject Property and adjacent properties.

City directories were not identified for the Subject Property.

City directory findings are presented in the following tables.

City Directory Search (Adjacent Properties)

Year(s)	Occupant	Address	Environmentally Sensitive
1982, 1987, 1992	K O A Camp Ground	375 Ross Ave	No
1997, 2002, 2006	Country Life Mobile Home	375 Ross Ave	No

Copies of reviewed city directories are included in Appendix G of this report.

5.3.7 Building Department Records

Building Department records were previously discussed in Section 5.1.8.

5.3.8 Zoning/Land Use Records

Zoning/land use records were previously discussed in Section 5.1.9.

5.3.9 Prior Reports

No prior reports were reviewed for this assessment.

5.3.10 Other Historical Sources

No other historical sources were reviewed for this assessment.

6 Site Reconnaissance

The initial unaccompanied site reconnaissance was conducted by Russ Hamblin of Cardno on October 15, 2021. This visit was focused on the publically accessible areas of the Subject Property and noted only exterior features.

Photographs of the Subject Property are included in Appendix C.

6.1 Methodology and Limiting Conditions

The site reconnaissance consisted of visual and/or physical observations of the Subject Property and improvements, adjoining sites as viewed from the Subject Property, and the surrounding area based on visual observations made during the trip to and from the Subject Property. At the time of the Subject Property inspection, the weather conditions were sunny and approximately 80 degrees Fahrenheit. The ground was clear, allowing for unobstructed visual inspection.

6.2 Hazardous Substance Use, Storage, and Disposal

No hazardous substances or petroleum products were observed on the Subject Property during the site reconnaissance.

6.3 Aboveground and Underground Hazardous Substance or Petroleum Product Storage Tanks

No evidence of current or former aboveground storage tanks (ASTs) or USTs was observed during the site reconnaissance.

6.4 Polychlorinated Biphenyls

No potential polychlorinated biphenyl (PCB)-containing equipment (transformers, oil-filled switches, hoists, lifts, dock levelers, hydraulic elevators, etc.) was observed on the Subject Property.

6.5 Unidentified Substance Containers

Cardno did not observe any unidentified substance containers on the Subject Property.

6.6 Non-hazardous Solid Waste

Cardno did not observe non-hazardous or solid waste on the Subject Property.

6.7 Wastewater

Cardno did not observe evidence of wastewater generated, treated or discharged (including sanitary sewage and storm water) on the Subject Property or to adjoining properties.

6.8 Waste Pits, Ponds and Lagoons

Cardno did not observe evidence of waste pits, ponds, or lagoons on the Subject Property.

6.9 Sumps

Cardno did not observe evidence of sumps or oil/water separators on the Subject Property.

6.10 Septic Systems

Cardno did not observe evidence of a septic system on the Subject Property.

6.11 Storm water Management System

Cardno did not observe evidence of surface water, surface impoundments, retention ponds, dry wells, or other storm water management systems at the Subject Property.

Storm water from the Subject Property either percolates into the ground or runs off the Subject Property to adjacent sites.

6.12 Wells

Cardno did not observe evidence of wells on the Subject Property.

7 Interviews

Persons were interviewed to obtain information regarding RECs in connection with the Subject Property. Pertinent information (if any) identified during those interviews are discussed in the respective sections of this report.

Record of Communication

Communication with	Date	Summary of Communication
Paul Heywood	October 12, 2021	Mr Heywood indicated they were unaware of any spills, uncontrolled releases, or violations associated with the Subject Property.

8 Other Environmental Conditions

8.1 Asbestos-Containing Material

Asbestos is the name given to a number of naturally occurring, fibrous silicate minerals mined for their useful properties such as thermal insulation, chemical and thermal stability, and high tensile strength. The Occupational Safety and Health Administration (OSHA) regulation 29 CFR 1926.1101 requires certain construction materials to be presumed to contain asbestos, for purposes of this regulation. All thermal system insulation (TSI), surfacing material, and asphalt/vinyl flooring that are present in a building constructed prior to 1981 and have not been appropriately tested are *presumed asbestos-containing material* (PACM).

Due to the undeveloped nature of the Subject Property, ACMs were not considered within the scope of this assessment.

8.2 Radon

Radon is a colorless, odorless, naturally occurring, radioactive, inert, gaseous element formed by radioactive decay of radium (Ra) atoms. The U.S. EPA has prepared a map to assist national, state, and local organizations to target their resources and to implement radon-resistant building codes. The map divides the country into three Radon Zones, as detailed in the following table.

U.S. EPA Radon Zones

Zones	Average Predicted Radon Levels	Potential
Zone 1	Exceed 4.0 pCi/L	Highest
Zone 2	Between 2.0 and 4.0 pCi/L	Moderate
Zone 3	Less than 2.0 pCi/L	Low

It is important to note that the U.S. EPA has found homes with elevated levels of radon in all three zones, and the U.S. EPA recommends site-specific testing to determine radon levels at a specific location; however, the map does give a valuable indication of the propensity of radon gas accumulation in structures.

Radon sampling was not conducted as part of this assessment. Review of the U.S. EPA Map of Radon Zones places the Subject Property in Zone 3. Based upon the radon zone classification, radon is not considered to be a significant environmental concern.

Due to the undeveloped nature of the Subject Property, radon is not considered to be a significant environmental concern.

A copy of the County Radon Map is included in Appendix G of this report.

8.3 Lead in Drinking Water

According to available information, a public water system operated by the City of El Centro Department of Public Works serves the Subject Property vicinity. According to the El Centro CCR Water Quality Report, shallow groundwater beneath the Subject Property is not used for domestic purposes. The sources of public water for the City of El Centro are surface water from the Central Main Canal. According to the City of El Centro and the 2020 Annual Water Quality Report, water supplied to the Subject Property is in compliance with all state and federal regulations pertaining to drinking water standards, including lead and copper.

Water sampling was not conducted to verify water quality.

8.4 Lead-Based Paint

Lead is a highly toxic metal that affects virtually every system of the body. Lead-based paint (LBP) is defined as any paint, varnish, stain, or other applied coating that has 1 mg/cm² (or 5,000 µg/g or 0.5% by weight) or more of lead. Congress passed the Residential Lead-Based Paint Hazard Reduction Act of 1992, also known as “Title X,” to protect families from exposure to lead from paint, dust, and soil. Under Section 1017 of Title X, intact LBP on most walls and ceilings is not considered a “hazard,” although the condition of the paint should be monitored and maintained to ensure that it does not become deteriorated. Further, Section 1018 of this law directed the U.S. Department of Housing and Urban Development (HUD) and the U.S. EPA to require the disclosure of known information on LBP and LBP hazards before the sale or lease of most housing built before 1978.

Due to the undeveloped nature of the Subject Property, LBP was not considered within the scope of this assessment.

8.5 Mold Screening

Molds are microscopic organisms found virtually everywhere, indoors and outdoors. Mold will grow and multiply under the right conditions, needing only sufficient moisture (e.g., in the form of very high humidity, condensation, or water from a leaking pipe), and organic material (e.g., ceiling tile, drywall, paper, or natural fiber carpet padding).

No obvious indications of water damage or mold growth were observed during Cardno, Inc.’s visual assessment.

Due to the undeveloped nature of the Subject Property, Mold Screening was not considered within the scope of this assessment.

8.6 Vapor Encroachment

Cardno, Inc. conducted a limited screening for potential vapor encroachment conditions (VECs) that may affect the Subject Property. The VEC screening focused on the current and historical usage of the Subject Property and also used the aforementioned regulatory database report provided by EDR to evaluate identified chemicals of concern, including petroleum hydrocarbons. The results of the limited screening did not indicate the presence of potential VECs for the Subject Property. This would not be considered a REC related to the Subject Property. A VEC report is located in Appendix K.

If the client should choose to further evaluate the potential VECs, Cardno, Inc. can provide those services accordingly.

9 References

ASTM International (ASTM). *Standard Practice for Environmental Site Assessments: Phase I Environmental Site Assessment Process, ASTM Designation E 1527-13*, dated November 2005.

ASTM International (ASTM). *Standard Guide for Readily Observable Mold and Conditions Conducive to Mold in Commercial Buildings: Baseline Survey Process, ASTM Designation E 2418-06*, dated March 2006.

Environmental Risk Information Services (ERIS). *ERIS Vapor Screening; Inquiry Number 21100500784*, dated October 8, 2021.

Environmental Risk Information Services (ERIS). *ERIS Fire Insurance Maps, Inquiry Number 21100500784*, dated October 6, 2021.

Environmental Risk Information Services (ERIS). *The ERIS Historical Aerials; Inquiry Number 21100500784*, dated October 7, 2021.

Environmental Risk Information Services (ERIS). *The ERIS-City Directory Report; Inquiry Number 21100500784*, dated October 8, 2021.

Environmental Risk Information Services (ERIS). *The ERIS Historical Topographic Map Report; Inquiry Number 21100500784*, dated October 6, 2021.

Environmental Risk Information Services (ERIS). *The ERIS Database Report; Inquiry Number 21100500784*, dated October 7, 2021.

Environmental Risk Information Services (ERIS). *The ERIS Physical Settings Report; Inquiry Number 21100500784*, dated October 6, 2021.

Federal Emergency Management Act, Map Service Center website, <https://msc.fema.gov/webapp/>, accessed October 18, 2021.

U.S. Fish and Wildlife Service, National Wetlands Inventory, <http://www.fws.gov/wetlands/Data/Mapper>, accessed October 18, 2021.

United States Department of Agriculture (USDA) Soil Conservation Service (SCS) Soil Survey website, <http://websoilsurvey.sc.egov.usda.gov/App/>, accessed October 18, 2021.

United States Geological Survey (USGS) Interactive Geologic Map of California, <http://ngmdb.usgs.gov/maps/>, accessed October 18, 2021.

Potential Maverik Acquisition - SEC of Ross Ave & Hawes Rd, El Centro,
CA

Appendix

A

Site Vicinity Map

EEC ORIGINAL PKG

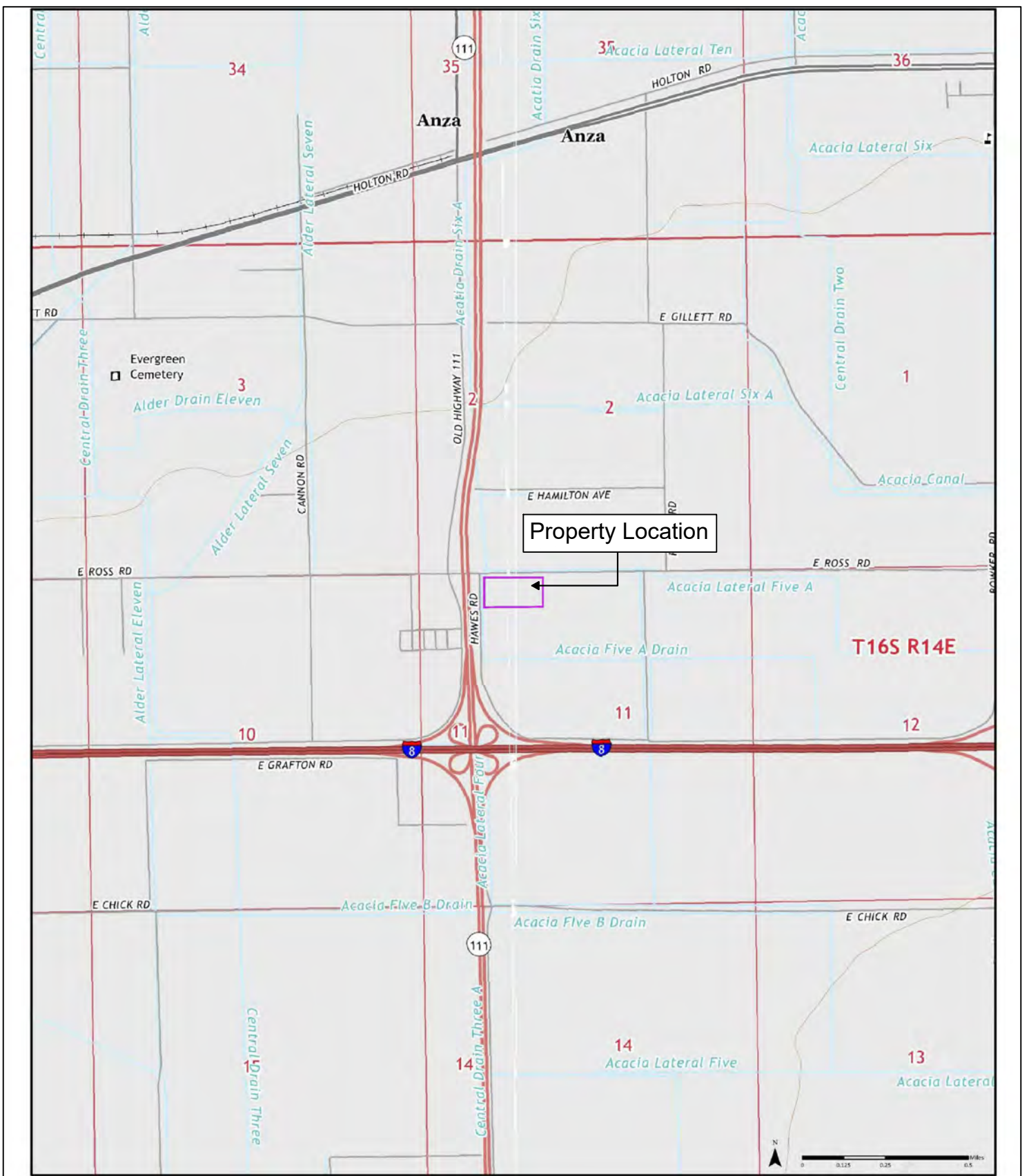

1

Latitude: 32° 46' 51" N
 Longitude: -115° 29' 56" W
 El Centro, CA, 2015
 Holtville West, CA, 2015
 Project No. 821AR00978.0001

This map and all data contained within are supplied as is with no warranty. Cardno, Inc. expressly disclaims responsibility for damages or liability from any claims that may arise out of the use or misuse of this map. It is the sole responsibility of the user to determine if the data on this map meets the user's needs. This map was not created as survey data, nor should it be used as such. It is the user's responsibility to obtain proper survey data, prepared by a licensed surveyor, where required by law.

Figure 1: Site Vicinity Map

Maverik - El Centro, CA
 Potential Maverik Location
 SEC of Ross Ave & Hawes Rd
 El Centro, Imperial County, California

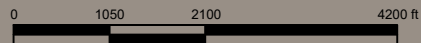

Cardno
 1142 WEST 2320 SOUTH, SUITE A
 WEST VALLEY, UTAH 84119
 P: 801-256-3800 F: 801-973-1095

EEC ORIGINAL PKG

Potential Maverik Acquisition - SEC of Ross Ave & Hawes Rd, El Centro,
CA

Appendix

B

Site Plan

EEC ORIGINAL PKG



2

This map and all data contained within are supplied as is with no warranty. Cardno, Inc. expressly disclaims responsibility for damages or liability from any claims that may arise out of the use or misuse of this map. It is the sole responsibility of the user to determine if the data on this map meets the user's needs. This map was not created as survey data, nor should it be used as such. It is the user's responsibility to obtain proper survey data, prepared by a licensed surveyor, where required by law.

Latitude: 32° 46' 51" N
 Longitude: -115° 29' 56" W

Project No. 821AR00978.0001

Figure 2: SITE PLAN
 Maverik - El Centro, CA
 Potential Maverik Location
 SEC of Ross Ave & Hawes Rd
 El Centro, Imperial County, California

0 250 500 ft



Cardno

1142 WEST 2320 SOUTH, SUITE A
 WEST VALLEY, UTAH 84119
 P: 801-256-3800 F: 801-973-1095

Potential Maverik Acquisition - SEC of Ross Ave & Hawes Rd, El Centro,
CA

Appendix

C

Subject Property Photographs

EEC ORIGINAL PKG



Photo 1
Comments: View to the W from the NE corner of the Subject Property along the northern boundary along Ross Ave.



Photo 2
Comments: View to the N across Ross Ave showing agricultural property to the N.



Photo 3
Comments: View to the SE showing agricultural property to the E of the Subject Property.



Photo 4
Comments: View of the Subject Property to the SW.



Photo 5
Comments: View to the S showing the center of the Subject Property.



Photo 6
Comments: View to the N from the NW corner showing a farmhouse across Ross Ave.



Photo 7
Comments: View to the W from the NW corner showing a drainage ditch.



Photo 8
Comments: View to the S showing the western property boundary from the NW corner.



Photo 9
Comments: View to the SE from the NW corner of the Subject Property.



Photo 10
Comments: View to the E showing the N side of the Subject Property from the NW corner.



Photo 11
Comments: View to the W showing an RV park to the w of the Subject Property across Hwy 111.



Photo 12
Comments: Another view of the drainage ditch to the w of the Subject Property looking S.



Photo 13
Comments: View to the S at the offsite agricultural field to the S from the SW corner.



Photo 14
Comments: View to the E showing the S side of Subject Property from the SW corner.



Photo 15
Comments: View to the N showing W side of the Subject Property from the SW corner.



Photo 16
Comments: View to the NE showing the Subject Property central area from the SW corner.



Photo 17
Comments: View to the N showing the E side of the Subject Property from the SE corner.



Photo 18
Comments: View to the S from the SE corner showing the offsite agricultural fields to the S.



Photo 19

Comments: View to the W showing the southside of the Subject Property from the SE corner.



Photo 20

Comments: View to the NW showing the Subject Property central area from SE corner.

Potential Maverik Acquisition - SEC of Ross Ave & Hawes Rd, El Centro,
CA

Appendix

D

User Provided Documentation

EEC ORIGINAL PKG

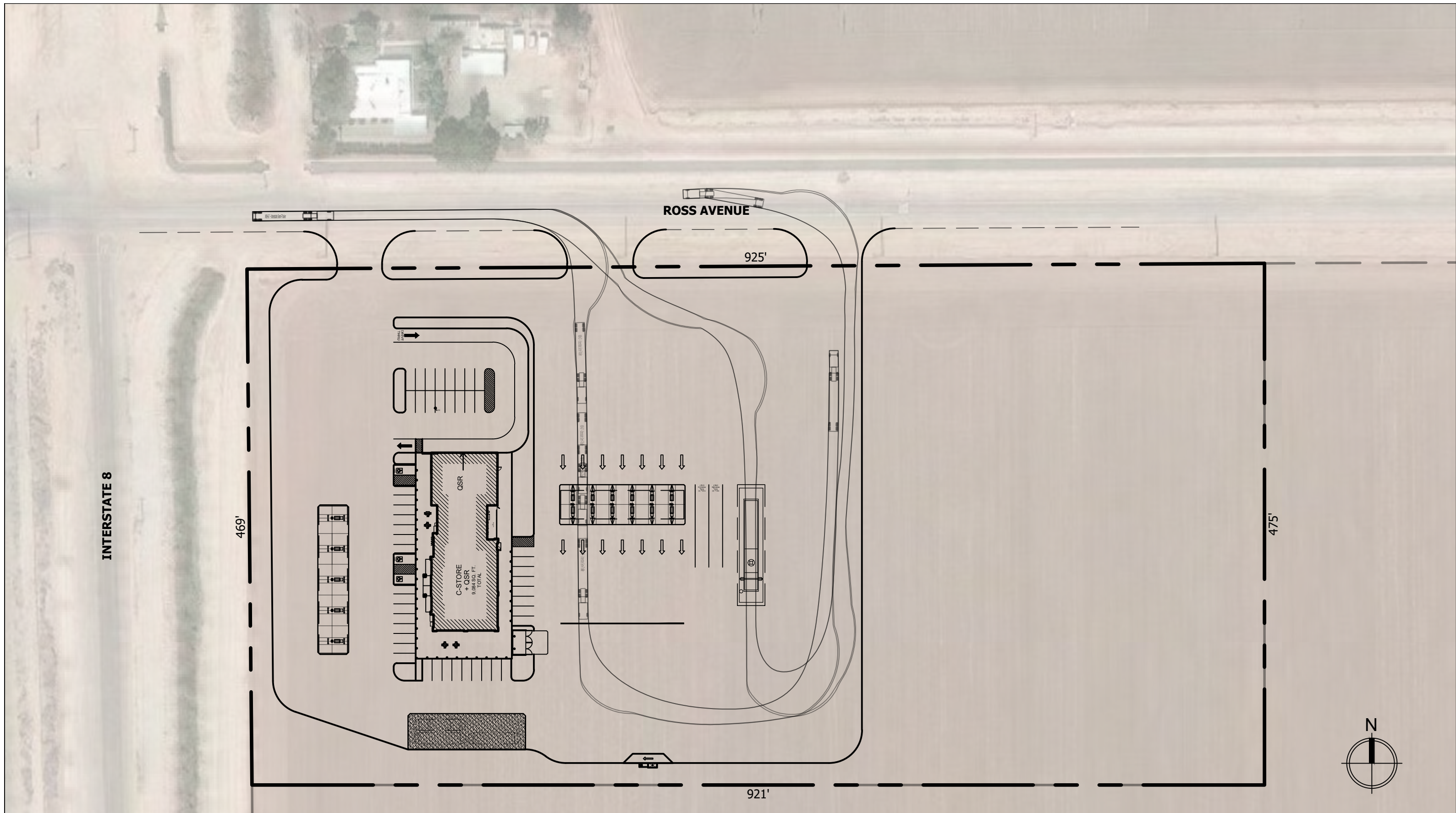

SITE DATA

PARKING:	APPROX. 51 STALLS PROVIDED
PARCEL AREA:	435,598 SQ. FT. 10.00 ACRES
BUILDING AREA:	9,084 SQ. FT. 0.21 ACRES

Scale:



Scale: 1" = 80'

QUICK FIT STUDY

ROSS AVENUE & INTERSTATE 8
EL CENTRO, CALIFORNIA

Date: 2021/09/27

BY: WO

Project number: 220170



185 S. State Street
Salt Lake City, Utah 84111

RED ORIGINAL PKG

Potential Maverik Acquisition - SEC of Ross Ave & Hawes Rd, El Centro,
CA

Appendix

E

Regulatory Database Report

EEC ORIGINAL PKG



DATABASE REPORT

Project Property: *Maverik El Centro
SEC of Ross Ave & Hawes Rd
El Centro CA*

Project No: *821AR00978.0001*

Report Type: *Database Report*

Order No: *21100500784*

Requested by: *Cardno Inc.*

Date Completed: *October 7, 2021*

Table of Contents

Table of Contents.....	2
Executive Summary.....	3
Executive Summary: Report Summary.....	4
Executive Summary: Site Report Summary - Project Property.....	9
Executive Summary: Site Report Summary - Surrounding Properties.....	10
Executive Summary: Summary by Data Source.....	11
Map.....	12
Aerial.....	15
Topographic Map.....	16
Detail Report.....	17
Unplottable Summary.....	20
Unplottable Report.....	21
Appendix: Database Descriptions.....	22
Definitions.....	36

Notice: IMPORTANT LIMITATIONS and YOUR LIABILITY

Reliance on information in Report: This report DOES NOT replace a full Phase I Environmental Site Assessment but is solely intended to be used as database review of environmental records.

License for use of information in Report: No page of this report can be used without this cover page, this notice and the project property identifier. The information in Report(s) may not be modified or re-sold.

Your Liability for misuse: Using this Service and/or its reports in a manner contrary to this Notice or your agreement will be in breach of copyright and contract and ERIS may obtain damages for such mis-use, including damages caused to third parties, and gives ERIS the right to terminate your account, rescind your license to any previous reports and to bar you from future use of the Service.

No warranty of Accuracy or Liability for ERIS: The information contained in this report has been produced by ERIS Information Inc. ("ERIS") using various sources of information, including information provided by Federal and State government departments. The report applies only to the address and up to the date specified on the cover of this report, and any alterations or deviation from this description will require a new report. This report and the data contained herein does not purport to be and does not constitute a guarantee of the accuracy of the information contained herein and does not constitute a legal opinion nor medical advice. Although ERIS has endeavored to present you with information that is accurate, ERIS disclaims, any and all liability for any errors, omissions, or inaccuracies in such information and data, whether attributable to inadvertence, negligence or otherwise, and for any consequences arising therefrom. Liability on the part of ERIS is limited to the monetary value paid for this report.

Trademark and Copyright: You may not use the ERIS trademarks or attribute any work to ERIS other than as outlined above. This Service and Report (s) are protected by copyright owned by ERIS Information Inc. Copyright in data used in the Service or Report(s) (the "Data") is owned by ERIS or its licensors. The Service, Report(s) and Data may not be copied or reproduced in whole or in any substantial part without prior written consent of ERIS.

Executive Summary

Property Information:

Project Property: *Maverik El Centro
SEC of Ross Ave & Hawes Rd El Centro CA*

Project No: *821AR00978.0001*

Coordinates:

Latitude: *32.78061451*
Longitude: *-115.49900409*
UTM Northing: *3,627,963.32*
UTM Easting: *640,569.47*
UTM Zone: *UTM Zone 11S*

Elevation: *-36 FT*

Order Information:

Order No: *21100500784*
Date Requested: *October 5, 2021*
Requested by: *Cardno Inc.*
Report Type: *Database Report*

Historicals/Products:

Aerial Photographs *Historical Aerials (Boundaries)*
City Directory Search *CD - 2 Street Search*
ERIS Xplorer [*ERIS Xplorer*](#)
Excel Add-On *Excel Add-On*
Fire Insurance Maps *US Fire Insurance Maps*
Physical Setting Report (PSR) *Physical Setting Report (PSR)*
Topographic Map *Topographic Maps*
Vapor Screening Tool *Vapor Screening Tool*

Executive Summary: Report Summary

Database	Searched	Search Radius	Project Property	Within 0.12mi	0.125mi to 0.25mi	0.25mi to 0.50mi	0.50mi to 1.00mi	Total
Standard Environmental Records								
Federal								
DOE FUSRAP	Y	1	0	0	0	0	0	0
NPL	Y	1	0	0	0	0	0	0
PROPOSED NPL	Y	1	0	0	0	0	0	0
DELETED NPL	Y	0.5	0	0	0	0	-	0
SEMS	Y	0.5	0	0	0	0	-	0
ODI	Y	0.5	0	0	0	0	-	0
SEMS ARCHIVE	Y	0.5	0	0	0	0	-	0
CERCLIS	Y	0.5	0	0	0	0	-	0
IODI	Y	0.5	0	0	0	0	-	0
CERCLIS NFRAP	Y	0.5	0	0	0	0	-	0
CERCLIS LIENS	Y	PO	0	-	-	-	-	0
RCRA CORRACTS	Y	1	0	0	0	0	0	0
RCRA TSD	Y	0.5	0	0	0	0	-	0
RCRA LQG	Y	0.25	0	0	0	-	-	0
RCRA SQG	Y	0.25	0	0	0	-	-	0
RCRA VSQG	Y	0.25	0	0	0	-	-	0
RCRA NON GEN	Y	0.25	0	0	0	-	-	0
FED ENG	Y	0.5	0	0	0	0	-	0
FED INST	Y	0.5	0	0	0	0	-	0
LUCIS	Y	0.5	0	0	0	0	-	0
ERNS 1982 TO 1986	Y	PO	0	-	-	-	-	0
ERNS 1987 TO 1989	Y	PO	0	-	-	-	-	0
ERNS	Y	PO	0	-	-	-	-	0
FED BROWNFIELDS	Y	0.5	0	0	0	0	-	0
FEMA UST	Y	0.25	0	0	0	-	-	0
FRP	Y	0.25	0	0	0	-	-	0
HIST GAS STATIONS	Y	0.25	0	0	0	-	-	0

Database	Searched	Search Radius	Project Property	Within 0.12mi	0.125mi to 0.25mi	0.25mi to 0.50mi	0.50mi to 1.00mi	Total
REFN	Y	0.25	0	0	0	-	-	0
BULK TERMINAL	Y	0.25	0	0	0	-	-	0
SEMS LIEN	Y	PO	0	-	-	-	-	0
SUPERFUND ROD	Y	1	0	0	0	0	0	0
State								
RESPONSE	Y	1	0	0	0	0	0	0
ENVIROSTOR	Y	1	0	0	0	0	0	0
DELISTED ENVS	Y	1	0	0	0	0	0	0
SWF/LF	Y	0.5	0	0	0	0	-	0
SWRCB SWF	Y	0.5	0	0	0	0	-	0
HWP	Y	1	0	0	0	0	0	0
SWAT	Y	0.5	0	0	0	0	-	0
C&D DEBRIS RECY	Y	0.5	0	0	0	0	-	0
RECYCLING	Y	0.5	0	0	0	0	-	0
PROCESSORS	Y	0.5	0	0	0	0	-	0
CONTAINER RECY	Y	0.5	0	0	0	0	-	0
LDS	Y	0.5	0	0	0	0	-	0
LUST	Y	0.5	0	0	1	0	-	1
DELISTED LST	Y	0.5	0	0	0	0	-	0
UST	Y	0.25	0	0	0	-	-	0
UST CLOSURE	Y	0.5	0	0	0	0	-	0
HHSS	Y	0.25	0	0	0	-	-	0
UST SWEEPS	Y	0.25	0	0	1	-	-	1
AST	Y	0.25	0	0	0	-	-	0
AST SWRCB	Y	0.25	0	0	0	-	-	0
TANK OIL GAS	Y	0.25	0	0	0	-	-	0
DELISTED TNK	Y	0.25	0	0	0	-	-	0
CERS TANK	Y	0.25	0	0	0	-	-	0
DELISTED CTNK	Y	0.25	0	0	0	-	-	0
HIST TANK	Y	0.25	0	0	0	-	-	0
LUR	Y	0.5	0	0	0	0	-	0
CALSITES	Y	0.5	0	0	0	0	-	0
HLUR	Y	0.5	0	0	0	0	-	0
DEED	Y	0.5	0	0	0	0	-	0

Database	Searched	Search Radius	Project Property	Within 0.12mi	0.125mi to 0.25mi	0.25mi to 0.50mi	0.50mi to 1.00mi	Total
VCP	Y	0.5	0	0	0	0	-	0
CLEANUP SITES	Y	0.5	0	0	0	0	-	0
DELISTED COUNTY	Y	0.25	0	0	0	-	-	0
Tribal								
INDIAN LUST	Y	0.5	0	0	0	0	-	0
INDIAN UST	Y	0.25	0	0	0	-	-	0
DELISTED ILST	Y	0.5	0	0	0	0	-	0
DELISTED IUST	Y	0.25	0	0	0	-	-	0
County								
CUPA IMPERIAL	Y	0.25	0	0	0	-	-	0
<u>Additional Environmental Records</u>								
Federal								
PFAS NPL	Y	0.5	0	0	0	0	-	0
FINDS/FRS	Y	PO	0	-	-	-	-	0
TRIS	Y	PO	0	-	-	-	-	0
PFAS TRI	Y	0.5	0	0	0	0	-	0
PFAS WATER	Y	0.5	0	0	0	0	-	0
HMIRS	Y	0.125	0	0	-	-	-	0
NCDL	Y	0.125	0	0	-	-	-	0
TSCA	Y	0.125	0	0	-	-	-	0
HIST TSCA	Y	0.125	0	0	-	-	-	0
FTTS ADMIN	Y	PO	0	-	-	-	-	0
FTTS INSP	Y	PO	0	-	-	-	-	0
PRP	Y	PO	0	-	-	-	-	0
SCRD DRYCLEANER	Y	0.5	0	0	0	0	-	0
ICIS	Y	PO	0	-	-	-	-	0
FED DRYCLEANERS	Y	0.25	0	0	0	-	-	0
DELISTED FED DRY	Y	0.25	0	0	0	-	-	0
FUDS	Y	1	0	0	0	0	0	0
FORMER NIKE	Y	1	0	0	0	0	0	0
PIPELINE INCIDENT	Y	PO	0	-	-	-	-	0
MLTS	Y	PO	0	-	-	-	-	0
HIST MLTS	Y	PO	0	-	-	-	-	0
MINES	Y	0.25	0	0	0	-	-	0

Database	Searched	Search Radius	Project Property	Within 0.12mi	0.125mi to 0.25mi	0.25mi to 0.50mi	0.50mi to 1.00mi	Total
SMCRA	Y	1	0	0	0	0	0	0
MRDS	Y	1	0	0	0	0	0	0
URANIUM	Y	1	0	0	0	0	0	0
ALT FUELS	Y	0.25	0	0	0	-	-	0
SSTS	Y	0.25	0	0	0	-	-	0
PCB	Y	0.5	0	0	0	0	-	0
State								
DRYCLEANERS	Y	0.25	0	0	0	-	-	0
DELISTED DRYCLEANERS	Y	0.25	0	0	0	-	-	0
DRYC GRANT	Y	0.25	0	0	0	-	-	0
PFAS	Y	0.5	0	0	0	0	-	0
PFAS GW	Y	0.5	0	0	0	0	-	0
HWSS CLEANUP	Y	0.5	0	0	0	0	-	0
DTSC HWF	Y	0.5	0	0	0	0	-	0
INSP COMP ENF	Y	1	0	0	0	0	0	0
SCH	Y	1	0	0	0	0	0	0
CHMIRS	Y	PO	0	-	-	-	-	0
HIST CHMIRS	Y	PO	0	-	-	-	-	0
HAZNET	Y	PO	0	-	-	-	-	0
HIST MANIFEST	Y	PO	0	-	-	-	-	0
HW TRANSPORT	Y	0.125	0	0	-	-	-	0
WASTE TIRE	Y	PO	0	-	-	-	-	0
MEDICAL WASTE	Y	0.25	0	0	0	-	-	0
HIST CORTESE	Y	0.5	0	0	0	0	-	0
CDO/CAO	Y	0.5	0	0	0	0	-	0
CERS HAZ	Y	0.125	0	0	-	-	-	0
DELISTED HAZ	Y	0.5	0	0	0	0	-	0
GEOTRACKER	Y	0.125	0	0	-	-	-	0
MINE	Y	1	0	0	0	0	0	0
LIEN	Y	PO	0	-	-	-	-	0
WASTE DISCHG	Y	0.25	0	0	0	-	-	0
EMISSIONS	Y	0.25	0	0	0	-	-	0
CDL	Y	0.125	0	0	-	-	-	0

Tribal

No Tribal additional environmental record sources available for this State.

<i>Database</i>	<i>Searched</i>	<i>Search Radius</i>	<i>Project Property</i>	<i>Within 0.12mi</i>	<i>0.125mi to 0.25mi</i>	<i>0.25mi to 0.50mi</i>	<i>0.50mi to 1.00mi</i>	<i>Total</i>
County	No County additional environmental databases were selected to be included in the search.							

<i>Total:</i>	0	0	2	0	0	2
---------------	---	---	---	---	---	---

* PO – Property Only

* 'Property and adjoining properties' database search radii are set at 0.25 miles.

Executive Summary: Site Report Summary - Project Property

<i>Map Key</i>	<i>DB</i>	<i>Company/Site Name</i>	<i>Address</i>	<i>Direction</i>	<i>Distance (mi/ft)</i>	<i>Elev Diff (ft)</i>	<i>Page Number</i>
--------------------	-----------	--------------------------	----------------	------------------	-----------------------------	---------------------------	------------------------

No records found in the selected databases for the project property.

Executive Summary: Site Report Summary - Surrounding Properties

Map Key	DB	Company/Site Name	Address	Direction	Distance (mi/ft)	Elev Diff (ft)	Page Number
1	LUST	KOA CAMPGROUND	375 ROSS ROAD EL CENTRO CA 92243	W	0.17 / 919.22	-1	17
<i>Global ID Status Status Date:</i> T0602500107 COMPLETED - CASE CLOSED 6/27/1996							
1	UST SWEEPS	KAMPGROUNDS OF AMERICA	375 E ROSS RD EL CENTRO CA	W	0.17 / 919.22	-1	19
<i>C C Status:</i> A13-000-457 ACTIVE <i>Tank ID:</i> 000001, 000002							

Executive Summary: Summary by Data Source

Standard

State

LUST - Leaking Underground Fuel Tank Reports

A search of the LUST database, dated Jun 22, 2021 has found that there are 1 LUST site(s) within approximately 0.50 miles of the project property.

<u>Lower Elevation</u>	<u>Address</u>	<u>Direction</u>	<u>Distance (mi/ft)</u>	<u>Map Key</u>
KOA CAMPGROUND	375 ROSS ROAD EL CENTRO CA 92243	W	0.17 / 919.22	1

Global ID | Status | Status Date: T0602500107 | COMPLETED - CASE CLOSED | 6/27/1996

UST SWEEPS - Statewide Environmental Evaluation and Planning System

A search of the UST SWEEPS database, dated Oct 1, 1994 has found that there are 1 UST SWEEPS site(s) within approximately 0.25 miles of the project property.

<u>Lower Elevation</u>	<u>Address</u>	<u>Direction</u>	<u>Distance (mi/ft)</u>	<u>Map Key</u>
KAMPGROUNDS OF AMERICA	375 E ROSS RD EL CENTRO CA	W	0.17 / 919.22	1

*C C | Status: A13-000-457 | ACTIVE
Tank ID: 000001, 000002*

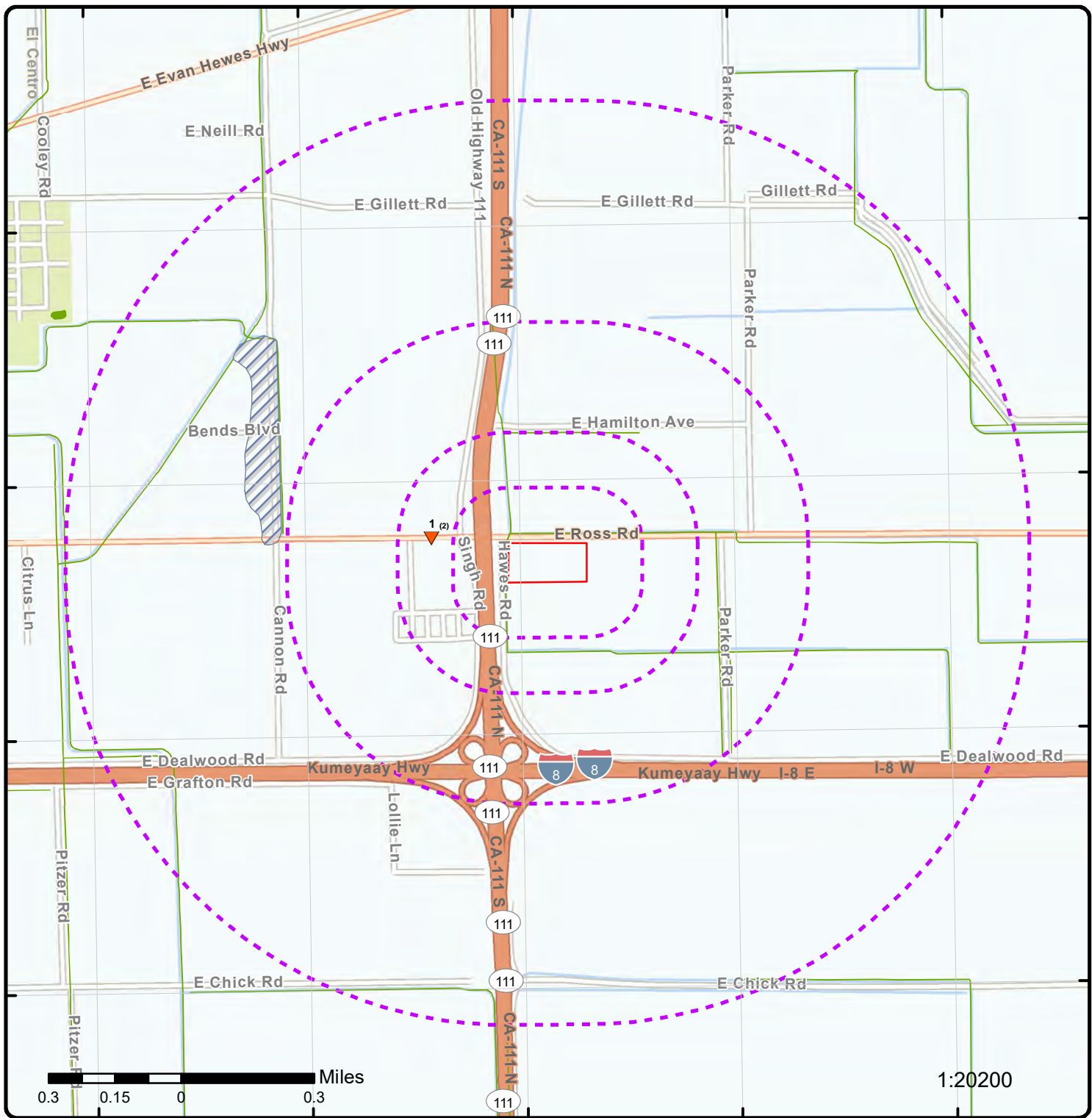

Map: 1.0 Mile Radius

Order Number: 21100500784

Address: SEC of Ross Ave & Hawes Rd, El Centro, CA



Project Property	Buffer Outline	State	FWS Special Designation Areas
Eris Sites with Higher Elevation	Freeways; Highways	Country	State Brownfield Sites
Eris Sites with Same Elevation	Traffic Circle; Ramp	National Priority List Sites	State Brownfield Areas
Eris Sites with Lower Elevation	Major & Minor Arterial	National Wetland	State Superfund Areas:Dept. of Defense
Eris Sites with Unknown Elevation	Traffic Circle; Ramp	Indian Reserve Land	State Superfund Areas:NPL
Eris Areas with Higher Elevation	Local Road	Historic Fill	WQARF Areas
Eris Areas with Same Elevation	Rail	100 Year Flood Zone	Federal Lands: Dept. of Defense (owned/administered areas)
Eris Areas with Lower Elevation		500 Year Flood Zone	Plume
Eris Areas with Unknown Elevation			

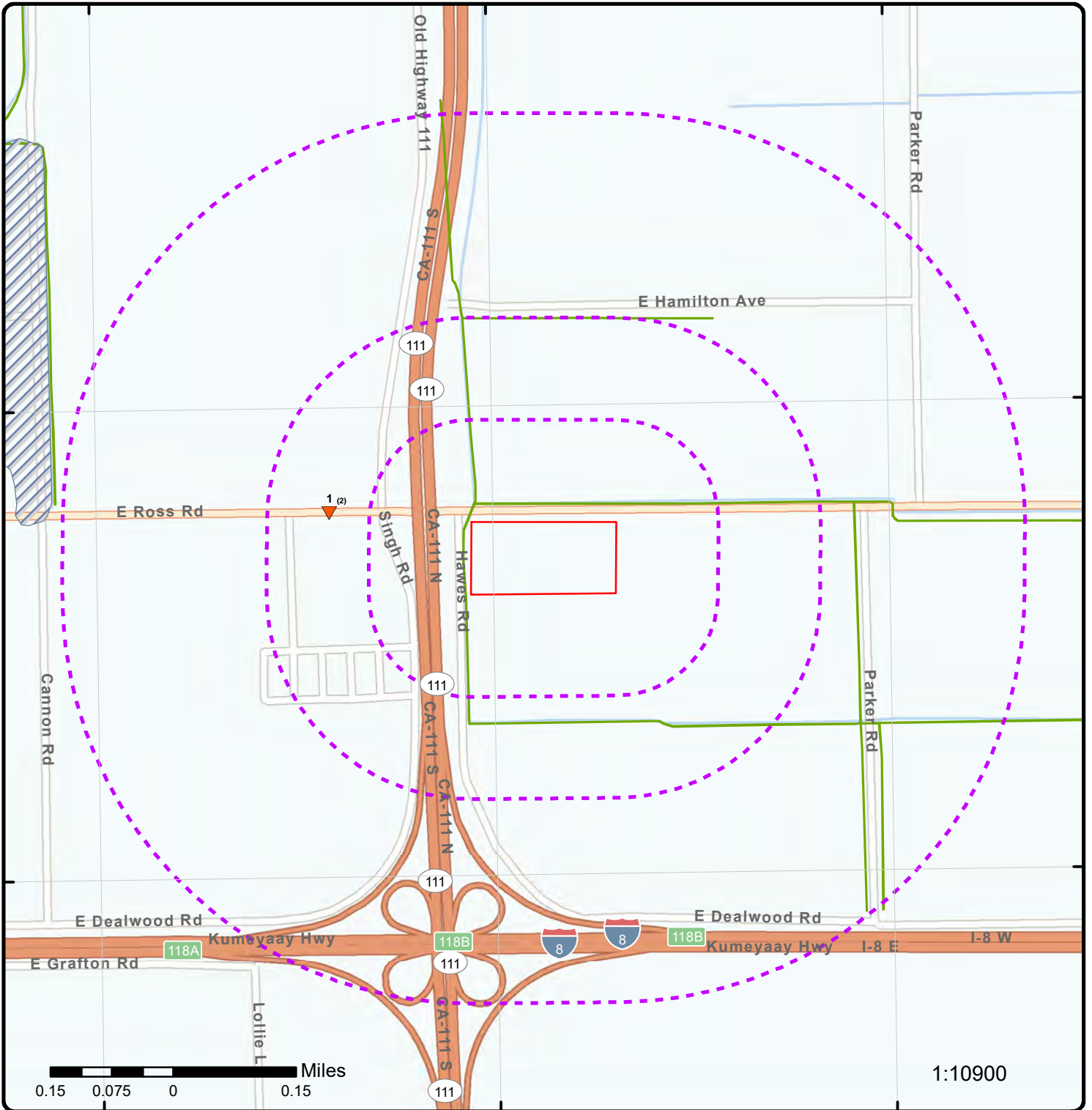

1:10900

Map: 0.5 Mile Radius

Order Number: 21100500784

Address: SEC of Ross Ave & Hawes Rd, El Centro, CA



Project Property	Buffer Outline	Freeways; Highways	State	FWS Special Designation Areas
Eris Sites with Higher Elevation	Traffic Circle; Ramp	Country	State Brownfield Sites	State Brownfield Areas
Eris Sites with Same Elevation	Major & Minor Arterial	National Priority List Sites	State Superfund Areas:Dept. of Defense	State Superfund Areas:NPL
Eris Sites with Lower Elevation	Traffic Circle; Ramp	National Wetland	WQARF Areas	Federal Lands: Dept. of Defense (owned/administered areas)
Eris Sites with Unknown Elevation	Local Road	Indian Reserve Land	Plume	
Eris Areas with Higher Elevation	Rail	Historic Fill		
Eris Areas with Same Elevation		100 Year Flood Zone		
Eris Areas with Lower Elevation		500 Year Flood Zone		
Eris Areas with Unknown Elevation				

115°30'W

32°47'N

32°47'N

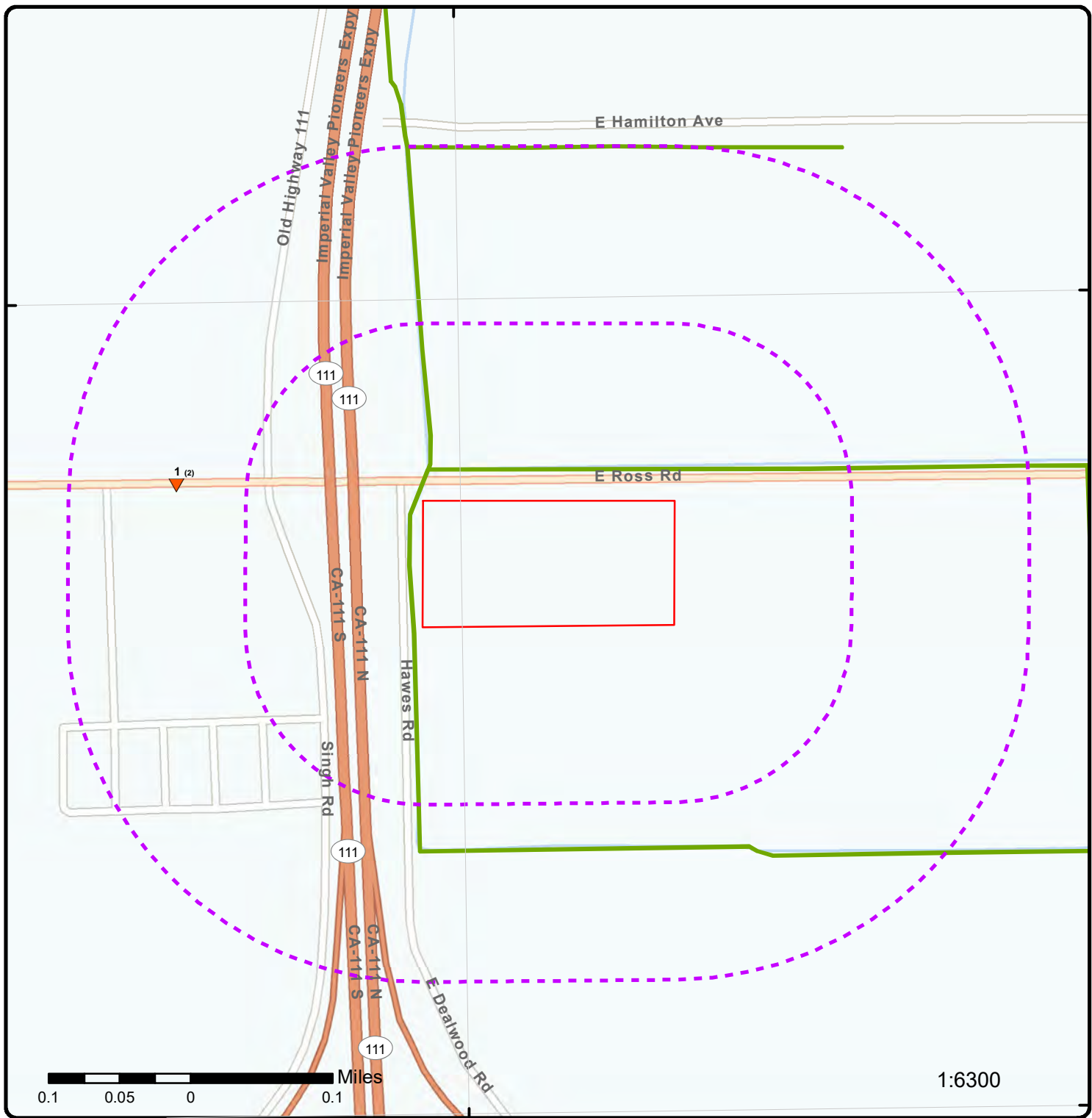

1:6300

32°46'30"N

Map: 0.25 Mile Radius

Order Number: 21100500784

Address: SEC of Ross Ave & Hawes Rd, El Centro, CA



Project Property	Buffer Outline	Freeways; Highways	State	FWS Special Designation Areas
Eris Sites with Higher Elevation	Traffic Circle; Ramp	Country	State Brownfield Sites	State Brownfield Areas
Eris Sites with Same Elevation	Major & Minor Arterial	National Priority List Sites	State Superfund Areas: Dept. of Defense	State Superfund Areas: NPL
Eris Sites with Lower Elevation	Traffic Circle; Ramp	National Wetland	WQARF Areas	Federal Lands: Dept. of Defense (owned/administered areas)
Eris Sites with Unknown Elevation	Local Road	Indian Reserve Land	Plume	
Eris Areas with Higher Elevation	Rail	Historic Fill		
Eris Areas with Same Elevation		100 Year Flood Zone		
Eris Areas with Lower Elevation		500 Year Flood Zone		
Eris Areas with Unknown Elevation				

115°30'30"W

115°30'W

115°29'30"W

32°47'N

32°47'N

32°46'30"N

32°46'30"N



0.1 0.05 0 0.1 Miles

1:10000

Source: Esri, Maxar, GeoEye, Earthstar Geographics, CNES/Airbus DS, USDA, USGS, AeroGRID, IGN, and the GIS User Community

Aerial Year: 2019

Order Number: 21100500784

Address: SEC of Ross Ave & Hawes Rd, El Centro, CA



Source: ESRI World Imagery

EEC ORIGINAL PKG © ERIS Information Inc.

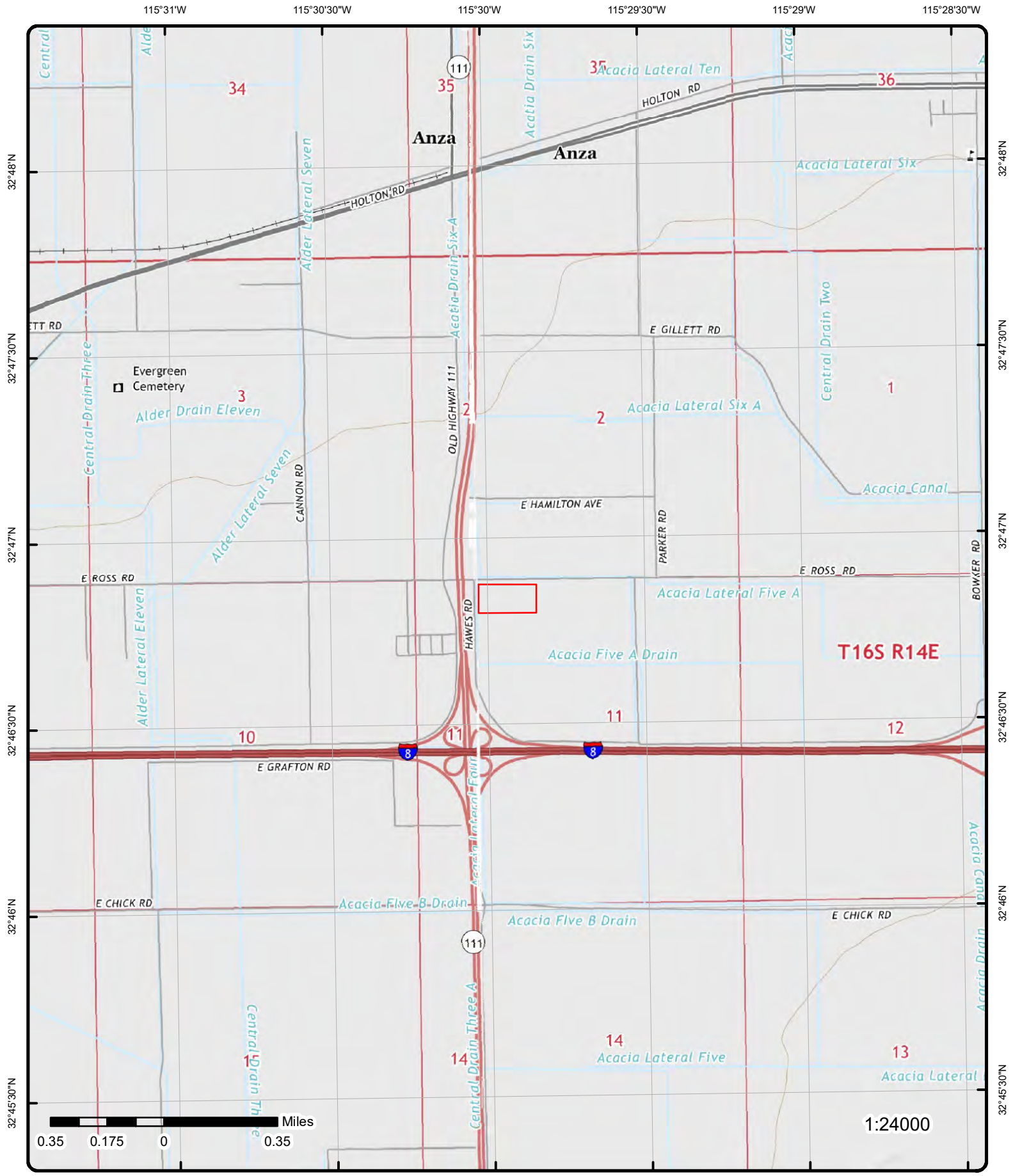

Topographic Map Year: 2015

Order Number: 21100500784

Address: SEC of Ross Ave & Hawes Rd, CA



Quadrangle(s): Holtville West, CA; El Centro, CA

EEC ORIGINAL PKG © ERIS Information Inc.

Source: USGS Topographic Map

Detail Report

Map Key	Number of Records	Direction	Distance (mi/ft)	Elev/Diff (ft)	Site	DB
<u>1</u>	1 of 2	W	0.17 / 919.22	-36.64 / -1	KOA CAMPGROUND 375 ROSS ROAD EL CENTRO CA 92243	LUST

Global ID: T0602500107 **County:** IMPERIAL
Status: COMPLETED - CASE CLOSED **Latitude:** 32.7814614
Status Date: 6/27/1996 **Longitude:** -115.5038017
Case Type: LUST CLEANUP SITE
Date Source: LUST Cleanup Sites & Military UST Site from GeoTracker Project Search Results Export; LUST Cleanup Sites & Military UST Site from GeoTracker Cleanup Sites Data Download

LUST Cleanup Sites from GeoTracker Cleanup Sites Data Download - Facilities Detail

RB Case No: 7T2243057 **Potential COC:** Gasoline
Local Case No: **How Discovered:** Other Means
Begin Date: 9/6/1994 **Stop Method:**
Lead Agency: COLORADO RIVER BASIN RWQCB (REGION 7) **Stop Description:**
Local Agency: IMPERIAL COUNTY **Case Worker:** KO
CUF Case: NO **File Location:**
Potential Media of Concern: Aquifer used for drinking water supply
How Discovered Description:
Calwater Watershed Name: Imperial - Brawley (723.10)
DWR GW Subbasin Name: Imperial Valley (7-030)
Disadvantaged Community:
Calenviroscreen Score: 81-85%
Site History:

LUST Cleanup Sites from GeoTracker Cleanup Sites Data Download - Regulatory Activity

Action Type: Other
Date : 9/14/1994
Action: Leak Reported

Action Type: Other
Date : 9/6/1994
Action: Leak Discovery

LUST Cleanup Sites from GeoTracker Cleanup Sites Data Download - Regulatory Contacts

Contact Type: Local Agency Caseworker **Address:** 939 MAIN STRET
Contact Name: JERRY STILWELL **Email:**
City: EL CENTRO **Phone No:**
Organization Name: IMPERIAL COUNTY

Contact Type: Regional Board Caseworker **Address:** 73-720 FRED WARING DRIVE, SUITE 100
Contact Name: KOLA OLATUNBOSUN **Email:** kola.olatunbosun@waterboards.ca.gov
City: PALM DESERT **Phone No:** 7607768958
Organization Name: COLORADO RIVER BASIN RWQCB (REGION 7)

LUST Cleanup Sites from GeoTracker Cleanup Sites Data Download - Status History

Status: Completed - Case Closed
Status Date: 6/27/1996

Map Key	Number of Records	Direction	Distance (mi/ft)	Elev/Diff (ft)	Site	DB
---------	-------------------	-----------	------------------	----------------	------	----

Status: Open - Site Assessment
 Status Date: 9/6/1994

Status: Open - Case Begin Date
 Status Date: 9/6/1994

LUST Sites from GeoTracker Search - Regulatory Profile

Site Facility Name:	KOA CAMPGROUND	Potential COC:	GASOLINE
Site Facility Type:	LUST CLEANUP SITE	Facility Type:	
Cleanup Status:	COMPLETED - CASE CLOSED	Composting Method:	
Project Status:		Address:	375 ROSS ROAD
WDR Place Type:		City:	EL CENTRO
WDR File:		Zip:	92243
WDR Order:		County:	IMPERIAL
CUF Priority Assig:		CUF Claim:	
CUF Amount Paid:			
File Location:			
Designated Beneficial Use:	MUN, IND		
Project Oversight Agencies:			
Report Link:	https://geotracker.waterboards.ca.gov/profile_report?global_id=T0602500107		
Cleanup Status Detail:	COMPLETED - CASE CLOSED AS OF 6/27/1996		
Cleanup History Link:	https://geotracker.waterboards.ca.gov/profile_report_include?global_id=T0602500107&tabname=regulatoryhistory		
Potential Media of Concern:	AQUIFER USED FOR DRINKING WATER SUPPLY		
User Defined Beneficial Use:			
DWR GW Sub Basin:	Imperial Valley (7-030)		
Calwater Watershed Name:	Imperial - Brawley (723.10)		
Post Closure Site Management:			
Future Land Use:			
Cleanup Oversight Agencies:	COLORADO RIVER BASIN RWQCB (REGION 7) (LEAD) - CASE #: 7T2243057 CASEWORKER: KOLA OLATUNBOSUN IMPERIAL COUNTY CASEWORKER: JERRY STILWELL		
Gndwater Monitoring Freque:			
Designated Beneficial Use	Municipal and Domestic Supply, Industrial Service Supply		
Desc:			
Site History:			

No site history available

LUST Sites from GeoTracker Search - Cleanup Status History

Status: Completed - Case Closed
 Date : 6/27/1996

Status: Open - Site Assessment
 Date : 9/6/1994

Status: Open - Case Begin Date
 Date : 9/6/1994

LUST Sites from GeoTracker Search - Regulatory Activities (as of May 29, 2021)

Action Type: Leak Action
Action Date: 9/14/1994
Received Issue Date:
Action: Leak Reported
Doc Link:
Title Description Comments:

Action Type: Leak Action
Action Date: 9/6/1994
Received Issue Date:

Map Key	Number of Records	Direction	Distance (mi/ft)	Elev/Diff (ft)	Site	DB
---------	-------------------	-----------	------------------	----------------	------	----

Action: Leak Discovery
 Doc Link:
 Title Description Comments:

<u>1</u>	2 of 2	W	0.17 / 919.22	-36.64 / -1	KAMPGROUNDS OF AMERICA 375 E ROSS RD EL CENTRO CA	UST SWEEPS
----------	--------	---	---------------	-------------	---	------------

C C:	A13-000-457	D Filename:	SITE07A
BOE:		Page No:	112
Comp:	457	County:	IMPERIAL
Status:	ACTIVE	State :	CA
No of Tanks:	2	Zip:	92243
Jurisdic:	IMPERIAL COUNTY	Latitude:	32.781285
Agency:	PLANNING BUILDING INSP.	Longitude:	-115.538767
Phone:		Georesult:	S5HPNTSCZA

Tank Details

Tank ID:	000001	S Contain:	
O Tank ID:	1	Stg:	P
SWRCB No:	13-000-000457-000001	Storage :	
Removed:		Storag Type:	PRODUCT
Installed:		P Contain:	
A Date:	07-25-90	Content:	LEADED
Capac:	10000	ONA:	
Tank Use:	M.V. FUEL	D File Name:	TANK7A

Tank Details

Tank ID:	000002	S Contain:	
O Tank ID:	2	Stg:	P
SWRCB No:	13-000-000457-000002	Storage :	
Removed:		Storag Type:	PRODUCT
Installed:		P Contain:	
A Date:	07-25-90	Content:	LEADED
Capac:	10000	ONA:	
Tank Use:	M.V. FUEL	D File Name:	TANK7A

Unplottable Summary

Total: 0 Unplottable sites

DB	Company Name/Site Name	Address	City	Zip	ERIS ID
----	------------------------	---------	------	-----	---------

No unplottable records were found that may be relevant for the search criteria.

Unplottable Report

No unplottable records were found that may be relevant for the search criteria.

Appendix: Database Descriptions

Environmental Risk Information Services (ERIS) can search the following databases. The extent of historical information varies with each database and current information is determined by what is publicly available to ERIS at the time of update. ERIS updates databases as set out in ASTM Standard E1527-13, Section 8.1.8 Sources of Standard Source Information:

"Government information from nongovernmental sources may be considered current if the source updates the information at least every 90 days, or, for information that is updated less frequently than quarterly by the government agency, within 90 days of the date the government agency makes the information available to the public."

Standard Environmental Record Sources

Federal

Formerly Utilized Sites Remedial Action Program:

DOE FUSRAP

The U.S. Department of Energy (DOE) established the Formerly Utilized Sites Remedial Action Program (FUSRAP) in 1974 to remediate sites where radioactive contamination remained from the Manhattan Project and early U.S. Atomic Energy Commission (AEC) operations. The DOE Office of Legacy Management (LM) established long-term surveillance and maintenance (LTS&M) requirements for remediated FUSRAP sites. DOE evaluates the final site conditions of a remediated site on the basis of risk for different future uses. DOE then confirms that LTS&M requirements will maintain protectiveness.

Government Publication Date: Mar 4, 2017

National Priority List:

NPL

National Priorities List (Superfund)-NPL: EPA's (United States Environmental Protection Agency) list of the most serious uncontrolled or abandoned hazardous waste sites identified for possible long-term remedial action under the Superfund program. The NPL, which EPA is required to update at least once a year, is based primarily on the score a site receives from EPA's Hazard Ranking System. A site must be on the NPL to receive money from the Superfund Trust Fund for remedial action.

Government Publication Date: Aug 25, 2021

National Priority List - Proposed:

PROPOSED NPL

Includes sites proposed (by the EPA, the state, or concerned citizens) for addition to the NPL due to contamination by hazardous waste and identified by the Environmental Protection Agency (EPA) as a candidate for cleanup because it poses a risk to human health and/or the environment.

Government Publication Date: Aug 25, 2021

Deleted NPL:

DELETED NPL

The National Oil and Hazardous Substances Pollution Contingency Plan (NCP) establishes the criteria that the EPA uses to delete sites from the NPL. In accordance with 40 CFR 300.425.(e), sites may be deleted from the NPL where no further response is appropriate.

Government Publication Date: Aug 25, 2021

SEMS List 8R Active Site Inventory:

SEMS

The Superfund Program has deployed the Superfund Enterprise Management System (SEMS), which integrates multiple legacy systems into a comprehensive tracking and reporting tool. This inventory contains active sites evaluated by the Superfund program that are either proposed to be or are on the National Priorities List (NPL) as well as sites that are in the screening and assessment phase for possible inclusion on the NPL. The Active Site Inventory Report displays site and location information at active SEMS sites. An active site is one at which site assessment, removal, remedial, enforcement, cost recovery, or oversight activities are being planned or conducted.

Government Publication Date: Jul 29, 2021

Inventory of Open Dumps, June 1985:

ODI

The Resource Conservation and Recovery Act (RCRA) provides for publication of an inventory of open dumps. The Act defines "open dumps" as facilities which do not comply with EPA's "Criteria for Classification of Solid Waste Disposal Facilities and Practices" (40 CFR 257).

Government Publication Date: Jun 1985

SEMS List 8R Archive Sites:

[SEMS ARCHIVE](#)

The Superfund Enterprise Management System (SEMS) Archived Site Inventory displays site and location information at sites archived from SEMS. An archived site is one at which EPA has determined that assessment has been completed and no further remedial action is planned under the Superfund program at this time.

Government Publication Date: Jul 29, 2021

Comprehensive Environmental Response, Compensation and Liability Information System -

[CERCLIS](#)

CERCLIS:

Superfund is a program administered by the United States Environmental Protection Agency (EPA) to locate, investigate, and clean up the worst hazardous waste sites throughout the United States. CERCLIS is a database of potential and confirmed hazardous waste sites at which the EPA Superfund program has some involvement. It contains sites that are either proposed to be or are on the National Priorities List (NPL) as well as sites that are in the screening and assessment phase for possible inclusion on the NPL. The EPA administers the Superfund program in cooperation with individual states and tribal governments; this database is made available by the EPA.

Government Publication Date: Oct 25, 2013

EPA Report on the Status of Open Dumps on Indian Lands:

[IODI](#)

Public Law 103-399, The Indian Lands Open Dump Cleanup Act of 1994, enacted October 22, 1994, identified congressional concerns that solid waste open dump sites located on American Indian or Alaska Native (AI/AN) lands threaten the health and safety of residents of those lands and contiguous areas. The purpose of the Act is to identify the location of open dumps on Indian lands, assess the relative health and environment hazards posed by those sites, and provide financial and technical assistance to Indian tribal governments to close such dumps in compliance with Federal standards and regulations or standards promulgated by Indian Tribal governments or Alaska Native entities.

Government Publication Date: Dec 31, 1998

CERCLIS - No Further Remedial Action Planned:

[CERCLIS NFRAP](#)

An archived site is one at which EPA has determined that assessment has been completed and no further remedial action is planned under the Superfund program at this time. The Archive designation means that, to the best of EPA's knowledge, assessment at a site has been completed and that EPA has determined no further steps will be taken to list this site on the National Priorities List (NPL). This decision does not necessarily mean that there is no hazard associated with a given site; it only means that, based upon available information, the location is not judged to be a potential NPL site.

Government Publication Date: Oct 25, 2013

CERCLIS Liens:

[CERCLIS LIENS](#)

A Federal Superfund lien exists at any property where EPA has incurred Superfund costs to address contamination ("Superfund site") and has provided notice of liability to the property owner. A Federal CERCLA ("Superfund") lien can exist by operation of law at any site or property at which EPA has spent Superfund monies. This database is made available by the United States Environmental Protection Agency (EPA).

Government Publication Date: Jan 30, 2014

RCRA CORRACTS-Corrective Action:

[RCRA CORRACTS](#)

RCRA Info is EPA's comprehensive information system, providing access to data supporting the Resource Conservation and Recovery Act (RCRA) of 1976 and the Hazardous and Solid Waste Amendments (HSWA) of 1984. At these sites, the Corrective Action Program ensures that cleanups occur. EPA and state regulators work with facilities and communities to design remedies based on the contamination, geology, and anticipated use unique to each site.

Government Publication Date: Jun 14, 2021

RCRA non-CORRACTS TSD Facilities:

[RCRA TSD](#)

RCRA Info is EPA's comprehensive information system, providing access to data supporting the Resource Conservation and Recovery Act (RCRA) of 1976 and the Hazardous and Solid Waste Amendments (HSWA) of 1984. This database includes Non-Corrective Action sites listed as treatment, storage and/or disposal facilities of hazardous waste as defined by the Resource Conservation and Recovery Act (RCRA).

Government Publication Date: Jun 14, 2021

RCRA Generator List:

[RCRA LQG](#)

RCRA Info is EPA's comprehensive information system, providing access to data supporting the Resource Conservation and Recovery Act (RCRA) of 1976 and the Hazardous and Solid Waste Amendments (HSWA) of 1984. RCRA Info replaces the data recording and reporting abilities of the Resource Conservation and Recovery Information System (RCRIS) and the Biennial Reporting System (BRS). A hazardous waste generator is any person or site whose processes and actions create hazardous waste (see 40 CFR 260.10). Large Quantity Generators (LQGs) generate 1,000 kilograms per month or more of hazardous waste or more than one kilogram per month of acutely hazardous waste.

Government Publication Date: Jun 14, 2021

RCRA Small Quantity Generators List:

[RCRA SQG](#)

RCRA Info is the EPA's comprehensive information system, providing access to data supporting the Resource Conservation and Recovery Act (RCRA) of 1976 and the Hazardous and Solid Waste Amendments (HSWA) of 1984. RCRA Info replaces the data recording and reporting abilities of the Resource Conservation and Recovery Information System (RCRIS) and the Biennial Reporting System (BRS). A hazardous waste generator is any person or site whose processes and actions create hazardous waste (see 40 CFR 260.10). Small Quantity Generators (SQGs) generate more than 100 kilograms, but less than 1,000 kilograms, of hazardous waste per month.

Government Publication Date: Jun 14, 2021

RCRA Very Small Quantity Generators List:

[RCRA VSQG](#)

RCRA Info is the EPA's comprehensive information system, providing access to data supporting the Resource Conservation and Recovery Act (RCRA) of 1976 and the Hazardous and Solid Waste Amendments (HSWA) of 1984. A hazardous waste generator is any person or site whose processes and actions create hazardous waste (see 40 CFR 260.10). Very Small Quantity Generators (VSQG) generate 100 kilograms or less per month of hazardous waste, or one kilogram or less per month of acutely hazardous waste. Additionally, VSQG may not accumulate more than 1,000 kilograms of hazardous waste at any time.

Government Publication Date: Jun 14, 2021

RCRA Non-Generators:

[RCRA NON GEN](#)

RCRA Info is EPA's comprehensive information system, providing access to data supporting the Resource Conservation and Recovery Act (RCRA) of 1976 and the Hazardous and Solid Waste Amendments (HSWA) of 1984. RCRA Info replaces the data recording and reporting abilities of the Resource Conservation and Recovery Information System (RCRIS) and the Biennial Reporting System (BRS). A hazardous waste generator is any person or site whose processes and actions create hazardous waste (see 40 CFR 260.10). Non-Generators do not presently generate hazardous waste.

Government Publication Date: Jun 14, 2021

Federal Engineering Controls-ECs:

[FED ENG](#)

Engineering controls (ECs) encompass a variety of engineered and constructed physical barriers (e.g., soil capping, sub-surface venting systems, mitigation barriers, fences) to contain and/or prevent exposure to contamination on a property. This database is made available by the United States Environmental Protection Agency (EPA).

Government Publication Date: Feb 23, 2021

Federal Institutional Controls- ICs:

[FED INST](#)

Institutional controls are non-engineered instruments, such as administrative and legal controls, that help minimize the potential for human exposure to contamination and/or protect the integrity of the remedy. Although it is EPA's (United States Environmental Protection Agency) expectation that treatment or engineering controls will be used to address principal threat wastes and that groundwater will be returned to its beneficial use whenever practicable, ICs play an important role in site remedies because they reduce exposure to contamination by limiting land or resource use and guide human behavior at a site.

Government Publication Date: Feb 23, 2021

Land Use Control Information System:

[LUCIS](#)

The LUCIS database is maintained by the U.S. Department of the Navy and contains information for former Base Realignment and Closure (BRAC) properties across the United States.

Government Publication Date: Sep 1, 2006

Emergency Response Notification System:

[ERNS 1982 TO 1986](#)

Database of oil and hazardous substances spill reports controlled by the National Response Center. The primary function of the National Response Center is to serve as the sole national point of contact for reporting oil, chemical, radiological, biological, and etiological discharges into the environment anywhere in the United States and its territories.

Government Publication Date: 1982-1986

Emergency Response Notification System:

[ERNS 1987 TO 1989](#)

Database of oil and hazardous substances spill reports controlled by the National Response Center. The primary function of the National Response Center is to serve as the sole national point of contact for reporting oil, chemical, radiological, biological, and etiological discharges into the environment anywhere in the United States and its territories.

Government Publication Date: 1987-1989

Emergency Response Notification System:

[ERNS](#)

Database of oil and hazardous substances spill reports made available by the United States Coast Guard National Response Center (NRC). The NRC fields initial reports for pollution and railroad incidents and forwards that information to appropriate federal/state agencies for response. These data contain initial incident data that has not been validated or investigated by a federal/state response agency.

Government Publication Date: Jul 26, 2021

The Assessment, Cleanup and Redevelopment Exchange System (ACRES) Brownfield Database:

[FED BROWNFIELDS](#)

Brownfields are real property, the expansion, redevelopment, or reuse of which may be complicated by the presence or potential presence of a hazardous substance, pollutant, or contaminant. Cleaning up and reinvesting in these properties protects the environment, reduces blight, and takes development pressures off greenspaces and working lands. This database is made available by the United States Environmental Protection Agency (EPA).

Government Publication Date: Aug 20, 2021

FEMA Underground Storage Tank Listing:

[FEMA UST](#)

The Federal Emergency Management Agency (FEMA) of the Department of Homeland Security maintains a list of FEMA owned underground storage tanks.

Government Publication Date: Dec 31, 2017

Facility Response Plan:

[FRP](#)

List of facilities that have submitted Facility Response Plans (FRP) to EPA. Facilities that could reasonably be expected to cause "substantial harm" to the environment by discharging oil into or on navigable waters are required to prepare and submit Facility Response Plans (FRPs). Harm is determined based on total oil storage capacity, secondary containment and age of tanks, oil transfer activities, history of discharges, proximity to a public drinking water intake or sensitive environments.

Government Publication Date: Dec 2, 2020

Historical Gas Stations:

[HIST GAS STATIONS](#)

This historic directory of service stations is provided by the Cities Service Company. The directory includes Cities Service filling stations that were located throughout the United States in 1930.

Government Publication Date: Jul 1, 1930

Petroleum Refineries:

[REFN](#)

List of petroleum refineries from the U.S. Energy Information Administration (EIA) Refinery Capacity Report. Includes operating and idle petroleum refineries (including new refineries under construction) and refineries shut down during the previous year located in the 50 States, the District of Columbia, Puerto Rico, the Virgin Islands, Guam, and other U.S. possessions. Survey locations adjusted using public data.

Government Publication Date: Jul 10, 2020

Petroleum Product and Crude Oil Rail Terminals:

[BULK TERMINAL](#)

List of petroleum product and crude oil rail terminals made available by the U.S. Energy Information Administration (EIA). Includes operable bulk petroleum product terminals located in the 50 States and the District of Columbia with a total bulk shell storage capacity of 50,000 barrels or more, and/or the ability to receive volumes from tanker, barge, or pipeline; also rail terminals handling the loading and unloading of crude oil that were active between 2017 and 2018. Petroleum product terminals comes from the EIA-815 Bulk Terminal and Blender Report, which includes working, shell in operation, and shell idle for several major product groupings. Survey locations adjusted using public data.

Government Publication Date: Apr 28, 2020

LIEN on Property:

[SEMS LIEN](#)

The EPA Superfund Enterprise Management System (SEMS) provides LIEN information on properties under the EPA Superfund Program.

Government Publication Date: Jul 29, 2021

Superfund Decision Documents:

[SUPERFUND ROD](#)

This database contains a listing of decision documents for Superfund sites. Decision documents serve to provide the reasoning for the choice of (or) changes to a Superfund Site cleanup plan. The decision documents include Records of Decision (ROD), ROD Amendments, Explanations of Significant Differences (ESD), along with other associated memos and files. This information is maintained and made available by the US EPA (Environmental Protection Agency).

Government Publication Date: Jun 28, 2021

State

State Response Sites:

[RESPONSE](#)

A list of identified confirmed release sites where the Department of Toxic Substances Control (DTSC) is involved in remediation, either in a lead or oversight capacity. These confirmed release sites are generally high-priority and high potential risk. This database is state equivalent NPL.

Government Publication Date: Jun 14, 2021

EnviroStor Database:

[ENVIROSTOR](#)

The EnviroStor Data Management System is made available by the Department of Toxic Substances Control (DTSC). Includes Corrective Action sites, Tiered Permit sites, Historical Sites and Evaluation/Investigation sites. This database is state equivalent CERCLIS.

Government Publication Date: Jun 14, 2021

Delisted State Response Sites:

[DELISTED ENVS](#)

Sites removed from the list of State Response Sites made available by the EnviroStor Data Management System, Department of Toxic Substances Control (DTSC).

Government Publication Date: Jun 14, 2021

Solid Waste Information System (SWIS):

[SWF/LF](#)

The Solid Waste Information System (SWIS) database made available by the Department of Resources Recycling and Recovery (CalRecycle) contains information on solid waste facilities, operations, and disposal sites throughout the State of California. The types of facilities found in this database include landfills, transfer stations, material recovery facilities, composting sites, transformation facilities, waste tire sites, and closed disposal sites.

Government Publication Date: Jul 20, 2021

Solid Waste Disposal Sites with Waste Constituents Above Hazardous Waste Levels:

[SWRCB SWF](#)

This is a list of solid waste disposal sites identified by California State Water Resources Control Board with waste constituents above hazardous waste levels outside the waste management unit.

Government Publication Date: Sep 20, 2006

EnviroStor Hazardous Waste Facilities:

[HWP](#)

A list of hazardous waste facilities including permitted, post-closure and historical facilities found in the Department of Toxic Substances Control (DTSC) EnviroStor database.

Government Publication Date: Jun 14, 2021

Sites Listed in the Solid Waste Assessment Test (SWAT) Program Report:

[SWAT](#)

In a 1993 Memorandum of Understanding, the State Water Resources Control Board (SWRCB) agreed to submit a comprehensive report on the Solid Waste Assessment Test (SWAT) Program to the California Integrated Waste Management Board (CIWMB). This report summarizes the work completed to date on the SWAT Program, and addresses both the impacts that leakage from solid waste disposal sites (SWDS) may have upon waters of the State and the actions taken to address such leakage.

Government Publication Date: Dec 31, 1995

Construction and Demolition Debris Recyclers:

[C&D DEBRIS RECY](#)

This listing of Construction and Demolition Debris Recyclers is maintained by the California Intergrated Waste Management Board-common C&D materials include lumber, drywall, metals, masonry (brick, concrete, etc.), carpet, plastic, pipe, rocks, dirt, paper, cardboard, or green waste related to land development.

Government Publication Date: Jun 20, 2018

Recycling Centers:

[RECYCLING](#)

This list of Certified Recycling Centers that are operating under the state of California's Beverage Container Recycling Program is maintained by the California Department of Resources Recycling and Recovery.

Government Publication Date: Nov 2, 2020

Listing of Certified Processors:

[PROCESSORS](#)

This list of Certified Processors that are operating under the state of California's Beverage Container Recycling Program is maintained by the California Department of Resources Recycling and Recovery.

Government Publication Date: Oct 27, 2020

Listing of Certified Dropoff, Collection, and Community Service Programs:

[CONTAINER RECY](#)

This list of Certified Dropoff, Collection, and Community Service Programs (non-buyback) operating under the state of California's Beverage Container Recycling Program is maintained by the California Department of Resources Recycling and Recovery.

Government Publication Date: Dec 16, 2020

Land Disposal Sites:

[LDS](#)

Land Disposal Sites in GeoTracker, the State Water Resources Control Board (SWRCB)'s data management system. The Land Disposal program regulates of waste discharge to land for treatment, storage and disposal in waste management units. Waste management units include waste piles, surface impoundments, and landfills.

Government Publication Date: Jun 22, 2021

Leaking Underground Fuel Tank Reports:

LUST

List of Leaking Underground Storage Tanks within the Cleanup Sites data in GeoTracker database. GeoTracker is the State Water Resources Control Board's (SWRCB) data management system for managing sites that impact groundwater, especially those that require groundwater cleanup (Underground Storage Tanks, Department of Defense and Site Cleanup Program) as well as permitted facilities such as operating Underground Storage Tanks. The Leak Prevention Program that overlooks LUST sites is the SWRCB in California's Environmental Protection Agency.

Government Publication Date: Jun 22, 2021

Delisted Leaking Storage Tanks:

DELISTED LST

List of Leaking Underground Storage Tanks (LUST) cleanup sites removed from GeoTracker, the State Water Resources Control Board (SWRCB)'s database system, as well as sites removed from the SWRCB's list of UST Case closures.

Government Publication Date: Jun 22, 2021

Permitted Underground Storage Tank (UST) in GeoTracker:

UST

List of Permitted Underground Storage Tank (UST) sites made available by the State Water Resources Control Board (SWRCB) in California's Environmental Protection Agency (EPA).

Government Publication Date: Jul 25, 2021

Proposed Closure of Underground Storage Tank Cases:

UST CLOSURE

List of UST cases that are being considered for closure by either the California Environmental Protection Agency, State Water Resources Control Board or the Executive Director that have been posted for a 60-day public comment period.

Government Publication Date: May 5, 2021

Historical Hazardous Substance Storage Information Database:

HHSS

The Historical Hazardous Substance Storage database contains information collected in the 1980s from facilities that stored hazardous substances. The information was originally collected on paper forms, was later transferred to microfiche, and recently indexed as a searchable database. When using this database, please be aware that it is based upon self-reported information submitted by facilities which has not been independently verified. It is unlikely that every facility responded to the survey and the database should not be expected to be a complete inventory of all facilities that were operating at that time. This database is maintained by the California State Water Resources Control Board's (SWRCB) Geotracker.

Government Publication Date: Aug 27, 2015

Statewide Environmental Evaluation and Planning System:

UST SWEEPS

The Statewide Environmental Evaluation and Planning System (SWEEPS) is a historical listing of active and inactive underground storage tanks made available by the California State Water Resources Control Board (SWRCB).

Government Publication Date: Oct 1, 1994

Aboveground Storage Tanks:

AST

A statewide list from 2009 of aboveground storage tanks (ASTs) made available by the Cal FIRE Office of the State Fire Marshal (OSFM). This list is no longer maintained or updated by the Cal FIRE OSFM.

Government Publication Date: Aug 31, 2009

SWRCB Historical Aboveground Storage Tanks:

AST SWRCB

A list of aboveground storage tanks made available by the California State Water Resources Control Board (SWRCB). Effective January 1, 2008, the Certified Unified Program Agencies (CUPAs) are vested with the responsibility and authority to implement the Aboveground Petroleum Storage Act (APSA).

Government Publication Date: Dec 1, 2007

Oil and Gas Facility Tanks:

TANK OIL GAS

Locations of oil and gas tanks that fall under the jurisdiction of the Geologic Energy Management Division of the California Department of Conservation (CalGEM) (CCR 1760). CalGEM was formerly the Division of Oil, Gas, and Geothermal Resources (DOGGR).

Government Publication Date: Sep 13, 2021

Delisted Storage Tanks:

DELISTED TNK

This database contains a list of storage tank sites that were removed by the State Water Resources Control Board (SWRCB) in California's Environmental Protection Agency (EPA) and the Cal FIRE Office of State Fire Marshal (OSFM).

Government Publication Date: Sep 13, 2021

California Environmental Reporting System (CERS) Tanks:

CERS TANK

List of sites in the California Environmental Protection Agency (CalEPA) Regulated Site Portal which fall under the Aboveground Petroleum Storage and Underground Storage Tank regulatory programs. The CalEPA oversees the statewide implementation of the Unified Program which applies regulatory standards to protect Californians from hazardous waste and materials.

Government Publication Date: Sep 24, 2021

Delisted California Environmental Reporting System (CERS) Tanks:

DELISTED CTNK

This database contains a list of Aboveground Petroleum Storage and Underground Storage Tank sites that were removed from in the California Environmental Protection Agency (CalEPA) Regulated Site Portal.

Government Publication Date: Sep 24, 2021

Historical Hazardous Substance Storage Container Information - Facility Summary:

HIST TANK

The State Water Resources Control Board maintained the Hazardous Substance Storage Containers listing and inventory in th 1980s. This facility summary lists historic tank sites where the following container types were present: farm motor vehicle fuel tanks; waste tanks; sumps; pits, ponds, lagoons, and others; and all other product tanks. This set, published in May 1988, lists facility and owner information, as well as the number of containers. This data is historic and will not be updated.

Government Publication Date: May 27, 1988

Site Mitigation and Brownfields Reuse Program Facility Sites with Land Use Restrictions:

LUR

The Department of Toxic Substances Control (DTSC) Site Mitigation and Brownfields Reuse Program (SMBRP) list includes sites cleaned up under the program's oversight and generally does not include current or former hazardous waste facilities that required a hazardous waste facility permit. The list represents land use restrictions that are active. Some sites have multiple land use restrictions.

Government Publication Date: Jun 14, 2021

CALSITES Database:

CALSITES

This historical database was maintained by the Department of Toxic Substance Control (DTSC) for more than a decade. CALSITES contains information on Brownfield properties with confirmed or potential hazardous contamination. In 2006, DTSC introduced EnviroStor as the latest Brownfields site database.

Government Publication Date: May 1, 2004

Hazardous Waste Management Program Facility Sites with Deed / Land Use Restrictions:

HLUR

The Department of Toxic Substances Control (DTSC) Hazardous Waste Management Program (HWMP) has developed a list of current or former hazardous waste facilities that have a recorded land use restriction at the local county recorder's office. The land use restrictions on this list were required by the DTSC HWMP as a result of the presence of hazardous substances that remain on site after the facility (or part of the facility) has been closed or cleaned up. The types of land use restriction include deed notice, deed restriction, or a land use restriction that binds current and future owners.

Government Publication Date: Feb 18, 2021

Deed Restrictions and Land Use Restrictions:

DEED

List of Deed Restrictions, Land Use Restrictions and Covenants in GeoTracker made available by the State Water Resources Control Board (SWRCB) in California's Environmental Protection Agency. A deed restriction (land use covenant) may be required to facilitate the remediation of past environmental contamination and to protect human health and the environment by reducing the risk of exposure to residual hazardous materials.

Government Publication Date: Jun 22, 2021

Voluntary Cleanup Program:

VCP

List of sites in the Voluntary Cleanup Program made available by the Department of Toxic Substances and Control (DTSC). The Voluntary Cleanup Program was designed to respond to lower priority sites. Under the Voluntary Cleanup Program, DTSC enters site-specific agreements with project proponents for DTSC oversight of site assessment, investigation, and/or removal or remediation activities, and the project proponents agree to pay DTSC's reasonable costs for those services.

Government Publication Date: Jun 14, 2021

GeoTracker Cleanup Program Sites:

CLEANUP SITES

A list of Cleanup Program sites in the state of California made available by The State Water Resources Control Board (SWRCB) of the California Environmental Protection Agency (EPA). SWRCB tracks leaking underground storage tank cleanups as well as other water board cleanups.

Government Publication Date: Jun 22, 2021

Delisted County Records:

DELISTED COUNTY

Records removed from county or CUPA databases. Records may be removed from the county lists made available by the respective county departments because they are inactive, or because they have been deemed to be below reportable thresholds.

Tribal

Leaking Underground Storage Tanks (LUSTs) on Indian Lands:
LUSTs on Tribal/Indian Lands in Region 9, which includes California.
Government Publication Date: Apr 8, 2020

INDIAN LUST

Underground Storage Tanks (USTs) on Indian Lands:
USTs on Tribal/Indian Lands in Region 9, which includes California.
Government Publication Date: Apr 8, 2020

INDIAN UST

Delisted Tribal Leaking Storage Tanks:
Leaking Underground Storage Tank facilities which have been removed from the Regional Tribal LUST lists made available by the EPA.
Government Publication Date: Apr 14, 2020

DELISTED ILST

Delisted Tribal Underground Storage Tanks:
Underground Storage Tank facilities which have been removed from the Regional Tribal UST lists made available by the EPA.
Government Publication Date: Apr 14, 2020

DELISTED IUST

County

Imperial County - CUPA Facility List:
A list of facilities associated with various Certified Unified Program Agency (CUPA) programs in Imperial County. This list is made available by the California Department of Toxic Substances Control (DTSC) which is appointed as CUPA for Imperial County.
Government Publication Date: Jul 14, 2021

CUPA IMPERIAL

Additional Environmental Record Sources

Federal

PFOA/PFOS Contaminated Sites:
List of sites where PFOA or PFOS contaminants have been found in drinking water or soil. Made available by the Federal Environmental Protection Agency (EPA).
Government Publication Date: Mar 1, 2021

PFAS NPL

Facility Registry Service/Facility Index:
The Facility Registry Service (FRS) is a centrally managed database that identifies facilities, sites, or places subject to environmental regulations or of environmental interest. FRS creates high-quality, accurate, and authoritative facility identification records through rigorous verification and management procedures that incorporate information from program national systems, state master facility records, and data collected from EPA's Central Data Exchange registrations and data management personnel. This list is made available by the Environmental Protection Agency (US EPA).
Government Publication Date: Nov 2, 2020

FINDS/FRS

Toxics Release Inventory (TRI) Program:
The EPA's Toxics Release Inventory (TRI) is a database containing data on disposal or other releases of over 650 toxic chemicals from thousands of U. S. facilities and information about how facilities manage those chemicals through recycling, energy recovery, and treatment. One of TRI's primary purposes is to inform communities about toxic chemical releases to the environment.
Government Publication Date: Aug 24, 2021

TRIS

Perfluorinated Alkyl Substances (PFAS) Releases:

PFAS TRI

List of Toxics Release Inventory (TRI) facilities at which the reported chemical is a Per- or polyfluorinated alkyl substance (PFAS) included in the Environmental Protection Agency (EPA)'s consolidated PFAS Master List of PFAS Substances. The EPA's Toxics Release Inventory (TRI) is a database containing data on disposal or other releases of over 650 toxic chemicals from thousands of U.S. facilities and information about how facilities manage those chemicals through recycling, energy recovery, and treatment.

Government Publication Date: Aug 24, 2021

Perfluorinated Alkyl Substances (PFAS) Water Quality:

PFAS WATER

The Water Quality Portal (WQP) is a cooperative service sponsored by the United States Geological Survey (USGS), the Environmental Protection Agency (EPA), and the National Water Quality Monitoring Council (NWQMC). This listing includes records from the Water Quality Portal where the characteristic (environmental measurement) is in the Environmental Protection Agency (EPA)'s consolidated PFAS Master List of PFAS Substances.

Government Publication Date: Jul 20, 2020

Hazardous Materials Information Reporting System:

HMIRS

US DOT - Department of Transportation Pipeline and Hazardous Materials Safety Administration (PHMSA) Incidents Reports Database taken from Hazmat Intelligence Portal, U.S. Department of Transportation.

Government Publication Date: Sep 1, 2020

National Clandestine Drug Labs:

NCDL

The U.S. Department of Justice ("the Department") provides this data as a public service. It contains addresses of some locations where law enforcement agencies reported they found chemicals or other items that indicated the presence of either clandestine drug laboratories or dumpsites. In most cases, the source of the entries is not the Department, and the Department has not verified the entry and does not guarantee its accuracy.

Government Publication Date: Oct 5, 2020

Toxic Substances Control Act:

TSCA

The Environmental Protection Agency (EPA) is amending the Toxic Substances Control Act (TSCA) section 8(a) Inventory Update Reporting (IUR) rule and changing its name to the Chemical Data Reporting (CDR) rule.

The CDR enables EPA to collect and publish information on the manufacturing, processing, and use of commercial chemical substances and mixtures (referred to hereafter as chemical substances) on the TSCA Chemical Substance Inventory (TSCA Inventory). This includes current information on chemical substance production volumes, manufacturing sites, and how the chemical substances are used. This information helps the Agency determine whether people or the environment are potentially exposed to reported chemical substances. EPA publishes submitted CDR data that is not Confidential Business Information (CBI).

Government Publication Date: Apr 11, 2019

Hist TSCA:

HIST TSCA

The Environmental Protection Agency (EPA) is amending the Toxic Substances Control Act (TSCA) section 8(a) Inventory Update Reporting (IUR) rule and changing its name to the Chemical Data Reporting (CDR) rule.

The 2006 IUR data summary report includes information about chemicals manufactured or imported in quantities of 25,000 pounds or more at a single site during calendar year 2005. In addition to the basic manufacturing information collected in previous reporting cycles, the 2006 cycle is the first time EPA collected information to characterize exposure during manufacturing, processing and use of organic chemicals. The 2006 cycle also is the first time manufacturers of inorganic chemicals were required to report basic manufacturing information.

Government Publication Date: Dec 31, 2006

FTTS Administrative Case Listing:

FTTS ADMIN

An administrative case listing from the Federal Insecticide, Fungicide, & Rodenticide Act (FIFRA) and Toxic Substances Control Act (TSCA), together known as FTTS. This database was obtained from the Environmental Protection Agency's (EPA) National Compliance Database (NCDB). The FTTS and NCDB was shut down in 2006.

Government Publication Date: Jan 19, 2007

FTTS Inspection Case Listing:

FTTS INSP

An inspection case listing from the Federal Insecticide, Fungicide, & Rodenticide Act (FIFRA) and Toxic Substances Control Act (TSCA), together known as FTTS. This database was obtained from the Environmental Protection Agency's (EPA) National Compliance Database (NCDB). The FTTS and NCDB was shut down in 2006.

Government Publication Date: Jan 19, 2007

Potentially Responsible Parties List:

PRP

Early in the cleanup process, the Environmental Protection Agency (EPA) conducts a search to find the potentially responsible parties (PRPs). EPA looks for evidence to determine liability by matching wastes found at the site with parties that may have contributed wastes to the site.

Government Publication Date: Jun 25, 2021

State Coalition for Remediation of Drycleaners Listing:

SCRD DRYCLEANER

The State Coalition for Remediation of Drycleaners (SCRD) was established in 1998, with support from the U.S. Environmental Protection Agency (EPA) Office of Superfund Remediation and Technology Innovation. Coalition members are states with mandated programs and funding for drycleaner site remediation. Current members are Alabama, Connecticut, Florida, Illinois, Kansas, Minnesota, Missouri, North Carolina, Oregon, South Carolina, Tennessee, Texas, and Wisconsin.

Government Publication Date: Nov 08, 2017

Integrated Compliance Information System (ICIS):

ICIS

The Integrated Compliance Information System (ICIS) is a system that provides information for the Federal Enforcement and Compliance (FE&C) and the National Pollutant Discharge Elimination System (NPDES) programs. The FE&C component supports the Environmental Protection Agency's (EPA) Civil Enforcement and Compliance program activities. These activities include Compliance Assistance, Compliance Monitoring and Enforcement. The NPDES program supports tracking of NPDES permits, limits, discharge monitoring data and other program reports.

Government Publication Date: Jun 14, 2021

Drycleaner Facilities:

FED DRYCLEANERS

A list of drycleaner facilities from Enforcement and Compliance History Online (ECHO) online search. The Environmental Protection Agency (EPA) tracks facilities that possess NAIC and SIC codes that classify businesses as drycleaner establishments.

Government Publication Date: May 5, 2021

Delisted Drycleaner Facilities:

DELISTED FED DRY

List of sites removed from the list of Drycleaner Facilities (sites in the EPA's Integrated Compliance Information System (ICIS) with NAIC or SIC codes identifying the business as a drycleaner establishment).

Government Publication Date: May 5, 2021

Formerly Used Defense Sites:

FUDS

Formerly Used Defense Sites (FUDS) are properties that were formerly owned by, leased to, or otherwise possessed by and under the jurisdiction of the Secretary of Defense prior to October 1986, where the Department of Defense (DoD) is responsible for an environmental restoration. This list is published by the U.S. Army Corps of Engineers.

Government Publication Date: May 26, 2021

Former Military Nike Missile Sites:

FORMER NIKE

This information was taken from report DRXTH-AS-IA-83A016 (Historical Overview of the Nike Missile System, 12/1984) which was performed by Environmental Science and Engineering, Inc. for the U.S. Army Toxic and Hazardous Materials Agency Assessment Division. The Nike system was deployed between 1954 and the mid-1970's. Among the substances used or stored on Nike sites were liquid missile fuel (JP-4); starter fluids (UDKH, aniline, and furfuryl alcohol); oxidizer (IRFNA); hydrocarbons (motor oil, hydraulic fluid, diesel fuel, gasoline, heating oil); solvents (carbon tetrachloride, trichloroethylene, trichloroethane, stoddard solvent); and battery electrolyte. The quantities of material a disposed of and procedures for disposal are not documented in published reports. Virtually all information concerning the potential for contamination at Nike sites is confined to personnel who were assigned to Nike sites. During deactivation most hardware was shipped to depot-level supply points. There were reportedly instances where excess materials were disposed of on or near the site itself at closure. There was reportedly no routine site decontamination.

Government Publication Date: Dec 2, 1984

PHMSA Pipeline Safety Flagged Incidents:

PIPELINE INCIDENT

A list of flagged pipeline incidents made available by the U.S. Department of Transportation (US DOT) Pipeline and Hazardous Materials Safety Administration (PHMSA). PHMSA regulations require incident and accident reports for five different pipeline system types.

Government Publication Date: Jul 7, 2020

Material Licensing Tracking System (MLTS):

MLTS

A list of sites that store radioactive material subject to the Nuclear Regulatory Commission (NRC) licensing requirements. This list is maintained by the NRC. As of September 2016, the NRC no longer releases location information for sites. Site locations were last received in July 2016.

Government Publication Date: May 11, 2021

Historic Material Licensing Tracking System (MLTS) sites:

HIST MLTS

A historic list of sites that have inactive licenses and/or removed from the Material Licensing Tracking System (MLTS). In some cases, a site is removed from the MLTS when the state becomes an "Agreement State". An Agreement State is a State that has signed an agreement with the Nuclear Regulatory Commission (NRC) authorizing the State to regulate certain uses of radioactive materials within the State.

Government Publication Date: Jan 31, 2010

Mines Master Index File:

MINES

The Master Index File (MIF) contains mine identification numbers issued by the Department of Labor Mine Safety and Health Administration (MSHA) for mines active or opened since 1971. Note that addresses may or may not correspond with the physical location of the mine itself.

Government Publication Date: Nov 3, 2020

Surface Mining Control and Reclamation Act Sites:

SMCRA

An inventory of land and water impacted by past mining (primarily coal mining) is maintained by the Office of Surface Mining Reclamation and Enforcement (OSMRE) to provide information needed to implement the Surface Mining Control and Reclamation Act of 1977 (SMCRA). The inventory contains information on the location, type, and extent of Abandoned Mine Land (AML) impacts, as well as information on the cost associated with the reclamation of those problems. The inventory is based upon field surveys by State, Tribal, and OSMRE program officials. It is dynamic to the extent that it is modified as new problems are identified and existing problems are reclaimed.

Government Publication Date: Dec 18, 2020

Mineral Resource Data System:

MRDS

The Mineral Resource Data System (MRDS) is a collection of reports describing metallic and nonmetallic mineral resources throughout the world. Included are deposit name, location, commodity, deposit description, geologic characteristics, production, reserves, resources, and references. This database contains the records previously provided in the Mineral Resource Data System (MRDS) of USGS and the Mineral Availability System/Mineral Industry Locator System (MAS/MILS) originated in the U.S. Bureau of Mines, which is now part of USGS. The USGS has ceased systematic updates of the MRDS database with their focus more recently on deposits of critical minerals while providing a well-documented baseline of historical mine locations from USGS topographic maps.

Government Publication Date: Mar 15, 2006

Uranium Mill Tailings Radiation Control Act Sites:

URANIUM

The Legacy Management Office of the Department of Energy (DOE) manages radioactive and chemical waste, environmental contamination, and hazardous material at over 100 sites across the U.S. The L.M. Office manages this database of sites registered under the Uranium Mill Tailings Control Act (UMTRCA).

Government Publication Date: Mar 4, 2017

Alternative Fueling Stations:

ALT FUELS

List of alternative fueling stations made available by the US Department of Energy's Office of Energy Efficiency & Renewable Energy. Includes Biodiesel stations, Ethanol (E85) stations, Liquefied Petroleum Gas (Propane) stations, Ethanol (E85) stations, Natural Gas stations, Hydrogen stations, and Electric Vehicle Supply Equipment (EVSE). The National Renewable Energy Laboratory (NREL) obtains information about new stations from trade media, Clean Cities coordinators, a Submit New Station form on the Station Locator website, and through collaborating with infrastructure equipment and fuel providers, original equipment manufacturers (OEMs), and industry groups.

Government Publication Date: Jul 12, 2021

Registered Pesticide Establishments:

SSTS

List of active EPA-registered foreign and domestic pesticide-producing and device-producing establishments based on data from the Section Seven Tracking System (SSTS). The Federal Insecticide, Fungicide, and Rodenticide Act (FIFRA) Section 7 requires that facilities producing pesticides, active ingredients, or devices be registered. The list of establishments is made available by the EPA.

Government Publication Date: Apr 13, 2021

Polychlorinated Biphenyl (PCB) Notifiers:

PCB

Facilities included in the national list of facilities that have notified the United States Environmental Protection Agency (EPA) of Polychlorinated Biphenyl (PCB) activities. Any company or person storing, transporting or disposing of PCBs or conducting PCB research and development must notify the EPA and receive an identification number.

Government Publication Date: Nov 19, 2020

State

Dry Cleaning Facilities:

DRYCLEANERS

A list of drycleaner related facilities that have EPA ID numbers. These are facilities with certain SIC codes: power laundries, family and commercial, linen supply, commercial laundry, dry cleaning and pressing machines - Coin Operated Laundry and Dry Cleaning. This is provided by the Department of Toxic Substance Control.

Government Publication Date: Aug 27, 2021

Delisted Drycleaners:

[DELISTED DRYCLEANERS](#)

Sites removed from the list of drycleaner related facilities that have EPA ID numbers, made available by the California Department of Toxic Substance Control.

Government Publication Date: Aug 27, 2021

Non-Toxic Dry Cleaning Incentive Program:

[DRYC GRANT](#)

A list of grant recipients of the Non-Toxic Dry Cleaning Incentive Program made available by the California Air Resources Board (CARB). The program provides grants to eligible dry cleaning businesses to assist them in transitioning away from PERC machines to alternative non-toxic and non-smog forming technologies.

Government Publication Date: Feb 28, 2018

Per- and Polyfluoroalkyl Substances (PFAS):

[PFAS](#)

List of sites from the State Water Resources Control Board (SWRCB)'s GeoTracker at which one or more of the potential contaminants of concern are in the PFAS Master List of PFAS Substances made available by the Environmental Protection Agency (US EPA).

Government Publication Date: Jun 22, 2021

PFOA/PFOS Groundwater:

[PFAS GW](#)

A list of water wells from the Groundwater Ambient Monitoring and Assessment Program (GAMA) Groundwater Information System with the groundwater chemical perfluorooctanoic acid (PFOA) (NL = 0.014 UG/L) or perfluorooctanoic sulfonate (PFOS) (NL = 0.013 UG/L). The GAMA Groundwater Information System search is made available by California Water Boards.

Government Publication Date: Oct 22, 2020

Hazardous Waste and Substances Site List - Site Cleanup:

[HWSS CLEANUP](#)

The Hazardous Waste and Substances Sites (Cortese) List is a planning document used by the State, local agencies and developers to comply with the California Environmental Quality Act requirements in providing information about the location of hazardous materials release sites. This list is published by California Department of Toxic Substance Control.

Government Publication Date: May 20, 2021

List of Hazardous Waste Facilities Subject to Corrective Action:

[DTSC HWF](#)

This is a list of hazardous waste facilities identified in Health and Safety Code (HSC) § 25187.5. These facilities are those where Department of Toxic Substances Control (DTSC) has taken or contracted for corrective action because a facility owner/operator has failed to comply with a date for taking corrective action in an order issued under HSC § 25187, or because DTSC determined that immediate corrective action was necessary to abate an imminent or substantial endangerment.

Government Publication Date: Jul 18, 2016

EnviroStor Inspection, Compliance, and Enforcement:

[INSP COMP ENF](#)

A list of permitted facilities with inspections and enforcements tracked in the Department of Toxic Substance Control (DTSC) EnviroStor.

Government Publication Date: Apr 29, 2021

School Property Evaluation Program Sites:

[SCH](#)

A list of sites registered with The Department of Toxic Substances Control (DTSC) School Property Evaluation and Cleanup (SPEC) Division. SPEC is responsible for assessing, investigating and cleaning up proposed school sites. The Division ensures that selected properties are free of contamination or, if the properties were previously contaminated, that they have been cleaned up to a level that protects the students and staff who will occupy the new school.

Government Publication Date: Jun 14, 2021

California Hazardous Material Incident Report System (CHMIRS):

[CHMIRS](#)

A list of reported hazardous material incidents, spills, and releases from the California Hazardous Material Incident Report System (CHMIRS). This list has been made available by the California Office of Emergency Services (OES).

Government Publication Date: Aug 1, 2021

Historical California Hazardous Material Incident Report System (CHMIRS):

[HIST CHMIRS](#)

A list of reported hazardous material incidents, spills, and releases from the California Hazardous Material Incident Report System (CHMIRS) prior to 1993. This list has been made available by the California Office of Emergency Services (OES).

Government Publication Date: Jan 1, 1993

Hazardous Waste Manifest Data:

[HAZNET](#)

A list of hazardous waste manifests received each year by Department of Toxic Substances Control (DTSC). The volume of manifests is typically 900,000 - 1,000,000 annually, representing approximately 450,000 - 500,000 shipments.

Government Publication Date: Oct 24, 2016

Historical Hazardous Waste Manifest Data:

[HIST MANIFEST](#)

A list of historic hazardous waste manifests received by the Department of Toxic Substances Control (DTSC) from year the 1980 to 1992. The volume of manifests is typically 900,000 - 1,000,000 annually, representing approximately 450,000 - 500,000 shipments.

Government Publication Date: Dec 31, 1992

DTSC Registered Hazardous Waste Transporters:

[HW TRANSPORT](#)

The California Department of Toxic Substances Control (DTSC) maintains this list of Registered Hazardous Waste Transporters.

Government Publication Date: Oct 19, 2020

Registered Waste Tire Haulers:

[WASTE TIRE](#)

This list of registered waste tire haulers is maintained by the California Department of Resources Recycling and Recovery.

Government Publication Date: Dec 16, 2020

California Medical Waste Management Program Facility List:

[MEDICAL WASTE](#)

This list of Medical Waste Management Program Facilities is maintained by the California Department of Public Health. The Medical Waste Management Program (MWMP) regulates the generation, handling, storage, treatment, and disposal of medical waste by providing oversight for the implementation of the Medical Waste Management Act (MWMA). The MWMP permits and inspects all medical waste off-site treatment facilities, medical waste transporters, and medical waste transfer stations. This list contains transporters, treatment, and transfer facilities.

Government Publication Date: Dec 31, 2020

Historical Cortese List:

[HIST CORTESE](#)

List of sites which were once included on the Cortese list. The Hazardous Waste and Substances Sites (Cortese) List is a planning document used by the State, local agencies and developers to comply with the California Environmental Quality Act requirements for providing information about the location of hazardous sites.

Government Publication Date: Nov 13, 2008

Cease and Desist Orders and Cleanup and Abatement Orders:

[CDO/CAO](#)

The California Environment Protection Agency "Cortese List" of active Cease and Desist Orders (CDO) and Cleanup and Abatement Orders (CAO). This list contains many CDOs and CAOs that do NOT concern the discharge of wastes that are hazardous materials. Many of the listed orders concern, as examples, discharges of domestic sewage, food processing wastes, or sediment that do not contain hazardous materials, but the Water Boards' database does not distinguish between these types of orders.

Government Publication Date: Feb 16, 2012

California Environmental Reporting System (CERS) Hazardous Waste Sites:

[CERS HAZ](#)

List of sites in the California Environmental Protection Agency (CalEPA) Regulated Site Portal which fall under the following regulatory programs: Hazardous Chemical Management, Hazardous Waste Onsite Treatment, Household Hazardous Waste Collection, Hazardous Waste Generator, RCRA LQ HW Generator. The CalEPA oversees the statewide implementation of the Unified Program which applies regulatory standards to protect Californians from hazardous waste and materials.

Government Publication Date: Sep 24, 2021

Delisted Environmental Reporting System (CERS) Hazardous Waste Sites:

[DELISTED HAZ](#)

This database contains a list of sites that were removed from the California Environmental Protection Agency (CalEPA) in the following regulatory programs: Hazardous Chemical Management, Hazardous Waste Onsite Treatment, Household Hazardous Waste Collection, Hazardous Waste Generator, RCRA LQ HW Generator.

Government Publication Date: Nov 29, 2018

Sites in GeoTracker:

[GEOTRACKER](#)

GeoTracker is the State Water Resource Control Boards' data management system for sites that impact, or have the potential to impact, water quality in California, with emphasis on groundwater. This is a list of sites in GeoTracker that aren't otherwise categorized as LUST, Land Disposal Sites (LDS), Cleanup Sites, or sites having Waste Discharge Requirements (WDR). This listing includes program types such as Underground Injection Control (UIC), Confined Animal Facilities (CAF), Irrigated Lands Regulatory Program, plans, and non-case information.

Government Publication Date: Jun 22, 2021

Mines Listing:

MINE

This list includes mine site locations extracted from the Mines Online database, maintained by the California Department of Conservation. Mines Online (MOL) is an interactive web map designed with GIS features that provide information such as the mine name, mine status, commodity sold, location, and other mine specific data. Please note: Mine location information is provided to assist experts in determining the location of mine operators in accordance with California Civil Code section 1103.4 and reflects information reported by mine operators in annual reports provided under Public Resources Code section 2207. While the Division of Mine Reclamation (DMR) attempts to populate MOL with accurate location information, the DMR cannot guarantee the accuracy of operator reported location information.

Government Publication Date: Jan 12, 2021

Recorded Environmental Cleanup Liens:

LIEN

The California Department of Toxic Substance Control (DTSC) maintains this list of liens placed upon real properties. A lien is utilized by the DTSC to obtain reimbursement from responsible parties for costs associated with the remediation of contaminated properties.

Government Publication Date: Nov 16, 2020

Waste Discharge Requirements:

WASTE DISCHG

List of sites in California State Water Resources Control Board (SWRCB) Waste Discharge Requirements (WDRs) Program in California, made available by the SWRCB via GeoTracker. The WDR program regulates point discharges that are exempt pursuant to Subsection 20090 of Title 27 and not subject to the Federal Water Pollution Control Act. The scope of the WDRs Program also includes the discharge of wastes classified as inert, pursuant to section 20230 of Title 27.

Government Publication Date: Jun 22, 2021

Toxic Pollutant Emissions Facilities:

EMISSIONS

A list of criteria and toxic pollutant emissions data for facilities in California made available by the California Environmental Protection Agency - Air Resources Board (ARB). Risk data may be based on previous inventory submittals. The toxics data are submitted to the ARB by the local air districts as requirement of the Air Toxics "Hot Spots" Program. This program requires emission inventory updates every four years.

Government Publication Date: Dec 31, 2019

Clandestine Drug Lab Sites:

CDL

The Department of Toxic Substances Control (DTSC) maintains a listing of drug lab sites. DTSC is responsible for removal and disposal of hazardous substances discovered by law enforcement officials while investigating illegal/ clandestine drug laboratories.

Government Publication Date: Jan 19, 2021

Tribal

No Tribal additional environmental record sources available for this State.

County

No County additional environmental databases were selected to be included in the search.

Definitions

Database Descriptions: This section provides a detailed explanation for each database including: source, information available, time coverage, and acronyms used. They are listed in alphabetic order.

Detail Report: This is the section of the report which provides the most detail for each individual record. Records are summarized by location, starting with the project property followed by records in closest proximity.

Distance: The distance value is the distance between plotted points, not necessarily the distance between the sites' boundaries. All values are an approximation.

Direction: The direction value is the compass direction of the site in respect to the project property and/or center point of the report.

Elevation: The elevation value is taken from the location at which the records for the site address have been plotted. All values are an approximation. Source: Google Elevation API.

Executive Summary: This portion of the report is divided into 3 sections:

'Report Summary'- Displays a chart indicating how many records fall on the project property and, within the report search radii.

'Site Report Summary'-Project Property'- This section lists all the records which fall on the project property. For more details, see the 'Detail Report' section.

'Site Report Summary-Surrounding Properties'- This section summarizes all records on adjacent properties, listing them in order of proximity from the project property. For more details, see the 'Detail Report' section.

Map Key: The map key number is assigned according to closest proximity from the project property. Map Key numbers always start at #1. The project property will always have a map key of '1' if records are available. If there is a number in brackets beside the main number, this will indicate the number of records on that specific property. If there is no number in brackets, there is only one record for that property.

The symbol and colour used indicates 'elevation': the red inverted triangle will dictate 'ERIS Sites with Lower Elevation', the yellow triangle will dictate 'ERIS Sites with Higher Elevation' and the orange square will dictate 'ERIS Sites with Same Elevation.'

Unplottables: These are records that could not be mapped due to various reasons, including limited geographic information. These records may or may not be in your study area, and are included as reference.



Property Information

Order Number:	21100500784p
Date Completed:	October 6, 2021
Project Number:	821AR00978.0001
Project Property:	Maverik El Centro SEC of Ross Ave & Hawes Rd El Centro CA
Coordinates:	
Latitude:	32.78061451
Longitude:	-115.49900409
UTM Northing:	3627963.32186 Meters
UTM Easting:	640569.474411 Meters
UTM Zone:	UTM Zone 11S
Elevation:	-36.09 ft
Slope Direction:	W

Topographic Information.....	2
Hydrologic Information.....	4
Geologic Information.....	7
Soil Information.....	9
Wells and Additional Sources.....	14
Summary.....	15
Detail Report.....	16
Radon Information.....	18
Appendix.....	19
Liability Notice.....	21

The ERIS **Physical Setting Report - PSR** provides comprehensive information about the physical setting around a site and includes a complete overview of topography and surface topology, in addition to hydrologic, geologic and soil characteristics. The location and detailed attributes of oil and gas wells, water wells, public water systems and radon are also included for review.

The compilation of both physical characteristics of a site and additional attribute data is useful in assessing the impact of migration of contaminants and subsequent impact on soils and groundwater.

Disclaimer

This Report does not provide a full environmental evaluation for the site or adjacent properties. Please see the terms and disclaimer at the end of the Report for greater detail.

Topographic Information



Current USGS Topo (2015)

Quadrangle(s): El Centro, CA; Holtville West, CA

Source: USGS 7.5 Minute Topographic Map



EEC ORIGINAL PKG

Topographic Information

The previous topographic map(s) are created by seamlessly merging and cutting current USGS topographic data. Below are shaded relief map(s), derived from USGS elevation data to show surrounding topography in further detail.

Topographic information at project property:

Elevation: -36.09 ft
Slope Direction: W

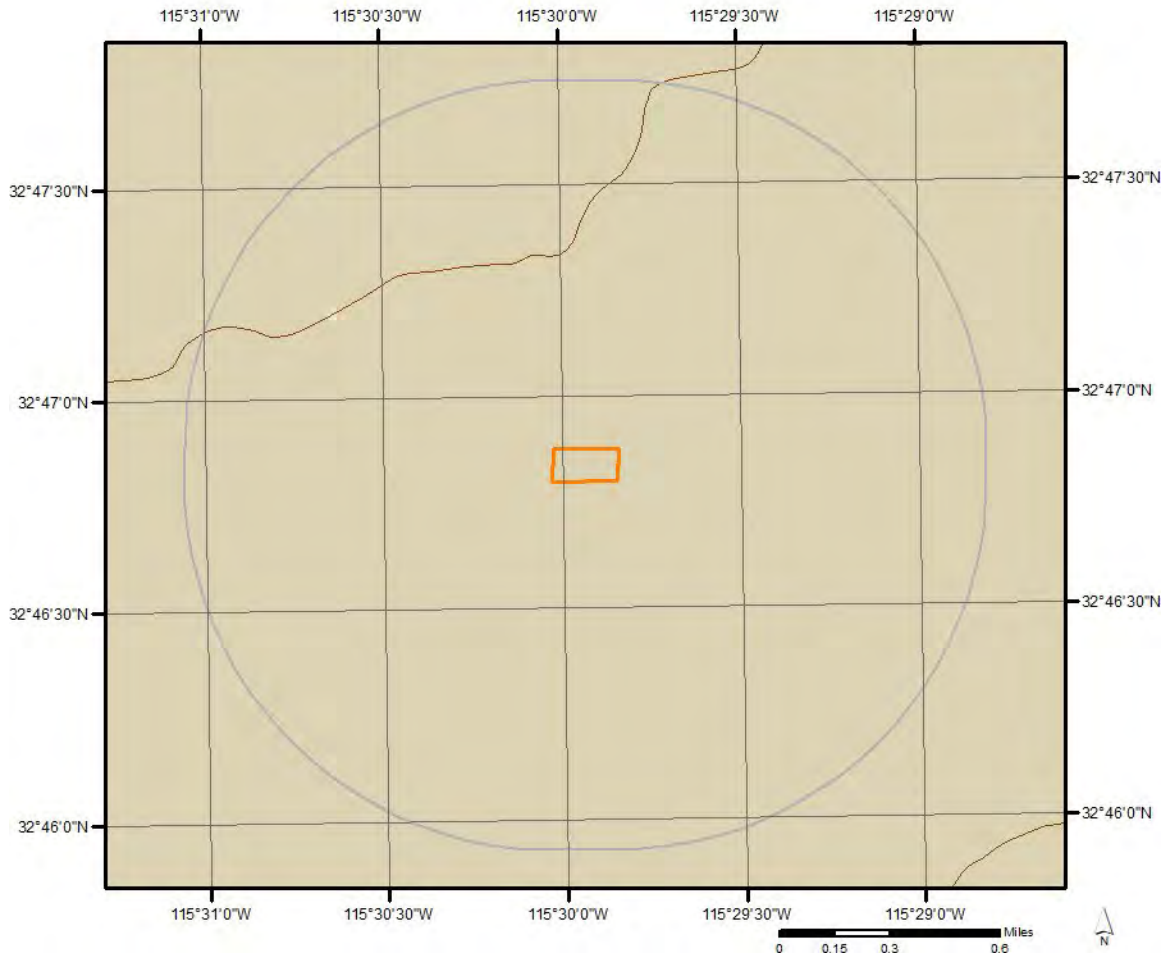

Hydrologic Information



Wetland

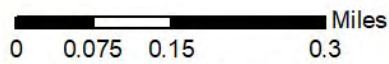

This map shows wetland existence using data from US Fish & Wildlife. Data coverage is shown to the right. Gray indicates no data available in the area.

- | | |
|---|---|
|  Estuarine and Marine Deepwater |  Freshwater Pond |
|  Estuarine and Marine Wetland |  Lake |
|  Freshwater Emergent Wetland |  Other |
|  Freshwater Forested/Shrub Wetland |  Riverine |



Hydrologic Information

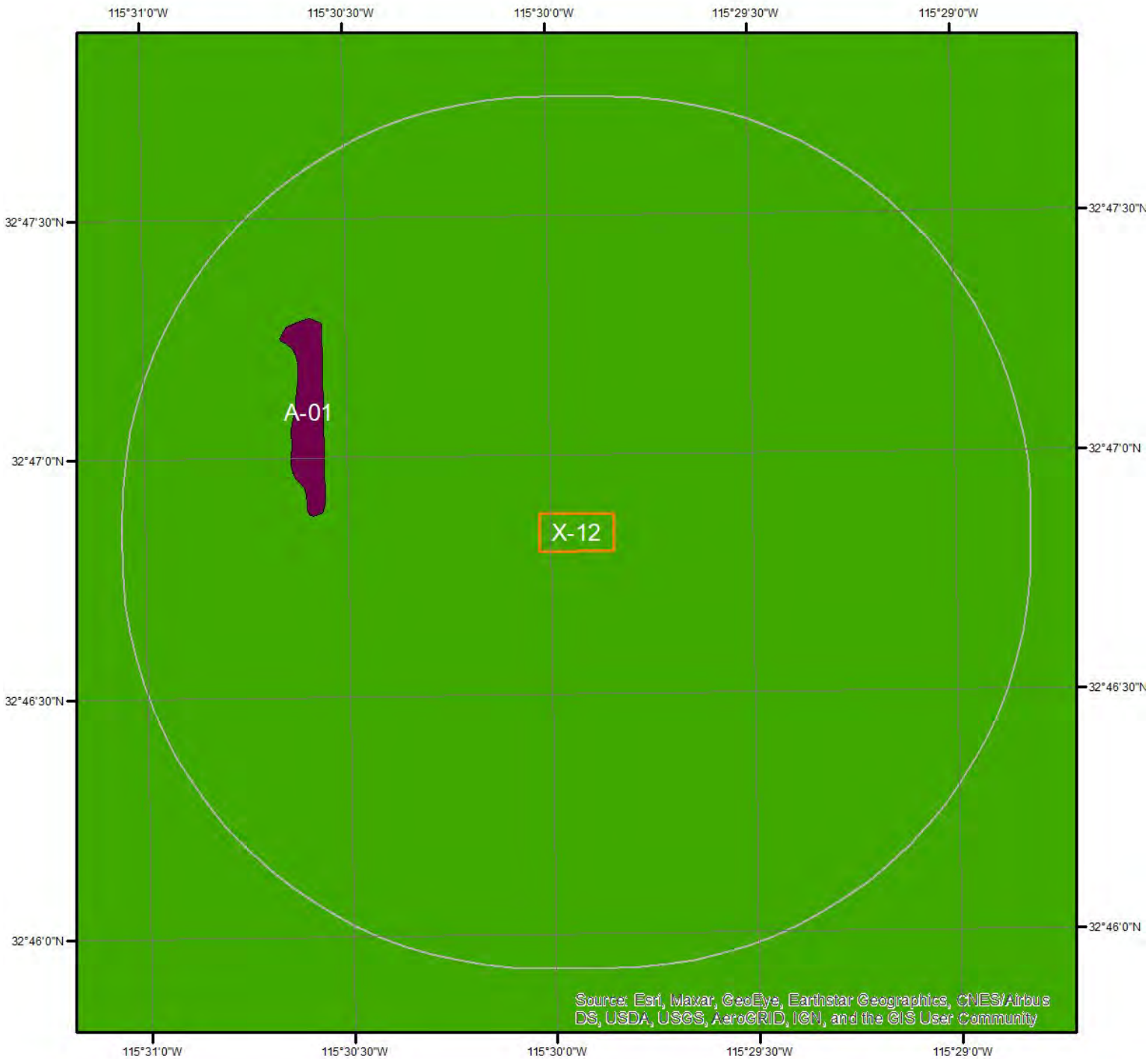

Flood Hazard Zones

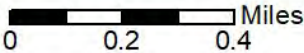

This map shows FEMA flood hazard zones. FIRM panels are shown to the right, and blank indicates no data is available.

- | | | |
|-----|----|-------------------|
| A | AO | X |
| A99 | V | OPEN WATER |
| AE | VE | NOT POPULATED |
| AH | D | AREA NOT INCLUDED |

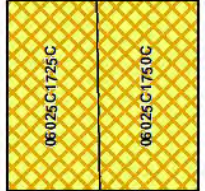

EEC ORIGINAL PKG

Hydrologic Information

The Wetland Type map shows wetland existence overlaid on an aerial imagery. The Flood Hazard Zones map shows FEMA flood hazard zones overlaid on an aerial imagery. Relevant FIRM panels and detailed zone information is provided below.

Available FIRM Panels in area: 06025C1725C(effective:2008-09-26) 06025C1750C(effective:2008-09-26)

Flood Zone A-01

Zone: A

Zone subtype:

Flood Zone X-12

Zone: X

Zone subtype: AREA OF MINIMAL FLOOD HAZARD

Geologic Information

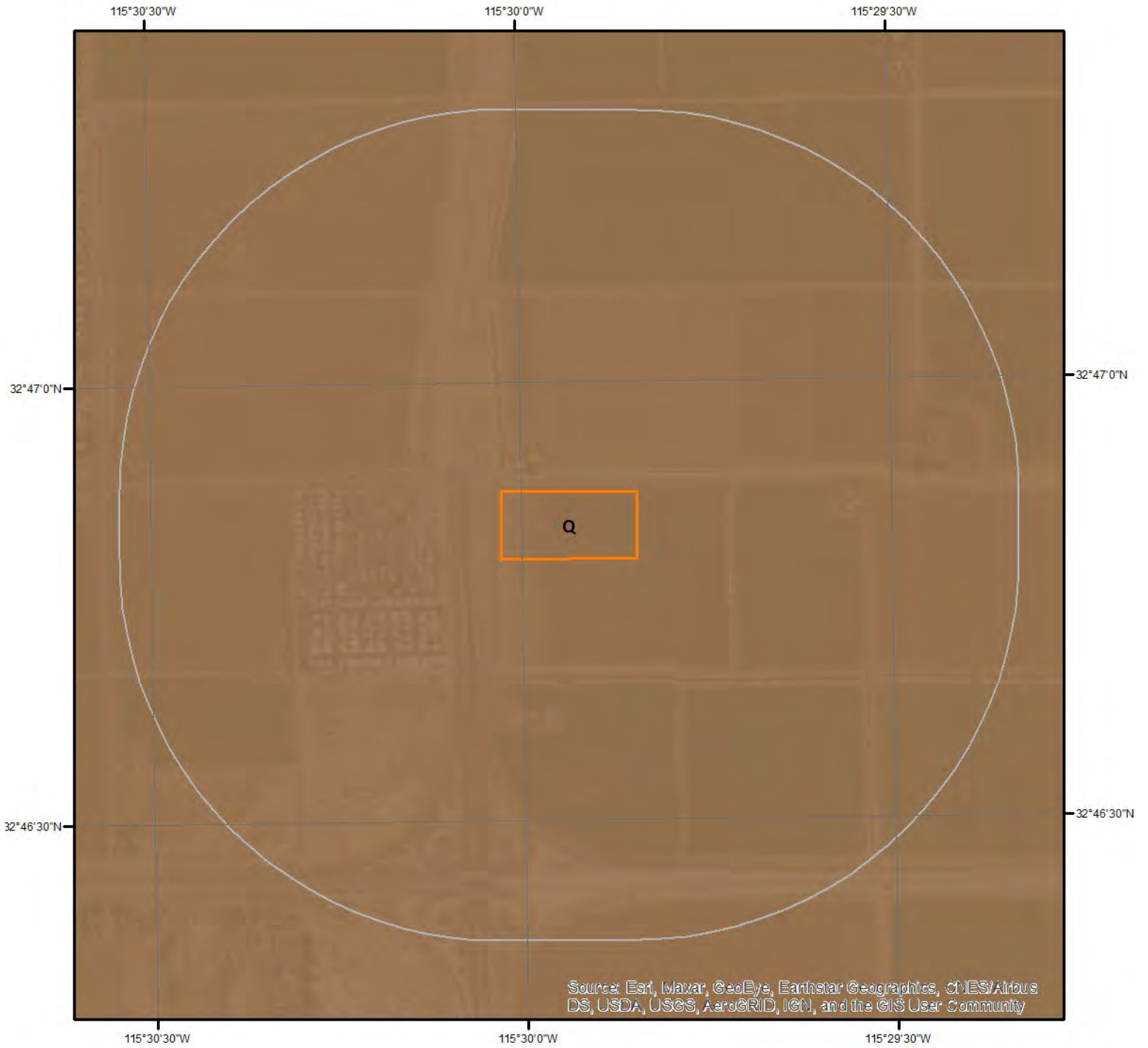

Geologic Units

This maps shows geologic units in the area. Please refer to the report for detailed descriptions.

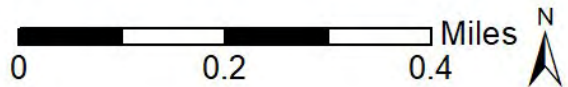

EEC ORIGINAL PKG

Geologic Information

The previous page shows USGS geology information. Detailed information about each unit is provided below.

Geologic Unit Q

Unit Name:	Quaternary alluvium and marine deposits
Unit Age:	Pliocene to Holocene
Primary Rock Type:	alluvium
Secondary Rock Type:	terrace
Unit Description:	Alluvium, lake, playa, and terrace deposits; unconsolidated and semi-consolidated. Mostly nonmarine, but includes marine deposits near the coast.

Soil Information

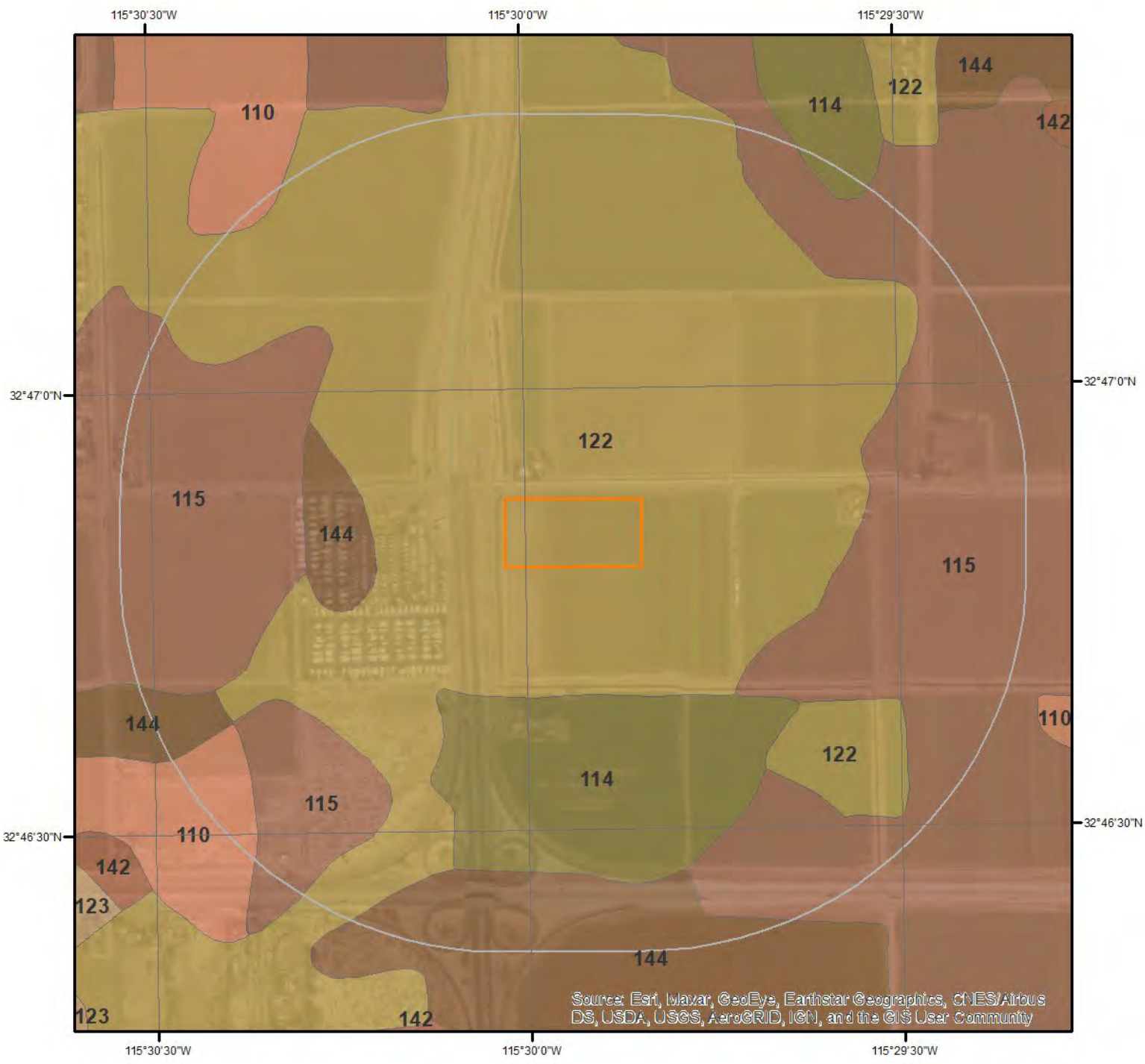

SSURGO Soils

This maps shows SSURGO soil units around the target property. Please refer to the report for detailed soil descriptions.



Soil Information

The previous page shows a soil map using SSURGO data from USDA Natural Resources Conservation Service. Detailed information about each unit is provided below.

Map Unit 110 (16.9%)

Map Unit Name:	Holtville silty clay, wet
Bedrock Depth - Min:	null
Watertable Depth - Annual Min:	null
Drainage Class - Dominant:	Moderately well drained
Hydrologic Group - Dominant:	D - Soils in this group have high runoff potential when thoroughly wet. Water movement through the soil is restricted or very restricted.

Major components are printed below

Holtville(85%)	
horizon H1(0cm to 43cm)	Silty clay
horizon H2(43cm to 61cm)	Clay
horizon H3(61cm to 89cm)	Silt loam
horizon H4(89cm to 152cm)	Loamy very fine sand

Component Description:

Minor map unit components are excluded from this report.

Map Unit: 110 - Holtville silty clay, wet

Component: Holtville (85%)

The Holtville, WET component makes up 85 percent of the map unit. Slopes are 0 to 2 percent. This component is on basin floors. The parent material consists of alluvium derived from mixed sources. Depth to a root restrictive layer is greater than 60 inches. The natural drainage class is moderately well drained. Water movement in the most restrictive layer is low. Available water to a depth of 60 inches (or restricted depth) is moderate. Shrink-swell potential is moderate. This soil is not flooded. It is not ponded. There is no zone of water saturation within a depth of 72 inches. Organic matter content in the surface horizon is about 1 percent. Nonirrigated land capability classification is 7w. Irrigated land capability classification is 2w. This soil does not meet hydric criteria. The calcium carbonate equivalent within 40 inches, typically, does not exceed 3 percent. The soil has a slightly saline horizon within 30 inches of the soil surface. The soil has a maximum sodium adsorption ratio of 8 within 30 inches of the soil surface.

Component: Glenbar (5%)

Generated brief soil descriptions are created for major soil components. The Glenbar soil is a minor component.

Component: Imperial (5%)

Generated brief soil descriptions are created for major soil components. The Imperial soil is a minor component.

Component: Indio (3%)

Generated brief soil descriptions are created for major soil components. The Indio soil is a minor component.

Component: Vint (2%)

Generated brief soil descriptions are created for major soil components. The Vint soil is a minor component.

Map Unit 114 (0.54%)

Map Unit Name:	Imperial silty clay, wet
Bedrock Depth - Min:	null
Watertable Depth - Annual Min:	null
Drainage Class - Dominant:	Moderately well drained
Hydrologic Group - Dominant:	C - Soils in this group have moderately high runoff potential when thoroughly wet. Water transmission through the soil is somewhat restricted.

Major components are printed below

Imperial(85%)

Soil Information

horizon H1(0cm to 30cm)
horizon H2(30cm to 152cm)

Silty clay
Silty clay loam

Component Description:

Minor map unit components are excluded from this report.

Map Unit: 114 - Imperial silty clay, wet

Component: Imperial (85%)

The Imperial, WET component makes up 85 percent of the map unit. Slopes are 0 to 2 percent. This component is on basin floors. The parent material consists of clayey alluvium derived from mixed and/or clayey lacustrine deposits derived from mixed. Depth to a root restrictive layer is greater than 60 inches. The natural drainage class is moderately well drained. Water movement in the most restrictive layer is moderately low. Available water to a depth of 60 inches (or restricted depth) is moderate. Shrink-swell potential is high. This soil is not flooded. It is not ponded. There is no zone of water saturation within a depth of 72 inches. Organic matter content in the surface horizon is about 1 percent. Nonirrigated land capability classification is 7w. Irrigated land capability classification is 3w. This soil does not meet hydric criteria. The calcium carbonate equivalent within 40 inches, typically, does not exceed 3 percent. The soil has a slightly saline horizon within 30 inches of the soil surface. The soil has a maximum sodium adsorption ratio of 15 within 30 inches of the soil surface.

Component: Meloland (4%)

Generated brief soil descriptions are created for major soil components. The Meloland soil is a minor component.

Component: Holtville (4%)

Generated brief soil descriptions are created for major soil components. The Holtville soil is a minor component.

Component: Glenbar (4%)

Generated brief soil descriptions are created for major soil components. The Glenbar soil is a minor component.

Component: Niland (3%)

Generated brief soil descriptions are created for major soil components. The Niland soil is a minor component.

Map Unit 115 (77.86%)

Map Unit Name:	Imperial-Glenbar silty clay loams, wet, 0 to 2 percent slopes
Bedrock Depth - Min:	null
Watertable Depth - Annual Min:	null
Drainage Class - Dominant:	Moderately well drained
Hydrologic Group - Dominant:	C - Soils in this group have moderately high runoff potential when thoroughly wet. Water transmission through the soil is somewhat restricted.

Major components are printed below

Glenbar(40%)

horizon H1(0cm to 33cm)	Silty clay loam
horizon H2(33cm to 152cm)	Clay loam

Imperial(40%)

horizon H1(0cm to 30cm)	Silty clay loam
horizon H2(30cm to 152cm)	Silty clay loam

Component Description:

Minor map unit components are excluded from this report.

Map Unit: 115 - Imperial-Glenbar silty clay loams, wet, 0 to 2 percent slopes

Component: Imperial (41%)

The Imperial, WET component makes up 40 percent of the map unit. Slopes are 0 to 2 percent. This component is on basin floors. The parent material consists of clayey alluvium derived from mixed and/or clayey lacustrine deposits derived from mixed. Depth to a root restrictive layer is greater than 60 inches. The natural drainage class is moderately well drained. Water movement in the most restrictive layer is moderately high. Available water to a depth of 60 inches (or restricted depth) is moderate. Shrink-swell potential is high. This soil is not flooded. It is not ponded. There is no zone of water saturation within a depth of 72 inches. Organic matter content in the surface horizon is about 1 percent. Nonirrigated land capability classification is 7w. Irrigated land capability classification is 3w.

Soil Information

This soil does not meet hydric criteria. The calcium carbonate equivalent within 40 inches, typically, does not exceed 3 percent. The soil has a slightly saline horizon within 30 inches of the soil surface. The soil has a maximum sodium adsorption ratio of 15 within 30 inches of the soil surface.

Component: Glenbar (40%)

The Glenbar, WET component makes up 40 percent of the map unit. Slopes are 0 to 2 percent. This component is on basin floors. The parent material consists of alluvium derived from mixed. Depth to a root restrictive layer is greater than 60 inches. The natural drainage class is moderately well drained. Water movement in the most restrictive layer is moderately high. Available water to a depth of 60 inches (or restricted depth) is high. Shrink-swell potential is moderate. This soil is not flooded. It is not ponded. There is no zone of water saturation within a depth of 72 inches. Organic matter content in the surface horizon is about 1 percent. Nonirrigated land capability classification is 7w. Irrigated land capability classification is 3w. This soil does not meet hydric criteria. The calcium carbonate equivalent within 40 inches, typically, does not exceed 3 percent. The soil has a slightly saline horizon within 30 inches of the soil surface. The soil has a maximum sodium adsorption ratio of 10 within 30 inches of the soil surface.

Component: Meloland (10%)

Generated brief soil descriptions are created for major soil components. The Meloland soil is a minor component.

Component: Holtville (9%)

Generated brief soil descriptions are created for major soil components. The Holtville soil is a minor component.

Map Unit 122 (3.74%)

Map Unit Name:	Meloland very fine sandy loam, wet
Bedrock Depth - Min:	null
Watertable Depth - Annual Min:	null
Drainage Class - Dominant:	Moderately well drained
Hydrologic Group - Dominant:	D - Soils in this group have high runoff potential when thoroughly wet. Water movement through the soil is restricted or very restricted.

Major components are printed below

Meloland(85%)

horizon H1(0cm to 30cm)	Very fine sandy loam
horizon H2(30cm to 66cm)	Stratified loamy fine sand to silt loam
horizon H3(66cm to 180cm)	Clay

Component Description:

Minor map unit components are excluded from this report.

Map Unit: 122 - Meloland very fine sandy loam, wet

Component: Meloland (85%)

The Meloland, WET component makes up 85 percent of the map unit. Slopes are 0 to 2 percent. This component is on basin floors. The parent material consists of alluvium derived from mixed and/or eolian deposits derived from mixed. Depth to a root restrictive layer is greater than 60 inches. The natural drainage class is moderately well drained. Water movement in the most restrictive layer is low. Available water to a depth of 60 inches (or restricted depth) is moderate. Shrink-swell potential is moderate. This soil is not flooded. It is not ponded. There is no zone of water saturation within a depth of 72 inches. Organic matter content in the surface horizon is about 1 percent. Nonirrigated land capability classification is 7w. Irrigated land capability classification is 3w. This soil does not meet hydric criteria. The calcium carbonate equivalent within 40 inches, typically, does not exceed 3 percent. The soil has a moderately saline horizon within 30 inches of the soil surface. The soil has a maximum sodium adsorption ratio of 12 within 30 inches of the soil surface.

Component: Glenbar (3%)

Generated brief soil descriptions are created for major soil components. The Glenbar soil is a minor component.

Component: Imperial (3%)

Generated brief soil descriptions are created for major soil components. The Imperial soil is a minor component.

Component: Indio (3%)

Generated brief soil descriptions are created for major soil components. The Indio soil is a minor component.

Component: Holtville (3%)

Soil Information

Generated brief soil descriptions are created for major soil components. The Holtville soil is a minor component.

Component: Vint (3%)

Generated brief soil descriptions are created for major soil components. The Vint soil is a minor component.

Map Unit 144 (0.96%)

Map Unit Name:	Vint and Indio very fine sandy loams, wet
Bedrock Depth - Min:	null
Watertable Depth - Annual Min:	null
Drainage Class - Dominant:	Moderately well drained
Hydrologic Group - Dominant:	B - Soils in this group have moderately low runoff potential when thoroughly wet. Water transmission through the soil is unimpeded.

Major components are printed below

Vint(50%)

horizon H1(0cm to 25cm)	Very fine sandy loam
horizon H2(25cm to 102cm)	Loamy fine sand
horizon H3(102cm to 152cm)	Silty clay

Indio(40%)

horizon H1(0cm to 30cm)	Very fine sandy loam
horizon H2(30cm to 102cm)	Stratified loamy very fine sand to silt loam
horizon H3(102cm to 152cm)	Silty clay

Component Description:

Minor map unit components are excluded from this report.

Map Unit: 144 - Vint and Indio very fine sandy loams, wet

Component: Vint (50%)

The Vint, WET component makes up 50 percent of the map unit. Slopes are 0 to 2 percent. This component is on basin floors. The parent material consists of alluvium derived from mixed sources and/or eolian deposits derived from mixed sources. Depth to a root restrictive layer is greater than 60 inches. The natural drainage class is moderately well drained. Water movement in the most restrictive layer is moderately low. Available water to a depth of 60 inches (or restricted depth) is moderate. Shrink-swell potential is moderate. This soil is not flooded. It is not ponded. There is no zone of water saturation within a depth of 72 inches. Organic matter content in the surface horizon is about 1 percent. Nonirrigated land capability classification is 7w. Irrigated land capability classification is 2w. This soil does not meet hydric criteria. The calcium carbonate equivalent within 40 inches, typically, does not exceed 3 percent. The soil has a slightly saline horizon within 30 inches of the soil surface.

Component: Indio (40%)

The Indio, WET component makes up 40 percent of the map unit. Slopes are 0 to 2 percent. This component is on basin floors. The parent material consists of alluvium and/or eolian deposits derived from mixed. Depth to a root restrictive layer is greater than 60 inches. The natural drainage class is moderately well drained. Water movement in the most restrictive layer is moderately low. Available water to a depth of 60 inches (or restricted depth) is moderate. Shrink-swell potential is moderate. This soil is not flooded. It is not ponded. There is no zone of water saturation within a depth of 72 inches. Organic matter content in the surface horizon is about 1 percent. Nonirrigated land capability classification is 7w. Irrigated land capability classification is 2w. This soil does not meet hydric criteria. The calcium carbonate equivalent within 40 inches, typically, does not exceed 3 percent. There are no saline horizons within 30 inches of the soil surface.

Component: Rositas (5%)

Generated brief soil descriptions are created for major soil components. The Rositas soil is a minor component.

Component: Meloland (5%)

Generated brief soil descriptions are created for major soil components. The Meloland soil is a minor component.

Wells and Additional Sources



Wells & Additional Sources



- | | |
|--------------------------------|------------------------------------|
| ▲ Sites with Higher Elevation | ▲ OGW Sites with Higher Elevation |
| ■ Sites with Same Elevation | ■ OGW Sites with Same Elevation |
| ▼ Sites with Lower Elevation | ▼ OGW Sites with Lower Elevation |
| ○ Sites with Unknown Elevation | ● OGW Sites with Unknown Elevation |



Wells and Additional Sources Summary

Federal Sources

Public Water Systems Violations and Enforcement Data

Map Key	PWS ID	Distance (ft)	Direction
1	CA1300550	902.56	WNW

Safe Drinking Water Information System (SDWIS)

Map Key	ID	Distance (ft)	Direction
	No records found		

USGS National Water Information System

Map Key	ID	Distance (ft)	Direction
	No records found		

State Sources

Oil and Gas Wells

Map Key	ID	Distance (ft)	Direction
	No records found		

Periodic Groundwater Level Measurement Locations

Map Key	ID	Distance (ft)	Direction
	No records found		

Well Completion Reports

Map Key	WCR No	Distance (ft)	Direction
2	WCR1994-011803	4265.66	WSW
2	WCR1994-011802	4265.66	WSW
2	WCR1994-011804	4265.66	WSW

Wells and Additional Sources Detail Report

Public Water Systems Violations and Enforcement Data

Map Key	Direction	Distance (mi)	Distance (ft)	Elevation (ft)	DB
1	WNW	0.17	902.56	-36.61	PWSV

Address Line 2:

State Code: CA
 Zip Code: 92243
 City Name: EL CENTRO
 Address Line 1: 375 EAST ROSS ROAD
 PWS ID: CA1300550
 PWS Type Code: CWS
 PWS Type Description: Community Water System
 Primary Source Code: SW
 Primary Source Desc: Surface Water
 PWS Activity Code: A
 PWS Activity Description: Active
 PWS Deactivation Date:
 Phone Number: 760-353-4223

--Details--

Population Served Count: 600
 City Served:
 County Served: Imperial
 State Served: CA
 Zip Code Served:

Well Completion Reports

Map Key	Direction	Distance (mi)	Distance (ft)	Elevation (ft)	DB
2	WSW	0.81	4,265.66	-34.99	WATER WELLS

WCR No: WCR1994-011803 City(OSWCR): El Centro
 City: El Centro County(OSWCR): Imperial
 County: Imperial Decimal Lat(OSWCR): 32.77409
 Decimal Latitude: 32.77409 Decim Long(OSWCR): -115.51254
 Decimal Longitude: -115.51254
 Location: 375 E Ross Road
 Location(OSWCR): 375 E Ross Road
 Original Source: California Department of Water Resources - OSWCR(Well Numbers); California Department of Water Resources - Well Completion Reports

Map Key	Direction	Distance (mi)	Distance (ft)	Elevation (ft)	DB
2	WSW	0.81	4,265.66	-34.99	WATER WELLS

Wells and Additional Sources Detail Report

WCR No:	WCR1994-011802	City(OSWCR):	El Centro
City:	El Centro	County(OSWCR):	Imperial
County:	Imperial	Decimal Lat(OSWCR):	32.77409
Decimal Latitude:	32.77409	Decim Long(OSWCR):	-115.51254
Decimal Longitude:	-115.51254		
Location:	375 E Ross Road		
Location(OSWCR):	375 E Ross Road		
Original Source:	California Department of Water Resources - OSWCR(Well Numbers); California Department of Water Resources - Well Completion Reports		

Map Key	Direction	Distance (mi)	Distance (ft)	Elevation (ft)	DB
2	WSW	0.81	4,265.66	-34.99	WATER WELLS

WCR No:	WCR1994-011804	City(OSWCR):	El Centro
City:	El Centro	County(OSWCR):	Imperial
County:	Imperial	Decimal Lat(OSWCR):	32.77409
Decimal Latitude:	32.77409	Decim Long(OSWCR):	-115.51254
Decimal Longitude:	-115.51254		
Location:	375 E Ross Road		
Location(OSWCR):	375 E Ross Road		
Original Source:	California Department of Water Resources - OSWCR(Well Numbers); California Department of Water Resources - Well Completion Reports		

Radon Information

This section lists any relevant radon information found for the target property.

Federal EPA Radon Zone for *IMPERIAL* County: **3**

Zone 1: Counties with predicted average indoor radon screening levels greater than 4 pCi/L

Zone 2: Counties with predicted average indoor radon screening levels from 2 to 4 pCi/L

Zone 3: Counties with predicted average indoor radon screening levels less than 2 pCi/L

Federal Area Radon Information for *IMPERIAL* County

No Measures/Homes:	2
Geometric Mean:	1.4
Arithmetic Mean:	1.5
Median:	1.5
Standard Deviation:	0.5
Maximum:	1.8
% >4 pCi/L:	0
% >20 pCi/L:	0
Notes on Data Table:	TABLE 1. Screening indoor radon data from the EPA/State Residential Radon Survey of California conducted during 1989-90. Data represent 2-7 day charcoal canister measurements from the lowest level of each home tested.

Federal Sources

FEMA National Flood Hazard Layer

FEMA FLOOD

The National Flood Hazard Layer (NFHL) data incorporates Flood Insurance Rate Map (FIRM) databases published by the Federal Emergency Management Agency (FEMA), and any Letters Of Map Revision (LOMRs) that have been issued against those databases since their publication date. The FIRM Database is the digital, geospatial version of the flood hazard information shown on the published paper FIRMs. The FIRM Database depicts flood risk information and supporting data used to develop the risk data. The FIRM Database is derived from Flood Insurance Studies (FISs), previously published FIRMs, flood hazard analyses performed in support of the FISs and FIRMs, and new mapping data, where available.

Indoor Radon Data

INDOOR RADON

Indoor radon measurements tracked by the Environmental Protection Agency(EPA) and the State Residential Radon Survey.

Public Water Systems Violations and Enforcement Data

PWSV

List of drinking water violations and enforcement actions from the Safe Drinking Water Information System (SDWIS) made available by the Drinking Water Protection Division of the US EPA's Office of Groundwater and Drinking Water. Enforcement sensitive actions are not included in the data released by the EPA. Address information provided in SWDIS may correspond either with the physical location of the water system, or with a contact address.

Radon Zone Level

RADON ZONE

Areas showing the level of Radon Zones (level 1, 2 or 3) by county. This data is maintained by the Environmental Protection Agency (EPA).

Safe Drinking Water Information System (SDWIS)

SDWIS

The Safe Drinking Water Information System (SDWIS) contains information about public water systems as reported to US Environmental Protection Agency (EPA) by the states. Addresses may correspond with the location of the water system, or with a contact address.

Soil Survey Geographic database

SSURGO

The Soil Survey Geographic database (SSURGO) contains information about soil as collected by the National Cooperative Soil Survey at the Natural Resources Conservation Service (NRCS). Soil maps outline areas called map units. The map units are linked to soil properties in a database. Each map unit may contain one to three major components and some minor components.

U.S. Fish & Wildlife Service Wetland Data

US WETLAND

The U.S. Fish & Wildlife Service Wetland layer represents the approximate location and type of wetlands and deepwater habitats in the United States.

USGS Current Topo

US TOPO

US Topo topographic maps are produced by the National Geospatial Program of the U.S. Geological Survey (USGS). The project was launched in late 2009, and the term "US Topo" refers specifically to quadrangle topographic maps published in 2009 and later.

USGS Geology

US GEOLOGY

Seamless maps depicting geological information provided by the United States Geological Survey (USGS).

USGS National Water Information System

FED USGS

The U.S. Geological Survey (USGS)'s National Water Information System (NWIS) is the nation's principal repository of water resources data. This database includes comprehensive information of well-construction details, time-series data for gage height, streamflow, groundwater level, and precipitation and water use data.

State Sources

Oil and Gas Wells

OGW

A list of Oil and Gas well locations. This is provided by California's Department of Conservation Division of

Appendix

Oil, Gas and Geothermal Resources.

Periodic Groundwater Level Measurement Locations

Locations of groundwater level monitoring wells in the Department of Water Resources (DWR)'s Periodic Groundwater Levels dataset. The DWR Periodic Groundwater Levels dataset contains seasonal and long-term groundwater level measurements collected by the Department of Water Resources and cooperating agencies.

MONITOR WELLS

Well Completion Reports

List of wells from the Well Completion Reports data made available by the California Department of Water Resources' (DWR) Online System for Well Completion Reports (OSWCR). Please note that the majority of well completion reports have been spatially registered to the center of the 1x1 mile Public Land Survey System section that the well is located in.

WATER WELLS

Liability Notice

Reliance on information in Report: The Physical Setting Report (PSR) DOES NOT replace a full Phase I Environmental Site Assessment but is solely intended to be used as a review of environmental databases and physical characteristics for the site or adjacent properties.

License for use of information in Report: No page of this report can be used without this cover page, this notice and the project property identifier. The information in Report(s) may not be modified or re-sold.

Your Liability for misuse: Using this Service and/or its reports in a manner contrary to this Notice or your agreement will be in breach of copyright and contract and ERIS may obtain damages for such mis-use, including damages caused to third parties, and gives ERIS the right to terminate your account, rescind your license to any previous reports and to bar you from future use of the Service.

No warranty of Accuracy or Liability for ERIS: The information contained in this report has been produced by ERIS Information Inc. ("ERIS") using various sources of information, including information provided by Federal and State government departments. The report applies only to the address and up to the date specified on the cover of this report, and any alterations or deviation from this description will require a new report. This report and the data contained herein does not purport to be and does not constitute a guarantee of the accuracy of the information contained herein and does not constitute a legal opinion nor medical advice. Although ERIS has endeavored to present you with information that is accurate, ERIS Information Inc. disclaims, any and all liability for any errors, omissions, or inaccuracies in such information and data, whether attributable to inadvertence, negligence or otherwise, and for any consequences arising therefrom. Liability on the part of ERIS is limited to the monetary value paid for this report.

Trademark and Copyright: You may not use the ERIS trademarks or attribute any work to ERIS other than as outlined above. This Service and Report(s) are protected by copyright owned by ERIS Information Inc. Copyright in data used in the Service or Report(s) (the "Data") is owned by ERIS or its licensors. The Service, Report(s) and Data may not be copied or reproduced in whole or in any substantial part without prior written consent of ERIS.

Potential Maverik Acquisition - SEC of Ross Ave & Hawes Rd, El Centro,
CA

Appendix

F

Aerial Photographs

EEC ORIGINAL PKG



HISTORICAL AERIALS

Project Property: Maverik El Centro

SEC of Ross Ave & Hawes Rd
El Centro CA

Project No: 821AR00978.0001

Requested By: Cardno Inc.

Order No: 21100500784

Date Completed: October 07,2021

Aerial Maps included in this report are produced by the sources listed above and are to be used for research purposes including a phase I report. Maps are not to be resold as commercial property. ERIS provides no warranty of accuracy or liability. The information contained in this report has been produced using aerial photos listed in above sources by ERIS Information Inc. (in the US) and ERIS Information Limited Partnership (in Canada), both doing business as 'ERIS'. The maps contained in this report do not purport to be and do not constitute a guarantee of the accuracy of the information contained herein. Although ERIS has endeavored to present information that is accurate, ERIS disclaims, any and all liability for any errors, omissions, or inaccuracies in such information and data, whether attributable to inadvertence, negligence or otherwise, and for any consequences arising therefrom. Liability on the part of ERIS is limited to the monetary value paid for this report.

Environmental Risk Information Services

A division of Glacier Media Inc.

1.866.517.5204 | info@erisinfo.com | erisinfo.com

EEC ORIGINAL PKG

Date	Source	Scale	Comments
2020	National Agriculture Information Program	1" = 500'	
2018	National Agriculture Information Program	1" = 500'	
2016	National Agriculture Information Program	1" = 500'	
2014	National Agriculture Information Program	1" = 500'	
2012	National Agriculture Information Program	1" = 500'	
2010	National Agriculture Information Program	1" = 500'	
2006	National Agriculture Information Program	1" = 500'	
2005	National Agriculture Information Program	1" = 500'	
2002	National Agriculture Information Program	1" = 500'	
1996	US Geological Survey	1" = 500'	
1984	National High Altitude Photography	1" = 500'	Best Copy Available
1976	US Geological Survey	1" = 500'	Best Copy Available
1969	National Aeronautics Space Administration	1" = 500'	
1956	Army Mapping Service	1" = 500'	Best Copy Available
1953	US Geological Survey	1" = 500'	
1937	Agriculture and Soil Conservation Service	1" = 500'	

Environmental Risk Information Services

A division of Glacier Media Inc.

1.866.517.5204 | info@erisinfo.com | erisinfo.com

EEC ORIGINAL PKG

one inch 



Year: 2020
Source: NAIP
Scale: 1" = 500'
Comment:

Address: SEC of Ross Ave & Hawes Rd, El Centro, CA
Approx Center: -115.49900409,32.78061451

Order No: 21100500784

one inch 

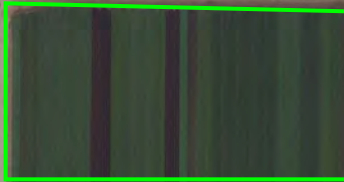

Year: 2018
Source: NAIP
Scale: 1" = 500'
Comment:

Address: SEC of Ross Ave & Hawes Rd, El Centro, CA
Approx Center: -115.49900409,32.78061451

Order No: 21100500784

one inch 



Year: 2016
Source: NAIP
Scale: 1" = 500'
Comment:

Address: SEC of Ross Ave & Hawes Rd, El Centro, CA
Approx Center: -115.49900409,32.78061451

Order No: 21100500784

one inch 



Year: 2014
Source: NAIP
Scale: 1" = 500'
Comment:

Address: SEC of Ross Ave & Hawes Rd, El Centro, CA
Approx Center: -115.49900409,32.78061451

Order No: 21100500784



Year: 2012
Source: NAIP
Scale: 1" = 500'
Comment:

Address: SEC of Ross Ave & Hawes Rd, El Centro, CA
Approx Center: -115.49900409,32.78061451

Order No: 21100500784

one inch 



Year: 2010
Source: NAIP
Scale: 1" = 500'
Comment:

Address: SEC of Ross Ave & Hawes Rd, El Centro, CA
Approx Center: -115.49900409,32.78061451

Order No: 21100500784

one inch 



Year: 2006
Source: NAIP
Scale: 1" = 500'
Comment:

Address: SEC of Ross Ave & Hawes Rd, El Centro, CA
Approx Center: -115.49900409,32.78061451

Order No: 21100500784

one inch



Year: 2005
Source: NAIP
Scale: 1" = 500'
Comment:

Address: SEC of Ross Ave & Hawes Rd, El Centro, CA
Approx Center: -115.49900409,32.78061451

Order No: 21100500784

one inch 

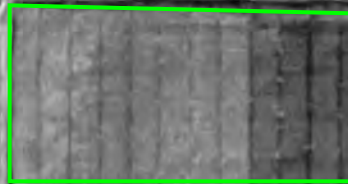

Year: 2002
Source: NAIP
Scale: 1" = 500'
Comment:

Address: SEC of Ross Ave & Hawes Rd, El Centro, CA
Approx Center: -115.49900409,32.78061451

Order No: 21100500784

one inch 



Year: 1996
Source: USGS
Scale: 1" = 500'
Comment:

Address: SEC of Ross Ave & Hawes Rd, El Centro, CA
Approx Center: -115.49900409,32.78061451

Order No: 21100500784

one inch 

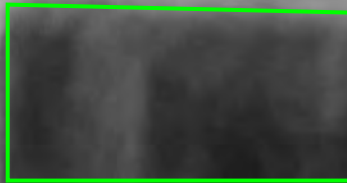

Year: 1984
Source: NHAP
Scale: 1" = 500'
Comment: Best Copy Available

Address: SEC of Ross Ave & Hawes Rd, El Centro, CA
Approx Center: -115.49900409,32.78061451

Order No: 21100500784

one inch 



Year: 1976
Source: USGS
Scale: 1" = 500'
Comment: Best Copy Available

Address: SEC of Ross Ave & Hawes Rd, El Centro, CA
Approx Center: -115.49900409,32.78061451

Order No: 21100500784

one inch

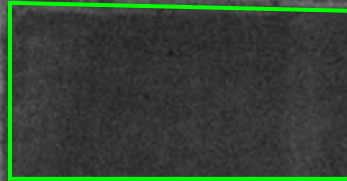

Year: 1969
Source: NASA
Scale: 1" = 500'
Comment:

Address: SEC of Ross Ave & Hawes Rd, El Centro, CA
Approx Center: -115.49900409,32.78061451

Order No: 21100500784

one inch 

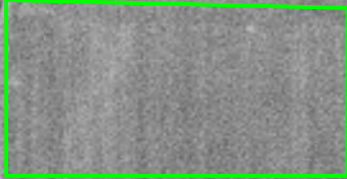

Year: 1956
Source: AMS
Scale: 1" = 500'

Address: SEC of Ross Ave & Hawes Rd, El Centro, CA
Approx Center: -115.49900409,32.78061451

Order No: 21100500784

Comment: Best Copy Available

one inch 



Year: 1953
Source: USGS
Scale: 1" = 500'
Comment:

Address: SEC of Ross Ave & Hawes Rd, El Centro, CA
Approx Center: -115.49900409,32.78061451

Order No: 21100500784

one inch 

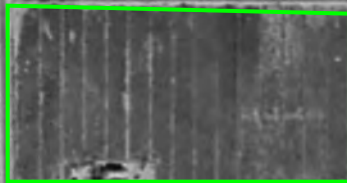

Year: 1937
Source: ASCS
Scale: 1" = 500'
Comment:

Address: SEC of Ross Ave & Hawes Rd, El Centro, CA
Approx Center: -115.49900409,32.78061451

Order No: 21100500784

Potential Maverik Acquisition - SEC of Ross Ave & Hawes Rd, El Centro,
CA

Appendix

G

Historical Research Documentation

EEC ORIGINAL PKG

National Flood Hazard Layer FIRMette



115°30'17"W 32°47'3"N



0 250 500 1,000 1,500 2,000 Feet 1:6,000
 Basemap: USGS National Map: Orthomagery: Data refreshed October, 2020

Legend

- SEE FIS REPORT FOR DETAILED LEGEND AND INDEX MAP FOR FIRM PANEL LAYOUT
- SPECIAL FLOOD HAZARD AREAS**
 - Without Base Flood Elevation (BFE) Zone A, V, AE
 - With BFE or Depth Zone AE, AO, AH, VE, AR
 - Regulatory Floodway
 - OTHER AREAS OF FLOOD HAZARD**
 - 0.2% Annual Chance Flood Hazard. Areas of 1% annual chance flood with average depth less than one foot or with drainage areas of less than one square mile Zone X
 - Future Conditions 1% Annual Chance Flood Hazard Zone X
 - Area with Reduced Flood Risk due to Levee. See Notes. Zone F
 - Area with Flood Risk due to Levee Zone D
 - OTHER AREAS**
 - NO SCREEN Area of Minimal Flood Hazard Zone X
 - Effective LOMRs
 - Area of Undetermined Flood Hazard Zone D
 - GENERAL STRUCTURES**
 - Channel, Culvert, or Storm Sewer
 - Levee, Dike, or Floodwall
 - OTHER FEATURES**
 - Cross Sections with 1% Annual Chance Water Surface Elevation
 - Coastal Transect
 - Base Flood Elevation Line (BFE)
 - Limit of Study
 - Jurisdiction Boundary
 - Coastal Transect Baseline
 - Profile Baseline
 - Hydrographic Feature
 - MAP PANELS**
 - Digital Data Available
 - No Digital Data Available
 - Unmapped
- The pin displayed on the map is an approximate point selected by the user and does not represent an authoritative property location.

This map complies with FEMA's standards for the use of digital flood maps if it is not void as described below. The basemap shown complies with FEMA's basemap accuracy standards.

The flood hazard information is derived directly from the authoritative NFHL web services provided by FEMA. This map was exported on 10/18/2021 at 3:00 PM and does not reflect changes or amendments subsequent to this date and time. The NFHL and effective information may change or become superseded by new data over time.

This map image is void if the one or more of the following map elements do not appear: basemap imagery, flood zone labels, legend, scale bar, map creation date, community identifiers, FIRM panel number, and FIRM effective date. Map images for unmapped and unmodernized areas cannot be used for regulatory purposes.

G-1

This map and all data contained within are supplied as is with no warranty. Cardno, Inc. expressly disclaims responsibility for damages or liability from any claims that may arise out of the use or misuse of this map. It is the sole responsibility of the user to determine if the data on this map meets the user's needs. This map was not created as survey data, nor should it be used as such. It is the user's responsibility to obtain proper survey data, prepared by a licensed surveyor, where required by law.

Latitude: 32° 46' 51" N
 Longitude: -115° 29' 56" W

Project No. 821AR00978.0001

Date Created: 10/18/2021 Date Revised: 10/18/2021 File Path: C:\Users\alisha_strong\OneDrive - Cardno\Desktop\Projects\Maverik\978 Maverik El Centro, CA\978 Figures\978 Figures.dwg
 Data Sources: FEMA's National Flood Hazard Layer

Appendix G-1: Flood Plain Map

Maverik - El Centro, CA
 Potential Maverik Location
 SEC of Ross Ave & Hawes Rd
 El Centro, Imperial County, California

1142 WEST 2320 SOUTH, SUITE A
 WEST VALLEY, UTAH 84119
 P: 801-256-3800 F: 801-973-1095

CAD Analyst: Alisha.Strong

EEC ORIGINAL PKG



U.S. Fish and Wildlife Service
National Wetlands Inventory

Wetlands



SUBJECT
PROPERTY

October 18, 2021

Wetlands

- Estuarine and Marine Deepwater
- Estuarine and Marine Wetland

- Freshwater Emergent Wetland
- Freshwater Forested/Shrub Wetland
- Freshwater Pond
- Lake
- Other
- Riverine

This map is for general reference only. The US Fish and Wildlife Service is not responsible for the accuracy or currentness of the base data shown on this map. All wetlands related data should be used in accordance with the layer metadata found on the Wetlands Mapper web site.

National Wetlands Inventory (NWI)
This page was produced by the NWI mapper

G-2

Latitude: 32° 46' 51" N
Longitude: -115° 29' 56" W

Project No. 821AR00978.0001

This map and all data contained within are supplied as is with no warranty. Cardno, Inc. expressly disclaims responsibility for damages or liability from any claims that may arise out of the use or misuse of this map. It is the sole responsibility of the user to determine if the data on this map meets the user's needs. This map was not created as survey data, nor should it be used as such. It is the user's responsibility to obtain proper survey data, prepared by a licensed surveyor, where required by law.

Appendix G-2: Wetlands Map

Maverik - El Centro, CA
Potential Maverik Location
SEC of Ross Ave & Hawes Rd
El Centro, Imperial County, California



1142 WEST 2320 SOUTH, SUITE A
WEST VALLEY, UTAH 84119
P: 801-256-3800 F: 801-973-1095

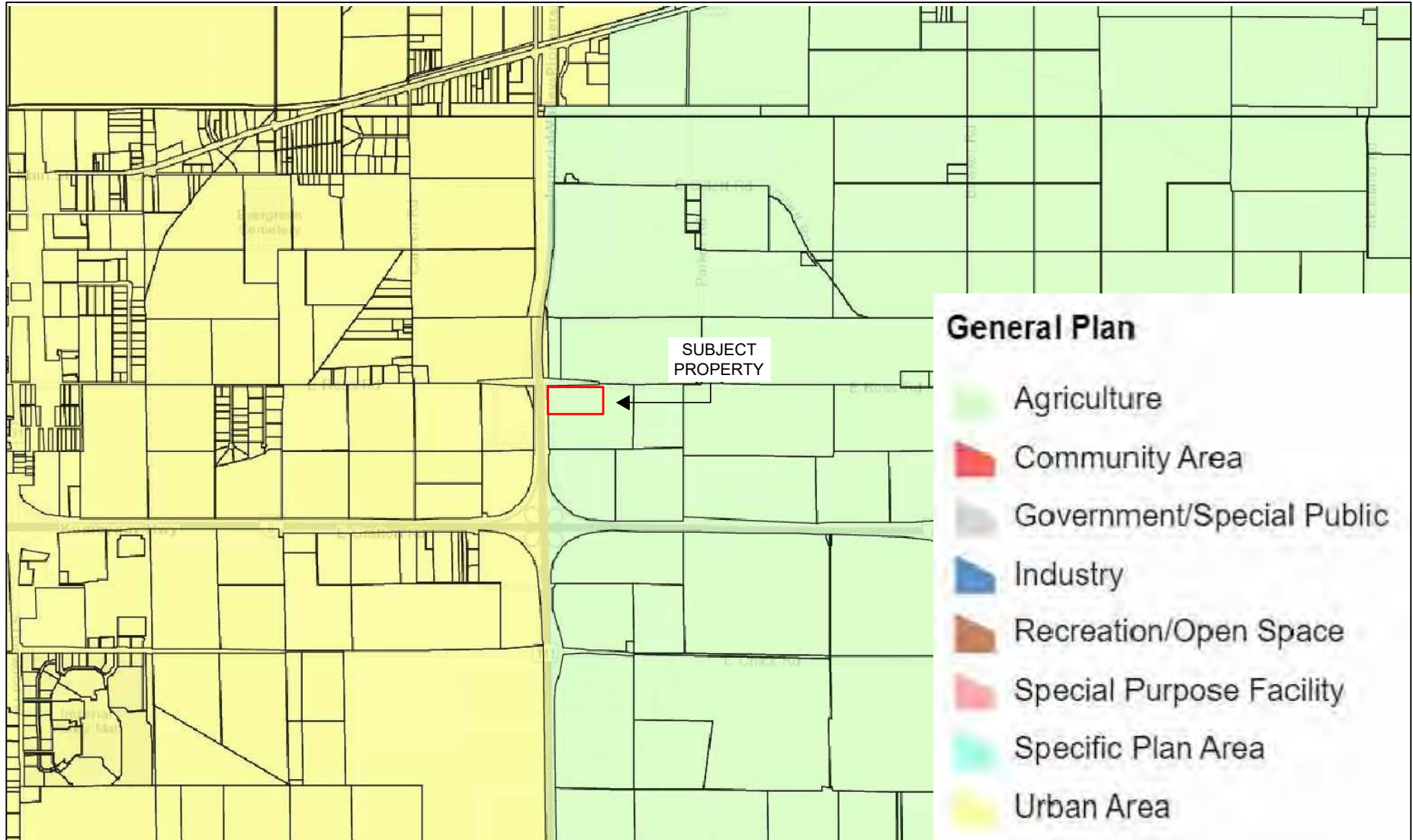

General Plan

- Agriculture
- Community Area
- Government/Special Public
- Industry
- Recreation/Open Space
- Special Purpose Facility
- Specific Plan Area
- Urban Area

G-3

Latitude: 32° 46' 51" N
 Longitude: -115° 29' 56" W

Project No. 821AR00978.0001

This map and all data contained within are supplied as is with no warranty. Cardno, Inc. expressly disclaims responsibility for damages or liability from any claims that may arise out of the use or misuse of this map. It is the sole responsibility of the user to determine if the data on this map meets the user's needs. This map was not created as survey data, nor should it be used as such. It is the user's responsibility to obtain proper survey data, prepared by a licensed surveyor, where required by law.

Appendix G3: Zoning Map
 Maverik - El Centro, CA
 Potential Maverik Location
 SEC of Ross Ave & Hawes Rd
 El Centro, Imperial County, California



Cardno

1142 WEST 2320 SOUTH, SUITE A
 WEST VALLEY, UTAH 84119
 P: 801-256-3800 F: 801-973-1095

EEC ORIGINAL PKG



TOPOGRAPHIC MAPS

Project Property: Maverik El Centro
SEC of Ross Ave & Hawes Rd
El Centro CA None

Project No: 821AR00978.0001

Requested By: Cardno Inc.

Order No: 21100500784

Date Completed: October 06, 2021

We have searched USGS collections of current topographic maps and historical topographic maps for the project property. Below is a list of maps found for the project property and adjacent area. Maps are from 7.5 and 15 minute topographic map series, if available.

Year	Map Series
2015	7.5
1979	7.5
1976	7.5
1957	7.5
1956	7.5
1957	15
1945	15
1940	15

Topographic Map Symbolology for the maps may be available in the following documents:

Pre-1947

[Page 223 of 1918 Topographic Instructions](#)

[Page 130 of 1928 Topographic Instructions](#)

1947-2009

[Topographic Map Symbols](#)

2009-present

[US Topo Map Symbols](#)

Topographic Maps included in this report are produced by the USGS and are to be used for research purposes including a phase I report. Maps are not to be resold as commercial property.

No warranty of Accuracy or Liability for ERIS: The information contained in this report has been produced by ERIS Information Inc.(in the US) and ERIS Information Limited Partnership (in Canada), both doing business as 'ERIS', using Topographic Maps produced by the USGS. This maps contained herein does not purport to be and does not constitute a guarantee of the accuracy of the information contained herein. Although ERIS has endeavored to present you with information that is accurate, ERIS disclaims, any and all liability for any errors, omissions, or inaccuracies in such information and data, whether attributable to inadvertence, negligence or otherwise, and for any consequences arising therefrom. Liability on the part of ERIS is limited to the monetary value paid for this report.

Environmental Risk Information Services

A division of Glacier Media Inc.

1.866.517.5204 | info@erisinfo.com | erisinfo.com

EEC ORIGINAL PKG

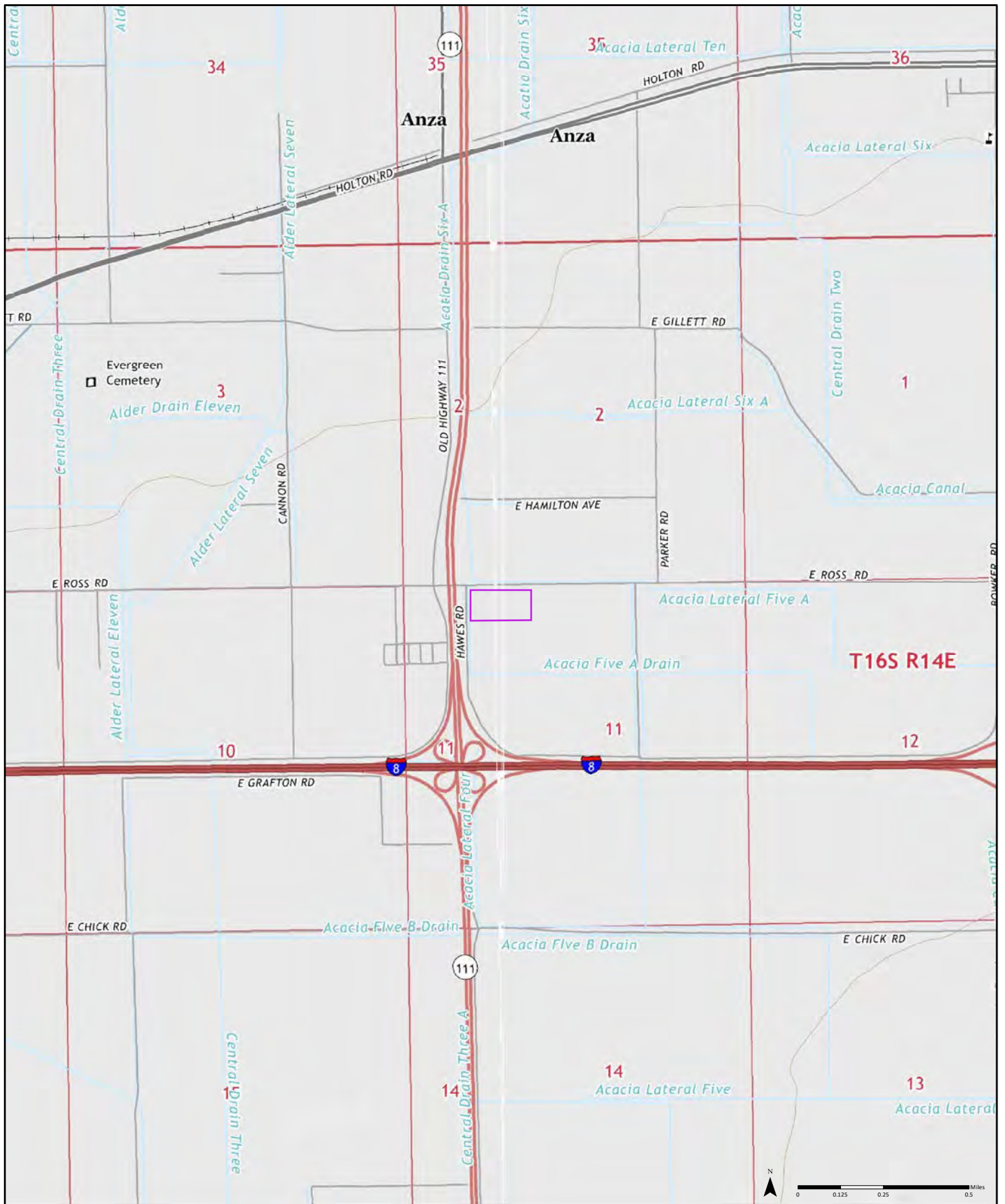

2015

Quadrangle(s): El Centro, CA; Holtville West, CA

Order No. 21100500784

Source: USGS 7.5 Minute Topographic Map

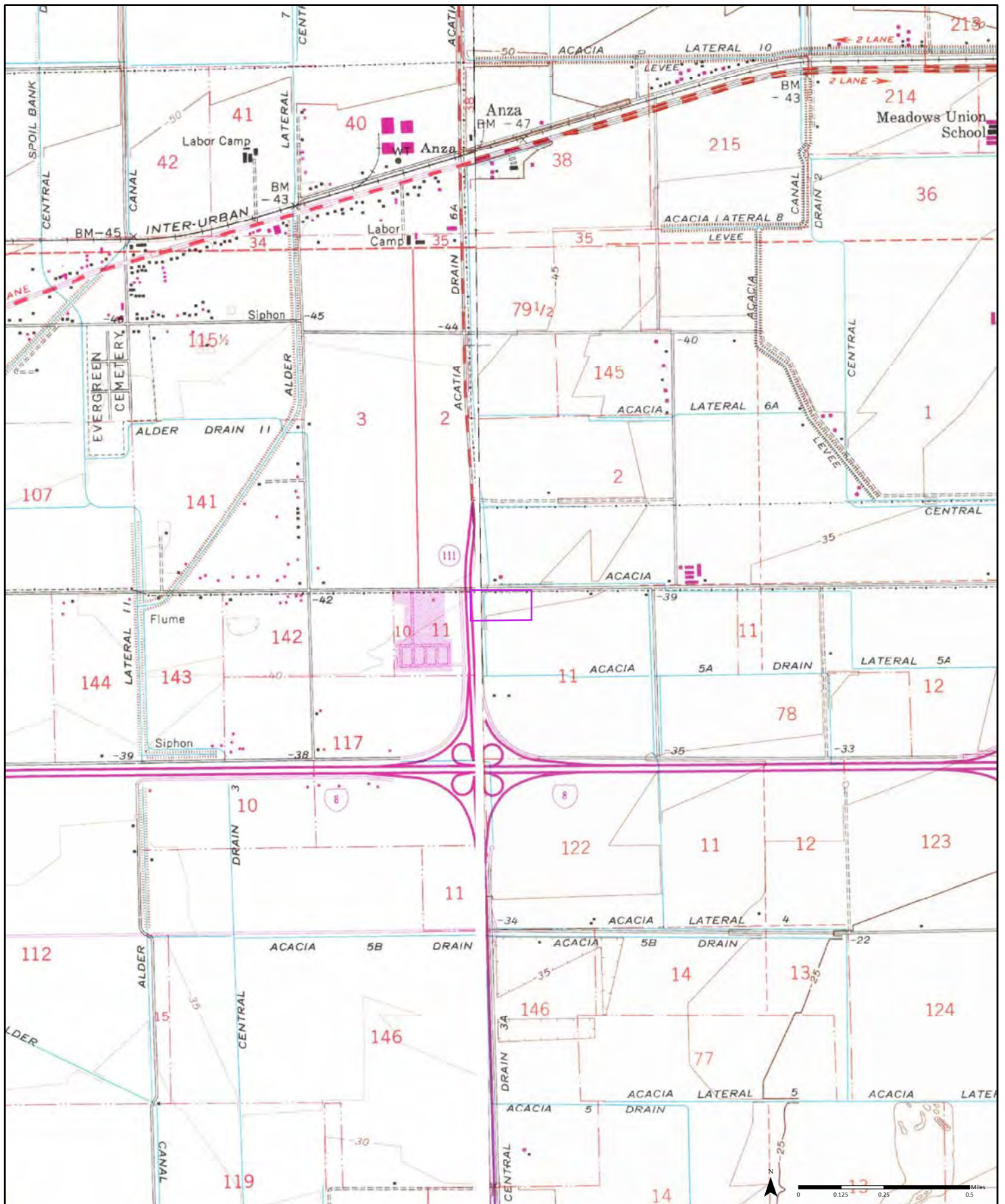

1979

⁽¹⁾ Aerial Photo Year: 1976
Photo Revision Year: 1979

⁽²⁾ Aerial Photo Year: 1976
Photo Revision Year: 1979

Quadrangle(s): Holtville West, CA₍₁₎; El Centro, CA₍₂₎

Order No. 21100500784

Source: USGS 7.5 Minute Topographic Map

EEC ORIGINAL PKGS



1976 ⁽¹⁾
Aerial Photo Year: 1976

Quadrangle(s): El Centro, CA⁽¹⁾

Order No. 21100500784

Source: USGS 7.5 Minute Topographic Map

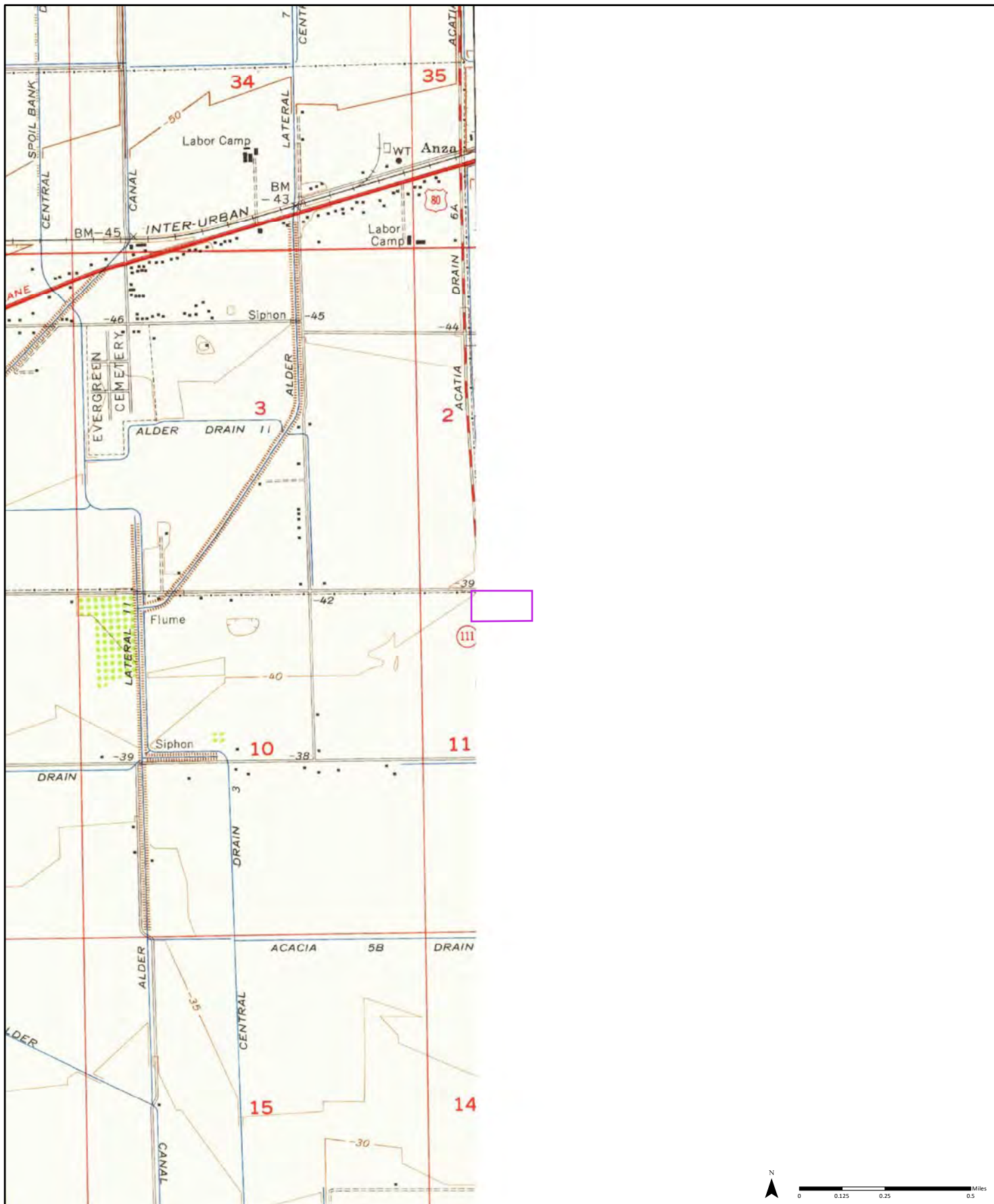

1957 ⁽¹⁾ Aerial Photo Year: 1953

Quadrangle(s): El Centro, CA₍₁₎

Order No. 21100500784

Source: USGS 7.5 Minute Topographic Map

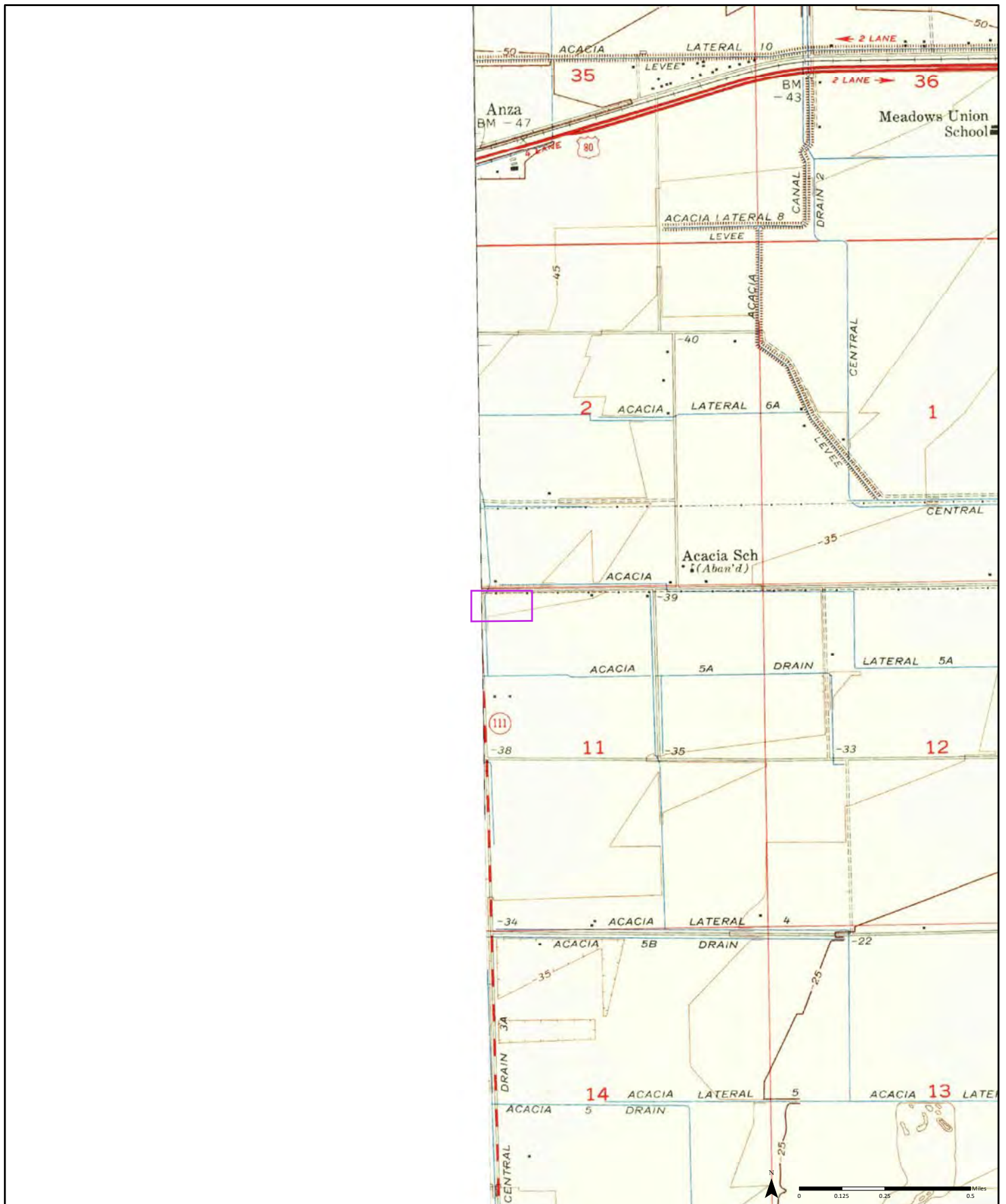

1956

Quadrangle(s): Holtville West, CA

Order No. 21100500784

Source: USGS 7.5 Minute Topographic Map

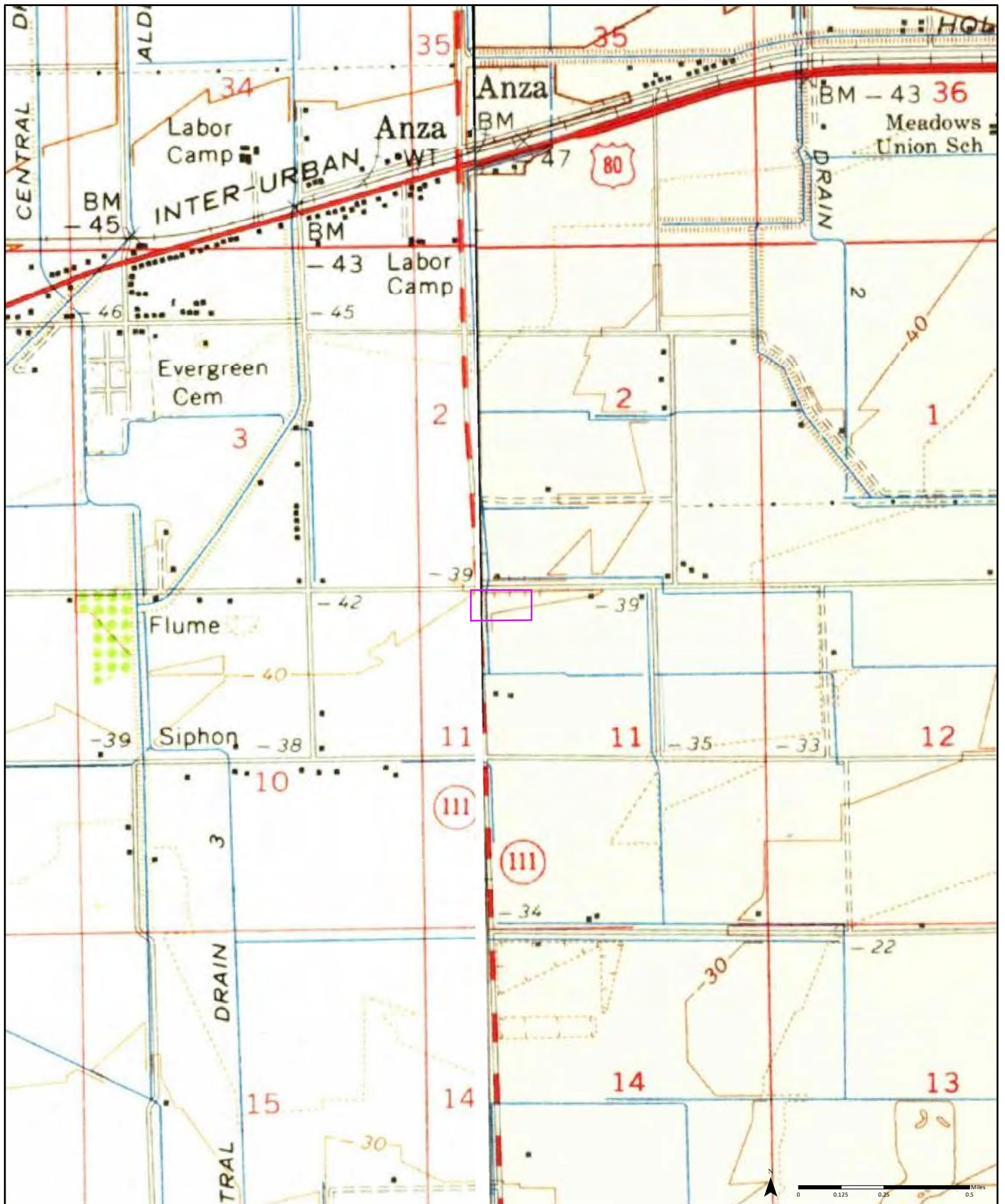

1957

⁽¹⁾ Aerial Photo Year: 1953

⁽²⁾ Aerial Photo Year: 1953

Quadrangle(s): Holtville, CA⁽¹⁾; Brawley, CA⁽²⁾

Order No. 21100500784

Source: USGS 15 Minute Topographic Map

EEC ORIGINAL **PKGS** 

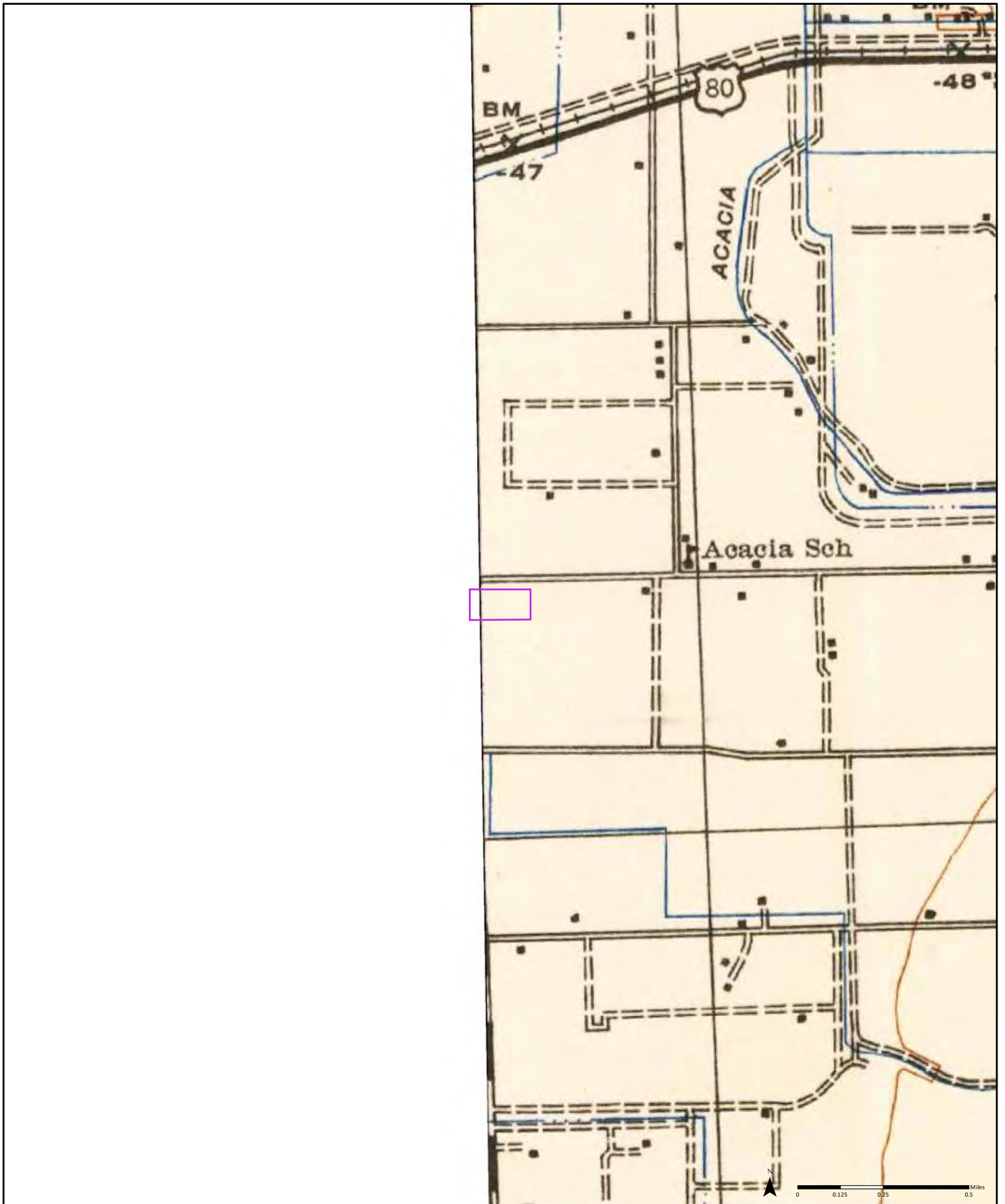

1945 ⁽¹⁾
Aerial Photo Year: 1940

Quadrangle(s): Alamo, CA₍₁₎

Order No. 21100500784

Source: USGS 15 Minute Topographic Map

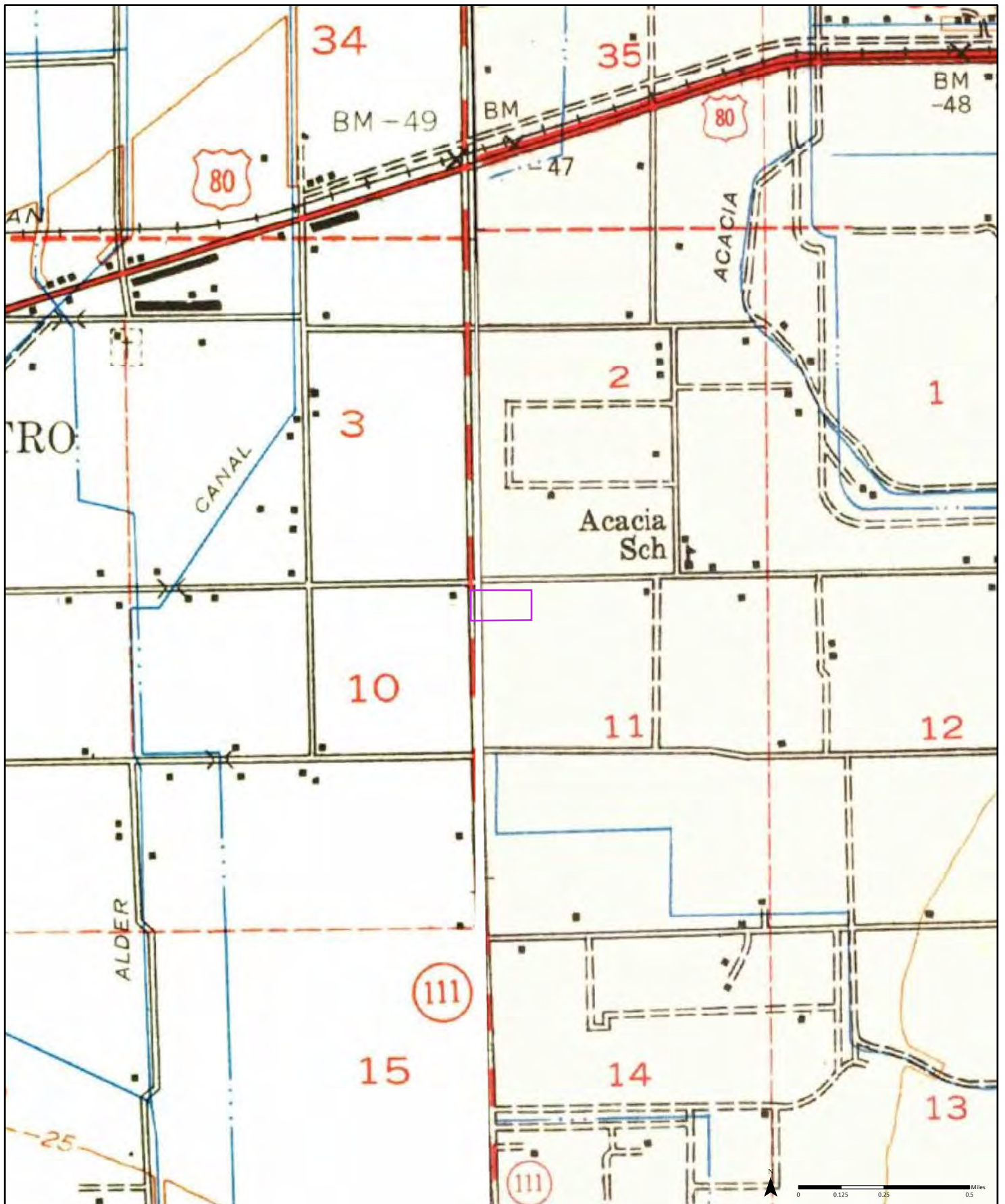

1940 ⁽¹⁾ Aerial Photo Year: 1940 ⁽²⁾ Aerial Photo Year: 1940

Quadrangle(s): Alamorio, CA₍₁₎; Brawley, CA₍₂₎

Order No. 21100500784

Source: USGS 15 Minute Topographic Map

EEC ORIGINAL PKGS



CITY DIRECTORY

Project Property: *Maverik El Centro
SEC of Ross Ave & Hawes Rd
El Centro, CA*

Project No: *821AR00978.0001*

Requested By: *Cardno Inc.*

Order No: *21100500784*

Date Completed: *October 8, 2021*

October 8, 2021
RE: CITY DIRECTORY RESEARCH
Maverik El Centro
SEC of Ross Ave & Hawes Rd El Centro, CA

Thank you for contacting ERIS for an City Directory Search for the site described above. Our staff has conducted a reverse listing City Directory search to determine prior occupants of the subject site and adjacent properties. We have provided the nearest addresses(s) when adjacent addresses are not listed. If we have searched a range of addresses, all addresses in that range found in the Directory are included.

Note: Reverse Listing Directories generally are focused on more highly developed areas. Newly developed areas may be covered in the more recent years, but the older directories will tend to cover only the "central" parts of the city. To complete the search, we have either utilized the ACPL, Library of Congress, State Archives, and/or a regional library or history center as well as multiple digitized directories. These do not claim to be a complete collection of all reverse listing city directories produced.

ERIS has made every effort to provide accurate and complete information but shall not be held liable for missing, incomplete or inaccurate information. To complete this search we used the general range(s) below to search for relevant findings. If you believe there are additional addresses or streets that require searching please contact us at 866-517-5204.

Search Criteria:

375-502 of Ross Ave
ALL of Hawes Rd

Search Results Summary

Date	Source	Comment
2020	DIGITAL BUSINESS DIRECTORY	
2016	DIGITAL BUSINESS DIRECTORY	
2012	DIGITAL BUSINESS DIRECTORY	
2009	DIGITAL BUSINESS DIRECTORY	
2006	POLKS	
2002	POLKS	
1997	POLKS	
1992	POLKS	
1987	POLKS	
1982	POLKS	
1977	POLKS	
1972	POLKS	
1967	POLKS	
1964	POLKS	
1957	POLKS	
1952	POLKS	
1947	LA DIR CO	

NO LISTING FOUND FOR THIS YEAR...

- 399 ELMS EQUIPMENT RENTAL INC...*Generatorselectricrepairing*
- 399 ELMS EQUIPMENT RENTAL INC...*Generators-electric (whls)*
- 502 AM-PM MINI-STORAGE...*Storage-household & Commercial*
- 502 SAFELITE AUTO GLASS...*Glass-auto Plate & Window & Etc*

NO LISTING FOUND FOR THIS YEAR...

- 399 ELMS EQUIPMENT RENTAL INC...*Generators-electric (whls)*
- 502 AM-PM MINI-STORAGE...*Business Records & Documents-storage*
- 502 AM-PM MINI-STORAGE...*Storage-household & Commercial*
- 502 SAFELITE AUTO GLASS...*Glass-auto Plate & Window & Etc*

NO LISTING FOUND FOR THIS YEAR...

- 399 ELMS EQUIPMENT RENTAL INC...Contractors-equipment & Supls-renting
- 502 AM-PM MINI-STORAGE...Storage-household & Commercial
- 502 SAFELITE AUTO GLASS...Glass-auto Plate & Window & Etc

NO LISTING FOUND FOR THIS YEAR...

- 399 RICH THOMPSON CNC...*Industrial Mchy Nec*
- 399 THOMPSON MACHINING...*Machine Shops*
- 502 AM-PM MINI-STORAGE...*Storage-household & Commercial*
- 502 AM-PM MINI-STORAGE...*Warehousing Self Stor*
- 502 SAFELITE AUTO GLASS...*Auto Glass Replace*

1750 BAKER RICHARD

375 COUNTRY LIFE RV MOBILE HOME MOBILE HOMES
375 MULTI TENANT RESIDENTIAL
379 CITY CARS AUTO DLRS - USED CARS
403 VOGEL HANS B
404 MULTI TENANT RESIDENTIAL
495 GUTIERREZ FERNANDO
498 MULTI TENANT RESIDENTIAL

1750 RAMSEY WANDA J

375 COUNTRY LIFE RV MOBILE HOME MOBILE HOME SITO OPR
375 MULTI TENANT RESIDENTIAL
379 CITY CARS
379 CLAUDIAS REGISTRATION SERVICE NOW USED CAR DLRS
403 VAGEL HANS K & JEANNE
404 MULTI TENANT RESIDENTIAL
495 CHAVEZ JUAN E
495 CHAVEZ POLINA
498 MULTI TENANT RESIDENTIAL
502 AM - PM MINI - STORAGE GENL WAREHOUSING / STG
502 RAMOS JOE D & ALTAGRACIA
502 RODRIGUEZ FOLIX

STREET NOT LISTED

- 375 COUNTRY LIFE MOBILE HOME PARK MOBILE HOMES
- 375 MULTI TENANT RESIDENTIAL
- 379 MODENE'S COUNTRY KITCHEN & STEAK HOUSE
- 399 THOMPSON MACHINING
- 541 I - LIFT FORKLIFT SLS

STREET NOT LISTED

375 K O A CAMP GROUND
379 MODENE'S COUNTRY KITCHEN

STREET NOT LISTED

375 K O A CAMP GROUND

STREET NOT LISTED

375 K O A CAMP GROUND

STREET NOT LISTED

NO LISTINGS IN RANGE

STREET NOT LISTED

NO LISTINGS IN RANGE

STREET NOT LISTED

323 VACANT
407 VOGEL HANS K

STREET NOT LISTED

323 PARRY CLARENCE E
407 VOGEL HANS K

STREET NOT LISTED

325 VOGEL HANS K
455 SINGH CARMEN O MRS

STREET NOT LISTED

NO LISTINGS IN RANGE

STREET NOT LISTED

STREET NOT LISTED



—
FIRE
INSURANCE
MAPS

Project Property: Maverik El Centro
SEC of Ross Ave & Hawes Rd
El Centro CA

Project No: 821AR00978.0001

Requested By: Cardno Inc.

Order No: 21100500784

Date Completed: October 06, 2021

Please note that no information was found for your site or adjacent properties.

Potential Maverik Acquisition - SEC of Ross Ave & Hawes Rd, El Centro,
CA

Appendix

H

Prior Reports (intentionally left blank)

EEC ORIGINAL PKG

Potential Maverik Acquisition - SEC of Ross Ave & Hawes Rd, El Centro,
CA

Appendix



Resumes

EEC ORIGINAL PKG

Russell D. Hamblin, P.G.

Current Position

Principal Geologist and
National Client Manager

Profession

Environmental Consultant

Years' Experience

29

Joined Cardno

May 2014

Education

M.S., Geology/Paleoecology,
Brigham Young University,
Provo, UT, 1985

B.S., Geology, Oregon State
University, Corvallis, Oregon
1983

Professional Registrations

UT PG, ID PG, OR PG, WI PG

Affiliations

National Ground Water
Association

Summary of Experience

Mr Hamblin has over 29 years of professional experience in the environmental consulting field. He currently serves as a Principal Geologist, Business Development Practice Leader and a National Client Manager for Cardno. His experience has included local and regional operations management, geologic and hydrogeologic hazardous materials investigations, remedial activities, compliance and air permitting, geotechnical investigations, cartography, and due diligence-related environmental assessments. Mr Hamblin has served as field supervisor and project manager for numerous environmental site assessments (ESAs), hydrogeologic assessments, solid waste assessments, industrial and agricultural waste compliance projects, environmental due diligence assessments, and underground storage tank (UST) investigations and related remedial activities throughout the United States and Canada. Mr Hamblin has also provided project management services on industrial-related remediation and compliance projects throughout the United States. Specific tasks include planning, conducting, and managing soil and groundwater sampling at hazardous and industrial waste sites; interpreting geologic and hydrogeologic conditions and laboratory analytical results; designing and implementing soil and groundwater remediation systems; obtaining air operational permits; client and regulatory agency contact; and preparing and editing final reports.

As a regional manager with SECOR from 2002 to 2005, Mr Hamblin managed over 9 offices including offices in Utah, Montana, Arizona, Nevada, Texas, Louisiana, and Oklahoma. As part of this assignment, Mr Hamblin provided leadership and a corporate vision for the regional offices to manage and mentor other senior and principal staff to carry forth a multi-disciplined operation to care for client and program needs at the highest level of professionalism. Areas of for mentoring of staff included holding workshops in key improvement issues such as professionalism, leadership, management, effective client development, time and cost efficiency, corporate and personal health and safety, and innovation towards solving complex environmental problems. Mr Hamblin was also responsible for ensuring appropriate execution of the client projects; review of office and regional monthly profit and loss reports with senior staff; conducting marketing and sales meetings to ensure appropriate level of balance between business development and billable client work; regular communication with other regional managers to support national clients, national business development opportunities, and holding of regular staffing and load levelling conference calls; and initial and support local and national recruiting needs. Regional management duties also included holding project and client managers accountable for budgets; marketing, junior staff reviews mentoring, and accounts receivables.

Selected Project Experience

Farmland Remedial Investigations

Investigation and remedial activities at 180,000-acre Cattle and Sheep ranches in Central and Eastern Montana. The total environmental spend was \$475,000. Activities included the investigation and soil and groundwater remediation at various ranch and farm-related facilities at each of these ranches including, several localized farm-related landfills, fuelling centers with USTs and ASTs, farm vehicle maintenance shops, drum storage areas, wood post treatment centers, and cattle and sheep dip tank operations. Hundreds of soil and groundwater samples were collected and analyzed and several groundwater monitoring wells were installed to establish groundwater networks for each area of investigation and remediation. Approximately 5,000 tons of soil contaminated with RCRA 8 metals (including Pb and As), petroleum (diesel, gasoline, and used oil), pentachlorophenol, dioxins, and pesticides (including DDT and Beta-BHC) were permitted and transported to various state and federal solid waste landfills including approximately 700 tons transported to a hazardous waste facility in Idaho. Penta, dioxin, and pesticide-contaminated groundwater from abandoned wood post treatment centers and sheep dip tank areas were treated via post excavation natural attenuation. Additional remediation activities of groundwater contaminated with DDT and beta-BHC required installation of an in situ groundwater infiltration curtain consisting of enclosed filter fabric filled with activated granular carbon charcoal material, various reactive chemicals, and fungus-containing pine tree bark chips designed to react and adsorb the dissolved Beta-BHC contaminants. Regulatory No Further Action Status letters were submitted by the MT Department of Environmental Quality for the closures of each of these facilities.

Professional History

Investigation and remediation activities of soil and groundwater at a 275-acre sod farm in Northern Utah. The total environmental spend was \$140,000. Activities included the investigation and soil and groundwater remediation at various farm-related facilities including three AST fueling centers and a farm vehicle maintenance shop with a drum storage area. Nearly 100 soil and groundwater samples were collected and analyzed and four groundwater monitoring wells were installed to establish a groundwater monitoring network one area of investigation and remediation. Diesel, gasoline, and used oil petroleum-related compounds were the main contaminants of concern. Approximately 500 tons of contaminated soil were removed from the three areas of investigation and transported to a local bioremediation repository near Salt Lake City, Utah. Groundwater was treated with several applications of an oxygen release compound (ORC). The ORC material was injected into on-site monitoring wells and directly into an open excavation to expedite the remediation process. Once confirmation sampling confirmed that site soils and groundwater reached compliance with respect to State of Utah screening levels, the remediation team applied for and obtained an Enforceable Written Assurance (EWA) letter, on a fast-track basis, with the Utah Division of Environmental Response and Remediation. The EWA letter allowed for the sale of the property to be completed.

Investigation and remediation activities of soil at a 2,500-acre hay farm in Northern California. The total environmental spend was \$30,000. Activities included the investigation and soil remediation at various farm-related facilities including a farm equipment storage and wash area, a drum storage area, and two AST fuelling centers. Approximately 30 soil and groundwater samples were collected and analyzed to determine the extent of contamination in these farm facilities. Diesel, gasoline, and used oil petroleum-related compounds were the main contaminants of concern. Approximately 175 tons of contaminated soil were removed from the three areas of investigation and transported to an on-site treatment cell constructed for this remediation activity. Contaminated soils were spread to a thickness of approximately 12 to 16 inches and contained on a plastic liner in a berm area in a remote location at the farm. The soils were treated with bioremediation and oxygen release compounds to allow for ex-situ bio-chemical degradation of the hydrocarbons in the soil. Following four months of product applications, tilling, and watering of the soil, the contaminant levels decreased within California Regional Water Quality Control Board soil

clean-up criteria and the treated soils were reused on site in non-farming areas.

Investigation and remediation activities of soil at three 500-acre grape vineyards in the Southern San Joaquin Valley, California. The total environmental spend was \$130,000. Activities included the investigation and soil remediation at various farm-related facilities including farm AST fuelling centers and drum storage area. Approximately 90 soil samples were collected and analyzed to determine the extent of contamination in these farm facilities. Diesel and used oil petroleum-related compounds were the main contaminants of concern. Approximately 500 tons of contaminated soil were removed from the three areas of investigation and transported to an off-site bioremediation treatment center for this remediation activity. The remediation team coordinated investigation, remediation, and site closure activities with the Kern County Environmental Department and the Central Valley Regional Water Quality Control Board for No Further Action Status at each of the three sites.

Investigation and remediation activities of soil at a farm labor camp and abandoned orange orchard totalling approximately 1,000 acres of derelict farm properties, located approximately 50 miles south of Tampa, Florida. The total environmental spend was \$72,000. Farm facilities consisted of an abandoned orange orchard with several AST fuel storage areas where about 400 tons of diesel-contaminated soils were excavated and transported to a county landfill. The services also included an investigation and soil remediation of approximately 100 tons of pesticide-contaminated and heavy oil contaminated soil associated with a former agricultural vehicle wash pad.

Completed several other farm-related investigation and remedial activities at contaminated agricultural sites in Eastern Montana, Southern Georgia, Northern California, Central California, Western Kansas, and in Northern Utah.

Mining-Related Investigations

In 2006-2007 Mr. Hamblin conducted detailed due diligence-related studies including a Phase I ESA, Expanded Phase I ESAs, and Phase II ESA sampling and analyses for a approximately 500-acre abandoned uranium mine site on Prince of Wales Island in Alaska. The studies included contamination assessments of uranium and other radioactive compounds and heavy metals of four areas where mine-related waste material have been disposed. The goal of the investigation was to differentiate areas which have been affected by radioactive mine waste materials and areas of naturally high radioactivity, which have not been affected by mining activities and associated waste materials.

In 2007-2008 Mr. Hamblin completed due diligence studies at two large open pit mining operations within the Mesabi Range in northern Minnesota. Evaluated past and current environmental issues including areas of petroleum contamination from USTs and ASTs and current and futures status of the facilities' Mine Closure Permit, Title V Air Quality Permit, and National Pollutant Discharge Elimination System (NPDES) permits with the State of Minnesota Department of Natural Resources and Pollution Control Agency to determine current and future liabilities for the prospective purchaser. This assessment was to allow the client to satisfy one of the requirements to qualify for the innocent landowner, contiguous property owner, or bona fide prospective purchaser limitations on CERCLA liability. The scope of services also included sampling and analyses of near surface soils in an abandoned explosives magazine. This assessment constituted all appropriate inquiry into the previous ownership and uses of the site consistent with good commercial or customary practice, as defined in 42 U.S.C. § 9601(35)(B) of CERCLA.

Conducted detailed due diligence-related studies on a mining operation in Emery County Utah including evaluation of facility compliance related to the use of on-site organic solvents; spill containment and integrity of aboveground storage tanks; evaluation of wastewater discharge permits; waste-rock storage evaluation; and ore processing operation.

Participated in the writing and review of several chapters of a Hydrologic Description Section

of an underground mine permit for proposed coal mining in western Colorado. The purpose of the Hydrologic Description was to evaluate the potential hydrologic consequences of additional underground mining operations. Evaluations included the study of groundwater chemistry from existing groundwater monitoring wells and surface water monitoring locations (including creeks and springs) and proposing additional monitoring wells to fill data gaps related to proposed additional mining locations.

Managed a team that completed and submitted a Notice of Intent (NOI) to Utah's Division of Air Quality as part of the Air Quality permitting process for a client conducting mining and milling of copper and other precious metals in Southern Utah. Services also included completing a fugitive dust permit and a compliance program to implement and stay in compliance with the air quality permit.

Conducted soil and vegetation sampling in Juab County as part of a University academic study on the potential for heavy metal (Cu, Au, Ag) absorption by desert flora. Tasks included field sampling, mapping, and laboratory sample preparation.

Manufacturing and Hazardous Waste-Related Investigations

Managed soil and groundwater assessments at chemical and industrial manufacturing facilities in Oregon, California, and Utah, including RCRA and CERCLA facilities. Soil and groundwater studies involved the investigations and remediation of halogenated and aromatic volatile constituents, petroleum (gasoline diesel, and waste oil) products and metals.

Managed a preliminary RCRA soil sampling investigation and completed a RCRA Facilities Investigation (RFI) Work Plan development at a solvent recovery in the Portland Oregon, area. Services have also included negotiations with state [Oregon Department of Environmental Quality (DEQ)] and Federal (EPA) regulatory agencies for corrective measures study (CMS).

Performed Hydrogeologic Assessment Report (HAR) studies for the State of California's Regional Water Quality Control Board (RQCB) at two chemical manufacturing facilities in Bakersfield and Fresno County. The study at the Fresno County facility involved investigation of radionuclides, metals, sulfuric acid, and dissolved solids. The Bakersfield facility involved the investigation of metals and chlorinated solvents. Both HARs included aquifer testing and characterization.

Conducted groundwater assessments and Solid Waste Assessment Testing (SWAT) for the State of California at several landfills, including sites near Fresno, Modesto, Visalia, and Corcoran. The studies included ongoing groundwater monitoring and aquifer- and vadose-zone monitoring.

Performed hydrogeologic investigations at several agricultural impoundment facilities throughout the West Coast. Included evaluation of pesticide and agricultural chemical source areas, including USTs, lined ponds, and unlined impoundments. Agricultural chemical included organophosphorus and chlorinated pesticides, carbonated and phenoxy herbicides investigations included soil and groundwater investigations and on-going quarterly groundwater monitoring.

Managed installation of groundwater remediation network at an NPL Superfund site in Salt Lake City, Utah. This remedial investigation included installation of extraction wells and piezometers, well development, soil sampling, step drawdown testing and evaluation, and well modification to network with an air-stripping system.

Conducted and managed a Remedial Investigation (RI) at a major paper products facility in Portland, Oregon. Multiple investigations were conducted at this facility concurrently, based on CERCLA investigation protocols, following the removal of over 25 USTs, which previously

contained various ethyl-based alcohols, MIBK, toluene, and diesel and gasoline fuels. Soil and groundwater samples were analyzed for several other organic chemicals including chlorinated solvents (TCE and PCE) and total priority pollutant metals. A vapor extraction system was designed, pilot tested, and installed at this site to remediate toluene-impacted soils.

Managed the design, implementation, and monitoring of five vapor extraction systems for soil and groundwater remediation systems at several UST and hazardous waste facilities in Oregon and Utah.

Designed and installed a vapor extraction/air sparging dual system at a wood products facility in North Bend, Oregon. The System operated for approximately 1.5 years and was successful in remediation of soil and shallow groundwater contaminated with mineral spirits. Multiple remedial investigations were also conducted at this facility to evaluate and assess hydraulic oil, mineral spirits, diesel, and gasoline contaminated soil and groundwater.

Managed design, implementation, and monitoring of soil mounding and venting bioremediation systems. Included treatment of over 1,000 cubic yards of excavated soils contaminated with gasoline, heavy fuels, and waste oil via injection of nitrogen and phosphate nutrients, microbes, and emulsifiers for bioremediation at an 80-year-old bulk storage facility for a major petroleum company in Cornelius, Oregon. Completion of the bioventing mound was accomplished in approximately one year.

Conducted feasibility studies at industrial waste facilities for soil and groundwater remediation considerations; including completing aquifer slug and pumping tests, vapor extraction pilot testing, air sparging pilot testing, soil permeability assessments, chemical evaluation, and historical research. Mr. Hamblin utilized data from these studies to evaluate the most feasible and cost-effective remedial action alternatives.

Designed, installed, and operated soil vapor extraction (SVE) system for a paper products company in Portland, Oregon, for the remediation of toluene-contaminated soils.

Underground Storage Tank (UST) Remedial Investigations

Managed soil and groundwater investigations and remediation relating to (Leaking Underground Storage Tanks (LUST systems at over 100 service station facilities and Managed soil and groundwater investigations and remediation relating to bulk chemical plants for major oil companies (7-Eleven, Texaco, Mid-State Petroleum, Unocal, ARCO, and Pennzoil) sites in Oregon, California, Washington, Idaho, and Utah. Projects included UST decommissioning, site inspections, initial contaminant abatement measures, follow-up soil and groundwater investigation to define the extent of contamination, and Feasibility Studies (FSs) for on-site and off-site remediation.

Managed a \$1.25 million remediation project for a major US oil company in a rural community in southern Utah. Remedial investigations included installation of 16 groundwater monitoring wells and 20 remediation wells, including 10 extraction wells, seven monitoring wells, and three injection wells. Well depths ranged from 40 to 120 feet. Remedial investigations also included quarterly groundwater monitoring, natural attenuation monitoring and evaluations, development of a remedial strategy, evaluation of light non-aqueous phase liquid (LNAPL), soil vapor extraction (SVE) and high vacuum (HiVac) pilot testing, ecologic and human health risk assessment, indoor air quality monitoring and evaluation, remedial design, and SVE/HiVac system installation, operation, monitoring, and maintenance. Also conducted sound monitoring and assisted with the design and construction of sound attenuation measures for the remediation system, which included a sound attenuation barrier and silencer emissions stack. Project management duties also included holding public meetings, preparation and

publication of community newsletter for public awareness, and conducting community public relations for the client.

Expert Witness

Served as an expert witness on a case in Hillsboro, Oregon for an owner of a gasoline service station who was in part bought out by the state of Oregon Highway Division as part of a state road expansion project. The buy-out resulted in the closure of the gasoline retail operation, and because contamination was encountered during closure of the USTs, the State offered minimal financial reimbursement for the property. Legal counsel and Mr. Hamblin were successful in negotiating additional State money for our client based on the argument that retail gasoline operations could have been reopened while in situ vapor extraction remedial activities were completed on site if the State had not purchased the property.

Due Diligence-Related Property Transfer Assessments and Auditing

Completed and managed over 1,600 Phase I and Phase II property transfer assessments for various landowners, land developers, commercial lending institutions, and industrial facilities in over 30 U.S. states, three Canadian Provinces, and Baja California, Mexico.

Managed and performed over 100 transaction screen process (TSP) investigations of proposed cellular tower sites in accordance with ASTM standards in Utah and Idaho for a major regional FCC-regulated cellular telecommunications company. TSPs were augmented with inquiries into National Environmental Policy Act (NEPA) issues including wilderness areas, wildlife preserves, endangered species, flood plains, wetlands, and archeological sites.

Managed a nationwide program that included Phase I, Phase II, and geotechnical investigations on over 1,300 sites for a worldwide church organization since 1993. Projects have included residential, agricultural, industrial, and commercial properties throughout the United States and Canada.

Conducted a Phase I environmental site assessment and an Environmental Compliance Audit for a facility in Utah that manufactures storage retrieval cranes and automated guided vehicles. Also managed a RCRA and Industrial Waste Compliance Audit for a national jeweler manufacturer in Bountiful, Utah.

Other Environmental and Geologic Projects

Conducted a Geologic Investigation near the Weber State University Campus in Ogden, Utah to determine potential geologic hazards in a seismic-sensitive area. The field investigation consisted of excavating four test trenches perpendicular to mapped fault traces along the east and west property boundaries and associated reporting.

Performed a slope stability and geologic hazards investigation and geologic mapping and aerial photography interpretation at two sites under consideration for development in the hills near Ventura, California.

Coordinated and assisted with completion of a hazardous waste minimization plan for an industrial coated-paper products facility in Portland, Oregon.

Conducted geotechnical soil and groundwater characterization and environmental investigation at sites near Sanger, California, under consideration for use as winery stillage disposal fields. Included evaluation of metals, dissolved solids, and pH of soil and groundwater samples. Hydrogeologic data were based on evaluation of permeability, percolation, and infiltration tests and from hydrographs.

Conducted drilling, soil sampling, compaction testing and building materials testing and inspections for several geotechnical studies in the Fresno and Visalia areas of California.

Management and coordination of demolition projects and geotechnical-related studies associated with environmental due diligence services for a real estate investor in over 25 U.S. states.

Education

M.S., Geology, Brigham Young University, Provo, Utah, 1985

B.S., Geology, Oregon State University, Corvallis, Oregon, 1983

Career Summary

BSK and Associates: Visalia and Fresno, CA: Soil Technician and Staff Geologist, 1985-1987

Kleinfelder and Associates: Fresno, CA: Staff Geologist, 1987-1988

Brown and Caldwell: Portland, OR: Senior Geologist, Project Manager, 1988-1991

SECOR International; Portland, OR and Salt Lake City, UT, Principal Geologist, Office Principal-in-Charge, Regional Manager; 1991-2005

SLR International Corporation; Salt Lake City, UT, Principal Geologist/Managing Principal; 2005-2014

Cardno, Salt Lake City, UT, Principal Geologist, Practice Leader, and National Client Manager, May 2014 to Present

Registrations/Certifications

Registered Professional Geologist, Oregon, 1989: No. 1057

Registered Professional Geologist, Idaho, 1990: No. 680

Professional Geologist, Utah, 2003: No. 5419780-2250

Certified UST Consultant, Utah, 1996-2004: No. CC0080

Additional training And certifications

40-Hour OSHA Health & Safety Certification (29 CFR 1910.120), 1988

40-Hour OSHA Health & Safety Annual Update Certification, 1997-2003

8-Hour OSHA Site Supervisor's Certification, 1995

PUBLICATIONS AND PRESENTATIONS

"The Stratigraphy and Depositional Environments of the Gebel El-Rus area, Eastern Faiyum, Egypt".

M.S. Thesis, BYU Geology Studies, Vol. 34, Pg. 1, 1987. "The Geology of the Gebel El-Rus Area and Archaeology Sites in the Eastern Faiyum, Egypt", excavations at Seila, Egypt, Religious Study Center, Brigham Young University, Provo, Utah, Vol. 1, 1988.



Alisha Strong

Current Position

Drafter

Profession

Environmental Science

Years' Experience

10+

Joined Cardno

January, 2016

Education

Associates of Science,
Southern Utah University
2006

Summary of Experience

Alisha has 10+ years of experience providing key staff-level support in environmental service sectors with a primary emphasis in environmental site assessments and remediation. Projects are primarily U.S. domestic-based with a significant segment focused on international projects. Additional service skills include CADD design/drafting, review of word processing/report structure, and finalization of report compilation.

Alisha interacts with program and project management, client representatives, and regulatory agencies. Alisha's key responsibilities include managing the scheduling and production for project administration, locating of sites via topographic maps, aerials, and/or legal descriptions, project report preparation, and delivery. This includes proposal preparation, contracting, project administrative set-up, and acquiring insurance documentation.

Alisha also manages the due diligence process by interpreting and defining the client site boundaries, requests/obtains regulatory database reports, prepares/submits FOIA requests, and prepares CADD report figures each site. She consolidates, provides interpretative analysis of the data, condenses the received data, incorporates the data into the report, and co-authors report sections. Alisha also provides the final support for formats, word processing, and then compiles the final work product.

Significant Experience

Phase I Environmental Site Assessments – Over the past 4 years, Alisha has managed over 250 Phase I Environmental Site Assessments (ESAs) to current SSTM Standard Practice E 1527-13 standards as well as HUD standards; including, but not limited to:

- Retail complexes
- Institutional (churches/schools) facilities
- Residential Properties
- Municipal Properties
- Petroleum facilities
- Manufacturing plants
- Commercial properties
- Scout camps
- Agricultural/grazing land

Phase II Environmental Site Assessments – Support and manage in the production of Phase II Environmental Site Assessment reports with in depth review of the regulatory history of the site as well as preparing CADD report figures and the final support for formats, word processing, and compilation of the final product.

Drafting – Drafted figures for Phase I ESA's and Phase II ESA's for Cardno for the past 10 years in AutoCAD. Examples of drawings Alisha has completed include, but not limit to:

- Site location maps
- Site plans with soil and groundwater sample locations
- Wetlands Delineation
- Flood Plain
- Radon Maps
- Boring Logs/GINT
- Quarterly reports for groundwater monitoring
- Geologic cross-section

Administrative – Support and managed office and administrative duties for an Engineering firm from 2007 to 2009. Alisha managed office operations and was tasked with creating/processing client invoicing, accounts payable/receivable, proposal identification and production, client networking, creation of marketing material in Photoshop and Microsoft PowerPoint.

Alisha is adept in the following software:

- Microsoft Suite including:
 - Word
 - Excel,
 - PowerPoint
 - Outlook.
- Adobe including:
 - Photoshop
 - Acrobat
- Autodesk AutoCAD
- gINT

Potential Maverik Acquisition - SEC of Ross Ave & Hawes Rd, El Centro,
CA

Appendix

J

Laboratory Reports (intentionally left blank)

EEC ORIGINAL PKG

Potential Maverik Acquisition - SEC of Ross Ave & Hawes Rd, El Centro,
CA

Appendix

K

Other Supporting Documentation

EEC ORIGINAL PKG

CALIFORNIA - EPA Map of Radon Zones

<http://www.epa.gov/radon/zonemap.html>

The purpose of this map is to assist National, State and local organizations to target their resources and to implement radon-resistant building codes.

This map is not intended to determine if a home in a given zone should be tested for radon. Homes with elevated levels of radon have been found in all three zones.

All homes should be tested, regardless of zone designation.

IMPORTANT: Consult the publication entitled "Preliminary Geologic Radon Potential Assessment of California" (USGS Open-file Report 93-292-1) before using this map. See <http://energy.cr.usgs.gov/radon/grpinfo.html> This document contains information on radon potential variations within counties. EPA also recommends that this map be supplemented with any available local data in order to further understand and predict the radon potential of a specific area.



K-1

Latitude: 32° 46' 51" N
Longitude: -115° 29' 56" W

Project No. 821AR00978.0001

This map and all data contained within are supplied as is with no warranty. Cardno, Inc. expressly disclaims responsibility for damages or liability from any claims that may arise out of the use or misuse of this map. It is the sole responsibility of the user to determine if the data on this map meets the user's needs. This map was not created as survey data, nor should it be used as such. It is the user's responsibility to obtain proper survey data, prepared by a licensed surveyor, where required by law.

Appendix K1: Radon Map
Maverik - El Centro, CA
Potential Maverik Location
SEC of Ross Ave & Hawes Rd
El Centro, Imperial County, California



1142 WEST 2320 SOUTH, SUITE A
WEST VALLEY, UTAH 84119
P: 801-256-3800 F: 801-973-1095



VAPOR
SCREENING

Project Property: *Maverik El Centro
SEC of Ross Ave & Hawes Rd
El Centro CA*

Project No: *821AR00978.0001*

Report Type: *Vapor Report with Database Details*

Order No: *21100500784v*

Requested by: *Cardno Inc.*

Date Completed: *October 8, 2021*

Table of Contents

Table of Contents.....2
Executive Summary.....3
 Executive Summary: Report Summary.....4
Map.....5
Detail Report.....7
Appendix: Database Descriptions.....8

Notice: IMPORTANT INFORMATION:

Service: Client has used a service offered by ERIS Information Inc. ("**ERIS**") to generate this report based upon certain search parameters set by Client, or in the case of ERIS's Vapor Encroachment Screening Tool and Checklist, certain search parameters set by ERIS and modified by Client (the "**Service**"). This report contains the results of a search conducted by ERIS of environmental records maintained by third parties. ERIS does not maintain, and has no responsibility for the accuracy or completeness of, such records.

Agreement: Client's use of the Service and any report generated thereby is subject to the Master Services Agreement previously entered into by Client and ERIS, or the terms and conditions accepted by Client in electronically submitting a request for the Service, (the "**Agreement**") and no provision of this Notice shall modify the Agreement. To the extent there is a conflict between any provision of this Notice and any provision of the Agreement, the latter shall control.

Liability Limitation: ERIS's liability for the Service and this report shall be limited to the amount paid by Client for this report and as otherwise set forth in the Agreement. Although in preparing this report ERIS has endeavored to present information that is accurate, ERIS will not have any liability for any errors, omissions or inaccuracies in such information, even if ERIS sets, or Client modifies, the parameters used to conduct the search.

Reliance on Report: This report (1) applies only to the address and the date specified on the cover page of this report and (2) is not a substitute for a Phase I Environmental Site Assessment, a Vapor Encroachment Assessment or any other similar assessment. It is solely intended to be used as a database search of current environmental records maintained by third parties, and Client should not rely on this report for any purpose for which it is not intended. Client may, in Client's discretion, modify search parameters within some of the tools of the Service that may affect the results for which ERIS is not responsible.

License for Use of Report: Client is licensed to use this report solely for its intended purpose as set forth in this Notice and the Agreement. No page of this report may be used by Client without including this report's cover page, this Notice and the project property identifier.

Client Liability: Use of the Service or this report in a manner contrary to this Notice or the Agreement will be a breach of contract and an infringement of ERIS's copyright and other intellectual property rights, for which ERIS will be entitled to damages and other remedies. In addition, upon any such breach or infringement, ERIS may terminate the Agreement, Client's account with ERIS, Client's license to use any reports previously generated for Client pursuant to the Service, and Client's future use of the Service.

Warranty Disclaimer: EXCEPT AS EXPRESSLY SET FORTH IN THE AGREEMENT, ERIS MAKES NO WARRANTY OR REPRESENTATION REGARDING THE SERVICE, THIS REPORT OR THE RESULTS OF ANY SEARCH CONDUCTED BY CLIENT USING THE SERVICE.

Ownership: Client may not use any of ERIS's trademarks or attribute any work product to ERIS other than as expressly set forth in this Notice or the Agreement. The Service and this reports are owned by ERIS (or its licensors) and protected by copyright and other intellectual property rights. No portion of this report may be, in whole or in part, modified, reproduced or transferred to a third party by Client, without the prior written consent of ERIS.

Executive Summary

This Report was produced through the ERIS Vapor Screening Tool. The ERIS Vapor Screening Tool and this report output are designed to help those in conducting a Vapor Encroachment Screening on a Property Involved in Real Estate Transactions under the ASTM Standard Designation E2600 – 15.

The following table lists the data sources searched and any hits in the Area of Concern (AOC) that have been included in the report. The search distances listed are based on search distances used in the Database Report and the search results are grouped based on the minimum default search distances for Chemicals of Concern (COCs) and Petroleum Hydrocarbon Chemicals of Concern (PHCOCs) as outlined in E2600-15. The default AOC may be expanded or reduced by the environmental professional (adjusted AOC) using experience and professional judgment.

<u>Standard Environmental Sources</u>	Search Distance (miles)*	Project Property	Within 1/10	1/10 plus	Total
Federal NPL site list	1.0	0	0	0	0
Federal Delisted NPL site list	0.5	0	0	0	0
Federal CERCLIS list	1.0	0	0	0	0
Federal CERCLIS NFRAP site list	0.5	0	0	0	0
Federal RCRA CORRACTS facilities list	1.0	0	0	0	0
Federal RCRA non-CORRACTS TSD facilities list	0.5	0	0	0	0
Federal RCRA generators list	0.25	0	0	0	0
Federal institutional control/engineering control registries	0.5	0	0	0	0
Federal ERNS list	PO	0	0	0	0
State and tribal equivalent NPL	1.0	0	0	0	0
State and tribal equivalent CERCLIS	1.0	0	0	0	0
State and tribal landfill and/or solid waste disposal site lists	0.5	0	0	0	0
State and tribal leaking storage tank lists	0.5	0	0	0	0
State and Tribal registered storage tank lists	0.25	0	0	0	0
State and tribal institutional control/engineering control registries	0.5	0	0	0	0
State and tribal voluntary cleanup sites	0.5	0	0	0	0
State and tribal Brownfield sites	0.5	0	0	0	0
State Hazardous Waste Facilities	1.0	0	0	0	0
Others	0.5	0	0	0	0

Non Standard Environmental Sources

Federal Spill sites list	0.125	0	0	0	0
Federal Drycleaner Facilities	0.5	0	0	0	0
State Hazardous Waste Facilities	0.5	0	0	0	0
State and Tribal Spill sites list	PO	0	0	0	0
State and Tribal Dry Cleaner Facilities	0.25	0	0	0	0
Others	1.0	0	0	0	0
Federal PFAS sites list	0.5	0	0	0	0
State and Tribal PFAS site list	0.5	0	0	0	0

* Please refer to the Appendix of this report to view specific databases searched within each category. Search distances within each category may vary by database - the largest search radius per category will be displayed.

Executive Summary: Report Summary

Project Property: Maverik El Centro
SEC of Ross Ave & Hawes Rd
El Centro CA

Coordinates: 32.78061451, -115.49900409

PO No: 821AR00978.0001

Order No: 21100500784v

Elevation: -36.09 ft

Project Property - Results

Map Key	DB	Company/Site Name	Address	Direction	Distance (m/ft)	Elev Diff (ft)	Page Number
----------------	-----------	--------------------------	----------------	------------------	------------------------	-----------------------	--------------------

No records for the project property.

Surrounding Properties - Results

Map Key	DB	Company/Site Name	Address	Direction	Distance (m/ft)	Elev Diff (ft)	Page Number
----------------	-----------	--------------------------	----------------	------------------	------------------------	-----------------------	--------------------

No records for the surrounding properties.

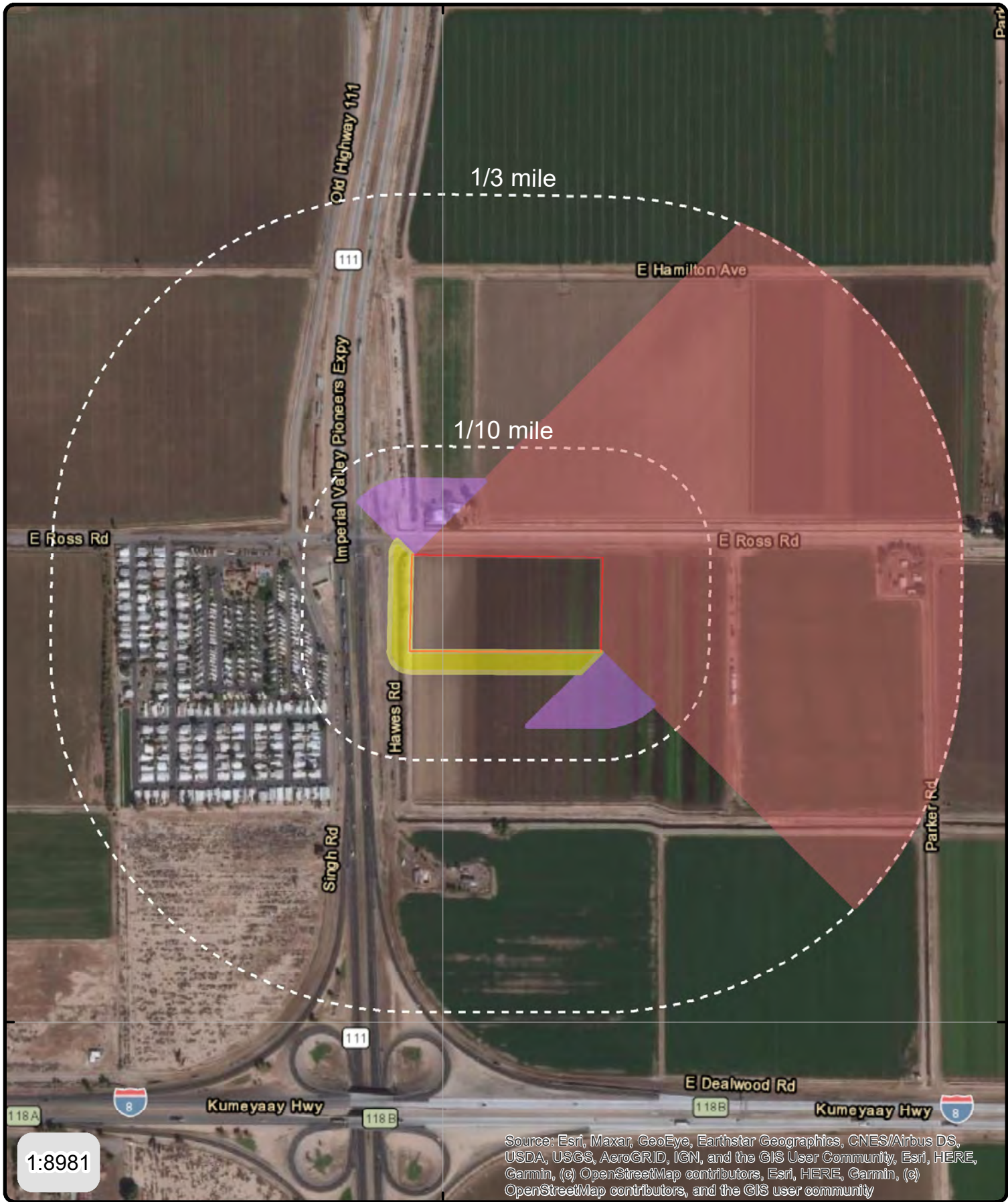

Source: Esri, Maxar, GeoEye, Earthstar Geographics, CNES/Airbus DS, USDA, USGS, AeroGRID, IGN, and the GIS User Community, Esri, HERE, Garmin, (c) OpenStreetMap contributors, Esri, HERE, Garmin, (c) OpenStreetMap contributors, and the GIS user community

Address: SEC of Ross Ave & Hawes Rd, El Centro, CA

Order No: 21100500784v

- Up-gradient
- Down-gradient
- Cross-gradients

EEC ORIGINAL PKG

© ERIS Information Inc.



1:23139

Source: Esri, Maxar, GeoEye, Earthstar Geographics, CNES/Airbus DS, USDA, USGS, AeroGRID, IGN, and the GIS User Community, Esri, HERE, Garmin, (c) OpenStreetMap contributors, Esri, HERE, Garmin, (c) OpenStreetMap contributors, and the GIS user community

Address: SEC of Ross Ave & Hawes Rd, El Centro, CA

Order No: 21100500784v

EEC ORIGINAL PKG

© ERIS Information Inc.

Detail Report

No details.

Appendix: Database Descriptions

The following are data source listings found in the attached report. For full descriptions, please refer to the associated ERIS Database Report.

<i>DB</i>	<i>Database Name</i>	<i>Publication Date</i>	<i>Source</i>	<i>Classification</i>	<i>ASTM Category</i>
-----------	----------------------	-------------------------	---------------	-----------------------	----------------------

Potential Maverik Acquisition - SEC of Ross Ave & Hawes Rd, El Centro,
CA

Appendix



Terminology

EEC ORIGINAL PKG

Terminology

The following provides definitions and descriptions of certain terms that may be used in this report. Italics indicate terms that are defined by ASTM Standard Practice E 1527-13. The Standard Practice should be referenced for further detail (such as the precise wording), related definitions, or additional explanation regarding the meaning of terms.

recognized environmental condition (REC) - the presence or likely presence of any hazardous substances or petroleum products in, on, or at the Subject Property: (1) due to any release to the environment, (2) under conditions indicative of a release to the environment, or (3) under conditions that pose a material threat of a future release to the environment.

de minimis conditions – conditions that generally do not present a threat to human health or the environment and that generally would not be the subject of an enforcement action if brought to the attention of appropriate governmental agencies. Conditions determined to be *de minimis* are not recognized environmental conditions.

historical recognized environmental condition (HREC) – a past release of any hazardous substances in connection with the Subject Property and has been addressed to the satisfaction of the applicable regulatory authority or meeting unrestricted use criteria established by a regulatory authority, without subjecting the V to any required controls (e.g., property use restrictions, AULs, institutional controls, or engineering controls). The final decision rests with the environmental professional and will be influenced by the current impact of the historical recognized environmental condition on the Subject Property.

controlled recognized environmental condition (CREC) – a recognized environmental condition resulting from a past release of hazardous substances or petroleum products that has been addressed to the satisfaction of the applicable regulatory authority (e.g., as evidenced by the issuance of a no further action letter or equivalent, or meeting risk-based criteria established by regulatory authority), with hazardous substances or petroleum products allowed to remain in place subject to the implementation of required controls.

material threat – a physically observable or obvious threat that is reasonably likely to lead to a release that, in the opinion of the environmental professional, is threatening and might result in impact to public health or the environment. An example might include an aboveground storage tank system that contains a hazardous substance and that shows evidence of damage such that it may cause or contribute to tank integrity failure with a release of contents to the environment.

threat to human health or the environment – a substantial risk of harm to public health or the environment resulting from the presence or likely presence of an existing release, a past release, or a material threat of a release of any hazardous substances or petroleum products into structures on the Subject Property or into the ground, ground water, or surface water of the Subject Property. An example might include a release of a hazardous substance in concentrations exceeding applicable governmental agency standards under conditions that could reasonably and foreseeably result in substantial exposure to humans or substantial damage to natural resources. The risk of that exposure or damage would represent a threat to human health or the environment.

generally would not be the subject of an enforcement action – the likelihood that an environmental condition would not be subject to enforcement action if brought to the attention of appropriate governmental agencies. If the circumstances suggest an enforcement action would be less likely than not, then the condition is considered to be generally not the likely the subject of an enforcement action.

November 3, 2021

Maverik, Inc.
185 South State Street, Suite 800
Salt Lake City, Utah 84111

SUBJECT: Limited Phase II Environmental Site Assessment (ESA)
Potential Maverik Acquisition
SEC of Ross Avenue and Hawes Road
El Centro, CA
Cardno Project Number: 819AR00978

This report presents the results of the Limited Phase II ESA conducted at the above-referenced property. Cardno, Inc. (Cardno) performed the investigation at the request of Maverik, Inc. The location of the Subject Property is shown on **Figure 1** in **Appendix A**.

1.0 INTRODUCTION AND BACKGROUND

Cardno completed a Phase I ESA report for the Subject Property on October 15, 2021, the results of which indicated the presence of one *recognized environmental condition* (REC) that was associated with the potential use of banned pesticides.

Based on this information and observations conducted during the Phase I ESA, Cardno conducted a Limited Phase II ESA on October 23, 2021 which included the following scope of services:

- Collection of surface soil samples at 5 soil locations. The soil samples were collected from depths of 0-6 inches below ground surface (bgs) and included samples AG-1, AG-2, AG-3, AG-4, and AG-5). The samples were analyzed for both organochlorine and organophosphorous pesticides by EPA Methods 8081A and 8141A at the project laboratory Eurofins CalScience of Irvine, CA.

2.0 FIELDWORK/INVESTIGATION RESULTS

The respective soil sample locations are illustrated on **Figure 2** in **Appendix A**. Each soil sample was collected with clean decontaminated stainless steel sampling trowels and placed into 8-ounce borosilicate glass sample containers. The samples were subsequently packaged into an insulated cooler with appropriate packing material and were hand-delivered to the project laboratory, Eurofins CalScience of Irvine, within 24 hours of collection, under standard chain-of-custody procedures.

Table 1 (Appendix B) summarizes the analytical data. In addition, a full summary of the soil sample laboratory analytical results is presented in a copy of the laboratory analytical report included in **Appendix C**.

Between both analytical pesticide suites, only the organochlorine pesticide DDE was detected at estimated concentrations ranging from 0.74 to 2.9 ug/Kg in 4 of the 5 samples. Based on comparison to the USEPA Region 9 Regional Screening Goals (RSL) for residential soil and groundwater protection, the analytical results indicated the presence of the detected pesticide occurred at concentrations that were orders of magnitude below the respective RSL.

4.0 CONCLUSIONS AND RECOMMENDATIONS

Based on the sample analytical results, the Phase I ESA REC associated with the potential presence of banned pesticides above regulatory cleanup levels has been sufficiently evaluated and a de minimis condition currently exists with no further reportable or regulatory concerns at this time.

Our services consist of professional opinions and recommendations made in accordance with generally accepted geotechnical and environmental engineering principles and practices. This warranty is in lieu of all other warranties either expressed or implied. Should you have any questions, please do not hesitate to call me at (801) 256-3800.

Respectfully submitted,
Cardno, Inc.



Russell D. Hamblin, P.G.
National Client Manager, Environmental Professional

Direct Line (801) 519-4246
Email: russ.hamblin@cardno.com

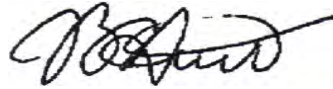

Joseph B. Hunt, P.G.
Senior Geologist

Direct Line (619) 857-6710
Email: joseph.hunt@cardno.com

Enclosures:

Appendix A	Figures
Appendix B	Data Summary Table
Appendix C	Soil Laboratory Analytical Report

APPENDIX A

FIGURES

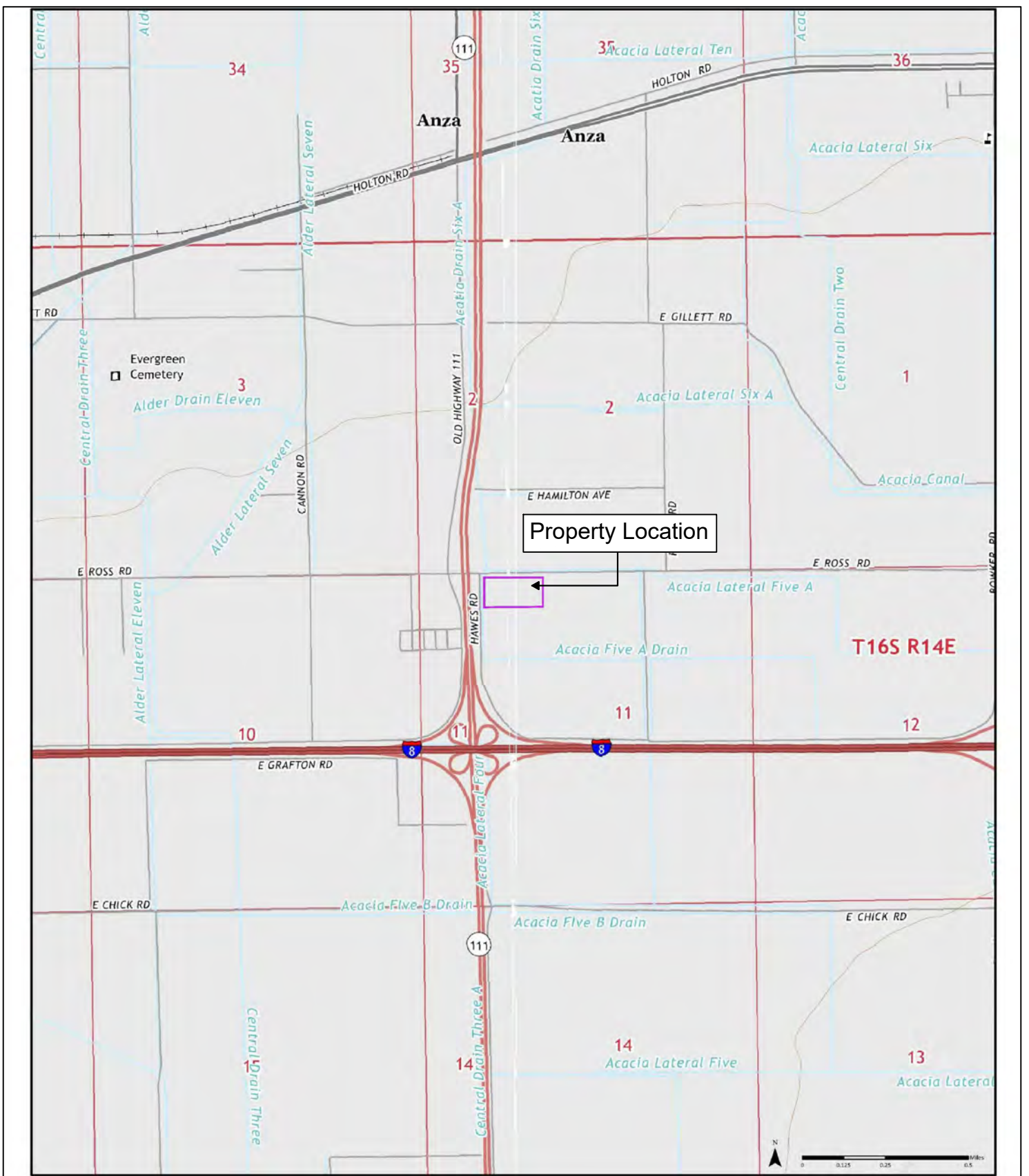

1

Latitude: 32° 46' 51" N
 Longitude: -115° 29' 56" W
 El Centro, CA, 2015
 Holtville West, CA, 2015
 Project No. 821AR00978.0001

This map and all data contained within are supplied as is with no warranty. Cardno, Inc. expressly disclaims responsibility for damages or liability from any claims that may arise out of the use or misuse of this map. It is the sole responsibility of the user to determine if the data on this map meets the user's needs. This map was not created as survey data, nor should it be used as such. It is the user's responsibility to obtain proper survey data, prepared by a licensed surveyor, where required by law.

Figure 1: Site Vicinity Map

Maverik - El Centro, CA
 Potential Maverik Location
 SEC of Ross Ave & Hawes Rd
 El Centro, Imperial County, California

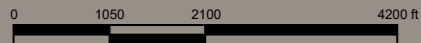

Cardno
 1142 WEST 2320 SOUTH, SUITE A
 WEST VALLEY, UTAH 84119
 P: 801-256-3800 F: 801-973-1095

EEC ORIGINAL PKG



2

This map and all data contained within are supplied as is with no warranty. Cardno, Inc. expressly disclaims responsibility for damages or liability from any claims that may arise out of the use or misuse of this map. It is the sole responsibility of the user to determine if the data on this map meets the user's needs. This map was not created as survey data, nor should it be used as such. It is the user's responsibility to obtain proper survey data, prepared by a licensed surveyor, where required by law.

Latitude: 32° 46' 51" N
 Longitude: -115° 29' 56" W

Project No. 821AR00978.0001

Figure 2: Soil Sample Locations
 Maverik - El Centro, CA
 Potential Maverik Location
 SEC of Ross Ave & Hawes Rd
 El Centro, Imperial County, California

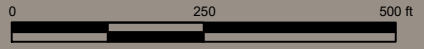

Cardno

1142 WEST 2320 SOUTH, SUITE A
 WEST VALLEY, UTAH 84119
 P: 801-256-3800 F: 801-973-1095

APPENDIX B
DATA SUMMARY TABLE

Table 1
Soil Sample Analytical Results
SEC of Ross Rd and Hawes Rd; El Centro, CA

Sample ID	Organochlorine Pesticides		
	DDD	DDE	DDT
AG-1	<5.0	<5.0	<5.0
AG-2	<5.0	1.1Jp	<5.0
AG-3	<4.9	2.9Jp	<4.9
AG-4	<5.0	0.85Jp	<5.0
AG-5	<5.0	0.74Jp	<5.0
EPA R9 RSL/RS	1,900	2,000	1,900
EPA R9 RSL/GP	7.5	11.0	77

Notes:

Organochlorine Pesticides by EPA Method 8081 (ug/Kg).

J = Result is < the MRL but >= MDL; concentration is an approximate value.

p = %RPD between primary/confirmation column is >40%.

BOLD = Denotes analyte detection.

Italics = Greater than or equal to the RSL screening levels for soil.

< = Less than the laboratory method reporting limit.

RSL = EPA Region 9 Regional Soil Screening Levels.

RS = Residential Soil Screening Level in microgram/kilogram (ug/Kg).

GP = Groundwater Protection Screening Level (ug/Kg).

APPENDIX C

SAMPLE LABORATORY ANALYTICAL REPORT

ANALYTICAL REPORT

Eurofins Calscience Irvine
17461 Derian Ave
Suite 100
Irvine, CA 92614-5817
Tel: (949)261-1022

Laboratory Job ID: 440-290441-1

Laboratory Sample Delivery Group: SWC Hawes & Ross Ave.
Client Project/Site: Maverick EI Central

For:

Cardno, Inc
1142 West 2320 South
Suite A
West Valley City, Utah 84119

Attn: Russ Hamblin



Authorized for release by:
11/2/2021 1:21:44 PM

Danielle Roberts, Senior Project Manager
(949)260-3249
Danielle.Roberts@Eurofinset.com

LINKS

Review your project
results through
TotalAccess

Have a Question?



Visit us at:

www.eurofinsus.com/Env

The test results in this report meet all 2003 NELAC, 2009 TNI, and 2016 TNI requirements for accredited parameters, exceptions are noted in this report. This report may not be reproduced except in full, and with written approval from the laboratory. For questions please contact the Project Manager at the e-mail address or telephone number listed on this page.

This report has been electronically signed and authorized by the signatory. Electronic signature is intended to be the legally binding equivalent of a traditionally handwritten signature.

Results relate only to the items tested and the sample(s) as received by the laboratory.

EEC ORIGINAL PKG



Table of Contents

Cover Page	1
Table of Contents	2
Sample Summary	3
Case Narrative	4
Detection Summary	5
Client Sample Results	6
Surrogate Summary	12
Method Summary	13
Lab Chronicle	14
QC Sample Results	16
QC Association Summary	21
Definitions/Glossary	23
Certification Summary	24
Chain of Custody	25
Receipt Checklists	27

Sample Summary

Client: Cardno, Inc
Project/Site: Maverick El Central

Job ID: 440-290441-1
SDG: SWC Hawes & Ross Ave.

Lab Sample ID	Client Sample ID	Matrix	Collected	Received
440-290441-1	AG-1	Solid	10/22/21 10:07	10/25/21 08:00
440-290441-2	AG-2	Solid	10/22/21 10:07	10/25/21 08:00
440-290441-3	AG-3	Solid	10/22/21 10:07	10/25/21 08:00
440-290441-4	AG-4	Solid	10/22/21 10:07	10/25/21 08:00
440-290441-5	AG-5	Solid	10/22/21 10:07	10/25/21 08:00

1

2

3

4

5

6

7

8

9

10

11

12

13

14

15

Case Narrative

Client: Cardno, Inc
Project/Site: Maverick El Central

Job ID: 440-290441-1
SDG: SWC Hawes & Ross Ave.

Job ID: 440-290441-1

Laboratory: Eurofins Calscience Irvine

Narrative

Job Narrative 440-290441-1

Comments

No additional comments.

Receipt

The samples were received on 10/25/2021 8:00 AM. Unless otherwise noted below, the samples arrived in good condition, and where required, properly preserved and on ice. The temperature of the cooler at receipt was 2.4° C.

GC Semi VOA

Method 8081A: The matrix spike / matrix spike duplicate (MS/MSD) recoveries and precision for preparation batch 570-189723 and analytical batch 570-189920 were outside control limits. Sample matrix interference and/or non-homogeneity are suspected because the associated laboratory control sample / laboratory sample control duplicate (LCS/LCSD) precision was within acceptance limits.

Method 8141A: Surrogate recovery for the following samples were outside the upper control limit: AG-1 (440-290441-1), AG-2 (440-290441-2) and AG-4 (440-290441-4). This sample did not contain any target analytes; therefore, re-extraction and/or re-analysis was not performed.

Method 8141A: The continuing calibration verification (CCV) associated with batch 570-190821 recovered above the upper control limit for Dichlorvos and Merphos. The samples associated with this CCV were non-detects for the affected analytes; therefore, the data have been reported. The associated sample is impacted: (MB 570-189184/1-A).

Method 8141A: The RPD of the laboratory control sample (LCS) and laboratory control sample duplicate (LCSD) for preparation batch 570-189184 and analytical batch 570-190014 recovered outside control limits for the following analytes: Dichlorvos

No additional analytical or quality issues were noted, other than those described above or in the Definitions/Glossary page.

Organic Prep

No analytical or quality issues were noted, other than those described in the Definitions/Glossary page.

Detection Summary

Client: Cardno, Inc
Project/Site: Maverick El Central

Job ID: 440-290441-1
SDG: SWC Hawes & Ross Ave.

Client Sample ID: AG-1

Lab Sample ID: 440-290441-1

No Detections.

Client Sample ID: AG-2

Lab Sample ID: 440-290441-2

Analyte	Result	Qualifier	RL	MDL	Unit	Dil Fac	D	Method	Prep Type
4,4'-DDE	1.1	J p	5.0	0.53	ug/Kg	1		8081A	Total/NA

Client Sample ID: AG-3

Lab Sample ID: 440-290441-3

Analyte	Result	Qualifier	RL	MDL	Unit	Dil Fac	D	Method	Prep Type
4,4'-DDE	2.9	J p	4.9	0.53	ug/Kg	1		8081A	Total/NA

Client Sample ID: AG-4

Lab Sample ID: 440-290441-4

Analyte	Result	Qualifier	RL	MDL	Unit	Dil Fac	D	Method	Prep Type
4,4'-DDE	0.85	J p	5.0	0.53	ug/Kg	1		8081A	Total/NA

Client Sample ID: AG-5

Lab Sample ID: 440-290441-5

Analyte	Result	Qualifier	RL	MDL	Unit	Dil Fac	D	Method	Prep Type
4,4'-DDE	0.74	J p	5.0	0.53	ug/Kg	1		8081A	Total/NA

This Detection Summary does not include radiochemical test results.

Eurofins Calscience Irvine

Client Sample Results

Client: Cardno, Inc
Project/Site: Maverick El Central

Job ID: 440-290441-1
SDG: SWC Hawes & Ross Ave.

Client Sample ID: AG-1
Date Collected: 10/22/21 10:07
Date Received: 10/25/21 08:00

Lab Sample ID: 440-290441-1
Matrix: Solid

Method: 8081A - Organochlorine Pesticides (GC)

Analyte	Result	Qualifier	RL	MDL	Unit	D	Prepared	Analyzed	Dil Fac
4,4'-DDD	ND		5.0	0.98	ug/Kg		10/27/21 12:16	10/28/21 16:39	1
4,4'-DDE	ND		5.0	0.53	ug/Kg		10/27/21 12:16	10/28/21 16:39	1
4,4'-DDT	ND		5.0	0.94	ug/Kg		10/27/21 12:16	10/28/21 16:39	1
Aldrin	ND		5.0	0.72	ug/Kg		10/27/21 12:16	10/28/21 16:39	1
alpha-BHC	ND		5.0	3.0	ug/Kg		10/27/21 12:16	10/28/21 16:39	1
alpha-Chlordane	ND		5.0	1.3	ug/Kg		10/27/21 12:16	10/28/21 16:39	1
beta-BHC	ND		5.0	3.6	ug/Kg		10/27/21 12:16	10/28/21 16:39	1
Chlordane	ND		25	2.4	ug/Kg		10/27/21 12:16	10/28/21 16:39	1
delta-BHC	ND		5.0	1.6	ug/Kg		10/27/21 12:16	10/28/21 16:39	1
Dieldrin	ND		5.0	0.25	ug/Kg		10/27/21 12:16	10/28/21 16:39	1
Endosulfan I	ND		5.0	1.1	ug/Kg		10/27/21 12:16	10/28/21 16:39	1
Endosulfan II	ND		5.0	0.30	ug/Kg		10/27/21 12:16	10/28/21 16:39	1
Endosulfan sulfate	ND		5.0	0.40	ug/Kg		10/27/21 12:16	10/28/21 16:39	1
Endrin	ND		5.0	0.33	ug/Kg		10/27/21 12:16	10/28/21 16:39	1
Endrin aldehyde	ND		5.0	1.8	ug/Kg		10/27/21 12:16	10/28/21 16:39	1
Endrin ketone	ND		5.0	0.47	ug/Kg		10/27/21 12:16	10/28/21 16:39	1
gamma-BHC	ND		5.0	0.62	ug/Kg		10/27/21 12:16	10/28/21 16:39	1
gamma-Chlordane	ND		5.0	1.3	ug/Kg		10/27/21 12:16	10/28/21 16:39	1
Heptachlor	ND		5.0	0.88	ug/Kg		10/27/21 12:16	10/28/21 16:39	1
Heptachlor epoxide	ND		5.0	0.66	ug/Kg		10/27/21 12:16	10/28/21 16:39	1
Methoxychlor	ND		5.0	0.80	ug/Kg		10/27/21 12:16	10/28/21 16:39	1
Toxaphene	ND		25	20	ug/Kg		10/27/21 12:16	10/28/21 16:39	1

Surrogate	%Recovery	Qualifier	Limits	Prepared	Analyzed	Dil Fac
DCB Decachlorobiphenyl (Surr)	61		37 - 151	10/27/21 12:16	10/28/21 16:39	1
Tetrachloro-m-xylene	63		38 - 148	10/27/21 12:16	10/28/21 16:39	1

Method: 8141A - Organophosphorous Pesticides (GC)

Analyte	Result	Qualifier	RL	MDL	Unit	D	Prepared	Analyzed	Dil Fac
Azinphos-methyl	ND		0.48	0.17	mg/Kg		10/26/21 11:12	11/02/21 06:02	1
Bolstar	ND		0.48	0.24	mg/Kg		10/26/21 11:12	11/02/21 06:02	1
Chlorpyrifos	ND		0.48	0.12	mg/Kg		10/26/21 11:12	11/02/21 06:02	1
Coumaphos	ND		0.48	0.19	mg/Kg		10/26/21 11:12	11/02/21 06:02	1
Demeton-o/s	ND		0.96	0.26	mg/Kg		10/26/21 11:12	11/02/21 06:02	1
Diazinon	ND		0.48	0.097	mg/Kg		10/26/21 11:12	11/02/21 06:02	1
Dichlorvos	ND		0.48	0.11	mg/Kg		10/26/21 11:12	11/02/21 06:02	1
Disulfoton	ND		0.48	0.12	mg/Kg		10/26/21 11:12	11/02/21 06:02	1
Ethoprop	ND		0.48	0.11	mg/Kg		10/26/21 11:12	11/02/21 06:02	1
Fensulfothion	ND		0.48	0.17	mg/Kg		10/26/21 11:12	11/02/21 06:02	1
Fenthion	ND		0.48	0.13	mg/Kg		10/26/21 11:12	11/02/21 06:02	1
Merphos	ND		0.48	0.21	mg/Kg		10/26/21 11:12	11/02/21 06:02	1
Methyl parathion	ND		0.48	0.24	mg/Kg		10/26/21 11:12	11/02/21 06:02	1
Mevinphos	ND		0.48	0.099	mg/Kg		10/26/21 11:12	11/02/21 06:02	1
Naled	ND		3.8	0.39	mg/Kg		10/26/21 11:12	11/02/21 06:02	1
Phorate	ND		0.48	0.12	mg/Kg		10/26/21 11:12	11/02/21 06:02	1
Ronnel	ND		0.48	0.13	mg/Kg		10/26/21 11:12	11/02/21 06:02	1
Stirophos	ND		1.9	0.14	mg/Kg		10/26/21 11:12	11/02/21 06:02	1
Tokuthion	ND		0.48	0.12	mg/Kg		10/26/21 11:12	11/02/21 06:02	1
Trichloronate	ND		0.48	0.11	mg/Kg		10/26/21 11:12	11/02/21 06:02	1

Eurofins Calscience Irvine

Client Sample Results

Client: Cardno, Inc
Project/Site: Maverick El Central

Job ID: 440-290441-1
SDG: SWC Hawes & Ross Ave.

Client Sample ID: AG-1
Date Collected: 10/22/21 10:07
Date Received: 10/25/21 08:00

Lab Sample ID: 440-290441-1
Matrix: Solid

Surrogate	%Recovery	Qualifier	Limits	Prepared	Analyzed	Dil Fac
Tributylphosphate	177	S1+	20 - 158	10/26/21 11:12	11/02/21 06:02	1

Client Sample ID: AG-2
Date Collected: 10/22/21 10:07
Date Received: 10/25/21 08:00

Lab Sample ID: 440-290441-2
Matrix: Solid

Method: 8081A - Organochlorine Pesticides (GC)

Analyte	Result	Qualifier	RL	MDL	Unit	D	Prepared	Analyzed	Dil Fac
4,4'-DDD	ND		5.0	0.98	ug/Kg	-	10/27/21 12:16	10/28/21 13:46	1
4,4'-DDE	1.1	J p	5.0	0.53	ug/Kg	-	10/27/21 12:16	10/28/21 13:46	1
4,4'-DDT	ND		5.0	0.94	ug/Kg	-	10/27/21 12:16	10/28/21 13:46	1
Aldrin	ND		5.0	0.72	ug/Kg	-	10/27/21 12:16	10/28/21 13:46	1
alpha-BHC	ND		5.0	3.0	ug/Kg	-	10/27/21 12:16	10/28/21 13:46	1
alpha-Chlordane	ND		5.0	1.3	ug/Kg	-	10/27/21 12:16	10/28/21 13:46	1
beta-BHC	ND		5.0	3.7	ug/Kg	-	10/27/21 12:16	10/28/21 13:46	1
Chlordane	ND		25	2.4	ug/Kg	-	10/27/21 12:16	10/28/21 13:46	1
delta-BHC	ND		5.0	1.6	ug/Kg	-	10/27/21 12:16	10/28/21 13:46	1
Dieldrin	ND		5.0	0.25	ug/Kg	-	10/27/21 12:16	10/28/21 13:46	1
Endosulfan I	ND		5.0	1.1	ug/Kg	-	10/27/21 12:16	10/28/21 13:46	1
Endosulfan II	ND		5.0	0.31	ug/Kg	-	10/27/21 12:16	10/28/21 13:46	1
Endosulfan sulfate	ND		5.0	0.40	ug/Kg	-	10/27/21 12:16	10/28/21 13:46	1
Endrin	ND		5.0	0.33	ug/Kg	-	10/27/21 12:16	10/28/21 13:46	1
Endrin aldehyde	ND		5.0	1.8	ug/Kg	-	10/27/21 12:16	10/28/21 13:46	1
Endrin ketone	ND		5.0	0.47	ug/Kg	-	10/27/21 12:16	10/28/21 13:46	1
gamma-BHC	ND		5.0	0.62	ug/Kg	-	10/27/21 12:16	10/28/21 13:46	1
gamma-Chlordane	ND		5.0	1.3	ug/Kg	-	10/27/21 12:16	10/28/21 13:46	1
Heptachlor	ND		5.0	0.88	ug/Kg	-	10/27/21 12:16	10/28/21 13:46	1
Heptachlor epoxide	ND		5.0	0.66	ug/Kg	-	10/27/21 12:16	10/28/21 13:46	1
Methoxychlor	ND		5.0	0.81	ug/Kg	-	10/27/21 12:16	10/28/21 13:46	1
Toxaphene	ND		25	20	ug/Kg	-	10/27/21 12:16	10/28/21 13:46	1

Surrogate	%Recovery	Qualifier	Limits	Prepared	Analyzed	Dil Fac
DCB Decachlorobiphenyl (Surr)	55		37 - 151	10/27/21 12:16	10/28/21 13:46	1
Tetrachloro-m-xylene	57		38 - 148	10/27/21 12:16	10/28/21 13:46	1

Method: 8141A - Organophosphorous Pesticides (GC)

Analyte	Result	Qualifier	RL	MDL	Unit	D	Prepared	Analyzed	Dil Fac
Azinphos-methyl	ND		0.50	0.18	mg/Kg	-	10/26/21 11:12	11/02/21 06:49	1
Bolstar	ND		0.50	0.25	mg/Kg	-	10/26/21 11:12	11/02/21 06:49	1
Chlorpyrifos	ND		0.50	0.12	mg/Kg	-	10/26/21 11:12	11/02/21 06:49	1
Coumaphos	ND		0.50	0.20	mg/Kg	-	10/26/21 11:12	11/02/21 06:49	1
Demeton-o/s	ND		1.0	0.27	mg/Kg	-	10/26/21 11:12	11/02/21 06:49	1
Diazinon	ND		0.50	0.10	mg/Kg	-	10/26/21 11:12	11/02/21 06:49	1
Dichlorvos	ND		0.50	0.11	mg/Kg	-	10/26/21 11:12	11/02/21 06:49	1
Disulfoton	ND		0.50	0.12	mg/Kg	-	10/26/21 11:12	11/02/21 06:49	1
Ethoprop	ND		0.50	0.11	mg/Kg	-	10/26/21 11:12	11/02/21 06:49	1
Fensulfothion	ND		0.50	0.18	mg/Kg	-	10/26/21 11:12	11/02/21 06:49	1
Fenthion	ND		0.50	0.13	mg/Kg	-	10/26/21 11:12	11/02/21 06:49	1
Merphos	ND		0.50	0.22	mg/Kg	-	10/26/21 11:12	11/02/21 06:49	1
Methyl parathion	ND		0.50	0.24	mg/Kg	-	10/26/21 11:12	11/02/21 06:49	1
Mevinphos	ND		0.50	0.10	mg/Kg	-	10/26/21 11:12	11/02/21 06:49	1

Eurofins Calscience Irvine

Client Sample Results

Client: Cardno, Inc
Project/Site: Maverick EI Central

Job ID: 440-290441-1
SDG: SWC Hawes & Ross Ave.

Client Sample ID: AG-2
Date Collected: 10/22/21 10:07
Date Received: 10/25/21 08:00

Lab Sample ID: 440-290441-2
Matrix: Solid

Method: 8141A - Organophosphorous Pesticides (GC) (Continued)

Analyte	Result	Qualifier	RL	MDL	Unit	D	Prepared	Analyzed	Dil Fac
Naled	ND		4.0	0.41	mg/Kg		10/26/21 11:12	11/02/21 06:49	1
Phorate	ND		0.50	0.13	mg/Kg		10/26/21 11:12	11/02/21 06:49	1
Ronnel	ND		0.50	0.13	mg/Kg		10/26/21 11:12	11/02/21 06:49	1
Stirophos	ND		2.0	0.14	mg/Kg		10/26/21 11:12	11/02/21 06:49	1
Tokuthion	ND		0.50	0.13	mg/Kg		10/26/21 11:12	11/02/21 06:49	1
Trichloronate	ND		0.50	0.12	mg/Kg		10/26/21 11:12	11/02/21 06:49	1

Surrogate	%Recovery	Qualifier	Limits	Prepared	Analyzed	Dil Fac
Tributylphosphate	165	S1+	20 - 158	10/26/21 11:12	11/02/21 06:49	1

Client Sample ID: AG-3
Date Collected: 10/22/21 10:07
Date Received: 10/25/21 08:00

Lab Sample ID: 440-290441-3
Matrix: Solid

Method: 8081A - Organochlorine Pesticides (GC)

Analyte	Result	Qualifier	RL	MDL	Unit	D	Prepared	Analyzed	Dil Fac
4,4'-DDD	ND		4.9	0.98	ug/Kg		10/27/21 12:16	10/28/21 14:00	1
4,4'-DDE	2.9	J p	4.9	0.53	ug/Kg		10/27/21 12:16	10/28/21 14:00	1
4,4'-DDT	ND		4.9	0.93	ug/Kg		10/27/21 12:16	10/28/21 14:00	1
Aldrin	ND		4.9	0.72	ug/Kg		10/27/21 12:16	10/28/21 14:00	1
alpha-BHC	ND		4.9	3.0	ug/Kg		10/27/21 12:16	10/28/21 14:00	1
alpha-Chlordane	ND		4.9	1.3	ug/Kg		10/27/21 12:16	10/28/21 14:00	1
beta-BHC	ND		4.9	3.6	ug/Kg		10/27/21 12:16	10/28/21 14:00	1
Chlordane	ND		25	2.3	ug/Kg		10/27/21 12:16	10/28/21 14:00	1
delta-BHC	ND		4.9	1.6	ug/Kg		10/27/21 12:16	10/28/21 14:00	1
Dieldrin	ND		4.9	0.25	ug/Kg		10/27/21 12:16	10/28/21 14:00	1
Endosulfan I	ND		4.9	1.1	ug/Kg		10/27/21 12:16	10/28/21 14:00	1
Endosulfan II	ND		4.9	0.30	ug/Kg		10/27/21 12:16	10/28/21 14:00	1
Endosulfan sulfate	ND		4.9	0.40	ug/Kg		10/27/21 12:16	10/28/21 14:00	1
Endrin	ND		4.9	0.33	ug/Kg		10/27/21 12:16	10/28/21 14:00	1
Endrin aldehyde	ND		4.9	1.7	ug/Kg		10/27/21 12:16	10/28/21 14:00	1
Endrin ketone	ND		4.9	0.47	ug/Kg		10/27/21 12:16	10/28/21 14:00	1
gamma-BHC	ND		4.9	0.62	ug/Kg		10/27/21 12:16	10/28/21 14:00	1
gamma-Chlordane	ND		4.9	1.3	ug/Kg		10/27/21 12:16	10/28/21 14:00	1
Heptachlor	ND		4.9	0.88	ug/Kg		10/27/21 12:16	10/28/21 14:00	1
Heptachlor epoxide	ND		4.9	0.66	ug/Kg		10/27/21 12:16	10/28/21 14:00	1
Methoxychlor	ND	F1 F2	4.9	0.80	ug/Kg		10/27/21 12:16	10/28/21 14:00	1
Toxaphene	ND		25	19	ug/Kg		10/27/21 12:16	10/28/21 14:00	1

Surrogate	%Recovery	Qualifier	Limits	Prepared	Analyzed	Dil Fac
DCB Decachlorobiphenyl (Surr)	65		37 - 151	10/27/21 12:16	10/28/21 14:00	1
Tetrachloro-m-xylene	67		38 - 148	10/27/21 12:16	10/28/21 14:00	1

Method: 8141A - Organophosphorous Pesticides (GC)

Analyte	Result	Qualifier	RL	MDL	Unit	D	Prepared	Analyzed	Dil Fac
Azinphos-methyl	ND		0.48	0.17	mg/Kg		10/26/21 11:12	11/02/21 07:37	1
Bolstar	ND		0.48	0.24	mg/Kg		10/26/21 11:12	11/02/21 07:37	1
Chlorpyrifos	ND		0.48	0.12	mg/Kg		10/26/21 11:12	11/02/21 07:37	1
Coumaphos	ND		0.48	0.19	mg/Kg		10/26/21 11:12	11/02/21 07:37	1
Demeton-o/s	ND		0.96	0.26	mg/Kg		10/26/21 11:12	11/02/21 07:37	1
Diazinon	ND		0.48	0.097	mg/Kg		10/26/21 11:12	11/02/21 07:37	1

Eurofins Calscience Irvine

Client Sample Results

Client: Cardno, Inc
Project/Site: Maverick El Central

Job ID: 440-290441-1
SDG: SWC Hawes & Ross Ave.

Client Sample ID: AG-3
Date Collected: 10/22/21 10:07
Date Received: 10/25/21 08:00

Lab Sample ID: 440-290441-3
Matrix: Solid

Method: 8141A - Organophosphorous Pesticides (GC) (Continued)

Analyte	Result	Qualifier	RL	MDL	Unit	D	Prepared	Analyzed	Dil Fac
Dichlorvos	ND		0.48	0.11	mg/Kg		10/26/21 11:12	11/02/21 07:37	1
Disulfoton	ND		0.48	0.12	mg/Kg		10/26/21 11:12	11/02/21 07:37	1
Ethoprop	ND		0.48	0.11	mg/Kg		10/26/21 11:12	11/02/21 07:37	1
Fensulfothion	ND		0.48	0.17	mg/Kg		10/26/21 11:12	11/02/21 07:37	1
Fenthion	ND		0.48	0.13	mg/Kg		10/26/21 11:12	11/02/21 07:37	1
Merphos	ND		0.48	0.21	mg/Kg		10/26/21 11:12	11/02/21 07:37	1
Methyl parathion	ND		0.48	0.24	mg/Kg		10/26/21 11:12	11/02/21 07:37	1
Mevinphos	ND		0.48	0.099	mg/Kg		10/26/21 11:12	11/02/21 07:37	1
Naled	ND		3.8	0.39	mg/Kg		10/26/21 11:12	11/02/21 07:37	1
Phorate	ND		0.48	0.12	mg/Kg		10/26/21 11:12	11/02/21 07:37	1
Ronnel	ND		0.48	0.13	mg/Kg		10/26/21 11:12	11/02/21 07:37	1
Stirophos	ND		1.9	0.14	mg/Kg		10/26/21 11:12	11/02/21 07:37	1
Tokuthion	ND		0.48	0.12	mg/Kg		10/26/21 11:12	11/02/21 07:37	1
Trichloronate	ND		0.48	0.11	mg/Kg		10/26/21 11:12	11/02/21 07:37	1
Surrogate	%Recovery	Qualifier	Limits				Prepared	Analyzed	Dil Fac
Tributylphosphate	75		20 - 158				10/26/21 11:12	11/02/21 07:37	1

Client Sample ID: AG-4
Date Collected: 10/22/21 10:07
Date Received: 10/25/21 08:00

Lab Sample ID: 440-290441-4
Matrix: Solid

Method: 8081A - Organochlorine Pesticides (GC)

Analyte	Result	Qualifier	RL	MDL	Unit	D	Prepared	Analyzed	Dil Fac
4,4'-DDD	ND		5.0	0.98	ug/Kg		10/27/21 12:16	10/28/21 16:53	1
4,4'-DDE	0.85	J p	5.0	0.53	ug/Kg		10/27/21 12:16	10/28/21 16:53	1
4,4'-DDT	ND		5.0	0.94	ug/Kg		10/27/21 12:16	10/28/21 16:53	1
Aldrin	ND		5.0	0.72	ug/Kg		10/27/21 12:16	10/28/21 16:53	1
alpha-BHC	ND		5.0	3.0	ug/Kg		10/27/21 12:16	10/28/21 16:53	1
alpha-Chlordane	ND		5.0	1.3	ug/Kg		10/27/21 12:16	10/28/21 16:53	1
beta-BHC	ND		5.0	3.6	ug/Kg		10/27/21 12:16	10/28/21 16:53	1
Chlordane	ND		25	2.4	ug/Kg		10/27/21 12:16	10/28/21 16:53	1
delta-BHC	ND		5.0	1.6	ug/Kg		10/27/21 12:16	10/28/21 16:53	1
Dieldrin	ND		5.0	0.25	ug/Kg		10/27/21 12:16	10/28/21 16:53	1
Endosulfan I	ND		5.0	1.1	ug/Kg		10/27/21 12:16	10/28/21 16:53	1
Endosulfan II	ND		5.0	0.31	ug/Kg		10/27/21 12:16	10/28/21 16:53	1
Endosulfan sulfate	ND		5.0	0.40	ug/Kg		10/27/21 12:16	10/28/21 16:53	1
Endrin	ND		5.0	0.33	ug/Kg		10/27/21 12:16	10/28/21 16:53	1
Endrin aldehyde	ND		5.0	1.8	ug/Kg		10/27/21 12:16	10/28/21 16:53	1
Endrin ketone	ND		5.0	0.47	ug/Kg		10/27/21 12:16	10/28/21 16:53	1
gamma-BHC	ND		5.0	0.62	ug/Kg		10/27/21 12:16	10/28/21 16:53	1
gamma-Chlordane	ND		5.0	1.3	ug/Kg		10/27/21 12:16	10/28/21 16:53	1
Heptachlor	ND		5.0	0.88	ug/Kg		10/27/21 12:16	10/28/21 16:53	1
Heptachlor epoxide	ND		5.0	0.66	ug/Kg		10/27/21 12:16	10/28/21 16:53	1
Methoxychlor	ND		5.0	0.80	ug/Kg		10/27/21 12:16	10/28/21 16:53	1
Toxaphene	ND		25	20	ug/Kg		10/27/21 12:16	10/28/21 16:53	1
Surrogate	%Recovery	Qualifier	Limits				Prepared	Analyzed	Dil Fac
DCB Decachlorobiphenyl (Surr)	57		37 - 151				10/27/21 12:16	10/28/21 16:53	1
Tetrachloro-m-xylene	57		38 - 148				10/27/21 12:16	10/28/21 16:53	1

Eurofins Calscience Irvine

Client Sample Results

Client: Cardno, Inc
Project/Site: Maverick EI Central

Job ID: 440-290441-1
SDG: SWC Hawes & Ross Ave.

Client Sample ID: AG-4
Date Collected: 10/22/21 10:07
Date Received: 10/25/21 08:00

Lab Sample ID: 440-290441-4
Matrix: Solid

Method: 8141A - Organophosphorous Pesticides (GC)

Analyte	Result	Qualifier	RL	MDL	Unit	D	Prepared	Analyzed	Dil Fac
Azinphos-methyl	ND		0.49	0.18	mg/Kg		10/26/21 11:12	11/02/21 08:24	1
Bolstar	ND		0.49	0.24	mg/Kg		10/26/21 11:12	11/02/21 08:24	1
Chlorpyrifos	ND		0.49	0.12	mg/Kg		10/26/21 11:12	11/02/21 08:24	1
Coumaphos	ND		0.49	0.19	mg/Kg		10/26/21 11:12	11/02/21 08:24	1
Demeton-o/s	ND		0.98	0.27	mg/Kg		10/26/21 11:12	11/02/21 08:24	1
Diazinon	ND		0.49	0.099	mg/Kg		10/26/21 11:12	11/02/21 08:24	1
Dichlorvos	ND		0.49	0.11	mg/Kg		10/26/21 11:12	11/02/21 08:24	1
Disulfoton	ND		0.49	0.12	mg/Kg		10/26/21 11:12	11/02/21 08:24	1
Ethoprop	ND		0.49	0.11	mg/Kg		10/26/21 11:12	11/02/21 08:24	1
Fensulfothion	ND		0.49	0.18	mg/Kg		10/26/21 11:12	11/02/21 08:24	1
Fenthion	ND		0.49	0.13	mg/Kg		10/26/21 11:12	11/02/21 08:24	1
Merphos	ND		0.49	0.21	mg/Kg		10/26/21 11:12	11/02/21 08:24	1
Methyl parathion	ND		0.49	0.24	mg/Kg		10/26/21 11:12	11/02/21 08:24	1
Mevinphos	ND		0.49	0.10	mg/Kg		10/26/21 11:12	11/02/21 08:24	1
Naled	ND		3.9	0.40	mg/Kg		10/26/21 11:12	11/02/21 08:24	1
Phorate	ND		0.49	0.13	mg/Kg		10/26/21 11:12	11/02/21 08:24	1
Ronnel	ND		0.49	0.13	mg/Kg		10/26/21 11:12	11/02/21 08:24	1
Stirophos	ND		2.0	0.14	mg/Kg		10/26/21 11:12	11/02/21 08:24	1
Tokuthion	ND		0.49	0.12	mg/Kg		10/26/21 11:12	11/02/21 08:24	1
Trichloronate	ND		0.49	0.12	mg/Kg		10/26/21 11:12	11/02/21 08:24	1

Surrogate	%Recovery	Qualifier	Limits	Prepared	Analyzed	Dil Fac
Tributylphosphate	184	S1+	20 - 158	10/26/21 11:12	11/02/21 08:24	1

Client Sample ID: AG-5
Date Collected: 10/22/21 10:07
Date Received: 10/25/21 08:00

Lab Sample ID: 440-290441-5
Matrix: Solid

Method: 8081A - Organochlorine Pesticides (GC)

Analyte	Result	Qualifier	RL	MDL	Unit	D	Prepared	Analyzed	Dil Fac
4,4'-DDD	ND		5.0	0.98	ug/Kg		10/27/21 12:16	10/28/21 14:15	1
4,4'-DDE	0.74	J p	5.0	0.53	ug/Kg		10/27/21 12:16	10/28/21 14:15	1
4,4'-DDT	ND		5.0	0.94	ug/Kg		10/27/21 12:16	10/28/21 14:15	1
Aldrin	ND		5.0	0.72	ug/Kg		10/27/21 12:16	10/28/21 14:15	1
alpha-BHC	ND		5.0	3.0	ug/Kg		10/27/21 12:16	10/28/21 14:15	1
alpha-Chlordane	ND		5.0	1.3	ug/Kg		10/27/21 12:16	10/28/21 14:15	1
beta-BHC	ND		5.0	3.6	ug/Kg		10/27/21 12:16	10/28/21 14:15	1
Chlordane	ND		25	2.3	ug/Kg		10/27/21 12:16	10/28/21 14:15	1
delta-BHC	ND		5.0	1.6	ug/Kg		10/27/21 12:16	10/28/21 14:15	1
Dieldrin	ND		5.0	0.25	ug/Kg		10/27/21 12:16	10/28/21 14:15	1
Endosulfan I	ND		5.0	1.1	ug/Kg		10/27/21 12:16	10/28/21 14:15	1
Endosulfan II	ND		5.0	0.30	ug/Kg		10/27/21 12:16	10/28/21 14:15	1
Endosulfan sulfate	ND		5.0	0.40	ug/Kg		10/27/21 12:16	10/28/21 14:15	1
Endrin	ND		5.0	0.33	ug/Kg		10/27/21 12:16	10/28/21 14:15	1
Endrin aldehyde	ND		5.0	1.8	ug/Kg		10/27/21 12:16	10/28/21 14:15	1
Endrin ketone	ND		5.0	0.47	ug/Kg		10/27/21 12:16	10/28/21 14:15	1
gamma-BHC	ND		5.0	0.62	ug/Kg		10/27/21 12:16	10/28/21 14:15	1
gamma-Chlordane	ND		5.0	1.3	ug/Kg		10/27/21 12:16	10/28/21 14:15	1
Heptachlor	ND		5.0	0.88	ug/Kg		10/27/21 12:16	10/28/21 14:15	1
Heptachlor epoxide	ND		5.0	0.66	ug/Kg		10/27/21 12:16	10/28/21 14:15	1

Eurofins Calscience Irvine

Client Sample Results

Client: Cardno, Inc
Project/Site: Maverick EI Central

Job ID: 440-290441-1
SDG: SWC Hawes & Ross Ave.

Client Sample ID: AG-5
Date Collected: 10/22/21 10:07
Date Received: 10/25/21 08:00

Lab Sample ID: 440-290441-5
Matrix: Solid

Method: 8081A - Organochlorine Pesticides (GC) (Continued)

Analyte	Result	Qualifier	RL	MDL	Unit	D	Prepared	Analyzed	Dil Fac
Methoxychlor	ND		5.0	0.80	ug/Kg		10/27/21 12:16	10/28/21 14:15	1
Toxaphene	ND		25	20	ug/Kg		10/27/21 12:16	10/28/21 14:15	1
Surrogate	%Recovery	Qualifier	Limits				Prepared	Analyzed	Dil Fac
DCB Decachlorobiphenyl (Surr)	55		37 - 151				10/27/21 12:16	10/28/21 14:15	1
Tetrachloro-m-xylene	54		38 - 148				10/27/21 12:16	10/28/21 14:15	1

Method: 8141A - Organophosphorous Pesticides (GC)

Analyte	Result	Qualifier	RL	MDL	Unit	D	Prepared	Analyzed	Dil Fac
Azinphos-methyl	ND		0.49	0.18	mg/Kg		10/26/21 11:12	11/02/21 09:12	1
Bolstar	ND		0.49	0.24	mg/Kg		10/26/21 11:12	11/02/21 09:12	1
Chlorpyrifos	ND		0.49	0.12	mg/Kg		10/26/21 11:12	11/02/21 09:12	1
Coumaphos	ND		0.49	0.19	mg/Kg		10/26/21 11:12	11/02/21 09:12	1
Demeton-o/s	ND		0.98	0.27	mg/Kg		10/26/21 11:12	11/02/21 09:12	1
Diazinon	ND		0.49	0.098	mg/Kg		10/26/21 11:12	11/02/21 09:12	1
Dichlorvos	ND		0.49	0.11	mg/Kg		10/26/21 11:12	11/02/21 09:12	1
Disulfoton	ND		0.49	0.12	mg/Kg		10/26/21 11:12	11/02/21 09:12	1
Ethoprop	ND		0.49	0.11	mg/Kg		10/26/21 11:12	11/02/21 09:12	1
Fensulfothion	ND		0.49	0.18	mg/Kg		10/26/21 11:12	11/02/21 09:12	1
Fenthion	ND		0.49	0.13	mg/Kg		10/26/21 11:12	11/02/21 09:12	1
Merphos	ND		0.49	0.21	mg/Kg		10/26/21 11:12	11/02/21 09:12	1
Methyl parathion	ND		0.49	0.24	mg/Kg		10/26/21 11:12	11/02/21 09:12	1
Mevinphos	ND		0.49	0.10	mg/Kg		10/26/21 11:12	11/02/21 09:12	1
Naled	ND		3.9	0.40	mg/Kg		10/26/21 11:12	11/02/21 09:12	1
Phorate	ND		0.49	0.13	mg/Kg		10/26/21 11:12	11/02/21 09:12	1
Ronnel	ND		0.49	0.13	mg/Kg		10/26/21 11:12	11/02/21 09:12	1
Stirophos	ND		2.0	0.14	mg/Kg		10/26/21 11:12	11/02/21 09:12	1
Tokuthion	ND		0.49	0.12	mg/Kg		10/26/21 11:12	11/02/21 09:12	1
Trichloronate	ND		0.49	0.12	mg/Kg		10/26/21 11:12	11/02/21 09:12	1
Surrogate	%Recovery	Qualifier	Limits				Prepared	Analyzed	Dil Fac
Tributylphosphate	132		20 - 158				10/26/21 11:12	11/02/21 09:12	1

Surrogate Summary

Client: Cardno, Inc
Project/Site: Maverick El Central

Job ID: 440-290441-1
SDG: SWC Hawes & Ross Ave.

Method: 8081A - Organochlorine Pesticides (GC)

Matrix: Solid

Prep Type: Total/NA

Percent Surrogate Recovery (Acceptance Limits)

Lab Sample ID	Client Sample ID	DCB1	TCX1
		(37-151)	(38-148)
440-290441-1	AG-1	61	63
440-290441-2	AG-2	55	57
440-290441-3	AG-3	65	67
440-290441-3 MS	AG-3	46	45
440-290441-3 MSD	AG-3	70	53
440-290441-4	AG-4	57	57
440-290441-5	AG-5	55	54
LCS 570-189723/2-A	Lab Control Sample	86	86
LCSD 570-189723/3-A	Lab Control Sample Dup	85	80
MB 570-189723/1-A	Method Blank	58	51

Surrogate Legend

DCB = DCB Decachlorobiphenyl (Surr)

TCX = Tetrachloro-m-xylene

Method: 8141A - Organophosphorous Pesticides (GC)

Matrix: Solid

Prep Type: Total/NA

Percent Surrogate Recovery (Acceptance Limits)

Lab Sample ID	Client Sample ID	TBPH1
		(20-158)
440-290441-1	AG-1	177 S1+
440-290441-2	AG-2	165 S1+
440-290441-3	AG-3	75
440-290441-4	AG-4	184 S1+
440-290441-5	AG-5	132
LCS 570-189184/2-A	Lab Control Sample	126
LCSD 570-189184/3-A	Lab Control Sample Dup	126
MB 570-189184/1-A	Method Blank	130

Surrogate Legend

TBPH = Tributylphosphate

Method Summary

Client: Cardno, Inc
Project/Site: Maverick El Central

Job ID: 440-290441-1
SDG: SWC Hawes & Ross Ave.

Method	Method Description	Protocol	Laboratory
8081A	Organochlorine Pesticides (GC)	SW846	ECL 1
8141A	Organophosphorous Pesticides (GC)	SW846	ECL 1
3546	Microwave Extraction	SW846	ECL 1

Protocol References:

SW846 = "Test Methods For Evaluating Solid Waste, Physical/Chemical Methods", Third Edition, November 1986 And Its Updates.

Laboratory References:

ECL 1 = Eurofins Calscience LLC Lincoln, 7440 Lincoln Way, Garden Grove, CA 92841, TEL (714)895-5494



Lab Chronicle

Client: Cardno, Inc
Project/Site: Maverick El Central

Job ID: 440-290441-1
SDG: SWC Hawes & Ross Ave.

Client Sample ID: AG-1

Lab Sample ID: 440-290441-1

Date Collected: 10/22/21 10:07

Matrix: Solid

Date Received: 10/25/21 08:00

Prep Type	Batch Type	Batch Method	Run	Dil Factor	Initial Amount	Final Amount	Batch Number	Prepared or Analyzed	Analyst	Lab
Total/NA	Prep	3546			20.17 g	10 mL	189723	10/27/21 12:16	USUL	ECL 1
Total/NA	Analysis	8081A		1			189920	10/28/21 16:39	UHHN	ECL 1
Total/NA	Prep	3546			10.40 g	10 mL	189184	10/26/21 11:12	USUL	ECL 1
Total/NA	Analysis	8141A		1			190821	11/02/21 06:02	UJ3K	ECL 1

Client Sample ID: AG-2

Lab Sample ID: 440-290441-2

Date Collected: 10/22/21 10:07

Matrix: Solid

Date Received: 10/25/21 08:00

Prep Type	Batch Type	Batch Method	Run	Dil Factor	Initial Amount	Final Amount	Batch Number	Prepared or Analyzed	Analyst	Lab
Total/NA	Prep	3546			20.11 g	10 mL	189723	10/27/21 12:16	USUL	ECL 1
Total/NA	Analysis	8081A		1			189920	10/28/21 13:46	UHHN	ECL 1
Total/NA	Prep	3546			10.04 g	10 mL	189184	10/26/21 11:12	USUL	ECL 1
Total/NA	Analysis	8141A		1			190821	11/02/21 06:49	UJ3K	ECL 1

Client Sample ID: AG-3

Lab Sample ID: 440-290441-3

Date Collected: 10/22/21 10:07

Matrix: Solid

Date Received: 10/25/21 08:00

Prep Type	Batch Type	Batch Method	Run	Dil Factor	Initial Amount	Final Amount	Batch Number	Prepared or Analyzed	Analyst	Lab
Total/NA	Prep	3546			20.24 g	10 mL	189723	10/27/21 12:16	USUL	ECL 1
Total/NA	Analysis	8081A		1			189920	10/28/21 14:00	UHHN	ECL 1
Total/NA	Prep	3546			10.42 g	10 mL	189184	10/26/21 11:12	USUL	ECL 1
Total/NA	Analysis	8141A		1			190821	11/02/21 07:37	UJ3K	ECL 1

Client Sample ID: AG-4

Lab Sample ID: 440-290441-4

Date Collected: 10/22/21 10:07

Matrix: Solid

Date Received: 10/25/21 08:00

Prep Type	Batch Type	Batch Method	Run	Dil Factor	Initial Amount	Final Amount	Batch Number	Prepared or Analyzed	Analyst	Lab
Total/NA	Prep	3546			20.16 g	10 mL	189723	10/27/21 12:16	USUL	ECL 1
Total/NA	Analysis	8081A		1			189920	10/28/21 16:53	UHHN	ECL 1
Total/NA	Prep	3546			10.19 g	10 mL	189184	10/26/21 11:12	USUL	ECL 1
Total/NA	Analysis	8141A		1			190821	11/02/21 08:24	UJ3K	ECL 1

Client Sample ID: AG-5

Lab Sample ID: 440-290441-5

Date Collected: 10/22/21 10:07

Matrix: Solid

Date Received: 10/25/21 08:00

Prep Type	Batch Type	Batch Method	Run	Dil Factor	Initial Amount	Final Amount	Batch Number	Prepared or Analyzed	Analyst	Lab
Total/NA	Prep	3546			20.19 g	10 mL	189723	10/27/21 12:16	USUL	ECL 1
Total/NA	Analysis	8081A		1			189920	10/28/21 14:15	UHHN	ECL 1
Total/NA	Prep	3546			10.23 g	10 mL	189184	10/26/21 11:12	USUL	ECL 1
Total/NA	Analysis	8141A		1			190821	11/02/21 09:12	UJ3K	ECL 1

Lab Chronicle

Client: Cardno, Inc
Project/Site: Maverick El Central

Job ID: 440-290441-1
SDG: SWC Hawes & Ross Ave.

Laboratory References:

ECL 1 = Eurofins Calscience LLC Lincoln, 7440 Lincoln Way, Garden Grove, CA 92841, TEL (714)895-5494

1

2

3

4

5

6

7

8

9

10

11

12

13

14

15

QC Sample Results

Client: Cardno, Inc
Project/Site: Maverick El Central

Job ID: 440-290441-1
SDG: SWC Hawes & Ross Ave.

Method: 8081A - Organochlorine Pesticides (GC)

Lab Sample ID: MB 570-189723/1-A
Matrix: Solid
Analysis Batch: 189920

Client Sample ID: Method Blank
Prep Type: Total/NA
Prep Batch: 189723

Analyte	MB	MB	RL	MDL	Unit	D	Prepared	Analyzed	Dil Fac
	Result	Qualifier							
4,4'-DDD	ND		5.0	0.99	ug/Kg		10/27/21 12:16	10/28/21 11:52	1
4,4'-DDE	ND		5.0	0.54	ug/Kg		10/27/21 12:16	10/28/21 11:52	1
4,4'-DDT	ND		5.0	0.94	ug/Kg		10/27/21 12:16	10/28/21 11:52	1
Aldrin	ND		5.0	0.72	ug/Kg		10/27/21 12:16	10/28/21 11:52	1
alpha-BHC	ND		5.0	3.0	ug/Kg		10/27/21 12:16	10/28/21 11:52	1
alpha-Chlordane	ND		5.0	1.3	ug/Kg		10/27/21 12:16	10/28/21 11:52	1
beta-BHC	ND		5.0	3.7	ug/Kg		10/27/21 12:16	10/28/21 11:52	1
Chlordane	ND		25	2.4	ug/Kg		10/27/21 12:16	10/28/21 11:52	1
delta-BHC	ND		5.0	1.6	ug/Kg		10/27/21 12:16	10/28/21 11:52	1
Dieldrin	ND		5.0	0.25	ug/Kg		10/27/21 12:16	10/28/21 11:52	1
Endosulfan I	ND		5.0	1.1	ug/Kg		10/27/21 12:16	10/28/21 11:52	1
Endosulfan II	ND		5.0	0.31	ug/Kg		10/27/21 12:16	10/28/21 11:52	1
Endosulfan sulfate	ND		5.0	0.40	ug/Kg		10/27/21 12:16	10/28/21 11:52	1
Endrin	ND		5.0	0.33	ug/Kg		10/27/21 12:16	10/28/21 11:52	1
Endrin aldehyde	ND		5.0	1.8	ug/Kg		10/27/21 12:16	10/28/21 11:52	1
Endrin ketone	ND		5.0	0.48	ug/Kg		10/27/21 12:16	10/28/21 11:52	1
gamma-BHC	ND		5.0	0.62	ug/Kg		10/27/21 12:16	10/28/21 11:52	1
gamma-Chlordane	ND		5.0	1.3	ug/Kg		10/27/21 12:16	10/28/21 11:52	1
Heptachlor	ND		5.0	0.89	ug/Kg		10/27/21 12:16	10/28/21 11:52	1
Heptachlor epoxide	ND		5.0	0.67	ug/Kg		10/27/21 12:16	10/28/21 11:52	1
Methoxychlor	ND		5.0	0.81	ug/Kg		10/27/21 12:16	10/28/21 11:52	1
Toxaphene	ND		25	20	ug/Kg		10/27/21 12:16	10/28/21 11:52	1

Surrogate	MB	MB	Limits	Prepared	Analyzed	Dil Fac
	%Recovery	Qualifier				
DCB Decachlorobiphenyl (Surr)	58		37 - 151	10/27/21 12:16	10/28/21 11:52	1
Tetrachloro-m-xylene	51		38 - 148	10/27/21 12:16	10/28/21 11:52	1

Lab Sample ID: LCS 570-189723/2-A
Matrix: Solid
Analysis Batch: 190353

Client Sample ID: Lab Control Sample
Prep Type: Total/NA
Prep Batch: 189723

Analyte	Spike Added	LCS	LCS	Unit	D	%Rec	%Rec.	Limits
		Result	Qualifier					
4,4'-DDD	25.0	21.1		ug/Kg		84		54 - 154
4,4'-DDE	25.0	21.1		ug/Kg		84		51 - 149
4,4'-DDT	25.0	22.8		ug/Kg		91		39 - 152
Aldrin	25.0	20.9		ug/Kg		83		52 - 138
alpha-BHC	25.0	21.5		ug/Kg		86		51 - 140
alpha-Chlordane	25.0	21.0		ug/Kg		84		53 - 141
beta-BHC	25.0	21.5		ug/Kg		86		53 - 141
delta-BHC	25.0	21.7		ug/Kg		87		20 - 132
Dieldrin	25.0	21.2		ug/Kg		85		52 - 144
Endosulfan I	25.0	21.3		ug/Kg		85		49 - 139
Endosulfan II	25.0	22.2		ug/Kg		89		51 - 150
Endosulfan sulfate	25.0	21.6		ug/Kg		87		45 - 139
Endrin	25.0	21.3		ug/Kg		85		53 - 151
Endrin aldehyde	25.0	23.8		ug/Kg		95		31 - 146
gamma-BHC	25.0	21.6		ug/Kg		86		53 - 141
gamma-Chlordane	25.0	22.3		ug/Kg		89		46 - 156

Eurofins Calscience Irvine

QC Sample Results

Client: Cardno, Inc
Project/Site: Maverick El Central

Job ID: 440-290441-1
SDG: SWC Hawes & Ross Ave.

Method: 8081A - Organochlorine Pesticides (GC) (Continued)

Lab Sample ID: LCS 570-189723/2-A
Matrix: Solid
Analysis Batch: 190353

Client Sample ID: Lab Control Sample
Prep Type: Total/NA
Prep Batch: 189723

Analyte	Spike Added	LCS Result	LCS Qualifier	Unit	D	%Rec	%Rec. Limits
Heptachlor	25.0	21.7		ug/Kg		87	52 - 144
Heptachlor epoxide	25.0	20.7		ug/Kg		83	54 - 141
Methoxychlor	25.0	22.9		ug/Kg		91	47 - 148

Surrogate	LCS %Recovery	LCS Qualifier	Limits
DCB Decachlorobiphenyl (Surr)	86		37 - 151
Tetrachloro-m-xylene	86		38 - 148

Lab Sample ID: LCSD 570-189723/3-A
Matrix: Solid
Analysis Batch: 190353

Client Sample ID: Lab Control Sample Dup
Prep Type: Total/NA
Prep Batch: 189723

Analyte	Spike Added	LCSD Result	LCSD Qualifier	Unit	D	%Rec	%Rec. Limits	RPD	Limit
4,4'-DDD	25.0	20.6		ug/Kg		82	54 - 154	2	30
4,4'-DDE	25.0	20.8		ug/Kg		83	51 - 149	1	28
4,4'-DDT	25.0	22.9		ug/Kg		92	39 - 152	1	31
Aldrin	25.0	19.2		ug/Kg		77	52 - 138	9	30
alpha-BHC	25.0	19.2		ug/Kg		77	51 - 140	11	29
alpha-Chlordane	25.0	19.8		ug/Kg		79	53 - 141	6	28
beta-BHC	25.0	19.2		ug/Kg		77	53 - 141	11	29
delta-BHC	25.0	18.5		ug/Kg		74	20 - 132	16	40
Dieldrin	25.0	20.2		ug/Kg		81	52 - 144	5	28
Endosulfan I	25.0	19.4		ug/Kg		78	49 - 139	9	28
Endosulfan II	25.0	22.5		ug/Kg		90	51 - 150	1	29
Endosulfan sulfate	25.0	19.6		ug/Kg		78	45 - 139	10	30
Endrin	25.0	20.6		ug/Kg		82	53 - 151	4	29
Endrin aldehyde	25.0	23.1		ug/Kg		92	31 - 146	3	40
gamma-BHC	25.0	19.2		ug/Kg		77	53 - 141	12	29
gamma-Chlordane	25.0	20.6		ug/Kg		83	46 - 156	8	39
Heptachlor	25.0	19.7		ug/Kg		79	52 - 144	10	29
Heptachlor epoxide	25.0	19.1		ug/Kg		76	54 - 141	8	29
Methoxychlor	25.0	23.6		ug/Kg		94	47 - 148	3	29

Surrogate	LCSD %Recovery	LCSD Qualifier	Limits
DCB Decachlorobiphenyl (Surr)	85		37 - 151
Tetrachloro-m-xylene	80		38 - 148

Lab Sample ID: 440-290441-3 MS
Matrix: Solid
Analysis Batch: 189920

Client Sample ID: AG-3
Prep Type: Total/NA
Prep Batch: 189723

Analyte	Sample Result	Sample Qualifier	Spike Added	MS Result	MS Qualifier	Unit	D	%Rec	%Rec. Limits
4,4'-DDD	ND		24.5	21.6		ug/Kg		88	27 - 144
4,4'-DDE	2.9	J p	24.5	16.6		ug/Kg		56	28 - 141
4,4'-DDT	ND		24.5	3.62	J	ug/Kg		15	10 - 154
Aldrin	ND		24.5	11.4		ug/Kg		47	26 - 125
alpha-BHC	ND		24.5	11.5		ug/Kg		47	24 - 125
alpha-Chlordane	ND		24.5	12.7		ug/Kg		52	17 - 144

Eurofins Calscience Irvine

QC Sample Results

Client: Cardno, Inc
Project/Site: Maverick El Central

Job ID: 440-290441-1
SDG: SWC Hawes & Ross Ave.

Method: 8081A - Organochlorine Pesticides (GC) (Continued)

Lab Sample ID: 440-290441-3 MS
Matrix: Solid
Analysis Batch: 189920

Client Sample ID: AG-3
Prep Type: Total/NA
Prep Batch: 189723

Analyte	Sample	Sample	Spike	MS	MS	Unit	D	%Rec	%Rec.	
	Result	Qualifier	Added	Result	Qualifier				Limits	RPD
beta-BHC	ND		24.5	11.3		ug/Kg		46	28 - 125	
delta-BHC	ND		24.5	12.2		ug/Kg		50	10 - 125	
Dieldrin	ND		24.5	12.3		ug/Kg		50	19 - 145	
Endosulfan I	ND		24.5	11.9		ug/Kg		48	25 - 125	
Endosulfan II	ND		24.5	12.0		ug/Kg		49	13 - 142	
Endosulfan sulfate	ND		24.5	10.3		ug/Kg		42	14 - 126	
Endrin	ND		24.5	11.7		ug/Kg		48	28 - 139	
Endrin aldehyde	ND		24.5	9.73		ug/Kg		40	12 - 125	
gamma-BHC	ND		24.5	10.6		ug/Kg		43	24 - 125	
gamma-Chlordane	ND		24.5	16.4		ug/Kg		67	10 - 160	
Heptachlor	ND		24.5	7.85		ug/Kg		32	19 - 127	
Heptachlor epoxide	ND		24.5	12.0		ug/Kg		49	33 - 123	
Methoxychlor	ND	F1 F2	24.5	2.27	J F1	ug/Kg		9	19 - 128	
MS MS										
Surrogate	%Recovery	Qualifier	Limits							
<i>DCB Decachlorobiphenyl (Surr)</i>	46		37 - 151							
<i>Tetrachloro-m-xylene</i>	45		38 - 148							

Lab Sample ID: 440-290441-3 MSD
Matrix: Solid
Analysis Batch: 189920

Client Sample ID: AG-3
Prep Type: Total/NA
Prep Batch: 189723

Analyte	Sample	Sample	Spike	MSD	MSD	Unit	D	%Rec	%Rec.		RPD	
	Result	Qualifier	Added	Result	Qualifier				Limits	RPD	Limit	
4,4'-DDD	ND		24.7	24.0		ug/Kg		97	27 - 144	10	40	
4,4'-DDE	2.9	J p	24.7	18.7		ug/Kg		64	28 - 141	12	32	
4,4'-DDT	ND		24.7	4.71	J	ug/Kg		19	10 - 154	26	40	
Aldrin	ND		24.7	12.8		ug/Kg		52	26 - 125	11	40	
alpha-BHC	ND		24.7	12.7		ug/Kg		51	24 - 125	10	40	
alpha-Chlordane	ND		24.7	14.0		ug/Kg		57	17 - 144	10	40	
beta-BHC	ND		24.7	12.6		ug/Kg		51	28 - 125	11	39	
delta-BHC	ND		24.7	13.9		ug/Kg		56	10 - 125	13	40	
Dieldrin	ND		24.7	13.1		ug/Kg		53	19 - 145	6	39	
Endosulfan I	ND		24.7	12.7		ug/Kg		51	25 - 125	7	39	
Endosulfan II	ND		24.7	14.4		ug/Kg		58	13 - 142	19	40	
Endosulfan sulfate	ND		24.7	12.6		ug/Kg		51	14 - 126	20	38	
Endrin	ND		24.7	12.9		ug/Kg		52	28 - 139	10	40	
Endrin aldehyde	ND		24.7	11.4		ug/Kg		46	12 - 125	16	40	
gamma-BHC	ND		24.7	11.8		ug/Kg		48	24 - 125	10	40	
gamma-Chlordane	ND		24.7	17.4		ug/Kg		70	10 - 160	6	40	
Heptachlor	ND		24.7	8.66		ug/Kg		35	19 - 127	10	40	
Heptachlor epoxide	ND		24.7	13.1		ug/Kg		53	33 - 123	9	34	
Methoxychlor	ND	F1 F2	24.7	4.06	J F1 F2	ug/Kg		16	19 - 128	57	40	
MSD MSD												
Surrogate	%Recovery	Qualifier	Limits									
<i>DCB Decachlorobiphenyl (Surr)</i>	70		37 - 151									
<i>Tetrachloro-m-xylene</i>	53		38 - 148									

QC Sample Results

Client: Cardno, Inc
Project/Site: Maverick El Central

Job ID: 440-290441-1
SDG: SWC Hawes & Ross Ave.

Method: 8141A - Organophosphorous Pesticides (GC)

Lab Sample ID: MB 570-189184/1-A
Matrix: Solid
Analysis Batch: 190821

Client Sample ID: Method Blank
Prep Type: Total/NA
Prep Batch: 189184

Analyte	MB	MB	RL	MDL	Unit	D	Prepared	Analyzed	Dil Fac
	Result	Qualifier							
Azinphos-methyl	ND		0.50	0.18	mg/Kg		10/25/21 17:24	11/02/21 03:39	1
Bolstar	ND		0.50	0.25	mg/Kg		10/25/21 17:24	11/02/21 03:39	1
Chlorpyrifos	ND		0.50	0.12	mg/Kg		10/25/21 17:24	11/02/21 03:39	1
Coumaphos	ND		0.50	0.20	mg/Kg		10/25/21 17:24	11/02/21 03:39	1
Demeton-o/s	ND		1.0	0.27	mg/Kg		10/25/21 17:24	11/02/21 03:39	1
Diazinon	ND		0.50	0.10	mg/Kg		10/25/21 17:24	11/02/21 03:39	1
Dichlorvos	ND		0.50	0.11	mg/Kg		10/25/21 17:24	11/02/21 03:39	1
Disulfoton	ND		0.50	0.12	mg/Kg		10/25/21 17:24	11/02/21 03:39	1
Ethoprop	ND		0.50	0.11	mg/Kg		10/25/21 17:24	11/02/21 03:39	1
Fensulfothion	ND		0.50	0.18	mg/Kg		10/25/21 17:24	11/02/21 03:39	1
Fenthion	ND		0.50	0.13	mg/Kg		10/25/21 17:24	11/02/21 03:39	1
Merphos	ND		0.50	0.22	mg/Kg		10/25/21 17:24	11/02/21 03:39	1
Methyl parathion	ND		0.50	0.25	mg/Kg		10/25/21 17:24	11/02/21 03:39	1
Mevinphos	ND		0.50	0.10	mg/Kg		10/25/21 17:24	11/02/21 03:39	1
Naled	ND		4.0	0.41	mg/Kg		10/25/21 17:24	11/02/21 03:39	1
Phorate	ND		0.50	0.13	mg/Kg		10/25/21 17:24	11/02/21 03:39	1
Ronnel	ND		0.50	0.14	mg/Kg		10/25/21 17:24	11/02/21 03:39	1
Stirophos	ND		2.0	0.14	mg/Kg		10/25/21 17:24	11/02/21 03:39	1
Tokuthion	ND		0.50	0.13	mg/Kg		10/25/21 17:24	11/02/21 03:39	1
Trichloronate	ND		0.50	0.12	mg/Kg		10/25/21 17:24	11/02/21 03:39	1

Surrogate	MB	MB	Limits	Prepared	Analyzed	Dil Fac
	%Recovery	Qualifier				
Tributylphosphate	130		20 - 158	10/25/21 17:24	11/02/21 03:39	1

Lab Sample ID: LCS 570-189184/2-A
Matrix: Solid
Analysis Batch: 190014

Client Sample ID: Lab Control Sample
Prep Type: Total/NA
Prep Batch: 189184

Analyte	Spike Added	LCS	LCS	Unit	D	%Rec	Limits
		Result	Qualifier				
Merphos	4.00	6.04	E	mg/Kg		151	20 - 180

Lab Sample ID: LCS 570-189184/2-A
Matrix: Solid
Analysis Batch: 190821

Client Sample ID: Lab Control Sample
Prep Type: Total/NA
Prep Batch: 189184

Analyte	Spike Added	LCS	LCS	Unit	D	%Rec	Limits
		Result	Qualifier				
Azinphos-methyl	4.00	4.98		mg/Kg		124	59 - 156
Bolstar	4.00	4.35		mg/Kg		109	45 - 145
Chlorpyrifos	4.00	4.27		mg/Kg		107	42 - 139
Coumaphos	4.00	4.48		mg/Kg		112	64 - 149
Diazinon	4.00	4.25		mg/Kg		106	36 - 149
Disulfoton	4.00	4.67		mg/Kg		117	45 - 132
Ethoprop	4.00	4.25		mg/Kg		106	41 - 138
Fensulfothion	4.00	4.41		mg/Kg		110	53 - 151
Fenthion	4.00	4.35		mg/Kg		109	49 - 150
Methyl parathion	4.00	4.62		mg/Kg		115	48 - 149
Phorate	4.00	4.33		mg/Kg		108	42 - 137
Ronnel	4.00	4.25		mg/Kg		106	45 - 141

Eurofins Calscience Irvine

QC Sample Results

Client: Cardno, Inc
Project/Site: Maverick El Central

Job ID: 440-290441-1
SDG: SWC Hawes & Ross Ave.

Method: 8141A - Organophosphorous Pesticides (GC) (Continued)

Lab Sample ID: LCS 570-189184/2-A
Matrix: Solid
Analysis Batch: 190821

Client Sample ID: Lab Control Sample
Prep Type: Total/NA
Prep Batch: 189184

Analyte	Spike Added	LCS Result	LCS Qualifier	Unit	D	%Rec	%Rec. Limits	
Stirophos	4.00	4.47		mg/Kg		112	43 - 166	
Tokuthion	4.00	4.28		mg/Kg		107	50 - 131	
Trichloronate	4.00	4.29		mg/Kg		107	45 - 138	
LCS LCS								
Surrogate	%Recovery	Qualifier						Limits
<i>Tributylphosphate</i>	126							20 - 158

Lab Sample ID: LCSD 570-189184/3-A
Matrix: Solid
Analysis Batch: 190014

Client Sample ID: Lab Control Sample Dup
Prep Type: Total/NA
Prep Batch: 189184

Analyte	Spike Added	LCSD Result	LCSD Qualifier	Unit	D	%Rec	%Rec. Limits	RPD	Limit
Merphos	4.00	5.74		mg/Kg		143	20 - 180	5	30

Lab Sample ID: LCSD 570-189184/3-A
Matrix: Solid
Analysis Batch: 190821

Client Sample ID: Lab Control Sample Dup
Prep Type: Total/NA
Prep Batch: 189184

Analyte	Spike Added	LCSD Result	LCSD Qualifier	Unit	D	%Rec	%Rec. Limits	RPD	Limit	
Azinphos-methyl	4.00	4.88		mg/Kg		122	59 - 156	2	27	
Bolstar	4.00	4.32		mg/Kg		108	45 - 145	1	24	
Chlorpyrifos	4.00	4.27		mg/Kg		107	42 - 139	0	28	
Coumaphos	4.00	4.51		mg/Kg		113	64 - 149	1	26	
Diazinon	4.00	4.21		mg/Kg		105	36 - 149	1	28	
Disulfoton	4.00	4.56		mg/Kg		114	45 - 132	2	27	
Ethoprop	4.00	4.35		mg/Kg		109	41 - 138	2	26	
Fensulfothion	4.00	4.37		mg/Kg		109	53 - 151	1	23	
Fenthion	4.00	4.34		mg/Kg		108	49 - 150	0	30	
Methyl parathion	4.00	4.71		mg/Kg		118	48 - 149	2	30	
Phorate	4.00	4.29		mg/Kg		107	42 - 137	1	29	
Ronnel	4.00	4.23		mg/Kg		106	45 - 141	1	30	
Stirophos	4.00	4.42		mg/Kg		111	43 - 166	1	25	
Tokuthion	4.00	4.28		mg/Kg		107	50 - 131	0	20	
Trichloronate	4.00	4.24		mg/Kg		106	45 - 138	1	30	
LCSD LCSD										
Surrogate	%Recovery	Qualifier								Limits
<i>Tributylphosphate</i>	126									20 - 158

QC Association Summary

Client: Cardno, Inc
Project/Site: Maverick El Central

Job ID: 440-290441-1
SDG: SWC Hawes & Ross Ave.

GC Semi VOA

Prep Batch: 189184

Lab Sample ID	Client Sample ID	Prep Type	Matrix	Method	Prep Batch
440-290441-1	AG-1	Total/NA	Solid	3546	
440-290441-2	AG-2	Total/NA	Solid	3546	
440-290441-3	AG-3	Total/NA	Solid	3546	
440-290441-4	AG-4	Total/NA	Solid	3546	
440-290441-5	AG-5	Total/NA	Solid	3546	
MB 570-189184/1-A	Method Blank	Total/NA	Solid	3546	
LCS 570-189184/2-A	Lab Control Sample	Total/NA	Solid	3546	
LCSD 570-189184/3-A	Lab Control Sample Dup	Total/NA	Solid	3546	

Prep Batch: 189723

Lab Sample ID	Client Sample ID	Prep Type	Matrix	Method	Prep Batch
440-290441-1	AG-1	Total/NA	Solid	3546	
440-290441-2	AG-2	Total/NA	Solid	3546	
440-290441-3	AG-3	Total/NA	Solid	3546	
440-290441-4	AG-4	Total/NA	Solid	3546	
440-290441-5	AG-5	Total/NA	Solid	3546	
MB 570-189723/1-A	Method Blank	Total/NA	Solid	3546	
LCS 570-189723/2-A	Lab Control Sample	Total/NA	Solid	3546	
LCSD 570-189723/3-A	Lab Control Sample Dup	Total/NA	Solid	3546	
440-290441-3 MS	AG-3	Total/NA	Solid	3546	
440-290441-3 MSD	AG-3	Total/NA	Solid	3546	

Analysis Batch: 189920

Lab Sample ID	Client Sample ID	Prep Type	Matrix	Method	Prep Batch
440-290441-1	AG-1	Total/NA	Solid	8081A	189723
440-290441-2	AG-2	Total/NA	Solid	8081A	189723
440-290441-3	AG-3	Total/NA	Solid	8081A	189723
440-290441-4	AG-4	Total/NA	Solid	8081A	189723
440-290441-5	AG-5	Total/NA	Solid	8081A	189723
MB 570-189723/1-A	Method Blank	Total/NA	Solid	8081A	189723
440-290441-3 MS	AG-3	Total/NA	Solid	8081A	189723
440-290441-3 MSD	AG-3	Total/NA	Solid	8081A	189723

Analysis Batch: 190014

Lab Sample ID	Client Sample ID	Prep Type	Matrix	Method	Prep Batch
LCS 570-189184/2-A	Lab Control Sample	Total/NA	Solid	8141A	189184
LCSD 570-189184/3-A	Lab Control Sample Dup	Total/NA	Solid	8141A	189184

Analysis Batch: 190353

Lab Sample ID	Client Sample ID	Prep Type	Matrix	Method	Prep Batch
LCS 570-189723/2-A	Lab Control Sample	Total/NA	Solid	8081A	189723
LCSD 570-189723/3-A	Lab Control Sample Dup	Total/NA	Solid	8081A	189723

Analysis Batch: 190821

Lab Sample ID	Client Sample ID	Prep Type	Matrix	Method	Prep Batch
440-290441-1	AG-1	Total/NA	Solid	8141A	189184
440-290441-2	AG-2	Total/NA	Solid	8141A	189184
440-290441-3	AG-3	Total/NA	Solid	8141A	189184
440-290441-4	AG-4	Total/NA	Solid	8141A	189184
440-290441-5	AG-5	Total/NA	Solid	8141A	189184
MB 570-189184/1-A	Method Blank	Total/NA	Solid	8141A	189184

Eurofins Calscience Irvine

QC Association Summary

Client: Cardno, Inc
Project/Site: Maverick El Central

Job ID: 440-290441-1
SDG: SWC Hawes & Ross Ave.

GC Semi VOA (Continued)

Analysis Batch: 190821 (Continued)

Lab Sample ID	Client Sample ID	Prep Type	Matrix	Method	Prep Batch
LCS 570-189184/2-A	Lab Control Sample	Total/NA	Solid	8141A	189184
LCSD 570-189184/3-A	Lab Control Sample Dup	Total/NA	Solid	8141A	189184

1

2

3

4

5

6

7

8

9

10

11

12

13

14

15

Definitions/Glossary

Client: Cardno, Inc
Project/Site: Maverick EI Central

Job ID: 440-290441-1
SDG: SWC Hawes & Ross Ave.

Qualifiers

GC Semi VOA

Qualifier	Qualifier Description
E	Result exceeded calibration range.
F1	MS and/or MSD recovery exceeds control limits.
F2	MS/MSD RPD exceeds control limits
J	Result is less than the RL but greater than or equal to the MDL and the concentration is an approximate value.
p	The %RPD between the primary and confirmation column/detector is >40%. The lower value has been reported.
S1+	Surrogate recovery exceeds control limits, high biased.

Glossary

Abbreviation	These commonly used abbreviations may or may not be present in this report.
α	Listed under the "D" column to designate that the result is reported on a dry weight basis
%R	Percent Recovery
CFL	Contains Free Liquid
CFU	Colony Forming Unit
CNF	Contains No Free Liquid
DER	Duplicate Error Ratio (normalized absolute difference)
Dil Fac	Dilution Factor
DL	Detection Limit (DoD/DOE)
DL, RA, RE, IN	Indicates a Dilution, Re-analysis, Re-extraction, or additional Initial metals/anion analysis of the sample
DLC	Decision Level Concentration (Radiochemistry)
EDL	Estimated Detection Limit (Dioxin)
LOD	Limit of Detection (DoD/DOE)
LOQ	Limit of Quantitation (DoD/DOE)
MCL	EPA recommended "Maximum Contaminant Level"
MDA	Minimum Detectable Activity (Radiochemistry)
MDC	Minimum Detectable Concentration (Radiochemistry)
MDL	Method Detection Limit
ML	Minimum Level (Dioxin)
MPN	Most Probable Number
MQL	Method Quantitation Limit
NC	Not Calculated
ND	Not Detected at the reporting limit (or MDL or EDL if shown)
NEG	Negative / Absent
POS	Positive / Present
PQL	Practical Quantitation Limit
PRES	Presumptive
QC	Quality Control
RER	Relative Error Ratio (Radiochemistry)
RL	Reporting Limit or Requested Limit (Radiochemistry)
RPD	Relative Percent Difference, a measure of the relative difference between two points
TEF	Toxicity Equivalent Factor (Dioxin)
TEQ	Toxicity Equivalent Quotient (Dioxin)
TNTC	Too Numerous To Count

Accreditation/Certification Summary

Client: Cardno, Inc
Project/Site: Maverick EI Central

Job ID: 440-290441-1
SDG: SWC Hawes & Ross Ave.

Laboratory: Eurofins Calscience LLC

All accreditations/certifications held by this laboratory are listed. Not all accreditations/certifications are applicable to this report.

Authority	Program	Identification Number	Expiration Date
Arkansas DEQ	State	88-0161	11-19-21
California	Los Angeles County Sanitation Districts	10109	09-30-22
California	SCAQMD LAP	17LA0919	11-30-21
California	State	2944	09-30-22
Guam	State	21-003R	06-22-22
Nevada	State	CA00111	07-31-22
Oregon	NELAP	CA300001	01-30-22
USDA	US Federal Programs	P330-20-00034	02-10-23
Washington	State	C916-18	10-12-22

- 1
- 2
- 3
- 4
- 5
- 6
- 7
- 8
- 9
- 10
- 11
- 12
- 13
- 14
- 15

Chain of Custody Record

Regulatory Program: DW NPDES RCRA Other

TestAmerica Laboratories, Inc. d/b/a Eurofins TestAmerica

Client Contact Company Name: <u>Cardano, Inc</u> Address: <u>1142 W 24th St, Suite 201A</u> City/State/Zip: <u>WVC WA 98148</u> Phone: <u>(801) 703-4487</u> FAX: Project Name: <u>Maverik El Central</u> Site: <u>SWC Hawes & Ross Ave</u> PO# <u>Job 822AR00978</u>		Project Manager: <u>Russ Hamblin</u> Email: <u>russ.hamblin@cardano.com</u> Tel/Fax: <u>(801) 703-4487 Com</u>		Site Contact: <u>Russ Hamblin</u> Date: <u>10-23-21</u> Lab Contact: Carrier:		COC No: _____ of _____ COCs TALS Project #: _____ Sampler: For Lab Use Only: Walk-in Client: _____ Lab Sampling: _____ Job / SDG No. _____																																											
Analysis Turnaround Time <input type="checkbox"/> CALENDAR DAYS <input type="checkbox"/> WORKING DAYS TAT if different from Below _____ <input type="checkbox"/> 2 weeks <input checked="" type="checkbox"/> 1 week <input type="checkbox"/> 2 days <input type="checkbox"/> 1 day		Sample Identification <table border="1" style="width:100%; border-collapse: collapse;"> <thead> <tr> <th>Sample Date</th> <th>Sample Time</th> <th>Sample Type (C=Comp, G=Grab)</th> <th>Matrix</th> <th># of Cont.</th> <th>Filtered Sample (Y/N)</th> <th>Performs / MSD (Y/N)</th> </tr> </thead> <tbody> <tr> <td>10-22-21</td> <td>1007</td> <td>G</td> <td>SO</td> <td>2</td> <td>✓</td> <td>✓</td> </tr> <tr> <td>10-22-21</td> <td>1107</td> <td>G</td> <td>SO</td> <td>2</td> <td>✓</td> <td>✓</td> </tr> <tr> <td>10-22-21</td> <td>1207</td> <td>G</td> <td>SO</td> <td>2</td> <td>✓</td> <td>✓</td> </tr> <tr> <td>10-22-21</td> <td>1307</td> <td>G</td> <td>SO</td> <td>2</td> <td>✓</td> <td>✓</td> </tr> <tr> <td>10-22-21</td> <td>1407</td> <td>G</td> <td>SO</td> <td>2</td> <td>✓</td> <td>✓</td> </tr> </tbody> </table>		Sample Date	Sample Time	Sample Type (C=Comp, G=Grab)	Matrix	# of Cont.	Filtered Sample (Y/N)	Performs / MSD (Y/N)	10-22-21	1007	G	SO	2	✓	✓	10-22-21	1107	G	SO	2	✓	✓	10-22-21	1207	G	SO	2	✓	✓	10-22-21	1307	G	SO	2	✓	✓	10-22-21	1407	G	SO	2	✓	✓	Preserved Samples (Y/N) Performs / MSD (Y/N) <u>Organic-Chlorine</u> <u>Organic-Pesticides</u>		Sample Specific Notes:	
Sample Date	Sample Time	Sample Type (C=Comp, G=Grab)	Matrix	# of Cont.	Filtered Sample (Y/N)	Performs / MSD (Y/N)																																											
10-22-21	1007	G	SO	2	✓	✓																																											
10-22-21	1107	G	SO	2	✓	✓																																											
10-22-21	1207	G	SO	2	✓	✓																																											
10-22-21	1307	G	SO	2	✓	✓																																											
10-22-21	1407	G	SO	2	✓	✓																																											
Preservation Used: 1- Ice, 2- HCl, 3- H2SO4, 4- HNO3, 5- H2O2, 6- OMS		Possible Hazard Identification: Are any samples from a listed EPA Hazardous Waste? Please List any EPA Waste Codes for the sample in the Comments Section if the lab is to dispose of the sample. <input type="checkbox"/> Non-Hazard <input type="checkbox"/> Flammable <input type="checkbox"/> Skin Irritant <input type="checkbox"/> Poison B <input type="checkbox"/> Unknown		Sample Disposal (A fee may be assessed if samples are retained longer than 1 month) <input type="checkbox"/> Return to Client <input type="checkbox"/> Disposal by Lab <input type="checkbox"/> Archive for _____ Months		 440-290441 Chain of Custody																																											
Special Instructions/QC Requirements & Comments:																																																	
Custody Seals Intact: <input type="checkbox"/> Yes <input type="checkbox"/> No		Custody Seal No. _____		Cooler Temp. (°C): Obs'd: <u>25</u> Cor'd: <u>24</u>		Therm ID No.: <u>12-90</u>																																											
Relinquished by: <u>[Signature]</u>		Company: <u>Cardano</u>		Date/Time: <u>10-25-21</u>		Received by: _____																																											
Relinquished by: _____		Company: _____		Date/Time: _____		Received by: _____																																											
Relinquished by: _____		Company: _____		Date/Time: _____		Received in Laboratory by: <u>[Signature]</u>																																											
Company: _____		Company: <u>ECIRV</u>		Date/Time: <u>1/25/21</u>		Date/Time: <u>0800</u>																																											



Eurofins Calscience Irvine

17461 Derian Ave Suite 100
 Irvine CA 92614-5817
 Phone 949-261-1022 Fax. 949-260-3297

Chain of Custody Record

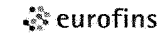

Environment
 America

Client Information (Sub Contract Lab)		Sampler		Lab PM Roberts, Danielle C		Carrier Tracking No(s):		COC No: 440-174635 1	
Client Contact: Shipping/Receiving		Phone:		E-Mail Danielle.Roberts@Eurofinset.com		State of Origin Colorado		Page Page 1 of 1	
Company Eurofins Calscience LLC		Due Date Requested 11/1/2021		Accreditations Required (See note): State Program - California		Job # 440-290441-1		Preservation Codes	
Address 7440 Lincoln Way,		TAT Requested (days)		Analysis Requested Field Filtered Sample (Yes or No) Perform MS/MSD (Yes or No) 8141A/3546 Routine OP Pesticides (standard spike list) 8151A/8151A_SP Routine Herbicides List (full spike list)		Total Number of Containers		A HCL M Hexane B - NaOH N None C Zn Acetate O AsNaO2 D Nitric Acid P Na2O4S E NaHSO4 Q Na2SO3 F - MeOH R Na2S2O3 G Amchlor S H2SO4 H Ascorbic Acid T TSP Dodecahydrate I Ice U Acetone J - DI Water V MCAA K EDTA W pH 4-5 L EDA Z other (specify)	
City Garden Grove		PO #:						Other:	
State, Zip CA, 92841		WO #:							
Phone: 714-895-5494(Tel) 714-894-7501(Fax)		Project #: 44020738							
Email		SSOW#:							
Project Name: Soil & Water		Site:							
Sample Identification - Client ID (Lab ID)		Sample Date	Sample Time	Sample Type (C=comp, G=grab)	Matrix (W=water, S=solid, O=waste/oil, BT=Tissue, A=Air)	Preservation Code:		Special Instructions/Note	
AG-1 (440-290441-1)	10/22/21	10:07 Mountain	Solid			X	X		2
AG-2 (440-290441-2)	10/22/21	10:07 Mountain	Solid			X	X		2
AG-3 (440-290441-3)	10/22/21	10:07 Mountain	Solid			X	X		2
AG-4 (440-290441-4)	10/22/21	10:07 Mountain	Solid			X	X		2
AG-5 (440-290441-5)	10/22/21	10:07 Mountain	Solid			X	X		2
Note: Since laboratory accreditations are subject to change, Eurofins Calscience places the ownership of method analyte & accreditation compliance upon out subcontract laboratories. This sample shipment is forwarded under chain-of-custody. If the laboratory does not currently maintain accreditation in the State of Origin listed above for analysis/tests/matrix being analyzed, the samples must be shipped back to the Eurofins Calscience laboratory or other instructions will be provided. Any changes to accreditation status should be brought to Eurofins Calscience attention immediately. If all requested accreditations are current to date, return the signed Chain of Custody attesting to said compliance to Eurofins Calscience.									
Possible Hazard Identification					Sample Disposal (A fee may be assessed if samples are retained longer than 1 month)				
Unconfirmed					<input type="checkbox"/> Return To Client <input type="checkbox"/> Disposal By Lab <input type="checkbox"/> Archive For _____ Months				
Deliverable Requested I, II, III, IV, Other (specify)			Primary Deliverable Rank 2		Special Instructions/QC Requirements				
Empty Kit Relinquished by:		Date	Time	Method of Shipment:					
Relinquished by: <i>[Signature]</i>		Date/Time: 10/25/21 0930	Company: <i>[Signature]</i>	Received by: <i>[Signature]</i>		Date/Time: 10/25/21 0930	Company: <i>[Signature]</i>		
Relinquished by:		Date/Time:	Company:	Received by:		Date/Time:	Company:		
Relinquished by:		Date/Time:	Company:	Received by:		Date/Time:	Company:		
Custody Seals Intact:	Custody Seal No	Cooler Temperature(s) °C and Other Remarks: 2.1/3.0 SCS							
Δ Yes Δ No									

Page 26 of 28

EEC ORIGINAL PKG 11/2/2021



Login Sample Receipt Checklist

Client: Cardno, Inc

Job Number: 440-290441-1
SDG Number: SWC Hawes & Ross Ave.

Login Number: 290441

List Number: 1

Creator: Skinner, Alma D

List Source: Eurofins Calscience Irvine

Question	Answer	Comment
Radioactivity wasn't checked or is </= background as measured by a survey meter.	True	
The cooler's custody seal, if present, is intact.	N/A	Not present
Sample custody seals, if present, are intact.	N/A	Not Present
The cooler or samples do not appear to have been compromised or tampered with.	True	
Samples were received on ice.	True	
Cooler Temperature is acceptable.	True	
Cooler Temperature is recorded.	True	
COC is present.	True	
COC is filled out in ink and legible.	True	
COC is filled out with all pertinent information.	True	
Is the Field Sampler's name present on COC?	True	
There are no discrepancies between the containers received and the COC.	True	
Samples are received within Holding Time (excluding tests with immediate HTs)	True	
Sample containers have legible labels.	True	
Containers are not broken or leaking.	True	
Sample collection date/times are provided.	True	
Appropriate sample containers are used.	True	
Sample bottles are completely filled.	True	
Sample Preservation Verified.	N/A	
There is sufficient vol. for all requested analyses, incl. any requested MS/MSDs	True	
Containers requiring zero headspace have no headspace or bubble is <6mm (1/4").	True	
Multiphasic samples are not present.	True	
Samples do not require splitting or compositing.	True	
Residual Chlorine Checked.	N/A	



Login Sample Receipt Checklist

Client: Cardno, Inc

Job Number: 440-290441-1
SDG Number: SWC Hawes & Ross Ave.

Login Number: 290441
List Number: 2
Creator: Cruise, Noel

List Source: Eurofins Calscience LLC
List Creation: 10/25/21 02:48 PM

Question	Answer	Comment
Radioactivity wasn't checked or is </= background as measured by a survey meter.	N/A	
The cooler's custody seal, if present, is intact.	N/A	Not present
Sample custody seals, if present, are intact.	N/A	Not Present
The cooler or samples do not appear to have been compromised or tampered with.	True	
Samples were received on ice.	True	
Cooler Temperature is acceptable.	True	
Cooler Temperature is recorded.	True	3.0
COC is present.	True	
COC is filled out in ink and legible.	True	
COC is filled out with all pertinent information.	True	
Is the Field Sampler's name present on COC?	False	Received project as a subcontract.
There are no discrepancies between the containers received and the COC.	True	
Samples are received within Holding Time (excluding tests with immediate HTs)	True	
Sample containers have legible labels.	True	
Containers are not broken or leaking.	True	
Sample collection date/times are provided.	True	
Appropriate sample containers are used.	True	
Sample bottles are completely filled.	True	
Sample Preservation Verified.	True	
There is sufficient vol. for all requested analyses, incl. any requested MS/MSDs	True	
Containers requiring zero headspace have no headspace or bubble is <6mm (1/4").	True	
Multiphasic samples are not present.	True	
Samples do not require splitting or compositing.	True	
Residual Chlorine Checked.	N/A	





Preliminary Drainage Study

This page intentionally left blank.

PRELIMINARY DRAINAGE STUDY

FOR
MAVERIK FUELING STATION AND CONVENIENCE STORE



PREPARED FOR:
Willis Environmental Planning

Prepared 11-14-23



LC ENGINEERING CONSULTANTS INC.

CIVIL ENGINEERING • LAND SURVEYING • CONSTRUCTION MANAGEMENT SERVICES
1065 STATE STREET, EL CENTRO, CA. 92243 TEL 760.353.8110 FAX 760.562.6408

EEC ORIGINAL PKG

Table of Contents

1	INTRODUCTION	3
	1.1 Purpose	3
2	LOCATION	3
3	SITE CONDITIONS AND PROPOSED DEVELOPMENT	5
4	FEMA FLOODPLAIN CLASSIFICATION	6
5	STORMWATER MANAGEMENT	7
	5.1 Existing Drainage Conditions	7
	5.2 Proposed Drainage Conditions	7
	5.3 Retention Basin Calculation Parameters	8
	5.4 Retention Basin Sizing	8
6	CONCLUSIONS	9
7	REFERENCES	9

List of Figures

Figure 1: Project Vicinity Map	4
Figure 2: Project Site Map	5

Exhibits

Exhibit A – FEMA FIRM Panel
Exhibit B – Drainage Map

1 INTRODUCTION

1.1 PURPOSE

The purpose of this drainage report is to present the drainage criteria, methodology and analysis of on-site drainage conditions, in support of the Maverik Fueling Station and Convenience Store and to provide recommendations for drainage and grading concepts for the proposed site development. This report addresses the recommended onsite drainage facilities by:

- Establishing drainage design criteria and concepts.
- Describing the existing and proposed drainage patterns.
- It is established in this drainage study that the whole project area will drain a proposed retention basin that will be located on the southwest side of the site.
- The drainage design will be conducted in accordance with the County of Imperial's design criteria which establishes that 100% of the 100-year storm (3 inches of rain) will be stored on-site and released into the IID drainage system using existing drainage connections.

Calculations were performed according to the methodology and procedures outlined in the *County of Imperial Department of Public Works Engineering Design Guidelines Manual for the Preparation and Checking of Street Improvements, Drainage and Grading Plans with Imperial County, 2008*.

Included in the appendices are the on-site drainage maps and retention calculations.

2 LOCATION

Maverik is proposing to develop a fueling station and convenience store on a 10-acre Assessor's Parcel Number (APN) 054-080-023. The Project would be located on 10 gross acres of the approximately 50-acre parcel within unincorporated Imperial County (County), California, approximately 1.5 miles east of the City of El Centro (Figure 1, Vicinity Map). The Project site is located on the southeast corner of Hawes Road and Ross Avenue, east of State Route 111 (SR-111/Imperial Valley Pioneers Expressway) and is bound by Ross Avenue on the north, by Hawes Road and the Imperial Irrigation District's Acacia

Five Drain A on the west (Figure 2, Project Site). The Project site is located within Section 11 of Township 16 South, Range 14 East, San Bernardino Base Meridian. The westbound offramp of Interstate 8 at SR-111 is located approximately 0.25 miles south of the Project site.



Figure 1: Project Vicinity Map



Figure 2: Project Site Map

3 SITE CONDITIONS AND PROPOSED DEVELOPMENT

The Project site is located at an elevation of approximately 36 feet below mean seal level (MSL) and slopes gently toward the west. The Project site has previously been used for agricultural purposes since at least 1937 and is currently an undeveloped alfalfa field. According to the most recent California Department of Conservation Farmland Mapping and Monitoring Program (FMMP) the Project site is entirely comprised of Prime Farmland (P) and is not subject to a Williamson Act contract (California Dept. of Conservation., 2023a and 2023b)

The Maverik Fueling Station and Convenience Store Project (proposed Project or Project) includes 19 fuel pumps (38 fueling positions) under two separate canopies (totaling 9,0000 square feet [SF]), and a 5,982 SF convenience store building. Additional improvements include three (3) underground storage tanks for fuel storage; two underground water storage tanks; on-site water and wastewater treatment facilities; parking, landscaping, drainage, and access improvements.

Vehicular access would be provided via three (3) ingress/egress drives along the south side of Ross Avenue. The westernmost access would be a 40-foot driveway that would allow for a left and right-turn movements by vehicles accessing the fueling area and convenience store (Figure 6, Site Plan). This entrance would be located approximately 215 feet east of the Ross Avenue/SR-111 intersection. The second proposed entrance would be located approximately 150 feet east of the first and would provide a 60-foot inbound/outbound driveway leading directly to the proposed truck fueling stations. The third and easternmost driveway would be located 220 feet east of the second and would provide a 50-foot driveway that would permit the full range of left and right-turn movements, inbound and outbound. All driveways' entrances would be constructed in accordance with the County's Road Standards.

Parking would be provided in three (3) parking areas for a total of 45 parking spaces, including 2 accessible spaces. No overnight parking would be allowed and parking within the fueling area would be limited to 30 minutes.

It is established in this drainage study that the entire Project will drain to the proposed retention basin and supported by the hydrology and hydraulic calculation it is determined that the proposed retention basin has the capacity to retain the volume resulting from a 100-year storm (3 inches of rain) over the entire drainage area of the project.

4 FEMA FLOODPLAIN CLASSIFICATION

Please note that according to the Federal Emergency Management Agency's Flood Insurance Rate Map (FIRM Panel 1750 of 2300 with Map Number 06025C1750C and FIRM Panel 1725 of 2300 with Map Number 06025C1725C with an effective date of September 26, 2008) the project site lies entirely within Zone "X". A partial copy of the referenced FEMA map is included in the report.

5 STORM WATER MANAGEMENT

5.1 Existing Drainage Conditions

The existing farm fields are graded to compounded planar slopes. Generally, the fields slope from east to west at slope percentage rates between 0.10% to 0.20%. The flat topography allows for the irrigation water to move slowly over the field and promote absorption in the existing clay soils.

Irrigation tailwater outlet boxes and 12" diameter concrete pipes drain the excess irrigation tailwater and storm event runoff water to the IID drains at all low areas for each farm field. Elevated field roads or drain bank maintenance roads that are graded to about one foot above the adjacent farm field, are located at the low ends of each field.

Based upon review of the existing topography, it is determined that off-site run off does not enter the project development areas due to the presence of physical features presenting barriers to the off-site flow (County Roads, IID Canal and Drains and private field roads). On-site retention will be provided to maintain the existing drainage conditions to handle the 100-year storm water flows to exit the site by means of the existing IID outlet discharge structures.

In most of the farm fields there is an existing subsurface tile drain system used to remove salts accumulating from agricultural irrigation and crop production. The existing tile drainpipes are located approximately 5' to 8' below existing grade. The existing site tile drain systems will remain in place and will only be removed from the site if they conflict with permanent structures (such as transmission power poles, collection systems, substation equipment etc.)

5.2 Proposed Drainage Conditions

The site will be developed with a Maverik Fueling Station and Convenience Store. The project will be graded to direct the drainage to the retention basin by sheet flow or through a drainage system consisting of catch basins and drainage pipes,. The drainage analysis is based on on-site volumes and will include the amount of storm water generated by the 100-year storm (3 inches of rain) and it is assumed that 100% of the 100-year storm (a "C" factor of 1) will be retained on site.

The existing IID drain connections and a 12" diameter concrete discharge pipes will be utilized to drain out the retention basin. The runoff volume resulting from

100-year storm (3 inches of rain). Retention basin calculations have been provided in Exhibits B and section 5.4.

All on-site storm water runoffs will be managed internally, and no storm water runoffs will be disposed on to any County Public Right of Way.

The project after a 100-year storm event should empty within 72 hours in order to provide mosquito abatement. If this is not possible then the owner should provide a mosquito abatement plan to the satisfaction of the Environmental Health Services Department (EHS).

The existing outlet discharge pipe will be upgraded (if required) in accordance with IID Standards to satisfy the requirements of the Hydrology/Hydraulic analysis performed by IID for the agricultural base flow conditions and the modeling scenario for the 100yr-24hr rainfall event contributions to the existing drain systems within the project area.

5.3 Retention Basin Calculation Parameters

Hydrologic calculations are made in accordance with the following parameters:

1. The total volume retained will be 100% of the 100-year storm (3 inches of rain).
2. Retention will be provided in a designated retention basin located at the southwest side of the site; the proposed retention basin will discharge into the IID Acacia Drain.

5.4 Retention Basin Sizing

The retention basins are sized according to the County of Imperial Public Works Department Drainage Design Criteria:

The volume is calculated using the following equation:

$$V=A \times P \times C$$

Where

V= Required storage volume in Cubic Feet

T-A= Total Area of the project in Acres (10 Acres)

D-A= Drainage Area of the project in Acres (8.34 Acres)

P= Precipitation depth in inches (3 inches)
C= Runoff coefficient reduction factor (1)

Storage Required

$$V=8.34 \times \frac{3}{12} \times 1 = 2.08 \text{ AC-FT}$$

Storage Provided

Water level Area = 0.59 AC
Basin Bottom Area = 0.33 AC
Average = 0.48 Ac
Basin Depth at water level = 4.50 FT
 $V = 0.48 \times 4.50 = 2.16 \text{ AC -}$

Storage provided > Storage required.
Therefore, the Retention basin size is **ADEQUATE**.

6 CONCLUSIONS

This drainage study report was prepared in accordance with the County of Imperial's design criteria that establishes that 100% of the 100-year storm (3 inches of rain) will be stored on-site and drainage be released into the IID drainage system using an existing drainage connection. Additionally, the following facts were considered in the preparation of the drainage report:

- Project drainage area will drain into the proposed retention basin located at the north side of the site.
- The drainage stored in the retention basin will be released in less than 72 hours or else a mosquito abatement plan shall be implemented.
- Connections to existing IID drainage facilities will be done according to the Imperial Irrigation District standards and according to the encroachment document conditions.
- It has been determined that off-site drainage from existing roads and adjacent fields have no impacts on the on-site drainage retention capacity.

7 REFERENCES

County of Imperial Department of Public Works, Engineering Design Guidelines Manual for the Preparation and Checking of Street Improvements, Drainage and Grading Plans within Imperial County, September 2008.

Exhibits

National Flood Hazard Layer FIRMeTte



115°30'14"W 32°47'10"N



EEC ORIGINAL PKG

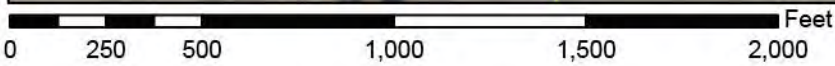

1:6,000

115°29'37"W 32°46'39"N

Basemap Imagery Source: USGS National Map 2023

Legend EXHIBIT A

SEE FIS REPORT FOR DETAILED LEGEND AND INDEX MAP FOR FIRM PANEL LAYOUT

SPECIAL FLOOD HAZARD AREAS		Without Base Flood Elevation (BFE) <i>Zone A, V, A99</i>
		With BFE or Depth <i>Zone AE, AO, AH, VE, AR</i>
		Regulatory Floodway
OTHER AREAS OF FLOOD HAZARD		0.2% Annual Chance Flood Hazard, Areas of 1% annual chance flood with average depth less than one foot or with drainage areas of less than one square mile <i>Zone X</i>
		Future Conditions 1% Annual Chance Flood Hazard <i>Zone X</i>
		Area with Reduced Flood Risk due to Levee. See Notes. <i>Zone X</i>
		Area with Flood Risk due to Levee <i>Zone D</i>
OTHER AREAS		NO SCREEN Area of Minimal Flood Hazard <i>Zone X</i>
		Effective LOMRs
GENERAL STRUCTURES		Area of Undetermined Flood Hazard <i>Zone D</i>
		Channel, Culvert, or Storm Sewer
		Levee, Dike, or Floodwall
OTHER FEATURES		20.2 Cross Sections with 1% Annual Chance Water Surface Elevation
		17.5 Coastal Transect
		Base Flood Elevation Line (BFE)
		Limit of Study
MAP PANELS		Jurisdiction Boundary
		Coastal Transect Baseline
		Profile Baseline
		Hydrographic Feature
		Digital Data Available
		No Digital Data Available
		Unmapped
		The pin displayed on the map is an approximate point selected by the user and does not represent an authoritative property location.

This map complies with FEMA's standards for the use of digital flood maps if it is not void as described below. The basemap shown complies with FEMA's basemap accuracy standards

The flood hazard information is derived directly from the authoritative NFHL web services provided by FEMA. This map was exported on **11/14/2023 at 6:53 PM** and does not reflect changes or amendments subsequent to this date and time. The NFHL and effective information may change or become superseded by new data over time.

This map image is void if the one or more of the following map elements do not appear: basemap imagery, flood zone labels, legend, scale bar, map creation date, community identifiers, FIRM panel number, and FIRM effective date. Map images for unmapped and unmodernized areas cannot be used for regulatory purposes.

L:\Projects\2023\23011-00 (DDC-Maverick CECA Level)\Drainage-CECA Level\CAD\C23011-00_DRAINAGE.dwg 11/14/2023 17:59

ECC ORIGINAL PLAN

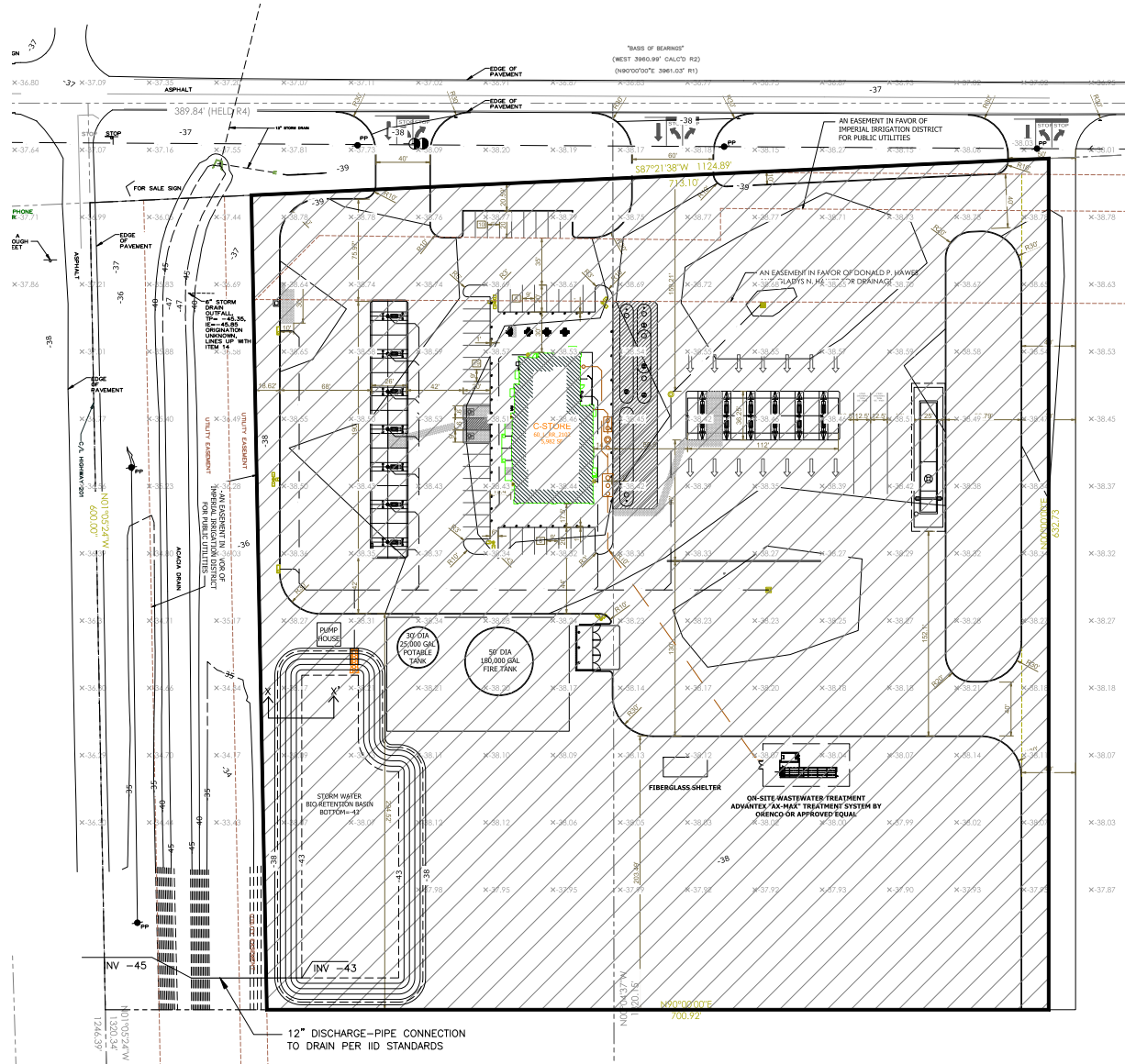
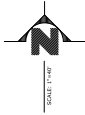

LEGEND



DRAINAGE CALCULATIONS:

- A) RETENTION BASIN (STORAGE REQUIRED) OF A 100 YEAR STORM (3 INCHES OF RAIN)
 TOTAL PROPERTY AREA=10.00 AC.
 DRAINAGE AREA=8.34 AC.
 $V=AREA \times 3"$
 $V=3/12 \times 8.34 = 2.08 \text{ AC-FT}$
- B) RETENTION BASIN (TOTAL STORAGE PROVIDED)
 TOP OF WATER AREA = 0.59 AC
 BOTTOM AREA= 0.33 AC
 AVERAGE= 0.48 AC
 DEPTH= 4.50 FEET
 $VOL= 4.5 \times 0.48 = 2.16 \text{ AC-FT}$

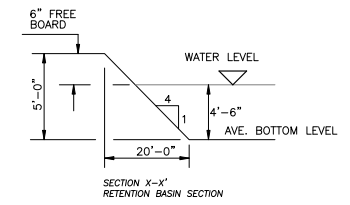

UNDERGROUND SERVICE ALERT
 CALL: TOLL FREE
 811
 TWO WORKING DAYS
 BEFORE YOU DIG

No.	DESCRIPTION	BY	DATE	APPROVED BY:
				COUNTY OF IMPERIAL
				BY: _____ DATE: _____
				R.C.E. NO.: _____

ENGINEER OF RECORD
 PLANS PREPARED UNDER THE SUPERVISION OF
 BY: CARLOS CORRALES, P.E. DATE: _____
 R.C.E. NO.: 55432

SEAL

 www.lc-engineering.com
 1065 State Street
 El Centro CA 92543
 (760) 325-1997

DATE: NOV. 14, 2023 BENCHMARK: SEE SHEET NO. 1

DRAINAGE MAP
 EXHIBIT B
 MAVERICK FUELING STATION
 AND CONVENIENCE STORE
 WILLIS ENVIRONMENTAL PLANNING

SHEET
 1 OF 1 SHEETS
 JOB NO.
 C23011-00

J

Noise Analysis

This page intentionally left blank.

MAVERIK FUELING STATION AND CONVENIENCE STORE PROJECT

NOISE STUDY

Prepared for:

Christina Willis, President
Willis Environmental Planning
238 Sychar Road
San Diego, CA 92114

Prepared by:



March 2024

EEC ORIGINAL PKG

MAVERIK FUELING STATION AND CONVENIENCE STORE PROJECT IMPERIAL COUNTY, CALIFORNIA Noise Study

Table of Contents

	Page
Project Description	1
Setting	4
Overview of Sound Measurement	4
Project Site Setting	6
Sensitive Receptors	8
Regulatory Setting	8
Vibration Standards	10
Impact Analysis	11
Methodology and Significance Thresholds	11
Temporary Construction Noise	12
Operational Noise Exposure	14
Temporary Construction Vibration	14
Operational Vibration	14
Conclusion	14
References	20

List of Figures

Figure 1 – Vicinity Map	2
Figure 2 – Site Plan	3
Figure 3 – Noise Monitoring Locations	7
Figure 4 – Noise Receivers	16

List of Tables

Table 1: Sound Levels of Typical Noise Sources and Environments	5
Table 2: Noise Monitoring Results	6
Table 3: Property Line Noise Level Limits	8

Table 4: Human Reaction and Damage to Buildings for Continuous or Frequent Intermittent Vibration Levels 10

Table 5: Typical Maximum Construction Noise Levels at Various Distances from Project Construction..... 13

Table 6: Modeled Noise Levels..... 15

Table 7: Vibration Source Levels for Construction Equipment 18

Appendices

Appendix A - Monitoring Sheet and Modeling Files

MAVERIK FUELING STATION AND CONVENIENCE STORE PROJECT IMPERIAL COUNTY, CALIFORNIA NOISE STUDY

This report is an analysis of the potential noise impacts associated with the proposed Maverik Fueling Station and Convenience Store Project in unincorporated Imperial County, California. This report has been prepared by Birdseye Planning Group (BPG) under contract to Willis Environmental Planning, Inc., to support preparation of the environmental documentation pursuant to the California Environmental Quality Act (CEQA).

PROJECT DESCRIPTION

Maverik is proposing to develop a fueling station and convenience store on a 10-acre site located on 10 gross acres of the approximately 50-acre parcel within unincorporated Imperial County (County), California, approximately 1.5 miles east of the City of El Centro (Figure 1 – Vicinity Map) (Assessor's Parcel Number 054-080-023). The Project site is located on the southeast corner of Hawes Road and Ross Avenue, east of State Route 111 (SR-111/Imperial Valley Pioneers Expressway) and is bound by Ross Avenue on the north, by Hawes Road and the Imperial Irrigation District's Acacia Five Drain A on the west (Figure 2 – Site Plan). The Project site is located within Section 11 of Township 16 South, Range 14 East, San Bernardino Base Meridian. The westbound offramp of Interstate 8 at SR-111 is located approximately 0.25 miles south of the Project site.

The Maverik Fueling Station and Convenience Store Project (Project) includes 19 fuel pumps (38 fueling positions) under two separate canopies (totaling 9,000 square feet (sf), and a 5,982 SF convenience store building. Additional improvements include three (3) underground storage tanks for fuel storage; two underground water storage tanks; on-site water and wastewater treatment facilities; parking, landscaping, drainage, and access improvements. Vehicular access would be provided via three (3) ingress/egress drives along the south side of Ross Avenue. The westernmost access would be a 40-foot driveway that would allow for left- and right-turn movements by vehicles accessing the fueling area and convenience store. This entrance would be located approximately 215 feet east of the Ross Avenue/SR-111 intersection. The second proposed entrance would be located approximately 150 feet east of the first and would provide a 60-foot inbound/outbound driveway leading directly to the proposed truck fueling stations. The third and easternmost driveway would be located 220 feet east of the second and would provide a 50-foot driveway that would permit the full range of left- and right-turn movements, inbound and outbound. Parking would be provided in three (3) parking areas for a total of 45-parking spaces, including two accessible spaces. No overnight parking would be allowed and parking within the fueling area would be limited to 30 minutes. Project construction is anticipated to begin in late 2024 and be operational in late 2025. The project site is shown in Figure 1. The site plan is shown in Figure 2.



Figure 1 — Vicinity Map

EEC ORIGINAL PKG

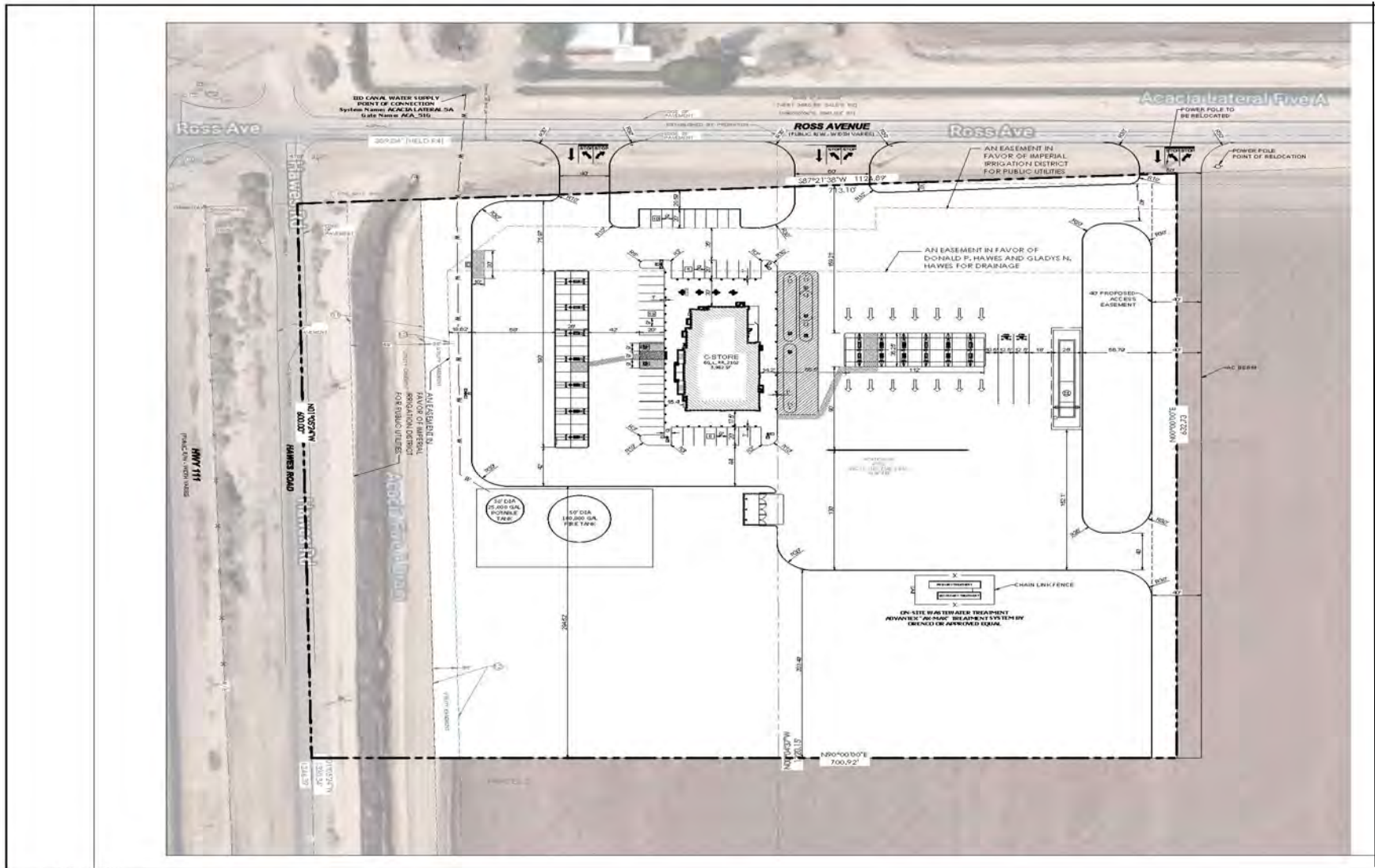

Source: SDC, 2023



Figure 2—Site Plan

EEC ORIGINAL PKG

SETTING

Overview of Sound Measurement

Noise level (or volume) is generally measured in decibels (dB) using the A-weighted sound pressure level (dBA). The A-weighting scale is an adjustment to the actual sound pressure levels to be consistent with that of human hearing response, which is most sensitive to frequencies around 4,000 Hertz (about the highest note on a piano) and less sensitive to low frequencies (below 100 Hertz). Table 1 shows noise levels associated with common sources.

Sound pressure level is measured on a logarithmic scale with the 0 dB level based on the lowest detectable sound pressure level that people can perceive (an audible sound that is not zero sound pressure level). Based on the logarithmic scale, a doubling of sound energy is equivalent to an increase of 3 dBA, and a sound that is 10 dBA less than the ambient sound level has no effect on ambient noise. Because of the nature of the human ear, a sound must be about 10 dBA greater than the reference sound to be judged as twice as loud. In general, a 3 dBA change in community noise levels is noticeable, while 1-2 dB changes generally are not perceived. Quiet suburban areas typically have noise levels in the range of 40-50 dBA, while arterial streets are in the 50-60+ dBA range. Normal conversational levels are in the 60-65 dBA range, and ambient noise levels greater than 65 dBA can interrupt conversations. Noise levels typically attenuate (or drop off) at a rate of 6 dBA per doubling of distance from point sources (i.e., industrial machinery). Noise from lightly traveled roads typically attenuates at a rate of about 4.5 dBA per doubling of distance. Noise from heavily traveled roads typically attenuates at about 3 dBA per doubling of distance. Noise levels may also be reduced by intervening structures; generally, a single row of buildings between the receptor and the noise source reduces the noise level by about 5 dBA, while a solid wall or berm reduces noise levels by 5 to 10 dBA. The manner in which older homes in California were constructed (approximately 30 years old or older) generally provides a reduction of exterior-to-interior noise levels of about 20 to 25 dBA with closed windows. The exterior-to-interior reduction of newer residential units and office buildings construction to California Energy Code standards is generally 30 dBA or more.

In addition to the actual instantaneous measurement of sound levels, the duration of sound is important since sounds that occur over a long period of time are more likely to be an annoyance. The Leq is defined as the single steady A-weighted level that is equivalent to the same amount of energy as that contained in the actual fluctuating levels over a period of time (essentially, the average noise level). Typically, Leq is summed over a one-hour period. Lmax is the highest RMS (root mean squared) sound pressure level within the measuring period, and Lmin is the lowest RMS sound pressure level within the measuring period.

The time period in which noise occurs is also important since noise that occurs at night tends to be more disturbing than that which occurs during the day. Community noise is usually measured using Day-Night Average Level (Ldn), which is the 24-hour average noise level with a 10-dBA penalty for noise occurring during nighttime (10 p.m. to 7 a.m.) hours, or Community

Table 1
Sound Levels of Typical Noise Sources and Noise Environments

Noise Source (at Given Distance)	Noise Environment	A-Weighted Sound Level (Decibels)	Human Judgment of Noise Loudness (Relative to Reference Loudness of 70 Decibels*)
Military Jet Takeoff with Afterburner (50 ft)	Carrier Flight Deck	140	128 times as loud
Civil Defense Siren (100 ft)		130	64 times as loud
Commercial Jet Take-off (200 ft)		120	32 times as loud Threshold of Pain
Pile Driver (50 ft)	Rock Music Concert Inside Subway Station (New York)	110	16 times as loud
Ambulance Siren (100 ft) Newspaper Press (5 ft) Gas Lawn Mower (3 ft)		100	8 times as loud Very Loud
Food Blender (3 ft) Propeller Plane Flyover (1,000 ft) Diesel Truck (150 ft)	Boiler Room Printing Press Plant	90	4 times as loud
Garbage Disposal (3 ft)	Noisy Urban Daytime	80	2 times as loud
Passenger Car, 65 mph (25 ft) Living Room Stereo (15 ft) Vacuum Cleaner (10 ft)	Commercial Areas	70	Reference Loudness Moderately Loud
Normal Speech (5 ft) Air Conditioning Unit (100 ft)	Data Processing Center Department Store	60	1/2 as loud
Light Traffic (100 ft)	Large Business Office Quiet Urban Daytime	50	1/4 as loud
Bird Calls (distant)	Quiet Urban Nighttime	40	1/8 as loud Quiet
Soft Whisper (5 ft)	Library and Bedroom at Night Quiet Rural Nighttime	30	1/16 as loud
	Broadcast and Recording Studio	20	1/32 as loud Just Audible
		0	1/64 as loud Threshold of Hearing

Source: Compiled by dBF Associates, Inc., 2016

Noise Equivalent Level (CNEL), which is the 24-hour average noise level with a 5 dBA penalty for noise occurring from 7 p.m. to 10 p.m. and a 10 dBA penalty for noise occurring from 10 p.m. to 7 a.m. Daytime Leq levels are louder than Ldn or CNEL levels; thus, if the Leq meets noise standards, the Ldn and CNEL are also met.

Project Site Setting

The project area is an urbanizing area within unincorporated Imperial County and located northeast of the Interstate 8/Highway 111 interchange east of the City of El Centro. The most common and primary sources of noise in the project site vicinity are motor vehicles (e.g., automobiles and trucks) operating on Highway 111. Traffic on Ross Avenue located along the northern site boundary contributes negligibly to ambient conditions Hawes Road borders the site to the west and provides access to one single-family residence located south of the project site adjacent to the Interstate 8 right of way. Motor vehicle noise is of concern because where a high number of individual events occur, it can create a sustained noise level. Aircraft overflights occur but do not noticeably contribute to the ambient noise environment.

To gather data on the general noise environment at the project site, two weekday morning 15-minute noise measurements were taken on the site on October 19, 2023, using an ANSI Type II integrating sound level meter. The predominant noise source was traffic. The temperature during monitoring was 75 degrees Fahrenheit with no cloud cover or perceptible wind.

Monitoring site (Site 1) is located at the northwest corner of the site adjacent to Ross Avenue and Hawes Road. Vehicles operating on Highway 111 and Ross Avenue were audible. During monitoring, 427 cars/light trucks, 24 medium trucks (six tires/two axles) and 39 heavy trucks (all vehicles with three or more axles) passed the site on Highway 111. During monitoring, 28 cars/light trucks, three medium trucks (six tires/two axles) and one heavy truck (all vehicles with three or more axles) passed the site on Ross Avenue.

Site 2 is located south of the site proximal to the single-family residence located at the southern terminus of Hawes Road. During monitoring, 407 cars/light trucks, 22 medium trucks (six tires/two axles) and 30 heavy trucks (all vehicles with three or more axles) passed the site on Highway 111. One vehicle passed the site on Hawes Road. The monitoring locations are shown in Figure 3. As shown in Table 2, the measured Leq was 68.1 dBA at Site 1 and 60.4 at Site 2.

Table 2
Noise Monitoring Results

Measurement Location	Primary Noise Source	Sample Time	Leq (dBA)
Northwest corner of site adjacent to Ross Avenue	Traffic	Weekday morning	62.5
South of project site proximal to the single-family residence located at the southern terminus of Hawes Road.	Traffic	Weekday morning	61.9

Source: Field visit using ANSI Type II Integrating sound level meter.



Figure 3 — Monitoring Locations

Sensitive Receptors

Noise exposure goals for various types of land uses reflect the varying noise sensitivities associated with each of these uses. Urban areas contain a variety of land use and development types that are noise sensitive including residences, schools, churches, hospitals and convalescent care facilities. One sensitive receiver is located on the north side of Ross Avenue north of the project site. As stated, a single-family residence is located at the south end of Hawes Road south of the project site.

The existing General Plan designation for the site is Agriculture. A General Plan Amendment is proposed to change the land use designation to Urban Area. The site is zoned General Agriculture (A-2). A zone change to Heavy Commercial (C-3) is also proposed.

Regulatory Setting

In 1976, the California Department of Health, State Office of Noise Control published a recommended noise/land use compatibility matrix which many jurisdictions have adopted as a standard in their general plan noise elements. The California State Office of Planning and Research 2017 updates to the General Plan Guidelines, Appendix D Noise Element Guidelines, Figure 2, shows that exterior noise levels up to 60 dBA (CNEL or Ldn) are normally compatible in rural residential areas. Noise levels up to 70 dBA (CNEL or Ldn) are conditionally compatible.

Imperial County Noise Ordinance

Operational Noise. The Property Line Noise Limits listed in Table 9 of the County of Imperial General Plan Noise Element and the County's Code of Ordinances, Title 9, Division 7 (Noise Abatement and Control) Section 90702.00 Subsection A provides acceptable Sound level limits based on the property zoning.

Stationary Noise. The applicable property line sound level limits are provided in Table 3 below and shall apply to noise generation from one property to an adjacent property. The standards imply the existence of a sensitive receptor on the adjacent, or receiving, property. In the absence of a sensitive receptor, an exception or variance to the standards may be appropriate. These standards do not apply to construction noise. Stationary sources associated with the project (i.e., heating, ventilation and air conditioning [HVAC]) would have an adverse effect if they exceed baseline conditions at receiving properties. For the purpose of the discussion below, truck movement on the site is considered a stationary source.

The increase of noise levels generally results in an adverse impact to the noise environment. The Noise/Land Use Compatibility Guidelines are not intended to allow the increase of ambient noise levels up to the maximum without consideration of feasible noise reduction measures. The following guidelines are established by the County of Imperial for the evaluation of significant noise impact.

**Table 3
Property Line Noise Level Limits**

Zone	Time	Applicable Limit – One Hour Average Sound Level (decibels)
Residential Zones	7 a.m. to 10 p.m.	50
	10 p.m. to 7 a.m.	45
Multi-residential Zones	7 a.m. to 10 p.m.	55
	10 p.m. to 7 a.m.	50
Commercial Zones	7 a.m. to 10 p.m.	60
	10 p.m. to 7 a.m.	55
Light Industrial/Industrial Park Zones, including agricultural and extraction industry	Anytime	70
General Industrial Zones	Anytime	75

When the noise-generating property and the receiving property have different uses, the more restrictive standard shall apply. When the ambient noise level is equal to or exceeds the Property Line noise standard, the increase of the existing or proposed noise shall not exceed 3 dB Leq.

The sound level limit between two zoning districts (different land uses) shall be measured at the property line between the properties.

Fixed-location public utility distribution or transmission facilities located on or adjacent to a property line shall be subject to the noise level limits of subsection A of this section, measured at or beyond six feet from the boundary of the easement upon which the equipment is located.

This section does not apply to noise generated by helicopters at heliports or helistops authorized by a conditional use permit.

This section does not apply to noise generated by standard agricultural field operating practices such as planting and harvesting of crops. The County of Imperial has a Right to Farm Ordinance (1031) which serves as recognition to agricultural practices to new development. Agricultural/industrial operations shall comply with the noise levels prescribed under the general industrial zones.

Source: County of Imperial Ordinance, Title 9, Division 7 (Noise Abatement and Control)

a. If the future noise level after the Project is completed will be within the "normally acceptable" noise levels shown in the Noise/Land Use Compatibility Guidelines, but will result in an increase of 5 dB CNEL or greater, the Project will have a potentially significant noise impact and mitigation measures must be considered.

b. If the future noise level after the Project is completed will be greater than the "normally acceptable" noise levels shown in the Noise/Land Use Compatibility Guidelines, a noise increase of 3 dB CNEL or greater shall be considered a potentially significant noise impact and mitigation measures must be considered.

Traffic Noise. The Imperial County General Plan Noise Element (2015) (Table 7), provides a range of land uses and compatibility criteria based on exterior noise levels. These standards are the same as those referenced in the California State Office of Planning and Research 2017 updates to the General Plan Guidelines, Appendix D Noise Element Guidelines, Figure 2.

These data show that exterior noise levels up to 60 dBA (CNEL or Ldn) are normally compatible in rural residential areas. Noise levels up to 70 dBA (CNEL or Ldn) are conditionally compatible. For the purpose of identifying potential traffic-related impacts associated with the proposed project, these standards are used. Because baseline conditions exceed 60 dBA, an impact is determined based on whether the project would cause a 3 dBA or greater increase in noise levels over baseline conditions.

Construction Noise. The Noise Element of the County of Imperial General Plan defines a construction noise impact as noise generated from a single piece of construction equipment or a combination of equipment that exceeds 75 dBA Leq when averaged over an 8-hour period (Leq(8)) and measured at the nearest sensitive receptor (e.g., homes, schools, hospitals, parks, and office buildings, and for certain non-human species, including riparian bird species). In cases of extended-length construction times, the standard may be reduced so as to not exceed 75 dB Leq when averaged over a one-hour period. The Noise Element also limits construction equipment operation to the hours of 7:00 a.m. to 7:00 p.m., Monday through Friday, and 9:00 a.m. to 5:00 p.m. Saturday and Sunday.

Vibration Standards

Vibration is a unique form of noise as the energy is transmitted through buildings, structures and the ground whereas audible noise energy is transmitted through the air. Thus, vibration is generally felt rather than heard. The ground motion caused by vibration is measured as particle velocity in inches per second (PPV) and which is also referenced as vibration decibels (VdB). The vibration velocity level threshold of perception for humans is approximately 0.006–0.019 PPV or 65 VdB. There are no federal or state regulatory standards for ground-borne vibration. However, various criteria have been established to assist in the evaluation of vibration impacts. For example, the California Department of Transportation (Caltrans) has developed vibration criteria based on potential structural damage risks and human annoyance. Table 4 shows various PPV and VdB levels and related human reactions and effects on buildings.

Table 4
Human Reaction and Damage to Buildings for Continuous or Frequent Intermittent
Vibration Levels

Peak Particle Velocity (inches/second)	Approximate Vibration Velocity Level (VdB)	Human Reaction	Effects on Buildings
0.006–0.019	64–74	Range of threshold of perception.	Vibrations unlikely to cause damage of any type.
0.08	87	Vibrations readily perceptible.	Recommended upper level to which ruins and ancient monuments should be subjected.
0.01	92	Level at which continuous vibrations may begin to annoy people, particularly those involved in vibration sensitive activities.	Virtually no risk of architectural damage to normal buildings.

0.2	94	Vibrations may begin to annoy people in buildings.	Threshold at which there is a risk of architectural damage to normal dwellings.
0.4–0.6	98-104	Vibrations considered unpleasant by people subjected to continuous vibrations and unacceptable to some people walking on bridges.	Architectural damage and possibly minor structural damage.

Source: Caltrans, April 2020

For the protection of fragile, historic, and residential structures, Caltrans recommends a threshold of 0.2 inches per second PPV (94 VdB). This same threshold would represent the level at which vibrations would be potentially annoying to people in buildings.

Construction activities such as blasting, pile driving, demolition, excavation and drilling have the potential to generate ground vibrations near structures. No historic buildings occur on the site or are known to occur near the site; thus, 94 VdB is used to quantify potential vibration impacts to neighboring structures. Construction activities referenced above that would generate significant vibration levels are not proposed. However, to provide information for use in completing the CEQA evaluation, construction-related vibration impacts are evaluated using the above referenced criteria.

IMPACT ANALYSIS

Methodology and Significance Thresholds

Construction noise estimates are based upon noise levels reported by the Federal Highway Administration for construction equipment and the distance between sensitive properties and the project site. Reference noise levels are used herein to estimate noise levels at nearby sensitive receptors based on a standard noise attenuation rate of 3 dBA for line sources such as haul roads and 6 dB per doubling of distance (line-of-sight method of sound attenuation) for stationary sources and construction equipment. For the purpose of CEQA review, noise levels along Highway 111, Ross Avenue and Hawes Road are estimated based on traffic volumes provided in the Trip Generation memorandum (November 2023).

The impact analysis provided below is based on the following CEQA Guidelines, as listed in Appendix G of the CEQA Guidelines. An impact is considered significant if the project would:

- a. Generate a substantial temporary or permanent increase in ambient noise levels in the vicinity of the project in excess of standards established in the local general plan or noise ordinance, or applicable standards of other agencies?
- b. Generate excessive groundborne vibration or groundborne noise levels?

- c. For a project located within the vicinity of a private airstrip or an airport land use plan or, where such a plan has not been adopted, within two miles of a public airport or public use airport, would the project expose people residing or working in the project area to excessive noise levels?

Construction noise estimates are based upon noise levels reported by the Federal Transit Administration, Office of Planning and Environment, and the distance to nearby sensitive receptors. Reference noise levels from that document were used to estimate noise levels at nearby sensitive receptors based on the applicable noise attenuation rate of 6 dB per doubling of distance (free field propagation of sound attenuation).

The proposed project would be a new use; thus, noise levels associated with existing and future traffic were based on the difference in trip volumes between existing conditions and the proposed use less the pass by trips generated by existing traffic. A doubling of traffic volumes would be required to cause a noticeable increase (3 dBA) in traffic noise. As stated, measured baseline conditions exceed 60 dBA CNEL, the normally acceptable exterior sound level for rural residential properties referenced in the General Plan Noise Element. However, baseline conditions do not exceed 70 dBA, the conditionally compatible standard.

As noted, a noise increase greater than 3 dBA is readily perceptible to the average human ear; and thus, is the level considered a substantial noise increase related to traffic operations. For the purpose of this evaluation, the CNEL is used for traffic noise as it provides a conservative estimate of potential noise levels.

- a. *Would the project generate a substantial temporary or permanent increase in ambient noise levels in the vicinity of the project in excess of standards established in the local general plan or noise ordinance, or applicable standards of other agencies?*

Temporary Construction Noise

The primary source of noise during construction activities would be comprised of heavy machinery used during site preparation (i.e., clearing/grubbing), grading and clearing the site, as well as equipment used during building construction and paving. Table 5 shows the typical noise levels associated with heavy construction equipment. As shown in Table 5, average noise levels associated with the use of heavy equipment at construction sites can range from 81 to 91 dBA at 25 feet from the source, depending upon the types of equipment in operation at any given time and phase of construction (FTA 2018).

Project construction would occur over the entire project site. Construction activities will vary in distance from the nearest sensitive properties; thus, noise levels will vary over the workday. As stated, the closest receiver is located north of the site at 498 Ross Avenue, approximately 130 feet north of the northern property line.

**Table 5
 Typical Maximum Construction Equipment Noise Levels**

Equipment Onsite	Typical Maximum Level (dBA) 25 Feet from the Source	Typical Maximum Level (dBA) 50 Feet from the Source	Typical Maximum Level (dBA) 100 Feet from the Source
Air Compressor	86	80	74
Backhoe	86	80	74
Bobcat Tractor	86	80	74
Concrete Mixer	91	85	79
Loader	86	80	74
Bulldozer	91	85	79
Jack Hammer	94	88	82
Pavement Roller	91	85	79
Street Sweeper	88	82	76
Man Lift	81	75	69
Dump Truck	90	84	78
Mobile Crane	89	83	77
Excavator/Scraper	91	85	79

*Source: FTA Noise and Vibration Impact Assessment Manual (September 2018), Table 7-1.
 Noise levels are based on actual maximum measured noise levels at 50 feet (L_{max}).
 Noise levels are based on a noise attenuation rate of 6 dBA per doubling of distance.*

While construction noise would attenuate over the distance between the project site and nearest receiver, noise would likely be audible. It is possible that noise levels would exceed 75 dBA at the northern property line; construction equipment are transient rather than stationary sources. Thus, noise levels are not likely to exceed a 75 dBA average over an 8-hour workday. While no noise mitigation is required, temporary construction noise could be reduced through implementation of the following conditions at the County’s discretion:

N-1: Construction Equipment. Electrical power shall be used to run air compressors and similar power tools. Internal combustion engines should be equipped with a muffler of a type recommended by the manufacturer and in good repair. All diesel equipment should be operated with closed engine doors and should be equipped with factory-recommended mufflers. Construction equipment that continues to generate substantial noise at the project boundaries should be shielded with temporary noise barriers, such as barriers that meet a sound transmission class (STC) rating of 25, sound absorptive panels, or sound blankets on individual pieces of construction equipment. Stationary noise-generating equipment, such as generators and compressors, should be located as far as practically possible from the nearest residential property lines.

N-2: Limit Operations Adjacent to Receivers. Limit the number of large pieces of equipment (i.e., bulldozers or concrete mixers) operating adjacent to receivers to one at any given time to the extent feasible.

N-3: Neighbor Notification. Provide notification to residential occupants nearest to the project site 7-14 days prior to initiation of construction activities that could result in noise levels exceeding 75 dBA at the property line adjacent to residences. This notification should include the anticipated hours and duration of construction and a description of noise reduction measures being implemented at the project site. The notification should include a telephone number for local residents to call to submit complaints associated with construction noise. The notification should be posted along Ross Avenue and Hawes Road and be visible.

With implementation of the above referenced noise control, if needed and at the County's discretion, temporary noise impacts would be **less than significant**.

Operational Noise

Operation of the proposed project was evaluated for potential exterior traffic related impacts caused by increased traffic volumes associated with the project as well as interior noise levels caused by traffic. The proposed project is considered a typical development that would not significantly contribute new vehicle trips to the existing road network. Traffic would primarily be comprised of existing pass by trips occurring on Highway 111. The project is expected to generate a total of 9,545 daily trips. However, approximately 75%, or 7,159 are daily pass by trips that are already occurring on Ross Avenue and Highway 111. Thus, new daily trips would total 2,386. However, for the purpose of estimating traffic noise, all peak hour trips were used because the majority of pass by traffic is concentrated on Highway 111 rather than Ross Road.

Exterior Traffic Noise. As stated, existing noise levels were measured at the project site on October 19, 2023 (Table 2). The Leq during the 15-minute monitoring period was 62.5 dBA at the northwest corner of the site and 61.9 near the southern site boundary. Thus, whether a traffic-related noise impact would occur is based on whether project traffic, when added to the existing traffic, would cause noise to noticeably increase over ambient conditions (i.e., +3 dBA) or exceed 65 dBA CNEL.

The roadway network adjacent to the project site (i.e., Highway 111, Ross Avenue and Hawes Road) was modeled using the Federal Highway Administration Traffic Noise Model (TNM) version 2.5 software. The model calculates traffic noise at receiver locations based on traffic volumes, travel speed, mix of vehicle types operating on the roadways (i.e., cars/trucks, medium trucks and heavy trucks) and related factors. Traffic volumes used to establish the vehicle mix and calibrate the noise model are based on traffic counts obtained during the monitoring period. Traffic volumes and distribution are based on data from the Trip Generation Memorandum (November 2023) prepared for the proposed project. Evening (P.M.) peak hour volumes were used because they are higher than morning (A.M.) peak hour

volumes. Hourly average baseline noise levels (Leq) were calculated for the following residential receivers:

1. Single-family residence at 498 Ross Road north of the site; and
2. Single-family residence at 1650 Hawes Road.

The receiver locations are shown in Figure 4 and the modeling results are shown in Table 6. As shown, baseline conditions exceed 60 dBA CNEL at both receivers. The Ldn/CNEL values associated with project-related traffic are estimated by adding 1 dB to predicted peak-hour Leq traffic noise levels for comparison with the Imperial County General Plan Noise Element criteria for exterior (65 dBA) and interior (45 dBA) noise levels generated by traffic.

Table 6
Modeled Noise Levels

Receptor	Existing Leq	Existing Ldn/CNEL	With Project Leq	With Project Ldn/CNEL	Decibel Change	Significant Impact
Receiver 1	62.2	63.2	65.8	66.8	+3.6	Yes
Receiver 2	61.4	62.4	61.5	62.5	+0.1	No

Noise levels associated with the project were calculated by distributing the 208 A.M. peak hour passenger cars/light trucks and heavy trucks onto Ross Road assuming 66 percent would come from Highway 111 and the remainder would come to the site via Ross Road east of the site. Volumes were concentrated in this area for the purpose of evaluating worst case noise conditions. As shown in Table 6, the project would increase noise levels at Receiver 1 which is expected given the fact that project traffic passing through the site would be concentrated on Ross Road. The increase would be greater than 3 dBA; thus, the project would cause an adverse impact at Receiver 1. The project would not noticeably change noise levels at Receiver 2. Thus, without mitigation, the project would have a significant impact under **threshold b**.

California Energy Code Title 24 standards specify construction methods and materials that result in energy efficient structures up to a 30 dBA reduction in exterior noise levels (assuming windows are closed). This includes operation of mechanical ventilation (e.g., heating and air conditioning), in combination with standard building construction that includes dual-glazed windows with a minimum Sound Transmission Class (STC) rating of 26 or higher. When windows are open, the insertion loss drops to about 10 dBA. Receiver 1 appears to have been constructed prior to Title 24. As stated, the manner in which older homes in California were constructed (approximately 30 years old or older) generally provides a reduction of exterior-to-interior noise levels of about 20 to 25 dBA with closed windows. Assuming windows are closed and a 20 dBA insertion loss, interior noise levels at Receiver 1 would be approximately 46.8 dBA CNEL which would exceed 45 dBA CNEL standard.

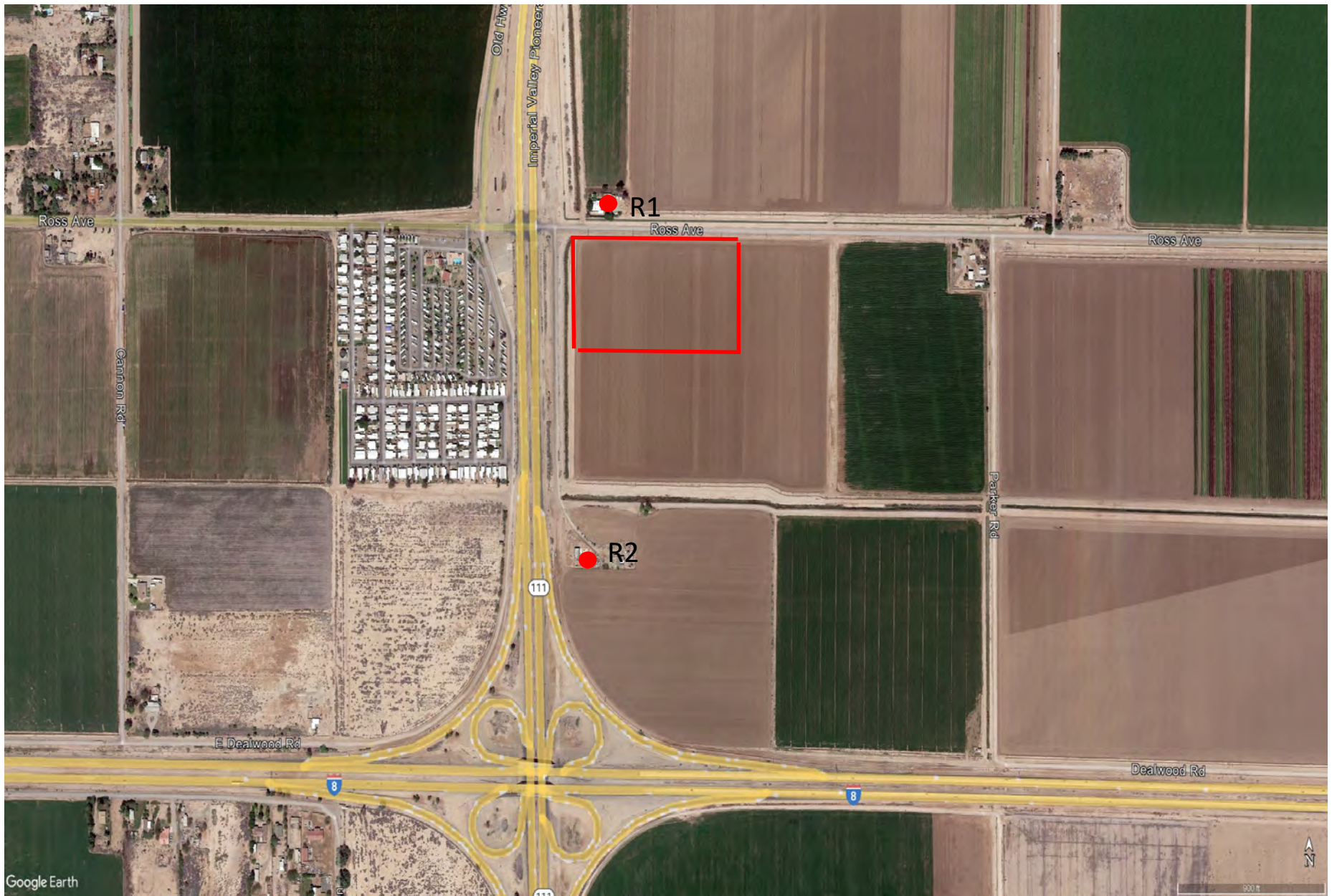

Figure 4 — Receiver Locations

Mitigation options are comprised of the following:

Mitigation Measure NOI-1. Applicant shall, with approval from the homeowner, retrofit the windows and doors facing Ross Road and the existing heating, ventilation and air conditioning system to ensure a Sound Transmission Class (STC) rating of at least 30 dBA is achieved to ensure the 45 dBA interior noise standard is met.

Mitigation Measure NOI-2. Construct a 6-foot concrete masonry unit (CMU) wall in place of the existing chain link fence along the southern and western exterior yard limits. The southern wall segment shall be approximately 120 feet in length, gated to allow ingress/egress from the parking area and residence and connect with the existing chain link fence along the eastern yard area boundary. The western segment shall be approximately 65 feet in length and connect with the chain link fence segment along the northern yard area boundary.

Insertion of the two wall segments would reduce the with-project Leq at Receiver 1 to 61.2 dBA and CNEL to 62.2 dBA. This would be 1 dBA less than baseline conditions. The increase would be less than 3 dBA; and thus, less than significant.

On-Site Truck Movement. Trucks would move around the project site entering and departing from Ross Avenue. To quantify on-site truck movement noise exposure in terms of the Ldn (24-hour average), individual truck movement sound exposure level (SEL) is used. The SEL is a measure of the total energy of a noise event, including consideration of event duration. The SEL is not actually heard, but is a derived value used for the calculation of energy-based noise exposure metrics such as the Ldn. The average measured truck event movement SEL is 78.1 decibels. As discussed, it is assumed that 1,568 truck events would occur each day and that the movements would be evenly distributed over a 24-hour day. The L_{dn} associated with truck movement is quantified using the following equation:

$$L_{dn} = SEL + 10 \log Neq - 49.4$$

SEL is the average SEL for a truck movement, Neq is the equivalent number of truck movements in a typical 24-hour period determined by adding 10 times the number of nighttime events (10 p.m. - 7 a.m.) to the actual number of daytime events (7 a.m. - 7 p.m.), and 49.4 is a time constant equal to 10 log the number of seconds in the day. Assuming 1,568 truck events per day, the resulting noise exposure on-site would be approximately 60.7 dB Ldn. Noise associated with on-site truck movement would attenuate between the fueling area and Receiver 1, a distance of approximately 500 feet, to 40.6 dBA. This would be within the 60 dBA limit for residential uses shown in Table 3 above.

Stationary Noise Sources

HVAC Systems. The HVAC system proposed for the convenience store has not been specified and noise levels vary depending on the size of the system. However, multiple HVAC systems

will be installed on the roof-tops of convenience store located along the east side of the site. Reference noise levels for the project are based on noise measurements made at similar outdoor facilities. HVAC noise levels can be expected to range from 60 to 70 dBA at 5 feet from the roof top equipment and ventilation openings. Assuming HVAC units are installed at the center of the roof top, or approximately 560 feet from Receiver 1. a 70 dBA reference noise level would attenuate to 29 dBA and inaudible off-site. This would be within the 60 dBA limit for residential uses shown in Table 3 above.

b. Generate excessive groundborne vibration or groundborne noise levels?

Temporary Construction-Related Vibration

As referenced, the closest sensitive property to the site is 130 feet to the north at 498 Ross Avenue. Based on the information presented in Table 7, vibration levels could be as high as 79 VdB at 100 feet from the source assuming operation of a large bulldozer. As discussed, 94 VdB is the threshold where minor damage can occur in fragile buildings. Vibration levels at the closest sensitive properties would be imperceptible because of the distance between the source and receiver. Thus, would not occur as a result of construction activities associated with the proposed project. Impacts would be **less than significant**.

Table 7
Vibration Source Levels for Construction Equipment

Equipment	Approximate VdB				
	25 Feet	50 Feet	60 Feet	75 Feet	100 Feet
Large Bulldozer	91	85	83	82	79
Loaded Trucks	90	84	82	81	78
Jackhammer	94	88	86	85	82
Loader	86	80	78	77	74

Source: FTA, 2018

Operational Vibration

The proposed project would be a travel center with a convenience store, fueling stations for both heavy trucks and passenger vehicles. These uses do not involve heavy industrial activities or impact sources that would generate vibration detectable off-site. **No impact** related operational vibration would occur.

c. For a project located within the vicinity of a private airstrip or an airport land use plan or, where such a plan has not been adopted, within two miles of a public airport or public use airport, would the project expose people residing or working in the project area to excessive noise levels?

The Project site is located approximately 6.0 miles southeast of the Imperial County Airport. The site is located outside the Airport Influence Area according to Figure 3-E. Thus, the project site is located outside the 60 dB contour line for airport operations. Project employees would not be exposed to excessive airport noise levels. **No impact** would occur.

CONCLUSION

The proposed project was evaluated for potential construction and operational noise impacts. As discussed herein, temporary construction noise impacts could exceed the Imperial County standard of 75 dBA (8-hour) Leq. Implementation of conditions N-1 through N-3 would reduce potentially significant construction impacts to less than significant. Operational impacts related to exterior and interior traffic noise would be significant at Receiver 1 without mitigation. Mitigation Measure NOI-1 would ensure the interior noise standard at Receiver 1 is met. Mitigation Measure NOI-2 would reduce the project-related noise increase to less than baseline conditions. Thus, traffic-related noise impacts would be less than significant.

Temporary impacts associated with construction vibration would be less than significant. The proposed project is a new travel center. The proposed uses do not generate vibration; thus, no vibration impacts are anticipated to occur with operation of the project.

Noise generated by truck movements on the site and operation of the convenience store HVAC system would not adversely impact Receiver 1.

With respect to airport operations, the project site is not located within a noise exposure range of 60–75 dB CNEL associated with operation of the Imperial County Airport. Thus, the project employees would not be exposed to excessive noise levels. Impacts would be less than significant.

REFERENCES

- California Department of Transportation (Caltrans). 2015. Standard Specifications, State of California Business, Transportation and Housing Agency, Department of Transportation, Available at http://www.dot.ca.gov/hq/esc/oe/construction_contract_standards/std_specs/2015_StdSpecs/2015_StdSpecs.pdf
- California Department of Transportation (Caltrans). 2020. Traffic Noise Analysis Protocol for New Highway Construction, Reconstruction Projects and Retrofit Barrier Projects. Division of Environmental Analysis. Sacramento, CA. April. Available at <https://dot.ca.gov/-/media/dot-media/programs/environmental-analysis/documents/env/traffic-noise-protocol-april-2020-a11y.pdf>
- California Office of Planning and Research. *OPR General Plan Guidelines*, 2017.
- County of Imperial Code, Section 90702.00, Subsection A, September, 2016
- County of Imperial, 2003. General Plan Noise Element.
- dBf & Associates, Inc., Reference Noise Level Compilation Table, 2016.
- Federal Highway Administration (FHWA), Office of Environmental. 2010. 23 CFR Part 772: Procedures for Abatement of Highway Traffic Noise and Construction Noise – Final Rule. Federal Register, Vol. 75, Number 133. Washington, DC. July.
- FHWA. 2004. U.S. Department of Transportation, FHWA Traffic Noise Model, TNM 2.5, Report No. FHWA -PD -96 -010, Revision No. 1. April 14.
- Federal Transit Administration. September 2018. *Transit noise and Vibration Impact Assessment Manual*. (FTA Report 0123). Prepared by John A. Volpe National Transportation Systems Center. https://www.transit.dot.gov/sites/fta.dot.gov/files/docs/research-innovation/118131/transit-noise-and-vibration-impact-assessment-manual-fta-report-no-0123_0.pdf
- Federal Highway Administration. *Roadway Construction Noise Model*. 2006. Users Guide Table 1.
- Imperial County Airport, Compatibility Maps, Figure 3E, September 2004.
- Mizuta Traffic Consulting, Inc., Maverik Travel Center Trip Generation Memorandum, November 2023

Appendix A

Monitoring Data Sheet and Modeling Results

FIELD NOISE MEASUREMENT DATA

Project Name: MAVERICK TRAVEL CENTER Page 1 of 1
 Project #: _____ Day / Date _____ My Name: _____

Sound Level Meter		Calibrator		Weather Meter	
Model #: <u>Piccolo II</u>	Model # _____	Model # _____	Model # _____	Serial # _____	Serial # _____
Serial # _____	Serial # _____	Serial # _____	Serial # _____	Serial # _____	Serial # _____
Weighting: <u>A/C / Flat</u>	Pre-Test: _____ dBA SPL	Terrain: <u>Hard / Soft / Mixed</u>	Topo: <u>Flat / Hilly (describe)</u>		
Response: <u>Slow / Fast / Impl</u>	Post-Test: _____ dBA SPL	Wind: <u>Steady / Gusty</u>			
Windscreen: <u>Yes / No</u>					

ID	Time Start	Time Stop	Leq	Lmin	Lmax	L10	L50	L90	Wind Spd/ Dir (mph)	Temp (°F)	RH (%)	Bar Psr (in Hg)	Cloud Cover (%)
1	8:05	8:20	62.5	51.7	75.5				1-3 SE 75				0%
2	8:30	8:45	61.9	51.5	71.5				1-3 SE 75				0%

Roadway Name	<u>NEWY III</u>	<u>ROSS ROAD</u>	Location(s) / GPS Reading(s):
Speed (post/obs)	<u>55</u>	<u>45</u>	<u>55 127 III</u>
Number of Lanes	<u>6</u>	<u>2</u>	<u>6</u>
Width (pave/row)	<u>72'</u>	<u>24'</u>	<u>72'</u>
1- or 2- way	<u>2</u>	<u>2</u>	<u>2</u>
Grade	<u>0%</u>	<u>0%</u>	<u>0%</u>
Bus Stops	<u>NO</u>	<u>NO</u>	<u>NO</u>
Stoplights	<u>YES</u>	<u>YES</u>	<u>YES</u>
Street Parking	<u>NO</u>	<u>NO</u>	<u>NO</u>
Automobiles	<u>42</u>	<u>28</u>	<u>40</u>
Medium Trucks	<u>24</u>	<u>3</u>	<u>22</u>
Heavy Trucks	<u>39</u>	<u>1</u>	<u>30</u>
		<u>0</u>	

Other Noise Sources: distant aircraft / roadway traf / trains / landscaping / rustling leaves / children playing / dogs barking / birds vocalizing
 Notes and Sketches on Reverse

Monitoring Site 1

Start Date 10/19/2023
Start Time 8:06:19 AM
End Time 8:21:18 AM
Duration 00:14:59
Meas Mode Single
Input Range Low
Input Type Mic
SPL Time Weight Slow
LN% Freq Weight dBA
Overload No
UnderRange No
Sensitivity 18.44mV/Pa

LZeq 72.5
LCeq 71.3
LAeq 62.5
LZSmax 85.7
LCSmax 85.3
LASmax 75.5
LZSmin 65.5
LCSmin 63.5
LASmin 51.7
LZE 102.0
LCE 100.8
LAE 92.0
LZpk 98.1
LCpk 97.9
LApk 88.1
LAS1% 70.8
LAS2% 69.6
LAS5% 68.1
LAS8% 66.9
LAS10% 66.0
LAS25% 62.3
LAS50% 60.0
LAS90% 56.5
LAS95% 55.5
LAS99% 53.4

Monitoring Site 2
Start Date 10/19/2023
Start Time 8:31:39 AM
End Time 8:46:38 AM
Duration 00:14:59
Meas Mode Single
Input Range Low
Input Type Mic
SPL Time Weight Slow
LN% Freq Weight dBA
Overload No
UnderRange No
Sensitivity 18.44mV/Pa

LZeq 71.0
LCeq 69.6
LAeq 61.9
LZSmax 87.2
LCSmax 81.8
LASmax 71.5
LZSmin 64.3
LCSmin 62.2
LASmin 51.5
LZE 100.5
LCE 99.1
LAE 91.4
LZpk 103.1
LCpk 99.1
LApk 90.4
LAS1% 69.0
LAS2% 67.9
LAS5% 66.4
LAS8% 65.6
LAS10% 65.2
LAS25% 62.7
LAS50% 60.6
LAS90% 55.4
LAS95% 54.3
LAS99% 52.3

RESULTS: SOUND LEVELS

<Project Name?>

<Organization?>

7 December 2023

<Analysis By?>

TNM 2.5

RESULTS: SOUND LEVELS

PROJECT/CONTRACT:

<Project Name?>

RUN:

Existing Conditions

BARRIER DESIGN:

INPUT HEIGHTS

Average pavement type shall be used unless a State highway agency substantiates the use of a different type with approval of FHWA.

ATMOSPHERICS:

68 deg F, 50% RH

Receiver

Name	No.	#DUs	Existing LAeq1h	No Barrier				With Barrier				
				LAeq1h		Increase over existing		Type Impact	Calculated LAeq1h	Noise Reduction		Calculated minus Goal
				Calculated	Crit'n	Calculated	Crit'n Sub'l Inc			Calculated	Goal	
			dB	dB	dB	dB		dB	dB	dB	dB	
Receiver1	1	1	0.0	62.2	66	62.2	10	---	62.2	0.0	8	-8.0
Receiver2	2	1	0.0	61.4	66	61.4	10	---	61.4	0.0	8	-8.0

Dwelling Units	# DUs	Noise Reduction		
		Min	Avg	Max
		dB	dB	dB
All Selected	2	0.0	0.0	0.0
All Impacted	0	0.0	0.0	0.0
All that meet NR Goal	0	0.0	0.0	0.0

RESULTS: SOUND LEVELS

<Project Name?>

<Organization?>

7 December 2023

<Analysis By?>

TNM 2.5

Calculated with TNM 2.5

RESULTS: SOUND LEVELS

PROJECT/CONTRACT:

<Project Name?>

RUN:

Maverik TC With Project

BARRIER DESIGN:

INPUT HEIGHTS

Average pavement type shall be used unless a State highway agency substantiates the use of a different type with approval of FHWA.

ATMOSPHERICS:

68 deg F, 50% RH

Receiver

Name	No.	#DUs	Existing LAeq1h	No Barrier				With Barrier				
				LAeq1h		Increase over existing		Type Impact	Calculated LAeq1h	Noise Reduction		Calculated minus Goal
				Calculated	Crit'n	Calculated	Crit'n Sub'l Inc			Calculated	Goal	
			dB	dB	dB	dB		dB	dB	dB	dB	
Receiver1	1	1	0.0	65.8	66	65.8	10	----	65.8	0.0	8	-8.0
Receiver2	2	1	0.0	61.5	66	61.5	10	----	61.5	0.0	8	-8.0

Dwelling Units	# DUs	Noise Reduction		
		Min	Avg	Max
		dB	dB	dB
All Selected	2	0.0	0.0	0.0
All Impacted	0	0.0	0.0	0.0
All that meet NR Goal	0	0.0	0.0	0.0

RESULTS: SOUND LEVELS

<Project Name?>

<Organization?>		6 March 2024										
<Analysis By?>		TNM 2.5										
		Calculated with TNM 2.5										
RESULTS: SOUND LEVELS												
PROJECT/CONTRACT:		<Project Name?>										
RUN:		Maverik TC With Project										
BARRIER DESIGN:		INPUT HEIGHTS										
		Average pavement type shall be used unless a State highway agency substantiates the use of a different type with approval of FHWA.										
ATMOSPHERICS:		68 deg F, 50% RH										
Receiver												
Name	No.	#DUs	Existing LAeq1h	No Barrier LAeq1h Calculated	Crit'n	Increase over existing		With Barrier				
						Calculated	Crit'n	Type Impact	Calculated LAeq1h	Noise Reduction		Calculated minus Goal
							Sub'l Inc			Calculated	Goal	Calculated minus Goal
			dB	dB	dB	dB	dB		dB	dB	dB	dB
Receiver1	1	1	0.0	61.2	66	61.2	10	----	61.2	0.0	8	-8.0
Receiver2	2	1	0.0	61.5	66	61.5	10	----	61.5	0.0	8	-8.0
Dwelling Units		# DUs	Noise Reduction									
			Min	Avg	Max							
			dB	dB	dB							
All Selected		2	0.0	0.0	0.0							
All Impacted		0	0.0	0.0	0.0							
All that meet NR Goal		0	0.0	0.0	0.0							

Maverik Fueling Station and Convenience Store Traffic Study

Prepared for:

Willis Environmental Planning
238 Sychar Road
San Diego, CA 92114

Prepared by:

Marc Mizuta, PE, TE, PTOE



5694 Mission Center Road, #602-121
San Diego, CA 92108

April 2024

EEC ORIGINAL PKG

TABLE OF CONTENTS

1	INTRODUCTION	1
1.1	PROJECT DESCRIPTION	1
2	ANALYSIS APPROACH AND METHODOLOGY	4
2.1	STUDY AREA	4
2.2	ANALYSIS SCENARIOS	4
2.3	METHODOLOGY	5
2.3.1	<i>Intersection Level of Service Analysis</i>	5
2.3.2	<i>Roadway Segment Analysis</i>	6
2.4	IMPROVEMENT CRITERIA	6
3	EXISTING CONDITIONS	7
3.1	ROADWAY NETWORK	7
3.2	TRAFFIC VOLUMES	8
3.3	INTERSECTION ANALYSIS	8
3.4	ROADWAY SEGMENT ANALYSIS	11
3.5	QUEUING ANALYSIS	11
4	PROJECT TRAFFIC	13
4.1	TRIP GENERATION	13
4.2	TRIP DISTRIBUTION AND ASSIGNMENT	15
5	OPENING YEAR CONDITIONS	18
5.1	ROADWAY NETWORK	18
5.2	CUMULATIVE PROJECTS	18
5.3	TRAFFIC VOLUMES	19
5.4	INTERSECTION ANALYSIS	19
5.5	ROADWAY SEGMENT ANALYSIS	22
5.6	QUEUING ANALYSIS	22
6	MULTI-MODAL ANALYSIS	23
6.1.1	<i>Pedestrian Access</i>	23
6.1.2	<i>Bicycle Access</i>	23
6.1.3	<i>Transit Service</i>	23
7	PROJECT CEQA TRANSPORTATION ANALYSIS	24
7.1	VMT ASSESSMENT	24
7.2	VMT SCREENING ANALYSIS	24
8	SUMMARY OF FINDINGS AND RECOMMENDATIONS	25

LIST OF FIGURES

Figure 1-1 Project Vicinity Map.....	2
Figure 1-2 Site Plan	3
Figure 3-1 Existing Intersection Geometrics	7
Figure 3-2 Existing Conditions Traffic Volumes	10
Figure 4-1 Project Trip Distribution	16
Figure 4-2 Project Trip Assignment	17
Figure 5-1 Opening Year with Project Intersection Geometrics	18
Figure 5-2 Opening Year 2025 Baseline Traffic Volumes.....	20
Figure 5-3 Opening Year 2025 Plus Project Traffic Volumes.....	21

LIST OF TABLES

Table 2-1 LOS Criteria for Intersections.....	5
Table 2-2 LOS Criteria for Roadway Segments.....	6
Table 3-1 Existing Peak Hour Intersection LOS Summary.....	9
Table 3-2 Existing Roadway Segment LOS Summary	11
Table 3-3 Intersection Queuing Summary	11
Table 4-1 Project Trip Generation.....	14
Table 5-1 Opening Year 2025 Peak Hour Intersection LOS Summary	19
Table 5-2 Opening Year 2025 Roadway LOS Summary.....	22
Table 5-3 Intersection Queuing Summary	22

APPENDICES

Appendix A	Existing Traffic Volume Data
Appendix B	Intersection LOS Worksheets
Appendix C	Queuing Worksheets
Appendix D	SCAG Profile of Imperial County Report Excerpts
Appendix E	VMT Supporting Information

I INTRODUCTION

This traffic study evaluates the traffic conditions associated with the proposed Maverik Fueling Station and Convenience Store project (herein referred to as “the Project”) located on a 10-acre vacant parcel (APN 054-080-023) on the southeast corner of the Hawes Road & Ross Avenue intersection in unincorporated Imperial County, CA. **Figure 1-1** shows the location of the project site within the study area. The traffic analyses have been prepared in accordance with the *County of Imperial Department of Public Works Traffic Study and Report Policy, June 29, 2007 (County Guidelines)* and consistent with the countywide goals toward the Congestion Management Program (CMP) in Imperial County.

1.1 Project Description

The proposed Project would consist of the development of a 21-vehicle fueling position fueling station with two canopies and a 5,982 square-foot (sf) convenience store. The fueling stations located to the east of the convenience store would be dedicated to larger trucks. The project is anticipated to be completed and in operation by 2025.

Access to the site will be provided by three driveways off Ross Avenue. **Figure 1-2** illustrates the Project site plan.

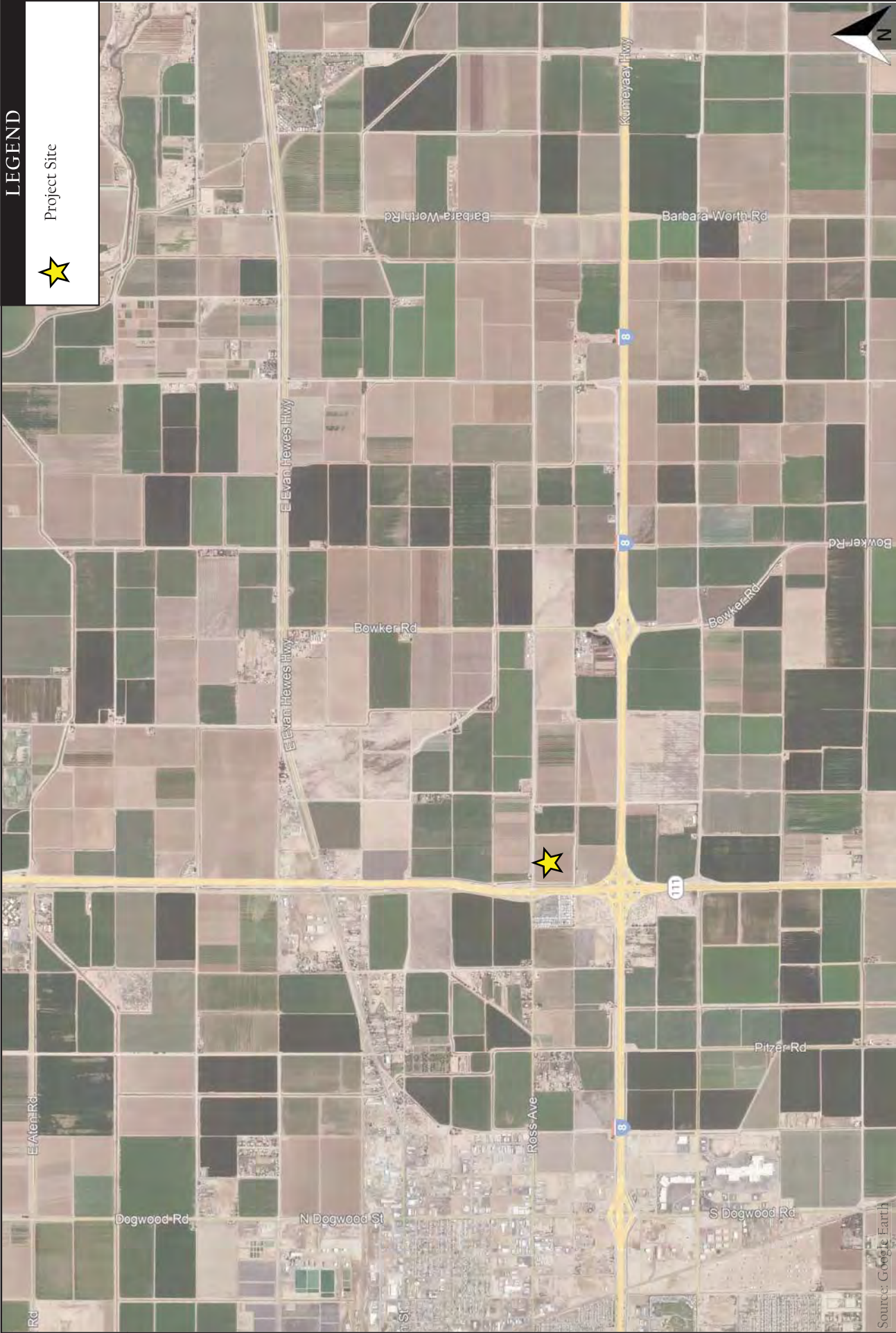

Maverik Fueling Station and Convenience Store

Figure 1-1
Project Vicinity Map

2 ANALYSIS APPROACH AND METHODOLOGY

This section summarizes the analysis approach and methodology used to evaluate the study intersections and roadway segments associated with the Project.

2.1 Study Area

This traffic study addresses potential operational impacts that could result from the addition of the Project traffic to the local circulation system.

The following intersections and roadway segments are included as part of the study area since they will carry majority of the project traffic:

Intersections

1. Highway 111 & E Evan Hewes Highway
2. Highway 111 & Ross Avenue
3. Bowker Road & Ross Avenue
4. West Project Driveway & Ross Avenue (constructed as part of Project)
5. Middle Project Driveway & Ross Avenue (constructed as part of Project)
6. East Project Driveway & Ross Avenue (constructed as part of Project)

Segments

1. Highway 111 north of Ross Avenue
2. Highway 111 south of Ross Avenue
3. Ross Avenue east of Highway 111

2.2 Analysis Scenarios

The following scenarios were evaluated as part of the project:

- Existing Conditions: This scenario represents the conditions on the ground at the time the traffic volume data was obtained (Thursday, November 9, 2023).
- Opening Year 2025 Baseline: This scenario represents the conditions on the anticipated year of opening for the Project, which is assumed to occur in 2025. This scenario also includes traffic from other approved and reasonably foreseeable pending projects that are expected to influence the study area.
- Opening Year 2025 Plus Project: This scenario represents the conditions on the anticipated year of opening for the Project and includes the Project traffic.

The traditional weekday peak-hour coinciding with the highest volume of traffic between 7:00 and 9:00 AM and between 4:00 and 6:00 PM was evaluated for each analysis scenario.

2.3 Methodology

2.3.1 Intersection Level of Service Analysis

Signalized and unsignalized intersection operations were analyzed with Synchro II software (Trafficware), using the methodologies outlined in the *Highway Capacity Manual 6th Edition (HCM6)*. The HCM methodology calculates delay, which corresponds to a particular LOS, to describe the overall operation of an intersection. Delay is a measure of driver and/or passenger discomfort, frustration, fuel consumption and lost travel time.

The LOS for unsignalized intersections is determined by the computed or measured control delay and is defined for each minor movement. At a one-way or two-way stop control intersection, the delay reported represents the worst movement, which is typically the left-turns from the minor street approach. The criteria for the LOS grade designations are provided in **Table 2-1**.

Within the County of Imperial, the threshold for acceptable operating conditions for signalized and unsignalized intersections is LOS C or better.

Table 2-1
LOS Criteria for Intersections

LOS	LOS Criteria (sec/veh)		Description
	Signalized Intersections	Unsignalized Intersections	
A	≤10	≤10	EXCELLENT. Operations with very low delay and most vehicles do not stop.
B	>10 and ≤20	>10 and ≤15	VERY GOOD. Operations with good progression but with some restricted movements.
C	>20 and ≤35	>15 and ≤25	GOOD. Operations where a significant number of vehicles are stopping with some backup and light congestion.
D	>35 and ≤55	>25 and ≤35	FAIR. Operations where congestion is noticeable, longer delays occur, and many vehicles stop. The proportion of vehicles not stopping declines.
E	>55 and ≤80	>35 and ≤50	POOR. Operations where there is significant delay, extensive queuing, and poor progression.
F	>80	>50	FAILURE. Operations that are unacceptable to most drivers, when the arrival rates exceed the capacity of the intersection.

Source: *Highway Capacity Manual 6th Edition*

2.3.2 Roadway Segment Analysis

Roadway segment LOS standards and thresholds provide the basis for analysis of arterial roadway segment performance. This analysis is based on the functional classification of the roadway, the maximum capacity, roadway geometrics, and the daily traffic volumes.

Table 2-2 summarizes the capacities for the various roadway classifications with the County of Imperial for each respective LOS.

Table 2-2
LOS Criteria for Roadway Segments

Facility Type	X-Section	LOS		
		C or Better	D	E
Expressway	154/210	< 60,000	< 70,000	< 80,000
Prime Arterial	106/136	< 44,600	< 50,000	< 57,000
Minor Arterial	82/102	< 29,600	< 33,400	< 37,000
Major Collector (Collector)	64/84	< 27,400	< 30,800	< 34,200
Minor Collector (Local Collector)	40/70	< 7,100	< 10,900	< 16,200
Local County (Residential)	40/60	< 1,500	*	*
Local County (Residential Cul-de-Sac or Loop Street)	40/60	< 200	*	*
Major Industrial Collector – (Industrial)	76/96	< 14,000	< 17,000	< 20,000
Industrial Local	44/64	< 7,000	< 8,500	< 10,000

Source: *Imperial County General Plan, Circulation and Scenic Highway Element, 2008*

* Levels of service are not applied to residential streets since their primary purpose is to serve abutting lots, not carry through traffic. Levels of service normally apply to roads carrying through traffic between major trip generators and attractors

2.4 Improvement Criteria

Senate Bill 743 (SB 743) was approved in 2013 and changes the way transportation impacts are measured under the California Environmental Quality Act (CEQA). Automobile delay resulting in a level of service (LOS) is no longer considered a significant impact under CEQA. However, the County of Imperial Department of Public Works requires transportation analyses to review roadway capacity in terms of LOS to identify deficiencies and require improvements to the circulation system outside of CEQA.

Based on the County General Plan, the LOS goal for intersections and roadway segments is to operate at LOS C or better. As a result, if an intersection or roadway segment degrades from LOS C or better to LOS D or worse with the addition of project traffic, improvements would be required.

3 EXISTING CONDITIONS

This section describes the existing roadway network, peak hour traffic volumes, and operations at the study area intersections and roadway segments.

3.1 Roadway Network

Highway 111 (Hwy 111) is a north-south divided roadway with 2 lanes of travel provided in each direction. According to the *County's Circulation and Scenic Highway Element*, Hwy 111 is classified as an Expressway. Parking is prohibited on both sides of the roadway. The posted speed limit is 55 miles per hour (mph).

Ross Avenue is an east-west roadway with 1 lane of travel provided in each direction. According to the *County's Circulation and Scenic Highway Element*, Ross Avenue is classified as a Minor Collector (Local Collector). Parking is prohibited on both sides of the road. There are no posted speed limit signs in the project vicinity.

Figure 3-1 illustrates the intersection geometrics at the study area intersections.

Figure 3-1 Existing Intersection Geometrics

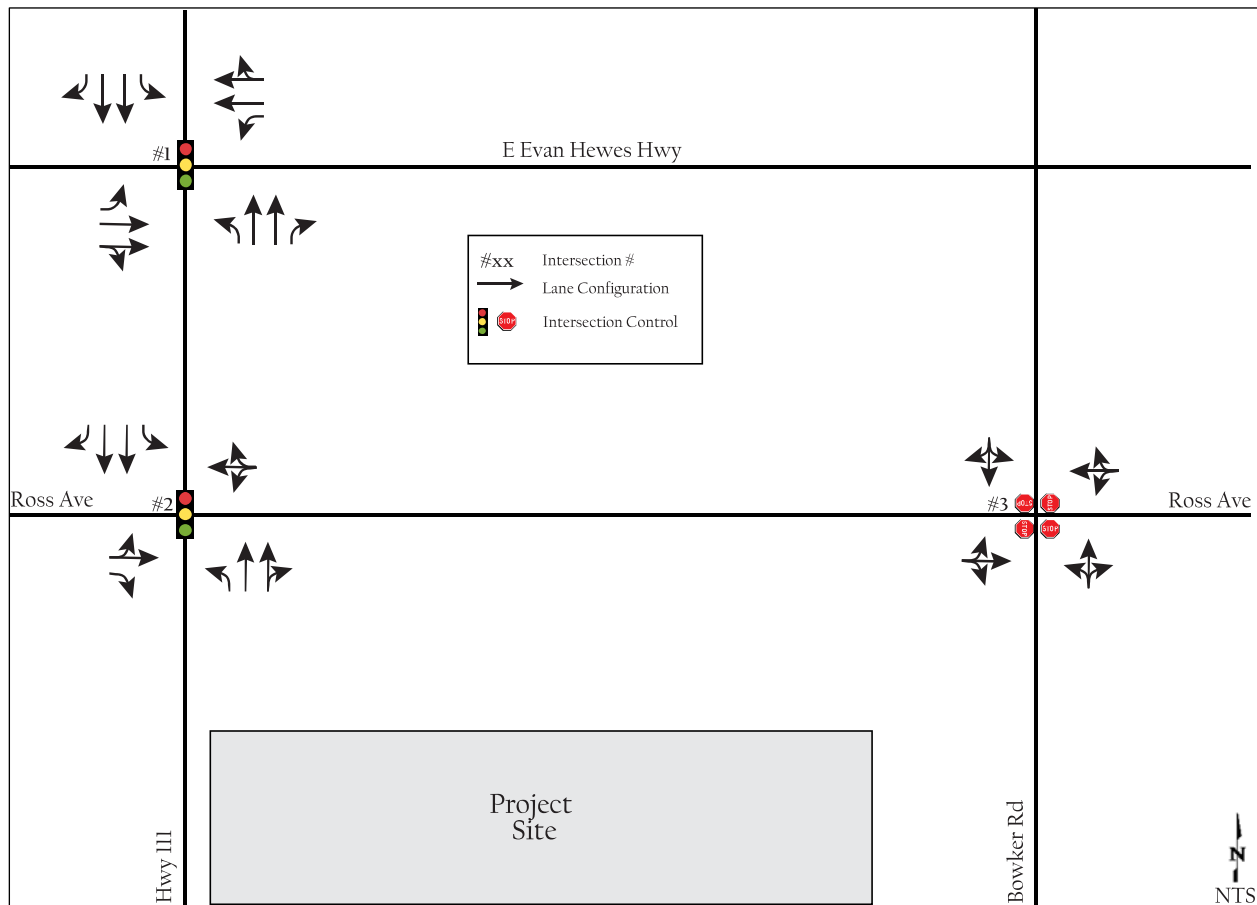

3.2 Traffic Volumes

Existing traffic volumes in the study area were obtained in November 2023. Figure 3-2 illustrates the study area traffic volumes.

Additionally, vehicle classification counts were obtained along Highway 111 and Ross Avenue. The following list summarizes the percentage of heavy vehicles, by direction:

- Highway 111
 - Northbound: 14 percent
 - Southbound: 14 percent
- Ross Avenue
 - Eastbound: 6 percent
 - Westbound: 9 percent

Appendix A contains a copy of the traffic volume data sheets.

3.3 Intersection Analysis

Table 3-1 summarizes the LOS analysis results for the study area intersections under Existing Conditions. As shown in the table, all intersections and project driveways operate at LOS C or better during the weekday peak-hours.

Appendix B contains the intersection LOS worksheets.

Table 3-1
Existing Peak Hour Intersection LOS Summary

#	Intersection	Traffic Control	Peak Hour	Existing Conditions	
				Delay ¹	LOS ²
1	Hwy 111 & E Evan Hewes Hwy	Signal	AM	24.5	C
			PM	25.6	C
2	Hwy 111 & Ross Ave	Signal	AM	11.4	B
			PM	16.4	B
3	Bowker Rd & Ross Ave	AWSC	AM	8.0	A
			PM	7.9	A
4	W Proj Dwy & Ross Ave	OWSC	AM	DNE ³	
			PM		
5	Mid Proj Dwy & Ross Ave	OWSC	AM	DNE ³	
			PM		
6	E Proj Dwy & Ross Ave	OWSC	AM	DNE ³	
			PM		

Notes:

Signal: Traffic Signal, AWSC: All-Way Stopped Control, OWSC: One-Way Stopped Control, TWSC: Two-Way Stopped Control

1. Delays are reported as the average control delay for the entire intersection at signalized intersections and the worst movement at unsignalized intersections.

2. LOS calculations are based on the methodology outlined in the *Highway Capacity Manual 6th Edition (HCM6)* and performed using Synchro II.

3. DNE: Does not exist and will be constructed as part of the Project.



xx / yy - AM / PM Peak-Hour Turning Movement Volumes
 The naming convention for intersections is North / South & East / West

xx,xxx ADT

Hwy 111 & E Evan Hewes Hwy		Hwy 111 & Ross Ave		Bowker Rd & Ross Ave		W Proj Dwy & Ross Ave	
58 / 74 712 / 1068 67 / 91 143 / 77 258 / 191 85 / 85 1		21 / 26 778 / 1223 2 / 6 4 / 5 41 / 29 5 / 5 2		34 / 16 90 / 94 2 / 0 2 / 1 7 / 5 3 / 8 3		Intersection does not exist	
37 / 37 165 / 237 50 / 106 118 / 84 761 / 693 99 / 98		50 / 35 39 / 47 99 / 156 98 / 95 943 / 816 6 / 8		35 / 41 6 / 9 7 / 30 15 / 8 96 / 70 6 / 3			
Mid Proj Dwy & Ross Ave		E Proj Dwy & Ross Ave					
Intersection does not exist		Intersection does not exist					



Maverik Fueling Station and Convenience Store

Existing Conditions Traffic Volumes

Figure 3-2

3.4 Roadway Segment Analysis

Table 3-2 summarizes the LOS analysis results for the study area roadway segments under Existing Conditions. As shown in the table, all roadway segments function at LOS B or better.

Table 3-2
Existing Roadway Segment LOS Summary

Roadway Segment	Functional Classification ¹	Capacity (LOS E)	ADT	v/c Ratio	LOS
Hwy III					
n/o Ross Ave	Expressway	80,000	30,051	0.38	B
s/o Ross Ave	Expressway	80,000	32,468	0.41	B
Ross Ave					
e/o Hwy III	Minor Collector (Local Collector)	16,200	959	0.06	A

Notes:

1. The roadway functional classification is based off the number of lanes that currently exist.

3.5 Queuing Analysis

A queuing analysis was also performed at the signalized intersections along Highway III to determine if queues could extend past the existing turn pocket and spill back onto Highway III. Table 3-3 summarizes the results of the queuing analysis.

Table 3-3
Intersection Queuing Summary

Intersection	Peak Hour	Movement	Storage Length (ft) ¹	Queue Length (ft) ²
				Existing
1 Proj Dwy/Glover Ave & H St	AM	NB LT	750	136
	PM			99
	AM	NB RT	435	6
	PM			4
	AM	SB LT	535	86
	PM			96
	AM	SB RT	350	0
	PM			0
2 Highway III & Ross Ave	AM	NB LT	550	87
	PM			92
	AM	SB LT	450	6
	PM			11
	AM	SB RT	450	0
	PM			0

Notes:

Values shown in **bold and shaded** indicate movements where the queue length exceeds the available storage length.

1. The storage length was estimated from Google Earth.
2. The queue length shown represents the 95th percentile queue length for each respective movement along Highway III.

As shown in the table, the 95th percentile queues for the northbound and southbound movements along Highway 111 would be contained in the left-turn or right-turn pockets and not extend back into the through lanes.

Appendix C contains the queuing worksheets.

4 PROJECT TRAFFIC

This section describes the estimated trip generation, trip distribution, and assignment of trips to the adjacent roadway network.

4.1 Trip Generation

The *ITE Trip Generation Manual* provides a convenience store/gas station and truck stop land use category (Land Use Codes 945 and 950) that was utilized for the project. It should be noted that the trips associated with the truck stop use have been separated into passenger cars and trucks and converted to passenger car equivalents (PCE). A PCE value of 3 was applied to the trips generated by the truck stop land use. Trip credits such as passby trips were applied to the proposed use based on standard rates published in the *ITE Trip Generation Manual*. Passby trips are trips that are already on the road network and “passing by” the project site.

The trip rates for the convenience store/gas station land use were applied to the 7 fuel pumps/14 vehicle fueling positions to the west of the convenience store. The trip rates for the truck stop were applied to the 12 fuel pumps/24 vehicle fueling positions to the east of the convenience store. It should be note that although 24 vehicle fueling positions are shown on the site plan, the analysis utilized 7 vehicle fueling positions, which represent the number of lanes where the large trucks will fill their tanks. Larger trucks have multiple fueling tanks and only one truck can fill its tanks while parked under the canopy.

Table 4-1 summarizes the weekday trip generation rates and calculations. As shown in the table, the Project is estimated to generate 9,545 daily trips with 736 AM peak-hour trips and 701 PM peak-hour trips at the project driveways. After applying the passby trip credits, the project is forecasted to generate a net total of 2,386 daily trips with 183 AM peak-hour trips and 175 PM peak-hour trips.

Table 4-1
Project Trip Generation

TRIP GENERATION RATES ¹									
Land Use	ITE Code	Weekday Daily trips / vfp	AM PEAK		PM PEAK				
			Rate	In:Out Ratio	Rate	In:Out Ratio			
Convenience Store/Gas Station - GFA (5.5-10K)	945	345.75	31.60	0.50 : 0.50	26.90	0.50 : 0.50			
Truck Stop	950	224.00	13.97	0.49 : 0.51	15.42	0.53 : 0.47			
TRIP GENERATION CALCULATIONS									
Land Use	Amount	ADT	In	Out	Total	In	Out	Total	
Proposed Use									
Convenience Store/Gas Station	14	4,841	221	221	442	189	188	377	
Less Pass-by Trips (76%-AM, 75%-PM/Daily) ²		-3,631	-166	-166	-332	-142	-141	-283	
Truck Stop	7	1,568	48	50	98	57	51	108	
Passenger Car Equivalent Factor (PCE) = 3.0		6,720	207	213	420	246	216	462	
Less Pass-by Trips (76%-AM, 75%-PM ex-Daily) ²		-5,040	-156	-160	-316	-185	-162	-347	
Proposed Driveway Trips (PCE)		9,545	365	371	736	360	341	701	
Less Pass-by Trips		-7,159	-274	-279	-553	-270	-256	-526	
Net New Traffic		2,386	91	92	183	90	85	175	

Notes:

- vfp: vehicle fueling position
- 1. The trip rates for the project's land use are based on the *Institute of Transportation Engineers (ITE) Trip Generation Manual, 11th Edition*.
- 2. The passby trip rate is based on the average rates published in the *ITE Trip Generation Manual, 11th Edition*.

4.2 Trip Distribution and Assignment

The Project trip distribution was estimated based on existing travel patterns and on logical routes to local roadway network. The following list summarizes the proposed trip distribution:

- 15 percent to/from the north
 - 10 percent via Highway 111
 - 5 percent via Bowker Road
- 15 percent to/from the south
 - 10 percent via Highway 111
 - 5 percent via Bowker Road
- 30 percent to/from the east
 - 10 percent via E Even Hewes Highway
 - 20 percent via Interstate 8
- 40 percent to/from the west
 - 10 percent via E Even Hewes Highway
 - 10 percent via Ross Avenue
 - 20 percent via Interstate 8

Figure 4-1 displays the assumed Project trip distribution through the study intersections and project driveways. Based on the Project trip generation and distribution, the Project trips were assigned to the study area. Figure 4-2 illustrates the Project trip assignment.



Hwy 111 & E Evan Hewes Hwy		Hwy 111 & Ross Ave		Bowker Rd & Ross Ave		W Proj Dwy & Ross Ave	
10% / (0%) 10% / (0%) 10% / (0%) 0% / (10%) 0% / (10%) 0% / (10%)	10% / (0%) 10% / (0%)	30% / (0%) 10% / (0%) 45% / (0%)	0% / (30%) 0% / (10%) 0% / (45%)	5% / (0%) 0% / (5%) 0% / (10%) 10% / (0%)	0% / (55%) 5% / (0%) 55% / (0%) 30% / (0%) 0% / (30%) 0% / (5%)		
Mid Proj Dwy & Ross Ave		E Proj Dwy & Ross Ave					
5% / (25%) 5% / (0%) 25% / (5%) 30% / (0%) 0% / (30%) 0% / (5%)	10% / (0%) 5% / (0%) 0% / (10%) 25% / (0%) 0% / (25%) 0% / (5%)						



Maverik Fueling Station and Convenience Store

Project Trip Distribution

Figure 4-1



xx / yy - AM / PM Peak-Hour Turning Movement Volumes
 The naming convention for intersections is North / South & East / West

Hwy 111 & E Evan Hewes Hwy		Hwy 111 & Ross Ave		Bowker Rd & Ross Ave		W Proj Dwy & Ross Ave	
Mid Proj Dwy & Ross Ave		E Proj Dwy & Ross Ave					



Maverik Fueling Station and Convenience Store

Project Trip Assignment

Figure 4-2

5 OPENING YEAR CONDITIONS

This section provides a summary of operations at the study area intersections, roadway segments, and project driveways with the addition of the project traffic in the anticipated year of opening in 2025.

5.1 Roadway Network

No changes to the existing roadway network are proposed under this condition except at the project driveways. The Project will construct the three driveways along Ross Avenue and include left- and right-turn pockets that are designed per the *Caltrans Highway Design Manual*. Figure 5-1 illustrates the intersection geometrics with the addition of the Project.

Figure 5-1 Opening Year with Project Intersection Geometrics

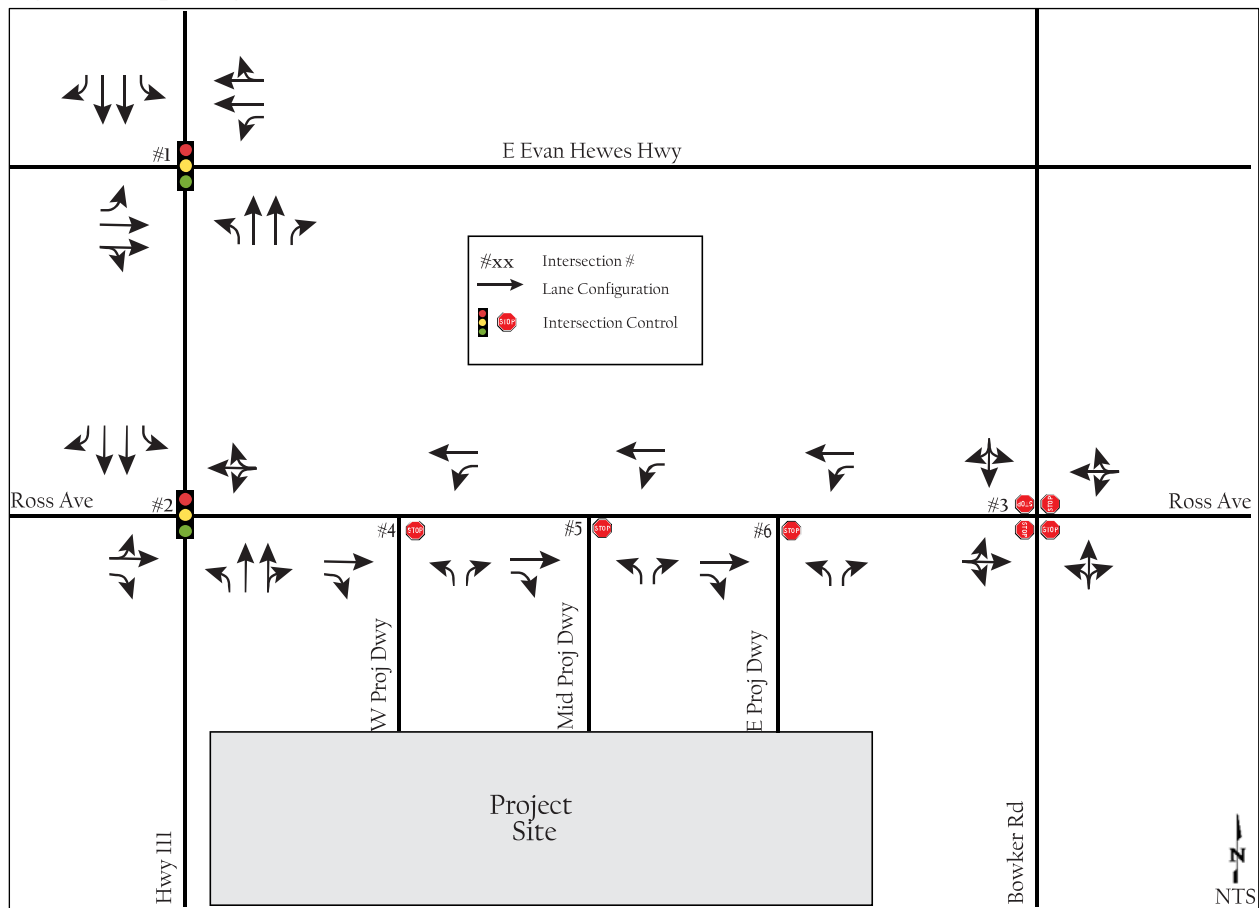

5.2 Cumulative Projects

There are no specific cumulative projects identified in the immediate vicinity of the project site. As such, a conservative three percent per year factor was used to account for the growth of any unidentified cumulative project. The cumulative growth factor was applied to the existing traffic volumes.

5.3 Traffic Volumes

The Opening Year 2025 Baseline Conditions traffic volumes were developed by applying a regional growth factor and including the cumulative traffic volumes. According to the *Southern California Association of Governments' (SCAG) Profile of Imperial County Report, May 2019*, the population of Imperial County grew by 48,263 people between 2000 and 2018, which corresponds to an annual growth rate of 1.4 percent. This growth rate was applied to the existing traffic volumes for three years to estimate the Year 2025 baseline conditions. Appendix D contains of the *SCAG Profile of Imperial County Report*.

The cumulative and growth factor results in an overall 5.8 percent growth over existing traffic volumes. Figure 5-2 illustrates the Opening Year 2025 Baseline traffic volumes. Figure 5-3 illustrates the Opening Year 2025 Plus Project traffic volumes.

5.4 Intersection Analysis

Table 5-1 displays the LOS analysis results for the study intersections and project driveways under Opening Year 2025 Baseline and Plus Project conditions. As shown in the table, all intersections, including the project driveways, are expected to operate at LOS C or better during the weekday peak-hours with the addition of the Project traffic.

Appendix B contains the intersection LOS worksheets.

Table 5-1
Opening Year 2025 Peak Hour Intersection LOS Summary

#	Intersection	Traffic Control	Peak Hour	Opening Year 2025		Opening Year 2025 w/Proj		Δ in Delay	Improvement?
				Delay ¹	LOS ²	Delay ¹	LOS ²		
1	Hwy III & E Evan Hewes Hwy	Signal	AM	26.5	C	27.4	C	0.9	No
			PM	30.4	C	33.9	C	3.5	No
2	Hwy III & Ross Ave	Signal	AM	12.2	B	15.5	B	3.3	No
			PM	20.5	C	21.2	C	0.7	No
3	Bowker Rd & Ross Ave	AWSC	AM	8.1	A	8.3	A	0.2	No
			PM	7.9	A	8.1	A	0.2	No
4	W Proj Dwy & Ross Ave	OWSC	AM	DNE ³		13.4	B	13.4	No
			PM	DNE ³		13.0	B	13.0	No
5	Mid Proj Dwy & Ross Ave	OWSC	AM	DNE ³		11.1	B	11.1	No
			PM	DNE ³		11.0	B	11.0	No
6	E Proj Dwy & Ross Ave	OWSC	AM	DNE ³		9.7	A	9.7	No
			PM	DNE ³		9.7	A	9.7	No

Notes:

Signal: Traffic Signal, AWSC: All-Way Stopped Control, OWSC: One-Way Stopped Control, TWSC: Two-Way Stopped Control

1. Delays are reported as the average control delay for the entire intersection at signalized intersections and the worst movement at unsignalized intersections.

2. LOS calculations are based on the methodology outlined in the *Highway Capacity Manual 6th Edition (HCM6)* and performed using Synchro II.

3. DNE: Does not exist and will be constructed as part of the Project.



xx / yy = AM / PM Peak-Hour Turning Movement Volumes
 The naming convention for intersections is North / South & East / West

xx,xxx ADT

Hwy 111 & E Evan Hewes Hwy	Hwy 111 & Ross Ave	Bowker Rd & Ross Ave	W Proj Dwy & Ross Ave																																				
<table border="1"> <tr> <td>61 / 78 ↘ ↙</td> <td>151 / 81 ↘ ↙</td> </tr> <tr> <td>753 / 1130 ↔</td> <td>273 / 202 ↔</td> </tr> <tr> <td>71 / 96 ↖ ↗</td> <td>90 / 90 ↖ ↗</td> </tr> </table> <p style="text-align: center;">1</p> <table border="1"> <tr> <td>39 / 39 ↖ ↗</td> <td>125 / 89 ↖ ↗</td> </tr> <tr> <td>175 / 251 ↔</td> <td>805 / 733 ↔</td> </tr> <tr> <td>53 / 112 ↘ ↙</td> <td>105 / 104 ↘ ↙</td> </tr> </table>	61 / 78 ↘ ↙	151 / 81 ↘ ↙	753 / 1130 ↔	273 / 202 ↔	71 / 96 ↖ ↗	90 / 90 ↖ ↗	39 / 39 ↖ ↗	125 / 89 ↖ ↗	175 / 251 ↔	805 / 733 ↔	53 / 112 ↘ ↙	105 / 104 ↘ ↙	<table border="1"> <tr> <td>22 / 28 ↘ ↙</td> <td>4 / 5 ↘ ↙</td> </tr> <tr> <td>823 / 1294 ↔</td> <td>43 / 31 ↔</td> </tr> <tr> <td>2 / 6 ↖ ↗</td> <td>5 / 5 ↖ ↗</td> </tr> </table> <p style="text-align: center;">2</p> <table border="1"> <tr> <td>53 / 37 ↖ ↗</td> <td>104 / 101 ↖ ↗</td> </tr> <tr> <td>41 / 50 ↔</td> <td>998 / 863 ↔</td> </tr> <tr> <td>105 / 165 ↘ ↙</td> <td>6 / 8 ↘ ↙</td> </tr> </table>	22 / 28 ↘ ↙	4 / 5 ↘ ↙	823 / 1294 ↔	43 / 31 ↔	2 / 6 ↖ ↗	5 / 5 ↖ ↗	53 / 37 ↖ ↗	104 / 101 ↖ ↗	41 / 50 ↔	998 / 863 ↔	105 / 165 ↘ ↙	6 / 8 ↘ ↙	<table border="1"> <tr> <td>36 / 17 ↘ ↙</td> <td>2 / 1 ↘ ↙</td> </tr> <tr> <td>95 / 99 ↔</td> <td>7 / 5 ↔</td> </tr> <tr> <td>2 / 0 ↖ ↗</td> <td>3 / 8 ↖ ↗</td> </tr> </table> <p style="text-align: center;">3</p> <table border="1"> <tr> <td>37 / 43 ↖ ↗</td> <td>16 / 8 ↖ ↗</td> </tr> <tr> <td>6 / 10 ↔</td> <td>102 / 74 ↔</td> </tr> <tr> <td>7 / 32 ↘ ↙</td> <td>6 / 3 ↘ ↙</td> </tr> </table>	36 / 17 ↘ ↙	2 / 1 ↘ ↙	95 / 99 ↔	7 / 5 ↔	2 / 0 ↖ ↗	3 / 8 ↖ ↗	37 / 43 ↖ ↗	16 / 8 ↖ ↗	6 / 10 ↔	102 / 74 ↔	7 / 32 ↘ ↙	6 / 3 ↘ ↙	Intersection does not exist
61 / 78 ↘ ↙	151 / 81 ↘ ↙																																						
753 / 1130 ↔	273 / 202 ↔																																						
71 / 96 ↖ ↗	90 / 90 ↖ ↗																																						
39 / 39 ↖ ↗	125 / 89 ↖ ↗																																						
175 / 251 ↔	805 / 733 ↔																																						
53 / 112 ↘ ↙	105 / 104 ↘ ↙																																						
22 / 28 ↘ ↙	4 / 5 ↘ ↙																																						
823 / 1294 ↔	43 / 31 ↔																																						
2 / 6 ↖ ↗	5 / 5 ↖ ↗																																						
53 / 37 ↖ ↗	104 / 101 ↖ ↗																																						
41 / 50 ↔	998 / 863 ↔																																						
105 / 165 ↘ ↙	6 / 8 ↘ ↙																																						
36 / 17 ↘ ↙	2 / 1 ↘ ↙																																						
95 / 99 ↔	7 / 5 ↔																																						
2 / 0 ↖ ↗	3 / 8 ↖ ↗																																						
37 / 43 ↖ ↗	16 / 8 ↖ ↗																																						
6 / 10 ↔	102 / 74 ↔																																						
7 / 32 ↘ ↙	6 / 3 ↘ ↙																																						
Mid Proj Dwy & Ross Ave	E Proj Dwy & Ross Ave																																						
Intersection does not exist	Intersection does not exist																																						



Maverik Fueling Station and Convenience Store

Opening Year 2025 Baseline Traffic Volumes

Figure 5-2



xx / yy = AM / PM Peak-Hour Turning Movement Volumes
 The naming convention for intersections is North / South & East / West

xx,xxx ADT

Hwy 111 & E Evan Hewes Hwy		Hwy 111 & Ross Ave		Bowker Rd & Ross Ave		W Proj Dwy & Ross Ave	
61 / 78 762 / 1139 71 / 96 151 / 81 273 / 202 99 / 99 1		22 / 28 823 / 1294 29 / 33 32 / 31 52 / 40 46 / 43 2		41 / 22 95 / 99 2 / 0 2 / 1 7 / 5 3 / 8 3		217 / 203 18 / 18 4	
39 / 39 175 / 251 62 / 121 134 / 98 814 / 742 114 / 113		53 / 37 50 / 59 105 / 165 104 / 101 998 / 863 47 / 49		42 / 47 6 / 10 16 / 41 25 / 17 102 / 74 6 / 3		216 / 211 110 / 108 111 / 102 19 / 17	
Mid Proj Dwy & Ross Ave		E Proj Dwy & Ross Ave					
124 / 118 18 / 18 5		50 / 51 18 / 18 6					
125 / 120 110 / 108 111 / 102 19 / 17		52 / 47 91 / 90 93 / 85 18 / 18					



Maverik Fueling Station and Convenience Store
 Opening Year 2025 With Project Traffic Volumes

Figure 5-3

5.5 Roadway Segment Analysis

Table 5-2 displays the LOS analysis for the study area roadway segments under the Opening Year 2025 with and without Project conditions.

Table 5-2
Opening Year 2025 Roadway LOS Summary

Roadway Segment	Opening Year 2025			Opening Year 2025 w/Proj			Δ in V/C	Improvement?
	ADT	v/c Ratio	LOS	ADT	v/c Ratio	LOS		
Hwy III								
n/o Ross Ave	31,794	0.40	B	32,510	0.41	B	0.009	No
s/o Ross Ave	34,351	0.43	B	35,425	0.44	B	0.014	No
Ross Ave								
e/o Hwy III	1,015	0.06	A	3,401	0.21	B	0.147	No

As shown in the table, the all roadway segments would continue to function at LOS B or better with the addition of the project traffic. As a result, no additional improvements are required and/or recommended.

5.6 Queuing Analysis

Table 5-3 summarizes the results of the queuing analysis under the Opening Year scenario.

Table 5-3
Intersection Queuing Summary

Intersection	Peak Hour	Movement	Storage Length (ft) ¹	Queue Length (ft) ²	
				Opening Year 2025	Opening Year 2025 w/Proj
1 Highway III & E Even Hewes Hwy	AM	NB LT	750	145	158
	PM			106	118
	AM	NB RT	435	9	13
	PM			6	10
	AM	SB LT	535	92	92
	PM			104	104
	AM	SB RT	350	0	0
PM	0			0	
2 Highway III & Ross Ave	AM	NB LT	550	94	98
	PM			100	101
	AM	SB LT	450	6	32
	PM			11	33
	AM	SB RT	450	0	0
	PM			0	0

Notes:

Values shown in **bold and shaded** indicate movements where the queue length exceeds the available storage length.

1. The storage lengths were estimated from Google Earth.

2. The queue length shown represents the 95th percentile queue length for each respective movement along Highway III.

As shown in the table, the 95th percentile queues for the northbound and southbound movements along Highway III would be contained in the left-turn or right-turn pockets and not extend back into the through lanes. Appendix C contains the queuing worksheets.

6 MULTI-MODAL ANALYSIS

In addition to the vehicular roadway network, alternative modes of travel such as pedestrian, bicycle, and transit are provided within the study area and described in more detail below.

6.1.1 Pedestrian Access

There are no pedestrian facilities within the study area. However, pedestrians are allowed at the Highway 111 & Ross Road intersection. Pedestrians are allowed to cross Highway 111 on the south leg and cross Ross Avenue on the east and west legs of the intersection.

An existing RV Park is located on the southwest corner of the Highway 111 & Ross Avenue intersection. There were no pedestrians crossing Highway 111 or Ross Avenue during the AM and PM peak-hours. However, with the Project, there could be an increased demand for pedestrian activity between the RV Park and Project. Pedestrians would be able to cross Highway 111 on the south leg in its respective pedestrian phase and walk along the paved shoulders of Ross Avenue to access the Project. The walking distance is approximately 800 feet.

6.1.2 Bicycle Access

There are no bicycle facilities within the study area. According to the *Imperial County Transportation Commission Regional Active Transportation Plan, February 2022*, a Class II bicycle facility is proposed along Highway 111 within the study area. Currently, there is no identified funding for this project.

6.1.3 Transit Service

Imperial Valley Transit provides transit service within Imperial County. However, there are no transit stops within the study area. The nearest transit stop is located at the Imperial Valley College, which is approximately 3.25 miles to the north along Highway 111.

7 PROJECT CEQA TRANSPORTATION ANALYSIS

This section summarizes the transportation analysis under the current California Environmental Quality Act (CEQA) guidelines for Vehicle Miles Traveled (VMT). Senate Bill 743 (SB 743) was approved in 2013 and changes the way transportation impacts are measured under CEQA. The Office of Planning and Research (OPR) has recommended the use of VMT as the required metric to replace the automobile delay-based LOS. The VMT assessment is required to satisfy CEQA guidelines that utilizes VMT as the required metric to determine transportation impacts. Since the County of Imperial has yet to adopt the VMT guidelines, the VMT assessment was based on the criteria outlined in the *Governor's Office of Planning and Research (OPR) Technical Advisory on Evaluating Transportation Impacts in CEQA (OPR's Technical Advisory)*.

7.1 VMT Assessment

According to the *OPR's Technical Advisory*, there are several screening criteria that can be applied to effectively screen projects from VMT project-level assessments. The purpose is to screen out projects that are presumed to have a non-significant transportation impact based on facts of a project and to avoid unnecessary analysis and findings that would be inconsistent with the intent of SB 743. The following lists the various screening criteria:

1. Small Projects
2. Transit Priority Area (TPA)
3. Project Type – Locally Serving Retail

If the project meets any of the screening criteria above, they are presumed to not have a significant impact and are screened out from completing additional VMT analysis.

7.2 VMT Screening Analysis

Upon reviewing the screening criteria, the most appropriate and applicable criteria for the project was the Local Serving Retail use less than 50,000 sf criteria. According to *OPR's Technical Advisory*, a project that is a locally serving retail land use under 50,000 sf would be presumed to have a less than significant impact and can be successfully screened from further VMT analysis. The project's convenience store/gas station area is 5,892 sf, which is much less than 50,000 sf. Additionally, if the two canopies area for the fueling pumps are included in the total, it would only add another 9,000 sf. The sum of both of these areas are still well below the 50,000 sf threshold. The presence of other gas stations in the immediate vicinity of the project also supports the conclusion that the project would indeed function as local serving retail with most customers likely traveling from nearby areas within the County/neighboring cities and with little potential to draw longer trips from the wider region.

As a result, the Project's total square footage is less than 50,000 sf and the screening threshold is met.

Appendix E contains VMT supporting information.

8 SUMMARY OF FINDINGS AND RECOMMENDATIONS

The following list summarizes the key findings for the Project:

- The Project consists of the development of a 21-vehicle fueling position fueling station with two canopies and a 5,982 square-foot (sf) convenience store.
- The Project is forecasted to generate 9,545 daily trips with 736 AM peak-hour trips and 701 PM peak-hour trips at the project driveways, which takes into account converting all truck traffic to PCE trips.
- After applying the passby trip credits, the project is forecasted to generate a net total of 2,386 daily trips with 183 AM peak-hour trips and 175 PM peak-hour trips.
- All intersections, roadway segments, and the project driveways in the study area are expected to operate at an acceptable LOS C or better under all scenarios.
- The Project satisfies the Local Serving Retail less than 50,000 sf under the Project Type screening and is presumed to result in a less than significant VMT impact.

This traffic study has been prepared in accordance with the *County of Imperial Department of Public Works Traffic Study and Report Policy, June 29, 2007*. The proposed Project will not result in any deficient facilities in the study area. No additional improvements are required or recommended of the proposed Project.

Appendix A

Existing Traffic Volume Data

County of Imperial
 N/S: Highway 111
 E/W: Evan Hewes Highway
 Weather: Clear

File Name : 01_CIM111EHAM
 Site Code : 23523104
 Start Date : 11/9/2023
 Page No : 1

Groups Printed- Total Volume

Start Time	Highway 111 Southbound				Evan Hewes Highway Westbound				Highway 111 Northbound				Evan Hewes Highway Eastbound				Int. Total
	Left	Thru	Right	App. Total	Left	Thru	Right	App. Total	Left	Thru	Right	App. Total	Left	Thru	Right	App. Total	
07:00 AM	11	111	11	133	5	40	13	58	19	181	11	211	5	21	8	34	436
07:15 AM	17	115	16	148	21	57	17	95	24	178	10	212	14	37	8	59	514
07:30 AM	23	199	17	239	23	51	31	105	25	254	24	303	11	42	14	67	714
07:45 AM	22	204	17	243	22	73	45	140	32	227	30	289	7	42	18	67	739
Total	73	629	61	763	71	221	106	398	100	840	75	1015	37	142	48	227	2403
08:00 AM	10	139	11	160	23	92	46	161	24	120	25	169	14	59	6	79	569
08:15 AM	12	170	13	195	17	42	21	80	37	160	20	217	5	22	12	39	531
08:30 AM	12	150	7	169	15	52	20	87	32	146	13	191	9	31	10	50	497
08:45 AM	20	151	13	184	14	51	21	86	23	150	18	191	9	30	9	48	509
Total	54	610	44	708	69	237	108	414	116	576	76	768	37	142	37	216	2106
Grand Total	127	1239	105	1471	140	458	214	812	216	1416	151	1783	74	284	85	443	4509
Apprch %	8.6	84.2	7.1		17.2	56.4	26.4		12.1	79.4	8.5		16.7	64.1	19.2		
Total %	2.8	27.5	2.3	32.6	3.1	10.2	4.7	18	4.8	31.4	3.3	39.5	1.6	6.3	1.9	9.8	

Start Time	Highway 111 Southbound				Evan Hewes Highway Westbound				Highway 111 Northbound				Evan Hewes Highway Eastbound				Int. Total
	Left	Thru	Right	App. Total	Left	Thru	Right	App. Total	Left	Thru	Right	App. Total	Left	Thru	Right	App. Total	
Peak Hour Analysis From 07:00 AM to 08:45 AM - Peak 1 of 1																	
Peak Hour for Entire Intersection Begins at 07:30 AM																	
07:30 AM	23	199	17	239	23	51	31	105	25	254	24	303	11	42	14	67	714
07:45 AM	22	204	17	243	22	73	45	140	32	227	30	289	7	42	18	67	739
08:00 AM	10	139	11	160	23	92	46	161	24	120	25	169	14	59	6	79	569
08:15 AM	12	170	13	195	17	42	21	80	37	160	20	217	5	22	12	39	531
Total Volume	67	712	58	837	85	258	143	486	118	761	99	978	37	165	50	252	2553
% App. Total	8	85.1	6.9		17.5	53.1	29.4		12.1	77.8	10.1		14.7	65.5	19.8		
PHF	.728	.873	.853	.861	.924	.701	.777	.755	.797	.749	.825	.807	.661	.699	.694	.797	.864

County of Imperial
 N/S: Highway 111
 E/W: Evan Hewes Highway
 Weather: Clear

File Name : 01_CIM111EHAM
 Site Code : 23523104
 Start Date : 11/9/2023
 Page No : 2

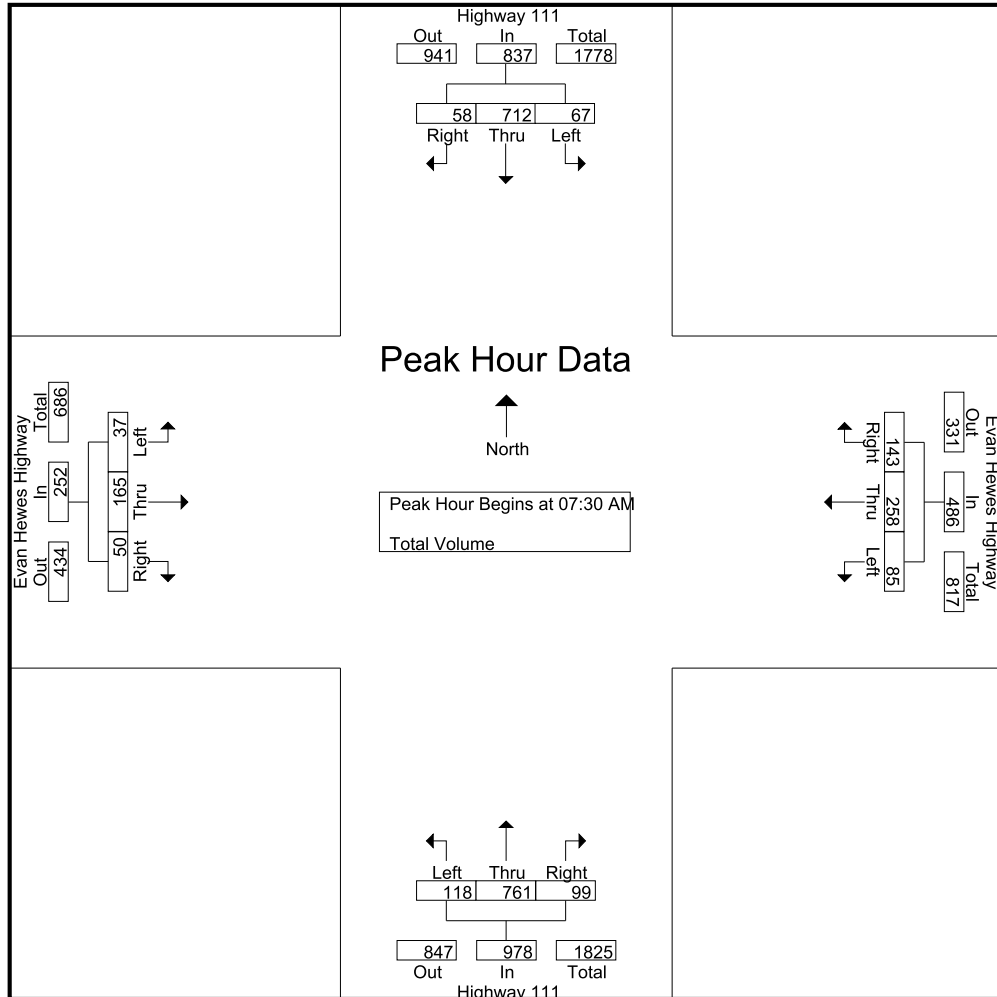

Peak Hour Analysis From 07:00 AM to 08:45 AM - Peak 1 of 1
 Peak Hour for Each Approach Begins at:

	07:30 AM				07:15 AM				07:00 AM				07:15 AM			
+0 mins.	23	199	17	239	21	57	17	95	19	181	11	211	14	37	8	59
+15 mins.	22	204	17	243	23	51	31	105	24	178	10	212	11	42	14	67
+30 mins.	10	139	11	160	22	73	45	140	25	254	24	303	7	42	18	67
+45 mins.	12	170	13	195	23	92	46	161	32	227	30	289	14	59	6	79
Total Volume	67	712	58	837	89	273	139	501	100	840	75	1015	46	180	46	272
% App. Total	8	85.1	6.9		17.8	54.5	27.7		9.9	82.8	7.4		16.9	66.2	16.9	
PHF	.728	.873	.853	.861	.967	.742	.755	.778	.781	.827	.625	.837	.821	.763	.639	.861

County of Imperial
 N/S: Highway 111
 E/W: Evan Hewes Highway
 Weather: Clear

File Name : 01_CIM111EHPM
 Site Code : 23523104
 Start Date : 11/9/2023
 Page No : 1

Groups Printed- Total Volume

Start Time	Highway 111 Southbound				Evan Hewes Highway Westbound				Highway 111 Northbound				Evan Hewes Highway Eastbound				Int. Total
	Left	Thru	Right	App. Total	Left	Thru	Right	App. Total	Left	Thru	Right	App. Total	Left	Thru	Right	App. Total	
04:00 PM	25	251	19	295	15	52	22	89	26	178	17	221	11	58	34	103	708
04:15 PM	22	282	15	319	23	42	21	86	17	195	24	236	5	60	25	90	731
04:30 PM	21	270	20	311	23	50	22	95	24	153	27	204	6	63	26	95	705
04:45 PM	23	265	20	308	24	47	12	83	17	167	30	214	15	56	21	92	697
Total	91	1068	74	1233	85	191	77	353	84	693	98	875	37	237	106	380	2841
05:00 PM	22	218	19	259	16	38	18	72	17	150	20	187	9	69	49	127	645
05:15 PM	23	278	12	313	34	32	23	89	20	218	16	254	16	58	40	114	770
05:30 PM	23	208	11	242	30	46	16	92	9	172	29	210	5	45	32	82	626
05:45 PM	18	194	9	221	22	46	21	89	23	157	21	201	7	41	20	68	579
Total	86	898	51	1035	102	162	78	342	69	697	86	852	37	213	141	391	2620
Grand Total	177	1966	125	2268	187	353	155	695	153	1390	184	1727	74	450	247	771	5461
Apprch %	7.8	86.7	5.5		26.9	50.8	22.3		8.9	80.5	10.7		9.6	58.4	32		
Total %	3.2	36	2.3	41.5	3.4	6.5	2.8	12.7	2.8	25.5	3.4	31.6	1.4	8.2	4.5	14.1	

Start Time	Highway 111 Southbound				Evan Hewes Highway Westbound				Highway 111 Northbound				Evan Hewes Highway Eastbound				Int. Total
	Left	Thru	Right	App. Total	Left	Thru	Right	App. Total	Left	Thru	Right	App. Total	Left	Thru	Right	App. Total	
Peak Hour Analysis From 04:00 PM to 05:45 PM - Peak 1 of 1																	
Peak Hour for Entire Intersection Begins at 04:00 PM																	
04:00 PM	25	251	19	295	15	52	22	89	26	178	17	221	11	58	34	103	708
04:15 PM	22	282	15	319	23	42	21	86	17	195	24	236	5	60	25	90	731
04:30 PM	21	270	20	311	23	50	22	95	24	153	27	204	6	63	26	95	705
04:45 PM	23	265	20	308	24	47	12	83	17	167	30	214	15	56	21	92	697
Total Volume	91	1068	74	1233	85	191	77	353	84	693	98	875	37	237	106	380	2841
% App. Total	7.4	86.6	6		24.1	54.1	21.8		9.6	79.2	11.2		9.7	62.4	27.9		
PHF	.910	.947	.925	.966	.885	.918	.875	.929	.808	.888	.817	.927	.617	.940	.779	.922	.972

County of Imperial
 N/S: Highway 111
 E/W: Evan Hewes Highway
 Weather: Clear

File Name : 01_CIM111EHPM
 Site Code : 23523104
 Start Date : 11/9/2023
 Page No : 2

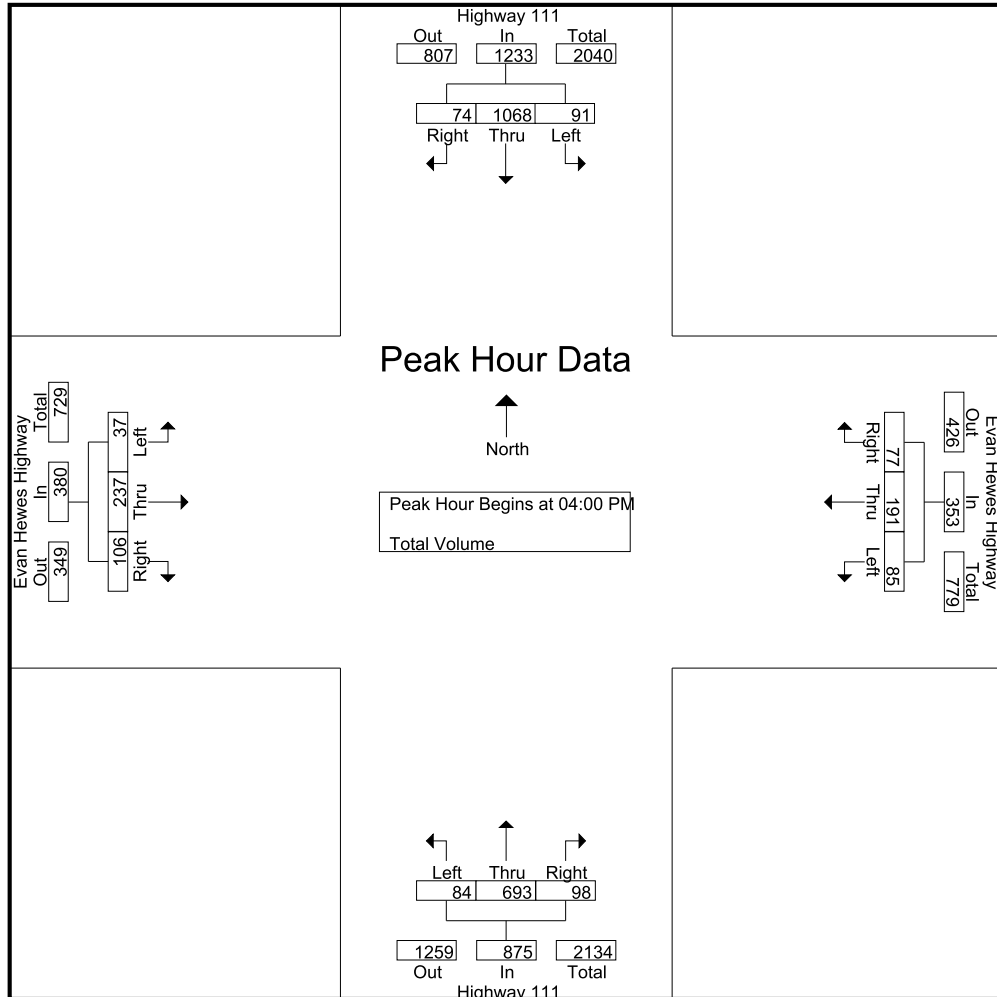

Peak Hour Analysis From 04:00 PM to 05:45 PM - Peak 1 of 1
 Peak Hour for Each Approach Begins at:

	04:00 PM				04:00 PM				04:00 PM				04:30 PM			
+0 mins.	25	251	19	295	15	52	22	89	26	178	17	221	6	63	26	95
+15 mins.	22	282	15	319	23	42	21	86	17	195	24	236	15	56	21	92
+30 mins.	21	270	20	311	23	50	22	95	24	153	27	204	9	69	49	127
+45 mins.	23	265	20	308	24	47	12	83	17	167	30	214	16	58	40	114
Total Volume	91	1068	74	1233	85	191	77	353	84	693	98	875	46	246	136	428
% App. Total	7.4	86.6	6		24.1	54.1	21.8		9.6	79.2	11.2		10.7	57.5	31.8	
PHF	.910	.947	.925	.966	.885	.918	.875	.929	.808	.888	.817	.927	.719	.891	.694	.843

County of Imperial
 N/S: Highway 111
 E/W: Ross Avenue
 Weather: Clear

File Name : 02_CIM111ROAM
 Site Code : 23523104
 Start Date : 11/9/2023
 Page No : 1

Groups Printed- Total Volume

Start Time	Highway 111 Southbound				Ross Avenue Westbound				Highway 111 Northbound				Ross Avenue Eastbound				Int. Total
	Left	Thru	Right	App. Total	Left	Thru	Right	App. Total	Left	Thru	Right	App. Total	Left	Thru	Right	App. Total	
07:00 AM	0	106	3	109	0	5	0	5	16	219	0	235	4	1	12	17	366
07:15 AM	2	159	3	164	1	3	2	6	27	242	3	272	11	4	19	34	476
07:30 AM	0	190	5	195	0	13	1	14	22	263	2	287	13	9	28	50	546
07:45 AM	0	233	7	240	2	9	0	11	20	267	1	288	17	14	27	58	597
Total	2	688	18	708	3	30	3	36	85	991	6	1082	45	28	86	159	1985
08:00 AM	0	196	6	202	2	16	1	19	29	171	0	200	9	12	25	46	467
08:15 AM	1	178	10	189	2	10	2	14	24	206	2	232	10	6	19	35	470
08:30 AM	0	184	3	187	0	2	1	3	30	157	0	187	8	2	17	27	404
08:45 AM	1	147	2	150	0	5	0	5	23	187	2	212	8	2	21	31	398
Total	2	705	21	728	4	33	4	41	106	721	4	831	35	22	82	139	1739
Grand Total	4	1393	39	1436	7	63	7	77	191	1712	10	1913	80	50	168	298	3724
Apprch %	0.3	97	2.7		9.1	81.8	9.1		10	89.5	0.5		26.8	16.8	56.4		
Total %	0.1	37.4	1	38.6	0.2	1.7	0.2	2.1	5.1	46	0.3	51.4	2.1	1.3	4.5	8	

Start Time	Highway 111 Southbound				Ross Avenue Westbound				Highway 111 Northbound				Ross Avenue Eastbound				Int. Total
	Left	Thru	Right	App. Total	Left	Thru	Right	App. Total	Left	Thru	Right	App. Total	Left	Thru	Right	App. Total	
Peak Hour Analysis From 07:00 AM to 08:45 AM - Peak 1 of 1																	
Peak Hour for Entire Intersection Begins at 07:15 AM																	
07:15 AM	2	159	3	164	1	3	2	6	27	242	3	272	11	4	19	34	476
07:30 AM	0	190	5	195	0	13	1	14	22	263	2	287	13	9	28	50	546
07:45 AM	0	233	7	240	2	9	0	11	20	267	1	288	17	14	27	58	597
08:00 AM	0	196	6	202	2	16	1	19	29	171	0	200	9	12	25	46	467
Total Volume	2	778	21	801	5	41	4	50	98	943	6	1047	50	39	99	188	2086
% App. Total	0.2	97.1	2.6		10	82	8		9.4	90.1	0.6		26.6	20.7	52.7		
PHF	.250	.835	.750	.834	.625	.641	.500	.658	.845	.883	.500	.909	.735	.696	.884	.810	.874

County of Imperial
 N/S: Highway 111
 E/W: Ross Avenue
 Weather: Clear

File Name : 02_CIM111ROAM
 Site Code : 23523104
 Start Date : 11/9/2023
 Page No : 2

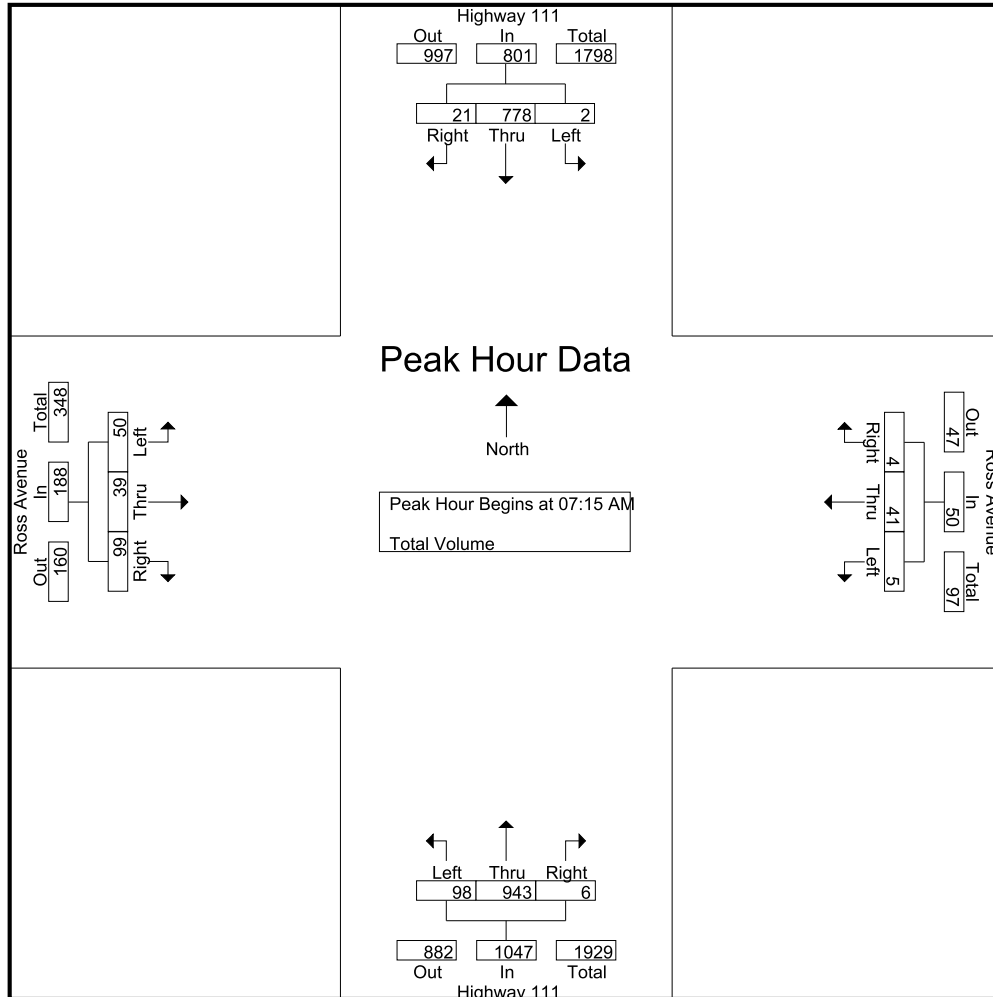

Peak Hour Analysis From 07:00 AM to 08:45 AM - Peak 1 of 1
 Peak Hour for Each Approach Begins at:

	07:30 AM				07:30 AM				07:00 AM				07:30 AM			
+0 mins.	0	190	5	195	0	13	1	14	16	219	0	235	13	9	28	50
+15 mins.	0	233	7	240	2	9	0	11	27	242	3	272	17	14	27	58
+30 mins.	0	196	6	202	2	16	1	19	22	263	2	287	9	12	25	46
+45 mins.	1	178	10	189	2	10	2	14	20	267	1	288	10	6	19	35
Total Volume	1	797	28	826	6	48	4	58	85	991	6	1082	49	41	99	189
% App. Total	0.1	96.5	3.4		10.3	82.8	6.9		7.9	91.6	0.6		25.9	21.7	52.4	
PHF	.250	.855	.700	.860	.750	.750	.500	.763	.787	.928	.500	.939	.721	.732	.884	.815

County of Imperial
 N/S: Highway 111
 E/W: Ross Avenue
 Weather: Clear

File Name : 02_CIM111RPM
 Site Code : 23523104
 Start Date : 11/9/2023
 Page No : 1

Groups Printed- Total Volume

Start Time	Highway 111 Southbound				Ross Avenue Westbound				Highway 111 Northbound				Ross Avenue Eastbound				Int. Total
	Left	Thru	Right	App. Total	Left	Thru	Right	App. Total	Left	Thru	Right	App. Total	Left	Thru	Right	App. Total	
04:00 PM	1	290	5	296	0	6	2	8	31	228	0	259	7	21	48	76	639
04:15 PM	3	306	5	314	1	5	0	6	17	223	2	242	7	15	31	53	615
04:30 PM	3	294	5	302	2	8	1	11	23	185	4	212	7	11	35	53	578
04:45 PM	0	299	5	304	1	5	2	8	31	191	2	224	12	18	46	76	612
Total	7	1189	20	1216	4	24	5	33	102	827	8	937	33	65	160	258	2444
05:00 PM	2	296	5	303	0	12	0	12	15	201	1	217	13	15	45	73	605
05:15 PM	1	334	11	346	2	4	2	8	26	239	1	266	3	3	30	36	656
05:30 PM	2	247	2	251	1	8	0	9	24	187	1	212	11	3	27	41	513
05:45 PM	3	222	12	237	3	16	2	21	17	187	2	206	7	5	25	37	501
Total	8	1099	30	1137	6	40	4	50	82	814	5	901	34	26	127	187	2275
Grand Total	15	2288	50	2353	10	64	9	83	184	1641	13	1838	67	91	287	445	4719
Apprch %	0.6	97.2	2.1		12	77.1	10.8		10	89.3	0.7		15.1	20.4	64.5		
Total %	0.3	48.5	1.1	49.9	0.2	1.4	0.2	1.8	3.9	34.8	0.3	38.9	1.4	1.9	6.1	9.4	

Start Time	Highway 111 Southbound				Ross Avenue Westbound				Highway 111 Northbound				Ross Avenue Eastbound				Int. Total
	Left	Thru	Right	App. Total	Left	Thru	Right	App. Total	Left	Thru	Right	App. Total	Left	Thru	Right	App. Total	
Peak Hour Analysis From 04:00 PM to 05:45 PM - Peak 1 of 1																	
Peak Hour for Entire Intersection Begins at 04:30 PM																	
04:30 PM	3	294	5	302	2	8	1	11	23	185	4	212	7	11	35	53	578
04:45 PM	0	299	5	304	1	5	2	8	31	191	2	224	12	18	46	76	612
05:00 PM	2	296	5	303	0	12	0	12	15	201	1	217	13	15	45	73	605
05:15 PM	1	334	11	346	2	4	2	8	26	239	1	266	3	3	30	36	656
Total Volume	6	1223	26	1255	5	29	5	39	95	816	8	919	35	47	156	238	2451
% App. Total	0.5	97.5	2.1		12.8	74.4	12.8		10.3	88.8	0.9		14.7	19.7	65.5		
PHF	.500	.915	.591	.907	.625	.604	.625	.813	.766	.854	.500	.864	.673	.653	.848	.783	.934

County of Imperial
 N/S: Highway 111
 E/W: Ross Avenue
 Weather: Clear

File Name : 02_CIM111ROP
 Site Code : 23523104
 Start Date : 11/9/2023
 Page No : 2

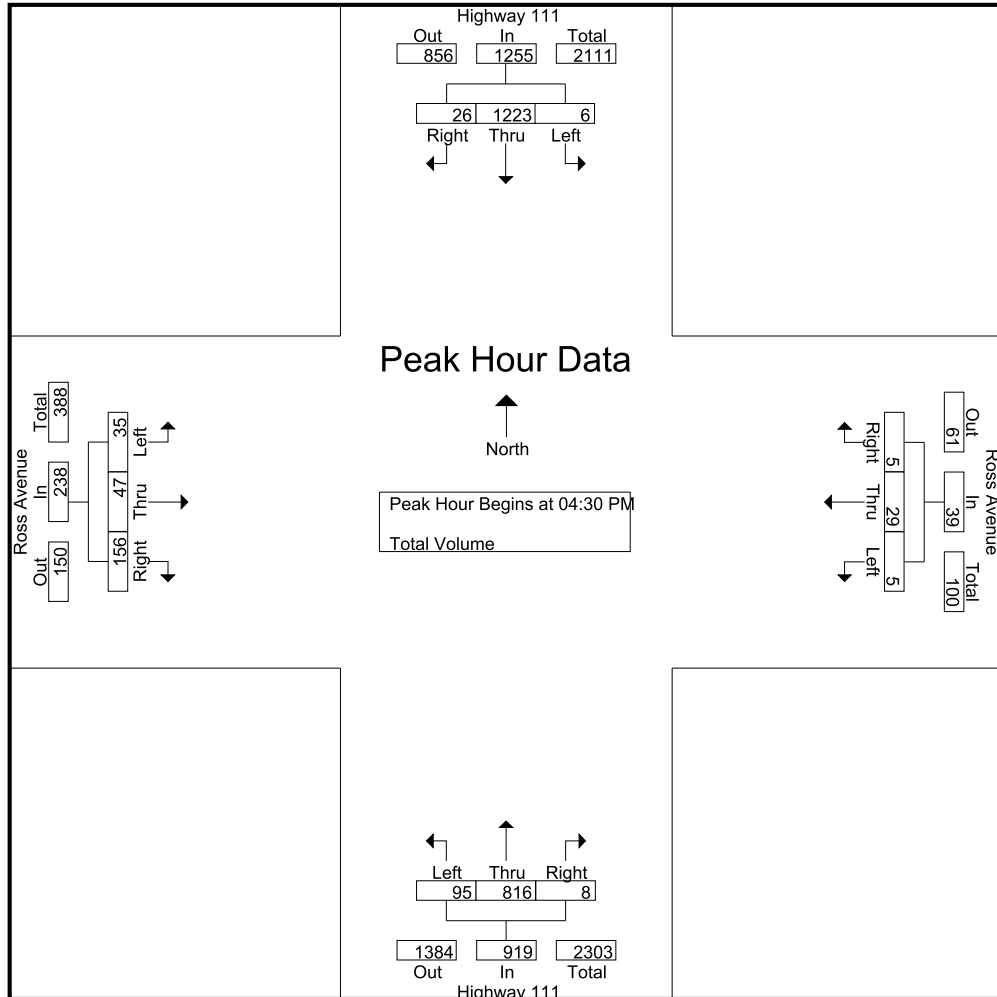

Peak Hour Analysis From 04:00 PM to 05:45 PM - Peak 1 of 1
 Peak Hour for Each Approach Begins at:

	04:30 PM				05:00 PM				04:00 PM				04:00 PM			
+0 mins.	3	294	5	302	0	12	0	12	31	228	0	259	7	21	48	76
+15 mins.	0	299	5	304	2	4	2	8	17	223	2	242	7	15	31	53
+30 mins.	2	296	5	303	1	8	0	9	23	185	4	212	7	11	35	53
+45 mins.	1	334	11	346	3	16	2	21	31	191	2	224	12	18	46	76
Total Volume	6	1223	26	1255	6	40	4	50	102	827	8	937	33	65	160	258
% App. Total	0.5	97.5	2.1		12	80	8		10.9	88.3	0.9		12.8	25.2	62	
PHF	.500	.915	.591	.907	.500	.625	.500	.595	.823	.907	.500	.904	.688	.774	.833	.849

Location: County of Imperial
 N/S: Highway 111
 E/W: Ross Ave



Date: 11/9/2023
 Day: Thursday

PEDESTRIANS

	North Leg Highway 111	East Leg Ross Ave	South Leg Highway 111	West Leg Ross Ave	
	Pedestrians	Pedestrians	Pedestrians	Pedestrians	
7:00 AM	0	0	0	0	0
7:15 AM	0	0	0	0	0
7:30 AM	0	0	0	0	0
7:45 AM	0	0	0	0	0
8:00 AM	0	0	0	0	0
8:15 AM	0	0	0	0	0
8:30 AM	0	0	0	0	0
8:45 AM	0	0	0	0	0
TOTAL VOLUMES:	0	0	0	0	0

	North Leg Highway 111	East Leg Ross Ave	South Leg Highway 111	West Leg Ross Ave	
	Pedestrians	Pedestrians	Pedestrians	Pedestrians	
4:00 PM	0	0	0	0	0
4:15 PM	0	0	0	0	0
4:30 PM	0	0	0	0	0
4:45 PM	0	0	0	0	0
5:00 PM	0	0	0	0	0
5:15 PM	0	0	0	0	0
5:30 PM	0	0	0	0	0
5:45 PM	0	0	0	0	0
TOTAL VOLUMES:	0	0	0	0	0

Location: County of Imperial
 N/S: Highway 111
 E/W: Ross Ave



Date: 11/9/2023
 Day: Thursday

BICYCLES

	Southbound Highway 111			Westbound Ross Ave			Northbound Highway 111			Eastbound Ross Ave			
	Left	Thru	Right	Left	Thru	Right	Left	Thru	Right	Left	Thru	Right	
7:00 AM	0	0	0	0	0	0	0	0	0	0	0	0	0
7:15 AM	0	0	0	0	0	0	0	0	0	0	0	0	0
7:30 AM	0	0	0	0	0	0	0	0	0	0	0	0	0
7:45 AM	0	0	0	0	0	0	0	0	0	0	0	0	0
8:00 AM	0	0	0	0	0	0	0	0	0	0	0	0	0
8:15 AM	0	0	0	0	0	0	1	0	0	0	0	0	1
8:30 AM	0	0	0	0	0	0	0	0	0	0	0	0	0
8:45 AM	0	0	0	0	0	0	0	1	0	0	0	0	1
TOTAL VOLUMES:	0	0	0	0	0	0	1	1	0	0	0	0	2

	Southbound Highway 111			Westbound Ross Ave			Northbound Highway 111			Eastbound Ross Ave			
	Left	Thru	Right	Left	Thru	Right	Left	Thru	Right	Left	Thru	Right	
4:00 PM	0	0	0	0	0	0	0	0	0	0	0	0	0
4:15 PM	0	0	0	0	0	0	0	0	0	0	0	0	0
4:30 PM	0	0	0	0	0	0	0	0	0	0	0	0	0
4:45 PM	0	0	0	0	0	0	0	0	0	0	0	0	0
5:00 PM	0	0	0	0	0	0	0	0	0	0	0	0	0
5:15 PM	0	0	0	0	0	0	0	0	0	0	0	0	0
5:30 PM	0	0	0	0	0	0	0	0	0	0	0	0	0
5:45 PM	0	0	0	0	0	0	0	0	0	0	0	0	0
TOTAL VOLUMES:	0	0	0	0	0	0	0	0	0	0	0	0	0

County of Imperial
 N/S: Bowker Road
 E/W: Ross Avenue
 Weather: Clear

File Name : 03_CIMBOROAM
 Site Code : 23523104
 Start Date : 11/9/2023
 Page No : 1

Groups Printed- Total Volume

Start Time	Bowker Road Southbound				Ross Avenue Westbound				Bowker Road Northbound				Ross Avenue Eastbound				Int. Total
	Left	Thru	Right	App. Total	Left	Thru	Right	App. Total	Left	Thru	Right	App. Total	Left	Thru	Right	App. Total	
07:00 AM	0	9	1	10	0	2	0	2	0	13	1	14	1	0	3	4	30
07:15 AM	1	24	2	27	1	2	1	4	3	19	2	24	3	3	0	6	61
07:30 AM	0	21	8	29	0	1	0	1	5	17	2	24	9	1	2	12	66
07:45 AM	1	22	7	30	1	2	0	3	4	32	2	38	9	1	1	11	82
Total	2	76	18	96	2	7	1	10	12	81	7	100	22	5	6	33	239
08:00 AM	0	23	17	40	1	2	1	4	3	28	0	31	14	1	4	19	94
08:15 AM	0	16	5	21	1	3	2	6	4	7	2	13	2	1	4	7	47
08:30 AM	1	6	0	7	3	2	1	6	2	11	0	13	1	1	2	4	30
08:45 AM	0	7	1	8	1	2	0	3	3	13	2	18	2	2	3	7	36
Total	1	52	23	76	6	9	4	19	12	59	4	75	19	5	13	37	207
Grand Total	3	128	41	172	8	16	5	29	24	140	11	175	41	10	19	70	446
Apprch %	1.7	74.4	23.8		27.6	55.2	17.2		13.7	80	6.3		58.6	14.3	27.1		
Total %	0.7	28.7	9.2	38.6	1.8	3.6	1.1	6.5	5.4	31.4	2.5	39.2	9.2	2.2	4.3	15.7	

Start Time	Bowker Road Southbound				Ross Avenue Westbound				Bowker Road Northbound				Ross Avenue Eastbound				Int. Total
	Left	Thru	Right	App. Total	Left	Thru	Right	App. Total	Left	Thru	Right	App. Total	Left	Thru	Right	App. Total	
Peak Hour Analysis From 07:00 AM to 08:45 AM - Peak 1 of 1																	
Peak Hour for Entire Intersection Begins at 07:15 AM																	
07:15 AM	1	24	2	27	1	2	1	4	3	19	2	24	3	3	0	6	61
07:30 AM	0	21	8	29	0	1	0	1	5	17	2	24	9	1	2	12	66
07:45 AM	1	22	7	30	1	2	0	3	4	32	2	38	9	1	1	11	82
08:00 AM	0	23	17	40	1	2	1	4	3	28	0	31	14	1	4	19	94
Total Volume	2	90	34	126	3	7	2	12	15	96	6	117	35	6	7	48	303
% App. Total	1.6	71.4	27		25	58.3	16.7		12.8	82.1	5.1		72.9	12.5	14.6		
PHF	.500	.938	.500	.788	.750	.875	.500	.750	.750	.750	.750	.770	.625	.500	.438	.632	.806

County of Imperial
 N/S: Bowker Road
 E/W: Ross Avenue
 Weather: Clear

File Name : 03_CIMBOROAM
 Site Code : 23523104
 Start Date : 11/9/2023
 Page No : 2

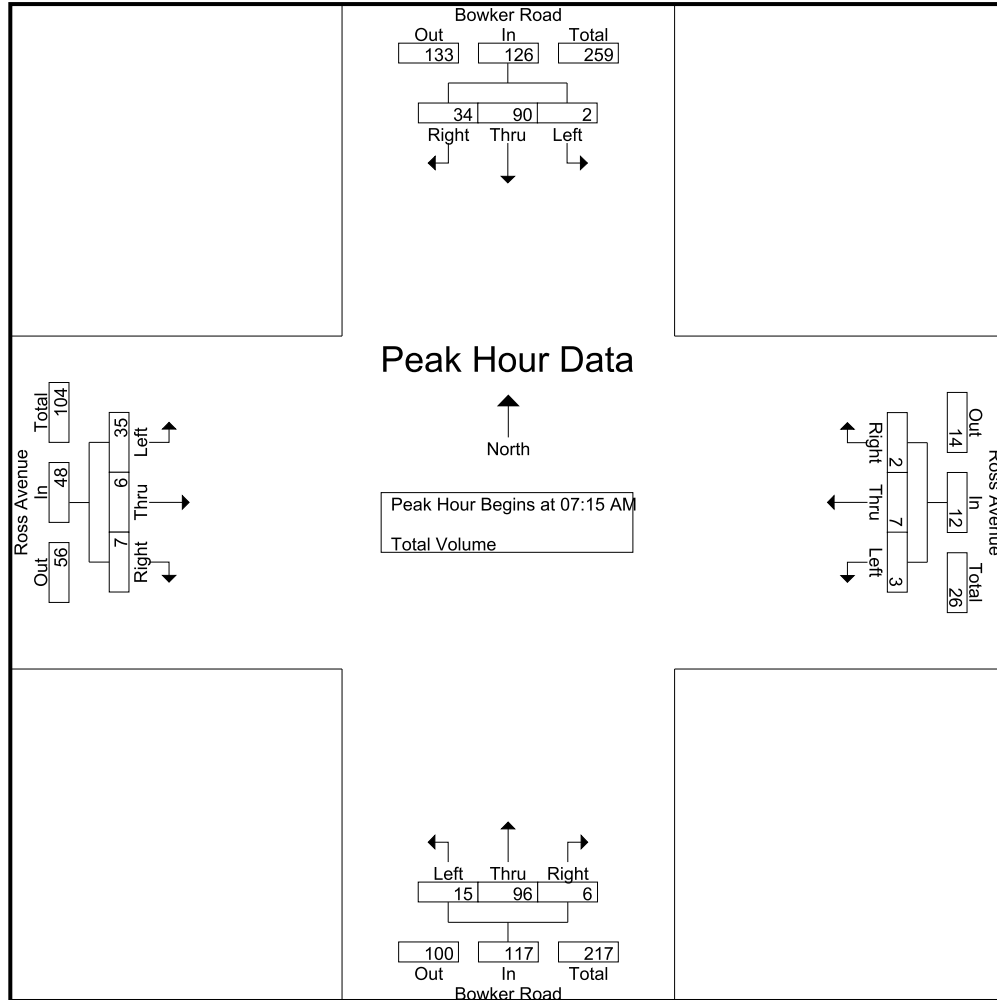

Peak Hour Analysis From 07:00 AM to 08:45 AM - Peak 1 of 1
 Peak Hour for Each Approach Begins at:

	07:15 AM				07:45 AM				07:15 AM				07:30 AM			
+0 mins.	1	24	2	27	1	2	0	3	3	19	2	24	9	1	2	12
+15 mins.	0	21	8	29	1	2	1	4	5	17	2	24	9	1	1	11
+30 mins.	1	22	7	30	1	3	2	6	4	32	2	38	14	1	4	19
+45 mins.	0	23	17	40	3	2	1	6	3	28	0	31	2	1	4	7
Total Volume	2	90	34	126	6	9	4	19	15	96	6	117	34	4	11	49
% App. Total	1.6	71.4	27		31.6	47.4	21.1		12.8	82.1	5.1		69.4	8.2	22.4	
PHF	.500	.938	.500	.788	.500	.750	.500	.792	.750	.750	.750	.770	.607	1.000	.688	.645

County of Imperial
 N/S: Bowker Road
 E/W: Ross Avenue
 Weather: Clear

File Name : 03_CIMBOROPM
 Site Code : 23523104
 Start Date : 11/9/2023
 Page No : 1

Groups Printed- Total Volume

Start Time	Bowker Road Southbound				Ross Avenue Westbound				Bowker Road Northbound				Ross Avenue Eastbound				Int. Total
	Left	Thru	Right	App. Total	Left	Thru	Right	App. Total	Left	Thru	Right	App. Total	Left	Thru	Right	App. Total	
04:00 PM	0	14	3	17	1	4	3	8	1	16	0	17	18	2	4	24	66
04:15 PM	0	29	3	32	2	0	1	3	0	16	1	17	12	1	3	16	68
04:30 PM	0	22	3	25	0	3	0	3	5	20	1	26	6	2	5	13	67
04:45 PM	0	18	2	20	2	2	0	4	2	13	1	16	13	2	12	27	67
Total	0	83	11	94	5	9	4	18	8	65	3	76	49	7	24	80	268
05:00 PM	0	25	8	33	4	0	0	4	1	21	0	22	10	4	10	24	83
05:15 PM	0	25	7	32	0	0	0	0	3	11	1	15	0	1	2	3	50
05:30 PM	0	16	8	24	0	0	1	1	1	14	3	18	0	1	4	5	48
05:45 PM	0	20	12	32	3	4	0	7	1	14	2	17	3	0	5	8	64
Total	0	86	35	121	7	4	1	12	6	60	6	72	13	6	21	40	245
Grand Total	0	169	46	215	12	13	5	30	14	125	9	148	62	13	45	120	513
Apprch %	0	78.6	21.4		40	43.3	16.7		9.5	84.5	6.1		51.7	10.8	37.5		
Total %	0	32.9	9	41.9	2.3	2.5	1	5.8	2.7	24.4	1.8	28.8	12.1	2.5	8.8	23.4	

Start Time	Bowker Road Southbound				Ross Avenue Westbound				Bowker Road Northbound				Ross Avenue Eastbound				Int. Total
	Left	Thru	Right	App. Total	Left	Thru	Right	App. Total	Left	Thru	Right	App. Total	Left	Thru	Right	App. Total	
Peak Hour Analysis From 04:00 PM to 05:45 PM - Peak 1 of 1																	
Peak Hour for Entire Intersection Begins at 04:15 PM																	
04:15 PM	0	29	3	32	2	0	1	3	0	16	1	17	12	1	3	16	68
04:30 PM	0	22	3	25	0	3	0	3	5	20	1	26	6	2	5	13	67
04:45 PM	0	18	2	20	2	2	0	4	2	13	1	16	13	2	12	27	67
05:00 PM	0	25	8	33	4	0	0	4	1	21	0	22	10	4	10	24	83
Total Volume	0	94	16	110	8	5	1	14	8	70	3	81	41	9	30	80	285
% App. Total	0	85.5	14.5		57.1	35.7	7.1		9.9	86.4	3.7		51.2	11.2	37.5		
PHF	.000	.810	.500	.833	.500	.417	.250	.875	.400	.833	.750	.779	.788	.563	.625	.741	.858

County of Imperial
 N/S: Bowker Road
 E/W: Ross Avenue
 Weather: Clear

File Name : 03_CIMBOROPM
 Site Code : 23523104
 Start Date : 11/9/2023
 Page No : 2

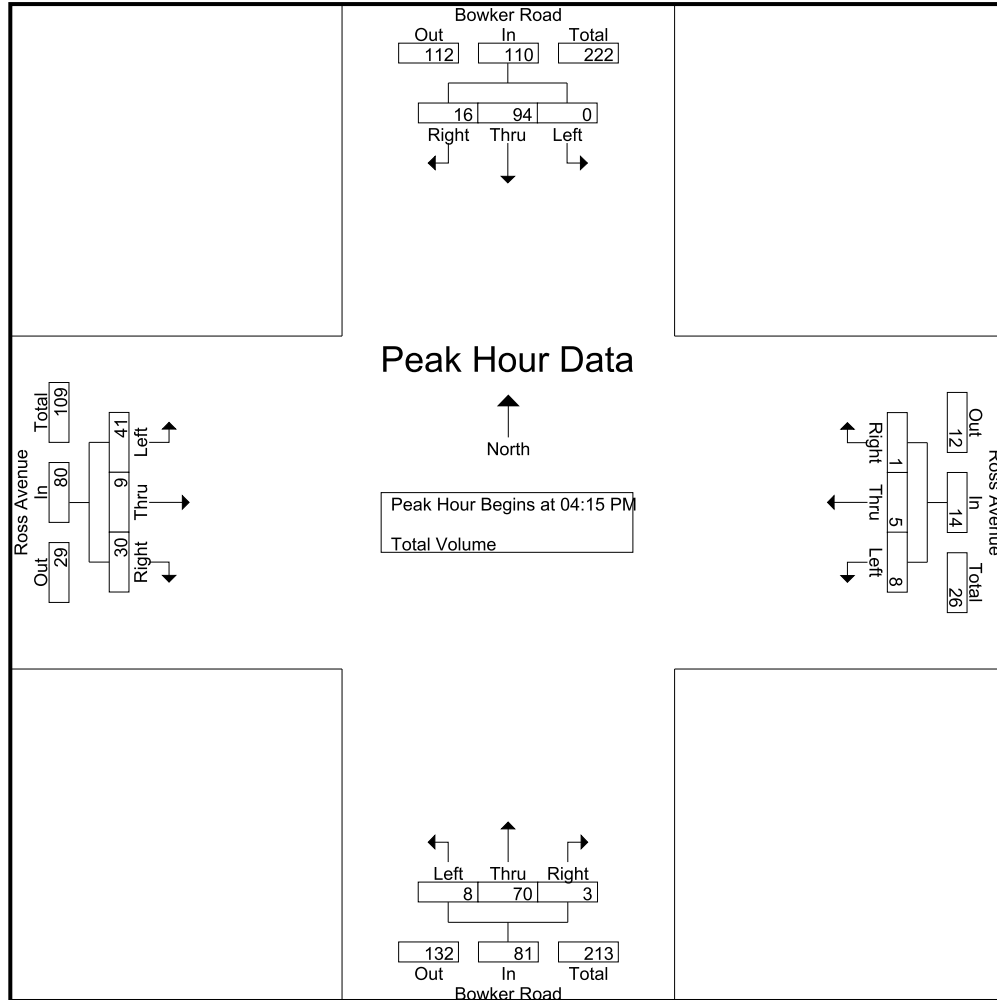

Peak Hour Analysis From 04:00 PM to 05:45 PM - Peak 1 of 1
 Peak Hour for Each Approach Begins at:

	05:00 PM				04:00 PM				04:15 PM				04:00 PM			
+0 mins.	0	25	8	33	1	4	3	8	0	16	1	17	18	2	4	24
+15 mins.	0	25	7	32	2	0	1	3	5	20	1	26	12	1	3	16
+30 mins.	0	16	8	24	0	3	0	3	2	13	1	16	6	2	5	13
+45 mins.	0	20	12	32	2	2	0	4	1	21	0	22	13	2	12	27
Total Volume	0	86	35	121	5	9	4	18	8	70	3	81	49	7	24	80
% App. Total	0	71.1	28.9		27.8	50	22.2		9.9	86.4	3.7		61.2	8.8	30	
PHF	.000	.860	.729	.917	.625	.563	.333	.563	.400	.833	.750	.779	.681	.875	.500	.741

Counts Unlimited, Inc.

PO Box 1178
 Corona, CA 92878
 Phone: (951) 268-6268
 email: counts@countsunlimited.com
 Site Code: 235-231041

County of Imperial
 Highway 111
 N/ Ross Avenue
 24 Hour Directional Classification Count
 Northbound

CIM001

Start Time	Bikes	Cars & Trailers	2 Axle Long	Buses	2 Axle 6 Tire	3 Axle Single	4 Axle Single	<5 Axl Double	5 Axle Double	>6 Axl Double	<6 Axl Multi	6 Axle Multi	>6 Axl Multi	Total
11/09/23	0	91	17	0	2	0	0	1	37	0	1	2	2	153
01:00	0	75	25	0	1	3	0	0	24	0	1	2	0	131
02:00	0	142	25	0	2	5	0	0	24	0	2	0	1	201
03:00	3	214	50	0	4	5	0	0	24	0	8	1	0	309
04:00	5	392	104	1	3	8	1	1	37	0	2	1	0	555
05:00	12	656	150	9	7	5	0	1	36	0	8	0	0	884
06:00	6	470	155	14	12	7	0	10	69	0	4	1	0	748
07:00	7	759	184	5	8	7	0	7	51	0	9	2	0	1039
08:00	0	532	129	6	18	4	2	6	54	0	9	1	0	761
09:00	4	523	141	4	16	8	0	9	86	1	14	2	0	808
10:00	0	458	116	2	24	9	0	10	81	0	8	3	1	712
11:00	2	467	120	8	18	4	1	13	69	0	9	5	0	716
12 PM	1	492	157	7	14	10	0	5	69	0	14	3	0	772
13:00	0	520	125	9	13	13	0	4	72	0	18	2	0	776
14:00	2	628	154	6	8	6	0	2	75	1	6	4	0	892
15:00	3	599	129	3	17	6	0	10	71	0	4	2	0	844
16:00	4	617	111	4	12	9	2	3	99	0	3	1	0	865
17:00	1	611	129	2	9	4	0	1	92	0	3	1	0	853
18:00	0	490	106	1	3	2	0	3	83	0	3	2	2	695
19:00	2	405	95	5	1	3	0	0	77	0	4	2	0	594
20:00	1	378	76	2	7	0	0	1	83	0	3	0	0	551
21:00	0	341	72	5	4	3	0	0	52	0	7	0	0	484
22:00	1	206	61	3	1	3	0	3	49	0	3	0	0	330
23:00	1	167	33	3	4	1	0	0	34	0	1	2	0	246
Total	55	10233	2464	99	208	125	6	90	1448	2	144	39	6	14919
Percent	0.4%	68.6%	16.5%	0.7%	1.4%	0.8%	0.0%	0.6%	9.7%	0.0%	1.0%	0.3%	0.0%	
AM Peak	05:00	07:00	07:00	06:00	10:00	10:00	08:00	11:00	09:00	09:00	09:00	11:00	00:00	07:00
Vol.	12	759	184	14	24	9	2	13	86	1	14	5	2	1039
PM Peak	16:00	14:00	12:00	13:00	15:00	13:00	16:00	15:00	16:00	14:00	13:00	14:00	18:00	14:00
Vol.	4	628	157	9	17	13	2	10	99	1	18	4	2	892
Grand Total	55	10233	2464	99	208	125	6	90	1448	2	144	39	6	14919
Percent	0.4%	68.6%	16.5%	0.7%	1.4%	0.8%	0.0%	0.6%	9.7%	0.0%	1.0%	0.3%	0.0%	

HV%
 NB: 14%
 SB: 14%

Counts Unlimited, Inc.

County of Imperial
 Highway 111
 N/ Ross Avenue
 24 Hour Directional Classification Count
 Southbound
 PO Box 1178
 Corona, CA 92878
 Phone: (951) 268-6268
 email: counts@countsunlimited.com
 CIM001
 Site Code: 235-231041

Start Time	Bikes	Cars & Trailers	2 Axle Long	Buses	2 Axle 6 Tire	3 Axle Single	4 Axle Single	<5 Axl Double	5 Axle Double	>6 Axl Double	<6 Axl Multi	6 Axle Multi	>6 Axl Multi	Total
11/09/23	1	86	15	0	0	3	0	0	41	0	7	0	0	153
01:00	0	84	7	1	0	3	0	0	30	0	5	0	0	130
02:00	2	70	12	0	0	7	0	0	33	0	1	0	0	125
03:00	0	100	10	1	1	3	0	1	43	0	5	0	0	164
04:00	0	113	31	0	2	1	0	1	32	0	12	0	0	192
05:00	0	208	57	6	4	4	1	3	49	0	3	0	0	335
06:00	12	233	77	1	10	3	0	4	69	0	9	2	0	420
07:00	14	488	101	5	17	9	0	3	58	0	10	1	2	708
08:00	4	496	119	5	12	8	2	6	64	0	12	1	0	729
09:00	28	522	149	8	13	11	0	6	98	0	10	0	0	845
10:00	3	504	153	0	20	5	0	8	78	0	14	0	0	785
11:00	28	530	138	1	20	10	0	5	85	0	17	2	0	836
12 PM	3	579	139	4	8	10	1	6	88	0	9	3	0	850
13:00	10	643	175	3	23	9	0	1	116	0	12	10	0	1002
14:00	4	792	217	10	10	8	0	4	94	0	8	4	1	1152
15:00	12	975	224	10	9	3	0	2	81	0	10	3	0	1329
16:00	11	915	195	1	10	2	0	2	75	1	2	2	0	1216
17:00	7	917	124	4	11	2	0	6	63	0	4	0	0	1138
18:00	0	638	54	1	5	4	0	2	75	0	5	0	0	784
19:00	1	510	47	0	3	3	0	0	58	0	2	0	0	624
20:00	0	418	48	1	0	3	0	3	44	0	1	0	0	518
21:00	0	347	45	1	3	1	0	0	51	0	1	1	0	450
22:00	0	271	49	0	0	1	0	0	55	0	3	2	0	381
23:00	0	172	28	0	2	1	0	2	58	0	3	0	0	266
Total	140	10611	2214	63	183	114	4	65	1538	1	165	31	3	15132
Percent	0.9%	70.1%	14.6%	0.4%	1.2%	0.8%	0.0%	0.4%	10.2%	0.0%	1.1%	0.2%	0.0%	
AM Peak	09:00	11:00	10:00	09:00	10:00	09:00	08:00	10:00	09:00	09:00	11:00	06:00	07:00	09:00
Vol.	28	530	153	8	20	11	2	8	98	17	17	2	2	845
PM Peak	15:00	15:00	15:00	14:00	13:00	12:00	12:00	12:00	13:00	16:00	13:00	13:00	14:00	15:00
Vol.	12	975	224	10	23	10	1	6	116	1	12	10	1	1329
Grand Total	140	10611	2214	63	183	114	4	65	1538	1	165	31	3	15132
Percent	0.9%	70.1%	14.6%	0.4%	1.2%	0.8%	0.0%	0.4%	10.2%	0.0%	1.1%	0.2%	0.0%	

Counts Unlimited, Inc.

County of Imperial
 Highway 111
 N/ Ross Avenue
 24 Hour Directional Classification Count
 Northbound, Southbound

PO Box 1178
 Corona, CA 92878
 Phone: (951) 268-6268
 email: counts@countsunlimited.com

CIM001
 Site Code: 235-231041

Start Time	Cars & Trailers		2 Axle Long	Buses	2 Axle 6 Tire	3 Axle Single	4 Axle Single	<5 Axl Double	5 Axle Double	>6 Axl Double	<6 Axl Multi	6 Axle Multi	>6 Axl Multi	Total
	Bikes	Trailers												
11/09/23	1	177	32	0	2	3	0	1	78	0	8	2	2	306
01:00	0	159	32	1	1	6	0	0	54	0	6	2	0	261
02:00	2	212	37	0	2	12	0	0	57	0	3	0	1	326
03:00	3	314	60	1	5	8	0	1	67	0	13	1	0	473
04:00	5	505	135	1	5	9	1	2	69	0	14	1	0	747
05:00	12	864	207	15	11	9	1	4	85	0	11	0	0	1219
06:00	18	703	232	15	22	10	0	14	138	0	13	3	0	1168
07:00	21	1247	285	10	25	16	0	10	109	0	19	3	2	1747
08:00	4	1028	248	11	30	12	4	12	118	0	21	2	0	1490
09:00	32	1045	290	12	29	19	0	15	184	1	24	2	0	1653
10:00	3	962	269	2	44	14	0	18	159	0	22	3	1	1497
11:00	30	997	258	9	38	14	1	18	154	0	26	7	0	1552
12 PM	4	1071	296	11	22	20	1	11	157	0	23	6	0	1622
13:00	10	1163	300	12	36	22	0	5	188	0	30	12	0	1778
14:00	6	1420	371	13	18	14	0	6	169	1	14	8	1	2044
15:00	15	1574	353	13	26	9	0	12	152	0	14	5	0	2173
16:00	15	1532	306	5	22	11	2	5	174	1	5	3	0	2081
17:00	8	1528	253	6	20	6	0	7	155	0	7	1	0	1991
18:00	0	1128	160	2	8	6	0	5	158	0	8	2	2	1479
19:00	3	915	142	5	4	6	0	0	135	0	6	2	0	1218
20:00	1	796	124	3	7	3	0	4	127	0	4	0	0	1069
21:00	0	688	117	6	7	4	0	0	103	0	8	1	0	934
22:00	1	477	110	3	1	4	0	3	104	0	6	2	0	711
23:00	1	339	61	3	6	2	0	2	92	0	4	2	0	512
Total	195	20844	4678	162	391	239	10	155	2986	3	309	70	9	30051
Percent	0.6%	69.4%	15.6%	0.5%	1.3%	0.8%	0.0%	0.5%	9.9%	0.0%	1.0%	0.2%	0.0%	
AM Peak	09:00	07:00	09:00	05:00	10:00	09:00	08:00	10:00	09:00	09:00	11:00	11:00	00:00	07:00
Vol.	32	1247	290	15	44	19	4	18	184	1	26	7	2	1747
PM Peak	15:00	15:00	14:00	14:00	13:00	13:00	16:00	15:00	13:00	14:00	13:00	13:00	18:00	15:00
Vol.	15	1574	371	16	36	22	2	12	188	1	30	12	2	2173
Grand Total	195	20844	4678	162	391	239	10	155	2986	3	309	70	9	30051
Percent	0.6%	69.4%	15.6%	0.5%	1.3%	0.8%	0.0%	0.5%	9.9%	0.0%	1.0%	0.2%	0.0%	

Counts Unlimited, Inc.

PO Box 1178
Corona, CA 92878
Phone: (951) 268-6268
email: counts@countsunlimited.com
Site Code: 235-231041

County of Imperial
Highway 111
S/ Ross Avenue
24 Hour Directional Classification Count
Northbound

CIM002

Start Time	Cars & Trailers		Buses	2 Axle		3 Axle Single	4 Axle		<5 Axl Double		5 Axle Double	>6 Axl Double		<6 Axl Multi		6 Axle Multi		>6 Axl Multi		Total
	Bikes	Trailers		Long	6 Tire		Single	Single	Double	Double		Double	Double	Multi	Multi	Multi	Multi	Multi	Multi	
11/09/23	0	99	0	2	0	0	0	0	1	37	0	0	1	2	2	0	0	2	164	
01:00	0	82	0	1	3	0	0	0	0	25	0	0	1	2	2	0	0	140		
02:00	0	149	0	3	5	0	0	0	0	25	0	0	2	0	0	1	0	219		
03:00	3	233	0	4	5	0	0	0	0	23	0	0	8	1	0	0	0	332		
04:00	9	410	1	3	7	1	1	1	1	36	0	0	2	1	0	0	0	587		
05:00	18	673	6	7	5	0	0	0	1	37	0	0	8	0	0	0	0	927		
06:00	12	554	10	13	8	0	0	0	10	67	0	0	4	1	0	0	0	854		
07:00	10	793	3	8	6	0	0	0	7	50	0	0	9	2	0	0	0	1083		
08:00	2	586	4	16	6	0	0	0	6	57	0	0	10	1	0	0	0	832		
09:00	4	574	4	16	9	0	0	0	9	87	0	0	14	2	0	0	0	861		
10:00	1	507	2	24	7	0	0	0	11	81	0	0	8	3	1	0	0	779		
11:00	2	505	7	18	4	1	0	0	13	69	0	0	10	5	0	0	0	771		
12 PM	6	543	6	14	9	0	0	0	5	67	0	0	14	3	0	0	0	824		
13:00	0	556	8	15	13	0	0	0	4	72	0	0	18	2	0	0	0	822		
14:00	3	687	6	10	7	0	0	0	3	75	0	0	6	4	0	0	0	976		
15:00	3	664	4	17	7	0	0	0	10	71	0	0	4	2	0	0	0	921		
16:00	4	676	3	13	10	0	0	0	3	101	0	0	3	1	0	0	0	938		
17:00	1	647	4	9	4	0	0	0	1	96	0	0	3	1	0	0	0	902		
18:00	0	543	2	4	2	0	0	0	3	84	0	0	3	2	0	0	0	762		
19:00	2	446	5	3	3	0	0	0	0	78	0	0	4	2	0	0	0	642		
20:00	1	415	3	8	0	0	0	0	1	83	0	0	3	0	0	0	0	594		
21:00	1	378	5	4	3	0	0	0	0	52	0	0	7	0	0	0	0	521		
22:00	1	230	3	1	3	0	0	0	3	48	0	0	3	0	0	0	0	354		
23:00	1	183	4	4	1	0	0	0	0	36	0	0	1	2	0	0	0	266		
Total	84	11133	90	217	127	0	6	92	0.6%	1457	1	146	0.9%	39	0.2%	0.0%	6	16071		
Percent	0.5%	69.3%	0.6%	1.4%	0.8%	0.0%	0.0%	0.6%	0.6%	9.1%	0.0%	0.9%	0.9%	0.2%	0.0%	0.0%	0.0%			
AM Peak	05:00	07:00	06:00	10:00	09:00	08:00	11:00	11:00	09:00	09:00	09:00	09:00	09:00	11:00	11:00	00:00	00:00	07:00		
Vol.	18	793	10	24	9	2	13	87	14	87	1	14	5	2	2	2	2	1083		
PM Peak	12:00	14:00	13:00	15:00	13:00	16:00	15:00	16:00	13:00	16:00	16:00	13:00	14:00	14:00	18:00	18:00	18:00	14:00		
Vol.	6	687	8	17	13	2	10	101	18	101	4	18	4	2	2	2	2	976		
Grand Total	84	11133	90	217	127	6	92	1457	1	146	39	146	39	6	6	6	6	16071		
Percent	0.5%	69.3%	0.6%	1.4%	0.8%	0.0%	0.6%	9.1%	0.6%	9.1%	0.0%	0.9%	0.2%	0.0%	0.0%	0.0%	0.0%			

HV%
NB: 14%
SB: 13%

Counts Unlimited, Inc.

County of Imperial
 Highway 111
 S/ Ross Avenue
 24 Hour Directional Classification Count
 Southbound
 PO Box 1178
 Corona, CA 92878
 Phone: (951) 268-6268
 email: counts@countsunlimited.com
 CIM002
 Site Code: 235-231041

Start Time	Bikes	Cars & Trailers	2 Axle Long	Buses	2 Axle 6 Tire	3 Axle Single	4 Axle Single	<5 Axl Double	5 Axle Double	>6 Axl Double	<6 Axl Multi	6 Axle Multi	>6 Axl Multi	Total
11/09/23	1	95	13	0	0	3	0	0	42	0	7	0	0	161
01:00	0	91	6	1	0	3	0	0	30	0	5	0	0	136
02:00	2	78	12	0	0	7	0	0	31	0	1	0	0	131
03:00	0	113	9	1	1	3	0	1	43	0	5	0	0	176
04:00	0	127	32	0	3	1	0	1	32	0	12	0	0	208
05:00	0	242	56	8	5	4	1	3	49	0	3	0	0	371
06:00	12	257	89	8	13	4	0	4	69	0	9	2	0	467
07:00	16	545	107	7	20	9	0	3	58	0	10	1	2	778
08:00	6	538	133	6	13	9	1	7	66	0	12	1	0	792
09:00	28	554	157	5	11	11	0	9	99	0	11	0	0	885
10:00	3	532	160	0	23	4	0	10	80	0	15	0	0	827
11:00	29	570	144	1	21	12	0	7	85	0	17	2	0	888
12 PM	3	644	151	4	11	8	0	8	88	0	8	3	0	928
13:00	11	735	190	3	24	10	0	2	114	0	13	10	0	1112
14:00	4	913	245	11	11	9	0	5	95	0	8	4	0	1305
15:00	15	1084	248	10	10	5	0	2	80	0	10	3	0	1467
16:00	16	1022	222	1	9	2	0	2	73	1	3	2	0	1353
17:00	8	1006	133	3	11	2	0	6	60	0	4	0	0	1233
18:00	1	688	52	0	5	4	0	2	74	0	5	0	0	831
19:00	1	544	46	0	2	3	0	0	58	0	2	0	0	656
20:00	0	441	56	1	0	3	0	3	44	0	1	0	0	549
21:00	0	379	46	1	3	1	0	0	49	0	2	1	0	482
22:00	0	278	51	0	0	1	0	0	55	0	3	2	0	390
23:00	0	175	30	0	2	1	0	2	58	0	3	0	0	271
Total	156	11651	2388	71	198	119	2	77	1532	1	169	31	2	16397
Percent	1.0%	71.1%	14.6%	0.4%	1.2%	0.7%	0.0%	0.5%	9.3%	0.0%	1.0%	0.2%	0.0%	
AM Peak	11:00	11:00	10:00	05:00	10:00	11:00	05:00	10:00	09:00	11:00	06:00	07:00	07:00	11:00
Vol.	29	570	160	8	23	12	1	10	99	17	2	2	2	888
PM Peak	16:00	15:00	15:00	14:00	13:00	13:00	16:00	12:00	13:00	13:00	13:00	13:00	13:00	15:00
Vol.	16	1084	248	11	24	10	1	8	114	1	13	10	10	1467
Grand Total	156	11651	2388	71	198	119	2	77	1532	1	169	31	2	16397
Percent	1.0%	71.1%	14.6%	0.4%	1.2%	0.7%	0.0%	0.5%	9.3%	0.0%	1.0%	0.2%	0.0%	

Counts Unlimited, Inc.
 PO Box 1178
 Corona, CA 92878
 Phone: (951) 268-6268
 email: counts@countsunlimited.com

County of Imperial
 Highway 111
 S/ Ross Avenue
 24 Hour Directional Classification Count
 Northbound, Southbound

CJM002
 Site Code: 235-231041

Start Time	Cars & Trailers		2 Axle Long		Buses		2 Axle 6 Tire		3 Axle Single		4 Axle Single		<5 Axl Double		5 Axle Double		>6 Axl Double		<6 Axl Multi		6 Axle Multi		>6 Axl Multi		Total
	Bikes	Trailers	Long	2 Axle	Buses	6 Tire	Single	Single	Double	Double	Double	Double	Double	Double	Double	Double	Double	Multi	Multi	Multi	Multi	Multi	Multi		
11/09/23	1	194	33	2	0	2	3	0	1	79	0	8	2	2	325										
01:00	0	173	32	1	1	1	6	0	0	55	0	6	2	276											
02:00	2	227	46	3	0	3	12	0	0	56	0	3	0	350											
03:00	3	346	64	5	1	5	8	0	1	66	0	13	1	508											
04:00	9	537	148	6	1	6	8	1	2	68	0	14	1	795											
05:00	18	915	228	12	14	12	9	1	4	86	0	11	0	1298											
06:00	24	811	264	18	18	26	12	0	14	136	0	13	3	1321											
07:00	26	1338	302	28	10	28	15	0	10	108	0	19	3	1861											
08:00	8	1124	275	10	10	29	15	3	13	123	0	22	2	1624											
09:00	32	1128	298	9	9	27	20	0	18	186	1	25	2	1746											
10:00	4	1039	294	4	2	47	11	0	21	161	0	23	3	1606											
11:00	31	1075	281	8	8	39	16	1	20	154	0	27	7	1659											
12 PM	9	1187	308	10	10	25	17	0	13	155	0	22	6	1752											
13:00	11	1291	324	11	11	39	23	0	6	186	0	31	12	1934											
14:00	7	1600	420	14	14	21	16	0	8	170	0	14	8	2281											
15:00	18	1748	387	14	14	27	12	0	12	151	0	14	5	2388											
16:00	20	1698	344	4	4	22	12	2	5	174	1	6	3	2291											
17:00	9	1653	269	7	7	20	6	0	7	156	0	7	1	2135											
18:00	1	1231	169	2	2	9	6	0	5	158	0	8	2	1593											
19:00	3	990	145	5	5	5	6	0	0	136	0	6	2	1298											
20:00	1	856	136	4	4	8	3	0	4	127	0	4	0	1143											
21:00	1	757	117	6	6	7	4	0	0	101	0	9	1	1003											
22:00	1	508	113	3	3	1	4	0	3	103	0	6	2	744											
23:00	1	358	64	4	4	6	2	0	2	94	0	4	2	537											
Total	240	22784	5061	161	161	415	246	8	169	2989	2	315	70	32468											
Percent	0.7%	70.2%	15.6%	0.5%	0.5%	1.3%	0.8%	0.0%	0.5%	9.2%	0.0%	1.0%	0.2%												
AM Peak	09:00	07:00	07:00	06:00	06:00	10:00	09:00	08:00	10:00	09:00	09:00	11:00	11:00	07:00											
Vol.	32	1338	302	18	18	47	20	3	21	186	1	27	7	1861											
PM Peak	16:00	15:00	14:00	14:00	14:00	13:00	13:00	16:00	12:00	13:00	16:00	13:00	13:00	15:00											
Vol.	20	1748	420	17	17	39	23	2	13	186	1	31	12	2388											
Grand Total	240	22784	5061	161	161	415	246	8	169	2989	2	315	70	32468											
Percent	0.7%	70.2%	15.6%	0.5%	0.5%	1.3%	0.8%	0.0%	0.5%	9.2%	0.0%	1.0%	0.2%												

Counts Unlimited, Inc.

PO Box 1178
 Corona, CA 92878
 Phone: (951) 268-6268
 email: counts@countsunlimited.com

County of Imperial
 Ross Avenue
 E/ Highway 111
 24 Hour Directional Classification Count
 Eastbound

CIM003
 Site Code: 235-231041

Start Time	Cars & Trailers	2 Axle Long	Buses	2 Axle 6 Tire	3 Axle Single	4 Axle Single	<5 Axl Double	5 Axle Double	>6 Axl Double	<6 Axl Multi	6 Axle Multi	>6 Axl Multi	Total
11/09/23	3	0	0	0	0	0	0	0	0	0	0	0	3
01:00	1	0	0	1	0	0	0	0	0	0	0	0	2
02:00	1	1	0	0	0	0	0	0	0	0	0	0	2
03:00	3	1	0	1	0	0	0	0	0	0	0	0	5
04:00	1	2	0	0	0	0	0	0	0	0	0	0	3
05:00	23	9	0	0	0	0	0	0	0	0	0	0	35
06:00	12	3	0	1	0	0	0	0	0	0	0	0	16
07:00	24	10	0	2	0	0	0	0	0	0	0	0	36
08:00	19	6	0	2	0	0	0	1	0	0	0	0	28
09:00	11	14	1	3	0	0	0	0	0	0	0	0	29
10:00	12	9	0	1	0	0	0	0	0	0	0	0	22
11:00	4	9	0	1	0	0	0	0	0	0	0	0	14
12 PM	9	11	0	2	0	0	2	1	0	0	0	0	25
13:00	1	9	0	1	0	0	1	0	0	0	0	0	34
14:00	1	7	0	1	1	0	1	0	0	0	0	0	39
15:00	1	4	0	0	1	0	1	0	0	0	0	0	43
16:00	68	11	0	1	0	0	0	0	0	0	0	0	80
17:00	31	4	0	0	0	0	0	1	0	0	0	0	39
18:00	10	1	0	0	0	0	0	0	0	0	0	0	11
19:00	4	0	0	0	0	0	0	0	0	0	0	0	4
20:00	9	1	0	0	0	0	0	0	0	0	0	0	10
21:00	5	0	0	0	1	0	0	0	0	0	0	0	6
22:00	2	1	0	0	0	0	0	0	0	0	0	0	3
23:00	2	0	0	0	0	0	0	0	0	0	0	0	2
Total	9	340	1	17	2	0	4	5	0	0	0	0	491
Percent	1.8%	69.2%	0.2%	3.5%	0.4%	0.0%	0.8%	1.0%	0.0%	0.0%	0.0%	0.0%	
AM Peak	05:00	07:00	09:00	09:00	14:00	14:00	12:00	08:00	14:00	07:00	07:00	07:00	36
Vol.	3	24	1	3	1	1	2	1	2	1	1	1	80
PM Peak	17:00	16:00	12:00	12:00	14:00	14:00	12:00	14:00	14:00	16:00	16:00	16:00	80
Vol.	3	68	11	2	1	1	2	2	2	2	2	2	80
Grand Total	9	340	1	17	2	0	4	5	0	0	0	0	491
Percent	1.8%	69.2%	0.2%	3.5%	0.4%	0.0%	0.8%	1.0%	0.0%	0.0%	0.0%	0.0%	

HV%
 EB: 6%
 WB: 9%

Counts Unlimited, Inc.

PO Box 1178
 Corona, CA 92878
 Phone: (951) 268-6268
 email: counts@countsunlimited.com
 Site Code: 235-231041
 CIM003

County of Imperial
 Ross Avenue
 E/ Highway 111
 24 Hour Directional Classification Count
 Westbound

Start Time	Bikes	Cars & Trailers	2 Axle Long	Buses	2 Axle 6 Tire	3 Axle Single	4 Axle Single	<5 Axl Double	5 Axle Double	>6 Axl Double	<6 Axl Multi	6 Axle Multi	>6 Axl Multi	Total
11/09/23	0	0	0	0	0	0	0	0	0	0	0	0	0	0
01:00	0	3	0	0	1	0	0	0	0	0	0	0	0	4
02:00	0	1	0	0	0	0	0	0	0	0	0	0	0	1
03:00	0	1	0	0	1	0	0	0	0	0	0	0	0	2
04:00	0	0	0	0	0	0	0	0	0	0	0	0	0	0
05:00	0	6	5	0	1	0	0	0	0	0	0	0	0	12
06:00	0	12	9	0	2	1	0	2	0	0	0	0	0	26
07:00	1	20	10	2	3	0	0	0	0	0	0	0	0	36
08:00	0	30	9	0	0	0	0	2	0	0	0	0	0	41
09:00	0	10	5	0	2	1	0	0	0	0	1	0	0	19
10:00	0	7	10	0	3	0	0	1	1	0	1	0	0	23
11:00	0	8	13	0	1	0	0	0	1	0	0	0	0	23
12 PM	0	11	6	0	1	0	1	0	0	0	0	0	0	19
13:00	0	14	11	0	5	0	0	0	0	0	0	0	0	30
14:00	2	29	15	1	3	0	0	0	0	0	0	0	0	50
15:00	0	22	15	0	2	0	0	1	0	0	0	0	0	40
16:00	0	25	8	0	0	0	0	0	0	0	0	0	0	33
17:00	0	38	9	1	2	0	0	0	0	0	0	0	0	50
18:00	1	38	1	0	0	0	0	0	0	0	0	0	0	40
19:00	0	4	0	0	0	0	0	0	0	0	0	0	0	4
20:00	0	4	2	0	0	0	0	0	0	0	0	0	0	6
21:00	0	5	0	0	0	1	0	0	0	0	0	0	0	6
22:00	0	2	0	0	0	0	0	0	0	0	0	0	0	2
23:00	0	1	0	0	0	0	0	0	0	0	0	0	0	1
Total	4	291	128	4	27	3	1	6	2	2	2	0	0	468
Percent	0.9%	62.2%	27.4%	0.9%	5.8%	0.6%	0.2%	1.3%	0.4%	0.0%	0.4%	0.0%	0.0%	
AM Peak	07:00	08:00	11:00	07:00	07:00	06:00	06:00	06:00	10:00	09:00	09:00	08:00	08:00	
Vol.	1	30	13	2	3	1	2	2	1	1	1	41	41	
PM Peak	14:00	17:00	14:00	14:00	13:00	21:00	12:00	15:00	15:00	14:00	14:00	14:00	14:00	
Vol.	2	38	15	1	5	1	1	1	1	1	1	50	50	
Grand Total	4	291	128	4	27	3	1	6	2	2	2	0	0	468
Percent	0.9%	62.2%	27.4%	0.9%	5.8%	0.6%	0.2%	1.3%	0.4%	0.0%	0.4%	0.0%	0.0%	

Counts Unlimited, Inc.

PO Box 1178
Corona, CA 92878
Phone: (951) 268-6268
email: counts@countsunlimited.com
Site Code: 235-231041

County of Imperial
Ross Avenue
E/ Highway 111
24 Hour Directional Classification Count
Eastbound, Westbound























Start Time	Cars & Trailers	2 Axle Long	Buses	2 Axle 6 Tire	3 Axle Single	4 Axle Single	<5 Axl Double	5 Axle Double	>6 Axl Double	<6 Axl Multi	6 Axle Multi	>6 Axl Multi	Total
11/09/23	3	0	0	0	0	0	0	0	0	0	0	0	3
01:00	4	0	0	2	0	0	0	0	0	0	0	0	6
02:00	2	1	0	0	0	0	0	0	0	0	0	0	3
03:00	4	1	0	2	0	0	0	0	0	0	0	0	7
04:00	1	2	0	0	0	0	0	0	0	0	0	0	3
05:00	29	14	0	1	0	0	0	0	0	0	0	0	47
06:00	24	12	0	3	1	0	2	0	0	0	0	0	42
07:00	44	20	2	5	0	0	0	0	0	0	0	0	72
08:00	49	15	0	2	0	0	2	1	0	0	0	0	69
09:00	21	19	1	5	1	0	0	0	0	1	0	0	48
10:00	19	19	0	4	0	0	1	1	0	1	0	0	45
11:00	12	22	0	2	0	0	0	1	0	0	0	0	37
12 PM	20	17	0	3	0	1	2	1	0	0	0	0	44
13:00	1	36	0	6	0	0	1	0	0	0	0	0	64
14:00	3	56	1	4	1	0	0	2	0	0	0	0	89
15:00	1	59	0	2	0	0	2	0	0	0	0	0	83
16:00	0	93	1	1	0	0	0	0	0	0	0	0	113
17:00	3	69	1	2	0	0	0	1	0	0	0	0	89
18:00	1	48	0	0	0	0	0	0	0	0	0	0	51
19:00	0	8	0	0	0	0	0	0	0	0	0	0	8
20:00	0	13	0	0	0	0	0	0	0	0	0	0	16
21:00	0	10	0	0	2	0	0	0	0	0	0	0	12
22:00	0	4	0	0	0	0	0	0	0	0	0	0	5
23:00	0	3	0	0	0	0	0	0	0	0	0	0	3
Total	13	631	5	44	5	1	10	7	0	2	0	0	959
Percent	1.4%	65.8%	0.5%	4.6%	0.5%	0.1%	1.0%	0.7%	0.0%	0.2%	0.0%	0.0%	
AM Peak	05:00	08:00	07:00	07:00	06:00	06:00	08:00	08:00	09:00	09:00	07:00	07:00	07:00
Vol.	3	49	2	5	1	2	1	1	1	1	1	1	72
PM Peak	14:00	16:00	14:00	13:00	21:00	12:00	14:00	14:00	12:00	12:00	16:00	16:00	16:00
Vol.	3	93	1	6	2	1	2	2	2	2	113	113	113
Grand Total	13	631	5	44	5	1	10	7	0	2	0	0	959
Percent	1.4%	65.8%	0.5%	4.6%	0.5%	0.1%	1.0%	0.7%	0.0%	0.2%	0.0%	0.0%	

Appendix B

Intersection LOS Worksheets





















HCM 6th Signalized Intersection Summary
 1: Hwy 111 & E Evan Hewes Hwy

Existing Conditions
 Timing Plan: AM PEAK

												
Movement	EBL	EBT	EBR	WBL	WBT	WBR	NBL	NBT	NBR	SBL	SBT	SBR
Lane Configurations												
Traffic Volume (veh/h)	37	165	50	85	258	143	118	761	99	67	712	58
Future Volume (veh/h)	37	165	50	85	258	143	118	761	99	67	712	58
Initial Q (Qb), veh	0	0	0	0	0	0	0	0	0	0	0	0
Ped-Bike Adj(A_pbT)	1.00		1.00	1.00		1.00	1.00		1.00	1.00		1.00
Parking Bus, Adj	1.00	1.00	1.00	1.00	1.00	1.00	1.00	1.00	1.00	1.00	1.00	1.00
Work Zone On Approach		No			No			No			No	
Adj Sat Flow, veh/h/ln	1870	1870	1870	1870	1870	1870	1870	1693	1870	1870	1693	1870
Adj Flow Rate, veh/h	43	192	58	99	300	166	137	885	115	78	828	67
Peak Hour Factor	0.86	0.86	0.86	0.86	0.86	0.86	0.86	0.86	0.86	0.86	0.86	0.86
Percent Heavy Veh, %	2	2	2	2	2	2	2	14	2	2	14	2
Cap, veh/h	76	445	131	127	429	232	174	1192	587	108	1072	529
Arrive On Green	0.04	0.16	0.16	0.07	0.19	0.19	0.10	0.37	0.37	0.06	0.33	0.33
Sat Flow, veh/h	1781	2709	796	1781	2229	1202	1781	3216	1585	1781	3216	1585
Grp Volume(v), veh/h	43	124	126	99	238	228	137	885	115	78	828	67
Grp Sat Flow(s),veh/h/ln	1781	1777	1727	1781	1777	1654	1781	1608	1585	1781	1608	1585
Q Serve(g_s), s	1.4	3.8	3.9	3.3	7.5	7.8	4.5	14.3	3.0	2.6	13.9	1.8
Cycle Q Clear(g_c), s	1.4	3.8	3.9	3.3	7.5	7.8	4.5	14.3	3.0	2.6	13.9	1.8
Prop In Lane	1.00		0.46	1.00		0.73	1.00		1.00	1.00		1.00
Lane Grp Cap(c), veh/h	76	292	284	127	342	319	174	1192	587	108	1072	529
V/C Ratio(X)	0.57	0.43	0.44	0.78	0.69	0.72	0.79	0.74	0.20	0.72	0.77	0.13
Avail Cap(c_a), veh/h	149	533	518	149	533	496	208	1192	587	149	1072	529
HCM Platoon Ratio	1.00	1.00	1.00	1.00	1.00	1.00	1.00	1.00	1.00	1.00	1.00	1.00
Upstream Filter(l)	1.00	1.00	1.00	1.00	1.00	1.00	1.00	1.00	1.00	1.00	1.00	1.00
Uniform Delay (d), s/veh	28.2	22.5	22.6	27.4	22.6	22.7	26.4	16.4	12.8	27.7	17.9	13.9
Incr Delay (d2), s/veh	6.5	1.0	1.1	20.2	2.5	3.0	15.3	4.2	0.7	10.2	5.4	0.5
Initial Q Delay(d3),s/veh	0.0	0.0	0.0	0.0	0.0	0.0	0.0	0.0	0.0	0.0	0.0	0.0
%ile BackOfQ(50%),veh/ln	0.7	1.6	1.6	2.0	3.1	3.1	2.5	5.3	1.1	1.3	5.4	0.6
Unsig. Movement Delay, s/veh												
LnGrp Delay(d),s/veh	34.6	23.5	23.7	47.6	25.1	25.7	41.8	20.6	13.6	37.9	23.3	14.4
LnGrp LOS	C	C	C	D	C	C	D	C	B	D	C	B
Approach Vol, veh/h		293			565			1137			973	
Approach Delay, s/veh		25.2			29.3			22.4			23.9	
Approach LOS		C			C			C			C	
Timer - Assigned Phs	1	2	3	4	5	6	7	8				
Phs Duration (G+Y+Rc), s	8.6	27.2	9.3	14.8	10.9	25.0	7.6	16.6				
Change Period (Y+Rc), s	5.0	5.0	5.0	5.0	5.0	5.0	5.0	5.0				
Max Green Setting (Gmax), s	5.0	22.0	5.0	18.0	7.0	20.0	5.0	18.0				
Max Q Clear Time (g_c+I1), s	4.6	16.3	5.3	5.9	6.5	15.9	3.4	9.8				
Green Ext Time (p_c), s	0.0	3.1	0.0	1.1	0.0	2.2	0.0	1.8				
Intersection Summary												
HCM 6th Ctrl Delay				24.5								
HCM 6th LOS				C								

HCM 6th Signalized Intersection Summary
 2: Hwy 111 & Ross Ave

Existing Conditions
 Timing Plan: AM PEAK

												
Movement	EBL	EBT	EBR	WBL	WBT	WBR	NBL	NBT	NBR	SBL	SBT	SBR
Lane Configurations												
Traffic Volume (veh/h)	50	39	99	5	41	4	98	943	6	2	778	21
Future Volume (veh/h)	50	39	99	5	41	4	98	943	6	2	778	21
Initial Q (Qb), veh	0	0	0	0	0	0	0	0	0	0	0	0
Ped-Bike Adj(A_pbT)	1.00		1.00	1.00		1.00	1.00		1.00	1.00		1.00
Parking Bus, Adj	1.00	1.00	1.00	1.00	1.00	1.00	1.00	1.00	1.00	1.00	1.00	1.00
Work Zone On Approach		No			No			No			No	
Adj Sat Flow, veh/h/ln	1870	1811	1870	1870	1767	1870	1870	1693	1870	1870	1693	1870
Adj Flow Rate, veh/h	57	45	114	6	47	5	113	1084	7	2	894	24
Peak Hour Factor	0.87	0.87	0.87	0.87	0.87	0.87	0.87	0.87	0.87	0.87	0.87	0.87
Percent Heavy Veh, %	2	6	2	2	9	2	2	14	2	2	14	2
Cap, veh/h	238	108	206	113	189	19	161	1587	10	5	1276	629
Arrive On Green	0.13	0.13	0.13	0.13	0.13	0.13	0.09	0.48	0.48	0.00	0.40	0.40
Sat Flow, veh/h	729	832	1585	92	1455	146	1781	3275	21	1781	3216	1585
Grp Volume(v), veh/h	102	0	114	58	0	0	113	532	559	2	894	24
Grp Sat Flow(s),veh/h/ln	1561	0	1585	1692	0	0	1781	1608	1689	1781	1608	1585
Q Serve(g_s), s	1.1	0.0	2.6	0.0	0.0	0.0	2.4	10.0	10.0	0.0	9.1	0.4
Cycle Q Clear(g_c), s	2.2	0.0	2.6	1.2	0.0	0.0	2.4	10.0	10.0	0.0	9.1	0.4
Prop In Lane	0.56		1.00	0.10		0.09	1.00		0.01	1.00		1.00
Lane Grp Cap(c), veh/h	346	0	206	321	0	0	161	779	818	5	1276	629
V/C Ratio(X)	0.29	0.00	0.55	0.18	0.00	0.00	0.70	0.68	0.68	0.41	0.70	0.04
Avail Cap(c_a), veh/h	838	0	728	865	0	0	273	903	948	227	1724	850
HCM Platoon Ratio	1.00	1.00	1.00	1.00	1.00	1.00	1.00	1.00	1.00	1.00	1.00	1.00
Upstream Filter(l)	1.00	0.00	1.00	1.00	0.00	0.00	1.00	1.00	1.00	1.00	1.00	1.00
Uniform Delay (d), s/veh	15.8	0.0	16.0	15.3	0.0	0.0	17.3	7.8	7.8	19.5	9.9	7.2
Incr Delay (d2), s/veh	0.5	0.0	2.3	0.3	0.0	0.0	5.5	1.8	1.7	46.7	0.8	0.0
Initial Q Delay(d3),s/veh	0.0	0.0	0.0	0.0	0.0	0.0	0.0	0.0	0.0	0.0	0.0	0.0
%ile BackOfQ(50%),veh/ln	0.8	0.0	0.9	0.4	0.0	0.0	1.1	2.5	2.6	0.1	2.4	0.1
Unsig. Movement Delay, s/veh												
LnGrp Delay(d),s/veh	16.2	0.0	18.3	15.6	0.0	0.0	22.8	9.5	9.5	66.2	10.7	7.3
LnGrp LOS	B	A	B	B	A	A	C	A	A	E	B	A
Approach Vol, veh/h		216			58			1204			920	
Approach Delay, s/veh		17.3			15.6			10.7			10.7	
Approach LOS		B			B			B			B	
Timer - Assigned Phs	1	2		4	5	6		8				
Phs Duration (G+Y+Rc), s	5.1	24.0		10.1	8.5	20.6		10.1				
Change Period (Y+Rc), s	5.0	5.0		5.0	5.0	5.0		5.0				
Max Green Setting (Gmax), s	5.0	22.0		18.0	6.0	21.0		18.0				
Max Q Clear Time (g_c+I1), s	2.0	12.0		4.6	4.4	11.1		3.2				
Green Ext Time (p_c), s	0.0	5.0		0.7	0.0	4.5		0.2				
Intersection Summary												
HCM 6th Ctrl Delay				11.4								
HCM 6th LOS				B								

Intersection	
Intersection Delay, s/veh	8
Intersection LOS	A

Movement	EBL	EBT	EBR	WBL	WBT	WBR	NBL	NBT	NBR	SBL	SBT	SBR
Lane Configurations		↕			↕			↕			↕	
Traffic Vol, veh/h	35	6	7	3	7	2	15	96	6	2	90	34
Future Vol, veh/h	35	6	7	3	7	2	15	96	6	2	90	34
Peak Hour Factor	0.81	0.81	0.81	0.81	0.81	0.81	0.81	0.81	0.81	0.81	0.81	0.81
Heavy Vehicles, %	2	2	2	2	2	2	2	2	2	2	2	2
Mvmt Flow	43	7	9	4	9	2	19	119	7	2	111	42
Number of Lanes	0	1	0	0	1	0	0	1	0	0	1	0

Approach	EB	WB	NB	SB
Opposing Approach	WB	EB	SB	NB
Opposing Lanes	1	1	1	1
Conflicting Approach Left	SB	NB	EB	WB
Conflicting Lanes Left	1	1	1	1
Conflicting Approach Right	NB	SB	WB	EB
Conflicting Lanes Right	1	1	1	1
HCM Control Delay	8	7.7	8.1	8
HCM LOS	A	A	A	A

Lane	NBLn1	EBLn1	WBLn1	SBLn1
Vol Left, %	13%	73%	25%	2%
Vol Thru, %	82%	12%	58%	71%
Vol Right, %	5%	15%	17%	27%
Sign Control	Stop	Stop	Stop	Stop
Traffic Vol by Lane	117	48	12	126
LT Vol	15	35	3	2
Through Vol	96	6	7	90
RT Vol	6	7	2	34
Lane Flow Rate	144	59	15	156
Geometry Grp	1	1	1	1
Degree of Util (X)	0.168	0.077	0.019	0.173
Departure Headway (Hd)	4.177	4.659	4.607	4.014
Convergence, Y/N	Yes	Yes	Yes	Yes
Cap	845	773	781	879
Service Time	2.268	2.66	2.61	2.109
HCM Lane V/C Ratio	0.17	0.076	0.019	0.177
HCM Control Delay	8.1	8	7.7	8
HCM Lane LOS	A	A	A	A
HCM 95th-tile Q	0.6	0.2	0.1	0.6





















HCM 6th Signalized Intersection Summary
 1: Hwy 111 & E Evan Hewes Hwy

Existing Conditions
 Timing Plan: PM PEAK

Movement	EBL	EBT	EBR	WBL	WBT	WBR	NBL	NBT	NBR	SBL	SBT	SBR
Lane Configurations												
Traffic Volume (veh/h)	37	237	106	85	191	77	84	693	98	91	1068	74
Future Volume (veh/h)	37	237	106	85	191	77	84	693	98	91	1068	74
Initial Q (Qb), veh	0	0	0	0	0	0	0	0	0	0	0	0
Ped-Bike Adj(A_pbT)	1.00		1.00	1.00		1.00	1.00		1.00	1.00		1.00
Parking Bus, Adj	1.00	1.00	1.00	1.00	1.00	1.00	1.00	1.00	1.00	1.00	1.00	1.00
Work Zone On Approach		No			No			No			No	
Adj Sat Flow, veh/h/ln	1870	1870	1870	1870	1870	1870	1870	1693	1870	1870	1693	1870
Adj Flow Rate, veh/h	38	244	109	88	197	79	87	714	101	94	1101	76
Peak Hour Factor	0.97	0.97	0.97	0.97	0.97	0.97	0.97	0.97	0.97	0.97	0.97	0.97
Percent Heavy Veh, %	2	2	2	2	2	2	2	14	2	2	14	2
Cap, veh/h	70	379	164	115	457	177	115	1192	587	121	1202	592
Arrive On Green	0.04	0.16	0.16	0.06	0.18	0.18	0.06	0.37	0.37	0.07	0.37	0.37
Sat Flow, veh/h	1781	2413	1046	1781	2503	970	1781	3216	1585	1781	3216	1585
Grp Volume(v), veh/h	38	178	175	88	138	138	87	714	101	94	1101	76
Grp Sat Flow(s),veh/h/ln	1781	1777	1682	1781	1777	1696	1781	1608	1585	1781	1608	1585
Q Serve(g_s), s	1.2	5.5	5.8	2.9	4.0	4.3	2.8	10.6	2.5	3.1	19.2	1.9
Cycle Q Clear(g_c), s	1.2	5.5	5.8	2.9	4.0	4.3	2.8	10.6	2.5	3.1	19.2	1.9
Prop In Lane	1.00		0.62	1.00		0.57	1.00		1.00	1.00		1.00
Lane Grp Cap(c), veh/h	70	279	264	115	324	310	115	1192	587	121	1202	592
V/C Ratio(X)	0.54	0.64	0.66	0.76	0.42	0.45	0.76	0.60	0.17	0.78	0.92	0.13
Avail Cap(c_a), veh/h	151	543	514	151	543	519	151	1192	587	182	1202	592
HCM Platoon Ratio	1.00	1.00	1.00	1.00	1.00	1.00	1.00	1.00	1.00	1.00	1.00	1.00
Upstream Filter(I)	1.00	1.00	1.00	1.00	1.00	1.00	1.00	1.00	1.00	1.00	1.00	1.00
Uniform Delay (d), s/veh	27.8	23.2	23.3	27.1	21.3	21.4	27.1	15.0	12.5	27.0	17.5	12.1
Incr Delay (d2), s/veh	6.4	2.4	2.8	15.1	0.9	1.0	14.4	2.2	0.6	11.5	12.3	0.4
Initial Q Delay(d3),s/veh	0.0	0.0	0.0	0.0	0.0	0.0	0.0	0.0	0.0	0.0	0.0	0.0
%ile BackOfQ(50%),veh/ln	0.6	2.3	2.3	1.6	1.6	1.7	1.6	3.8	0.9	1.6	8.2	0.7
Unsig. Movement Delay, s/veh												
LnGrp Delay(d),s/veh	34.1	25.6	26.2	42.2	22.2	22.4	41.5	17.2	13.1	38.6	29.9	12.6
LnGrp LOS	C	C	C	D	C	C	D	B	B	D	C	B
Approach Vol, veh/h		391			364			902			1271	
Approach Delay, s/veh		26.7			27.1			19.1			29.5	
Approach LOS		C			C			B			C	
Timer - Assigned Phs	1	2	3	4	5	6	7	8				
Phs Duration (G+Y+Rc), s	9.0	26.8	8.8	14.2	8.8	27.0	7.3	15.7				
Change Period (Y+Rc), s	5.0	5.0	5.0	5.0	5.0	5.0	5.0	5.0				
Max Green Setting (Gmax), s	6.0	21.0	5.0	18.0	5.0	22.0	5.0	18.0				
Max Q Clear Time (g_c+I1), s	5.1	12.6	4.9	7.8	4.8	21.2	3.2	6.3				
Green Ext Time (p_c), s	0.0	3.4	0.0	1.5	0.0	0.6	0.0	1.2				
Intersection Summary												
HCM 6th Ctrl Delay			25.6									
HCM 6th LOS			C									

HCM 6th Signalized Intersection Summary
2: Hwy 111 & Ross Ave

Existing Conditions
Timing Plan: PM PEAK

												
Movement	EBL	EBT	EBR	WBL	WBT	WBR	NBL	NBT	NBR	SBL	SBT	SBR
Lane Configurations												
Traffic Volume (veh/h)	35	47	156	5	29	5	95	816	8	6	1223	26
Future Volume (veh/h)	35	47	156	5	29	5	95	816	8	6	1223	26
Initial Q (Qb), veh	0	0	0	0	0	0	0	0	0	0	0	0
Ped-Bike Adj(A_pbT)	1.00		1.00	1.00		1.00	1.00		1.00	1.00		1.00
Parking Bus, Adj	1.00	1.00	1.00	1.00	1.00	1.00	1.00	1.00	1.00	1.00	1.00	1.00
Work Zone On Approach		No			No			No			No	
Adj Sat Flow, veh/h/ln	1870	1811	1870	1870	1767	1870	1870	1693	1870	1870	1693	1870
Adj Flow Rate, veh/h	38	51	168	5	31	5	102	877	9	6	1315	28
Peak Hour Factor	0.93	0.93	0.93	0.93	0.93	0.93	0.93	0.93	0.93	0.93	0.93	0.93
Percent Heavy Veh, %	2	6	2	2	9	2	2	14	2	2	14	2
Cap, veh/h	179	184	246	97	216	32	138	1703	17	14	1455	717
Arrive On Green	0.16	0.16	0.16	0.16	0.16	0.16	0.08	0.52	0.52	0.01	0.45	0.45
Sat Flow, veh/h	460	1184	1585	82	1394	205	1781	3261	33	1781	3216	1585
Grp Volume(v), veh/h	89	0	168	41	0	0	102	432	454	6	1315	28
Grp Sat Flow(s),veh/h/ln	1644	0	1585	1680	0	0	1781	1608	1686	1781	1608	1585
Q Serve(g_s), s	0.0	0.0	4.8	0.0	0.0	0.0	2.7	8.4	8.4	0.2	18.1	0.5
Cycle Q Clear(g_c), s	2.1	0.0	4.8	1.0	0.0	0.0	2.7	8.4	8.4	0.2	18.1	0.5
Prop In Lane	0.43		1.00	0.12		0.12	1.00		0.02	1.00		1.00
Lane Grp Cap(c), veh/h	363	0	246	345	0	0	138	840	881	14	1455	717
V/C Ratio(X)	0.25	0.00	0.68	0.12	0.00	0.00	0.74	0.51	0.51	0.42	0.90	0.04
Avail Cap(c_a), veh/h	712	0	599	704	0	0	187	840	881	187	1484	732
HCM Platoon Ratio	1.00	1.00	1.00	1.00	1.00	1.00	1.00	1.00	1.00	1.00	1.00	1.00
Upstream Filter(I)	1.00	0.00	1.00	1.00	0.00	0.00	1.00	1.00	1.00	1.00	1.00	1.00
Uniform Delay (d), s/veh	17.9	0.0	19.0	17.4	0.0	0.0	21.5	7.4	7.4	23.5	12.1	7.3
Incr Delay (d2), s/veh	0.3	0.0	3.3	0.2	0.0	0.0	9.7	0.5	0.5	18.5	8.0	0.0
Initial Q Delay(d3),s/veh	0.0	0.0	0.0	0.0	0.0	0.0	0.0	0.0	0.0	0.0	0.0	0.0
%ile BackOfQ(50%),veh/ln	0.8	0.0	1.8	0.4	0.0	0.0	1.4	2.2	2.3	0.1	6.5	0.1
Unsig. Movement Delay, s/veh												
LnGrp Delay(d),s/veh	18.2	0.0	22.4	17.6	0.0	0.0	31.2	8.0	8.0	42.0	20.1	7.3
LnGrp LOS	B	A	C	B	A	A	C	A	A	D	C	A
Approach Vol, veh/h		257			41			988			1349	
Approach Delay, s/veh		20.9			17.6			10.4			19.9	
Approach LOS		C			B			B			B	
Timer - Assigned Phs	1	2		4	5	6		8				
Phs Duration (G+Y+Rc), s	5.4	29.9		12.4	8.7	26.6		12.4				
Change Period (Y+Rc), s	5.0	5.0		5.0	5.0	5.0		5.0				
Max Green Setting (Gmax), s	5.0	22.0		18.0	5.0	22.0		18.0				
Max Q Clear Time (g_c+I1), s	2.2	10.4		6.8	4.7	20.1		3.0				
Green Ext Time (p_c), s	0.0	4.4		0.8	0.0	1.5		0.1				
Intersection Summary												
HCM 6th Ctrl Delay			16.4									
HCM 6th LOS			B									

Intersection	
Intersection Delay, s/veh	7.9
Intersection LOS	A

Movement	EBL	EBT	EBR	WBL	WBT	WBR	NBL	NBT	NBR	SBL	SBT	SBR
Lane Configurations		↔			↔			↔			↔	
Traffic Vol, veh/h	41	9	30	8	5	1	8	70	3	0	94	16
Future Vol, veh/h	41	9	30	8	5	1	8	70	3	0	94	16
Peak Hour Factor	0.86	0.86	0.86	0.86	0.86	0.86	0.86	0.86	0.86	0.86	0.86	0.86
Heavy Vehicles, %	2	2	2	2	2	2	2	2	2	2	2	2
Mvmt Flow	48	10	35	9	6	1	9	81	3	0	109	19
Number of Lanes	0	1	0	0	1	0	0	1	0	0	1	0

Approach	EB	WB	NB	SB
Opposing Approach	WB	EB	SB	NB
Opposing Lanes	1	1	1	1
Conflicting Approach Left	SB	NB	EB	WB
Conflicting Lanes Left	1	1	1	1
Conflicting Approach Right	NB	SB	WB	EB
Conflicting Lanes Right	1	1	1	1
HCM Control Delay	7.9	7.7	7.9	7.9
HCM LOS	A	A	A	A

Lane	NBLn1	EBLn1	WBLn1	SBLn1
Vol Left, %	10%	51%	57%	0%
Vol Thru, %	86%	11%	36%	85%
Vol Right, %	4%	38%	7%	15%
Sign Control	Stop	Stop	Stop	Stop
Traffic Vol by Lane	81	80	14	110
LT Vol	8	41	8	0
Through Vol	70	9	5	94
RT Vol	3	30	1	16
Lane Flow Rate	94	93	16	128
Geometry Grp	1	1	1	1
Degree of Util (X)	0.11	0.112	0.021	0.146
Departure Headway (Hd)	4.221	4.321	4.601	4.109
Convergence, Y/N	Yes	Yes	Yes	Yes
Cap	834	834	782	858
Service Time	2.321	2.322	2.604	2.204
HCM Lane V/C Ratio	0.113	0.112	0.02	0.149
HCM Control Delay	7.9	7.9	7.7	7.9
HCM Lane LOS	A	A	A	A
HCM 95th-tile Q	0.4	0.4	0.1	0.5

HCM 6th Signalized Intersection Summary
 1: Hwy 111 & E Evan Hewes Hwy

Opening Year 2025
 Timing Plan: AM PEAK



Movement	EBL	EBT	EBR	WBL	WBT	WBR	NBL	NBT	NBR	SBL	SBT	SBR
Lane Configurations	↖	↗		↖	↗		↖	↗	↗	↖	↗	↖
Traffic Volume (veh/h)	39	175	53	90	273	151	125	805	105	71	753	61
Future Volume (veh/h)	39	175	53	90	273	151	125	805	105	71	753	61
Initial Q (Qb), veh	0	0	0	0	0	0	0	0	0	0	0	0
Ped-Bike Adj(A_pbT)	1.00		1.00	1.00		1.00	1.00		1.00	1.00		1.00
Parking Bus, Adj	1.00	1.00	1.00	1.00	1.00	1.00	1.00	1.00	1.00	1.00	1.00	1.00
Work Zone On Approach		No			No			No			No	
Adj Sat Flow, veh/h/ln	1870	1870	1870	1870	1870	1870	1870	1693	1870	1870	1693	1870
Adj Flow Rate, veh/h	45	203	62	105	317	176	145	936	122	83	876	71
Peak Hour Factor	0.86	0.86	0.86	0.86	0.86	0.86	0.86	0.86	0.86	0.86	0.86	0.86
Percent Heavy Veh, %	2	2	2	2	2	2	2	14	2	2	14	2
Cap, veh/h	78	453	134	134	443	240	183	1184	583	110	1052	519
Arrive On Green	0.04	0.17	0.17	0.08	0.20	0.20	0.10	0.37	0.37	0.06	0.33	0.33
Sat Flow, veh/h	1781	2700	803	1781	2223	1207	1781	3216	1585	1781	3216	1585
Grp Volume(v), veh/h	45	132	133	105	252	241	145	936	122	83	876	71
Grp Sat Flow(s),veh/h/ln	1781	1777	1726	1781	1777	1653	1781	1608	1585	1781	1608	1585
Q Serve(g_s), s	1.5	4.1	4.3	3.5	8.1	8.4	4.9	15.9	3.2	2.8	15.4	1.9
Cycle Q Clear(g_c), s	1.5	4.1	4.3	3.5	8.1	8.4	4.9	15.9	3.2	2.8	15.4	1.9
Prop In Lane	1.00		0.46	1.00		0.73	1.00		1.00	1.00		1.00
Lane Grp Cap(c), veh/h	78	298	289	134	354	329	183	1184	583	110	1052	519
V/C Ratio(X)	0.58	0.44	0.46	0.78	0.71	0.73	0.79	0.79	0.21	0.75	0.83	0.14
Avail Cap(c_a), veh/h	146	523	508	146	523	487	204	1184	583	146	1052	519
HCM Platoon Ratio	1.00	1.00	1.00	1.00	1.00	1.00	1.00	1.00	1.00	1.00	1.00	1.00
Upstream Filter(l)	1.00	1.00	1.00	1.00	1.00	1.00	1.00	1.00	1.00	1.00	1.00	1.00
Uniform Delay (d), s/veh	28.7	22.9	23.0	27.8	22.8	22.9	26.8	17.2	13.2	28.2	19.0	14.5
Incr Delay (d2), s/veh	6.6	1.0	1.1	22.0	2.7	3.1	17.3	5.4	0.8	14.4	7.7	0.5
Initial Q Delay(d3),s/veh	0.0	0.0	0.0	0.0	0.0	0.0	0.0	0.0	0.0	0.0	0.0	0.0
%ile BackOfQ(50%),veh/ln	0.8	1.7	1.7	2.3	3.4	3.3	2.8	6.1	1.2	1.6	6.3	0.7
Unsig. Movement Delay, s/veh												
LnGrp Delay(d),s/veh	35.3	23.9	24.1	49.8	25.5	26.1	44.1	22.7	14.0	42.6	26.7	15.0
LnGrp LOS	D	C	C	D	C	C	D	C	B	D	C	B
Approach Vol, veh/h		310			598			1203			1030	
Approach Delay, s/veh		25.6			30.0			24.4			27.2	
Approach LOS		C			C			C			C	
Timer - Assigned Phs	1	2	3	4	5	6	7	8				
Phs Duration (G+Y+Rc), s	8.8	27.5	9.6	15.2	11.3	25.0	7.7	17.2				
Change Period (Y+Rc), s	5.0	5.0	5.0	5.0	5.0	5.0	5.0	5.0				
Max Green Setting (Gmax), s	5.0	22.0	5.0	18.0	7.0	20.0	5.0	18.0				
Max Q Clear Time (g_c+I1), s	4.8	17.9	5.5	6.3	6.9	17.4	3.5	10.4				
Green Ext Time (p_c), s	0.0	2.5	0.0	1.1	0.0	1.5	0.0	1.8				

Intersection Summary												
HCM 6th Ctrl Delay											26.5	
HCM 6th LOS											C	

HCM 6th Signalized Intersection Summary
2: Hwy 111 & Ross Ave

Opening Year 2025
Timing Plan: AM PEAK

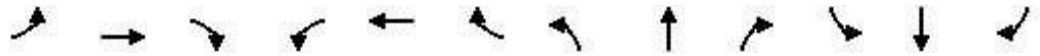

Movement	EBL	EBT	EBR	WBL	WBT	WBR	NBL	NBT	NBR	SBL	SBT	SBR
Lane Configurations		↖	↗		↔		↖	↕		↖	↕	↗
Traffic Volume (veh/h)	53	41	105	5	43	4	104	998	6	2	823	22
Future Volume (veh/h)	53	41	105	5	43	4	104	998	6	2	823	22
Initial Q (Qb), veh	0	0	0	0	0	0	0	0	0	0	0	0
Ped-Bike Adj(A_pbT)	1.00		1.00	1.00		1.00	1.00		1.00	1.00		1.00
Parking Bus, Adj	1.00	1.00	1.00	1.00	1.00	1.00	1.00	1.00	1.00	1.00	1.00	1.00
Work Zone On Approach		No			No			No			No	
Adj Sat Flow, veh/h/ln	1870	1811	1870	1870	1767	1870	1870	1693	1870	1870	1693	1870
Adj Flow Rate, veh/h	61	47	121	6	49	5	120	1147	7	2	946	25
Peak Hour Factor	0.87	0.87	0.87	0.87	0.87	0.87	0.87	0.87	0.87	0.87	0.87	0.87
Percent Heavy Veh, %	2	6	2	2	9	2	2	14	2	2	14	2
Cap, veh/h	237	111	213	109	197	19	163	1618	10	5	1303	642
Arrive On Green	0.13	0.13	0.13	0.13	0.13	0.13	0.09	0.49	0.49	0.00	0.41	0.41
Sat Flow, veh/h	734	824	1585	85	1470	141	1781	3277	20	1781	3216	1585
Grp Volume(v), veh/h	108	0	121	60	0	0	120	563	591	2	946	25
Grp Sat Flow(s),veh/h/ln	1557	0	1585	1696	0	0	1781	1608	1689	1781	1608	1585
Q Serve(g_s), s	1.2	0.0	2.9	0.0	0.0	0.0	2.7	11.1	11.1	0.0	10.1	0.4
Cycle Q Clear(g_c), s	2.5	0.0	2.9	1.3	0.0	0.0	2.7	11.1	11.1	0.0	10.1	0.4
Prop In Lane	0.56		1.00	0.10		0.08	1.00		0.01	1.00		1.00
Lane Grp Cap(c), veh/h	348	0	213	325	0	0	163	794	834	5	1303	642
V/C Ratio(X)	0.31	0.00	0.57	0.18	0.00	0.00	0.74	0.71	0.71	0.41	0.73	0.04
Avail Cap(c_a), veh/h	807	0	702	836	0	0	263	871	915	219	1663	820
HCM Platoon Ratio	1.00	1.00	1.00	1.00	1.00	1.00	1.00	1.00	1.00	1.00	1.00	1.00
Upstream Filter(l)	1.00	0.00	1.00	1.00	0.00	0.00	1.00	1.00	1.00	1.00	1.00	1.00
Uniform Delay (d), s/veh	16.2	0.0	16.5	15.8	0.0	0.0	18.0	8.0	8.0	20.2	10.2	7.3
Incr Delay (d2), s/veh	0.5	0.0	2.4	0.3	0.0	0.0	6.4	2.4	2.3	46.7	1.2	0.0
Initial Q Delay(d3),s/veh	0.0	0.0	0.0	0.0	0.0	0.0	0.0	0.0	0.0	0.0	0.0	0.0
%ile BackOfQ(50%),veh/ln	0.8	0.0	1.0	0.5	0.0	0.0	1.2	3.0	3.1	0.1	2.8	0.1
Unsig. Movement Delay, s/veh												
LnGrp Delay(d),s/veh	16.7	0.0	18.9	16.0	0.0	0.0	24.4	10.4	10.3	67.0	11.4	7.3
LnGrp LOS	B	A	B	B	A	A	C	B	B	E	B	A
Approach Vol, veh/h		229			60			1274				973
Approach Delay, s/veh		17.9			16.0			11.7				11.4
Approach LOS		B			B			B				B
Timer - Assigned Phs	1	2		4	5	6		8				
Phs Duration (G+Y+Rc), s	5.1	25.0		10.5	8.7	21.5		10.5				
Change Period (Y+Rc), s	5.0	5.0		5.0	5.0	5.0		5.0				
Max Green Setting (Gmax), s	5.0	22.0		18.0	6.0	21.0		18.0				
Max Q Clear Time (g_c+I1), s	2.0	13.1		4.9	4.7	12.1		3.3				
Green Ext Time (p_c), s	0.0	4.9		0.8	0.0	4.4		0.2				
Intersection Summary												
HCM 6th Ctrl Delay				12.2								
HCM 6th LOS				B								

Intersection	
Intersection Delay, s/veh	8.1
Intersection LOS	A

Movement	EBL	EBT	EBR	WBL	WBT	WBR	NBL	NBT	NBR	SBL	SBT	SBR
Lane Configurations		↕			↕			↕			↕	
Traffic Vol, veh/h	37	6	7	3	7	2	16	102	6	2	95	36
Future Vol, veh/h	37	6	7	3	7	2	16	102	6	2	95	36
Peak Hour Factor	0.81	0.81	0.81	0.81	0.81	0.81	0.81	0.81	0.81	0.81	0.81	0.81
Heavy Vehicles, %	2	2	2	2	2	2	2	2	2	2	2	2
Mvmt Flow	46	7	9	4	9	2	20	126	7	2	117	44
Number of Lanes	0	1	0	0	1	0	0	1	0	0	1	0

Approach	EB	WB	NB	SB
Opposing Approach	WB	EB	SB	NB
Opposing Lanes	1	1	1	1
Conflicting Approach Left	SB	NB	EB	WB
Conflicting Lanes Left	1	1	1	1
Conflicting Approach Right	NB	SB	WB	EB
Conflicting Lanes Right	1	1	1	1
HCM Control Delay	8.1	7.8	8.2	8.1
HCM LOS	A	A	A	A

Lane	NBLn1	EBLn1	WBLn1	SBLn1
Vol Left, %	13%	74%	25%	2%
Vol Thru, %	82%	12%	58%	71%
Vol Right, %	5%	14%	17%	27%
Sign Control	Stop	Stop	Stop	Stop
Traffic Vol by Lane	124	50	12	133
LT Vol	16	37	3	2
Through Vol	102	6	7	95
RT Vol	6	7	2	36
Lane Flow Rate	153	62	15	164
Geometry Grp	1	1	1	1
Degree of Util (X)	0.178	0.081	0.019	0.188
Departure Headway (Hd)	4.291	4.704	4.65	4.125
Convergence, Y/N	Yes	Yes	Yes	Yes
Cap	842	765	773	875
Service Time	2.291	2.712	2.661	2.125
HCM Lane V/C Ratio	0.182	0.081	0.019	0.187
HCM Control Delay	8.2	8.1	7.8	8.1
HCM Lane LOS	A	A	A	A
HCM 95th-tile Q	0.6	0.3	0.1	0.7

HCM 6th Signalized Intersection Summary
 1: Hwy 111 & E Evan Hewes Hwy

Opening Year 2025
 Timing Plan: PM PEAK

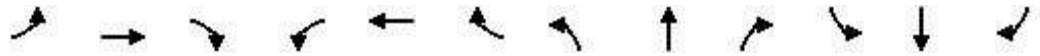

Movement	EBL	EBT	EBR	WBL	WBT	WBR	NBL	NBT	NBR	SBL	SBT	SBR
Lane Configurations	↶	↶↷		↶	↶↷		↶	↶↷	↶	↶	↶↷	↶
Traffic Volume (veh/h)	39	251	112	90	202	81	89	733	104	96	1130	78
Future Volume (veh/h)	39	251	112	90	202	81	89	733	104	96	1130	78
Initial Q (Qb), veh	0	0	0	0	0	0	0	0	0	0	0	0
Ped-Bike Adj(A_pbT)	1.00		1.00	1.00		1.00	1.00		1.00	1.00		1.00
Parking Bus, Adj	1.00	1.00	1.00	1.00	1.00	1.00	1.00	1.00	1.00	1.00	1.00	1.00
Work Zone On Approach		No			No			No			No	
Adj Sat Flow, veh/h/ln	1870	1870	1870	1870	1870	1870	1870	1693	1870	1870	1693	1870
Adj Flow Rate, veh/h	40	259	115	93	208	84	92	756	107	99	1165	80
Peak Hour Factor	0.97	0.97	0.97	0.97	0.97	0.97	0.97	0.97	0.97	0.97	0.97	0.97
Percent Heavy Veh, %	2	2	2	2	2	2	2	14	2	2	14	2
Cap, veh/h	72	394	170	119	472	185	118	1169	576	127	1186	585
Arrive On Green	0.04	0.16	0.16	0.07	0.19	0.19	0.07	0.36	0.36	0.07	0.37	0.37
Sat Flow, veh/h	1781	2417	1043	1781	2496	975	1781	3216	1585	1781	3216	1585
Grp Volume(v), veh/h	40	188	186	93	146	146	92	756	107	99	1165	80
Grp Sat Flow(s),veh/h/ln	1781	1777	1683	1781	1777	1695	1781	1608	1585	1781	1608	1585
Q Serve(g_s), s	1.3	5.9	6.2	3.1	4.3	4.6	3.0	11.7	2.7	3.3	21.4	2.0
Cycle Q Clear(g_c), s	1.3	5.9	6.2	3.1	4.3	4.6	3.0	11.7	2.7	3.3	21.4	2.0
Prop In Lane	1.00		0.62	1.00		0.58	1.00		1.00	1.00		1.00
Lane Grp Cap(c), veh/h	72	290	274	119	336	321	118	1169	576	127	1186	585
V/C Ratio(X)	0.55	0.65	0.68	0.78	0.43	0.46	0.78	0.65	0.19	0.78	0.98	0.14
Avail Cap(c_a), veh/h	149	536	508	149	536	511	149	1169	576	179	1186	585
HCM Platoon Ratio	1.00	1.00	1.00	1.00	1.00	1.00	1.00	1.00	1.00	1.00	1.00	1.00
Upstream Filter(I)	1.00	1.00	1.00	1.00	1.00	1.00	1.00	1.00	1.00	1.00	1.00	1.00
Uniform Delay (d), s/veh	28.1	23.4	23.5	27.4	21.4	21.5	27.4	15.8	13.0	27.2	18.6	12.5
Incr Delay (d2), s/veh	6.4	2.5	2.9	18.7	0.9	1.0	18.4	2.8	0.7	13.2	22.2	0.5
Initial Q Delay(d3),s/veh	0.0	0.0	0.0	0.0	0.0	0.0	0.0	0.0	0.0	0.0	0.0	0.0
%ile BackOfQ(50%),veh/ln	0.7	2.5	2.5	1.8	1.8	1.8	1.8	4.2	1.0	1.8	10.6	0.7
Unsig. Movement Delay, s/veh												
LnGrp Delay(d),s/veh	34.5	25.8	26.4	46.1	22.2	22.5	45.9	18.6	13.7	40.5	40.8	13.0
LnGrp LOS	C	C	C	D	C	C	D	B	B	D	D	B
Approach Vol, veh/h		414			385			955			1344	
Approach Delay, s/veh		26.9			28.1			20.6			39.1	
Approach LOS		C			C			C			D	
Timer - Assigned Phs	1	2	3	4	5	6	7	8				
Phs Duration (G+Y+Rc), s	9.3	26.7	9.0	14.7	8.9	27.0	7.4	16.3				
Change Period (Y+Rc), s	5.0	5.0	5.0	5.0	5.0	5.0	5.0	5.0				
Max Green Setting (Gmax), s	6.0	21.0	5.0	18.0	5.0	22.0	5.0	18.0				
Max Q Clear Time (g_c+I1), s	5.3	13.7	5.1	8.2	5.0	23.4	3.3	6.6				
Green Ext Time (p_c), s	0.0	3.2	0.0	1.5	0.0	0.0	0.0	1.2				
Intersection Summary												
HCM 6th Ctrl Delay				30.4								
HCM 6th LOS				C								

HCM 6th Signalized Intersection Summary
 2: Hwy 111 & Ross Ave

Opening Year 2025
 Timing Plan: PM PEAK

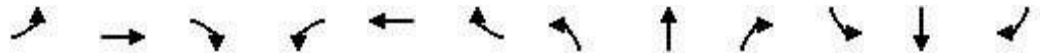

Movement	EBL	EBT	EBR	WBL	WBT	WBR	NBL	NBT	NBR	SBL	SBT	SBR
Lane Configurations		↖	↗		↔		↖	↕		↗	↕	↗
Traffic Volume (veh/h)	37	50	165	5	31	5	101	863	8	6	1294	28
Future Volume (veh/h)	37	50	165	5	31	5	101	863	8	6	1294	28
Initial Q (Qb), veh	0	0	0	0	0	0	0	0	0	0	0	0
Ped-Bike Adj(A_pbT)	1.00		1.00	1.00		1.00	1.00		1.00	1.00		1.00
Parking Bus, Adj	1.00	1.00	1.00	1.00	1.00	1.00	1.00	1.00	1.00	1.00	1.00	1.00
Work Zone On Approach		No			No			No			No	
Adj Sat Flow, veh/h/ln	1870	1811	1870	1870	1767	1870	1870	1693	1870	1870	1693	1870
Adj Flow Rate, veh/h	40	54	177	5	33	5	109	928	9	6	1391	30
Peak Hour Factor	0.93	0.93	0.93	0.93	0.93	0.93	0.93	0.93	0.93	0.93	0.93	0.93
Percent Heavy Veh, %	2	6	2	2	9	2	2	14	2	2	14	2
Cap, veh/h	180	189	255	95	227	31	141	1707	17	14	1454	716
Arrive On Green	0.16	0.16	0.16	0.16	0.16	0.16	0.08	0.52	0.52	0.01	0.45	0.45
Sat Flow, veh/h	463	1179	1585	75	1413	196	1781	3263	32	1781	3216	1585
Grp Volume(v), veh/h	94	0	177	43	0	0	109	457	480	6	1391	30
Grp Sat Flow(s),veh/h/ln	1642	0	1585	1684	0	0	1781	1608	1687	1781	1608	1585
Q Serve(g_s), s	0.0	0.0	5.1	0.0	0.0	0.0	2.9	9.2	9.2	0.2	20.3	0.5
Cycle Q Clear(g_c), s	2.2	0.0	5.1	1.0	0.0	0.0	2.9	9.2	9.2	0.2	20.3	0.5
Prop In Lane	0.43		1.00	0.12		0.12	1.00		0.02	1.00		1.00
Lane Grp Cap(c), veh/h	369	0	255	353	0	0	141	841	883	14	1454	716
V/C Ratio(X)	0.25	0.00	0.70	0.12	0.00	0.00	0.77	0.54	0.54	0.42	0.96	0.04
Avail Cap(c_a), veh/h	697	0	586	691	0	0	183	841	883	183	1454	716
HCM Platoon Ratio	1.00	1.00	1.00	1.00	1.00	1.00	1.00	1.00	1.00	1.00	1.00	1.00
Upstream Filter(l)	1.00	0.00	1.00	1.00	0.00	0.00	1.00	1.00	1.00	1.00	1.00	1.00
Uniform Delay (d), s/veh	18.1	0.0	19.3	17.6	0.0	0.0	22.0	7.7	7.7	24.0	12.9	7.4
Incr Delay (d2), s/veh	0.4	0.0	3.4	0.2	0.0	0.0	14.0	0.7	0.7	18.5	14.6	0.0
Initial Q Delay(d3),s/veh	0.0	0.0	0.0	0.0	0.0	0.0	0.0	0.0	0.0	0.0	0.0	0.0
%ile BackOfQ(50%),veh/ln	0.9	0.0	1.9	0.4	0.0	0.0	1.7	2.5	2.6	0.1	8.5	0.1
Unsig. Movement Delay, s/veh												
LnGrp Delay(d),s/veh	18.4	0.0	22.7	17.7	0.0	0.0	35.9	8.5	8.4	42.5	27.5	7.5
LnGrp LOS	B	A	C	B	A	A	D	A	A	D	C	A
Approach Vol, veh/h		271			43			1046			1427	
Approach Delay, s/veh		21.2			17.7			11.3			27.2	
Approach LOS		C			B			B			C	
Timer - Assigned Phs	1	2		4	5	6		8				
Phs Duration (G+Y+Rc), s	5.4	30.5		12.8	8.9	27.0		12.8				
Change Period (Y+Rc), s	5.0	5.0		5.0	5.0	5.0		5.0				
Max Green Setting (Gmax), s	5.0	22.0		18.0	5.0	22.0		18.0				
Max Q Clear Time (g_c+I1), s	2.2	11.2		7.1	4.9	22.3		3.0				
Green Ext Time (p_c), s	0.0	4.5		0.8	0.0	0.0		0.1				
Intersection Summary												
HCM 6th Ctrl Delay			20.5									
HCM 6th LOS			C									

Intersection	
Intersection Delay, s/veh	7.9
Intersection LOS	A

Movement	EBL	EBT	EBR	WBL	WBT	WBR	NBL	NBT	NBR	SBL	SBT	SBR
Lane Configurations		↕			↕			↕			↕	
Traffic Vol, veh/h	43	10	32	8	5	1	8	74	3	0	99	17
Future Vol, veh/h	43	10	32	8	5	1	8	74	3	0	99	17
Peak Hour Factor	0.86	0.86	0.86	0.86	0.86	0.86	0.86	0.86	0.86	0.86	0.86	0.86
Heavy Vehicles, %	2	2	2	2	2	2	2	2	2	2	2	2
Mvmt Flow	50	12	37	9	6	1	9	86	3	0	115	20
Number of Lanes	0	1	0	0	1	0	0	1	0	0	1	0

Approach	EB	WB	NB	SB
Opposing Approach	WB	EB	SB	NB
Opposing Lanes	1	1	1	1
Conflicting Approach Left	SB	NB	EB	WB
Conflicting Lanes Left	1	1	1	1
Conflicting Approach Right	NB	SB	WB	EB
Conflicting Lanes Right	1	1	1	1
HCM Control Delay	7.9	7.8	7.9	8
HCM LOS	A	A	A	A

Lane	NBLn1	EBLn1	WBLn1	SBLn1
Vol Left, %	9%	51%	57%	0%
Vol Thru, %	87%	12%	36%	85%
Vol Right, %	4%	38%	7%	15%
Sign Control	Stop	Stop	Stop	Stop
Traffic Vol by Lane	85	85	14	116
LT Vol	8	43	8	0
Through Vol	74	10	5	99
RT Vol	3	32	1	17
Lane Flow Rate	99	99	16	135
Geometry Grp	1	1	1	1
Degree of Util (X)	0.119	0.119	0.021	0.158
Departure Headway (Hd)	4.342	4.345	4.635	4.222
Convergence, Y/N	Yes	Yes	Yes	Yes
Cap	830	827	774	854
Service Time	2.346	2.359	2.652	2.225
HCM Lane V/C Ratio	0.119	0.12	0.021	0.158
HCM Control Delay	7.9	7.9	7.8	8
HCM Lane LOS	A	A	A	A
HCM 95th-tile Q	0.4	0.4	0.1	0.6

HCM 6th Signalized Intersection Summary
 1: Hwy 111 & E Evan Hewes Hwy

Opening Year 2025 w/Proj
 Timing Plan: AM PEAK

Movement	EBL	EBT	EBR	WBL	WBT	WBR	NBL	NBT	NBR	SBL	SBT	SBR
Lane Configurations												
Traffic Volume (veh/h)	39	175	62	99	273	151	134	814	114	71	762	61
Future Volume (veh/h)	39	175	62	99	273	151	134	814	114	71	762	61
Initial Q (Qb), veh	0	0	0	0	0	0	0	0	0	0	0	0
Ped-Bike Adj(A_pbT)	1.00		1.00	1.00		1.00	1.00		1.00	1.00		1.00
Parking Bus, Adj	1.00	1.00	1.00	1.00	1.00	1.00	1.00	1.00	1.00	1.00	1.00	1.00
Work Zone On Approach		No			No			No			No	
Adj Sat Flow, veh/h/ln	1870	1870	1870	1870	1870	1870	1870	1693	1870	1870	1693	1870
Adj Flow Rate, veh/h	45	203	72	115	317	176	156	947	133	83	886	71
Peak Hour Factor	0.86	0.86	0.86	0.86	0.86	0.86	0.86	0.86	0.86	0.86	0.86	0.86
Percent Heavy Veh, %	2	2	2	2	2	2	2	14	2	2	14	2
Cap, veh/h	78	418	144	144	442	240	195	1197	590	110	1042	514
Arrive On Green	0.04	0.16	0.16	0.08	0.20	0.20	0.11	0.37	0.37	0.06	0.32	0.32
Sat Flow, veh/h	1781	2594	892	1781	2223	1207	1781	3216	1585	1781	3216	1585
Grp Volume(v), veh/h	45	137	138	115	252	241	156	947	133	83	886	71
Grp Sat Flow(s),veh/h/ln	1781	1777	1710	1781	1777	1653	1781	1608	1585	1781	1608	1585
Q Serve(g_s), s	1.5	4.3	4.5	3.9	8.2	8.4	5.3	16.2	3.5	2.8	15.9	2.0
Cycle Q Clear(g_c), s	1.5	4.3	4.5	3.9	8.2	8.4	5.3	16.2	3.5	2.8	15.9	2.0
Prop In Lane	1.00		0.52	1.00		0.73	1.00		1.00	1.00		1.00
Lane Grp Cap(c), veh/h	78	286	275	144	353	328	195	1197	590	110	1042	514
V/C Ratio(X)	0.58	0.48	0.50	0.80	0.71	0.73	0.80	0.79	0.23	0.76	0.85	0.14
Avail Cap(c_a), veh/h	144	518	499	144	518	482	202	1197	590	144	1042	514
HCM Platoon Ratio	1.00	1.00	1.00	1.00	1.00	1.00	1.00	1.00	1.00	1.00	1.00	1.00
Upstream Filter(I)	1.00	1.00	1.00	1.00	1.00	1.00	1.00	1.00	1.00	1.00	1.00	1.00
Uniform Delay (d), s/veh	29.0	23.5	23.6	27.9	23.1	23.2	26.8	17.2	13.3	28.5	19.5	14.8
Incr Delay (d2), s/veh	6.7	1.2	1.4	26.0	2.7	3.2	19.3	5.4	0.9	15.1	8.7	0.6
Initial Q Delay(d3),s/veh	0.0	0.0	0.0	0.0	0.0	0.0	0.0	0.0	0.0	0.0	0.0	0.0
%ile BackOfQ(50%),veh/ln	0.8	1.8	1.8	2.6	3.4	3.4	3.2	6.2	1.3	1.6	6.6	0.7
Unsig. Movement Delay, s/veh												
LnGrp Delay(d),s/veh	35.6	24.8	25.0	53.8	25.8	26.4	46.1	22.6	14.2	43.6	28.1	15.3
LnGrp LOS	D	C	C	D	C	C	D	C	B	D	C	B
Approach Vol, veh/h		320			608			1236			1040	
Approach Delay, s/veh		26.4			31.3			24.7			28.5	
Approach LOS		C			C			C			C	
Timer - Assigned Phs	1	2	3	4	5	6	7	8				
Phs Duration (G+Y+Rc), s	8.8	28.0	10.0	14.9	11.8	25.0	7.7	17.3				
Change Period (Y+Rc), s	5.0	5.0	5.0	5.0	5.0	5.0	5.0	5.0				
Max Green Setting (Gmax), s	5.0	22.0	5.0	18.0	7.0	20.0	5.0	18.0				
Max Q Clear Time (g_c+I1), s	4.8	18.2	5.9	6.5	7.3	17.9	3.5	10.4				
Green Ext Time (p_c), s	0.0	2.3	0.0	1.2	0.0	1.3	0.0	1.8				
Intersection Summary												
HCM 6th Ctrl Delay				27.4								
HCM 6th LOS				C								

HCM 6th Signalized Intersection Summary
2: Hwy 111 & Ross Ave

Opening Year 2025 w/Proj
Timing Plan: AM PEAK



Movement	EBL	EBT	EBR	WBL	WBT	WBR	NBL	NBT	NBR	SBL	SBT	SBR
Lane Configurations		↕	↗		↕		↖	↕		↖	↕	↗
Traffic Volume (veh/h)	53	50	105	46	52	32	104	998	47	29	823	22
Future Volume (veh/h)	53	50	105	46	52	32	104	998	47	29	823	22
Initial Q (Qb), veh	0	0	0	0	0	0	0	0	0	0	0	0
Ped-Bike Adj(A_pbT)	1.00		1.00	1.00		1.00	1.00		1.00	1.00		1.00
Parking Bus, Adj	1.00	1.00	1.00	1.00	1.00	1.00	1.00	1.00	1.00	1.00	1.00	1.00
Work Zone On Approach		No			No			No			No	
Adj Sat Flow, veh/h/ln	1870	1811	1870	1870	1767	1870	1870	1693	1870	1870	1693	1870
Adj Flow Rate, veh/h	61	57	121	53	60	37	120	1147	54	33	946	25
Peak Hour Factor	0.87	0.87	0.87	0.87	0.87	0.87	0.87	0.87	0.87	0.87	0.87	0.87
Percent Heavy Veh, %	2	6	2	2	9	2	2	14	2	2	14	2
Cap, veh/h	236	169	264	166	114	55	157	1412	66	67	1291	636
Arrive On Green	0.17	0.17	0.17	0.17	0.17	0.17	0.09	0.45	0.45	0.04	0.40	0.40
Sat Flow, veh/h	663	1012	1585	326	683	331	1781	3127	147	1781	3216	1585
Grp Volume(v), veh/h	118	0	121	150	0	0	120	590	611	33	946	25
Grp Sat Flow(s),veh/h/ln	1675	0	1585	1340	0	0	1781	1608	1666	1781	1608	1585
Q Serve(g_s), s	0.0	0.0	3.0	2.2	0.0	0.0	2.9	13.8	13.9	0.8	10.9	0.4
Cycle Q Clear(g_c), s	2.6	0.0	3.0	4.8	0.0	0.0	2.9	13.8	13.9	0.8	10.9	0.4
Prop In Lane	0.52		1.00	0.35		0.25	1.00		0.09	1.00		1.00
Lane Grp Cap(c), veh/h	404	0	264	335	0	0	157	726	752	67	1291	636
V/C Ratio(X)	0.29	0.00	0.46	0.45	0.00	0.00	0.77	0.81	0.81	0.49	0.73	0.04
Avail Cap(c_a), veh/h	768	0	654	686	0	0	245	811	841	204	1549	764
HCM Platoon Ratio	1.00	1.00	1.00	1.00	1.00	1.00	1.00	1.00	1.00	1.00	1.00	1.00
Upstream Filter(I)	1.00	0.00	1.00	1.00	0.00	0.00	1.00	1.00	1.00	1.00	1.00	1.00
Uniform Delay (d), s/veh	16.2	0.0	16.4	17.0	0.0	0.0	19.4	10.4	10.4	20.6	11.1	7.9
Incr Delay (d2), s/veh	0.4	0.0	1.2	0.9	0.0	0.0	7.6	5.7	5.6	5.4	1.5	0.0
Initial Q Delay(d3),s/veh	0.0	0.0	0.0	0.0	0.0	0.0	0.0	0.0	0.0	0.0	0.0	0.0
%ile BackOfQ(50%),veh/ln	1.0	0.0	1.0	1.3	0.0	0.0	1.4	4.7	4.8	0.4	3.2	0.1
Unsig. Movement Delay, s/veh												
LnGrp Delay(d),s/veh	16.6	0.0	17.6	18.0	0.0	0.0	27.1	16.1	15.9	26.0	12.5	8.0
LnGrp LOS	B	A	B	B	A	A	C	B	B	C	B	A
Approach Vol, veh/h		239			150			1321			1004	
Approach Delay, s/veh		17.1			18.0			17.0			12.9	
Approach LOS		B			B			B			B	
Timer - Assigned Phs	1	2		4	5	6		8				
Phs Duration (G+Y+Rc), s	6.6	24.7		12.3	8.8	22.5		12.3				
Change Period (Y+Rc), s	5.0	5.0		5.0	5.0	5.0		5.0				
Max Green Setting (Gmax), s	5.0	22.0		18.0	6.0	21.0		18.0				
Max Q Clear Time (g_c+1/2), s	12.8	15.9		5.0	4.9	12.9		6.8				
Green Ext Time (p_c), s	0.0	3.8		0.8	0.0	4.1		0.6				

Intersection Summary

HCM 6th Ctrl Delay	15.5
HCM 6th LOS	B

Intersection												
Intersection Delay, s/veh	8.3											
Intersection LOS	A											

Movement	EBL	EBT	EBR	WBL	WBT	WBR	NBL	NBT	NBR	SBL	SBT	SBR
Lane Configurations		↕			↕			↕			↕	
Traffic Vol, veh/h	42	6	16	3	7	2	25	102	6	2	95	41
Future Vol, veh/h	42	6	16	3	7	2	25	102	6	2	95	41
Peak Hour Factor	0.81	0.81	0.81	0.81	0.81	0.81	0.81	0.81	0.81	0.81	0.81	0.81
Heavy Vehicles, %	2	2	2	2	2	2	2	2	2	2	2	2
Mvmt Flow	52	7	20	4	9	2	31	126	7	2	117	51
Number of Lanes	0	1	0	0	1	0	0	1	0	0	1	0

Approach	EB	WB	NB	SB
Opposing Approach	WB	EB	SB	NB
Opposing Lanes	1	1	1	1
Conflicting Approach Left	SB	NB	EB	WB
Conflicting Lanes Left	1	1	1	1
Conflicting Approach Right	NB	SB	WB	EB
Conflicting Lanes Right	1	1	1	1
HCM Control Delay	8.2	7.8	8.4	8.2
HCM LOS	A	A	A	A

Lane	NBLn1	EBLn1	WBLn1	SBLn1
Vol Left, %	19%	66%	25%	1%
Vol Thru, %	77%	9%	58%	69%
Vol Right, %	5%	25%	17%	30%
Sign Control	Stop	Stop	Stop	Stop
Traffic Vol by Lane	133	64	12	138
LT Vol	25	42	3	2
Through Vol	102	6	7	95
RT Vol	6	16	2	41
Lane Flow Rate	164	79	15	170
Geometry Grp	1	1	1	1
Degree of Util (X)	0.198	0.102	0.019	0.197
Departure Headway (Hd)	4.345	4.664	4.715	4.159
Convergence, Y/N	Yes	Yes	Yes	Yes
Cap	829	770	760	865
Service Time	2.355	2.682	2.737	2.17
HCM Lane V/C Ratio	0.198	0.103	0.02	0.197
HCM Control Delay	8.4	8.2	7.8	8.2
HCM Lane LOS	A	A	A	A
HCM 95th-tile Q	0.7	0.3	0.1	0.7

Intersection						
Int Delay, s/veh	2.7					
Movement	EBT	EBR	WBL	WBT	NBL	NBR
Lane Configurations	↑	↗	↖	↑	↖	↗
Traffic Vol, veh/h	216	110	18	217	111	19
Future Vol, veh/h	216	110	18	217	111	19
Conflicting Peds, #/hr	0	0	0	0	0	0
Sign Control	Free	Free	Free	Free	Stop	Stop
RT Channelized	-	None	-	None	-	None
Storage Length	-	200	100	-	0	0
Veh in Median Storage, #	0	-	-	0	0	-
Grade, %	0	-	-	0	0	-
Peak Hour Factor	92	92	92	92	92	92
Heavy Vehicles, %	6	2	2	9	2	2
Mvmt Flow	235	120	20	236	121	21

Major/Minor	Major1	Major2	Minor1			
Conflicting Flow All	0	0	355	0	511	235
Stage 1	-	-	-	-	235	-
Stage 2	-	-	-	-	276	-
Critical Hdwy	-	-	4.12	-	6.42	6.22
Critical Hdwy Stg 1	-	-	-	-	5.42	-
Critical Hdwy Stg 2	-	-	-	-	5.42	-
Follow-up Hdwy	-	-	2.218	-	3.518	3.318
Pot Cap-1 Maneuver	-	-	1204	-	523	804
Stage 1	-	-	-	-	804	-
Stage 2	-	-	-	-	771	-
Platoon blocked, %	-	-	-	-	-	-
Mov Cap-1 Maneuver	-	-	1204	-	514	804
Mov Cap-2 Maneuver	-	-	-	-	514	-
Stage 1	-	-	-	-	804	-
Stage 2	-	-	-	-	758	-

Approach	EB	WB	NB
HCM Control Delay, s	0	0.6	13.4
HCM LOS			B

Minor Lane/Major Mvmt	NBLn1	NBLn2	EBT	EBR	WBL	WBT
Capacity (veh/h)	514	804	-	-	1204	-
HCM Lane V/C Ratio	0.235	0.026	-	-	0.016	-
HCM Control Delay (s)	14.1	9.6	-	-	8	-
HCM Lane LOS	B	A	-	-	A	-
HCM 95th %tile Q(veh)	0.9	0.1	-	-	0.1	-

Intersection						
Int Delay, s/veh	3.1					
Movement	EBT	EBR	WBL	WBT	NBL	NBR
Lane Configurations	↑	↗	↘	↑	↘	↗
Traffic Vol, veh/h	125	110	18	124	111	19
Future Vol, veh/h	125	110	18	124	111	19
Conflicting Peds, #/hr	0	0	0	0	0	0
Sign Control	Free	Free	Free	Free	Stop	Stop
RT Channelized	-	None	-	None	-	None
Storage Length	-	200	100	-	0	0
Veh in Median Storage, #	0	-	-	0	0	-
Grade, %	0	-	-	0	0	-
Peak Hour Factor	92	92	92	92	92	92
Heavy Vehicles, %	6	2	2	9	2	2
Mvmt Flow	136	120	20	135	121	21

Major/Minor	Major1	Major2	Minor1		
Conflicting Flow All	0	0	256	0	311
Stage 1	-	-	-	-	136
Stage 2	-	-	-	-	175
Critical Hdwy	-	-	4.12	-	6.42
Critical Hdwy Stg 1	-	-	-	-	5.42
Critical Hdwy Stg 2	-	-	-	-	5.42
Follow-up Hdwy	-	-	2.218	-	3.518
Pot Cap-1 Maneuver	-	-	1309	-	681
Stage 1	-	-	-	-	890
Stage 2	-	-	-	-	855
Platoon blocked, %	-	-	-	-	-
Mov Cap-1 Maneuver	-	-	1309	-	671
Mov Cap-2 Maneuver	-	-	-	-	671
Stage 1	-	-	-	-	890
Stage 2	-	-	-	-	842

Approach	EB	WB	NB
HCM Control Delay, s	0	1	11.1
HCM LOS			B

Minor Lane/Major Mvmt	NBLn1	NBLn2	EBT	EBR	WBL	WBT
Capacity (veh/h)	671	913	-	-	1309	-
HCM Lane V/C Ratio	0.18	0.023	-	-	0.015	-
HCM Control Delay (s)	11.5	9	-	-	7.8	-
HCM Lane LOS	B	A	-	-	A	-
HCM 95th %tile Q(veh)	0.7	0.1	-	-	0	-

Intersection						
Int Delay, s/veh	3.8					
Movement	EBT	EBR	WBL	WBT	NBL	NBR
Lane Configurations	↑	↗	↖	↑	↖	↗
Traffic Vol, veh/h	52	91	18	50	93	18
Future Vol, veh/h	52	91	18	50	93	18
Conflicting Peds, #/hr	0	0	0	0	0	0
Sign Control	Free	Free	Free	Free	Stop	Stop
RT Channelized	-	None	-	None	-	None
Storage Length	-	200	100	-	0	0
Veh in Median Storage, #	0	-	-	0	0	-
Grade, %	0	-	-	0	0	-
Peak Hour Factor	92	92	92	92	92	92
Heavy Vehicles, %	6	2	2	9	2	2
Mvmt Flow	57	99	20	54	101	20

Major/Minor	Major1	Major2	Minor1		
Conflicting Flow All	0	0	156	0	151
Stage 1	-	-	-	-	57
Stage 2	-	-	-	-	94
Critical Hdwy	-	-	4.12	-	6.42
Critical Hdwy Stg 1	-	-	-	-	5.42
Critical Hdwy Stg 2	-	-	-	-	5.42
Follow-up Hdwy	-	-	2.218	-	3.518
Pot Cap-1 Maneuver	-	-	1424	-	841
Stage 1	-	-	-	-	966
Stage 2	-	-	-	-	930
Platoon blocked, %	-	-	-	-	-
Mov Cap-1 Maneuver	-	-	1424	-	829
Mov Cap-2 Maneuver	-	-	-	-	829
Stage 1	-	-	-	-	966
Stage 2	-	-	-	-	917

Approach	EB	WB	NB
HCM Control Delay, s	0	2	9.7
HCM LOS			A

Minor Lane/Major Mvmt	NBLn1	NBLn2	EBT	EBR	WBL	WBT
Capacity (veh/h)	829	1009	-	-	1424	-
HCM Lane V/C Ratio	0.122	0.019	-	-	0.014	-
HCM Control Delay (s)	9.9	8.6	-	-	7.6	-
HCM Lane LOS	A	A	-	-	A	-
HCM 95th %tile Q(veh)	0.4	0.1	-	-	0	-

HCM 6th Signalized Intersection Summary
 1: Hwy 111 & E Evan Hewes Hwy

Opening Year 2025 w/Proj
 Timing Plan: PM PEAK

Movement	EBL	EBT	EBR	WBL	WBT	WBR	NBL	NBT	NBR	SBL	SBT	SBR
Lane Configurations												
Traffic Volume (veh/h)	39	251	121	99	202	81	98	742	113	96	1139	78
Future Volume (veh/h)	39	251	121	99	202	81	98	742	113	96	1139	78
Initial Q (Qb), veh	0	0	0	0	0	0	0	0	0	0	0	0
Ped-Bike Adj(A_pbT)	1.00		1.00	1.00		1.00	1.00		1.00	1.00		1.00
Parking Bus, Adj	1.00	1.00	1.00	1.00	1.00	1.00	1.00	1.00	1.00	1.00	1.00	1.00
Work Zone On Approach		No			No			No			No	
Adj Sat Flow, veh/h/ln	1870	1870	1870	1870	1870	1870	1870	1693	1870	1870	1693	1870
Adj Flow Rate, veh/h	40	259	125	102	208	84	101	765	116	99	1174	80
Peak Hour Factor	0.97	0.97	0.97	0.97	0.97	0.97	0.97	0.97	0.97	0.97	0.97	0.97
Percent Heavy Veh, %	2	2	2	2	2	2	2	14	2	2	14	2
Cap, veh/h	72	388	182	130	495	193	129	1164	574	127	1160	572
Arrive On Green	0.04	0.17	0.17	0.07	0.20	0.20	0.07	0.36	0.36	0.07	0.36	0.36
Sat Flow, veh/h	1781	2349	1100	1781	2496	975	1781	3216	1585	1781	3216	1585
Grp Volume(v), veh/h	40	194	190	102	146	146	101	765	116	99	1174	80
Grp Sat Flow(s),veh/h/ln	1781	1777	1672	1781	1777	1695	1781	1608	1585	1781	1608	1585
Q Serve(g_s), s	1.3	6.2	6.5	3.4	4.4	4.6	3.4	12.1	3.1	3.3	22.0	2.1
Cycle Q Clear(g_c), s	1.3	6.2	6.5	3.4	4.4	4.6	3.4	12.1	3.1	3.3	22.0	2.1
Prop In Lane	1.00		0.66	1.00		0.58	1.00		1.00	1.00		1.00
Lane Grp Cap(c), veh/h	72	294	277	130	352	336	129	1164	574	127	1160	572
V/C Ratio(X)	0.56	0.66	0.69	0.78	0.41	0.43	0.78	0.66	0.20	0.78	1.01	0.14
Avail Cap(c_a), veh/h	146	525	494	146	525	500	146	1164	574	175	1160	572
HCM Platoon Ratio	1.00	1.00	1.00	1.00	1.00	1.00	1.00	1.00	1.00	1.00	1.00	1.00
Upstream Filter(I)	1.00	1.00	1.00	1.00	1.00	1.00	1.00	1.00	1.00	1.00	1.00	1.00
Uniform Delay (d), s/veh	28.7	23.8	24.0	27.8	21.4	21.4	27.8	16.3	13.4	27.8	19.5	13.1
Incr Delay (d2), s/veh	6.6	2.5	3.0	21.4	0.8	0.9	21.2	2.9	0.8	14.0	29.4	0.5
Initial Q Delay(d3),s/veh	0.0	0.0	0.0	0.0	0.0	0.0	0.0	0.0	0.0	0.0	0.0	0.0
%ile BackOfQ(50%),veh/ln	0.7	2.7	2.6	2.2	1.8	1.8	2.1	4.4	1.1	1.8	11.9	0.8
Unsig. Movement Delay, s/veh												
LnGrp Delay(d),s/veh	35.3	26.4	27.0	49.1	22.1	22.3	49.0	19.2	14.2	41.8	48.8	13.6
LnGrp LOS	D	C	C	D	C	C	D	B	B	D	F	B
Approach Vol, veh/h		424			394			982			1353	
Approach Delay, s/veh		27.5			29.2			21.7			46.2	
Approach LOS		C			C			C			D	
Timer - Assigned Phs	1	2	3	4	5	6	7	8				
Phs Duration (G+Y+Rc), s	9.3	27.1	9.5	15.1	9.4	27.0	7.5	17.1				
Change Period (Y+Rc), s	5.0	5.0	5.0	5.0	5.0	5.0	5.0	5.0				
Max Green Setting (Gmax), s	6.0	21.0	5.0	18.0	5.0	22.0	5.0	18.0				
Max Q Clear Time (g_c+I1), s	5.3	14.1	5.4	8.5	5.4	24.0	3.3	6.6				
Green Ext Time (p_c), s	0.0	3.1	0.0	1.6	0.0	0.0	0.0	1.2				
Intersection Summary												
HCM 6th Ctrl Delay				33.9								
HCM 6th LOS				C								

HCM 6th Signalized Intersection Summary

2: Hwy 111 & Ross Ave

Opening Year 2025 w/Proj
Timing Plan: PM PEAK



Movement	EBL	EBT	EBR	WBL	WBT	WBR	NBL	NBT	NBR	SBL	SBT	SBR
Lane Configurations		↔	↔		↔		↔	↕		↔	↕	↔
Traffic Volume (veh/h)	37	59	165	43	40	31	101	863	49	33	1294	28
Future Volume (veh/h)	37	59	165	43	40	31	101	863	49	33	1294	28
Initial Q (Qb), veh	0	0	0	0	0	0	0	0	0	0	0	0
Ped-Bike Adj(A_pbT)	1.00		1.00	1.00		1.00	1.00		1.00	1.00		1.00
Parking Bus, Adj	1.00	1.00	1.00	1.00	1.00	1.00	1.00	1.00	1.00	1.00	1.00	1.00
Work Zone On Approach		No			No			No			No	
Adj Sat Flow, veh/h/ln	1870	1811	1870	1870	1767	1870	1870	1693	1870	1870	1693	1870
Adj Flow Rate, veh/h	40	63	177	46	43	33	109	928	53	35	1391	30
Peak Hour Factor	0.93	0.93	0.93	0.93	0.93	0.93	0.93	0.93	0.93	0.93	0.93	0.93
Percent Heavy Veh, %	2	6	2	2	9	2	2	14	2	2	14	2
Cap, veh/h	172	203	258	160	109	62	141	1519	87	69	1450	715
Arrive On Green	0.16	0.16	0.16	0.16	0.16	0.16	0.08	0.49	0.49	0.04	0.45	0.45
Sat Flow, veh/h	429	1245	1585	356	672	381	1781	3092	177	1781	3216	1585
Grp Volume(v), veh/h	103	0	177	122	0	0	109	483	498	35	1391	30
Grp Sat Flow(s),veh/h/ln	1673	0	1585	1410	0	0	1781	1608	1661	1781	1608	1585
Q Serve(g_s), s	0.0	0.0	5.1	1.3	0.0	0.0	2.9	10.6	10.6	0.9	20.4	0.5
Cycle Q Clear(g_c), s	2.5	0.0	5.1	3.7	0.0	0.0	2.9	10.6	10.6	0.9	20.4	0.5
Prop In Lane	0.39		1.00	0.38		0.27	1.00		0.11	1.00		1.00
Lane Grp Cap(c), veh/h	375	0	258	331	0	0	141	790	816	69	1450	715
V/C Ratio(X)	0.27	0.00	0.69	0.37	0.00	0.00	0.77	0.61	0.61	0.51	0.96	0.04
Avail Cap(c_a), veh/h	696	0	585	613	0	0	182	790	816	182	1450	715
HCM Platoon Ratio	1.00	1.00	1.00	1.00	1.00	1.00	1.00	1.00	1.00	1.00	1.00	1.00
Upstream Filter(I)	1.00	0.00	1.00	1.00	0.00	0.00	1.00	1.00	1.00	1.00	1.00	1.00
Uniform Delay (d), s/veh	18.1	0.0	19.3	18.6	0.0	0.0	22.0	9.0	9.0	23.0	13.0	7.5
Incr Delay (d2), s/veh	0.4	0.0	3.2	0.7	0.0	0.0	14.1	1.4	1.3	5.7	15.1	0.0
Initial Q Delay(d3),s/veh	0.0	0.0	0.0	0.0	0.0	0.0	0.0	0.0	0.0	0.0	0.0	0.0
%ile BackOfQ(50%),veh/ln	1.0	0.0	1.9	1.2	0.0	0.0	1.7	3.1	3.2	0.5	8.6	0.1
Unsig. Movement Delay, s/veh												
LnGrp Delay(d),s/veh	18.5	0.0	22.5	19.2	0.0	0.0	36.2	10.4	10.4	28.7	28.1	7.5
LnGrp LOS	B	A	C	B	A	A	D	B	B	C	C	A
Approach Vol, veh/h		280			122			1090			1456	
Approach Delay, s/veh		21.0			19.2			13.0			27.7	
Approach LOS		C			B			B			C	
Timer - Assigned Phs	1	2		4	5	6		8				
Phs Duration (G+Y+Rc), s	6.9	29.0		12.9	8.9	27.0		12.9				
Change Period (Y+Rc), s	5.0	5.0		5.0	5.0	5.0		5.0				
Max Green Setting (Gmax), s	5.0	22.0		18.0	5.0	22.0		18.0				
Max Q Clear Time (g_c+I), s	12.6	12.6		7.1	4.9	22.4		5.7				
Green Ext Time (p_c), s	0.0	4.3		0.8	0.0	0.0		0.5				
Intersection Summary												
HCM 6th Ctrl Delay											21.2	
HCM 6th LOS											C	

Intersection												
Intersection Delay, s/veh	8.1											
Intersection LOS	A											

Movement	EBL	EBT	EBR	WBL	WBT	WBR	NBL	NBT	NBR	SBL	SBT	SBR
Lane Configurations		↕			↕			↕			↕	
Traffic Vol, veh/h	47	10	41	8	5	1	17	74	3	0	99	22
Future Vol, veh/h	47	10	41	8	5	1	17	74	3	0	99	22
Peak Hour Factor	0.86	0.86	0.86	0.86	0.86	0.86	0.86	0.86	0.86	0.86	0.86	0.86
Heavy Vehicles, %	2	2	2	2	2	2	2	2	2	2	2	2
Mvmt Flow	55	12	48	9	6	1	20	86	3	0	115	26
Number of Lanes	0	1	0	0	1	0	0	1	0	0	1	0

Approach	EB	WB	NB	SB
Opposing Approach	WB	EB	SB	NB
Opposing Lanes	1	1	1	1
Conflicting Approach Left	SB	NB	EB	WB
Conflicting Lanes Left	1	1	1	1
Conflicting Approach Right	NB	SB	WB	EB
Conflicting Lanes Right	1	1	1	1
HCM Control Delay	8.1	7.8	8.1	8.1
HCM LOS	A	A	A	A

Lane	NBLn1	EBLn1	WBLn1	SBLn1
Vol Left, %	18%	48%	57%	0%
Vol Thru, %	79%	10%	36%	82%
Vol Right, %	3%	42%	7%	18%
Sign Control	Stop	Stop	Stop	Stop
Traffic Vol by Lane	94	98	14	121
LT Vol	17	47	8	0
Through Vol	74	10	5	99
RT Vol	3	41	1	22
Lane Flow Rate	109	114	16	141
Geometry Grp	1	1	1	1
Degree of Util (X)	0.134	0.138	0.021	0.166
Departure Headway (Hd)	4.397	4.356	4.695	4.242
Convergence, Y/N	Yes	Yes	Yes	Yes
Cap	818	825	764	848
Service Time	2.411	2.372	2.715	2.255
HCM Lane V/C Ratio	0.133	0.138	0.021	0.166
HCM Control Delay	8.1	8.1	7.8	8.1
HCM Lane LOS	A	A	A	A
HCM 95th-tile Q	0.5	0.5	0.1	0.6

Intersection						
Int Delay, s/veh	2.6					
Movement	EBT	EBR	WBL	WBT	NBL	NBR
Lane Configurations	↑	↗	↘	↑	↘	↗
Traffic Vol, veh/h	211	108	18	203	102	17
Future Vol, veh/h	211	108	18	203	102	17
Conflicting Peds, #/hr	0	0	0	0	0	0
Sign Control	Free	Free	Free	Free	Stop	Stop
RT Channelized	-	None	-	None	-	None
Storage Length	-	200	100	-	0	0
Veh in Median Storage, #	0	-	-	0	0	-
Grade, %	0	-	-	0	0	-
Peak Hour Factor	92	92	92	92	92	92
Heavy Vehicles, %	2	2	2	2	2	2
Mvmt Flow	229	117	20	221	111	18

Major/Minor	Major1	Major2	Minor1		
Conflicting Flow All	0	0	346	0	490 229
Stage 1	-	-	-	-	229 -
Stage 2	-	-	-	-	261 -
Critical Hdwy	-	-	4.12	-	6.42 6.22
Critical Hdwy Stg 1	-	-	-	-	5.42 -
Critical Hdwy Stg 2	-	-	-	-	5.42 -
Follow-up Hdwy	-	-	2.218	-	3.518 3.318
Pot Cap-1 Maneuver	-	-	1213	-	537 810
Stage 1	-	-	-	-	809 -
Stage 2	-	-	-	-	783 -
Platoon blocked, %	-	-	-	-	-
Mov Cap-1 Maneuver	-	-	1213	-	528 810
Mov Cap-2 Maneuver	-	-	-	-	528 -
Stage 1	-	-	-	-	809 -
Stage 2	-	-	-	-	770 -

Approach	EB	WB	NB
HCM Control Delay, s	0	0.7	13
HCM LOS			B

Minor Lane/Major Mvmt	NBLn1	NBLn2	EBT	EBR	WBL	WBT
Capacity (veh/h)	528	810	-	-	1213	-
HCM Lane V/C Ratio	0.21	0.023	-	-	0.016	-
HCM Control Delay (s)	13.6	9.5	-	-	8	-
HCM Lane LOS	B	A	-	-	A	-
HCM 95th %tile Q(veh)	0.8	0.1	-	-	0	-

Intersection						
Int Delay, s/veh	3					
Movement	EBT	EBR	WBL	WBT	NBL	NBR
Lane Configurations	↑	↗	↖	↑	↖	↗
Traffic Vol, veh/h	120	108	18	118	102	17
Future Vol, veh/h	120	108	18	118	102	17
Conflicting Peds, #/hr	0	0	0	0	0	0
Sign Control	Free	Free	Free	Free	Stop	Stop
RT Channelized	-	None	-	None	-	None
Storage Length	-	200	100	-	0	0
Veh in Median Storage, #	0	-	-	0	0	-
Grade, %	0	-	-	0	0	-
Peak Hour Factor	92	92	92	92	92	92
Heavy Vehicles, %	2	2	2	2	2	2
Mvmt Flow	130	117	20	128	111	18

Major/Minor	Major1	Major2	Minor1
Conflicting Flow All	0	0	247
Stage 1	-	-	-
Stage 2	-	-	-
Critical Hdwy	-	-	4.12
Critical Hdwy Stg 1	-	-	-
Critical Hdwy Stg 2	-	-	-
Follow-up Hdwy	-	-	2.218
Pot Cap-1 Maneuver	-	-	1319
Stage 1	-	-	-
Stage 2	-	-	-
Platoon blocked, %	-	-	-
Mov Cap-1 Maneuver	-	-	1319
Mov Cap-2 Maneuver	-	-	-
Stage 1	-	-	-
Stage 2	-	-	-

Approach	EB	WB	NB
HCM Control Delay, s	0	1	11
HCM LOS			B

Minor Lane/Major Mvmt	NBLn1	NBLn2	EBT	EBR	WBL	WBT
Capacity (veh/h)	683	920	-	-	1319	-
HCM Lane V/C Ratio	0.162	0.02	-	-	0.015	-
HCM Control Delay (s)	11.3	9	-	-	7.8	-
HCM Lane LOS	B	A	-	-	A	-
HCM 95th %tile Q(veh)	0.6	0.1	-	-	0	-

Intersection						
Int Delay, s/veh	3.7					
Movement	EBT	EBR	WBL	WBT	NBL	NBR
Lane Configurations	↑	↗	↘	↑	↘	↗
Traffic Vol, veh/h	47	90	18	51	85	18
Future Vol, veh/h	47	90	18	51	85	18
Conflicting Peds, #/hr	0	0	0	0	0	0
Sign Control	Free	Free	Free	Free	Stop	Stop
RT Channelized	-	None	-	None	-	None
Storage Length	-	200	100	-	0	0
Veh in Median Storage, #	0	-	-	0	0	-
Grade, %	0	-	-	0	0	-
Peak Hour Factor	92	92	92	92	92	92
Heavy Vehicles, %	2	2	2	2	2	2
Mvmt Flow	51	98	20	55	92	20

Major/Minor	Major1	Major2	Minor1		
Conflicting Flow All	0	0	149	0	146
Stage 1	-	-	-	-	51
Stage 2	-	-	-	-	95
Critical Hdwy	-	-	4.12	-	6.42
Critical Hdwy Stg 1	-	-	-	-	5.42
Critical Hdwy Stg 2	-	-	-	-	5.42
Follow-up Hdwy	-	-	2.218	-	3.518
Pot Cap-1 Maneuver	-	-	1432	-	846
Stage 1	-	-	-	-	971
Stage 2	-	-	-	-	929
Platoon blocked, %	-	-	-	-	-
Mov Cap-1 Maneuver	-	-	1432	-	834
Mov Cap-2 Maneuver	-	-	-	-	834
Stage 1	-	-	-	-	971
Stage 2	-	-	-	-	916

Approach	EB	WB	NB
HCM Control Delay, s	0	2	9.7
HCM LOS			A

Minor Lane/Major Mvmt	NBLn1	NBLn2	EBT	EBR	WBL	WBT
Capacity (veh/h)	834	1017	-	-	1432	-
HCM Lane V/C Ratio	0.111	0.019	-	-	0.014	-
HCM Control Delay (s)	9.9	8.6	-	-	7.5	-
HCM Lane LOS	A	A	-	-	A	-
HCM 95th %tile Q(veh)	0.4	0.1	-	-	0	-

Appendix C

Queuing Worksheets

Queues
1: Hwy 111 & E Evan Hewes Hwy

Existing Conditions
Timing Plan: AM PEAK



Lane Group	EBL	EBT	WBL	WBT	NBL	NBT	NBR	SBL	SBT	SBR
Lane Group Flow (vph)	43	250	99	466	137	885	115	78	828	67
v/c Ratio	0.30	0.37	0.68	0.55	0.67	0.69	0.15	0.54	0.80	0.10
Control Delay	35.1	18.7	57.2	17.5	48.3	22.8	1.3	46.1	28.2	0.3
Queue Delay	0.0	0.0	0.0	0.0	0.0	0.0	0.0	0.0	0.0	0.0
Total Delay	35.1	18.7	57.2	17.5	48.3	22.8	1.3	46.1	28.2	0.3
Queue Length 50th (ft)	16	35	38	59	52	159	0	30	153	0
Queue Length 95th (ft)	45	60	#113	94	#136	#273	6	#86	#266	0
Internal Link Dist (ft)		182		545		1517			242	
Turn Bay Length (ft)	150		235		750		435	535		350
Base Capacity (vph)	145	1048	145	1093	203	1274	748	145	1041	645
Starvation Cap Reductn	0	0	0	0	0	0	0	0	0	0
Spillback Cap Reductn	0	0	0	0	0	0	0	0	0	0
Storage Cap Reductn	0	0	0	0	0	0	0	0	0	0
Reduced v/c Ratio	0.30	0.24	0.68	0.43	0.67	0.69	0.15	0.54	0.80	0.10

Intersection Summary

95th percentile volume exceeds capacity, queue may be longer.
Queue shown is maximum after two cycles.

Queues
2: Hwy 111 & Ross Ave

Existing Conditions
Timing Plan: AM PEAK



Lane Group	EBT	EBR	WBT	NBL	NBT	SBL	SBT	SBR
Lane Group Flow (vph)	102	114	58	113	1091	2	894	24
v/c Ratio	0.38	0.29	0.19	0.49	0.52	0.01	0.54	0.03
Control Delay	22.9	5.9	17.9	31.6	9.8	22.0	13.3	0.0
Queue Delay	0.0	0.0	0.0	0.0	0.0	0.0	0.0	0.0
Total Delay	22.9	5.9	17.9	31.6	9.8	22.0	13.3	0.0
Queue Length 50th (ft)	28	0	14	32	77	1	107	0
Queue Length 95th (ft)	60	26	36	#87	#255	6	174	0
Internal Link Dist (ft)	705		195		857		1517	
Turn Bay Length (ft)		125		550		450		450
Base Capacity (vph)	568	696	652	230	2079	191	1677	898
Starvation Cap Reductn	0	0	0	0	0	0	0	0
Spillback Cap Reductn	0	0	0	0	0	0	0	0
Storage Cap Reductn	0	0	0	0	0	0	0	0
Reduced v/c Ratio	0.18	0.16	0.09	0.49	0.52	0.01	0.53	0.03

Intersection Summary

95th percentile volume exceeds capacity, queue may be longer.
Queue shown is maximum after two cycles.

Queues
1: Hwy 111 & E Evan Hewes Hwy

Existing Conditions
Timing Plan: PM PEAK



Lane Group	EBL	EBT	WBL	WBT	NBL	NBT	NBR	SBL	SBT	SBR
Lane Group Flow (vph)	38	353	88	276	87	714	101	94	1101	76
v/c Ratio	0.24	0.53	0.56	0.32	0.55	0.59	0.14	0.50	0.88	0.10
Control Delay	32.2	19.6	45.5	15.2	45.1	19.6	0.7	39.1	31.1	0.3
Queue Delay	0.0	0.0	0.0	0.0	0.0	0.0	0.0	0.0	0.0	0.0
Total Delay	32.2	19.6	45.5	15.2	45.1	19.6	0.7	39.1	31.1	0.3
Queue Length 50th (ft)	14	46	33	27	32	117	0	35	210	0
Queue Length 95th (ft)	42	82	#100	65	#99	191	4	#96	#379	0
Internal Link Dist (ft)		182		545		1517			242	
Turn Bay Length (ft)	150		235		750		435	535		350
Base Capacity (vph)	158	1153	158	1173	158	1206	718	190	1246	736
Starvation Cap Reductn	0	0	0	0	0	0	0	0	0	0
Spillback Cap Reductn	0	0	0	0	0	0	0	0	0	0
Storage Cap Reductn	0	0	0	0	0	0	0	0	0	0
Reduced v/c Ratio	0.24	0.31	0.56	0.24	0.55	0.59	0.14	0.49	0.88	0.10

Intersection Summary

95th percentile volume exceeds capacity, queue may be longer.
Queue shown is maximum after two cycles.

Queues
2: Hwy 111 & Ross Ave

Existing Conditions
Timing Plan: PM PEAK



Lane Group	EBT	EBR	WBT	NBL	NBT	SBL	SBT	SBR
Lane Group Flow (vph)	89	168	41	102	886	6	1315	28
v/c Ratio	0.34	0.41	0.15	0.57	0.42	0.03	0.76	0.03
Control Delay	22.3	7.3	17.2	38.3	7.6	22.3	19.1	0.1
Queue Delay	0.0	0.0	0.0	0.0	0.0	0.0	0.0	0.0
Total Delay	22.3	7.3	17.2	38.3	7.6	22.3	19.1	0.1
Queue Length 50th (ft)	24	0	9	29	54	2	182	0
Queue Length 95th (ft)	56	39	29	#92	174	11	#359	0
Internal Link Dist (ft)	705		195		857		1517	
Turn Bay Length (ft)		125		550		450		450
Base Capacity (vph)	564	688	611	180	2103	180	1725	920
Starvation Cap Reductn	0	0	0	0	0	0	0	0
Spillback Cap Reductn	0	0	0	0	0	0	0	0
Storage Cap Reductn	0	0	0	0	0	0	0	0
Reduced v/c Ratio	0.16	0.24	0.07	0.57	0.42	0.03	0.76	0.03

Intersection Summary

95th percentile volume exceeds capacity, queue may be longer.
Queue shown is maximum after two cycles.

Queues
1: Hwy 111 & E Evan Hewes Hwy

Opening Year 2025
Timing Plan: AM PEAK



Lane Group	EBL	EBT	WBL	WBT	NBL	NBT	NBR	SBL	SBT	SBR
Lane Group Flow (vph)	45	265	105	493	145	936	122	83	876	71
v/c Ratio	0.33	0.39	0.76	0.52	0.75	0.78	0.17	0.60	0.88	0.11
Control Delay	36.4	19.1	67.0	17.1	55.5	26.1	1.6	51.1	35.0	0.4
Queue Delay	0.0	0.0	0.0	0.0	0.0	0.0	0.0	0.0	0.0	0.0
Total Delay	36.4	19.1	67.0	17.1	55.5	26.1	1.6	51.1	35.0	0.4
Queue Length 50th (ft)	17	37	42	64	57	180	0	33	173	0
Queue Length 95th (ft)	47	62	#120	100	#145	#297	9	#92	#290	0
Internal Link Dist (ft)		182		545		1517			242	
Turn Bay Length (ft)	150		235		750		435	535		350
Base Capacity (vph)	138	1003	138	1050	194	1200	716	138	992	624
Starvation Cap Reductn	0	0	0	0	0	0	0	0	0	0
Spillback Cap Reductn	0	0	0	0	0	0	0	0	0	0
Storage Cap Reductn	0	0	0	0	0	0	0	0	0	0
Reduced v/c Ratio	0.33	0.26	0.76	0.47	0.75	0.78	0.17	0.60	0.88	0.11

Intersection Summary

95th percentile volume exceeds capacity, queue may be longer.
Queue shown is maximum after two cycles.

Queues
2: Hwy 111 & Ross Ave

Opening Year 2025
Timing Plan: AM PEAK



Lane Group	EBT	EBR	WBT	NBL	NBT	SBL	SBT	SBR
Lane Group Flow (vph)	108	121	60	120	1154	2	946	25
v/c Ratio	0.41	0.31	0.20	0.55	0.56	0.01	0.57	0.03
Control Delay	23.5	6.4	18.0	34.6	10.6	22.5	14.2	0.0
Queue Delay	0.0	0.0	0.0	0.0	0.0	0.0	0.0	0.0
Total Delay	23.5	6.4	18.0	34.6	10.6	22.5	14.2	0.0
Queue Length 50th (ft)	29	0	14	35	85	1	117	0
Queue Length 95th (ft)	63	28	37	#94	#284	6	191	0
Internal Link Dist (ft)	705		195		857		1517	
Turn Bay Length (ft)		125		550		450		450
Base Capacity (vph)	538	666	622	218	2078	182	1664	892
Starvation Cap Reductn	0	0	0	0	0	0	0	0
Spillback Cap Reductn	0	0	0	0	0	0	0	0
Storage Cap Reductn	0	0	0	0	0	0	0	0
Reduced v/c Ratio	0.20	0.18	0.10	0.55	0.56	0.01	0.57	0.03

Intersection Summary

95th percentile volume exceeds capacity, queue may be longer.
Queue shown is maximum after two cycles.

Queues
1: Hwy 111 & E Evan Hewes Hwy

Opening Year 2025
Timing Plan: PM PEAK



Lane Group	EBL	EBT	WBL	WBT	NBL	NBT	NBR	SBL	SBT	SBR
Lane Group Flow (vph)	40	374	93	292	92	756	107	99	1165	80
v/c Ratio	0.25	0.55	0.59	0.33	0.59	0.63	0.15	0.53	0.94	0.11
Control Delay	32.7	20.1	48.2	15.1	47.8	20.8	1.0	40.9	38.3	0.3
Queue Delay	0.0	0.0	0.0	0.0	0.0	0.0	0.0	0.0	0.0	0.0
Total Delay	32.7	20.1	48.2	15.1	47.8	20.8	1.0	40.9	38.3	0.3
Queue Length 50th (ft)	15	50	35	29	35	128	0	37	~260	0
Queue Length 95th (ft)	43	87	#107	68	#106	208	6	#104	#415	0
Internal Link Dist (ft)		182		545		1517			242	
Turn Bay Length (ft)	150		235		750		435	535		350
Base Capacity (vph)	157	1145	157	1178	157	1198	715	188	1237	732
Starvation Cap Reductn	0	0	0	0	0	0	0	0	0	0
Spillback Cap Reductn	0	0	0	0	0	0	0	0	0	0
Storage Cap Reductn	0	0	0	0	0	0	0	0	0	0
Reduced v/c Ratio	0.25	0.33	0.59	0.25	0.59	0.63	0.15	0.53	0.94	0.11

Intersection Summary

~ Volume exceeds capacity, queue is theoretically infinite.
Queue shown is maximum after two cycles.

95th percentile volume exceeds capacity, queue may be longer.
Queue shown is maximum after two cycles.

Queues
2: Hwy 111 & Ross Ave

Opening Year 2025
Timing Plan: PM PEAK



Lane Group	EBT	EBR	WBT	NBL	NBT	SBL	SBT	SBR
Lane Group Flow (vph)	94	177	43	109	937	6	1391	30
v/c Ratio	0.36	0.43	0.15	0.61	0.45	0.03	0.81	0.03
Control Delay	22.5	7.3	17.2	41.0	7.9	22.3	21.2	0.1
Queue Delay	0.0	0.0	0.0	0.0	0.0	0.0	0.0	0.0
Total Delay	22.5	7.3	17.2	41.0	7.9	22.3	21.2	0.1
Queue Length 50th (ft)	25	0	10	32	59	2	~202	0
Queue Length 95th (ft)	58	39	30	#100	188	11	#391	0
Internal Link Dist (ft)	705		195		857		1517	
Turn Bay Length (ft)		125		550		450		450
Base Capacity (vph)	563	693	610	180	2101	180	1721	918
Starvation Cap Reductn	0	0	0	0	0	0	0	0
Spillback Cap Reductn	0	0	0	0	0	0	0	0
Storage Cap Reductn	0	0	0	0	0	0	0	0
Reduced v/c Ratio	0.17	0.26	0.07	0.61	0.45	0.03	0.81	0.03

Intersection Summary

~ Volume exceeds capacity, queue is theoretically infinite.
Queue shown is maximum after two cycles.

95th percentile volume exceeds capacity, queue may be longer.
Queue shown is maximum after two cycles.

Queues
1: Hwy 111 & E Evan Hewes Hwy

Opening Year 2025 w/Proj
Timing Plan: AM PEAK



Lane Group	EBL	EBT	WBL	WBT	NBL	NBT	NBR	SBL	SBT	SBR
Lane Group Flow (vph)	45	275	115	493	156	947	133	83	886	71
v/c Ratio	0.33	0.40	0.83	0.52	0.80	0.79	0.19	0.60	0.89	0.11
Control Delay	36.4	18.4	77.7	17.1	62.2	26.6	1.9	51.1	36.0	0.4
Queue Delay	0.0	0.0	0.0	0.0	0.0	0.0	0.0	0.0	0.0	0.0
Total Delay	36.4	18.4	77.7	17.1	62.2	26.6	1.9	51.1	36.0	0.4
Queue Length 50th (ft)	17	36	46	64	62	183	0	33	175	0
Queue Length 95th (ft)	47	63	#133	100	#158	#303	13	#92	#295	0
Internal Link Dist (ft)		182		545		1517			242	
Turn Bay Length (ft)	150		235		750		435	535		350
Base Capacity (vph)	138	1008	138	1050	194	1201	716	138	993	624
Starvation Cap Reductn	0	0	0	0	0	0	0	0	0	0
Spillback Cap Reductn	0	0	0	0	0	0	0	0	0	0
Storage Cap Reductn	0	0	0	0	0	0	0	0	0	0
Reduced v/c Ratio	0.33	0.27	0.83	0.47	0.80	0.79	0.19	0.60	0.89	0.11

Intersection Summary

95th percentile volume exceeds capacity, queue may be longer.
Queue shown is maximum after two cycles.

Queues
2: Hwy 111 & Ross Ave

Opening Year 2025 w/Proj
Timing Plan: AM PEAK



Lane Group	EBT	EBR	WBT	NBL	NBT	SBL	SBT	SBR
Lane Group Flow (vph)	118	121	150	120	1201	33	946	25
v/c Ratio	0.43	0.30	0.51	0.57	0.62	0.19	0.58	0.03
Control Delay	23.5	6.1	21.8	36.2	14.1	25.6	14.9	0.0
Queue Delay	0.0	0.0	0.0	0.0	0.0	0.0	0.0	0.0
Total Delay	23.5	6.1	21.8	36.2	14.1	25.6	14.9	0.0
Queue Length 50th (ft)	32	0	33	35	94	9	120	0
Queue Length 95th (ft)	67	28	73	#98	#315	32	199	0
Internal Link Dist (ft)	705		195		857		1517	
Turn Bay Length (ft)		125		550		450		450
Base Capacity (vph)	525	652	545	212	1939	177	1649	885
Starvation Cap Reductn	0	0	0	0	0	0	0	0
Spillback Cap Reductn	0	0	0	0	0	0	0	0
Storage Cap Reductn	0	0	0	0	0	0	0	0
Reduced v/c Ratio	0.22	0.19	0.28	0.57	0.62	0.19	0.57	0.03

Intersection Summary

95th percentile volume exceeds capacity, queue may be longer.
Queue shown is maximum after two cycles.

Queues
1: Hwy 111 & E Evan Hewes Hwy

Opening Year 2025 w/Proj
Timing Plan: PM PEAK



Lane Group	EBL	EBT	WBL	WBT	NBL	NBT	NBR	SBL	SBT	SBR
Lane Group Flow (vph)	40	384	102	292	101	765	116	99	1174	80
v/c Ratio	0.27	0.57	0.69	0.29	0.69	0.68	0.17	0.56	1.01	0.11
Control Delay	33.4	19.8	57.2	14.9	56.4	22.1	1.4	42.9	53.0	0.3
Queue Delay	0.0	0.0	0.0	0.0	0.0	0.0	0.0	0.0	0.0	0.0
Total Delay	33.4	19.8	57.2	14.9	56.4	22.1	1.4	42.9	53.0	0.3
Queue Length 50th (ft)	15	50	39	29	38	130	0	37	~263	0
Queue Length 95th (ft)	43	86	#120	68	#118	211	10	#104	#420	0
Internal Link Dist (ft)		182		545		1517			242	
Turn Bay Length (ft)	150		235		750		435	535		350
Base Capacity (vph)	147	1088	147	1110	147	1121	681	177	1161	699
Starvation Cap Reductn	0	0	0	0	0	0	0	0	0	0
Spillback Cap Reductn	0	0	0	0	0	0	0	0	0	0
Storage Cap Reductn	0	0	0	0	0	0	0	0	0	0
Reduced v/c Ratio	0.27	0.35	0.69	0.26	0.69	0.68	0.17	0.56	1.01	0.11

Intersection Summary

~ Volume exceeds capacity, queue is theoretically infinite.
Queue shown is maximum after two cycles.

95th percentile volume exceeds capacity, queue may be longer.
Queue shown is maximum after two cycles.

Queues
2: Hwy 111 & Ross Ave

Opening Year 2025 w/Proj
Timing Plan: PM PEAK



Lane Group	EBT	EBR	WBT	NBL	NBT	SBL	SBT	SBR
Lane Group Flow (vph)	103	177	122	109	981	35	1391	30
v/c Ratio	0.37	0.42	0.43	0.61	0.50	0.20	0.81	0.03
Control Delay	22.3	7.0	19.5	41.6	10.4	25.2	21.8	0.1
Queue Delay	0.0	0.0	0.0	0.0	0.0	0.0	0.0	0.0
Total Delay	22.3	7.0	19.5	41.6	10.4	25.2	21.8	0.1
Queue Length 50th (ft)	28	0	24	32	64	10	~209	0
Queue Length 95th (ft)	62	39	61	#101	204	33	#398	0
Internal Link Dist (ft)	705		195		857		1517	
Turn Bay Length (ft)		125		550		450		450
Base Capacity (vph)	578	689	551	179	1965	179	1712	914
Starvation Cap Reductn	0	0	0	0	0	0	0	0
Spillback Cap Reductn	0	0	0	0	0	0	0	0
Storage Cap Reductn	0	0	0	0	0	0	0	0
Reduced v/c Ratio	0.18	0.26	0.22	0.61	0.50	0.20	0.81	0.03

Intersection Summary

~ Volume exceeds capacity, queue is theoretically infinite.
Queue shown is maximum after two cycles.

95th percentile volume exceeds capacity, queue may be longer.
Queue shown is maximum after two cycles.

Appendix D

SCAG Profile of Imperial County Report Excerpts



Profile of Imperial County

Southern California Association of Governments (SCAG) Regional Council includes 69 districts which represent 191 cities and 6 counties in the SCAG region

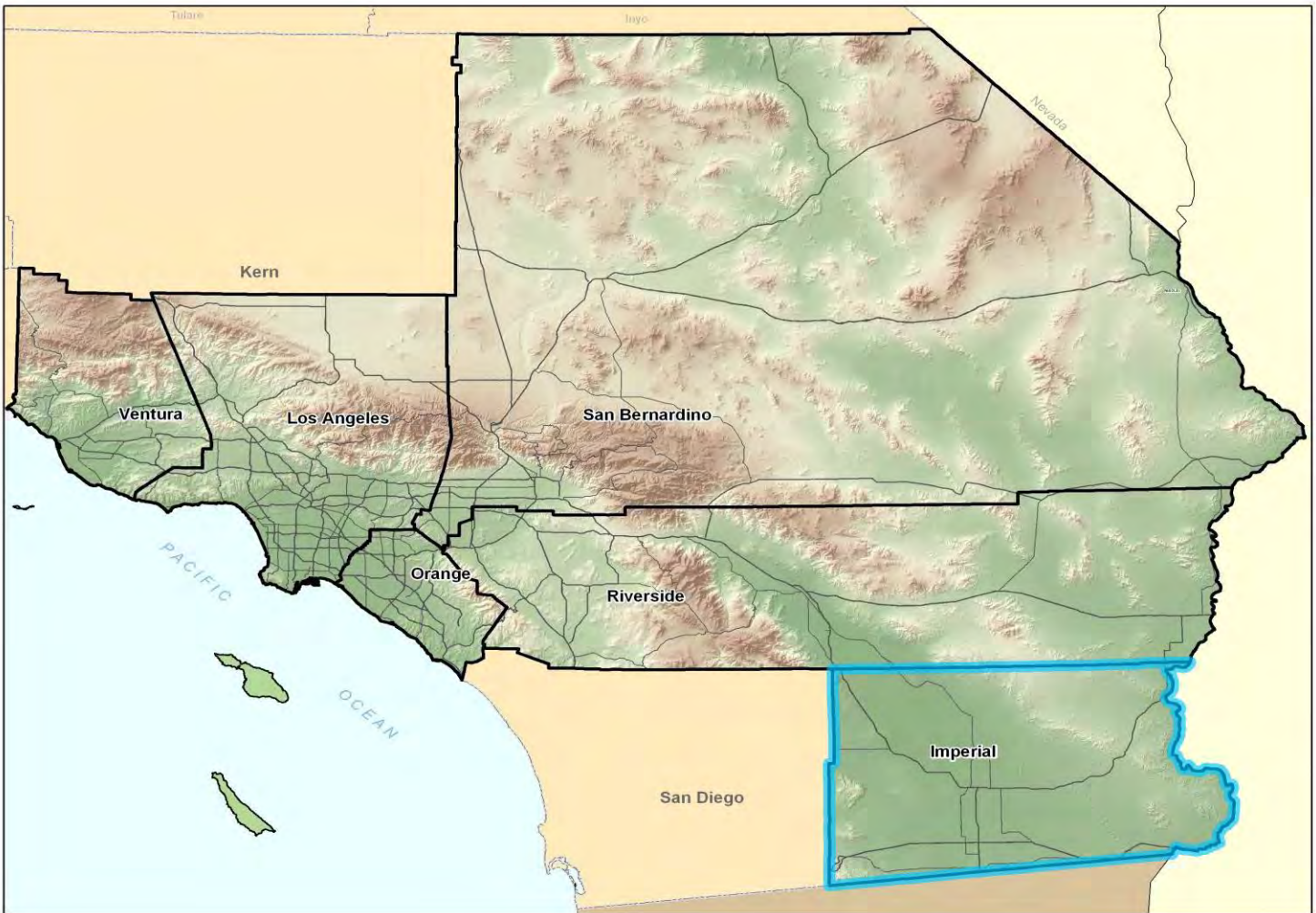

LOCAL PROFILES REPORT 2019

This profile report was prepared by the Southern California Association of Governments and shared with Imperial County. SCAG provides local governments with a variety of benefits and services including, for example, data and information, GIS training, planning and technical assistance, and sustainability planning grants.

II. POPULATION

Population Growth

Population: 2000 - 2018

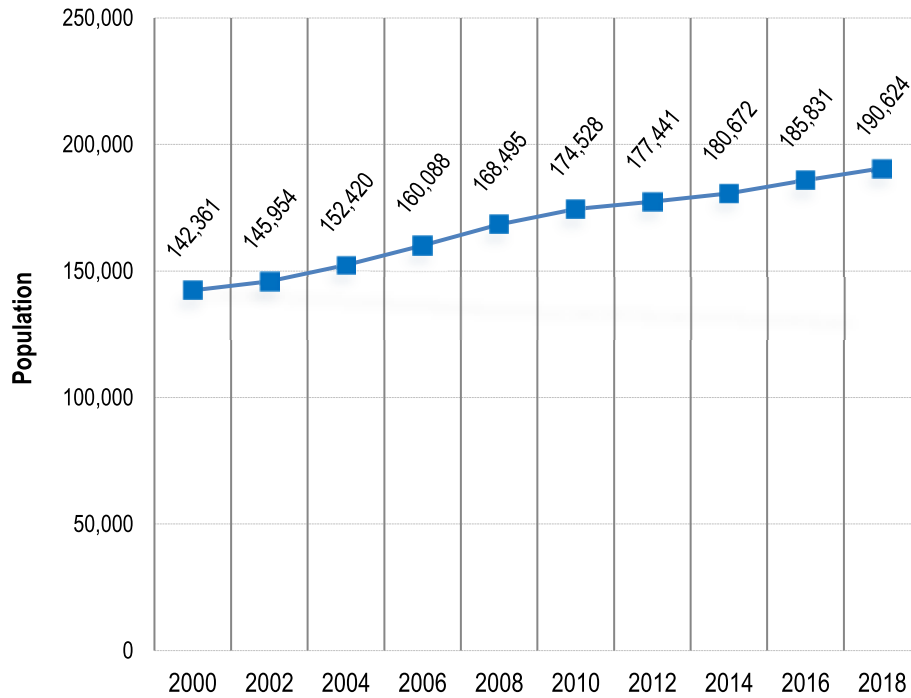

Source: California Department of Finance, E-5, 2000-2018

- Between 2000 and 2018, the total population of Imperial County increased by 48,263 to 190,624.
- During this 18-year period, the county's population growth rate of 33.9 percent was higher than the SCAG Region rate of 15.9 percent.
- 1.0 percent of the total population of SCAG Region is in Imperial County.
- Population values for 2000 and 2010 are from the U.S. Decennial Census.
- Values for other years are estimates by the California Department of Finance.

Appendix E

VMT Supporting Information

Maverik Fueling Station and Convenience Store

Gas stations located within 3-mi radius from Project site

Legend

- 3-mi radius
- Gas Stations
- Project Site

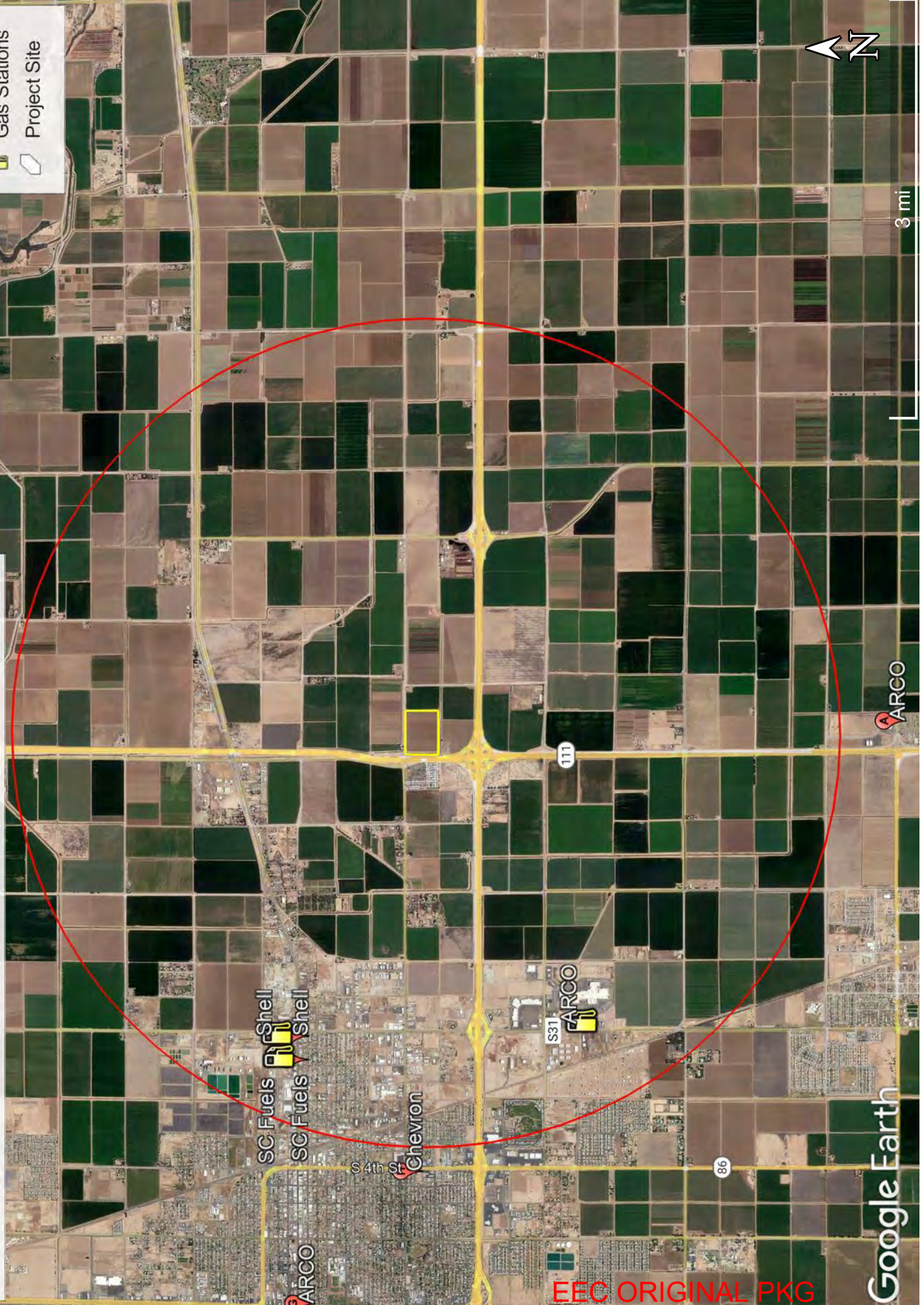

3 mi

COMMENTS

EEC ORIGINAL PKG



March 14, 2024

Mr. Jim Minnick
Planning Director
801 Main Street
El Centro, CA 92243

SUBJECT: Air Quality & Greenhouse Gas Study – Maverik Fueling Station and Convenience Store (GPA 22-0002, ZC 22-0002, PM 02499)

Dear Mr. Minnick,

The Imperial County Air Pollution Control District (Air District) thanks you for the opportunity to review the Air Quality and Greenhouse Gas Study ("Air Quality Study") for the Maverik Fueling Station and Convenience Store. The proposed project would be located on the southeast corner of Highway 111 and Ross Road (also identified as Assessor's Parcel Number 054-080-023).

In a comment letter dated September 25, 2023, the Air District addressed rules and regulations (including Regulation VIII and Rule 207) as well as other requirements to which the project proponent must adhere. At that time an Air Quality Study was not included in the packet.

Upon review of the Air Quality Study, the Air District identified changes to default settings of the California Emissions Estimator Model (CalEEMod) that were made without justification or prior approval of the Air District. Such actions can result in the Air District finding that the Air Quality Study is not consistent with the Air District's CEQA Air Quality Handbook.

Regardless, the Air District is confident that emissions can be brought to a "less than significant" level by additional mitigation measures. For the construction phase, the Air District is requesting that an Enhanced Dust Control Plan be **placed as a condition** in the Condition Use Permit (CUP). An Enhanced Dust Control Plan could include such measures as erecting mesh construction fencing, increased watering, and ceasing construction when winds exceed 20 mph rather than 25 mph. For the operational phase, submittal to the Air District for an Authority to Construct and Permit to Operate must be **placed as a condition** in the CUP.

The Air District's Rules and Regulations and CEQA Handbook can be found online for review at <https://apcd.imperialcounty.org/rules-and-regulations/> and <https://apcd.imperialcounty.org/wp-content/uploads/2020/01/CEQAHandbk.pdf>. Please contact our office at (442) 265-1800 to if you have any additional questions or concerns.

Sincerely,



Curtis Blondell
Environmental Coordinator

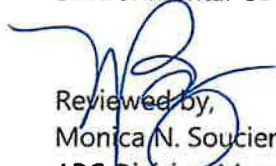

Reviewed by,
Monica N. Soucier
APC Division Manager

ADMINISTRATION / TRAINING

1078 Dogwood Road
Heber, CA 92249

Administration
Phone: (442) 265-6000
Fax: (760) 482-2427

Training
Phone: (442) 265-6011

**OPERATIONS/PREVENTION**

2514 La Brucherie Road
Imperial, CA 92251

Operations
Phone: (442) 265-3000
Fax: (760) 355-1482

Prevention
Phone: (442) 265-3020

RECEIVED

By Imperial County Planning & Development Services at 8:12 am, Oct 12, 2023

October 12, 2023

RE: General Plan Amendment #22-0002/Zone Change #22-0002/Parcel Map #02499
Maverik, Inc

Address: Southwest Corner of HWY 111 and Ross Road
APN: 054-080-023

Imperial County Fire Department would like to thank you for the opportunity to review and comment on the General Plan Amendment #22-0002, Zone Change #22-0002, and Parcel Map #02499 for Maverik, Inc.

Imperial County Fire Department has the following comments and/or requirements.

- An approved water supply capable of supplying the required fire flow determined by appendix B in the California Fire Code shall be installed and maintained. Private fire service mains and appurtenance shall be installed in accordance with NFPA 24.
- Fire Department access roads shall be installed and maintained in accordance with the California Fire Code. Roadways within the project will be provided with all-weather surface and capable of supporting impose loads of fire apparatus. Secondary access will be required for the project. Roadway width will be determined upon further review of the site plan. Knox box (locks) will be required for the project. All locks and gates shall be installed in accordance with the California Fire Code.
- Automatic fire sprinklers requirements will be determined by Imperial County Fire Department officials and the California Fire Code
- Automatic fire detection and notification systems requirements will be determined by Imperial County Fire Department officials and the California Fire Code.
- Motor Fuel-dispensing shall be in accordance with Chapter 23 of the California Fire Code
- Compliance with all required sections of the fire code.

The zone change will require an approved pressurized water supply capable of meeting required fire flows to be installed and maintained in accordance with the California Fire Code. C-3 zone is used for heavy commercial and will require greater water demand due to the potential hazards and fire loads associated with heavy commercial operations.

ADMINISTRATION / TRAINING

1078 Dogwood Road
Heber, CA 92249

Administration

Phone: (442) 265-6000
Fax: (760) 482-2427

Training

Phone: (442) 265-6011



OPERATIONS/PREVENTION

2514 La Brucherie Road
Imperial, CA 92251

Operations

Phone: (442) 265-3000
Fax: (760) 355-1482

Prevention

Phone: (442) 265-3020

Imperial County Fire Department shall review the project for impacts that may create a negative effect on Imperial County Fire Department and/or the County of Imperial in concerns with life safety, property conservation, and/or environmental concerns. These items shall be addressed between Imperial County Fire Department Official, County of Imperial Officials and project applicant/developers.

Imperial County Fire Department reserves the right to comment and request additional requirements pertaining to this project regarding fire and life safety measures, California Building and Fire Code, and National Fire Protection Association standards at a later time as we see necessary.

If you have any questions, please contact the Imperial County Fire Prevention Bureau at 442-265-3020 or 442-265-3021

Sincerely

Andrew Loper

Lieutenant/Fire Prevention Specialist
Imperial County Fire Department
Fire Prevention Bureau

David Lantzer

Fire Chief

Imperial County Fire Department

Robert Malek

Deputy Chief/Deputy Fire Marshal

Imperial County Fire Department

Fire Prevention Bureau



FW: Maverick Gas Station - Ross Rd. & Hwy 111



Thank you,

Derek Newland
Planner III
County of Imperial
Planning and Development Services
dereknewland@co.imperial.ca.us
(442) 265-1736

From: Jorge Perez <JorgePerez@co.imperial.ca.us>
Sent: Thursday, September 21, 2023 2:53 PM
To: Derek Newland <DerekNewland@co.imperial.ca.us>
Cc: Daniel Gutierrez <DanielGutierrez@co.imperial.ca.us>; Jeff Lamoure <JeffLamoure@co.imperial.ca.us>; Mario Salinas <MarioSalinas@co.imperial.ca.us>
Subject: Maverick Gas Station - Ross Rd. & Hwy 111

Derek,

Attached is a guidance document (and code sections) for the Technical Report the applicants for the proposed Maverick Gas Station will have to complete at least 6 months prior to any water related construction at the site. Please pass this along to the applicants and let me know if you would like us to meet with them to discuss some of the requirements and what it all means for their project.

As I mentioned, the Technical Report is reviewed and approved by the State Water Board – Division of Drinking Water. The applicants will either have to connect to the adjacent community water system (Country Life Mobile Home and RV – Facility No. 1300550), or they will construct their own public water system. The approval from DDW will provide the direction the applicants will proceed with.

We will be following up with a formal comment letter at a later date, but I want to get this to you now to ensure the applicants are aware.

Regards,
Jorge A. Perez
Environmental Health Services Manager
Imperial County Public Health Department
Environmental Health Division
797 Main Street, Suite B, El Centro, CA 92243
T: 442-265-1888
F: 442-265-1903
C: 760-427-1190
www.icphd.org



The preceding e-mail message (including any attachments) contains information that may be confidential, be protected by the attorney-client or other applicable privileges, or constitute non-public information. It is intended to be conveyed only to the designated recipient(s). If you are not an intended recipient of this message, please notify the sender by replying to this message and then delete it from your system. Use, dissemination, distribution, or reproduction of this message by unintended recipients is not authorized and may be unlawful.

← Reply ↶ Reply all → Forward

EEC ORIGINAL PKG

Preliminary Technical Report Guidance

Updated Aug 2021

Purpose

This guidance is intended to assist applicants in completing the preliminary technical report required for all new public water systems (California Health and Safety Code (CHSC), Section 116527) that are not subject to the exemptions specified in Section 116527(h). In accordance with Section 116527(b), this report is ***required to be completed 6 months before any water-related construction for a new public water system.***

This guidance is a summary of the elements to consider in completing a preliminary technical report. However, not all elements included in this guidance will apply to all proposed public water systems, and some proposed systems will require more elements, details, and documentation. Throughout this guidance sections of the California Health and Safety Code and the California Code of Regulations (CCR) are provided as a reference for the requirements included. New public water systems must demonstrate adequate financial, managerial, and technical capacity prior to the State Board issuing a domestic water supply permit.

Exemptions

Section 116527(h) provides exemptions under the following conditions: (1) domestic water supply applications deemed complete prior to January 1, 2017, (2) extension of, or annexation to, an existing public water system, or (3) building construction applicants that certify they will not rely on the establishment of a new public water system.

Section I. Applicant General Information

Name of applicant:

Phone number of applicant:

Email address of applicant:

Name of engineering consultant responsible for the project:

Phone number of engineering consultant:

Email of engineering consultant:

Have you previously applied to be a public water system for this property?

- Yes
- No

Who is the legal owner of the property?

(Proof of ownership of any water treatment facilities and well sites must be documented.)

EEC ORIGINAL PKG

Section II. General Information on the Proposed Water System

County of proposed new public water system:

Assessor's Parcel Number(s) or address of proposed new public water system:

Number of proposed connections (e.g. buildings, homes, etc.) the new public water system would serve:

Number of people the new public water system would serve:

Number of days per year the new public water system will serve water (e.g. 365):

What are the sources of water for the proposed public water system (mark all that apply, note: more detailed source information is required in Section VI):

- Lake or Pond
- River/Stream
- Spring
- Creek
- Multiple Wells
- Well within 100 feet of a lake, river, or creek
- Unknown/source does not exist yet

What type of properties will be served, indicate all that are applicable, or provide a copy of the use permit:

- Residential Community
- Businesses
- Industrial Park
- Schools/Daycares
- Winery
- Restaurant
- Park/Recreation
- Mobile Home Park
- Other:

If the proposed water source is surface water (e.g. lake, river, creek, well near river, etc.) do you currently possess water rights to the source? (*Surface water rights must be documented.*)

- Yes
- No

Is any treatment known to be required for the source water? If yes, explain.

Provide a summary description of the proposed water system (physical facilities, type of legal entity it will be, who it will serve, who will manage it, existing facilities that will be incorporated, any contamination in the local area that could impact the water quality, other pertinent factors).

A map of the proposed boundaries of the new public water system will be required.

EEC ORIGINAL PKG

Section III. Discussion of the Potential for the Proposed Water System to be served by an Existing Water System:

List the names of all community water systems with boundaries within a 3-mile distance from the proposed public water system's service below. CHSC (116527(c)(1). Ways to find nearby public water systems include:

- The [Drinking Water Watch website](#) has a list of all community water systems by county. Please do not consider those water systems with a status of "I", which means they are inactive.
- The [California Water System Area Boundary map](#) has locations of some, but not all, public water systems. We are in the process of collecting and verifying data for this map layer.
- If you are still unable to find a nearby community water systems using these tools, please [contact our District Offices](#) and verify that none exist in the 3-mile radius. A map of the contact numbers for our District Offices can be found on the following website.

Community Water Systems in 3-mile Radius

- 1.
- 2.
- 3.
- 4.
- 5.

(include additional systems if present in the 3-mile radius)

Is the proposed water system in the County Local Area Formation Commission's (LAFCo) sphere of influence boundary for any city or municipal water service? CHSC 116527(c)(9)

- Yes
 No

Attach a feasibility report evaluating the possibility of obtaining water supply from each public water system listed above and the estimated costs. The report should include:

- dates of contact with the public water systems;
- names and titles of all parties involved as well as phone numbers and email addresses of all parties;
- a summary of their responses;
- all actions taken to obtain service for the proposed new public water system's service area; CHSC 116527(c)(2)
- all information provided by each identified public water system regarding the feasibility of annexing, connecting or otherwise supplying domestic water to the proposed service area.

The feasibility report should also include dates of contact with the County Local Area Formation

EEC ORIGINAL PKG

Commission's (LAFCo) executive officer and/or staff regarding identified public water systems.

Please note: If as a result of this process you decide to be served by another public water system and not become a new public water system, write a letter to the State Water Resource Control Board, Division of Drinking Water and the County building/planning department indicating that it is your intent. Provide the name and contact of the water system that will be supplying water service to your development and begin the process of obtaining water service.

Section IV. Managerial Consolidation

If physically connecting to another water system appears unfeasible, submit a discussion of all actions taken by the applicant to pursue a contract for managerial or operational oversight from the identified community water systems in Section III. This should include a summary of names, dates and contact information of those individuals you have interacted with as well as their responses. CHSC 116527(c)(7)

Section V. Cost of Proposed New Public Water System

We recommend that you review the [Drinking Water Related Regulations](#) related to operating a public water system. Please attach a report on the proposed cost to construct, operate, and maintain the proposed new public water system for 20 years. We recommend this report be prepared by an engineer who is knowledgeable regarding the legal requirements for public water systems, typically an engineer that has experience in working on public water systems. The new water system should consider the following costs listed below, as they would apply to the proposed water system. The report must also include a discussion of the proposed rates based on the costs. CHSC 116527(c)(5) Other costs may also be applicable, particularly those with other regulatory agencies, such as Division of Water Rights, LAFCo, Public Utilities Commission, business licenses, etc. To facilitate review of each cost, the section from the CCR Title 22, Division 5 discussing the specific requirements is included in parentheses. If the requirement comes from another regulatory section, the location is noted:

- System engineering and design costs for construction and permitting (§64552), including pump tests (§64554), two water supply well sources for communities (§64554c and §64561), a 50-foot source protection zone around wells (§64560), and initial monitoring costs
- Construction costs, backup electricity for pumps to maintain 40 pounds per square inch (psi) minimum pressure at all times (§64602), proper construction of distribution systems (§64570- 64580), installation of meters (§64561), adequate storage capacity (§64554 and 64585) and fire capacity (contact local fire official)
- Monthly electricity costs for pumps, other utilities, interest on any debt service
- Cost of as-built maps (§64604)
- Annual water-treatment quality chemical costs (§64590), and equipment for distribution monitoring of any added chemical treatment (dependent on the type of needed treatment)

- Ongoing raw water chemical monitoring sampling and analysis costs (§64431-64445.2)
- Ongoing bacteriological monitoring sampling and analysis costs for untreated water (§64430)
- Ongoing bacteriological monitoring sampling and analysis costs for treated water (§64421-64430, Table 64423-A)
- Maintenance of bacteriological plans (§64422) and emergency notification plans for notification of water quality emergencies (§64463-64466)
- Required lead and copper monitoring sampling and analysis costs and maintenance of lead and copper plan (§64670-64690.80, Table 64675-A)
- Required disinfection byproducts monitoring costs and maintenance of associated plan (§64530-64537.6, Table 64534.2-A)
- Customer water quality complaint program (§64470)
- Flushing (§64575), valve and meter maintenance (§64600), and maintaining maps (§64604)
- Cross connection program and annual backflow device testing and maintenance (from Title 17, §7583-7605)
- Salary for licensed operator staff costs, including time for reports and inspections required by Division of Drinking Water staff (§64413.1-64413.7)
- The cost to maintain written procedures for system maintenance, for example main line breaks procedures, etc. (§64580, 64582, and 64583)
- Source capacity planning studies and permit amendments for any additional growth (§64558 and §64556)
- Annual Consumer Confidence Report preparation and distribution costs (§64480-64483)
- Annual electronic Report to State Water Resource Control Board-Division of Drinking Water (Health and Safety Code §116530)
- Records of the estimated life of all pumps, treatment, storage, and distribution system and an annual capital improvement plan to fund replacement
- Metering and billing staff costs
- Emergency reserve costs for drought, regulatory changes, public notice of bacteriological or chemical failures, etc.
- Maintaining of business licenses and paying annual permit fees (Ca Health and Safety Code §116565) and any State enforcement fees for actions resulting from water system non-compliance (Ca Health and Safety Code §116577)
- Appropriate workspace to house staff, records (§64470, §64423.1), and appropriate containment of chemicals
- Insurance and liability for staff, for duties including climbing tanks, handling hazardous chemicals, if appropriate.
- Knowledgeable management staff costs to coordinate the above and maintain financial controls (per Corporation Code and Government Code requirements and Health and

Safety Code §116540) and office supplies

- If the source is surface water (lake, stream, pond, etc.), additional costs should be considered for the following:
 - A water treatment plant meeting all the requirements of the Surface Water Treatment Rule (§64650 through §64666)
 - Continuous operator supervision of the water treatment plant when operating (§64660) chemical monitoring equipment, at minimum turbidity and chlorine (§64655-64656.5, §64659)
 - Operations Plan (§64661)
 - Alarms (§64659)
 - Monthly monitoring reports to the Division of Drinking Water (§64662- 64664.2)
 - Additional raw water sampling requirements (§64654.8)
 - Watershed Sanitary Survey, every five years (§64665), and
 - Engineering Report after one year of operation for system optimization for alternative technologies (§64653 (i)).

Resources to help with cost analyses

Rural community assistance corporation (RCAC) provides FREE live and online classes on water system financial management, budgeting, rate setting, board training, as well as a host of other water system related classes. Training schedules can be found on their website at www.rcac.org.

Section VI. 20 Year Evaluation of Proposed New Public Water System's Supply Capacity CHSC 116527(c)(8)

Submit an analysis of the proposed new public water systems' total projected water supplies available during normal, single dry, or multiple dry water years to meet current demand, and any anticipated growth, for the next 20 years. If a source has not yet been constructed (e.g. a well) an engineer shall evaluate demands required under these scenarios. Please be aware that for a community water system using wells, it will be required to have at least two well sources and must be capable of meeting the maximum day demand with the highest-capacity source off-line, prior to being granted an initial domestic water supply permit, per Section 64554(c).

Section VII. Cost-Comparison CHSC 116527(c)(6)

Submit an analysis comparing the 20-year estimated costs associated with the construction, operation, and maintenance of the proposed new public water system to the 20-year costs associated with providing water through connecting to an existing public water system. Also, compare the long-term sustainability of each water system, including but not limited to local groundwater contamination migration, global climate change, and potential treatment needs.

Some water systems will require proposed water system to annex or enter into an out-of-area service agreement to obtain water. These identified water systems may not be excluded from cost comparison evaluation due to the need for annexation or out-of-area agreements.

EEC ORIGINAL PKG

Submit the COMPLETED Preliminary Technical Report to:

State Water Resource Control Board, Division of Drinking Water's District Office

The report should be addressed to the [District Engineer for the County](#) where the proposed water system will be located.

For projects that are within the counties listed below, an [additional copy must be submitted to the County's Local Primacy Agency-Small Water System Program](#), typically found in the Environmental Health Department.

[Alpine](#)

[Butte](#)

[Calaveras](#)

[Contra Costa](#)

[El Dorado](#)

[Imperial](#)

[Kings](#)

[Los Angeles](#)

[Madera](#)

[Mono](#)

[Monterey](#)

[Napa](#)

[Nevada](#)

[Placer](#)

[Plumas](#)

[Riverside](#)

[Sacramento](#)

[San Bernadino](#)

[San Diego](#)

[San Joaquin](#)

[San Luis Obispo](#)

[Santa Barbara](#)

[Santa Cruz](#)

[Shasta](#)

[Stanislaus](#)

[Tehama](#)

[Yolo](#)

[Yuba](#)

Once the PTR has been submitted it will be reviewed by appropriate Division staff. If deemed Complete, a letter will be sent to the applicant allowing them to move forward with the permitting process through the Division and/or County Environmental Health. If rejected, a letter will be sent to the applicant notifying them as to why the PTR is rejected. If appropriate, the applicant may resubmit a revised PTR for approval.

EEC ORIGINAL PKG

Technical, Managerial, and Financial (TMF) Capacity -

If the applicant has received a letter deeming the PTR submittal as completed, the applicant may move forward with the permitting process with the appropriate Division and/or County Environmental Health. One of the initial requirements for all new public water systems (CHSC 116540(a)(1)) is to submit additional information regarding the technical, managerial, and financial (TMF) capacity of the proposed water system. If the Division and/or County Environmental Health deem that the required TMF components are adequate, the applicant may submit a permit application. A permit application will include items such as initial water monitoring, and a permit engineering report containing detailed plans and specifications, etc. The details of the permit application will be provided separately.

For a proposed water system with existing infrastructure, TMF Instructions and forms can be found [on our website](#).

For a proposed community water system with no existing infrastructure please provide the following:

1. A copy of the deed of trust for the location where water treatment facilities, including any wells, are proposed to be located.
2. An organizational chart and description of what organization will own and operate the water system.
3. List the median household income(s) of the zip code(s) in the area to be served by the public water system based on the most recent year available [from the U.S. census](#).
4. Calculate the average annual rate per customer needed to support the water costs previously calculated in Section V, including depreciation and replacement of all infrastructure based on its usable life over a 20-year period.
5. Is the annual rate per customer greater than 1.5% of the surrounding median household income?

Resources

[Average usable life of typical water treatment equipment](#)

[Sample Excel spreadsheet for budgeting](#)



Office of the Agricultural Commissioner
Sealer of Weights and Measures
852 Broadway, El Centro CA 92243

Jolene Dessert
Commissioner / Sealer

Rachel Garewal
Asst. Commissioner / Sealer

October 04, 2023

Derek Newland, Planner II
Imperial County
Planning & Development Services
801 Main Street
El Centro, CA 92243

Re: General Plant Amendment #22-0002/Zone Change #22-0002/Parcel Map #02499

Mr. Newland:

Our office has reviewed the documents pertaining to GPA #22-0002/ZC #22-0002/PM #02499 for applicant Maverik, Inc., a company proposing a general plan amendment from Agriculture to Commercial, Zone Change from A-2 to C-3 and parcel map proposing a 40 acre parcel and a 10 acre parcel for a fueling station and convenience store to be located at South East corner of Highway 111 and Ross Avenue, El Centro, CA 92243 (APN 054-080-023).

As mentioned on the project, the applicant will use landscaping. Should the project require movement of plant material into Imperial County, the applicant must follow the requirements for movement of plant material into Imperial County from other counties or from out of state. The applicant can contact our Pest Detection and Eradication Division for any questions regarding the quarantines of movement of plant material, as there are several quarantines that must be observed. Please contact CDFA Nursery Services Program for requirements regarding movement of cannabis nursery stock and nursery license.

Please refer to the handouts attached. The handouts will explain the need for the applicant to register their point of sale systems and scales with our office, determining what type of scale(s) if any required by their operations and the regulations involving labeling/signage for the retail motor fueling station. The handouts also include information pertinent to Weighmaster licensing and regulations. Please be advised that any commercial weighing and measuring devices are required to be type approved for commercial use and must be registered, inspected and sealed by our office on an annual basis. The applicant can also register any non-commercial scale, such as prepacking scales, with our office and have them inspected upon request for a fee.

If you or the applicant have any questions, please feel free to contact our office at (442) 265-1500.

Regards,

A handwritten signature in blue ink that reads "Jolene Dessert".

Jolene Dessert



Excerpts from Petroleum Products Labeling Regulations

Extracted from Business & Professions Codes ("BPC") CHAPTER 14. Fuels and Lubricants [§ 13400 - 13620] and CHAPTER 14.5. Service Stations [§13650 - 13660] as well as California Code of Regulations ("CCR") CHAPTER 7. Advertising of Gasoline and Other Motor Vehicle Fuels [§4200 – 4207])

ARTICLE 8 & 9 – PRICE INDICATIONS & LABELING

Deceptive, False, or Misleading Statements: Unfair Trade Practices (BPC § 13413)

- (a) It is unlawful for any person or other legal entity to make any deceptive, false, or misleading statement by any means whatever regarding quality, quantity, performance, price, discount, or saving used in the sale or selling of any commodity regulated pursuant to this chapter.
- (b) The following misleading, unfair, or deceptive acts or practices committed or permitted by any person offering for sale any product that is regulated by this chapter are also a violation of this section:
- (1) Misrepresenting the brand, grade, quality, or price of a motor vehicle fuel or lubricant.
 - (2) Using false or deceptive representations or designations in connection with the sale of motor vehicle fuels or lubricants.
 - (3) Advertising motor vehicle fuels or lubricants or services and not selling them as advertised.
 - (4) Advertising motor vehicle fuels or lubricants of a designated brand, grade, trademark, or trade name not actually sold or available for sale.
 - (5) Making false, deceptive, or misleading statements concerning conditions of sale or price reductions.
 - (6) Representing that the consumer will receive a rebate, discount, or other economic benefit and then failing to give that rebate, discount, or other economic benefit.
 - (7) Except as otherwise permitted, selling a grade of motor vehicle fuel at more than one price and advertising only the lower price without advertising each of the higher prices in equal size numerals on the same advertising medium.
 - (8) Placing letters, words, figures, or numerals on any advertising medium offering for sale any goods or merchandise, other than motor vehicle fuel, if the advertising medium may be construed by any reasonable person as advertising a price of motor vehicle fuel.
 - (9) Forging or falsifying any records or documents required by this chapter or knowingly keeping, using, or displaying the false or forged records or documents.

Display Of Price Sign On Dispensing Apparatus: Contents Of Sign (BPC § 13470)

- (a) A person shall not sell at retail to the general public, any motor vehicle fuel from any place of business in this state unless there is displayed on the dispensing apparatus in a conspicuous place at least one sign or price indicator showing the total price per gallon, liter, or other unit of measurement adopted pursuant to Section 12107, 13404, or 13404.5 of all motor vehicle fuel sold therefrom. The total price per gallon, liter, or other unit of measurement shall include applicable fuel taxes and all sales taxes.
- (b) (1) A person shall not sell at retail to the general public, any compressed natural gas for use as a motor vehicle fuel from any place of business in this state unless there is displayed and labeled on the dispensing apparatus in a conspicuous place "Gasoline gallon equivalent."
- (2) A person shall not sell at retail to the general public, any liquefied natural gas for use as a motor vehicle fuel from any place of business in this state unless there is displayed and labeled on

the dispensing apparatus in a conspicuous place "Diesel gallon equivalent."

(c) When a discount is offered from a dispenser computing only at a higher price, at least one sign or label shall be conspicuously displayed on the dispenser indicating that the dispenser is computing at the higher price and indicating the amount of the discount per unit of measurement in letters and numerals not less than one-half inch high.

(d) If motor vehicle fuel is sold by unit of measurement other than gallon, that unit shall be conspicuously displayed on the side of the dispensing apparatus from which service can be made.

Placement of Signs (BPC § 13471)

Each sign required by this article shall be placed in a conspicuous place on the dispensing apparatus and if service of motor vehicle fuel may be made from more than one side of such dispensing apparatus the sign shall be so placed as to be visible from at least two sides of the dispensing apparatus.

Size of Letters and Figures (BPC § 13473)

Unless otherwise provided, all letters, figures, or numerals on each sign required by this article, however affixed, marked, imprinted, placed, or embossed, shall be at least three-fourths of an inch in height and all lines or marks used in the making or forming of all the letters, figures, or numerals which are a part of the sign shall be at least one-eighth of an inch in width.

Legibility of Signs (BPC § 13474)

All letters, figures or numerals which are part of any sign or price indicator required by this article shall be plainly legible. The color or tint shall contrast with the background and other parts of the sign.

Sale, Etc., of Motor Vehicle Fuels or Lubricants from Unlabeled Containers, Etc., Unlawful: Viscosity Rating: Containers with Net Content of Gallon or Less (BPC § 13480)

(a) It is unlawful for any person to sell any motor vehicle fuel or lubricant referred to in this chapter at any place where motor vehicle fuels or lubricants are kept or stored for sale, unless there is affixed to each container, receptacle, pump, dispenser, and inlet end of the fill pipe of each underground storage tank, from which or into which that product is drawn or poured out for sale or delivery, a sign or label plainly visible consisting of the name of the product, the brand, trademark, or trade name of the product, and, in the case of motor vehicle fuel and kerosene, the grade or brand name designation.

(c) When the product is automotive spark-ignition engine fuel the secretary shall make rules and regulations as are reasonably necessary to define and enforce the octane number, antiknock index labeling requirements, or other labeling requirements of the product sold.

Labeling and Price Sign Advertising Requirements for Biodiesel and Biodiesel Blends. (CCR § 4202)

(a) The labeling on biodiesel and biodiesel blend dispensers shall meet the requirements of the Federal Trade Commission (FTC) 16 CFR Part 306 "Automotive Fuel Ratings, Certification and Posting" Rule, as published in the Federal Register Volume 75, Number 50, dated March 16, 2010, which are hereby incorporated.

(b) The name of the product and grade designation shall be on all dispensers, advertising signs, and storage tank labels as required in Section 13480 and 13532 of the Business and Professions Code.

(c) Every biodiesel dispenser dispensing blends greater than 5. volume percent shall display on each customer side, as required by Section 13484 of the Business and Professions Code, a sign clearly visible

which reads as follows:

“THIS FUEL CONTAINS BIODIESEL. CHECK THE OWNER’S MANUAL OR WITH YOUR ENGINE MANUFACTURER BEFORE USING.”

ARTICLE 9 – STORAGE TANKS

Sale, Etc., of Motor Vehicle Fuels or Lubricants from Unlabeled Containers, Etc., Unlawful: Viscosity Rating: Containers with Net Content of Gallon or Less (BPC § 13480)

(a) It is unlawful for any person to sell any motor vehicle fuel or lubricant referred to in this chapter at any place where motor vehicle fuels or lubricants are kept or stored for sale, unless there is affixed to each container, receptacle, pump, dispenser, and inlet end of the fill pipe of each underground storage tank, from which or into which that product is drawn or poured out for sale or delivery, a sign or label plainly visible consisting of the name of the product, the brand, trademark, or trade name of the product, and, in the case of motor vehicle fuel and kerosene, the grade or brand name designation.

Application of Rules Respecting Lettering to Signs, Etc., at Inlet End of Storage Tanks (BC § 13843)

The provisions of this article as to size of letters shall not apply to signs or labels at the inlet end of any underground storage tank, which letters may be of any convenient size but such letters shall be plainly visible while such underground storage tank is being filled.

ARTICLE 12 – PRICE SIGN ADVERTISING

Deceptive, False, or Misleading Statements: Unfair Trade Practices (BPC § 13413)

(a) It is unlawful for any person or other legal entity to make any deceptive, false, or misleading statement by any means whatever regarding quality, quantity, performance, price, discount, or saving used in the sale or selling of any commodity regulated pursuant to this chapter.

(b) The following misleading, unfair, or deceptive acts or practices committed or permitted by any person offering for sale any product that is regulated by this chapter are also a violation of this section:

- (1) Misrepresenting the brand, grade, quality, or price of a motor vehicle fuel or lubricant.
- (2) Using false or deceptive representations or designations in connection with the sale of motor vehicle fuels or lubricants.
- (3) Advertising motor vehicle fuels or lubricants or services and not selling them as advertised.
- (4) Advertising motor vehicle fuels or lubricants of a designated brand, grade, trademark, or trade name not actually sold or available for sale.
- (5) Making false, deceptive, or misleading statements concerning conditions of sale or price reductions.
- (6) Representing that the consumer will receive a rebate, discount, or other economic benefit and then failing to give that rebate, discount, or other economic benefit.
- (7) Except as otherwise permitted, selling a grade of motor vehicle fuel at more than one price and advertising only the lower price without advertising each of the higher prices in equal size numerals on the same advertising medium.
- (8) Placing letters, words, figures, or numerals on any advertising medium offering for sale any goods or merchandise, other than motor vehicle fuel, if the advertising medium may be construed by any reasonable person as advertising a price of motor vehicle fuel.

(9) Forging or falsifying any records or documents required by this chapter or knowingly keeping, using, or displaying the false or forged records or documents.

Application of Article: Display of Price per Gallon, Liter, or Other Unit of Measurement (BPC § 13530)

(a) Nothing in this article applies to price indicators and signs referred to in Article 8 (commencing with Section 13470). However, any numerals designating the total price per gallon, liter, or other unit of measurement adopted pursuant to Section 12107, 13404, or 13404.5 for a particular brand and grade of motor vehicle fuel permitted or required under Article 8 (commencing with Section 13470) shall, unless otherwise stated, be identical in numerical value with the price per gallon, liter, or other unit of measurement for the same brand and grade of motor vehicle fuel permitted or required under this article.

Display Requirements: Exemption of Specified Geographic Areas: Violations: Enforcement (BPC § 13531)

- (a) (1) Every person offering for sale or selling any motor vehicle fuel to the public from any place of business shall display on the premises an advertising medium that complies with the requirements of this article and that advertises the total prices of the three major grades of motor vehicle fuel offered for sale.
- (2) The advertising medium shall be clearly visible from the street or highway adjacent to the premises. When the place of business is situated at an intersection, the advertising medium shall be clearly visible from each street of the intersection.
- (3) For purposes of this subdivision, motor vehicle fuel does not include propane or dimethyl ether-propane fuel blend.
- (4) For purposes of this subdivision, electricity and natural gas sold as a motor vehicle fuel shall meet only the requirements adopted pursuant to Sections 13404 and 13404.5.

Motor Vehicle Fuel: Contents of Display (BPC § 13532)

- (a) It is unlawful for any person to display any advertising medium that indicates the price of motor vehicle fuel unless the advertising medium displays all of the following:
- (1) The total price per gallon, liter, or other unit of measurement adopted pursuant to Section 12107, 13404, or 13404.5, including all taxes, in numerals, and fractions when applicable, not less than six inches in height and of uniform size and color. For purposes of this article, fractions are considered one numeral. For purposes of this section, electricity sold as a motor vehicle fuel shall meet only the requirements adopted pursuant to Section 13404.5.
- (2) The trademark or brand of the motor vehicle fuel in letters, figures, or numerals not less than one third the size of the numerals designating the price.
- (3) The word "gasoline" or the name of other motor vehicle fuel in letters not less than one-third the size of the numerals designating the price, but these words need not be more than four inches in height.
- (4) The grade designation of the motor vehicle fuel in letters or numerals not less than one-sixth the size of the numerals designating the price, but this designation need not be more than four inches in height.
- (5) If motor vehicle fuel prices are advertised by the unit of measurement other than gallon, the unit shall be displayed on the advertising medium in letters not less than one-third the size of the numerals designating the price.

(b) (1) It is unlawful for any person to display an advertising medium that advertises a discount or price reduction for motor vehicle fuel, unless the advertising medium contains all the following:

(A) The total price per gallon, liter, or other unit of measurement adopted pursuant to Section 12107, 13404, or 13404.5 from which the discount or price reduction is to be taken.

(B) The amount of the discount or price reduction in cents per gallon, liter, or other unit of measurement using numerals that do not exceed the height of the numerals in the advertised price.

(C) The conditions of the discount or price reduction using words whose letters are not less than one-third the size of the price numerals.

(2) Any limitations under which the discount or price reduction is offered shall be explained in words whose letters are not less than one-third the size of the numerals indicating the prices.

(3) There shall be available for each customer's reference, a chart showing the amount of discount for each type of unit being sold or fraction thereof in one cent (\$0.01) increments, or the retail dispensers used to dispense motor vehicle fuel at the discount price shall be set to compute the total sale at the discounted price per gallon or liter and shall be clearly labeled "Includes Cash Discount" in letters not less than one inch in height.

(4) For purposes of this subdivision, the motor vehicle fuel shall be sold in the same unit of measure in which the discount and the price from which the discount is taken are advertised.

(c) In the event that the same grade of motor vehicle fuel is sold at different prices from any single place of business, it is unlawful for any person to display any advertising medium that advertises a price of a grade of motor vehicle fuel unless the advertising medium advertises in numerals of equal size each of the higher prices, including all taxes for which the grade is sold or offered for sale, and unless the advertising medium explains the conditions, and any limitations, under which that grade is sold or offered for sale at different prices. The words of explanation shall be clearly shown in letters at least one-third the size of the numerals indicating the prices. The different prices at which the same grade of motor vehicle fuel is sold or offered for sale shall be advertised in the same unit of measure as permitted or required by law.

(d) Nothing in this section prohibits any person who has posted or displayed a sign or advertising medium in compliance with this chapter from displaying additional signs or advertising media that state either (1) the amount of discount in cents per gallon, liter, or other unit of measurement adopted pursuant to Section 12107, 13404, or 13404.5, or (2) the total price of one or more brands or grades of motor vehicle fuel sold or offered for sale, provided the conditions and any limitations of the discount or price of the brand or grade of motor vehicle fuel are included in the additional advertising media in letters not less than one-third the size of the numerals indicating the discount or price.

Additional Advertising Matter (BPC § 13534)

(a) Except as provided by subdivision (b), and subdivisions (b), (c), and (d) of Section 13532, it is unlawful for any person to place any additional advertising matter on any advertising medium referred to in this article except:

(1) A description of the products offered for sale in letters or numerals not larger than the price numerals.

(2) Methods of sale, such as self-serve or full-serve, in letters not less than one-third the size of the price numerals.

(3) Words describing the type of services offered at the place of business, such as food market, car wash, tune-up, and the registered trademark or trade name of the service, but not the price of the

service.

(b) Subdivision (a) does not apply to electronic changeable message centers when the advertising content includes both the product offered for sale and its price in a single advertising message, or when the product and price components of the advertising message clearly relate to one another and the price neither starts nor ends the message.

Legibility (BPC § 13536)

All letters, words, figures, or numerals which are part of the advertising media referred to in this article shall have a heavy type face or stroke, shall be clearly visible, and of a color or tint that will contrast the letters, words, figures, or numerals with the background of the advertising media. The height of the letters, figures, and numerals, except the letter "1" and numeral one, shall not be more than twice the width.

Illumination (CCR § 4205)

In addition to the requirements of Section 13536, Business and Professions Code, when any advertising message is illuminated, the entire message shall be uniformly illuminated.

CHAPTER 14.5 – SERVICE STATIONS

Provision of Air, Water and Pressure Gauge (BPC § 13651)

(a) (1) On and after January 1, 2000, every service station in this state shall provide, during operating hours, and make available at no cost to customers who purchase motor vehicle fuel, water, compressed air, and a gauge for measuring air pressure, to the public for use in servicing any passenger vehicle, as defined in Section 465 of the Vehicle Code, or any commercial vehicle, as defined in Section 260 of the Vehicle Code, with an unladen weight of 6,000 pounds or less.

(2) Every service station in this state shall display, at a conspicuous place on, at, or near the dispensing apparatus, at least one clearly visible sign which shall read as follows:

**"CALIFORNIA LAW REQUIRES THIS STATION TO PROVIDE FREE AIR AND WATER FOR AUTOMOTIVE PURPOSES TO ITS CUSTOMERS WHO PURCHASE MOTOR VEHICLE FUEL. IF YOU HAVE A COMPLAINT NOTIFY THE STATION ATTENDANT AND/OR CALL THIS TOLL-FREE TELEPHONE NUMBER:
1 (800) _____."**

This sign shall meet the requirements of Sections 13473 and 13474 with regard to letter size and contrast. As used in this paragraph, automotive purposes does not include the washing of vehicles.

Refueling Services to Disabled Drivers (BPC § 13660)

(c) (1) Every person, firm, partnership, association, trustee, or corporation required to provide refueling service for persons with disabilities pursuant to this section shall post the following notice, or a notice with substantially similar language, in a manner and single location that is conspicuous to a driver seeking refueling service:

“Service to Disabled Persons

Disabled individuals properly displaying a disabled person’s plate or placard, or a disabled veteran’s plate, issued by the Department of Motor Vehicles, are entitled to request and receive refueling service at this service station for which they may not be charged more than the self-service price.”

(2) If refueling service is limited to certain hours pursuant to an exemption set forth in subdivision (b), the notice required by paragraph (1) shall also specify the hours during which refueling service for persons with disabilities is available.

(3) Every person, firm, partnership, association, trustee, or corporation that, consistent with subdivision (b), does not provide refueling service for persons with disabilities during any hours of operation shall post the following notice in a manner and single location that is conspicuous to a driver seeking refueling service:

“No Service for Disabled Persons

This service station does not provide refueling service for disabled individuals.”

(4) The signs required by paragraphs (1) and (3) shall also include a statement indicating that drivers seeking information about enforcement of laws related to refueling services for persons with disabilities may call one or more toll free telephone numbers specified and maintained by the Department of Rehabilitation. By January 31, 1999, the Director of the Department of Rehabilitation shall notify the State Board of Equalization of the toll free telephone number or numbers to be included on the signs required by this subdivision. At least one of these toll free telephone numbers shall be accessible to persons using telephone devices for the deaf. The State Board of Equalization shall publish information regarding the toll free telephone numbers as part of its annual notification required by subdivision (i). In the event that the toll-free telephone number or numbers change, the Director of the Department of Rehabilitation shall notify the State Board of Equalization of the new toll-free telephone number or numbers to be used.



Office of the Agricultural Commissioner
Sealer of Weights and Measures
852 Broadway, El Centro CA 92243

Jolene Dessert
Commissioner / Sealer

Rachel Garewal
Asst. Commissioner / Sealer

June 21, 2023

Landscaper/Nursery

This letter is to remind you of the requirements you must follow for movement of plant material into Imperial County. There are many quarantines which must be observed. The most complex is for the glassy-winged sharpshooter and detailed directions for compliance follow. However, there are a few other quarantines that you should be aware of and they are listed at the end of this letter.

There is a State Interior Quarantine in place to prevent artificial movement of the glassy-winged sharpshooter (GWSS). The GWSS is a hardy insect which feeds on many common landscape plants and crops. It carries and spreads *Xylella fastidiosa*, a bacterium which is deadly to many plants. Imperial County is the only Southern California County that is not infested with the glassy-winged sharpshooter, and is designated as an enforcing county.

A summary of the quarantine requirements for entry of GWSS-host nursery stock from infested counties:

- Nursery stock must be purchased from a nursery that is under Compliance Agreement with the Agricultural Commissioner's office in that County. The plants should enter Imperial County with paperwork that includes the GWSS Compliance Agreement Number stamp, the required blue tag (see below), and Certificate of Quarantine Compliance (CQC) if applicable.
- Every shipment of nursery stock from an infested county must be accompanied by a Warning Hold for Inspection Certificate also known as a blue tag. As stated on the blue tag, this requires the receiver to hold the shipment off sale upon arrival and call our office for an inspection. It is very important that we be notified immediately upon arrival of the plant shipment. You must not commingle the new shipment with previously-released nursery stock until released by our office. Our office hours are Monday through Friday, 8:00 AM to 5:00 PM. Please call as early as possible. If you intend to bring in plants on a Saturday or Holiday, you must notify our office in advance.
- Landscapers that have their own growing ground or holding yard where they store nursery stock are required to be licensed as a nursery. Landscapers that do not hold or store that stock prior to its delivery to the planting site do not need a license.
- All landscapers must comply with the requirements listed above for every shipment brought into the County. You also must hold the stock at its destination (preferably away from other plants) and call our office for an inspection - you may not plant any of the nursery stock until the plants have been inspected and released by our office. If you are buying and transporting nursery stock into Imperial County, it is your responsibility to obtain the required documents from the origin nursery and call for the inspection upon arrival.
- For every shipment, you must have a proof of ownership document for the nursery stock.

Penalties for failure to comply with the quarantine requirements listed above:

- Any violation of quarantine requirements is an infraction punishable by a fine of \$1,000 for the first offense. For a second or subsequent offense within three years, the violation is punishable as a misdemeanor (Food and Ag Code, Section 5309).
- In lieu of any civil action, the Agricultural Commissioner may levy a civil penalty for up to \$2,500 for each violation (Food and Ag Code, Section 5311).
- In addition to any other action taken, any violation of these requirements may be liable civilly in an amount not to exceed \$10,000 for each violation (Food and Ag Code, Section 5310).
- Anyone that negligently or intentionally violates any quarantine regulation and imports a GWSS-infested plant that results in an infestation, or the spread of an infestation, may be civilly liable in an amount up to \$25,000 for each violation (Food and Ag Code, Section 5028(c)).

Other restricted plant materials (if you intend to bring in any of the following commodities from outside Imperial County please contact us before the shipment date):

- Citrus species – All Citrus species are restricted from most locations within California.
- Phoenix palms – All palms of the Phoenix genus (this includes *Phoenix roebelinii*, a common landscape plant) originating in California are prohibited, unless it is from certain portions of Riverside County.
- Florida nursery stock- Must comply with California State Interior Quarantine CCR. 3271 Burrowing and Reniform Nematodes, RIFA federal Quarantine and other quarantines may apply.
- Arizona nursery stock- Must comply with California State Interior Quarantine CCR. 3261 Ozonium Root Rot.
- Also, if you intend to remove any plants from the soil and ship them out of Imperial County you must be certified free from Ozonium Root Rot. To do so you must be part of our program and you should contact our office.

If you have any questions please contact our office at (442) 265-1500.

Sincerely,



Nelson Perez
Deputy Agricultural Commissioner
Pest Detection and Eradication

EEC ORIGINAL PKG

SCALES USED FOR COMMERCIAL PURPOSES

All scales used for commercial purposes must meet strict standards for accuracy and customer visibility in the California Code of Regulations. Appropriate and suitable scales must be of a type approved by the Division of Measurement Standards and issued either a California Type Evaluation Program (CTEP) Certificate of Approval or a National Type Evaluation Program (NTEP) Certificate of Conformance before commercial use. This process is known as "Type Evaluation." See the CTEP Information Guide at: <https://www.cdfa.ca.gov/dms/programs/ctep/CTEPInfoGuide.pdf>

Step 1: Selecting a suitable scale to meet your business needs.

Step 2: Setting up your scale.

Step 3: Using and maintaining your scale.

Step 4: Notifying your County Weights and Measures Office.

Step 1: Selecting a suitable scale to meet your business needs.

Consider:

- Range of weighing (minimum and maximum capacities)
- Division (increment) size
- Precision (i.e., scales that comply with Accuracy Class I & II parameters)

Legal-for-trade scales purchased from a scale dealer or purchased online will require calibration before use. A Registered Service Agency (RSA) can assist you in the selection of a type approved and suitable scale. They will ensure the scale is accurate and correct, install and place the scale into commercial use pending inspection by a local weights and measures official, and can assist in the scale registration process. [RSAs listings](#) can be found at <https://www.cdfa.ca.gov/dms/programs/rsa/rsa.html> or via online searches.

Step 2: Setting up your scale.

- Scales must be installed and operated per the manufacturer's instructions and California laws and regulations.
- Scales must be placed on a level solid surface and properly used and maintained (refer to owner's manual).
- Legal-for-trade scales must be "inspected, tested and sealed" by a County Weights and Measures Office.
- Precision scales may need to be verified and recalibrated when moved to another location within a production facility or retail establishment.

Step 3: Using and maintaining your scale.

- Use the scale according to the owner's reference manual.
- Deduct "TARE" (packaging, wrappings, containers, labels etc.) to determine "NET" weight (NET = GROSS – TARE).
- The owner or user is responsible for ensuring the accuracy and proper maintenance of a commercial scale.
- EVERYBODY benefits from an accurate scale. The customer is not cheated, and the seller is protected by weights and measures officials who ensure a level playing field for all competing businesses.

Step 4: Register a scale with your county.

- Most California counties have local ordinances requiring annual registration of commercial scales.
- Find your County Weights and Measures Office at: <https://www.cdfa.ca.gov/exec/county/countymap/>



Office of the Agricultural Commissioner
Sealer of Weights and Measures
852 Broadway, El Centro CA 92243

Jolene Dessert
Commissioner / Sealer

Rachel Garewal
Asst. Commissioner / Sealer

POINT-OF-SALE SCANNERS & ELECTRONIC PRICING DEVICES

The Imperial County Weighing and Measuring Devices and Point-of-Sale Systems ordinance (Chapter 5.68) requires businesses to register with the Imperial County Sealer of Weights and Measures Department and pay an annual registration fee. Registration certificate fees are based on the number of point of sale stations at each retail location. This registration certificate is required in addition to any other certificate, license or permit which may be required by the county, cities, or any public entity. Any registration certificate for which fees have not been paid within forty –five (45) days from the date that such payment is due, will be subject to a twenty percent (20%) penalty. See the attached fee schedule for reference.

All retail locations that utilize a point of sale system are subject to the county ordinance. Such systems include Universal Product Code (UPC) scanners, price look-up codes, or any other system that relies on the retrieval of electronically stored information to complete a transaction. Per the ordinance, all systems shall be available for testing and inspection by the county sealer of weights and measures.

The Imperial County Weights and Measures Office enforces the California Business and Professions Code as well as the California Code of Regulations as it pertains to point-of-sale systems. Below is a summary of applicable code sections:

In accordance to the California Business and Professions Code § 12024.2 and § 12024.6, it is unlawful for any person, at the time of sale of a commodity, to do any of the following:

- Charge an amount greater than the price, or to compute an amount greater than a true extension of a price per unit, that is then advertised, posted, marked, displayed, or quoted for that commodity.
- Charge an amount greater than the lowest price posted on the commodity itself or on a shelf tag that corresponds to the commodity, notwithstanding any limitation of the time period for which the posted price is in effect.

EEC ORIGINAL PKG

- No person, firm, corporation, or association shall advertise, solicit, or represent by any means, a product for sale or purchase if it is intended to entice a customer into a transaction different from that originally represented.

In accordance to the California Business and Professions Code sections § 13300-13303 and § 12024.6:

- Any business that uses a point-of-sale system must have a display of the prices charged visible to the customer from a reasonable and typical position
- When a price reduction or discount regarding an item is advertised, the checkout system customer indicator shall display either the discounted price for that item, or alternatively, the regular price and a credit or reduction of the advertised savings
- Any surcharges and the total value to be charged for the overall transaction also shall be displayed for the consumer at least once before the consumer is required to pay for the goods or services
- "Point-Of-Sale System" means any computer or electronic price look-up system that retrieves the price of the item being purchased

The Imperial County Sealer of Weights and Measures is authorized to levy a civil penalty against a person violating any provision of this law or regulation adopted pursuant to this law, of not more than one thousand dollars (\$1,000) for each violation.

Please remember that it is the responsibility of the owner/operator of a business to obtain a current registration from the Sealer's Office before using an electronic point-of-sale checkout system. Our office is open to the public from 8:00AM to 5:00PM, Monday through Friday. If you have any questions or need assistance, please contact us at (442) 265-1500. We will be happy to assist you.

Sincerely,



Margo Sanchez
Deputy Sealer of Weights & Measures
Special Projects Division

EEC ORIGINAL PKG

County of Imperial Division of Weights and Measures

Registration Fees = Location fee + Device fee + DMS fee (State Surcharge)

Fees are based on a statewide fee structure approved by the State Legislature and Governor. Fees partially offset the cost of administering the commercial weighing and measuring program, and are based on the number and type(s) in use per location. These fees have been adopted in the Imperial County Ordinance Chapter 5.68 and are authorized by the California Business and Professions Code: Device Fees Section 12240(f)-(t); Location Fee Section 12240(u); State Administrative Fee: Section 12241 and California Code of Regulations Title 4, Division 9, Chapter 3, Article 3, Section 4075.

All fees are due and payable by January 1st. Any registration paid after forty-five (45) days will be considered delinquent and be subject to penalties. The penalties are twenty percent (20%) of total device registration fee and location fee accruing each forty-five (45) days in arrears.

Device Location Fee: Each location (scanner/point-of-sale excluded) is charged a location fee of \$100. A location is considered a business with one or more types of devices that require specialized testing equipment that will necessitate more than one trip. Additionally, if a commercial device is installed on a vehicle, each vehicle is considered a single location.

Device Registration Fees	Fee per Device	DMS fee per Device
CNG Meter	\$20.00	\$16.00
Computing Scales <2,000#	\$20.00	\$2.20
Counter Scale < 2,000#	\$50.00	\$2.20
Electric Submeter	\$3.00	\$0.50
Fabric/Cord/Wire	\$20.00	\$2.20
Hanging Scale < 2,000#	\$50.00	\$2.20
Hanging Scale 2,000-10,000#	\$150.00	\$16.00
Hopper & Tank > 10,000#	\$250.00	\$24.00
Hopper & Tank 2,000-10,000#	\$150.00	\$16.00
L.P.G. Meter	\$185.00	\$16.00
Livestock Scale > 10,000#	\$150.00	\$24.00
Livestock Scale 2,000-10,000#	\$100.00	\$16.00
Misc. Measuring Devices	\$20.00	\$2.20
Misc. Weighing Devices < 2,000#	\$50.00	\$2.20
Monorail/Meat < 2,000#	\$50.00	\$2.20
Monorail/Meat 2,000-10,000#	\$150.00	\$16.00
Odometers	\$60.00	\$2.20
Platform/Dormant <2,000#	\$50.00	\$2.20
Platform/Dormant > 10,000#	\$250.00	\$16.00
Platform/Dormant 2,000-10,000#	\$150.00	\$16.00
Class II Scale (Non-prescription/jewelry)	\$20.00	\$2.20
Pres/Jewel Scale <2,000#	\$80.00	\$2.20
Railway Scale > 10,000#	\$250.00	\$24.00
Retail Meter Fuel (Gas pumps)	\$20.00	\$2.20
Retail Water Meter (Dispensers, Vending)	\$20.00	\$2.20
Vehicle Meter (Any vehicle mounted meter)	\$75.00	\$2.20
Vehicle Scale > 10,000#	\$250.00	\$24.00
Water Submeters	\$2.00	\$0.50
Wholesale Meter (Stationary Hi-volume sale)	\$75.00	\$2.20
Scanner/Point of Sale Registration Fees	Fee per Scanners	DMS Fee per Scanners
Scanners (1-3)	\$89.00	\$0.00
Scanners (4-16)	\$129.00	\$0.00
Scanners (17-30)	\$190.00	\$0.00
Scanners (31 or more)	\$240.00	\$0.00

Please note that some device types cap at \$1,000 per location. If you have any questions please call the Division of Weights and Measures at (442) 265-1500.

EEC ORIGINAL PKG



Division of Measurement Standards (DMS) Weighmaster Licensing

FREQUENTLY ASKED QUESTIONS (REV.09/18)

What is a Weighmaster?

A person who, for hire or otherwise, weighs, measures, or counts any commodity and issues a statement or memorandum of the weight, measure, or count that is used as the basis for either the purchase or sale of that commodity or charge for service.

Why do I need a fictitious name statement?

Every person doing business for profit under a fictitious name must file a "Fictitious Business Name Statement" form with your local County Clerk's office within 40 days of commencement of business (*Business and Professions Code Section 17910*). The purpose of filing a fictitious name statement is to make available to the public and creditors the identities of people doing business for profit in the State of California.

What are the fees for a Weighmaster License?

Principal fixed location	\$ 75.00
Additional fixed location	\$ 30.00
Operating at non-fixed location	\$ 200.00
Deputy Weighmasters	\$ 20.00
Junk Dealer/Recycler location	\$ 500.00

Who can be a Deputy Weighmaster and is there an age limit?

A Weighmaster may employ any person to act for them as a Deputy Weighmaster and shall be responsible for all acts performed by that person. There is no age limit.

Is there a test required to become a Deputy?

No. However, training is offered by DMS. Other resource include a [Self Help Exam](#) and [Weighmaster/Deputy Requirements Handout](#) that may be downloaded for use.

How long is a Weighmaster License valid?

Licenses are valid for one year and must be renewed annually. The expiration date of the license is stated on the front of the license and it is the licensee's responsibility to ensure that the license is renewed before license expiration date. As a courtesy, DMS staff will mail the renewal application four (4) weeks in advance of the renewal date; however, it is licensee's responsibility to maintain a valid mailing address with DMS to receive the renewal application.

How do I renew my license?

NEW ONLINE SERVICES! The licensee may now renew its license through the [Weighmaster Public Licensing Portal](#).

By Mail: The licensee may return the renewal application, payment and any additional documents by mail. If you did not receive a renewal form, you may mail a copy of your Weighmaster License with fees to DMS. You may also complete a [Weighmaster License Application](#) form to submit to DMS.

I paid for my renewal. When can I expect a copy of my license?

License information must be verified by DMS staff and may take up to three weeks.

How will my license be sent to me?

NEW ONLINE SERVICES! Licensees may sign up for online services through the [Weighmaster Public Licensing Portal](#). Once signed up to receive online services, the license will be electronically mailed to the email address listed on the license. Otherwise, licenses will be delivered via USPS to the mailing address listed on the License Application.

Can you email me a copy of my license?

Yes, if the licensee is signed up for online services through the [Weighmaster Public Licensing Portal](#).

Can I make changes to my license any time?

Yes, licensees may make changes anytime through the [Weighmaster Public Licensing Portal](#).

How do I cancel my license?

Print and complete the [Weighmaster Cancellation Form](#) and send to DMS for processing. When a license is cancelled, the licensee must inform DMS of the following:

- Where the used certificates will be stored. Certificates must be stored for four (4) years from date of issue.
- How and when blank Weighmaster Certificates are destroyed.

How do I add/delete or change deputies?

NEW ONLINE SERVICES! The licensee may make deputy changes through the [Weighmaster Public Licensing Portal](#) at any time. If adding deputies online, a deputy may begin signing Weighmaster Certificates once the licensee has received a submission confirmation from the Licensing Portal.

By Mail: Begin with a copy of the current Weighmaster License.

- To add and/or make corrections to current deputies, legibly write the name(s) you want to add/or any corrections on the copy of the license. If adding additional deputies, \$20 is required for each deputy position added.
- To delete deputies, strike through the deputy name you want to delete and email the license to dms@cdfa.ca.gov or mail it to DMS.

You may add/delete the same number of deputies at no charge.

Deputies may begin signing Weighmaster Certificates on the date the license is postmarked and sent to DMS. Do not fax changes.

I made a change to my deputy list. When can I expect a revised copy of my license?

Changes to your license must be verified by DMS staff and may take up to three (3) weeks.

When can my added deputies issue Weighmaster Certificates?

If adding deputies through the Weighmaster Public Licensing Portal, a deputy may begin signing Weighmaster Certificates once the licensee has received a submission confirmation from the Licensing Portal.

If deputies were added via mail and accompanied with the required fees, they may begin signing Weighmaster Certificates on the date the license is postmarked and sent to DMS.

How do I add/delete locations?

NEW ONLINE SERVICES! The licensee may make location changes through the Weighmaster Public Licensing Portal at any time.

By Mail:

- To add a location, the licensee must complete and submit:
 - Pages 1, 2, and 4 of the Weighmaster License Application.
 - \$30 per added location.
 - A copy of the current year's license.

Weighing cannot begin until the application and proper fees are submitted. Once submitted, weighing may begin on postmark date.

- To delete a location, use a copy of the current year's license and strike through the location you want to delete. Email the copy to dms@cdfa.ca.gov or mail it to DMS.
Note: All Weighmaster Certificates issued at this location must be stored for four (4) years.

A licensee who adds and deletes a branch location cannot receive credit for, or be equally exchanged for, the deleted branch.

Can I fax a request to make updates?

No, facsimiles (fax) are no longer accepted as a method to update a license.

Can I make a payment by phone?

No, phone payments are not accepted.

The licensee can make payment through the Weighmaster Public Licensing Portal at any time.

What additional information is needed for a Junk Dealer Recycler (JDR)?

JDRs must submit the following before a license is issued:

- Current business license for each location.
- Current list of Deputy Weighmasters.
- E-mail address where Scrap Theft Alerts are received.

- Declaration that the JDR has applied for a required Storm Water Permit or proof that a permit is not required.
- Declaration that thumbprinting and photographic equipment is available if purchasing non-ferrous metals as described in BPC Section 21608.5.

California Department of Transportation

DISTRICT 11
4050 TAYLOR STREET, MS-240
SAN DIEGO, CA 92110
(619) 709-5152 | FAX (619) 688-4299 TTY 711
www.dot.ca.gov



October 5, 2023

11-IMP-111
PM 8.2

Maverik Convenience Store with Fueling Station
Zone Change/General Plan Amendment Review

Mr. Derek Newland
Planner III
Imperial County Planning and Development Services
801 Main Street
El Centro, CA 92243

Dear Mr. Newland:

Thank you for including the California Department of Transportation (Caltrans) in the zone change/general plan amendment review process for the proposed Maverik Convenience Store with Fueling Station project located near State Route 111 (SR-111) and Ross Ave. The mission of Caltrans is to provide a safe and reliable transportation network that serves all people and respects the environment. The Local Development Review (LDR) Program reviews land use projects and plans to ensure consistency with our mission and state planning priorities.

Safety is one of Caltrans' strategic goals. Caltrans strives to make the year 2050 the first year without a single death or serious injury on California's roads. We are striving for more equitable outcomes for the transportation network's diverse users. To achieve these ambitious goals, we will pursue meaningful collaboration with our partners. We encourage the implementation of new technologies, innovations, and best practices that will enhance the safety on the transportation network. These pursuits are both ambitious and urgent, and their accomplishment involves a focused departure from the status quo as we continue to institutionalize safety in all our work.

Caltrans is committed to prioritizing projects that are equitable and provide meaningful benefits to historically underserved communities, to ultimately improve transportation accessibility and quality of life for people in the communities we serve.

We look forward to working with the County of Imperial in areas where the County and Caltrans have joint jurisdiction to improve the transportation network and connections

Mr. Derek Newland, Planner III
October 5, 2023

between various modes of travel, with the goal of improving the experience of those who use the transportation system.

Caltrans has the following comments:

Traffic Analysis

A Vehicle Miles of Travel (VMT) based Traffic Impact Study (TIS), and Mobility Analysis should be provided for this project. Please use the Governor's Office of Planning and Research Guidance to identify VMT related impacts.¹

The TIS may also need to identify the proposed project's near-term and long-term safety or operational issues, on or adjacent to any existing State facilities.

Design

Since SR-111 is part of the Freeway and Expressway System and is a Terminal Access Route for large trucks, consider using a higher level of design (urban driveway instead of rural driveway) based on vehicle speeds on SR-111 and to accommodate the types of vehicles turning into and out of Ross Avenue and Hawkes Road.

Caltrans References:

- Encroachment Permit Manual—Chapter 510, Table 5.21 and Appendix J Highway Design Manual—Chapter 200, sections 205.3(4) Commercial Driveways and 205.4 Driveways on Frontage Road and Rural Areas.
- Standard Plans A87A can also be consulted.
- Imperial County Design Standards should also be consulted in case the County wants a consistent driveway design for emergency services.

Please consider sight distance, adequate space for truck turning movement into the access road (Hawkes Road) and Ross Avenue, acceleration/deceleration lanes. Please follow the guidelines in the Highway Design Manual (HDM) <https://dot.ca.gov/programs/design/manual-highway-design-manual-hdm> and Appendix J of the Encroachment Permits Manual. Please note that this information is only preliminary. Once more information and plans are available then a more accurate review can be made.

¹ California Governor's Office of Planning and Research (OPR) 2018. "Technical Advisory on Evaluating Transportation Impacts in CEQA." http://opr.ca.gov/docs/20190122-743_Technical_Advisory.pdf

Mr. Derek Newland, Planner III
October 5, 2023

Hydrology and Drainage Studies

1. Provide Improvement Plans outside Caltrans' Right-of-Way (R/W) (offsite) and include:
 - Grading Plans with 0.2-foot contour intervals.
 - Drainage Infrastructures Plans (existing and proposed).
 - Complete Hydrology and Hydraulics Report that includes bio-retention areas.
 - Show Caltrans' R/W and SR-111 centerline.
2. If applicable, provide SR-111 Improvement Plans (onsite) and include:
 - Existing and Proposed Grading Plans with 0.1-foot contour intervals.
 - Existing and Proposed Drainage Features.
 - Department's Right of Way and centerline.
 - Existing and Proposed Roadway Features.
3. SR-111 onsite Hydrology and Hydraulics Studies in accordance with Caltrans Highway Design Manual (HDM) for the existing and proposed conditions. Early coordination with Caltrans is recommended.
4. Caltrans generally does not allow development projects to impact hydraulics within the State's R/W. Any modification to the existing Caltrans drainage and/or increase in runoff to State facilities will not be allowed.

Traffic Control Plan/Hauling

Caltrans has discretionary authority with respect to highways under its jurisdiction and may, upon application and if good cause appears, issue a special permit to operate or move a vehicle or combination of vehicles or special mobile equipment of a size or weight of vehicle or load exceeding the maximum limitations specified in the California Vehicle Code. The Caltrans Transportation Permits Issuance Branch is responsible for the issuance of these special transportation permits for oversize/overweight vehicles on the State Highway network. Additional information is provided online at: <http://www.dot.ca.gov/trafficops/permits/index.html>

A Traffic Control Plan is to be submitted to Caltrans District 11, including the intersection at SR-111/Ross Avenue, at least 30 days prior to the start of any construction. Traffic shall not be unreasonably delayed. The plan shall also outline suggested detours to use during closures, including routes and signage.

Potential impacts to the highway facilities (Route 111) and traveling public from the detour, demolition and other construction activities should be discussed and addressed before work begins.

Environmental

Caltrans welcomes the opportunity to be a Responsible Agency under the California Environmental Quality Act (CEQA), as we have some discretionary authority of a

Mr. Derek Newland, Planner III
October 5, 2023

portion of the project that is in Caltrans' R/W through the form of an encroachment permit process. We look forward to the coordination of our efforts to ensure that Caltrans can adopt the alternative and/or mitigation measure for our R/W. We would appreciate meeting with you to discuss the elements of the environmental document that Caltrans will use for our subsequent environmental compliance.

An encroachment permit will be required for any work within the Caltrans' R/W prior to construction. As part of the encroachment permit process, the applicant must provide approved final environmental documents for this project, corresponding technical studies, and necessary regulatory and resource agency permits. Specifically, CEQA determination or exemption. The supporting documents must address all environmental impacts within the Caltrans' R/W and address any impacts from avoidance and/or mitigation measures.

We recommend that this project specifically identifies and assesses potential impacts caused by the project or impacts from mitigation efforts that occur within Caltrans' R/W that includes impacts to the natural environment, infrastructure including but not limited to highways, roadways, structures, intelligent transportation systems elements, on-ramps and off-ramps, and appurtenant features including but not limited to lighting, signage, drainage, guardrail, slopes and landscaping. Caltrans is interested in any additional mitigation measures identified for the project's draft Environmental Document.

Broadband

Caltrans recognizes that teleworking and remote learning lessen the impacts of traffic on our roadways and surrounding communities. This reduces the amount of VMT and decreases the amount of greenhouse gas (GHG) emissions and other pollutants. The availability of affordable and reliable, high-speed broadband is a key component in supporting travel demand management and reaching the state's transportation and climate action goals.

Mitigation

Caltrans endeavors that any direct and cumulative impacts to the State Highway network be eliminated or reduced to a level of insignificance pursuant to the CEQA and National Environmental Policy Act (NEPA) standards.

Right-of-Way

Hawes Road is not part of the Caltrans R/W. However, please be aware of the proximity to state R/W and Imperial Irrigation District (IID) facilities. Additional analysis would be required if direct access to the proposed project is proposed via Hawes Road. Please see attached right of way documents for reference.

Mr. Derek Newland, Planner III
October 5, 2023

Per Business and Profession Code 8771, perpetuation of survey monuments by a licensed land surveyor is required, if they are being destroyed by any construction.

County of Imperial shall prepare and submit to Caltrans closure plans as part of the encroachment permit application. The plans shall require that closure or partial closure of SR-111 be limited to times as to create the least possible inconvenience to the traveling public and that signage be posted prior to the closure to alert drivers of the closure in accordance with Caltrans requirements. Traffic shall not be unreasonably delayed. The plan shall also outline suggested detours to use during the closures, traffic, including routes and signage.

The Highway Closure Plan, as part of the encroachment permit, should be submitted to Caltrans at least 30 days prior to initiating installation of the crossings. No work shall begin in Caltrans' R/W until an encroachment permit is approved.

Any work performed within Caltrans' R/W will require discretionary review and approval by Caltrans and an encroachment permit will be required for any work within the Caltrans' R/W prior to construction. As part of the encroachment permit process, the applicant must provide an approved final environmental document including the CEQA determination addressing any environmental impacts with the Caltrans' R/W, and any corresponding technical studies.

Additional information regarding encroachment permits may be obtained by contacting the Caltrans Permits Office at (619) 688-6158 or emailing D11.Permits@dot.ca.gov or by visiting the website at <https://dot.ca.gov/programs/traffic-operations/ep>. Early coordination with Caltrans is strongly advised for all encroachment permits.

Please see the following chapters in the Caltrans' manuals:

- Chapter 600 of the Encroachment Permits Manual for requirements regarding utilities and state R/W: <https://dot.ca.gov/-/media/dot-media/programs/traffic-operations/documents/encroachment-permits/chapter-6-ada-a11y.pdf>.
- Chapter 2-2.13 of the Plans Preparation Manual for requirements regarding utilities and state R/W: <https://dot.ca.gov/-/media/dot-media/programs/design/documents/cadd/ppm-text-ch2-sect2-13-a11y.pdf>
- Chapter 17 of the Project Development Procedures Manual <https://dot.ca.gov/-/media/dot-media/programs/design/documents/pdpm-chapter17-a11y.pdf>.

Mr. Derek Newland, Planner III
October 5, 2023

If you have any questions, please contact Mark McCumsey, LDR Coordinator, at (619) 985-4957 or by e-mail sent to mark.mccumsey@dot.ca.gov.

Sincerely,

Maurice A. Eaton

MAURICE EATON
Branch Chief
Local Development Review

Attachments: - R15090 Map
 - R15090 RecRes
 - Right of Way Map SR-111.Ross

STATE OF CALIFORNIA
 TRANSPORTATION AGENCY
 DEPARTMENT OF PUBLIC WORKS
 DIVISION OF HIGHWAYS
 DISTRICT 11

Page 82 STATE HIGHWAY MAP BOOK 2

DIST.	CO	RTE	P.M.
11	IMP	8	35.6/21.4
11	IMP	111	7.2/8.3

D. DeWolf
 DISTRICT 11 ENGINEER DISTRICT 11

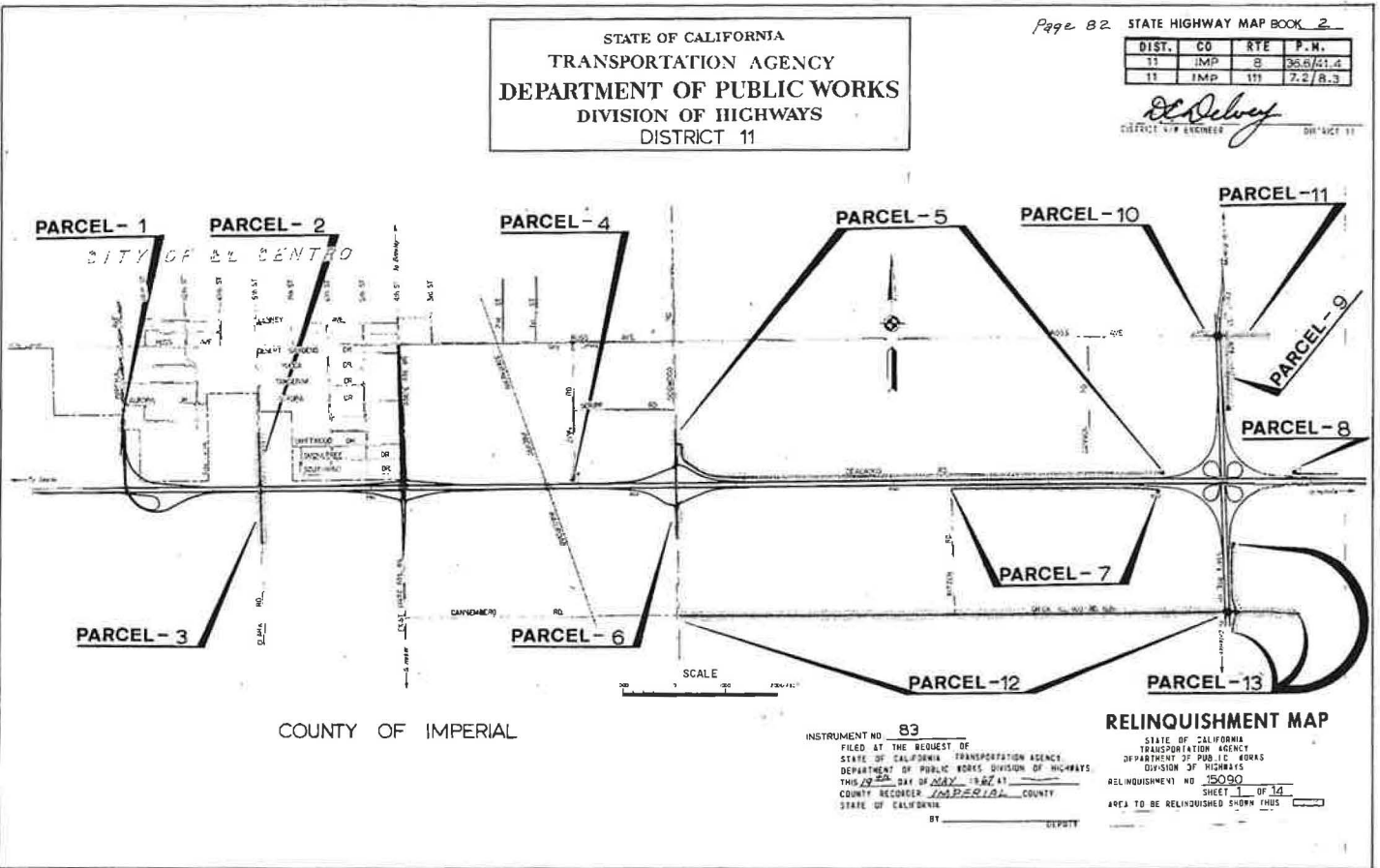

INSTRUMENT NO. 83
 FILED AT THE REQUEST OF
 STATE OF CALIFORNIA TRANSPORTATION AGENCY
 DEPARTMENT OF PUBLIC WORKS DIVISION OF HIGHWAYS
 THIS 29 DAY OF MAY 1962
 COUNTY RECORDER IMPERIAL COUNTY
 STATE OF CALIFORNIA
 BY _____ DEPUTY

RELINQUISHMENT MAP
 STATE OF CALIFORNIA
 TRANSPORTATION AGENCY
 DEPARTMENT OF PUBLIC WORKS
 DIVISION OF HIGHWAYS
 RELINQUISHMENT NO. 15090
 SHEET 1 OF 10
 AREA TO BE RELINQUISHED SHOWN THUS _____

EEC ORIGINAL PKG

DIST.	CO	RYE	P.W.
11	IMP	9	386/11.4
11	IMP	111	7.2/8.3

D. DeWay
 DISTRICT 11

T.S.S. A. & E. S.B.M.
 According to U.S. Government Survey Approved February 6, 1909

COUNTY OF IMPERIAL
 SEC. 11
 GAYL LOT 3

PARCEL-9

PARCEL-10

PARCEL-11

TRACT 117

DETAIL

BEARINGS AND DISTANCES SHOWN ARE ON THE CALIFORNIA COORDINATE SYSTEM. TO OBTAIN GROUND LEVEL DISTANCES, MULTIPLY DISTANCES SHOWN BY 0.99999730

RELINQUISHMENT MAP

STATE OF CALIFORNIA
 TRANSPORTATION AGENCY
 DEPARTMENT OF PUBLIC WORKS
 DIVISION OF HIGHWAYS
 RELINQUISHMENT TO 15000
 AREA TO BE RELINQUISHED SHOWN THUS
 ACCESS PROHIBITED INDICATED THUS
 SCALE 1" = 1000'

EEC ORIGINAL PKG

RECORDING REQUESTED BY
and RETURN TO:
 State of California
 Division of Highways
 P. O. Box 390
 San Diego, California 92112
 Attn: Mr. D. E. Delvey,
 District R/W Engineer

23

JOHN W. KENNEDY
 COUNTY ENGINEER

BOOK 1251 PAGE 902

HIGHWAY COMMISSION
RESOLUTION NO.
 - 1052

'67 SEP 28 AM 5:30

BOOK 1251 PAGE 902

Passed by C.H.C.

OFFICE OF THE COUNTY ENGINEER
 IMPERIAL COUNTY, CALIF.

SEP 20 1967

NO FEE

RELINQUISHMENT OF HIGHWAY RIGHT OF WAY IN THE
COUNTY OF IMPERIAL, ROAD 11-IMP-8, 111-36.6-41.4, 7.2-8.3
REQUEST NO. 15000

WHEREAS, highway right of way within the County of Imperial, on Route 111, between Chick Road and Ross Avenue, road 11-imp-111, hereinafter particularly described, has been superseded by a change in the location of said highway; and

WHEREAS, by freeway agreement dated June 18, 1962, between the County of Imperial and the State of California, the County agreed to accept title to frontage roads, reconstructed county roads and other local roads, upon relinquishment thereof to said County by the State of California; and

WHEREAS, the State of California has acquired right of way for and has constructed the above mentioned collateral facilities in the County of Imperial on Route 8, between Imperial Avenue and Route 111 and on Route 111, between Chick Road and Ross Avenue, road 11-imp-8, 111, in accordance with said agreement; and

WHEREAS, this Commission has found and determined, and does hereby find and determine, that it is desirable and in the public interest that said highway right of way so superseded and

EEC ORIGINAL PKG

said collateral facilities be relinquished to the County of Imperial for use as county highways:

NOW, THEREFORE, IT IS VOTED by the California Highway Commission that it relinquish, and it does hereby relinquish, to the County of Imperial, effective upon the recordation of a certified copy hereof with the Recorder of Imperial County, all of the State of California's right, title and interest in and to said superseded highway right of way and said collateral facilities in said County, together with the right of way and appurtenances thereof, described as follows:

All those portions of superseded State highway right of way, frontage roads, reconstructed county roads, and cul-de-sacs in the County of Imperial designated as Parcels 1 through 13 on those certain relinquishment maps filed for record as State Highway Map Book No. 2, pages 82 through 95 inclusive, on May 19, 1967 in the office of the Recorder of Imperial County.

EXCEPTING and RESERVING unto the State of California any and all rights of ingress to or egress from the highway hereby relinquished, in and to the adjoining freeway, except at such points as now are or may be established by resolution of this Commission.

ALSO EXCEPTING and RESERVING unto the State of California with the understanding and agreement on the part of the County of Imperial that it will hold the hereinabove designated parcels 9, 10, 11, the Easterly 1000 feet of parcel 12, and parcel 13 inviolate for public highway purposes and will not vacate or abandon such roads or any part thereof without the State's written consent. This exception and reservation to automatically terminate with the completion of planned reconstruction of State Highway (Road 11-Impr-111).

THIS IS TO CERTIFY That the foregoing is a full and correct copy of the original resolution duly passed by the California Highway Commission at its meeting regularly called and held on the <u>20th</u> day of <u>SEPTEMBER</u> , 196 <u>7</u>
In the City of <u>SACRAMENTO</u>
Dated this <u>20th</u> day of <u>SEPTEMBER</u> , 196 <u>7</u>
<i>Robert T. Martin</i> ROBERT T. MARTIN ASSISTANT SECRETARY OF THE CALIFORNIA HIGHWAY COMMISSION

REP. no. 1102-660-001-001

EEC ORIGINAL PKG

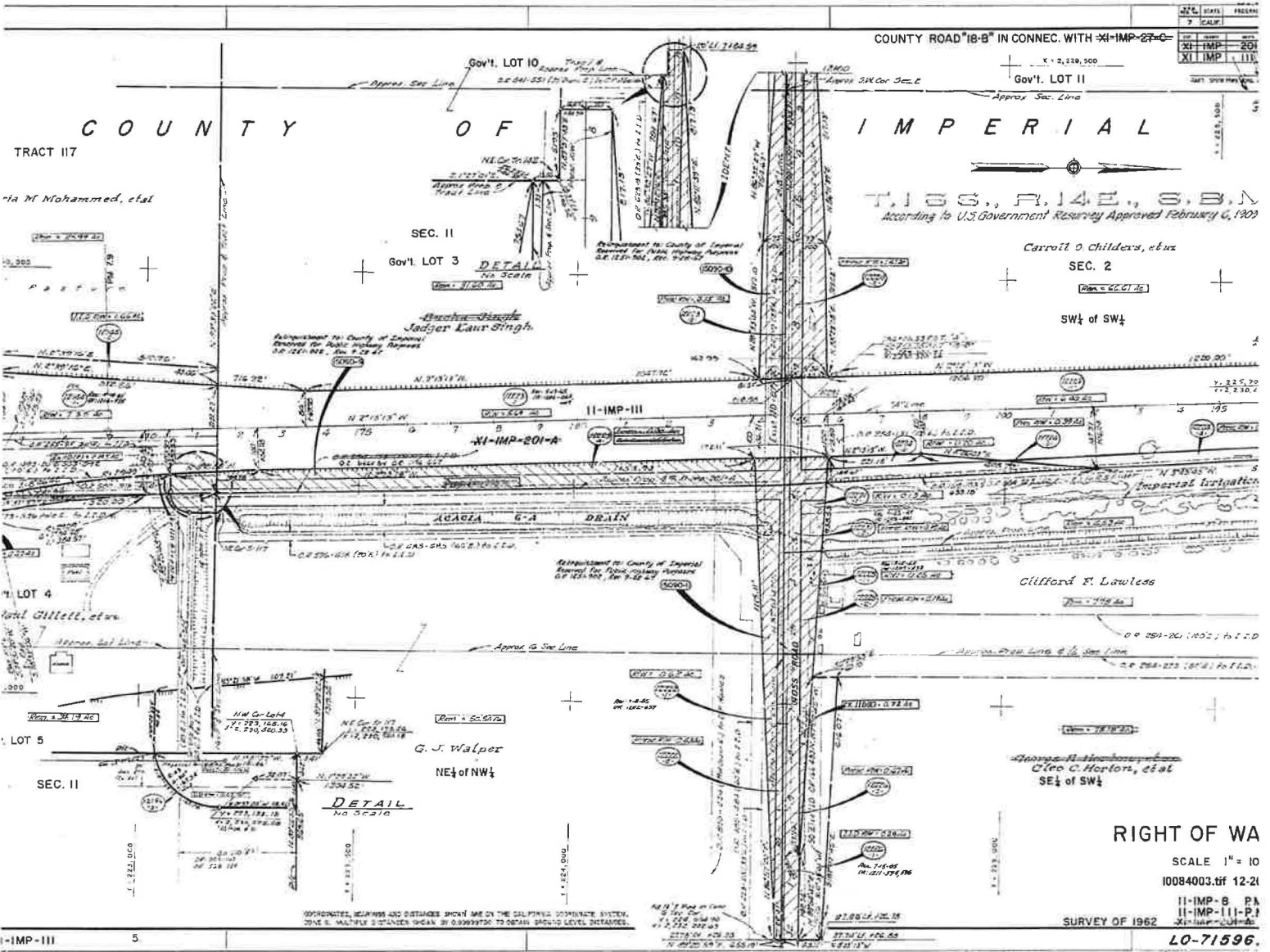

NO.	DATE	REVISION
1	12-21-62	SCALE
2		XI-IMP-201
3		XI-IMP-111

COUNTY ROAD "B-B" IN CONN. WITH XI-IMP-27-C

COUNTY OF IMPERIAL

IMPERIAL

T. 16 S., R. 14 E., S. 2 N.
According to U.S. Government Resurvey Approved February 4, 1909

TRACT I17
via M. Mohammed, et al

Carroll O. Childers, et ux
SEC. 2
SW 1/4 of SW 1/4

Gov't. LOT 3
DETAIL
No Scale
Abraham Kaur Singh
Judge Kaur Singh

Clifford F. Lawless

G. J. Walper
NE 1/4 of NW 1/4

Clifford F. Lawless
Dora C. Horford, et al
SE 1/4 of SW 1/4

RIGHT OF WAY

SCALE 1" = 100'

10084003.tif 12-21

II-IMP-B PA

II-IMP-III-P1

SURVEY OF 1962

LO-71596

AVI RNC

COORDINATES, BEARINGS AND DISTANCES SHOWN ARE IN THE CALIFORNIA COORDINATE SYSTEM. ZONE 8. MULTIPLY DISTANCES SHOWN BY 0.99999730 TO OBTAIN GEODESIC LEVEL DISTANCES.

EEC ORIGINAL PKG

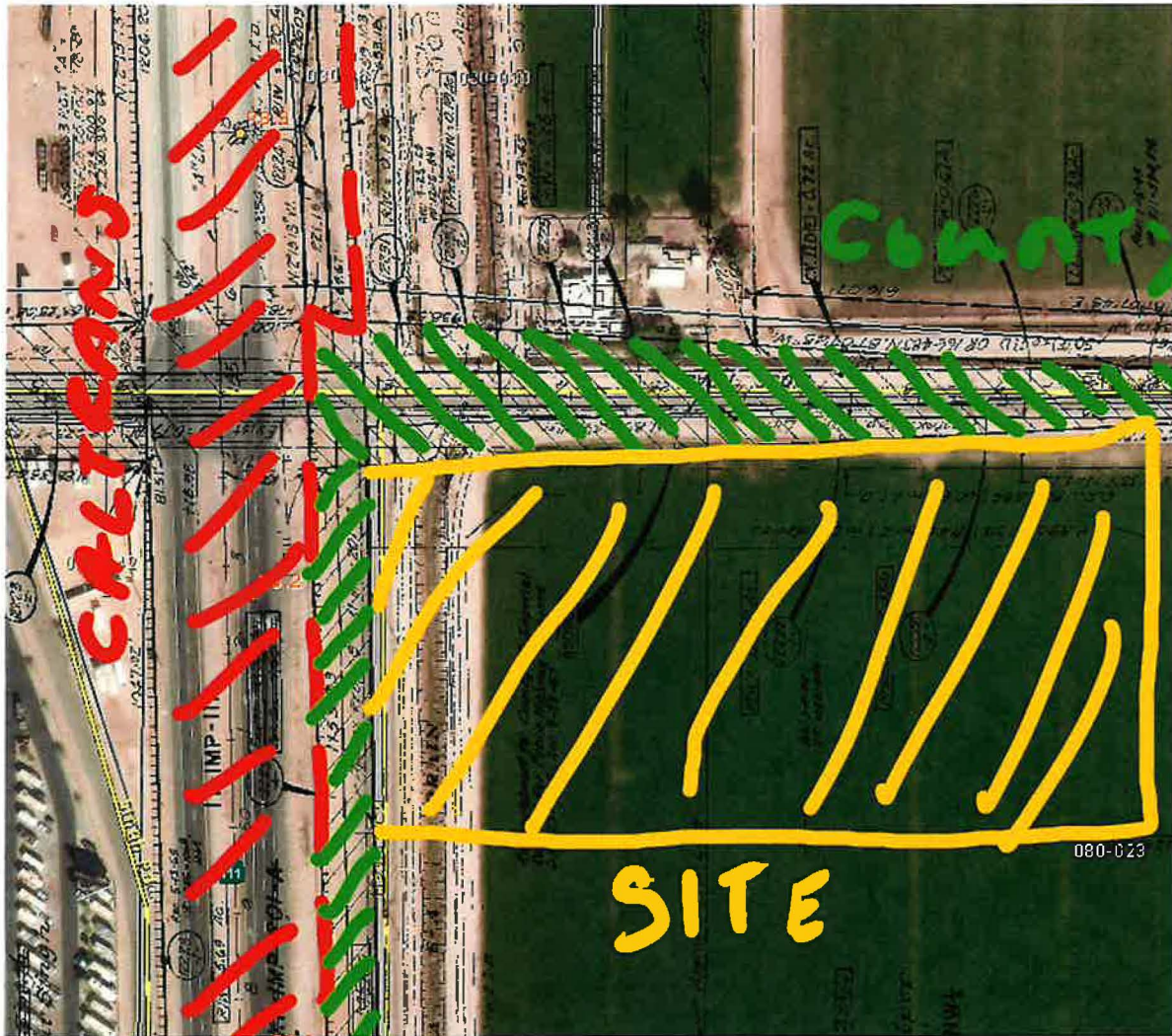

EEC ORIGINAL PKG

COUNTY EXECUTIVE OFFICE

Miguel Figueroa
County Executive Officer
miguelfigueroa@co.imperial.ca.us
www.co.imperial.ca.us



County Administration Center
940 Main Street, Suite 208
El Centro, CA 92243
Tel: 442-265-1001
Fax: 442-265-1010

RECEIVED

By Imperial County Planning & Development Services at 10:21 am, Oct 03, 2023

October 03, 2023

TO: Derek Newland, Planning and Development Services Department
FROM: Rosa Lopez-Solis, Executive Office 
SUBJECT: Comments – Maverik, Inc GPA 22-0002 / APN 054-080-023-000

The County of Imperial Executive Office is commenting on Maverik, Inc GPA 22-0002 / APN 054-080-023-000 project. The Executive Office would like to inform the developer of conditions and responsibilities should the applicant seek a Conditional Use Permit (CUP). The conditions commence prior to the approval of an initial grading permit and subsequently continue throughout the permitting process. This includes, but not limited to:

- **Sales Tax Condition.** The permittee is required to have a Construction Site Permit reflecting the project site address, allowing all eligible sales tax payments are allocated to the **County of Imperial, Jurisdictional Code 13998**. The permittee will provide the County of Imperial a copy of the CDTFA account number and sub-permit for its contractor and subcontractors (if any) related to the jobsite. Permittee shall provide in written verification to the County Executive Office that the necessary sales and use tax permits have been obtained, prior to the issuance of any grading permits.
- **Construction/Material Budget:** Prior to a grading permit, the permittee will provide the County Executive Office a construction materials budget: an official construction materials budget or detailed budget outlining the construction and materials cost for the processing facility on permittee letterhead.

Should there be any concerns and/or questions, do not hesitate to contact me.



Public Works works for the Public



COUNTY OF IMPERIAL

DEPARTMENT OF PUBLIC WORKS

155 S. 11th Street
El Centro, CA
92243

Tel: (442) 265-1818
Fax: (442) 265-1858

Follow Us:



www.facebook.com/ImperialCountyDPW/



<https://twitter.com/CountyDpw/>

October 5, 2023

Mr. Jim Minnick, Director
Planning & Development Services Department
801 Main Street
El Centro, CA 92243

Attention: Derek Newland, Planner III

SUBJECT: PM 2499 / GPA 22-002 / ZC 22-0002 Maverik, Inc.;
Located on the Southeast Corner of Highway 111 and Ross Rd,
El Centro, CA 92243
APN 054-080-023

Dear Mr. Minnick:

This letter is in response to your submittal received on September 21, 2023 for the above-mentioned project. The applicant is proposing a General Plan Amendment from Agriculture to Commercial, Zone Change from A-2 (General Agriculture) to C-3 (Heavy Commercial) and a Parcel Map proposing a 40 acre parcel and a 10 acre parcel for a fueling station and convenience store.

Department staff has reviewed the package information and the following comments:

1. Ross Road is classified as Minor Collector / Local Collector – two (2) lanes, requiring seventy feet (70) of right of way, being thirty five (35) feet from existing centerline. It is required that sufficient right of way be provided to meet this road classification. **(As directed by Imperial County Board of Supervisors per Minute Order #6 dated 11/22/1994 per the Imperial County Circulation Element Plan of the General Plan).**
2. Hawes Road is classified as Local Road / Residential – two (2) lanes, requiring seventy feet (60) of right of way, being thirty five (30) feet from existing centerline. It is required that sufficient right of way be provided to meet this road classification. **(As directed by Imperial County Board of Supervisors per Minute Order #6 dated 11/22/1994 per the Imperial County Circulation Element Plan of the General Plan).**
3. The applicant shall prepare and submit a Traffic Impact Study per the County of Imperial Department of Public Works Traffic Study and Report Policy for review and approval. The Traffic Impact Study shall evaluate the project impacts to state and county roads, including but not limited to, level of service, intersection delays, traffic delays at site access points (need for turn lanes), etc. The project site is located immediately east of the County Life RV Park. The Traffic Impact Study shall also evaluate the project impacts due to pedestrian/bicycle traffic. The Traffic Impact Study shall include exiting traffic counts (obtained within a year of the preparation of the study) along state and

county roads in the vicinity of the project. Any mitigation measures identified on the Traffic Impact Study shall be approved by this department. The applicant shall be responsible for the planning, design, implementation and/or construction of any traffic mitigation measures identified on the Traffic Impact Study. Such traffic mitigation measures shall be a requirement for the issuance of a Certificate of Occupancy.

4. Provide a Parcel Map prepared by a California Licensed Land Surveyor or a Civil Engineer licensed before 1982 per the California Business & Professions Code and submit to the Department of Public Works, for review and recordation.
5. Provide a tax certificate from the Tax Collector's Office prior to recordation of the Parcel Map.
6. The Parcel Map shall be based upon a field survey. The basis of bearings for the Parcel Map shall be derived from the current epoch of the California Coordinate System (CCS), North America Datum of 1983 (NAD83). The survey shall show connections to a minimum of two (2) Continuously Operating Reference Stations (CORS) of the California Real Time Network (CRTN). NAD 83 coordinates shall be established for every monument shown on the Parcel map.
7. Each parcel created or affected by this map shall abut a maintained road and/or have legal access to a public road before this Parcel Map is recorded.
8. Applicant shall verify with the Imperial Irrigation District (IID) if the field has sub-surface drainage tiles, which will need to be removed or capped.
9. The Applicant shall furnish a Drainage and Grading Plan/Study to provide for property grading and drainage control, which shall also include prevention of sedimentation of damage to off-site properties. Said plan shall be completed per County of Imperial Department of Public Works Engineering Design Guidelines Manual for the Preparation and Checking of Street Improvement, Drainage, and Grading Plans within Imperial County. The Study/Plan shall be submitted to the Department of Public Works for review and approval. The applicant shall implement the approved plan. Employment of the appropriate Best Management Practices (BMP's) shall be included (Per Imperial County Code of Ordinances, Chapter 12.10.020 B).
10. Street Improvements shall be required for Ross Ave. and Hawes Rd along the frontage of the property. Improvement Plan shall be submitted approved by this Department prior to recordation of the Parcel Map.
11. All permanent structures abutting public roads shall be located outside County ultimate right-of-way.
12. All off-site improvements within Imperial County right-of-way shall be financially secured by either a road improvement bond or letter of credit prior to recordation of Parcel Map.

EEC ORIGINAL PKG

13. Prior to the issuance of any grading and/or building permits, the Developer shall procure an encroachment permit from this department for any off-site improvements required for this project.
14. Prior to issuance of final certificate of completion, Developer shall provide a grading improvement certificate letter prepared by a California Licensed Civil Engineer or Surveyor that all recommended drainage and grading improvements were completed per approved grading plans.
15. All solid and hazardous waste shall be disposed of in approved solid waste disposal sites in accordance with existing County, State and Federal regulations (Per Imperial County Code of Ordinances, Chapter 8.72).
16. All on-site traffic areas shall be hard surfaced to provide all weather access for emergency vehicles. The surfacing shall meet the Department of Public Works and Fire/Office of Emergency Services (EOS) Standards as well as those of the Air Pollution Control District (APCD).
17. The project may require a National Pollutant Discharge Elimination System (NPDES) permit and Notice of Intent (NOI) from the Regional Water Quality Control Board (RWQCB) prior to County approval of onsite grading plan (40 CFR 122.28).
18. A Transportation Permit may be required from road agency(s) having jurisdiction over the haul route(s) for any hauls of heavy equipment and/or large vehicles which impose greater than legal loads on riding surfaces, including bridges. (Per Imperial County Code of Ordinances, Chapter 10.12 - OVERWEIGHT VEHICLES AND LOADS).
19. Effective September 15, 2020, the State's Mandatory Organic Waste Recycling Law (AB 1826 or Chapter 727, Statutes of 2014) decreased the threshold requiring all businesses and multi-dwelling facilitates of 5 units or more generating two (2) cubic yards or more of solid waste per week to recycle their organic waste including landscape waste, wood waste, and food waste. Information about possible organics waste recycling services can be found at the CalRecycle site at:
<https://www.calrecycle.ca.gov/Recycle/Commercial/Organics/>

Respectfully,



David Dale, PE, PLS
Assistant Public Works Director

CY/gv

EEC ORIGINAL PKG

Derek Newland

From: Carlos Yee
Sent: Thursday, March 28, 2024 9:09 AM
To: Derek Newland
Cc: John Gay; David Dale; Michael Abraham; Diana Robinson
Subject: RE: Traffic Study for GPA22-0002/ZC22-0002/PM02499 Maverik Fueling Station

Good morning Derek,

Please see our staff's traffic comments below with regards to the above mentioned project:

1. Figure 5-3 of the traffic study illustrates peak-hour traffic volumes with project traffic at opening year at the 3 proposed site driveways, identified as Intersections 4, 5 and 6. 18 left-turns are identified for all three driveways during both AM and PM Peak Hours. 110 and 108 right-turns are identified for Driveways 4 and 5 during AM and PM Peak Hours, respectively. 91 and 90 right-turns are identified for Driveways 6 during AM and PM Peak Hours, respectively.
 - The turning movements at the proposed site driveways meet the ITE Traffic Engineering Handbook Warrants for left-turn and right-turn lanes. The project shall include the installation of left-turn and right-turn lanes on Ross Road. Turn lanes shall include deceleration lanes and storage per the Caltrans Highway Design Manual. The traffic study shall be revised to include these turn lane improvements.
2. The project site is located within 0.25 miles of a trailer park. The trailer park is located immediately southwest of the SR-111 and Ross Road intersection. The traffic signals controlling the SR-111 and Ross Road intersection are provided with push buttons and signal faces for pedestrian traffic along the west, south, and east sides of the intersection. There is a potential for the project, specifically the convenience store, to generate pedestrian traffic, and the intersection controls at SR-111 and Ross Road allow for pedestrian traffic. However, there is no mention of pedestrian traffic in the traffic study.
 - The traffic study shall be revised to include of pedestrian traffic in its analysis.

Regards.

Carlos Yee | Permit Specialist
ICDPW - Engineering Division | 155 S. 11th Street. El Centro, CA 92243
Phone: (442)265-1818 x1838 | Fax: (442)265-1858 | Email: CarlosYee@co.imperial.ca.us

From: Derek Newland <DerekNewland@co.imperial.ca.us>
Sent: Friday, March 22, 2024 3:40 PM
To: Carlos Yee <CarlosYee@co.imperial.ca.us>
Cc: John Gay <JohnGay@co.imperial.ca.us>; David Dale <daviddale@co.imperial.ca.us>; Michael Abraham <MichaelAbraham@co.imperial.ca.us>; Diana Robinson <DianaRobinson@co.imperial.ca.us>
Subject: RE: Traffic Study for GPA22-0002/ZC22-0002/PM02499 Maverik Fueling Station

Good Afternoon Carlos,
I just checking in on if Public Works has any comments regarding the traffic study.

Thank you,

Derek Newland
Planner III

EEC ORIGINAL PKG

County of Imperial
Planning and Development Services
dereknewland@co.imperial.ca.us
(442) 265-1736

From: Derek Newland
Sent: Tuesday, March 5, 2024 2:19 PM
To: Carlos Yee <CarlosYee@co.imperial.ca.us>
Cc: John Gay <JohnGay@co.imperial.ca.us>; David Dale <daviddale@co.imperial.ca.us>; Michael Abraham <MichaelAbraham@co.imperial.ca.us>; Diana Robinson <DianaRobinson@co.imperial.ca.us>
Subject: Traffic Study for GPA22-0002/ZC22-0002/PM02499 Maverik Fueling Station

Good Afternoon Carlos,
Please see the enclosed traffic study that was prepared for the Maverik Fueling Station project. If you have any questions please let me know.

Thank you,

Derek Newland
Planner III
County of Imperial
Planning and Development Services
dereknewland@co.imperial.ca.us
(442) 265-1736

EEC ORIGINAL PKG



IID

A century of service.

www.iid.com

Since 1911

October 4, 2023

Mr. Derek Newland
Planner II
Planning & Development Services Department
County of Imperial
801 Main Street
El Centro, CA 92243

SUBJECT: Subdivision for a Maverik, Inc. Fueling Station and Convenience Store (GPA22-0002/ZC22-0002/PM02499)

Dear Mr. Newland:

On September 21, 2023, the Imperial Irrigation District received from the Imperial County Planning & Development Services Department, a request for agency comments on a minor subdivision application for a Maverik, Inc. fueling station and convenience store project (General Plan Amendment No. 22-0002/Zone Change No. 22-0002/Parcel Map No. 02499). The applicant proposes to subdivide an approximately 50-acre lot into 40-acre and 10-acre parcels to accommodate an approximately 6,000 sq. ft. fueling station and convenience store. The originating parcel is located at the southeast corner of Hwy. 111 and Ross Road, El Centro, CA (APN 054-080-023).

The IID has reviewed the application and has the following comments:

1. If the proposed project requires electrical service, the applicant should be advised to contact Ignacio Romo, IID project development service planner, at (760) 482-3426 or e-mail Mr. Romo at igromo@iid.com to initiate the customer service application process. In addition to submitting a formal application (available for download at the IID website <http://www.iid.com/home/showdocument?id=12923>), the applicant will be required to submit an AutoCAD file of site plan, approved electrical plans, electrical panel size and panel location, operating voltage, electrical loads, project schedule, and the applicable fees, permits, easements and environmental compliance documentation pertaining to the provision of electrical service to the project. The applicant shall be responsible for all costs and mitigation measures related to providing electrical service to the project.
2. Electrical capacity is limited in the project area. Consequently, a circuit study may be required to identify any system improvements or mitigation to enable the provision of electrical service to the project.
3. Applicant shall provide a surveyed legal description and an associated exhibit certified by a licensed surveyor for all rights of way deemed by IID as necessary to accommodate the project electrical infrastructure. Rights-of-Way and easements shall be in a form acceptable to and at no cost to IID for installation, operation, and maintenance of all electrical facilities.

EEC ORIGINAL PKG

4. IID water facilities that may be impacted include the Acacia 5A Drain and Acacia 5A Drain No. 1.
5. All flows being discharge into IID's drains will have to be in conformance with the laws and regulations of the County of Imperial and the various state and federal agencies having jurisdiction over water quality control. Drainage restrictions are outlined in the IID's Rules and Regulations Governing the Distribution and Use of Water located at: <http://www.iid.com/home/showdocument?id=7989> and the applicant should review Regulation #36 – Use of Drains, Regulation #46 – Industrial Tailwater Assessment, and Regulation No. 39 – Agricultural Tailwater Structures.
6. A new or change in existing drainage discharge locations may substantially alter the existing drainage pattern of the site or area and may adversely impact IID drains. To mitigate these impacts, a comprehensive IID hydraulic drainage system analysis may be required. IID's hydraulic drainage system analysis includes an associated drain impact fee. For further information, applicant should contact Water Department Engineering Services Section at (760) 339-9265.
7. The project's documentation states a sewer treatment plant and a water treatment plant will be constructed. Should IID water service be needed applicant should contact Justina Gamboa-Arce at (760) 339-9085 or jgamboaarce@iid.com. IID has implemented a water allocation or apportionment program pursuant to its revised Equitable Distribution Plan. The project will be subject to any amendments or superseding policy for the same or similar purposes, during all or any part of the term of said water supply agreement. IID shall have the right to apportion the project's water as an industrial water user. For more information on how to obtain a water supply agreement, please visit IID's website at <https://www.iid.com/water/municipal-industrial-and-commercial-customers>.
8. To insure there are no impacts to IID water facilities, the applicant should contact the IID WDES Section prior to the project's final design for review and coordination.
9. Any construction or operation on IID property or within its existing and proposed right of way or easements including but not limited to: surface improvements such as proposed new streets, driveways, parking lots, landscape; and all water, sewer, storm water, or any other above ground or underground utilities; will require an encroachment permit, or encroachment agreement (depending on the circumstances). A copy of the IID encroachment permit application and instructions for its completion are available at <https://www.iid.com/about-iid/department-directory/real-estate>. The IID Real Estate Section should be contacted at (760) 339-9239 for additional information regarding encroachment permits or agreements. No foundations or buildings will be allowed within IID's right of way.
10. In addition to IID's recorded easements, IID claims, at a minimum, a prescriptive right of way to the toe of slope of all existing canals and drains. Where space is limited and depending upon the specifics of adjacent modifications, the IID may claim additional secondary easements/prescriptive rights of ways to ensure operation and maintenance of IID's facilities can be maintained and are not impacted and if impacted mitigated. Thus, IID should be consulted prior to the installation of any facilities adjacent to IID's facilities.

Certain conditions may be placed on adjacent facilities to mitigate or avoid impacts to IID's facilities.

11. The applicant may not use IID's canal or drain banks to access the project site. Any abandonment of easements or facilities will be approved by IID based on systems (Irrigation, Drainage, Power, etc.) needs.
12. Fences should be installed at the boundary of IID's right of way for safety purposes and to allow access for IID operation and maintenance activities. The project's fencing plan should address IID's right of way.
13. Any new, relocated, modified or reconstructed IID facilities required for and by the project (which can include but is not limited to electrical utility substations, electrical transmission and distribution lines, water deliveries, canals, drains, etc.) need to be included as part of the project's California Environmental Quality Act (CEQA) and/or National Environmental Policy Act (NEPA) documentation, environmental impact analysis and mitigation. Failure to do so will result in postponement of any construction and/or modification of IID facilities until such time as the environmental documentation is amended and environmental impacts are fully analyzed. Any and all mitigation necessary as a result of the construction, relocation and/or upgrade of IID facilities is the responsibility of the applicant.

Should you have any questions, please do not hesitate to contact me at 760-482-3609 or at dvargas@iid.com. Thank you for the opportunity to comment on this matter.

Respectfully,



Donald Vargas
Compliance Administrator II

Jamie Asbury – General Manager
Mike Pacheco – Manager, Water Dept.
Matthew H Smelser – Manager, Energy Dept.
Geoffrey Holbrook – General Counsel
Michael P. Kemp – Superintendent General, Fleet Services and Reg. & Environ. Compliance
Laura Cervantes. – Supervisor, Real Estate
Jessica Humes – Environmental Project Mgr. Sr., Water Dept.

EEC ORIGINAL PKG

Derek Newland

From: Kelley, Ryan <RKelley@icso.org>
Sent: Tuesday, March 5, 2024 2:27 PM
To: Derek Newland
Subject: Maverick

CAUTION: This email originated outside our organization; please use caution.

Derek, in regards to the comment letter we submitted for the Maverick zone change, please remove our comment letter. Thank you.

Ryan Kelley | Chief Deputy

Imperial County Sheriff's Office
328 Applestill Road
El Centro, Ca. 92243
OFFICE (442) 265-2003 | CELL (760) 455-0215



EEC ORIGINAL PKG

Derek Newland

From: Aimee Trujillo
Sent: Thursday, September 21, 2023 1:59 PM
To: Krug, Robert@DTSC
Cc: Derek Newland; Aimee Trujillo; John Robb; Kamika Mitchell; Cassandra Castaneda; Laryssa Alvarado; Rosa Soto
Subject: RE: GPA22-0002/ZC22-0002/PM02499 Request for Comments

Good afternoon,

Comments received.

Thank You

Aimee Trujillo

Office Assistant III

Imperial County Planning & Development Services
801 Main Street
El Centro, CA 92243
(442) 265-1736
(442) 265-1735 (Fax)
aimeetrujillo@co.imperial.ca.us



From: Krug, Robert@DTSC <Robert.Krug@dtsc.ca.gov>
Sent: Thursday, September 21, 2023 1:50 PM
To: Aimee Trujillo <aimeetrujillo@co.imperial.ca.us>; Antonio Venegas <AntonioVenegas@co.imperial.ca.us>; Jolene Dessert <JoleneDessert@co.imperial.ca.us>; Margo Sanchez <MargoSanchez@co.imperial.ca.us>; Ashley Jauregui <AshleyJauregui@co.imperial.ca.us>; Belen Leon-Lopez <BelenLeon@co.imperial.ca.us>; Monica Soucier <MonicaSoucier@co.imperial.ca.us>; Jesus Ramirez <JesusRamirez@co.imperial.ca.us>; John Hawk <johnhawk@co.imperial.ca.us>; Miguel Figueroa <miguelfigueroa@co.imperial.ca.us>; Rosa Lopez <RosaLopez@co.imperial.ca.us>; Vanessa Ramirez <VanessaRamirez@co.imperial.ca.us>; Jeff Lamoure <JeffLamoure@co.imperial.ca.us>; Mario Salinas <MarioSalinas@co.imperial.ca.us>; Jorge Perez <JorgePerez@co.imperial.ca.us>; Alphonso Andrade <AlphonsoAndrade@co.imperial.ca.us>; Salvador Flores <SalvadorFlores@co.imperial.ca.us>; Robert Malek <RobertMalek@co.imperial.ca.us>; Ryan Kelley <rkelley@icso.org>; Andrew Loper <AndrewLoper@co.imperial.ca.us>; David Lantzer <davidlantzer@co.imperial.ca.us>; Carlos Yee <CarlosYee@co.imperial.ca.us>; John Gay <JohnGay@co.imperial.ca.us>; rbenavidez@icso.org; Fred Miramontes <fmiramontes@icso.org>; Donald Vargas - IID <DVargas@IID.com>; thagen@cityofelcentro.org; angelhernandez@cityofelcentro.org; Cedric Cesena <ccesena@cityofelcentro.org>; Eaton, Maurice A@DOT <maurice.eaton@dot.ca.gov>; Dodson, Kimberly@DOT <kimberly.dodson@dot.ca.gov>; Sanchez Rangel, Rogelio@DOT <roger.sanchez-rangel@dot.ca.gov>; marcuscuero@campo-nsn.gov; jmesa@campo-nsn.gov; historicpreservation@quechantribe.com; Quechan Indian Tribe <tribalsecretary@quechantribe.com>; byronfrontier@yahoo.com
Cc: Jim Minnick <JimMinnick@co.imperial.ca.us>; Michael Abraham <MichaelAbraham@co.imperial.ca.us>; Diana Robinson <DianaRobinson@co.imperial.ca.us>; Derek Newland <DerekNewland@co.imperial.ca.us>; John Robb <JohnRobb@co.imperial.ca.us>; Kamika Mitchell <kamikamitchell@co.imperial.ca.us>; Cassandra Castaneda

EEC ORIGINAL PKG

<kassandrastaneda@co.imperial.ca.us>; Laryssa Alvarado <laryssaalvarado@co.imperial.ca.us>; Rosa Soto <RosaSoto@co.imperial.ca.us>

Subject: RE: GPA22-0002/ZC22-0002/PM02499 Request for Comments

CAUTION: This email originated outside our organization; please use caution.

Hi Aimee,

No issue with the rezone, but I think this was a former gas station facility. So, when they apply for the permit to construct the facility, they should have done a Phase 1 Environmental investigation to determine if there is potential soil contamination at the property (if they have not already done so). Then a Phase 2 if the Phase 1 identifies anything.

Thanks,

Bob

From: Aimee Trujillo <aimeetrujillo@co.imperial.ca.us>

Sent: Thursday, September 21, 2023 1:04 PM

To: Antonio Venegas <AntonioVenegas@co.imperial.ca.us>; Jolene Dessert <JoleneDessert@co.imperial.ca.us>; Sanchez, Margo <margosanchez@co.imperial.ca.us>; Ashley Jauregui <AshleyJauregui@co.imperial.ca.us>; Belen Leon-Lopez <BelenLeon@co.imperial.ca.us>; Soucier, Monica@Imperial <monicasoucier@co.imperial.ca.us>; Jesus Ramirez <JesusRamirez@co.imperial.ca.us>; John Hawk <johnhawk@co.imperial.ca.us>; Miguel Figueroa <miguelfigueroa@co.imperial.ca.us>; Rosa Lopez <RosaLopez@co.imperial.ca.us>; Vanessa Ramirez <VanessaRamirez@co.imperial.ca.us>; Jeff Lamoure <JeffLamoure@co.imperial.ca.us>; Mario Salinas <MarioSalinas@co.imperial.ca.us>; Jorge Perez <JorgePerez@co.imperial.ca.us>; Alphonso Andrade <AlphonsoAndrade@co.imperial.ca.us>; Salvador Flores <SalvadorFlores@co.imperial.ca.us>; Robert Malek <RobertMalek@co.imperial.ca.us>; Ryan Kelley <rkelly@icso.org>; Andrew Loper <AndrewLoper@co.imperial.ca.us>; David Lantzer <davidlantzer@co.imperial.ca.us>; Carlos Yee <CarlosYee@co.imperial.ca.us>; John Gay <JohnGay@co.imperial.ca.us>; rbenavidez@icso.org; Fred Miramontes <fmiramontes@icso.org>; Donald Vargas - IID <DVargas@IID.com>; thagen@cityofelcentro.org; angelhernandez@cityofelcentro.org; Cedric Cesena <ccesena@cityofelcentro.org>; Eaton, Maurice A@DOT <maurice.eaton@dot.ca.gov>; Dodson, Kimberly@DOT <kimberly.dodson@dot.ca.gov>; Sanchez Rangel, Rogelio@DOT <roger.sanchez-rangel@dot.ca.gov>; Krug, Robert@DTSC <Robert.Krug@dtsc.ca.gov>; marcuscuero@campo-nsn.gov; jmesa@campo-nsn.gov; historicpreservation@quechantribe.com; Quechan Indian Tribe <tribalsecretary@quechantribe.com>; byronfrontier@yahoo.com

Cc: Jim Minnick <JimMinnick@co.imperial.ca.us>; Michael Abraham <MichaelAbraham@co.imperial.ca.us>; Diana Robinson <DianaRobinson@co.imperial.ca.us>; Derek Newland <DerekNewland@co.imperial.ca.us>; Aimee Trujillo <aimeetrujillo@co.imperial.ca.us>; John Robb <JohnRobb@co.imperial.ca.us>; Kamika Mitchell <kamikamitchell@co.imperial.ca.us>; Cassandra Castaneda <kassandrastaneda@co.imperial.ca.us>; Laryssa Alvarado <laryssaalvarado@co.imperial.ca.us>; Rosa Soto <RosaSoto@co.imperial.ca.us>

Subject: GPA22-0002/ZC22-0002/PM02499 Request for Comments

Good afternoon,

Please see attached Request for Comments packet for **GPA22-0002/ZC22-0002/PM02499**, APN **054-080-023** {Southeast Corner of HWY 111 and Ross Rd., El Centro} **Maverik, Inc.**

Comments are due by **October 5th 2023 at 5:00PM.**

In an effort to increase the efficiency at which information is distributed and reduce paper usage, the Request for Comments packet is being sent to you via this email.

Should you have any questions, please feel free to contact Derek Newland at (442) 265-1736, or submit your comment letters to ICPDScommentletters@co.imperial.ca.us.

EEC ORIGINAL PKG

Thank you,

Aimee Trujillo

Office Assistant III

Imperial County Planning & Development Services

801 Main Street

El Centro, CA 92243

(442) 265-1736

(442) 265-1735 (Fax)

aimeetrujillo@co.imperial.ca.us



EEC ORIGINAL PKG

APPLICATION

EEC ORIGINAL PKG



185 SOUTH STATE STREET
SUITE 800
SALT LAKE CITY, UT 84111
801-936-5557 | MAVERIK.COM

April 11, 2024

Derek Newland
County of Imperial
Planning and Development Services

Re: Maverik Fueling Station & Convenience Store - General Plan Amendment #22-0002, Zone Change #22-0002 and Parcel Map #02499

Derek,

This letter is to request a General Plan Amendment for the proposed Maverik Fueling Station & Convenience Store project at the SEC of Highway 111 and Ross Avenue.

- Zone Change to change zoning from A-2 (General Agricultural) to C-3 (Heavy Commercial).
- General Plan Amendment to change the project site's land use designation from "Agriculture" to "Urban Area"

The project site is zoned A-2 (General Agricultural) which is intended primarily for agricultural uses and related compatible uses. Fueling stations and convenience stores are not permitted within the A-2 zone. Therefore, Maverik is requesting a General Plan Amendment to change the land use designation from "Agriculture" to "Urban Area" and a change of zone from A-2 (General Agricultural) to C-3 (Heavy Commercial).

Sincerely,

A handwritten signature in blue ink, appearing to read "Kevin Deis".

Kevin Deis
Maverik
185 S State Street, Suite 800
Salt Lake City, UT 84111

EEC ORIGINAL PKG

CHANGE OF ZONE

I.C. PLANNING & DEVELOPMENT SERVICES DEPT.
801 Main Street, El Centro, CA 92243 (760) 482-4236

- APPLICANT MUST COMPLETE ALL NUMBERED (black & blue) SPACES - Please type or print -

1. PROPERTY OWNER'S NAME As noted in Schedule A attached.	EMAIL ADDRESS Charlietuna1929@gmail.com	
2. MAILING ADDRESS (Street / P O Box, City, State) 1066 Kimberly Woods Drive, El Cajon, CA	ZIP CODE 92020	PHONE NUMBER (619) 787-2329
3. ENGINEER'S NAME Farman Shirmohammadi	CA. LICENSE NO. C63868	EMAIL ADDRESS fshir@sdcollaborative.net
4. MAILING ADDRESS (Street / P O Box, City, State) 245 East 3 rd Street, Long Beach, CA	ZIP CODE 90802	PHONE NUMBER (714) 906-5739

5. ASSESSOR'S PARCEL NO. 054-080-023-000	ZONING (existing) A-2 (General Agricultural)	ZONING (proposed) C-3 (Heavy Commercial)
6. PROPERTY (site) ADDRESS Address not assigned.		SIZE OF PROPERTY (in acres or square foot) +/- 10 AC
7. GENERAL LOCATION (i.e. city, town, cross street) SEC Highway 111 and Ross Avenue, El Centro, CA 92243		
8. LEGAL DESCRIPTION As noted in Exhibit A attached.		

8. DESCRIBE CURRENT USE ON / OF PROPERTY (list and describe in detail) Vacant agricultural land.
9. PLEASE STATE REASON FOR PROPOSED USE (be specific) Maverik Fueling Station with Convenience Store
10. DESCRIBE SURROUNDING PROPERTY USES Agricultural uses.

I / WE THE LEGAL OWNER (S) OF THE ABOVE PROPERTY CERTIFY THAT THE INFORMATION SHOWN OR STATED HEREIN IS TRUE AND CORRECT.

CHARLES CIRALO 6-16-22
Print Name Date
[Signature]
Signature

REQUIRED SUPPORT DOCUMENTS

- A. SITE PLAN
- B. PRELIMINARY TITLE REPORT (6 months or newer)
- C. FEE
- D. OTHER

APPLICATION RECEIVED BY: _____	DATE _____	REVIEW / APPROVAL BY OTHER DEPT'S required.
APPLICATION DEEMED COMPLETE BY: _____	DATE _____	<input type="checkbox"/> P. W.
APPLICATION REJECTED BY: _____	DATE _____	<input type="checkbox"/> E. H. S.
TENTATIVE HEARING BY: _____	DATE _____	<input type="checkbox"/> A. P. C. D.
FINAL ACTION: <input type="checkbox"/> APPROVED <input type="checkbox"/> DENIED	DATE _____	<input type="checkbox"/> O. E. S.
		<input type="checkbox"/> _____
		<input type="checkbox"/> _____

ZC #

EEC ORIGINAL PKG

MINOR SUBDIVISION

I.C. PLANNING & DEVELOPMENT SERVICES DEPT
801 Main Street, El Centro, CA 92243 (760) 482-4236

- APPLICANT MUST COMPLETE ALL NUMBERED (black) SPACES - Please type or print -

1. PROPERTY OWNER'S NAME As noted in Schedule A attached.	EMAIL ADDRESS Charlietuna1929@gmail.com	
2. MAILING ADDRESS 1066 Kimberly Woods Drive, El Cajon, CA	ZIP CODE 92020	PHONE NUMBER (619) 787-2329
3. ENGINEER'S NAME Farman Shirmohammadi	CAL. LICENSE NO. C63868	EMAIL ADDRESS fshir@sdcollaborative.net
4. MAILING ADDRESS 245 East 3rd Street, Long Beach, CA	ZIP CODE 90802	PHONE NUMBER (714) 906-5739
5. PROPERTY (site) ADDRESS Address not assigned.	LOCATION SEC Highway 111 and Ross Avenue, El Centro, CA 92243	
6. ASSESSOR'S PARCEL NO. 054-080-023-000	SIZE OF PROPERTY (in acres or square foot) +/- 50.28 AC	
7. LEGAL DESCRIPTION (attach separate sheet if necessary) As noted in Exhibit A attached.		
8. EXPLAIN PURPOSE/REASON FOR MINOR SUBDIVISION Construction of a +/- -5,982 SF Maverik Fueling Fueling Station with Convenience Store.		

9. Proposed DIVISION of the above specified land is as follows:

PARCEL	SIZE in acres or sq. feet	EXISTING USE	PROPOSED USE	ZONE
1 or A		Agricultural	Commercial	C-3 (Proposed)
2 or B				
3 or C				
4 or D				

PLEASE PROVIDE CLEAR & CONCISE INFORMATION (ATTACH SEPARATE SHEET IF NEEDED)

10. DESCRIBE PROPOSED SEWER SYSTEM(s)	Sewer Treatment Plant
11. DESCRIBE PROPOSED WATER SYSTEM	Water Treatment Plant
12. DESCRIBE PROPOSED ACCESS TO SUBDIVIDED LOTS	Access drive along Ross Avenue.
13. IS THIS PARCEL PLANNED TO BE ANNEXED?	IF YES, TO WHAT CITY or DISTRICT?
<input type="checkbox"/> Yes <input checked="" type="checkbox"/> No	

I HEREBY APPLY FOR PERMISSION TO DIVIDE THE ABOVE SPECIFIED PROPERTY THAT I OWN CONTROL, AS PER ATTACHED INFORMATION, AND PER THE MAP ACT AND PER THE SUBDIVISION ORDINANCE.

I, CERTIFY THAT THE ABOVE INFORMATION, TO THE BEST OF MY KNOWLEDGE, IS TRUE AND CORRECT.

CHARLES CIRACHO 6-16-22
Print Name (owner) Date

[Signature]
Signature (owner)

Print Name (Agent) Date

Signature (Agent)

REQUIRED SUPPORT DOCUMENTS

- A. TENTATIVE MAP
- B. PRELIMINARY TITLE REPORT (6 months or newer)
- C. FEE _____
- D. OTHER _____

Special Note:
An notarized owners affidavit is required if application is signed by Agent.

APPLICATION RECEIVED BY: _____	DATE _____	REVIEW / APPROVAL BY OTHER DEPT'S required.
APPLICATION DEEMED COMPLETE BY: _____	DATE _____	<input type="checkbox"/> P. W.
APPLICATION REJECTED BY: _____	DATE _____	<input type="checkbox"/> E. H. S.
TENTATIVE HEARING BY: _____	DATE _____	<input type="checkbox"/> A. P. C. D.
FINAL ACTION: <input type="checkbox"/> APPROVED <input type="checkbox"/> DENIED	DATE _____	<input type="checkbox"/> O. E. S.
		<input type="checkbox"/> _____
		<input type="checkbox"/> _____

PM#

EEC ORIGINAL PKG

Project Location

The site is located at the southeast intersection of Hawes Road and Ross Avenue, just east of State Route 111 (SR-111), within the unincorporated boundaries of Imperial County, California.

Maverik is proposing to develop 10 acres of a 50.28-acre site (APN#054-080-023) as depicted on the project plans. The remaining area south and east of the proposed development would remain vacant.

The western edge is bordered by an Imperial District Irrigation (IID) drainage canal, with Hawes Road skirting the site to the west and SR-111 just beyond. Surrounding landscapes to the south and east predominately feature agricultural and undeveloped land, while Ross Avenue bounds the northern side. Past Ross Avenue lies another IID water canal and farmland.

Project Description

Characterized by a mild westward gradient (0 to 2% slopes), the groundwater in the region follows the same westward flow. The site's soil is primarily Melolo and very fine sandy loam. It is located within Zone X, areas of minimal flood risks and contains no wetlands.

Maverik is proposing the construction of a new fueling station consisting of 18 fuel pumps, fuel islands, canopies, a truck scale, underground fuel storage tanks and a 5,982 square foot convenience store building which will include alcohol and tobacco sales. Signage will include a 24' pylon sign with 200 square feet, a 6' monument sign with 48 square feet and a Freeway pylon sign. Excavations up to eighteen (18') feet below ground surface (bgs) are anticipated for the installation of underground fuel tanks.

The applicant also proposes associated site improvements, including parking, landscaping, street improvements, and utilities.

Ross Avenue, a two-lane undivided roadway, offers three primary access driveways to the project.

Electric service would be provided to the project site by the Imperial Irrigation District. Water service will be provided from an Imperial Irrigation District drainage canal. A water treatment system will be required in conjunction with the project. Sewer service is not available at the project site. A package Wastewater Treatment Plant will be required due to existing soil conditions in the area. Natural gas service is not available at the project site; propane is proposed.

The project will require the following approvals from Imperial County for the proposed use:

- A General Plan Amendment from an Agriculture use to a Commercial use
- Change of Zone from A-2 (General Agricultural) to C-3 (Heavy Commercial)
- Tentative Map & Final (to create the +/- 10-acre parcel)
- Site Plan Review
- CEQA

The project will require the following approvals from the Imperial County Irrigation District for the proposed use:

- A Water Supply Development Report
- Water Supply Agreement

Operations

The Maverik Fueling station and convenience store will provide round-the-clock service all year long, employing about fifteen staff across varied shifts.

California Department of Transportation

DISTRICT 11
4050 TAYLOR STREET, MS-240
SAN DIEGO, CA 92110
(619) 709-5152 | FAX (619) 688-4299 TTY 711
www.dot.ca.gov



June 22, 2022

11-IMP-111

PM 8.2

Maverik Convenience Store with Fueling
May 2022 Site Plan Review

Mr. Kevin Deis
Entitlement Manager
185 South State Street, Suite 800
Salt Lake City, UT 84111

Dear Mr. Deis:

Thank you for including the California Department of Transportation (Caltrans) in the review process for the proposed gas station project located near State Route 111 (SR-111) and Ross Ave. The mission of Caltrans is to provide a safe and reliable transportation network that serves all people and respects the environment. The Local Development Review (LDR) Program reviews land use projects and plans to ensure consistency with our mission and state planning priorities.

Caltrans has the following comments:

Traffic Analysis

A Vehicle Miles of Travel (VMT) based Traffic Impact Study (TIS), and Mobility Analysis should be provided for this project. Please use the Governor's Office of Planning and Research Guidance to identify VMT related impacts.¹

The TIS may also need to identify the proposed project's near-term and long-term safety or operational issues, on or adjacent to any existing State facilities.

Right-of-Way

Hawes Road is not part of the Caltrans right of way (R/W). However, please be aware of the close proximity to state R/W and Imperial Irrigation District (IID) facilities. Additional analysis would be required if direct access to the proposed project is proposed via Hawes Road. Please see attached right of way documents for reference.

¹ California Governor's Office of Planning and Research (OPR) 2018. "Technical Advisory on Evaluating Transportation Impacts in CEQA." http://opr.ca.gov/docs/20190122-743_Technical_Advisory.pdf

"Provide a safe and reliable transportation network that serves all people and respects the environment"

Mr. Kevin Deis
June 22, 2022

Per Business and Profession Code 8771, perpetuation of survey monuments by a licensed land surveyor is required, if they are being destroyed by any construction.

Any work performed within Caltrans' Right of Way (R/W) will require discretionary review and approval by Caltrans. As part of the encroachment permit process, the applicant must provide an approved final environmental document, corresponding technical studies, and necessary regulatory and resource agency permits, specifically, any CEQA determinations or exemptions.

If you have any questions or concerns, please contact Roger Sanchez, LDR Coordinator, at (619) 987-1043 or by e-mail sent to roger.sanchez-rangel@dot.ca.gov.

Sincerely,

Maurice A. Eaton

MAURICE EATON
Branch Chief
Local Development Review

Attachments: - R15090 Map
 - R15090 RecRes
 - Right of Way Map SR-111.Ross



IID

A century of service.

www.iid.com

Since 1911

February 23, 2022

Mr. Kevin Deis
Maverik, Inc.
185 South State Street, Suite 800
Salt Lake City, UT 84111

Subject: Water Supply Request for Maverik El Centro Project

Dear Mr. Deis:

This letter is in response to your February 9, 2022 request for an annual water supply of 4.5 acre-feet for the proposed gas station, drive-thru restaurant and convenience store project proposed to be located at the southeast corner of Highway 111 and Ross Road, having Assessor Parcel No. 054-080-023. Some project facilities include water storage tanks for fire suppression and a proposed water treatment plant. Maverik, Inc., proposes to receive water from the Acacia Lateral 5A, Gate ACA_51G in an unincorporated area of Imperial County, within the IID water service area.

This letter may serve as evidence of the intention of IID to supply raw Colorado River water to this project as provided for under IID's Interim Water Supply Policy for Non-Agricultural Projects that was adopted in September 2009 (see www.iid.com/iwsp). IID water for the proposed project may be delivered from the Acacia Lateral 5A, Gate ACA_51G noted above to an onsite raw water pond or other water storage facility that must provide a minimum water supply storage capacity of six days. The requested 4.5 acre-feet of annual operational water is well within the remaining balance of 23,800 acre-feet of water available for new non-agricultural uses as designated by the IWSP.

IID has, or will have, sufficient physical capacity to provide water to the project under the above-referenced conditions. To the extent that modifications to the IID delivery system are required for the project to achieve such capacity, determined through consultations with the Water Department's Engineering Section, Maverik, Inc., will be required to fund such work. The use of existing agricultural drainage facilities to handle the surface and subsurface runoff from the project is similarly not a topic of this response and must also be approved separately through the Water Department's Engineering Section.

EEC ORIGINAL PKG

Mr. Kevin Deis
February 23, 2022
Page 2

In order to obtain a water supply from IID for the project, Maverik, Inc., will be required to comply with all applicable IID policies and regulations and must enter into a water supply agreement with the IID. Such policies and regulations require, among other things, that all potential environmental and water supply impacts of the project be adequately assessed, suitable mitigation developed and implemented as warranted, and adoption of appropriate conditions by the relevant land use permitting/approving agencies.

As noted above, water will be supplied to this project in accordance with the IWSP. In order to qualify for a water supply under the IWSP, Maverik, Inc., will be required to meet standards for water use efficiency and best management practices, as well as other water use efficiency standards, adopted by IID or local government agencies. Maverik, Inc., at its sole cost, shall construct, install, and maintain a water metering device reasonably acceptable to IID at the connection with the canal (or other location that is acceptable to both parties) that is annually calibrated and certified in accordance with good industry practices. Onsite water storage may also be required to ensure water supply reliability. These and other requirements will be determined through the engineering and water supply contracting processes described above.

The previously provided checklist of submittal requirements for IWSP compliance continues to be in effect. Please forward to my attention copies of the project's recorded Conditional Use Permit and CEQA upon completion. I may be contacted at (760) 339-9085 or jgamboaarce@iid.com should you have any questions regarding this communication or the water supply process.

Sincerely,

Justina Gamboa-Arce
Water Resources Planner

cc: Tina Shields, Water Manager
Ismael Gomez, Water Assistant Manager/Chief Engineer

EEC ORIGINAL PKG

EEC ORIGINAL PKG

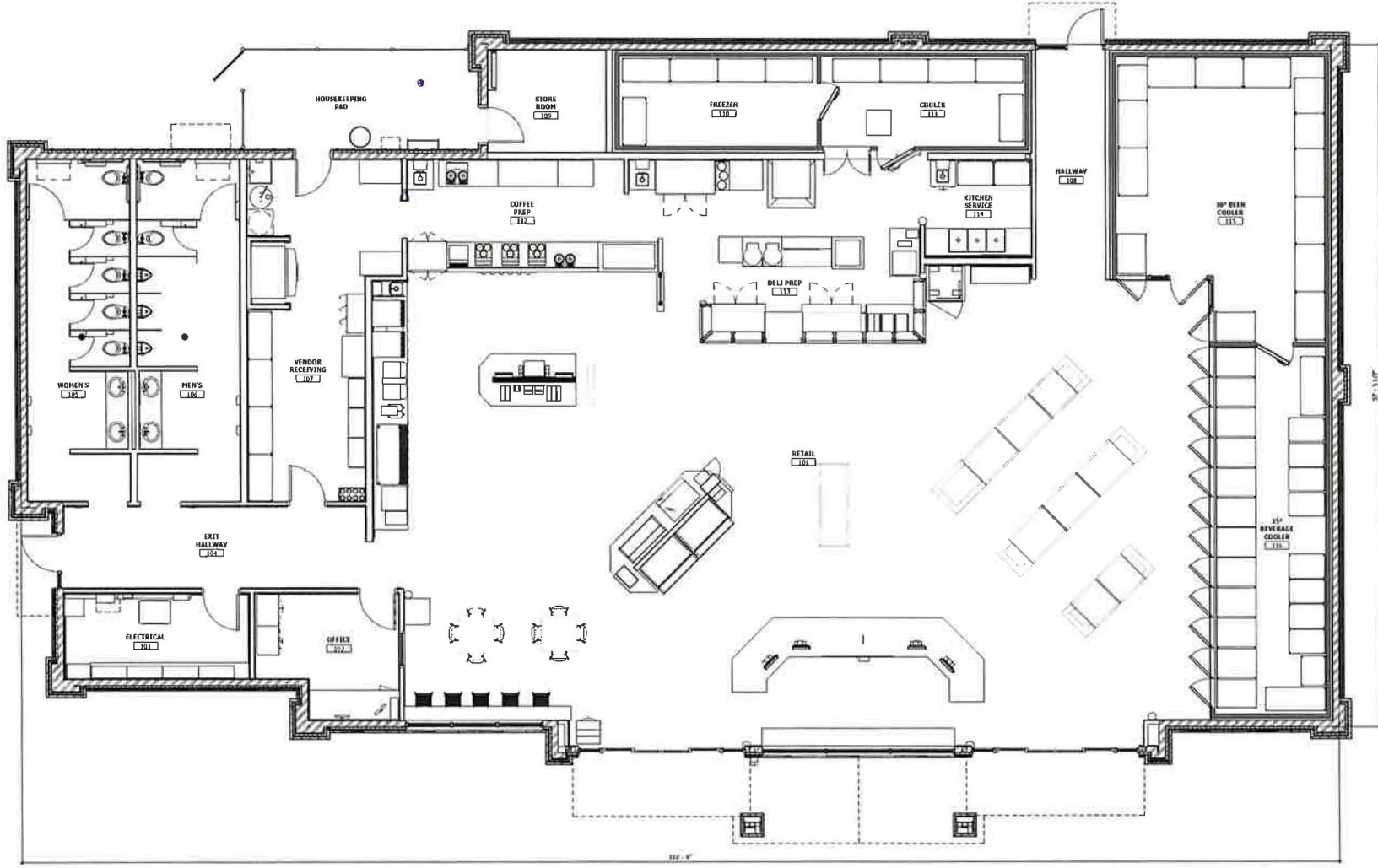

1 FLOOR PLAN
SCALE: 1/4" = 1'-0"

PROPOSED MAVERIK C-STORE

Prototype Version: 60_L_RR_2102
Building Square Footage: 5,982 SF
Construction Type/Occupancy Classification: V-B / M

A-1 | FLOOR PLAN



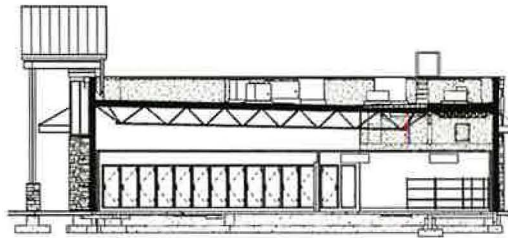

3 BUILDING SECTION
SCALE: 1/8" = 1'-0"

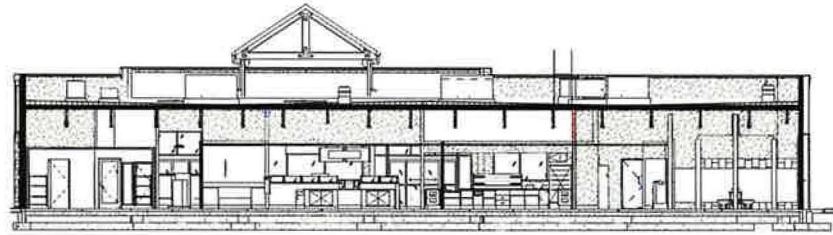

2 BUILDING SECTION
SCALE: 1/8" = 1'-0"

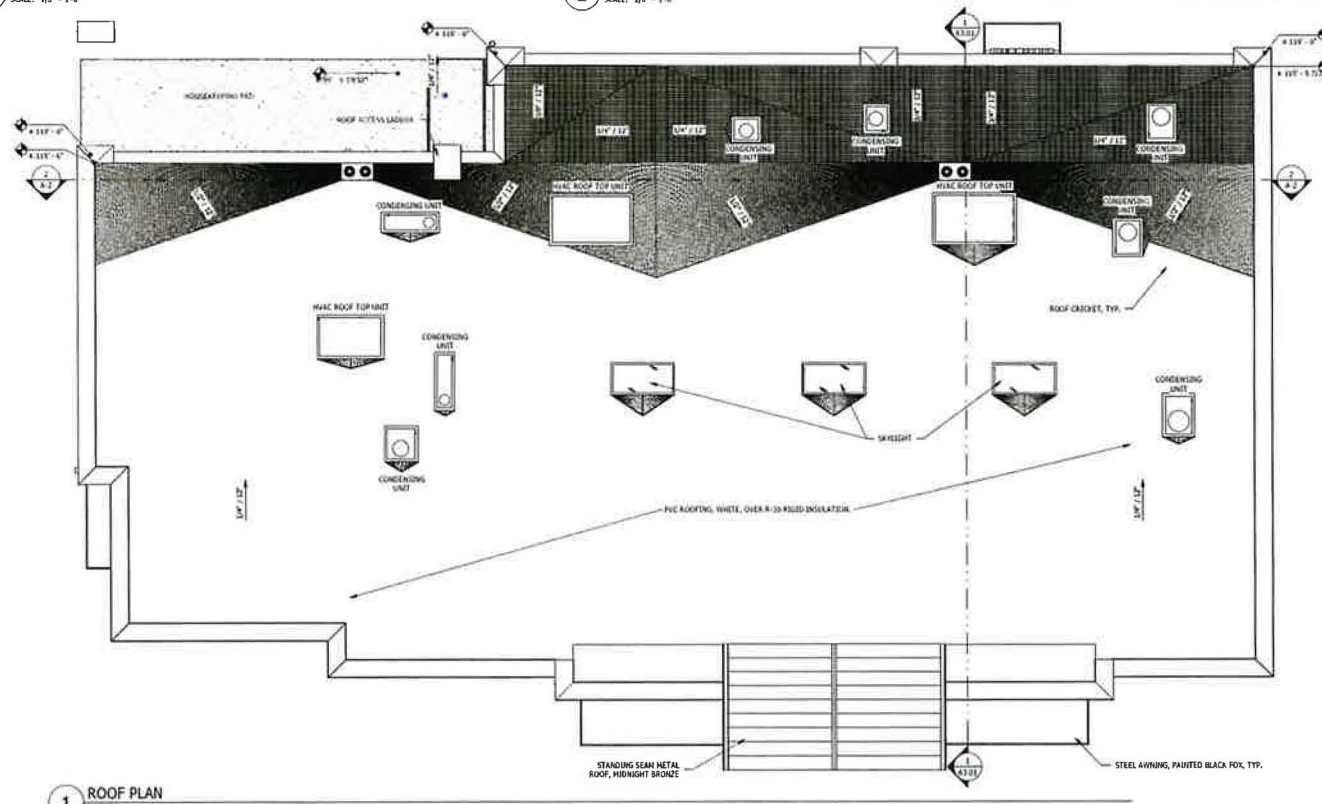

EEC ORIGINAL PKG

PROPOSED MAVERIK C-STORE

Prototype Version: 60_L_RR_2102
 Building Square Footage: 5,982 SF
 Construction Type/Occupancy Classification: V-B / M

A-2 | ROOF PLAN





2 FRONT PERSPECTIVE - FRONT LEFT
SCALE



1 BUILDING PERSPECTIVE - FRONT RIGHT
SCALE

EEC ORIGINAL PKG

PROPOSED MAVERIK C-STORE

Prototype Version: 60_L_RR_2102
 Building Square Footage: 5,982 SF
 Construction Type/Occupancy Classification: V-B / M

A-3 | PERSPECTIVE VIEWS



KEYED NOTES

- 04-05 CURB-TURNED STONE VENEER, SPLITLINE, CORNER & LEDGESTONE
- 04-06 CULTURED STONE VENEER CAP, SPLITLINE, CORNER & LEDGESTONE
- 05-01 FIBER-FINISHED GUTTER AND DOWNSPOUT, WHITE ALU.
- 05-05 MICH FINE FINISHED ROOF, COLOR C-1, 1/2" STANDING SEAM
- 05-21 FINE FINISHED METAL CEILING, COLOR MICHIGAN SPICAZ
- 05-69 STEEL AWNING, COLOR F-9
- 06-24 FIBER CEMENT BOARD & BATTEN SIDING, DR-2
- 06-55 FIBER CEMENT BOARD & BATTEN SIDING, DR-1
- 06-56 FIBER CEMENT TRIM DR-3
- 06-59 HORIZONTAL ROOF TO SIDING
- 08-82 ALUMINUM STOREFRONT SYSTEM, DARK BRONZE
- 08-85 WINDOW, SEE SCHEDULE
- 10-01 R/OP W/ FEELS AND/OR W/ SECURITY FATE, SEE DETAIL 1/AS-11. POWDER COATED COLOR TO MATCH SIDING DR-1
- 32-01 CHAIN LINK FENCE WITH PRIVACY SLATS. COLOR TO MATCH BUILDING FIELD COLOR



2 LEFT ELEVATION
SCALE: 1/4" = 1'-0"



FRONT ELEVATION
SCALE: 1/4" = 1'-0"

ECC ORIGINAL PKG

PROPOSED MAVERIK C-STORE

Prototype Version: 60_L_RR_2102
 Building Square Footage: 5,982 SF
 Construction Type/Occupancy Classification: V-B / M

A-4 | EXTERIOR ELEVATIONS



KEYED NOTES

- 04.05 CULTURED STONE VENEER, SPYHOLE, COUNTRY LEDGESTONE
- 04.06 CULTURED STONE VENEER GAB, SKYLARK, COUNTRY LEDGESTONE
- 05.01 PINE FINISHED GUTTER AND DOWNPOUT, BRATE RED
- 05.02 PAINTED STEEL, BLACK POW
- 05.06 MBCI P.E. FINISHED METAL ROOF, 1 1/4" STANDING SEAM, HIGHLIGHT BRONZE
- 05.21 PINE FINISHED METAL COLUMN, CLEAR PIGMENT GLAZE
- 06.08 STEEL HANDING, COLOUR P-8
- 06.04 FIBER CEMENT BOARD & BATTEN CEILING, BR-2
- 06.05 FIBER CEMENT BOARD & BATTEN CEILING, BR-3
- 06.06 FIBER CEMENT TYSB BR-3
- 06.39 HORIZONTAL JOINT ON TISSING
- 10.01 ROOF ACCESS LADDER W/ SECURITY GATE, SEE DETAIL IAS-11, POWDER COATED COLOR TO MATCH SIDING BR-1
- 22.01 ROOF OVERFLOW DRAIN SLUICER, SEE PLUMBING DRAWINGS



2 RIGHT ELEVATION
SCALE: 1/4" = 1'-0"

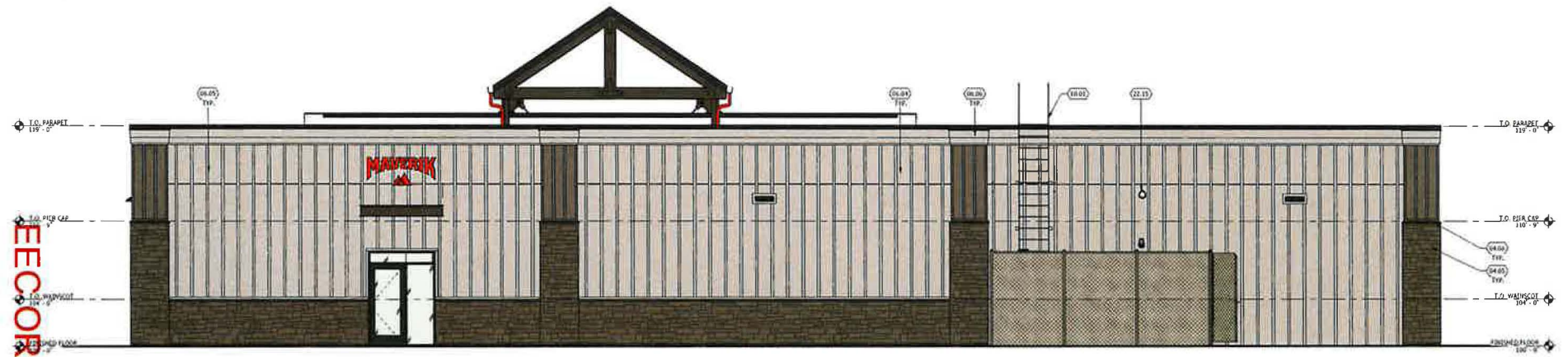

1 REAR ELEVATION
SCALE: 1/4" = 1'-0"

PROPOSED MAVERIK C-STORE

ECCO ORIGINAL PKG

Prototype Version: 60_L_RR_2102
 Building Square Footage: 5,982 SF
 Construction Type/Occupancy Classification: V-B / M

A-5 | EXTERIOR ELEVATIONS



EEC ORIGINAL PKG

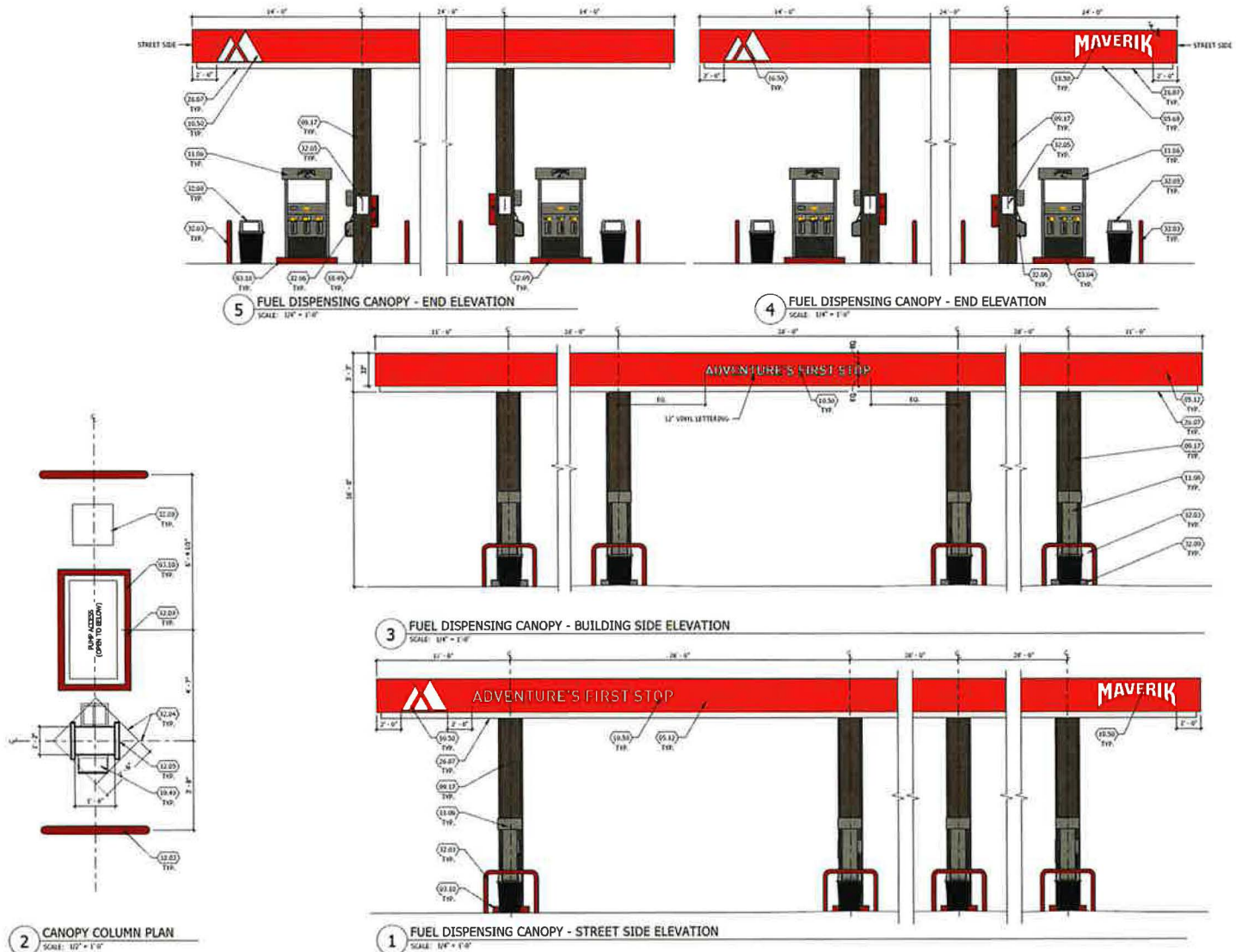

- KEYED NOTES**
- 83.04 REINFORCED CONCRETE FGD
 - 83.05 4" MIN. BASED CONCRETE ISLAND W/ TOUNDED EDGES AND CORNERS. VERIFY SIZE W/ DISPENSER SUPPLIER. 11" MIN. HIGH METAL FRAME. ACCESSIBLE ISLAND TO BE 4". SEE CIVIL DRAWING FOR LOCATION
 - 83.12 ALUMINUM COMPOSITE METAL PANEL, GALVANNEED
 - 83.04 ALUMINUM COMPOSITE METAL PANEL, WHITE
 - 83.17 FRAME COLUMN CLADDING, COLOR TO MATCH P-5
 - 83.04 4" MIN. BC FINE CERTIFIED/BLACK W/ CASE. LOCATE WITHIN 75' OF ALL PUMPS, DISPENSERS, OR STORAGE TANK. LOCATION TO BE FINALIZED BY FASE MANUAL
 - 83.04 SIGNAGE TO BE COORDINATED BY FUEL CANOPY CONTRACTOR WITH OWNER DISPENSING STATION (BY OTHERS)
 - 83.04 ALL LIGHT FIXTURES (NOT SHOWN) TO BE FLUSH MOUNTED WITHIN THE DECK PANEL. SOFFIT (SOFFIT COLOR P-7). SEE ELECTRICAL AND FUEL DISPENSING DRAWINGS
 - 83.04 4" SQUARE "V" BOLLARD, SET AND FILLED W/ CONCRETE, SEE CIVIL DRAWINGS. PAINTED P-4
 - 83.04 EXPANSION JOINTS, TO BE FILLED W/ SET FIRE RESISTANT SEALANT, SEE CIVIL DRAWINGS
 - 83.04 SIGNAGE, BY OWNER, TO BE COORDINATED WITH FASE AND POSTED ON EACH SIDE OF COLUMN
 - 83.04 S.L.L. (WINDOWN WASH/PAPER TOWEL) PROVIDED BY OWNER. INSTALLED BY CONTRACTOR. HOOKED TO COLUMN PER IGA REQUIREMENTS (4" MAX A.P.F. TO PAPER TOWEL FOLD)
 - 83.04 TRASH CONTAINER, PROVIDED BY OWNER
 - 83.04 PAINT CONCRETE CURB EDGE P-4, SEE SCHEDULE ON SHEET A5.03

PROPOSED MAVERIK C-STORE

NOTE:
FUEL CANOPY DRAWINGS PROVIDED ARE CONCEPTUAL, AND MAY VARY FROM SITE TO SITE.

Prototype Version: 60_L_RR_2102
 Building Square Footage: 5,982 SF
 Construction Type/Occupancy Classification: V-B / M

A-6 | CANOPY ELEVATIONS





BB-1 Fiberboard -
Worldly Gray

BB-2 Fiberboard -
Gauntlet Gray

BB-3 Fiberboard -
Worldly Gray

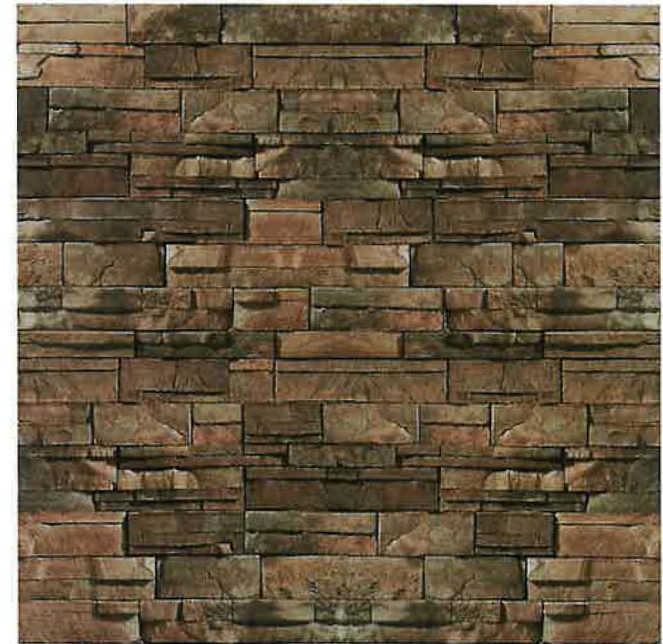

Cultured Stone - Skyline, Country Ledgestone



C-1 MBCI Midnight Bronze



C-2 MBCI Brite Red



Anodized - Dark Bronze



Paint - Black Fox

EEC ORIGINAL PKG

PROPOSED MAVERIK C-STORE

Prototype Version: 60_L_RR_2102
 Building Square Footage: 5,982 SF
 Construction Type/Occupancy Classification: V-B / M

A-7 | EXTERIOR MATERIALS BOARD

