

Appendices

Appendix 1

Transportation Memorandum and
LADOT Approval



MEMORANDUM

TO: Wes Pringle, LADOT

FROM: Pat Gibson
Jonathan Chambers
Lauren Mullarkey-Williams

DATE: November 29, 2021

RE: Design of Sunset & Beaudry
1111 Sunset Mixed-Use Project

Ref: J1388

This memo represents a supplemental report to the 1111 Sunset Boulevard Mixed-Use Project EIR¹. The memo deals with the updated design of the intersection of Sunset & Beaudry on the southeast corner of the proposed development. The Draft Environmental Impact Report (DEIR) contained a proposed re-design of the intersection (Modified Design) which has now been reviewed and modified by the Los Angeles Department of Transportation (LADOT) Design Division. This memo presents the Modified Design and the performance metrics for that Modified Design.

DESIGN PROPOSAL

DEIR Design

Alterations to the design of the intersection of Sunset & Beaudry were proposed as part of the analysis of the Project traffic impacts. The biggest change proposed for the intersection involved the elimination of the SB to WB channelized right turn slot which was eliminated because of its potential negative impact on pedestrian flow and pedestrian safety.

The channelized right turn slot was eliminated from the DEIR design and the SB to WB right turn movement was incorporated into the southbound lanes of the intersection. The north leg of the intersection included three southbound lanes (one left turn lane, one through lane and one right turn lane) and one lane to serve northbound through traffic.

¹ *Transportation Assessment for the 1111 Sunset Boulevard Mixed-Use Project*, Gibson Transportation Consulting, Inc. October 2020

The south leg of the intersection was proposed to be restriped to include one southbound through lane and two northbound lanes (one left turn lane and one optional through and right turn lane). The east and west legs of the intersection remain as they exist today.

Modified Design

Upon review of the design proposed in the DEIR, LADOT Design Division made some minor changes to the design, primarily to facilitate large truck turns through the intersection. Figure 1A shows the Modified Design suggested by LADOT.

In the southeast corner of the intersection, a larger curb radius was developed that would allow northbound trucks to turn right onto EB Sunset without encroaching into the westbound Sunset lanes. The center lane on the south leg was narrowed slightly to allow wider curb lanes to facilitate truck turns to/from Sunset Boulevard.

The north leg of the intersection had the most changes. The northbound lane was widened and the stop line was shifted to the north a few feet to give trucks turning from Sunset Boulevard more room to make the turn. The three southbound lanes were shifted and realigned to increase the storage length of the lanes. The storage length of the right turn lane was increased the most because the SB lane will likely operate under a No Right Turn on Red restriction due to the sight distance limitation caused by the location of the existing building on the northeast corner of the intersection.

Figures 1B and 1C show the tests of the truck turning movements from each leg of the intersection.

INTERSECTION PERFORMANCE

Tables 1 and 2 show the results of the intersection capacity calculations presented in the DEIR (for each Project land use alternative) as compared to the performance of the modified intersection design presented in Figure 1A.

Under Future without Project conditions, the intersection of Sunset & Beaudry and the intersection of Sunset & White Knoll both operate acceptably in the morning and poorly in the evening. Sunset & White Knoll is controlled by side street stop signs in this test which explains its poor performance.

The Project intends to signalize the intersection of Sunset & White Knoll which results in a LOS B performance in both peak hours under both Project land use alternatives. As reported in the

DEIR, the previous design for Sunset & Beaudry operated at LOS E and F in the AM and PM peak hours, respectively, with the Project in place.

It is not likely that two intersections so close to one another, especially ones that are connected by a circular roadway and ones that serve the same neighborhoods and land uses, would operate so differently in the peak hours. Repeat travelers like neighborhood residents would tend to avoid the congested intersection and use the less congested intersection at least until their overall performance evened out to a closer operational level.

Under the third set of capacity calculations, reflecting the Modified Design, some local trips shift away from the congestion at Beaudry and toward the White Knoll intersection until the White Knoll operates at LOS C in the peak hours and Beaudry operates at LOS E or a LOS F with delays that are comparable to the previous intersection design reported in the DEIR.

QUEUING

The queue lengths at the Sunset & Beaudry intersection were tested and two turn maneuvers exceeded their turn pocket lengths during either the morning or afternoon peak hours at the intersection.

The southbound Beaudry right turn onto westbound Sunset exceeds its 90-foot turn pocket under Future without Project conditions, but both the DEIR design and the Modified Design can accommodate the right turns without backing up into the adjacent through lane.

The eastbound Sunset to southbound Beaudry right turn requires a long queue in the morning peak hour when Beaudry is used as a route into Downtown Los Angeles. The right lane on eastbound Sunset is reserved for buses and right turns only so there is room to accommodate a long right turn queue. The right turn queue will extend along the Bus Only lane further under the Modified Design as a result of signal timing changes at the intersection, but in no case will the right turn queue block the eastbound through lane.

SUMMARY

The intersection of Sunset & Beaudry under the Modified Design format suggested by LADOT will serve pedestrians better as a result of the elimination of the SB to EB channelized right turn slot.

The signalization of the intersection at Sunset & White Knoll (which is part of the Project's proposed transportation improvements) allows local traffic to distribute itself and balance the performance between the two nearby traffic signals.

The modifications suggested by the LADOT Design Division result in overall intersection performance similar to the levels associated with the previous intersection design as shown in the DEIR.

The benefits of the reconfigured intersection, including the Modified Design are summarized as follows:

- The addition of north-south left turn lanes from Beaudry provides clearer definition to accommodate a very heavy northbound left turn movement.
- Control of the north-south left turns from Beaudry with separate protected signal phases will increase the safety of intersection operations.
- The intersection will be better organized overall with more positive vehicular and pedestrian traffic control.
- The elimination of the existing separate right turn channelized roadway from SB Beaudry to WB Sunset will increase pedestrian safety by eliminating the need to cross the north-south movements and then cross the additional right turn roadway.
- Folding the SB Beaudry to WB Sunset right turn movement back into the intersection will reduce the speed of the right turn movements thereby increasing pedestrian and vehicular safety.
- Pedestrian safety is also enhanced by the requirement that the SB right turn from Beaudry to Sunset is signed No Right Turn On Red.
- The intersection reconfiguration allows the Uber/Lyft pick-up/drop-off activities to be accommodated off-street in the Project's transportation center.
- The Project's signalization of Sunset and White Knoll as part of the 1111 Sunset Project will allow project and neighborhood traffic to shift away from the Sunset/Beaudry intersection and enter/leave the project and the neighborhood using White Knoll. This would be especially helpful in reducing SB traffic on Beaudry.

LEGEND

- 1. = EXISTING STRIPING & MARKINGS TO REMAIN.
- 2. = EXISTING STRIPING & MARKINGS TO BE REMOVED.
- 3. = PROPOSED STRIPING & MARKINGS.
- 4. = SIGNALIZED INTERSECTION.
- 5. = EXISTING RED CURB MARKINGS TO REMAIN.
- 6. = EXISTING RED CURB MARKINGS TO BE REMOVED.
- 7. = PROPOSED RED CURB MARKINGS.

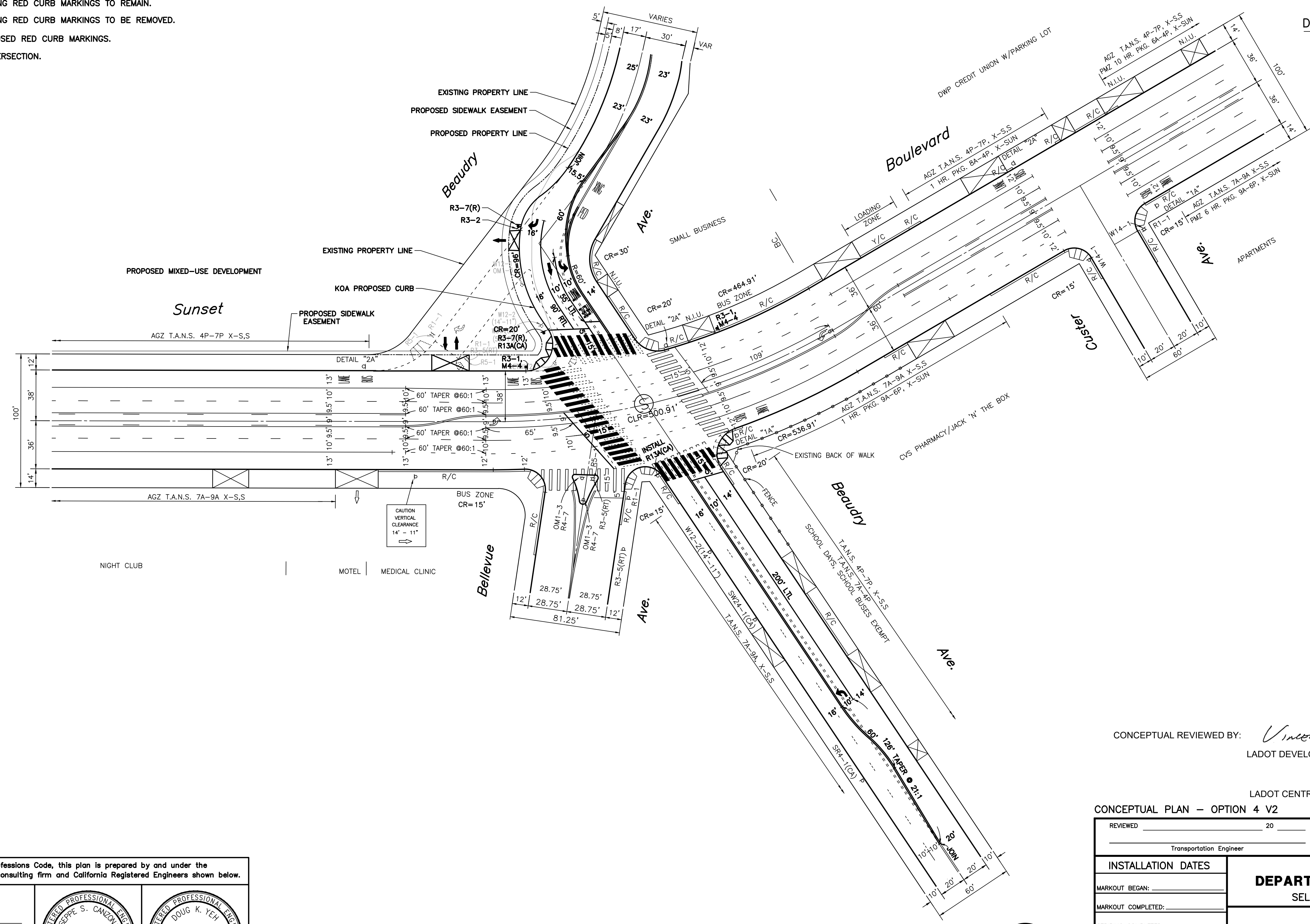
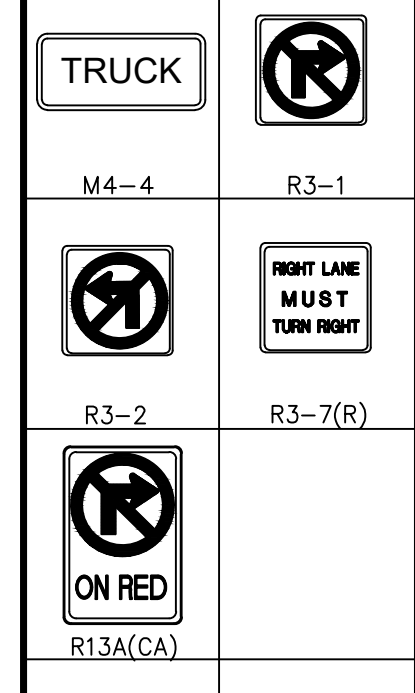

CONCEPTUAL REVIEWED BY: *Vincent Chen* 11/18/21
 LADOT DEVELOPMENT PLAN REVIEW SECTION
 11/24/21
 LADOT CENTRAL DISTRICT OFFICE

CONCEPTUAL PLAN - OPTION 4 V2

REVIEWED	20	ACCEPTED	20
Transportation Engineer		Senior Transportation Engineer	
INSTALLATION DATES		CITY OF LOS ANGELES	
MARKOUT BEGAN:		DEPARTMENT OF TRANSPORTATION	
MARKOUT COMPLETED:		SELETA J. REYNOLDS, GENERAL MANAGER	
STRIPING COMPLETED:		BEAUDRY AVENUE AT SUNSET BOULEVARD	
District		IF THIS PLAN HAS NOT BEEN IMPLEMENTED WITHIN TWO (2) YEARS OF THE ACCEPTANCE DATE, IT MUST BE RESUBMITTED TO LADOT PERMIT PLAN REVIEW SECTION FOR REVIEW AND MAY REQUIRE A SUBSEQUENT ACCEPTANCE.	
References: A-6267		PROJECT NO.	DRAWING NO.
			1/3

Pursuant to the California Business and Professions Code, this plan is prepared by and under the responsible charge of work of, the named consulting firm and California Registered Engineers shown below.

Plan Prepared By: **KOA** Date: _____

KOA CORPORATION BUSINESS TAX REGISTRATION NO.: 0000371566-0001-7

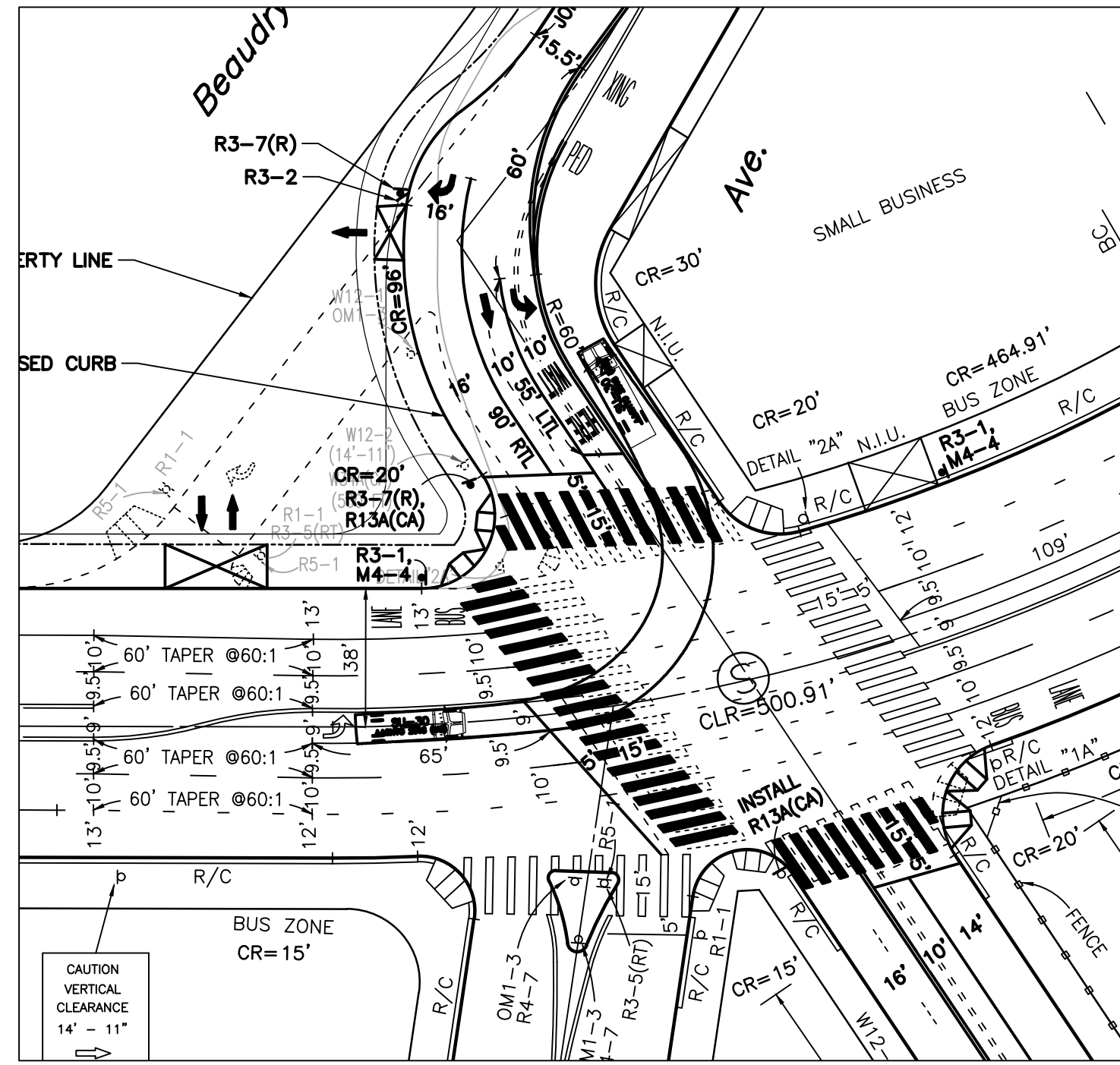

SU-30 TURNING TEMPLATE
NO SCALE

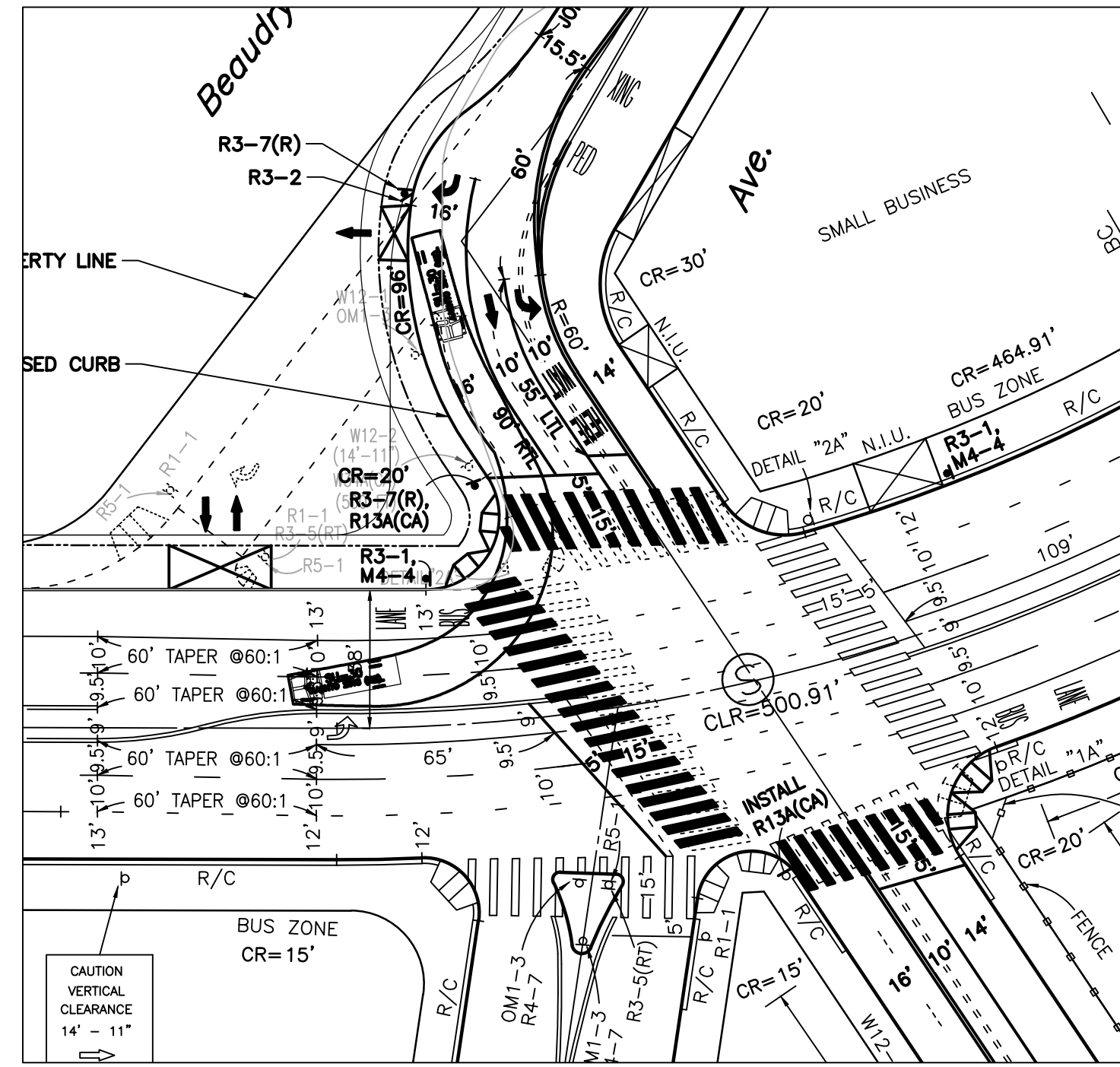

SU-30 TURNING TEMPLATE
NO SCALE

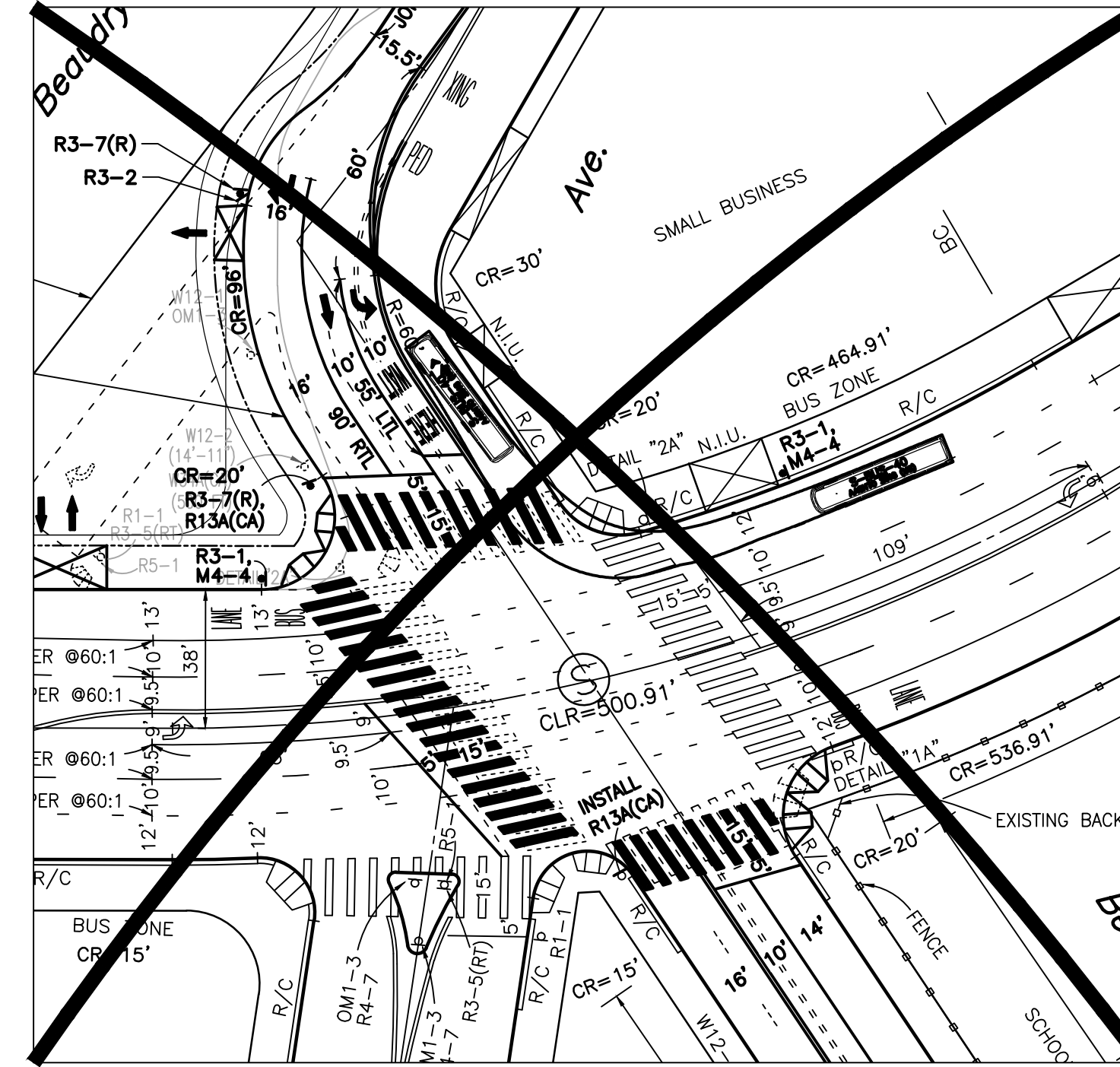

S-BUS-40 TURNING TEMPLATE
NO SCALE

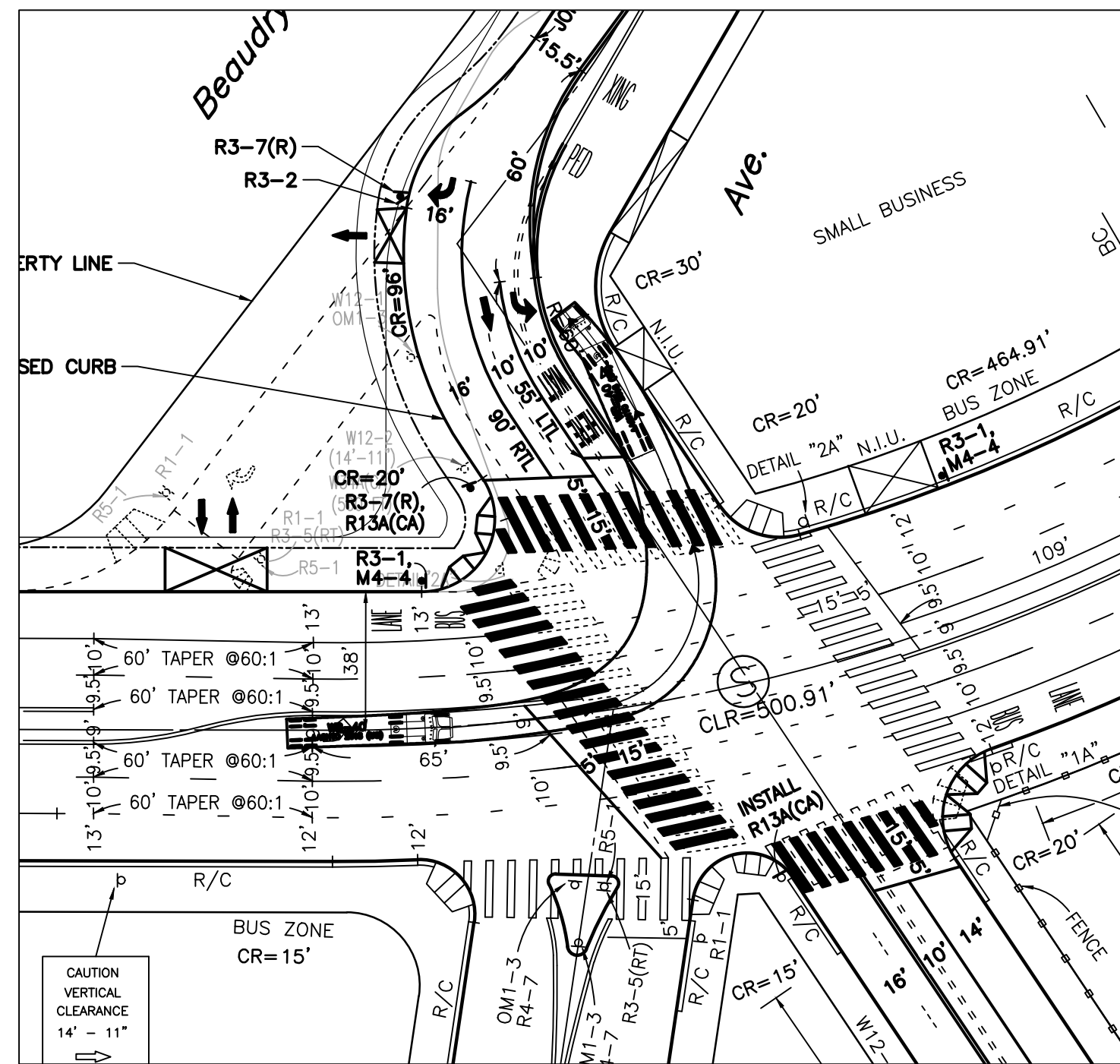

WB-40 TURNING TEMPLATE
NO SCALE

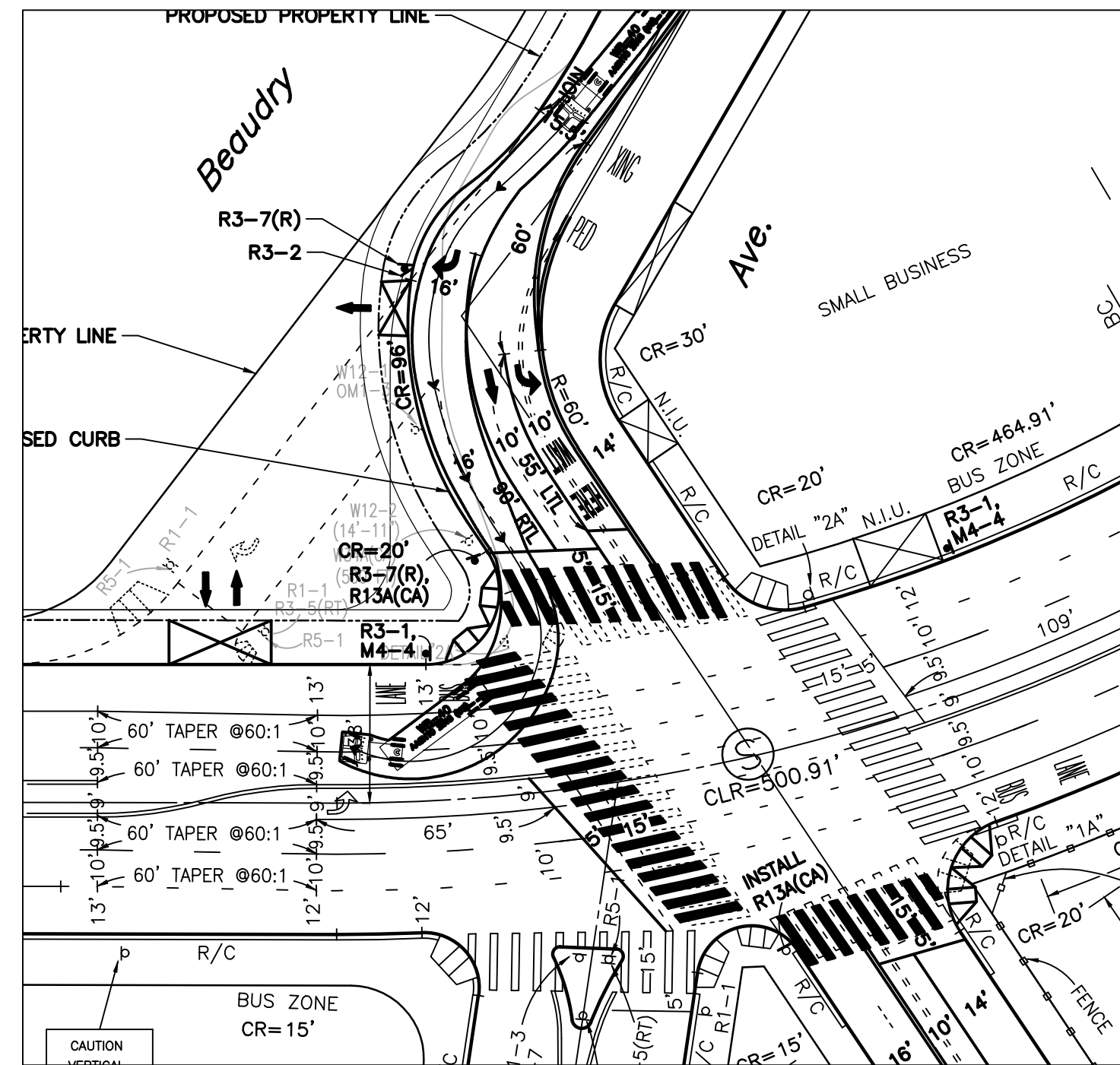

WB-40 TURNING TEMPLATE
NO SCALE

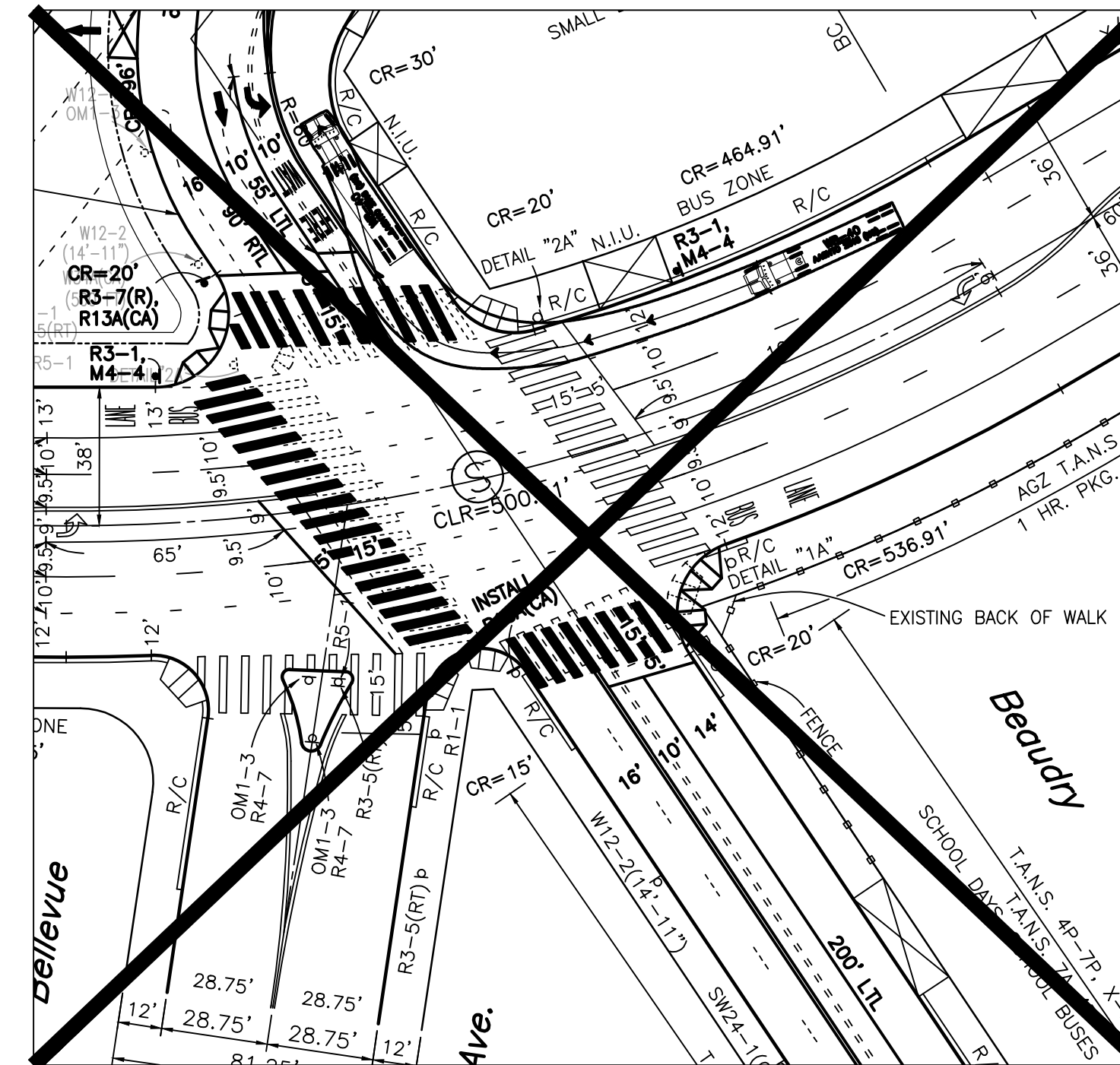

WB-40 TURNING TEMPLATE
NO SCALE

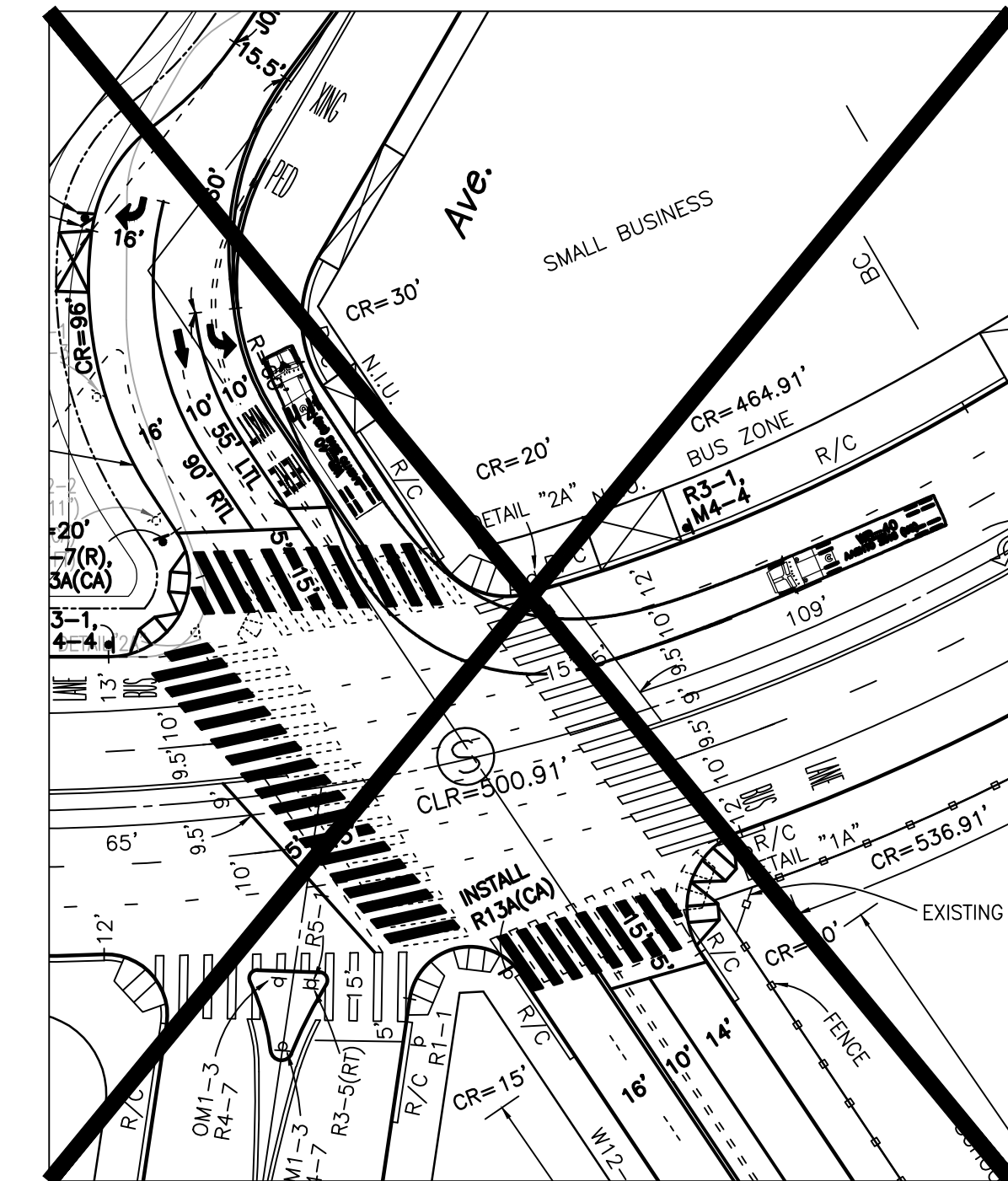

WB-40 TURNING TEMPLATE
NO SCALE

Pursuant to the California Business and Professions Code, this plan is prepared by and under the responsible charge of work of, the named consulting firm and California Registered Engineers shown below.

Plan Prepared By:

1100 Corporate Center Drive, Suite 201
Monterey Park, California 91754
Tel: (323) 260-4703 Fax: (323) 260-4705

Giuseppe S. Canonelli
No. C79006
Exp. 03/31/22
CIVIL
STATE OF CALIFORNIA

Doug K. Yeh
No. TR1900
Exp. 06/30/21
TRAFFIC
STATE OF CALIFORNIA

Date: _____

KOA CORPORATION BUSINESS TAX REGISTRATION NO.: 0000371566-0001-7

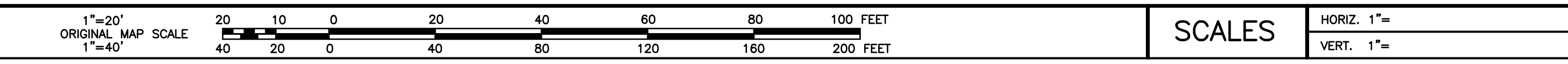
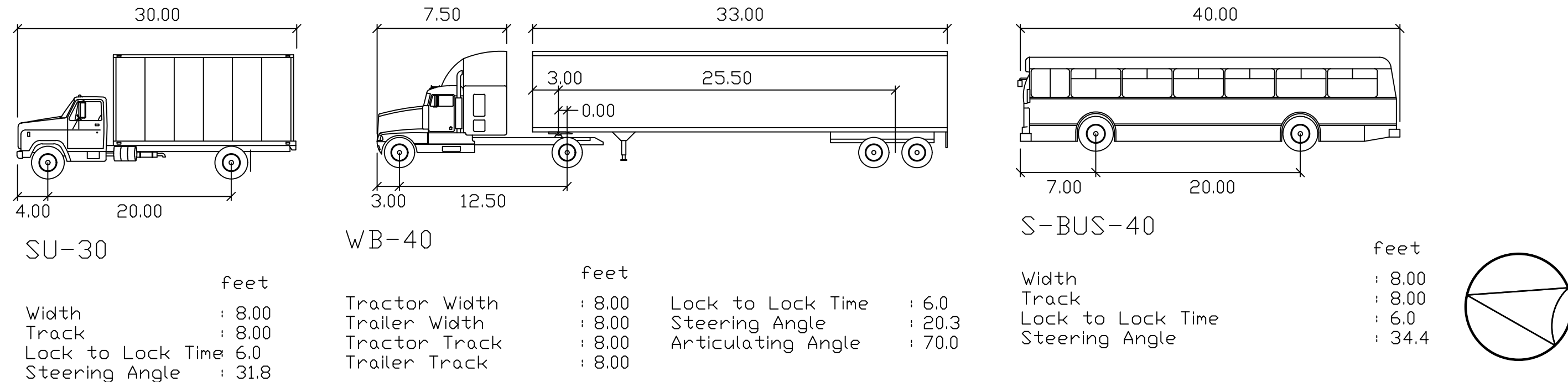

CONCEPTUAL PLAN - OPTION 4 V2

REVIEWED	20	ACCEPTED	20
Transportation Engineer		Senior Transportation Engineer	
CITY OF LOS ANGELES DEPARTMENT OF TRANSPORTATION SELETA J. REYNOLDS, GENERAL MANAGER			
BEAUDRY AVENUE AT SUNSET BOULEVARD			
<small>IF THIS PLAN HAS NOT BEEN IMPLEMENTED WITHIN TWO (2) YEARS OF THE ACCEPTANCE DATE, IT MUST BE RESUBMITTED TO LADOT PERMIT PLAN REVIEW SECTION FOR REVIEW AND MAY REQUIRE A SUBSEQUENT ACCEPTANCE.</small>			
PROJECT NO.	DRAWING NO.		2 / 3

SCALES: HORIZ. 1"=, VERT. 1"=

SHEET: INDEX NUMBER

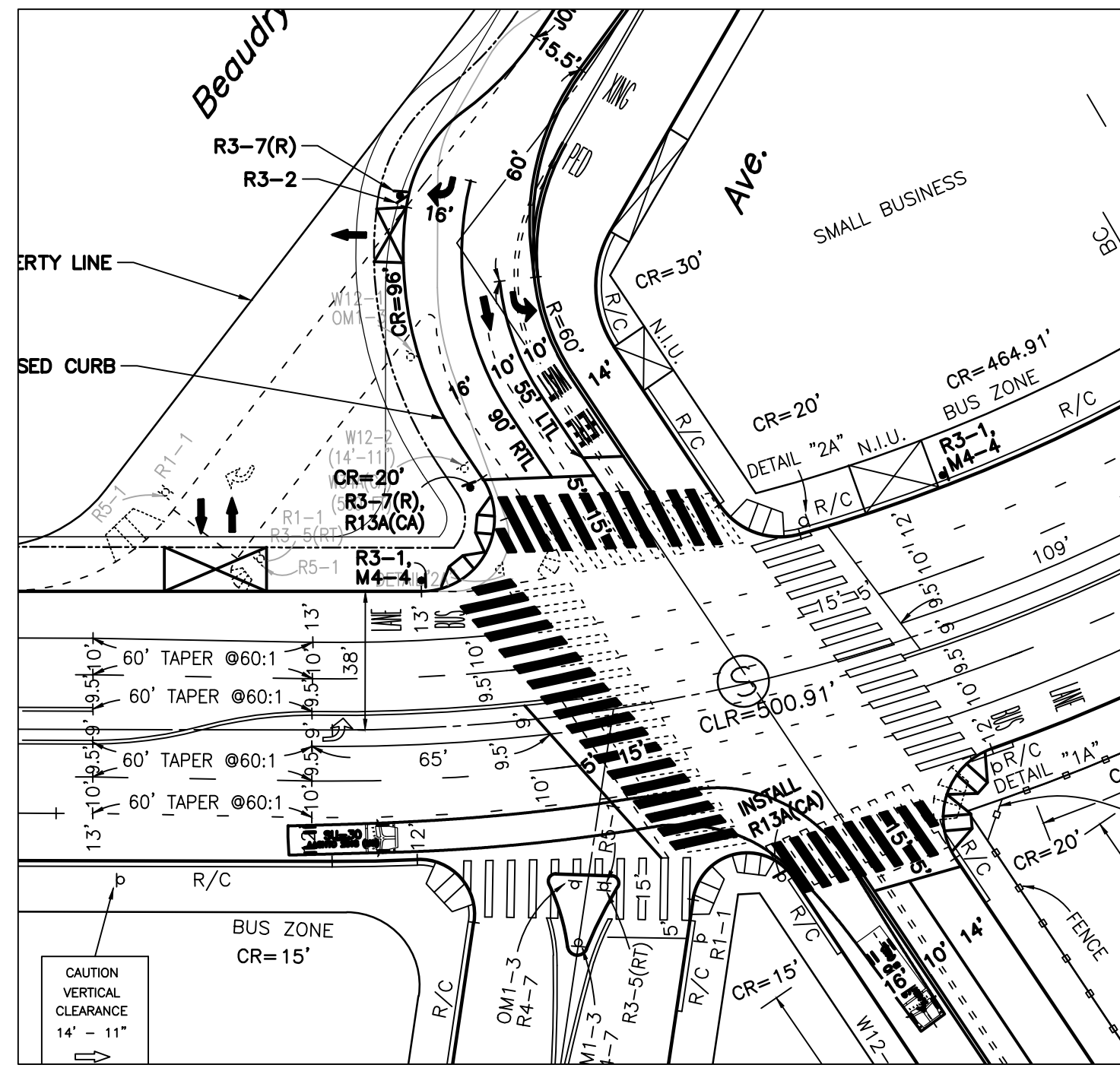

SU-30 TURNING TEMPLATE
NO SCALE

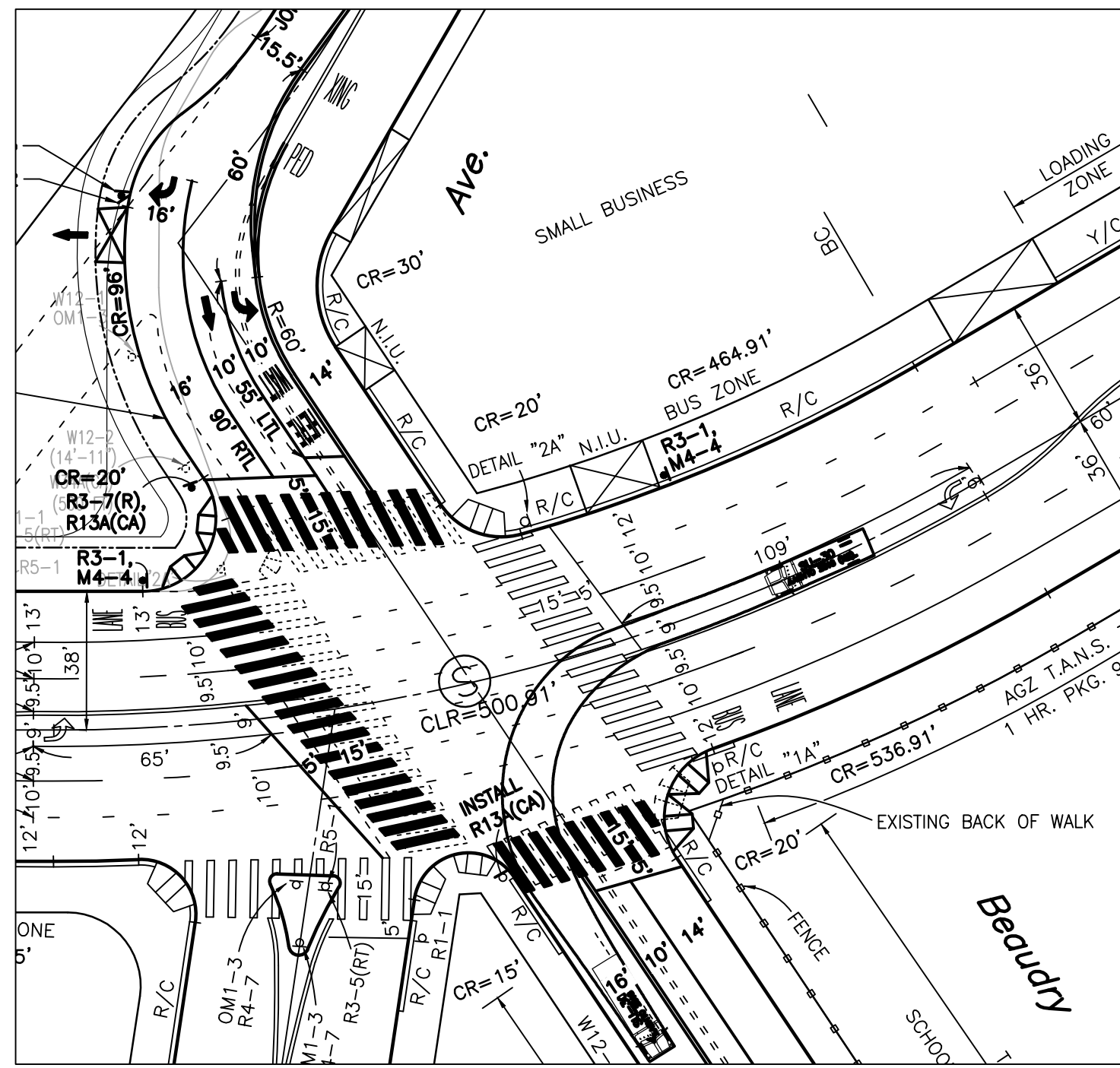

SU-30 TURNING TEMPLATE
NO SCALE

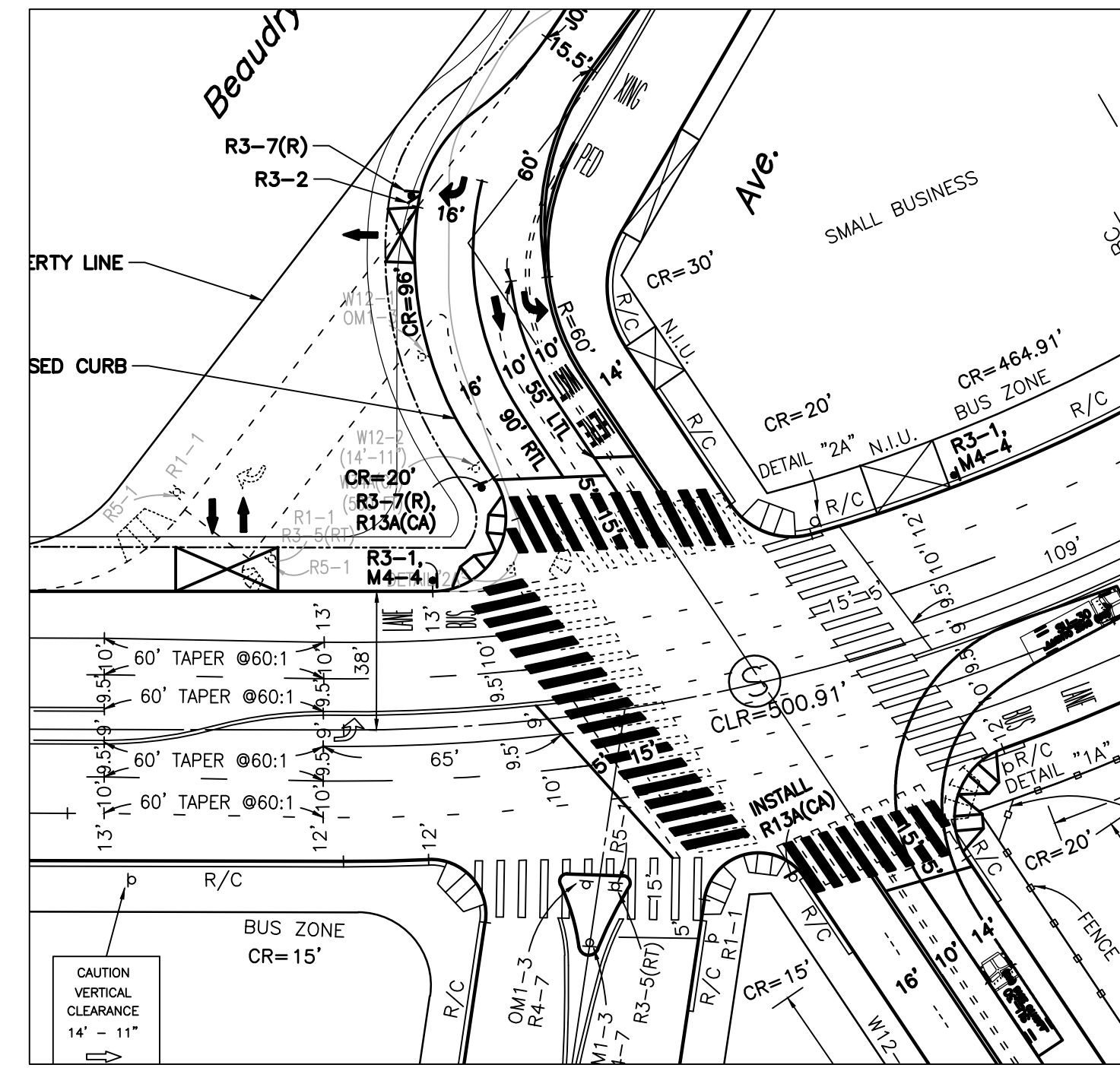

SU-30 TURNING TEMPLATE
NO SCALE

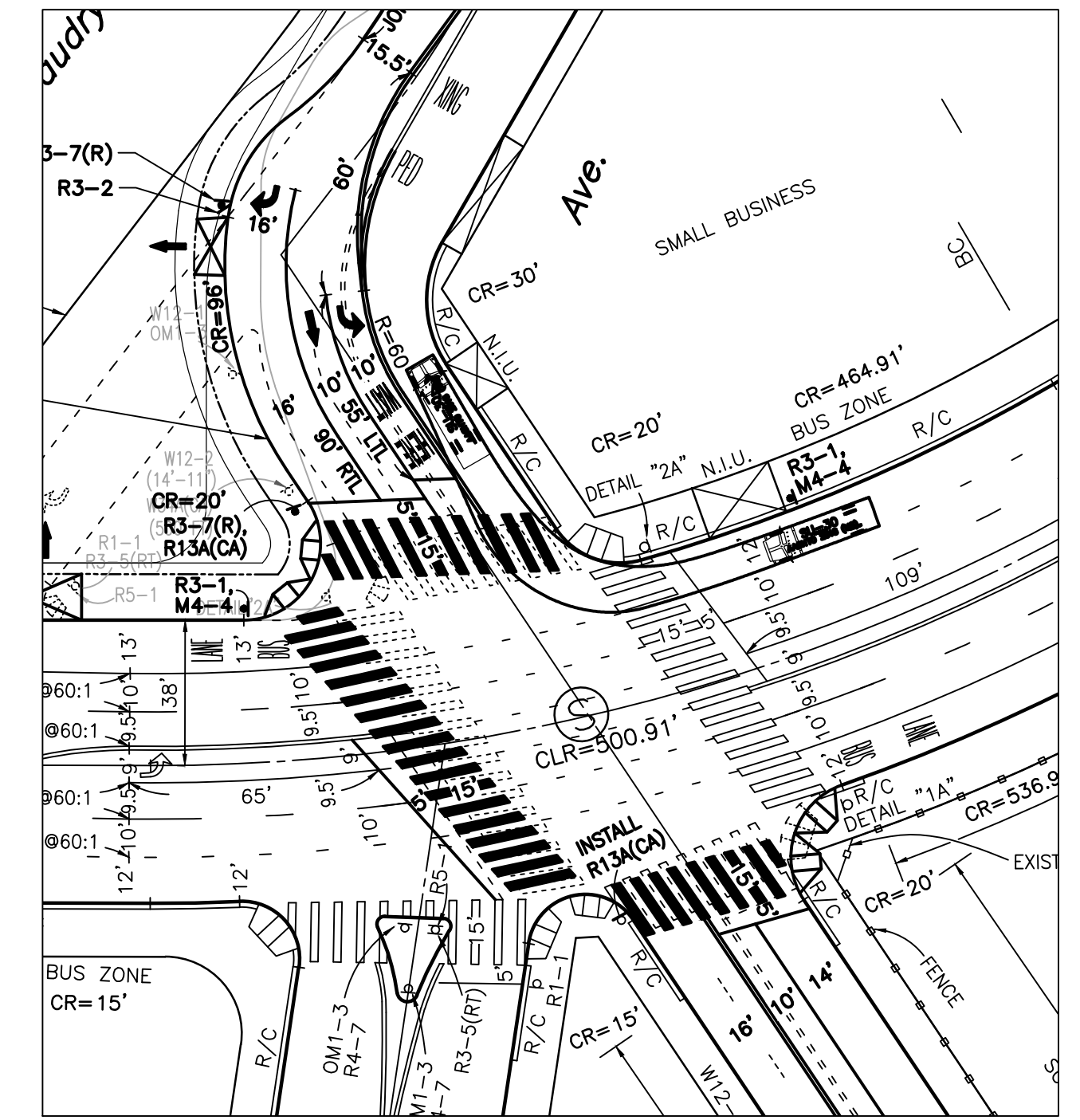

SU-30 TURNING TEMPLATE
NO SCALE

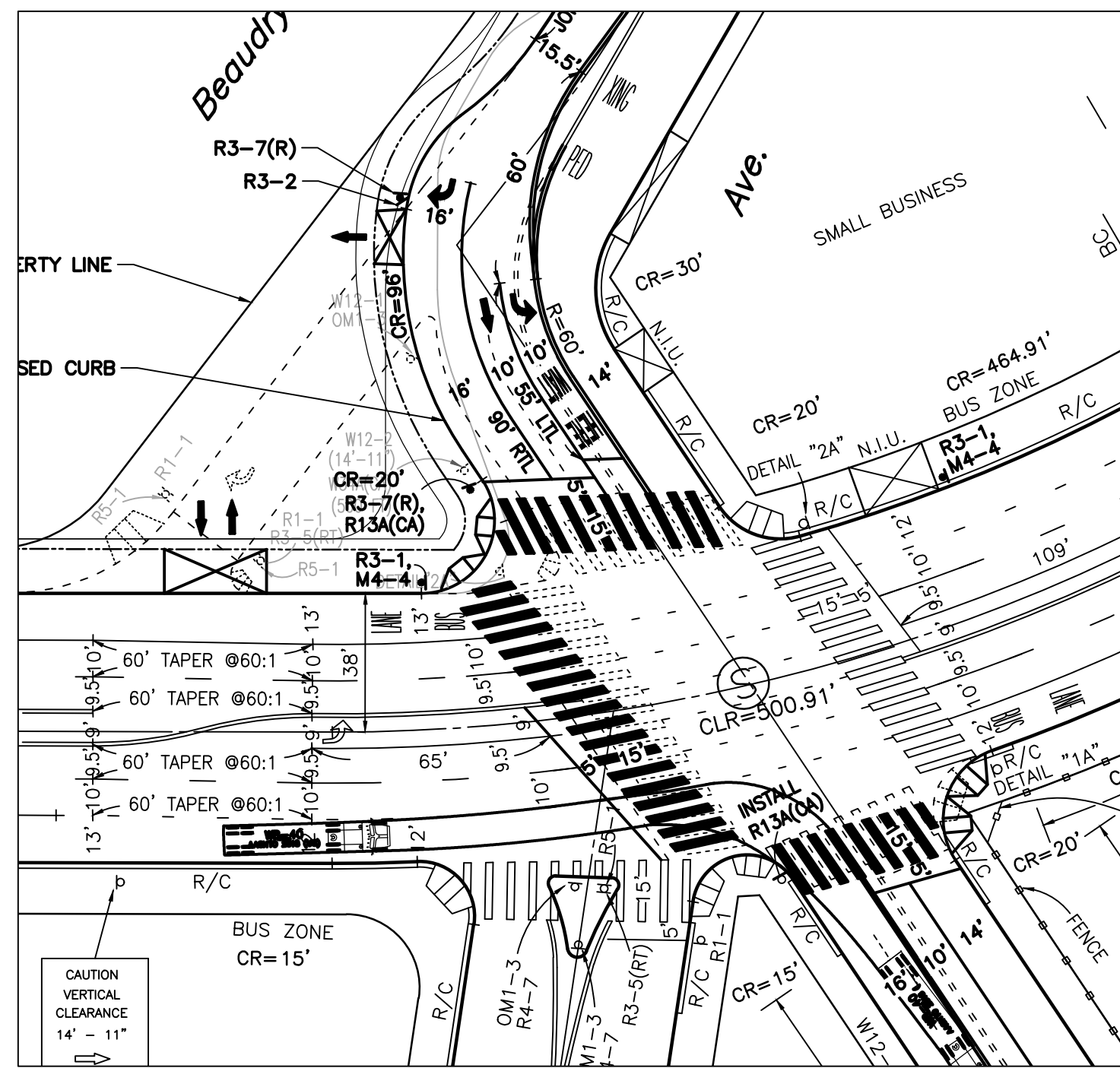

WB-40 TURNING TEMPLATE
NO SCALE

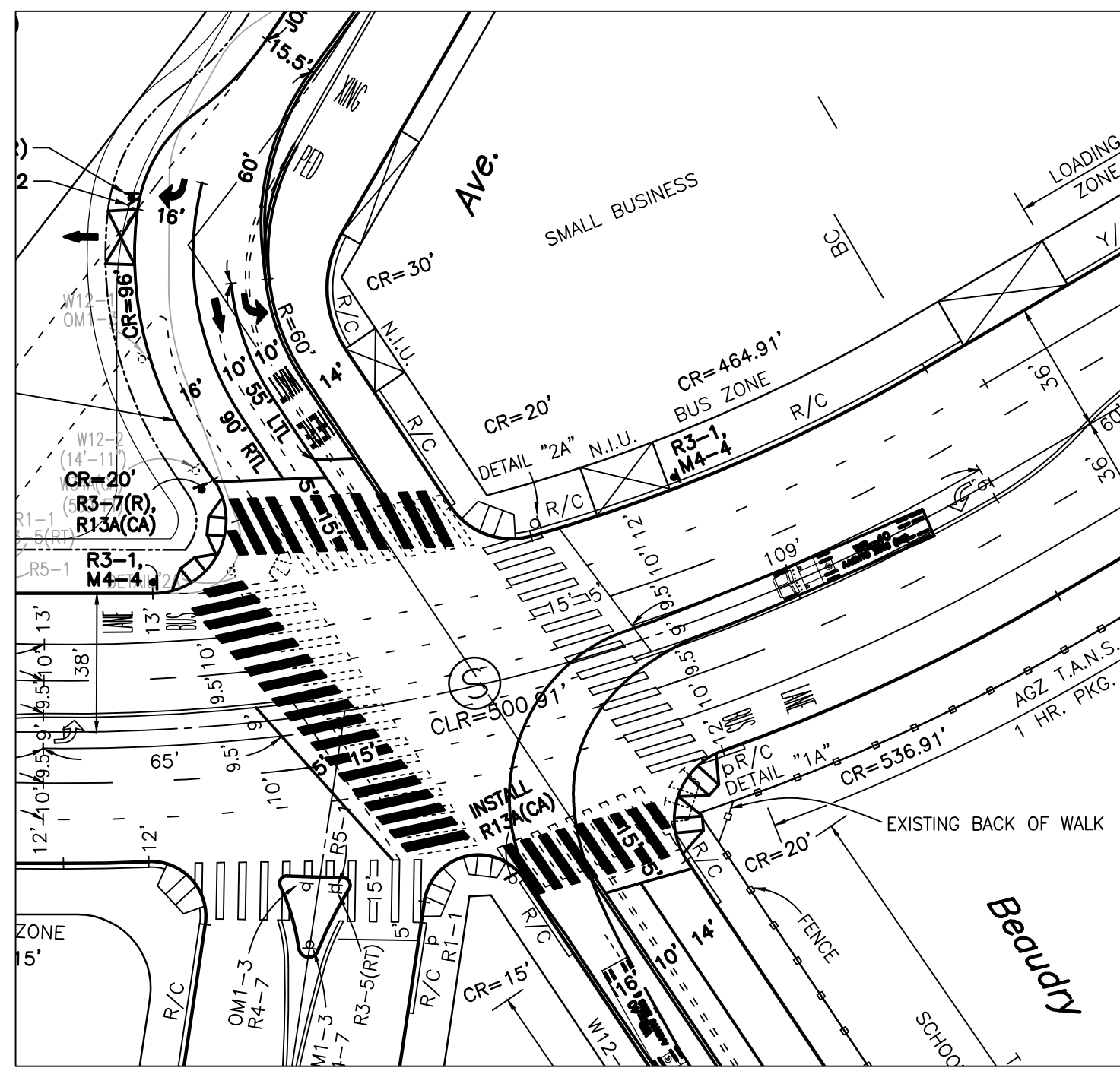

WB-40 TURNING TEMPLATE
NO SCALE

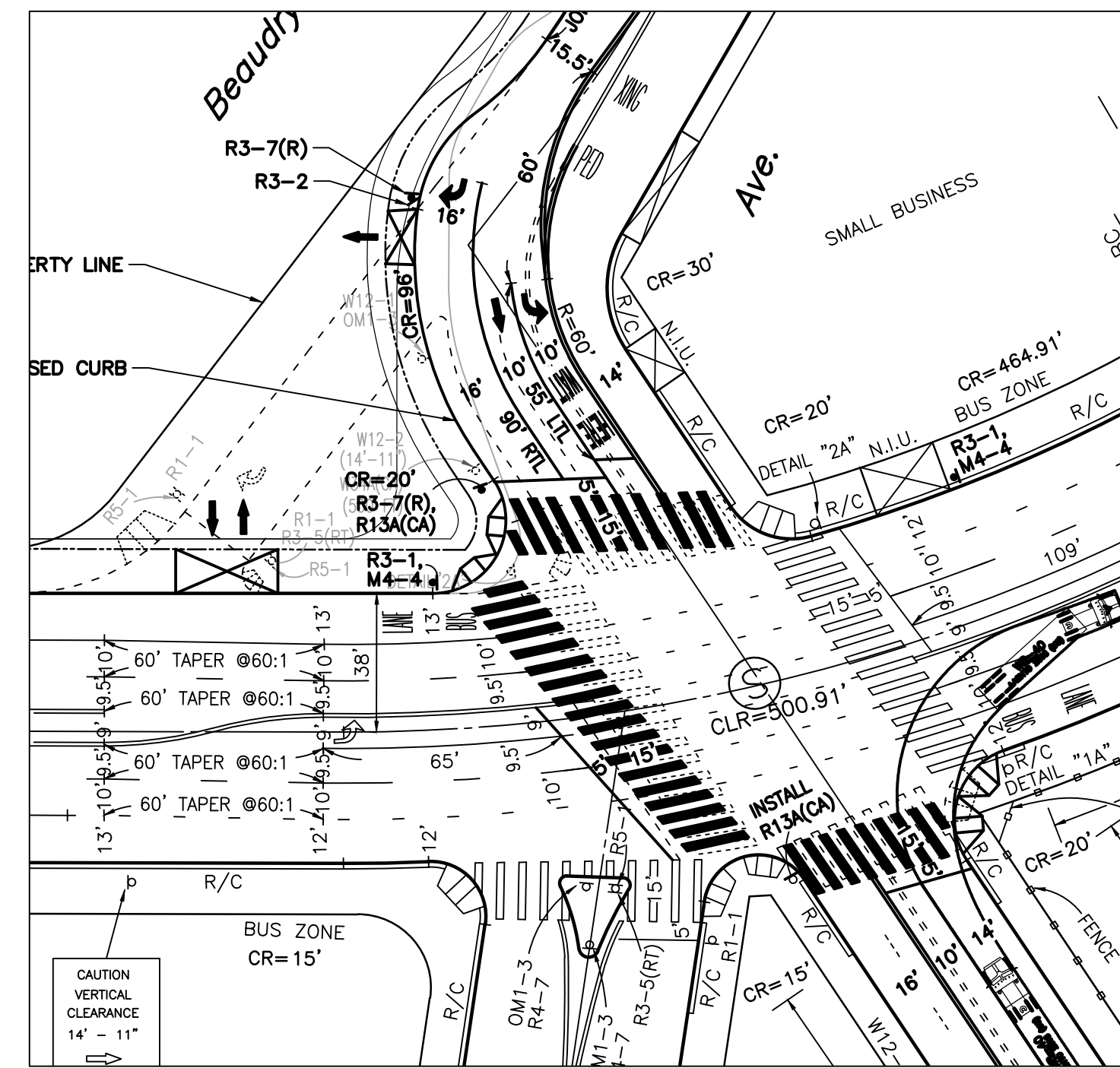

WB-40 TURNING TEMPLATE
NO SCALE

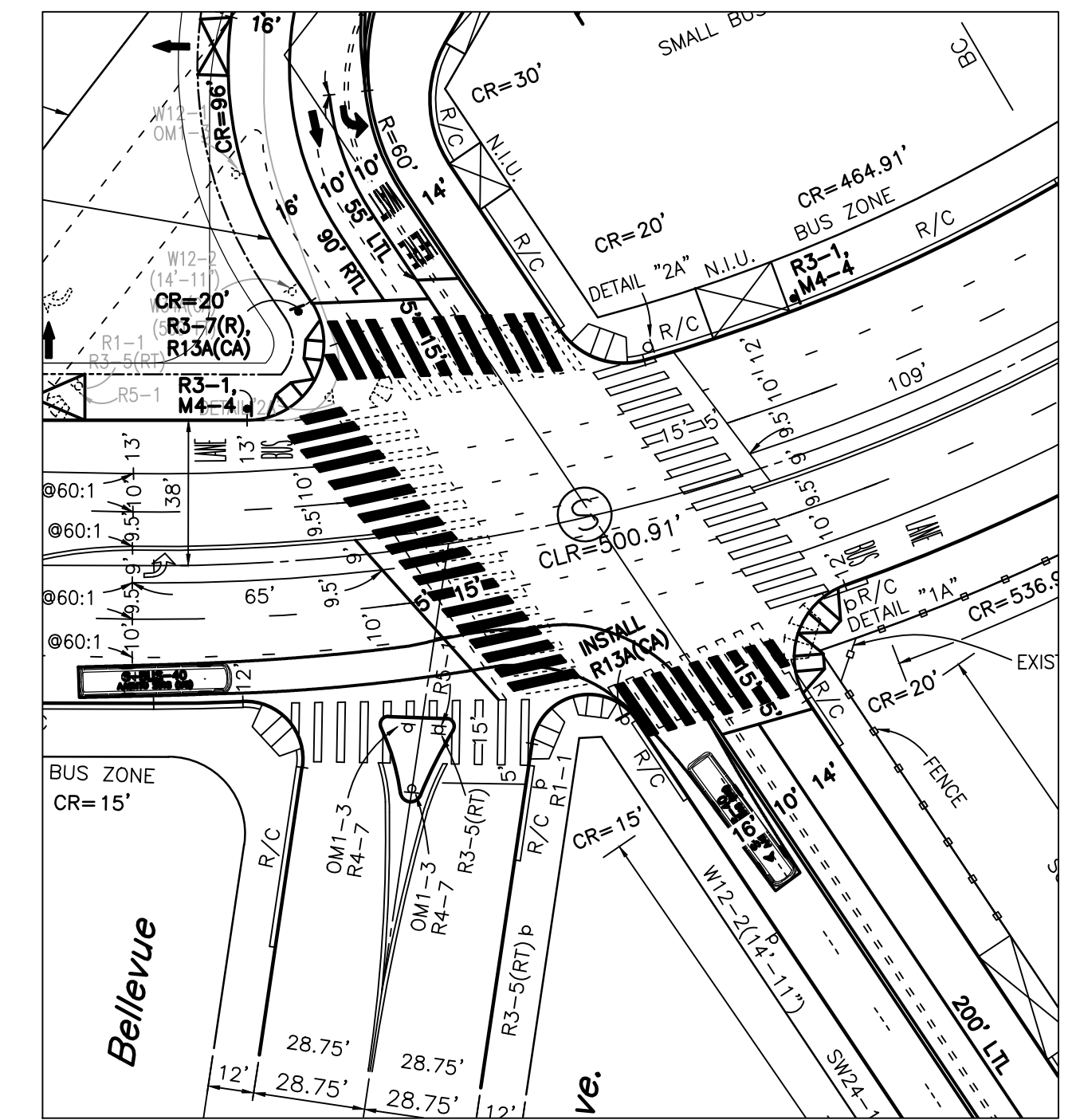

S-BUS-40 TURNING TEMPLATE
NO SCALE

Pursuant to the California Business and Professions Code, this plan is prepared by and under the responsible charge of work of, the named consulting firm and California Registered Engineers shown below.

Plan Prepared By:



Date

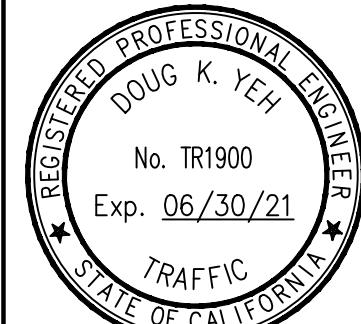

KOA CORPORATION BUSINESS TAX REGISTRATION NO.:

0000371566-0001-7

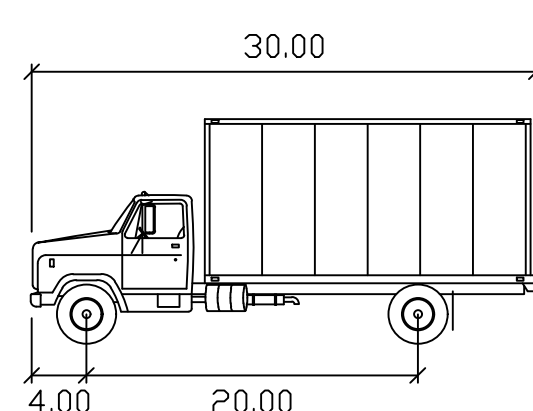

SU-30

- feet
- Width : 8.00
- Track : 8.00
- Lock to Lock Time : 6.0
- Steering Angle : 31.8

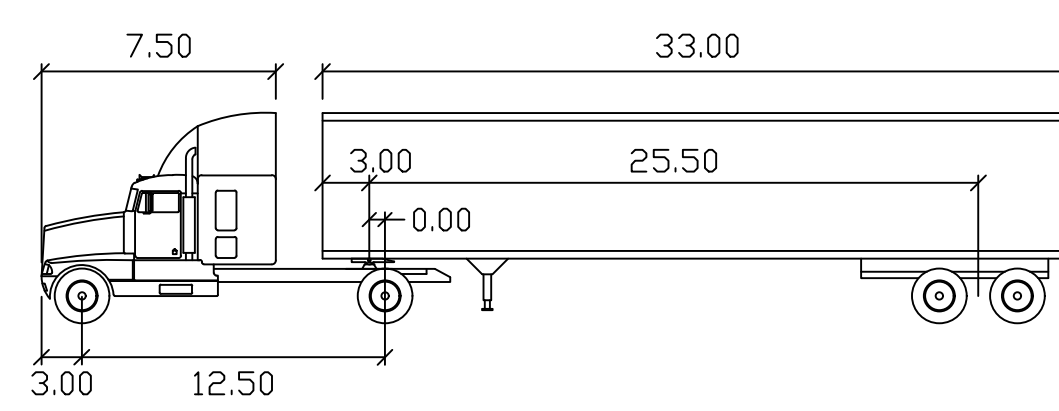

WB-40

- feet
- Tractor Width : 8.00
- Trailer Width : 8.00
- Tractor Track : 8.00
- Trailer Track : 8.00
- Lock to Lock Time : 6.0
- Steering Angle : 20.3
- Articulating Angle : 70.0

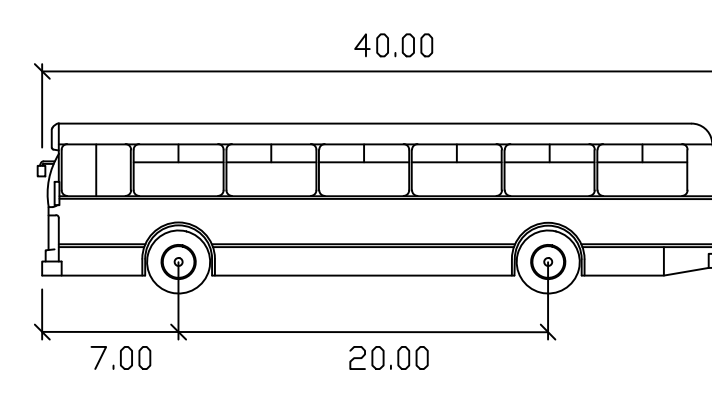

S-BUS-40

- feet
- Width : 8.00
- Track : 8.00
- Lock to Lock Time : 6.0
- Steering Angle : 34.4

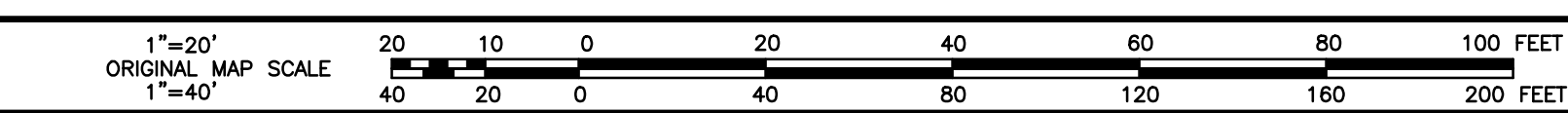

SCALES

HORIZ. 1"=

VERT. 1"=

CONCEPTUAL PLAN - OPTION 4 V2

REVIEWED	20	ACCEPTED	20
Transportation Engineer		Senior Transportation Engineer	

INSTALLATION DATES

MARKOUT BEGAN:

MARKOUT COMPLETED:

STRIPING COMPLETED:

District

References: A-6267

CITY OF LOS ANGELES

DEPARTMENT OF TRANSPORTATION

SELETA J. REYNOLDS, GENERAL MANAGER

BEAUDRY AVENUE

AT SUNSET BOULEVARD

IF THIS PLAN HAS NOT BEEN IMPLEMENTED WITHIN TWO (2) YEARS OF THE ACCEPTANCE DATE, IT MUST BE RESUBMITTED TO LADOT PERMIT PLAN REVIEW SECTION FOR REVIEW AND MAY REQUIRE A SUBSEQUENT ACCEPTANCE.

PROJECT NO.

DRAWING NO.

3

3

SHEET

INDEX NUMBER

REVIEWED	DATE	T.E.	DATE
T.E.A.	DATE	S.T.E.	DATE
CIVIL ENGINEER	DATE	REVISION	DESCRIPTION
NO.	NO.	NO.	NO.

**TABLE 1
FUTURE WITH PROJECT CONDITIONS INTERSECTION LEVELS OF SERVICE
MIXED-USE DEVELOPMENT SCENARIO**

No.	Intersection	Peak Hour	Future without Project Conditions		Future with Project Conditions (Draft EIR Design)			Future with Project Conditions (Modified Design)		
			Delay	LOS	Delay	LOS	Δ Delay	Delay	LOS	Δ Delay
4.	Beaudry Avenue & Sunset Boulevard	A.M.	34.0	C	65.3	E	31.3	74.2	E	40.2
		P.M.	113.0	F	126.8	F	13.8	114.3	F	1.3
14. [a][b]	White Knoll Drive & Sunset Boulevard	A.M.	23.4	C	16.7	B	-6.7	35.0	C	11.6
		P.M.	50.3	F	16.9	B	-33.4	28.7	C	-21.6

Notes:

[a] Future without Project Conditions assumes operation under all-way stop-control at this intersection. Average delay is reported.

[b] Future with Project Conditions include installing a traffic signal at this intersection. Average delay is reported.

**TABLE 2
FUTURE WITH PROJECT CONDITIONS INTERSECTION LEVELS OF SERVICE
NO-HOTEL DEVELOPMENT SCENARIO**

No.	Intersection	Peak Hour	Future without Project Conditions		Future with Project Conditions (Draft EIR Design)			Future with Project Conditions (Modified Design)		
			Delay	LOS	Delay	LOS	Δ Delay	Delay	LOS	Δ Delay
4.	Beaudry Avenue & Sunset Boulevard	A.M.	34.0	C	60.5	E	26.5	70.6	E	36.6
		P.M.	113.0	F	121.3	F	8.3	108.8	F	-4.2
14. [a][b]	White Knoll Drive & Sunset Boulevard	A.M.	23.4	C	16.3	B	-7.1	34.9	C	11.5
		P.M.	50.3	F	15.2	B	-35.1	26.2	C	-24.1

Notes:

[a] Future without Project Conditions assumes operation under all-way stop-control at this intersection. Average delay is reported.

[b] Future with Project Conditions include installing a traffic signal at this intersection. Average delay is reported.

**TABLE 3
INTERSECTION QUEUES**

Location	Turn Pocket Length	Peak Hour	Queue Length (feet)			
			Existing Conditions	Future without Project Conditions	Future with Project Conditions (Draft EIR) [a, b]	Future with Project Conditions (Modified Design) [a, b]
Intersection #4, Beaudry Avenue & Sunset Boulevard						
Southbound Right-Turn <i>from Beaudry Avenue to Sunset Boulevard</i>	90	A.M.	45	80	98	27
		P.M.	71	104	89	32
Eastbound Right-Turn <i>from Sunset Boulevard to Beaudry Avenue</i>	700 [c]	A.M.	238	321	613	844
		P.M.	71	91	159	86

Notes:

All lengths shown in feet. Queues based on 95th percentile queue calculated by the HCM methodology.

[a] Conditions shown are based on the Mixed-Use Development Scenario, which generates more trips than the No-Hotel Development Scenario.

[b] Bold values are those that exceed the turn pocket length.

[c] Distance from Beaudry Avenue to N. Boylston Street.

Attachment

Level of Service and Queuing Worksheets

Queues

4: Beaudry & Sunset

11/24/2021



Lane Group	WBL2	WBL	WBR	SBL2	SBL	SBR	NWL	NWR	NWR2	NEL	NER
Lane Group Flow (vph)	98	421	91	70	1596	1040	103	1155	52	315	282
v/c Ratio	0.65	1.08	0.21	0.61	0.91	1.05	1.41	0.81	0.06	1.32	0.59
Control Delay	65.1	106.5	4.9	44.9	31.9	59.1	274.6	26.3	0.1	207.9	30.1
Queue Delay	0.0	0.0	0.0	0.0	0.0	0.0	0.0	0.0	0.0	0.0	0.0
Total Delay	65.1	106.5	4.9	44.9	31.9	59.1	274.6	26.3	0.1	207.9	30.1
Queue Length 50th (ft)	61	~301	0	30	459	~597	-88	334	0	~261	119
Queue Length 95th (ft)	#130	#489	27	#108	#629	#844	#150	438	0	#429	208
Internal Link Dist (ft)		190			505		24			830	
Turn Bay Length (ft)			125	585	585		104	327	327		
Base Capacity (vph)	157	391	424	114	1750	993	73	1421	868	238	474
Starvation Cap Reductn	0	0	0	0	0	0	0	0	0	0	0
Spillback Cap Reductn	0	0	0	0	0	0	0	0	0	0	0
Storage Cap Reductn	0	0	0	0	0	0	0	0	0	0	0
Reduced v/c Ratio	0.62	1.08	0.21	0.61	0.91	1.05	1.41	0.81	0.06	1.32	0.59

Intersection Summary

~ Volume exceeds capacity, queue is theoretically infinite.

Queue shown is maximum after two cycles.

























95th percentile volume exceeds capacity, queue may be longer.

Queue shown is maximum after two cycles.

HCM 6th Signalized Intersection Summary

4: Beaudry & Sunset

11/24/2021

												
Movement	WBL2	WBL	WBR	SBL2	SBL	SBR	NWL	NWR	NWR2	NEL	NER	NER2
Lane Configurations												
Traffic Volume (veh/h)	90	387	84	64	1468	957	95	1063	48	290	132	128
Future Volume (veh/h)	90	387	84	64	1468	957	95	1063	48	290	132	128
Initial Q (Qb), veh	0	0	0	0	0	0	0	0	0	0	0	0
Ped-Bike Adj(A_pbT)	1.00	1.00	1.00	1.00	1.00	1.00	1.00	1.00	1.00	1.00	1.00	1.00
Parking Bus, Adj	1.00	1.00	1.00	1.00	1.00	1.00	1.00	1.00	1.00	1.00	1.00	1.00
Work Zone On Approach		No			No		No			No		
Adj Sat Flow, veh/h/ln	1870	1870	1870	1870	1870	1870	1870	1870	1870	1870	1870	1870
Adj Flow Rate, veh/h	98	98	91	70	70	1040	103	52	52	315	139	139
Peak Hour Factor	0.92	0.92	0.92	0.92	0.92	0.92	0.92	0.92	0.92	0.92	0.92	0.92
Percent Heavy Veh, %	2	2	2	2	2	2	2	2	2	2	2	2
Cap, veh/h	124	124	333	186	186	808	86	808	808	240	233	233
Arrive On Green	0.07	0.07	0.21	0.51	0.51	0.51	0.51	0.51	0.51	0.14	0.28	0.28
Sat Flow, veh/h	1781	1781	1585	463	463	1585	115	1585	1585	1781	847	847
Grp Volume(v), veh/h	98	98	91	70	70	1040	103	52	52	315	282	282
Grp Sat Flow(s),veh/h/ln	1781	1781	1585	463	463	1585	115	1585	1585	1781	1718	1718
Q Serve(g_s), s	5.4	5.4	4.8	13.4	13.4	51.0	12.5	1.7	1.7	13.5	14.2	14.2
Cycle Q Clear(g_c), s	5.4	5.4	4.8	39.9	39.9	51.0	51.0	1.7	1.7	13.5	14.2	14.2
Prop In Lane	1.00	1.00	1.00	1.00	1.00	1.00	1.00	1.00	1.00	1.00	0.49	0.49
Lane Grp Cap(c), veh/h	124	124	333	186	186	808	86	808	808	240	473	473
V/C Ratio(X)	0.79	0.79	0.27	0.38	0.38	1.29	1.19	0.06	0.06	1.31	0.60	0.60
Avail Cap(c_a), veh/h	159	159	333	186	186	808	86	808	808	240	473	473
HCM Platoon Ratio	1.00	1.00	1.00	1.00	1.00	1.00	1.00	1.00	1.00	1.00	1.00	1.00
Upstream Filter(I)	1.00	1.00	1.00	1.00	1.00	1.00	0.69	0.69	0.69	1.00	1.00	1.00
Uniform Delay (d), s/veh	45.8	45.8	33.1	33.6	33.6	24.5	49.0	12.4	12.4	43.3	31.4	31.4
Incr Delay (d2), s/veh	18.5	18.5	0.4	5.8	5.8	138.3	141.4	0.1	0.1	166.0	2.0	2.0
Initial Q Delay(d3),s/veh	0.0	0.0	0.0	0.0	0.0	0.0	0.0	0.0	0.0	0.0	0.0	0.0
%ile BackOfQ(50%),veh/ln	3.0	3.0	1.9	1.8	1.8	48.7	5.5	0.6	0.6	17.0	6.1	6.1
Unsig. Movement Delay, s/veh												
LnGrp Delay(d),s/veh	64.3	64.3	33.5	39.3	39.3	162.8	190.4	12.5	12.5	209.3	33.4	33.4
LnGrp LOS	E	E	C	D	D	F	F	B	B	F	C	C
Approach Vol, veh/h	610	610		2706	2706		1310			597		
Approach Delay, s/veh	88.1	88.1		79.5	79.5		33.2			126.2		
Approach LOS	F	F		E	E		C			F		
Timer - Assigned Phs		2	3	4		6	7	8				
Phs Duration (G+Y+Rc), s		55.6	11.5	32.9		55.6	18.0	26.4				
Change Period (Y+Rc), s		* 4.6	4.5	* 5.4		* 4.6	4.5	5.4				
Max Green Setting (Gmax), s		* 51	8.9	* 27		* 51	13.5	21.0				
Max Q Clear Time (g_c+I1), s		53.0	7.4	16.2		53.0	15.5	23.0				
Green Ext Time (p_c), s		0.0	0.0	0.6		0.0	0.0	0.0				
Intersection Summary												
HCM 6th Ctrl Delay				74.2								
HCM 6th LOS				E								
Notes												
* HCM 6th computational engine requires equal clearance times for the phases crossing the barrier.												

Queues

4: Beaudry & Sunset

11/24/2021



Lane Group	WBL2	WBL	WBR	SBL2	SBL	SBR	NWL	NWR	NWR2	NEL	NER
Lane Group Flow (vph)	84	393	98	92	1346	514	99	1572	72	736	685
v/c Ratio	0.81	1.01	0.23	1.24	1.01	0.56	1.34	1.45	0.10	1.63	0.98
Control Delay	95.5	87.6	5.9	215.5	57.4	5.5	249.3	234.0	1.0	322.5	58.0
Queue Delay	0.0	0.0	0.0	0.0	0.0	0.0	0.0	0.0	0.0	0.0	0.0
Total Delay	95.5	87.6	5.9	215.5	57.4	5.5	249.3	234.0	1.0	322.5	58.0
Queue Length 50th (ft)	54	~254	0	~73	~440	13	~82	~779	0	~681	393
Queue Length 95th (ft)	#140	#446	32	#174	#596	86	#186	#927	6	#905	#645
Internal Link Dist (ft)		190			505		24			830	
Turn Bay Length (ft)			125	585	585		104	327	327		
Base Capacity (vph)	104	391	424	74	1338	910	74	1086	693	451	696
Starvation Cap Reductn	0	0	0	0	0	0	0	0	0	0	0
Spillback Cap Reductn	0	0	0	0	0	0	0	0	0	0	0
Storage Cap Reductn	0	0	0	0	0	0	0	0	0	0	0
Reduced v/c Ratio	0.81	1.01	0.23	1.24	1.01	0.56	1.34	1.45	0.10	1.63	0.98

Intersection Summary

~ Volume exceeds capacity, queue is theoretically infinite.

Queue shown is maximum after two cycles.

95th percentile volume exceeds capacity, queue may be longer.

Queue shown is maximum after two cycles.

HCM 6th Signalized Intersection Summary

4: Beaudry & Sunset

11/24/2021



Movement	WBL2	WBL	WBR	SBL2	SBL	SBR	NWL	NWR	NWR2	NEL	NER	NER2
Lane Configurations												
Traffic Volume (veh/h)	77	362	90	85	1238	473	91	1446	66	677	486	144
Future Volume (veh/h)	77	362	90	85	1238	473	91	1446	66	677	486	144
Initial Q (Qb), veh	0	0	0	0	0	0	0	0	0	0	0	0
Ped-Bike Adj(A_pbT)	1.00	1.00	1.00	1.00	1.00	1.00	1.00	1.00	1.00	1.00	1.00	1.00
Parking Bus, Adj	1.00	1.00	1.00	1.00	1.00	1.00	1.00	1.00	1.00	1.00	1.00	1.00
Work Zone On Approach		No		No		No		No		No		No
Adj Sat Flow, veh/h/ln	1870	1870	1870	1870	1870	1870	1870	1870	1870	1870	1870	1870
Adj Flow Rate, veh/h	84	84	98	92	92	514	99	72	72	736	157	157
Peak Hour Factor	0.92	0.92	0.92	0.92	0.92	0.92	0.92	0.92	0.92	0.92	0.92	0.92
Percent Heavy Veh, %	2	2	2	2	2	2	2	2	2	2	2	2
Cap, veh/h	105	105	333	72	72	618	79	618	618	454	167	167
Arrive On Green	0.06	0.06	0.21	0.39	0.39	0.39	0.39	0.39	0.39	0.25	0.41	0.41
Sat Flow, veh/h	1781	1781	1585	305	305	1585	247	1585	1585	1781	412	412
Grp Volume(v), veh/h	84	84	98	92	92	514	99	72	72	736	685	685
Grp Sat Flow(s),veh/h/ln	1781	1781	1585	305	305	1585	247	1585	1585	1781	1796	1796
Q Serve(g_s), s	4.7	4.7	5.2	0.0	0.0	29.3	3.0	2.9	2.9	25.5	36.6	36.6
Cycle Q Clear(g_c), s	4.7	4.7	5.2	39.0	39.0	29.3	39.0	2.9	2.9	25.5	36.6	36.6
Prop In Lane	1.00	1.00	1.00	1.00	1.00	1.00	1.00	1.00	1.00	1.00	0.23	0.23
Lane Grp Cap(c), veh/h	105	105	333	72	72	618	79	618	618	454	729	729
V/C Ratio(X)	0.80	0.80	0.29	1.28	1.28	0.83	1.25	0.12	0.12	1.62	0.94	0.94
Avail Cap(c_a), veh/h	105	105	333	72	72	618	79	618	618	454	745	745
HCM Platoon Ratio	1.00	1.00	1.00	1.00	1.00	1.00	1.00	1.00	1.00	1.00	1.00	1.00
Upstream Filter(I)	1.00	1.00	1.00	1.00	1.00	1.00	0.34	0.34	0.34	1.00	1.00	1.00
Uniform Delay (d), s/veh	46.5	46.5	33.3	50.0	50.0	27.5	49.9	19.5	19.5	37.3	28.5	28.5
Incr Delay (d2), s/veh	34.0	34.0	0.5	197.7	197.7	12.4	141.1	0.1	0.1	289.1	19.5	19.5
Initial Q Delay(d3),s/veh	0.0	0.0	0.0	0.0	0.0	0.0	0.0	0.0	0.0	0.0	0.0	0.0
%ile BackOfQ(50%),veh/ln	3.0	3.0	2.0	5.7	5.7	12.8	5.1	1.1	1.1	47.3	19.0	19.0
Unsig. Movement Delay, s/veh												
LnGrp Delay(d),s/veh	80.4	80.4	33.7	247.7	247.7	39.9	191.0	19.6	19.6	326.4	48.0	48.0
LnGrp LOS	F	F	C	F	F	D	F	B	B	F	D	D
Approach Vol, veh/h	575	575		1952	1952		1743			1421		
Approach Delay, s/veh	75.6	75.6		52.8	52.8		132.6			192.2		
Approach LOS	E	E		D	D		F			F		
Timer - Assigned Phs		2	3	4		6	7	8				
Phs Duration (G+Y+Rc), s		43.6	10.4	46.0		43.6	30.0	26.4				
Change Period (Y+Rc), s		* 4.6	4.5	* 5.4		* 4.6	4.5	5.4				
Max Green Setting (Gmax), s		* 39	5.9	* 42		* 39	25.5	21.0				
Max Q Clear Time (g_c+I1), s		41.0	6.7	38.6		41.0	27.5	23.0				
Green Ext Time (p_c), s		0.0	0.0	0.8		0.0	0.0	0.0				

Intersection Summary

HCM 6th Ctrl Delay	114.3
HCM 6th LOS	F

Notes

* HCM 6th computational engine requires equal clearance times for the phases crossing the barrier.

Queues

4: Beaudry & Sunset

11/24/2021



Lane Group	WBL2	WBL	WBR	SBL2	SBL	SBR	NWL	NWR	NWR2	NEL	NER
Lane Group Flow (vph)	98	423	91	65	1589	1036	103	1146	52	293	282
v/c Ratio	0.65	1.08	0.24	0.53	0.89	1.03	1.39	0.79	0.06	1.33	0.61
Control Delay	65.1	108.1	14.1	35.1	29.3	53.9	266.5	24.6	1.6	210.8	31.4
Queue Delay	0.0	0.0	0.0	0.0	0.0	0.0	0.0	0.0	0.0	0.0	0.0
Total Delay	65.1	108.1	14.1	35.1	29.3	53.9	266.5	24.6	1.6	210.8	31.4
Queue Length 50th (ft)	61	~303	12	26	445	~588	-88	322	0	-243	121
Queue Length 95th (ft)	#130	#490	54	#92	558	#837	#150	422	11	#407	211
Internal Link Dist (ft)		190			505		24			830	
Turn Bay Length (ft)			125	585	585		104	327	327		
Base Capacity (vph)	157	391	385	123	1785	1004	74	1449	859	221	459
Starvation Cap Reductn	0	0	0	0	0	0	0	0	0	0	0
Spillback Cap Reductn	0	0	0	0	0	0	0	0	0	0	0
Storage Cap Reductn	0	0	0	0	0	0	0	0	0	0	0
Reduced v/c Ratio	0.62	1.08	0.24	0.53	0.89	1.03	1.39	0.79	0.06	1.33	0.61

Intersection Summary

~ Volume exceeds capacity, queue is theoretically infinite.

Queue shown is maximum after two cycles.

95th percentile volume exceeds capacity, queue may be longer.

Queue shown is maximum after two cycles.

HCM 6th Signalized Intersection Summary

4: Beaudry & Sunset

11/24/2021

Movement	WBL2	WBL	WBR	SBL2	SBL	SBR	NWL	NWR	NWR2	NEL	NER	NER2
Lane Configurations												
Traffic Volume (veh/h)	90	389	84	60	1462	953	95	1054	48	270	132	128
Future Volume (veh/h)	90	389	84	60	1462	953	95	1054	48	270	132	128
Initial Q (Qb), veh	0	0	0	0	0	0	0	0	0	0	0	0
Ped-Bike Adj(A_pbT)	1.00	1.00	1.00	1.00	1.00	1.00	1.00	1.00	1.00	1.00	1.00	1.00
Parking Bus, Adj	1.00	1.00	1.00	1.00	1.00	1.00	1.00	1.00	1.00	1.00	1.00	1.00
Work Zone On Approach		No			No		No			No		
Adj Sat Flow, veh/h/ln	1870	1870	1870	1870	1870	1870	1870	1870	1870	1870	1870	1870
Adj Flow Rate, veh/h	98	98	91	65	65	1036	103	52	52	293	139	139
Peak Hour Factor	0.92	0.92	0.92	0.92	0.92	0.92	0.92	0.92	0.92	0.92	0.92	0.92
Percent Heavy Veh, %	2	2	2	2	2	2	2	2	2	2	2	2
Cap, veh/h	124	124	333	195	195	824	89	824	824	223	225	225
Arrive On Green	0.07	0.07	0.21	0.52	0.52	0.52	0.52	0.52	0.52	0.13	0.27	0.27
Sat Flow, veh/h	1781	1781	1585	467	467	1585	116	1585	1585	1781	847	847
Grp Volume(v), veh/h	98	98	91	65	65	1036	103	52	52	293	282	282
Grp Sat Flow(s),veh/h/ln	1781	1781	1585	467	467	1585	116	1585	1585	1781	1718	1718
Q Serve(g_s), s	5.4	5.4	4.8	11.9	11.9	52.0	14.6	1.6	1.6	12.5	14.4	14.4
Cycle Q Clear(g_c), s	5.4	5.4	4.8	37.5	37.5	52.0	52.0	1.6	1.6	12.5	14.4	14.4
Prop In Lane	1.00	1.00	1.00	1.00	1.00	1.00	1.00	1.00	1.00	1.00	0.49	0.49
Lane Grp Cap(c), veh/h	124	124	333	195	195	824	89	824	824	223	456	456
V/C Ratio(X)	0.79	0.79	0.27	0.33	0.33	1.26	1.16	0.06	0.06	1.32	0.62	0.62
Avail Cap(c_a), veh/h	159	159	333	195	195	824	89	824	824	223	456	456
HCM Platoon Ratio	1.00	1.00	1.00	1.00	1.00	1.00	1.00	1.00	1.00	1.00	1.00	1.00
Upstream Filter(I)	1.00	1.00	1.00	1.00	1.00	1.00	0.70	0.70	0.70	1.00	1.00	1.00
Uniform Delay (d), s/veh	45.8	45.8	33.1	31.5	31.5	24.0	48.6	11.9	11.9	43.8	32.3	32.3
Incr Delay (d2), s/veh	18.5	18.5	0.4	4.5	4.5	125.5	128.7	0.1	0.1	170.3	2.5	2.5
Initial Q Delay(d3),s/veh	0.0	0.0	0.0	0.0	0.0	0.0	0.0	0.0	0.0	0.0	0.0	0.0
%ile BackOfQ(50%),veh/ln	3.0	3.0	1.9	1.6	1.6	46.7	5.4	0.6	0.6	16.0	6.2	6.2
Unsig. Movement Delay, s/veh												
LnGrp Delay(d),s/veh	64.3	64.3	33.5	36.0	36.0	149.5	177.3	12.0	12.0	214.0	34.8	34.8
LnGrp LOS	E	E	C	D	D	F	F	B	B	F	C	C
Approach Vol, veh/h	612	612		2690	2690		1301			575		
Approach Delay, s/veh	89.2	89.2		73.4	73.4		31.4			126.1		
Approach LOS	F	F		E	E		C			F		
Timer - Assigned Phs		2	3	4		6	7	8				
Phs Duration (G+Y+Rc), s		56.6	11.5	31.9		56.6	17.0	26.4				
Change Period (Y+Rc), s		* 4.6	4.5	* 5.4		* 4.6	4.5	5.4				
Max Green Setting (Gmax), s		* 52	8.9	* 26		* 52	12.5	21.0				
Max Q Clear Time (g_c+I1), s		54.0	7.4	16.4		54.0	14.5	23.0				
Green Ext Time (p_c), s		0.0	0.0	0.6		0.0	0.0	0.0				
Intersection Summary												
HCM 6th Ctrl Delay				70.6								
HCM 6th LOS				E								
Notes												
* HCM 6th computational engine requires equal clearance times for the phases crossing the barrier.												

Queues

4: Beaudry & Sunset

11/24/2021



Lane Group	WBL2	WBL	WBR	SBL2	SBL	SBR	NWL	NWR	NWR2	NEL	NER
Lane Group Flow (vph)	80	390	98	89	1333	502	99	1563	74	718	690
v/c Ratio	0.81	1.00	0.23	1.20	0.97	0.54	1.34	1.40	0.10	1.66	1.01
Control Delay	97.6	85.9	5.9	201.6	48.5	4.8	249.1	214.3	1.1	334.4	64.3
Queue Delay	0.0	0.0	0.0	0.0	0.0	0.0	0.0	0.0	0.0	0.0	0.0
Total Delay	97.6	85.9	5.9	201.6	48.5	4.8	249.1	214.3	1.1	334.4	64.3
Queue Length 50th (ft)	51	250	0	-69	421	8	-82	-762	0	-669	-409
Queue Length 95th (ft)	#135	#442	32	#169	#575	73	#187	#910	7	#890	#659
Internal Link Dist (ft)		190			505		24			830	
Turn Bay Length (ft)			125	585	585		104	327	327		
Base Capacity (vph)	99	391	424	74	1373	922	74	1114	707	433	685
Starvation Cap Reductn	0	0	0	0	0	0	0	0	0	0	0
Spillback Cap Reductn	0	0	0	0	0	0	0	0	0	0	0
Storage Cap Reductn	0	0	0	0	0	0	0	0	0	0	0
Reduced v/c Ratio	0.81	1.00	0.23	1.20	0.97	0.54	1.34	1.40	0.10	1.66	1.01

Intersection Summary

~ Volume exceeds capacity, queue is theoretically infinite.

Queue shown is maximum after two cycles.

95th percentile volume exceeds capacity, queue may be longer.

Queue shown is maximum after two cycles.

HCM 6th Signalized Intersection Summary

4: Beaudry & Sunset

11/24/2021



Movement	WBL2	WBL	WBR	SBL2	SBL	SBR	NWL	NWR	NWR2	NEL	NER	NER2
Lane Configurations												
Traffic Volume (veh/h)	74	359	90	82	1226	462	91	1438	68	661	490	144
Future Volume (veh/h)	74	359	90	82	1226	462	91	1438	68	661	490	144
Initial Q (Qb), veh	0	0	0	0	0	0	0	0	0	0	0	0
Ped-Bike Adj(A_pbT)	1.00	1.00	1.00	1.00	1.00	1.00	1.00	1.00	1.00	1.00	1.00	1.00
Parking Bus, Adj	1.00	1.00	1.00	1.00	1.00	1.00	1.00	1.00	1.00	1.00	1.00	1.00
Work Zone On Approach		No			No		No			No		
Adj Sat Flow, veh/h/ln	1870	1870	1870	1870	1870	1870	1870	1870	1870	1870	1870	1870
Adj Flow Rate, veh/h	80	80	98	89	89	502	99	74	74	718	157	157
Peak Hour Factor	0.92	0.92	0.92	0.92	0.92	0.92	0.92	0.92	0.92	0.92	0.92	0.92
Percent Heavy Veh, %	2	2	2	2	2	2	2	2	2	2	2	2
Cap, veh/h	100	100	333	72	72	634	85	634	634	436	163	163
Arrive On Green	0.06	0.06	0.21	0.40	0.40	0.40	0.40	0.40	0.40	0.25	0.40	0.40
Sat Flow, veh/h	1781	1781	1585	307	307	1585	253	1585	1585	1781	409	409
Grp Volume(v), veh/h	80	80	98	89	89	502	99	74	74	718	690	690
Grp Sat Flow(s),veh/h/ln	1781	1781	1585	307	307	1585	253	1585	1585	1781	1797	1797
Q Serve(g_s), s	4.4	4.4	5.2	0.0	0.0	27.8	5.2	2.9	2.9	24.5	37.5	37.5
Cycle Q Clear(g_c), s	4.4	4.4	5.2	40.0	40.0	27.8	40.0	2.9	2.9	24.5	37.5	37.5
Prop In Lane	1.00	1.00	1.00	1.00	1.00	1.00	1.00	1.00	1.00	1.00	0.23	0.23
Lane Grp Cap(c), veh/h	100	100	333	72	72	634	85	634	634	436	717	717
V/C Ratio(X)	0.80	0.80	0.29	1.24	1.24	0.79	1.16	0.12	0.12	1.65	0.96	0.96
Avail Cap(c_a), veh/h	100	100	333	72	72	634	85	634	634	436	733	733
HCM Platoon Ratio	1.00	1.00	1.00	1.00	1.00	1.00	1.00	1.00	1.00	1.00	1.00	1.00
Upstream Filter(I)	1.00	1.00	1.00	1.00	1.00	1.00	0.34	0.34	0.34	1.00	1.00	1.00
Uniform Delay (d), s/veh	46.7	46.7	33.3	50.0	50.0	26.3	49.6	18.9	18.9	37.8	29.3	29.3
Incr Delay (d2), s/veh	35.9	35.9	0.5	182.5	182.5	9.8	108.5	0.1	0.1	300.5	24.1	24.1
Initial Q Delay(d3),s/veh	0.0	0.0	0.0	0.0	0.0	0.0	0.0	0.0	0.0	0.0	0.0	0.0
%ile BackOfQ(50%),veh/ln	2.9	2.9	2.0	5.4	5.4	11.8	4.7	1.1	1.1	46.9	20.2	20.2
Unsig. Movement Delay, s/veh												
LnGrp Delay(d),s/veh	82.6	82.6	33.7	232.5	232.5	36.1	158.1	19.0	19.0	338.3	53.4	53.4
LnGrp LOS	F	F	C	F	F	D	F	B	B	F	D	D
Approach Vol, veh/h	568	568		1924	1924		1736			1408		
Approach Delay, s/veh	74.3	74.3		47.4	47.4		115.2			198.7		
Approach LOS	E	E		D	D		F			F		
Timer - Assigned Phs		2	3	4		6	7	8				
Phs Duration (G+Y+Rc), s		44.6	10.1	45.3		44.6	29.0	26.4				
Change Period (Y+Rc), s		* 4.6	4.5	* 5.4		* 4.6	4.5	5.4				
Max Green Setting (Gmax), s		* 40	5.6	* 41		* 40	24.5	21.0				
Max Q Clear Time (g_c+I1), s		42.0	6.4	39.5		42.0	26.5	22.8				
Green Ext Time (p_c), s		0.0	0.0	0.4		0.0	0.0	0.0				

Intersection Summary

HCM 6th Ctrl Delay	108.8
HCM 6th LOS	F

Notes

* HCM 6th computational engine requires equal clearance times for the phases crossing the barrier.

Queues

14: Sunset & White Knoll

11/23/2021



Lane Group	WBT	NBL	NBT	NBR	SBL	SBT
Lane Group Flow (vph)	282	11	1427	20	108	2743
v/c Ratio	0.82	0.13	0.55	0.02	0.53	1.07
Control Delay	45.5	6.3	4.8	1.6	13.0	51.0
Queue Delay	0.0	0.0	0.0	0.0	0.0	14.7
Total Delay	45.5	6.3	4.8	1.6	13.0	65.7
Queue Length 50th (ft)	113	2	125	1	24	~964
Queue Length 95th (ft)	#223	m3	m135	m1	m28	#1116
Internal Link Dist (ft)	220		510			30
Turn Bay Length (ft)						
Base Capacity (vph)	389	82	2573	1156	203	2573
Starvation Cap Reductn	0	0	0	0	0	317
Spillback Cap Reductn	0	0	0	0	0	0
Storage Cap Reductn	0	0	0	0	0	0
Reduced v/c Ratio	0.72	0.13	0.55	0.02	0.53	1.22

Intersection Summary

~ Volume exceeds capacity, queue is theoretically infinite.

Queue shown is maximum after two cycles.

95th percentile volume exceeds capacity, queue may be longer.



















Queue shown is maximum after two cycles.

m Volume for 95th percentile queue is metered by upstream signal.

HCM 6th Signalized Intersection Summary

14: Sunset & White Knoll

11/23/2021

												
Movement	EBL	EBT	EBR	WBL	WBT	WBR	NBL	NBT	NBR	SBL	SBT	SBR
Lane Configurations												
Traffic Volume (veh/h)	0	0	0	71	0	189	10	1313	18	99	2524	0
Future Volume (veh/h)	0	0	0	71	0	189	10	1313	18	99	2524	0
Initial Q (Qb), veh				0	0	0	0	0	0	0	0	0
Ped-Bike Adj(A_pbT)				1.00		1.00	1.00		1.00	1.00		1.00
Parking Bus, Adj				1.00	1.00	1.00	1.00	1.00	1.00	1.00	1.00	1.00
Work Zone On Approach				No		No		No		No		No
Adj Sat Flow, veh/h/ln				1870	1870	1870	1870	1870	1870	1870	1870	0
Adj Flow Rate, veh/h				77	0	205	11	1427	20	108	2743	0
Peak Hour Factor				0.92	0.92	0.92	0.92	0.92	0.92	0.92	0.92	0.92
Percent Heavy Veh, %				2	2	2	2	2	2	2	2	0
Cap, veh/h				86	0	228	153	2515	1122	268	2515	0
Arrive On Green				0.19	0.00	0.19	0.71	0.71	0.71	1.00	1.00	0.00
Sat Flow, veh/h				446	0	1188	103	3554	1585	368	3647	0
Grp Volume(v), veh/h				282	0	0	11	1427	20	108	2743	0
Grp Sat Flow(s),veh/h/ln				1634	0	0	103	1777	1585	368	1777	0
Q Serve(g_s), s				15.2	0.0	0.0	3.1	17.6	0.3	12.5	0.0	0.0
Cycle Q Clear(g_c), s				15.2	0.0	0.0	3.1	17.6	0.3	30.1	0.0	0.0
Prop In Lane				0.27		0.73	1.00		1.00	1.00		0.00
Lane Grp Cap(c), veh/h				314	0	0	153	2515	1122	268	2515	0
V/C Ratio(X)				0.90	0.00	0.00	0.07	0.57	0.02	0.40	1.09	0.00
Avail Cap(c_a), veh/h				327	0	0	153	2515	1122	268	2515	0
HCM Platoon Ratio				1.00	1.00	1.00	1.00	1.00	1.00	2.00	2.00	1.00
Upstream Filter(I)				1.00	0.00	0.00	1.00	1.00	1.00	1.00	1.00	0.00
Uniform Delay (d), s/veh				35.5	0.0	0.0	4.3	6.4	3.9	4.2	0.0	0.0
Incr Delay (d2), s/veh				25.5	0.0	0.0	0.9	0.9	0.0	4.4	48.0	0.0
Initial Q Delay(d3),s/veh				0.0	0.0	0.0	0.0	0.0	0.0	0.0	0.0	0.0
%ile BackOfQ(50%),veh/ln				8.1	0.0	0.0	0.1	5.6	0.1	0.9	16.8	0.0
Unsig. Movement Delay, s/veh												
LnGrp Delay(d),s/veh				61.0	0.0	0.0	5.2	7.4	3.9	8.6	48.0	0.0
LnGrp LOS				E	A	A	A	A	A	A	F	A
Approach Vol, veh/h					282			1458			2851	
Approach Delay, s/veh					61.0			7.3			46.5	
Approach LOS					E			A			D	
Timer - Assigned Phs		2				6		8				
Phs Duration (G+Y+Rc), s		68.2				68.2		21.8				
Change Period (Y+Rc), s		4.5				4.5		4.5				
Max Green Setting (Gmax), s		63.0				63.0		18.0				
Max Q Clear Time (g_c+I1), s		19.6				32.1		17.2				
Green Ext Time (p_c), s		17.4				28.9		0.1				
Intersection Summary												
HCM 6th Ctrl Delay				35.0								
HCM 6th LOS				C								

Queues

14: Sunset & White Knoll

11/23/2021



Lane Group	WBT	NBL	NBT	NBR	SBL	SBT
Lane Group Flow (vph)	301	16	2374	16	149	1478
v/c Ratio	0.89	0.09	0.95	0.01	1.82	0.59
Control Delay	63.0	5.6	11.5	2.5	422.1	3.5
Queue Delay	1.3	0.0	7.3	0.0	0.0	0.6
Total Delay	64.4	5.6	18.8	2.5	422.1	4.1
Queue Length 50th (ft)	157	3	259	0	-87	47
Queue Length 95th (ft)	#304	m3	m177	m0	m#201	56
Internal Link Dist (ft)	220		510			30
Turn Bay Length (ft)						
Base Capacity (vph)	348	177	2501	1124	82	2501
Starvation Cap Reductn	0	0	0	0	0	557
Spillback Cap Reductn	7	0	134	0	0	0
Storage Cap Reductn	0	0	0	0	0	0
Reduced v/c Ratio	0.88	0.09	1.00	0.01	1.82	0.76

Intersection Summary

~ Volume exceeds capacity, queue is theoretically infinite.

Queue shown is maximum after two cycles.

95th percentile volume exceeds capacity, queue may be longer.



















Queue shown is maximum after two cycles.

m Volume for 95th percentile queue is metered by upstream signal.

HCM 6th Signalized Intersection Summary

14: Sunset & White Knoll

11/23/2021

												
Movement	EBL	EBT	EBR	WBL	WBT	WBR	NBL	NBT	NBR	SBL	SBT	SBR
Lane Configurations												
Traffic Volume (veh/h)	0	0	0	99	0	178	15	2184	15	137	1360	0
Future Volume (veh/h)	0	0	0	99	0	178	15	2184	15	137	1360	0
Initial Q (Qb), veh				0	0	0	0	0	0	0	0	0
Ped-Bike Adj(A_pbT)				1.00		1.00	1.00		1.00	1.00		1.00
Parking Bus, Adj				1.00	1.00	1.00	1.00	1.00	1.00	1.00	1.00	1.00
Work Zone On Approach				No		No		No		No		No
Adj Sat Flow, veh/h/ln				1870	1870	1870	1870	1870	1870	1870	1870	0
Adj Flow Rate, veh/h				108	0	193	16	2374	16	149	1478	0
Peak Hour Factor				0.92	0.92	0.92	0.92	0.92	0.92	0.92	0.92	0.92
Percent Heavy Veh, %				2	2	2	2	2	2	2	2	0
Cap, veh/h				118	0	212	330	2488	1110	94	2488	0
Arrive On Green				0.20	0.00	0.20	0.70	0.70	0.70	1.00	1.00	0.00
Sat Flow, veh/h				592	0	1058	357	3554	1585	146	3647	0
Grp Volume(v), veh/h				301	0	0	16	2374	16	149	1478	0
Grp Sat Flow(s),veh/h/ln				1650	0	0	357	1777	1585	146	1777	0
Q Serve(g_s), s				16.1	0.0	0.0	1.3	54.3	0.3	8.7	0.0	0.0
Cycle Q Clear(g_c), s				16.1	0.0	0.0	1.3	54.3	0.3	63.0	0.0	0.0
Prop In Lane				0.36		0.64	1.00		1.00	1.00		0.00
Lane Grp Cap(c), veh/h				330	0	0	330	2488	1110	94	2488	0
V/C Ratio(X)				0.91	0.00	0.00	0.05	0.95	0.01	1.58	0.59	0.00
Avail Cap(c_a), veh/h				330	0	0	330	2488	1110	94	2488	0
HCM Platoon Ratio				1.00	1.00	1.00	1.00	1.00	1.00	2.00	2.00	1.00
Upstream Filter(I)				1.00	0.00	0.00	1.00	1.00	1.00	1.00	1.00	0.00
Uniform Delay (d), s/veh				35.2	0.0	0.0	4.2	12.2	4.1	30.9	0.0	0.0
Incr Delay (d2), s/veh				28.4	0.0	0.0	0.3	10.1	0.0	306.9	1.1	0.0
Initial Q Delay(d3),s/veh				0.0	0.0	0.0	0.0	0.0	0.0	0.0	0.0	0.0
%ile BackOfQ(50%),veh/ln				8.9	0.0	0.0	0.1	20.0	0.1	10.0	0.4	0.0
Unsig. Movement Delay, s/veh												
LnGrp Delay(d),s/veh				63.6	0.0	0.0	4.5	22.3	4.1	337.8	1.1	0.0
LnGrp LOS				E	A	A	A	C	A	F	A	A
Approach Vol, veh/h					301			2406			1627	
Approach Delay, s/veh					63.6			22.1			31.9	
Approach LOS					E			C			C	
Timer - Assigned Phs		2				6		8				
Phs Duration (G+Y+Rc), s		67.5				67.5		22.5				
Change Period (Y+Rc), s		4.5				4.5		4.5				
Max Green Setting (Gmax), s		63.0				63.0		18.0				
Max Q Clear Time (g_c+I1), s		56.3				65.0		18.1				
Green Ext Time (p_c), s		6.3				0.0		0.0				
Intersection Summary												
HCM 6th Ctrl Delay				28.7								
HCM 6th LOS				C								

Queues

14: Sunset & White Knoll

11/23/2021



Lane Group	WBT	NBL	NBT	NBR	SBL	SBT
Lane Group Flow (vph)	283	4	1421	20	98	2738
v/c Ratio	0.82	0.05	0.55	0.02	0.48	1.06
Control Delay	45.5	4.8	5.0	1.6	10.8	50.5
Queue Delay	0.0	0.0	0.0	0.0	0.0	15.5
Total Delay	45.5	4.8	5.0	1.6	10.8	66.0
Queue Length 50th (ft)	113	1	127	1	20	~961
Queue Length 95th (ft)	#224	m1	m141	m1	m23	#1114
Internal Link Dist (ft)	220		510			30
Turn Bay Length (ft)						
Base Capacity (vph)	389	82	2573	1156	204	2573
Starvation Cap Reductn	0	0	0	0	0	317
Spillback Cap Reductn	0	0	0	0	0	0
Storage Cap Reductn	0	0	0	0	0	0
Reduced v/c Ratio	0.73	0.05	0.55	0.02	0.48	1.21



















Intersection Summary

- ~ Volume exceeds capacity, queue is theoretically infinite.
Queue shown is maximum after two cycles.
- # 95th percentile volume exceeds capacity, queue may be longer.
Queue shown is maximum after two cycles.
- m Volume for 95th percentile queue is metered by upstream signal.

HCM 6th Signalized Intersection Summary

14: Sunset & White Knoll

11/23/2021

												
Movement	EBL	EBT	EBR	WBL	WBT	WBR	NBL	NBT	NBR	SBL	SBT	SBR
Lane Configurations												
Traffic Volume (veh/h)	0	0	0	69	0	191	4	1307	18	90	2519	0
Future Volume (veh/h)	0	0	0	69	0	191	4	1307	18	90	2519	0
Initial Q (Qb), veh				0	0	0	0	0	0	0	0	0
Ped-Bike Adj(A_pbT)				1.00		1.00	1.00		1.00	1.00		1.00
Parking Bus, Adj				1.00	1.00	1.00	1.00	1.00	1.00	1.00	1.00	1.00
Work Zone On Approach				No		No		No		No		No
Adj Sat Flow, veh/h/ln				1870	1870	1870	1870	1870	1870	1870	1870	0
Adj Flow Rate, veh/h				75	0	208	4	1421	20	98	2738	0
Peak Hour Factor				0.92	0.92	0.92	0.92	0.92	0.92	0.92	0.92	0.92
Percent Heavy Veh, %				2	2	2	2	2	2	2	2	0
Cap, veh/h				83	0	231	80	2513	1121	270	2513	0
Arrive On Green				0.19	0.00	0.19	0.71	0.71	0.71	1.00	1.00	0.00
Sat Flow, veh/h				433	0	1200	103	3554	1585	370	3647	0
Grp Volume(v), veh/h				283	0	0	4	1421	20	98	2738	0
Grp Sat Flow(s),veh/h/ln				1633	0	0	103	1777	1585	370	1777	0
Q Serve(g_s), s				15.2	0.0	0.0	0.0	17.6	0.3	10.5	63.6	0.0
Cycle Q Clear(g_c), s				15.2	0.0	0.0	63.6	17.6	0.3	28.1	63.6	0.0
Prop In Lane				0.27		0.73	1.00		1.00	1.00		0.00
Lane Grp Cap(c), veh/h				315	0	0	80	2513	1121	270	2513	0
V/C Ratio(X)				0.90	0.00	0.00	0.05	0.57	0.02	0.36	1.09	0.00
Avail Cap(c_a), veh/h				327	0	0	80	2513	1121	270	2513	0
HCM Platoon Ratio				1.00	1.00	1.00	1.00	1.00	1.00	2.00	2.00	1.00
Upstream Filter(I)				1.00	0.00	0.00	1.00	1.00	1.00	1.00	1.00	0.00
Uniform Delay (d), s/veh				35.5	0.0	0.0	45.0	6.4	3.9	3.9	0.0	0.0
Incr Delay (d2), s/veh				25.7	0.0	0.0	1.2	0.9	0.0	3.8	47.6	0.0
Initial Q Delay(d3),s/veh				0.0	0.0	0.0	0.0	0.0	0.0	0.0	0.0	0.0
%ile BackOfQ(50%),veh/ln				8.2	0.0	0.0	0.1	5.6	0.1	0.7	16.6	0.0
Unsig. Movement Delay, s/veh												
LnGrp Delay(d),s/veh				61.2	0.0	0.0	46.2	7.4	3.9	7.6	47.6	0.0
LnGrp LOS				E	A	A	D	A	A	A	F	A
Approach Vol, veh/h					283			1445			2836	
Approach Delay, s/veh					61.2			7.4			46.3	
Approach LOS					E			A			D	
Timer - Assigned Phs		2				6		8				
Phs Duration (G+Y+Rc), s		68.1				68.1		21.9				
Change Period (Y+Rc), s		4.5				4.5		4.5				
Max Green Setting (Gmax), s		63.0				63.0		18.0				
Max Q Clear Time (g_c+I1), s		65.6				65.6		17.2				
Green Ext Time (p_c), s		0.0				0.0		0.1				
Intersection Summary												
HCM 6th Ctrl Delay				34.9								
HCM 6th LOS				C								

Queues

14: Sunset & White Knoll

11/23/2021



Lane Group	WBT	NBL	NBT	NBR	SBL	SBT
Lane Group Flow (vph)	300	2	2360	17	141	1474
v/c Ratio	0.89	0.01	0.94	0.02	1.72	0.59
Control Delay	62.7	5.0	11.3	2.5	378.9	3.5
Queue Delay	1.1	0.0	6.5	0.0	0.0	0.6
Total Delay	63.8	5.0	17.8	2.5	378.9	4.1
Queue Length 50th (ft)	157	0	254	0	-77	47
Queue Length 95th (ft)	#301	m0	m176	m1	m#192	56
Internal Link Dist (ft)	220		510			30
Turn Bay Length (ft)						
Base Capacity (vph)	348	177	2502	1124	82	2502
Starvation Cap Reductn	0	0	0	0	0	556
Spillback Cap Reductn	6	0	137	0	0	0
Storage Cap Reductn	0	0	0	0	0	0
Reduced v/c Ratio	0.88	0.01	1.00	0.02	1.72	0.76



















Intersection Summary

- ~ Volume exceeds capacity, queue is theoretically infinite.
Queue shown is maximum after two cycles.
- # 95th percentile volume exceeds capacity, queue may be longer.
Queue shown is maximum after two cycles.
- m Volume for 95th percentile queue is metered by upstream signal.

HCM 6th Signalized Intersection Summary

14: Sunset & White Knoll

11/23/2021

												
Movement	EBL	EBT	EBR	WBL	WBT	WBR	NBL	NBT	NBR	SBL	SBT	SBR
Lane Configurations												
Traffic Volume (veh/h)	0	0	0	96	0	180	2	2171	16	130	1356	0
Future Volume (veh/h)	0	0	0	96	0	180	2	2171	16	130	1356	0
Initial Q (Qb), veh				0	0	0	0	0	0	0	0	0
Ped-Bike Adj(A_pbT)				1.00		1.00	1.00		1.00	1.00		1.00
Parking Bus, Adj				1.00	1.00	1.00	1.00	1.00	1.00	1.00	1.00	1.00
Work Zone On Approach				No		No		No		No		No
Adj Sat Flow, veh/h/ln				1870	1870	1870	1870	1870	1870	1870	1870	0
Adj Flow Rate, veh/h				104	0	196	2	2360	17	141	1474	0
Peak Hour Factor				0.92	0.92	0.92	0.92	0.92	0.92	0.92	0.92	0.92
Percent Heavy Veh, %				2	2	2	2	2	2	2	2	0
Cap, veh/h				114	0	215	331	2488	1110	96	2488	0
Arrive On Green				0.20	0.00	0.20	0.70	0.70	0.70	1.00	1.00	0.00
Sat Flow, veh/h				571	0	1077	359	3554	1585	148	3647	0
Grp Volume(v), veh/h				300	0	0	2	2360	17	141	1474	0
Grp Sat Flow(s),veh/h/ln				1648	0	0	359	1777	1585	148	1777	0
Q Serve(g_s), s				16.0	0.0	0.0	0.2	53.4	0.3	9.6	0.0	0.0
Cycle Q Clear(g_c), s				16.0	0.0	0.0	0.2	53.4	0.3	63.0	0.0	0.0
Prop In Lane				0.35		0.65	1.00		1.00	1.00		0.00
Lane Grp Cap(c), veh/h				330	0	0	331	2488	1110	96	2488	0
V/C Ratio(X)				0.91	0.00	0.00	0.01	0.95	0.02	1.47	0.59	0.00
Avail Cap(c_a), veh/h				330	0	0	331	2488	1110	96	2488	0
HCM Platoon Ratio				1.00	1.00	1.00	1.00	1.00	1.00	2.00	2.00	1.00
Upstream Filter(I)				1.00	0.00	0.00	1.00	1.00	1.00	1.00	1.00	0.00
Uniform Delay (d), s/veh				35.2	0.0	0.0	4.1	12.1	4.1	30.7	0.0	0.0
Incr Delay (d2), s/veh				28.1	0.0	0.0	0.0	9.5	0.0	259.8	1.0	0.0
Initial Q Delay(d3),s/veh				0.0	0.0	0.0	0.0	0.0	0.0	0.0	0.0	0.0
%ile BackOfQ(50%),veh/ln				8.8	0.0	0.0	0.0	19.5	0.1	8.9	0.4	0.0
Unsig. Movement Delay, s/veh												
LnGrp Delay(d),s/veh				63.3	0.0	0.0	4.1	21.5	4.1	290.5	1.0	0.0
LnGrp LOS				E	A	A	A	C	A	F	A	A
Approach Vol, veh/h					300			2379			1615	
Approach Delay, s/veh					63.3			21.4			26.3	
Approach LOS					E			C			C	
Timer - Assigned Phs		2				6		8				
Phs Duration (G+Y+Rc), s		67.5				67.5		22.5				
Change Period (Y+Rc), s		4.5				4.5		4.5				
Max Green Setting (Gmax), s		63.0				63.0		18.0				
Max Q Clear Time (g_c+I1), s		55.4				65.0		18.0				
Green Ext Time (p_c), s		7.1				0.0		0.0				
Intersection Summary												
HCM 6th Ctrl Delay				26.2								
HCM 6th LOS				C								

Ashley Munoz

Subject: FW: Memo On Sunset/Beaudry (1111 Sunset Bl Mixed-Use Project)

From: Wes Pringle <wes.pringle@lacity.org>

Sent: Thursday, December 2, 2021 4:26 PM

To: Kathleen King <kathleen.king@lacity.org>

Cc: Milena Zasadzien <milena.zasadzien@lacity.org>; Jonathan Chambers <jchambers@gibsontrans.com>; Patrick Gibson <pgibson@gibsontrans.com>





Subject: Memo On Sunset/Beaudry (1111 Sunset Bl Mixed-Use Project)

Hi Kathleen,

The Department of Transportation (DOT) reviewed the traffic analysis, dated October 2020, prepared by Gibson Transportation Consulting, Inc., for the proposed mixed-use project located at 1111-1115 Sunset Boulevard and issued an assessment letter for this study on November 2, 2020. In the study the project proposed a voluntary improvement to reconfigure the intersection of Beaudry Avenue and Sunset Boulevard. The improvement would remove the island and channelized (slip lane) right-turn so that the intersection would have a right-turn lane, a through lane, and a left-turn lane in the southbound direction. DOT preliminarily approved of the proposed improvement.

Since DOT issued the assessment letter the design of the improvement has been modified. Gibson Transportation Consulting has issued a supplemental report to the original study detailing the changes to the original intersection improvement design, dated November 29, 2021. DOT has reviewed the report and concurs that the changes to the design are minimal and will not cause any adverse delays or queueing. All of the recommendations in DOT's original, November 2, 2021 letter shall remain in effect.

Wes

--

Wes Pringle, P.E.
Transportation EngineerMetro
Development Review100 S. Main St,
9th FloorLos Angeles, CA 90012

Los Angeles Department of
Transportation

213.972.8482



Notice: The information contained in this message is proprietary information belonging to the City of Los Angeles and/or its Proprietary Departments and is intended only for the confidential use of the addressee. If you have received this message in error, are not the addressee, an agent of the addressee, or otherwise authorized to receive this information, please delete/destroy and notify the sender immediately. Any review, dissemination, distribution or copying of the information contained in this message is strictly prohibited.