

APPENDIX K

TRAFFIC IMPACT ANALYSIS

This page intentionally left blank

TRAFFIC IMPACT ANALYSIS

**VILLAGE D SPECIFIC PLAN
CITY OF MADERA
MADERA COUNTY, CALIFORNIA**

LSA

June 2020

TRAFFIC IMPACT ANALYSIS

VILLAGE D SPECIFIC PLAN PROJECT

CITY OF MADERA

MADERA COUNTY, CALIFORNIA

Prepared for:

Keith Helmuth, P.E., City Engineer
City of Madera, Engineering Department
205 W 4th Street
Madera, California 93637

Prepared by:

LSA Associates, Inc.
1500 Iowa Avenue, Suite 200
Riverside, California 92507
(951) 781-9310

Project No. CMD1801



June 2020

TABLE OF CONTENTS

1.0	INTRODUCTION	1
1.1	PROJECT DESCRIPTION	1
1.2	STUDY AREA	2
1.2.1	Study Intersections.....	2
1.2.2	Roadway Segments	4
1.2.3	Caltrans Facilities.....	5
1.3	LIST OF CHAPTER 1.0 FIGURES AND TABLES	5
2.0	ANALYSIS METHODOLOGY	10
2.1	INTERSECTION AND ROADWAY SEGMENT LEVEL OF SERVICE DEFINITIONS	10
2.2	FREEWAY LEVEL OF SERVICE DEFINITIONS	10
2.3	HEAVY VEHICLE FACTOR IN LEVEL OF SERVICE CALCULATIONS.....	11
2.4	LEVEL OF SERVICE STANDARDS AND SIGNIFICANCE THRESHOLDS.....	11
2.5	LIST OF CHAPTER 2.0 TABLES	11
3.0	CIRCULATION NETWORK SETTING	15
3.1	EXISTING CIRCULATION NETWORK	15
3.2	BIKES, TRAILS, AND TRANSIT	16
3.3	LIST OF CHAPTER 3.0 FIGURES AND TABLES	17
4.0	TRAFFIC VOLUMES FOR WITHOUT PROJECT SCENARIOS.....	27
4.1	EXISTING TRAFFIC VOLUMES.....	27
4.2	PHASE I PROJECT COMPLETION YEAR (2029) WITHOUT PROJECT TRAFFIC VOLUMES	27
4.3	PHASE II PROJECT COMPLETION YEAR (2039) WITHOUT PROJECT TRAFFIC VOLUMES	28
4.4	PHASE III PROJECT COMPLETION YEAR (2049) WITHOUT PROJECT TRAFFIC VOLUMES	28
4.5	LIST OF CHAPTER 4.0 FIGURES AND TABLES	28
5.0	PROJECT TRAFFIC.....	46
5.1	PROJECT TRIP GENERATION	46
5.2	PROJECT TRIP DISTRIBUTION AND ASSIGNMENT	47
5.3	LIST OF CHAPTER 5.0 FIGURES AND TABLES	47
6.0	TRAFFIC VOLUMES FOR “WITH PROJECT” SCENARIOS	92

6.1	LIST OF CHAPTER 6.0 FIGURES	92
7.0	INTERSECTION AND ROADWAY SEGMENT LEVELS OF SERVICE	101
7.1	EXISTING LEVELS OF SERVICE	101
7.1.1	Study Intersections.....	101
7.1.2	Roadway Segments	101
7.1.3	Freeway Segments and Ramps	101
7.2	EXISTING WITH PROJECT LEVELS OF SERVICE	102
7.2.1	Study Intersections.....	102
7.2.2	Roadway Segments	104
7.2.3	Freeway Segments and Ramps	104
7.3	PHASE I PROJECT COMPLETION YEAR (2029) WITHOUT PROJECT LEVELS OF SERVICE.....	106
7.3.1	Study Intersections.....	106
7.3.2	Roadway Segments	106
7.3.3	Freeway Segments and Ramps	107
7.4	PHASE I PROJECT COMPLETION YEAR (2029) WITH PROJECT LEVELS OF SERVICE ..	107
7.4.1	Study Intersections.....	107
7.4.2	Roadway Segments	108
7.4.3	Freeway Segments and Ramps	108
7.5	PHASE II PROJECT COMPLETION YEAR (2039) WITHOUT PROJECT LEVELS OF SERVICE.....	109
7.5.1	Study Intersections.....	109
7.5.2	Roadway Segments	109
7.5.3	Freeway Segments and Ramps	110
7.6	PHASE II PROJECT COMPLETION YEAR (2039) WITH PROJECT LEVELS OF SERVICE .	110
7.6.1	Study Intersections.....	110
7.6.2	Roadway Segments	112
7.6.3	Freeway Segments and Ramps	112
7.7	PHASE III PROJECT COMPLETION YEAR (2049) WITHOUT PROJECT LEVELS OF SERVICE.....	113
7.7.1	Study Intersections.....	113
7.7.2	Roadway Segments	114
7.7.3	Freeway Segments and Ramps	114
7.8	PHASE III PROJECT COMPLETION YEAR (2049) WITH PROJECT LEVELS OF SERVICE	115
7.8.1	Study Intersections.....	115
7.8.2	Roadway Segments	116
7.8.3	Freeway Segments and Ramps	117
7.9	LIST OF CHAPTER 7.0 FIGURES AND TABLES	118
8.0	QUEUING ANALYSIS.....	152
8.1	LIST OF CHAPTER 8.0 TABLES	152

9.0	CIRCULATION IMPROVEMENTS AND FUNDING SOURCES	161
9.1	RECOMMENDED IMPROVEMENTS.....	161
9.2	FUNDING SOURCES AND MECHANISMS	161
9.2.1	Measure “T” Program	162
9.2.2	Capital Improvement Plan.....	162
9.2.3	Development Impact Fee Program	162
9.2.4	Project Fair Share	162
9.3	LIST OF CHAPTER 9.0 TABLES	163
10.0	SIGNAL WARRANT ANALYSIS.....	186
10.1	LIST OF CHAPTER 10.0 TABLES	186
11.0	VMT EVALUATION	188
11.1	METHODOLOGY.....	189
11.2	VMT ANALYSIS.....	192
12.0	SUMMARY AND CONCLUSIONS.....	193
12.1	EXISTING CONDITIONS SUMMARY	193
12.2	PHASE I PROJECT COMPLETION YEAR (2029) CONDITIONS SUMMARY	193
12.3	PHASE II PROJECT COMPLETION YEAR (2039) CONDITIONS SUMMARY	193
12.4	PHASE III PROJECT COMPLETION YEAR (2049) CONDITIONS SUMMARY	193
12.5	VMT EVALUATION SUMMARY.....	194

APPENDICES

- A: SCOPING AGREEMENT
- B: TRAFFIC COUNT SHEETS
- C: VOLUME DEVELOPMENT WORKSHEETS
- D: INTERSECTION LEVEL OF SERVICE WORKSHEETS
- E: FREEWAY LEVEL OF SERVICE WORKSHEETS
- F: QUEUING ANALYSIS WORKSHEETS
- G: SIGNAL WARRANT ANALYSIS WORKSHEETS
- H: VMT CALCULATION WORKSHEETS

FIGURES AND TABLES

FIGURES

Figure 1-1: Regional and Project Location.....	6
Figure 1-2: Conceptual Land Use Plan.....	7
Figure 1-3: Study Area Intersections	8
Figure 3-1A: Existing Study Intersection Geometrics and Traffic Control (Int. 1–30)	18
Figure 3-1B: Existing Study Intersection Geometrics and Traffic Control (Int. 31–58)	19
Figure 3-2A: Existing with Project Study Intersection Geometrics and Traffic Control (Int. 1–30)	20
Figure 3-2B: Existing with Project Study Intersection Geometrics and Traffic Control (Int. 31–58)	21
Figure 3-3: City of Madera General Plan Circulation Master Plan	22
Figure 3-4: City of Madera Parks and Trails.....	23
Figure 3-5: City of Madera Existing and Planned Bikeways	24
Figure 3-6: City of Madera Existing Transit Facilities.....	25
Figure 4-1A: Existing Peak Hour Traffic Volumes (Int. 1–30)	30
Figure 4-1B: Existing Peak Hour Traffic Volumes (Int. 31–58).....	31
Figure 4-2A: Phase I Project Completion Year (2029) without Project Peak Hour Traffic Volumes (Int. 1–30)	32
Figure 4-2B: Phase I Project Completion Year (2029) without Project Peak Hour Traffic Volumes (Int. 31–58)	33
Figure 4-3A: Phase II Project Completion Year (2039) without Project Peak Hour Traffic Volumes (Int. 1–30)	34
Figure 4-3B: Phase II Project Completion Year (2039) without Project Peak Hour Traffic Volumes (Int. 31–58)	35
Figure 4-4A: Phase III Project Completion Year (2049) without Project Peak Hour Traffic Volumes (Int. 1–30)	36
Figure 4-4B: Phase III Project Completion Year (2049) without Project Peak Hour Traffic Volumes (Int. 31–58)	37
Figure 5-1:.....	50
Figure 5-2A: Phase I Project Internal Trip Assignment (Int. 1–30)	51
Figure 5-2B: Phase I Project Internal Trip Assignment (Int. 31–58)	52
Figure 5-3A: Phase II Project Internal Trip Assignment (Int. 1–30)	53
Figure 5-3B: Phase II Project Internal Trip Assignment (Int. 31–58)	54
Figure 5-4A: Phase III Project Internal Trip Assignment (Int. 1–30)	55
Figure 5-4B: Phase III Project internal Trip Assignment (Int. 31–58)	56
Figure 5-5A: Phase I Project Pass-by Trip Assignment (Int. 1–30).....	57
Figure 5-5B: Phase I Project Pass-by Trip Assignment (Int. 31–58).....	58
Figure 5-6A: Phase II Project Pass-by Trip Assignment (Int. 1–30).....	59
Figure 5-6B: Phase II Project Pass-by Trip Assignment (Int. 31–58).....	60
Figure 5-7A: Phase III Project Pass-by Trip Assignment (Int. 1–30).....	61
Figure 5-7B: Phase III Project Pass-by Trip Assignment (Int. 31–58).....	62
Figure 5-8A: Phase I TAZ 615 Project Trip Distribution (Int. 1–30)	63

Figure 5-8B: Phase I TAZ 615 Project Trip Distribution (Int. 31–58).....	64
Figure 5-9A: Phase I TAZ 616 Project Trip Distribution (Int. 1–30)	65
Figure 5-9B: Phase I TAZ 616 Project Trip Distribution (Int. 31–58).....	66
Figure 5-10A: Phase I TAZ 626 Project Trip Distribution (Int. 1–30)	67
Figure 5-10B: Phase I TAZ 626 Project Trip Distribution (Int. 31–58).....	68
Figure 5-11A: Phase II TAZ 627 Project Trip Distribution (Int. 1–30)	69
Figure 5-11B: Phase II TAZ 627 Project Trip Distribution (Int. 31–58).....	70
Figure 5-12A: Phase II TAZ 628 Project Trip Distribution (Int. 1–30)	71
Figure 5-12B: Phase II TAZ 628 Project Trip Distribution (Int. 31–58).....	72
Figure 5-13A: Phase II TAZ 629 Project Trip Distribution (Int. 1–30)	73
Figure 5-13B: Phase II TAZ 629 Project Trip Distribution (Int. 31–58).....	74
Figure 5-14A: Phase III TAZ 630 Project Trip Distribution (Int. 1–30)	75
Figure 5-14B: Phase III TAZ 630 Project Trip Distribution (Int. 31–58).....	76
Figure 5-15A: Phase III TAZ 631 Project Trip Distribution (Int. 1–30)	77
Figure 5-15B: Phase III TAZ 631 Project Trip Distribution (Int. 31–58).....	78
Figure 5-16A: Phase III TAZ 632 Project Trip Distribution (Int. 1–30)	79
Figure 5-16B: Phase III TAZ 632 Project Trip Distribution (Int. 31–58).....	80
Figure 5-17A: Phase I Project Trip Assignment (Int. 1–30).....	81
Figure 5-17B: Phase I Project Trip Assignment (Int. 31–58).....	82
Figure 5-18A: Phase II Project Trip Assignment (Int. 1–30).....	83
Figure 5-18B: Phase II Project Trip Assignment (Int. 31–58).....	84
Figure 5-19A: Phase III Project Trip Assignment (Int. 1–30).....	85
Figure 5-19B: Phase III Project Trip Assignment (Int. 31–58).....	86
Figure 6-1A: Existing with Project Peak Hour Traffic Volumes (Int. 1–30)	93
Figure 6-1B: Existing with Project Peak Hour Traffic Volumes (Int. 31–58)	94
Figure 6-2A: Phase I Project Completion Year (2029) with Project Peak Hour Traffic Volumes (Int. 1–30)	95
Figure 6-2B: Phase I Project Completion Year (2029) with Project Peak Hour Traffic Volumes (Int. 31–58)	96
Figure 6-3A: Phase II Project Completion Year (2039) with Project Peak Hour Traffic Volumes (Int. 1–30)	97
Figure 6-3B: Phase II Project Completion Year (2039) with Project Peak Hour Traffic Volumes (Int. 31–58)	98
Figure 6-4A: Phase III Project Completion Year (2049) with Project Peak Hour Traffic Volumes (Int. 1–30)	99
Figure 6-4B: Phase III Project Completion Year (2049) with Project Peak Hour Traffic Volumes (Int. 31–58)	100
Figure 7-1: Existing Intersection Levels of Service	120
Figure 7-2: Existing without Project Roadway Segment Daily Volumes and Levels of Service	121
Figure 7-3: Existing with Project Roadway Segment Daily Volumes and Levels of Service.....	122
Figure 7-4: Phase I Project Completion Year (2029) Intersection Levels of Service.....	123
Figure 7-5: Phase I Project Completion Year (2029) without Project Roadway Segment Daily Volumes and Levels of Service.....	124
Figure 7-6: Phase I Project Completion Year (2029) with Project Roadway Segment Daily Volumes and Levels of Service.....	125

Figure 7-7: Phase II Project Completion Year (2039) Intersection Levels of Service..... 126

Figure 7-8: Phase II Project Completion Year (2039) without Project Roadway Segment Daily
Volumes and Levels of Service..... 127

Figure 7-9: Phase II Project Completion Year (2039) with Project Roadway Segment Daily
Volumes and Levels of Service..... 128

Figure 7-10: Phase III Project Completion Year (2049) Intersection Levels of Service..... 129

Figure 7-11: Phase III Project Completion Year (2049) without Project Roadway Segments
Daily Volumes and Levels of Service..... 130

Figure 7-12: Phase III Project Completion Year (2049) with Project Roadway Segments Daily
Volumes and Levels of Service..... 131

Figure 9-1A: Phase I Project Completion Year (2029) with Project with Improvements Study
Intersection Geometrics and Traffic Control (Int. 1–30) 165

Figure 9-1B: Phase I Project Completion Year (2029) with Project with Improvements Study
Intersection Geometrics and Traffic Control (Int. 31–58) 166

Figure 9-2A: Phase II Project Completion Year (2039) with Project with Improvements Study
Intersection Geometrics and Traffic Control (Int. 1–30) 167

Figure 9-2B: Phase II Project Completion Year (2039) with Project with Improvements Study
Intersection Geometrics and Traffic Control (Int. 31–58) 168

Figure 9-3A: Phase III Project Completion (General Plan Build-out) Year (2049) with Project
with Improvements Study Intersection Geometrics and Traffic Control (Int. 1–30)..... 169

Figure 9-3B: Phase III Project Completion (General Plan Build-out) Year (2049) with Project
with Improvements Study Intersection Geometrics and Traffic Control (Int. 31–58)..... 170

TABLES

Table 1-A: Proposed Project Phases..... 9

Table 2-A: Intersection Level of Service Definitions..... 13

Table 2-B: Roadway Segment Level of Service Definitions 13

Table 2-C: Level of Service Criteria for Unsignalized and Signalized Intersections 14

Table 2-D: Roadway Segment Capacity and Levels of Service (City of Madera) 14

Table 2-E: Level of Service Criteria for Freeway Segments 14

Table 2-F: Level Of Service Criteria for Ramps and Ramp Junctions 14

Table 3-A: City of Madera Roadway Segment Classification..... 26

Table 4-A: Existing Roadway Segment Daily Traffic Volumes 38

Table 4-B: Existing Freeway Segment and Ramp Traffic Volumes 39

Table 4-C: Phase I Project Completion Year (2029) Roadway Segment Daily Traffic Volumes..... 40

Table 4-D: Phase I Project Completion Year (2029) Freeway Segment and Ramp Traffic
Volumes 41

Table 4-E: Phase II Project Completion Year (2039) Roadway Segment Daily Traffic Volumes..... 42

Table 4-F: Phase II Project Completion Year (2039) Freeway Segment and Ramp Traffic
Volumes 43

Table 4-G: Phase III Project Completion Year (2049) Roadway Segment Daily Traffic Volumes 44

Table 4-H: Phase III Project Completion Year (2049) Freeway Segment and Ramp Traffic
Volumes 45

Table 5-A: Project Trip Generation..... 87

Table 7-A: Existing Intersection Levels of Service	132
Table 7-B: Existing Roadway Segment Levels of Service	134
Table 7-C: Existing Freeway Segment and Ramp Levels of Service	135
Table 7-D: Phase I Project Completion Year (2029) Intersection Levels of Service	137
Table 7-E: Phase I Project Completion Year (2029) Roadway Segment Levels of Service	139
Table 7-F: Phase I Project Completion Year (2029) Freeway Segment and Ramp Levels of Service.....	140
Table 7-G: Phase II Project Completion Year (2039) Intersection Levels of Service	142
Table 7-H: Phase II Project Completion Year (2039) Roadway Segment Levels of Service	144
Table 7-I: Phase II Project Completion Year (2039) Freeway Segment and Ramp Levels of Service.....	145
Table 7-J: Phase III Project Completion Year (2049) Intersection Levels of Service.....	147
Table 7-K: Phase III Project Completion Year (2049) Roadway Segment Levels of Service	149
Table 7-L: Phase III Project Completion Year (2049) Freeway Segment and Ramp Levels of Service.....	150
Table 8-A: Existing Queuing Analysis.....	153
Table 8-B: Phase I Project Completion Year (2029) Queuing Analysis	155
Table 8-C: Phase II Project Completion Year (2039) Queuing Analysis	157
Table 8-D: Phase III Project Completion Year (2049) Queuing Analysis.....	159
Table 9-A: Recommended Improvements for Intersections	171
Table 9-B: Existing with Project with Improvements Intersection Levels of Service	173
Table 9-C: Phase I Project Completion Year (2029) with Project with Improvements Intersection Levels of Service	174
Table 9-D: Phase II Project Completion Year (2039) with Project with Improvements Intersection Levels of Service	175
Table 9-E: Phase III Project Completion (General Plan Build-out) Year (2049) with Project with Improvements Intersection Levels of Service.....	176
Table 9-F: Recommended Improvements for Roadway Segments.....	178
Table 9-G: Existing with Project with Improvements Roadway Segments Levels of Service	179
Table 9-H: Phase I Project Completion Year (2029) with Project with Improvements Roadway Segments Levels of Service	180
Table 9-I: Phase II Project Completion Year (2039) with Project with Improvements Roadway Segments Levels of Service	181
Table 9-J: Phase III Project Completion (General Plan Build-out) Year (2049) with Project with Improvements Roadway Segments Levels of Service.....	182
Table 9-K: Intersection Improvements Funding Mechanism and Fair Share	183
Table 9-L: Roadway Segment Improvements Funding Mechanism and Fair Share	185
Table 10-A: Signal Warrant Analysis Summary	187
Table 11-A: Existing and Year 2049 VMT Comparison	192

1.0 INTRODUCTION

The Traffic Impact Analysis (TIA) has been prepared for the proposed Village D Specific Plan project (project) to be located at the western edge of the City of Madera (City). The project is bounded by the Fresno River to the south, Road 24 to the east, Avenue 17 to the north, and Road 22 to the west. Figure 1-1 illustrates the regional and project location. (Figures and tables are located at the end of each chapter.)

This report is intended to satisfy the requirements established by the City and Caltrans, where applicable, as well as the requirements for the disclosure of potential impacts and mitigation measures pursuant to the California Environmental Quality Act (CEQA). The scope of work for this TIA, including trip generation, trip distribution, study area, and analysis methodologies, has been approved by City staff via the Scoping Agreement process. A copy of the Scoping Agreement is included as Appendix A.

This study examines traffic operations in the vicinity of the proposed project under the following eight scenarios:

- Existing Conditions;
- Existing with Project Conditions;
- Phase I Project Completion Year (2029) without Project Conditions;
- Phase I Project Completion Year (2029) with Project Conditions;
- Phase II Project Completion Year (2039) without Project Conditions;
- Phase II Project Completion Year (2039) with Project Conditions;
- Phase III Project Completion Year (2049) without Project Conditions; and
- Phase III Project Completion Year (2049) with Project Conditions [Project Build-out].

Traffic conditions were examined for the weekday daily, a.m., and p.m. peak hour conditions. The a.m. peak hour is defined as the one hour of highest traffic volumes occurring between 7:00 and 9:00 a.m. The p.m. peak hour is defined as the one hour of highest traffic volumes occurring between 4:00 and 6:00 p.m.

1.1 PROJECT DESCRIPTION

The site is currently zoned as Agricultural Rural Exclusive with agricultural operations around the project site. The proposed project will add 6,640 single-family dwelling units, 4,161 multifamily dwelling units, 232,610 square feet (sf) of business park, 1,835,618 sf of village mixed use, and three elementary schools serving 2,100 students. Figure 1-2 illustrates the conceptual land use plan for the project.

Most of the project site is currently vacant or used for agricultural purposes. The proposed project will replace existing uses and is anticipated to be built in three phases. Phase I consists of the

southeastern quadrant of the project site. Phase II consists of the northwestern quadrant of the project site. Phase III consists of the southwestern quadrant of the project site. Figure 1-2 illustrates the phase boundaries. Phase I is anticipated to be completed by 2029. Phase II is anticipated to be completed by 2039. Phase III is anticipated to be completed by 2049. Table 1-A summarizes each of the proposed phases.

As illustrated in Figure 1-2, access to the project will be provided along Avenue 17, Avenue 16, Cleveland Avenue, Road 22, Road 23, and Road 24.

1.2 STUDY AREA

1.2.1 Study Intersections

Based on the scoping agreement process and discussions with the City staff and Caltrans District 6 staff, the following intersections have been analyzed in the TIA:

1. Road 22/Avenue 17 [Future Intersection] (Madera County);
2. Road 22/Avenue 16 (Madera County);
3. Golden State Boulevard/Avenue 18½ (Madera County);
4. Pistachio Drive/Avenue 18½ (Madera County);
5. State Route 99 (SR-99) Southbound Ramps–Road 23/Avenue 18½ (Caltrans);
6. SR-99 Northbound Ramps/Avenue 18½ (Caltrans);
7. Road 23/Avenue 17 (City of Madera/Madera County);
8. Road 23/Avenue 16 (City of Madera/Madera County);
9. Road 23/Cleveland Avenue (Madera County);
10. Road 23/Avenue 14½ (Madera County);
11. Road 23/Avenue 14 (Madera County);
12. Road 23/Avenue 12 (Madera County);
13. Golden State Boulevard–Airport Drive/Avenue 17 (City of Madera);
14. SR-99 Southbound Ramps/Avenue 17 (Caltrans);
15. SR-99 Northbound Ramps/Avenue 17 (Caltrans);
16. Love’s Truck Stop Driveway/Avenue 17 (Madera County);
17. Westberry Boulevard/Cleveland Avenue (City of Madera);
18. Westberry Boulevard/Sunset Avenue (City of Madera);
19. Westberry Boulevard/Avenue 14 (City of Madera/Madera County);
20. Westberry Boulevard/Avenue 16 (City of Madera/Madera County);
21. Granada Drive/Cleveland Avenue (City of Madera);
22. Granada Drive/Sunset Avenue (City of Madera);

23. Avenue 16–Ellis Street/Kennedy Street (City of Madera/Madera County);
24. Schnoor Street/Kennedy Street (City of Madera/Madera County);
25. SR-99 Southbound Ramps/Kennedy Street–Gateway Drive (Caltrans);
26. SR-99 Northbound Off-Ramp/Gateway Drive (Caltrans);
27. SR-99 Northbound Off-Ramps (Caltrans);
28. SR-99 Northbound Off-Ramp/Gateway Drive (Caltrans);
29. Schnoor Avenue/Cleveland Avenue (City of Madera);
30. Fairgrounds/Cleveland Avenue (City of Madera/Madera County);
31. SR-99 Southbound Ramps/Cleveland Avenue (Caltrans);
32. SR-99 Northbound Ramps/Cleveland Avenue (Caltrans);
33. Gateway Drive/Cleveland Avenue (City of Madera);
34. Cleveland Avenue–Country Club Drive/W. Cleveland Avenue (City of Madera);
35. Country Club Drive/Sharon Boulevard (City of Madera);
36. Pine Street/Howard Road (City of Madera);
37. Q Street–Olive Avenue/Yosemite Avenue–Howard Road (City of Madera);
38. I Street/SR-99 Southbound Off-Ramp–2nd Street (Caltrans);
39. 4th Street/Sunset Avenue (City of Madera);
40. H Street/SR-99 Northbound On-Ramp–2nd Street (Caltrans);
41. I Street/4th Street (City of Madera);
42. SR-99 Southbound On-Ramp/4th Street (Caltrans);
43. H Street–SR-99 Northbound Off-Ramp/4th Street (Caltrans);
44. I Street/Olive Avenue (City of Madera);
45. SR-99 Southbound Off-Ramp/Olive Avenue (Caltrans);
46. Madera Avenue/SR-99 Northbound Ramps (Caltrans);
47. Madera Avenue/Olive Avenue–SR-99 Southbound On-Ramp (Caltrans);
48. Madera Avenue (SR-145)/Lewis Street (Caltrans);
49. Yosemite Avenue/Cleveland Avenue–Tozer Street (Caltrans);
50. Road 22/Cleveland Avenue [Future Intersection] (Madera County);
51. Project Driveway 1/Avenue 17 [Future Intersection] (Madera County);
52. Road 22½–Project Driveway 2/Avenue 16 (Madera County);
53. Road 22½/Cleveland Avenue (Madera County);
54. Road 22½/Project Driveway 5 [Future Intersection] (Madera County);

55. Road 23/Project Driveway 3 (City of Madera/Madera County);
56. Road 23/Project Driveway 4 [Future Intersection] (Madera County);
57. Road 23/Project Driveway 5 (Madera County); and
58. Project Driveway 6/Cleveland Avenue [Future Intersection] (Madera County).

Figure 1-3 illustrates the locations of all analysis intersections.

All non-Caltrans intersections fall under the City's General Plan Planning Area.

1.2.2 Roadway Segments

Based on the scoping agreement process and discussions with City staff, the following roadway segments have been analyzed in the TIA:

1. Road 23/Avenue 17 to Project Driveway 3 (City of Madera/Madera County);
2. Road 23/Project Driveway 3 to Avenue 16 (City of Madera/Madera County);
3. Road 23/Avenue 16 to Cleveland Avenue (Madera County);
4. Road 23/Cleveland Avenue to Project Driveway 4 (Madera County);
5. Road 23/Project Driveway 4 to Project Driveway 5 (Madera County);
6. Road 23/Project Driveway 5 to Avenue 14½ (Madera County);
7. Road 23/Avenue 14½ to Avenue 14 (Madera County);
8. Westberry Boulevard/Sunset Avenue to Avenue 14/Howard Road (City of Madera);
9. Granada Drive/Cleveland Avenue to Fresno River (City of Madera);
10. Granada Drive/Sunset Avenue to Avenue 14/Howard Road (City of Madera);
11. Avenue 17/Road 22 to Project Driveway 1 (Madera County);
12. Avenue 17/Project Driveway 1 to Road 23 (Madera County);
13. Avenue 17/Road 23 to Golden State Boulevard (City of Madera/Madera County);
14. Avenue 17/Golden State Boulevard to SR-99 Southbound Off-Ramp (City of Madera);
15. Avenue 16/Road 22 to Project Driveway 2/Road 22½ (Madera County);
16. Avenue 16/Project Driveway 2/Road 22½ to Road 23 (Madera County);
17. Cleveland Avenue/Road 22½ to Road 23 (Madera County);
18. Cleveland Avenue/Road 23 to Project Driveway 6 (Madera County);
19. Cleveland Avenue/Project Driveway 6 to Westberry Boulevard (City of Madera/Madera County);
20. Cleveland Avenue/Westberry Boulevard to Granada Drive (City of Madera);

21. Cleveland Avenue/Granada Drive to Schnoor Street (City of Madera);
22. Cleveland Avenue/Schnoor Street to Fairgrounds (City of Madera/Madera County);
23. Cleveland Avenue/Fairgrounds to SR-99 Southbound Ramps (City of Madera/Madera County);
24. Sunset Avenue/Granada Drive to Schnoor Street (City of Madera);
25. Howard Road/Granada Drive to Schnoor Street (City of Madera);
26. Howard Road/Schnoor Street to Pine Street (City of Madera);
27. Olive Avenue/Yosemite Avenue to I Street (City of Madera);
28. Olive Avenue/I Street to SR-99 Southbound Off-Ramp (City of Madera); and
29. Olive Avenue/SR-99 Southbound Off-Ramp to Madera Avenue (SR-145) (City of Madera).

1.2.3 Caltrans Facilities

Based on discussions with Caltrans District 6 staff, the following freeway segments along SR-99 have been analyzed in the TIA:

1. Avenue 20–Avenue 20½ to Avenue 18½;
2. Avenue 18½ to Avenue 17;
3. Avenue 17 to Avenue 16/Gateway Drive;
4. Avenue 16/Gateway Drive to Cleveland Avenue;
5. Cleveland Avenue to 2nd Street;
6. 2nd Street to 4th Street;
7. 4th Street to Madera Avenue (SR-145); and
8. Madera Avenue (SR-145) to Almond Avenue.

Additionally, all ramp merge/diverge areas along SR-99 from Avenue 18½ interchange to Madera Avenue (SR-145) interchange have been analyzed in this TIA.

1.3 LIST OF CHAPTER 1.0 FIGURES AND TABLES

- Figure 1-1: Regional and Project Location
- Figure 1-2: Conceptual Land Use Plan
- Figure 1-3: Study Area Intersections
- Table 1-A: Proposed Project Phases

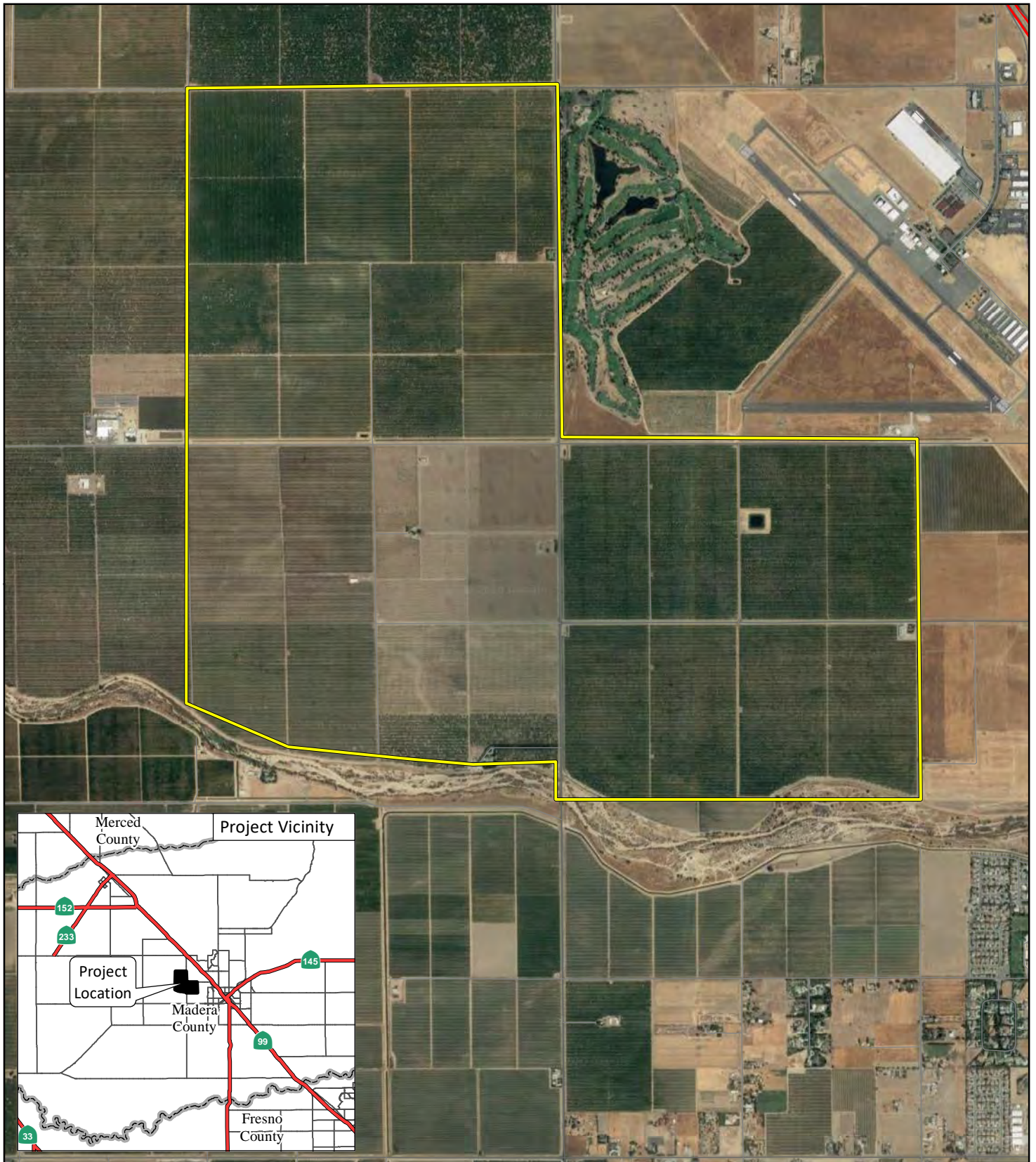
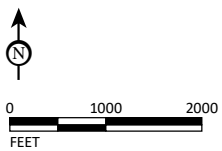

FIGURE 1-1

LSA

LEGEND

 Project Boundary



SOURCE: ESRI Streetmap (2013); Google Earth (2018).
 I:\CMD1801\Reports\Traffic\fig1-1_Reg_Loc.mxd (2/16/2020)

Village D Specific Plan
 Traffic Impact Analysis
 Regional and Project Location

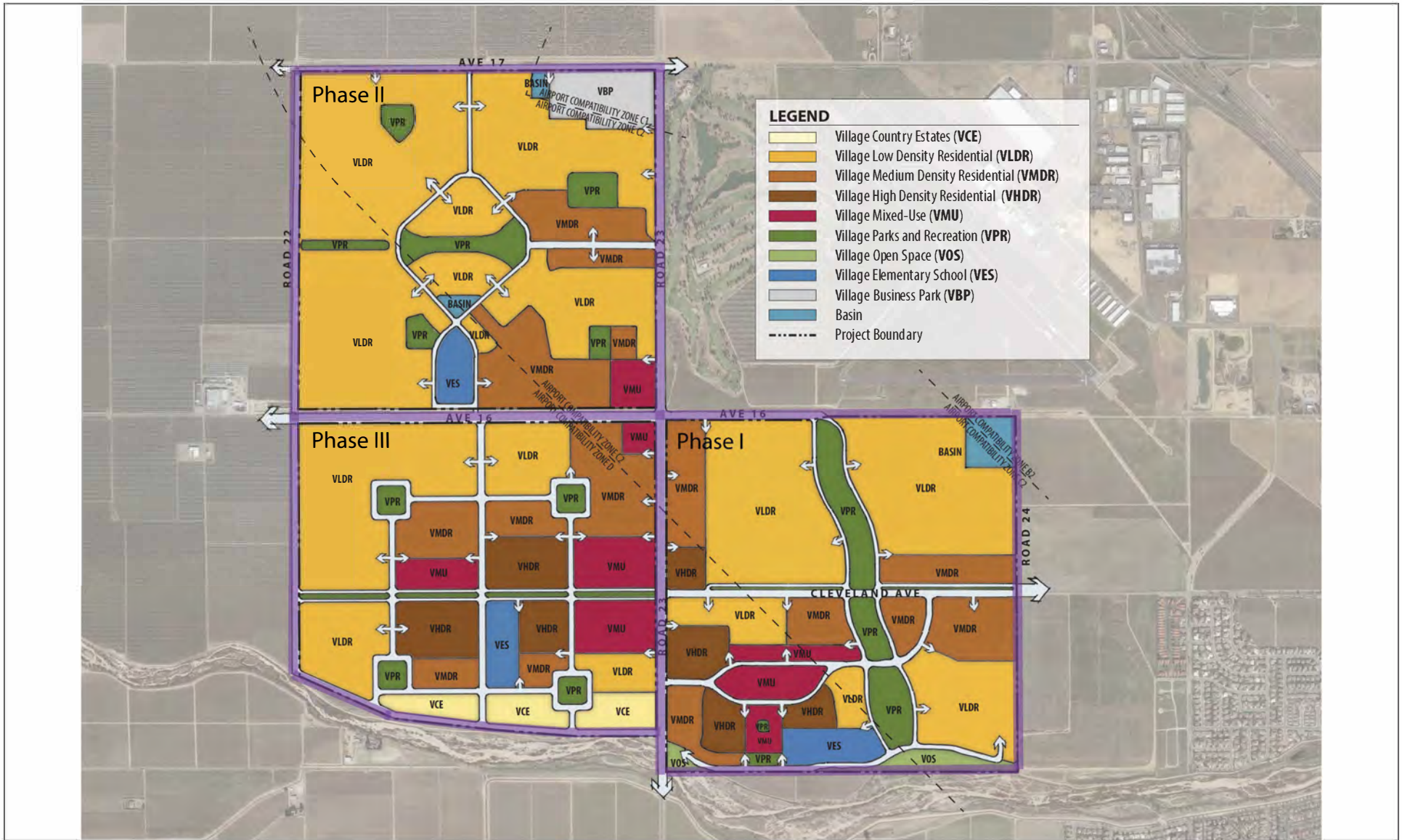

FIGURE 1-2

LSA

Legend

Phase Boundary



NOT TO SCALE

SOURCE: KTG, DECEMBER 2018.

P:\CMD1801 Madera Village D\PRODUCTS\Project Description\Figure Content\Fig_3-5.ai (2/12/19))

Village D Specific Plan EIR
 Traffic Impact Analysis
 Conceptual Land Use Plan

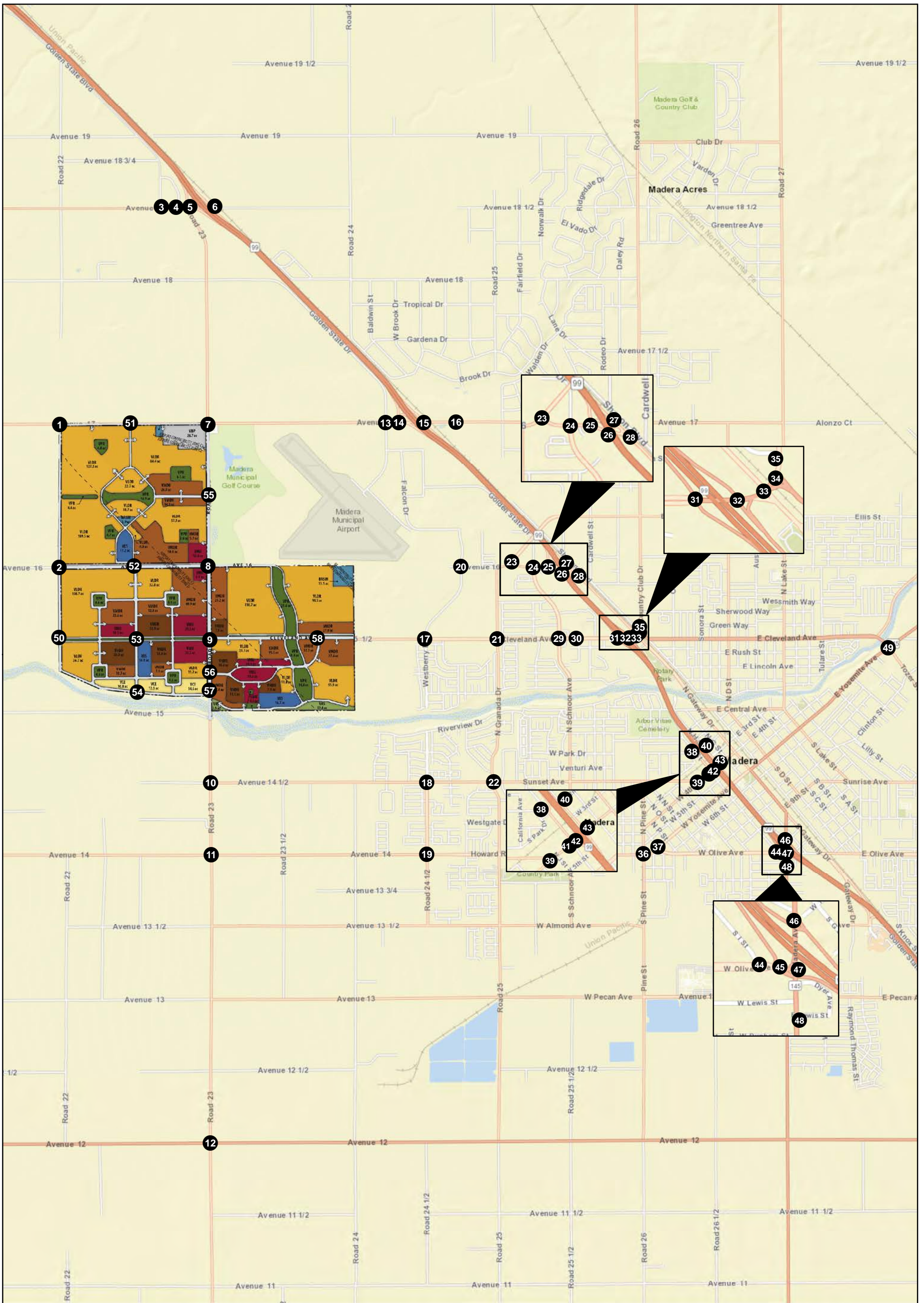

LSA

LEGEND

- Study Area Intersection

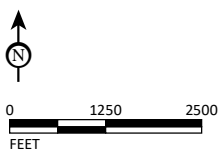

SOURCE: ESRI

I:\CMD1801\Reports\Traffic\fig1-3_Intersections-11.19.19.mxd (2/16/2020)

FIGURE 1-3

Table 1-A: Proposed Project Phases

Phase	Single-Family Residential	Multifamily Residential	Business Park	Village Mixed-Use	Elementary School
Phase I	2,257 DU	1,718 DU	—	651,004 SF	700 STU
Phase II	2,786 DU	560 DU	232,610 SF	189,050 SF	700 STU
Phase III	1,597 DU	1,883 DU	—	995,564 SF	700 STU
Total	6,640 DU	4,161 DU	232,610 SF	1835,618 SF	2,100 STU

DU = Dwelling Units
 SF = Square Feet
 STU = Students

2.0 ANALYSIS METHODOLOGY

2.1 INTERSECTION AND ROADWAY SEGMENT LEVEL OF SERVICE DEFINITIONS

Level of service (LOS) can be characterized for the whole intersection, each intersection approach, and by each lane group. Control delay alone is used to characterize LOS for the entire intersection. Control delay quantifies the increase in travel time due to the traffic signal control and is a surrogate measure of driver discomfort and fuel consumption.

A complete description of the meaning of LOS can be found in the Transportation Research Board Special Report 209, *Highway Capacity Manual* (HCM). The HCM establishes LOS A through F for intersections. A description of LOS for signalized and unsignalized intersections is summarized in Table 2-A. A description of LOS for roadway segments is summarized in Table 2-B.

Table 2-C shows the LOS criteria for unsignalized and signalized intersections. Table 2-D summarizes the LOS criteria used to evaluate roadway segments based on the daily capacity for each functional classification according to the *City of Madera General Plan Update Draft EIR* (General Plan Draft EIR) (dated April 29, 2009). The daily traffic volumes represent the total vehicles (both directions) traveling on a roadway segment within 24 hours.

For all study area intersections, the *Highway Capacity Manual 6th Edition* (HCM 6) analysis methodologies were used to determine intersection LOS. Intersection LOS was calculated using Synchro 10 software, which uses the HCM 6 methodologies.

2.2 FREEWAY LEVEL OF SERVICE DEFINITIONS

Basic freeway segments have uniform traffic conditions and roadway characteristics. The measure used to provide an estimate of LOS is density, where density is calculated from the average vehicle flow rate per lane and the average speed. Table 2-E shows the correlation between LOS and flow density. LOS A represents a freeway segment with density less than or equal to 11 passenger cars per mile per lane (pc/mi/ln). LOS F represents a freeway segment with density greater than 45 pc/mi/ln. Based on the HCM, the LOS for freeway ramps is determined by traffic flow density. Table 2-F shows the correlation between LOS and traffic flow density defined in the HCM. LOS A represents traffic flow density less than or equal to 10 pc/mi/ln (all vehicles will be converted to the equivalent of passenger cars). LOS F represents overflow conditions with high density and congestion.

Based on the HCM, the LOS for freeway weaving segments is determined by traffic flow density. LOS A represents traffic flow density less than or equal to 10 pc/mi/ln (all vehicles will be converted to the equivalent of passenger cars). LOS F represents a freeway weaving segment with a density greater than 43 pc/mi/ln, or where demand exceeds capacity.

For freeway segments, ramp merge/diverge study areas, and weaving segments, the Highway Capacity 7 Software (HCS 7) was used. The software calculates freeway segments and ramp merge/diverge densities using the HCM 6 methodologies.

2.3 HEAVY VEHICLE FACTOR IN LEVEL OF SERVICE CALCULATIONS

Heavy vehicles, such as trucks and recreational vehicles, utilize more capacity on the roadway network than passenger cars due to factors such as their larger size, slower start-up times, and reduced maneuverability. The heavy vehicle factor is calculated using the percentage of heavy vehicles and adjusts the saturation flow rate of the roadway. The saturation flow rate is the number of vehicles that can pass a particular point during one hour. Typically HCM 6 utilizes a saturation flow rate of 1,900 vehicles per hour per lane for roadways and 2,300 vehicles per hour per lane for freeways. However, this is reduced based on a number of factors such as lane width, adjacent parking maneuvers, heavy vehicles and grade. Therefore, the HCM analysis includes existing heavy vehicle percentages for all no project scenarios. Under with project conditions, the heavy vehicle percentage was adjusted based on percentage change that will occur due to addition of project traffic to the corresponding no project scenario.

2.4 LEVEL OF SERVICE STANDARDS AND SIGNIFICANCE THRESHOLDS

Study intersections and roadway segments analyzed in this report are under the jurisdictions of the City of Madera and the County of Madera. Intersections located at freeway on-ramps and off-ramps are under the jurisdiction of Caltrans.

The City of Madera uses LOS C as its minimum LOS criteria for intersections and roadway segments. As stated in the Circulation and Infrastructure Element of the *City of Madera General Plan* (dated October 7, 2009), LOS D is applicable to arterial roadways, or roadway segments with at-grade railroad crossings that were experiencing congestion exceeding LOS C during peak hour travel times as of the date the *General Plan Update* is adopted. LOS D is also applicable to intersections and roadway segments in the Downtown District as defined in the Land Use Element of the City's General Plan. The County of Madera uses LOS D as the minimum LOS criteria for all State and County roadways.

At study intersections and roadway segments under the jurisdiction of the City of Madera, it has been considered that a significant impact occurs when the LOS falls below the target LOS of C or D with the addition of project traffic or when a project contributes to an unsatisfactory condition (LOS D, E, or F).

Caltrans considers an acceptable LOS to be between LOS C and D at all intersections under its jurisdiction (delay of 45 seconds at signalized intersections and delay of 30 seconds at unsignalized intersections). However, for freeway segments and ramp merge/diverge areas, the *Caltrans Guide for the Preparation of Traffic Impact Studies* (2002) states that transition between LOS C and D may not be feasible and allows the local jurisdictions to set the LOS threshold based on local conditions.

Caltrans does not have significant impact criteria for study intersections, freeway segments, and freeway merge/diverge areas. Therefore, a significant impact occurs when the project causes an unsatisfactory condition or when the project contributes to an existing deficiency.

2.5 LIST OF CHAPTER 2.0 TABLES

- Table 2-A: Intersection Level of Service Definitions

-
- Table 2-B: Roadway Segment Level of Service Definitions
 - Table 2-C: Level of Service Criteria for Unsignalized and Signalized Intersections
 - Table 2-D: Roadway Segment Capacity and Levels of Service (City of Madera)
 - Table 2-E: Level of Service Criteria for Freeway Segments
 - Table 2-F: Level of Service Criteria for Ramps and Ramp Junctions

Table 2-A: Intersection Level of Service Definitions

LOS	Description
A	Traffic operations with a control delay of 10 seconds per vehicle or less and a volume-to-capacity ratio no greater than 1.0. This level is typically assigned when the volume-to-capacity ratio is low and either progression is exceptionally favorable or the cycle length is very short. If LOS A is the result of favorable progression, most vehicles arrive during the green indication and travel through the intersection without stopping.
B	Traffic operations with control delay between 10 seconds per vehicle and 20 seconds per vehicle and a volume-to-capacity ratio no greater than 1.0. This level is typically assigned when the volume-to-capacity ratio is low and either progression is highly favorable or the cycle length is short. More vehicles stop than with LOS A.
C	Traffic operations with control delay between 20 and 35 seconds per vehicle and a volume-to-capacity ratio no greater than 1.0. This level is typically assigned when progression is favorable or the cycle length is moderate. Individual cycle failures (i.e., one or more queued vehicles are not able to depart as a result of the insufficient capacity during the cycle) may begin to appear at this level. The number of vehicles stopping is significant, although many vehicles still pass through the intersection without stopping.
D	Traffic operations with control delay between 35 and 55 seconds per vehicle and a volume-to-capacity ratio no greater than 1.0. This level is typically assigned when the volume-to-capacity ratio is high and either progression is ineffective or the cycle length is long. Many vehicles stop and individual cycle failures are noticeable.
E	Traffic operations with control delay between 55 and 80 seconds per vehicle and a volume-to-capacity ratio no greater than 1.0. This level is typically assigned when volume-to-capacity ratio is high, progression is unfavorable, and the cycle length is long. Individual cycle failures are frequent.
F	Traffic operations with control delay exceeding 80 seconds per vehicle or a volume-to-capacity ratio greater than 1.0. This level is typically assigned when the volume-to-capacity ratio is very high, progression is very poor, and the cycle length is long. Most cycles fail to clear the queue.

Source: *Highway Capacity Manual* (6th Edition)

Table 2-B: Roadway Segment Level of Service Definitions

LOS	Description
A	Describes primarily free-flow operation. Vehicles are completely unimpeded in their ability to maneuver within the traffic stream. Control Delay at the boundary intersection is minimal. The travel speed exceeds 80% of the base free-flow speed, and the volume-to-capacity ratio is no greater than 1.0.
B	Describes reasonably unimpeded operation. The ability to maneuver within the traffic stream is only slightly restricted, and control delay at the boundary is not significant. The travel speed is between 67% and 80% of the base free-flow speed, and the volume-to-capacity ratio is no greater than 1.0.
C	Describes stable operation. The ability to maneuver and change lanes at mid-segment locations may be more restricted than at LOS B. Longer queues at the boundary intersection may contribute to lower travel speeds. The travel speed is between 50% and 67% of the base free-flow speed, and the volume-to-capacity ratio is no greater than 1.0.
D	Indicates a less stable condition in which small increases in flow may cause substantial increases in delay and decreases in travel speed. This operation may be due to adverse signal progression, high volume, or inappropriate signal timing at the boundary intersections. The travel speed is between 40% and 50% of the base free-flow speed, and the volume-to-capacity ratio is no greater than 1.0.
E	Characterized by unstable operation and significant delay. Such operations may be due to some combination of adverse progression, high volume, and inappropriate signal timing at the boundary intersections. The travel speed is between 30% and 40% of the base free-flow speed, and the volume-to-capacity ratio is no greater than 1.0.
F	Characterized by flow at extremely low speed. Congestion is likely occurring at the boundary intersections, as indicated by high delay and extensive queuing. The travel speed is between 30% or less of the base free-flow speed, and the volume-to-capacity ratio is greater than 1.0.

Source: *Highway Capacity Manual* (6th Edition)

Table 2-C: Level of Service Criteria for Unsignalized and Signalized Intersections

Level of Service	Unsignalized Intersection Average Delay per Vehicle (sec.)	Signalized Intersection Average Delay per Vehicle (sec.)
A	≤ 10	≤ 10
B	> 10 and ≤ 15	> 10 and ≤ 20
C	> 15 and ≤ 25	> 20 and ≤ 35
D	> 25 and ≤ 35	> 35 and ≤ 55
E	> 35 and ≤ 50	> 55 and ≤ 80
F	> 50	> 80

Source: *Highway Capacity Manual* (6th Edition)

Table 2-D: Roadway Segment Capacity and Levels of Service (City of Madera)

Type of Roadway	Number of Lanes	Level of Service				
		A	B	C	D	E
Urban Collector	2	7,500	8,750	10,000	11,250	12,500
Urban Collector	4	14,460	16,870	19,280	21,690	24,100
Rural Collector	2	8,400	9,800	11,200	12,600	14,000
Rural Collector	4	16,440	19,180	21,920	24,660	27,400
Urban Arterial	2	10,320	12,040	13,760	15,480	17,200
Urban Arterial	4	20,700	24,150	27,600	31,050	34,500
Urban Arterial	6	31,020	36,190	41,360	46,530	51,700
Rural Road	2	10,800	12,600	14,400	16,200	18,000
Rural Road	4	21,600	25,200	28,800	32,400	36,000
Freeway	4	46,800	54,600	62,400	70,200	78,000
Freeway	6	76,680	89,460	102,240	115,020	127,800

Source: City of Madera *General Plan Update Draft EIR*, April 29, 2009

Table 2-E: Level of Service Criteria for Freeway Segments

Level of Service	Density (pc/mi/ln)
A	≤ 11
B	> 11 and < 18
C	> 17 and < 26
D	> 26 and < 35
E	> 35 and < 45
F	> 45

Table 2-F: Level Of Service Criteria for Ramps and Ramp Junctions

Level of Service	Density (pc/mi/ln)
A	≤ 10
B	> 10–20
C	> 20–28
D	> 28–35
E	> 35
F	Demand exceeds capacity

3.0 CIRCULATION NETWORK SETTING

3.1 EXISTING CIRCULATION NETWORK

This section provides a description of the circulation network within the study area. Figure 3-1 illustrates existing geometrics and traffic control for study intersections. Figure 3-2 illustrates existing with project geometrics and traffic control for study intersections. Within the City of Madera, all major roadways are classified based on the City's General Plan Circulation Master Plan. Figure 3-3 illustrates roadway classifications per the City's General Plan Circulation Master Plan.

Table 3-A summarizes the classifications of major roadways within the TIA study area limits. Following is a brief description of the roadways analyzed in this TIA:

- **Road 23:** Road 23 is a north-south rural road within the City of Madera. Within the study area, Road 23 is an undivided rural road with two lanes. In the City's Circulation Master Plan, Road 23 is designated as "Rural Road" under existing conditions. Under proposed General Plan Year 2030 conditions, Road 23 is designated as a six-lane "Loop Road" between Avenue 17 and Sunset Avenue and as a four-lane "Urban Arterial" between Avenue 13 and Avenue 12. The "Loop Road" is also an arterial roadway with more restrictive access (i.e. less driveways and traffic signals) compared to other arterials.
- **Westberry Boulevard:** Westberry Boulevard is a north-south divided arterial within the City of Madera. Within the study area, the number of lanes varies between two and three. In the City's Circulation Master Plan, Westberry Boulevard is designated as "Urban Arterial" under existing conditions. Under proposed General Plan Year 2030 conditions, Westberry Boulevard is designated as a four-lane "Urban Arterial" between Sunset Avenue and Howard Road.
- **Granada Drive:** Granada Drive is a north-south undivided collector within the City of Madera. Within the study area, the number of lanes varies between two and three. In the City's Circulation Master Plan, Granada Avenue is designated as "Urban Collector" under existing conditions. Under proposed General Plan Year 2030 conditions, Granada Drive is designated as a four-lane "Urban Collector" between Howard Road and Avenue 13, between Cleveland Avenue and Fresno River, and between Sunset Avenue and Avenue 14.
- **Avenue 17:** Avenue 17 is an east-west undivided arterial within the City of Madera. Within the study area, the number of lanes varies from two to four. In the City's Circulation Master Plan, Avenue 17 is designated as "Urban Arterial" under existing conditions. Under proposed General Plan Year 2030 conditions, Avenue 17 is designated as a six-lane "Loop Road" between SR-99 and Country Club Drive, and between Road 23 and SR-99, and as a four-lane "Loop Road" between Country Club Drive and Lake Street. The "Loop Road" is also an arterial roadway with more restrictive access (i.e. less driveways and traffic signals) compared to other arterials.
- **Avenue 16:** Avenue 16 is an east-west arterial within the City of Madera. Within the study area, Avenue 16 is an undivided arterial with two lanes. In the City's Circulation Master Plan, Avenue 16 is designated as "Urban Arterial" under existing and proposed General Plan Year 2030 conditions.

- **Cleveland Avenue:** Cleveland Avenue is an east-west divided arterial within the City of Madera. Within the study area, the number of lanes varies from two to six. In the City's Circulation Master Plan, Cleveland Avenue is designated as "Urban Arterial" under existing conditions. Under proposed General Plan Year 2030 conditions, Cleveland Avenue is designated as a six-lane "Urban Arterial" between Schnoor Avenue and SR-99, and as a four-lane "Urban Arterial" between Granada Drive and Schnoor Street and between Sharon Road and D Street.
- **Sunset Avenue:** Sunset Avenue is an east-west undivided collector within the City of Madera. Within the study area, the number of lanes varies from two to four. In the City's Circulation Master Plan, Sunset Avenue is designated as "Urban Collector" under existing conditions. Under proposed General Plan Year 2030 conditions, Sunset Avenue is designated as a four-lane "Urban Arterial" between Granada Drive and Schnoor Avenue.
- **Howard Road:** Howard Road is an east-west divided arterial within the City of Madera. Within the study area, the number of lanes varies between four and five. In the City's Circulation Master Plan, Howard Road is designated as "Urban Arterial" under existing conditions. Under proposed General Plan Year 2030 conditions, Howard Road is designated as a six-lane "Urban Arterial" between Schnoor Street and Pine Street and as a four-lane "Urban Arterial" between Grenada Drive and Schnoor Street.
- **Olive Avenue:** Olive Avenue is an east-west divided arterial within the City of Madera. Within the study area, the number of lanes varies between four and five. In the City's Circulation Master Plan, Olive Avenue is designated as "Urban Arterial" under existing conditions. Under proposed General Plan Year 2030 conditions, Olive Avenue is designated as a four-lane "Urban Arterial" between Yosemite Avenue and Madera Avenue (SR-145).
- **SR-99:** SR-99 is a north-south state highway in California, which stretches almost the entire length of the Central Valley. The segment of SR-99 within the study area currently has four lanes (two northbound and two southbound lanes). However, currently the freeway is being widened from four to six lanes south of the Avenue 18½ interchange. Therefore, the freeway has been analyzed as a four-lane facility under existing conditions, but, as a six-lane facility, for all other analysis scenarios.

3.2 BIKES, TRAILS, AND TRANSIT

Figure 3-4 illustrates the trails within the City and surrounding region. These trails include bikeways and multiuse trails readily available and planned for both pedestrian and cyclist usage.

The existing bicycle facilities within the City include Class I, Class II, and Class III routes:

- Class I bike facilities provide completely separate right-of-way (ROW) and are designated for the exclusive use of bicycles and pedestrians with minimal vehicle and pedestrian cross-flow.
- Class II bike facilities provide restricted ROW and are designated for the use of bicycles with a striped lane on a street or highway.
- Class III bike facilities provide for a ROW designated by signs or pavement markings (sharrows) for shared use with pedestrian or motor vehicles.

Figure 3-5 illustrates the existing and planned bikeways in the City.

Public transportation in the City includes bus and rail service. The study area is serviced by the Madera Area Express System, the JET Express System, and the Madera County Connection System. The City has an Amtrak station on Road 26 and there are plans to add a High-Speed Rail stop in the City in the future. Figure 3-6 illustrates the existing transit facilities in the City.

3.3 LIST OF CHAPTER 3.0 FIGURES AND TABLES

- Figure 3-1A: Existing Study Intersection Geometrics and Traffic Control (Int. 1–30)
- Figure 3-1B: Existing Study Intersection Geometrics and Traffic Control (Int. 31–58)
- Figure 3-2A: Existing with Project Study Intersection Geometrics and Traffic Control (Int. 1–30)
- Figure 3-2B: Existing with Project Study Intersection Geometrics and Traffic Control (Int. 31–58)
- Figure 3-3: City of Madera General Plan Circulation Master Plan
- Figure 3-4: City of Madera Parks and Trails
- Figure 3-5: City of Madera Existing and Planned Bikeways
- Figure 3-6: City of Madera Existing Transit Facilities
- Table 3-A: City of Madera Roadway Segment Classification

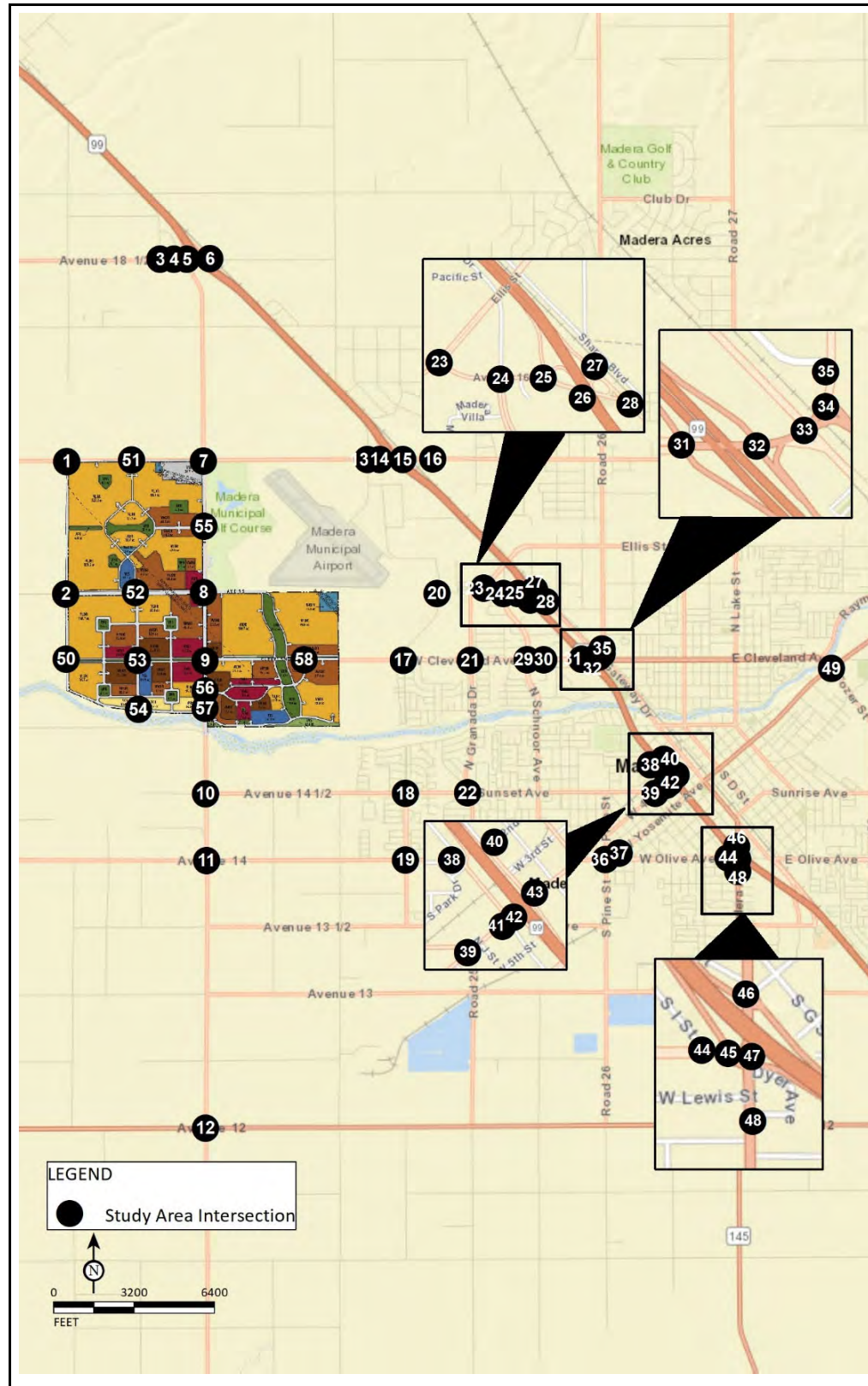

LSA

FIGURE 3-1A

- Legend
- Signal
 - Stop Sign
 - Defacto right turn
 - Free right-turn
 - Right-turn overlap

Village D Specific Plan
Traffic Impact Analysis

Existing Study Intersection Geometrics and Traffic Control (Int. 1-30)

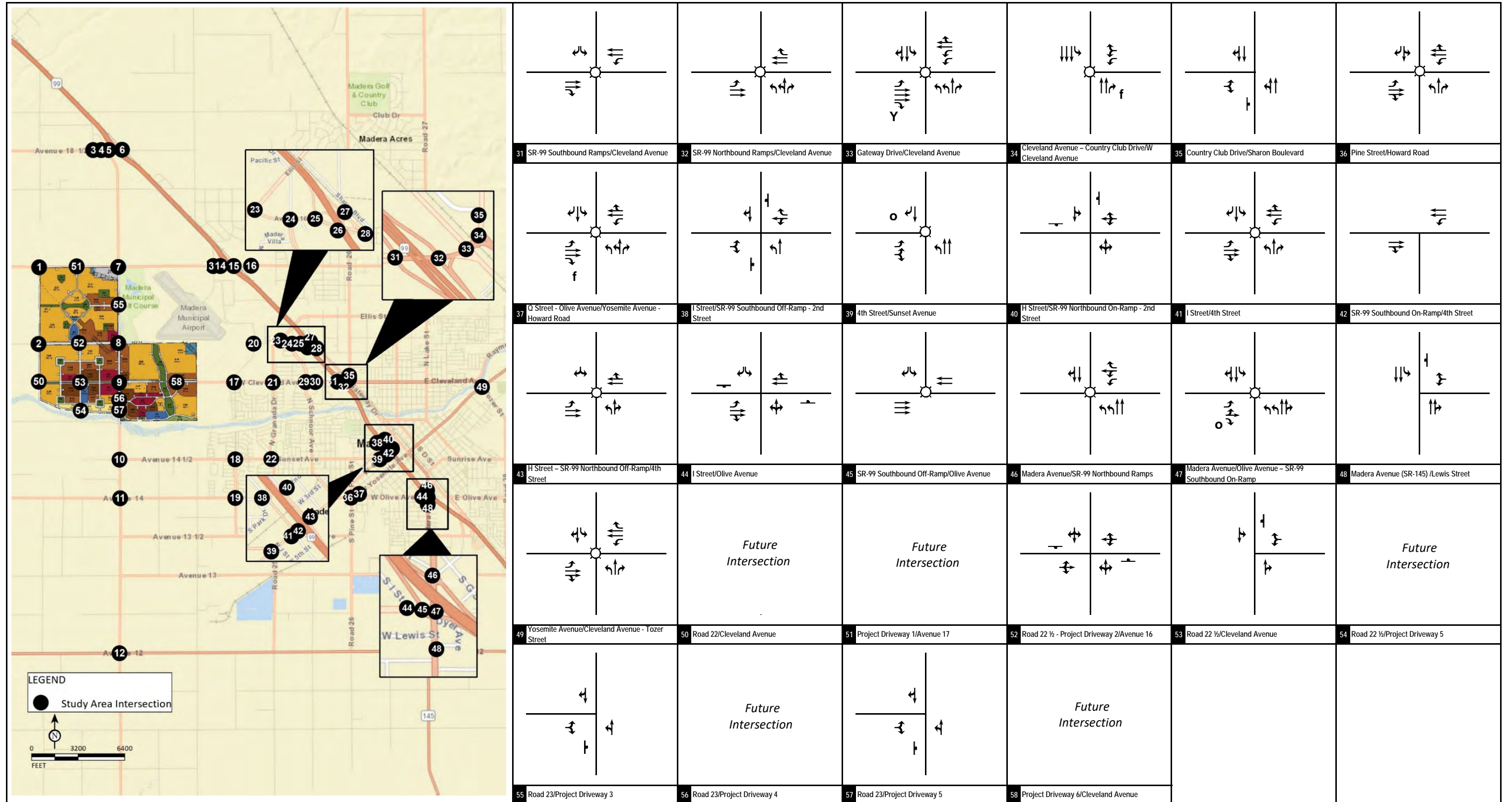

LSA

FIGURE 3-1B

Legend

- ⊙ Signal
- ⊠ Stop Sign
- d Defacto right turn
- f Free right-turn
- Right-turn overlap
- Y Yield

----- Project Driveway

Village D Specific Plan
Traffic Impact Analysis

Existing Study Intersection Geometrics and Traffic Control (Int. 31-58)

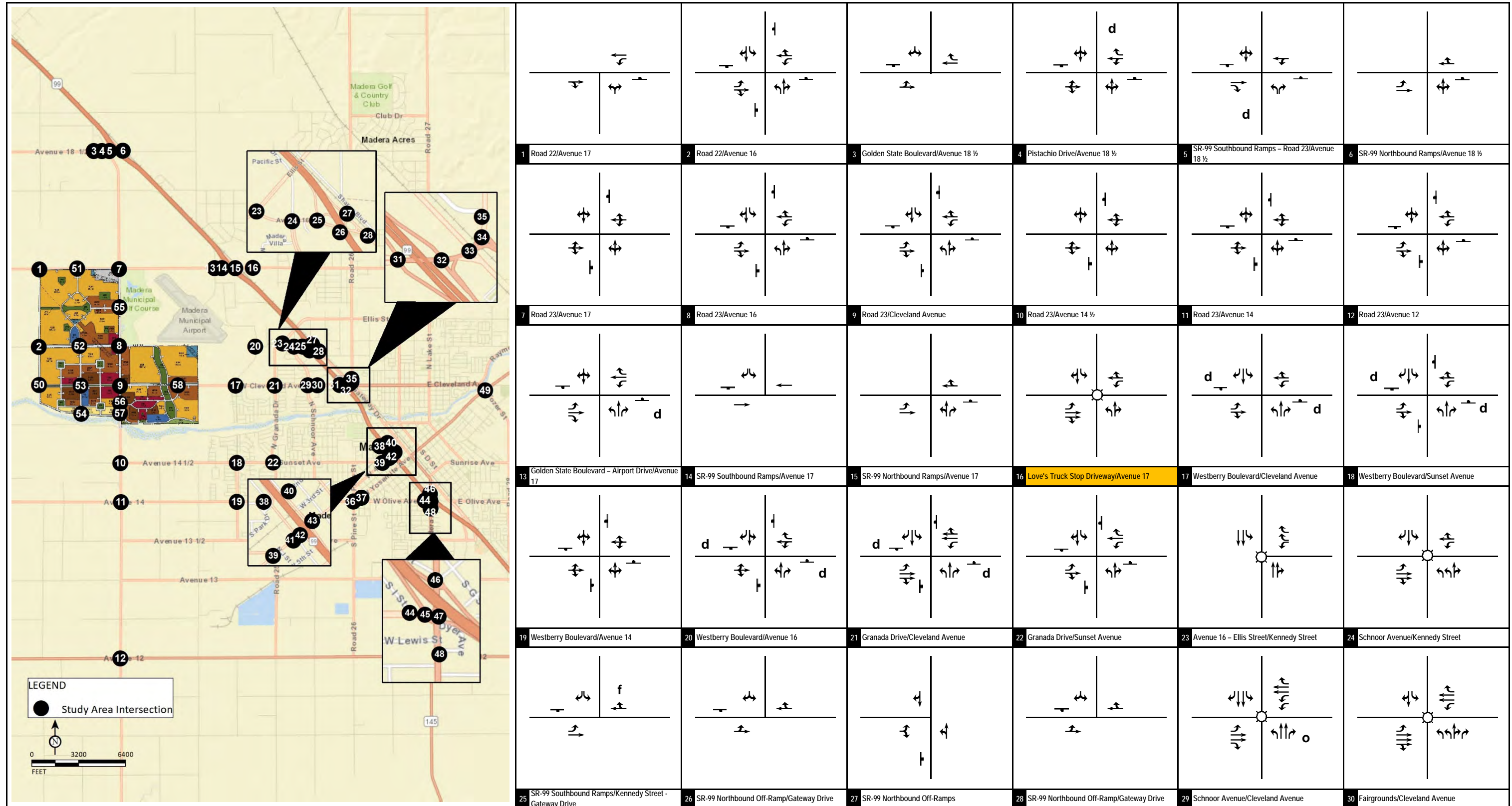

FIGURE 3-2A

LSA

- Legend
- Study Area Intersection
 - ⊙ Signal
 - ⊠ Stop Sign
 - d Defacto right turn
 - f Free right-turn
 - Right-turn overlap
 - Intersection assumed to be built in Phase I and onward.

Village D Specific Plan
Traffic Impact Analysis

Existing with Project Study Intersection Geometrics and Traffic Control (Int. 1-30)

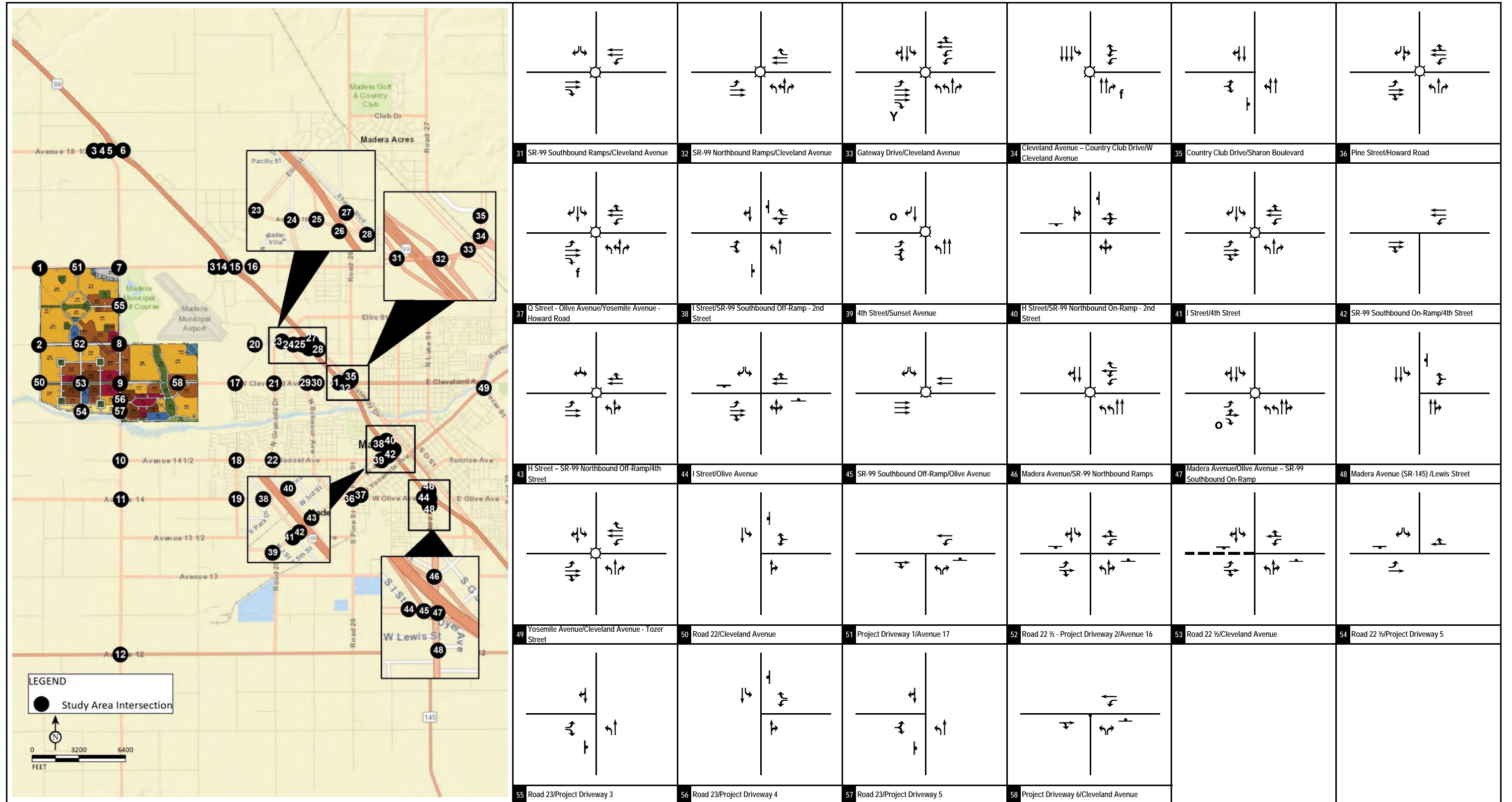

FIGURE 3-2B

LSA

Legend

- ⊙ Signal
- ⊠ Stop Sign
- d Defacto right turn
- f Free right-turn
- Right-turn overlap
- Y Yield

Village D Specific Plan
Traffic Impact Analysis

Existing with Project Study Intersection Geometrics and Traffic Control (Int. 31-58)

City of Madera General Plan Circulation Master Plan

City Limits
 City Limits
Sphere of Influence
 Sphere of Influence
Urban Growth Boundary
 Urban Growth Boundary
General Plan Planning Area
 General Plan Planning Area

Transportation
 State Hwy 99
 Highway 145
 Arterial
 Collector
 Loop Road
 Other Roads
 Railroads
 Existing Bridge
 Proposed Bridge
 Freeway Interchange
 Railroad Crossing

NOTE: Loop Road is an arterial roadway.

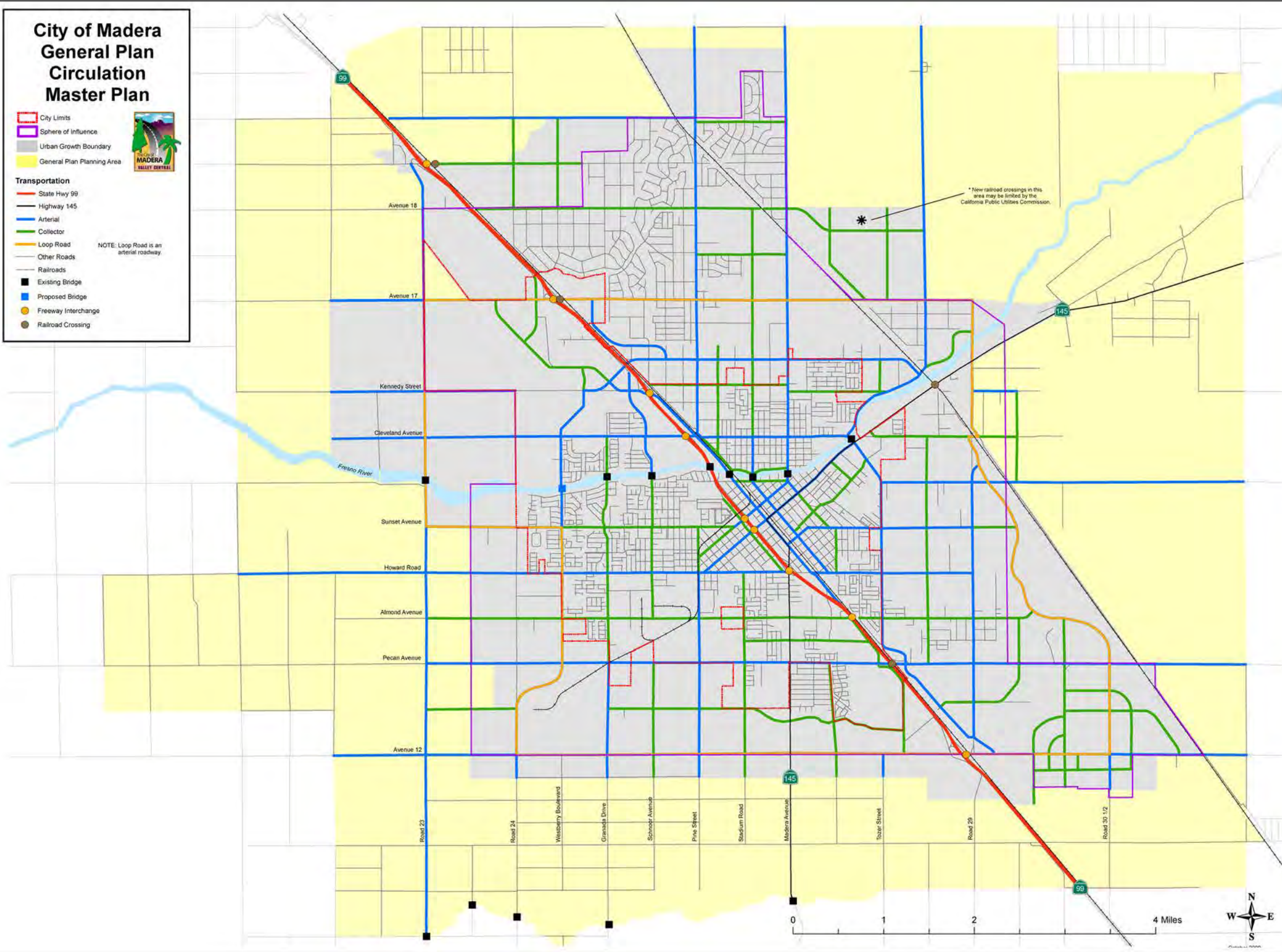

LSA

FIGURE 3-3



Village D Specific Plan
Traffic Impact Analysis

City of Madera General Plan Circulation Master Plan

Source: City of Madera General Plan, October, 2009

I:\CMD1801\Reports\Traffic\fig3-3_Madera_Circulation_Plan.psd (02/16/2020)

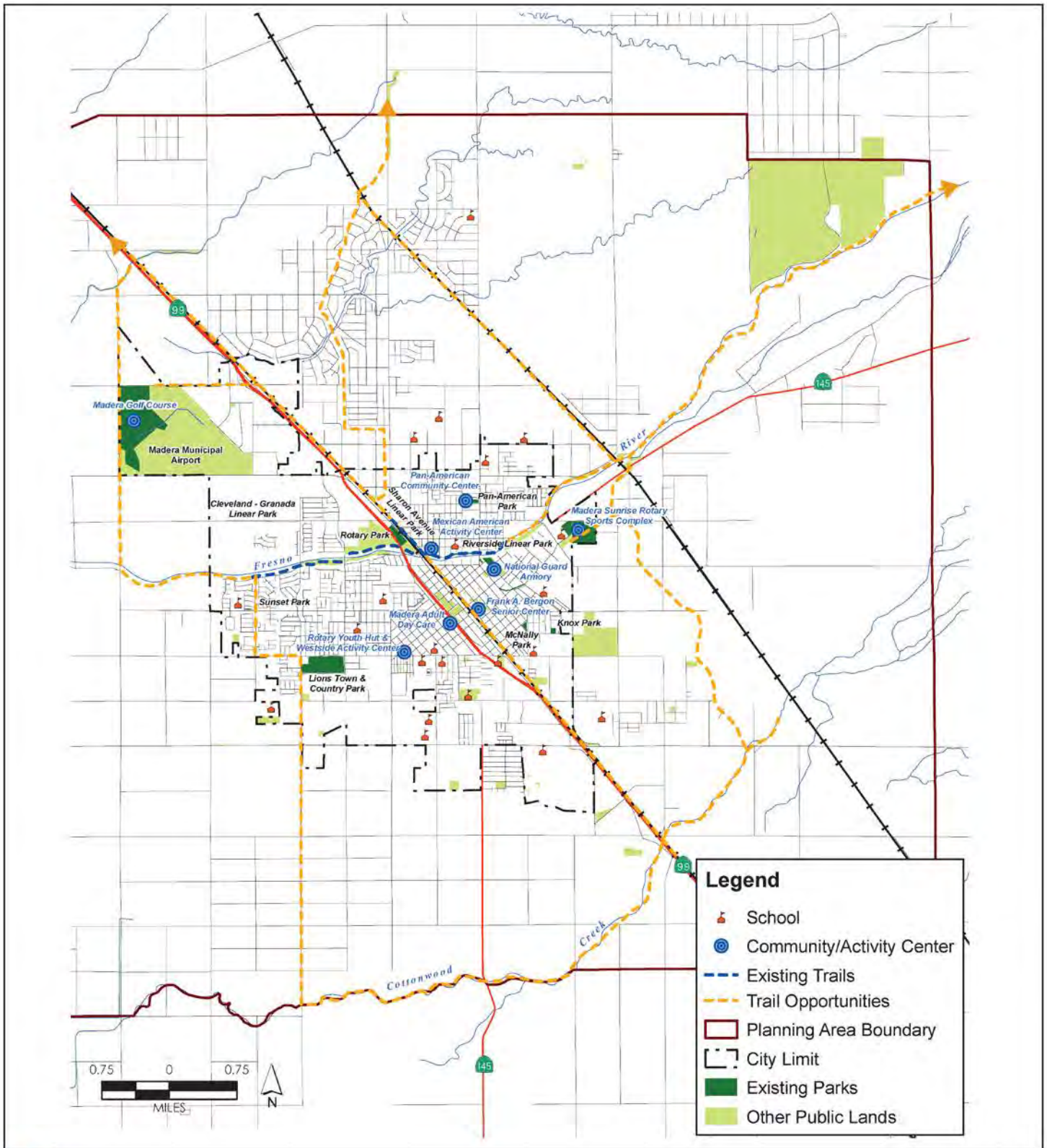

LSA

FIGURE 3-4



Village D Specific Plan
Traffic Impact Analysis

City of Madera Parks and Trails

SOURCE: City of Madera General Plan Update Draft EIR, April, 2009
I:\CMD1801\Reports\Traffic\fig3-4_Madera_Parks_Plan.ai (02/16/2020)

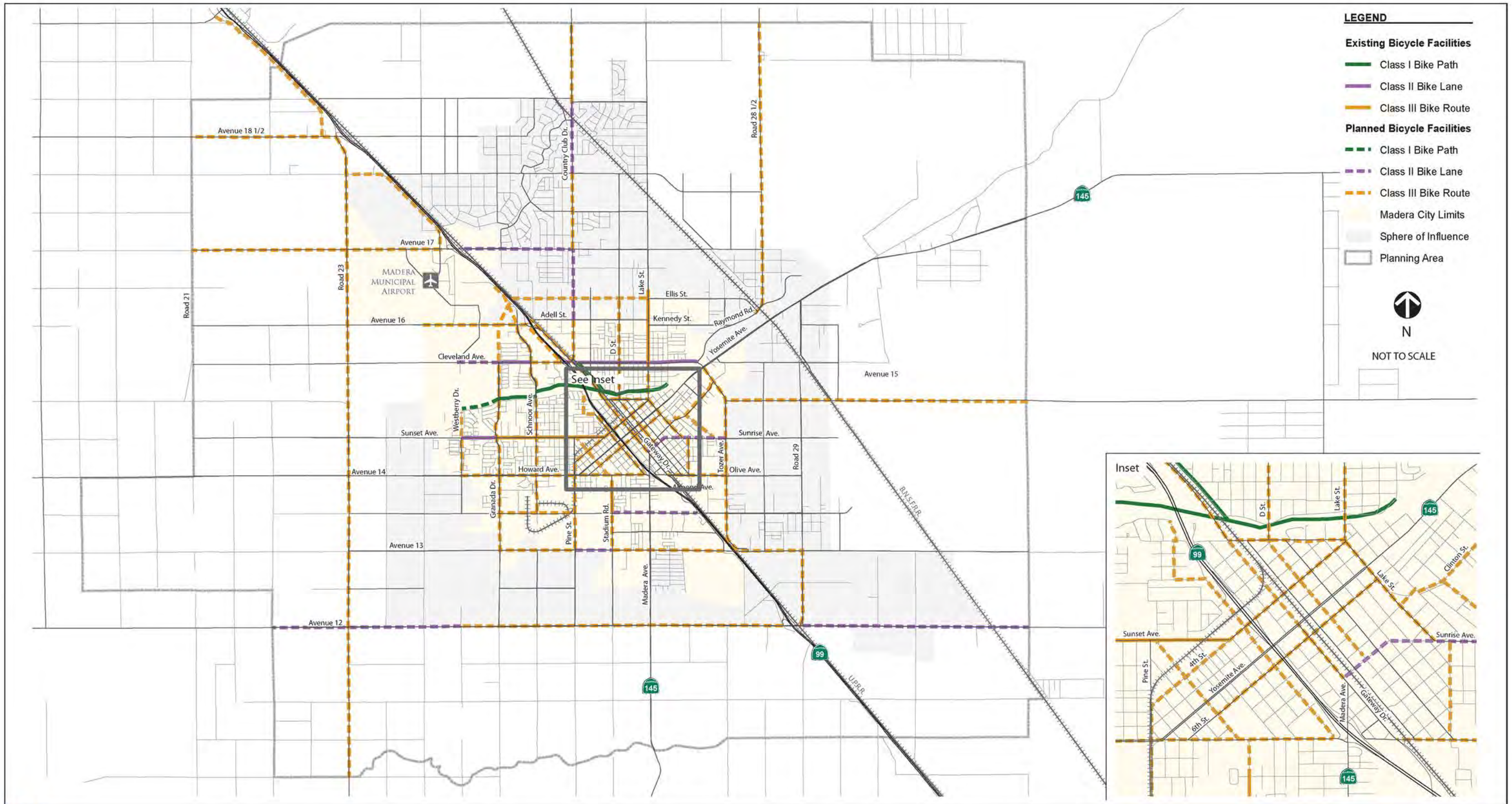

LSA



FIGURE 3-5

Village D Specific Plan
Traffic Impact Analysis

City of Madera Existing and Planned Bikeways

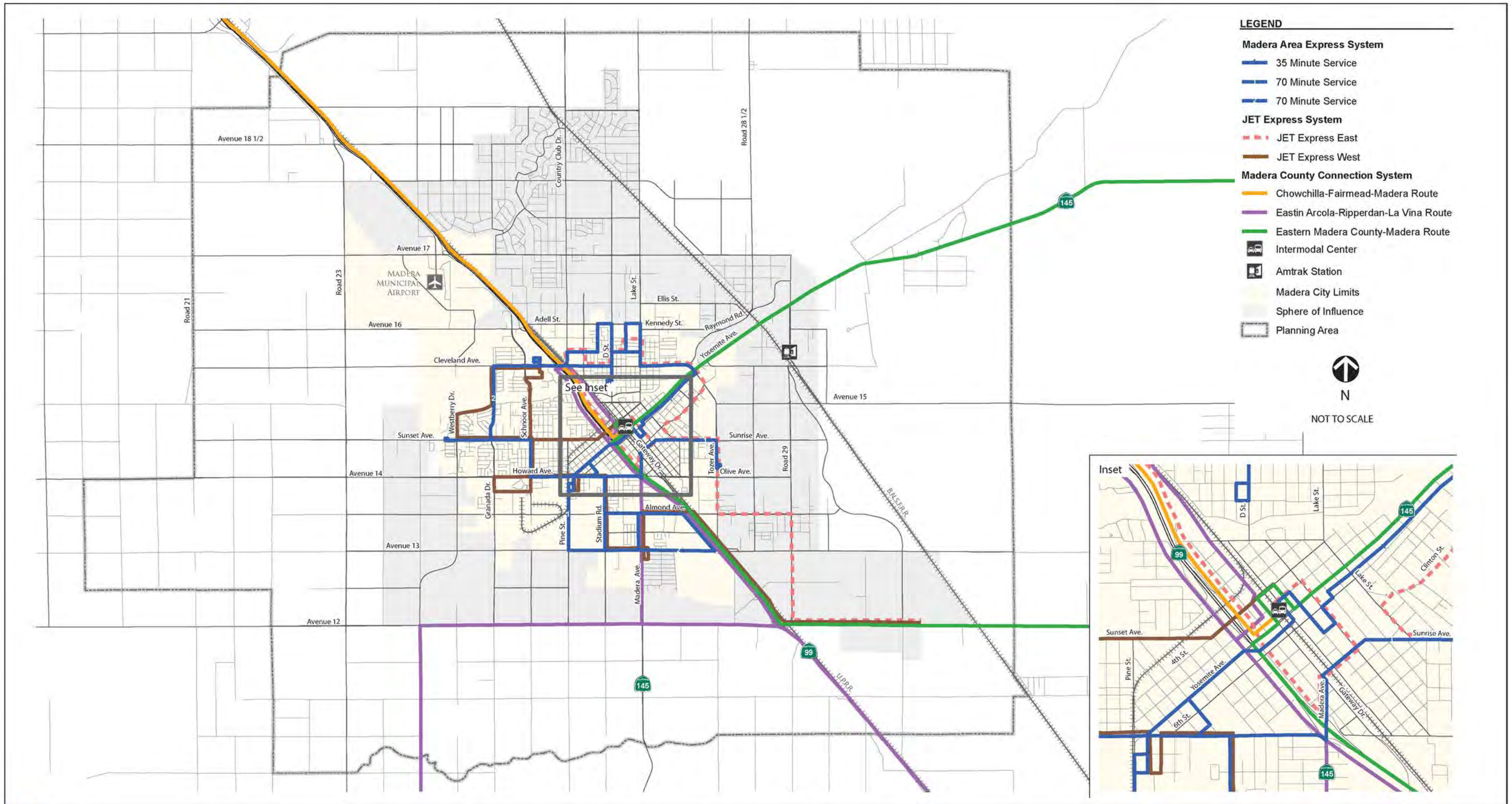

LSA



FIGURE 3-6

Village D Specific Plan
Traffic Impact Analysis

City of Madera Existing Transit Facilities

Table 3-A - Roadway Segment Classification

Roadway	#	Segment	Jurisdiction	Existing Conditions Classification ¹	Existing Conditions Number of Lanes	General Plan Classification ¹	General Plan Number of Lanes
Road 23	1	between Avenue 17 and Project Driveway 3	City of Madera/Madera County	Rural Road	2	Urban Arterial	6
	2	between Project Driveway 3 and Avenue 16	City of Madera/Madera County	Rural Road	2	Urban Arterial	6
	3	between Avenue 16 and Cleveland Avenue	Madera County	Rural Road	2	Urban Arterial	6
	4	between Cleveland Avenue and Project Driveway 4	Madera County	Rural Road	2	Urban Arterial	6
	5	between Project Driveway 4 and Project Driveway 5	Madera County	Rural Road	2	Urban Arterial	6
	6	between Project Driveway 5 and Avenue 14 1/2	Madera County	Rural Road	2	Urban Arterial	6
	7	between Avenue 14 1/2 and Avenue 14	Madera County	Rural Road	2	Urban Arterial	6
Westberry Boulevard	8	between Sunset Avenue and Avenue 14/Howard Road	City of Madera	Urban Arterial	2	Urban Arterial	4
Granada Drive	9	between Cleveland Avenue and Fresno River	City of Madera	Urban Collector	2	Urban Collector	4
	10	between Sunset Avenue and Avenue 14/Howard Road	City of Madera	Urban Collector	2	Urban Collector	4
Avenue 17	11	between Road 22 and Project Driveway 1	Madera County	Urban Arterial	2	Urban Arterial	4
	12	between Project Driveway 1 and Road 23	Madera County	Urban Arterial	2	Urban Arterial	4
	13	between Road 23 and Golden State Boulevard	City of Madera/Madera County	Urban Arterial	2	Urban Arterial	4
	14	between Golden State Boulevard and State Route 99 Southbound Off-Ramp	City of Madera	Urban Arterial	2	Urban Arterial	4
Avenue 16	15	between Road 22 and Project Driveway 2/Road 22 1/2	Madera County	Urban Arterial	2	Urban Arterial	4
	16	between Project Driveway 2/Road 22 1/2 and Road 23	Madera County	Urban Arterial	2	Urban Arterial	4
Cleveland Avenue	17	between Road 22 1/2 and Road 23	Madera County	Urban Arterial	2	Urban Arterial	4
	18	between Road 23 and Project Driveway 6	Madera County	Urban Arterial	2	Urban Arterial	4
	19	between Project Driveway 6 and Westberry Boulevard	City of Madera/Madera County	Urban Arterial	2	Urban Arterial	4
	20	between Westberry Boulevard and Granada Drive	City of Madera	Urban Arterial	4	Urban Arterial	4
	21	between Granada Drive and Schnoor Street	City of Madera	Urban Arterial	4	Urban Arterial	4
	22	between Schnoor Street and Fairgrounds	City of Madera/Madera County	Urban Arterial	6	Urban Arterial	6
	23	between Fairgrounds and State Route 99 Southbound Ramps	City of Madera/Madera County	Urban Arterial	6	Urban Arterial	6
Sunset Avenue	24	between Granada Drive and Schnoor Street	City of Madera	Urban Collector	2	Urban Collector	4
Howard Road	25	between Granada Drive and Schnoor Street	City of Madera	Urban Arterial	4	Urban Arterial	4
	26	between Schnoor Street and Pine Street	City of Madera	Urban Arterial	4	Urban Arterial	4
Olive Avenue	27	between Yosemite Avenue and I Street	City of Madera	Urban Arterial	4	Urban Arterial	4
	28	between I Street and State Route 99 Southbound Off-Ramp	City of Madera	Urban Arterial	5	Urban Arterial	5
	29	between State Route 99 Southbound Off-Ramp and Madera Avenue	City of Madera	Urban Arterial	5	Urban Arterial	5

Notes:

¹Classifications for all segments have been obtained from the City of Madera General Plan Circulation Master Plan.

4.0 TRAFFIC VOLUMES FOR WITHOUT PROJECT SCENARIOS

4.1 EXISTING TRAFFIC VOLUMES

Existing traffic volumes are based on counts collected by Counts Unlimited in September 2019. Counts at the intersection of Road 23/Project Driveway 5 were collected in November 2019. Daily tube counts were collected for roadway segments while a.m. and p.m. peak hour turning movement counts were collected at study intersections. All U-turns were considered as left turns for analysis purposes. Detailed count sheets are included in Appendix B.

Vehicle classification counts were conducted at selected intersections. Truck percentages for every approach at these intersections were obtained from the classification counts. As for the remaining study intersections without classification counts, truck percentages for the various approaches were obtained based on the truck counts at the adjacent intersections. Figures 4-1A and 4-1B illustrate existing peak hour traffic volumes at study intersections. Table 4-A summarizes the existing roadway segment daily traffic volumes.

Typically, freeway traffic volumes are developed using Annual Average Daily Traffic (AADT) volume data published by Caltrans. The most recent Caltrans AADT volume data are from 2017. These volumes were utilized to develop existing (2019) conditions freeway volumes using an average growth per annum from the Madera County Transportation Commission (MCTC) travel demand forecasting (TDF) model. The 2019 AADT volumes were then multiplied by the appropriate K and D factors from Caltrans to obtain the one-way peak period directional flow rates. The traffic volumes were then split between passenger vehicles and trucks by applying the appropriate truck percentages obtained from Caltrans data. Finally, conservation of flow was applied between freeway mainline segment volumes and ramp volumes (obtained from traffic counts) to develop the traffic volumes throughout the freeway facilities.

Table 4-B summarizes the existing peak hour traffic volumes at study area freeway ramp merge/diverge areas and freeway segments.

4.2 PHASE I PROJECT COMPLETION YEAR (2029) WITHOUT PROJECT TRAFFIC VOLUMES

Based on discussion with City staff during the scoping agreement process, it was determined that the traffic volumes for each phase will be developed by interpolating between the existing and Phase III project completion year without project traffic volumes. Traffic volumes for Phase I project completion year without project conditions were obtained by interpolating the forecast volume growth from MCTC TDF model and adding the growth and the volumes from two projects (Love's Truck Stop and Madera Town Center) to the existing traffic volumes.

Figures 4-2A and 4-2B illustrate peak hour traffic volumes at study intersections for Phase I project completion year without project conditions. Table 4-C summarizes the Phase I project completion year roadway segment daily traffic volumes. Table 4-D summarizes the Phase I project completion year peak hour traffic volumes at study area freeway ramp merge/diverge areas and freeway segments.

4.3 PHASE II PROJECT COMPLETION YEAR (2039) WITHOUT PROJECT TRAFFIC VOLUMES

Based on discussion with City staff during the scoping agreement process, it was determined that the traffic volumes for each phase will be developed by interpolating between the existing and Phase III project completion year without project traffic volumes. Traffic volumes for Phase II project completion year without project conditions were obtained by interpolating the forecast volume growth from MCTC TDF model and adding the growth and the volumes from two projects (Love's Truck Stop and Madera Town Center) to the existing traffic volumes.

Figures 4-3A and 4-3B illustrate peak hour traffic volumes at study intersections for Phase II project completion year without project conditions. Table 4-E summarizes the Phase II project completion year roadway segment daily traffic volumes. Table 4-F summarizes the Phase II project completion year peak hour traffic volumes at study area freeway ramp merge/diverge areas and freeway segments.

Detailed volume development worksheets are included in Appendix C.

4.4 PHASE III PROJECT COMPLETION YEAR (2049) WITHOUT PROJECT TRAFFIC VOLUMES

Traffic volumes for Phase III project completion year without project conditions were developed using forecast volumes obtained from the MCTC TDF model. The base year of the model is year 2018 and the future year is year 2042. Therefore, year 2049 volumes were developed by applying post-processing methodologies, as per the National Cooperative Highway Research Program (NCHRP), between year 2018 and year 2042, and extrapolating these volumes to year 2049. Two projects (Love's Truck Stop and Madera Town Center) at the intersection of Love's Truck Stop Driveway/Avenue 17 were not included in the model. Traffic volumes from these two projects were added to the post-processed volumes to obtain the Phase III project completion year without project traffic volumes.

Figures 4-4A and 4-4B illustrate peak hour traffic volumes at study intersections for Phase III project completion year without project conditions. Table 4-G summarizes the Phase III project completion year roadway segment daily traffic volumes. Table 4-H summarizes the Phase III project completion year peak hour traffic volumes at study area freeway ramp merge/diverge areas and freeway segments.

4.5 LIST OF CHAPTER 4.0 FIGURES AND TABLES

- Figure 4-1A: Existing Peak Hour Traffic Volumes (Int. 1–30)
- Figure 4-1B: Existing Peak Hour Traffic Volumes (Int. 31–58)
- Figure 4-2A: Phase I Project Completion Year (2029) without Project Peak Hour Traffic Volumes (Int. 1–30)
- Figure 4-2B: Phase I Project Completion Year (2029) without Project Peak Hour Traffic Volumes (Int. 31–58)

- Figure 4-3A: Phase II Project Completion Year (2039) without Project Peak Hour Traffic Volumes (Int. 1–30)
- Figure 4-3B: Phase II Project Completion Year (2039) without Project Peak Hour Traffic Volumes (Int. 31–58)
- Figure 4-4A: Phase III Project Completion Year (2049) without Project Peak Hour Traffic Volumes (Int. 1–30)
- Figure 4-4B: Phase III Project Completion Year (2049) without Project Peak Hour Traffic Volumes (Int. 31–58)
- Table 4-A: Existing Roadway Segment Daily Traffic Volumes
- Table 4-B: Existing Freeway Segment and Ramp Traffic Volumes
- Table 4-C: Phase I Project Completion Year (2029) Roadway Segment Daily Traffic Volumes
- Table 4-D: Phase I Project Completion Year (2029) Freeway Segment and Ramp Traffic Volumes
- Table 4-E: Phase II Project Completion Year (2039) Roadway Segment Daily Traffic Volumes
- Table 4-F: Phase II Project Completion Year (2039) Freeway Segment and Ramp Traffic Volumes
- Table 4-G: Phase III Project Completion Year (2049) Roadway Segment Daily Traffic Volumes
- Table 4-H: Phase III Project Completion Year (2049) Freeway Segment and Ramp Traffic Volumes

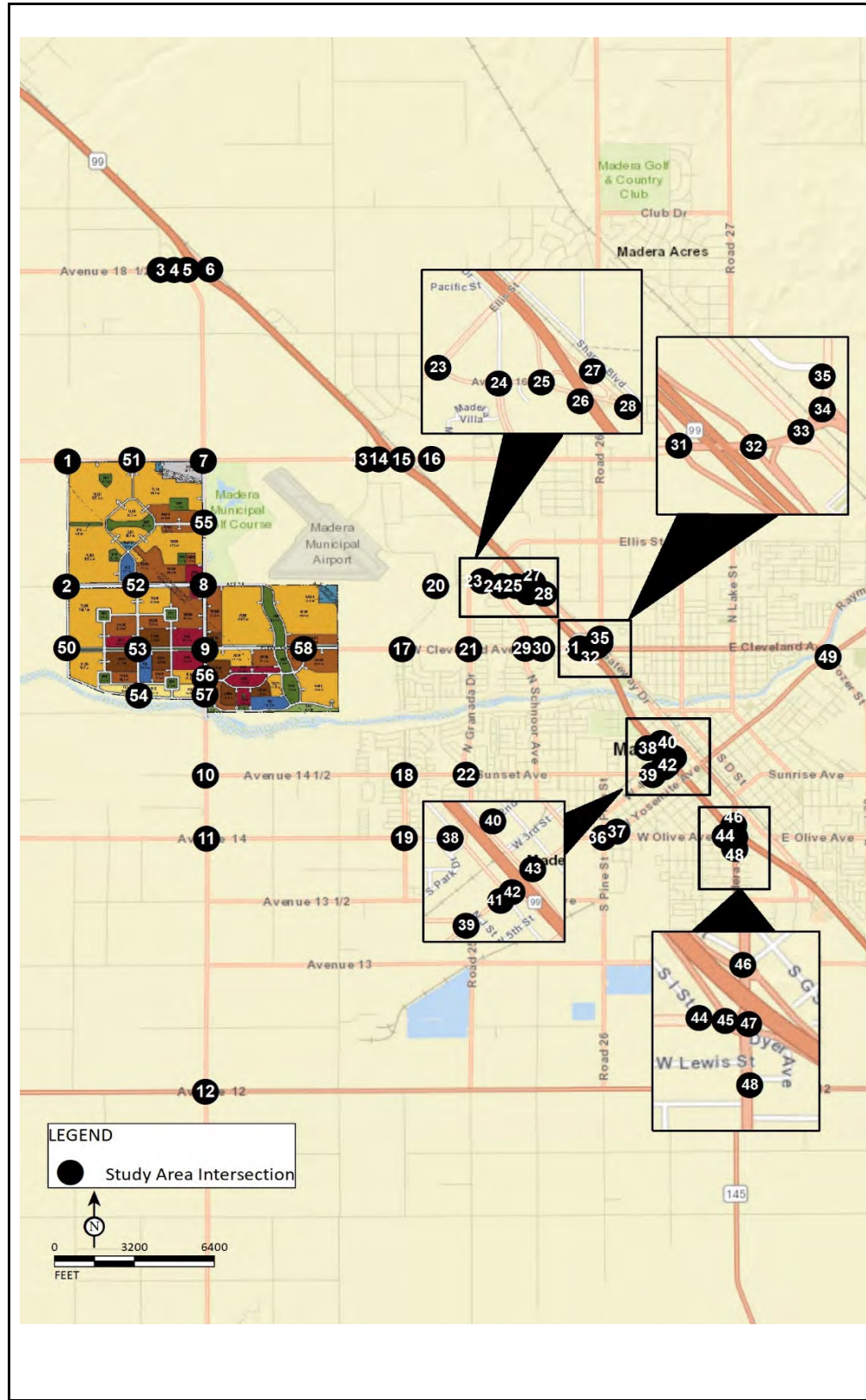

1	Road 22/Avenue 17	2	Road 22/Avenue 16	3	Golden State Boulevard/Avenue 18 1/2	4	Pistachio Drive/Avenue 18 1/2	5	SR-99 Southbound Ramps - Road 23/Avenue 18 1/2	6	SR-99 Northbound Ramps/Avenue 18 1/2
7	Road 23/Avenue 17	8	Road 23/Avenue 16	9	Road 23/Cleveland Avenue	10	Road 23/Avenue 14 1/2	11	Road 23/Avenue 14	12	Road 23/Avenue 12
13	Golden State Boulevard - Airport Drive/Avenue 17	14	SR-99 Southbound Ramps/Avenue 17	15	SR-99 Northbound Ramps/Avenue 17	16	Love's Truck Stop Driveway/Avenue 17	17	Westberry Boulevard/Cleveland Avenue	18	Westberry Boulevard/Sunset Avenue
19	Westberry Boulevard/Avenue 14	20	Westberry Boulevard/Avenue 16	21	Granada Drive/Cleveland Avenue	22	Granada Drive/Sunset Avenue	23	Avenue 16 - Ellis Street/Kennedy Street	24	Schnoor Avenue/Kennedy Street
25	SR-99 Southbound Ramps/Kennedy Street - Gateway Drive	26	SR-99 Northbound Off-Ramp/Gateway Drive	27	SR-99 Northbound Off-Ramps	28	SR-99 Northbound Off-Ramp/Gateway Drive	29	Schnoor Avenue/Cleveland Avenue	30	Fairgrounds/Cleveland Avenue

LSA

XXX / YYY

---- Project Driveway

AM / PM Peak Hour Traffic Volumes

FIGURE 4-1A

Village D Specific Plan
Traffic Impact Analysis

Existing Peak Hour Traffic Volumes (Int. 1-30)

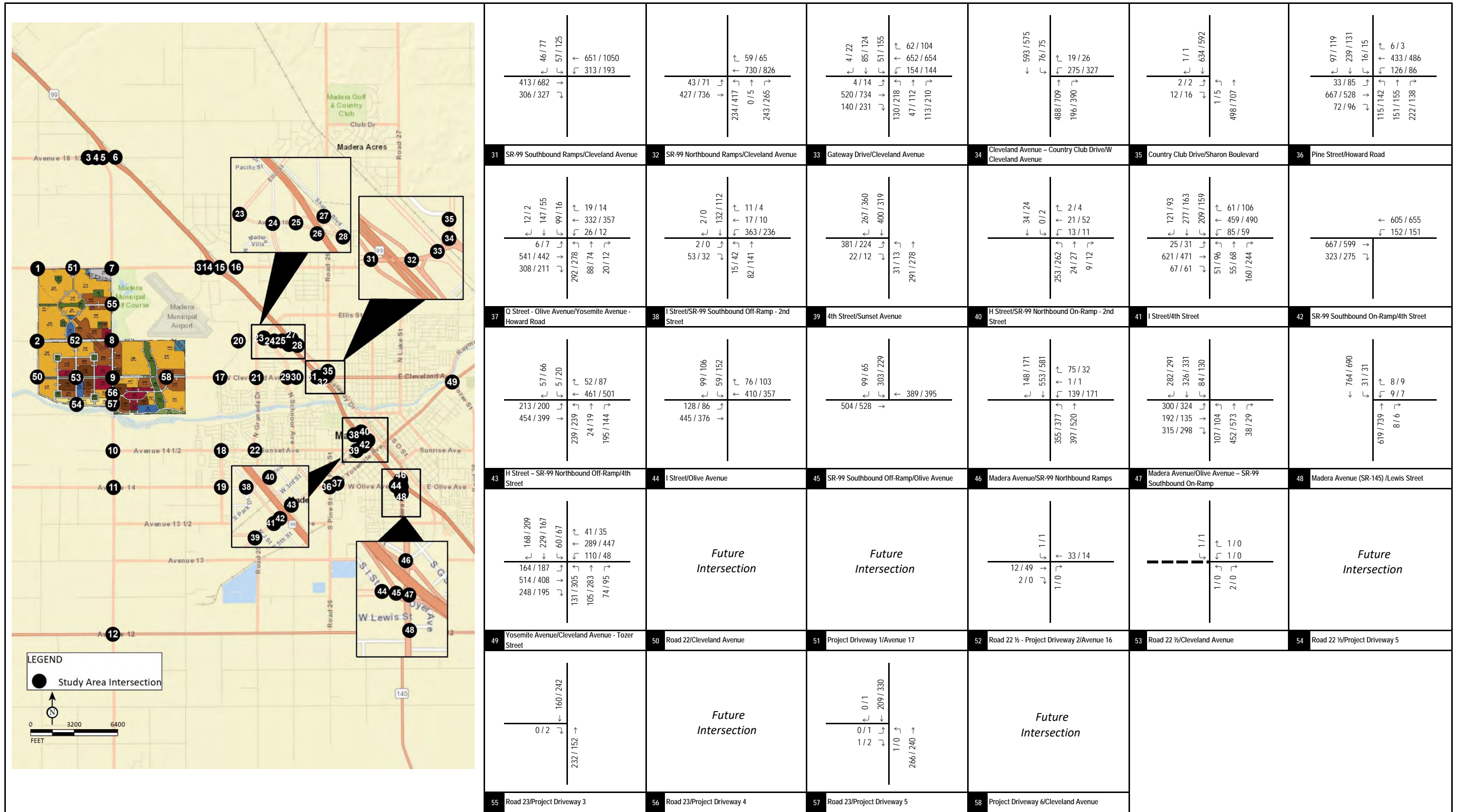
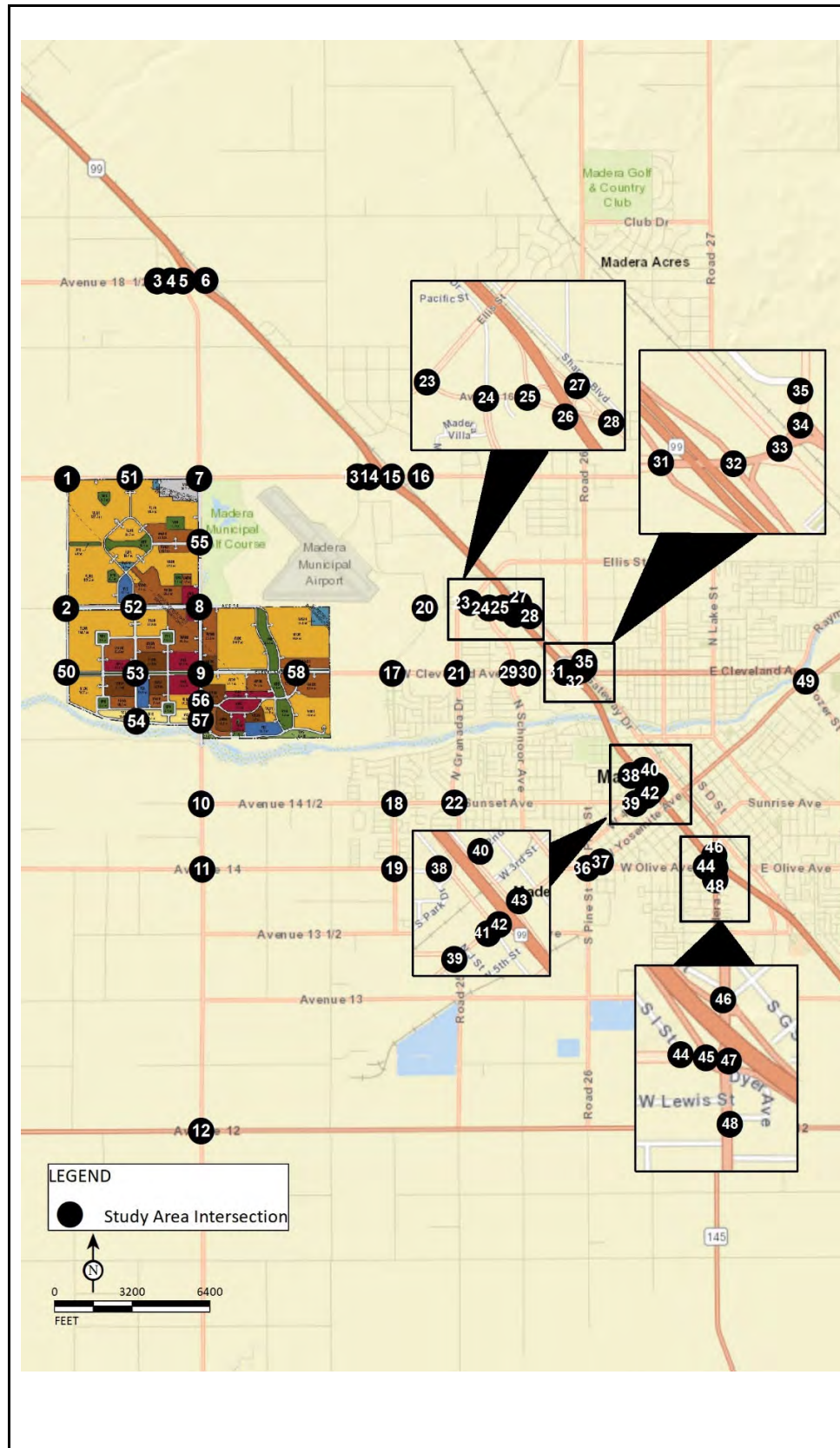

FIGURE 4-1B

LSA
 XXX / YYY
 AM / PM Peak Hour Traffic Volumes
 ---- Project Driveway

Village D Specific Plan
 Traffic Impact Analysis

Existing Peak Hour Traffic Volumes (Int. 31-58)



1	Road 22/Avenue 17	2	Road 22/Avenue 16	3	Golden State Boulevard/Avenue 18 ½	4	Pistachio Drive/Avenue 18 ½	5	SR-99 Southbound Ramps - Road 23/Avenue 18 ½	6	SR-99 Northbound Ramps/Avenue 18 ½
7	Road 23/Avenue 17	8	Road 23/Avenue 16	9	Road 23/Cleveland Avenue	10	Road 23/Avenue 14 ½	11	Road 23/Avenue 14	12	Road 23/Avenue 12
13	Golden State Boulevard - Airport Drive/Avenue 17	14	SR-99 Southbound Ramps/Avenue 17	15	SR-99 Northbound Ramps/Avenue 17	16	Love's Truck Stop Driveway/Avenue 17	17	Westberry Boulevard/Cleveland Avenue	18	Westberry Boulevard/Sunset Avenue
19	Westberry Boulevard/Avenue 14	20	Westberry Boulevard/Avenue 16	21	Granada Drive/Cleveland Avenue	22	Granada Drive/Sunset Avenue	23	Avenue 16 - Ellis Street/Kennedy Street	24	Schnoor Avenue/Kennedy Street
25	SR-99 Southbound Ramps/Kennedy Street - Gateway Drive	26	SR-99 Northbound Off-Ramp/Gateway Drive	27	SR-99 Northbound Off-Ramps	28	SR-99 Northbound Off-Ramp/Gateway Drive	29	Schnoor Avenue/Cleveland Avenue	30	Fairgrounds/Cleveland Avenue

LSA

XXX / YYY
AM / PM Peak Hour Traffic Volumes

---- Project Driveway

FIGURE 4-2A

Village D Specific Plan
Traffic Impact Analysis

Phase I Project Completion Year (2029) without Project Peak Hour Traffic Volumes (Int. 1-30)

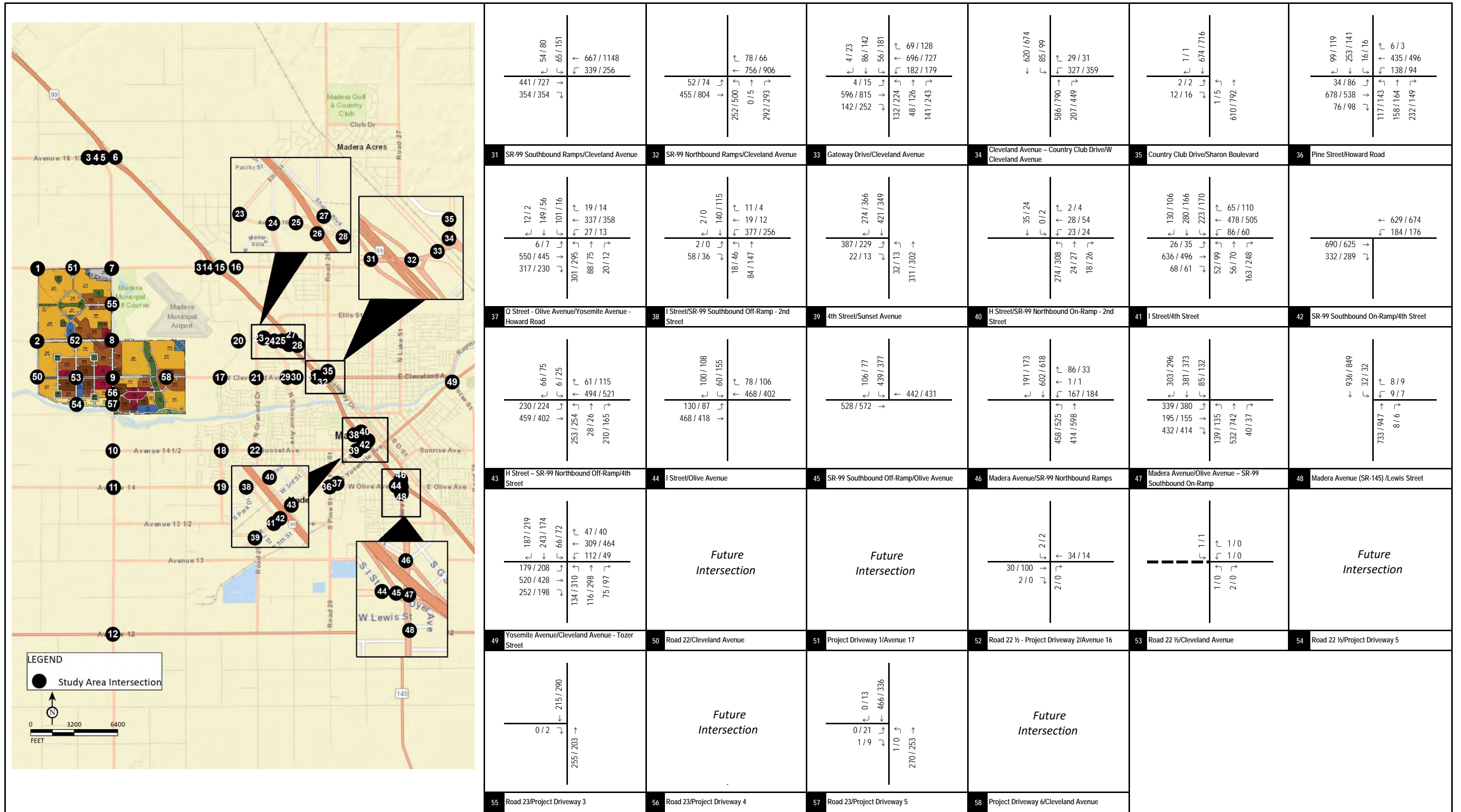

LSA

XXX / YYY
 AM / PM Peak Hour Traffic Volumes
 ---- Project Driveway

FIGURE 4-2B
 Village D Specific Plan
 Traffic Impact Analysis

Phase I Project Completion Year (2029) without Project Peak Hour Traffic Volumes (Int. 31-58)

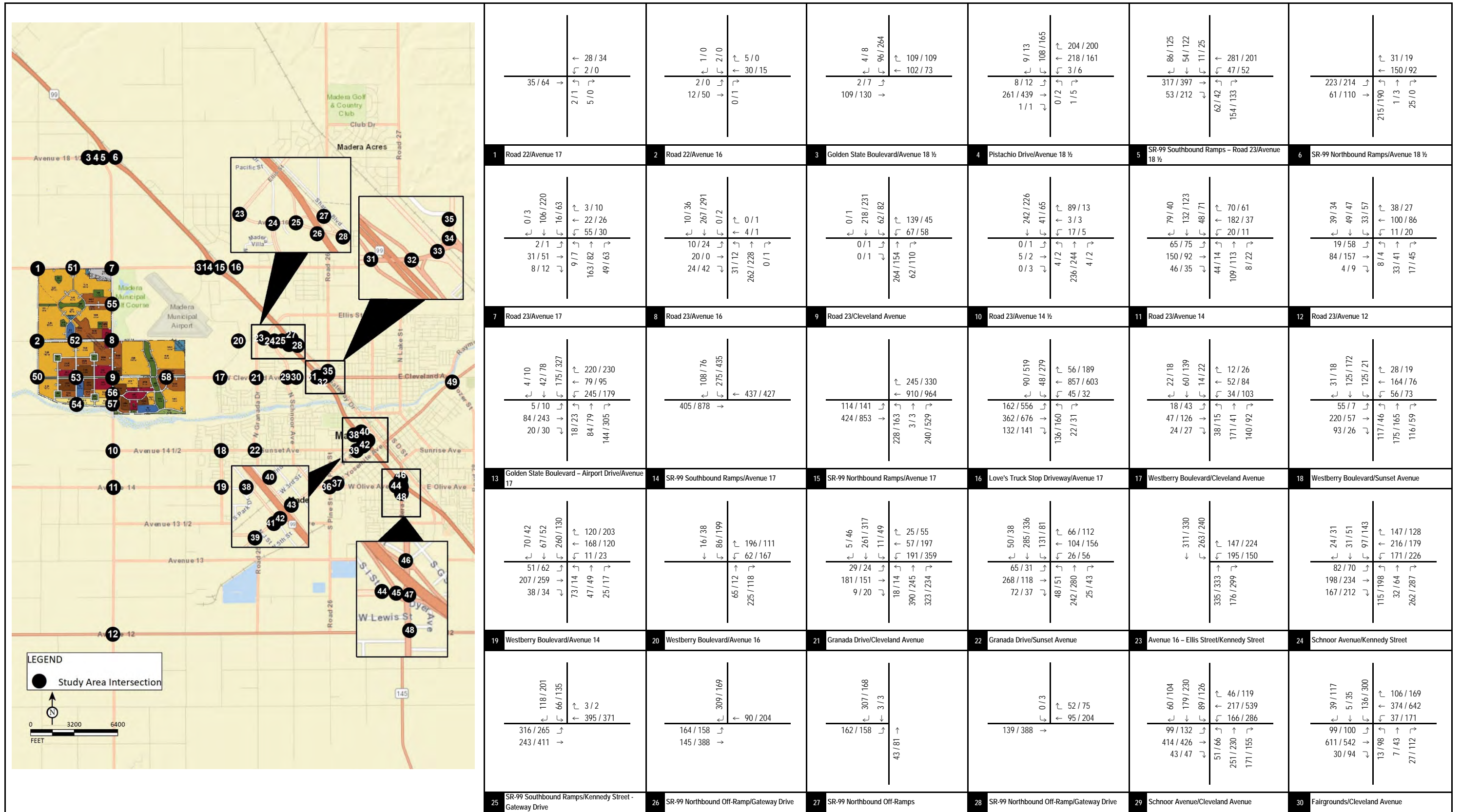

LSA

XXX / YYY
 AM / PM Peak Hour Traffic Volumes
 ---- Project Driveway

FIGURE 4-3A
 Village D Specific Plan
 Traffic Impact Analysis

Phase II Project Completion Year (2039) without Project Peak Hour Traffic Volumes (Int. 1-30)

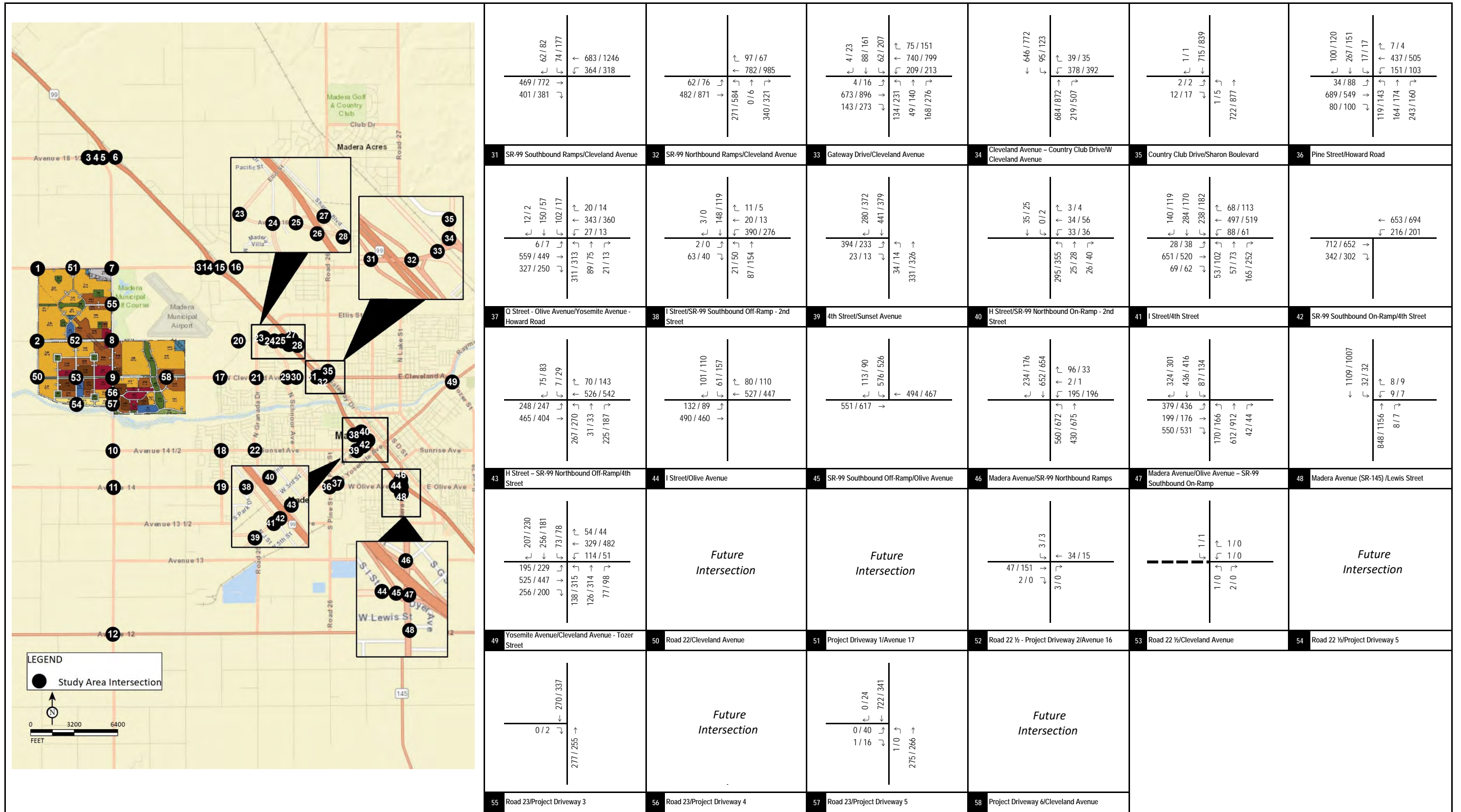

LSA

XXXX / YYYY
---- Project Driveway
AM / PM Peak Hour Traffic Volumes

FIGURE 4-3B

Village D Specific Plan
Traffic Impact Analysis

Phase II Project Completion Year (2039) without Project Peak Hour Traffic Volumes (Int. 31-58)

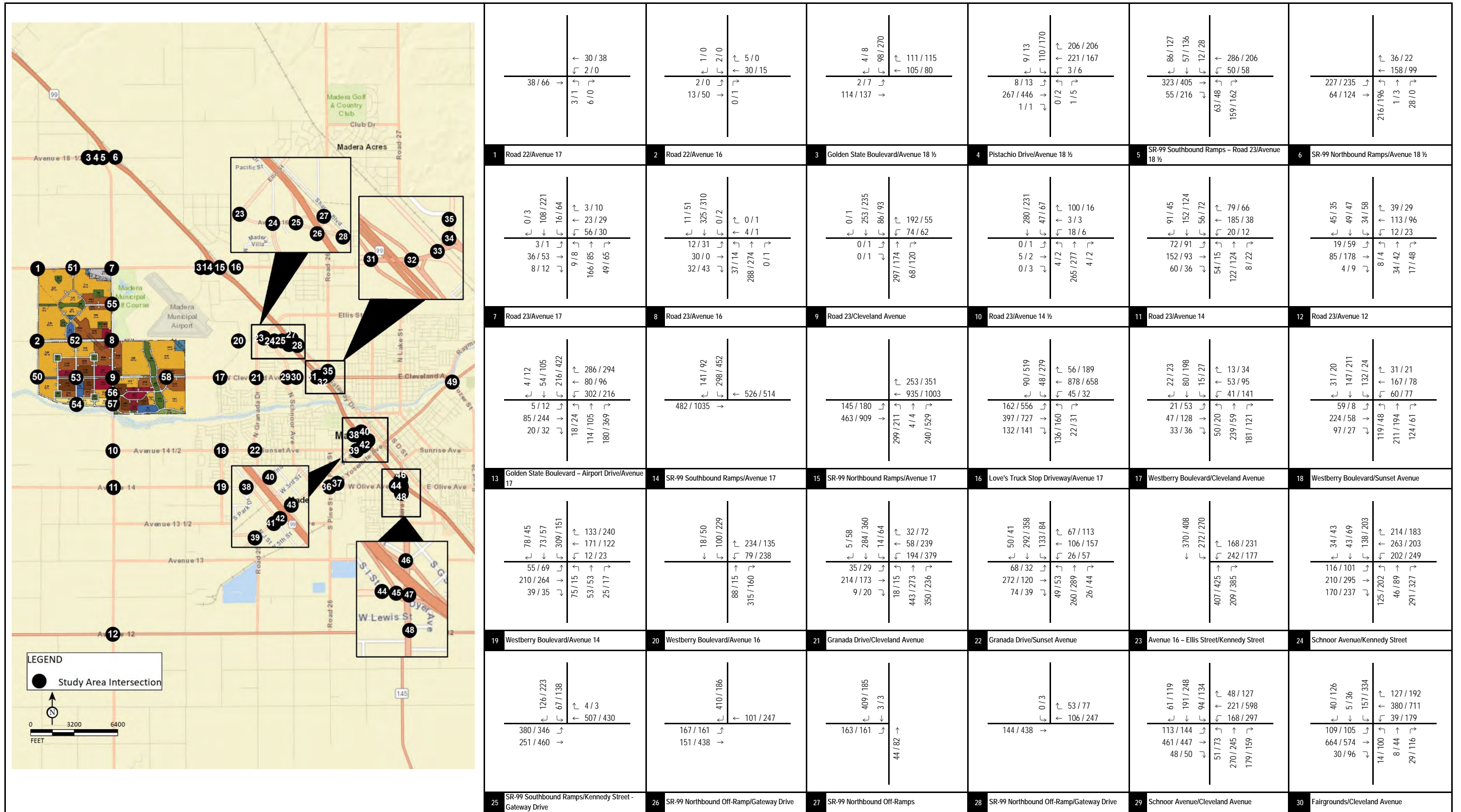

LSA

XXXX / YYYY
AM / PM Peak Hour Traffic Volumes

---- Project Driveway

FIGURE 4-4A

Village D Specific Plan
Traffic Impact Analysis

Phase III Project Completion Year (2049) without Project [General Plan Build-out] Peak Hour Traffic Volumes (Int. 1-30)

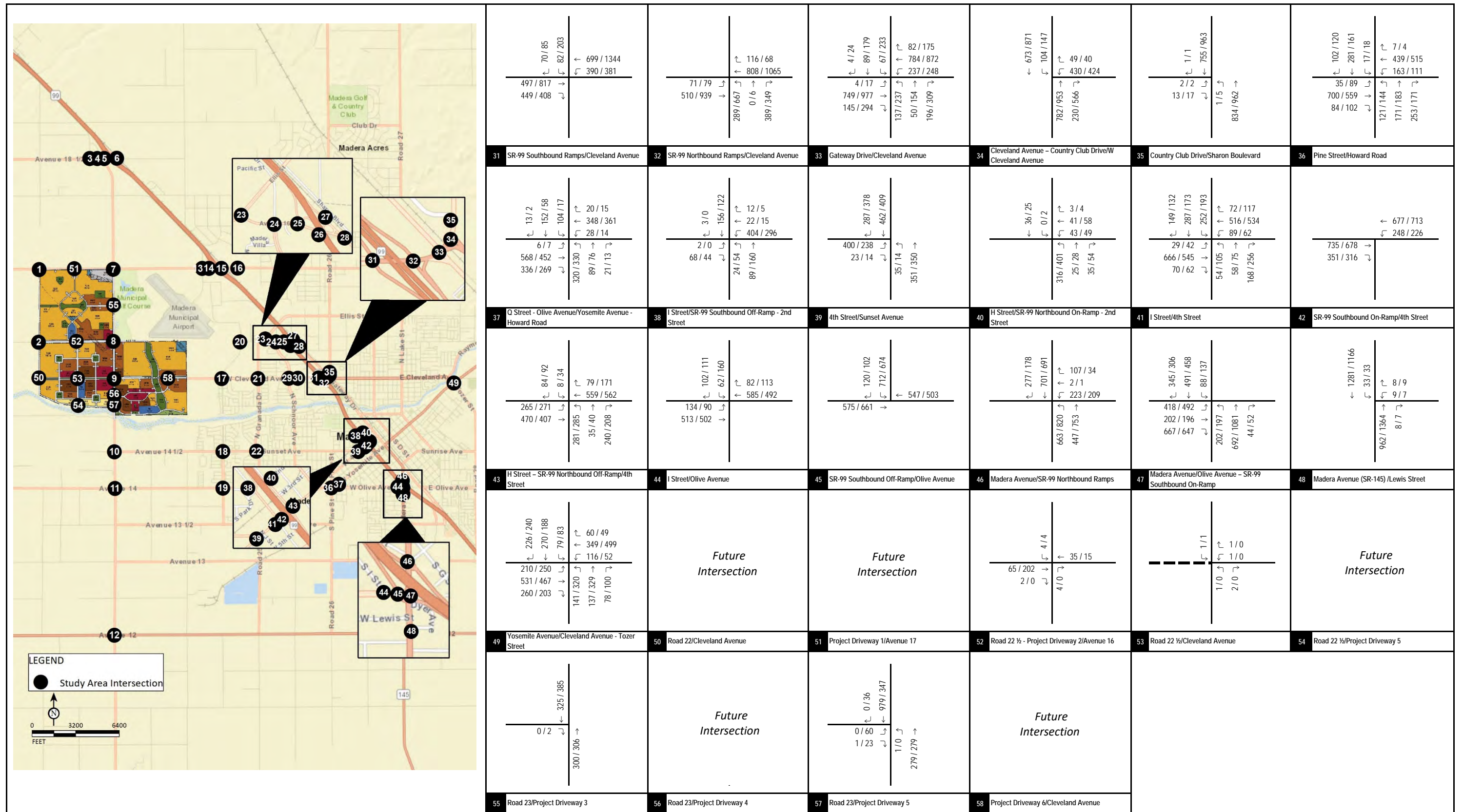

LSA

XXX / YYY
AM / PM Peak Hour Traffic Volumes

---- Project Driveway

FIGURE 4-4B

Village D Specific Plan
Traffic Impact Analysis

Phase III Project Completion Year (2049) without Project [General Plan Build-out] Peak Hour Traffic Volumes (Int. 31-58)

Table 4-A - Existing Roadway Segment Daily Traffic Volumes

Roadway	#	Segment	Jurisdiction	Existing ADT	External Project Trips	Internal Project Trips	Pass-By Trips	Existing With Project ADT
Road 23	1	between Avenue 17 and Project Driveway 3	City of Madera/Madera County	4,458	34,054	2,124	0	40,636
	2	between Project Driveway 3 and Avenue 16	City of Madera/Madera County	4,458	23,896	5,398	219	33,971
	3	between Avenue 16 and Cleveland Avenue	Madera County	4,658	24,062	5,013	1,193	34,926
	4	between Cleveland Avenue and Project Driveway 4	Madera County	5,575	25,684	5,353	28	36,640
	5	between Project Driveway 4 and Project Driveway 5	Madera County	5,575	27,250	478	0	33,303
	6	between Project Driveway 5 and Avenue 14 1/2	Madera County	5,575	28,090	0	0	33,665
	7	between Avenue 14 1/2 and Avenue 14	Madera County	5,052	21,570	0	0	26,622
Westberry Boulevard	8	between Sunset Avenue and Avenue 14/Howard Road	City of Madera	3,888	1,172	0	0	5,060
Granada Drive	9	between Cleveland Avenue and Fresno River	City of Madera	10,439	356	0	0	10,795
	10	between Sunset Avenue and Avenue 14/Howard Road	City of Madera	7,707	0	0	0	7,707
Avenue 17	11	between Road 22 and Project Driveway 1	Madera County	802	1,404	94	0	2,300
	12	between Project Driveway 1 and Road 23	Madera County	802	10,140	497	0	11,439
	13	between Road 23 and Golden State Boulevard	City of Madera/Madera County	2,233	25,658	0	0	27,891
	14	between Golden State Boulevard and State Route 99 Southbound Off-Ramp	City of Madera	9,626	20,356	0	0	29,982
Avenue 16	15	between Road 22 and Project Driveway 2/Road 22 1/2	Madera County	453	238	0	0	691
	16	between Project Driveway 2/Road 22 1/2 and Road 23	Madera County	453	7,990	2,013	0	10,456
Cleveland Avenue	17	between Road 22 1/2 and Road 23	Madera County	36	30,978	2,954	750	34,719
	18	between Road 23 and Project Driveway 6	Madera County	2,349	24,332	2,271	(613)	28,339
	19	between Project Driveway 6 and Westberry Boulevard	City of Madera/Madera County	2,349	28,884	644	0	31,877
	20	between Westberry Boulevard and Granada Drive	City of Madera	3,879	18,922	0	0	22,801
	21	between Granada Drive and Schnoor Street	City of Madera	9,473	17,334	0	0	26,807
	22	between Schnoor Street and Fairgrounds	City of Madera/Madera County	15,080	14,714	0	0	29,794
	23	between Fairgrounds and State Route 99 Southbound Ramps	City of Madera/Madera County	15,080	15,098	0	0	30,178
Sunset Avenue	24	between Granada Drive and Schnoor Street	City of Madera	6,123	1,432	0	0	7,555
Howard Road	25	between Granada Drive and Schnoor Street	City of Madera	10,751	8,924	0	0	19,675
	26	between Schnoor Street and Pine Street	City of Madera	16,597	8,924	0	0	25,521
Olive Avenue	27	between Yosemite Avenue and I Street	City of Madera	11,314	6,554	0	0	17,868
	28	between I Street and State Route 99 Southbound Off-Ramp	City of Madera	11,314	5,002	0	0	16,316
	29	between State Route 99 Southbound Off-Ramp and Madera Avenue	City of Madera	11,314	6,736	0	0	18,050

Table 4-B - Existing Freeway Segment and Ramp Traffic Volumes

Northbound																			
SR-99 Northbound	Type	AM Peak Hour										PM Peak Hour							
		NP Mainline	NP Mainline	NP Ramp	NP Ramp	Project	WP Mainline	WP Mainline	WP Ramp	WP Ramp	NP Mainline	NP Mainline	NP Ramp	NP Ramp	Project	WP Mainline	WP Mainline	WP Ramp	WP Ramp
		Total Volumes	TR Percentage	Total Volumes	TR Percentage	Trips	Total Volumes	TR Percentage	Total Volumes	TR Percentage	Total Volumes	TR Percentage	Total Volumes	TR Percentage	Trips	Total Volumes	TR Percentage	Total Volumes	TR Percentage
1 . South of Madera Avenue Off-Ramp	Basic	2,679	17.57%				2,972	15.84%			2,974	17.57%			3,772	13.85%			
2 . Madera Avenue Off-Ramp	Ramp (Diverge)			215	4.65%	66				281	3.56%			165				369	0.54%
3 . Madera Avenue Off-Ramp and Madera Avenue On-Ramp	Basic	2,464	18.70%				2,691	17.12%			2,770	18.79%			3,403	15.30%			
4 . Madera Avenue On-Ramp	Ramp (Merge)			504	9.94%	71				575	8.70%			195				744	2.02%
5 . Madera Avenue On-Ramp and 4th Street Off-Ramp	Basic	2,968	17.21%				3,266	15.64%			3,319	16.14%			4,147	12.91%			
6 . 4th Street Off-Ramp	Ramp (Diverge)			458	1.77%	0				458	1.75%			0				402	1.24%
7 . 4th Street Off-Ramp and 2nd Street On-Ramp	Basic	2,510	20.03%				2,808	17.90%			2,917	18.19%			3,745	14.17%			
8 . 2nd Street On-Ramp	Ramp (Merge)			274	2.92%	39				313	2.56%			106				420	1.67%
9 . 2nd Street On-Ramp and Cleveland Avenue Off-Ramp	Basic	2,784	18.34%				3,121	16.36%			3,231	16.64%			4,165	12.91%			
10 . Cleveland Avenue Off-Ramp	Ramp (Diverge)			477	4.61%	149				626	3.51%			423				1,110	0.63%
11 . Cleveland Avenue Off-Ramp and Cleveland Avenue On-Ramp	Basic	2,307	21.18%				2,495	19.59%			2,544	20.85%			3,055	17.37%			
12 . Cleveland Avenue On-Ramp	Ramp (Merge)			102	2.94%	71				173	1.73%			203				344	2.33%
13 . Cleveland Avenue On-Ramp and Gateway Drive Loop Off-Ramp	Basic	2,409	20.41%				2,668	18.43%			2,685	20.06%			3,399	15.84%			
14 . Gateway Drive Loop Off-Ramp	Ramp (Diverge)			107	6.54%	23				130	5.38%			123				261	1.92%
15 . Gateway Drive Loop Off-Ramp and Gateway Drive On-Ramp	Basic	2,302	21.06%				2,538	19.10%			2,547	20.95%			3,138	17.00%			
16 . Gateway Drive On-Ramp	Ramp (Merge)			202	4.46%	11				213	4.23%			19				250	4.00%
17 . Gateway Drive On-Ramp and Avenue 17 Off-Ramp	Basic	2,504	19.72%				2,751	17.95%			2,778	19.57%			3,388	16.04%			
18 . Avenue 17 Off-Ramp	Ramp (Diverge)			87	13.79%	247				334	3.59%			610				677	1.03%
19 . Avenue 17 Off-Ramp and Avenue 17 On-Ramp	Basic	2,417	19.93%				2,417	19.93%			2,711	19.79%			2,711	19.79%			
20 . Avenue 17 On-Ramp	Ramp (Merge)			153	10.46%	0				153	10.46%			0				131	6.87%
21 . Avenue 17 On-Ramp and Avenue 18 1/2 Off-Ramp	Basic	2,570	19.37%				2,570	19.37%			2,842	19.20%			2,842	19.20%			
22 . Avenue 18 1/2 Off-Ramp	Ramp (Diverge)			232	28.64%	0				232	28.45%			0				181	24.31%
23 . Avenue 18 1/2 Off-Ramp and Avenue 18 1/2 On-Ramp	Basic	2,338	18.47%				2,338	18.47%			2,661	18.85%			2,661	18.85%			
24 . Avenue 18 1/2 On-Ramp	Ramp (Merge)			239	32.90%	579				818	9.66%			307				493	8.92%
25 . North of Avenue 18 1/2 On-Ramp	Basic	2,577	19.82%				3,156	16.18%			2,847	19.16%			3,154	17.30%			

Southbound																			
SR-99 Southbound	Type	AM Peak Hour										PM Peak Hour							
		NP Mainline	NP Mainline	NP Ramp	NP Ramp	Project	WP Mainline	WP Mainline	WP Ramp	WP Ramp	NP Mainline	NP Mainline	NP Ramp	NP Ramp	Project	WP Mainline	WP Mainline	WP Ramp	WP Ramp
		Total Volumes	TR Percentage	Total Volumes	TR Percentage	Trips	Total Volumes	TR Percentage	Total Volumes	TR Percentage	Total Volumes	TR Percentage	Total Volumes	TR Percentage	Trips	Total Volumes	TR Percentage	Total Volumes	TR Percentage
26 . North of Avenue 18 1/2 Off-Ramp	Basic	2,083	27.23%				2,291	24.76%			3,048	20.73%			3,607	17.52%			
27 . Avenue 18 1/2 Off-Ramp	Ramp (Diverge)			142	35.29%	208				350	14.29%			559				791	7.71%
28 . Avenue 18 1/2 Off-Ramp and Avenue 18 1/2 Loop On-Ramp	Basic	1,941	26.65%				1,941	26.65%			2,816	20.28%			2,816	20.28%			
29 . Avenue 18 1/2 Loop On-Ramp	Ramp (Merge)			36	13.89%	0				36	13.89%			0				27	7.41%
30 . Avenue 18 1/2 Loop On-Ramp and Avenue 18 1/2 Slip-On Ramp	Basic	1,977	26.42%				1,977	26.42%			2,843	20.15%			2,843	20.15%			
31 . Avenue 18 1/2 Slip-On Ramp	Ramp (Merge)			188	32.07%	0				188	31.91%			0				222	22.07%
32 . Avenue 18 1/2 Slip-On Ramp and Avenue 17 Off-Ramp	Basic	2,165	26.89%				2,165	26.89%			3,065	20.29%			3,065	20.29%			
33 . Avenue 17 Off-Ramp	Ramp (Diverge)			101	18.81%	0				101	18.81%			0				196	4.59%
34 . Avenue 17 Off-Ramp and Avenue 17 Loop On-Ramp	Basic	2,064	27.29%				2,064	27.29%			2,869	21.37%			2,869	21.37%			
35 . Avenue 17 Loop On-Ramp	Ramp (Merge)			494	4.05%	0				494	4.05%			0				173	6.36%
36 . Avenue 17 Loop On-Ramp and Avenue 17 Slip-On Ramp	Basic	2,558	22.80%				2,558	22.80%			3,042	20.51%			3,042	20.51%			
37 . Avenue 17 Slip-On Ramp	Ramp (Merge)			75	14.67%	670				745	1.48%			313				460	1.09%
38 . Avenue 17 Slip-On Ramp and Gateway Drive Off-Ramp	Basic	2,633	22.57%				3,303	17.99%			3,189	19.72%			3,502	17.96%			
39 . Gateway Drive Off-Ramp	Ramp (Diverge)			167	4.19%	42				209	3.35%			26				312	3.21%
40 . Gateway Drive Off-Ramp and Gateway Drive Loop On-Ramp	Basic	2,466	23.81%				3,094	18.98%			2,903	21.32%			3,190	19.40%			
41 . Gateway Drive Loop On-Ramp	Ramp (Merge)			188	2.66%	112				300	1.67%			41				144	4.17%
42 . Gateway Drive Loop On-Ramp and Cleveland Avenue Off-Ramp	Basic	2,654	22.32%				3,394	17.45%			3,006	20.79%			3,334	18.75%			
43 . Cleveland Avenue Off-Ramp	Ramp (Diverge)			103	14.71%	216				319	4.70%			102				304	2.63%
44 . Cleveland Avenue Off-Ramp and Cleveland Avenue On-Ramp	Basic	2,551	22.63%				3,075	18.77%			2,804	22.00%			3,030	20.36%			
45 . Cleveland Avenue On-Ramp	Ramp (Merge)			619	3.10%	418				1,037	1.83%			241				761	1.05%
46 . Cleveland Avenue On-Ramp and 2nd Street Off-Ramp	Basic	3,170	18.81%				4,112	14.50%			3,324	18.80%			3,791	16.49%			
47 . 2nd Street Off-Ramp	Ramp (Diverge)			391	3.32%	119				510	2.55%			51				301	2.33%
48 . 2nd Street Off-Ramp and 4th Street On-Ramp	Basic	2,779	20.99%				3,602	16.19%			3,074	20.10%			3,490	17.71%			
49 . 4th Street On-Ramp	Ramp (Merge)			475	0.84%	0				475	0.84%			0				426	1.17%
50 . 4th Street On-Ramp and Olive Avenue Off-Ramp	Basic	3,254	18.05%				4,077	14.40%			3,500	17.80%			3,916	15.91%			
51 . Olive Avenue Off-Ramp	Ramp (Diverge)			402	9.70%	202				604	6.46%			102				396	3.28%
52 . Olive Avenue Off-Ramp and Madera Avenue On-Ramp	Basic	2,852	19.22%				3,473	15.79%			3,206	19.03%			3,520	17.33%			
53 . Madera Avenue On-Ramp	Ramp (Merge)			314	2.57%	175				489	1.64%			91				385	1.30%
54 . South of Madera Avenue On-Ramp	Basic	3,166	17.57%				3,962	14.04%			3,500	17.57%			3,905	15.75%			

Table 4-C - Phase III Project Completion Year (2049) Roadway Segment Daily Traffic Volumes

Roadway	#	Segment	Jurisdiction	Phase III Project Completion Year (2049) without Project ADT	Phase I+II+III External Project Trips	Phase I+II+III Internal Project Trips	Phase I+II+III Pass-By Trips	Phase III Project Completion Year (2049) with Project ADT
Road 23	1	between Avenue 17 and Project Driveway 3	City of Madera/Madera County	4,657	34,054	2,124	0	40,835
	2	between Project Driveway 3 and Avenue 16	City of Madera/Madera County	4,799	23,896	5,398	219	34,312
	3	between Avenue 16 and Cleveland Avenue	Madera County	7,443	24,062	5,013	1,193	37,711
	4	between Cleveland Avenue and Project Driveway 4	Madera County	7,528	25,684	5,353	28	38,592
	5	between Project Driveway 4 and Project Driveway 5	Madera County	6,714	27,250	478	0	34,442
	6	between Project Driveway 5 and Avenue 14 1/2	Madera County	5,829	28,090	0	0	33,919
	7	between Avenue 14 1/2 and Avenue 14	Madera County	5,541	21,570	0	0	27,111
Westberry Boulevard	8	between Sunset Avenue and Avenue 14/Howard Road	City of Madera	6,761	1,172	0	0	7,933
Granada Drive	9	between Cleveland Avenue and Fresno River	City of Madera	14,145	356	0	0	14,501
	10	between Sunset Avenue and Avenue 14/Howard Road	City of Madera	8,843	0	0	0	8,843
Avenue 17	11	between Road 22 and Project Driveway 1	Madera County	1,080	1,404	94	0	2,577
	12	between Project Driveway 1 and Road 23	Madera County	1,103	10,140	497	0	11,740
	13	between Road 23 and Golden State Boulevard	City of Madera/Madera County	3,441	25,658	0	0	29,099
	14	between Golden State Boulevard and State Route 99 Southbound Off-Ramp	City of Madera	21,374	20,356	0	0	41,730
Avenue 16	15	between Road 22 and Project Driveway 2/Road 22 1/2	Madera County	471	238	0	0	709
	16	between Project Driveway 2/Road 22 1/2 and Road 23	Madera County	2,654	7,990	2,013	0	12,657
Cleveland Avenue	17	between Road 22 1/2 and Road 23	Madera County	38	30,978	2,954	750	34,721
	18	between Road 23 and Project Driveway 6	Madera County	2,577	24,332	2,271	(613)	28,566
	19	between Project Driveway 6 and Westberry Boulevard	City of Madera/Madera County	4,204	28,884	644	0	33,732
	20	between Westberry Boulevard and Granada Drive	City of Madera	7,068	18,922	0	0	25,990
	21	between Granada Drive and Schnoor Street	City of Madera	14,044	17,334	0	0	31,378
	22	between Schnoor Street and Fairgrounds	City of Madera/Madera County	19,364	14,714	0	0	34,078
Sunset Avenue	23	between Fairgrounds and State Route 99 Southbound Ramps	City of Madera/Madera County	21,825	15,098	0	0	36,923
Sunset Avenue	24	between Granada Drive and Schnoor Street	City of Madera	6,429	1,432	0	0	7,861
Howard Road	25	between Granada Drive and Schnoor Street	City of Madera	12,395	8,924	0	0	21,319
	26	between Schnoor Street and Pine Street	City of Madera	17,545	8,924	0	0	26,469
Olive Avenue	27	between Yosemite Avenue and I Street	City of Madera	14,875	6,554	0	0	21,429
	28	between I Street and State Route 99 Southbound Off-Ramp	City of Madera	14,875	5,002	0	0	19,877
	29	between State Route 99 Southbound Off-Ramp and Madera Avenue	City of Madera	20,783	6,736	0	0	27,519

Table 4-D - Phase I (2029) Freeway Segment and Ramp Traffic Volumes

Northbound																			
SR-99 Northbound	Type	AM Peak Hour								PM Peak Hour									
		NP Mainline Total Volumes	NP Mainline TR Percentage	NP Ramp Total Volumes	NP Ramp TR Percentage	Project Trips	WP Mainline Total Volumes	WP Mainline TR Percentage	WP Ramp Total Volumes	WP Ramp TR Percentage	NP Mainline Total Volumes	NP Mainline TR Percentage	NP Ramp Total Volumes	NP Ramp TR Percentage	Project Trips	WP Mainline Total Volumes	WP Mainline TR Percentage	WP Ramp Total Volumes	WP Ramp TR Percentage
1 . South of Madera Avenue Off-Ramp	Basic	2,977	17.57%				3,077	17.00%		3,210	17.57%				3,488	16.17%			
2 . Madera Avenue Off-Ramp	Ramp (Diverge)			254	4.65%	11			265	4.53%			217	0.99%	30			247	0.81%
3 . Madera Avenue Off-Ramp and Madera Avenue On-Ramp	Basic	2,723	18.78%				2,812	18.19%		2,994	18.77%				3,241	17.34%			
4 . Madera Avenue On-Ramp	Ramp (Merge)			650	9.94%	27			677	9.60%			699	2.75%	78			777	2.45%
5 . Madera Avenue On-Ramp and 4th Street Off-Ramp	Basic	3,373	17.08%				3,489	16.51%		3,692	15.74%				4,018	14.46%			
6 . 4th Street Off-Ramp	Ramp (Diverge)			491	1.77%	0			491	1.83%			446	1.24%	0			446	1.35%
7 . 4th Street Off-Ramp and 2nd Street On-Ramp	Basic	2,882	19.69%				2,998	18.93%		3,246	17.72%				3,572	16.11%			
8 . 2nd Street On-Ramp	Ramp (Merge)			302	2.92%	5			307	2.93%			362	2.23%	14			376	2.13%
9 . 2nd Street On-Ramp and Cleveland Avenue Off-Ramp	Basic	3,184	18.09%				3,305	17.43%		3,609	16.17%				3,949	14.77%			
10 . Cleveland Avenue Off-Ramp	Ramp (Diverge)			544	4.61%	121			665	3.76%			799	1.02%	340			1,139	0.70%
11 . Cleveland Avenue Off-Ramp and Cleveland Avenue On-Ramp	Basic	2,640	20.88%				2,640	20.88%		2,810	20.48%				2,810	20.48%			
12 . Cleveland Avenue On-Ramp	Ramp (Merge)			130	2.94%	0			130	3.07%			145	5.67%	0			145	5.51%
13 . Cleveland Avenue On-Ramp and Gateway Drive Loop Off-Ramp	Basic	2,770	20.04%				2,770	20.04%		2,955	19.75%				2,955	19.75%			
14 . Gateway Drive Loop Off-Ramp	Ramp (Diverge)			209	6.54%	0			209	6.71%			155	3.62%	0			155	3.88%
15 . Gateway Drive Loop Off-Ramp and Gateway Drive On-Ramp	Basic	2,562	21.14%				2,562	21.14%		2,800	20.64%				2,800	20.64%			
16 . Gateway Drive On-Ramp	Ramp (Merge)			204	4.46%	0			204	4.42%			235	4.33%	0			235	4.26%
17 . Gateway Drive On-Ramp and Avenue 17 Off-Ramp	Basic	2,765	19.91%				2,765	19.91%		3,035	19.39%				3,035	19.39%			
18 . Avenue 17 Off-Ramp	Ramp (Diverge)			399	13.79%	0			399	13.78%			645	10.45%	0			645	10.38%
19 . Avenue 17 Off-Ramp and Avenue 17 On-Ramp	Basic	2,366	20.94%				2,366	20.94%		2,390	21.82%				2,390	21.82%			
20 . Avenue 17 On-Ramp	Ramp (Merge)			321	10.46%	0			321	10.58%			414	6.87%	0			414	6.77%
21 . Avenue 17 On-Ramp and Avenue 18 1/2 Off-Ramp	Basic	2,688	19.70%				2,688	19.70%		2,804	19.60%				2,804	19.60%			
22 . Avenue 18 1/2 Off-Ramp	Ramp (Diverge)			236	28.64%	0			236	28.77%			187	24.06%	0			187	24.06%
23 . Avenue 18 1/2 Off-Ramp and Avenue 18 1/2 On-Ramp	Basic	2,451	18.83%				2,451	18.83%		2,617	19.28%				2,617	19.28%			
24 . Avenue 18 1/2 On-Ramp	Ramp (Merge)			247	32.90%	191			438	18.48%			211	23.78%	102			313	15.99%
25 . North of Avenue 18 1/2 On-Ramp	Basic	2,699	20.10%				2,890	18.77%		2,827	19.61%				2,929	18.93%			

Southbound																			
SR-99 Southbound	Type	AM Peak Hour								PM Peak Hour									
		NP Mainline Total Volumes	NP Mainline TR Percentage	NP Ramp Total Volumes	NP Ramp TR Percentage	Project Trips	WP Mainline Total Volumes	WP Mainline TR Percentage	WP Ramp Total Volumes	WP Ramp TR Percentage	NP Mainline Total Volumes	NP Mainline TR Percentage	NP Ramp Total Volumes	NP Ramp TR Percentage	Project Trips	WP Mainline Total Volumes	WP Mainline TR Percentage	WP Ramp Total Volumes	WP Ramp TR Percentage
26 . North of Avenue 18 1/2 Off-Ramp	Basic	2,310	28.18%				2,376	27.40%		3,028	22.06%				3,215	20.78%			
27 . Avenue 18 1/2 Off-Ramp	Ramp (Diverge)			146	35.29%	66			212	24.49%			252	26.18%	186			438	15.08%
28 . Avenue 18 1/2 Off-Ramp and Avenue 18 1/2 Loop On-Ramp	Basic	2,163	27.68%				2,163	27.68%		2,777	21.68%				2,777	21.68%			
29 . Avenue 18 1/2 Loop On-Ramp	Ramp (Merge)			36	13.89%	0			36	13.76%			28	7.41%	0			28	7.14%
30 . Avenue 18 1/2 Loop On-Ramp and Avenue 18 1/2 Slip-On Ramp	Basic	2,200	27.45%				2,200	27.45%		2,805	21.54%				2,805	21.53%			
31 . Avenue 18 1/2 Slip-On Ramp	Ramp (Merge)			193	32.07%	0			193	32.07%			229	21.94%	0			229	21.83%
32 . Avenue 18 1/2 Slip-On Ramp and Avenue 17 Off-Ramp	Basic	2,393	27.82%				2,393	27.82%		3,034	21.56%				3,034	21.55%			
33 . Avenue 17 Off-Ramp	Ramp (Diverge)			326	18.81%	0			326	18.69%			477	4.59%	0			477	4.61%
34 . Avenue 17 Off-Ramp and Avenue 17 Loop On-Ramp	Basic	2,067	29.27%				2,067	29.27%		2,556	24.72%				2,557	24.72%			
35 . Avenue 17 Loop On-Ramp	Ramp (Merge)			692	4.05%	0			692	4.04%			695	6.36%	0			695	6.33%
36 . Avenue 17 Loop On-Ramp and Avenue 17 Slip-On Ramp	Basic	2,759	22.94%				2,759	22.94%		3,251	20.79%				3,252	20.79%			
37 . Avenue 17 Slip-On Ramp	Ramp (Merge)			107	14.67%	0			107	14.91%			230	3.40%	0			230	3.47%
38 . Avenue 17 Slip-On Ramp and Gateway Drive Off-Ramp	Basic	2,866	22.63%				2,866	22.63%		3,482	19.64%				3,482	19.64%			
39 . Gateway Drive Off-Ramp	Ramp (Diverge)			176	4.19%	0			176	3.98%			311	3.62%	0			311	3.54%
40 . Gateway Drive Off-Ramp and Gateway Drive Loop On-Ramp	Basic	2,691	23.83%				2,691	23.83%		3,171	21.22%				3,171	21.22%			
41 . Gateway Drive Loop On-Ramp	Ramp (Merge)			253	2.66%	0			253	2.76%			185	5.83%	0			185	5.95%
42 . Gateway Drive Loop On-Ramp and Cleveland Avenue Off-Ramp	Basic	2,944	22.01%				2,944	22.01%		3,356	20.37%				3,356	20.37%			
43 . Cleveland Avenue Off-Ramp	Ramp (Diverge)			119	14.71%	0			119	15.08%			231	3.96%	0			231	3.90%
44 . Cleveland Avenue Off-Ramp and Cleveland Avenue On-Ramp	Basic	2,825	22.32%				2,825	22.32%		3,125	21.59%				3,125	21.59%			
45 . Cleveland Avenue On-Ramp	Ramp (Merge)			692	3.10%	415			1,107	1.90%			610	1.56%	141			751	1.33%
46 . Cleveland Avenue On-Ramp and 2nd Street Off-Ramp	Basic	3,517	18.54%				3,932	16.58%		3,735	18.31%				3,876	17.65%			
47 . 2nd Street Off-Ramp	Ramp (Diverge)			407	3.32%	18			425	3.30%			272	2.80%	6			278	2.88%
48 . 2nd Street Off-Ramp and 4th Street On-Ramp	Basic	3,110	20.52%				3,507	18.20%		3,462	19.53%				3,598	18.80%			
49 . 4th Street On-Ramp	Ramp (Merge)			516	0.84%	0			516	0.77%			465	1.18%	0			465	1.08%
50 . 4th Street On-Ramp and Olive Avenue Off-Ramp	Basic	3,627	17.72%				4,024	15.97%		3,928	17.35%				4,063	16.78%			
51 . Olive Avenue Off-Ramp	Ramp (Diverge)			545	9.70%	94			639	8.29%			455	4.45%	32			487	4.11%
52 . Olive Avenue Off-Ramp and Madera Avenue On-Ramp	Basic	3,081	19.13%				3,384	17.42%		3,472	19.04%				3,576	18.49%			
53 . Madera Avenue On-Ramp	Ramp (Merge)			321	2.57%	0			321	2.49%			324	1.70%	37			361	1.66%
54 . South of Madera Avenue On-Ramp	Basic	3,402	17.57%				3,705	16.14%		3,797	17.57%				3,937	16.94%			

Table 4-E - Phase I Project Completion Year (2029) Roadway Segment Daily Traffic Volumes

Roadway	#	Segment	Jurisdiction	Phase I Project Completion Year (2029) without Project ADT	Phase I External Project Trips	Phase I Internal Project Trips	Phase I Pass-By Trips	Phase I Project Completion Year (2029) with Project ADT
Road 23	1	between Avenue 17 and Project Driveway 3	City of Madera/Madera County	4,524	7,572	0	0	12,096
	2	between Project Driveway 3 and Avenue 16	City of Madera/Madera County	4,572	7,572	0	0	12,144
	3	between Avenue 16 and Cleveland Avenue	Madera County	5,586	6,738	0	0	12,324
	4	between Cleveland Avenue and Project Driveway 4	Madera County	6,226	8,472	0	28	14,726
	5	between Project Driveway 4 and Project Driveway 5	Madera County	5,955	10,040	0	0	15,995
	6	between Project Driveway 5 and Avenue 14 1/2	Madera County	5,660	10,040	0	0	15,700
	7	between Avenue 14 1/2 and Avenue 14	Madera County	5,215	7,862	0	0	13,077
Westberry Boulevard	8	between Sunset Avenue and Avenue 14/Howard Road	City of Madera	4,846	768	0	0	5,614
Granada Drive	9	between Cleveland Avenue and Fresno River	City of Madera	11,674	256	0	0	11,930
	10	between Sunset Avenue and Avenue 14/Howard Road	City of Madera	8,086	0	0	0	8,086
Avenue 17	11	between Road 22 and Project Driveway 1	Madera County	895	464	0	0	1,359
	12	between Project Driveway 1 and Road 23	Madera County	902	464	0	0	1,366
	13	between Road 23 and Golden State Boulevard	City of Madera/Madera County	3,262	2,076	0	0	5,338
	14	between Golden State Boulevard and State Route 99 Southbound Off-Ramp	City of Madera	14,169	1,716	0	0	15,885
Avenue 16	15	between Road 22 and Project Driveway 2/Road 22 1/2	Madera County	459	0	0	0	459
	16	between Project Driveway 2/Road 22 1/2 and Road 23	Madera County	1,187	0	0	0	1,187
Cleveland Avenue	17	between Road 22 1/2 and Road 23	Madera County	37	0	0	0	37
	18	between Road 23 and Project Driveway 6	Madera County	2,425	13,206	0	(671)	14,959
	19	between Project Driveway 6 and Westberry Boulevard	City of Madera/Madera County	2,967	17,758	379	0	21,105
	20	between Westberry Boulevard and Granada Drive	City of Madera	4,942	12,066	0	0	17,008
	21	between Granada Drive and Schnoor Street	City of Madera	10,997	11,236	0	0	22,233
	22	between Schnoor Street and Fairgrounds	City of Madera/Madera County	16,508	9,612	0	0	26,120
Sunset Avenue	23	between Fairgrounds and State Route 99 Southbound Ramps	City of Madera/Madera County	17,328	9,612	0	0	26,940
	24	between Granada Drive and Schnoor Street	City of Madera	6,225	484	0	0	6,709
Howard Road	25	between Granada Drive and Schnoor Street	City of Madera	11,299	3,144	0	0	14,443
	26	between Schnoor Street and Pine Street	City of Madera	16,913	3,144	0	0	20,057
Olive Avenue	27	between Yosemite Avenue and I Street	City of Madera	12,501	1,940	0	0	14,441
	28	between I Street and State Route 99 Southbound Off-Ramp	City of Madera	12,501	1,334	0	0	13,835
	29	between State Route 99 Southbound Off-Ramp and Madera Avenue	City of Madera	14,470	1,967	0	0	16,437

Table 4-F - Phase II (2039) Freeway Segment and Ramp Traffic Volumes

Northbound																			
SR-99 Northbound	Type	AM Peak Hour								PM Peak Hour									
		NP Mainline Total Volumes	NP Mainline TR Percentage	NP Ramp Total Volumes	NP Ramp TR Percentage	Project Trips	WP Mainline Total Volumes	WP Mainline TR Percentage	WP Ramp Total Volumes	WP Ramp TR Percentage	NP Mainline Total Volumes	NP Mainline TR Percentage	NP Ramp Total Volumes	NP Ramp TR Percentage	Project Trips	WP Mainline Total Volumes	WP Mainline TR Percentage	WP Ramp Total Volumes	WP Ramp TR Percentage
1 . South of Madera Avenue Off-Ramp	Basic	3,275	17.57%				3,485	16.52%			3,446	17.57%			4,006	15.12%			
2 . Madera Avenue Off-Ramp	Ramp (Diverge)			293	4.65%	11				304	4.61%			30			260	0.77%	
3 . Madera Avenue Off-Ramp and Madera Avenue On-Ramp	Basic	2,982	18.85%				3,181	17.67%			3,216	18.77%			3,746	16.11%			
4 . Madera Avenue On-Ramp	Ramp (Merge)			796	9.94%	65				861	9.18%			179			1,028	2.24%	
5 . Madera Avenue On-Ramp and 4th Street Off-Ramp	Basic	3,778	16.98%				4,042	15.87%			4,065	15.41%			4,774	13.12%			
6 . 4th Street Off-Ramp	Ramp (Diverge)			523	1.77%	0				523	1.72%			0			489	1.23%	
7 . 4th Street Off-Ramp and 2nd Street On-Ramp	Basic	3,255	19.43%				3,519	17.97%			3,575	17.35%			4,284	14.48%			
8 . 2nd Street On-Ramp	Ramp (Merge)			329	2.92%	36				365	2.74%			91			502	1.79%	
9 . 2nd Street On-Ramp and Cleveland Avenue Off-Ramp	Basic	3,584	17.90%				3,884	16.52%			3,986	15.79%			4,786	13.15%			
10 . Cleveland Avenue Off-Ramp	Ramp (Diverge)			611	4.61%	121				732	3.83%			340			1,250	0.72%	
11 . Cleveland Avenue Off-Ramp and Cleveland Avenue On-Ramp	Basic	2,973	20.64%				3,152	19.47%			3,076	20.16%			3,536	17.54%			
12 . Cleveland Avenue On-Ramp	Ramp (Merge)			159	2.94%	62				221	2.27%			152			301	2.66%	
13 . Cleveland Avenue On-Ramp and Gateway Drive Loop Off-Ramp	Basic	3,132	19.75%				3,373	18.34%			3,225	19.50%			3,837	16.39%			
14 . Gateway Drive Loop Off-Ramp	Ramp (Diverge)			310	6.54%	5				315	6.34%			21			192	3.12%	
15 . Gateway Drive Loop Off-Ramp and Gateway Drive On-Ramp	Basic	2,821	21.20%				3,057	19.57%			3,053	20.39%			3,644	17.08%			
16 . Gateway Drive On-Ramp	Ramp (Merge)			205	4.46%	11				216	4.16%			19			258	3.88%	
17 . Gateway Drive On-Ramp and Avenue 17 Off-Ramp	Basic	3,027	20.06%				3,274	18.55%			3,292	19.23%			3,902	16.23%			
18 . Avenue 17 Off-Ramp	Ramp (Diverge)			471	13.79%	247				718	9.05%			610			1,305	5.60%	
19 . Avenue 17 Off-Ramp and Avenue 17 On-Ramp	Basic	2,556	21.22%				2,556	21.22%			2,597	21.57%			2,597	21.57%			
20 . Avenue 17 On-Ramp	Ramp (Merge)			362	10.46%	0				362	10.51%			0			474	6.96%	
21 . Avenue 17 On-Ramp and Avenue 18 1/2 Off-Ramp	Basic	2,917	19.89%				2,917	19.89%			3,072	19.31%			3,072	19.31%			
22 . Avenue 18 1/2 Off-Ramp	Ramp (Diverge)			241	28.64%	0				241	28.67%			0			193	23.83%	
23 . Avenue 18 1/2 Off-Ramp and Avenue 18 1/2 On-Ramp	Basic	2,677	19.10%				2,677	19.10%			2,879	19.01%			2,879	19.01%			
24 . Avenue 18 1/2 On-Ramp	Ramp (Merge)			256	32.90%	397				653	12.87%			194			429	13.04%	
25 . North of Avenue 18 1/2 On-Ramp	Basic	2,932	20.30%				3,329	17.88%			3,114	19.37%			3,308	18.23%			

Southbound																			
SR-99 Southbound	Type	AM Peak Hour								PM Peak Hour									
		NP Mainline Total Volumes	NP Mainline TR Percentage	NP Ramp Total Volumes	NP Ramp TR Percentage	Project Trips	WP Mainline Total Volumes	WP Mainline TR Percentage	WP Ramp Total Volumes	WP Ramp TR Percentage	NP Mainline Total Volumes	NP Mainline TR Percentage	NP Ramp Total Volumes	NP Ramp TR Percentage	Project Trips	WP Mainline Total Volumes	WP Mainline TR Percentage	WP Ramp Total Volumes	WP Ramp TR Percentage
26 . North of Avenue 18 1/2 Off-Ramp	Basic	2,557	27.78%				2,699	26.32%			3,279	22.08%			3,650	19.84%			
27 . Avenue 18 1/2 Off-Ramp	Ramp (Diverge)			151	35.29%	142				293	18.11%			370			641	11.07%	
28 . Avenue 18 1/2 Off-Ramp and Avenue 18 1/2 Loop On-Ramp	Basic	2,407	27.32%				2,407	27.32%			3,008	21.71%			3,008	21.71%			
29 . Avenue 18 1/2 Loop On-Ramp	Ramp (Merge)			37	13.89%	0				37	13.64%			0			29	6.90%	
30 . Avenue 18 1/2 Loop On-Ramp and Avenue 18 1/2 Slip-On Ramp	Basic	2,443	27.11%				2,443	27.11%			3,037	21.57%			3,037	21.57%			
31 . Avenue 18 1/2 Slip-On Ramp	Ramp (Merge)			199	32.07%	0				199	32.21%			0			236	22.03%	
32 . Avenue 18 1/2 Slip-On Ramp and Avenue 17 Off-Ramp	Basic	2,642	27.50%				2,642	27.50%			3,273	21.60%			3,273	21.60%			
33 . Avenue 17 Off-Ramp	Ramp (Diverge)			383	18.81%	0				383	18.82%			0			511	4.50%	
34 . Avenue 17 Off-Ramp and Avenue 17 Loop On-Ramp	Basic	2,259	28.97%				2,259	28.97%			2,762	24.76%			2,763	24.76%			
35 . Avenue 17 Loop On-Ramp	Ramp (Merge)			700	4.05%	0				700	4.00%			0			698	6.31%	
36 . Avenue 17 Loop On-Ramp and Avenue 17 Slip-On Ramp	Basic	2,960	23.06%				2,960	23.06%			3,460	21.04%			3,460	21.04%			
37 . Avenue 17 Slip-On Ramp	Ramp (Merge)			140	14.67%	670				810	2.47%			313			627	1.76%	
38 . Avenue 17 Slip-On Ramp and Gateway Drive Off-Ramp	Basic	3,099	22.67%				3,769	18.64%			3,774	19.58%			4,087	18.08%			
39 . Gateway Drive Off-Ramp	Ramp (Diverge)			184	4.19%	42				226	3.53%			26			362	3.31%	
40 . Gateway Drive Off-Ramp and Gateway Drive Loop On-Ramp	Basic	2,915	23.85%				3,543	19.62%			3,438	21.15%			3,725	19.52%			
41 . Gateway Drive Loop On-Ramp	Ramp (Merge)			319	2.66%	0				319	2.51%			0			267	5.99%	
42 . Gateway Drive Loop On-Ramp and Cleveland Avenue Off-Ramp	Basic	3,234	21.75%				3,862	18.22%			3,704	20.04%			3,992	18.60%			
43 . Cleveland Avenue Off-Ramp	Ramp (Diverge)			136	14.71%	160				296	6.76%			81			340	2.94%	
44 . Cleveland Avenue Off-Ramp and Cleveland Avenue On-Ramp	Basic	3,098	22.07%				3,566	19.17%			3,445	21.26%			3,651	20.06%			
45 . Cleveland Avenue On-Ramp	Ramp (Merge)			766	3.10%	415				1,181	2.03%			141			840	1.31%	
46 . Cleveland Avenue On-Ramp and 2nd Street Off-Ramp	Basic	3,864	18.31%				4,747	14.90%			4,145	17.92%			4,492	16.54%			
47 . 2nd Street Off-Ramp	Ramp (Diverge)			422	3.32%	103				525	2.67%			45			339	2.36%	
48 . 2nd Street Off-Ramp and 4th Street On-Ramp	Basic	3,442	20.14%				4,222	16.42%			3,851	19.08%			4,153	17.69%			
49 . 4th Street On-Ramp	Ramp (Merge)			558	0.84%	0				558	0.90%			0			503	1.19%	
50 . 4th Street On-Ramp and Olive Avenue Off-Ramp	Basic	3,999	17.45%				4,779	14.60%			4,354	17.00%			4,656	15.90%			
51 . Olive Avenue Off-Ramp	Ramp (Diverge)			689	9.70%	201				890	7.53%			84			699	3.86%	
52 . Olive Avenue Off-Ramp and Madera Avenue On-Ramp	Basic	3,311	19.05%				3,890	16.22%			3,739	19.06%			3,957	18.01%			
53 . Madera Avenue On-Ramp	Ramp (Merge)			327	2.57%	0				327	2.44%			37			391	1.53%	
54 . South of Madera Avenue On-Ramp	Basic	3,638	17.58%				4,217	15.16%			4,093	17.57%			4,348	16.54%			

Table 4-G - Phase II Project Completion Year (2039) Roadway Segment Daily Traffic Volumes

Roadway	#	Segment	Jurisdiction	Phase II Project Completion Year (2039) without Project ADT	Phase I+II External Project Trips	Phase I+II Internal Project Trips	Phase I+II Pass-By Trips	Phase II Project Completion Year (2039) with Project ADT
Road 23	1	between Avenue 17 and Project Driveway 3	City of Madera/Madera County	4,591	20,808	961	0	26,359
	2	between Project Driveway 3 and Avenue 16	City of Madera/Madera County	4,686	10,648	2,574	219	18,126
	3	between Avenue 16 and Cleveland Avenue	Madera County	6,515	9,862	2,082	0	18,459
	4	between Cleveland Avenue and Project Driveway 4	Madera County	6,877	11,160	1,870	28	19,935
	5	between Project Driveway 4 and Project Driveway 5	Madera County	6,334	12,728	0	0	19,062
	6	between Project Driveway 5 and Avenue 14 1/2	Madera County	5,744	12,730	0	0	18,474
	7	between Avenue 14 1/2 and Avenue 14	Madera County	5,378	9,784	0	0	15,162
Westberry Boulevard	8	between Sunset Avenue and Avenue 14/Howard Road	City of Madera	5,803	768	0	0	6,571
Granada Drive	9	between Cleveland Avenue and Fresno River	City of Madera	12,910	356	0	0	13,266
	10	between Sunset Avenue and Avenue 14/Howard Road	City of Madera	8,465	0	0	0	8,465
Avenue 17	11	between Road 22 and Project Driveway 1	Madera County	987	1,404	0	0	2,391
	12	between Project Driveway 1 and Road 23	Madera County	1,003	10,140	266	0	11,409
	13	between Road 23 and Golden State Boulevard	City of Madera/Madera County	3,351	19,112	0	0	22,463
Avenue 16	14	between Golden State Boulevard and State Route 99 Southbound Off-Ramp	City of Madera	17,771	16,144	0	0	33,915
	15	between Road 22 and Project Driveway 2/Road 22 1/2	Madera County	465	0	0	0	465
	16	between Project Driveway 2/Road 22 1/2 and Road 23	Madera County	1,921	2,336	947	0	5,203
Cleveland Avenue	17	between Road 22 1/2 and Road 23	Madera County	37	0	184	0	221
	18	between Road 23 and Project Driveway 6	Madera County	2,501	13,642	396	(671)	15,868
	19	between Project Driveway 6 and Westberry Boulevard	City of Madera/Madera County	3,586	18,194	497	0	22,277
	20	between Westberry Boulevard and Granada Drive	City of Madera	6,005	12,066	0	0	18,071
	21	between Granada Drive and Schnoor Street	City of Madera	12,521	11,236	0	0	23,757
	22	between Schnoor Street and Fairgrounds	City of Madera/Madera County	17,936	9,612	0	0	27,548
Sunset Avenue	23	between Fairgrounds and State Route 99 Southbound Ramps	City of Madera/Madera County	19,577	10,148	0	0	29,725
Howard Road	24	between Granada Drive and Schnoor Street	City of Madera	6,327	484	0	0	6,811
Howard Road	25	between Granada Drive and Schnoor Street	City of Madera	11,847	3,376	0	0	15,223
	26	between Schnoor Street and Pine Street	City of Madera	17,229	3,376	0	0	20,605
Olive Avenue	27	between Yosemite Avenue and I Street	City of Madera	13,688	1,940	0	0	15,628
	28	between I Street and State Route 99 Southbound Off-Ramp	City of Madera	13,688	1,334	0	0	15,022
	29	between State Route 99 Southbound Off-Ramp and Madera Avenue	City of Madera	17,627	2,865	0	0	20,492

Table 4-H - Build-out (2049) Freeway Segment and Ramp Traffic Volumes

Northbound																					
SR-99 Northbound	Type	AM Peak Hour					PM Peak Hour					AM Peak Hour					PM Peak Hour				
		NP Mainline Total Volumes	NP Mainline TR Percentage	NP Ramp Total Volumes	NP Ramp TR Percentage	Project Trips	WP Mainline Total Volumes	WP Mainline TR Percentage	WP Ramp Total Volumes	WP Ramp TR Percentage	NP Mainline Total Volumes	NP Mainline TR Percentage	NP Ramp Total Volumes	NP Ramp TR Percentage	Project Trips	WP Mainline Total Volumes	WP Mainline TR Percentage	WP Ramp Total Volumes	WP Ramp TR Percentage		
1 . South of Madera Avenue Off-Ramp	Basic	3,573	17.57%				3,866	16.24%			3,682	17.57%			4,480	14.44%					
2 . Madera Avenue Off-Ramp	Ramp (Diverge)			332	4.65%	66			398	3.77%			244	0.99%	165			409	0.49%		
3 . Madera Avenue Off-Ramp and Madera Avenue On-Ramp	Basic	3,241	18.91%				3,468	17.68%			3,438	18.76%			4,071	15.84%					
4 . Madera Avenue On-Ramp	Ramp (Merge)			942	9.94%	71			1,013	9.28%			999	2.75%	195			1,194	2.26%		
5 . Madera Avenue On-Ramp and 4th Street Off-Ramp	Basic	4,183	16.90%				4,481	15.78%			4,437	15.14%			5,265	12.76%					
6 . 4th Street Off-Ramp	Ramp (Diverge)			556	1.77%	0			556	1.80%			533	1.24%	0			533	1.31%		
7 . 4th Street Off-Ramp and 2nd Street On-Ramp	Basic	3,627	19.22%				3,925	17.76%			3,904	17.03%			4,732	14.05%					
8 . 2nd Street On-Ramp	Ramp (Merge)			357	2.92%	39			396	2.53%			459	2.23%	106			565	1.77%		
9 . 2nd Street On-Ramp and Cleveland Avenue Off-Ramp	Basic	3,984	17.75%				4,321	16.36%			4,363	15.47%			5,297	12.74%					
10 . Cleveland Avenue Off-Ramp	Ramp (Diverge)			678	4.61%	149			827	3.75%			1,022	1.02%	423			1,445	0.69%		
11 . Cleveland Avenue Off-Ramp and Cleveland Avenue On-Ramp	Basic	3,306	20.45%				3,494	19.35%			3,341	19.90%			3,852	17.26%					
12 . Cleveland Avenue On-Ramp	Ramp (Merge)			187	2.94%	71			258	2.33%			153	5.67%	203			356	2.53%		
13 . Cleveland Avenue On-Ramp and Gateway Drive Loop Off-Ramp	Basic	3,493	19.52%				3,752	18.18%			3,495	19.29%			4,209	16.01%					
14 . Gateway Drive Loop Off-Ramp	Ramp (Diverge)			412	6.54%	23			435	6.20%			188	3.62%	123			311	2.25%		
15 . Gateway Drive Loop Off-Ramp and Gateway Drive On-Ramp	Basic	3,081	21.26%				3,317	19.75%			3,307	20.17%			3,898	17.11%					
16 . Gateway Drive On-Ramp	Ramp (Merge)			207	4.46%	11			218	4.13%			243	4.33%	19			262	4.21%		
17 . Gateway Drive On-Ramp and Avenue 17 Off-Ramp	Basic	3,288	20.19%				3,535	18.78%			3,549	19.10%			4,159	16.30%					
18 . Avenue 17 Off-Ramp	Ramp (Diverge)			543	13.79%	247			790	9.49%			744	10.45%	610			1,354	5.76%		
19 . Avenue 17 Off-Ramp and Avenue 17 On-Ramp	Basic	2,745	21.46%				2,745	21.46%			2,805	21.39%			2,805	21.39%					
20 . Avenue 17 On-Ramp	Ramp (Merge)			402	10.46%	0			402	10.45%			535	6.87%	0			535	6.92%		
21 . Avenue 17 On-Ramp and Avenue 18 1/2 Off-Ramp	Basic	3,147	20.05%				3,147	20.05%			3,340	19.07%			3,340	19.07%					
22 . Avenue 18 1/2 Off-Ramp	Ramp (Diverge)			245	28.64%	0			245	28.57%			199	24.06%	0			199	24.12%		
23 . Avenue 18 1/2 Off-Ramp and Avenue 18 1/2 On-Ramp	Basic	2,902	19.33%				2,902	19.33%			3,141	18.75%			3,141	18.75%					
24 . Avenue 18 1/2 On-Ramp	Ramp (Merge)			264	32.90%	579			843	10.32%			260	23.78%	307			567	10.93%		
25 . North of Avenue 18 1/2 On-Ramp	Basic	3,166	20.47%				3,745	17.30%			3,401	19.14%			3,708	17.56%					

Southbound																					
SR-99 Southbound	Type	AM Peak Hour					PM Peak Hour					AM Peak Hour					PM Peak Hour				
		NP Mainline Total Volumes	NP Mainline TR Percentage	NP Ramp Total Volumes	NP Ramp TR Percentage	Project Trips	WP Mainline Total Volumes	WP Mainline TR Percentage	WP Ramp Total Volumes	WP Ramp TR Percentage	NP Mainline Total Volumes	NP Mainline TR Percentage	NP Ramp Total Volumes	NP Ramp TR Percentage	Project Trips	WP Mainline Total Volumes	WP Mainline TR Percentage	WP Ramp Total Volumes	WP Ramp TR Percentage		
26 . North of Avenue 18 1/2 Off-Ramp	Basic	2,805	27.49%				3,013	25.59%			3,530	22.12%			4,089	19.10%					
27 . Avenue 18 1/2 Off-Ramp	Ramp (Diverge)			155	35.29%	208			363	15.15%			291	26.18%	559			850	8.94%		
28 . Avenue 18 1/2 Off-Ramp and Avenue 18 1/2 Loop On-Ramp	Basic	2,650	27.02%				2,650	27.02%			3,239	21.76%			3,239	21.76%					
29 . Avenue 18 1/2 Loop On-Ramp	Ramp (Merge)			37	13.89%	0			37	13.51%			30	7.41%	0			30	6.67%		
30 . Avenue 18 1/2 Loop On-Ramp and Avenue 18 1/2 Slip-On Ramp	Basic	2,687	26.83%				2,687	26.83%			3,269	21.63%			3,269	21.63%					
31 . Avenue 18 1/2 Slip-On Ramp	Ramp (Merge)			204	32.07%	0			204	31.86%			243	21.94%	0			243	21.81%		
32 . Avenue 18 1/2 Slip-On Ramp and Avenue 17 Off-Ramp	Basic	2,891	27.19%				2,891	27.19%			3,512	21.64%			3,512	21.64%					
33 . Avenue 17 Off-Ramp	Ramp (Diverge)			439	18.81%	0			439	18.91%			544	4.59%	0			544	4.60%		
34 . Avenue 17 Off-Ramp and Avenue 17 Loop On-Ramp	Basic	2,452	28.67%				2,452	28.67%			2,968	24.76%			2,968	24.76%					
35 . Avenue 17 Loop On-Ramp	Ramp (Merge)			709	4.05%	0			709	4.09%			701	6.36%	0			701	6.42%		
36 . Avenue 17 Loop On-Ramp and Avenue 17 Slip-On Ramp	Basic	3,161	23.16%				3,161	23.16%			3,669	21.26%			3,669	21.26%					
37 . Avenue 17 Slip-On Ramp	Ramp (Merge)			172	14.67%	670			842	2.97%			397	3.40%	313			710	1.97%		
38 . Avenue 17 Slip-On Ramp and Gateway Drive Off-Ramp	Basic	3,333	22.72%				4,003	18.91%			4,066	19.53%			4,379	18.13%					
39 . Gateway Drive Off-Ramp	Ramp (Diverge)			193	4.19%	42			235	3.40%			361	3.62%	26			387	3.36%		
40 . Gateway Drive Off-Ramp and Gateway Drive Loop On-Ramp	Basic	3,139	23.86%				3,767	19.88%			3,705	21.08%			3,992	19.57%					
41 . Gateway Drive Loop On-Ramp	Ramp (Merge)			384	2.66%	112			496	2.02%			349	5.83%	41			390	5.13%		
42 . Gateway Drive Loop On-Ramp and Cleveland Avenue Off-Ramp	Basic	3,523	21.54%				4,263	17.80%			4,054	19.76%			4,382	18.28%					
43 . Cleveland Avenue Off-Ramp	Ramp (Diverge)			152	14.71%	216			368	5.98%			288	3.96%	102			390	2.82%		
44 . Cleveland Avenue Off-Ramp and Cleveland Avenue On-Ramp	Basic	3,371	21.86%				3,895	18.92%			3,766	20.98%			3,992	19.79%					
45 . Cleveland Avenue On-Ramp	Ramp (Merge)			839	3.10%	418			1,257	2.07%			789	1.56%	241			1,030	1.17%		
46 . Cleveland Avenue On-Ramp and 2nd Street Off-Ramp	Basic	4,210	18.12%				5,152	14.81%			4,555	17.61%			5,022	15.97%					
47 . 2nd Street Off-Ramp	Ramp (Diverge)			438	3.32%	119			557	2.70%			316	2.80%	51			367	2.45%		
48 . 2nd Street Off-Ramp and 4th Street On-Ramp	Basic	3,773	19.83%				4,596	16.28%			4,239	18.71%			4,655	17.04%					
49 . 4th Street On-Ramp	Ramp (Merge)			599	0.84%	0			599	0.83%			542	1.18%	0			542	1.11%		
50 . 4th Street On-Ramp and Olive Avenue Off-Ramp	Basic	4,372	17.22%				5,195	14.50%			4,781	16.71%			5,197	15.38%					
51 . Olive Avenue Off-Ramp	Ramp (Diverge)			832	9.70%	202			1,034	7.83%			776	4.45%	102			878	3.99%		
52 . Olive Avenue Off-Ramp and Madera Avenue On-Ramp	Basic	3,540	18.98%				4,161	16.15%			4,005	19.08%			4,319	17.69%					
53 . Madera Avenue On-Ramp	Ramp (Merge)			334	2.57%	175			509	1.77%			385	1.70%	91			476	1.47%		
54 . South of Madera Avenue On-Ramp	Basic	3,874	17.57%				4,670	14.58%			4,389	17.57%			4,794	16.08%					

5.0 PROJECT TRAFFIC

5.1 PROJECT TRIP GENERATION

The trip generation for the proposed project was developed using rates from the Institute of Transportation Engineers (ITE) *Trip Generation Manual*, 10th Edition. Land use rates include Land Use 210 – “Single-Family Detached Housing,” Land Use 220 – “Multifamily Housing (Low-Rise),” Land Use 770 – “Business Park,” Land Use 820 – “Shopping Center,” and Land Use 520 – “Elementary School.”

Because of the mixed-use character of the project, a portion of trips generated by the project will be made entirely within the project itself. Examples of such trips could be a trip from a residential area in the project to a shopping center within the project. These projects are referred to as “internal trips” and do not affect the regional street traffic, but only roadways internal to and bordering the project. The internal capture percentage for the overall project was calculated from the MCTC TDF model. As shown in Table 5-A, the project consists of three communities: northwest, southwest, and southeast communities. LSA disaggregated the MCTC TDF traffic analysis zones (TAZs) within the project areas to incorporate the project land uses into the model. Specifically, each community was disaggregated into three TAZs. Within each community, two of the TAZs included residential uses while the third TAZ included non-residential uses. As such, the following TAZs were considered for analysis in the different phases of the project:

- **Phase I:** Residential TAZs (615 and 616), Non-Residential TAZ (626).
- **Phase II:** Residential TAZs (627 and 628), Non-Residential TAZ (629).
- **Phase III:** Residential TAZs (630 and 631), Non-Residential TAZ (632).

The TAZs for the different phases are illustrated in Figure 5-1.

Since, the project has a mix of residential and non-residential land uses, it is anticipated that a certain percentage of project trips will remain within the Specific Plan. These trips will be travelling between the residential, retail, schools, and business parks. For purposes of this analysis, these trips have been considered as internal trips. Under full build-out conditions for the project, internal capture distributions from one TAZ to another were developed using select zone runs obtained from the MCTC TDF model. The internal capture distributions were multiplied with the overall internal trips to obtain the corresponding internal capture assignments in between the different TAZs. Further, the internal trip capture to and from one TAZ to all the other TAZs were added to obtain the overall internal trips for a particular TAZ. The internal trips for a TAZ were then subtracted from the gross trips for that TAZ to obtain the external trips for the TAZ. The internal capture for Phases I and II were obtained by normalizing the internal trips for the build-out scenario considering trip for only those portions of the project that will be developed in these two phases. Internal trip assignments in Phases I, II, and III are illustrated in Figures 5-2A and 5-2B, 5-3A and 5-3B, and 5-4A and 5-4B, respectively.

For retail establishments, a certain percentage of external trips comprise pass-by trips. A pass-by trip is a trip where an intermediate stop is made on the way from the origin to the primary destination of the trip without making a route diversion. It is not actually a “new” trip added to the

surrounding circulation system. Since there is not much existing development around the project site, the trips in the street network in and along the project site are very low. Therefore, the pass-by trip distributions for the various phases of the project were obtained using a combination of existing trips from the counts as well as project trips. Pass-by trip percentages were obtained from the *ITE Trip Generation Handbook* (3rd Edition) for Land Use 820 – “Shopping Center.” The *ITE Handbook* does not provide a.m. peak hour and daily pass-by rates for Land Use 820. The p.m. peak hour pass-by rate of 34 percent was used as the daily rate. The pass-by trip generation in each phase was applied to the pass-by trip distribution for the phase to obtain the corresponding pass-by trip assignment. Pass-by trip assignments in Phases I, II, and III are illustrated in Figures 5-5A and 5-5B, 5-6A and 5-6B, and 5-7A and 5-7B, respectively. After deducting the pass-by trips from the total external trips for every TAZ, the net external trips for the retail uses in the different TAZs were obtained. The net external trips in every TAZ were added to obtain the total net external trip generation for the project. As shown in Table 5-A, under full build-out conditions, the overall project is anticipated to generate 6,841 trips in the a.m. peak hour, 7,597 trips in the p.m. peak hour, and 89,647 daily trips.

5.2 PROJECT TRIP DISTRIBUTION AND ASSIGNMENT

Trip distribution patterns were developed using the MCTC TDF model. Trip distribution patterns were derived from the select zone model runs obtained from the MCTC TDF model. The disaggregation of the model into different TAZs, as described above, helped in developing project trip distribution patterns both within and outside the Specific Plan. Figures 5-8A and 5-8B, 5-9A and 5-9B, and 5-10A and 5-10B illustrate the overall net external project trip distributions for Phase I TAZs 615, 616, and 626, respectively. Figures 5-11A and 5-11B, 5-12A and 5-12B, and 5-13A and 5-13B illustrate the overall net external project trip distributions for Phase II TAZs 627, 628, and 629, respectively. Figures 5-14A and 5-14B, 5-15A and 5-15B, and 5-16A and 5-16B illustrate the overall net external project trip distributions for Phase III TAZs 630, 631, and 632, respectively.

The project trip assignment for each TAZ is the product of the trip generation for the TAZ and the corresponding trip distribution. Further, assignments for Phase I TAZs 615, 616, and 626 were added to obtain the total project trip assignment at the study intersections for Phase I. The Phase I project trip assignment is illustrated in Figures 5-17A and 5-17B. The Phase I project trip assignment was then added to the assignments for Phase II TAZs 627, 628, and 629 to obtain the total project trip assignment at the study intersections for Phase II. The Phase II project trip assignment is illustrated in Figures 5-18A and 5-18B. Finally, the total project trip assignment for Phase II was added to the assignments for Phase III TAZs 630, 631, and 632 to obtain the total project trip assignment at the study intersections for Phase III. The Phase III project trip assignment is illustrated in Figures 5-19A and 5-19B.

It is to be noted that all internal, pass-by, and project trip assignments for Phase II include project trips for Phases I and II combined. Also, all internal, pass-by, and project trip assignments for Phase III include project trips for Phases I, II, and III combined.

5.3 LIST OF CHAPTER 5.0 FIGURES AND TABLES

- Figure 5-1: Traffic Analysis Zones for Different Project Phases

- Figure 5-2A: Phase I Project Internal Trip Assignment (Int. 1–30)
- Figure 5-2B: Phase I Project Internal Trip Assignment (Int. 31–58)
- Figure 5-3A: Phase II Project Internal Trip Assignment (Int. 1–30)
- Figure 5-3B: Phase II Project Internal Trip Assignment (Int. 31–58)
- Figure 5-4A: Phase III Project Internal Trip Assignment (Int. 1–30)
- Figure 5-4B: Phase III Project internal Trip Assignment (Int. 31–58)
- Figure 5-5A: Phase I Project Pass-by Trip Assignment (Int. 1–30)
- Figure 5-5B: Phase I Project Pass-by Trip Assignment (Int. 31–58)
- Figure 5-6A: Phase II Project Pass-by Trip Assignment (Int. 1–30)
- Figure 5-6B: Phase II Project Pass-by Trip Assignment (Int. 31–58)
- Figure 5-7A: Phase III Project Pass-by Trip Assignment (Int. 1–30)
- Figure 5-7B: Phase III Project Pass-by Trip Assignment (Int. 31–58)
- Figure 5-8A: Phase I TAZ 615 Project Trip Distribution (Int. 1–30)
- Figure 5-8B: Phase I TAZ 615 Project Trip Distribution (Int. 31–58)
- Figure 5-9A: Phase I TAZ 616 Project Trip Distribution (Int. 1–30)
- Figure 5-9B: Phase I TAZ 616 Project Trip Distribution (Int. 31–58)
- Figure 5-10A: Phase I TAZ 626 Project Trip Distribution (Int. 1–30)
- Figure 5-10B: Phase I TAZ 626 Project Trip Distribution (Int. 31–58)
- Figure 5-11A: Phase II TAZ 627 Project Trip Distribution (Int. 1–30)
- Figure 5-11B: Phase II TAZ 627 Project Trip Distribution (Int. 31–58)
- Figure 5-12A: Phase II TAZ 628 Project Trip Distribution (Int. 1–30)
- Figure 5-12B: Phase II TAZ 628 Project Trip Distribution (Int. 31–58)
- Figure 5-13A: Phase II TAZ 629 Project Trip Distribution (Int. 1–30)
- Figure 5-13B: Phase II TAZ 629 Project Trip Distribution (Int. 31–58)
- Figure 5-14A: Phase III TAZ 630 Project Trip Distribution (Int. 1–30)
- Figure 5-14B: Phase III TAZ 630 Project Trip Distribution (Int. 31–58)
- Figure 5-15A: Phase III TAZ 631 Project Trip Distribution (Int. 1–30)
- Figure 5-15B: Phase III TAZ 631 Project Trip Distribution (Int. 31–58)
- Figure 5-16A: Phase III TAZ 632 Project Trip Distribution (Int. 1–30)
- Figure 5-16B: Phase III TAZ 632 Project Trip Distribution (Int. 31–58)
- Figure 5-17A: Phase I Project Trip Assignment (Int. 1–30)
- Figure 5-17B: Phase I Project Trip Assignment (Int. 31–58)

-
- Figure 5-18A: Phase II Project Trip Assignment (Int. 1–30)
 - Figure 5-18B: Phase II Project Trip Assignment (Int. 31–58)
 - Figure 5-19A: Phase III Project Trip Assignment (Int. 1–30)
 - Figure 5-19B: Phase III Project Trip Assignment (Int. 31–58)
 - Table 5-A: Project Trip Generation

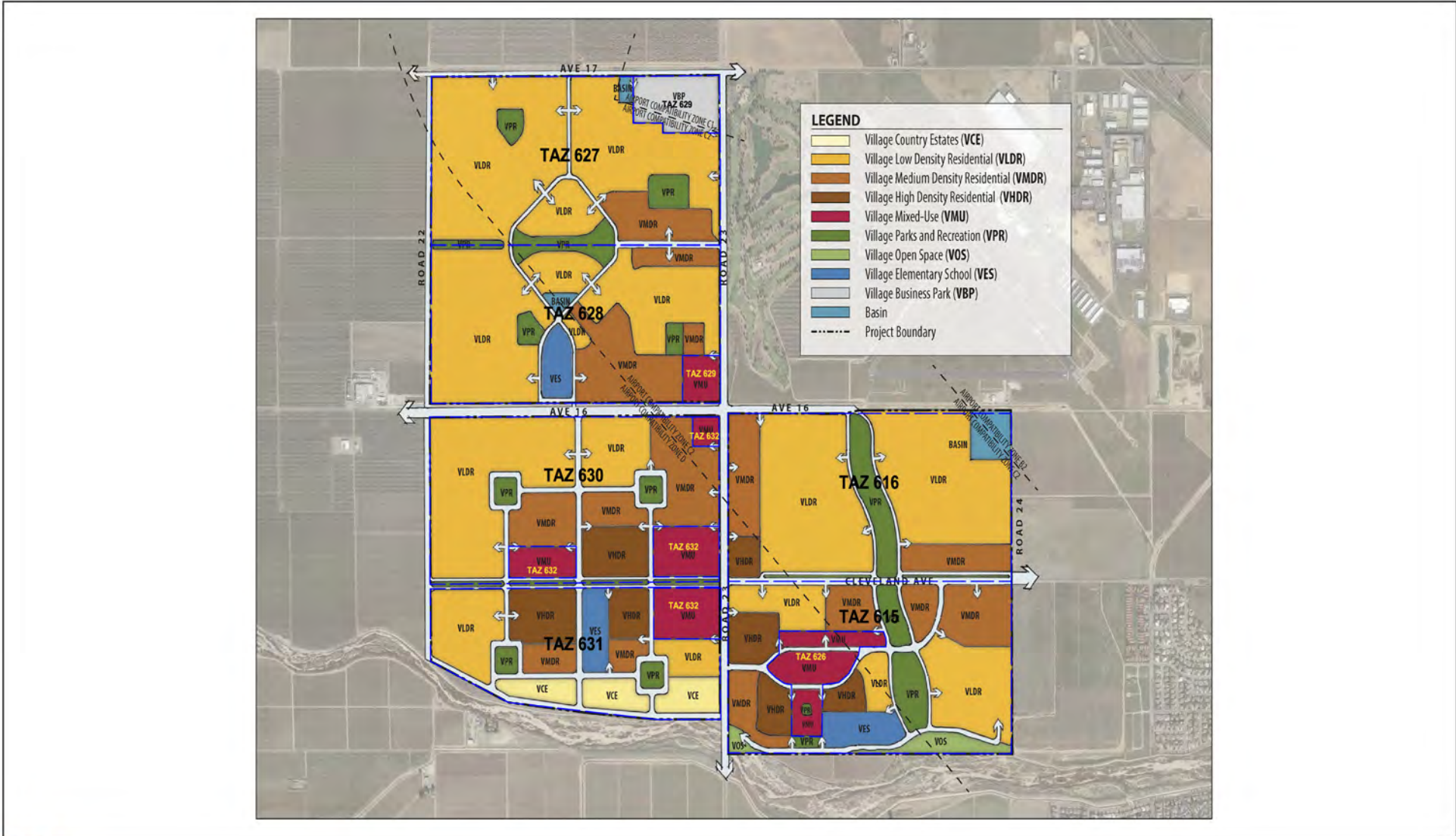

FIGURE 5-1

LSA



PROJECT PHASES
 Phase I - TAZ 615 + TAZ 616 + TAZ 626
 Phase II - TAZ 627 + TAZ 628 + TAZ 629
 Phase III - TAZ 630 + TAZ 631 + TAZ 632

NOT TO SCALE

Village D Specific Plan
 Traffic Impact Analysis

Traffic Analysis Zones for Different Project Phases

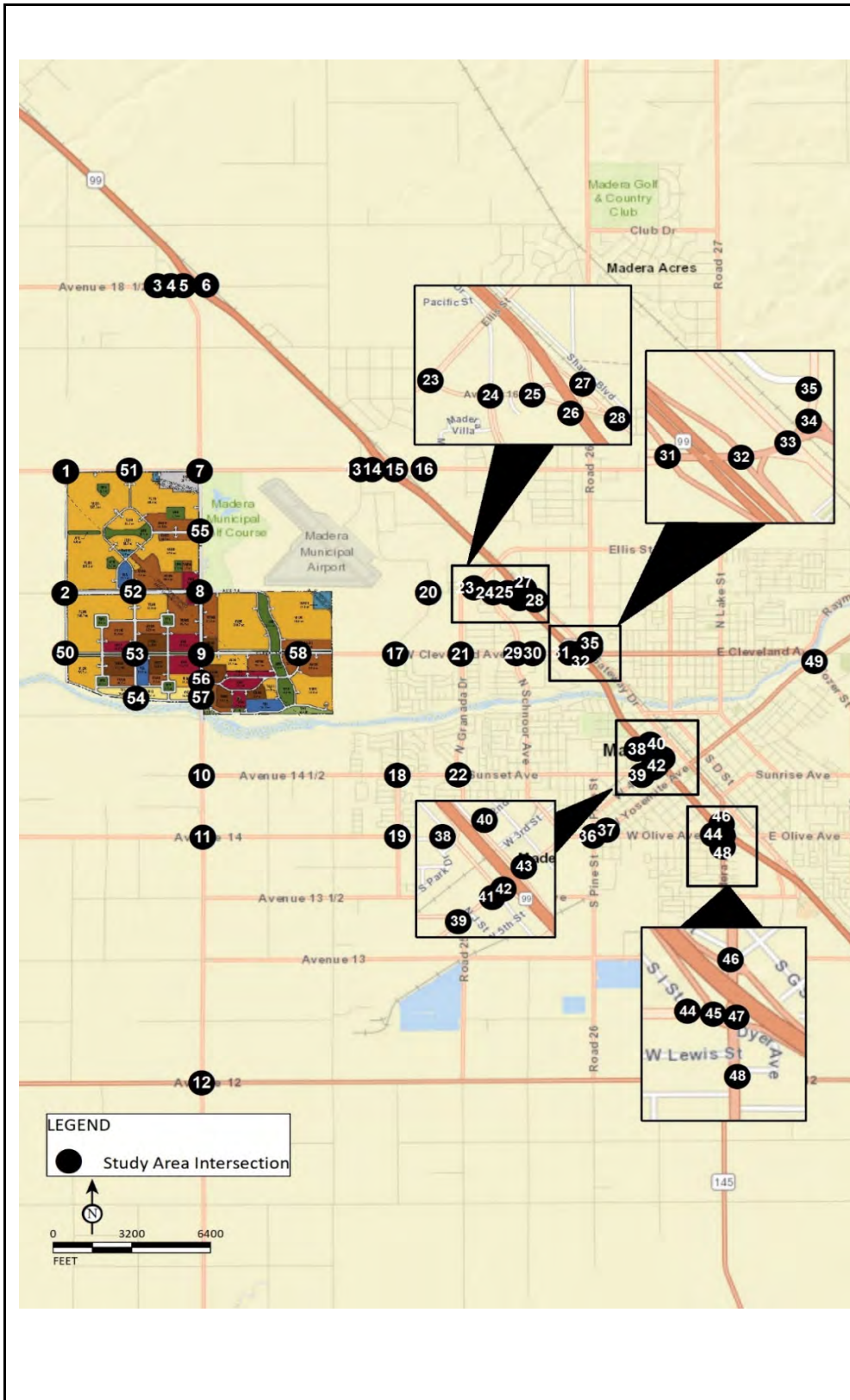

1 Road 22/Avenue 17	2 Road 22/Avenue 16	3 Golden State Boulevard/Avenue 18 ½	4 Pistachio Drive/Avenue 18 ½	5 SR-99 Southbound Ramps - Road 23/Avenue 18 ½	6 SR-99 Northbound Ramps/Avenue 18 ½
7 Road 23/Avenue 17	8 Road 23/Avenue 16	9 Road 23/Cleveland Avenue	10 Road 23/Avenue 14 ½	11 Road 23/Avenue 14	12 Road 23/Avenue 12
13 Golden State Boulevard - Airport Drive/Avenue 17	14 SR-99 Southbound Ramps/Avenue 17	15 SR-99 Northbound Ramps/Avenue 17	16 Love's Truck Stop Driveway/Avenue 17	17 Westberry Boulevard/Cleveland Avenue	18 Westberry Boulevard/Sunset Avenue
19 Westberry Boulevard/Avenue 14	20 Westberry Boulevard/Avenue 16	21 Granada Drive/Cleveland Avenue	22 Granada Drive/Sunset Avenue	23 Avenue 16 - Ellis Street/Kennedy Street	24 Schnoor Avenue/Kennedy Street
25 SR-99 Southbound Ramps/Kennedy Street - Gateway Drive	26 SR-99 Northbound Off-Ramp/Gateway Drive	27 SR-99 Northbound Off-Ramps	28 SR-99 Northbound Off-Ramp/Gateway Drive	29 Schnoor Avenue/Cleveland Avenue	30 Fairgrounds/Cleveland Avenue

LSA

FIGURE 5-2A

XX / YY — - Future Project Driveway/Road
 AM / PM Peak Hour Traffic Volumes

Village D Specific Plan
 Traffic Impact Analysis

Phase I Project Internal Trip Assignment (Int. 1-30)

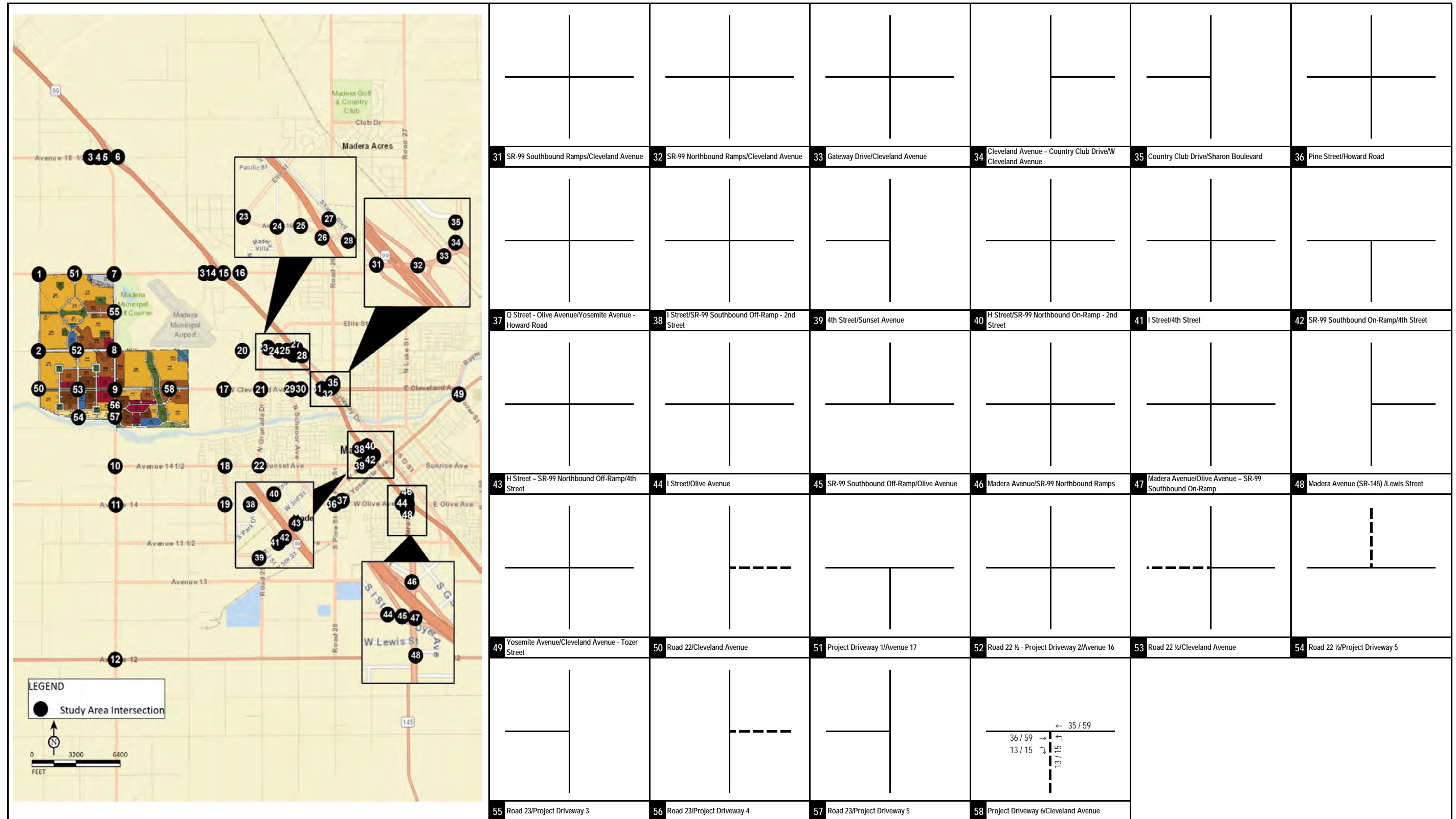

FIGURE 5-2B



XX / YY
 AM / PM Peak Hour Traffic Volumes

- - Future Project Driveway/Road

Village D Specific Plan
 Traffic Impact Analysis

Phase I Project Internal Trip Assignment (Int. 31-58)

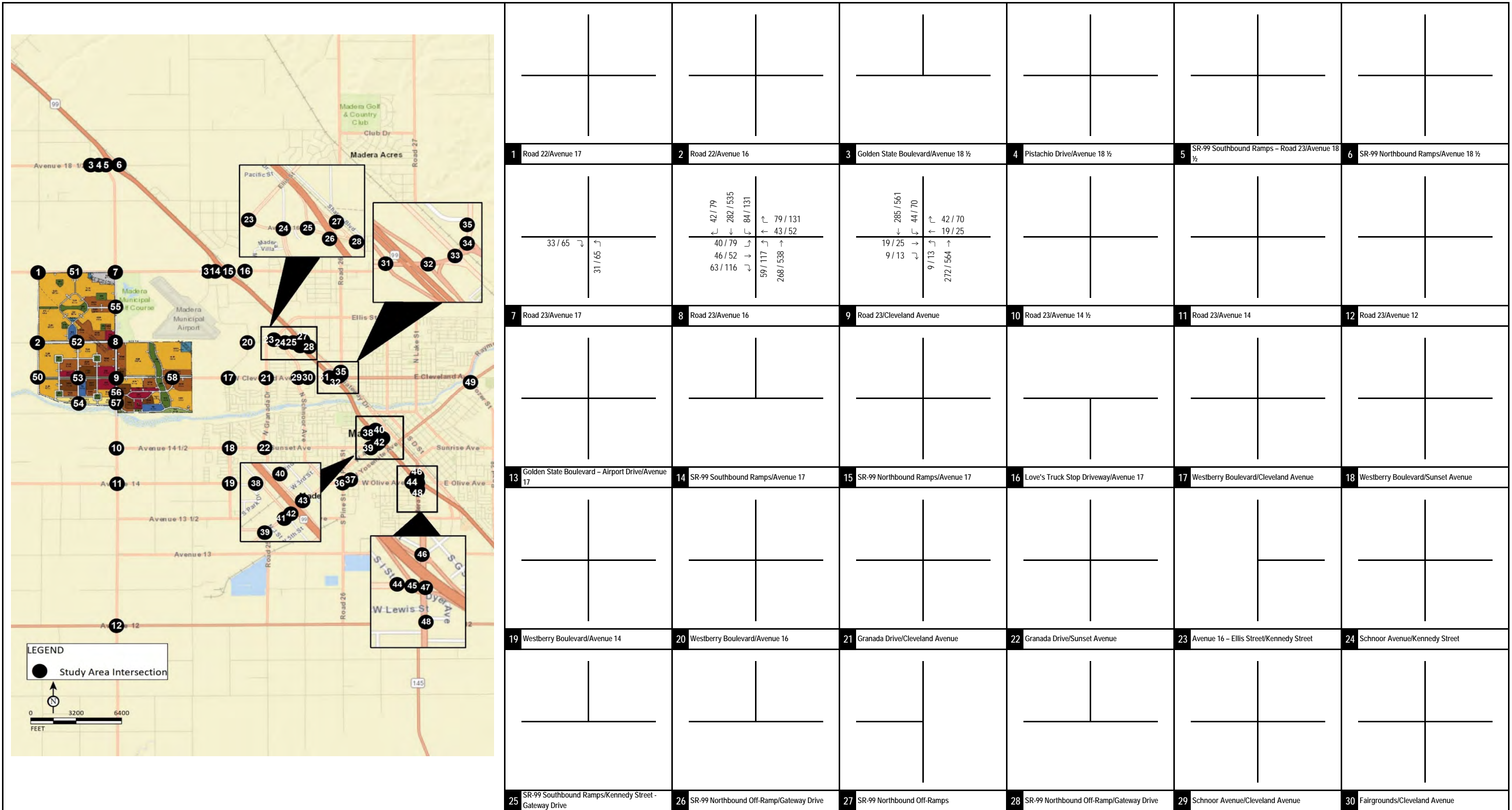

FIGURE 5-3A



XXX / YYY - - Future Project Driveway/Road
 AM / PM Peak Hour Traffic Volumes

Village D Specific Plan
 Traffic Impact Analysis

Phase II Project Internal Trip Assignment (Int. 1-30)

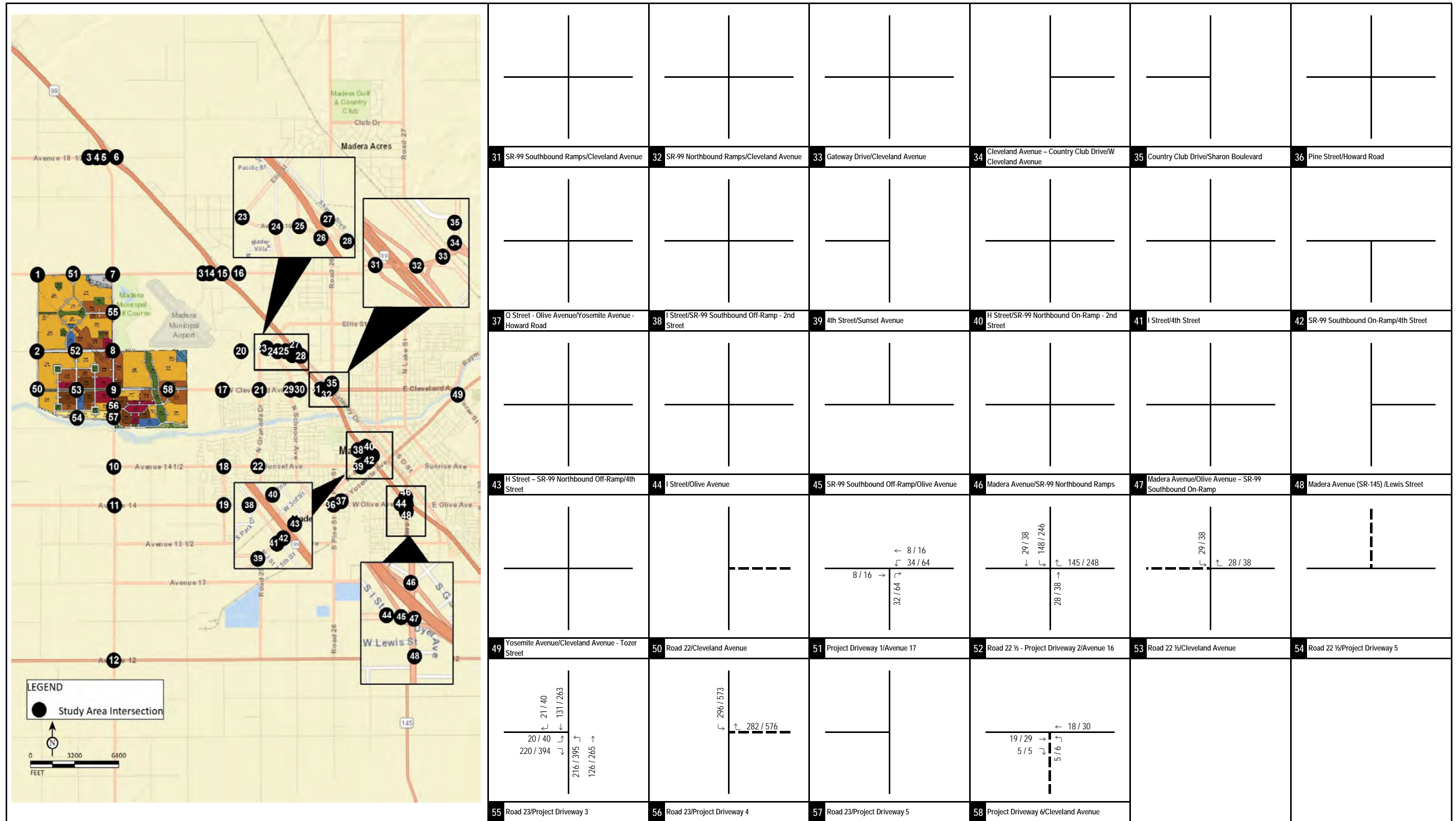

FIGURE 5-3B



XXX / YYY

AM / PM Peak Hour Traffic Volumes

- - Future Project Driveway/Road

Village D Specific Plan
Traffic Impact Analysis

Phase II Project Internal Trip Assignment (Int. 31-58)

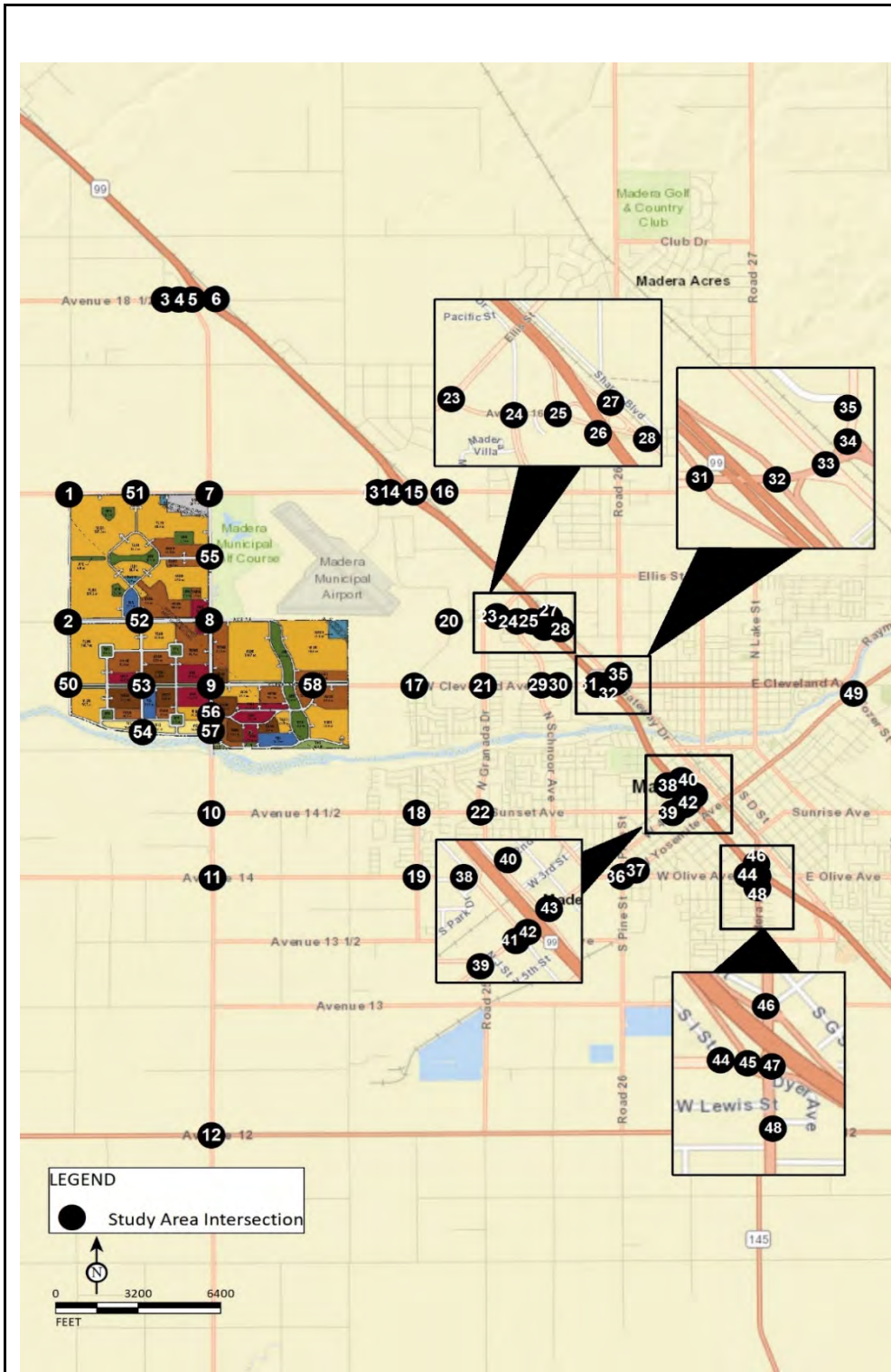

	8/8	8/8			
1 Road 22/Avenue 17	2 Road 22/Avenue 16	3 Golden State Boulevard/Avenue 18 1/2	4 Pistachio Drive/Avenue 18 1/2	5 SR-99 Southbound Ramps - Road 23/Avenue 18 1/2	6 SR-99 Northbound Ramps/Avenue 18 1/2
10/17	28/51 177/357 29/51 34/25 24/41	56/113 153/346 58/112 116/137 149/352			
7 Road 23/Avenue 17	8 Road 23/Avenue 16	9 Road 23/Cleveland Avenue	10 Road 23/Avenue 14 1/2	11 Road 23/Avenue 14	12 Road 23/Avenue 12
13 Golden State Boulevard - Airport Drive/Avenue 17	14 SR-99 Southbound Ramps/Avenue 17	15 SR-99 Northbound Ramps/Avenue 17	16 Love's Truck Stop Driveway/Avenue 17	17 Westberry Boulevard/Cleveland Avenue	18 Westberry Boulevard/Sunset Avenue
19 Westberry Boulevard/Avenue 14	20 Westberry Boulevard/Avenue 16	21 Granada Drive/Cleveland Avenue	22 Granada Drive/Sunset Avenue	23 Avenue 16 - Ellis Street/Kennedy Street	24 Schnoor Avenue/Kennedy Street
25 SR-99 Southbound Ramps/Kennedy Street - Gateway Drive	26 SR-99 Northbound Off-Ramp/Gateway Drive	27 SR-99 Northbound Off-Ramps	28 SR-99 Northbound Off-Ramp/Gateway Drive	29 Schnoor Avenue/Cleveland Avenue	30 Fairgrounds/Cleveland Avenue

LSA

FIGURE 5-4A

XXX / YYY - - Future Project Driveway/Road
 AM / PM Peak Hour Traffic Volumes

Village D Specific Plan
 Traffic Impact Analysis

Phase III Project Internal Trip Assignment (Int. 1-30)

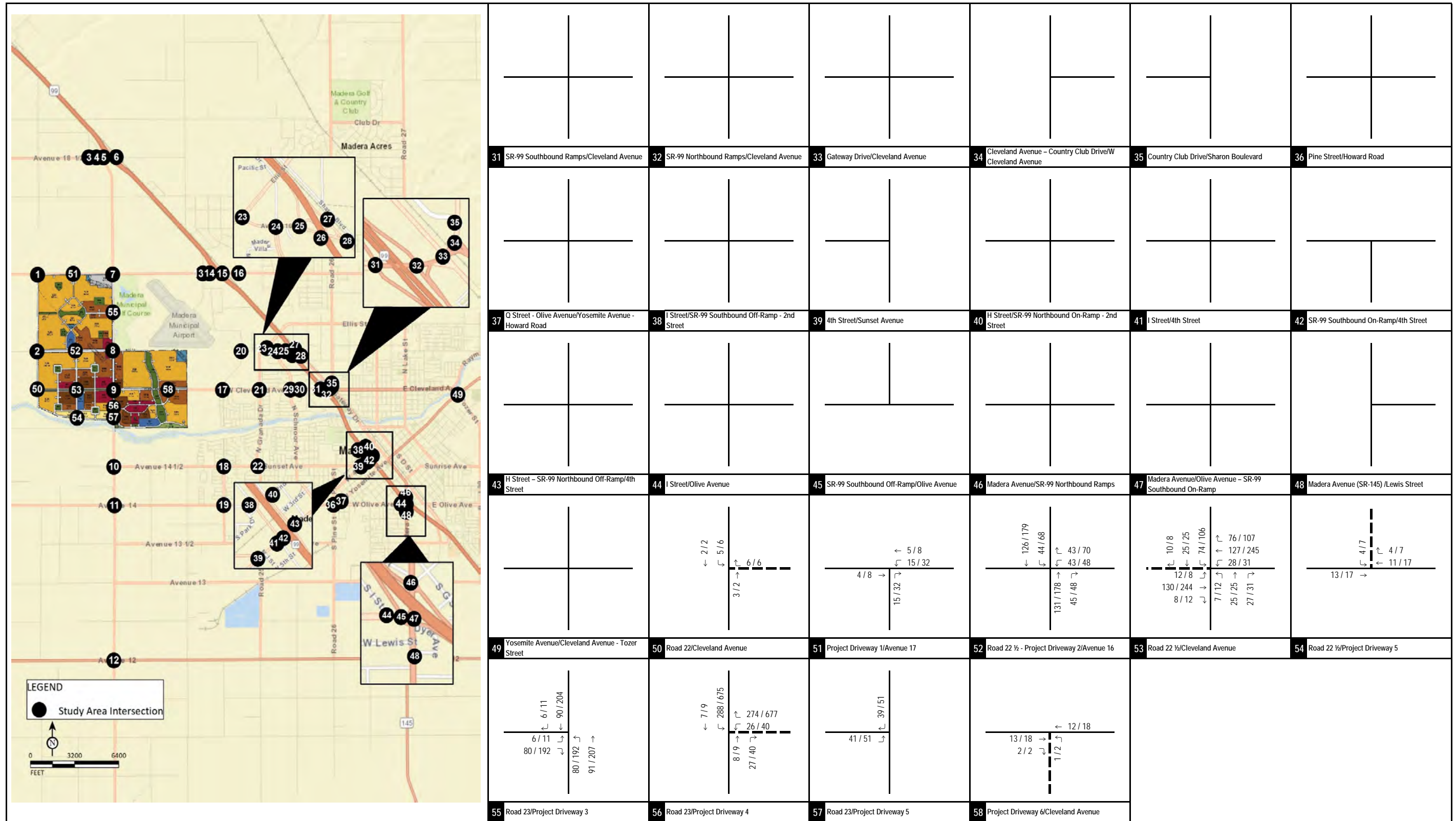

FIGURE 5-4B

LSA

XXX / YYY

AM / PM Peak Hour Traffic Volumes

- - Future Project Driveway/Road

Village D Specific Plan
Traffic Impact Analysis

Phase III Project Internal Trip Assignment (Int. 31-58)

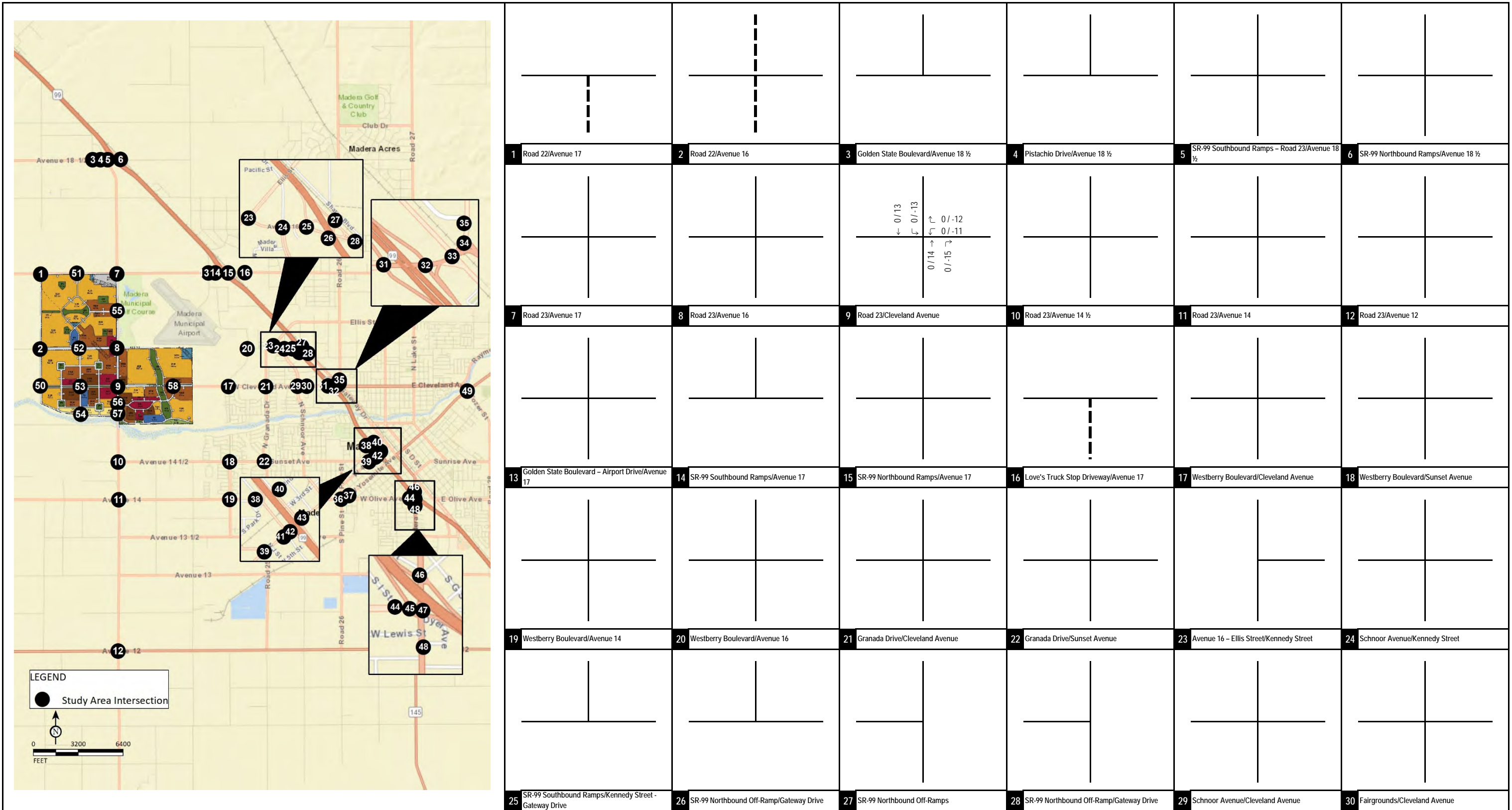

FIGURE 5-5A



XX / YY ----- Future Project Driveway/Road
 AM / PM Peak Hour Traffic Volumes

Village D Specific Plan
 Traffic Impact Analysis

Phase I Project Pass-by Trip Assignment (Int. 1-30)

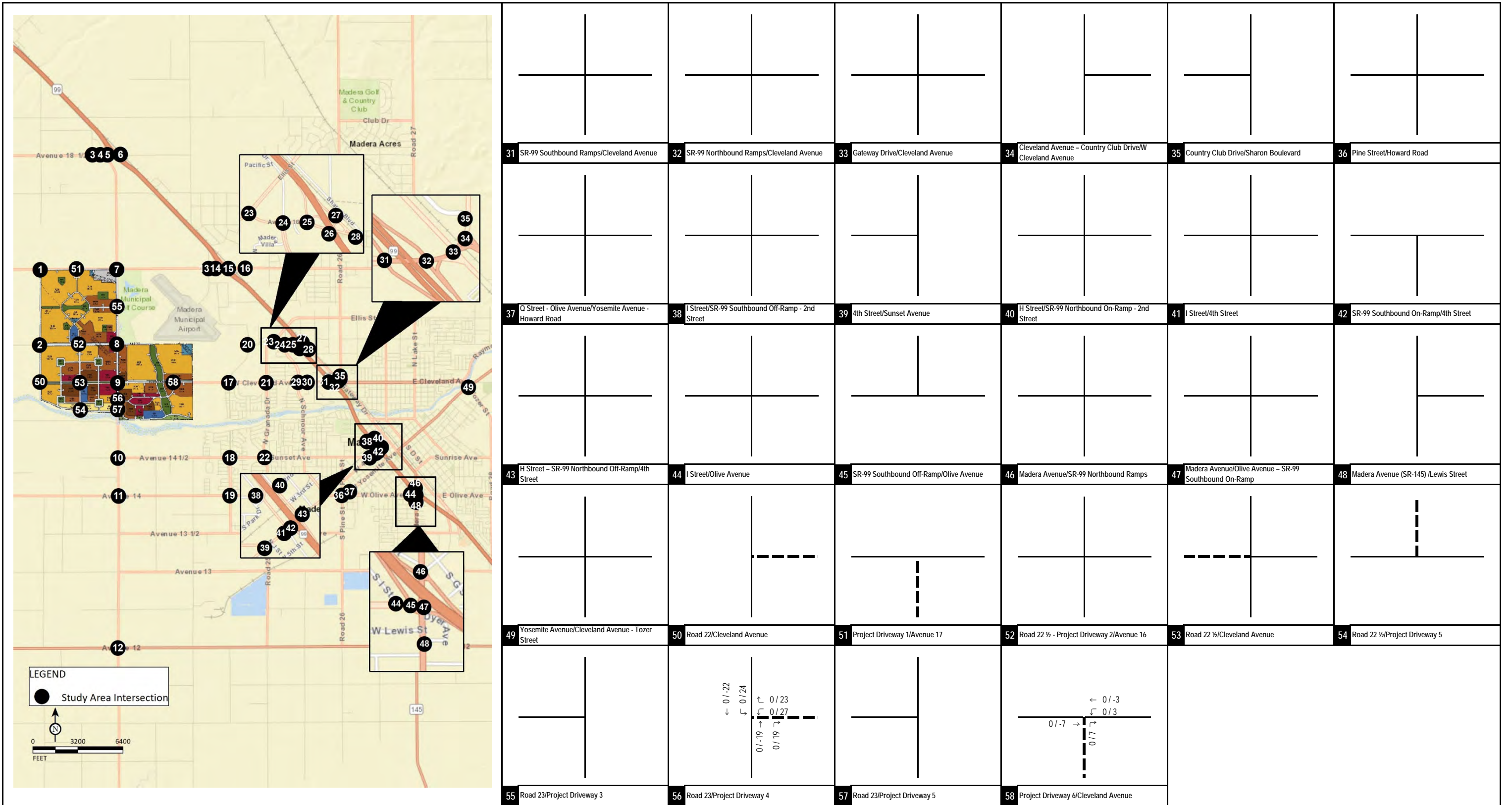

LSA

FIGURE 5-5B

XX / YY

---- Future Project Driveway/Road

AM / PM Peak Hour Traffic Volumes

Village D Specific Plan
Traffic Impact Analysis

Phase I Project Pass-by Trip Assignment (Int. 31-58)

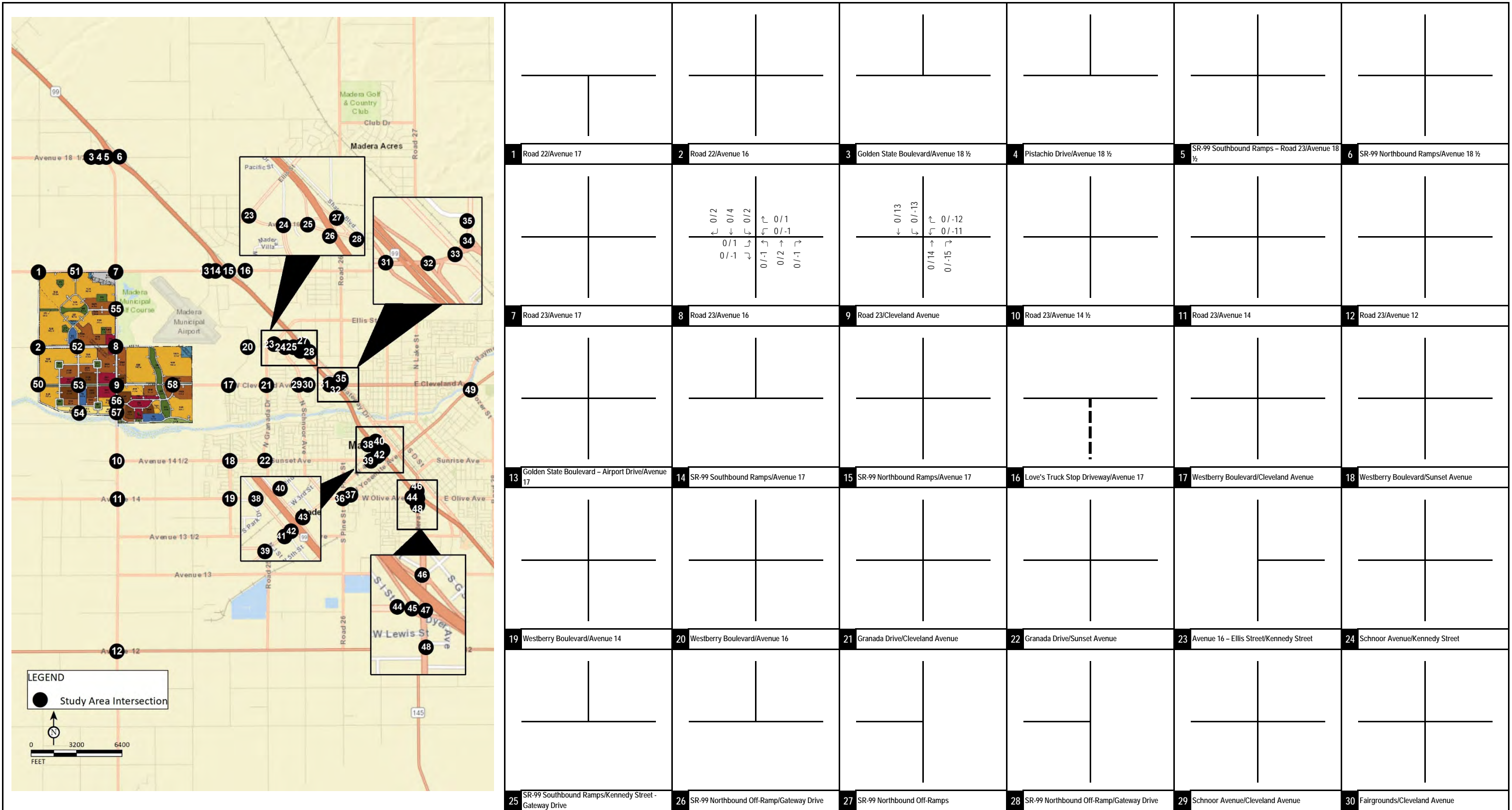

FIGURE 5-6A



XX / YY
AM / PM Peak Hour Traffic Volumes

---- Future Project Driveway/Road

Village D Specific Plan
Traffic Impact Analysis

Phase II Project Pass-by Trip Assignment (Int. 1-30)

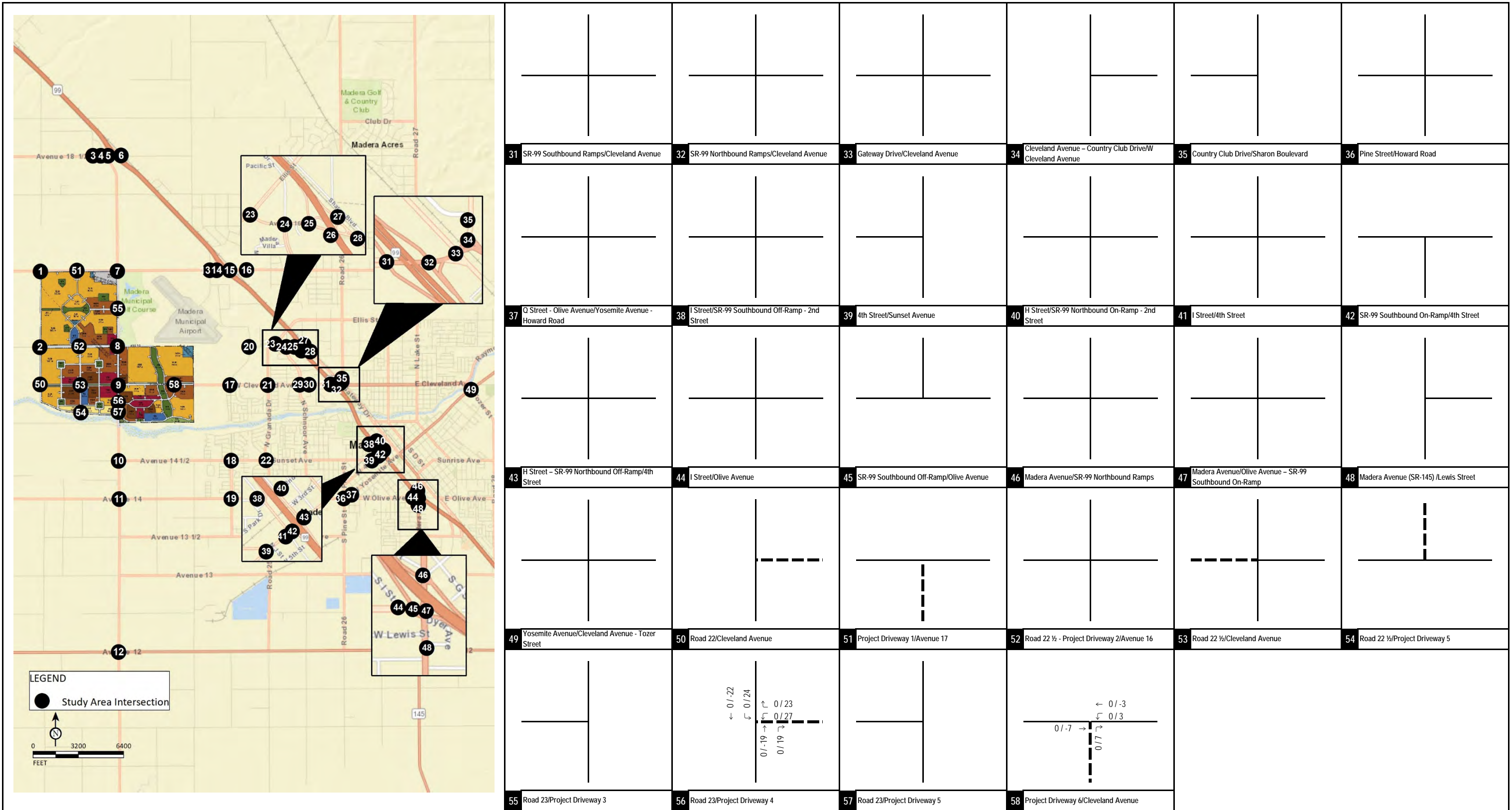

FIGURE 5-6B

LSA

XX / YY
AM / PM Peak Hour Traffic Volumes

---- Future Project Driveway/Road

Village D Specific Plan
Traffic Impact Analysis

Phase II Project Pass-by Trip Assignment (Int. 31-58)

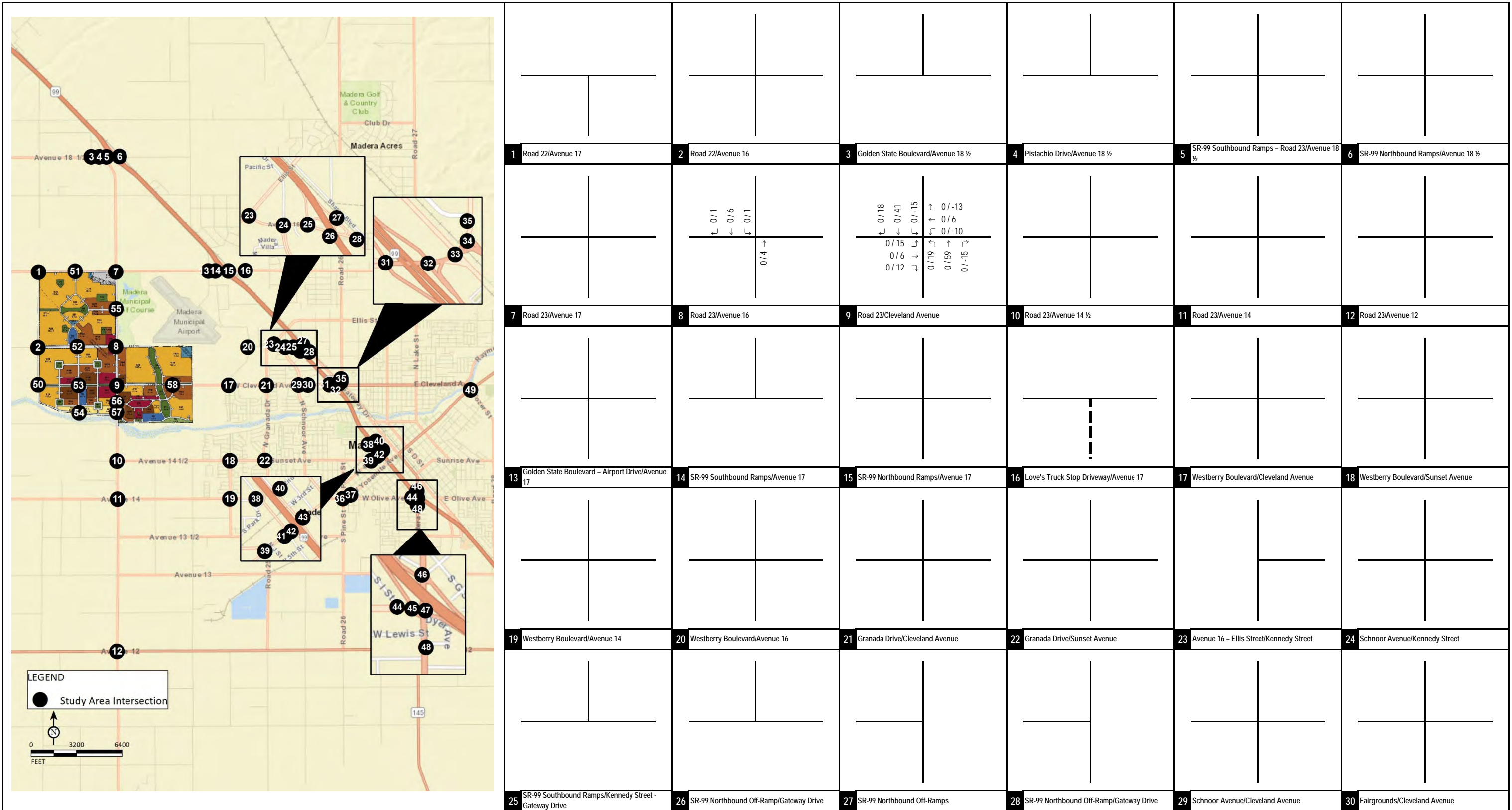

LSA

FIGURE 5-7A

XX / YY
 AM / PM Peak Hour Traffic Volumes

---- Future Project Driveway/Road

Village D Specific Plan
 Traffic Impact Analysis

Phase III Project Pass-by Trip Assignment (Int. 1-30)

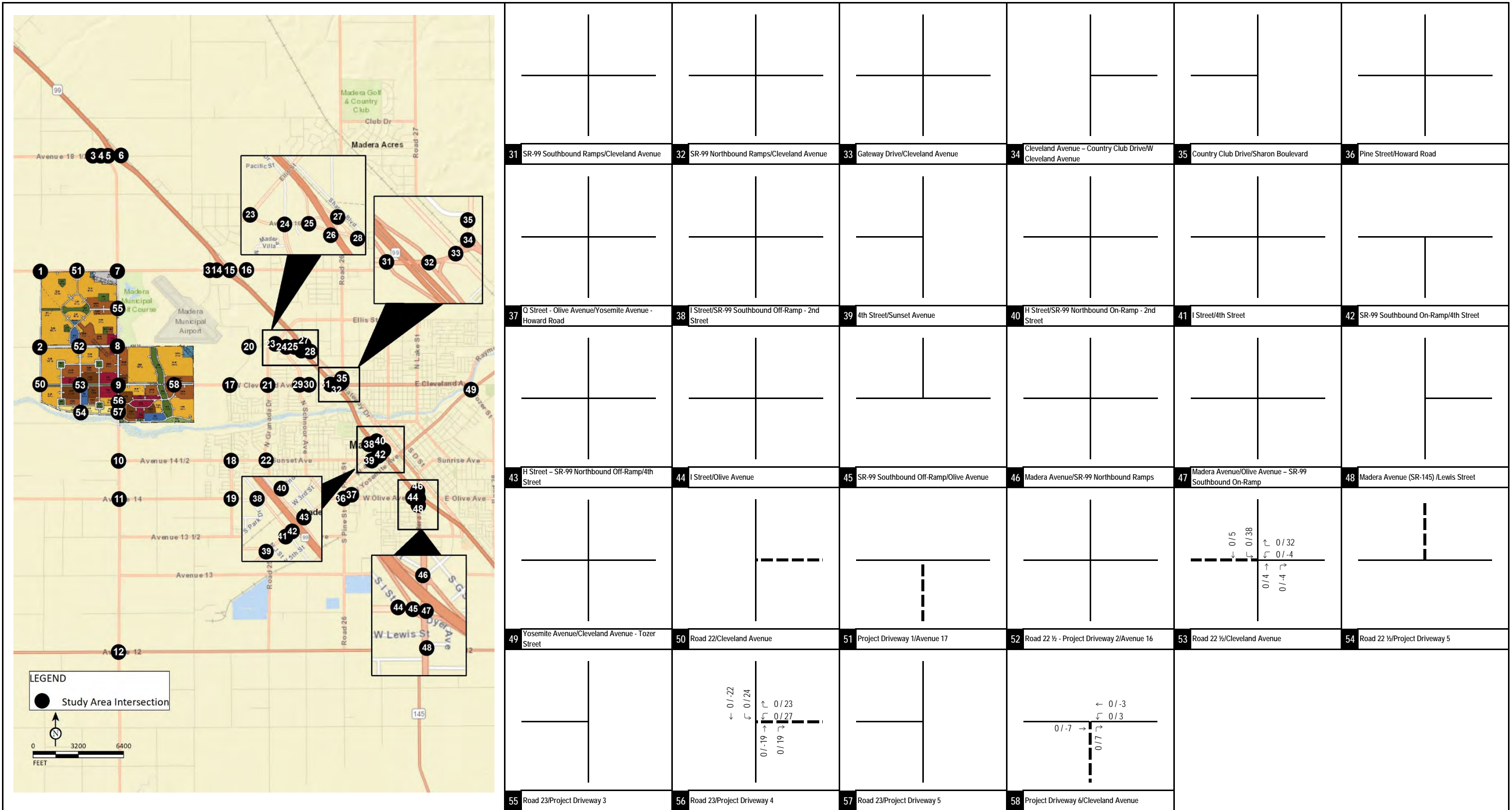

FIGURE 5-7B



XX / YY
AM / PM Peak Hour Traffic Volumes

---- Future Project Driveway/Road

Village D Specific Plan
Traffic Impact Analysis

Phase III Project Pass-by Trip Assignment (Int. 31-58)

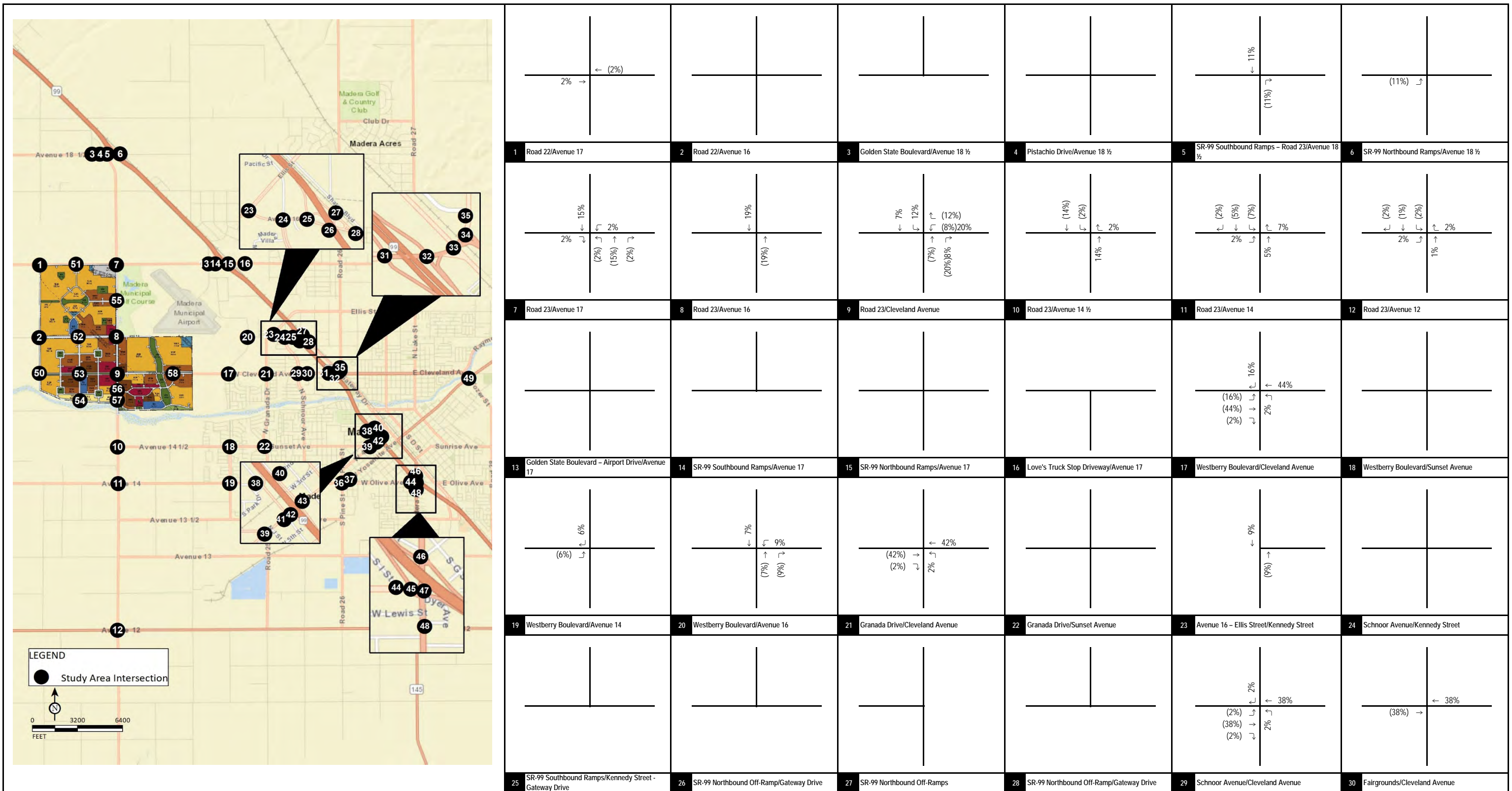

FIGURE 5-8A

LSA

XX% (YY%) -- Project Driveway
 Inbound (Outbound) Distribution

Village D Specific Plan
 Traffic Impact Analysis

Phase I TAZ 615 Project Trip Distribution (Int. 1-30)

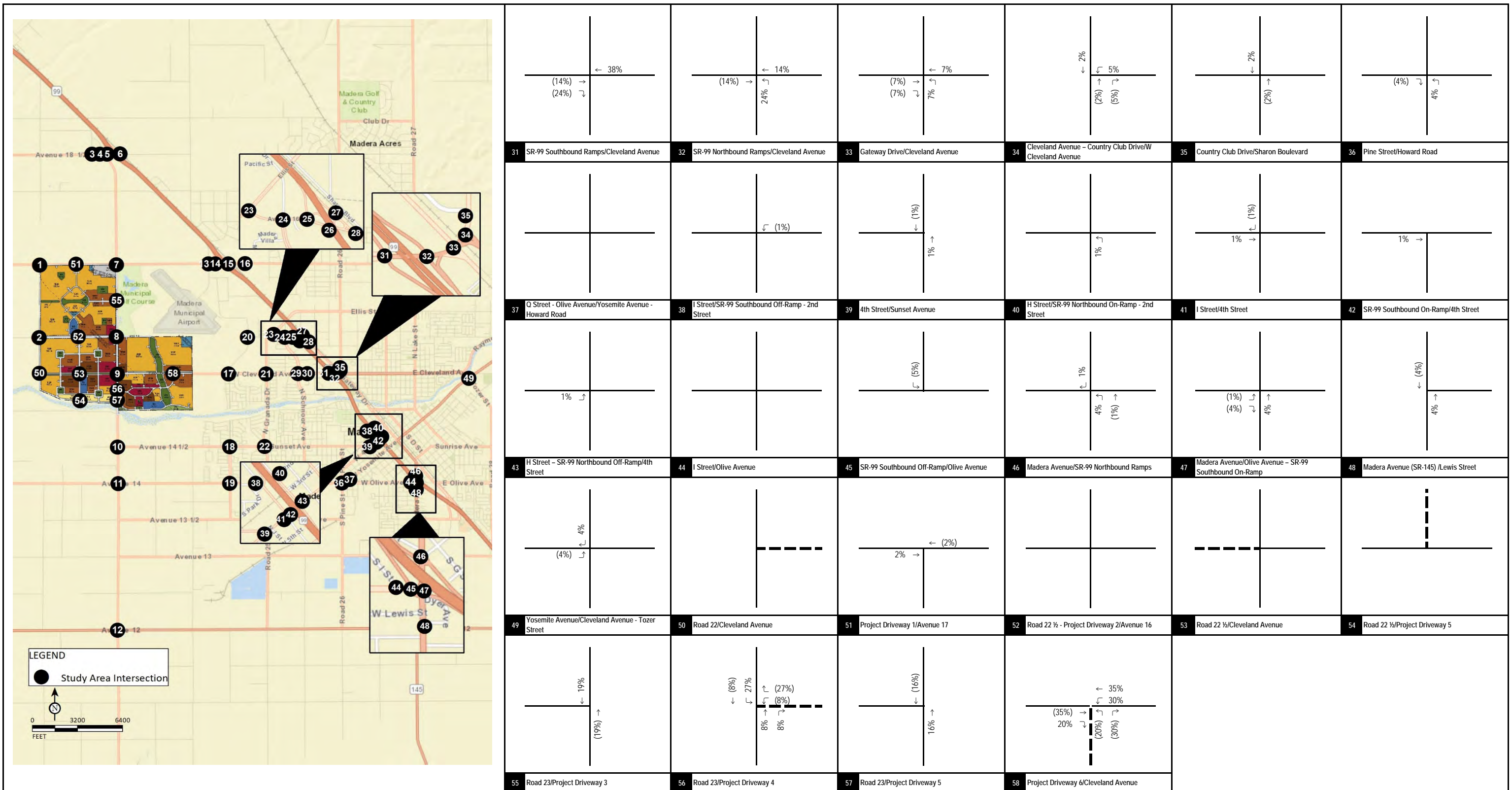

FIGURE 5-8B

LSA
 XX% (YY%)
 Inbound (Outbound) Distribution
 -- Project Driveway

Village D Specific Plan
 Traffic Impact Analysis

Phase I TAZ 615 Project Trip Distribution (Int. 31-58)

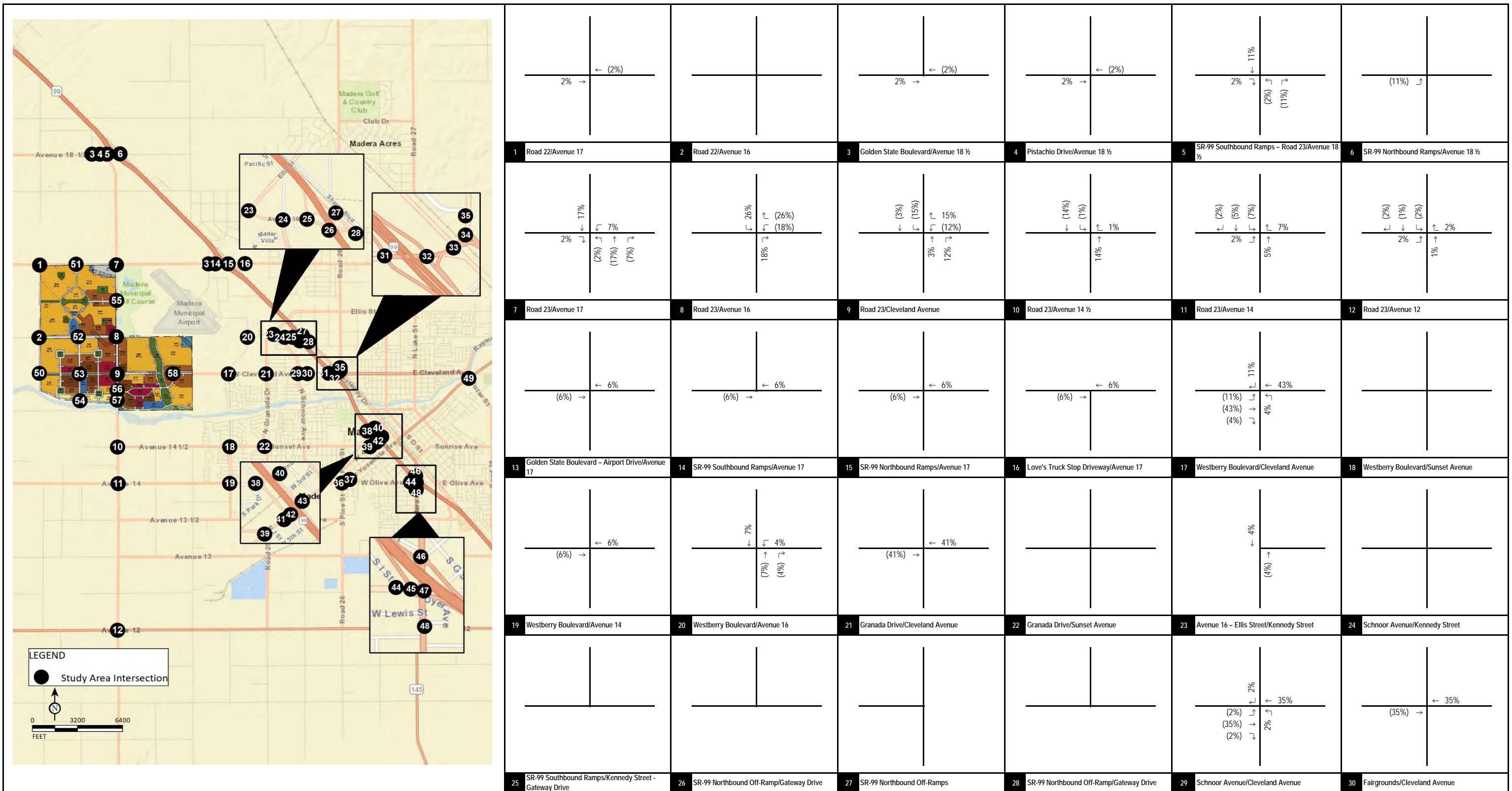

FIGURE 5-9A

LSA

XX% (YY%)
 Inbound (Outbound) Distribution

-- Project Driveway

Village D Specific Plan
 Traffic Impact Analysis

Phase I TAZ 616 Project Trip Distribution (Int. 1-30)

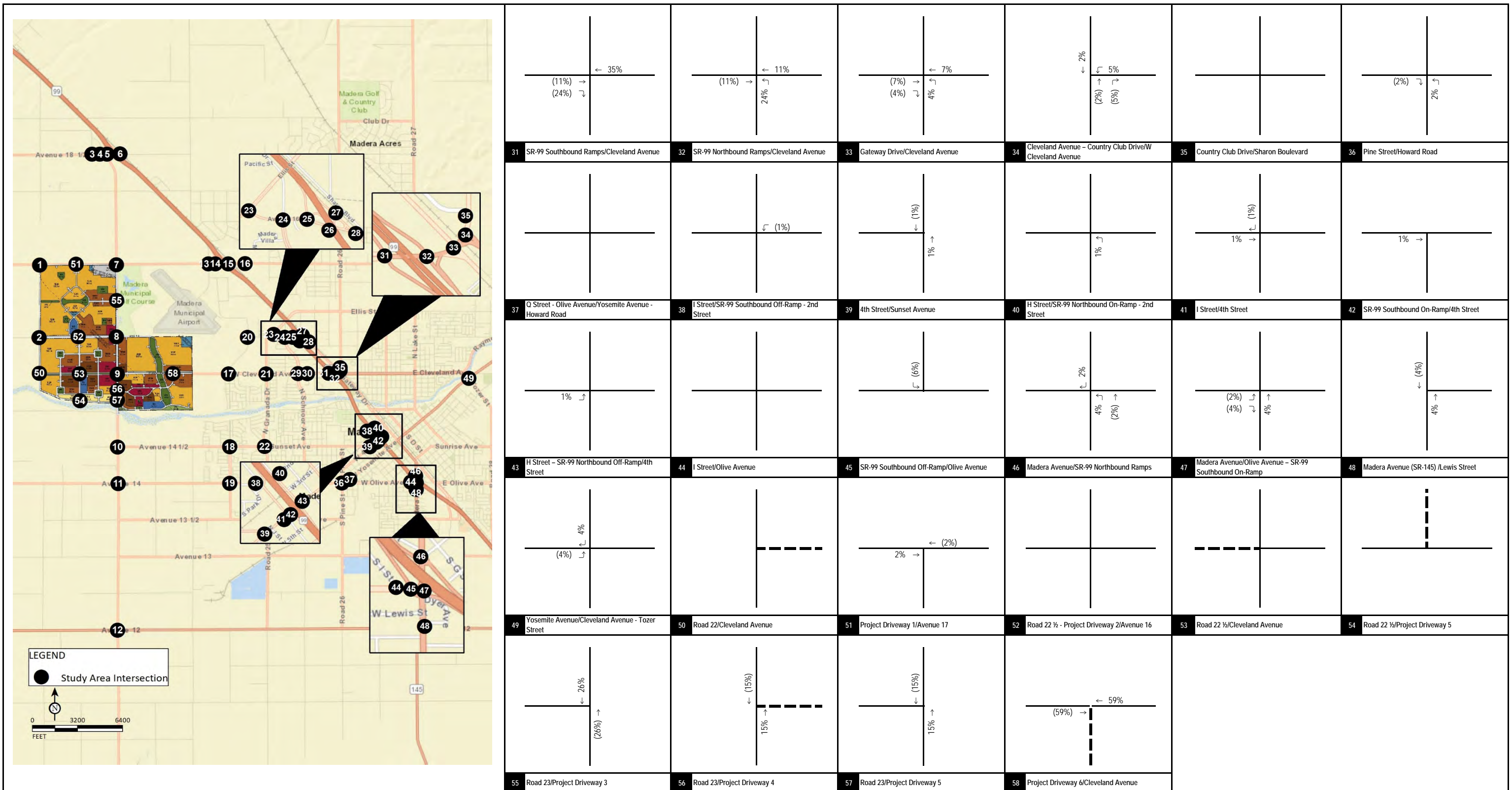

FIGURE 5-9B

LSA
 XX% (YY%)
 Inbound (Outbound) Distribution
 -- Project Driveway

Village D Specific Plan
 Traffic Impact Analysis

Phase I TAZ 616 Project Trip Distribution (Int. 31-58)

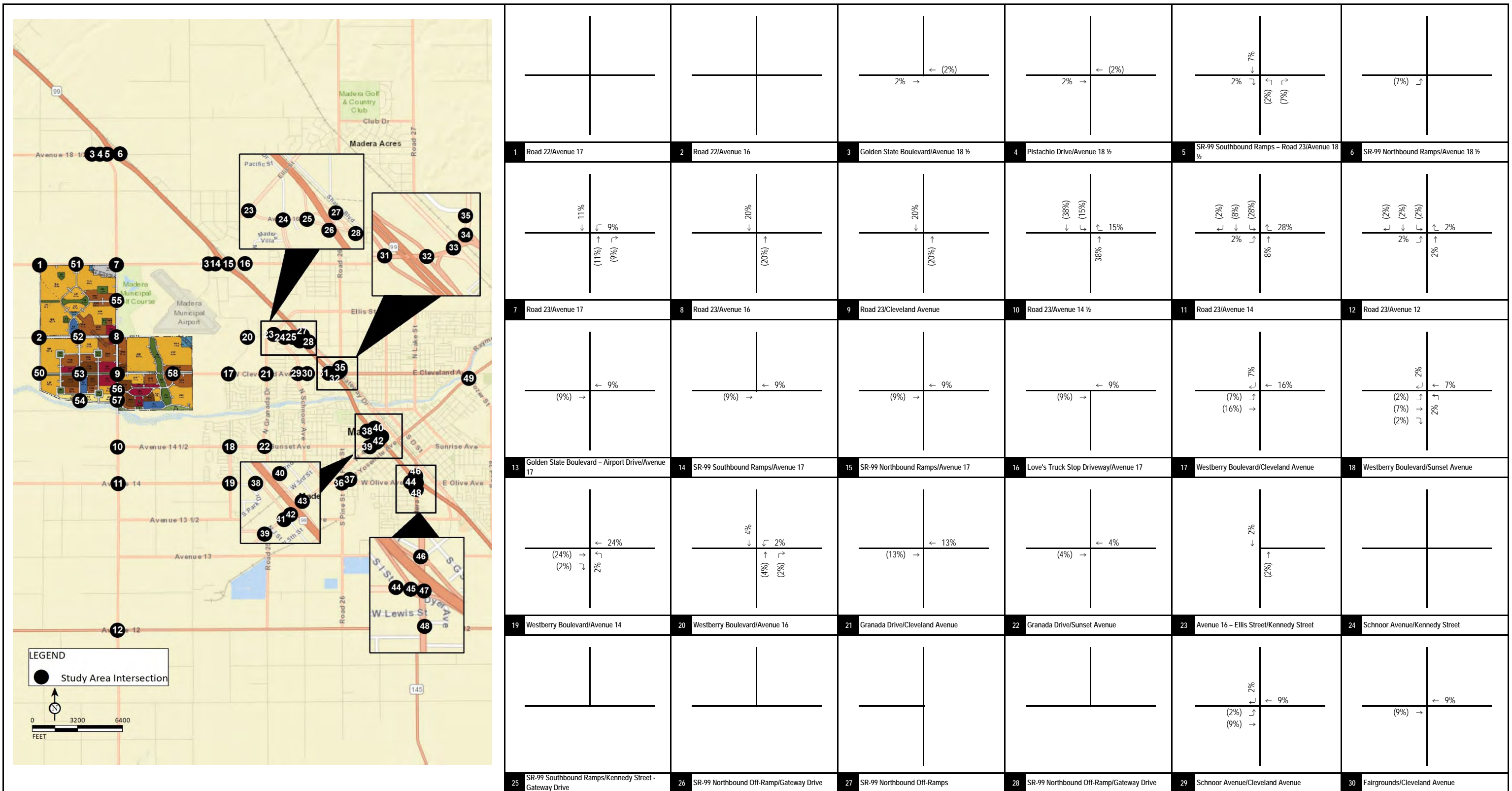

FIGURE 5-10A

LSA

XX% (YY%) -- Project Driveway
 Inbound (Outbound) Distribution

Village D Specific Plan
 Traffic Impact Analysis

Phase I TAZ 626 Project Trip Distribution (Int. 1-30)

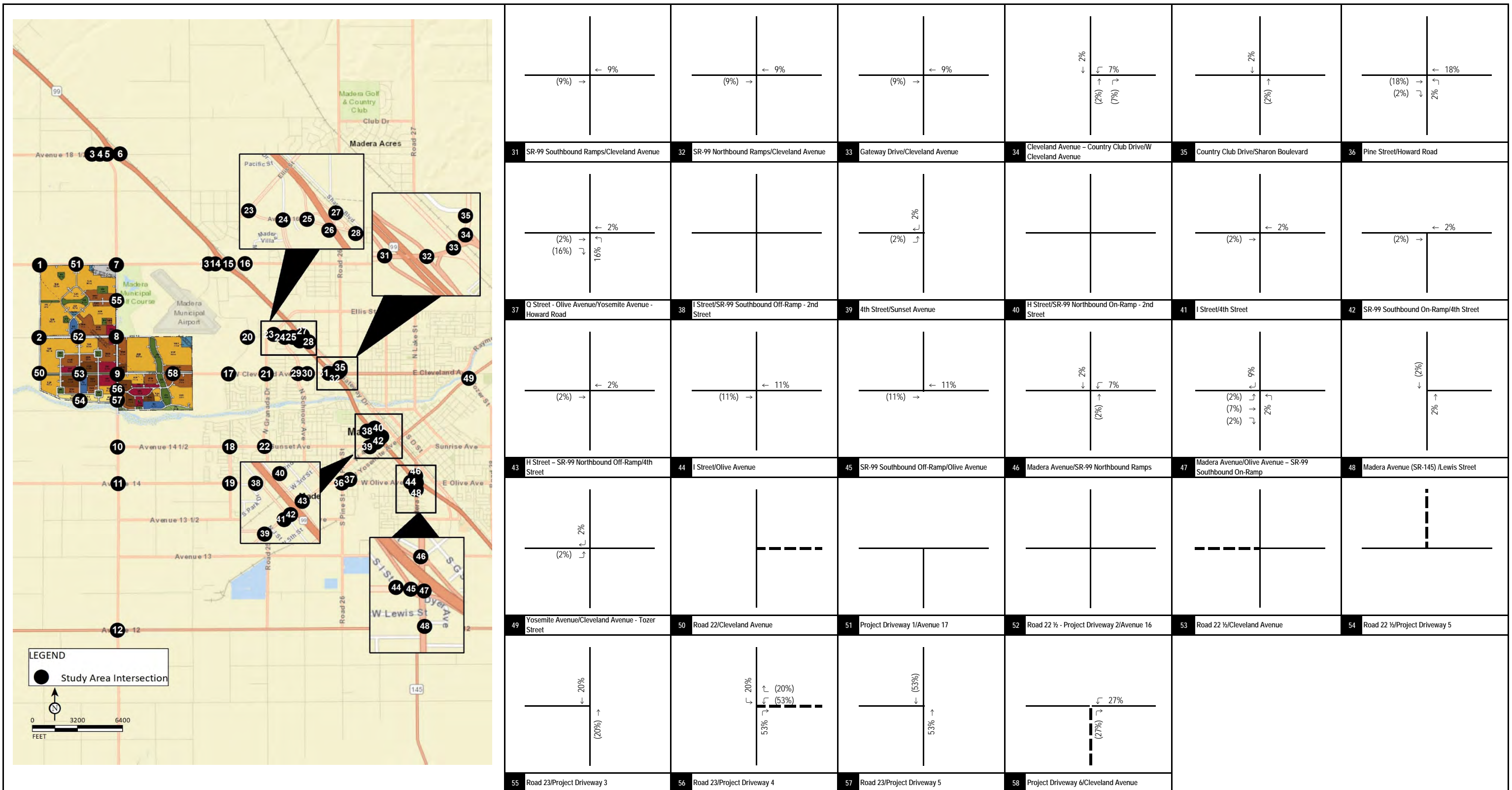

FIGURE 5-10B

LSA
 XX% (YY%)
 Inbound (Outbound) Distribution
 -- Project Driveway

Village D Specific Plan
 Traffic Impact Analysis

Phase I TAZ 626 Project Trip Distribution (Int. 31-58)

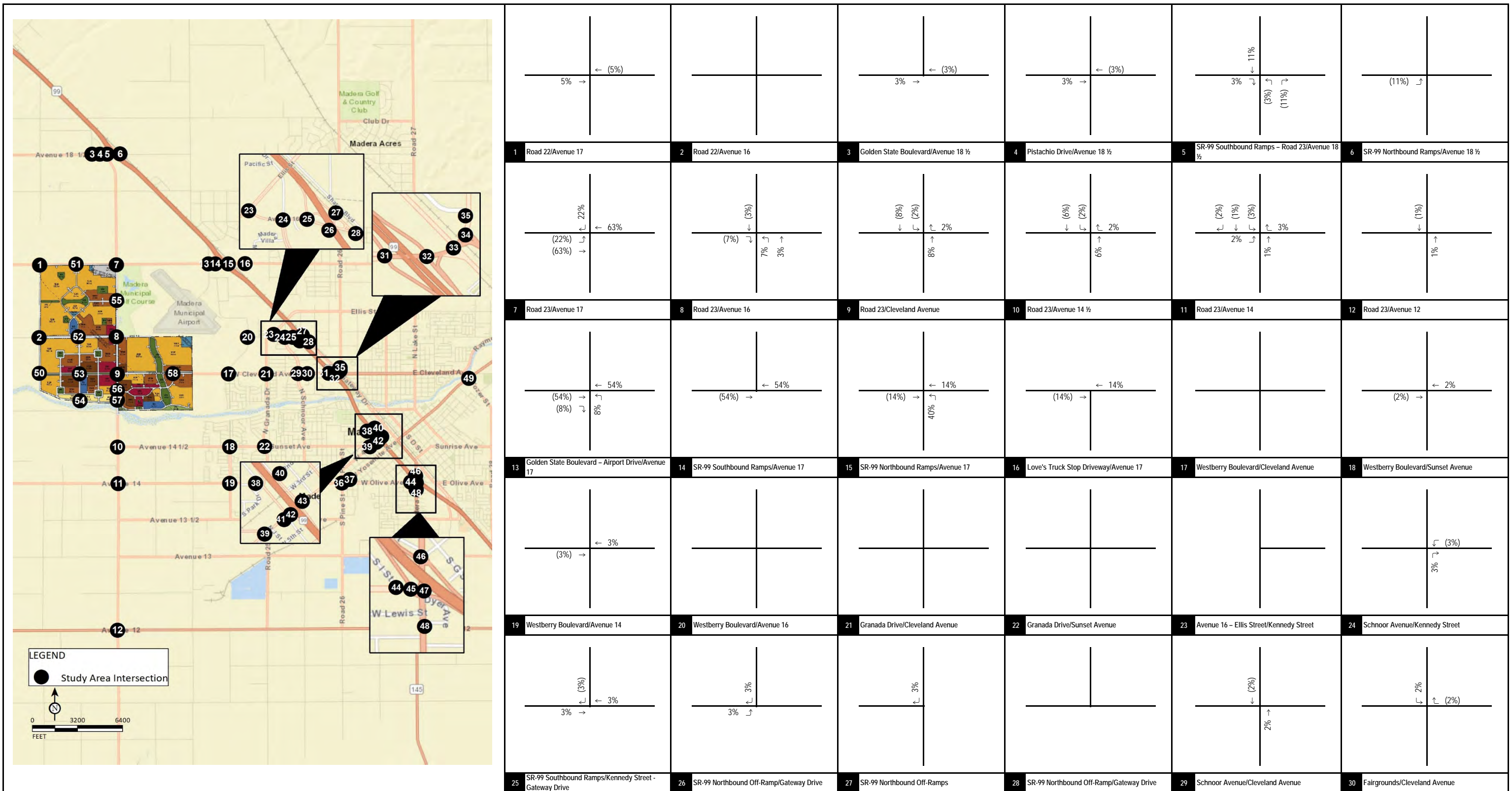

FIGURE 5-11A



XX% (YY%) -- Project Driveway
 Inbound (Outbound) Distribution

Village D Specific Plan
 Traffic Impact Analysis

Phase II TAZ 627 Project Trip Distribution (Int. 1-30)

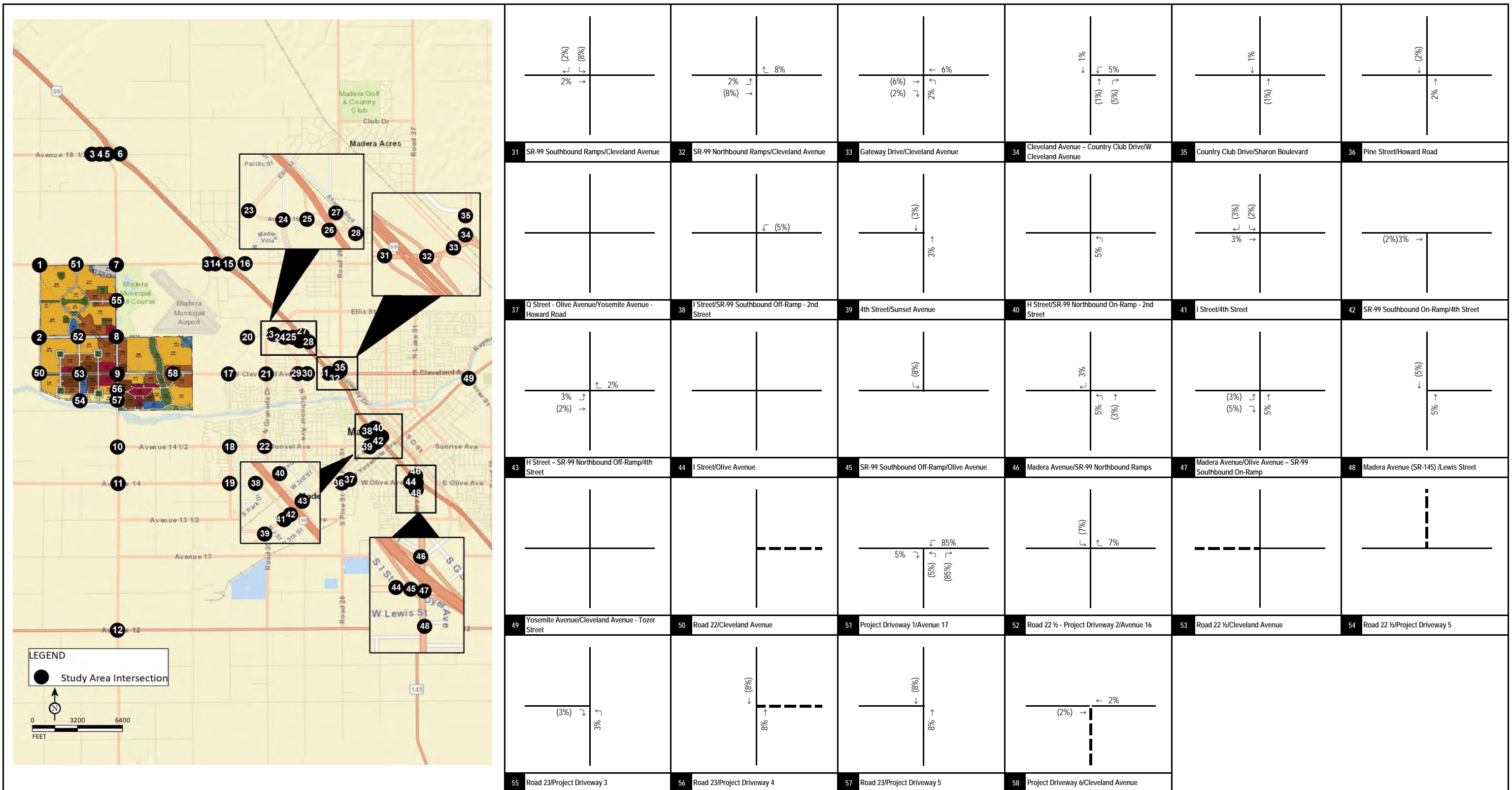

FIGURE 5-11B

LSA

XX% (YY%) -- Project Driveway
 Inbound (Outbound) Distribution

Village D Specific Plan
 Traffic Impact Analysis

Phase II TAZ 627 Project Trip Distribution (Int. 31-58)

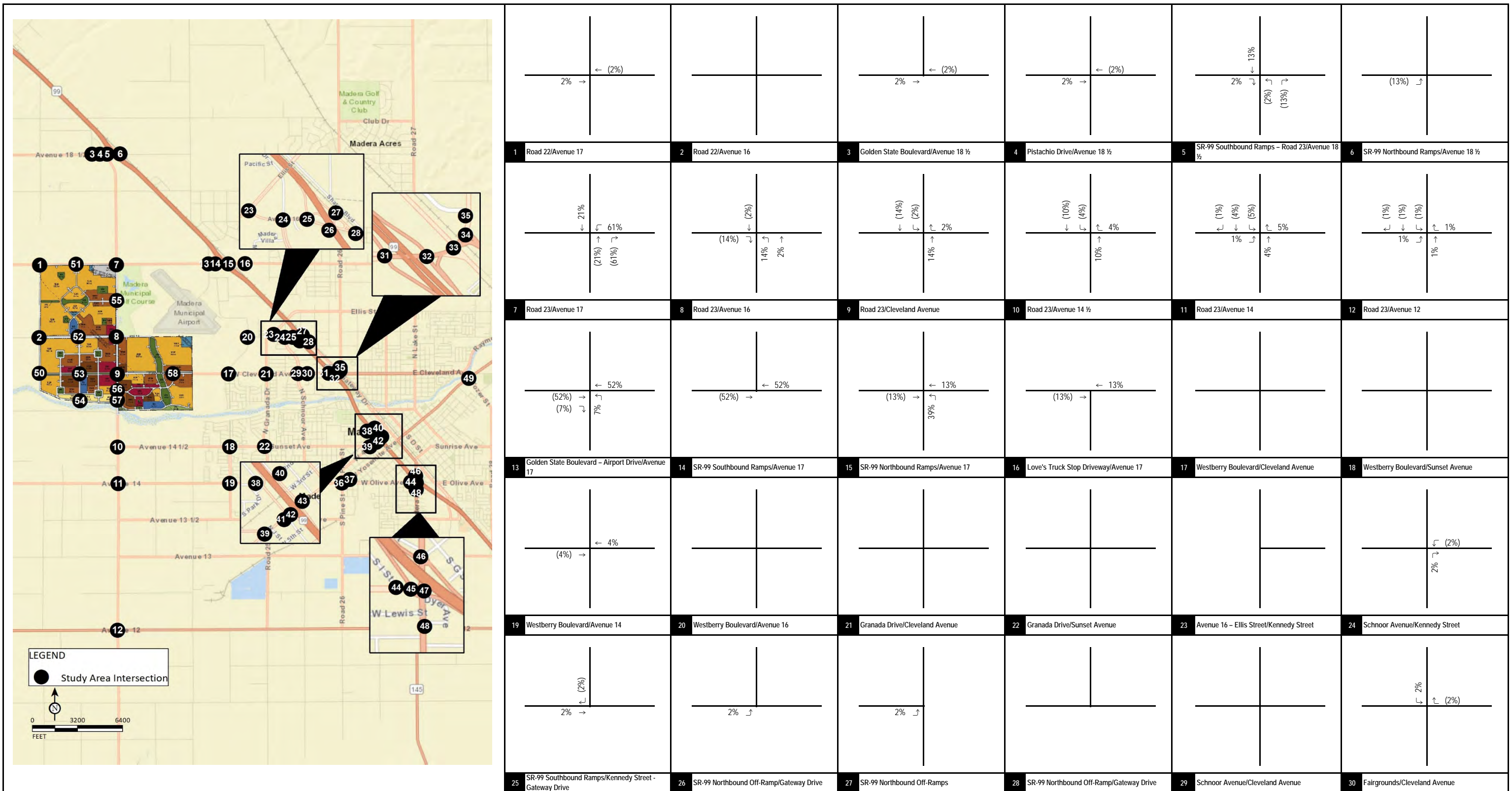

FIGURE 5-12A

LSA

XX% (YY%) -- Project Driveway
 Inbound (Outbound) Distribution

Village D Specific Plan
 Traffic Impact Analysis

Phase II TAZ 628 Project Trip Distribution (Int. 1-30)

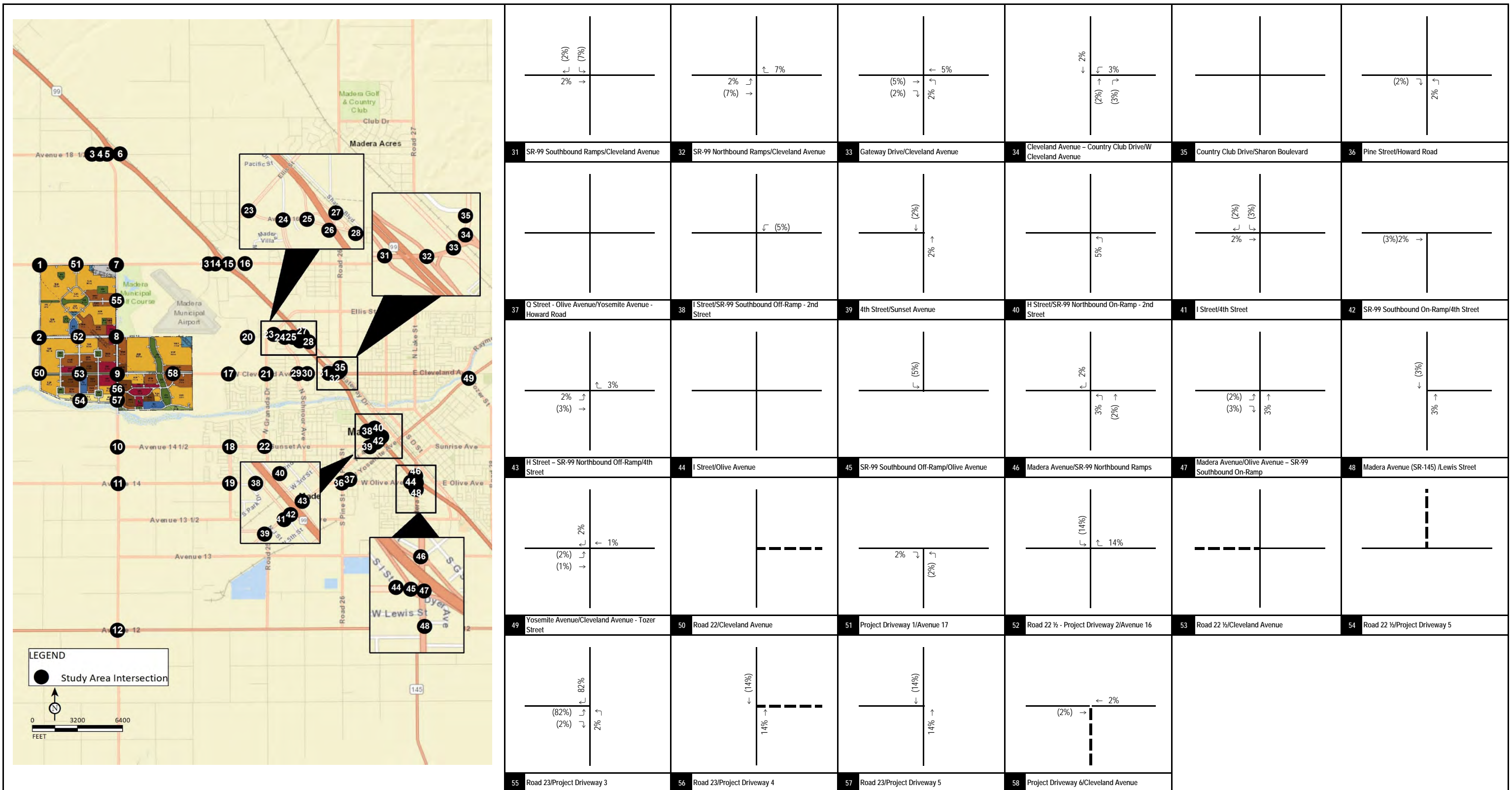

FIGURE 5-12B

LSA
 XX% (YY%)
 Inbound (Outbound) Distribution
 -- Project Driveway

Village D Specific Plan
 Traffic Impact Analysis

Phase II TAZ 628 Project Trip Distribution (Int. 31-58)

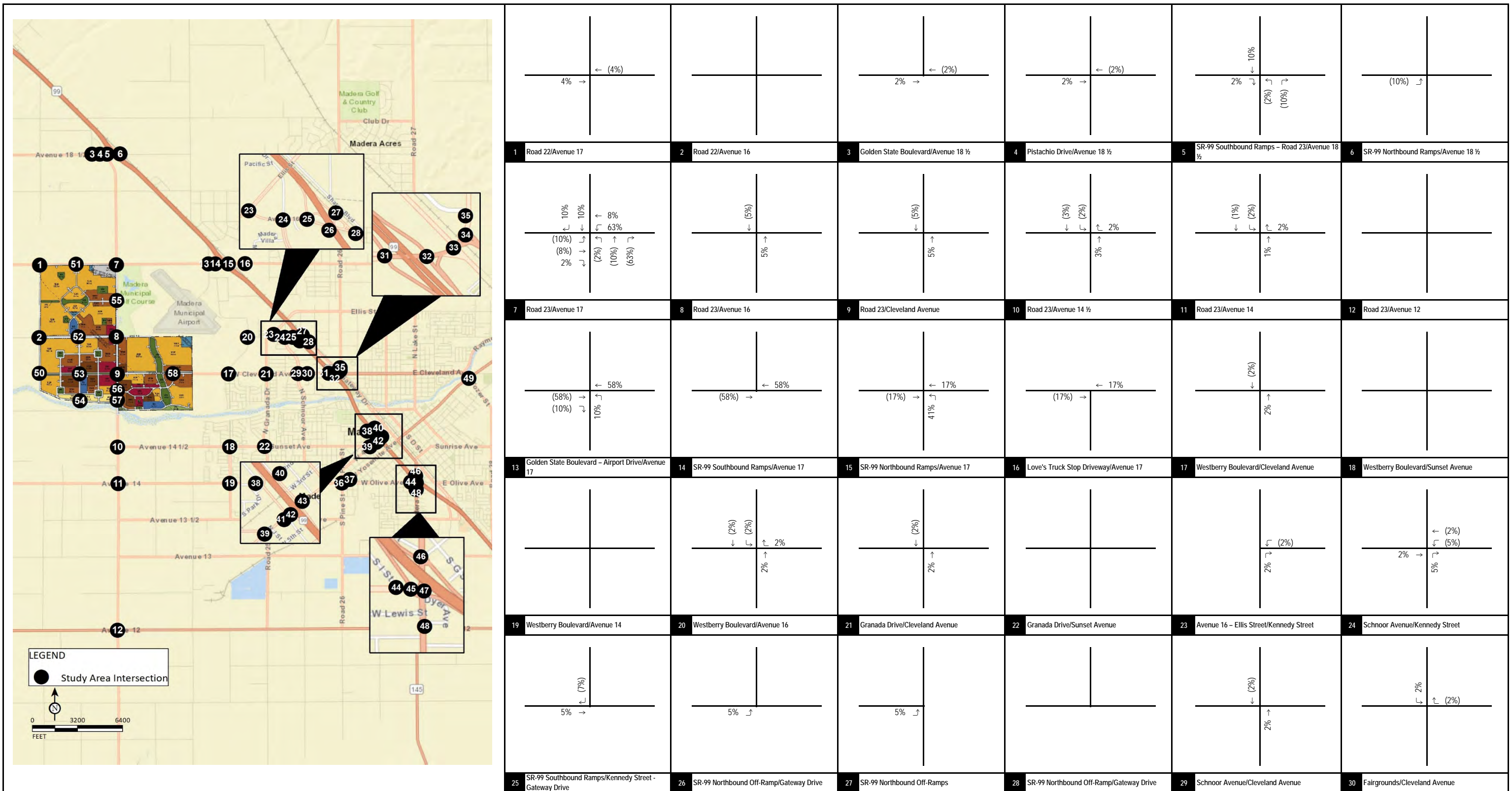

FIGURE 5-13A

LSA

XX% (YY%) -- Project Driveway
 Inbound (Outbound) Distribution

Village D Specific Plan
 Traffic Impact Analysis

Phase II TAZ 629 Project Trip Distribution (Int. 1-30)

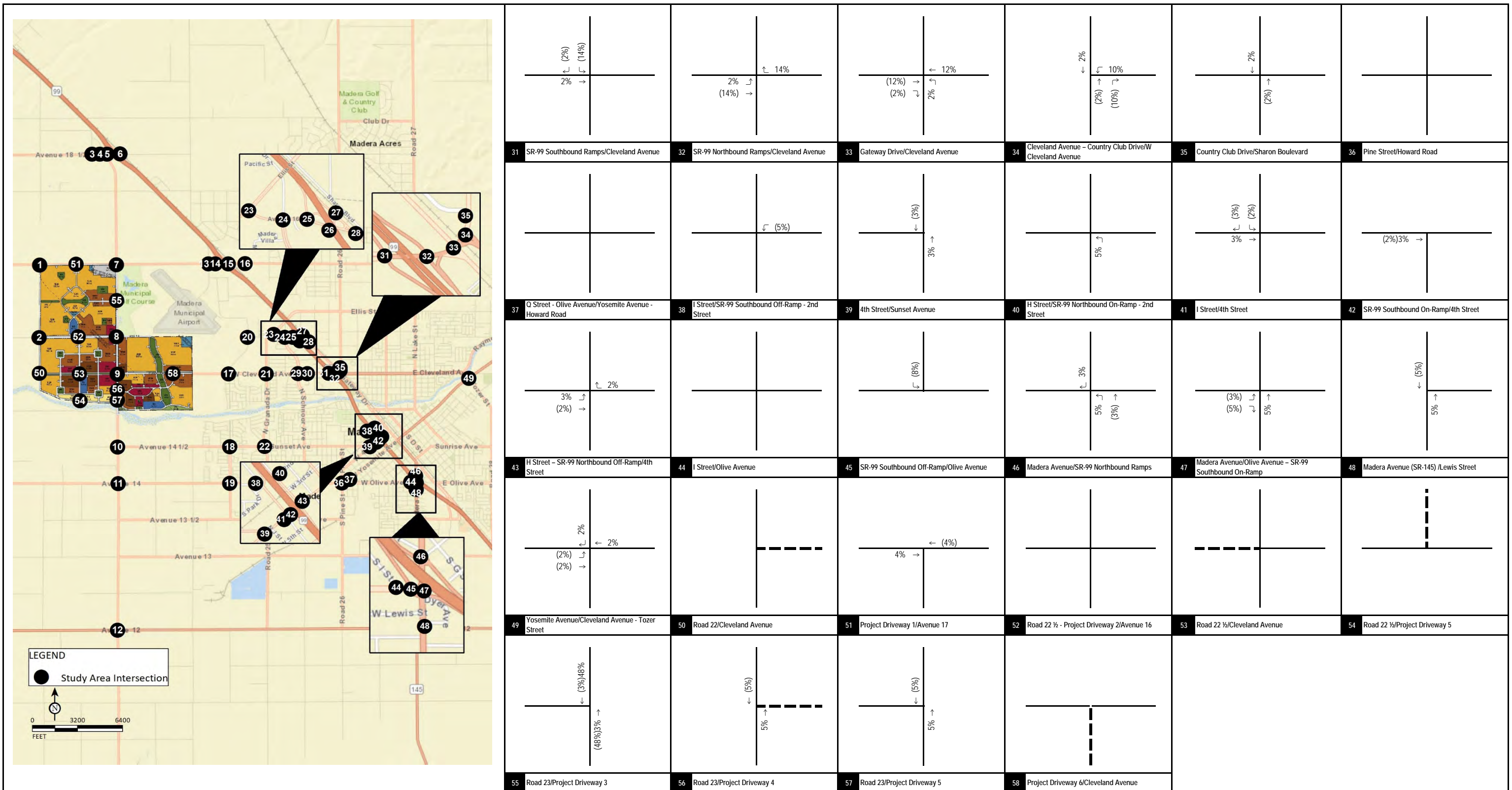

FIGURE 5-13B

LSA
 XX% (YY%)
 Inbound (Outbound) Distribution
 -- Project Driveway

Village D Specific Plan
 Traffic Impact Analysis
 Phase II TAZ 629 Project Trip Distribution (Int. 31-58)

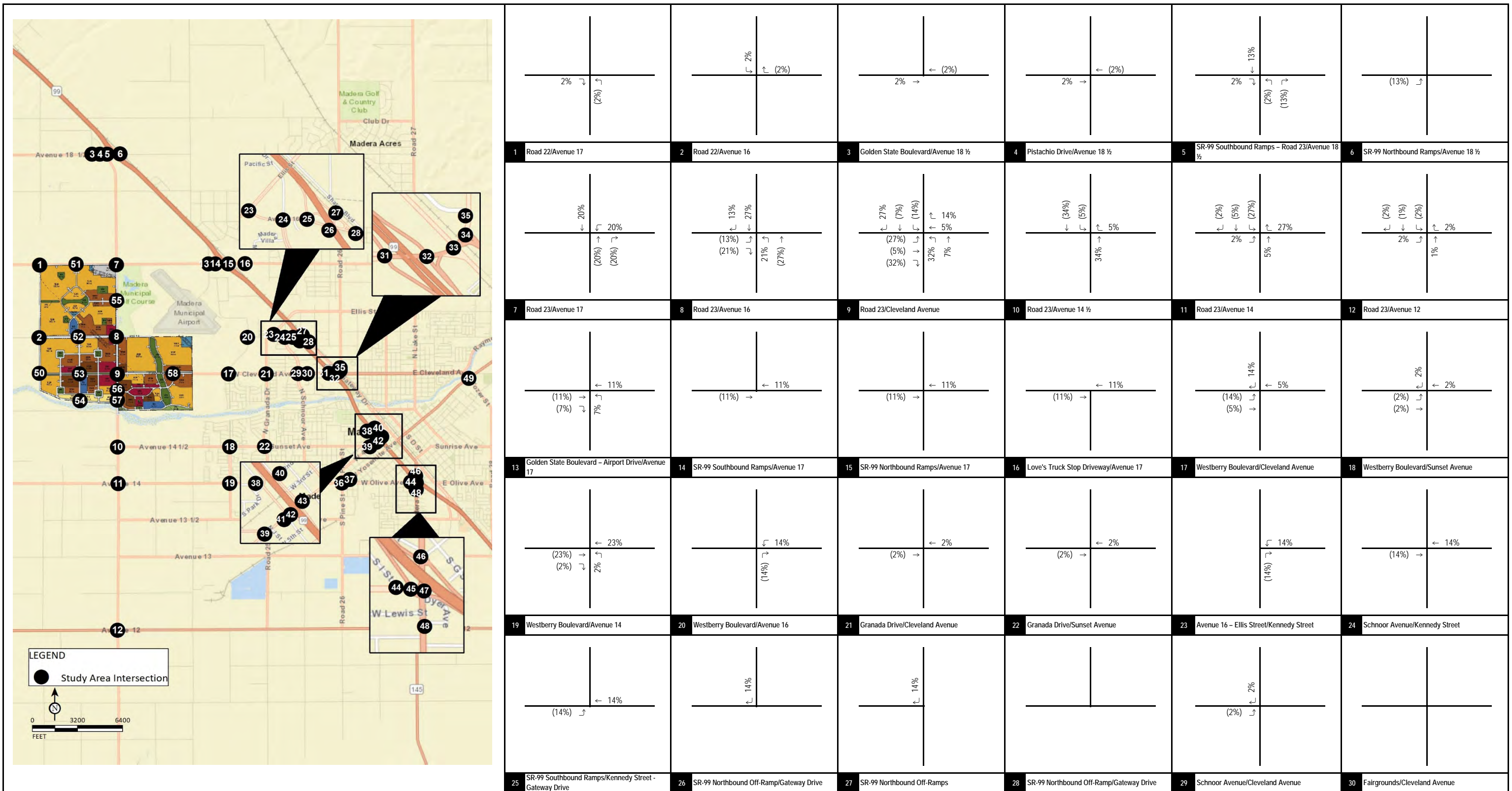

FIGURE 5-14A

LSA

XX% (YY%) -- Project Driveway
 Inbound (Outbound) Distribution

Village D Specific Plan
 Traffic Impact Analysis

Phase III TAZ 630 Project Trip Distribution (Int. 1-30)

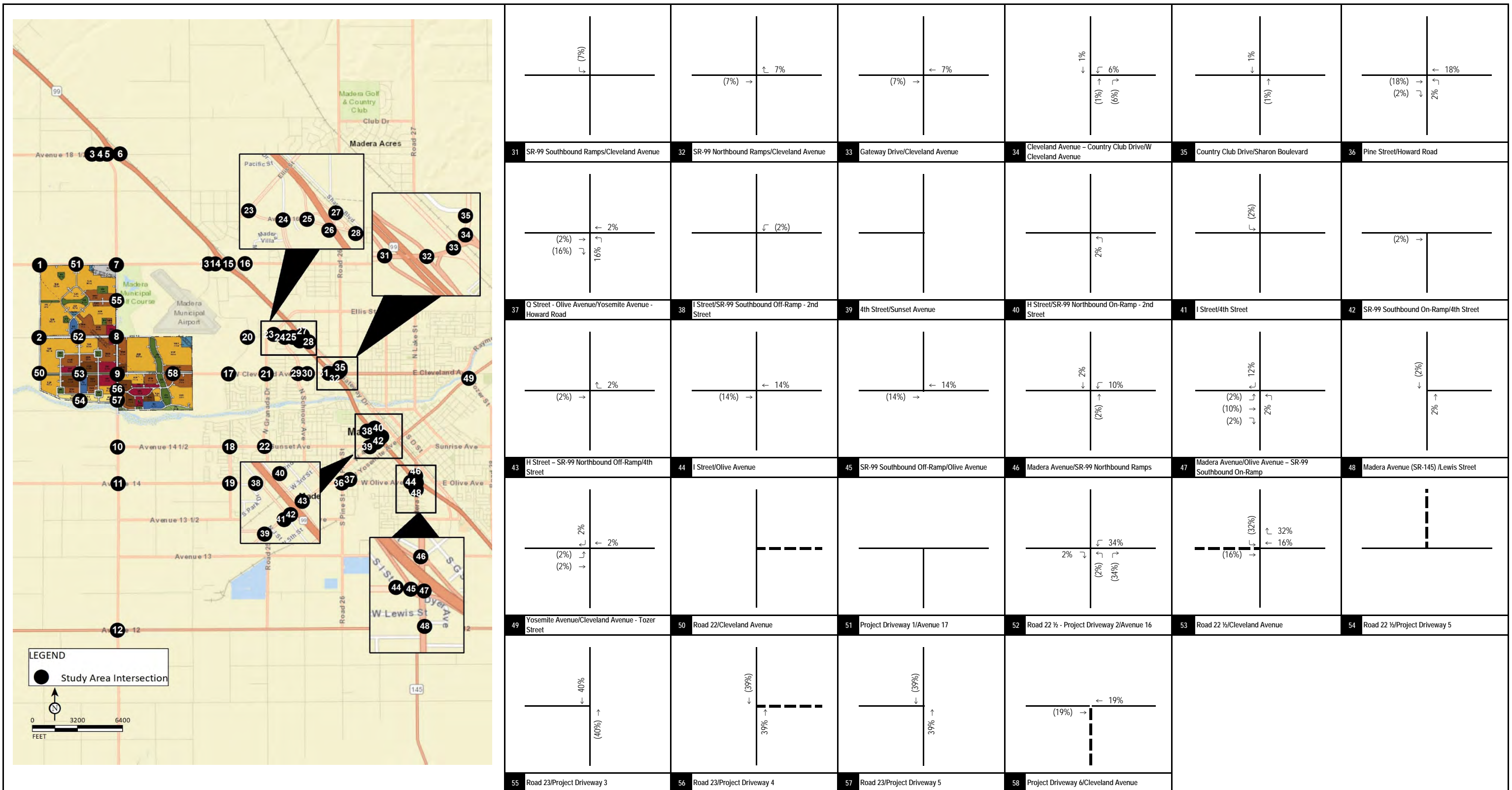

FIGURE 5-14B



XX% (YY%) -- Project Driveway
 Inbound (Outbound) Distribution

Village D Specific Plan
 Traffic Impact Analysis

Phase III TAZ 630 Project Trip Distribution (Int. 31-58)

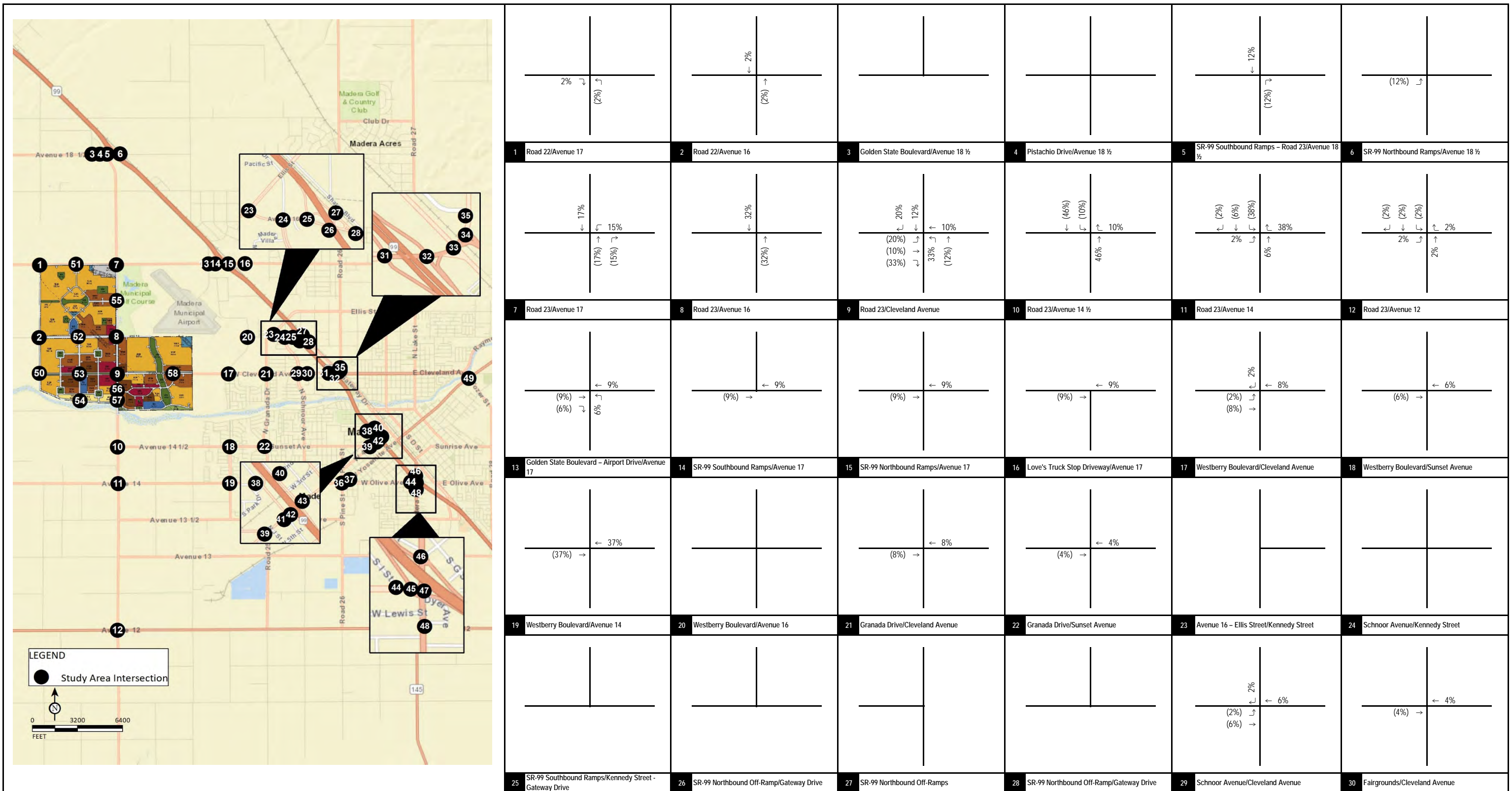

FIGURE 5-15A

LSA

XX% (YY%) -- Project Driveway
 Inbound (Outbound) Distribution

Village D Specific Plan
 Traffic Impact Analysis

Phase III TAZ 631 Project Trip Distribution (Int. 1-30)

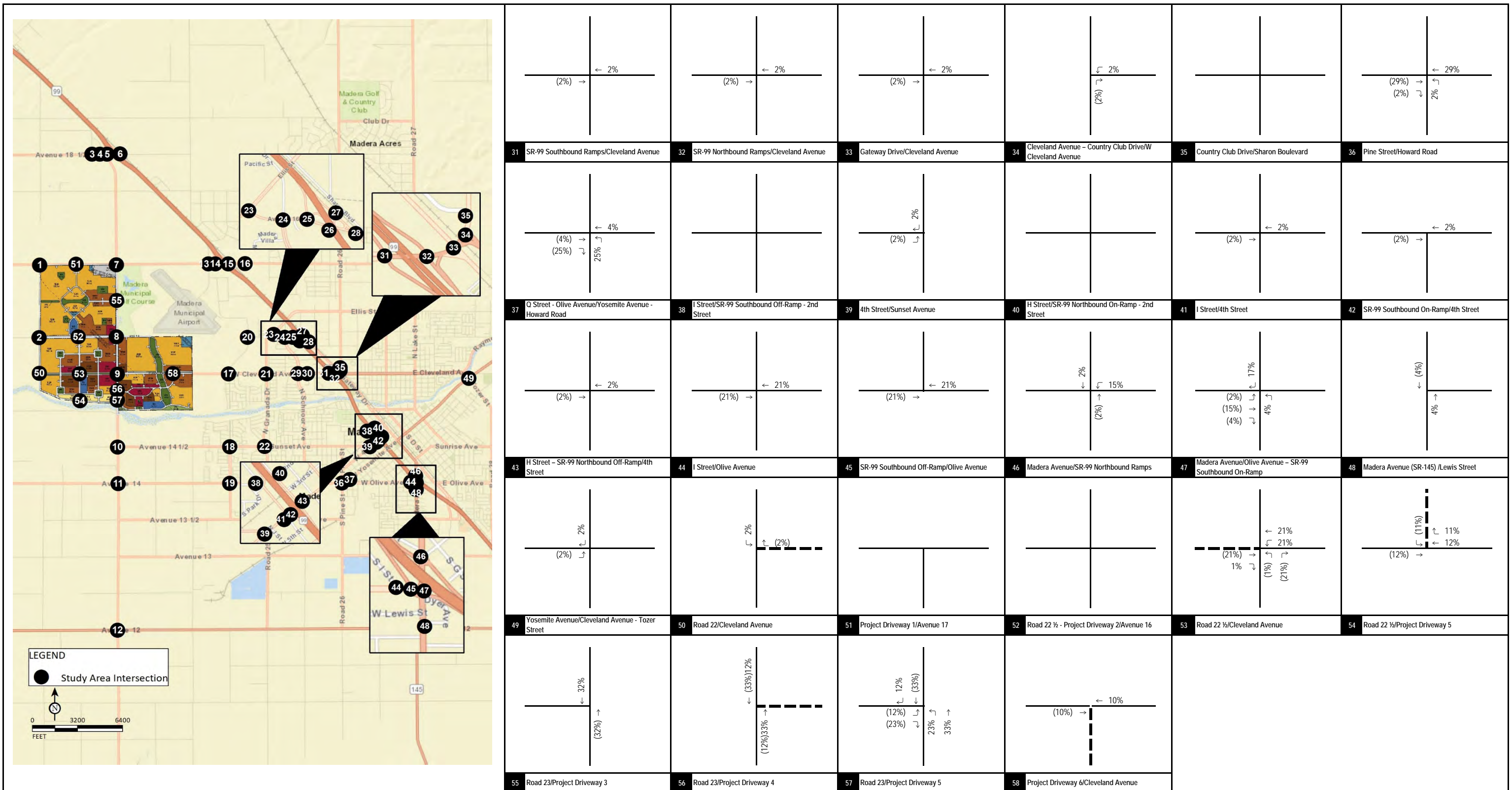

FIGURE 5-15B

LSA
 XX% (YY%)
 Inbound (Outbound) Distribution
 -- Project Driveway

Village D Specific Plan
 Traffic Impact Analysis

Phase III TAZ 631 Project Trip Distribution (Int. 31-58)

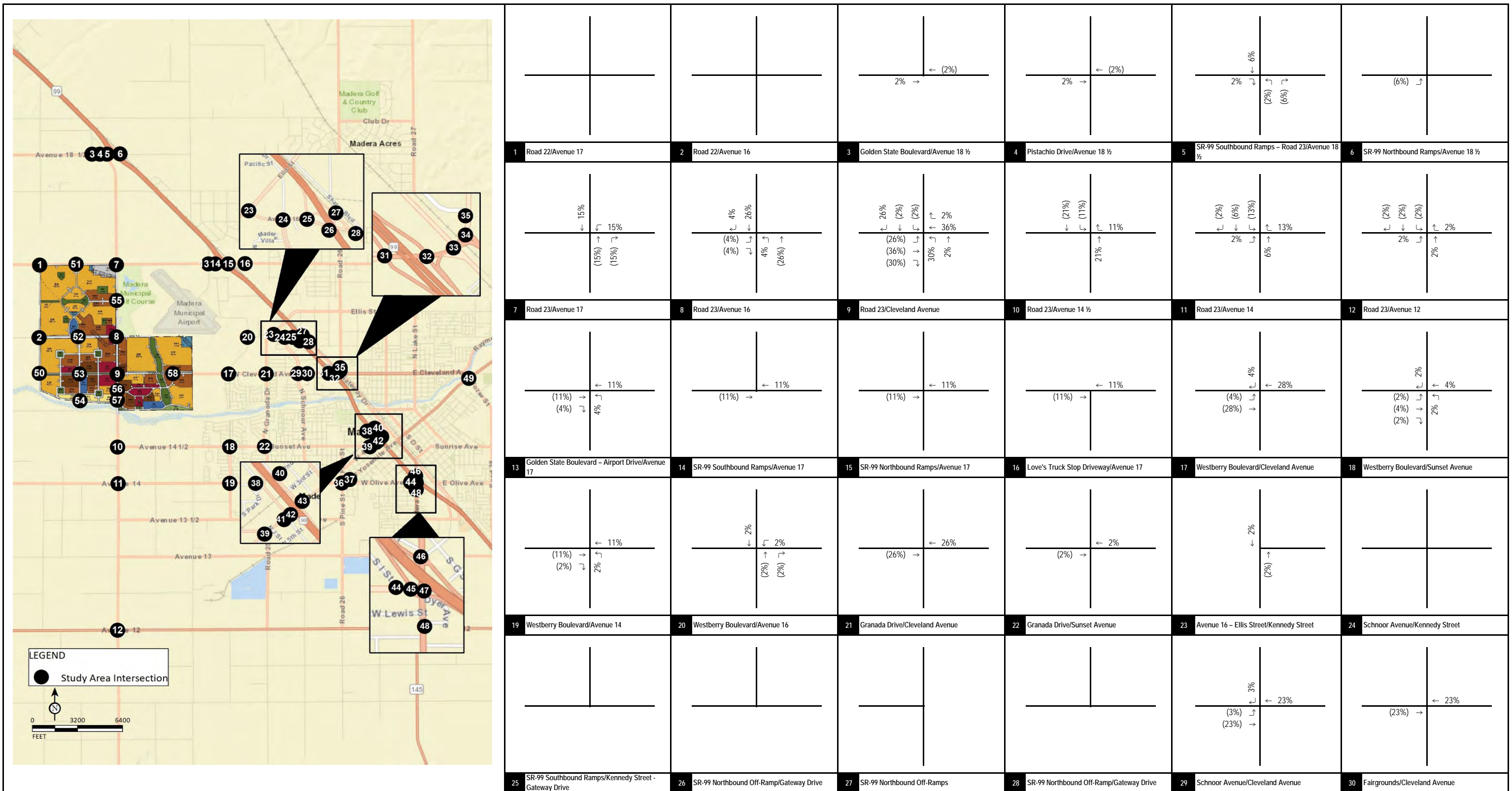

FIGURE 5-16A

LSA

XX% (YY%) -- Project Driveway
 Inbound (Outbound) Distribution

Village D Specific Plan
 Traffic Impact Analysis

Phase III TAZ 632 Project Trip Distribution (Int. 1-30)

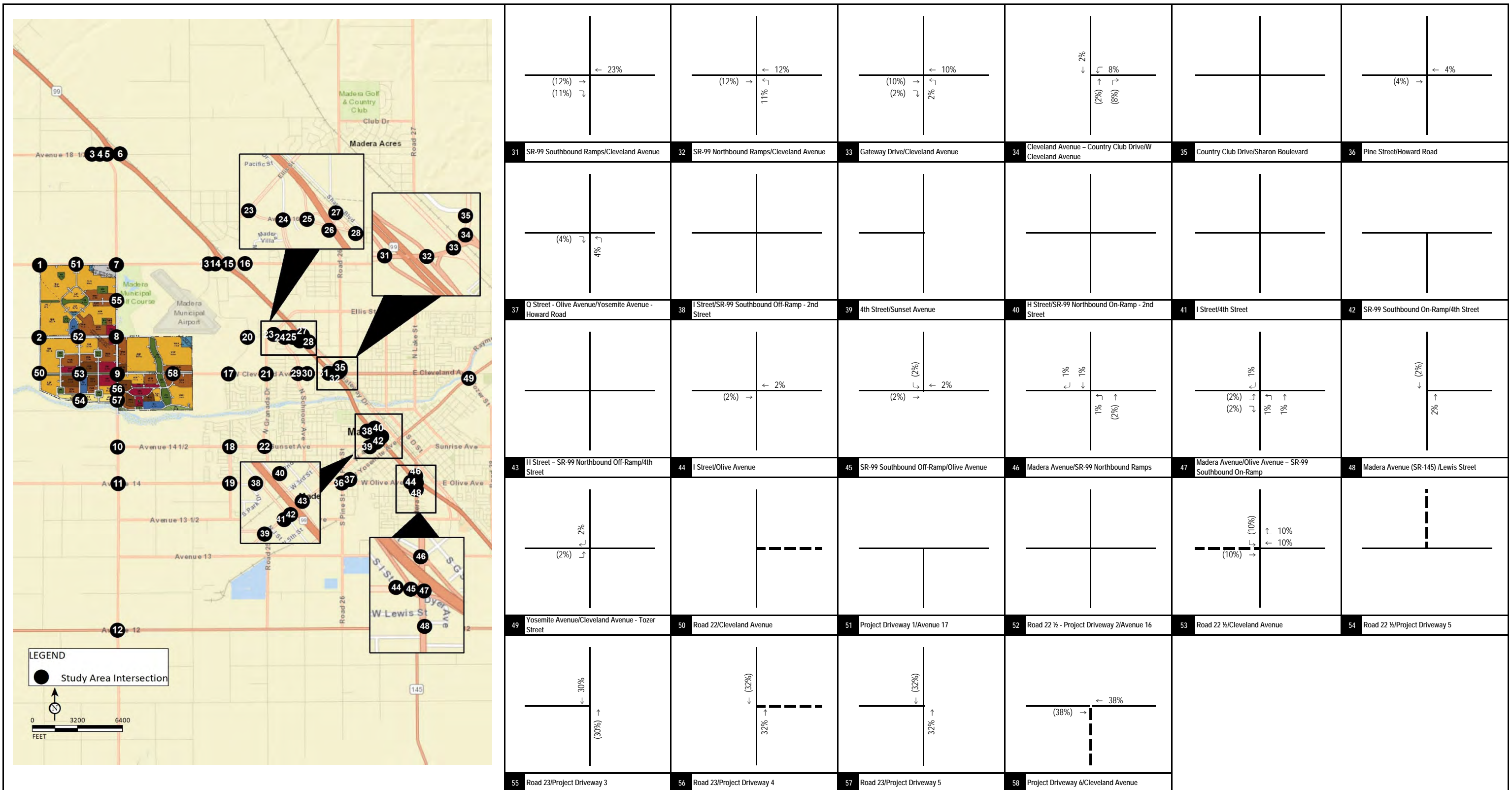

FIGURE 5-16B

LSA
 XX% (YY%)
 Inbound (Outbound) Distribution
 -- Project Driveway

Village D Specific Plan
 Traffic Impact Analysis
 Phase III TAZ 632 Project Trip Distribution (Int. 31-58)

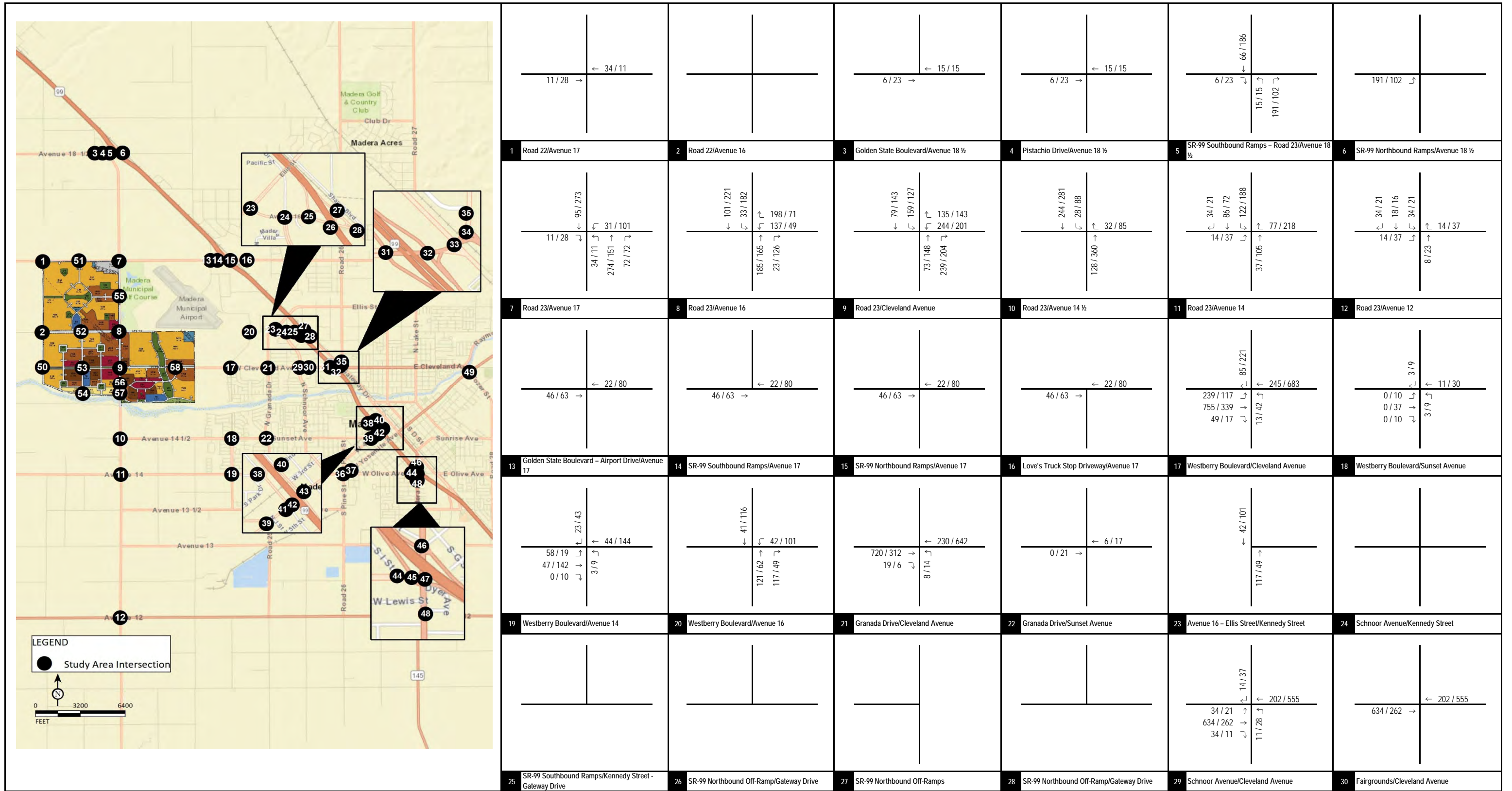

FIGURE 5-17A



XXX / YYY
 AM / PM Peak Hour Traffic Volumes
 -- Project Driveway

Village D Specific Plan
 Traffic Impact Analysis
 Phase I Project Trip Assignment (Int. 1-30)

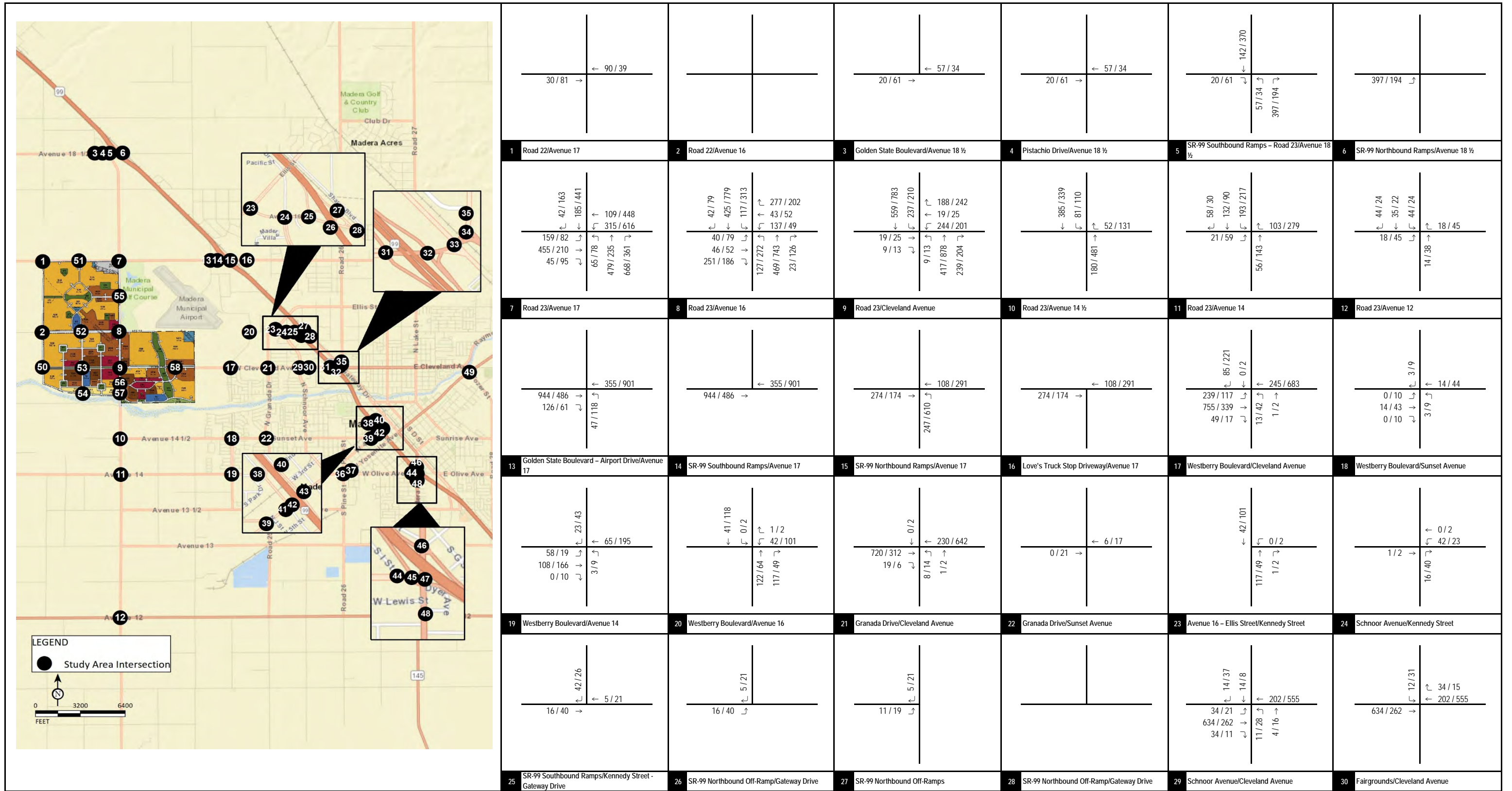

FIGURE 5-18A



XXX / YYY
 AM / PM Peak Hour Traffic Volumes
 -- Project Driveway

Village D Specific Plan
 Traffic Impact Analysis
 Phase II Project Trip Assignment (Int. 1-30)

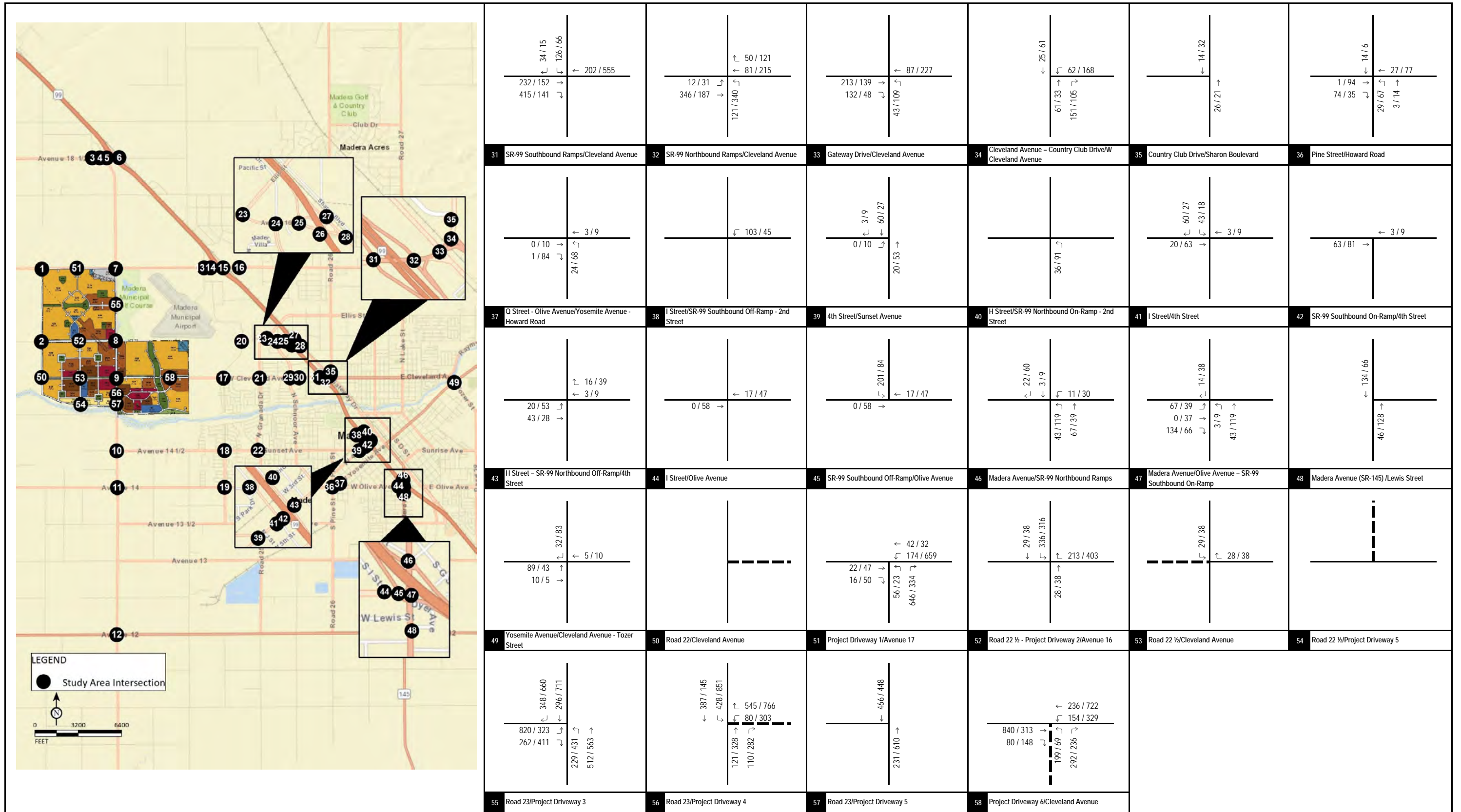

FIGURE 5-18B

LSA
 XXX / YYY
 AM / PM Peak Hour Traffic Volumes

-- Project Driveway

Village D Specific Plan
 Traffic Impact Analysis

Phase II Project Trip Assignment (Int. 31-58)

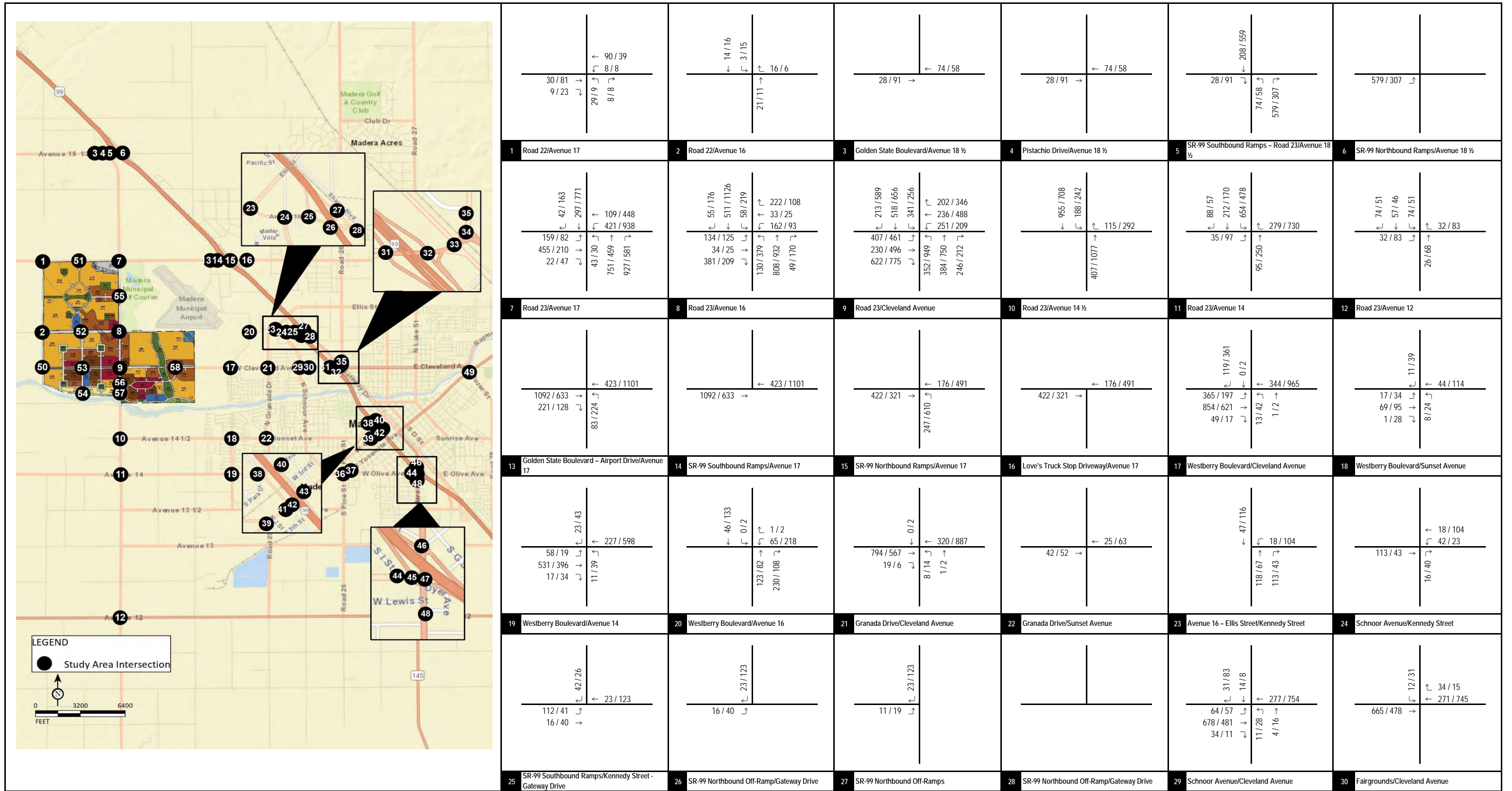

FIGURE 5-19A



XXXX / YYYY
 AM / PM Peak Hour Traffic Volumes
 -- Project Driveway

Village D Specific Plan
 Traffic Impact Analysis

Phase III Project Trip Assignment (Int. 1-30)

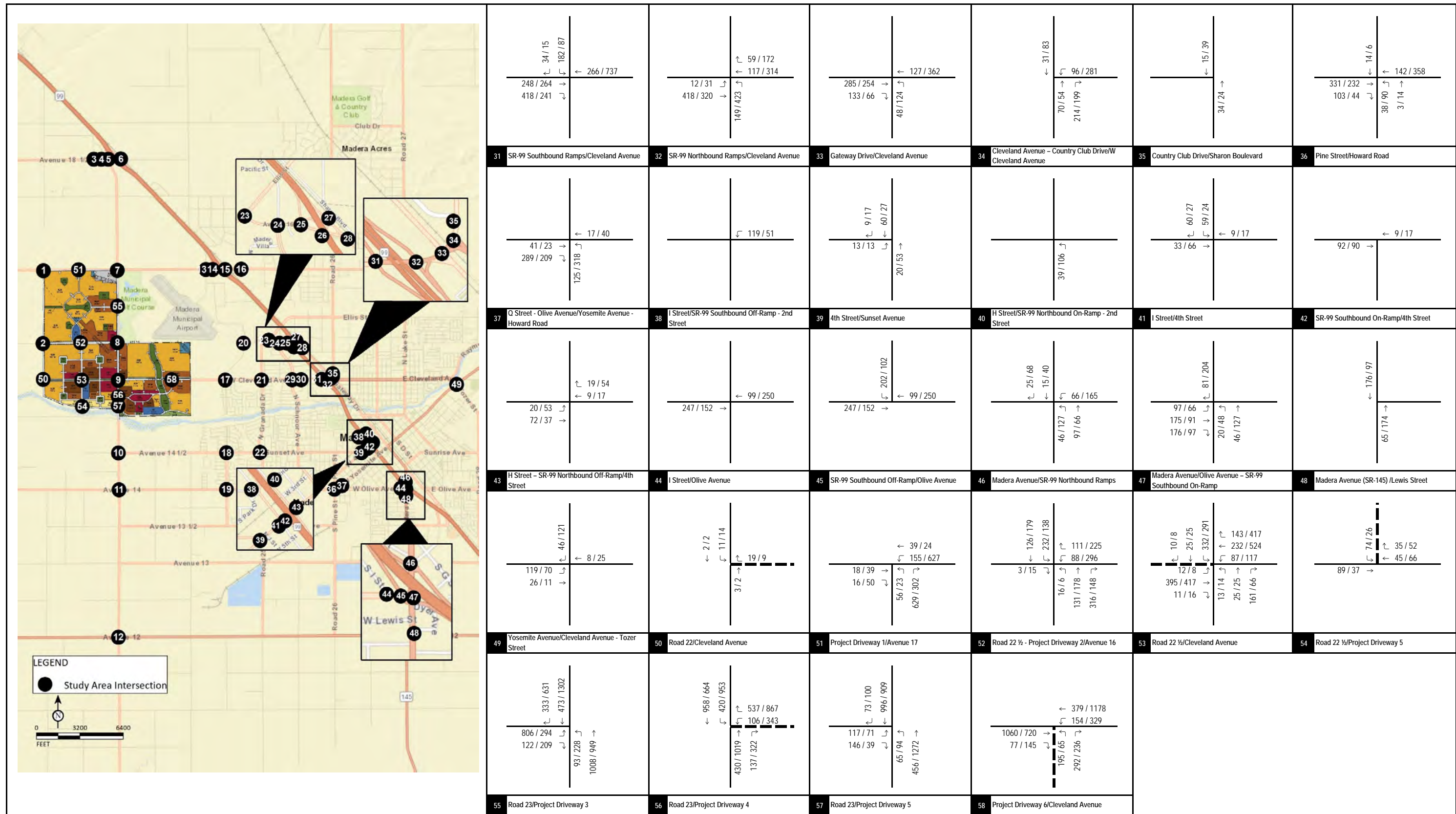

FIGURE 5-19B

LSA
 XXXX / YYYY
 AM / PM Peak Hour Traffic Volumes
 --- Project Driveway

Village D Specific Plan
 Traffic Impact Analysis

Phase III Project Trip Assignment (Int. 31-58)

Table 5-A - Project Trip Generation

Community Land Use	Units	A.M. Peak Hour			P.M. Peak Hour			Daily
		In	Out	Total	In	Out	Total	
PHASE I								
Southeast Quadrant								
TAZ615								
1	Single-Family Dwelling Units	864	DU					
	Trips/Unit ¹	0.19	0.56	0.74	0.62	0.37	0.99	9.44
	Trip Generation	160	480	640	539	316	855	8,156
2	Multi-Family Dwelling Units	1,247	DU					
	Trips/Unit ²	0.11	0.35	0.46	0.35	0.21	0.56	7.32
	Trip Generation	132	442	574	440	258	698	9,128
3	Elementary School	700	STU					
	Trips/Unit ³	0.36	0.31	0.67	0.08	0.09	0.17	1.89
	Trip Generation	253	216	469	57	62	119	1,323
	TAZ615							
	Gross Project Trips	545	1,138	1,683	1,036	636	1,672	18,607
	Internal Capture⁴	(169)	(169)	(337)	(321)	(321)	(643)	(5,797)
	Total External Trips	376	969	1,346	715	315	1,029	12,810
	Pass-by Trips	0	0	0	0	0	0	0
	Net Project Trips	376	969	1,346	715	315	1,029	12,810
TAZ616								
1	Single-Family Dwelling Units	1,393	DU					
	Trips/Unit ¹	0.19	0.56	0.74	0.62	0.37	0.99	9.44
	Trip Generation	258	773	1,031	869	510	1,379	13,150
2	Multi-Family Dwelling Units	471	DU					
	Trips/Unit ²	0.11	0.35	0.46	0.35	0.21	0.56	7.32
	Trip Generation	50	167	217	166	98	264	3,448
	TAZ616							
	Gross Project Trips	308	940	1,248	1,035	608	1,643	16,598
	Internal Capture⁴	(180)	(180)	(360)	(335)	(335)	(670)	(6,157)
	Total External Trips	128	760	888	700	273	973	10,441
	Pass-by Trips	0	0	0	0	0	0	0
	Net Project Trips	128	760	888	700	273	973	10,441

Table 5-A - Project Trip Generation

Community Land Use		Units	A.M. Peak Hour			P.M. Peak Hour			Daily
			In	Out	Total	In	Out	Total	
TAZ626									
1	Village Mixed Use	651.00 TSF							
	Trips/Unit ⁵		0.58	0.36	0.94	1.83	1.98	3.81	37.75
	Trip Generation		379	233	612	1,191	1,290	2,481	24,575
	TAZ626								
	Gross Project Trips		379	233	612	1,191	1,290	2,481	24,575
	Internal Capture ⁴		(228)	(228)	(457)	(766)	(766)	(1,531)	(12,455)
	Total External Trips		151	5	155	425	524	950	12,120
	Pass-by Trips ⁶		0	0	0	(145)	(178)	(323)	(4,121)
	Net Project Trips		151	5	155	280	346	627	7,999
Southeast Community									
	Gross Project Trips		1,232	2,311	3,543	3,262	2,534	5,796	59,780
	Internal Capture ⁴		(577)	(577)	(1,155)	(1,422)	(1,422)	(2,845)	(24,409)
	Total External Trips		655	1,734	2,388	1,840	1,112	2,951	35,371
	Pass-by Trips		0	0	0	(145)	(178)	(323)	(4,121)
	Net Project Trips		655	1,734	2,388	1,695	934	2,628	31,250
PHASE II									
Northwest Quadrant									
TAZ627									
1	Single-Family Dwelling Units	1,394 DU							
	Trips/Unit ¹		0.19	0.56	0.74	0.62	0.37	0.99	9.44
	Trip Generation		258	774	1,032	869	511	1,380	13,159
2	Multi-Family Dwelling Units	163 DU							
	Trips/Unit ²		0.11	0.35	0.46	0.35	0.21	0.56	7.32
	Trip Generation		17	58	75	58	34	92	1,193
	TAZ627								
	Gross Project Trips		275	832	1,107	927	545	1,472	14,352
	Internal Capture ⁴		(110)	(110)	(220)	(227)	(227)	(454)	(4,139)
	Total External Trips		165	722	887	700	318	1,018	10,213
	Pass-by Trips		0	0	0	0	0	0	0
	Net Project Trips		165	722	887	700	318	1,018	10,213

Table 5-A - Project Trip Generation

Community Land Use	Units	A.M. Peak Hour			P.M. Peak Hour			Daily
		In	Out	Total	In	Out	Total	
TAZ628								
1	Single-Family Dwelling Units	1,392	DU					
	Trips/Unit ¹	0.19	0.56	0.74	0.62	0.37	0.99	9.44
	Trip Generation	258	773	1,031	868	510	1,378	13,140
2	Multi-Family Dwelling Units	397	DU					
	Trips/Unit ²	0.11	0.35	0.46	0.35	0.21	0.56	7.32
	Trip Generation	42	141	183	140	82	222	2,906
3	Elementary School	700	STU					
	Trips/Unit ³	0.36	0.31	0.67	0.08	0.09	0.17	1.89
	Trip Generation	253	216	469	57	62	119	1,323
	TAZ628							
	Gross Project Trips	553	1,130	1,683	1,065	654	1,719	17,369
	Internal Capture ⁴	(155)	(155)	(309)	(309)	(309)	(618)	(5,778)
	Total External Trips	398	975	1,374	756	345	1,101	11,591
	Pass-by Trips	0	0	0	0	0	0	0
	Net Project Trips	398	975	1,374	756	345	1,101	11,591
TAZ629								
1	Village Business Park	232.61	TSF					
	Trips/Unit ⁷	0.24	0.16	0.40	0.19	0.23	0.42	12.44
	Trip Generation	57	36	93	45	53	98	2,894
2	Village Mixed Use	189.05	TSF					
	Trips/Unit ⁵	0.58	0.36	0.94	1.83	1.98	3.81	37.75
	Trip Generation	110	68	178	346	375	721	7,137
	TAZ629							
	Gross Project Trips	167	104	271	391	428	819	10,031
	Internal Capture ⁴	(103)	(103)	(205)	(305)	(305)	(609)	(5,058)
	Total External Trips	64	1	66	86	123	210	4,973
	Pass-by Trips ⁶	0	0	0	(26)	(37)	(63)	(1,203)
	Net Project Trips	64	1	66	60	86	147	3,770
Northwest Community								
	Gross Project Trips	995	2,066	3,061	2,383	1,627	4,010	41,752
	Internal Capture ⁴	(367)	(367)	(735)	(840)	(840)	(1,681)	(14,974)
	Total External Trips	628	1,699	2,326	1,543	787	2,329	26,778
	Pass-by Trips	0	0	0	(26)	(37)	(63)	(1,203)
	Net Project Trips	628	1,699	2,326	1,517	750	2,266	25,575

Table 5-A - Project Trip Generation

Community Land Use	Units	A.M. Peak Hour			P.M. Peak Hour			Daily
		In	Out	Total	In	Out	Total	
PHASE III								
Southwest Quadrant								
TAZ630								
1	Single-Family Dwelling Units	1,168	DU					
	Trips/Unit ¹	0.19	0.56	0.74	0.62	0.37	0.99	9.44
	Trip Generation	216	648	864	728	428	1,156	11,026
2	Multi-Family Dwelling Units	944	DU					
	Trips/Unit ²	0.11	0.35	0.46	0.35	0.21	0.56	7.32
	Trip Generation	100	334	434	333	196	529	6,910
	TAZ630							
	Gross Project Trips	316	982	1,298	1,061	624	1,685	17,936
	Internal Capture ⁴	(184)	(184)	(368)	(330)	(330)	(661)	(6,063)
	Total External Trips	132	798	930	731	294	1,024	11,873
	Pass-by Trips	0	0	0	0	0	0	0
	Net Project Trips	132	798	930	731	294	1,024	11,873
TAZ631								
1	Single-Family Dwelling Units	429	DU					
	Trips/Unit ¹	0.19	0.56	0.74	0.62	0.37	0.99	9.44
	Trip Generation	79	238	317	268	157	425	4,050
2	Multi-Family Dwelling Units	939	DU					
	Trips/Unit ²	0.11	0.35	0.46	0.35	0.21	0.56	7.32
	Trip Generation	99	333	432	331	195	526	6,873
3	Elementary School	700	STU					
	Trips/Unit ³	0.36	0.31	0.67	0.08	0.09	0.17	1.89
	Trip Generation	253	216	469	57	62	119	1,323
	TAZ631							
	Gross Project Trips	431	787	1,218	656	414	1,070	12,246
	Internal Capture ⁴	(150)	(150)	(301)	(245)	(245)	(491)	(4,621)
	Total External Trips	281	637	917	411	169	579	7,625
	Pass-by Trips	0	0	0	0	0	0	0
	Net Project Trips	281	637	917	411	169	579	7,625

Table 5-A - Project Trip Generation

Community Land Use	Units	A.M. Peak Hour			P.M. Peak Hour			Daily
		In	Out	Total	In	Out	Total	
TAZ632								
1 Village Mixed Use	995.56 TSF							
	Trips/Unit ⁵	0.58	0.36	0.94	1.83	1.98	3.81	37.75
	Trip Generation	580	356	936	1,821	1,972	3,793	37,583
TAZ632								
	Gross Project Trips	580	356	936	1,821	1,972	3,793	37,583
	Internal Capture⁴	(328)	(328)	(657)	(1,063)	(1,063)	(2,127)	(17,394)
	Total External Trips	252	28	279	758	909	1,666	20,189
	Pass-by Trips⁶	0	0	0	(258)	(309)	(567)	(6,864)
	Net Project Trips	252	28	279	500	600	1,099	13,325
Southwest Community								
	Gross Project Trips	1,327	2,125	3,452	3,538	3,010	6,548	67,765
	Internal Capture⁴	(663)	(663)	(1,326)	(1,639)	(1,639)	(3,278)	(28,078)
	Total External Trips	664	1,462	2,126	1,899	1,371	3,270	39,687
	Pass-by Trips	0	0	0	(258)	(309)	(567)	(6,864)
	Net Project Trips	664	1,462	2,126	1,641	1,062	2,703	32,823
Project Total Gross Trips		3,554	6,502	10,056	9,183	7,171	16,354	169,297
Project Total Internal Trips⁴		(1,608)	(1,608)	(3,215)	(3,902)	(3,902)	(7,804)	(67,462)
Project Total Net Project Trips		1,947	4,895	6,841	5,281	3,269	8,550	101,835
Project Total Pass-By Trips		0	0	0	(429)	(524)	(953)	(12,188)
Project Total External Trips		1,947	4,895	6,841	4,852	2,745	7,597	89,647

Notes:

DU = Dwelling Units; STU = Students; TSF = Thousand Square Feet

- 1 Rates based on Land Use 210 - "Single-Family Detached Housing" from the Institute of Transportation Engineers (ITE) *Trip Generation Manual* (10th Edition), Setting/Location - General Urban/Suburban.
- 2 Rates based on Land Use 220 - "Multifamily Housing (Low-Rise)" from the ITE *Trip Generation Manual* (10th Edition), Setting/Location - General Urban/Suburban.
- 3 Rates based on Land Use 520 - "Elementary School" from the ITE *Trip Generation Manual* (10th Edition), Setting/Location - General Urban/Suburban.
- 4 Internal capture calculated using select zone model runs for the project TAZs created in the MCTC TDF model. This takes into account the interaction between residential, commercial, office, and school uses within the Specific Plan.
- 5 Rates based on Land Use 820 - "Shopping Center" from the ITE *Trip Generation Manual* (10th Edition), Setting/Location - General Urban/Suburban.
- 6 Pass-by rates from the ITE *Trip Generation Handbook* (3rd Edition) for Land Use 820 - "Shopping Center." A pass-by rate of 34% was used for the p.m. peak hour. Since there is no data available for daily pass-by trips in the ITE Handbook, the p.m. peak hour rate was used as the daily rate.
- 7 Rates based on Land Use 770 - "Business Park" from the ITE *Trip Generation Manual* (10th Edition), Setting/Location - General Urban/Suburban.

6.0 TRAFFIC VOLUMES FOR “WITH PROJECT” SCENARIOS

Existing and Phases I, II, and III project completion years with project traffic volumes were developed by adding project traffic to the corresponding without project scenarios. Figures 6-1A and 6-1B illustrate “with project” peak hour traffic volumes at study intersections under existing plus full project buildout volumes. Figures 6-2A and 6-2B illustrates “with project” peak hour traffic volumes at study intersections under Phase I Project Completion Year (2029) plus Phase I project volumes. Figures 6-3A and 6-3B illustrates “with project” peak hour traffic volumes at study intersections under Phase II Project Completion Year (2039) plus Phases I and II project volumes. Figures 6-4A and 6-4B illustrate “with project” peak hour traffic volumes at study intersections under Phase III Project Completion Year (2049) plus full project buildout volumes.

Previously referenced Tables 4-A, 4-E, 4-G, and 4-C summarize the “with project” roadway segment daily traffic volumes under existing and Phases I, II, and III project completion year conditions, respectively.

Previously referenced Tables 4-B, 4-F, 4-H, and 4-D summarize the “with project” peak hour traffic volumes at study area freeway ramp merge/diverge areas and freeway segments under existing and Phases I, II, and III project completion year conditions, respectively.

Detailed volume development worksheets are included in Appendix C.

6.1 LIST OF CHAPTER 6.0 FIGURES

- Figure 6-1A: Existing with Project Peak Hour Traffic Volumes (Int. 1–30)
- Figure 6-1B: Existing with Project Peak Hour Traffic Volumes (Int. 31–58)
- Figure 6-2A: Phase I Project Completion Year (2029) with Project Peak Hour Traffic Volumes (Int. 1–30)
- Figure 6-2B: Phase I Project Completion Year (2029) with Project Peak Hour Traffic Volumes (Int. 31–58)
- Figure 6-3A: Phase II Project Completion Year (2039) with Project Peak Hour Traffic Volumes (Int. 1–30)
- Figure 6-3B: Phase II Project Completion Year (2039) with Project Peak Hour Traffic Volumes (Int. 31–58)
- Figure 6-4A: Phase III Project Completion Year (2049) with Project Peak Hour Traffic Volumes (Int. 1–30)
- Figure 6-4B: Phase III Project Completion Year (2049) with Project Peak Hour Traffic Volumes (Int. 31–58)

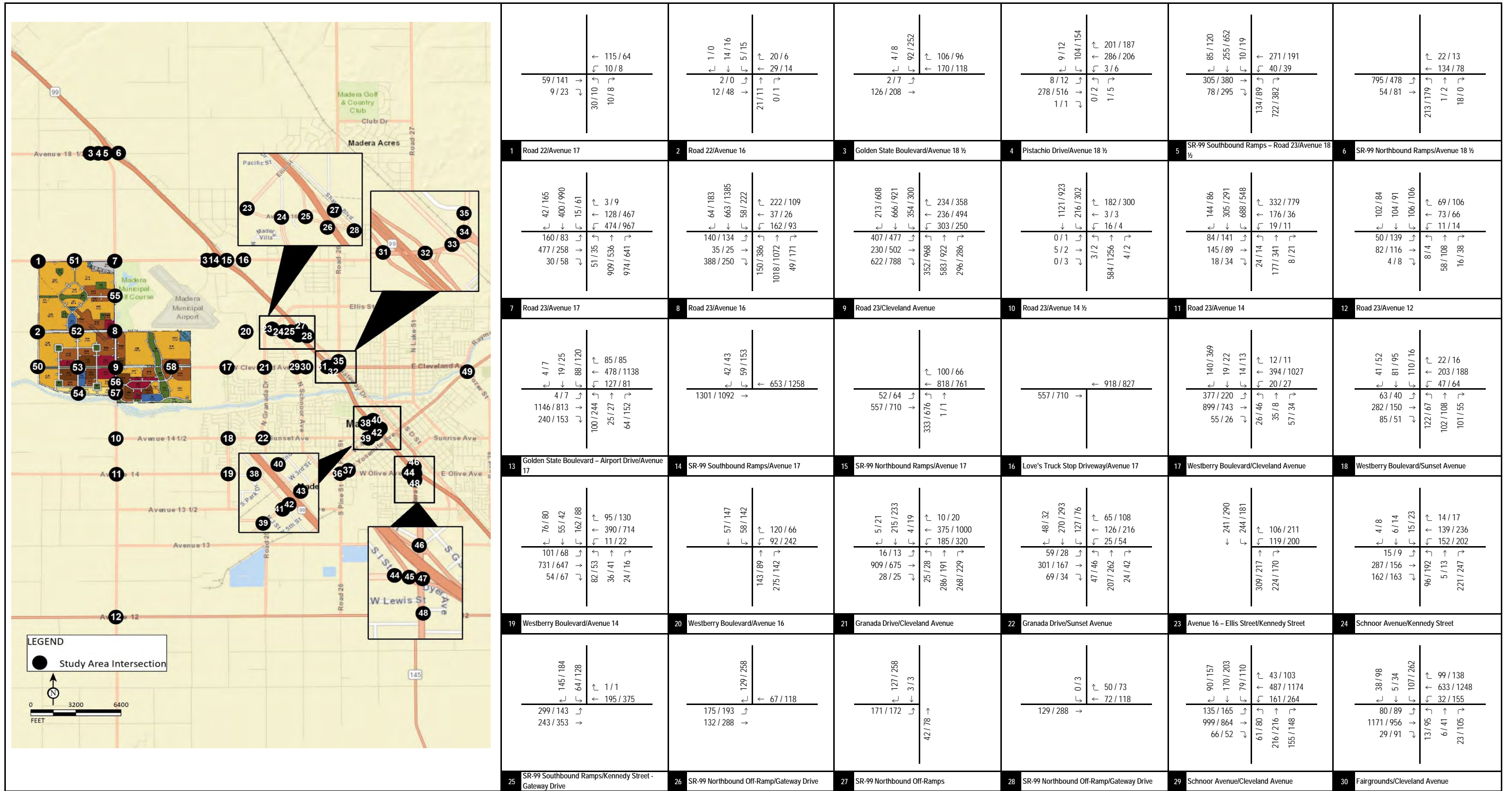

FIGURE 6-1A



XXXX / YYYY
 AM / PM Peak Hour Traffic Volumes

---- Project Driveway

Village D Specific Plan
 Traffic Impact Analysis

Existing with Project Peak Hour Traffic Volumes (Int. 1-30)

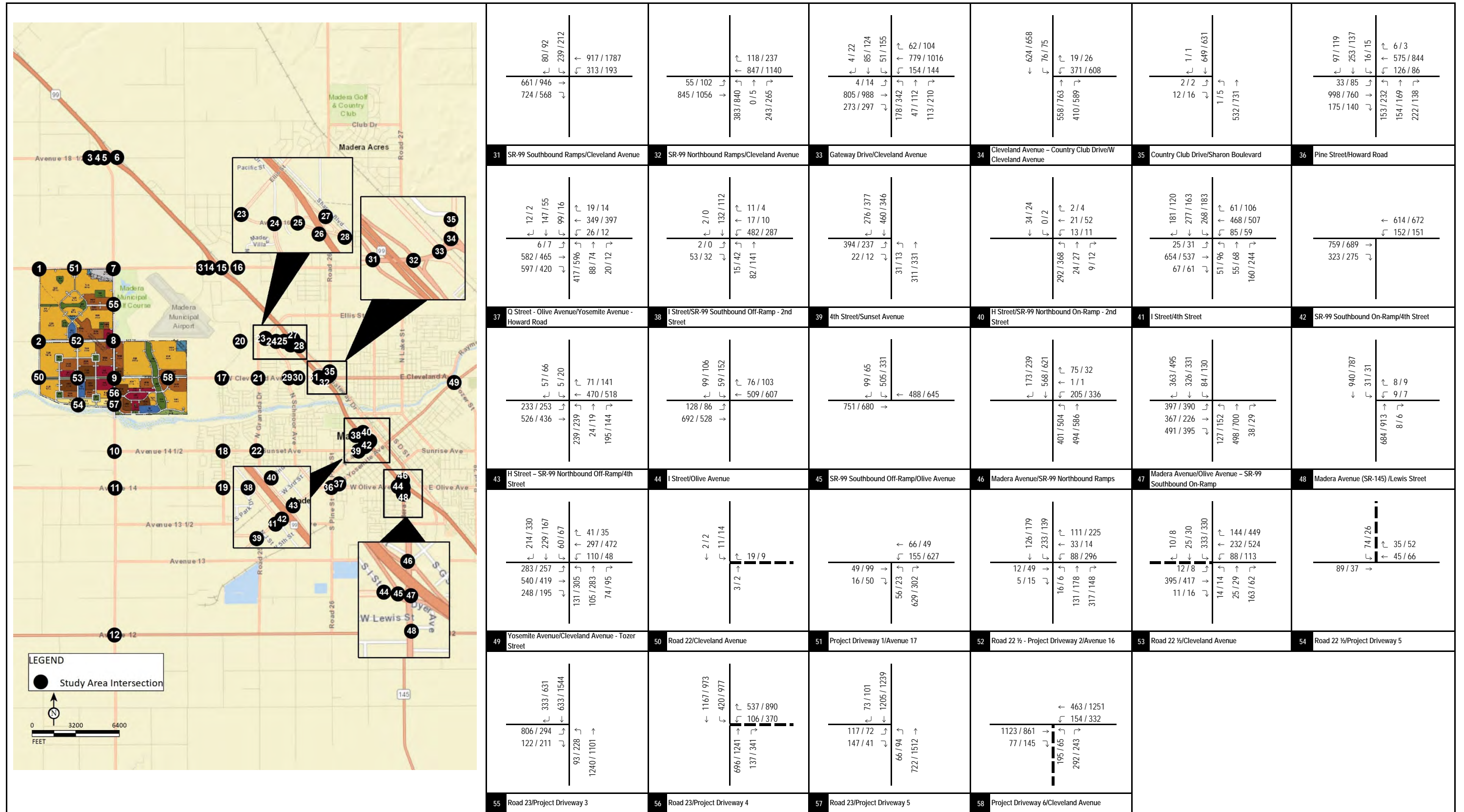

LSA

XXXX / YYYY
AM / PM Peak Hour Traffic Volumes

---- Project Driveway

FIGURE 6-1B

Village D Specific Plan
Traffic Impact Analysis

Existing with Project Peak Hour Traffic Volumes (Int. 31-58)

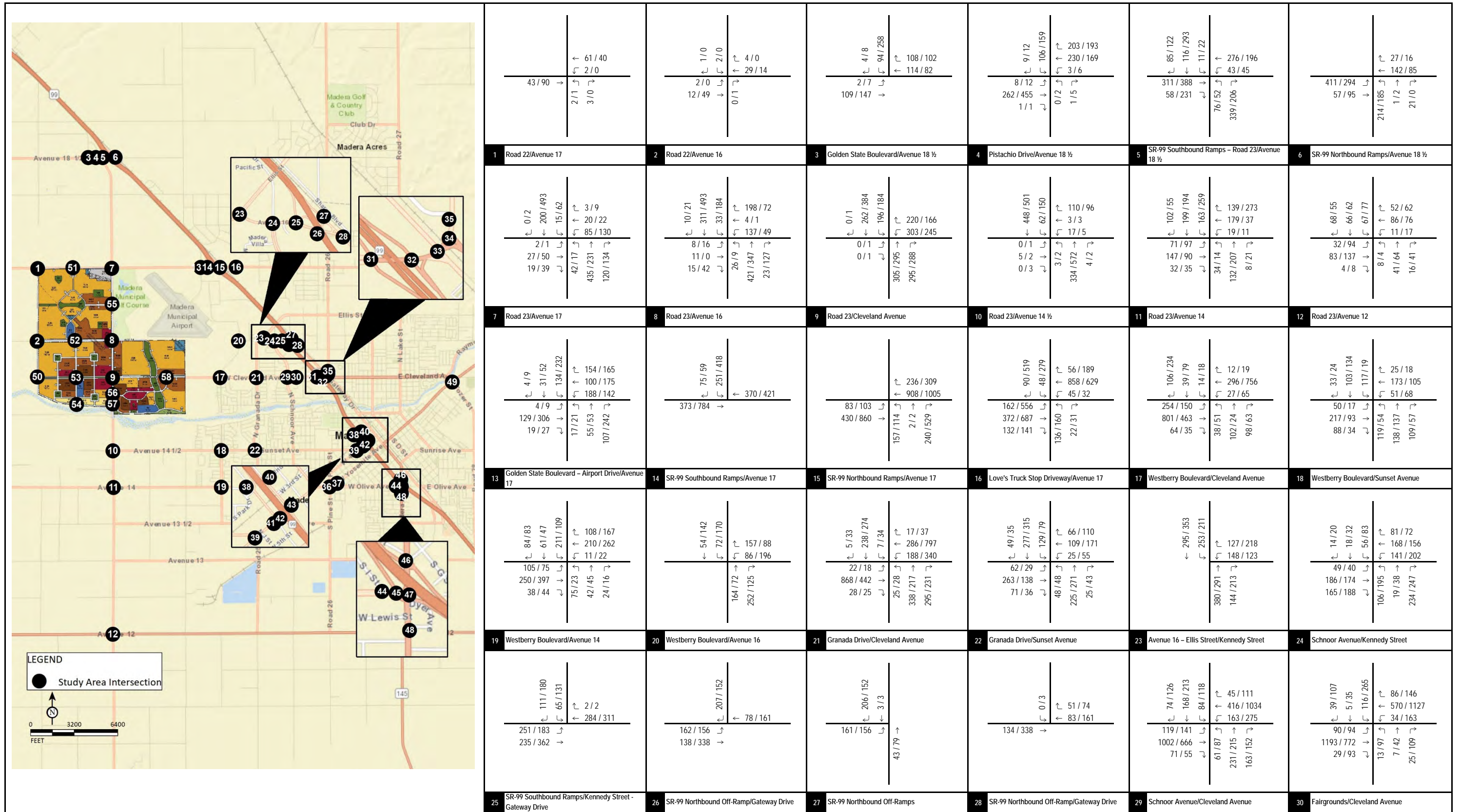

LSA

XXXX / YYYY
AM / PM Peak Hour Traffic Volumes

---- Project Driveway

FIGURE 6-2A

Village D Specific Plan
Traffic Impact Analysis

Phase I Project Completion Year (2029) with Project Peak Hour Traffic Volumes (Int. 1-30)

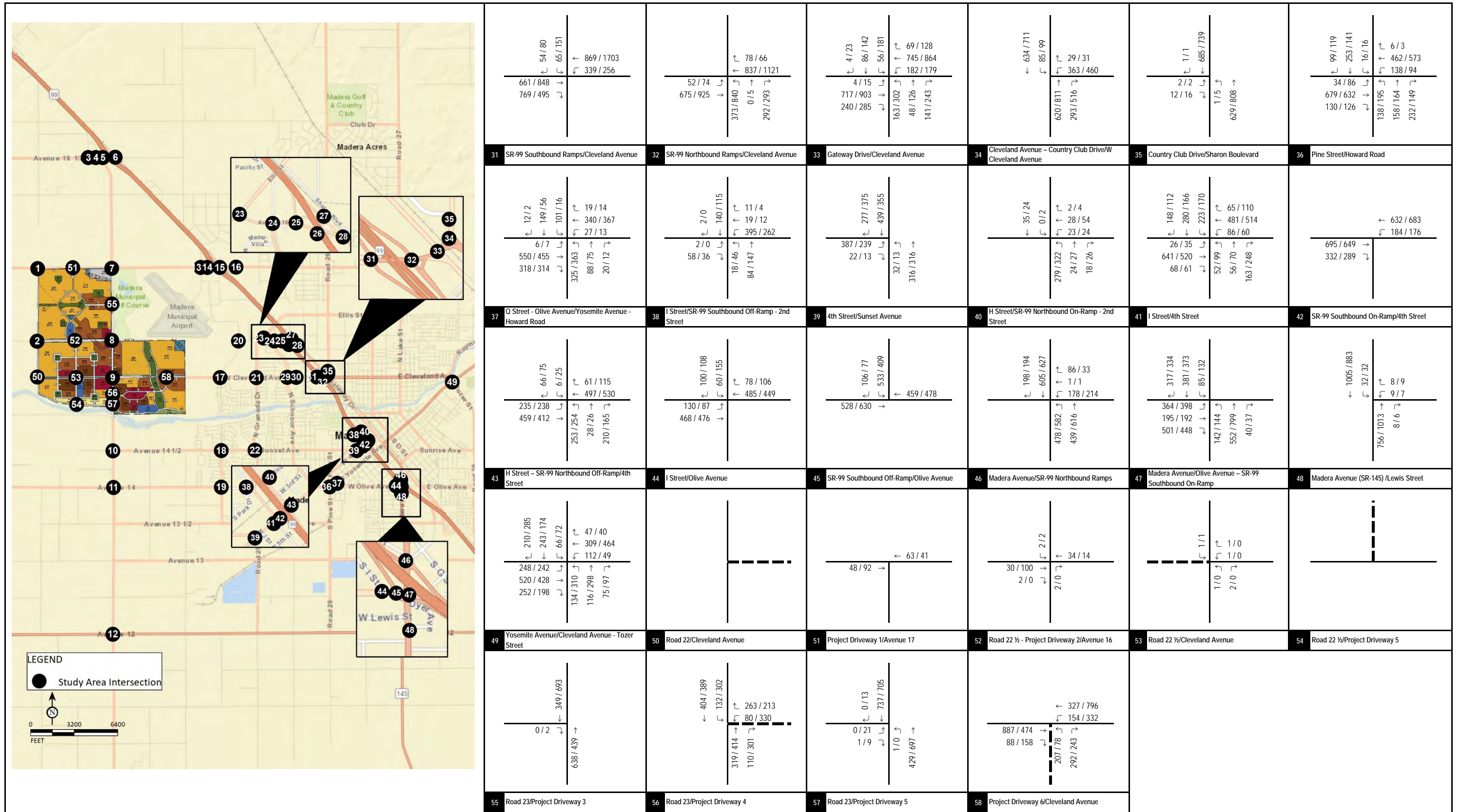

LSA

XXXX / YYYY
AM / PM Peak Hour Traffic Volumes

---- Project Driveway

FIGURE 6-2B

Village D Specific Plan
Traffic Impact Analysis

Phase I Project Completion Year (2029) with Project Peak Hour Traffic Volumes (Int. 31-58)

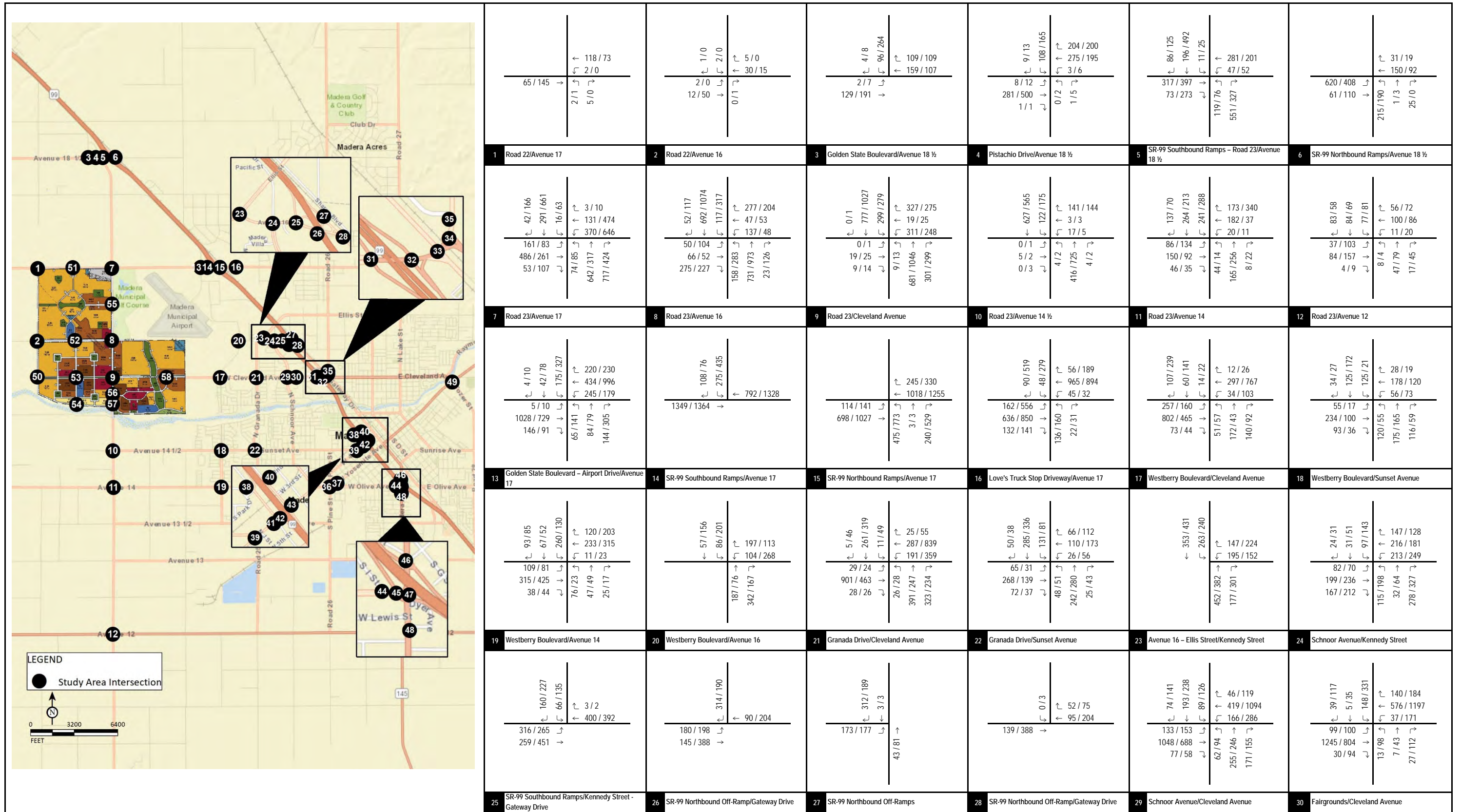

LSA

XXXX / YYYY ----- Project Driveway
AM / PM Peak Hour Traffic Volumes

FIGURE 6-3A
Village D Specific Plan
Traffic Impact Analysis

Phase II Project Completion Year (2039) with Project Peak Hour Traffic Volumes (Int. 1-30)

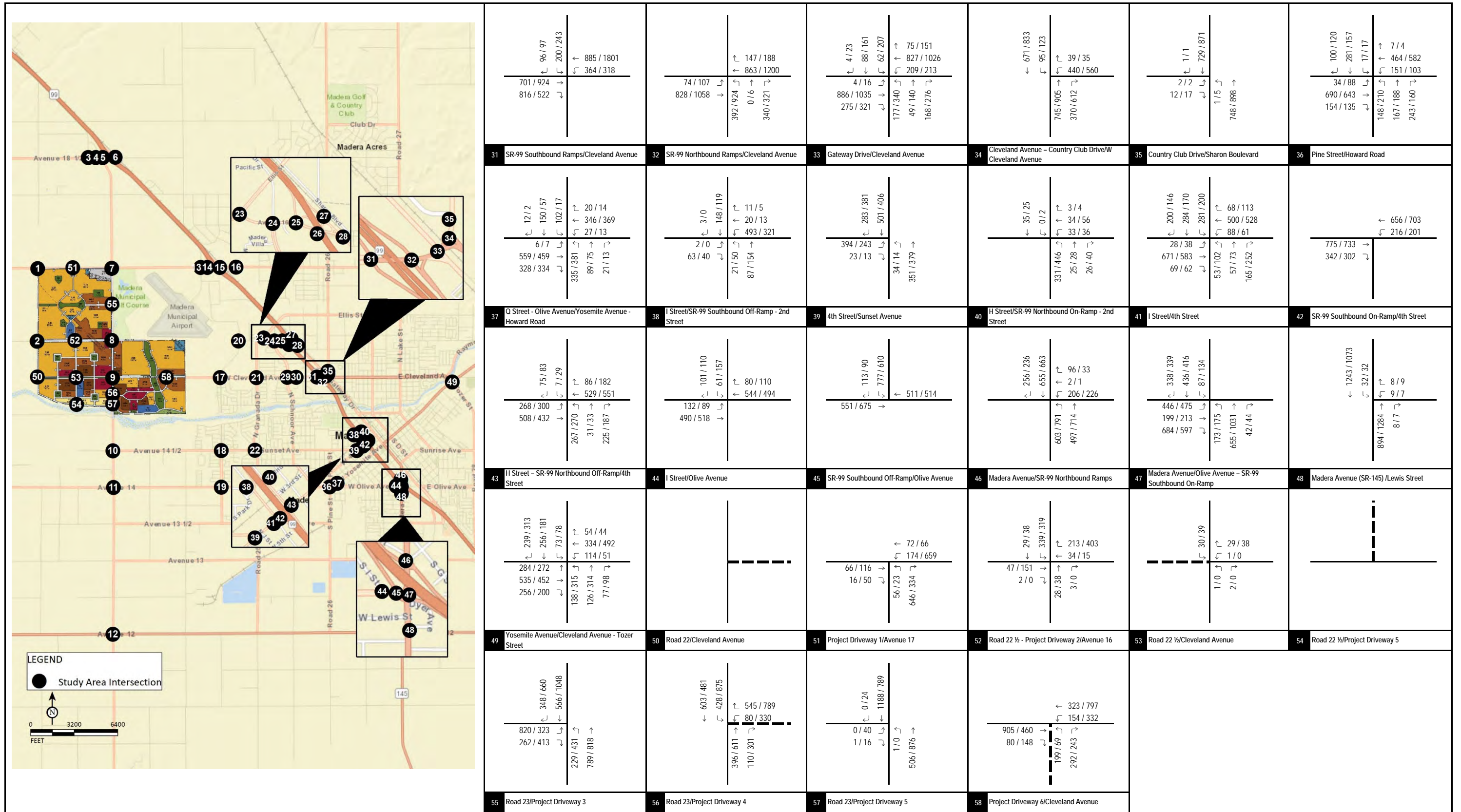

LEGEND
 Study Area Intersection

XXXX / YYYY
 ---- Project Driveway
 AM / PM Peak Hour Traffic Volumes

FIGURE 6-3B

Village D Specific Plan
 Traffic Impact Analysis

Phase II Project Completion Year (2039) with Project Peak Hour Traffic Volumes (Int. 31-58)

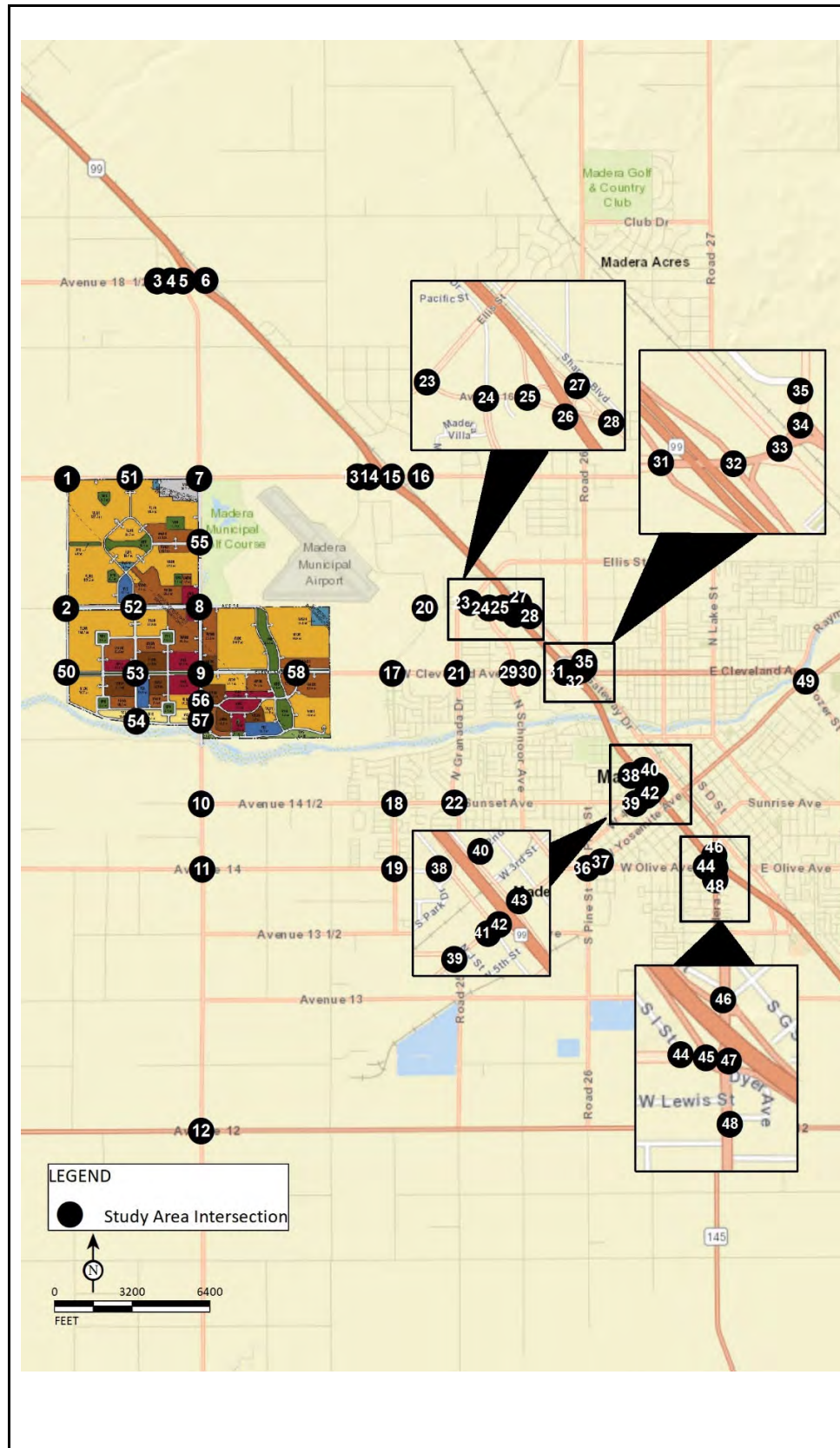

1	Road 22/Avenue 17	2	Road 22/Avenue 16	3	Golden State Boulevard/Avenue 18 ½	4	Pistachio Drive/Avenue 18 ½	5	SR-99 Southbound Ramps - Road 23/Avenue 18 ½	6	SR-99 Northbound Ramps/Avenue 18 ½
7	Road 23/Avenue 17	8	Road 23/Avenue 16	9	Road 23/Cleveland Avenue	10	Road 23/Avenue 14 ½	11	Road 23/Avenue 14	12	Road 23/Avenue 12
13	Golden State Boulevard - Airport Drive/Avenue 17	14	SR-99 Southbound Ramps/Avenue 17	15	SR-99 Northbound Ramps/Avenue 17	16	Love's Truck Stop Driveway/Avenue 17	17	Westberry Boulevard/Cleveland Avenue	18	Westberry Boulevard/Sunset Avenue
19	Westberry Boulevard/Avenue 14	20	Westberry Boulevard/Avenue 16	21	Granada Drive/Cleveland Avenue	22	Granada Drive/Sunset Avenue	23	Avenue 16 - Ellis Street/Kennedy Street	24	Schnoor Avenue/Kennedy Street
25	SR-99 Southbound Ramps/Kennedy Street - Gateway Drive	26	SR-99 Northbound Off-Ramp/Gateway Drive	27	SR-99 Northbound Off-Ramps	28	SR-99 Northbound Off-Ramp/Gateway Drive	29	Schnoor Avenue/Cleveland Avenue	30	Fairgrounds/Cleveland Avenue

LSA

XXXX / YYYY
AM / PM Peak Hour Traffic Volumes

---- Project Driveway

FIGURE 6-4A

Village D Specific Plan
Traffic Impact Analysis

Phase III Project Completion Year (2049) with Project [General Plan Build-out] Peak Hour Traffic Volumes (Int. 1-30)

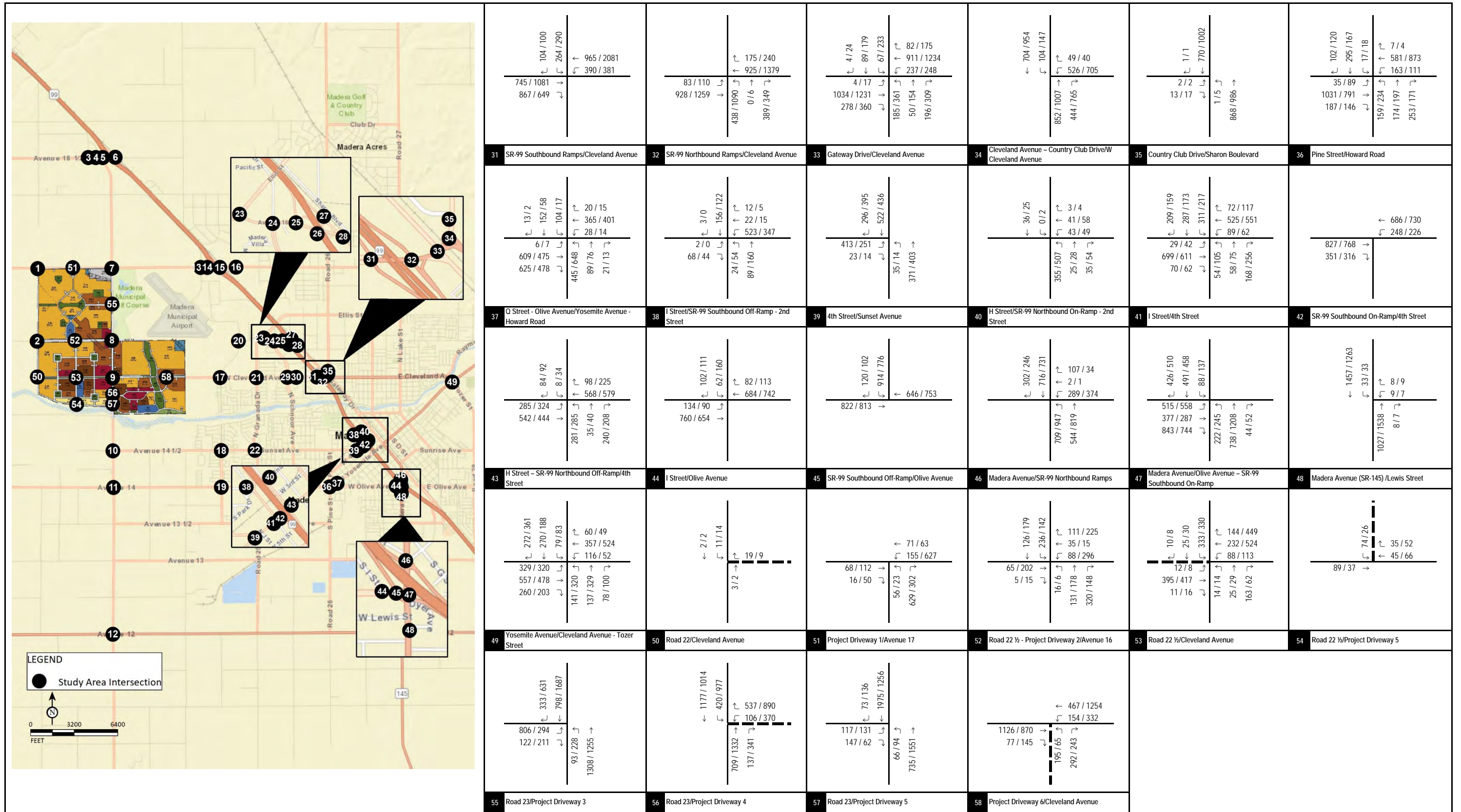

LSA

XXXX / YYYY
AM / PM Peak Hour Traffic Volumes

---- Project Driveway

FIGURE 6-4B

Village D Specific Plan
Traffic Impact Analysis

Phase III Project Completion Year (2049) with Project [General Plan Build-out] Peak Hour Traffic Volumes (Int. 31-58)

7.0 INTERSECTION AND ROADWAY SEGMENT LEVELS OF SERVICE

7.1 EXISTING LEVELS OF SERVICE

7.1.1 Study Intersections

Previously referenced Figure 3-1 illustrates existing study geometrics and traffic control. An intersection LOS analysis was conducted for existing conditions using the methodologies previously discussed. Table 7-A summarizes the results of the analysis and shows that the following intersections are currently operating at an unsatisfactory LOS:

- Intersection 5: SR-99 Southbound Ramps–Road 23/Avenue 18½ (both a.m. and p.m. peak hours);
- Intersection 6: SR-99 Northbound Ramps/Avenue 18½ (a.m. peak hour only);
- Intersection 15: SR-99 Northbound Ramps/Avenue 17 (a.m. peak hour only);
- Intersection 18: Westberry Boulevard/Sunset Avenue (a.m. peak hour only);
- Intersection 22: Granada Drive/Sunset Avenue (a.m. peak hour only);
- Intersection 25: SR-99 Southbound Ramps/Kennedy Street–Gateway Drive (p.m. peak hour only); and
- Intersection 49: Yosemite Avenue/Cleveland Avenue–Tozer Street (both a.m. and p.m. peak hours).

All other intersections currently operate at a satisfactory LOS.

Figure 7-1 illustrates intersection levels of service under existing conditions.

7.1.2 Roadway Segments

A roadway segment LOS analysis was conducted for existing conditions using the methodologies previously discussed. Table 7-B summarizes the results of this analysis and shows that all roadway segments are forecast to operate at a satisfactory LOS under existing conditions.

Figure 7-2 illustrates roadway segment levels of service under existing conditions.

7.1.3 Freeway Segments and Ramps

A freeway segment and ramp LOS analysis was conducted for existing conditions using the methodologies previously discussed. Table 7-C summarizes the results of this analysis and shows that the following freeway segments and ramps are currently operating at an unsatisfactory LOS:

- SR-99 Northbound:
 - Madera Avenue On-Ramp and 4th Street Off-Ramp (p.m. peak hour only);
 - 4th Street Off-Ramp (p.m. peak hour only);

- 2nd Street On-Ramp and Cleveland Avenue Off-Ramp (p.m. peak hour only); and
- Cleveland Avenue Off-Ramp (p.m. peak hour only).
- SR-99 Southbound
 - Avenue 18½ Off-Ramp (p.m. peak hour only);
 - Avenue 17 Off-Ramp (p.m. peak hour only);
 - Avenue 17 Slip-On Ramp and Gateway Drive Off-Ramp (p.m. peak hour only);
 - Gateway Drive Off-Ramp (p.m. peak hour only);
 - Cleveland Avenue Off-Ramp (p.m. peak hour only);
 - Cleveland Avenue On-Ramp (p.m. peak hour only);
 - Cleveland Avenue On-Ramp and 2nd Street Off-Ramp (both a.m. and p.m. peak hours);
 - 2nd Street Off-Ramp (both a.m. and p.m. peak hours);
 - 4th Street On-Ramp (p.m. peak hour only);
 - 4th Street On-Ramp and Olive Avenue Off-Ramp (both a.m. and p.m. peak hours);
 - Olive Avenue Off-Ramp (both a.m. and p.m. peak hours);
 - Olive Avenue Off-Ramp and Madera Avenue On-Ramp (p.m. peak hour only);
 - Madera Avenue On-Ramp (p.m. peak hour only); and
 - South of Madera Avenue On-Ramp (p.m. peak hour only).

All other freeway segments currently operate at a satisfactory LOS.

7.2 EXISTING WITH PROJECT LEVELS OF SERVICE

Analysis of the existing with project scenario is provided for CEQA compliance to identify direct project impacts if the project were to be built and in operation today. This scenario eliminates the effects of ambient growth and other cumulative projects and deals specifically with project impacts.

7.2.1 Study Intersections

An intersection LOS analysis was conducted for existing with project conditions using the methodologies previously discussed. Table 7-A summarizes the results of the analysis and shows that the following intersections are forecast to operate at an unsatisfactory LOS under existing with project conditions:

- Intersection 4: Pistachio Drive/Avenue 18½ (p.m. peak hour only);
- Intersection 5: SR-99 Southbound Ramps–Ramp 23/Avenue 18½ (both a.m. and p.m. peak hours);
- Intersection 6: SR-99 Northbound Ramps/Avenue 18½ (both a.m. and p.m. peak hours);
- Intersection 8: Road 23/Avenue 16 (both a.m. and p.m. peak hours);

- Intersection 9: Road 23/Cleveland Avenue (both a.m. and p.m. peak hours);
- Intersection 11: Road 23/Avenue 14 (both a.m. and p.m. peak hours);
- Intersection 13: Golden State Boulevard-Airport Drive/Avenue 17 (both a.m. and p.m. peak hours);
- Intersection 14: SR-99 Southbound Ramps/Avenue 17 (both a.m. and p.m. peak hours);
- Intersection 15: SR-99 Northbound Ramps/Avenue 17 (both a.m. and p.m. peak hours);
- Intersection 17: Westberry Boulevard/Cleveland Avenue (both a.m. and p.m. peak hours);
- Intersection 18: Westberry Boulevard/Sunset Avenue (a.m. peak hour only);
- Intersection 19: Westberry Boulevard/Avenue 14 (both a.m. and p.m. peak hours);
- Intersection 21: Granada Drive/Cleveland Avenue (both a.m. and p.m. peak hours);
- Intersection 22: Granada Drive/Sunset Avenue (a.m. peak hour only);
- Intersection 25: SR-99 Southbound Ramps/Kennedy Street–Gateway Drive (both a.m. and p.m. peak hours);
- Intersection 31: SR-99 Southbound Ramps/Cleveland Avenue (a.m. peak hour only);
- Intersection 36: Pine Street/Howard Road (a.m. peak hour);
- Intersection 38: I Street/SR-99 Southbound Off-Ramp-2nd Street (a.m. peak hour only);
- Intersection 49: Yosemite Avenue/Cleveland Avenue–Tozer Street (both a.m. and p.m. peak hours);
- Intersection 51: Project Driveway 1/Avenue 17 (p.m. peak hour only);
- Intersection 52: Road 22½–Project Driveway 2/Avenue 16 (both a.m. and p.m. peak hours);
- Intersection 53: Road 22½/Cleveland Avenue (both a.m. and p.m. peak hours);
- Intersection 55: Road 23/Project Driveway 3 (both a.m. and p.m. peak hours);
- Intersection 56: Road 23/Project Driveway 4 (both a.m. and p.m. peak hours);
- Intersection 57: Road 23/Project Driveway 5 (both a.m. and p.m. peak hours); and
- Intersection 58: Project Driveway 6/Cleveland Avenue (both a.m. and p.m. peak hours).

Seven of these intersections operate at an unsatisfactory LOS even under existing conditions; therefore, the project contributes to the existing deficiency at these intersections. As such, the project has a significant impact at these intersections. The project has a direct significant impact at the other intersections that are forecast to operate at an unsatisfactory LOS under existing with project conditions. All other intersections are forecast to operate at a satisfactory LOS.

Figure 7-1 illustrates intersection levels of service under existing with project conditions.

7.2.2 Roadway Segments

A roadway segment LOS analysis was conducted for existing with project conditions using the methodologies previously discussed. Table 7-B summarizes the results of this analysis and shows that the following roadway segments are forecast to operate at an unsatisfactory LOS under existing with project conditions:

- Road 23 between Avenue 17 and Project Driveway 3;
- Road 23 between Project Driveway 3 and Avenue 16;
- Road 23 between Avenue 16 and Cleveland Avenue;
- Road 23 between Cleveland Avenue and Project Driveway 4;
- Road 23 between Project Driveway 4 and Project Driveway 5;
- Road 23 between Project Driveway 5 and Avenue 14½;
- Road 23 between Avenue 14½ and Avenue 14;
- Avenue 17 between Road 23 and Golden State Boulevard;
- Avenue 17 between Golden State Boulevard and State Route 99 Southbound Off-Ramp;
- Cleveland Avenue between Road 22½ and Road 23;
- Cleveland Avenue between Road 23 and Project Driveway 6;
- Cleveland Avenue between Project Driveway 6 and Westberry Boulevard; and
- Cleveland Avenue between Westberry Boulevard and Granada Drive.

None of these roadway segments operates at a deficient LOS under existing conditions. Therefore, the project has a direct significant impact at these segments. All other roadway segments are forecast to operate at a satisfactory LOS.

Figure 7-3 illustrates roadway segment levels of service under existing with project conditions.

7.2.3 Freeway Segments and Ramps

A freeway segment and ramp LOS analysis was conducted for existing with project conditions using the methodologies previously discussed. Table 7-C summarizes the results of this analysis and shows that the following freeway segments and ramps are forecast to operate at an unsatisfactory LOS under existing with project conditions:

- SR-99 Northbound:
 - South of Madera Avenue Off-Ramp (p.m. peak hour only);
 - Madera Avenue Off-Ramp and Madera Avenue On-Ramp (p.m. peak hour only);
 - Madera Avenue On-Ramp (p.m. peak hour only);
 - Madera Avenue On-Ramp and 4th Street Off-Ramp (p.m. peak hour only);

- 4th Street Off-Ramp (both a.m. and p.m. peak hours);
- 4th Street Off-Ramp and 2nd Street On-Ramp (p.m. peak hour only);
- 2nd Street On-Ramp (p.m. peak hour only);
- 2nd Street On-Ramp and Cleveland Avenue Off-Ramp (p.m. peak hour only);
- Cleveland Avenue Off-Ramp (both a.m. and p.m. peak hours);
- Cleveland Avenue On-Ramp (p.m. peak hour only);
- Cleveland Avenue On-Ramp and Gateway Drive Loop Off-Ramp (p.m. peak hour only);
- Gateway Drive Loop Off-Ramp (p.m. peak hour only);
- Gateway Drive On-Ramp and Avenue 17 Off-Ramp (p.m. peak hour only); and
- Avenue 17 Off-Ramp (p.m. peak hour only).
- SR-99 Southbound:
 - North of Avenue 18½ Off-Ramp (p.m. peak hour only);
 - Avenue 18½ Off-Ramp (p.m. peak hour only);
 - Avenue 17 Off-Ramp (p.m. peak hour only);
 - Avenue 17 Slip-On Ramp (p.m. peak hour only);
 - Avenue 17 Slip-On Ramp and Gateway Drive Off-Ramp (both a.m. and p.m. peak hours);
 - Gateway Drive Off-Ramp (both a.m. and p.m. peak hours);
 - Gateway Drive Off-Ramp and Gateway Drive Loop On-Ramp (p.m. peak hour only);
 - Gateway Drive Loop On-Ramp and Cleveland Avenue Off-Ramp (both a.m. and p.m. peak hours);
 - Cleveland Avenue Off-Ramp (both a.m. and p.m. peak hours);
 - Cleveland Avenue On-Ramp (both a.m. and p.m. peak hours);
 - Cleveland Avenue On-Ramp and 2nd Street Off-Ramp (both a.m. and p.m. peak hours);
 - 2nd Street Off-Ramp (both a.m. and p.m. peak hours);
 - 2nd Street Off-Ramp and 4th Street On-Ramp (both a.m. and p.m. peak hours);
 - 4th Street On-Ramp (both a.m. and p.m. peak hours);
 - 4th Street On-Ramp and Olive Avenue Off-Ramp (both a.m. and p.m. peak hours);
 - Olive Avenue Off-Ramp (both a.m. and p.m. peak hours);
 - Olive Avenue Off-Ramp and Madera Avenue On-Ramp (both a.m. and p.m. peak hours);
 - Madera Avenue On-Ramp (both a.m. and p.m. peak hours); and
 - South of Madera Avenue On-Ramp (both a.m. and p.m. peak hours).

All other freeway segments are forecast to operate at a satisfactory LOS under existing with project conditions.

7.3 PHASE I PROJECT COMPLETION YEAR (2029) WITHOUT PROJECT LEVELS OF SERVICE

7.3.1 Study Intersections

An intersection LOS analysis was conducted for Phase I project completion year without project conditions using the methodologies previously discussed. Table 7-D summarizes the results of the analysis and shows that the following intersections are forecast to operate at an unsatisfactory LOS under Phase I project completion year without project conditions:

- Intersection 5: SR-99 Southbound Ramps–Road 23/Avenue 18½ (both a.m. and p.m. peak hours);
- Intersection 6: SR-99 Northbound Ramps/Avenue 18½ (a.m. peak hour only);
- Intersection 13: Golden State Boulevard–Airport Drive/Avenue 17 (both a.m. and p.m. peak hours);
- Intersection 14: SR-99 Southbound Ramps/Avenue 17 (both a.m. and p.m. peak hours);
- Intersection 15: SR-99 Northbound Ramps/Avenue 17 (both a.m. and p.m. peak hours);
- Intersection 16: Love’s Truck Stop Driveway/Avenue 17 (both a.m. and p.m. peak hours);
- Intersection 22: Granada Drive/Sunset Avenue (both a.m. and p.m. peak hours);
- Intersection 25: SR-99 Southbound Ramps/Kennedy Street–Gateway Drive (both a.m. and p.m. peak hours); and
- Intersection 49: Yosemite Avenue/Cleveland Avenue–Tozer Street (both a.m. and p.m. peak hours).

All other intersections are forecast to operate at a satisfactory LOS.

Figure 7-4 illustrates intersection levels of service under Phase I project completion year without project conditions.

7.3.2 Roadway Segments

A roadway segment LOS analysis was conducted for Phase I project completion year without project conditions using the methodologies previously discussed. Table 7-E summarizes the results of this analysis and shows that the following roadway segments are forecast to operate at an unsatisfactory LOS under Phase I project completion year without project conditions:

- Granada Drive between Cleveland Avenue and Fresno River.

All other roadway segments are forecast to operate at a satisfactory LOS.

Figure 7-5 illustrates roadway segment levels of service under Phase I project completion year without project conditions.

7.3.3 Freeway Segments and Ramps

A freeway segment and ramp LOS analysis was conducted for Phase I project completion year without project conditions using the methodologies previously discussed. Table 7-F summarizes the results of this analysis and shows that the following freeway segments and ramps are forecast to operate at an unsatisfactory LOS under Phase I project completion year without project conditions:

- SR-99 Southbound:
 - Avenue 18½ Off-Ramp (p.m. peak hour only).

All other freeway segments are forecast to operate at a satisfactory LOS under Phase I project completion year without project conditions.

7.4 PHASE I PROJECT COMPLETION YEAR (2029) WITH PROJECT LEVELS OF SERVICE

7.4.1 Study Intersections

An intersection LOS analysis was conducted for Phase I project completion year with project conditions using the methodologies previously discussed. Table 7-D summarizes the results of the analysis and shows that the following intersections are forecast to operate at an unsatisfactory LOS under Phase I project completion year with project conditions:

- Intersection 4: Pistachio Drive/Avenue 18½ (p.m. peak hour only);
- Intersection 5: SR-99 Southbound Ramps–Ramp 23/Avenue 18½ (both a.m. and p.m. peak hours);
- Intersection 6: SR-99 Northbound Ramps/Avenue 18½ (both a.m. and p.m. peak hours);
- Intersection 7: Road 23/Avenue 17 (both a.m. and p.m. peak hours);
- Intersection 9: Road 23/Cleveland Avenue (both a.m. and p.m. peak hours);
- Intersection 11: Road 23/Avenue 14 (both a.m. and p.m. peak hours);
- Intersection 13: Golden State Boulevard–Airport Drive/Avenue 17 (both a.m. and p.m. peak hours);
- Intersection 14: SR-99 Southbound Ramps/Avenue 17 (both a.m. and p.m. peak hours);
- Intersection 15: SR-99 Northbound Ramps/Avenue 17 (both a.m. and p.m. peak hours);
- Intersection 16: Love’s Truck Stop Driveway/Avenue 17 (both a.m. and p.m. peak hours);
- Intersection 17: Westberry Boulevard/Cleveland Avenue (both a.m. and p.m. peak hours);
- Intersection 19: Westberry Boulevard/Avenue 14 (p.m. peak hour only);
- Intersection 21: Granada Drive/Cleveland Avenue (both a.m. and p.m. peak hours);
- Intersection 22: Granada Drive/Sunset Avenue (both a.m. and p.m. peak hours);

- Intersection 25: SR-99 Southbound Ramps/Kennedy Street–Gateway Drive (both a.m. and p.m. peak hours);
- Intersection 31: SR-99 Southbound Ramps/Cleveland Avenue (a.m. peak hour only);
- Intersection 49: Yosemite Avenue/Cleveland Avenue–Tozer Street (both a.m. and p.m. peak hours);
- Intersection 56: Road 23/Project Driveway 4 (both a.m. and p.m. peak hours); and
- Intersection 58: Project Driveway 6/Cleveland Avenue (both a.m. and p.m. peak hours).

Nine of these intersections are forecast to operate at an unsatisfactory LOS even under Phase I project completion year without project conditions. Therefore, the project contributes to the forecast deficiency at these intersections. As such, the project has a cumulative impact at all the intersections forecast to operate at a deficient LOS. All other intersections are forecast to operate at a satisfactory LOS.

Figure 7-4 illustrates intersection levels of service under Phase I project completion year with project conditions.

7.4.2 Roadway Segments

A roadway segment LOS analysis was conducted for Phase I project completion year with project conditions using the methodologies previously discussed. Table 7-E summarizes the results of this analysis and shows that the following roadway segments are forecast to operate at an unsatisfactory LOS under Phase I project completion year with project conditions:

- Granada Drive between Cleveland Avenue and Fresno River;
- Avenue 17 between Golden State Boulevard and SR-99 Southbound Off-Ramp;
- Cleveland Avenue between Project Driveway 6 and Westberry Boulevard; and
- Cleveland Avenue between Westberry Boulevard and Granada Drive.

Only the segment of Granada Drive between Cleveland Avenue and Fresno River is forecast to operate at a deficient LOS under Phase I project completion year without project conditions. Thus, the project contributes to the forecast deficiency at this segment. As such, the project has a cumulative impact at all of the segments operating at a deficient LOS. All other roadway segments are forecast to operate at a satisfactory LOS.

Roadway segment levels of service under Phase I project completion year with project conditions are illustrated in Figure 7-6.

7.4.3 Freeway Segments and Ramps

A freeway segment and ramp LOS analysis was conducted for Phase I project completion year with project conditions using the methodologies previously discussed. Table 7-F summarizes the results of this analysis and shows that the following freeway segments and ramps are forecast to operate at an unsatisfactory LOS under Phase I project completion year with project conditions:

- SR-99 Southbound:
 - Avenue 18½ Off-Ramp (p.m. peak hour only).

All other freeway segments are forecast to operate at a satisfactory LOS under Phase I project completion year with project conditions.

7.5 PHASE II PROJECT COMPLETION YEAR (2039) WITHOUT PROJECT LEVELS OF SERVICE

7.5.1 Study Intersections

An intersection LOS analysis was conducted for Phase II project completion year without project conditions using the methodologies previously discussed. Table 7-G summarizes the results of the analysis and shows that the following intersections are forecast to operate at an unsatisfactory LOS under Phase II project completion year without project conditions:

- Intersection 4: Pistachio Drive/Avenue 18½ (p.m. peak hour only);
- Intersection 5: SR-99 Southbound Ramps–Road 23/Avenue 18½ (both a.m. and p.m. peak hours);
- Intersection 6: SR-99 Northbound Ramps/Avenue 18½ (both a.m. and p.m. peak hours);
- Intersection 13: Golden State Boulevard–Airport Drive/Avenue 17 (both a.m. and p.m. peak hours);
- Intersection 14: SR-99 Southbound Ramps/Avenue 17 (both a.m. and p.m. peak hours);
- Intersection 15: SR-99 Northbound Ramps/Avenue 17 (both a.m. and p.m. peak hours);
- Intersection 16: Love’s Truck Stop Driveway/Avenue 17 (both a.m. and p.m. peak hours);
- Intersection 21: Granada Drive/Cleveland Avenue (p.m. peak hour);
- Intersection 22: Granada Drive/Sunset Avenue (both a.m. and p.m. peak hours);
- Intersection 25: SR-99 Southbound Ramps/Kennedy Street–Gateway Drive (both a.m. and p.m. peak hours);
- Intersection 43: H Street–SR-99 Northbound Off-Ramp/4th Street (p.m. peak hour only); and
- Intersection 49: Yosemite Avenue/Cleveland Avenue–Tozer Street (both a.m. and p.m. peak hours).

All other intersections are forecast to operate at a satisfactory LOS.

Figure 7-7 illustrates intersection levels of service under Phase II project completion year without project conditions.

7.5.2 Roadway Segments

A roadway segment LOS analysis was conducted for Phase II project completion year without project conditions using the methodologies previously discussed. Table 7-H summarizes the results of this

analysis and shows that the following roadway segments are forecast to operate at an unsatisfactory LOS under Phase II project completion year without project conditions:

- Granada Drive between Cleveland Avenue and Fresno River; and
- Avenue 17 between Golden State Boulevard and SR-99 Southbound Off-Ramp.

All other roadway segments are forecast to operate at a satisfactory LOS.

Roadway segment levels of service under Phase II project completion year without project conditions are illustrated in Figure 7-8.

7.5.3 Freeway Segments and Ramps

A freeway segment and ramp LOS analysis was conducted for Phase II project completion year without project conditions using the methodologies previously discussed. Table 7-I summarizes the results of this analysis and shows that the following roadway segments and ramps are forecast to operate at an unsatisfactory LOS under Phase II project completion year without project conditions:

- SR-99 Northbound:
 - Avenue 18½ Off-Ramp (p.m. peak hour only).
- SR-99 Southbound:
 - North of Avenue 18½ Off-Ramp (p.m. peak hour only);
 - Avenue 18½ Off-Ramp (p.m. peak hour only);
 - Avenue 18½ Slip-On Ramp (p.m. peak hour only); and
 - Avenue 18½ Slip-On Ramp and Avenue 17 Off-Ramp (p.m. peak hour only).

All other freeway segments are forecast to operate at a satisfactory LOS under Phase II project completion year without project conditions.

7.6 PHASE II PROJECT COMPLETION YEAR (2039) WITH PROJECT LEVELS OF SERVICE

7.6.1 Study Intersections

An intersection LOS analysis was conducted for Phase II project completion year with project conditions using the methodologies previously discussed. Table 7-G summarizes the results of the analysis and shows that the following intersections are forecast to operate at an unsatisfactory LOS under Phase II project completion year with project conditions:

- Intersection 4: Pistachio Drive/Avenue 18½ (p.m. peak hour only);
- Intersection 5: SR-99 Southbound Ramps–Ramp 23/Avenue 18½ (both a.m. and p.m. peak hours);
- Intersection 6: SR-99 Northbound Ramps/Avenue 18½ (both a.m. and p.m. peak hours);
- Intersection 7: Road 23/Avenue 17 (both a.m. and p.m. peak hours);

- Intersection 8: Road 23/Avenue 16 (both a.m. and p.m. peak hours);
- Intersection 9: Road 23/Cleveland Avenue (both a.m. and p.m. peak hours);
- Intersection 10: Road 23/Avenue 14½ (both a.m. and p.m. peak hours);
- Intersection 11: Road 23/Avenue 14 (both a.m. and p.m. peak hours);
- Intersection 13: Golden State Boulevard–Airport Drive/Avenue 17 (both a.m. and p.m. peak hours);
- Intersection 14: SR-99 Southbound Ramps/Avenue 17 (both a.m. and p.m. peak hours);
- Intersection 15: SR-99 Northbound Ramps/Avenue 17 (both a.m. and p.m. peak hours);
- Intersection 16: Love’s Truck Stop Driveway/Avenue 17 (both a.m. and p.m. peak hours);
- Intersection 17: Westberry Boulevard/Cleveland Avenue (both a.m. and p.m. peak hours);
- Intersection 19: Westberry Boulevard/Avenue 14 (p.m. peak hour only);
- Intersection 21: Granada Drive/Cleveland Avenue (both a.m. and p.m. peak hours);
- Intersection 22: Granada Drive/Sunset Avenue (both a.m. and p.m. peak hours);
- Intersection 25: SR-99 Southbound Ramps/Kennedy Street–Gateway Drive (both a.m. and p.m. peak hours);
- Intersection 31: SR-99 Southbound Ramps/Cleveland Avenue (a.m. peak hour only);
- Intersection 38: I Street/SR-99 Southbound Off-Ramp–2nd Street (a.m. peak hour only);
- Intersection 43: H Street–SR-99 Northbound Off-Ramp/4th Street (both a.m. and p.m. peak hours);
- Intersection 49: Yosemite Avenue/Cleveland Avenue–Tozer Street (both a.m. and p.m. peak hours);
- Intersection 51: Project Driveway 1/Avenue 17 (p.m. peak hour only);
- Intersection 55: Road 23/Project Driveway 3 (both a.m. and p.m. peak hours);
- Intersection 56: Road 23/Project Driveway 4 (both a.m. and p.m. peak hours);
- Intersection 57: Road 23/Project Driveway 5 (p.m. peak hour); and
- Intersection 58: Project Driveway 6/Cleveland Avenue (both a.m. and p.m. peak hours).

Twelve of these intersections are forecast to operate at an unsatisfactory LOS even under Phase II project completion year without project conditions. Thus, the project contributes to the forecast deficiency at these intersections. As such, the project has a cumulative impact at all the intersections forecast to operate at a deficient LOS. All other intersections are forecast to operate at a satisfactory LOS.

Figure 7-7 illustrates intersection levels of service under Phase II project completion year with project conditions.

7.6.2 Roadway Segments

A roadway segment LOS analysis was conducted for Phase II project completion year with project conditions using the methodologies previously discussed. Table 7-H summarizes the results of this analysis and shows that the following roadway segments are forecast to operate at an unsatisfactory LOS under Phase II project completion year with project conditions:

- Road 23 between Avenue 17 and Project Driveway 3;
- Road 23 between Project Driveway 3 and Avenue 16;
- Road 23 between Avenue 16 and Cleveland Avenue;
- Road 23 between Cleveland Avenue and Project Driveway 4;
- Road 23 between Project Driveway 4 and Project Driveway 5;
- Road 23 between Project Driveway 5 and Avenue 14½;
- Granada Drive between Cleveland Avenue and Fresno River;
- Avenue 17 between Road 23 and Golden State Boulevard;
- Avenue 17 between Golden State Boulevard and SR-99 Southbound Off-Ramp;
- Cleveland Avenue between Road 23 and Project Driveway 6;
- Cleveland Avenue between Project Driveway 6 and Westberry Boulevard; and
- Cleveland Avenue between Westberry Boulevard and Granada Drive.

Only the segments of Granada Drive between Cleveland Avenue and Fresno River, and Avenue 17 between Golden State Boulevard and SR-99 Southbound Off-Ramp are forecast to operate at a deficient LOS under Phase II project completion year without project conditions. Thus, the project contributes to the forecast deficiency at these segments. As such, the project has a cumulative impact at all the segments operating at a deficient LOS. All other roadway segments are forecast to operate at a satisfactory LOS.

Roadway segment levels of service under Phase II project completion year with project conditions are illustrated in Figure 7-9.

7.6.3 Freeway Segments and Ramps

A freeway segment and ramp LOS analysis was conducted for Phase II project completion year with project conditions using the methodologies previously discussed. Table 7-I summarizes the results of this analysis and shows that the following freeway segments and ramps are forecast to operate at an unsatisfactory LOS under Phase II project completion year with project conditions:

- SR-99 Northbound:
 - Avenue 18½ Off-Ramp (p.m. peak hour only); and
 - North of Avenue 18½ On-Ramp (a.m. peak hour only).

- SR-99 Southbound:
 - North of Avenue 18½ Off-Ramp (p.m. peak hour only);
 - Avenue 18½ Off-Ramp (p.m. peak hour only);
 - Avenue 18½ Slip-On Ramp (p.m. peak hour only);
 - Avenue 18½ Slip-On Ramp and Avenue 17 Off-Ramp (p.m. peak hour only); and
 - Olive Avenue Off-Ramp (a.m. peak hour only).

All other freeway segments are forecast to operate at a satisfactory LOS under Phase II project completion year with project conditions.

7.7 PHASE III PROJECT COMPLETION YEAR (2049) WITHOUT PROJECT LEVELS OF SERVICE

7.7.1 Study Intersections

An intersection LOS analysis was conducted for Phase III project completion year without project conditions using the methodologies previously discussed. Table 7-J summarizes the results of the analysis and shows that the following intersections are forecast to operate at an unsatisfactory LOS under Phase III project completion year without project conditions:

- Intersection 4: Pistachio Drive/Avenue 18½ (p.m. peak hour only);
- Intersection 5: SR-99 Southbound Ramps–Road 23/Avenue 18½ (both a.m. and p.m. peak hours);
- Intersection 6: SR-99 Northbound Ramps/Avenue 18½ (both a.m. and p.m. peak hours);
- Intersection 13: Golden State Boulevard–Airport Drive/Avenue 17 (both a.m. and p.m. peak hours);
- Intersection 14: SR-99 Southbound Ramps/Avenue 17 (both a.m. and p.m. peak hours);
- Intersection 15: SR-99 Northbound Ramps/Avenue 17 (both a.m. and p.m. peak hours);
- Intersection 16: Love’s Truck Stop Driveway/Avenue 17 (both a.m. and p.m. peak hours);
- Intersection 17: Westberry Boulevard/Cleveland Avenue (p.m. peak hour only);
- Intersection 19: Westberry Boulevard/Avenue 14 (a.m. peak hour only);
- Intersection 21: Granada Drive/Cleveland Avenue (both a.m. and p.m. peak hours);
- Intersection 22: Granada Drive/Sunset Avenue (both a.m. and p.m. peak hours);
- Intersection 25: SR-99 Southbound Ramps/Kennedy Street–Gateway Drive (both a.m. and p.m. peak hours);
- Intersection 38: I Street/SR-99 Southbound Off-Ramp–2nd Street (a.m. peak hour only);
- Intersection 43: H Street–SR-99 Northbound Off-Ramp/4th Street (both a.m. and p.m. peak hours); and

- Intersection 49: Yosemite Avenue/Cleveland Avenue–Tozer Street (both a.m. and p.m. peak hours).

All other intersections are forecast to operate at a satisfactory LOS.

Figure 7-10 illustrates intersection levels of service under Phase III project completion year without project conditions.

7.7.2 Roadway Segments

A roadway segment LOS analysis was conducted for Phase III project completion year without project conditions using the methodologies previously discussed. Table 7-K summarizes the results of this analysis and shows that the following roadway segments are forecast to operate at an unsatisfactory LOS under Phase III project completion year without project conditions:

- Granada Drive between Cleveland Avenue and Fresno River; and
- Avenue 17 between Golden State Boulevard and SR-99 Southbound Off-Ramp.

All other roadway segments are forecast to operate at a satisfactory LOS.

Roadway segment levels of service under Phase III project completion year without project conditions are illustrated in Figure 7-11.

7.7.3 Freeway Segments and Ramps

A freeway segment and ramp LOS analysis was conducted for Phase III project completion year without project conditions using the methodologies previously discussed. Table 7-L summarizes the results of this analysis and shows that the following freeway segments and ramps are forecast to operate at an unsatisfactory LOS under Phase III project completion year without project conditions:

- SR-99 Northbound:
 - Avenue 17 On-Ramp and Avenue 18½ Off-Ramp (p.m. peak hour only);
 - Avenue 18½ Off-Ramp (both a.m. and p.m. peak hours); and
 - North of Avenue 18½ On-Ramp (p.m. peak hour only).
- SR-99 Southbound:
 - North of Avenue 18½ Off-Ramp (p.m. peak hour only);
 - Avenue 18½ Off-Ramp (both a.m. and p.m. peak hours);
 - Avenue 18½ Off-Ramp and Avenue 18½ Loop On-Ramp (p.m. peak hour only);
 - Avenue 18½ Loop-On Ramp and Avenue 18½ Slip-On Ramp (p.m. peak hour only);
 - Avenue 18½ Slip-On Ramp (p.m. peak hour only);
 - Avenue 18½ Slip-On Ramp and Avenue 17 Off-Ramp (p.m. peak hour only); and
 - Olive Avenue Off-Ramp (p.m. peak hour only).

All other freeway segments are forecast to operate at a satisfactory LOS under Phase III project completion year without project conditions.

7.8 PHASE III PROJECT COMPLETION YEAR (2049) WITH PROJECT LEVELS OF SERVICE

7.8.1 Study Intersections

An intersection LOS analysis was conducted for Phase III project completion year with project conditions using the methodologies previously discussed. Table 7-J summarizes the results of the analysis and shows that the following intersections are forecast to operate at an unsatisfactory LOS under Phase III project completion year with project conditions:

- Intersection 4: Pistachio Drive/Avenue 18½ (p.m. peak hour only);
- Intersection 5: SR-99 Southbound Ramps–Ramp 23/Avenue 18½ (both a.m. and p.m. peak hours);
- Intersection 6: SR-99 Northbound Ramps/Avenue 18½ (both a.m. and p.m. peak hours);
- Intersection 7: Road 23/Avenue 17 (both a.m. and p.m. peak hours);
- Intersection 8: Road 23/Avenue 16 (both a.m. and p.m. peak hours);
- Intersection 9: Road 23/Cleveland Avenue (both a.m. and p.m. peak hours);
- Intersection 10: Road 23/Avenue 14½ (both a.m. and p.m. peak hours);
- Intersection 11: Road 23/Avenue 14 (both a.m. and p.m. peak hours);
- Intersection 13: Golden State Boulevard–Airport Drive/Avenue 17 (both a.m. and p.m. peak hours);
- Intersection 14: SR-99 Southbound Ramps/Avenue 17 (both a.m. and p.m. peak hours);
- Intersection 15: SR-99 Northbound Ramps/Avenue 17 (both a.m. and p.m. peak hours);
- Intersection 16: Love’s Truck Stop Driveway/Avenue 17 (both a.m. and p.m. peak hours);
- Intersection 17: Westberry Boulevard/Cleveland Avenue (both a.m. and p.m. peak hours);
- Intersection 18: Westberry Boulevard/Sunset Avenue (a.m. peak hour only);
- Intersection 19: Westberry Boulevard/Avenue 14 (both a.m. and p.m. peak hours);
- Intersection 20: Westberry Boulevard/Avenue 16 (p.m. peak hour only);
- Intersection 21: Granada Drive/Cleveland Avenue (both a.m. and p.m. peak hours);
- Intersection 22: Granada Drive/Sunset Avenue (both a.m. and p.m. peak hours);
- Intersection 24: Schnoor Avenue/Kennedy Street (both a.m. and p.m. peak hours);
- Intersection 25: SR-99 Southbound Ramps/Kennedy Street–Gateway Drive (both a.m. and p.m. peak hours);
- Intersection 30: Fairgrounds/Cleveland Avenue (p.m. peak hour only);

- Intersection 31: SR-99 Southbound Ramps/Cleveland Avenue (a.m. peak hour only);
- Intersection 32: SR-99 Northbound Ramps/Cleveland Avenue (p.m. peak hour only);
- Intersection 36: Pine Street/Howard Road (a.m. peak hour only);
- Intersection 38: I Street/SR-99 Southbound Off-Ramp–2nd Street (a.m. peak hour only);
- Intersection 43: H Street–SR-99 Northbound Off-Ramp/4th Street (both a.m. and p.m. peak hours);
- Intersection 44: I Street/Olive Avenue (p.m. peak hour only);
- Intersection 49: Yosemite Avenue/Cleveland Avenue–Tozer Street (both a.m. and p.m. peak hours);
- Intersection 51: Project Driveway 1/Avenue 17 (p.m. peak hour only);
- Intersection 52: Road 22½–Project Driveway 2/Avenue 16 (both a.m. and p.m. peak hours);
- Intersection 53: Road 22½/Cleveland Avenue (both a.m. and p.m. peak hours);
- Intersection 55: Road 23/Project Driveway 3 (both a.m. and p.m. peak hours);
- Intersection 56: Road 23/Project Driveway 4 (both a.m. and p.m. peak hours);
- Intersection 57: Road 23/Project Driveway 5 (both a.m. and p.m. peak hours); and
- Intersection 58: Project Driveway 6/Cleveland Avenue (both a.m. and p.m. peak hours).

Fifteen of these intersections are forecast to operate at an unsatisfactory LOS even under Phase III project completion year without project conditions. Thus, the project contributes to the forecast deficiency at these intersections. As such, the project has a cumulative impact at all the intersections which are forecast to operate at a deficient LOS. All other intersections are forecast to operate at a satisfactory LOS.

Figure 7-10 illustrates intersection levels of service under Phase III project completion year with project conditions.

Detailed intersection level of service worksheets are included in Appendix D.

7.8.2 Roadway Segments

A roadway segment LOS analysis was conducted for Phase III project completion year with project conditions using the methodologies previously discussed. Table 7-K summarizes the results of this analysis and shows that the following roadway segments are forecast to operate at an unsatisfactory LOS under Phase III project completion year with project conditions:

- Road 23 between Avenue 17 and Project Driveway 3;
- Road 23 between Project Driveway 3 and Avenue 16;
- Road 23 between Avenue 16 and Cleveland Avenue;
- Road 23 between Cleveland Avenue and Project Driveway 4;

- Road 23 between Project Driveway 4 and Project Driveway 5;
- Road 23 between Project Driveway 5 and Avenue 14½;
- Road 23 between Avenue 14½ and Avenue 14;
- Granada Drive between Cleveland Avenue and Fresno River;
- Avenue 17 between Road 23 and Golden State Boulevard;
- Avenue 17 between Golden State Boulevard and SR-99 Southbound Off-Ramp;
- Cleveland Avenue between Road 22½ and Road 23;
- Cleveland Avenue between Road 23 and Project Driveway 6;
- Cleveland Avenue between Project Driveway 6 and Westberry Boulevard;
- Cleveland Avenue between Westberry Boulevard and Granada Drive;
- Cleveland Avenue between Granada Drive and Schnoor Street; and
- Cleveland Avenue between Schnoor Street and Fairgrounds.

Only the segments of Granada Drive between Cleveland Avenue and Fresno River, and Avenue 17 between Golden State Boulevard and SR-99 Southbound Off-Ramp are forecast to operate at a deficient LOS under Phase III project completion year without project conditions. Thus, the project contributes to the forecast deficiency at these segments. The project has a cumulative impact at all the segments operating at a deficient LOS. All other roadway segments are forecast to operate at a satisfactory LOS.

Roadway segment levels of service under Phase III project completion year with project conditions are illustrated in Figure 7-12.

7.8.3 Freeway Segments and Ramps

A freeway segment and ramp LOS analysis was conducted for Phase III project completion year with project conditions using the methodologies previously discussed. Table 7-L summarizes the results of this analysis and shows that the following freeway segments and ramps are forecast to operate at an unsatisfactory LOS under Phase III project completion year with project conditions:

- SR-99 Northbound:
 - Madera Avenue On-Ramp (both a.m. and p.m. peak hours);
 - Madera Avenue On-Ramp and 4th Street Off-Ramp (p.m. peak hour only);
 - 4th Street Off-Ramp (p.m. peak hour only);
 - 2nd Street On-Ramp and Cleveland Avenue Off-Ramp (p.m. peak hour only);
 - Cleveland Avenue Off-Ramp (p.m. peak hour only);
 - Avenue 17 On-Ramp and Avenue 18½ Off-Ramp (p.m. peak hour only);
 - Avenue 18½ Off-Ramp (both a.m. and p.m. peak hours);

- Avenue 18½ On-Ramp (both a.m. and p.m. peak hours); and
- North of Avenue 18½ On-Ramp (both a.m. and p.m. peak hours).
- SR-99 Southbound:
 - North of Avenue 18½ Off-Ramp (p.m. peak hour only);
 - Avenue 18½ Off-Ramp (both a.m. and p.m. peak hours);
 - Avenue 18½ Off-Ramp and Avenue 18½ Loop On-Ramp (p.m. peak hour only);
 - Avenue 18½ Loop-On Ramp and Avenue 18½ Slip-On Ramp (p.m. peak hour only);
 - Avenue 18½ Slip-On Ramp (p.m. peak hour only);
 - Avenue 18½ Slip-On Ramp and Avenue 17 Off-Ramp (p.m. peak hour only);
 - Cleveland Avenue On-Ramp (a.m. peak hour only);
 - Cleveland Avenue On-Ramp and 2nd Street Off-Ramp (both a.m. and p.m. peak hours);
 - 2nd Street Off-Ramp (both a.m. and p.m. peak hours);
 - 4th Street On-Ramp and Olive Avenue Off-Ramp (both a.m. and p.m. peak hours); and
 - Olive Avenue Off-Ramp (both a.m. and p.m. peak hours).

All other freeway segments are forecast to operate at a satisfactory LOS under Phase III project completion year with project conditions.

Detailed freeway level of service worksheets are included in Appendix E.

7.9 LIST OF CHAPTER 7.0 FIGURES AND TABLES

- Figure 7-1: Existing Intersection Levels of Service
- Figure 7-2: Existing without Project Roadway Segments Daily Volumes and Levels of Service
- Figure 7-3: Existing with Project Roadway Segments Daily Volumes and Levels of Service
- Figure 7-4: Phase I Project Completion Year (2029) Intersection Levels of Service
- Figure 7-5: Phase I Project Completion Year (2029) without Project Roadway Segments Daily Volumes and Levels of Service
- Figure 7-6: Phase I Project Completion Year (2029) with Project Roadway Segments Daily Volumes and Levels of Service
- Figure 7-7: Phase II Project Completion Year (2039) Intersection Levels of Service
- Figure 7-8: Phase II Project Completion Year (2039) without Project Roadway Segments Daily Volumes and Levels of Service
- Figure 7-9: Phase II Project Completion Year (2039) with Project Roadway Segments Daily Volumes and Levels of Service
- Figure 7-10: Phase III Project Completion Year (2049) Intersection Levels of Service

- Figure 7-11: Phase III Project Completion Year (2049) without Project Roadway Segments Daily Volumes and Levels of Service
- Figure 7-12: Phase III Project Completion Year (2049) with Project Roadway Segments Daily Volumes and Levels of Service
- Table 7-A: Existing Intersection Levels of Service
- Table 7-B: Existing Roadway Segment Levels of Service
- Table 7-C: Existing Freeway Segment and Ramp Levels of Service
- Table 7-D: Phase I Project Completion Year (2029) Intersection Levels of Service
- Table 7-E: Phase I Project Completion Year (2029) Roadway Segment Levels of Service
- Table 7-F: Phase I Project Completion Year (2029) Freeway Segment and Ramp Levels of Service
- Table 7-G: Phase II Project Completion Year (2039) Intersection Levels of Service
- Table 7-H: Phase II Project Completion Year (2039) Roadway Segment Levels of Service
- Table 7-I: Phase II Project Completion Year (2039) Freeway Segment and Ramp Levels of Service
- Table 7-J: Phase III Project Completion Year (2049) Intersection Levels of Service
- Table 7-K: Phase III Project Completion Year (2049) Roadway Segment Levels of Service
- Table 7-L: Phase III Project Completion Year (2049) Freeway Segment and Ramp Levels of Service

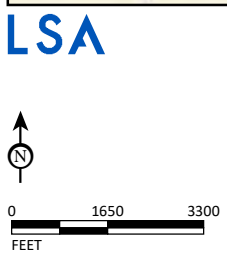
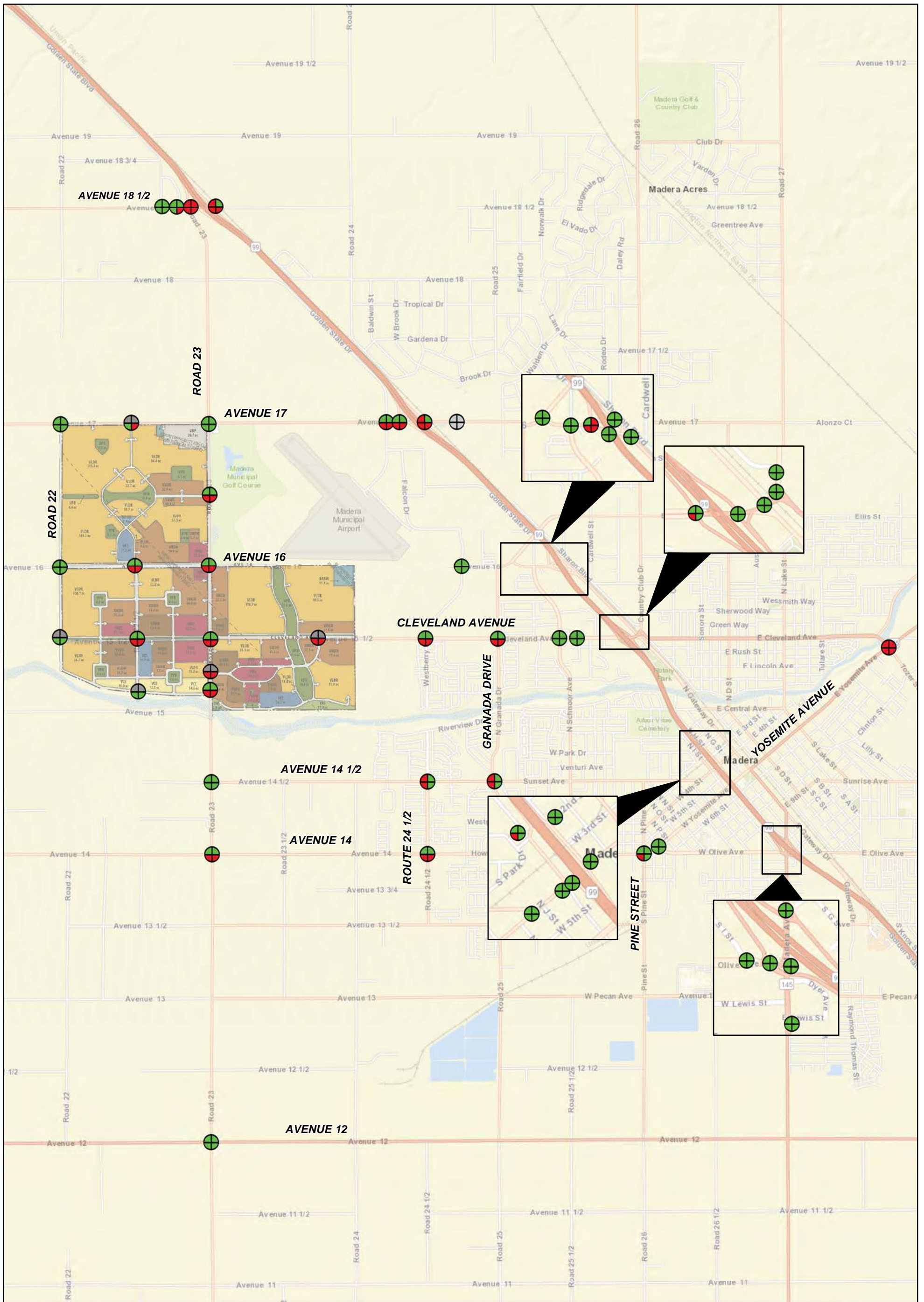

LEGEND

- AM Levels of Service
- PM Levels of Service
- Without Project Levels of Service
- With Project Levels of Service
- Acceptable Levels of Service
- Unacceptable Levels of Service
- Intersection Does Not Exist

FIGURE 7-1

*Village D Specific Plan
Traffic Impact Analysis
Existing Intersection Levels of Service*

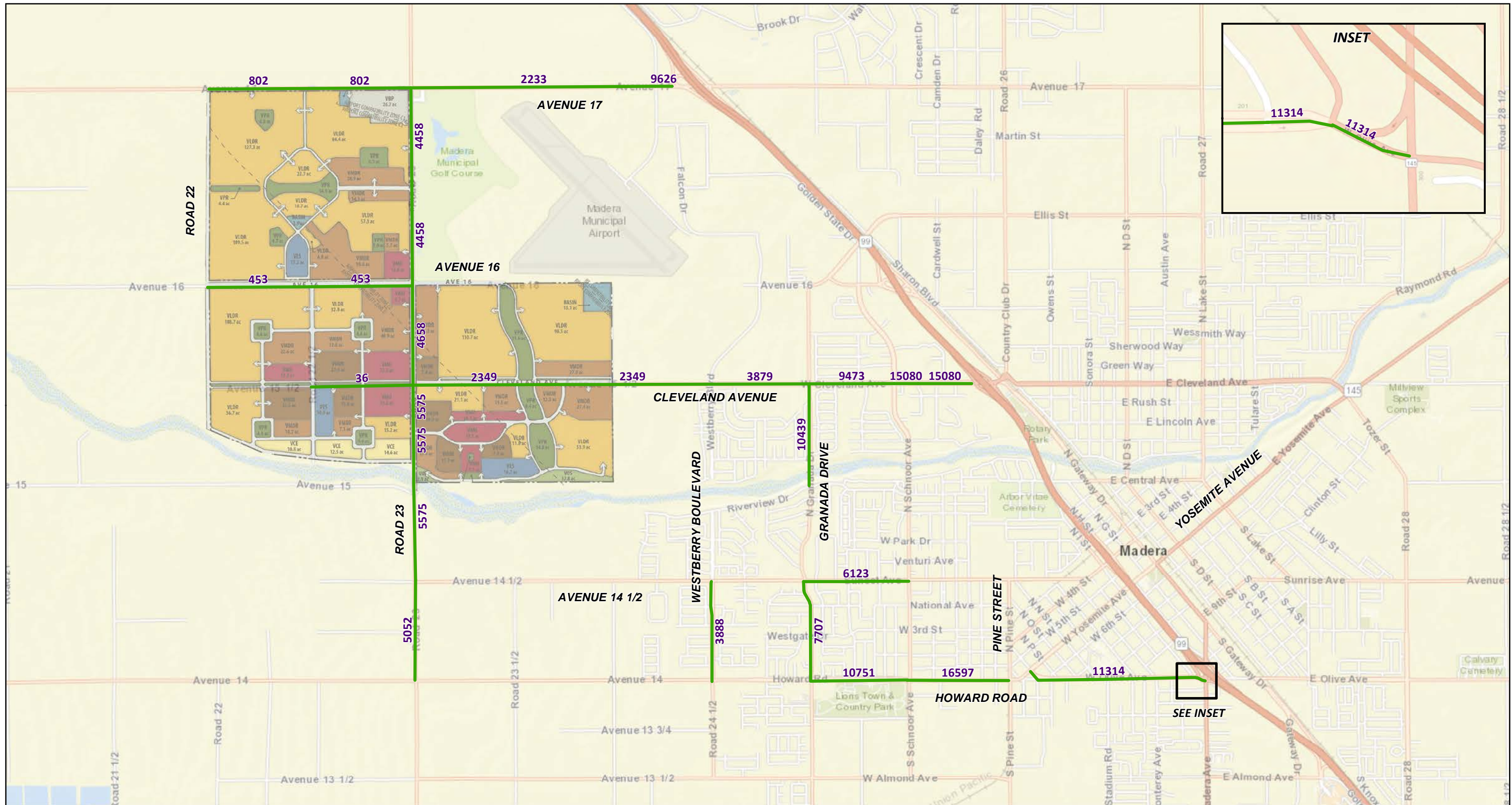

LSA

LEGEND

- Acceptable Levels of Service
- XXXXX Daily Volumes

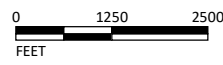

SOURCE: ESRI

I:\CMD1801\Reports\Traffic\fig7-2_Exist_NP_ADT_LOS.mxd (2/17/2020)

FIGURE 7-2

Village D Specific Plan
Traffic Impact Analysis

Existing without Project Roadway Segments Daily Volumes and Levels of Service

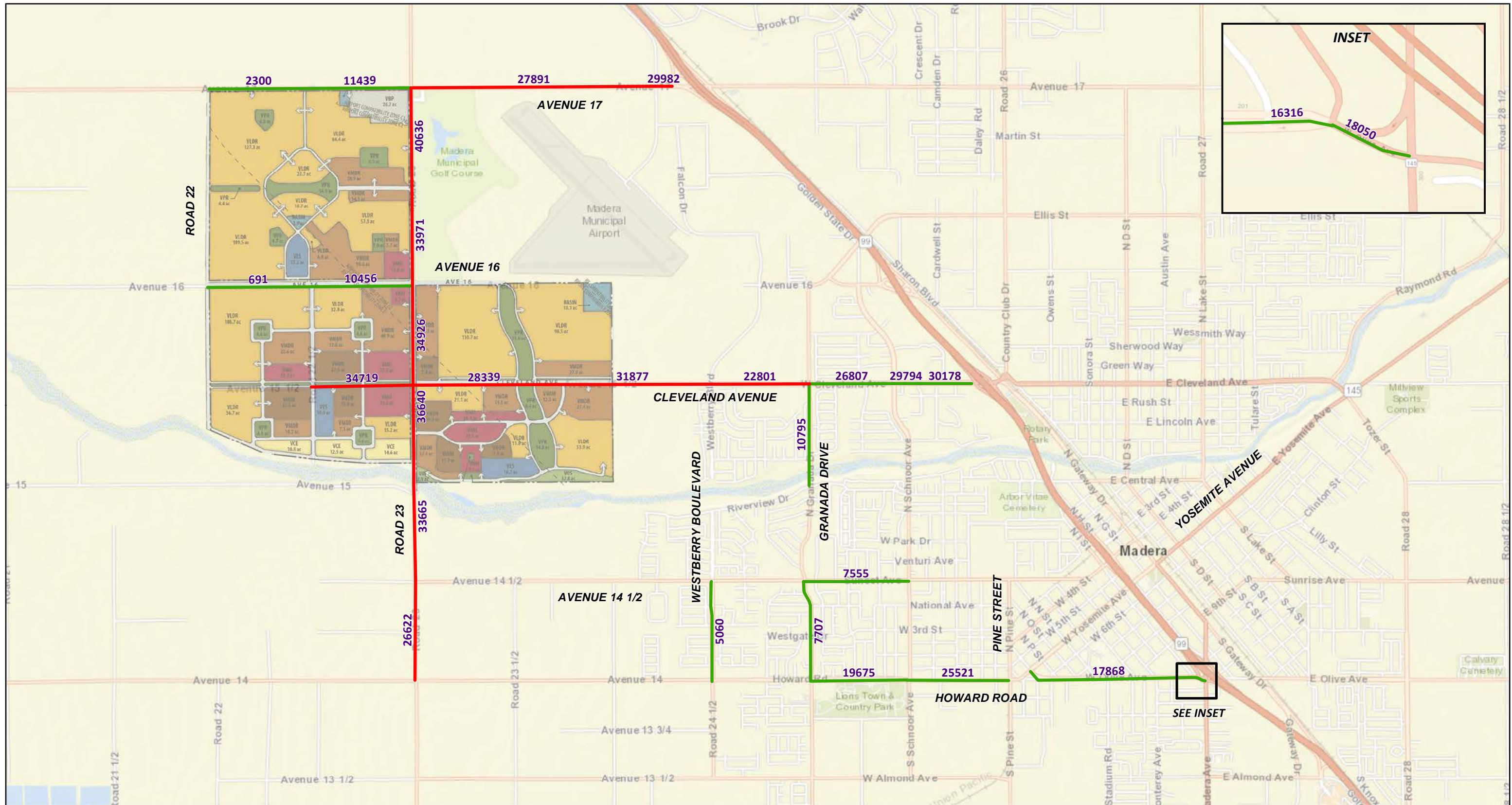

LSA

LEGEND

- Acceptable Levels of Service
- Deficient Levels of Service
- Daily Volumes

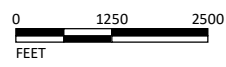

SOURCE: ESRI

I:\CMD1801\Reports\Traffic\fig7-3_Exist_WP_ADT_LOS.mxd (2/17/2020)

FIGURE 7-3

Village D Specific Plan
Traffic Impact Analysis

Existing with Project Roadway Segments Daily Volumes and Levels of Service

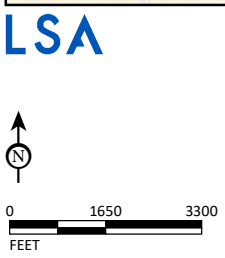
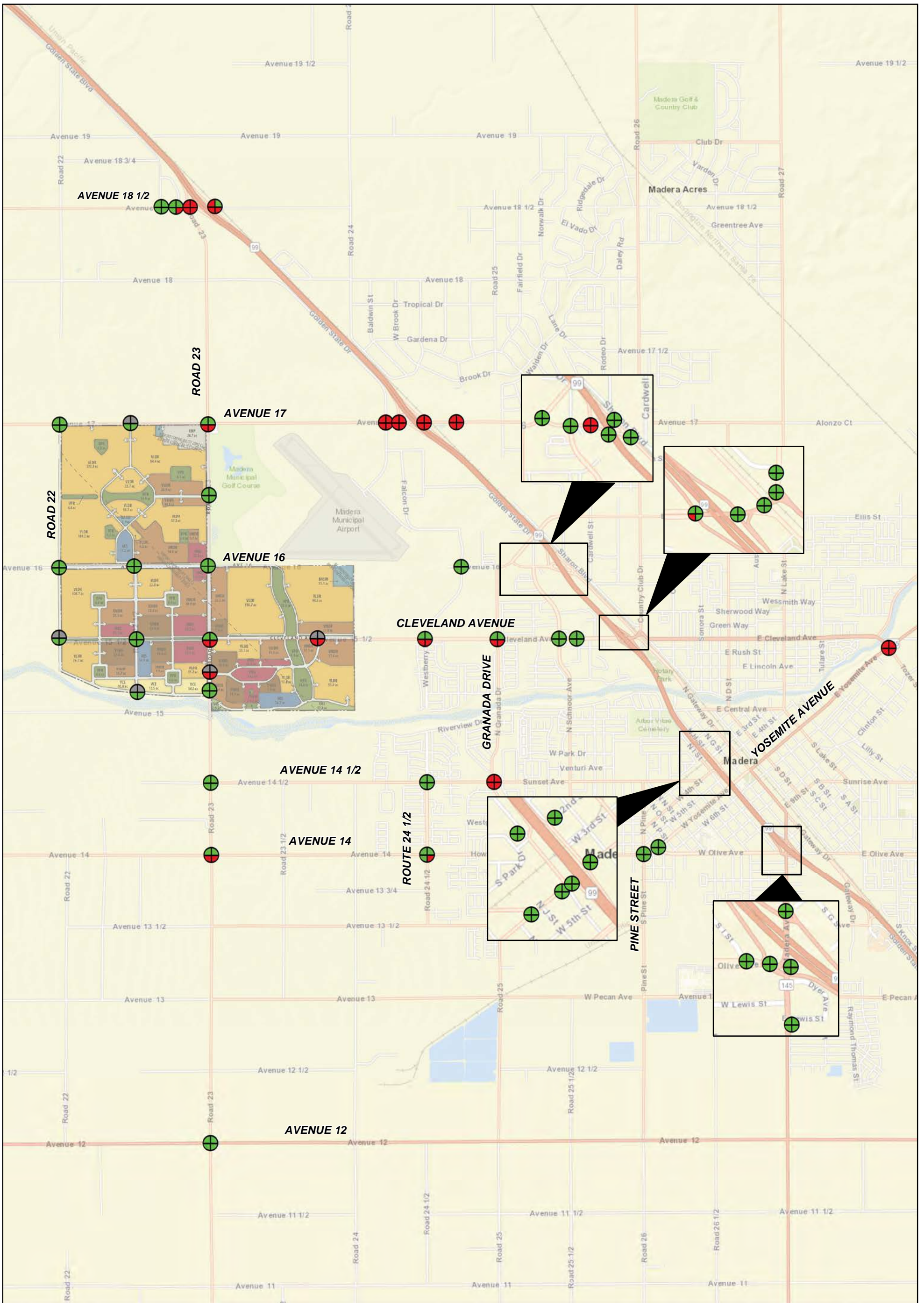

- LEGEND**
- AM Levels of Service
 - PM Levels of Service
 - Without Project Levels of Service
 - With Project Levels of Service
 - Acceptable Levels of Service
 - Unacceptable Levels of Service
 - Intersection Does Not Exist

FIGURE 7-4

Village D Specific Plan
Traffic Impact Analysis

Phase I Project Completion Year (2029) Intersection Levels of Service

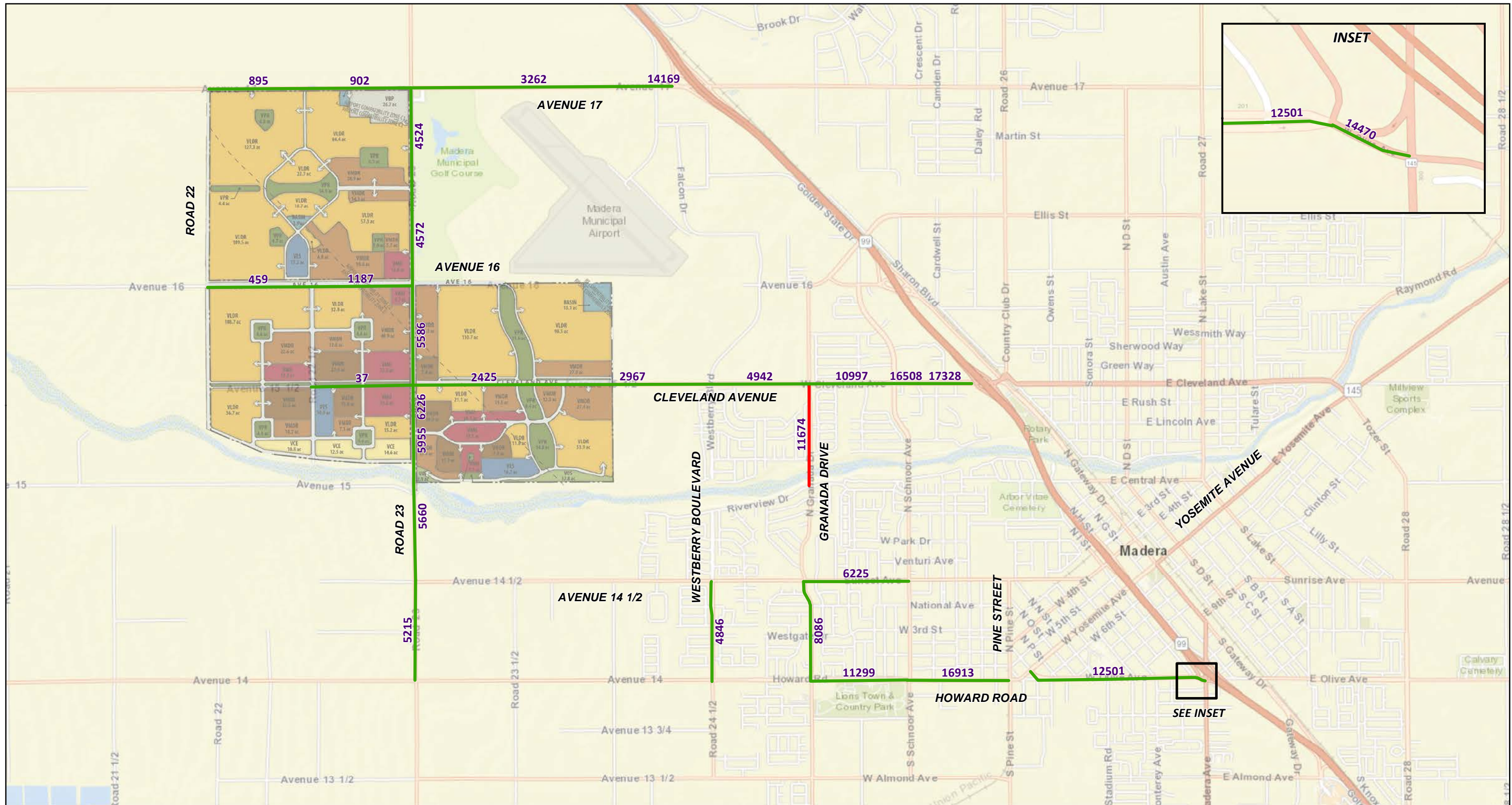

LSA

LEGEND

- Acceptable Levels of Service
- Deficient Levels of Service
- Daily Volumes

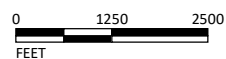

SOURCE: ESRI

I:\CMD1801\Reports\Traffic\fig7-5_PH1_NP_ADT_LOS.mxd (2/17/2020)

FIGURE 7-5

Village D Specific Plan
Traffic Impact Analysis

Phase I Project Completion Year (2029) without Project Roadway Segments Daily Volumes and Levels of Service

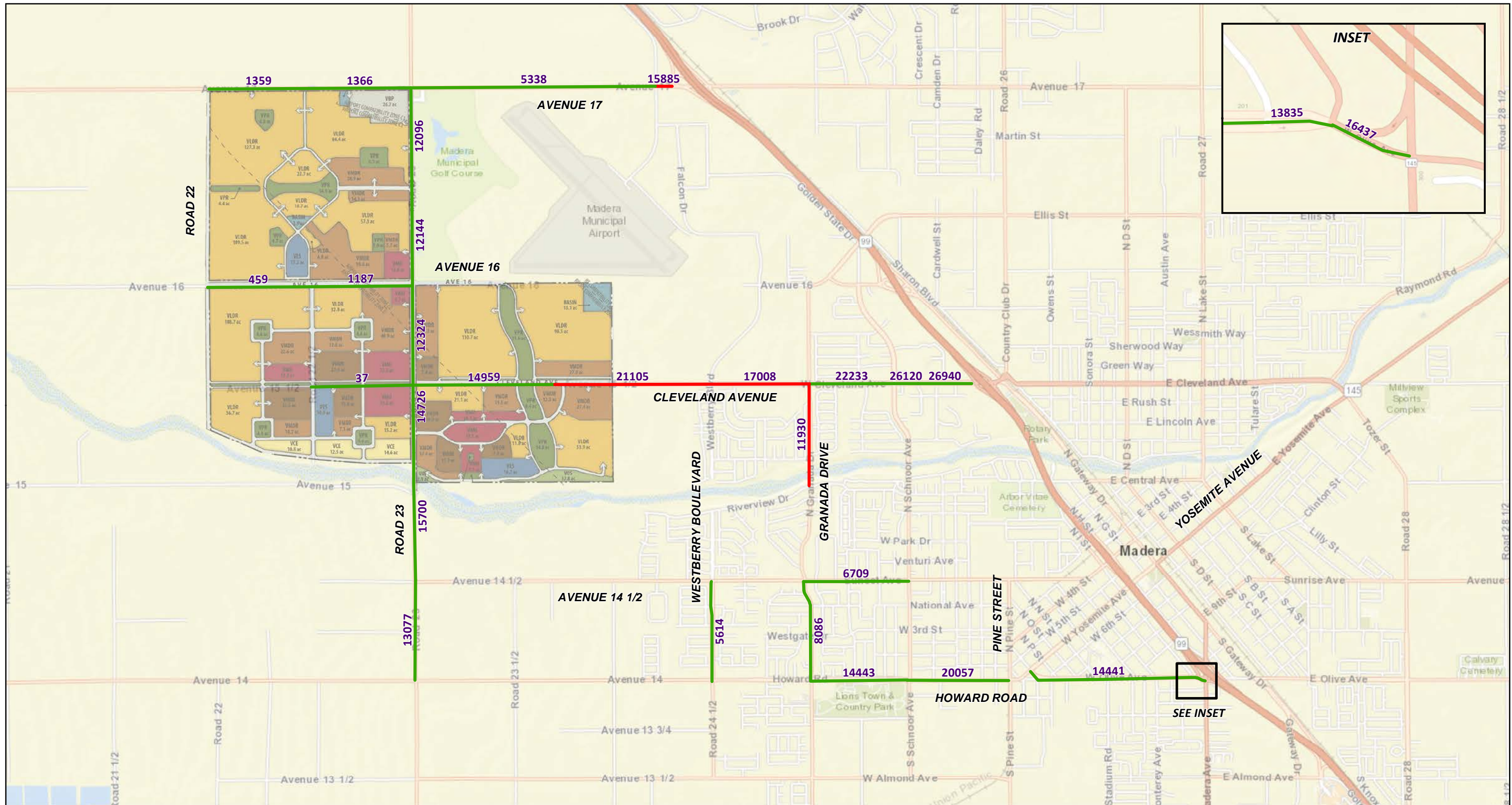

LSA

LEGEND

- Acceptable Levels of Service
- Deficient Levels of Service
- XXXX Daily Volumes

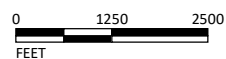

SOURCE: ESRI

I:\CMD1801\Reports\Traffic\fig7-6_Ph1_WP_ADT_LOS.mxd (2/15/2020)

FIGURE 7-6

Village D Specific Plan
Traffic Impact Analysis

Phase I Project Completion Year (2029) with Project Roadway Segments Daily Volumes and Levels of Service

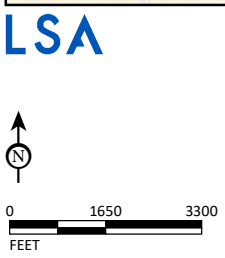
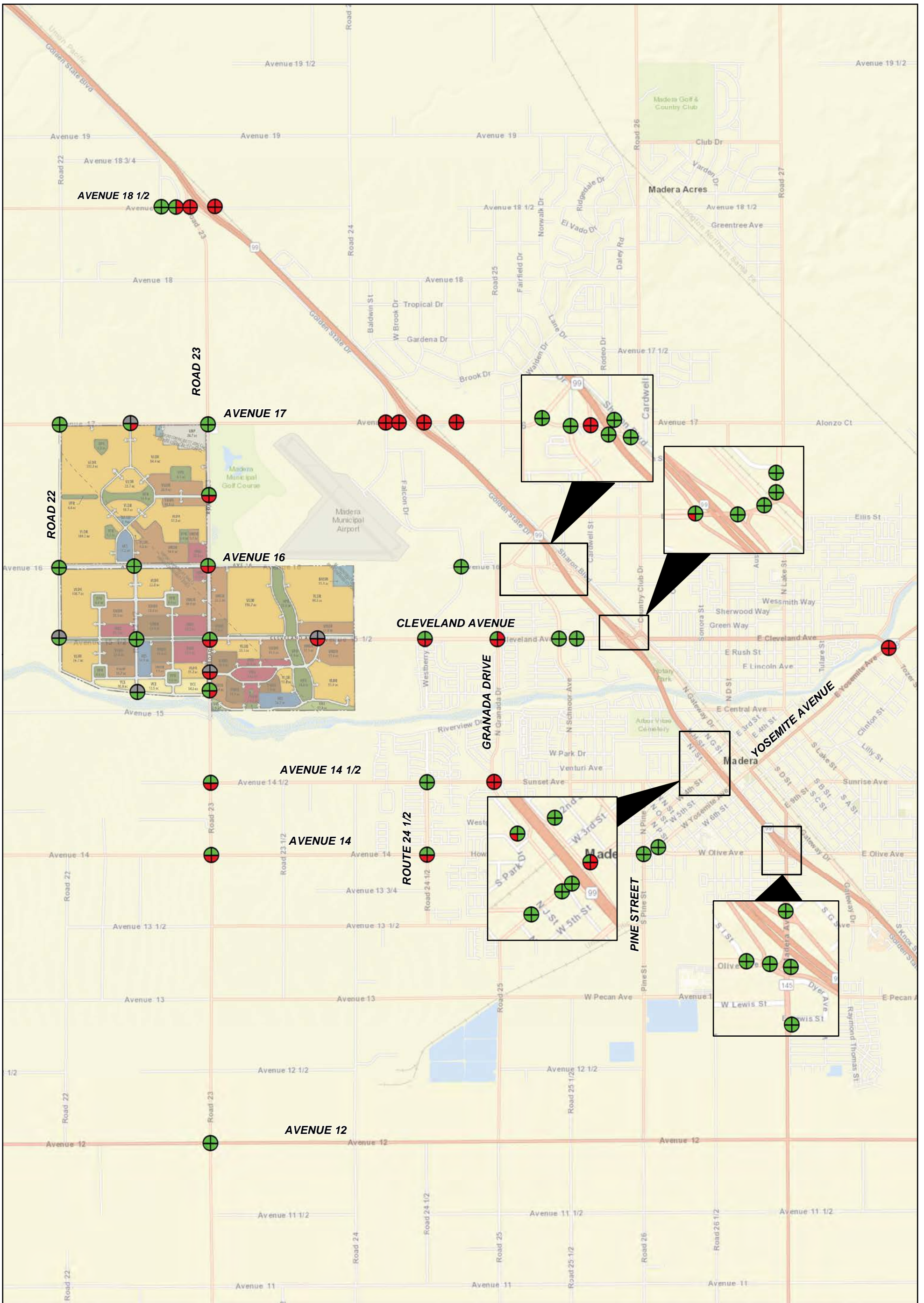

LEGEND

- AM Levels of Service
- PM Levels of Service
- Without Project Levels of Service
- With Project Levels of Service
- Acceptable Levels of Service
- Unacceptable Levels of Service
- Intersection Does Not Exist

FIGURE 7-7

*Village D Specific Plan
Traffic Impact Analysis*

Phase II Project Completion Year (2039) Intersection Levels of Service

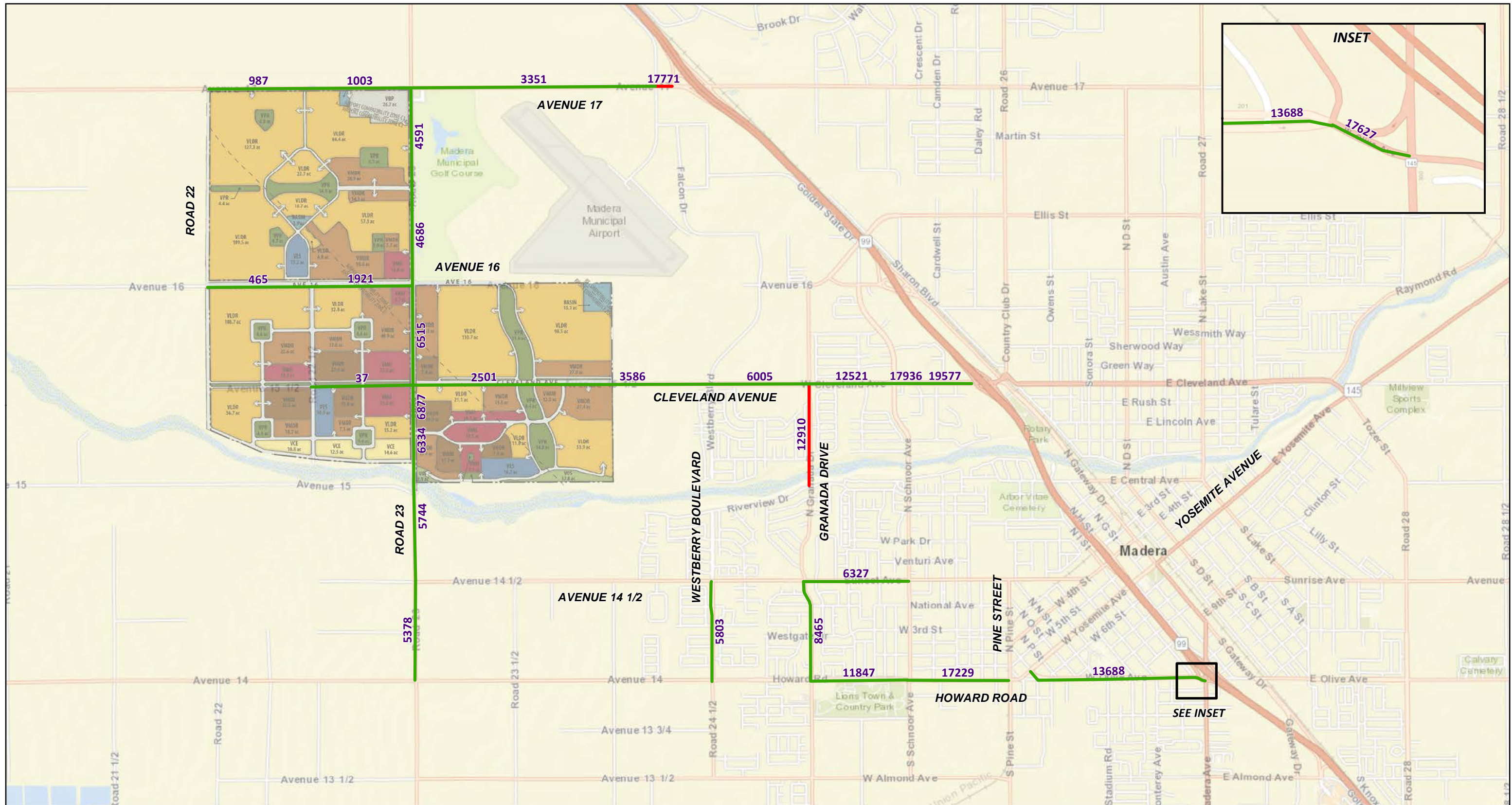

LSA

LEGEND

- Acceptable Levels of Service
- Deficient Levels of Service
- Daily Volumes

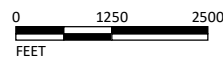

SOURCE: ESRI

I:\CMD1801\Reports\Traffic\fig7-8_PH2_NP_ADT_LOS.mxd (2/15/2020)

FIGURE 7-8

Village D Specific Plan
Traffic Impact Analysis

Phase II Project Completion Year (2039) without Project Roadway Segments Daily Volumes and Levels of Service

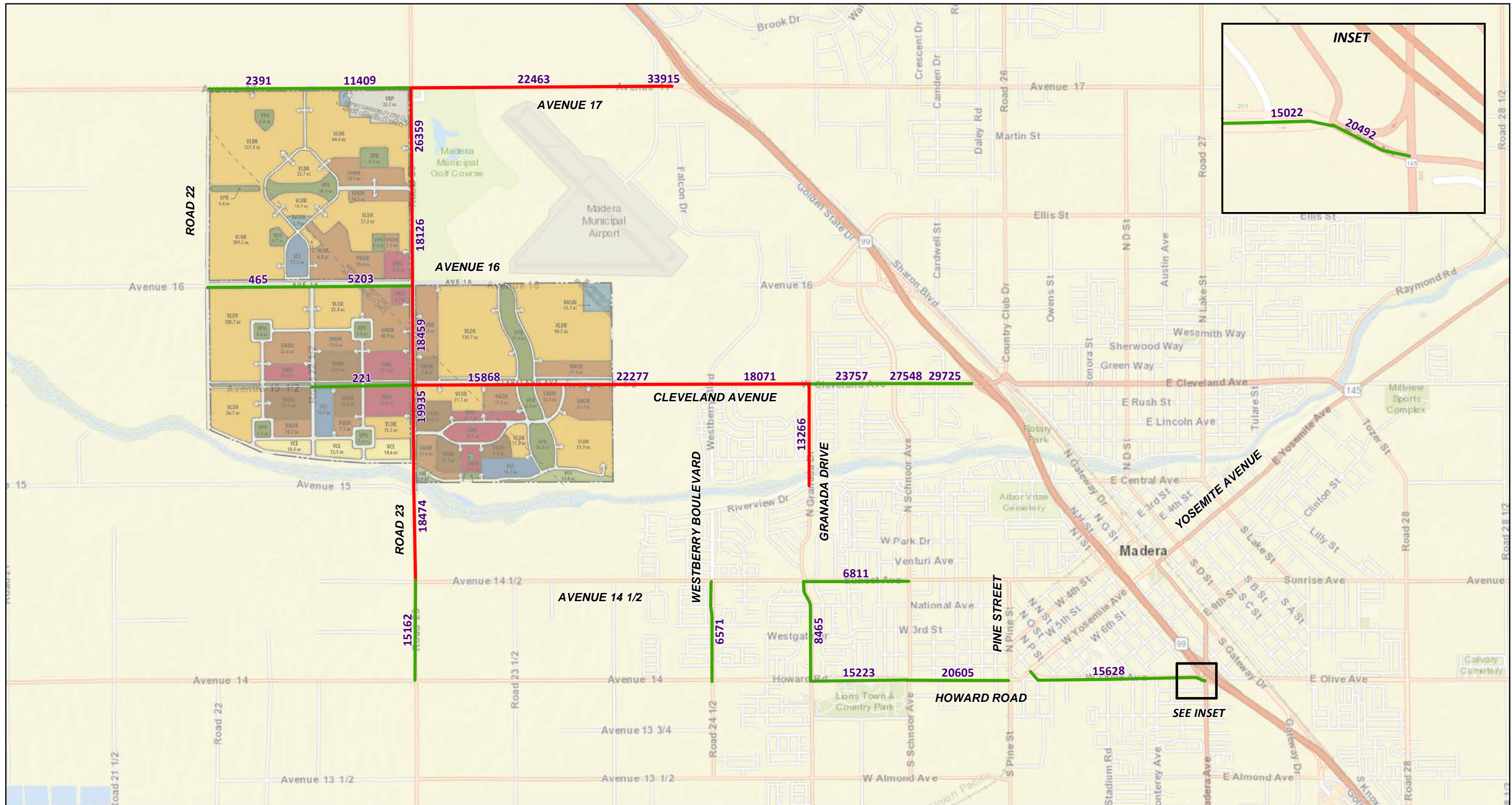

LSA

LEGEND

- Acceptable Levels of Service
- Deficient Levels of Service
- XXXXX Daily Volumes

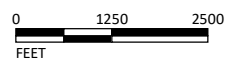

SOURCE: ESRI

I:\CMD1801\Reports\Traffic\fig7-9_PH2_WP_ADT_LOS.mxd (2/15/2020)

FIGURE 7-9

Village D Specific Plan
Traffic Impact Analysis

Phase II Project Completion Year (2039) with Project Roadway Segments Daily Volumes and Levels of Service

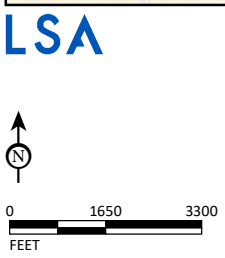
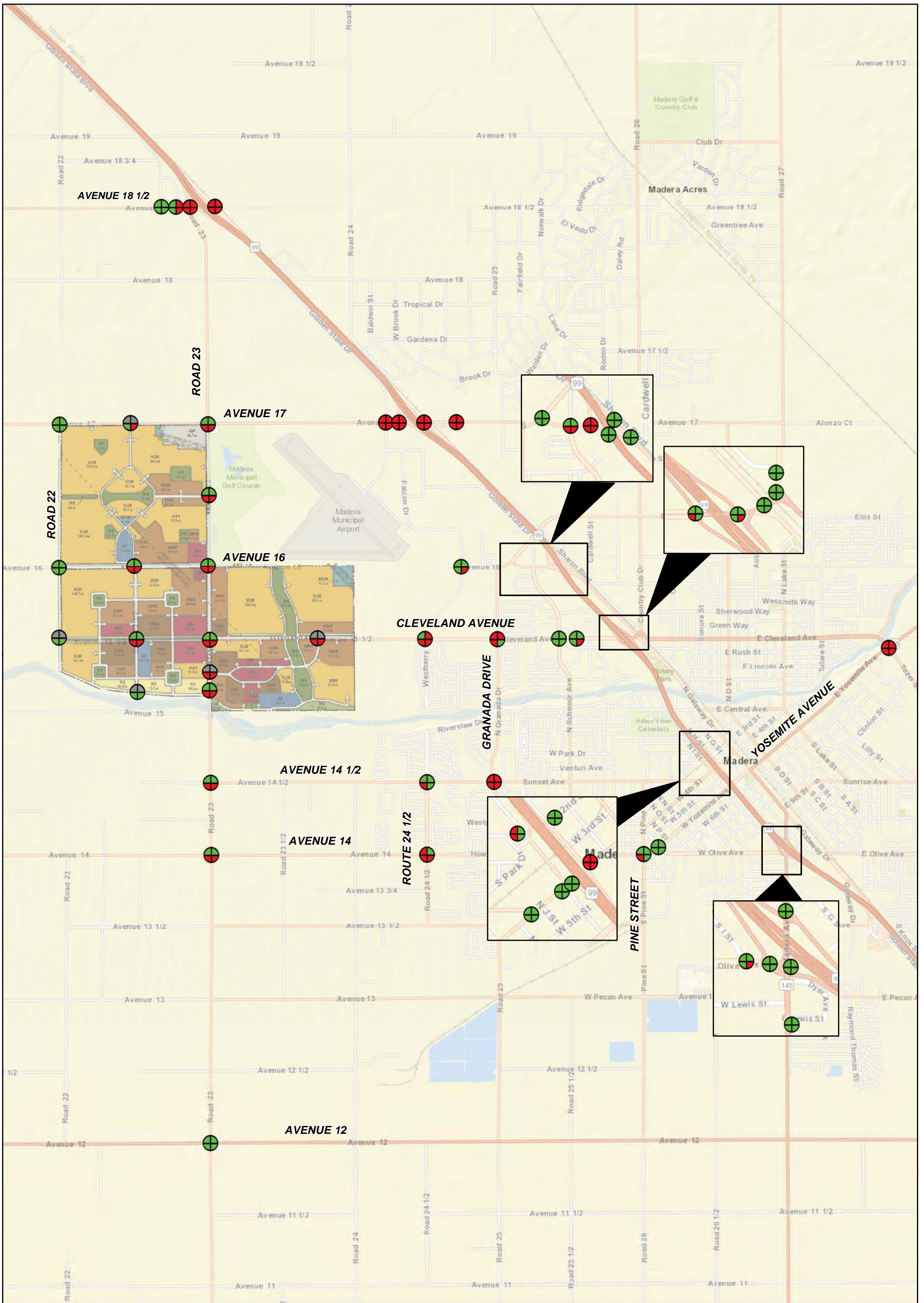

LEGEND

- AM Levels of Service
- PM Levels of Service
- Without Project Levels of Service
- With Project Levels of Service
- Acceptable Levels of Service
- Unacceptable Levels of Service
- Intersection Does Not Exist

FIGURE 7-10

*Village D Specific Plan
Traffic Impact Analysis*

Phase III Project Completion Year (2049) Intersection Levels of Service

SOURCE: ESRI

I:\CMD1801\Reports\Traffic\fig7-10_PH3_LOS_INT.mxd (2/17/2020)

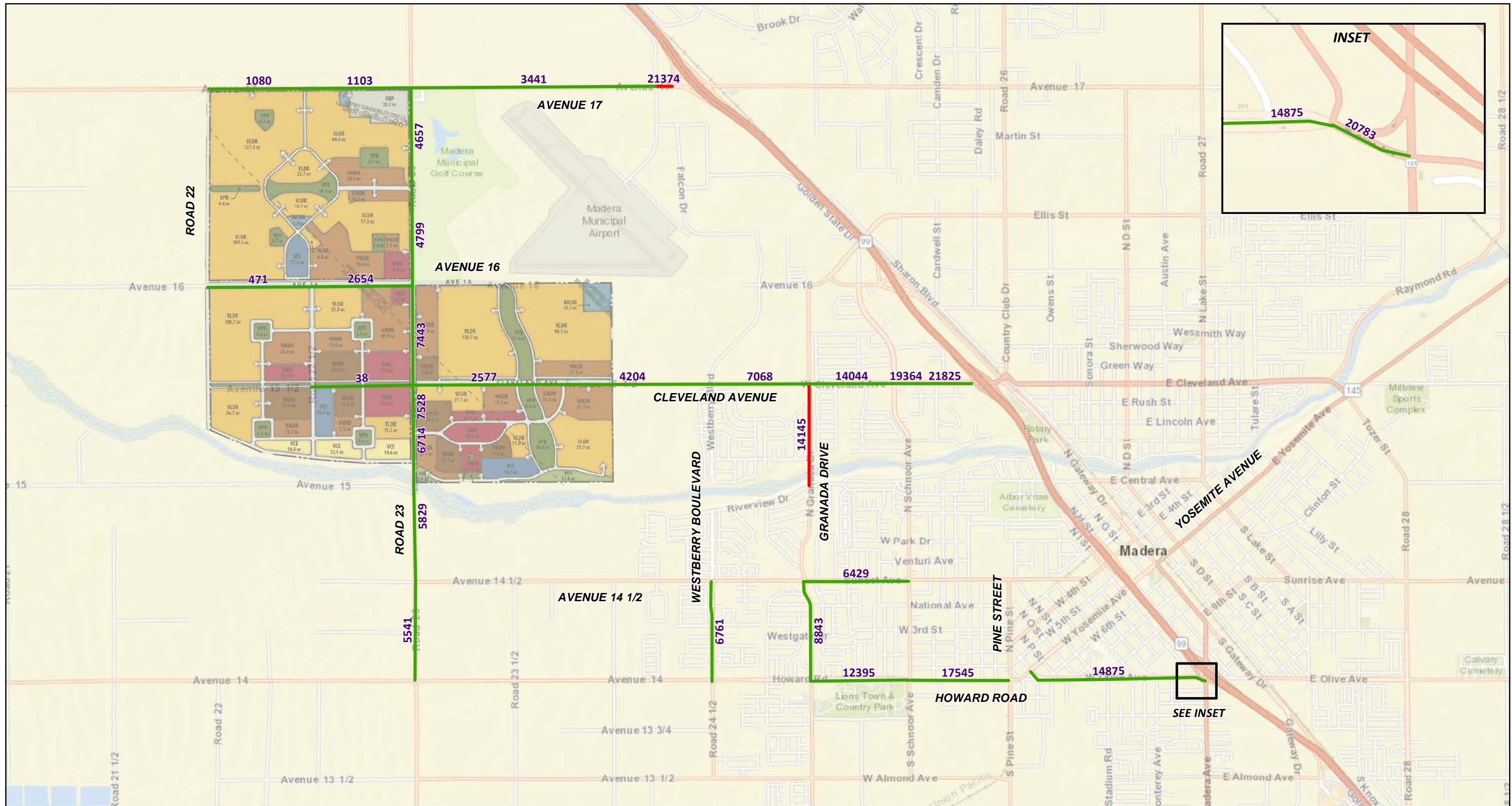

LSA

LEGEND

- Acceptable Levels of Service
- Deficient Levels of Service
- Daily Volumes

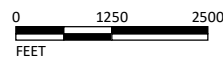

SOURCE: ESRI

I:\CMD1801\Reports\Traffic\fig7-11_PH3_NP_ADT_LOS.mxd (2/15/2020)

FIGURE 7-11

Village D Specific Plan
Traffic Impact Analysis

Phase III Project Completion Year (2049) without Project Roadway Segments Daily Volumes and Levels of Service

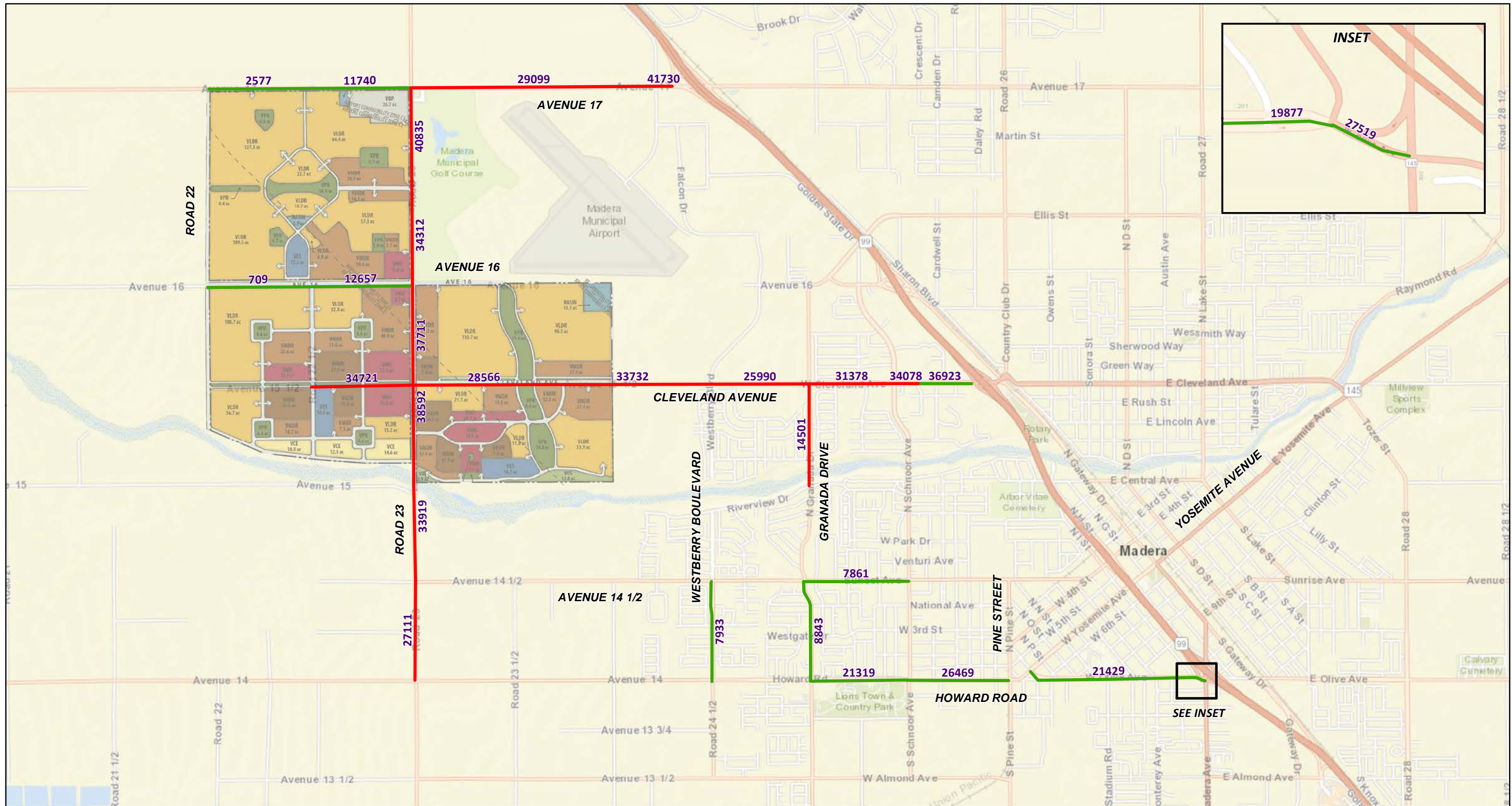

LSA

LEGEND

- Acceptable Levels of Service
- Deficient Levels of Service
- XXXXX Daily Volumes



SOURCE: ESRI

I:\CMD1801\Reports\Traffic\fig7-12_PH3_WP_ADT_LOS.mxd (2/15/2020)

FIGURE 7-12

Village D Specific Plan
Traffic Impact Analysis

Phase III Project Completion Year (2049) with Project Roadway Segments Daily Volumes and Levels of Service

Table 7-A - Existing Intersection Levels of Service

Intersection	Jurisdiction	LOS Standard	Control	Without Project				With Project				Significant Impact	
				A.M. Peak Hour		P.M. Peak Hour		A.M. Peak Hour		P.M. Peak Hour			
				Delay (sec.)	LOS	Delay (sec.)	LOS	Delay (sec.)	LOS	Delay (sec.)	LOS		
1 . Road 22/Avenue 17	Madera County	D	OWSC	8.6	A	9.1	A	OWSC	9.6	A	9.6	A	No
2 . Road 22/Avenue 16	Madera County	D	TWSC	8.7	A	8.7	A	AWSC	7.5	A	7.7	A	No
3 . Golden State Boulevard/Avenue 18 ½	Madera County	C	OWSC	11.8	B	14.2	B	OWSC	13.3	B	19.9	C	No
4 . Pistachio Drive/Avenue 18 ½	Madera County	C	OWSC	15.6	C	22.8	C	OWSC	18.4	C	34.3	D *	Yes
5 . SR-99 Southbound Ramps – Road 23/Avenue 18 ½	Caltrans	30 sec	TWSC	34.2	D *	34.4	D *	TWSC	122.7	F *	>200	F *	Yes
6 . SR-99 Northbound Ramps/Avenue 18 ½	Caltrans	30 sec	OWSC	91.3	F *	22.7	C	OWSC	>200	F *	>200	F *	Yes
7 . Road 23/Avenue 17	City of Madera/Madera County	D	TWSC	13.6	B	14.5	B	TWSC	19.4	C	12.6	B	No
8 . Road 23/Avenue 16	City of Madera/Madera County	D	TWSC	13.4	B	11.3	B	TWSC	>200	F *	>200	F *	Yes
9 . Road 23/Cleveland Avenue	Madera County	D	TWSC	13.0	B	13.3	B	TWSC	>200	F *	>200	F *	Yes
10 . Road 23/Avenue 14 ½	Madera County	D	TWSC	12.7	B	11.9	B	TWSC	12.1	B	29.8	D	No
11 . Road 23/Avenue 14	Madera County	D	AWSC	13.7	B	9.6	A	AWSC	>200	F *	>200	F *	Yes
12 . Road 23/Avenue 12	Madera County	D	AWSC	9.2	A	9.2	A	AWSC	12.9	B	12.3	B	No
13 . Golden State Boulevard – Airport Drive/Avenue 17	City of Madera	D	TWSC	17.0	C	25.9	D	TWSC	>200	F *	>200	F *	Yes
14 . SR-99 Southbound Ramps/Avenue 17	Caltrans	30 sec	OWSC	13.2	B	19.2	C	OWSC	>200	F *	>200	F *	Yes
15 . SR-99 Northbound Ramps/Avenue 17	Caltrans	30 sec	OWSC	30.6	D *	20.9	C	OWSC	>200	F *	>200	F *	Yes
16 . Love's Truck Stop Driveway/Avenue 17	Madera County	D	-	Does Not Exist		Does Not Exist		-	Does Not Exist		Does Not Exist		No
17 . Westberry Boulevard/Cleveland Avenue	City of Madera	D	TWSC	11.1	B	11.9	B	TWSC	>200	F *	>200	F *	Yes
18 . Westberry Boulevard/Sunset Avenue	City of Madera	D	AWSC	40.5	E *	9.2	A	AWSC	83.4	F *	11.8	B	Yes
19 . Westberry Boulevard/Avenue 14	City of Madera/Madera County	D	AWSC	15.6	C	12.5	B	AWSC	>200	F *	>200	F *	Yes
20 . Westberry Boulevard/Avenue 16	City of Madera/Madera County	D	AWSC	8.1	A	8.8	A	AWSC	10.7	B	14.9	B	No
21 . Granada Drive/Cleveland Avenue	City of Madera	D	AWSC	18.7	C	19.3	C	AWSC	>200	F *	>200	F *	Yes
22 . Granada Drive/Sunset Avenue	City of Madera	C	AWSC	49.8	E *	23.4	C	AWSC	66.0	F *	30.3	D	Yes
23 . Avenue 16 – Ellis Street/Kennedy Street	City of Madera/Madera County	D	Signal	20.2	C	22.3	C	Signal	23.2	C	22.4	C	No
24 . Schnoor Avenue/Kennedy Street	City of Madera/Madera County	D	Signal	32.4	C	32.5	C	Signal	33.7	C	33.9	C	No
25 . SR-99 Southbound Ramps/Kennedy Street - Gateway Drive	Caltrans	30 sec	OWSC	24.5	C	32.7	D *	OWSC	51.1	F *	88.8	F *	Yes
26 . SR-99 Northbound Off-Ramp/Gateway Drive	Caltrans	30 sec	OWSC	9.3	A	9.9	A	OWSC	9.5	A	11.1	B	No
27 . SR-99 Northbound Off-Ramps	Caltrans	30 sec	OWSC	10.5	B	11.4	B	OWSC	10.8	B	12.9	B	No
28 . SR-99 Northbound Off-Ramp/Gateway Drive	Caltrans	30 sec	OWSC	0.0	A	12.0	B	OWSC	0.0	A	12.0	B	No
29 . Schnoor Avenue/Cleveland Avenue	City of Madera	D	Signal	27.7	C	31.3	C	Signal	28.6	C	31.8	C	No
30 . Fairgrounds/Cleveland Avenue	City of Madera/Madera County	D	Signal	31.4	C	34.8	C	Signal	31.7	C	35.1	D	No
31 . SR-99 Southbound Ramps/Cleveland Avenue	Caltrans	45 sec	Signal	23.6	C	14.5	B	Signal	64.5	E *	16.0	B	Yes
32 . SR-99 Northbound Ramps/Cleveland Avenue	Caltrans	45 sec	Signal	23.0	C	23.2	C	Signal	26.3	C	26.8	C	No
33 . Gateway Drive/Cleveland Avenue	City of Madera	D	Signal	33.7	C	30.8	C	Signal	36.0	D	32.3	C	No
34 . Cleveland Avenue – Country Club Drive/W Cleveland Avenue	City of Madera	D	Signal	10.5	B	10.8	B	Signal	12.1	B	14.8	B	No
35 . Country Club Drive/Sharon Boulevard	City of Madera	D	OWSC	11.8	B	10.7	B	OWSC	11.8	B	10.9	B	No
36 . Pine Street/Howard Road	City of Madera	D	Signal	47.3	D	36.1	D	Signal	58.5	E *	43.2	D	Yes
37 . Q Street - Olive Avenue/Yosemite Avenue - Howard Road	City of Madera	D	Signal	37.0	D	29.9	C	Signal	38.3	D	31.3	C	No
38 . I Street/SR-99 Southbound Off-Ramp - 2nd Street	Caltrans	30 sec	OWSC	22.8	C	15.1	C	OWSC	43.0	E *	16.7	C	Yes
39 . 4th Street/Sunset Avenue	City of Madera	D	Signal	13.5	B	12.1	B	Signal	13.6	B	12.4	B	No
40 . H Street/SR-99 Northbound On-Ramp - 2nd Street	Caltrans	30 sec	TWSC	6.9	A	6.3	A	TWSC	8.9	A	6.8	A	No
41 . I Street/4th Street	City of Madera	D	Signal	35.5	D	40.5	D	Signal	36.0	D	41.2	D	No

Table 7-A - Existing Intersection Levels of Service

Intersection	Jurisdiction	LOS Standard	Without Project						With Project						Significant Impact
			Control	A.M. Peak Hour		P.M. Peak Hour		Control	A.M. Peak Hour		P.M. Peak Hour				
				Delay (sec.)	LOS	Delay (sec.)	LOS		Delay (sec.)	LOS	Delay (sec.)	LOS			
42 . SR-99 Southbound On-Ramp/4th Street	Caltrans	-	- ¹	-	-	-	-	- ¹	-	-	-	-	No		
43 . H Street – SR-99 Northbound Off-Ramp/4th Street	Caltrans	45 sec	Signal	39.8	D	39.6	D	Signal	41.7	D	43.5	D	No		
44 . I Street/Olive Avenue	City of Madera	D	OWSC	18.9	C	20.8	C	OWSC	25.4	D	28.1	D	No		
45 . SR-99 Southbound Off-Ramp/Olive Avenue	Caltrans	45 sec	Signal	23.9	C	28.3	C	Signal	23.9	C	28.5	C	No		
46 . Madera Avenue/SR-99 Northbound Ramps	Caltrans	45 sec	Signal	16.4	B	16.6	B	Signal	16.7	B	21.4	C	No		
47 . Madera Avenue/Olive Avenue – SR-99 Southbound On-Ramp	Caltrans	45 sec	Signal	26.2	C	28.1	C	Signal	26.9	C	28.5	C	No		
48 . Madera Avenue (SR-145) /Lewis Street	Caltrans	30 sec	OWSC	12.8	B	13.2	B	OWSC	13.3	B	15.1	C	No		
49 . Yosemite Avenue/Cleveland Avenue - Tozer Street	Caltrans	45 sec	Signal	46.4	D *	45.6	D *	Signal	57.7	E *	66.2	E *	Yes		
50 . Road 22/Cleveland Avenue	Madera County	D	-	Does Not Exist		Does Not Exist		OWSC	8.4	A	8.3	A	No		
51 . Project Driveway 1/Avenue 17	Madera County	D	-	Does Not Exist		Does Not Exist		OWSC	15.7	C	89.6	F *	Yes		
52 . Road 22 ½ - Project Driveway 2/Avenue 16	Madera County	D	TWSC	8.9	A	9.2	A	TWSC	132.6	F *	>200	F *	Yes		
53 . Road 22 ½/Cleveland Avenue	Madera County	D	OWSC	8.4	A	0.0	A	TWSC	>200	F *	>200	F *	Yes		
54 . Road 22 ½/Project Driveway 5	Madera County	C	-	Does Not Exist		Does Not Exist		OWSC	9.8	A	9.3	A	No		
55 . Road 23/Project Driveway 3	City of Madera/Madera County	D	OWSC	0.0	A	9.7	A	OWSC	>200	F *	>200	F *	Yes		
56 . Road 23/Project Driveway 4	Madera County	D	-	Does Not Exist		Does Not Exist		OWSC	>200	F *	>200	F *	Yes		
57 . Road 23/Project Driveway 5	Madera County	D	OWSC	9.5	A	12.9	B	OWSC	>200	F *	>200	F *	Yes		
58 . Project Driveway 6/Cleveland Avenue	Madera County	D	-	Does Not Exist		Does Not Exist		OWSC	>200	F *	>200	F *	Yes		

Notes:

OWSC = One-Way Stop Control; TWSC = Two-Way Stop Control; AWSC = All-Way Stop Control; LOS = Level of Service
 Delay = Average control delay in seconds (For OWSC/TWSC intersections, reported delay is for worst-case movement).

* Exceeds LOS Standard

¹ This intersection has no stop control. Hence, Synchro did not report a delay for this intersection.

Table 7-B - Existing Roadway Segment Levels of Service

Roadway Segment	Jurisdiction	Classification ¹	Existing Number of Lanes	Without Project			With Project			Significant Impact
				Roadway Capacity	Daily Volume	LOS	Roadway Capacity	Daily Volume	LOS	
Segments on Road 23										
1 . between Avenue 17 and Project Driveway 3	City of Madera/Madera County	Urban Arterial	2	18,000	4,500	A	18,000	40,700	F *	Yes
2 . between Project Driveway 3 and Avenue 16	City of Madera/Madera County	Urban Arterial	2	18,000	4,500	A	18,000	34,000	F *	Yes
3 . between Avenue 16 and Cleveland Avenue	Madera County	Urban Arterial	2	18,000	4,700	A	18,000	35,000	F *	Yes
4 . between Cleveland Avenue and Project Driveway 4	Madera County	Urban Arterial	2	18,000	5,600	A	18,000	36,700	F *	Yes
5 . between Project Driveway 4 and Project Driveway 5	Madera County	Urban Arterial	2	18,000	5,600	A	18,000	33,400	F *	Yes
6 . between Project Driveway 5 and Avenue 14 1/2	Madera County	Urban Arterial	2	18,000	5,600	A	18,000	33,700	F *	Yes
7 . between Avenue 14 1/2 and Avenue 14	Madera County	Urban Arterial	2	18,000	5,100	A	18,000	26,700	F *	Yes
Segments on Westberry Boulevard										
8 . between Sunset Avenue and Avenue 14/Howard Road	City of Madera	Urban Arterial	2	17,200	3,900	A	17,200	5,100	A	No
Segments on Granada Drive										
9 . between Cleveland Avenue and Fresno River	City of Madera	Urban Collector	2	12,500	10,500	D	12,500	10,800	D	No
10 . between Sunset Avenue and Avenue 14/Howard Road	City of Madera	Urban Collector	2	12,500	7,800	B	12,500	7,800	B	No
Segments on Avenue 17										
11 . between Road 22 and Project Driveway 1	Madera County	Urban Arterial	2	17,200	900	A	17,200	2,300	A	No
12 . between Project Driveway 1 and Road 23	Madera County	Urban Arterial	2	17,200	900	A	17,200	11,500	B	No
13 . between Road 23 and Golden State Boulevard	City of Madera/Madera County	Urban Arterial	2	17,200	2,300	A	17,200	27,900	F *	Yes
14 . between Golden State Boulevard and State Route 99 Southbound Off-Ramp	City of Madera	Urban Arterial	2	17,200	9,700	A	17,200	30,000	F *	Yes
Segments on Avenue 16										
15 . between Road 22 and Project Driveway 2/Road 22 1/2	Madera County	Urban Arterial	2	17,200	500	A	17,200	700	A	No
16 . between Project Driveway 2/Road 22 1/2 and Road 23	Madera County	Urban Arterial	2	17,200	500	A	17,200	10,500	B	No
Segments on Cleveland Avenue										
17 . between Road 22 1/2 and Road 23	Madera County	Urban Arterial	2	17,200	100	A	17,200	34,800	F *	Yes
18 . between Road 23 and Project Driveway 6	Madera County	Urban Arterial	2	17,200	2,400	A	17,200	28,400	F *	Yes
19 . between Project Driveway 6 and Westberry Boulevard	City of Madera/Madera County	Urban Arterial	2	17,200	2,400	A	17,200	31,900	F *	Yes
20 . between Westberry Boulevard and Granada Drive	City of Madera	Urban Arterial	2	17,200	3,900	A	17,200	22,900	F *	Yes
21 . between Granada Drive and Schnoor Street	City of Madera	Urban Arterial	4	34,500	9,500	A	34,500	26,900	C	No
22 . between Schnoor Street and Fairgrounds	City of Madera/Madera County	Urban Arterial	4	34,500	15,100	A	34,500	29,800	D	No
23 . between Fairgrounds and State Route 99 Southbound Ramps	City of Madera/Madera County	Urban Arterial	5	43,100	15,100	A	43,100	30,200	C	No
Segments on Sunset Avenue										
24 . between Granada Drive and Schnoor Street	City of Madera	Urban Collector	2	12,500	6,200	A	12,500	7,600	B	No
Segments on Howard Road										
25 . between Granada Drive and Schnoor Street	City of Madera	Urban Arterial	4	34,500	10,800	A	34,500	19,700	A	No
26 . between Schnoor Street and Pine Street	City of Madera	Urban Arterial	4	34,500	16,600	A	34,500	25,600	C	No
Segments on Olive Avenue										
27 . between Yosemite Avenue and I Street	City of Madera	Urban Arterial	4	34,500	11,400	A	34,500	17,900	A	No
28 . between I Street and State Route 99 Southbound Off-Ramp	City of Madera	Urban Arterial	5	43,100	11,400	A	43,100	16,400	A	No
29 . between State Route 99 Southbound Off-Ramp and Madera Avenue	City of Madera	Urban Arterial	5	43,100	11,400	A	43,100	18,100	A	No

Notes:

LOS = Level of Service

* Exceeds LOS Standard

¹ Roadway Classifications and capacity for the segments have been obtained from the City of Madera General Plan Circulation Master Plan.

Table 7-C - Existing Freeway Segment and Ramp Levels of Service

SR-99 Freeway	Type	Mainline Lanes	Without Project						With Project						Significant Impact
			AM Peak Hour			PM Peak Hour			AM Peak Hour			PM Peak Hour			
			Speed (mi/hr)	Density (pc/mi/ln)	LOS	Speed (mi/hr)	Density (pc/mi/ln)	LOS	Speed (mi/hr)	Density (pc/mi/ln)	LOS	Speed (mi/hr)	Density (pc/mi/ln)	LOS	
Northbound															
1 . South of Madera Avenue Off-Ramp	Basic	2	59.5	28.1	D	58.5	31.8	D	58.7	31.2	D	51.3	44.5	E	Yes
2 . Madera Avenue Off-Ramp	Ramp (Diverge)	2	54.6	31.7	D	54.7	25.4	C	54.5	34.4	D	54.3	32.8	D	No
3 . Madera Avenue Off-Ramp and Madera Avenue On-Ramp	Basic	2	59.6	26.1	D	59.3	29.5	D	59.5	28.2	D	55.5	37.6	E	Yes
4 . Madera Avenue On-Ramp	Ramp (Merge)	2	54.7	31.4	D	52.9	34.5	D	53.4	33.8	D	-	-	F	Yes
5 . Madera Avenue On-Ramp and 4th Street Off-Ramp	Basic	2	59.2	31.3	D	56.6	36.2	E	57.3	35.0	D	-	-	F	Yes
6 . 4th Street Off-Ramp	Ramp (Diverge)	2	54.1	34.9	D	54.3	38.4	E	54.1	37.6	E	-	-	F	Yes
7 . 4th Street Off-Ramp and 2nd Street On-Ramp	Basic	2	60.0	26.7	D	59.0	31.1	D	59.5	29.6	D	51.8	43.9	E	Yes
8 . 2nd Street On-Ramp	Ramp (Merge)	2	55.4	29.6	D	53.5	33.5	D	54.1	32.4	D	-	-	F	Yes
9 . 2nd Street On-Ramp and Cleveland Avenue Off-Ramp	Basic	2	59.3	29.5	D	56.8	35.3	E	57.7	33.5	D	-	-	F	Yes
10 . Cleveland Avenue Off-Ramp	Ramp (Diverge)	2	54.1	32.2	D	53.6	36.5	E	53.7	35.3	E	-	-	F	Yes
11 . Cleveland Avenue Off-Ramp and Cleveland Avenue On-Ramp	Basic	2	59.6	25.0	C	59.6	27.4	D	59.6	26.6	D	58.0	32.9	D	No
12 . Cleveland Avenue On-Ramp	Ramp (Merge)	2	56.2	27.4	C	55.4	30.0	D	55.6	29.5	D	52.3	35.9	E	Yes
13 . Cleveland Avenue On-Ramp and Gateway Drive Loop Off-Ramp	Basic	2	59.6	25.9	C	59.4	28.9	D	59.5	28.3	D	55.3	37.9	E	Yes
14 . Gateway Drive Loop Off-Ramp	Ramp (Diverge)	2	48.9	29.5	D	48.9	32.4	D	48.9	31.8	D	48.6	38.9	E	Yes
15 . Gateway Drive Loop Off-Ramp and Gateway Drive On-Ramp	Basic	2	60.0	24.7	C	60.0	27.3	D	60.0	26.8	D	57.8	33.8	D	No
16 . Gateway Drive On-Ramp	Ramp (Merge)	2	56.3	27.0	C	55.4	29.7	D	55.6	29.1	D	52.6	34.7	D	No
17 . Gateway Drive On-Ramp and Avenue 17 Off-Ramp	Basic	2	60.0	26.6	D	59.5	29.7	D	59.7	28.9	D	55.6	37.6	E	Yes
18 . Avenue 17 Off-Ramp	Ramp (Diverge)	2	54.9	29.9	D	55.0	32.9	D	54.4	32.1	D	53.7	38.4	E	Yes
19 . Avenue 17 Off-Ramp and Avenue 17 On-Ramp	Basic	2	65.1	23.7	C	63.8	27.1	D	65.1	23.7	C	63.8	27.1	D	No
20 . Avenue 17 On-Ramp	Ramp (Merge)	2	58.9	28.4	D	57.8	31.1	D	58.9	28.4	D	57.8	31.1	D	No
21 . Avenue 17 On-Ramp and Avenue 18 1/2 Off-Ramp	Basic	2	65.6	24.9	C	63.9	28.2	D	65.6	24.9	C	63.9	28.2	D	No
22 . Avenue 18 1/2 Off-Ramp	Ramp (Diverge)	2	57.2	30.5	D	57.4	33.4	D	57.2	30.5	D	57.4	33.4	D	No
23 . Avenue 18 1/2 Off-Ramp and Avenue 18 1/2 On-Ramp	Basic	2	66.5	22.2	C	65.1	25.9	C	66.5	22.2	C	65.1	25.9	C	No
24 . Avenue 18 1/2 On-Ramp	Ramp (Merge)	2	59.5	26.6	C	58.4	29.2	D	57.0	31.1	D	56.8	31.6	D	No
25 . North of Avenue 18 1/2 On-Ramp	Basic	2	65.5	25.1	C	63.8	28.3	D	61.7	31.6	D	61.4	32.0	D	No

Table 7-C - Existing Freeway Segment and Ramp Levels of Service

SR-99 Freeway	Type	Mainline Lanes	Without Project						With Project						Significant Impact
			AM Peak Hour			PM Peak Hour			AM Peak Hour			PM Peak Hour			
			Speed (mi/hr)	Density (pc/mi/ln)	LOS	Speed (mi/hr)	Density (pc/mi/ln)	LOS	Speed (mi/hr)	Density (pc/mi/ln)	LOS	Speed (mi/hr)	Density (pc/mi/ln)	LOS	
Southbound															
26 . North of Avenue 18 1/2 Off-Ramp	Basic	2	66.7	21.1	C	61.6	31.8	D	66.3	22.9	C	55.6	40.5	E	Yes
27 . Avenue 18 1/2 Off-Ramp	Ramp (Diverge)	2	63.0	27.1	C	62.7	36.6	E	62.4	29.0	D	61.2	41.7	E	Yes
28 . Avenue 18 1/2 Off-Ramp and Avenue 18 1/2 Loop On-Ramp	Basic	2	65.9	19.8	C	63.3	28.5	D	65.9	19.8	C	63.3	28.5	D	No
29 . Avenue 18 1/2 Loop On-Ramp	Ramp (Merge)	2	60.6	22.5	C	58.0	30.1	D	60.6	22.5	C	58.0	30.1	D	No
30 . Avenue 18 1/2 Loop On-Ramp and Avenue 18 1/2 Slip-On Ramp	Basic	2	65.9	20.2	C	63.1	28.8	D	65.9	20.2	C	63.1	28.8	D	No
31 . Avenue 18 1/2 Slip-On Ramp	Ramp (Merge)	2	59.9	25.1	C	56.5	32.9	D	59.9	25.1	C	56.5	32.9	D	No
32 . Avenue 18 1/2 Slip-On Ramp and Avenue 17 Off-Ramp	Basic	2	65.8	22.2	C	61.0	32.2	D	65.8	22.2	C	61.0	32.2	D	No
33 . Avenue 17 Off-Ramp	Ramp (Diverge)	2	57.7	28.0	C	57.5	36.6	E	57.7	28.0	C	57.5	36.6	E	Yes
34 . Avenue 17 Off-Ramp and Avenue 17 Loop On-Ramp	Basic	2	65.0	21.5	C	62.1	29.8	D	65.0	21.5	C	62.1	29.8	D	No
35 . Avenue 17 Loop On-Ramp	Ramp (Merge)	2	56.1	27.6	C	54.1	32.1	D	56.1	27.6	C	54.1	32.1	D	No
36 . Avenue 17 Loop On-Ramp and Avenue 17 Slip-On Ramp	Basic	2	59.5	28.1	D	57.5	33.9	D	59.5	28.1	D	57.5	33.9	D	No
37 . Avenue 17 Slip-On Ramp	Ramp (Merge)	2	55.8	28.5	D	53.4	33.4	D	52.9	33.8	D	51.3	35.8	E	Yes
38 . Avenue 17 Slip-On Ramp and Gateway Drive Off-Ramp	Basic	2	58.7	29.2	D	55.9	36.4	E	55.3	37.5	E	53.0	41.4	E	Yes
39 . Gateway Drive Off-Ramp	Ramp (Diverge)	2	56.3	32.4	D	56.0	37.8	E	56.2	38.5	E	55.9	40.7	E	Yes
40 . Gateway Drive Off-Ramp and Gateway Drive Loop On-Ramp	Basic	2	59.6	27.2	D	58.4	32.1	D	57.4	34.1	D	56.5	35.8	E	Yes
41 . Gateway Drive Loop On-Ramp	Ramp (Merge)	2	56.1	27.4	C	54.6	30.6	D	52.7	33.5	D	52.9	33.3	D	No
42 . Gateway Drive Loop On-Ramp and Cleveland Avenue Off-Ramp	Basic	2	58.7	29.4	D	57.2	33.8	D	54.4	39.0	E	54.7	38.5	E	Yes
43 . Cleveland Avenue Off-Ramp	Ramp (Diverge)	2	54.9	32.1	D	54.7	35.7	E	54.4	38.9	E	54.5	38.7	E	Yes
44 . Cleveland Avenue Off-Ramp and Cleveland Avenue On-Ramp	Basic	2	58.8	28.3	D	58.2	31.3	D	57.1	34.0	D	57.1	34.0	D	No
45 . Cleveland Avenue On-Ramp	Ramp (Merge)	2	53.2	34.3	D	52.2	35.9	E	-	-	F	48.3	39.6	E	Yes
46 . Cleveland Avenue On-Ramp and 2nd Street Off-Ramp	Basic	2	56.4	35.5	E	54.8	38.3	E	-	-	F	-	-	F	Yes
47 . 2nd Street Off-Ramp	Ramp (Diverge)	2	48.3	37.3	E	48.6	39.0	E	-	-	F	48.5	43.3	E	Yes
48 . 2nd Street Off-Ramp and 4th Street On-Ramp	Basic	2	59.1	30.3	D	57.4	34.2	D	52.7	42.2	E	53.6	40.7	E	Yes
49 . 4th Street On-Ramp	Ramp (Merge)	2	53.0	34.3	D	51.2	36.7	E	-	-	F	-	-	F	Yes
50 . 4th Street On-Ramp and Olive Avenue Off-Ramp	Basic	2	56.2	36.4	E	53.4	41.1	E	-	-	F	-	-	F	Yes
51 . Olive Avenue Off-Ramp	Ramp (Diverge)	2	54.2	38.1	E	54.5	40.7	E	-	-	F	-	-	F	Yes
52 . Olive Avenue Off-Ramp and Madera Avenue On-Ramp	Basic	2	58.3	31.0	D	56.0	36.2	E	54.1	39.5	E	52.9	41.6	E	Yes
53 . Madera Avenue On-Ramp	Ramp (Merge)	2	53.6	33.4	D	51.2	36.7	E	-	-	F	-	-	F	Yes
54 . South of Madera Avenue On-Ramp	Basic	2	56.7	34.9	D	53.1	41.2	E	-	-	F	-	-	F	Yes

Notes:

SR-99 = State Route 99

mi/hr : miles per hour

pc/mi/ln: passenger cars per mile per lane

Bold indicates deficient LOS

Table 7-D - Phase I Project Completion Year (2029) Intersection Levels of Service

Intersection	Jurisdiction	LOS Standard	Control	Without Project				With Project				Significant Impact	
				A.M. Peak Hour		P.M. Peak Hour		A.M. Peak Hour		P.M. Peak Hour			
				Delay (sec.)	LOS	Delay (sec.)	LOS	Delay (sec.)	LOS	Delay (sec.)	LOS		
1 . Road 22/Avenue 17	Madera County	D	OWSC	8.6	A	9.0	A	OWSC	8.8	A	9.2	A	No
2 . Road 22/Avenue 16	Madera County	D	TWSC	8.7	A	8.5	A	AWSC	7.5	A	7.7	A	No
3 . Golden State Boulevard/Avenue 18 ½	Madera County	C	OWSC	12.0	B	13.6	B	OWSC	12.2	B	14.4	B	No
4 . Pistachio Drive/Avenue 18 ½	Madera County	C	OWSC	15.9	C	24.1	C	OWSC	16.5	C	26.5	D *	Yes
5 . SR-99 Southbound Ramps – Road 23/Avenue 18 ½	Caltrans	30 sec	TWSC	32.7	D *	47.2	E *	TWSC	55.7	F *	>200	F *	Yes
6 . SR-99 Northbound Ramps/Avenue 18 ½	Caltrans	30 sec	OWSC	53.1	F *	28.0	D	OWSC	>200	F *	72.0	F *	Yes
7 . Road 23/Avenue 17	City of Madera/Madera County	D	TWSC	13.2	B	14.7	B	TWSC	39.6	E *	>200	F *	Yes
8 . Road 23/Avenue 16	City of Madera/Madera County	D	TWSC	14.1	B	12.0	B	TWSC	27.1	D	28.8	D	No
9 . Road 23/Cleveland Avenue	Madera County	D	TWSC	13.8	B	14.0	B	TWSC	76.4	F *	61.6	F *	Yes
10 . Road 23/Avenue 14 ½	Madera County	D	TWSC	13.3	B	12.0	B	TWSC	21.3	C	33.0	D	No
11 . Road 23/Avenue 14	Madera County	D	AWSC	12.6	B	9.9	A	AWSC	38.2	E *	41.2	E *	Yes
12 . Road 23/Avenue 12	Madera County	D	AWSC	9.0	A	9.5	A	AWSC	9.6	A	10.4	B	No
13 . Golden State Boulevard – Airport Drive/Avenue 17	City of Madera	D	TWSC	52.0	F *	>200	F *	TWSC	76.6	F *	>200	F *	Yes
14 . SR-99 Southbound Ramps/Avenue 17	Caltrans	30 sec	OWSC	39.2	E *	>200	F *	OWSC	46.9	E *	>200	F *	Yes
15 . SR-99 Northbound Ramps/Avenue 17	Caltrans	30 sec	OWSC	>200	F *	>200	F *	OWSC	>200	F *	>200	F *	Yes
16 . Love's Truck Stop Driveway/Avenue 17	Madera County	D	Signal	65.1	E *	>200	F *	Signal	105.7	F *	>200	F *	Yes
17 . Westberry Boulevard/Cleveland Avenue	City of Madera	D	TWSC	12.7	B	14.6	B	TWSC	>200	F *	>200	F *	Yes
18 . Westberry Boulevard/Sunset Avenue	City of Madera	D	AWSC	17.8	C	9.8	A	AWSC	18.6	C	10.5	B	No
19 . Westberry Boulevard/Avenue 14	City of Madera/Madera County	D	AWSC	16.7	C	13.3	B	AWSC	28.6	D	39.2	E *	Yes
20 . Westberry Boulevard/Avenue 16	City of Madera/Madera County	D	AWSC	8.5	A	9.6	A	AWSC	10.1	B	13.0	B	No
21 . Granada Drive/Cleveland Avenue	City of Madera	D	AWSC	20.1	C	25.4	D	AWSC	159.7	F *	144.5	F *	Yes
22 . Granada Drive/Sunset Avenue	City of Madera	C	AWSC	33.0	D *	27.6	D *	AWSC	33.5	D *	30.3	D *	Yes
23 . Avenue 16 – Ellis Street/Kennedy Street	City of Madera/Madera County	D	Signal	21.3	C	22.4	C	Signal	22.1	C	25.4	C	No
24 . Schnoor Avenue/Kennedy Street	City of Madera/Madera County	D	Signal	33.3	C	34.1	C	Signal	33.3	C	34.1	C	No
25 . SR-99 Southbound Ramps/Kennedy Street - Gateway Drive	Caltrans	30 sec	OWSC	37.4	E *	67.9	F *	OWSC	37.4	E *	67.9	F *	Yes
26 . SR-99 Northbound Off-Ramp/Gateway Drive	Caltrans	30 sec	OWSC	9.9	A	10.2	B	OWSC	9.9	A	10.2	B	No
27 . SR-99 Northbound Off-Ramps	Caltrans	30 sec	OWSC	10.5	B	10.5	B	OWSC	10.5	B	10.5	B	No
28 . SR-99 Northbound Off-Ramp/Gateway Drive	Caltrans	30 sec	OWSC	0.0	A	12.6	B	OWSC	0.0	A	12.6	B	No
29 . Schnoor Avenue/Cleveland Avenue	City of Madera	D	Signal	27.7	C	31.4	C	Signal	28.4	C	31.4	C	No
30 . Fairgrounds/Cleveland Avenue	City of Madera/Madera County	D	Signal	33.6	C	35.8	D	Signal	34.7	C	35.8	D	No
31 . SR-99 Southbound Ramps/Cleveland Avenue	Caltrans	45 sec	Signal	25.0	C	14.5	B	Signal	48.7	D *	15.2	B	Yes
32 . SR-99 Northbound Ramps/Cleveland Avenue	Caltrans	45 sec	Signal	23.6	C	23.1	C	Signal	24.8	C	26.5	C	No
33 . Gateway Drive/Cleveland Avenue	City of Madera	D	Signal	33.7	C	31.5	C	Signal	35.3	D	31.8	C	No
34 . Cleveland Avenue – Country Club Drive/W Cleveland Avenue	City of Madera	D	Signal	11.1	B	10.8	B	Signal	11.7	B	12.4	B	No
35 . Country Club Drive/Sharon Boulevard	City of Madera	D	OWSC	11.6	B	11.4	B	OWSC	11.6	B	11.5	B	No
36 . Pine Street/Howard Road	City of Madera	D	Signal	47.9	D	36.5	D	Signal	47.9	D	38.2	D	No
37 . Q Street - Olive Avenue/Yosemite Avenue - Howard Road	City of Madera	D	Signal	37.2	D	29.5	C	Signal	39.5	D	30.9	C	No
38 . I Street/SR-99 Southbound Off-Ramp - 2nd Street	Caltrans	30 sec	OWSC	24.4	C	16.5	C	OWSC	26.3	D	16.7	C	No
39 . 4th Street/Sunset Avenue	City of Madera	D	Signal	13.8	B	12.2	B	Signal	13.8	B	12.6	B	No
40 . H Street/SR-99 Northbound On-Ramp - 2nd Street	Caltrans	30 sec	TWSC	6.1	A	9.3	A	TWSC	5.7	A	6.2	A	No
41 . I Street/4th Street	City of Madera	D	Signal	35.6	D	40.5	D	Signal	35.6	D	40.8	D	No

Table 7-D - Phase I Project Completion Year (2029) Intersection Levels of Service

Intersection	Jurisdiction	LOS Standard	Without Project						With Project				Significant Impact
			Control	A.M. Peak Hour		P.M. Peak Hour		Control	A.M. Peak Hour		P.M. Peak Hour		
				Delay (sec.)	LOS	Delay (sec.)	LOS		Delay (sec.)	LOS	Delay (sec.)	LOS	
42 . SR-99 Southbound On-Ramp/4th Street	Caltrans	-	- ¹	-	-	-	-	- ¹	-	-	-	-	No
43 . H Street – SR-99 Northbound Off-Ramp/4th Street	Caltrans	45 sec	Signal	40.5	D	42.0	D	Signal	40.9	D	42.7	D	No
44 . I Street/Olive Avenue	City of Madera	D	OWSC	21.8	C	21.7	C	OWSC	22.4	C	22.9	C	No
45 . SR-99 Southbound Off-Ramp/Olive Avenue	Caltrans	45 sec	Signal	23.0	C	28.3	C	Signal	21.9	C	27.5	C	No
46 . Madera Avenue/SR-99 Northbound Ramps	Caltrans	45 sec	Signal	18.5	B	16.7	B	Signal	18.5	B	16.7	B	No
47 . Madera Avenue/Olive Avenue – SR-99 Southbound On-Ramp	Caltrans	45 sec	Signal	28.0	C	30.1	C	Signal	28.4	C	33.4	C	No
48 . Madera Avenue (SR-145) /Lewis Street	Caltrans	30 sec	OWSC	13.8	B	15.6	C	OWSC	14.0	B	16.5	C	No
49 . Yosemite Avenue/Cleveland Avenue - Tozer Street	Caltrans	45 sec	Signal	47.3	D *	47.7	D *	Signal	47.3	D *	57.4	E *	Yes
50 . Road 22/Cleveland Avenue	Madera County	D	-	Does Not Exist		Does Not Exist		OWSC	0.0	A	0.0	A	No
51 . Project Driveway 1/Avenue 17	Madera County	D	-	Does Not Exist		Does Not Exist		OWSC	0.0	A	0.0	A	No
52 . Road 22 ½ - Project Driveway 2/Avenue 16	Madera County	D	TWSC	8.9	A	9.2	A	TWSC	8.9	A	9.2	A	No
53 . Road 22 ½/Cleveland Avenue	Madera County	D	OWSC	8.4	A	0.0	A	TWSC	8.5	A	8.5	A	No
54 . Road 22 ½/Project Driveway 5	Madera County	C	-	Does Not Exist		Does Not Exist		OWSC	0.0	A	0.0	A	No
55 . Road 23/Project Driveway 3	City of Madera/Madera County	D	OWSC	0.0	A	9.9	A	OWSC	0.0	A	13.8	B	No
56 . Road 23/Project Driveway 4	Madera County	D	-	Does Not Exist		Does Not Exist		OWSC	37.0	E *	>200	F *	Yes
57 . Road 23/Project Driveway 5	Madera County	D	OWSC	11.3	B	12.9	B	OWSC	14.3	B	32.5	D	No
58 . Project Driveway 6/Cleveland Avenue	Madera County	D	-	Does Not Exist		Does Not Exist		OWSC	>200	F *	>200	F *	Yes

Notes:

- OWSC = One-Way Stop Control; TWSC = Two-Way Stop Control; AWSC = All-Way Stop Control; LOS = Level of Service
- Delay = Average control delay in seconds (For OWSC/TWSC intersections, reported delay is for worst-case movement).
- * Exceeds LOS Standard
- ¹ This intersection has no stop control. Hence, Synchro did not report a delay for this intersection.

Table 7-E - Phase I Project Completion Year (2029) Roadway Segment Levels of Service

Roadway Segment	Jurisdiction	Classification ¹	Existing Number of Lanes	Without Project			With Project			Significant Impact
				Roadway Capacity	Daily Volume	LOS	Roadway Capacity	Daily Volume	LOS	
Segments on Road 23										
1 . between Avenue 17 and Project Driveway 3	City of Madera/Madera County	Urban Arterial	2	18,000	4,600	A	18,000	12,100	B	No
2 . between Project Driveway 3 and Avenue 16	City of Madera/Madera County	Urban Arterial	2	18,000	4,600	A	18,000	12,200	B	No
3 . between Avenue 16 and Cleveland Avenue	Madera County	Urban Arterial	2	18,000	5,600	A	18,000	12,400	B	No
4 . between Cleveland Avenue and Project Driveway 4	Madera County	Urban Arterial	2	18,000	6,300	A	18,000	14,800	D	No
5 . between Project Driveway 4 and Project Driveway 5	Madera County	Urban Arterial	2	18,000	6,000	A	18,000	16,000	D	No
6 . between Project Driveway 5 and Avenue 14 1/2	Madera County	Urban Arterial	2	18,000	5,700	A	18,000	15,700	D	No
7 . between Avenue 14 1/2 and Avenue 14	Madera County	Urban Arterial	2	18,000	5,300	A	18,000	13,100	C	No
Segments on Westberry Boulevard										
8 . between Sunset Avenue and Avenue 14/Howard Road	City of Madera	Urban Arterial	2	17,200	4,900	A	17,200	5,700	A	No
Segments on Granada Drive										
9 . between Cleveland Avenue and Fresno River	City of Madera	Urban Collector	2	12,500	11,700	E *	12,500	12,000	E *	Yes
10 . between Sunset Avenue and Avenue 14/Howard Road	City of Madera	Urban Collector	2	12,500	8,100	B	12,500	8,100	B	No
Segments on Avenue 17										
11 . between Road 22 and Project Driveway 1	Madera County	Urban Arterial	2	17,200	900	A	17,200	1,400	A	No
12 . between Project Driveway 1 and Road 23	Madera County	Urban Arterial	2	17,200	1,000	A	17,200	1,400	A	No
13 . between Road 23 and Golden State Boulevard	City of Madera/Madera County	Urban Arterial	2	17,200	3,300	A	17,200	5,400	A	No
14 . between Golden State Boulevard and State Route 99 Southbound Off-Ramp	City of Madera	Urban Arterial	2	17,200	14,200	D	17,200	15,900	E *	Yes
Segments on Avenue 16										
15 . between Road 22 and Project Driveway 2/Road 22 1/2	Madera County	Urban Arterial	2	17,200	500	A	17,200	500	A	No
16 . between Project Driveway 2/Road 22 1/2 and Road 23	Madera County	Urban Arterial	2	17,200	1,200	A	17,200	1,200	A	No
Segments on Cleveland Avenue										
17 . between Road 22 1/2 and Road 23	Madera County	Urban Arterial	2	17,200	100	A	17,200	100	A	No
18 . between Road 23 and Project Driveway 6	Madera County	Urban Arterial	2	17,200	2,500	A	17,200	15,000	D	No
19 . between Project Driveway 6 and Westberry Boulevard	City of Madera/Madera County	Urban Arterial	2	17,200	3,000	A	17,200	21,200	F *	Yes
20 . between Westberry Boulevard and Granada Drive	City of Madera	Urban Arterial	2	17,200	5,000	A	17,200	17,100	E *	Yes
21 . between Granada Drive and Schnoor Street	City of Madera	Urban Arterial	4	34,500	11,000	A	34,500	22,300	B	No
22 . between Schnoor Street and Fairgrounds	City of Madera/Madera County	Urban Arterial	4	34,500	16,600	A	34,500	26,200	C	No
23 . between Fairgrounds and State Route 99 Southbound Ramps	City of Madera/Madera County	Urban Arterial	5	43,100	17,400	A	43,100	27,000	B	No
Segments on Sunset Avenue										
24 . between Granada Drive and Schnoor Street	City of Madera	Urban Collector	2	12,500	6,300	A	12,500	6,800	A	No
Segments on Howard Road										
25 . between Granada Drive and Schnoor Street	City of Madera	Urban Arterial	4	34,500	11,300	A	34,500	14,500	A	No
26 . between Schnoor Street and Pine Street	City of Madera	Urban Arterial	4	34,500	17,000	A	34,500	20,100	A	No
Segments on Olive Avenue										
27 . between Yosemite Avenue and I Street	City of Madera	Urban Arterial	4	34,500	12,600	A	34,500	14,500	A	No
28 . between I Street and State Route 99 Southbound Off-Ramp	City of Madera	Urban Arterial	5	43,100	12,600	A	43,100	13,900	A	No
29 . between State Route 99 Southbound Off-Ramp and Madera Avenue	City of Madera	Urban Arterial	5	43,100	14,500	A	43,100	16,500	A	No

Notes:
 LOS = Level of Service
 * Exceeds LOS Standard
¹ Roadway Classifications and capacity for the segments have been obtained from the City of Madera General Plan Circulation Master Plan.

Table 7-F - Phase I Project Completion Year (2029) Freeway Segment and Ramp Levels of Service

SR-99 Freeway	Type	Mainline Lanes	Without Project						With Project						Significant Impact
			AM Peak Hour			PM Peak Hour			AM Peak Hour			PM Peak Hour			
			Speed (mi/hr)	Density (pc/mi/ln)	LOS	Speed (mi/hr)	Density (pc/mi/ln)	LOS	Speed (mi/hr)	Density (pc/mi/ln)	LOS	Speed (mi/hr)	Density (pc/mi/ln)	LOS	
Northbound															
1 . South of Madera Avenue Off-Ramp	Basic	3	59.6	20.8	C	59.6	22.4	C	59.6	21.4	C	59.6	24.1	C	No
2 . Madera Avenue Off-Ramp	Ramp (Diverge)	3	54.6	24.7	C	54.7	26.0	C	54.5	25.2	C	54.6	27.4	C	No
3 . Madera Avenue Off-Ramp and Madera Avenue On-Ramp	Basic	3	59.6	19.2	C	59.6	21.2	C	59.6	19.8	C	59.6	22.6	C	No
4 . Madera Avenue On-Ramp	Ramp (Merge)	3	56.9	24.2	C	56.5	25.8	C	56.7	24.8	C	56.1	27.6	C	No
5 . Madera Avenue On-Ramp and 4th Street Off-Ramp	Basic	3	60.5	23.2	C	60.5	25.0	C	60.5	23.8	C	60.5	26.9	D	No
6 . 4th Street Off-Ramp	Ramp (Diverge)	3	54.1	27.6	C	54.2	29.0	D	54.1	28.1	D	54.2	30.6	D	No
7 . 4th Street Off-Ramp and 2nd Street On-Ramp	Basic	3	60.0	20.4	C	60.0	22.6	C	60.0	21.1	C	60.0	24.5	C	No
8 . 2nd Street On-Ramp	Ramp (Merge)	3	57.3	21.8	C	57.0	24.1	C	57.2	22.4	C	56.6	25.8	C	No
9 . 2nd Street On-Ramp and Cleveland Avenue Off-Ramp	Basic	3	59.6	22.4	C	59.6	24.9	C	59.6	23.1	C	59.6	27.0	D	No
10 . Cleveland Avenue Off-Ramp	Ramp (Diverge)	3	53.9	25.7	C	53.4	28.3	D	53.6	26.5	C	52.6	30.6	D	No
11 . Cleveland Avenue Off-Ramp and Cleveland Avenue On-Ramp	Basic	3	59.6	19.0	C	59.6	20.2	C	59.6	19.0	C	59.6	20.2	C	No
12 . Cleveland Avenue On-Ramp	Ramp (Merge)	3	57.4	19.9	B	57.3	21.0	C	57.4	19.9	B	57.3	21.0	C	No
13 . Cleveland Avenue On-Ramp and Gateway Drive Loop Off-Ramp	Basic	3	59.6	19.8	C	59.6	21.1	C	59.6	19.8	C	59.6	21.1	C	No
14 . Gateway Drive Loop Off-Ramp	Ramp (Diverge)	3	48.7	23.7	C	48.8	24.7	C	48.7	23.7	C	48.8	24.7	C	No
15 . Gateway Drive Loop Off-Ramp and Gateway Drive On-Ramp	Basic	3	60.0	18.4	C	60.0	20.0	C	60.0	18.4	C	60.0	20.0	C	No
16 . Gateway Drive On-Ramp	Ramp (Merge)	3	57.7	19.2	B	57.5	20.8	C	57.7	19.2	B	57.5	20.8	C	No
17 . Gateway Drive On-Ramp and Avenue 17 Off-Ramp	Basic	3	60.0	19.6	C	60.0	21.4	C	60.0	19.6	C	60.0	21.4	D	No
18 . Avenue 17 Off-Ramp	Ramp (Diverge)	3	54.2	23.6	C	53.6	25.7	C	54.2	23.6	C	53.6	25.7	C	No
19 . Avenue 17 Off-Ramp and Avenue 17 On-Ramp	Basic	3	65.5	15.5	B	65.5	15.8	B	65.5	15.5	B	65.5	15.8	B	No
20 . Avenue 17 On-Ramp	Ramp (Merge)	3	60.8	19.8	B	60.7	20.7	C	60.8	19.8	B	60.7	20.7	C	No
21 . Avenue 17 On-Ramp and Avenue 18 1/2 Off-Ramp	Basic	2	64.9	26.4	D	64.1	27.8	D	64.9	26.4	D	64.1	27.8	D	No
22 . Avenue 18 1/2 Off-Ramp	Ramp (Diverge)	2	57.2	31.9	D	57.4	33.1	D	57.2	31.9	D	57.4	33.1	D	No
23 . Avenue 18 1/2 Off-Ramp and Avenue 18 1/2 On-Ramp	Basic	2	66.2	23.4	C	65.3	25.4	C	66.2	23.4	C	65.3	25.4	C	No
24 . Avenue 18 1/2 On-Ramp	Ramp (Merge)	2	59.0	27.9	C	58.4	29.1	D	58.2	29.4	D	57.9	29.9	D	No
25 . North of Avenue 18 1/2 On-Ramp	Basic	2	64.7	26.6	D	63.9	28.1	D	63.5	28.8	D	63.2	29.3	D	No

Table 7-F - Phase I Project Completion Year (2029) Freeway Segment and Ramp Levels of Service

SR-99 Freeway	Type	Mainline Lanes	Without Project						With Project						Significant Impact
			AM Peak Hour			PM Peak Hour			AM Peak Hour			PM Peak Hour			
			Speed (mi/hr)	Density (pc/mi/ln)	LOS	Speed (mi/hr)	Density (pc/mi/ln)	LOS	Speed (mi/hr)	Density (pc/mi/ln)	LOS	Speed (mi/hr)	Density (pc/mi/ln)	LOS	
Southbound															
26 . North of Avenue 18 1/2 Off-Ramp	Basic	2	66.0	23.9	C	61.5	32.0	D	65.8	24.5	C	59.7	34.6	D	No
27 . Avenue 18 1/2 Off-Ramp	Ramp (Diverge)	2	62.9	30.0	D	62.6	36.7	E	62.8	30.6	D	62.1	38.4	E	Yes
28 . Avenue 18 1/2 Off-Ramp and Avenue 18 1/2 Loop On-Ramp	Basic	2	65.7	22.4	C	63.3	28.4	D	65.7	22.4	C	63.3	28.4	D	No
29 . Avenue 18 1/2 Loop On-Ramp	Ramp (Merge)	2	60.0	25.0	C	58.1	30.1	D	60.0	25.0	C	58.1	30.1	D	No
30 . Avenue 18 1/2 Loop On-Ramp and Avenue 18 1/2 Slip-On Ramp	Basic	2	65.7	22.7	C	63.2	28.7	D	65.7	22.7	C	63.2	28.7	D	No
31 . Avenue 18 1/2 Slip-On Ramp	Ramp (Merge)	2	59.2	27.7	C	56.5	32.9	D	59.2	27.7	C	56.5	32.9	D	No
32 . Avenue 18 1/2 Slip-On Ramp and Avenue 17 Off-Ramp	Basic	2	65.0	25.0	C	61.0	32.1	D	65.0	25.0	C	61.0	32.1	D	No
33 . Avenue 17 Off-Ramp	Ramp (Diverge)	3	57.0	22.6	C	56.7	26.1	C	57.0	22.6	C	56.7	26.1	C	No
34 . Avenue 17 Off-Ramp and Avenue 17 Loop On-Ramp	Basic	3	65.0	14.6	C	56.0	17.4	B	65.0	14.6	B	65.0	17.4	B	No
35 . Avenue 17 Loop On-Ramp	Ramp (Merge)	3	57.5	20.6	C	57.1	23.3	C	57.5	20.6	C	57.1	23.3	C	No
36 . Avenue 17 Loop On-Ramp and Avenue 17 Slip-On Ramp	Basic	3	59.6	20.2	C	59.6	23.4	C	59.6	20.2	C	59.6	23.4	C	No
37 . Avenue 17 Slip-On Ramp	Ramp (Merge)	3	57.7	19.5	B	57.2	23.0	C	57.7	19.5	B	57.2	23.0	C	No
38 . Avenue 17 Slip-On Ramp and Gateway Drive Off-Ramp	Basic	3	58.8	21.2	C	58.8	25.1	C	58.8	21.2	C	58.8	25.1	C	No
39 . Gateway Drive Off-Ramp	Ramp (Diverge)	3	56.2	24.6	C	55.9	28.1	D	56.2	24.6	C	55.9	28.1	D	No
40 . Gateway Drive Off-Ramp and Gateway Drive Loop On-Ramp	Basic	3	59.6	19.8	C	59.6	22.9	C	59.6	19.8	C	59.6	22.9	C	No
41 . Gateway Drive Loop On-Ramp	Ramp (Merge)	3	57.9	19.1	B	57.6	21.2	C	57.9	19.1	B	57.6	21.2	C	No
42 . Gateway Drive Loop On-Ramp and Cleveland Avenue Off-Ramp	Basic	3	58.8	21.6	C	58.8	24.4	C	58.8	21.6	C	58.8	24.4	C	No
43 . Cleveland Avenue Off-Ramp	Ramp (Diverge)	3	54.9	24.5	C	54.6	26.9	C	54.9	24.5	C	54.6	26.9	C	No
44 . Cleveland Avenue Off-Ramp and Cleveland Avenue On-Ramp	Basic	3	58.8	20.8	C	58.8	22.9	C	58.8	20.8	C	58.8	22.9	C	No
45 . Cleveland Avenue On-Ramp	Ramp (Merge)	3	56.5	25.7	C	56.3	26.7	C	55.6	29.0	D	56.0	27.8	C	No
46 . Cleveland Avenue On-Ramp and 2nd Street Off-Ramp	Basic	3	58.8	25.1	C	58.8	26.6	D	58.8	27.6	D	58.8	27.5	D	No
47 . 2nd Street Off-Ramp	Ramp (Diverge)	3	48.3	28.3	D	48.6	29.3	D	48.2	30.3	D	48.6	30.0	D	No
48 . 2nd Street Off-Ramp and 4th Street On-Ramp	Basic	3	59.6	22.3	C	59.6	24.6	C	59.6	24.7	C	59.6	25.4	C	No
49 . 4th Street On-Ramp	Ramp (Merge)	3	56.7	25.1	C	56.4	26.7	C	56.2	27.1	C	56.2	27.3	C	No
50 . 4th Street On-Ramp and Olive Avenue Off-Ramp	Basic	3	59.6	25.4	C	59.6	27.4	D	59.6	27.8	D	59.5	28.3	D	No
51 . Olive Avenue Off-Ramp	Ramp (Diverge)	3	53.8	29.2	D	54.1	30.6	D	53.6	31.2	D	54.0	31.3	D	No
52 . Olive Avenue Off-Ramp and Madera Avenue On-Ramp	Basic	3	58.8	22.1	C	58.8	24.9	C	58.8	23.9	C	58.8	25.5	C	No
53 . Madera Avenue On-Ramp	Ramp (Merge)	3	57.1	23.3	C	56.6	25.5	C	56.8	24.7	C	56.4	26.3	C	No
54 . South of Madera Avenue On-Ramp	Basic	3	58.8	24.1	C	58.8	26.9	D	58.8	26.0	C	58.8	27.8	D	No

Notes:

- SR-99 = State Route 99
- mi/hr : miles per hour
- pc/mi/ln: passenger cars per mile per lane

Bold Indicates deficient LOS

Table 7-G - Phase II Project Completion Year (2039) Intersection Levels of Service

Intersection	Jurisdiction	LOS Standard	Control	Without Project				With Project				Significant Impact	
				A.M. Peak Hour		P.M. Peak Hour		A.M. Peak Hour		P.M. Peak Hour			
				Delay (sec.)	LOS	Delay (sec.)	LOS	Delay ² (sec.)	LOS	Delay ² (sec.)	LOS		
1 . Road 22/Avenue 17	Madera County	D	OWSC	8.6	A	9.0	A	OWSC	8.9	A	9.8	A	No
2 . Road 22/Avenue 16	Madera County	D	TWSC	8.7	A	8.5	A	AWSC	7.5	A	7.7	A	No
3 . Golden State Boulevard/Avenue 18 ½	Madera County	C	OWSC	12.1	B	14.0	B	OWSC	13.3	B	16.5	C	No
4 . Pistachio Drive/Avenue 18 ½	Madera County	C	OWSC	16.2	C	25.6	D *	OWSC	18.4	C	34.1	D *	Yes
5 . SR-99 Southbound Ramps – Road 23/Avenue 18 ½	Caltrans	30 sec	TWSC	35.7	E *	76.3	F *	TWSC	>200	F *	>200	F *	Yes
6 . SR-99 Northbound Ramps/Avenue 18 ½	Caltrans	30 sec	OWSC	60.3	F *	37.3	E *	OWSC	>200	F *	>200	F *	Yes
7 . Road 23/Avenue 17	City of Madera/Madera County	D	TWSC	13.5	B	15.0	B	TWSC	-	F *	-	F *	Yes
8 . Road 23/Avenue 16	City of Madera/Madera County	D	TWSC	15.5	C	12.9	B	TWSC	>200	F *	>200	F *	Yes
9 . Road 23/Cleveland Avenue	Madera County	D	TWSC	17.1	C	15.0	C	TWSC	>200	F *	>200	F *	Yes
10 . Road 23/Avenue 14 ½	Madera County	D	TWSC	14.5	B	12.4	B	TWSC	39.1	E *	62.5	F *	Yes
11 . Road 23/Avenue 14	Madera County	D	AWSC	14.6	B	10.3	B	AWSC	134.0	F *	93.8	F *	Yes
12 . Road 23/Avenue 12	Madera County	D	AWSC	9.1	A	9.7	A	AWSC	10.2	B	11.1	B	No
13 . Golden State Boulevard – Airport Drive/Avenue 17	City of Madera	D	TWSC	>200	F *	>200	F *	TWSC	>200	F *	>200	F *	Yes
14 . SR-99 Southbound Ramps/Avenue 17	Caltrans	30 sec	OWSC	109.2	F *	>200	F *	OWSC	>200	F *	>200	F *	Yes
15 . SR-99 Northbound Ramps/Avenue 17	Caltrans	30 sec	OWSC	>200	F *	>200	F *	OWSC	>200	F *	>200	F *	Yes
16 . Love's Truck Stop Driveway/Avenue 17	Madera County	D	Signal	68.9	E *	>200	F *	Signal	108.8	F *	>200	F *	Yes
17 . Westberry Boulevard/Cleveland Avenue	City of Madera	D	TWSC	15.7	C	21.6	C	TWSC	>200	F *	>200	F *	Yes
18 . Westberry Boulevard/Sunset Avenue	City of Madera	D	AWSC	20.7	C	10.5	B	AWSC	22.9	C	11.4	B	No
19 . Westberry Boulevard/Avenue 14	City of Madera/Madera County	D	AWSC	22.1	C	15.0	B	AWSC	68.2	F *	71.1	F *	Yes
20 . Westberry Boulevard/Avenue 16	City of Madera/Madera County	D	AWSC	9.5	A	11.0	B	AWSC	11.9	B	17.2	C	No
21 . Granada Drive/Cleveland Avenue	City of Madera	D	AWSC	28.4	D	37.6	E *	AWSC	>200	F *	182.9	F *	Yes
22 . Granada Drive/Sunset Avenue	City of Madera	C	AWSC	37.9	E *	33.4	D *	AWSC	38.7	E *	37.0	E *	Yes
23 . Avenue 16 – Ellis Street/Kennedy Street	City of Madera/Madera County	D	Signal	22.5	C	22.6	C	Signal	23.9	C	22.7	C	No
24 . Schnoor Avenue/Kennedy Street	City of Madera/Madera County	D	Signal	35.5	D	37.5	D	Signal	37.5	D	41.5	D	No
25 . SR-99 Southbound Ramps/Kennedy Street - Gateway Drive	Caltrans	30 sec	OWSC	84.9	F *	>200	F *	OWSC	91.3	F *	>200	F *	Yes
26 . SR-99 Northbound Off-Ramp/Gateway Drive	Caltrans	30 sec	OWSC	10.9	B	10.7	B	OWSC	11.0	B	10.9	B	No
27 . SR-99 Northbound Off-Ramps	Caltrans	30 sec	OWSC	11.1	B	10.7	B	OWSC	11.2	B	11.0	B	No
28 . SR-99 Northbound Off-Ramp/Gateway Drive	Caltrans	30 sec	OWSC	0.0	A	13.7	B	OWSC	0.0	A	13.7	B	No
29 . Schnoor Avenue/Cleveland Avenue	City of Madera	D	Signal	27.7	C	31.4	C	Signal	29.1	C	32.0	C	No
30 . Fairgrounds/Cleveland Avenue	City of Madera/Madera County	D	Signal	35.0	D	36.3	D	Signal	37.9	D	41.3	D	No
31 . SR-99 Southbound Ramps/Cleveland Avenue	Caltrans	45 sec	Signal	28.9	C	14.1	B	Signal	78.7	E *	16.0	B	Yes
32 . SR-99 Northbound Ramps/Cleveland Avenue	Caltrans	45 sec	Signal	24.7	C	23.4	C	Signal	25.6	C	32.8	C	No
33 . Gateway Drive/Cleveland Avenue	City of Madera	D	Signal	34.1	C	32.8	C	Signal	34.2	C	35.4	D	No
34 . Cleveland Avenue – Country Club Drive/W Cleveland Avenue	City of Madera	D	Signal	11.8	B	11.0	B	Signal	12.6	B	13.5	B	No
35 . Country Club Drive/Sharon Boulevard	City of Madera	D	OWSC	11.8	B	12.2	B	OWSC	11.9	B	12.4	B	No
36 . Pine Street/Howard Road	City of Madera	D	Signal	49.5	D	37.3	D	Signal	50.4	D	39.2	D	No
37 . Q Street - Olive Avenue/Yosemite Avenue - Howard Road	City of Madera	D	Signal	36.3	D	29.4	C	Signal	39.4	D	30.7	C	No
38 . I Street/SR-99 Southbound Off-Ramp - 2nd Street	Caltrans	30 sec	OWSC	29.0	D	18.4	C	OWSC	55.9	F *	20.8	C	Yes
39 . 4th Street/Sunset Avenue	City of Madera	D	Signal	13.9	B	12.1	B	Signal	14.6	B	12.4	B	No
40 . H Street/SR-99 Northbound On-Ramp - 2nd Street	Caltrans	30 sec	TWSC	7.4	A	16.8	C	TWSC	8.4	A	13.9	B	No
41 . I Street/4th Street	City of Madera	D	Signal	35.7	D	40.8	D	Signal	35.8	D	41.5	D	No

Table 7-G - Phase II Project Completion Year (2039) Intersection Levels of Service

Intersection	Jurisdiction	LOS Standard	Control	Without Project				With Project				Significant Impact	
				A.M. Peak Hour		P.M. Peak Hour		A.M. Peak Hour		P.M. Peak Hour			
				Delay (sec.)	LOS	Delay (sec.)	LOS	Delay ² (sec.)	LOS	Delay ² (sec.)	LOS		
42 . SR-99 Southbound On-Ramp/4th Street	Caltrans	-	- ¹	-	-	-	-	- ¹	-	-	-	-	No
43 . H Street – SR-99 Northbound Off-Ramp/4th Street	Caltrans	45 sec	Signal	44.6	D	45.3	D *	Signal	47.5	D *	51.2	D *	Yes
44 . I Street/Olive Avenue	City of Madera	D	OWSC	22.5	C	22.9	C	OWSC	23.2	C	28.5	D	No
45 . SR-99 Southbound Off-Ramp/Olive Avenue	Caltrans	45 sec	Signal	21.6	C	27.2	C	Signal	22.0	C	27.5	C	No
46 . Madera Avenue/SR-99 Northbound Ramps	Caltrans	45 sec	Signal	20.3	C	17.0	B	Signal	20.3	C	18.6	B	No
47 . Madera Avenue/Olive Avenue – SR-99 Southbound On-Ramp	Caltrans	45 sec	Signal	30.9	C	33.1	C	Signal	32.2	C	34.6	C	No
48 . Madera Avenue (SR-145) /Lewis Street	Caltrans	30 sec	OWSC	15.2	C	18.8	C	OWSC	15.6	C	21.3	C	No
49 . Yosemite Avenue/Cleveland Avenue - Tozer Street	Caltrans	45 sec	Signal	47.9	D *	50.7	D *	Signal	55.1	E *	66.9	E *	Yes
50 . Road 22/Cleveland Avenue	Madera County	D	-	Does Not Exist		Does Not Exist		OWSC	0.0	A	0.0	A	No
51 . Project Driveway 1/Avenue 17	Madera County	D	-	Does Not Exist		Does Not Exist		OWSC	17.2	C	119.6	F *	Yes
52 . Road 22 ½ - Project Driveway 2/Avenue 16	Madera County	D	TWSC	9.0	A	9.6	A	TWSC	15.5	C	26.4	D	No
53 . Road 22 ½/Cleveland Avenue	Madera County	D	OWSC	8.4	A	0.0	A	TWSC	8.7	A	8.8	A	No
54 . Road 22 ½/Project Driveway 5	Madera County	C	-	Does Not Exist		Does Not Exist		OWSC	0.0	A	0.0	A	No
55 . Road 23/Project Driveway 3	City of Madera/Madera County	D	OWSC	0.0	A	10.3	B	OWSC	>200	F *	>200	F *	Yes
56 . Road 23/Project Driveway 4	Madera County	D	-	Does Not Exist		Does Not Exist		OWSC	>200	F *	>200	F *	Yes
57 . Road 23/Project Driveway 5	Madera County	D	OWSC	14.1	B	13.7	B	OWSC	23.0	C	72.3	F *	Yes
58 . Project Driveway 6/Cleveland Avenue	Madera County	D	-	Does Not Exist		Does Not Exist		OWSC	>200	F *	>200	F *	Yes

Notes:

OWSC = One-Way Stop Control; TWSC = Two-Way Stop Control; AWSC = All-Way Stop Control; LOS = Level of Service

Delay = Average control delay in seconds (For OWSC/TWSC intersections, reported delay is for worst-case movement).

* Exceeds LOS Standard

¹ This intersection has no stop control. Hence, Synchro did not report a delay for this intersection.

² Based on Synchro results, at the intersection of Road 23/Avenue 17, the delay is represented with a dash (-) as through volumes block the turn movements throughout the peak hour. As such, Synchro did not report a delay at this intersections for the blocked turn movements. Therefore, the worst-case movements at this intersection operate at LOS F.

Table 7-H - Phase II Project Completion Year (2039) Roadway Segment Levels of Service

Roadway Segment	Jurisdiction	Classification ¹	Existing Number of Lanes	Without Project			With Project			Significant Impact
				Roadway Capacity ¹	Daily Volume	LOS	Roadway Capacity ¹	Daily Volume	LOS	
Segments on Road 23										
1 . between Avenue 17 and Project Driveway 3	City of Madera/Madera County	Urban Arterial	2	18,000	4,600	A	18,000	26,400	F *	Yes
2 . between Project Driveway 3 and Avenue 16	City of Madera/Madera County	Urban Arterial	2	18,000	4,700	A	18,000	18,200	F *	Yes
3 . between Avenue 16 and Cleveland Avenue	Madera County	Urban Arterial	2	18,000	6,600	A	18,000	18,500	F *	Yes
4 . between Cleveland Avenue and Project Driveway 4	Madera County	Urban Arterial	2	18,000	6,900	A	18,000	20,000	F *	Yes
5 . between Project Driveway 4 and Project Driveway 5	Madera County	Urban Arterial	2	18,000	6,400	A	18,000	19,100	F *	Yes
6 . between Project Driveway 5 and Avenue 14 1/2	Madera County	Urban Arterial	2	18,000	5,800	A	18,000	18,500	F *	Yes
7 . between Avenue 14 1/2 and Avenue 14	Madera County	Urban Arterial	2	18,000	5,400	A	18,000	15,200	D	No
Segments on Westberry Boulevard										
8 . between Sunset Avenue and Avenue 14/Howard Road	City of Madera	Urban Arterial	2	17,200	5,900	A	17,200	6,600	A	No
Segments on Granada Drive										
9 . between Cleveland Avenue and Fresno River	City of Madera	Urban Collector	2	12,500	13,000	F *	12,500	13,300	F *	Yes
10 . between Sunset Avenue and Avenue 14/Howard Road	City of Madera	Urban Collector	2	12,500	8,500	B	12,500	8,500	B	No
Segments on Avenue 17										
11 . between Road 22 and Project Driveway 1	Madera County	Urban Arterial	2	17,200	1,000	A	17,200	2,400	A	No
12 . between Project Driveway 1 and Road 23	Madera County	Urban Arterial	2	17,200	1,100	A	17,200	11,500	B	No
13 . between Road 23 and Golden State Boulevard	City of Madera/Madera County	Urban Arterial	2	17,200	3,400	A	17,200	22,500	F *	Yes
14 . between Golden State Boulevard and State Route 99 Southbound Off-Ramp	City of Madera	Urban Arterial	2	17,200	17,800	F *	17,200	34,000	F *	Yes
Segments on Avenue 16										
15 . between Road 22 and Project Driveway 2/Road 22 1/2	Madera County	Urban Arterial	2	17,200	500	A	17,200	500	A	No
16 . between Project Driveway 2/Road 22 1/2 and Road 23	Madera County	Urban Arterial	2	17,200	2,000	A	17,200	5,300	A	No
Segments on Cleveland Avenue										
17 . between Road 22 1/2 and Road 23	Madera County	Urban Arterial	2	17,200	100	A	17,200	300	A	No
18 . between Road 23 and Project Driveway 6	Madera County	Urban Arterial	2	17,200	2,600	A	17,200	15,900	E *	Yes
19 . between Project Driveway 6 and Westberry Boulevard	City of Madera/Madera County	Urban Arterial	2	17,200	3,600	A	17,200	22,300	F *	Yes
20 . between Westberry Boulevard and Granada Drive	City of Madera	Urban Arterial	2	17,200	6,100	A	17,200	18,100	F *	Yes
21 . between Granada Drive and Schnoor Street	City of Madera	Urban Arterial	4	34,500	12,600	A	34,500	23,800	B	No
22 . between Schnoor Street and Fairgrounds	City of Madera/Madera County	Urban Arterial	4	34,500	18,000	A	34,500	27,600	D	No
23 . between Fairgrounds and State Route 99 Southbound Ramps	City of Madera/Madera County	Urban Arterial	5	43,100	19,600	A	43,100	29,800	B	No
Segments on Sunset Avenue										
24 . between Granada Drive and Schnoor Street	City of Madera	Urban Collector	2	12,500	6,400	A	12,500	6,900	A	No
Segments on Howard Road										
25 . between Granada Drive and Schnoor Street	City of Madera	Urban Arterial	4	34,500	11,900	A	34,500	15,300	A	No
26 . between Schnoor Street and Pine Street	City of Madera	Urban Arterial	4	34,500	17,300	A	34,500	20,700	B	No
Segments on Olive Avenue										
27 . between Yosemite Avenue and I Street	City of Madera	Urban Arterial	4	34,500	13,700	A	34,500	15,700	A	No
28 . between I Street and State Route 99 Southbound Off-Ramp	City of Madera	Urban Arterial	5	43,100	13,700	A	43,100	15,100	A	No
29 . between State Route 99 Southbound Off-Ramp and Madera Avenue	City of Madera	Urban Arterial	5	43,100	17,700	A	43,100	20,500	A	No

Notes:

LOS = Level of Service

* Exceeds LOS Standard

¹ Roadway Classifications and capacity for the segments have been obtained from the City of Madera General Plan Circulation Master Plan.

Table 7-I - Phase II Project Completion Year (2039) Freeway Segment and Ramp Levels of Service

SR-99 Freeway	Type	Mainline Lanes	Without Project						With Project						Significant Impact
			AM Peak Hour			PM Peak Hour			AM Peak Hour			PM Peak Hour			
			Speed (mi/hr)	Density (pc/mi/ln)	LOS	Speed (mi/hr)	Density (pc/mi/ln)	LOS	Speed (mi/hr)	Density (pc/mi/ln)	LOS	Speed (mi/hr)	Density (pc/mi/ln)	LOS	
Northbound															
1 . South of Madera Avenue Off-Ramp	Basic	3	59.6	22.9	C	59.6	24.1	C	59.6	24.2	C	59.6	27.4	D	No
2 . Madera Avenue Off-Ramp	Ramp (Diverge)	3	54.5	26.5	C	54.6	27.4	C	54.5	27.6	C	54.6	30.2	D	No
3 . Madera Avenue Off-Ramp and Madera Avenue On-Ramp	Basic	3	59.6	21.1	C	59.6	22.7	C	59.6	22.3	C	59.6	25.9	C	No
4 . Madera Avenue On-Ramp	Ramp (Merge)	3	56.2	26.9	C	55.8	28.3	D	55.8	28.4	D	54.1	32.3	D	No
5 . Madera Avenue On-Ramp and 4th Street Off-Ramp	Basic	3	60.5	25.9	C	60.4	27.6	D	60.4	27.5	D	58.5	32.7	D	No
6 . 4th Street Off-Ramp	Ramp (Diverge)	3	54.0	29.9	D	54.1	31.1	D	54.0	31.1	D	54.1	34.2	D	No
7 . 4th Street Off-Ramp and 2nd Street On-Ramp	Basic	3	60.0	23.0	C	60.0	24.8	C	60.0	24.5	C	59.7	29.1	D	No
8 . 2nd Street On-Ramp	Ramp (Merge)	3	56.9	24.2	C	56.4	26.3	C	56.6	25.7	C	55.0	30.5	D	No
9 . 2nd Street On-Ramp and Cleveland Avenue Off-Ramp	Basic	3	59.6	25.2	C	59.6	27.4	D	59.6	26.9	D	57.9	33.2	D	No
10 . Cleveland Avenue Off-Ramp	Ramp (Diverge)	3	53.8	28.1	D	53.1	30.5	D	53.5	29.7	D	52.4	34.6	D	No
11 . Cleveland Avenue Off-Ramp and Cleveland Avenue On-Ramp	Basic	3	59.6	21.3	C	59.6	22.0	C	59.6	22.4	C	59.6	24.7	C	No
12 . Cleveland Avenue On-Ramp	Ramp (Merge)	3	57.2	22.1	C	57.1	22.6	C	57.0	23.5	C	56.5	26.0	C	No
13 . Cleveland Avenue On-Ramp and Gateway Drive Loop Off-Ramp	Basic	3	59.6	22.3	C	59.6	22.9	C	59.6	23.8	C	59.6	26.6	D	No
14 . Gateway Drive Loop Off-Ramp	Ramp (Diverge)	3	48.4	26.1	C	48.8	26.4	C	48.4	27.3	C	48.7	29.4	D	No
15 . Gateway Drive Loop Off-Ramp and Gateway Drive On-Ramp	Basic	3	60.0	20.2	C	60.0	21.7	C	60.0	21.6	C	60.0	25.2	C	No
16 . Gateway Drive On-Ramp	Ramp (Merge)	3	57.5	20.7	C	57.3	22.3	C	57.3	22.0	C	56.7	25.3	C	No
17 . Gateway Drive On-Ramp and Avenue 17 Off-Ramp	Basic	3	60.0	21.5	C	60.0	23.2	C	60.0	22.9	C	60.0	26.8	D	No
18 . Avenue 17 Off-Ramp	Ramp (Diverge)	3	54.0	25.4	C	53.5	27.3	C	53.4	27.2	C	52.1	31.6	D	No
19 . Avenue 17 Off-Ramp and Avenue 17 On-Ramp	Basic	3	65.5	16.8	B	65.5	17.1	B	65.5	16.8	B	65.5	17.1	B	No
20 . Avenue 17 On-Ramp	Ramp (Merge)	3	60.6	21.3	C	60.5	22.4	C	60.6	21.3	C	60.5	22.4	C	No
21 . Avenue 17 On-Ramp and Avenue 18 1/2 Off-Ramp	Basic	2	63.1	29.5	D	61.7	31.6	D	63.1	29.5	D	61.7	31.6	D	No
22 . Avenue 18 1/2 Off-Ramp	Ramp (Diverge)	2	57.2	34.5	D	57.4	36.0	E	57.2	34.5	D	57.4	36.0	E	Yes
23 . Avenue 18 1/2 Off-Ramp and Avenue 18 1/2 On-Ramp	Basic	2	65.0	26.1	D	63.6	28.7	D	65.0	26.1	D	63.6	28.7	D	No
24 . Avenue 18 1/2 On-Ramp	Ramp (Merge)	2	57.7	30.3	D	56.7	31.9	D	55.3	33.4	D	55.4	33.4	D	No
25 . North of Avenue 18 1/2 On-Ramp	Basic	2	62.9	29.8	D	61.3	32.2	D	59.2	35.3	E	59.4	35.0	D	Yes

Table 7-1 - Phase II Project Completion Year (2039) Freeway Segment and Ramp Levels of Service

SR-99 Freeway	Type	Mainline Lanes	Without Project						With Project						Significant Impact
			AM Peak Hour			PM Peak Hour			AM Peak Hour			PM Peak Hour			
			Speed (mi/hr)	Density (pc/mi/ln)	LOS	Speed (mi/hr)	Density (pc/mi/ln)	LOS	Speed (mi/hr)	Density (pc/mi/ln)	LOS	Speed (mi/hr)	Density (pc/mi/ln)	LOS	
Southbound															
26 . North of Avenue 18 1/2 Off-Ramp	Basic	2	64.6	26.9	D	58.4	36.5	E	63.7	28.4	D	53.7	43.4	E	Yes
27 . Avenue 18 1/2 Off-Ramp	Ramp (Diverge)	2	62.9	32.8	D	62.6	39.5	E	62.6	34.1	D	61.6	42.9	E	Yes
28 . Avenue 18 1/2 Off-Ramp and Avenue 18 1/2 Loop On-Ramp	Basic	2	64.9	25.1	C	61.3	31.7	D	64.9	25.1	C	61.3	31.7	D	No
29 . Avenue 18 1/2 Loop On-Ramp	Ramp (Merge)	2	59.2	27.6	C	56.6	32.4	D	59.2	27.6	C	56.6	32.4	D	No
30 . Avenue 18 1/2 Loop On-Ramp and Avenue 18 1/2 Slip-On Ramp	Basic	2	64.8	25.5	C	61.0	32.2	D	64.8	25.5	C	61.0	32.2	D	No
31 . Avenue 18 1/2 Slip-On Ramp	Ramp (Merge)	2	70.0	30.2	D	54.5	35.3	E	58.1	30.2	D	54.5	35.3	E	Yes
32 . Avenue 18 1/2 Slip-On Ramp and Avenue 17 Off-Ramp	Basic	2	63.4	28.3	D	58.2	36.4	E	63.4	28.3	D	58.2	36.4	E	Yes
33 . Avenue 17 Off-Ramp	Ramp (Diverge)	3	56.8	24.3	C	56.6	27.6	C	56.8	24.3	C	56.6	27.6	C	No
34 . Avenue 17 Off-Ramp and Avenue 17 Loop On-Ramp	Basic	3	65.0	15.9	B	65.0	18.8	C	65.0	15.9	B	65.0	18.8	C	No
35 . Avenue 17 Loop On-Ramp	Ramp (Merge)	3	57.4	21.8	C	61.4	24.6	C	57.4	21.8	C	56.8	24.6	C	No
36 . Avenue 17 Loop On-Ramp and Avenue 17 Slip-On Ramp	Basic	3	59.6	21.7	C	59.6	24.9	C	59.6	21.7	C	59.6	24.9	C	No
37 . Avenue 17 Slip-On Ramp	Ramp (Merge)	3	57.5	21.0	C	56.8	25.0	C	56.4	26.2	C	56.1	27.4	C	No
38 . Avenue 17 Slip-On Ramp and Gateway Drive Off-Ramp	Basic	3	58.8	22.9	C	58.8	27.2	D	58.8	27.0	D	58.7	29.1	D	No
39 . Gateway Drive Off-Ramp	Ramp (Diverge)	3	56.2	26.1	C	55.9	29.8	D	56.1	29.5	D	55.8	31.3	D	No
40 . Gateway Drive Off-Ramp and Gateway Drive Loop On-Ramp	Basic	3	59.6	21.5	C	59.6	24.8	C	59.6	25.2	C	59.6	26.5	D	No
41 . Gateway Drive Loop On-Ramp	Ramp (Merge)	3	57.6	21.1	C	57.2	23.5	C	57.0	24.2	C	56.8	24.9	C	No
42 . Gateway Drive Loop On-Ramp and Cleveland Avenue Off-Ramp	Basic	3	58.8	23.8	C	58.8	26.8	D	58.8	27.5	D	58.8	28.6	D	No
43 . Cleveland Avenue Off-Ramp	Ramp (Diverge)	3	54.8	26.3	C	54.6	28.9	D	54.5	29.6	D	54.4	30.4	D	No
44 . Cleveland Avenue Off-Ramp and Cleveland Avenue On-Ramp	Basic	3	58.8	22.8	C	58.8	25.2	C	58.8	25.6	C	58.8	26.4	D	No
45 . Cleveland Avenue On-Ramp	Ramp (Merge)	3	56.0	27.9	C	55.6	29.2	D	53.6	33.5	D	54.8	31.3	D	No
46 . Cleveland Avenue On-Ramp and 2nd Street Off-Ramp	Basic	3	58.8	27.4	D	58.7	29.5	D	57.2	33.8	D	58.0	32.0	D	No
47 . 2nd Street Off-Ramp	Ramp (Diverge)	3	48.2	30.2	D	48.5	31.5	D	48.0	34.3	D	48.4	33.1	D	No
48 . 2nd Street Off-Ramp and 4th Street On-Ramp	Basic	3	59.6	24.6	C	59.6	27.3	D	59.3	29.4	D	59.3	29.2	D	No
49 . 4th Street On-Ramp	Ramp (Merge)	3	56.1	27.4	C	55.6	29.1	D	54.8	31.2	D	55.0	30.6	D	No
50 . 4th Street On-Ramp and Olive Avenue Off-Ramp	Basic	3	59.6	28.0	D	58.9	30.7	D	57.6	33.7	D	58.0	33.0	D	No
51 . Olive Avenue Off-Ramp	Ramp (Diverge)	3	53.5	31.5	D	53.7	33.0	D	53.0	35.2	E	53.6	34.5	D	Yes
52 . Olive Avenue Off-Ramp and Madera Avenue On-Ramp	Basic	3	58.8	23.8	C	58.8	26.8	D	58.8	27.3	D	58.8	28.2	D	No
53 . Madera Avenue On-Ramp	Ramp (Merge)	3	56.8	24.6	C	56.2	27.3	C	56.1	27.5	C	55.8	38.7	D	No
54 . South of Madera Avenue On-Ramp	Basic	3	58.8	25.8	C	58.7	29.1	D	58.7	29.4	D	58.4	30.8	D	No

Notes:

SR-99 = State Route 99

mi/hr : miles per hour

pc/mi/ln: passenger cars per mile per lane

Bold Indicates deficient LOS

Table 7-J - Phase III Project Completion Year (2049) Intersection Levels of Service

Intersection	Jurisdiction	LOS Standard	Control	Without Project					With Project					Significant Impact
				A.M. Peak Hour			P.M. Peak Hour		A.M. Peak Hour		P.M. Peak Hour			
				Delay (sec.)	Delay (sec.)	LOS	Delay (sec.)	LOS	Delay ² (sec.)	LOS	Delay ² (sec.)	LOS		
1 . Road 22/Avenue 17	Madera County	D	OWSC	8.6	8.6	A	9.1	A	OWSC	9.7	A	9.7	A	No
2 . Road 22/Avenue 16	Madera County	D	TWSC	8.7	8.7	A	8.5	A	AWSC	7.5	A	7.7	A	No
3 . Golden State Boulevard/Avenue 18 ½	Madera County	C	OWSC	12.3	12.3	B	14.5	B	OWSC	13.9	B	19.5	C	No
4 . Pistachio Drive/Avenue 18 ½	Madera County	C	OWSC	16.5	16.5	C	27.4	D *	OWSC	19.6	C	45.3	E *	Yes
5 . SR-99 Southbound Ramps – Road 23/Avenue 18 ½	Caltrans	30 sec	TWSC	38.8	38.8	E *	126.5	F *	TWSC	114.6	F *	>200	F *	Yes
6 . SR-99 Northbound Ramps/Avenue 18 ½	Caltrans	30 sec	OWSC	69.8	69.8	F *	52.3	F *	OWSC	>200	F *	>200	F *	Yes
7 . Road 23/Avenue 17	City of Madera/Madera County	D	TWSC	13.7	13.7	B	15.3	C	TWSC	-	F *	-	F *	Yes
8 . Road 23/Avenue 16	City of Madera/Madera County	D	TWSC	17.3	17.3	C	13.8	B	TWSC	>200	F *	>200	F *	Yes
9 . Road 23/Cleveland Avenue	Madera County	D	TWSC	24.0	24.0	C	16.2	C	TWSC	>200	F *	>200	F *	Yes
10 . Road 23/Avenue 14 ½	Madera County	D	TWSC	15.7	15.7	C	12.8	B	TWSC	-	F *	-	F *	Yes
11 . Road 23/Avenue 14	Madera County	D	AWSC	17.4	17.4	C	10.7	B	AWSC	>200	F *	>200	F *	Yes
12 . Road 23/Avenue 12	Madera County	D	AWSC	9.3	9.3	A	10.0	A	AWSC	12.1	B	14.1	B	No
13 . Golden State Boulevard – Airport Drive/Avenue 17	City of Madera	D	TWSC	>200	2636.1	F *	>200	F *	TWSC	>200	F *	>200	F *	Yes
14 . SR-99 Southbound Ramps/Avenue 17	Caltrans	30 sec	OWSC	>200	279.4	F *	>200	F *	OWSC	>200	F *	>200	F *	Yes
15 . SR-99 Northbound Ramps/Avenue 17	Caltrans	30 sec	OWSC	>200	3178.8	F *	>200	F *	OWSC	>200	F *	>200	F *	Yes
16 . Love's Truck Stop Driveway/Avenue 17	Madera County	D	Signal	70.3	70.3	E *	>200	F *	Signal	118.7	F *	>200	F *	Yes
17 . Westberry Boulevard/Cleveland Avenue	City of Madera	D	TWSC	20.5	20.5	C	46.5	E *	TWSC	>200	F *	>200	F *	Yes
18 . Westberry Boulevard/Sunset Avenue	City of Madera	D	AWSC	24.4	24.4	C	11.3	B	AWSC	42.5	E *	15.3	C	Yes
19 . Westberry Boulevard/Avenue 14	City of Madera/Madera County	D	AWSC	35.8	35.8	E *	18.0	C	AWSC	>200	F *	>200	F *	Yes
20 . Westberry Boulevard/Avenue 16	City of Madera/Madera County	D	AWSC	11.2	11.2	B	13.5	B	AWSC	23.1	C	51.6	F *	Yes
21 . Granada Drive/Cleveland Avenue	City of Madera	D	AWSC	45.5	45.5	E *	58.7	F *	AWSC	>200	F *	>200	F *	Yes
22 . Granada Drive/Sunset Avenue	City of Madera	C	AWSC	46.0	46.0	E *	41.1	E *	AWSC	56.3	F *	53.6	F *	Yes
23 . Avenue 16 – Ellis Street/Kennedy Street	City of Madera/Madera County	D	Signal	24.5	24.5	C	23.0	C	Signal	34.9	C	24.0	C	No
24 . Schnoor Avenue/Kennedy Street	City of Madera/Madera County	D	Signal	51.6	51.6	D	51.8	D	Signal	55.3	E *	65.6	E *	Yes
25 . SR-99 Southbound Ramps/Kennedy Street - Gateway Drive	Caltrans	30 sec	OWSC	>200	264.8	F *	>200	F *	OWSC	>200	F *	>200	F *	Yes
26 . SR-99 Northbound Off-Ramp/Gateway Drive	Caltrans	30 sec	OWSC	12.4	12.4	B	11.4	B	OWSC	12.7	B	13.2	B	No
27 . SR-99 Northbound Off-Ramps	Caltrans	30 sec	OWSC	11.7	11.7	B	10.8	B	OWSC	12.0	B	11.7	B	No
28 . SR-99 Northbound Off-Ramp/Gateway Drive	Caltrans	30 sec	OWSC	0.0	0.0	A	15.0	B	OWSC	0.0	A	15.0	B	No
29 . Schnoor Avenue/Cleveland Avenue	City of Madera	D	Signal	28.0	28.0	C	31.5	C	Signal	32.0	C	42.2	D	No
30 . Fairgrounds/Cleveland Avenue	City of Madera/Madera County	D	Signal	35.4	35.4	D	37.4	D	Signal	37.3	D	73.1	E *	Yes
31 . SR-99 Southbound Ramps/Cleveland Avenue	Caltrans	45 sec	Signal	43.0	43.0	D	14.5	B	Signal	85.8	F *	22.3	C	Yes
32 . SR-99 Northbound Ramps/Cleveland Avenue	Caltrans	45 sec	Signal	25.3	25.3	C	23.5	C	Signal	25.7	C	54.1	D *	Yes
33 . Gateway Drive/Cleveland Avenue	City of Madera	D	Signal	34.1	34.1	C	35.4	D	Signal	34.6	C	51.6	D	No
34 . Cleveland Avenue – Country Club Drive/W Cleveland Avenue	City of Madera	D	Signal	12.5	12.5	B	11.3	B	Signal	13.8	B	15.5	B	No
35 . Country Club Drive/Sharon Boulevard	City of Madera	D	OWSC	12.1	12.1	B	13.0	B	OWSC	12.2	B	13.4	B	No
36 . Pine Street/Howard Road	City of Madera	D	Signal	52.2	52.2	D	38.4	D	Signal	61.8	E *	46.5	D	Yes
37 . Q Street - Olive Avenue/Yosemite Avenue - Howard Road	City of Madera	D	Signal	36.2	36.2	D	29.9	C	Signal	37.5	D	30.1	C	No
38 . I Street/SR-99 Southbound Off-Ramp - 2nd Street	Caltrans	30 sec	OWSC	35.8	35.8	E *	20.8	C	OWSC	83.8	F *	24.8	C	Yes
39 . 4th Street/Sunset Avenue	City of Madera	D	Signal	13.9	13.9	B	12.5	B	Signal	15.3	B	15.7	B	No
40 . H Street/SR-99 Northbound On-Ramp - 2nd Street	Caltrans	30 sec	TWSC	8.1	8.1	A	13.0	B	TWSC	11.2	B	17.9	C	No
41 . I Street/4th Street	City of Madera	D	Signal	35.9	35.9	D	41.3	D	Signal	36.2	D	42.0	D	No

Table 7-J - Phase III Project Completion Year (2049) Intersection Levels of Service

Intersection	Jurisdiction	LOS Standard	Without Project						With Project				Significant Impact		
			Control	A.M. Peak Hour			P.M. Peak Hour			A.M. Peak Hour		P.M. Peak Hour			
				Delay (sec.)	Delay (sec.)	LOS	Delay (sec.)	LOS	Control	Delay ² (sec.)	LOS	Delay ² (sec.)		LOS	
42 . SR-99 Southbound On-Ramp/4th Street	Caltrans	-	- ¹	-	-	-	-	-	- ¹	-	-	-	-	No	
43 . H Street – SR-99 Northbound Off-Ramp/4th Street	Caltrans	45 sec	Signal	51.9	51.9	D *	50.4	D *	Signal	56.2	E *	64.6	E *	Yes	
44 . I Street/Olive Avenue	City of Madera	D	OWSC	26.4	26.4	D	28.4	D	OWSC	34.2	D	59.7	F *	Yes	
45 . SR-99 Southbound Off-Ramp/Olive Avenue	Caltrans	45 sec	Signal	21.9	21.9	C	26.8	C	Signal	27.2	C	27.7	C	No	
46 . Madera Avenue/SR-99 Northbound Ramps	Caltrans	45 sec	Signal	22.9	22.9	C	17.6	B	Signal	24.0	C	24.2	C	No	
47 . Madera Avenue/Olive Avenue – SR-99 Southbound On-Ramp	Caltrans	45 sec	Signal	38.8	38.8	D	38.9	D	Signal	41.3	D	41.1	D	No	
48 . Madera Avenue (SR-145) /Lewis Street	Caltrans	30 sec	OWSC	16.8	16.8	C	23.3	C	OWSC	17.9	C	28.2	D	No	
49 . Yosemite Avenue/Cleveland Avenue - Tozer Street	Caltrans	45 sec	Signal	53.7	53.7	D *	54.7	D *	Signal	68.4	E *	86.3	F *	Yes	
50 . Road 22/Cleveland Avenue	Madera County	D	-	Does Not Exist			Does Not Exist			OWSC	8.4	A	8.3	A	No
51 . Project Driveway 1/Avenue 17	Madera County	D	-	Does Not Exist			Does Not Exist			OWSC	16.6	C	95.6	F *	Yes
52 . Road 22 ½ - Project Driveway 2/Avenue 16	Madera County	D	TWSC	9.2	9.2	A	10.0	A	TWSC	>200	F *	>200	F *	Yes	
53 . Road 22 ½/Cleveland Avenue	Madera County	D	OWSC	8.4	8.4	A	0.0	A	TWSC	>200	F *	>200	F *	Yes	
54 . Road 22 ½/Project Driveway 5	Madera County	C	-	Does Not Exist			Does Not Exist			OWSC	9.8	A	9.3	A	No
55 . Road 23/Project Driveway 3	City of Madera/Madera County	D	OWSC	0.0	0.0	A	10.7	B	OWSC	>200	F *	>200	F *	Yes	
56 . Road 23/Project Driveway 4	Madera County	D	-	Does Not Exist			Does Not Exist			OWSC	>200	F *	>200	F *	Yes
57 . Road 23/Project Driveway 5	Madera County	D	OWSC	18.2	18.2	C	14.8	B	OWSC	>200	F *	>200	F *	Yes	
58 . Project Driveway 6/Cleveland Avenue	Madera County	D	-	Does Not Exist			Does Not Exist			OWSC	>200	F *	>200	F *	Yes

Notes:

OWSC = One-Way Stop Control; TWSC = Two-Way Stop Control; AWSC = All-Way Stop Control; LOS = Level of Service

Delay = Average control delay in seconds (For OWSC/TWSC intersections, reported delay is for worst-case movement).

* Exceeds LOS Standard

¹ This intersection has no stop control. Hence, Synchro did not report a delay for this intersection.

² Based on Synchro results, at the intersection of Road 23/Avenue 17 and Road 23/Avenue 14 ½, the delay is represented with a dash (-) as through volumes block the turn movements throughout the peak hour. As such, Synchro did not report a delay at these intersections for the blocked turn movements. Therefore, the worst-case movements at these intersections operate at LOS F.

Table 7-K - Phase III Project Completion Year (2049) Roadway Segment Levels of Service

Roadway Segment	Jurisdiction	Classification ¹	Existing Number of Lanes	Without Project			With Project			Significant Impact
				Roadway Capacity	Daily Volume	LOS	Roadway Capacity	Daily Volume	LOS	
Segments on Road 23										
1 . between Avenue 17 and Project Driveway 3	City of Madera/Madera County	Urban Arterial	2	18,000	4,700	A	18,000	40,900	F *	Yes
2 . between Project Driveway 3 and Avenue 16	City of Madera/Madera County	Urban Arterial	2	18,000	4,800	A	18,000	34,400	F *	Yes
3 . between Avenue 16 and Cleveland Avenue	Madera County	Urban Arterial	2	18,000	7,500	A	18,000	37,800	F *	Yes
4 . between Cleveland Avenue and Project Driveway 4	Madera County	Urban Arterial	2	18,000	7,600	A	18,000	38,600	F *	Yes
5 . between Project Driveway 4 and Project Driveway 5	Madera County	Urban Arterial	2	18,000	6,800	A	18,000	34,500	F *	Yes
6 . between Project Driveway 5 and Avenue 14 1/2	Madera County	Urban Arterial	2	18,000	5,900	A	18,000	34,000	F *	Yes
7 . between Avenue 14 1/2 and Avenue 14	Madera County	Urban Arterial	2	18,000	5,600	A	18,000	27,200	F *	Yes
Segments on Westberry Boulevard										
8 . between Sunset Avenue and Avenue 14/Howard Road	City of Madera	Urban Arterial	2	17,200	6,800	A	17,200	8,000	A	No
Segments on Granada Drive										
9 . between Cleveland Avenue and Fresno River	City of Madera	Urban Collector	2	12,500	14,200	F *	12,500	14,600	F *	Yes
10 . between Sunset Avenue and Avenue 14/Howard Road	City of Madera	Urban Collector	2	12,500	8,900	C	12,500	8,900	C	No
Segments on Avenue 17										
11 . between Road 22 and Project Driveway 1	Madera County	Urban Arterial	2	17,200	1,100	A	17,200	2,600	A	No
12 . between Project Driveway 1 and Road 23	Madera County	Urban Arterial	2	17,200	1,200	A	17,200	11,800	B	No
13 . between Road 23 and Golden State Boulevard	City of Madera/Madera County	Urban Arterial	2	17,200	3,500	A	17,200	29,100	F *	Yes
14 . between Golden State Boulevard and State Route 99 Southbound Off-Ramp	City of Madera	Urban Arterial	2	17,200	21,400	F *	17,200	41,800	F *	Yes
Segments on Avenue 16										
15 . between Road 22 and Project Driveway 2/Road 22 1/2	Madera County	Urban Arterial	2	17,200	500	A	17,200	800	A	No
16 . between Project Driveway 2/Road 22 1/2 and Road 23	Madera County	Urban Arterial	2	17,200	2,700	A	17,200	12,700	C	No
Segments on Cleveland Avenue										
17 . between Road 22 1/2 and Road 23	Madera County	Urban Arterial	2	17,200	100	A	17,200	34,800	F *	Yes
18 . between Road 23 and Project Driveway 6	Madera County	Urban Arterial	2	17,200	2,600	A	17,200	28,600	F *	Yes
19 . between Project Driveway 6 and Westberry Boulevard	City of Madera/Madera County	Urban Arterial	2	17,200	4,300	A	17,200	33,800	F *	Yes
20 . between Westberry Boulevard and Granada Drive	City of Madera	Urban Arterial	2	17,200	7,100	A	17,200	26,000	F *	Yes
21 . between Granada Drive and Schnoor Street	City of Madera	Urban Arterial	4	34,500	14,100	A	34,500	31,400	E *	Yes
22 . between Schnoor Street and Fairgrounds	City of Madera/Madera County	Urban Arterial	4	34,500	19,400	A	34,500	34,100	E *	Yes
23 . between Fairgrounds and State Route 99 Southbound Ramps	City of Madera/Madera County	Urban Arterial	5	43,100	21,900	A	43,100	37,000	D	No
Segments on Sunset Avenue										
24 . between Granada Drive and Schnoor Street	City of Madera	Urban Collector	2	12,500	6,500	A	12,500	7,900	B	No
Segments on Howard Road										
25 . between Granada Drive and Schnoor Street	City of Madera	Urban Arterial	4	34,500	12,400	A	34,500	21,400	B	No
26 . between Schnoor Street and Pine Street	City of Madera	Urban Arterial	4	34,500	17,600	A	34,500	26,500	C	No
Segments on Olive Avenue										
27 . between Yosemite Avenue and I Street	City of Madera	Urban Arterial	4	34,500	14,900	A	34,500	21,500	B	No
28 . between I Street and State Route 99 Southbound Off-Ramp	City of Madera	Urban Arterial	5	43,100	14,900	A	43,100	19,900	A	No
29 . between State Route 99 Southbound Off-Ramp and Madera Avenue	City of Madera	Urban Arterial	5	43,100	20,800	A	43,100	27,600	B	No

Notes:

- LOS = Level of Service
- * Exceeds LOS Standard
- ¹ Roadway Classifications and capacity for the segments have been obtained from the City of Madera General Plan Circulation Master Plan.

Table 7-L - Phase III Project Completion Year (2049) Freeway Segment and Ramp Levels of Service

SR-99 Freeway	Type	Mainline Lanes	Without Project						With Project						Significant Impact
			AM Peak Hour			PM Peak Hour			AM Peak Hour			PM Peak Hour			
			Speed (mi/hr)	Density (pc/mi/ln)	LOS	Speed (mi/hr)	Density (pc/mi/ln)	LOS	Speed (mi/hr)	Density (pc/mi/ln)	LOS	Speed (mi/hr)	Density (pc/mi/ln)	LOS	
Northbound															
1 . South of Madera Avenue Off-Ramp	Basic	3	59.6	25.0	C	59.6	25.7	C	59.6	26.7	D	58.8	30.9	D	No
2 . Madera Avenue Off-Ramp	Ramp (Diverge)	3	54.6	28.8	D	59.6	24.3	C	54.2	29.8	D	54.3	32.7	D	No
3 . Madera Avenue Off-Ramp and Madera Avenue On-Ramp	Basic	3	59.6	22.9	C	59.6	24.3	C	59.6	24.3	C	59.5	28.1	D	No
4 . Madera Avenue On-Ramp	Ramp (Merge)	3	55.3	29.7	D	54.6	31.4	D	-	-	F	52.0	35.4	E	Yes
5 . Madera Avenue On-Ramp and 4th Street Off-Ramp	Basic	3	60.1	28.9	D	59.6	30.4	D	59.3	31.0	D	55.6	37.9	E	Yes
6 . 4th Street Off-Ramp	Ramp (Diverge)	3	53.9	32.1	D	54.0	33.0	D	53.9	33.4	D	54.0	36.5	E	Yes
7 . 4th Street Off-Ramp and 2nd Street On-Ramp	Basic	3	60.0	25.6	C	60.0	27.0	D	60.0	27.3	D	58.2	32.9	D	No
8 . 2nd Street On-Ramp	Ramp (Merge)	3	56.4	26.5	C	55.8	28.5	D	55.9	28.3	D	53.5	33.4	D	No
9 . 2nd Street On-Ramp and Cleveland Avenue Off-Ramp	Basic	3	59.6	27.9	D	59.1	30.2	D	59.1	30.2	D	-	-	F	Yes
10 . Cleveland Avenue Off-Ramp	Ramp (Diverge)	3	53.6	30.4	D	52.9	32.6	D	53.3	32.2	D	52.0	37.3	E	Yes
11 . Cleveland Avenue Off-Ramp and Cleveland Avenue On-Ramp	Basic	3	59.6	23.7	C	59.6	23.8	C	59.6	24.8	C	59.6	26.9	D	No
12 . Cleveland Avenue On-Ramp	Ramp (Merge)	3	56.9	24.3	C	58.7	24.1	D	56.6	25.7	C	56.0	28.2	D	No
13 . Cleveland Avenue On-Ramp and Gateway Drive Loop Off-Ramp	Basic	3	59.6	24.8	C	59.6	24.8	C	59.6	26.4	D	59.4	29.2	D	No
14 . Gateway Drive Loop Off-Ramp	Ramp (Diverge)	3	48.2	28.4	D	48.7	28.0	C	48.2	29.6	D	48.5	31.5	D	No
15 . Gateway Drive Loop Off-Ramp and Gateway Drive On-Ramp	Basic	3	60.0	22.1	C	60.0	23.5	C	60.0	23.5	C	60.0	27.0	D	No
16 . Gateway Drive On-Ramp	Ramp (Merge)	3	57.3	22.3	C	557.0	23.8	C	57.1	23.5	C	56.3	26.8	C	No
17 . Gateway Drive On-Ramp and Avenue 17 Off-Ramp	Basic	3	60.0	23.4	C	60.0	25.0	C	60.0	24.8	C	59.8	28.7	D	No
18 . Avenue 17 Off-Ramp	Ramp (Diverge)	3	53.8	27.2	C	53.3	28.7	D	53.2	28.8	D	52.0	33.0	D	No
19 . Avenue 17 Off-Ramp and Avenue 17 On-Ramp	Basic	3	65.5	18.1	C	65.5	18.4	C	65.5	18.1	C	65.5	18.4	C	No
20 . Avenue 17 On-Ramp	Ramp (Merge)	3	60.4	22.8	C	60.1	24.1	C	60.4	22.8	C	60.1	24.1	C	No
21 . Avenue 17 On-Ramp and Avenue 18 1/2 Off-Ramp	Basic	2	60.7	33.1	D	58.7	36.0	E	60.7	33.1	D	58.7	36.0	E	Yes
22 . Avenue 18 1/2 Off-Ramp	Ramp (Diverge)	2	57.2	37.0	E	57.3	38.8	E	57.2	37.0	E	57.3	38.8	E	Yes
23 . Avenue 18 1/2 Off-Ramp and Avenue 18 1/2 On-Ramp	Basic	2	63.3	29.1	D	61.2	32.4	D	63.3	29.1	D	61.2	32.4	D	No
24 . Avenue 18 1/2 On-Ramp	Ramp (Merge)	2	56.1	32.6	D	54.2	34.6	D	50.7	37.2	E	51.1	37.1	E	Yes
25 . North of Avenue 18 1/2 On-Ramp	Basic	2	60.4	33.6	D	57.8	37.3	E	53.5	43.7	E	54.0	42.9	E	Yes

Table 7-L - Phase III Project Completion Year (2049) Freeway Segment and Ramp Levels of Service

SR-99 Freeway	Type	Mainline Lanes	Without Project						With Project						Significant Impact
			AM Peak Hour			PM Peak Hour			AM Peak Hour			PM Peak Hour			
			Speed (mi/hr)	Density (pc/mi/ln)	LOS	Speed (mi/hr)	Density (pc/mi/ln)	LOS	Speed (mi/hr)	Density (pc/mi/ln)	LOS	Speed (mi/hr)	Density (pc/mi/ln)	LOS	
Southbound															
26 . North of Avenue 18 1/2 Off-Ramp	Basic	2	62.5	30.4	D	54.6	42.0	E	60.6	33.2	D	-	-	F	Yes
27 . Avenue 18 1/2 Off-Ramp	Ramp (Diverge)	2	62.9	35.6	E	62.3	42.3	E	62.4	37.5	E	-	-	F	Yes
28 . Avenue 18 1/2 Off-Ramp and Avenue 18 1/2 Loop On-Ramp	Basic	2	63.4	28.2	D	58.6	35.8	E	63.4	28.2	D	58.6	35.8	E	Yes
29 . Avenue 18 1/2 Loop On-Ramp	Ramp (Merge)	2	58.1	30.1	D	54.7	34.8	D	58.1	30.1	D	54.7	34.8	D	No
30 . Avenue 18 1/2 Loop On-Ramp and Avenue 18 1/2 Slip-On Ramp	Basic	2	63.1	28.7	D	58.2	36.4	E	63.1	28.7	D	58.2	36.4	E	Yes
31 . Avenue 18 1/2 Slip-On Ramp	Ramp (Merge)	2	56.5	32.8	D	51.7	37.7	E	56.5	32.8	D	51.7	37.7	E	Yes
32 . Avenue 18 1/2 Slip-On Ramp and Avenue 17 Off-Ramp	Basic	2	61.1	32.0	D	54.7	41.5	E	61.1	32.0	D	54.7	41.5	E	Yes
33 . Avenue 17 Off-Ramp	Ramp (Diverge)	3	56.6	26.1	C	56.5	29.1	D	56.6	26.1	C	56.5	29.1	D	No
34 . Avenue 17 Off-Ramp and Avenue 17 Loop On-Ramp	Basic	3	65.0	17.2	B	65.0	17.2	B	63.9	26.3	D	65.0	20.2	C	No
35 . Avenue 17 Loop On-Ramp	Ramp (Merge)	3	57.1	23.1	C	56.5	25.9	C	57.1	23.1	C	56.5	25.9	C	No
36 . Avenue 17 Loop On-Ramp and Avenue 17 Slip-On Ramp	Basic	3	59.6	23.2	C	59.6	26.5	D	59.6	23.2	C	59.6	26.5	D	No
37 . Avenue 17 Slip-On Ramp	Ramp (Merge)	3	57.3	22.5	C	56.3	26.9	C	55.9	27.7	C	55.4	29.4	D	No
38 . Avenue 17 Slip-On Ramp and Gateway Drive Off-Ramp	Basic	3	58.8	24.7	C	58.7	29.4	D	58.8	28.7	D	58.1	31.5	D	No
39 . Gateway Drive Off-Ramp	Ramp (Diverge)	3	56.2	27.5	C	55.8	31.4	D	56.1	30.8	D	55.8	32.9	D	No
40 . Gateway Drive Off-Ramp and Gateway Drive Loop On-Ramp	Basic	3	59.6	23.1	C	59.6	26.7	D	59.6	26.9	D	59.5	28.5	D	No
41 . Gateway Drive Loop On-Ramp	Ramp (Merge)	3	57.3	23.0	C	56.6	25.7	C	56.2	27.0	C	56.0	27.5	C	No
42 . Gateway Drive Loop On-Ramp and Cleveland Avenue Off-Ramp	Basic	3	58.8	25.8	C	58.7	29.3	D	58.5	30.4	D	58.1	31.7	D	No
43 . Cleveland Avenue Off-Ramp	Ramp (Diverge)	3	54.8	28.0	C	54.5	30.9	D	54.3	31.7	D	54.3	32.5	D	No
44 . Cleveland Avenue Off-Ramp and Cleveland Avenue On-Ramp	Basic	3	58.8	24.8	C	58.8	27.5	D	58.8	27.9	D	58.8	28.8	D	No
45 . Cleveland Avenue On-Ramp	Ramp (Merge)	3	55.2	30.1	D	54.6	31.8	D	51.8	35.9	E	52.8	34.8	D	Yes
46 . Cleveland Avenue On-Ramp and 2nd Street Off-Ramp	Basic	3	58.5	30.1	D	57.6	33.0	D	54.9	38.2	E	55.4	37.3	E	Yes
47 . 2nd Street Off-Ramp	Ramp (Diverge)	3	48.2	32.1	D	48.5	33.6	D	47.9	36.2	E	48.3	35.6	E	Yes
48 . 2nd Street Off-Ramp and 4th Street On-Ramp	Basic	3	59.6	26.9	D	59.1	30.2	D	58.2	32.6	D	57.7	33.5	D	No
49 . 4th Street On-Ramp	Ramp (Merge)	3	55.4	29.6	D	54.6	31.7	D	53.5	33.6	D	53.4	33.7	D	No
50 . 4th Street On-Ramp and Olive Avenue Off-Ramp	Basic	3	58.8	30.9	D	57.2	34.6	D	55.1	38.3	E	54.8	38.8	E	Yes
51 . Olive Avenue Off-Ramp	Ramp (Diverge)	3	53.2	33.7	D	53.4	35.4	E	52.7	37.4	E	53.2	37.2	E	Yes
52 . Olive Avenue Off-Ramp and Madera Avenue On-Ramp	Basic	3	58.8	25.4	C	58.8	28.8	D	58.7	29.2	D	58.3	30.9	D	No
53 . Madera Avenue On-Ramp	Ramp (Merge)	3	56.5	26.0	C	55.6	29.1	D	55.1	30.4	D	54.7	31.4	D	No
54 . South of Madera Avenue On-Ramp	Basic	3	58.8	27.4	D	58.2	31.4	D	57.6	32.9	D	56.7	34.8	D	No

Notes:

SR-99 = State Route 99
mi/hr : miles per hour
pc/mi/ln: passenger cars per mile per lane

Bold Indicates deficient LOS

8.0 QUEUING ANALYSIS

Consistent with Caltrans provisions, a queuing analysis is required at all study intersections under the jurisdiction of Caltrans. However, the queuing analysis has been prepared for disclosure purposes only and is not for determining project impacts. Tables 8-A through 8-D list the available turn-pocket storage lengths and summarize the 95th percentile back-of-queue lengths at the study intersections under the jurisdiction of Caltrans under existing, Phase I project completion year, Phase II project completion year, and Phase III project completion year conditions. The queues for the signalized intersections have been reported from Synchro, while for unsignalized intersections, the SimTraffic queues have been reported since Synchro does not appropriately report queues at unsignalized intersections. As shown in Tables 8-A through 8-D, queues for some of the movements are projected to exceed the existing available turn-pocket storage lengths under existing and Phase I, II, and III project completion years without and with project conditions. The remaining intersections have sufficient storage lengths to accommodate forecast queues.

Detailed queuing worksheets are included in Appendix F. Additional queuing worksheets for all signalized study intersections under all analysis scenarios are also included in Appendix F.

8.1 LIST OF CHAPTER 8.0 TABLES

- Table 8-A: Existing Queuing Analysis
- Table 8-B: Phase I Project Completion Year (2029) Queuing Analysis
- Table 8-C: Phase II Project Completion Year (2039) Queuing Analysis
- Table 8-D: Phase III Project Completion Year (2049) Queuing Analysis

Table 8-A - Existing Queuing Analysis

Intersection	Movement	Storage Length ¹ (ft/ln)	Without Project ²		With Project ²	
			AM	PM	AM	PM
5 . SR-99 Southbound Ramps – Road 23/Avenue 18 ½ TWSC	NBL	2765	50	70	415	350
	NBR	25	70	60	75	80
	SBLTR	860	105	220	305	295
	EBR	270	15	40	30	50
	WBTL	110	55	75	50	100
6 . SR-99 Northbound Ramps/Avenue 18 ½ OWSC	NBLTR	1085	175	150	710	335
	EBL	145	60	50	105	75
	WBTR	2355	0	0	10	0
14 . SR-99 Southbound Ramps/Avenue 17 OWSC	SBL	1255	85	75	80	120
	SBR	610	60	45	80	485
15 . SR-99 Northbound Ramps/Avenue 17 OWSC	NBL	1065	110	50	675	655
	NBR	50	0	0	0	0
	EBL	125	70	25	20	35
	WBR	85	0	0	300	595
25 . SR-99 Southbound Ramps/Kennedy Street - Gateway Drive OWSC	SBL	1035	45	85	75	115
	SBR	335	45	65	60	100
	EBL	140	75	50	120	75
26 . SR-99 Northbound Off-Ramp/Gateway Drive OWSC	SBLTR	75	70	60	60	60
	EBLT	790	35	70	50	65
	WBTR	110	0	0	0	0
27 . SR-99 Northbound Off-Ramps OWSC	SBTR	1130	25	15	40	45
	EBL	70	60	65	65	65
28 . SR-99 Northbound Off-Ramp/Gateway Drive OWSC	SBLR	110	0	25	0	15
	EBLT	130	0	0	0	0
	WBTR	3015	0	0	0	0
31 . SR-99 Southbound Ramps/Cleveland Avenue Signal	SBL	905	65	110	245	185
	SBR	140	20	35	35	50
	EBR	460	60	40	330	25
	WBL	115	305	160	310	105
32 . SR-99 Northbound Ramps/Cleveland Avenue Signal	NBL ¹	540	105	165	165	345
	NBR	325	40	110	145	160
	EBL	90	65	95	70	105
	WBR	50	5	5	10	70
38 . I Street/SR-99 Southbound Off-Ramp - 2nd Street TWSC	NBL	80	0	15	0	10
	SBTR	725	0	0	0	0
	EBLTR	155	55	50	50	45
	WBL	645	150	90	205	0
	WBR	50	0	0	55	110
40 . H Street/SR-99 Northbound On-Ramp - 2nd Street AWSC	NBLTR	380	0	0	0	10
	SBLTR	305	30	20	20	25
	WBLTR	330	50	65	55	70
42 . SR-99 Southbound On-Ramp/4th Street No Traffic Control	EBTR	50	55	60	75	60
	WBL	180	75	100	125	120
43 . H Street – SR-99 Northbound Off-Ramp/4th Street Signal	NBL	620	240	240	240	240
	NBTR	195	70	70	70	70
	SBLTR	350	5	30	5	30
	EBL	180	185	220	215	295
	WBTR	265	235	255	255	310

Table 8-A - Existing Queuing Analysis

Intersection	Movement	Storage Length ¹ (ft/ln)	Without Project ²		With Project ²	
			AM	PM	AM	PM
45 . SR-99 Southbound Off-Ramp/Olive Avenue Signal	SBL	1165	105	80	195	120
	SBR	25	15	15	30	25
46 . Madera Avenue/SR-99 Northbound Ramps Signal	NBL	205	145	80	120	205
	SBTR	335	175	150	205	285
	WBL	130	80	100	100	170
	WBLT	1195	80	100	105	170
	WBR	150	40	10	35	10
47 . Madera Avenue/Olive Avenue – SR-99 Southbound On-Ramp Signal	NBL	120	50	55	60	50
	NBTR	310	140	190	135	130
	SBL	90	90	110	100	135
	SBTR	310	185	225	35	10
	EBL	125	180	225	345	355
	EBR	130	145	180	45	10
48 . Madera Avenue (SR-145) /Lewis Street OWSC	NBTR	155	0	0	0	0
	SBL	100	50	35	45	45
	WBLTR	255	50	45	45	50
49 . Yosemite Avenue/Cleveland Avenue - Tozer Street Signal	NBL	240	190	225	190	390
	NBR	460	0	10	0	10
	SBL	150	75	90	75	90
	SBTR	545	375	365	440	535
	EBL	210	160	225	320	345
	EBTR	450	265	230	280	235
	WBL	150	160	80	160	80
	WBR	60	0	0	0	0

Notes:

ft/ln = feet per lane

AWSC = All-Way Stop Control; TWSC = Two-Way Stop Control; OWSC = One-Way Stop Control

EB = Eastbound; WB = Westbound; NB = Northbound; SB = Southbound

L = Left; T = Through; R = Right

Bold = Queue exceeds available storage.

¹ Storage length for all movements obtained from Google Earth measurements.

² All queues reported are 95th percentile queues. Queues for signalized intersections have been reported from Synchro, while queues for unsignalized intersections have been reported from SimTraffic.

Table 8-B - Phase I Project Completion Year (2029) Queuing Analysis

Intersection	Movement	Storage Length ¹ (ft/ln)	Without Project ²		With Project ²	
			AM	PM	AM	PM
5 . SR-99 Southbound Ramps – Road 23/Avenue 18 ½ TWSC	NBL	2765	115	60	180	130
	NBR	25	90	80	80	85
	SBLTR	860	160	265	230	300
	EBR	270	15	45	20	30
	WBTL	110	80	80	65	100
6 . SR-99 Northbound Ramps/Avenue 18 ½ OWSC	NBLTR	1085	215	140	715	190
	EBL	145	85	45	95	50
	WBTR	2355	0	0	0	0
14 . SR-99 Southbound Ramps/Avenue 17 OWSC	SBL	1255	180	1240	140	1170
	SBR	610	80	1005	70	915
15 . SR-99 Northbound Ramps/Avenue 17 OWSC	NBL	1065	680	680	670	640
	NBR	50	140	140	145	95
	EBL	125	100	110	190	315
	WBR	85	20	35	0	0
25 . SR-99 Southbound Ramps/Kennedy Street - Gateway Drive OWSC	SBL	1035	70	80	60	105
	SBR	335	40	75	50	75
	EBL	140	80	65	95	55
26 . SR-99 Northbound Off-Ramp/Gateway Drive OWSC	SBLTR	75	75	65	70	65
	EBLT	790	40	60	75	75
	WBTR	110	0	0	0	0
27 . SR-99 Northbound Off-Ramps OWSC	SBTR	1130	70	40	55	20
	EBL	70	45	55	65	65
28 . SR-99 Northbound Off-Ramp/Gateway Drive OWSC	SBLR	110	0	15	0	20
	EBLT	130	0	0	0	0
	WBTR	3015	0	0	0	0
31 . SR-99 Southbound Ramps/Cleveland Avenue Signal	SBL	905	70	125	35	135
	SBR	140	25	35	0	40
	EBR	460	70	45	135	40
	WBL	115	320	305	350	195
32 . SR-99 Northbound Ramps/Cleveland Avenue Signal	NBL ¹	540	110	190	160	335
	NBR	325	60	145	120	160
	EBL	90	70	95	70	85
	WBR	50	5	0	5	10
38 . I Street/SR-99 Southbound Off-Ramp - 2nd Street TWSC	NBL	80	10	30	10	35
	SBTR	725	0	0	15	0
	EBLTR	155	55	45	45	45
	WBL	645	120	105	125	105
	WBR	50	0	0	0	0
40 . H Street/SR-99 Northbound On-Ramp - 2nd Street AWSC	NBLTR	380	35	0	0	0
	SBLTR	305	30	15	20	30
	WBLTR	330	60	75	50	65
42 . SR-99 Southbound On-Ramp/4th Street No Traffic Control	EBTR	50	75	60	85	60
	WBL	180	115	145	115	125
43 . H Street – SR-99 Northbound Off-Ramp/4th Street Signal	NBL	620	260	270	260	270
	NBTR	195	80	80	80	80
	SBLTR	350	15	40	15	40
	EBL	180	190	245	215	270
	WBTR	265	265	285	265	300

Table 8-B - Phase I Project Completion Year (2029) Queuing Analysis

Intersection	Movement	Storage Length ¹ (ft/ln)	Without Project ²		With Project ²	
			AM	PM	AM	PM
45 . SR-99 Southbound Off-Ramp/Olive Avenue Signal	SBL	1165	155	120	215	150
	SBR	25	25	20	30	20
46 . Madera Avenue/SR-99 Northbound Ramps Signal	NBL	205	180	190	160	240
	SBTR	335	215	250	220	260
	WBL	130	85	105	90	115
	WBLT	1195	90	105	90	115
	WBR	150	40	10	40	10
47 . Madera Avenue/Olive Avenue – SR-99 Southbound On-Ramp Signal	NBL	120	60	65	60	70
	NBTR	310	170	270	145	200
	SBL	90	85	115	95	145
	SBTR	310	210	240	40	50
	EBL	125	185	215	255	335
	EBR	130	190	210	230	215
48 . Madera Avenue (SR-145) /Lewis Street OWSC	NBTR	155	0	0	0	0
	SBL	100	35	45	50	45
	WBLTR	255	60	45	35	30
49 . Yosemite Avenue/Cleveland Avenue - Tozer Street Signal	NBL	240	215	400	195	385
	NBR	460	0	10	0	10
	SBL	150	85	95	85	95
	SBTR	545	420	390	450	490
	EBL	210	170	260	265	320
	EBTR	450	250	240	265	240
	WBL	150	180	85	165	90
	WBR	60	0	0	0	0

Notes:

ft/ln = feet per lane

AWSC = All-Way Stop Control; TWSC = Two-Way Stop Control; OWSC = One-Way Stop Control

EB = Eastbound; WB = Westbound; NB = Northbound; SB = Southbound

L = Left; T = Through; R = Right

Bold = Queue exceeds available storage.

¹ Storage length for all movements obtained from Google Earth measurements.

² All queues reported are 95th percentile queues. Queues for signalized intersections have been reported from Synchro, while queues for unsignalized intersections have been reported from SimTraffic.

Table 8-C - Phase II Project Completion Year (2039) Queuing Analysis

Intersection	Movement	Storage Length ¹ (ft/ln)	Without Project ²		With Project ²	
			AM	PM	AM	PM
5 . SR-99 Southbound Ramps – Road 23/Avenue 18 ½ TWSC	NBL	2765	125	110	410	455
	NBR	25	95	85	75	85
	SBLTR	860	175	350	315	295
	EBR	270	15	15	25	50
	WBTL	110	60	105	80	190
6 . SR-99 Northbound Ramps/Avenue 18 ½ OWSC	NBLTR	1085	335	155	780	260
	EBL	145	65	65	90	70
	WBTR	2355	0	0	0	0
14 . SR-99 Southbound Ramps/Avenue 17 OWSC	SBL	1255	180	1080	1175	1245
	SBR	610	70	1085	920	910
15 . SR-99 Northbound Ramps/Avenue 17 OWSC	NBL	1065	680	670	655	655
	NBR	50	145	130	115	145
	EBL	125	135	170	90	250
	WBR	85	0	0	0	0
25 . SR-99 Southbound Ramps/Kennedy Street - Gateway Drive OWSC	SBL	1035	95	135	155	150
	SBR	335	60	75	275	90
	EBL	140	75	105	135	95
26 . SR-99 Northbound Off-Ramp/Gateway Drive OWSC	SBLTR	75	75	70	85	70
	EBLT	790	45	95	55	80
	WBTR	110	0	0	0	0
27 . SR-99 Northbound Off-Ramps OWSC	SBTR	1130	125	40	110	40
	EBL	70	65	65	65	65
28 . SR-99 Northbound Off-Ramp/Gateway Drive OWSC	SBLR	110	0	15	0	25
	EBLT	130	0	0	0	0
	WBTR	3015	0	0	0	0
31 . SR-99 Southbound Ramps/Cleveland Avenue Signal	SBL	905	80	155	190	210
	SBR	140	30	40	45	55
	EBR	460	75	50	500	50
	WBL	115	340	330	395	240
32 . SR-99 Northbound Ramps/Cleveland Avenue Signal	NBL ¹	540	120	230	170	425
	NBR	325	80	180	205	205
	EBL	90	80	95	85	115
	WBR	50	10	5	10	40
38 . I Street/SR-99 Southbound Off-Ramp - 2nd Street TWSC	NBL	80	25	20	15	25
	SBTR	725	0	0	0	0
	EBLTR	155	55	50	55	45
	WBL	645	145	135	265	135
	WBR	50	0	0	55	40
40 . H Street/SR-99 Northbound On-Ramp - 2nd Street AWSC	NBLTR	380	0	0	0	0
	SBLTR	305	20	35	20	25
	WBLTR	330	55	60	55	75
42 . SR-99 Southbound On-Ramp/4th Street No Traffic Control	EBTR	50	70	60	85	65
	WBL	180	105	170	130	120
43 . H Street – SR-99 Northbound Off-Ramp/4th Street Signal	NBL	620	280	295	280	295
	NBTR	195	85	85	85	85
	SBLTR	350	20	50	20	50
	EBL	180	230	290	260	370
	WBTR	265	295	330	305	365

Table 8-C - Phase II Project Completion Year (2039) Queuing Analysis

Intersection	Movement	Storage Length ¹ (ft/ln)	Without Project ²		With Project ²	
			AM	PM	AM	PM
45 . SR-99 Southbound Off-Ramp/Olive Avenue Signal	SBL	1165	275	185	440	230
	SBR	25	30	25	35	25
46 . Madera Avenue/SR-99 Northbound Ramps Signal	NBL	205	235	240	260	380
	SBTR	335	255	280	265	295
	WBL	130	95	110	100	120
	WBLT	1195	100	110	105	125
	WBR	150	40	10	40	10
47 . Madera Avenue/Olive Avenue – SR-99 Southbound On-Ramp Signal	NBL	120	70	75	70	85
	NBTR	310	195	345	205	325
	SBL	90	65	120	90	145
	SBTR	310	240	260	165	55
	EBL	125	205	240	165	310
	EBR	130	240	265	395	320
48 . Madera Avenue (SR-145) /Lewis Street OWSC	NBTR	155	0	55	0	55
	SBL	100	65	50	50	50
	WBLTR	255	40	45	45	35
49 . Yosemite Avenue/Cleveland Avenue - Tozer Street Signal	NBL	240	200	405	200	405
	NBR	460	0	10	0	10
	SBL	150	90	105	90	105
	SBTR	545	465	420	510	535
	EBL	210	185	300	320	370
	EBTR	450	270	255	275	255
	WBL	150	165	85	165	85
	WBR	60	0	0	0	0

Notes:

ft/ln = feet per lane

AWSC = All-Way Stop Control; TWSC = Two-Way Stop Control; OWSC = One-Way Stop Control

EB = Eastbound; WB = Westbound; NB = Northbound; SB = Southbound

L = Left; T = Through; R = Right

Bold = Queue exceeds available storage.

¹ Storage length for all movements obtained from Google Earth measurements.

² All queues reported are 95th percentile queues. Queues for signalized intersections have been reported from Synchro, while queues for unsignalized intersections have been reported from SimTraffic.

Table 8-D - Phase III Project Completion Year (2049) Queuing Analysis

Intersection	Movement	Storage Length ¹ (ft/ln)	Without Project ²		With Project ²	
			AM	PM	AM	PM
5 . SR-99 Southbound Ramps – Road 23/Avenue 18 ½ TWSC	NBL	2765	170	180	405	410
	NBR	25	95	90	75	75
	SBLTR	860	225	365	295	295
	EBR	270	5	50	20	55
	WBTL	110	50	70	45	105
6 . SR-99 Northbound Ramps/Avenue 18 ½ OWSC	NBLTR	1085	305	185	715	705
	EBL	145	80	65	200	85
	WBTR	2355	0	0	0	0
14 . SR-99 Southbound Ramps/Avenue 17 OWSC	SBL	1255	610	1070	1275	1055
	SBR	610	100	1065	1085	1050
15 . SR-99 Northbound Ramps/Avenue 17 OWSC	NBL	1065	660	660	670	650
	NBR	50	105	95	110	95
	EBL	125	190	220	75	245
	WBR	85	0	60	0	530
25 . SR-99 Southbound Ramps/Kennedy Street - Gateway Drive OWSC	SBL	1035	175	285	340	625
	SBR	335	95	145	155	705
	EBL	140	160	120	180	170
26 . SR-99 Northbound Off-Ramp/Gateway Drive OWSC	SBLTR	75	80	75	75	80
	EBLT	790	65	90	85	95
	WBTR	110	0	0	0	0
27 . SR-99 Northbound Off-Ramps OWSC	SBTR	1130	125	45	110	75
	EBL	70	65	65	70	65
28 . SR-99 Northbound Off-Ramp/Gateway Drive OWSC	SBLR	110	0	20	0	20
	EBLT	130	0	0	0	0
	WBTR	3015	0	0	0	0
31 . SR-99 Southbound Ramps/Cleveland Avenue Signal	SBL	905	85	175	295	265
	SBR	140	35	45	45	55
	EBR	460	80	50	585	50
	WBL	115	310	335	265	260
32 . SR-99 Northbound Ramps/Cleveland Avenue Signal	NBL ¹	540	130	260	190	545
	NBR	325	95	215	280	230
	EBL	90	85	85	85	100
	WBR	50	5	5	15	55
38 . I Street/SR-99 Southbound Off-Ramp - 2nd Street TWSC	NBL	80	20	30	10	20
	SBTR	725	0	0	20	0
	EBLTR	155	50	50	75	45
	WBL	645	130	120	360	140
	WBR	50	40	0	95	40
40 . H Street/SR-99 Northbound On-Ramp - 2nd Street AWSC	NBLTR	380	0	0	0	0
	SBLTR	305	25	30	35	30
	WBLTR	330	60	75	60	60
42 . SR-99 Southbound On-Ramp/4th Street No Traffic Control	EBTR	50	65	70	80	60
	WBL	180	145	130	155	135
43 . H Street – SR-99 Northbound Off-Ramp/4th Street Signal	NBL	620	300	325	300	325
	NBTR	195	90	95	90	95
	SBLTR	350	30	65	30	65
	EBL	180	255	330	265	400
	WBTR	265	325	370	345	420

Table 8-D - Phase III Project Completion Year (2049) Queuing Analysis

Intersection	Movement	Storage Length ¹ (ft/ln)	Without Project ²		With Project ²	
			AM	PM	AM	PM
45 . SR-99 Southbound Off-Ramp/Olive Avenue Signal	SBL	1165	405	275	695	440
	SBR	25	35	30	40	40
46 . Madera Avenue/SR-99 Northbound Ramps Signal	NBL	205	305	395	335	450
	SBTR	335	305	280	345	340
	WBL	130	105	115	130	185
	WBLT	1195	105	115	130	190
	WBR	150	40	10	40	10
47 . Madera Avenue/Olive Avenue – SR-99 Southbound On-Ramp Signal	NBL	120	80	90	85	115
	NBTR	310	225	490	260	590
	SBL	90	65	125	80	120
	SBTR	310	265	280	305	190
	EBL	125	225	270	180	190
	EBR	130	265	275	565	570
48 . Madera Avenue (SR-145) /Lewis Street OWSC	NBTR	155	0	255	0	280
	SBL	100	45	70	55	45
	WBLTR	255	40	155	45	60
49 . Yosemite Avenue/Cleveland Avenue - Tozer Street Signal	NBL	240	205	415	205	415
	NBR	460	0	15	0	15
	SBL	150	95	110	95	110
	SBTR	545	515	445	575	615
	EBL	210	200	335	390	450
	EBTR	450	275	265	290	270
	WBL	150	170	90	170	90
	WBR	60	0	0	0	0

Notes:

ft/ln = feet per lane

AWSC = All-Way Stop Control; TWSC = Two-Way Stop Control; OWSC = One-Way Stop Control

EB = Eastbound; WB = Westbound; NB = Northbound; SB = Southbound

L = Left; T = Through; R = Right

Bold = Queue exceeds available storage.

¹ Storage length for all movements obtained from Google Earth measurements.

² All queues reported are 95th percentile queues. Queues for signalized intersections have been reported from Synchro, while queues for unsignalized intersections have been reported from SimTraffic.

9.0 CIRCULATION IMPROVEMENTS AND FUNDING SOURCES

9.1 RECOMMENDED IMPROVEMENTS

At intersections and roadway segments where the level of service is forecast to be unsatisfactory or where the project would have a significant impact, improvements have been recommended to improve the LOS to the LOS standards or better for the corresponding jurisdictions. At intersections where a signal was recommended as a mitigation and that is not covered by any funding programs, a signal warrant analysis was conducted. The signal warrant analysis are summarized in Chapter 10.

Table 9-A summarizes the recommended improvements for study intersections under all scenarios. Figures 9-1A and 9-1B, 9-2A and 9-2B, and 9-3A and 9-3B, and illustrate the Phase I, II, and III project completion years with project with improvements study intersection geometrics and traffic control. Tables 9-B through 9-E illustrate the post-improvement intersection levels of service for the different scenarios. As shown in these tables, impacts at some of the intersections in some scenarios cannot be fully mitigated because of right-of-way constraints. Where such physical improvements were identified, the intersection and roadway segments were also reviewed to determine whether physical improvements would require significant encroachments on existing adjacent development or other improvements. Based on the results of this review and analysis, improvements have been recommended for impacted study intersections and roadway segments where consistent with the General Plan and existing adjacent development. As such, these intersections will continue to operate at a deficient LOS.

Table 9-F summarizes the recommended improvements for roadway segments under all scenarios. Tables 9-G through 9-J illustrate the proposed roadway segment improvements and the corresponding levels of service for the different scenarios. As shown in these tables, multiple roadway segments are either currently built out or additional improvements are infeasible. The feasibility of the recommended improvements are based on the City's General Plan classification, as stated in the Measure "T" Strategic Plan (adopted July 20, 2016), the City's Capital Improvement Plan (CIP) (for the fiscal years 2018–2019 to 2022–2023), or the City's Development Impact Fee (DIF) Program, and also considering availability of right-of-way. As such, many of these segments which have either already been built to the General Plan classification or do not have adequate right-of-way will continue to operate at a deficient LOS as no further mitigations are feasible.

9.2 FUNDING SOURCES AND MECHANISMS

Where there is a funding mechanism (fee program) for the recommended improvements, payment into the fee program would be considered sufficient project obligation to alleviate project impacts. At study locations where the addition of project traffic creates a direct significant impact (existing with project conditions) and there is no funding mechanism in place, the project will be responsible for the implementation of the improvement. At locations where the project adds to or creates a forecast deficiency and there is no funding mechanism in place (project completion conditions), the project is responsible for its fair-share payment.

9.2.1 Measure “T” Program

The Madera County Transportation Authority (MCTA) was established to administer the proceeds of Measure “T,” a ½ cent sales tax to be utilized for local transportation projects. The Measure “T” program is a 20-year program that funds highway and road capital projects including improvement of traffic safety, reduction of traffic congestion, and leverage of other state and federal funds. The program is projected to yield approximately \$213 million for transportation projects in the County through 2027. The revenues from the Measure “T” tax are administered through a planning and programming process, including an Expenditure Plan and Annual Work Program (AWP). Per the policy of the MCTA, the AWP is prepared annually and serves as the annual funding authority for the Measure “T” program. The AWP determines the availability of funds for various projects according to the Measure “T” Investment Plan and outlines the Annual Expenditure Plan for each local jurisdiction on the basis of the available funds.

9.2.2 Capital Improvement Plan

The CIP is a five-year plan prepared and maintained by the City staff and presented to the Planning Commission for conformity. The CIP for the fiscal years 2018–2019 to 2022–2023 was created based on the following criteria:

1. Projects represent improvements, studies, or tasks that may advance a physical development.
2. Projects cycle through a five-year timeframe.
3. Projects budget a minimum of \$5,000.

The CIP comprises departmental needs focused on the City’s objectives and fiscal capacity. It is a coordinated effort to increase efficiencies and serves as a source of information for the public. The CIP is a progressive and continuous plan that is updated annually and presented to Council for input, direction, and approval. It is a useful planning tool that matches projects with programmed funds and includes them in the annual budget proposals.

9.2.3 Development Impact Fee Program

The funding for citywide public improvements to serve new developments is included in the development impact fees for new residential, commercial, and industrial projects in the City. The DIF is used by the City to construct the new improvements, or to reimburse developers when they construct eligible improvements. For intersections where the project has a cumulative, significant impact that can be mitigated with improvements covered by the City’s DIF program, the project shall pay toward those fees.

9.2.4 Project Fair Share

Intersection or road improvements are eligible for reimbursement from the City’s DIF program regardless of location so long as the improvement corresponds to the definition of what is eligible. The following improvements are eligible for reimbursements:

1. Traffic Signals – All arterial by arterial, arterial by collector, or collector by collector are eligible for traffic signal equipment (no roadway related improvements). Traffic signal equipment is reimbursed once per location. Relocations of equipment are not reimbursable.
2. Collector Roadways – The center tree lanes (median lane and adjacent travel lanes) are eligible.
3. Arterial Roadways – The center tree lanes (median lane and adjacent travel lanes) are eligible.

It should be noted that timing of reimbursements is subject to availability of funds and/or determination by City to provide impact fee credits.

In the absence of a fee program where the project has an impact on the roadway network, the project shall pay its fair share of the cost for further improvements required to mitigate the impacts. The project's fair share has been calculated based on project traffic as a percentage of total growth from existing to Phase III project completion year conditions. However, for intersections and roadway segments around the project site, improvements have been considered to be the project's full responsibility.

Tables 9-K and 9-L summarize the project fair share corresponding to the improvements recommended and the funding programs in place that cover recommended improvements for intersections and roadway segments, respectively.

9.3 LIST OF CHAPTER 9.0 TABLES

- Figure 9-1A: Phase I Project Completion Year (2029) with Project with Improvements Study Intersection Geometrics and Traffic Control (Int. 1–30)
- Figure 9-1B: Phase I Project Completion Year (2029) with Project with Improvements Study Intersection Geometrics and Traffic Control (Int. 31–58)
- Figure 9-2A: Phase II Project Completion Year (2039) with Project with Improvements Study Intersection Geometrics and Traffic Control (Int. 1–30)
- Figure 9-2B: Phase II Project Completion Year (2039) with Project with Improvements Study Intersection Geometrics and Traffic Control (Int. 31–58)
- Figure 9-3A: Phase III Project Completion (General Plan Build-out) Year (2049) with Project with Improvements Study Intersection Geometrics and Traffic Control (Int. 1–30)
- Figure 9-3B: Phase III Project Completion (General Plan Build-out) Year (2049) with Project with Improvements Study Intersection Geometrics and Traffic Control (Int. 31–58)
- Table 9-A: Recommended Improvements for Intersections
- Table 9-B: Existing with Project with Improvements Intersection Levels of Service
- Table 9-C: Phase I Project Completion Year (2029) with Project with Improvements Intersection Levels of Service
- Table 9-D: Phase II Project Completion Year (2039) with Project with Improvements Intersection Levels of Service

- Table 9-E: Phase III Project Completion (General Plan Build-out) Year (2049) with Project with Improvements Intersection Levels of Service
- Table 9-F: Recommended Improvements for Roadway Segments
- Table 9-G: Existing with Project with Improvements Roadway Segment Levels of Service
- Table 9-H: Phase I Project Completion Year (2029) with Project with Improvements Roadway Segment Levels of Service
- Table 9-I: Phase II Project Completion Year (2039) with Project with Improvements Roadway Segment Levels of Service
- Table 9-J: Phase III Project Completion (General Plan Build-out) Year (2049) with Project with Improvements Roadway Segment Levels of Service
- Table 9-K: Intersection Improvement Funding Mechanism and Fair Share
- Table 9-L: Roadway Segment Improvement Funding Mechanism and Fair Share

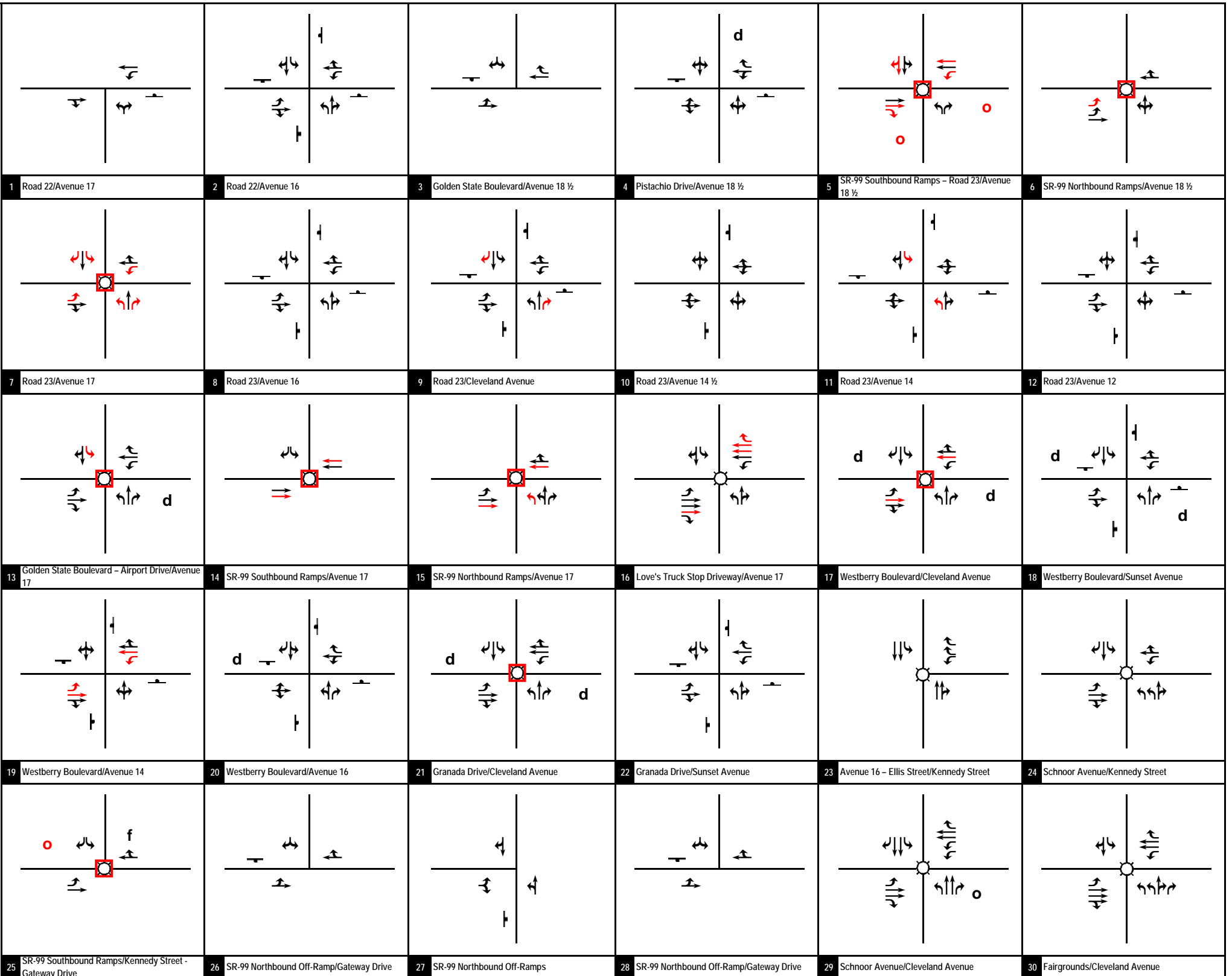
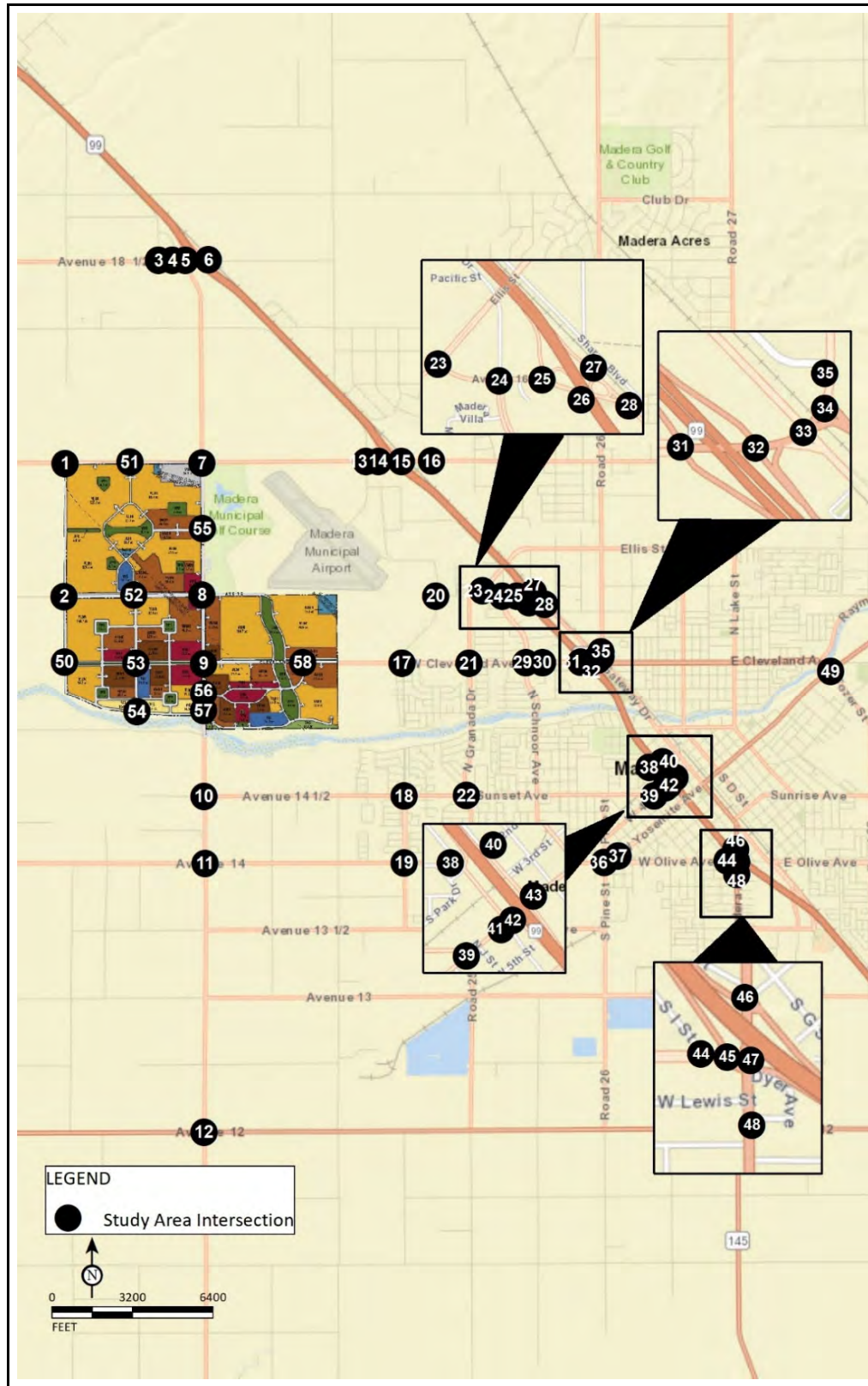

LSA

FIGURE 9-1A

- Legend
- Study Area Intersection
 - Signal
 - Free right-turn
 - Defacto right turn
 - Stop Sign
 - Right-turn overlap
 - Recommended Improvements

Village D Specific Plan
Traffic Impact Analysis

Phase I Project Completion Year (2029) with Project with Improvements Study Intersection Geometrics and Traffic Control (Int. 1-30)

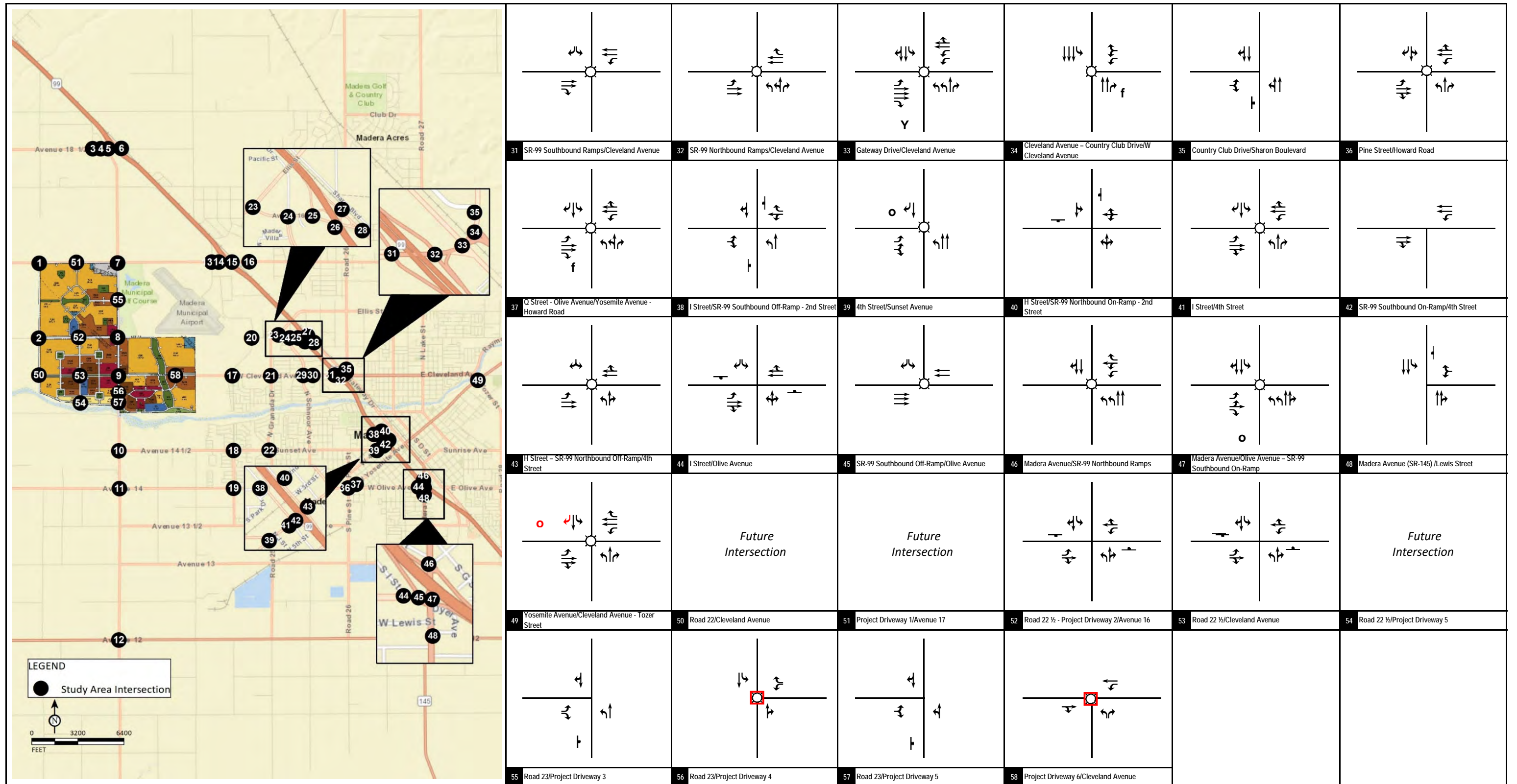

FIGURE 9-1B



- Legend
- ⊙ Signal
 - ⊙ Right-turn overlap
 - ⊙ Defacto right turn
 - ⊙ Yield
 - f Free right-turn
 - Right-turn overlap
 - Y Yield
 - ➔ Stop Sign
 - ➔ Recommended Improvements

Village D Specific Plan
Traffic Impact Analysis

Phase I Project Completion Year (2029) with Project with Improvements Study Intersection Geometrics and Traffic Control (Int. 31-58)

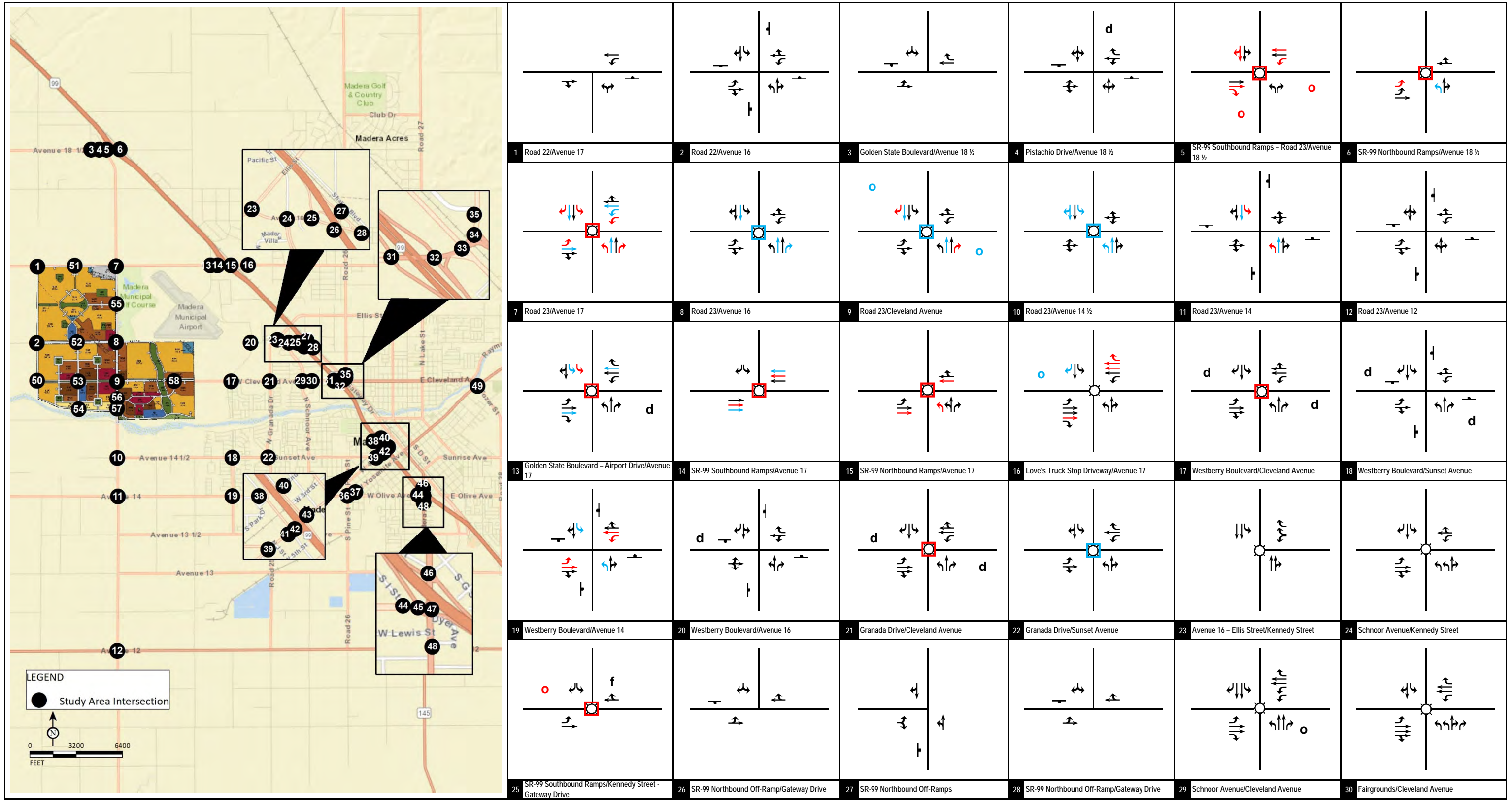

LSA

FIGURE 9-2A

Legend

- Signal
- Stop Sign
- d Defacto right turn
- f Free right-turn
- Right-turn overlap
- ➔ Phase I Recommended Improvements
- ➔ Phase II Recommended Improvements

Village D Specific Plan
Traffic Impact Analysis

Phase II Project Completion Year (2039) with Project with Improvements Study Intersection Geometrics and Traffic Control (Int. 1-30)

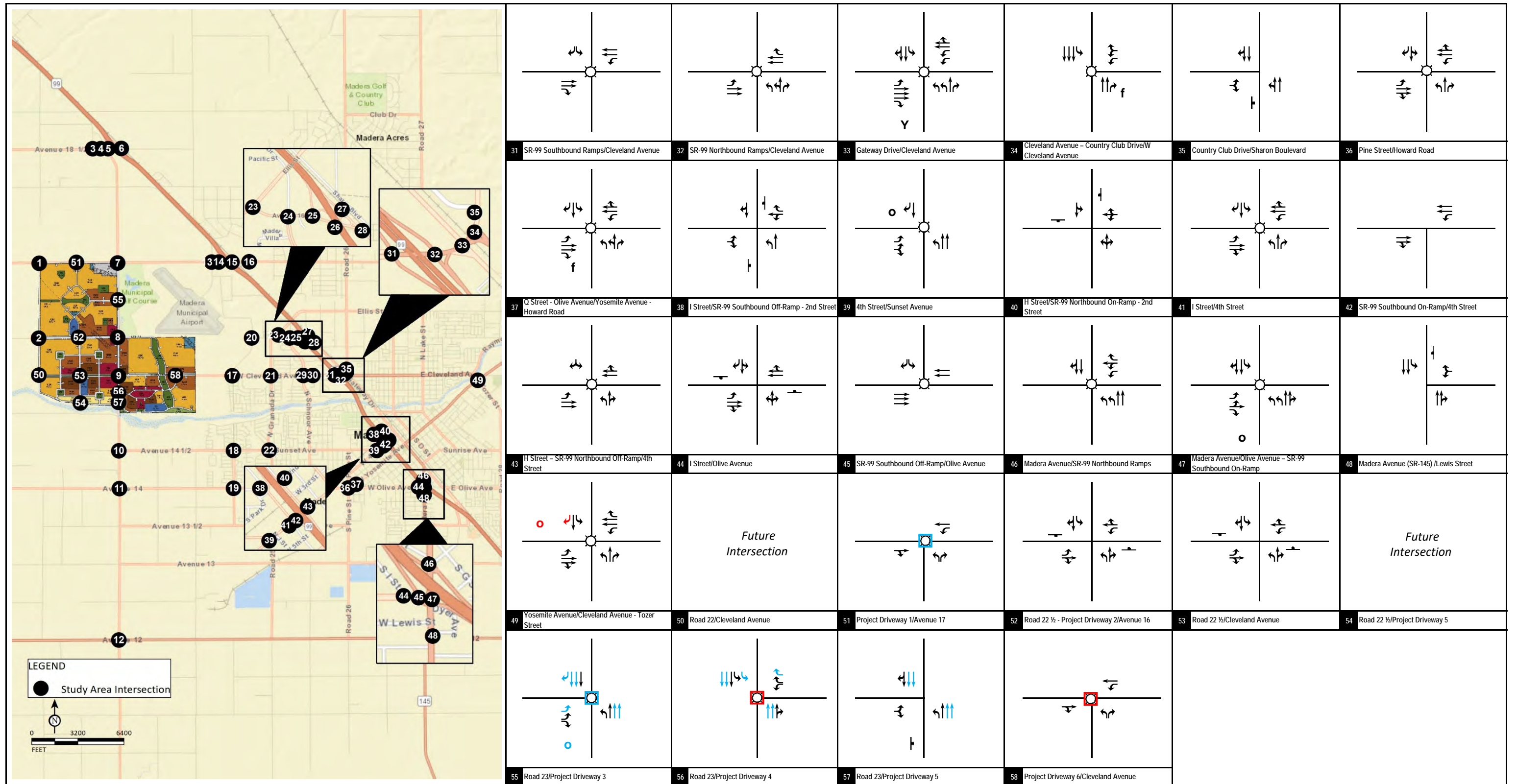

LSA

FIGURE 9-2B

Legend

- ⊙ Signal
- ⊙ Right-turn overlap
- ⊙ Defacto right turn
- f Free right-turn
- Right-turn overlap
- Y Yield
- ➔ Phase I Recommended Improvements
- ➔ Phase II Recommended Improvements

Village D Specific Plan
Traffic Impact Analysis

Phase II Project Completion Year (2039) with Project with Improvements Study Intersection Geometrics and Traffic Control (Int. 31-58)

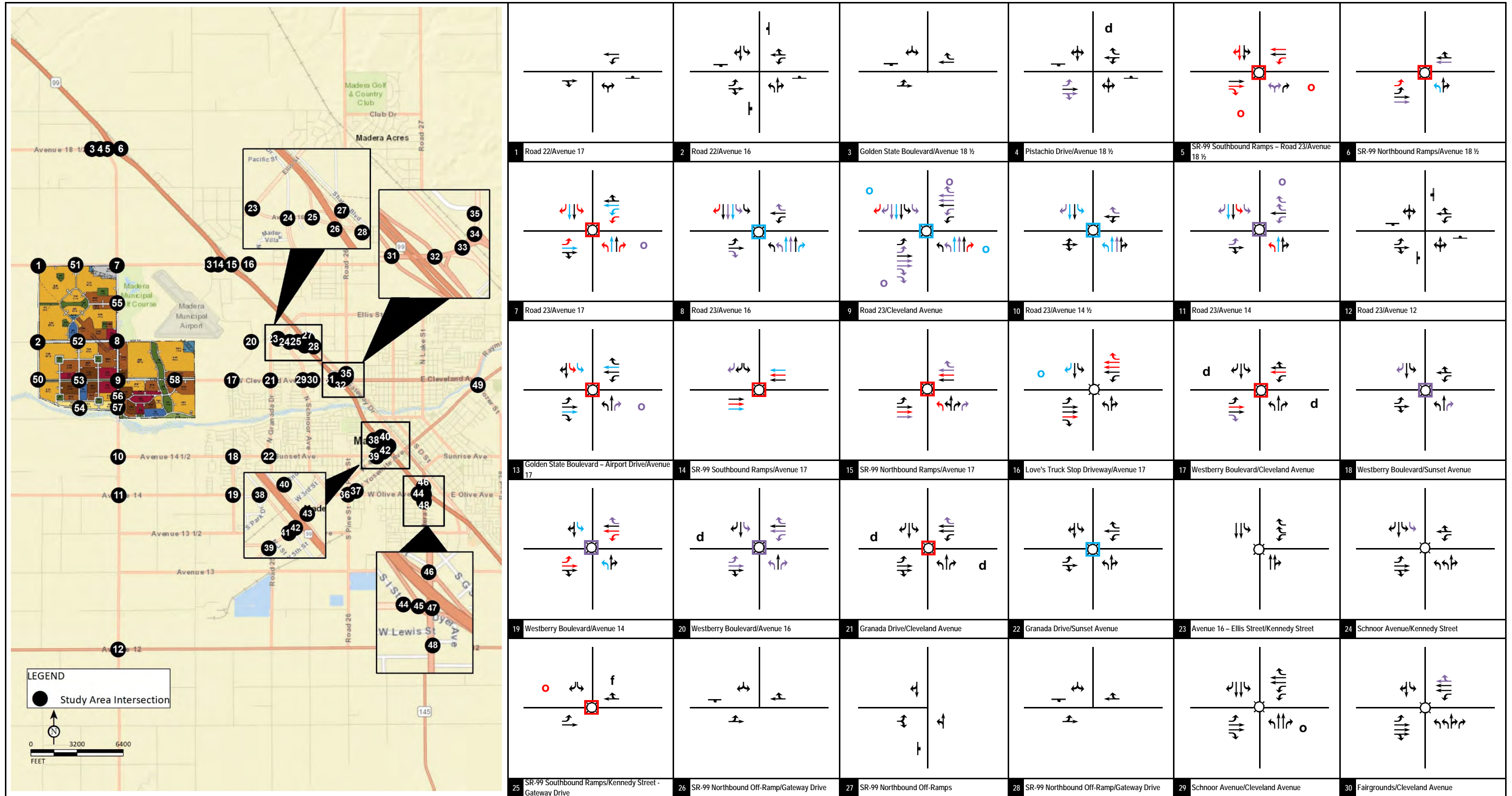

FIGURE 9-3A

LSA

Legend

- ⊞ Signal
- ⊞ Stop Sign
- d Defacto right turn
- f Free right-turn
- Right-turn overlap
- ↗ Phase I Recommended Improvements
- ↘ Phase II Recommended Improvements
- ↖ Phase III Recommended Improvements

Village D Specific Plan
Traffic Impact Analysis

Phase III Project Completion Year (2049) with Project with Improvements Study Intersection Geometrics and Traffic Control (Int. 1-30)

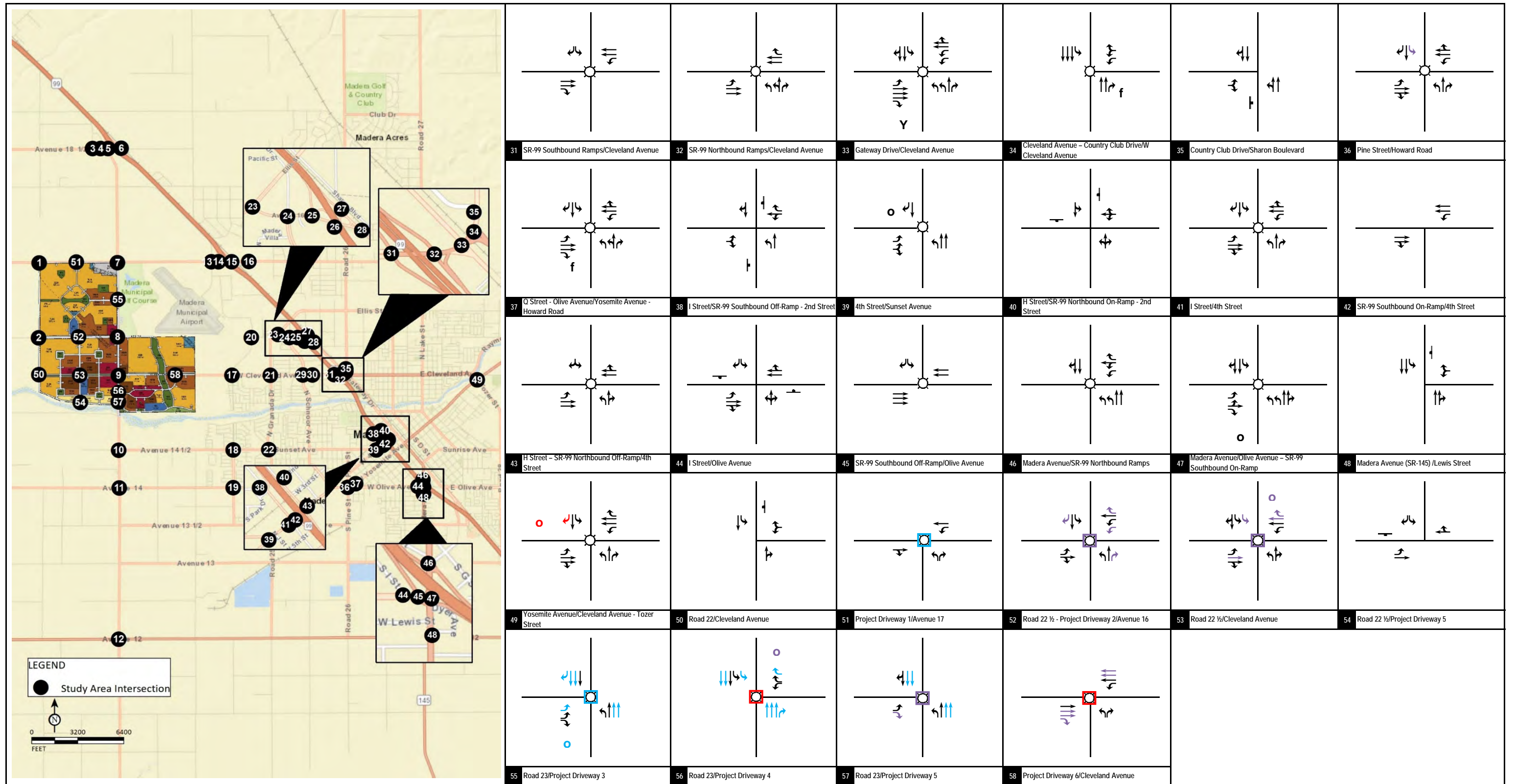

LSA

FIGURE 9-3B

Legend

- ⊗ Signal
- ⊥ Stop Sign
- d Defacto right turn
- f Free right-turn
- Right-turn overlap
- Y Yield
- ➔ Phase I Recommended Improvements
- ➔ Phase II Recommended Improvements
- ➔ Phase III Recommended Improvements

Village D Specific Plan
Traffic Impact Analysis

Phase III Project Completion Year (2049) with Project with Improvements Study Intersection Geometrics and Traffic Control (Int. 31-58)

Table 9-A - Recommended Improvements for Intersections

Intersection	Existing with Project Mitigations ¹	Phase I Completion Year (2029) with Project Mitigations ²	Phase II Completion Year (2039) with Project Mitigations ²	Phase III Completion Year (2049) with Project Mitigations ²
4 . Pistachio Drive/Avenue 18 ½				Widen eastbound approach from EBLTR to EBL, EBT, EBTR.
5 . SR-99 Southbound Ramps – Road 23/Avenue 18 ½	Install signal with protected left-turn phasing for WBL and split phasing for NB/SB. Widen southbound approach from SBLTR to SBTL and SBTR. Restripe NBL to NBLR. Add EBT, EBR, WBL, WBT. Add right-turn overlap phasing for NBR and EBR. Interchange redesign/reconstruction required. This is not covered under any funding program. The project will be required to pay its fair share for improving this interchange.	Install signal with protected left-turn phasing for WBL and split phasing for N/S. Widen southbound approach from SBLTR to SBTL and SBTR. Add EBT, EBR, WBL, WBT. Add right turn overlap phasing for NBR and EBR. Interchange redesign/reconstruction required. This is not covered under any funding program. The project will be required to pay its fair share for improving this interchange.	Phase I Mitigations. Interchange redesign/reconstruction required. This is not covered under any funding program. The project will be required to pay its fair share for improving this interchange.	Phase I Mitigations + Phase II Mitigations + Restripe NBL to NBLR. Interchange redesign/reconstruction required. This is not covered under any funding program. The project will be required to pay its fair share for improving this interchange.
6 . SR-99 Northbound Ramps/Avenue 18 ½	Install signal with protected left turn phasing. Interchange redesign/reconstruction required. This is not covered under any funding program. The project will be required to pay its fair share for improving this interchange.	Install signal with protected left turn phasing. Add EBL. Interchange redesign/reconstruction required. This is not covered under any funding program. The project will be required to pay its fair share for improving this interchange.	Phase I Mitigations + Widen northbound approach from NBLTR to NBL and NBTR. Interchange redesign/reconstruction required. This is not covered under any funding program. The project will be required to pay its fair share for improving this interchange.	Phase I Mitigations + Phase II Mitigations + Add EBT, WBT. Interchange redesign/reconstruction required. This is not covered under any funding program. The project will be required to pay its fair share for improving this interchange.
7 . Road 23/Avenue 17	Add NBL, NBT, NBR, SBL, SBT, EBL, EBT, 2 WBL, WBT. Install signal with protected left-turn phasing. Add right-turn overlap phasing to NBR.	Add NBL, NBR, SBL, SBR, EBL, WBL. Install signal with protected left-turn phasing.	Phase I Mitigations + Add NBT, SBT, EBT, WBL, WBT.	Phase I Mitigations + Phase II Mitigations + Add right turn overlap phasing to NBR.
8 . Road 23/Avenue 16	Add NBL, NBT, NBR, SBL, SBT, EBR, WBR. Install signal with protected left-turn phasing.		Add NBT, NBR, SBT. Install signal with protected left-turn phasing.	Phase II Mitigations + Add NBL, NBT, SBL, SBT, SBR, EBR, WBR.
9 . Road 23/Cleveland Avenue	Add NBL, NBT, NBR, SBL, SBT, SBR, EBL, 2 EBT, 2 EBR, WBL, WBT, WBR. Install signal with protected left-turn phasing. Add right-turn overlap phasing to all right turns.	Add NBR, SBR.	Phase I Mitigations + Add NBT, SBT. Install signal with protected left-turn phasing. Add right-turn overlap phasing to NBR and SBR.	Phase I Mitigations + Phase II Mitigations + Add NBL, NBT, SBL, SBT, SBR, EBL, 2 EBT, 2 EBR, WBL, 2 WBT, WBR. Add right-turn overlap phasing to EBR, WBR.
10 . Road 23/Avenue 14 ½	Add NBL, NBT, SBL, SBT, WBR. Install signal with protected left-turn phasing for NB/SB.		Add NBL, NBT, SBL, SBT. Install signal with protected left-turn phasing for NB/SB.	Phase II Mitigations + Add NBT, SBR, WBR.
11 . Road 23/Avenue 14	Install signal with protected left-turn phasing. Add NBL, NBT, 2 SBL, SBT, EBL, WBL, 2 WBR. Add right-turn overlap phasing to WBR.	Add NBL, SBL.	Phase I Mitigations + Add NBT, SBT.	Phase I Mitigations + Phase II Mitigations + Install signal with protected left-turn phasing. Add SBL, SBR, EBL, WBL, 2 WBR. Add right-turn overlap phasing to WBR.
13 . Golden State Boulevard – Airport Drive/Avenue 17	Install signal with protected left-turn phasing. Stripe NBR. Add SBL, EBT, WBT.	Install signal with protected left-turn phasing. Add SBL.	Phase I Mitigations + Add SBL, EBT, WBT.	Phase I Mitigations + Phase II Mitigations + Stripe NBR. Add right-turn overlap phasing for NBR.
14 . SR-99 Southbound Ramps/Avenue 17	Install signal. Add EBT, WBT.	Install signal. Add EBT, add WBT.	Phase I Mitigations + Add EBT, WBT.	Phase I Mitigations + Phase II Mitigations + Add SBR.
15 . SR-99 Northbound Ramps/Avenue 17	Install signal with protected left-turn phasing. Add NBL, EBT, WBT.	Install signal with protected left-turn phasing. Add NBL, EBT, WBT.	Phase I Mitigations	Phase I Mitigations + Phase II Mitigations + Add NBR, EBT, WBT, WBR.
16 . Love's Truck Stop Driveway/Avenue 17		Add EBT, 2 WBT, WBR.	Phase I Mitigations + Add SBR. Add right turn overlap phasing to SBR.	Phase I Mitigations + Phase II Mitigations
17 . Westberry Boulevard/Cleveland Avenue	Add EBT, WBT. Install signal with protected left-turn phasing	Add EBT, WBT. Install signal with protected left-turn phasing.	Phase I Mitigations	Phase I Mitigations + Phase II Mitigations + Add EBR.
18 . Westberry Boulevard/Sunset Avenue	Striping NBR, SBR. Install signal with protected left-turn phasing for N/S.			Striping NBR, SBR. Install signal with protected left-turn phasing for N/S.
19 . Westberry Boulevard/Avenue 14	Install signal with protected left-turn phasing. Add NBL, SBL, EBL, EBT, WBL, WBT	Add EBL, EBT, WBL, WBT.	Phase I Mitigations + Add NBL, SBL.	Phase I Mitigations + Phase II Mitigations + Install signal with protected left-turn phasing. Add WBR.
20 . Westberry Boulevard/Avenue 16				Install signal with protected left-turn phasing. Add NBL, NBR, SBL, EBL, EBT, WBL, WBT, WBR.
21 . Granada Drive/Cleveland Avenue	Install signal with protected left-turn phasing.	Install signal with protected left-turn phasing.	Phase I Mitigations	Phase I Mitigations + Phase II Mitigations + Add WBR.
22 . Granada Drive/Sunset Avenue	Install signal with protected left-turn phasing.		Install signal with protected left-turn phasing.	Phase II Mitigations
24 . Schnoor Avenue/Kennedy Street				Add second SBL
25 . SR-99 Southbound Ramps/Kennedy Street - Gateway Drive	Convert from OWSC to AWSC	Install signal with protected left turn-phasing for EBL. Add right-turn overlap phasing for SBR.	Phase I Mitigations	Phase I Mitigations

Table 9-A - Recommended Improvements for Intersections

Intersection	Existing with Project Mitigations ¹	Phase I Completion Year (2029) with Project Mitigations ²	Phase II Completion Year (2039) with Project Mitigations ²	Phase III Completion Year (2049) with Project Mitigations ²
30 . Fairgrounds/Cleveland Avenue				Restripe WBR to WBTR.
31 . SR-99 Southbound Ramps/Cleveland Avenue	Interchange redesign/reconstruction required. This is not covered under any funding program. The project will be required to pay its fair share for improving this interchange.	Interchange redesign/reconstruction required. This is not covered under any funding program. The project will be required to pay its fair share for improving this interchange.	Interchange redesign/reconstruction required. This is not covered under any funding program. The project will be required to pay its fair share for improving this interchange.	Interchange redesign/reconstruction required. This is not covered under any funding program. The project will be required to pay its fair share for improving this interchange.
32 . SR-99 Northbound Ramps/Cleveland Avenue				Interchange redesign/reconstruction required. This is not covered under any funding program. The project will be required to pay its fair share for improving this interchange.
36 . Pine Street/Howard Road	Widen SB approach. Add SBL. Restripe the southbound approach from SBT/SBR to SBL/SBT/SBR. Change N/S split phasing to protected left-turn phasing.			Widen SB approach. Add SBL. Restripe the southbound approach from SBT/SBR to SBL/SBT/SBR. Change N/S split phasing to protected left-turn phasing.
38 . I Street/SR-99 Southbound Off-Ramp - 2nd Street	Install signal with split phasing for the E/W approaches. This intersection does not meet a signal warrant and no right-of-way is available for other improvements. Therefore, further evaluation is required prior to installation of the recommended improvement.		Install signal with split phasing for the E/W approaches. This intersection does not meet a signal warrant and no right-of-way is available for other improvements. Therefore, further evaluation is required prior to installation of the recommended improvement.	Phase II Mitigations. This intersection does not meet a signal warrant and no right-of-way is available for other improvements. Therefore, further evaluation is required prior to installation of the recommended improvement.
43 . H Street – SR-99 Northbound Off-Ramp/4th Street				Ramp intersection redesign/reconstruction required. This is not covered under any funding program. The project will be required to pay its fair share for improving this interchange.
44 . I Street/Olive Avenue	Install a sign restricting WBL movements for safety and clarity.	Install a sign restricting WBL movements for safety and clarity.	Install a sign restricting WBL movements for safety and clarity.	Install a sign restricting WBL movements for safety and clarity. Restrict the southbound left turn movement. All southbound movements will shift to intersections west of this intersection and re-routed as eastbound through movements. Since the streets are under the jurisdiction of the City, further evaluation of the recommended improvement is required prior to implementation of the improvement.
49 . Yosemite Avenue/Cleveland Avenue - Tozer Street	Add SBR with right-turn overlap phasing. Restripe SBTR to SBT.	Add SBR with right-turn overlap phasing. Restripe SBTR to SBT.	Phase I Mitigations	Phase I Mitigations
51 . Project Driveway 1/Avenue 17	Install signal with protected left-turn phasing		Install signal with protected left-turn phasing.	Phase II Mitigations
52 . Road 22 ½ - Project Driveway 2/Avenue 16	Convert from TWSC to AWSC			Add NBR, SBR, WBL, WBR. Install signal with protected left-turn phasing.
53 . Road 22 ½/Cleveland Avenue	Add SBL, EBT, WBT, WBR. Install signal with protected left-turn phasing.			Add SBL, EBT, WBT, WBR. Install signal with protected left-turn phasing. Add right-turn overlap to WBR.
55 . Road 23/Project Driveway 3	Add NBT, SBT, SBR. Install signal with protected left-turn phasing. Add right-turn overlap phasing to EBR.		Add 2 NBT, 2 SBT, SBR, EBL. Install signal with protected left-turn phasing. Add right turn overlap phasing to EBR.	Phase II Mitigations
56 . Road 23/Project Driveway 4	Add NBT, SBL, SBT, WBR. Install signal with protected left-turn phasing. Add right-turn overlap phasing to WBR	Install signal with protected left-turn phasing.	Phase I Mitigations + Add 2 NBT, NBR, SBL, 2 SBT, WBR.	Phase I Mitigations + Phase II Mitigations. Add right-turn overlap phasing to WBR.
57 . Road 23/Project Driveway 5	Add NBT, SBT, EBR. Install signal with protected left-turn phasing.		Add 2 NBT, 2 SBT.	Phase II Mitigations + Add EBR. Install signal with protected left-turn phasing.
58 . Project Driveway 6/Cleveland Avenue	Add EBT, WBT. Install signal with protected left-turn phasing.	Install signal with protected left-turn phasing.	Phase I Mitigations	Phase I Mitigations + Phase II Mitigations + Add 2 EBT, EBR, 2 WBT.

Notes:

NB = Northbound, SB = Southbound, EB = Eastbound, WB = Westbound

L = Left, T = Through, R = Right

¹ Recommended mitigation for Existing with Project is for informational purposes only. As such, the project shall only implement the recommended mitigations for Phase I and beyond.

² Recommended improvements covered through Madera County Transportation Authority's Measure T program or the City's Capital Improvement Plan (CIP) are not considered adequate mitigation measures. This is because there is no guaranteed timeline for implementation of these improvements through these programs.

Therefore, impacts at intersections where mitigations are included through the aforementioned funding programs should be considered significant and unavoidable.

Table 9-B - Existing with Project Recommended Improvements Intersection Levels of Service

Intersection	Jurisdiction	With Project Without Improvements						With Project With Improvements							
		Control	A.M. Peak Hour			P.M. Peak Hour			Control	A.M. Peak Hour			P.M. Peak Hour		
			Delay (sec.)	LOS		Delay (sec.)	LOS			Delay (sec.)	LOS		Delay (sec.)	LOS	
5 . SR-99 Southbound Ramps – Road 23/Avenue 18 ½	Caltrans	TWSC	122.7	F	*	>200	F	*	Signal	39.0	D		40.4	D	
8 . Road 23/Avenue 16	City of Madera/Madera County	TWSC	>200	F	*	>200	F	*	Signal	52.1	D		45.5	D	
9 . Road 23/Cleveland Avenue	Madera County	TWSC	>200	F	*	>200	F	*	Signal	33.7	C		53.3	D	
11 . Road 23/Avenue 14	Madera County	AWSC	>200	F	*	>200	F	*	Signal	37.4	D		41.1	D	
13 . Golden State Boulevard – Airport Drive/Avenue 17	City of Madera	TWSC	>200	F	*	>200	F	*	Signal	30.1	C		31.5	C	
14 . SR-99 Southbound Ramps/Avenue 17	Caltrans	OWSC	>200	F	*	>200	F	*	Signal	10.7	B		11.7	B	
15 . SR-99 Northbound Ramps/Avenue 17	Caltrans	OWSC	>200	F	*	>200	F	*	Signal	22.8	C		23.4	C	
17 . Westberry Boulevard/Cleveland Avenue	City of Madera	TWSC	>200	F	*	>200	F	*	Signal	37.3	D		48.2	D	
18 . Westberry Boulevard/Sunset Avenue	City of Madera	AWSC	83.4	F	*	11.8	B		Signal	15.6	B		10.1	B	
19 . Westberry Boulevard/Avenue 14	City of Madera/Madera County	AWSC	>200	F	*	>200	F	*	Signal	17.4	B		15.6	B	
21 . Granada Drive/Cleveland Avenue	City of Madera	AWSC	>200	F	*	>200	F	*	Signal	39.0	D		35.1	D	
22 . Granada Drive/Sunset Avenue	City of Madera	AWSC	66.0	F	*	30.3	D		Signal	22.2	C		17.3	B	
25 . SR-99 Southbound Ramps/Kennedy Street - Gateway Drive	Caltrans	OWSC	51.1	F	*	88.8	F	*	OWSC	13.7	B		21.9	C	
31 . SR-99 Southbound Ramps/Cleveland Avenue	Caltrans	Signal	64.5	E	*	16.0	B		Signal	64.5	E	*	17.5	B	
36 . Pine Street/Howard Road	City of Madera	Signal	58.5	E	*	43.2	D		Signal	49.6	D		42.6	D	
38 . I Street/SR-99 Southbound Off-Ramp - 2nd Street	Caltrans	OWSC	43.0	E	*	16.7	C		Signal	30.9	C		25.5	C	
49 . Yosemite Avenue/Cleveland Avenue - Tozer Street	Caltrans	Signal	57.7	E	*	66.2	E	*	Signal	33.4	C		37.8	D	
51 . Project Driveway 1/Avenue 17	Madera County	OWSC	15.7	C		89.6	F	*	Signal	21.3	C		52.3	D	
52 . Road 22 ½ - Project Driveway 2/Avenue 16	Madera County	TWSC	132.6	F	*	>200	F	*	AWSC	16.5	C		18.8	C	
53 . Road 22 ½/Cleveland Avenue	Madera County	TWSC	>200	F	*	>200	F	*	Signal	41.7	D		47.6	D	
55 . Road 23/Project Driveway 3	City of Madera/Madera County	OWSC	>200	F	*	>200	F	*	Signal	42.0	D		34.6	C	
56 . Road 23/Project Driveway 4	Madera County	OWSC	>200	F	*	>200	F	*	Signal	11.4	B		35.1	D	
57 . Road 23/Project Driveway 5	Madera County	OWSC	>200	F	*	>200	F	*	Signal	9.1	A		5.9	A	
58 . Project Driveway 6/Cleveland Avenue	Madera County	OWSC	>200	F	*	>200	F	*	Signal	30.3	C		33.0	C	

Notes:

OWSC = One-Way Stop Control; TWSC = Two-Way Stop Control; AWSC = All-Way Stop Control; LOS = Level of Service

Delay = Average control delay in seconds (For OWSC/TWSC intersections, reported delay is for worst-case movement).

* Exceeds LOS Standard

Table 9-C - Phase I Project Completion Year (2029) with Project Recommended Improvements Intersection Levels of Service

Intersection	Jurisdiction	With Project Without Improvements						With Project With Improvements							
		Control	A.M. Peak Hour			P.M. Peak Hour			Control	A.M. Peak Hour			P.M. Peak Hour		
			Delay (sec.)	LOS	*	Delay (sec.)	LOS	*		Delay (sec.)	LOS	*	Delay (sec.)	LOS	*
5 . SR-99 Southbound Ramps – Road 23/Avenue 18 ½	Caltrans	TWSC	55.7	F	*	>200	F	*	Signal	35.5	D		38.0	D	
6 . SR-99 Northbound Ramps/Avenue 18 ½	Caltrans	OWSC	>200	F	*	72.0	F	*	Signal	29.8	C		27.3	C	
7 . Road 23/Avenue 17	Madera	TWSC	39.6	E	*	>200	F	*	Signal	20.2	C		24.9	C	
9 . Road 23/Cleveland Avenue	Madera	TWSC	76.4	F	*	61.6	F	*	TWSC	30.0	D		31.8	D	
11 . Road 23/Avenue 14	Madera	AWSC	38.2	E	*	41.2	E	*	AWSC	19.6	C		18.4	C	
13 . Golden State Boulevard – Airport Drive/Avenue 17	Madera	TWSC	76.6	F	*	>200	F	*	Signal	28.5	C		30.2	C	
14 . SR-99 Southbound Ramps/Avenue 17	Caltrans	OWSC	46.9	E	*	>200	F	*	Signal	24.1	C		18.7	B	
15 . SR-99 Northbound Ramps/Avenue 17	Caltrans	OWSC	>200	F	*	>200	F	*	Signal	23.8	C		41.3	D	
16 . Love's Truck Stop Driveway/Avenue 17	Madera	Signal	105.7	F	*	>200	F	*	Signal	30.5	C		50.0	D	
17 . Westberry Boulevard/Cleveland Avenue	Madera	TWSC	>200	F	*	>200	F	*	Signal	30.4	C		32.4	C	
19 . Westberry Boulevard/Avenue 14	Madera	AWSC	28.6	D		39.2	E	*	AWSC	19.5	C		15.3	C	
21 . Granada Drive/Cleveland Avenue	Madera	AWSC	159.7	F	*	144.5	F	*	Signal	37.1	D		28.3	C	
25 . SR-99 Southbound Ramps/Kennedy Street - Gateway Drive	Caltrans	OWSC	37.4	E	*	67.9	F	*	Signal	25.3	C		23.9	C	
31 . SR-99 Southbound Ramps/Cleveland Avenue	Caltrans	Signal	48.7	D	*	15.2	B		Signal	48.7	D	*	15.2	B	
49 . Yosemite Avenue/Cleveland Avenue - Tozer Street	Madera	Signal	47.3	D	*	57.4	E	*	Signal	29.9	C		35.4	D	
56 . Road 23/Project Driveway 4	Madera	OWSC	37.0	E	*	>200	F	*	Signal	22.9	C		53.8	D	
58 . Project Driveway 6/Cleveland Avenue	Madera	OWSC	>200	F	*	>200	F	*	Signal	51.0	D		35.2	D	

Notes:

OWSC = One-Way Stop Control; TWSC = Two-Way Stop Control; AWSC = All-Way Stop Control; LOS = Level of Service
 Delay = Average control delay in seconds (For OWSC/TWSC intersections, reported delay is for worst-case movement).
 * Exceeds LOS Standard

Table 9-D - Phase II Project Completion Year (2039) with Project Recommended Improvements Intersection Levels of Service

Intersection	Jurisdiction	With Project Without Improvements						With Project With Improvements							
		Control	A.M. Peak Hour			P.M. Peak Hour			Control	A.M. Peak Hour			P.M. Peak Hour		
			Delay (sec.)	LOS		Delay (sec.)	LOS			Delay (sec.)	LOS		Delay (sec.)	LOS	
5 . SR-99 Southbound Ramps – Road 23/Avenue 18 ½	Caltrans	TWSC	>200	F	*	>200	F	*	Signal	41.6	D		36.2	D	
6 . SR-99 Northbound Ramps/Avenue 18 ½	Caltrans	OWSC	>200	F	*	>200	F	*	Signal	30.9	C		27.3	C	
7 . Road 23/Avenue 17	Madera	TWSC	-	F	*	-	F	*	Signal	43.1	D		43.2	D	
8 . Road 23/Avenue 16	Madera	TWSC	>200	F	*	>200	F	*	Signal	37.2	D		41.0	D	
9 . Road 23/Cleveland Avenue	Madera	TWSC	>200	F	*	>200	F	*	Signal	33.3	C		32.1	C	
10 . Road 23/Avenue 14 ½	Madera	TWSC	39.1	E	*	62.5	F	*	Signal	13.5	B		14.3	B	
11 . Road 23/Avenue 14	Madera	AWSC	134.0	F	*	93.8	F	*	AWSC	31.6	D		29.2	D	
13 . Golden State Boulevard – Airport Drive/Avenue 17	Madera	TWSC	>200	F	*	>200	F	*	Signal	33.1	C		28.6	C	
14 . SR-99 Southbound Ramps/Avenue 17	Caltrans	OWSC	>200	F	*	>200	F	*	Signal	18.9	B		16.3	B	
15 . SR-99 Northbound Ramps/Avenue 17	Caltrans	OWSC	>200	F	*	>200	F	*	Signal	23.6	C		52.1	D	
16 . Love's Truck Stop Driveway/Avenue 17	Madera	Signal	108.8	F	*	>200	F	*	Signal	29.1	C		38.8	D	
17 . Westberry Boulevard/Cleveland Avenue	Madera	TWSC	>200	F	*	>200	F	*	Signal	30.1	C		32.9	C	
19 . Westberry Boulevard/Avenue 14	Madera	AWSC	68.2	F	*	71.1	F	*	AWSC	19.8	C		20.2	C	
21 . Granada Drive/Cleveland Avenue	Madera	AWSC	>200	F	*	182.9	F	*	Signal	38.6	D		29.3	C	
22 . Granada Drive/Sunset Avenue	Madera	AWSC	38.7	E	*	37.0	E	*	Signal	29.1	C		22.2	C	
25 . SR-99 Southbound Ramps/Kennedy Street - Gateway Drive	Caltrans	OWSC	91.3	F	*	>200	F	*	Signal	29.9	C		25.6	C	
31 . SR-99 Southbound Ramps/Cleveland Avenue	Caltrans	Signal	78.7	E	*	16.0	B	0.0	Signal	73.6	E	*	16.0	B	
38 . I Street/SR-99 Southbound Off-Ramp - 2nd Street	Caltrans	OWSC	55.9	F	*	20.8	C	0.0	Signal	33.3	C		24.2	C	
49 . Yosemite Avenue/Cleveland Avenue - Tozer Street	Madera	Signal	55.1	E	*	66.9	E	*	Signal	31.5	C		39.1	D	
51 . Project Driveway 1/Avenue 17	Madera	OWSC	17.2	C		119.6	F	*	Signal	21.3	C		39.6	D	
55 . Road 23/Project Driveway 3	Madera	OWSC	>200	F	*	>200	F	*	Signal	52.6	D		42.5	D	
56 . Road 23/Project Driveway 4	Madera	OWSC	>200	F	*	>200	F	*	Signal	30.6	C		44.9	D	
57 . Road 23/Project Driveway 5	Madera	OWSC	23.0	C		72.3	F	*	OWSC	18.6	C		21.7	C	
58 . Project Driveway 6/Cleveland Avenue	Madera	OWSC	>200	F	*	>200	F	*	Signal	52.2	D		33.1	C	

Notes:

OWSC = One-Way Stop Control; TWSC = Two-Way Stop Control; AWSC = All-Way Stop Control; LOS = Level of Service
 Delay = Average control delay in seconds (For OWSC/TWSC intersections, reported delay is for worst-case movement).
 * Exceeds LOS Standard

Table 9-E - Phase III Project Completion Year (2049) with Project Recommended Improvements Intersection Levels of Service

Intersection	Jurisdiction	With Project Without Improvements						With Project With Improvements							
		Control	A.M. Peak Hour		P.M. Peak Hour		Control	A.M. Peak Hour		P.M. Peak Hour					
			Delay (sec.)	LOS	Delay (sec.)	LOS		Delay (sec.)	LOS	Delay (sec.)	LOS				
4 . Pistachio Drive/Avenue 18 ½	Madera	OWSC	19.6	C	45.3	E	*	OWSC	10.6	B	13.7	B			
5 . SR-99 Southbound Ramps – Road 23/Avenue 18 ½	Caltrans	TWSC	114.6	F	*	>200	F	*	Signal	38.4	D	43.2	D		
6 . SR-99 Northbound Ramps/Avenue 18 ½	Caltrans	OWSC	>200	F	*	>200	F	*	Signal	42.3	D	40.7	D		
7 . Road 23/Avenue 17	Madera	TWSC	-	F	*	-	F	*	Signal	48.1	D	42.8	D		
8 . Road 23/Avenue 16	Madera	TWSC	>200	F	*	>200	F	*	Signal	44.8	D	30.9	C		
9 . Road 23/Cleveland Avenue	Madera	TWSC	>200	F	*	>200	F	*	Signal	37.9	D	40.9	D		
10 . Road 23/Avenue 14 ½	Madera	TWSC	-	F	*	-	F	*	Signal	19.0	B	46.1	D		
11 . Road 23/Avenue 14	Madera	AWSC	>200	F	*	>200	F	*	Signal	19.3	B	26.7	C		
13 . Golden State Boulevard – Airport Drive/Avenue 17	Madera	TWSC	>200	F	*	>200	F	*	Signal	42.7	D	33.5	C		
14 . SR-99 Southbound Ramps/Avenue 17	Caltrans	OWSC	>200	F	*	>200	F	*	Signal	8.0	A	8.2	A		
15 . SR-99 Northbound Ramps/Avenue 17	Caltrans	OWSC	>200	F	*	>200	F	*	Signal	21.6	C	23.6	C		
16 . Love’s Truck Stop Driveway/Avenue 17	Madera	Signal	118.7	F	*	>200	F	*	Signal	42.4	D	43.0	D		
17 . Westberry Boulevard/Cleveland Avenue	Madera	TWSC	>200	F	*	>200	F	*	Signal	30.7	C	47.5	D		
18 . Westberry Boulevard/Sunset Avenue	Madera	AWSC	42.5	E	*	15.3	C		Signal	15.0	B	11.0	B		
19 . Westberry Boulevard/Avenue 14	Madera	AWSC	>200	F	*	>200	F	*	Signal	21.2	C	16.5	B		
20 . Westberry Boulevard/Avenue 16	Madera	AWSC	23.1	C		51.6	F	*	Signal	19.0	B	22.5	C		
21 . Granada Drive/Cleveland Avenue	Madera	AWSC	>200	F	*	>200	F	*	Signal	46.4	D	38.8	D		
22 . Granada Drive/Sunset Avenue	Madera	AWSC	56.3	F	*	53.6	F	*	Signal	30.4	C	23.2	C		
24 . Schnoor Avenue/Kennedy Street	Madera	Signal	55.3	E	*	65.6	E	*	Signal	51.5	D	53.0	D		
25 . SR-99 Southbound Ramps/Kennedy Street - Gateway Drive	Caltrans	OWSC	>200	F	*	>200	F	*	Signal	44.2	D	32.0	C		
30 . Fairgrounds/Cleveland Avenue	Madera	Signal	37.3	D		73.1	E	*	Signal	45.9	D	46.1	D		
31 . SR-99 Southbound Ramps/Cleveland Avenue	Caltrans	Signal	85.8	F	*	22.3	C		Signal	85.8	F	*	22.3	C	
32 . SR-99 Northbound Ramps/Cleveland Avenue	Caltrans	Signal	25.7	C		54.1	D		Signal	25.7	C	54.1	D		
33 . Gateway Drive/Cleveland Avenue	Madera	Signal	34.6	C		51.6	D		Signal	34.6	C	51.6	D		
36 . Pine Street/Howard Road	Madera	Signal	61.8	E	*	46.5	D		Signal	51.2	D	43.7	D		
38 . I Street/SR-99 Southbound Off-Ramp - 2nd Street	Caltrans	OWSC	83.8	F	*	24.8	C		Signal	31.4	C	25.9	C		
43 . H Street – SR-99 Northbound Off-Ramp/4th Street	Caltrans	Signal	56.2	E	*	64.6	E	*	Signal	56.2	E	*	64.6	E	*
44 . I Street/Olive Avenue	Madera	OWSC	34.2	D		59.7	F	*	OWSC	8.5	A	10.3	B		
47 . Madera Avenue/Olive Avenue – SR-99 Southbound On-Ramp	Caltrans	Signal	41.3	D		41.1	D		Signal	41.3	D	41.1	D		
49 . Yosemite Avenue/Cleveland Avenue - Tozer Street	Madera	Signal	68.4	E	*	86.3	F	*	Signal	32.4	C	40.5	D		
51 . Project Driveway 1/Avenue 17	Madera	OWSC	16.6	C		95.6	F	*	Signal	20.0	B	42.8	D		
52 . Road 22 ½ - Project Driveway 2/Avenue 16	Madera	TWSC	>200	F	*	>200	F	*	Signal	33.1	C	44.9	D		

Table 9-E - Phase III Project Completion Year (2049) with Project Recommended Improvements Intersection Levels of Service

Intersection	Jurisdiction	With Project Without Improvements						With Project With Improvements					
		Control	A.M. Peak Hour			P.M. Peak Hour			Control	A.M. Peak Hour		P.M. Peak Hour	
			Delay (sec.)	LOS	*	Delay (sec.)	LOS	*		Delay (sec.)	LOS	Delay (sec.)	LOS
53 . Road 22 ½/Cleveland Avenue	Madera	TWSC	>200	F	*	>200	F	*	Signal	39.7	D	44.0	D
55 . Road 23/Project Driveway 3	Madera	OWSC	>200	F	*	>200	F	*	Signal	24.5	C	18.8	B
56 . Road 23/Project Driveway 4	Madera	OWSC	>200	F	*	>200	F	*	Signal	13.9	B	23.8	C
57 . Road 23/Project Driveway 5	Madera	OWSC	>200	F	*	>200	F	*	Signal	7.2	A	6.9	A
58 . Project Driveway 6/Cleveland Avenue	Madera	OWSC	>200	F	*	>200	F	*	Signal	27.6	C	33.2	C

Notes:

OWSC = One-Way Stop Control; TWSC = Two-Way Stop Control; AWSC = All-Way Stop Control; LOS = Level of Service
 Delay = Average control delay in seconds (For OWSC/TWSC intersections, reported delay is for worst-case movement).
 * Exceeds LOS Standard

Table 9-F - Recommended Improvements for Roadway Segments

Roadway Segment	Existing with Project Mitigations ¹	Phase I Completion Year (2029) with Project Mitigations ²	Phase II Completion Year (2039) with Project Mitigations ²	Phase III Completion Year (2049) with Project Mitigations ²
Segments on Road 23				
1 . between Avenue 17 and Project Driveway 3	Widen from 2 lanes to 6 lanes with a median lane.		Widen from 2 lanes to 4 lanes with a median lane.	Phase II Mitigations + Widen from 4 lanes to 6 lanes.
2 . between Project Driveway 3 and Avenue 16	Widen from 2 lanes to 6 lanes with a median lane.		Widen from 2 lanes to 4 lanes with a median lane.	Phase II Mitigations + Widen from 4 lanes to 6 lanes.
3 . between Avenue 16 and Cleveland Avenue	Widen from 2 lanes to 6 lanes with a median lane.		Widen from 2 lanes to 4 lanes with a median lane.	Phase II Mitigations + Widen from 4 lanes to 6 lanes.
4 . between Cleveland Avenue and Project Driveway 4	Widen from 2 lanes to 6 lanes with a median lane.		Widen from 2 lanes to 4 lanes with a median lane.	Phase II Mitigations + Widen from 4 lanes to 6 lanes.
5 . between Project Driveway 4 and Project Driveway 5	Widen from 2 lanes to 6 lanes with a median lane.		Widen from 2 lanes to 4 lanes with a median lane.	Phase II Mitigations + Widen from 4 lanes to 6 lanes.
6 . between Project Driveway 5 and Avenue 14 1/2	Widen from 2 lanes to 6 lanes with a median lane.		Widen from 2 lanes to 4 lanes with a median lane.	Phase II Mitigations + Widen from 4 lanes to 6 lanes.
7 . between Avenue 14 1/2 and Avenue 14	Widen from 2 lanes to 4 lanes with a median lane.			Widen from 2 lanes to 4 lanes with a median lane.
Segments on Granada Drive				
9 . between Cleveland Avenue and Fresno River		Widen from 2 lanes to 4 lanes with a median lane.	Phase I Mitigations	Phase I Mitigations
Segments on Avenue 17				
13 . between Road 23 and Golden State Boulevard	Widen from 2 lanes to 4 lanes with a median lane.		Widen from 2 lanes to 4 lanes with a median lane.	Phase II Mitigations
14 . between Golden State Boulevard and State Route 99 Southbound Off-Ramp	Widen from 2 lanes to 4 lanes with a median lane.	Widen from 2 lanes to 4 lanes with a median lane.	Phase I Mitigations + Widen from 4 lanes to 6 lanes.	Phase I Mitigations + Phase II Mitigations
Segments on Cleveland Avenue				
17 . between Road 22 1/2 and Road 23	Widen from 2 lanes to 6 lanes with a median lane.			Widen from 2 lanes to 6 lanes with a median lane.
18 . between Road 23 and Project Driveway 6	Widen from 2 lanes to 4 lanes with a median lane.		Widen from 2 lanes to 4 lanes with a median lane.	Phase II Mitigations + Widen from 4 lanes to 6 lanes.
19 . between Project Driveway 6 and Westberry Boulevard	Widen from 2 lanes to 6 lanes with a median lane.	Widen from 2 lanes to 4 lanes with a median lane.	Phase I Mitigations	Phase I Mitigations + Phase II Mitigations + Widen from 4 lanes to 6 lanes.
20 . between Westberry Boulevard and Granada Drive	Widen from 2 lanes to 4 lanes.	Widen from 2 lanes to 4 lanes with a median lane.	Phase I Mitigations	Phase I Mitigations
21 . between Granada Drive and Schnoor Street				Widen from 4 lanes to 6 lanes.
22 . between Schnoor Street and Fairgrounds				Widen from 4 lanes to 6 lanes.

Notes:

¹ Recommended mitigation for Existing with Project is for informational purposes only. As such, the project shall only implement the recommended mitigations for Phase I and beyond.

² Recommended improvements covered through Madera County Transportation Authority's Measure T program or the City's Capital Improvement Plan (CIP) are not considered adequate mitigation measures. This is because there is no guaranteed timeline for implementation of these improvements through these programs. Therefore, impacts at roadway segments where mitigations are included through the aforementioned funding programs should be considered significant and unavoidable.

Table 9-G - Existing with Project with Improvements Roadway Segment Levels of Service

Roadway Segment	Jurisdiction	With Project Without Improvements					With Project With Improvements				
		Classification ¹	Number of Lanes	Roadway Capacity ²	Daily Volume	LOS	Classification ¹	Number of Lanes	Roadway Capacity ²	Daily Volume	LOS
Segments on Road 23											
1 . between Avenue 17 and Project Driveway 3	City of Madera/Madera County	Urban Arterial	2	18,000	40,700	F *	Urban Arterial	6	51,700	40,700	C
2 . between Project Driveway 3 and Avenue 16	City of Madera/Madera County	Urban Arterial	2	18,000	34,000	F *	Urban Arterial	6	51,700	34,000	B
3 . between Avenue 16 and Cleveland Avenue	Madera County	Urban Arterial	2	18,000	35,000	F *	Urban Arterial	6	51,700	35,000	B
4 . between Cleveland Avenue and Project Driveway 4	Madera County	Urban Arterial	2	18,000	36,700	F *	Urban Arterial	6	51,700	36,700	C
5 . between Project Driveway 4 and Project Driveway 5	Madera County	Urban Arterial	2	18,000	33,400	F *	Urban Arterial	6	51,700	33,400	B
6 . between Project Driveway 5 and Avenue 14 1/2	Madera County	Urban Arterial	2	18,000	33,700	F *	Urban Arterial	6	51,700	33,700	B
7 . between Avenue 14 1/2 and Avenue 14	Madera County	Urban Arterial	2	18,000	26,700	F *	Urban Arterial	4	34,500	26,700	C
Segments on Avenue 17											
13 . between Road 23 and Golden State Boulevard	City of Madera/Madera County	Urban Arterial	2	17,200	27,900	F *	Urban Arterial	4	34,500	27,900	D
14 . between Golden State Boulevard and State Route 99 Southbound Off-Ramp	City of Madera	Urban Arterial	2	17,200	30,000	F *	Urban Arterial	4	34,500	30,000	D
Segments on Cleveland Avenue											
17 . between Road 22 1/2 and Road 23	Madera County	Urban Arterial	2	17,200	34,800	F *	Urban Arterial	6	51,700	34,800	B
18 . between Road 23 and Project Driveway 6	Madera County	Urban Arterial	2	17,200	28,400	F *	Urban Arterial	4	34,500	28,400	D
19 . between Project Driveway 6 and Westberry Boulevard	City of Madera/Madera County	Urban Arterial	2	17,200	31,900	F *	Urban Arterial	6	51,700	31,900	B
20 . between Westberry Boulevard and Granada Drive	City of Madera	Urban Arterial	2	17,200	22,900	F *	Urban Arterial	4	34,500	22,900	B

Notes:

LOS = Level of Service

* Exceeds LOS Standard

¹ Classifications for the segments have been obtained from the City of Madera General Plan Update , adopted May, 2009.

² Roadway Capacity for different roadway classifications have been obtained from the Madera County Regional Transportation Plan , adopted 2007.

Table 9-H - Phase I Project Completion Year (2029) with Project with Improvements Roadway Segment Levels of Service

Roadway Segment	Jurisdiction	With Project Without Improvements					With Project With Improvements				
		Classification ¹	Number of Lanes	Roadway Capacity ²	Daily Volume	LOS	Classification ¹	Number of Lanes	Roadway Capacity ²	Daily Volume	LOS
Segments on Granada Drive											
9 . between Cleveland Avenue and Fresno River	City of Madera	Urban Collector	2	12,500	12,000	E *	Urban Collector	4	24,100	12,000	A
Segments on Avenue 17											
14 . between Golden State Boulevard and State Route 99 Southbound Off-Ramp	City of Madera	Urban Arterial	2	17,200	15,900	E *	Urban Arterial	4	34,500	15,900	A
Segments on Cleveland Avenue											
19 . between Project Driveway 6 and Westberry Boulevard	City of Madera/Madera County	Urban Arterial	2	17,200	21,200	F *	Urban Arterial	4	34,500	21,200	B
20 . between Westberry Boulevard and Granada Drive	City of Madera	Urban Arterial	2	17,200	17,100	E *	Urban Arterial	4	34,500	17,100	A

Notes:

LOS = Level of Service

* Exceeds LOS Standard

¹ Classifications for the segments have been obtained from the *City of Madera General Plan Update*, adopted May, 2009.

² Roadway Capacity for different roadway classifications have been obtained from the *Madera County Regional Transportation Plan*, adopted 2007.

Table 9-I - Phase II Project Completion Year (2039) with Project with Improvements Roadway Segment Levels of Service

Roadway Segment	Jurisdiction	With Project Without Improvements					With Project With Improvements				
		Classification ¹	Number of Lanes	Roadway Capacity ²	Daily Volume	LOS	Classification ¹	Number of Lanes	Roadway Capacity ²	Daily Volume	LOS
Segments on Road 23											
1 . between Avenue 17 and Project Driveway 3	City of Madera/Madera County	Urban Arterial	2	18,000	26,400	F *	Urban Arterial	4	34,500	26,400	C
2 . between Project Driveway 3 and Avenue 16	City of Madera/Madera County	Urban Arterial	2	18,000	18,200	F *	Urban Arterial	4	34,500	18,200	A
3 . between Avenue 16 and Cleveland Avenue	Madera County	Urban Arterial	2	18,000	18,500	F *	Urban Arterial	4	34,500	18,500	A
4 . between Cleveland Avenue and Project Driveway 4	Madera County	Urban Arterial	2	18,000	20,000	F *	Urban Arterial	4	34,500	20,000	A
5 . between Project Driveway 4 and Project Driveway 5	Madera County	Urban Arterial	2	18,000	19,100	F *	Urban Arterial	4	34,500	19,100	A
6 . between Project Driveway 5 and Avenue 14 1/2	Madera County	Urban Arterial	2	18,000	18,500	F *	Urban Arterial	4	34,500	18,500	A
Segments on Granada Drive											
9 . between Cleveland Avenue and Fresno River	City of Madera	Urban Collector	2	12,500	13,300	F *	Urban Collector	4	24,100	13,300	A
Segments on Avenue 17											
13 . between Road 23 and Golden State Boulevard	City of Madera/Madera County	Urban Arterial	2	17,200	22,500	F *	Urban Arterial	4	34,500	22,500	B
14 . between Golden State Boulevard and State Route 99 Southbound Off-Ramp	City of Madera	Urban Arterial	2	17,200	34,000	F *	Urban Arterial	6	51,700	34,000	B
Segments on Cleveland Avenue											
18 . between Road 23 and Project Driveway 6	Madera County	Urban Arterial	2	17,200	15,900	E *	Urban Arterial	4	34,500	15,900	A
19 . between Project Driveway 6 and Westberry Boulevard	City of Madera/Madera County	Urban Arterial	2	17,200	22,300	F *	Urban Arterial	4	34,500	22,300	B
20 . between Westberry Boulevard and Granada Drive	City of Madera	Urban Arterial	2	17,200	18,100	F *	Urban Arterial	4	34,500	18,100	A

Notes:

LOS = Level of Service

* Exceeds LOS Standard

¹ Classifications for the segments have been obtained from the City of Madera General Plan Update, adopted May, 2009.

² Roadway Capacity for different roadway classifications have been obtained from the Madera County Regional Transportation Plan, adopted 2007.

Table 9-J - Phase III Project Completion Year (2049) with Project with Improvements Roadway Segment Levels of Service

Roadway Segment	Jurisdiction	With Project Without Improvements					With Project With Improvements				
		Classification ¹	Number of Lanes	Roadway Capacity ²	Daily Volume	LOS	Classification ¹	Number of Lanes	Roadway Capacity ²	Daily Volume	LOS
Segments on Road 23											
1 . between Avenue 17 and Project Driveway 3	City of Madera/Madera County	Urban Arterial	2	18,000	40,900	F *	Urban Arterial	6	51,700	40,900	C
2 . between Project Driveway 3 and Avenue 16	City of Madera/Madera County	Urban Arterial	2	18,000	34,400	F *	Urban Arterial	6	51,700	34,400	B
3 . between Avenue 16 and Cleveland Avenue	Madera County	Urban Arterial	2	18,000	37,800	F *	Urban Arterial	6	51,700	37,800	C
4 . between Cleveland Avenue and Project Driveway 4	Madera County	Urban Arterial	2	18,000	38,600	F *	Urban Arterial	6	51,700	38,600	C
5 . between Project Driveway 4 and Project Driveway 5	Madera County	Urban Arterial	2	18,000	34,500	F *	Urban Arterial	6	51,700	34,500	B
6 . between Project Driveway 5 and Avenue 14 1/2	Madera County	Urban Arterial	2	18,000	34,000	F *	Urban Arterial	6	51,700	34,000	B
7 . between Avenue 14 1/2 and Avenue 14	Madera County	Urban Arterial	2	18,000	27,200	F *	Urban Arterial	4	34,500	27,200	C
Segments on Granada Drive											
9 . between Cleveland Avenue and Fresno River	City of Madera	Urban Collector	2	12,500	14,600	F *	Urban Collector	4	24,100	14,600	B
Segments on Avenue 17											
13 . between Road 23 and Golden State Boulevard	City of Madera/Madera County	Urban Arterial	2	17,200	29,100	F *	Urban Arterial	4	34,500	29,100	D
14 . between Golden State Boulevard and State Route 99 Southbound Off-Ramp	City of Madera	Urban Arterial	2	17,200	41,800	F *	Urban Arterial	6	51,700	41,800	D
Segments on Cleveland Avenue											
17 . between Road 22 1/2 and Road 23	Madera County	Urban Arterial	2	17,200	34,800	F *	Urban Arterial	6	51,700	34,800	B
18 . between Road 23 and Project Driveway 6	Madera County	Urban Arterial	2	17,200	28,600	F *	Urban Arterial	6	51,700	28,600	A
19 . between Project Driveway 6 and Westberry Boulevard	City of Madera/Madera County	Urban Arterial	2	17,200	33,800	F *	Urban Arterial	6	51,700	33,800	B
20 . between Westberry Boulevard and Granada Drive	City of Madera	Urban Arterial	2	17,200	26,000	F *	Urban Arterial	4	34,500	26,000	C
21 . between Granada Drive and Schnoor Street	City of Madera	Urban Arterial	4	34,500	31,400	E *	Urban Arterial	6	51,700	31,400	B
22 . between Schnoor Street and Fairgrounds	City of Madera/Madera County	Urban Arterial	4	34,500	34,100	E *	Urban Arterial	6	51,700	34,100	B

Notes:

LOS = Level of Service

* Exceeds LOS Standard

¹ Classifications for the segments have been obtained from the City of Madera General Plan Update, adopted May, 2009.

² Roadway Capacity for different roadway classifications have been obtained from the Madera County Regional Transportation Plan, adopted 2007.

Table 9-K - Intersection Improvement Funding Mechanism and Fair Share

Intersection	Mitigations	Improvements Covered by MCTA Measure T ¹	Improvements Covered by City's Capital Improvement Plan ¹ or Development Impact Fee Program ¹	Improvements Covered Under Fair Share	Project Fair Share or 100% Project Responsibility ²
4 . Pistachio Drive/Avenue 18 ½	Widen eastbound approach from EBLTR to EBL, EBT, EBTR.			Widen eastbound approach from EBLTR to EBL, EBT, EBTR.	65.84%
5 . SR-99 Southbound Ramps – Road 23/Avenue 18 ½	Install signal with protected left-turn phasing for WBL and split phasing for N/S. Widen southbound approach from SBLTR to SBTL and SBTR. Restripe NBL to NBLR. Add EBT, EBR, WBL, WBT. Add right-turn overlap phasing for NBR and EBR. Interchange redesign/reconstruction required. This is not covered under any funding program. The project will be required to pay its fair share for improving this interchange.			Install signal with protected left-turn phasing for WBL and split phasing for N/S. Widen southbound approach from SBLTR to SBTL and SBTR. Restripe NBL to NBLR. Add EBT, EBR, WBL, WBT. Add right-turn overlap phasing for NBR and EBR. Interchange redesign/reconstruction required. This is not covered under any funding program. The project will be required to pay its fair share for improving this interchange.	91.74%
6 . SR-99 Northbound Ramps/Avenue 18 ½	Install signal with protected left turn phasing. Widen northbound approach from NBLTR to NBL and NBTR. Add EBL, EBT, WBT. Interchange redesign/reconstruction required. This is not covered under any funding program. The project will be required to pay its fair share for improving this interchange			Install signal with protected left turn phasing. Widen northbound approach from NBLTR to NBL and NBTR. Add EBL, EBT, WBT. Interchange redesign/reconstruction required. This is not covered under any funding program. The project will be required to pay its fair share for improving this interchange	88.93%
7 . Road 23/Avenue 17	Add NBL, NBT, NBR, SBL, SBT, SBR, EBL, EBT, 2 WBL, WBT. Install signal with protected left-turn phasing. Add right turn overlap phasing to NBR.		Install signal with protected left-turn phasing.	Add NBL, NBT, NBR, SBL, SBT, SBR, EBL, EBT, 2 WBL, WBT. Add right turn overlap phasing to NBR.	100%
8 . Road 23/Avenue 16	Add NBL, 2 NBT, NBR, SBL, 2 SBT, SBR, EBR, WBR. Install signal with protected left-turn phasing.		Install signal with protected left-turn phasing.	Add NBL, 2 NBT, NBR, SBL, 2 SBT, EBR, WBR.	100%
9 . Road 23/Cleveland Avenue	Add NBL, 2 NBT, NBR, SBL, 2 SBT, 2 SBR, EBL, 2 EBT, 2 EBR, WBL, 2 WBT, WBR. Install signal with protected left-turn phasing. Add right-turn overlap phasing to all right turns.		Install signal with protected left-turn phasing.	Add NBL, 2 NBT, NBR, SBL, 2 SBT, 2 SBR, EBL, 2 EBT, 2 EBR, WBL, 2 WBT, WBR. Add right-turn overlap phasing to all right turns.	100%
10 . Road 23/Avenue 14 ½	Add NBL, 2 NBT, SBL, SBT, SBR, WBR. Install signal with protected left-turn phasing for NB/SB.		Install signal with protected left-turn phasing for NB/SB.	Add NBL, 2 NBT, SBL, SBT, SBR, WBR.	94.63%
11 . Road 23/Avenue 14	Install signal with protected left-turn phasing. Add NBL, NBT, 2 SBL, SBT, SBR, EBL, WBL, 2 WBR. Add right-turn overlap phasing to WBR.		Install signal with protected left-turn phasing.	Add NBL, NBT, 2 SBL, SBT, SBR, EBL, WBL, 2 WBR. Add right-turn overlap phasing to WBR.	93.31%
13 . Golden State Boulevard – Airport Drive/Avenue 17	Install signal with protected left-turn phasing. Stripe NBR. Add 2 SBL, EBT, WBT. Add right-turn overlap phasing for NBR.		Install signal with protected left-turn phasing.	Stripe NBR. Add 2 SBL, EBT, WBT. Add right-turn overlap phasing for NBR.	69.39%
14 . SR-99 Southbound Ramps/Avenue 17	Install signal. Add SBR, 2 EBT, 2 WBT.			Install signal. Add SBR, 2 EBT, 2 WBT.	62.55%
15 . SR-99 Northbound Ramps/Avenue 17	Install signal with protected left-turn phasing. Add NBL, NBR, 2 EBT, 2 WBT, WBR.			Install signal with protected left-turn phasing. Add NBL, NBR, 2 EBT, 2 WBT, WBR.	38.98%
16 . Love's Truck Stop Driveway/Avenue 17	Add SBR, EBT, 2 WBT, WBR. Add right-turn overlap phasing to SBR.			Add SBR, EBT, 2 WBT, WBR. Add right-turn overlap phasing to SBR.	35.45%
17 . Westberry Boulevard/Cleveland Avenue	Add EBT, EBR, WBT. Install signal with protected left-turn phasing.		Install signal with protected left-turn phasing.	Add EBT, EBR, WBT.	78.73%
18 . Westberry Boulevard/Sunset Avenue	Striping NBR, SBR. Install signal with protected left-turn phasing for N/S.		Install signal with protected left-turn phasing for N/S.	Striping NBR, SBR.	33.89%
19 . Westberry Boulevard/Avenue 14	Install signal with protected left-turn phasing. Add NBL, SBL, EBL, EBT, WBL, WBT, WBR.		Install signal with protected left-turn phasing.	Add NBL, SBL, EBL, EBT, WBL, WBT, WBR.	81.84%
20 . Westberry Boulevard/Avenue 16	Install signal with protected left-turn phasing. Add NBL, NBR, SBL, EBL, EBT, WBL, WBT, WBR.		Install signal with protected left-turn phasing.	Add NBL, NBR, SBL, EBL, EBT, WBL, WBT, WBR.	50.05%

Table 9-K - Intersection Improvement Funding Mechanism and Fair Share

Intersection	Mitigations	Improvements Covered by MCTA Measure T ¹	Improvements Covered by City's Capital Improvement Plan ¹ or Development Impact Fee Program ¹	Improvements Covered Under Fair Share	Project Fair Share or 100% Project Responsibility ²
21 . Granada Drive/Cleveland Avenue	Install signal with protected left-turn phasing. Add WBR.		Install signal with protected left-turn phasing.	Add WBR.	70.73%
22 . Granada Drive/Sunset Avenue	Install signal with protected left-turn phasing.		Install signal with protected left-turn phasing.		44.37%
24 . Schnoor Avenue/Kennedy Street	Add second SBL			Add second SBL	16.96%
25 . SR-99 Southbound Ramps/Kennedy Street - Gateway Drive	Install signal with protected left-turn phasing for EBL. Add right-turn overlap phasing for SBR.			Install signal with protected left-turn phasing for EBL. Add right-turn overlap phasing for SBR.	26.24%
30 . Fairgrounds/Cleveland Avenue	Restripe WBR to WBTR.	Restripe WBR to WBTR.			69.03%
31 . SR-99 Southbound Ramps/Cleveland Avenue	Interchange redesign/reconstruction required. This is not covered under any funding program. The project will be required to pay its fair share for improving this interchange.			Interchange redesign/reconstruction required. This is not covered under any funding program. The project will be required to pay its fair share for improving this interchange.	74.11%
32 . SR-99 Northbound Ramps/Cleveland Avenue	Interchange redesign/reconstruction required. This is not covered under any funding program. The project will be required to pay its fair share for improving this interchange.			Interchange redesign/reconstruction required. This is not covered under any funding program. The project will be required to pay its fair share for improving this interchange.	61.52%
36 . Pine Street/Howard Road	Widen SB approach. Add SBL. Restripe the southbound approach from SBT/SBR to SBL/SBT/SBR. Change N/S split phasing to protected left-turn phasing.		Widen SB approach. Add SBL. Restripe the southbound approach from SBT/SBR to SBL/SBT/SBR. Change N/S split phasing to protected left-turn phasing.		-
38 . I Street/SR-99 Southbound Off-Ramp - 2nd Street	Install signal with split phasing for the E/W approaches. This intersection does not meet a signal warrant and no right-of-way is available for other improvements. Therefore, further evaluation is required prior to installation of the recommended improvement.			Install signal with split phasing for the E/W approaches. This intersection does not meet a signal warrant and no right-of-way is available for other improvements. Therefore, further evaluation is required prior to installation of the recommended improvement.	53.69%
43 . H Street – SR-99 Northbound Off-Ramp/4th Street	Ramp intersection redesign/reconstruction required. This is not covered under any funding program. The project will be required to pay its fair share for improving this interchange.			Ramp intersection redesign/reconstruction required. This is not covered under any funding program. The project will be required to pay its fair share for improving this interchange.	28.96%
44 . I Street/Olive Avenue	Restrict the southbound left turn movement. All southbound movements will shift to intersections west of this intersection and re-routed as eastbound through movements. Since the streets are under the jurisdiction of the City, further evaluation of the recommended improvement is required prior to implementation of the improvement.			Restrict the southbound left turn movement. All southbound movements will shift to intersections west of this intersection and re-routed as eastbound through movements. Since the streets are under the jurisdiction of the City, further evaluation of the recommended improvement is required prior to implementation of the improvement.	58.23%
49 . Yosemite Avenue/Cleveland Avenue - Tozer Street	Add SBR with right-turn overlap phasing. Restripe SBTR to SBT.			Add SBR with right-turn overlap phasing. Restripe SBTR to SBT.	40.46%
51 . Project Driveway 1/Avenue 17	Install signal with protected left-turn phasing		Install signal with protected left-turn phasing		100%
52 . Road 22 ½ - Project Driveway 2/Avenue 16	Add NBR, SBR, WBL, WBR. Install signal with protected left-turn phasing.		Install signal with protected left-turn phasing.	Add NBR, SBR, WBL, WBR.	100%
53 . Road 22 ½/Cleveland Avenue	Add SBL, EBT, WBT, WBR. Install signal with protected left-turn phasing. Add right-turn overlap to WBR.		Install signal with protected left-turn phasing.	Add SBL, EBT, WBT, WBR. Add right-turn overlap to WBR.	100%
55 . Road 23/Project Driveway 3	Add 2 NBT, 2 SBT, SBR, EBL. Install signal with protected left-turn phasing. Add right-turn overlap to EBR.		Install signal with protected left-turn phasing.	Add 2 NBT, 2 SBT, SBR, EBL. Add right-turn overlap to EBR.	100%
56 . Road 23/Project Driveway 4	Add 2 NBT, NBR, SBL, 2 SBT, WBR. Install signal with protected left-turn phasing. Add right-turn overlap phasing to WBR		Install signal with protected left-turn phasing.	Add 2 NBT, NBR, SBL, 2 SBT, WBR. Add right-turn overlap phasing to WBR	100%
57 . Road 23/Project Driveway 5	Add 2 NBT, 2 SBT, EBR. Install signal with protected left-turn phasing.		Install signal with protected left-turn phasing.	Add 2 NBT, 2 SBT, EBR.	100%
58 . Project Driveway 6/Cleveland Avenue	Add 2 EBT, EBR, 2 WBT. Install signal with protected left-turn phasing.		Install signal with protected left-turn phasing.	Add 2 EBT, EBR, 2 WBT.	100%

Notes:

NB = Northbound, SB = Southbound, EB = Eastbound, WB = Westbound

L = Left, T = Through, R = Right

MCTA is the Madera County Transportation Authority.

¹ Recommended improvements covered through the Measure T, City's CIP, or City's Development Impact Fee programs are not considered adequate mitigation measures. This is because there is no guaranteed timeline for implementation of these improvements through the programs.

Therefore, impacts at intersections where mitigations are included through Measure T or the City's CIP should be considered significant and unavoidable.

² Project Fair Share Percentage is the highest fair share value of the AM and PM peak hour when both peak hours are impacted by the project, or only in the peak hour where the project has an impact.

Table 9-L - Roadway Segment Improvements Funding Mechanism and Fair Share

Roadway Segment	Mitigations	Improvements Covered by MCTA Measure T ¹	Improvements Covered by City's Capital Improvement Plan ¹ or Development Impact Fee Program ¹	Improvements Covered Under Fair Share	Project Fair Share or 100% Project Responsibility
Segments on Road 23					
1 . between Avenue 17 and Project Driveway 3	Widen from 2 lanes to 6 lanes with a median lane.		Median lane.		100%
2 . between Project Driveway 3 and Avenue 16	Widen from 2 lanes to 6 lanes with a median lane.		Median lane.		100%
3 . between Avenue 16 and Cleveland Avenue	Widen from 2 lanes to 6 lanes with a median lane.		Median lane.		100%
4 . between Cleveland Avenue and Project Driveway 4	Widen from 2 lanes to 6 lanes with a median lane.		Median lane.		100%
5 . between Project Driveway 4 and Project Driveway 5	Widen from 2 lanes to 6 lanes with a median lane.		Median lane.		100%
6 . between Project Driveway 5 and Avenue 14 1/2	Widen from 2 lanes to 6 lanes with a median lane.		Median lane.	Widen from 2 to 6 lanes from project limits to Avenue 14 1/2.	99.45%
7 . between Avenue 14 1/2 and Avenue 14	Widen from 2 lanes to 4 lanes with a median lane.		Median lane.	Widen from 2 lanes to 4 lanes.	97.78%
Segments on Granada Drive					
9 . between Cleveland Avenue and Fresno River	Widen from 2 lanes to 4 lanes with a median lane.		Median lane.	Widen from 2 lanes to 4 lanes.	8.76%
Segments on Avenue 17					
13 . between Road 23 and Golden State Boulevard	Widen from 2 lanes to 4 lanes with a median lane.		Median lane.		95.51%
14 . between Golden State Boulevard and State Route 99 Southbound Off-Ramp	Widen from 2 lanes to 6 lanes with a median lane.		Median lane.	Widen from 2 lanes to 6 lanes.	63.41%
Segments on Cleveland Avenue					
17 . between Road 22 1/2 and Road 23	Widen from 2 lanes to 6 lanes with a median lane.		Median lane.		100%
18 . between Road 23 and Project Driveway 6	Widen from 2 lanes to 6 lanes with a median lane.		Median lane.		100%
19 . between Project Driveway 6 and Westberry Boulevard	Widen from 2 lanes to 6 lanes with a median lane.		Median lane.	Widen from 2 to 4 lanes from project limits to Westberry Boulevard.	94.09%
20 . between Westberry Boulevard and Granada Drive	Widen from 2 lanes to 4 lanes with a median lane.		Median lane.		85.58%
21 . between Granada Drive and Schnoor Street	Widen from 4 lanes to 6 lanes.			Widen from 4 lanes to 6 lanes.	79.13%
22 . between Schnoor Street and Fairgrounds	Widen from 4 lanes to 6 lanes.	Widen from 4 lanes to 6 lanes.			77.45%

Notes:

MCTA is the Madera County Transportation Authority.

¹ Recommended improvements covered through the Measure T, City's CIP, or City's Development Impact Fee programs are not considered adequate mitigation measures. This is because there is no guaranteed timeline for implementation of these improvements through the programs.

Therefore, impacts at roadway segments where mitigations are included through Measure T or the City's CIP should be considered significant and unavoidable.

10.0 SIGNAL WARRANT ANALYSIS

A peak hour signal warrant analysis was conducted at unsignalized study intersections where a signal was recommended as a mitigation measure to improve the forecast LOS deficiency. The signal warrant analysis was conducted with the peak hour warrants from the most recent edition the *California Manual on Uniform Traffic Control Devices (CAMUTCD)*. Therefore, this analysis is based on the provisions of the CAMUTCD, 2014, Chapter 4C *Traffic Control Signal Needs Studies for Warrant 3 – Peak Hour*. The peak hour signal warrant is intended for use where traffic conditions are such that for a minimum of one hour on an average day, the minor-street traffic suffers undue delay when entering or crossing the major street. While some intersections do not meet the signal warrant under the initial phases, they do meet the warrant in the later phases. The only exception is the intersection of I Street/2nd Street – SR-99 Southbound Off-Ramp where there is minimal traffic on three approaches while there is heavy movement exiting the ramp.

Table 10-A summarizes the signal warrant analysis results.

Detailed signal warrant analysis worksheets are included in Appendix G.

10.1 LIST OF CHAPTER 10.0 TABLES

- Table 10-A: Signal Warrant Analysis Summary

Table 10-A - Signal Warrant Analysis Summary

Intersection	Existing Control	Signal Proposed In	Signal Warranted In
5 . SR-99 Southbound Ramps – Road 23/Avenue 18 ½	TWSC	Phase I	Phase I
6 . SR-99 Northbound Ramps/Avenue 18 ½	OWSC	Phase I	Phase III
7 . Road 23/Avenue 17	TWSC	Phase I	Phase II
8 . Road 23/Avenue 16	TWSC	Phase II	Phase II
9 . Road 23/Cleveland Avenue	TWSC	Phase II	Phase II
10 . Road 23/Avenue 14 ½	TWSC	Phase II	Phase II
11 . Road 23/Avenue 14	AWSC	Phase III	Phase III
13 . Golden State Boulevard – Airport Drive/Avenue 17	TWSC	Phase I	Phase I
14 . SR-99 Southbound Ramps/Avenue 17	OWSC	Phase I	Phase I
15 . SR-99 Northbound Ramps/Avenue 17	OWSC	Phase I	Phase I
17 . Westberry Boulevard/Cleveland Avenue	TWSC	Phase I	Phase I
18 . Westberry Boulevard/Sunset Avenue	AWSC	Phase III	Phase III
20 . Westberry Boulevard/Avenue 16	AWSC	Phase III	Phase III
22 . Granada Drive/Sunset Avenue	AWSC	Phase II	Phase II
25 . SR-99 Southbound Ramps/Kennedy Street - Gateway Drive	OWSC	Phase I	Phase I
51 . Project Driveway 1/Avenue 17	OWSC	Phase II	Phase II
52 . Road 22 ½ - Project Driveway 2/Avenue 16	TWSC	Phase III	Phase III
53 . Road 22 ½/Cleveland Avenue	TWSC	Phase III	Phase III
55 . Road 23/Project Driveway 3	OWSC	Phase II	Phase II
56 . Road 23/Project Driveway 4	OWSC	Phase I	Phase I
57 . Road 23/Project Driveway 5	OWSC	Phase III	Phase III
58 . Project Driveway 6/Cleveland Avenue	OWSC	Phase I	Phase I

Notes:

Phase I = Year 2029

Phase II = Year 2039

Phase III = Year 2049

11.0 VMT EVALUATION

On December 28, 2018, the California Office of Administrative Law cleared the revised CEQA guidelines for use. Among the changes to the guidelines was removal of vehicle delay and LOS from consideration under CEQA. LOS is a qualitative measure that would assess the level of congestion and delay of a roadway segment. With the adopted guidelines, transportation impacts are to be evaluated based on a project's effect on Vehicle Miles Traveled (VMT). VMT is calculated by multiplying the number of vehicle trips by the estimated number of miles driven per trip. Projects that create a significant impact based on VMT will be required to mitigate their impacts through Transportation Demand Measures (TDMs) such as car sharing, improved transit, and enhanced bicycle infrastructure. Lead agencies are allowed to opt in to the revised transportation guidelines, but the new guidelines must be used starting July 1, 2020.

In accordance to updated guidelines, local jurisdictions throughout California have begun a departure from considering LOS as the only measure of a transportation system's effectiveness. However, the City has not yet established thresholds related to VMT. Once VMT thresholds are established by the City, the project impacts will be evaluated against established thresholds to determine the significance and identify mitigation measures, similar to LOS methodology. Specific details about thresholds and methodologies for project impact evaluation and mitigations will be identified by the City in the near future.

The State law provides guidance to evaluate the impacts related to vehicles miles traveled.

California Public Resources Code Section 15064.3(b)(4) states (in part) that:

A lead agency has discretion to choose the most appropriate methodology to evaluate a project's vehicle miles traveled, including whether to express the change in absolute terms, per capita, per household, or in any other measure.

To provide an abundance of information on the effects of the Specific Plan, this analysis includes Total Population VMT, Total Employment VMT, VMT per capita (population), VMT per employee and VMT per service population. For context, the project VMT is compared to the larger Madera County.

VMT calculations for the countywide baseline conditions (2019) were derived from the MCTC TDF model. The data are presented in terms of daily VMT per capita, VMT per employee and VMT per service population for the entire County for the existing (2019) conditions and project VMT per capita, VMT per employee and VMT per service population under the model horizon year (2042) conditions. Following is a detailed description of VMT calculation methodology, analysis and findings.

11.1 METHODOLOGY

The Governor's Office of Planning and Research (OPR) guidance has provided guidance on the treatment of California Environmental Quality Act (CEQA) traffic analyses for land use plans in the Technical Advisory (TA). The TA reiterates previous direction regarding individual land use assessments:

- Analyze the Vehicle Miles Traveled (VMT) outcomes over the full area over which the plan may substantively affect travel patterns (the definition of region).
- VMT should be counted in full rather than split between origins and destinations (the full impact of the project VMT).

The TA also states, "A general plan, area plan, or community plan may have a significant impact on transportation if proposed new residential, office or retail land uses would in aggregate exceed the respective thresholds recommended above." This recommendation refers to 85 percent of the existing city or regional average, and no net gain for residential, office, and retail land uses.

However, OPR is recommending a focus on specific trip purposes (i.e., home-based trips for residential projects and work-based trips for office projects). Depending on the modeling platform, at least four other trip types are recognized as contributors to large-scale plan-level analyses. Home-based origins will have interactions with other non-work-based destinations. Therefore, if home-based trips are the focus of a plan-level assessment, a great deal of VMT will not be accounted for in the estimation of total VMT. Therefore, to assess a land plan, the total VMT for the plan should be identified for all trip types and all potential VMT contributors within the plan area.

The Senate Bill (SB) 375 process and the Regional Targets Advisory Committee (RTAC) greenhouse gas (GHG) goal setting has established a baseline GHG emissions reduction that local Metropolitan Planning Organizations (MPOs) and Regional Transportation Planning Agencies (RTPAs) can achieve. And these achievements are provided in the integration of land use planning and transportation, not solely through the imposition of regulation on passenger cars and light-duty trucks. The California Air Resources Board (CARB) reviews the GHG reduction strategies and has approved the most recent round of GHG emission reductions for MPOs and RTPAs around the State.

Therefore, the recommended methodology for conducting VMT assessments for land plans is to compare the existing VMT per capita, VMT per employee and VMT per service population for the region with the expected horizon year VMT per capita, VMT per employee and VMT per service population for the land plan area. The recommended target is to achieve a lower VMT per capita, VMT per employee and VMT per service population in the horizon year with the proposed land plan than occurs for the existing condition.

As mentioned above, the TA recommends analyzing the effect of a land use plan over the area where the plan substantially affects the travel pattern. It is estimated that the effect of the project will mostly be contained within Madera County. Therefore, for purposes of this analysis, the County has been considered as the region.

The MCTC TDF has been used to estimate both the regional and project VMT. MCTC TDF socioeconomic database for horizon (2042) scenario was updated with the project land use to calculate project VMT. Regional and project VMT were calculated from the MCTC TDF model runs as described below:

Regional VMT Calculation

The first step in preparation of this analysis was to calculate the existing (2019) regional VMT that will be compared with horizon year (2042) project VMT to determine project impact. The regional VMT was calculated for both base (2018) and horizon (2042) scenarios from MCTC TDF. Existing (2019) VMT was developed by interpolating between the base and horizon year model scenarios.

Project Traffic Analysis Zone Update

Upon completion of the calculation of the regional VMT, the next step was to update the traffic analysis zones (TAZs) in the model horizon year (2042) scenario that includes the project. LSA converted the project land use into model socioeconomic categories using the MCTC TDF socioeconomic build-out assumptions and methodology. Nine additional zones were added to the model and updated with the socioeconomic data developed for the proposed project land use. The horizon year roadway network within the project, and the surrounding area were also updated.

Project VMT Calculation

Upon completion of the socioeconomic data update, LSA conducted model runs for the horizon year (2042) scenario. The model runs included select zone model runs for the project TAZs. The select zone runs have been utilized in determining project specific VMT data from the model outputs.

VMT Estimation Methodology

VMT is simply the product of trips and their trip lengths. This calculation can be conducted using output traffic volumes from the model and length of roadway links. However based on OPR guidance VMT should be estimated based on trip purpose depending on the type of land use being evaluated. The travel model doesn't retain trip types after the final step (traffic assignment) of the model that produces traffic volumes. In order to estimate VMT by trip purpose, outputs from mode choice step were used as trips and the trip lengths are derived from the skimming step.

Mode choice outputs in the model include person trips by trip purpose, mode and are segmented by number of household vehicles. The trips were aggregated by retaining trip purpose and travel mode. Only auto modes were considered for VMT estimation purposes. The person trip tables were appropriately converted to vehicle trips by using average auto occupancy factors from the model.

The trip length or distance side of the equation was obtained using the model outputs from the "Skimming" step. The model skim outputs include peak and off peak skim matrices by mode (DA – Drive Alone, SR2- Shared Ride 2, SR3 – Shared Ride 3+) and are segmented by number of household vehicles, similar to trip outputs from the model. Skimming outputs from the peak period were used for trip lengths in the VMT calculations.

OPR guidance suggests to include entire trip length of a trip even if the trip crosses jurisdictional boundaries. For example, trips in the model that travel from the county to outside or from outside into the county are referred as external trips. In order to account for external trip lengths properly, LSA has reviewed the trip lengths for external trips to/from Madera County from the California Statewide Travel Demand Model (CSTDm) and realized that the external centroid connectors were appropriately taking care of the external trip lengths.

Below are the list of files that were used in the VMT calculation.

```
-- scenario folder \07_ModeChoice\scenarioname_PERTRIPS_DA
-- scenario folder \07_ModeChoice\scenarioname_PERTRIPS_SR2
-- scenario folder \07_ModeChoice\scenarioname_PERTRIPS_SR3
-- scenario folder \01_Skims\scenarioname_SKM_PK_D1
-- scenario folder \01_Skims\scenarioname_SKM_PK_SR2
-- scenario folder \01_Skims\scenarioname_SKM_PK_SR3
```

LSA has reported 3 different VMT metrics – VMT per capita, VMT per employee and VMT per service population. VMT per capita is generally used for household projects, VMT per employee is used for non-residential projects, and VMT per service population is usually used for mixed use projects with both residential and non residential uses. Since the project includes households and employment, all three VMT metrics were reported.

Different trips purposes in the model are used in the estimation of different VMT metrics. For VMT per capita, all home base trip purposes are included, for VMT per employee only homebased work trips are used whereas for VMT per service population estimates all trip purposes are included in the VMT calculations.

11.2 VMT ANALYSIS

VMT per capita, VMT per service population and VMT per employee for the project under horizon year (2042) were compared with corresponding values for the existing (2019) regional VMT per capita, VMT per service population and VMT per employee respectively. Table 11-A shows the project VMT per capita, VMT per service population and VMT per employee estimates under the horizon year (2042), and corresponding values for the region under existing (2019) conditions. As shown in Table 11-A, horizon year (2042) project VMT per capita is 24.6% lower than the existing (2019) regional average. Similarly, horizon year VMT per service population for the project is 20.1% lower than the existing (2019) regional average. The project’s horizon year VMT per employee is 35.6% lower than existing (2019) regional average. In summary, although the City is yet to adopt thresholds for VMT impacts, the project may not have a significant transportation impact based on the OPR TA. This is because, the project will have a lower VMT per capita, VMT per service population and VMT per employee compared to the regional average and therefore will not have a significant VMT impact.

Detailed VMT calculation worksheets are included in Appendix H.

Table 11-A: Existing (2019) Regional and Horizon Year (2042) Project VMT Comparison

Metric	Existing (2019) Regional Average	Horizon Year (2042) Project Average	Percentage Difference
VMT per Capita	14.64	11.04	-24.6%
VMT per Service Population	23.18	18.52	-20.1%
VMT per Employee	24.92	16.04	-35.6%

Source: MCTC TDF
VMT = vehicle miles traveled

12.0 SUMMARY AND CONCLUSIONS

The proposed Village D Specific Plan Project will add 6,640 single-family dwelling units, 4,161 multifamily dwelling units, 232,610 sf of business park, 1,835,618 sf of village mixed use, and three elementary schools serving 2,100 students.

The proposed project will replace existing uses and is anticipated to be built in three phases. Phase I consists of the southeastern quadrant of the project site. Phase II consists of the northwestern quadrant of the project site. Phase III consists of the southwestern quadrant of the project site. Phase I is anticipated to be completed by 2029. Phase II is anticipated to be completed by 2039. Phase III is anticipated to be completed by 2049. Under full build-out (Phase III) condition, the project will generate 89,647 net daily trips, with 6,841 net trips occurring during the a.m. peak hour and 7,597 net trips occurring during the p.m. peak hour.

12.1 EXISTING CONDITIONS SUMMARY

Based on the significance criteria as discussed in the 'Level of Service Standards and Significance Thresholds' section of this report, under existing conditions, a significant project impact occurs at seven intersections, while a significant direct impact occurs at nineteen intersections and thirteen segments. With the implementation of the improvements listed in Chapter 9.0 of this report, some of the intersections and roadway segments are forecast to operate at a satisfactory LOS, while the impacts at other intersections and roadway segments cannot be mitigated due to right-of-way constraints.

12.2 PHASE I PROJECT COMPLETION YEAR (2029) CONDITIONS SUMMARY

Based on the significance criteria as discussed in the 'Level of Service Standards and Significance Thresholds' section of this report, under Phase I project completion year conditions, a cumulative project impact occurs at nineteen intersections and four roadway segments. With the implementation of the improvements listed in Chapter 9.0 of this report, some of the intersections and roadway segments are forecast to operate at a satisfactory LOS, while the impacts at other intersections and roadway segments cannot be mitigated due to right-of-way constraints.

12.3 PHASE II PROJECT COMPLETION YEAR (2039) CONDITIONS SUMMARY

Based on the significance criteria as discussed in the 'Level of Service Standards and Significance Thresholds' section of this report, under Phase II project completion year conditions, a cumulative project impact occurs at twenty-six intersections and twelve roadway segments. With the implementation of the improvements listed in Chapter 9.0 of this report, some of the intersections and roadway segments are forecast to operate at a satisfactory LOS, while the impacts at other intersections and roadway segments cannot be mitigated due to right-of-way constraints.

12.4 PHASE III PROJECT COMPLETION YEAR (2049) CONDITIONS SUMMARY

Based on the significance criteria as discussed in the 'Level of Service Standards and Significance Thresholds' section of this report, under Phase III project completion year conditions, a cumulative project impact occurs at thirty-five intersections and sixteen roadway segments. With the

implementation of the improvements listed in Chapter 9.0 of this report, some of the intersections and roadway segments are forecast to operate at a satisfactory LOS, while the impacts at other intersections and roadway segments cannot be mitigated due to right-of-way constraints.

12.5 VMT EVALUATION SUMMARY

VMT per capita, VMT per service population and VMT per employee for the project under horizon year (2042) were compared with corresponding values for the existing (2019) regional VMT per capita, VMT per service population and VMT per employee respectively. The City is yet to adopt thresholds for VMT impacts. The project may not have a significant transportation impact based on the OPR TA because the project will have a lower VMT per capita, VMT per service population and VMT per employee compared to the regional average.

APPENDIX A:

SCOPING AGREEMENT



CARLSBAD
FRESNO
IRVINE
LOS ANGELES
PALM SPRINGS
POINT RICHMOND
RIVERSIDE
ROSEVILLE
SAN LUIS OBISPO

February 19, 2020

Mr. Keith Helmuth, P.E.
City Engineer
City of Madera, Engineering Department
205 W 4th Street
Madera, California 93637

Subject: Scope of Work for the Village D Specific Plan Project Traffic Impact Analysis (LSA Project No. CMD1801)

Dear Keith:

LSA is under contract to prepare a traffic impact analysis (TIA) for the proposed Village D Specific Plan Project to be located at the western edge of the City of Madera (City). The project is bounded by the Fresno River to the south, Road 24 to the east, Avenue 17 to the north, and Road 22 to the west.

The site is currently zoned as Agricultural Rural Exclusive with agricultural operations around the project site. The proposed project will add 6,640 single-family dwelling units, 4,161 multi-family dwelling units, 232,610 square feet of business park, 1,835,620 square feet of village mixed use, and three elementary schools serving 2,100 students. Figure 1 (all figures attached) illustrates the regional and project location. Figure 2 illustrates the conceptual site plan. As illustrated in Figure 2, access to the project will be provided along Avenue 17, Avenue 16, Cleveland Avenue, Road 22, Road 23, and Road 24.

The proposed project is anticipated to be built in three phases. Phase I consists of the southeastern quadrant of the project site. Phase II consists of the northwestern quadrant of the project site. Phase III consists of the southwestern quadrant of the project site. Previously referenced Figure 2 illustrates the phase boundaries. Phase I is anticipated to be completed by year 2029. Phase II is anticipated to be completed by year 2039. Phase III is anticipated to be completed by year 2049.

LSA anticipates that the following scope of work will be required to prepare the TIA for the proposed project.

SCOPE OF WORK

Study Intersection Analysis

All study intersections will be analyzed during the a.m. and p.m. peak hours. The a.m. peak hour is defined as the one hour of highest traffic volumes occurring between 7:00 and 9:00 a.m. while the p.m. peak hour is defined as the one hour of highest traffic volumes occurring between 4:00 and 6:00 p.m. Intersection levels of service (LOS) will be calculated using the *Highway Capacity Manual 6*

(HCM 6) analysis methodologies and using Synchro 10 software. Based on discussion with City staff and Caltrans, the TIA will examine the following intersections:

1. Road 22/Avenue 17 [Future Intersection] (Madera County);
2. Road 22/Avenue 16 (Madera County);
3. Golden State Boulevard/Avenue 18½ (Madera County);
4. Pistachio Drive/Avenue 18½ (Madera County);
5. State Route 99 (SR-99) Southbound Ramps–Road 23/Avenue 18½ (Caltrans);
6. SR-99 Northbound Ramps/Avenue 18½ (Caltrans);
7. Road 23/Avenue 17 (City of Madera/Madera County);
8. Road 23/Avenue 16 (City of Madera/Madera County);
9. Road 23/Cleveland Avenue (Madera County);
10. Road 23/Avenue 14½ (Madera County);
11. Road 23/Avenue 14 (Madera County);
12. Road 23/Avenue 12 (Madera County);
13. Golden State Boulevard–Airport Drive/Avenue 17 (City of Madera);
14. SR-99 Southbound Ramps/Avenue 17 (Caltrans);
15. SR-99 Northbound Ramps/Avenue 17 (Caltrans);
16. Love’s Truck Stop Driveway/Avenue 17 (Madera County);
17. Westberry Boulevard/Cleveland Avenue (City of Madera);
18. Westberry Boulevard/Sunset Avenue (City of Madera);
19. Westberry Boulevard/Avenue 14 (City of Madera/Madera County);
20. Westberry Boulevard/Avenue 16 (City of Madera/Madera County);
21. Granada Drive/Cleveland Avenue (City of Madera);
22. Granada Drive/Sunset Avenue (City of Madera);
23. Avenue 16–Ellis Street/Kennedy Street (City of Madera/Madera County);
24. Schnoor Street/Kennedy Street (City of Madera/Madera County);
25. SR-99 Southbound Ramps/Kennedy Street–Gateway Drive (Caltrans);
26. SR-99 Northbound Off-Ramp/Gateway Drive (Caltrans);
27. SR-99 Northbound Off-Ramps (Caltrans);
28. SR-99 Northbound Off-Ramp/Gateway Drive (Caltrans);
29. Schnoor Avenue/Cleveland Avenue (City of Madera);
30. Fairgrounds/Cleveland Avenue (City of Madera/Madera County);

31. SR-99 Southbound Ramps/Cleveland Avenue (Caltrans);
32. SR-99 Northbound Ramps/Cleveland Avenue (Caltrans);
33. Gateway Drive/Cleveland Avenue (City of Madera);
34. Cleveland Avenue–Country Club Drive/W. Cleveland Avenue (City of Madera);
35. Country Club Drive/Sharon Boulevard (City of Madera);
36. Pine Street/Howard Road (City of Madera);
37. Q Street–Olive Avenue/Yosemite Avenue–Howard Road (City of Madera);
38. I Street/SR-99 Southbound Off-Ramp–2nd Street (Caltrans);
39. 4th Street/Sunset Avenue (City of Madera);
40. H Street/SR-99 Northbound On-Ramp–2nd Street (Caltrans);
41. I Street/4th Street (City of Madera);
42. SR-99 Southbound On-Ramp/4th Street (Caltrans);
43. H Street–SR-99 Northbound Off-Ramp/4th Street (Caltrans);
44. I Street/Olive Avenue (City of Madera);
45. SR-99 Southbound Off-Ramp/Olive Avenue (Caltrans);
46. Madera Avenue/SR-99 Northbound Ramps (Caltrans);
47. Madera Avenue/Olive Avenue–SR-99 Southbound On-Ramp (Caltrans);
48. Madera Avenue (SR-145)/Lewis Street (Caltrans);
49. Yosemite Avenue/Cleveland Avenue–Tozer Street (Caltrans);
50. Road 22/Cleveland Avenue [Future Intersection] (Madera County);
51. Project Driveway 1/Avenue 17 [Future Intersection] (Madera County);
52. Road 22½–Project Driveway 2/Avenue 16 (Madera County);
53. Road 22½/Cleveland Avenue (Madera County);
54. Road 22½/Project Driveway 5 [Future Intersection] (Madera County);
55. Road 23/Project Driveway 3 (City of Madera/Madera County);
56. Road 23/Project Driveway 4 [Future Intersection] (Madera County);
57. Road 23/Project Driveway 5 (Madera County); and
58. Project Driveway 6/Cleveland Avenue [Future Intersection] (Madera County).

Figure 3 illustrates the study area intersections.

Roadway Segments

Based on discussion with City staff, LSA recommends evaluating the eleven roadway segments west of SR-99 and between Avenue 18 ½ and Avenue 14 within the study area. The roadway segments are as follows:

1. Road 23/Avenue 17 to Project Driveway 3 (City of Madera/Madera County);
2. Road 23/Project Driveway 3 to Avenue 16 (City of Madera/Madera County);
3. Road 23/Avenue 16 to Cleveland Avenue (Madera County);
4. Road 23/Cleveland Avenue to Project Driveway 4 (Madera County);
5. Road 23/Project Driveway 4 to Project Driveway 5 (Madera County);
6. Road 23/Project Driveway 5 to Avenue 14½ (Madera County);
7. Road 23/Avenue 14½ to Avenue 14 (Madera County);
8. Westberry Boulevard/Sunset Avenue to Avenue 14/Howard Road (City of Madera);
9. Granada Drive/Cleveland Avenue to Fresno River (City of Madera);
10. Granada Drive/Sunset Avenue to Avenue 14/Howard Road (City of Madera);
11. Avenue 17/Road 22 to Project Driveway 1 (Madera County);
12. Avenue 17/Project Driveway 1 to Road 23 (Madera County);
13. Avenue 17/Road 23 to Golden State Boulevard (City of Madera/Madera County);
14. Avenue 17/Golden State Boulevard to SR-99 Southbound Off-Ramp (City of Madera);
15. Avenue 16/Road 22 to Project Driveway 2/Road 22½ (Madera County);
16. Avenue 16/Project Driveway 2/Road 22½ to Road 23 (Madera County);
17. Cleveland Avenue/Road 22½ to Road 23 (Madera County);
18. Cleveland Avenue/Road 23 to Project Driveway 6 (Madera County);
19. Cleveland Avenue/Project Driveway 6 to Westberry Boulevard (City of Madera/Madera County);
20. Cleveland Avenue/Westberry Boulevard to Granada Drive (City of Madera);
21. Cleveland Avenue/Granada Drive to Schnoor Street (City of Madera);
22. Cleveland Avenue/Schnoor Street to Fairgrounds (City of Madera/Madera County);
23. Cleveland Avenue/Fairgrounds to SR-99 Southbound Ramps (City of Madera/Madera County);
24. Sunset Avenue/Granada Drive to Schnoor Street (City of Madera);
25. Howard Road/Granada Drive to Schnoor Street (City of Madera);

26. Howard Road/Schnoor Street to Pine Street (City of Madera);
27. Olive Avenue/Yosemite Avenue to I Street (City of Madera);
28. Olive Avenue/I Street to SR-99 Southbound Off-Ramp (City of Madera); and
29. Olive Avenue/SR-99 Southbound Off-Ramp to Madera Avenue (SR-145) (City of Madera).

Caltrans Facilities

Caltrans requires analysis of freeway mainline segments where the project adds more than 100 peak hour trips and ramp merge-diverge areas where the project adds more than 50 peak hour trips. Based on evaluation of project trip assignment the following freeway segments along SR 99 will be analyzed in the TIA:

1. Avenue 20–Avenue 20½ to Avenue 18½;
2. Avenue 18½ to Avenue 17;
3. Avenue 17 to Avenue 16/Gateway Drive;
4. Avenue 16/Gateway Drive to Cleveland Avenue;
5. Cleveland Avenue to 2nd Street;
6. 2nd Street to 4th Street;
7. 4th Street to Madera Avenue (SR-145); and
8. Madera Avenue (SR-145) to Almond Avenue.

Additionally, all ramp merge/diverge areas along SR-99 from Avenue 18½ interchange to Madera Avenue (SR-145) interchange will be analyzed in the TIA.

Trip Generation

The trip generation for the proposed project was developed using rates from the Institute of Transportation Engineers (ITE) *Trip Generation Manual* (10th Edition). Land use rates include Land Use 210 – “Single-Family Detached Housing”, Land Use 220 – “Multifamily Housing (Low-Rise)”, Land Use 770 – “Business Park”, Land Use 820 – “Shopping Center”, and Land Use 520 – “Elementary School”. Table A summarizes the daily, a.m., and p.m. peak hour project trip generation. The proposed project is estimated to generate 169,299 daily total trips, with 10,053 trips occurring during the a.m. peak hour and 16,355 trips occurring during the p.m. peak hour.

Trip distribution patterns were developed using the Madera County Transportation Commission (MCTC) travel demand forecasting (TDF) model. Trip distribution patterns were derived from the select zone model runs obtained from the MCTC TDF model. As shown in Table A, the project consists of three communities; northwest, southwest and southeast communities. LSA disaggregated the MCTC TDF traffic analysis zones within the project areas to incorporate the project land uses into the model. Specifically, each community was disaggregated into three traffic analysis zones (TAZs). Within each community, two of the TAZs included residential uses while the

third TAZ included non-residential uses. As such, the following TAZs were considered for analysis in the different phases of the project:

- **Phase I:** Residential TAZs (615 and 616), Non-Residential TAZ (626).
- **Phase II:** Residential TAZs (627 and 628), Non-Residential TAZ (629).
- **Phase III:** Residential TAZs (630 and 631), Non-Residential TAZ (632).

The disaggregation of the model helped in developing project trip distribution patterns both within and outside the Specific Plan. Figures 4A and 4B, 5A and 5B, and 6A and 6B illustrate the overall net external project trip distributions for Phase I TAZs 615, 616, and 626, respectively. Figures 7A and 7B, 8A and 8B, and 9A and 9B illustrate the overall net external project trip distributions for Phase II TAZs 627, 628, and 629, respectively. Figures 10A and 10B, 11A and 11B, and 12A and 12B illustrate the overall net external project trip distributions for Phase III TAZs 630, 631, and 632, respectively.

The project trip assignment for each TAZ is the product of the trip generation for the TAZ and the corresponding trip distribution. Further, assignments for Phase I TAZs 615, 616, and 626 were added to obtain the total project trip assignment at the study intersections for Phase I. The Phase I project trip assignment is illustrated in Figures 13A and 13B. The Phase I project trip assignment was then added to the assignments for Phase II TAZs 627, 628, and 629 to obtain the total project trip assignment at the study intersections for Phase II. The Phase II project trip assignment is illustrated in Figures 14A and 14B. Finally, the total project trip assignment for Phase II was added to the assignments for Phase III TAZs 630, 631, and 632 to obtain the total project trip assignment at the study intersections for Phase III. The Phase III project trip assignment is illustrated in Figures 15A and 15B.

Since, the project has a mix of residential and non-residential land uses, it is anticipated that a certain percentage of project trips will remain within the Specific Plan. These trips will be travelling between the residential, retail, schools, and business parks. For purposes of this analysis, these trips have been considered as internal trips. Under full build-out conditions for the project, internal capture distributions from one TAZ to another were developed using select zone runs obtained from the MCTC TDF model. The internal capture distributions were multiplied with the overall internal trips to obtain the corresponding internal capture assignments in between the different TAZs. Further, the internal trip capture to and from one TAZ to all the other TAZs were added to obtain the overall internal trips for a particular TAZ. The internal trips for a TAZ were then subtracted from the gross trips for that TAZ to obtain the external trips for the TAZ. The internal capture for Phases I and II were obtained by normalizing the internal trips for the build-out scenario considering trip for only those portions of the project that will be developed in these two phases. Internal trip assignments in Phases I, II, and III are illustrated in Figures 16A and 16B, 17A and 17B, and 18A and 18B, respectively.

Analysis Scenarios

The TIA will satisfy the requirements established by the City and Caltrans where applicable as well as the requirements for the disclosure of potential impacts and mitigation measures pursuant to the

California Environmental Quality Act (CEQA). The TIA will evaluate three project phases. The following scenarios will be included in the TIA:

- Existing Conditions;
- Existing with Project Conditions;
- Phase I Project Completion Year (2029) without Project Conditions;
- Phase I Project Completion Year (2029) with Project Conditions;
- Phase II Project Completion Year (2039) without Project Conditions;
- Phase II Project Completion Year (2039) with Project Conditions;
- Phase III Project Completion Year (2049) without Project Conditions [General Plan Build-out]; and
- Phase III Project Completion Year (2049) with Project Conditions [Project Build-out and General Plan Build-out].

Volume Development and Analysis Methodology

Traffic volumes for existing year traffic conditions will be based on existing count data collected at study intersections. Future build-out volumes will be developed using the growth forecasts from the MCTC TDF model. LSA will discuss with City staff to ensure that all approved and pending projects that will affect the study area are included in the model. Volume development for project phases conditions between existing and future build-out conditions will be developed by interpolating between existing and future build-out traffic volumes.

Existing, future build-out, and project phases with project volumes will be developed by adding project traffic to the corresponding without project scenarios.

As previously stated, the TIA will analyze study intersections during the a.m. and p.m. peak hours. Intersection LOS will be calculated using HCM 6 analysis methodologies by using the Synchro 10 software. Roadway segments will be analyzed for daily traffic using volume-to-capacity ratio. Roadway capacity will be obtained from the City's General Plan. Freeway mainline and ramp merge/diverge analysis will be conducted using HCM 6 methodologies and HCS software.

Project Impact Assessment and Mitigation Measures

Levels of service without the project will be compared to levels of service with the project for all analysis scenarios to determine potential project impacts. Determination of significant project impacts will be made based on the City's LOS standards and significance threshold criteria set forth per consultation with City staff.

Mitigation measures will be recommended at locations operating at an unsatisfactory LOS or where the project causes significant impacts. Mitigation measures may include addition of intersection turn

lanes, and signalization. The LOS with mitigation will be calculated and summarized along with a comparison of the LOS without mitigation.

Signal Warrant Analysis

A signal warrant analysis would be conducted at unsignalized intersections if a signal is recommended as a mitigation measure. Peak hour approach volumes for the study intersections will be examined to determine whether signalization may be warranted per the criteria defined in the California supplement of the Manual on Uniform Traffic Control Devices (CA-MUTCD).

Vehicle Miles Traveled Analysis

The TIA will include a separate, special analysis section presenting VMT methodology and analysis for the project. The analysis will be conducted using the MCTC TDF model. The project VMT will be compared to the regional VMT and the results will be reported in the analysis. Since, the City is yet to adopt its VMT thresholds, this section will not attempt to establish future standards but will be included primarily as an informational item. This analysis is envisioned to be a comparison of Village D per capita VMT model output to the regional average.

Should you have any questions, please do not hesitate to contact me at (951) 781-9310 or email me at Ambarish.Mukherjee@lsa.net.

Sincerely,

LSA ASSOCIATES, INC.



Ambarish Mukherjee, AICP, PE
Associate/Senior Transportation Planner

Attachments:

- Table A: Project Trip Generation
- Figure 1: Regional and Project Location
- Figure 2: Conceptual Site Plan
- Figure 3: Study Area Intersections
- Figure 4A: Phase I TAZ 615 Project Trip Distribution (Int. 1–30)
- Figure 4B: Phase I TAZ 615 Project Trip Distribution (Int. 31–58)
- Figure 5A: Phase I TAZ 616 Project Trip Distribution (Int. 1–30)
- Figure 5B: Phase I TAZ 616 Project Trip Distribution (Int. 31–58)

Figure 6A: Phase I TAZ 626 Project Trip Distribution (Int. 1–30)
Figure 6B: Phase I TAZ 626 Project Trip Distribution (Int. 31–58)
Figure 7A: Phase II TAZ 627 Project Trip Distribution (Int. 1–30)
Figure 7B: Phase II TAZ 627 Project Trip Distribution (Int. 31–58)
Figure 8A: Phase II TAZ 628 Project Trip Distribution (Int. 1–30)
Figure 8B: Phase II TAZ 628 Project Trip Distribution (Int. 31–58)
Figure 9A: Phase II TAZ 629 Project Trip Distribution (Int. 1–30)
Figure 9B: Phase II TAZ 629 Project Trip Distribution (Int. 31–58)
Figure 10A: Phase III TAZ 630 Project Trip Distribution (Int. 1–30)
Figure 10B: Phase III TAZ 630 Project Trip Distribution (Int. 31–58)
Figure 11A: Phase III TAZ 631 Project Trip Distribution (Int. 1–30)
Figure 11B: Phase III TAZ 631 Project Trip Distribution (Int. 31–58)
Figure 12A: Phase III TAZ 632 Project Trip Distribution (Int. 1–30)
Figure 12B: Phase III TAZ 632 Project Trip Distribution (Int. 31–58)
Figure 13A: Phase I Project Trip Assignment (Int. 1–30)
Figure 13B: Phase I Project Trip Assignment (Int. 31–58)
Figure 14A: Phase II Project Trip Assignment (Int. 1–30)
Figure 14B: Phase II Project Trip Assignment (Int. 31–58)
Figure 15A: Phase III Project Trip Assignment (Int. 1–30)
Figure 15B: Phase III Project Trip Assignment (Int. 31–58)
Figure 16A: Phase I Project Internal Trip Assignment (Int. 1–30)
Figure 16B: Phase I Project Internal Trip Assignment (Int. 31–58)
Figure 17A: Phase II Project Internal Trip Assignment (Int. 1–30)
Figure 17B: Phase II Project Internal Trip Assignment (Int. 31–58)
Figure 18A: Phase III Project Internal Trip Assignment (Int. 1–30)
Figure 18B: Phase III Project Internal Trip Assignment (Int. 31–58)

Table A - Project Trip Generation

Community Land Use	Units	A.M. Peak Hour			P.M. Peak Hour			Daily
		In	Out	Total	In	Out	Total	
PHASE I								
Southeast Quadrant								
TAZ615								
1	Single-Family Dwelling Units	864	DU					
	Trips/Unit ¹	0.19	0.56	0.74	0.62	0.37	0.99	9.44
	Trip Generation	160	480	640	539	316	855	8,156
2	Multi-Family Dwelling Units	1,247	DU					
	Trips/Unit ²	0.11	0.35	0.46	0.35	0.21	0.56	7.32
	Trip Generation	132	442	574	440	258	698	9,128
3	Elementary School	700	STU					
	Trips/Unit ³	0.36	0.31	0.67	0.08	0.09	0.17	1.89
	Trip Generation	253	216	469	57	62	119	1,323
	TAZ615							
	Gross Project Trips	545	1,138	1,683	1,036	636	1,672	18,607
	Internal Capture ⁴	(169)	(169)	(337)	(321)	(321)	(643)	(5,797)
	Total External Trips	376	969	1,346	715	315	1,029	12,810
	Pass-by Trips	0	0	0	0	0	0	0
	Net Project Trips	376	969	1,346	715	315	1,029	12,810
TAZ616								
1	Single-Family Dwelling Units	1,393	DU					
	Trips/Unit ¹	0.19	0.56	0.74	0.62	0.37	0.99	9.44
	Trip Generation	258	773	1,031	869	510	1,379	13,150
2	Multi-Family Dwelling Units	471	DU					
	Trips/Unit ²	0.11	0.35	0.46	0.35	0.21	0.56	7.32
	Trip Generation	50	167	217	166	98	264	3,448
	TAZ616							
	Gross Project Trips	308	940	1,248	1,035	608	1,643	16,598
	Internal Capture ⁴	(180)	(180)	(360)	(335)	(335)	(670)	(6,157)
	Total External Trips	128	760	888	700	273	973	10,441
	Pass-by Trips	0	0	0	0	0	0	0
	Net Project Trips	128	760	888	700	273	973	10,441

Table 5-A - Project Trip Generation

Community Land Use	Units	A.M. Peak Hour			P.M. Peak Hour			Daily
		In	Out	Total	In	Out	Total	
TAZ626								
1 Village Mixed Use	651.00 TSF							
	Trips/Unit ⁵	0.58	0.36	0.94	1.83	1.98	3.81	37.75
	Trip Generation	379	233	612	1,191	1,290	2,481	24,575
TAZ626								
	Gross Project Trips	379	233	612	1,191	1,290	2,481	24,575
	Internal Capture ⁴	(228)	(228)	(457)	(766)	(766)	(1,531)	(12,455)
	Total External Trips	151	5	155	425	524	950	12,120
	Pass-by Trips ⁶	0	0	0	(145)	(178)	(323)	(4,121)
	Net Project Trips	151	5	155	280	346	627	7,999
Southeast Community								
	Gross Project Trips	1,232	2,311	3,543	3,262	2,534	5,796	59,780
	Internal Capture ⁴	(577)	(577)	(1,155)	(1,422)	(1,422)	(2,845)	(24,409)
	Total External Trips	655	1,734	2,388	1,840	1,112	2,951	35,371
	Pass-by Trips	0	0	0	(145)	(178)	(323)	(4,121)
	Net Project Trips	655	1,734	2,388	1,695	934	2,628	31,250
PHASE II								
Northwest Quadrant								
TAZ627								
1 Single-Family Dwelling Units	1,394 DU							
	Trips/Unit ¹	0.19	0.56	0.74	0.62	0.37	0.99	9.44
	Trip Generation	258	774	1,032	869	511	1,380	13,159
2 Multi-Family Dwelling Units	163 DU							
	Trips/Unit ²	0.11	0.35	0.46	0.35	0.21	0.56	7.32
	Trip Generation	17	58	75	58	34	92	1,193
TAZ627								
	Gross Project Trips	275	832	1,107	927	545	1,472	14,352
	Internal Capture ⁴	(110)	(110)	(220)	(227)	(227)	(454)	(4,139)
	Total External Trips	165	722	887	700	318	1,018	10,213
	Pass-by Trips	0	0	0	0	0	0	0
	Net Project Trips	165	722	887	700	318	1,018	10,213

Table 5-A - Project Trip Generation

Community Land Use	Units	A.M. Peak Hour			P.M. Peak Hour			Daily
		In	Out	Total	In	Out	Total	
TAZ628								
1	Single-Family Dwelling Units	1,392	DU					
	Trips/Unit ¹	0.19	0.56	0.74	0.62	0.37	0.99	9.44
	Trip Generation	258	773	1,031	868	510	1,378	13,140
2	Multi-Family Dwelling Units	397	DU					
	Trips/Unit ²	0.11	0.35	0.46	0.35	0.21	0.56	7.32
	Trip Generation	42	141	183	140	82	222	2,906
3	Elementary School	700	STU					
	Trips/Unit ³	0.36	0.31	0.67	0.08	0.09	0.17	1.89
	Trip Generation	253	216	469	57	62	119	1,323
	TAZ628							
	Gross Project Trips	553	1,130	1,683	1,065	654	1,719	17,369
	Internal Capture ⁴	(155)	(155)	(309)	(309)	(309)	(618)	(5,778)
	Total External Trips	398	975	1,374	756	345	1,101	11,591
	Pass-by Trips	0	0	0	0	0	0	0
	Net Project Trips	398	975	1,374	756	345	1,101	11,591
TAZ629								
1	Village Business Park	232.61	TSF					
	Trips/Unit ⁷	0.24	0.16	0.40	0.19	0.23	0.42	12.44
	Trip Generation	57	36	93	45	53	98	2,894
2	Village Mixed Use	189.05	TSF					
	Trips/Unit ⁵	0.58	0.36	0.94	1.83	1.98	3.81	37.75
	Trip Generation	110	68	178	346	375	721	7,137
	TAZ629							
	Gross Project Trips	167	104	271	391	428	819	10,031
	Internal Capture ⁴	(103)	(103)	(205)	(305)	(305)	(609)	(5,058)
	Total External Trips	64	1	66	86	123	210	4,973
	Pass-by Trips ⁶	0	0	0	(26)	(37)	(63)	(1,203)
	Net Project Trips	64	1	66	60	86	147	3,770
Northwest Community								
	Gross Project Trips	995	2,066	3,061	2,383	1,627	4,010	41,752
	Internal Capture ⁴	(367)	(367)	(735)	(840)	(840)	(1,681)	(14,974)
	Total External Trips	628	1,699	2,326	1,543	787	2,329	26,778
	Pass-by Trips	0	0	0	(26)	(37)	(63)	(1,203)
	Net Project Trips	628	1,699	2,326	1,517	750	2,266	25,575

Table 5-A - Project Trip Generation

Community Land Use	Units	A.M. Peak Hour			P.M. Peak Hour			Daily
		In	Out	Total	In	Out	Total	
PHASE III								
Southwest Quadrant								
TAZ630								
1	Single-Family Dwelling Units	1,168	DU					
	Trips/Unit ¹	0.19	0.56	0.74	0.62	0.37	0.99	9.44
	Trip Generation	216	648	864	728	428	1,156	11,026
2	Multi-Family Dwelling Units	944	DU					
	Trips/Unit ²	0.11	0.35	0.46	0.35	0.21	0.56	7.32
	Trip Generation	100	334	434	333	196	529	6,910
	TAZ630							
	Gross Project Trips	316	982	1,298	1,061	624	1,685	17,936
	Internal Capture ⁴	(184)	(184)	(368)	(330)	(330)	(661)	(6,063)
	Total External Trips	132	798	930	731	294	1,024	11,873
	Pass-by Trips	0	0	0	0	0	0	0
	Net Project Trips	132	798	930	731	294	1,024	11,873
TAZ631								
1	Single-Family Dwelling Units	429	DU					
	Trips/Unit ¹	0.19	0.56	0.74	0.62	0.37	0.99	9.44
	Trip Generation	79	238	317	268	157	425	4,050
2	Multi-Family Dwelling Units	939	DU					
	Trips/Unit ²	0.11	0.35	0.46	0.35	0.21	0.56	7.32
	Trip Generation	99	333	432	331	195	526	6,873
3	Elementary School	700	STU					
	Trips/Unit ³	0.36	0.31	0.67	0.08	0.09	0.17	1.89
	Trip Generation	253	216	469	57	62	119	1,323
	TAZ631							
	Gross Project Trips	431	787	1,218	656	414	1,070	12,246
	Internal Capture ⁴	(150)	(150)	(301)	(245)	(245)	(491)	(4,621)
	Total External Trips	281	637	917	411	169	579	7,625
	Pass-by Trips	0	0	0	0	0	0	0
	Net Project Trips	281	637	917	411	169	579	7,625

Table 5-A - Project Trip Generation

Community Land Use	Units	A.M. Peak Hour			P.M. Peak Hour			Daily
		In	Out	Total	In	Out	Total	
TAZ632								
1 Village Mixed Use	995.56 TSF							
	Trips/Unit ⁵	0.58	0.36	0.94	1.83	1.98	3.81	37.75
	Trip Generation	580	356	936	1,821	1,972	3,793	37,583
TAZ632								
	Gross Project Trips	580	356	936	1,821	1,972	3,793	37,583
	Internal Capture⁴	(328)	(328)	(657)	(1,063)	(1,063)	(2,127)	(17,394)
	Total External Trips	252	28	279	758	909	1,666	20,189
	Pass-by Trips⁶	0	0	0	(258)	(309)	(567)	(6,864)
	Net Project Trips	252	28	279	500	600	1,099	13,325
Southwest Community								
	Gross Project Trips	1,327	2,125	3,452	3,538	3,010	6,548	67,765
	Internal Capture⁴	(663)	(663)	(1,326)	(1,639)	(1,639)	(3,278)	(28,078)
	Total External Trips	664	1,462	2,126	1,899	1,371	3,270	39,687
	Pass-by Trips	0	0	0	(258)	(309)	(567)	(6,864)
	Net Project Trips	664	1,462	2,126	1,641	1,062	2,703	32,823
Project Total Gross Trips		3,554	6,502	10,056	9,183	7,171	16,354	169,297
Project Total Internal Trips⁴		(1,608)	(1,608)	(3,215)	(3,902)	(3,902)	(7,804)	(67,462)
Project Total Net Project Trips		1,947	4,895	6,841	5,281	3,269	8,550	101,835
Project Total Pass-By Trips		0	0	0	(429)	(524)	(953)	(12,188)
Project Total External Trips		1,947	4,895	6,841	4,852	2,745	7,597	89,647

Notes:

DU = Dwelling Units; STU = Students; TSF = Thousand Square Feet

- Rates based on Land Use 210 - "Single-Family Detached Housing" from the Institute of Transportation Engineers (ITE) *Trip Generation Manual* (10th Edition), Setting/Location - General Urban/Suburban.
- Rates based on Land Use 220 - "Multifamily Housing (Low-Rise)" from the ITE *Trip Generation Manual* (10th Edition), Setting/Location - General Urban/Suburban.
- Rates based on Land Use 520 - "Elementary School" from the ITE *Trip Generation Manual* (10th Edition), Setting/Location - General Urban/Suburban.
- Internal capture calculated using select zone model runs for the project TAZs created in the MCTC TDF model. This takes into account the interaction between residential, commercial, office, and school uses within the Specific Plan.
- Rates based on Land Use 820 - "Shopping Center" from the ITE *Trip Generation Manual* (10th Edition), Setting/Location - General Urban/Suburban.
- Pass-by rates from the ITE *Trip Generation Handbook* (3rd Edition) for Land Use 820 - "Shopping Center." A pass-by rate of 34% was used for the p.m. peak hour. Since there is no data available for daily pass-by trips in the ITE Handbook, the p.m. peak hour rate was used as the daily rate.
- Rates based on Land Use 770 - "Business Park" from the ITE *Trip Generation Manual* (10th Edition), Setting/Location - General Urban/Suburban.

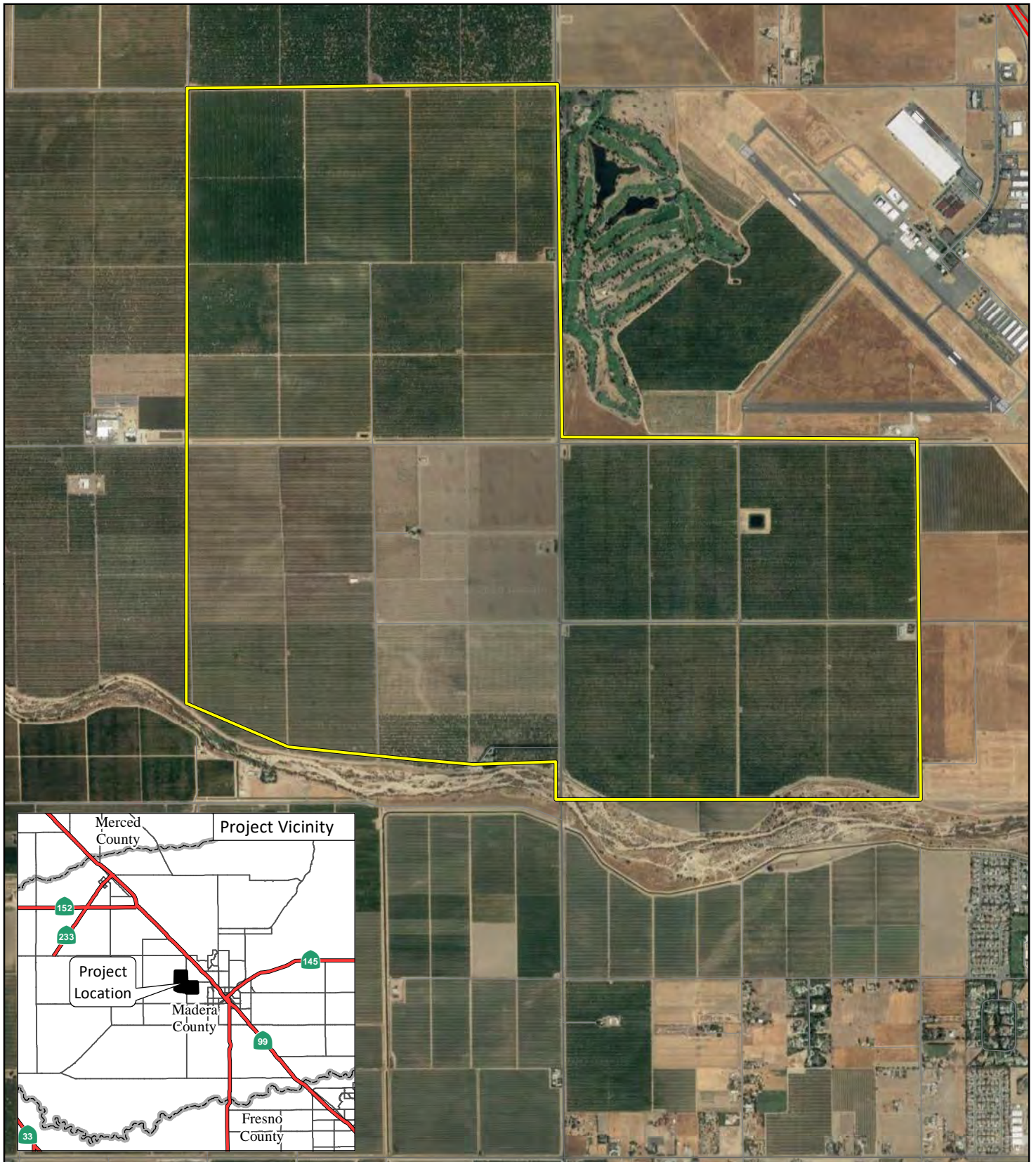
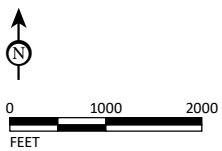

FIGURE 1

LSA

LEGEND

Project Boundary



SOURCE: ESRI Streetmap (2013); Google Earth (2018).
 I:\CMD1801\Reports\Traffic\fig1-1_Reg_Loc.mxd (2/16/2020)

*Village D Specific Plan
 Traffic Impact Analysis
 Regional and Project Location*

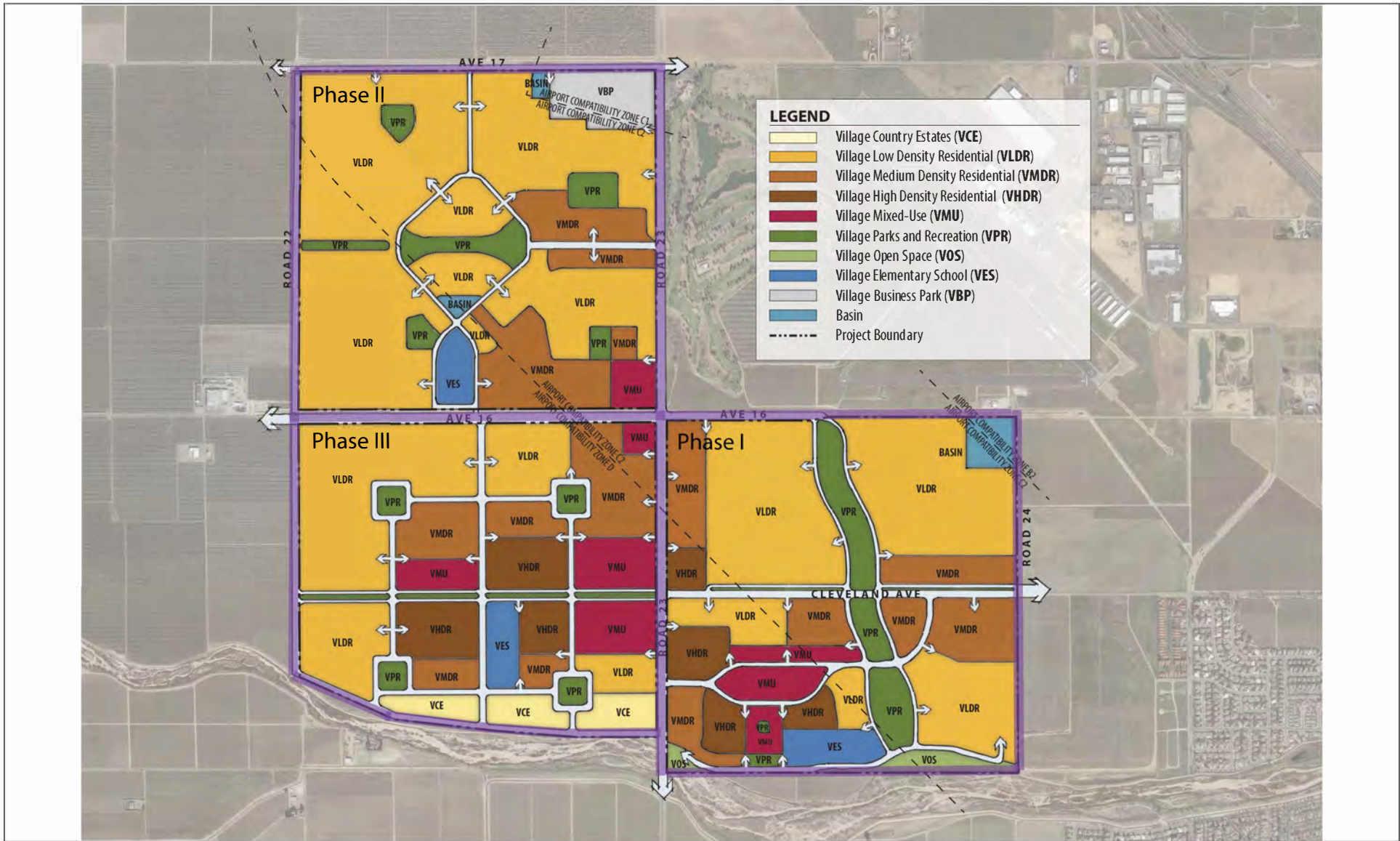

FIGURE 2

LSA

Legend

Phase Boundary



NOT TO SCALE

Village D Specific Plan EIR
 Traffic Impact Analysis
 Conceptual Land Use Plan

SOURCE: KTG, DECEMBER 2018.

P:\CMD1801 Madera Village D\PRODUCTS\Project Description\Figure Content\Fig_3-5.ai (2/12/19))

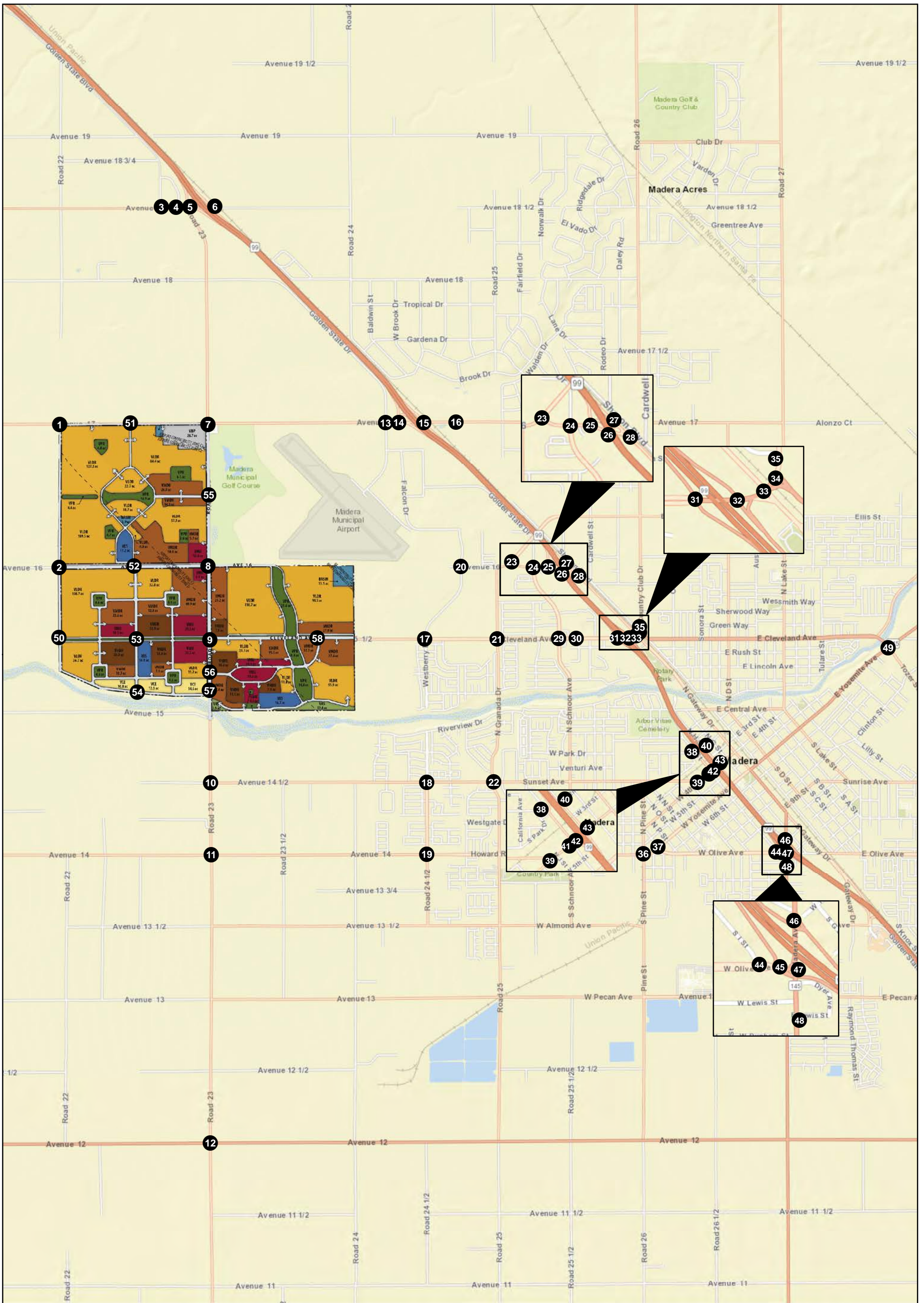

LSA

LEGEND

- Study Area Intersection

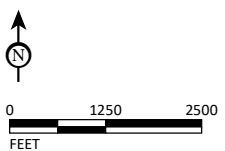

SOURCE: ESRI

I:\CMD1801\Reports\Traffic\fig1-3_Intersections-11.19.19.mxd (2/16/2020)

FIGURE 3

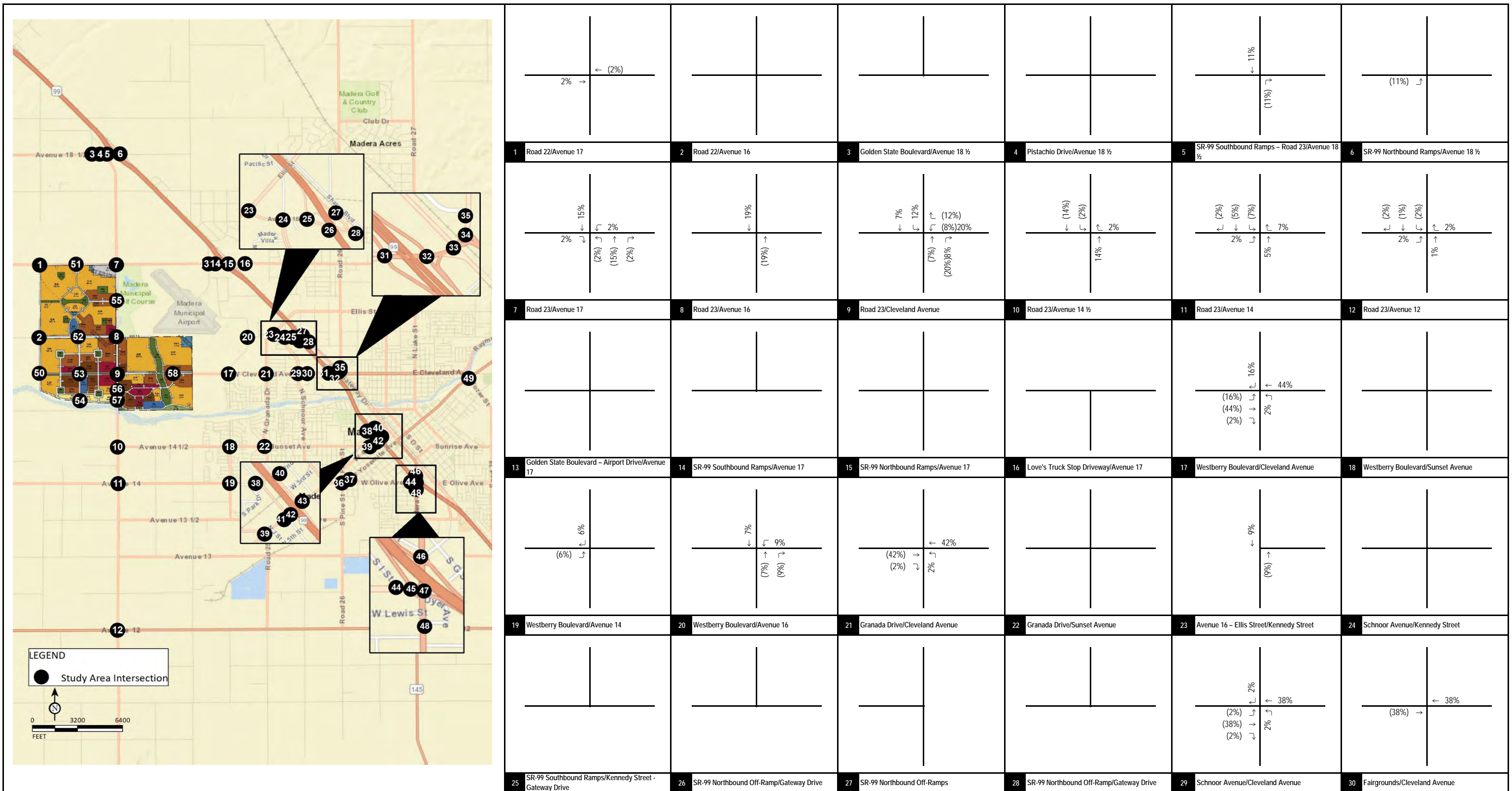

FIGURE 4A

LSA

XX% (YY%) -- Project Driveway
 Inbound (Outbound) Distribution

Village D Specific Plan
 Traffic Impact Analysis

Phase I TAZ 615 Project Trip Distribution (Int. 1-30)

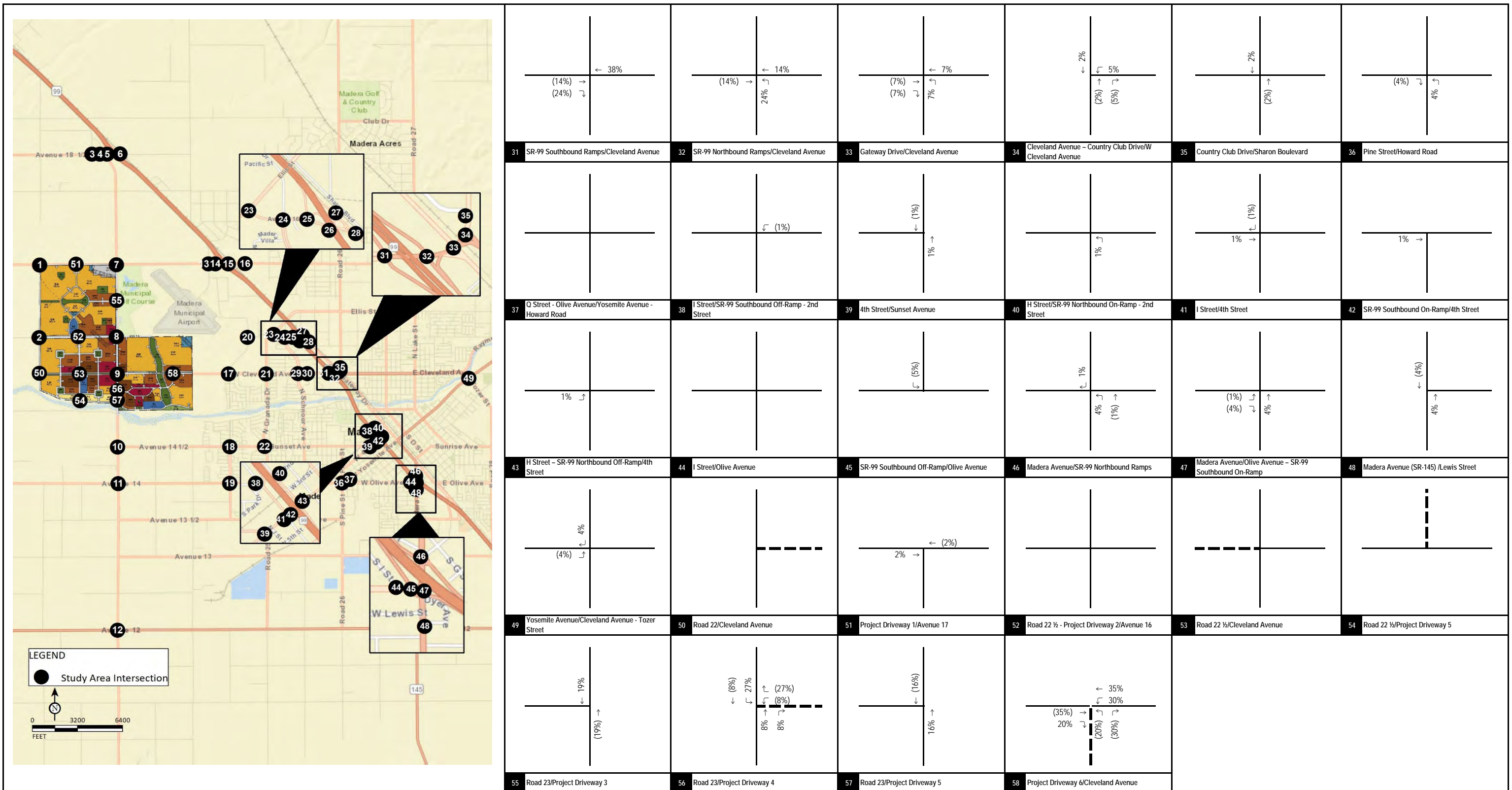

FIGURE 4B

LSA

XX% (YY%)
 Inbound (Outbound) Distribution

-- Project Driveway

Village D Specific Plan
 Traffic Impact Analysis

Phase I TAZ 615 Project Trip Distribution (Int. 31-58)

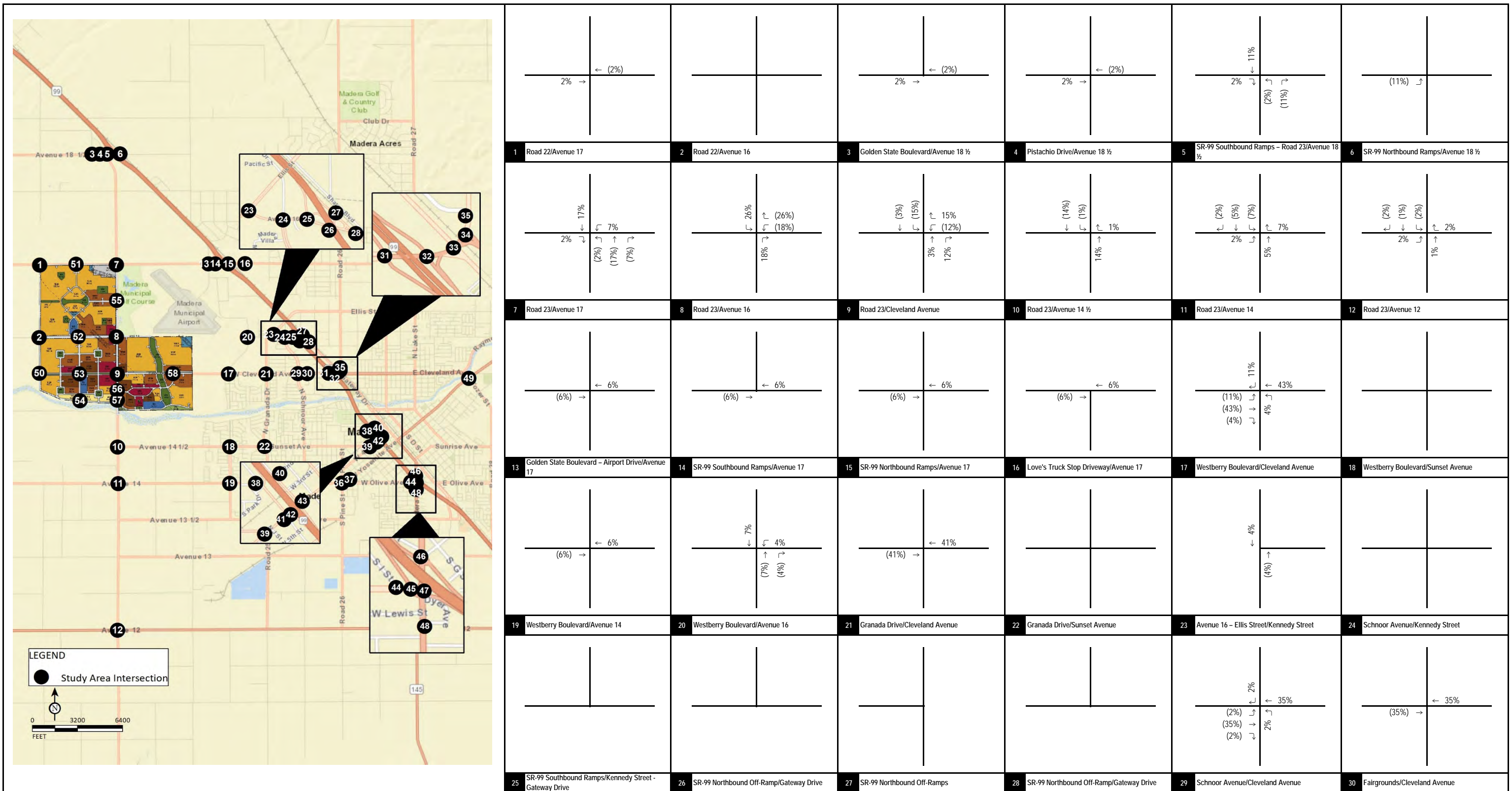

FIGURE 5A

LSA

XX% (YY%) -- Project Driveway
 Inbound (Outbound) Distribution

Village D Specific Plan
 Traffic Impact Analysis

Phase I TAZ 616 Project Trip Distribution (Int. 1-30)

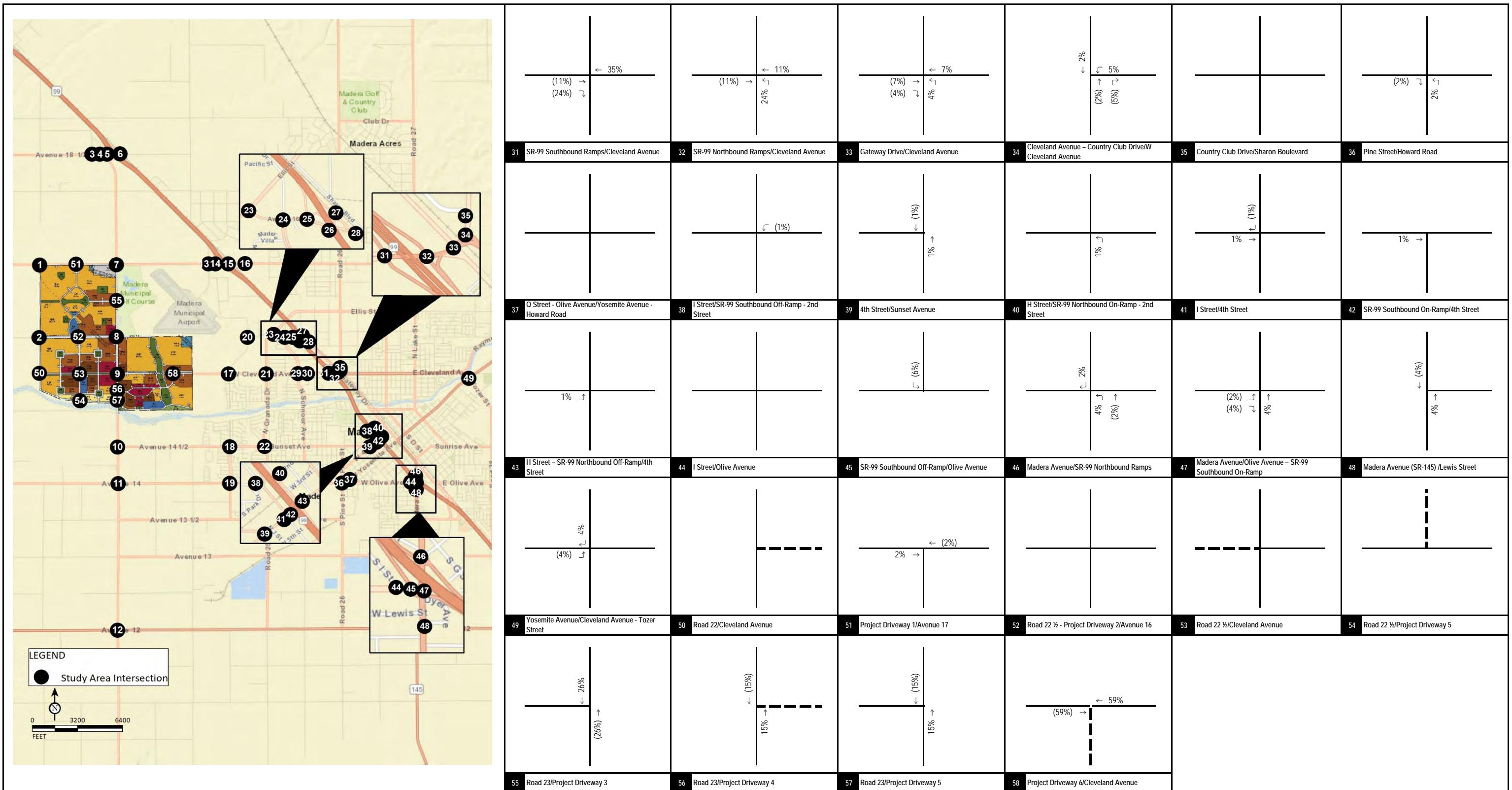

FIGURE 5B

LSA

XX% (YY%) -- Project Driveway
 Inbound (Outbound) Distribution

Village D Specific Plan
 Traffic Impact Analysis

Phase I TAZ 616 Project Trip Distribution (Int. 31-58)

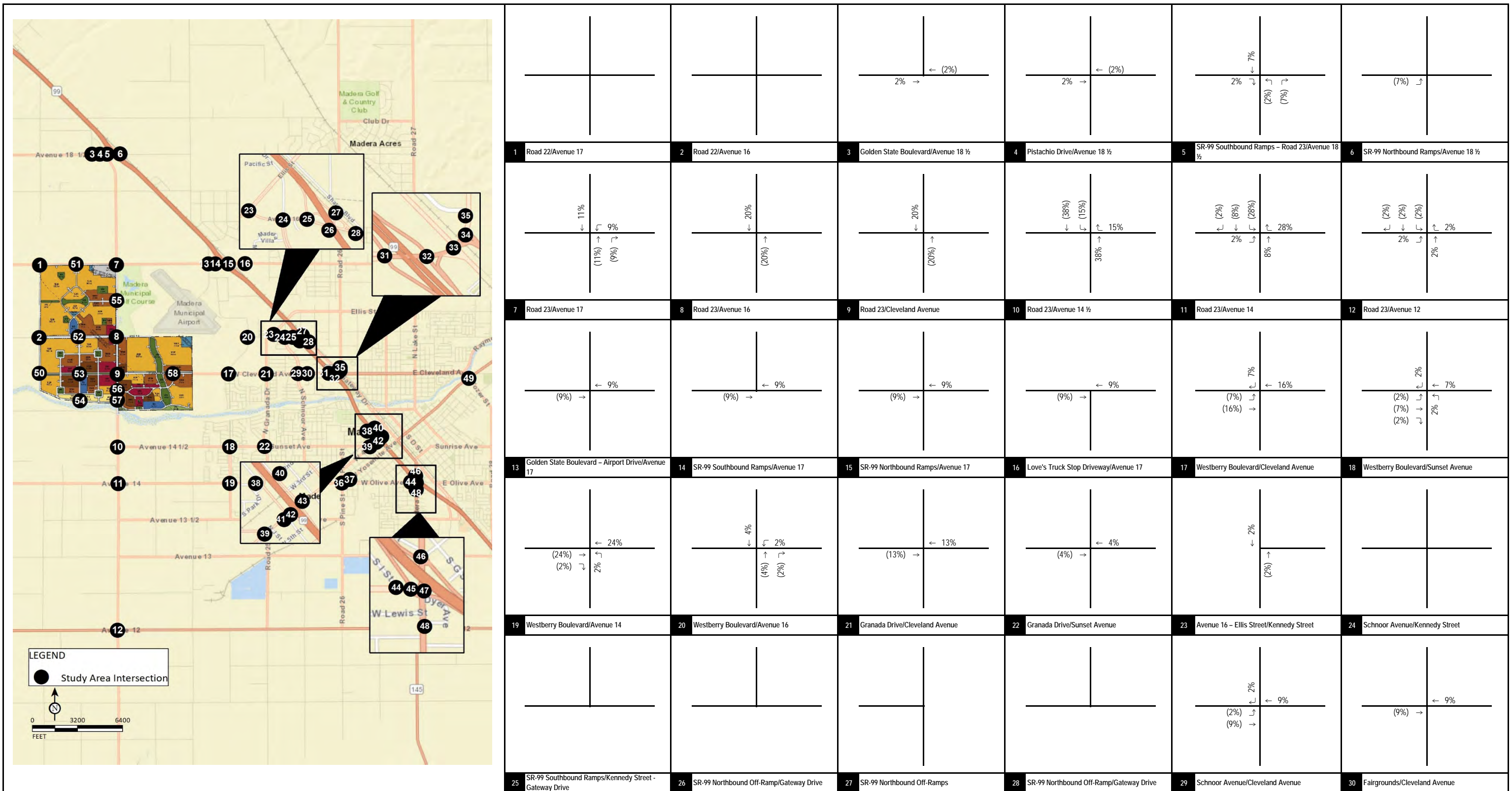

FIGURE 6A

LSA

XX% (YY%) -- Project Driveway
 Inbound (Outbound) Distribution

Village D Specific Plan
 Traffic Impact Analysis

Phase I TAZ 626 Project Trip Distribution (Int. 1-30)

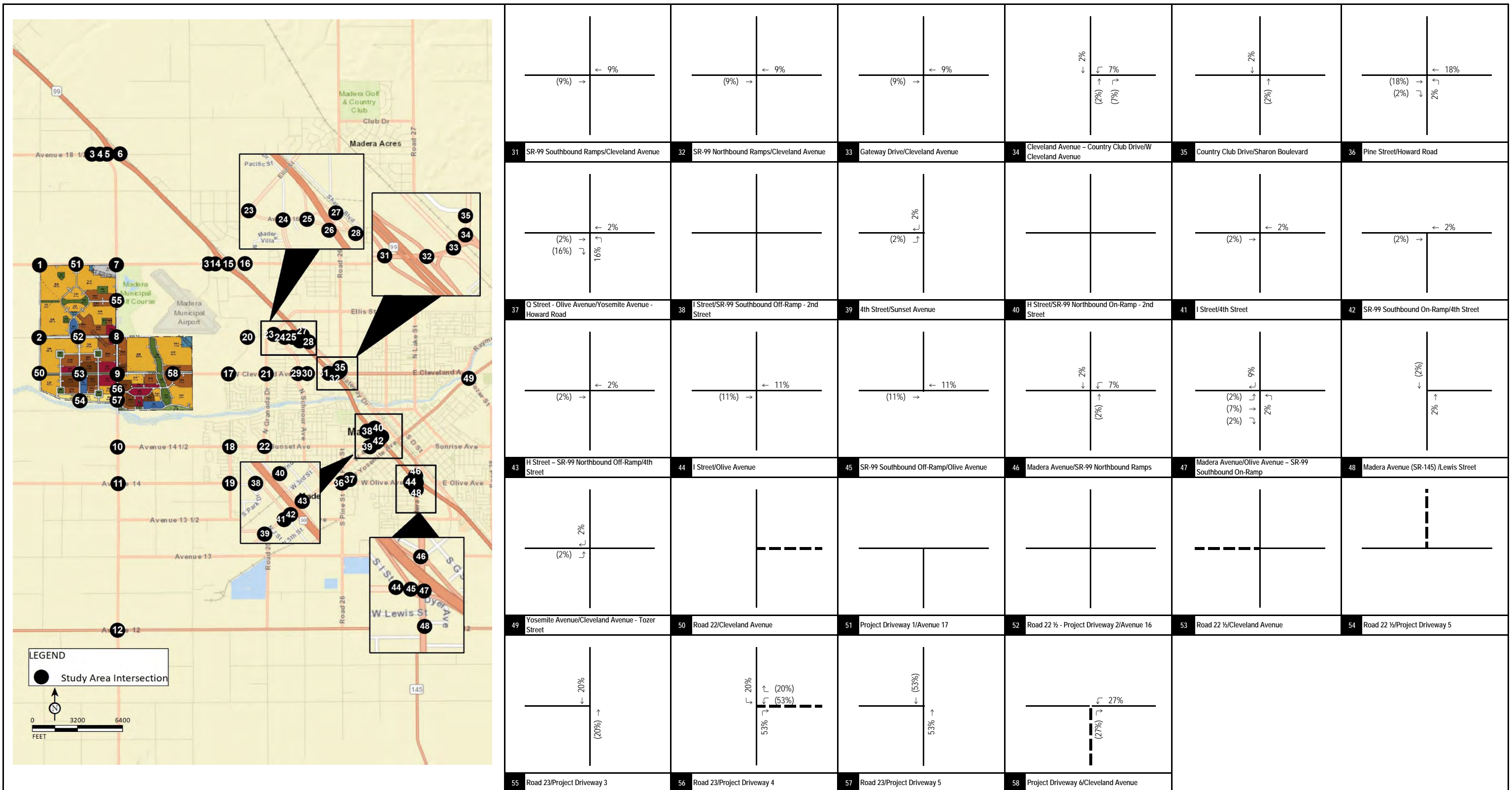

FIGURE 6B

LSA

XX% (YY%) -- Project Driveway
 Inbound (Outbound) Distribution

Village D Specific Plan
 Traffic Impact Analysis

Phase I TAZ 626 Project Trip Distribution (Int. 31-58)

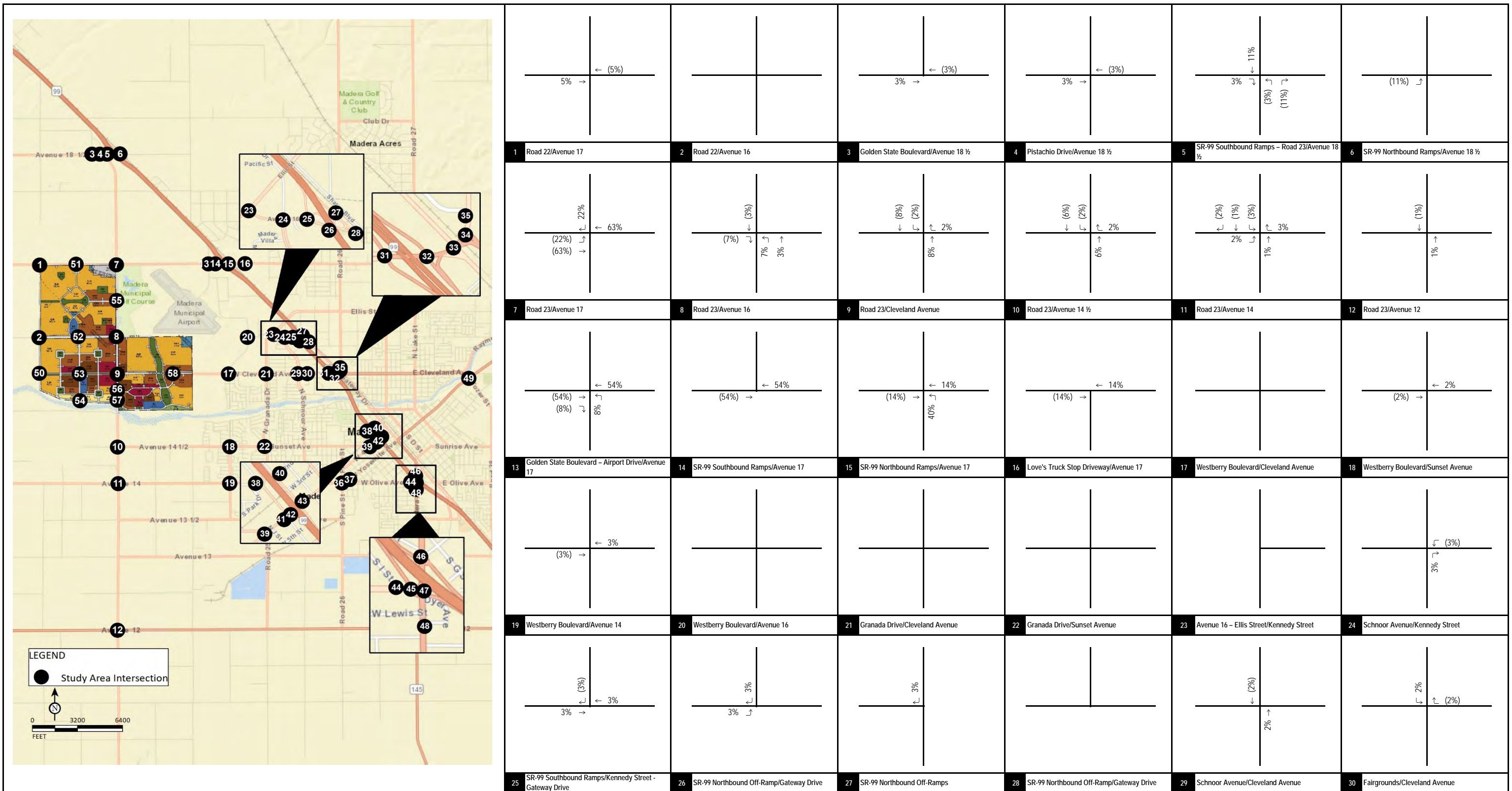

FIGURE 7A

LSA

XX% (YY%) -- Project Driveway
 Inbound (Outbound) Distribution

Village D Specific Plan
 Traffic Impact Analysis

Phase II TAZ 627 Project Trip Distribution (Int. 1-30)

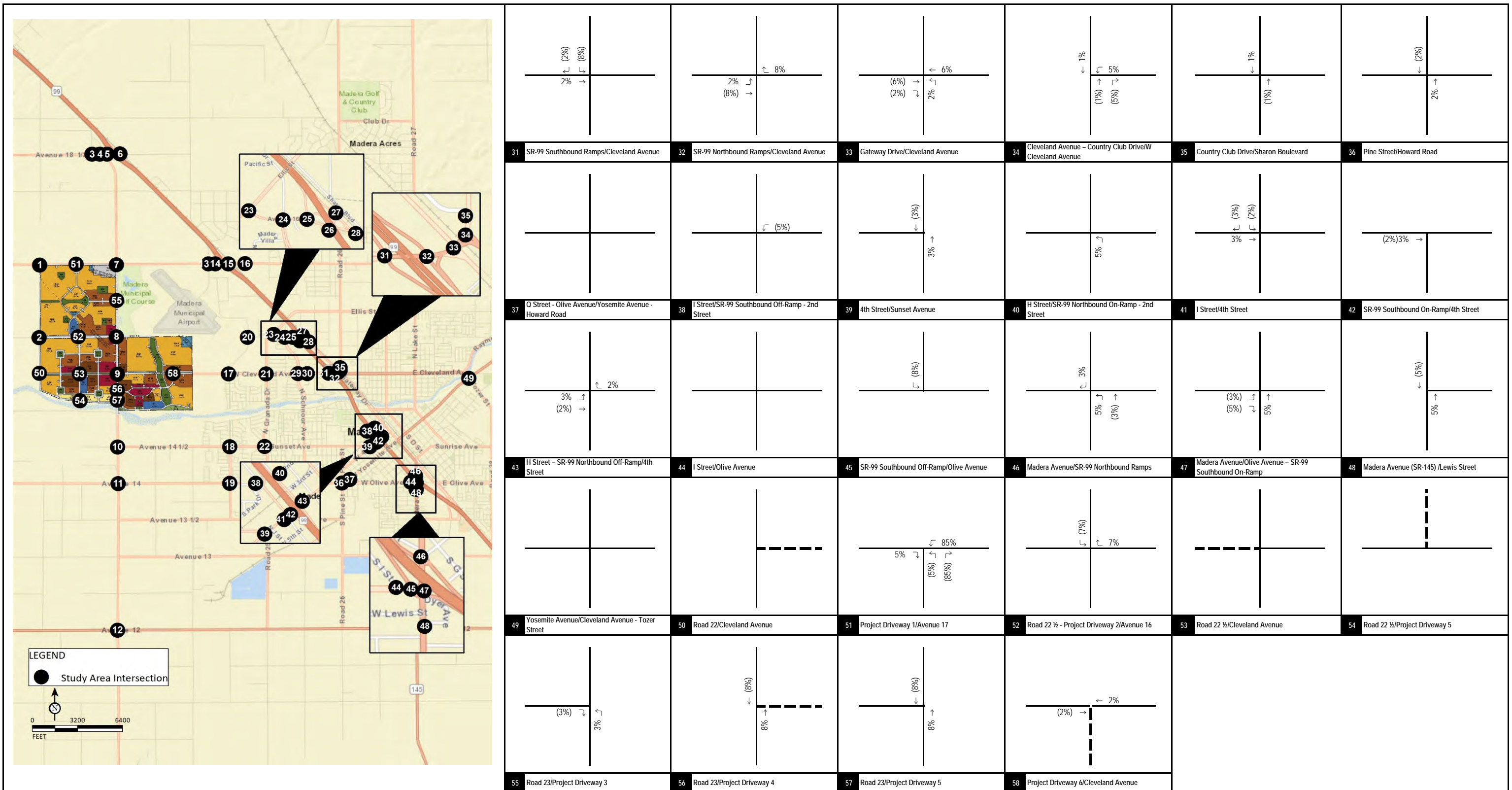

FIGURE 7B

LSA

XX% (YY%)
 Inbound (Outbound) Distribution
 -- Project Driveway

Village D Specific Plan
 Traffic Impact Analysis

Phase II TAZ 627 Project Trip Distribution (Int. 31-58)

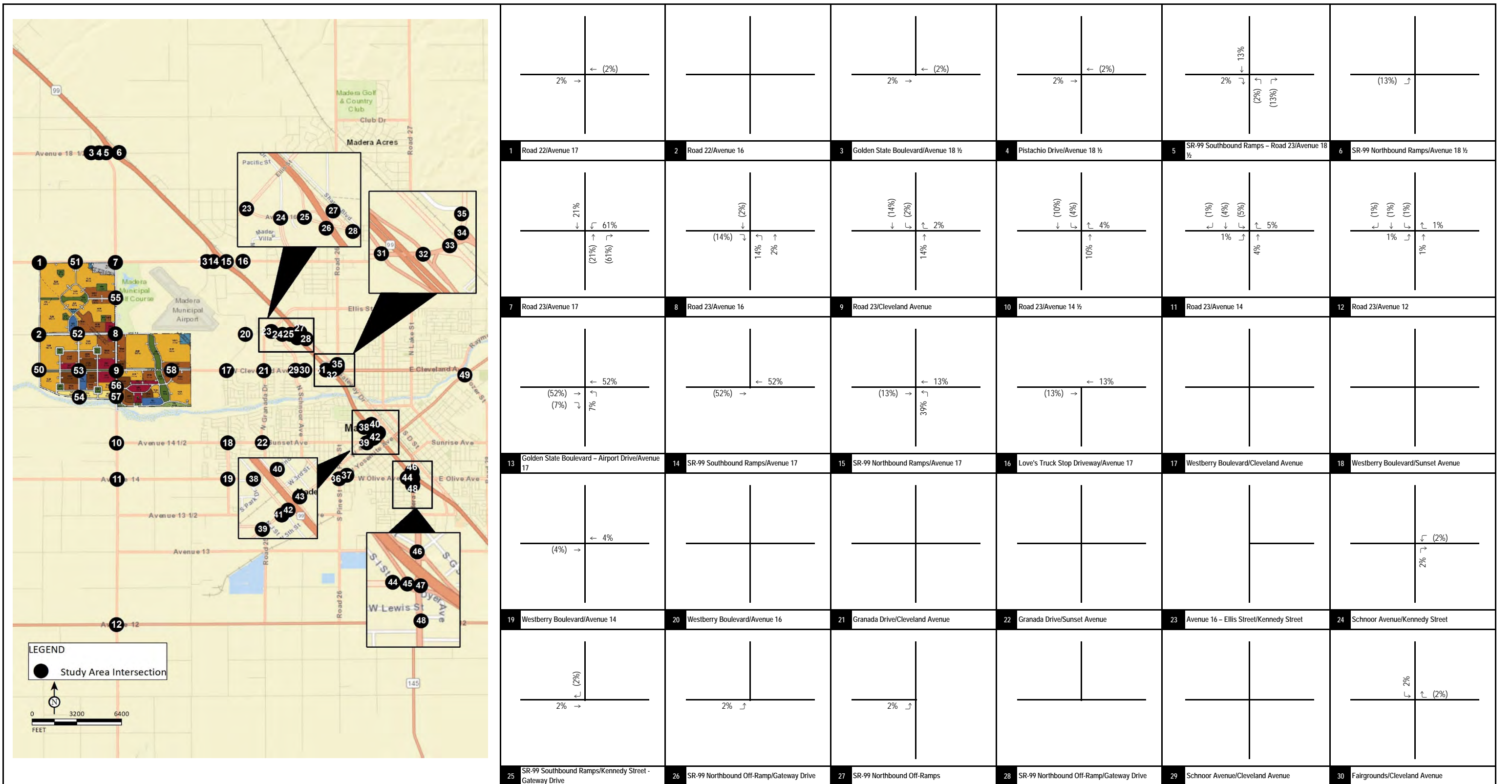

FIGURE 8A

LSA

XX% (YY%) -- Project Driveway
 Inbound (Outbound) Distribution

Village D Specific Plan
 Traffic Impact Analysis

Phase II TAZ 628 Project Trip Distribution (Int. 1-30)

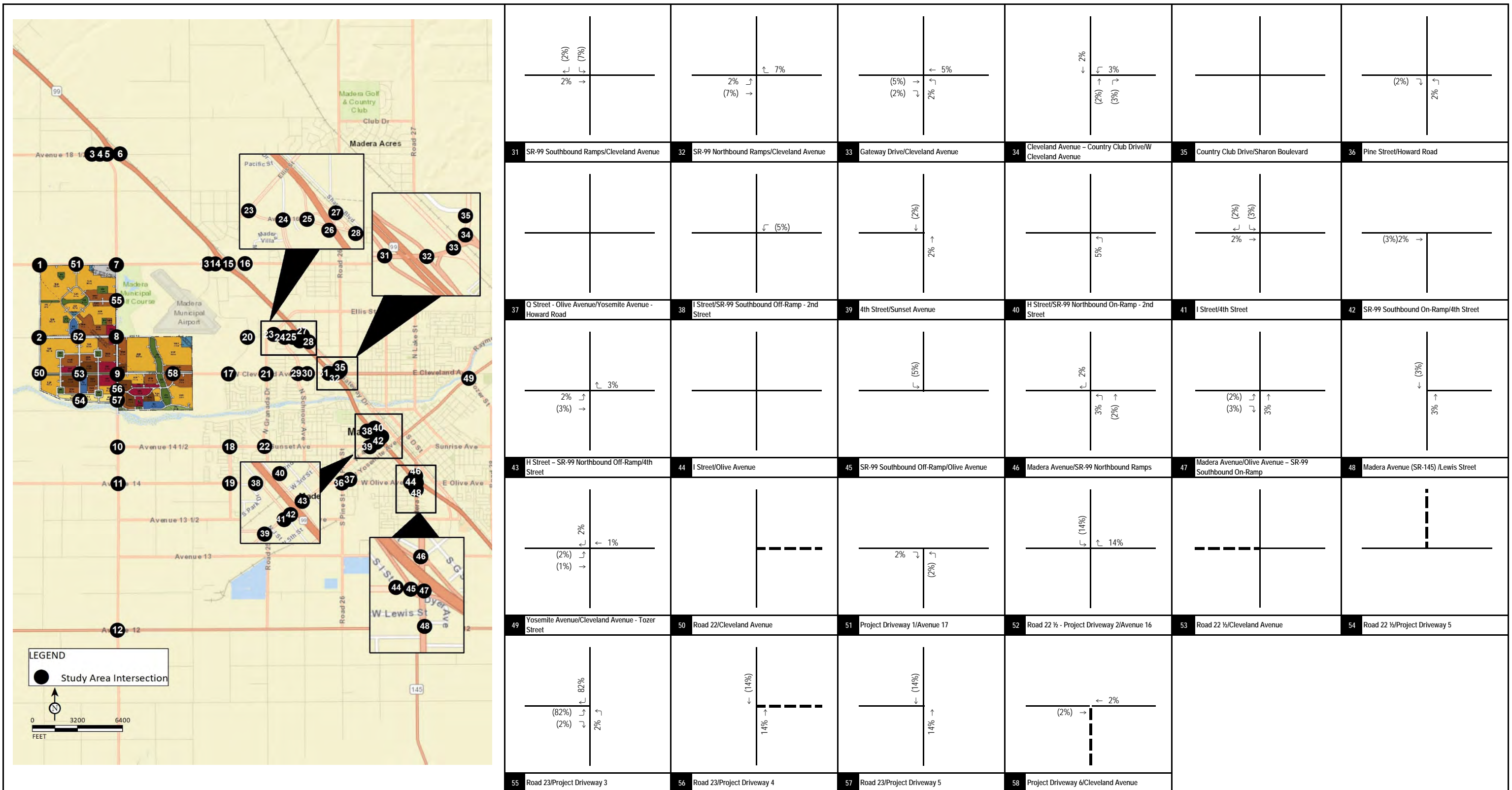

FIGURE 8B

LSA

XX% (YY%)
 Inbound (Outbound) Distribution
 -- Project Driveway

Village D Specific Plan
 Traffic Impact Analysis

Phase II TAZ 628 Project Trip Distribution (Int. 31-58)

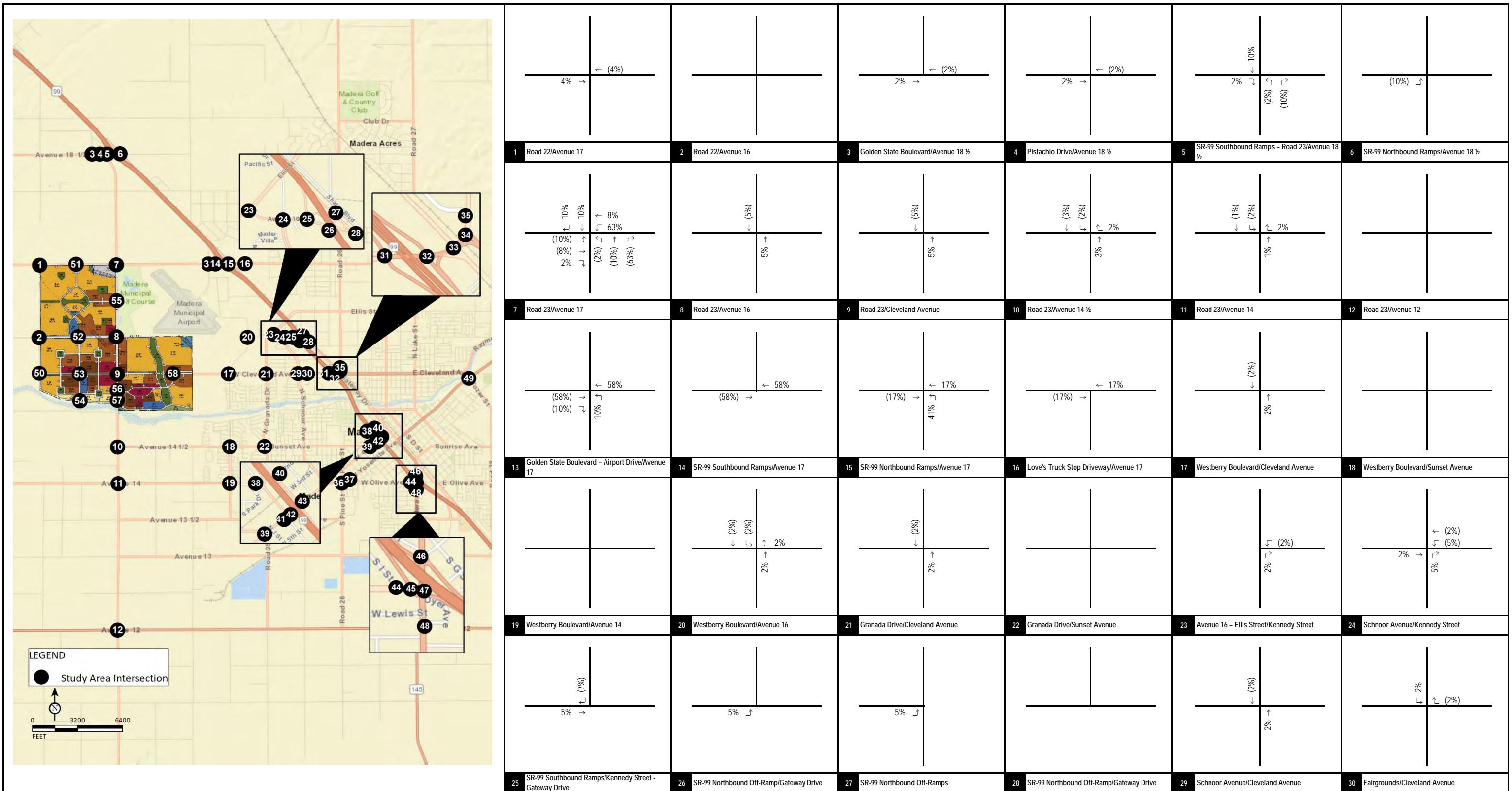

LSA

XX% (YY%)
Inbound (Outbound) Distribution

-- Project Driveway

FIGURE 9A

Village D Specific Plan
Traffic Impact Analysis

Phase II TAZ 629 Project Trip Distribution (Int. 1-30)

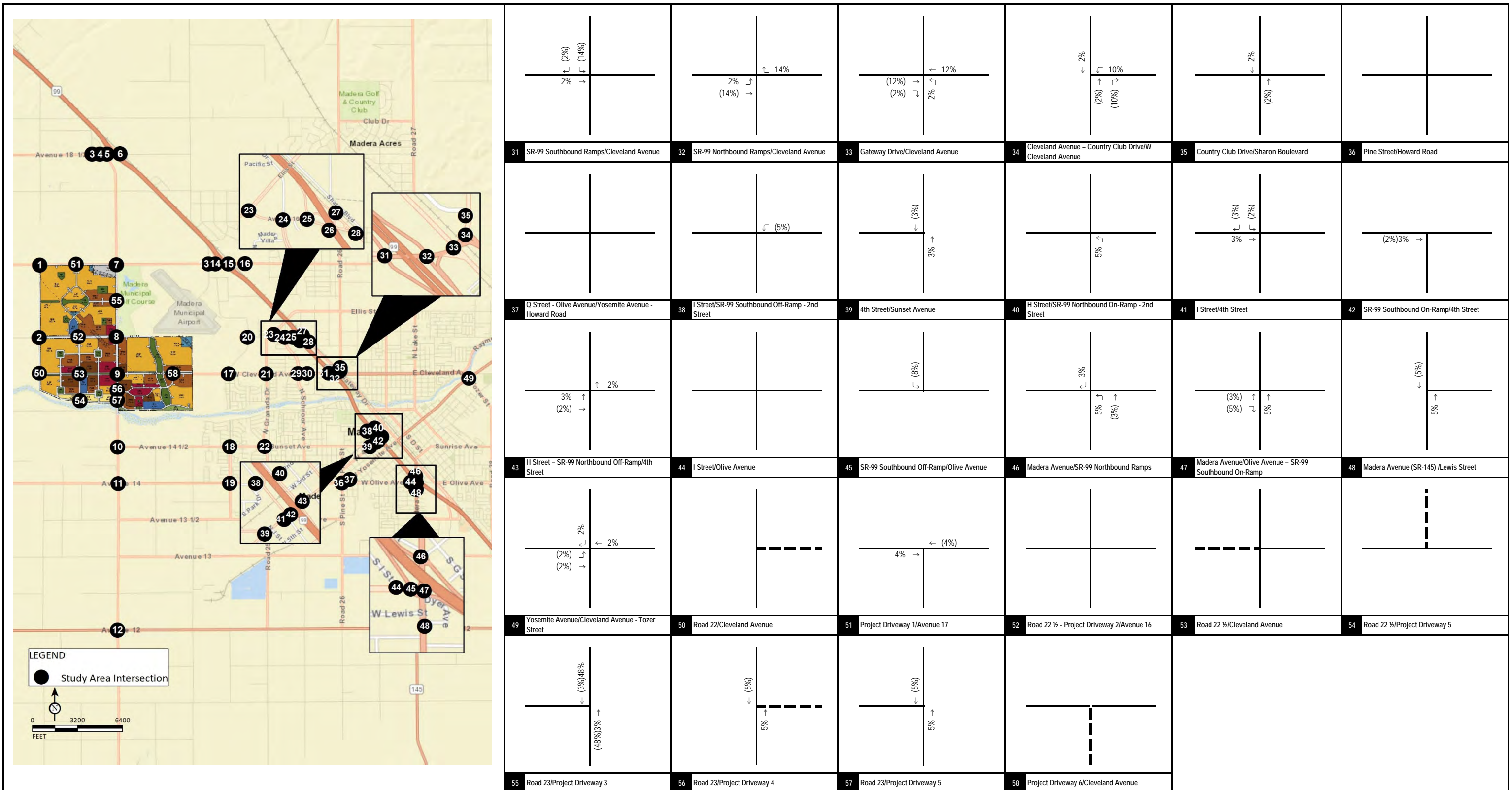

FIGURE 9B

LSA

XX% (YY%) -- Project Driveway
 Inbound (Outbound) Distribution

Village D Specific Plan
 Traffic Impact Analysis

Phase II TAZ 629 Project Trip Distribution (Int. 31-58)

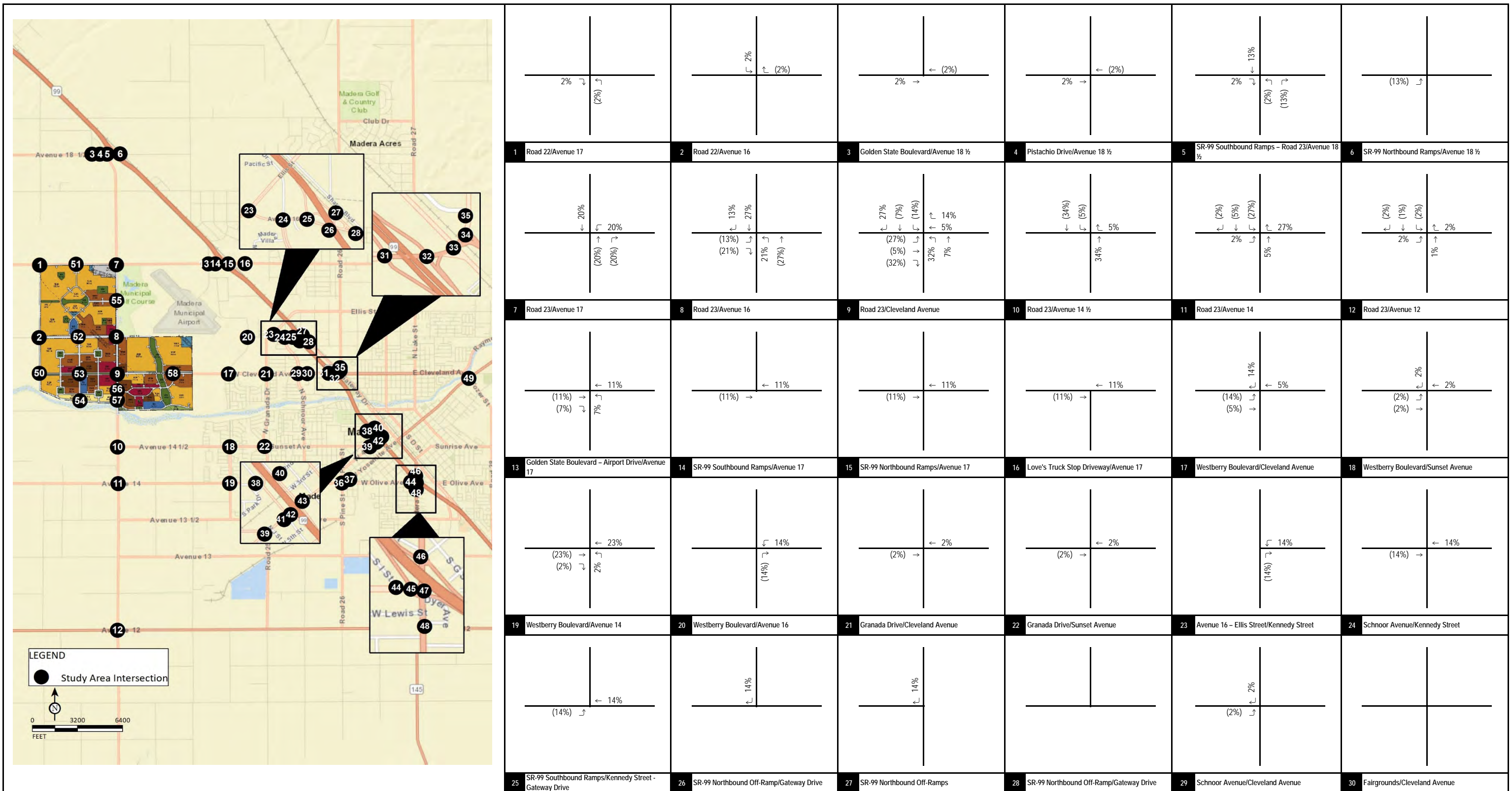

FIGURE 10A

LSA

XX% (YY%) -- Project Driveway
 Inbound (Outbound) Distribution

Village D Specific Plan
 Traffic Impact Analysis

Phase III TAZ 630 Project Trip Distribution (Int. 1-30)

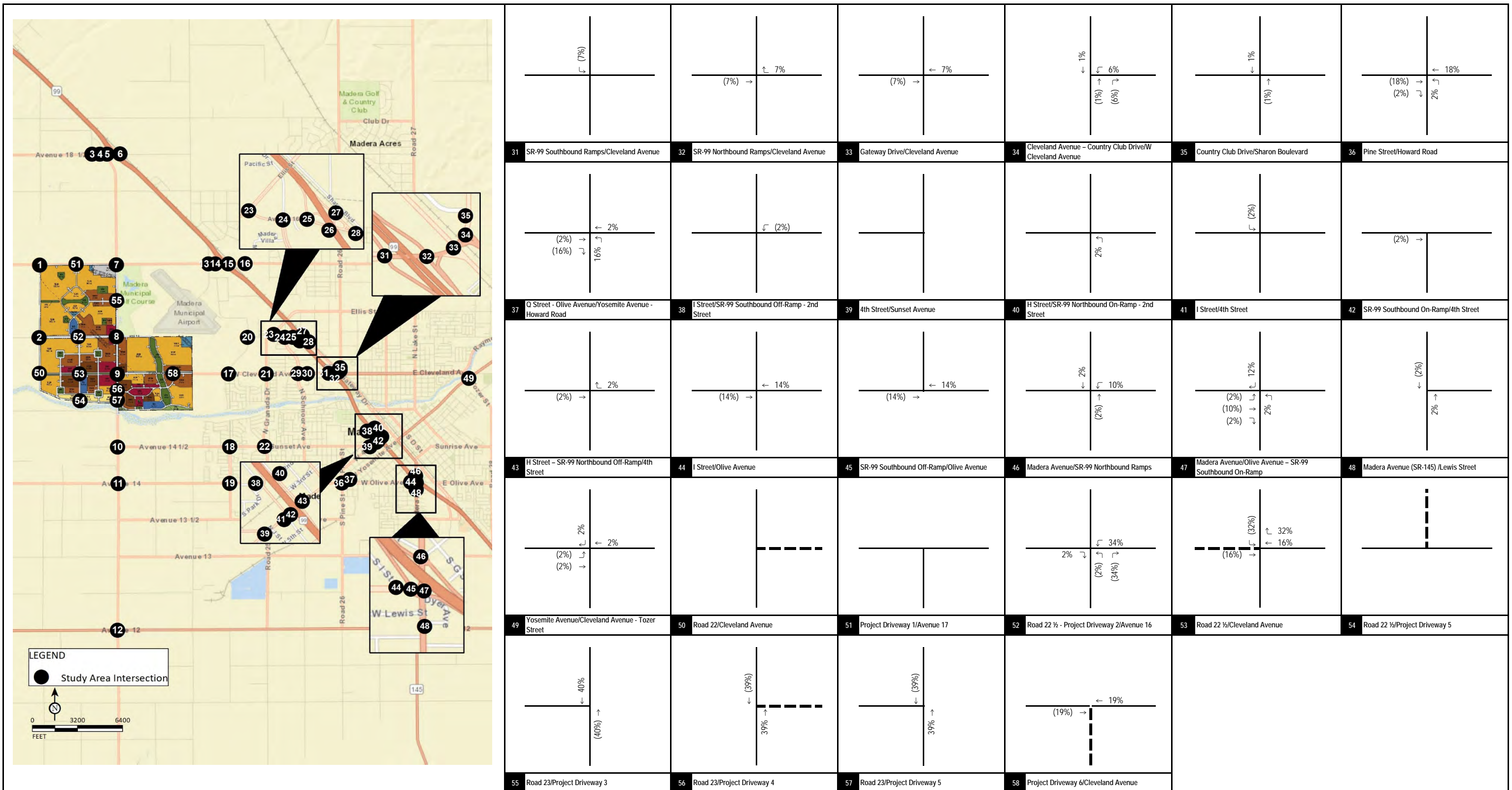

FIGURE 10B



XX% (YY%) -- Project Driveway
 Inbound (Outbound) Distribution

Village D Specific Plan
 Traffic Impact Analysis

Phase III TAZ 630 Project Trip Distribution (Int. 31-58)

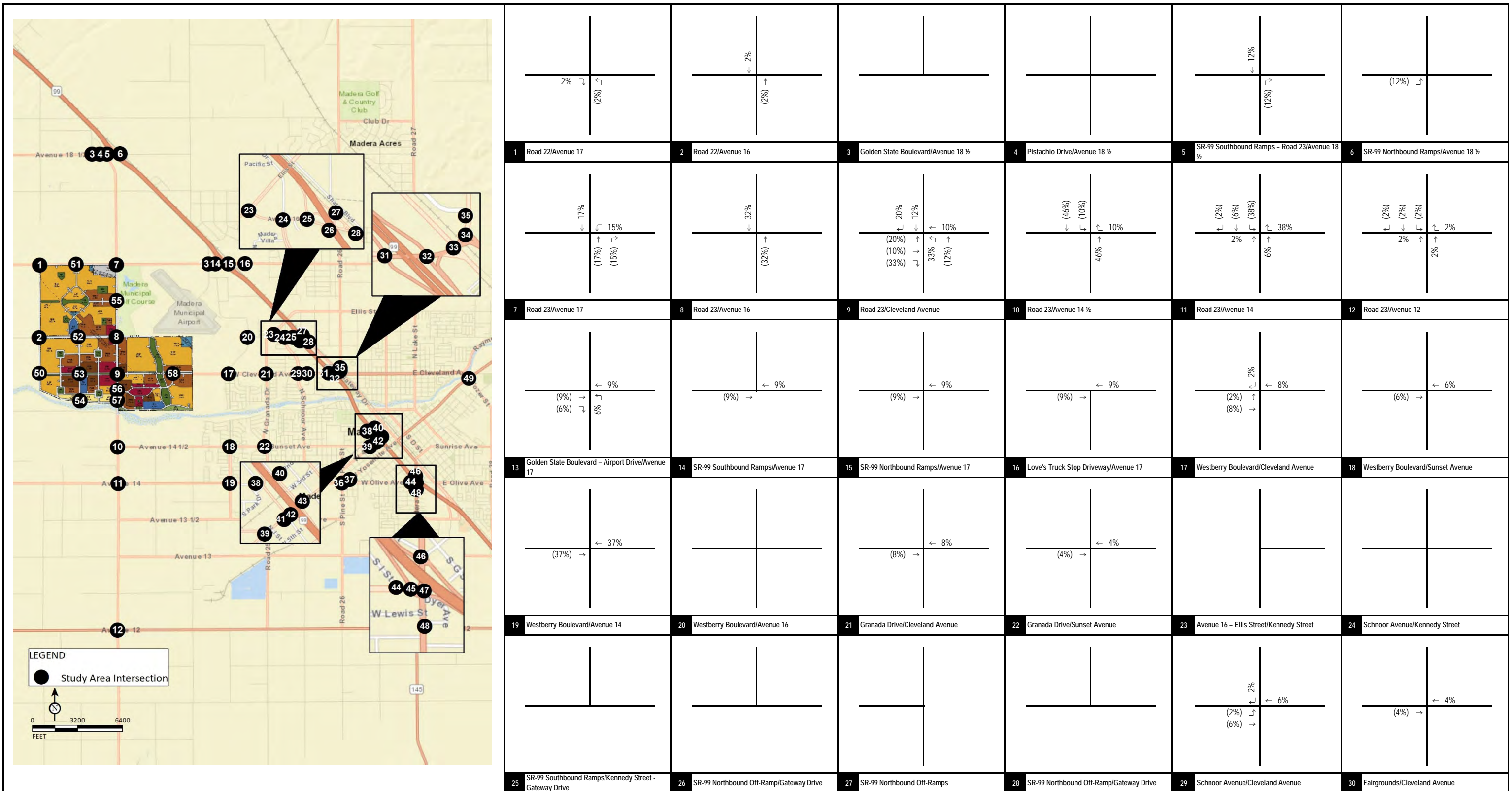

FIGURE 11A

LSA

XX% (YY%) -- Project Driveway
 Inbound (Outbound) Distribution

Village D Specific Plan
 Traffic Impact Analysis

Phase III TAZ 631 Project Trip Distribution (Int. 1-30)

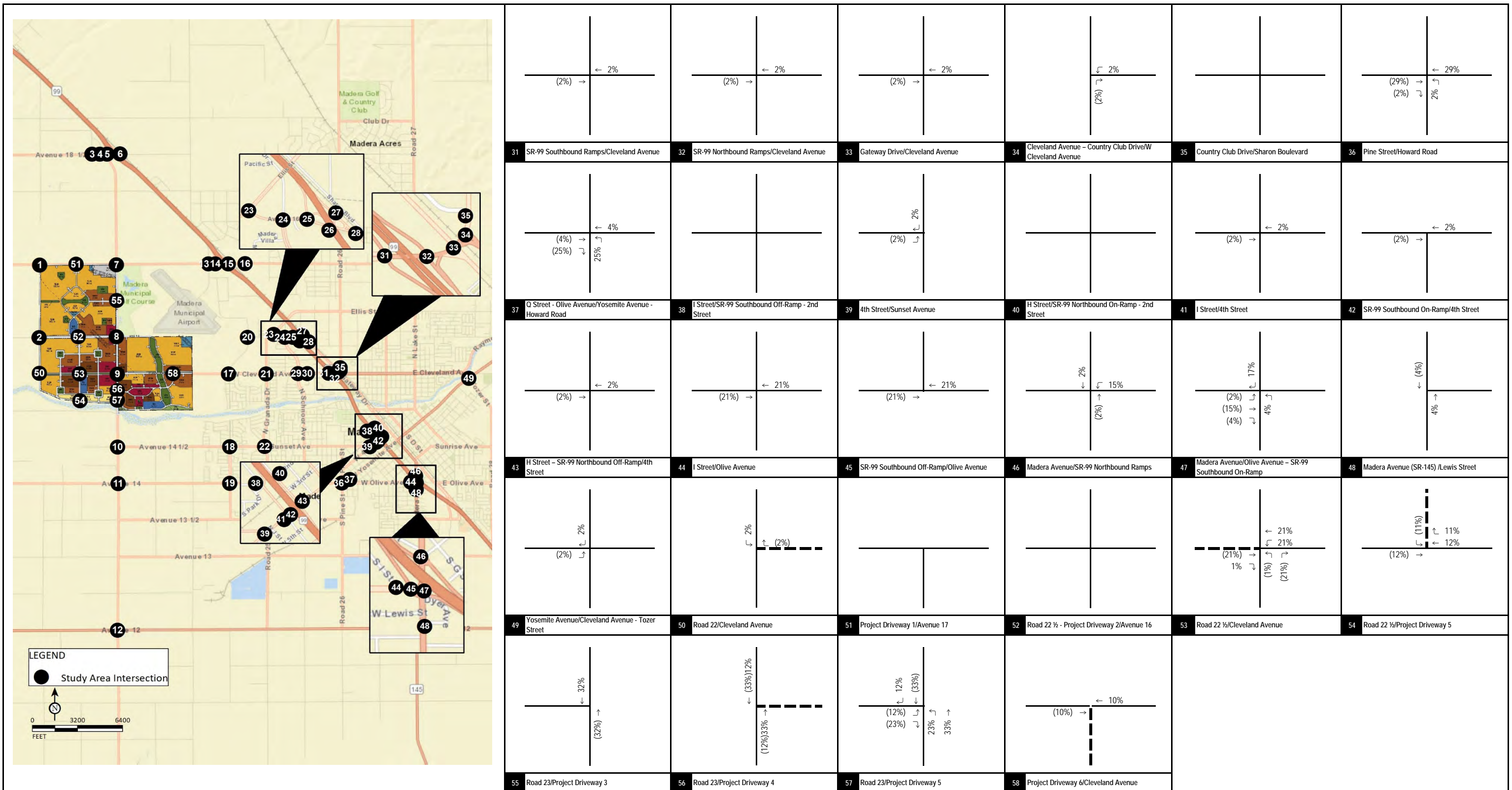

FIGURE 11B

LSA

XX% (YY%) -- Project Driveway
 Inbound (Outbound) Distribution

Village D Specific Plan
 Traffic Impact Analysis

Phase III TAZ 631 Project Trip Distribution (Int. 31-58)

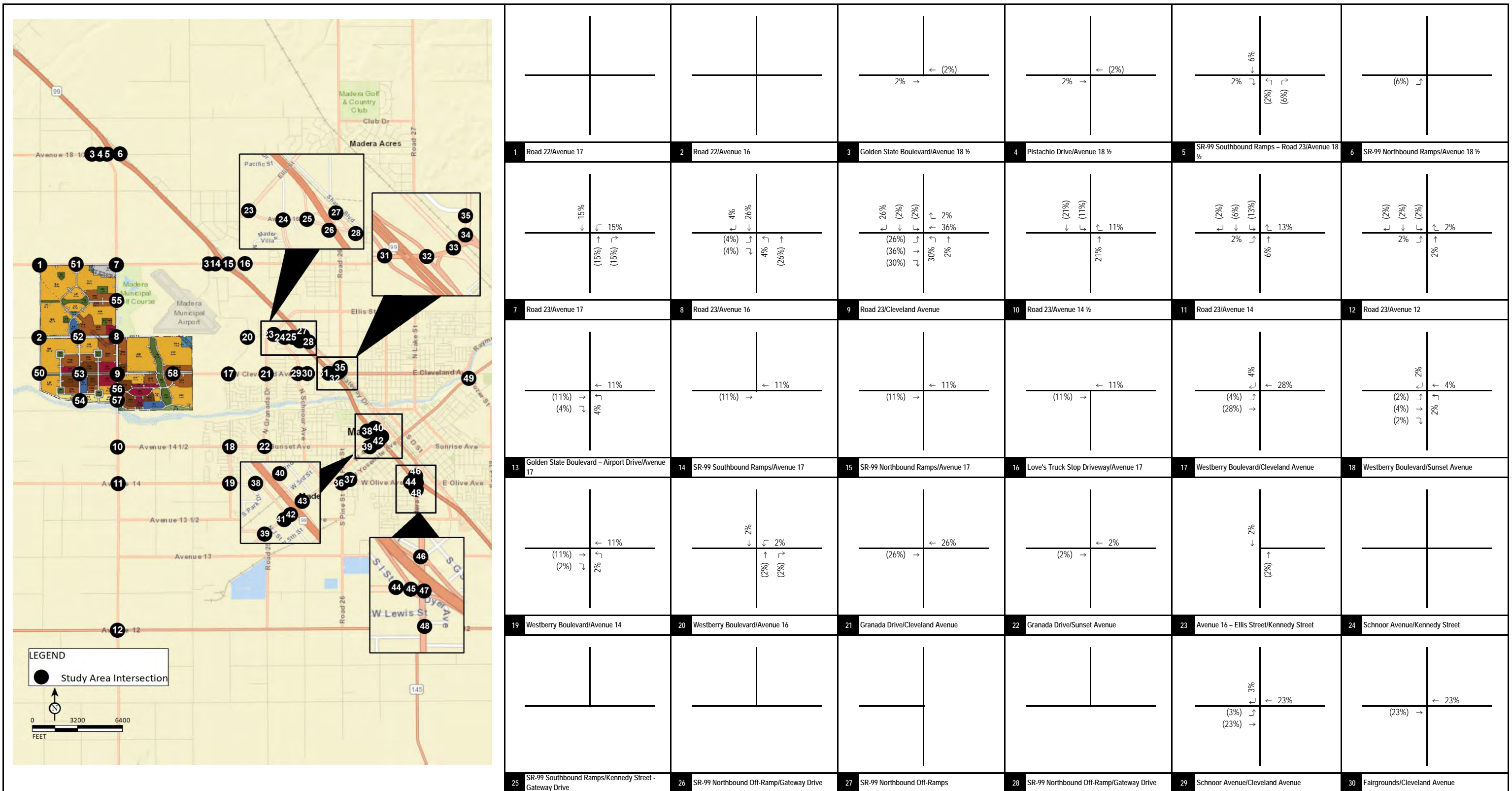

FIGURE 12A

LSA

XX% (YY%) -- Project Driveway
 Inbound (Outbound) Distribution

Village D Specific Plan
 Traffic Impact Analysis

Phase III TAZ 632 Project Trip Distribution (Int. 1-30)

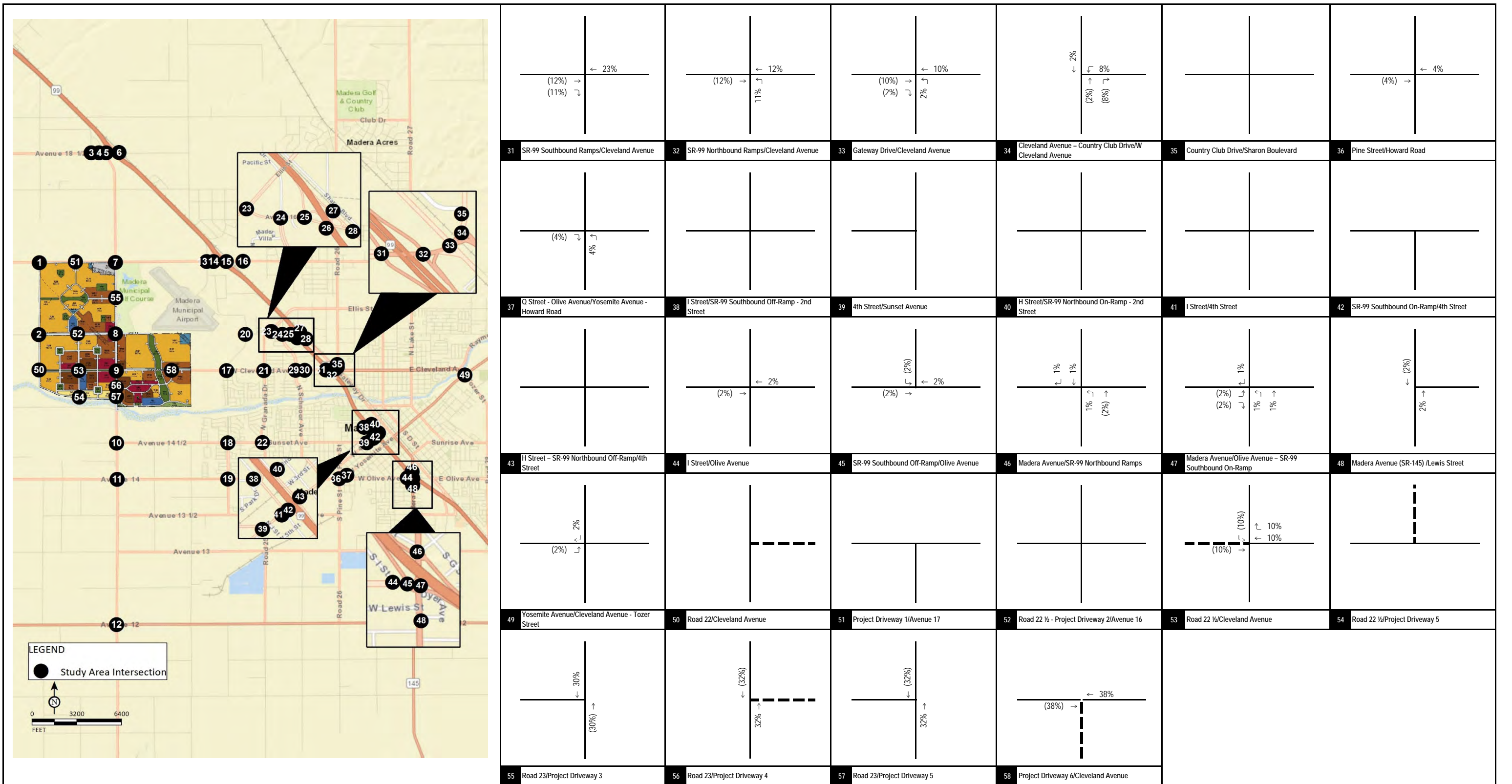

FIGURE 12B



XX% (YY%) -- Project Driveway
 Inbound (Outbound) Distribution

Village D Specific Plan
 Traffic Impact Analysis

Phase III TAZ 632 Project Trip Distribution (Int. 31-58)

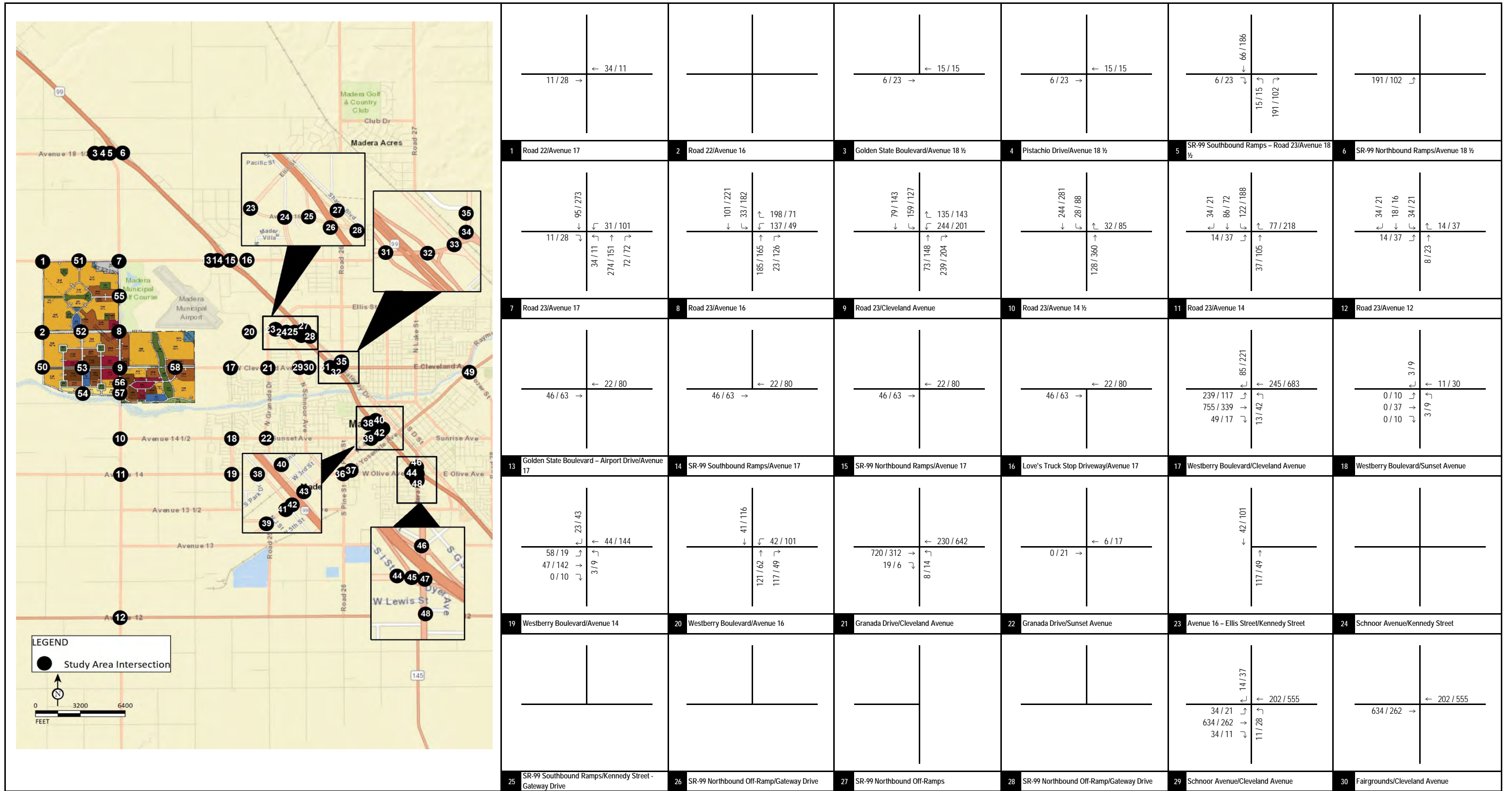

LSA

XXX / YYY
AM / PM Peak Hour Traffic Volumes

-- Project Driveway

FIGURE 13A

Village D Specific Plan
Traffic Impact Analysis

Phase I Project Trip Assignment (Int. 1-30)

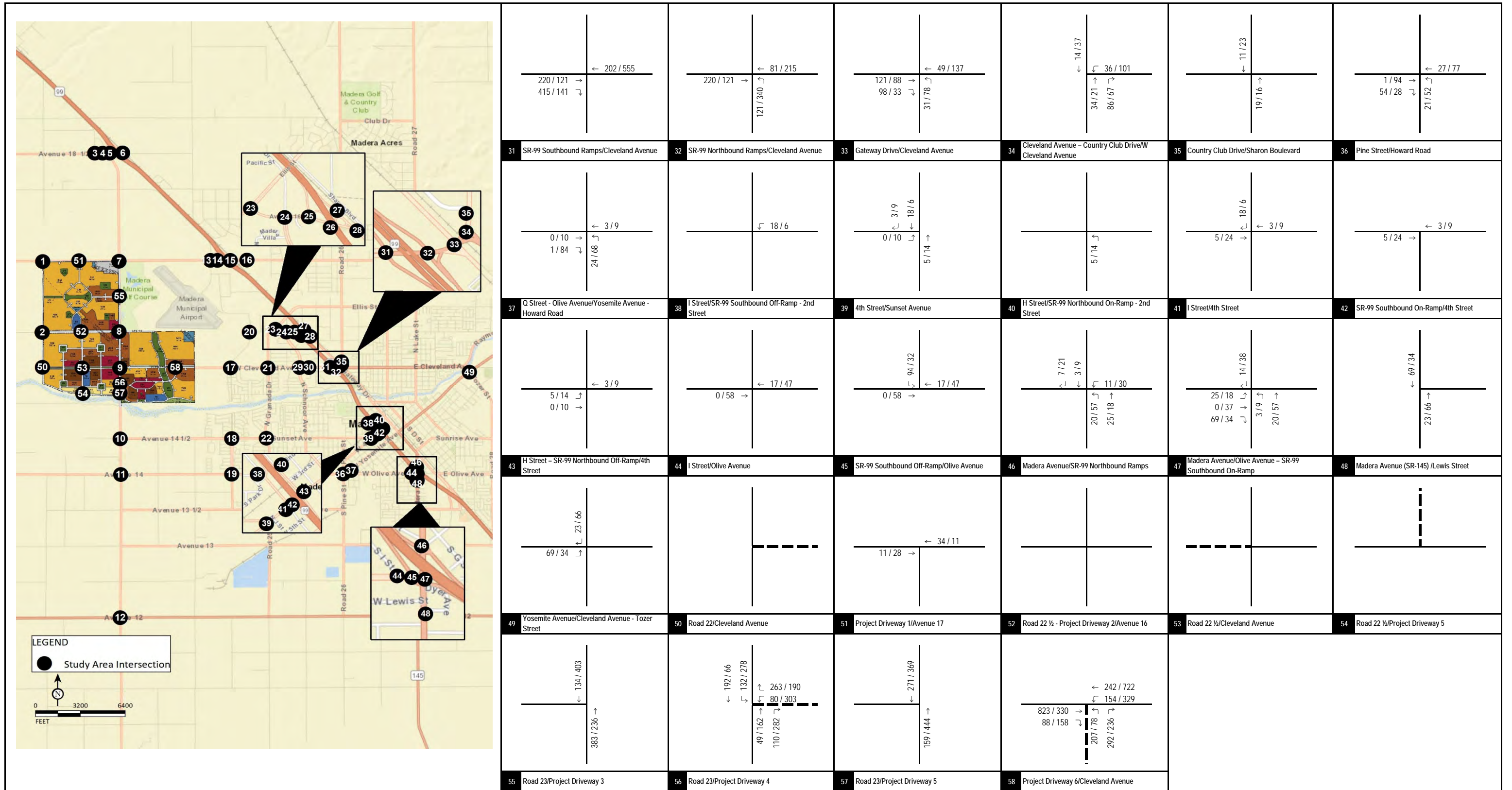

LSA

XXX / YYY
AM / PM Peak Hour Traffic Volumes

-- Project Driveway

FIGURE 13B

Village D Specific Plan
Traffic Impact Analysis

Phase I Project Trip Assignment (Int. 31-58)

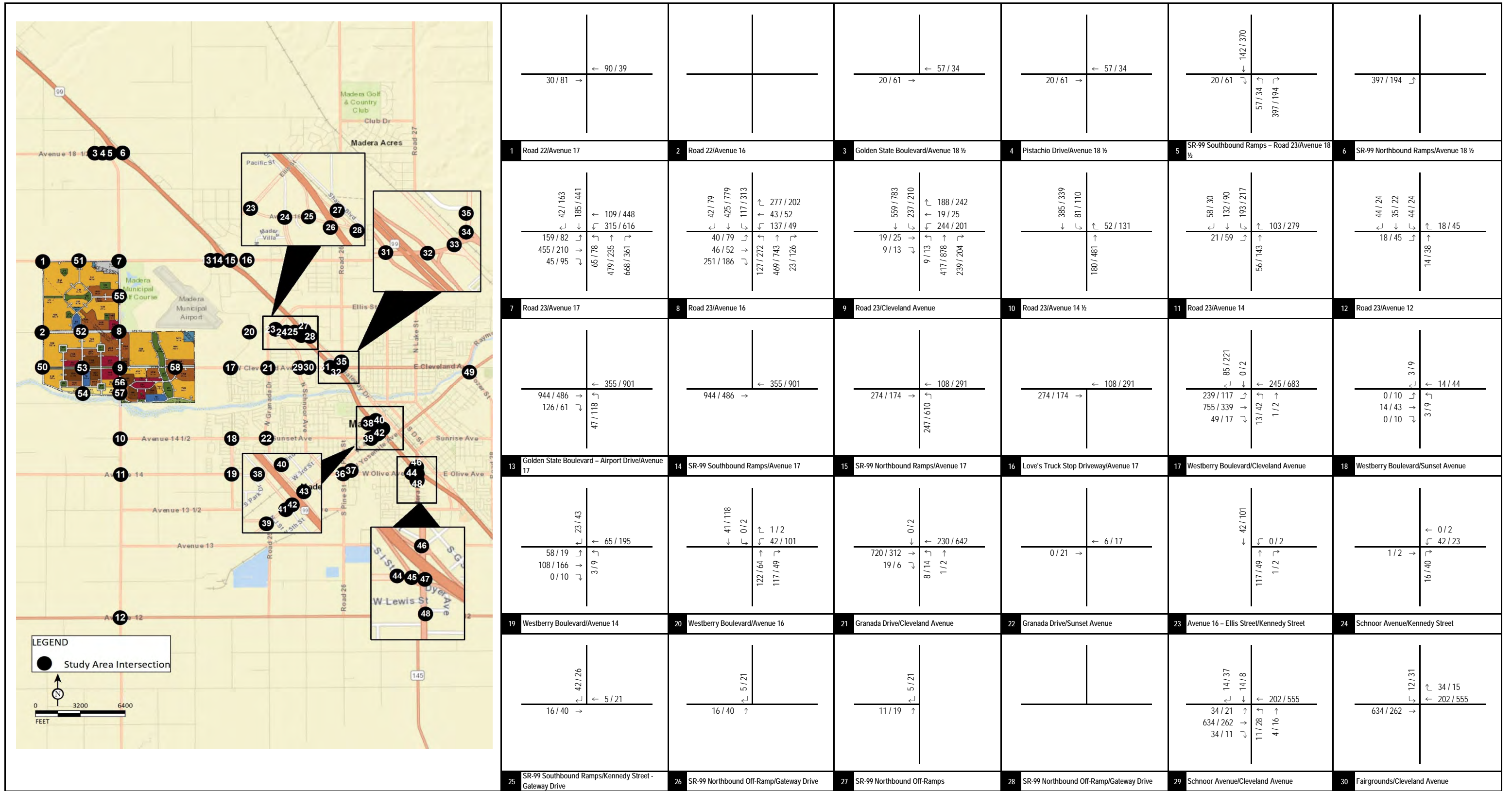
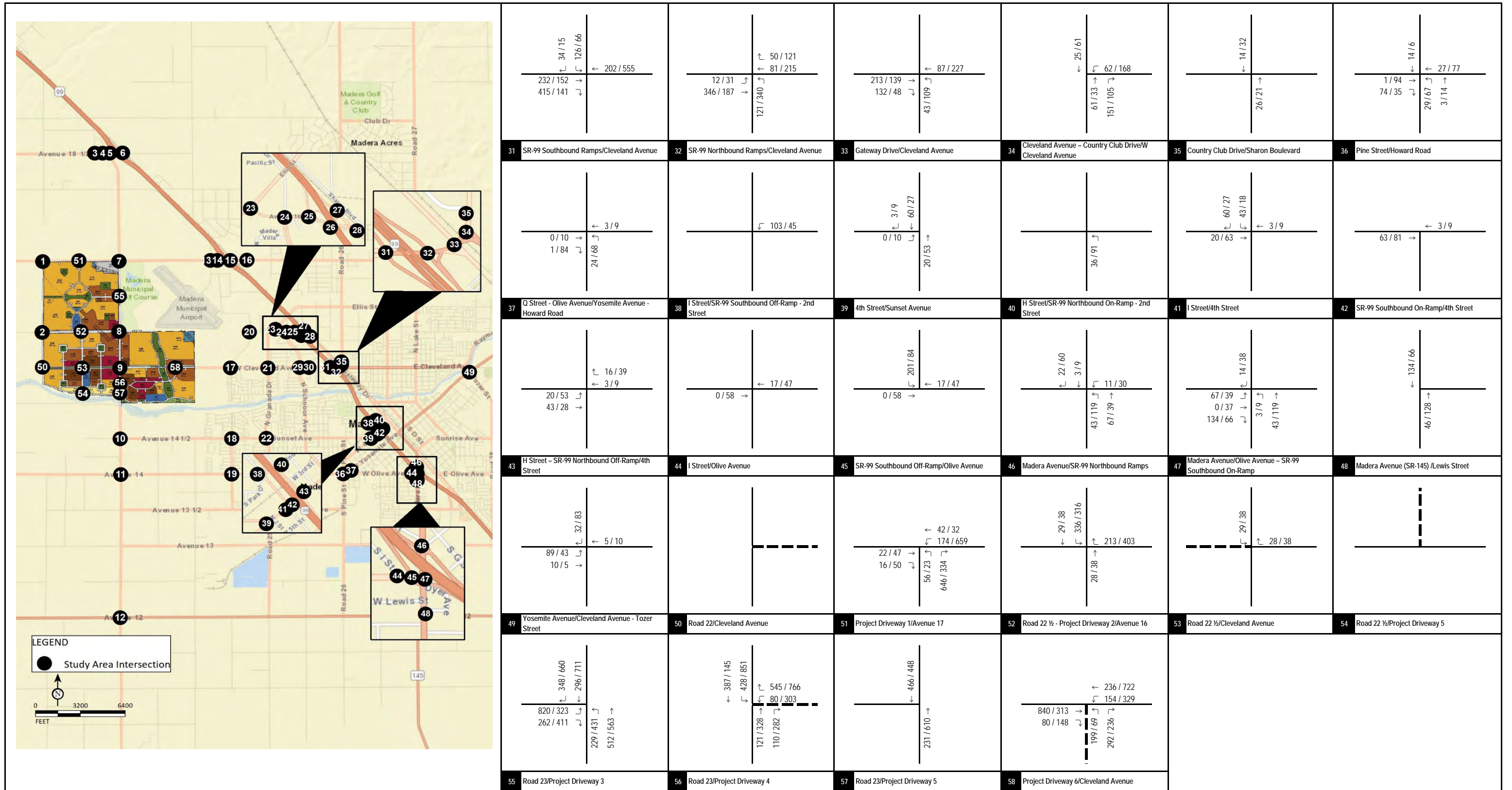

FIGURE 14A



XXX / YYY
AM / PM Peak Hour Traffic Volumes
-- Project Driveway

Village D Specific Plan
Traffic Impact Analysis
Phase II Project Trip Assignment (Int. 1-30)



LSA

XXX / YYY
AM / PM Peak Hour Traffic Volumes

--- Project Driveway

FIGURE 14B

Village D Specific Plan
Traffic Impact Analysis

Phase II Project Trip Assignment (Int. 31-58)

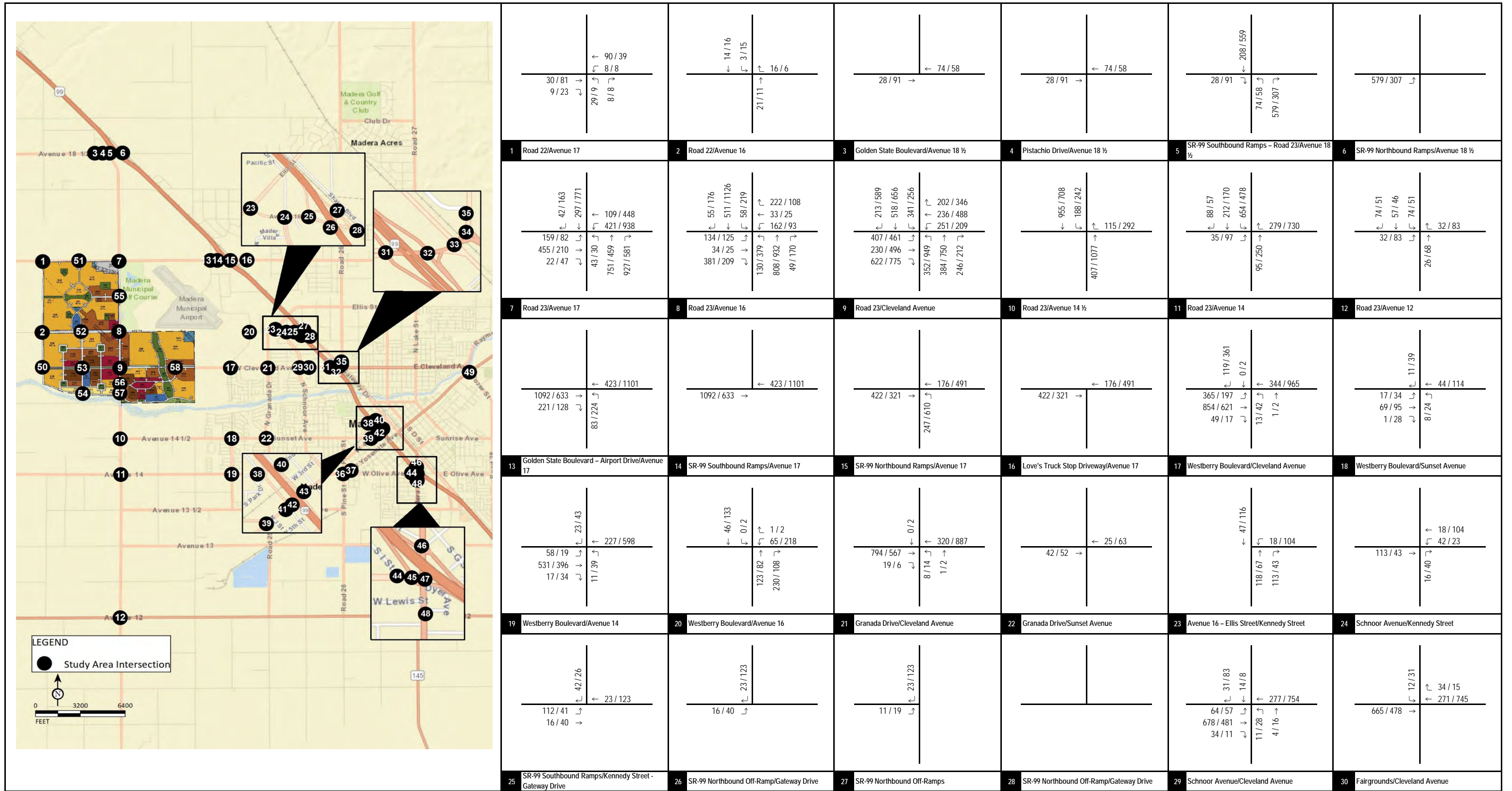

LSA

XXXX / YYYY
AM / PM Peak Hour Traffic Volumes

-- Project Driveway

FIGURE 15A

Village D Specific Plan
Traffic Impact Analysis

Phase III Project Trip Assignment (Int. 1-30)

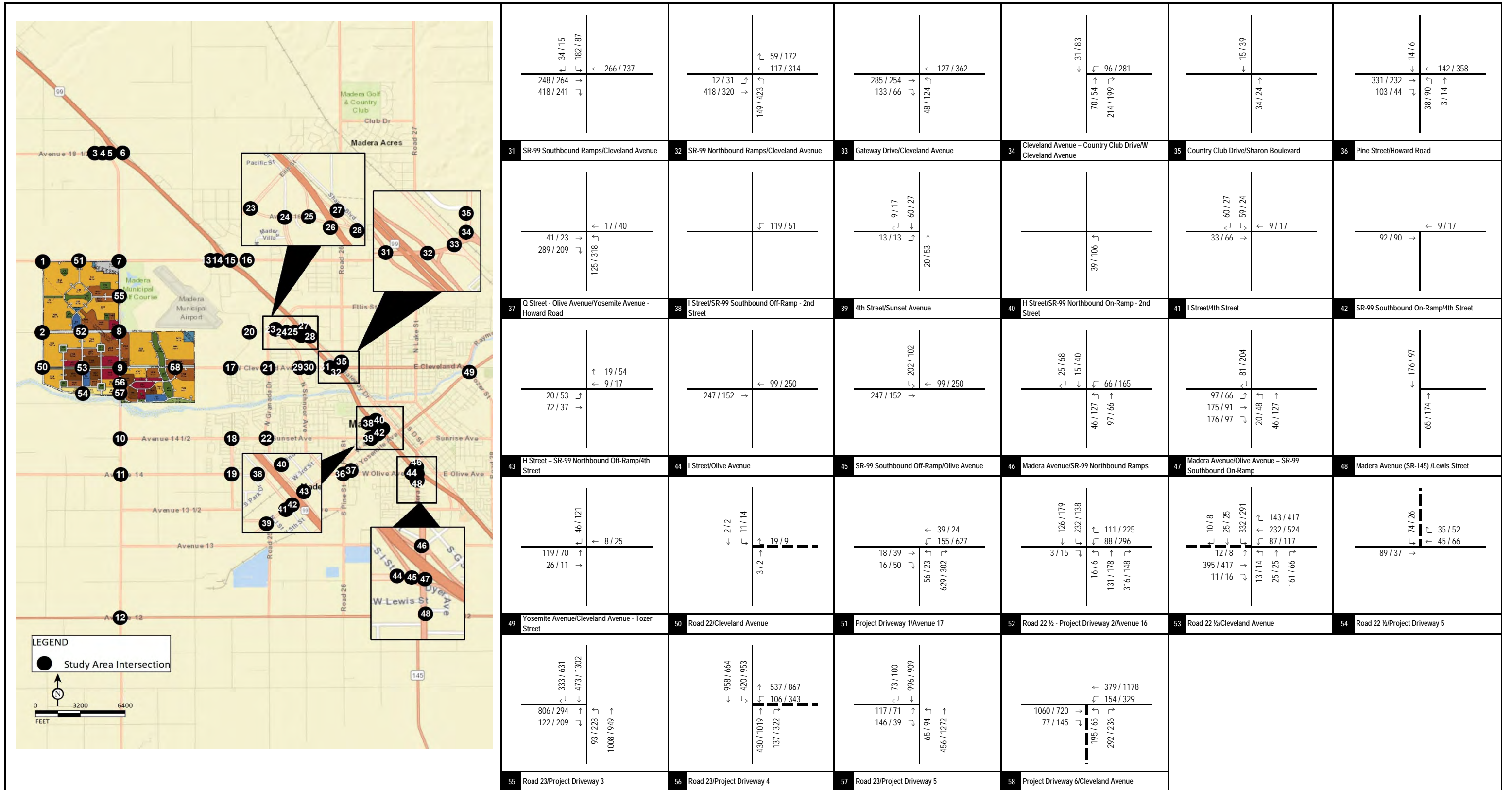

LSA

XXXX / YYYY
AM / PM Peak Hour Traffic Volumes

-- Project Driveway

FIGURE 15B

Village D Specific Plan
Traffic Impact Analysis

Phase III Project Trip Assignment (Int. 31-58)

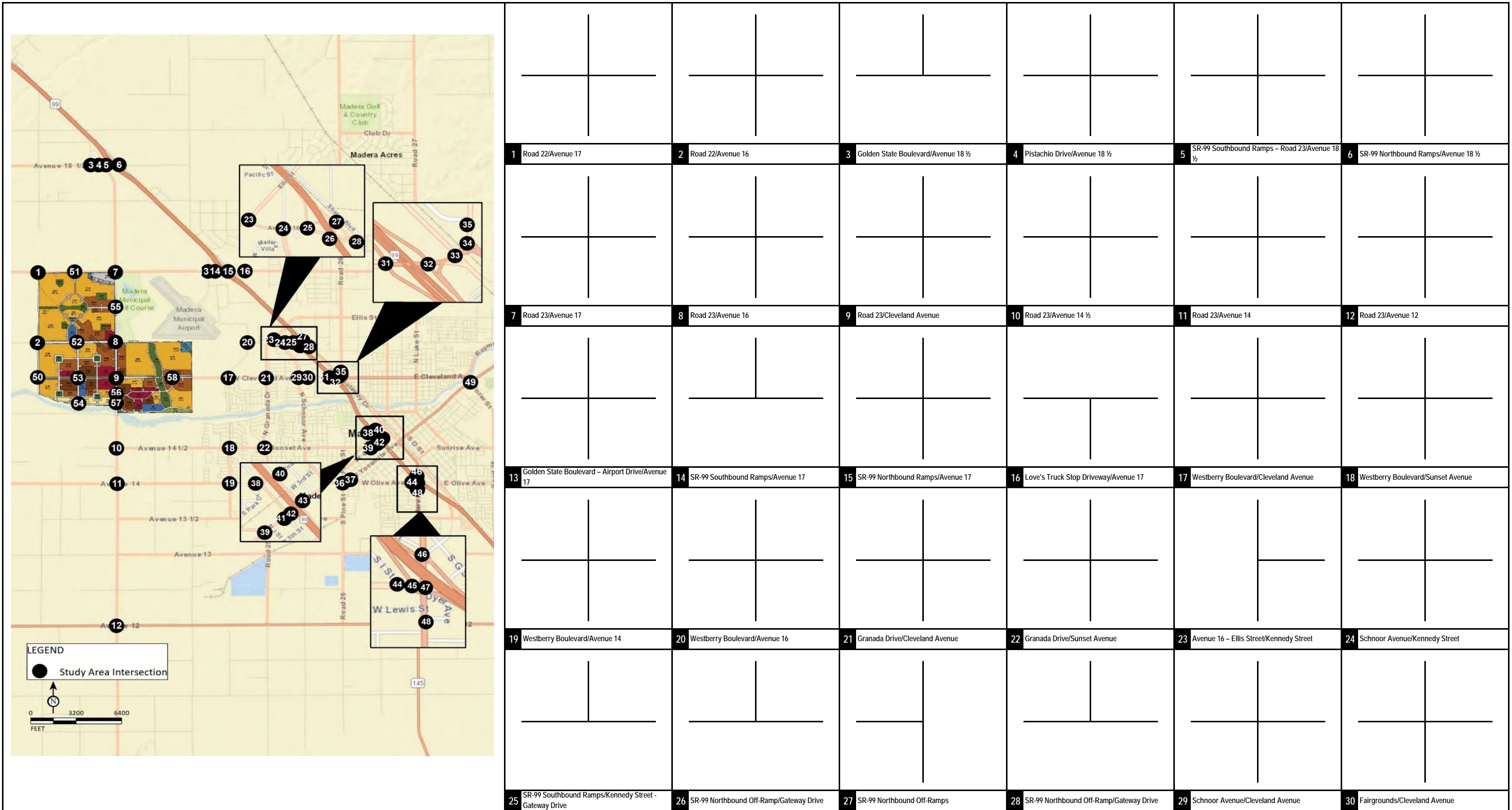

LSA

FIGURE 16A

XX / YY — - Future Project Driveway/Road
 AM / PM Peak Hour Traffic Volumes

Village D Specific Plan
 Traffic Impact Analysis

Phase I Project Internal Trip Assignment (Int. 1-30)

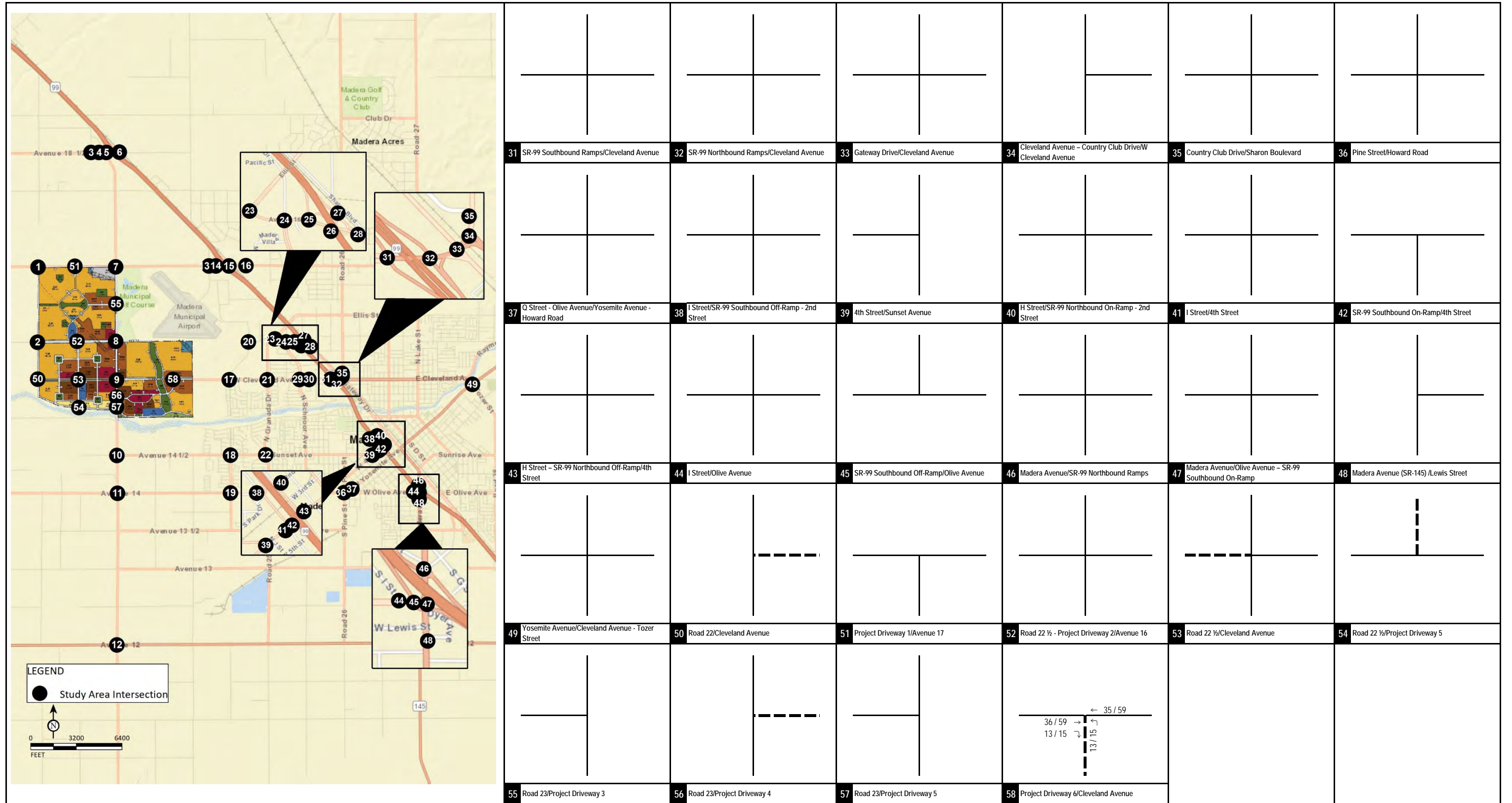

LSA

FIGURE 16B

XX / YY
AM / PM Peak Hour Traffic Volumes

-- Future Project Driveway/Road

Village D Specific Plan
Traffic Impact Analysis

Phase I Project Internal Trip Assignment (Int. 31-58)

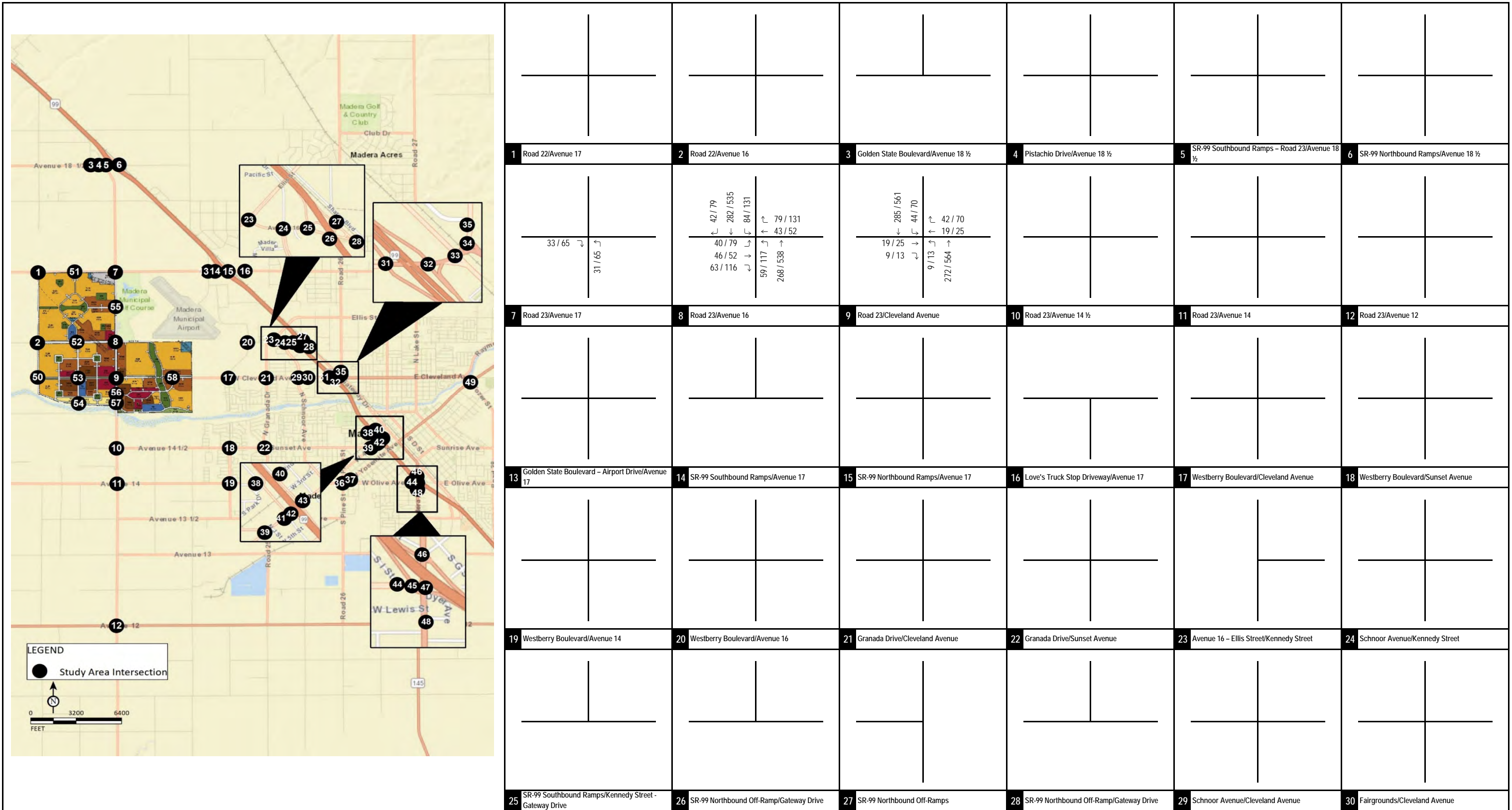

FIGURE 17A



XXX / YYY - - Future Project Driveway/Road
 AM / PM Peak Hour Traffic Volumes

Village D Specific Plan
 Traffic Impact Analysis

Phase II Project Internal Trip Assignment (Int. 1-30)

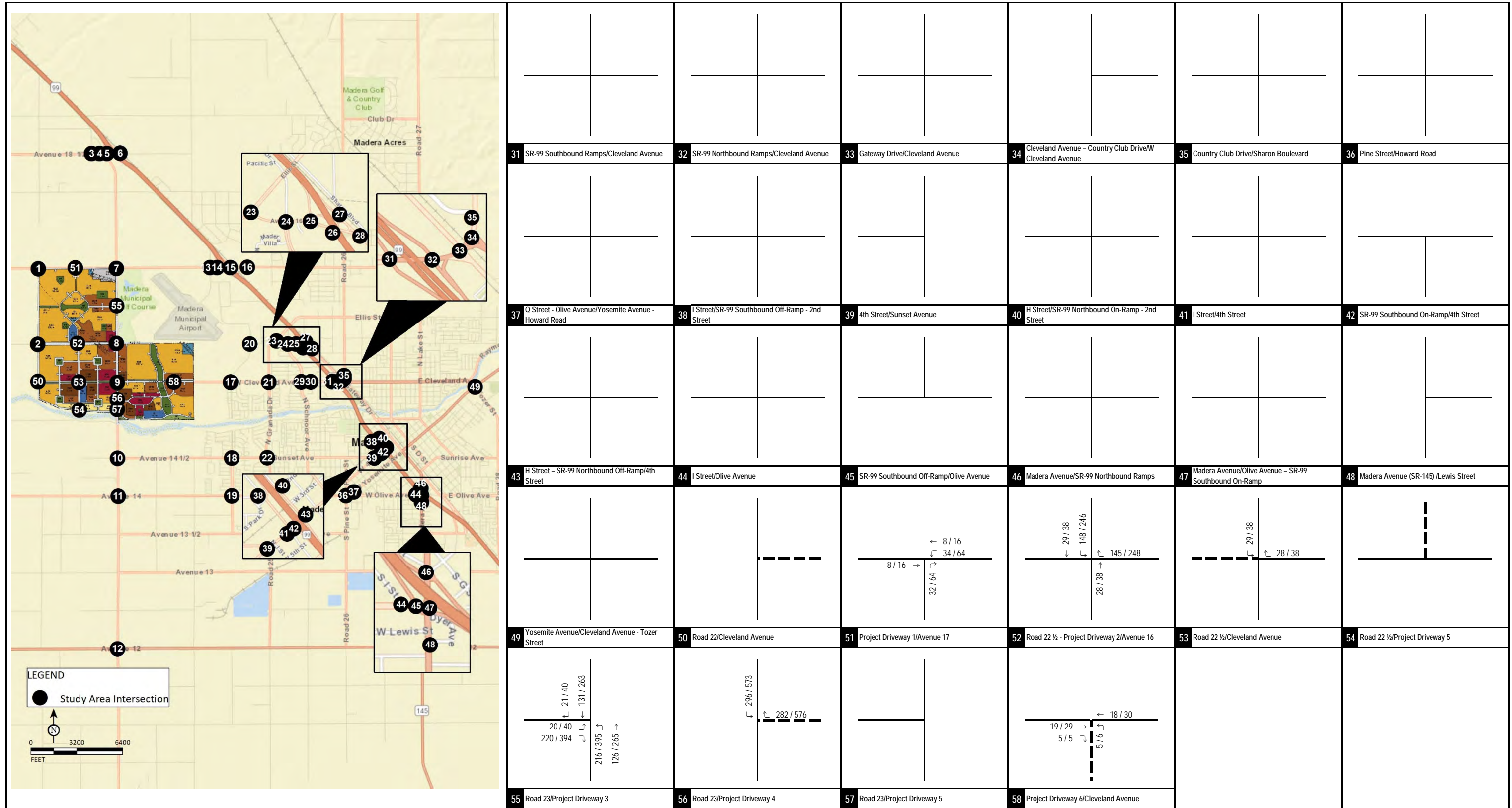

FIGURE 17B



XXX / YYY
 AM / PM Peak Hour Traffic Volumes

--- Future Project Driveway/Road

Village D Specific Plan
 Traffic Impact Analysis

Phase II Project Internal Trip Assignment (Int. 31-58)

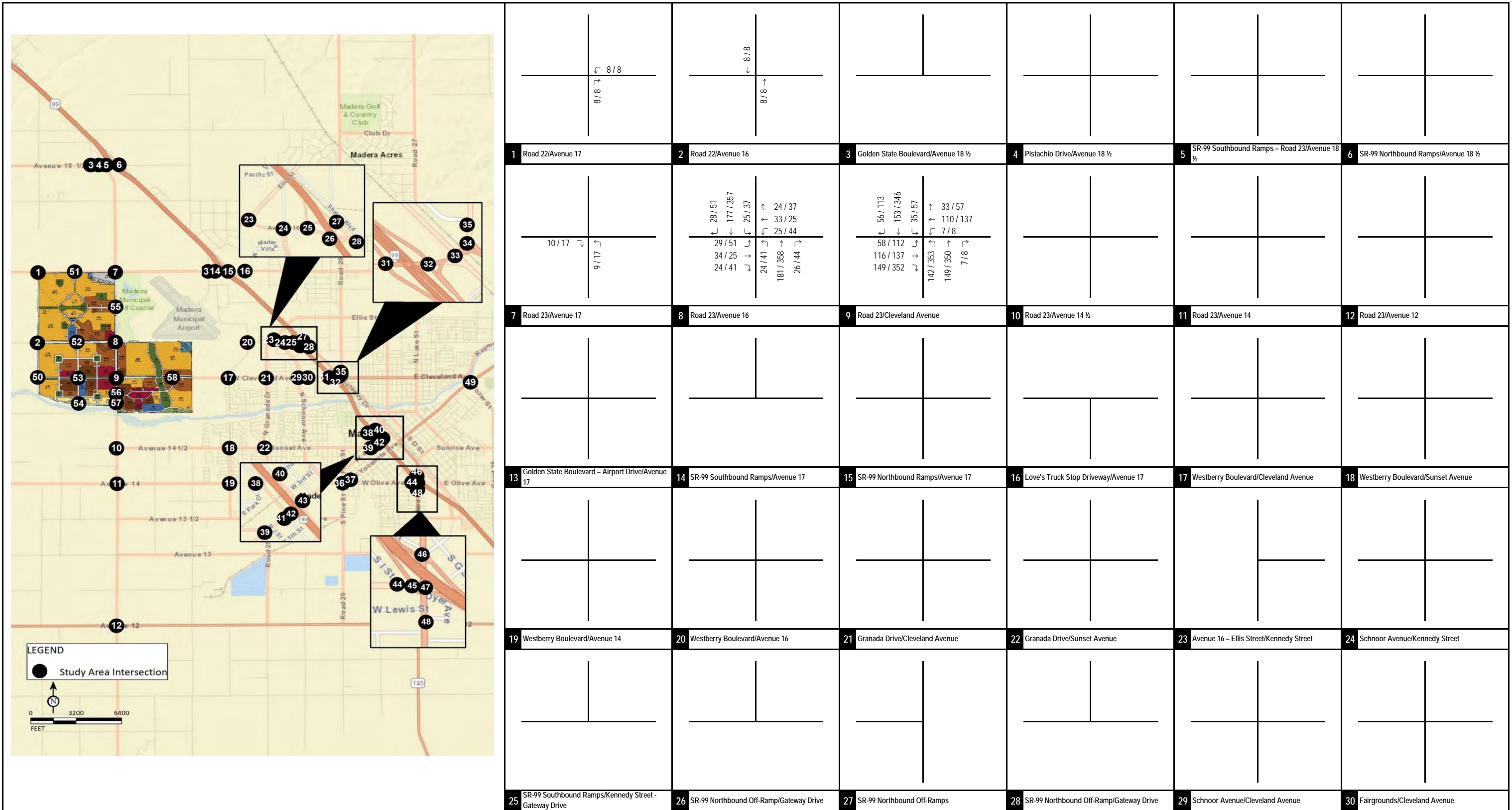

FIGURE 18A



XXX / YYY - - Future Project Driveway/Road
 AM / PM Peak Hour Traffic Volumes

Village D Specific Plan
 Traffic Impact Analysis

Phase III Project Internal Trip Assignment (Int. 1-30)

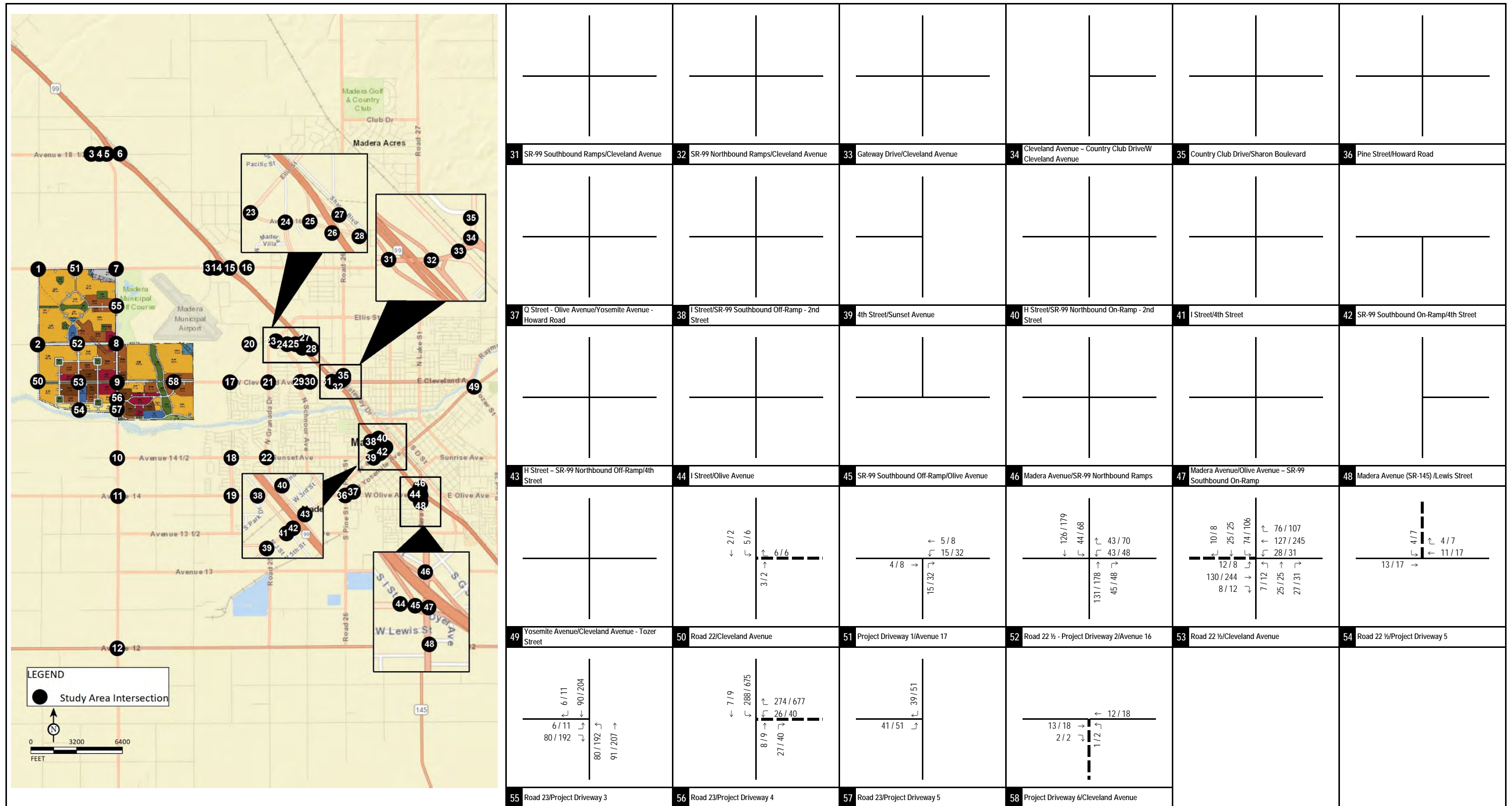

FIGURE 18B

LSA

XXX / YYY
 AM / PM Peak Hour Traffic Volumes

-- Future Project Driveway/Road

Village D Specific Plan
 Traffic Impact Analysis

Phase III Project Internal Trip Assignment (Int. 31-58)

APPENDIX B:

TRAFFIC COUNT SHEETS

City of Madera
 N/S: Road 22
 E/W: Avenue 17
 Weather: Clear

File Name : 01_MDA_Rd 22_Ave 17 AM
 Site Code : 00319628
 Start Date : 9/18/2019
 Page No : 1

Groups Printed- Total Volume

Start Time	Road 22 Southbound					Avenue 17 Westbound					Road 22 Northbound					Avenue 17 Eastbound					Int. Total
	Left	Thru	Right	U-Turns	App. Total	Left	Thru	Right	U-Turns	App. Total	Left	Thru	Right	U-Turns	App. Total	Left	Thru	Right	U-Turns	App. Total	
07:00 AM	0	0	0	0	0	1	2	0	0	3	0	0	1	0	1	0	5	0	0	5	9
07:15 AM	0	0	0	0	0	0	4	0	0	4	0	0	0	1	1	0	3	0	0	3	8
07:30 AM	0	0	0	0	0	0	9	0	0	9	0	0	1	0	1	0	4	0	0	4	14
07:45 AM	0	0	0	0	0	0	7	0	0	7	1	0	0	0	1	0	11	0	0	11	19
Total	0	0	0	0	0	1	22	0	0	23	1	0	2	1	4	0	23	0	0	23	50
08:00 AM	0	0	0	0	0	1	3	0	0	4	0	0	0	0	0	0	10	0	0	10	14
08:15 AM	0	0	0	0	0	1	4	0	0	5	0	0	1	0	1	0	5	0	0	5	11
08:30 AM	0	0	0	0	0	1	7	0	0	8	0	0	1	0	1	0	4	0	0	4	13
08:45 AM	0	0	0	0	0	1	2	0	0	3	1	0	1	0	2	0	6	0	0	6	11
Total	0	0	0	0	0	4	16	0	0	20	1	0	3	0	4	0	25	0	0	25	49
Grand Total	0	0	0	0	0	5	38	0	0	43	2	0	5	1	8	0	48	0	0	48	99
Apprch %	0	0	0	0		11.6	88.4	0	0		25	0	62.5	12.5		0	100	0	0		
Total %	0	0	0	0	0	5.1	38.4	0	0	43.4	2	0	5.1	1	8.1	0	48.5	0	0	48.5	

Start Time	Road 22 Southbound					Avenue 17 Westbound					Road 22 Northbound					Avenue 17 Eastbound					Int. Total
	Left	Thru	Right	U-Turns	App. Total	Thru	Right	U-Turns	App. Total	Thru	Right	U-Turns	App. Total	Thru	Right	U-Turns	App. Total				
Peak Hour Analysis From 07:00 AM to 08:45 AM - Peak 1 of 1																					
Peak Hour for Entire Intersection Begins at 07:30 AM																					
07:30 AM	0	0	0	0	0	0	9	0	0	9	0	0	1	0	1	0	4	0	0	4	14
07:45 AM	0	0	0	0	0	0	7	0	0	7	1	0	0	0	1	0	11	0	0	11	19
08:00 AM	0	0	0	0	0	1	3	0	0	4	0	0	0	0	0	0	10	0	0	10	14
08:15 AM	0	0	0	0	0	1	4	0	0	5	0	0	1	0	1	0	5	0	0	5	11
Total Volume	0	0	0	0	0	2	23	0	0	25	1	0	2	0	3	0	30	0	0	30	58
% App. Total	0	0	0	0		8	92	0	0		33.3	0	66.7	0		0	100	0	0		
PHF	.000	.000	.000	.000	.000	.500	.639	.000	.000	.694	.250	.000	.500	.000	.750	.000	.682	.000	.000	.682	.763

City of Madera
 N/S: Road 22
 E/W: Avenue 17
 Weather: Clear

File Name : 01_MDA_Rd 22_Ave 17 AM
 Site Code : 00319628
 Start Date : 9/18/2019
 Page No : 2

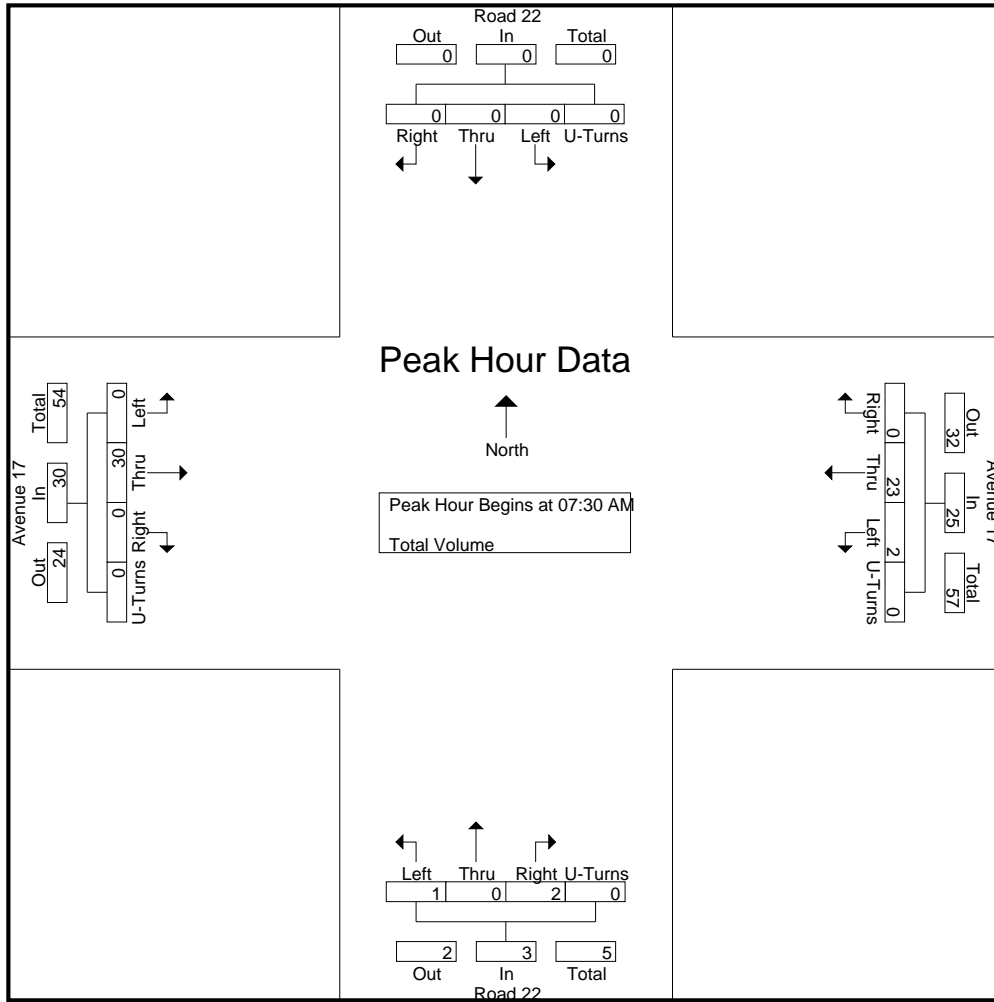

Peak Hour Analysis From 07:00 AM to 08:45 AM - Peak 1 of 1
 Peak Hour for Each Approach Begins at:

	07:00 AM					07:30 AM					07:00 AM					07:30 AM				
+0 mins.	0	0	0	0	0	0	9	0	0	9	0	0	1	0	1	0	4	0	0	4
+15 mins.	0	0	0	0	0	0	7	0	0	7	0	0	0	1	1	0	11	0	0	11
+30 mins.	0	0	0	0	0	1	3	0	0	4	0	0	1	0	1	0	10	0	0	10
+45 mins.	0	0	0	0	0	1	4	0	0	5	1	0	0	0	1	0	5	0	0	5
Total Volume	0	0	0	0	0	2	23	0	0	25	1	0	2	1	4	0	30	0	0	30
% App. Total	0	0	0	0	0	8	92	0	0	25	25	0	50	25	25	0	100	0	0	100
PHF	.000	.000	.000	.000	.000	.500	.639	.000	.000	.694	.250	.000	.500	.250	1.000	.000	.682	.000	.000	.682

City of Madera
 N/S: Road 22
 E/W: Avenue 17
 Weather: Clear

File Name : 01_MDA_Rd 22_Ave 17 PM
 Site Code : 00319628
 Start Date : 9/18/2019
 Page No : 1

Groups Printed- Total Volume

Start Time	Road 22 Southbound					Avenue 17 Westbound					Road 22 Northbound					Avenue 17 Eastbound					Int. Total
	Left	Thru	Right	U-Turns	App. Total	Left	Thru	Right	U-Turns	App. Total	Left	Thru	Right	U-Turns	App. Total	Left	Thru	Right	U-Turns	App. Total	
04:00 PM	0	0	0	0	0	0	6	0	0	6	0	0	0	0	0	0	18	0	0	18	24
04:15 PM	0	0	0	0	0	0	11	0	0	11	1	0	0	0	1	0	20	0	0	20	32
04:30 PM	0	0	0	0	0	0	3	0	0	3	0	0	0	0	0	0	8	0	0	8	11
04:45 PM	0	0	0	0	0	0	5	0	0	5	0	0	0	0	0	0	14	0	0	14	19
Total	0	0	0	0	0	0	25	0	0	25	1	0	0	0	1	0	60	0	0	60	86
05:00 PM	0	0	0	0	0	0	9	0	0	9	0	0	0	0	0	0	6	0	0	6	15
05:15 PM	0	0	0	0	0	0	14	0	0	14	0	0	0	0	0	0	6	0	0	6	20
05:30 PM	0	0	0	0	0	0	2	0	0	2	0	0	0	0	0	0	11	0	0	11	13
05:45 PM	0	0	0	0	0	0	3	0	0	3	0	0	0	0	0	0	10	0	0	10	13
Total	0	0	0	0	0	0	28	0	0	28	0	0	0	0	0	0	33	0	0	33	61
Grand Total	0	0	0	0	0	0	53	0	0	53	1	0	0	0	1	0	93	0	0	93	147
Apprch %	0	0	0	0	0	0	100	0	0	100	100	0	0	0	0	0	100	0	0	100	
Total %	0	0	0	0	0	0	36.1	0	0	36.1	0.7	0	0	0	0.7	0	63.3	0	0	63.3	

Start Time	Road 22 Southbound					Avenue 17 Westbound					Road 22 Northbound					Avenue 17 Eastbound					Int. Total
	Left	Thru	Right	U-Turns	App. Total	Thru	Right	U-Turns	App. Total	Thru	Right	U-Turns	App. Total	Thru	Right	U-Turns	App. Total				
Peak Hour Analysis From 04:00 PM to 05:45 PM - Peak 1 of 1																					
Peak Hour for Entire Intersection Begins at 04:00 PM																					
04:00 PM	0	0	0	0	0	0	6	0	0	6	0	0	0	0	0	0	18	0	0	18	24
04:15 PM	0	0	0	0	0	0	11	0	0	11	1	0	0	0	1	0	20	0	0	20	32
04:30 PM	0	0	0	0	0	0	3	0	0	3	0	0	0	0	0	0	8	0	0	8	11
04:45 PM	0	0	0	0	0	0	5	0	0	5	0	0	0	0	0	0	14	0	0	14	19
Total Volume	0	0	0	0	0	0	25	0	0	25	1	0	0	0	1	0	60	0	0	60	86
% App. Total	0	0	0	0	0	0	100	0	0	100	100	0	0	0	0	0	100	0	0	100	
PHF	.000	.000	.000	.000	.000	.000	.568	.000	.000	.568	.250	.000	.000	.000	.250	.000	.750	.000	.000	.750	.672

City of Madera
 N/S: Road 22
 E/W: Avenue 17
 Weather: Clear

File Name : 01_MDA_Rd 22_Ave 17 PM
 Site Code : 00319628
 Start Date : 9/18/2019
 Page No : 2

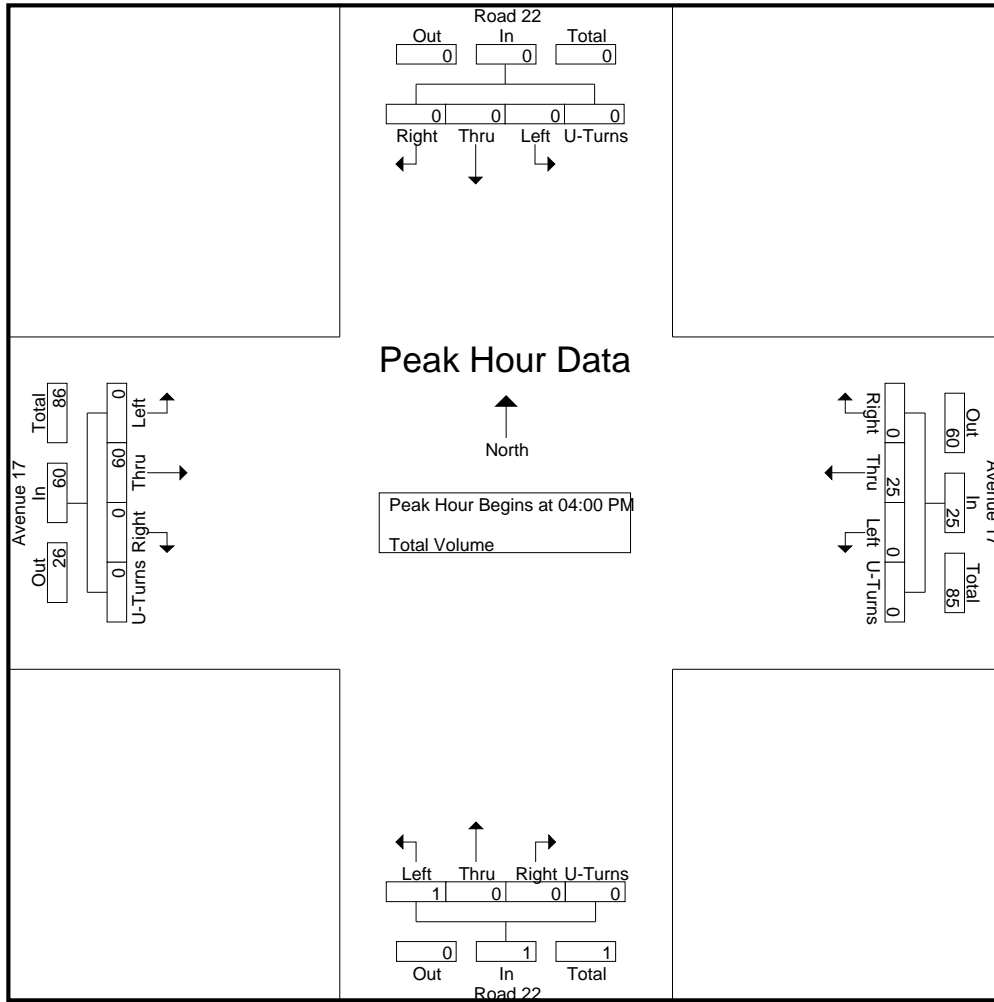

Peak Hour Analysis From 04:00 PM to 05:45 PM - Peak 1 of 1
 Peak Hour for Each Approach Begins at:

	04:00 PM					04:30 PM					04:00 PM					04:00 PM				
+0 mins.	0	0	0	0	0	0	3	0	0	3	0	0	0	0	0	0	18	0	0	18
+15 mins.	0	0	0	0	0	0	5	0	0	5	1	0	0	0	1	0	20	0	0	20
+30 mins.	0	0	0	0	0	0	9	0	0	9	0	0	0	0	0	0	8	0	0	8
+45 mins.	0	0	0	0	0	0	14	0	0	14	0	0	0	0	0	0	14	0	0	14
Total Volume	0	0	0	0	0	0	31	0	0	31	1	0	0	0	1	0	60	0	0	60
% App. Total	0	0	0	0	0	0	100	0	0	0	100	0	0	0	0	0	100	0	0	0
PHF	.000	.000	.000	.000	.000	.000	.554	.000	.000	.554	.250	.000	.000	.000	.250	.000	.750	.000	.000	.750

Location: Madera
 N/S: Road 22
 E/W: Avenue 17



Date: 9/18/2019
 Day: Wednesday

PEDESTRIANS

	North Leg Road 22	East Leg Avenue 17	South Leg Road 22	West Leg Avenue 17	
	Pedestrians	Pedestrians	Pedestrians	Pedestrians	
7:00 AM	0	0	0	0	0
7:15 AM	0	0	0	0	0
7:30 AM	0	0	0	0	0
7:45 AM	0	0	0	0	0
8:00 AM	0	0	0	0	0
8:15 AM	0	0	0	0	0
8:30 AM	0	0	0	0	0
8:45 AM	0	0	0	0	0
TOTAL VOLUMES:	0	0	0	0	0

	North Leg Road 22	East Leg Avenue 17	South Leg Road 22	West Leg Avenue 17	
	Pedestrians	Pedestrians	Pedestrians	Pedestrians	
4:00 PM	0	0	0	0	0
4:15 PM	0	0	0	0	0
4:30 PM	0	0	0	0	0
4:45 PM	0	0	0	0	0
5:00 PM	0	0	0	0	0
5:15 PM	0	0	0	0	0
5:30 PM	0	0	0	0	0
5:45 PM	0	0	0	0	0
TOTAL VOLUMES:	0	0	0	0	0

Location: Madera
 N/S: Road 22
 E/W: Avenue 17



Date: 9/18/2019
 Day: Wednesday

BICYCLES

	Southbound Road 22			Westbound Avenue 17			Northbound Road 22			Eastbound Avenue 17			
	Left	Thru	Right	Left	Thru	Right	Left	Thru	Right	Left	Thru	Right	
7:00 AM	0	0	0	0	0	0	0	0	0	0	0	0	0
7:15 AM	0	0	0	0	0	0	0	0	0	0	0	0	0
7:30 AM	0	0	0	0	0	0	0	0	0	0	0	0	0
7:45 AM	0	0	0	0	0	0	0	0	0	0	0	0	0
8:00 AM	0	0	0	0	0	0	0	0	0	0	0	0	0
8:15 AM	0	0	0	0	0	0	0	0	0	0	0	0	0
8:30 AM	0	0	0	0	0	0	0	0	0	0	0	0	0
8:45 AM	0	0	0	0	0	0	0	0	0	0	0	0	0
TOTAL VOLUMES:	0	0	0	0	0	0	0	0	0	0	0	0	0

	Southbound Road 22			Westbound Avenue 17			Northbound Road 22			Eastbound Avenue 17			
	Left	Thru	Right	Left	Thru	Right	Left	Thru	Right	Left	Thru	Right	
4:00 PM	0	0	0	0	0	0	0	0	0	0	0	0	0
4:15 PM	0	0	0	0	0	0	0	0	0	0	0	0	0
4:30 PM	0	0	0	0	0	0	0	0	0	0	0	0	0
4:45 PM	0	0	0	0	0	0	0	0	0	0	0	0	0
5:00 PM	0	0	0	0	0	0	0	0	0	0	0	0	0
5:15 PM	0	0	0	0	0	0	0	0	0	0	0	0	0
5:30 PM	0	0	0	0	0	0	0	0	0	0	0	0	0
5:45 PM	0	0	0	0	0	0	0	0	0	0	0	0	0
TOTAL VOLUMES:	0	0	0	0	0	0	0	0	0	0	0	0	0

City of Madera
 N/S: Road 22
 E/W: Avenue 16
 Weather: Clear

File Name : 02_MDA_Rd 22_Ave 16 AM
 Site Code : 00319628
 Start Date : 9/18/2019
 Page No : 1

Groups Printed- Total Volume

Start Time	Road 22 Southbound					Avenue 16 Westbound					Road 22 Northbound					Avenue 16 Eastbound					Int. Total
	Left	Thru	Right	U-Turns	App. Total	Left	Thru	Right	U-Turns	App. Total	Left	Thru	Right	U-Turns	App. Total	Left	Thru	Right	U-Turns	App. Total	
07:00 AM	0	0	0	0	0	0	5	0	0	5	0	0	0	0	0	0	1	0	0	1	6
07:15 AM	0	0	0	0	0	0	7	0	0	7	0	0	0	0	0	0	2	0	0	2	9
07:30 AM	0	0	0	0	0	0	9	0	0	9	0	0	0	0	0	1	2	0	0	3	12
07:45 AM	1	0	0	0	1	0	8	3	0	11	0	0	0	0	0	0	3	0	0	3	15
Total	1	0	0	0	1	0	29	3	0	32	0	0	0	0	0	1	8	0	0	9	42
08:00 AM	1	0	1	0	2	0	5	1	0	6	0	0	0	0	0	1	5	0	0	6	14
08:15 AM	1	0	0	0	1	0	4	0	0	4	0	0	0	0	0	0	1	0	0	1	6
08:30 AM	0	0	1	0	1	0	2	2	0	4	0	0	0	0	0	2	4	0	0	6	11
08:45 AM	2	0	0	0	2	0	4	1	0	5	0	0	0	0	0	0	3	0	0	3	10
Total	4	0	2	0	6	0	15	4	0	19	0	0	0	0	0	3	13	0	0	16	41
Grand Total	5	0	2	0	7	0	44	7	0	51	0	0	0	0	0	4	21	0	0	25	83
Apprch %	71.4	0	28.6	0		0	86.3	13.7	0		0	0	0	0		16	84	0	0		
Total %	6	0	2.4	0	8.4	0	53	8.4	0	61.4	0	0	0	0	0	4.8	25.3	0	0	30.1	

Start Time	Road 22 Southbound					Avenue 16 Westbound					Road 22 Northbound					Avenue 16 Eastbound					Int. Total
	Left	Thru	Right	U-Turns	App. Total	Thru	Right	U-Turns	App. Total	Thru	Right	U-Turns	App. Total	Thru	Right	U-Turns	App. Total				
Peak Hour Analysis From 07:00 AM to 08:45 AM - Peak 1 of 1																					
Peak Hour for Entire Intersection Begins at 07:15 AM																					
07:15 AM	0	0	0	0	0	0	7	0	0	7	0	0	0	0	0	0	2	0	0	2	9
07:30 AM	0	0	0	0	0	0	9	0	0	9	0	0	0	0	0	1	2	0	0	3	12
07:45 AM	1	0	0	0	1	0	8	3	0	11	0	0	0	0	0	0	3	0	0	3	15
08:00 AM	1	0	1	0	2	0	5	1	0	6	0	0	0	0	0	1	5	0	0	6	14
Total Volume	2	0	1	0	3	0	29	4	0	33	0	0	0	0	0	2	12	0	0	14	50
% App. Total	66.7	0	33.3	0		0	87.9	12.1	0		0	0	0	0		14.3	85.7	0	0		
PHF	.500	.000	.250	.000	.375	.000	.806	.333	.000	.750	.000	.000	.000	.000	.000	.500	.600	.000	.000	.583	.833

City of Madera
 N/S: Road 22
 E/W: Avenue 16
 Weather: Clear

File Name : 02_MDA_Rd 22_Ave 16 AM
 Site Code : 00319628
 Start Date : 9/18/2019
 Page No : 2

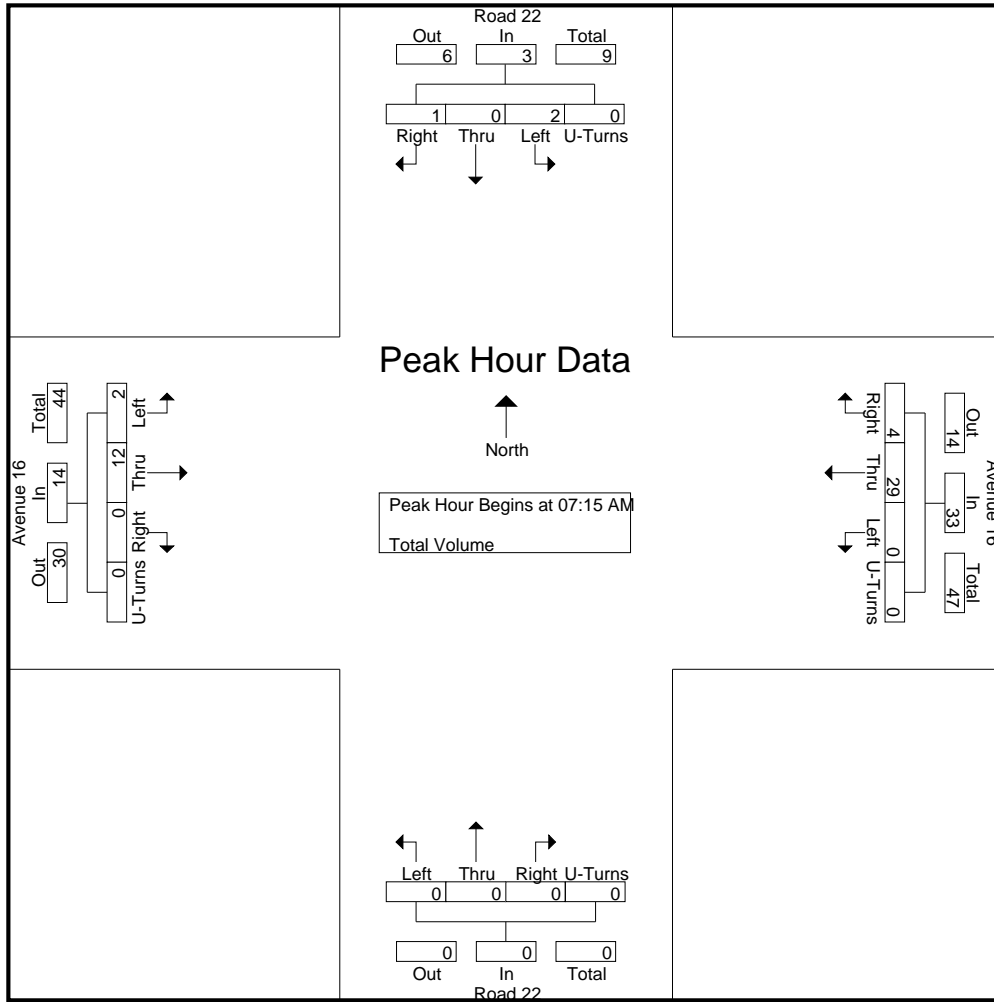

Peak Hour Analysis From 07:00 AM to 08:45 AM - Peak 1 of 1
 Peak Hour for Each Approach Begins at:

	08:00 AM					07:15 AM					07:00 AM					07:45 AM				
+0 mins.	1	0	1	0	2	0	7	0	0	7	0	0	0	0	0	0	3	0	0	3
+15 mins.	1	0	0	0	1	0	9	0	0	9	0	0	0	0	0	1	5	0	0	6
+30 mins.	0	0	1	0	1	0	8	3	0	11	0	0	0	0	0	0	1	0	0	1
+45 mins.	2	0	0	0	2	0	5	1	0	6	0	0	0	0	0	2	4	0	0	6
Total Volume	4	0	2	0	6	0	29	4	0	33	0	0	0	0	0	3	13	0	0	16
% App. Total	66.7	0	33.3	0		0	87.9	12.1	0		0	0	0	0	0	18.8	81.2	0	0	
PHF	.500	.000	.500	.000	.750	.000	.806	.333	.000	.750	.000	.000	.000	.000	.000	.375	.650	.000	.000	.667

City of Madera
 N/S: Road 22
 E/W: Avenue 16
 Weather: Clear

File Name : 02_MDA_Rd 22_Ave 16 PM
 Site Code : 00319628
 Start Date : 9/18/2019
 Page No : 1

Groups Printed- Total Volume

Start Time	Road 22 Southbound					Avenue 16 Westbound					Road 22 Northbound					Avenue 16 Eastbound					Int. Total
	Left	Thru	Right	U-Turns	App. Total	Left	Thru	Right	U-Turns	App. Total	Left	Thru	Right	U-Turns	App. Total	Left	Thru	Right	U-Turns	App. Total	
04:00 PM	0	0	0	0	0	0	2	0	0	2	0	0	0	0	0	0	3	0	0	3	5
04:15 PM	0	0	0	0	0	0	2	0	0	2	0	0	1	0	1	0	18	0	0	18	21
04:30 PM	0	0	0	0	0	0	4	0	0	4	0	0	0	0	0	0	6	0	0	6	10
04:45 PM	0	0	0	0	0	0	3	0	0	3	0	0	0	0	0	0	6	0	0	6	9
Total	0	0	0	0	0	0	11	0	0	11	0	0	1	0	1	0	33	0	0	33	45
05:00 PM	0	0	0	0	0	0	2	0	0	2	0	0	0	0	0	0	3	0	0	3	5
05:15 PM	0	0	0	0	0	0	6	0	0	6	0	0	0	0	0	0	1	0	0	1	7
05:30 PM	0	0	0	0	0	0	3	0	0	3	0	0	0	0	0	0	11	0	0	11	14
05:45 PM	0	0	0	0	0	0	5	0	0	5	0	0	0	0	0	0	5	0	0	5	10
Total	0	0	0	0	0	0	16	0	0	16	0	0	0	0	0	0	20	0	0	20	36
Grand Total	0	0	0	0	0	0	27	0	0	27	0	0	1	0	1	0	53	0	0	53	81
Apprch %	0	0	0	0	0	0	100	0	0	100	0	0	100	0	100	0	100	0	0	100	
Total %	0	0	0	0	0	0	33.3	0	0	33.3	0	0	1.2	0	1.2	0	65.4	0	0	65.4	

Start Time	Road 22 Southbound					Avenue 16 Westbound					Road 22 Northbound					Avenue 16 Eastbound					Int. Total
	Left	Thru	Right	U-Turns	App. Total	Thru	Right	U-Turns	App. Total	Thru	Right	U-Turns	App. Total	Thru	Right	U-Turns	App. Total				
Peak Hour Analysis From 04:00 PM to 05:45 PM - Peak 1 of 1																					
Peak Hour for Entire Intersection Begins at 04:00 PM																					
04:00 PM	0	0	0	0	0	0	2	0	0	2	0	0	0	0	0	0	3	0	0	3	5
04:15 PM	0	0	0	0	0	0	2	0	0	2	0	0	1	0	1	0	18	0	0	18	21
04:30 PM	0	0	0	0	0	0	4	0	0	4	0	0	0	0	0	0	6	0	0	6	10
04:45 PM	0	0	0	0	0	0	3	0	0	3	0	0	0	0	0	0	6	0	0	6	9
Total Volume	0	0	0	0	0	0	11	0	0	11	0	0	1	0	1	0	33	0	0	33	45
% App. Total	0	0	0	0	0	0	100	0	0	100	0	0	100	0	100	0	100	0	0	100	
PHF	.000	.000	.000	.000	.000	.000	.688	.000	.000	.688	.000	.000	.250	.000	.250	.000	.458	.000	.000	.458	.536

City of Madera
 N/S: Road 22
 E/W: Avenue 16
 Weather: Clear

File Name : 02_MDA_Rd 22_Ave 16 PM
 Site Code : 00319628
 Start Date : 9/18/2019
 Page No : 2

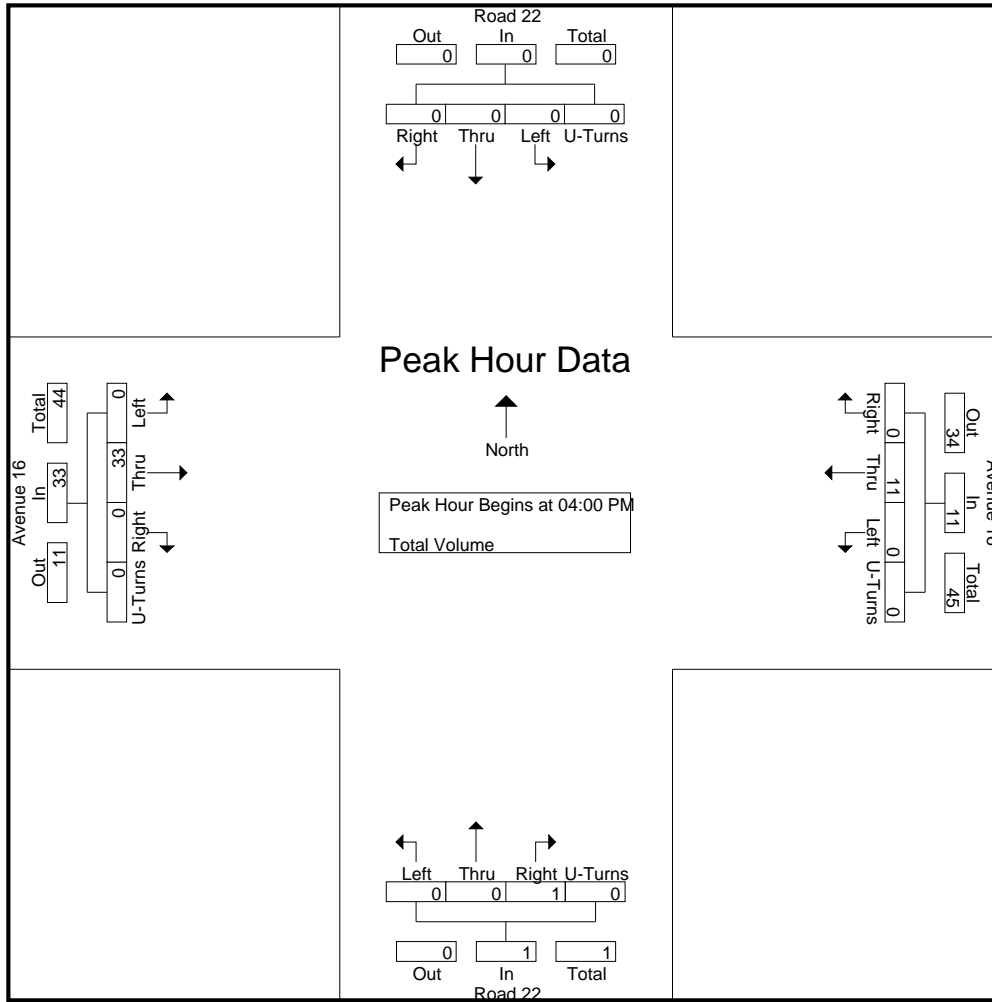

Peak Hour Analysis From 04:00 PM to 05:45 PM - Peak 1 of 1
 Peak Hour for Each Approach Begins at:

	04:00 PM					05:00 PM					04:00 PM					04:00 PM				
+0 mins.	0	0	0	0	0	0	2	0	0	2	0	0	0	0	0	0	3	0	0	3
+15 mins.	0	0	0	0	0	0	6	0	0	6	0	0	1	0	1	0	18	0	0	18
+30 mins.	0	0	0	0	0	0	3	0	0	3	0	0	0	0	0	0	6	0	0	6
+45 mins.	0	0	0	0	0	0	5	0	0	5	0	0	0	0	0	0	6	0	0	6
Total Volume	0	0	0	0	0	0	16	0	0	16	0	0	1	0	1	0	33	0	0	33
% App. Total	0	0	0	0	0	0	100	0	0	100	0	0	100	0	0	0	100	0	0	100
PHF	.000	.000	.000	.000	.000	.000	.667	.000	.000	.667	.000	.000	.250	.000	.250	.000	.458	.000	.000	.458

Location: Madera
 N/S: Road 22
 E/W: Avenue 16



Date: 9/18/2019
 Day: Wednesday

PEDESTRIANS

	North Leg Road 22	East Leg Avenue 16	South Leg Road 22	West Leg Avenue 16	
	Pedestrians	Pedestrians	Pedestrians	Pedestrians	
7:00 AM	0	0	0	0	0
7:15 AM	1	0	0	0	1
7:30 AM	0	0	0	0	0
7:45 AM	0	0	0	0	0
8:00 AM	0	0	0	0	0
8:15 AM	0	0	0	0	0
8:30 AM	0	0	0	0	0
8:45 AM	0	0	0	0	0
TOTAL VOLUMES:	1	0	0	0	1

	North Leg Road 22	East Leg Avenue 16	South Leg Road 22	West Leg Avenue 16	
	Pedestrians	Pedestrians	Pedestrians	Pedestrians	
4:00 PM	0	0	0	0	0
4:15 PM	0	0	0	0	0
4:30 PM	0	0	0	0	0
4:45 PM	0	0	0	0	0
5:00 PM	0	0	0	0	0
5:15 PM	0	0	0	0	0
5:30 PM	0	0	0	0	0
5:45 PM	0	0	0	0	0
TOTAL VOLUMES:	0	0	0	0	0

Location: Madera
 N/S: Road 22
 E/W: Avenue 16



Date: 9/18/2019
 Day: Wednesday

BICYCLES

	Southbound Road 22			Westbound Avenue 16			Northbound Road 22			Eastbound Avenue 16			
	Left	Thru	Right	Left	Thru	Right	Left	Thru	Right	Left	Thru	Right	
7:00 AM	0	0	0	0	0	0	0	0	0	0	0	0	0
7:15 AM	0	0	0	0	0	0	0	0	0	0	0	0	0
7:30 AM	0	0	0	0	0	0	0	0	0	0	0	0	0
7:45 AM	0	0	0	0	0	0	0	0	0	0	0	0	0
8:00 AM	0	0	0	0	0	0	0	0	0	0	0	0	0
8:15 AM	0	0	0	0	0	0	0	0	0	0	0	0	0
8:30 AM	0	0	0	0	0	0	0	0	0	0	0	0	0
8:45 AM	0	0	0	0	0	0	0	0	0	0	0	0	0
TOTAL VOLUMES:	0	0	0	0	0	0	0	0	0	0	0	0	0

	Southbound Road 22			Westbound Avenue 16			Northbound Road 22			Eastbound Avenue 16			
	Left	Thru	Right	Left	Thru	Right	Left	Thru	Right	Left	Thru	Right	
4:00 PM	0	0	0	0	0	0	0	0	0	0	0	0	0
4:15 PM	0	0	0	0	0	0	0	0	0	0	0	0	0
4:30 PM	0	0	0	0	0	0	0	0	0	0	0	0	0
4:45 PM	0	0	0	0	0	0	0	0	0	0	0	0	0
5:00 PM	0	0	0	0	0	0	0	0	0	0	0	0	0
5:15 PM	0	0	0	0	0	0	0	0	0	0	0	0	0
5:30 PM	0	0	0	0	0	0	0	0	0	0	0	0	0
5:45 PM	0	0	0	0	0	0	0	0	0	0	0	0	0
TOTAL VOLUMES:	0	0	0	0	0	0	0	0	0	0	0	0	0

City of Madera
 N/S: Golden State Boulevard
 E/W: Avenue 18 1/2
 Weather: Clear

File Name : 49_MDA_Golden State_Ave 18 1-2 AM
 Site Code : 00319628
 Start Date : 9/26/2019
 Page No : 1

Groups Printed- Passenger Vehicles - Large 2 Axle Vehicles - 3 Axle Vehicles - 4+ Axle Trucks

Start Time	Golden State Boulevard Southbound				Avenue 18 1/2 Westbound				Avenue 18 1/2 Eastbound				Int. Total
	Left	Right	U-Turns	App. Total	Thru	Right	U-Turns	App. Total	Left	Thru	U-Turns	App. Total	
07:00 AM	25	0	0	25	19	17	0	36	0	15	0	15	76
07:15 AM	23	0	0	23	15	26	0	41	1	12	0	13	77
07:30 AM	27	1	0	28	28	28	0	56	0	15	0	15	99
07:45 AM	26	2	0	28	31	23	0	54	1	25	0	26	108
Total	101	3	0	104	93	94	0	187	2	67	0	69	360
08:00 AM	20	1	0	21	15	28	0	43	1	34	0	35	99
08:15 AM	19	0	0	19	22	27	0	49	0	24	0	24	92
08:30 AM	30	1	0	31	9	30	0	39	0	15	0	15	85
08:45 AM	24	2	0	26	13	31	0	44	0	13	0	13	83
Total	93	4	0	97	59	116	0	175	1	86	0	87	359
Grand Total	194	7	0	201	152	210	0	362	3	153	0	156	719
Apprch %	96.5	3.5	0		42	58	0		1.9	98.1	0		
Total %	27	1	0	28	21.1	29.2	0	50.3	0.4	21.3	0	21.7	
Passenger Vehicles	35	1	0	36	126	36	0	162	1	132	0	133	331
% Passenger Vehicles	18	14.3	0	17.9	82.9	17.1	0	44.8	33.3	86.3	0	85.3	46
Large 2 Axle Vehicles	5	2	0	7	11	7	0	18	1	7	0	8	33
% Large 2 Axle Vehicles	2.6	28.6	0	3.5	7.2	3.3	0	5	33.3	4.6	0	5.1	4.6
3 Axle Vehicles	9	1	0	10	1	16	0	17	0	4	0	4	31
% 3 Axle Vehicles	4.6	14.3	0	5	0.7	7.6	0	4.7	0	2.6	0	2.6	4.3
4+ Axle Trucks	145	3	0	148	14	151	0	165	1	10	0	11	324
% 4+ Axle Trucks	74.7	42.9	0	73.6	9.2	71.9	0	45.6	33.3	6.5	0	7.1	45.1

Start Time	Golden State Boulevard Southbound				Avenue 18 1/2 Westbound				Avenue 18 1/2 Eastbound				Int. Total
	Left	Right	U-Turns	App. Total	Thru	Right	U-Turns	App. Total	Left	Thru	U-Turns	App. Total	
Peak Hour Analysis From 07:00 AM to 08:45 AM - Peak 1 of 1													
Peak Hour for Entire Intersection Begins at 07:30 AM													
07:30 AM	27	1	0	28	28	28	0	56	0	15	0	15	99
07:45 AM	26	2	0	28	31	23	0	54	1	25	0	26	108
08:00 AM	20	1	0	21	15	28	0	43	1	34	0	35	99
08:15 AM	19	0	0	19	22	27	0	49	0	24	0	24	92
Total Volume	92	4	0	96	96	106	0	202	2	98	0	100	398
% App. Total	95.8	4.2	0		47.5	52.5	0		2	98	0		
PHF	.852	.500	.000	.857	.774	.946	.000	.902	.500	.721	.000	.714	.921

City of Madera
 N/S: Golden State Boulevard
 E/W: Avenue 18 1/2
 Weather: Clear

File Name : 49_MDA_Golden State_Ave 18 1-2 AM
 Site Code : 00319628
 Start Date : 9/26/2019
 Page No : 2

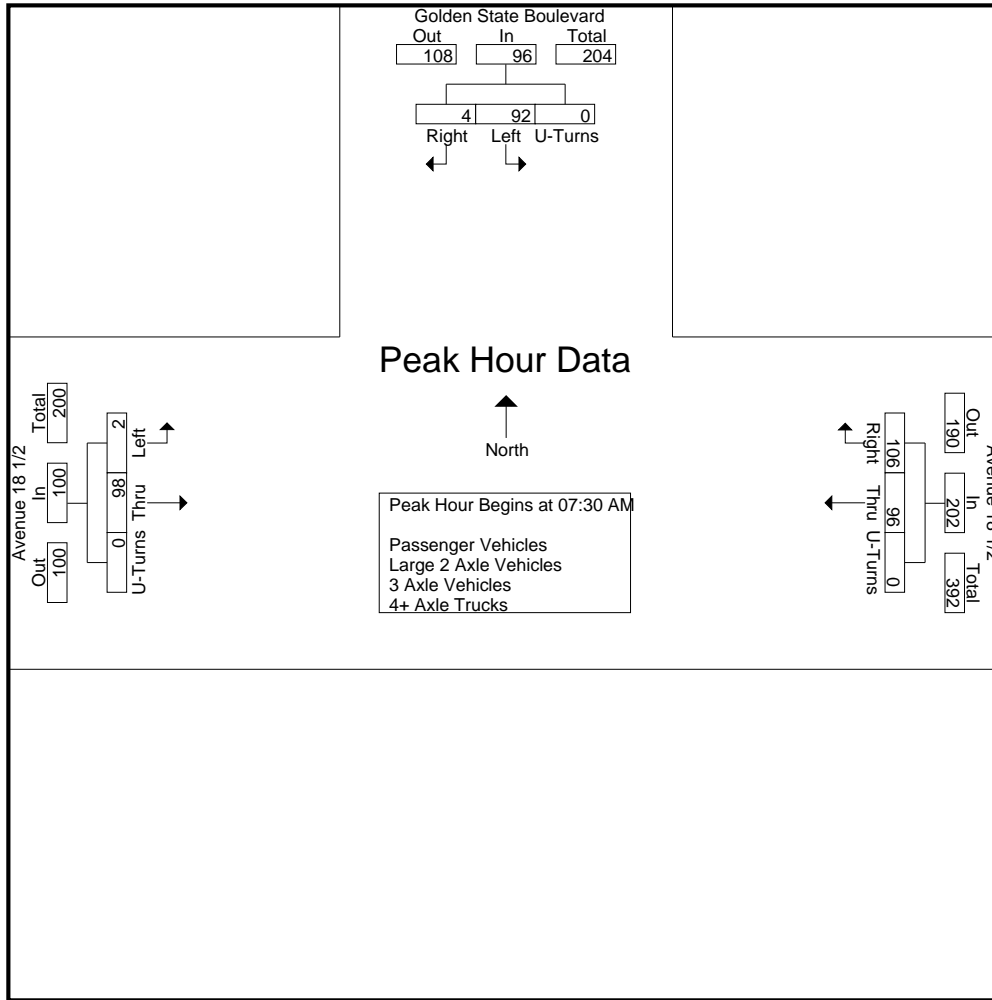

Peak Hour Analysis From 07:00 AM to 08:45 AM - Peak 1 of 1
 Peak Hour for Each Approach Begins at:

	07:00 AM				07:30 AM				07:30 AM			
+0 mins.	25	0	0	25	28	28	0	56	0	15	0	15
+15 mins.	23	0	0	23	31	23	0	54	1	25	0	26
+30 mins.	27	1	0	28	15	28	0	43	1	34	0	35
+45 mins.	26	2	0	28	22	27	0	49	0	24	0	24
Total Volume	101	3	0	104	96	106	0	202	2	98	0	100
% App. Total	97.1	2.9	0		47.5	52.5	0		2	98	0	
PHF	.935	.375	.000	.929	.774	.946	.000	.902	.500	.721	.000	.714

City of Madera
 N/S: Golden State Boulevard
 E/W: Avenue 18 1/2
 Weather: Clear

File Name : 49_MDA_Golden State_Ave 18 1-2 AM
 Site Code : 00319628
 Start Date : 9/26/2019
 Page No : 1

Groups Printed- Passenger Vehicles

Start Time	Golden State Boulevard Southbound				Avenue 18 1/2 Westbound				Avenue 18 1/2 Eastbound				Int. Total
	Left	Right	U-Turns	App. Total	Thru	Right	U-Turns	App. Total	Left	Thru	U-Turns	App. Total	
07:00 AM	3	0	0	3	18	3	0	21	0	15	0	15	39
07:15 AM	4	0	0	4	10	4	0	14	1	9	0	10	28
07:30 AM	5	0	0	5	25	6	0	31	0	14	0	14	50
07:45 AM	6	0	0	6	29	9	0	38	0	22	0	22	66
Total	18	0	0	18	82	22	0	104	1	60	0	61	183
08:00 AM	6	0	0	6	12	3	0	15	0	28	0	28	49
08:15 AM	1	0	0	1	16	1	0	17	0	20	0	20	38
08:30 AM	6	0	0	6	7	6	0	13	0	14	0	14	33
08:45 AM	4	1	0	5	9	4	0	13	0	10	0	10	28
Total	17	1	0	18	44	14	0	58	0	72	0	72	148
Grand Total	35	1	0	36	126	36	0	162	1	132	0	133	331
Apprch %	97.2	2.8	0		77.8	22.2	0		0.8	99.2	0		
Total %	10.6	0.3	0	10.9	38.1	10.9	0	48.9	0.3	39.9	0	40.2	

Start Time	Golden State Boulevard Southbound				Avenue 18 1/2 Westbound				Avenue 18 1/2 Eastbound				Int. Total
	Left	Right	U-Turns	App. Total	Thru	Right	U-Turns	App. Total	Left	Thru	U-Turns	App. Total	
07:30 AM	5	0	0	5	25	6	0	31	0	14	0	14	50
07:45 AM	6	0	0	6	29	9	0	38	0	22	0	22	66
08:00 AM	6	0	0	6	12	3	0	15	0	28	0	28	49
08:15 AM	1	0	0	1	16	1	0	17	0	20	0	20	38
Total Volume	18	0	0	18	82	19	0	101	0	84	0	84	203
% App. Total	100	0	0		81.2	18.8	0		0	100	0		
PHF	.750	.000	.000	.750	.707	.528	.000	.664	.000	.750	.000	.750	.769

Peak Hour Analysis From 07:30 AM to 08:15 AM - Peak 1 of 1

Peak Hour for Entire Intersection Begins at 07:30 AM

City of Madera
 N/S: Golden State Boulevard
 E/W: Avenue 18 1/2
 Weather: Clear

File Name : 49_MDA_Golden State_Ave 18 1-2 AM
 Site Code : 00319628
 Start Date : 9/26/2019
 Page No : 2

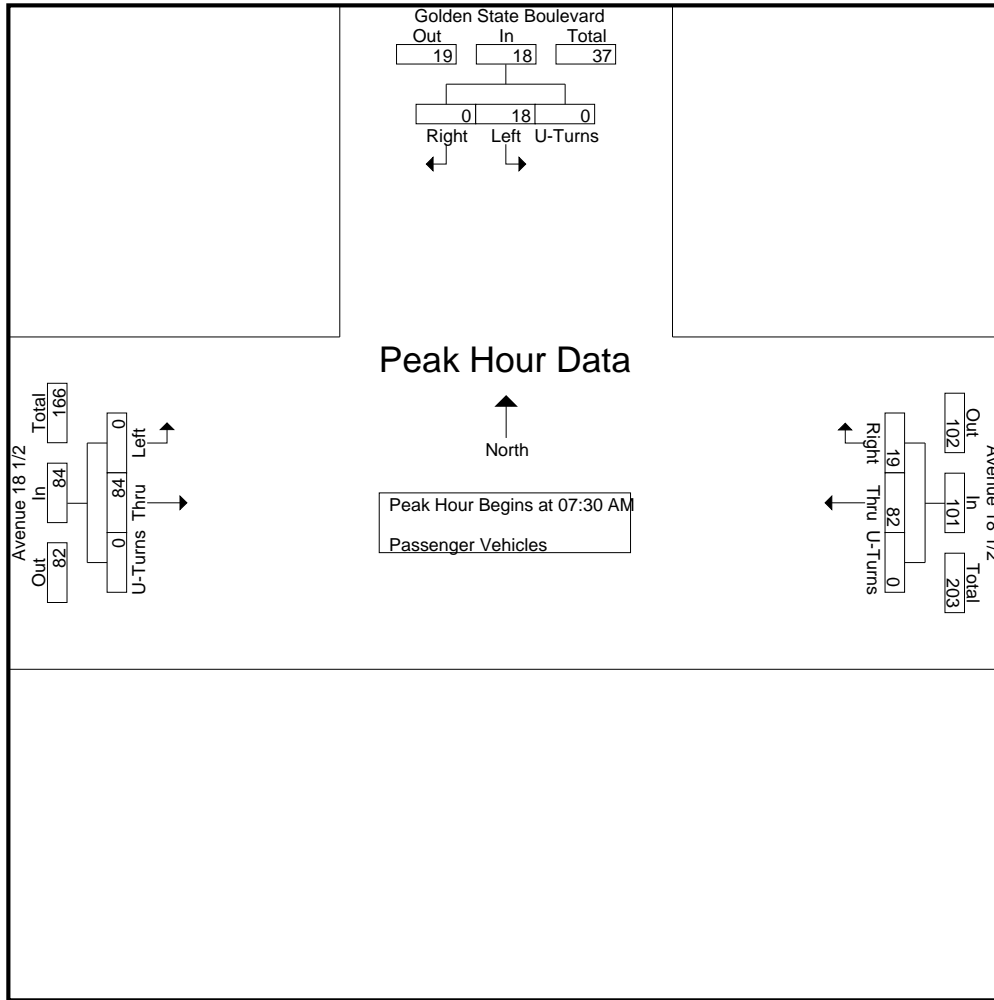

Peak Hour Analysis From 07:30 AM to 08:15 AM - Peak 1 of 1
 Peak Hour for Each Approach Begins at:

	07:30 AM				07:30 AM				07:30 AM			
+0 mins.	5	0	0	5	25	6	0	31	0	14	0	14
+15 mins.	6	0	0	6	29	9	0	38	0	22	0	22
+30 mins.	6	0	0	6	12	3	0	15	0	28	0	28
+45 mins.	1	0	0	1	16	1	0	17	0	20	0	20
Total Volume	18	0	0	18	82	19	0	101	0	84	0	84
% App. Total	100	0	0		81.2	18.8	0		0	100	0	
PHF	.750	.000	.000	.750	.707	.528	.000	.664	.000	.750	.000	.750

City of Madera
 N/S: Golden State Boulevard
 E/W: Avenue 18 1/2
 Weather: Clear

File Name : 49_MDA_Golden State_Ave 18 1-2 AM
 Site Code : 00319628
 Start Date : 9/26/2019
 Page No : 1

Groups Printed- Large 2 Axle Vehicles

Start Time	Golden State Boulevard Southbound				Avenue 18 1/2 Westbound				Avenue 18 1/2 Eastbound				Int. Total
	Left	Right	U-Turns	App. Total	Thru	Right	U-Turns	App. Total	Left	Thru	U-Turns	App. Total	
07:00 AM	1	0	0	1	1	0	0	1	0	0	0	0	2
07:15 AM	0	0	0	0	2	2	0	4	0	2	0	2	6
07:30 AM	0	0	0	0	1	1	0	2	0	1	0	1	3
07:45 AM	0	1	0	1	2	0	0	2	0	0	0	0	3
Total	1	1	0	2	6	3	0	9	0	3	0	3	14
08:00 AM	2	0	0	2	1	1	0	2	1	2	0	3	7
08:15 AM	1	0	0	1	2	0	0	2	0	1	0	1	4
08:30 AM	0	1	0	1	1	2	0	3	0	0	0	0	4
08:45 AM	1	0	0	1	1	1	0	2	0	1	0	1	4
Total	4	1	0	5	5	4	0	9	1	4	0	5	19
Grand Total	5	2	0	7	11	7	0	18	1	7	0	8	33
Apprch %	71.4	28.6	0		61.1	38.9	0		12.5	87.5	0		
Total %	15.2	6.1	0	21.2	33.3	21.2	0	54.5	3	21.2	0	24.2	

Start Time	Golden State Boulevard Southbound				Avenue 18 1/2 Westbound				Avenue 18 1/2 Eastbound				Int. Total
	Left	Right	U-Turns	App. Total	Thru	Right	U-Turns	App. Total	Left	Thru	U-Turns	App. Total	
07:30 AM	0	0	0	0	1	1	0	2	0	1	0	1	3
07:45 AM	0	1	0	1	2	0	0	2	0	0	0	0	3
08:00 AM	2	0	0	2	1	1	0	2	1	2	0	3	7
08:15 AM	1	0	0	1	2	0	0	2	0	1	0	1	4
Total Volume	3	1	0	4	6	2	0	8	1	4	0	5	17
% App. Total	75	25	0		75	25	0		20	80	0		
PHF	.375	.250	.000	.500	.750	.500	.000	1.00	.250	.500	.000	.417	.607

Peak Hour Analysis From 07:30 AM to 08:15 AM - Peak 1 of 1

Peak Hour for Entire Intersection Begins at 07:30 AM

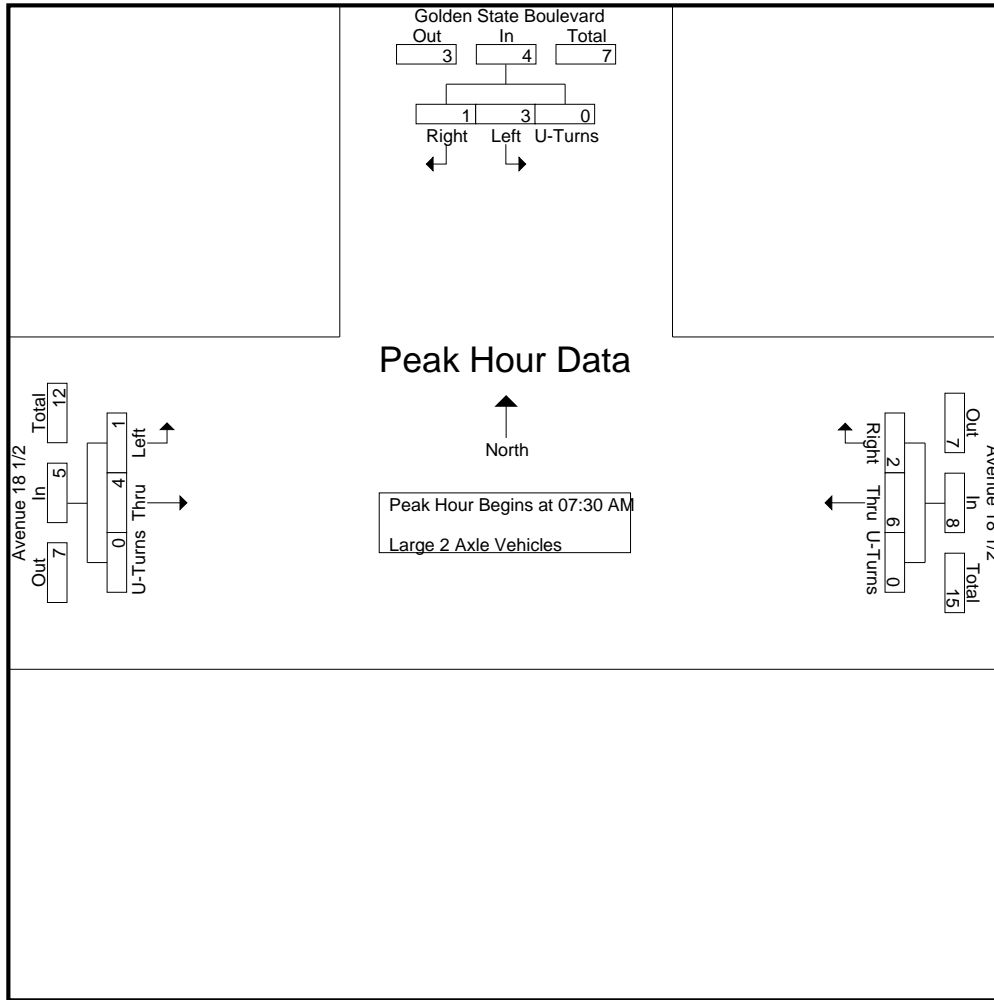

Peak Hour Analysis From 07:30 AM to 08:15 AM - Peak 1 of 1
 Peak Hour for Each Approach Begins at:

	07:30 AM				07:30 AM				07:30 AM			
+0 mins.	0	0	0	0	1	1	0	2	0	1	0	1
+15 mins.	0	1	0	1	2	0	0	2	0	0	0	0
+30 mins.	2	0	0	2	1	1	0	2	1	2	0	3
+45 mins.	1	0	0	1	2	0	0	2	0	1	0	1
Total Volume	3	1	0	4	6	2	0	8	1	4	0	5
% App. Total	75	25	0		75	25	0		20	80	0	
PHF	.375	.250	.000	.500	.750	.500	.000	1.000	.250	.500	.000	.417

City of Madera
 N/S: Golden State Boulevard
 E/W: Avenue 18 1/2
 Weather: Clear

File Name : 49_MDA_Golden State_Ave 18 1-2 AM
 Site Code : 00319628
 Start Date : 9/26/2019
 Page No : 1

Groups Printed- 3 Axle Vehicles

Start Time	Golden State Boulevard Southbound				Avenue 18 1/2 Westbound				Avenue 18 1/2 Eastbound				Int. Total
	Left	Right	U-Turns	App. Total	Thru	Right	U-Turns	App. Total	Left	Thru	U-Turns	App. Total	
07:00 AM	1	0	0	1	0	2	0	2	0	0	0	0	3
07:15 AM	0	0	0	0	1	1	0	2	0	1	0	1	3
07:30 AM	2	1	0	3	0	4	0	4	0	0	0	0	7
07:45 AM	2	0	0	2	0	2	0	2	0	1	0	1	5
Total	5	1	0	6	1	9	0	10	0	2	0	2	18
08:00 AM	1	0	0	1	0	2	0	2	0	2	0	2	5
08:15 AM	1	0	0	1	0	3	0	3	0	0	0	0	4
08:30 AM	1	0	0	1	0	1	0	1	0	0	0	0	2
08:45 AM	1	0	0	1	0	1	0	1	0	0	0	0	2
Total	4	0	0	4	0	7	0	7	0	2	0	2	13
Grand Total	9	1	0	10	1	16	0	17	0	4	0	4	31
Apprch %	90	10	0		5.9	94.1	0		0	100	0		
Total %	29	3.2	0	32.3	3.2	51.6	0	54.8	0	12.9	0	12.9	

Start Time	Golden State Boulevard Southbound				Avenue 18 1/2 Westbound				Avenue 18 1/2 Eastbound				Int. Total
	Left	Right	U-Turns	App. Total	Thru	Right	U-Turns	App. Total	Left	Thru	U-Turns	App. Total	
07:30 AM	2	1	0	3	0	4	0	4	0	0	0	0	7
07:45 AM	2	0	0	2	0	2	0	2	0	1	0	1	5
08:00 AM	1	0	0	1	0	2	0	2	0	2	0	2	5
08:15 AM	1	0	0	1	0	3	0	3	0	0	0	0	4
Total Volume	6	1	0	7	0	11	0	11	0	3	0	3	21
% App. Total	85.7	14.3	0		0	100	0		0	100	0		
PHF	.750	.250	.000	.583	.000	.688	.000	.688	.000	.375	.000	.375	.750

Peak Hour Analysis From 07:30 AM to 08:15 AM - Peak 1 of 1

Peak Hour for Entire Intersection Begins at 07:30 AM

City of Madera
 N/S: Golden State Boulevard
 E/W: Avenue 18 1/2
 Weather: Clear

File Name : 49_MDA_Golden State_Ave 18 1-2 AM
 Site Code : 00319628
 Start Date : 9/26/2019
 Page No : 2

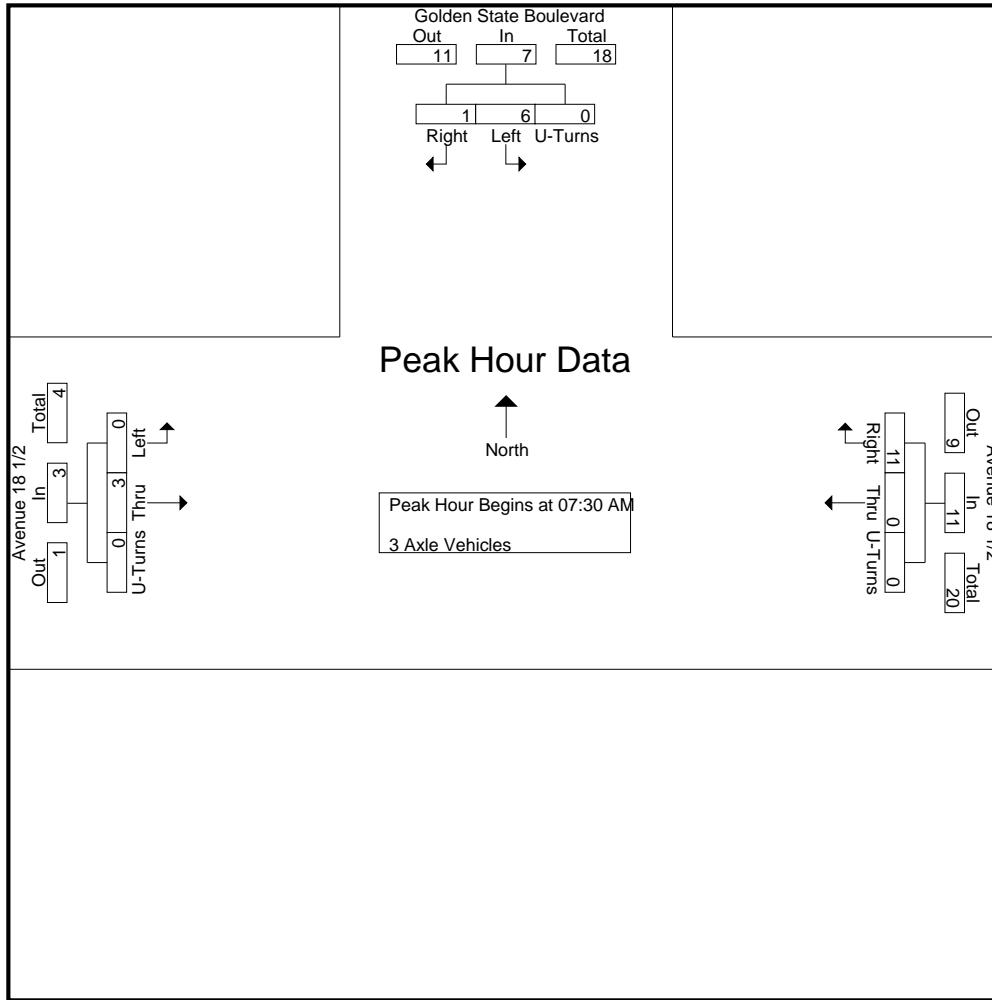

Peak Hour Analysis From 07:30 AM to 08:15 AM - Peak 1 of 1
 Peak Hour for Each Approach Begins at:

	07:30 AM				07:30 AM				07:30 AM			
+0 mins.	2	1	0	3	0	4	0	4	0	0	0	0
+15 mins.	2	0	0	2	0	2	0	2	0	1	0	1
+30 mins.	1	0	0	1	0	2	0	2	0	2	0	2
+45 mins.	1	0	0	1	0	3	0	3	0	0	0	0
Total Volume	6	1	0	7	0	11	0	11	0	3	0	3
% App. Total	85.7	14.3	0		0	100	0		0	100	0	
PHF	.750	.250	.000	.583	.000	.688	.000	.688	.000	.375	.000	.375

City of Madera
 N/S: Golden State Boulevard
 E/W: Avenue 18 1/2
 Weather: Clear

File Name : 49_MDA_Golden State_Ave 18 1-2 AM
 Site Code : 00319628
 Start Date : 9/26/2019
 Page No : 1

Groups Printed- 4+ Axle Trucks

Start Time	Golden State Boulevard Southbound				Avenue 18 1/2 Westbound				Avenue 18 1/2 Eastbound				Int. Total
	Left	Right	U-Turns	App. Total	Thru	Right	U-Turns	App. Total	Left	Thru	U-Turns	App. Total	
07:00 AM	20	0	0	20	0	12	0	12	0	0	0	0	32
07:15 AM	19	0	0	19	2	19	0	21	0	0	0	0	40
07:30 AM	20	0	0	20	2	17	0	19	0	0	0	0	39
07:45 AM	18	1	0	19	0	12	0	12	1	2	0	3	34
Total	77	1	0	78	4	60	0	64	1	2	0	3	145
08:00 AM	11	1	0	12	2	22	0	24	0	2	0	2	38
08:15 AM	16	0	0	16	4	23	0	27	0	3	0	3	46
08:30 AM	23	0	0	23	1	21	0	22	0	1	0	1	46
08:45 AM	18	1	0	19	3	25	0	28	0	2	0	2	49
Total	68	2	0	70	10	91	0	101	0	8	0	8	179
Grand Total	145	3	0	148	14	151	0	165	1	10	0	11	324
Apprch %	98	2	0		8.5	91.5	0		9.1	90.9	0		
Total %	44.8	0.9	0	45.7	4.3	46.6	0	50.9	0.3	3.1	0	3.4	

Start Time	Golden State Boulevard Southbound				Avenue 18 1/2 Westbound				Avenue 18 1/2 Eastbound				Int. Total
	Left	Right	U-Turns	App. Total	Thru	Right	U-Turns	App. Total	Left	Thru	U-Turns	App. Total	
Peak Hour Analysis From 07:30 AM to 08:15 AM - Peak 1 of 1													
Peak Hour for Entire Intersection Begins at 07:30 AM													
07:30 AM	20	0	0	20	2	17	0	19	0	0	0	0	39
07:45 AM	18	1	0	19	0	12	0	12	1	2	0	3	34
08:00 AM	11	1	0	12	2	22	0	24	0	2	0	2	38
08:15 AM	16	0	0	16	4	23	0	27	0	3	0	3	46
Total Volume	65	2	0	67	8	74	0	82	1	7	0	8	157
% App. Total	97	3	0		9.8	90.2	0		12.5	87.5	0		
PHF	.813	.500	.000	.838	.500	.804	.000	.759	.250	.583	.000	.667	.853

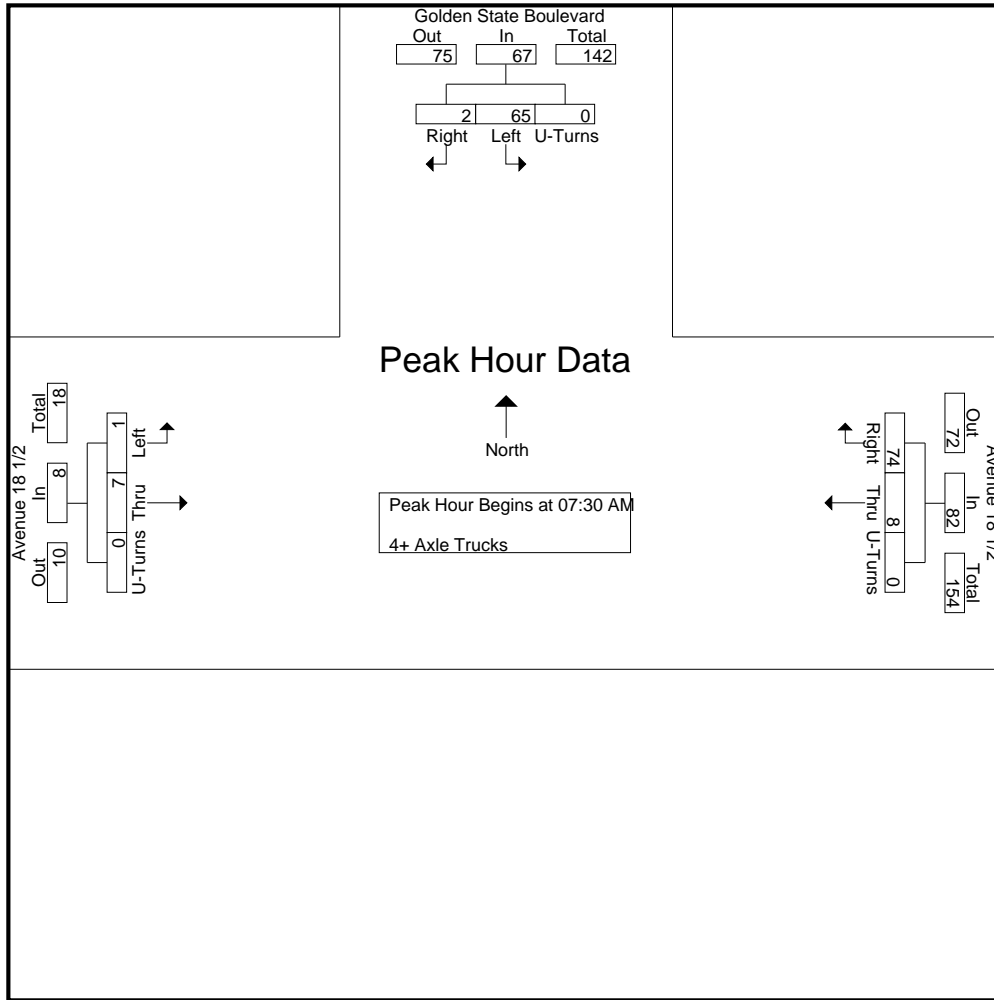

Peak Hour Analysis From 07:30 AM to 08:15 AM - Peak 1 of 1
 Peak Hour for Each Approach Begins at:

	07:30 AM				07:30 AM				07:30 AM			
+0 mins.	20	0	0	20	2	17	0	19	0	0	0	0
+15 mins.	18	1	0	19	0	12	0	12	1	2	0	3
+30 mins.	11	1	0	12	2	22	0	24	0	2	0	2
+45 mins.	16	0	0	16	4	23	0	27	0	3	0	3
Total Volume	65	2	0	67	8	74	0	82	1	7	0	8
% App. Total	97	3	0		9.8	90.2	0		12.5	87.5	0	
PHF	.813	.500	.000	.838	.500	.804	.000	.759	.250	.583	.000	.667

City of Madera
 N/S: Golden State Boulevard
 E/W: Avenue 18 1/2
 Weather: Clear

File Name : 49_MDA_Golden State_Ave 18 1-2 PM
 Site Code : 00319628
 Start Date : 9/26/2019
 Page No : 1

Groups Printed- Passenger Vehicles - Large 2 Axle Vehicles - 3 Axle Vehicles - 4+ Axle Trucks

Start Time	Golden State Boulevard Southbound				Avenue 18 1/2 Westbound				Avenue 18 1/2 Eastbound				Int. Total
	Left	Right	U-Turns	App. Total	Thru	Right	U-Turns	App. Total	Left	Thru	U-Turns	App. Total	
04:00 PM	87	3	0	90	13	21	0	34	1	37	0	38	162
04:15 PM	60	1	0	61	17	23	0	40	0	25	0	25	126
04:30 PM	55	2	0	57	11	29	0	40	3	31	0	34	131
04:45 PM	50	2	0	52	19	23	0	42	3	24	0	27	121
Total	252	8	0	260	60	96	0	156	7	117	0	124	540
05:00 PM	24	0	0	24	24	22	0	46	1	29	0	30	100
05:15 PM	35	1	0	36	24	20	0	44	0	29	0	29	109
05:30 PM	18	1	0	19	22	15	0	37	0	25	0	25	81
05:45 PM	20	1	0	21	24	11	0	35	1	25	0	26	82
Total	97	3	0	100	94	68	0	162	2	108	0	110	372
Grand Total	349	11	0	360	154	164	0	318	9	225	0	234	912
Apprch %	96.9	3.1	0		48.4	51.6	0		3.8	96.2	0		
Total %	38.3	1.2	0	39.5	16.9	18	0	34.9	1	24.7	0	25.7	
Passenger Vehicles	227	3	0	230	134	25	0	159	4	204	0	208	597
% Passenger Vehicles	65	27.3	0	63.9	87	15.2	0	50	44.4	90.7	0	88.9	65.5
Large 2 Axle Vehicles	6	3	0	9	10	5	0	15	3	7	0	10	34
% Large 2 Axle Vehicles	1.7	27.3	0	2.5	6.5	3	0	4.7	33.3	3.1	0	4.3	3.7
3 Axle Vehicles	6	0	0	6	1	3	0	4	0	3	0	3	13
% 3 Axle Vehicles	1.7	0	0	1.7	0.6	1.8	0	1.3	0	1.3	0	1.3	1.4
4+ Axle Trucks	110	5	0	115	9	131	0	140	2	11	0	13	268
% 4+ Axle Trucks	31.5	45.5	0	31.9	5.8	79.9	0	44	22.2	4.9	0	5.6	29.4

Start Time	Golden State Boulevard Southbound				Avenue 18 1/2 Westbound				Avenue 18 1/2 Eastbound				Int. Total
	Left	Right	U-Turns	App. Total	Thru	Right	U-Turns	App. Total	Left	Thru	U-Turns	App. Total	
Peak Hour Analysis From 04:00 PM to 05:45 PM - Peak 1 of 1													
Peak Hour for Entire Intersection Begins at 04:00 PM													
04:00 PM	87	3	0	90	13	21	0	34	1	37	0	38	162
04:15 PM	60	1	0	61	17	23	0	40	0	25	0	25	126
04:30 PM	55	2	0	57	11	29	0	40	3	31	0	34	131
04:45 PM	50	2	0	52	19	23	0	42	3	24	0	27	121
Total Volume	252	8	0	260	60	96	0	156	7	117	0	124	540
% App. Total	96.9	3.1	0		38.5	61.5	0		5.6	94.4	0		
PHF	.724	.667	.000	.722	.789	.828	.000	.929	.583	.791	.000	.816	.833

City of Madera
 N/S: Golden State Boulevard
 E/W: Avenue 18 1/2
 Weather: Clear

File Name : 49_MDA_Golden State_Ave 18 1-2 PM
 Site Code : 00319628
 Start Date : 9/26/2019
 Page No : 2

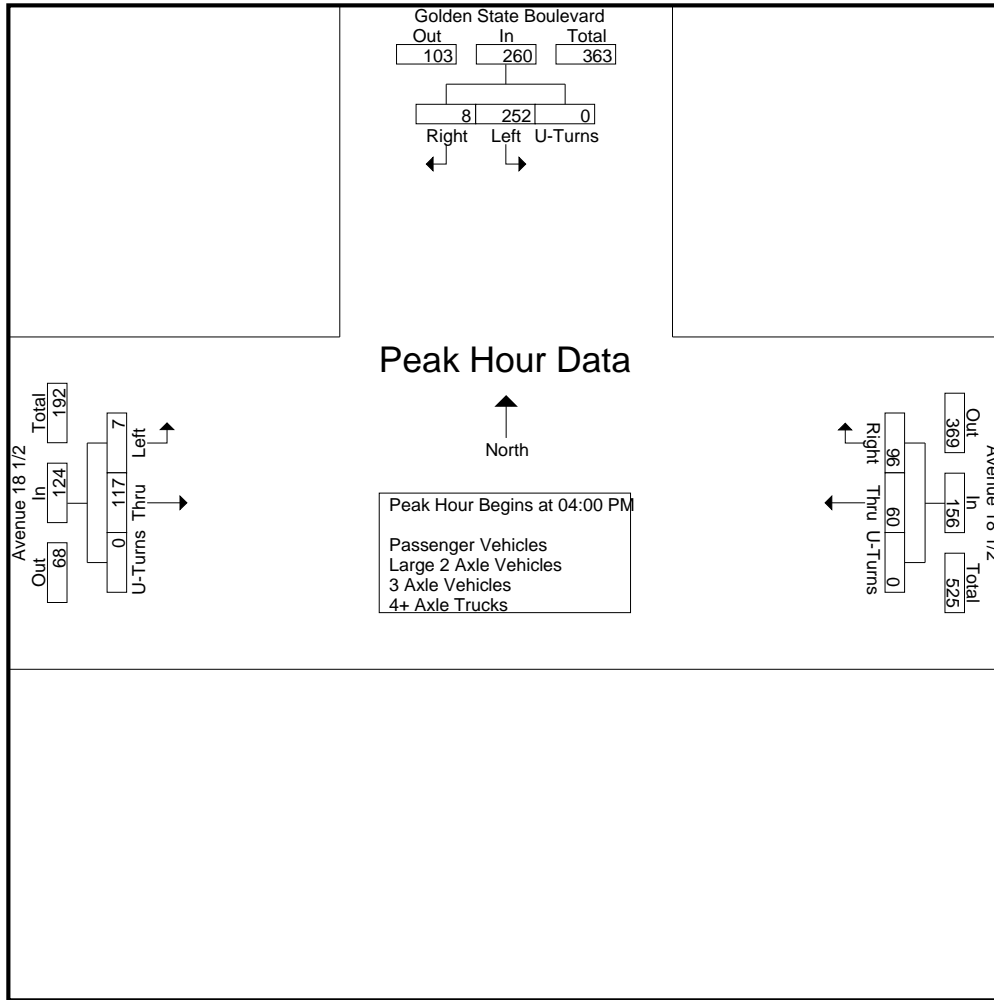

Peak Hour Analysis From 04:00 PM to 05:45 PM - Peak 1 of 1

Peak Hour for Each Approach Begins at:

	04:00 PM				04:30 PM				04:00 PM			
+0 mins.	87	3	0	90	11	29	0	40	1	37	0	38
+15 mins.	60	1	0	61	19	23	0	42	0	25	0	25
+30 mins.	55	2	0	57	24	22	0	46	3	31	0	34
+45 mins.	50	2	0	52	24	20	0	44	3	24	0	27
Total Volume	252	8	0	260	78	94	0	172	7	117	0	124
% App. Total	96.9	3.1	0		45.3	54.7	0		5.6	94.4	0	
PHF	.724	.667	.000	.722	.813	.810	.000	.935	.583	.791	.000	.816

City of Madera
 N/S: Golden State Boulevard
 E/W: Avenue 18 1/2
 Weather: Clear

File Name : 49_MDA_Golden State_Ave 18 1-2 PM
 Site Code : 00319628
 Start Date : 9/26/2019
 Page No : 1

Groups Printed- Passenger Vehicles

Start Time	Golden State Boulevard Southbound				Avenue 18 1/2 Westbound				Avenue 18 1/2 Eastbound				Int. Total
	Left	Right	U-Turns	App. Total	Thru	Right	U-Turns	App. Total	Left	Thru	U-Turns	App. Total	
04:00 PM	65	1	0	66	10	3	0	13	0	34	0	34	113
04:15 PM	44	0	0	44	14	5	0	19	0	21	0	21	84
04:30 PM	39	1	0	40	8	6	0	14	2	28	0	30	84
04:45 PM	31	1	0	32	16	4	0	20	2	22	0	24	76
Total	179	3	0	182	48	18	0	66	4	105	0	109	357
05:00 PM	16	0	0	16	22	2	0	24	0	29	0	29	69
05:15 PM	18	0	0	18	24	4	0	28	0	25	0	25	71
05:30 PM	5	0	0	5	18	1	0	19	0	20	0	20	44
05:45 PM	9	0	0	9	22	0	0	22	0	25	0	25	56
Total	48	0	0	48	86	7	0	93	0	99	0	99	240
Grand Total	227	3	0	230	134	25	0	159	4	204	0	208	597
Apprch %	98.7	1.3	0		84.3	15.7	0		1.9	98.1	0		
Total %	38	0.5	0	38.5	22.4	4.2	0	26.6	0.7	34.2	0	34.8	

Start Time	Golden State Boulevard Southbound				Avenue 18 1/2 Westbound				Avenue 18 1/2 Eastbound				Int. Total
	Left	Right	U-Turns	App. Total	Thru	Right	U-Turns	App. Total	Left	Thru	U-Turns	App. Total	
04:00 PM	65	1	0	66	10	3	0	13	0	34	0	34	113
04:15 PM	44	0	0	44	14	5	0	19	0	21	0	21	84
04:30 PM	39	1	0	40	8	6	0	14	2	28	0	30	84
04:45 PM	31	1	0	32	16	4	0	20	2	22	0	24	76
Total Volume	179	3	0	182	48	18	0	66	4	105	0	109	357
% App. Total	98.4	1.6	0		72.7	27.3	0		3.7	96.3	0		
PHF	.688	.750	.000	.689	.750	.750	.000	.825	.500	.772	.000	.801	.790

Peak Hour Analysis From 04:00 PM to 04:45 PM - Peak 1 of 1

Peak Hour for Entire Intersection Begins at 04:00 PM

City of Madera
 N/S: Golden State Boulevard
 E/W: Avenue 18 1/2
 Weather: Clear

File Name : 49_MDA_Golden State_Ave 18 1-2 PM
 Site Code : 00319628
 Start Date : 9/26/2019
 Page No : 2

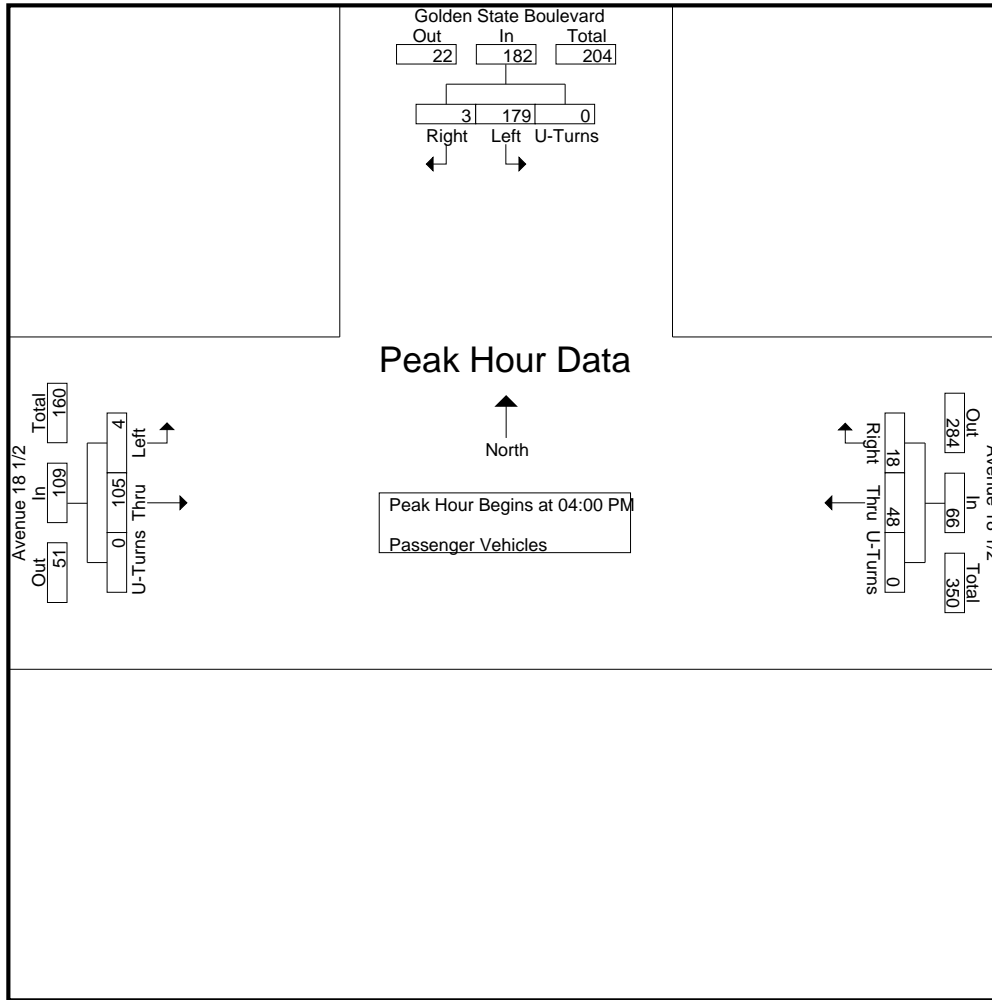

Peak Hour Analysis From 04:00 PM to 04:45 PM - Peak 1 of 1
 Peak Hour for Each Approach Begins at:

	04:00 PM				04:00 PM				04:00 PM			
+0 mins.	65	1	0	66	10	3	0	13	0	34	0	34
+15 mins.	44	0	0	44	14	5	0	19	0	21	0	21
+30 mins.	39	1	0	40	8	6	0	14	2	28	0	30
+45 mins.	31	1	0	32	16	4	0	20	2	22	0	24
Total Volume	179	3	0	182	48	18	0	66	4	105	0	109
% App. Total	98.4	1.6	0		72.7	27.3	0		3.7	96.3	0	
PHF	.688	.750	.000	.689	.750	.750	.000	.825	.500	.772	.000	.801

City of Madera
 N/S: Golden State Boulevard
 E/W: Avenue 18 1/2
 Weather: Clear

File Name : 49_MDA_Golden State_Ave 18 1-2 PM
 Site Code : 00319628
 Start Date : 9/26/2019
 Page No : 1

Groups Printed- Large 2 Axle Vehicles

Start Time	Golden State Boulevard Southbound				Avenue 18 1/2 Westbound				Avenue 18 1/2 Eastbound				Int. Total
	Left	Right	U-Turns	App. Total	Thru	Right	U-Turns	App. Total	Left	Thru	U-Turns	App. Total	
04:00 PM	3	1	0	4	0	0	0	0	0	0	0	0	4
04:15 PM	1	0	0	1	1	2	0	3	0	0	0	0	4
04:30 PM	0	0	0	0	2	1	0	3	1	1	0	2	5
04:45 PM	1	1	0	2	2	1	0	3	0	1	0	1	6
Total	5	2	0	7	5	4	0	9	1	2	0	3	19
05:00 PM	0	0	0	0	1	0	0	1	1	0	0	1	2
05:15 PM	0	1	0	1	0	1	0	1	0	2	0	2	4
05:30 PM	0	0	0	0	2	0	0	2	0	3	0	3	5
05:45 PM	1	0	0	1	2	0	0	2	1	0	0	1	4
Total	1	1	0	2	5	1	0	6	2	5	0	7	15
Grand Total	6	3	0	9	10	5	0	15	3	7	0	10	34
Apprch %	66.7	33.3	0		66.7	33.3	0		30	70	0		
Total %	17.6	8.8	0	26.5	29.4	14.7	0	44.1	8.8	20.6	0	29.4	

Start Time	Golden State Boulevard Southbound				Avenue 18 1/2 Westbound				Avenue 18 1/2 Eastbound				Int. Total
	Left	Right	U-Turns	App. Total	Thru	Right	U-Turns	App. Total	Left	Thru	U-Turns	App. Total	
04:00 PM	3	1	0	4	0	0	0	0	0	0	0	0	4
04:15 PM	1	0	0	1	1	2	0	3	0	0	0	0	4
04:30 PM	0	0	0	0	2	1	0	3	1	1	0	2	5
04:45 PM	1	1	0	2	2	1	0	3	0	1	0	1	6
Total Volume	5	2	0	7	5	4	0	9	1	2	0	3	19
% App. Total	71.4	28.6	0		55.6	44.4	0		33.3	66.7	0		
PHF	.417	.500	.000	.438	.625	.500	.000	.750	.250	.500	.000	.375	.792

Peak Hour Analysis From 04:00 PM to 04:45 PM - Peak 1 of 1

Peak Hour for Entire Intersection Begins at 04:00 PM

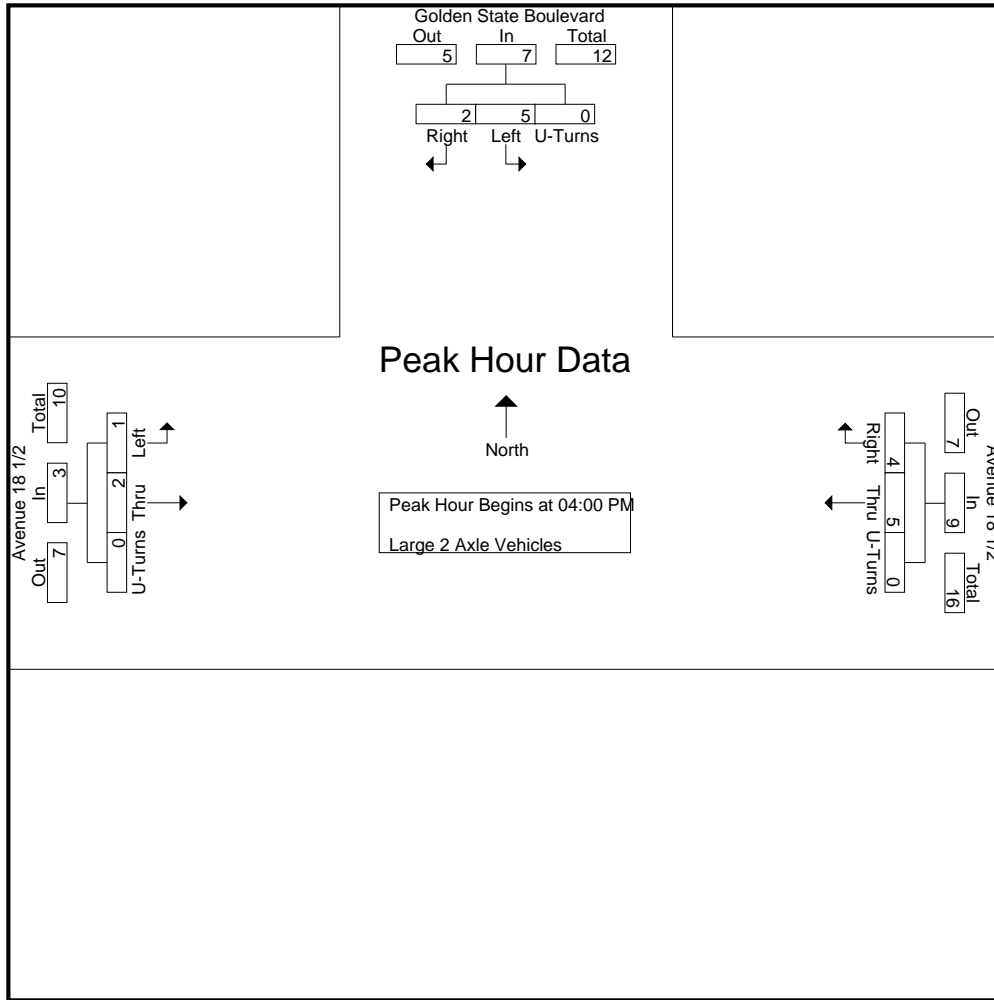

Peak Hour Analysis From 04:00 PM to 04:45 PM - Peak 1 of 1
 Peak Hour for Each Approach Begins at:

	04:00 PM				04:00 PM				04:00 PM			
+0 mins.	3	1	0	4	0	0	0	0	0	0	0	0
+15 mins.	1	0	0	1	1	2	0	3	0	0	0	0
+30 mins.	0	0	0	0	2	1	0	3	1	1	0	2
+45 mins.	1	1	0	2	2	1	0	3	0	1	0	1
Total Volume	5	2	0	7	5	4	0	9	1	2	0	3
% App. Total	71.4	28.6	0		55.6	44.4	0		33.3	66.7	0	
PHF	.417	.500	.000	.438	.625	.500	.000	.750	.250	.500	.000	.375

City of Madera
 N/S: Golden State Boulevard
 E/W: Avenue 18 1/2
 Weather: Clear

File Name : 49_MDA_Golden State_Ave 18 1-2 PM
 Site Code : 00319628
 Start Date : 9/26/2019
 Page No : 1

Groups Printed- 3 Axle Vehicles

Start Time	Golden State Boulevard Southbound				Avenue 18 1/2 Westbound				Avenue 18 1/2 Eastbound				Int. Total
	Left	Right	U-Turns	App. Total	Thru	Right	U-Turns	App. Total	Left	Thru	U-Turns	App. Total	
04:00 PM	1	0	0	1	1	0	0	1	0	1	0	1	3
04:15 PM	3	0	0	3	0	0	0	0	0	0	0	0	3
04:30 PM	0	0	0	0	0	1	0	1	0	1	0	1	2
04:45 PM	1	0	0	1	0	1	0	1	0	0	0	0	2
Total	5	0	0	5	1	2	0	3	0	2	0	2	10
05:00 PM	1	0	0	1	0	0	0	0	0	0	0	0	1
05:15 PM	0	0	0	0	0	0	0	0	0	0	0	0	0
05:30 PM	0	0	0	0	0	1	0	1	0	1	0	1	2
05:45 PM	0	0	0	0	0	0	0	0	0	0	0	0	0
Total	1	0	0	1	0	1	0	1	0	1	0	1	3
Grand Total	6	0	0	6	1	3	0	4	0	3	0	3	13
Apprch %	100	0	0		25	75	0		0	100	0		
Total %	46.2	0	0	46.2	7.7	23.1	0	30.8	0	23.1	0	23.1	

Start Time	Golden State Boulevard Southbound				Avenue 18 1/2 Westbound				Avenue 18 1/2 Eastbound				Int. Total
	Left	Right	U-Turns	App. Total	Thru	Right	U-Turns	App. Total	Left	Thru	U-Turns	App. Total	
04:00 PM	1	0	0	1	1	0	0	1	0	1	0	1	3
04:15 PM	3	0	0	3	0	0	0	0	0	0	0	0	3
04:30 PM	0	0	0	0	0	1	0	1	0	1	0	1	2
04:45 PM	1	0	0	1	0	1	0	1	0	0	0	0	2
Total Volume	5	0	0	5	1	2	0	3	0	2	0	2	10
% App. Total	100	0	0		33.3	66.7	0		0	100	0		
PHF	.417	.000	.000	.417	.250	.500	.000	.750	.000	.500	.000	.500	.833

Peak Hour Analysis From 04:00 PM to 04:45 PM - Peak 1 of 1

Peak Hour for Entire Intersection Begins at 04:00 PM

City of Madera
 N/S: Golden State Boulevard
 E/W: Avenue 18 1/2
 Weather: Clear

File Name : 49_MDA_Golden State_Ave 18 1-2 PM
 Site Code : 00319628
 Start Date : 9/26/2019
 Page No : 2

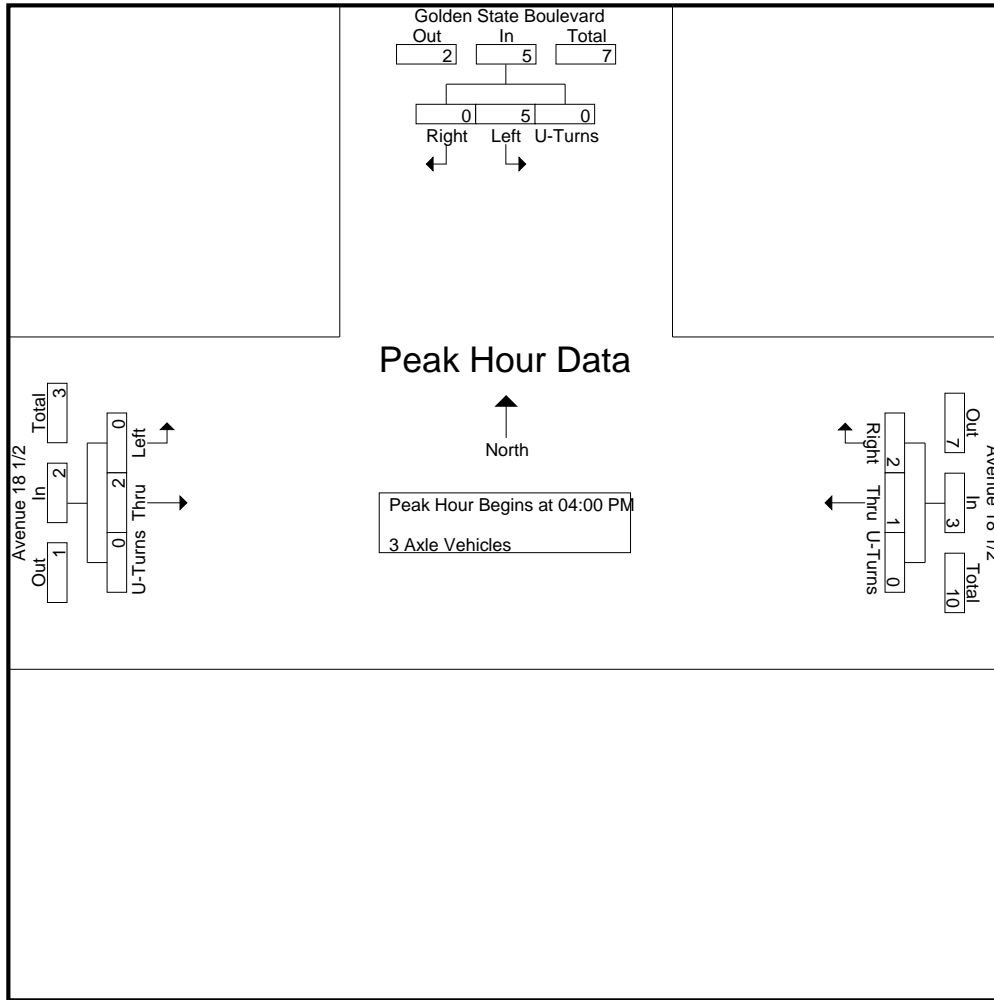

Peak Hour Analysis From 04:00 PM to 04:45 PM - Peak 1 of 1
 Peak Hour for Each Approach Begins at:

	04:00 PM				04:00 PM				04:00 PM			
+0 mins.	1	0	0	1	1	0	0	1	0	1	0	1
+15 mins.	3	0	0	3	0	0	0	0	0	0	0	0
+30 mins.	0	0	0	0	0	1	0	1	0	1	0	1
+45 mins.	1	0	0	1	0	1	0	1	0	0	0	0
Total Volume	5	0	0	5	1	2	0	3	0	2	0	2
% App. Total	100	0	0		33.3	66.7	0		0	100	0	
PHF	.417	.000	.000	.417	.250	.500	.000	.750	.000	.500	.000	.500

City of Madera
 N/S: Golden State Boulevard
 E/W: Avenue 18 1/2
 Weather: Clear

File Name : 49_MDA_Golden State_Ave 18 1-2 PM
 Site Code : 00319628
 Start Date : 9/26/2019
 Page No : 1

Groups Printed- 4+ Axle Trucks

Start Time	Golden State Boulevard Southbound				Avenue 18 1/2 Westbound				Avenue 18 1/2 Eastbound				Int. Total
	Left	Right	U-Turns	App. Total	Thru	Right	U-Turns	App. Total	Left	Thru	U-Turns	App. Total	
04:00 PM	18	1	0	19	2	18	0	20	1	2	0	3	42
04:15 PM	12	1	0	13	2	16	0	18	0	4	0	4	35
04:30 PM	16	1	0	17	1	21	0	22	0	1	0	1	40
04:45 PM	17	0	0	17	1	17	0	18	1	1	0	2	37
Total	63	3	0	66	6	72	0	78	2	8	0	10	154
05:00 PM	7	0	0	7	1	20	0	21	0	0	0	0	28
05:15 PM	17	0	0	17	0	15	0	15	0	2	0	2	34
05:30 PM	13	1	0	14	2	13	0	15	0	1	0	1	30
05:45 PM	10	1	0	11	0	11	0	11	0	0	0	0	22
Total	47	2	0	49	3	59	0	62	0	3	0	3	114
Grand Total	110	5	0	115	9	131	0	140	2	11	0	13	268
Apprch %	95.7	4.3	0		6.4	93.6	0		15.4	84.6	0		
Total %	41	1.9	0	42.9	3.4	48.9	0	52.2	0.7	4.1	0	4.9	

Start Time	Golden State Boulevard Southbound				Avenue 18 1/2 Westbound				Avenue 18 1/2 Eastbound				Int. Total
	Left	Right	U-Turns	App. Total	Thru	Right	U-Turns	App. Total	Left	Thru	U-Turns	App. Total	
Peak Hour Analysis From 04:00 PM to 04:45 PM - Peak 1 of 1													
Peak Hour for Entire Intersection Begins at 04:00 PM													
04:00 PM	18	1	0	19	2	18	0	20	1	2	0	3	42
04:15 PM	12	1	0	13	2	16	0	18	0	4	0	4	35
04:30 PM	16	1	0	17	1	21	0	22	0	1	0	1	40
04:45 PM	17	0	0	17	1	17	0	18	1	1	0	2	37
Total Volume	63	3	0	66	6	72	0	78	2	8	0	10	154
% App. Total	95.5	4.5	0		7.7	92.3	0		20	80	0		
PHF	.875	.750	.000	.868	.750	.857	.000	.886	.500	.500	.000	.625	.917

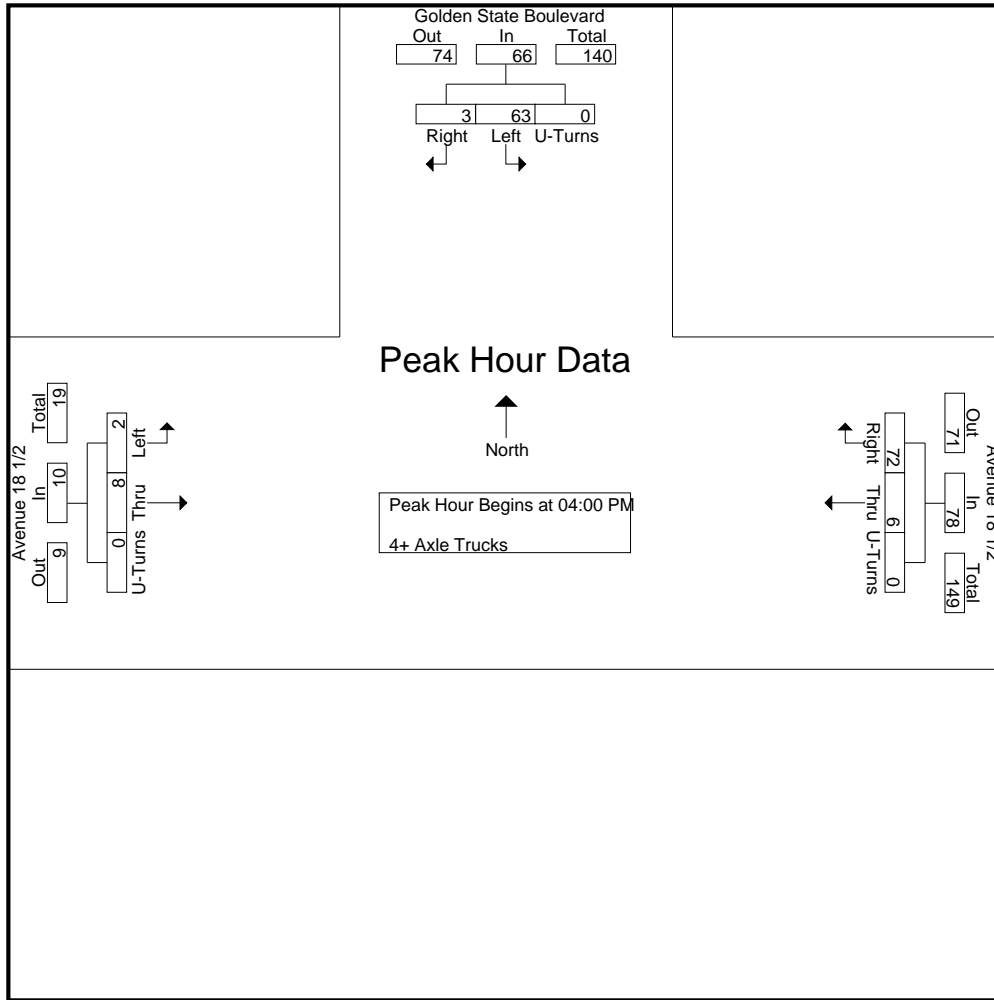

Peak Hour Analysis From 04:00 PM to 04:45 PM - Peak 1 of 1
 Peak Hour for Each Approach Begins at:

	04:00 PM				04:00 PM				04:00 PM			
+0 mins.	18	1	0	19	2	18	0	20	1	2	0	3
+15 mins.	12	1	0	13	2	16	0	18	0	4	0	4
+30 mins.	16	1	0	17	1	21	0	22	0	1	0	1
+45 mins.	17	0	0	17	1	17	0	18	1	1	0	2
Total Volume	63	3	0	66	6	72	0	78	2	8	0	10
% App. Total	95.5	4.5	0		7.7	92.3	0		20	80	0	
PHF	.875	.750	.000	.868	.750	.857	.000	.886	.500	.500	.000	.625

Location: Madera
 N/S: Golden State Boulevard
 E/W: Avenue 18 1/2



Date: 9/26/2019
 Day: Thursday

PEDESTRIANS

	North Leg Golden State Boulevard	East Leg Avenue 18 1/2	South Leg Dead End	West Leg Avenue 18 1/2	
	Pedestrians	Pedestrians	Pedestrians	Pedestrians	
7:00 AM	0	0	0	0	0
7:15 AM	0	0	0	0	0
7:30 AM	0	0	0	0	0
7:45 AM	0	0	0	0	0
8:00 AM	0	0	0	0	0
8:15 AM	0	0	0	0	0
8:30 AM	0	0	0	0	0
8:45 AM	0	0	0	0	0
TOTAL VOLUMES:	0	0	0	0	0

	North Leg Golden State Boulevard	East Leg Avenue 18 1/2	South Leg Dead End	West Leg Avenue 18 1/2	
	Pedestrians	Pedestrians	Pedestrians	Pedestrians	
4:00 PM	0	0	0	0	0
4:15 PM	0	0	0	0	0
4:30 PM	0	0	0	0	0
4:45 PM	0	0	0	0	0
5:00 PM	2	0	0	0	2
5:15 PM	0	0	0	0	0
5:30 PM	0	0	0	0	0
5:45 PM	0	0	0	0	0
TOTAL VOLUMES:	2	0	0	0	2

Location: Madera
 N/S: Golden State Boulevard
 E/W: Avenue 18 1/2



Date: 9/26/2019
 Day: Thursday

BICYCLES

	Southbound Golden State Boulevard			Westbound Avenue 18 1/2			Northbound Dead End			Eastbound Avenue 18 1/2			
	Left	Thru	Right	Left	Thru	Right	Left	Thru	Right	Left	Thru	Right	
7:00 AM	0	0	0	0	0	0	0	0	0	0	0	0	0
7:15 AM	0	0	0	0	0	0	0	0	0	0	0	0	0
7:30 AM	0	0	0	0	0	0	0	0	0	0	0	0	0
7:45 AM	0	0	0	0	0	0	0	0	0	0	0	0	0
8:00 AM	0	0	0	0	0	0	0	0	0	0	0	0	0
8:15 AM	0	0	0	0	0	0	0	0	0	0	0	0	0
8:30 AM	0	0	0	0	0	0	0	0	0	0	0	0	0
8:45 AM	0	0	0	0	0	0	0	0	0	0	0	0	0
TOTAL VOLUMES:	0	0	0	0	0	0	0	0	0	0	0	0	0

	Southbound Golden State Boulevard			Westbound Avenue 18 1/2			Northbound Dead End			Eastbound Avenue 18 1/2			
	Left	Thru	Right	Left	Thru	Right	Left	Thru	Right	Left	Thru	Right	
4:00 PM	0	0	0	0	0	0	0	0	0	0	0	0	0
4:15 PM	0	0	0	0	0	0	0	0	0	0	0	0	0
4:30 PM	0	0	0	0	0	0	0	0	0	0	0	0	0
4:45 PM	0	0	0	0	0	0	0	0	0	0	0	0	0
5:00 PM	0	0	0	0	0	0	0	0	0	0	1	0	1
5:15 PM	0	0	0	0	0	0	0	0	0	0	0	0	0
5:30 PM	0	0	0	0	0	0	0	0	0	0	0	0	0
5:45 PM	0	0	0	0	0	0	0	0	0	0	0	0	0
TOTAL VOLUMES:	0	0	0	0	0	0	0	0	0	0	1	0	1

City of Madera
 N/S: Pistachio Drive
 E/W: Avenue 18 1/2
 Weather: Clear

File Name : 48_MDA_Pistachio_Ave 18 1-2 AM
 Site Code : 00319628
 Start Date : 9/26/2019
 Page No : 1

Groups Printed- Passenger Vehicles - Large 2 Axle Vehicles - 3 Axle Vehicles - 4+ Axle Trucks

Start Time	Pistachio Drive Southbound					Avenue 18 1/2 Westbound					Truck Parking Lot Northbound					Avenue 18 1/2 Eastbound					Int. Total
	Left	Thru	Right	U-Turns	App. Total	Left	Thru	Right	U-Turns	App. Total	Left	Thru	Right	U-Turns	App. Total	Left	Thru	Right	U-Turns	App. Total	
07:00 AM	26	0	3	0	29	0	31	45	0	76	0	0	0	0	0	3	48	0	0	51	156
07:15 AM	26	0	2	0	28	0	46	54	0	100	0	0	0	0	0	0	64	0	0	64	192
07:30 AM	25	0	4	0	29	1	58	51	0	110	0	0	0	0	0	1	46	0	0	47	186
07:45 AM	31	0	2	0	33	0	53	51	0	104	0	0	1	0	1	2	72	1	0	75	213
Total	108	0	11	0	119	1	188	201	0	390	0	0	1	0	1	6	230	1	0	237	747
08:00 AM	26	0	1	0	27	2	53	47	0	102	0	0	0	0	0	2	61	0	0	63	192
08:15 AM	22	0	2	0	24	0	48	52	0	100	0	0	0	0	0	3	71	0	0	74	198
08:30 AM	27	0	0	0	27	1	41	49	0	91	0	0	0	0	0	2	57	0	0	59	177
08:45 AM	25	1	5	0	31	0	44	33	0	77	0	0	1	0	1	0	53	1	0	54	163
Total	100	1	8	0	109	3	186	181	0	370	0	0	1	0	1	7	242	1	0	250	730
Grand Total	208	1	19	0	228	4	374	382	0	760	0	0	2	0	2	13	472	2	0	487	1477
Apprch %	91.2	0.4	8.3	0		0.5	49.2	50.3	0		0	0	100	0		2.7	96.9	0.4	0		
Total %	14.1	0.1	1.3	0	15.4	0.3	25.3	25.9	0	51.5	0	0	0.1	0	0.1	0.9	32	0.1	0	33	
Passenger Vehicles																					
% Passenger Vehicles	86.1	100	78.9	0	85.5	50	54	89.8	0	72	0	0	50	0	50	84.6	59.1	50	0	59.8	70
Large 2 Axle Vehicles																					
% Large 2 Axle Vehicles	6.2	0	0	0	5.7	50	5.1	5.8	0	5.7	0	0	50	0	50	0	5.7	50	0	5.7	5.8
3 Axle Vehicles	4	0	1	0	5	0	6	5	0	11	0	0	0	0	0	2	12	0	0	14	30
% 3 Axle Vehicles	1.9	0	5.3	0	2.2	0	1.6	1.3	0	1.4	0	0	0	0	0	15.4	2.5	0	0	2.9	2
4+ Axle Trucks	12	0	3	0	15	0	147	12	0	159	0	0	0	0	0	0	154	0	0	154	328
% 4+ Axle Trucks																					

Start Time	Pistachio Drive Southbound					Avenue 18 1/2 Westbound					Truck Parking Lot Northbound					Avenue 18 1/2 Eastbound					Int. Total
	Left	Thru	Right	U-Turns	App. Total	Left	Thru	Right	U-Turns	App. Total	Left	Thru	Right	U-Turns	App. Total	Left	Thru	Right	U-Turns	App. Total	
Peak Hour Analysis From 07:00 AM to 08:45 AM - Peak 1 of 1																					
Peak Hour for Entire Intersection Begins at 07:30 AM																					
07:30 AM	25	0	4	0	29	1	58	51	0	110	0	0	0	0	0	1	46	0	0	47	186
07:45 AM	31	0	2	0	33	0	53	51	0	104	0	0	1	0	1	2	72	1	0	75	213
08:00 AM	26	0	1	0	27	2	53	47	0	102	0	0	0	0	0	2	61	0	0	63	192
08:15 AM	22	0	2	0	24	0	48	52	0	100	0	0	0	0	0	3	71	0	0	74	198
Total Volume	104	0	9	0	113	3	212	201	0	416	0	0	1	0	1	8	250	1	0	259	789
% App. Total	92	0	8	0		0.7	51	48.3	0		0	0	100	0		3.1	96.5	0.4	0		
PHF	.839	.000	.563	.000	.856	.375	.914	.966	.000	.945	.000	.000	.250	.000	.250	.667	.868	.250	.000	.863	.926

City of Madera
 N/S: Pistachio Drive
 E/W: Avenue 18 1/2
 Weather: Clear

File Name : 48_MDA_Pistachio_Ave 18 1-2 AM
 Site Code : 00319628
 Start Date : 9/26/2019
 Page No : 2

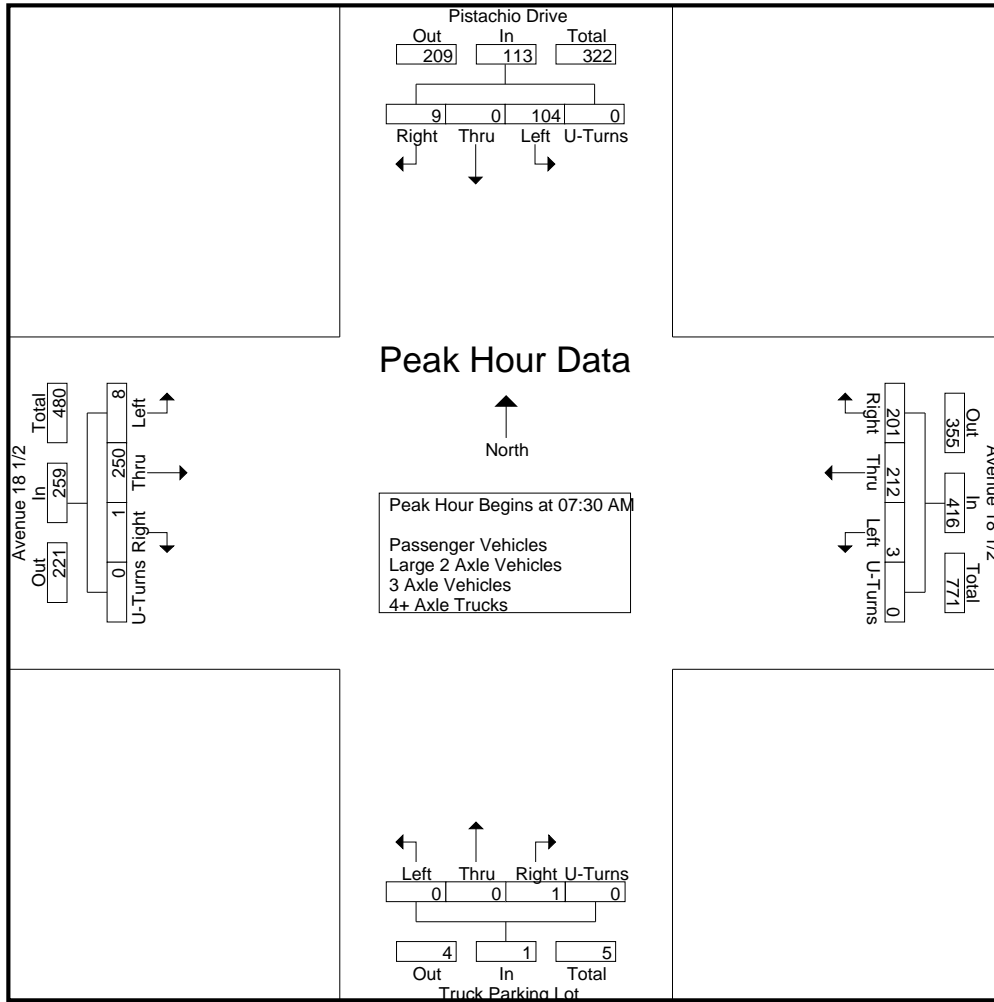

Peak Hour Analysis From 07:00 AM to 08:45 AM - Peak 1 of 1
 Peak Hour for Each Approach Begins at:

	07:00 AM					07:15 AM					07:30 AM					07:45 AM				
+0 mins.	26	0	3	0	29	0	46	54	0	100	0	0	0	0	0	2	72	1	0	75
+15 mins.	26	0	2	0	28	1	58	51	0	110	0	0	0	0	0	2	61	0	0	63
+30 mins.	25	0	4	0	29	0	53	51	0	104	0	0	0	0	0	3	71	0	0	74
+45 mins.	31	0	2	0	33	2	53	47	0	102	0	0	1	0	1	2	57	0	0	59
Total Volume	108	0	11	0	119	3	210	203	0	416	0	0	1	0	1	9	261	1	0	271
% App. Total	90.8	0	9.2	0		0.7	50.5	48.8	0		0	0	100	0		3.3	96.3	0.4	0	
PHF	.871	.000	.688	.000	.902	.375	.905	.940	.000	.945	.000	.000	.250	.000	.250	.750	.906	.250	.000	.903

City of Madera
 N/S: Pistachio Drive
 E/W: Avenue 18 1/2
 Weather: Clear

File Name : 48_MDA_Pistachio_Ave 18 1-2 AM
 Site Code : 00319628
 Start Date : 9/26/2019
 Page No : 1

Groups Printed- Passenger Vehicles

Start Time	Pistachio Drive Southbound					Avenue 18 1/2 Westbound					Truck Parking Lot Northbound					Avenue 18 1/2 Eastbound					Int. Total
	Left	Thru	Right	U-Turns	App. Total	Left	Thru	Right	U-Turns	App. Total	Left	Thru	Right	U-Turns	App. Total	Left	Thru	Right	U-Turns	App. Total	
07:00 AM	20	0	2	0	22	0	13	42	0	55	0	0	0	0	0	3	19	0	0	22	99
07:15 AM	24	0	2	0	26	0	22	50	0	72	0	0	0	0	0	0	37	0	0	37	135
07:30 AM	24	0	4	0	28	0	36	47	0	83	0	0	0	0	0	1	32	0	0	33	144
07:45 AM	23	0	2	0	25	0	40	48	0	88	0	0	0	0	0	1	46	0	0	47	160
Total	91	0	10	0	101	0	111	187	0	298	0	0	0	0	0	5	134	0	0	139	538
08:00 AM	26	0	1	0	27	2	28	40	0	70	0	0	0	0	0	1	39	0	0	40	137
08:15 AM	18	0	1	0	19	0	21	47	0	68	0	0	0	0	0	3	49	0	0	52	139
08:30 AM	25	0	0	0	25	0	17	40	0	57	0	0	0	0	0	2	37	0	0	39	121
08:45 AM	19	1	3	0	23	0	25	29	0	54	0	0	1	0	1	0	20	1	0	21	99
Total	88	1	5	0	94	2	91	156	0	249	0	0	1	0	1	6	145	1	0	152	496
Grand Total	179	1	15	0	195	2	202	343	0	547	0	0	1	0	1	11	279	1	0	291	1034
Apprch %	91.8	0.5	7.7	0		0.4	36.9	62.7	0		0	0	100	0		3.8	95.9	0.3	0		
Total %	17.3	0.1	1.5	0	18.9	0.2	19.5	33.2	0	52.9	0	0	0.1	0	0.1	1.1	27	0.1	0	28.1	

Start Time	Pistachio Drive Southbound					Avenue 18 1/2 Westbound					Truck Parking Lot Northbound					Avenue 18 1/2 Eastbound					Int. Total
	Left	Thru	Right	U-Turns	App. Total	Left	Thru	Right	U-Turns	App. Total	Left	Thru	Right	U-Turns	App. Total	Left	Thru	Right	U-Turns	App. Total	
07:30 AM	24	0	4	0	28	0	36	47	0	83	0	0	0	0	0	1	32	0	0	33	144
07:45 AM	23	0	2	0	25	0	40	48	0	88	0	0	0	0	0	1	46	0	0	47	160
08:00 AM	26	0	1	0	27	2	28	40	0	70	0	0	0	0	0	1	39	0	0	40	137
08:15 AM	18	0	1	0	19	0	21	47	0	68	0	0	0	0	0	3	49	0	0	52	139
Total Volume	91	0	8	0	99	2	125	182	0	309	0	0	0	0	0	6	166	0	0	172	580
% App. Total	91.9	0	8.1	0		0.6	40.5	58.9	0		0	0	0	0		3.5	96.5	0	0		
PHF	.875	.000	.500	.000	.884	.250	.781	.948	.000	.878	.000	.000	.000	.000	.000	.500	.847	.000	.000	.827	.906

Peak Hour Analysis From 07:30 AM to 08:15 AM - Peak 1 of 1

Peak Hour for Entire Intersection Begins at 07:30 AM

City of Madera
 N/S: Pistachio Drive
 E/W: Avenue 18 1/2
 Weather: Clear

File Name : 48_MDA_Pistachio_Ave 18 1-2 AM
 Site Code : 00319628
 Start Date : 9/26/2019
 Page No : 2

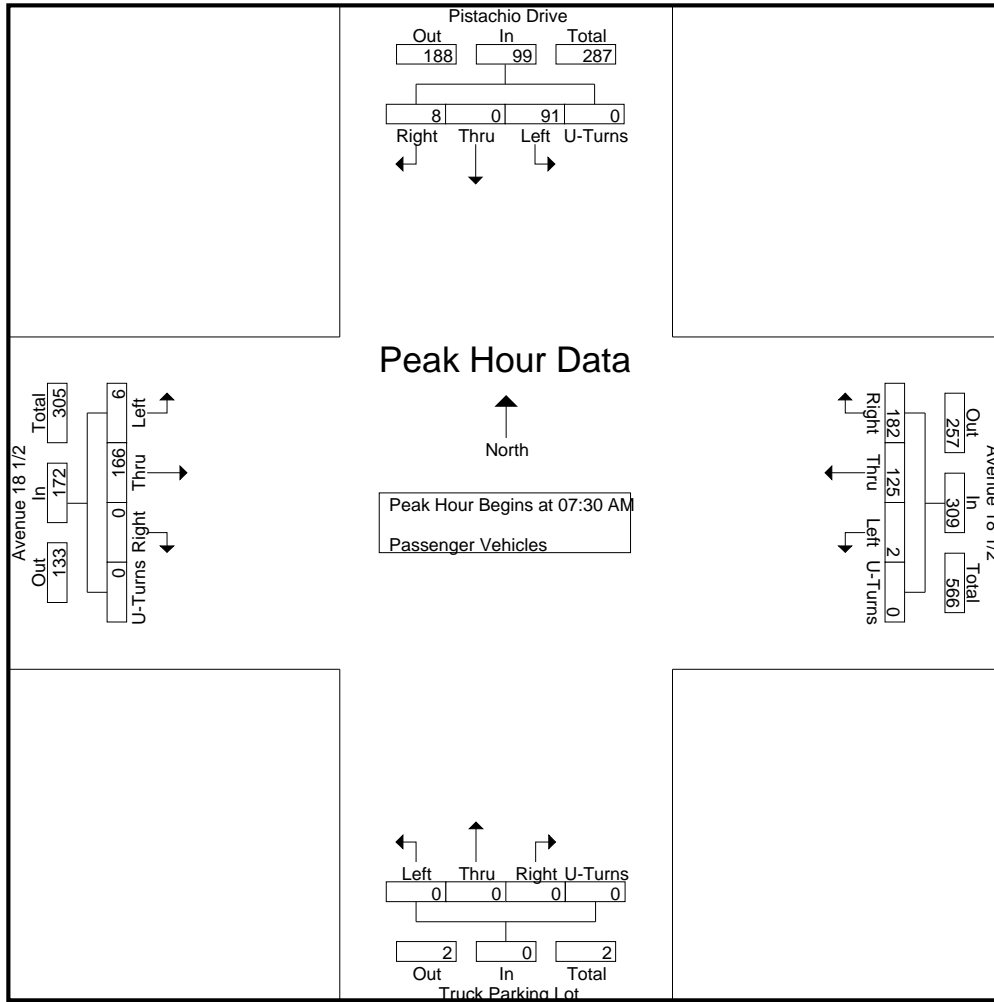

Peak Hour Analysis From 07:30 AM to 08:15 AM - Peak 1 of 1
 Peak Hour for Each Approach Begins at:

	07:30 AM					07:30 AM					07:30 AM									
+0 mins.	24	0	4	0	28	0	36	47	0	83	0	0	0	0	0	1	32	0	0	33
+15 mins.	23	0	2	0	25	0	40	48	0	88	0	0	0	0	0	1	46	0	0	47
+30 mins.	26	0	1	0	27	2	28	40	0	70	0	0	0	0	0	1	39	0	0	40
+45 mins.	18	0	1	0	19	0	21	47	0	68	0	0	0	0	0	3	49	0	0	52
Total Volume	91	0	8	0	99	2	125	182	0	309	0	0	0	0	0	6	166	0	0	172
% App. Total	91.9	0	8.1	0		0.6	40.5	58.9	0		0	0	0	0		3.5	96.5	0	0	
PHF	.875	.000	.500	.000	.884	.250	.781	.948	.000	.878	.000	.000	.000	.000	.000	.500	.847	.000	.000	.827

City of Madera
 N/S: Pistachio Drive
 E/W: Avenue 18 1/2
 Weather: Clear

File Name : 48_MDA_Pistachio_Ave 18 1-2 AM
 Site Code : 00319628
 Start Date : 9/26/2019
 Page No : 1

Groups Printed- Large 2 Axle Vehicles

Start Time	Pistachio Drive Southbound					Avenue 18 1/2 Westbound					Truck Parking Lot Northbound					Avenue 18 1/2 Eastbound					Int. Total
	Left	Thru	Right	U-Turns	App. Total	Left	Thru	Right	U-Turns	App. Total	Left	Thru	Right	U-Turns	App. Total	Left	Thru	Right	U-Turns	App. Total	
07:00 AM	2	0	0	0	2	0	3	2	0	5	0	0	0	0	0	0	3	0	0	3	10
07:15 AM	0	0	0	0	0	0	2	3	0	5	0	0	0	0	0	0	6	0	0	6	11
07:30 AM	1	0	0	0	1	1	6	1	0	8	0	0	0	0	0	0	3	0	0	3	12
07:45 AM	6	0	0	0	6	0	2	3	0	5	0	0	1	0	1	0	4	1	0	5	17
Total	9	0	0	0	9	1	13	9	0	23	0	0	1	0	1	0	16	1	0	17	50
08:00 AM	0	0	0	0	0	0	2	3	0	5	0	0	0	0	0	0	2	0	0	2	7
08:15 AM	2	0	0	0	2	0	2	3	0	5	0	0	0	0	0	0	3	0	0	3	10
08:30 AM	1	0	0	0	1	1	1	5	0	7	0	0	0	0	0	0	1	0	0	1	9
08:45 AM	1	0	0	0	1	0	1	2	0	3	0	0	0	0	0	0	5	0	0	5	9
Total	4	0	0	0	4	1	6	13	0	20	0	0	0	0	0	0	11	0	0	11	35
Grand Total	13	0	0	0	13	2	19	22	0	43	0	0	1	0	1	0	27	1	0	28	85
Apprch %	100	0	0	0		4.7	44.2	51.2	0		0	0	100	0		0	96.4	3.6	0		
Total %	15.3	0	0	0	15.3	2.4	22.4	25.9	0	50.6	0	0	1.2	0	1.2	0	31.8	1.2	0	32.9	

Start Time	Pistachio Drive Southbound					Avenue 18 1/2 Westbound					Truck Parking Lot Northbound					Avenue 18 1/2 Eastbound					Int. Total
	Left	Thru	Right	U-Turns	App. Total	Thru	Right	U-Turns	App. Total	Thru	Right	U-Turns	App. Total	Thru	Right	U-Turns	App. Total				
Peak Hour Analysis From 07:30 AM to 08:15 AM - Peak 1 of 1																					
Peak Hour for Entire Intersection Begins at 07:30 AM																					
07:30 AM	1	0	0	0	1	1	6	1	0	8	0	0	0	0	0	0	3	0	0	3	12
07:45 AM	6	0	0	0	6	0	2	3	0	5	0	0	1	0	1	0	4	1	0	5	17
08:00 AM	0	0	0	0	0	0	2	3	0	5	0	0	0	0	0	0	2	0	0	2	7
08:15 AM	2	0	0	0	2	0	2	3	0	5	0	0	0	0	0	0	3	0	0	3	10
Total Volume	9	0	0	0	9	1	12	10	0	23	0	0	1	0	1	0	12	1	0	13	46
% App. Total	100	0	0	0		4.3	52.2	43.5	0		0	0	100	0		0	92.3	7.7	0		
PHF	.375	.000	.000	.000	.375	.250	.500	.833	.000	.719	.000	.000	.250	.000	.250	.000	.750	.250	.000	.650	.676

City of Madera
 N/S: Pistachio Drive
 E/W: Avenue 18 1/2
 Weather: Clear

File Name : 48_MDA_Pistachio_Ave 18 1-2 AM
 Site Code : 00319628
 Start Date : 9/26/2019
 Page No : 2

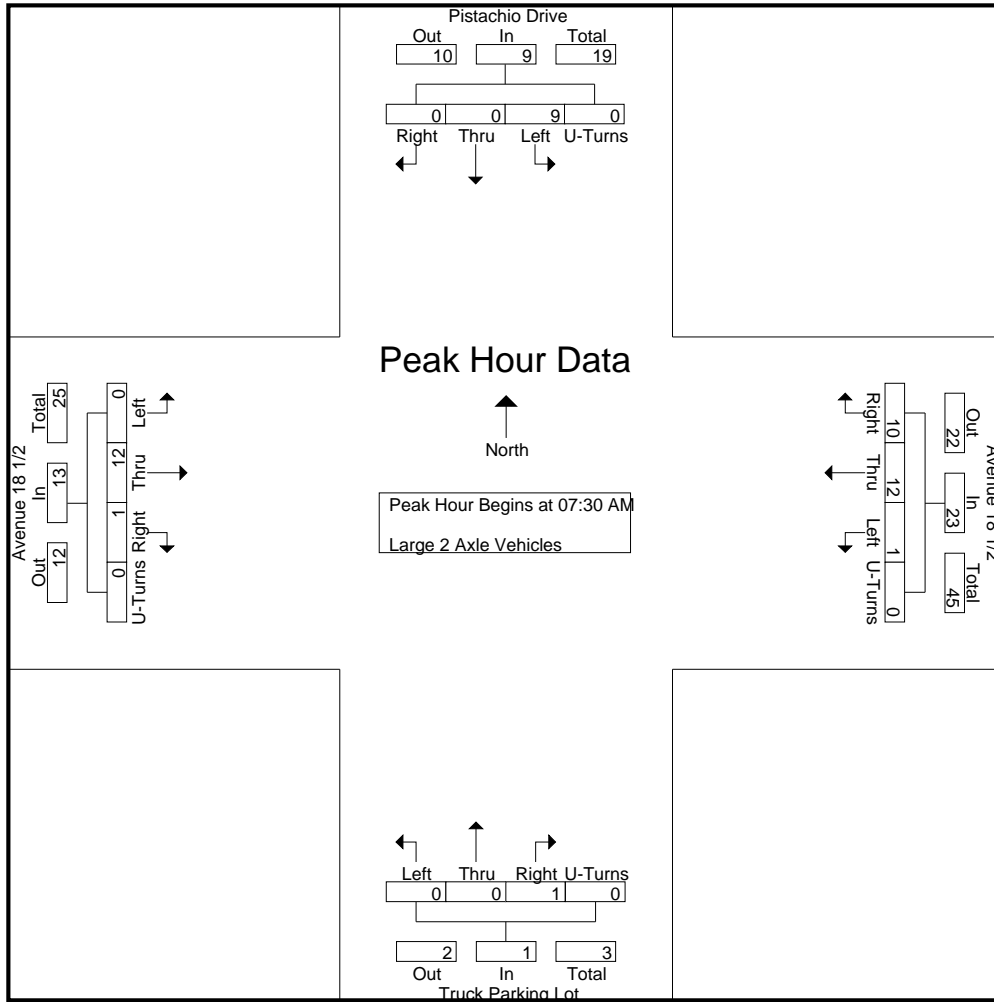

Peak Hour Analysis From 07:30 AM to 08:15 AM - Peak 1 of 1
 Peak Hour for Each Approach Begins at:

	07:30 AM					07:30 AM					07:30 AM									
+0 mins.	1	0	0	0	1	1	6	1	0	8	0	0	0	0	0	0	3	0	0	3
+15 mins.	6	0	0	0	6	0	2	3	0	5	0	0	1	0	1	0	4	1	0	5
+30 mins.	0	0	0	0	0	0	2	3	0	5	0	0	0	0	0	0	2	0	0	2
+45 mins.	2	0	0	0	2	0	2	3	0	5	0	0	0	0	0	0	3	0	0	3
Total Volume	9	0	0	0	9	1	12	10	0	23	0	0	1	0	1	0	12	1	0	13
% App. Total	100	0	0	0		4.3	52.2	43.5	0		0	0	100	0		0	92.3	7.7	0	
PHF	.375	.000	.000	.000	.375	.250	.500	.833	.000	.719	.000	.000	.250	.000	.250	.000	.750	.250	.000	.650

City of Madera
 N/S: Pistachio Drive
 E/W: Avenue 18 1/2
 Weather: Clear

File Name : 48_MDA_Pistachio_Ave 18 1-2 AM
 Site Code : 00319628
 Start Date : 9/26/2019
 Page No : 1

Groups Printed- 3 Axle Vehicles

Start Time	Pistachio Drive Southbound					Avenue 18 1/2 Westbound					Truck Parking Lot Northbound					Avenue 18 1/2 Eastbound					Int. Total
	Left	Thru	Right	U-Turns	App. Total	Left	Thru	Right	U-Turns	App. Total	Left	Thru	Right	U-Turns	App. Total	Left	Thru	Right	U-Turns	App. Total	
07:00 AM	2	0	1	0	3	0	0	1	0	1	0	0	0	0	0	0	1	0	0	1	5
07:15 AM	0	0	0	0	0	0	0	0	0	0	0	0	0	0	0	0	2	0	0	2	2
07:30 AM	0	0	0	0	0	0	1	1	0	2	0	0	0	0	0	0	0	0	0	0	2
07:45 AM	0	0	0	0	0	0	1	0	0	1	0	0	0	0	0	1	0	0	0	1	2
Total	2	0	1	0	3	0	2	2	0	4	0	0	0	0	0	1	3	0	0	4	11
08:00 AM	0	0	0	0	0	0	3	1	0	4	0	0	0	0	0	1	1	0	0	2	6
08:15 AM	2	0	0	0	2	0	0	1	0	1	0	0	0	0	0	0	2	0	0	2	5
08:30 AM	0	0	0	0	0	0	1	1	0	2	0	0	0	0	0	0	2	0	0	2	4
08:45 AM	0	0	0	0	0	0	0	0	0	0	0	0	0	0	0	0	4	0	0	4	4
Total	2	0	0	0	2	0	4	3	0	7	0	0	0	0	0	1	9	0	0	10	19
Grand Total	4	0	1	0	5	0	6	5	0	11	0	0	0	0	0	2	12	0	0	14	30
Apprch %	80	0	20	0		0	54.5	45.5	0		0	0	0	0		14.3	85.7	0	0		
Total %	13.3	0	3.3	0	16.7	0	20	16.7	0	36.7	0	0	0	0	0	6.7	40	0	0	46.7	

Start Time	Pistachio Drive Southbound					Avenue 18 1/2 Westbound					Truck Parking Lot Northbound					Avenue 18 1/2 Eastbound					Int. Total
	Left	Thru	Right	U-Turns	App. Total	Thru	Right	U-Turns	App. Total	Thru	Right	U-Turns	App. Total	Thru	Right	U-Turns	App. Total				
Peak Hour Analysis From 07:30 AM to 08:15 AM - Peak 1 of 1																					
Peak Hour for Entire Intersection Begins at 07:30 AM																					
07:30 AM	0	0	0	0	0	0	1	1	0	2	0	0	0	0	0	0	0	0	0	0	2
07:45 AM	0	0	0	0	0	0	1	0	0	1	0	0	0	0	0	1	0	0	0	1	2
08:00 AM	0	0	0	0	0	0	3	1	0	4	0	0	0	0	0	1	1	0	0	2	6
08:15 AM	2	0	0	0	2	0	0	1	0	1	0	0	0	0	0	0	2	0	0	2	5
Total Volume	2	0	0	0	2	0	5	3	0	8	0	0	0	0	0	2	3	0	0	5	15
% App. Total	100	0	0	0		0	62.5	37.5	0		0	0	0	0		40	60	0	0		
PHF	.250	.000	.000	.000	.250	.000	.417	.750	.000	.500	.000	.000	.000	.000	.000	.500	.375	.000	.000	.625	.625

City of Madera
 N/S: Pistachio Drive
 E/W: Avenue 18 1/2
 Weather: Clear

File Name : 48_MDA_Pistachio_Ave 18 1-2 AM
 Site Code : 00319628
 Start Date : 9/26/2019
 Page No : 2

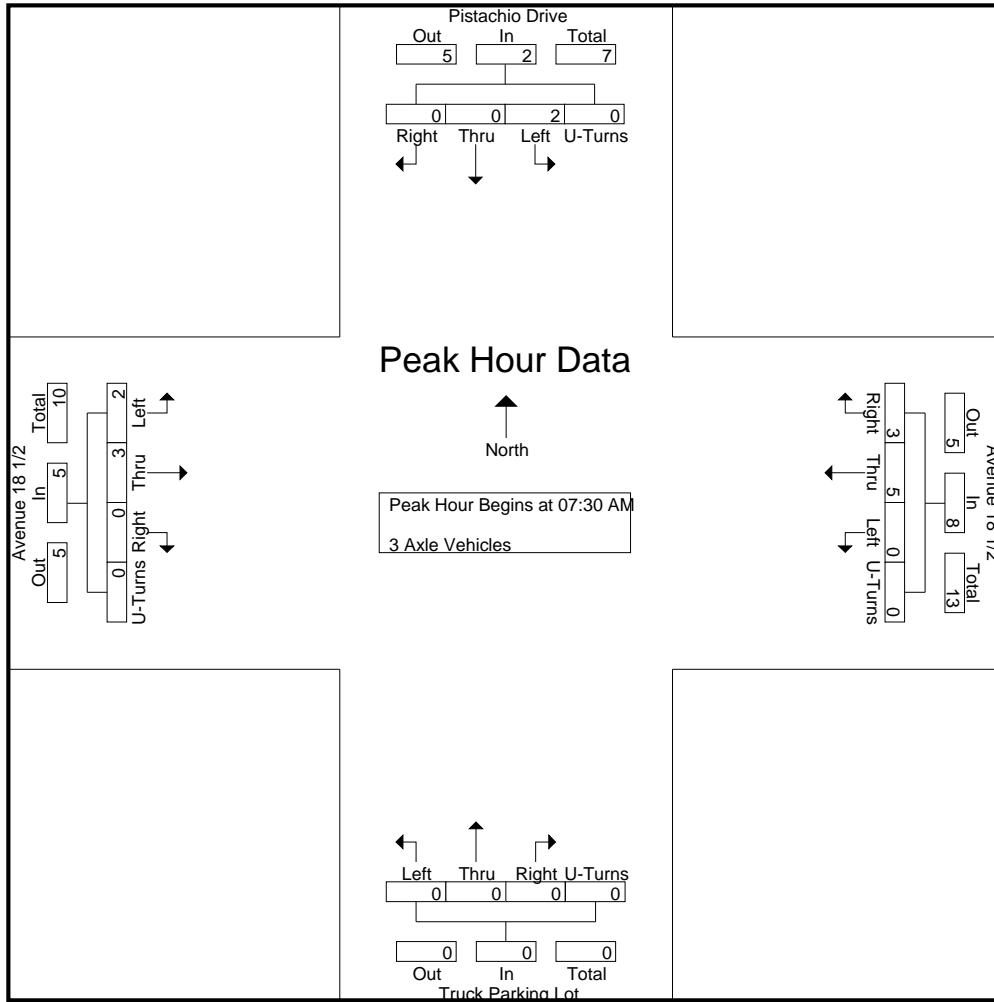

Peak Hour Analysis From 07:30 AM to 08:15 AM - Peak 1 of 1
 Peak Hour for Each Approach Begins at:

	07:30 AM					07:30 AM					07:30 AM									
+0 mins.	0	0	0	0	0	0	1	1	0	2	0	0	0	0	0	0	0	0	0	0
+15 mins.	0	0	0	0	0	0	1	0	0	1	0	0	0	0	0	1	0	0	0	1
+30 mins.	0	0	0	0	0	0	3	1	0	4	0	0	0	0	0	1	1	0	0	2
+45 mins.	2	0	0	0	2	0	0	1	0	1	0	0	0	0	0	0	2	0	0	2
Total Volume	2	0	0	0	2	0	5	3	0	8	0	0	0	0	0	2	3	0	0	5
% App. Total	100	0	0	0	0	0	62.5	37.5	0	0	0	0	0	0	0	40	60	0	0	0
PHF	.250	.000	.000	.000	.250	.000	.417	.750	.000	.500	.000	.000	.000	.000	.000	.500	.375	.000	.000	.625

City of Madera
 N/S: Pistachio Drive
 E/W: Avenue 18 1/2
 Weather: Clear

File Name : 48_MDA_Pistachio_Ave 18 1-2 AM
 Site Code : 00319628
 Start Date : 9/26/2019
 Page No : 1

Groups Printed- 4+ Axle Trucks

Start Time	Pistachio Drive Southbound					Avenue 18 1/2 Westbound					Truck Parking Lot Northbound					Avenue 18 1/2 Eastbound					Int. Total
	Left	Thru	Right	U-Turns	App. Total	Left	Thru	Right	U-Turns	App. Total	Left	Thru	Right	U-Turns	App. Total	Left	Thru	Right	U-Turns	App. Total	
07:00 AM	2	0	0	0	2	0	15	0	0	15	0	0	0	0	0	0	25	0	0	25	42
07:15 AM	2	0	0	0	2	0	22	1	0	23	0	0	0	0	0	0	19	0	0	19	44
07:30 AM	0	0	0	0	0	0	15	2	0	17	0	0	0	0	0	0	11	0	0	11	28
07:45 AM	2	0	0	0	2	0	10	0	0	10	0	0	0	0	0	0	22	0	0	22	34
Total	6	0	0	0	6	0	62	3	0	65	0	0	0	0	0	0	77	0	0	77	148
08:00 AM	0	0	0	0	0	0	20	3	0	23	0	0	0	0	0	0	19	0	0	19	42
08:15 AM	0	0	1	0	1	0	25	1	0	26	0	0	0	0	0	0	17	0	0	17	44
08:30 AM	1	0	0	0	1	0	22	3	0	25	0	0	0	0	0	0	17	0	0	17	43
08:45 AM	5	0	2	0	7	0	18	2	0	20	0	0	0	0	0	0	24	0	0	24	51
Total	6	0	3	0	9	0	85	9	0	94	0	0	0	0	0	0	77	0	0	77	180
Grand Total	12	0	3	0	15	0	147	12	0	159	0	0	0	0	0	0	154	0	0	154	328
Apprch %	80	0	20	0		0	92.5	7.5	0		0	0	0	0	0	0	100	0	0		
Total %	3.7	0	0.9	0	4.6	0	44.8	3.7	0	48.5	0	0	0	0	0	0	47	0	0	47	

Start Time	Pistachio Drive Southbound					Avenue 18 1/2 Westbound					Truck Parking Lot Northbound					Avenue 18 1/2 Eastbound					Int. Total
	Left	Thru	Right	U-Turns	App. Total	Thru	Right	U-Turns	App. Total	Thru	Right	U-Turns	App. Total	Thru	Right	U-Turns	App. Total				
Peak Hour Analysis From 07:30 AM to 08:15 AM - Peak 1 of 1																					
Peak Hour for Entire Intersection Begins at 07:30 AM																					
07:30 AM	0	0	0	0	0	0	15	2	0	17	0	0	0	0	0	0	11	0	0	11	28
07:45 AM	2	0	0	0	2	0	10	0	0	10	0	0	0	0	0	0	22	0	0	22	34
08:00 AM	0	0	0	0	0	0	20	3	0	23	0	0	0	0	0	0	19	0	0	19	42
08:15 AM	0	0	1	0	1	0	25	1	0	26	0	0	0	0	0	0	17	0	0	17	44
Total Volume	2	0	1	0	3	0	70	6	0	76	0	0	0	0	0	0	69	0	0	69	148
% App. Total	66.7	0	33.3	0		0	92.1	7.9	0		0	0	0	0	0	0	100	0	0		
PHF	.250	.000	.250	.000	.375	.000	.700	.500	.000	.731	.000	.000	.000	.000	.000	.000	.784	.000	.000	.784	.841

City of Madera
 N/S: Pistachio Drive
 E/W: Avenue 18 1/2
 Weather: Clear

File Name : 48_MDA_Pistachio_Ave 18 1-2 AM
 Site Code : 00319628
 Start Date : 9/26/2019
 Page No : 2

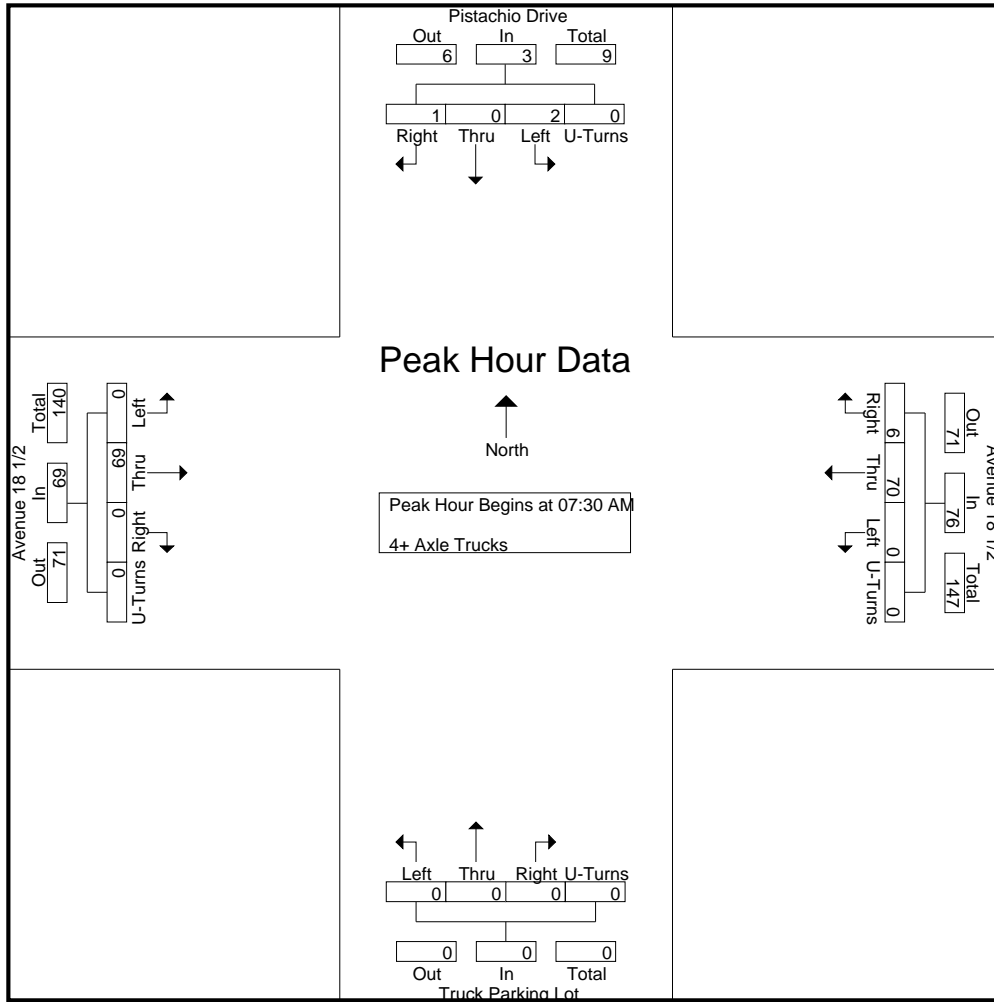

Peak Hour Analysis From 07:30 AM to 08:15 AM - Peak 1 of 1
 Peak Hour for Each Approach Begins at:

	07:30 AM					07:30 AM					07:30 AM									
+0 mins.	0	0	0	0	0	0	15	2	0	17	0	0	0	0	0	0	11	0	0	11
+15 mins.	2	0	0	0	2	0	10	0	0	10	0	0	0	0	0	0	22	0	0	22
+30 mins.	0	0	0	0	0	0	20	3	0	23	0	0	0	0	0	0	19	0	0	19
+45 mins.	0	0	1	0	1	0	25	1	0	26	0	0	0	0	0	0	17	0	0	17
Total Volume	2	0	1	0	3	0	70	6	0	76	0	0	0	0	0	0	69	0	0	69
% App. Total	66.7	0	33.3	0		0	92.1	7.9	0		0	0	0	0		0	100	0	0	
PHF	.250	.000	.250	.000	.375	.000	.700	.500	.000	.731	.000	.000	.000	.000	.000	.000	.784	.000	.000	.784

City of Madera
 N/S: Pistachio Drive
 E/W: Avenue 18 1/2
 Weather: Clear

File Name : 48_MDA_Pistachio_Ave 18 1-2 PM
 Site Code : 00319628
 Start Date : 9/26/2019
 Page No : 1

Groups Printed- Passenger Vehicles - Large 2 Axle Vehicles - 3 Axle Vehicles - 4+ Axle Trucks

Start Time	Pistachio Drive Southbound					Avenue 18 1/2 Westbound					Truck Parking Lot Northbound					Avenue 18 1/2 Eastbound					Int. Total
	Left	Thru	Right	U-Turns	App. Total	Left	Thru	Right	U-Turns	App. Total	Left	Thru	Right	U-Turns	App. Total	Left	Thru	Right	U-Turns	App. Total	
04:00 PM	37	0	5	0	42	2	43	44	0	89	0	0	1	0	1	4	121	0	0	125	257
04:15 PM	34	0	1	0	35	1	42	46	0	89	0	0	0	0	0	4	111	1	0	116	240
04:30 PM	41	0	4	0	45	2	33	47	1	83	2	0	3	0	5	3	102	0	0	105	238
04:45 PM	42	0	2	0	44	0	30	50	0	80	0	0	1	0	1	1	91	0	0	92	217
Total	154	0	12	0	166	5	148	187	1	341	2	0	5	0	7	12	425	1	0	438	952
05:00 PM	28	0	1	0	29	1	41	37	0	79	0	0	1	0	1	1	71	0	0	72	181
05:15 PM	27	0	4	0	31	0	42	52	0	94	0	0	1	0	1	3	70	0	0	73	199
05:30 PM	32	0	0	0	32	0	39	38	0	77	0	0	0	0	0	2	60	0	0	62	171
05:45 PM	23	0	2	0	25	0	36	40	0	76	0	0	0	0	0	2	60	0	0	62	163
Total	110	0	7	0	117	1	158	167	0	326	0	0	2	0	2	8	261	0	0	269	714
Grand Total	264	0	19	0	283	6	306	354	1	667	2	0	7	0	9	20	686	1	0	707	1666
Apprch %	93.3	0	6.7	0		0.9	45.9	53.1	0.1		22.2	0	77.8	0		2.8	97	0.1	0		
Total %	15.8	0	1.1	0	17	0.4	18.4	21.2	0.1	40	0.1	0	0.4	0	0.5	1.2	41.2	0.1	0	42.4	
Passenger Vehicles																					
% Passenger Vehicles	95.1	0	94.7	0	95.1	50	54.9	92.7	100	75	50	0	28.6	0	33.3	75	75.8	0	0	75.7	78.5
Large 2 Axle Vehicles																					
% Large 2 Axle Vehicles	1.9	0	0	0	1.8	16.7	3.9	2.3	0	3.1	0	0	42.9	0	33.3	5	3.2	100	0	3.4	3.2
3 Axle Vehicles																					
% 3 Axle Vehicles	0.8	0	0	0	0.7	16.7	1.6	1.1	0	1.5	50	0	14.3	0	22.2	0	1.9	0	0	1.8	1.6
4+ Axle Trucks	6	0	1	0	7	1	121	14	0	136	0	0	1	0	1	4	131	0	0	135	279
% 4+ Axle Trucks																					

Start Time	Pistachio Drive Southbound					Avenue 18 1/2 Westbound					Truck Parking Lot Northbound					Avenue 18 1/2 Eastbound					Int. Total
	Left	Thru	Right	U-Turns	App. Total	Left	Thru	Right	U-Turns	App. Total	Left	Thru	Right	U-Turns	App. Total	Left	Thru	Right	U-Turns	App. Total	
Peak Hour Analysis From 04:00 PM to 05:45 PM - Peak 1 of 1																					
Peak Hour for Entire Intersection Begins at 04:00 PM																					
04:00 PM	37	0	5	0	42	2	43	44	0	89	0	0	1	0	1	4	121	0	0	125	257
04:15 PM	34	0	1	0	35	1	42	46	0	89	0	0	0	0	0	4	111	1	0	116	240
04:30 PM	41	0	4	0	45	2	33	47	1	83	2	0	3	0	5	3	102	0	0	105	238
04:45 PM	42	0	2	0	44	0	30	50	0	80	0	0	1	0	1	1	91	0	0	92	217
Total Volume	154	0	12	0	166	5	148	187	1	341	2	0	5	0	7	12	425	1	0	438	952
% App. Total	92.8	0	7.2	0		1.5	43.4	54.8	0.3		28.6	0	71.4	0		2.7	97	0.2	0		
PHF	.917	.000	.600	.000	.922	.625	.860	.935	.250	.958	.250	.000	.417	.000	.350	.750	.878	.250	.000	.876	.926

City of Madera
 N/S: Pistachio Drive
 E/W: Avenue 18 1/2
 Weather: Clear

File Name : 48_MDA_Pistachio_Ave 18 1-2 PM
 Site Code : 00319628
 Start Date : 9/26/2019
 Page No : 2

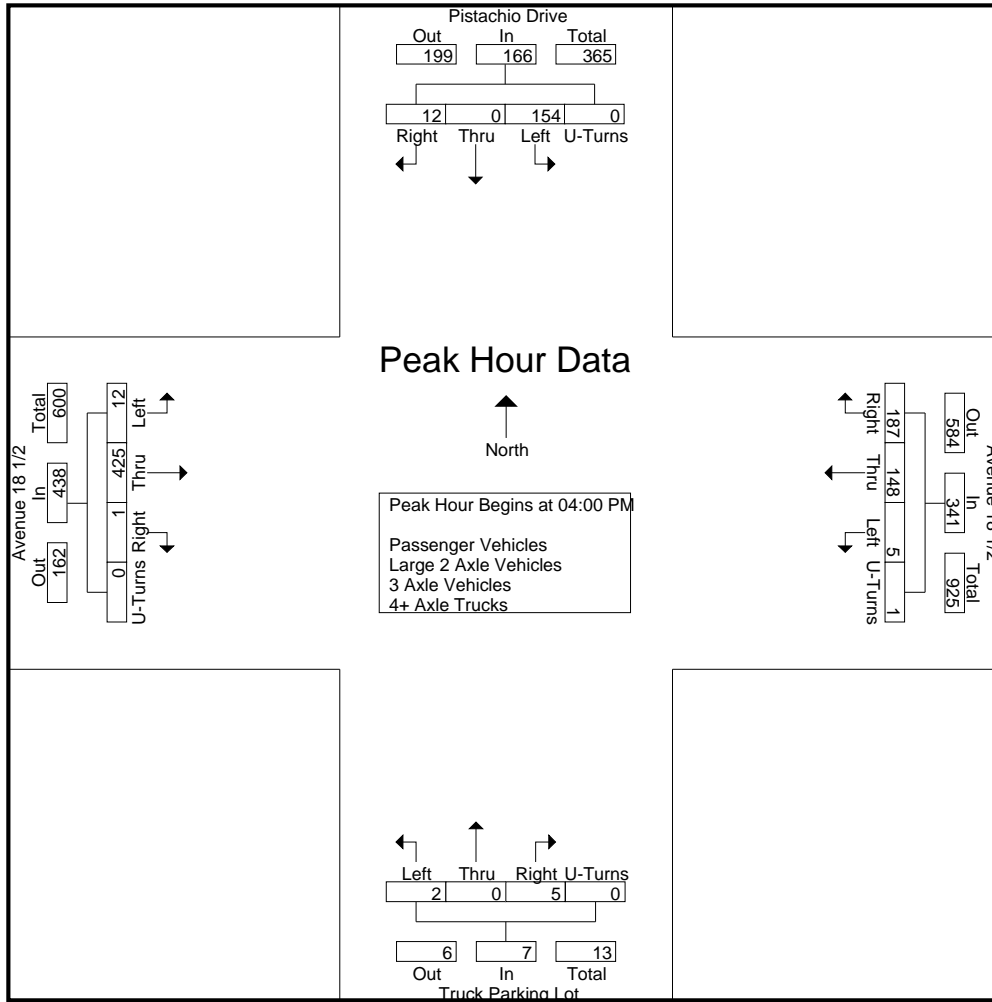

Peak Hour Analysis From 04:00 PM to 05:45 PM - Peak 1 of 1
 Peak Hour for Each Approach Begins at:

	04:00 PM					04:00 PM					04:30 PM					04:00 PM				
+0 mins.	37	0	5	0	42	2	43	44	0	89	2	0	3	0	5	4	121	0	0	125
+15 mins.	34	0	1	0	35	1	42	46	0	89	0	0	1	0	1	4	111	1	0	116
+30 mins.	41	0	4	0	45	2	33	47	1	83	0	0	1	0	1	3	102	0	0	105
+45 mins.	42	0	2	0	44	0	30	50	0	80	0	0	1	0	1	1	91	0	0	92
Total Volume	154	0	12	0	166	5	148	187	1	341	2	0	6	0	8	12	425	1	0	438
% App. Total	92.8	0	7.2	0		1.5	43.4	54.8	0.3		25	0	75	0		2.7	97	0.2	0	
PHF	.917	.000	.600	.000	.922	.625	.860	.935	.250	.958	.250	.000	.500	.000	.400	.750	.878	.250	.000	.876

City of Madera
 N/S: Pistachio Drive
 E/W: Avenue 18 1/2
 Weather: Clear

File Name : 48_MDA_Pistachio_Ave 18 1-2 PM
 Site Code : 00319628
 Start Date : 9/26/2019
 Page No : 1

Groups Printed- Passenger Vehicles

Start Time	Pistachio Drive Southbound					Avenue 18 1/2 Westbound					Truck Parking Lot Northbound					Avenue 18 1/2 Eastbound					Int. Total
	Left	Thru	Right	U-Turns	App. Total	Left	Thru	Right	U-Turns	App. Total	Left	Thru	Right	U-Turns	App. Total	Left	Thru	Right	U-Turns	App. Total	
04:00 PM	36	0	5	0	41	0	18	42	0	60	0	0	1	0	1	3	97	0	0	100	202
04:15 PM	33	0	1	0	34	1	23	44	0	68	0	0	0	0	0	3	83	0	0	86	188
04:30 PM	38	0	4	0	42	2	13	43	1	59	1	0	0	0	1	3	82	0	0	85	187
04:45 PM	39	0	2	0	41	0	18	48	0	66	0	0	0	0	0	1	66	0	0	67	174
Total	146	0	12	0	158	3	72	177	1	253	1	0	1	0	2	10	328	0	0	338	751
05:00 PM	27	0	1	0	28	0	26	34	0	60	0	0	1	0	1	1	57	0	0	58	147
05:15 PM	26	0	4	0	30	0	24	47	0	71	0	0	0	0	0	2	56	0	0	58	159
05:30 PM	31	0	0	0	31	0	21	36	0	57	0	0	0	0	0	1	40	0	0	41	129
05:45 PM	21	0	1	0	22	0	25	34	0	59	0	0	0	0	0	1	39	0	0	40	121
Total	105	0	6	0	111	0	96	151	0	247	0	0	1	0	1	5	192	0	0	197	556
Grand Total	251	0	18	0	269	3	168	328	1	500	1	0	2	0	3	15	520	0	0	535	1307
Apprch %	93.3	0	6.7	0		0.6	33.6	65.6	0.2		33.3	0	66.7	0		2.8	97.2	0	0		
Total %	19.2	0	1.4	0	20.6	0.2	12.9	25.1	0.1	38.3	0.1	0	0.2	0	0.2	1.1	39.8	0	0	40.9	

Start Time	Pistachio Drive Southbound					Avenue 18 1/2 Westbound					Truck Parking Lot Northbound					Avenue 18 1/2 Eastbound					Int. Total
	Left	Thru	Right	U-Turns	App. Total	Thru	Right	U-Turns	App. Total	Thru	Right	U-Turns	App. Total	Thru	Right	U-Turns	App. Total				
Peak Hour Analysis From 04:00 PM to 04:45 PM - Peak 1 of 1																					
Peak Hour for Entire Intersection Begins at 04:00 PM																					
04:00 PM	36	0	5	0	41	0	18	42	0	60	0	0	1	0	1	3	97	0	0	100	202
04:15 PM	33	0	1	0	34	1	23	44	0	68	0	0	0	0	0	3	83	0	0	86	188
04:30 PM	38	0	4	0	42	2	13	43	1	59	1	0	0	0	1	3	82	0	0	85	187
04:45 PM	39	0	2	0	41	0	18	48	0	66	0	0	0	0	0	1	66	0	0	67	174
Total Volume	146	0	12	0	158	3	72	177	1	253	1	0	1	0	2	10	328	0	0	338	751
% App. Total	92.4	0	7.6	0		1.2	28.5	70	0.4		50	0	50	0		3	97	0	0		
PHF	.936	.000	.600	.000	.940	.375	.783	.922	.250	.930	.250	.000	.250	.000	.500	.833	.845	.000	.000	.845	.929

City of Madera
 N/S: Pistachio Drive
 E/W: Avenue 18 1/2
 Weather: Clear

File Name : 48_MDA_Pistachio_Ave 18 1-2 PM
 Site Code : 00319628
 Start Date : 9/26/2019
 Page No : 2

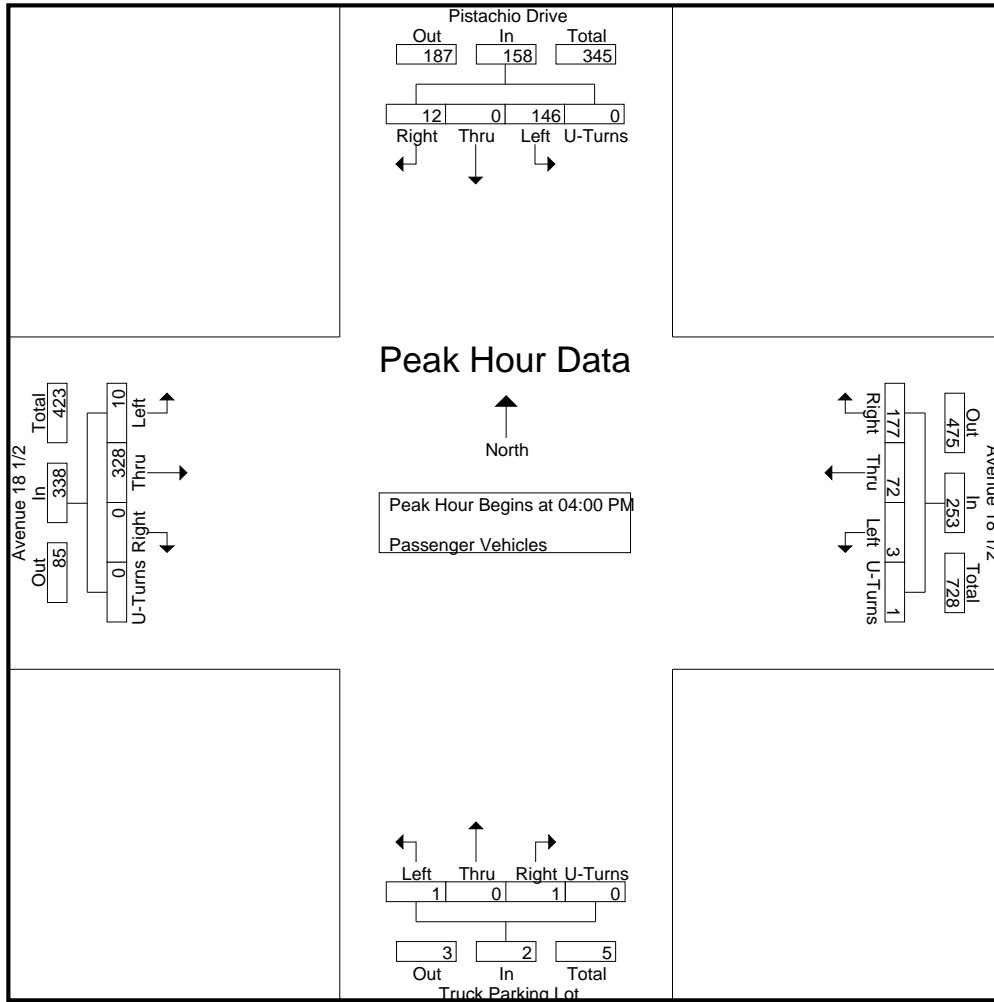

Peak Hour Analysis From 04:00 PM to 04:45 PM - Peak 1 of 1
 Peak Hour for Each Approach Begins at:

	04:00 PM					04:00 PM					04:00 PM									
+0 mins.	36	0	5	0	41	0	18	42	0	60	0	0	1	0	1	3	97	0	0	100
+15 mins.	33	0	1	0	34	1	23	44	0	68	0	0	0	0	0	3	83	0	0	86
+30 mins.	38	0	4	0	42	2	13	43	1	59	1	0	0	0	1	3	82	0	0	85
+45 mins.	39	0	2	0	41	0	18	48	0	66	0	0	0	0	0	1	66	0	0	67
Total Volume	146	0	12	0	158	3	72	177	1	253	1	0	1	0	2	10	328	0	0	338
% App. Total	92.4	0	7.6	0		1.2	28.5	70	0.4		50	0	50	0		3	97	0	0	
PHF	.936	.000	.600	.000	.940	.375	.783	.922	.250	.930	.250	.000	.250	.000	.500	.833	.845	.000	.000	.845

City of Madera
 N/S: Pistachio Drive
 E/W: Avenue 18 1/2
 Weather: Clear

File Name : 48_MDA_Pistachio_Ave 18 1-2 PM
 Site Code : 00319628
 Start Date : 9/26/2019
 Page No : 1

Groups Printed- Large 2 Axle Vehicles

Start Time	Pistachio Drive Southbound					Avenue 18 1/2 Westbound					Truck Parking Lot Northbound					Avenue 18 1/2 Eastbound					Int. Total
	Left	Thru	Right	U-Turns	App. Total	Left	Thru	Right	U-Turns	App. Total	Left	Thru	Right	U-Turns	App. Total	Left	Thru	Right	U-Turns	App. Total	
04:00 PM	0	0	0	0	0	0	2	0	0	2	0	0	0	0	0	0	1	0	0	1	3
04:15 PM	0	0	0	0	0	0	1	0	0	1	0	0	0	0	0	0	3	1	0	4	5
04:30 PM	1	0	0	0	1	0	1	1	0	2	0	0	1	0	1	0	4	0	0	4	8
04:45 PM	1	0	0	0	1	0	1	0	0	1	0	0	1	0	1	0	4	0	0	4	7
Total	2	0	0	0	2	0	5	1	0	6	0	0	2	0	2	0	12	1	0	13	23
05:00 PM	0	0	0	0	0	1	3	1	0	5	0	0	0	0	0	0	0	0	0	0	5
05:15 PM	1	0	0	0	1	0	1	2	0	3	0	0	1	0	1	0	2	0	0	2	7
05:30 PM	1	0	0	0	1	0	1	1	0	2	0	0	0	0	0	0	2	0	0	2	5
05:45 PM	1	0	0	0	1	0	2	3	0	5	0	0	0	0	0	1	6	0	0	7	13
Total	3	0	0	0	3	1	7	7	0	15	0	0	1	0	1	1	10	0	0	11	30
Grand Total	5	0	0	0	5	1	12	8	0	21	0	0	3	0	3	1	22	1	0	24	53
Apprch %	100	0	0	0		4.8	57.1	38.1	0		0	0	100	0		4.2	91.7	4.2	0		
Total %	9.4	0	0	0	9.4	1.9	22.6	15.1	0	39.6	0	0	5.7	0	5.7	1.9	41.5	1.9	0	45.3	

Start Time	Pistachio Drive Southbound					Avenue 18 1/2 Westbound					Truck Parking Lot Northbound					Avenue 18 1/2 Eastbound					Int. Total
	Left	Thru	Right	U-Turns	App. Total	Thru	Right	U-Turns	App. Total	Thru	Right	U-Turns	App. Total	Thru	Right	U-Turns	App. Total				
Peak Hour Analysis From 04:00 PM to 04:45 PM - Peak 1 of 1																					
Peak Hour for Entire Intersection Begins at 04:00 PM																					
04:00 PM	0	0	0	0	0	0	2	0	0	2	0	0	0	0	0	0	1	0	0	1	3
04:15 PM	0	0	0	0	0	0	1	0	0	1	0	0	0	0	0	0	3	1	0	4	5
04:30 PM	1	0	0	0	1	0	1	1	0	2	0	0	1	0	1	0	4	0	0	4	8
04:45 PM	1	0	0	0	1	0	1	0	0	1	0	0	1	0	1	0	4	0	0	4	7
Total Volume	2	0	0	0	2	0	5	1	0	6	0	0	2	0	2	0	12	1	0	13	23
% App. Total	100	0	0	0		0	83.3	16.7	0		0	0	100	0		0	92.3	7.7	0		
PHF	.500	.000	.000	.000	.500	.000	.625	.250	.000	.750	.000	.000	.500	.000	.500	.000	.750	.250	.000	.813	.719

City of Madera
 N/S: Pistachio Drive
 E/W: Avenue 18 1/2
 Weather: Clear

File Name : 48_MDA_Pistachio_Ave 18 1-2 PM
 Site Code : 00319628
 Start Date : 9/26/2019
 Page No : 2

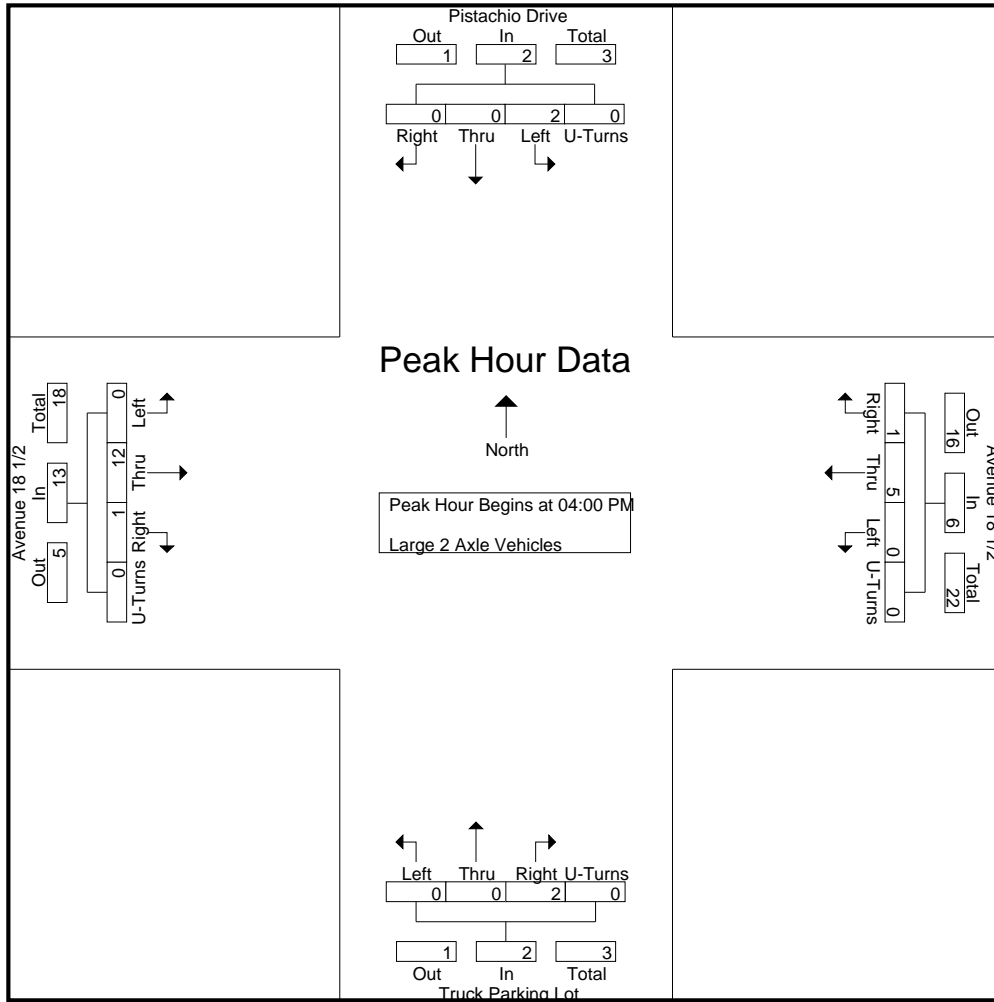

Peak Hour Analysis From 04:00 PM to 04:45 PM - Peak 1 of 1
 Peak Hour for Each Approach Begins at:

	04:00 PM					04:00 PM					04:00 PM									
+0 mins.	0	0	0	0	0	0	2	0	0	2	0	0	0	0	0	0	1	0	0	1
+15 mins.	0	0	0	0	0	0	1	0	0	1	0	0	0	0	0	0	3	1	0	4
+30 mins.	1	0	0	0	1	0	1	1	0	2	0	0	1	0	1	0	4	0	0	4
+45 mins.	1	0	0	0	1	0	1	0	0	1	0	0	1	0	1	0	4	0	0	4
Total Volume	2	0	0	0	2	0	5	1	0	6	0	0	2	0	2	0	12	1	0	13
% App. Total	100	0	0	0	0	0	83.3	16.7	0	0	0	0	100	0	0	0	92.3	7.7	0	0
PHF	.500	.000	.000	.000	.500	.000	.625	.250	.000	.750	.000	.000	.500	.000	.500	.000	.750	.250	.000	.813

City of Madera
 N/S: Pistachio Drive
 E/W: Avenue 18 1/2
 Weather: Clear

File Name : 48_MDA_Pistachio_Ave 18 1-2 PM
 Site Code : 00319628
 Start Date : 9/26/2019
 Page No : 1

Groups Printed- 3 Axle Vehicles

Start Time	Pistachio Drive Southbound					Avenue 18 1/2 Westbound					Truck Parking Lot Northbound					Avenue 18 1/2 Eastbound					Int. Total
	Left	Thru	Right	U-Turns	App. Total	Left	Thru	Right	U-Turns	App. Total	Left	Thru	Right	U-Turns	App. Total	Left	Thru	Right	U-Turns	App. Total	
04:00 PM	0	0	0	0	0	1	1	1	0	3	0	0	0	0	0	0	5	0	0	5	8
04:15 PM	0	0	0	0	0	0	0	1	0	1	0	0	0	0	0	0	1	0	0	1	2
04:30 PM	1	0	0	0	1	0	3	1	0	4	1	0	1	0	2	0	1	0	0	1	8
04:45 PM	1	0	0	0	1	0	0	0	0	0	0	0	0	0	0	0	3	0	0	3	4
Total	2	0	0	0	2	1	4	3	0	8	1	0	1	0	2	0	10	0	0	10	22
05:00 PM	0	0	0	0	0	0	0	0	0	0	0	0	0	0	0	0	1	0	0	1	1
05:15 PM	0	0	0	0	0	0	0	0	0	0	0	0	0	0	0	0	2	0	0	2	2
05:30 PM	0	0	0	0	0	0	0	0	0	0	0	0	0	0	0	0	0	0	0	0	0
05:45 PM	0	0	0	0	0	0	1	1	0	2	0	0	0	0	0	0	0	0	0	0	2
Total	0	0	0	0	0	0	1	1	0	2	0	0	0	0	0	0	3	0	0	3	5
Grand Total	2	0	0	0	2	1	5	4	0	10	1	0	1	0	2	0	13	0	0	13	27
Apprch %	100	0	0	0		10	50	40	0		50	0	50	0		0	100	0	0		
Total %	7.4	0	0	0	7.4	3.7	18.5	14.8	0	37	3.7	0	3.7	0	7.4	0	48.1	0	0	48.1	

Start Time	Pistachio Drive Southbound					Avenue 18 1/2 Westbound					Truck Parking Lot Northbound					Avenue 18 1/2 Eastbound					Int. Total
	Left	Thru	Right	U-Turns	App. Total	Thru	Right	U-Turns	App. Total	Thru	Right	U-Turns	App. Total	Thru	Right	U-Turns	App. Total				
Peak Hour Analysis From 04:00 PM to 04:45 PM - Peak 1 of 1																					
Peak Hour for Entire Intersection Begins at 04:00 PM																					
04:00 PM	0	0	0	0	0	1	1	1	0	3	0	0	0	0	0	0	5	0	0	5	8
04:15 PM	0	0	0	0	0	0	0	1	0	1	0	0	0	0	0	0	1	0	0	1	2
04:30 PM	1	0	0	0	1	0	3	1	0	4	1	0	1	0	2	0	1	0	0	1	8
04:45 PM	1	0	0	0	1	0	0	0	0	0	0	0	0	0	0	0	3	0	0	3	4
Total Volume	2	0	0	0	2	1	4	3	0	8	1	0	1	0	2	0	10	0	0	10	22
% App. Total	100	0	0	0		12.5	50	37.5	0		50	0	50	0		0	100	0	0		
PHF	.500	.000	.000	.000	.500	.250	.333	.750	.000	.500	.250	.000	.250	.000	.250	.000	.500	.000	.000	.500	.688

City of Madera
 N/S: Pistachio Drive
 E/W: Avenue 18 1/2
 Weather: Clear

File Name : 48_MDA_Pistachio_Ave 18 1-2 PM
 Site Code : 00319628
 Start Date : 9/26/2019
 Page No : 2

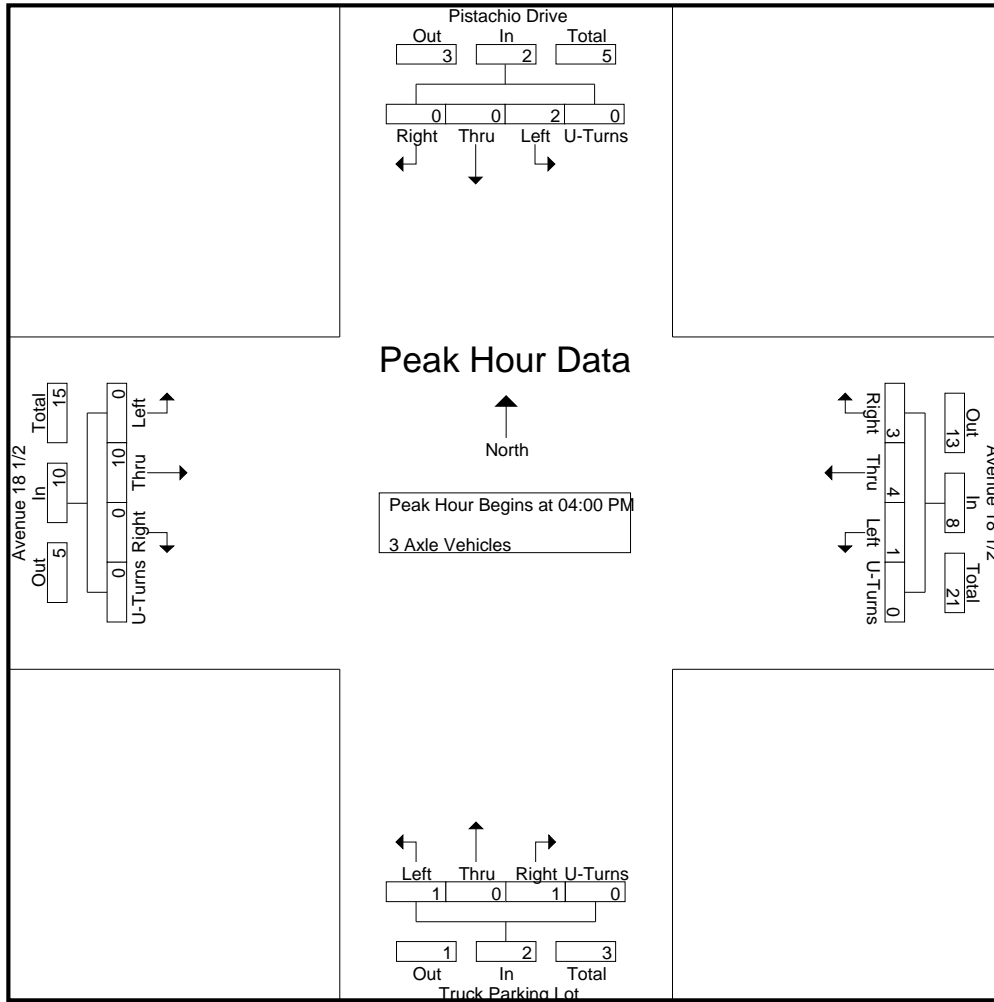

Peak Hour Analysis From 04:00 PM to 04:45 PM - Peak 1 of 1
 Peak Hour for Each Approach Begins at:

	04:00 PM					04:00 PM					04:00 PM									
+0 mins.	0	0	0	0	0	1	1	1	0	3	0	0	0	0	0	0	5	0	0	5
+15 mins.	0	0	0	0	0	0	0	1	0	1	0	0	0	0	0	0	1	0	0	1
+30 mins.	1	0	0	0	1	0	3	1	0	4	1	0	1	0	2	0	1	0	0	1
+45 mins.	1	0	0	0	1	0	0	0	0	0	0	0	0	0	0	0	3	0	0	3
Total Volume	2	0	0	0	2	1	4	3	0	8	1	0	1	0	2	0	10	0	0	10
% App. Total	100	0	0	0	0	12.5	50	37.5	0	50	50	0	50	0	0	0	100	0	0	0
PHF	.500	.000	.000	.000	.500	.250	.333	.750	.000	.500	.250	.000	.250	.000	.250	.000	.500	.000	.000	.500

City of Madera
 N/S: Pistachio Drive
 E/W: Avenue 18 1/2
 Weather: Clear

File Name : 48_MDA_Pistachio_Ave 18 1-2 PM
 Site Code : 00319628
 Start Date : 9/26/2019
 Page No : 1

Groups Printed- 4+ Axle Trucks

Start Time	Pistachio Drive Southbound					Avenue 18 1/2 Westbound					Truck Parking Lot Northbound					Avenue 18 1/2 Eastbound					Int. Total
	Left	Thru	Right	U-Turns	App. Total	Left	Thru	Right	U-Turns	App. Total	Left	Thru	Right	U-Turns	App. Total	Left	Thru	Right	U-Turns	App. Total	
04:00 PM	1	0	0	0	1	1	22	1	0	24	0	0	0	0	0	1	18	0	0	19	44
04:15 PM	1	0	0	0	1	0	18	1	0	19	0	0	0	0	0	1	24	0	0	25	45
04:30 PM	1	0	0	0	1	0	16	2	0	18	0	0	1	0	1	0	15	0	0	15	35
04:45 PM	1	0	0	0	1	0	11	2	0	13	0	0	0	0	0	0	18	0	0	18	32
Total	4	0	0	0	4	1	67	6	0	74	0	0	1	0	1	2	75	0	0	77	156
05:00 PM	1	0	0	0	1	0	12	2	0	14	0	0	0	0	0	0	13	0	0	13	28
05:15 PM	0	0	0	0	0	0	17	3	0	20	0	0	0	0	0	1	10	0	0	11	31
05:30 PM	0	0	0	0	0	0	17	1	0	18	0	0	0	0	0	1	18	0	0	19	37
05:45 PM	1	0	1	0	2	0	8	2	0	10	0	0	0	0	0	0	15	0	0	15	27
Total	2	0	1	0	3	0	54	8	0	62	0	0	0	0	0	2	56	0	0	58	123
Grand Total	6	0	1	0	7	1	121	14	0	136	0	0	1	0	1	4	131	0	0	135	279
Apprch %	85.7	0	14.3	0		0.7	89	10.3	0		0	0	100	0		3	97	0	0		
Total %	2.2	0	0.4	0	2.5	0.4	43.4	5	0	48.7	0	0	0.4	0	0.4	1.4	47	0	0	48.4	

Start Time	Pistachio Drive Southbound					Avenue 18 1/2 Westbound					Truck Parking Lot Northbound					Avenue 18 1/2 Eastbound					Int. Total
	Left	Thru	Right	U-Turns	App. Total	Thru	Right	U-Turns	App. Total	Thru	Right	U-Turns	App. Total	Thru	Right	U-Turns	App. Total				
Peak Hour Analysis From 04:00 PM to 04:45 PM - Peak 1 of 1																					
Peak Hour for Entire Intersection Begins at 04:00 PM																					
04:00 PM	1	0	0	0	1	1	22	1	0	24	0	0	0	0	0	1	18	0	0	19	44
04:15 PM	1	0	0	0	1	0	18	1	0	19	0	0	0	0	0	1	24	0	0	25	45
04:30 PM	1	0	0	0	1	0	16	2	0	18	0	0	1	0	1	0	15	0	0	15	35
04:45 PM	1	0	0	0	1	0	11	2	0	13	0	0	0	0	0	0	18	0	0	18	32
Total Volume	4	0	0	0	4	1	67	6	0	74	0	0	1	0	1	2	75	0	0	77	156
% App. Total	100	0	0	0		1.4	90.5	8.1	0		0	0	100	0		2.6	97.4	0	0		
PHF	1.00	.000	.000	.000	1.00	.250	.761	.750	.000	.771	.000	.000	.250	.000	.250	.500	.781	.000	.000	.770	.867

City of Madera
 N/S: Pistachio Drive
 E/W: Avenue 18 1/2
 Weather: Clear

File Name : 48_MDA_Pistachio_Ave 18 1-2 PM
 Site Code : 00319628
 Start Date : 9/26/2019
 Page No : 2

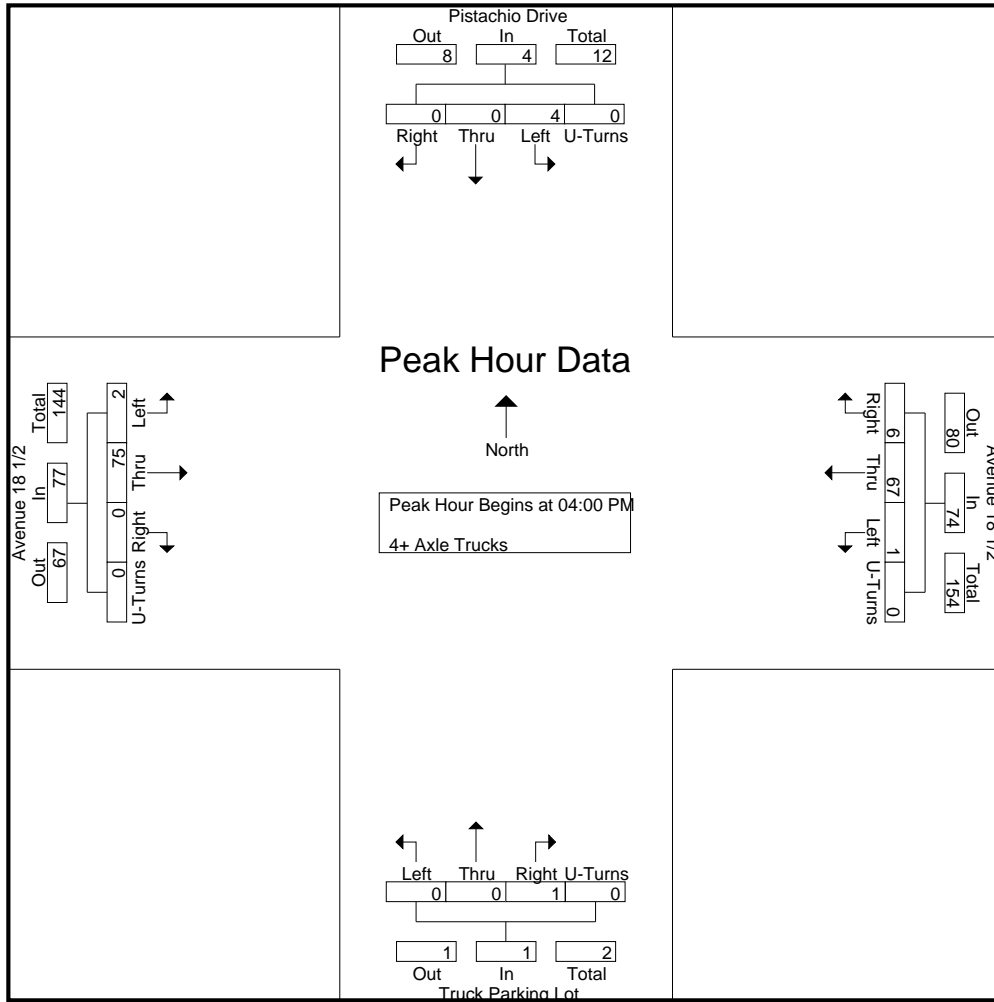

Peak Hour Analysis From 04:00 PM to 04:45 PM - Peak 1 of 1
 Peak Hour for Each Approach Begins at:

	04:00 PM					04:00 PM					04:00 PM									
+0 mins.	1	0	0	0	1	1	22	1	0	24	0	0	0	0	0	1	18	0	0	19
+15 mins.	1	0	0	0	1	0	18	1	0	19	0	0	0	0	0	1	24	0	0	25
+30 mins.	1	0	0	0	1	0	16	2	0	18	0	0	1	0	1	0	15	0	0	15
+45 mins.	1	0	0	0	1	0	11	2	0	13	0	0	0	0	0	0	18	0	0	18
Total Volume	4	0	0	0	4	1	67	6	0	74	0	0	1	0	1	2	75	0	0	77
% App. Total	100	0	0	0	0	1.4	90.5	8.1	0	0	0	0	100	0	0	2.6	97.4	0	0	0
PHF	1.000	.000	.000	.000	1.000	.250	.761	.750	.000	.771	.000	.000	.250	.000	.250	.500	.781	.000	.000	.770

Location: Madera
 N/S: Pistachio Drive
 E/W: Avenue 18 1/2



Date: 9/26/2019
 Day: Thursday

PEDESTRIANS

	North Leg Pistachio Drive	East Leg Avenue 18 1/2	South Leg Truck Parking Lot	West Leg Avenue 18 1/2	
	Pedestrians	Pedestrians	Pedestrians	Pedestrians	
7:00 AM	0	0	0	0	0
7:15 AM	0	0	0	0	0
7:30 AM	0	0	0	0	0
7:45 AM	0	0	0	0	0
8:00 AM	0	0	0	0	0
8:15 AM	0	0	0	0	0
8:30 AM	0	0	0	0	0
8:45 AM	0	0	0	0	0
TOTAL VOLUMES:	0	0	0	0	0

	North Leg Pistachio Drive	East Leg Avenue 18 1/2	South Leg Truck Parking Lot	West Leg Avenue 18 1/2	
	Pedestrians	Pedestrians	Pedestrians	Pedestrians	
4:00 PM	0	0	0	0	0
4:15 PM	0	0	0	0	0
4:30 PM	0	0	0	0	0
4:45 PM	0	1	0	0	1
5:00 PM	0	0	0	0	0
5:15 PM	0	0	0	0	0
5:30 PM	0	0	0	0	0
5:45 PM	0	0	0	0	0
TOTAL VOLUMES:	0	1	0	0	1

Location: Madera
 N/S: Pistachio Drive
 E/W: Avenue 18 1/2



Date: 9/26/2019
 Day: Thursday

BICYCLES

	Southbound Pistachio Drive			Westbound Avenue 18 1/2			Northbound Truck Parking Lot			Eastbound Avenue 18 1/2			
	Left	Thru	Right	Left	Thru	Right	Left	Thru	Right	Left	Thru	Right	
7:00 AM	0	0	0	0	0	0	0	0	0	0	0	0	0
7:15 AM	0	0	0	0	0	0	0	0	0	0	0	0	0
7:30 AM	0	0	0	0	0	0	0	0	0	0	0	0	0
7:45 AM	0	0	0	0	0	0	0	0	0	0	0	0	0
8:00 AM	0	0	0	0	0	0	0	0	0	0	0	0	0
8:15 AM	0	0	0	0	0	0	0	0	0	0	0	0	0
8:30 AM	0	0	0	0	0	0	0	0	0	0	0	0	0
8:45 AM	0	0	0	0	0	0	0	0	0	0	0	0	0
TOTAL VOLUMES:	0	0	0	0	0	0	0	0	0	0	0	0	0

	Southbound Pistachio Drive			Westbound Avenue 18 1/2			Northbound Truck Parking Lot			Eastbound Avenue 18 1/2			
	Left	Thru	Right	Left	Thru	Right	Left	Thru	Right	Left	Thru	Right	
4:00 PM	0	0	0	0	0	0	0	0	0	0	0	0	0
4:15 PM	0	0	0	0	0	0	0	0	0	0	0	0	0
4:30 PM	0	0	0	0	0	0	0	0	0	0	0	0	0
4:45 PM	0	0	0	0	0	0	0	0	0	0	0	0	0
5:00 PM	0	0	0	0	0	0	0	0	0	0	0	0	0
5:15 PM	0	0	0	0	0	0	0	0	0	0	0	0	0
5:30 PM	0	0	0	0	0	0	0	0	0	0	0	0	0
5:45 PM	0	0	0	0	0	0	0	0	0	0	0	0	0
TOTAL VOLUMES:	0	0	0	0	0	0	0	0	0	0	0	0	0

Counts Unlimited
 PO Box 1178
 Corona, CA 92878
 (951) 268-6268

City of Madera
 N/S: SR-99 SB Off Ramp/Road 23
 E/W: Avenue 18 1/2
 Weather: Clear

File Name : 03_MDA_99S Off Ramp_Ave 18 1-2 AM
 Site Code : 00319628
 Start Date : 9/18/2019
 Page No : 1

Groups Printed- Passenger Vehicles - Large 2 Axle Vehicles - 3 Axle Vehicles - 4+ Axle Trucks

Start Time	SR-99 Southbound Off Ramp Southbound					Avenue 18 1/2 Westbound					Road 23 Northbound					Avenue 18 1/2 Eastbound					Int. Total
	Left	Thru	Right	U-Turns	App. Total	Left	Thru	Right	U-Turns	App. Total	Left	Thru	Right	U-Turns	App. Total	Left	Thru	Right	U-Turns	App. Total	
07:00 AM	2	11	26	0	39	6	35	0	0	41	10	0	14	0	24	0	67	10	0	77	181
07:15 AM	1	15	19	0	35	10	53	0	0	63	10	0	28	0	38	0	72	9	0	81	217
07:30 AM	2	10	22	0	34	13	71	0	1	85	15	0	46	0	61	0	67	4	0	71	251
07:45 AM	2	12	19	0	33	11	77	0	0	88	16	0	43	0	59	0	73	21	0	94	274
Total	7	48	86	0	141	40	236	0	1	277	51	0	131	0	182	0	279	44	0	323	923
08:00 AM	1	10	23	0	34	5	51	0	0	56	15	0	26	0	41	0	82	14	0	96	227
08:15 AM	5	8	22	0	35	5	48	0	0	53	12	0	21	0	33	0	66	9	0	75	196
08:30 AM	5	12	26	0	43	11	52	0	0	63	11	0	25	0	36	0	68	14	0	82	224
08:45 AM	7	10	36	0	53	11	47	0	0	58	11	0	26	0	37	0	64	9	0	73	221
Total	18	40	107	0	165	32	198	0	0	230	49	0	98	0	147	0	280	46	0	326	868
Grand Total	25	88	193	0	306	72	434	0	1	507	100	0	229	0	329	0	559	90	0	649	1791
Apprch %	8.2	28.8	63.1	0		14.2	85.6	0	0.2		30.4	0	69.6	0		0	86.1	13.9	0		
Total %	1.4	4.9	10.8	0	17.1	4	24.2	0	0.1	28.3	5.6	0	12.8	0	18.4	0	31.2	5	0	36.2	
Passenger Vehicles	76	60.2	67.9	0	66.3	70.8	74.2	0	100	73.8	82	0	74.7	0	76.9	0	66.2	77.8	0	67.8	70.9
% Passenger Vehicles	3	6	0	0	9	8	26	0	0	34	4	0	11	0	15	0	36	3	0	39	97
Large 2 Axle Vehicles	0	3.4	3.1	0	2.9	11.1	6	0	0	6.7	4	0	4.8	0	4.6	0	6.4	3.3	0	6	5.4
% Large 2 Axle Vehicles	0	2	1	0	3	1	2	0	0	3	1	0	4	0	5	0	3	6	0	9	20
3 Axle Vehicles	0	2.3	0.5	0	1	1.4	0.5	0	0	0.6	1	0	1.7	0	1.5	0	0.5	6.7	0	1.4	1.1
% 3 Axle Vehicles	6	30	55	0	91	12	84	0	0	96	13	0	43	0	56	0	150	11	0	161	404
4+ Axle Trucks	24	34.1	28.5	0	29.7	16.7	19.4	0	0	18.9	13	0	18.8	0	17	0	26.8	12.2	0	24.8	22.6
% 4+ Axle Trucks																					

Start Time	SR-99 Southbound Off Ramp Southbound					Avenue 18 1/2 Westbound					Road 23 Northbound					Avenue 18 1/2 Eastbound					Int. Total
	Left	Thru	Right	U-Turns	App. Total	Left	Thru	Right	U-Turns	App. Total	Left	Thru	Right	U-Turns	App. Total	Left	Thru	Right	U-Turns	App. Total	
Peak Hour Analysis From 07:00 AM to 08:45 AM - Peak 1 of 1																					
Peak Hour for Entire Intersection Begins at 07:15 AM																					
07:15 AM	1	15			35																
07:30 AM	2	10	22	0	34	13	71	0	1	85	15	0	46	0	61	0	67	4	0	71	251
07:45 AM	2	12	19	0	33	11	77	0	0	88	16	0	43	0	59	0	73	21	0	94	274
08:00 AM	1	10	23	0	34	5	51	0	0	56	15	0	26	0	41	0	82	14	0	96	227
Total Volume	6	47	83	0	136	39	252	0	1	292	56	0	143	0	199	0	294	48	0	342	969
% App. Total	4.4	34.6	61	0		13.4	86.3	0	0.3		28.1	0	71.9	0		0	86	14	0		
PHF	.750	.783	.902	.000	.971	.750	.818	.000	.250	.830	.875	.000	.777	.000	.816	.000	.896	.571	.000	.891	.884

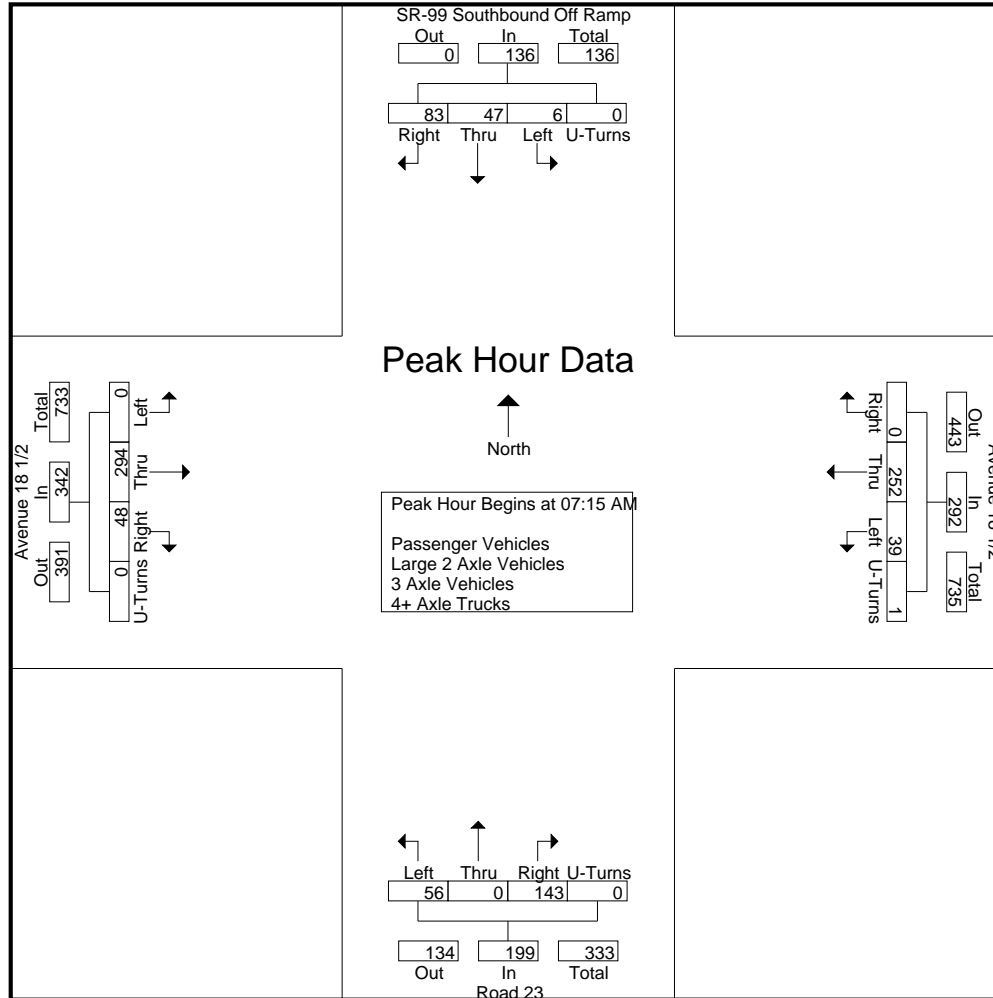

Counts Unlimited
 PO Box 1178
 Corona, CA 92878
 (951) 268-6268

City of Madera
 N/S: SR-99 SB Off Ramp/Road 23
 E/W: Avenue 18 1/2
 Weather: Clear

File Name : 03_MDA_99S Off Ramp_Ave 18 1-2 AM
 Site Code : 00319628
 Start Date : 9/18/2019
 Page No : 3

Start Time	SR-99 Southbound Off Ramp Southbound					Avenue 18 1/2 Westbound					Road 23 Northbound					Avenue 18 1/2 Eastbound					Int. Total
	Left	Thru	Right	U-Turns	App. Total	Left	Thru	Right	U-Turns	App. Total	Left	Thru	Right	U-Turns	App. Total	Left	Thru	Right	U-Turns	App. Total	
Peak Hour Analysis From 07:00 AM to 08:45 AM - Peak 1 of 1																					
Peak Hour for Each Approach Begins at:																					
	08:00 AM					07:15 AM					07:15 AM					07:45 AM					
+0 mins.	1	10	23	0	34	10	53	0	0	63	10	0	28	0	38	0	73	21	0	94	
+15 mins.	5	8	22	0	35	13	71	0	1	85	15	0	46	0	61	0	82	14	0	96	
+30 mins.	5	12	26	0	43	11	77	0	0	88	16	0	43	0	59	0	66	9	0	75	
+45 mins.	7	10	36	0	53	5	51	0	0	56	15	0	26	0	41	0	68	14	0	82	
Total Volume	18	40	107	0	165	39	252	0	1	292	56	0	143	0	199	0	289	58	0	347	
% App. Total	10.9	24.2	64.8	0		13.4	86.3	0	0.3		28.1	0	71.9	0		0	83.3	16.7	0		
PHF	.643	.833	.743	.000	.778	.750	.818	.000	.250	.830	.875	.000	.777	.000	.816	.000	.881	.690	.000	.904	

City of Madera
 N/S: SR-99 SB Off Ramp/Road 23
 E/W: Avenue 18 1/2
 Weather: Clear

File Name : 03_MDA_99S Off Ramp_Ave 18 1-2 AM
 Site Code : 00319628
 Start Date : 9/18/2019
 Page No : 1

Groups Printed- Passenger Vehicles

Start Time	SR-99 Southbound Off Ramp Southbound					Avenue 18 1/2 Westbound					Road 23 Northbound					Avenue 18 1/2 Eastbound					Int. Total
	Left	Thru	Right	U-Turns	App. Total	Left	Thru	Right	U-Turns	App. Total	Left	Thru	Right	U-Turns	App. Total	Left	Thru	Right	U-Turns	App. Total	
07:00 AM	2	6	20	0	28	5	27	0	0	32	5	0	10	0	15	0	38	6	0	44	119
07:15 AM	0	7	12	0	19	6	37	0	0	43	8	0	20	0	28	0	44	9	0	53	143
07:30 AM	1	7	18	0	26	9	53	0	1	63	14	0	39	0	53	0	40	4	0	44	186
07:45 AM	2	8	11	0	21	10	63	0	0	73	15	0	30	0	45	0	49	19	0	68	207
Total	5	28	61	0	94	30	180	0	1	211	42	0	99	0	141	0	171	38	0	209	655
08:00 AM	1	9	12	0	22	4	34	0	0	38	11	0	21	0	32	0	56	9	0	65	157
08:15 AM	5	4	14	0	23	3	39	0	0	42	12	0	16	0	28	0	46	6	0	52	145
08:30 AM	4	6	17	0	27	7	37	0	0	44	7	0	15	0	22	0	50	10	0	60	153
08:45 AM	4	6	27	0	37	7	32	0	0	39	10	0	20	0	30	0	47	7	0	54	160
Total	14	25	70	0	109	21	142	0	0	163	40	0	72	0	112	0	199	32	0	231	615
Grand Total	19	53	131	0	203	51	322	0	1	374	82	0	171	0	253	0	370	70	0	440	1270
Apprch %	9.4	26.1	64.5	0		13.6	86.1	0	0.3		32.4	0	67.6	0		0	84.1	15.9	0		
Total %	1.5	4.2	10.3	0	16	4	25.4	0	0.1	29.4	6.5	0	13.5	0	19.9	0	29.1	5.5	0	34.6	

Start Time	SR-99 Southbound Off Ramp Southbound					Avenue 18 1/2 Westbound					Road 23 Northbound					Avenue 18 1/2 Eastbound					Int. Total
	Left	Thru	Right	U-Turns	App. Total	Left	Thru	Right	U-Turns	App. Total	Left	Thru	Right	U-Turns	App. Total	Left	Thru	Right	U-Turns	App. Total	
Peak Hour Analysis From 07:15 AM to 08:00 AM - Peak 1 of 1																					
Peak Hour for Entire Intersection Begins at 07:15 AM																					
07:15 AM	0	7	12	0	19	6	37	0	0	43	8	0	20	0	28	0	44	9	0	53	143
07:30 AM	1	7	18	0	26	9	53	0	1	63	14	0	39	0	53	0	40	4	0	44	186
07:45 AM	2	8	11	0	21	10	63	0	0	73	15	0	30	0	45	0	49	19	0	68	207
08:00 AM	1	9	12	0	22	4	34	0	0	38	11	0	21	0	32	0	56	9	0	65	157
Total Volume	4	31	53	0	88	29	187	0	1	217	48	0	110	0	158	0	189	41	0	230	693
% App. Total	4.5	35.2	60.2	0		13.4	86.2	0	0.5		30.4	0	69.6	0		0	82.2	17.8	0		
PHF	.500	.861	.736	.000	.846	.725	.742	.000	.250	.743	.800	.000	.705	.000	.745	.000	.844	.539	.000	.846	.837

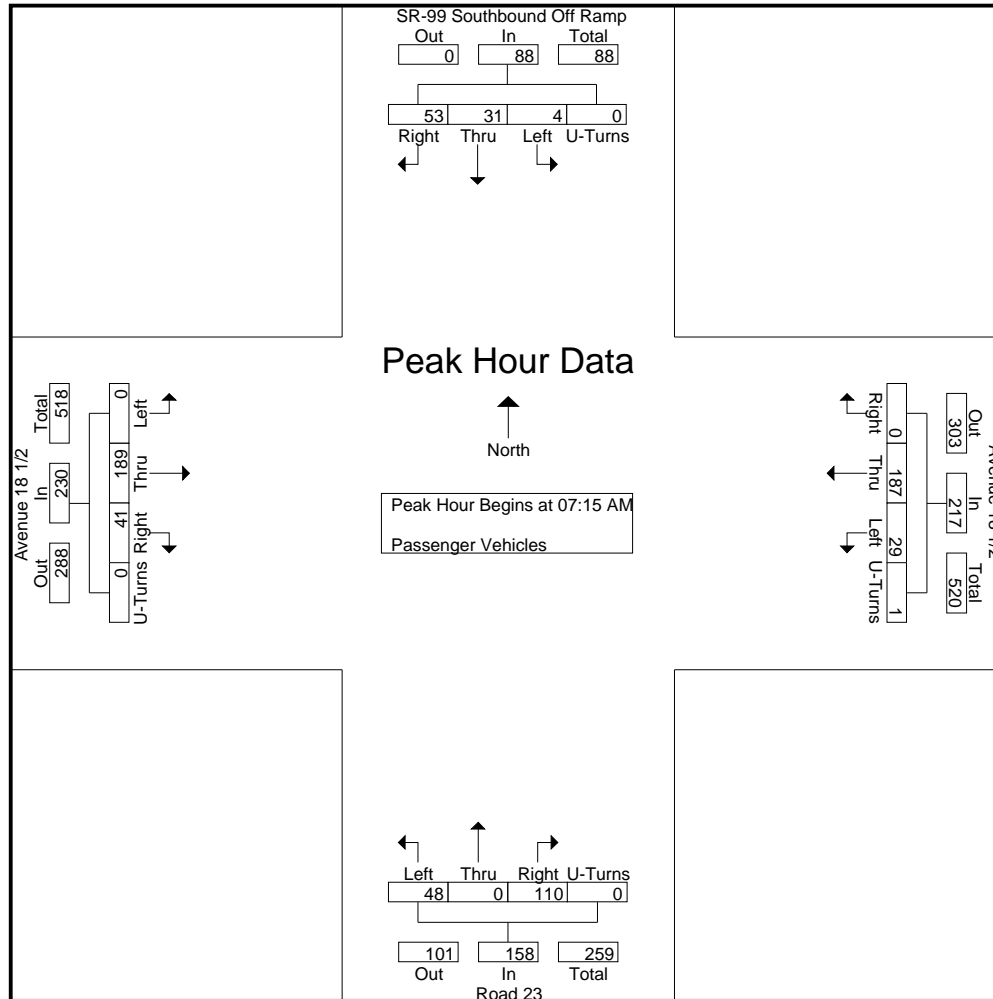

Counts Unlimited
 PO Box 1178
 Corona, CA 92878
 (951) 268-6268

City of Madera
 N/S: SR-99 SB Off Ramp/Road 23
 E/W: Avenue 18 1/2
 Weather: Clear

File Name : 03_MDA_99S Off Ramp_Ave 18 1-2 AM
 Site Code : 00319628
 Start Date : 9/18/2019
 Page No : 3

Start Time	SR-99 Southbound Off Ramp Southbound					Avenue 18 1/2 Westbound					Road 23 Northbound					Avenue 18 1/2 Eastbound					Int. Total
	Left	Thru	Right	U-Turns	App. Total	Left	Thru	Right	U-Turns	App. Total	Left	Thru	Right	U-Turns	App. Total	Left	Thru	Right	U-Turns	App. Total	

Peak Hour Analysis From 07:15 AM to 08:00 AM - Peak 1 of 1
 Peak Hour for Each Approach Begins at:

	07:15 AM					07:15 AM					07:15 AM					07:15 AM				
+0 mins.	0	7	12	0	19	6	37	0	0	43	8	0	20	0	28	0	44	9	0	53
+15 mins.	1	7	18	0	26	9	53	0	1	63	14	0	39	0	53	0	40	4	0	44
+30 mins.	2	8	11	0	21	10	63	0	0	73	15	0	30	0	45	0	49	19	0	68
+45 mins.	1	9	12	0	22	4	34	0	0	38	11	0	21	0	32	0	56	9	0	65
Total Volume	4	31	53	0	88	29	187	0	1	217	48	0	110	0	158	0	189	41	0	230
% App. Total	4.5	35.2	60.2	0		13.4	86.2	0	0.5		30.4	0	69.6	0		0	82.2	17.8	0	
PHF	.500	.861	.736	.000	.846	.725	.742	.000	.250	.743	.800	.000	.705	.000	.745	.000	.844	.539	.000	.846

City of Madera
 N/S: SR-99 SB Off Ramp/Road 23
 E/W: Avenue 18 1/2
 Weather: Clear

File Name : 03_MDA_99S Off Ramp_Ave 18 1-2 AM
 Site Code : 00319628
 Start Date : 9/18/2019
 Page No : 1

Groups Printed- Large 2 Axle Vehicles

Start Time	SR-99 Southbound Off Ramp Southbound					Avenue 18 1/2 Westbound					Road 23 Northbound					Avenue 18 1/2 Eastbound					Int. Total
	Left	Thru	Right	U-Turns	App. Total	Left	Thru	Right	U-Turns	App. Total	Left	Thru	Right	U-Turns	App. Total	Left	Thru	Right	U-Turns	App. Total	
07:00 AM	0	0	1	0	1	0	4	0	0	4	0	0	1	0	1	0	6	0	0	6	12
07:15 AM	0	1	0	0	1	1	1	0	0	2	0	0	0	0	0	0	3	0	0	3	6
07:30 AM	0	0	1	0	1	1	7	0	0	8	0	0	1	0	1	0	6	0	0	6	16
07:45 AM	0	1	2	0	3	1	6	0	0	7	0	0	1	0	1	0	6	0	0	6	17
Total	0	2	4	0	6	3	18	0	0	21	0	0	3	0	3	0	21	0	0	21	51
08:00 AM	0	0	1	0	1	1	2	0	0	3	1	0	2	0	3	0	5	1	0	6	13
08:15 AM	0	0	0	0	0	1	1	0	0	2	0	0	1	0	1	0	3	1	0	4	7
08:30 AM	0	1	0	0	1	2	4	0	0	6	3	0	3	0	6	0	3	1	0	4	17
08:45 AM	0	0	1	0	1	1	1	0	0	2	0	0	2	0	2	0	4	0	0	4	9
Total	0	1	2	0	3	5	8	0	0	13	4	0	8	0	12	0	15	3	0	18	46
Grand Total	0	3	6	0	9	8	26	0	0	34	4	0	11	0	15	0	36	3	0	39	97
Apprch %	0	33.3	66.7	0		23.5	76.5	0	0		26.7	0	73.3	0		0	92.3	7.7	0		
Total %	0	3.1	6.2	0	9.3	8.2	26.8	0	0	35.1	4.1	0	11.3	0	15.5	0	37.1	3.1	0	40.2	

Start Time	SR-99 Southbound Off Ramp Southbound					Avenue 18 1/2 Westbound					Road 23 Northbound					Avenue 18 1/2 Eastbound					Int. Total
	Left	Thru	Right	U-Turns	App. Total	Left	Thru	Right	U-Turns	App. Total	Left	Thru	Right	U-Turns	App. Total	Left	Thru	Right	U-Turns	App. Total	
Peak Hour Analysis From 07:15 AM to 08:00 AM - Peak 1 of 1																					
Peak Hour for Entire Intersection Begins at 07:15 AM																					
07:15 AM	0	1	0	0	1	1	1	0	0	2	0	0	0	0	0	0	3	0	0	3	6
07:30 AM	0	0	1	0	1	1	7	0	0	8	0	0	1	0	1	0	6	0	0	6	16
07:45 AM	0	1	2	0	3	1	6	0	0	7	0	0	1	0	1	0	6	0	0	6	17
08:00 AM	0	0	1	0	1	1	2	0	0	3	1	0	2	0	3	0	5	1	0	6	13
Total Volume	0	2	4	0	6	4	16	0	0	20	1	0	4	0	5	0	20	1	0	21	52
% App. Total	0	33.3	66.7	0		20	80	0	0		20	0	80	0		0	95.2	4.8	0		
PHF	.000	.500	.500	.000	.500	1.00	.571	.000	.000	.625	.250	.000	.500	.000	.417	.000	.833	.250	.000	.875	.765

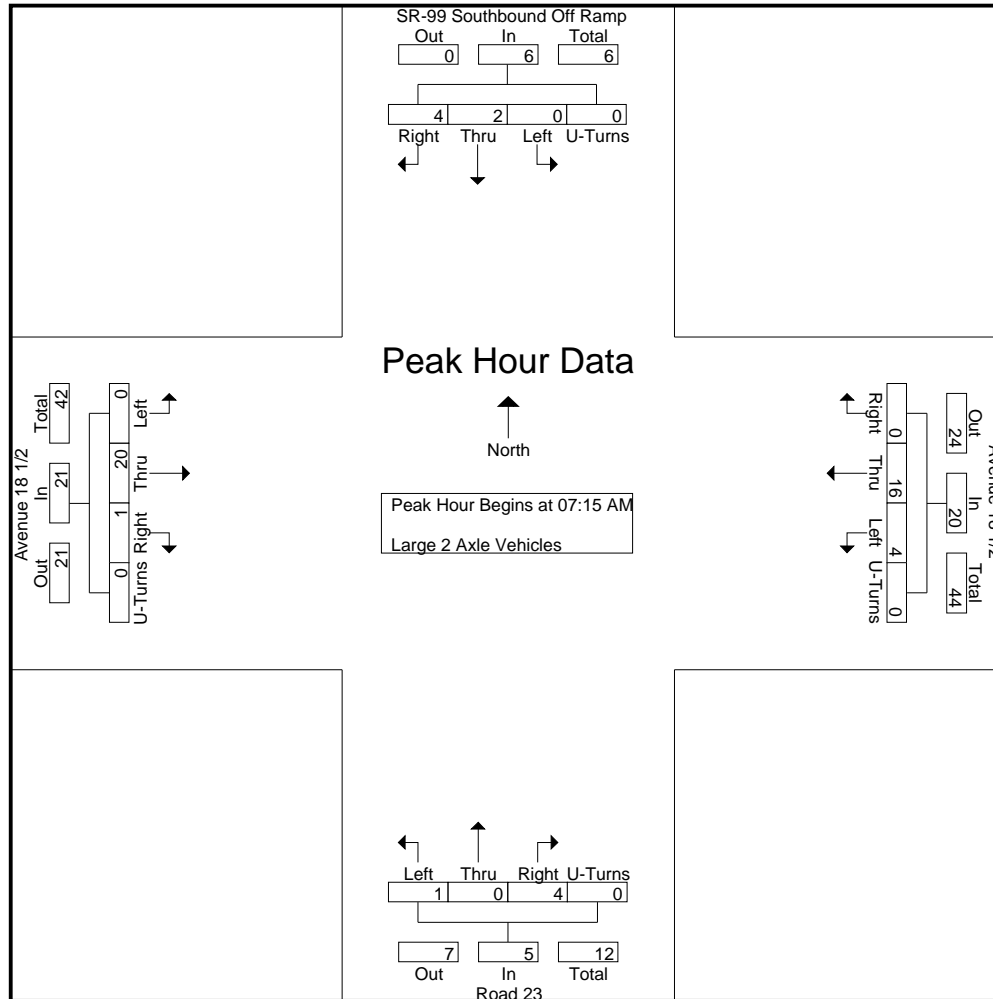

Counts Unlimited
 PO Box 1178
 Corona, CA 92878
 (951) 268-6268

City of Madera
 N/S: SR-99 SB Off Ramp/Road 23
 E/W: Avenue 18 1/2
 Weather: Clear

File Name : 03_MDA_99S Off Ramp_Ave 18 1-2 AM
 Site Code : 00319628
 Start Date : 9/18/2019
 Page No : 3

Start Time	SR-99 Southbound Off Ramp Southbound					Avenue 18 1/2 Westbound					Road 23 Northbound					Avenue 18 1/2 Eastbound					Int. Total
	Left	Thru	Right	U-Turns	App. Total	Left	Thru	Right	U-Turns	App. Total	Left	Thru	Right	U-Turns	App. Total	Left	Thru	Right	U-Turns	App. Total	

Peak Hour Analysis From 07:15 AM to 08:00 AM - Peak 1 of 1
 Peak Hour for Each Approach Begins at:

	07:15 AM					07:15 AM					07:15 AM					07:15 AM					
+0 mins.	0	1	0	0	1	1	1	0	0	2	0	0	0	0	0	0	3	0	0	0	3
+15 mins.	0	0	1	0	1	1	7	0	0	8	0	0	1	0	1	0	6	0	0	0	6
+30 mins.	0	1	2	0	3	1	6	0	0	7	0	0	1	0	1	0	6	0	0	0	6
+45 mins.	0	0	1	0	1	1	2	0	0	3	1	0	2	0	3	0	5	1	0	0	6
Total Volume	0	2	4	0	6	4	16	0	0	20	1	0	4	0	5	0	20	1	0	0	21
% App. Total	0	33.3	66.7	0		20	80	0	0		20	0	80	0		0	95.2	4.8	0	0	
PHF	.000	.500	.500	.000	.500	1.000	.571	.000	.000	.625	.250	.000	.500	.000	.417	.000	.833	.250	.000	.000	.875

City of Madera
 N/S: SR-99 SB Off Ramp/Road 23
 E/W: Avenue 18 1/2
 Weather: Clear

File Name : 03_MDA_99S Off Ramp_Ave 18 1-2 AM
 Site Code : 00319628
 Start Date : 9/18/2019
 Page No : 1

Groups Printed- 3 Axle Vehicles

Start Time	SR-99 Southbound Off Ramp Southbound					Avenue 18 1/2 Westbound					Road 23 Northbound					Avenue 18 1/2 Eastbound					Int. Total
	Left	Thru	Right	U-Turns	App. Total	Left	Thru	Right	U-Turns	App. Total	Left	Thru	Right	U-Turns	App. Total	Left	Thru	Right	U-Turns	App. Total	
07:00 AM	0	0	1	0	1	0	0	0	0	0	1	0	1	0	2	0	0	3	0	3	6
07:15 AM	0	1	0	0	1	0	0	0	0	0	0	0	1	0	1	0	1	0	0	1	3
07:30 AM	0	0	0	0	0	0	0	0	0	0	0	0	0	0	0	0	1	0	0	1	1
07:45 AM	0	0	0	0	0	0	0	0	0	0	0	0	0	0	0	0	0	1	0	1	1
Total	0	1	1	0	2	0	0	0	0	0	1	0	2	0	3	0	2	4	0	6	11
08:00 AM	0	0	0	0	0	0	0	0	0	0	0	0	1	0	1	0	0	0	0	0	1
08:15 AM	0	0	0	0	0	0	1	0	0	1	0	0	1	0	1	0	0	0	0	0	2
08:30 AM	0	0	0	0	0	0	0	0	0	0	0	0	0	0	0	0	0	1	0	1	1
08:45 AM	0	1	0	0	1	1	1	0	0	2	0	0	0	0	0	0	1	1	0	2	5
Total	0	1	0	0	1	1	2	0	0	3	0	0	2	0	2	0	1	2	0	3	9
Grand Total	0	2	1	0	3	1	2	0	0	3	1	0	4	0	5	0	3	6	0	9	20
Apprch %	0	66.7	33.3	0		33.3	66.7	0	0		20	0	80	0		0	33.3	66.7	0		
Total %	0	10	5	0	15	5	10	0	0	15	5	0	20	0	25	0	15	30	0	45	

Start Time	SR-99 Southbound Off Ramp Southbound					Avenue 18 1/2 Westbound					Road 23 Northbound					Avenue 18 1/2 Eastbound					Int. Total
	Left	Thru	Right	U-Turns	App. Total	Left	Thru	Right	U-Turns	App. Total	Left	Thru	Right	U-Turns	App. Total	Left	Thru	Right	U-Turns	App. Total	
Peak Hour Analysis From 07:15 AM to 08:00 AM - Peak 1 of 1																					
Peak Hour for Entire Intersection Begins at 07:15 AM																					
07:15 AM	0	1	0	0	1	0	0	0	0	0	0	0	1	0	1	0	1	0	0	1	3
07:30 AM	0	0	0	0	0	0	0	0	0	0	0	0	0	0	0	0	1	0	0	1	1
07:45 AM	0	0	0	0	0	0	0	0	0	0	0	0	0	0	0	0	0	1	0	1	1
08:00 AM	0	0	0	0	0	0	0	0	0	0	0	0	1	0	1	0	0	0	0	0	1
Total Volume	0	1	0	0	1	0	0	0	0	0	0	0	2	0	2	0	2	1	0	3	6
% App. Total	0	100	0	0		0	0	0	0		0	0	100	0		0	66.7	33.3	0		
PHF	.000	.250	.000	.000	.250	.000	.000	.000	.000	.000	.000	.000	.500	.000	.500	.000	.500	.250	.000	.750	.500

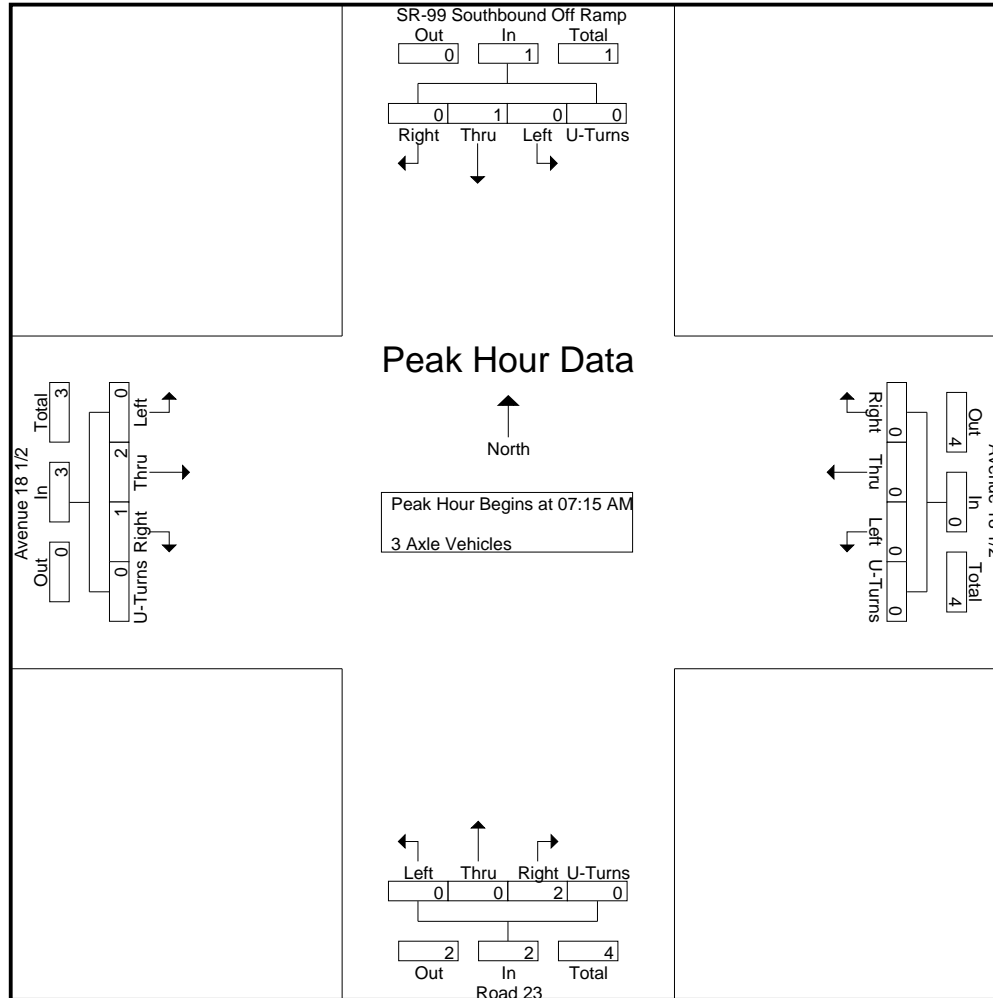

City of Madera
 N/S: SR-99 SB Off Ramp/Road 23
 E/W: Avenue 18 1/2
 Weather: Clear

File Name : 03_MDA_99S Off Ramp_Ave 18 1-2 AM
 Site Code : 00319628
 Start Date : 9/18/2019
 Page No : 3

Start Time	SR-99 Southbound Off Ramp Southbound					Avenue 18 1/2 Westbound					Road 23 Northbound					Avenue 18 1/2 Eastbound					Int. Total
	Left	Thru	Right	U-Turns	App. Total	Left	Thru	Right	U-Turns	App. Total	Left	Thru	Right	U-Turns	App. Total	Left	Thru	Right	U-Turns	App. Total	

Peak Hour Analysis From 07:15 AM to 08:00 AM - Peak 1 of 1
 Peak Hour for Each Approach Begins at:

	07:15 AM					07:15 AM					07:15 AM					07:15 AM				
+0 mins.	0	1	0	0	1	0	0	0	0	0	0	0	1	0	1	0	1	0	0	1
+15 mins.	0	0	0	0	0	0	0	0	0	0	0	0	0	0	0	0	1	0	0	1
+30 mins.	0	0	0	0	0	0	0	0	0	0	0	0	0	0	0	0	0	1	0	1
+45 mins.	0	0	0	0	0	0	0	0	0	0	0	0	1	0	1	0	0	0	0	0
Total Volume	0	1	0	0	1	0	0	0	0	0	0	0	2	0	2	0	2	1	0	3
% App. Total	0	100	0	0	0	0	0	0	0	0	0	0	100	0	0	0	66.7	33.3	0	0
PHF	.000	.250	.000	.000	.250	.000	.000	.000	.000	.000	.000	.000	.500	.000	.500	.000	.500	.250	.000	.750

City of Madera
 N/S: SR-99 SB Off Ramp/Road 23
 E/W: Avenue 18 1/2
 Weather: Clear

File Name : 03_MDA_99S Off Ramp_Ave 18 1-2 AM
 Site Code : 00319628
 Start Date : 9/18/2019
 Page No : 1

Groups Printed- 4+ Axle Trucks

Start Time	SR-99 Southbound Off Ramp Southbound					Avenue 18 1/2 Westbound					Road 23 Northbound					Avenue 18 1/2 Eastbound					Int. Total
	Left	Thru	Right	U-Turns	App. Total	Left	Thru	Right	U-Turns	App. Total	Left	Thru	Right	U-Turns	App. Total	Left	Thru	Right	U-Turns	App. Total	
07:00 AM	0	5	4	0	9	1	4	0	0	5	4	0	2	0	6	0	23	1	0	24	44
07:15 AM	1	6	7	0	14	3	15	0	0	18	2	0	7	0	9	0	24	0	0	24	65
07:30 AM	1	3	3	0	7	3	11	0	0	14	1	0	6	0	7	0	20	0	0	20	48
07:45 AM	0	3	6	0	9	0	8	0	0	8	1	0	12	0	13	0	18	1	0	19	49
Total	2	17	20	0	39	7	38	0	0	45	8	0	27	0	35	0	85	2	0	87	206
08:00 AM	0	1	10	0	11	0	15	0	0	15	3	0	2	0	5	0	21	4	0	25	56
08:15 AM	0	4	8	0	12	1	7	0	0	8	0	0	3	0	3	0	17	2	0	19	42
08:30 AM	1	5	9	0	15	2	11	0	0	13	1	0	7	0	8	0	15	2	0	17	53
08:45 AM	3	3	8	0	14	2	13	0	0	15	1	0	4	0	5	0	12	1	0	13	47
Total	4	13	35	0	52	5	46	0	0	51	5	0	16	0	21	0	65	9	0	74	198
Grand Total	6	30	55	0	91	12	84	0	0	96	13	0	43	0	56	0	150	11	0	161	404
Apprch %	6.6	33	60.4	0		12.5	87.5	0	0		23.2	0	76.8	0		0	93.2	6.8	0		
Total %	1.5	7.4	13.6	0	22.5	3	20.8	0	0	23.8	3.2	0	10.6	0	13.9	0	37.1	2.7	0	39.9	

Start Time	SR-99 Southbound Off Ramp Southbound					Avenue 18 1/2 Westbound					Road 23 Northbound					Avenue 18 1/2 Eastbound					Int. Total
	Left	Thru	Right	U-Turns	App. Total	Left	Thru	Right	U-Turns	App. Total	Left	Thru	Right	U-Turns	App. Total	Left	Thru	Right	U-Turns	App. Total	
Peak Hour Analysis From 07:15 AM to 08:00 AM - Peak 1 of 1																					
Peak Hour for Entire Intersection Begins at 07:15 AM																					
07:15 AM	1	6	7	0	14	3	15	0	0	18	2	0	7	0	9	0	24	0	0	24	65
07:30 AM	1	3	3	0	7	3	11	0	0	14	1	0	6	0	7	0	20	0	0	20	48
07:45 AM	0	3	6	0	9	0	8	0	0	8	1	0	12	0	13	0	18	1	0	19	49
08:00 AM	0	1	10	0	11	0	15	0	0	15	3	0	2	0	5	0	21	4	0	25	56
Total Volume	2	13	26	0	41	6	49	0	0	55	7	0	27	0	34	0	83	5	0	88	218
% App. Total	4.9	31.7	63.4	0		10.9	89.1	0	0		20.6	0	79.4	0		0	94.3	5.7	0		
PHF	.500	.542	.650	.000	.732	.500	.817	.000	.000	.764	.583	.000	.563	.000	.654	.000	.865	.313	.000	.880	.838

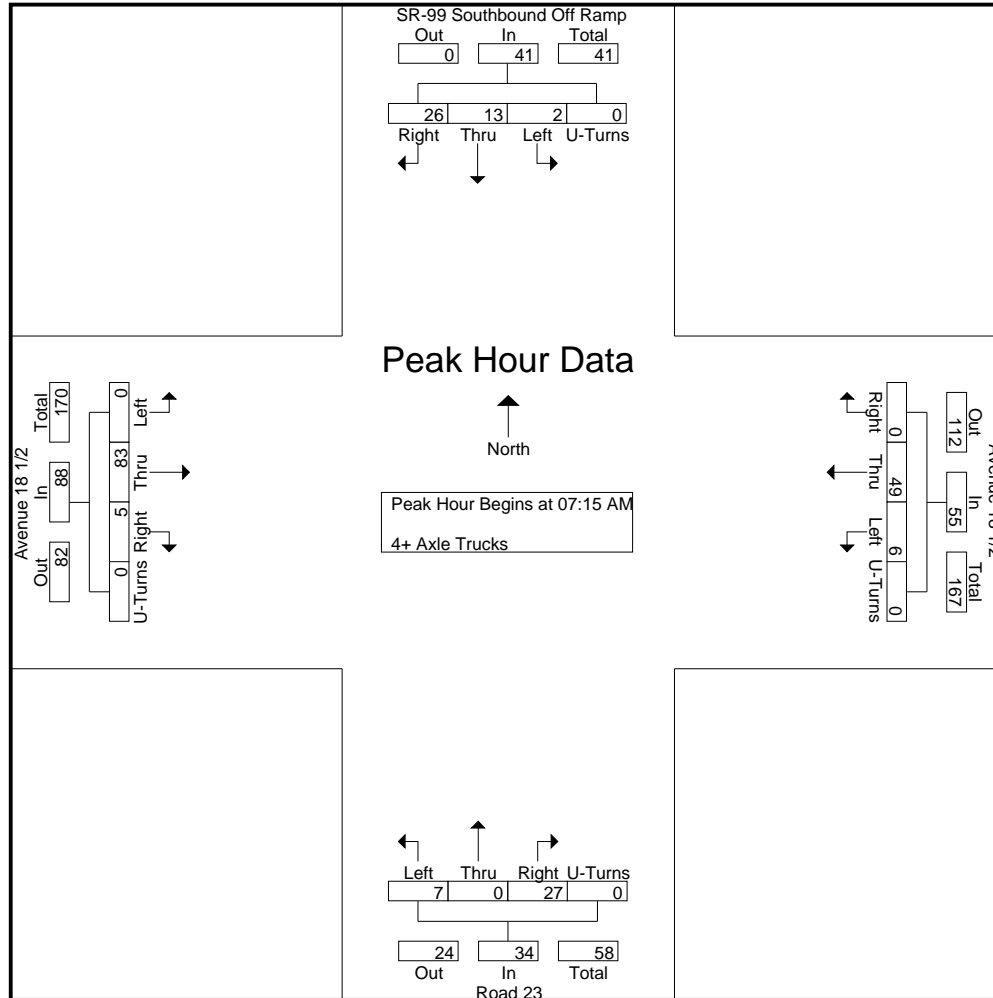

Counts Unlimited
 PO Box 1178
 Corona, CA 92878
 (951) 268-6268

City of Madera
 N/S: SR-99 SB Off Ramp/Road 23
 E/W: Avenue 18 1/2
 Weather: Clear

File Name : 03_MDA_99S Off Ramp_Ave 18 1-2 AM
 Site Code : 00319628
 Start Date : 9/18/2019
 Page No : 3

Start Time	SR-99 Southbound Off Ramp Southbound					Avenue 18 1/2 Westbound					Road 23 Northbound					Avenue 18 1/2 Eastbound					Int. Total
	Left	Thru	Right	U-Turns	App. Total	Left	Thru	Right	U-Turns	App. Total	Left	Thru	Right	U-Turns	App. Total	Left	Thru	Right	U-Turns	App. Total	

Peak Hour Analysis From 07:15 AM to 08:00 AM - Peak 1 of 1
 Peak Hour for Each Approach Begins at:

	07:15 AM					07:15 AM					07:15 AM					07:15 AM					
+0 mins.	1	6	7	0	14	3	15	0	0	18	2	0	7	0	9	0	24	0	0	0	24
+15 mins.	1	3	3	0	7	3	11	0	0	14	1	0	6	0	7	0	20	0	0	0	20
+30 mins.	0	3	6	0	9	0	8	0	0	8	1	0	12	0	13	0	18	1	0	0	19
+45 mins.	0	1	10	0	11	0	15	0	0	15	3	0	2	0	5	0	21	4	0	0	25
Total Volume	2	13	26	0	41	6	49	0	0	55	7	0	27	0	34	0	83	5	0	0	88
% App. Total	4.9	31.7	63.4	0		10.9	89.1	0	0		20.6	0	79.4	0		0	94.3	5.7	0	0	
PHF	.500	.542	.650	.000	.732	.500	.817	.000	.000	.764	.583	.000	.563	.000	.654	.000	.865	.313	.000	.000	.880

City of Madera
 N/S: SR-99 SB Off Ramp/Road 23
 E/W: Avenue 18 1/2
 Weather: Clear

File Name : 03_MDA_99S Off Ramp_Ave 18 1-2 PM
 Site Code : 00319628
 Start Date : 9/18/2019
 Page No : 1

Groups Printed- Passenger Vehicles - Large 2 Axle Vehicles - 3 Axle Vehicles - 4+ Axle Trucks

Start Time	SR-99 Southbound Off Ramp Southbound					Avenue 18 1/2 Westbound					Road 23 Northbound					Avenue 18 1/2 Eastbound					Int. Total
	Left	Thru	Right	U-Turns	App. Total	Left	Thru	Right	U-Turns	App. Total	Left	Thru	Right	U-Turns	App. Total	Left	Thru	Right	U-Turns	App. Total	
04:00 PM	5	17	26	0	48	9	42	0	0	51	10	0	21	0	31	0	86	54	0	140	270
04:15 PM	5	36	34	0	75	14	43	0	0	57	5	0	22	0	27	0	69	51	0	120	279
04:30 PM	4	29	34	0	67	6	54	0	0	60	5	0	19	0	24	0	87	32	0	119	270
04:45 PM	5	11	27	0	43	10	54	0	0	64	11	0	13	0	24	0	73	32	0	105	236
Total	19	93	121	0	233	39	193	0	0	232	31	0	75	0	106	0	315	169	0	484	1055
05:00 PM	4	13	22	0	39	9	39	0	0	48	9	0	16	0	25	0	87	30	0	117	229
05:15 PM	6	19	20	0	45	8	53	0	0	61	9	0	25	0	34	0	76	24	0	100	240
05:30 PM	7	16	32	0	55	4	46	0	0	50	8	0	26	0	34	0	63	20	0	83	222
05:45 PM	7	13	17	0	37	3	52	0	0	55	13	0	14	0	27	0	75	17	0	92	211
Total	24	61	91	0	176	24	190	0	0	214	39	0	81	0	120	0	301	91	0	392	902
Grand Total	43	154	212	0	409	63	383	0	0	446	70	0	156	0	226	0	616	260	0	876	1957
Apprch %	10.5	37.7	51.8	0		14.1	85.9	0	0		31	0	69	0		0	70.3	29.7	0		
Total %	2.2	7.9	10.8	0	20.9	3.2	19.6	0	0	22.8	3.6	0	8	0	11.5	0	31.5	13.3	0	44.8	
Passenger Vehicles	40	135	133	0	308	57	279	0	0	336	63	0	135	0	198	0	449	238	0	687	1529
% Passenger Vehicles	93	87.7	62.7	0	75.3	90.5	72.8	0	0	75.3	90	0	86.5	0	87.6	0	72.9	91.5	0	78.4	78.1
Large 2 Axle Vehicles	1	0	6	0	7	1	20	0	0	21	1	0	4	0	5	0	29	9	0	38	71
% Large 2 Axle Vehicles	2.3	0	2.8	0	1.7	1.6	5.2	0	0	4.7	1.4	0	2.6	0	2.2	0	4.7	3.5	0	4.3	3.6
3 Axle Vehicles	0	0	0	0	0	0	6	0	0	6	1	0	0	0	1	0	10	0	0	10	17
% 3 Axle Vehicles	0	0	0	0	0	0	1.6	0	0	1.3	1.4	0	0	0	0.4	0	1.6	0	0	1.1	0.9
4+ Axle Trucks	2	19	73	0	94	5	78	0	0	83	5	0	17	0	22	0	128	13	0	141	340
% 4+ Axle Trucks	4.7	12.3	34.4	0	23	7.9	20.4	0	0	18.6	7.1	0	10.9	0	9.7	0	20.8	5	0	16.1	17.4

Start Time	SR-99 Southbound Off Ramp Southbound					Avenue 18 1/2 Westbound					Road 23 Northbound					Avenue 18 1/2 Eastbound					Int. Total
	Left	Thru	Right	U-Turns	App. Total	Left	Thru	Right	U-Turns	App. Total	Left	Thru	Right	U-Turns	App. Total	Left	Thru	Right	U-Turns	App. Total	
Peak Hour Analysis From 04:00 PM to 05:45 PM - Peak 1 of 1																					
Peak Hour for Entire Intersection Begins at 04:00 PM																					
04:00 PM	5	17	26	0	48	9	42	0	0	51	10	0	21	0	31	0	86	54	0	140	270
04:15 PM	5	36	34	0	75	14	43	0	0	57	5	0	22	0	27	0	69	51	0	120	279
04:30 PM	4	29	34	0	67	6	54	0	0	60	5	0	19	0	24	0	87	32	0	119	270
04:45 PM	5	11	27	0	43	10	54	0	0	64	11	0	13	0	24	0	73	32	0	105	236
Total Volume	19	93	121	0	233	39	193	0	0	232	31	0	75	0	106	0	315	169	0	484	1055
% App. Total	8.2	39.9	51.9	0		16.8	83.2	0	0		29.2	0	70.8	0		0	65.1	34.9	0		
PHF	.950	.646	.890	.000	.777	.696	.894	.000	.000	.906	.705	.000	.852	.000	.855	.000	.905	.782	.000	.864	.945

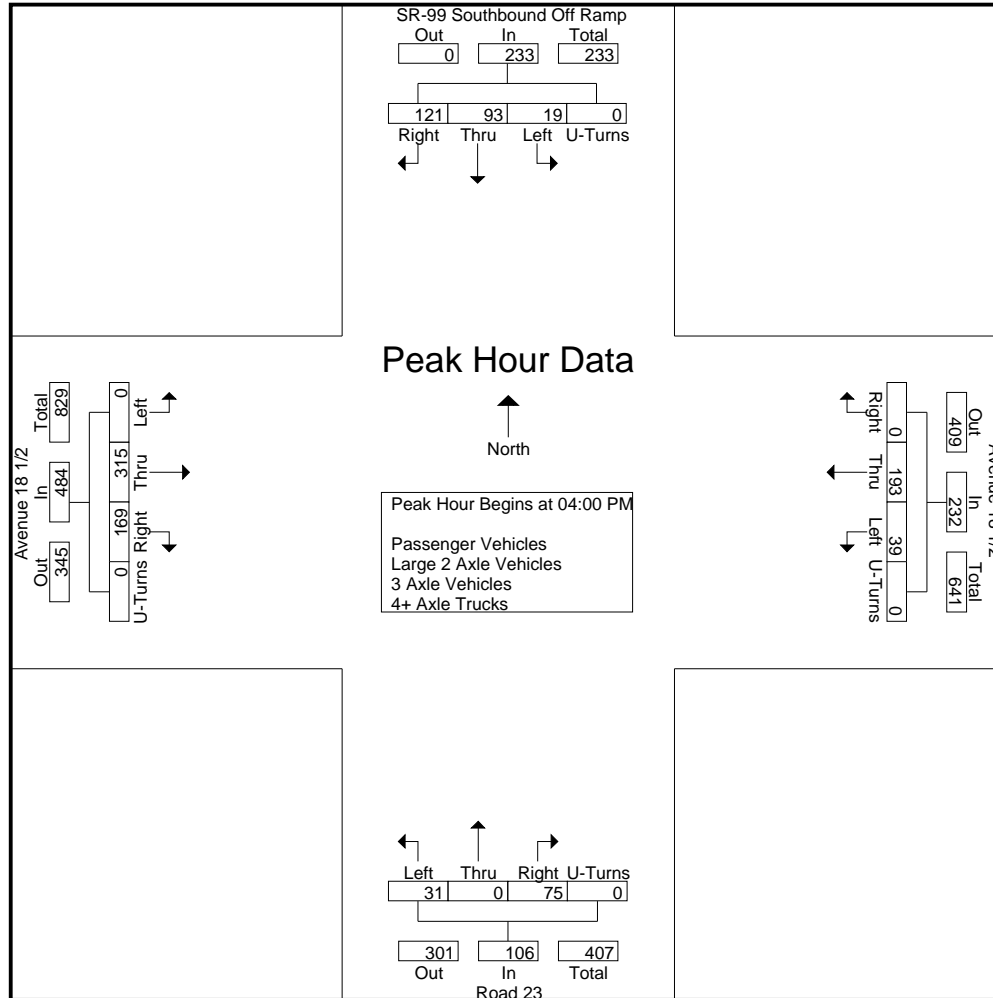

Counts Unlimited
 PO Box 1178
 Corona, CA 92878
 (951) 268-6268

City of Madera
 N/S: SR-99 SB Off Ramp/Road 23
 E/W: Avenue 18 1/2
 Weather: Clear

File Name : 03_MDA_99S Off Ramp_Ave 18 1-2 PM
 Site Code : 00319628
 Start Date : 9/18/2019
 Page No : 3

Start Time	SR-99 Southbound Off Ramp Southbound					Avenue 18 1/2 Westbound					Road 23 Northbound					Avenue 18 1/2 Eastbound					Int. Total
	Left	Thru	Right	U-Turns	App. Total	Left	Thru	Right	U-Turns	App. Total	Left	Thru	Right	U-Turns	App. Total	Left	Thru	Right	U-Turns	App. Total	

Peak Hour Analysis From 04:00 PM to 05:45 PM - Peak 1 of 1
 Peak Hour for Each Approach Begins at:

	04:00 PM					04:30 PM					05:00 PM					04:00 PM				
+0 mins.	5	17	26	0	48	6	54	0	0	60	9	0	16	0	25	0	86	54	0	140
+15 mins.	5	36	34	0	75	10	54	0	0	64	9	0	25	0	34	0	69	51	0	120
+30 mins.	4	29	34	0	67	9	39	0	0	48	8	0	26	0	34	0	87	32	0	119
+45 mins.	5	11	27	0	43	8	53	0	0	61	13	0	14	0	27	0	73	32	0	105
Total Volume	19	93	121	0	233	33	200	0	0	233	39	0	81	0	120	0	315	169	0	484
% App. Total	8.2	39.9	51.9	0		14.2	85.8	0	0		32.5	0	67.5	0		0	65.1	34.9	0	
PHF	.950	.646	.890	.000	.777	.825	.926	.000	.000	.910	.750	.000	.779	.000	.882	.000	.905	.782	.000	.864

City of Madera
 N/S: SR-99 SB Off Ramp/Road 23
 E/W: Avenue 18 1/2
 Weather: Clear

File Name : 03_MDA_99S Off Ramp_Ave 18 1-2 PM
 Site Code : 00319628
 Start Date : 9/18/2019
 Page No : 1

Groups Printed- Passenger Vehicles

Start Time	SR-99 Southbound Off Ramp Southbound					Avenue 18 1/2 Westbound					Road 23 Northbound					Avenue 18 1/2 Eastbound					Int. Total
	Left	Thru	Right	U-Turns	App. Total	Left	Thru	Right	U-Turns	App. Total	Left	Thru	Right	U-Turns	App. Total	Left	Thru	Right	U-Turns	App. Total	
04:00 PM	4	15	14	0	33	9	24	0	0	33	10	0	17	0	27	0	61	51	0	112	205
04:15 PM	5	35	22	0	62	10	30	0	0	40	5	0	15	0	20	0	50	49	0	99	221
04:30 PM	4	23	19	0	46	5	39	0	0	44	5	0	15	0	20	0	60	27	0	87	197
04:45 PM	5	10	16	0	31	9	37	0	0	46	11	0	11	0	22	0	60	29	0	89	188
Total	18	83	71	0	172	33	130	0	0	163	31	0	58	0	89	0	231	156	0	387	811
05:00 PM	3	10	15	0	28	9	32	0	0	41	8	0	15	0	23	0	63	28	0	91	183
05:15 PM	6	18	11	0	35	8	38	0	0	46	7	0	23	0	30	0	57	21	0	78	189
05:30 PM	6	14	24	0	44	4	39	0	0	43	6	0	26	0	32	0	44	19	0	63	182
05:45 PM	7	10	12	0	29	3	40	0	0	43	11	0	13	0	24	0	54	14	0	68	164
Total	22	52	62	0	136	24	149	0	0	173	32	0	77	0	109	0	218	82	0	300	718
Grand Total	40	135	133	0	308	57	279	0	0	336	63	0	135	0	198	0	449	238	0	687	1529
Apprch %	13	43.8	43.2	0		17	83	0	0		31.8	0	68.2	0		0	65.4	34.6	0		
Total %	2.6	8.8	8.7	0	20.1	3.7	18.2	0	0	22	4.1	0	8.8	0	12.9	0	29.4	15.6	0	44.9	

Start Time	SR-99 Southbound Off Ramp Southbound					Avenue 18 1/2 Westbound					Road 23 Northbound					Avenue 18 1/2 Eastbound					Int. Total
	Left	Thru	Right	U-Turns	App. Total	Left	Thru	Right	U-Turns	App. Total	Left	Thru	Right	U-Turns	App. Total	Left	Thru	Right	U-Turns	App. Total	
Peak Hour Analysis From 04:00 PM to 04:45 PM - Peak 1 of 1																					
Peak Hour for Entire Intersection Begins at 04:00 PM																					
04:00 PM	4	15	14	0	33	9	24	0	0	33	10	0	17	0	27	0	61	51	0	112	205
04:15 PM	5	35	22	0	62	10	30	0	0	40	5	0	15	0	20	0	50	49	0	99	221
04:30 PM	4	23	19	0	46	5	39	0	0	44	5	0	15	0	20	0	60	27	0	87	197
04:45 PM	5	10	16	0	31	9	37	0	0	46	11	0	11	0	22	0	60	29	0	89	188
Total Volume	18	83	71	0	172	33	130	0	0	163	31	0	58	0	89	0	231	156	0	387	811
% App. Total	10.5	48.3	41.3	0		20.2	79.8	0	0		34.8	0	65.2	0		0	59.7	40.3	0		
PHF	.900	.593	.807	.000	.694	.825	.833	.000	.000	.886	.705	.000	.853	.000	.824	.000	.947	.765	.000	.864	.917

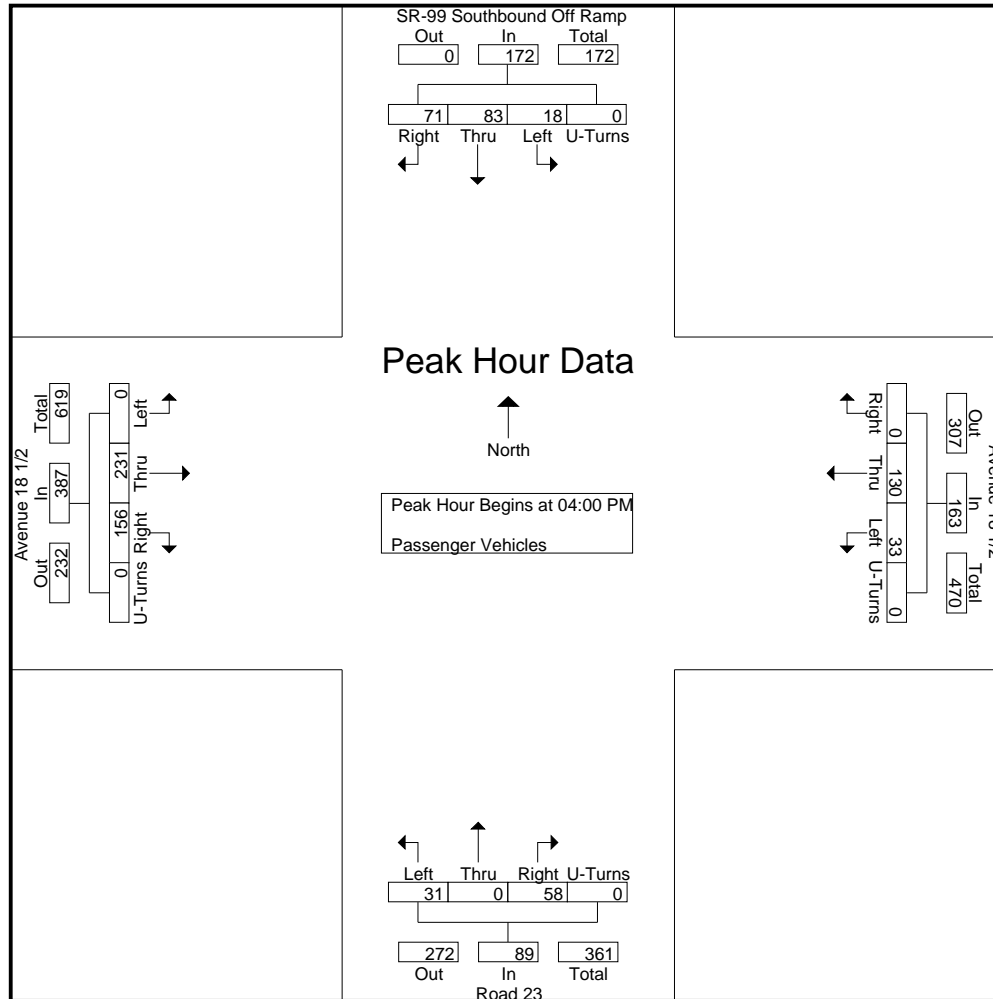

Counts Unlimited
 PO Box 1178
 Corona, CA 92878
 (951) 268-6268

City of Madera
 N/S: SR-99 SB Off Ramp/Road 23
 E/W: Avenue 18 1/2
 Weather: Clear

File Name : 03_MDA_99S Off Ramp_Ave 18 1-2 PM
 Site Code : 00319628
 Start Date : 9/18/2019
 Page No : 3

Start Time	SR-99 Southbound Off Ramp Southbound					Avenue 18 1/2 Westbound					Road 23 Northbound					Avenue 18 1/2 Eastbound					Int. Total
	Left	Thru	Right	U-Turns	App. Total	Left	Thru	Right	U-Turns	App. Total	Left	Thru	Right	U-Turns	App. Total	Left	Thru	Right	U-Turns	App. Total	

Peak Hour Analysis From 04:00 PM to 04:45 PM - Peak 1 of 1
 Peak Hour for Each Approach Begins at:

	04:00 PM					04:00 PM					04:00 PM					04:00 PM				
+0 mins.	4	15	14	0	33	9	24	0	0	33	10	0	17	0	27	0	61	51	0	112
+15 mins.	5	35	22	0	62	10	30	0	0	40	5	0	15	0	20	0	50	49	0	99
+30 mins.	4	23	19	0	46	5	39	0	0	44	5	0	15	0	20	0	60	27	0	87
+45 mins.	5	10	16	0	31	9	37	0	0	46	11	0	11	0	22	0	60	29	0	89
Total Volume	18	83	71	0	172	33	130	0	0	163	31	0	58	0	89	0	231	156	0	387
% App. Total	10.5	48.3	41.3	0		20.2	79.8	0	0		34.8	0	65.2	0		0	59.7	40.3	0	
PHF	.900	.593	.807	.000	.694	.825	.833	.000	.000	.886	.705	.000	.853	.000	.824	.000	.947	.765	.000	.864

City of Madera
 N/S: SR-99 SB Off Ramp/Road 23
 E/W: Avenue 18 1/2
 Weather: Clear

File Name : 03_MDA_99S Off Ramp_Ave 18 1-2 PM
 Site Code : 00319628
 Start Date : 9/18/2019
 Page No : 1

Groups Printed- Large 2 Axle Vehicles

Start Time	SR-99 Southbound Off Ramp Southbound					Avenue 18 1/2 Westbound					Road 23 Northbound					Avenue 18 1/2 Eastbound					Int. Total
	Left	Thru	Right	U-Turns	App. Total	Left	Thru	Right	U-Turns	App. Total	Left	Thru	Right	U-Turns	App. Total	Left	Thru	Right	U-Turns	App. Total	
04:00 PM	0	0	1	0	1	0	1	0	0	1	0	0	1	0	1	0	2	2	0	4	7
04:15 PM	0	0	2	0	2	0	1	0	0	1	0	0	1	0	1	0	3	1	0	4	8
04:30 PM	0	0	0	0	0	0	5	0	0	5	0	0	0	0	0	0	5	2	0	7	12
04:45 PM	0	0	0	0	0	1	4	0	0	5	0	0	1	0	1	0	1	1	0	2	8
Total	0	0	3	0	3	1	11	0	0	12	0	0	3	0	3	0	11	6	0	17	35
05:00 PM	1	0	0	0	1	0	3	0	0	3	1	0	0	0	1	0	3	1	0	4	9
05:15 PM	0	0	1	0	1	0	2	0	0	2	0	0	1	0	1	0	6	1	0	7	11
05:30 PM	0	0	2	0	2	0	1	0	0	1	0	0	0	0	0	0	6	1	0	7	10
05:45 PM	0	0	0	0	0	0	3	0	0	3	0	0	0	0	0	0	3	0	0	3	6
Total	1	0	3	0	4	0	9	0	0	9	1	0	1	0	2	0	18	3	0	21	36
Grand Total	1	0	6	0	7	1	20	0	0	21	1	0	4	0	5	0	29	9	0	38	71
Apprch %	14.3	0	85.7	0		4.8	95.2	0	0		20	0	80	0		0	76.3	23.7	0		
Total %	1.4	0	8.5	0	9.9	1.4	28.2	0	0	29.6	1.4	0	5.6	0	7	0	40.8	12.7	0	53.5	

Start Time	SR-99 Southbound Off Ramp Southbound					Avenue 18 1/2 Westbound					Road 23 Northbound					Avenue 18 1/2 Eastbound					Int. Total
	Left	Thru	Right	U-Turns	App. Total	Left	Thru	Right	U-Turns	App. Total	Left	Thru	Right	U-Turns	App. Total	Left	Thru	Right	U-Turns	App. Total	
Peak Hour Analysis From 04:00 PM to 04:45 PM - Peak 1 of 1																					
Peak Hour for Entire Intersection Begins at 04:00 PM																					
04:00 PM	0	0	1	0	1	0	1	0	0	1	0	0	1	0	1	0	2	2	0	4	7
04:15 PM	0	0	2	0	2	0	1	0	0	1	0	0	1	0	1	0	3	1	0	4	8
04:30 PM	0	0	0	0	0	0	5	0	0	5	0	0	0	0	0	0	5	2	0	7	12
04:45 PM	0	0	0	0	0	1	4	0	0	5	0	0	1	0	1	0	1	1	0	2	8
Total Volume	0	0	3	0	3	1	11	0	0	12	0	0	3	0	3	0	11	6	0	17	35
% App. Total	0	0	100	0		8.3	91.7	0	0		0	0	100	0		0	64.7	35.3	0		
PHF	.000	.000	.375	.000	.375	.250	.550	.000	.000	.600	.000	.000	.750	.000	.750	.000	.550	.750	.000	.607	.729

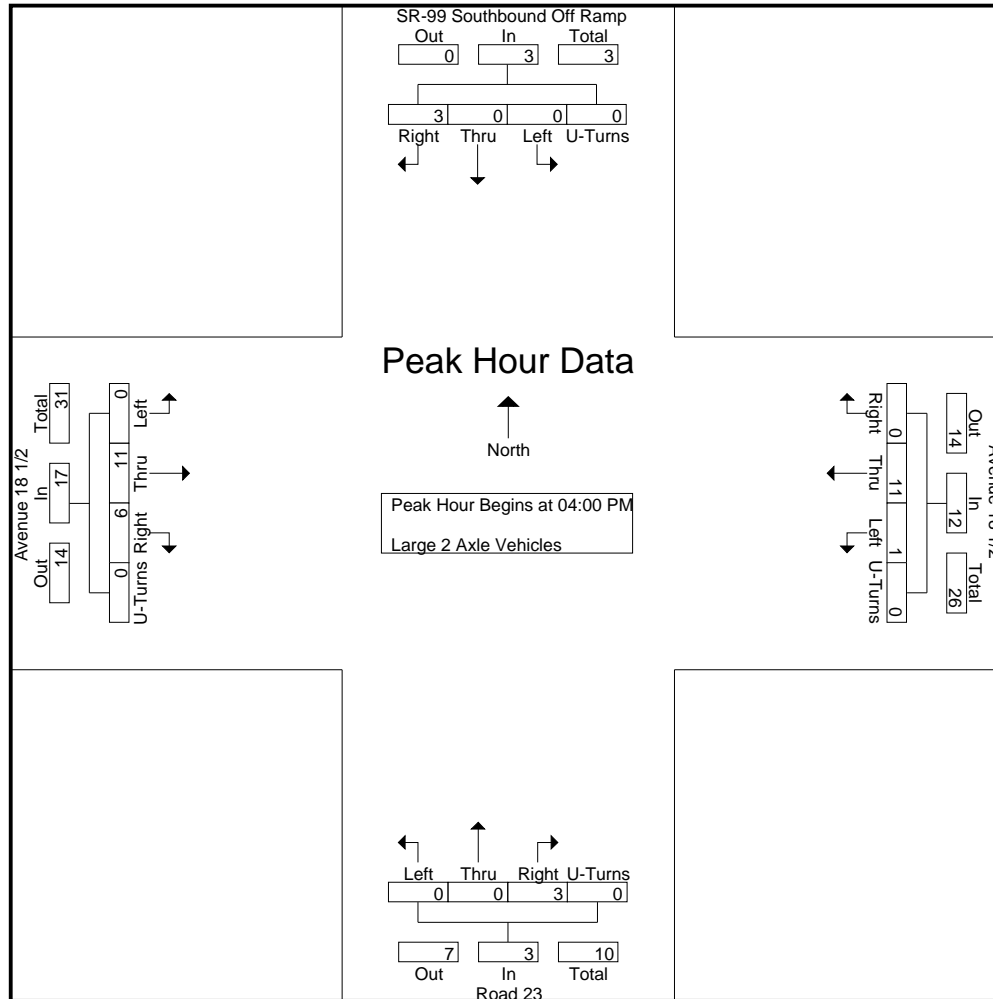

City of Madera
 N/S: SR-99 SB Off Ramp/Road 23
 E/W: Avenue 18 1/2
 Weather: Clear

File Name : 03_MDA_99S Off Ramp_Ave 18 1-2 PM
 Site Code : 00319628
 Start Date : 9/18/2019
 Page No : 3

Start Time	SR-99 Southbound Off Ramp Southbound					Avenue 18 1/2 Westbound					Road 23 Northbound					Avenue 18 1/2 Eastbound					Int. Total
	Left	Thru	Right	U-Turns	App. Total	Left	Thru	Right	U-Turns	App. Total	Left	Thru	Right	U-Turns	App. Total	Left	Thru	Right	U-Turns	App. Total	

Peak Hour Analysis From 04:00 PM to 04:45 PM - Peak 1 of 1
 Peak Hour for Each Approach Begins at:

	04:00 PM					04:00 PM					04:00 PM					04:00 PM									
+0 mins.	0	0	1	0	1	0	1	0	0	1	0	0	1	0	1	0	2	2	0	4	0	3	1	0	4
+15 mins.	0	0	2	0	2	0	1	0	0	1	0	0	1	0	1	0	3	1	0	4	0	5	2	0	7
+30 mins.	0	0	0	0	0	0	5	0	0	5	0	0	0	0	0	0	5	2	0	7	0	1	1	0	2
+45 mins.	0	0	0	0	0	1	4	0	0	5	0	0	1	0	1	0	1	1	0	2	0	1	1	0	2
Total Volume	0	0	3	0	3	1	11	0	0	12	0	0	3	0	3	0	11	6	0	17	0	64.7	35.3	0	100
% App. Total	0	0	100	0		8.3	91.7	0	0		0	0	100	0		0	64.7	35.3	0		0	64.7	35.3	0	
PHF	.000	.000	.375	.000	.375	.250	.550	.000	.000	.600	.000	.000	.750	.000	.750	.000	.550	.750	.000	.607	.000	.550	.750	.000	.607

City of Madera
 N/S: SR-99 SB Off Ramp/Road 23
 E/W: Avenue 18 1/2
 Weather: Clear

File Name : 03_MDA_99S Off Ramp_Ave 18 1-2 PM
 Site Code : 00319628
 Start Date : 9/18/2019
 Page No : 1

Groups Printed- 3 Axle Vehicles

Start Time	SR-99 Southbound Off Ramp Southbound					Avenue 18 1/2 Westbound					Road 23 Northbound					Avenue 18 1/2 Eastbound					Int. Total
	Left	Thru	Right	U-Turns	App. Total	Left	Thru	Right	U-Turns	App. Total	Left	Thru	Right	U-Turns	App. Total	Left	Thru	Right	U-Turns	App. Total	
04:00 PM	0	0	0	0	0	0	2	0	0	2	0	0	0	0	0	0	1	0	0	1	3
04:15 PM	0	0	0	0	0	0	0	0	0	0	0	0	0	0	0	0	0	0	0	0	0
04:30 PM	0	0	0	0	0	0	0	0	0	0	0	0	0	0	0	0	3	0	0	3	3
04:45 PM	0	0	0	0	0	0	0	0	0	0	0	0	0	0	0	0	1	0	0	1	1
Total	0	0	0	0	0	0	2	0	0	2	0	0	0	0	0	0	5	0	0	5	7
05:00 PM	0	0	0	0	0	0	0	0	0	0	0	0	0	0	0	0	0	0	0	0	0
05:15 PM	0	0	0	0	0	0	1	0	0	1	0	0	0	0	0	0	1	0	0	1	2
05:30 PM	0	0	0	0	0	0	1	0	0	1	0	0	0	0	0	0	2	0	0	2	3
05:45 PM	0	0	0	0	0	0	2	0	0	2	1	0	0	0	1	0	2	0	0	2	5
Total	0	0	0	0	0	0	4	0	0	4	1	0	0	0	1	0	5	0	0	5	10
Grand Total	0	0	0	0	0	0	6	0	0	6	1	0	0	0	1	0	10	0	0	10	17
Apprch %	0	0	0	0	0	0	100	0	0	100	0	0	0	0	0	0	100	0	0	100	
Total %	0	0	0	0	0	0	35.3	0	0	35.3	5.9	0	0	0	5.9	0	58.8	0	0	58.8	

Start Time	SR-99 Southbound Off Ramp Southbound					Avenue 18 1/2 Westbound					Road 23 Northbound					Avenue 18 1/2 Eastbound					Int. Total
	Left	Thru	Right	U-Turns	App. Total	Left	Thru	Right	U-Turns	App. Total	Left	Thru	Right	U-Turns	App. Total	Left	Thru	Right	U-Turns	App. Total	
Peak Hour Analysis From 04:00 PM to 04:45 PM - Peak 1 of 1																					
Peak Hour for Entire Intersection Begins at 04:00 PM																					
04:00 PM	0	0	0	0	0	0	2	0	0	2	0	0	0	0	0	0	1	0	0	1	3
04:15 PM	0	0	0	0	0	0	0	0	0	0	0	0	0	0	0	0	0	0	0	0	0
04:30 PM	0	0	0	0	0	0	0	0	0	0	0	0	0	0	0	0	3	0	0	3	3
04:45 PM	0	0	0	0	0	0	0	0	0	0	0	0	0	0	0	0	1	0	0	1	1
Total Volume	0	0	0	0	0	0	2	0	0	2	0	0	0	0	0	0	5	0	0	5	7
% App. Total	0	0	0	0	0	0	100	0	0	100	0	0	0	0	0	0	100	0	0	100	
PHF	.000	.000	.000	.000	.000	.000	.250	.000	.000	.250	.000	.000	.000	.000	.000	.000	.417	.000	.000	.417	.583

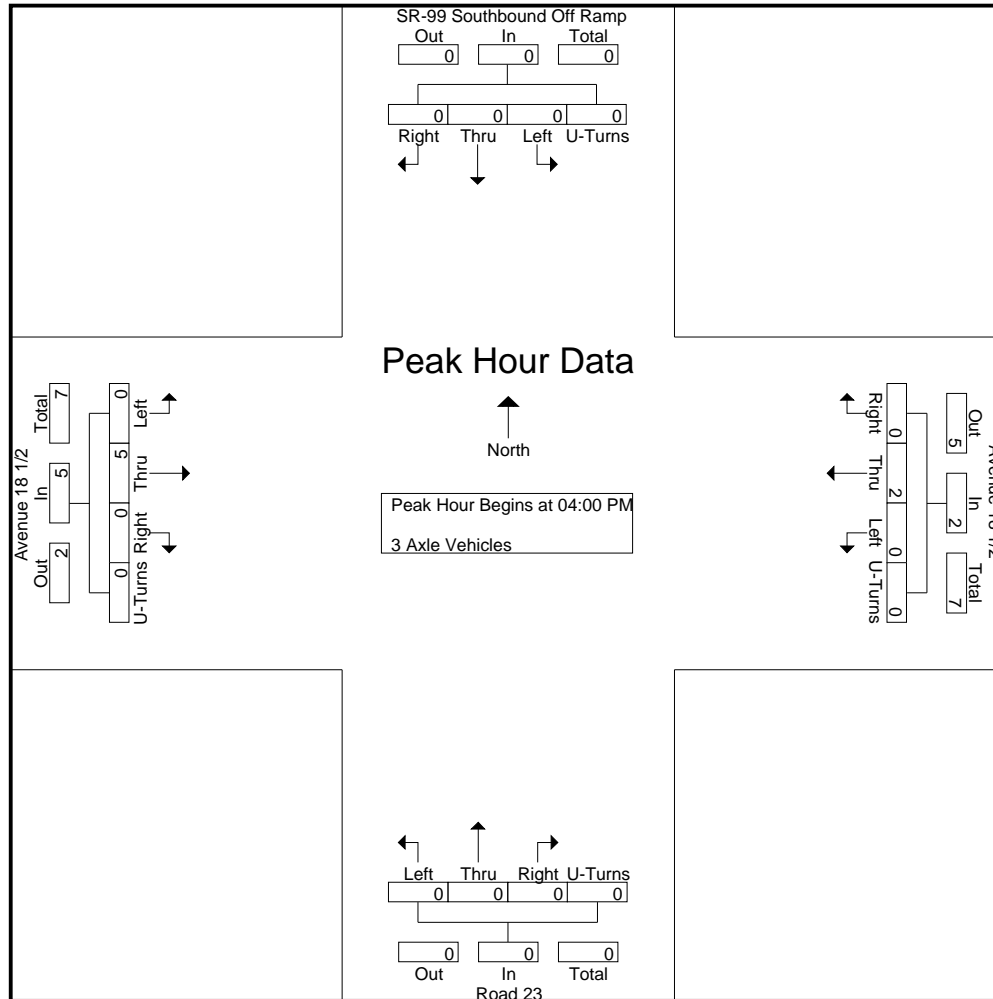

City of Madera
 N/S: SR-99 SB Off Ramp/Road 23
 E/W: Avenue 18 1/2
 Weather: Clear

File Name : 03_MDA_99S Off Ramp_Ave 18 1-2 PM
 Site Code : 00319628
 Start Date : 9/18/2019
 Page No : 3

Start Time	SR-99 Southbound Off Ramp Southbound					Avenue 18 1/2 Westbound					Road 23 Northbound					Avenue 18 1/2 Eastbound					Int. Total
	Left	Thru	Right	U-Turns	App. Total	Left	Thru	Right	U-Turns	App. Total	Left	Thru	Right	U-Turns	App. Total	Left	Thru	Right	U-Turns	App. Total	

Peak Hour Analysis From 04:00 PM to 04:45 PM - Peak 1 of 1
 Peak Hour for Each Approach Begins at:

	04:00 PM					04:00 PM					04:00 PM					04:00 PM				
+0 mins.	0	0	0	0	0	0	2	0	0	2	0	0	0	0	0	0	1	0	0	1
+15 mins.	0	0	0	0	0	0	0	0	0	0	0	0	0	0	0	0	0	0	0	0
+30 mins.	0	0	0	0	0	0	0	0	0	0	0	0	0	0	0	0	3	0	0	3
+45 mins.	0	0	0	0	0	0	0	0	0	0	0	0	0	0	0	0	1	0	0	1
Total Volume	0	0	0	0	0	0	2	0	0	2	0	0	0	0	0	0	5	0	0	5
% App. Total	0	0	0	0	0	0	100	0	0	0	0	0	0	0	0	0	100	0	0	0
PHF	.000	.000	.000	.000	.000	.000	.250	.000	.000	.250	.000	.000	.000	.000	.000	.000	.417	.000	.000	.417

City of Madera
 N/S: SR-99 SB Off Ramp/Road 23
 E/W: Avenue 18 1/2
 Weather: Clear

File Name : 03_MDA_99S Off Ramp_Ave 18 1-2 PM
 Site Code : 00319628
 Start Date : 9/18/2019
 Page No : 1

Groups Printed- 4+ Axle Trucks

Start Time	SR-99 Southbound Off Ramp Southbound					Avenue 18 1/2 Westbound					Road 23 Northbound					Avenue 18 1/2 Eastbound					Int. Total
	Left	Thru	Right	U-Turns	App. Total	Left	Thru	Right	U-Turns	App. Total	Left	Thru	Right	U-Turns	App. Total	Left	Thru	Right	U-Turns	App. Total	
04:00 PM	1	2	11	0	14	0	15	0	0	15	0	0	3	0	3	0	22	1	0	23	55
04:15 PM	0	1	10	0	11	4	12	0	0	16	0	0	6	0	6	0	16	1	0	17	50
04:30 PM	0	6	15	0	21	1	10	0	0	11	0	0	4	0	4	0	19	3	0	22	58
04:45 PM	0	1	11	0	12	0	13	0	0	13	0	0	1	0	1	0	11	2	0	13	39
Total	1	10	47	0	58	5	50	0	0	55	0	0	14	0	14	0	68	7	0	75	202
05:00 PM	0	3	7	0	10	0	4	0	0	4	0	0	1	0	1	0	21	1	0	22	37
05:15 PM	0	1	8	0	9	0	12	0	0	12	2	0	1	0	3	0	12	2	0	14	38
05:30 PM	1	2	6	0	9	0	5	0	0	5	2	0	0	0	2	0	11	0	0	11	27
05:45 PM	0	3	5	0	8	0	7	0	0	7	1	0	1	0	2	0	16	3	0	19	36
Total	1	9	26	0	36	0	28	0	0	28	5	0	3	0	8	0	60	6	0	66	138
Grand Total	2	19	73	0	94	5	78	0	0	83	5	0	17	0	22	0	128	13	0	141	340
Apprch %	2.1	20.2	77.7	0		6	94	0	0		22.7	0	77.3	0		0	90.8	9.2	0		
Total %	0.6	5.6	21.5	0	27.6	1.5	22.9	0	0	24.4	1.5	0	5	0	6.5	0	37.6	3.8	0	41.5	

Start Time	SR-99 Southbound Off Ramp Southbound					Avenue 18 1/2 Westbound					Road 23 Northbound					Avenue 18 1/2 Eastbound					Int. Total
	Left	Thru	Right	U-Turns	App. Total	Left	Thru	Right	U-Turns	App. Total	Left	Thru	Right	U-Turns	App. Total	Left	Thru	Right	U-Turns	App. Total	
Peak Hour Analysis From 04:00 PM to 04:45 PM - Peak 1 of 1																					
Peak Hour for Entire Intersection Begins at 04:00 PM																					
04:00 PM	1	2	11	0	14	0	15	0	0	15	0	0	3	0	3	0	22	1	0	23	55
04:15 PM	0	1	10	0	11	4	12	0	0	16	0	0	6	0	6	0	16	1	0	17	50
04:30 PM	0	6	15	0	21	1	10	0	0	11	0	0	4	0	4	0	19	3	0	22	58
04:45 PM	0	1	11	0	12	0	13	0	0	13	0	0	1	0	1	0	11	2	0	13	39
Total Volume	1	10	47	0	58	5	50	0	0	55	0	0	14	0	14	0	68	7	0	75	202
% App. Total	1.7	17.2	81	0		9.1	90.9	0	0		0	0	100	0		0	90.7	9.3	0		
PHF	.250	.417	.783	.000	.690	.313	.833	.000	.000	.859	.000	.000	.583	.000	.583	.000	.773	.583	.000	.815	.871

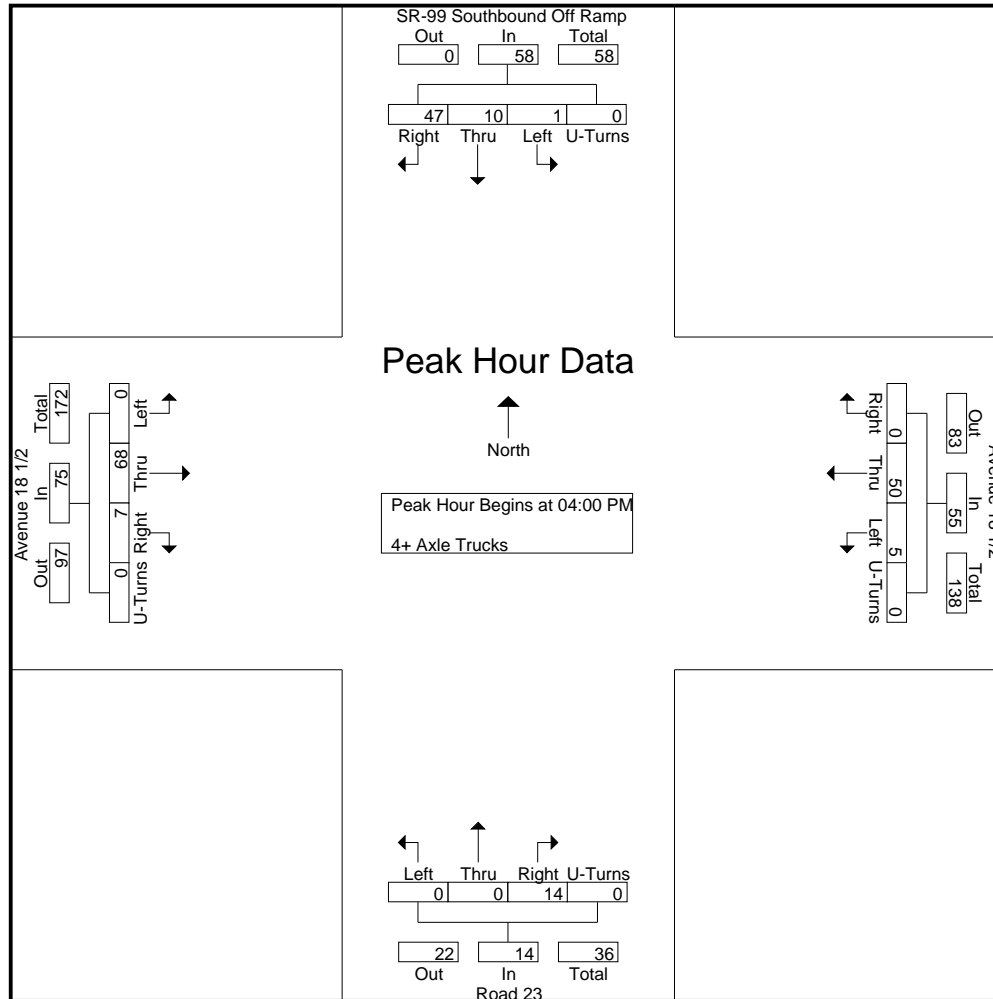

City of Madera
 N/S: SR-99 SB Off Ramp/Road 23
 E/W: Avenue 18 1/2
 Weather: Clear

File Name : 03_MDA_99S Off Ramp_Ave 18 1-2 PM
 Site Code : 00319628
 Start Date : 9/18/2019
 Page No : 3

Start Time	SR-99 Southbound Off Ramp Southbound					Avenue 18 1/2 Westbound					Road 23 Northbound					Avenue 18 1/2 Eastbound					Int. Total
	Left	Thru	Right	U-Turns	App. Total	Left	Thru	Right	U-Turns	App. Total	Left	Thru	Right	U-Turns	App. Total	Left	Thru	Right	U-Turns	App. Total	

Peak Hour Analysis From 04:00 PM to 04:45 PM - Peak 1 of 1
 Peak Hour for Each Approach Begins at:

	04:00 PM					04:00 PM					04:00 PM					04:00 PM				
+0 mins.	1	2	11	0	14	0	15	0	0	15	0	0	3	0	3	0	22	1	0	23
+15 mins.	0	1	10	0	11	4	12	0	0	16	0	0	6	0	6	0	16	1	0	17
+30 mins.	0	6	15	0	21	1	10	0	0	11	0	0	4	0	4	0	19	3	0	22
+45 mins.	0	1	11	0	12	0	13	0	0	13	0	0	1	0	1	0	11	2	0	13
Total Volume	1	10	47	0	58	5	50	0	0	55	0	0	14	0	14	0	68	7	0	75
% App. Total	1.7	17.2	81	0		9.1	90.9	0	0		0	0	100	0		0	90.7	9.3	0	
PHF	.250	.417	.783	.000	.690	.313	.833	.000	.000	.859	.000	.000	.583	.000	.583	.000	.773	.583	.000	.815

Location: Madera
 N/S: SR-99 SB Off Ramp/Road 23
 E/W: Avenue 18 1/2



PEDESTRIANS

	North Leg SR-99 SB Off Ramp	East Leg Avenue 18 1/2	South Leg Road 23	West Leg Avenue 18 1/2	
	Pedestrians	Pedestrians	Pedestrians	Pedestrians	
7:00 AM	0	0	0	0	0
7:15 AM	0	0	0	0	0
7:30 AM	0	0	0	0	0
7:45 AM	0	0	0	0	0
8:00 AM	0	1	0	0	1
8:15 AM	0	0	0	0	0
8:30 AM	0	0	0	0	0
8:45 AM	0	0	0	0	0
TOTAL VOLUMES:	0	1	0	0	1

	North Leg SR-99 SB Off Ramp	East Leg Avenue 18 1/2	South Leg Road 23	West Leg Avenue 18 1/2	
	Pedestrians	Pedestrians	Pedestrians	Pedestrians	
4:00 PM	0	0	0	0	0
4:15 PM	0	0	0	0	0
4:30 PM	0	0	0	0	0
4:45 PM	0	0	0	0	0
5:00 PM	1	0	1	0	2
5:15 PM	1	0	0	0	1
5:30 PM	0	0	0	0	0
5:45 PM	0	0	0	0	0
TOTAL VOLUMES:	2	0	1	0	3

Location: Madera
 N/S: SR-99 SB Off Ramp/Road 23
 E/W: Avenue 18 1/2



BICYCLES

	Southbound SR-99 SB Off Ramp			Westbound Avenue 18 1/2			Northbound Road 23			Eastbound Avenue 18 1/2			
	Left	Thru	Right	Left	Thru	Right	Left	Thru	Right	Left	Thru	Right	
7:00 AM	0	0	0	0	0	0	0	0	0	0	0	0	0
7:15 AM	0	0	0	0	0	0	0	0	0	0	0	0	0
7:30 AM	0	0	0	0	0	0	0	0	0	0	0	0	0
7:45 AM	0	0	0	0	0	0	0	0	0	0	0	0	0
8:00 AM	0	0	0	0	0	0	0	0	0	0	0	0	0
8:15 AM	0	0	0	0	0	0	0	0	0	0	0	0	0
8:30 AM	0	0	0	0	0	0	0	0	0	0	0	0	0
8:45 AM	0	0	0	0	0	0	0	0	0	0	0	0	0
TOTAL VOLUMES:	0	0	0	0	0	0	0	0	0	0	0	0	0

	Southbound SR-99 SB Off Ramp			Westbound Avenue 18 1/2			Northbound Road 23			Eastbound Avenue 18 1/2			
	Left	Thru	Right	Left	Thru	Right	Left	Thru	Right	Left	Thru	Right	
4:00 PM	0	0	0	0	0	0	0	0	0	0	1	0	1
4:15 PM	0	1	0	0	0	0	0	0	0	0	0	0	1
4:30 PM	0	0	0	0	0	0	1	0	0	0	0	0	1
4:45 PM	0	0	0	0	0	0	0	0	0	0	0	0	0
5:00 PM	0	0	0	0	0	0	0	0	0	0	0	0	0
5:15 PM	0	0	0	0	0	0	0	0	0	0	0	0	0
5:30 PM	0	0	0	0	0	0	0	0	0	0	0	0	0
5:45 PM	0	0	0	0	0	0	3	0	0	0	0	0	3
TOTAL VOLUMES:	0	1	0	0	0	0	4	0	0	0	1	0	6

City of Madera
 N/S: SR-99 Northbound Ramps
 E/W: Avenue 18 1/2
 Weather: Clear

File Name : 04_MDA_99N_Ave 18 1-2 AM
 Site Code : 00319628
 Start Date : 9/18/2019
 Page No : 1

Groups Printed- Passenger Vehicles - Large 2 Axle Vehicles - 3 Axle Vehicles - 4+ Axle Trucks

Start Time	SR-99 Northbound On Ramp Southbound					Avenue 18 1/2 Westbound					SR-99 Northbound Off Ramp Northbound					Avenue 18 1/2 Eastbound					Int. Total
	Left	Thru	Right	U-Turns	App. Total	Left	Thru	Right	U-Turns	App. Total	Left	Thru	Right	U-Turns	App. Total	Left	Thru	Right	U-Turns	App. Total	
07:00 AM	0	0	0	0	0	0	24	7	0	31	33	1	2	0	36	31	10	0	0	41	108
07:15 AM	0	0	0	0	0	0	26	4	0	30	47	1	4	0	52	42	9	0	0	51	133
07:30 AM	0	0	0	0	0	0	44	11	0	55	57	0	5	0	62	62	9	0	0	71	188
07:45 AM	0	0	0	0	0	0	44	6	0	50	49	0	7	0	56	62	16	0	0	78	184
Total	0	0	0	0	0	0	138	28	0	166	186	2	18	0	206	197	44	0	0	241	613
08:00 AM	0	0	0	0	0	0	12	1	0	13	48	0	2	0	50	42	18	0	0	60	123
08:15 AM	0	0	0	0	0	0	20	5	0	25	45	0	3	0	48	43	9	0	0	52	125
08:30 AM	0	0	0	0	0	0	28	4	0	32	44	0	1	0	45	47	12	0	0	59	136
08:45 AM	0	0	0	0	0	0	14	1	0	15	51	0	1	0	52	35	16	0	0	51	118
Total	0	0	0	0	0	0	74	11	0	85	188	0	7	0	195	167	55	0	0	222	502
Grand Total	0	0	0	0	0	0	212	39	0	251	374	2	25	0	401	364	99	0	0	463	1115
Apprch %	0	0	0	0	0	0	84.5	15.5	0	93.3	0.5	6.2	0	0	78.6	21.4	0	0	0	51	
Total %	0	0	0	0	0	0	19	3.5	0	22.5	33.5	0.2	2.2	0	36	32.6	8.9	0	0	41.5	
Passenger Vehicles	0	0	0	0	0	0	172	33	0	205	264	1	15	0	280	242	79	0	0	321	806
% Passenger Vehicles	0	0	0	0	0	0	81.1	84.6	0	81.7	70.6	50	60	0	69.8	66.5	79.8	0	0	69.3	72.3
Large 2 Axle Vehicles	0	0	0	0	0	0	10	0	0	10	21	1	0	0	22	17	8	0	0	25	57
% Large 2 Axle Vehicles	0	0	0	0	0	0	4.7	0	0	4	5.6	50	0	0	5.5	4.7	8.1	0	0	5.4	5.1
3 Axle Vehicles	0	0	0	0	0	0	0	1	0	1	3	0	1	0	4	2	0	0	0	2	7
% 3 Axle Vehicles	0	0	0	0	0	0	0	2.6	0	0.4	0.8	0	4	0	1	0.5	0	0	0	0.4	0.6
4+ Axle Trucks	0	0	0	0	0	0	30	5	0	35	86	0	9	0	95	103	12	0	0	115	245
% 4+ Axle Trucks	0	0	0	0	0	0	14.2	12.8	0	13.9	23	0	36	0	23.7	28.3	12.1	0	0	24.8	22

Start Time	SR-99 Northbound On Ramp Southbound					Avenue 18 1/2 Westbound					SR-99 Northbound Off Ramp Northbound					Avenue 18 1/2 Eastbound					Int. Total
	Left	Thru	Right	U-Turns	App. Total	Left	Thru	Right	U-Turns	App. Total	Left	Thru	Right	U-Turns	App. Total	Left	Thru	Right	U-Turns	App. Total	
Peak Hour Analysis From 07:00 AM to 08:45 AM - Peak 1 of 1																					
Peak Hour for Entire Intersection Begins at 07:15 AM																					
07:15 AM	0	0	0	0	0	0	26	4	0	30	47	1	4	0	52	42	9	0	0	51	133
07:30 AM	0	0	0	0	0	0	44	11	0	55	57	0	5	0	62	62	9	0	0	71	188
07:45 AM	0	0	0	0	0	0	44	6	0	50	49	0	7	0	56	62	16	0	0	78	184
08:00 AM	0	0	0	0	0	0	12	1	0	13	48	0	2	0	50	42	18	0	0	60	123
Total Volume	0	0	0	0	0	0	126	22	0	148	201	1	18	0	220	208	52	0	0	260	628
% App. Total	0	0	0	0	0	0	85.1	14.9	0	91.4	0.5	8.2	0	0	80	20	0	0	0	260	
PHF	.000	.000	.000	.000	.000	.000	.716	.500	.000	.673	.882	.250	.643	.000	.887	.839	.722	.000	.000	.833	.835

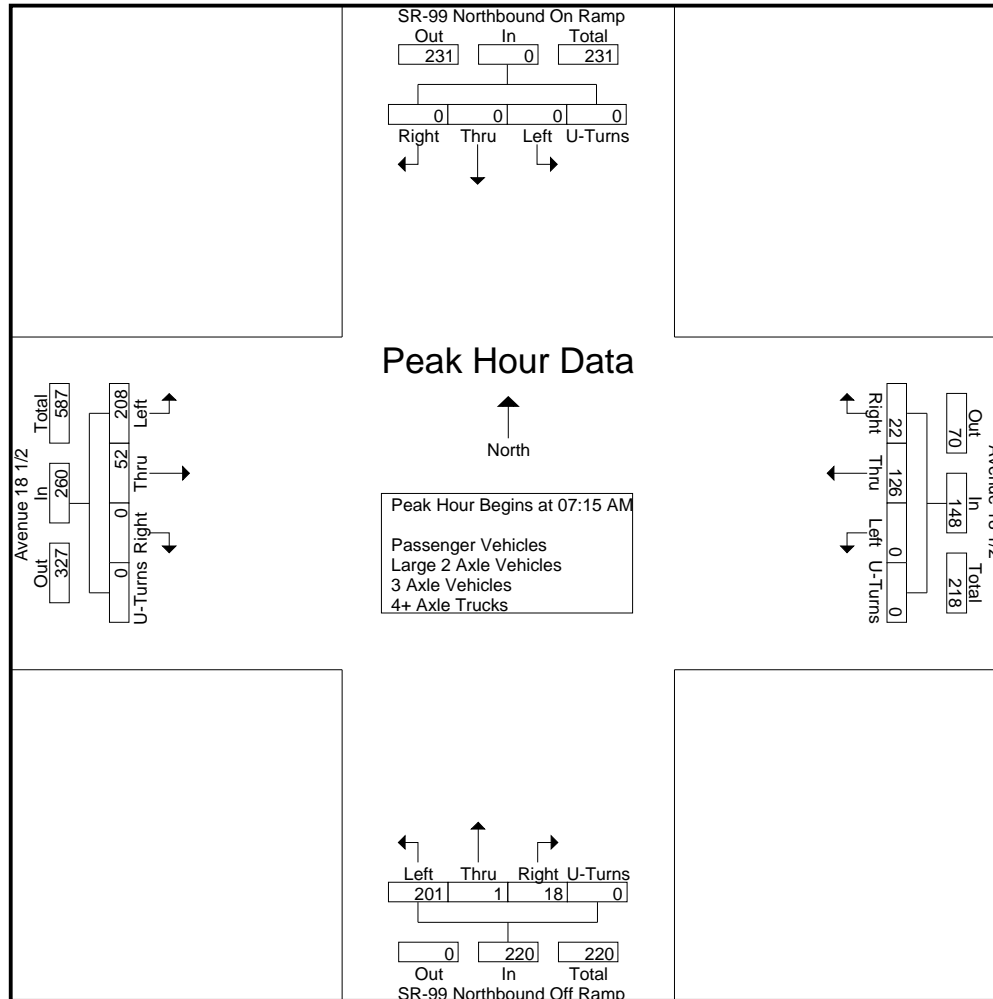

Counts Unlimited
 PO Box 1178
 Corona, CA 92878
 (951) 268-6268

City of Madera
 N/S: SR-99 Northbound Ramps
 E/W: Avenue 18 1/2
 Weather: Clear

File Name : 04_MDA_99N_Ave 18 1-2 AM
 Site Code : 00319628
 Start Date : 9/18/2019
 Page No : 3

Start Time	SR-99 Northbound On Ramp Southbound					Avenue 18 1/2 Westbound					SR-99 Northbound Off Ramp Northbound					Avenue 18 1/2 Eastbound					Int. Total
	Left	Thru	Right	U-Turns	App. Total	Left	Thru	Right	U-Turns	App. Total	Left	Thru	Right	U-Turns	App. Total	Left	Thru	Right	U-Turns	App. Total	

Peak Hour Analysis From 07:00 AM to 08:45 AM - Peak 1 of 1
 Peak Hour for Each Approach Begins at:

	07:00 AM					07:00 AM					07:15 AM					07:30 AM				
+0 mins.	0	0	0	0	0	0	24	7	0	31	47	1	4	0	52	62	9	0	0	71
+15 mins.	0	0	0	0	0	0	26	4	0	30	57	0	5	0	62	62	16	0	0	78
+30 mins.	0	0	0	0	0	0	44	11	0	55	49	0	7	0	56	42	18	0	0	60
+45 mins.	0	0	0	0	0	0	44	6	0	50	48	0	2	0	50	43	9	0	0	52
Total Volume	0	0	0	0	0	0	138	28	0	166	201	1	18	0	220	209	52	0	0	261
% App. Total	0	0	0	0	0	0	83.1	16.9	0		91.4	0.5	8.2	0		80.1	19.9	0	0	
PHF	.000	.000	.000	.000	.000	.000	.784	.636	.000	.755	.882	.250	.643	.000	.887	.843	.722	.000	.000	.837

City of Madera
 N/S: SR-99 Northbound Ramps
 E/W: Avenue 18 1/2
 Weather: Clear

File Name : 04_MDA_99N_Ave 18 1-2 AM
 Site Code : 00319628
 Start Date : 9/18/2019
 Page No : 1

Groups Printed- Passenger Vehicles

Start Time	SR-99 Northbound On Ramp Southbound					Avenue 18 1/2 Westbound					SR-99 Northbound Off Ramp Northbound					Avenue 18 1/2 Eastbound					Int. Total
	Left	Thru	Right	U-Turns	App. Total	Left	Thru	Right	U-Turns	App. Total	Left	Thru	Right	U-Turns	App. Total	Left	Thru	Right	U-Turns	App. Total	
07:00 AM	0	0	0	0	0	0	19	6	0	25	23	0	2	0	25	19	7	0	0	26	76
07:15 AM	0	0	0	0	0	0	24	4	0	28	30	1	3	0	34	26	8	0	0	34	96
07:30 AM	0	0	0	0	0	0	34	8	0	42	42	0	5	0	47	45	6	0	0	51	140
07:45 AM	0	0	0	0	0	0	36	4	0	40	39	0	4	0	43	38	12	0	0	50	133
Total	0	0	0	0	0	0	113	22	0	135	134	1	14	0	149	128	33	0	0	161	445
08:00 AM	0	0	0	0	0	0	11	1	0	12	32	0	1	0	33	28	17	0	0	45	90
08:15 AM	0	0	0	0	0	0	18	5	0	23	34	0	0	0	34	28	9	0	0	37	94
08:30 AM	0	0	0	0	0	0	19	4	0	23	30	0	0	0	30	32	9	0	0	41	94
08:45 AM	0	0	0	0	0	0	11	1	0	12	34	0	0	0	34	26	11	0	0	37	83
Total	0	0	0	0	0	0	59	11	0	70	130	0	1	0	131	114	46	0	0	160	361
Grand Total	0	0	0	0	0	0	172	33	0	205	264	1	15	0	280	242	79	0	0	321	806
Apprch %	0	0	0	0	0	0	83.9	16.1	0	25.4	94.3	0.4	5.4	0	34.7	75.4	24.6	0	0	39.8	
Total %	0	0	0	0	0	0	21.3	4.1	0	25.4	32.8	0.1	1.9	0	34.7	30	9.8	0	0	39.8	

Start Time	SR-99 Northbound On Ramp Southbound					Avenue 18 1/2 Westbound					SR-99 Northbound Off Ramp Northbound					Avenue 18 1/2 Eastbound					Int. Total
	Left	Thru	Right	U-Turns	App. Total	Left	Thru	Right	U-Turns	App. Total	Left	Thru	Right	U-Turns	App. Total	Left	Thru	Right	U-Turns	App. Total	
Peak Hour Analysis From 07:15 AM to 08:00 AM - Peak 1 of 1																					
Peak Hour for Entire Intersection Begins at 07:15 AM																					
07:15 AM	0	0	0	0	0	0	24	4	0	28	30	1	3	0	34	26	8	0	0	34	96
07:30 AM	0	0	0	0	0	0	34	8	0	42	42	0	5	0	47	45	6	0	0	51	140
07:45 AM	0	0	0	0	0	0	36	4	0	40	39	0	4	0	43	38	12	0	0	50	133
08:00 AM	0	0	0	0	0	0	11	1	0	12	32	0	1	0	33	28	17	0	0	45	90
Total Volume	0	0	0	0	0	0	105	17	0	122	143	1	13	0	157	137	43	0	0	180	459
% App. Total	0	0	0	0	0	0	86.1	13.9	0	25.4	91.1	0.6	8.3	0	34.7	76.1	23.9	0	0	39.8	
PHF	.000	.000	.000	.000	.000	.000	.729	.531	.000	.726	.851	.250	.650	.000	.835	.761	.632	.000	.000	.882	.820

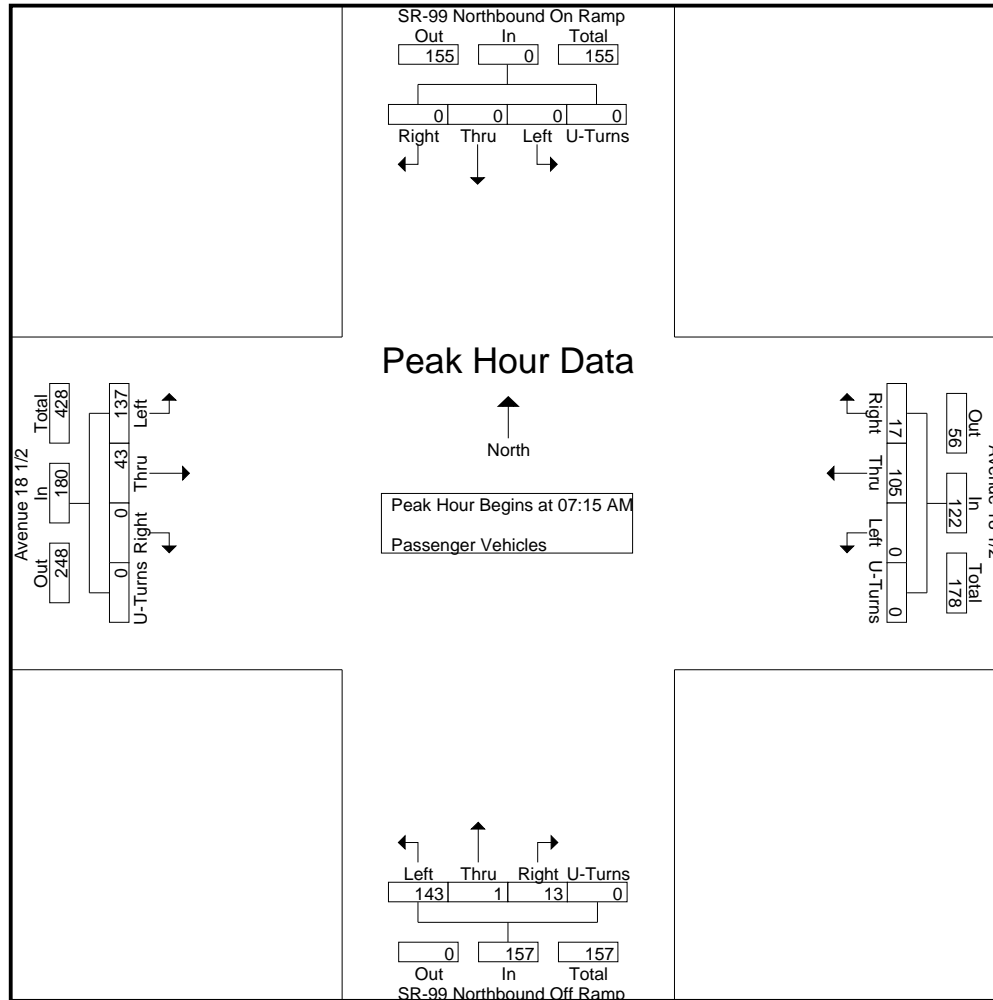

Counts Unlimited
 PO Box 1178
 Corona, CA 92878
 (951) 268-6268

City of Madera
 N/S: SR-99 Northbound Ramps
 E/W: Avenue 18 1/2
 Weather: Clear

File Name : 04_MDA_99N_Ave 18 1-2 AM
 Site Code : 00319628
 Start Date : 9/18/2019
 Page No : 3

Start Time	SR-99 Northbound On Ramp Southbound					Avenue 18 1/2 Westbound					SR-99 Northbound Off Ramp Northbound					Avenue 18 1/2 Eastbound					Int. Total
	Left	Thru	Right	U-Turns	App. Total	Left	Thru	Right	U-Turns	App. Total	Left	Thru	Right	U-Turns	App. Total	Left	Thru	Right	U-Turns	App. Total	

Peak Hour Analysis From 07:15 AM to 08:00 AM - Peak 1 of 1
 Peak Hour for Each Approach Begins at:

	07:15 AM					07:15 AM					07:15 AM					07:15 AM				
+0 mins.	0	0	0	0	0	0	24	4	0	28	30	1	3	0	34	26	8	0	0	34
+15 mins.	0	0	0	0	0	0	34	8	0	42	42	0	5	0	47	45	6	0	0	51
+30 mins.	0	0	0	0	0	0	36	4	0	40	39	0	4	0	43	38	12	0	0	50
+45 mins.	0	0	0	0	0	0	11	1	0	12	32	0	1	0	33	28	17	0	0	45
Total Volume	0	0	0	0	0	0	105	17	0	122	143	1	13	0	157	137	43	0	0	180
% App. Total	0	0	0	0	0	0	86.1	13.9	0		91.1	0.6	8.3	0		76.1	23.9	0	0	
PHF	.000	.000	.000	.000	.000	.000	.729	.531	.000	.726	.851	.250	.650	.000	.835	.761	.632	.000	.000	.882

City of Madera
 N/S: SR-99 Northbound Ramps
 E/W: Avenue 18 1/2
 Weather: Clear

File Name : 04_MDA_99N_Ave 18 1-2 AM
 Site Code : 00319628
 Start Date : 9/18/2019
 Page No : 1

Groups Printed- Large 2 Axle Vehicles

Start Time	SR-99 Northbound On Ramp Southbound					Avenue 18 1/2 Westbound					SR-99 Northbound Off Ramp Northbound					Avenue 18 1/2 Eastbound					Int. Total
	Left	Thru	Right	U-Turns	App. Total	Left	Thru	Right	U-Turns	App. Total	Left	Thru	Right	U-Turns	App. Total	Left	Thru	Right	U-Turns	App. Total	
07:00 AM	0	0	0	0	0	0	1	0	0	1	2	1	0	0	3	3	1	0	0	4	8
07:15 AM	0	0	0	0	0	0	1	0	0	1	2	0	0	0	2	1	0	0	0	1	4
07:30 AM	0	0	0	0	0	0	2	0	0	2	5	0	0	0	5	3	1	0	0	4	11
07:45 AM	0	0	0	0	0	0	3	0	0	3	3	0	0	0	3	4	1	0	0	5	11
Total	0	0	0	0	0	0	7	0	0	7	12	1	0	0	13	11	3	0	0	14	34
08:00 AM	0	0	0	0	0	0	0	0	0	0	2	0	0	0	2	1	1	0	0	2	4
08:15 AM	0	0	0	0	0	0	0	0	0	0	1	0	0	0	1	1	0	0	0	1	2
08:30 AM	0	0	0	0	0	0	2	0	0	2	4	0	0	0	4	2	2	0	0	4	10
08:45 AM	0	0	0	0	0	0	1	0	0	1	2	0	0	0	2	2	2	0	0	4	7
Total	0	0	0	0	0	0	3	0	0	3	9	0	0	0	9	6	5	0	0	11	23
Grand Total	0	0	0	0	0	0	10	0	0	10	21	1	0	0	22	17	8	0	0	25	57
Apprch %	0	0	0	0	0	0	100	0	0	0	95.5	4.5	0	0	0	68	32	0	0	0	
Total %	0	0	0	0	0	0	17.5	0	0	17.5	36.8	1.8	0	0	38.6	29.8	14	0	0	43.9	

Start Time	SR-99 Northbound On Ramp Southbound					Avenue 18 1/2 Westbound					SR-99 Northbound Off Ramp Northbound					Avenue 18 1/2 Eastbound					Int. Total
	Left	Thru	Right	U-Turns	App. Total	Left	Thru	Right	U-Turns	App. Total	Left	Thru	Right	U-Turns	App. Total	Left	Thru	Right	U-Turns	App. Total	
Peak Hour Analysis From 07:15 AM to 08:00 AM - Peak 1 of 1																					
Peak Hour for Entire Intersection Begins at 07:15 AM																					
07:15 AM	0	0	0	0	0	0	1	0	0	1	2	0	0	0	2	1	0	0	0	1	4
07:30 AM	0	0	0	0	0	0	2	0	0	2	5	0	0	0	5	3	1	0	0	4	11
07:45 AM	0	0	0	0	0	0	3	0	0	3	3	0	0	0	3	4	1	0	0	5	11
08:00 AM	0	0	0	0	0	0	0	0	0	0	2	0	0	0	2	1	1	0	0	2	4
Total Volume	0	0	0	0	0	0	6	0	0	6	12	0	0	0	12	9	3	0	0	12	30
% App. Total	0	0	0	0	0	0	100	0	0	0	100	0	0	0	0	75	25	0	0	0	
PHF	.000	.000	.000	.000	.000	.000	.500	.000	.000	.500	.600	.000	.000	.000	.600	.563	.750	.000	.000	.600	.682

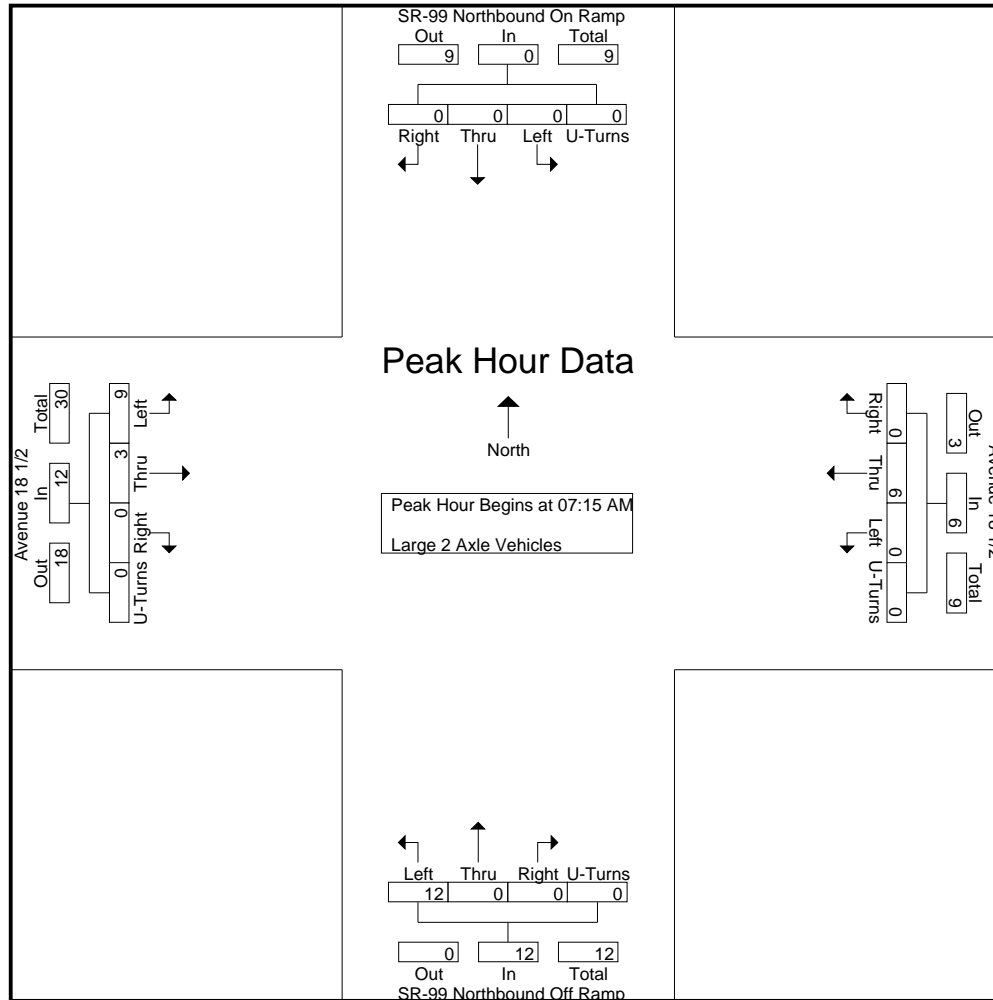

City of Madera
 N/S: SR-99 Northbound Ramps
 E/W: Avenue 18 1/2
 Weather: Clear

File Name : 04_MDA_99N_Ave 18 1-2 AM
 Site Code : 00319628
 Start Date : 9/18/2019
 Page No : 3

Start Time	SR-99 Northbound On Ramp Southbound					Avenue 18 1/2 Westbound					SR-99 Northbound Off Ramp Northbound					Avenue 18 1/2 Eastbound					Int. Total
	Left	Thru	Right	U-Turns	App. Total	Left	Thru	Right	U-Turns	App. Total	Left	Thru	Right	U-Turns	App. Total	Left	Thru	Right	U-Turns	App. Total	

Peak Hour Analysis From 07:15 AM to 08:00 AM - Peak 1 of 1
 Peak Hour for Each Approach Begins at:

	07:15 AM					07:15 AM					07:15 AM					07:15 AM				
+0 mins.	0	0	0	0	0	0	1	0	0	1	2	0	0	0	2	1	0	0	0	1
+15 mins.	0	0	0	0	0	0	2	0	0	2	5	0	0	0	5	3	1	0	0	4
+30 mins.	0	0	0	0	0	0	3	0	0	3	3	0	0	0	3	4	1	0	0	5
+45 mins.	0	0	0	0	0	0	0	0	0	0	2	0	0	0	2	1	1	0	0	2
Total Volume	0	0	0	0	0	0	6	0	0	6	12	0	0	0	12	9	3	0	0	12
% App. Total	0	0	0	0	0	0	100	0	0	100	100	0	0	0	100	75	25	0	0	100
PHF	.000	.000	.000	.000	.000	.000	.500	.000	.000	.500	.600	.000	.000	.000	.600	.563	.750	.000	.000	.600

City of Madera
 N/S: SR-99 Northbound Ramps
 E/W: Avenue 18 1/2
 Weather: Clear

File Name : 04_MDA_99N_Ave 18 1-2 AM
 Site Code : 00319628
 Start Date : 9/18/2019
 Page No : 1

Groups Printed- 3 Axle Vehicles

Start Time	SR-99 Northbound On Ramp Southbound					Avenue 18 1/2 Westbound					SR-99 Northbound Off Ramp Northbound					Avenue 18 1/2 Eastbound					Int. Total
	Left	Thru	Right	U-Turns	App. Total	Left	Thru	Right	U-Turns	App. Total	Left	Thru	Right	U-Turns	App. Total	Left	Thru	Right	U-Turns	App. Total	
07:00 AM	0	0	0	0	0	0	0	0	0	0	0	0	0	0	0	0	0	0	0	0	0
07:15 AM	0	0	0	0	0	0	0	0	0	0	0	0	1	0	1	0	0	0	0	0	0
07:30 AM	0	0	0	0	0	0	0	0	0	0	0	0	0	0	0	1	0	0	0	1	1
07:45 AM	0	0	0	0	0	0	0	1	0	1	0	0	0	0	0	0	0	0	0	0	0
Total	0	0	0	0	0	0	0	1	0	1	0	0	1	0	1	1	0	0	0	1	3
08:00 AM	0	0	0	0	0	0	0	0	0	0	0	0	0	0	0	0	0	0	0	0	0
08:15 AM	0	0	0	0	0	0	0	0	0	0	1	0	0	0	1	1	0	0	0	1	2
08:30 AM	0	0	0	0	0	0	0	0	0	0	0	0	0	0	0	0	0	0	0	0	0
08:45 AM	0	0	0	0	0	0	0	0	0	0	2	0	0	0	2	0	0	0	0	0	2
Total	0	0	0	0	0	0	0	0	0	0	3	0	0	0	3	1	0	0	0	1	4
Grand Total	0	0	0	0	0	0	0	1	0	1	3	0	1	0	4	2	0	0	0	2	7
Apprch %	0	0	0	0	0	0	0	100	0	0	75	0	25	0	0	100	0	0	0	0	0
Total %	0	0	0	0	0	0	0	14.3	0	14.3	42.9	0	14.3	0	57.1	28.6	0	0	0	28.6	0

Start Time	SR-99 Northbound On Ramp Southbound					Avenue 18 1/2 Westbound					SR-99 Northbound Off Ramp Northbound					Avenue 18 1/2 Eastbound					Int. Total
	Left	Thru	Right	U-Turns	App. Total	Left	Thru	Right	U-Turns	App. Total	Left	Thru	Right	U-Turns	App. Total	Left	Thru	Right	U-Turns	App. Total	
Peak Hour Analysis From 07:15 AM to 08:00 AM - Peak 1 of 1																					
Peak Hour for Entire Intersection Begins at 07:15 AM																					
07:15 AM	0	0	0	0	0	0	0	0	0	0	0	0	1	0	1	0	0	0	0	0	1
07:30 AM	0	0	0	0	0	0	0	0	0	0	0	0	0	0	0	1	0	0	0	1	1
07:45 AM	0	0	0	0	0	0	0	1	0	1	0	0	0	0	0	0	0	0	0	0	1
08:00 AM	0	0	0	0	0	0	0	0	0	0	0	0	0	0	0	0	0	0	0	0	0
Total Volume	0	0	0	0	0	0	0	1	0	1	0	0	1	0	1	1	0	0	0	1	3
% App. Total	0	0	0	0	0	0	0	100	0	0	0	0	100	0	0	100	0	0	0	0	0
PHF	.000	.000	.000	.000	.000	.000	.000	.250	.000	.250	.000	.000	.250	.000	.250	.250	.000	.000	.000	.250	.750

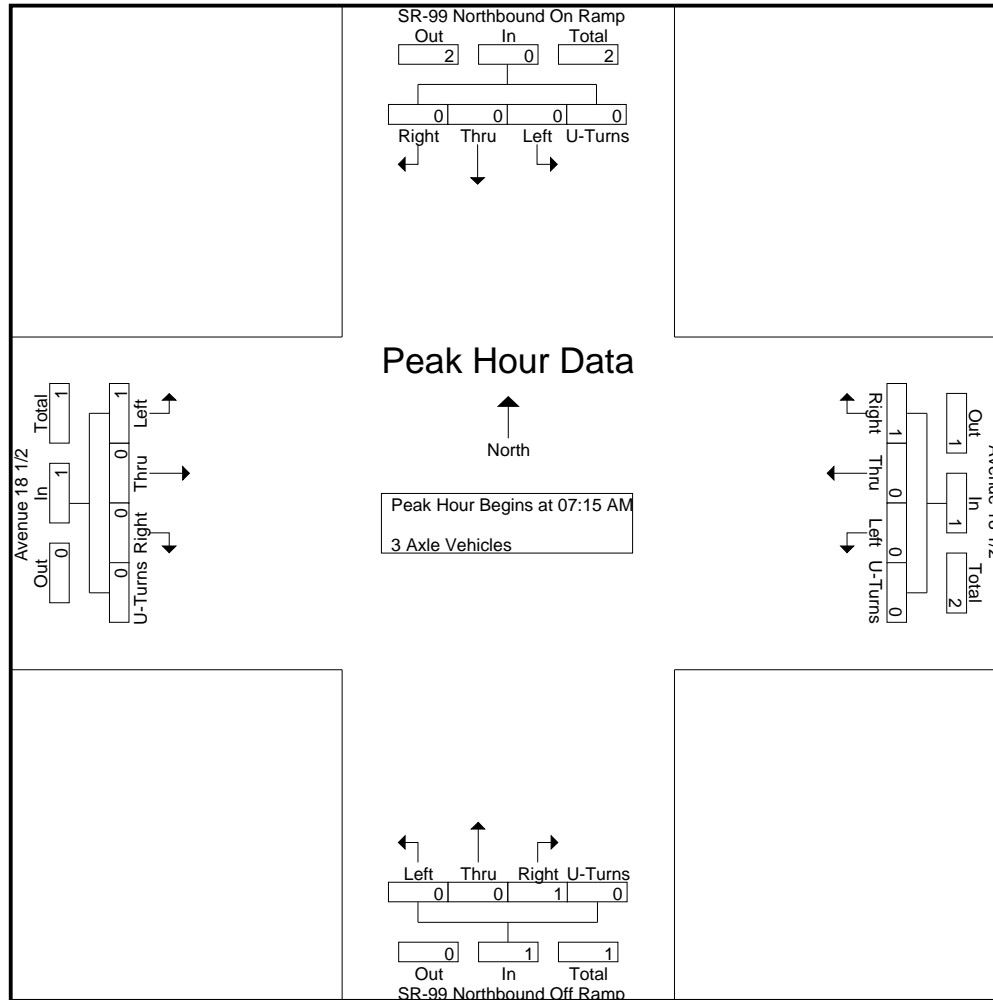

City of Madera
 N/S: SR-99 Northbound Ramps
 E/W: Avenue 18 1/2
 Weather: Clear

File Name : 04_MDA_99N_Ave 18 1-2 AM
 Site Code : 00319628
 Start Date : 9/18/2019
 Page No : 3

Start Time	SR-99 Northbound On Ramp Southbound					Avenue 18 1/2 Westbound					SR-99 Northbound Off Ramp Northbound					Avenue 18 1/2 Eastbound					Int. Total
	Left	Thru	Right	U-Turns	App. Total	Left	Thru	Right	U-Turns	App. Total	Left	Thru	Right	U-Turns	App. Total	Left	Thru	Right	U-Turns	App. Total	

Peak Hour Analysis From 07:15 AM to 08:00 AM - Peak 1 of 1
 Peak Hour for Each Approach Begins at:

	07:15 AM					07:15 AM					07:15 AM					07:15 AM				
+0 mins.	0	0	0	0	0	0	0	0	0	0	0	0	1	0	1	0	0	0	0	0
+15 mins.	0	0	0	0	0	0	0	0	0	0	0	0	0	0	0	1	0	0	0	1
+30 mins.	0	0	0	0	0	0	0	1	0	1	0	0	0	0	0	0	0	0	0	0
+45 mins.	0	0	0	0	0	0	0	0	0	0	0	0	0	0	0	0	0	0	0	0
Total Volume	0	0	0	0	0	0	0	1	0	1	0	0	1	0	1	1	0	0	0	1
% App. Total	0	0	0	0	0	0	0	100	0	100	0	0	100	0	100	100	0	0	0	100
PHF	.000	.000	.000	.000	.000	.000	.000	.250	.000	.250	.000	.000	.250	.000	.250	.250	.000	.000	.000	.250

City of Madera
 N/S: SR-99 Northbound Ramps
 E/W: Avenue 18 1/2
 Weather: Clear

File Name : 04_MDA_99N_Ave 18 1-2 AM
 Site Code : 00319628
 Start Date : 9/18/2019
 Page No : 1

Groups Printed- 4+ Axle Trucks

Start Time	SR-99 Northbound On Ramp Southbound					Avenue 18 1/2 Westbound					SR-99 Northbound Off Ramp Northbound					Avenue 18 1/2 Eastbound					Int. Total
	Left	Thru	Right	U-Turns	App. Total	Left	Thru	Right	U-Turns	App. Total	Left	Thru	Right	U-Turns	App. Total	Left	Thru	Right	U-Turns	App. Total	
07:00 AM	0	0	0	0	0	0	4	1	0	5	8	0	0	0	8	9	2	0	0	11	24
07:15 AM	0	0	0	0	0	0	1	0	0	1	15	0	0	0	15	15	1	0	0	16	32
07:30 AM	0	0	0	0	0	0	8	3	0	11	10	0	0	0	10	13	2	0	0	15	36
07:45 AM	0	0	0	0	0	0	5	1	0	6	7	0	3	0	10	20	3	0	0	23	39
Total	0	0	0	0	0	0	18	5	0	23	40	0	3	0	43	57	8	0	0	65	131
08:00 AM	0	0	0	0	0	0	1	0	0	1	14	0	1	0	15	13	0	0	0	13	29
08:15 AM	0	0	0	0	0	0	2	0	0	2	9	0	3	0	12	13	0	0	0	13	27
08:30 AM	0	0	0	0	0	0	7	0	0	7	10	0	1	0	11	13	1	0	0	14	32
08:45 AM	0	0	0	0	0	0	2	0	0	2	13	0	1	0	14	7	3	0	0	10	26
Total	0	0	0	0	0	0	12	0	0	12	46	0	6	0	52	46	4	0	0	50	114
Grand Total	0	0	0	0	0	0	30	5	0	35	86	0	9	0	95	103	12	0	0	115	245
Apprch %	0	0	0	0	0	0	85.7	14.3	0	35	90.5	0	9.5	0	35	89.6	10.4	0	0	115	245
Total %	0	0	0	0	0	0	12.2	2	0	14.3	35.1	0	3.7	0	38.8	42	4.9	0	0	46.9	114

Start Time	SR-99 Northbound On Ramp Southbound					Avenue 18 1/2 Westbound					SR-99 Northbound Off Ramp Northbound					Avenue 18 1/2 Eastbound					Int. Total
	Left	Thru	Right	U-Turns	App. Total	Left	Thru	Right	U-Turns	App. Total	Left	Thru	Right	U-Turns	App. Total	Left	Thru	Right	U-Turns	App. Total	
Peak Hour Analysis From 07:15 AM to 08:00 AM - Peak 1 of 1																					
Peak Hour for Entire Intersection Begins at 07:15 AM																					
07:15 AM	0	0	0	0	0	0	1	0	0	1	15	0	0	0	15	15	1	0	0	16	32
07:30 AM	0	0	0	0	0	0	8	3	0	11	10	0	0	0	10	13	2	0	0	15	36
07:45 AM	0	0	0	0	0	0	5	1	0	6	7	0	3	0	10	20	3	0	0	23	39
08:00 AM	0	0	0	0	0	0	1	0	0	1	14	0	1	0	15	13	0	0	0	13	29
Total Volume	0	0	0	0	0	0	15	4	0	19	46	0	4	0	50	61	6	0	0	67	136
% App. Total	0	0	0	0	0	0	78.9	21.1	0	19	92	0	8	0	92	91	9	0	0	100	136
PHF	.000	.000	.000	.000	.000	.000	.469	.333	.000	.432	.767	.000	.333	.000	.833	.763	.500	.000	.000	.728	.872

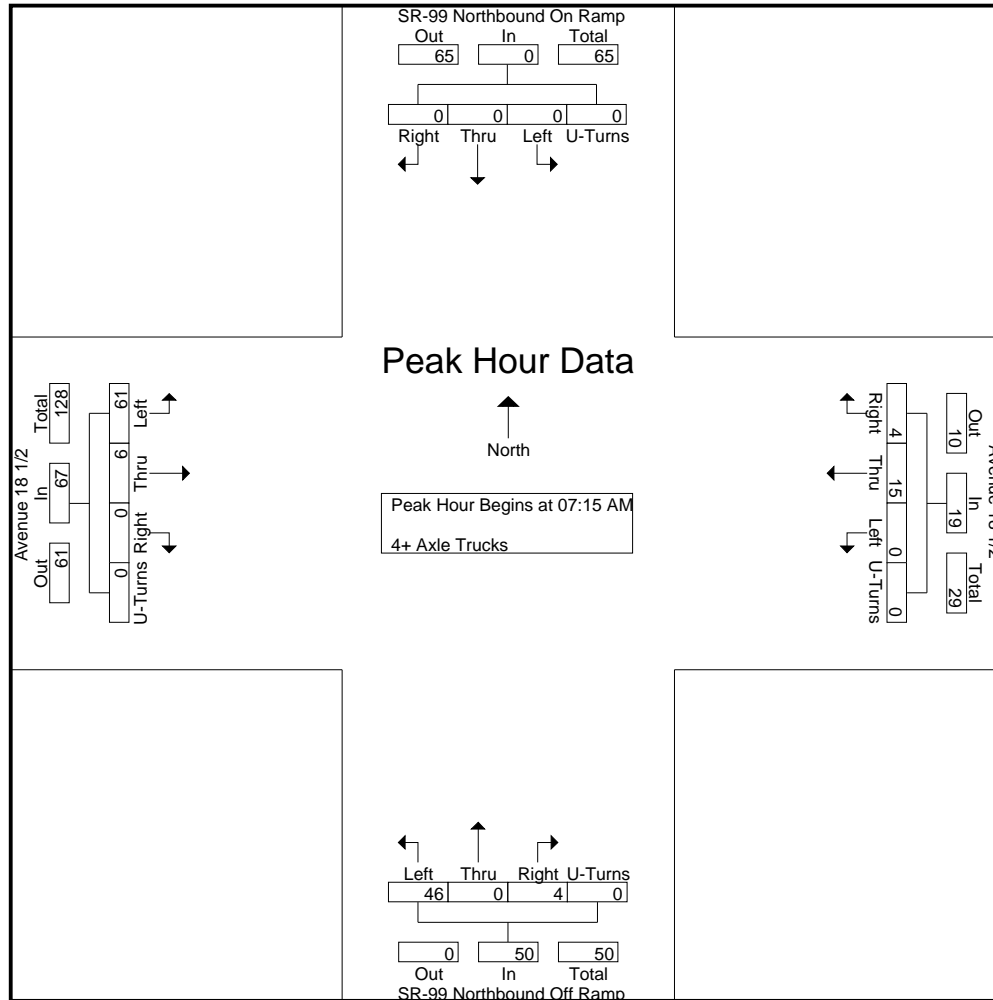

Counts Unlimited
 PO Box 1178
 Corona, CA 92878
 (951) 268-6268

City of Madera
 N/S: SR-99 Northbound Ramps
 E/W: Avenue 18 1/2
 Weather: Clear

File Name : 04_MDA_99N_Ave 18 1-2 AM
 Site Code : 00319628
 Start Date : 9/18/2019
 Page No : 3

Start Time	SR-99 Northbound On Ramp Southbound					Avenue 18 1/2 Westbound					SR-99 Northbound Off Ramp Northbound					Avenue 18 1/2 Eastbound					Int. Total
	Left	Thru	Right	U-Turns	App. Total	Left	Thru	Right	U-Turns	App. Total	Left	Thru	Right	U-Turns	App. Total	Left	Thru	Right	U-Turns	App. Total	

Peak Hour Analysis From 07:15 AM to 08:00 AM - Peak 1 of 1
 Peak Hour for Each Approach Begins at:

	07:15 AM					07:15 AM					07:15 AM					07:15 AM				
+0 mins.	0	0	0	0	0	0	1	0	0	1	15	0	0	0	15	15	1	0	0	16
+15 mins.	0	0	0	0	0	0	8	3	0	11	10	0	0	0	10	13	2	0	0	15
+30 mins.	0	0	0	0	0	0	5	1	0	6	7	0	3	0	10	20	3	0	0	23
+45 mins.	0	0	0	0	0	0	1	0	0	1	14	0	1	0	15	13	0	0	0	13
Total Volume	0	0	0	0	0	0	15	4	0	19	46	0	4	0	50	61	6	0	0	67
% App. Total	0	0	0	0	0	0	78.9	21.1	0		92	0	8	0		91	9	0	0	
PHF	.000	.000	.000	.000	.000	.000	.469	.333	.000	.432	.767	.000	.333	.000	.833	.763	.500	.000	.000	.728

City of Madera
 N/S: SR-99 Northbound Ramps
 E/W: Avenue 18 1/2
 Weather: Clear

File Name : 04_MDA_99N_Ave 18 1-2 PM
 Site Code : 00319628
 Start Date : 9/18/2019
 Page No : 1

Groups Printed- Passenger Vehicles - Large 2 Axle Vehicles - 3 Axle Vehicles - 4+ Axle Trucks

Start Time	SR-99 Northbound On Ramp Southbound					Avenue 18 1/2 Westbound					SR-99 Northbound Off Ramp Northbound					Avenue 18 1/2 Eastbound					Int. Total
	Left	Thru	Right	U-Turns	App. Total	Left	Thru	Right	U-Turns	App. Total	Left	Thru	Right	U-Turns	App. Total	Left	Thru	Right	U-Turns	App. Total	
04:00 PM	0	0	0	0	0	0	25	5	0	30	35	0	0	0	35	39	17	0	0	56	121
04:15 PM	0	0	0	0	0	0	20	3	0	23	44	1	0	0	45	34	17	0	0	51	119
04:30 PM	0	0	0	0	0	0	17	2	0	19	44	0	0	0	44	39	18	0	0	57	120
04:45 PM	0	0	0	0	0	0	20	1	0	21	52	1	0	0	53	33	10	0	0	43	117
Total	0	0	0	0	0	0	82	11	0	93	175	2	0	0	177	145	62	0	0	207	477
05:00 PM	0	0	0	0	0	0	17	7	0	24	43	0	0	0	43	44	17	0	0	61	128
05:15 PM	0	0	0	0	0	0	27	3	0	30	46	1	0	0	47	33	26	0	0	59	136
05:30 PM	0	0	0	0	0	0	25	3	0	28	38	0	0	0	38	35	18	0	0	53	119
05:45 PM	0	0	0	0	0	0	13	3	0	16	42	0	0	0	42	31	18	0	0	49	107
Total	0	0	0	0	0	0	82	16	0	98	169	1	0	0	170	143	79	0	0	222	490
Grand Total	0	0	0	0	0	0	164	27	0	191	344	3	0	0	347	288	141	0	0	429	967
Apprch %	0	0	0	0	0	0	85.9	14.1	0	99.1	0.9	0	0	0	67.1	32.9	0	0	0	59	136
Total %	0	0	0	0	0	0	17	2.8	0	19.8	35.6	0.3	0	0	35.9	29.8	14.6	0	0	44.4	119
Passenger Vehicles	0	0	0	0	0	0	146	24	0	170	246	3	0	0	249	214	127	0	0	341	760
% Passenger Vehicles	0	0	0	0	0	0	89	88.9	0	89	71.5	100	0	0	71.8	74.3	90.1	0	0	79.5	78.6
Large 2 Axle Vehicles	0	0	0	0	0	0	7	0	0	7	14	0	0	0	14	9	7	0	0	16	37
% Large 2 Axle Vehicles	0	0	0	0	0	0	4.3	0	0	3.7	4.1	0	0	0	4	3.1	5	0	0	3.7	3.8
3 Axle Vehicles	0	0	0	0	0	0	1	1	0	2	6	0	0	0	6	4	1	0	0	5	13
% 3 Axle Vehicles	0	0	0	0	0	0	0.6	3.7	0	1	1.7	0	0	0	1.7	1.4	0.7	0	0	1.2	1.3
4+ Axle Trucks	0	0	0	0	0	0	10	2	0	12	78	0	0	0	78	61	6	0	0	67	157
% 4+ Axle Trucks	0	0	0	0	0	0	6.1	7.4	0	6.3	22.7	0	0	0	22.5	21.2	4.3	0	0	15.6	16.2

Start Time	SR-99 Northbound On Ramp Southbound					Avenue 18 1/2 Westbound					SR-99 Northbound Off Ramp Northbound					Avenue 18 1/2 Eastbound					Int. Total
	Left	Thru	Right	U-Turns	App. Total	Left	Thru	Right	U-Turns	App. Total	Left	Thru	Right	U-Turns	App. Total	Left	Thru	Right	U-Turns	App. Total	
Peak Hour Analysis From 04:00 PM to 05:45 PM - Peak 1 of 1																					
Peak Hour for Entire Intersection Begins at 04:30 PM																					
04:30 PM	0	0	0	0	0	0	17	2	0	19	44	0	0	0	44	39	18	0	0	57	120
04:45 PM	0	0	0	0	0	0	20	1	0	21	52	1	0	0	53	33	10	0	0	43	117
05:00 PM	0	0	0	0	0	0	17	7	0	24	43	0	0	0	43	44	17	0	0	61	128
05:15 PM	0	0	0	0	0	0	27	3	0	30	46	1	0	0	47	33	26	0	0	59	136
Total Volume	0	0	0	0	0	0	81	13	0	94	185	2	0	0	187	149	71	0	0	220	501
% App. Total	0	0	0	0	0	0	86.2	13.8	0	98.9	1.1	0	0	0	67.7	32.3	0	0	0	220	501
PHF	.000	.000	.000	.000	.000	.000	.750	.464	.000	.783	.889	.500	.000	.000	.882	.847	.683	.000	.000	.902	.921

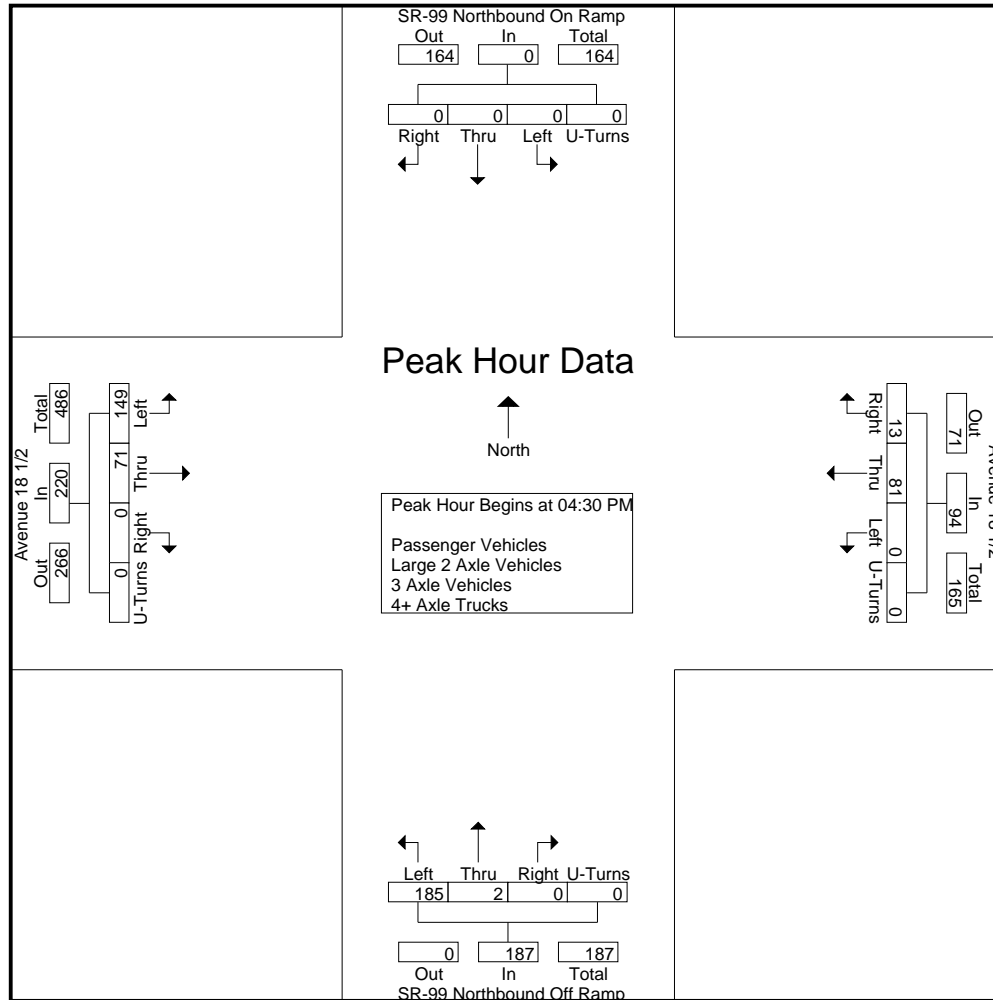

Counts Unlimited
 PO Box 1178
 Corona, CA 92878
 (951) 268-6268

City of Madera
 N/S: SR-99 Northbound Ramps
 E/W: Avenue 18 1/2
 Weather: Clear

File Name : 04_MDA_99N_Ave 18 1-2 PM
 Site Code : 00319628
 Start Date : 9/18/2019
 Page No : 3

Start Time	SR-99 Northbound On Ramp Southbound					Avenue 18 1/2 Westbound					SR-99 Northbound Off Ramp Northbound					Avenue 18 1/2 Eastbound					Int. Total
	Left	Thru	Right	U-Turns	App. Total	Left	Thru	Right	U-Turns	App. Total	Left	Thru	Right	U-Turns	App. Total	Left	Thru	Right	U-Turns	App. Total	

Peak Hour Analysis From 04:00 PM to 05:45 PM - Peak 1 of 1
 Peak Hour for Each Approach Begins at:

	04:00 PM					04:45 PM					04:30 PM					05:00 PM				
+0 mins.	0	0	0	0	0	0	20	1	0	21	44	0	0	0	44	44	17	0	0	61
+15 mins.	0	0	0	0	0	0	17	7	0	24	52	1	0	0	53	33	26	0	0	59
+30 mins.	0	0	0	0	0	0	27	3	0	30	43	0	0	0	43	35	18	0	0	53
+45 mins.	0	0	0	0	0	0	25	3	0	28	46	1	0	0	47	31	18	0	0	49
Total Volume	0	0	0	0	0	0	89	14	0	103	185	2	0	0	187	143	79	0	0	222
% App. Total	0	0	0	0	0	0	86.4	13.6	0		98.9	1.1	0	0		64.4	35.6	0	0	
PHF	.000	.000	.000	.000	.000	.000	.824	.500	.000	.858	.889	.500	.000	.000	.882	.813	.760	.000	.000	.910

City of Madera
 N/S: SR-99 Northbound Ramps
 E/W: Avenue 18 1/2
 Weather: Clear

File Name : 04_MDA_99N_Ave 18 1-2 PM
 Site Code : 00319628
 Start Date : 9/18/2019
 Page No : 1

Groups Printed- Passenger Vehicles

Start Time	SR-99 Northbound On Ramp Southbound					Avenue 18 1/2 Westbound					SR-99 Northbound Off Ramp Northbound					Avenue 18 1/2 Eastbound					Int. Total
	Left	Thru	Right	U-Turns	App. Total	Left	Thru	Right	U-Turns	App. Total	Left	Thru	Right	U-Turns	App. Total	Left	Thru	Right	U-Turns	App. Total	
04:00 PM	0	0	0	0	0	0	23	4	0	27	17	0	0	0	17	25	12	0	0	37	81
04:15 PM	0	0	0	0	0	0	17	3	0	20	26	1	0	0	27	26	15	0	0	41	88
04:30 PM	0	0	0	0	0	0	13	2	0	15	33	0	0	0	33	25	16	0	0	41	89
04:45 PM	0	0	0	0	0	0	19	1	0	20	36	1	0	0	37	27	9	0	0	36	93
Total	0	0	0	0	0	0	72	10	0	82	112	2	0	0	114	103	52	0	0	155	351
05:00 PM	0	0	0	0	0	0	16	6	0	22	37	0	0	0	37	31	16	0	0	47	106
05:15 PM	0	0	0	0	0	0	23	3	0	26	34	1	0	0	35	28	24	0	0	52	113
05:30 PM	0	0	0	0	0	0	22	2	0	24	31	0	0	0	31	28	17	0	0	45	100
05:45 PM	0	0	0	0	0	0	13	3	0	16	32	0	0	0	32	24	18	0	0	42	90
Total	0	0	0	0	0	0	74	14	0	88	134	1	0	0	135	111	75	0	0	186	409
Grand Total	0	0	0	0	0	0	146	24	0	170	246	3	0	0	249	214	127	0	0	341	760
Apprch %	0	0	0	0	0	0	85.9	14.1	0	22.4	98.8	1.2	0	0	32.8	62.8	37.2	0	0	44.9	
Total %	0	0	0	0	0	0	19.2	3.2	0	22.4	32.4	0.4	0	0	32.8	28.2	16.7	0	0	44.9	

Start Time	SR-99 Northbound On Ramp Southbound					Avenue 18 1/2 Westbound					SR-99 Northbound Off Ramp Northbound					Avenue 18 1/2 Eastbound					Int. Total
	Left	Thru	Right	U-Turns	App. Total	Left	Thru	Right	U-Turns	App. Total	Left	Thru	Right	U-Turns	App. Total	Left	Thru	Right	U-Turns	App. Total	
Peak Hour Analysis From 04:30 PM to 05:15 PM - Peak 1 of 1																					
Peak Hour for Entire Intersection Begins at 04:30 PM																					
04:30 PM	0	0	0	0	0	0	13	2	0	15	33	0	0	0	33	25	16	0	0	41	89
04:45 PM	0	0	0	0	0	0	19	1	0	20	36	1	0	0	37	27	9	0	0	36	93
05:00 PM	0	0	0	0	0	0	16	6	0	22	37	0	0	0	37	31	16	0	0	47	106
05:15 PM	0	0	0	0	0	0	23	3	0	26	34	1	0	0	35	28	24	0	0	52	113
Total Volume	0	0	0	0	0	0	71	12	0	83	140	2	0	0	142	111	65	0	0	176	401
% App. Total	0	0	0	0	0	0	85.5	14.5	0	22.4	98.6	1.4	0	0	32.8	63.1	36.9	0	0	44.9	
PHF	.000	.000	.000	.000	.000	.000	.772	.500	.000	.798	.946	.500	.000	.000	.959	.895	.677	.000	.000	.846	.887

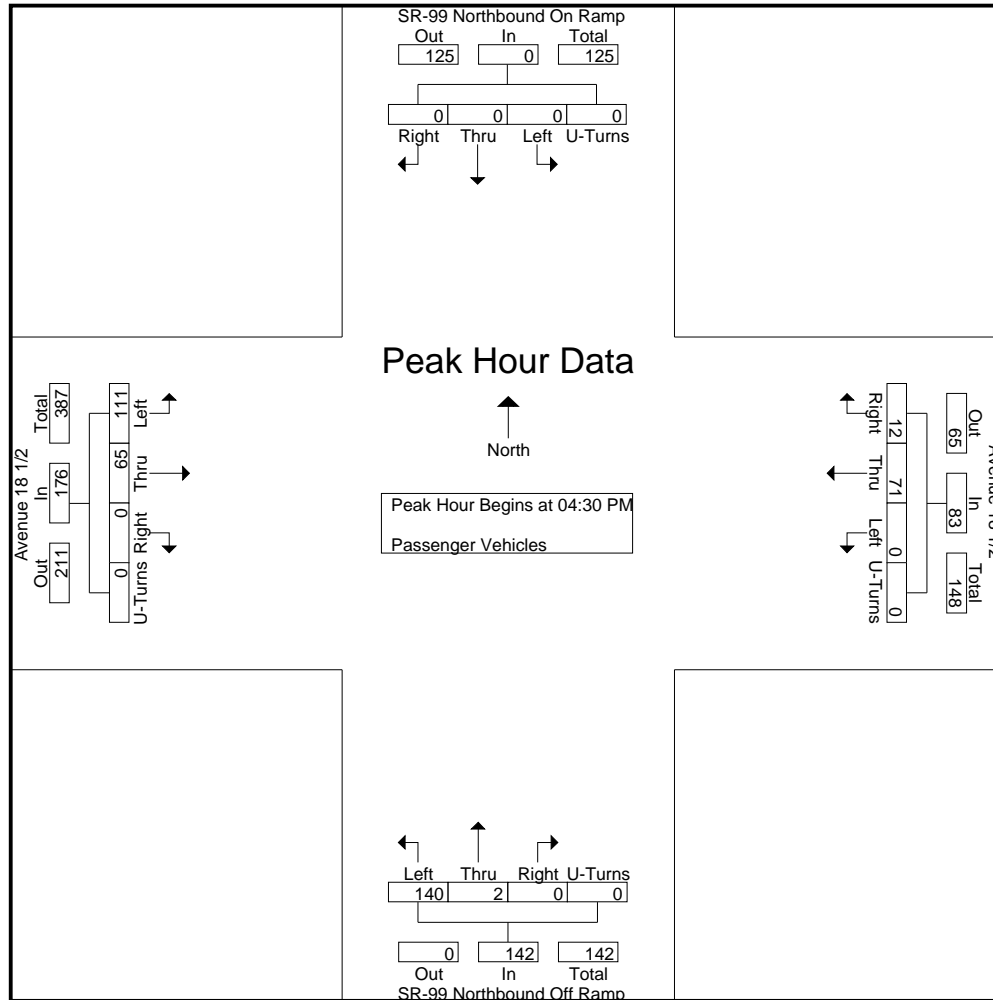

Counts Unlimited
 PO Box 1178
 Corona, CA 92878
 (951) 268-6268

City of Madera
 N/S: SR-99 Northbound Ramps
 E/W: Avenue 18 1/2
 Weather: Clear

File Name : 04_MDA_99N_Ave 18 1-2 PM
 Site Code : 00319628
 Start Date : 9/18/2019
 Page No : 3

Start Time	SR-99 Northbound On Ramp Southbound					Avenue 18 1/2 Westbound					SR-99 Northbound Off Ramp Northbound					Avenue 18 1/2 Eastbound					Int. Total
	Left	Thru	Right	U-Turns	App. Total	Left	Thru	Right	U-Turns	App. Total	Left	Thru	Right	U-Turns	App. Total	Left	Thru	Right	U-Turns	App. Total	

Peak Hour Analysis From 04:30 PM to 05:15 PM - Peak 1 of 1
 Peak Hour for Each Approach Begins at:

	04:30 PM					04:30 PM					04:30 PM					04:30 PM				
+0 mins.	0	0	0	0	0	0	13	2	0	15	33	0	0	0	33	25	16	0	0	41
+15 mins.	0	0	0	0	0	0	19	1	0	20	36	1	0	0	37	27	9	0	0	36
+30 mins.	0	0	0	0	0	0	16	6	0	22	37	0	0	0	37	31	16	0	0	47
+45 mins.	0	0	0	0	0	0	23	3	0	26	34	1	0	0	35	28	24	0	0	52
Total Volume	0	0	0	0	0	0	71	12	0	83	140	2	0	0	142	111	65	0	0	176
% App. Total	0	0	0	0	0	0	85.5	14.5	0		98.6	1.4	0	0		63.1	36.9	0	0	
PHF	.000	.000	.000	.000	.000	.000	.772	.500	.000	.798	.946	.500	.000	.000	.959	.895	.677	.000	.000	.846

City of Madera
 N/S: SR-99 Northbound Ramps
 E/W: Avenue 18 1/2
 Weather: Clear

File Name : 04_MDA_99N_Ave 18 1-2 PM
 Site Code : 00319628
 Start Date : 9/18/2019
 Page No : 1

Groups Printed- Large 2 Axle Vehicles

Start Time	SR-99 Northbound On Ramp Southbound					Avenue 18 1/2 Westbound					SR-99 Northbound Off Ramp Northbound					Avenue 18 1/2 Eastbound					Int. Total
	Left	Thru	Right	U-Turns	App. Total	Left	Thru	Right	U-Turns	App. Total	Left	Thru	Right	U-Turns	App. Total	Left	Thru	Right	U-Turns	App. Total	
04:00 PM	0	0	0	0	0	0	2	0	0	2	1	0	0	0	1	1	2	0	0	3	6
04:15 PM	0	0	0	0	0	0	0	0	0	0	2	0	0	0	2	1	1	0	0	2	4
04:30 PM	0	0	0	0	0	0	2	0	0	2	3	0	0	0	3	0	0	0	0	0	5
04:45 PM	0	0	0	0	0	0	1	0	0	1	3	0	0	0	3	2	0	0	0	2	6
Total	0	0	0	0	0	0	5	0	0	5	9	0	0	0	9	4	3	0	0	7	21
05:00 PM	0	0	0	0	0	0	0	0	0	0	3	0	0	0	3	1	1	0	0	2	5
05:15 PM	0	0	0	0	0	0	1	0	0	1	0	0	0	0	0	1	2	0	0	3	4
05:30 PM	0	0	0	0	0	0	1	0	0	1	0	0	0	0	0	3	1	0	0	4	5
05:45 PM	0	0	0	0	0	0	0	0	0	0	2	0	0	0	2	0	0	0	0	0	2
Total	0	0	0	0	0	0	2	0	0	2	5	0	0	0	5	5	4	0	0	9	16
Grand Total	0	0	0	0	0	0	7	0	0	7	14	0	0	0	14	9	7	0	0	16	37
Apprch %	0	0	0	0	0	0	100	0	0	100	100	0	0	0	100	56.2	43.8	0	0	100	
Total %	0	0	0	0	0	0	18.9	0	0	18.9	37.8	0	0	0	37.8	24.3	18.9	0	0	43.2	

Start Time	SR-99 Northbound On Ramp Southbound					Avenue 18 1/2 Westbound					SR-99 Northbound Off Ramp Northbound					Avenue 18 1/2 Eastbound					Int. Total
	Left	Thru	Right	U-Turns	App. Total	Left	Thru	Right	U-Turns	App. Total	Left	Thru	Right	U-Turns	App. Total	Left	Thru	Right	U-Turns	App. Total	
Peak Hour Analysis From 04:30 PM to 05:15 PM - Peak 1 of 1																					
Peak Hour for Entire Intersection Begins at 04:30 PM																					
04:30 PM	0	0	0	0	0	0	2	0	0	2	3	0	0	0	3	0	0	0	0	0	5
04:45 PM	0	0	0	0	0	0	1	0	0	1	3	0	0	0	3	2	0	0	0	2	6
05:00 PM	0	0	0	0	0	0	0	0	0	0	3	0	0	0	3	1	1	0	0	2	5
05:15 PM	0	0	0	0	0	0	1	0	0	1	0	0	0	0	0	1	2	0	0	3	4
Total Volume	0	0	0	0	0	0	4	0	0	4	9	0	0	0	9	4	3	0	0	7	20
% App. Total	0	0	0	0	0	0	100	0	0	100	100	0	0	0	100	57.1	42.9	0	0	100	
PHF	.000	.000	.000	.000	.000	.000	.500	.000	.000	.500	.750	.000	.000	.000	.750	.500	.375	.000	.000	.583	.833

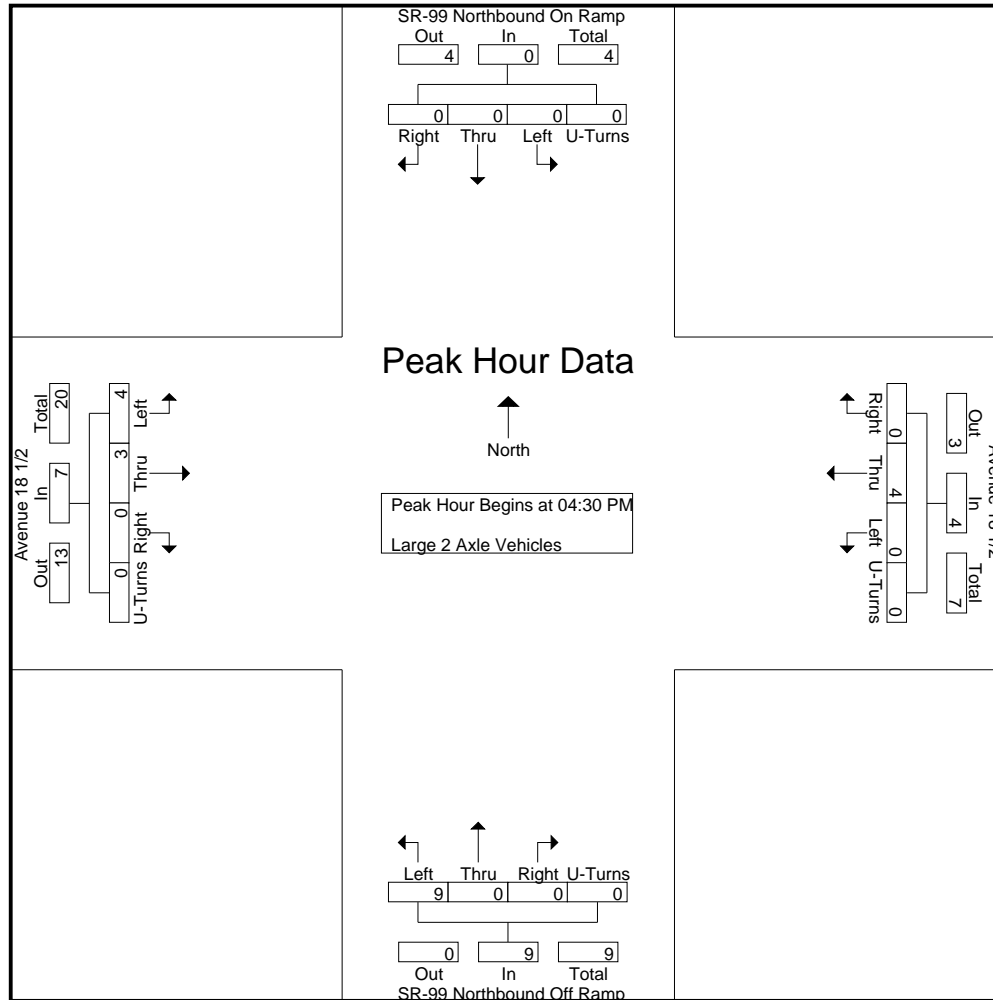

Counts Unlimited
 PO Box 1178
 Corona, CA 92878
 (951) 268-6268

City of Madera
 N/S: SR-99 Northbound Ramps
 E/W: Avenue 18 1/2
 Weather: Clear

File Name : 04_MDA_99N_Ave 18 1-2 PM
 Site Code : 00319628
 Start Date : 9/18/2019
 Page No : 3

Start Time	SR-99 Northbound On Ramp Southbound					Avenue 18 1/2 Westbound					SR-99 Northbound Off Ramp Northbound					Avenue 18 1/2 Eastbound					Int. Total
	Left	Thru	Right	U-Turns	App. Total	Left	Thru	Right	U-Turns	App. Total	Left	Thru	Right	U-Turns	App. Total	Left	Thru	Right	U-Turns	App. Total	

Peak Hour Analysis From 04:30 PM to 05:15 PM - Peak 1 of 1
 Peak Hour for Each Approach Begins at:

	04:30 PM					04:30 PM					04:30 PM					04:30 PM				
+0 mins.	0	0	0	0	0	0	2	0	0	2	3	0	0	0	3	0	0	0	0	0
+15 mins.	0	0	0	0	0	0	1	0	0	1	3	0	0	0	3	2	0	0	0	2
+30 mins.	0	0	0	0	0	0	0	0	0	0	3	0	0	0	3	1	1	0	0	2
+45 mins.	0	0	0	0	0	0	1	0	0	1	0	0	0	0	0	1	2	0	0	3
Total Volume	0	0	0	0	0	0	4	0	0	4	9	0	0	0	9	4	3	0	0	7
% App. Total	0	0	0	0	0	0	100	0	0	100	100	0	0	0	100	57.1	42.9	0	0	100
PHF	.000	.000	.000	.000	.000	.000	.500	.000	.000	.500	.750	.000	.000	.000	.750	.500	.375	.000	.000	.583

City of Madera
 N/S: SR-99 Northbound Ramps
 E/W: Avenue 18 1/2
 Weather: Clear

File Name : 04_MDA_99N_Ave 18 1-2 PM
 Site Code : 00319628
 Start Date : 9/18/2019
 Page No : 1

Groups Printed- 3 Axle Vehicles

Start Time	SR-99 Northbound On Ramp Southbound					Avenue 18 1/2 Westbound					SR-99 Northbound Off Ramp Northbound					Avenue 18 1/2 Eastbound					Int. Total
	Left	Thru	Right	U-Turns	App. Total	Left	Thru	Right	U-Turns	App. Total	Left	Thru	Right	U-Turns	App. Total	Left	Thru	Right	U-Turns	App. Total	
04:00 PM	0	0	0	0	0	0	0	0	0	0	2	0	0	0	2	1	0	0	0	1	3
04:15 PM	0	0	0	0	0	0	1	0	0	1	0	0	0	0	0	0	0	0	0	0	1
04:30 PM	0	0	0	0	0	0	0	0	0	0	0	0	0	0	0	1	1	0	0	2	2
04:45 PM	0	0	0	0	0	0	0	0	0	0	0	0	0	0	0	0	0	0	0	0	0
Total	0	0	0	0	0	0	1	0	0	1	2	0	0	0	2	2	1	0	0	3	6
05:00 PM	0	0	0	0	0	0	0	0	0	0	0	0	0	0	0	0	0	0	0	0	0
05:15 PM	0	0	0	0	0	0	0	0	0	0	1	0	0	0	1	0	0	0	0	0	1
05:30 PM	0	0	0	0	0	0	0	1	0	1	2	0	0	0	2	0	0	0	0	0	3
05:45 PM	0	0	0	0	0	0	0	0	0	0	1	0	0	0	1	2	0	0	0	2	3
Total	0	0	0	0	0	0	0	1	0	1	4	0	0	0	4	2	0	0	0	2	7
Grand Total	0	0	0	0	0	0	1	1	0	2	6	0	0	0	6	4	1	0	0	5	13
Apprch %	0	0	0	0	0	0	50	50	0	100	100	0	0	0	46.2	80	20	0	0	38.5	
Total %	0	0	0	0	0	0	7.7	7.7	0	15.4	46.2	0	0	0	46.2	30.8	7.7	0	0	38.5	

Start Time	SR-99 Northbound On Ramp Southbound					Avenue 18 1/2 Westbound					SR-99 Northbound Off Ramp Northbound					Avenue 18 1/2 Eastbound					Int. Total
	Left	Thru	Right	U-Turns	App. Total	Left	Thru	Right	U-Turns	App. Total	Left	Thru	Right	U-Turns	App. Total	Left	Thru	Right	U-Turns	App. Total	
Peak Hour Analysis From 04:30 PM to 05:15 PM - Peak 1 of 1																					
Peak Hour for Entire Intersection Begins at 04:30 PM																					
04:30 PM	0	0	0	0	0	0	0	0	0	0	0	0	0	0	0	1	1	0	0	2	2
04:45 PM	0	0	0	0	0	0	0	0	0	0	0	0	0	0	0	0	0	0	0	0	0
05:00 PM	0	0	0	0	0	0	0	0	0	0	0	0	0	0	0	0	0	0	0	0	0
05:15 PM	0	0	0	0	0	0	0	0	0	0	1	0	0	0	1	0	0	0	0	0	1
Total Volume	0	0	0	0	0	0	0	0	0	0	1	0	0	0	1	1	1	0	0	2	3
% App. Total	0	0	0	0	0	0	0	0	0	0	100	0	0	0	46.2	50	50	0	0	38.5	
PHF	.000	.000	.000	.000	.000	.000	.000	.000	.000	.000	.250	.000	.000	.000	.250	.250	.250	.000	.000	.250	.375

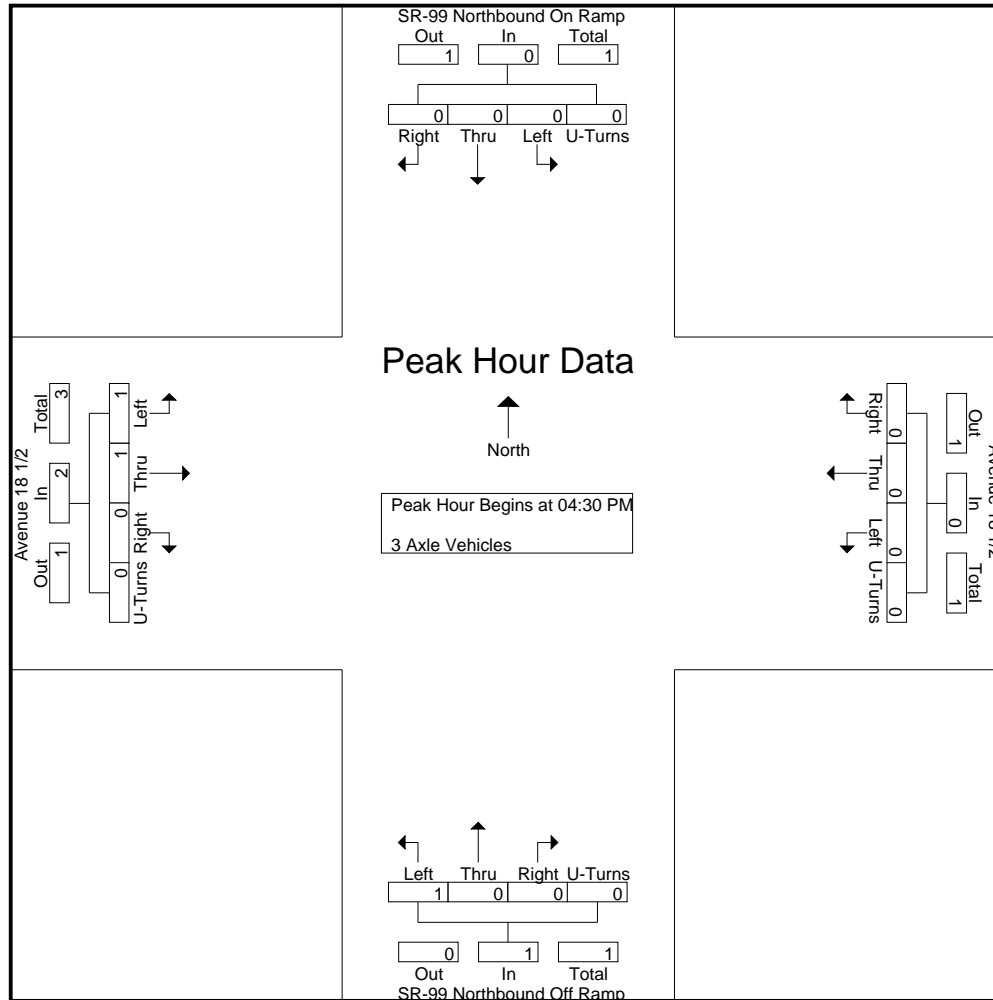

City of Madera
 N/S: SR-99 Northbound Ramps
 E/W: Avenue 18 1/2
 Weather: Clear

File Name : 04_MDA_99N_Ave 18 1-2 PM
 Site Code : 00319628
 Start Date : 9/18/2019
 Page No : 3

Start Time	SR-99 Northbound On Ramp Southbound					Avenue 18 1/2 Westbound					SR-99 Northbound Off Ramp Northbound					Avenue 18 1/2 Eastbound					Int. Total
	Left	Thru	Right	U-Turns	App. Total	Left	Thru	Right	U-Turns	App. Total	Left	Thru	Right	U-Turns	App. Total	Left	Thru	Right	U-Turns	App. Total	

Peak Hour Analysis From 04:30 PM to 05:15 PM - Peak 1 of 1
 Peak Hour for Each Approach Begins at:

	04:30 PM					04:30 PM					04:30 PM					04:30 PM				
+0 mins.	0	0	0	0	0	0	0	0	0	0	0	0	0	0	0	1	1	0	0	2
+15 mins.	0	0	0	0	0	0	0	0	0	0	0	0	0	0	0	0	0	0	0	0
+30 mins.	0	0	0	0	0	0	0	0	0	0	0	0	0	0	0	0	0	0	0	0
+45 mins.	0	0	0	0	0	0	0	0	0	0	1	0	0	0	1	0	0	0	0	0
Total Volume	0	0	0	0	0	0	0	0	0	0	1	0	0	0	1	1	1	0	0	2
% App. Total	0	0	0	0	0	0	0	0	0	0	100	0	0	0	50	50	50	0	0	0
PHF	.000	.000	.000	.000	.000	.000	.000	.000	.000	.000	.250	.000	.000	.000	.250	.250	.250	.000	.000	.250

City of Madera
 N/S: SR-99 Northbound Ramps
 E/W: Avenue 18 1/2
 Weather: Clear

File Name : 04_MDA_99N_Ave 18 1-2 PM
 Site Code : 00319628
 Start Date : 9/18/2019
 Page No : 1

Groups Printed- 4+ Axle Trucks

Start Time	SR-99 Northbound On Ramp Southbound					Avenue 18 1/2 Westbound					SR-99 Northbound Off Ramp Northbound					Avenue 18 1/2 Eastbound					Int. Total
	Left	Thru	Right	U-Turns	App. Total	Left	Thru	Right	U-Turns	App. Total	Left	Thru	Right	U-Turns	App. Total	Left	Thru	Right	U-Turns	App. Total	
04:00 PM	0	0	0	0	0	0	0	1	0	1	15	0	0	0	15	12	3	0	0	15	31
04:15 PM	0	0	0	0	0	0	2	0	0	2	16	0	0	0	16	7	1	0	0	8	26
04:30 PM	0	0	0	0	0	0	2	0	0	2	8	0	0	0	8	13	1	0	0	14	24
04:45 PM	0	0	0	0	0	0	0	0	0	0	13	0	0	0	13	4	1	0	0	5	18
Total	0	0	0	0	0	0	4	1	0	5	52	0	0	0	52	36	6	0	0	42	99
05:00 PM	0	0	0	0	0	0	1	1	0	2	3	0	0	0	3	12	0	0	0	12	17
05:15 PM	0	0	0	0	0	0	3	0	0	3	11	0	0	0	11	4	0	0	0	4	18
05:30 PM	0	0	0	0	0	0	2	0	0	2	5	0	0	0	5	4	0	0	0	4	11
05:45 PM	0	0	0	0	0	0	0	0	0	0	7	0	0	0	7	5	0	0	0	5	12
Total	0	0	0	0	0	0	6	1	0	7	26	0	0	0	26	25	0	0	0	25	58
Grand Total	0	0	0	0	0	0	10	2	0	12	78	0	0	0	78	61	6	0	0	67	157
Apprch %	0	0	0	0	0	0	83.3	16.7	0	7.6	100	0	0	0	49.7	91	9	0	0	42.7	
Total %	0	0	0	0	0	0	6.4	1.3	0	7.6	49.7	0	0	0	49.7	38.9	3.8	0	0	42.7	

Start Time	SR-99 Northbound On Ramp Southbound					Avenue 18 1/2 Westbound					SR-99 Northbound Off Ramp Northbound					Avenue 18 1/2 Eastbound					Int. Total
	Left	Thru	Right	U-Turns	App. Total	Left	Thru	Right	U-Turns	App. Total	Left	Thru	Right	U-Turns	App. Total	Left	Thru	Right	U-Turns	App. Total	
Peak Hour Analysis From 04:30 PM to 05:15 PM - Peak 1 of 1																					
Peak Hour for Entire Intersection Begins at 04:30 PM																					
04:30 PM	0	0	0	0	0	0	2	0	0	2	8	0	0	0	8	13	1	0	0	14	24
04:45 PM	0	0	0	0	0	0	0	0	0	0	13	0	0	0	13	4	1	0	0	5	18
05:00 PM	0	0	0	0	0	0	1	1	0	2	3	0	0	0	3	12	0	0	0	12	17
05:15 PM	0	0	0	0	0	0	3	0	0	3	11	0	0	0	11	4	0	0	0	4	18
Total Volume	0	0	0	0	0	0	6	1	0	7	35	0	0	0	35	33	2	0	0	35	77
% App. Total	0	0	0	0	0	0	85.7	14.3	0	7.6	100	0	0	0	49.7	94.3	5.7	0	0	42.7	
PHF	.000	.000	.000	.000	.000	.000	.500	.250	.000	.583	.673	.000	.000	.000	.673	.635	.500	.000	.000	.625	.802

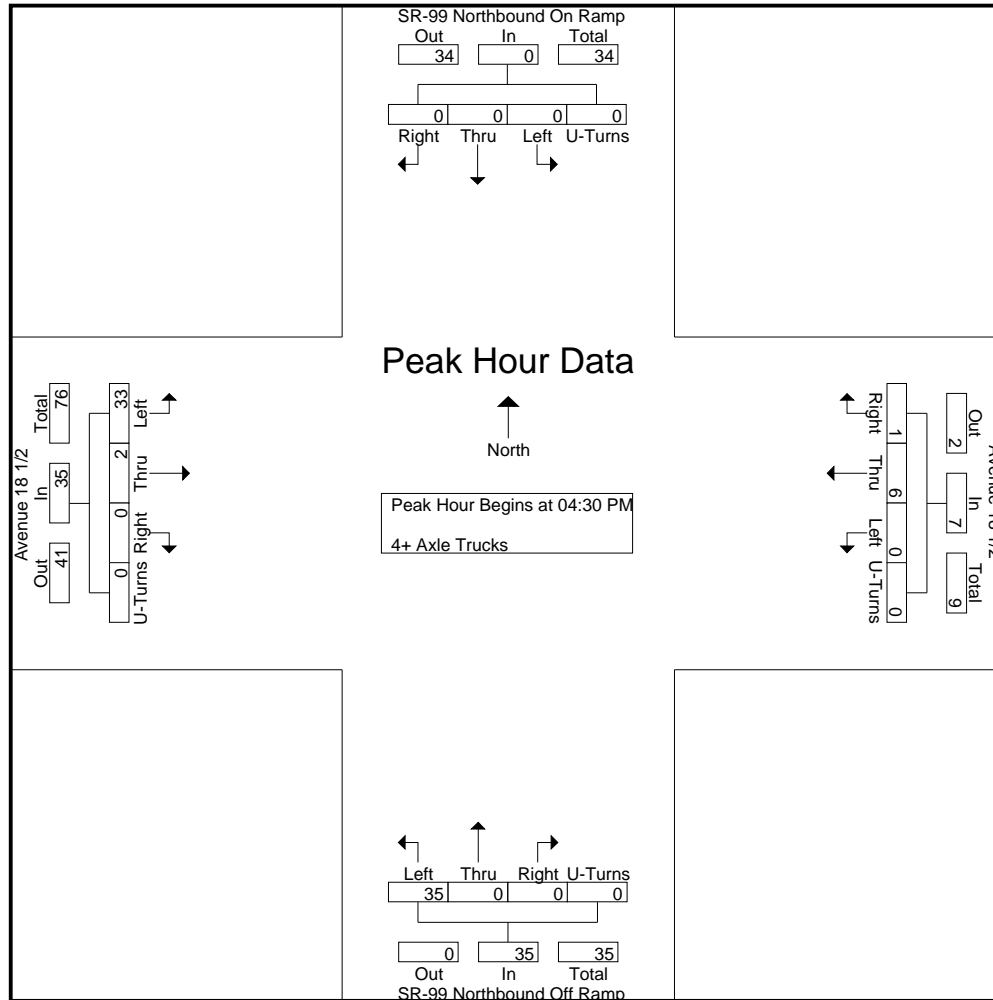

Counts Unlimited
 PO Box 1178
 Corona, CA 92878
 (951) 268-6268

City of Madera
 N/S: SR-99 Northbound Ramps
 E/W: Avenue 18 1/2
 Weather: Clear

File Name : 04_MDA_99N_Ave 18 1-2 PM
 Site Code : 00319628
 Start Date : 9/18/2019
 Page No : 3

Start Time	SR-99 Northbound On Ramp Southbound					Avenue 18 1/2 Westbound					SR-99 Northbound Off Ramp Northbound					Avenue 18 1/2 Eastbound					Int. Total
	Left	Thru	Right	U-Turns	App. Total	Left	Thru	Right	U-Turns	App. Total	Left	Thru	Right	U-Turns	App. Total	Left	Thru	Right	U-Turns	App. Total	

Peak Hour Analysis From 04:30 PM to 05:15 PM - Peak 1 of 1
 Peak Hour for Each Approach Begins at:

	04:30 PM					04:30 PM					04:30 PM					04:30 PM				
+0 mins.	0	0	0	0	0	0	2	0	0	2	8	0	0	0	8	13	1	0	0	14
+15 mins.	0	0	0	0	0	0	0	0	0	0	13	0	0	0	13	4	1	0	0	5
+30 mins.	0	0	0	0	0	0	1	1	0	2	3	0	0	0	3	12	0	0	0	12
+45 mins.	0	0	0	0	0	0	3	0	0	3	11	0	0	0	11	4	0	0	0	4
Total Volume	0	0	0	0	0	0	6	1	0	7	35	0	0	0	35	33	2	0	0	35
% App. Total	0	0	0	0	0	0	85.7	14.3	0		100	0	0	0		94.3	5.7	0	0	
PHF	.000	.000	.000	.000	.000	.000	.500	.250	.000	.583	.673	.000	.000	.000	.673	.635	.500	.000	.000	.625

Location: Madera
 N/S: SR-99 Northbound Ramps
 E/W: Avenue 18 1/2



PEDESTRIANS

	North Leg SR-99 Northbound Ramps	East Leg Avenue 18 1/2	South Leg SR-99 Northbound Ramps	West Leg Avenue 18 1/2	
	Pedestrians	Pedestrians	Pedestrians	Pedestrians	
7:00 AM	0	0	0	0	0
7:15 AM	0	0	0	0	0
7:30 AM	0	0	0	0	0
7:45 AM	0	0	0	0	0
8:00 AM	1	0	0	0	1
8:15 AM	0	0	0	0	0
8:30 AM	0	0	0	0	0
8:45 AM	0	0	0	0	0
TOTAL VOLUMES:	1	0	0	0	1

	North Leg SR-99 Northbound Ramps	East Leg Avenue 18 1/2	South Leg SR-99 Northbound Ramps	West Leg Avenue 18 1/2	
	Pedestrians	Pedestrians	Pedestrians	Pedestrians	
4:00 PM	0	0	0	0	0
4:15 PM	0	0	0	0	0
4:30 PM	0	0	0	0	0
4:45 PM	0	0	0	0	0
5:00 PM	0	0	0	0	0
5:15 PM	0	0	0	0	0
5:30 PM	0	0	0	0	0
5:45 PM	0	0	0	0	0
TOTAL VOLUMES:	0	0	0	0	0

Location: Madera
 N/S: SR-99 Northbound Ramps
 E/W: Avenue 18 1/2



BICYCLES

	Southbound SR-99 Northbound Ramps			Westbound Avenue 18 1/2			Northbound SR-99 Northbound Ramps			Eastbound Avenue 18 1/2			
	Left	Thru	Right	Left	Thru	Right	Left	Thru	Right	Left	Thru	Right	
7:00 AM	0	0	0	0	0	0	0	0	0	0	0	0	0
7:15 AM	0	0	0	0	0	0	0	0	0	0	0	0	0
7:30 AM	0	0	0	0	0	0	0	0	0	0	0	0	0
7:45 AM	0	0	0	0	0	0	0	0	0	0	0	0	0
8:00 AM	0	0	0	0	0	0	0	0	0	0	0	0	0
8:15 AM	0	0	0	0	0	0	0	0	0	0	0	0	0
8:30 AM	0	0	0	0	0	0	0	0	0	0	0	0	0
8:45 AM	0	0	0	0	0	0	0	0	0	0	0	0	0
TOTAL VOLUMES:	0	0	0	0	0	0	0	0	0	0	0	0	0

	Southbound SR-99 Northbound Ramps			Westbound Avenue 18 1/2			Northbound SR-99 Northbound Ramps			Eastbound Avenue 18 1/2			
	Left	Thru	Right	Left	Thru	Right	Left	Thru	Right	Left	Thru	Right	
4:00 PM	0	0	0	0	0	0	0	0	0	0	1	0	1
4:15 PM	0	0	0	0	0	0	0	0	0	0	0	0	0
4:30 PM	0	0	0	0	0	0	0	0	0	0	0	0	0
4:45 PM	0	0	0	0	0	0	0	0	0	0	0	0	0
5:00 PM	0	0	0	0	0	0	0	0	0	0	0	0	0
5:15 PM	0	0	0	0	0	0	0	0	0	0	0	0	0
5:30 PM	0	0	0	0	0	0	0	0	0	0	0	0	0
5:45 PM	0	0	0	0	0	0	0	0	0	0	0	0	0
TOTAL VOLUMES:	0	0	0	0	0	0	0	0	0	0	1	0	1

City of Madera
 N/S: Road 23
 E/W: Avenue 17
 Weather: Clear

File Name : 05_MDA_Rd 23_Ave 17 AM
 Site Code : 00319628
 Start Date : 9/18/2019
 Page No : 1

Groups Printed- Passenger Vehicles - Large 2 Axle Vehicles - 3 Axle Vehicles - 4+ Axle Trucks

Start Time	Road 23 Southbound					Avenue 17 Westbound					Road 23 Northbound					Avenue 17 Eastbound					Int. Total
	Left	Thru	Right	U-Turns	App. Total	Left	Thru	Right	U-Turns	App. Total	Left	Thru	Right	U-Turns	App. Total	Left	Thru	Right	U-Turns	App. Total	
07:00 AM	3	19	0	0	22	9	3	1	0	13	0	16	3	0	19	0	6	0	0	6	60
07:15 AM	3	16	0	0	19	14	4	3	0	21	0	37	7	0	44	0	3	0	0	3	87
07:30 AM	3	34	0	0	37	10	5	0	0	15	4	47	18	0	69	0	2	3	0	5	126
07:45 AM	7	29	0	0	36	15	5	0	0	20	2	42	12	0	56	1	10	1	0	12	124
Total	16	98	0	0	114	48	17	4	0	69	6	142	40	0	188	1	21	4	0	26	397
08:00 AM	2	24	0	0	26	14	2	0	0	16	1	32	10	0	43	0	7	4	0	11	96
08:15 AM	1	16	1	0	18	11	1	2	1	15	1	36	8	0	45	0	3	3	0	6	84
08:30 AM	1	23	1	0	25	6	7	4	0	17	1	24	5	0	30	0	3	2	0	5	77
08:45 AM	3	21	0	0	24	2	3	2	0	7	0	25	2	0	27	0	4	1	0	5	63
Total	7	84	2	0	93	33	13	8	1	55	3	117	25	0	145	0	17	10	0	27	320
Grand Total	23	182	2	0	207	81	30	12	1	124	9	259	65	0	333	1	38	14	0	53	717
Apprch %	11.1	87.9	1	0		65.3	24.2	9.7	0.8		2.7	77.8	19.5	0		1.9	71.7	26.4	0		
Total %	3.2	25.4	0.3	0	28.9	11.3	4.2	1.7	0.1	17.3	1.3	36.1	9.1	0	46.4	0.1	5.3	2	0	7.4	
Passenger Vehicles	87	69.2	50	0	71	85.2	70	91.7	100	82.3	77.8	79.9	86.2	0	81.1	100	94.7	100	0	96.2	79.5
Large 2 Axle Vehicles	0	6	50	0	5.8	7.4	23.3	8.3	0	11.3	22.2	4.6	4.6	0	5.1	0	2.6	0	0	1.9	6.1
3 Axle Vehicles	8.7	2.7	0	0	3.4	2.5	0	0	0	1.6	0	1.5	0	0	1.2	0	0	0	0	0	1.8
4+ Axle Trucks	1	40	0	0	41	4	2	0	0	6	0	36	6	0	42	0	1	0	0	1	90

Start Time	Road 23 Southbound					Avenue 17 Westbound					Road 23 Northbound					Avenue 17 Eastbound					Int. Total
	Left	Thru	Right	U-Turns	App. Total	Left	Thru	Right	U-Turns	App. Total	Left	Thru	Right	U-Turns	App. Total	Left	Thru	Right	U-Turns	App. Total	
Peak Hour Analysis From 07:00 AM to 08:45 AM - Peak 1 of 1																					
Peak Hour for Entire Intersection Begins at 07:15 AM																					
07:15 AM	3	16	0	0	19	14	4	3	0	21	0	37	7	0	44	0	3	0	0	3	87
07:30 AM	3	34	0	0	37	10	5	0	0	15	4	47	18	0	69	0	2	3	0	5	126
07:45 AM	7	29	0	0	36	15	5	0	0	20	2	42	12	0	56	1	10	1	0	12	124
08:00 AM	2	24	0	0	26	14	2	0	0	16	1	32	10	0	43	0	7	4	0	11	96
Total Volume	15	103	0	0	118	53	16	3	0	72	7	158	47	0	212	1	22	8	0	31	433
% App. Total	12.7	87.3	0	0		73.6	22.2	4.2	0		3.3	74.5	22.2	0		3.2	71	25.8	0		
PHF	.536	.757	.000	.000	.797	.883	.800	.250	.000	.857	.438	.840	.653	.000	.768	.250	.550	.500	.000	.646	.859

City of Madera
 N/S: Road 23
 E/W: Avenue 17
 Weather: Clear

File Name : 05_MDA_Rd 23_Ave 17 AM
 Site Code : 00319628
 Start Date : 9/18/2019
 Page No : 2

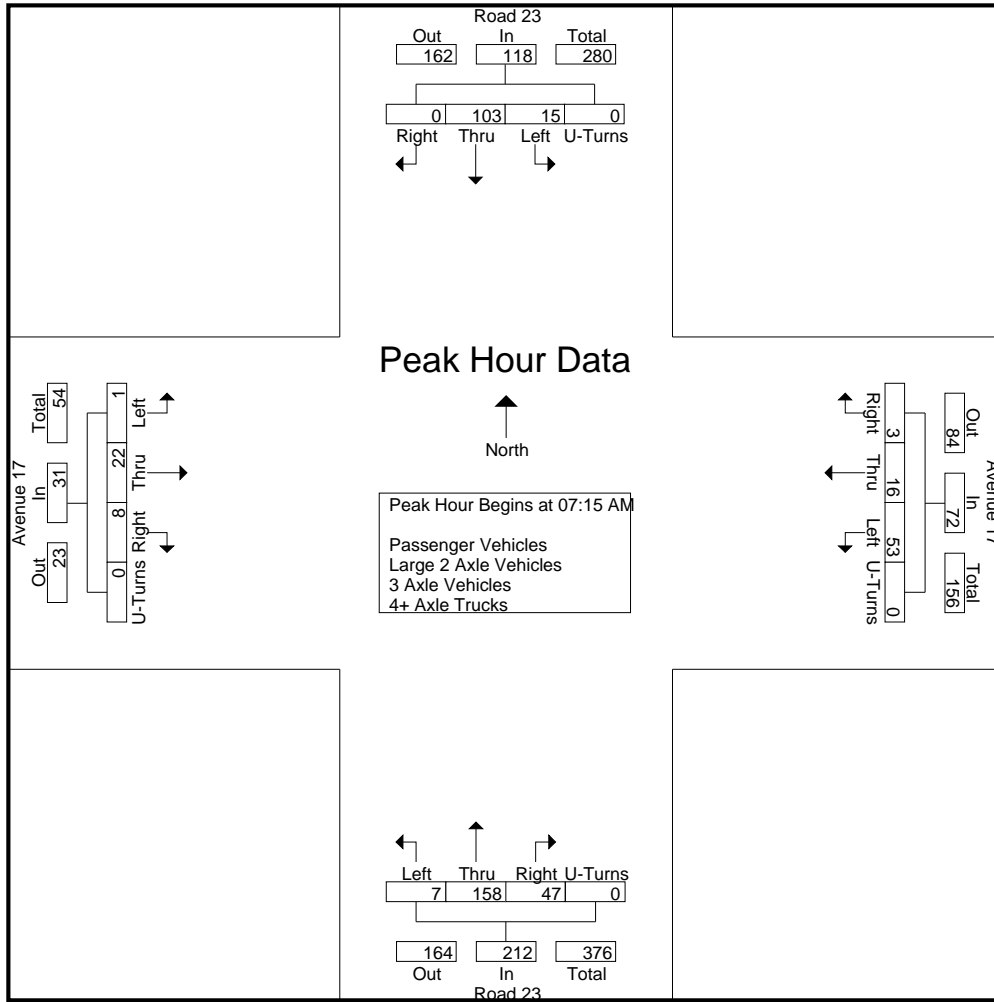

Peak Hour Analysis From 07:00 AM to 08:45 AM - Peak 1 of 1
 Peak Hour for Each Approach Begins at:

	07:15 AM					07:30 AM					07:45 AM									
+0 mins.	3	16	0	0	19	14	4	3	0	21	4	47	18	0	69	0	2	3	0	5
+15 mins.	3	34	0	0	37	10	5	0	0	15	2	42	12	0	56	1	10	1	0	12
+30 mins.	7	29	0	0	36	15	5	0	0	20	1	32	10	0	43	0	7	4	0	11
+45 mins.	2	24	0	0	26	14	2	0	0	16	1	36	8	0	45	0	3	3	0	6
Total Volume	15	103	0	0	118	53	16	3	0	72	8	157	48	0	213	1	22	11	0	34
% App. Total	12.7	87.3	0	0		73.6	22.2	4.2	0		3.8	73.7	22.5	0		2.9	64.7	32.4	0	
PHF	.536	.757	.000	.000	.797	.883	.800	.250	.000	.857	.500	.835	.667	.000	.772	.250	.550	.688	.000	.708

City of Madera
 N/S: Road 23
 E/W: Avenue 17
 Weather: Clear

File Name : 05_MDA_Rd 23_Ave 17 AM
 Site Code : 00319628
 Start Date : 9/18/2019
 Page No : 1

Groups Printed- Passenger Vehicles

Start Time	Road 23 Southbound					Avenue 17 Westbound					Road 23 Northbound					Avenue 17 Eastbound					Int. Total
	Left	Thru	Right	U-Turns	App. Total	Left	Thru	Right	U-Turns	App. Total	Left	Thru	Right	U-Turns	App. Total	Left	Thru	Right	U-Turns	App. Total	
07:00 AM	2	14	0	0	16	7	2	1	0	10	0	13	3	0	16	0	6	0	0	6	48
07:15 AM	3	10	0	0	13	13	3	3	0	19	0	31	6	0	37	0	3	0	0	3	72
07:30 AM	3	21	0	0	24	10	2	0	0	12	4	40	17	0	61	0	2	3	0	5	102
07:45 AM	7	24	0	0	31	14	4	0	0	18	2	31	10	0	43	1	9	1	0	11	103
Total	15	69	0	0	84	44	11	4	0	59	6	115	36	0	157	1	20	4	0	25	325
08:00 AM	1	21	0	0	22	7	2	0	0	9	0	27	7	0	34	0	6	4	0	10	75
08:15 AM	1	9	1	0	11	10	1	2	1	14	1	30	7	0	38	0	3	3	0	6	69
08:30 AM	1	14	0	0	15	6	5	4	0	15	0	16	4	0	20	0	3	2	0	5	55
08:45 AM	2	13	0	0	15	2	2	1	0	5	0	19	2	0	21	0	4	1	0	5	46
Total	5	57	1	0	63	25	10	7	1	43	1	92	20	0	113	0	16	10	0	26	245
Grand Total	20	126	1	0	147	69	21	11	1	102	7	207	56	0	270	1	36	14	0	51	570
Apprch %	13.6	85.7	0.7	0		67.6	20.6	10.8	1		2.6	76.7	20.7	0		2	70.6	27.5	0		
Total %	3.5	22.1	0.2	0	25.8	12.1	3.7	1.9	0.2	17.9	1.2	36.3	9.8	0	47.4	0.2	6.3	2.5	0	8.9	

Start Time	Road 23 Southbound					Avenue 17 Westbound					Road 23 Northbound					Avenue 17 Eastbound					Int. Total
	Left	Thru	Right	U-Turns	App. Total	Thru	Right	U-Turns	App. Total	Thru	Right	U-Turns	App. Total	Thru	Right	U-Turns	App. Total				
Peak Hour Analysis From 07:15 AM to 08:00 AM - Peak 1 of 1																					
Peak Hour for Entire Intersection Begins at 07:15 AM																					
07:15 AM	3	10	0	0	13	13	3	3	0	19	0	31	6	0	37	0	3	0	0	3	72
07:30 AM	3	21	0	0	24	10	2	0	0	12	4	40	17	0	61	0	2	3	0	5	102
07:45 AM	7	24	0	0	31	14	4	0	0	18	2	31	10	0	43	1	9	1	0	11	103
08:00 AM	1	21	0	0	22	7	2	0	0	9	0	27	7	0	34	0	6	4	0	10	75
Total Volume	14	76	0	0	90	44	11	3	0	58	6	129	40	0	175	1	20	8	0	29	352
% App. Total	15.6	84.4	0	0		75.9	19	5.2	0		3.4	73.7	22.9	0		3.4	69	27.6	0		
PHF	.500	.792	.000	.000	.726	.786	.688	.250	.000	.763	.375	.806	.588	.000	.717	.250	.556	.500	.000	.659	.854

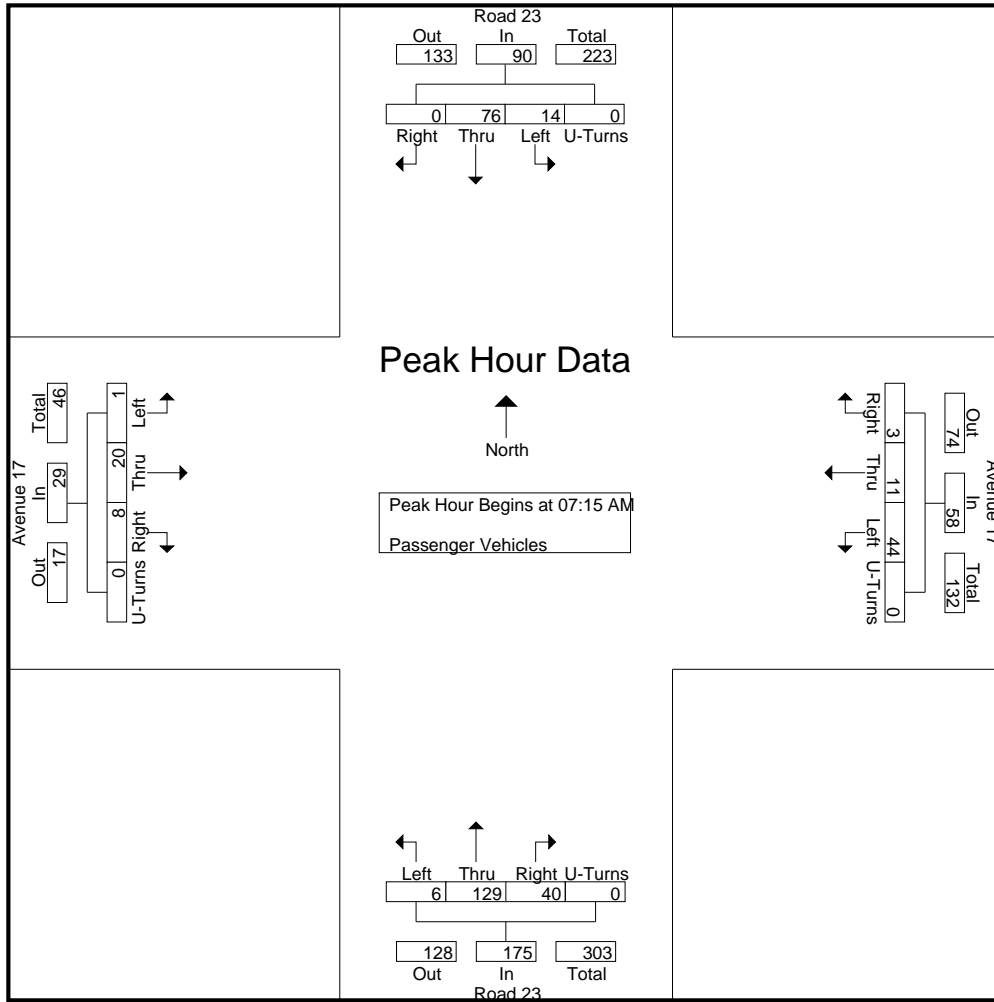

Peak Hour Analysis From 07:15 AM to 08:00 AM - Peak 1 of 1
 Peak Hour for Each Approach Begins at:

	07:15 AM					07:15 AM					07:15 AM									
+0 mins.	3	10	0	0	13	13	3	3	0	19	0	31	6	0	37	0	3	0	0	3
+15 mins.	3	21	0	0	24	10	2	0	0	12	4	40	17	0	61	0	2	3	0	5
+30 mins.	7	24	0	0	31	14	4	0	0	18	2	31	10	0	43	1	9	1	0	11
+45 mins.	1	21	0	0	22	7	2	0	0	9	0	27	7	0	34	0	6	4	0	10
Total Volume	14	76	0	0	90	44	11	3	0	58	6	129	40	0	175	1	20	8	0	29
% App. Total	15.6	84.4	0	0		75.9	19	5.2	0		3.4	73.7	22.9	0		3.4	69	27.6	0	
PHF	.500	.792	.000	.000	.726	.786	.688	.250	.000	.763	.375	.806	.588	.000	.717	.250	.556	.500	.000	.659

City of Madera
 N/S: Road 23
 E/W: Avenue 17
 Weather: Clear

File Name : 05_MDA_Rd 23_Ave 17 AM
 Site Code : 00319628
 Start Date : 9/18/2019
 Page No : 1

Groups Printed- Large 2 Axle Vehicles

Start Time	Road 23 Southbound					Avenue 17 Westbound					Road 23 Northbound					Avenue 17 Eastbound					Int. Total
	Left	Thru	Right	U-Turns	App. Total	Left	Thru	Right	U-Turns	App. Total	Left	Thru	Right	U-Turns	App. Total	Left	Thru	Right	U-Turns	App. Total	
07:00 AM	0	0	0	0	0	1	0	0	0	1	0	1	0	0	1	0	0	0	0	0	2
07:15 AM	0	1	0	0	1	0	1	0	0	1	0	0	0	0	0	0	0	0	0	0	2
07:30 AM	0	3	0	0	3	0	2	0	0	2	0	1	1	0	2	0	0	0	0	0	7
07:45 AM	0	1	0	0	1	1	1	0	0	2	0	2	1	0	3	0	1	0	0	1	7
Total	0	5	0	0	5	2	4	0	0	6	0	4	2	0	6	0	1	0	0	1	18
08:00 AM	0	1	0	0	1	4	0	0	0	4	1	1	1	0	3	0	0	0	0	0	8
08:15 AM	0	2	0	0	2	0	0	0	0	0	0	2	0	0	2	0	0	0	0	0	4
08:30 AM	0	2	1	0	3	0	2	0	0	2	1	3	0	0	4	0	0	0	0	0	9
08:45 AM	0	1	0	0	1	0	1	1	0	2	0	2	0	0	2	0	0	0	0	0	5
Total	0	6	1	0	7	4	3	1	0	8	2	8	1	0	11	0	0	0	0	0	26
Grand Total	0	11	1	0	12	6	7	1	0	14	2	12	3	0	17	0	1	0	0	1	44
Apprch %	0	91.7	8.3	0		42.9	50	7.1	0		11.8	70.6	17.6	0		0	100	0	0		
Total %	0	25	2.3	0	27.3	13.6	15.9	2.3	0	31.8	4.5	27.3	6.8	0	38.6	0	2.3	0	0	2.3	

Start Time	Road 23 Southbound					Avenue 17 Westbound					Road 23 Northbound					Avenue 17 Eastbound					Int. Total
	Left	Thru	Right	U-Turns	App. Total	Thru	Right	U-Turns	App. Total	Thru	Right	U-Turns	App. Total	Thru	Right	U-Turns	App. Total				
Peak Hour Analysis From 07:15 AM to 08:00 AM - Peak 1 of 1																					
Peak Hour for Entire Intersection Begins at 07:15 AM																					
07:15 AM	0	1	0	0	1	0	1	0	0	1	0	0	0	0	0	0	0	0	0	0	2
07:30 AM	0	3	0	0	3	0	2	0	0	2	0	1	1	0	2	0	0	0	0	0	7
07:45 AM	0	1	0	0	1	1	1	0	0	2	0	2	1	0	3	0	1	0	0	1	7
08:00 AM	0	1	0	0	1	4	0	0	0	4	1	1	1	0	3	0	0	0	0	0	8
Total Volume	0	6	0	0	6	5	4	0	0	9	1	4	3	0	8	0	1	0	0	1	24
% App. Total	0	100	0	0		55.6	44.4	0	0		12.5	50	37.5	0		0	100	0	0		
PHF	.000	.500	.000	.000	.500	.313	.500	.000	.000	.563	.250	.500	.750	.000	.667	.000	.250	.000	.000	.250	.750

City of Madera
 N/S: Road 23
 E/W: Avenue 17
 Weather: Clear

File Name : 05_MDA_Rd 23_Ave 17 AM
 Site Code : 00319628
 Start Date : 9/18/2019
 Page No : 2

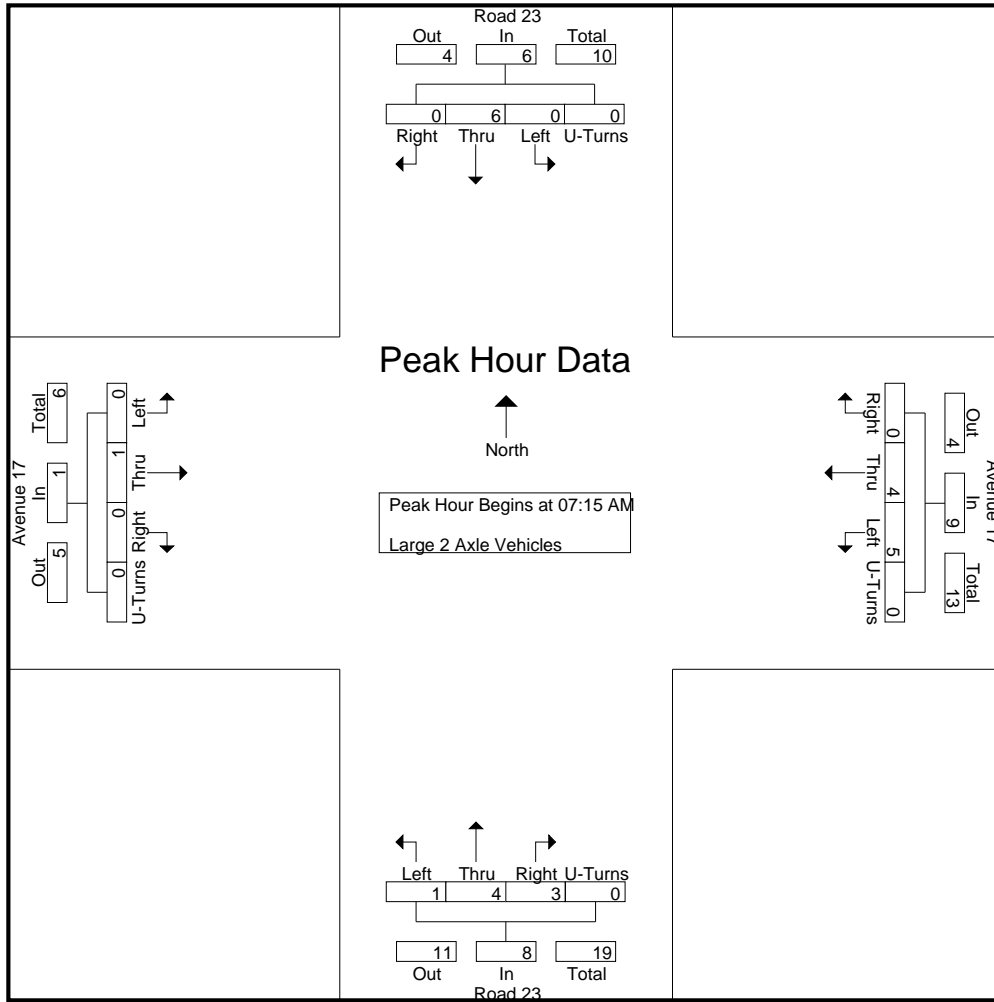

Peak Hour Analysis From 07:15 AM to 08:00 AM - Peak 1 of 1
 Peak Hour for Each Approach Begins at:

	07:15 AM					07:15 AM					07:15 AM					07:15 AM				
+0 mins.	0	1	0	0	1	0	1	0	0	1	0	0	0	0	0	0	0	0	0	0
+15 mins.	0	3	0	0	3	0	2	0	0	2	0	1	1	0	2	0	0	0	0	0
+30 mins.	0	1	0	0	1	1	1	0	0	2	0	2	1	0	3	0	1	0	0	1
+45 mins.	0	1	0	0	1	4	0	0	0	4	1	1	1	0	3	0	0	0	0	0
Total Volume	0	6	0	0	6	5	4	0	0	9	1	4	3	0	8	0	1	0	0	1
% App. Total	0	100	0	0	0	55.6	44.4	0	0	0	12.5	50	37.5	0	0	0	100	0	0	0
PHF	.000	.500	.000	.000	.500	.313	.500	.000	.000	.563	.250	.500	.750	.000	.667	.000	.250	.000	.000	.250

City of Madera
 N/S: Road 23
 E/W: Avenue 17
 Weather: Clear

File Name : 05_MDA_Rd 23_Ave 17 AM
 Site Code : 00319628
 Start Date : 9/18/2019
 Page No : 2

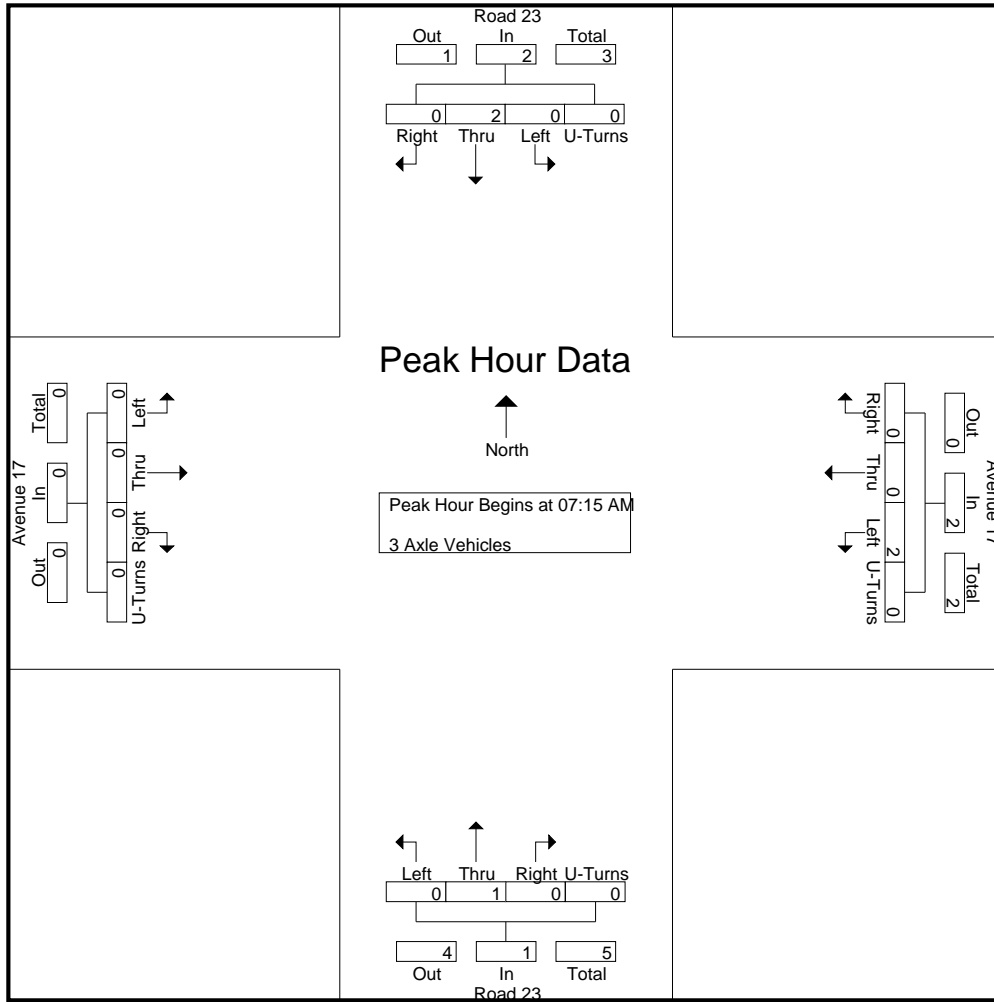

Peak Hour Analysis From 07:15 AM to 08:00 AM - Peak 1 of 1
 Peak Hour for Each Approach Begins at:

	07:15 AM					07:15 AM					07:15 AM									
+0 mins.	0	2	0	0	2	0	0	0	0	0	0	0	0	0	0	0	0	0	0	0
+15 mins.	0	0	0	0	0	0	0	0	0	0	0	1	0	0	1	0	0	0	0	0
+30 mins.	0	0	0	0	0	0	0	0	0	0	0	0	0	0	0	0	0	0	0	0
+45 mins.	0	0	0	0	0	2	0	0	0	2	0	0	0	0	0	0	0	0	0	0
Total Volume	0	2	0	0	2	2	0	0	0	2	0	1	0	0	1	0	0	0	0	0
% App. Total	0	100	0	0	0	100	0	0	0	0	0	100	0	0	0	0	0	0	0	0
PHF	.000	.250	.000	.000	.250	.250	.000	.000	.000	.250	.000	.250	.000	.000	.250	.000	.000	.000	.000	.000

City of Madera
 N/S: Road 23
 E/W: Avenue 17
 Weather: Clear

File Name : 05_MDA_Rd 23_Ave 17 AM
 Site Code : 00319628
 Start Date : 9/18/2019
 Page No : 1

Groups Printed- 4+ Axle Trucks

Start Time	Road 23 Southbound					Avenue 17 Westbound					Road 23 Northbound					Avenue 17 Eastbound					Int. Total
	Left	Thru	Right	U-Turns	App. Total	Left	Thru	Right	U-Turns	App. Total	Left	Thru	Right	U-Turns	App. Total	Left	Thru	Right	U-Turns	App. Total	
07:00 AM	0	4	0	0	4	1	1	0	0	2	0	2	0	0	2	0	0	0	0	0	8
07:15 AM	0	3	0	0	3	1	0	0	0	1	0	6	1	0	7	0	0	0	0	0	11
07:30 AM	0	10	0	0	10	0	1	0	0	1	0	5	0	0	5	0	0	0	0	0	16
07:45 AM	0	4	0	0	4	0	0	0	0	0	0	9	1	0	10	0	0	0	0	0	14
Total	0	21	0	0	21	2	2	0	0	4	0	22	2	0	24	0	0	0	0	0	49
08:00 AM	1	2	0	0	3	1	0	0	0	1	0	4	2	0	6	0	1	0	0	1	11
08:15 AM	0	5	0	0	5	1	0	0	0	1	0	3	1	0	4	0	0	0	0	0	10
08:30 AM	0	6	0	0	6	0	0	0	0	0	0	4	1	0	5	0	0	0	0	0	11
08:45 AM	0	6	0	0	6	0	0	0	0	0	0	3	0	0	3	0	0	0	0	0	9
Total	1	19	0	0	20	2	0	0	0	2	0	14	4	0	18	0	1	0	0	1	41
Grand Total	1	40	0	0	41	4	2	0	0	6	0	36	6	0	42	0	1	0	0	1	90
Apprch %	2.4	97.6	0	0		66.7	33.3	0	0		0	85.7	14.3	0		0	100	0	0		
Total %	1.1	44.4	0	0	45.6	4.4	2.2	0	0	6.7	0	40	6.7	0	46.7	0	1.1	0	0	1.1	

Start Time	Road 23 Southbound					Avenue 17 Westbound					Road 23 Northbound					Avenue 17 Eastbound					Int. Total
	Left	Thru	Right	U-Turns	App. Total	Thru	Right	U-Turns	App. Total	Thru	Right	U-Turns	App. Total	Thru	Right	U-Turns	App. Total				
Peak Hour Analysis From 07:15 AM to 08:00 AM - Peak 1 of 1																					
Peak Hour for Entire Intersection Begins at 07:15 AM																					
07:15 AM	0	3	0	0	3	1	0	0	0	1	0	6	1	0	7	0	0	0	0	0	11
07:30 AM	0	10	0	0	10	0	1	0	0	1	0	5	0	0	5	0	0	0	0	0	16
07:45 AM	0	4	0	0	4	0	0	0	0	0	0	9	1	0	10	0	0	0	0	0	14
08:00 AM	1	2	0	0	3	1	0	0	0	1	0	4	2	0	6	0	1	0	0	1	11
Total Volume	1	19	0	0	20	2	1	0	0	3	0	24	4	0	28	0	1	0	0	1	52
% App. Total	5	95	0	0		66.7	33.3	0	0		0	85.7	14.3	0		0	100	0	0		
PHF	.250	.475	.000	.000	.500	.500	.250	.000	.000	.750	.000	.667	.500	.000	.700	.000	.250	.000	.000	.250	.813

City of Madera
 N/S: Road 23
 E/W: Avenue 17
 Weather: Clear

File Name : 05_MDA_Rd 23_Ave 17 AM
 Site Code : 00319628
 Start Date : 9/18/2019
 Page No : 2

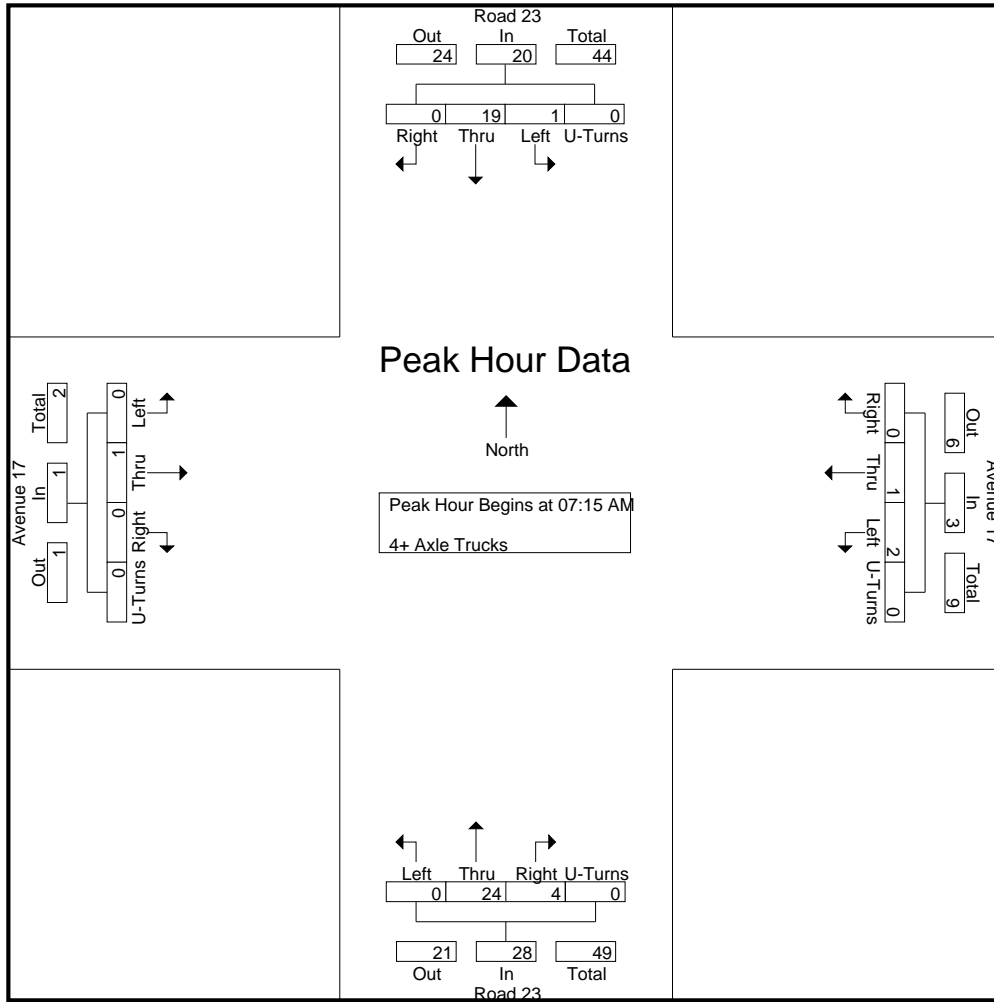

Peak Hour Analysis From 07:15 AM to 08:00 AM - Peak 1 of 1
 Peak Hour for Each Approach Begins at:

	07:15 AM					07:15 AM					07:15 AM									
+0 mins.	0	3	0	0	3	1	0	0	0	1	0	6	1	0	7	0	0	0	0	0
+15 mins.	0	10	0	0	10	0	1	0	0	1	0	5	0	0	5	0	0	0	0	0
+30 mins.	0	4	0	0	4	0	0	0	0	0	0	9	1	0	10	0	0	0	0	0
+45 mins.	1	2	0	0	3	1	0	0	0	1	0	4	2	0	6	0	1	0	0	1
Total Volume	1	19	0	0	20	2	1	0	0	3	0	24	4	0	28	0	1	0	0	1
% App. Total	5	95	0	0		66.7	33.3	0	0		0	85.7	14.3	0		0	100	0	0	
PHF	.250	.475	.000	.000	.500	.500	.250	.000	.000	.750	.000	.667	.500	.000	.700	.000	.250	.000	.000	.250

City of Madera
 N/S: Road 23
 E/W: Avenue 17
 Weather: Clear

File Name : 05_MDA_Rd 23_Ave 17 PM
 Site Code : 00319628
 Start Date : 9/18/2019
 Page No : 1

Groups Printed- Passenger Vehicles - Large 2 Axle Vehicles - 3 Axle Vehicles - 4+ Axle Trucks

Start Time	Road 23 Southbound					Avenue 17 Westbound					Road 23 Northbound					Avenue 17 Eastbound					Int. Total
	Left	Thru	Right	U-Turns	App. Total	Left	Thru	Right	U-Turns	App. Total	Left	Thru	Right	U-Turns	App. Total	Left	Thru	Right	U-Turns	App. Total	
04:00 PM	18	67	1	0	86	1	4	0	0	5	2	19	8	0	29	0	12	4	0	16	136
04:15 PM	20	59	1	0	80	4	9	0	0	13	1	20	19	0	40	0	13	2	0	15	148
04:30 PM	15	54	0	0	69	13	2	3	0	18	1	19	12	0	32	0	12	2	0	14	133
04:45 PM	8	39	0	0	47	11	5	6	0	22	1	19	21	0	41	1	10	3	0	14	124
Total	61	219	2	0	282	29	20	9	0	58	5	77	60	0	142	1	47	11	0	59	541
05:00 PM	4	43	0	0	47	8	9	2	0	19	2	22	7	0	31	0	4	2	0	6	103
05:15 PM	5	35	0	0	40	10	8	1	0	19	4	19	7	0	30	2	5	0	0	7	96
05:30 PM	8	29	0	0	37	8	3	0	0	11	0	28	11	0	39	0	8	3	0	11	98
05:45 PM	3	27	0	0	30	7	4	3	0	14	0	19	16	0	35	0	6	3	0	9	88
Total	20	134	0	0	154	33	24	6	0	63	6	88	41	0	135	2	23	8	0	33	385
Grand Total	81	353	2	0	436	62	44	15	0	121	11	165	101	0	277	3	70	19	0	92	926
Apprch %	18.6	81	0.5	0		51.2	36.4	12.4	0		4	59.6	36.5	0		3.3	76.1	20.7	0		
Total %	8.7	38.1	0.2	0	47.1	6.7	4.8	1.6	0	13.1	1.2	17.8	10.9	0	29.9	0.3	7.6	2.1	0	9.9	
Passenger Vehicles	97.5	89.5	100	0	91.1	93.5	100	93.3	0	95.9	90.9	92.1	92.1	0	92.1	100	97.1	100	0	97.8	92.7
Large 2 Axle Vehicles	2.5	1.7	0	0	1.8	4.8	0	0	0	2.5	0	1.8	4	0	2.5	0	1.4	0	0	1.1	2.1
3 Axle Vehicles	0	1	0	0	1	1	0	1	0	2	1	0	1	0	2	0	0	0	0	0	5
% 3 Axle Vehicles	0	0.3	0	0	0.2	1.6	0	6.7	0	1.7	9.1	0	1	0	0.7	0	0	0	0	0	0.5
4+ Axle Trucks	0	30	0	0	30	0	0	0	0	0	0	10	3	0	13	0	1	0	0	1	44
% 4+ Axle Trucks																					

Start Time	Road 23 Southbound					Avenue 17 Westbound					Road 23 Northbound					Avenue 17 Eastbound					Int. Total
	Left	Thru	Right	U-Turns	App. Total	Left	Thru	Right	U-Turns	App. Total	Left	Thru	Right	U-Turns	App. Total	Left	Thru	Right	U-Turns	App. Total	
Peak Hour Analysis From 04:00 PM to 05:45 PM - Peak 1 of 1																					
Peak Hour for Entire Intersection Begins at 04:00 PM																					
04:00 PM	18	67	1	0	86	1	4	0	0	5	2	19	8	0	29	0	12	4	0	16	136
04:15 PM	20	59	1	0	80	4	9	0	0	13	1	20	19	0	40	0	13	2	0	15	148
04:30 PM	15	54	0	0	69	13	2	3	0	18	1	19	12	0	32	0	12	2	0	14	133
04:45 PM	8	39	0	0	47	11	5	6	0	22	1	19	21	0	41	1	10	3	0	14	124
Total Volume	61	219	2	0	282	29	20	9	0	58	5	77	60	0	142	1	47	11	0	59	541
% App. Total	21.6	77.7	0.7	0		50	34.5	15.5	0		3.5	54.2	42.3	0		1.7	79.7	18.6	0		
PHF	.763	.817	.500	.000	.820	.558	.556	.375	.000	.659	.625	.963	.714	.000	.866	.250	.904	.688	.000	.922	.914

City of Madera
 N/S: Road 23
 E/W: Avenue 17
 Weather: Clear

File Name : 05_MDA_Rd 23_Ave 17 PM
 Site Code : 00319628
 Start Date : 9/18/2019
 Page No : 2

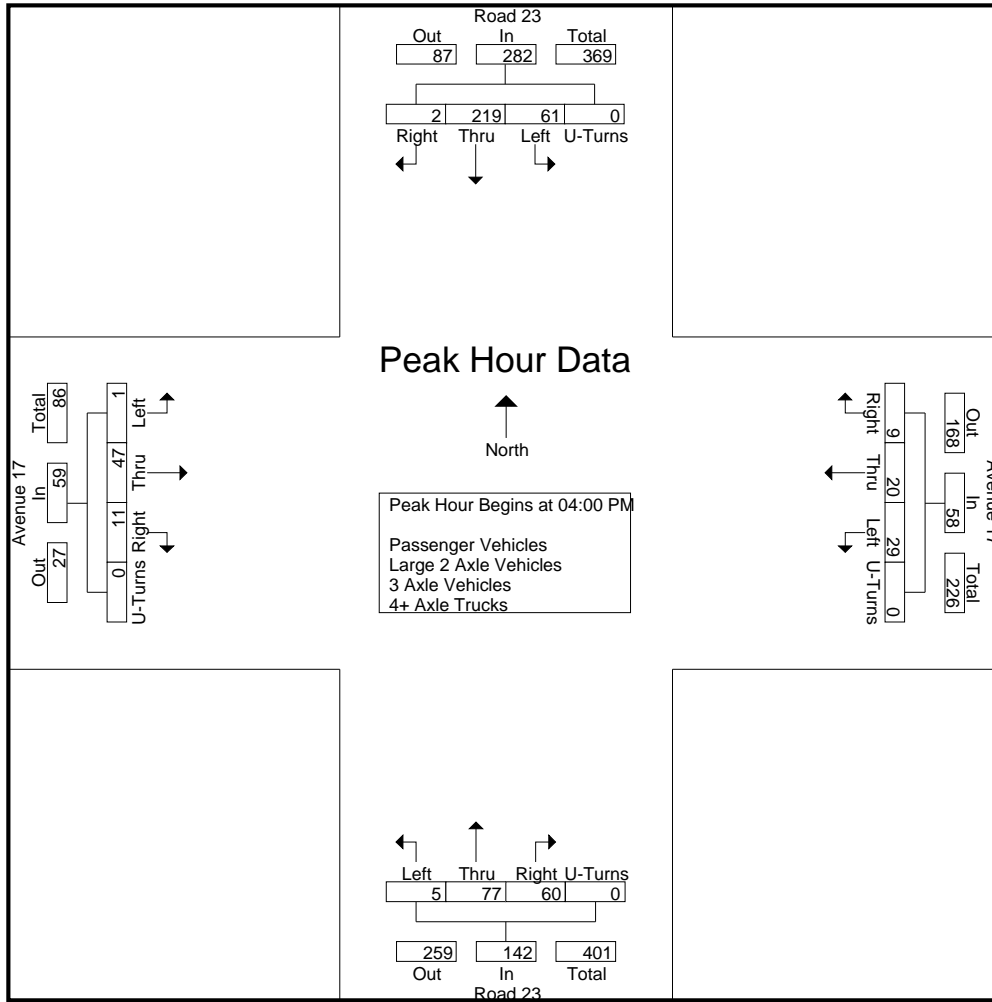

Peak Hour Analysis From 04:00 PM to 05:45 PM - Peak 1 of 1
 Peak Hour for Each Approach Begins at:

	04:00 PM					04:30 PM					04:15 PM					04:00 PM				
+0 mins.	18	67	1	0	86	13	2	3	0	18	1	20	19	0	40	0	12	4	0	16
+15 mins.	20	59	1	0	80	11	5	6	0	22	1	19	12	0	32	0	13	2	0	15
+30 mins.	15	54	0	0	69	8	9	2	0	19	1	19	21	0	41	0	12	2	0	14
+45 mins.	8	39	0	0	47	10	8	1	0	19	2	22	7	0	31	1	10	3	0	14
Total Volume	61	219	2	0	282	42	24	12	0	78	5	80	59	0	144	1	47	11	0	59
% App. Total	21.6	77.7	0.7	0		53.8	30.8	15.4	0		3.5	55.6	41	0		1.7	79.7	18.6	0	
PHF	.763	.817	.500	.000	.820	.808	.667	.500	.000	.886	.625	.909	.702	.000	.878	.250	.904	.688	.000	.922

City of Madera
 N/S: Road 23
 E/W: Avenue 17
 Weather: Clear

File Name : 05_MDA_Rd 23_Ave 17 PM
 Site Code : 00319628
 Start Date : 9/18/2019
 Page No : 1

Groups Printed- Passenger Vehicles

Start Time	Road 23 Southbound					Avenue 17 Westbound					Road 23 Northbound					Avenue 17 Eastbound					Int. Total
	Left	Thru	Right	U-Turns	App. Total	Left	Thru	Right	U-Turns	App. Total	Left	Thru	Right	U-Turns	App. Total	Left	Thru	Right	U-Turns	App. Total	
04:00 PM	17	62	1	0	80	1	4	0	0	5	1	19	7	0	27	0	12	4	0	16	128
04:15 PM	20	55	1	0	76	4	9	0	0	13	1	18	19	0	38	0	13	2	0	15	142
04:30 PM	14	47	0	0	61	13	2	3	0	18	1	17	12	0	30	0	11	2	0	13	122
04:45 PM	8	33	0	0	41	9	5	5	0	19	1	16	18	0	35	1	9	3	0	13	108
Total	59	197	2	0	258	27	20	8	0	55	4	70	56	0	130	1	45	11	0	57	500
05:00 PM	4	38	0	0	42	7	9	2	0	18	2	18	5	0	25	0	4	2	0	6	91
05:15 PM	5	31	0	0	36	10	8	1	0	19	4	17	7	0	28	2	5	0	0	7	90
05:30 PM	8	28	0	0	36	7	3	0	0	10	0	28	9	0	37	0	8	3	0	11	94
05:45 PM	3	22	0	0	25	7	4	3	0	14	0	19	16	0	35	0	6	3	0	9	83
Total	20	119	0	0	139	31	24	6	0	61	6	82	37	0	125	2	23	8	0	33	358
Grand Total	79	316	2	0	397	58	44	14	0	116	10	152	93	0	255	3	68	19	0	90	858
Apprch %	19.9	79.6	0.5	0		50	37.9	12.1	0		3.9	59.6	36.5	0		3.3	75.6	21.1	0		
Total %	9.2	36.8	0.2	0	46.3	6.8	5.1	1.6	0	13.5	1.2	17.7	10.8	0	29.7	0.3	7.9	2.2	0	10.5	

Start Time	Road 23 Southbound					Avenue 17 Westbound					Road 23 Northbound					Avenue 17 Eastbound					Int. Total
	Left	Thru	Right	U-Turns	App. Total	Thru	Right	U-Turns	App. Total	Thru	Right	U-Turns	App. Total	Thru	Right	U-Turns	App. Total				
Peak Hour Analysis From 04:00 PM to 04:45 PM - Peak 1 of 1																					
Peak Hour for Entire Intersection Begins at 04:00 PM																					
04:00 PM	17	62	1	0	80	1	4	0	0	5	1	19	7	0	27	0	12	4	0	16	128
04:15 PM	20	55	1	0	76	4	9	0	0	13	1	18	19	0	38	0	13	2	0	15	142
04:30 PM	14	47	0	0	61	13	2	3	0	18	1	17	12	0	30	0	11	2	0	13	122
04:45 PM	8	33	0	0	41	9	5	5	0	19	1	16	18	0	35	1	9	3	0	13	108
Total Volume	59	197	2	0	258	27	20	8	0	55	4	70	56	0	130	1	45	11	0	57	500
% App. Total	22.9	76.4	0.8	0		49.1	36.4	14.5	0		3.1	53.8	43.1	0		1.8	78.9	19.3	0		
PHF	.738	.794	.500	.000	.806	.519	.556	.400	.000	.724	1.00	.921	.737	.000	.855	.250	.865	.688	.000	.891	.880

City of Madera
 N/S: Road 23
 E/W: Avenue 17
 Weather: Clear

File Name : 05_MDA_Rd 23_Ave 17 PM
 Site Code : 00319628
 Start Date : 9/18/2019
 Page No : 2

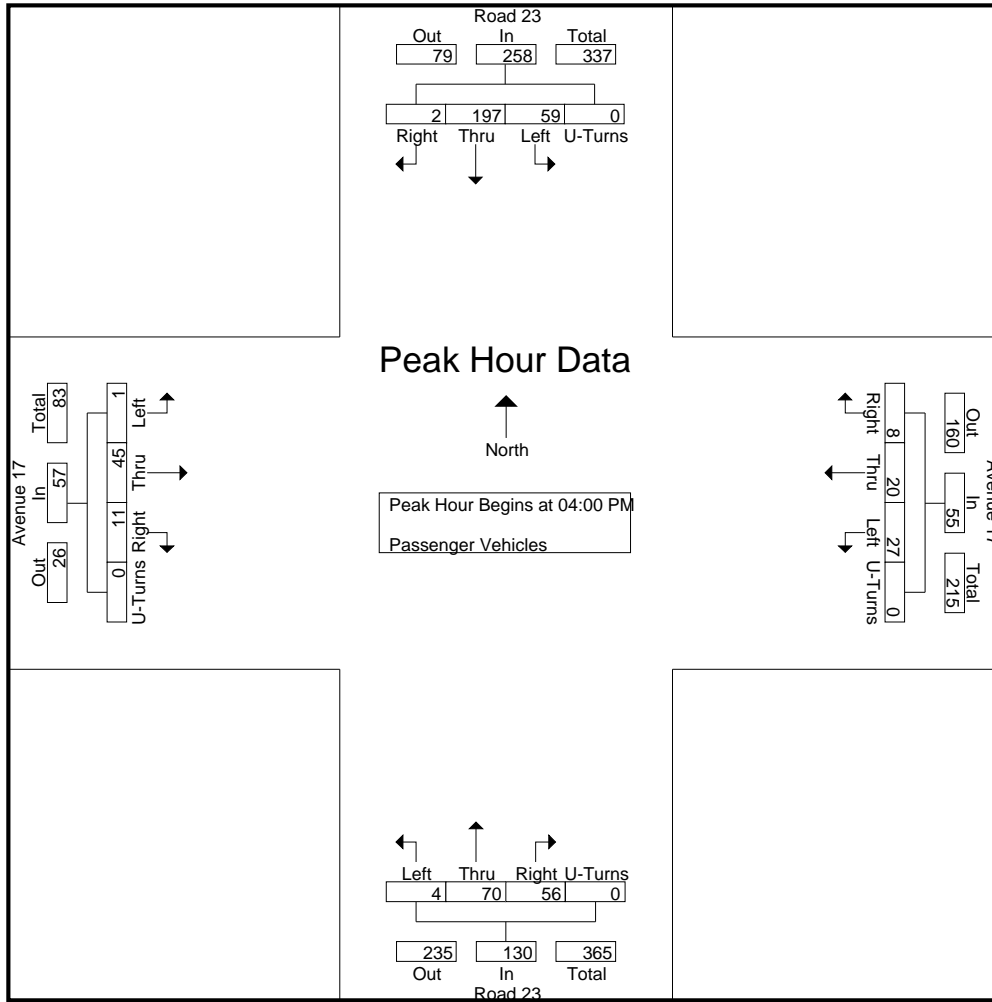

Peak Hour Analysis From 04:00 PM to 04:45 PM - Peak 1 of 1
 Peak Hour for Each Approach Begins at:

	04:00 PM					04:00 PM					04:00 PM									
+0 mins.	17	62	1	0	80	1	4	0	0	5	1	19	7	0	27	0	12	4	0	16
+15 mins.	20	55	1	0	76	4	9	0	0	13	1	18	19	0	38	0	13	2	0	15
+30 mins.	14	47	0	0	61	13	2	3	0	18	1	17	12	0	30	0	11	2	0	13
+45 mins.	8	33	0	0	41	9	5	5	0	19	1	16	18	0	35	1	9	3	0	13
Total Volume	59	197	2	0	258	27	20	8	0	55	4	70	56	0	130	1	45	11	0	57
% App. Total	22.9	76.4	0.8	0		49.1	36.4	14.5	0		3.1	53.8	43.1	0		1.8	78.9	19.3	0	
PHF	.738	.794	.500	.000	.806	.519	.556	.400	.000	.724	1.000	.921	.737	.000	.855	.250	.865	.688	.000	.891

City of Madera
 N/S: Road 23
 E/W: Avenue 17
 Weather: Clear

File Name : 05_MDA_Rd 23_Ave 17 PM
 Site Code : 00319628
 Start Date : 9/18/2019
 Page No : 1

Groups Printed- Large 2 Axle Vehicles

Start Time	Road 23 Southbound					Avenue 17 Westbound					Road 23 Northbound					Avenue 17 Eastbound					Int. Total	
	Left	Thru	Right	U-Turns	App. Total	Left	Thru	Right	U-Turns	App. Total	Left	Thru	Right	U-Turns	App. Total	Left	Thru	Right	U-Turns	App. Total		
04:00 PM	1	3	0	0	4	0	0	0	0	0	0	0	1	0	1	0	0	0	0	0	0	5
04:15 PM	0	1	0	0	1	0	0	0	0	0	0	0	0	0	0	0	0	0	0	0	0	1
04:30 PM	1	0	0	0	1	0	0	0	0	0	0	0	0	0	0	0	1	0	0	0	1	2
04:45 PM	0	2	0	0	2	2	0	0	0	2	0	2	2	0	4	0	0	0	0	0	0	8
Total	2	6	0	0	8	2	0	0	0	2	0	2	3	0	5	0	1	0	0	0	1	16
05:00 PM	0	0	0	0	0	0	0	0	0	0	0	1	1	0	2	0	0	0	0	0	0	2
05:15 PM	0	0	0	0	0	0	0	0	0	0	0	0	0	0	0	0	0	0	0	0	0	0
05:30 PM	0	0	0	0	0	1	0	0	0	1	0	0	0	0	0	0	0	0	0	0	0	1
05:45 PM	0	0	0	0	0	0	0	0	0	0	0	0	0	0	0	0	0	0	0	0	0	0
Total	0	0	0	0	0	1	0	0	0	1	0	1	1	0	2	0	0	0	0	0	0	3
Grand Total	2	6	0	0	8	3	0	0	0	3	0	3	4	0	7	0	1	0	0	1	19	
Apprch %	25	75	0	0		100	0	0	0		0	42.9	57.1	0		0	100	0	0			
Total %	10.5	31.6	0	0	42.1	15.8	0	0	0	15.8	0	15.8	21.1	0	36.8	0	5.3	0	0	5.3		

Start Time	Road 23 Southbound					Avenue 17 Westbound					Road 23 Northbound					Avenue 17 Eastbound					Int. Total
	Left	Thru	Right	U-Turns	App. Total	Thru	Right	U-Turns	App. Total	Thru	Right	U-Turns	App. Total	Thru	Right	U-Turns	App. Total				
Peak Hour Analysis From 04:00 PM to 04:45 PM - Peak 1 of 1																					
Peak Hour for Entire Intersection Begins at 04:00 PM																					
04:00 PM	1	3	0	0	4	0	0	0	0	0	0	0	1	0	1	0	0	0	0	0	5
04:15 PM	0	1	0	0	1	0	0	0	0	0	0	0	0	0	0	0	0	0	0	0	1
04:30 PM	1	0	0	0	1	0	0	0	0	0	0	0	0	0	0	0	1	0	0	1	2
04:45 PM	0	2	0	0	2	2	0	0	0	2	0	2	2	0	4	0	0	0	0	0	8
Total Volume	2	6	0	0	8	2	0	0	0	2	0	2	3	0	5	0	1	0	0	1	16
% App. Total	25	75	0	0		100	0	0	0		0	40	60	0		0	100	0	0		
PHF	.500	.500	.000	.000	.500	.250	.000	.000	.000	.250	.000	.250	.375	.000	.313	.000	.250	.000	.000	.250	.500

City of Madera
 N/S: Road 23
 E/W: Avenue 17
 Weather: Clear

File Name : 05_MDA_Rd 23_Ave 17 PM
 Site Code : 00319628
 Start Date : 9/18/2019
 Page No : 2

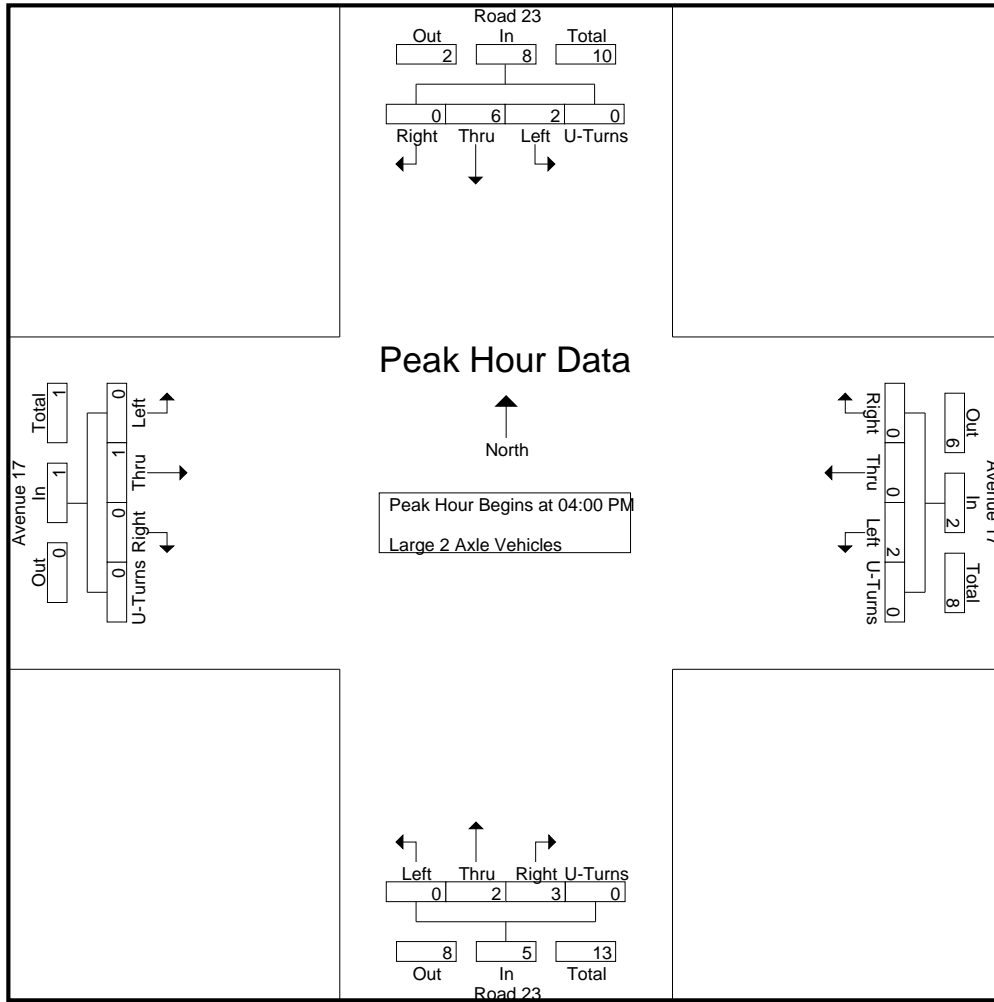

Peak Hour Analysis From 04:00 PM to 04:45 PM - Peak 1 of 1
 Peak Hour for Each Approach Begins at:

	04:00 PM					04:00 PM					04:00 PM									
+0 mins.	1	3	0	0	4	0	0	0	0	0	0	0	1	0	1	0	0	0	0	0
+15 mins.	0	1	0	0	1	0	0	0	0	0	0	0	0	0	0	0	0	0	0	0
+30 mins.	1	0	0	0	1	0	0	0	0	0	0	0	0	0	0	0	1	0	0	1
+45 mins.	0	2	0	0	2	2	0	0	0	2	0	2	2	0	4	0	0	0	0	0
Total Volume	2	6	0	0	8	2	0	0	0	2	0	2	3	0	5	0	1	0	0	1
% App. Total	25	75	0	0		100	0	0	0		0	40	60	0		0	100	0	0	
PHF	.500	.500	.000	.000	.500	.250	.000	.000	.000	.250	.000	.250	.375	.000	.313	.000	.250	.000	.000	.250

City of Madera
 N/S: Road 23
 E/W: Avenue 17
 Weather: Clear

File Name : 05_MDA_Rd 23_Ave 17 PM
 Site Code : 00319628
 Start Date : 9/18/2019
 Page No : 1

Groups Printed- 3 Axle Vehicles

Start Time	Road 23 Southbound					Avenue 17 Westbound					Road 23 Northbound					Avenue 17 Eastbound					Int. Total
	Left	Thru	Right	U-Turns	App. Total	Left	Thru	Right	U-Turns	App. Total	Left	Thru	Right	U-Turns	App. Total	Left	Thru	Right	U-Turns	App. Total	
04:00 PM	0	0	0	0	0	0	0	0	0	0	1	0	0	0	1	0	0	0	0	0	1
04:15 PM	0	0	0	0	0	0	0	0	0	0	0	0	0	0	0	0	0	0	0	0	0
04:30 PM	0	0	0	0	0	0	0	0	0	0	0	0	0	0	0	0	0	0	0	0	0
04:45 PM	0	0	0	0	0	0	0	1	0	1	0	0	1	0	1	0	0	0	0	0	2
Total	0	0	0	0	0	0	0	1	0	1	1	0	1	0	2	0	0	0	0	0	3
05:00 PM	0	0	0	0	0	1	0	0	0	1	0	0	0	0	0	0	0	0	0	0	1
05:15 PM	0	1	0	0	1	0	0	0	0	0	0	0	0	0	0	0	0	0	0	0	1
05:30 PM	0	0	0	0	0	0	0	0	0	0	0	0	0	0	0	0	0	0	0	0	0
05:45 PM	0	0	0	0	0	0	0	0	0	0	0	0	0	0	0	0	0	0	0	0	0
Total	0	1	0	0	1	1	0	0	0	1	0	0	0	0	0	0	0	0	0	0	2
Grand Total	0	1	0	0	1	1	0	1	0	2	1	0	1	0	2	0	0	0	0	0	5
Apprch %	0	100	0	0		50	0	50	0		50	0	50	0		0	0	0	0		
Total %	0	20	0	0	20	20	0	20	0	40	20	0	20	0	40	0	0	0	0	0	

Start Time	Road 23 Southbound					Avenue 17 Westbound					Road 23 Northbound					Avenue 17 Eastbound					Int. Total
	Left	Thru	Right	U-Turns	App. Total	Left	Thru	Right	U-Turns	App. Total	Left	Thru	Right	U-Turns	App. Total	Left	Thru	Right	U-Turns	App. Total	
Peak Hour Analysis From 04:00 PM to 04:45 PM - Peak 1 of 1																					
Peak Hour for Entire Intersection Begins at 04:00 PM																					
04:00 PM	0	0	0	0	0	0	0	0	0	0	1	0	0	0	1	0	0	0	0	0	1
04:15 PM	0	0	0	0	0	0	0	0	0	0	0	0	0	0	0	0	0	0	0	0	0
04:30 PM	0	0	0	0	0	0	0	0	0	0	0	0	0	0	0	0	0	0	0	0	0
04:45 PM	0	0	0	0	0	0	0	1	0	1	0	0	1	0	1	0	0	0	0	0	2
Total Volume	0	0	0	0	0	0	0	1	0	1	1	0	1	0	2	0	0	0	0	0	3
% App. Total	0	0	0	0	0	0	0	100	0		50	0	50	0		0	0	0	0		
PHF	.000	.000	.000	.000	.000	.000	.000	.250	.000	.250	.250	.000	.250	.000	.500	.000	.000	.000	.000	.000	.375

City of Madera
 N/S: Road 23
 E/W: Avenue 17
 Weather: Clear

File Name : 05_MDA_Rd 23_Ave 17 PM
 Site Code : 00319628
 Start Date : 9/18/2019
 Page No : 2

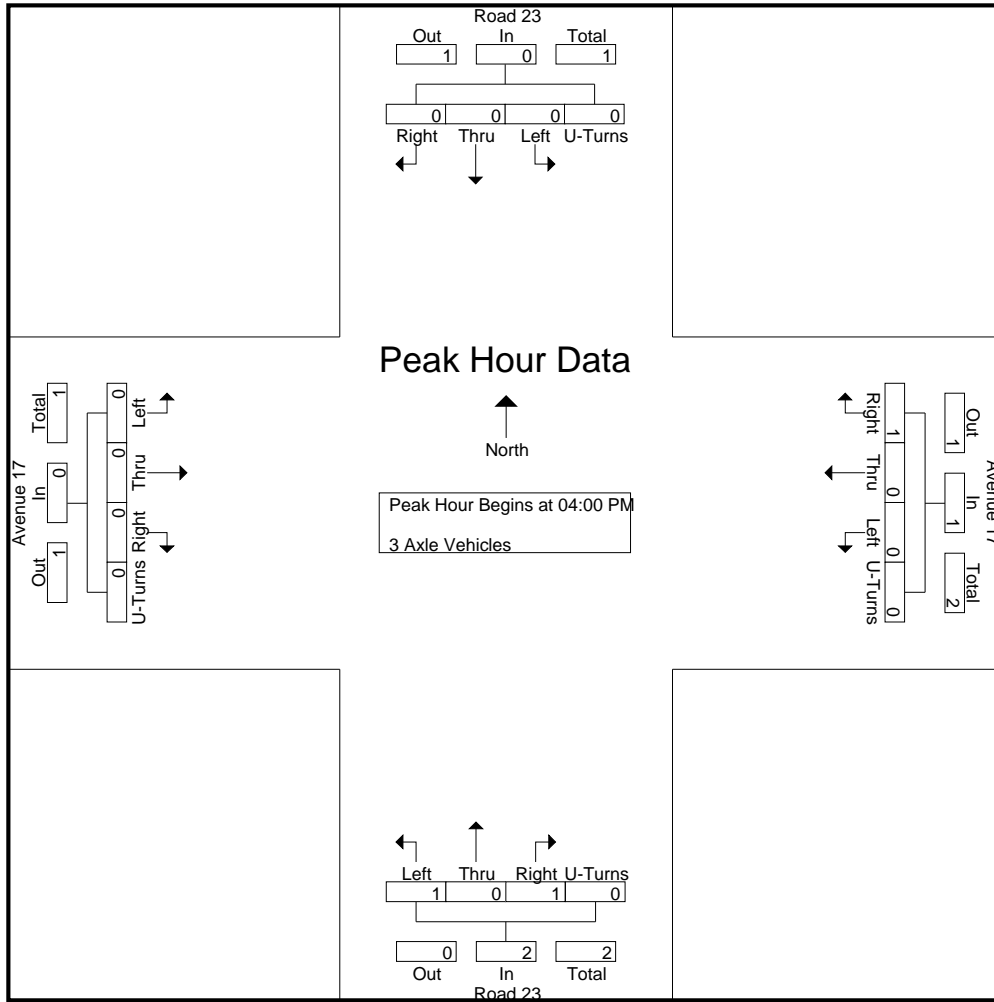

Peak Hour Analysis From 04:00 PM to 04:45 PM - Peak 1 of 1
 Peak Hour for Each Approach Begins at:

	04:00 PM					04:00 PM					04:00 PM					04:00 PM									
+0 mins.	0	0	0	0	0	0	0	0	0	0	1	0	0	0	0	1	0	0	0	0	0	0	0	0	0
+15 mins.	0	0	0	0	0	0	0	0	0	0	0	0	0	0	0	0	0	0	0	0	0	0	0	0	0
+30 mins.	0	0	0	0	0	0	0	0	0	0	0	0	0	0	0	0	0	0	0	0	0	0	0	0	0
+45 mins.	0	0	0	0	0	0	0	1	0	1	0	0	1	0	1	0	0	0	0	0	0	0	0	0	0
Total Volume	0	0	0	0	0	0	0	1	0	1	1	0	1	0	2	0	0	0	0	0	0	0	0	0	0
% App. Total	0	0	0	0	0	0	0	100	0	0	50	0	50	0	0	0	0	0	0	0	0	0	0	0	0
PHF	.000	.000	.000	.000	.000	.000	.000	.250	.000	.250	.250	.000	.250	.000	.500	.000	.000	.000	.000	.000	.000	.000	.000	.000	.000

City of Madera
 N/S: Road 23
 E/W: Avenue 17
 Weather: Clear

File Name : 05_MDA_Rd 23_Ave 17 PM
 Site Code : 00319628
 Start Date : 9/18/2019
 Page No : 1

Groups Printed- 4+ Axle Trucks

Start Time	Road 23 Southbound					Avenue 17 Westbound					Road 23 Northbound					Avenue 17 Eastbound					Int. Total					
	Left	Thru	Right	U-Turns	App. Total	Left	Thru	Right	U-Turns	App. Total	Left	Thru	Right	U-Turns	App. Total	Left	Thru	Right	U-Turns	App. Total						
04:00 PM	0	2	0	0	2	0	0	0	0	0	0	0	0	0	0	0	0	0	0	0	0	0	0	0	0	2
04:15 PM	0	3	0	0	3	0	0	0	0	0	0	2	0	0	2	0	0	0	0	0	0	0	0	0	0	5
04:30 PM	0	7	0	0	7	0	0	0	0	0	0	2	0	0	2	0	0	0	0	0	0	0	0	0	0	9
04:45 PM	0	4	0	0	4	0	0	0	0	0	0	1	0	0	1	0	1	0	0	0	0	1	0	0	1	6
Total	0	16	0	0	16	0	0	0	0	0	0	5	0	0	5	0	1	0	0	0	0	1	0	0	1	22
05:00 PM	0	5	0	0	5	0	0	0	0	0	0	3	1	0	4	0	0	0	0	0	0	0	0	0	0	9
05:15 PM	0	3	0	0	3	0	0	0	0	0	0	2	0	0	2	0	0	0	0	0	0	0	0	0	0	5
05:30 PM	0	1	0	0	1	0	0	0	0	0	0	0	2	0	2	0	0	0	0	0	0	0	0	0	0	3
05:45 PM	0	5	0	0	5	0	0	0	0	0	0	0	0	0	0	0	0	0	0	0	0	0	0	0	0	5
Total	0	14	0	0	14	0	0	0	0	0	0	5	3	0	8	0	0	0	0	0	0	0	0	0	0	22
Grand Total	0	30	0	0	30	0	0	0	0	0	0	10	3	0	13	0	1	0	0	0	0	1	0	0	1	44
Apprch %	0	100	0	0		0	0	0	0		0	76.9	23.1	0		0	100	0	0		0	100	0	0		
Total %	0	68.2	0	0	68.2	0	0	0	0	0	0	22.7	6.8	0	29.5	0	2.3	0	0	2.3	0	2.3	0	0	2.3	

Start Time	Road 23 Southbound					Avenue 17 Westbound					Road 23 Northbound					Avenue 17 Eastbound					Int. Total					
	Left	Thru	Right	U-Turns	App. Total	Thru	Right	U-Turns	App. Total	Thru	Right	U-Turns	App. Total	Thru	Right	U-Turns	App. Total									
Peak Hour Analysis From 04:00 PM to 04:45 PM - Peak 1 of 1																										
Peak Hour for Entire Intersection Begins at 04:00 PM																										
04:00 PM	0	2	0	0	2	0	0	0	0	0	0	0	0	0	0	0	0	0	0	0	0	0	0	0	0	2
04:15 PM	0	3	0	0	3	0	0	0	0	0	0	2	0	0	2	0	0	0	0	0	0	0	0	0	0	5
04:30 PM	0	7	0	0	7	0	0	0	0	0	0	2	0	0	2	0	0	0	0	0	0	0	0	0	0	9
04:45 PM	0	4	0	0	4	0	0	0	0	0	0	1	0	0	1	0	1	0	0	0	0	1	0	0	1	6
Total Volume	0	16	0	0	16	0	0	0	0	0	0	5	0	0	5	0	1	0	0	0	0	1	0	0	1	22
% App. Total	0	100	0	0		0	0	0	0		0	100	0	0		0	100	0	0		0	100	0	0		
PHF	.000	.571	.000	.000	.571	.000	.000	.000	.000	.000	.000	.625	.000	.000	.625	.000	.250	.000	.000	.250	.000	.250	.000	.000	.250	.611

City of Madera
 N/S: Road 23
 E/W: Avenue 17
 Weather: Clear

File Name : 05_MDA_Rd 23_Ave 17 PM
 Site Code : 00319628
 Start Date : 9/18/2019
 Page No : 2

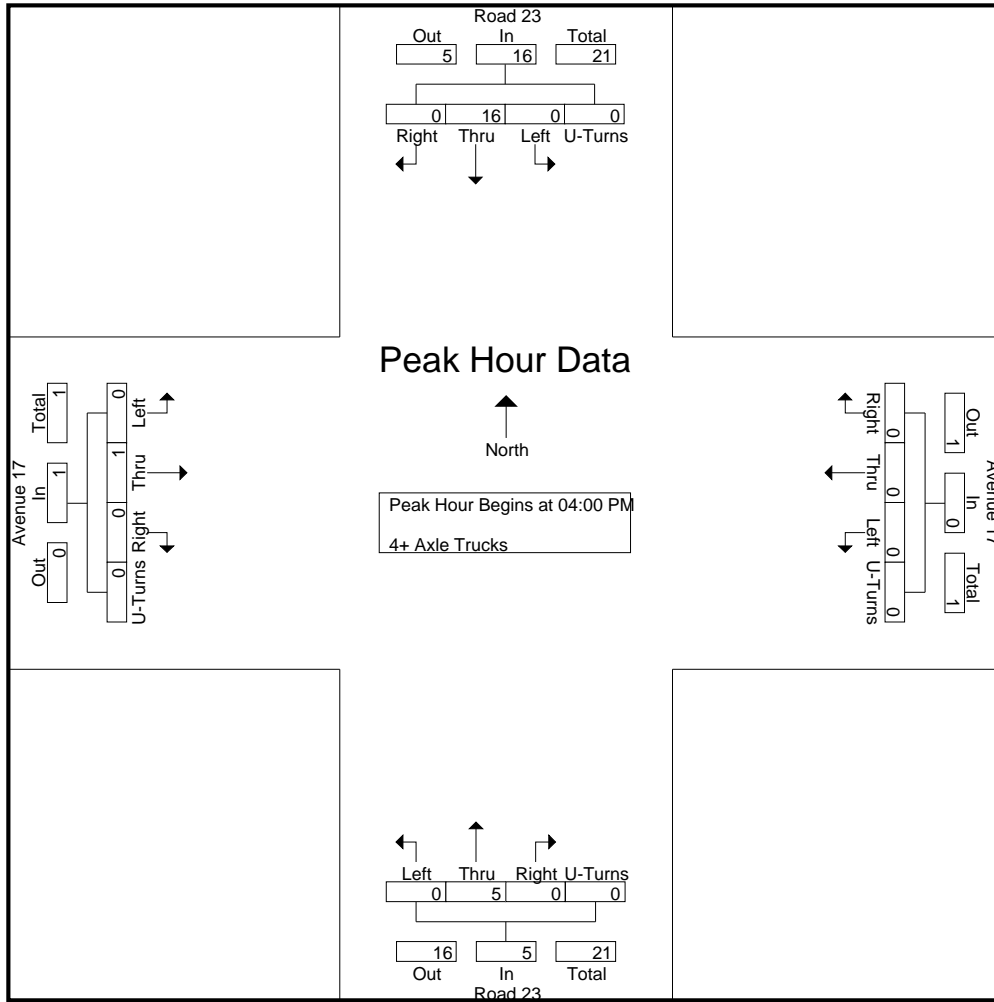

Peak Hour Analysis From 04:00 PM to 04:45 PM - Peak 1 of 1
 Peak Hour for Each Approach Begins at:

	04:00 PM					04:00 PM					04:00 PM									
+0 mins.	0	2	0	0	2	0	0	0	0	0	0	0	0	0	0	0	0	0	0	0
+15 mins.	0	3	0	0	3	0	0	0	0	0	0	2	0	0	2	0	0	0	0	0
+30 mins.	0	7	0	0	7	0	0	0	0	0	0	2	0	0	2	0	0	0	0	0
+45 mins.	0	4	0	0	4	0	0	0	0	0	0	1	0	0	1	0	1	0	0	1
Total Volume	0	16	0	0	16	0	0	0	0	0	0	5	0	0	5	0	1	0	0	1
% App. Total	0	100	0	0	0	0	0	0	0	0	0	100	0	0	0	0	100	0	0	0
PHF	.000	.571	.000	.000	.571	.000	.000	.000	.000	.000	.000	.625	.000	.000	.625	.000	.250	.000	.000	.250

Location: Madera
 N/S: Road 23
 E/W: Avenue 17



Date: 9/18/2019
 Day: Wednesday

PEDESTRIANS

	North Leg Road 23	East Leg Avenue 17	South Leg Road 23	West Leg Avenue 17	
	Pedestrians	Pedestrians	Pedestrians	Pedestrians	
7:00 AM	0	0	0	0	0
7:15 AM	0	0	0	0	0
7:30 AM	0	0	0	0	0
7:45 AM	0	0	0	0	0
8:00 AM	0	0	0	0	0
8:15 AM	0	0	0	0	0
8:30 AM	0	0	0	0	0
8:45 AM	0	0	0	0	0
TOTAL VOLUMES:	0	0	0	0	0

	North Leg Road 23	East Leg Avenue 17	South Leg Road 23	West Leg Avenue 17	
	Pedestrians	Pedestrians	Pedestrians	Pedestrians	
4:00 PM	0	0	0	0	0
4:15 PM	0	0	0	0	0
4:30 PM	0	0	0	0	0
4:45 PM	0	0	0	0	0
5:00 PM	0	0	0	0	0
5:15 PM	0	0	0	0	0
5:30 PM	0	0	0	0	0
5:45 PM	0	0	0	0	0
TOTAL VOLUMES:	0	0	0	0	0

Location: Madera
 N/S: Road 23
 E/W: Avenue 17



Date: 9/18/2019
 Day: Wednesday

BICYCLES

	Southbound Road 23			Westbound Avenue 17			Northbound Road 23			Eastbound Avenue 17			
	Left	Thru	Right	Left	Thru	Right	Left	Thru	Right	Left	Thru	Right	
7:00 AM	0	0	0	0	0	0	0	0	0	0	0	0	0
7:15 AM	0	0	0	0	0	0	0	0	0	0	0	0	0
7:30 AM	0	0	0	0	0	0	0	0	0	0	0	0	0
7:45 AM	0	0	0	0	0	0	0	0	0	0	0	0	0
8:00 AM	0	0	0	0	0	0	0	0	0	0	0	0	0
8:15 AM	0	0	0	0	0	0	0	0	0	0	0	0	0
8:30 AM	0	0	0	0	0	0	0	0	0	0	0	0	0
8:45 AM	0	0	0	0	0	0	0	0	0	0	0	0	0
TOTAL VOLUMES:	0	0	0	0	0	0	0	0	0	0	0	0	0

	Southbound Road 23			Westbound Avenue 17			Northbound Road 23			Eastbound Avenue 17			
	Left	Thru	Right	Left	Thru	Right	Left	Thru	Right	Left	Thru	Right	
4:00 PM	0	0	0	0	0	0	0	0	0	0	0	0	0
4:15 PM	0	0	0	0	0	0	0	0	0	0	0	0	0
4:30 PM	0	0	0	0	0	0	0	0	0	0	0	0	0
4:45 PM	0	0	0	0	0	0	0	0	0	0	0	0	0
5:00 PM	0	0	0	0	0	0	0	0	0	0	0	0	0
5:15 PM	0	0	0	0	0	0	0	0	0	0	0	0	0
5:30 PM	0	0	0	0	0	0	0	0	0	0	0	0	0
5:45 PM	0	0	0	0	0	0	0	0	0	0	0	0	0
TOTAL VOLUMES:	0	0	0	0	0	0	0	0	0	0	0	0	0

Counts Unlimited
 PO Box 1178
 Corona, CA 92878
 (951) 268-6268

City of Madera
 N/S: Road 23
 E/W: Avenue 16
 Weather: Clear

File Name : 06_MDA_Rd 23_Ave 16 AM
 Site Code : 00319628
 Start Date : 9/18/2019
 Page No : 1

Groups Printed- Passenger Vehicles - Large 2 Axle Vehicles - 3 Axle Vehicles - 4+ Axle Trucks

Start Time	Road 23 Southbound					Avenue 16 Westbound					Road 23 Northbound					Avenue 16 Eastbound					Int. Total
	Left	Thru	Right	U-Turns	App. Total	Left	Thru	Right	U-Turns	App. Total	Left	Thru	Right	U-Turns	App. Total	Left	Thru	Right	U-Turns	App. Total	
07:00 AM	0	27	1	0	28	0	0	0	0	0	5	16	0	0	21	1	0	0	0	1	50
07:15 AM	0	29	2	0	31	0	0	0	0	0	4	47	0	0	51	0	0	2	0	2	84
07:30 AM	0	43	3	0	46	0	0	0	0	0	7	68	0	0	75	1	0	1	0	2	123
07:45 AM	0	45	3	0	48	0	3	0	0	3	3	60	0	0	63	1	1	1	0	3	117
Total	0	144	9	0	153	0	3	0	0	3	19	191	0	0	210	3	1	4	0	8	374
08:00 AM	0	35	1	0	36	0	1	0	0	1	5	35	0	0	40	3	0	2	0	5	82
08:15 AM	0	28	2	0	30	0	0	0	0	0	2	40	0	0	42	0	1	1	0	2	74
08:30 AM	0	21	1	0	22	0	2	0	0	2	3	29	0	0	32	1	0	3	0	4	60
08:45 AM	0	26	0	0	26	0	0	0	0	0	4	24	0	0	28	0	1	3	0	4	58
Total	0	110	4	0	114	0	3	0	0	3	14	128	0	0	142	4	2	9	0	15	274
Grand Total	0	254	13	0	267	0	6	0	0	6	33	319	0	0	352	7	3	13	0	23	648
Apprch %	0	95.1	4.9	0		0	100	0	0		9.4	90.6	0	0		30.4	13	56.5	0		
Total %	0	39.2	2	0	41.2	0	0.9	0	0	0.9	5.1	49.2	0	0	54.3	1.1	0.5	2	0	3.5	
Passenger Vehicles	0	77.2	84.6	0	77.5	0	83.3	0	0	83.3	87.9	83.1	0	0	83.5	42.9	100	84.6	0	73.9	80.7
% Passenger Vehicles	0	8	0	0	8	0	1	0	0	1	2	7	0	0	9	4	0	2	0	6	24
Large 2 Axle Vehicles	0	3.1	0	0	3	0	16.7	0	0	16.7	6.1	2.2	0	0	2.6	57.1	0	15.4	0	26.1	3.7
% Large 2 Axle Vehicles	0	7	0	0	7	0	0	0	0	0	1	3	0	0	4	0	0	0	0	0	11
3 Axle Vehicles	0	2.8	0	0	2.6	0	0	0	0	0	3	0.9	0	0	1.1	0	0	0	0	0	1.7
% 3 Axle Vehicles	0	43	2	0	45	0	0	0	0	0	1	44	0	0	45	0	0	0	0	0	90
4+ Axle Trucks	0	16.9	15.4	0	16.9	0	0	0	0	0	3	13.8	0	0	12.8	0	0	0	0	0	13.9
% 4+ Axle Trucks																					

Start Time	Road 23 Southbound					Avenue 16 Westbound					Road 23 Northbound					Avenue 16 Eastbound					Int. Total
	Left	Thru	Right	U-Turns	App. Total	Left	Thru	Right	U-Turns	App. Total	Left	Thru	Right	U-Turns	App. Total	Left	Thru	Right	U-Turns	App. Total	
Peak Hour Analysis From 07:00 AM to 08:45 AM - Peak 1 of 1																					
Peak Hour for Entire Intersection Begins at 07:15 AM																					
07:15 AM	0	29	2	0	31	0	0	0	0	0	4	47	0	0	51	0	0	2	0	2	123
07:30 AM	0	43	3	0	46	0	0	0	0	0	7	68	0	0	75	1	0	1	0	3	117
07:45 AM	0	45	3	0	48	0	3	0	0	3	3	60	0	0	63	1	1	1	0	3	117
08:00 AM	0	35	1	0	36	0	1	0	0	1	5	35	0	0	40	3	0	2	0	5	82
Total Volume	0	152	9	0	161	0	4	0	0	4	19	210	0	0	229	5	1	6	0	12	406
% App. Total	0	94.4	5.6	0		0	100	0	0		8.3	91.7	0	0		41.7	8.3	50	0		
PHF	.000	.844	.750	.000	.839	.000	.333	.000	.000	.333	.679	.772	.000	.000	.763	.417	.250	.750	.000	.600	.825

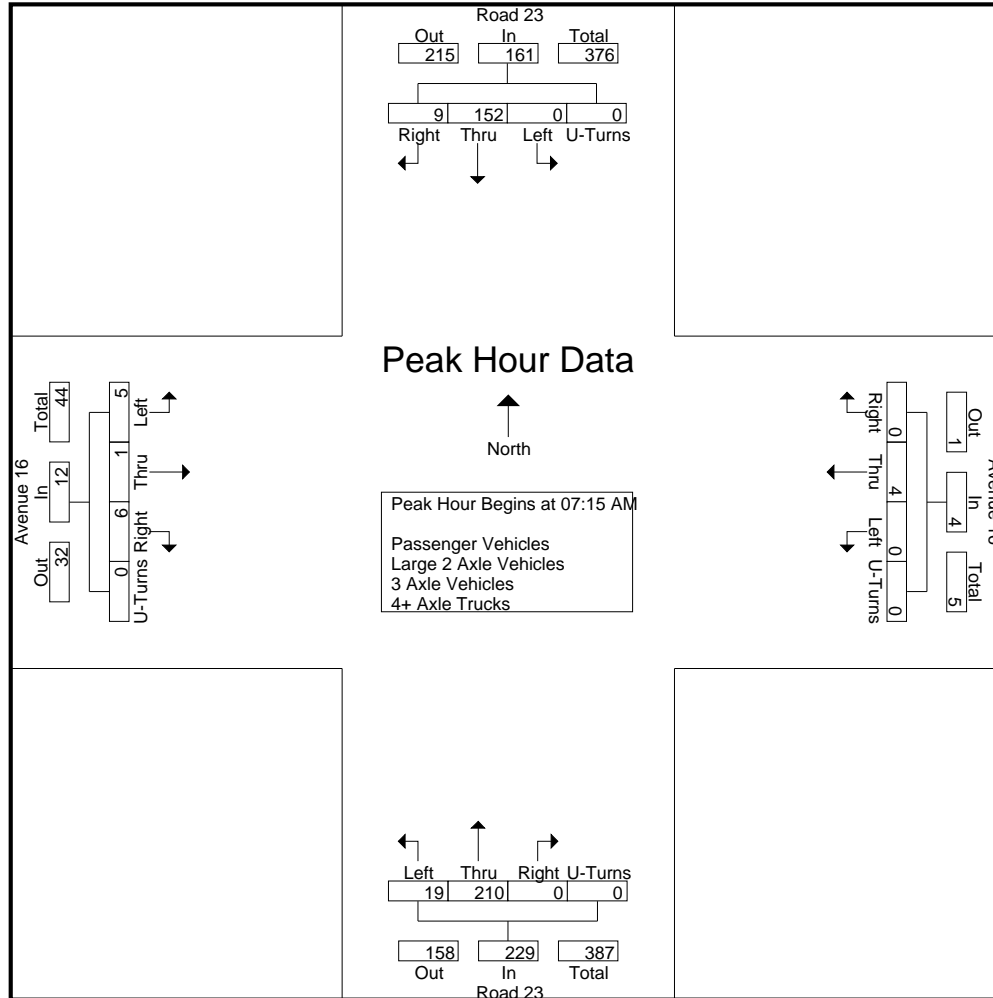

Counts Unlimited
 PO Box 1178
 Corona, CA 92878
 (951) 268-6268

City of Madera
 N/S: Road 23
 E/W: Avenue 16
 Weather: Clear

File Name : 06_MDA_Rd 23_Ave 16 AM
 Site Code : 00319628
 Start Date : 9/18/2019
 Page No : 3

Start Time	Road 23 Southbound					Avenue 16 Westbound					Road 23 Northbound					Avenue 16 Eastbound					Int. Total
	Left	Thru	Right	U-Turns	App. Total	Left	Thru	Right	U-Turns	App. Total	Left	Thru	Right	U-Turns	App. Total	Left	Thru	Right	U-Turns	App. Total	
Peak Hour Analysis From 07:00 AM to 08:45 AM - Peak 1 of 1																					
Peak Hour for Each Approach Begins at:																					
	07:15 AM					07:45 AM					07:15 AM					08:00 AM					
+0 mins.	0	29	2	0	31	0	3	0	0	3	4	47	0	0	51	3	0	2	0	5	
+15 mins.	0	43	3	0	46	0	1	0	0	1	7	68	0	0	75	0	1	1	0	2	
+30 mins.	0	45	3	0	48	0	0	0	0	0	3	60	0	0	63	1	0	3	0	4	
+45 mins.	0	35	1	0	36	0	2	0	0	2	5	35	0	0	40	0	1	3	0	4	
Total Volume	0	152	9	0	161	0	6	0	0	6	19	210	0	0	229	4	2	9	0	15	
% App. Total	0	94.4	5.6	0		0	100	0	0		8.3	91.7	0	0		26.7	13.3	60	0		
PHF	.000	.844	.750	.000	.839	.000	.500	.000	.000	.500	.679	.772	.000	.000	.763	.333	.500	.750	.000	.750	

Counts Unlimited
 PO Box 1178
 Corona, CA 92878
 (951) 268-6268

City of Madera
 N/S: Road 23
 E/W: Avenue 16
 Weather: Clear

File Name : 06_MDA_Rd 23_Ave 16 AM
 Site Code : 00319628
 Start Date : 9/18/2019
 Page No : 1

Groups Printed- Passenger Vehicles

Start Time	Road 23 Southbound					Avenue 16 Westbound					Road 23 Northbound					Avenue 16 Eastbound					Int. Total
	Left	Thru	Right	U-Turns	App. Total	Left	Thru	Right	U-Turns	App. Total	Left	Thru	Right	U-Turns	App. Total	Left	Thru	Right	U-Turns	App. Total	
07:00 AM	0	20	1	0	21	0	0	0	0	0	4	14	0	0	18	0	0	0	0	0	39
07:15 AM	0	22	2	0	24	0	0	0	0	0	4	40	0	0	44	0	0	2	0	2	70
07:30 AM	0	34	2	0	36	0	0	0	0	0	7	60	0	0	67	1	0	1	0	2	105
07:45 AM	0	40	3	0	43	0	2	0	0	2	3	50	0	0	53	0	1	1	0	2	100
Total	0	116	8	0	124	0	2	0	0	2	18	164	0	0	182	1	1	4	0	6	314
08:00 AM	0	28	1	0	29	0	1	0	0	1	5	28	0	0	33	1	0	2	0	3	66
08:15 AM	0	20	2	0	22	0	0	0	0	0	1	36	0	0	37	0	1	1	0	2	61
08:30 AM	0	14	0	0	14	0	2	0	0	2	3	20	0	0	23	1	0	2	0	3	42
08:45 AM	0	18	0	0	18	0	0	0	0	0	2	17	0	0	19	0	1	2	0	3	40
Total	0	80	3	0	83	0	3	0	0	3	11	101	0	0	112	2	2	7	0	11	209
Grand Total	0	196	11	0	207	0	5	0	0	5	29	265	0	0	294	3	3	11	0	17	523
Apprch %	0	94.7	5.3	0		0	100	0	0		9.9	90.1	0	0		17.6	17.6	64.7	0		
Total %	0	37.5	2.1	0	39.6	0	1	0	0	1	5.5	50.7	0	0	56.2	0.6	0.6	2.1	0	3.3	

Start Time	Road 23 Southbound					Avenue 16 Westbound					Road 23 Northbound					Avenue 16 Eastbound					Int. Total
	Left	Thru	Right	U-Turns	App. Total	Left	Thru	Right	U-Turns	App. Total	Left	Thru	Right	U-Turns	App. Total	Left	Thru	Right	U-Turns	App. Total	
Peak Hour Analysis From 07:15 AM to 08:00 AM - Peak 1 of 1																					
Peak Hour for Entire Intersection Begins at 07:15 AM																					
07:15 AM	0	22	2	0	24	0	0	0	0	0	4	40	0	0	44	0	0	2	0	2	70
07:30 AM	0	34	2	0	36	0	0	0	0	0	7	60	0	0	67	1	0	1	0	2	105
07:45 AM	0	40	3	0	43	0	2	0	0	2	3	50	0	0	53	0	1	1	0	2	100
08:00 AM	0	28	1	0	29	0	1	0	0	1	5	28	0	0	33	1	0	2	0	3	66
Total Volume	0	124	8	0	132	0	3	0	0	3	19	178	0	0	197	2	1	6	0	9	341
% App. Total	0	93.9	6.1	0		0	100	0	0		9.6	90.4	0	0		22.2	11.1	66.7	0		
PHF	.000	.775	.667	.000	.767	.000	.375	.000	.000	.375	.679	.742	.000	.000	.735	.500	.250	.750	.000	.750	.812

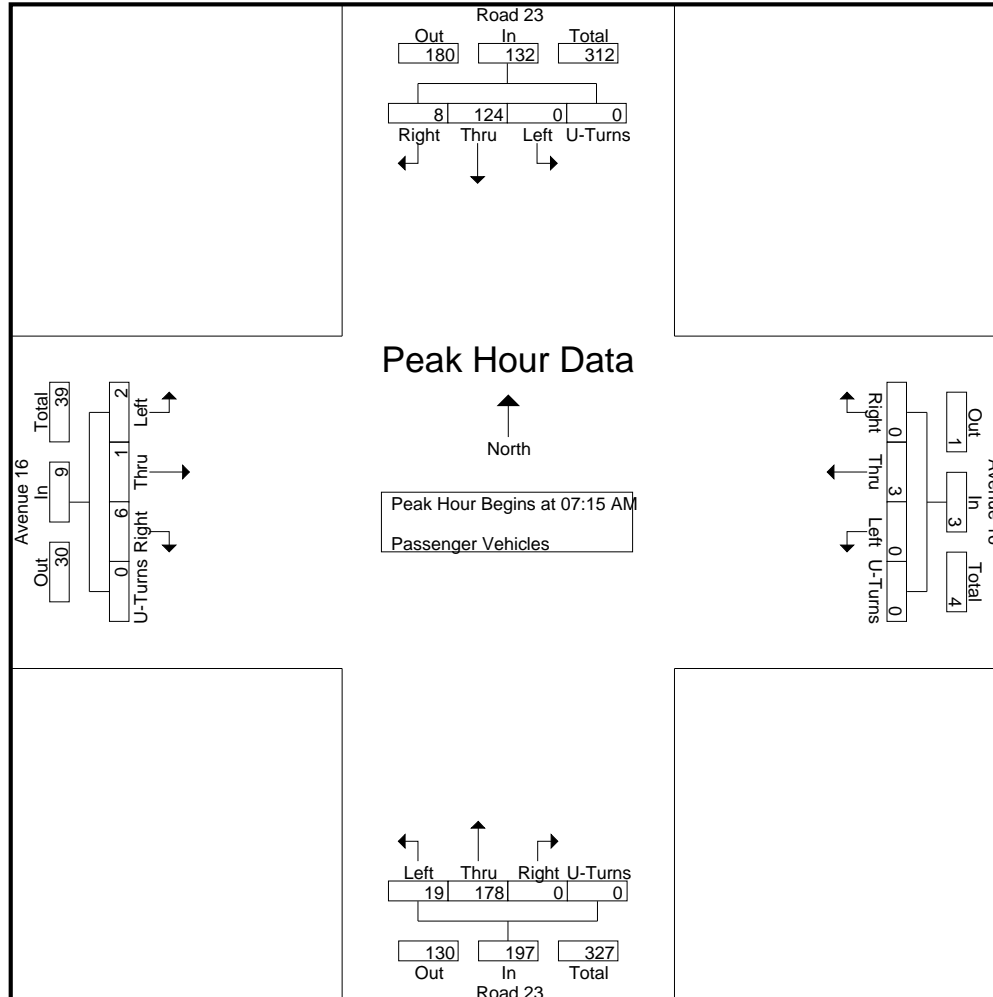

Counts Unlimited
 PO Box 1178
 Corona, CA 92878
 (951) 268-6268

City of Madera
 N/S: Road 23
 E/W: Avenue 16
 Weather: Clear

File Name : 06_MDA_Rd 23_Ave 16 AM
 Site Code : 00319628
 Start Date : 9/18/2019
 Page No : 3

Start Time	Road 23 Southbound					Avenue 16 Westbound					Road 23 Northbound					Avenue 16 Eastbound					Int. Total
	Left	Thru	Right	U-Turns	App. Total	Left	Thru	Right	U-Turns	App. Total	Left	Thru	Right	U-Turns	App. Total	Left	Thru	Right	U-Turns	App. Total	

Peak Hour Analysis From 07:15 AM to 08:00 AM - Peak 1 of 1

Peak Hour for Each Approach Begins at:

	07:15 AM					07:15 AM					07:15 AM					07:15 AM				
+0 mins.	0	22	2	0	24	0	0	0	0	0	4	40	0	0	44	0	0	2	0	2
+15 mins.	0	34	2	0	36	0	0	0	0	0	7	60	0	0	67	1	0	1	0	2
+30 mins.	0	40	3	0	43	0	2	0	0	2	3	50	0	0	53	0	1	1	0	2
+45 mins.	0	28	1	0	29	0	1	0	0	1	5	28	0	0	33	1	0	2	0	3
Total Volume	0	124	8	0	132	0	3	0	0	3	19	178	0	0	197	2	1	6	0	9
% App. Total	0	93.9	6.1	0		0	100	0	0		9.6	90.4	0	0		22.2	11.1	66.7	0	
PHF	.000	.775	.667	.000	.767	.000	.375	.000	.000	.375	.679	.742	.000	.000	.735	.500	.250	.750	.000	.750

City of Madera
 N/S: Road 23
 E/W: Avenue 16
 Weather: Clear

File Name : 06_MDA_Rd 23_Ave 16 AM
 Site Code : 00319628
 Start Date : 9/18/2019
 Page No : 1

Groups Printed- Large 2 Axle Vehicles

Start Time	Road 23 Southbound					Avenue 16 Westbound					Road 23 Northbound					Avenue 16 Eastbound					Int. Total
	Left	Thru	Right	U-Turns	App. Total	Left	Thru	Right	U-Turns	App. Total	Left	Thru	Right	U-Turns	App. Total	Left	Thru	Right	U-Turns	App. Total	
07:00 AM	0	0	0	0	0	0	0	0	0	0	0	0	0	0	0	1	0	0	0	1	1
07:15 AM	0	1	0	0	1	0	0	0	0	0	0	0	0	0	0	0	0	0	0	0	0
07:30 AM	0	1	0	0	1	0	0	0	0	0	0	2	0	0	2	0	0	0	0	0	3
07:45 AM	0	0	0	0	0	0	1	0	0	1	0	0	0	0	0	1	0	0	0	1	2
Total	0	2	0	0	2	0	1	0	0	1	0	2	0	0	2	2	0	0	0	2	7
08:00 AM	0	2	0	0	2	0	0	0	0	0	0	0	0	0	0	2	0	0	0	2	4
08:15 AM	0	3	0	0	3	0	0	0	0	0	1	1	0	0	2	0	0	0	0	0	5
08:30 AM	0	0	0	0	0	0	0	0	0	0	0	4	0	0	4	0	0	1	0	1	5
08:45 AM	0	1	0	0	1	0	0	0	0	0	1	0	0	0	1	0	0	1	0	1	3
Total	0	6	0	0	6	0	0	0	0	0	2	5	0	0	7	2	0	2	0	4	17
Grand Total	0	8	0	0	8	0	1	0	0	1	2	7	0	0	9	4	0	2	0	6	24
Apprch %	0	100	0	0		0	100	0	0		22.2	77.8	0	0		66.7	0	33.3	0		
Total %	0	33.3	0	0	33.3	0	4.2	0	0	4.2	8.3	29.2	0	0	37.5	16.7	0	8.3	0	25	

Start Time	Road 23 Southbound					Avenue 16 Westbound					Road 23 Northbound					Avenue 16 Eastbound					Int. Total
	Left	Thru	Right	U-Turns	App. Total	Left	Thru	Right	U-Turns	App. Total	Left	Thru	Right	U-Turns	App. Total	Left	Thru	Right	U-Turns	App. Total	
07:15 AM	0	1	0	0	1	0	0	0	0	0	0	0	0	0	0	0	0	0	0	0	1
07:30 AM	0	1	0	0	1	0	0	0	0	0	0	2	0	0	2	0	0	0	0	0	3
07:45 AM	0	0	0	0	0	0	1	0	0	1	0	0	0	0	0	1	0	0	0	1	2
08:00 AM	0	2	0	0	2	0	0	0	0	0	0	0	0	0	0	2	0	0	0	2	4
Total Volume	0	4	0	0	4	0	1	0	0	1	0	2	0	0	2	3	0	0	0	3	10
% App. Total	0	100	0	0		0	100	0	0		0	100	0	0		100	0	0	0		
PHF	.000	.500	.000	.000	.500	.000	.250	.000	.000	.250	.000	.250	.000	.000	.250	.375	.000	.000	.000	.375	.625

Peak Hour Analysis From 07:15 AM to 08:00 AM - Peak 1 of 1
 Peak Hour for Entire Intersection Begins at 07:15 AM

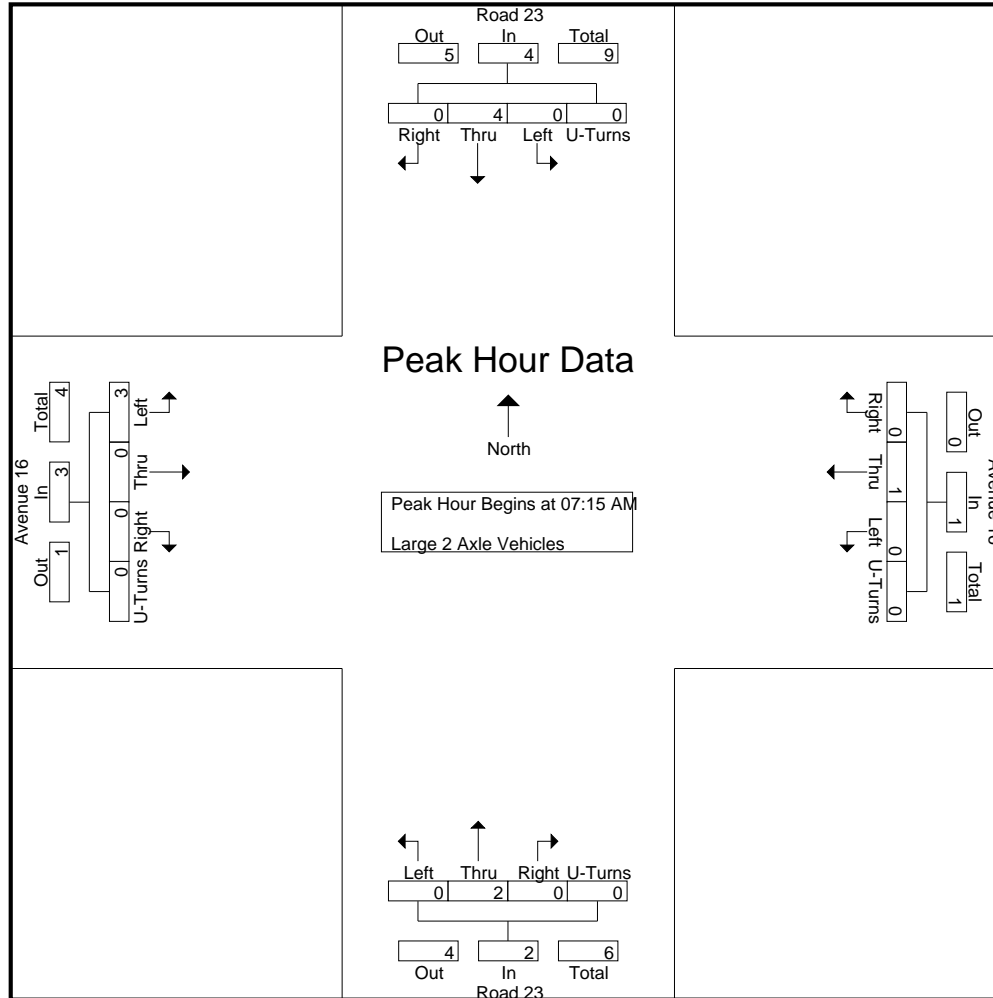

Counts Unlimited
 PO Box 1178
 Corona, CA 92878
 (951) 268-6268

City of Madera
 N/S: Road 23
 E/W: Avenue 16
 Weather: Clear

File Name : 06_MDA_Rd 23_Ave 16 AM
 Site Code : 00319628
 Start Date : 9/18/2019
 Page No : 3

Start Time	Road 23 Southbound					Avenue 16 Westbound					Road 23 Northbound					Avenue 16 Eastbound					Int. Total
	Left	Thru	Right	U-Turns	App. Total	Left	Thru	Right	U-Turns	App. Total	Left	Thru	Right	U-Turns	App. Total	Left	Thru	Right	U-Turns	App. Total	

Peak Hour Analysis From 07:15 AM to 08:00 AM - Peak 1 of 1

Peak Hour for Each Approach Begins at:

	07:15 AM					07:15 AM					07:15 AM					07:15 AM					
+0 mins.	0	1	0	0	1	0	0	0	0	0	0	0	0	0	0	0	0	0	0	0	0
+15 mins.	0	1	0	0	1	0	0	0	0	0	0	0	0	0	0	0	0	0	0	0	0
+30 mins.	0	0	0	0	0	0	1	0	0	1	0	0	0	0	0	1	0	0	0	0	1
+45 mins.	0	2	0	0	2	0	0	0	0	0	0	0	0	0	0	2	0	0	0	0	2
Total Volume	0	4	0	0	4	0	1	0	0	1	0	2	0	0	2	3	0	0	0	0	3
% App. Total	0	100	0	0		0	100	0	0		0	100	0	0		100	0	0	0		
PHF	.000	.500	.000	.000	.500	.000	.250	.000	.000	.250	.000	.250	.000	.000	.250	.375	.000	.000	.000		.375

Counts Unlimited
 PO Box 1178
 Corona, CA 92878
 (951) 268-6268

City of Madera
 N/S: Road 23
 E/W: Avenue 16
 Weather: Clear

File Name : 06_MDA_Rd 23_Ave 16 AM
 Site Code : 00319628
 Start Date : 9/18/2019
 Page No : 1

Groups Printed- 3 Axle Vehicles

Start Time	Road 23 Southbound					Avenue 16 Westbound					Road 23 Northbound					Avenue 16 Eastbound					Int. Total					
	Left	Thru	Right	U-Turns	App. Total	Left	Thru	Right	U-Turns	App. Total	Left	Thru	Right	U-Turns	App. Total	Left	Thru	Right	U-Turns	App. Total						
07:00 AM	0	1	0	0	1	0	0	0	0	0	1	0	0	0	1	0	0	0	0	0	0	0	0	0	0	2
07:15 AM	0	2	0	0	2	0	0	0	0	0	0	0	0	0	0	0	0	0	0	0	0	0	0	0	0	2
07:30 AM	0	0	0	0	0	0	0	0	0	0	0	1	0	0	1	0	0	0	0	0	0	0	0	0	0	1
07:45 AM	0	0	0	0	0	0	0	0	0	0	0	0	0	0	0	0	0	0	0	0	0	0	0	0	0	0
Total	0	3	0	0	3	0	0	0	0	0	1	1	0	0	2	0	0	0	0	0	0	0	0	0	0	5
08:00 AM	0	2	0	0	2	0	0	0	0	0	0	0	0	0	0	0	0	0	0	0	0	0	0	0	0	2
08:15 AM	0	0	0	0	0	0	0	0	0	0	0	1	0	0	1	0	0	0	0	0	0	0	0	0	0	1
08:30 AM	0	1	0	0	1	0	0	0	0	0	0	0	0	0	0	0	0	0	0	0	0	0	0	0	0	1
08:45 AM	0	1	0	0	1	0	0	0	0	0	0	1	0	0	1	0	0	0	0	0	0	0	0	0	0	2
Total	0	4	0	0	4	0	0	0	0	0	0	2	0	0	2	0	0	0	0	0	0	0	0	0	0	6
Grand Total	0	7	0	0	7	0	0	0	0	0	1	3	0	0	4	0	0	0	0	0	0	0	0	0	0	11
Apprch %	0	100	0	0		0	0	0	0		25	75	0	0		0	0	0	0		0	0	0	0		
Total %	0	63.6	0	0	63.6	0	0	0	0		9.1	27.3	0	0	36.4	0	0	0	0		0	0	0	0		

Start Time	Road 23 Southbound					Avenue 16 Westbound					Road 23 Northbound					Avenue 16 Eastbound					Int. Total					
	Left	Thru	Right	U-Turns	App. Total	Left	Thru	Right	U-Turns	App. Total	Left	Thru	Right	U-Turns	App. Total	Left	Thru	Right	U-Turns	App. Total						
Peak Hour Analysis From 07:15 AM to 08:00 AM - Peak 1 of 1																										
Peak Hour for Entire Intersection Begins at 07:15 AM																										
07:15 AM	0	2	0	0	2	0	0	0	0	0	0	0	0	0	0	0	0	0	0	0	0	0	0	0	0	2
07:30 AM	0	0	0	0	0	0	0	0	0	0	0	1	0	0	1	0	0	0	0	0	0	0	0	0	0	1
07:45 AM	0	0	0	0	0	0	0	0	0	0	0	0	0	0	0	0	0	0	0	0	0	0	0	0	0	0
08:00 AM	0	2	0	0	2	0	0	0	0	0	0	0	0	0	0	0	0	0	0	0	0	0	0	0	0	2
Total Volume	0	4	0	0	4	0	0	0	0	0	0	1	0	0	1	0	0	0	0	0	0	0	0	0	0	5
% App. Total	0	100	0	0		0	0	0	0		0	100	0	0		0	0	0	0		0	0	0	0		
PHF	.000	.500	.000	.000	.500	.000	.000	.000	.000	.000	.000	.250	.000	.000	.250	.000	.000	.000	.000	.000	.000	.000	.000	.000	.625	

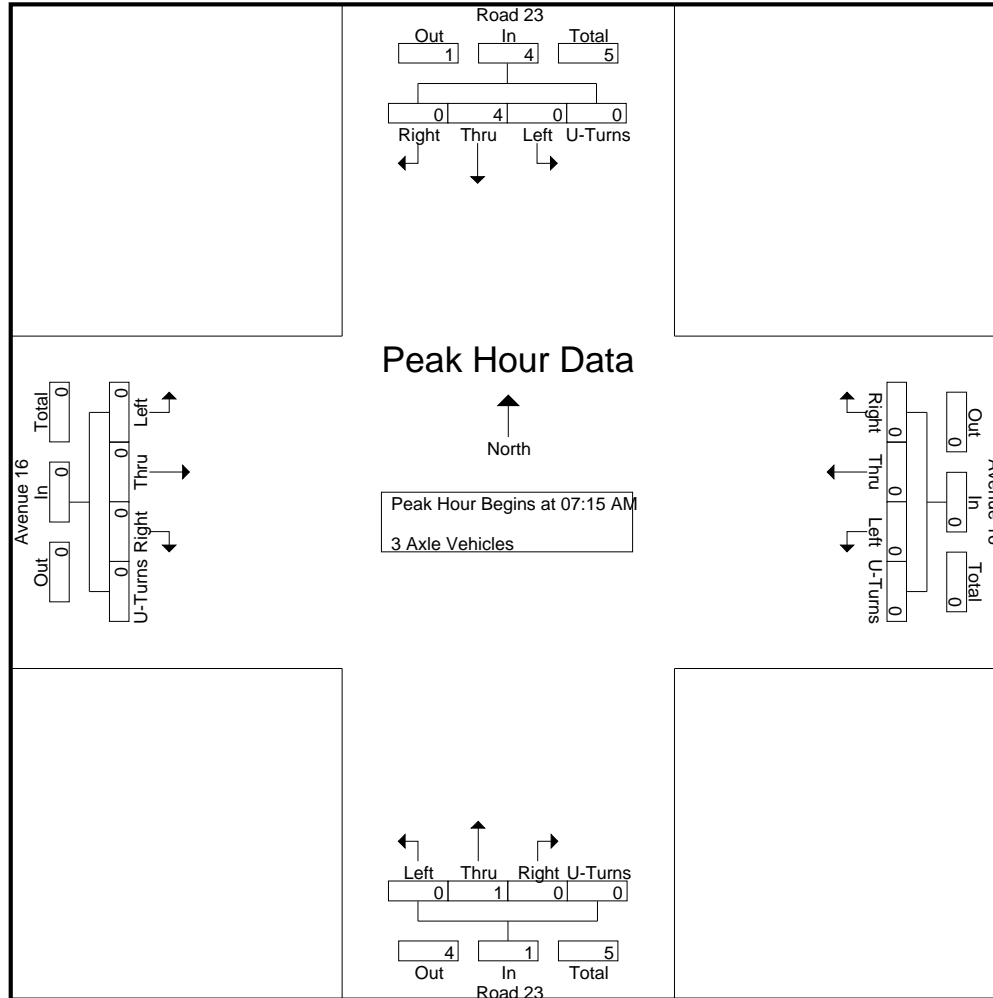

Counts Unlimited
 PO Box 1178
 Corona, CA 92878
 (951) 268-6268

City of Madera
 N/S: Road 23
 E/W: Avenue 16
 Weather: Clear

File Name : 06_MDA_Rd 23_Ave 16 AM
 Site Code : 00319628
 Start Date : 9/18/2019
 Page No : 1

Groups Printed- 4+ Axle Trucks

Start Time	Road 23 Southbound					Avenue 16 Westbound					Road 23 Northbound					Avenue 16 Eastbound					Int. Total
	Left	Thru	Right	U-Turns	App. Total	Left	Thru	Right	U-Turns	App. Total	Left	Thru	Right	U-Turns	App. Total	Left	Thru	Right	U-Turns	App. Total	
07:00 AM	0	6	0	0	6	0	0	0	0	0	0	2	0	0	2	0	0	0	0	0	8
07:15 AM	0	4	0	0	4	0	0	0	0	0	0	7	0	0	7	0	0	0	0	0	11
07:30 AM	0	8	1	0	9	0	0	0	0	0	0	5	0	0	5	0	0	0	0	0	14
07:45 AM	0	5	0	0	5	0	0	0	0	0	0	10	0	0	10	0	0	0	0	0	15
Total	0	23	1	0	24	0	0	0	0	0	0	24	0	0	24	0	0	0	0	0	48
08:00 AM	0	3	0	0	3	0	0	0	0	0	0	7	0	0	7	0	0	0	0	0	10
08:15 AM	0	5	0	0	5	0	0	0	0	0	0	2	0	0	2	0	0	0	0	0	7
08:30 AM	0	6	1	0	7	0	0	0	0	0	0	5	0	0	5	0	0	0	0	0	12
08:45 AM	0	6	0	0	6	0	0	0	0	0	1	6	0	0	7	0	0	0	0	0	13
Total	0	20	1	0	21	0	0	0	0	0	1	20	0	0	21	0	0	0	0	0	42
Grand Total	0	43	2	0	45	0	0	0	0	0	1	44	0	0	45	0	0	0	0	0	90
Apprch %	0	95.6	4.4	0		0	0	0	0		2.2	97.8	0	0		0	0	0	0		
Total %	0	47.8	2.2	0	50	0	0	0	0	0	1.1	48.9	0	0	50	0	0	0	0	0	

Start Time	Road 23 Southbound					Avenue 16 Westbound					Road 23 Northbound					Avenue 16 Eastbound					Int. Total
	Left	Thru	Right	U-Turns	App. Total	Left	Thru	Right	U-Turns	App. Total	Left	Thru	Right	U-Turns	App. Total	Left	Thru	Right	U-Turns	App. Total	
07:15 AM	0	4	0	0	4	0	0	0	0	0	0	7	0	0	7	0	0	0	0	0	11
07:30 AM	0	8	1	0	9	0	0	0	0	0	0	5	0	0	5	0	0	0	0	0	14
07:45 AM	0	5	0	0	5	0	0	0	0	0	0	10	0	0	10	0	0	0	0	0	15
08:00 AM	0	3	0	0	3	0	0	0	0	0	0	7	0	0	7	0	0	0	0	0	10
Total Volume	0	20	1	0	21	0	0	0	0	0	0	29	0	0	29	0	0	0	0	0	50
% App. Total	0	95.2	4.8	0		0	0	0	0		0	100	0	0		0	0	0	0		
PHF	.000	.625	.250	.000	.583	.000	.000	.000	.000	.000	.000	.725	.000	.000	.725	.000	.000	.000	.000	.000	.833

Peak Hour Analysis From 07:15 AM to 08:00 AM - Peak 1 of 1
 Peak Hour for Entire Intersection Begins at 07:15 AM

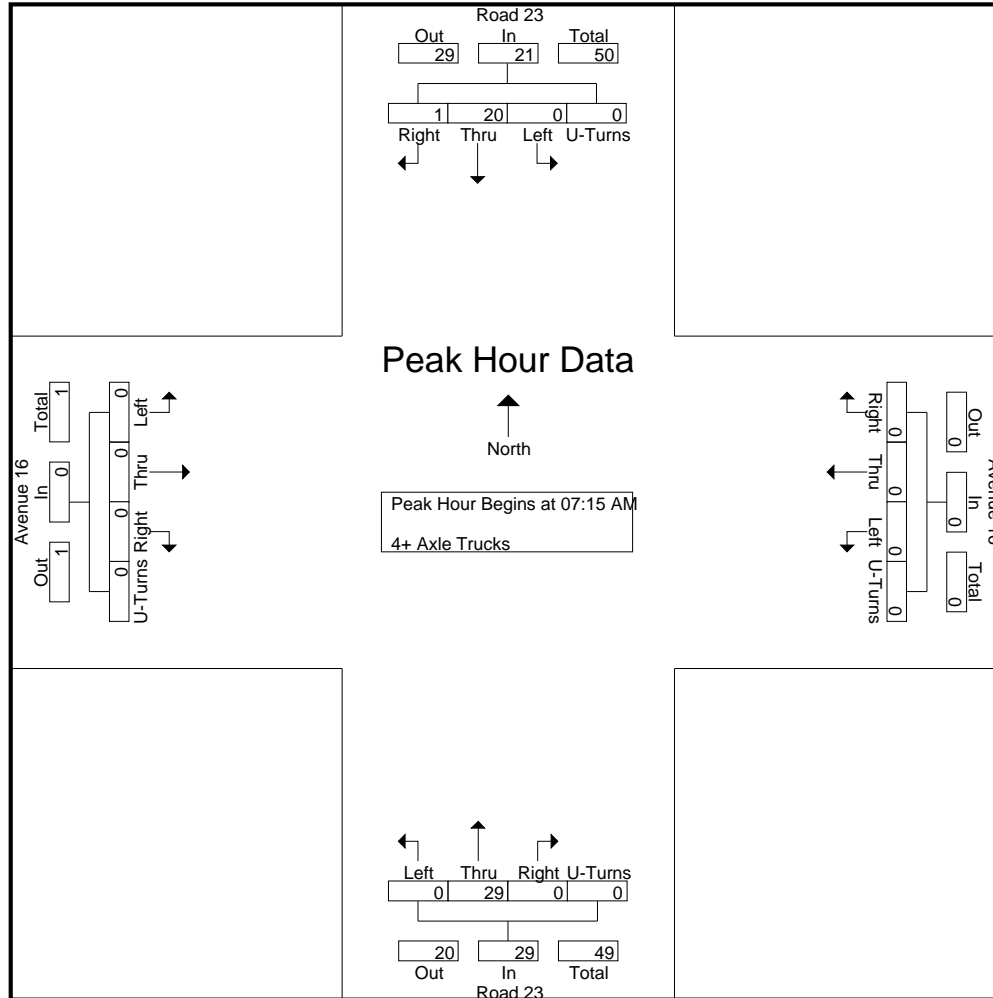

Counts Unlimited
 PO Box 1178
 Corona, CA 92878
 (951) 268-6268

City of Madera
 N/S: Road 23
 E/W: Avenue 16
 Weather: Clear

File Name : 06_MDA_Rd 23_Ave 16 AM
 Site Code : 00319628
 Start Date : 9/18/2019
 Page No : 3

Start Time	Road 23 Southbound					Avenue 16 Westbound					Road 23 Northbound					Avenue 16 Eastbound					Int. Total
	Left	Thru	Right	U-Turns	App. Total	Left	Thru	Right	U-Turns	App. Total	Left	Thru	Right	U-Turns	App. Total	Left	Thru	Right	U-Turns	App. Total	

Peak Hour Analysis From 07:15 AM to 08:00 AM - Peak 1 of 1

Peak Hour for Each Approach Begins at:

	07:15 AM					07:15 AM					07:15 AM					07:15 AM				
+0 mins.	0	4	0	0	4	0	0	0	0	0	0	7	0	0	7	0	0	0	0	0
+15 mins.	0	3	1	0	3	0	0	0	0	0	0	5	0	0	5	0	0	0	0	0
+30 mins.	0	5	0	0	5	0	0	0	0	0	0	7	0	0	10	0	0	0	0	0
+45 mins.	0	3	0	0	3	0	0	0	0	0	0	7	0	0	7	0	0	0	0	0
Total Volume	0	20	1	0	21	0	0	0	0	0	0	29	0	0	29	0	0	0	0	0
% App. Total	0	95.2	4.8	0		0	0	0	0		0	100	0	0		0	0	0	0	
PHF	.000	.625	.250	.000	.583	.000	.000	.000	.000	.000	.000	.725	.000	.000	.725	.000	.000	.000	.000	.000

City of Madera
 N/S: Road 23
 E/W: Avenue 16
 Weather: Clear

File Name : 06_MDA_Rd 23_Ave 16 PM
 Site Code : 00319628
 Start Date : 9/18/2019
 Page No : 1

Groups Printed- Passenger Vehicles - Large 2 Axle Vehicles - 3 Axle Vehicles - 4+ Axle Trucks

Start Time	Road 23 Southbound					Avenue 16 Westbound					Road 23 Northbound					Avenue 16 Eastbound					Int. Total
	Left	Thru	Right	U-Turns	App. Total	Left	Thru	Right	U-Turns	App. Total	Left	Thru	Right	U-Turns	App. Total	Left	Thru	Right	U-Turns	App. Total	
04:00 PM	0	77	0	0	77	0	0	0	0	0	2	31	1	0	34	0	0	3	0	3	114
04:15 PM	2	59	2	0	63	0	0	0	0	0	1	37	0	0	38	4	0	10	0	14	115
04:30 PM	0	63	1	0	64	0	1	1	0	2	3	32	0	0	35	2	0	8	0	10	111
04:45 PM	0	54	3	0	57	0	0	0	0	0	1	36	0	0	37	0	0	5	0	5	99
Total	2	253	6	0	261	0	1	1	0	2	7	136	1	0	144	6	0	26	0	32	439
05:00 PM	0	56	0	0	56	0	0	1	0	1	4	30	1	1	36	2	1	3	0	6	99
05:15 PM	0	49	3	0	52	0	0	0	0	0	5	24	0	0	29	0	0	2	0	2	83
05:30 PM	0	52	1	0	53	0	0	0	0	0	2	34	0	0	36	0	0	4	0	4	93
05:45 PM	0	35	0	0	35	0	0	0	0	0	2	21	0	0	23	0	0	3	0	3	61
Total	0	192	4	0	196	0	0	1	0	1	13	109	1	1	124	2	1	12	0	15	336
Grand Total	2	445	10	0	457	0	1	2	0	3	20	245	2	1	268	8	1	38	0	47	775
Apprch %	0.4	97.4	2.2	0		0	33.3	66.7	0		7.5	91.4	0.7	0.4		17	2.1	80.9	0		
Total %	0.3	57.4	1.3	0	59	0	0.1	0.3	0	0.4	2.6	31.6	0.3	0.1	34.6	1	0.1	4.9	0	6.1	
Passenger Vehicles																					
% Passenger Vehicles	100	92.4	70	0	91.9	0	0	100	0	66.7	90	92.2	100	100	92.2	75	100	94.7	0	91.5	91.9
Large 2 Axle Vehicles	0	8	2	0	10	0	0	0	0	0	2	9	0	0	11	0	0	2	0	2	23
% Large 2 Axle Vehicles	0	1.8	20	0	2.2	0	0	0	0	0	10	3.7	0	0	4.1	0	0	5.3	0	4.3	3
3 Axle Vehicles	0	2	0	0	2	0	0	0	0	0	0	1	0	0	1	0	0	0	0	0	3
% 3 Axle Vehicles	0	0.4	0	0	0.4	0	0	0	0	0	0	0.4	0	0	0.4	0	0	0	0	0	0.4
4+ Axle Trucks	0	24	1	0	25	0	1	0	0	1	0	9	0	0	9	2	0	0	0	2	37
% 4+ Axle Trucks	0	5.4	10	0	5.5	0	100	0	0	33.3	0	3.7	0	0	3.4	25	0	0	0	4.3	4.8

Start Time	Road 23 Southbound					Avenue 16 Westbound					Road 23 Northbound					Avenue 16 Eastbound					Int. Total
	Left	Thru	Right	U-Turns	App. Total	Left	Thru	Right	U-Turns	App. Total	Left	Thru	Right	U-Turns	App. Total	Left	Thru	Right	U-Turns	App. Total	
Peak Hour Analysis From 04:00 PM to 05:45 PM - Peak 1 of 1																					
Peak Hour for Entire Intersection Begins at 04:00 PM																					
04:00 PM	0	77			77								1								
04:15 PM	2	59	2	0	63	0	0	0	0	0	1	37	0	0	38	4	0	10	0	14	115
04:30 PM	0	63	1	0	64	0	1	1	0	2	3	32	0	0	35	2	0	8	0	10	111
04:45 PM	0	54	3	0	57	0	0	0	0	0	1	36	0	0	37	0	0	5	0	5	99
Total Volume	2	253	6	0	261	0	1	1	0	2	7	136	1	0	144	6	0	26	0	32	439
% App. Total	0.8	96.9	2.3	0		0	50	50	0		4.9	94.4	0.7	0		18.8	0	81.2	0		
PHF	.250	.821	.500	.000	.847	.000	.250	.250	.000	.250	.583	.919	.250	.000	.947	.375	.000	.650	.000	.571	.954

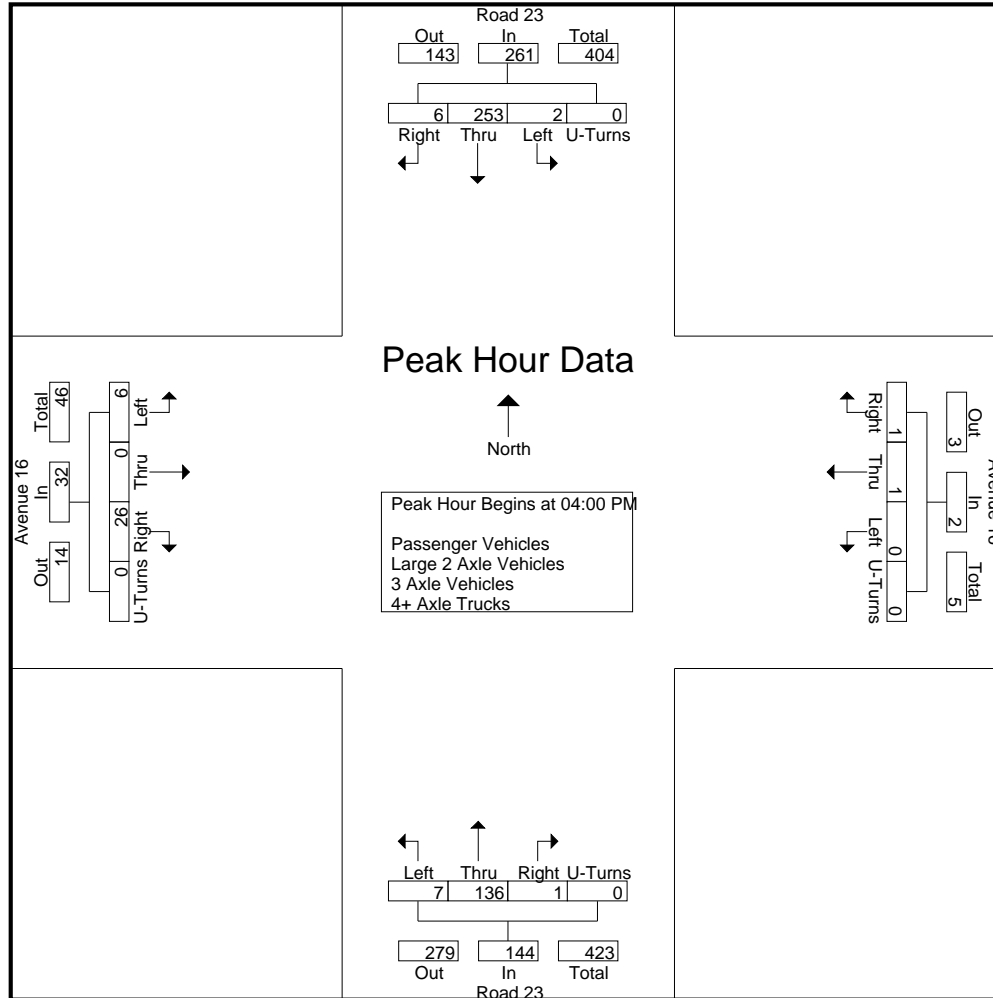

Counts Unlimited
 PO Box 1178
 Corona, CA 92878
 (951) 268-6268

City of Madera
 N/S: Road 23
 E/W: Avenue 16
 Weather: Clear

File Name : 06_MDA_Rd 23_Ave 16 PM
 Site Code : 00319628
 Start Date : 9/18/2019
 Page No : 3

Start Time	Road 23 Southbound					Avenue 16 Westbound					Road 23 Northbound					Avenue 16 Eastbound					Int. Total
	Left	Thru	Right	U-Turns	App. Total	Left	Thru	Right	U-Turns	App. Total	Left	Thru	Right	U-Turns	App. Total	Left	Thru	Right	U-Turns	App. Total	
Peak Hour Analysis From 04:00 PM to 05:45 PM - Peak 1 of 1																					
Peak Hour for Each Approach Begins at:																					
	04:00 PM					04:15 PM					04:15 PM					04:15 PM					
+0 mins.	0	77	0	0	77	0	0	0	0	0	1	37	0	0	38	4	0	10	0	14	
+15 mins.	2	59	2	0	63	0	1	1	0	2	3	32	0	0	35	2	0	8	0	10	
+30 mins.	0	63	1	0	64	0	0	0	0	0	1	36	0	0	37	0	0	5	0	5	
+45 mins.	0	54	3	0	57	0	0	1	0	1	4	30	1	1	36	2	1	3	0	6	
Total Volume	2	253	6	0	261	0	1	2	0	3	9	135	1	1	146	8	1	26	0	35	
% App. Total	0.8	96.9	2.3	0		0	33.3	66.7	0		6.2	92.5	0.7	0.7		22.9	2.9	74.3	0		
PHF	.250	.821	.500	.000	.847	.000	.250	.500	.000	.375	.563	.912	.250	.250	.961	.500	.250	.650	.000	.625	

Counts Unlimited
 PO Box 1178
 Corona, CA 92878
 (951) 268-6268

City of Madera
 N/S: Road 23
 E/W: Avenue 16
 Weather: Clear

File Name : 06_MDA_Rd 23_Ave 16 PM
 Site Code : 00319628
 Start Date : 9/18/2019
 Page No : 1

Groups Printed- Passenger Vehicles

Start Time	Road 23 Southbound					Avenue 16 Westbound					Road 23 Northbound					Avenue 16 Eastbound					Int. Total
	Left	Thru	Right	U-Turns	App. Total	Left	Thru	Right	U-Turns	App. Total	Left	Thru	Right	U-Turns	App. Total	Left	Thru	Right	U-Turns	App. Total	
04:00 PM	0	73	0	0	73	0	0	0	0	0	2	28	1	0	31	0	0	3	0	3	107
04:15 PM	2	55	1	0	58	0	0	0	0	0	1	36	0	0	37	4	0	9	0	13	108
04:30 PM	0	57	1	0	58	0	0	1	0	1	3	30	0	0	33	2	0	7	0	9	101
04:45 PM	0	48	1	0	49	0	0	0	0	0	1	31	0	0	32	0	0	5	0	5	86
Total	2	233	3	0	238	0	0	1	0	1	7	125	1	0	133	6	0	24	0	30	402
05:00 PM	0	52	0	0	52	0	0	1	0	1	3	26	1	1	31	0	1	3	0	4	88
05:15 PM	0	45	3	0	48	0	0	0	0	0	5	22	0	0	27	0	0	2	0	2	77
05:30 PM	0	50	1	0	51	0	0	0	0	0	1	32	0	0	33	0	0	4	0	4	88
05:45 PM	0	31	0	0	31	0	0	0	0	0	2	21	0	0	23	0	0	3	0	3	57
Total	0	178	4	0	182	0	0	1	0	1	11	101	1	1	114	0	1	12	0	13	310
Grand Total	2	411	7	0	420	0	0	2	0	2	18	226	2	1	247	6	1	36	0	43	712
Apprch %	0.5	97.9	1.7	0		0	0	100	0		7.3	91.5	0.8	0.4		14	2.3	83.7	0		
Total %	0.3	57.7	1	0	59	0	0	0.3	0	0.3	2.5	31.7	0.3	0.1	34.7	0.8	0.1	5.1	0	6	

Start Time	Road 23 Southbound					Avenue 16 Westbound					Road 23 Northbound					Avenue 16 Eastbound					Int. Total
	Left	Thru	Right	U-Turns	App. Total	Left	Thru	Right	U-Turns	App. Total	Left	Thru	Right	U-Turns	App. Total	Left	Thru	Right	U-Turns	App. Total	
Peak Hour Analysis From 04:00 PM to 04:45 PM - Peak 1 of 1																					
Peak Hour for Entire Intersection Begins at 04:00 PM																					
04:00 PM	0	73	0	0	73	0	0	0	0	0	2	28	1	0	31	0	0	3	0	3	107
04:15 PM	2	55	1	0	58	0	0	0	0	0	1	36	0	0	37	4	0	9	0	13	108
04:30 PM	0	57	1	0	58	0	0	1	0	1	3	30	0	0	33	2	0	7	0	9	101
04:45 PM	0	48	1	0	49	0	0	0	0	0	1	31	0	0	32	0	0	5	0	5	86
Total Volume	2	233	3	0	238	0	0	1	0	1	7	125	1	0	133	6	0	24	0	30	402
% App. Total	0.8	97.9	1.3	0		0	0	100	0		5.3	94	0.8	0		20	0	80	0		
PHF	.250	.798	.750	.000	.815	.000	.000	.250	.000	.250	.583	.868	.250	.000	.899	.375	.000	.667	.000	.577	.931

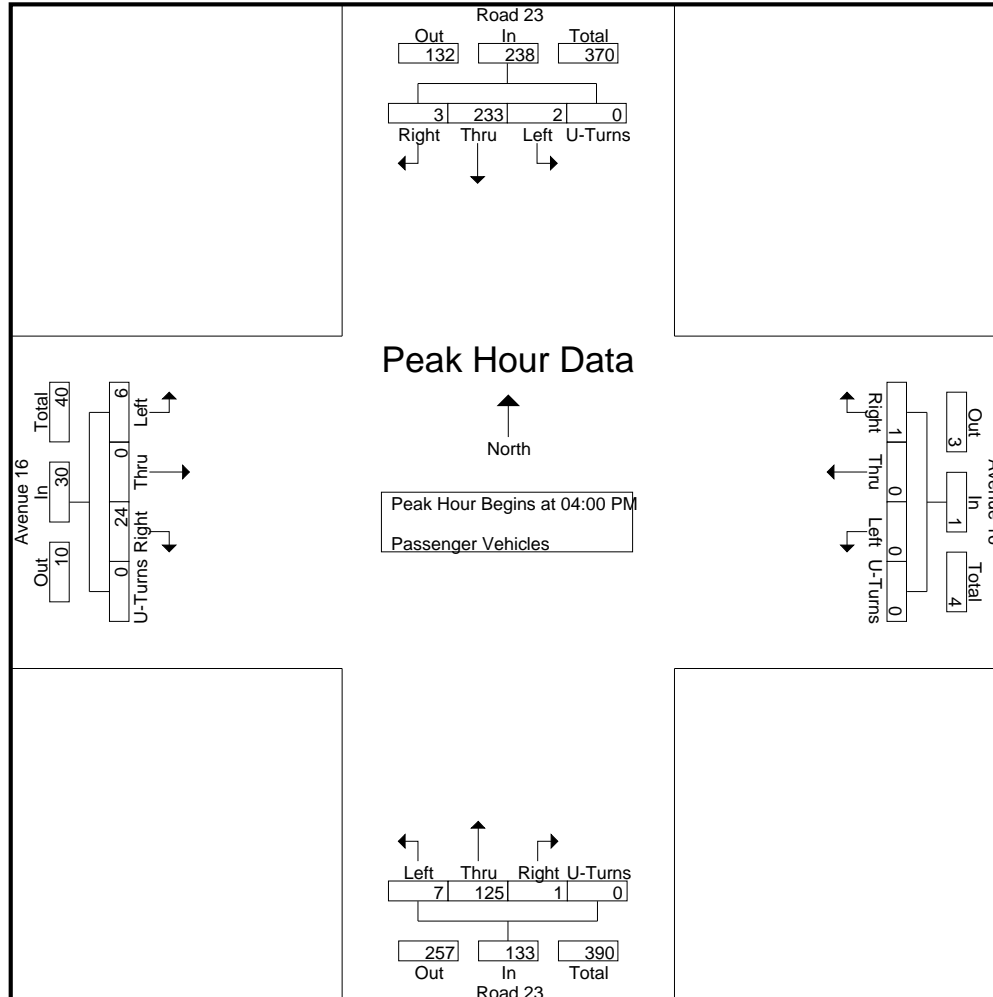

Counts Unlimited
 PO Box 1178
 Corona, CA 92878
 (951) 268-6268

City of Madera
 N/S: Road 23
 E/W: Avenue 16
 Weather: Clear

File Name : 06_MDA_Rd 23_Ave 16 PM
 Site Code : 00319628
 Start Date : 9/18/2019
 Page No : 3

Start Time	Road 23 Southbound					Avenue 16 Westbound					Road 23 Northbound					Avenue 16 Eastbound					Int. Total
	Left	Thru	Right	U-Turns	App. Total	Left	Thru	Right	U-Turns	App. Total	Left	Thru	Right	U-Turns	App. Total	Left	Thru	Right	U-Turns	App. Total	

Peak Hour Analysis From 04:00 PM to 04:45 PM - Peak 1 of 1

Peak Hour for Each Approach Begins at:

	04:00 PM					04:00 PM					04:00 PM					04:00 PM				
+0 mins.	0	⁷³	0	0	⁷³	0	0	0	0	0	2	28	¹	0	31	0	0	3	0	3
+15 mins.	²	55	¹	0	58	0	0	0	0	0	1	36	0	0	37	4	0	9	0	13
+30 mins.	0	57	1	0	58	0	0	1	0	1	3	30	0	0	33	2	0	7	0	9
+45 mins.	0	48	1	0	49	0	0	0	0	0	1	31	0	0	32	0	0	5	0	5
Total Volume	2	233	3	0	238	0	0	1	0	1	7	125	1	0	133	6	0	24	0	30
% App. Total	0.8	97.9	1.3	0		0	0	100	0		5.3	94	0.8	0		20	0	80	0	
PHF	.250	.798	.750	.000	.815	.000	.000	.250	.000	.250	.583	.868	.250	.000	.899	.375	.000	.667	.000	.577

Counts Unlimited
 PO Box 1178
 Corona, CA 92878
 (951) 268-6268

City of Madera
 N/S: Road 23
 E/W: Avenue 16
 Weather: Clear

File Name : 06_MDA_Rd 23_Ave 16 PM
 Site Code : 00319628
 Start Date : 9/18/2019
 Page No : 1

Groups Printed- Large 2 Axle Vehicles

Start Time	Road 23 Southbound					Avenue 16 Westbound					Road 23 Northbound					Avenue 16 Eastbound					Int. Total
	Left	Thru	Right	U-Turns	App. Total	Left	Thru	Right	U-Turns	App. Total	Left	Thru	Right	U-Turns	App. Total	Left	Thru	Right	U-Turns	App. Total	
04:00 PM	0	3	0	0	3	0	0	0	0	0	0	2	0	0	2	0	0	0	0	0	5
04:15 PM	0	1	0	0	1	0	0	0	0	0	0	0	0	0	0	0	0	1	0	1	2
04:30 PM	0	1	0	0	1	0	0	0	0	0	0	1	0	0	1	0	0	1	0	1	3
04:45 PM	0	2	2	0	4	0	0	0	0	0	0	3	0	0	3	0	0	0	0	0	7
Total	0	7	2	0	9	0	0	0	0	0	0	6	0	0	6	0	0	2	0	2	17
05:00 PM	0	0	0	0	0	0	0	0	0	0	1	1	0	0	2	0	0	0	0	0	2
05:15 PM	0	0	0	0	0	0	0	0	0	0	0	1	0	0	1	0	0	0	0	0	1
05:30 PM	0	1	0	0	1	0	0	0	0	0	1	1	0	0	2	0	0	0	0	0	3
05:45 PM	0	0	0	0	0	0	0	0	0	0	0	0	0	0	0	0	0	0	0	0	0
Total	0	1	0	0	1	0	0	0	0	0	2	3	0	0	5	0	0	0	0	0	6
Grand Total	0	8	2	0	10	0	0	0	0	0	2	9	0	0	11	0	0	2	0	2	23
Apprch %	0	80	20	0		0	0	0	0		18.2	81.8	0	0		0	0	100	0		
Total %	0	34.8	8.7	0	43.5	0	0	0	0	0	8.7	39.1	0	0	47.8	0	0	8.7	0	8.7	

Start Time	Road 23 Southbound					Avenue 16 Westbound					Road 23 Northbound					Avenue 16 Eastbound					Int. Total
	Left	Thru	Right	U-Turns	App. Total	Left	Thru	Right	U-Turns	App. Total	Left	Thru	Right	U-Turns	App. Total	Left	Thru	Right	U-Turns	App. Total	
Peak Hour Analysis From 04:00 PM to 04:45 PM - Peak 1 of 1																					
Peak Hour for Entire Intersection Begins at 04:00 PM																					
04:00 PM	0	3	0	0	3	0	0	0	0	0	0	2	0	0	2	0	0	0	0	0	5
04:15 PM	0	1	0	0	1	0	0	0	0	0	0	0	0	0	0	0	0	1	0	1	2
04:30 PM	0	1	0	0	1	0	0	0	0	0	0	1	0	0	1	0	0	1	0	1	3
04:45 PM	0	2	2	0	4	0	0	0	0	0	0	3	0	0	3	0	0	0	0	0	7
Total Volume	0	7	2	0	9	0	0	0	0	0	0	6	0	0	6	0	0	2	0	2	17
% App. Total	0	77.8	22.2	0		0	0	0	0		0	100	0	0		0	0	100	0		
PHF	.000	.583	.250	.000	.563	.000	.000	.000	.000	.000	.000	.500	.000	.000	.500	.000	.000	.500	.000	.500	.607

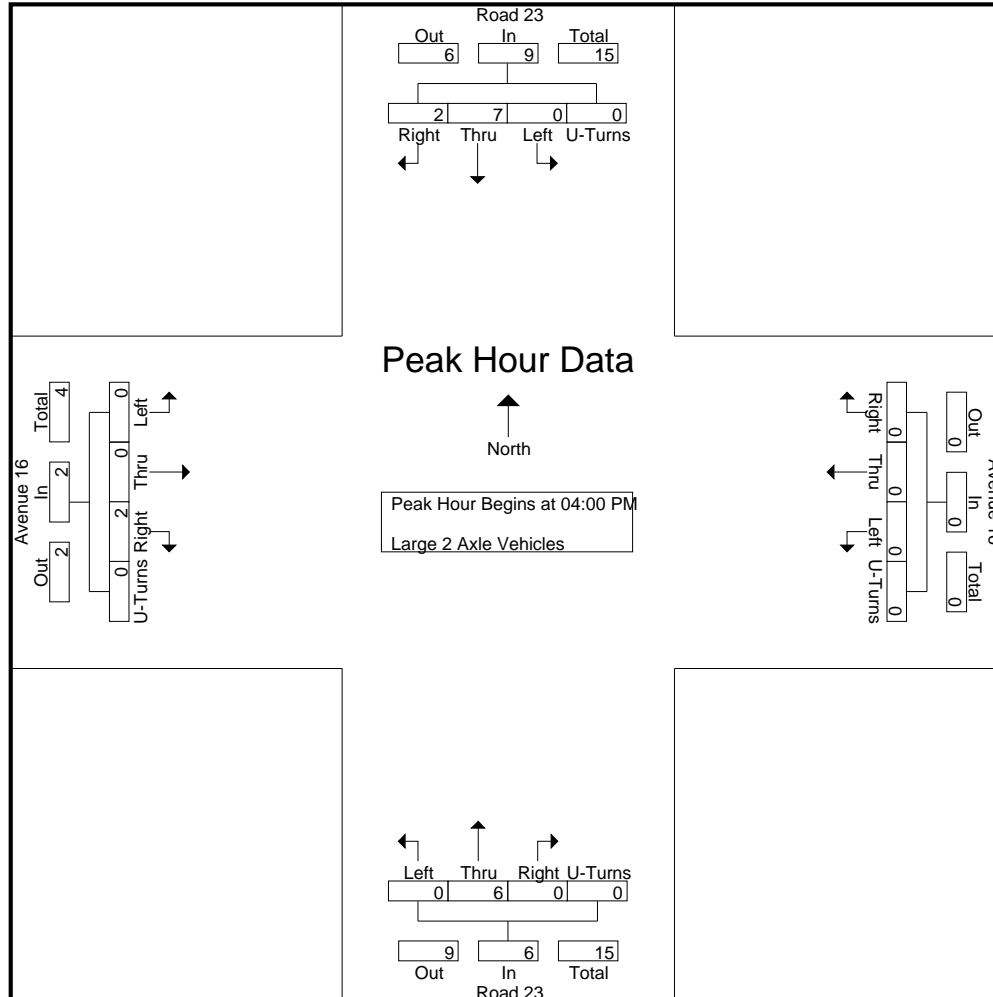

Counts Unlimited
 PO Box 1178
 Corona, CA 92878
 (951) 268-6268

City of Madera
 N/S: Road 23
 E/W: Avenue 16
 Weather: Clear

File Name : 06_MDA_Rd 23_Ave 16 PM
 Site Code : 00319628
 Start Date : 9/18/2019
 Page No : 3

Start Time	Road 23 Southbound					Avenue 16 Westbound					Road 23 Northbound					Avenue 16 Eastbound					Int. Total
	Left	Thru	Right	U-Turns	App. Total	Left	Thru	Right	U-Turns	App. Total	Left	Thru	Right	U-Turns	App. Total	Left	Thru	Right	U-Turns	App. Total	

Peak Hour Analysis From 04:00 PM to 04:45 PM - Peak 1 of 1

Peak Hour for Each Approach Begins at:

	04:00 PM					04:00 PM					04:00 PM					04:00 PM				
+0 mins.	0	3	0	0	3	0	0	0	0	0	0	2	0	0	2	0	0	0	0	0
+15 mins.	0	1	0	0	1	0	0	0	0	0	0	0	0	0	0	0	0	0	0	0
+30 mins.	0	1	0	0	1	0	0	0	0	0	0	1	0	0	1	0	0	1	0	1
+45 mins.	0	2	2	0	4	0	0	0	0	0	0	3	0	0	3	0	0	0	0	0
Total Volume	0	7	2	0	9	0	0	0	0	0	0	6	0	0	6	0	0	2	0	2
% App. Total	0	77.8	22.2	0		0	0	0	0		0	100	0	0		0	0	100	0	
PHF	.000	.583	.250	.000	.563	.000	.000	.000	.000	.000	.000	.500	.000	.000	.500	.000	.000	.500	.000	.500

Counts Unlimited
 PO Box 1178
 Corona, CA 92878
 (951) 268-6268

City of Madera
 N/S: Road 23
 E/W: Avenue 16
 Weather: Clear

File Name : 06_MDA_Rd 23_Ave 16 PM
 Site Code : 00319628
 Start Date : 9/18/2019
 Page No : 1

Groups Printed- 3 Axle Vehicles

Start Time	Road 23 Southbound					Avenue 16 Westbound					Road 23 Northbound					Avenue 16 Eastbound					Int. Total
	Left	Thru	Right	U-Turns	App. Total	Left	Thru	Right	U-Turns	App. Total	Left	Thru	Right	U-Turns	App. Total	Left	Thru	Right	U-Turns	App. Total	
04:00 PM	0	0	0	0	0	0	0	0	0	0	0	0	0	0	0	0	0	0	0	0	0
04:15 PM	0	0	0	0	0	0	0	0	0	0	0	0	0	0	0	0	0	0	0	0	0
04:30 PM	0	0	0	0	0	0	0	0	0	0	0	0	0	0	0	0	0	0	0	0	0
04:45 PM	0	0	0	0	0	0	0	0	0	0	0	1	0	0	1	0	0	0	0	0	0
Total	0	0	0	0	0	0	0	0	0	0	0	1	0	0	1	0	0	0	0	0	1
05:00 PM	0	1	0	0	1	0	0	0	0	0	0	0	0	0	0	0	0	0	0	0	1
05:15 PM	0	1	0	0	1	0	0	0	0	0	0	0	0	0	0	0	0	0	0	0	1
05:30 PM	0	0	0	0	0	0	0	0	0	0	0	0	0	0	0	0	0	0	0	0	0
05:45 PM	0	0	0	0	0	0	0	0	0	0	0	0	0	0	0	0	0	0	0	0	0
Total	0	2	0	0	2	0	0	0	0	0	0	0	0	0	0	0	0	0	0	0	2
Grand Total	0	2	0	0	2	0	0	0	0	0	0	1	0	0	1	0	0	0	0	0	3
Apprch %	0	100	0	0		0	0	0	0		0	100	0	0		0	0	0	0		
Total %	0	66.7	0	0	66.7	0	0	0	0		0	33.3	0	0	33.3	0	0	0	0		

Start Time	Road 23 Southbound					Avenue 16 Westbound					Road 23 Northbound					Avenue 16 Eastbound					Int. Total
	Left	Thru	Right	U-Turns	App. Total	Left	Thru	Right	U-Turns	App. Total	Left	Thru	Right	U-Turns	App. Total	Left	Thru	Right	U-Turns	App. Total	
Peak Hour Analysis From 04:00 PM to 04:45 PM - Peak 1 of 1																					
Peak Hour for Entire Intersection Begins at 04:00 PM																					
04:00 PM	0	0	0	0	0	0	0	0	0	0	0	0	0	0	0	0	0	0	0	0	0
04:15 PM	0	0	0	0	0	0	0	0	0	0	0	0	0	0	0	0	0	0	0	0	0
04:30 PM	0	0	0	0	0	0	0	0	0	0	0	0	0	0	0	0	0	0	0	0	0
04:45 PM	0	0	0	0	0	0	0	0	0	0	0	1	0	0	1	0	0	0	0	0	0
Total Volume	0	0	0	0	0	0	0	0	0	0	0	1	0	0	1	0	0	0	0	0	1
% App. Total	0	0	0	0		0	0	0	0		0	100	0	0		0	0	0	0		
PHF	.000	.000	.000	.000	.000	.000	.000	.000	.000	.000	.000	.250	.000	.000	.250	.000	.000	.000	.000	.000	.250

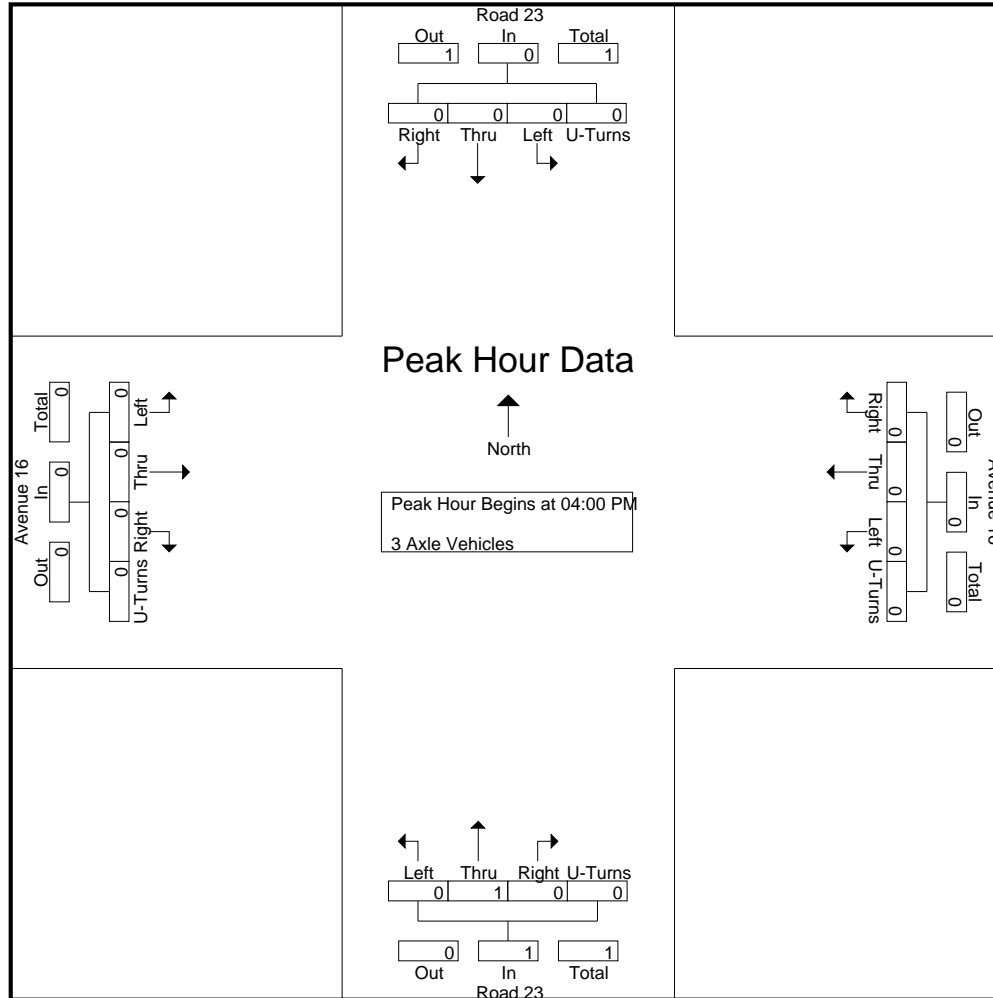

Counts Unlimited
 PO Box 1178
 Corona, CA 92878
 (951) 268-6268

City of Madera
 N/S: Road 23
 E/W: Avenue 16
 Weather: Clear

File Name : 06_MDA_Rd 23_Ave 16 PM
 Site Code : 00319628
 Start Date : 9/18/2019
 Page No : 3

Start Time	Road 23 Southbound					Avenue 16 Westbound					Road 23 Northbound					Avenue 16 Eastbound					Int. Total
	Left	Thru	Right	U-Turns	App. Total	Left	Thru	Right	U-Turns	App. Total	Left	Thru	Right	U-Turns	App. Total	Left	Thru	Right	U-Turns	App. Total	

Peak Hour Analysis From 04:00 PM to 04:45 PM - Peak 1 of 1

Peak Hour for Each Approach Begins at:

	04:00 PM					04:00 PM					04:00 PM					04:00 PM									
+0 mins.	0	0	0	0	0	0	0	0	0	0	0	0	0	0	0	0	0	0	0	0	0	0	0	0	0
+15 mins.	0	0	0	0	0	0	0	0	0	0	0	0	0	0	0	0	0	0	0	0	0	0	0	0	0
+30 mins.	0	0	0	0	0	0	0	0	0	0	0	0	0	0	0	0	0	0	0	0	0	0	0	0	0
+45 mins.	0	0	0	0	0	0	0	0	0	0	0	0	0	0	1	0	0	0	0	0	0	0	0	0	0
Total Volume	0	0	0	0	0	0	0	0	0	0	0	1	0	0	1	0	0	0	0	0	0	0	0	0	0
% App. Total	0	0	0	0	0	0	0	0	0	0	0	100	0	0	0	0	0	0	0	0	0	0	0	0	0
PHF	.000	.000	.000	.000	.000	.000	.000	.000	.000	.000	.000	.250	.000	.000	.250	.000	.000	.000	.000	.000	.000	.000	.000	.000	.000

Counts Unlimited
 PO Box 1178
 Corona, CA 92878
 (951) 268-6268

City of Madera
 N/S: Road 23
 E/W: Avenue 16
 Weather: Clear

File Name : 06_MDA_Rd 23_Ave 16 PM
 Site Code : 00319628
 Start Date : 9/18/2019
 Page No : 1

Groups Printed- 4+ Axle Trucks

Start Time	Road 23 Southbound					Avenue 16 Westbound					Road 23 Northbound					Avenue 16 Eastbound					Int. Total					
	Left	Thru	Right	U-Turns	App. Total	Left	Thru	Right	U-Turns	App. Total	Left	Thru	Right	U-Turns	App. Total	Left	Thru	Right	U-Turns	App. Total						
04:00 PM	0	1	0	0	1	0	0	0	0	0	0	1	0	0	1	0	0	0	0	0	0	0	0	0	0	2
04:15 PM	0	3	1	0	4	0	0	0	0	0	0	1	0	0	1	0	0	0	0	0	0	0	0	0	0	5
04:30 PM	0	5	0	0	5	0	1	0	0	1	0	1	0	0	1	0	0	0	0	0	0	0	0	0	0	7
04:45 PM	0	4	0	0	4	0	0	0	0	0	0	1	0	0	1	0	0	0	0	0	0	0	0	0	0	5
Total	0	13	1	0	14	0	1	0	0	1	0	4	0	0	4	0	0	0	0	0	0	0	0	0	0	19
05:00 PM	0	3	0	0	3	0	0	0	0	0	0	3	0	0	3	2	0	0	0	0	2	0	0	0	0	8
05:15 PM	0	3	0	0	3	0	0	0	0	0	0	1	0	0	1	0	0	0	0	0	0	0	0	0	0	4
05:30 PM	0	1	0	0	1	0	0	0	0	0	0	1	0	0	1	0	0	0	0	0	0	0	0	0	0	2
05:45 PM	0	4	0	0	4	0	0	0	0	0	0	0	0	0	0	0	0	0	0	0	0	0	0	0	0	4
Total	0	11	0	0	11	0	0	0	0	0	0	5	0	0	5	2	0	0	0	0	2	0	0	0	2	18
Grand Total	0	24	1	0	25	0	1	0	0	1	0	9	0	0	9	2	0	0	0	0	2	0	0	0	37	
Apprch %	0	96	4	0		0	100	0	0		0	100	0	0		100	0	0	0							
Total %	0	64.9	2.7	0	67.6	0	2.7	0	0	2.7	0	24.3	0	0	24.3	5.4	0	0	0	5.4						

Start Time	Road 23 Southbound					Avenue 16 Westbound					Road 23 Northbound					Avenue 16 Eastbound					Int. Total					
	Left	Thru	Right	U-Turns	App. Total	Left	Thru	Right	U-Turns	App. Total	Left	Thru	Right	U-Turns	App. Total	Left	Thru	Right	U-Turns	App. Total						
04:00 PM	0	1	0	0	1	0	0	0	0	0	0	1	0	0	1	0	0	0	0	0	0	0	0	0	0	2
04:15 PM	0	3	1	0	4	0	0	0	0	0	0	1	0	0	1	0	0	0	0	0	0	0	0	0	0	5
04:30 PM	0	5	0	0	5	0	1	0	0	1	0	1	0	0	1	0	0	0	0	0	0	0	0	0	0	7
04:45 PM	0	4	0	0	4	0	0	0	0	0	0	1	0	0	1	0	0	0	0	0	0	0	0	0	0	5
Total Volume	0	13	1	0	14	0	1	0	0	1	0	4	0	0	4	0	0	0	0	0	0	0	0	0	0	19
% App. Total	0	92.9	7.1	0		0	100	0	0		0	100	0	0		0	0	0	0							
PHF	.000	.650	.250	.000	.700	.000	.250	.000	.000	.250	.000	1.00	.000	.000	1.00	.000	.000	.000	.000	.000						.679

Peak Hour Analysis From 04:00 PM to 04:45 PM - Peak 1 of 1
 Peak Hour for Entire Intersection Begins at 04:00 PM

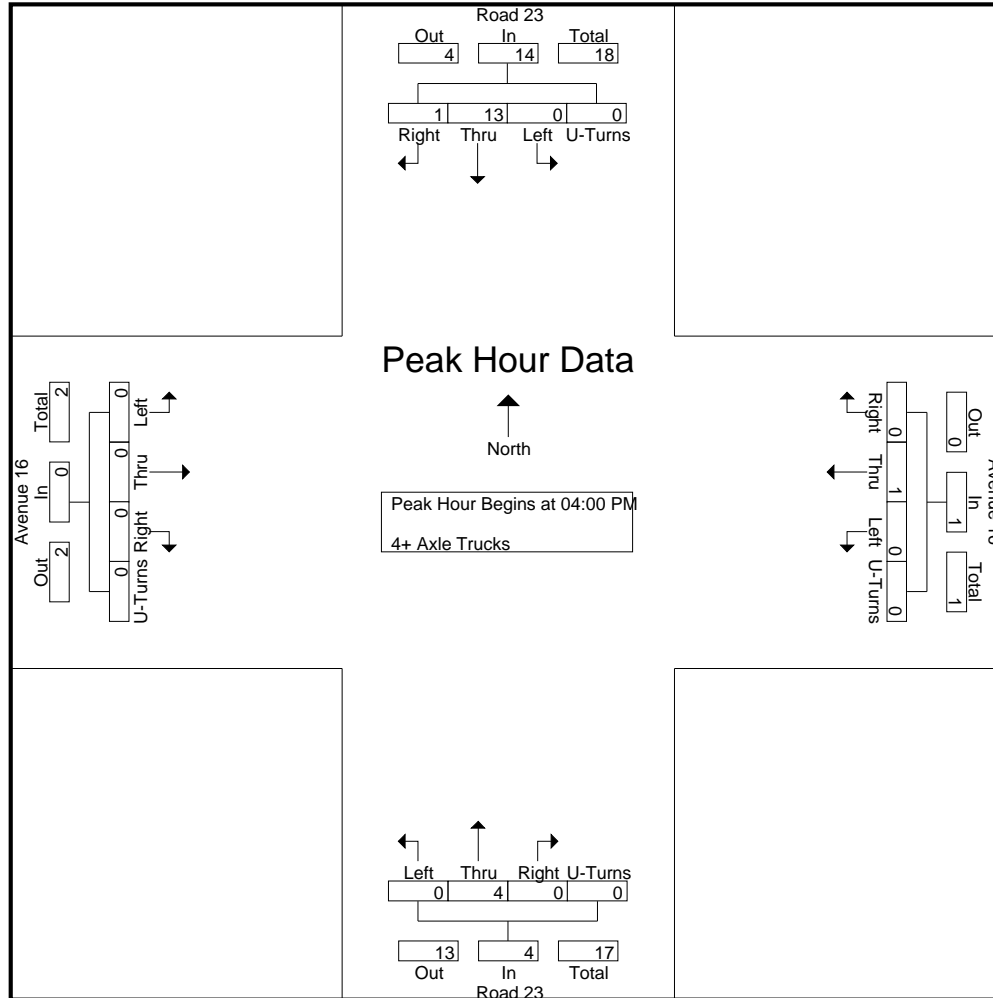

Counts Unlimited
 PO Box 1178
 Corona, CA 92878
 (951) 268-6268

City of Madera
 N/S: Road 23
 E/W: Avenue 16
 Weather: Clear

File Name : 06_MDA_Rd 23_Ave 16 PM
 Site Code : 00319628
 Start Date : 9/18/2019
 Page No : 3

Start Time	Road 23 Southbound					Avenue 16 Westbound					Road 23 Northbound					Avenue 16 Eastbound					Int. Total
	Left	Thru	Right	U-Turns	App. Total	Left	Thru	Right	U-Turns	App. Total	Left	Thru	Right	U-Turns	App. Total	Left	Thru	Right	U-Turns	App. Total	

Peak Hour Analysis From 04:00 PM to 04:45 PM - Peak 1 of 1

Peak Hour for Each Approach Begins at:

	04:00 PM					04:00 PM					04:00 PM					04:00 PM				
+0 mins.	0	1	0	0	1	0	0	0	0	0	0	1	0	0	1	0	0	0	0	0
+15 mins.	0	3	1	0	4	0	0	0	0	0	0	1	0	0	1	0	0	0	0	0
+30 mins.	0	5	0	0	5	0	1	0	0	1	0	1	0	0	1	0	0	0	0	0
+45 mins.	0	4	0	0	4	0	0	0	0	0	0	1	0	0	1	0	0	0	0	0
Total Volume	0	13	1	0	14	0	1	0	0	1	0	4	0	0	4	0	0	0	0	0
% App. Total	0	92.9	7.1	0		0	100	0	0		0	100	0	0		0	0	0	0	
PHF	.000	.650	.250	.000	.700	.000	.250	.000	.000	.250	.000	1.000	.000	.000	1.000	.000	.000	.000	.000	.000

Location: Madera
 N/S: Road 23
 E/W: Avenue 16



PEDESTRIANS

	North Leg Road 23	East Leg Avenue 16	South Leg Road 23	West Leg Avenue 16	
	Pedestrians	Pedestrians	Pedestrians	Pedestrians	
7:00 AM	0	0	0	0	0
7:15 AM	0	0	0	0	0
7:30 AM	0	0	0	0	0
7:45 AM	0	0	0	0	0
8:00 AM	0	0	0	0	0
8:15 AM	0	0	0	0	0
8:30 AM	0	0	0	0	0
8:45 AM	0	0	0	0	0
TOTAL VOLUMES:	0	0	0	0	0

	North Leg Road 23	East Leg Avenue 16	South Leg Road 23	West Leg Avenue 16	
	Pedestrians	Pedestrians	Pedestrians	Pedestrians	
4:00 PM	0	0	0	0	0
4:15 PM	0	0	0	0	0
4:30 PM	0	0	0	0	0
4:45 PM	0	0	0	0	0
5:00 PM	0	0	0	0	0
5:15 PM	0	0	0	0	0
5:30 PM	0	0	0	0	0
5:45 PM	0	0	0	0	0
TOTAL VOLUMES:	0	0	0	0	0

Location: Madera
 N/S: Road 23
 E/W: Avenue 16



BICYCLES

	Southbound Road 23			Westbound Avenue 16			Northbound Road 23			Eastbound Avenue 16			
	Left	Thru	Right	Left	Thru	Right	Left	Thru	Right	Left	Thru	Right	
7:00 AM	0	0	0	0	0	0	0	0	0	0	0	0	0
7:15 AM	0	0	0	0	0	0	0	0	0	0	0	0	0
7:30 AM	0	0	0	0	0	0	0	0	0	0	0	0	0
7:45 AM	0	0	0	0	0	0	0	0	0	0	0	0	0
8:00 AM	0	0	0	0	0	0	0	0	0	0	0	0	0
8:15 AM	0	0	0	0	0	0	0	0	0	0	0	0	0
8:30 AM	0	0	0	0	0	0	0	0	0	0	0	0	0
8:45 AM	0	0	0	0	0	0	0	0	0	0	0	0	0
TOTAL VOLUMES:	0	0	0	0	0	0	0	0	0	0	0	0	0

	Southbound Road 23			Westbound Avenue 16			Northbound Road 23			Eastbound Avenue 16			
	Left	Thru	Right	Left	Thru	Right	Left	Thru	Right	Left	Thru	Right	
4:00 PM	0	0	0	0	0	0	0	0	0	0	0	0	0
4:15 PM	0	0	0	0	0	0	0	0	0	0	0	0	0
4:30 PM	0	0	0	0	0	0	0	0	0	0	0	0	0
4:45 PM	0	0	0	0	0	0	0	0	0	0	0	0	0
5:00 PM	0	0	0	0	0	0	0	0	0	0	0	0	0
5:15 PM	0	0	0	0	0	0	0	0	0	0	0	0	0
5:30 PM	0	0	0	0	0	0	0	0	0	0	0	0	0
5:45 PM	0	0	0	0	0	0	0	0	0	0	0	0	0
TOTAL VOLUMES:	0	0	0	0	0	0	0	0	0	0	0	0	0

City of Madera
 N/S: Road 23
 E/W: Cleveland Avenue
 Weather: Clear

File Name : 07_MDA_Rd 23_Cleveland AM
 Site Code : 00319628
 Start Date : 9/18/2019
 Page No : 2

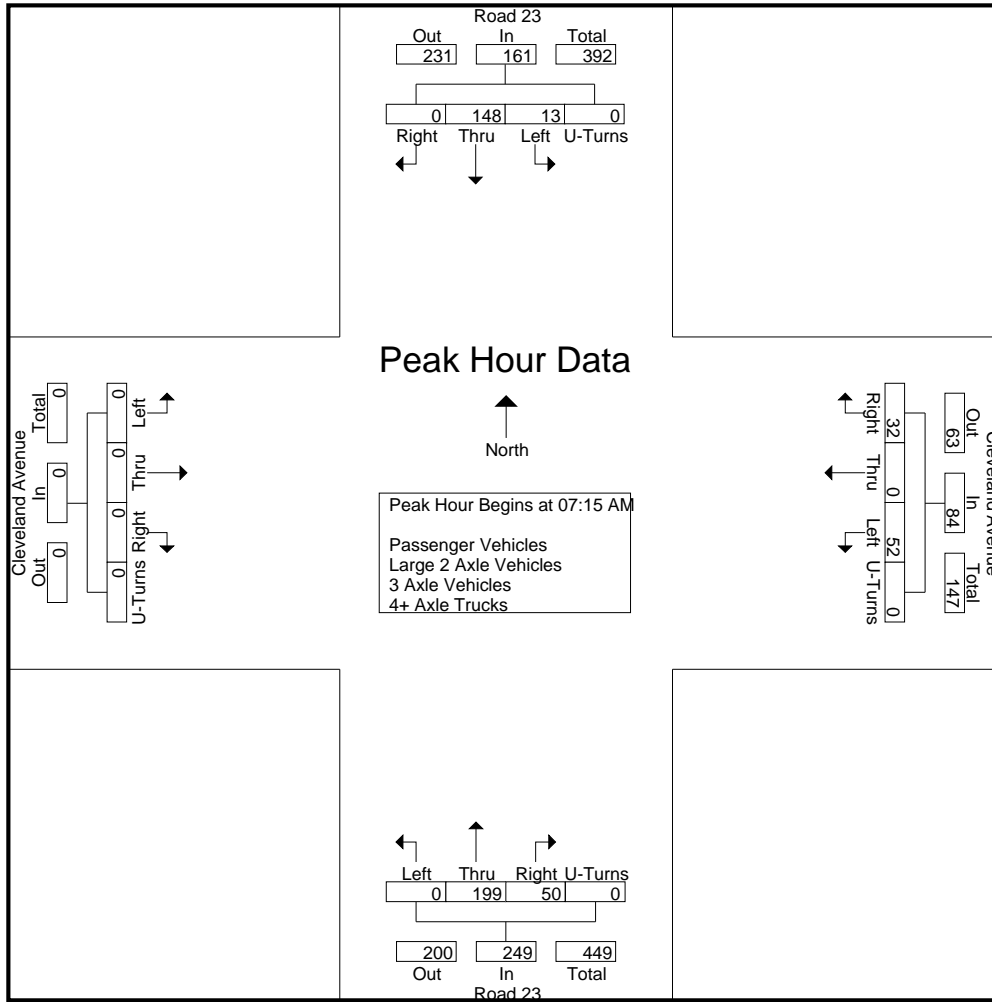

Peak Hour Analysis From 07:00 AM to 08:45 AM - Peak 1 of 1
 Peak Hour for Each Approach Begins at:

	07:15 AM					07:30 AM					07:00 AM									
+0 mins.	2	29	0	0	31	12	0	6	0	18	0	66	17	0	83	0	0	0	0	0
+15 mins.	1	41	0	0	42	16	0	9	0	25	0	49	16	0	65	0	0	0	0	0
+30 mins.	5	43	0	0	48	14	0	13	0	27	0	39	12	0	51	0	0	0	0	0
+45 mins.	5	35	0	0	40	10	0	4	0	14	0	41	11	0	52	0	0	0	0	0
Total Volume	13	148	0	0	161	52	0	32	0	84	0	195	56	0	251	0	0	0	0	0
% App. Total	8.1	91.9	0	0		61.9	0	38.1	0		0	77.7	22.3	0		0	0	0	0	0
PHF	.650	.860	.000	.000	.839	.813	.000	.615	.000	.778	.000	.739	.824	.000	.756	.000	.000	.000	.000	.000

City of Madera
 N/S: Road 23
 E/W: Cleveland Avenue
 Weather: Clear

File Name : 07_MDA_Rd 23_Cleveland AM
 Site Code : 00319628
 Start Date : 9/18/2019
 Page No : 2

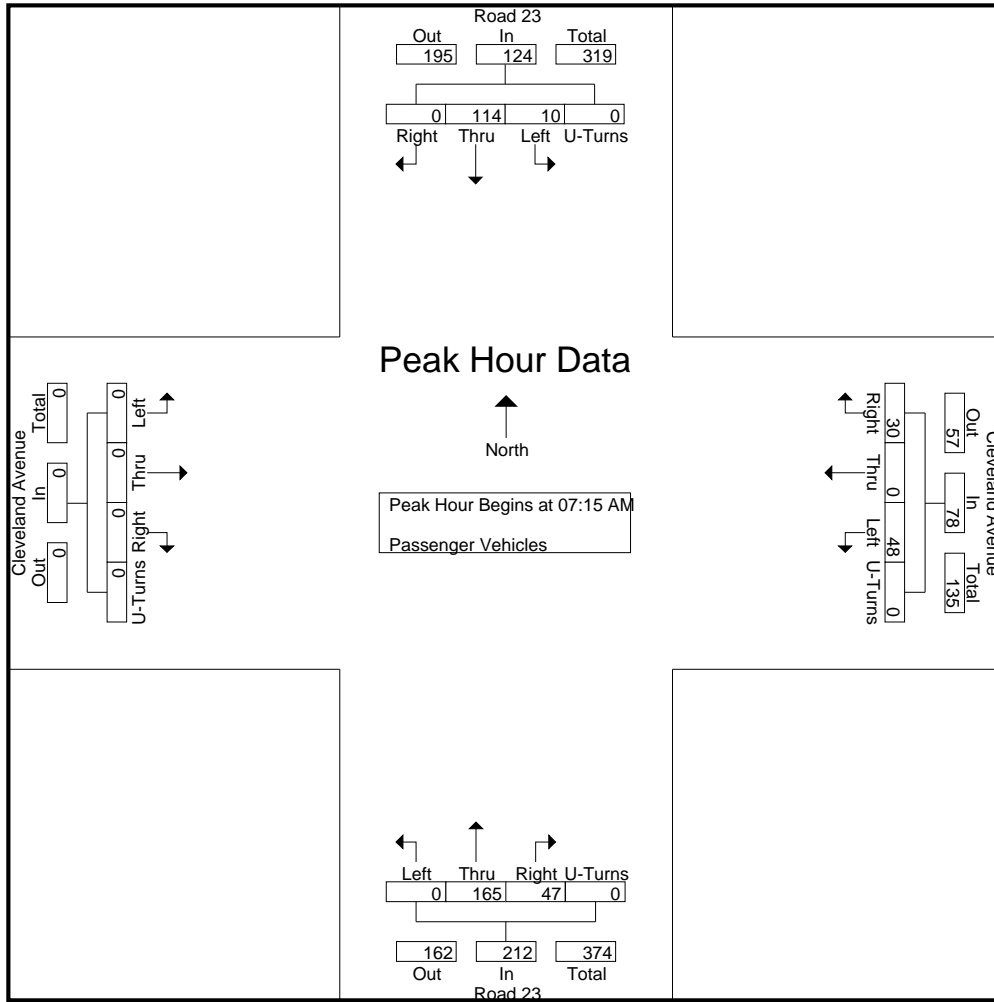

Peak Hour Analysis From 07:15 AM to 08:00 AM - Peak 1 of 1
 Peak Hour for Each Approach Begins at:

	07:15 AM					07:15 AM					07:15 AM					07:15 AM				
+0 mins.	1	21	0	0	22	10	0	6	0	16	0	37	4	0	41	0	0	0	0	0
+15 mins.	1	28	0	0	29	15	0	9	0	24	0	56	16	0	72	0	0	0	0	0
+30 mins.	5	37	0	0	42	14	0	12	0	26	0	40	15	0	55	0	0	0	0	0
+45 mins.	3	28	0	0	31	9	0	3	0	12	0	32	12	0	44	0	0	0	0	0
Total Volume	10	114	0	0	124	48	0	30	0	78	0	165	47	0	212	0	0	0	0	0
% App. Total	8.1	91.9	0	0		61.5	0	38.5	0		0	77.8	22.2	0		0	0	0	0	0
PHF	.500	.770	.000	.000	.738	.800	.000	.625	.000	.750	.000	.737	.734	.000	.736	.000	.000	.000	.000	.000

City of Madera
 N/S: Road 23
 E/W: Cleveland Avenue
 Weather: Clear

File Name : 07_MDA_Rd 23_Cleveland AM
 Site Code : 00319628
 Start Date : 9/18/2019
 Page No : 1

Groups Printed- Large 2 Axle Vehicles

Start Time	Road 23 Southbound					Cleveland Avenue Westbound					Road 23 Northbound					Cleveland Avenue Eastbound					Int. Total
	Left	Thru	Right	U-Turns	App. Total	Left	Thru	Right	U-Turns	App. Total	Left	Thru	Right	U-Turns	App. Total	Left	Thru	Right	U-Turns	App. Total	
07:00 AM	0	0	0	0	0	0	0	0	0	0	0	0	0	0	0	0	0	0	0	0	0
07:15 AM	1	2	0	0	3	1	0	0	0	1	0	1	0	0	1	0	0	0	0	0	5
07:30 AM	0	4	0	0	4	1	0	0	0	1	0	4	1	0	5	0	0	0	0	0	10
07:45 AM	0	1	0	0	1	0	0	1	0	1	0	0	0	0	0	0	0	0	0	0	2
Total	1	7	0	0	8	2	0	1	0	3	0	5	1	0	6	0	0	0	0	0	17
08:00 AM	1	3	0	0	4	1	0	1	0	2	0	0	0	0	0	0	0	0	0	0	6
08:15 AM	0	4	0	0	4	0	0	0	0	0	0	2	1	0	3	0	0	0	0	0	7
08:30 AM	0	2	0	0	2	0	0	1	0	1	0	5	2	0	7	0	0	0	0	0	10
08:45 AM	0	4	0	0	4	1	0	0	0	1	0	2	2	0	4	0	0	0	0	0	9
Total	1	13	0	0	14	2	0	2	0	4	0	9	5	0	14	0	0	0	0	0	32
Grand Total	2	20	0	0	22	4	0	3	0	7	0	14	6	0	20	0	0	0	0	0	49
Apprch %	9.1	90.9	0	0		57.1	0	42.9	0		0	70	30	0		0	0	0	0		
Total %	4.1	40.8	0	0	44.9	8.2	0	6.1	0	14.3	0	28.6	12.2	0	40.8	0	0	0	0	0	

Start Time	Road 23 Southbound					Cleveland Avenue Westbound					Road 23 Northbound					Cleveland Avenue Eastbound					Int. Total
	Left	Thru	Right	U-Turns	App. Total	Thru	Right	U-Turns	App. Total	Thru	Right	U-Turns	App. Total	Thru	Right	U-Turns	App. Total				
Peak Hour Analysis From 07:15 AM to 08:00 AM - Peak 1 of 1																					
Peak Hour for Entire Intersection Begins at 07:15 AM																					
07:15 AM	1	2	0	0	3	1	0	0	0	1	0	1	0	0	1	0	0	0	0	0	5
07:30 AM	0	4	0	0	4	1	0	0	0	1	0	4	1	0	5	0	0	0	0	0	10
07:45 AM	0	1	0	0	1	0	0	1	0	1	0	0	0	0	0	0	0	0	0	0	2
08:00 AM	1	3	0	0	4	1	0	1	0	2	0	0	0	0	0	0	0	0	0	0	6
Total Volume	2	10	0	0	12	3	0	2	0	5	0	5	1	0	6	0	0	0	0	0	23
% App. Total	16.7	83.3	0	0		60	0	40	0		0	83.3	16.7	0		0	0	0	0		
PHF	.500	.625	.000	.000	.750	.750	.000	.500	.000	.625	.000	.313	.250	.000	.300	.000	.000	.000	.000	.000	.575

City of Madera
 N/S: Road 23
 E/W: Cleveland Avenue
 Weather: Clear

File Name : 07_MDA_Rd 23_Cleveland AM
 Site Code : 00319628
 Start Date : 9/18/2019
 Page No : 2

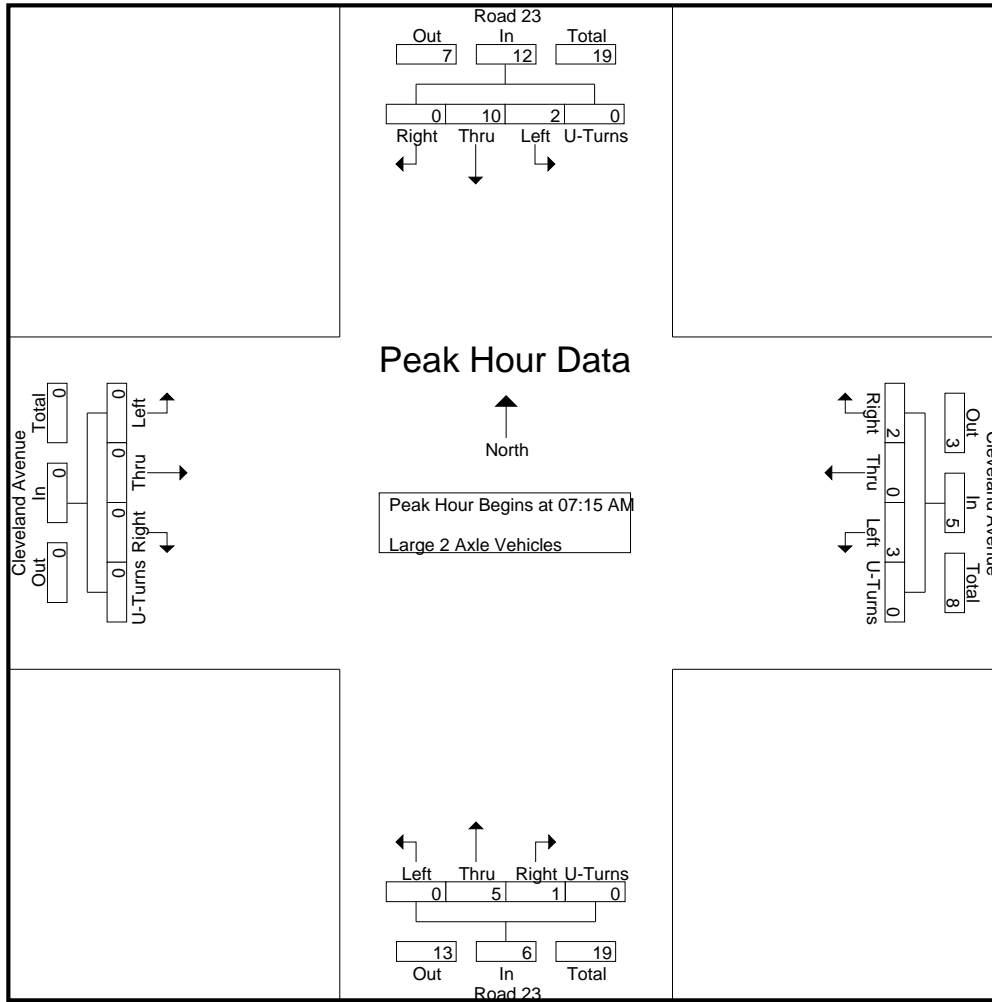

Peak Hour Analysis From 07:15 AM to 08:00 AM - Peak 1 of 1
 Peak Hour for Each Approach Begins at:

	07:15 AM					07:15 AM					07:15 AM									
+0 mins.	1	2	0	0	3	1	0	0	0	1	0	1	0	0	1	0	0	0	0	0
+15 mins.	0	4	0	0	4	1	0	0	0	1	0	4	1	0	5	0	0	0	0	0
+30 mins.	0	1	0	0	1	0	0	1	0	1	0	0	0	0	0	0	0	0	0	0
+45 mins.	1	3	0	0	4	1	0	1	0	2	0	0	0	0	0	0	0	0	0	0
Total Volume	2	10	0	0	12	3	0	2	0	5	0	5	1	0	6	0	0	0	0	0
% App. Total	16.7	83.3	0	0		60	0	40	0		0	83.3	16.7	0		0	0	0	0	
PHF	.500	.625	.000	.000	.750	.750	.000	.500	.000	.625	.000	.313	.250	.000	.300	.000	.000	.000	.000	.000

City of Madera
 N/S: Road 23
 E/W: Cleveland Avenue
 Weather: Clear

File Name : 07_MDA_Rd 23_Cleveland AM
 Site Code : 00319628
 Start Date : 9/18/2019
 Page No : 1

Groups Printed- 3 Axle Vehicles

Start Time	Road 23 Southbound					Cleveland Avenue Westbound					Road 23 Northbound					Cleveland Avenue Eastbound					Int. Total	
	Left	Thru	Right	U-Turns	App. Total	Left	Thru	Right	U-Turns	App. Total	Left	Thru	Right	U-Turns	App. Total	Left	Thru	Right	U-Turns	App. Total		
07:00 AM	0	1	0	0	1	0	0	0	0	0	0	1	0	0	1	0	0	0	0	0	0	2
07:15 AM	0	1	0	0	1	1	0	0	0	1	0	0	1	0	1	0	0	0	0	0	0	3
07:30 AM	0	1	0	0	1	0	0	0	0	0	0	0	0	0	0	0	0	0	0	0	0	1
07:45 AM	0	0	0	0	0	0	0	0	0	0	0	0	0	0	0	0	0	0	0	0	0	0
Total	0	3	0	0	3	1	0	0	0	1	0	1	1	0	2	0	0	0	0	0	0	6
08:00 AM	1	1	0	0	2	0	0	0	0	0	0	0	0	0	0	0	0	0	0	0	0	2
08:15 AM	0	0	0	0	0	0	0	0	0	0	0	2	0	0	2	0	0	0	0	0	0	2
08:30 AM	0	1	0	0	1	0	0	0	0	0	0	0	0	0	0	0	0	0	0	0	0	1
08:45 AM	0	1	0	0	1	0	0	0	0	0	0	2	0	0	2	0	0	0	0	0	0	3
Total	1	3	0	0	4	0	0	0	0	0	0	4	0	0	4	0	0	0	0	0	0	8
Grand Total	1	6	0	0	7	1	0	0	0	1	0	5	1	0	6	0	0	0	0	0	0	14
Apprch %	14.3	85.7	0	0		100	0	0	0		0	83.3	16.7	0		0	0	0	0			
Total %	7.1	42.9	0	0	50	7.1	0	0	0	7.1	0	35.7	7.1	0	42.9	0	0	0	0	0	0	

Start Time	Road 23 Southbound					Cleveland Avenue Westbound					Road 23 Northbound					Cleveland Avenue Eastbound					Int. Total	
	Left	Thru	Right	U-Turns	App. Total	Thru	Right	U-Turns	App. Total	Thru	Right	U-Turns	App. Total	Thru	Right	U-Turns	App. Total					
Peak Hour Analysis From 07:15 AM to 08:00 AM - Peak 1 of 1																						
Peak Hour for Entire Intersection Begins at 07:15 AM																						
07:15 AM	0	1	0	0	1	1	0	0	0	1	0	0	1	0	1	0	0	0	0	0	0	3
07:30 AM	0	1	0	0	1	0	0	0	0	0	0	0	0	0	0	0	0	0	0	0	0	1
07:45 AM	0	0	0	0	0	0	0	0	0	0	0	0	0	0	0	0	0	0	0	0	0	0
08:00 AM	1	1	0	0	2	0	0	0	0	0	0	0	0	0	0	0	0	0	0	0	0	2
Total Volume	1	3	0	0	4	1	0	0	0	1	0	0	1	0	1	0	0	0	0	0	0	6
% App. Total	25	75	0	0		100	0	0	0		0	0	100	0		0	0	0	0	0	0	
PHF	.250	.750	.000	.000	.500	.250	.000	.000	.000	.250	.000	.000	.250	.000	.250	.000	.000	.000	.000	.000	.000	.500

City of Madera
 N/S: Road 23
 E/W: Cleveland Avenue
 Weather: Clear

File Name : 07_MDA_Rd 23_Cleveland AM
 Site Code : 00319628
 Start Date : 9/18/2019
 Page No : 2

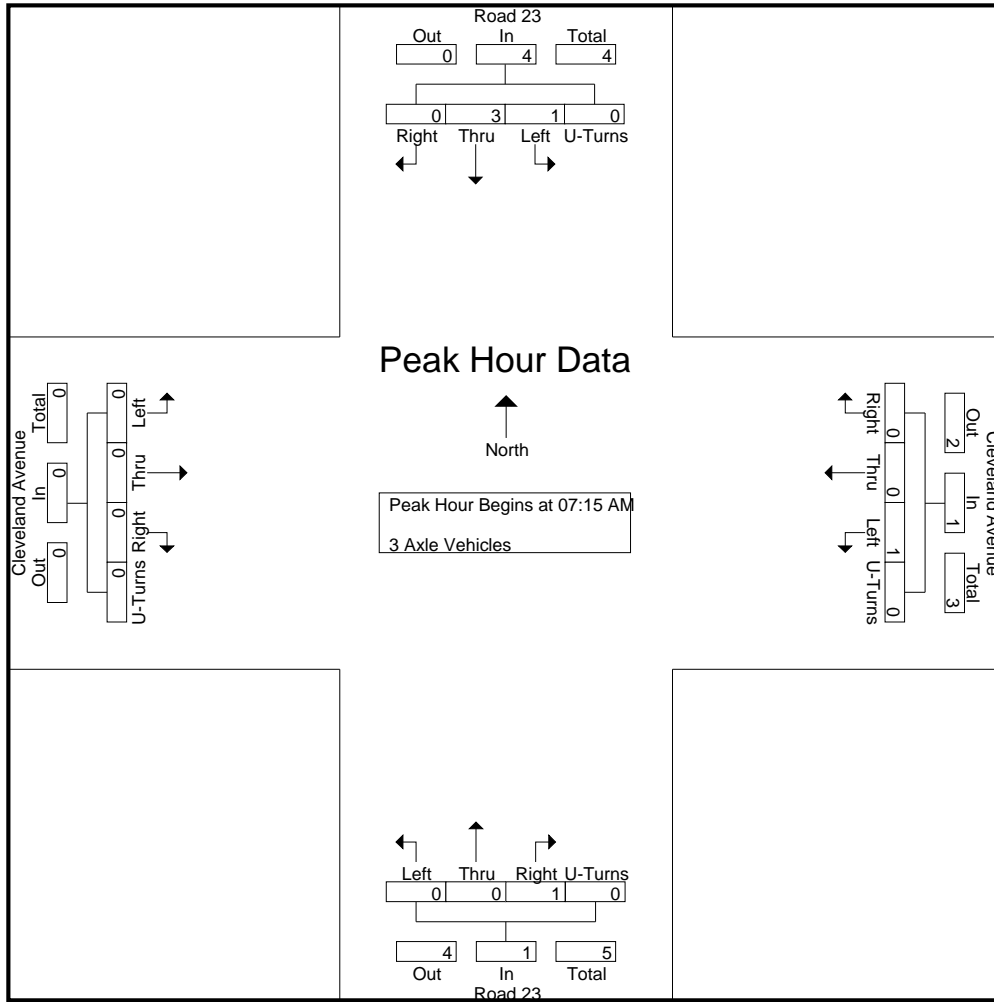

Peak Hour Analysis From 07:15 AM to 08:00 AM - Peak 1 of 1
 Peak Hour for Each Approach Begins at:

	07:15 AM					07:15 AM					07:15 AM									
+0 mins.	0	1	0	0	1	1	0	0	0	1	0	0	1	0	1	0	0	0	0	0
+15 mins.	0	1	0	0	1	0	0	0	0	0	0	0	0	0	0	0	0	0	0	0
+30 mins.	0	0	0	0	0	0	0	0	0	0	0	0	0	0	0	0	0	0	0	0
+45 mins.	1	1	0	0	2	0	0	0	0	0	0	0	0	0	0	0	0	0	0	0
Total Volume	1	3	0	0	4	1	0	0	0	1	0	0	1	0	1	0	0	0	0	0
% App. Total	25	75	0	0		100	0	0	0		0	0	100	0		0	0	0	0	
PHF	.250	.750	.000	.000	.500	.250	.000	.000	.000	.250	.000	.000	.250	.000	.250	.000	.000	.000	.000	.000

City of Madera
 N/S: Road 23
 E/W: Cleveland Avenue
 Weather: Clear

File Name : 07_MDA_Rd 23_Cleveland AM
 Site Code : 00319628
 Start Date : 9/18/2019
 Page No : 2

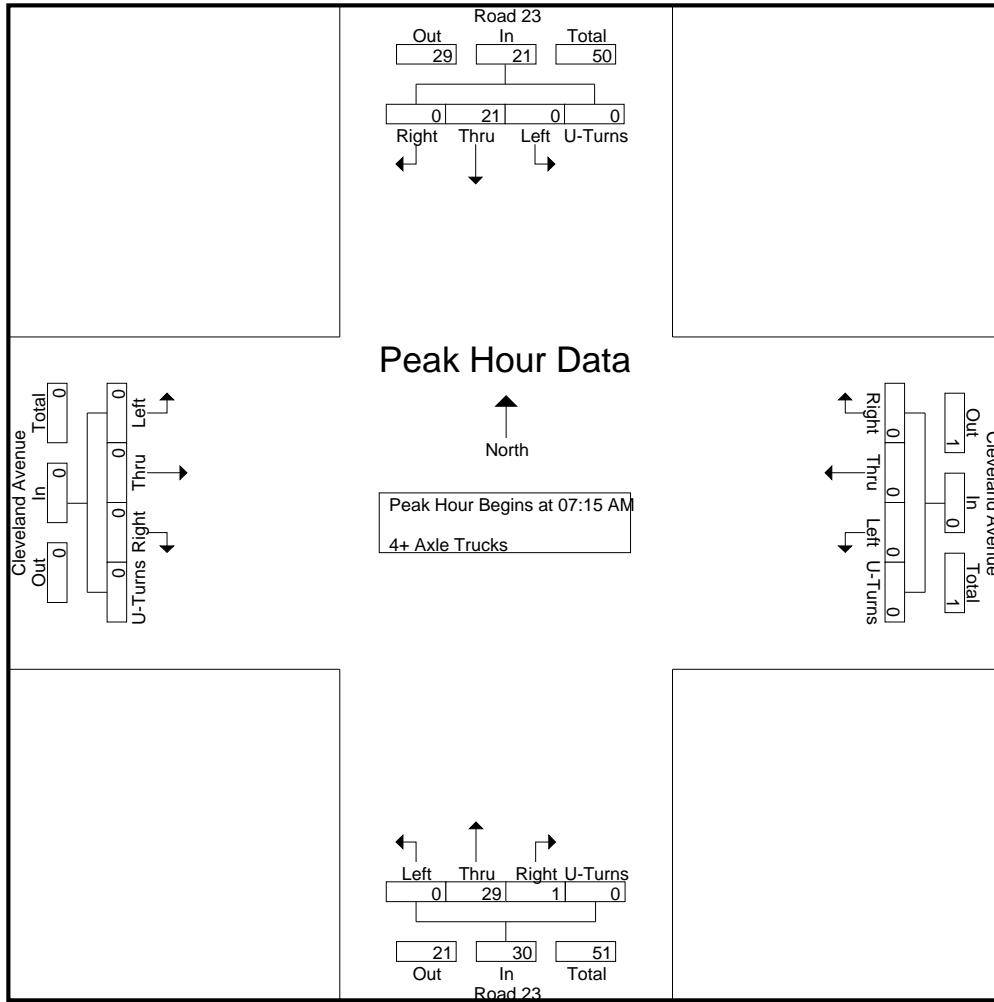

Peak Hour Analysis From 07:15 AM to 08:00 AM - Peak 1 of 1
 Peak Hour for Each Approach Begins at:

	07:15 AM					07:15 AM					07:15 AM									
+0 mins.	0	5	0	0	5	0	0	0	0	0	0	7	0	0	7	0	0	0	0	0
+15 mins.	0	8	0	0	8	0	0	0	0	0	0	6	0	0	6	0	0	0	0	0
+30 mins.	0	5	0	0	5	0	0	0	0	0	0	9	1	0	10	0	0	0	0	0
+45 mins.	0	3	0	0	3	0	0	0	0	0	0	7	0	0	7	0	0	0	0	0
Total Volume	0	21	0	0	21	0	0	0	0	0	0	29	1	0	30	0	0	0	0	0
% App. Total	0	100	0	0		0	0	0	0		0	96.7	3.3	0		0	0	0	0	
PHF	.000	.656	.000	.000	.656	.000	.000	.000	.000	.000	.000	.806	.250	.000	.750	.000	.000	.000	.000	.000

City of Madera
 N/S: Road 23
 E/W: Cleveland Avenue
 Weather: Clear

File Name : 07_MDA_Rd 23_Cleveland PM
 Site Code : 00319628
 Start Date : 9/18/2019
 Page No : 1

Groups Printed- Passenger Vehicles - Large 2 Axle Vehicles - 3 Axle Vehicles - 4+ Axle Trucks

Start Time	Road 23 Southbound					Cleveland Avenue Westbound					Road 23 Northbound					Cleveland Avenue Eastbound					Int. Total
	Left	Thru	Right	U-Turns	App. Total	Left	Thru	Right	U-Turns	App. Total	Left	Thru	Right	U-Turns	App. Total	Left	Thru	Right	U-Turns	App. Total	
04:00 PM	14	60	0	0	74	17	0	8	0	25	0	26	27	0	53	0	0	0	0	0	152
04:15 PM	19	57	0	0	76	13	0	9	0	22	0	27	18	0	45	0	0	0	0	0	143
04:30 PM	18	54	0	0	72	14	0	4	0	18	0	31	24	0	55	0	0	0	0	0	145
04:45 PM	8	53	1	0	62	7	0	4	0	11	0	29	20	0	49	1	0	1	0	2	124
Total	59	224	1	0	284	51	0	25	0	76	0	113	89	0	202	1	0	1	0	2	564
05:00 PM	11	48	0	0	59	12	0	5	0	17	0	35	27	0	62	0	0	0	0	0	138
05:15 PM	6	43	0	0	49	18	0	4	0	22	0	22	27	0	49	0	0	0	0	0	120
05:30 PM	11	39	0	0	50	9	0	9	0	18	0	26	21	0	47	0	0	0	0	0	115
05:45 PM	10	29	0	0	39	13	0	7	0	20	0	25	19	0	44	0	0	0	0	0	103
Total	38	159	0	0	197	52	0	25	0	77	0	108	94	0	202	0	0	0	0	0	476
Grand Total	97	383	1	0	481	103	0	50	0	153	0	221	183	0	404	1	0	1	0	2	1040
Apprch %	20.2	79.6	0.2	0		67.3	0	32.7	0		0	54.7	45.3	0		50	0	50	0		
Total %	9.3	36.8	0.1	0	46.2	9.9	0	4.8	0	14.7	0	21.2	17.6	0	38.8	0.1	0	0.1	0	0.2	
Passenger Vehicles	95.9	90.1	100	0	91.3	96.1	0	100	0	97.4	0	89.1	97.3	0	92.8	100	0	100	0	100	92.8
Large 2 Axle Vehicles	4.1	2.3	0	0	2.7	3.9	0	0	0	2.6	0	5.4	1.6	0	3.7	0	0	0	0	0	3.1
3 Axle Vehicles	0	2	0	0	2	0	0	0	0	0	0	1	0	0	1	0	0	0	0	0	3
% 3 Axle Vehicles	0	0.5	0	0	0.4	0	0	0	0	0	0	0.5	0	0	0.2	0	0	0	0	0	0.3
4+ Axle Trucks	0	27	0	0	27	0	0	0	0	0	0	11	2	0	13	0	0	0	0	0	40
% 4+ Axle Trucks																					

Start Time	Road 23 Southbound					Cleveland Avenue Westbound					Road 23 Northbound					Cleveland Avenue Eastbound					Int. Total
	Left	Thru	Right	U-Turns	App. Total	Left	Thru	Right	U-Turns	App. Total	Left	Thru	Right	U-Turns	App. Total	Left	Thru	Right	U-Turns	App. Total	
Peak Hour Analysis From 04:00 PM to 05:45 PM - Peak 1 of 1																					
Peak Hour for Entire Intersection Begins at 04:00 PM																					
04:00 PM	14	60	0	0	74	17	0	8	0	25	0	26	27	0	53	0	0	0	0	0	152
04:15 PM	19	57	0	0	76	13	0	9	0	22	0	27	18	0	45	0	0	0	0	0	143
04:30 PM	18	54	0	0	72	14	0	4	0	18	0	31	24	0	55	0	0	0	0	0	145
04:45 PM	8	53	1	0	62	7	0	4	0	11	0	29	20	0	49	1	0	1	0	2	124
Total Volume	59	224	1	0	284	51	0	25	0	76	0	113	89	0	202	1	0	1	0	2	564
% App. Total	20.8	78.9	0.4	0		67.1	0	32.9	0		0	55.9	44.1	0		50	0	50	0		
PHF	.776	.933	.250	.000	.934	.750	.000	.694	.000	.760	.000	.911	.824	.000	.918	.250	.000	.250	.000	.250	.928

City of Madera
 N/S: Road 23
 E/W: Cleveland Avenue
 Weather: Clear

File Name : 07_MDA_Rd 23_Cleveland PM
 Site Code : 00319628
 Start Date : 9/18/2019
 Page No : 2

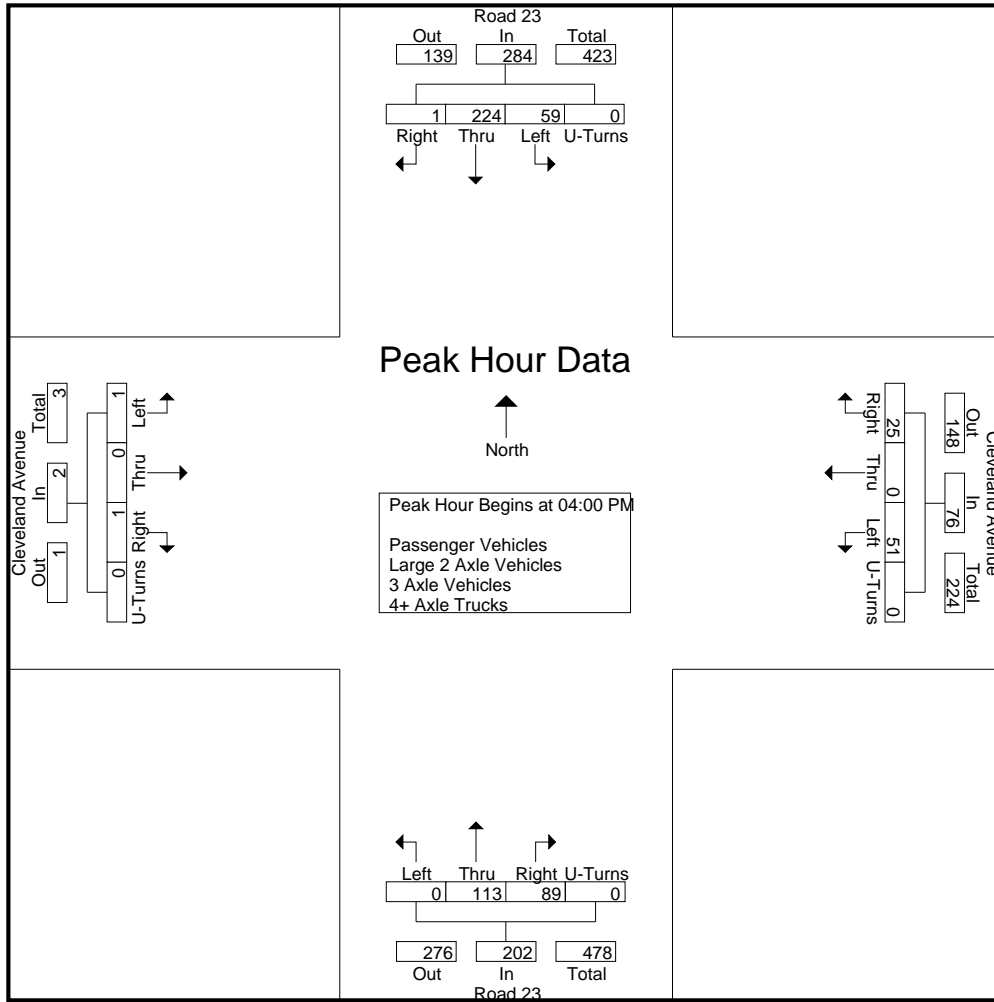

Peak Hour Analysis From 04:00 PM to 05:45 PM - Peak 1 of 1
 Peak Hour for Each Approach Begins at:

	04:00 PM					05:00 PM					04:30 PM					04:00 PM				
+0 mins.	14	60	0	0	74	12	0	5	0	17	0	31	24	0	55	0	0	0	0	0
+15 mins.	19	57	0	0	76	18	0	4	0	22	0	29	20	0	49	0	0	0	0	0
+30 mins.	18	54	0	0	72	9	0	9	0	18	0	35	27	0	62	0	0	0	0	0
+45 mins.	8	53	1	0	62	13	0	7	0	20	0	22	27	0	49	1	0	1	0	2
Total Volume	59	224	1	0	284	52	0	25	0	77	0	117	98	0	215	1	0	1	0	2
% App. Total	20.8	78.9	0.4	0	67.5	0	32.5	0		0	54.4	45.6	0		50	0	50	0		0
PHF	.776	.933	.250	.000	.934	.722	.000	.694	.000	.875	.000	.836	.907	.000	.867	.250	.000	.250	.000	.250

City of Madera
 N/S: Road 23
 E/W: Cleveland Avenue
 Weather: Clear

File Name : 07_MDA_Rd 23_Cleveland PM
 Site Code : 00319628
 Start Date : 9/18/2019
 Page No : 1

Groups Printed- Passenger Vehicles

Start Time	Road 23 Southbound					Cleveland Avenue Westbound					Road 23 Northbound					Cleveland Avenue Eastbound					Int. Total	
	Left	Thru	Right	U-Turns	App. Total	Left	Thru	Right	U-Turns	App. Total	Left	Thru	Right	U-Turns	App. Total	Left	Thru	Right	U-Turns	App. Total		
04:00 PM	14	57	0	0	71	16	0	8	0	24	0	24	27	0	51	0	0	0	0	0	0	146
04:15 PM	17	52	0	0	69	13	0	9	0	22	0	27	18	0	45	0	0	0	0	0	0	136
04:30 PM	17	46	0	0	63	13	0	4	0	17	0	28	23	0	51	0	0	0	0	0	0	131
04:45 PM	8	46	1	0	55	6	0	4	0	10	0	21	19	0	40	1	0	1	0	0	2	107
Total	56	201	1	0	258	48	0	25	0	73	0	100	87	0	187	1	0	1	0	0	2	520
05:00 PM	11	42	0	0	53	12	0	5	0	17	0	30	25	0	55	0	0	0	0	0	0	125
05:15 PM	6	39	0	0	45	17	0	4	0	21	0	19	27	0	46	0	0	0	0	0	0	112
05:30 PM	10	38	0	0	48	9	0	9	0	18	0	23	20	0	43	0	0	0	0	0	0	109
05:45 PM	10	25	0	0	35	13	0	7	0	20	0	25	19	0	44	0	0	0	0	0	0	99
Total	37	144	0	0	181	51	0	25	0	76	0	97	91	0	188	0	0	0	0	0	0	445
Grand Total	93	345	1	0	439	99	0	50	0	149	0	197	178	0	375	1	0	1	0	0	2	965
Apprch %	21.2	78.6	0.2	0		66.4	0	33.6	0		0	52.5	47.5	0		50	0	50	0	0		
Total %	9.6	35.8	0.1	0	45.5	10.3	0	5.2	0	15.4	0	20.4	18.4	0	38.9	0.1	0	0.1	0	0	0.2	

Start Time	Road 23 Southbound					Cleveland Avenue Westbound					Road 23 Northbound					Cleveland Avenue Eastbound					Int. Total
	Left	Thru	Right	U-Turns	App. Total	Thru	Right	U-Turns	App. Total	Thru	Right	U-Turns	App. Total	Thru	Right	U-Turns	App. Total				
Peak Hour Analysis From 04:00 PM to 04:45 PM - Peak 1 of 1																					
Peak Hour for Entire Intersection Begins at 04:00 PM																					
04:00 PM	14	57	0	0	71	16	0	8	0	24	0	24	27	0	51	0	0	0	0	0	146
04:15 PM	17	52	0	0	69	13	0	9	0	22	0	27	18	0	45	0	0	0	0	0	136
04:30 PM	17	46	0	0	63	13	0	4	0	17	0	28	23	0	51	0	0	0	0	0	131
04:45 PM	8	46	1	0	55	6	0	4	0	10	0	21	19	0	40	1	0	1	0	2	107
Total Volume	56	201	1	0	258	48	0	25	0	73	0	100	87	0	187	1	0	1	0	0	520
% App. Total	21.7	77.9	0.4	0		65.8	0	34.2	0		0	53.5	46.5	0		50	0	50	0		
PHF	.824	.882	.250	.000	.908	.750	.000	.694	.000	.760	.000	.893	.806	.000	.917	.250	.000	.250	.000	.250	.890

City of Madera
 N/S: Road 23
 E/W: Cleveland Avenue
 Weather: Clear

File Name : 07_MDA_Rd 23_Cleveland PM
 Site Code : 00319628
 Start Date : 9/18/2019
 Page No : 2

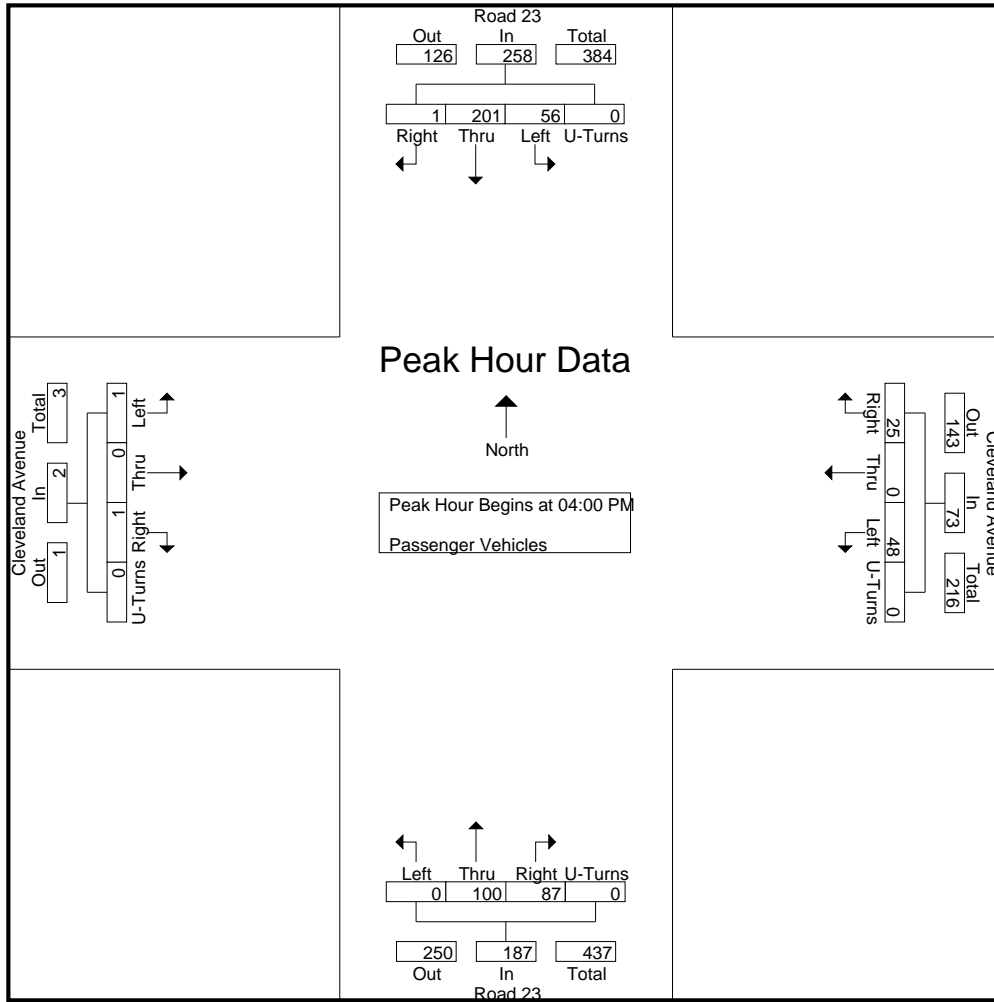

Peak Hour Analysis From 04:00 PM to 04:45 PM - Peak 1 of 1
 Peak Hour for Each Approach Begins at:

	04:00 PM					04:00 PM					04:00 PM					04:00 PM				
+0 mins.	14	57	0	0	71	16	0	8	0	24	0	24	27	0	51	0	0	0	0	0
+15 mins.	17	52	0	0	69	13	0	9	0	22	0	27	18	0	45	0	0	0	0	0
+30 mins.	17	46	0	0	63	13	0	4	0	17	0	28	23	0	51	0	0	0	0	0
+45 mins.	8	46	1	0	55	6	0	4	0	10	0	21	19	0	40	1	0	1	0	2
Total Volume	56	201	1	0	258	48	0	25	0	73	0	100	87	0	187	1	0	1	0	2
% App. Total	21.7	77.9	0.4	0		65.8	0	34.2	0		0	53.5	46.5	0		50	0	50	0	
PHF	.824	.882	.250	.000	.908	.750	.000	.694	.000	.760	.000	.893	.806	.000	.917	.250	.000	.250	.000	.250

City of Madera
 N/S: Road 23
 E/W: Cleveland Avenue
 Weather: Clear

File Name : 07_MDA_Rd 23_Cleveland PM
 Site Code : 00319628
 Start Date : 9/18/2019
 Page No : 1

Groups Printed- Large 2 Axle Vehicles

Start Time	Road 23 Southbound					Cleveland Avenue Westbound					Road 23 Northbound					Cleveland Avenue Eastbound					Int. Total
	Left	Thru	Right	U-Turns	App. Total	Left	Thru	Right	U-Turns	App. Total	Left	Thru	Right	U-Turns	App. Total	Left	Thru	Right	U-Turns	App. Total	
04:00 PM	0	3	0	0	3	1	0	0	0	1	0	0	0	0	0	0	0	0	0	0	4
04:15 PM	2	1	0	0	3	0	0	0	0	0	0	0	0	0	0	0	0	0	0	0	3
04:30 PM	1	3	0	0	4	1	0	0	0	1	0	1	0	0	1	0	0	0	0	0	6
04:45 PM	0	2	0	0	2	1	0	0	0	1	0	6	1	0	7	0	0	0	0	0	10
Total	3	9	0	0	12	3	0	0	0	3	0	7	1	0	8	0	0	0	0	0	23
05:00 PM	0	0	0	0	0	0	0	0	0	0	0	2	1	0	3	0	0	0	0	0	3
05:15 PM	0	0	0	0	0	1	0	0	0	1	0	1	0	0	1	0	0	0	0	0	2
05:30 PM	1	0	0	0	1	0	0	0	0	0	0	2	1	0	3	0	0	0	0	0	4
05:45 PM	0	0	0	0	0	0	0	0	0	0	0	0	0	0	0	0	0	0	0	0	0
Total	1	0	0	0	1	1	0	0	0	1	0	5	2	0	7	0	0	0	0	0	9
Grand Total	4	9	0	0	13	4	0	0	0	4	0	12	3	0	15	0	0	0	0	0	32
Apprch %	30.8	69.2	0	0		100	0	0	0		0	80	20	0		0	0	0	0		
Total %	12.5	28.1	0	0	40.6	12.5	0	0	0	12.5	0	37.5	9.4	0	46.9	0	0	0	0	0	

Start Time	Road 23 Southbound					Cleveland Avenue Westbound					Road 23 Northbound					Cleveland Avenue Eastbound					Int. Total
	Left	Thru	Right	U-Turns	App. Total	Thru	Right	U-Turns	App. Total	Thru	Right	U-Turns	App. Total	Thru	Right	U-Turns	App. Total				
Peak Hour Analysis From 04:00 PM to 04:45 PM - Peak 1 of 1																					
Peak Hour for Entire Intersection Begins at 04:00 PM																					
04:00 PM	0	3	0	0	3	1	0	0	0	1	0	0	0	0	0	0	0	0	0	0	4
04:15 PM	2	1	0	0	3	0	0	0	0	0	0	0	0	0	0	0	0	0	0	0	3
04:30 PM	1	3	0	0	4	1	0	0	0	1	0	1	0	0	1	0	0	0	0	0	6
04:45 PM	0	2	0	0	2	1	0	0	0	1	0	6	1	0	7	0	0	0	0	0	10
Total Volume	3	9	0	0	12	3	0	0	0	3	0	7	1	0	8	0	0	0	0	0	23
% App. Total	25	75	0	0		100	0	0	0		0	87.5	12.5	0		0	0	0	0		
PHF	.375	.750	.000	.000	.750	.750	.000	.000	.000	.750	.000	.292	.250	.000	.286	.000	.000	.000	.000	.000	.575

City of Madera
 N/S: Road 23
 E/W: Cleveland Avenue
 Weather: Clear

File Name : 07_MDA_Rd 23_Cleveland PM
 Site Code : 00319628
 Start Date : 9/18/2019
 Page No : 2

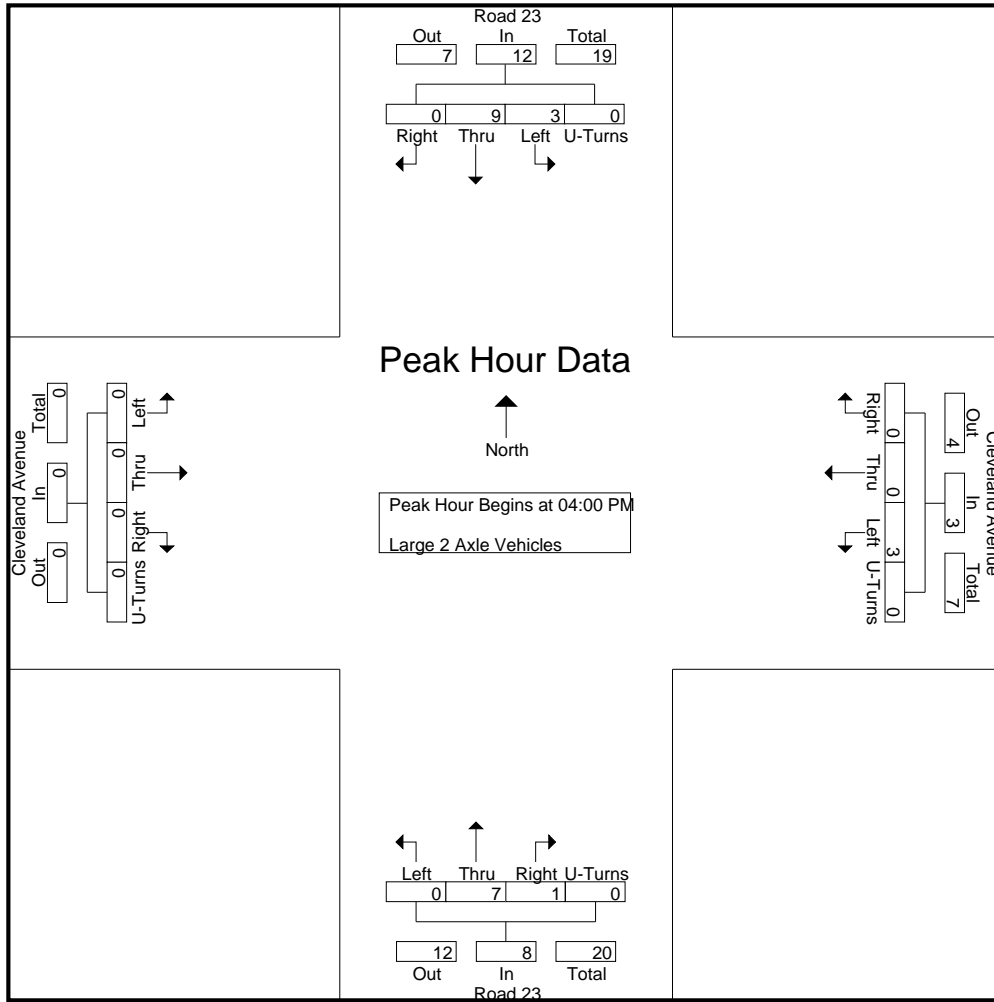

Peak Hour Analysis From 04:00 PM to 04:45 PM - Peak 1 of 1
 Peak Hour for Each Approach Begins at:

	04:00 PM					04:00 PM					04:00 PM					04:00 PM				
+0 mins.	0	3	0	0	3	1	0	0	0	1	0	0	0	0	0	0	0	0	0	0
+15 mins.	2	1	0	0	3	0	0	0	0	0	0	0	0	0	0	0	0	0	0	0
+30 mins.	1	3	0	0	4	1	0	0	0	1	0	1	0	0	1	0	0	0	0	0
+45 mins.	0	2	0	0	2	1	0	0	0	1	0	6	1	0	7	0	0	0	0	0
Total Volume	3	9	0	0	12	3	0	0	0	3	0	7	1	0	8	0	0	0	0	0
% App. Total	25	75	0	0		100	0	0	0		0	87.5	12.5	0		0	0	0	0	
PHF	.375	.750	.000	.000	.750	.750	.000	.000	.000	.750	.000	.292	.250	.000	.286	.000	.000	.000	.000	.000

City of Madera
 N/S: Road 23
 E/W: Cleveland Avenue
 Weather: Clear

File Name : 07_MDA_Rd 23_Cleveland PM
 Site Code : 00319628
 Start Date : 9/18/2019
 Page No : 1

Groups Printed- 3 Axle Vehicles

Start Time	Road 23 Southbound					Cleveland Avenue Westbound					Road 23 Northbound					Cleveland Avenue Eastbound					Int. Total
	Left	Thru	Right	U-Turns	App. Total	Left	Thru	Right	U-Turns	App. Total	Left	Thru	Right	U-Turns	App. Total	Left	Thru	Right	U-Turns	App. Total	
04:00 PM	0	0	0	0	0	0	0	0	0	0	0	0	0	0	0	0	0	0	0	0	0
04:15 PM	0	0	0	0	0	0	0	0	0	0	0	0	0	0	0	0	0	0	0	0	0
04:30 PM	0	0	0	0	0	0	0	0	0	0	0	0	0	0	0	0	0	0	0	0	0
04:45 PM	0	0	0	0	0	0	0	0	0	0	0	1	0	0	1	0	0	0	0	0	1
Total	0	0	0	0	0	0	0	0	0	0	0	1	0	0	1	0	0	0	0	0	1
05:00 PM	0	1	0	0	1	0	0	0	0	0	0	0	0	0	0	0	0	0	0	0	1
05:15 PM	0	1	0	0	1	0	0	0	0	0	0	0	0	0	0	0	0	0	0	0	1
05:30 PM	0	0	0	0	0	0	0	0	0	0	0	0	0	0	0	0	0	0	0	0	0
05:45 PM	0	0	0	0	0	0	0	0	0	0	0	0	0	0	0	0	0	0	0	0	0
Total	0	2	0	0	2	0	0	0	0	0	0	0	0	0	0	0	0	0	0	0	2
Grand Total	0	2	0	0	2	0	0	0	0	0	0	1	0	0	1	0	0	0	0	0	3
Apprch %	0	100	0	0		0	0	0	0		0	100	0	0		0	0	0	0		
Total %	0	66.7	0	0	66.7	0	0	0	0	0	0	33.3	0	0	33.3	0	0	0	0	0	

Start Time	Road 23 Southbound					Cleveland Avenue Westbound					Road 23 Northbound					Cleveland Avenue Eastbound					Int. Total
	Left	Thru	Right	U-Turns	App. Total	Thru	Right	U-Turns	App. Total	Thru	Right	U-Turns	App. Total	Thru	Right	U-Turns	App. Total				
Peak Hour Analysis From 04:00 PM to 04:45 PM - Peak 1 of 1																					
Peak Hour for Entire Intersection Begins at 04:00 PM																					
04:00 PM	0	0	0	0	0	0	0	0	0	0	0	0	0	0	0	0	0	0	0	0	0
04:15 PM	0	0	0	0	0	0	0	0	0	0	0	0	0	0	0	0	0	0	0	0	0
04:30 PM	0	0	0	0	0	0	0	0	0	0	0	0	0	0	0	0	0	0	0	0	0
04:45 PM	0	0	0	0	0	0	0	0	0	0	0	1	0	0	1	0	0	0	0	0	1
Total Volume	0	0	0	0	0	0	0	0	0	0	0	1	0	0	1	0	0	0	0	0	1
% App. Total	0	0	0	0		0	0	0	0		0	100	0	0		0	0	0	0		
PHF	.000	.000	.000	.000	.000	.000	.000	.000	.000	.000	.000	.250	.000	.000	.250	.000	.000	.000	.000	.000	.250

City of Madera
 N/S: Road 23
 E/W: Cleveland Avenue
 Weather: Clear

File Name : 07_MDA_Rd 23_Cleveland PM
 Site Code : 00319628
 Start Date : 9/18/2019
 Page No : 2

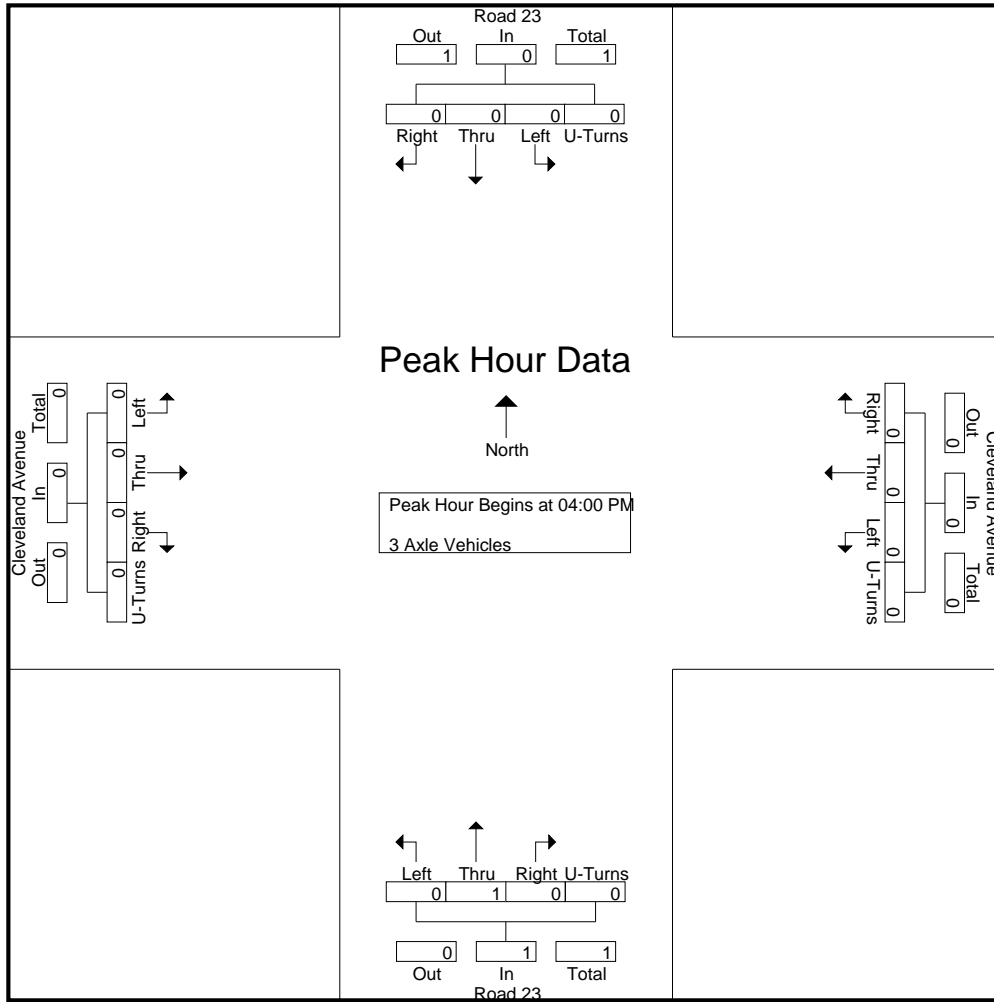

Peak Hour Analysis From 04:00 PM to 04:45 PM - Peak 1 of 1
 Peak Hour for Each Approach Begins at:

	04:00 PM					04:00 PM					04:00 PM					04:00 PM				
+0 mins.	0	0	0	0	0	0	0	0	0	0	0	0	0	0	0	0	0	0	0	0
+15 mins.	0	0	0	0	0	0	0	0	0	0	0	0	0	0	0	0	0	0	0	0
+30 mins.	0	0	0	0	0	0	0	0	0	0	0	0	0	0	0	0	0	0	0	0
+45 mins.	0	0	0	0	0	0	0	0	0	0	0	1	0	0	1	0	0	0	0	0
Total Volume	0	0	0	0	0	0	0	0	0	0	0	1	0	0	1	0	0	0	0	0
% App. Total	0	0	0	0	0	0	0	0	0	0	0	100	0	0	0	0	0	0	0	0
PHF	.000	.000	.000	.000	.000	.000	.000	.000	.000	.000	.000	.250	.000	.000	.250	.000	.000	.000	.000	.000

City of Madera
 N/S: Road 23
 E/W: Cleveland Avenue
 Weather: Clear

File Name : 07_MDA_Rd 23_Cleveland PM
 Site Code : 00319628
 Start Date : 9/18/2019
 Page No : 1

Groups Printed- 4+ Axle Trucks

Start Time	Road 23 Southbound					Cleveland Avenue Westbound					Road 23 Northbound					Cleveland Avenue Eastbound					Int. Total	
	Left	Thru	Right	U-Turns	App. Total	Left	Thru	Right	U-Turns	App. Total	Left	Thru	Right	U-Turns	App. Total	Left	Thru	Right	U-Turns	App. Total		
04:00 PM	0	0	0	0	0	0	0	0	0	0	0	2	0	0	2	0	0	0	0	0	0	2
04:15 PM	0	4	0	0	4	0	0	0	0	0	0	0	0	0	0	0	0	0	0	0	0	4
04:30 PM	0	5	0	0	5	0	0	0	0	0	0	2	1	0	3	0	0	0	0	0	0	8
04:45 PM	0	5	0	0	5	0	0	0	0	0	0	1	0	0	1	0	0	0	0	0	0	6
Total	0	14	0	0	14	0	0	0	0	0	0	5	1	0	6	0	0	0	0	0	0	20
05:00 PM	0	5	0	0	5	0	0	0	0	0	0	3	1	0	4	0	0	0	0	0	0	9
05:15 PM	0	3	0	0	3	0	0	0	0	0	0	2	0	0	2	0	0	0	0	0	0	5
05:30 PM	0	1	0	0	1	0	0	0	0	0	0	1	0	0	1	0	0	0	0	0	0	2
05:45 PM	0	4	0	0	4	0	0	0	0	0	0	0	0	0	0	0	0	0	0	0	0	4
Total	0	13	0	0	13	0	0	0	0	0	0	6	1	0	7	0	0	0	0	0	0	20
Grand Total	0	27	0	0	27	0	0	0	0	0	0	11	2	0	13	0	0	0	0	0	0	40
Apprch %	0	100	0	0		0	0	0	0		0	84.6	15.4	0		0	0	0	0			
Total %	0	67.5	0	0	67.5	0	0	0	0	0	0	27.5	5	0	32.5	0	0	0	0	0		

Start Time	Road 23 Southbound					Cleveland Avenue Westbound					Road 23 Northbound					Cleveland Avenue Eastbound					Int. Total	
	Left	Thru	Right	U-Turns	App. Total	Thru	Right	U-Turns	App. Total	Thru	Right	U-Turns	App. Total	Thru	Right	U-Turns	App. Total					
Peak Hour Analysis From 04:00 PM to 04:45 PM - Peak 1 of 1																						
Peak Hour for Entire Intersection Begins at 04:00 PM																						
04:00 PM	0	0	0	0	0	0	0	0	0	0	0	2	0	0	2	0	0	0	0	0	0	2
04:15 PM	0	4	0	0	4	0	0	0	0	0	0	0	0	0	0	0	0	0	0	0	0	4
04:30 PM	0	5	0	0	5	0	0	0	0	0	0	2	1	0	3	0	0	0	0	0	0	8
04:45 PM	0	5	0	0	5	0	0	0	0	0	0	1	0	0	1	0	0	0	0	0	0	6
Total Volume	0	14	0	0	14	0	0	0	0	0	0	5	1	0	6	0	0	0	0	0	0	20
% App. Total	0	100	0	0		0	0	0	0		0	83.3	16.7	0		0	0	0	0			
PHF	.000	.700	.000	.000	.700	.000	.000	.000	.000	.000	.000	.625	.250	.000	.500	.000	.000	.000	.000	.000		.625

City of Madera
 N/S: Road 23
 E/W: Cleveland Avenue
 Weather: Clear

File Name : 07_MDA_Rd 23_Cleveland PM
 Site Code : 00319628
 Start Date : 9/18/2019
 Page No : 2

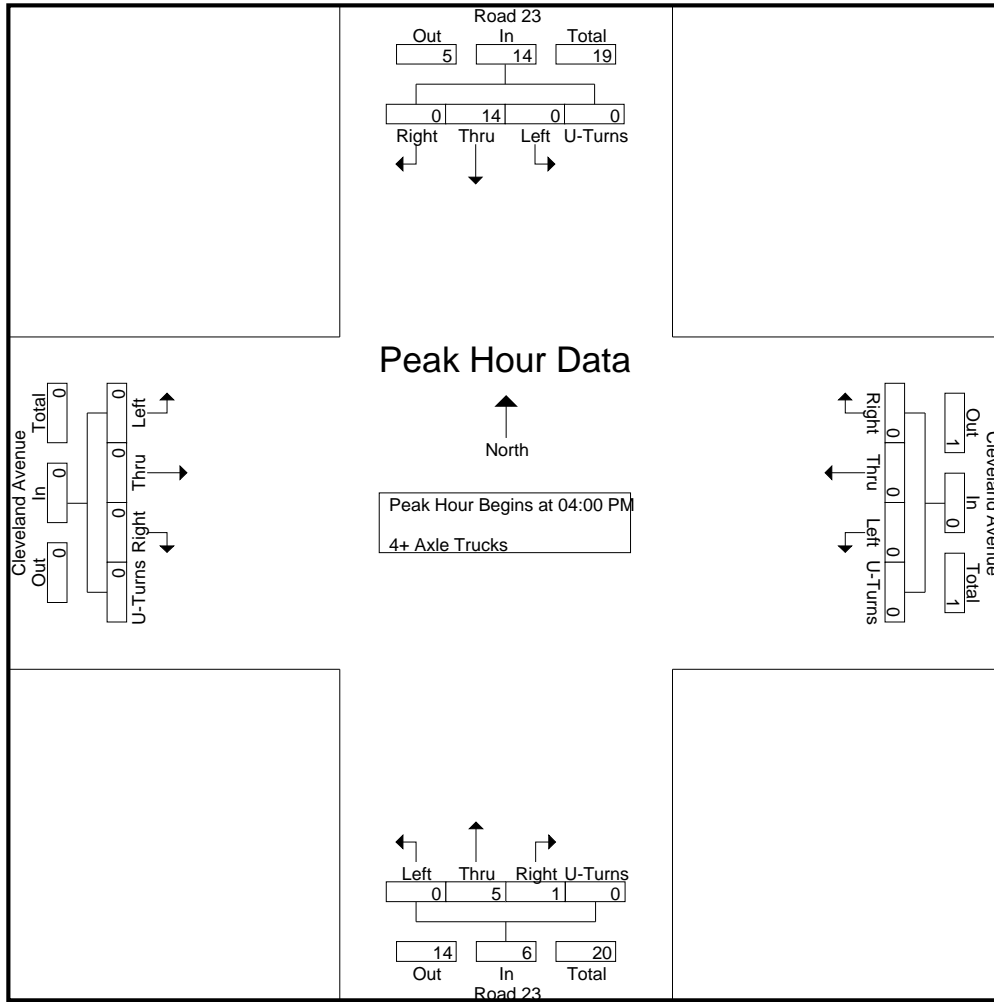

Peak Hour Analysis From 04:00 PM to 04:45 PM - Peak 1 of 1
 Peak Hour for Each Approach Begins at:

	04:00 PM					04:00 PM					04:00 PM					04:00 PM				
+0 mins.	0	0	0	0	0	0	0	0	0	0	0	2	0	0	2	0	0	0	0	0
+15 mins.	0	4	0	0	4	0	0	0	0	0	0	0	0	0	0	0	0	0	0	0
+30 mins.	0	5	0	0	5	0	0	0	0	0	0	2	1	0	3	0	0	0	0	0
+45 mins.	0	5	0	0	5	0	0	0	0	0	0	1	0	0	1	0	0	0	0	0
Total Volume	0	14	0	0	14	0	0	0	0	0	0	5	1	0	6	0	0	0	0	0
% App. Total	0	100	0	0	0	0	0	0	0	0	0	83.3	16.7	0	0	0	0	0	0	0
PHF	.000	.700	.000	.000	.700	.000	.000	.000	.000	.000	.000	.625	.250	.000	.500	.000	.000	.000	.000	.000

Location: Madera
 N/S: Road 23
 E/W: Cleveland Avenue



Date: 9/18/2019
 Day: Wednesday

PEDESTRIANS

	North Leg Road 23	East Leg Cleveland Avenue	South Leg Road 23	West Leg Cleveland Avenue	
	Pedestrians	Pedestrians	Pedestrians	Pedestrians	
7:00 AM	0	0	0	0	0
7:15 AM	0	0	0	0	0
7:30 AM	0	0	0	0	0
7:45 AM	0	0	0	0	0
8:00 AM	0	0	0	0	0
8:15 AM	0	0	0	0	0
8:30 AM	0	0	0	0	0
8:45 AM	0	0	0	0	0
TOTAL VOLUMES:	0	0	0	0	0

	North Leg Road 23	East Leg Cleveland Avenue	South Leg Road 23	West Leg Cleveland Avenue	
	Pedestrians	Pedestrians	Pedestrians	Pedestrians	
4:00 PM	0	0	0	0	0
4:15 PM	0	0	0	0	0
4:30 PM	0	0	0	0	0
4:45 PM	0	0	0	0	0
5:00 PM	0	0	0	0	0
5:15 PM	0	0	0	0	0
5:30 PM	0	0	0	0	0
5:45 PM	0	0	0	0	0
TOTAL VOLUMES:	0	0	0	0	0

Location: Madera
 N/S: Road 23
 E/W: Cleveland Avenue



Date: 9/18/2019
 Day: Wednesday

BICYCLES

	Southbound Road 23			Westbound Cleveland Avenue			Northbound Road 23			Eastbound Cleveland Avenue			
	Left	Thru	Right	Left	Thru	Right	Left	Thru	Right	Left	Thru	Right	
7:00 AM	0	0	0	0	0	0	0	0	0	0	0	0	0
7:15 AM	0	0	0	0	0	0	0	0	0	0	0	0	0
7:30 AM	0	0	0	0	0	0	0	0	0	0	1	0	1
7:45 AM	0	0	0	0	0	0	0	0	0	0	0	0	0
8:00 AM	0	0	0	0	0	0	0	0	0	0	0	0	0
8:15 AM	0	0	0	0	0	0	0	0	0	0	0	0	0
8:30 AM	0	0	0	0	0	0	0	0	0	0	0	0	0
8:45 AM	0	0	0	0	0	0	0	0	0	0	0	0	0
TOTAL VOLUMES:	0	0	0	0	0	0	0	0	0	0	1	0	1

	Southbound Road 23			Westbound Cleveland Avenue			Northbound Road 23			Eastbound Cleveland Avenue			
	Left	Thru	Right	Left	Thru	Right	Left	Thru	Right	Left	Thru	Right	
4:00 PM	0	0	0	0	0	0	0	0	0	0	0	0	0
4:15 PM	0	0	0	0	0	0	0	0	0	0	0	0	0
4:30 PM	0	0	0	0	0	0	0	0	0	0	0	0	0
4:45 PM	0	0	0	0	0	0	0	0	0	0	0	0	0
5:00 PM	0	0	0	0	0	0	0	0	0	0	0	0	0
5:15 PM	0	0	0	0	0	0	0	0	0	0	0	0	0
5:30 PM	0	0	0	0	0	0	0	0	0	0	0	0	0
5:45 PM	0	0	0	0	0	0	0	0	0	0	0	0	0
TOTAL VOLUMES:	0	0	0	0	0	0	0	0	0	0	0	0	0

City of Madera
 N/S: Road 23
 E/W: Avenue 14 1/2
 Weather: Clear

File Name : 08_MDA_Rd 23_Ave 14 1-2 AM
 Site Code : 00319628
 Start Date : 9/18/2019
 Page No : 1

Groups Printed- Total Volume

Start Time	Road 23 Southbound					Avenue 14 1/2 Westbound					Road 23 Northbound					Avenue 14 1/2 Eastbound					Int. Total
	Left	Thru	Right	U-Turns	App. Total	Left	Thru	Right	U-Turns	App. Total	Left	Thru	Right	U-Turns	App. Total	Left	Thru	Right	U-Turns	App. Total	
07:00 AM	2	27	0	0	29	2	1	8	0	11	1	23	0	0	24	0	1	0	0	1	65
07:15 AM	4	34	0	0	38	4	1	17	0	22	0	35	3	0	38	0	1	0	0	1	99
07:30 AM	4	48	0	0	52	2	1	25	0	28	1	57	0	0	58	0	0	0	0	0	138
07:45 AM	14	48	0	0	62	6	0	11	0	17	2	49	1	0	52	0	2	0	0	2	133
Total	24	157	0	0	181	14	3	61	0	78	4	164	4	0	172	0	4	0	0	4	435
08:00 AM	6	36	0	0	42	4	1	14	0	19	0	36	0	0	36	0	2	0	0	2	99
08:15 AM	2	32	0	0	34	1	1	5	0	7	0	47	0	0	47	1	2	1	0	4	92
08:30 AM	2	40	0	0	42	2	2	7	0	11	1	38	0	0	39	1	0	0	0	1	93
08:45 AM	3	25	0	0	28	1	0	6	0	7	0	34	0	0	34	0	1	0	0	1	70
Total	13	133	0	0	146	8	4	32	0	44	1	155	0	0	156	2	5	1	0	8	354
Grand Total	37	290	0	0	327	22	7	93	0	122	5	319	4	0	328	2	9	1	0	12	789
Apprch %	11.3	88.7	0	0		18	5.7	76.2	0		1.5	97.3	1.2	0		16.7	75	8.3	0		
Total %	4.7	36.8	0	0	41.4	2.8	0.9	11.8	0	15.5	0.6	40.4	0.5	0	41.6	0.3	1.1	0.1	0	1.5	

Start Time	Road 23 Southbound					Avenue 14 1/2 Westbound					Road 23 Northbound					Avenue 14 1/2 Eastbound					Int. Total
	Left	Thru	Right	U-Turns	App. Total	Thru	Right	U-Turns	App. Total	Thru	Right	U-Turns	App. Total	Thru	Right	U-Turns	App. Total				
Peak Hour Analysis From 07:00 AM to 08:45 AM - Peak 1 of 1																					
Peak Hour for Entire Intersection Begins at 07:15 AM																					
07:15 AM	4	34	0	0	38	4	1	17	0	22	0	35	3	0	38	0	1	0	0	1	99
07:30 AM	4	48	0	0	52	2	1	25	0	28	1	57	0	0	58	0	0	0	0	0	138
07:45 AM	14	48	0	0	62	6	0	11	0	17	2	49	1	0	52	0	2	0	0	2	133
08:00 AM	6	36	0	0	42	4	1	14	0	19	0	36	0	0	36	0	2	0	0	2	99
Total Volume	28	166	0	0	194	16	3	67	0	86	3	177	4	0	184	0	5	0	0	5	469
% App. Total	14.4	85.6	0	0		18.6	3.5	77.9	0		1.6	96.2	2.2	0		0	100	0	0		
PHF	.500	.865	.000	.000	.782	.667	.750	.670	.000	.768	.375	.776	.333	.000	.793	.000	.625	.000	.000	.625	.850

City of Madera
 N/S: Road 23
 E/W: Avenue 14 1/2
 Weather: Clear

File Name : 08_MDA_Rd 23_Ave 14 1-2 AM
 Site Code : 00319628
 Start Date : 9/18/2019
 Page No : 2

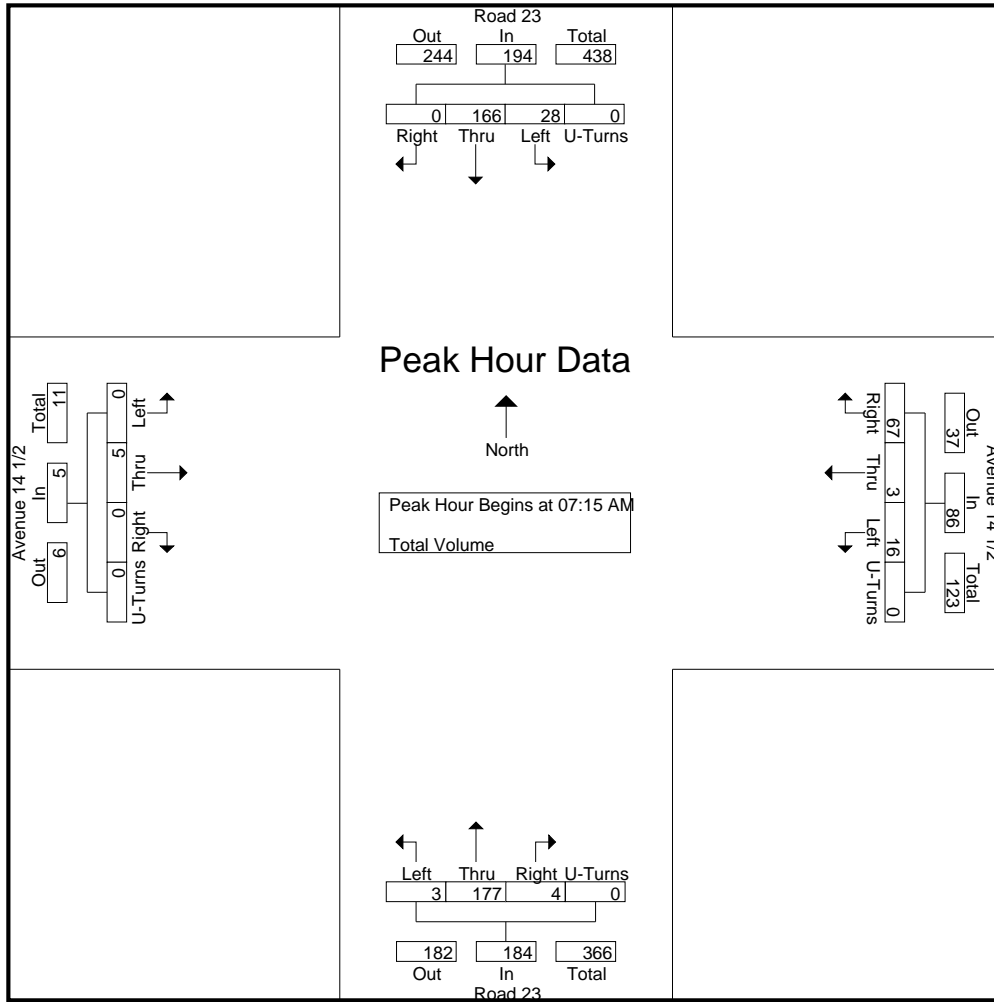

Peak Hour Analysis From 07:00 AM to 08:45 AM - Peak 1 of 1
 Peak Hour for Each Approach Begins at:

	07:15 AM					07:15 AM					07:30 AM					07:45 AM				
+0 mins.	4	34	0	0	38	4	1	17	0	22	1	57	0	0	58	0	2	0	0	2
+15 mins.	4	48	0	0	52	2	1	25	0	28	2	49	1	0	52	0	2	0	0	2
+30 mins.	14	48	0	0	62	6	0	11	0	17	0	36	0	0	36	1	2	1	0	4
+45 mins.	6	36	0	0	42	4	1	14	0	19	0	47	0	0	47	1	0	0	0	1
Total Volume	28	166	0	0	194	16	3	67	0	86	3	189	1	0	193	2	6	1	0	9
% App. Total	14.4	85.6	0	0		18.6	3.5	77.9	0		1.6	97.9	0.5	0		22.2	66.7	11.1	0	
PHF	.500	.865	.000	.000	.782	.667	.750	.670	.000	.768	.375	.829	.250	.000	.832	.500	.750	.250	.000	.563

City of Madera
 N/S: Road 23
 E/W: Avenue 14 1/2
 Weather: Clear

File Name : 08_MDA_Rd 23_Ave 14 1-2 PM
 Site Code : 00319628
 Start Date : 9/18/2019
 Page No : 1

Groups Printed- Total Volume

Start Time	Road 23 Southbound					Avenue 14 1/2 Westbound					Road 23 Northbound					Avenue 14 1/2 Eastbound					Int. Total
	Left	Thru	Right	U-Turns	App. Total	Left	Thru	Right	U-Turns	App. Total	Left	Thru	Right	U-Turns	App. Total	Left	Thru	Right	U-Turns	App. Total	
04:00 PM	16	57	0	0	73	3	0	1	0	4	1	43	0	0	44	0	0	0	0	0	121
04:15 PM	17	50	0	0	67	0	1	3	0	4	0	41	0	0	41	0	0	1	0	1	113
04:30 PM	14	58	0	0	72	1	2	2	0	5	1	52	2	0	55	1	2	1	0	4	136
04:45 PM	13	50	0	0	63	0	0	2	0	2	0	43	0	0	43	0	0	1	0	1	109
Total	60	215	0	0	275	4	3	8	0	15	2	179	2	0	183	1	2	3	0	6	479
05:00 PM	13	46	0	0	59	0	0	4	0	4	0	53	0	0	53	0	0	0	0	0	116
05:15 PM	16	44	0	0	60	0	0	5	0	5	0	44	3	0	47	0	0	1	0	1	113
05:30 PM	10	36	0	0	46	0	0	2	0	2	0	48	6	0	54	0	0	0	0	0	102
05:45 PM	10	33	0	0	43	2	0	8	0	10	0	36	1	0	37	0	0	2	0	2	92
Total	49	159	0	0	208	2	0	19	0	21	0	181	10	0	191	0	0	3	0	3	423
Grand Total	109	374	0	0	483	6	3	27	0	36	2	360	12	0	374	1	2	6	0	9	902
Apprch %	22.6	77.4	0	0		16.7	8.3	75	0		0.5	96.3	3.2	0		11.1	22.2	66.7	0		
Total %	12.1	41.5	0	0	53.5	0.7	0.3	3	0	4	0.2	39.9	1.3	0	41.5	0.1	0.2	0.7	0	1	

Start Time	Road 23 Southbound					Avenue 14 1/2 Westbound					Road 23 Northbound					Avenue 14 1/2 Eastbound					Int. Total
	Left	Thru	Right	U-Turns	App. Total	Thru	Right	U-Turns	App. Total	Thru	Right	U-Turns	App. Total	Thru	Right	U-Turns	App. Total				
Peak Hour Analysis From 04:00 PM to 05:45 PM - Peak 1 of 1																					
Peak Hour for Entire Intersection Begins at 04:00 PM																					
04:00 PM	16	57	0	0	73	3	0	1	0	4	1	43	0	0	44	0	0	0	0	0	121
04:15 PM	17	50	0	0	67	0	1	3	0	4	0	41	0	0	41	0	0	1	0	1	113
04:30 PM	14	58	0	0	72	1	2	2	0	5	1	52	2	0	55	1	2	1	0	4	136
04:45 PM	13	50	0	0	63	0	0	2	0	2	0	43	0	0	43	0	0	1	0	1	109
Total Volume	60	215	0	0	275	4	3	8	0	15	2	179	2	0	183	1	2	3	0	6	479
% App. Total	21.8	78.2	0	0		26.7	20	53.3	0		1.1	97.8	1.1	0		16.7	33.3	50	0		
PHF	.882	.927	.000	.000	.942	.333	.375	.667	.000	.750	.500	.861	.250	.000	.832	.250	.250	.750	.000	.375	.881

City of Madera
 N/S: Road 23
 E/W: Avenue 14 1/2
 Weather: Clear

File Name : 08_MDA_Rd 23_Ave 14 1-2 PM
 Site Code : 00319628
 Start Date : 9/18/2019
 Page No : 2

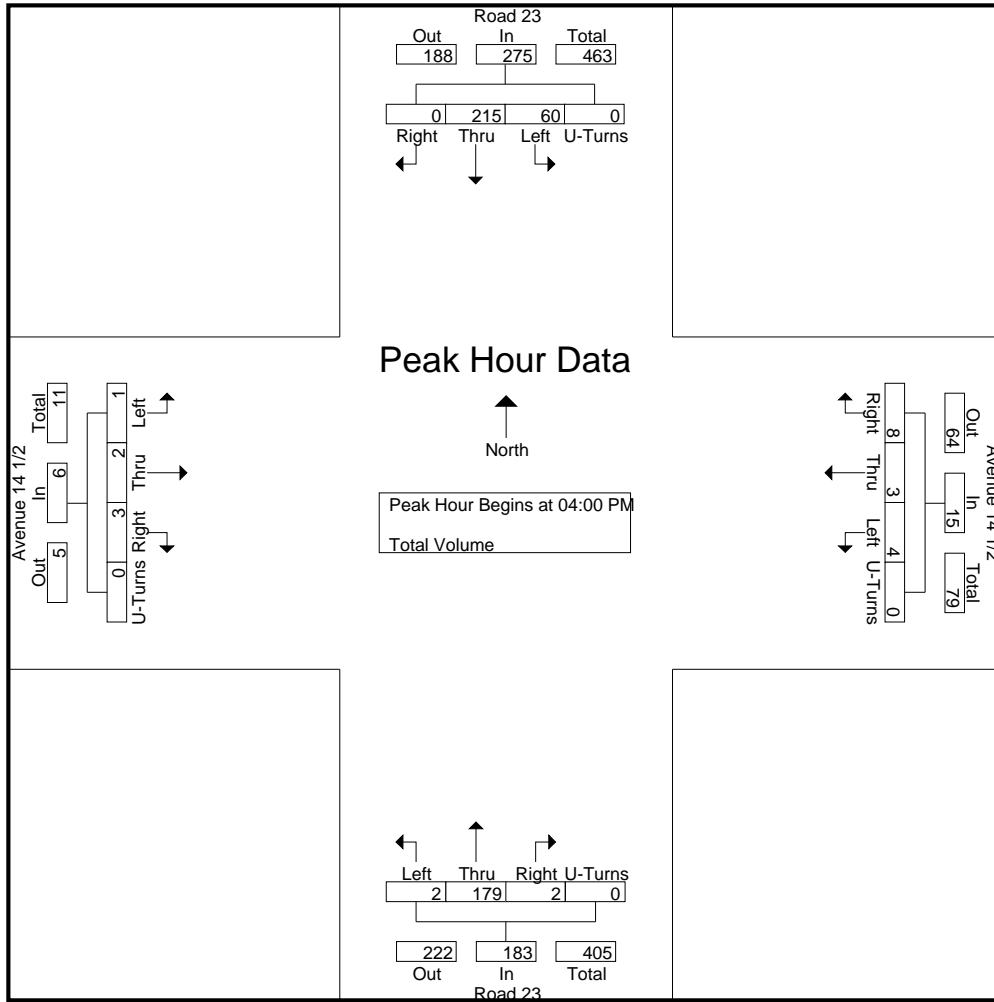

Peak Hour Analysis From 04:00 PM to 05:45 PM - Peak 1 of 1
 Peak Hour for Each Approach Begins at:

	04:00 PM					05:00 PM					04:30 PM					04:00 PM				
+0 mins.	16	57	0	0	73	0	0	4	0	4	1	52	2	0	55	0	0	0	0	0
+15 mins.	17	50	0	0	67	0	0	5	0	5	0	43	0	0	43	0	0	1	0	1
+30 mins.	14	58	0	0	72	0	0	2	0	2	0	53	0	0	53	1	2	1	0	4
+45 mins.	13	50	0	0	63	2	0	8	0	10	0	44	3	0	47	0	0	1	0	1
Total Volume	60	215	0	0	275	2	0	19	0	21	1	192	5	0	198	1	2	3	0	6
% App. Total	21.8	78.2	0	0		9.5	0	90.5	0		0.5	97	2.5	0		16.7	33.3	50	0	
PHF	.882	.927	.000	.000	.942	.250	.000	.594	.000	.525	.250	.906	.417	.000	.900	.250	.250	.750	.000	.375

Location: Madera
 N/S: Road 23
 E/W: Avenue 14 1/2



Date: 9/18/2019
 Day: Wednesday

PEDESTRIANS

	North Leg Road 23	East Leg Avenue 14 1/2	South Leg Road 23	West Leg Avenue 14 1/2	
	Pedestrians	Pedestrians	Pedestrians	Pedestrians	
7:00 AM	0	0	0	0	0
7:15 AM	0	0	0	0	0
7:30 AM	0	0	0	0	0
7:45 AM	0	0	0	0	0
8:00 AM	0	0	0	0	0
8:15 AM	0	0	0	0	0
8:30 AM	0	0	0	0	0
8:45 AM	0	0	0	0	0
TOTAL VOLUMES:	0	0	0	0	0

	North Leg Road 23	East Leg Avenue 14 1/2	South Leg Road 23	West Leg Avenue 14 1/2	
	Pedestrians	Pedestrians	Pedestrians	Pedestrians	
4:00 PM	0	0	0	0	0
4:15 PM	0	0	0	0	0
4:30 PM	0	0	0	0	0
4:45 PM	0	0	0	0	0
5:00 PM	0	0	0	0	0
5:15 PM	0	0	0	0	0
5:30 PM	0	0	0	0	0
5:45 PM	0	0	0	0	0
TOTAL VOLUMES:	0	0	0	0	0

Location: Madera
 N/S: Road 23
 E/W: Avenue 14 1/2



Date: 9/18/2019
 Day: Wednesday

BICYCLES

	Southbound Road 23			Westbound Avenue 14 1/2			Northbound Road 23			Eastbound Avenue 14 1/2			
	Left	Thru	Right	Left	Thru	Right	Left	Thru	Right	Left	Thru	Right	
7:00 AM	0	0	0	0	0	0	0	0	0	0	0	0	0
7:15 AM	0	0	0	0	0	0	0	0	0	0	0	0	0
7:30 AM	0	0	0	0	0	0	0	0	0	0	0	0	0
7:45 AM	0	0	0	0	0	0	0	0	0	0	0	0	0
8:00 AM	0	0	0	0	0	0	0	0	0	0	0	0	0
8:15 AM	0	0	0	0	0	0	0	0	0	0	0	0	0
8:30 AM	0	0	0	0	0	0	0	0	0	0	0	0	0
8:45 AM	0	0	0	0	0	0	0	0	0	0	0	0	0
TOTAL VOLUMES:	0	0	0	0	0	0	0	0	0	0	0	0	0

	Southbound Road 23			Westbound Avenue 14 1/2			Northbound Road 23			Eastbound Avenue 14 1/2			
	Left	Thru	Right	Left	Thru	Right	Left	Thru	Right	Left	Thru	Right	
4:00 PM	0	0	0	0	0	0	0	0	0	0	0	0	0
4:15 PM	0	0	0	0	0	0	0	0	0	0	0	0	0
4:30 PM	0	0	0	0	0	0	0	0	0	0	0	0	0
4:45 PM	0	0	0	0	0	0	0	0	0	0	0	0	0
5:00 PM	0	0	0	0	0	0	0	0	0	0	0	0	0
5:15 PM	0	0	0	0	0	0	0	0	0	0	0	0	0
5:30 PM	0	0	0	0	0	0	0	0	0	0	0	0	0
5:45 PM	0	0	0	0	0	0	0	0	0	0	0	0	0
TOTAL VOLUMES:	0	0	0	0	0	0	0	0	0	0	0	0	0

City of Madera
 N/S: Road 23
 E/W: Avenue 14
 Weather: Clear

File Name : 09_MDA_Rd 23_Ave 14 AM
 Site Code : 00319628
 Start Date : 9/18/2019
 Page No : 1

Groups Printed- Passenger Vehicles - Large 2 Axle Vehicles - 3 Axle Vehicles - 4+ Axle Trucks

Start Time	Road 23 Southbound					Avenue 14 Westbound					Road 23 Northbound					Avenue 14 Eastbound					Int. Total
	Left	Thru	Right	U-Turns	App. Total	Left	Thru	Right	U-Turns	App. Total	Left	Thru	Right	U-Turns	App. Total	Left	Thru	Right	U-Turns	App. Total	
07:00 AM	9	12	6	0	27	3	7	11	0	21	6	11	2	0	19	3	7	2	0	12	79
07:15 AM	3	21	15	0	39	7	29	13	0	49	2	21	1	0	24	4	5	3	0	12	124
07:30 AM	9	30	12	0	51	7	63	21	0	91	9	18	0	0	27	19	42	4	0	65	234
07:45 AM	11	26	14	0	51	2	69	14	0	85	9	26	4	0	39	12	56	6	0	74	249
Total	32	89	47	0	168	19	168	59	0	246	26	76	7	0	109	38	110	15	0	163	686
08:00 AM	11	16	15	0	42	3	15	5	0	23	4	17	3	0	24	14	42	5	0	61	150
08:15 AM	10	20	5	0	35	1	17	23	0	41	3	18	4	0	25	5	8	9	0	22	123
08:30 AM	11	24	6	0	41	2	14	12	0	28	4	23	3	0	30	5	11	1	0	17	116
08:45 AM	10	16	1	0	27	2	9	10	0	21	3	23	5	0	31	2	11	6	0	19	98
Total	42	76	27	0	145	8	55	50	0	113	14	81	15	0	110	26	72	21	0	119	487
Grand Total	74	165	74	0	313	27	223	109	0	359	40	157	22	0	219	64	182	36	0	282	1173
Apprch %	23.6	52.7	23.6	0		7.5	62.1	30.4	0		18.3	71.7	10	0		22.7	64.5	12.8	0		
Total %	6.3	14.1	6.3	0	26.7	2.3	19	9.3	0	30.6	3.4	13.4	1.9	0	18.7	5.5	15.5	3.1	0	24	
Passenger Vehicles	79.7	70.3	95.9	0	78.6	96.3	95.5	81.7	0	91.4	67.5	70.1	90.9	0	71.7	90.6	97.3	66.7	0	91.8	84.4
% Passenger Vehicles																					
Large 2 Axle Vehicles	1.4	7.9	2.7	0	5.1	3.7	3.1	6.4	0	4.2	7.5	4.5	9.1	0	5.5	1.6	2.7	13.9	0	3.9	4.6
% Large 2 Axle Vehicles																					
3 Axle Vehicles	2.7	3	0	0	2.2	0	0.4	1.8	0	0.8	0	1.9	0	0	1.4	0	0	0	0	0	1.1
% 3 Axle Vehicles																					
4+ Axle Trucks	12	31	1	0	44	0	2	11	0	13	10	37	0	0	47	5	0	7	0	12	116
% 4+ Axle Trucks																					

Start Time	Road 23 Southbound					Avenue 14 Westbound					Road 23 Northbound					Avenue 14 Eastbound					Int. Total
	Left	Thru	Right	U-Turns	App. Total	Left	Thru	Right	U-Turns	App. Total	Left	Thru	Right	U-Turns	App. Total	Left	Thru	Right	U-Turns	App. Total	
Peak Hour Analysis From 07:00 AM to 08:45 AM - Peak 1 of 1																					
Peak Hour for Entire Intersection Begins at 07:15 AM																					
07:15 AM	3	21	15	0	39	7	29	13	0	49	2	21	1	0	24	4	5	3	0	12	124
07:30 AM	9	30	12	0	51	7	63	21	0	91	9	18	0	0	27	19	42	4	0	65	234
07:45 AM	11	26	14	0	51	2	69	14	0	85	9	26	4	0	39	12	56	6	0	74	249
08:00 AM	11	16	15	0	42	3	15	5	0	23	4	17	3	0	24	14	42	5	0	61	150
Total Volume	34	93	56	0	183	19	176	53	0	248	24	82	8	0	114	49	145	18	0	212	757
% App. Total	18.6	50.8	30.6	0		7.7	71	21.4	0		21.1	71.9	7	0		23.1	68.4	8.5	0		
PHF	.773	.775	.933	.000	.897	.679	.638	.631	.000	.681	.667	.788	.500	.000	.731	.645	.647	.750	.000	.716	.760

City of Madera
 N/S: Road 23
 E/W: Avenue 14
 Weather: Clear

File Name : 09_MDA_Rd 23_Ave 14 AM
 Site Code : 00319628
 Start Date : 9/18/2019
 Page No : 2

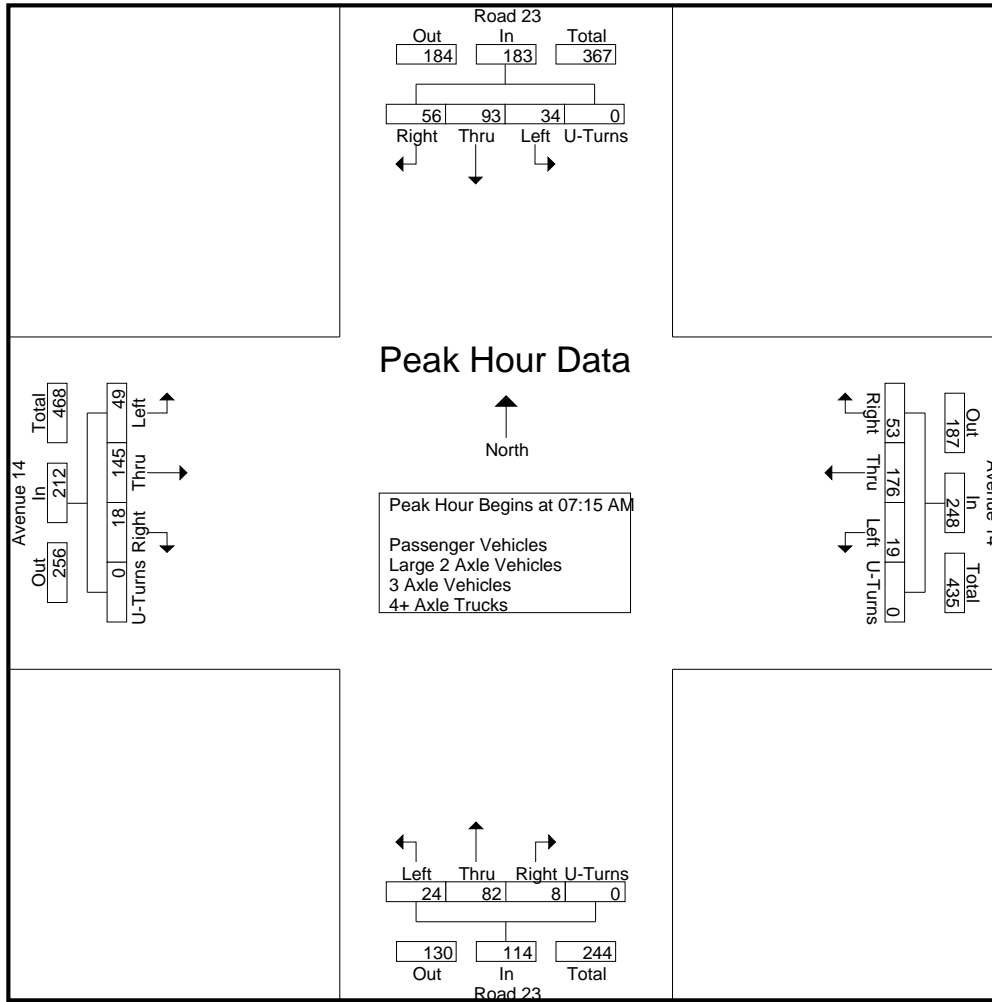

Peak Hour Analysis From 07:00 AM to 08:45 AM - Peak 1 of 1
 Peak Hour for Each Approach Begins at:

	07:15 AM					07:15 AM					07:45 AM					07:30 AM				
+0 mins.	3	21	15	0	39	7	29	13	0	49	9	26	4	0	39	19	42	4	0	65
+15 mins.	9	30	12	0	51	7	63	21	0	91	4	17	3	0	24	12	56	6	0	74
+30 mins.	11	26	14	0	51	2	69	14	0	85	3	18	4	0	25	14	42	5	0	61
+45 mins.	11	16	15	0	42	3	15	5	0	23	4	23	3	0	30	5	8	9	0	22
Total Volume	34	93	56	0	183	19	176	53	0	248	20	84	14	0	118	50	148	24	0	222
% App. Total	18.6	50.8	30.6	0		7.7	71	21.4	0		16.9	71.2	11.9	0		22.5	66.7	10.8	0	
PHF	.773	.775	.933	.000	.897	.679	.638	.631	.000	.681	.556	.808	.875	.000	.756	.658	.661	.667	.000	.750

City of Madera
 N/S: Road 23
 E/W: Avenue 14
 Weather: Clear

File Name : 09_MDA_Rd 23_Ave 14 AM
 Site Code : 00319628
 Start Date : 9/18/2019
 Page No : 1

Groups Printed- Passenger Vehicles

Start Time	Road 23 Southbound					Avenue 14 Westbound					Road 23 Northbound					Avenue 14 Eastbound					Int. Total
	Left	Thru	Right	U-Turns	App. Total	Left	Thru	Right	U-Turns	App. Total	Left	Thru	Right	U-Turns	App. Total	Left	Thru	Right	U-Turns	App. Total	
07:00 AM	7	10	6	0	23	3	7	11	0	21	6	9	2	0	17	3	7	2	0	12	73
07:15 AM	3	14	14	0	31	7	28	12	0	47	0	15	0	0	15	3	4	2	0	9	102
07:30 AM	7	21	12	0	40	7	60	15	0	82	5	15	0	0	20	18	42	4	0	64	206
07:45 AM	11	20	14	0	45	2	66	11	0	79	8	19	4	0	31	12	55	1	0	68	223
Total	28	65	46	0	139	19	161	49	0	229	19	58	6	0	83	36	108	9	0	153	604
08:00 AM	9	13	14	0	36	3	14	4	0	21	2	11	2	0	15	14	41	3	0	58	130
08:15 AM	8	15	5	0	28	1	16	21	0	38	1	15	4	0	20	3	6	6	0	15	101
08:30 AM	7	15	5	0	27	2	13	10	0	25	2	12	3	0	17	3	11	0	0	14	83
08:45 AM	7	8	1	0	16	1	9	5	0	15	3	14	5	0	22	2	11	6	0	19	72
Total	31	51	25	0	107	7	52	40	0	99	8	52	14	0	74	22	69	15	0	106	386
Grand Total	59	116	71	0	246	26	213	89	0	328	27	110	20	0	157	58	177	24	0	259	990
Apprch %	24	47.2	28.9	0		7.9	64.9	27.1	0		17.2	70.1	12.7	0		22.4	68.3	9.3	0		
Total %	6	11.7	7.2	0	24.8	2.6	21.5	9	0	33.1	2.7	11.1	2	0	15.9	5.9	17.9	2.4	0	26.2	

Start Time	Road 23 Southbound					Avenue 14 Westbound					Road 23 Northbound					Avenue 14 Eastbound					Int. Total
	Left	Thru	Right	U-Turns	App. Total	Thru	Right	U-Turns	App. Total	Thru	Right	U-Turns	App. Total	Thru	Right	U-Turns	App. Total				
Peak Hour Analysis From 07:15 AM to 08:00 AM - Peak 1 of 1																					
Peak Hour for Entire Intersection Begins at 07:15 AM																					
07:15 AM	3	14	14	0	31	7	28	12	0	47	0	15	0	0	15	3	4	2	0	9	102
07:30 AM	7	21	12	0	40	7	60	15	0	82	5	15	0	0	20	18	42	4	0	64	206
07:45 AM	11	20	14	0	45	2	66	11	0	79	8	19	4	0	31	12	55	1	0	68	223
08:00 AM	9	13	14	0	36	3	14	4	0	21	2	11	2	0	15	14	41	3	0	58	130
Total Volume	30	68	54	0	152	19	168	42	0	229	15	60	6	0	81	47	142	10	0	199	661
% App. Total	19.7	44.7	35.5	0		8.3	73.4	18.3	0		18.5	74.1	7.4	0		23.6	71.4	5	0		
PHF	.682	.810	.964	.000	.844	.679	.636	.700	.000	.698	.469	.789	.375	.000	.653	.653	.645	.625	.000	.732	.741

City of Madera
 N/S: Road 23
 E/W: Avenue 14
 Weather: Clear

File Name : 09_MDA_Rd 23_Ave 14 AM
 Site Code : 00319628
 Start Date : 9/18/2019
 Page No : 2

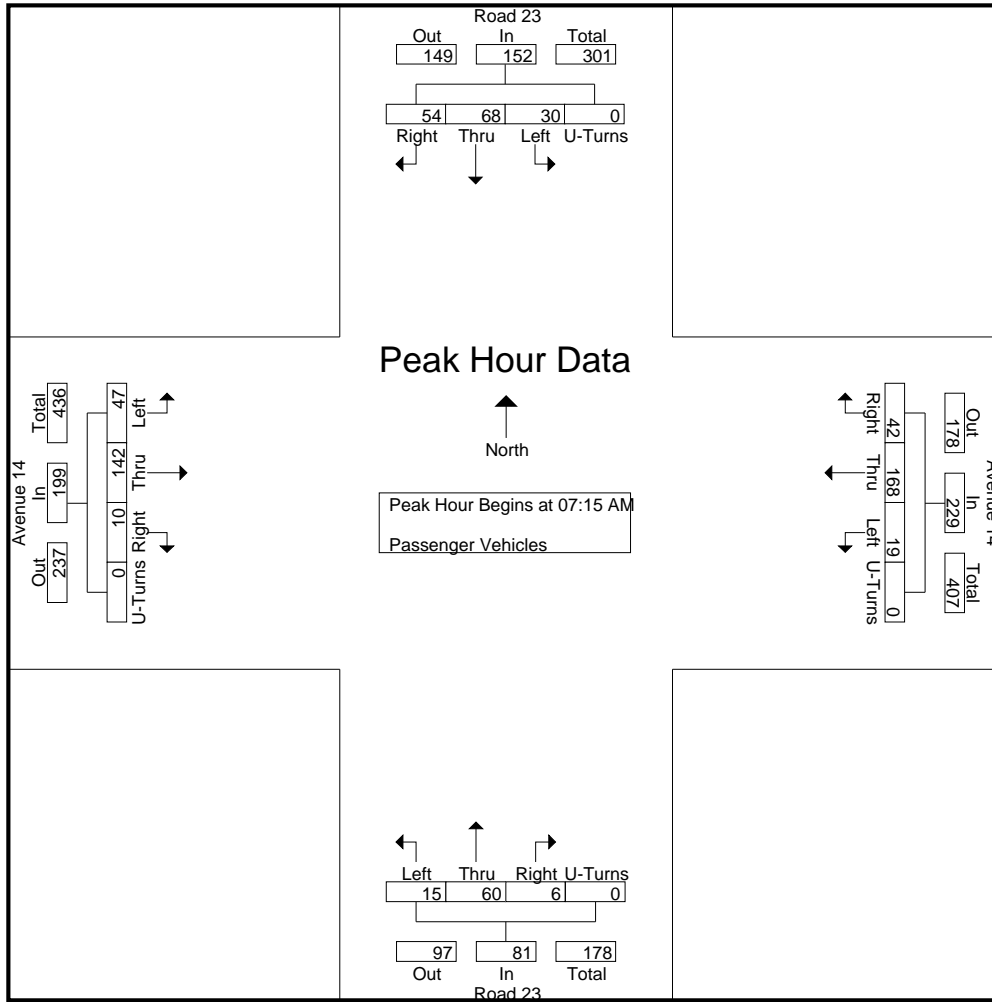

Peak Hour Analysis From 07:15 AM to 08:00 AM - Peak 1 of 1
 Peak Hour for Each Approach Begins at:

	07:15 AM					07:15 AM					07:15 AM									
+0 mins.	3	14	14	0	31	7	28	12	0	47	0	15	0	0	15	3	4	2	0	9
+15 mins.	7	21	12	0	40	7	60	15	0	82	5	15	0	0	20	18	42	4	0	64
+30 mins.	11	20	14	0	45	2	66	11	0	79	8	19	4	0	31	12	55	1	0	68
+45 mins.	9	13	14	0	36	3	14	4	0	21	2	11	2	0	15	14	41	3	0	58
Total Volume	30	68	54	0	152	19	168	42	0	229	15	60	6	0	81	47	142	10	0	199
% App. Total	19.7	44.7	35.5	0		8.3	73.4	18.3	0		18.5	74.1	7.4	0		23.6	71.4	5	0	
PHF	.682	.810	.964	.000	.844	.679	.636	.700	.000	.698	.469	.789	.375	.000	.653	.653	.645	.625	.000	.732

City of Madera
 N/S: Road 23
 E/W: Avenue 14
 Weather: Clear

File Name : 09_MDA_Rd 23_Ave 14 AM
 Site Code : 00319628
 Start Date : 9/18/2019
 Page No : 1

Groups Printed- Large 2 Axle Vehicles

Start Time	Road 23 Southbound					Avenue 14 Westbound					Road 23 Northbound					Avenue 14 Eastbound					Int. Total	
	Left	Thru	Right	U-Turns	App. Total	Left	Thru	Right	U-Turns	App. Total	Left	Thru	Right	U-Turns	App. Total	Left	Thru	Right	U-Turns	App. Total		
07:00 AM	0	0	0	0	0	0	0	0	0	0	0	1	0	0	1	0	0	0	0	0	0	1
07:15 AM	0	2	0	0	2	0	0	0	0	0	1	0	1	0	2	0	1	0	0	0	0	1
07:30 AM	0	2	0	0	2	0	3	3	0	6	0	0	0	0	0	0	0	0	0	0	0	0
07:45 AM	0	0	0	0	0	0	2	0	0	2	1	0	0	0	1	0	1	4	0	0	0	5
Total	0	4	0	0	4	0	5	3	0	8	2	1	1	0	4	0	2	4	0	6	6	22
08:00 AM	0	0	1	0	1	0	1	0	0	1	0	0	1	0	1	0	1	0	0	0	0	1
08:15 AM	1	3	0	0	4	0	1	2	0	3	1	1	0	0	2	0	2	0	0	0	0	2
08:30 AM	0	2	1	0	3	0	0	1	0	1	0	2	0	0	2	1	0	1	0	0	0	2
08:45 AM	0	4	0	0	4	1	0	1	0	2	0	3	0	0	3	0	0	0	0	0	0	0
Total	1	9	2	0	12	1	2	4	0	7	1	6	1	0	8	1	3	1	0	5	5	32
Grand Total	1	13	2	0	16	1	7	7	0	15	3	7	2	0	12	1	5	5	0	11	11	54
Apprch %	6.2	81.2	12.5	0		6.7	46.7	46.7	0		25	58.3	16.7	0		9.1	45.5	45.5	0			
Total %	1.9	24.1	3.7	0	29.6	1.9	13	13	0	27.8	5.6	13	3.7	0	22.2	1.9	9.3	9.3	0	20.4		

Start Time	Road 23 Southbound					Avenue 14 Westbound					Road 23 Northbound					Avenue 14 Eastbound					Int. Total	
	Left	Thru	Right	U-Turns	App. Total	Thru	Right	U-Turns	App. Total	Thru	Right	U-Turns	App. Total	Thru	Right	U-Turns	App. Total					
Peak Hour Analysis From 07:15 AM to 08:00 AM - Peak 1 of 1																						
Peak Hour for Entire Intersection Begins at 07:15 AM																						
07:15 AM	0	2	0	0	2	0	0	0	0	0	1	0	1	0	2	0	1	0	0	0	0	1
07:30 AM	0	2	0	0	2	0	3	3	0	6	0	0	0	0	0	0	0	0	0	0	0	0
07:45 AM	0	0	0	0	0	0	2	0	0	2	1	0	0	0	1	0	1	4	0	0	0	5
08:00 AM	0	0	1	0	1	0	1	0	0	1	0	0	1	0	1	0	1	0	0	0	0	1
Total Volume	0	4	1	0	5	0	6	3	0	9	2	0	2	0	4	0	3	4	0	0	0	7
% App. Total	0	80	20	0		0	66.7	33.3	0		50	0	50	0		0	42.9	57.1	0			
PHF	.000	.500	.250	.000	.625	.000	.500	.250	.000	.375	.500	.000	.500	.000	.500	.000	.750	.250	.000	.350		.781

City of Madera
 N/S: Road 23
 E/W: Avenue 14
 Weather: Clear

File Name : 09_MDA_Rd 23_Ave 14 AM
 Site Code : 00319628
 Start Date : 9/18/2019
 Page No : 2

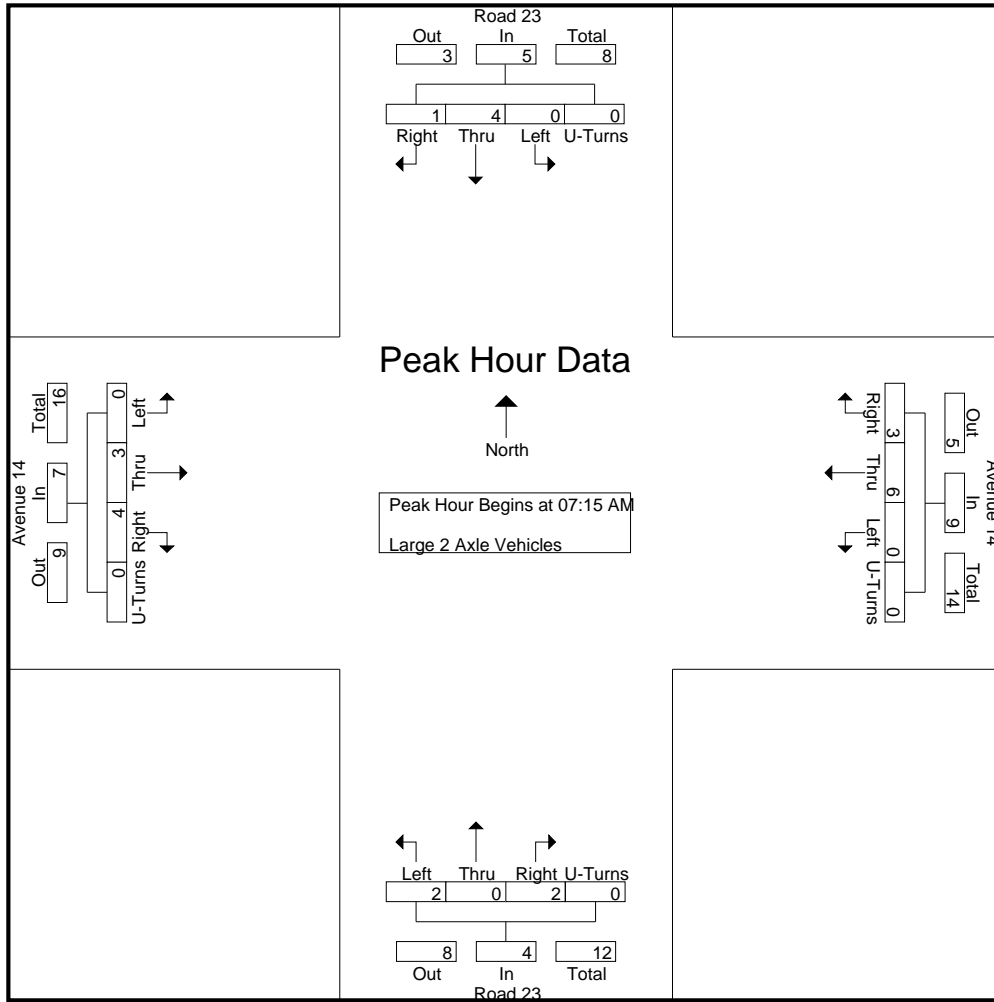

Peak Hour Analysis From 07:15 AM to 08:00 AM - Peak 1 of 1
 Peak Hour for Each Approach Begins at:

	07:15 AM					07:15 AM					07:15 AM									
+0 mins.	0	2	0	0	2	0	0	0	0	0	1	0	1	0	2	0	1	0	0	1
+15 mins.	0	2	0	0	2	0	3	3	0	6	0	0	0	0	0	0	0	0	0	0
+30 mins.	0	0	0	0	0	0	2	0	0	2	1	0	0	0	1	0	1	4	0	5
+45 mins.	0	0	1	0	1	0	1	0	0	1	0	0	1	0	1	0	1	0	0	1
Total Volume	0	4	1	0	5	0	6	3	0	9	2	0	2	0	4	0	3	4	0	7
% App. Total	0	80	20	0		0	66.7	33.3	0		50	0	50	0		0	42.9	57.1	0	
PHF	.000	.500	.250	.000	.625	.000	.500	.250	.000	.375	.500	.000	.500	.000	.500	.000	.750	.250	.000	.350

City of Madera
 N/S: Road 23
 E/W: Avenue 14
 Weather: Clear

File Name : 09_MDA_Rd 23_Ave 14 AM
 Site Code : 00319628
 Start Date : 9/18/2019
 Page No : 1

Groups Printed- 3 Axle Vehicles

Start Time	Road 23 Southbound					Avenue 14 Westbound					Road 23 Northbound					Avenue 14 Eastbound					Int. Total
	Left	Thru	Right	U-Turns	App. Total	Left	Thru	Right	U-Turns	App. Total	Left	Thru	Right	U-Turns	App. Total	Left	Thru	Right	U-Turns	App. Total	
07:00 AM	0	0	0	0	0	0	0	0	0	0	0	0	0	0	0	0	0	0	0	0	0
07:15 AM	0	1	0	0	1	0	0	1	0	1	0	0	0	0	0	0	0	0	0	0	0
07:30 AM	1	1	0	0	2	0	0	0	0	0	0	0	0	0	0	0	0	0	0	0	0
07:45 AM	0	0	0	0	0	0	1	0	0	1	0	0	0	0	0	0	0	0	0	0	0
Total	1	2	0	0	3	0	1	1	0	2	0	0	0	0	0	0	0	0	0	0	5
08:00 AM	0	1	0	0	1	0	0	0	0	0	0	1	0	0	1	0	0	0	0	0	0
08:15 AM	0	0	0	0	0	0	0	0	0	0	0	1	0	0	1	0	0	0	0	0	0
08:30 AM	0	2	0	0	2	0	0	0	0	0	0	0	0	0	0	0	0	0	0	0	0
08:45 AM	1	0	0	0	1	0	0	1	0	1	0	1	0	0	1	0	0	0	0	0	0
Total	1	3	0	0	4	0	0	1	0	1	0	3	0	0	3	0	0	0	0	0	8
Grand Total	2	5	0	0	7	0	1	2	0	3	0	3	0	0	3	0	0	0	0	0	13
Apprch %	28.6	71.4	0	0		0	33.3	66.7	0		0	100	0	0		0	0	0	0		
Total %	15.4	38.5	0	0	53.8	0	7.7	15.4	0	23.1	0	23.1	0	0	23.1	0	0	0	0	0	

Start Time	Road 23 Southbound					Avenue 14 Westbound					Road 23 Northbound					Avenue 14 Eastbound					Int. Total
	Left	Thru	Right	U-Turns	App. Total	Thru	Right	U-Turns	App. Total	Thru	Right	U-Turns	App. Total	Thru	Right	U-Turns	App. Total				
Peak Hour Analysis From 07:15 AM to 08:00 AM - Peak 1 of 1																					
Peak Hour for Entire Intersection Begins at 07:15 AM																					
07:15 AM	0	1	0	0	1	0	0	1	0	1	0	0	0	0	0	0	0	0	0	0	2
07:30 AM	1	1	0	0	2	0	0	0	0	0	0	0	0	0	0	0	0	0	0	0	2
07:45 AM	0	0	0	0	0	0	1	0	0	1	0	0	0	0	0	0	0	0	0	0	1
08:00 AM	0	1	0	0	1	0	0	0	0	0	0	1	0	0	1	0	0	0	0	0	2
Total Volume	1	3	0	0	4	0	1	1	0	2	0	1	0	0	1	0	0	0	0	0	7
% App. Total	25	75	0	0		0	50	50	0		0	100	0	0		0	0	0	0		
PHF	.250	.750	.000	.000	.500	.000	.250	.250	.000	.500	.000	.250	.000	.000	.250	.000	.000	.000	.000	.000	.875

City of Madera
 N/S: Road 23
 E/W: Avenue 14
 Weather: Clear

File Name : 09_MDA_Rd 23_Ave 14 AM
 Site Code : 00319628
 Start Date : 9/18/2019
 Page No : 2

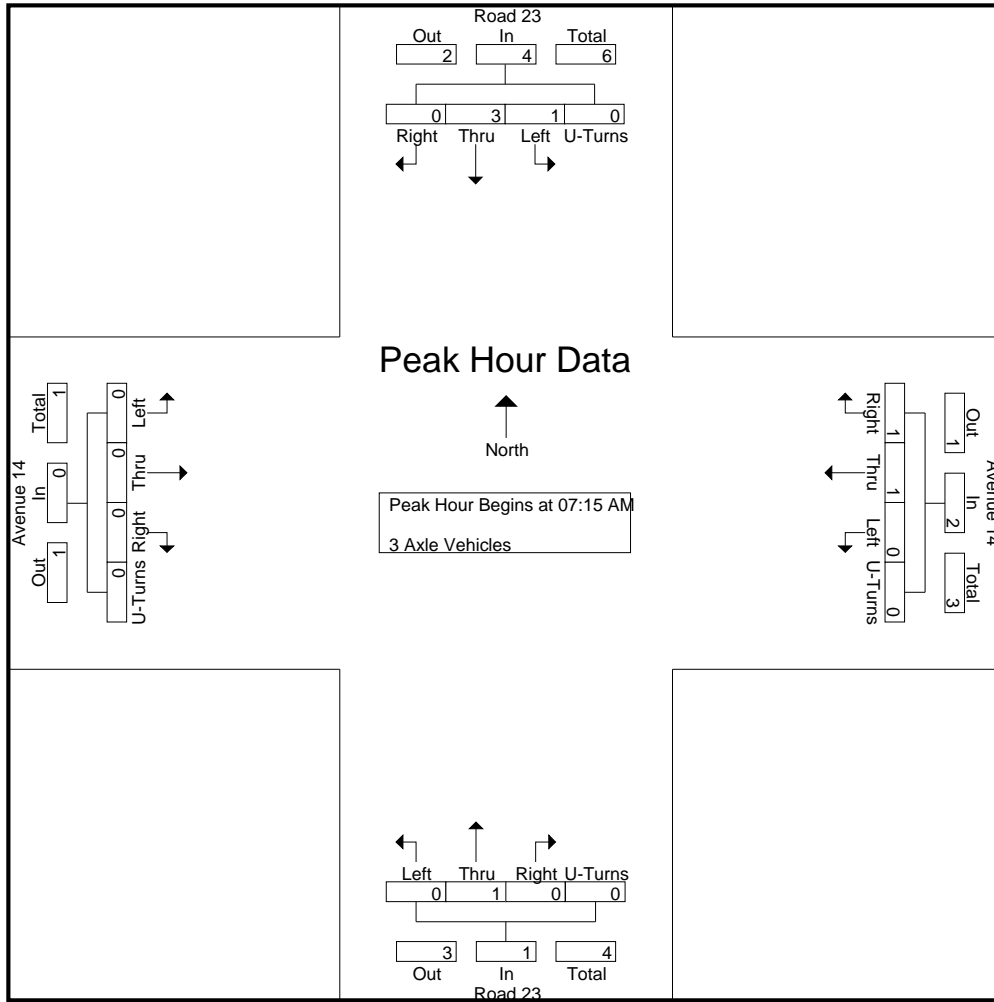

Peak Hour Analysis From 07:15 AM to 08:00 AM - Peak 1 of 1
 Peak Hour for Each Approach Begins at:

	07:15 AM					07:15 AM					07:15 AM					07:15 AM									
+0 mins.	0	1	0	0	1	0	0	1	0	1	0	0	0	0	0	0	0	0	0	0	0	0	0	0	0
+15 mins.	1	1	0	0	2	0	0	0	0	0	0	0	0	0	0	0	0	0	0	0	0	0	0	0	0
+30 mins.	0	0	0	0	0	0	1	0	0	1	0	0	0	0	0	0	0	0	0	0	0	0	0	0	0
+45 mins.	0	1	0	0	1	0	0	0	0	0	0	1	0	0	1	0	0	0	0	0	0	0	0	0	0
Total Volume	1	3	0	0	4	0	1	1	0	2	0	1	0	0	1	0	0	0	0	0	0	0	0	0	0
% App. Total	25	75	0	0		0	50	50	0		0	100	0	0		0	0	0	0		0	0	0	0	
PHF	.250	.750	.000	.000	.500	.000	.250	.250	.000	.500	.000	.250	.000	.000	.250	.000	.000	.000	.000	.000	.000	.000	.000	.000	.000

City of Madera
 N/S: Road 23
 E/W: Avenue 14
 Weather: Clear

File Name : 09_MDA_Rd 23_Ave 14 AM
 Site Code : 00319628
 Start Date : 9/18/2019
 Page No : 1

Groups Printed- 4+ Axle Trucks

Start Time	Road 23 Southbound					Avenue 14 Westbound					Road 23 Northbound					Avenue 14 Eastbound					Int. Total
	Left	Thru	Right	U-Turns	App. Total	Left	Thru	Right	U-Turns	App. Total	Left	Thru	Right	U-Turns	App. Total	Left	Thru	Right	U-Turns	App. Total	
07:00 AM	2	2	0	0	4	0	0	0	0	0	0	1	0	0	1	0	0	0	0	0	5
07:15 AM	0	4	1	0	5	0	1	0	0	1	1	6	0	0	7	1	0	1	0	2	15
07:30 AM	1	6	0	0	7	0	0	3	0	3	4	3	0	0	7	1	0	0	0	1	18
07:45 AM	0	6	0	0	6	0	0	3	0	3	0	7	0	0	7	0	0	1	0	1	17
Total	3	18	1	0	22	0	1	6	0	7	5	17	0	0	22	2	0	2	0	4	55
08:00 AM	2	2	0	0	4	0	0	1	0	1	2	5	0	0	7	0	0	2	0	2	14
08:15 AM	1	2	0	0	3	0	0	0	0	0	1	1	0	0	2	2	0	3	0	5	10
08:30 AM	4	5	0	0	9	0	1	1	0	2	2	9	0	0	11	1	0	0	0	1	23
08:45 AM	2	4	0	0	6	0	0	3	0	3	0	5	0	0	5	0	0	0	0	0	14
Total	9	13	0	0	22	0	1	5	0	6	5	20	0	0	25	3	0	5	0	8	61
Grand Total	12	31	1	0	44	0	2	11	0	13	10	37	0	0	47	5	0	7	0	12	116
Apprch %	27.3	70.5	2.3	0		0	15.4	84.6	0		21.3	78.7	0	0		41.7	0	58.3	0		
Total %	10.3	26.7	0.9	0	37.9	0	1.7	9.5	0	11.2	8.6	31.9	0	0	40.5	4.3	0	6	0	10.3	

Start Time	Road 23 Southbound					Avenue 14 Westbound					Road 23 Northbound					Avenue 14 Eastbound					Int. Total
	Left	Thru	Right	U-Turns	App. Total	Thru	Right	U-Turns	App. Total	Thru	Right	U-Turns	App. Total	Thru	Right	U-Turns	App. Total				
Peak Hour Analysis From 07:15 AM to 08:00 AM - Peak 1 of 1																					
Peak Hour for Entire Intersection Begins at 07:15 AM																					
07:15 AM	0	4	1	0	5	0	1	0	0	1	1	6	0	0	7	1	0	1	0	2	15
07:30 AM	1	6	0	0	7	0	0	3	0	3	4	3	0	0	7	1	0	0	0	1	18
07:45 AM	0	6	0	0	6	0	0	3	0	3	0	7	0	0	7	0	0	1	0	1	17
08:00 AM	2	2	0	0	4	0	0	1	0	1	2	5	0	0	7	0	0	2	0	2	14
Total Volume	3	18	1	0	22	0	1	7	0	8	7	21	0	0	28	2	0	4	0	6	64
% App. Total	13.6	81.8	4.5	0		0	12.5	87.5	0		25	75	0	0		33.3	0	66.7	0		
PHF	.375	.750	.250	.000	.786	.000	.250	.583	.000	.667	.438	.750	.000	.000	1.00	.500	.000	.500	.000	.750	.889

City of Madera
 N/S: Road 23
 E/W: Avenue 14
 Weather: Clear

File Name : 09_MDA_Rd 23_Ave 14 AM
 Site Code : 00319628
 Start Date : 9/18/2019
 Page No : 2

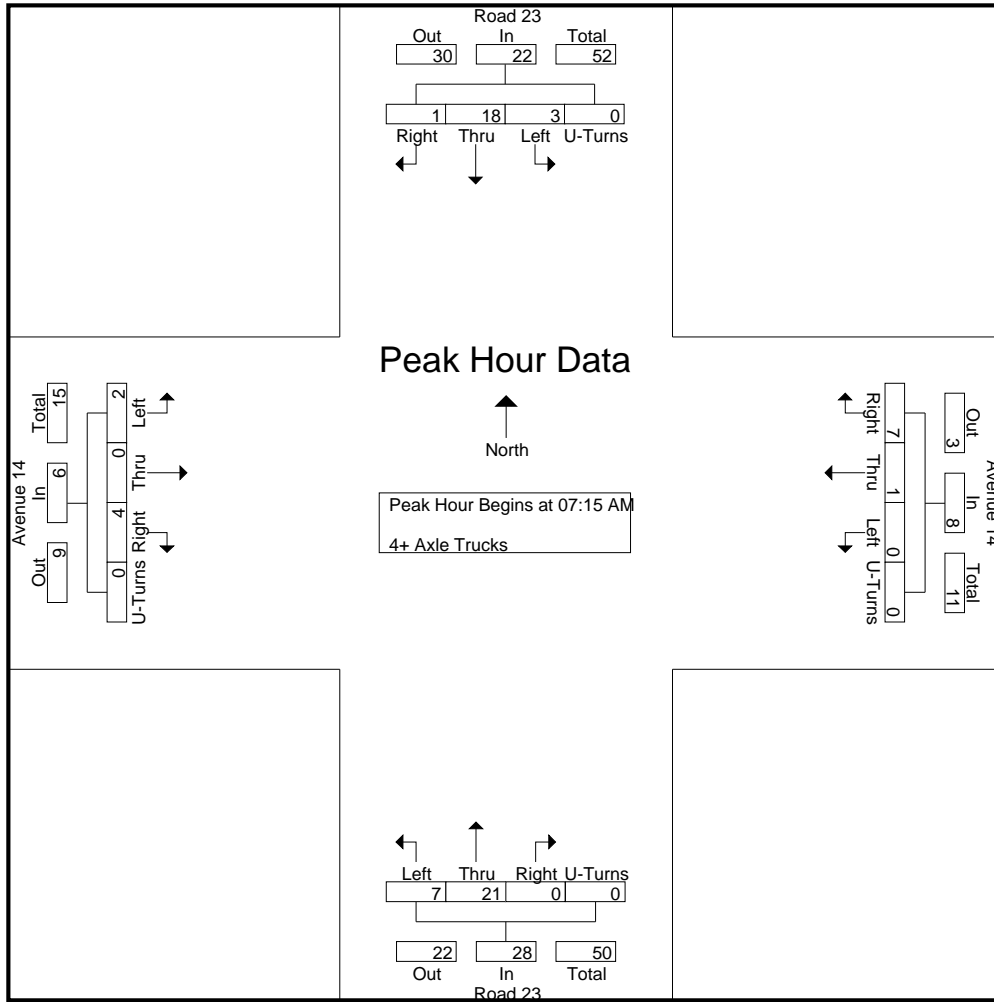

Peak Hour Analysis From 07:15 AM to 08:00 AM - Peak 1 of 1
 Peak Hour for Each Approach Begins at:

	07:15 AM					07:15 AM					07:15 AM					07:15 AM				
+0 mins.	0	4	1	0	5	0	1	0	0	1	1	6	0	0	7	1	0	1	0	2
+15 mins.	1	6	0	0	7	0	0	3	0	3	4	3	0	0	7	1	0	0	0	1
+30 mins.	0	6	0	0	6	0	0	3	0	3	0	7	0	0	7	0	0	1	0	1
+45 mins.	2	2	0	0	4	0	0	1	0	1	2	5	0	0	7	0	0	2	0	2
Total Volume	3	18	1	0	22	0	1	7	0	8	7	21	0	0	28	2	0	4	0	6
% App. Total	13.6	81.8	4.5	0		0	12.5	87.5	0		25	75	0	0		33.3	0	66.7	0	
PHF	.375	.750	.250	.000	.786	.000	.250	.583	.000	.667	.438	.750	.000	.000	1.000	.500	.000	.500	.000	.750

City of Madera
 N/S: Road 23
 E/W: Avenue 14
 Weather: Clear

File Name : 09_MDA_Rd 23_Ave 14 PM
 Site Code : 00319628
 Start Date : 9/18/2019
 Page No : 1

Groups Printed- Passenger Vehicles - Large 2 Axle Vehicles - 3 Axle Vehicles - 4+ Axle Trucks

Start Time	Road 23 Southbound					Avenue 14 Westbound					Road 23 Northbound					Avenue 14 Eastbound					Int. Total
	Left	Thru	Right	U-Turns	App. Total	Left	Thru	Right	U-Turns	App. Total	Left	Thru	Right	U-Turns	App. Total	Left	Thru	Right	U-Turns	App. Total	
04:00 PM	21	31	7	0	59	5	11	13	0	29	3	20	3	0	26	9	20	9	0	38	152
04:15 PM	15	26	7	0	48	2	12	6	0	20	5	25	10	0	40	11	25	9	0	45	153
04:30 PM	14	36	10	0	60	3	6	18	0	27	4	26	2	0	32	15	19	7	0	41	160
04:45 PM	20	28	5	0	53	1	7	12	0	20	2	20	6	0	28	9	25	9	0	43	144
Total	70	121	29	0	220	11	36	49	0	96	14	91	21	0	126	44	89	34	0	167	609
05:00 PM	19	23	6	0	48	3	8	14	0	25	6	22	6	0	34	18	18	3	0	39	146
05:15 PM	18	21	5	0	44	3	14	3	0	20	4	23	0	0	27	18	39	6	0	63	154
05:30 PM	13	25	1	0	39	2	5	13	0	20	4	23	2	0	29	16	20	3	0	39	127
05:45 PM	8	22	6	0	36	3	10	9	0	22	3	20	2	0	25	9	12	2	0	23	106
Total	58	91	18	0	167	11	37	39	0	87	17	88	10	0	115	61	89	14	0	164	533
Grand Total	128	212	47	0	387	22	73	88	0	183	31	179	31	0	241	105	178	48	0	331	1142
Apprch %	33.1	54.8	12.1	0		12	39.9	48.1	0		12.9	74.3	12.9	0		31.7	53.8	14.5	0		
Total %	11.2	18.6	4.1	0	33.9	1.9	6.4	7.7	0	16	2.7	15.7	2.7	0	21.1	9.2	15.6	4.2	0	29	
Passenger Vehicles	88.3	89.2	95.7	0	89.7	95.5	97.3	96.6	0	96.7	58.1	89.9	100	0	87.1	95.2	93.3	83.3	0	92.4	91.1
Large 2 Axle Vehicles	2.3	3.3	2.1	0	2.8	4.5	1.4	2.3	0	2.2	6.5	3.9	0	0	3.7	2.9	4.5	4.2	0	3.9	3.2
% Large 2 Axle Vehicles	0	1	0	0	1	0	0	0	0	0	0	1	0	0	1	0	0	0	0	0	2
3 Axle Vehicles	0	0.5	0	0	0.3	0	0	0	0	0	0	0.6	0	0	0.4	0	0	0	0	0	0.2
% 3 Axle Vehicles	12	15	1	0	28	0	1	1	0	2	11	10	0	0	21	2	4	6	0	12	63
4+ Axle Trucks																					
% 4+ Axle Trucks																					

Start Time	Road 23 Southbound					Avenue 14 Westbound					Road 23 Northbound					Avenue 14 Eastbound					Int. Total
	Left	Thru	Right	U-Turns	App. Total	Left	Thru	Right	U-Turns	App. Total	Left	Thru	Right	U-Turns	App. Total	Left	Thru	Right	U-Turns	App. Total	
Peak Hour Analysis From 04:00 PM to 05:45 PM - Peak 1 of 1																					
Peak Hour for Entire Intersection Begins at 04:00 PM																					
04:00 PM	21	31	7	0	59	5	11	13	0	29	3	20	3	0	26	9	20	9	0	38	152
04:15 PM	15	26	7	0	48	2	12	6	0	20	5	25	10	0	40	11	25	9	0	45	153
04:30 PM	14	36	10	0	60	3	6	18	0	27	4	26	2	0	32	15	19	7	0	41	160
04:45 PM	20	28	5	0	53	1	7	12	0	20	2	20	6	0	28	9	25	9	0	43	144
Total Volume	70	121	29	0	220	11	36	49	0	96	14	91	21	0	126	44	89	34	0	167	609
% App. Total	31.8	55	13.2	0		11.5	37.5	51	0		11.1	72.2	16.7	0		26.3	53.3	20.4	0		
PHF	.833	.840	.725	.000	.917	.550	.750	.681	.000	.828	.700	.875	.525	.000	.788	.733	.890	.944	.000	.928	.952

City of Madera
 N/S: Road 23
 E/W: Avenue 14
 Weather: Clear

File Name : 09_MDA_Rd 23_Ave 14 PM
 Site Code : 00319628
 Start Date : 9/18/2019
 Page No : 2

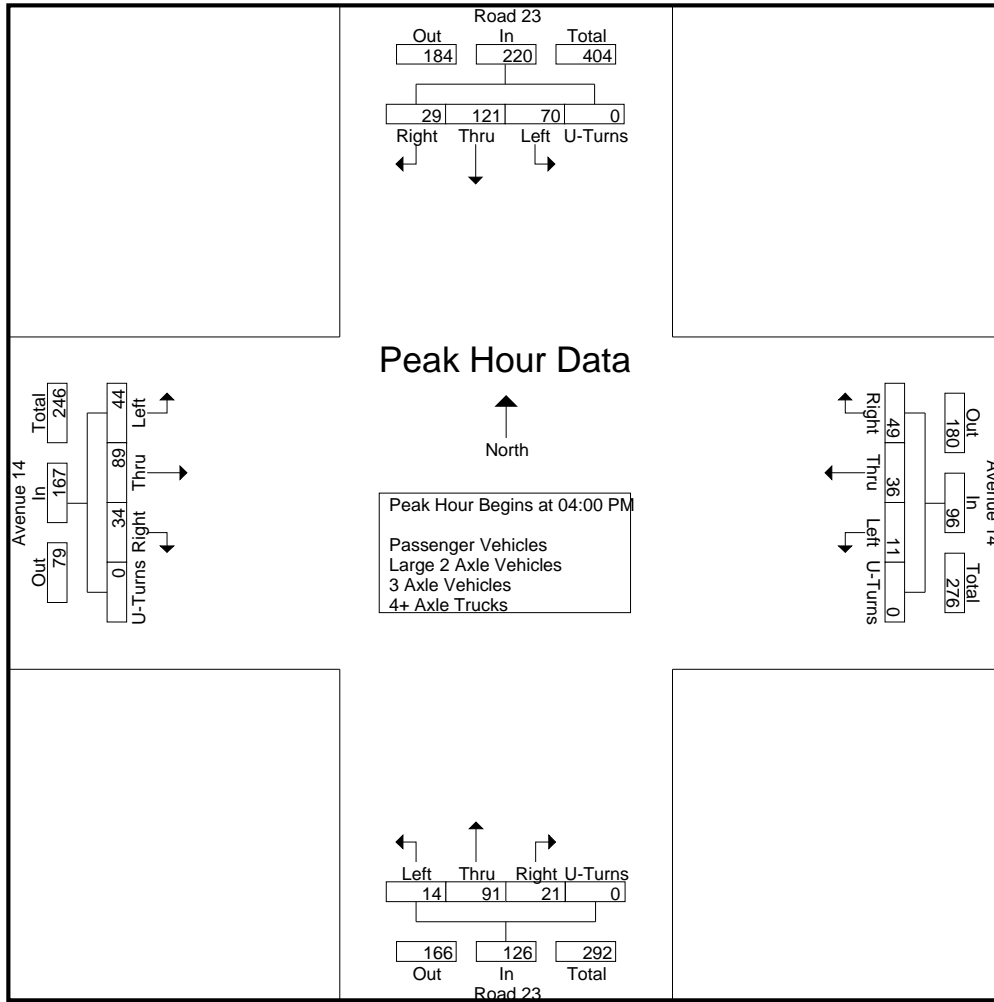

Peak Hour Analysis From 04:00 PM to 05:45 PM - Peak 1 of 1
 Peak Hour for Each Approach Begins at:

	04:00 PM					04:00 PM					04:15 PM					04:30 PM				
+0 mins.	21	31	7	0	59	5	11	13	0	29	5	25	10	0	40	15	19	7	0	41
+15 mins.	15	26	7	0	48	2	12	6	0	20	4	26	2	0	32	9	25	9	0	43
+30 mins.	14	36	10	0	60	3	6	18	0	27	2	20	6	0	28	18	18	3	0	39
+45 mins.	20	28	5	0	53	1	7	12	0	20	6	22	6	0	34	18	39	6	0	63
Total Volume	70	121	29	0	220	11	36	49	0	96	17	93	24	0	134	60	101	25	0	186
% App. Total	31.8	55	13.2	0		11.5	37.5	51	0		12.7	69.4	17.9	0		32.3	54.3	13.4	0	
PHF	.833	.840	.725	.000	.917	.550	.750	.681	.000	.828	.708	.894	.600	.000	.838	.833	.647	.694	.000	.738

City of Madera
 N/S: Road 23
 E/W: Avenue 14
 Weather: Clear

File Name : 09_MDA_Rd 23_Ave 14 PM
 Site Code : 00319628
 Start Date : 9/18/2019
 Page No : 1

Groups Printed- Passenger Vehicles

Start Time	Road 23 Southbound					Avenue 14 Westbound					Road 23 Northbound					Avenue 14 Eastbound					Int. Total
	Left	Thru	Right	U-Turns	App. Total	Left	Thru	Right	U-Turns	App. Total	Left	Thru	Right	U-Turns	App. Total	Left	Thru	Right	U-Turns	App. Total	
04:00 PM	19	30	7	0	56	4	10	13	0	27	1	17	3	0	21	9	19	6	0	34	138
04:15 PM	15	23	6	0	44	2	12	6	0	20	3	25	10	0	38	11	24	9	0	44	146
04:30 PM	13	29	10	0	52	3	6	17	0	26	3	25	2	0	30	14	17	5	0	36	144
04:45 PM	16	24	5	0	45	1	7	11	0	19	2	16	6	0	24	8	22	9	0	39	127
Total	63	106	28	0	197	10	35	47	0	92	9	83	21	0	113	42	82	29	0	153	555
05:00 PM	16	20	6	0	42	3	7	14	0	24	2	19	6	0	27	15	18	3	0	36	129
05:15 PM	15	19	4	0	38	3	14	3	0	20	2	19	0	0	21	18	39	6	0	63	142
05:30 PM	13	24	1	0	38	2	5	12	0	19	2	20	2	0	24	16	16	0	0	32	113
05:45 PM	6	20	6	0	32	3	10	9	0	22	3	20	2	0	25	9	11	2	0	22	101
Total	50	83	17	0	150	11	36	38	0	85	9	78	10	0	97	58	84	11	0	153	485
Grand Total	113	189	45	0	347	21	71	85	0	177	18	161	31	0	210	100	166	40	0	306	1040
Apprch %	32.6	54.5	13	0		11.9	40.1	48	0		8.6	76.7	14.8	0		32.7	54.2	13.1	0		
Total %	10.9	18.2	4.3	0	33.4	2	6.8	8.2	0	17	1.7	15.5	3	0	20.2	9.6	16	3.8	0	29.4	

Start Time	Road 23 Southbound					Avenue 14 Westbound					Road 23 Northbound					Avenue 14 Eastbound					Int. Total
	Left	Thru	Right	U-Turns	App. Total	Thru	Right	U-Turns	App. Total	Thru	Right	U-Turns	App. Total	Thru	Right	U-Turns	App. Total				
Peak Hour Analysis From 04:00 PM to 04:45 PM - Peak 1 of 1																					
Peak Hour for Entire Intersection Begins at 04:00 PM																					
04:00 PM	19	30	7	0	56	4	10	13	0	27	1	17	3	0	21	9	19	6	0	34	138
04:15 PM	15	23	6	0	44	2	12	6	0	20	3	25	10	0	38	11	24	9	0	44	146
04:30 PM	13	29	10	0	52	3	6	17	0	26	3	25	2	0	30	14	17	5	0	36	144
04:45 PM	16	24	5	0	45	1	7	11	0	19	2	16	6	0	24	8	22	9	0	39	127
Total Volume	63	106	28	0	197	10	35	47	0	92	9	83	21	0	113	42	82	29	0	153	555
% App. Total	32	53.8	14.2	0		10.9	38	51.1	0		8	73.5	18.6	0		27.5	53.6	19	0		
PHF	.829	.883	.700	.000	.879	.625	.729	.691	.000	.852	.750	.830	.525	.000	.743	.750	.854	.806	.000	.869	.950

City of Madera
 N/S: Road 23
 E/W: Avenue 14
 Weather: Clear

File Name : 09_MDA_Rd 23_Ave 14 PM
 Site Code : 00319628
 Start Date : 9/18/2019
 Page No : 2

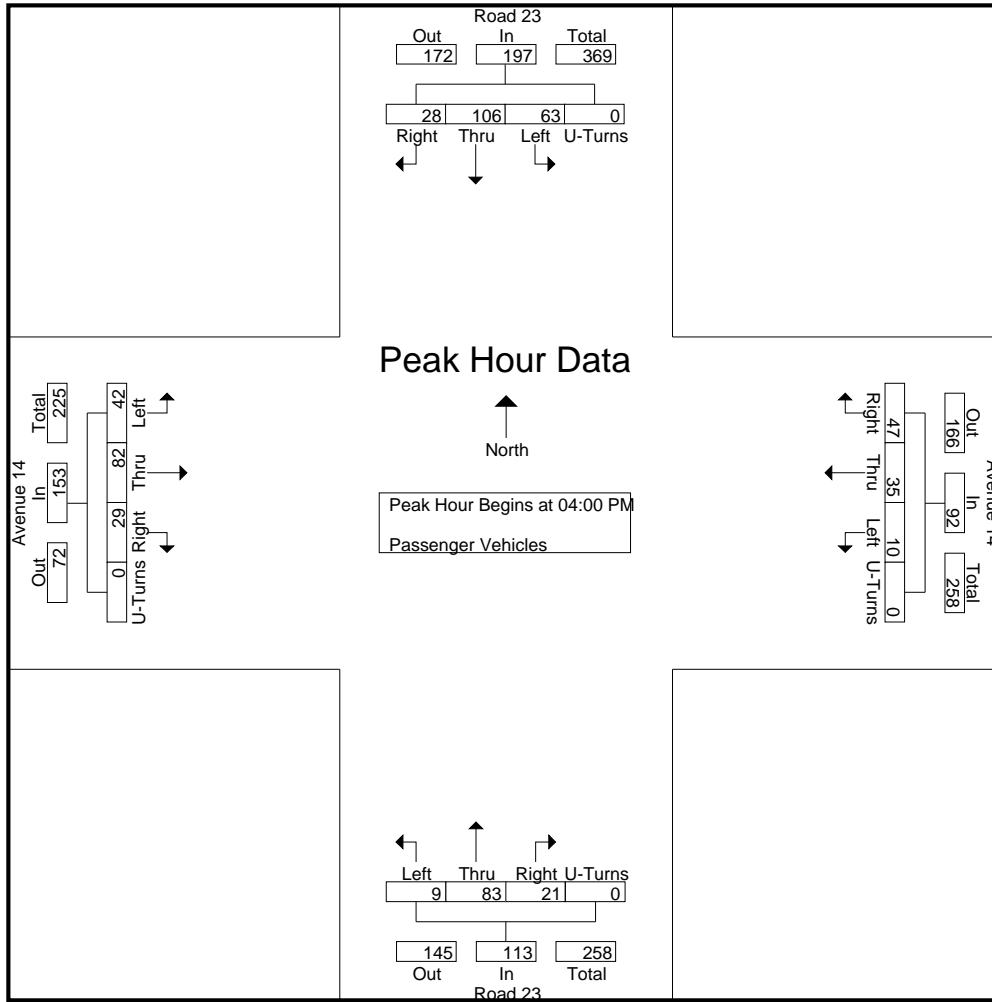

Peak Hour Analysis From 04:00 PM to 04:45 PM - Peak 1 of 1
 Peak Hour for Each Approach Begins at:

	04:00 PM					04:00 PM					04:00 PM									
+0 mins.	19	30	7	0	56	4	10	13	0	27	1	17	3	0	21	9	19	6	0	34
+15 mins.	15	23	6	0	44	2	12	6	0	20	3	25	10	0	38	11	24	9	0	44
+30 mins.	13	29	10	0	52	3	6	17	0	26	3	25	2	0	30	14	17	5	0	36
+45 mins.	16	24	5	0	45	1	7	11	0	19	2	16	6	0	24	8	22	9	0	39
Total Volume	63	106	28	0	197	10	35	47	0	92	9	83	21	0	113	42	82	29	0	153
% App. Total	32	53.8	14.2	0		10.9	38	51.1	0		8	73.5	18.6	0		27.5	53.6	19	0	
PHF	.829	.883	.700	.000	.879	.625	.729	.691	.000	.852	.750	.830	.525	.000	.743	.750	.854	.806	.000	.869

City of Madera
 N/S: Road 23
 E/W: Avenue 14
 Weather: Clear

File Name : 09_MDA_Rd 23_Ave 14 PM
 Site Code : 00319628
 Start Date : 9/18/2019
 Page No : 1

Groups Printed- Large 2 Axle Vehicles

Start Time	Road 23 Southbound					Avenue 14 Westbound					Road 23 Northbound					Avenue 14 Eastbound					Int. Total
	Left	Thru	Right	U-Turns	App. Total	Left	Thru	Right	U-Turns	App. Total	Left	Thru	Right	U-Turns	App. Total	Left	Thru	Right	U-Turns	App. Total	
04:00 PM	2	1	0	0	3	1	0	0	0	1	0	1	0	0	1	0	1	1	0	2	7
04:15 PM	0	1	0	0	1	0	0	0	0	0	0	0	0	0	0	0	0	0	0	0	1
04:30 PM	0	1	0	0	1	0	0	0	0	0	0	0	0	0	0	0	2	0	0	2	3
04:45 PM	1	3	0	0	4	0	0	1	0	1	0	2	0	0	2	1	2	0	0	3	10
Total	3	6	0	0	9	1	0	1	0	2	0	3	0	0	3	1	5	1	0	7	21
05:00 PM	0	0	0	0	0	0	1	0	0	1	0	0	0	0	0	2	0	0	0	2	3
05:15 PM	0	1	1	0	2	0	0	0	0	0	2	2	0	0	4	0	0	0	0	0	6
05:30 PM	0	0	0	0	0	0	0	1	0	1	0	2	0	0	2	0	3	1	0	4	7
05:45 PM	0	0	0	0	0	0	0	0	0	0	0	0	0	0	0	0	0	0	0	0	0
Total	0	1	1	0	2	0	1	1	0	2	2	4	0	0	6	2	3	1	0	6	16
Grand Total	3	7	1	0	11	1	1	2	0	4	2	7	0	0	9	3	8	2	0	13	37
Apprch %	27.3	63.6	9.1	0		25	25	50	0		22.2	77.8	0	0		23.1	61.5	15.4	0		
Total %	8.1	18.9	2.7	0	29.7	2.7	2.7	5.4	0	10.8	5.4	18.9	0	0	24.3	8.1	21.6	5.4	0	35.1	

Start Time	Road 23 Southbound					Avenue 14 Westbound					Road 23 Northbound					Avenue 14 Eastbound					Int. Total
	Left	Thru	Right	U-Turns	App. Total	Thru	Right	U-Turns	App. Total	Thru	Right	U-Turns	App. Total	Thru	Right	U-Turns	App. Total				
Peak Hour Analysis From 04:00 PM to 04:45 PM - Peak 1 of 1																					
Peak Hour for Entire Intersection Begins at 04:00 PM																					
04:00 PM	2	1	0	0	3	1	0	0	0	1	0	1	0	0	1	0	1	1	0	2	7
04:15 PM	0	1	0	0	1	0	0	0	0	0	0	0	0	0	0	0	0	0	0	0	1
04:30 PM	0	1	0	0	1	0	0	0	0	0	0	0	0	0	0	0	2	0	0	2	3
04:45 PM	1	3	0	0	4	0	0	1	0	1	0	2	0	0	2	1	2	0	0	3	10
Total Volume	3	6	0	0	9	1	0	1	0	2	0	3	0	0	3	1	5	1	0	7	21
% App. Total	33.3	66.7	0	0		50	0	50	0		0	100	0	0		14.3	71.4	14.3	0		
PHF	.375	.500	.000	.000	.563	.250	.000	.250	.000	.500	.000	.375	.000	.000	.375	.250	.625	.250	.000	.583	.525

City of Madera
 N/S: Road 23
 E/W: Avenue 14
 Weather: Clear

File Name : 09_MDA_Rd 23_Ave 14 PM
 Site Code : 00319628
 Start Date : 9/18/2019
 Page No : 2

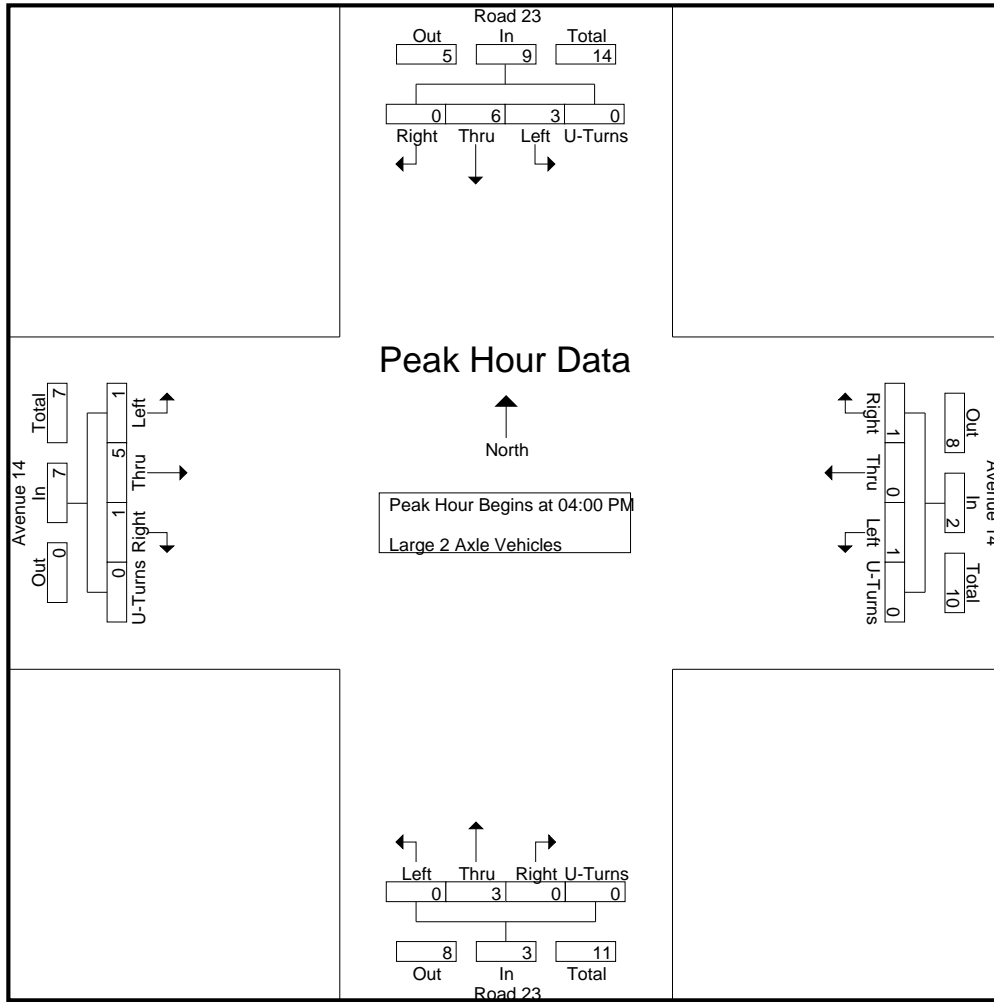

Peak Hour Analysis From 04:00 PM to 04:45 PM - Peak 1 of 1
 Peak Hour for Each Approach Begins at:

	04:00 PM					04:00 PM					04:00 PM									
+0 mins.	2	1	0	0	3	1	0	0	0	1	0	1	0	0	1	0	1	1	0	2
+15 mins.	0	1	0	0	1	0	0	0	0	0	0	0	0	0	0	0	0	0	0	0
+30 mins.	0	1	0	0	1	0	0	0	0	0	0	0	0	0	0	0	2	0	0	2
+45 mins.	1	3	0	0	4	0	0	1	0	1	0	2	0	0	2	1	2	0	0	3
Total Volume	3	6	0	0	9	1	0	1	0	2	0	3	0	0	3	1	5	1	0	7
% App. Total	33.3	66.7	0	0		50	0	50	0		0	100	0	0		14.3	71.4	14.3	0	
PHF	.375	.500	.000	.000	.563	.250	.000	.250	.000	.500	.000	.375	.000	.000	.375	.250	.625	.250	.000	.583

City of Madera
 N/S: Road 23
 E/W: Avenue 14
 Weather: Clear

File Name : 09_MDA_Rd 23_Ave 14 PM
 Site Code : 00319628
 Start Date : 9/18/2019
 Page No : 1

Groups Printed- 3 Axle Vehicles

Start Time	Road 23 Southbound					Avenue 14 Westbound					Road 23 Northbound					Avenue 14 Eastbound					Int. Total
	Left	Thru	Right	U-Turns	App. Total	Left	Thru	Right	U-Turns	App. Total	Left	Thru	Right	U-Turns	App. Total	Left	Thru	Right	U-Turns	App. Total	
04:00 PM	0	0	0	0	0	0	0	0	0	0	0	0	0	0	0	0	0	0	0	0	0
04:15 PM	0	0	0	0	0	0	0	0	0	0	0	0	0	0	0	0	0	0	0	0	0
04:30 PM	0	0	0	0	0	0	0	0	0	0	0	0	0	0	0	0	0	0	0	0	0
04:45 PM	0	0	0	0	0	0	0	0	0	0	0	1	0	0	1	0	0	0	0	0	1
Total	0	0	0	0	0	0	0	0	0	0	0	1	0	0	1	0	0	0	0	0	1
05:00 PM	0	1	0	0	1	0	0	0	0	0	0	0	0	0	0	0	0	0	0	0	1
05:15 PM	0	0	0	0	0	0	0	0	0	0	0	0	0	0	0	0	0	0	0	0	0
05:30 PM	0	0	0	0	0	0	0	0	0	0	0	0	0	0	0	0	0	0	0	0	0
05:45 PM	0	0	0	0	0	0	0	0	0	0	0	0	0	0	0	0	0	0	0	0	0
Total	0	1	0	0	1	0	0	0	0	0	0	0	0	0	0	0	0	0	0	0	1
Grand Total	0	1	0	0	1	0	0	0	0	0	0	1	0	0	1	0	0	0	0	0	2
Apprch %	0	100	0	0		0	0	0	0		0	100	0	0		0	0	0	0		
Total %	0	50	0	0	50	0	0	0	0	0	0	50	0	0	50	0	0	0	0	0	0

Start Time	Road 23 Southbound					Avenue 14 Westbound					Road 23 Northbound					Avenue 14 Eastbound					Int. Total
	Left	Thru	Right	U-Turns	App. Total	Left	Thru	Right	U-Turns	App. Total	Left	Thru	Right	U-Turns	App. Total	Left	Thru	Right	U-Turns	App. Total	
Peak Hour Analysis From 04:00 PM to 04:45 PM - Peak 1 of 1																					
Peak Hour for Entire Intersection Begins at 04:00 PM																					
04:00 PM	0	0	0	0	0	0	0	0	0	0	0	0	0	0	0	0	0	0	0	0	0
04:15 PM	0	0	0	0	0	0	0	0	0	0	0	0	0	0	0	0	0	0	0	0	0
04:30 PM	0	0	0	0	0	0	0	0	0	0	0	0	0	0	0	0	0	0	0	0	0
04:45 PM	0	0	0	0	0	0	0	0	0	0	0	1	0	0	1	0	0	0	0	0	1
Total Volume	0	0	0	0	0	0	0	0	0	0	0	1	0	0	1	0	0	0	0	0	1
% App. Total	0	0	0	0		0	0	0	0		0	100	0	0		0	0	0	0		
PHF	.000	.000	.000	.000	.000	.000	.000	.000	.000	.000	.000	.250	.000	.000	.250	.000	.000	.000	.000	.000	.250

City of Madera
 N/S: Road 23
 E/W: Avenue 14
 Weather: Clear

File Name : 09_MDA_Rd 23_Ave 14 PM
 Site Code : 00319628
 Start Date : 9/18/2019
 Page No : 2

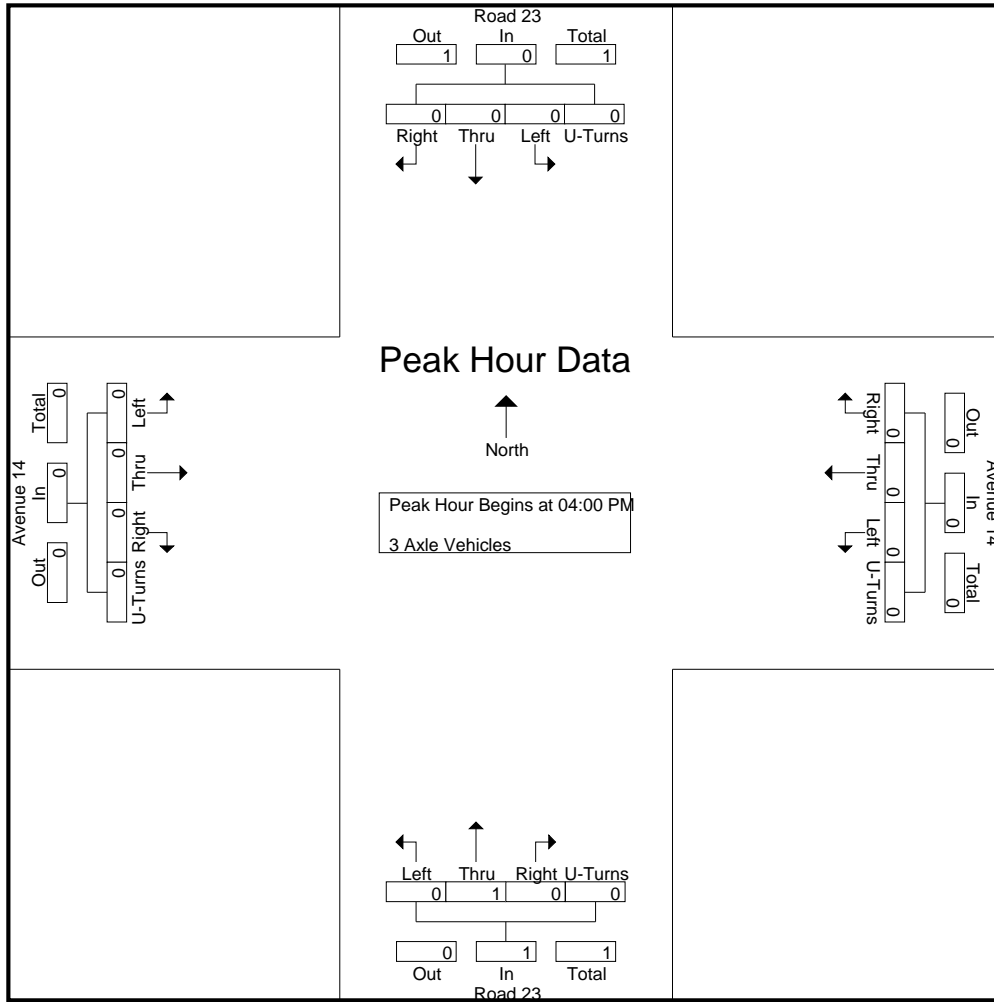

Peak Hour Analysis From 04:00 PM to 04:45 PM - Peak 1 of 1
 Peak Hour for Each Approach Begins at:

	04:00 PM					04:00 PM					04:00 PM					04:00 PM				
+0 mins.	0	0	0	0	0	0	0	0	0	0	0	0	0	0	0	0	0	0	0	0
+15 mins.	0	0	0	0	0	0	0	0	0	0	0	0	0	0	0	0	0	0	0	0
+30 mins.	0	0	0	0	0	0	0	0	0	0	0	0	0	0	0	0	0	0	0	0
+45 mins.	0	0	0	0	0	0	0	0	0	0	0	1	0	0	1	0	0	0	0	0
Total Volume	0	0	0	0	0	0	0	0	0	0	0	1	0	0	1	0	0	0	0	0
% App. Total	0	0	0	0	0	0	0	0	0	0	0	100	0	0	0	0	0	0	0	0
PHF	.000	.000	.000	.000	.000	.000	.000	.000	.000	.000	.000	.250	.000	.000	.250	.000	.000	.000	.000	.000

City of Madera
 N/S: Road 23
 E/W: Avenue 14
 Weather: Clear

File Name : 09_MDA_Rd 23_Ave 14 PM
 Site Code : 00319628
 Start Date : 9/18/2019
 Page No : 1

Groups Printed- 4+ Axle Trucks

Start Time	Road 23 Southbound					Avenue 14 Westbound					Road 23 Northbound					Avenue 14 Eastbound					Int. Total
	Left	Thru	Right	U-Turns	App. Total	Left	Thru	Right	U-Turns	App. Total	Left	Thru	Right	U-Turns	App. Total	Left	Thru	Right	U-Turns	App. Total	
04:00 PM	0	0	0	0	0	0	1	0	0	1	2	2	0	0	4	0	0	2	0	2	7
04:15 PM	0	2	1	0	3	0	0	0	0	0	2	0	0	0	2	0	1	0	0	1	6
04:30 PM	1	6	0	0	7	0	0	1	0	1	1	1	0	0	2	1	0	2	0	3	13
04:45 PM	3	1	0	0	4	0	0	0	0	0	0	1	0	0	1	0	1	0	0	1	6
Total	4	9	1	0	14	0	1	1	0	2	5	4	0	0	9	1	2	4	0	7	32
05:00 PM	3	2	0	0	5	0	0	0	0	0	4	3	0	0	7	1	0	0	0	1	13
05:15 PM	3	1	0	0	4	0	0	0	0	0	0	2	0	0	2	0	0	0	0	0	6
05:30 PM	0	1	0	0	1	0	0	0	0	0	2	1	0	0	3	0	1	2	0	3	7
05:45 PM	2	2	0	0	4	0	0	0	0	0	0	0	0	0	0	0	1	0	0	1	5
Total	8	6	0	0	14	0	0	0	0	0	6	6	0	0	12	1	2	2	0	5	31
Grand Total	12	15	1	0	28	0	1	1	0	2	11	10	0	0	21	2	4	6	0	12	63
Apprch %	42.9	53.6	3.6	0		0	50	50	0		52.4	47.6	0	0		16.7	33.3	50	0		
Total %	19	23.8	1.6	0	44.4	0	1.6	1.6	0	3.2	17.5	15.9	0	0	33.3	3.2	6.3	9.5	0	19	

Start Time	Road 23 Southbound					Avenue 14 Westbound					Road 23 Northbound					Avenue 14 Eastbound					Int. Total
	Left	Thru	Right	U-Turns	App. Total	Thru	Right	U-Turns	App. Total	Thru	Right	U-Turns	App. Total	Thru	Right	U-Turns	App. Total				
Peak Hour Analysis From 04:00 PM to 04:45 PM - Peak 1 of 1																					
Peak Hour for Entire Intersection Begins at 04:00 PM																					
04:00 PM	0	0	0	0	0	0	1	0	0	1	2	2	0	0	4	0	0	2	0	2	7
04:15 PM	0	2	1	0	3	0	0	0	0	0	2	0	0	0	2	0	1	0	0	1	6
04:30 PM	1	6	0	0	7	0	0	1	0	1	1	1	0	0	2	1	0	2	0	3	13
04:45 PM	3	1	0	0	4	0	0	0	0	0	0	1	0	0	1	0	1	0	0	1	6
Total Volume	4	9	1	0	14	0	1	1	0	2	5	4	0	0	9	1	2	4	0	7	32
% App. Total	28.6	64.3	7.1	0		0	50	50	0		55.6	44.4	0	0		14.3	28.6	57.1	0		
PHF	.333	.375	.250	.000	.500	.000	.250	.250	.000	.500	.625	.500	.000	.000	.563	.250	.500	.500	.000	.583	.615

City of Madera
 N/S: Road 23
 E/W: Avenue 14
 Weather: Clear

File Name : 09_MDA_Rd 23_Ave 14 PM
 Site Code : 00319628
 Start Date : 9/18/2019
 Page No : 2

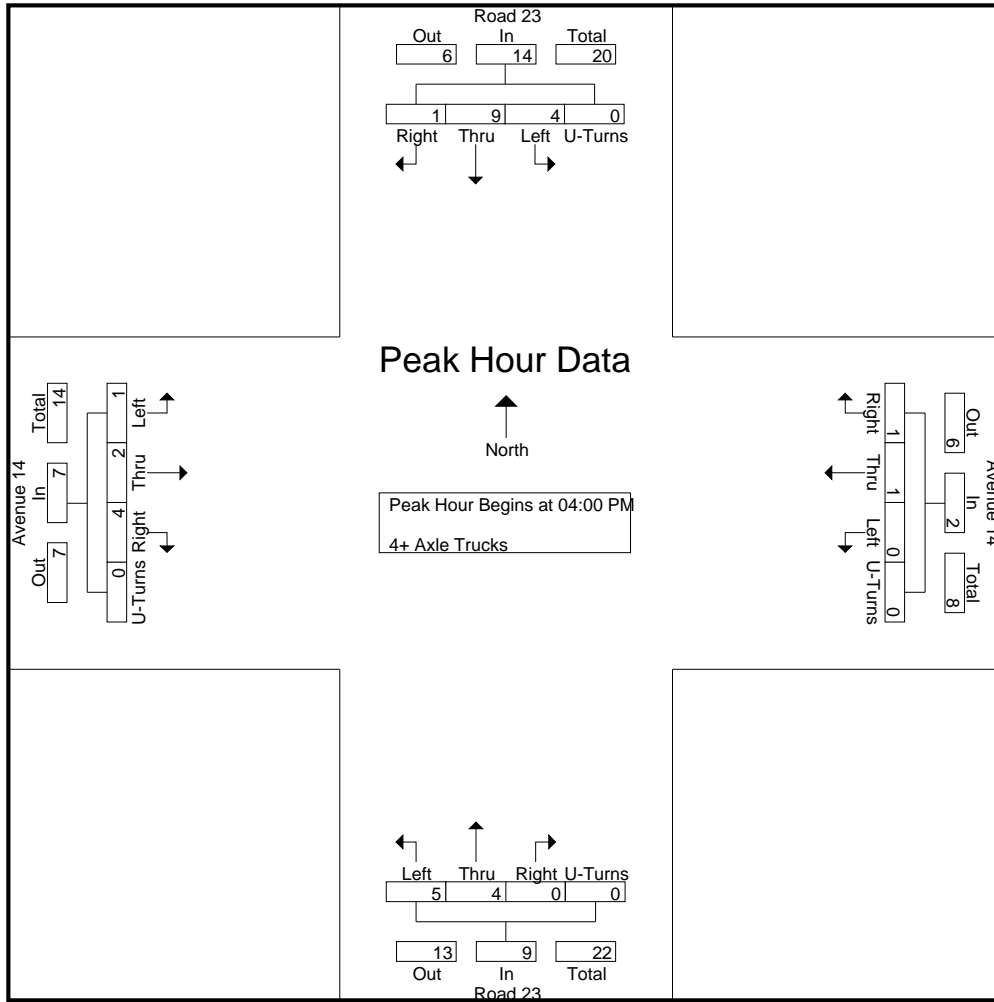

Peak Hour Analysis From 04:00 PM to 04:45 PM - Peak 1 of 1
 Peak Hour for Each Approach Begins at:

	04:00 PM					04:00 PM					04:00 PM									
+0 mins.	0	0	0	0	0	0	1	0	0	1	2	2	0	0	4	0	0	2	0	2
+15 mins.	0	2	1	0	3	0	0	0	0	0	2	0	0	0	2	0	1	0	0	1
+30 mins.	1	6	0	0	7	0	0	1	0	1	1	1	0	0	2	1	0	2	0	3
+45 mins.	3	1	0	0	4	0	0	0	0	0	0	1	0	0	1	0	1	0	0	1
Total Volume	4	9	1	0	14	0	1	1	0	2	5	4	0	0	9	1	2	4	0	7
% App. Total	28.6	64.3	7.1	0		0	50	50	0		55.6	44.4	0	0		14.3	28.6	57.1	0	
PHF	.333	.375	.250	.000	.500	.000	.250	.250	.000	.500	.625	.500	.000	.000	.563	.250	.500	.500	.000	.583

Location: Madera
 N/S: Road 23
 E/W: Avenue 14



Date: 9/18/2019
 Day: Wednesday

PEDESTRIANS

	North Leg Road 23	East Leg Avenue 14	South Leg Road 23	West Leg Avenue 14	
	Pedestrians	Pedestrians	Pedestrians	Pedestrians	
7:00 AM	0	0	0	0	0
7:15 AM	0	0	0	0	0
7:30 AM	0	0	0	0	0
7:45 AM	0	0	0	0	0
8:00 AM	0	0	0	0	0
8:15 AM	0	0	0	0	0
8:30 AM	0	0	0	0	0
8:45 AM	0	0	0	0	0
TOTAL VOLUMES:	0	0	0	0	0

	North Leg Road 23	East Leg Avenue 14	South Leg Road 23	West Leg Avenue 14	
	Pedestrians	Pedestrians	Pedestrians	Pedestrians	
4:00 PM	0	0	0	0	0
4:15 PM	0	0	0	0	0
4:30 PM	0	0	0	0	0
4:45 PM	0	0	0	0	0
5:00 PM	0	0	0	0	0
5:15 PM	0	0	0	0	0
5:30 PM	0	0	0	0	0
5:45 PM	0	0	0	0	0
TOTAL VOLUMES:	0	0	0	0	0

Location: Madera
 N/S: Road 23
 E/W: Avenue 14



Date: 9/18/2019
 Day: Wednesday

BICYCLES

	Southbound Road 23			Westbound Avenue 14			Northbound Road 23			Eastbound Avenue 14			
	Left	Thru	Right	Left	Thru	Right	Left	Thru	Right	Left	Thru	Right	
7:00 AM	0	0	0	0	0	0	0	0	0	0	0	0	0
7:15 AM	0	0	0	0	0	0	0	0	0	0	0	0	0
7:30 AM	0	0	0	0	0	0	0	0	0	0	0	0	0
7:45 AM	0	0	0	0	0	0	0	0	0	0	0	0	0
8:00 AM	0	0	0	0	0	0	0	0	0	0	0	0	0
8:15 AM	0	0	0	0	0	0	0	0	0	0	0	0	0
8:30 AM	0	0	0	0	0	0	0	0	0	0	0	0	0
8:45 AM	0	0	0	0	0	0	0	0	0	0	0	0	0
TOTAL VOLUMES:	0	0	0	0	0	0	0	0	0	0	0	0	0

	Southbound Road 23			Westbound Avenue 14			Northbound Road 23			Eastbound Avenue 14			
	Left	Thru	Right	Left	Thru	Right	Left	Thru	Right	Left	Thru	Right	
4:00 PM	0	0	0	0	0	0	0	0	0	0	0	0	0
4:15 PM	0	0	0	0	0	0	0	0	0	0	0	0	0
4:30 PM	0	0	0	0	0	0	0	0	0	0	0	0	0
4:45 PM	0	0	0	0	0	0	0	0	0	0	0	0	0
5:00 PM	0	0	0	0	0	0	0	0	0	0	0	0	0
5:15 PM	0	0	0	0	0	0	0	0	0	0	0	0	0
5:30 PM	0	0	0	0	0	0	0	0	0	0	0	0	0
5:45 PM	0	0	0	0	0	0	0	0	0	0	0	0	0
TOTAL VOLUMES:	0	0	0	0	0	0	0	0	0	0	0	0	0

City of Madera
 N/S: Road 23
 E/W: Avenue 12
 Weather: Clear

File Name : 10_MDA_Rd 23_Ave 12 AM
 Site Code : 00319628
 Start Date : 9/18/2019
 Page No : 1

Groups Printed- Passenger Vehicles - Large 2 Axle Vehicles - 3 Axle Vehicles - 4+ Axle Trucks

Start Time	Road 23 Southbound					Avenue 12 Westbound					Road 23 Northbound					Avenue 12 Eastbound					Int. Total
	Left	Thru	Right	U-Turns	App. Total	Left	Thru	Right	U-Turns	App. Total	Left	Thru	Right	U-Turns	App. Total	Left	Thru	Right	U-Turns	App. Total	
07:00 AM	3	4	6	1	14	1	18	6	0	25	1	3	5	0	9	4	12	3	0	19	67
07:15 AM	8	12	7	0	27	0	25	7	0	32	2	7	0	0	9	1	13	1	0	15	83
07:30 AM	8	18	10	0	36	5	22	11	0	38	1	7	6	0	14	6	29	1	0	36	124
07:45 AM	6	11	6	0	23	5	14	14	0	33	5	11	6	0	22	5	24	2	0	31	109
Total	25	45	29	1	100	11	79	38	0	128	9	28	17	0	54	16	78	7	0	101	383
08:00 AM	10	6	5	0	21	1	12	5	0	18	0	7	4	0	11	6	16	0	0	22	72
08:15 AM	10	9	4	0	23	3	18	1	0	22	1	6	3	0	10	9	14	0	0	23	78
08:30 AM	7	8	10	0	25	7	20	5	0	32	3	8	3	0	14	7	19	0	0	26	97
08:45 AM	5	5	6	0	16	2	15	9	0	26	2	7	2	0	11	12	14	0	0	26	79
Total	32	28	25	0	85	13	65	20	0	98	6	28	12	0	46	34	63	0	0	97	326
Grand Total	57	73	54	1	185	24	144	58	0	226	15	56	29	0	100	50	141	7	0	198	709
Apprch %	30.8	39.5	29.2	0.5		10.6	63.7	25.7	0		15	56	29	0		25.3	71.2	3.5	0		
Total %	8	10.3	7.6	0.1	26.1	3.4	20.3	8.2	0	31.9	2.1	7.9	4.1	0	14.1	7.1	19.9	1	0	27.9	
Passenger Vehicles																					
% Passenger Vehicles	50.9	86.3	81.5	100	74.1	83.3	77.1	58.6	0	73	73.3	75	93.1	0	80	90	87.2	85.7	0	87.9	78.4
Large 2 Axle Vehicles																					
% Large 2 Axle Vehicles	12.3	6.8	5.6	0	8.1	16.7	5.6	8.6	0	7.5	20	12.5	6.9	0	12	4	3.5	14.3	0	4	7.3
3 Axle Vehicles																					
% 3 Axle Vehicles	5.3	0	1.9	0	2.2	0	3.5	3.4	0	3.1	6.7	0	0	0	1	0	0	0	0	0	1.7
4+ Axle Trucks	18	5	6	0	29	0	20	17	0	37	0	7	0	0	7	3	13	0	0	16	89
% 4+ Axle Trucks																					

Start Time	Road 23 Southbound					Avenue 12 Westbound					Road 23 Northbound					Avenue 12 Eastbound					Int. Total
	Left	Thru	Right	U-Turns	App. Total	Left	Thru	Right	U-Turns	App. Total	Left	Thru	Right	U-Turns	App. Total	Left	Thru	Right	U-Turns	App. Total	
Peak Hour Analysis From 07:00 AM to 08:45 AM - Peak 1 of 1																					
Peak Hour for Entire Intersection Begins at 07:15 AM																					
07:15 AM	8	12	7	0	27	0	25	7	0	32	2	7	0	0	9	1	13	1	0	15	83
07:30 AM	8	18	10	0	36	5	22	11	0	38	1	7	6	0	14	6	29	1	0	36	124
07:45 AM	6	11	6	0	23	5	14	14	0	33	5	11	6	0	22	5	24	2	0	31	109
08:00 AM	10	6	5	0	21	1	12	5	0	18	0	7	4	0	11	6	16	0	0	22	72
Total Volume	32	47	28	0	107	11	73	37	0	121	8	32	16	0	56	18	82	4	0	104	388
% App. Total	29.9	43.9	26.2	0		9.1	60.3	30.6	0		14.3	57.1	28.6	0		17.3	78.8	3.8	0		
PHF	.800	.653	.700	.000	.743	.550	.730	.661	.000	.796	.400	.727	.667	.000	.636	.750	.707	.500	.000	.722	.782

City of Madera
 N/S: Road 23
 E/W: Avenue 12
 Weather: Clear

File Name : 10_MDA_Rd 23_Ave 12 AM
 Site Code : 00319628
 Start Date : 9/18/2019
 Page No : 2

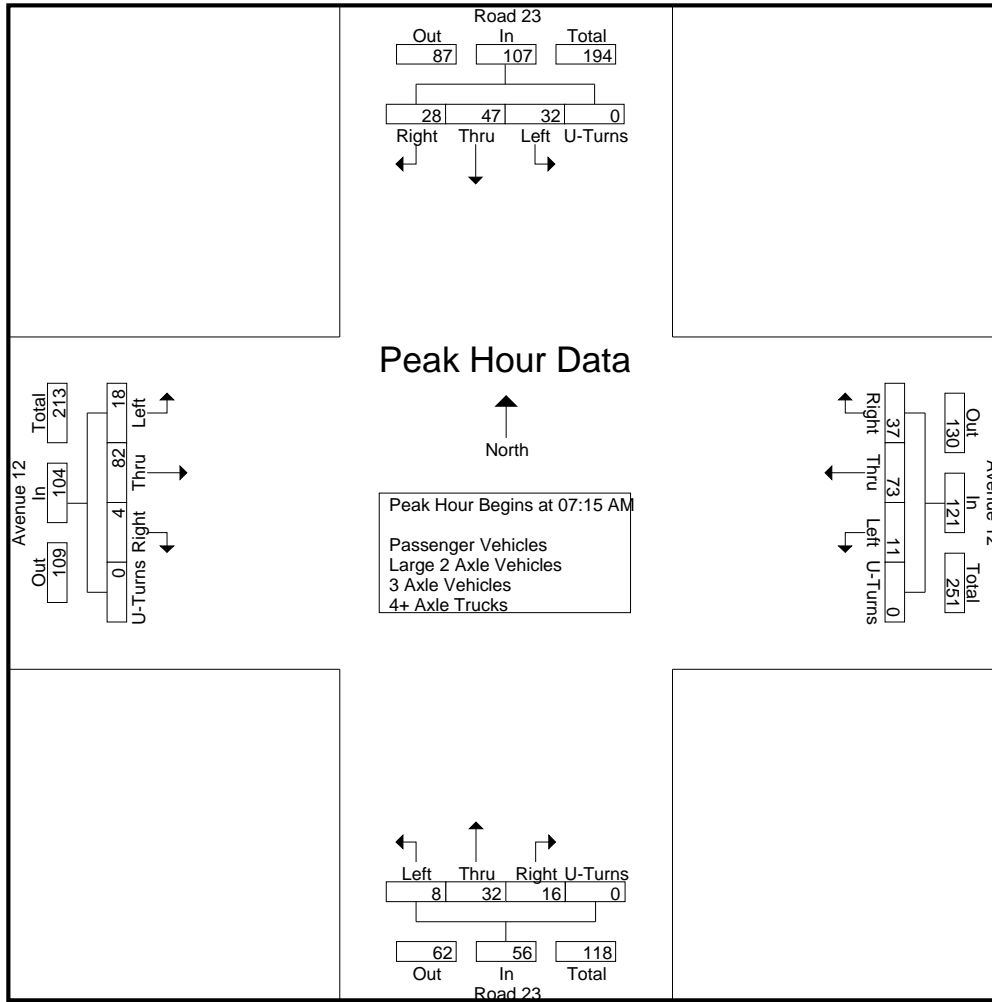

Peak Hour Analysis From 07:00 AM to 08:45 AM - Peak 1 of 1
 Peak Hour for Each Approach Begins at:

	07:15 AM					07:00 AM					07:30 AM					07:30 AM				
+0 mins.	8	12	7	0	27	1	18	6	0	25	1	7	6	0	14	6	29	1	0	36
+15 mins.	8	18	10	0	36	0	25	7	0	32	5	11	6	0	22	5	24	2	0	31
+30 mins.	6	11	6	0	23	5	22	11	0	38	0	7	4	0	11	6	16	0	0	22
+45 mins.	10	6	5	0	21	5	14	14	0	33	1	6	3	0	10	9	14	0	0	23
Total Volume	32	47	28	0	107	11	79	38	0	128	7	31	19	0	57	26	83	3	0	112
% App. Total	29.9	43.9	26.2	0		8.6	61.7	29.7	0		12.3	54.4	33.3	0		23.2	74.1	2.7	0	
PHF	.800	.653	.700	.000	.743	.550	.790	.679	.000	.842	.350	.705	.792	.000	.648	.722	.716	.375	.000	.778

City of Madera
 N/S: Road 23
 E/W: Avenue 12
 Weather: Clear

File Name : 10_MDA_Rd 23_Ave 12 AM
 Site Code : 00319628
 Start Date : 9/18/2019
 Page No : 1

Groups Printed- Passenger Vehicles

Start Time	Road 23 Southbound					Avenue 12 Westbound					Road 23 Northbound					Avenue 12 Eastbound					Int. Total
	Left	Thru	Right	U-Turns	App. Total	Left	Thru	Right	U-Turns	App. Total	Left	Thru	Right	U-Turns	App. Total	Left	Thru	Right	U-Turns	App. Total	
07:00 AM	2	4	6	1	13	1	15	5	0	21	0	2	5	0	7	4	9	2	0	15	56
07:15 AM	4	12	5	0	21	0	18	2	0	20	2	7	0	0	9	1	11	1	0	13	63
07:30 AM	5	16	9	0	30	5	16	6	0	27	1	5	6	0	12	6	27	1	0	34	103
07:45 AM	5	10	4	0	19	4	11	8	0	23	4	10	5	0	19	4	21	2	0	27	88
Total	16	42	24	1	83	10	60	21	0	91	7	24	16	0	47	15	68	6	0	89	310
08:00 AM	4	6	5	0	15	1	9	3	0	13	0	6	4	0	10	5	14	0	0	19	57
08:15 AM	6	7	1	0	14	2	12	0	0	14	1	5	3	0	9	8	13	0	0	21	58
08:30 AM	0	6	8	0	14	5	15	2	0	22	1	2	2	0	5	5	17	0	0	22	63
08:45 AM	3	2	6	0	11	2	15	8	0	25	2	5	2	0	9	12	11	0	0	23	68
Total	13	21	20	0	54	10	51	13	0	74	4	18	11	0	33	30	55	0	0	85	246
Grand Total	29	63	44	1	137	20	111	34	0	165	11	42	27	0	80	45	123	6	0	174	556
Apprch %	21.2	46	32.1	0.7		12.1	67.3	20.6	0		13.8	52.5	33.8	0		25.9	70.7	3.4	0		
Total %	5.2	11.3	7.9	0.2	24.6	3.6	20	6.1	0	29.7	2	7.6	4.9	0	14.4	8.1	22.1	1.1	0	31.3	

Start Time	Road 23 Southbound					Avenue 12 Westbound					Road 23 Northbound					Avenue 12 Eastbound					Int. Total
	Left	Thru	Right	U-Turns	App. Total	Thru	Right	U-Turns	App. Total	Thru	Right	U-Turns	App. Total	Thru	Right	U-Turns	App. Total				
Peak Hour Analysis From 07:15 AM to 08:00 AM - Peak 1 of 1																					
Peak Hour for Entire Intersection Begins at 07:15 AM																					
07:15 AM	4	12	5	0	21	0	18	2	0	20	2	7	0	0	9	1	11	1	0	13	63
07:30 AM	5	16	9	0	30	5	16	6	0	27	1	5	6	0	12	6	27	1	0	34	103
07:45 AM	5	10	4	0	19	4	11	8	0	23	4	10	5	0	19	4	21	2	0	27	88
08:00 AM	4	6	5	0	15	1	9	3	0	13	0	6	4	0	10	5	14	0	0	19	57
Total Volume	18	44	23	0	85	10	54	19	0	83	7	28	15	0	50	16	73	4	0	93	311
% App. Total	21.2	51.8	27.1	0		12	65.1	22.9	0		14	56	30	0		17.2	78.5	4.3	0		
PHF	.900	.688	.639	.000	.708	.500	.750	.594	.000	.769	.438	.700	.625	.000	.658	.667	.676	.500	.000	.684	.755

City of Madera
 N/S: Road 23
 E/W: Avenue 12
 Weather: Clear

File Name : 10_MDA_Rd 23_Ave 12 AM
 Site Code : 00319628
 Start Date : 9/18/2019
 Page No : 2

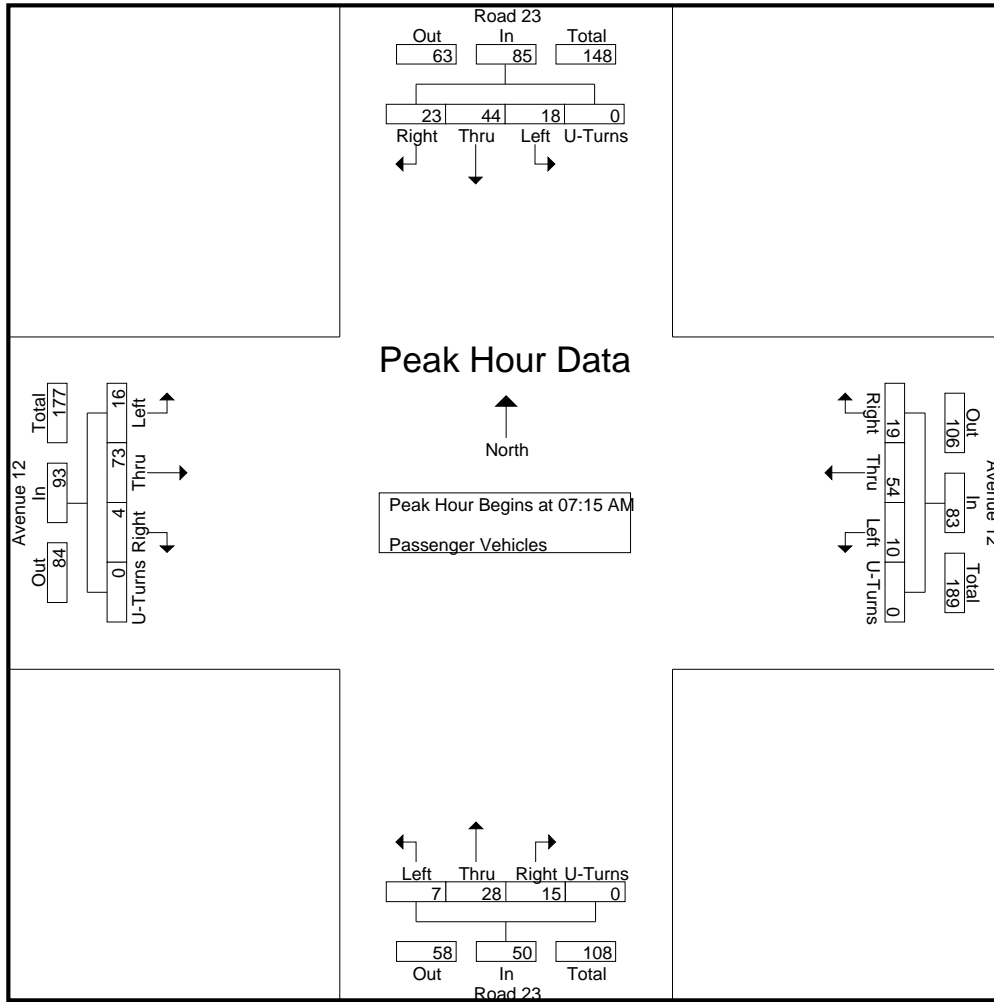

Peak Hour Analysis From 07:15 AM to 08:00 AM - Peak 1 of 1
 Peak Hour for Each Approach Begins at:

	07:15 AM					07:15 AM					07:15 AM					07:15 AM				
+0 mins.	4	12	5	0	21	0	18	2	0	20	2	7	0	0	9	1	11	1	0	13
+15 mins.	5	16	9	0	30	5	16	6	0	27	1	5	6	0	12	6	27	1	0	34
+30 mins.	5	10	4	0	19	4	11	8	0	23	4	10	5	0	19	4	21	2	0	27
+45 mins.	4	6	5	0	15	1	9	3	0	13	0	6	4	0	10	5	14	0	0	19
Total Volume	18	44	23	0	85	10	54	19	0	83	7	28	15	0	50	16	73	4	0	93
% App. Total	21.2	51.8	27.1	0		12	65.1	22.9	0		14	56	30	0		17.2	78.5	4.3	0	
PHF	.900	.688	.639	.000	.708	.500	.750	.594	.000	.769	.438	.700	.625	.000	.658	.667	.676	.500	.000	.684

City of Madera
 N/S: Road 23
 E/W: Avenue 12
 Weather: Clear

File Name : 10_MDA_Rd 23_Ave 12 AM
 Site Code : 00319628
 Start Date : 9/18/2019
 Page No : 1

Groups Printed- Large 2 Axle Vehicles

Start Time	Road 23 Southbound					Avenue 12 Westbound					Road 23 Northbound					Avenue 12 Eastbound					Int. Total
	Left	Thru	Right	U-Turns	App. Total	Left	Thru	Right	U-Turns	App. Total	Left	Thru	Right	U-Turns	App. Total	Left	Thru	Right	U-Turns	App. Total	
07:00 AM	0	0	0	0	0	0	0	1	0	1	0	1	0	0	1	0	1	1	0	2	4
07:15 AM	1	0	1	0	2	0	0	1	0	1	0	0	0	0	0	0	0	0	0	0	3
07:30 AM	2	1	0	0	3	0	2	0	0	2	0	0	0	0	0	0	0	0	0	0	5
07:45 AM	0	0	0	0	0	1	1	0	0	2	1	1	1	0	3	1	2	0	0	3	8
Total	3	1	1	0	5	1	3	2	0	6	1	2	1	0	4	1	3	1	0	5	20
08:00 AM	1	0	0	0	1	0	0	0	0	0	0	1	0	0	1	0	1	0	0	1	3
08:15 AM	1	0	2	0	3	1	3	0	0	4	0	1	0	0	1	0	0	0	0	0	8
08:30 AM	1	2	0	0	3	2	2	3	0	7	2	3	1	0	6	1	0	0	0	1	17
08:45 AM	1	2	0	0	3	0	0	0	0	0	0	0	0	0	0	0	1	0	0	1	4
Total	4	4	2	0	10	3	5	3	0	11	2	5	1	0	8	1	2	0	0	3	32
Grand Total	7	5	3	0	15	4	8	5	0	17	3	7	2	0	12	2	5	1	0	8	52
Apprch %	46.7	33.3	20	0		23.5	47.1	29.4	0		25	58.3	16.7	0		25	62.5	12.5	0		
Total %	13.5	9.6	5.8	0	28.8	7.7	15.4	9.6	0	32.7	5.8	13.5	3.8	0	23.1	3.8	9.6	1.9	0	15.4	

Start Time	Road 23 Southbound					Avenue 12 Westbound					Road 23 Northbound					Avenue 12 Eastbound					Int. Total
	Left	Thru	Right	U-Turns	App. Total	Thru	Right	U-Turns	App. Total	Thru	Right	U-Turns	App. Total	Thru	Right	U-Turns	App. Total				
Peak Hour Analysis From 07:15 AM to 08:00 AM - Peak 1 of 1																					
Peak Hour for Entire Intersection Begins at 07:15 AM																					
07:15 AM	1	0	1	0	2	0	0	1	0	1	0	0	0	0	0	0	0	0	0	0	3
07:30 AM	2	1	0	0	3	0	2	0	0	2	0	0	0	0	0	0	0	0	0	0	5
07:45 AM	0	0	0	0	0	1	1	0	0	2	1	1	1	0	3	1	2	0	0	3	8
08:00 AM	1	0	0	0	1	0	0	0	0	0	0	1	0	0	1	0	1	0	0	1	3
Total Volume	4	1	1	0	6	1	3	1	0	5	1	2	1	0	4	1	3	0	0	4	19
% App. Total	66.7	16.7	16.7	0		20	60	20	0		25	50	25	0		25	75	0	0		
PHF	.500	.250	.250	.000	.500	.250	.375	.250	.000	.625	.250	.500	.250	.000	.333	.250	.375	.000	.000	.333	.594

City of Madera
 N/S: Road 23
 E/W: Avenue 12
 Weather: Clear

File Name : 10_MDA_Rd 23_Ave 12 AM
 Site Code : 00319628
 Start Date : 9/18/2019
 Page No : 2

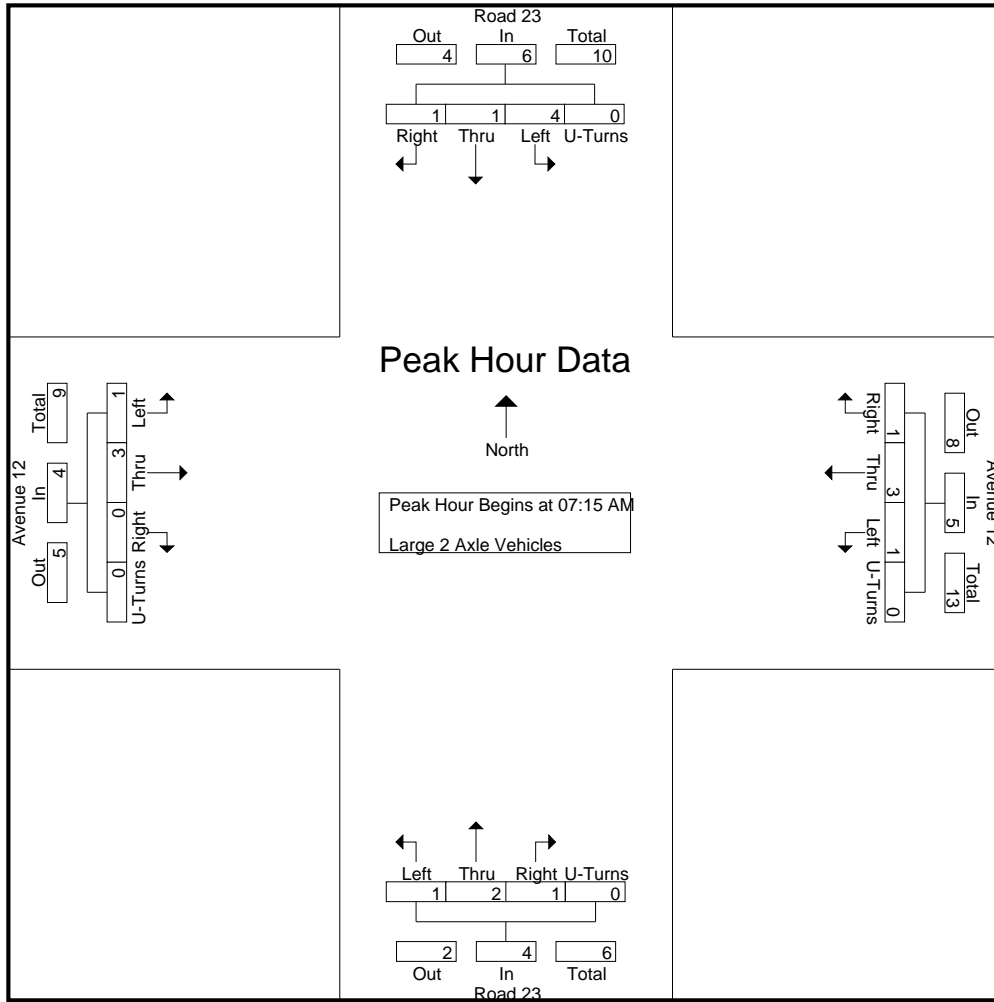

Peak Hour Analysis From 07:15 AM to 08:00 AM - Peak 1 of 1
 Peak Hour for Each Approach Begins at:

	07:15 AM					07:15 AM					07:15 AM					07:15 AM				
+0 mins.	1	0	1	0	2	0	0	1	0	1	0	0	0	0	0	0	0	0	0	0
+15 mins.	2	1	0	0	3	0	2	0	0	2	0	0	0	0	0	0	0	0	0	0
+30 mins.	0	0	0	0	0	1	1	0	0	2	1	1	1	0	3	1	2	0	0	3
+45 mins.	1	0	0	0	1	0	0	0	0	0	0	1	0	0	1	0	1	0	0	1
Total Volume	4	1	1	0	6	1	3	1	0	5	1	2	1	0	4	1	3	0	0	4
% App. Total	66.7	16.7	16.7	0		20	60	20	0		25	50	25	0		25	75	0	0	
PHF	.500	.250	.250	.000	.500	.250	.375	.250	.000	.625	.250	.500	.250	.000	.333	.250	.375	.000	.000	.333

City of Madera
 N/S: Road 23
 E/W: Avenue 12
 Weather: Clear

File Name : 10_MDA_Rd 23_Ave 12 AM
 Site Code : 00319628
 Start Date : 9/18/2019
 Page No : 1

Groups Printed- 3 Axle Vehicles

Start Time	Road 23 Southbound					Avenue 12 Westbound					Road 23 Northbound					Avenue 12 Eastbound					Int. Total
	Left	Thru	Right	U-Turns	App. Total	Left	Thru	Right	U-Turns	App. Total	Left	Thru	Right	U-Turns	App. Total	Left	Thru	Right	U-Turns	App. Total	
07:00 AM	0	0	0	0	0	0	0	0	0	0	1	0	0	0	1	0	0	0	0	0	1
07:15 AM	0	0	0	0	0	0	2	0	0	2	0	0	0	0	0	0	0	0	0	0	0
07:30 AM	1	0	0	0	1	0	0	0	0	0	0	0	0	0	0	0	0	0	0	0	0
07:45 AM	0	0	0	0	0	0	1	0	0	1	0	0	0	0	0	0	0	0	0	0	0
Total	1	0	0	0	1	0	3	0	0	3	1	0	0	0	1	0	0	0	0	0	0
08:00 AM	1	0	0	0	1	0	1	1	0	2	0	0	0	0	0	0	0	0	0	0	0
08:15 AM	0	0	0	0	0	0	0	0	0	0	0	0	0	0	0	0	0	0	0	0	0
08:30 AM	1	0	1	0	2	0	1	0	0	1	0	0	0	0	0	0	0	0	0	0	0
08:45 AM	0	0	0	0	0	0	0	1	0	1	0	0	0	0	0	0	0	0	0	0	0
Total	2	0	1	0	3	0	2	2	0	4	0	0	0	0	0	0	0	0	0	0	0
Grand Total	3	0	1	0	4	0	5	2	0	7	1	0	0	0	1	0	0	0	0	0	0
Apprch %	75	0	25	0		0	71.4	28.6	0		100	0	0	0		0	0	0	0		
Total %	25	0	8.3	0	33.3	0	41.7	16.7	0	58.3	8.3	0	0	0	8.3	0	0	0	0	0	0

Start Time	Road 23 Southbound					Avenue 12 Westbound					Road 23 Northbound					Avenue 12 Eastbound					Int. Total
	Left	Thru	Right	U-Turns	App. Total	Thru	Right	U-Turns	App. Total	Thru	Right	U-Turns	App. Total	Thru	Right	U-Turns	App. Total				
Peak Hour Analysis From 07:15 AM to 08:00 AM - Peak 1 of 1																					
Peak Hour for Entire Intersection Begins at 07:15 AM																					
07:15 AM	0	0	0	0	0	0	2	0	0	2	0	0	0	0	0	0	0	0	0	0	0
07:30 AM	1	0	0	0	1	0	0	0	0	0	0	0	0	0	0	0	0	0	0	0	0
07:45 AM	0	0	0	0	0	0	1	0	0	1	0	0	0	0	0	0	0	0	0	0	0
08:00 AM	1	0	0	0	1	0	1	1	0	2	0	0	0	0	0	0	0	0	0	0	0
Total Volume	2	0	0	0	2	0	4	1	0	5	0	0	0	0	0	0	0	0	0	0	0
% App. Total	100	0	0	0		0	80	20	0		0	0	0	0		0	0	0	0		
PHF	.500	.000	.000	.000	.500	.000	.500	.250	.000	.625	.000	.000	.000	.000	.000	.000	.000	.000	.000	.000	.583

City of Madera
 N/S: Road 23
 E/W: Avenue 12
 Weather: Clear

File Name : 10_MDA_Rd 23_Ave 12 AM
 Site Code : 00319628
 Start Date : 9/18/2019
 Page No : 2

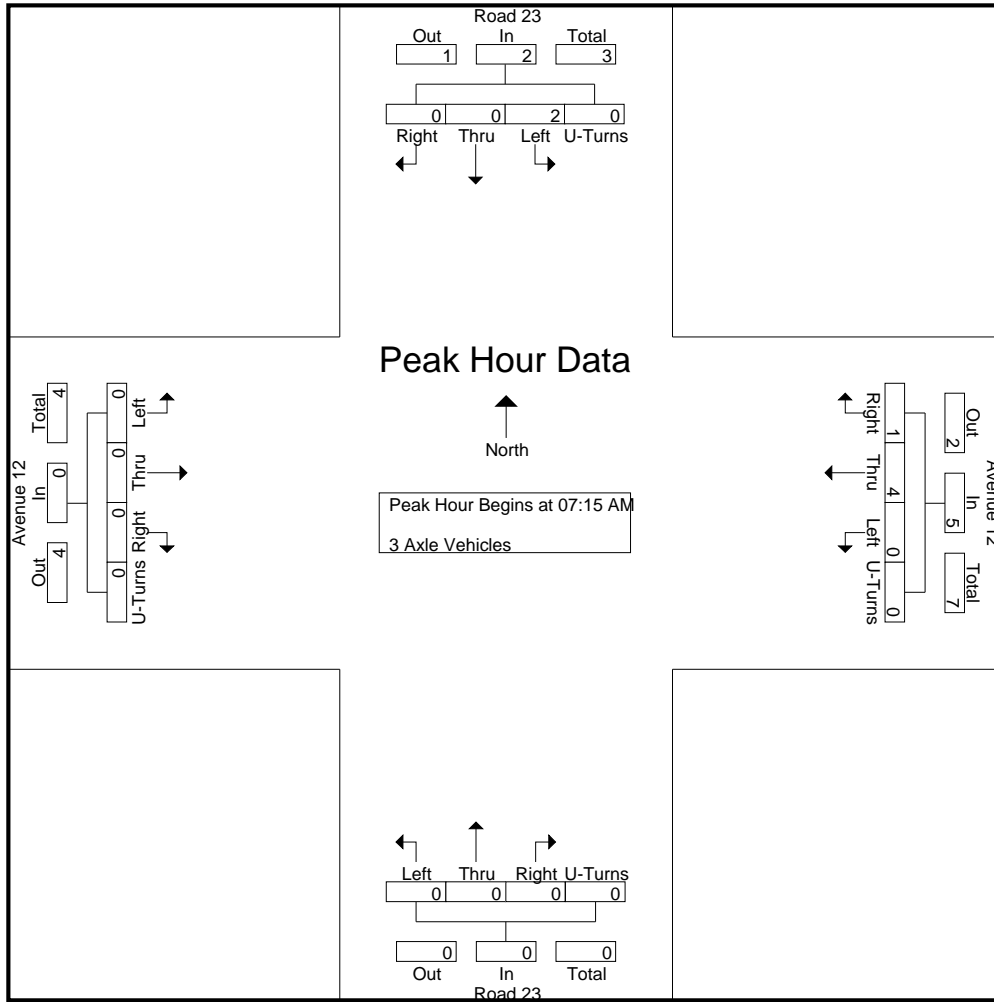

Peak Hour Analysis From 07:15 AM to 08:00 AM - Peak 1 of 1
 Peak Hour for Each Approach Begins at:

	07:15 AM					07:15 AM					07:15 AM					07:15 AM				
+0 mins.	0	0	0	0	0	0	2	0	0	2	0	0	0	0	0	0	0	0	0	0
+15 mins.	1	0	0	0	1	0	0	0	0	0	0	0	0	0	0	0	0	0	0	0
+30 mins.	0	0	0	0	0	0	1	0	0	1	0	0	0	0	0	0	0	0	0	0
+45 mins.	1	0	0	0	1	0	1	1	0	2	0	0	0	0	0	0	0	0	0	0
Total Volume	2	0	0	0	2	0	4	1	0	5	0	0	0	0	0	0	0	0	0	0
% App. Total	100	0	0	0	0	0	80	20	0	0	0	0	0	0	0	0	0	0	0	0
PHF	.500	.000	.000	.000	.500	.000	.500	.250	.000	.625	.000	.000	.000	.000	.000	.000	.000	.000	.000	.000

City of Madera
 N/S: Road 23
 E/W: Avenue 12
 Weather: Clear

File Name : 10_MDA_Rd 23_Ave 12 AM
 Site Code : 00319628
 Start Date : 9/18/2019
 Page No : 1

Groups Printed- 4+ Axle Trucks

Start Time	Road 23 Southbound					Avenue 12 Westbound					Road 23 Northbound					Avenue 12 Eastbound					Int. Total
	Left	Thru	Right	U-Turns	App. Total	Left	Thru	Right	U-Turns	App. Total	Left	Thru	Right	U-Turns	App. Total	Left	Thru	Right	U-Turns	App. Total	
07:00 AM	1	0	0	0	1	0	3	0	0	3	0	0	0	0	0	0	2	0	0	2	6
07:15 AM	3	0	1	0	4	0	5	4	0	9	0	0	0	0	0	0	2	0	0	2	15
07:30 AM	0	1	1	0	2	0	4	5	0	9	0	2	0	0	2	0	2	0	0	2	15
07:45 AM	1	1	2	0	4	0	1	6	0	7	0	0	0	0	0	0	1	0	0	1	12
Total	5	2	4	0	11	0	13	15	0	28	0	2	0	0	2	0	7	0	0	7	48
08:00 AM	4	0	0	0	4	0	2	1	0	3	0	0	0	0	0	1	1	0	0	2	9
08:15 AM	3	2	1	0	6	0	3	1	0	4	0	0	0	0	0	1	1	0	0	2	12
08:30 AM	5	0	1	0	6	0	2	0	0	2	0	3	0	0	3	1	2	0	0	3	14
08:45 AM	1	1	0	0	2	0	0	0	0	0	0	2	0	0	2	0	2	0	0	2	6
Total	13	3	2	0	18	0	7	2	0	9	0	5	0	0	5	3	6	0	0	9	41
Grand Total	18	5	6	0	29	0	20	17	0	37	0	7	0	0	7	3	13	0	0	16	89
Apprch %	62.1	17.2	20.7	0		0	54.1	45.9	0		0	100	0	0		18.8	81.2	0	0		
Total %	20.2	5.6	6.7	0	32.6	0	22.5	19.1	0	41.6	0	7.9	0	0	7.9	3.4	14.6	0	0	18	

Start Time	Road 23 Southbound					Avenue 12 Westbound					Road 23 Northbound					Avenue 12 Eastbound					Int. Total
	Left	Thru	Right	U-Turns	App. Total	Thru	Right	U-Turns	App. Total	Thru	Right	U-Turns	App. Total	Thru	Right	U-Turns	App. Total				
Peak Hour Analysis From 07:15 AM to 08:00 AM - Peak 1 of 1																					
Peak Hour for Entire Intersection Begins at 07:15 AM																					
07:15 AM	3	0	1	0	4	0	5	4	0	9	0	0	0	0	0	0	2	0	0	2	15
07:30 AM	0	1	1	0	2	0	4	5	0	9	0	2	0	0	2	0	2	0	0	2	15
07:45 AM	1	1	2	0	4	0	1	6	0	7	0	0	0	0	0	0	1	0	0	1	12
08:00 AM	4	0	0	0	4	0	2	1	0	3	0	0	0	0	0	1	1	0	0	2	9
Total Volume	8	2	4	0	14	0	12	16	0	28	0	2	0	0	2	1	6	0	0	7	51
% App. Total	57.1	14.3	28.6	0		0	42.9	57.1	0		0	100	0	0		14.3	85.7	0	0		
PHF	.500	.500	.500	.000	.875	.000	.600	.667	.000	.778	.000	.250	.000	.000	.250	.250	.750	.000	.000	.875	.850

City of Madera
 N/S: Road 23
 E/W: Avenue 12
 Weather: Clear

File Name : 10_MDA_Rd 23_Ave 12 AM
 Site Code : 00319628
 Start Date : 9/18/2019
 Page No : 2

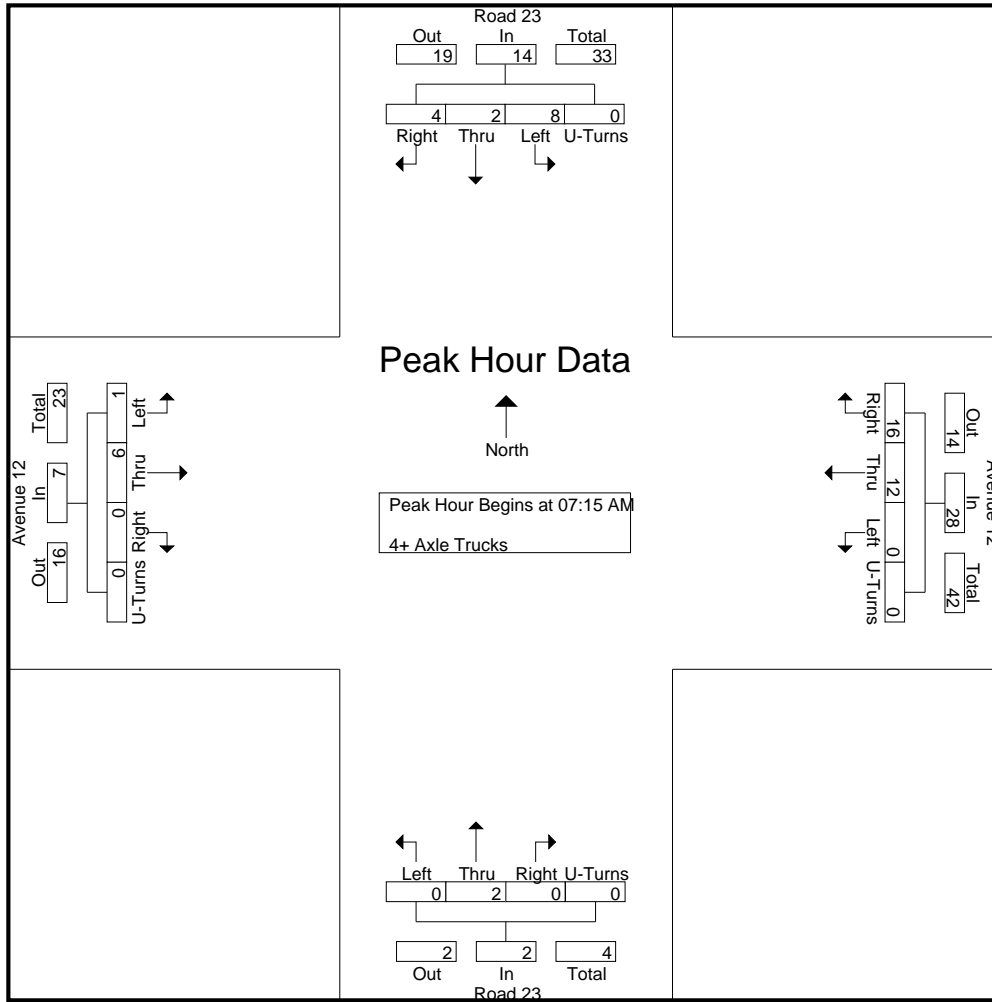

Peak Hour Analysis From 07:15 AM to 08:00 AM - Peak 1 of 1
 Peak Hour for Each Approach Begins at:

	07:15 AM					07:15 AM					07:15 AM					07:15 AM									
+0 mins.	3	0	1	0	4	0	5	4	0	9	0	0	0	0	0	0	2	0	0	2	0	2	0	0	2
+15 mins.	0	1	1	0	2	0	4	5	0	9	0	2	0	0	2	0	2	0	0	2	0	1	0	0	1
+30 mins.	1	1	2	0	4	0	1	6	0	7	0	0	0	0	0	0	0	0	0	0	0	1	0	0	1
+45 mins.	4	0	0	0	4	0	2	1	0	3	0	0	0	0	0	0	0	0	0	0	1	1	0	0	2
Total Volume	8	2	4	0	14	0	12	16	0	28	0	2	0	0	2	1	6	0	0	7	14.3	85.7	0	0	7
% App. Total	57.1	14.3	28.6	0		0	42.9	57.1	0		0	100	0	0		14.3	85.7	0	0		14.3	85.7	0	0	
PHF	.500	.500	.500	.000	.875	.000	.600	.667	.000	.778	.000	.250	.000	.000	.250	.250	.750	.000	.000	.875	.250	.750	.000	.000	.875

City of Madera
 N/S: Road 23
 E/W: Avenue 12
 Weather: Clear

File Name : 10_MDA_Rd 23_Ave 12 PM
 Site Code : 00319628
 Start Date : 9/18/2019
 Page No : 1

Groups Printed- Passenger Vehicles - Large 2 Axle Vehicles - 3 Axle Vehicles - 4+ Axle Trucks

Start Time	Road 23 Southbound					Avenue 12 Westbound					Road 23 Northbound					Avenue 12 Eastbound					Int. Total
	Left	Thru	Right	U-Turns	App. Total	Left	Thru	Right	U-Turns	App. Total	Left	Thru	Right	U-Turns	App. Total	Left	Thru	Right	U-Turns	App. Total	
04:00 PM	14	14	12	0	40	3	16	6	0	25	0	10	11	0	21	12	24	2	0	38	124
04:15 PM	9	5	9	0	23	7	16	5	0	28	2	8	10	0	20	14	29	3	0	46	117
04:30 PM	20	14	7	0	41	3	20	5	0	28	1	11	9	0	21	14	29	2	0	45	135
04:45 PM	12	12	5	0	29	1	14	7	0	22	1	11	8	0	20	16	34	1	0	51	122
Total	55	45	33	0	133	14	66	23	0	103	4	40	38	0	82	56	116	8	0	180	498
05:00 PM	13	10	4	0	27	2	17	8	0	27	0	12	3	0	15	6	32	0	0	38	107
05:15 PM	3	11	13	0	27	2	19	9	0	30	1	8	4	0	13	13	36	1	0	50	120
05:30 PM	8	13	4	0	25	4	12	4	0	20	0	7	2	0	9	11	16	3	0	30	84
05:45 PM	5	7	8	0	20	3	12	5	0	20	0	10	5	0	15	8	14	2	0	24	79
Total	29	41	29	0	99	11	60	26	0	97	1	37	14	0	52	38	98	6	0	142	390
Grand Total	84	86	62	0	232	25	126	49	0	200	5	77	52	0	134	94	214	14	0	322	888
Apprch %	36.2	37.1	26.7	0		12.5	63	24.5	0		3.7	57.5	38.8	0		29.2	66.5	4.3	0		
Total %	9.5	9.7	7	0	26.1	2.8	14.2	5.5	0	22.5	0.6	8.7	5.9	0	15.1	10.6	24.1	1.6	0	36.3	
Passenger Vehicles	82.1	89.5	96.8	0	88.8	84	84.9	57.1	0	78	80	92.2	88.5	0	90.3	94.7	83.6	78.6	0	86.6	85.8
Large 2 Axle Vehicles	4.8	8.1	1.6	0	5.2	16	3.2	10.2	0	6.5	0	6.5	7.7	0	6.7	4.3	5.1	14.3	0	5.3	5.7
3 Axle Vehicles	0	0	0	0	0	0	0	2	0	0.5	0	0	3.8	0	1.5	0	0.9	0	0	0.6	0.6
4+ Axle Trucks	11	2	1	0	14	0	15	15	0	30	1	1	0	0	2	1	22	1	0	24	70
% 4+ Axle Trucks																					

Start Time	Road 23 Southbound					Avenue 12 Westbound					Road 23 Northbound					Avenue 12 Eastbound					Int. Total
	Left	Thru	Right	U-Turns	App. Total	Left	Thru	Right	U-Turns	App. Total	Left	Thru	Right	U-Turns	App. Total	Left	Thru	Right	U-Turns	App. Total	
Peak Hour Analysis From 04:00 PM to 05:45 PM - Peak 1 of 1																					
Peak Hour for Entire Intersection Begins at 04:00 PM																					
04:00 PM	14	14	12	0	40	3	16	6	0	25	0	10	11	0	21	12	24	2	0	38	124
04:15 PM	9	5	9	0	23	7	16	5	0	28	2	8	10	0	20	14	29	3	0	46	117
04:30 PM	20	14	7	0	41	3	20	5	0	28	1	11	9	0	21	14	29	2	0	45	135
04:45 PM	12	12	5	0	29	1	14	7	0	22	1	11	8	0	20	16	34	1	0	51	122
Total Volume	55	45	33	0	133	14	66	23	0	103	4	40	38	0	82	56	116	8	0	180	498
% App. Total	41.4	33.8	24.8	0		13.6	64.1	22.3	0		4.9	48.8	46.3	0		31.1	64.4	4.4	0		
PHF	.688	.804	.688	.000	.811	.500	.825	.821	.000	.920	.500	.909	.864	.000	.976	.875	.853	.667	.000	.882	.922

City of Madera
 N/S: Road 23
 E/W: Avenue 12
 Weather: Clear

File Name : 10_MDA_Rd 23_Ave 12 PM
 Site Code : 00319628
 Start Date : 9/18/2019
 Page No : 2

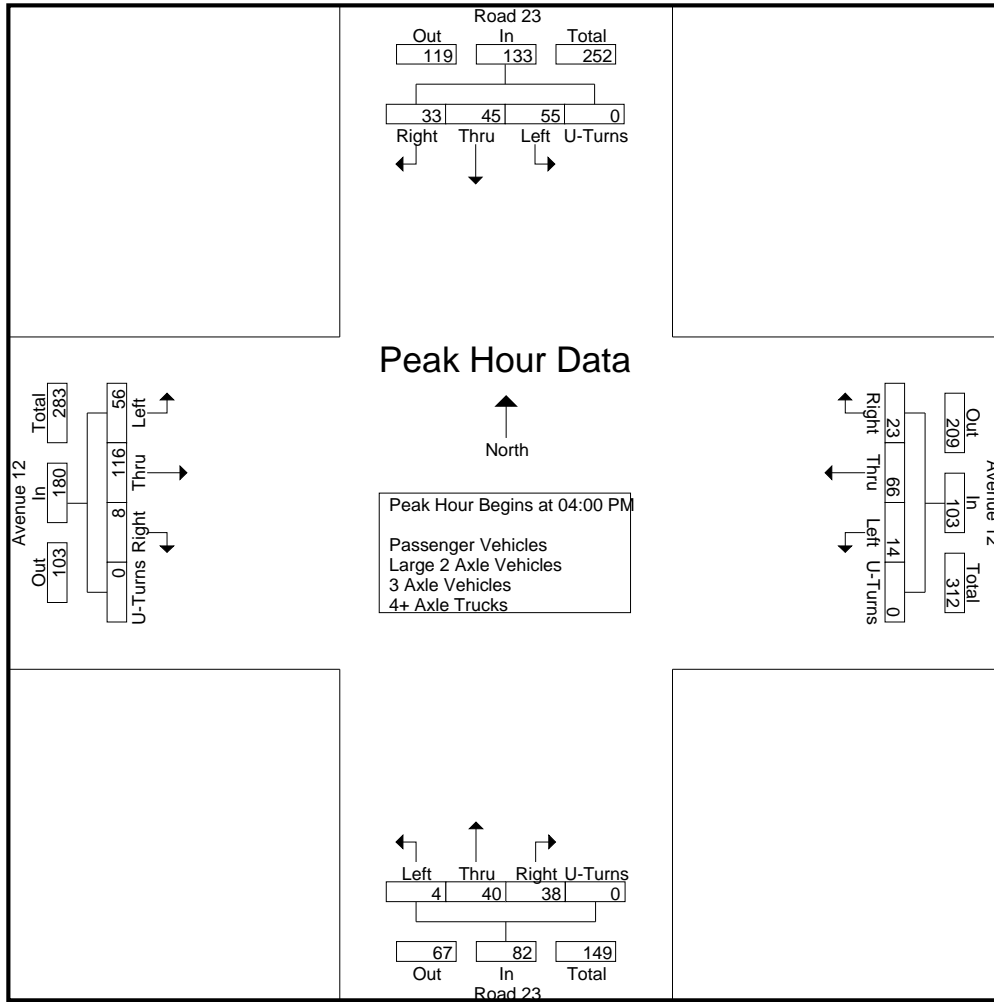

Peak Hour Analysis From 04:00 PM to 05:45 PM - Peak 1 of 1
 Peak Hour for Each Approach Begins at:

	04:00 PM					04:30 PM					04:00 PM					04:30 PM				
+0 mins.	14	14	12	0	40	3	20	5	0	28	0	10	11	0	21	14	29	2	0	45
+15 mins.	9	5	9	0	23	1	14	7	0	22	2	8	10	0	20	16	34	1	0	51
+30 mins.	20	14	7	0	41	2	17	8	0	27	1	11	9	0	21	6	32	0	0	38
+45 mins.	12	12	5	0	29	2	19	9	0	30	1	11	8	0	20	13	36	1	0	50
Total Volume	55	45	33	0	133	8	70	29	0	107	4	40	38	0	82	49	131	4	0	184
% App. Total	41.4	33.8	24.8	0		7.5	65.4	27.1	0		4.9	48.8	46.3	0		26.6	71.2	2.2	0	
PHF	.688	.804	.688	.000	.811	.667	.875	.806	.000	.892	.500	.909	.864	.000	.976	.766	.910	.500	.000	.902

City of Madera
 N/S: Road 23
 E/W: Avenue 12
 Weather: Clear

File Name : 10_MDA_Rd 23_Ave 12 PM
 Site Code : 00319628
 Start Date : 9/18/2019
 Page No : 1

Groups Printed- Passenger Vehicles

Start Time	Road 23 Southbound					Avenue 12 Westbound					Road 23 Northbound					Avenue 12 Eastbound					Int. Total
	Left	Thru	Right	U-Turns	App. Total	Left	Thru	Right	U-Turns	App. Total	Left	Thru	Right	U-Turns	App. Total	Left	Thru	Right	U-Turns	App. Total	
04:00 PM	12	13	11	0	36	3	14	2	0	19	0	10	11	0	21	11	17	1	0	29	105
04:15 PM	6	5	9	0	20	6	13	3	0	22	2	8	10	0	20	14	26	3	0	43	105
04:30 PM	17	11	7	0	35	3	16	3	0	22	0	10	8	0	18	14	22	2	0	38	113
04:45 PM	11	10	4	0	25	1	13	4	0	18	1	9	6	0	16	14	29	1	0	44	103
Total	46	39	31	0	116	13	56	12	0	81	3	37	35	0	75	53	94	7	0	154	426
05:00 PM	12	8	4	0	24	0	15	3	0	18	0	11	3	0	14	6	27	0	0	33	89
05:15 PM	3	10	13	0	26	2	18	6	0	26	1	7	4	0	12	11	32	1	0	44	108
05:30 PM	5	13	4	0	22	4	9	2	0	15	0	6	2	0	8	11	15	1	0	27	72
05:45 PM	3	7	8	0	18	2	9	5	0	16	0	10	2	0	12	8	11	2	0	21	67
Total	23	38	29	0	90	8	51	16	0	75	1	34	11	0	46	36	85	4	0	125	336
Grand Total	69	77	60	0	206	21	107	28	0	156	4	71	46	0	121	89	179	11	0	279	762
Apprch %	33.5	37.4	29.1	0		13.5	68.6	17.9	0		3.3	58.7	38	0		31.9	64.2	3.9	0		
Total %	9.1	10.1	7.9	0	27	2.8	14	3.7	0	20.5	0.5	9.3	6	0	15.9	11.7	23.5	1.4	0	36.6	

Start Time	Road 23 Southbound					Avenue 12 Westbound					Road 23 Northbound					Avenue 12 Eastbound					Int. Total
	Left	Thru	Right	U-Turns	App. Total	Thru	Right	U-Turns	App. Total	Thru	Right	U-Turns	App. Total	Thru	Right	U-Turns	App. Total				
Peak Hour Analysis From 04:00 PM to 04:45 PM - Peak 1 of 1																					
Peak Hour for Entire Intersection Begins at 04:00 PM																					
04:00 PM	12	13	11	0	36	3	14	2	0	19	0	10	11	0	21	11	17	1	0	29	105
04:15 PM	6	5	9	0	20	6	13	3	0	22	2	8	10	0	20	14	26	3	0	43	105
04:30 PM	17	11	7	0	35	3	16	3	0	22	0	10	8	0	18	14	22	2	0	38	113
04:45 PM	11	10	4	0	25	1	13	4	0	18	1	9	6	0	16	14	29	1	0	44	103
Total Volume	46	39	31	0	116	13	56	12	0	81	3	37	35	0	75	53	94	7	0	154	426
% App. Total	39.7	33.6	26.7	0		16	69.1	14.8	0		4	49.3	46.7	0		34.4	61	4.5	0		
PHF	.676	.750	.705	.000	.806	.542	.875	.750	.000	.920	.375	.925	.795	.000	.893	.946	.810	.583	.000	.875	.942

City of Madera
 N/S: Road 23
 E/W: Avenue 12
 Weather: Clear

File Name : 10_MDA_Rd 23_Ave 12 PM
 Site Code : 00319628
 Start Date : 9/18/2019
 Page No : 2

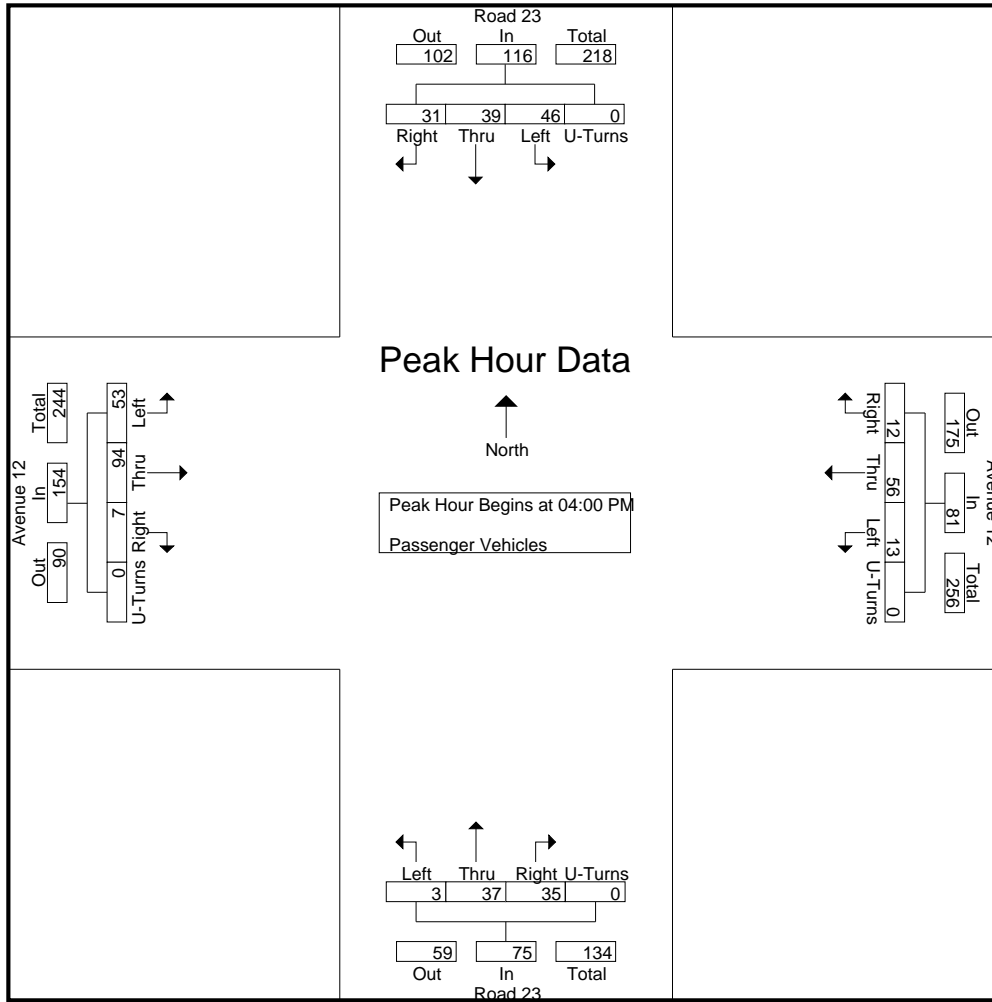

Peak Hour Analysis From 04:00 PM to 04:45 PM - Peak 1 of 1
 Peak Hour for Each Approach Begins at:

	04:00 PM					04:00 PM					04:00 PM									
+0 mins.	12	13	11	0	36	3	14	2	0	19	0	10	11	0	21	11	17	1	0	29
+15 mins.	6	5	9	0	20	6	13	3	0	22	2	8	10	0	20	14	26	3	0	43
+30 mins.	17	11	7	0	35	3	16	3	0	22	0	10	8	0	18	14	22	2	0	38
+45 mins.	11	10	4	0	25	1	13	4	0	18	1	9	6	0	16	14	29	1	0	44
Total Volume	46	39	31	0	116	13	56	12	0	81	3	37	35	0	75	53	94	7	0	154
% App. Total	39.7	33.6	26.7	0		16	69.1	14.8	0		4	49.3	46.7	0		34.4	61	4.5	0	
PHF	.676	.750	.705	.000	.806	.542	.875	.750	.000	.920	.375	.925	.795	.000	.893	.946	.810	.583	.000	.875

City of Madera
 N/S: Road 23
 E/W: Avenue 12
 Weather: Clear

File Name : 10_MDA_Rd 23_Ave 12 PM
 Site Code : 00319628
 Start Date : 9/18/2019
 Page No : 1

Groups Printed- Large 2 Axle Vehicles

Start Time	Road 23 Southbound					Avenue 12 Westbound					Road 23 Northbound					Avenue 12 Eastbound					Int. Total
	Left	Thru	Right	U-Turns	App. Total	Left	Thru	Right	U-Turns	App. Total	Left	Thru	Right	U-Turns	App. Total	Left	Thru	Right	U-Turns	App. Total	
04:00 PM	0	1	1	0	2	0	1	2	0	3	0	0	0	0	0	1	0	1	0	2	7
04:15 PM	2	0	0	0	2	1	0	0	0	1	0	0	0	0	0	0	1	0	0	1	4
04:30 PM	0	1	0	0	1	0	2	1	0	3	0	1	1	0	2	0	3	0	0	3	9
04:45 PM	1	2	0	0	3	0	0	0	0	0	0	1	1	0	2	2	1	0	0	3	8
Total	3	4	1	0	8	1	3	3	0	7	0	2	2	0	4	3	5	1	0	9	28
05:00 PM	0	2	0	0	2	2	0	0	0	2	0	1	0	0	1	0	3	0	0	3	8
05:15 PM	0	1	0	0	1	0	0	1	0	1	0	1	0	0	1	1	1	0	0	2	5
05:30 PM	1	0	0	0	1	0	1	1	0	2	0	1	0	0	1	0	1	1	0	2	6
05:45 PM	0	0	0	0	0	1	0	0	0	1	0	0	2	0	2	0	1	0	0	1	4
Total	1	3	0	0	4	3	1	2	0	6	0	3	2	0	5	1	6	1	0	8	23
Grand Total	4	7	1	0	12	4	4	5	0	13	0	5	4	0	9	4	11	2	0	17	51
Apprch %	33.3	58.3	8.3	0		30.8	30.8	38.5	0		0	55.6	44.4	0		23.5	64.7	11.8	0		
Total %	7.8	13.7	2	0	23.5	7.8	7.8	9.8	0	25.5	0	9.8	7.8	0	17.6	7.8	21.6	3.9	0	33.3	

Start Time	Road 23 Southbound					Avenue 12 Westbound					Road 23 Northbound					Avenue 12 Eastbound					Int. Total
	Left	Thru	Right	U-Turns	App. Total	Thru	Right	U-Turns	App. Total	Thru	Right	U-Turns	App. Total	Thru	Right	U-Turns	App. Total				
Peak Hour Analysis From 04:00 PM to 04:45 PM - Peak 1 of 1																					
Peak Hour for Entire Intersection Begins at 04:00 PM																					
04:00 PM	0	1	1	0	2	0	1	2	0	3	0	0	0	0	0	1	0	1	0	2	7
04:15 PM	2	0	0	0	2	1	0	0	0	1	0	0	0	0	0	0	1	0	0	1	4
04:30 PM	0	1	0	0	1	0	2	1	0	3	0	1	1	0	2	0	3	0	0	3	9
04:45 PM	1	2	0	0	3	0	0	0	0	0	0	1	1	0	2	2	1	0	0	3	8
Total Volume	3	4	1	0	8	1	3	3	0	7	0	2	2	0	4	3	5	1	0	9	28
% App. Total	37.5	50	12.5	0		14.3	42.9	42.9	0		0	50	50	0		33.3	55.6	11.1	0		
PHF	.375	.500	.250	.000	.667	.250	.375	.375	.000	.583	.000	.500	.500	.000	.500	.375	.417	.250	.000	.750	.778

City of Madera
 N/S: Road 23
 E/W: Avenue 12
 Weather: Clear

File Name : 10_MDA_Rd 23_Ave 12 PM
 Site Code : 00319628
 Start Date : 9/18/2019
 Page No : 2

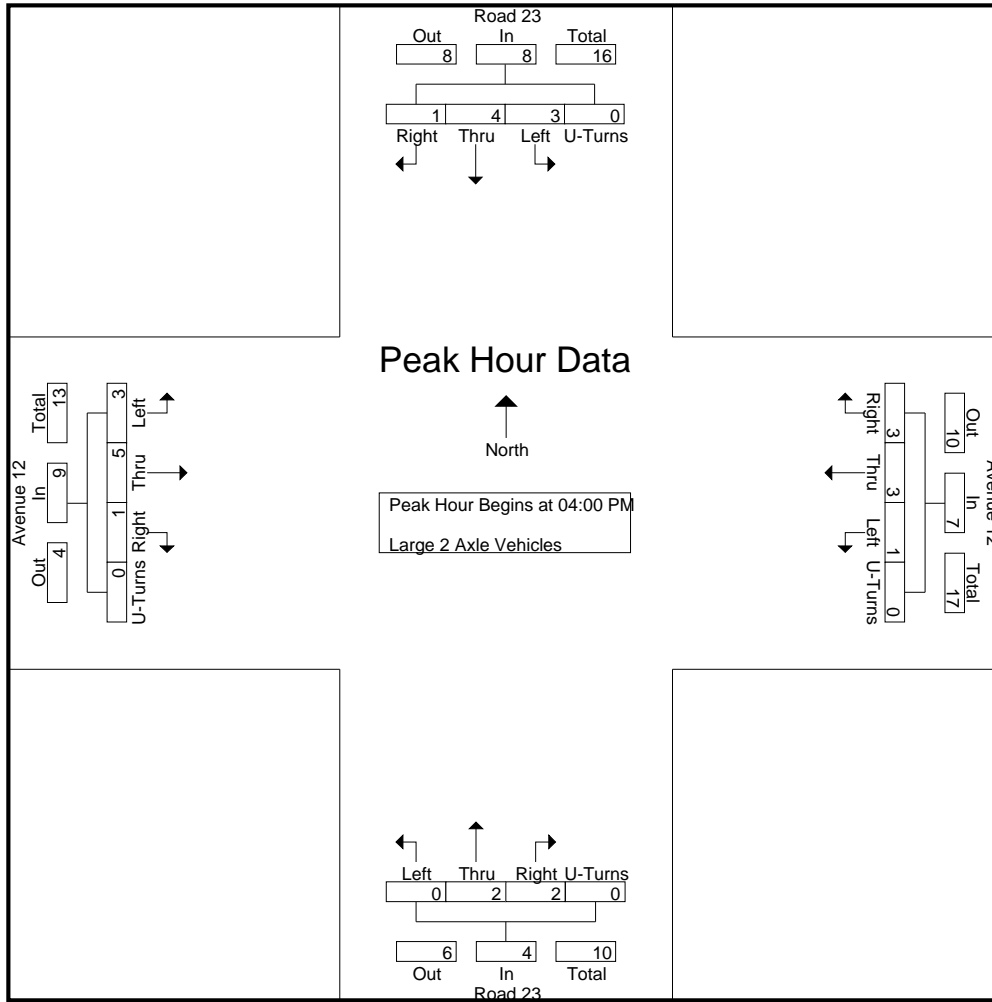

Peak Hour Analysis From 04:00 PM to 04:45 PM - Peak 1 of 1
 Peak Hour for Each Approach Begins at:

	04:00 PM					04:00 PM					04:00 PM					04:00 PM				
+0 mins.	0	1	1	0	2	0	1	2	0	3	0	0	0	0	0	1	0	1	0	2
+15 mins.	2	0	0	0	2	1	0	0	0	1	0	0	0	0	0	0	1	0	0	1
+30 mins.	0	1	0	0	1	0	2	1	0	3	0	1	1	0	2	0	3	0	0	3
+45 mins.	1	2	0	0	3	0	0	0	0	0	0	1	1	0	2	2	1	0	0	3
Total Volume	3	4	1	0	8	1	3	3	0	7	0	2	2	0	4	3	5	1	0	9
% App. Total	37.5	50	12.5	0		14.3	42.9	42.9	0		0	50	50	0		33.3	55.6	11.1	0	
PHF	.375	.500	.250	.000	.667	.250	.375	.375	.000	.583	.000	.500	.500	.000	.500	.375	.417	.250	.000	.750

City of Madera
 N/S: Road 23
 E/W: Avenue 12
 Weather: Clear

File Name : 10_MDA_Rd 23_Ave 12 PM
 Site Code : 00319628
 Start Date : 9/18/2019
 Page No : 1

Groups Printed- 3 Axle Vehicles

Start Time	Road 23 Southbound					Avenue 12 Westbound					Road 23 Northbound					Avenue 12 Eastbound					Int. Total	
	Left	Thru	Right	U-Turns	App. Total	Left	Thru	Right	U-Turns	App. Total	Left	Thru	Right	U-Turns	App. Total	Left	Thru	Right	U-Turns	App. Total		
04:00 PM	0	0	0	0	0	0	0	0	0	0	0	0	0	0	0	0	0	0	0	0	0	0
04:15 PM	0	0	0	0	0	0	0	0	0	0	0	0	0	0	0	0	0	0	0	0	0	0
04:30 PM	0	0	0	0	0	0	0	0	0	0	0	0	0	0	0	0	0	0	0	0	0	0
04:45 PM	0	0	0	0	0	0	0	1	0	1	0	0	1	0	1	0	1	0	0	1	1	3
Total	0	0	0	0	0	0	0	1	0	1	0	0	1	0	1	0	1	0	0	1	1	3
05:00 PM	0	0	0	0	0	0	0	0	0	0	0	0	0	0	0	0	0	0	0	0	0	0
05:15 PM	0	0	0	0	0	0	0	0	0	0	0	0	0	0	0	0	1	0	0	1	1	1
05:30 PM	0	0	0	0	0	0	0	0	0	0	0	0	0	0	0	0	0	0	0	0	0	0
05:45 PM	0	0	0	0	0	0	0	0	0	0	0	0	1	0	1	0	0	0	0	0	0	1
Total	0	0	0	0	0	0	0	0	0	0	0	0	1	0	1	0	1	0	0	1	1	2
Grand Total	0	0	0	0	0	0	0	1	0	1	0	0	2	0	2	0	2	0	0	2	2	5
Apprch %	0	0	0	0		0	0	100	0		0	0	100	0		0	100	0	0			
Total %	0	0	0	0	0	0	0	20	0	20	0	0	40	0	40	0	40	0	0	40		

Start Time	Road 23 Southbound					Avenue 12 Westbound					Road 23 Northbound					Avenue 12 Eastbound					Int. Total	
	Left	Thru	Right	U-Turns	App. Total	Left	Thru	Right	U-Turns	App. Total	Left	Thru	Right	U-Turns	App. Total	Left	Thru	Right	U-Turns	App. Total		
Peak Hour Analysis From 04:00 PM to 04:45 PM - Peak 1 of 1																						
Peak Hour for Entire Intersection Begins at 04:00 PM																						
04:00 PM	0	0	0	0	0	0	0	0	0	0	0	0	0	0	0	0	0	0	0	0	0	0
04:15 PM	0	0	0	0	0	0	0	0	0	0	0	0	0	0	0	0	0	0	0	0	0	0
04:30 PM	0	0	0	0	0	0	0	0	0	0	0	0	0	0	0	0	0	0	0	0	0	0
04:45 PM	0	0	0	0	0	0	0	1	0	1	0	0	1	0	1	0	1	0	0	1	1	3
Total Volume	0	0	0	0	0	0	0	1	0	1	0	0	1	0	1	0	1	0	0	1	1	3
% App. Total	0	0	0	0		0	0	100	0		0	0	100	0		0	100	0	0			
PHF	.000	.000	.000	.000	.000	.000	.000	.250	.000	.250	.000	.000	.250	.000	.250	.000	.250	.000	.000	.250	.250	.250

City of Madera
 N/S: Road 23
 E/W: Avenue 12
 Weather: Clear

File Name : 10_MDA_Rd 23_Ave 12 PM
 Site Code : 00319628
 Start Date : 9/18/2019
 Page No : 2

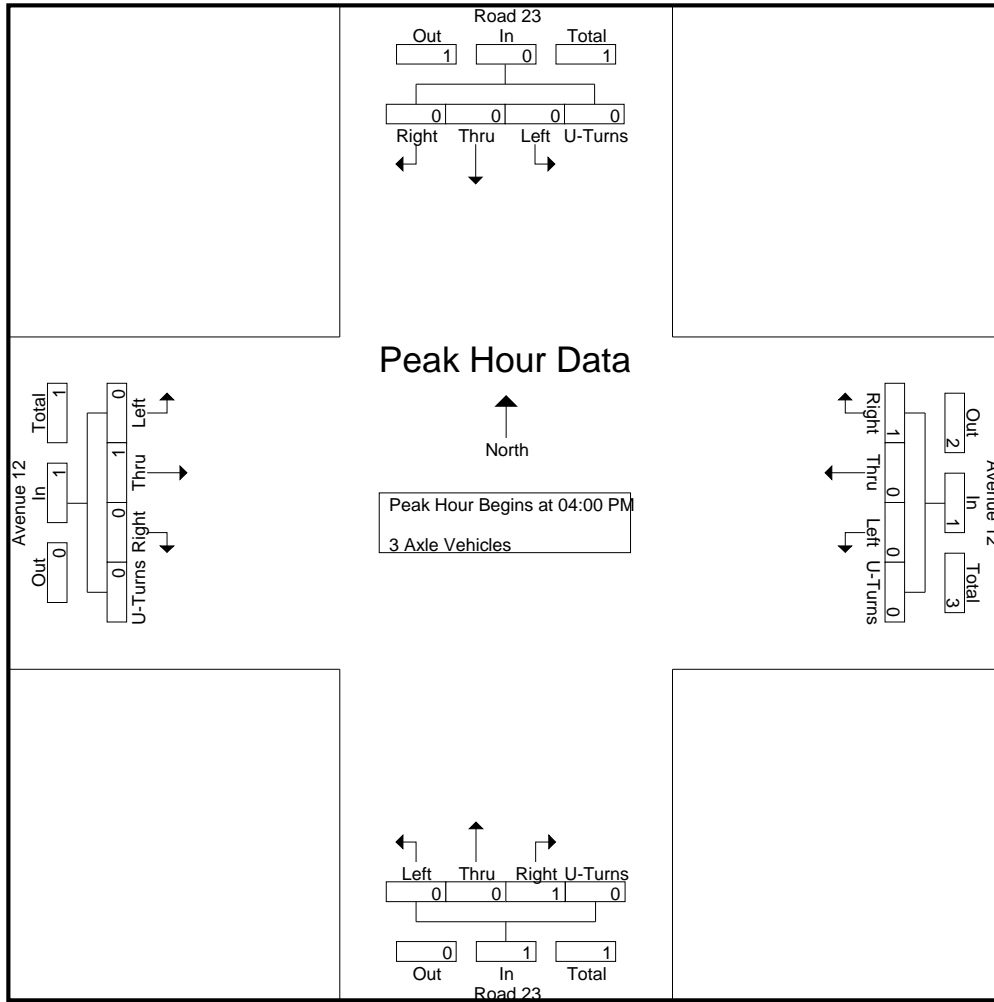

Peak Hour Analysis From 04:00 PM to 04:45 PM - Peak 1 of 1
 Peak Hour for Each Approach Begins at:

	04:00 PM					04:00 PM					04:00 PM				
+0 mins.	0	0	0	0	0	0	0	0	0	0	0	0	0	0	0
+15 mins.	0	0	0	0	0	0	0	0	0	0	0	0	0	0	0
+30 mins.	0	0	0	0	0	0	0	0	0	0	0	0	0	0	0
+45 mins.	0	0	0	0	0	0	0	1	0	1	0	0	1	0	1
Total Volume	0	0	0	0	0	0	0	1	0	1	0	0	1	0	1
% App. Total	0	0	0	0	0	0	0	100	0	0	0	0	100	0	0
PHF	.000	.000	.000	.000	.000	.000	.000	.250	.000	.250	.000	.000	.250	.000	.250

City of Madera
 N/S: Road 23
 E/W: Avenue 12
 Weather: Clear

File Name : 10_MDA_Rd 23_Ave 12 PM
 Site Code : 00319628
 Start Date : 9/18/2019
 Page No : 1

Groups Printed- 4+ Axle Trucks

Start Time	Road 23 Southbound					Avenue 12 Westbound					Road 23 Northbound					Avenue 12 Eastbound					Int. Total
	Left	Thru	Right	U-Turns	App. Total	Left	Thru	Right	U-Turns	App. Total	Left	Thru	Right	U-Turns	App. Total	Left	Thru	Right	U-Turns	App. Total	
04:00 PM	2	0	0	0	2	0	1	2	0	3	0	0	0	0	0	0	7	0	0	7	12
04:15 PM	1	0	0	0	1	0	3	2	0	5	0	0	0	0	0	0	2	0	0	2	8
04:30 PM	3	2	0	0	5	0	2	1	0	3	1	0	0	0	1	0	4	0	0	4	13
04:45 PM	0	0	1	0	1	0	1	2	0	3	0	1	0	0	1	0	3	0	0	3	8
Total	6	2	1	0	9	0	7	7	0	14	1	1	0	0	2	0	16	0	0	16	41
05:00 PM	1	0	0	0	1	0	2	5	0	7	0	0	0	0	0	0	2	0	0	2	10
05:15 PM	0	0	0	0	0	0	1	2	0	3	0	0	0	0	0	1	2	0	0	3	6
05:30 PM	2	0	0	0	2	0	2	1	0	3	0	0	0	0	0	0	0	1	0	1	6
05:45 PM	2	0	0	0	2	0	3	0	0	3	0	0	0	0	0	0	2	0	0	2	7
Total	5	0	0	0	5	0	8	8	0	16	0	0	0	0	0	1	6	1	0	8	29
Grand Total	11	2	1	0	14	0	15	15	0	30	1	1	0	0	2	1	22	1	0	24	70
Apprch %	78.6	14.3	7.1	0		0	50	50	0		50	50	0	0		4.2	91.7	4.2	0		
Total %	15.7	2.9	1.4	0	20	0	21.4	21.4	0	42.9	1.4	1.4	0	0	2.9	1.4	31.4	1.4	0	34.3	

Start Time	Road 23 Southbound					Avenue 12 Westbound					Road 23 Northbound					Avenue 12 Eastbound					Int. Total
	Left	Thru	Right	U-Turns	App. Total	Thru	Right	U-Turns	App. Total	Thru	Right	U-Turns	App. Total	Thru	Right	U-Turns	App. Total				
Peak Hour Analysis From 04:00 PM to 04:45 PM - Peak 1 of 1																					
Peak Hour for Entire Intersection Begins at 04:00 PM																					
04:00 PM	2	0	0	0	2	0	1	2	0	3	0	0	0	0	0	0	7	0	0	7	12
04:15 PM	1	0	0	0	1	0	3	2	0	5	0	0	0	0	0	0	2	0	0	2	8
04:30 PM	3	2	0	0	5	0	2	1	0	3	1	0	0	0	1	0	4	0	0	4	13
04:45 PM	0	0	1	0	1	0	1	2	0	3	0	1	0	0	1	0	3	0	0	3	8
Total Volume	6	2	1	0	9	0	7	7	0	14	1	1	0	0	2	0	16	0	0	16	41
% App. Total	66.7	22.2	11.1	0		0	50	50	0		50	50	0	0		0	100	0	0		
PHF	.500	.250	.250	.000	.450	.000	.583	.875	.000	.700	.250	.250	.000	.000	.500	.000	.571	.000	.000	.571	.788

City of Madera
 N/S: Road 23
 E/W: Avenue 12
 Weather: Clear

File Name : 10_MDA_Rd 23_Ave 12 PM
 Site Code : 00319628
 Start Date : 9/18/2019
 Page No : 2

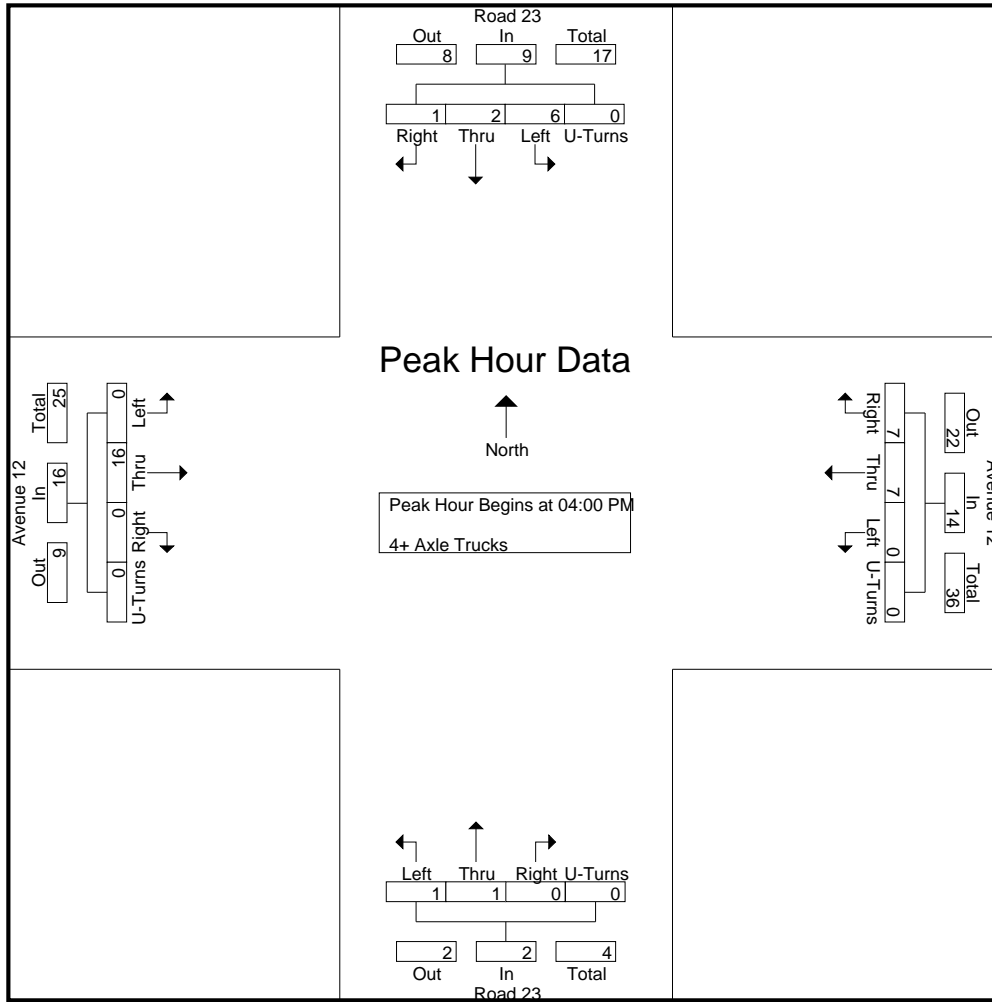

Peak Hour Analysis From 04:00 PM to 04:45 PM - Peak 1 of 1
 Peak Hour for Each Approach Begins at:

	04:00 PM					04:00 PM					04:00 PM					04:00 PM				
+0 mins.	2	0	0	0	2	0	1	2	0	3	0	0	0	0	0	0	7	0	0	7
+15 mins.	1	0	0	0	1	0	3	2	0	5	0	0	0	0	0	0	2	0	0	2
+30 mins.	3	2	0	0	5	0	2	1	0	3	1	0	0	0	1	0	4	0	0	4
+45 mins.	0	0	1	0	1	0	1	2	0	3	0	1	0	0	1	0	3	0	0	3
Total Volume	6	2	1	0	9	0	7	7	0	14	1	1	0	0	2	0	16	0	0	16
% App. Total	66.7	22.2	11.1	0		0	50	50	0		50	50	0	0		0	100	0	0	
PHF	.500	.250	.250	.000	.450	.000	.583	.875	.000	.700	.250	.250	.000	.000	.500	.000	.571	.000	.000	.571

Location: Madera
 N/S: Road 23
 E/W: Avenue 12



Date: 9/18/2019
 Day: Wednesday

PEDESTRIANS

	North Leg Road 23	East Leg Avenue 12	South Leg Road 23	West Leg Avenue 12	
	Pedestrians	Pedestrians	Pedestrians	Pedestrians	
7:00 AM	0	0	0	0	0
7:15 AM	0	0	0	0	0
7:30 AM	0	0	0	0	0
7:45 AM	0	0	0	0	0
8:00 AM	0	0	0	0	0
8:15 AM	0	0	0	0	0
8:30 AM	0	0	0	0	0
8:45 AM	0	0	0	0	0
TOTAL VOLUMES:	0	0	0	0	0

	North Leg Road 23	East Leg Avenue 12	South Leg Road 23	West Leg Avenue 12	
	Pedestrians	Pedestrians	Pedestrians	Pedestrians	
4:00 PM	0	0	0	0	0
4:15 PM	0	0	0	0	0
4:30 PM	0	0	0	0	0
4:45 PM	0	0	0	0	0
5:00 PM	0	0	0	0	0
5:15 PM	0	0	0	0	0
5:30 PM	0	0	0	0	0
5:45 PM	0	0	0	0	0
TOTAL VOLUMES:	0	0	0	0	0

Location: Madera
 N/S: Road 23
 E/W: Avenue 12



Date: 9/18/2019
 Day: Wednesday

BICYCLES

	Southbound Road 23			Westbound Avenue 12			Northbound Road 23			Eastbound Avenue 12			
	Left	Thru	Right	Left	Thru	Right	Left	Thru	Right	Left	Thru	Right	
7:00 AM	0	0	0	0	0	0	0	0	0	0	0	0	0
7:15 AM	0	0	0	0	0	0	0	0	0	0	0	0	0
7:30 AM	0	0	0	0	0	0	0	0	0	0	0	0	0
7:45 AM	0	0	0	0	0	0	0	0	0	0	0	0	0
8:00 AM	0	0	0	0	0	0	0	0	0	0	0	0	0
8:15 AM	0	0	0	0	0	0	0	0	0	0	0	0	0
8:30 AM	0	0	0	0	0	0	0	0	0	0	0	0	0
8:45 AM	0	0	0	0	0	0	0	0	0	0	0	0	0
TOTAL VOLUMES:	0	0	0	0	0	0	0	0	0	0	0	0	0

	Southbound Road 23			Westbound Avenue 12			Northbound Road 23			Eastbound Avenue 12			
	Left	Thru	Right	Left	Thru	Right	Left	Thru	Right	Left	Thru	Right	
4:00 PM	0	0	0	0	0	0	0	0	0	0	0	0	0
4:15 PM	0	0	0	0	0	0	0	0	0	0	0	0	0
4:30 PM	0	0	0	0	0	0	0	0	0	0	0	0	0
4:45 PM	0	0	0	0	0	0	0	0	0	0	0	0	0
5:00 PM	0	0	0	0	0	0	0	0	0	0	0	0	0
5:15 PM	0	0	0	0	0	0	0	0	0	0	0	0	0
5:30 PM	0	0	0	0	0	0	0	0	0	0	0	0	0
5:45 PM	0	0	0	0	0	0	0	0	0	0	0	0	0
TOTAL VOLUMES:	0	0	0	0	0	0	0	0	0	0	0	0	0

City of Madera
 N/S: Golden State Blvd/Airport Drive
 E/W: Avenue 17
 Weather: Clear

File Name : 11_MDA_Airport_Ave 17 AM
 Site Code : 00319628
 Start Date : 9/18/2019
 Page No : 1

Groups Printed- Passenger Vehicles - Large 2 Axle Vehicles - 3 Axle Vehicles - 4+ Axle Trucks

Start Time	Golden State Boulevard Southbound					Avenue 17 Westbound					Airport Drive Northbound					Avenue 17 Eastbound					Int. Total
	Left	Thru	Right	U-Turns	App. Total	Left	Thru	Right	U-Turns	App. Total	Left	Thru	Right	U-Turns	App. Total	Left	Thru	Right	U-Turns	App. Total	
07:00 AM	24	4	1	0	29	21	14	17	0	52	2	3	13	0	18	2	15	2	0	19	118
07:15 AM	25	2	2	0	29	28	14	27	0	69	6	3	18	0	27	0	6	2	0	8	133
07:30 AM	17	7	0	0	24	21	13	19	1	54	0	9	16	0	25	0	16	4	0	20	123
07:45 AM	20	4	1	0	25	47	16	16	0	79	6	6	14	2	28	1	13	6	0	20	152
Total	86	17	4	0	107	117	57	79	1	254	14	21	61	2	98	3	50	14	0	67	526
08:00 AM	26	6	1	0	33	31	12	23	0	66	3	7	16	0	26	3	19	7	0	29	154
08:15 AM	22	3	0	0	25	25	8	19	0	52	0	6	26	0	32	3	9	2	0	14	123
08:30 AM	24	7	2	0	33	23	5	19	0	47	0	7	19	0	26	2	10	2	0	14	120
08:45 AM	14	2	1	0	17	25	10	13	0	48	3	7	14	0	24	3	7	6	0	16	105
Total	86	18	4	0	108	104	35	74	0	213	6	27	75	0	108	11	45	17	0	73	502
Grand Total	172	35	8	0	215	221	92	153	1	467	20	48	136	2	206	14	95	31	0	140	1028
Apprch %	80	16.3	3.7	0		47.3	19.7	32.8	0.2		9.7	23.3	66	1		10	67.9	22.1	0		
Total %	16.7	3.4	0.8	0	20.9	21.5	8.9	14.9	0.1	45.4	1.9	4.7	13.2	0.2	20	1.4	9.2	3	0	13.6	
Passenger Vehicles	88.4	91.4	75	0	88.4	89.6	93.5	92.8	0	91.2	100	87.5	80.1	100	84	100	90.5	77.4	0	88.6	88.8
Large 2 Axle Vehicles	4.1	5.7	0	0	4.2	4.1	1.1	3.9	0	3.4	0	6.2	8.8	0	7.3	0	4.2	12.9	0	5.7	4.7
3 Axle Vehicles	2.3	2.9	0	0	2.3	0.9	1.1	0.7	100	1.1	0	2.1	1.5	0	1.5	0	0	0	0	0	1.3
4+ Axle Trucks	9	0	2	0	11	12	4	4	0	20	0	2	13	0	15	0	5	3	0	8	54
% 4+ Axle Trucks																					

Start Time	Golden State Boulevard Southbound					Avenue 17 Westbound					Airport Drive Northbound					Avenue 17 Eastbound					Int. Total
	Left	Thru	Right	U-Turns	App. Total	Left	Thru	Right	U-Turns	App. Total	Left	Thru	Right	U-Turns	App. Total	Left	Thru	Right	U-Turns	App. Total	
Peak Hour Analysis From 07:00 AM to 08:45 AM - Peak 1 of 1																					
Peak Hour for Entire Intersection Begins at 07:15 AM																					
07:15 AM	25	2	2	0	29	28	14	27	0	69	6	3	18	0	27	0	6	2	0	8	133
07:30 AM	17	7	0	0	24	21	13	19	1	54	0	9	16	0	25	0	16	4	0	20	123
07:45 AM	20	4	1	0	25	47	16	16	0	79	6	6	14	2	28	1	13	6	0	20	152
08:00 AM	26	6	1	0	33	31	12	23	0	66	3	7	16	0	26	3	19	7	0	29	154
Total Volume	88	19	4	0	111	127	55	85	1	268	15	25	64	2	106	4	54	19	0	77	562
% App. Total	79.3	17.1	3.6	0		47.4	20.5	31.7	0.4		14.2	23.6	60.4	1.9		5.2	70.1	24.7	0		
PHF	.846	.679	.500	.000	.841	.676	.859	.787	.250	.848	.625	.694	.889	.250	.946	.333	.711	.679	.000	.664	.912

City of Madera
 N/S: Golden State Blvd/Airport Drive
 E/W: Avenue 17
 Weather: Clear

File Name : 11_MDA_Airport_Ave 17 AM
 Site Code : 00319628
 Start Date : 9/18/2019
 Page No : 2

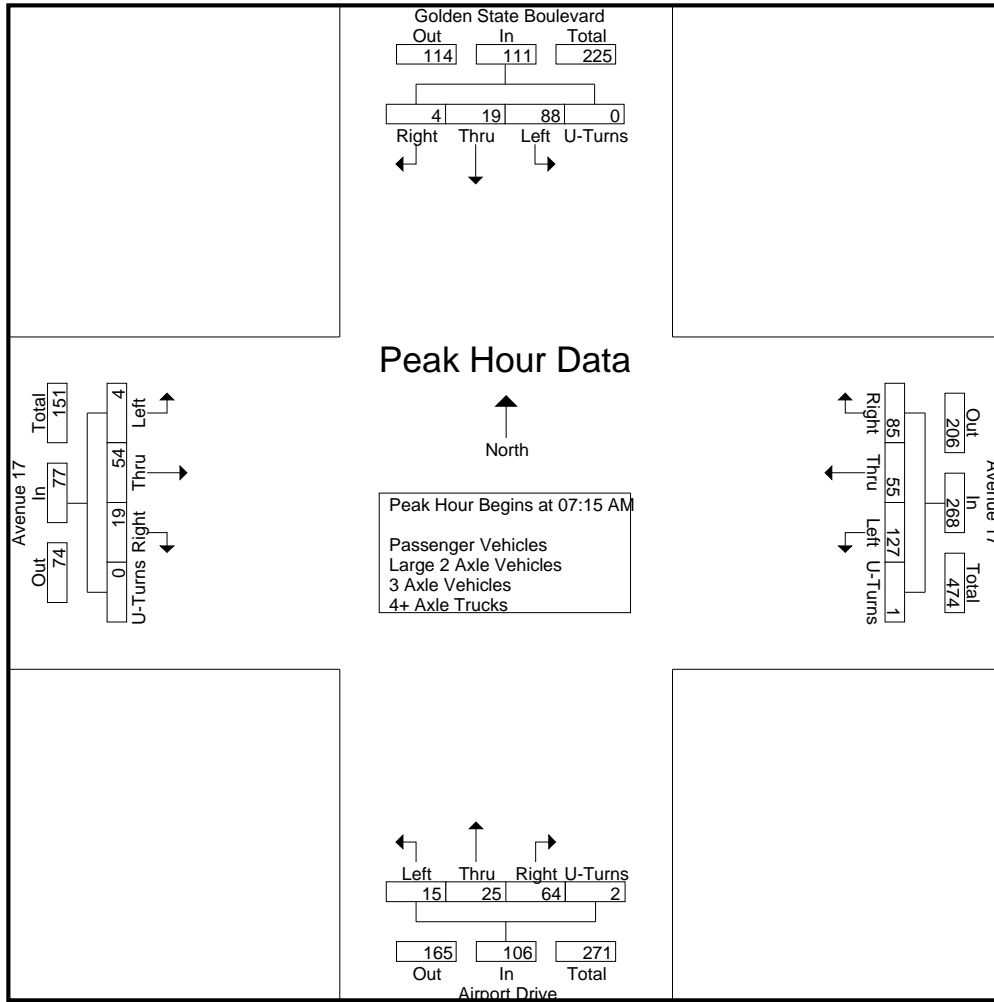

Peak Hour Analysis From 07:00 AM to 08:45 AM - Peak 1 of 1
 Peak Hour for Each Approach Begins at:

	07:45 AM					07:15 AM					07:45 AM					07:30 AM				
+0 mins.	20	4	1	0	25	28	14	27	0	69	6	6	14	2	28	0	16	4	0	20
+15 mins.	26	6	1	0	33	21	13	19	1	54	3	7	16	0	26	1	13	6	0	20
+30 mins.	22	3	0	0	25	47	16	16	0	79	0	6	26	0	32	3	19	7	0	29
+45 mins.	24	7	2	0	33	31	12	23	0	66	0	7	19	0	26	3	9	2	0	14
Total Volume	92	20	4	0	116	127	55	85	1	268	9	26	75	2	112	7	57	19	0	83
% App. Total	79.3	17.2	3.4	0		47.4	20.5	31.7	0.4		8	23.2	67	1.8		8.4	68.7	22.9	0	
PHF	.885	.714	.500	.000	.879	.676	.859	.787	.250	.848	.375	.929	.721	.250	.875	.583	.750	.679	.000	.716

City of Madera
 N/S: Golden State Blvd/Airport Drive
 E/W: Avenue 17
 Weather: Clear

File Name : 11_MDA_Airport_Ave 17 AM
 Site Code : 00319628
 Start Date : 9/18/2019
 Page No : 1

Groups Printed- Passenger Vehicles

Start Time	Golden State Boulevard Southbound					Avenue 17 Westbound					Airport Drive Northbound					Avenue 17 Eastbound					Int. Total
	Left	Thru	Right	U-Turns	App. Total	Left	Thru	Right	U-Turns	App. Total	Left	Thru	Right	U-Turns	App. Total	Left	Thru	Right	U-Turns	App. Total	
07:00 AM	20	4	1	0	25	18	13	16	0	47	2	3	10	0	15	2	14	2	0	18	105
07:15 AM	21	2	2	0	25	24	14	24	0	62	6	3	16	0	25	0	6	1	0	7	119
07:30 AM	16	7	0	0	23	18	12	17	0	47	0	8	13	0	21	0	14	2	0	16	107
07:45 AM	19	3	1	0	23	41	15	16	0	72	6	4	13	2	25	1	12	5	0	18	138
Total	76	16	4	0	96	101	54	73	0	228	14	18	52	2	86	3	46	10	0	59	469
08:00 AM	24	5	1	0	30	30	10	22	0	62	3	7	11	0	21	3	18	6	0	27	140
08:15 AM	21	3	0	0	24	24	8	19	0	51	0	3	17	0	20	3	8	1	0	12	107
08:30 AM	19	6	1	0	26	22	5	17	0	44	0	7	18	0	25	2	8	2	0	12	107
08:45 AM	12	2	0	0	14	21	9	11	0	41	3	7	11	0	21	3	6	5	0	14	90
Total	76	16	2	0	94	97	32	69	0	198	6	24	57	0	87	11	40	14	0	65	444
Grand Total	152	32	6	0	190	198	86	142	0	426	20	42	109	2	173	14	86	24	0	124	913
Apprch %	80	16.8	3.2	0		46.5	20.2	33.3	0		11.6	24.3	63	1.2		11.3	69.4	19.4	0		
Total %	16.6	3.5	0.7	0	20.8	21.7	9.4	15.6	0	46.7	2.2	4.6	11.9	0.2	18.9	1.5	9.4	2.6	0	13.6	

Start Time	Golden State Boulevard Southbound					Avenue 17 Westbound					Airport Drive Northbound					Avenue 17 Eastbound					Int. Total
	Left	Thru	Right	U-Turns	App. Total	Thru	Right	U-Turns	App. Total	Thru	Right	U-Turns	App. Total	Thru	Right	U-Turns	App. Total				
Peak Hour Analysis From 07:15 AM to 08:00 AM - Peak 1 of 1																					
Peak Hour for Entire Intersection Begins at 07:15 AM																					
07:15 AM	21	2	2	0	25	24	14	24	0	62	6	3	16	0	25	0	6	1	0	7	119
07:30 AM	16	7	0	0	23	18	12	17	0	47	0	8	13	0	21	0	14	2	0	16	107
07:45 AM	19	3	1	0	23	41	15	16	0	72	6	4	13	2	25	1	12	5	0	18	138
08:00 AM	24	5	1	0	30	30	10	22	0	62	3	7	11	0	21	3	18	6	0	27	140
Total Volume	80	17	4	0	101	113	51	79	0	243	15	22	53	2	92	4	50	14	0	68	504
% App. Total	79.2	16.8	4	0		46.5	21	32.5	0		16.3	23.9	57.6	2.2		5.9	73.5	20.6	0		
PHF	.833	.607	.500	.000	.842	.689	.850	.823	.000	.844	.625	.688	.828	.250	.920	.333	.694	.583	.000	.630	.900

City of Madera
 N/S: Golden State Blvd/Airport Drive
 E/W: Avenue 17
 Weather: Clear

File Name : 11_MDA_Airport_Ave 17 AM
 Site Code : 00319628
 Start Date : 9/18/2019
 Page No : 2

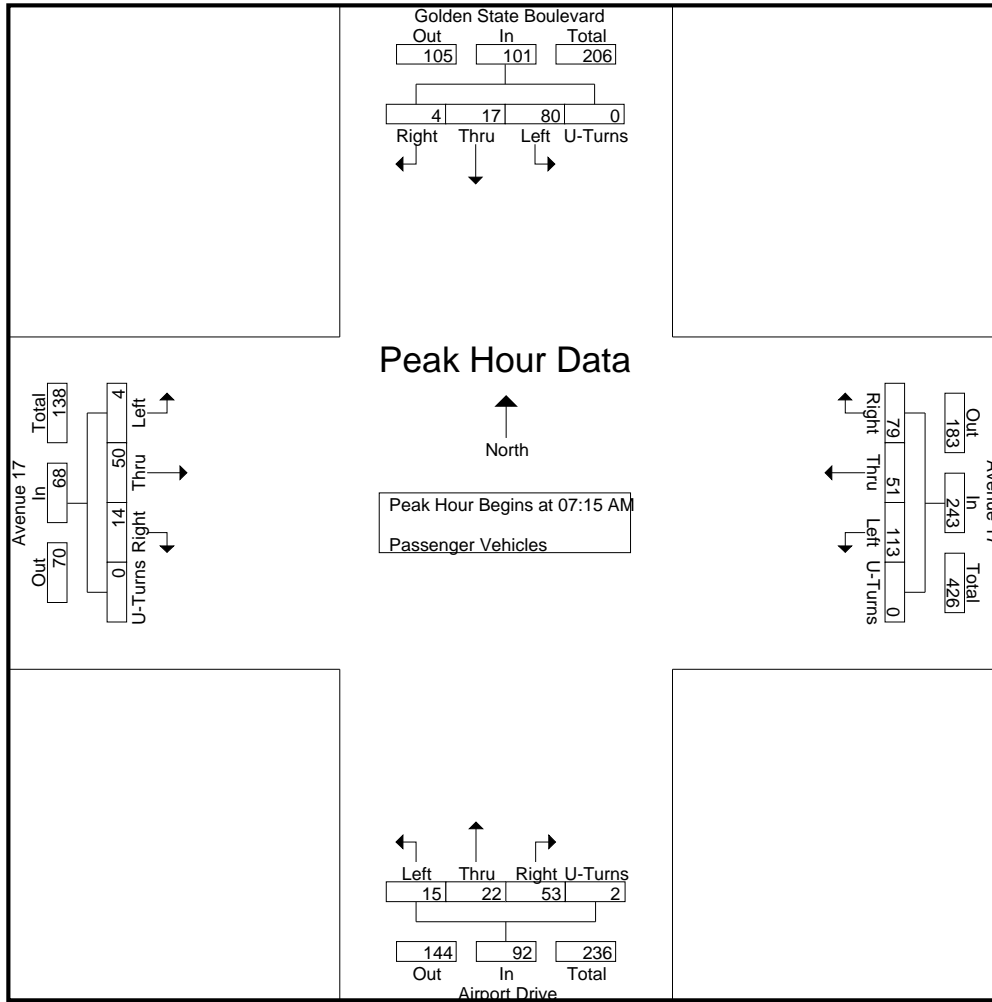

Peak Hour Analysis From 07:15 AM to 08:00 AM - Peak 1 of 1
 Peak Hour for Each Approach Begins at:

	07:15 AM					07:15 AM					07:15 AM									
+0 mins.	21	2	2	0	25	24	14	24	0	62	6	3	16	0	25	0	6	1	0	7
+15 mins.	16	7	0	0	23	18	12	17	0	47	0	8	13	0	21	0	14	2	0	16
+30 mins.	19	3	1	0	23	41	15	16	0	72	6	4	13	2	25	1	12	5	0	18
+45 mins.	24	5	1	0	30	30	10	22	0	62	3	7	11	0	21	3	18	6	0	27
Total Volume	80	17	4	0	101	113	51	79	0	243	15	22	53	2	92	4	50	14	0	68
% App. Total	79.2	16.8	4	0		46.5	21	32.5	0		16.3	23.9	57.6	2.2		5.9	73.5	20.6	0	
PHF	.833	.607	.500	.000	.842	.689	.850	.823	.000	.844	.625	.688	.828	.250	.920	.333	.694	.583	.000	.630

City of Madera
 N/S: Golden State Blvd/Airport Drive
 E/W: Avenue 17
 Weather: Clear

File Name : 11_MDA_Airport_Ave 17 AM
 Site Code : 00319628
 Start Date : 9/18/2019
 Page No : 1

Groups Printed- Large 2 Axle Vehicles

Start Time	Golden State Boulevard Southbound					Avenue 17 Westbound					Airport Drive Northbound					Avenue 17 Eastbound					Int. Total
	Left	Thru	Right	U-Turns	App. Total	Left	Thru	Right	U-Turns	App. Total	Left	Thru	Right	U-Turns	App. Total	Left	Thru	Right	U-Turns	App. Total	
07:00 AM	2	0	0	0	2	1	0	1	0	2	0	0	0	0	0	0	0	0	0	0	4
07:15 AM	0	0	0	0	0	0	0	2	0	2	0	0	1	0	1	0	0	1	0	1	4
07:30 AM	1	0	0	0	1	1	0	1	0	2	0	0	1	0	1	0	1	1	0	2	6
07:45 AM	1	0	0	0	1	4	0	0	0	4	0	2	1	0	3	0	1	1	0	2	10
Total	4	0	0	0	4	6	0	4	0	10	0	2	3	0	5	0	2	3	0	5	24
08:00 AM	0	1	0	0	1	0	1	0	0	1	0	0	3	0	3	0	1	0	0	1	6
08:15 AM	0	0	0	0	0	0	0	0	0	0	0	1	5	0	6	0	0	0	0	0	6
08:30 AM	2	1	0	0	3	1	0	2	0	3	0	0	0	0	0	0	0	0	0	0	6
08:45 AM	1	0	0	0	1	2	0	0	0	2	0	0	1	0	1	0	1	1	0	2	6
Total	3	2	0	0	5	3	1	2	0	6	0	1	9	0	10	0	2	1	0	3	24
Grand Total	7	2	0	0	9	9	1	6	0	16	0	3	12	0	15	0	4	4	0	8	48
Apprch %	77.8	22.2	0	0		56.2	6.2	37.5	0		0	20	80	0		0	50	50	0		
Total %	14.6	4.2	0	0	18.8	18.8	2.1	12.5	0	33.3	0	6.2	25	0	31.2	0	8.3	8.3	0	16.7	

Start Time	Golden State Boulevard Southbound					Avenue 17 Westbound					Airport Drive Northbound					Avenue 17 Eastbound					Int. Total
	Left	Thru	Right	U-Turns	App. Total	Thru	Right	U-Turns	App. Total	Thru	Right	U-Turns	App. Total	Thru	Right	U-Turns	App. Total				
Peak Hour Analysis From 07:15 AM to 08:00 AM - Peak 1 of 1																					
Peak Hour for Entire Intersection Begins at 07:15 AM																					
07:15 AM	0	0	0	0	0	0	0	2	0	2	0	0	1	0	1	0	0	1	0	1	4
07:30 AM	1	0	0	0	1	1	0	1	0	2	0	0	1	0	1	0	1	1	0	2	6
07:45 AM	1	0	0	0	1	4	0	0	0	4	0	2	1	0	3	0	1	1	0	2	10
08:00 AM	0	1	0	0	1	0	1	0	0	1	0	0	3	0	3	0	1	0	0	1	6
Total Volume	2	1	0	0	3	5	1	3	0	9	0	2	6	0	8	0	3	3	0	6	26
% App. Total	66.7	33.3	0	0		55.6	11.1	33.3	0		0	25	75	0		0	50	50	0		
PHF	.500	.250	.000	.000	.750	.313	.250	.375	.000	.563	.000	.250	.500	.000	.667	.000	.750	.750	.000	.750	.650

City of Madera
 N/S: Golden State Blvd/Airport Drive
 E/W: Avenue 17
 Weather: Clear

File Name : 11_MDA_Airport_Ave 17 AM
 Site Code : 00319628
 Start Date : 9/18/2019
 Page No : 2

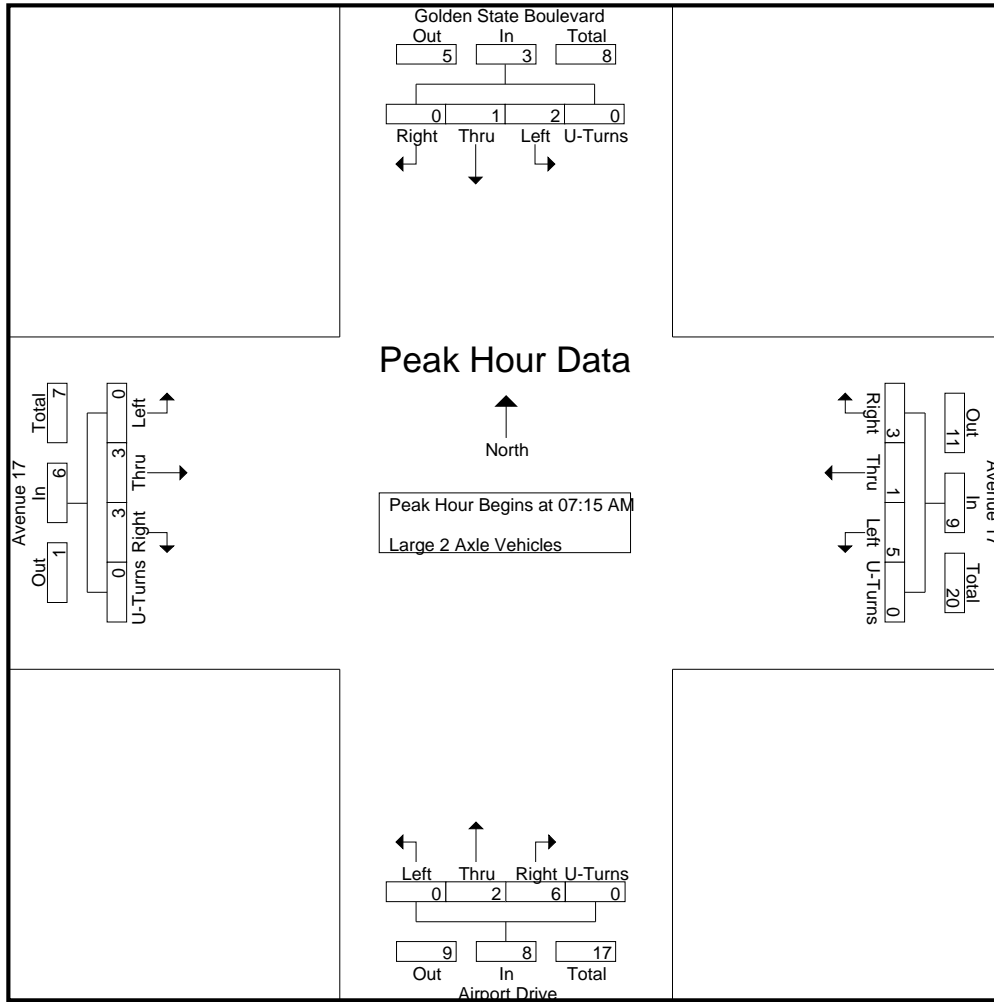

Peak Hour Analysis From 07:15 AM to 08:00 AM - Peak 1 of 1
 Peak Hour for Each Approach Begins at:

	07:15 AM					07:15 AM					07:15 AM									
+0 mins.	0	0	0	0	0	0	0	2	0	2	0	0	1	0	1	0	0	1	0	1
+15 mins.	1	0	0	0	1	1	0	1	0	2	0	0	1	0	1	0	1	1	0	2
+30 mins.	1	0	0	0	1	4	0	0	0	4	0	2	1	0	3	0	1	1	0	2
+45 mins.	0	1	0	0	1	0	1	0	0	1	0	0	3	0	3	0	1	0	0	1
Total Volume	2	1	0	0	3	5	1	3	0	9	0	2	6	0	8	0	3	3	0	6
% App. Total	66.7	33.3	0	0		55.6	11.1	33.3	0		0	25	75	0		0	50	50	0	
PHF	.500	.250	.000	.000	.750	.313	.250	.375	.000	.563	.000	.250	.500	.000	.667	.000	.750	.750	.000	.750

City of Madera
 N/S: Golden State Blvd/Airport Drive
 E/W: Avenue 17
 Weather: Clear

File Name : 11_MDA_Airport_Ave 17 AM
 Site Code : 00319628
 Start Date : 9/18/2019
 Page No : 1

Groups Printed- 3 Axle Vehicles

Start Time	Golden State Boulevard Southbound					Avenue 17 Westbound					Airport Drive Northbound					Avenue 17 Eastbound					Int. Total
	Left	Thru	Right	U-Turns	App. Total	Left	Thru	Right	U-Turns	App. Total	Left	Thru	Right	U-Turns	App. Total	Left	Thru	Right	U-Turns	App. Total	
07:00 AM	1	0	0	0	1	0	0	0	0	0	0	0	0	0	0	0	0	0	0	0	0
07:15 AM	1	0	0	0	1	1	0	0	0	1	0	0	0	0	0	0	0	0	0	0	0
07:30 AM	0	0	0	0	0	1	0	1	1	3	0	1	0	0	1	0	0	0	0	0	0
07:45 AM	0	1	0	0	1	0	0	0	0	0	0	0	0	0	0	0	0	0	0	0	0
Total	2	1	0	0	3	2	0	1	1	4	0	1	0	0	1	0	0	0	0	0	8
08:00 AM	0	0	0	0	0	0	1	0	0	1	0	0	0	0	0	0	0	0	0	0	0
08:15 AM	0	0	0	0	0	0	0	0	0	0	0	0	0	0	0	0	0	0	0	0	0
08:30 AM	1	0	0	0	1	0	0	0	0	0	0	0	0	0	0	0	0	0	0	0	0
08:45 AM	1	0	0	0	1	0	0	0	0	0	0	0	2	0	2	0	0	0	0	0	0
Total	2	0	0	0	2	0	1	0	0	1	0	0	2	0	2	0	0	0	0	0	5
Grand Total	4	1	0	0	5	2	1	1	1	5	0	1	2	0	3	0	0	0	0	0	13
Apprch %	80	20	0	0		40	20	20	20		0	33.3	66.7	0		0	0	0	0		
Total %	30.8	7.7	0	0	38.5	15.4	7.7	7.7	7.7	38.5	0	7.7	15.4	0	23.1	0	0	0	0	0	

Start Time	Golden State Boulevard Southbound					Avenue 17 Westbound					Airport Drive Northbound					Avenue 17 Eastbound					Int. Total
	Left	Thru	Right	U-Turns	App. Total	Thru	Right	U-Turns	App. Total	Thru	Right	U-Turns	App. Total	Thru	Right	U-Turns	App. Total				
Peak Hour Analysis From 07:15 AM to 08:00 AM - Peak 1 of 1																					
Peak Hour for Entire Intersection Begins at 07:15 AM																					
07:15 AM	1	0	0	0	1	1	0	0	0	1	0	0	0	0	0	0	0	0	0	0	2
07:30 AM	0	0	0	0	0	1	0	1	1	3	0	1	0	0	1	0	0	0	0	0	4
07:45 AM	0	1	0	0	1	0	0	0	0	0	0	0	0	0	0	0	0	0	0	0	1
08:00 AM	0	0	0	0	0	0	1	0	0	1	0	0	0	0	0	0	0	0	0	0	1
Total Volume	1	1	0	0	2	2	1	1	1	5	0	1	0	0	1	0	0	0	0	0	8
% App. Total	50	50	0	0		40	20	20	20		0	100	0	0		0	0	0	0		
PHF	.250	.250	.000	.000	.500	.500	.250	.250	.250	.417	.000	.250	.000	.000	.250	.000	.000	.000	.000	.000	.500

City of Madera
 N/S: Golden State Blvd/Airport Drive
 E/W: Avenue 17
 Weather: Clear

File Name : 11_MDA_Airport_Ave 17 AM
 Site Code : 00319628
 Start Date : 9/18/2019
 Page No : 2

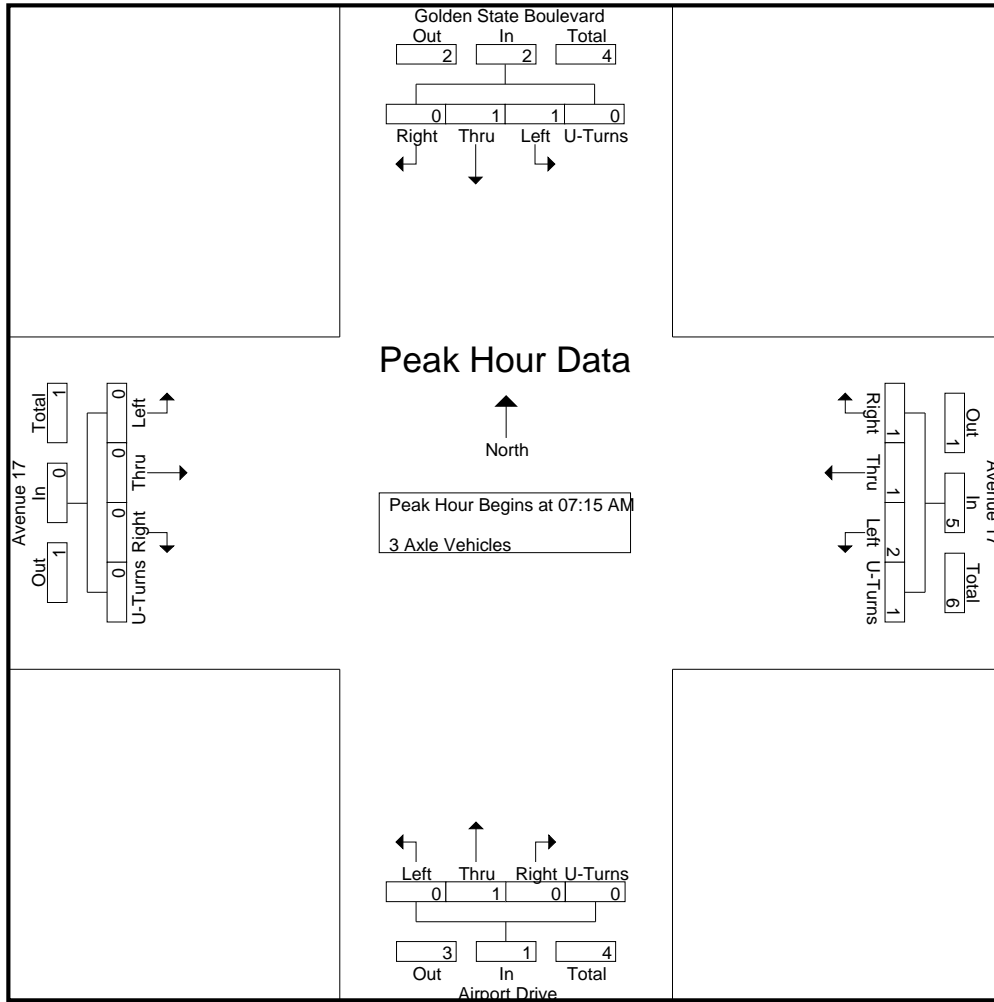

Peak Hour Analysis From 07:15 AM to 08:00 AM - Peak 1 of 1
 Peak Hour for Each Approach Begins at:

	07:15 AM					07:15 AM					07:15 AM					07:15 AM				
+0 mins.	1	0	0	0	1	1	0	0	0	1	0	0	0	0	0	0	0	0	0	0
+15 mins.	0	0	0	0	0	1	0	1	1	3	0	1	0	0	1	0	0	0	0	0
+30 mins.	0	1	0	0	1	0	0	0	0	0	0	0	0	0	0	0	0	0	0	0
+45 mins.	0	0	0	0	0	0	1	0	0	1	0	0	0	0	0	0	0	0	0	0
Total Volume	1	1	0	0	2	2	1	1	1	5	0	1	0	0	1	0	0	0	0	0
% App. Total	50	50	0	0		40	20	20	20		0	100	0	0		0	0	0	0	
PHF	.250	.250	.000	.000	.500	.500	.250	.250	.250	.417	.000	.250	.000	.000	.250	.000	.000	.000	.000	.000

City of Madera
 N/S: Golden State Blvd/Airport Drive
 E/W: Avenue 17
 Weather: Clear

File Name : 11_MDA_Airport_Ave 17 AM
 Site Code : 00319628
 Start Date : 9/18/2019
 Page No : 1

Groups Printed- 4+ Axle Trucks

Start Time	Golden State Boulevard Southbound					Avenue 17 Westbound					Airport Drive Northbound					Avenue 17 Eastbound					Int. Total
	Left	Thru	Right	U-Turns	App. Total	Left	Thru	Right	U-Turns	App. Total	Left	Thru	Right	U-Turns	App. Total	Left	Thru	Right	U-Turns	App. Total	
07:00 AM	1	0	0	0	1	2	1	0	0	3	0	0	3	0	3	0	1	0	0	1	8
07:15 AM	3	0	0	0	3	3	0	1	0	4	0	0	1	0	1	0	0	0	0	0	8
07:30 AM	0	0	0	0	0	1	1	0	0	2	0	0	2	0	2	0	1	1	0	2	6
07:45 AM	0	0	0	0	0	2	1	0	0	3	0	0	0	0	0	0	0	0	0	0	3
Total	4	0	0	0	4	8	3	1	0	12	0	0	6	0	6	0	2	1	0	3	25
08:00 AM	2	0	0	0	2	1	0	1	0	2	0	0	2	0	2	0	0	1	0	1	7
08:15 AM	1	0	0	0	1	1	0	0	0	1	0	2	4	0	6	0	1	1	0	2	10
08:30 AM	2	0	1	0	3	0	0	0	0	0	0	0	1	0	1	0	2	0	0	2	6
08:45 AM	0	0	1	0	1	2	1	2	0	5	0	0	0	0	0	0	0	0	0	0	6
Total	5	0	2	0	7	4	1	3	0	8	0	2	7	0	9	0	3	2	0	5	29
Grand Total	9	0	2	0	11	12	4	4	0	20	0	2	13	0	15	0	5	3	0	8	54
Apprch %	81.8	0	18.2	0		60	20	20	0		0	13.3	86.7	0		0	62.5	37.5	0		
Total %	16.7	0	3.7	0	20.4	22.2	7.4	7.4	0	37	0	3.7	24.1	0	27.8	0	9.3	5.6	0	14.8	

Start Time	Golden State Boulevard Southbound					Avenue 17 Westbound					Airport Drive Northbound					Avenue 17 Eastbound					Int. Total
	Left	Thru	Right	U-Turns	App. Total	Left	Thru	Right	U-Turns	App. Total	Left	Thru	Right	U-Turns	App. Total	Left	Thru	Right	U-Turns	App. Total	
Peak Hour Analysis From 07:15 AM to 08:00 AM - Peak 1 of 1																					
Peak Hour for Entire Intersection Begins at 07:15 AM																					
07:15 AM	3	0	0	0	3	3	0	1	0	4	0	0	1	0	1	0	0	0	0	0	8
07:30 AM	0	0	0	0	0	1	1	0	0	2	0	0	2	0	2	0	1	1	0	2	6
07:45 AM	0	0	0	0	0	2	1	0	0	3	0	0	0	0	0	0	0	0	0	0	3
08:00 AM	2	0	0	0	2	1	0	1	0	2	0	0	2	0	2	0	0	1	0	1	7
Total Volume	5	0	0	0	5	7	2	2	0	11	0	0	5	0	5	0	1	2	0	3	24
% App. Total	100	0	0	0		63.6	18.2	18.2	0		0	0	100	0		0	33.3	66.7	0		
PHF	.417	.000	.000	.000	.417	.583	.500	.500	.000	.688	.000	.000	.625	.000	.625	.000	.250	.500	.000	.375	.750

City of Madera
 N/S: Golden State Blvd/Airport Drive
 E/W: Avenue 17
 Weather: Clear

File Name : 11_MDA_Airport_Ave 17 AM
 Site Code : 00319628
 Start Date : 9/18/2019
 Page No : 2

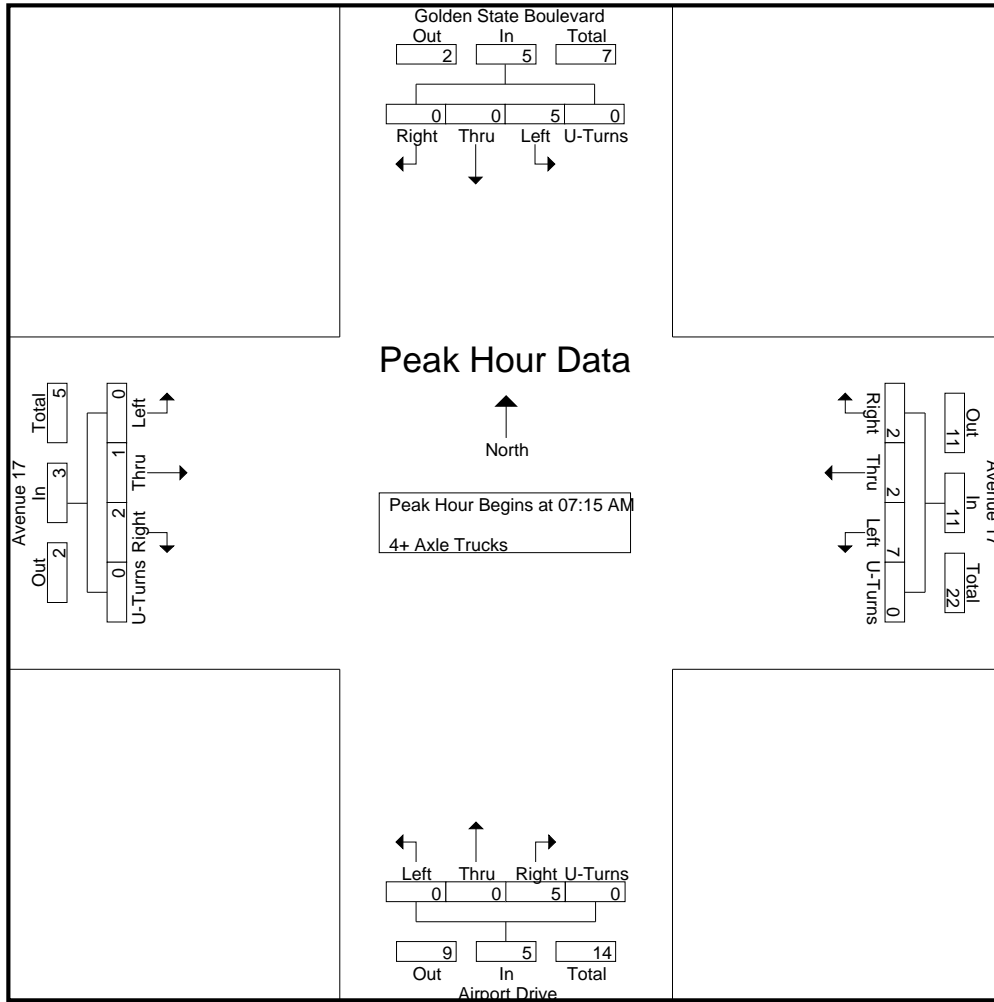

Peak Hour Analysis From 07:15 AM to 08:00 AM - Peak 1 of 1
 Peak Hour for Each Approach Begins at:

	07:15 AM					07:15 AM					07:15 AM									
+0 mins.	3	0	0	0	3	3	0	1	0	4	0	0	1	0	1	0	0	0	0	0
+15 mins.	0	0	0	0	0	1	1	0	0	2	0	0	2	0	2	0	1	1	0	2
+30 mins.	0	0	0	0	0	2	1	0	0	3	0	0	0	0	0	0	0	0	0	0
+45 mins.	2	0	0	0	2	1	0	1	0	2	0	0	2	0	2	0	0	1	0	1
Total Volume	5	0	0	0	5	7	2	2	0	11	0	0	5	0	5	0	1	2	0	3
% App. Total	100	0	0	0		63.6	18.2	18.2	0		0	0	100	0		0	33.3	66.7	0	
PHF	.417	.000	.000	.000	.417	.583	.500	.500	.000	.688	.000	.000	.625	.000	.625	.000	.250	.500	.000	.375

City of Madera
 N/S: Golden State Blvd/Airport Drive
 E/W: Avenue 17
 Weather: Clear

File Name : 11_MDA_Airport_Ave 17 PM
 Site Code : 00319628
 Start Date : 9/18/2019
 Page No : 1

Groups Printed- Passenger Vehicles - Large 2 Axle Vehicles - 3 Axle Vehicles - 4+ Axle Trucks

Start Time	Golden State Boulevard Southbound					Avenue 17 Westbound					Airport Drive Northbound					Avenue 17 Eastbound					Int. Total
	Left	Thru	Right	U-Turns	App. Total	Left	Thru	Right	U-Turns	App. Total	Left	Thru	Right	U-Turns	App. Total	Left	Thru	Right	U-Turns	App. Total	
04:00 PM	33	9	1	0	43	26	9	23	1	59	3	5	41	0	49	3	52	9	0	64	215
04:15 PM	23	9	2	0	34	21	16	16	0	53	3	3	33	0	39	3	50	5	0	58	184
04:30 PM	28	3	1	0	32	19	6	20	0	45	6	13	52	0	71	0	38	7	0	45	193
04:45 PM	36	4	3	0	43	14	6	26	0	46	8	6	26	0	40	1	40	4	0	45	174
Total	120	25	7	0	152	80	37	85	1	203	20	27	152	0	199	7	180	25	0	212	766
05:00 PM	33	8	2	0	43	23	17	28	0	68	3	8	41	0	52	2	21	2	0	25	188
05:15 PM	27	6	0	0	33	16	18	26	0	60	2	3	16	0	21	2	24	1	0	27	141
05:30 PM	22	4	0	0	26	25	12	17	0	54	1	6	13	0	20	1	12	0	0	13	113
05:45 PM	16	5	1	0	22	17	20	20	0	57	2	5	18	0	25	1	21	1	0	23	127
Total	98	23	3	0	124	81	67	91	0	239	8	22	88	0	118	6	78	4	0	88	569
Grand Total	218	48	10	0	276	161	104	176	1	442	28	49	240	0	317	13	258	29	0	300	1335
Apprch %	79	17.4	3.6	0		36.4	23.5	39.8	0.2		8.8	15.5	75.7	0		4.3	86	9.7	0		
Total %	16.3	3.6	0.7	0	20.7	12.1	7.8	13.2	0.1	33.1	2.1	3.7	18	0	23.7	1	19.3	2.2	0	22.5	
Passenger Vehicles	96.8	97.9	90	0	96.7	92.5	99	94.9	100	95	100	95.9	94.2	0	95	100	96.9	100	0	97.3	95.9
Large 2 Axle Vehicles	0.5	2.1	10	0	1.1	1.2	0	2.8	0	1.6	0	2	2.1	0	1.9	0	0.4	0	0	0.3	1.3
3 Axle Vehicles	0	0	0	0	0	2	0	0	0	2	0	0	4	0	4	0	0	0	0	0	6
% 3 Axle Vehicles	0	0	0	0	0	1.2	0	0	0	0.5	0	0	1.7	0	1.3	0	0	0	0	0	0.4
4+ Axle Trucks	6	0	0	0	6	8	1	4	0	13	0	1	5	0	6	0	7	0	0	7	32
% 4+ Axle Trucks																					

Start Time	Golden State Boulevard Southbound					Avenue 17 Westbound					Airport Drive Northbound					Avenue 17 Eastbound					Int. Total
	Left	Thru	Right	U-Turns	App. Total	Left	Thru	Right	U-Turns	App. Total	Left	Thru	Right	U-Turns	App. Total	Left	Thru	Right	U-Turns	App. Total	
Peak Hour Analysis From 04:00 PM to 05:45 PM - Peak 1 of 1																					
Peak Hour for Entire Intersection Begins at 04:00 PM																					
04:00 PM	33	9	1	0	43	26	9	23	1	59	3	5	41	0	49	3	52	9	0	64	215
04:15 PM	23	9	2	0	34	21	16	16	0	53	3	3	33	0	39	3	50	5	0	58	184
04:30 PM	28	3	1	0	32	19	6	20	0	45	6	13	52	0	71	0	38	7	0	45	193
04:45 PM	36	4	3	0	43	14	6	26	0	46	8	6	26	0	40	1	40	4	0	45	174
Total Volume	120	25	7	0	152	80	37	85	1	203	20	27	152	0	199	7	180	25	0	212	766
% App. Total	78.9	16.4	4.6	0		39.4	18.2	41.9	0.5		10.1	13.6	76.4	0		3.3	84.9	11.8	0		
PHF	.833	.694	.583	.000	.884	.769	.578	.817	.250	.860	.625	.519	.731	.000	.701	.583	.865	.694	.000	.828	.891

City of Madera
 N/S: Golden State Blvd/Airport Drive
 E/W: Avenue 17
 Weather: Clear

File Name : 11_MDA_Airport_Ave 17 PM
 Site Code : 00319628
 Start Date : 9/18/2019
 Page No : 2

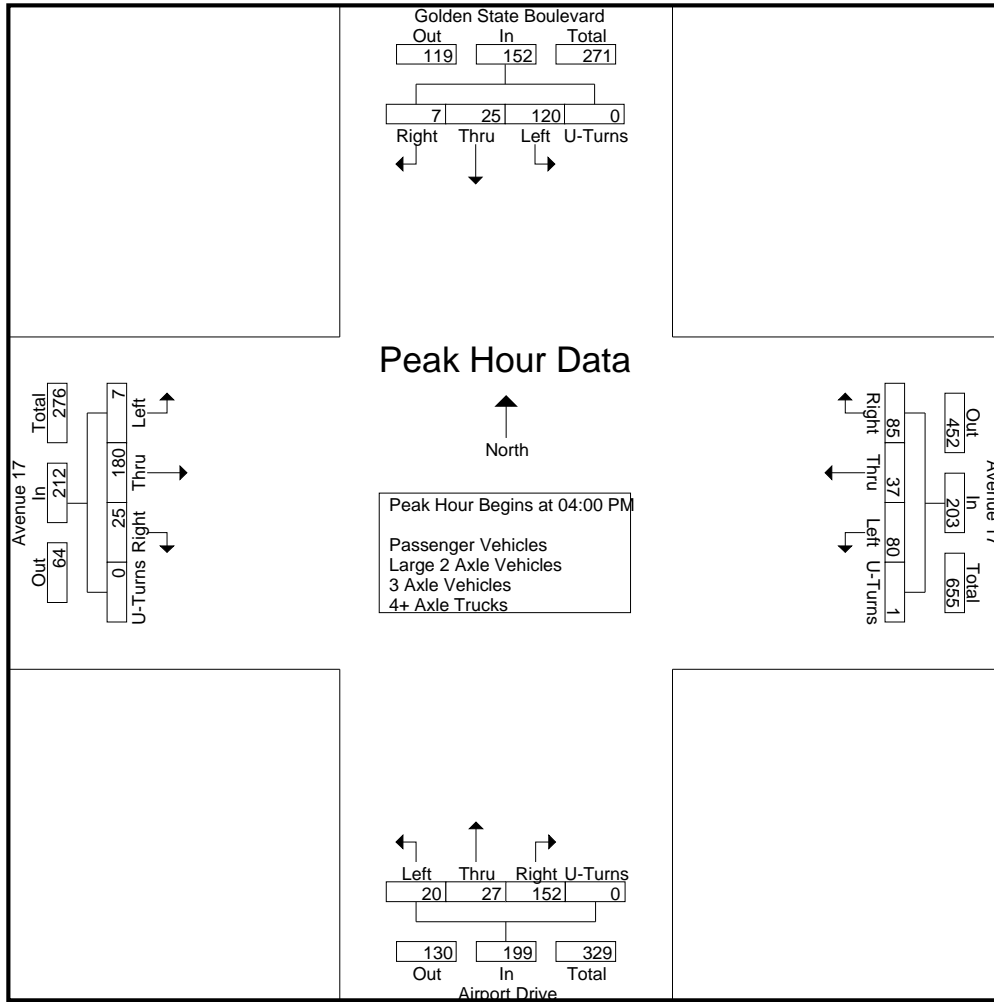

Peak Hour Analysis From 04:00 PM to 05:45 PM - Peak 1 of 1
 Peak Hour for Each Approach Begins at:

	04:00 PM					05:00 PM					04:15 PM					04:00 PM				
+0 mins.	33	9	1	0	43	23	17	28	0	68	3	3	33	0	39	3	52	9	0	64
+15 mins.	23	9	2	0	34	16	18	26	0	60	6	13	52	0	71	3	50	5	0	58
+30 mins.	28	3	1	0	32	25	12	17	0	54	8	6	26	0	40	0	38	7	0	45
+45 mins.	36	4	3	0	43	17	20	20	0	57	3	8	41	0	52	1	40	4	0	45
Total Volume	120	25	7	0	152	81	67	91	0	239	20	30	152	0	202	7	180	25	0	212
% App. Total	78.9	16.4	4.6	0		33.9	28	38.1	0		9.9	14.9	75.2	0		3.3	84.9	11.8	0	
PHF	.833	.694	.583	.000	.884	.810	.838	.813	.000	.879	.625	.577	.731	.000	.711	.583	.865	.694	.000	.828

City of Madera
 N/S: Golden State Blvd/Airport Drive
 E/W: Avenue 17
 Weather: Clear

File Name : 11_MDA_Airport_Ave 17 PM
 Site Code : 00319628
 Start Date : 9/18/2019
 Page No : 1

Groups Printed- Passenger Vehicles

Start Time	Golden State Boulevard Southbound					Avenue 17 Westbound					Airport Drive Northbound					Avenue 17 Eastbound					Int. Total
	Left	Thru	Right	U-Turns	App. Total	Left	Thru	Right	U-Turns	App. Total	Left	Thru	Right	U-Turns	App. Total	Left	Thru	Right	U-Turns	App. Total	
04:00 PM	32	8	1	0	41	24	9	22	1	56	3	5	41	0	49	3	52	9	0	64	210
04:15 PM	22	9	2	0	33	20	16	16	0	52	3	3	29	0	35	3	49	5	0	57	177
04:30 PM	28	3	0	0	31	18	6	18	0	42	6	12	50	0	68	0	35	7	0	42	183
04:45 PM	36	4	3	0	43	12	6	25	0	43	8	5	24	0	37	1	39	4	0	44	167
Total	118	24	6	0	148	74	37	81	1	193	20	25	144	0	189	7	175	25	0	207	737
05:00 PM	33	8	2	0	43	23	16	26	0	65	3	8	41	0	52	2	21	2	0	25	185
05:15 PM	27	6	0	0	33	14	18	24	0	56	2	3	13	0	18	2	21	1	0	24	131
05:30 PM	20	4	0	0	24	23	12	16	0	51	1	6	12	0	19	1	12	0	0	13	107
05:45 PM	13	5	1	0	19	15	20	20	0	55	2	5	16	0	23	1	21	1	0	23	120
Total	93	23	3	0	119	75	66	86	0	227	8	22	82	0	112	6	75	4	0	85	543
Grand Total	211	47	9	0	267	149	103	167	1	420	28	47	226	0	301	13	250	29	0	292	1280
Apprch %	79	17.6	3.4	0		35.5	24.5	39.8	0.2		9.3	15.6	75.1	0		4.5	85.6	9.9	0		
Total %	16.5	3.7	0.7	0	20.9	11.6	8	13	0.1	32.8	2.2	3.7	17.7	0	23.5	1	19.5	2.3	0	22.8	

Start Time	Golden State Boulevard Southbound					Avenue 17 Westbound					Airport Drive Northbound					Avenue 17 Eastbound					Int. Total
	Left	Thru	Right	U-Turns	App. Total	Thru	Right	U-Turns	App. Total	Thru	Right	U-Turns	App. Total	Thru	Right	U-Turns	App. Total				
Peak Hour Analysis From 04:00 PM to 04:45 PM - Peak 1 of 1																					
Peak Hour for Entire Intersection Begins at 04:00 PM																					
04:00 PM	32	8	1	0	41	24	9	22	1	56	3	5	41	0	49	3	52	9	0	64	210
04:15 PM	22	9	2	0	33	20	16	16	0	52	3	3	29	0	35	3	49	5	0	57	177
04:30 PM	28	3	0	0	31	18	6	18	0	42	6	12	50	0	68	0	35	7	0	42	183
04:45 PM	36	4	3	0	43	12	6	25	0	43	8	5	24	0	37	1	39	4	0	44	167
Total Volume	118	24	6	0	148	74	37	81	1	193	20	25	144	0	189	7	175	25	0	207	737
% App. Total	79.7	16.2	4.1	0		38.3	19.2	42	0.5		10.6	13.2	76.2	0		3.4	84.5	12.1	0		
PHF	.819	.667	.500	.000	.860	.771	.578	.810	.250	.862	.625	.521	.720	.000	.695	.583	.841	.694	.000	.809	.877

City of Madera
 N/S: Golden State Blvd/Airport Drive
 E/W: Avenue 17
 Weather: Clear

File Name : 11_MDA_Airport_Ave 17 PM
 Site Code : 00319628
 Start Date : 9/18/2019
 Page No : 2

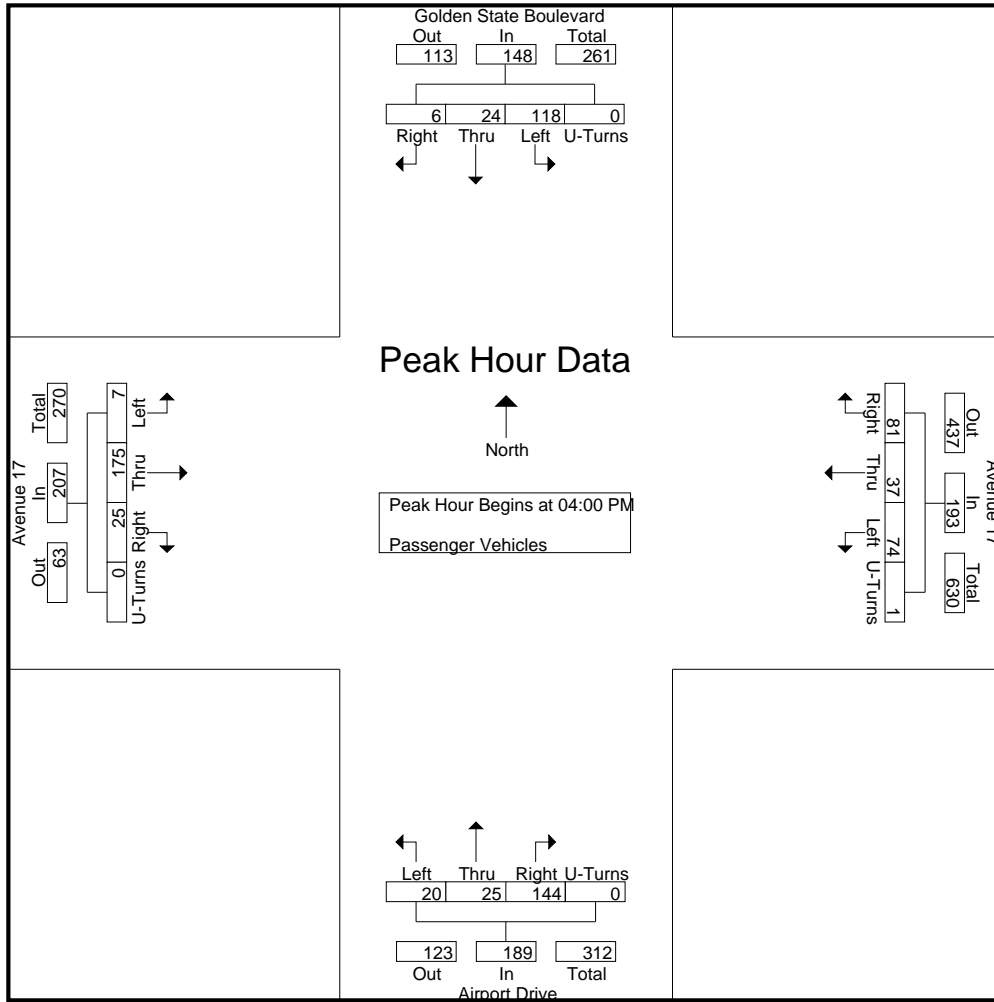

Peak Hour Analysis From 04:00 PM to 04:45 PM - Peak 1 of 1
 Peak Hour for Each Approach Begins at:

	04:00 PM					04:00 PM					04:00 PM									
+0 mins.	32	8	1	0	41	24	9	22	1	56	3	5	41	0	49	3	52	9	0	64
+15 mins.	22	9	2	0	33	20	16	16	0	52	3	3	29	0	35	3	49	5	0	57
+30 mins.	28	3	0	0	31	18	6	18	0	42	6	12	50	0	68	0	35	7	0	42
+45 mins.	36	4	3	0	43	12	6	25	0	43	8	5	24	0	37	1	39	4	0	44
Total Volume	118	24	6	0	148	74	37	81	1	193	20	25	144	0	189	7	175	25	0	207
% App. Total	79.7	16.2	4.1	0		38.3	19.2	42	0.5		10.6	13.2	76.2	0		3.4	84.5	12.1	0	
PHF	.819	.667	.500	.000	.860	.771	.578	.810	.250	.862	.625	.521	.720	.000	.695	.583	.841	.694	.000	.809

City of Madera
 N/S: Golden State Blvd/Airport Drive
 E/W: Avenue 17
 Weather: Clear

File Name : 11_MDA_Airport_Ave 17 PM
 Site Code : 00319628
 Start Date : 9/18/2019
 Page No : 1

Groups Printed- Large 2 Axle Vehicles

Start Time	Golden State Boulevard Southbound					Avenue 17 Westbound					Airport Drive Northbound					Avenue 17 Eastbound					Int. Total
	Left	Thru	Right	U-Turns	App. Total	Left	Thru	Right	U-Turns	App. Total	Left	Thru	Right	U-Turns	App. Total	Left	Thru	Right	U-Turns	App. Total	
04:00 PM	0	1	0	0	1	0	0	1	0	1	0	0	0	0	0	0	0	0	0	0	2
04:15 PM	0	0	0	0	0	0	0	0	0	0	0	0	1	0	1	0	0	0	0	0	1
04:30 PM	0	0	1	0	1	0	0	1	0	1	0	0	1	0	1	0	1	0	0	1	4
04:45 PM	0	0	0	0	0	0	0	1	0	1	0	1	1	0	2	0	0	0	0	0	3
Total	0	1	1	0	2	0	0	3	0	3	0	1	3	0	4	0	1	0	0	1	10
05:00 PM	0	0	0	0	0	0	0	2	0	2	0	0	0	0	0	0	0	0	0	0	2
05:15 PM	0	0	0	0	0	0	0	0	0	0	0	0	1	0	1	0	0	0	0	0	1
05:30 PM	0	0	0	0	0	1	0	0	0	1	0	0	1	0	1	0	0	0	0	0	2
05:45 PM	1	0	0	0	1	1	0	0	0	1	0	0	0	0	0	0	0	0	0	0	2
Total	1	0	0	0	1	2	0	2	0	4	0	0	2	0	2	0	0	0	0	0	7
Grand Total	1	1	1	0	3	2	0	5	0	7	0	1	5	0	6	0	1	0	0	1	17
Apprch %	33.3	33.3	33.3	0		28.6	0	71.4	0		0	16.7	83.3	0		0	100	0	0		
Total %	5.9	5.9	5.9	0	17.6	11.8	0	29.4	0	41.2	0	5.9	29.4	0	35.3	0	5.9	0	0	5.9	

Start Time	Golden State Boulevard Southbound					Avenue 17 Westbound					Airport Drive Northbound					Avenue 17 Eastbound					Int. Total
	Left	Thru	Right	U-Turns	App. Total	Thru	Right	U-Turns	App. Total	Thru	Right	U-Turns	App. Total	Thru	Right	U-Turns	App. Total				
Peak Hour Analysis From 04:00 PM to 04:45 PM - Peak 1 of 1																					
Peak Hour for Entire Intersection Begins at 04:00 PM																					
04:00 PM	0	1	0	0	1	0	0	1	0	1	0	0	0	0	0	0	0	0	0	0	2
04:15 PM	0	0	0	0	0	0	0	0	0	0	0	0	1	0	1	0	0	0	0	0	1
04:30 PM	0	0	1	0	1	0	0	1	0	1	0	0	1	0	1	0	1	0	0	1	4
04:45 PM	0	0	0	0	0	0	0	1	0	1	0	1	1	0	2	0	0	0	0	0	3
Total Volume	0	1	1	0	2	0	0	3	0	3	0	1	3	0	4	0	1	0	0	1	10
% App. Total	0	50	50	0		0	0	100	0		0	25	75	0		0	100	0	0		
PHF	.000	.250	.250	.000	.500	.000	.000	.750	.000	.750	.000	.250	.750	.000	.500	.000	.250	.000	.000	.250	.625

City of Madera
 N/S: Golden State Blvd/Airport Drive
 E/W: Avenue 17
 Weather: Clear

File Name : 11_MDA_Airport_Ave 17 PM
 Site Code : 00319628
 Start Date : 9/18/2019
 Page No : 2

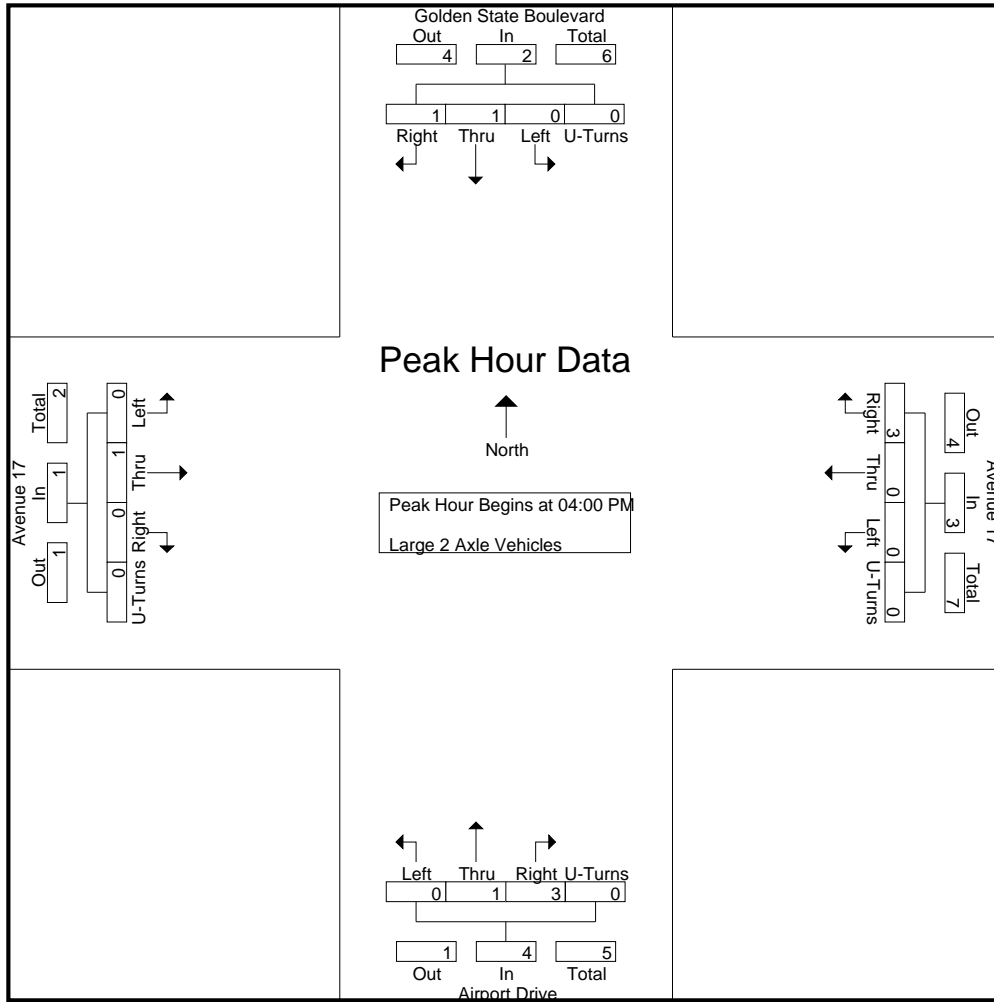

Peak Hour Analysis From 04:00 PM to 04:45 PM - Peak 1 of 1
 Peak Hour for Each Approach Begins at:

	04:00 PM					04:00 PM					04:00 PM					04:00 PM				
+0 mins.	0	1	0	0	1	0	0	1	0	1	0	0	0	0	0	0	0	0	0	0
+15 mins.	0	0	0	0	0	0	0	0	0	0	0	0	1	0	1	0	0	0	0	0
+30 mins.	0	0	1	0	1	0	0	1	0	1	0	0	1	0	1	0	1	0	0	1
+45 mins.	0	0	0	0	0	0	0	1	0	1	0	1	1	0	2	0	0	0	0	0
Total Volume	0	1	1	0	2	0	0	3	0	3	0	1	3	0	4	0	1	0	0	1
% App. Total	0	50	50	0		0	0	100	0		0	25	75	0		0	100	0	0	
PHF	.000	.250	.250	.000	.500	.000	.000	.750	.000	.750	.000	.250	.750	.000	.500	.000	.250	.000	.000	.250

City of Madera
 N/S: Golden State Blvd/Airport Drive
 E/W: Avenue 17
 Weather: Clear

File Name : 11_MDA_Airport_Ave 17 PM
 Site Code : 00319628
 Start Date : 9/18/2019
 Page No : 1

Groups Printed- 3 Axle Vehicles

Start Time	Golden State Boulevard Southbound					Avenue 17 Westbound					Airport Drive Northbound					Avenue 17 Eastbound					Int. Total	
	Left	Thru	Right	U-Turns	App. Total	Left	Thru	Right	U-Turns	App. Total	Left	Thru	Right	U-Turns	App. Total	Left	Thru	Right	U-Turns	App. Total		
04:00 PM	0	0	0	0	0	0	0	0	0	0	0	0	0	0	0	0	0	0	0	0	0	0
04:15 PM	0	0	0	0	0	0	0	0	0	0	0	0	2	0	2	0	0	0	0	0	0	0
04:30 PM	0	0	0	0	0	0	0	0	0	0	0	0	0	0	0	0	0	0	0	0	0	0
04:45 PM	0	0	0	0	0	0	0	0	0	0	0	0	0	0	0	0	0	0	0	0	0	0
Total	0	0	0	0	0	0	0	0	0	0	0	0	2	0	2	0	0	0	0	0	0	0
05:00 PM	0	0	0	0	0	0	0	0	0	0	0	0	0	0	0	0	0	0	0	0	0	0
05:15 PM	0	0	0	0	0	0	0	0	0	0	0	0	1	0	1	0	0	0	0	0	0	0
05:30 PM	0	0	0	0	0	1	0	0	0	1	0	0	0	0	0	0	0	0	0	0	0	0
05:45 PM	0	0	0	0	0	1	0	0	0	1	0	0	1	0	1	0	0	0	0	0	0	0
Total	0	0	0	0	0	2	0	0	0	2	0	0	2	0	2	0	0	0	0	0	0	0
Grand Total	0	0	0	0	0	2	0	0	0	2	0	0	4	0	4	0	0	0	0	0	0	0
Apprch %	0	0	0	0		100	0	0	0		0	0	100	0		0	0	0	0		0	0
Total %	0	0	0	0	0	33.3	0	0	0	33.3	0	0	66.7	0	66.7	0	0	0	0	0	0	0

Start Time	Golden State Boulevard Southbound					Avenue 17 Westbound					Airport Drive Northbound					Avenue 17 Eastbound					Int. Total	
	Left	Thru	Right	U-Turns	App. Total	Thru	Right	U-Turns	App. Total	Thru	Right	U-Turns	App. Total	Thru	Right	U-Turns	App. Total					
Peak Hour Analysis From 04:00 PM to 04:45 PM - Peak 1 of 1																						
Peak Hour for Entire Intersection Begins at 04:00 PM																						
04:00 PM	0	0	0	0	0	0	0	0	0	0	0	0	0	0	0	0	0	0	0	0	0	0
04:15 PM	0	0	0	0	0	0	0	0	0	0	0	0	2	0	2	0	0	0	0	0	0	0
04:30 PM	0	0	0	0	0	0	0	0	0	0	0	0	0	0	0	0	0	0	0	0	0	0
04:45 PM	0	0	0	0	0	0	0	0	0	0	0	0	0	0	0	0	0	0	0	0	0	0
Total Volume	0	0	0	0	0	0	0	0	0	0	0	0	2	0	2	0	0	0	0	0	0	0
% App. Total	0	0	0	0	0	0	0	0	0	0	0	0	100	0	0	0	0	0	0	0	0	
PHF	.000	.000	.000	.000	.000	.000	.000	.000	.000	.000	.000	.000	.250	.000	.250	.000	.000	.000	.000	.000	.000	.250

City of Madera
 N/S: Golden State Blvd/Airport Drive
 E/W: Avenue 17
 Weather: Clear

File Name : 11_MDA_Airport_Ave 17 PM
 Site Code : 00319628
 Start Date : 9/18/2019
 Page No : 2

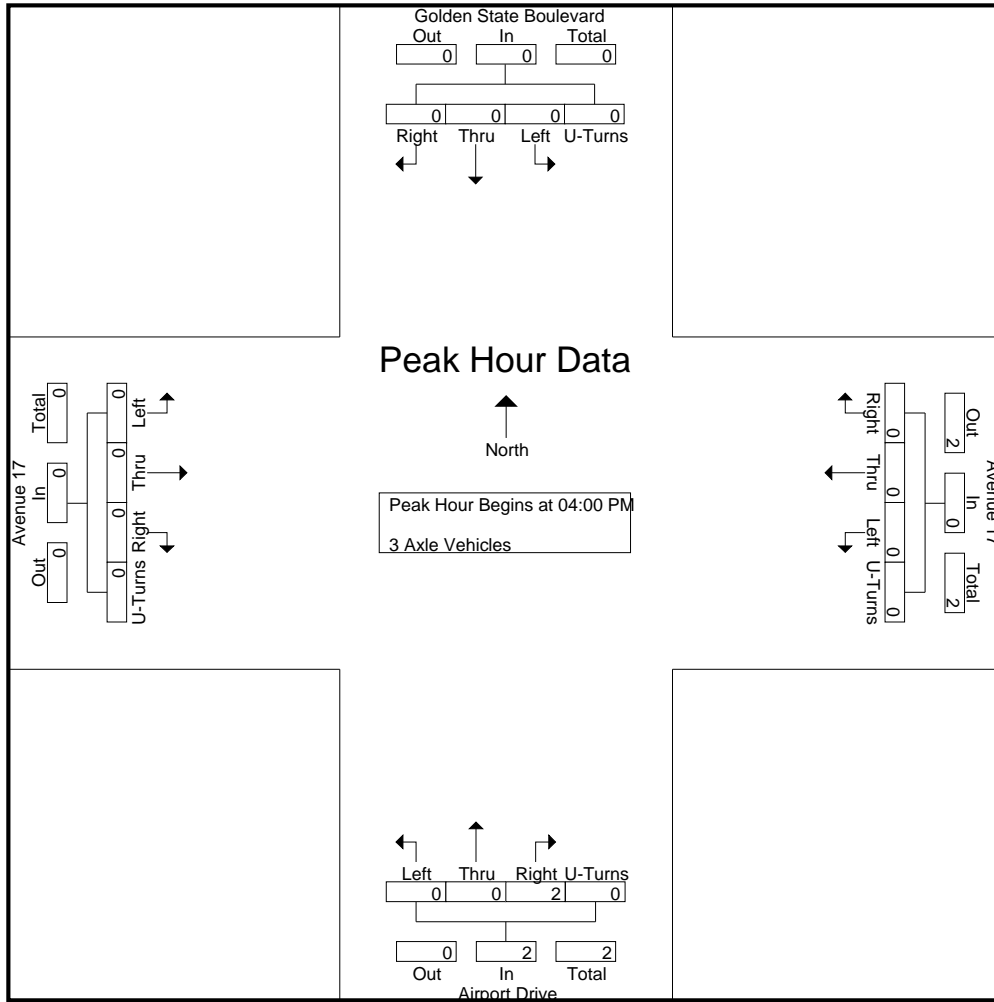

Peak Hour Analysis From 04:00 PM to 04:45 PM - Peak 1 of 1
 Peak Hour for Each Approach Begins at:

	04:00 PM					04:00 PM					04:00 PM									
+0 mins.	0	0	0	0	0	0	0	0	0	0	0	0	0	0	0	0	0	0	0	0
+15 mins.	0	0	0	0	0	0	0	0	0	0	0	0	2	0	2	0	0	0	0	0
+30 mins.	0	0	0	0	0	0	0	0	0	0	0	0	0	0	0	0	0	0	0	0
+45 mins.	0	0	0	0	0	0	0	0	0	0	0	0	0	0	0	0	0	0	0	0
Total Volume	0	0	0	0	0	0	0	0	0	0	0	0	2	0	2	0	0	0	0	0
% App. Total	0	0	0	0	0	0	0	0	0	0	0	0	100	0	0	0	0	0	0	0
PHF	.000	.000	.000	.000	.000	.000	.000	.000	.000	.000	.000	.000	.250	.000	.250	.000	.000	.000	.000	.000

City of Madera
 N/S: Golden State Blvd/Airport Drive
 E/W: Avenue 17
 Weather: Clear

File Name : 11_MDA_Airport_Ave 17 PM
 Site Code : 00319628
 Start Date : 9/18/2019
 Page No : 1

Groups Printed- 4+ Axle Trucks

Start Time	Golden State Boulevard Southbound					Avenue 17 Westbound					Airport Drive Northbound					Avenue 17 Eastbound					Int. Total
	Left	Thru	Right	U-Turns	App. Total	Left	Thru	Right	U-Turns	App. Total	Left	Thru	Right	U-Turns	App. Total	Left	Thru	Right	U-Turns	App. Total	
04:00 PM	1	0	0	0	1	2	0	0	0	2	0	0	0	0	0	0	0	0	0	0	3
04:15 PM	1	0	0	0	1	1	0	0	0	1	0	0	1	0	1	0	1	0	0	1	4
04:30 PM	0	0	0	0	0	1	0	1	0	2	0	1	1	0	2	0	2	0	0	2	6
04:45 PM	0	0	0	0	0	2	0	0	0	2	0	0	1	0	1	0	1	0	0	1	4
Total	2	0	0	0	2	6	0	1	0	7	0	1	3	0	4	0	4	0	0	4	17
05:00 PM	0	0	0	0	0	0	1	0	0	1	0	0	0	0	0	0	0	0	0	0	1
05:15 PM	0	0	0	0	0	2	0	2	0	4	0	0	1	0	1	0	3	0	0	3	8
05:30 PM	2	0	0	0	2	0	0	1	0	1	0	0	0	0	0	0	0	0	0	0	3
05:45 PM	2	0	0	0	2	0	0	0	0	0	0	0	1	0	1	0	0	0	0	0	3
Total	4	0	0	0	4	2	1	3	0	6	0	0	2	0	2	0	3	0	0	3	15
Grand Total	6	0	0	0	6	8	1	4	0	13	0	1	5	0	6	0	7	0	0	7	32
Apprch %	100	0	0	0		61.5	7.7	30.8	0		0	16.7	83.3	0		0	100	0	0		
Total %	18.8	0	0	0	18.8	25	3.1	12.5	0	40.6	0	3.1	15.6	0	18.8	0	21.9	0	0	21.9	

Start Time	Golden State Boulevard Southbound					Avenue 17 Westbound					Airport Drive Northbound					Avenue 17 Eastbound					Int. Total
	Left	Thru	Right	U-Turns	App. Total	Thru	Right	U-Turns	App. Total	Thru	Right	U-Turns	App. Total	Thru	Right	U-Turns	App. Total				
Peak Hour Analysis From 04:00 PM to 04:45 PM - Peak 1 of 1																					
Peak Hour for Entire Intersection Begins at 04:00 PM																					
04:00 PM	1	0	0	0	1	2	0	0	0	2	0	0	0	0	0	0	0	0	0	0	3
04:15 PM	1	0	0	0	1	1	0	0	0	1	0	0	1	0	1	0	1	0	0	1	4
04:30 PM	0	0	0	0	0	1	0	1	0	2	0	1	1	0	2	0	2	0	0	2	6
04:45 PM	0	0	0	0	0	2	0	0	0	2	0	0	1	0	1	0	1	0	0	1	4
Total Volume	2	0	0	0	2	6	0	1	0	7	0	1	3	0	4	0	4	0	0	4	17
% App. Total	100	0	0	0		85.7	0	14.3	0		0	25	75	0		0	100	0	0		
PHF	.500	.000	.000	.000	.500	.750	.000	.250	.000	.875	.000	.250	.750	.000	.500	.000	.500	.000	.000	.500	.708

City of Madera
 N/S: Golden State Blvd/Airport Drive
 E/W: Avenue 17
 Weather: Clear

File Name : 11_MDA_Airport_Ave 17 PM
 Site Code : 00319628
 Start Date : 9/18/2019
 Page No : 2

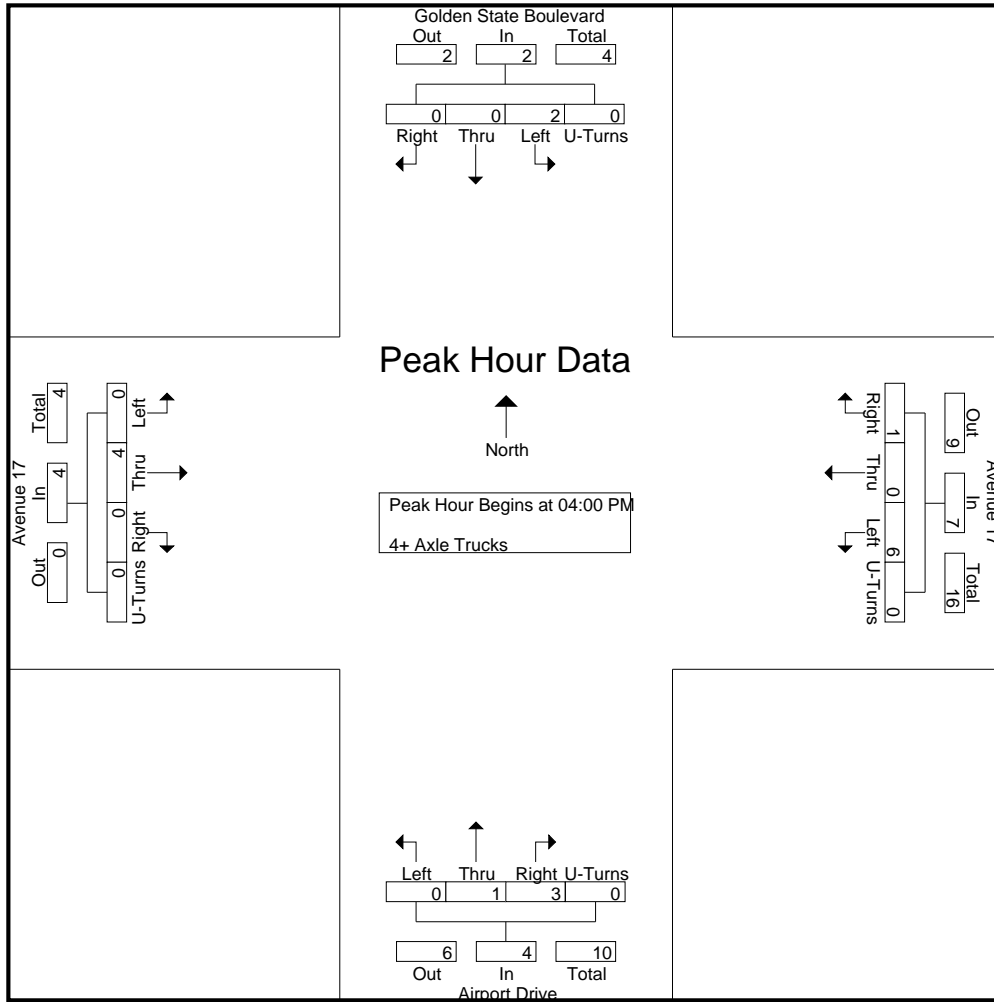

Peak Hour Analysis From 04:00 PM to 04:45 PM - Peak 1 of 1
 Peak Hour for Each Approach Begins at:

	04:00 PM					04:00 PM					04:00 PM					04:00 PM				
+0 mins.	1	0	0	0	1	2	0	0	0	2	0	0	0	0	0	0	0	0	0	0
+15 mins.	1	0	0	0	1	1	0	0	0	1	0	0	1	0	1	0	1	0	0	1
+30 mins.	0	0	0	0	0	1	0	1	0	2	0	1	1	0	2	0	2	0	0	2
+45 mins.	0	0	0	0	0	2	0	0	0	2	0	0	1	0	1	0	1	0	0	1
Total Volume	2	0	0	0	2	6	0	1	0	7	0	1	3	0	4	0	4	0	0	4
% App. Total	100	0	0	0	0	85.7	0	14.3	0	0	0	25	75	0	0	0	100	0	0	0
PHF	.500	.000	.000	.000	.500	.750	.000	.250	.000	.875	.000	.250	.750	.000	.500	.000	.500	.000	.000	.500

Location: Madera
 N/S: Golden State Blvd/Airport Dr
 E/W: Avenue 17



Date: 9/18/2019
 Day: Wednesday

PEDESTRIANS

	North Leg Golden State Boulevard	East Leg Avenue 17	South Leg Airport Drive	West Leg Avenue 17	
	Pedestrians	Pedestrians	Pedestrians	Pedestrians	
7:00 AM	0	0	0	1	1
7:15 AM	0	0	0	0	0
7:30 AM	0	0	0	0	0
7:45 AM	0	0	0	0	0
8:00 AM	0	0	0	1	1
8:15 AM	0	1	0	0	1
8:30 AM	0	0	0	0	0
8:45 AM	0	0	0	0	0
TOTAL VOLUMES:	0	1	0	2	3

	North Leg Golden State Boulevard	East Leg Avenue 17	South Leg Airport Drive	West Leg Avenue 17	
	Pedestrians	Pedestrians	Pedestrians	Pedestrians	
4:00 PM	0	0	0	0	0
4:15 PM	0	0	0	0	0
4:30 PM	0	0	0	0	0
4:45 PM	0	0	0	0	0
5:00 PM	0	0	0	0	0
5:15 PM	0	0	0	0	0
5:30 PM	0	0	0	0	0
5:45 PM	0	0	0	0	0
TOTAL VOLUMES:	0	0	0	0	0

Location: Madera
 N/S: Golden State Blvd/Airport Dr
 E/W: Avenue 17



Date: 9/18/2019
 Day: Wednesday

BICYCLES

	Southbound Golden State Boulevard			Westbound Avenue 17			Northbound Airport Drive			Eastbound Avenue 17			
	Left	Thru	Right	Left	Thru	Right	Left	Thru	Right	Left	Thru	Right	
7:00 AM	0	0	0	0	0	0	0	0	0	0	0	0	0
7:15 AM	0	0	0	0	0	0	0	0	0	0	0	0	0
7:30 AM	0	0	0	0	0	0	0	0	0	0	0	0	0
7:45 AM	0	0	0	0	0	0	0	0	0	0	0	0	0
8:00 AM	0	0	0	0	0	0	0	0	0	0	0	0	0
8:15 AM	0	0	0	0	0	0	0	0	0	0	0	0	0
8:30 AM	0	0	0	0	0	0	0	0	0	0	0	0	0
8:45 AM	0	0	0	0	0	0	0	0	0	0	0	0	0
TOTAL VOLUMES:	0	0	0	0	0	0	0	0	0	0	0	0	0

	Southbound Golden State Boulevard			Westbound Avenue 17			Northbound Airport Drive			Eastbound Avenue 17			
	Left	Thru	Right	Left	Thru	Right	Left	Thru	Right	Left	Thru	Right	
4:00 PM	0	0	0	0	0	0	0	0	0	0	0	0	0
4:15 PM	0	0	0	0	0	0	0	0	0	0	0	0	0
4:30 PM	0	0	0	0	0	0	0	0	0	0	0	0	0
4:45 PM	0	0	0	0	0	0	0	0	0	0	0	0	0
5:00 PM	0	0	0	0	0	0	0	0	0	0	0	0	0
5:15 PM	0	0	0	0	0	0	0	0	0	0	0	0	0
5:30 PM	0	0	0	0	0	0	0	0	0	0	0	0	0
5:45 PM	0	0	0	0	0	0	0	0	0	0	0	0	0
TOTAL VOLUMES:	0	0	0	0	0	0	0	0	0	0	0	0	0

City of Madera
 N/S: SR-99 Southbound Off Ramp
 E/W: Avenue 17
 Weather: Clear

File Name : 12_MDA_99S Off Ramp_Ave 17 AM
 Site Code : 00319628
 Start Date : 9/18/2019
 Page No : 1

Groups Printed- Passenger Vehicles - Large 2 Axle Vehicles - 3 Axle Vehicles - 4+ Axle Trucks

Start Time	SR-99 Southbound Off Ramp Southbound				Avenue 17 Westbound				Avenue 17 Eastbound				Int. Total
	Left	Right	U-Turns	App. Total	Thru	Right	U-Turns	App. Total	Left	Thru	U-Turns	App. Total	
07:00 AM	10	9	0	19	42	0	0	42	0	51	0	51	112
07:15 AM	14	9	0	23	59	0	0	59	0	51	0	51	133
07:30 AM	11	10	0	21	44	0	0	44	0	50	0	50	115
07:45 AM	21	11	0	32	71	0	0	71	0	48	0	48	151
Total	56	39	0	95	216	0	0	216	0	200	0	200	511
08:00 AM	13	12	0	25	56	0	0	56	0	60	0	60	141
08:15 AM	17	14	0	31	38	0	0	38	0	59	0	59	128
08:30 AM	7	14	0	21	33	0	0	33	0	55	0	55	109
08:45 AM	11	11	0	22	33	0	0	33	0	35	0	35	90
Total	48	51	0	99	160	0	0	160	0	209	0	209	468
Grand Total	104	90	0	194	376	0	0	376	0	409	0	409	979
Apprch %	53.6	46.4	0		100	0	0		0	100	0		
Total %	10.6	9.2	0	19.8	38.4	0	0	38.4	0	41.8	0	41.8	
Passenger Vehicles	87	75	0	162	339	0	0	339	0	348	0	348	849
% Passenger Vehicles	83.7	83.3	0	83.5	90.2	0	0	90.2	0	85.1	0	85.1	86.7
Large 2 Axle Vehicles	7	3	0	10	28	0	0	28	0	30	0	30	68
% Large 2 Axle Vehicles	6.7	3.3	0	5.2	7.4	0	0	7.4	0	7.3	0	7.3	6.9
3 Axle Vehicles	2	3	0	5	0	0	0	0	0	8	0	8	13
% 3 Axle Vehicles	1.9	3.3	0	2.6	0	0	0	0	0	2	0	2	1.3
4+ Axle Trucks	8	9	0	17	9	0	0	9	0	23	0	23	49
% 4+ Axle Trucks	7.7	10	0	8.8	2.4	0	0	2.4	0	5.6	0	5.6	5

Start Time	SR-99 Southbound Off Ramp Southbound				Avenue 17 Westbound				Avenue 17 Eastbound				Int. Total
	Left	Right	U-Turns	App. Total	Thru	Right	U-Turns	App. Total	Left	Thru	U-Turns	App. Total	
Peak Hour Analysis From 07:00 AM to 08:45 AM - Peak 1 of 1													
Peak Hour for Entire Intersection Begins at 07:15 AM													
07:15 AM	14	9	0	23	59	0	0	59	0	51	0	51	133
07:30 AM	11	10	0	21	44	0	0	44	0	50	0	50	115
07:45 AM	21	11	0	32	71	0	0	71	0	48	0	48	151
08:00 AM	13	12	0	25	56	0	0	56	0	60	0	60	141
Total Volume	59	42	0	101	230	0	0	230	0	209	0	209	540
% App. Total	58.4	41.6	0		100	0	0		0	100	0		
PHF	.702	.875	.000	.789	.810	.000	.000	.810	.000	.871	.000	.871	.894

City of Madera
 N/S: SR-99 Southbound Off Ramp
 E/W: Avenue 17
 Weather: Clear

File Name : 12_MDA_99S Off Ramp_Ave 17 AM
 Site Code : 00319628
 Start Date : 9/18/2019
 Page No : 2

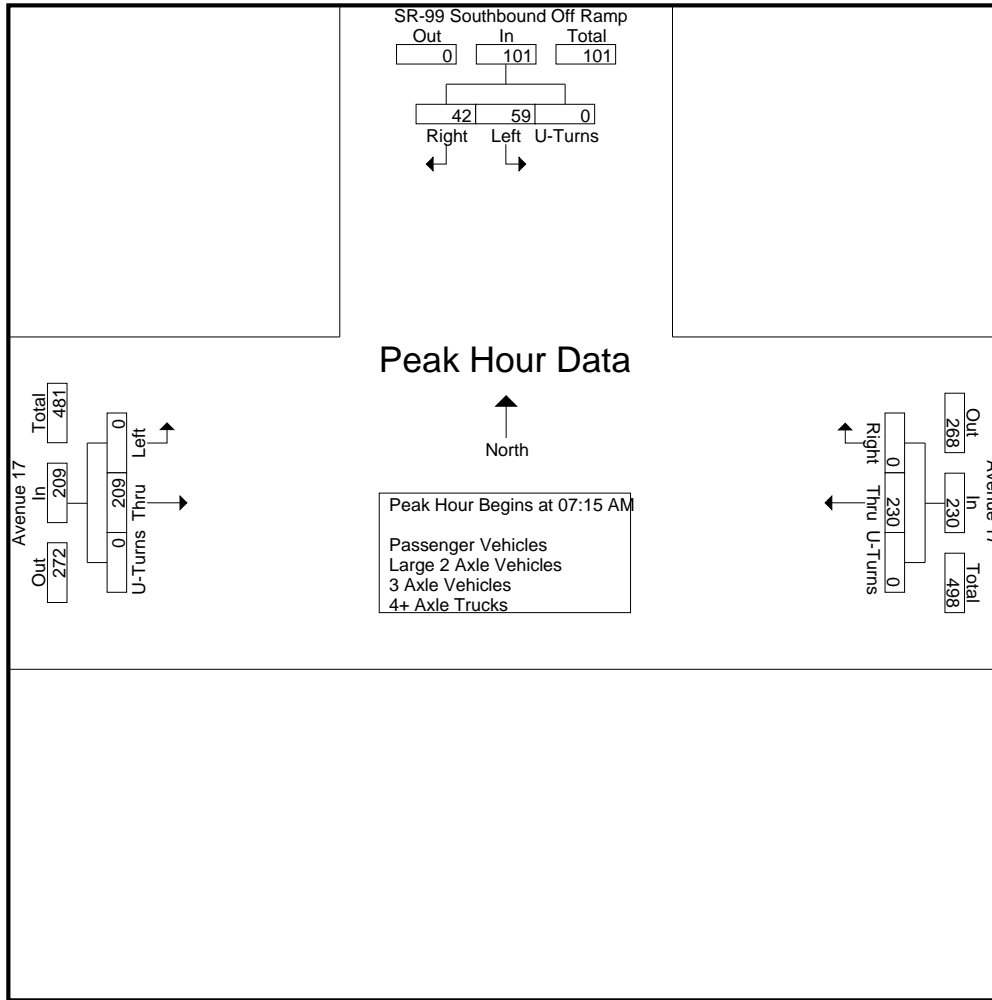

Peak Hour Analysis From 07:00 AM to 08:45 AM - Peak 1 of 1
 Peak Hour for Each Approach Begins at:

	07:30 AM				07:15 AM				07:45 AM			
+0 mins.	11	10	0	21	59	0	0	59	0	48	0	48
+15 mins.	21	11	0	32	44	0	0	44	0	60	0	60
+30 mins.	13	12	0	25	71	0	0	71	0	59	0	59
+45 mins.	17	14	0	31	56	0	0	56	0	55	0	55
Total Volume	62	47	0	109	230	0	0	230	0	222	0	222
% App. Total	56.9	43.1	0		100	0	0		0	100	0	
PHF	.738	.839	.000	.852	.810	.000	.000	.810	.000	.925	.000	.925

City of Madera
 N/S: SR-99 Southbound Off Ramp
 E/W: Avenue 17
 Weather: Clear

File Name : 12_MDA_99S Off Ramp_Ave 17 AM
 Site Code : 00319628
 Start Date : 9/18/2019
 Page No : 1

Groups Printed- Passenger Vehicles

Start Time	SR-99 Southbound Off Ramp Southbound				Avenue 17 Westbound				Avenue 17 Eastbound				Int. Total
	Left	Right	U-Turns	App. Total	Thru	Right	U-Turns	App. Total	Left	Thru	U-Turns	App. Total	
07:00 AM	7	8	0	15	34	0	0	34	0	43	0	43	92
07:15 AM	14	6	0	20	54	0	0	54	0	45	0	45	119
07:30 AM	9	7	0	16	42	0	0	42	0	42	0	42	100
07:45 AM	18	10	0	28	60	0	0	60	0	45	0	45	133
Total	48	31	0	79	190	0	0	190	0	175	0	175	444
08:00 AM	9	9	0	18	51	0	0	51	0	50	0	50	119
08:15 AM	16	14	0	30	37	0	0	37	0	48	0	48	115
08:30 AM	5	13	0	18	31	0	0	31	0	46	0	46	95
08:45 AM	9	8	0	17	30	0	0	30	0	29	0	29	76
Total	39	44	0	83	149	0	0	149	0	173	0	173	405
Grand Total	87	75	0	162	339	0	0	339	0	348	0	348	849
Apprch %	53.7	46.3	0		100	0	0		0	100	0		
Total %	10.2	8.8	0	19.1	39.9	0	0	39.9	0	41	0	41	

Start Time	SR-99 Southbound Off Ramp Southbound				Avenue 17 Westbound				Avenue 17 Eastbound				Int. Total
	Left	Right	U-Turns	App. Total	Thru	Right	U-Turns	App. Total	Left	Thru	U-Turns	App. Total	
Peak Hour Analysis From 07:15 AM to 08:00 AM - Peak 1 of 1													
Peak Hour for Entire Intersection Begins at 07:15 AM													
07:15 AM	14	6	0	20	54	0	0	54	0	45	0	45	119
07:30 AM	9	7	0	16	42	0	0	42	0	42	0	42	100
07:45 AM	18	10	0	28	60	0	0	60	0	45	0	45	133
08:00 AM	9	9	0	18	51	0	0	51	0	50	0	50	119
Total Volume	50	32	0	82	207	0	0	207	0	182	0	182	471
% App. Total	61	39	0		100	0	0		0	100	0		
PHF	.694	.800	.000	.732	.863	.000	.000	.863	.000	.910	.000	.910	.885

City of Madera
 N/S: SR-99 Southbound Off Ramp
 E/W: Avenue 17
 Weather: Clear

File Name : 12_MDA_99S Off Ramp_Ave 17 AM
 Site Code : 00319628
 Start Date : 9/18/2019
 Page No : 2

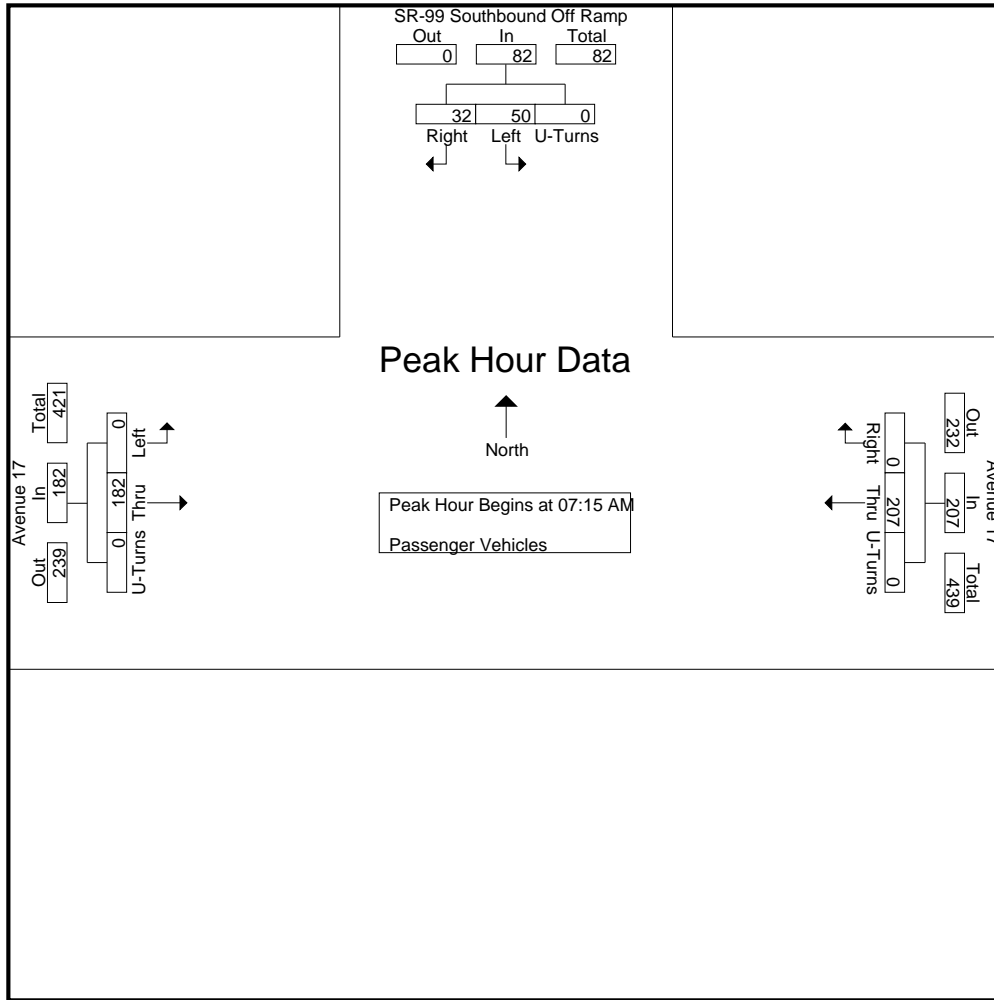

Peak Hour Analysis From 07:15 AM to 08:00 AM - Peak 1 of 1
 Peak Hour for Each Approach Begins at:

	07:15 AM				07:15 AM				07:15 AM			
+0 mins.	14	6	0	20	54	0	0	54	0	45	0	45
+15 mins.	9	7	0	16	42	0	0	42	0	42	0	42
+30 mins.	18	10	0	28	60	0	0	60	0	45	0	45
+45 mins.	9	9	0	18	51	0	0	51	0	50	0	50
Total Volume	50	32	0	82	207	0	0	207	0	182	0	182
% App. Total	61	39	0		100	0	0		0	100	0	
PHF	.694	.800	.000	.732	.863	.000	.000	.863	.000	.910	.000	.910

City of Madera
 N/S: SR-99 Southbound Off Ramp
 E/W: Avenue 17
 Weather: Clear

File Name : 12_MDA_99S Off Ramp_Ave 17 AM
 Site Code : 00319628
 Start Date : 9/18/2019
 Page No : 1

Groups Printed- Large 2 Axle Vehicles

Start Time	SR-99 Southbound Off Ramp Southbound				Avenue 17 Westbound				Avenue 17 Eastbound				Int. Total
	Left	Right	U-Turns	App. Total	Thru	Right	U-Turns	App. Total	Left	Thru	U-Turns	App. Total	
07:00 AM	2	0	0	2	6	0	0	6	0	3	0	3	11
07:15 AM	0	0	0	0	4	0	0	4	0	2	0	2	6
07:30 AM	1	1	0	2	1	0	0	1	0	4	0	4	7
07:45 AM	1	0	0	1	9	0	0	9	0	3	0	3	13
Total	4	1	0	5	20	0	0	20	0	12	0	12	37
08:00 AM	1	1	0	2	4	0	0	4	0	6	0	6	12
08:15 AM	1	0	0	1	0	0	0	0	0	6	0	6	7
08:30 AM	1	1	0	2	2	0	0	2	0	3	0	3	7
08:45 AM	0	0	0	0	2	0	0	2	0	3	0	3	5
Total	3	2	0	5	8	0	0	8	0	18	0	18	31
Grand Total	7	3	0	10	28	0	0	28	0	30	0	30	68
Apprch %	70	30	0		100	0	0		0	100	0		
Total %	10.3	4.4	0	14.7	41.2	0	0	41.2	0	44.1	0	44.1	

Start Time	SR-99 Southbound Off Ramp Southbound				Avenue 17 Westbound				Avenue 17 Eastbound				Int. Total
	Left	Right	U-Turns	App. Total	Thru	Right	U-Turns	App. Total	Left	Thru	U-Turns	App. Total	
07:15 AM	0	0	0	0	4	0	0	4	0	2	0	2	6
07:30 AM	1	1	0	2	1	0	0	1	0	4	0	4	7
07:45 AM	1	0	0	1	9	0	0	9	0	3	0	3	13
08:00 AM	1	1	0	2	4	0	0	4	0	6	0	6	12
Total Volume	3	2	0	5	18	0	0	18	0	15	0	15	38
% App. Total	60	40	0		100	0	0		0	100	0		
PHF	.750	.500	.000	.625	.500	.000	.000	.500	.000	.625	.000	.625	.731

Peak Hour Analysis From 07:15 AM to 08:00 AM - Peak 1 of 1

Peak Hour for Entire Intersection Begins at 07:15 AM

City of Madera
 N/S: SR-99 Southbound Off Ramp
 E/W: Avenue 17
 Weather: Clear

File Name : 12_MDA_99S Off Ramp_Ave 17 AM
 Site Code : 00319628
 Start Date : 9/18/2019
 Page No : 2

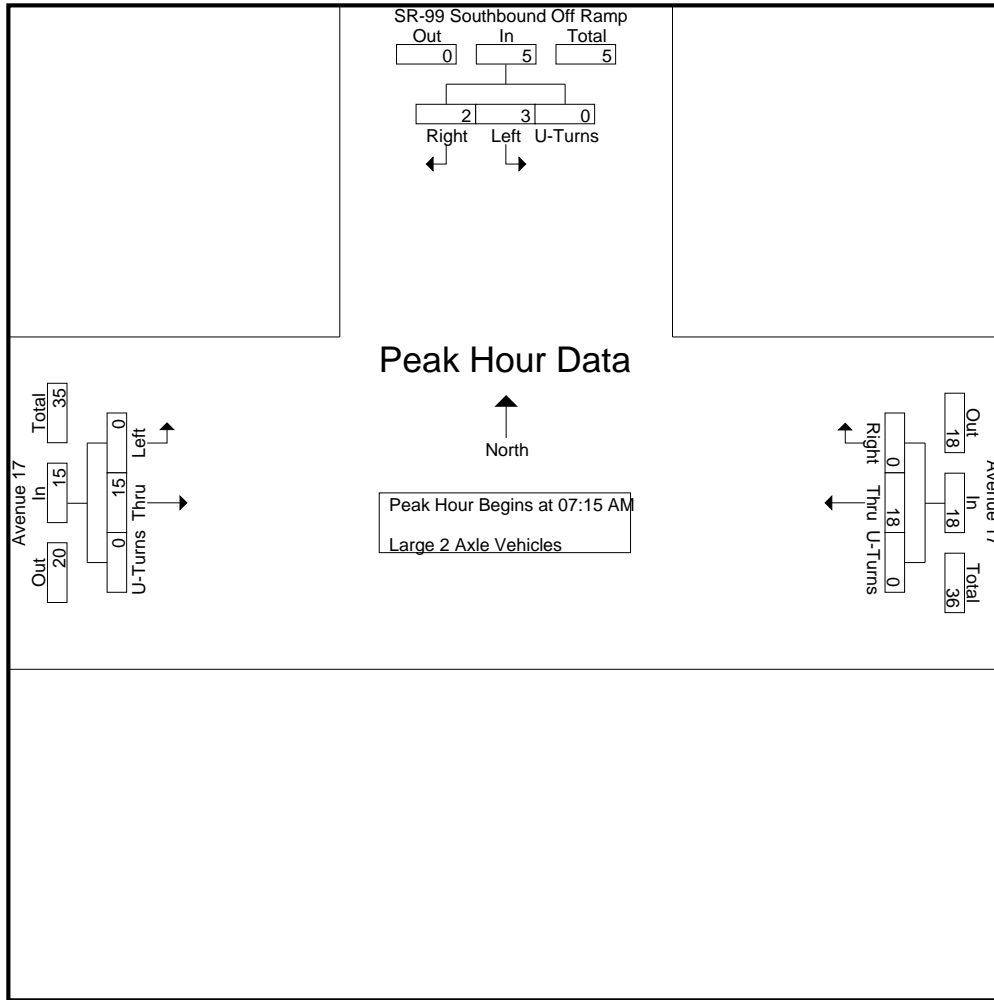

Peak Hour Analysis From 07:15 AM to 08:00 AM - Peak 1 of 1
 Peak Hour for Each Approach Begins at:

	07:15 AM				07:15 AM				07:15 AM			
+0 mins.	0	0	0	0	4	0	0	4	0	2	0	2
+15 mins.	1	1	0	2	1	0	0	1	0	4	0	4
+30 mins.	1	0	0	1	9	0	0	9	0	3	0	3
+45 mins.	1	1	0	2	4	0	0	4	0	6	0	6
Total Volume	3	2	0	5	18	0	0	18	0	15	0	15
% App. Total	60	40	0		100	0	0		0	100	0	
PHF	.750	.500	.000	.625	.500	.000	.000	.500	.000	.625	.000	.625

City of Madera
 N/S: SR-99 Southbound Off Ramp
 E/W: Avenue 17
 Weather: Clear

File Name : 12_MDA_99S Off Ramp_Ave 17 AM
 Site Code : 00319628
 Start Date : 9/18/2019
 Page No : 1

Groups Printed- 3 Axle Vehicles

Start Time	SR-99 Southbound Off Ramp Southbound				Avenue 17 Westbound				Avenue 17 Eastbound				Int. Total
	Left	Right	U-Turns	App. Total	Thru	Right	U-Turns	App. Total	Left	Thru	U-Turns	App. Total	
07:00 AM	0	0	0	0	0	0	0	0	0	2	0	2	2
07:15 AM	0	1	0	1	0	0	0	0	0	1	0	1	2
07:30 AM	0	1	0	1	0	0	0	0	0	1	0	1	2
07:45 AM	0	0	0	0	0	0	0	0	0	0	0	0	0
Total	0	2	0	2	0	0	0	0	0	4	0	4	6
08:00 AM	2	1	0	3	0	0	0	0	0	0	0	0	3
08:15 AM	0	0	0	0	0	0	0	0	0	0	0	0	0
08:30 AM	0	0	0	0	0	0	0	0	0	1	0	1	1
08:45 AM	0	0	0	0	0	0	0	0	0	3	0	3	3
Total	2	1	0	3	0	0	0	0	0	4	0	4	7
Grand Total	2	3	0	5	0	0	0	0	0	8	0	8	13
Apprch %	40	60	0		0	0	0		0	100	0		
Total %	15.4	23.1	0	38.5	0	0	0	0	0	61.5	0	61.5	

Start Time	SR-99 Southbound Off Ramp Southbound				Avenue 17 Westbound				Avenue 17 Eastbound				Int. Total
	Left	Right	U-Turns	App. Total	Thru	Right	U-Turns	App. Total	Left	Thru	U-Turns	App. Total	
07:15 AM	0	1	0	1	0	0	0	0	0	1	0	1	2
07:30 AM	0	1	0	1	0	0	0	0	0	1	0	1	2
07:45 AM	0	0	0	0	0	0	0	0	0	0	0	0	0
08:00 AM	2	1	0	3	0	0	0	0	0	0	0	0	3
Total Volume	2	3	0	5	0	0	0	0	0	2	0	2	7
% App. Total	40	60	0		0	0	0		0	100	0		
PHF	.250	.750	.000	.417	.000	.000	.000	.000	.000	.500	.000	.500	.583

Peak Hour Analysis From 07:15 AM to 08:00 AM - Peak 1 of 1

Peak Hour for Entire Intersection Begins at 07:15 AM

City of Madera
 N/S: SR-99 Southbound Off Ramp
 E/W: Avenue 17
 Weather: Clear

File Name : 12_MDA_99S Off Ramp_Ave 17 AM
 Site Code : 00319628
 Start Date : 9/18/2019
 Page No : 2

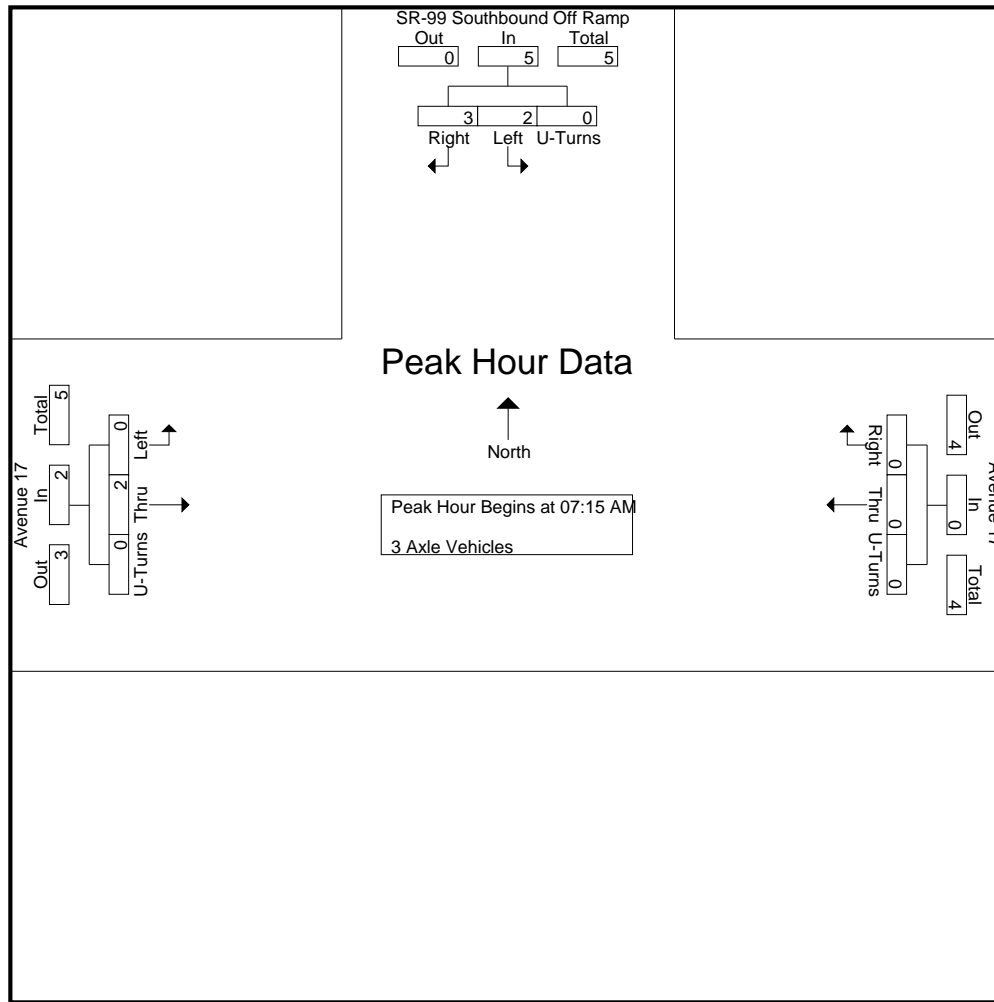

Peak Hour Analysis From 07:15 AM to 08:00 AM - Peak 1 of 1
 Peak Hour for Each Approach Begins at:

	07:15 AM				07:15 AM				07:15 AM			
+0 mins.	0	1	0	1	0	0	0	0	0	1	0	1
+15 mins.	0	1	0	1	0	0	0	0	0	1	0	1
+30 mins.	0	0	0	0	0	0	0	0	0	0	0	0
+45 mins.	2	1	0	3	0	0	0	0	0	0	0	0
Total Volume	2	3	0	5	0	0	0	0	0	2	0	2
% App. Total	40	60	0		0	0	0		0	100	0	
PHF	.250	.750	.000	.417	.000	.000	.000	.000	.000	.500	.000	.500

City of Madera
 N/S: SR-99 Southbound Off Ramp
 E/W: Avenue 17
 Weather: Clear

File Name : 12_MDA_99S Off Ramp_Ave 17 AM
 Site Code : 00319628
 Start Date : 9/18/2019
 Page No : 1

Groups Printed- 4+ Axle Trucks

Start Time	SR-99 Southbound Off Ramp Southbound				Avenue 17 Westbound				Avenue 17 Eastbound				Int. Total
	Left	Right	U-Turns	App. Total	Thru	Right	U-Turns	App. Total	Left	Thru	U-Turns	App. Total	
07:00 AM	1	1	0	2	2	0	0	2	0	3	0	3	7
07:15 AM	0	2	0	2	1	0	0	1	0	3	0	3	6
07:30 AM	1	1	0	2	1	0	0	1	0	3	0	3	6
07:45 AM	2	1	0	3	2	0	0	2	0	0	0	0	5
Total	4	5	0	9	6	0	0	6	0	9	0	9	24
08:00 AM	1	1	0	2	1	0	0	1	0	4	0	4	7
08:15 AM	0	0	0	0	1	0	0	1	0	5	0	5	6
08:30 AM	1	0	0	1	0	0	0	0	0	5	0	5	6
08:45 AM	2	3	0	5	1	0	0	1	0	0	0	0	6
Total	4	4	0	8	3	0	0	3	0	14	0	14	25
Grand Total	8	9	0	17	9	0	0	9	0	23	0	23	49
Apprch %	47.1	52.9	0		100	0	0		0	100	0		
Total %	16.3	18.4	0	34.7	18.4	0	0	18.4	0	46.9	0	46.9	

Start Time	SR-99 Southbound Off Ramp Southbound				Avenue 17 Westbound				Avenue 17 Eastbound				Int. Total
	Left	Right	U-Turns	App. Total	Thru	Right	U-Turns	App. Total	Left	Thru	U-Turns	App. Total	
07:15 AM	0	2	0	2	1	0	0	1	0	3	0	3	6
07:30 AM	1	1	0	2	1	0	0	1	0	3	0	3	6
07:45 AM	2	1	0	3	2	0	0	2	0	0	0	0	5
08:00 AM	1	1	0	2	1	0	0	1	0	4	0	4	7
Total Volume	4	5	0	9	5	0	0	5	0	10	0	10	24
% App. Total	44.4	55.6	0		100	0	0		0	100	0		
PHF	.500	.625	.000	.750	.625	.000	.000	.625	.000	.625	.000	.625	.857

Peak Hour Analysis From 07:15 AM to 08:00 AM - Peak 1 of 1

Peak Hour for Entire Intersection Begins at 07:15 AM

City of Madera
 N/S: SR-99 Southbound Off Ramp
 E/W: Avenue 17
 Weather: Clear

File Name : 12_MDA_99S Off Ramp_Ave 17 AM
 Site Code : 00319628
 Start Date : 9/18/2019
 Page No : 2

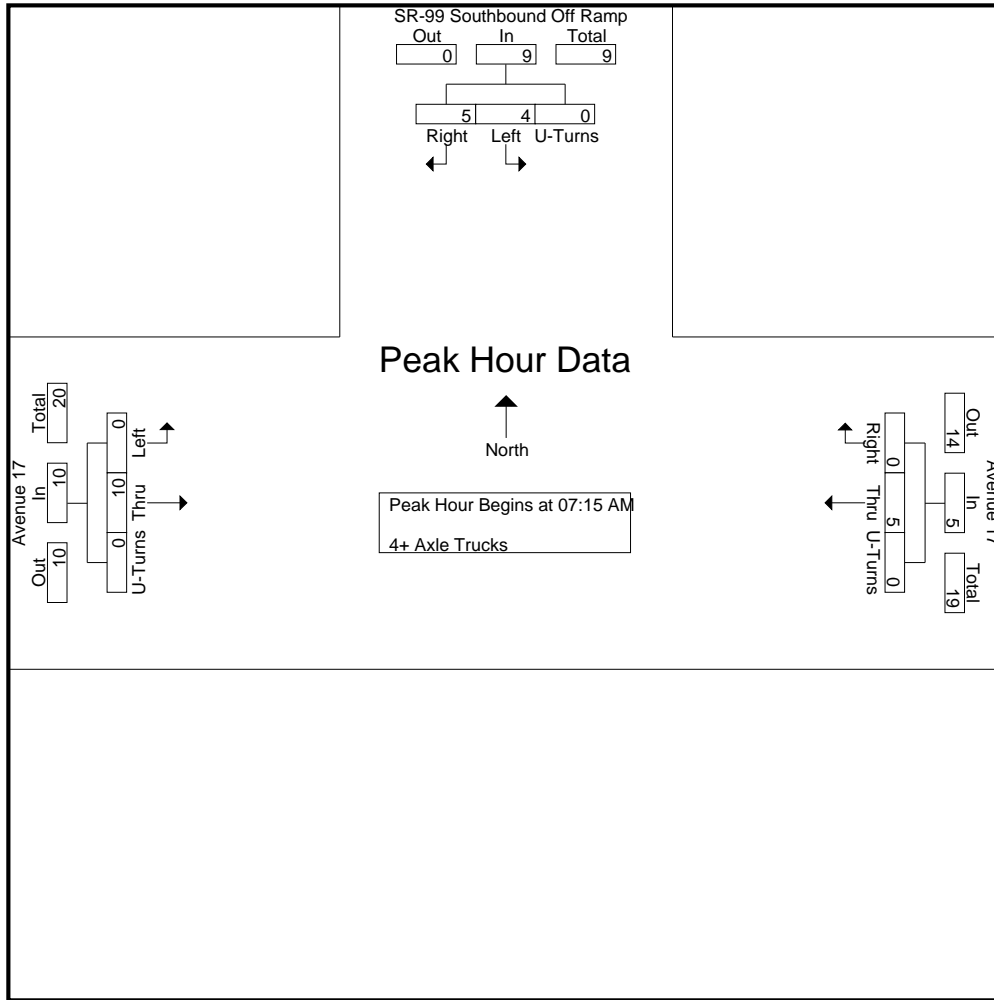

Peak Hour Analysis From 07:15 AM to 08:00 AM - Peak 1 of 1
 Peak Hour for Each Approach Begins at:

	07:15 AM				07:15 AM				07:15 AM			
+0 mins.	0	2	0	2	1	0	0	1	0	3	0	3
+15 mins.	1	1	0	2	1	0	0	1	0	3	0	3
+30 mins.	2	1	0	3	2	0	0	2	0	0	0	0
+45 mins.	1	1	0	2	1	0	0	1	0	4	0	4
Total Volume	4	5	0	9	5	0	0	5	0	10	0	10
% App. Total	44.4	55.6	0		100	0	0		0	100	0	
PHF	.500	.625	.000	.750	.625	.000	.000	.625	.000	.625	.000	.625

City of Madera
 N/S: SR-99 Southbound Off Ramp
 E/W: Avenue 17
 Weather: Clear

File Name : 12_MDA_99S Off Ramp_Ave 17 PM
 Site Code : 00319628
 Start Date : 9/18/2019
 Page No : 1

Groups Printed- Passenger Vehicles - Large 2 Axle Vehicles - 3 Axle Vehicles - 4+ Axle Trucks

Start Time	SR-99 Southbound Off Ramp Southbound				Avenue 17 Westbound				Avenue 17 Eastbound				Int. Total
	Left	Right	U-Turns	App. Total	Thru	Right	U-Turns	App. Total	Left	Thru	U-Turns	App. Total	
04:00 PM	28	15	0	43	44	0	0	44	0	133	0	133	220
04:15 PM	40	8	0	48	42	0	0	42	0	103	0	103	193
04:30 PM	38	10	0	48	35	0	0	35	0	123	0	123	206
04:45 PM	47	10	0	57	36	0	0	36	0	100	0	100	193
Total	153	43	0	196	157	0	0	157	0	459	0	459	812
05:00 PM	36	18	0	54	54	0	0	54	0	95	0	95	203
05:15 PM	37	7	0	44	48	0	0	48	0	69	0	69	161
05:30 PM	35	9	0	44	47	0	0	47	0	48	0	48	139
05:45 PM	25	10	0	35	46	0	0	46	0	53	0	53	134
Total	133	44	0	177	195	0	0	195	0	265	0	265	637
Grand Total	286	87	0	373	352	0	0	352	0	724	0	724	1449
Apprch %	76.7	23.3	0		100	0	0		0	100	0		
Total %	19.7	6	0	25.7	24.3	0	0	24.3	0	50	0	50	
Passenger Vehicles	269	79	0	348	329	0	0	329	0	686	0	686	1363
% Passenger Vehicles	94.1	90.8	0	93.3	93.5	0	0	93.5	0	94.8	0	94.8	94.1
Large 2 Axle Vehicles	8	3	0	11	12	0	0	12	0	16	0	16	39
% Large 2 Axle Vehicles	2.8	3.4	0	2.9	3.4	0	0	3.4	0	2.2	0	2.2	2.7
3 Axle Vehicles	2	1	0	3	3	0	0	3	0	4	0	4	10
% 3 Axle Vehicles	0.7	1.1	0	0.8	0.9	0	0	0.9	0	0.6	0	0.6	0.7
4+ Axle Trucks	7	4	0	11	8	0	0	8	0	18	0	18	37
% 4+ Axle Trucks	2.4	4.6	0	2.9	2.3	0	0	2.3	0	2.5	0	2.5	2.6

Start Time	SR-99 Southbound Off Ramp Southbound				Avenue 17 Westbound				Avenue 17 Eastbound				Int. Total
	Left	Right	U-Turns	App. Total	Thru	Right	U-Turns	App. Total	Left	Thru	U-Turns	App. Total	
Peak Hour Analysis From 04:00 PM to 05:45 PM - Peak 1 of 1													
Peak Hour for Entire Intersection Begins at 04:00 PM													
04:00 PM	28	15	0	43	44	0	0	44	0	133	0	133	220
04:15 PM	40	8	0	48	42	0	0	42	0	103	0	103	193
04:30 PM	38	10	0	48	35	0	0	35	0	123	0	123	206
04:45 PM	47	10	0	57	36	0	0	36	0	100	0	100	193
Total Volume	153	43	0	196	157	0	0	157	0	459	0	459	812
% App. Total	78.1	21.9	0		100	0	0		0	100	0		
PHF	.814	.717	.000	.860	.892	.000	.000	.892	.000	.863	.000	.863	.923

City of Madera
 N/S: SR-99 Southbound Off Ramp
 E/W: Avenue 17
 Weather: Clear

File Name : 12_MDA_99S Off Ramp_Ave 17 PM
 Site Code : 00319628
 Start Date : 9/18/2019
 Page No : 2

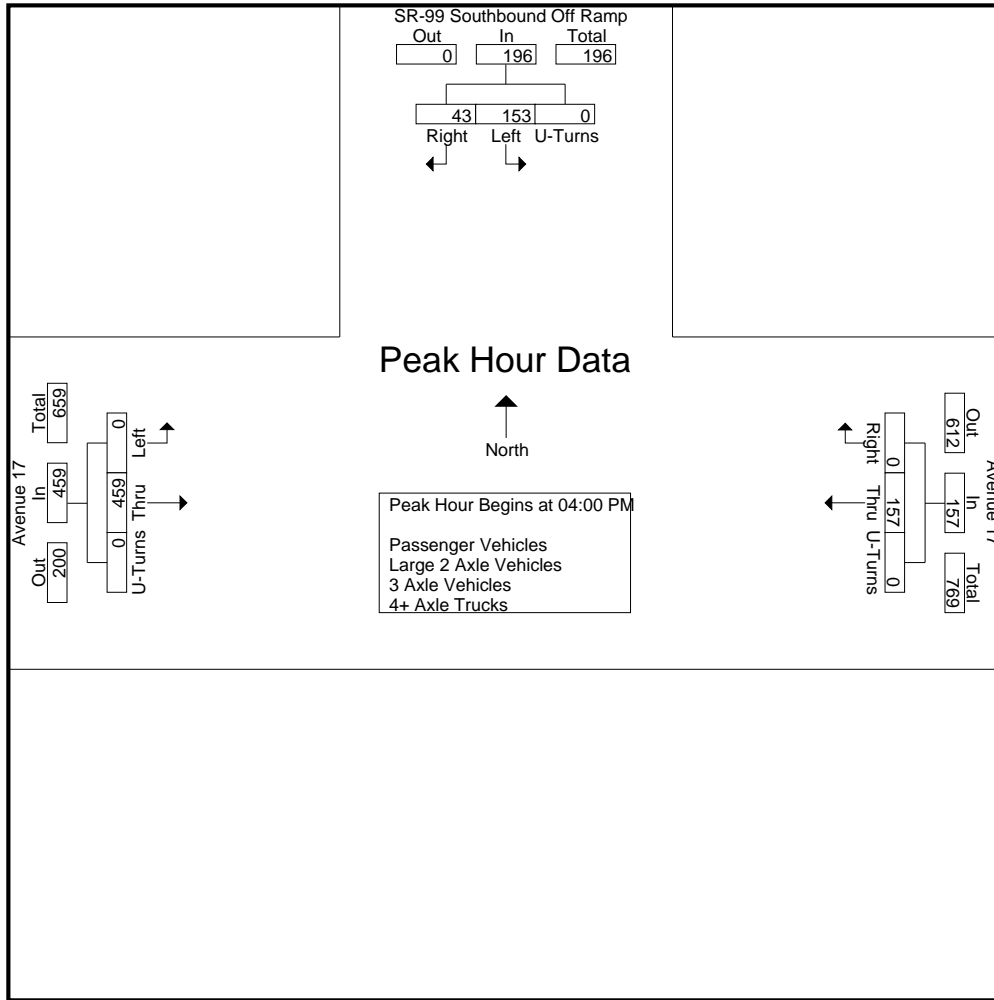

Peak Hour Analysis From 04:00 PM to 05:45 PM - Peak 1 of 1
 Peak Hour for Each Approach Begins at:

	04:15 PM				05:00 PM				04:00 PM			
+0 mins.	40	8	0	48	54	0	0	54	0	133	0	133
+15 mins.	38	10	0	48	48	0	0	48	0	103	0	103
+30 mins.	47	10	0	57	47	0	0	47	0	123	0	123
+45 mins.	36	18	0	54	46	0	0	46	0	100	0	100
Total Volume	161	46	0	207	195	0	0	195	0	459	0	459
% App. Total	77.8	22.2	0		100	0	0		0	100	0	
PHF	.856	.639	.000	.908	.903	.000	.000	.903	.000	.863	.000	.863

City of Madera
 N/S: SR-99 Southbound Off Ramp
 E/W: Avenue 17
 Weather: Clear

File Name : 12_MDA_99S Off Ramp_Ave 17 PM
 Site Code : 00319628
 Start Date : 9/18/2019
 Page No : 1

Groups Printed- Passenger Vehicles

Start Time	SR-99 Southbound Off Ramp Southbound				Avenue 17 Westbound				Avenue 17 Eastbound				Int. Total
	Left	Right	U-Turns	App. Total	Thru	Right	U-Turns	App. Total	Left	Thru	U-Turns	App. Total	
04:00 PM	28	14	0	42	40	0	0	40	0	131	0	131	213
04:15 PM	40	8	0	48	39	0	0	39	0	95	0	95	182
04:30 PM	36	8	0	44	32	0	0	32	0	116	0	116	192
04:45 PM	44	9	0	53	33	0	0	33	0	97	0	97	183
Total	148	39	0	187	144	0	0	144	0	439	0	439	770
05:00 PM	33	17	0	50	50	0	0	50	0	94	0	94	194
05:15 PM	34	6	0	40	46	0	0	46	0	61	0	61	147
05:30 PM	30	8	0	38	45	0	0	45	0	45	0	45	128
05:45 PM	24	9	0	33	44	0	0	44	0	47	0	47	124
Total	121	40	0	161	185	0	0	185	0	247	0	247	593
Grand Total	269	79	0	348	329	0	0	329	0	686	0	686	1363
Apprch %	77.3	22.7	0		100	0	0		0	100	0		
Total %	19.7	5.8	0	25.5	24.1	0	0	24.1	0	50.3	0	50.3	

Start Time	SR-99 Southbound Off Ramp Southbound				Avenue 17 Westbound				Avenue 17 Eastbound				Int. Total
	Left	Right	U-Turns	App. Total	Thru	Right	U-Turns	App. Total	Left	Thru	U-Turns	App. Total	
Peak Hour Analysis From 04:00 PM to 04:45 PM - Peak 1 of 1													
Peak Hour for Entire Intersection Begins at 04:00 PM													
04:00 PM	28	14	0	42	40	0	0	40	0	131	0	131	213
04:15 PM	40	8	0	48	39	0	0	39	0	95	0	95	182
04:30 PM	36	8	0	44	32	0	0	32	0	116	0	116	192
04:45 PM	44	9	0	53	33	0	0	33	0	97	0	97	183
Total Volume	148	39	0	187	144	0	0	144	0	439	0	439	770
% App. Total	79.1	20.9	0		100	0	0		0	100	0		
PHF	.841	.696	.000	.882	.900	.000	.000	.900	.000	.838	.000	.838	.904

City of Madera
 N/S: SR-99 Southbound Off Ramp
 E/W: Avenue 17
 Weather: Clear

File Name : 12_MDA_99S Off Ramp_Ave 17 PM
 Site Code : 00319628
 Start Date : 9/18/2019
 Page No : 2

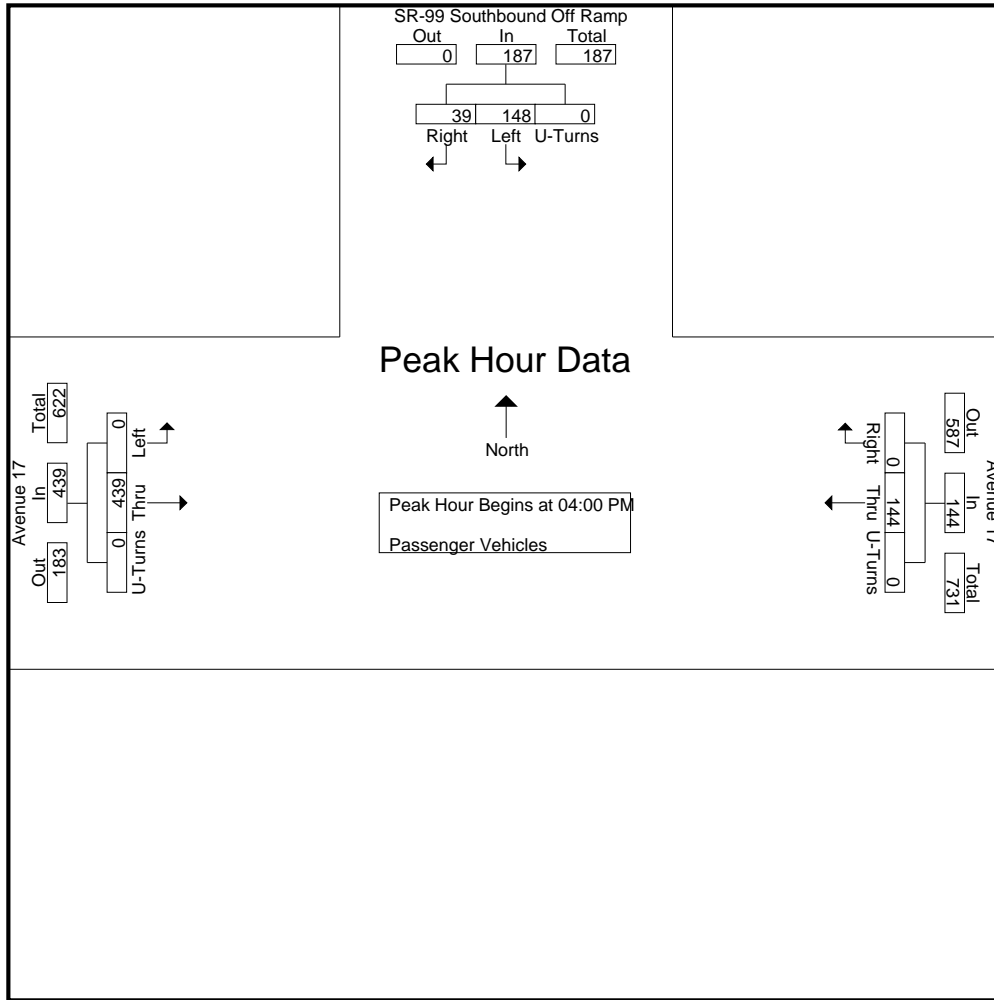

Peak Hour Analysis From 04:00 PM to 04:45 PM - Peak 1 of 1
 Peak Hour for Each Approach Begins at:

	04:00 PM				04:00 PM				04:00 PM			
+0 mins.	28	14	0	42	40	0	0	40	0	131	0	131
+15 mins.	40	8	0	48	39	0	0	39	0	95	0	95
+30 mins.	36	8	0	44	32	0	0	32	0	116	0	116
+45 mins.	44	9	0	53	33	0	0	33	0	97	0	97
Total Volume	148	39	0	187	144	0	0	144	0	439	0	439
% App. Total	79.1	20.9	0		100	0	0		0	100	0	
PHF	.841	.696	.000	.882	.900	.000	.000	.900	.000	.838	.000	.838

City of Madera
 N/S: SR-99 Southbound Off Ramp
 E/W: Avenue 17
 Weather: Clear

File Name : 12_MDA_99S Off Ramp_Ave 17 PM
 Site Code : 00319628
 Start Date : 9/18/2019
 Page No : 1

Groups Printed- Large 2 Axle Vehicles

Start Time	SR-99 Southbound Off Ramp Southbound				Avenue 17 Westbound				Avenue 17 Eastbound				Int. Total
	Left	Right	U-Turns	App. Total	Thru	Right	U-Turns	App. Total	Left	Thru	U-Turns	App. Total	
04:00 PM	0	0	0	0	2	0	0	2	0	1	0	1	3
04:15 PM	0	0	0	0	2	0	0	2	0	3	0	3	5
04:30 PM	1	1	0	2	2	0	0	2	0	4	0	4	8
04:45 PM	2	0	0	2	2	0	0	2	0	1	0	1	5
Total	3	1	0	4	8	0	0	8	0	9	0	9	21
05:00 PM	2	1	0	3	2	0	0	2	0	1	0	1	6
05:15 PM	1	0	0	1	0	0	0	0	0	3	0	3	4
05:30 PM	2	0	0	2	1	0	0	1	0	1	0	1	4
05:45 PM	0	1	0	1	1	0	0	1	0	2	0	2	4
Total	5	2	0	7	4	0	0	4	0	7	0	7	18
Grand Total	8	3	0	11	12	0	0	12	0	16	0	16	39
Apprch %	72.7	27.3	0		100	0	0		0	100	0		
Total %	20.5	7.7	0	28.2	30.8	0	0	30.8	0	41	0	41	

Start Time	SR-99 Southbound Off Ramp Southbound				Avenue 17 Westbound				Avenue 17 Eastbound				Int. Total
	Left	Right	U-Turns	App. Total	Thru	Right	U-Turns	App. Total	Left	Thru	U-Turns	App. Total	
04:00 PM	0	0	0	0	2	0	0	2	0	1	0	1	3
04:15 PM	0	0	0	0	2	0	0	2	0	3	0	3	5
04:30 PM	1	1	0	2	2	0	0	2	0	4	0	4	8
04:45 PM	2	0	0	2	2	0	0	2	0	1	0	1	5
Total Volume	3	1	0	4	8	0	0	8	0	9	0	9	21
% App. Total	75	25	0		100	0	0		0	100	0		
PHF	.375	.250	.000	.500	1.00	.000	.000	1.00	.000	.563	.000	.563	.656

Peak Hour Analysis From 04:00 PM to 04:45 PM - Peak 1 of 1

Peak Hour for Entire Intersection Begins at 04:00 PM

City of Madera
 N/S: SR-99 Southbound Off Ramp
 E/W: Avenue 17
 Weather: Clear

File Name : 12_MDA_99S Off Ramp_Ave 17 PM
 Site Code : 00319628
 Start Date : 9/18/2019
 Page No : 2

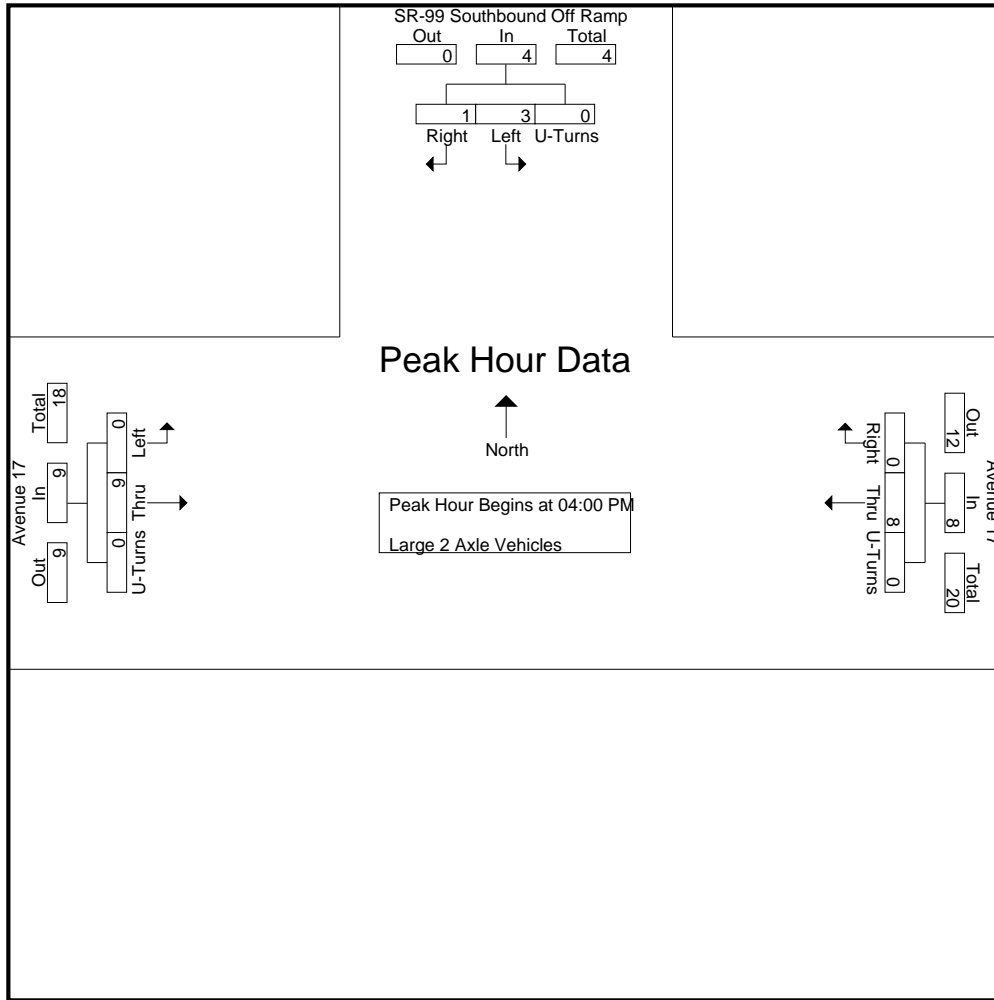

Peak Hour Analysis From 04:00 PM to 04:45 PM - Peak 1 of 1
 Peak Hour for Each Approach Begins at:

	04:00 PM				04:00 PM				04:00 PM			
+0 mins.	0	0	0	0	2	0	0	2	0	1	0	1
+15 mins.	0	0	0	0	2	0	0	2	0	3	0	3
+30 mins.	1	1	0	2	2	0	0	2	0	4	0	4
+45 mins.	2	0	0	2	2	0	0	2	0	1	0	1
Total Volume	3	1	0	4	8	0	0	8	0	9	0	9
% App. Total	75	25	0		100	0	0		0	100	0	
PHF	.375	.250	.000	.500	1.000	.000	.000	1.000	.000	.563	.000	.563

City of Madera
 N/S: SR-99 Southbound Off Ramp
 E/W: Avenue 17
 Weather: Clear

File Name : 12_MDA_99S Off Ramp_Ave 17 PM
 Site Code : 00319628
 Start Date : 9/18/2019
 Page No : 1

Groups Printed- 3 Axle Vehicles

Start Time	SR-99 Southbound Off Ramp Southbound				Avenue 17 Westbound				Avenue 17 Eastbound				Int. Total
	Left	Right	U-Turns	App. Total	Thru	Right	U-Turns	App. Total	Left	Thru	U-Turns	App. Total	
04:00 PM	0	0	0	0	1	0	0	1	0	0	0	0	1
04:15 PM	0	0	0	0	0	0	0	0	0	2	0	2	2
04:30 PM	0	0	0	0	0	0	0	0	0	0	0	0	0
04:45 PM	0	0	0	0	0	0	0	0	0	0	0	0	0
Total	0	0	0	0	1	0	0	1	0	2	0	2	3
05:00 PM	0	0	0	0	1	0	0	1	0	0	0	0	1
05:15 PM	1	0	0	1	0	0	0	0	0	1	0	1	2
05:30 PM	0	1	0	1	0	0	0	0	0	0	0	0	1
05:45 PM	1	0	0	1	1	0	0	1	0	1	0	1	3
Total	2	1	0	3	2	0	0	2	0	2	0	2	7
Grand Total	2	1	0	3	3	0	0	3	0	4	0	4	10
Apprch %	66.7	33.3	0		100	0	0		0	100	0		
Total %	20	10	0	30	30	0	0	30	0	40	0	40	

Start Time	SR-99 Southbound Off Ramp Southbound				Avenue 17 Westbound				Avenue 17 Eastbound				Int. Total
	Left	Right	U-Turns	App. Total	Thru	Right	U-Turns	App. Total	Left	Thru	U-Turns	App. Total	
04:00 PM	0	0	0	0	1	0	0	1	0	0	0	0	1
04:15 PM	0	0	0	0	0	0	0	0	0	2	0	2	2
04:30 PM	0	0	0	0	0	0	0	0	0	0	0	0	0
04:45 PM	0	0	0	0	0	0	0	0	0	0	0	0	0
Total Volume	0	0	0	0	1	0	0	1	0	2	0	2	3
% App. Total	0	0	0		100	0	0		0	100	0		
PHF	.000	.000	.000	.000	.250	.000	.000	.250	.000	.250	.000	.250	.375

Peak Hour Analysis From 04:00 PM to 04:45 PM - Peak 1 of 1

Peak Hour for Entire Intersection Begins at 04:00 PM

City of Madera
 N/S: SR-99 Southbound Off Ramp
 E/W: Avenue 17
 Weather: Clear

File Name : 12_MDA_99S Off Ramp_Ave 17 PM
 Site Code : 00319628
 Start Date : 9/18/2019
 Page No : 2

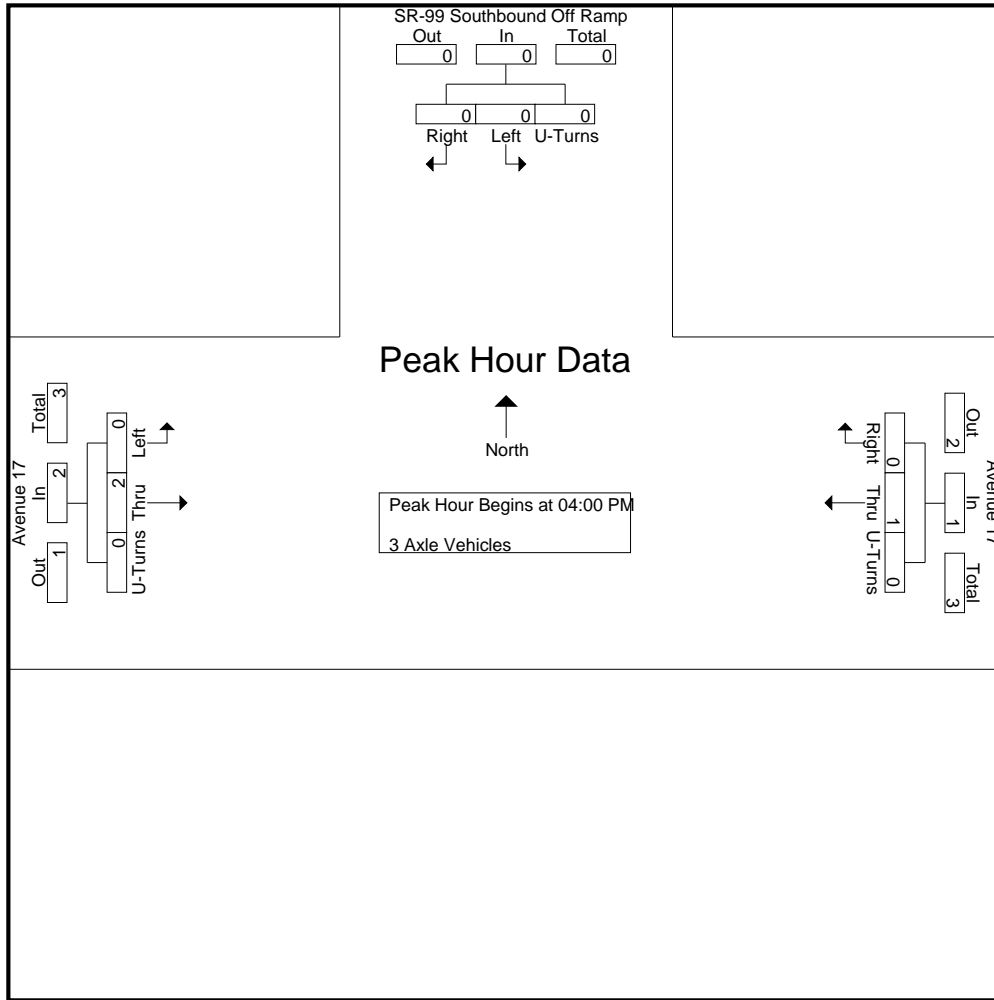

Peak Hour Analysis From 04:00 PM to 04:45 PM - Peak 1 of 1
 Peak Hour for Each Approach Begins at:

	04:00 PM				04:00 PM				04:00 PM			
+0 mins.	0	0	0	0	1	0	0	1	0	0	0	0
+15 mins.	0	0	0	0	0	0	0	0	0	2	0	2
+30 mins.	0	0	0	0	0	0	0	0	0	0	0	0
+45 mins.	0	0	0	0	0	0	0	0	0	0	0	0
Total Volume	0	0	0	0	1	0	0	1	0	2	0	2
% App. Total	0	0	0	0	100	0	0	0	0	100	0	0
PHF	.000	.000	.000	.000	.250	.000	.000	.250	.000	.250	.000	.250

City of Madera
 N/S: SR-99 Southbound Off Ramp
 E/W: Avenue 17
 Weather: Clear

File Name : 12_MDA_99S Off Ramp_Ave 17 PM
 Site Code : 00319628
 Start Date : 9/18/2019
 Page No : 1

Groups Printed- 4+ Axle Trucks

Start Time	SR-99 Southbound Off Ramp Southbound				Avenue 17 Westbound				Avenue 17 Eastbound				Int. Total
	Left	Right	U-Turns	App. Total	Thru	Right	U-Turns	App. Total	Left	Thru	U-Turns	App. Total	
04:00 PM	0	1	0	1	1	0	0	1	0	1	0	1	3
04:15 PM	0	0	0	0	1	0	0	1	0	3	0	3	4
04:30 PM	1	1	0	2	1	0	0	1	0	3	0	3	6
04:45 PM	1	1	0	2	1	0	0	1	0	2	0	2	5
Total	2	3	0	5	4	0	0	4	0	9	0	9	18
05:00 PM	1	0	0	1	1	0	0	1	0	0	0	0	2
05:15 PM	1	1	0	2	2	0	0	2	0	4	0	4	8
05:30 PM	3	0	0	3	1	0	0	1	0	2	0	2	6
05:45 PM	0	0	0	0	0	0	0	0	0	3	0	3	3
Total	5	1	0	6	4	0	0	4	0	9	0	9	19
Grand Total	7	4	0	11	8	0	0	8	0	18	0	18	37
Apprch %	63.6	36.4	0		100	0	0		0	100	0		
Total %	18.9	10.8	0	29.7	21.6	0	0	21.6	0	48.6	0	48.6	

Start Time	SR-99 Southbound Off Ramp Southbound				Avenue 17 Westbound				Avenue 17 Eastbound				Int. Total
	Left	Right	U-Turns	App. Total	Thru	Right	U-Turns	App. Total	Left	Thru	U-Turns	App. Total	
04:00 PM	0	1	0	1	1	0	0	1	0	1	0	1	3
04:15 PM	0	0	0	0	1	0	0	1	0	3	0	3	4
04:30 PM	1	1	0	2	1	0	0	1	0	3	0	3	6
04:45 PM	1	1	0	2	1	0	0	1	0	2	0	2	5
Total Volume	2	3	0	5	4	0	0	4	0	9	0	9	18
% App. Total	40	60	0		100	0	0		0	100	0		
PHF	.500	.750	.000	.625	1.00	.000	.000	1.00	.000	.750	.000	.750	.750

Peak Hour Analysis From 04:00 PM to 04:45 PM - Peak 1 of 1

Peak Hour for Entire Intersection Begins at 04:00 PM

City of Madera
 N/S: SR-99 Southbound Off Ramp
 E/W: Avenue 17
 Weather: Clear

File Name : 12_MDA_99S Off Ramp_Ave 17 PM
 Site Code : 00319628
 Start Date : 9/18/2019
 Page No : 2

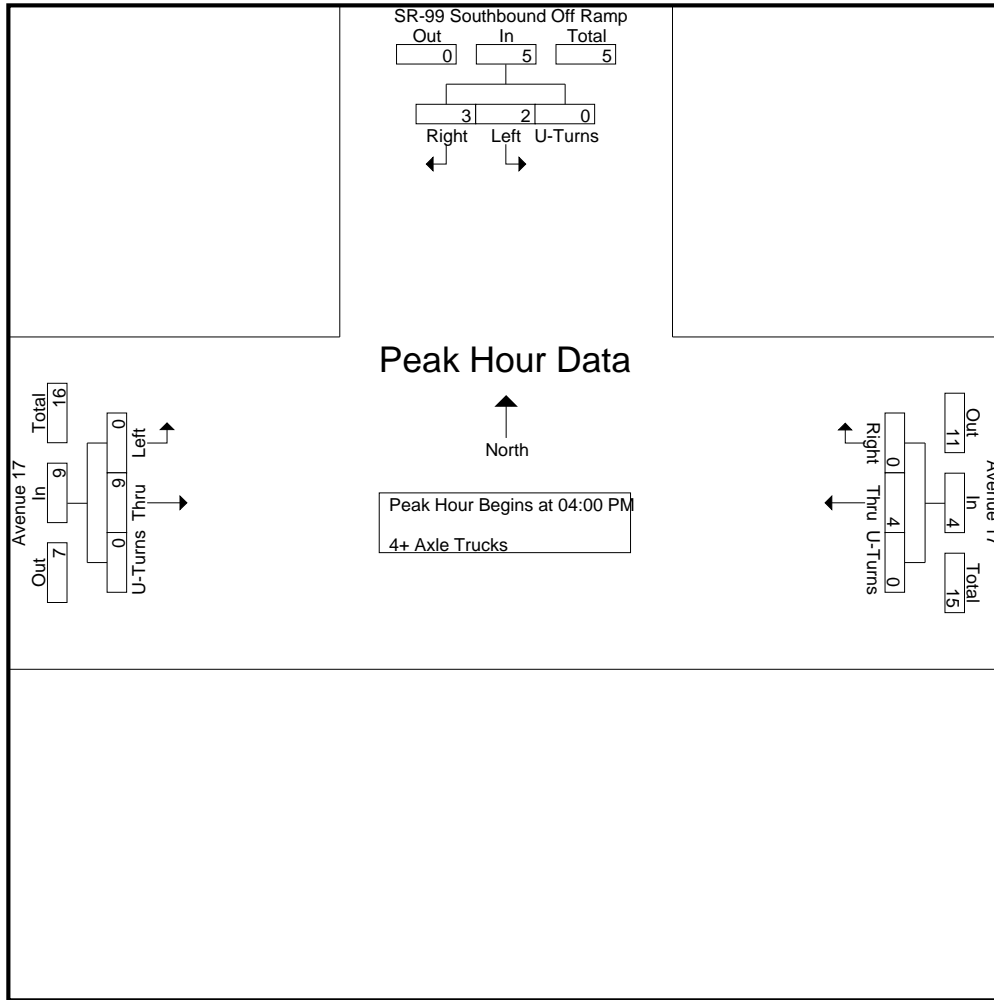

Peak Hour Analysis From 04:00 PM to 04:45 PM - Peak 1 of 1
 Peak Hour for Each Approach Begins at:

	04:00 PM				04:00 PM				04:00 PM			
+0 mins.	0	1	0	1	1	0	0	1	0	1	0	1
+15 mins.	0	0	0	0	1	0	0	1	0	3	0	3
+30 mins.	1	1	0	2	1	0	0	1	0	3	0	3
+45 mins.	1	1	0	2	1	0	0	1	0	2	0	2
Total Volume	2	3	0	5	4	0	0	4	0	9	0	9
% App. Total	40	60	0		100	0	0		0	100	0	
PHF	.500	.750	.000	.625	1.000	.000	.000	1.000	.000	.750	.000	.750

Location: Madera
 N/S: SR-99 SB Off Ramp
 E/W: Avenue 17



Date: 9/18/2019
 Day: Wednesday

PEDESTRIANS

	North Leg SR-99 SB Off Ramp	East Leg Avenue 17	South Leg Dead End	West Leg Avenue 17	
	Pedestrians	Pedestrians	Pedestrians	Pedestrians	
7:00 AM	0	0	0	0	0
7:15 AM	0	0	0	0	0
7:30 AM	0	0	0	0	0
7:45 AM	0	0	0	0	0
8:00 AM	0	0	0	0	0
8:15 AM	0	0	0	0	0
8:30 AM	0	0	0	0	0
8:45 AM	0	0	0	0	0
TOTAL VOLUMES:	0	0	0	0	0

	North Leg SR-99 SB Off Ramp	East Leg Avenue 17	South Leg Dead End	West Leg Avenue 17	
	Pedestrians	Pedestrians	Pedestrians	Pedestrians	
4:00 PM	0	0	0	0	0
4:15 PM	0	0	0	0	0
4:30 PM	0	0	0	0	0
4:45 PM	0	0	0	0	0
5:00 PM	0	0	0	0	0
5:15 PM	0	0	0	0	0
5:30 PM	0	0	0	0	0
5:45 PM	0	0	0	0	0
TOTAL VOLUMES:	0	0	0	0	0

Location: Madera
 N/S: SR-99 SB Off Ramp
 E/W: Avenue 17



Date: 9/18/2019
 Day: Wednesday

BICYCLES

	Southbound SR-99 SB Off Ramp			Westbound Avenue 17			Northbound Dead End			Eastbound Avenue 17			
	Left	Thru	Right	Left	Thru	Right	Left	Thru	Right	Left	Thru	Right	
7:00 AM	0	0	0	0	0	0	0	0	0	0	0	0	0
7:15 AM	0	0	0	0	0	0	0	0	0	0	0	0	0
7:30 AM	0	0	0	0	0	0	0	0	0	0	0	0	0
7:45 AM	0	0	0	0	0	0	0	0	0	0	0	0	0
8:00 AM	0	0	0	0	0	0	0	0	0	0	0	0	0
8:15 AM	0	0	0	0	0	0	0	0	0	0	0	0	0
8:30 AM	0	0	0	0	0	0	0	0	0	0	0	0	0
8:45 AM	0	0	0	0	0	0	0	0	0	0	0	0	0
TOTAL VOLUMES:	0	0	0	0	0	0	0	0	0	0	0	0	0

	Southbound SR-99 SB Off Ramp			Westbound Avenue 17			Northbound Dead End			Eastbound Avenue 17			
	Left	Thru	Right	Left	Thru	Right	Left	Thru	Right	Left	Thru	Right	
4:00 PM	0	0	0	0	0	0	0	0	0	0	0	0	0
4:15 PM	0	0	0	0	0	0	0	0	0	0	0	0	0
4:30 PM	0	0	0	0	0	0	0	0	0	0	0	0	0
4:45 PM	0	0	0	0	0	0	0	0	0	0	0	0	0
5:00 PM	0	0	0	0	0	0	0	0	0	0	0	0	0
5:15 PM	0	0	0	0	0	0	0	0	0	0	0	0	0
5:30 PM	0	0	0	0	0	0	0	0	0	0	0	0	0
5:45 PM	0	0	0	0	0	0	0	0	0	0	0	0	0
TOTAL VOLUMES:	0	0	0	0	0	0	0	0	0	0	0	0	0

City of Madera
 N/S: SR-99 Northbound Ramps
 E/W: Avenue 17
 Weather: Clear

File Name : 13_MDA_99N_Ave 17 AM
 Site Code : 00319628
 Start Date : 9/18/2019
 Page No : 1

Groups Printed- Passenger Vehicles - Large 2 Axle Vehicles - 3 Axle Vehicles - 4+ Axle Trucks

Start Time	SR-99 Northbound On Ramp Southbound					Avenue 17 Westbound					SR-99 Northbound Off Ramp Northbound					Avenue 17 Eastbound					Int. Total
	Left	Thru	Right	U-Turns	App. Total	Left	Thru	Right	U-Turns	App. Total	Left	Thru	Right	U-Turns	App. Total	Left	Thru	Right	U-Turns	App. Total	
07:00 AM	0	0	0	0	0	0	150	24	0	174	15	0	0	0	15	18	27	0	0	45	234
07:15 AM	0	0	0	0	0	0	181	29	0	210	21	1	0	0	22	10	33	0	0	43	275
07:30 AM	0	0	0	0	0	0	152	22	0	174	18	0	0	0	18	14	33	0	0	47	239
07:45 AM	0	0	0	0	0	0	159	25	0	184	32	0	0	0	32	10	42	0	0	52	268
Total	0	0	0	0	0	0	642	100	0	742	86	1	0	0	87	52	135	0	0	187	1016
08:00 AM	0	0	0	0	0	0	139	14	0	153	23	0	0	0	23	7	39	0	0	46	222
08:15 AM	0	0	0	0	0	0	134	23	0	157	18	0	0	0	18	25	31	0	0	56	231
08:30 AM	0	0	0	0	0	0	96	21	0	117	12	0	0	0	12	11	30	0	0	41	170
08:45 AM	0	0	0	0	0	0	80	18	0	98	21	0	0	0	21	13	22	0	0	35	154
Total	0	0	0	0	0	0	449	76	0	525	74	0	0	0	74	56	122	0	0	178	777
Grand Total	0	0	0	0	0	0	1091	176	0	1267	160	1	0	0	161	108	257	0	0	365	1793
Apprch %	0	0	0	0	0	0	86.1	13.9	0		99.4	0.6	0	0		29.6	70.4	0	0		
Total %	0	0	0	0	0	0	60.8	9.8	0	70.7	8.9	0.1	0	0	9	6	14.3	0	0	20.4	
Passenger Vehicles	1053																				
% Passenger Vehicles	0	0	0	0	0	0	96.5	85.2	0	94.9	87.5	100	0	0	87.6	75.9	91.1	0	0	86.6	92.6
Large 2 Axle Vehicles	1053																				
% Large 2 Axle Vehicles	0	0	0	0	0	0	1.9	2.8	0	2.1	6.2	0	0	0	6.2	4.6	4.3	0	0	4.4	2.9
3 Axle Vehicles	0	0	0	0	0	0	0	2	0	2	1	0	0	0	1	2	4	0	0	6	9
% 3 Axle Vehicles	0	0	0	0	0	0	0	1.1	0	0.2	0.6	0	0	0	0.6	1.9	1.6	0	0	1.6	0.5
4+ Axle Trucks	0	0	0	0	0	0	17	19	0	36	9	0	0	0	9	19	8	0	0	27	72
% 4+ Axle Trucks																					

Start Time	SR-99 Northbound On Ramp Southbound					Avenue 17 Westbound					SR-99 Northbound Off Ramp Northbound					Avenue 17 Eastbound					Int. Total
	Left	Thru	Right	U-Turns	App. Total	Left	Thru	Right	U-Turns	App. Total	Left	Thru	Right	U-Turns	App. Total	Left	Thru	Right	U-Turns	App. Total	
Peak Hour Analysis From 07:00 AM to 08:45 AM - Peak 1 of 1																					
Peak Hour for Entire Intersection Begins at 07:00 AM																					
07:00 AM	0	0	0	0	0	0	150	24	0	174	15	0	0	0	15	18	27	0	0	45	234
07:15 AM	0	0	0	0	0	0	181	29	0	210	21	1	0	0	22	10	33	0	0	43	275
07:30 AM	0	0	0	0	0	0	152	22	0	174	18	0	0	0	18	14	33	0	0	47	239
07:45 AM	0	0	0	0	0	0	159	25	0	184	32	0	0	0	32	10	42	0	0	52	268
Total Volume	0	0	0	0	0	0	642	100	0	742	86	1	0	0	87	52	135	0	0	187	1016
% App. Total	0	0	0	0	0	0	86.5	13.5	0		98.9	1.1	0	0		27.8	72.2	0	0		
PHF	.000	.000	.000	.000	.000	.000	.887	.862	.000	.883	.672	.250	.000	.000	.680	.722	.804	.000	.000	.899	.924

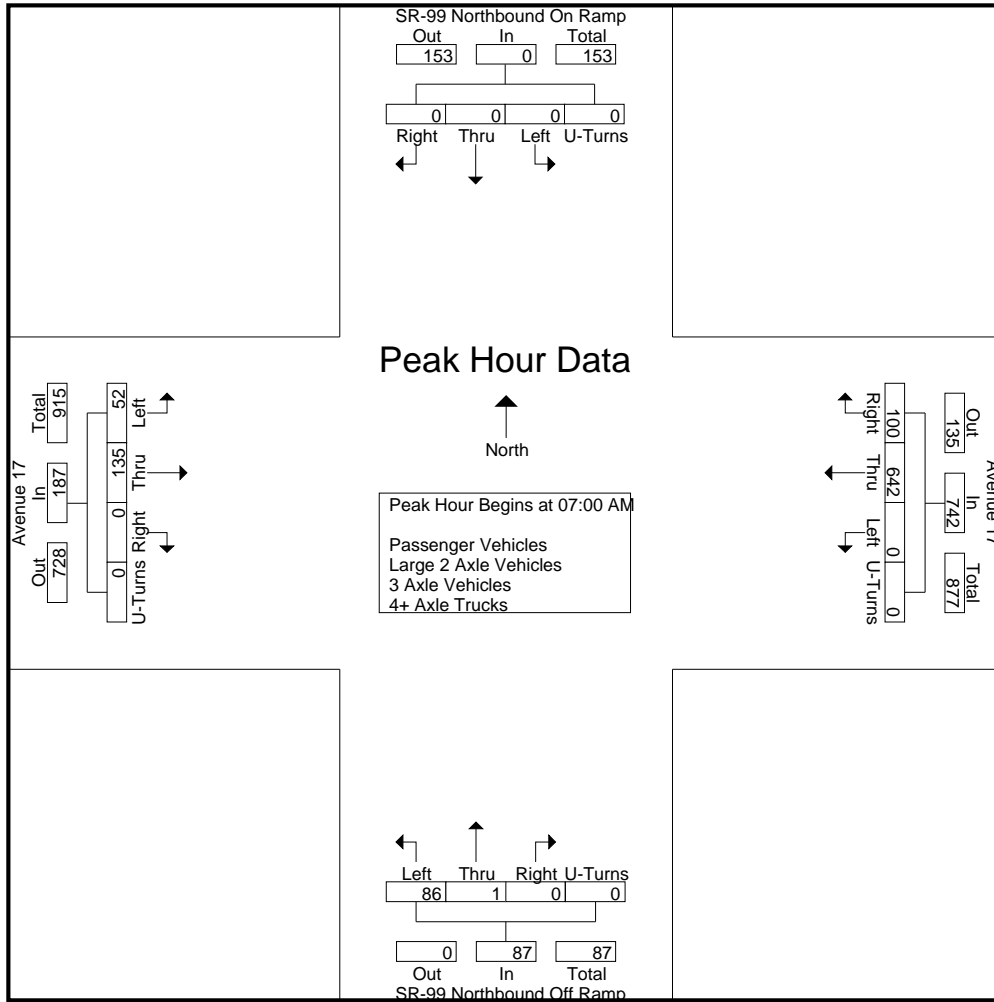

Peak Hour Analysis From 07:00 AM to 08:45 AM - Peak 1 of 1
 Peak Hour for Each Approach Begins at:

	07:00 AM					07:15 AM					07:30 AM									
+0 mins.	0	0	0	0	0	0	150	24	0	174	21	1	0	0	22	14	33	0	0	47
+15 mins.	0	0	0	0	0	0	181	29	0	210	18	0	0	0	18	10	42	0	0	52
+30 mins.	0	0	0	0	0	0	152	22	0	174	32	0	0	0	32	7	39	0	0	46
+45 mins.	0	0	0	0	0	0	159	25	0	184	23	0	0	0	23	25	31	0	0	56
Total Volume	0	0	0	0	0	0	642	100	0	742	94	1	0	0	95	56	145	0	0	201
% App. Total	0	0	0	0	0	0	86.5	13.5	0		98.9	1.1	0	0		27.9	72.1	0	0	
PHF	.000	.000	.000	.000	.000	.000	.887	.862	.000	.883	.734	.250	.000	.000	.742	.560	.863	.000	.000	.897

City of Madera
 N/S: SR-99 Northbound Ramps
 E/W: Avenue 17
 Weather: Clear

File Name : 13_MDA_99N_Ave 17 AM
 Site Code : 00319628
 Start Date : 9/18/2019
 Page No : 1

Groups Printed- Passenger Vehicles

Start Time	SR-99 Northbound On Ramp Southbound					Avenue 17 Westbound					SR-99 Northbound Off Ramp Northbound					Avenue 17 Eastbound					Int. Total
	Left	Thru	Right	U-Turns	App. Total	Left	Thru	Right	U-Turns	App. Total	Left	Thru	Right	U-Turns	App. Total	Left	Thru	Right	U-Turns	App. Total	
07:00 AM	0	0	0	0	0	0	148	23	0	171	11	0	0	0	11	15	22	0	0	37	219
07:15 AM	0	0	0	0	0	0	173	26	0	199	20	1	0	0	21	7	33	0	0	40	260
07:30 AM	0	0	0	0	0	0	149	20	0	169	16	0	0	0	16	13	31	0	0	44	229
07:45 AM	0	0	0	0	0	0	155	25	0	180	27	0	0	0	27	7	39	0	0	46	253
Total	0	0	0	0	0	0	625	94	0	719	74	1	0	0	75	42	125	0	0	167	961
08:00 AM	0	0	0	0	0	0	133	13	0	146	20	0	0	0	20	6	32	0	0	38	204
08:15 AM	0	0	0	0	0	0	125	17	0	142	17	0	0	0	17	17	30	0	0	47	206
08:30 AM	0	0	0	0	0	0	91	12	0	103	11	0	0	0	11	7	27	0	0	34	148
08:45 AM	0	0	0	0	0	0	79	14	0	93	18	0	0	0	18	10	20	0	0	30	141
Total	0	0	0	0	0	0	428	56	0	484	66	0	0	0	66	40	109	0	0	149	699
Grand Total	0	0	0	0	0	0	1053	150	0	1203	140	1	0	0	141	82	234	0	0	316	1660
Apprch %	0	0	0	0	0	0	87.5	12.5	0		99.3	0.7	0	0		25.9	74.1	0	0		
Total %	0	0	0	0	0	0	63.4	9	0	72.5	8.4	0.1	0	0	8.5	4.9	14.1	0	0	19	

Start Time	SR-99 Northbound On Ramp Southbound					Avenue 17 Westbound					SR-99 Northbound Off Ramp Northbound					Avenue 17 Eastbound					Int. Total
	Left	Thru	Right	U-Turns	App. Total	Thru	Right	U-Turns	App. Total	Thru	Right	U-Turns	App. Total	Thru	Right	U-Turns	App. Total				
Peak Hour Analysis From 07:00 AM to 07:45 AM - Peak 1 of 1																					
Peak Hour for Entire Intersection Begins at 07:00 AM																					
07:00 AM	0	0	0	0	0	0	148	23	0	171	11	0	0	0	11	15	22	0	0	37	219
07:15 AM	0	0	0	0	0	0	173	26	0	199	20	1	0	0	21	7	33	0	0	40	260
07:30 AM	0	0	0	0	0	0	149	20	0	169	16	0	0	0	16	13	31	0	0	44	229
07:45 AM	0	0	0	0	0	0	155	25	0	180	27	0	0	0	27	7	39	0	0	46	253
Total Volume	0	0	0	0	0	0	625	94	0	719	74	1	0	0	75	42	125	0	0	167	961
% App. Total	0	0	0	0	0	0	86.9	13.1	0		98.7	1.3	0	0		25.1	74.9	0	0		
PHF	.000	.000	.000	.000	.000	.000	.903	.904	.000	.903	.685	.250	.000	.000	.694	.700	.801	.000	.000	.908	.924

City of Madera
 N/S: SR-99 Northbound Ramps
 E/W: Avenue 17
 Weather: Clear

File Name : 13_MDA_99N_Ave 17 AM
 Site Code : 00319628
 Start Date : 9/18/2019
 Page No : 2

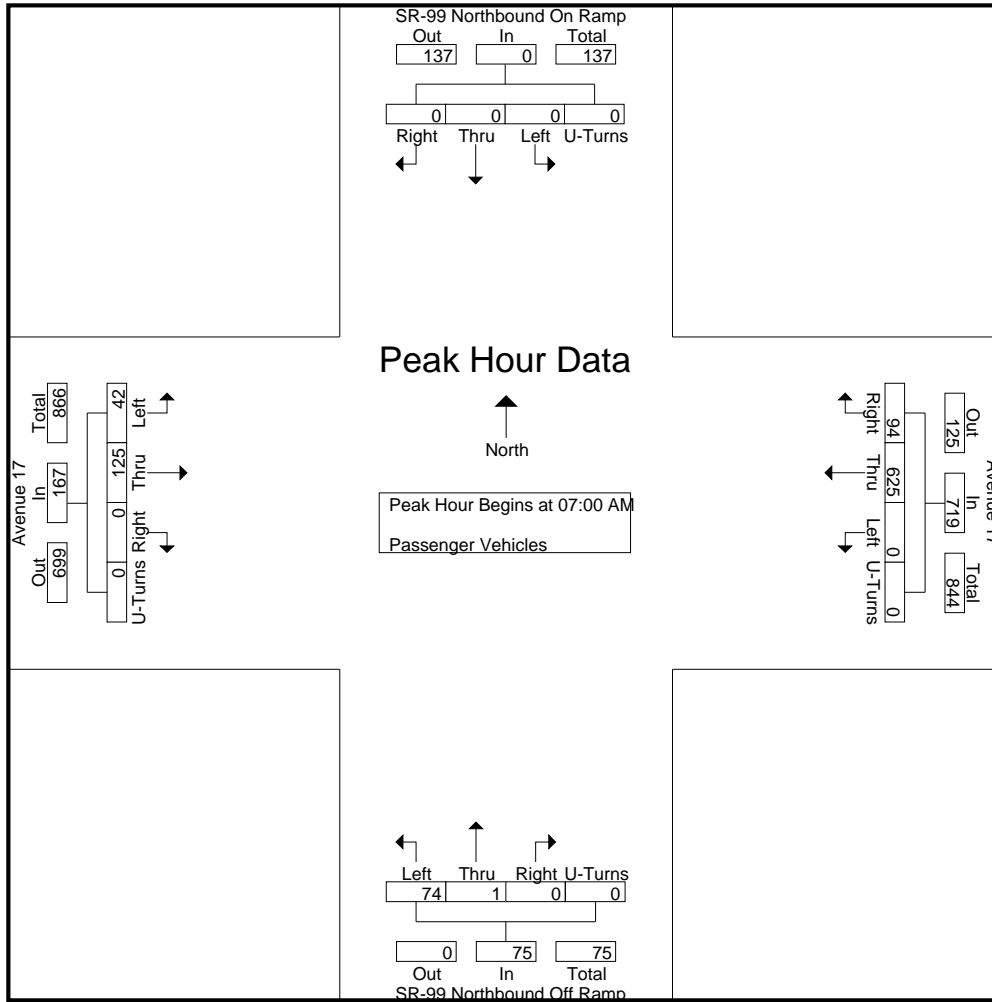

Peak Hour Analysis From 07:00 AM to 07:45 AM - Peak 1 of 1
 Peak Hour for Each Approach Begins at:

	07:00 AM					07:00 AM					07:00 AM									
+0 mins.	0	0	0	0	0	0	148	23	0	171	11	0	0	0	11	15	22	0	0	37
+15 mins.	0	0	0	0	0	0	173	26	0	199	20	1	0	0	21	7	33	0	0	40
+30 mins.	0	0	0	0	0	0	149	20	0	169	16	0	0	0	16	13	31	0	0	44
+45 mins.	0	0	0	0	0	0	155	25	0	180	27	0	0	0	27	7	39	0	0	46
Total Volume	0	0	0	0	0	0	625	94	0	719	74	1	0	0	75	42	125	0	0	167
% App. Total	0	0	0	0	0	0	86.9	13.1	0		98.7	1.3	0	0		25.1	74.9	0	0	
PHF	.000	.000	.000	.000	.000	.000	.903	.904	.000	.903	.685	.250	.000	.000	.694	.700	.801	.000	.000	.908

City of Madera
 N/S: SR-99 Northbound Ramps
 E/W: Avenue 17
 Weather: Clear

File Name : 13_MDA_99N_Ave 17 AM
 Site Code : 00319628
 Start Date : 9/18/2019
 Page No : 1

Groups Printed- Large 2 Axle Vehicles

Start Time	SR-99 Northbound On Ramp Southbound					Avenue 17 Westbound					SR-99 Northbound Off Ramp Northbound					Avenue 17 Eastbound					Int. Total
	Left	Thru	Right	U-Turns	App. Total	Left	Thru	Right	U-Turns	App. Total	Left	Thru	Right	U-Turns	App. Total	Left	Thru	Right	U-Turns	App. Total	
07:00 AM	0	0	0	0	0	0	1	1	0	2	3	0	0	0	3	0	2	0	0	2	7
07:15 AM	0	0	0	0	0	0	3	1	0	4	0	0	0	0	0	0	0	0	0	0	4
07:30 AM	0	0	0	0	0	0	1	2	0	3	1	0	0	0	1	0	1	0	0	1	5
07:45 AM	0	0	0	0	0	0	3	0	0	3	2	0	0	0	2	2	2	0	0	4	9
Total	0	0	0	0	0	0	8	4	0	12	6	0	0	0	6	2	5	0	0	7	25
08:00 AM	0	0	0	0	0	0	2	0	0	2	1	0	0	0	1	0	4	0	0	4	7
08:15 AM	0	0	0	0	0	0	8	0	0	8	0	0	0	0	0	2	1	0	0	3	11
08:30 AM	0	0	0	0	0	0	2	1	0	3	1	0	0	0	1	0	1	0	0	1	5
08:45 AM	0	0	0	0	0	0	1	0	0	1	2	0	0	0	2	1	0	0	0	1	4
Total	0	0	0	0	0	0	13	1	0	14	4	0	0	0	4	3	6	0	0	9	27
Grand Total	0	0	0	0	0	0	21	5	0	26	10	0	0	0	10	5	11	0	0	16	52
Apprch %	0	0	0	0	0	0	80.8	19.2	0		100	0	0	0		31.2	68.8	0	0		
Total %	0	0	0	0	0	0	40.4	9.6	0	50	19.2	0	0	0	19.2	9.6	21.2	0	0	30.8	

Start Time	SR-99 Northbound On Ramp Southbound					Avenue 17 Westbound					SR-99 Northbound Off Ramp Northbound					Avenue 17 Eastbound					Int. Total
	Left	Thru	Right	U-Turns	App. Total	Thru	Right	U-Turns	App. Total	Thru	Right	U-Turns	App. Total	Thru	Right	U-Turns	App. Total				
Peak Hour Analysis From 07:00 AM to 07:45 AM - Peak 1 of 1																					
Peak Hour for Entire Intersection Begins at 07:00 AM																					
07:00 AM	0	0	0	0	0	0	1	1	0	2	3	0	0	0	3	0	2	0	0	2	7
07:15 AM	0	0	0	0	0	0	3	1	0	4	0	0	0	0	0	0	0	0	0	0	4
07:30 AM	0	0	0	0	0	0	1	2	0	3	1	0	0	0	1	0	1	0	0	1	5
07:45 AM	0	0	0	0	0	0	3	0	0	3	2	0	0	0	2	2	2	0	0	4	9
Total Volume	0	0	0	0	0	0	8	4	0	12	6	0	0	0	6	2	5	0	0	7	25
% App. Total	0	0	0	0	0	0	66.7	33.3	0		100	0	0	0		28.6	71.4	0	0		
PHF	.000	.000	.000	.000	.000	.000	.667	.500	.000	.750	.500	.000	.000	.000	.500	.250	.625	.000	.000	.438	.694

City of Madera
 N/S: SR-99 Northbound Ramps
 E/W: Avenue 17
 Weather: Clear

File Name : 13_MDA_99N_Ave 17 AM
 Site Code : 00319628
 Start Date : 9/18/2019
 Page No : 2

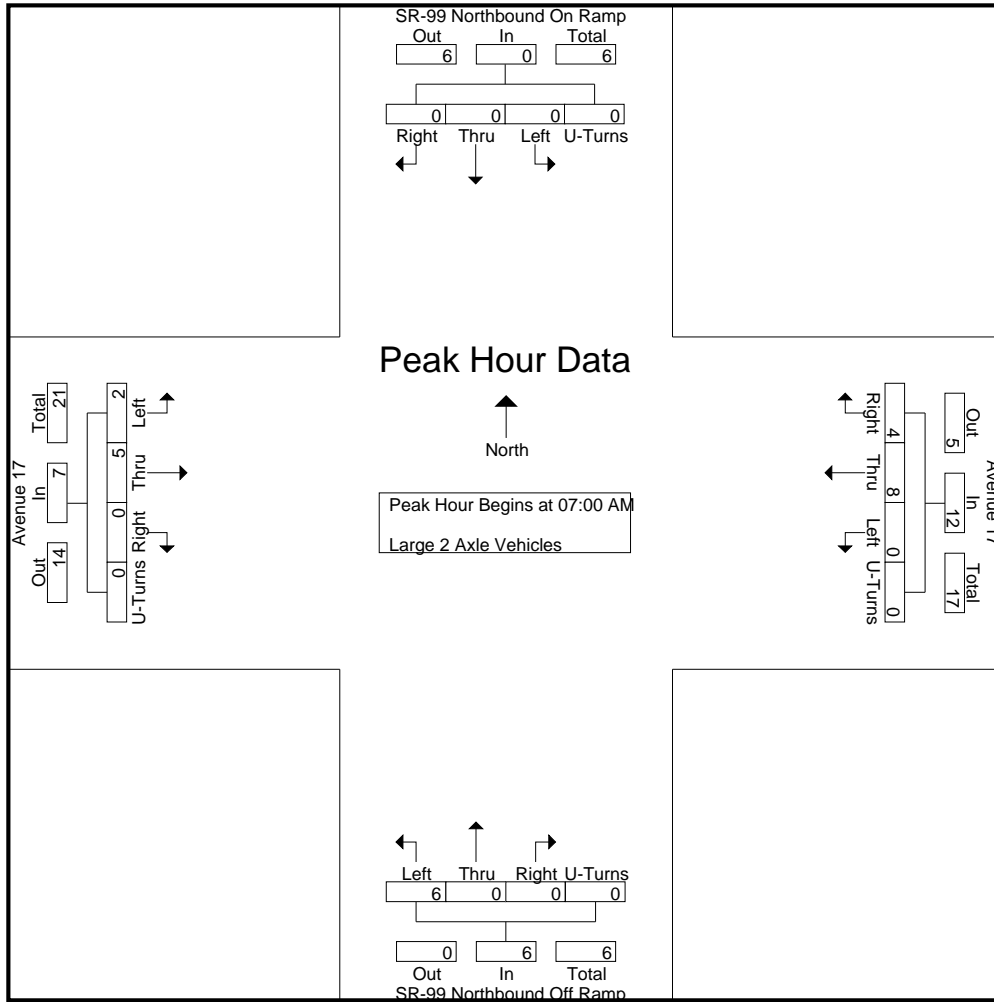

Peak Hour Analysis From 07:00 AM to 07:45 AM - Peak 1 of 1
 Peak Hour for Each Approach Begins at:

	07:00 AM					07:00 AM					07:00 AM									
+0 mins.	0	0	0	0	0	0	1	1	0	2	3	0	0	0	3	0	2	0	0	2
+15 mins.	0	0	0	0	0	0	3	1	0	4	0	0	0	0	0	0	0	0	0	0
+30 mins.	0	0	0	0	0	0	1	2	0	3	1	0	0	0	1	0	1	0	0	1
+45 mins.	0	0	0	0	0	0	3	0	0	3	2	0	0	0	2	2	2	0	0	4
Total Volume	0	0	0	0	0	0	8	4	0	12	6	0	0	0	6	2	5	0	0	7
% App. Total	0	0	0	0	0	0	66.7	33.3	0	100	100	0	0	0	0	28.6	71.4	0	0	0
PHF	.000	.000	.000	.000	.000	.000	.667	.500	.000	.750	.500	.000	.000	.000	.500	.250	.625	.000	.000	.438

City of Madera
 N/S: SR-99 Northbound Ramps
 E/W: Avenue 17
 Weather: Clear

File Name : 13_MDA_99N_Ave 17 AM
 Site Code : 00319628
 Start Date : 9/18/2019
 Page No : 1

Groups Printed- 3 Axle Vehicles

Start Time	SR-99 Northbound On Ramp Southbound					Avenue 17 Westbound					SR-99 Northbound Off Ramp Northbound					Avenue 17 Eastbound					Int. Total
	Left	Thru	Right	U-Turns	App. Total	Left	Thru	Right	U-Turns	App. Total	Left	Thru	Right	U-Turns	App. Total	Left	Thru	Right	U-Turns	App. Total	
07:00 AM	0	0	0	0	0	0	0	0	0	0	0	0	0	0	0	0	2	0	0	2	2
07:15 AM	0	0	0	0	0	0	0	0	0	0	0	0	0	0	0	0	0	0	0	0	0
07:30 AM	0	0	0	0	0	0	0	0	0	0	0	0	0	0	0	0	0	0	0	0	0
07:45 AM	0	0	0	0	0	0	0	0	0	0	1	0	0	0	1	0	0	0	0	0	1
Total	0	0	0	0	0	0	0	0	0	0	1	0	0	0	1	0	2	0	0	2	3
08:00 AM	0	0	0	0	0	0	0	0	0	0	0	0	0	0	0	0	2	0	0	2	2
08:15 AM	0	0	0	0	0	0	0	0	0	0	0	0	0	0	0	0	0	0	0	0	0
08:30 AM	0	0	0	0	0	0	0	1	0	1	0	0	0	0	0	0	0	0	0	0	1
08:45 AM	0	0	0	0	0	0	0	1	0	1	0	0	0	0	0	2	0	0	0	2	3
Total	0	0	0	0	0	0	0	2	0	2	0	0	0	0	0	2	2	0	0	4	6
Grand Total	0	0	0	0	0	0	0	2	0	2	1	0	0	0	1	2	4	0	0	6	9
Apprch %	0	0	0	0		0	0	100	0		100	0	0	0		33.3	66.7	0	0		
Total %	0	0	0	0		0	0	22.2	0	22.2	11.1	0	0	0	11.1	22.2	44.4	0	0	66.7	

Start Time	SR-99 Northbound On Ramp Southbound					Avenue 17 Westbound					SR-99 Northbound Off Ramp Northbound					Avenue 17 Eastbound					Int. Total
	Left	Thru	Right	U-Turns	App. Total	Thru	Right	U-Turns	App. Total	Thru	Right	U-Turns	App. Total	Thru	Right	U-Turns	App. Total				
Peak Hour Analysis From 07:00 AM to 07:45 AM - Peak 1 of 1																					
Peak Hour for Entire Intersection Begins at 07:00 AM																					
07:00 AM	0	0	0	0	0	0	0	0	0	0	0	0	0	0	0	0	2	0	0	2	2
07:15 AM	0	0	0	0	0	0	0	0	0	0	0	0	0	0	0	0	0	0	0	0	0
07:30 AM	0	0	0	0	0	0	0	0	0	0	0	0	0	0	0	0	0	0	0	0	0
07:45 AM	0	0	0	0	0	0	0	0	0	0	1	0	0	0	1	0	0	0	0	0	1
Total Volume	0	0	0	0	0	0	0	0	0	0	1	0	0	0	1	0	2	0	0	2	3
% App. Total	0	0	0	0		0	0	0	0		100	0	0	0		0	100	0	0		
PHF	.000	.000	.000	.000	.000	.000	.000	.000	.000	.000	.250	.000	.000	.000	.250	.000	.250	.000	.000	.250	.375

City of Madera
 N/S: SR-99 Northbound Ramps
 E/W: Avenue 17
 Weather: Clear

File Name : 13_MDA_99N_Ave 17 AM
 Site Code : 00319628
 Start Date : 9/18/2019
 Page No : 2

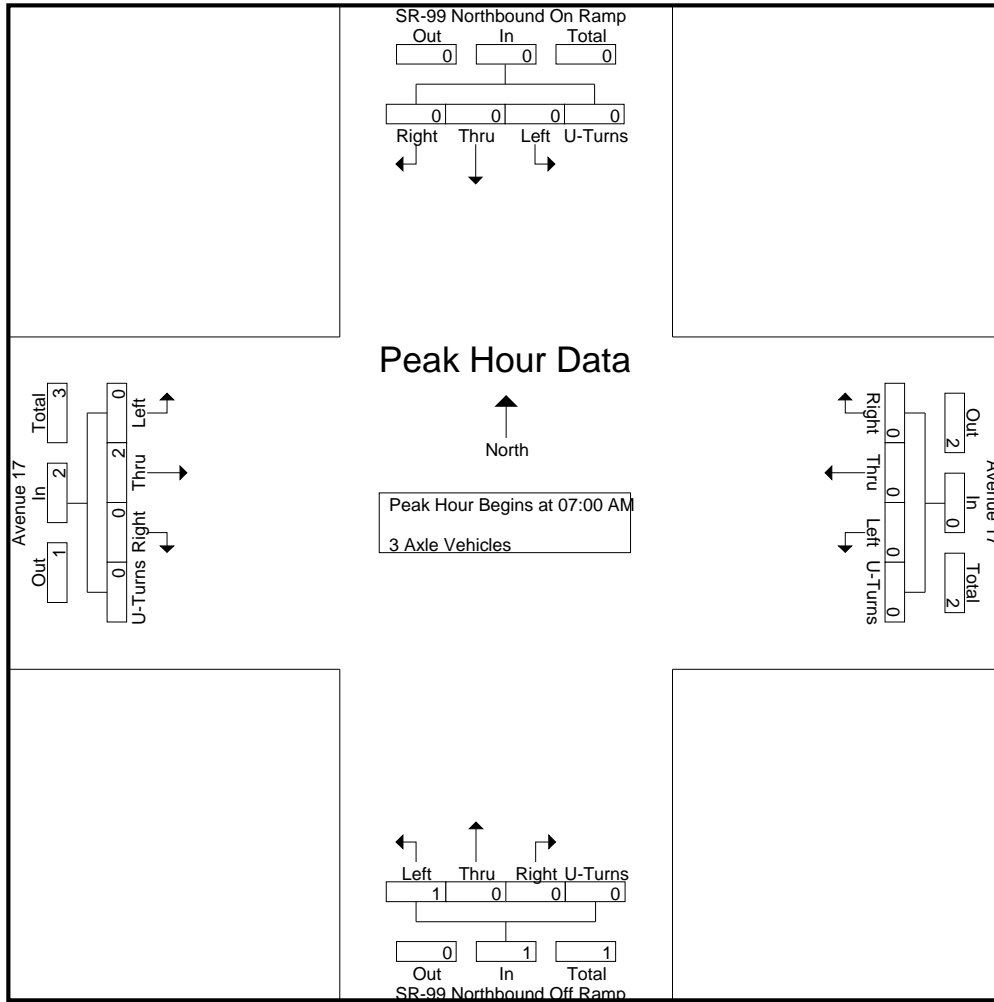

Peak Hour Analysis From 07:00 AM to 07:45 AM - Peak 1 of 1
 Peak Hour for Each Approach Begins at:

	07:00 AM					07:00 AM					07:00 AM									
+0 mins.	0	0	0	0	0	0	0	0	0	0	0	0	0	0	0	0	2	0	0	2
+15 mins.	0	0	0	0	0	0	0	0	0	0	0	0	0	0	0	0	0	0	0	0
+30 mins.	0	0	0	0	0	0	0	0	0	0	0	0	0	0	0	0	0	0	0	0
+45 mins.	0	0	0	0	0	0	0	0	0	0	1	0	0	0	1	0	0	0	0	0
Total Volume	0	0	0	0	0	0	0	0	0	0	1	0	0	0	1	0	2	0	0	2
% App. Total	0	0	0	0	0	0	0	0	0	0	100	0	0	0	0	0	100	0	0	0
PHF	.000	.000	.000	.000	.000	.000	.000	.000	.000	.000	.250	.000	.000	.000	.250	.000	.250	.000	.000	.250

City of Madera
 N/S: SR-99 Northbound Ramps
 E/W: Avenue 17
 Weather: Clear

File Name : 13_MDA_99N_Ave 17 AM
 Site Code : 00319628
 Start Date : 9/18/2019
 Page No : 1

Groups Printed- 4+ Axle Trucks

Start Time	SR-99 Northbound On Ramp Southbound					Avenue 17 Westbound					SR-99 Northbound Off Ramp Northbound					Avenue 17 Eastbound					Int. Total
	Left	Thru	Right	U-Turns	App. Total	Left	Thru	Right	U-Turns	App. Total	Left	Thru	Right	U-Turns	App. Total	Left	Thru	Right	U-Turns	App. Total	
07:00 AM	0	0	0	0	0	0	1	0	0	1	1	0	0	0	1	3	1	0	0	4	6
07:15 AM	0	0	0	0	0	0	5	2	0	7	1	0	0	0	1	3	0	0	0	3	11
07:30 AM	0	0	0	0	0	0	2	0	0	2	1	0	0	0	1	1	1	0	0	2	5
07:45 AM	0	0	0	0	0	0	1	0	0	1	2	0	0	0	2	1	1	0	0	2	5
Total	0	0	0	0	0	0	9	2	0	11	5	0	0	0	5	8	3	0	0	11	27
08:00 AM	0	0	0	0	0	0	4	1	0	5	2	0	0	0	2	1	1	0	0	2	9
08:15 AM	0	0	0	0	0	0	1	6	0	7	1	0	0	0	1	6	0	0	0	6	14
08:30 AM	0	0	0	0	0	0	3	7	0	10	0	0	0	0	0	4	2	0	0	6	16
08:45 AM	0	0	0	0	0	0	0	3	0	3	1	0	0	0	1	0	2	0	0	2	6
Total	0	0	0	0	0	0	8	17	0	25	4	0	0	0	4	11	5	0	0	16	45
Grand Total	0	0	0	0	0	0	17	19	0	36	9	0	0	0	9	19	8	0	0	27	72
Apprch %	0	0	0	0	0	0	47.2	52.8	0		100	0	0	0		70.4	29.6	0	0		
Total %	0	0	0	0	0	0	23.6	26.4	0	50	12.5	0	0	0	12.5	26.4	11.1	0	0	37.5	

Start Time	SR-99 Northbound On Ramp Southbound					Avenue 17 Westbound					SR-99 Northbound Off Ramp Northbound					Avenue 17 Eastbound					Int. Total
	Left	Thru	Right	U-Turns	App. Total	Thru	Right	U-Turns	App. Total	Thru	Right	U-Turns	App. Total	Thru	Right	U-Turns	App. Total				
Peak Hour Analysis From 07:00 AM to 07:45 AM - Peak 1 of 1																					
Peak Hour for Entire Intersection Begins at 07:00 AM																					
07:00 AM	0	0	0	0	0	0	1	0	0	1	1	0	0	0	1	3	1	0	0	4	6
07:15 AM	0	0	0	0	0	0	5	2	0	7	1	0	0	0	1	3	0	0	0	3	11
07:30 AM	0	0	0	0	0	0	2	0	0	2	1	0	0	0	1	1	1	0	0	2	5
07:45 AM	0	0	0	0	0	0	1	0	0	1	2	0	0	0	2	1	1	0	0	2	5
Total Volume	0	0	0	0	0	0	9	2	0	11	5	0	0	0	5	8	3	0	0	11	27
% App. Total	0	0	0	0	0	0	81.8	18.2	0		100	0	0	0		72.7	27.3	0	0		
PHF	.000	.000	.000	.000	.000	.000	.450	.250	.000	.393	.625	.000	.000	.000	.625	.667	.750	.000	.000	.688	.614

City of Madera
 N/S: SR-99 Northbound Ramps
 E/W: Avenue 17
 Weather: Clear

File Name : 13_MDA_99N_Ave 17 AM
 Site Code : 00319628
 Start Date : 9/18/2019
 Page No : 2

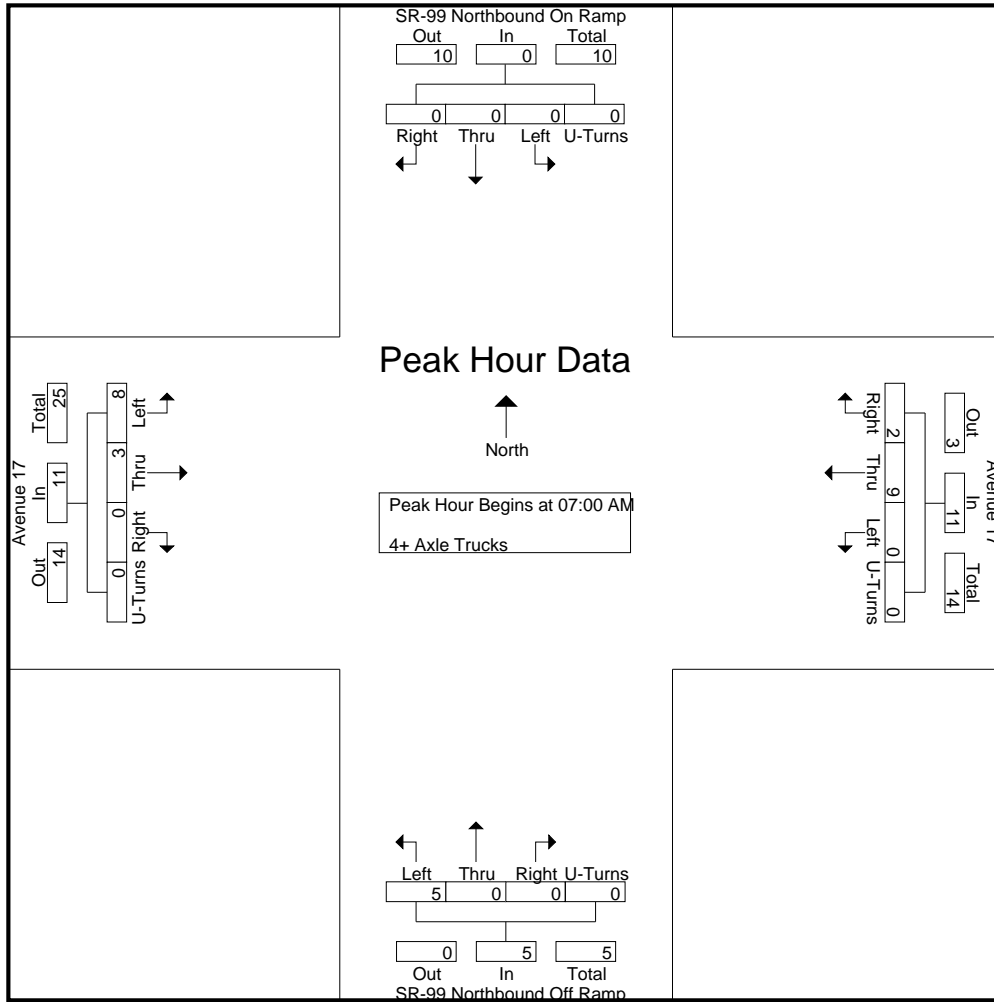

Peak Hour Analysis From 07:00 AM to 07:45 AM - Peak 1 of 1
 Peak Hour for Each Approach Begins at:

	07:00 AM					07:00 AM					07:00 AM									
+0 mins.	0	0	0	0	0	0	1	0	0	1	1	0	0	0	1	3	1	0	0	4
+15 mins.	0	0	0	0	0	0	5	2	0	7	1	0	0	0	1	3	0	0	0	3
+30 mins.	0	0	0	0	0	0	2	0	0	2	1	0	0	0	1	1	1	0	0	2
+45 mins.	0	0	0	0	0	0	1	0	0	1	2	0	0	0	2	1	1	0	0	2
Total Volume	0	0	0	0	0	0	9	2	0	11	5	0	0	0	5	8	3	0	0	11
% App. Total	0	0	0	0	0	0	81.8	18.2	0	100	100	0	0	0	0	72.7	27.3	0	0	0
PHF	.000	.000	.000	.000	.000	.000	.450	.250	.000	.393	.625	.000	.000	.000	.625	.667	.750	.000	.000	.688

City of Madera
 N/S: SR-99 Northbound Ramps
 E/W: Avenue 17
 Weather: Clear

File Name : 13_MDA_99N_Ave 17 PM
 Site Code : 00319628
 Start Date : 9/18/2019
 Page No : 1

Groups Printed- Passenger Vehicles - Large 2 Axle Vehicles - 3 Axle Vehicles - 4+ Axle Trucks

Start Time	SR-99 Northbound On Ramp Southbound					Avenue 17 Westbound					SR-99 Northbound Off Ramp Northbound					Avenue 17 Eastbound					Int. Total
	Left	Thru	Right	U-Turns	App. Total	Left	Thru	Right	U-Turns	App. Total	Left	Thru	Right	U-Turns	App. Total	Left	Thru	Right	U-Turns	App. Total	
04:00 PM	0	0	0	0	0	0	76	18	0	94	18	0	0	0	18	13	93	0	0	106	218
04:15 PM	0	0	0	0	0	0	72	17	0	89	20	0	0	0	20	12	94	0	0	106	215
04:30 PM	0	0	0	0	0	0	60	11	0	71	11	0	0	0	11	19	97	0	0	116	198
04:45 PM	0	0	0	0	0	0	62	20	0	82	17	1	0	0	18	20	105	0	0	125	225
Total	0	0	0	0	0	0	270	66	0	336	66	1	0	0	67	64	389	0	0	453	856
05:00 PM	0	0	0	0	0	0	89	16	0	105	18	0	0	0	18	20	65	0	0	85	208
05:15 PM	0	0	0	0	0	0	76	19	0	95	20	0	0	0	20	13	77	0	0	90	205
05:30 PM	0	0	0	0	0	0	86	26	0	112	17	0	0	0	17	14	57	0	0	71	200
05:45 PM	0	0	0	0	0	0	77	17	0	94	22	1	0	0	23	5	43	0	0	48	165
Total	0	0	0	0	0	0	328	78	0	406	77	1	0	0	78	52	242	0	0	294	778
Grand Total	0	0	0	0	0	0	598	144	0	742	143	2	0	0	145	116	631	0	0	747	1634
Apprch %	0	0	0	0	0	0	80.6	19.4	0		98.6	1.4	0	0		15.5	84.5	0	0		
Total %	0	0	0	0	0	0	36.6	8.8	0	45.4	8.8	0.1	0	0	8.9	7.1	38.6	0	0	45.7	
Passenger Vehicles	0	0	0	0	0	0	96.8	96.5	0	96.8	92.3	100	0	0	92.4	85.3	96.2	0	0	94.5	95.3
Large 2 Axle Vehicles	0	0	0	0	0	0	2.3	2.1	0	2.3	2.1	0	0	0	2.1	2.6	2.1	0	0	2.1	2.2
3 Axle Vehicles	0	0	0	0	0	0	1	1	0	2	2	0	0	0	2	3	3	0	0	6	10
% 3 Axle Vehicles	0	0	0	0	0	0	0.2	0.7	0	0.3	1.4	0	0	0	1.4	2.6	0.5	0	0	0.8	0.6
4+ Axle Trucks	0	0	0	0	0	0	4	1	0	5	6	0	0	0	6	11	8	0	0	19	30
% 4+ Axle Trucks																					

Start Time	SR-99 Northbound On Ramp Southbound					Avenue 17 Westbound					SR-99 Northbound Off Ramp Northbound					Avenue 17 Eastbound					Int. Total
	Left	Thru	Right	U-Turns	App. Total	Left	Thru	Right	U-Turns	App. Total	Left	Thru	Right	U-Turns	App. Total	Left	Thru	Right	U-Turns	App. Total	
Peak Hour Analysis From 04:00 PM to 05:45 PM - Peak 1 of 1																					
Peak Hour for Entire Intersection Begins at 04:00 PM																					
04:00 PM	0	0	0	0	0	0	76	18	0	94	18	0	0	0	18	13	93	0	0	106	218
04:15 PM	0	0	0	0	0	0	72	17	0	89	20	0	0	0	20	12	94	0	0	106	215
04:30 PM	0	0	0	0	0	0	60	11	0	71	11	0	0	0	11	19	97	0	0	116	198
04:45 PM	0	0	0	0	0	0	62	20	0	82	17	1	0	0	18	20	105	0	0	125	225
Total Volume	0	0	0	0	0	0	270	66	0	336	66	1	0	0	67	64	389	0	0	453	856
% App. Total	0	0	0	0	0	0	80.4	19.6	0		98.5	1.5	0	0		14.1	85.9	0	0		
PHF	.000	.000	.000	.000	.000	.000	.888	.825	.000	.894	.825	.250	.000	.000	.838	.800	.926	.000	.000	.906	.951

City of Madera
 N/S: SR-99 Northbound Ramps
 E/W: Avenue 17
 Weather: Clear

File Name : 13_MDA_99N_Ave 17 PM
 Site Code : 00319628
 Start Date : 9/18/2019
 Page No : 2

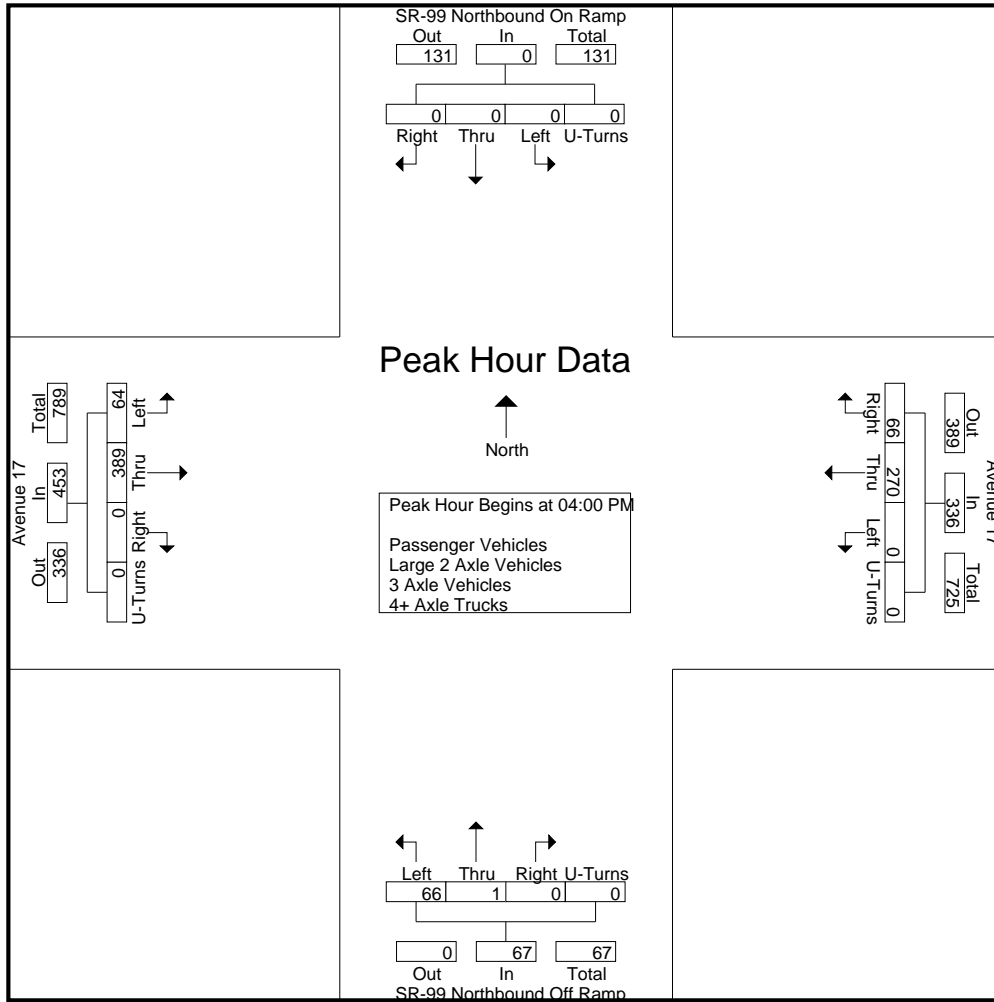

Peak Hour Analysis From 04:00 PM to 05:45 PM - Peak 1 of 1
 Peak Hour for Each Approach Begins at:

	04:00 PM					05:00 PM					05:00 PM					04:00 PM				
+0 mins.	0	0	0	0	0	0	89	16	0	105	18	0	0	0	18	13	93	0	0	106
+15 mins.	0	0	0	0	0	0	76	19	0	95	20	0	0	0	20	12	94	0	0	106
+30 mins.	0	0	0	0	0	0	86	26	0	112	17	0	0	0	17	19	97	0	0	116
+45 mins.	0	0	0	0	0	0	77	17	0	94	22	1	0	0	23	20	105	0	0	125
Total Volume	0	0	0	0	0	0	328	78	0	406	77	1	0	0	78	64	389	0	0	453
% App. Total	0	0	0	0	0	0	80.8	19.2	0		98.7	1.3	0	0		14.1	85.9	0	0	
PHF	.000	.000	.000	.000	.000	.000	.921	.750	.000	.906	.875	.250	.000	.000	.848	.800	.926	.000	.000	.906

City of Madera
 N/S: SR-99 Northbound Ramps
 E/W: Avenue 17
 Weather: Clear

File Name : 13_MDA_99N_Ave 17 PM
 Site Code : 00319628
 Start Date : 9/18/2019
 Page No : 1

Groups Printed- Passenger Vehicles

Start Time	SR-99 Northbound On Ramp Southbound					Avenue 17 Westbound					SR-99 Northbound Off Ramp Northbound					Avenue 17 Eastbound					Int. Total
	Left	Thru	Right	U-Turns	App. Total	Left	Thru	Right	U-Turns	App. Total	Left	Thru	Right	U-Turns	App. Total	Left	Thru	Right	U-Turns	App. Total	
04:00 PM	0	0	0	0	0	0	70	17	0	87	16	0	0	0	16	13	93	0	0	106	209
04:15 PM	0	0	0	0	0	0	71	16	0	87	19	0	0	0	19	9	92	0	0	101	207
04:30 PM	0	0	0	0	0	0	56	11	0	67	10	0	0	0	10	16	95	0	0	111	188
04:45 PM	0	0	0	0	0	0	62	20	0	82	14	1	0	0	15	19	100	0	0	119	216
Total	0	0	0	0	0	0	259	64	0	323	59	1	0	0	60	57	380	0	0	437	820
05:00 PM	0	0	0	0	0	0	86	14	0	100	18	0	0	0	18	20	63	0	0	83	201
05:15 PM	0	0	0	0	0	0	74	18	0	92	18	0	0	0	18	10	71	0	0	81	191
05:30 PM	0	0	0	0	0	0	84	26	0	110	16	0	0	0	16	11	52	0	0	63	189
05:45 PM	0	0	0	0	0	0	76	17	0	93	21	1	0	0	22	1	41	0	0	42	157
Total	0	0	0	0	0	0	320	75	0	395	73	1	0	0	74	42	227	0	0	269	738
Grand Total	0	0	0	0	0	0	579	139	0	718	132	2	0	0	134	99	607	0	0	706	1558
Apprch %	0	0	0	0	0	0	80.6	19.4	0		98.5	1.5	0	0		14	86	0	0		
Total %	0	0	0	0	0	0	37.2	8.9	0	46.1	8.5	0.1	0	0	8.6	6.4	39	0	0	45.3	

Start Time	SR-99 Northbound On Ramp Southbound					Avenue 17 Westbound					SR-99 Northbound Off Ramp Northbound					Avenue 17 Eastbound					Int. Total
	Left	Thru	Right	U-Turns	App. Total	Thru	Right	U-Turns	App. Total	Thru	Right	U-Turns	App. Total	Thru	Right	U-Turns	App. Total				
Peak Hour Analysis From 04:00 PM to 04:45 PM - Peak 1 of 1																					
Peak Hour for Entire Intersection Begins at 04:00 PM																					
04:00 PM	0	0	0	0	0	0	70	17	0	87	16	0	0	0	16	13	93	0	0	106	209
04:15 PM	0	0	0	0	0	0	71	16	0	87	19	0	0	0	19	9	92	0	0	101	207
04:30 PM	0	0	0	0	0	0	56	11	0	67	10	0	0	0	10	16	95	0	0	111	188
04:45 PM	0	0	0	0	0	0	62	20	0	82	14	1	0	0	15	19	100	0	0	119	216
Total Volume	0	0	0	0	0	0	259	64	0	323	59	1	0	0	60	57	380	0	0	437	820
% App. Total	0	0	0	0	0	0	80.2	19.8	0		98.3	1.7	0	0		13	87	0	0		
PHF	.000	.000	.000	.000	.000	.000	.912	.800	.000	.928	.776	.250	.000	.000	.789	.750	.950	.000	.000	.918	.949

City of Madera
 N/S: SR-99 Northbound Ramps
 E/W: Avenue 17
 Weather: Clear

File Name : 13_MDA_99N_Ave 17 PM
 Site Code : 00319628
 Start Date : 9/18/2019
 Page No : 2

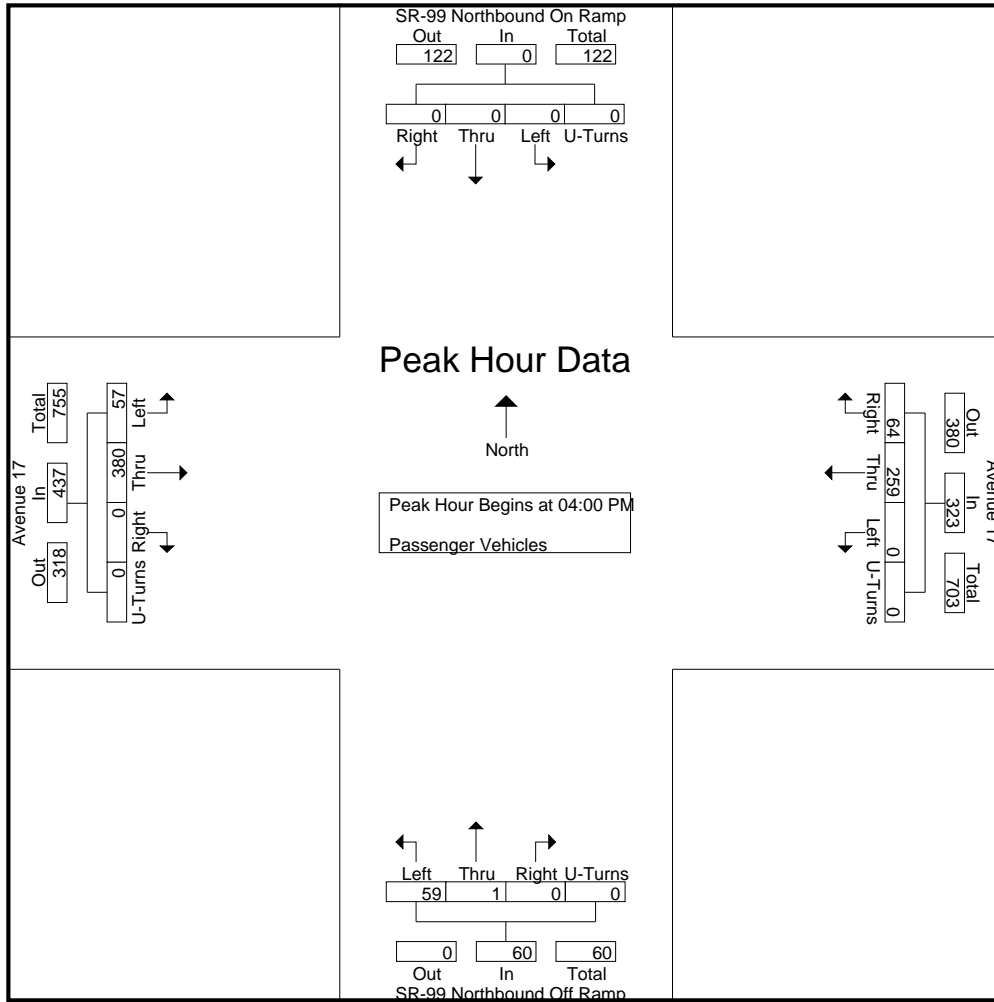

Peak Hour Analysis From 04:00 PM to 04:45 PM - Peak 1 of 1
 Peak Hour for Each Approach Begins at:

	04:00 PM					04:00 PM					04:00 PM									
+0 mins.	0	0	0	0	0	0	70	17	0	87	16	0	0	0	16	13	93	0	0	106
+15 mins.	0	0	0	0	0	0	71	16	0	87	19	0	0	0	19	9	92	0	0	101
+30 mins.	0	0	0	0	0	0	56	11	0	67	10	0	0	0	10	16	95	0	0	111
+45 mins.	0	0	0	0	0	0	62	20	0	82	14	1	0	0	15	19	100	0	0	119
Total Volume	0	0	0	0	0	0	259	64	0	323	59	1	0	0	60	57	380	0	0	437
% App. Total	0	0	0	0	0	0	80.2	19.8	0		98.3	1.7	0	0		13	87	0	0	
PHF	.000	.000	.000	.000	.000	.000	.912	.800	.000	.928	.776	.250	.000	.000	.789	.750	.950	.000	.000	.918

City of Madera
 N/S: SR-99 Northbound Ramps
 E/W: Avenue 17
 Weather: Clear

File Name : 13_MDA_99N_Ave 17 PM
 Site Code : 00319628
 Start Date : 9/18/2019
 Page No : 1

Groups Printed- Large 2 Axle Vehicles

Start Time	SR-99 Northbound On Ramp Southbound					Avenue 17 Westbound					SR-99 Northbound Off Ramp Northbound					Avenue 17 Eastbound					Int. Total
	Left	Thru	Right	U-Turns	App. Total	Left	Thru	Right	U-Turns	App. Total	Left	Thru	Right	U-Turns	App. Total	Left	Thru	Right	U-Turns	App. Total	
04:00 PM	0	0	0	0	0	0	6	0	0	6	1	0	0	0	1	0	0	0	0	0	7
04:15 PM	0	0	0	0	0	0	1	1	0	2	0	0	0	0	0	1	1	0	0	2	4
04:30 PM	0	0	0	0	0	0	4	0	0	4	0	0	0	0	0	0	1	0	0	1	5
04:45 PM	0	0	0	0	0	0	0	0	0	0	1	0	0	0	1	0	4	0	0	4	5
Total	0	0	0	0	0	0	11	1	0	12	2	0	0	0	2	1	6	0	0	7	21
05:00 PM	0	0	0	0	0	0	1	1	0	2	0	0	0	0	0	0	1	0	0	1	3
05:15 PM	0	0	0	0	0	0	0	1	0	1	0	0	0	0	0	1	3	0	0	4	5
05:30 PM	0	0	0	0	0	0	1	0	0	1	1	0	0	0	1	1	2	0	0	3	5
05:45 PM	0	0	0	0	0	0	1	0	0	1	0	0	0	0	0	0	1	0	0	1	2
Total	0	0	0	0	0	0	3	2	0	5	1	0	0	0	1	2	7	0	0	9	15
Grand Total	0	0	0	0	0	0	14	3	0	17	3	0	0	0	3	3	13	0	0	16	36
Apprch %	0	0	0	0	0	0	82.4	17.6	0		100	0	0	0		18.8	81.2	0	0		
Total %	0	0	0	0	0	0	38.9	8.3	0	47.2	8.3	0	0	0	8.3	8.3	36.1	0	0	44.4	

Start Time	SR-99 Northbound On Ramp Southbound					Avenue 17 Westbound					SR-99 Northbound Off Ramp Northbound					Avenue 17 Eastbound					Int. Total
	Left	Thru	Right	U-Turns	App. Total	Thru	Right	U-Turns	App. Total	Thru	Right	U-Turns	App. Total	Thru	Right	U-Turns	App. Total				
Peak Hour Analysis From 04:00 PM to 04:45 PM - Peak 1 of 1																					
Peak Hour for Entire Intersection Begins at 04:00 PM																					
04:00 PM	0	0	0	0	0	0	6	0	0	6	1	0	0	0	1	0	0	0	0	0	7
04:15 PM	0	0	0	0	0	0	1	1	0	2	0	0	0	0	0	1	1	0	0	2	4
04:30 PM	0	0	0	0	0	0	4	0	0	4	0	0	0	0	0	0	1	0	0	1	5
04:45 PM	0	0	0	0	0	0	0	0	0	0	1	0	0	0	1	0	4	0	0	4	5
Total Volume	0	0	0	0	0	0	11	1	0	12	2	0	0	0	2	1	6	0	0	7	21
% App. Total	0	0	0	0	0	0	91.7	8.3	0		100	0	0	0		14.3	85.7	0	0		
PHF	.000	.000	.000	.000	.000	.000	.458	.250	.000	.500	.500	.000	.000	.000	.500	.250	.375	.000	.000	.438	.750

City of Madera
 N/S: SR-99 Northbound Ramps
 E/W: Avenue 17
 Weather: Clear

File Name : 13_MDA_99N_Ave 17 PM
 Site Code : 00319628
 Start Date : 9/18/2019
 Page No : 2

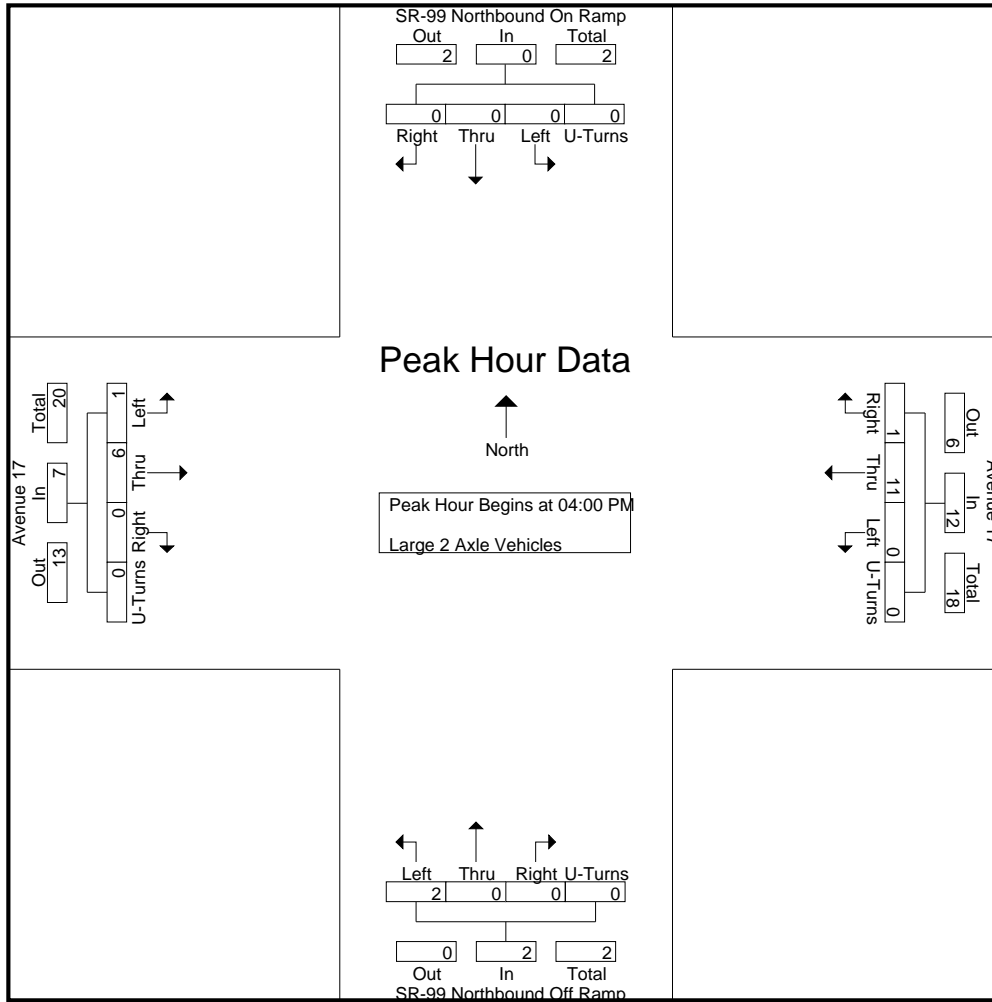

Peak Hour Analysis From 04:00 PM to 04:45 PM - Peak 1 of 1
 Peak Hour for Each Approach Begins at:

	04:00 PM					04:00 PM					04:00 PM									
+0 mins.	0	0	0	0	0	0	6	0	0	6	1	0	0	0	1	0	0	0	0	0
+15 mins.	0	0	0	0	0	0	1	1	0	2	0	0	0	0	0	1	1	0	0	2
+30 mins.	0	0	0	0	0	0	4	0	0	4	0	0	0	0	0	0	1	0	0	1
+45 mins.	0	0	0	0	0	0	0	0	0	0	1	0	0	0	1	0	4	0	0	4
Total Volume	0	0	0	0	0	0	11	1	0	12	2	0	0	0	2	1	6	0	0	7
% App. Total	0	0	0	0	0	0	91.7	8.3	0	100	100	0	0	0	0	14.3	85.7	0	0	0
PHF	.000	.000	.000	.000	.000	.000	.458	.250	.000	.500	.500	.000	.000	.000	.500	.250	.375	.000	.000	.438

City of Madera
 N/S: SR-99 Northbound Ramps
 E/W: Avenue 17
 Weather: Clear

File Name : 13_MDA_99N_Ave 17 PM
 Site Code : 00319628
 Start Date : 9/18/2019
 Page No : 1

Groups Printed- 3 Axle Vehicles

Start Time	SR-99 Northbound On Ramp Southbound					Avenue 17 Westbound					SR-99 Northbound Off Ramp Northbound					Avenue 17 Eastbound					Int. Total
	Left	Thru	Right	U-Turns	App. Total	Left	Thru	Right	U-Turns	App. Total	Left	Thru	Right	U-Turns	App. Total	Left	Thru	Right	U-Turns	App. Total	
04:00 PM	0	0	0	0	0	0	0	0	0	0	0	0	0	0	0	0	0	0	0	0	0
04:15 PM	0	0	0	0	0	0	0	0	0	0	0	0	0	0	0	1	1	0	0	0	2
04:30 PM	0	0	0	0	0	0	0	0	0	0	0	0	0	0	0	0	0	0	0	0	0
04:45 PM	0	0	0	0	0	0	0	0	0	0	1	0	0	0	1	0	0	0	0	0	1
Total	0	0	0	0	0	0	0	0	0	0	1	0	0	0	1	1	1	0	0	0	2
05:00 PM	0	0	0	0	0	0	1	1	0	2	0	0	0	0	0	0	0	0	0	0	2
05:15 PM	0	0	0	0	0	0	0	0	0	0	0	0	0	0	0	0	2	0	0	0	2
05:30 PM	0	0	0	0	0	0	0	0	0	0	0	0	0	0	0	0	0	0	0	0	0
05:45 PM	0	0	0	0	0	0	0	0	0	0	1	0	0	0	1	2	0	0	0	0	2
Total	0	0	0	0	0	0	1	1	0	2	1	0	0	0	1	2	2	0	0	0	4
Grand Total	0	0	0	0	0	0	1	1	0	2	2	0	0	0	2	3	3	0	0	0	6
Apprch %	0	0	0	0		0	50	50	0		100	0	0	0		50	50	0	0		
Total %	0	0	0	0	0	0	10	10	0	20	20	0	0	0	20	30	30	0	0	60	

Start Time	SR-99 Northbound On Ramp Southbound					Avenue 17 Westbound					SR-99 Northbound Off Ramp Northbound					Avenue 17 Eastbound					Int. Total
	Left	Thru	Right	U-Turns	App. Total	Left	Thru	Right	U-Turns	App. Total	Left	Thru	Right	U-Turns	App. Total	Left	Thru	Right	U-Turns	App. Total	
Peak Hour Analysis From 04:00 PM to 04:45 PM - Peak 1 of 1																					
Peak Hour for Entire Intersection Begins at 04:00 PM																					
04:00 PM	0	0	0	0	0	0	0	0	0	0	0	0	0	0	0	0	0	0	0	0	0
04:15 PM	0	0	0	0	0	0	0	0	0	0	0	0	0	0	0	1	1	0	0	0	2
04:30 PM	0	0	0	0	0	0	0	0	0	0	0	0	0	0	0	0	0	0	0	0	0
04:45 PM	0	0	0	0	0	0	0	0	0	0	1	0	0	0	1	0	0	0	0	0	1
Total Volume	0	0	0	0	0	0	0	0	0	0	1	0	0	0	1	1	1	0	0	0	2
% App. Total	0	0	0	0	0	0	0	0	0	0	100	0	0	0	0	50	50	0	0	0	
PHF	.000	.000	.000	.000	.000	.000	.000	.000	.000	.000	.250	.000	.000	.000	.250	.250	.250	.000	.000	.250	.375

City of Madera
 N/S: SR-99 Northbound Ramps
 E/W: Avenue 17
 Weather: Clear

File Name : 13_MDA_99N_Ave 17 PM
 Site Code : 00319628
 Start Date : 9/18/2019
 Page No : 2

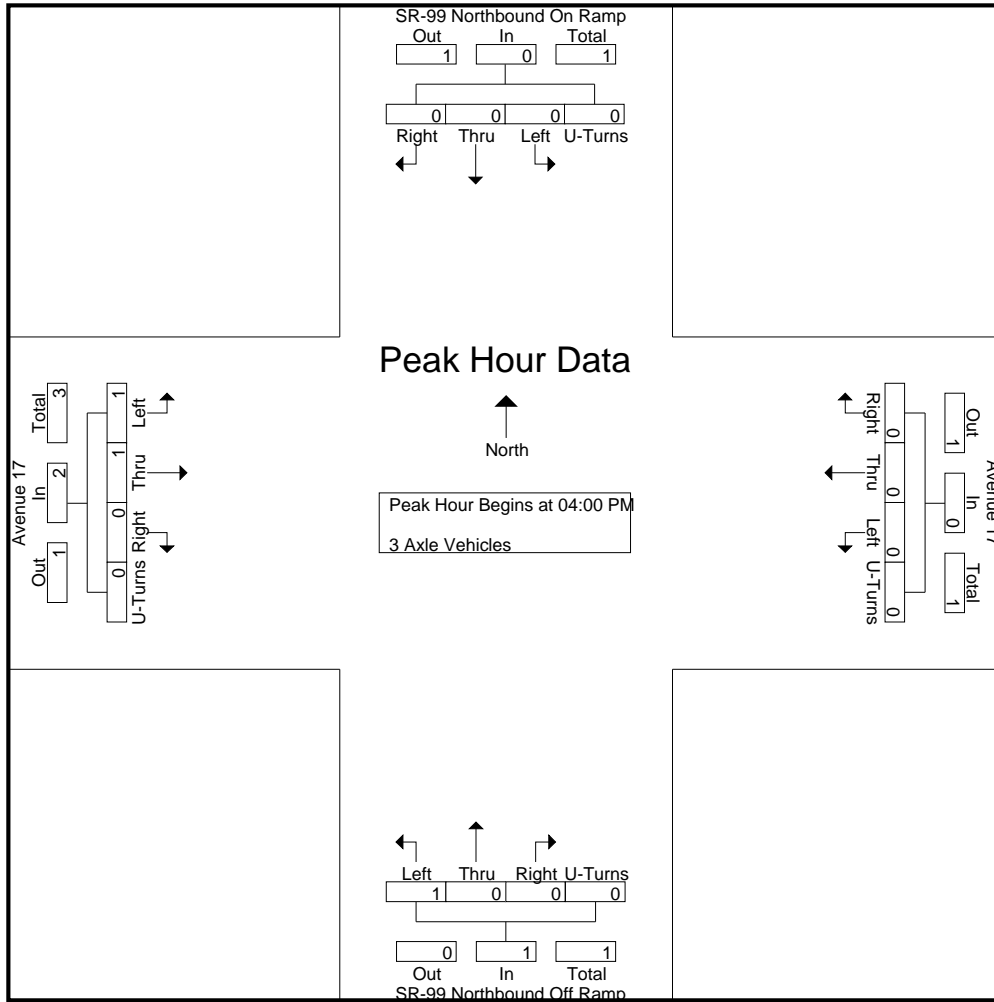

Peak Hour Analysis From 04:00 PM to 04:45 PM - Peak 1 of 1
 Peak Hour for Each Approach Begins at:

	04:00 PM					04:00 PM					04:00 PM					04:00 PM				
+0 mins.	0	0	0	0	0	0	0	0	0	0	0	0	0	0	0	0	0	0	0	0
+15 mins.	0	0	0	0	0	0	0	0	0	0	0	0	0	0	0	1	1	0	0	2
+30 mins.	0	0	0	0	0	0	0	0	0	0	0	0	0	0	0	0	0	0	0	0
+45 mins.	0	0	0	0	0	0	0	0	0	0	1	0	0	0	1	0	0	0	0	0
Total Volume	0	0	0	0	0	0	0	0	0	0	1	0	0	0	1	1	1	0	0	2
% App. Total	0	0	0	0	0	0	0	0	0	0	100	0	0	0	0	50	50	0	0	0
PHF	.000	.000	.000	.000	.000	.000	.000	.000	.000	.000	.250	.000	.000	.000	.250	.250	.250	.000	.000	.250

City of Madera
 N/S: SR-99 Northbound Ramps
 E/W: Avenue 17
 Weather: Clear

File Name : 13_MDA_99N_Ave 17 PM
 Site Code : 00319628
 Start Date : 9/18/2019
 Page No : 1

Groups Printed- 4+ Axle Trucks

Start Time	SR-99 Northbound On Ramp Southbound					Avenue 17 Westbound					SR-99 Northbound Off Ramp Northbound					Avenue 17 Eastbound					Int. Total
	Left	Thru	Right	U-Turns	App. Total	Left	Thru	Right	U-Turns	App. Total	Left	Thru	Right	U-Turns	App. Total	Left	Thru	Right	U-Turns	App. Total	
04:00 PM	0	0	0	0	0	0	0	1	0	1	1	0	0	0	1	0	0	0	0	0	2
04:15 PM	0	0	0	0	0	0	0	0	0	0	1	0	0	0	1	1	0	0	0	0	2
04:30 PM	0	0	0	0	0	0	0	0	0	0	1	0	0	0	1	3	1	0	0	4	5
04:45 PM	0	0	0	0	0	0	0	0	0	0	1	0	0	0	1	1	1	0	0	2	3
Total	0	0	0	0	0	0	0	1	0	1	4	0	0	0	4	5	2	0	0	7	12
05:00 PM	0	0	0	0	0	0	1	0	0	1	0	0	0	0	0	0	1	0	0	1	2
05:15 PM	0	0	0	0	0	0	2	0	0	2	2	0	0	0	2	2	1	0	0	3	7
05:30 PM	0	0	0	0	0	0	1	0	0	1	0	0	0	0	0	2	3	0	0	5	6
05:45 PM	0	0	0	0	0	0	0	0	0	0	0	0	0	0	0	2	1	0	0	3	3
Total	0	0	0	0	0	0	4	0	0	4	2	0	0	0	2	6	6	0	0	12	18
Grand Total	0	0	0	0	0	0	4	1	0	5	6	0	0	0	6	11	8	0	0	19	30
Apprch %	0	0	0	0	0	0	80	20	0	0	100	0	0	0	0	57.9	42.1	0	0	0	
Total %	0	0	0	0	0	0	13.3	3.3	0	16.7	20	0	0	0	20	36.7	26.7	0	0	63.3	

Start Time	SR-99 Northbound On Ramp Southbound					Avenue 17 Westbound					SR-99 Northbound Off Ramp Northbound					Avenue 17 Eastbound					Int. Total
	Left	Thru	Right	U-Turns	App. Total	Thru	Right	U-Turns	App. Total	Thru	Right	U-Turns	App. Total	Thru	Right	U-Turns	App. Total				
Peak Hour Analysis From 04:00 PM to 04:45 PM - Peak 1 of 1																					
Peak Hour for Entire Intersection Begins at 04:00 PM																					
04:00 PM	0	0	0	0	0	0	0	1	0	1	1	0	0	0	1	0	0	0	0	0	2
04:15 PM	0	0	0	0	0	0	0	0	0	0	1	0	0	0	1	1	0	0	0	1	2
04:30 PM	0	0	0	0	0	0	0	0	0	0	1	0	0	0	1	3	1	0	0	4	5
04:45 PM	0	0	0	0	0	0	0	0	0	0	1	0	0	0	1	1	1	0	0	2	3
Total Volume	0	0	0	0	0	0	0	1	0	1	4	0	0	0	4	5	2	0	0	7	12
% App. Total	0	0	0	0	0	0	0	100	0	0	100	0	0	0	0	71.4	28.6	0	0	0	
PHF	.000	.000	.000	.000	.000	.000	.000	.250	.000	.250	1.00	.000	.000	.000	1.00	.417	.500	.000	.000	.438	.600

City of Madera
 N/S: SR-99 Northbound Ramps
 E/W: Avenue 17
 Weather: Clear

File Name : 13_MDA_99N_Ave 17 PM
 Site Code : 00319628
 Start Date : 9/18/2019
 Page No : 2

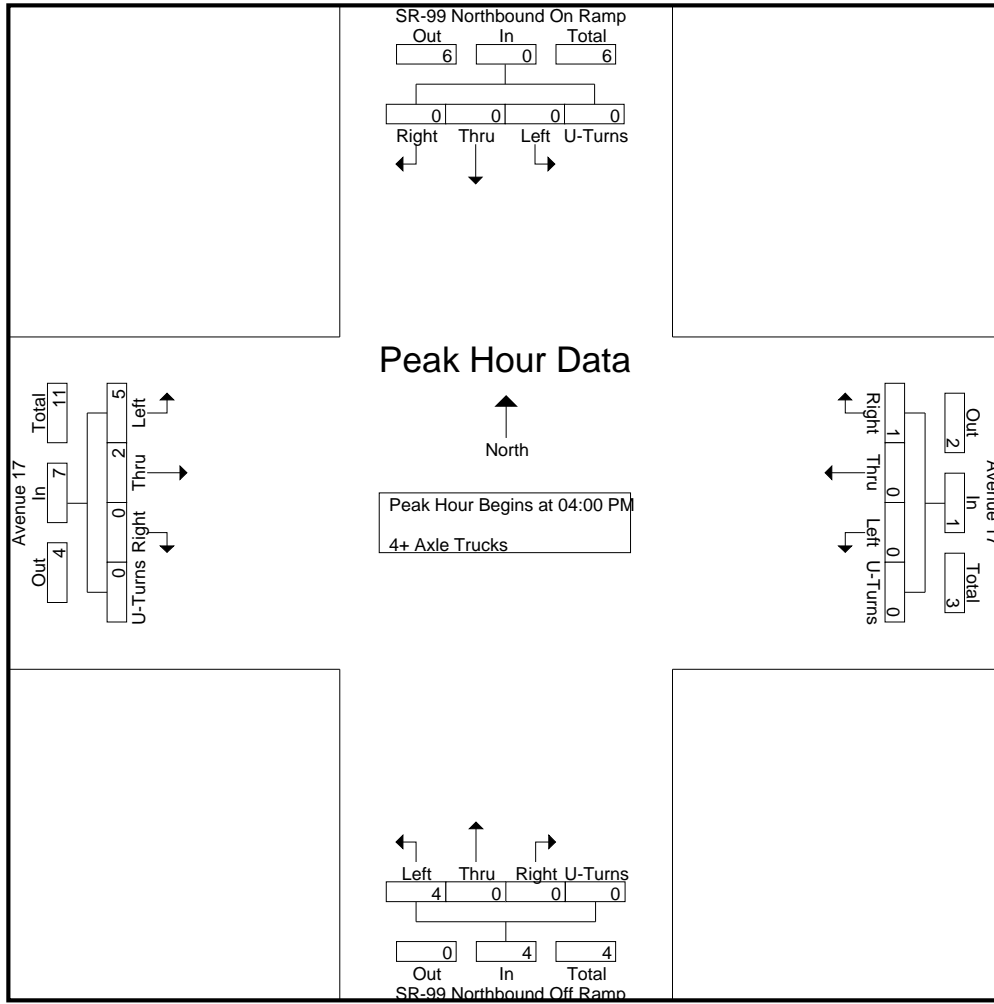

Peak Hour Analysis From 04:00 PM to 04:45 PM - Peak 1 of 1
 Peak Hour for Each Approach Begins at:

	04:00 PM					04:00 PM					04:00 PM					04:00 PM				
+0 mins.	0	0	0	0	0	0	0	1	0	1	1	0	0	0	1	0	0	0	0	0
+15 mins.	0	0	0	0	0	0	0	0	0	0	1	0	0	0	1	1	0	0	0	1
+30 mins.	0	0	0	0	0	0	0	0	0	0	1	0	0	0	1	3	1	0	0	4
+45 mins.	0	0	0	0	0	0	0	0	0	0	1	0	0	0	1	1	1	0	0	2
Total Volume	0	0	0	0	0	0	0	1	0	1	4	0	0	0	4	5	2	0	0	7
% App. Total	0	0	0	0	0	0	0	100	0	0	100	0	0	0	0	71.4	28.6	0	0	0
PHF	.000	.000	.000	.000	.000	.000	.000	.250	.000	.250	1.000	.000	.000	.000	1.000	.417	.500	.000	.000	.438

Location: Madera
 N/S: SR-99 Northbound Ramps
 E/W: Avenue 17



Date: 9/18/2019
 Day: Wednesday

PEDESTRIANS

	North Leg SR-99 Northbound Ramps	East Leg Avenue 17	South Leg SR-99 Northbound Ramps	West Leg Avenue 17	
	Pedestrians	Pedestrians	Pedestrians	Pedestrians	
7:00 AM	0	0	0	0	0
7:15 AM	0	0	0	0	0
7:30 AM	0	0	0	0	0
7:45 AM	0	0	0	0	0
8:00 AM	0	0	0	0	0
8:15 AM	0	0	0	0	0
8:30 AM	0	0	0	0	0
8:45 AM	0	0	0	0	0
TOTAL VOLUMES:	0	0	0	0	0

	North Leg SR-99 Northbound Ramps	East Leg Avenue 17	South Leg SR-99 Northbound Ramps	West Leg Avenue 17	
	Pedestrians	Pedestrians	Pedestrians	Pedestrians	
4:00 PM	0	0	0	0	0
4:15 PM	0	0	0	0	0
4:30 PM	0	0	0	0	0
4:45 PM	0	0	0	0	0
5:00 PM	0	0	0	0	0
5:15 PM	0	0	0	0	0
5:30 PM	0	0	0	0	0
5:45 PM	0	0	0	0	0
TOTAL VOLUMES:	0	0	0	0	0

Location: Madera
 N/S: SR-99 Northbound Ramps
 E/W: Avenue 17



Date: 9/18/2019
 Day: Wednesday

BICYCLES

	Southbound SR-99 Northbound Ramps			Westbound Avenue 17			Northbound SR-99 Northbound Ramps			Eastbound Avenue 17			
	Left	Thru	Right	Left	Thru	Right	Left	Thru	Right	Left	Thru	Right	
7:00 AM	0	0	0	0	0	0	0	0	0	0	0	0	0
7:15 AM	0	0	0	0	0	0	0	0	0	0	0	0	0
7:30 AM	0	0	0	0	0	0	0	0	0	0	0	0	0
7:45 AM	0	0	0	0	0	0	0	0	0	0	0	0	0
8:00 AM	0	0	0	0	0	0	0	0	0	0	0	0	0
8:15 AM	0	0	0	0	0	0	0	0	0	0	0	0	0
8:30 AM	0	0	0	0	0	0	0	0	0	0	0	0	0
8:45 AM	0	0	0	0	0	0	0	0	0	0	0	0	0
TOTAL VOLUMES:	0	0	0	0	0	0	0	0	0	0	0	0	0

	Southbound SR-99 Northbound Ramps			Westbound Avenue 17			Northbound SR-99 Northbound Ramps			Eastbound Avenue 17			
	Left	Thru	Right	Left	Thru	Right	Left	Thru	Right	Left	Thru	Right	
4:00 PM	0	0	0	0	0	0	0	0	0	0	0	0	0
4:15 PM	0	0	0	0	0	0	0	0	0	0	0	0	0
4:30 PM	0	0	0	0	0	0	0	0	0	0	0	0	0
4:45 PM	0	0	0	0	0	0	0	0	0	0	0	0	0
5:00 PM	0	0	0	0	0	0	0	0	0	0	0	0	0
5:15 PM	0	0	0	0	0	0	0	0	0	0	0	0	0
5:30 PM	0	0	0	0	0	0	0	0	0	0	0	0	0
5:45 PM	0	0	0	0	0	0	0	0	0	0	0	0	0
TOTAL VOLUMES:	0	0	0	0	0	0	0	0	0	0	0	0	0

City of Madera
 N/S: Westberry Boulevard
 E/W: Avenue 15 1/2 /Cleveland Avenue
 Weather: Clear

File Name : 14_MDA_Westberry_Cleveland AM
 Site Code : 00319628
 Start Date : 9/18/2019
 Page No : 1

Groups Printed- Total Volume

Start Time	Westberry Boulevard Southbound					Cleveland Avenue Westbound					Westberry Boulevard Northbound					Avenue 15 1/2 Eastbound					Int. Total
	Left	Thru	Right	U-Turns	App. Total	Left	Thru	Right	U-Turns	App. Total	Left	Thru	Right	U-Turns	App. Total	Left	Thru	Right	U-Turns	App. Total	
07:00 AM	1	5	1	0	7	9	8	2	0	19	0	9	8	0	17	3	4	0	0	7	50
07:15 AM	3	3	7	0	13	2	7	1	0	10	5	12	15	0	32	2	5	0	0	7	62
07:30 AM	3	1	8	0	12	6	17	3	0	26	4	8	14	0	26	3	15	1	0	19	83
07:45 AM	3	7	5	0	15	6	16	8	0	30	4	10	18	0	32	3	9	2	0	14	91
Total	10	16	21	0	47	23	48	14	0	85	13	39	55	0	107	11	33	3	0	47	286
08:00 AM	5	8	1	0	14	6	10	0	0	16	0	4	10	0	14	4	16	3	0	23	67
08:15 AM	2	2	5	0	9	6	9	4	0	19	0	9	7	0	16	0	13	1	0	14	58
08:30 AM	0	6	3	0	9	8	12	0	0	20	2	0	17	0	19	4	15	1	0	20	68
08:45 AM	2	2	2	0	6	5	8	1	0	14	0	4	4	0	8	2	19	2	0	23	51
Total	9	18	11	0	38	25	39	5	0	69	2	17	38	0	57	10	63	7	0	80	244
Grand Total	19	34	32	0	85	48	87	19	0	154	15	56	93	0	164	21	96	10	0	127	530
Apprch %	22.4	40	37.6	0		31.2	56.5	12.3	0		9.1	34.1	56.7	0		16.5	75.6	7.9	0		
Total %	3.6	6.4	6	0	16	9.1	16.4	3.6	0	29.1	2.8	10.6	17.5	0	30.9	4	18.1	1.9	0	24	

Start Time	Westberry Boulevard Southbound					Cleveland Avenue Westbound					Westberry Boulevard Northbound					Avenue 15 1/2 Eastbound					Int. Total
	Left	Thru	Right	U-Turns	App. Total	Left	Thru	Right	U-Turns	App. Total	Left	Thru	Right	U-Turns	App. Total	Left	Thru	Right	U-Turns	App. Total	
Peak Hour Analysis From 07:00 AM to 08:45 AM - Peak 1 of 1																					
Peak Hour for Entire Intersection Begins at 07:15 AM																					
07:15 AM	3	3	7	0	13	2	7	1	0	10	5	12	15	0	32	2	5	0	0	7	62
07:30 AM	3	1	8	0	12	6	17	3	0	26	4	8	14	0	26	3	15	1	0	19	83
07:45 AM	3	7	5	0	15	6	16	8	0	30	4	10	18	0	32	3	9	2	0	14	91
08:00 AM	5	8	1	0	14	6	10	0	0	16	0	4	10	0	14	4	16	3	0	23	67
Total Volume	14	19	21	0	54	20	50	12	0	82	13	34	57	0	104	12	45	6	0	63	303
% App. Total	25.9	35.2	38.9	0		24.4	61	14.6	0		12.5	32.7	54.8	0		19	71.4	9.5	0		
PHF	.700	.594	.656	.000	.900	.833	.735	.375	.000	.683	.650	.708	.792	.000	.813	.750	.703	.500	.000	.685	.832

City of Madera
 N/S: Westberry Boulevard
 E/W: Avenue 15 1/2 /Cleveland Avenue
 Weather: Clear

File Name : 14_MDA_Westberry_Cleveland AM
 Site Code : 00319628
 Start Date : 9/18/2019
 Page No : 2

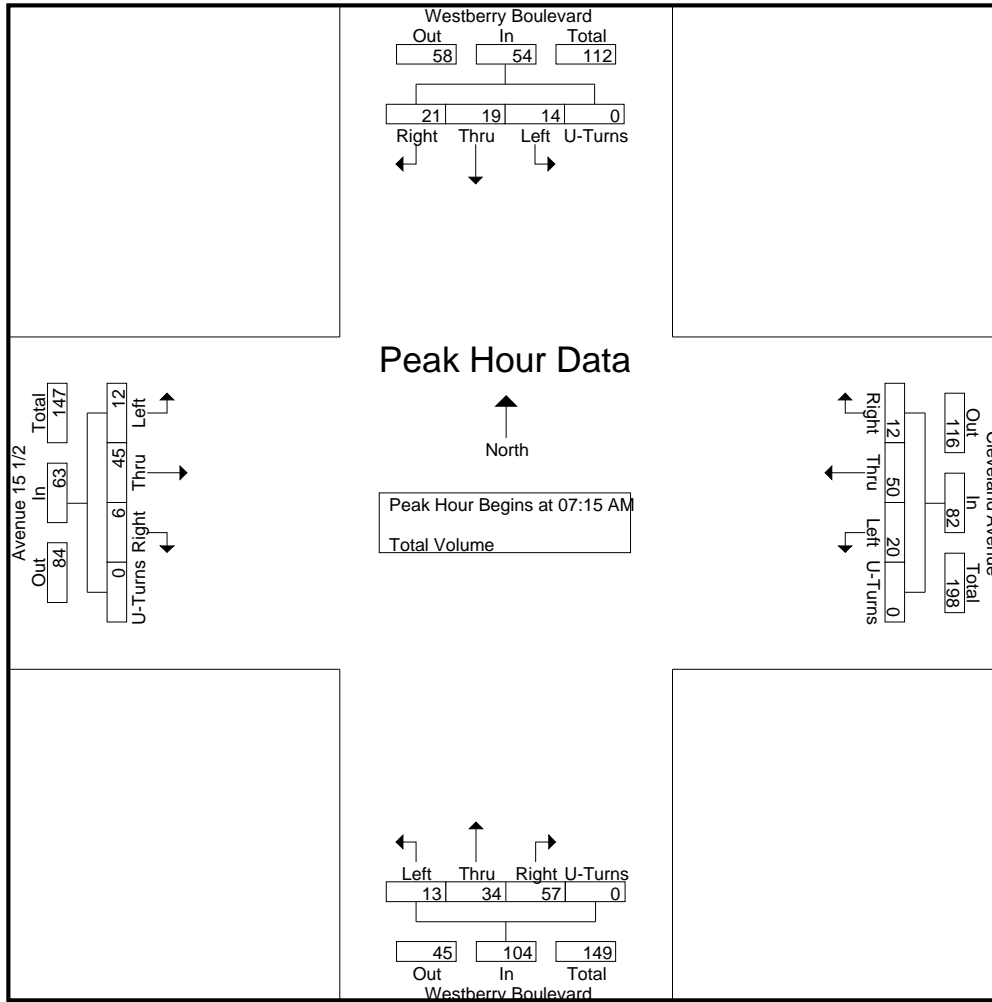

Peak Hour Analysis From 07:00 AM to 08:45 AM - Peak 1 of 1
 Peak Hour for Each Approach Begins at:

	07:15 AM					07:30 AM					07:00 AM					08:00 AM				
+0 mins.	3	3	7	0	13	6	17	3	0	26	0	9	8	0	17	4	16	3	0	23
+15 mins.	3	1	8	0	12	6	16	8	0	30	5	12	15	0	32	0	13	1	0	14
+30 mins.	3	7	5	0	15	6	10	0	0	16	4	8	14	0	26	4	15	1	0	20
+45 mins.	5	8	1	0	14	6	9	4	0	19	4	10	18	0	32	2	19	2	0	23
Total Volume	14	19	21	0	54	24	52	15	0	91	13	39	55	0	107	10	63	7	0	80
% App. Total	25.9	35.2	38.9	0		26.4	57.1	16.5	0		12.1	36.4	51.4	0		12.5	78.8	8.8	0	
PHF	.700	.594	.656	.000	.900	1.000	.765	.469	.000	.758	.650	.813	.764	.000	.836	.625	.829	.583	.000	.870

City of Madera
 N/S: Westberry Boulevard
 E/W: Avenue 15 1/2 /Cleveland Avenue
 Weather: Clear

File Name : 14_MDA_Westberry_Cleveland PM
 Site Code : 00319628
 Start Date : 9/18/2019
 Page No : 1

Groups Printed- Total Volume

Start Time	Westberry Boulevard Southbound					Cleveland Avenue Westbound					Westberry Boulevard Northbound					Avenue 15 1/2 Eastbound					Int. Total
	Left	Thru	Right	U-Turns	App. Total	Left	Thru	Right	U-Turns	App. Total	Left	Thru	Right	U-Turns	App. Total	Left	Thru	Right	U-Turns	App. Total	
04:00 PM	5	12	3	0	20	9	20	2	0	31	2	3	6	0	11	5	33	1	0	39	101
04:15 PM	3	4	2	0	9	6	15	2	0	23	1	1	9	0	11	5	31	3	0	39	82
04:30 PM	4	2	2	0	8	8	19	5	0	32	0	1	9	0	10	8	33	2	0	43	93
04:45 PM	1	2	1	0	4	4	8	2	0	14	1	1	10	0	12	5	25	3	0	33	63
Total	13	20	8	0	41	27	62	11	0	100	4	6	34	0	44	23	122	9	0	154	339
05:00 PM	5	4	3	0	12	15	16	0	0	31	1	2	7	0	10	9	25	2	0	36	89
05:15 PM	4	5	4	0	13	10	19	1	0	30	2	2	8	0	12	8	19	3	0	30	85
05:30 PM	3	5	2	0	10	6	11	0	0	17	3	3	7	1	14	7	33	3	0	43	84
05:45 PM	3	2	3	0	8	10	20	0	0	30	0	4	4	0	8	0	27	1	0	28	74
Total	15	16	12	0	43	41	66	1	0	108	6	11	26	1	44	24	104	9	0	137	332
Grand Total	28	36	20	0	84	68	128	12	0	208	10	17	60	1	88	47	226	18	0	291	671
Apprch %	33.3	42.9	23.8	0		32.7	61.5	5.8	0		11.4	19.3	68.2	1.1		16.2	77.7	6.2	0		
Total %	4.2	5.4	3	0	12.5	10.1	19.1	1.8	0	31	1.5	2.5	8.9	0.1	13.1	7	33.7	2.7	0	43.4	

Start Time	Westberry Boulevard Southbound					Cleveland Avenue Westbound					Westberry Boulevard Northbound					Avenue 15 1/2 Eastbound					Int. Total
	Left	Thru	Right	U-Turns	App. Total	Thru	Right	U-Turns	App. Total	Thru	Right	U-Turns	App. Total	Thru	Right	U-Turns	App. Total				
Peak Hour Analysis From 04:00 PM to 05:45 PM - Peak 1 of 1																					
Peak Hour for Entire Intersection Begins at 04:00 PM																					
04:00 PM	5	12	3	0	20	9	20	2	0	31	2	3	6	0	11	5	33	1	0	39	101
04:15 PM	3	4	2	0	9	6	15	2	0	23	1	1	9	0	11	5	31	3	0	39	82
04:30 PM	4	2	2	0	8	8	19	5	0	32	0	1	9	0	10	8	33	2	0	43	93
04:45 PM	1	2	1	0	4	4	8	2	0	14	1	1	10	0	12	5	25	3	0	33	63
Total Volume	13	20	8	0	41	27	62	11	0	100	4	6	34	0	44	23	122	9	0	154	339
% App. Total	31.7	48.8	19.5	0		27	62	11	0		9.1	13.6	77.3	0		14.9	79.2	5.8	0		
PHF	.650	.417	.667	.000	.513	.750	.775	.550	.000	.781	.500	.500	.850	.000	.917	.719	.924	.750	.000	.895	.839

City of Madera
 N/S: Westberry Boulevard
 E/W: Avenue 15 1/2 /Cleveland Avenue
 Weather: Clear

File Name : 14_MDA_Westberry_Cleveland PM
 Site Code : 00319628
 Start Date : 9/18/2019
 Page No : 2

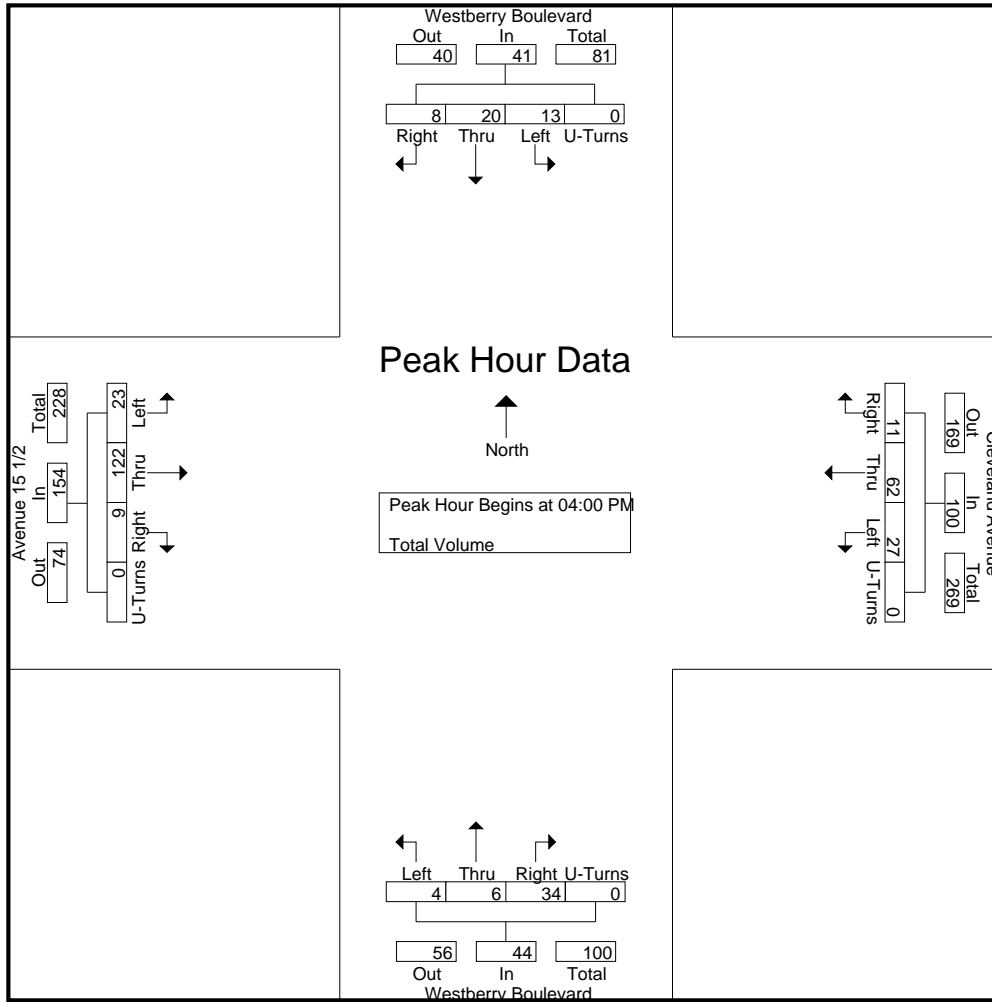

Peak Hour Analysis From 04:00 PM to 05:45 PM - Peak 1 of 1
 Peak Hour for Each Approach Begins at:

	05:00 PM					05:00 PM					04:45 PM					04:00 PM				
+0 mins.	5	4	3	0	12	15	16	0	0	31	1	1	10	0	12	5	33	1	0	39
+15 mins.	4	5	4	0	13	10	19	1	0	30	1	2	7	0	10	5	31	3	0	39
+30 mins.	3	5	2	0	10	6	11	0	0	17	2	2	8	0	12	8	33	2	0	43
+45 mins.	3	2	3	0	8	10	20	0	0	30	3	3	7	1	14	5	25	3	0	33
Total Volume	15	16	12	0	43	41	66	1	0	108	7	8	32	1	48	23	122	9	0	154
% App. Total	34.9	37.2	27.9	0		38	61.1	0.9	0		14.6	16.7	66.7	2.1		14.9	79.2	5.8	0	
PHF	.750	.800	.750	.000	.827	.683	.825	.250	.000	.871	.583	.667	.800	.250	.857	.719	.924	.750	.000	.895

Location: Madera
 N/S: Westberry Boulevard
 E/W: Ave 15 1/2 /Cleveland Avenue



Date: 9/18/2019
 Day: Wednesday

PEDESTRIANS

	North Leg Westberry Boulevard Pedestrians	East Leg Cleveland Avenue Pedestrians	South Leg Westberry Boulevard Pedestrians	West Leg Avenue 15 1/2 Pedestrians	
7:00 AM	0	0	0	0	0
7:15 AM	0	0	0	0	0
7:30 AM	0	1	2	1	4
7:45 AM	1	0	0	0	1
8:00 AM	0	0	0	0	0
8:15 AM	0	0	0	0	0
8:30 AM	0	0	1	0	1
8:45 AM	0	1	2	0	3
TOTAL VOLUMES:	1	2	5	1	9

	North Leg Westberry Boulevard Pedestrians	East Leg Cleveland Avenue Pedestrians	South Leg Westberry Boulevard Pedestrians	West Leg Avenue 15 1/2 Pedestrians	
4:00 PM	0	0	3	0	3
4:15 PM	0	0	0	0	0
4:30 PM	0	0	0	0	0
4:45 PM	0	0	0	0	0
5:00 PM	0	0	0	0	0
5:15 PM	0	0	0	0	0
5:30 PM	0	0	0	0	0
5:45 PM	0	0	0	0	0
TOTAL VOLUMES:	0	0	3	0	3

Location: Madera
 N/S: Westberry Boulevard
 E/W: Ave 15 1/2 /Cleveland Avenue



Date: 9/18/2019
 Day: Wednesday

BICYCLES

	Southbound Westberry Boulevard			Westbound Cleveland Avenue			Northbound Westberry Boulevard			Eastbound Avenue 15 1/2			
	Left	Thru	Right	Left	Thru	Right	Left	Thru	Right	Left	Thru	Right	
7:00 AM	0	0	0	0	0	0	0	0	0	0	0	0	0
7:15 AM	0	0	0	0	0	0	0	0	0	0	0	0	0
7:30 AM	0	0	0	0	0	0	0	0	0	1	0	0	1
7:45 AM	0	0	0	0	0	0	0	0	0	0	0	0	0
8:00 AM	0	0	0	0	0	0	0	0	0	0	0	0	0
8:15 AM	0	0	0	0	0	0	0	0	0	0	0	0	0
8:30 AM	0	0	0	0	0	0	0	0	0	0	0	0	0
8:45 AM	0	0	0	0	0	0	0	0	0	0	0	0	0
TOTAL VOLUMES:	0	0	0	0	0	0	0	0	0	1	0	0	1

	Southbound Westberry Boulevard			Westbound Cleveland Avenue			Northbound Westberry Boulevard			Eastbound Avenue 15 1/2			
	Left	Thru	Right	Left	Thru	Right	Left	Thru	Right	Left	Thru	Right	
4:00 PM	0	0	0	0	0	0	0	0	0	0	0	0	0
4:15 PM	0	0	0	0	0	0	0	0	0	0	0	0	0
4:30 PM	0	0	0	0	0	0	0	0	0	0	0	0	0
4:45 PM	0	0	0	0	0	0	0	0	0	0	0	0	0
5:00 PM	0	0	0	0	0	0	0	0	0	0	0	0	0
5:15 PM	0	0	0	0	0	0	0	0	0	0	0	0	0
5:30 PM	0	0	0	0	0	3	0	0	0	0	0	0	3
5:45 PM	0	0	0	0	0	0	0	0	0	0	0	0	0
TOTAL VOLUMES:	0	0	0	0	0	3	0	0	0	0	0	0	3

City of Madera
 N/S: Westberry Boulevard
 E/W: Sunset Avenue
 Weather: Clear

File Name : 15_MDA_Westberry_Sunset AM
 Site Code : 00319628
 Start Date : 9/18/2019
 Page No : 1

Groups Printed- Total Volume

Start Time	Westberry Boulevard Southbound					Sunset Avenue Westbound					Westberry Boulevard Northbound					Sunset Avenue Eastbound					Int. Total
	Left	Thru	Right	U-Turns	App. Total	Left	Thru	Right	U-Turns	App. Total	Left	Thru	Right	U-Turns	App. Total	Left	Thru	Right	U-Turns	App. Total	
07:00 AM	4	13	0	0	17	4	16	0	0	20	13	11	11	0	35	0	14	6	0	20	92
07:15 AM	31	26	7	1	65	19	62	9	0	90	47	43	41	0	131	13	68	32	0	113	399
07:30 AM	19	9	6	1	35	10	34	6	0	50	29	27	27	0	83	7	42	22	0	71	239
07:45 AM	38	21	17	7	83	14	44	7	0	65	29	20	19	0	68	21	60	20	0	101	317
Total	92	69	30	9	200	47	156	22	0	225	118	101	98	0	317	41	184	80	0	305	1047
08:00 AM	13	25	0	0	38	4	19	0	0	23	8	12	14	1	35	5	43	10	0	58	154
08:15 AM	12	15	2	0	29	10	16	4	0	30	7	16	15	0	38	0	25	3	0	28	125
08:30 AM	6	4	0	0	10	11	17	6	0	34	5	19	14	0	38	0	13	5	0	18	100
08:45 AM	5	4	1	0	10	10	12	10	0	32	3	13	8	0	24	1	15	3	0	19	85
Total	36	48	3	0	87	35	64	20	0	119	23	60	51	1	135	6	96	21	0	123	464
Grand Total	128	117	33	9	287	82	220	42	0	344	141	161	149	1	452	47	280	101	0	428	1511
Apprch %	44.6	40.8	11.5	3.1		23.8	64	12.2	0		31.2	35.6	33	0.2		11	65.4	23.6	0		
Total %	8.5	7.7	2.2	0.6	19	5.4	14.6	2.8	0	22.8	9.3	10.7	9.9	0.1	29.9	3.1	18.5	6.7	0	28.3	

Start Time	Westberry Boulevard Southbound					Sunset Avenue Westbound					Westberry Boulevard Northbound					Sunset Avenue Eastbound					Int. Total
	Left	Thru	Right	U-Turns	App. Total	Thru	Right	U-Turns	App. Total	Thru	Right	U-Turns	App. Total	Thru	Right	U-Turns	App. Total				
Peak Hour Analysis From 07:00 AM to 08:45 AM - Peak 1 of 1																					
Peak Hour for Entire Intersection Begins at 07:15 AM																					
07:15 AM	31	26	7	1	65	19	62	9	0	90	47	43	41	0	131	13	68	32	0	113	399
07:30 AM	19	9	6	1	35	10	34	6	0	50	29	27	27	0	83	7	42	22	0	71	239
07:45 AM	38	21	17	7	83	14	44	7	0	65	29	20	19	0	68	21	60	20	0	101	317
08:00 AM	13	25	0	0	38	4	19	0	0	23	8	12	14	1	35	5	43	10	0	58	154
Total Volume	101	81	30	9	221	47	159	22	0	228	113	102	101	1	317	46	213	84	0	343	1109
% App. Total	45.7	36.7	13.6	4.1		20.6	69.7	9.6	0		35.6	32.2	31.9	0.3		13.4	62.1	24.5	0		
PHF	.664	.779	.441	.321	.666	.618	.641	.611	.000	.633	.601	.593	.616	.250	.605	.548	.783	.656	.000	.759	.695

City of Madera
 N/S: Westberry Boulevard
 E/W: Sunset Avenue
 Weather: Clear

File Name : 15_MDA_Westberry_Sunset AM
 Site Code : 00319628
 Start Date : 9/18/2019
 Page No : 2

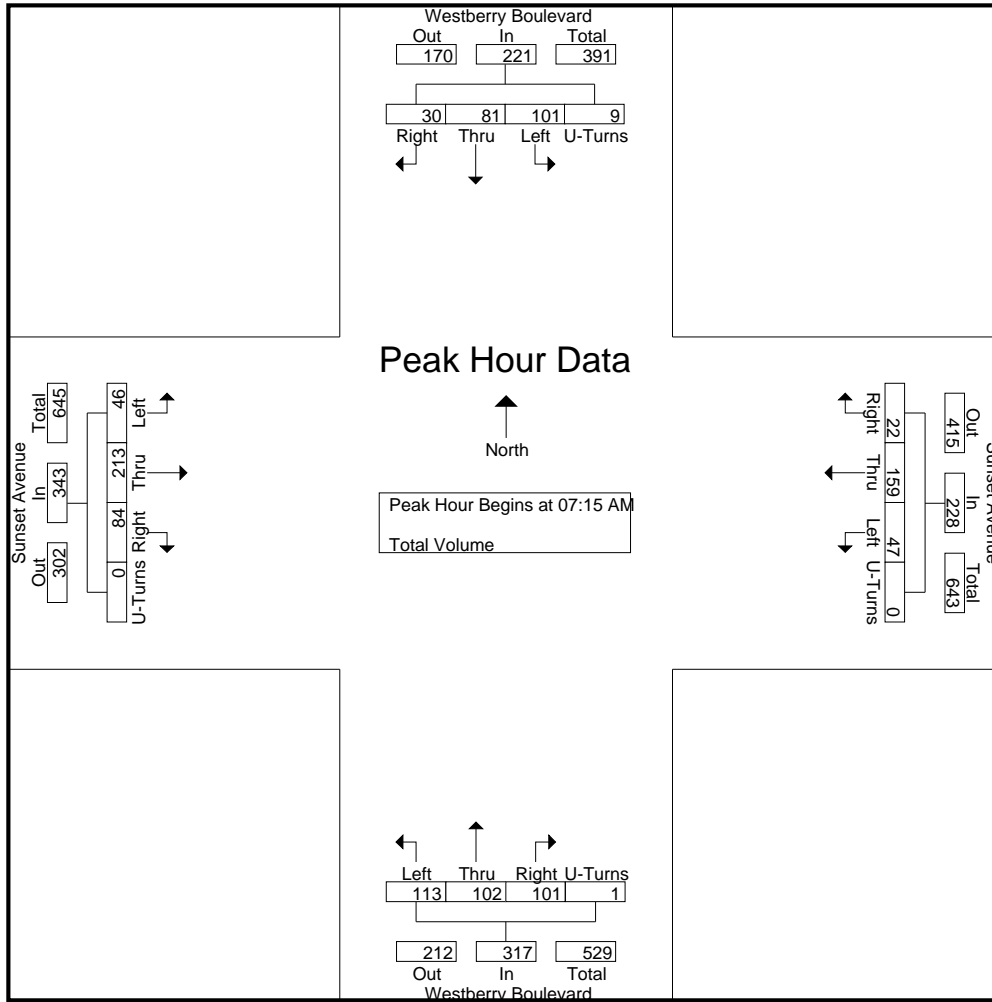

Peak Hour Analysis From 07:00 AM to 08:45 AM - Peak 1 of 1
 Peak Hour for Each Approach Begins at:

	07:15 AM					07:15 AM					07:00 AM					07:15 AM				
+0 mins.	31	26	7	1	65	19	62	9	0	90	13	11	11	0	35	13	68	32	0	113
+15 mins.	19	9	6	1	35	10	34	6	0	50	47	43	41	0	131	7	42	22	0	71
+30 mins.	38	21	17	7	83	14	44	7	0	65	29	27	27	0	83	21	60	20	0	101
+45 mins.	13	25	0	0	38	4	19	0	0	23	29	20	19	0	68	5	43	10	0	58
Total Volume	101	81	30	9	221	47	159	22	0	228	118	101	98	0	317	46	213	84	0	343
% App. Total	45.7	36.7	13.6	4.1		20.6	69.7	9.6	0		37.2	31.9	30.9	0		13.4	62.1	24.5	0	
PHF	.664	.779	.441	.321	.666	.618	.641	.611	.000	.633	.628	.587	.598	.000	.605	.548	.783	.656	.000	.759

City of Madera
 N/S: Westberry Boulevard
 E/W: Sunset Avenue
 Weather: Clear

File Name : 15_MDA_Westberry_Sunset PM
 Site Code : 00319628
 Start Date : 9/18/2019
 Page No : 1

Groups Printed- Total Volume

Start Time	Westberry Boulevard Southbound					Sunset Avenue Westbound					Westberry Boulevard Northbound					Sunset Avenue Eastbound					Int. Total
	Left	Thru	Right	U-Turns	App. Total	Left	Thru	Right	U-Turns	App. Total	Left	Thru	Right	U-Turns	App. Total	Left	Thru	Right	U-Turns	App. Total	
04:00 PM	3	27	5	0	35	13	8	3	0	24	10	29	16	1	56	4	15	11	0	30	145
04:15 PM	5	17	1	0	23	14	6	0	0	20	9	19	13	0	41	3	17	7	0	27	111
04:30 PM	2	20	0	0	22	6	14	3	0	23	8	25	9	0	42	3	26	11	0	40	127
04:45 PM	5	16	0	0	21	16	8	5	0	29	10	19	11	0	40	2	11	11	0	24	114
Total	15	80	6	0	101	49	36	11	0	96	37	92	49	1	179	12	69	40	0	121	497
05:00 PM	3	26	5	0	34	19	19	3	0	41	5	31	14	0	50	1	14	7	0	22	147
05:15 PM	3	24	2	0	29	13	26	3	0	42	14	26	10	0	50	1	16	7	0	24	145
05:30 PM	2	24	4	0	30	17	21	7	0	45	13	22	17	0	52	2	14	5	0	21	148
05:45 PM	7	21	2	1	31	15	8	3	0	26	11	29	14	0	54	2	11	4	0	17	128
Total	15	95	13	1	124	64	74	16	0	154	43	108	55	0	206	6	55	23	0	84	568
Grand Total	30	175	19	1	225	113	110	27	0	250	80	200	104	1	385	18	124	63	0	205	1065
Apprch %	13.3	77.8	8.4	0.4		45.2	44	10.8	0		20.8	51.9	27	0.3		8.8	60.5	30.7	0		
Total %	2.8	16.4	1.8	0.1	21.1	10.6	10.3	2.5	0	23.5	7.5	18.8	9.8	0.1	36.2	1.7	11.6	5.9	0	19.2	

Start Time	Westberry Boulevard Southbound					Sunset Avenue Westbound					Westberry Boulevard Northbound					Sunset Avenue Eastbound					Int. Total
	Left	Thru	Right	U-Turns	App. Total	Thru	Right	U-Turns	App. Total	Thru	Right	U-Turns	App. Total	Thru	Right	U-Turns	App. Total				
Peak Hour Analysis From 04:00 PM to 05:45 PM - Peak 1 of 1																					
Peak Hour for Entire Intersection Begins at 05:00 PM																					
05:00 PM	3	26	5	0	34	19	19	3	0	41	5	31	14	0	50	1	14	7	0	22	147
05:15 PM	3	24	2	0	29	13	26	3	0	42	14	26	10	0	50	1	16	7	0	24	145
05:30 PM	2	24	4	0	30	17	21	7	0	45	13	22	17	0	52	2	14	5	0	21	148
05:45 PM	7	21	2	1	31	15	8	3	0	26	11	29	14	0	54	2	11	4	0	17	128
Total Volume	15	95	13	1	124	64	74	16	0	154	43	108	55	0	206	6	55	23	0	84	568
% App. Total	12.1	76.6	10.5	0.8		41.6	48.1	10.4	0		20.9	52.4	26.7	0		7.1	65.5	27.4	0		
PHF	.536	.913	.650	.250	.912	.842	.712	.571	.000	.856	.768	.871	.809	.000	.954	.750	.859	.821	.000	.875	.959

City of Madera
 N/S: Westberry Boulevard
 E/W: Sunset Avenue
 Weather: Clear

File Name : 15_MDA_Westberry_Sunset PM
 Site Code : 00319628
 Start Date : 9/18/2019
 Page No : 2

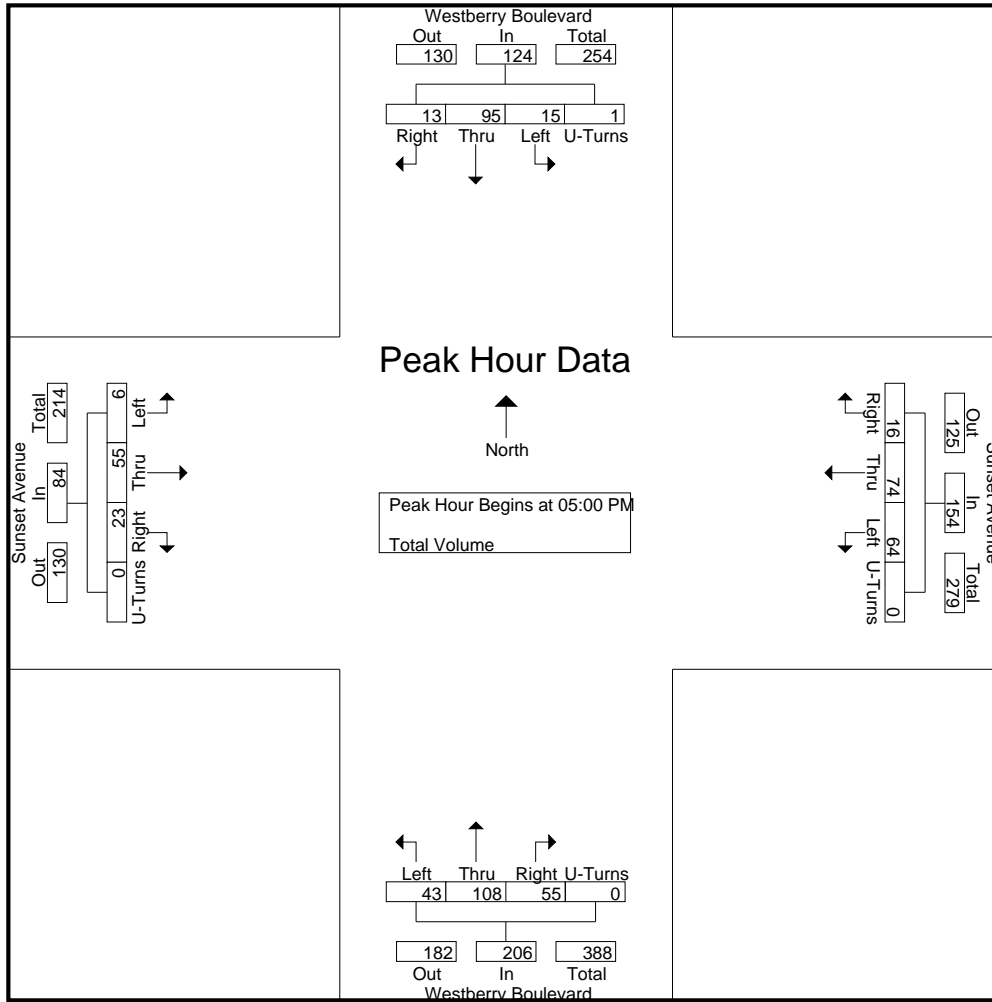

Peak Hour Analysis From 04:00 PM to 05:45 PM - Peak 1 of 1
 Peak Hour for Each Approach Begins at:

	05:00 PM					04:45 PM					05:00 PM					04:00 PM				
+0 mins.	3	26	5	0	34	16	8	5	0	29	5	31	14	0	50	4	15	11	0	30
+15 mins.	3	24	2	0	29	19	19	3	0	41	14	26	10	0	50	3	17	7	0	27
+30 mins.	2	24	4	0	30	13	26	3	0	42	13	22	17	0	52	3	26	11	0	40
+45 mins.	7	21	2	1	31	17	21	7	0	45	11	29	14	0	54	2	11	11	0	24
Total Volume	15	95	13	1	124	65	74	18	0	157	43	108	55	0	206	12	69	40	0	121
% App. Total	12.1	76.6	10.5	0.8		41.4	47.1	11.5	0		20.9	52.4	26.7	0		9.9	57	33.1	0	
PHF	.536	.913	.650	.250	.912	.855	.712	.643	.000	.872	.768	.871	.809	.000	.954	.750	.663	.909	.000	.756

Location: Madera
 N/S: Westberry Boulevard
 E/W: Sunset Avenue



Date: 9/18/2019
 Day: Wednesday

PEDESTRIANS

	North Leg Westberry Boulevard Pedestrians	East Leg Sunset Avenue Pedestrians	South Leg Westberry Boulevard Pedestrians	West Leg Sunset Avenue Pedestrians	
7:00 AM	1	0	0	0	1
7:15 AM	0	2	0	2	4
7:30 AM	0	1	0	0	1
7:45 AM	1	1	0	0	2
8:00 AM	1	0	0	1	2
8:15 AM	0	0	0	2	2
8:30 AM	1	0	0	0	1
8:45 AM	2	0	0	0	2
TOTAL VOLUMES:	6	4	0	5	15

	North Leg Westberry Boulevard Pedestrians	East Leg Sunset Avenue Pedestrians	South Leg Westberry Boulevard Pedestrians	West Leg Sunset Avenue Pedestrians	
4:00 PM	0	0	0	0	0
4:15 PM	0	0	0	0	0
4:30 PM	1	0	0	4	5
4:45 PM	0	0	0	0	0
5:00 PM	0	0	0	0	0
5:15 PM	0	0	0	0	0
5:30 PM	0	0	0	0	0
5:45 PM	0	0	0	0	0
TOTAL VOLUMES:	1	0	0	4	5

Location: Madera
 N/S: Westberry Boulevard
 E/W: Sunset Avenue



Date: 9/18/2019
 Day: Wednesday

BICYCLES

	Southbound Westberry Boulevard			Westbound Sunset Avenue			Northbound Westberry Boulevard			Eastbound Sunset Avenue			
	Left	Thru	Right	Left	Thru	Right	Left	Thru	Right	Left	Thru	Right	
7:00 AM	0	0	0	0	0	0	0	0	0	0	0	0	0
7:15 AM	0	0	2	0	0	1	0	0	0	0	0	0	3
7:30 AM	0	0	0	0	0	0	0	0	0	0	0	0	0
7:45 AM	0	0	0	0	0	0	0	0	0	0	0	0	0
8:00 AM	0	0	0	0	0	0	0	0	0	0	0	0	0
8:15 AM	0	0	0	0	0	0	0	0	0	0	0	0	0
8:30 AM	0	0	0	0	0	0	0	0	0	0	0	0	0
8:45 AM	0	0	0	0	0	0	0	0	0	0	0	0	0
TOTAL VOLUMES:	0	0	2	0	0	1	0	0	0	0	0	0	3

	Southbound Westberry Boulevard			Westbound Sunset Avenue			Northbound Westberry Boulevard			Eastbound Sunset Avenue			
	Left	Thru	Right	Left	Thru	Right	Left	Thru	Right	Left	Thru	Right	
4:00 PM	0	0	0	0	0	0	0	0	0	0	0	0	0
4:15 PM	0	0	0	0	0	0	0	0	0	0	0	0	0
4:30 PM	0	0	0	0	0	0	0	0	0	0	0	0	0
4:45 PM	0	0	0	0	0	0	0	0	0	0	0	0	0
5:00 PM	0	0	0	0	0	0	0	0	0	0	0	0	0
5:15 PM	0	0	0	0	0	0	0	0	0	0	0	0	0
5:30 PM	0	0	0	0	0	0	0	0	0	0	0	0	0
5:45 PM	0	0	0	0	0	0	0	2	0	0	0	0	2
TOTAL VOLUMES:	0	0	0	0	0	0	0	2	0	0	0	0	2

City of Madera
 N/S: Westberry Boulevard
 E/W: Avenue 14
 Weather: Clear

File Name : 16_MDA_Westberry_Ave 14 AM
 Site Code : 00319628
 Start Date : 9/19/2019
 Page No : 1

Groups Printed- Total Volume

Start Time	Westberry Boulevard Southbound					Avenue 14 Westbound					Westberry Boulevard Northbound					Avenue 14 Eastbound					Int. Total
	Left	Thru	Right	U-Turns	App. Total	Left	Thru	Right	U-Turns	App. Total	Left	Thru	Right	U-Turns	App. Total	Left	Thru	Right	U-Turns	App. Total	
07:00 AM	22	8	8	0	38	1	21	9	0	31	4	10	2	0	16	4	27	4	0	35	120
07:15 AM	37	17	14	0	68	3	52	19	0	74	11	12	4	0	27	4	34	6	0	44	213
07:30 AM	34	17	20	0	71	0	33	26	0	59	27	9	9	0	45	12	44	4	0	60	235
07:45 AM	44	9	12	0	65	4	52	29	0	85	30	12	5	0	47	12	50	18	0	80	277
Total	137	51	54	0	242	8	158	83	0	249	72	43	20	0	135	32	155	32	0	219	845
08:00 AM	47	12	7	0	66	4	26	21	0	51	3	3	6	0	12	15	72	9	0	96	225
08:15 AM	36	10	9	0	55	3	23	22	0	48	5	4	7	0	16	8	40	5	0	53	172
08:30 AM	24	4	4	0	32	5	29	14	0	48	5	7	2	0	14	4	22	5	0	31	125
08:45 AM	16	2	4	0	22	1	22	22	0	45	3	8	0	0	11	4	25	1	0	30	108
Total	123	28	24	0	175	13	100	79	0	192	16	22	15	0	53	31	159	20	0	210	630
Grand Total	260	79	78	0	417	21	258	162	0	441	88	65	35	0	188	63	314	52	0	429	1475
Apprch %	62.4	18.9	18.7	0		4.8	58.5	36.7	0		46.8	34.6	18.6	0		14.7	73.2	12.1	0		
Total %	17.6	5.4	5.3	0	28.3	1.4	17.5	11	0	29.9	6	4.4	2.4	0	12.7	4.3	21.3	3.5	0	29.1	

Start Time	Westberry Boulevard Southbound					Avenue 14 Westbound					Westberry Boulevard Northbound					Avenue 14 Eastbound					Int. Total
	Left	Thru	Right	U-Turns	App. Total	Thru	Right	U-Turns	App. Total	Thru	Right	U-Turns	App. Total	Thru	Right	U-Turns	App. Total				
Peak Hour Analysis From 07:00 AM to 08:45 AM - Peak 1 of 1																					
Peak Hour for Entire Intersection Begins at 07:15 AM																					
07:15 AM	37	17	14	0	68	3	52	19	0	74	11	12	4	0	27	4	34	6	0	44	213
07:30 AM	34	17	20	0	71	0	33	26	0	59	27	9	9	0	45	12	44	4	0	60	235
07:45 AM	44	9	12	0	65	4	52	29	0	85	30	12	5	0	47	12	50	18	0	80	277
08:00 AM	47	12	7	0	66	4	26	21	0	51	3	3	6	0	12	15	72	9	0	96	225
Total Volume	162	55	53	0	270	11	163	95	0	269	71	36	24	0	131	43	200	37	0	280	950
% App. Total	60	20.4	19.6	0		4.1	60.6	35.3	0		54.2	27.5	18.3	0		15.4	71.4	13.2	0		
PHF	.862	.809	.663	.000	.951	.688	.784	.819	.000	.791	.592	.750	.667	.000	.697	.717	.694	.514	.000	.729	.857

City of Madera
 N/S: Westberry Boulevard
 E/W: Avenue 14
 Weather: Clear

File Name : 16_MDA_Westberry_Ave 14 AM
 Site Code : 00319628
 Start Date : 9/19/2019
 Page No : 2

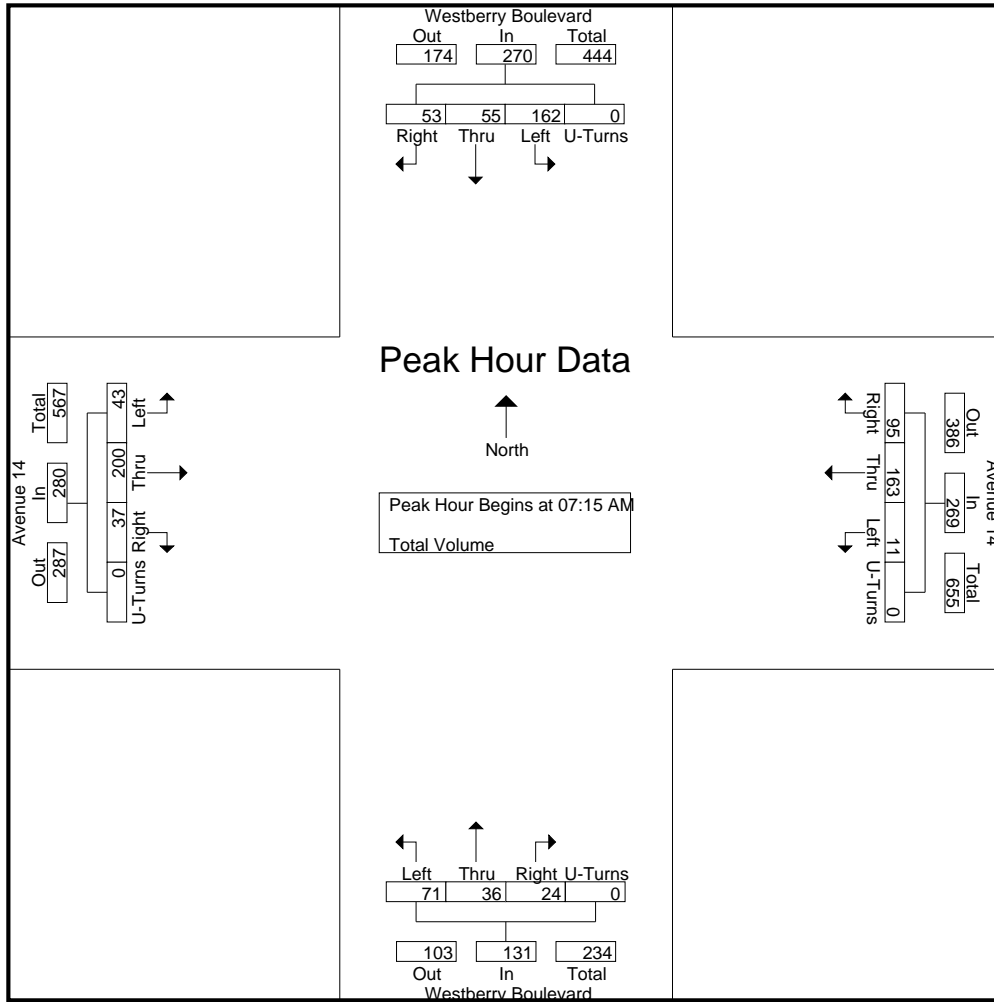

Peak Hour Analysis From 07:00 AM to 08:45 AM - Peak 1 of 1
 Peak Hour for Each Approach Begins at:

	07:15 AM					07:00 AM					07:30 AM									
+0 mins.	37	17	14	0	68	3	52	19	0	74	4	10	2	0	16	12	44	4	0	60
+15 mins.	34	17	20	0	71	0	33	26	0	59	11	12	4	0	27	12	50	18	0	80
+30 mins.	44	9	12	0	65	4	52	29	0	85	27	9	9	0	45	15	72	9	0	96
+45 mins.	47	12	7	0	66	4	26	21	0	51	30	12	5	0	47	8	40	5	0	53
Total Volume	162	55	53	0	270	11	163	95	0	269	72	43	20	0	135	47	206	36	0	289
% App. Total	60	20.4	19.6	0		4.1	60.6	35.3	0		53.3	31.9	14.8	0		16.3	71.3	12.5	0	
PHF	.862	.809	.663	.000	.951	.688	.784	.819	.000	.791	.600	.896	.556	.000	.718	.783	.715	.500	.000	.753

City of Madera
 N/S: Westberry Boulevard
 E/W: Avenue 14
 Weather: Clear

File Name : 16_MDA_Westberry_Ave 14 PM
 Site Code : 00319628
 Start Date : 9/19/2019
 Page No : 1

Groups Printed- Total Volume

Start Time	Westberry Boulevard Southbound					Avenue 14 Westbound					Westberry Boulevard Northbound					Avenue 14 Eastbound					Int. Total
	Left	Thru	Right	U-Turns	App. Total	Left	Thru	Right	U-Turns	App. Total	Left	Thru	Right	U-Turns	App. Total	Left	Thru	Right	U-Turns	App. Total	
04:00 PM	25	7	7	1	40	5	32	27	0	64	1	7	6	0	14	16	53	13	0	82	200
04:15 PM	14	13	21	0	48	3	28	30	0	61	4	8	2	0	14	16	63	7	0	86	209
04:30 PM	28	15	5	0	48	5	31	43	1	80	5	14	5	0	24	9	69	7	0	85	237
04:45 PM	20	7	4	0	31	8	25	30	0	63	4	12	3	0	19	8	66	6	0	80	193
Total	87	42	37	1	167	21	116	130	1	268	14	41	16	0	71	49	251	33	0	333	839
05:00 PM	16	15	6	0	37	6	27	48	0	81	5	8	1	0	14	10	44	6	0	60	192
05:15 PM	29	8	9	0	46	8	40	30	0	78	7	14	5	0	26	12	45	2	0	59	209
05:30 PM	21	8	5	0	34	3	18	39	0	60	2	12	4	0	18	5	42	6	0	53	165
05:45 PM	13	7	11	0	31	2	29	35	0	66	2	8	4	0	14	8	27	4	0	39	150
Total	79	38	31	0	148	19	114	152	0	285	16	42	14	0	72	35	158	18	0	211	716
Grand Total	166	80	68	1	315	40	230	282	1	553	30	83	30	0	143	84	409	51	0	544	1555
Apprch %	52.7	25.4	21.6	0.3		7.2	41.6	51	0.2		21	58	21	0		15.4	75.2	9.4	0		
Total %	10.7	5.1	4.4	0.1	20.3	2.6	14.8	18.1	0.1	35.6	1.9	5.3	1.9	0	9.2	5.4	26.3	3.3	0	35	

Start Time	Westberry Boulevard Southbound					Avenue 14 Westbound					Westberry Boulevard Northbound					Avenue 14 Eastbound					Int. Total
	Left	Thru	Right	U-Turns	App. Total	Thru	Right	U-Turns	App. Total	Thru	Right	U-Turns	App. Total	Thru	Right	U-Turns	App. Total				
Peak Hour Analysis From 04:00 PM to 05:45 PM - Peak 1 of 1																					
Peak Hour for Entire Intersection Begins at 04:00 PM																					
04:00 PM	25	7	7	1	40	5	32	27	0	64	1	7	6	0	14	16	53	13	0	82	200
04:15 PM	14	13	21	0	48	3	28	30	0	61	4	8	2	0	14	16	63	7	0	86	209
04:30 PM	28	15	5	0	48	5	31	43	1	80	5	14	5	0	24	9	69	7	0	85	237
04:45 PM	20	7	4	0	31	8	25	30	0	63	4	12	3	0	19	8	66	6	0	80	193
Total Volume	87	42	37	1	167	21	116	130	1	268	14	41	16	0	71	49	251	33	0	333	839
% App. Total	52.1	25.1	22.2	0.6		7.8	43.3	48.5	0.4		19.7	57.7	22.5	0		14.7	75.4	9.9	0		
PHF	.777	.700	.440	.250	.870	.656	.906	.756	.250	.838	.700	.732	.667	.000	.740	.766	.909	.635	.000	.968	.885

City of Madera
 N/S: Westberry Boulevard
 E/W: Avenue 14
 Weather: Clear

File Name : 16_MDA_Westberry_Ave 14 PM
 Site Code : 00319628
 Start Date : 9/19/2019
 Page No : 2

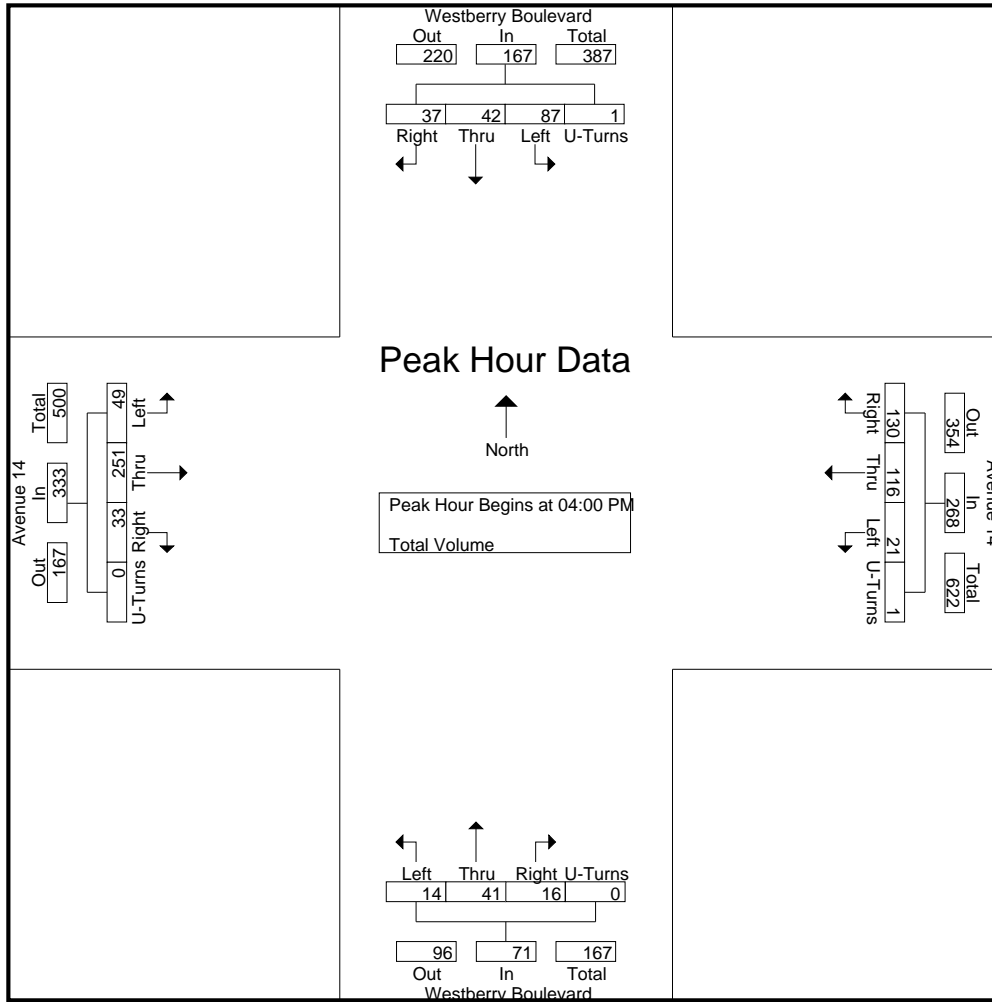

Peak Hour Analysis From 04:00 PM to 05:45 PM - Peak 1 of 1
 Peak Hour for Each Approach Begins at:

	04:00 PM					04:30 PM					04:00 PM									
+0 mins.	25	7	7	1	40	5	31	43	1	80	5	14	5	0	24	16	53	13	0	82
+15 mins.	14	13	21	0	48	8	25	30	0	63	4	12	3	0	19	16	63	7	0	86
+30 mins.	28	15	5	0	48	6	27	48	0	81	5	8	1	0	14	9	69	7	0	85
+45 mins.	20	7	4	0	31	8	40	30	0	78	7	14	5	0	26	8	66	6	0	80
Total Volume	87	42	37	1	167	27	123	151	1	302	21	48	14	0	83	49	251	33	0	333
% App. Total	52.1	25.1	22.2	0.6		8.9	40.7	50	0.3		25.3	57.8	16.9	0		14.7	75.4	9.9	0	
PHF	.777	.700	.440	.250	.870	.844	.769	.786	.250	.932	.750	.857	.700	.000	.798	.766	.909	.635	.000	.968

Location: Madera
 N/S: Westberry Boulevard
 E/W: Avenue 14



Date: 9/19/2019
 Day: Thursday

PEDESTRIANS

	North Leg Westberry Boulevard	East Leg Avenue 14	South Leg Westberry Boulevard	West Leg Avenue 14	
	Pedestrians	Pedestrians	Pedestrians	Pedestrians	
7:00 AM	0	0	0	0	0
7:15 AM	0	0	0	0	0
7:30 AM	2	0	0	0	2
7:45 AM	0	0	0	0	0
8:00 AM	1	0	0	0	1
8:15 AM	0	0	0	0	0
8:30 AM	0	0	0	0	0
8:45 AM	0	1	0	0	1
TOTAL VOLUMES:	3	1	0	0	4

	North Leg Westberry Boulevard	East Leg Avenue 14	South Leg Westberry Boulevard	West Leg Avenue 14	
	Pedestrians	Pedestrians	Pedestrians	Pedestrians	
4:00 PM	2	0	0	0	2
4:15 PM	0	1	0	0	1
4:30 PM	0	0	0	0	0
4:45 PM	1	0	0	0	1
5:00 PM	0	0	0	0	0
5:15 PM	0	0	0	0	0
5:30 PM	1	0	0	0	1
5:45 PM	0	0	0	0	0
TOTAL VOLUMES:	4	1	0	0	5

Location: Madera
 N/S: Westberry Boulevard
 E/W: Avenue 14



Date: 9/19/2019
 Day: Thursday

BICYCLES

	Southbound Westberry Boulevard			Westbound Avenue 14			Northbound Westberry Boulevard			Eastbound Avenue 14			
	Left	Thru	Right	Left	Thru	Right	Left	Thru	Right	Left	Thru	Right	
7:00 AM	0	0	0	0	0	0	0	0	0	0	1	0	1
7:15 AM	0	0	0	0	0	0	0	0	0	0	0	0	0
7:30 AM	0	0	0	0	0	0	0	0	0	0	0	0	0
7:45 AM	0	0	0	0	0	0	0	0	0	0	1	0	1
8:00 AM	0	0	0	0	0	0	0	0	0	0	0	0	0
8:15 AM	0	0	0	0	0	0	0	0	0	0	0	0	0
8:30 AM	0	0	0	0	0	0	0	0	0	0	0	0	0
8:45 AM	0	0	0	0	0	0	0	0	0	0	0	0	0
TOTAL VOLUMES:	0	0	0	0	0	0	0	0	0	0	2	0	2

	Southbound Westberry Boulevard			Westbound Avenue 14			Northbound Westberry Boulevard			Eastbound Avenue 14			
	Left	Thru	Right	Left	Thru	Right	Left	Thru	Right	Left	Thru	Right	
4:00 PM	0	0	0	0	0	0	0	0	0	0	0	0	0
4:15 PM	0	0	0	0	0	0	0	0	0	0	0	0	0
4:30 PM	0	0	0	0	0	0	0	0	0	0	0	0	0
4:45 PM	0	0	0	0	0	2	0	0	0	0	0	0	2
5:00 PM	0	0	0	0	0	0	0	0	0	0	0	0	0
5:15 PM	0	0	0	0	0	0	0	0	0	0	0	0	0
5:30 PM	0	0	0	0	0	0	0	0	0	0	0	0	0
5:45 PM	0	0	0	0	0	0	0	2	0	0	0	0	2
TOTAL VOLUMES:	0	0	0	0	0	2	0	2	0	0	0	0	4

City of Madera
 N/S: Condor Rd/Westberry Boulevard
 E/W: Avenue 16
 Weather: Clear

File Name : 17_MDA_Westberry_Ave 16 AM
 Site Code : 00319628
 Start Date : 9/19/2019
 Page No : 2

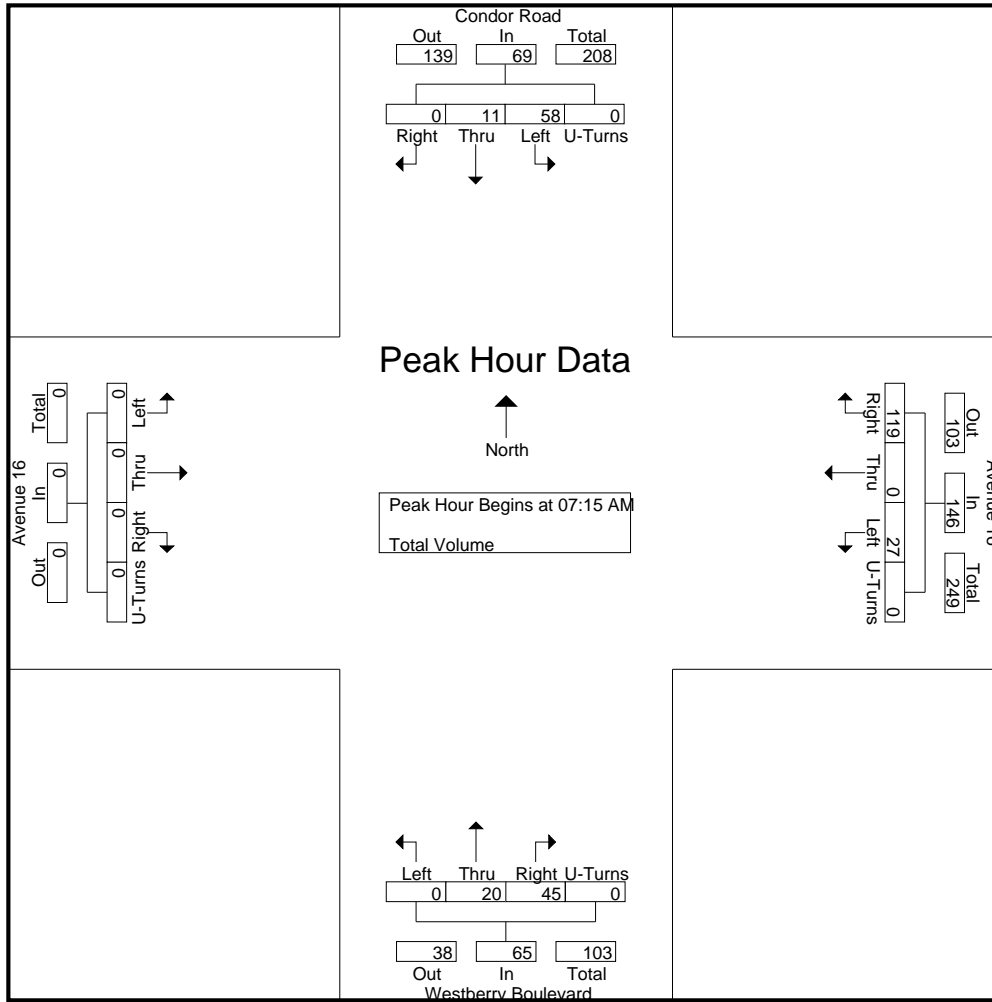

Peak Hour Analysis From 07:00 AM to 08:45 AM - Peak 1 of 1
 Peak Hour for Each Approach Begins at:

	07:45 AM					07:15 AM					07:00 AM									
+0 mins.	17	4	0	0	21	9	0	21	0	30	0	6	5	0	11	0	0	0	0	0
+15 mins.	17	4	0	0	21	7	0	28	0	35	0	3	15	0	18	0	0	0	0	0
+30 mins.	15	5	0	0	20	3	0	46	0	49	0	8	14	0	22	0	0	0	0	0
+45 mins.	13	4	0	0	17	8	0	24	0	32	0	5	12	0	17	0	0	0	0	0
Total Volume	62	17	0	0	79	27	0	119	0	146	0	22	46	0	68	0	0	0	0	0
% App. Total	78.5	21.5	0	0		18.5	0	81.5	0		0	32.4	67.6	0		0	0	0	0	
PHF	.912	.850	.000	.000	.940	.750	.000	.647	.000	.745	.000	.688	.767	.000	.773	.000	.000	.000	.000	.000

City of Madera
 N/S: Condor Rd/Westberry Boulevard
 E/W: Avenue 16
 Weather: Clear

File Name : 17_MDA_Westberry_Ave 16 PM
 Site Code : 00319628
 Start Date : 9/19/2019
 Page No : 2

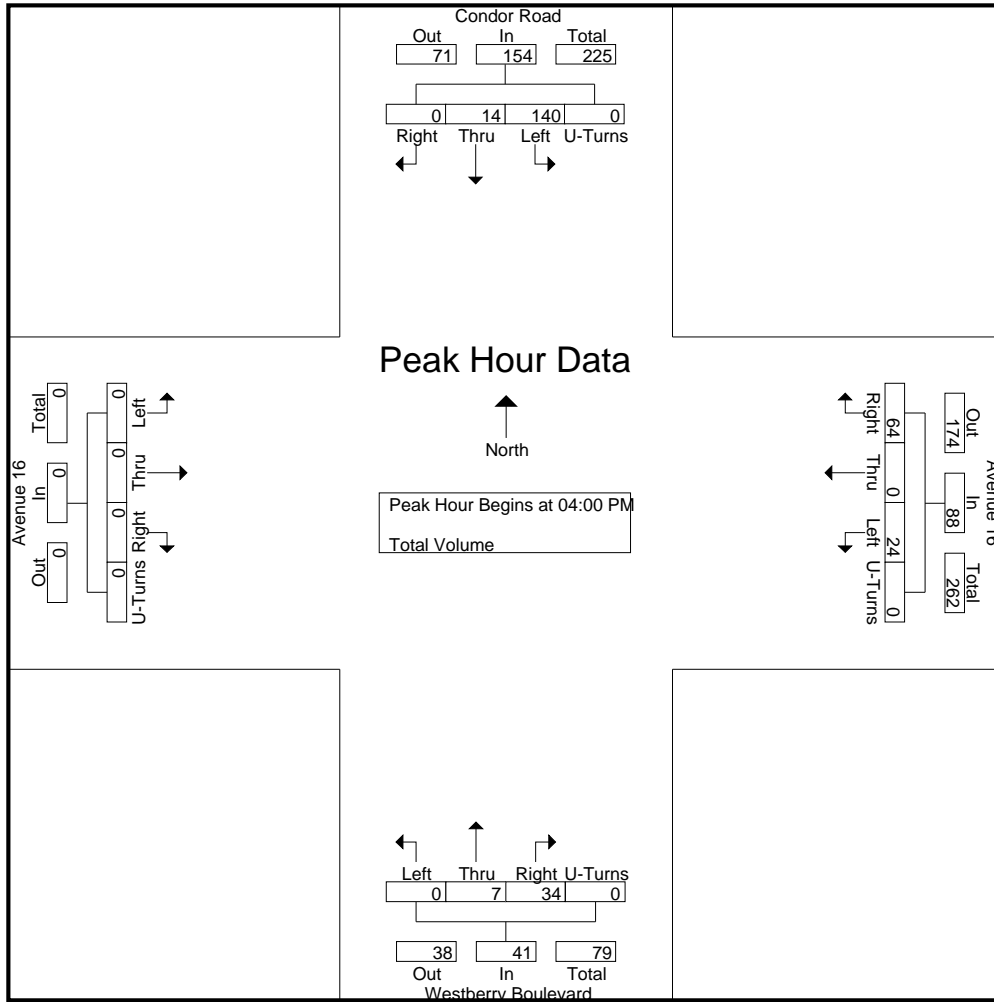

Peak Hour Analysis From 04:00 PM to 05:45 PM - Peak 1 of 1
 Peak Hour for Each Approach Begins at:

	04:00 PM					04:15 PM					04:00 PM					04:00 PM				
+0 mins.	53	4	0	0	57	7	0	13	0	20	0	1	7	0	8	0	0	0	0	0
+15 mins.	27	7	0	0	34	8	0	15	0	23	0	0	10	0	10	0	0	0	0	0
+30 mins.	33	0	0	0	33	4	0	23	0	27	0	4	11	0	15	0	0	0	0	0
+45 mins.	27	3	0	0	30	8	0	13	0	21	0	2	6	0	8	0	0	0	0	0
Total Volume	140	14	0	0	154	27	0	64	0	91	0	7	34	0	41	0	0	0	0	0
% App. Total	90.9	9.1	0	0		29.7	0	70.3	0		0	17.1	82.9	0		0	0	0	0	
PHF	.660	.500	.000	.000	.675	.844	.000	.696	.000	.843	.000	.438	.773	.000	.683	.000	.000	.000	.000	.000

Location: Madera
 N/S: Condor Rd/Westberry Blvd
 E/W: Avenue 16



PEDESTRIANS

	North Leg Condor Road	East Leg Avenue 16	South Leg Westberry Boulevard	West Leg Avenue 16	
	Pedestrians	Pedestrians	Pedestrians	Pedestrians	
7:00 AM	0	0	0	0	0
7:15 AM	0	0	0	0	0
7:30 AM	0	0	0	0	0
7:45 AM	1	0	0	0	1
8:00 AM	0	0	0	0	0
8:15 AM	1	0	0	0	1
8:30 AM	0	0	0	0	0
8:45 AM	0	0	0	0	0
TOTAL VOLUMES:	2	0	0	0	2

	North Leg Condor Road	East Leg Avenue 16	South Leg Westberry Boulevard	West Leg Avenue 16	
	Pedestrians	Pedestrians	Pedestrians	Pedestrians	
4:00 PM	0	0	0	0	0
4:15 PM	0	0	0	0	0
4:30 PM	0	0	0	0	0
4:45 PM	0	0	0	0	0
5:00 PM	0	0	0	0	0
5:15 PM	0	0	0	0	0
5:30 PM	0	0	0	0	0
5:45 PM	0	0	0	0	0
TOTAL VOLUMES:	0	0	0	0	0

Location: Madera
 N/S: Condor Rd/Westberry Blvd
 E/W: Avenue 16



BICYCLES

	Southbound Condor Road			Westbound Avenue 16			Northbound Westberry Boulevard			Eastbound Avenue 16			
	Left	Thru	Right	Left	Thru	Right	Left	Thru	Right	Left	Thru	Right	
7:00 AM	0	0	0	0	0	0	0	0	0	0	0	0	0
7:15 AM	0	0	0	0	0	0	0	0	0	0	0	0	0
7:30 AM	0	0	0	0	0	0	0	0	0	0	0	0	0
7:45 AM	0	0	0	0	0	0	0	0	0	0	0	0	0
8:00 AM	0	0	0	0	0	0	0	0	0	0	0	0	0
8:15 AM	0	0	0	0	0	0	0	0	0	0	0	0	0
8:30 AM	0	0	0	0	0	0	0	0	0	0	0	0	0
8:45 AM	0	0	0	0	0	0	0	0	0	0	0	0	0
TOTAL VOLUMES:	0	0	0	0	0	0	0	0	0	0	0	0	0

	Southbound Condor Road			Westbound Avenue 16			Northbound Westberry Boulevard			Eastbound Avenue 16			
	Left	Thru	Right	Left	Thru	Right	Left	Thru	Right	Left	Thru	Right	
4:00 PM	0	0	0	0	0	0	0	0	0	0	0	0	0
4:15 PM	0	0	0	0	0	0	0	0	0	0	0	0	0
4:30 PM	1	0	0	0	0	0	0	0	0	0	0	0	1
4:45 PM	0	0	0	0	0	0	0	0	0	0	0	0	0
5:00 PM	0	0	0	0	0	0	0	0	0	0	0	0	0
5:15 PM	0	0	0	0	0	0	0	0	0	0	0	0	0
5:30 PM	0	0	0	0	0	0	0	0	0	0	0	0	0
5:45 PM	0	0	0	0	0	0	0	0	0	0	0	0	0
TOTAL VOLUMES:	1	0	0	0	0	0	0	0	0	0	0	0	1

City of Madera
 N/S: Granada Drive
 E/W: Ave 15 1/2 /Cleveland Ave
 Weather: Clear

File Name : 18_MDA_Granada_Cleveland AM
 Site Code : 00319628
 Start Date : 9/19/2019
 Page No : 1

Groups Printed- Total Volume

Start Time	Granada Drive Southbound					Cleveland Avenue Westbound					Granada Drive Northbound					Avenue 15 1/2 Eastbound					Int. Total
	Left	Thru	Right	U-Turns	App. Total	Left	Thru	Right	U-Turns	App. Total	Left	Thru	Right	U-Turns	App. Total	Left	Thru	Right	U-Turns	App. Total	
07:00 AM	2	30	1	0	33	21	14	1	0	36	1	42	53	0	96	4	17	5	0	26	191
07:15 AM	1	32	2	0	35	40	11	4	0	55	5	66	58	0	129	0	29	1	0	30	249
07:30 AM	0	51	0	0	51	43	16	2	0	61	3	81	68	0	152	6	35	1	0	42	306
07:45 AM	2	69	0	0	71	55	17	1	0	73	6	90	80	0	176	4	23	6	0	33	353
Total	5	182	3	0	190	159	58	8	0	225	15	279	259	0	553	14	104	13	0	131	1099
08:00 AM	1	63	3	0	67	47	11	3	0	61	3	48	62	0	113	6	28	1	0	35	276
08:15 AM	1	55	2	0	58	38	15	2	0	55	6	40	48	0	94	1	30	7	0	38	245
08:30 AM	0	28	2	0	30	18	10	5	0	33	5	42	43	0	90	2	23	0	0	25	178
08:45 AM	4	29	1	0	34	37	15	2	1	55	2	37	44	0	83	2	11	2	0	15	187
Total	6	175	8	0	189	140	51	12	1	204	16	167	197	0	380	11	92	10	0	113	886
Grand Total	11	357	11	0	379	299	109	20	1	429	31	446	456	0	933	25	196	23	0	244	1985
Apprch %	2.9	94.2	2.9	0		69.7	25.4	4.7	0.2		3.3	47.8	48.9	0		10.2	80.3	9.4	0		
Total %	0.6	18	0.6	0	19.1	15.1	5.5	1	0.1	21.6	1.6	22.5	23	0	47	1.3	9.9	1.2	0	12.3	

Start Time	Granada Drive Southbound					Cleveland Avenue Westbound					Granada Drive Northbound					Avenue 15 1/2 Eastbound					Int. Total
	Left	Thru	Right	U-Turns	App. Total	Left	Thru	Right	U-Turns	App. Total	Left	Thru	Right	U-Turns	App. Total	Left	Thru	Right	U-Turns	App. Total	
Peak Hour Analysis From 07:00 AM to 08:45 AM - Peak 1 of 1																					
Peak Hour for Entire Intersection Begins at 07:15 AM																					
07:15 AM	1	32	2	0	35	40	11	4	0	55	5	66	58	0	129	0	29	1	0	30	249
07:30 AM	0	51	0	0	51	43	16	2	0	61	3	81	68	0	152	6	35	1	0	42	306
07:45 AM	2	69	0	0	71	55	17	1	0	73	6	90	80	0	176	4	23	6	0	33	353
08:00 AM	1	63	3	0	67	47	11	3	0	61	3	48	62	0	113	6	28	1	0	35	276
Total Volume	4	215	5	0	224	185	55	10	0	250	17	285	268	0	570	16	115	9	0	140	1184
% App. Total	1.8	96	2.2	0		74	22	4	0		3	50	47	0		11.4	82.1	6.4	0		
PHF	.500	.779	.417	.000	.789	.841	.809	.625	.000	.856	.708	.792	.838	.000	.810	.667	.821	.375	.000	.833	.839

City of Madera
 N/S: Granada Drive
 E/W: Ave 15 1/2 /Cleveland Ave
 Weather: Clear

File Name : 18_MDA_Granada_Cleveland AM
 Site Code : 00319628
 Start Date : 9/19/2019
 Page No : 2

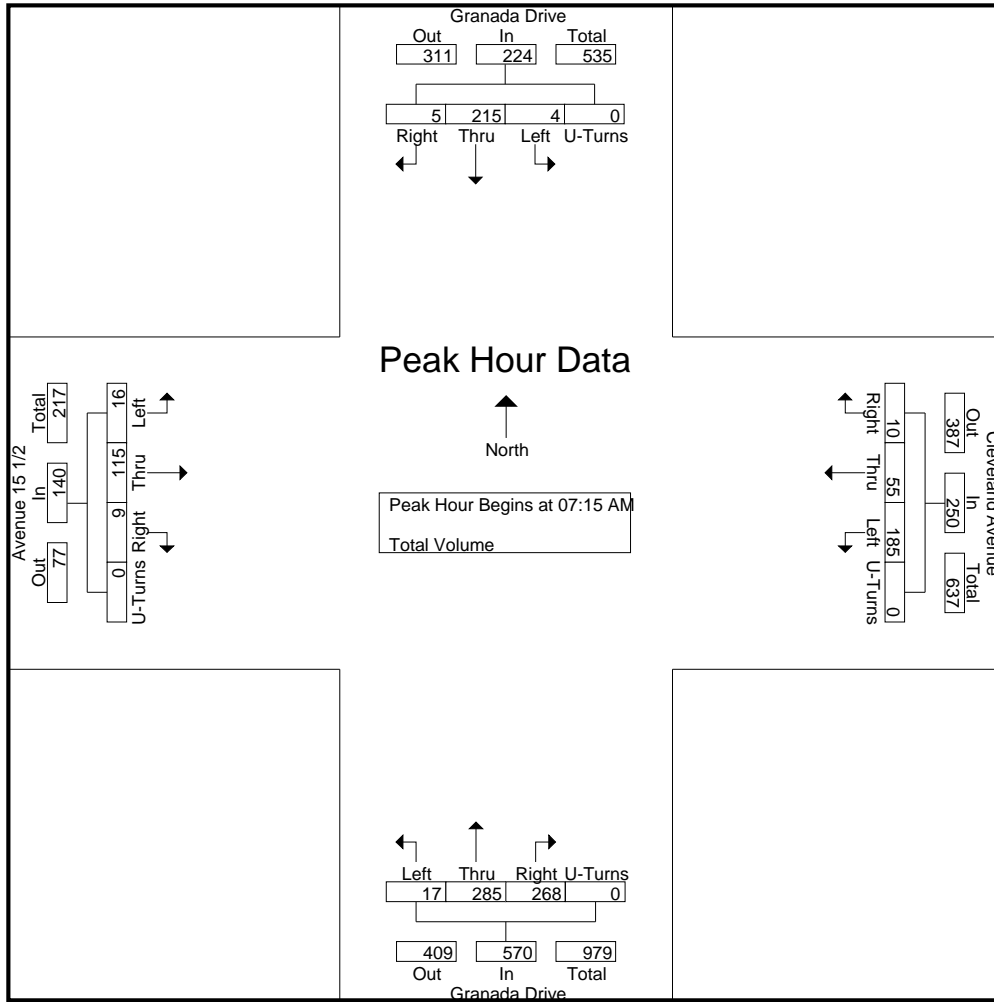

Peak Hour Analysis From 07:00 AM to 08:45 AM - Peak 1 of 1
 Peak Hour for Each Approach Begins at:

	07:30 AM					07:15 AM					07:00 AM									
+0 mins.	0	51	0	0	51	40	11	4	0	55	5	66	58	0	129	6	35	1	0	42
+15 mins.	2	69	0	0	71	43	16	2	0	61	3	81	68	0	152	4	23	6	0	33
+30 mins.	1	63	3	0	67	55	17	1	0	73	6	90	80	0	176	6	28	1	0	35
+45 mins.	1	55	2	0	58	47	11	3	0	61	3	48	62	0	113	1	30	7	0	38
Total Volume	4	238	5	0	247	185	55	10	0	250	17	285	268	0	570	17	116	15	0	148
% App. Total	1.6	96.4	2	0		74	22	4	0		3	50	47	0		11.5	78.4	10.1	0	
PHF	.500	.862	.417	.000	.870	.841	.809	.625	.000	.856	.708	.792	.838	.000	.810	.708	.829	.536	.000	.881

City of Madera
 N/S: Granada Drive
 E/W: Ave 15 1/2 /Cleveland Ave
 Weather: Clear

File Name : 18_MDA_Granada_Cleveland PM
 Site Code : 00319628
 Start Date : 9/19/2019
 Page No : 1

Groups Printed- Total Volume

Start Time	Granada Drive Southbound					Cleveland Avenue Westbound					Granada Drive Northbound					Avenue 15 1/2 Eastbound					Int. Total
	Left	Thru	Right	U-Turns	App. Total	Left	Thru	Right	U-Turns	App. Total	Left	Thru	Right	U-Turns	App. Total	Left	Thru	Right	U-Turns	App. Total	
04:00 PM	3	35	1	0	39	79	28	0	0	107	4	45	55	0	104	5	40	10	0	55	305
04:15 PM	2	38	5	0	45	64	22	6	1	93	2	32	61	0	95	3	36	16	0	55	288
04:30 PM	2	60	1	0	63	65	28	6	2	101	4	47	54	0	105	1	44	6	0	51	320
04:45 PM	4	63	1	0	68	61	27	5	1	94	4	38	52	0	94	6	42	4	0	52	308
Total	11	196	8	0	215	269	105	17	4	395	14	162	222	0	398	15	162	36	0	213	1221
05:00 PM	8	76	2	0	86	89	19	6	0	114	3	40	44	0	87	1	30	5	0	36	323
05:15 PM	6	44	7	0	57	88	30	4	0	122	4	53	74	0	131	4	26	3	0	33	343
05:30 PM	1	43	6	0	50	62	36	7	1	106	4	61	44	0	109	4	30	9	0	43	308
05:45 PM	4	68	6	0	78	80	28	3	0	111	2	35	67	1	105	4	22	2	0	28	322
Total	19	231	21	0	271	319	113	20	1	453	13	189	229	1	432	13	108	19	0	140	1296
Grand Total	30	427	29	0	486	588	218	37	5	848	27	351	451	1	830	28	270	55	0	353	2517
Apprch %	6.2	87.9	6	0		69.3	25.7	4.4	0.6		3.3	42.3	54.3	0.1		7.9	76.5	15.6	0		
Total %	1.2	17	1.2	0	19.3	23.4	8.7	1.5	0.2	33.7	1.1	13.9	17.9	0	33	1.1	10.7	2.2	0	14	

Start Time	Granada Drive Southbound					Cleveland Avenue Westbound					Granada Drive Northbound					Avenue 15 1/2 Eastbound					Int. Total
	Left	Thru	Right	U-Turns	App. Total	Left	Thru	Right	U-Turns	App. Total	Left	Thru	Right	U-Turns	App. Total	Left	Thru	Right	U-Turns	App. Total	
Peak Hour Analysis From 04:00 PM to 05:45 PM - Peak 1 of 1																					
Peak Hour for Entire Intersection Begins at 05:00 PM																					
05:00 PM	8	76	2	0	86	89	19	6	0	114	3	40	44	0	87	1	30	5	0	36	323
05:15 PM	6	44	7	0	57	88	30	4	0	122	4	53	74	0	131	4	26	3	0	33	343
05:30 PM	1	43	6	0	50	62	36	7	1	106	4	61	44	0	109	4	30	9	0	43	308
05:45 PM	4	68	6	0	78	80	28	3	0	111	2	35	67	1	105	4	22	2	0	28	322
Total Volume	19	231	21	0	271	319	113	20	1	453	13	189	229	1	432	13	108	19	0	140	1296
% App. Total	7	85.2	7.7	0		70.4	24.9	4.4	0.2		3	43.8	53	0.2		9.3	77.1	13.6	0		
PHF	.594	.760	.750	.000	.788	.896	.785	.714	.250	.928	.813	.775	.774	.250	.824	.813	.900	.528	.000	.814	.945

City of Madera
 N/S: Granada Drive
 E/W: Ave 15 1/2 /Cleveland Ave
 Weather: Clear

File Name : 18_MDA_Granada_Cleveland PM
 Site Code : 00319628
 Start Date : 9/19/2019
 Page No : 2

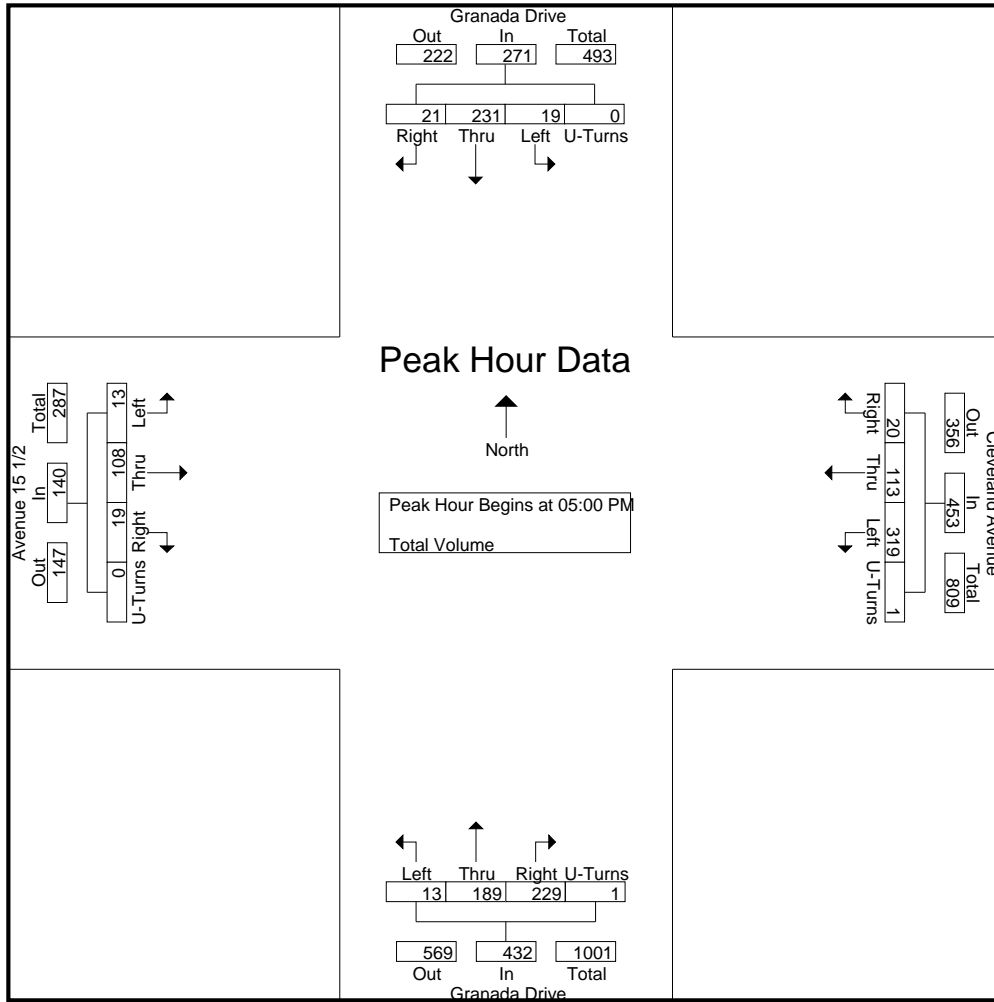

Peak Hour Analysis From 04:00 PM to 05:45 PM - Peak 1 of 1
 Peak Hour for Each Approach Begins at:

	04:30 PM					05:00 PM					05:00 PM					04:00 PM				
+0 mins.	2	60	1	0	63	89	19	6	0	114	3	40	44	0	87	5	40	10	0	55
+15 mins.	4	63	1	0	68	88	30	4	0	122	4	53	74	0	131	3	36	16	0	55
+30 mins.	8	76	2	0	86	62	36	7	1	106	4	61	44	0	109	1	44	6	0	51
+45 mins.	6	44	7	0	57	80	28	3	0	111	2	35	67	1	105	6	42	4	0	52
Total Volume	20	243	11	0	274	319	113	20	1	453	13	189	229	1	432	15	162	36	0	213
% App. Total	7.3	88.7	4	0		70.4	24.9	4.4	0.2		3	43.8	53	0.2		7	76.1	16.9	0	
PHF	.625	.799	.393	.000	.797	.896	.785	.714	.250	.928	.813	.775	.774	.250	.824	.625	.920	.563	.000	.968

Location: Madera
 N/S: Granada Drive
 E/W: Ave 15 1/2 /Cleveland Ave



Date: 9/19/2019
 Day: Thursday

PEDESTRIANS

	North Leg Granada Drive	East Leg Cleveland Avenue	South Leg Granada Drive	West Leg Avenue 15 1/2	
	Pedestrians	Pedestrians	Pedestrians	Pedestrians	
7:00 AM	0	0	0	0	0
7:15 AM	0	0	0	0	0
7:30 AM	0	0	1	1	2
7:45 AM	2	0	0	1	3
8:00 AM	0	0	0	0	0
8:15 AM	0	0	0	2	2
8:30 AM	0	0	0	0	0
8:45 AM	0	0	0	1	1
TOTAL VOLUMES:	2	0	1	5	8

	North Leg Granada Drive	East Leg Cleveland Avenue	South Leg Granada Drive	West Leg Avenue 15 1/2	
	Pedestrians	Pedestrians	Pedestrians	Pedestrians	
4:00 PM	0	1	0	0	1
4:15 PM	3	1	1	4	9
4:30 PM	0	0	0	1	1
4:45 PM	0	6	0	0	6
5:00 PM	0	0	0	0	0
5:15 PM	0	0	0	0	0
5:30 PM	0	0	2	0	2
5:45 PM	0	0	0	0	0
TOTAL VOLUMES:	3	8	3	5	19

Location: Madera
 N/S: Granada Drive
 E/W: Ave 15 1/2 /Cleveland Ave



Date: 9/19/2019
 Day: Thursday

BICYCLES

	Southbound Granada Drive			Westbound Cleveland Avenue			Northbound Granada Drive			Eastbound Avenue 15 1/2			
	Left	Thru	Right	Left	Thru	Right	Left	Thru	Right	Left	Thru	Right	
7:00 AM	0	0	0	0	0	0	0	0	0	0	0	0	0
7:15 AM	0	0	0	0	0	1	0	0	0	0	0	0	1
7:30 AM	0	0	0	0	0	0	0	0	0	0	0	0	0
7:45 AM	0	0	0	0	1	0	0	1	0	0	0	0	2
8:00 AM	0	0	0	0	0	0	0	0	1	0	0	0	1
8:15 AM	0	0	0	0	0	0	0	0	0	0	0	0	0
8:30 AM	0	0	0	0	0	0	0	0	0	0	0	0	0
8:45 AM	0	0	0	0	0	0	0	0	0	0	0	0	0
TOTAL VOLUMES:	0	0	0	0	1	1	0	1	1	0	0	0	4

	Southbound Granada Drive			Westbound Cleveland Avenue			Northbound Granada Drive			Eastbound Avenue 15 1/2			
	Left	Thru	Right	Left	Thru	Right	Left	Thru	Right	Left	Thru	Right	
4:00 PM	0	0	0	0	0	0	0	0	0	0	0	0	0
4:15 PM	0	0	0	0	0	0	0	0	0	0	0	0	0
4:30 PM	0	0	0	0	0	0	0	0	0	0	0	0	0
4:45 PM	0	0	0	0	0	0	0	0	0	0	0	0	0
5:00 PM	0	0	0	0	0	0	0	0	2	0	0	0	2
5:15 PM	0	0	0	0	0	0	0	0	0	0	0	0	0
5:30 PM	0	1	0	1	0	0	0	0	0	0	0	0	2
5:45 PM	0	0	0	0	0	0	0	0	0	0	0	0	0
TOTAL VOLUMES:	0	1	0	1	0	0	0	0	2	0	0	0	4

City of Madera
 N/S: Granada Drive
 E/W: Sunset Avenue
 Weather: Clear

File Name : 19_MDA_Granada_Sunset AM
 Site Code : 00319628
 Start Date : 9/19/2019
 Page No : 1

Groups Printed- Passenger Vehicles - Large 2 Axle Vehicles - 3 Axle Vehicles - 4+ Axle Trucks

Start Time	Granada Drive Southbound					Sunset Avenue Westbound					Granada Drive Northbound					Sunset Avenue Eastbound					Int. Total
	Left	Thru	Right	U-Turns	App. Total	Left	Thru	Right	U-Turns	App. Total	Left	Thru	Right	U-Turns	App. Total	Left	Thru	Right	U-Turns	App. Total	
07:00 AM	21	41	6	0	68	2	15	7	0	24	5	48	6	0	59	4	26	6	0	36	187
07:15 AM	24	49	17	0	90	5	19	10	0	34	10	43	6	0	59	8	54	13	0	75	258
07:30 AM	34	66	12	0	112	5	28	10	0	43	15	46	5	0	66	10	69	16	0	95	316
07:45 AM	46	57	15	0	118	6	31	21	0	58	20	57	6	0	83	27	78	32	0	137	396
Total	125	213	50	0	388	18	93	48	0	159	50	194	23	0	267	49	227	67	0	343	1157
08:00 AM	19	67	6	0	92	9	18	22	0	49	6	49	3	0	58	14	53	12	0	79	278
08:15 AM	28	80	15	0	123	5	24	12	0	41	6	55	10	0	71	8	59	9	0	76	311
08:30 AM	31	43	12	0	86	7	27	27	0	61	6	56	16	0	78	6	30	4	0	40	265
08:45 AM	16	41	18	0	75	2	19	12	0	33	6	49	14	0	69	6	25	7	0	38	215
Total	94	231	51	0	376	23	88	73	0	184	24	209	43	0	276	34	167	32	0	233	1069
Grand Total	219	444	101	0	764	41	181	121	0	343	74	403	66	0	543	83	394	99	0	576	2226
Apprch %	28.7	58.1	13.2	0		12	52.8	35.3	0		13.6	74.2	12.2	0		14.4	68.4	17.2	0		
Total %	9.8	19.9	4.5	0	34.3	1.8	8.1	5.4	0	15.4	3.3	18.1	3	0	24.4	3.7	17.7	4.4	0	25.9	
Passenger Vehicles	99.5	98.2	97	0	98.4	100	96.1	93.4	0	95.6	98.6	98	100	0	98.3	97.6	98	99	0	98.1	97.9
Large 2 Axle Vehicles	0.5	1.4	2	0	1.2	0	3.3	6.6	0	4.1	1.4	1.7	0	0	1.5	2.4	1.8	1	0	1.7	1.8
% Large 2 Axle Vehicles	0	0	0	0	0	0	1	0	0	1	0	1	0	0	1	0	1	0	0	1	3
3 Axle Vehicles	0	0	0	0	0	0	0.6	0	0	0.3	0	0.2	0	0	0.2	0	0.3	0	0	0.2	0.1
% 3 Axle Vehicles	0	2	1	0	3	0	0	0	0	0	0	0	0	0	0	0	0	0	0	0	3
4+ Axle Trucks	0	2	1	0	3	0	0	0	0	0	0	0	0	0	0	0	0	0	0	0	3
% 4+ Axle Trucks																					

Start Time	Granada Drive Southbound					Sunset Avenue Westbound					Granada Drive Northbound					Sunset Avenue Eastbound					Int. Total
	Left	Thru	Right	U-Turns	App. Total	Left	Thru	Right	U-Turns	App. Total	Left	Thru	Right	U-Turns	App. Total	Left	Thru	Right	U-Turns	App. Total	
Peak Hour Analysis From 07:00 AM to 08:45 AM - Peak 1 of 1																					
Peak Hour for Entire Intersection Begins at 07:30 AM																					
07:30 AM	34	66	12	0	112	5	28	10	0	43	15	46	5	0	66	10	69	16	0	95	316
07:45 AM	46	57	15	0	118	6	31	21	0	58	20	57	6	0	83	27	78	32	0	137	396
08:00 AM	19	67	6	0	92	9	18	22	0	49	6	49	3	0	58	14	53	12	0	79	278
08:15 AM	28	80	15	0	123	5	24	12	0	41	6	55	10	0	71	8	59	9	0	76	311
Total Volume	127	270	48	0	445	25	101	65	0	191	47	207	24	0	278	59	259	69	0	387	1301
% App. Total	28.5	60.7	10.8	0		13.1	52.9	34	0		16.9	74.5	8.6	0		15.2	66.9	17.8	0		
PHF	.690	.844	.800	.000	.904	.694	.815	.739	.000	.823	.588	.908	.600	.000	.837	.546	.830	.539	.000	.706	.821

City of Madera
 N/S: Granada Drive
 E/W: Sunset Avenue
 Weather: Clear

File Name : 19_MDA_Granada_Sunset AM
 Site Code : 00319628
 Start Date : 9/19/2019
 Page No : 2

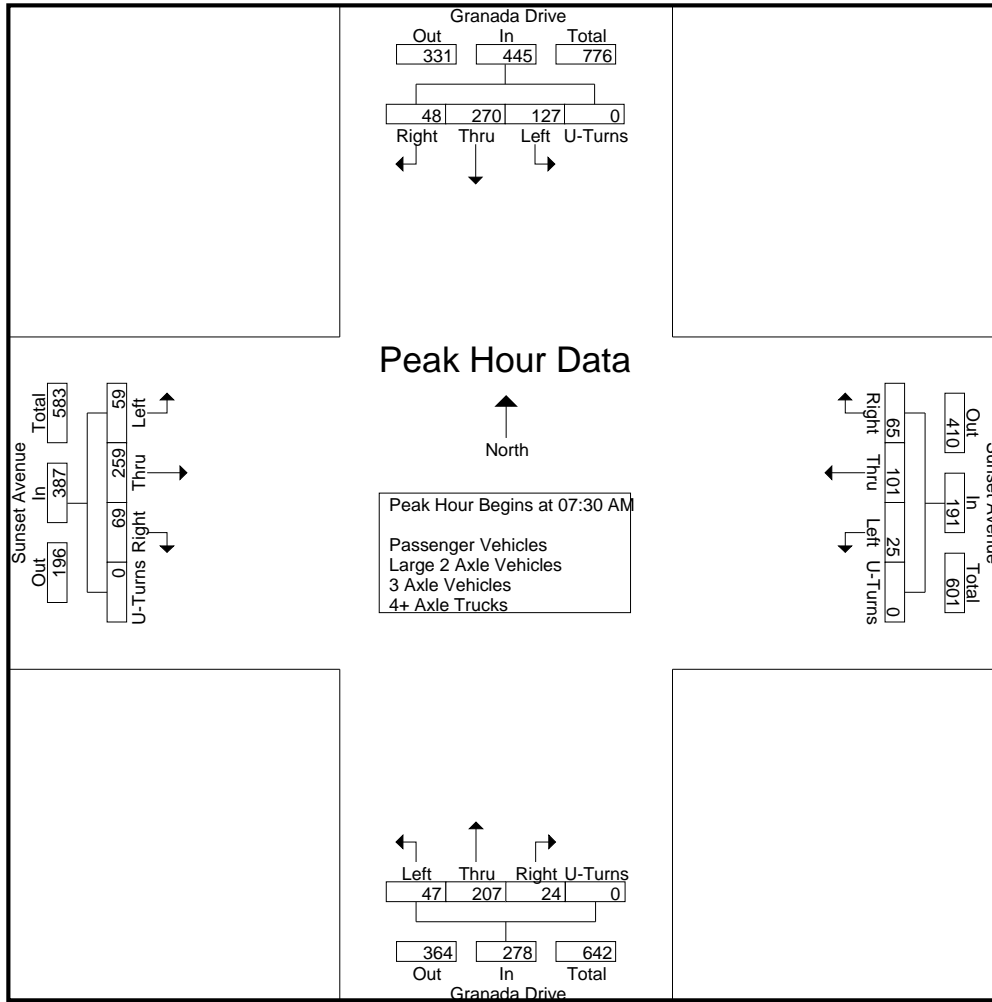

Peak Hour Analysis From 07:00 AM to 08:45 AM - Peak 1 of 1
 Peak Hour for Each Approach Begins at:

	07:30 AM					07:45 AM					07:30 AM									
+0 mins.	34	66	12	0	112	6	31	21	0	58	20	57	6	0	83	10	69	16	0	95
+15 mins.	46	57	15	0	118	9	18	22	0	49	6	49	3	0	58	27	78	32	0	137
+30 mins.	19	67	6	0	92	5	24	12	0	41	6	55	10	0	71	14	53	12	0	79
+45 mins.	28	80	15	0	123	7	27	27	0	61	6	56	16	0	78	8	59	9	0	76
Total Volume	127	270	48	0	445	27	100	82	0	209	38	217	35	0	290	59	259	69	0	387
% App. Total	28.5	60.7	10.8	0		12.9	47.8	39.2	0		13.1	74.8	12.1	0		15.2	66.9	17.8	0	
PHF	.690	.844	.800	.000	.904	.750	.806	.759	.000	.857	.475	.952	.547	.000	.873	.546	.830	.539	.000	.706

City of Madera
 N/S: Granada Drive
 E/W: Sunset Avenue
 Weather: Clear

File Name : 19_MDA_Granada_Sunset AM
 Site Code : 00319628
 Start Date : 9/19/2019
 Page No : 1

Groups Printed- Passenger Vehicles

Start Time	Granada Drive Southbound					Sunset Avenue Westbound					Granada Drive Northbound					Sunset Avenue Eastbound					Int. Total
	Left	Thru	Right	U-Turns	App. Total	Left	Thru	Right	U-Turns	App. Total	Left	Thru	Right	U-Turns	App. Total	Left	Thru	Right	U-Turns	App. Total	
07:00 AM	21	40	6	0	67	2	15	6	0	23	5	46	6	0	57	4	26	6	0	36	183
07:15 AM	24	48	17	0	89	5	19	9	0	33	10	42	6	0	58	8	53	13	0	74	254
07:30 AM	34	66	12	0	112	5	27	8	0	40	14	46	5	0	65	9	66	16	0	91	308
07:45 AM	46	56	15	0	117	6	28	21	0	55	20	53	6	0	79	27	77	32	0	136	387
Total	125	210	50	0	385	18	89	44	0	151	49	187	23	0	259	48	222	67	0	337	1132
08:00 AM	18	67	5	0	90	9	18	20	0	47	6	49	3	0	58	13	53	12	0	78	273
08:15 AM	28	78	13	0	119	5	23	10	0	38	6	55	10	0	71	8	57	9	0	74	302
08:30 AM	31	43	12	0	86	7	26	27	0	60	6	55	16	0	77	6	30	3	0	39	262
08:45 AM	16	38	18	0	72	2	18	12	0	32	6	49	14	0	69	6	24	7	0	37	210
Total	93	226	48	0	367	23	85	69	0	177	24	208	43	0	275	33	164	31	0	228	1047
Grand Total	218	436	98	0	752	41	174	113	0	328	73	395	66	0	534	81	386	98	0	565	2179
Apprch %	29	58	13	0		12.5	53	34.5	0		13.7	74	12.4	0		14.3	68.3	17.3	0		
Total %	10	20	4.5	0	34.5	1.9	8	5.2	0	15.1	3.4	18.1	3	0	24.5	3.7	17.7	4.5	0	25.9	

Start Time	Granada Drive Southbound					Sunset Avenue Westbound					Granada Drive Northbound					Sunset Avenue Eastbound					Int. Total
	Left	Thru	Right	U-Turns	App. Total	Left	Thru	Right	U-Turns	App. Total	Left	Thru	Right	U-Turns	App. Total	Left	Thru	Right	U-Turns	App. Total	
Peak Hour Analysis From 07:30 AM to 08:15 AM - Peak 1 of 1																					
Peak Hour for Entire Intersection Begins at 07:30 AM																					
07:30 AM	34	66	12	0	112	5	27	8	0	40	14	46	5	0	65	9	66	16	0	91	308
07:45 AM	46	56	15	0	117	6	28	21	0	55	20	53	6	0	79	27	77	32	0	136	387
08:00 AM	18	67	5	0	90	9	18	20	0	47	6	49	3	0	58	13	53	12	0	78	273
08:15 AM	28	78	13	0	119	5	23	10	0	38	6	55	10	0	71	8	57	9	0	74	302
Total Volume	126	267	45	0	438	25	96	59	0	180	46	203	24	0	273	57	253	69	0	379	1270
% App. Total	28.8	61	10.3	0		13.9	53.3	32.8	0		16.8	74.4	8.8	0		15	66.8	18.2	0		
PHF	.685	.856	.750	.000	.920	.694	.857	.702	.000	.818	.575	.923	.600	.000	.864	.528	.821	.539	.000	.697	.820

City of Madera
 N/S: Granada Drive
 E/W: Sunset Avenue
 Weather: Clear

File Name : 19_MDA_Granada_Sunset AM
 Site Code : 00319628
 Start Date : 9/19/2019
 Page No : 2

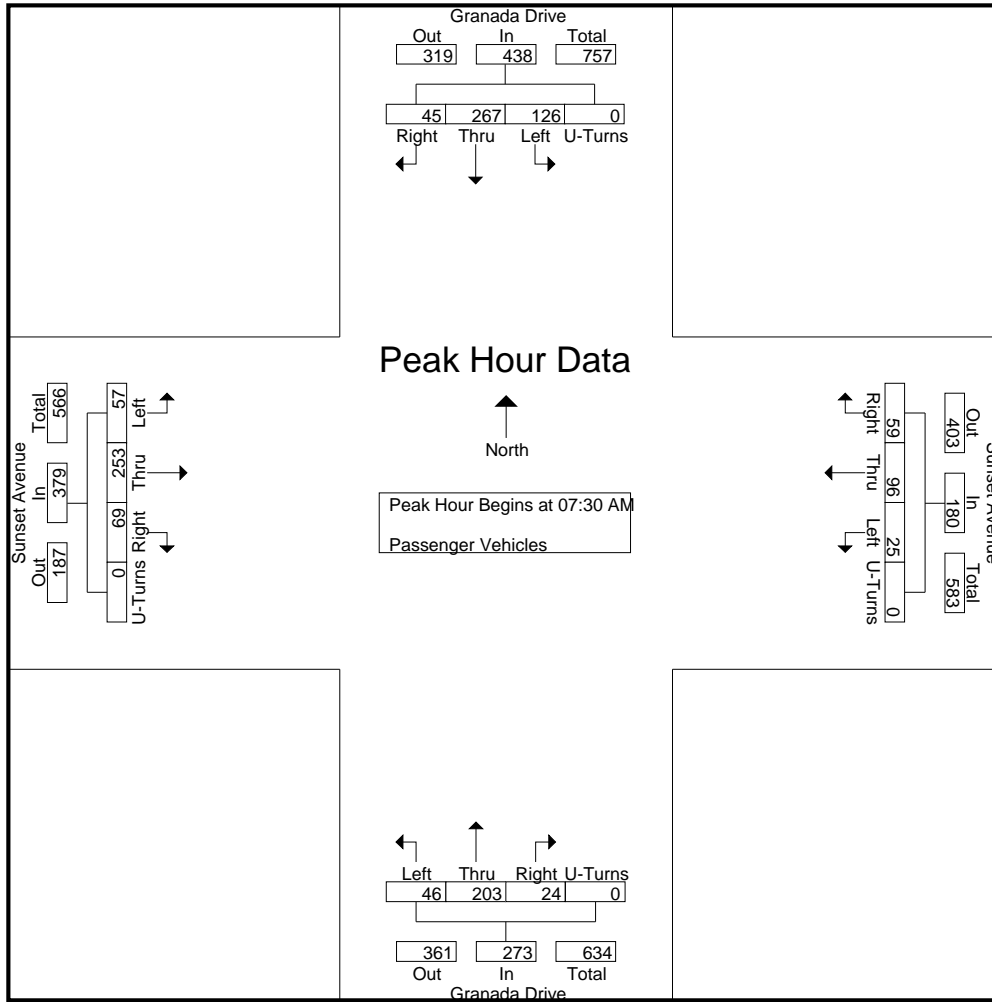

Peak Hour Analysis From 07:30 AM to 08:15 AM - Peak 1 of 1
 Peak Hour for Each Approach Begins at:

	07:30 AM					07:30 AM					07:30 AM									
+0 mins.	34	66	12	0	112	5	27	8	0	40	14	46	5	0	65	9	66	16	0	91
+15 mins.	46	56	15	0	117	6	28	21	0	55	20	53	6	0	79	27	77	32	0	136
+30 mins.	18	67	5	0	90	9	18	20	0	47	6	49	3	0	58	13	53	12	0	78
+45 mins.	28	78	13	0	119	5	23	10	0	38	6	55	10	0	71	8	57	9	0	74
Total Volume	126	267	45	0	438	25	96	59	0	180	46	203	24	0	273	57	253	69	0	379
% App. Total	28.8	61	10.3	0		13.9	53.3	32.8	0		16.8	74.4	8.8	0		15	66.8	18.2	0	
PHF	.685	.856	.750	.000	.920	.694	.857	.702	.000	.818	.575	.923	.600	.000	.864	.528	.821	.539	.000	.697

City of Madera
 N/S: Granada Drive
 E/W: Sunset Avenue
 Weather: Clear

File Name : 19_MDA_Granada_Sunset AM
 Site Code : 00319628
 Start Date : 9/19/2019
 Page No : 1

Groups Printed- Large 2 Axle Vehicles

Start Time	Granada Drive Southbound					Sunset Avenue Westbound					Granada Drive Northbound					Sunset Avenue Eastbound					Int. Total
	Left	Thru	Right	U-Turns	App. Total	Left	Thru	Right	U-Turns	App. Total	Left	Thru	Right	U-Turns	App. Total	Left	Thru	Right	U-Turns	App. Total	
07:00 AM	0	1	0	0	1	0	0	1	0	1	0	2	0	0	2	0	0	0	0	0	4
07:15 AM	0	1	0	0	1	0	0	1	0	1	0	1	0	0	1	0	1	0	0	1	4
07:30 AM	0	0	0	0	0	0	1	2	0	3	1	0	0	0	1	1	3	0	0	4	8
07:45 AM	0	0	0	0	0	0	3	0	0	3	0	3	0	0	3	0	1	0	0	1	7
Total	0	2	0	0	2	0	4	4	0	8	1	6	0	0	7	1	5	0	0	6	23
08:00 AM	1	0	1	0	2	0	0	2	0	2	0	0	0	0	0	1	0	0	0	1	5
08:15 AM	0	1	1	0	2	0	0	2	0	2	0	0	0	0	0	0	2	0	0	2	6
08:30 AM	0	0	0	0	0	0	1	0	0	1	0	1	0	0	1	0	0	1	0	1	3
08:45 AM	0	3	0	0	3	0	1	0	0	1	0	0	0	0	0	0	0	0	0	0	4
Total	1	4	2	0	7	0	2	4	0	6	0	1	0	0	1	1	2	1	0	4	18
Grand Total	1	6	2	0	9	0	6	8	0	14	1	7	0	0	8	2	7	1	0	10	41
Apprch %	11.1	66.7	22.2	0		0	42.9	57.1	0		12.5	87.5	0	0		20	70	10	0		
Total %	2.4	14.6	4.9	0	22	0	14.6	19.5	0	34.1	2.4	17.1	0	0	19.5	4.9	17.1	2.4	0	24.4	

Start Time	Granada Drive Southbound					Sunset Avenue Westbound					Granada Drive Northbound					Sunset Avenue Eastbound					Int. Total
	Left	Thru	Right	U-Turns	App. Total	Thru	Right	U-Turns	App. Total	Thru	Right	U-Turns	App. Total	Thru	Right	U-Turns	App. Total				
Peak Hour Analysis From 07:30 AM to 08:15 AM - Peak 1 of 1																					
Peak Hour for Entire Intersection Begins at 07:30 AM																					
07:30 AM	0	0	0	0	0	0	1	2	0	3	1	0	0	0	1	1	3	0	0	4	8
07:45 AM	0	0	0	0	0	0	3	0	0	3	0	3	0	0	3	0	1	0	0	1	7
08:00 AM	1	0	1	0	2	0	0	2	0	2	0	0	0	0	0	1	0	0	0	1	5
08:15 AM	0	1	1	0	2	0	0	2	0	2	0	0	0	0	0	0	2	0	0	2	6
Total Volume	1	1	2	0	4	0	4	6	0	10	1	3	0	0	4	2	6	0	0	8	26
% App. Total	25	25	50	0		0	40	60	0		25	75	0	0		25	75	0	0		
PHF	.250	.250	.500	.000	.500	.000	.333	.750	.000	.833	.250	.250	.000	.000	.333	.500	.500	.000	.000	.500	.813

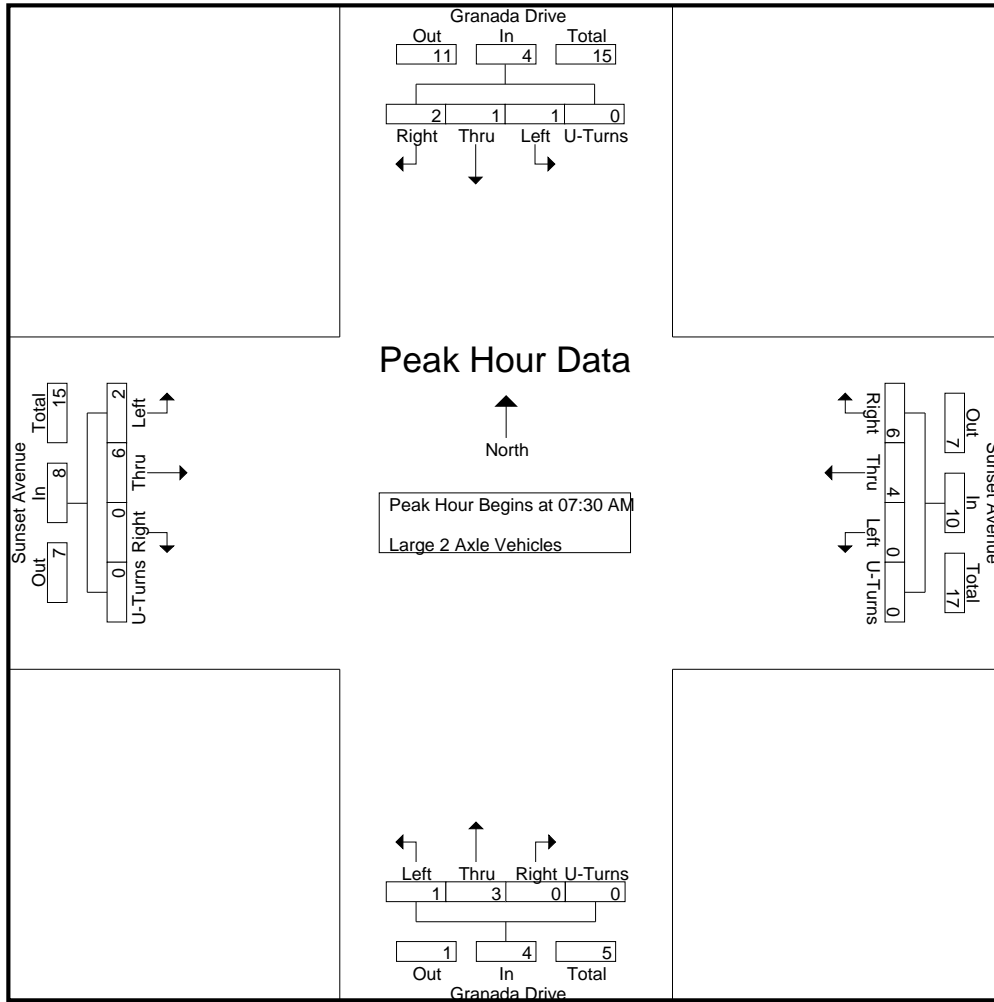

Peak Hour Analysis From 07:30 AM to 08:15 AM - Peak 1 of 1
 Peak Hour for Each Approach Begins at:

	07:30 AM					07:30 AM					07:30 AM									
+0 mins.	0	0	0	0	0	0	1	2	0	3	1	0	0	0	1	1	3	0	0	4
+15 mins.	0	0	0	0	0	0	3	0	0	3	0	3	0	0	3	0	1	0	0	1
+30 mins.	1	0	1	0	2	0	0	2	0	2	0	0	0	0	0	1	0	0	0	1
+45 mins.	0	1	1	0	2	0	0	2	0	2	0	0	0	0	0	0	2	0	0	2
Total Volume	1	1	2	0	4	0	4	6	0	10	1	3	0	0	4	2	6	0	0	8
% App. Total	25	25	50	0		0	40	60	0		25	75	0	0		25	75	0	0	
PHF	.250	.250	.500	.000	.500	.000	.333	.750	.000	.833	.250	.250	.000	.000	.333	.500	.500	.000	.000	.500

City of Madera
 N/S: Granada Drive
 E/W: Sunset Avenue
 Weather: Clear

File Name : 19_MDA_Granada_Sunset AM
 Site Code : 00319628
 Start Date : 9/19/2019
 Page No : 1

Groups Printed- 3 Axle Vehicles

Start Time	Granada Drive Southbound					Sunset Avenue Westbound					Granada Drive Northbound					Sunset Avenue Eastbound					Int. Total
	Left	Thru	Right	U-Turns	App. Total	Left	Thru	Right	U-Turns	App. Total	Left	Thru	Right	U-Turns	App. Total	Left	Thru	Right	U-Turns	App. Total	
07:00 AM	0	0	0	0	0	0	0	0	0	0	0	0	0	0	0	0	0	0	0	0	0
07:15 AM	0	0	0	0	0	0	0	0	0	0	0	0	0	0	0	0	0	0	0	0	0
07:30 AM	0	0	0	0	0	0	0	0	0	0	0	0	0	0	0	0	0	0	0	0	0
07:45 AM	0	0	0	0	0	0	0	0	0	0	0	1	0	0	1	0	0	0	0	0	1
Total	0	0	0	0	0	0	0	0	0	0	0	1	0	0	1	0	0	0	0	0	1
08:00 AM	0	0	0	0	0	0	0	0	0	0	0	0	0	0	0	0	0	0	0	0	0
08:15 AM	0	0	0	0	0	0	1	0	0	1	0	0	0	0	0	0	0	0	0	0	1
08:30 AM	0	0	0	0	0	0	0	0	0	0	0	0	0	0	0	0	0	0	0	0	0
08:45 AM	0	0	0	0	0	0	0	0	0	0	0	0	0	0	0	0	1	0	0	1	1
Total	0	0	0	0	0	0	1	0	0	1	0	0	0	0	0	0	1	0	0	1	2
Grand Total	0	0	0	0	0	0	1	0	0	1	0	1	0	0	1	0	1	0	0	1	3
Apprch %	0	0	0	0		0	100	0	0		0	100	0	0		0	100	0	0		
Total %	0	0	0	0	0	0	33.3	0	0	33.3	0	33.3	0	0	33.3	0	33.3	0	0	33.3	

Start Time	Granada Drive Southbound					Sunset Avenue Westbound					Granada Drive Northbound					Sunset Avenue Eastbound					Int. Total
	Left	Thru	Right	U-Turns	App. Total	Left	Thru	Right	U-Turns	App. Total	Left	Thru	Right	U-Turns	App. Total	Left	Thru	Right	U-Turns	App. Total	
Peak Hour Analysis From 07:30 AM to 08:15 AM - Peak 1 of 1																					
Peak Hour for Entire Intersection Begins at 07:30 AM																					
07:30 AM	0	0	0	0	0	0	0	0	0	0	0	0	0	0	0	0	0	0	0	0	0
07:45 AM	0	0	0	0	0	0	0	0	0	0	0	1	0	0	1	0	0	0	0	0	1
08:00 AM	0	0	0	0	0	0	0	0	0	0	0	0	0	0	0	0	0	0	0	0	0
08:15 AM	0	0	0	0	0	0	1	0	0	1	0	0	0	0	0	0	0	0	0	0	1
Total Volume	0	0	0	0	0	0	1	0	0	1	0	1	0	0	1	0	0	0	0	0	2
% App. Total	0	0	0	0	0	0	100	0	0		0	100	0	0		0	0	0	0	0	
PHF	.000	.000	.000	.000	.000	.000	.250	.000	.000	.250	.000	.250	.000	.000	.250	.000	.000	.000	.000	.000	.500

City of Madera
 N/S: Granada Drive
 E/W: Sunset Avenue
 Weather: Clear

File Name : 19_MDA_Granada_Sunset AM
 Site Code : 00319628
 Start Date : 9/19/2019
 Page No : 2

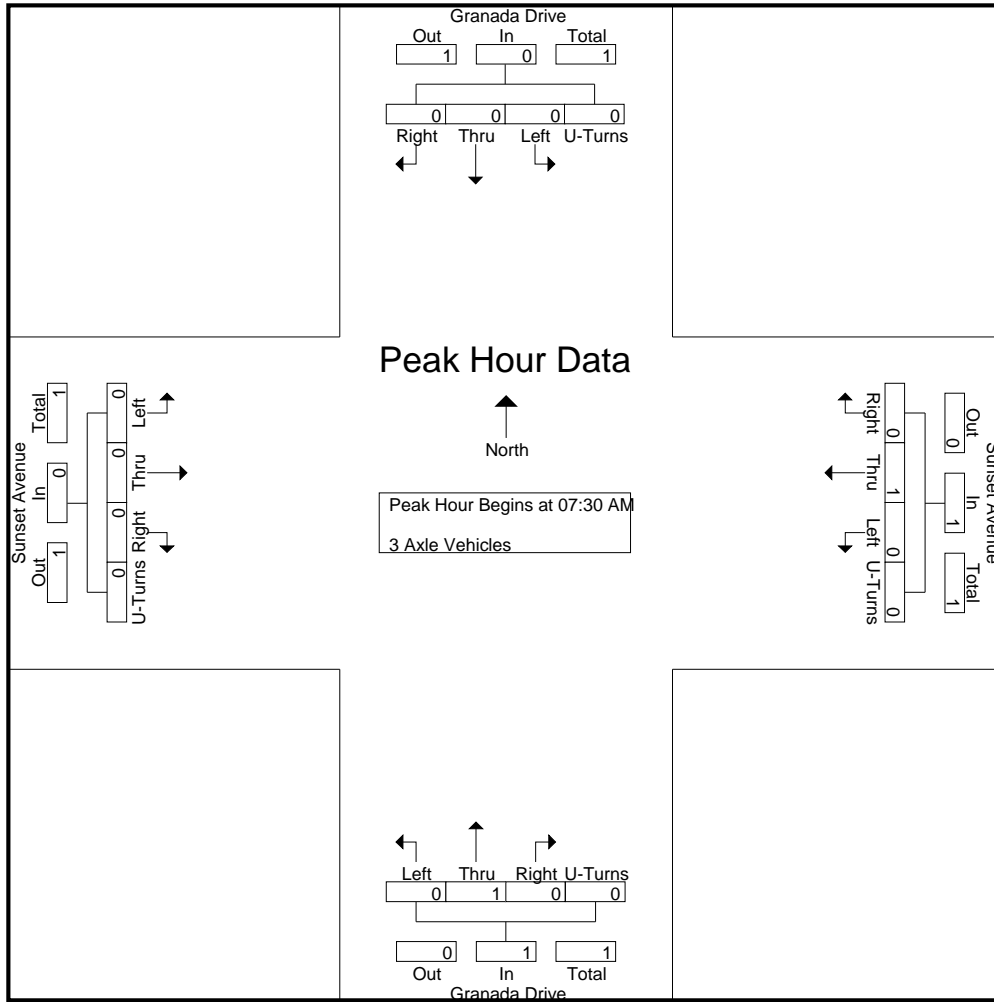

Peak Hour Analysis From 07:30 AM to 08:15 AM - Peak 1 of 1
 Peak Hour for Each Approach Begins at:

	07:30 AM					07:30 AM					07:30 AM									
+0 mins.	0	0	0	0	0	0	0	0	0	0	0	0	0	0	0	0	0	0	0	0
+15 mins.	0	0	0	0	0	0	0	0	0	0	0	1	0	0	1	0	0	0	0	0
+30 mins.	0	0	0	0	0	0	0	0	0	0	0	0	0	0	0	0	0	0	0	0
+45 mins.	0	0	0	0	0	0	1	0	0	1	0	0	0	0	0	0	0	0	0	0
Total Volume	0	0	0	0	0	0	1	0	0	1	0	1	0	0	1	0	0	0	0	0
% App. Total	0	0	0	0	0	0	100	0	0	0	0	100	0	0	0	0	0	0	0	0
PHF	.000	.000	.000	.000	.000	.000	.250	.000	.000	.250	.000	.250	.000	.000	.250	.000	.000	.000	.000	.000

City of Madera
 N/S: Granada Drive
 E/W: Sunset Avenue
 Weather: Clear

File Name : 19_MDA_Granada_Sunset AM
 Site Code : 00319628
 Start Date : 9/19/2019
 Page No : 1

Groups Printed- 4+ Axle Trucks

Start Time	Granada Drive Southbound					Sunset Avenue Westbound					Granada Drive Northbound					Sunset Avenue Eastbound					Int. Total
	Left	Thru	Right	U-Turns	App. Total	Left	Thru	Right	U-Turns	App. Total	Left	Thru	Right	U-Turns	App. Total	Left	Thru	Right	U-Turns	App. Total	
07:00 AM	0	0	0	0	0	0	0	0	0	0	0	0	0	0	0	0	0	0	0	0	0
07:15 AM	0	0	0	0	0	0	0	0	0	0	0	0	0	0	0	0	0	0	0	0	0
07:30 AM	0	0	0	0	0	0	0	0	0	0	0	0	0	0	0	0	0	0	0	0	0
07:45 AM	0	1	0	0	1	0	0	0	0	0	0	0	0	0	0	0	0	0	0	0	1
Total	0	1	0	0	1	0	0	0	0	0	0	0	0	0	0	0	0	0	0	0	1
08:00 AM	0	0	0	0	0	0	0	0	0	0	0	0	0	0	0	0	0	0	0	0	0
08:15 AM	0	1	1	0	2	0	0	0	0	0	0	0	0	0	0	0	0	0	0	0	2
08:30 AM	0	0	0	0	0	0	0	0	0	0	0	0	0	0	0	0	0	0	0	0	0
08:45 AM	0	0	0	0	0	0	0	0	0	0	0	0	0	0	0	0	0	0	0	0	0
Total	0	1	1	0	2	0	0	0	0	0	0	0	0	0	0	0	0	0	0	0	2
Grand Total	0	2	1	0	3	0	0	0	0	0	0	0	0	0	0	0	0	0	0	0	3
Apprch %	0	66.7	33.3	0		0	0	0	0		0	0	0	0		0	0	0	0		
Total %	0	66.7	33.3	0	100	0	0	0	0	0	0	0	0	0	0	0	0	0	0	0	

Start Time	Granada Drive Southbound					Sunset Avenue Westbound					Granada Drive Northbound					Sunset Avenue Eastbound					Int. Total
	Left	Thru	Right	U-Turns	App. Total	Thru	Right	U-Turns	App. Total	Thru	Right	U-Turns	App. Total	Thru	Right	U-Turns	App. Total				
Peak Hour Analysis From 07:30 AM to 08:15 AM - Peak 1 of 1																					
Peak Hour for Entire Intersection Begins at 07:30 AM																					
07:30 AM	0	0	0	0	0	0	0	0	0	0	0	0	0	0	0	0	0	0	0	0	0
07:45 AM	0	1	0	0	1	0	0	0	0	0	0	0	0	0	0	0	0	0	0	0	1
08:00 AM	0	0	0	0	0	0	0	0	0	0	0	0	0	0	0	0	0	0	0	0	0
08:15 AM	0	1	1	0	2	0	0	0	0	0	0	0	0	0	0	0	0	0	0	0	2
Total Volume	0	2	1	0	3	0	0	0	0	0	0	0	0	0	0	0	0	0	0	0	3
% App. Total	0	66.7	33.3	0		0	0	0	0		0	0	0	0		0	0	0	0		
PHF	.000	.500	.250	.000	.375	.000	.000	.000	.000	.000	.000	.000	.000	.000	.000	.000	.000	.000	.000	.000	.375

City of Madera
 N/S: Granada Drive
 E/W: Sunset Avenue
 Weather: Clear

File Name : 19_MDA_Granada_Sunset AM
 Site Code : 00319628
 Start Date : 9/19/2019
 Page No : 2

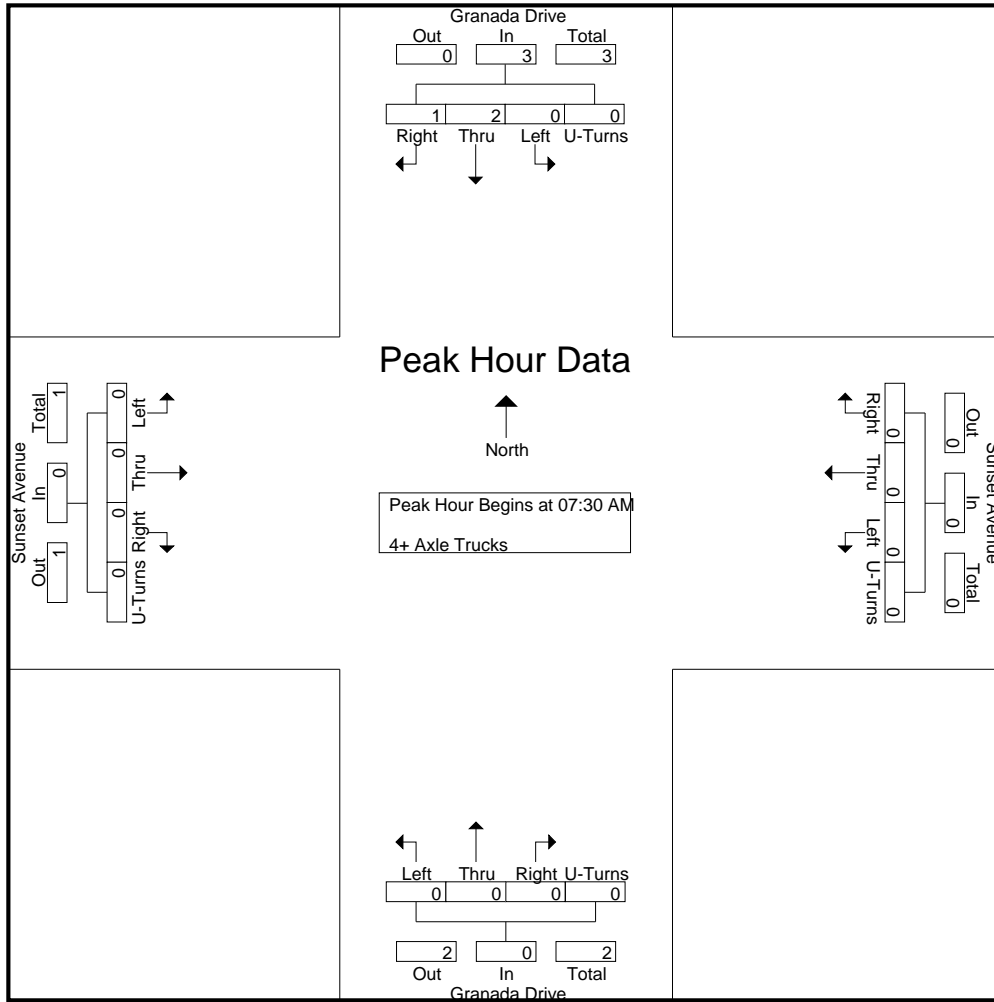

Peak Hour Analysis From 07:30 AM to 08:15 AM - Peak 1 of 1
 Peak Hour for Each Approach Begins at:

	07:30 AM					07:30 AM					07:30 AM									
+0 mins.	0	0	0	0	0	0	0	0	0	0	0	0	0	0	0	0	0	0	0	0
+15 mins.	0	1	0	0	1	0	0	0	0	0	0	0	0	0	0	0	0	0	0	0
+30 mins.	0	0	0	0	0	0	0	0	0	0	0	0	0	0	0	0	0	0	0	0
+45 mins.	0	1	1	0	2	0	0	0	0	0	0	0	0	0	0	0	0	0	0	0
Total Volume	0	2	1	0	3	0	0	0	0	0	0	0	0	0	0	0	0	0	0	0
% App. Total	0	66.7	33.3	0		0	0	0	0		0	0	0	0		0	0	0	0	
PHF	.000	.500	.250	.000	.375	.000	.000	.000	.000	.000	.000	.000	.000	.000	.000	.000	.000	.000	.000	.000

City of Madera
 N/S: Granada Drive
 E/W: Sunset Avenue
 Weather: Clear

File Name : 19_MDA_Granada_Sunset PM
 Site Code : 00319628
 Start Date : 9/19/2019
 Page No : 1

Groups Printed- Passenger Vehicles - Large 2 Axle Vehicles - 3 Axle Vehicles - 4+ Axle Trucks

Start Time	Granada Drive Southbound					Sunset Avenue Westbound					Granada Drive Northbound					Sunset Avenue Eastbound					Int. Total
	Left	Thru	Right	U-Turns	App. Total	Left	Thru	Right	U-Turns	App. Total	Left	Thru	Right	U-Turns	App. Total	Left	Thru	Right	U-Turns	App. Total	
04:00 PM	20	57	6	0	83	8	25	24	0	57	4	67	14	0	85	6	29	7	0	42	267
04:15 PM	11	61	6	0	78	6	22	17	0	45	1	64	9	0	74	7	26	7	0	40	237
04:30 PM	24	64	1	0	89	11	24	22	0	57	8	72	9	0	89	6	33	3	0	42	277
04:45 PM	27	67	2	0	96	13	33	19	0	65	8	75	9	0	92	5	28	4	0	37	290
Total	82	249	15	0	346	38	104	82	0	224	21	278	41	0	340	24	116	21	0	161	1071
05:00 PM	16	81	11	0	108	10	44	29	0	83	9	73	8	0	90	7	31	5	0	43	324
05:15 PM	25	84	10	0	119	13	39	34	0	86	8	68	11	0	87	10	27	5	0	42	334
05:30 PM	21	60	2	0	83	17	41	24	0	82	16	60	11	0	87	5	26	9	0	40	292
05:45 PM	14	68	9	0	91	14	29	21	0	64	13	61	12	0	86	6	31	15	0	52	293
Total	76	293	32	0	401	54	153	108	0	315	46	262	42	0	350	28	115	34	0	177	1243
Grand Total	158	542	47	0	747	92	257	190	0	539	67	540	83	0	690	52	231	55	0	338	2314
Apprch %	21.2	72.6	6.3	0		17.1	47.7	35.3	0		9.7	78.3	12	0		15.4	68.3	16.3	0		
Total %	6.8	23.4	2	0	32.3	4	11.1	8.2	0	23.3	2.9	23.3	3.6	0	29.8	2.2	10	2.4	0	14.6	
Passenger Vehicles	96.8	98.9	95.7	0	98.3	97.8	99.2	97.9	0	98.5	98.5	99.4	100	0	99.4	92.3	100	100	0	98.8	98.7
Large 2 Axle Vehicles	2.5	1.1	4.3	0	1.6	2.2	0.8	2.1	0	1.5	1.5	0.2	0	0	0.3	7.7	0	0	0	1.2	1.1
3 Axle Vehicles	1	0	0	0	1	0	0	0	0	0	0	0	0	0	0	0	0	0	0	0	1
% 3 Axle Vehicles	0.6	0	0	0	0.1	0	0	0	0	0	0	0	0	0	0	0	0	0	0	0	0
4+ Axle Trucks	0	0	0	0	0	0	0	0	0	0	0	2	0	0	2	0	0	0	0	0	2
% 4+ Axle Trucks												0.3	0	0	0.6						0.1

Start Time	Granada Drive Southbound					Sunset Avenue Westbound					Granada Drive Northbound					Sunset Avenue Eastbound					Int. Total
	Left	Thru	Right	U-Turns	App. Total	Left	Thru	Right	U-Turns	App. Total	Left	Thru	Right	U-Turns	App. Total	Left	Thru	Right	U-Turns	App. Total	
Peak Hour Analysis From 04:00 PM to 05:45 PM - Peak 1 of 1																					
Peak Hour for Entire Intersection Begins at 05:00 PM																					
05:00 PM	16	81	11	0	108	10	44	29	0	83	9	73	8	0	90	7	31	5	0	43	324
05:15 PM	25	84	10	0	119	13	39	34	0	86	8	68	11	0	87	10	27	5	0	42	334
05:30 PM	21	60	2	0	83	17	41	24	0	82	16	60	11	0	87	5	26	9	0	40	292
05:45 PM	14	68	9	0	91	14	29	21	0	64	13	61	12	0	86	6	31	15	0	52	293
Total Volume	76	293	32	0	401	54	153	108	0	315	46	262	42	0	350	28	115	34	0	177	1243
% App. Total	19	73.1	8	0		17.1	48.6	34.3	0		13.1	74.9	12	0		15.8	65	19.2	0		
PHF	.760	.872	.727	.000	.842	.794	.869	.794	.000	.916	.719	.897	.875	.000	.972	.700	.927	.567	.000	.851	.930

City of Madera
 N/S: Granada Drive
 E/W: Sunset Avenue
 Weather: Clear

File Name : 19_MDA_Granada_Sunset PM
 Site Code : 00319628
 Start Date : 9/19/2019
 Page No : 2

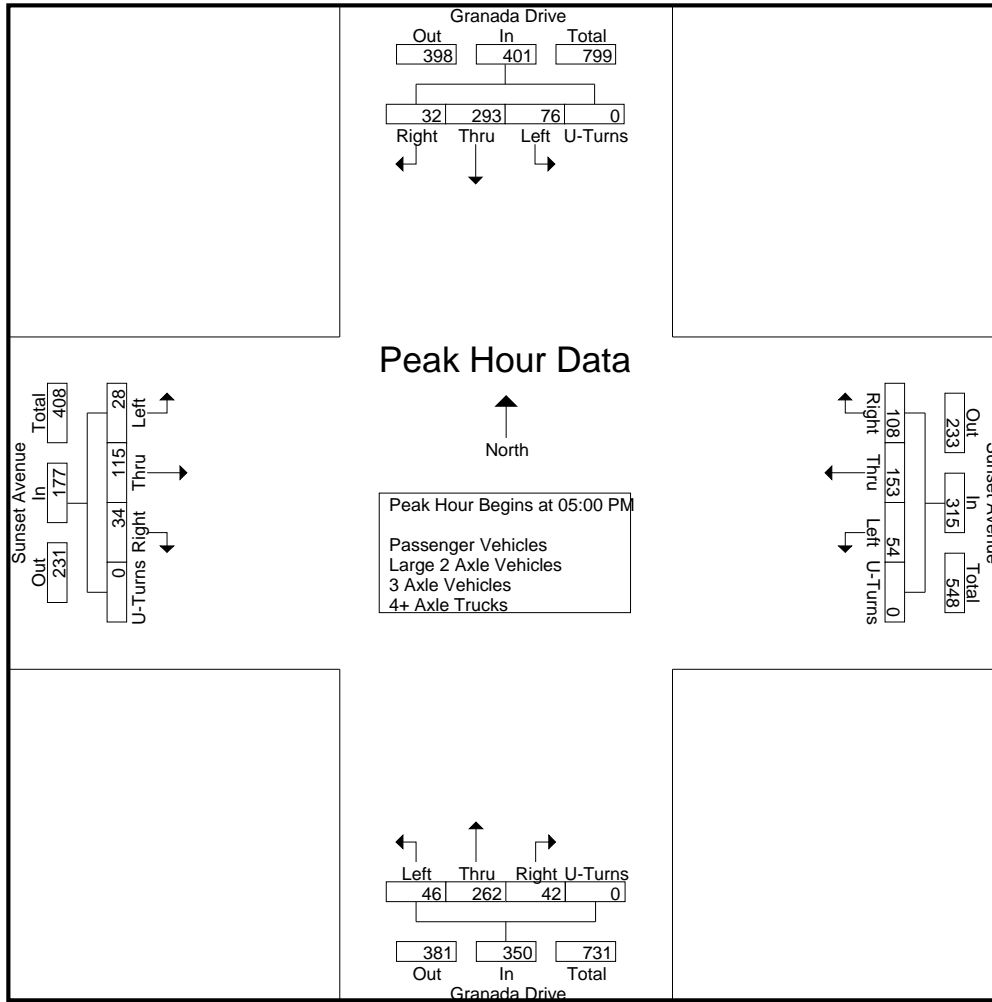

Peak Hour Analysis From 04:00 PM to 05:45 PM - Peak 1 of 1
 Peak Hour for Each Approach Begins at:

	04:30 PM					04:45 PM					05:00 PM					05:15 PM				
+0 mins.	24	64	1	0	89	13	33	19	0	65	8	72	9	0	89	7	31	5	0	43
+15 mins.	27	67	2	0	96	10	44	29	0	83	8	75	9	0	92	10	27	5	0	42
+30 mins.	16	81	11	0	108	13	39	34	0	86	9	73	8	0	90	5	26	9	0	40
+45 mins.	25	84	10	0	119	17	41	24	0	82	8	68	11	0	87	6	31	15	0	52
Total Volume	92	296	24	0	412	53	157	106	0	316	33	288	37	0	358	28	115	34	0	177
% App. Total	22.3	71.8	5.8	0		16.8	49.7	33.5	0		9.2	80.4	10.3	0		15.8	65	19.2	0	
PHF	.852	.881	.545	.000	.866	.779	.892	.779	.000	.919	.917	.960	.841	.000	.973	.700	.927	.567	.000	.851

City of Madera
 N/S: Granada Drive
 E/W: Sunset Avenue
 Weather: Clear

File Name : 19_MDA_Granada_Sunset PM
 Site Code : 00319628
 Start Date : 9/19/2019
 Page No : 1

Groups Printed- Passenger Vehicles

Start Time	Granada Drive Southbound					Sunset Avenue Westbound					Granada Drive Northbound					Sunset Avenue Eastbound					Int. Total
	Left	Thru	Right	U-Turns	App. Total	Left	Thru	Right	U-Turns	App. Total	Left	Thru	Right	U-Turns	App. Total	Left	Thru	Right	U-Turns	App. Total	
04:00 PM	19	57	5	0	81	8	23	24	0	55	4	66	14	0	84	5	29	7	0	41	261
04:15 PM	10	60	5	0	75	6	22	16	0	44	1	64	9	0	74	6	26	7	0	39	232
04:30 PM	24	63	1	0	88	10	24	22	0	56	8	72	9	0	89	6	33	3	0	42	275
04:45 PM	25	67	2	0	94	12	33	17	0	62	8	75	9	0	92	4	28	4	0	36	284
Total	78	247	13	0	338	36	102	79	0	217	21	277	41	0	339	21	116	21	0	158	1052
05:00 PM	15	80	11	0	106	10	44	29	0	83	9	72	8	0	89	7	31	5	0	43	321
05:15 PM	25	83	10	0	118	13	39	33	0	85	8	67	11	0	86	10	27	5	0	42	331
05:30 PM	21	59	2	0	82	17	41	24	0	82	15	60	11	0	86	4	26	9	0	39	289
05:45 PM	14	67	9	0	90	14	29	21	0	64	13	61	12	0	86	6	31	15	0	52	292
Total	75	289	32	0	396	54	153	107	0	314	45	260	42	0	347	27	115	34	0	176	1233
Grand Total	153	536	45	0	734	90	255	186	0	531	66	537	83	0	686	48	231	55	0	334	2285
Apprch %	20.8	73	6.1	0		16.9	48	35	0		9.6	78.3	12.1	0		14.4	69.2	16.5	0		
Total %	6.7	23.5	2	0	32.1	3.9	11.2	8.1	0	23.2	2.9	23.5	3.6	0	30	2.1	10.1	2.4	0	14.6	

Start Time	Granada Drive Southbound					Sunset Avenue Westbound					Granada Drive Northbound					Sunset Avenue Eastbound					Int. Total
	Left	Thru	Right	U-Turns	App. Total	Left	Thru	Right	U-Turns	App. Total	Left	Thru	Right	U-Turns	App. Total	Left	Thru	Right	U-Turns	App. Total	
Peak Hour Analysis From 05:00 PM to 05:45 PM - Peak 1 of 1																					
Peak Hour for Entire Intersection Begins at 05:00 PM																					
05:00 PM	15	80	11	0	106	10	44	29	0	83	9	72	8	0	89	7	31	5	0	43	321
05:15 PM	25	83	10	0	118	13	39	33	0	85	8	67	11	0	86	10	27	5	0	42	331
05:30 PM	21	59	2	0	82	17	41	24	0	82	15	60	11	0	86	4	26	9	0	39	289
05:45 PM	14	67	9	0	90	14	29	21	0	64	13	61	12	0	86	6	31	15	0	52	292
Total Volume	75	289	32	0	396	54	153	107	0	314	45	260	42	0	347	27	115	34	0	176	1233
% App. Total	18.9	73	8.1	0		17.2	48.7	34.1	0		13	74.9	12.1	0		15.3	65.3	19.3	0		
PHF	.750	.870	.727	.000	.839	.794	.869	.811	.000	.924	.750	.903	.875	.000	.975	.675	.927	.567	.000	.846	.931

City of Madera
 N/S: Granada Drive
 E/W: Sunset Avenue
 Weather: Clear

File Name : 19_MDA_Granada_Sunset PM
 Site Code : 00319628
 Start Date : 9/19/2019
 Page No : 2

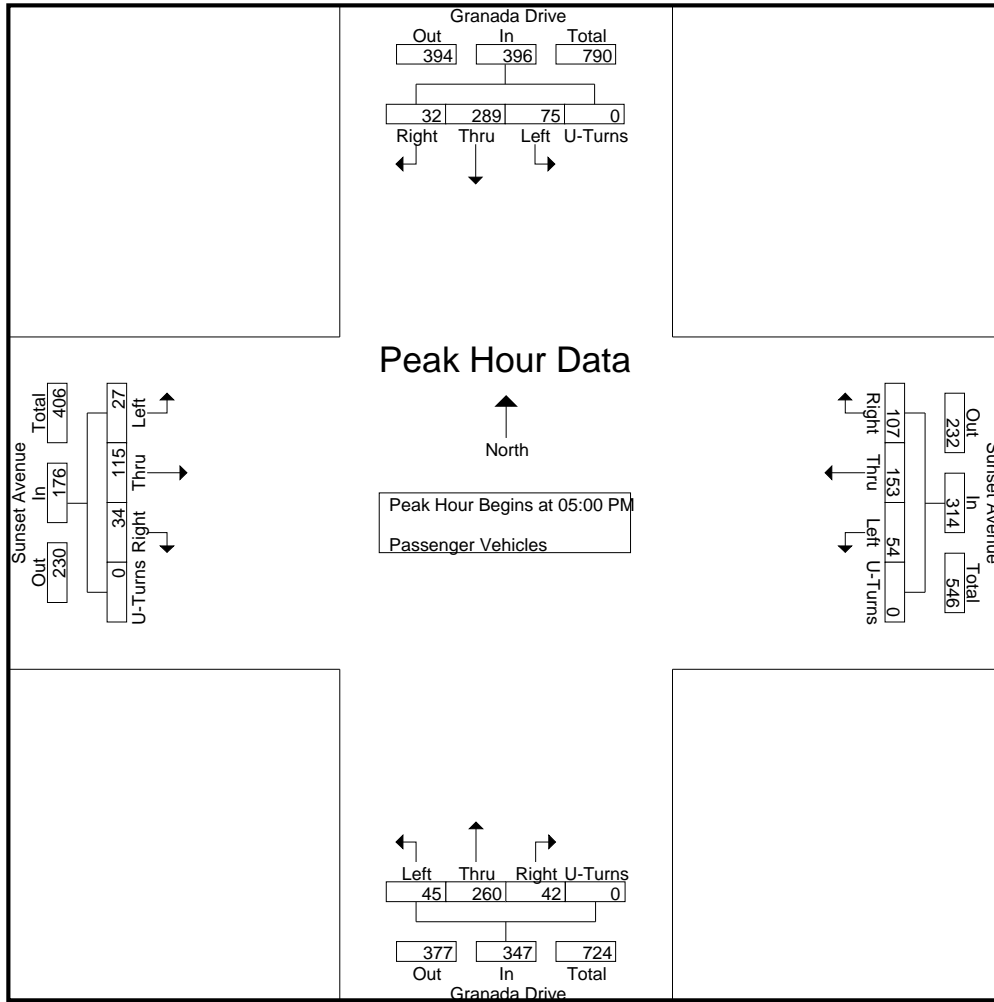

Peak Hour Analysis From 05:00 PM to 05:45 PM - Peak 1 of 1
 Peak Hour for Each Approach Begins at:

	05:00 PM					05:00 PM					05:00 PM									
+0 mins.	15	80	11	0	106	10	44	29	0	83	9	72	8	0	89	7	31	5	0	43
+15 mins.	25	83	10	0	118	13	39	33	0	85	8	67	11	0	86	10	27	5	0	42
+30 mins.	21	59	2	0	82	17	41	24	0	82	15	60	11	0	86	4	26	9	0	39
+45 mins.	14	67	9	0	90	14	29	21	0	64	13	61	12	0	86	6	31	15	0	52
Total Volume	75	289	32	0	396	54	153	107	0	314	45	260	42	0	347	27	115	34	0	176
% App. Total	18.9	73	8.1	0		17.2	48.7	34.1	0		13	74.9	12.1	0		15.3	65.3	19.3	0	
PHF	.750	.870	.727	.000	.839	.794	.869	.811	.000	.924	.750	.903	.875	.000	.975	.675	.927	.567	.000	.846

City of Madera
 N/S: Granada Drive
 E/W: Sunset Avenue
 Weather: Clear

File Name : 19_MDA_Granada_Sunset PM
 Site Code : 00319628
 Start Date : 9/19/2019
 Page No : 1

Groups Printed- Large 2 Axle Vehicles

Start Time	Granada Drive Southbound					Sunset Avenue Westbound					Granada Drive Northbound					Sunset Avenue Eastbound					Int. Total	
	Left	Thru	Right	U-Turns	App. Total	Left	Thru	Right	U-Turns	App. Total	Left	Thru	Right	U-Turns	App. Total	Left	Thru	Right	U-Turns	App. Total		
04:00 PM	1	0	1	0	2	0	2	0	0	2	0	0	0	0	0	1	0	0	0	1	5	
04:15 PM	0	1	1	0	2	0	0	1	0	1	0	0	0	0	0	1	0	0	0	0	1	4
04:30 PM	0	1	0	0	1	1	0	0	0	1	0	0	0	0	0	0	0	0	0	0	0	2
04:45 PM	2	0	0	0	2	1	0	2	0	3	0	0	0	0	0	1	0	0	0	0	1	6
Total	3	2	2	0	7	2	2	3	0	7	0	0	0	0	0	3	0	0	0	0	3	17
05:00 PM	1	1	0	0	2	0	0	0	0	0	0	0	0	0	0	0	0	0	0	0	0	2
05:15 PM	0	1	0	0	1	0	0	1	0	1	0	1	0	0	1	0	0	0	0	0	0	3
05:30 PM	0	1	0	0	1	0	0	0	0	0	1	0	0	0	1	1	0	0	0	0	1	3
05:45 PM	0	1	0	0	1	0	0	0	0	0	0	0	0	0	0	0	0	0	0	0	0	1
Total	1	4	0	0	5	0	0	1	0	1	1	1	0	0	2	1	0	0	0	0	1	9
Grand Total	4	6	2	0	12	2	2	4	0	8	1	1	0	0	2	4	0	0	0	0	4	26
Apprch %	33.3	50	16.7	0		25	25	50	0		50	50	0	0		100	0	0	0	0		
Total %	15.4	23.1	7.7	0	46.2	7.7	7.7	15.4	0	30.8	3.8	3.8	0	0	7.7	15.4	0	0	0	0	15.4	

Start Time	Granada Drive Southbound					Sunset Avenue Westbound					Granada Drive Northbound					Sunset Avenue Eastbound					Int. Total
	Left	Thru	Right	U-Turns	App. Total	Thru	Right	U-Turns	App. Total	Thru	Right	U-Turns	App. Total	Thru	Right	U-Turns	App. Total				
Peak Hour Analysis From 05:00 PM to 05:45 PM - Peak 1 of 1																					
Peak Hour for Entire Intersection Begins at 05:00 PM																					
05:00 PM	1	1	0	0	2	0	0	0	0	0	0	0	0	0	0	0	0	0	0	0	2
05:15 PM	0	1	0	0	1	0	0	1	0	1	0	1	0	0	1	0	0	0	0	0	3
05:30 PM	0	1	0	0	1	0	0	0	0	0	1	0	0	0	1	1	0	0	0	0	3
05:45 PM	0	1	0	0	1	0	0	0	0	0	0	0	0	0	0	0	0	0	0	0	1
Total Volume	1	4	0	0	5	0	0	1	0	1	1	1	0	0	2	1	0	0	0	0	9
% App. Total	20	80	0	0		0	0	100	0		50	50	0	0		100	0	0	0	0	
PHF	.250	1.00	.000	.000	.625	.000	.000	.250	.000	.250	.250	.250	.000	.000	.500	.250	.000	.000	.000	.250	.750

City of Madera
 N/S: Granada Drive
 E/W: Sunset Avenue
 Weather: Clear

File Name : 19_MDA_Granada_Sunset PM
 Site Code : 00319628
 Start Date : 9/19/2019
 Page No : 2

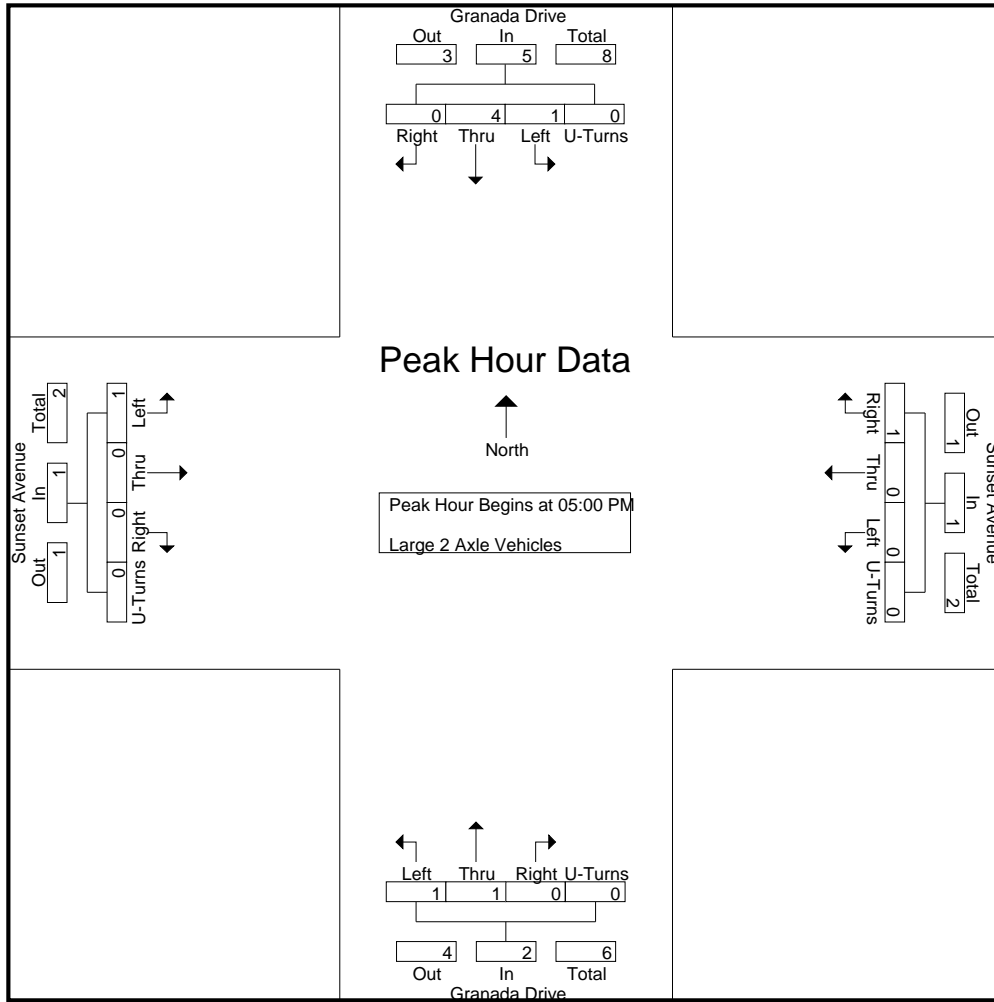

Peak Hour Analysis From 05:00 PM to 05:45 PM - Peak 1 of 1
 Peak Hour for Each Approach Begins at:

	05:00 PM					05:00 PM					05:00 PM									
+0 mins.	1	1	0	0	2	0	0	0	0	0	0	0	0	0	0	0	0	0	0	0
+15 mins.	0	1	0	0	1	0	0	1	0	1	0	1	0	0	1	0	0	0	0	0
+30 mins.	0	1	0	0	1	0	0	0	0	0	1	0	0	0	1	1	0	0	0	1
+45 mins.	0	1	0	0	1	0	0	0	0	0	0	0	0	0	0	0	0	0	0	0
Total Volume	1	4	0	0	5	0	0	1	0	1	1	1	0	0	2	1	0	0	0	1
% App. Total	20	80	0	0		0	0	100	0		50	50	0	0		100	0	0	0	
PHF	.250	1.000	.000	.000	.625	.000	.000	.250	.000	.250	.250	.250	.000	.000	.500	.250	.000	.000	.000	.250

City of Madera
 N/S: Granada Drive
 E/W: Sunset Avenue
 Weather: Clear

File Name : 19_MDA_Granada_Sunset PM
 Site Code : 00319628
 Start Date : 9/19/2019
 Page No : 1

Groups Printed- 3 Axle Vehicles

Start Time	Granada Drive Southbound					Sunset Avenue Westbound					Granada Drive Northbound					Sunset Avenue Eastbound					Int. Total
	Left	Thru	Right	U-Turns	App. Total	Left	Thru	Right	U-Turns	App. Total	Left	Thru	Right	U-Turns	App. Total	Left	Thru	Right	U-Turns	App. Total	
04:00 PM	0	0	0	0	0	0	0	0	0	0	0	0	0	0	0	0	0	0	0	0	0
04:15 PM	1	0	0	0	1	0	0	0	0	0	0	0	0	0	0	0	0	0	0	0	0
04:30 PM	0	0	0	0	0	0	0	0	0	0	0	0	0	0	0	0	0	0	0	0	0
04:45 PM	0	0	0	0	0	0	0	0	0	0	0	0	0	0	0	0	0	0	0	0	0
Total	1	0	0	0	1	0	0	0	0	0	0	0	0	0	0	0	0	0	0	0	1
05:00 PM	0	0	0	0	0	0	0	0	0	0	0	0	0	0	0	0	0	0	0	0	0
05:15 PM	0	0	0	0	0	0	0	0	0	0	0	0	0	0	0	0	0	0	0	0	0
05:30 PM	0	0	0	0	0	0	0	0	0	0	0	0	0	0	0	0	0	0	0	0	0
05:45 PM	0	0	0	0	0	0	0	0	0	0	0	0	0	0	0	0	0	0	0	0	0
Total	0	0	0	0	0	0	0	0	0	0	0	0	0	0	0	0	0	0	0	0	0
Grand Total	1	0	0	0	1	0	0	0	0	0	0	0	0	0	0	0	0	0	0	0	1
Apprch %	100	0	0	0		0	0	0	0		0	0	0	0		0	0	0	0		
Total %	100	0	0	0	100	0	0	0	0	0	0	0	0	0	0	0	0	0	0	0	0

Start Time	Granada Drive Southbound					Sunset Avenue Westbound					Granada Drive Northbound					Sunset Avenue Eastbound					Int. Total
	Left	Thru	Right	U-Turns	App. Total	Left	Thru	Right	U-Turns	App. Total	Left	Thru	Right	U-Turns	App. Total	Left	Thru	Right	U-Turns	App. Total	
Peak Hour Analysis From 05:00 PM to 05:45 PM - Peak 1 of 1																					
Peak Hour for Entire Intersection Begins at 05:00 PM																					
05:00 PM	0	0	0	0	0	0	0	0	0	0	0	0	0	0	0	0	0	0	0	0	0
05:15 PM	0	0	0	0	0	0	0	0	0	0	0	0	0	0	0	0	0	0	0	0	0
05:30 PM	0	0	0	0	0	0	0	0	0	0	0	0	0	0	0	0	0	0	0	0	0
05:45 PM	0	0	0	0	0	0	0	0	0	0	0	0	0	0	0	0	0	0	0	0	0
Total Volume	0	0	0	0	0	0	0	0	0	0	0	0	0	0	0	0	0	0	0	0	0
% App. Total	0	0	0	0		0	0	0	0		0	0	0	0		0	0	0	0		
PHF	.000	.000	.000	.000	.000	.000	.000	.000	.000	.000	.000	.000	.000	.000	.000	.000	.000	.000	.000	.000	.000

City of Madera
 N/S: Granada Drive
 E/W: Sunset Avenue
 Weather: Clear

File Name : 19_MDA_Granada_Sunset PM
 Site Code : 00319628
 Start Date : 9/19/2019
 Page No : 2

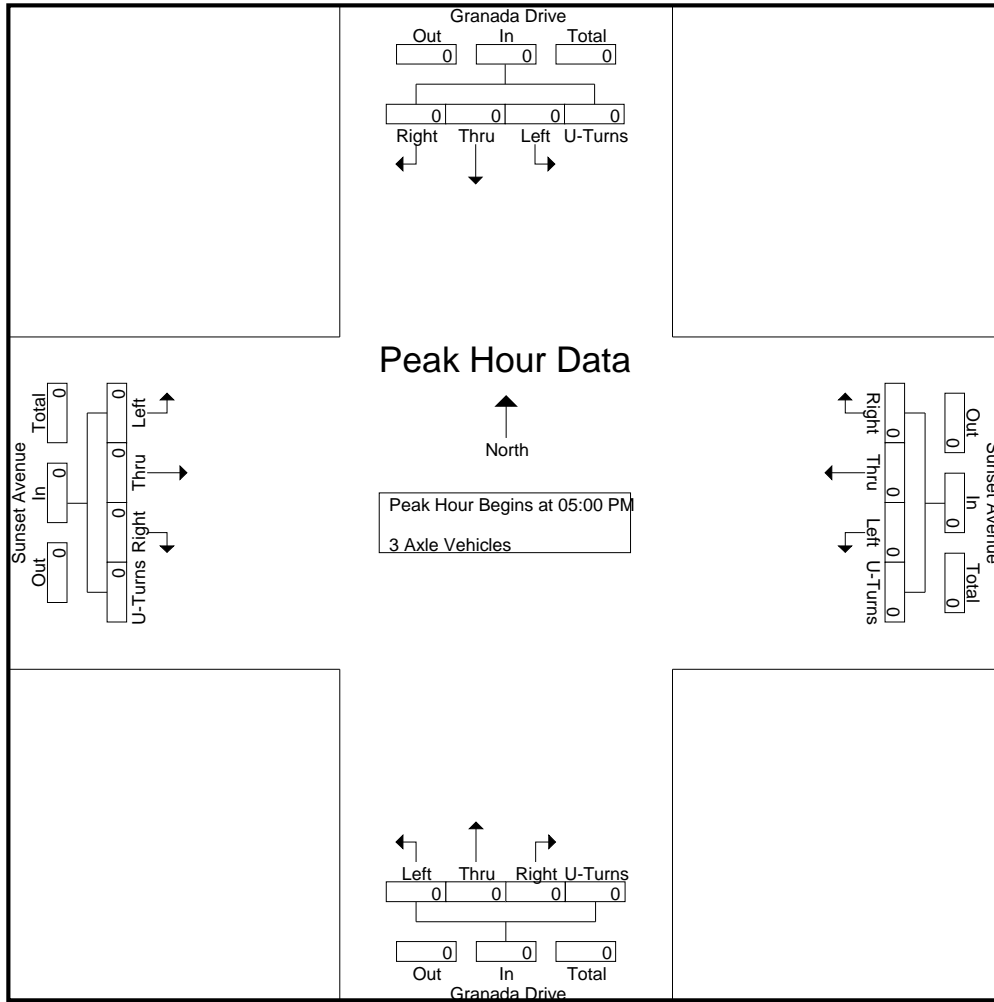

Peak Hour Analysis From 05:00 PM to 05:45 PM - Peak 1 of 1
 Peak Hour for Each Approach Begins at:

	05:00 PM					05:00 PM					05:00 PM					05:00 PM									
+0 mins.	0	0	0	0	0	0	0	0	0	0	0	0	0	0	0	0	0	0	0	0	0	0	0	0	0
+15 mins.	0	0	0	0	0	0	0	0	0	0	0	0	0	0	0	0	0	0	0	0	0	0	0	0	0
+30 mins.	0	0	0	0	0	0	0	0	0	0	0	0	0	0	0	0	0	0	0	0	0	0	0	0	0
+45 mins.	0	0	0	0	0	0	0	0	0	0	0	0	0	0	0	0	0	0	0	0	0	0	0	0	0
Total Volume	0	0	0	0	0	0	0	0	0	0	0	0	0	0	0	0	0	0	0	0	0	0	0	0	0
% App. Total	0	0	0	0	0	0	0	0	0	0	0	0	0	0	0	0	0	0	0	0	0	0	0	0	0
PHF	.000	.000	.000	.000	.000	.000	.000	.000	.000	.000	.000	.000	.000	.000	.000	.000	.000	.000	.000	.000	.000	.000	.000	.000	.000

City of Madera
 N/S: Granada Drive
 E/W: Sunset Avenue
 Weather: Clear

File Name : 19_MDA_Granada_Sunset PM
 Site Code : 00319628
 Start Date : 9/19/2019
 Page No : 1

Groups Printed- 4+ Axle Trucks

Start Time	Granada Drive Southbound					Sunset Avenue Westbound					Granada Drive Northbound					Sunset Avenue Eastbound					Int. Total					
	Left	Thru	Right	U-Turns	App. Total	Left	Thru	Right	U-Turns	App. Total	Left	Thru	Right	U-Turns	App. Total	Left	Thru	Right	U-Turns	App. Total						
04:00 PM	0	0	0	0	0	0	0	0	0	0	0	1	0	0	1	0	0	0	0	0	0	0	0	0	0	1
04:15 PM	0	0	0	0	0	0	0	0	0	0	0	0	0	0	0	0	0	0	0	0	0	0	0	0	0	0
04:30 PM	0	0	0	0	0	0	0	0	0	0	0	0	0	0	0	0	0	0	0	0	0	0	0	0	0	0
04:45 PM	0	0	0	0	0	0	0	0	0	0	0	0	0	0	0	0	0	0	0	0	0	0	0	0	0	0
Total	0	0	0	0	0	0	0	0	0	0	0	1	0	0	1	0	0	0	0	0	0	0	0	0	0	1
05:00 PM	0	0	0	0	0	0	0	0	0	0	0	1	0	0	1	0	0	0	0	0	0	0	0	0	0	1
05:15 PM	0	0	0	0	0	0	0	0	0	0	0	0	0	0	0	0	0	0	0	0	0	0	0	0	0	0
05:30 PM	0	0	0	0	0	0	0	0	0	0	0	0	0	0	0	0	0	0	0	0	0	0	0	0	0	0
05:45 PM	0	0	0	0	0	0	0	0	0	0	0	0	0	0	0	0	0	0	0	0	0	0	0	0	0	0
Total	0	0	0	0	0	0	0	0	0	0	0	1	0	0	1	0	0	0	0	0	0	0	0	0	0	1
Grand Total	0	0	0	0	0	0	0	0	0	0	0	2	0	0	2	0	0	0	0	0	0	0	0	0	0	2
Apprch %	0	0	0	0		0	0	0	0		0	100	0	0		0	0	0	0		0	0	0	0		
Total %	0	0	0	0	0	0	0	0	0	0	0	100	0	0	100	0	0	0	0	0	0	0	0	0	0	

Start Time	Granada Drive Southbound					Sunset Avenue Westbound					Granada Drive Northbound					Sunset Avenue Eastbound					Int. Total					
	Left	Thru	Right	U-Turns	App. Total	Left	Thru	Right	U-Turns	App. Total	Left	Thru	Right	U-Turns	App. Total	Left	Thru	Right	U-Turns	App. Total						
Peak Hour Analysis From 05:00 PM to 05:45 PM - Peak 1 of 1																										
Peak Hour for Entire Intersection Begins at 05:00 PM																										
05:00 PM	0	0	0	0	0	0	0	0	0	0	0	1	0	0	1	0	0	0	0	0	0	0	0	0	0	1
05:15 PM	0	0	0	0	0	0	0	0	0	0	0	0	0	0	0	0	0	0	0	0	0	0	0	0	0	0
05:30 PM	0	0	0	0	0	0	0	0	0	0	0	0	0	0	0	0	0	0	0	0	0	0	0	0	0	0
05:45 PM	0	0	0	0	0	0	0	0	0	0	0	0	0	0	0	0	0	0	0	0	0	0	0	0	0	0
Total Volume	0	0	0	0	0	0	0	0	0	0	0	1	0	0	1	0	0	0	0	0	0	0	0	0	0	1
% App. Total	0	0	0	0		0	0	0	0		0	100	0	0		0	0	0	0		0	0	0	0		
PHF	.000	.000	.000	.000	.000	.000	.000	.000	.000	.000	.000	.250	.000	.000	.250	.000	.000	.000	.000	.000	.000	.000	.000	.000	.250	

City of Madera
 N/S: Granada Drive
 E/W: Sunset Avenue
 Weather: Clear

File Name : 19_MDA_Granada_Sunset PM
 Site Code : 00319628
 Start Date : 9/19/2019
 Page No : 2

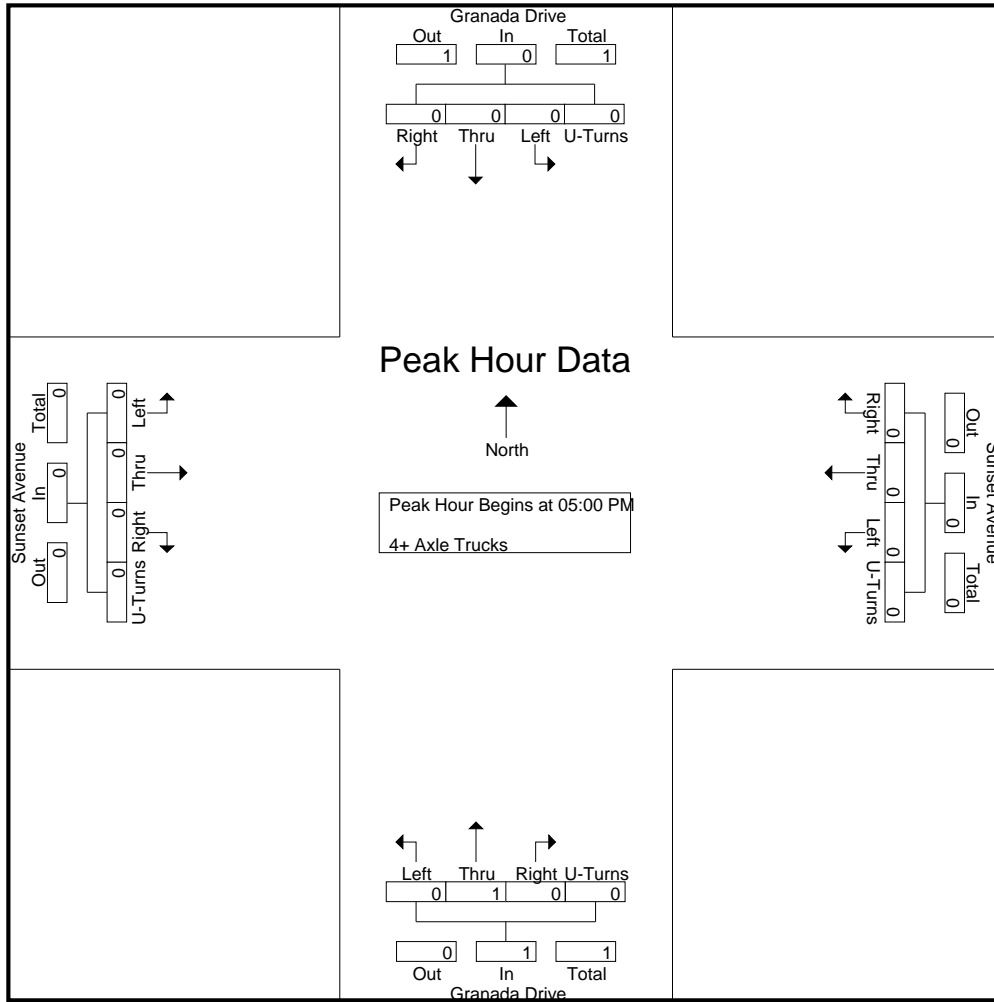

Peak Hour Analysis From 05:00 PM to 05:45 PM - Peak 1 of 1
 Peak Hour for Each Approach Begins at:

	05:00 PM					05:00 PM					05:00 PM									
+0 mins.	0	0	0	0	0	0	0	0	0	0	0	1	0	0	1	0	0	0	0	0
+15 mins.	0	0	0	0	0	0	0	0	0	0	0	0	0	0	0	0	0	0	0	0
+30 mins.	0	0	0	0	0	0	0	0	0	0	0	0	0	0	0	0	0	0	0	0
+45 mins.	0	0	0	0	0	0	0	0	0	0	0	0	0	0	0	0	0	0	0	0
Total Volume	0	0	0	0	0	0	0	0	0	0	0	1	0	0	1	0	0	0	0	0
% App. Total	0	0	0	0	0	0	0	0	0	0	0	100	0	0	0	0	0	0	0	0
PHF	.000	.000	.000	.000	.000	.000	.000	.000	.000	.000	.000	.250	.000	.000	.250	.000	.000	.000	.000	.000

Location: Madera
 N/S: Granada Drive
 E/W: Sunset Avenue



Date: 9/19/2019
 Day: Thursday

PEDESTRIANS

	North Leg Granada Drive	East Leg Sunset Avenue	South Leg Granada Drive	West Leg Sunset Avenue	
	Pedestrians	Pedestrians	Pedestrians	Pedestrians	
7:00 AM	0	0	1	0	1
7:15 AM	0	0	0	0	0
7:30 AM	0	0	0	0	0
7:45 AM	0	0	0	0	0
8:00 AM	0	3	0	0	3
8:15 AM	0	1	0	0	1
8:30 AM	0	0	0	0	0
8:45 AM	0	0	0	0	0
TOTAL VOLUMES:	0	4	1	0	5

	North Leg Granada Drive	East Leg Sunset Avenue	South Leg Granada Drive	West Leg Sunset Avenue	
	Pedestrians	Pedestrians	Pedestrians	Pedestrians	
4:00 PM	0	0	1	0	1
4:15 PM	4	0	0	0	4
4:30 PM	2	0	0	1	3
4:45 PM	1	0	0	0	1
5:00 PM	0	6	0	1	7
5:15 PM	0	0	0	0	0
5:30 PM	2	0	0	0	2
5:45 PM	1	0	0	0	1
TOTAL VOLUMES:	10	6	1	2	19

Location: Madera
 N/S: Granada Drive
 E/W: Sunset Avenue



Date: 9/19/2019
 Day: Thursday

BICYCLES

	Southbound Granada Drive			Westbound Sunset Avenue			Northbound Granada Drive			Eastbound Sunset Avenue			
	Left	Thru	Right	Left	Thru	Right	Left	Thru	Right	Left	Thru	Right	
7:00 AM	0	0	0	0	0	0	0	0	0	0	0	0	0
7:15 AM	0	0	0	0	0	0	0	1	0	0	0	0	1
7:30 AM	0	0	0	0	0	0	0	0	0	0	0	0	0
7:45 AM	0	0	0	0	0	0	0	0	0	0	0	0	0
8:00 AM	0	0	0	0	0	0	0	0	0	0	1	0	1
8:15 AM	0	0	0	0	0	0	0	0	0	0	0	0	0
8:30 AM	0	0	0	0	0	0	0	0	0	0	0	0	0
8:45 AM	0	0	0	0	0	0	0	0	0	0	0	0	0
TOTAL VOLUMES:	0	0	0	0	0	0	0	1	0	0	1	0	2

	Southbound Granada Drive			Westbound Sunset Avenue			Northbound Granada Drive			Eastbound Sunset Avenue			
	Left	Thru	Right	Left	Thru	Right	Left	Thru	Right	Left	Thru	Right	
4:00 PM	0	0	0	0	0	0	0	0	0	0	0	0	0
4:15 PM	0	0	1	0	0	0	0	0	0	0	0	0	1
4:30 PM	0	0	0	0	0	0	0	0	0	0	0	0	0
4:45 PM	0	0	0	0	0	0	0	0	0	0	0	0	0
5:00 PM	0	0	0	0	0	0	0	0	0	0	0	0	0
5:15 PM	0	0	0	0	0	0	0	0	0	0	0	0	0
5:30 PM	0	0	0	0	0	0	0	0	0	0	0	0	0
5:45 PM	0	0	0	0	0	0	0	0	0	0	0	0	0
TOTAL VOLUMES:	0	0	1	0	0	0	0	0	0	0	0	0	1

City of Madera
 N/S: Ellis Street/Avenue 16
 E/W: Avenue 16
 Weather: Clear

File Name : 20_MDA_Ellis_Ave 16 AM
 Site Code : 00319628
 Start Date : 9/19/2019
 Page No : 1

Groups Printed- Passenger Vehicles - Large 2 Axle Vehicles - 3 Axle Vehicles - 4+ Axle Trucks

Start Time	Ellis Street Southbound				Avenue 16 Westbound				Avenue 16 Northbound				Int. Total
	Left	Thru	U-Turns	App. Total	Left	Right	U-Turns	App. Total	Thru	Right	U-Turns	App. Total	
07:00 AM	26	25	0	51	20	11	0	31	15	24	0	39	121
07:15 AM	36	25	0	61	19	26	0	45	47	24	0	71	177
07:30 AM	51	43	0	94	30	23	0	53	49	35	0	84	231
07:45 AM	60	55	0	115	34	25	0	59	67	24	0	91	265
Total	173	148	0	321	103	85	0	188	178	107	0	285	794
08:00 AM	97	71	0	168	18	32	0	50	28	28	0	56	274
08:15 AM	55	35	0	90	22	19	0	41	22	23	0	45	176
08:30 AM	38	22	0	60	20	26	0	46	28	20	0	48	154
08:45 AM	40	22	0	62	17	21	0	38	25	23	0	48	148
Total	230	150	0	380	77	98	0	175	103	94	0	197	752
Grand Total	403	298	0	701	180	183	0	363	281	201	0	482	1546
Apprch %	57.5	42.5	0		49.6	50.4	0		58.3	41.7	0		
Total %	26.1	19.3	0	45.3	11.6	11.8	0	23.5	18.2	13	0	31.2	
Passenger Vehicles	392	292	0	684	169	172	0	341	278	186	0	464	1489
% Passenger Vehicles	97.3	98	0	97.6	93.9	94	0	93.9	98.9	92.5	0	96.3	96.3
Large 2 Axle Vehicles	8	5	0	13	7	3	0	10	3	10	0	13	36
% Large 2 Axle Vehicles	2	1.7	0	1.9	3.9	1.6	0	2.8	1.1	5	0	2.7	2.3
3 Axle Vehicles	0	0	0	0	0	0	0	0	0	1	0	1	1
% 3 Axle Vehicles	0	0	0	0	0	0	0	0	0	0.5	0	0.2	0.1
4+ Axle Trucks	3	1	0	4	4	8	0	12	0	4	0	4	20
% 4+ Axle Trucks	0.7	0.3	0	0.6	2.2	4.4	0	3.3	0	2	0	0.8	1.3

Start Time	Ellis Street Southbound				Avenue 16 Westbound				Avenue 16 Northbound				Int. Total
	Left	Thru	U-Turns	App. Total	Left	Right	U-Turns	App. Total	Thru	Right	U-Turns	App. Total	
Peak Hour Analysis From 07:00 AM to 08:45 AM - Peak 1 of 1													
Peak Hour for Entire Intersection Begins at 07:15 AM													
07:15 AM	36	25	0	61	19	26	0	45	47	24	0	71	177
07:30 AM	51	43	0	94	30	23	0	53	49	35	0	84	231
07:45 AM	60	55	0	115	34	25	0	59	67	24	0	91	265
08:00 AM	97	71	0	168	18	32	0	50	28	28	0	56	274
Total Volume	244	194	0	438	101	106	0	207	191	111	0	302	947
% App. Total	55.7	44.3	0		48.8	51.2	0		63.2	36.8	0		
PHF	.629	.683	.000	.652	.743	.828	.000	.877	.713	.793	.000	.830	.864

City of Madera
 N/S: Ellis Street/Avenue 16
 E/W: Avenue 16
 Weather: Clear

File Name : 20_MDA_Ellis_Ave 16 AM
 Site Code : 00319628
 Start Date : 9/19/2019
 Page No : 2

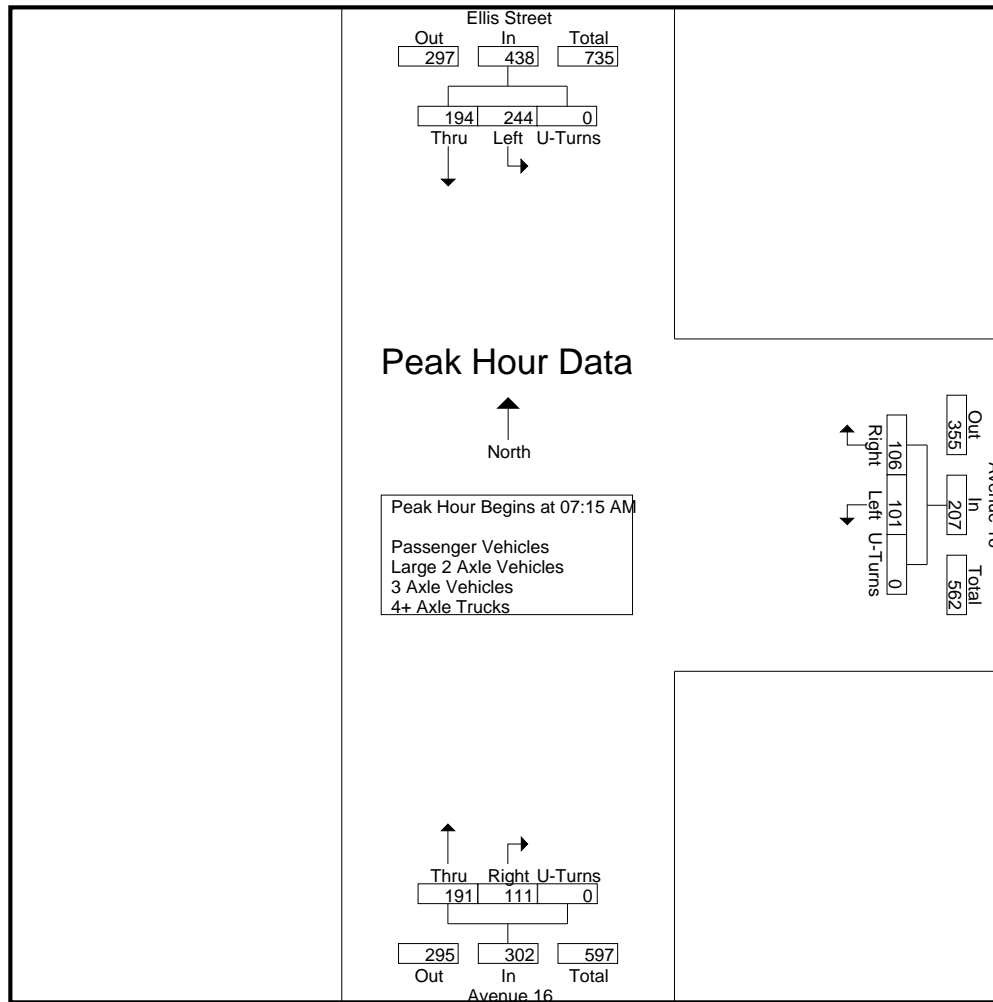

Peak Hour Analysis From 07:00 AM to 08:45 AM - Peak 1 of 1
 Peak Hour for Each Approach Begins at:

	07:30 AM				07:15 AM				07:15 AM			
+0 mins.	51	43	0	94	19	26	0	45	47	24	0	71
+15 mins.	60	55	0	115	30	23	0	53	49	35	0	84
+30 mins.	97	71	0	168	34	25	0	59	67	24	0	91
+45 mins.	55	35	0	90	18	32	0	50	28	28	0	56
Total Volume	263	204	0	467	101	106	0	207	191	111	0	302
% App. Total	56.3	43.7	0		48.8	51.2	0		63.2	36.8	0	
PHF	.678	.718	.000	.695	.743	.828	.000	.877	.713	.793	.000	.830

City of Madera
 N/S: Ellis Street/Avenue 16
 E/W: Avenue 16
 Weather: Clear

File Name : 20_MDA_Ellis_Ave 16 AM
 Site Code : 00319628
 Start Date : 9/19/2019
 Page No : 1

Groups Printed- Passenger Vehicles

Start Time	Ellis Street Southbound				Avenue 16 Westbound				Avenue 16 Northbound				Int. Total
	Left	Thru	U-Turns	App. Total	Left	Right	U-Turns	App. Total	Thru	Right	U-Turns	App. Total	
07:00 AM	25	25	0	50	19	7	0	26	15	23	0	38	114
07:15 AM	36	25	0	61	19	24	0	43	46	24	0	70	174
07:30 AM	49	42	0	91	27	23	0	50	48	32	0	80	221
07:45 AM	58	55	0	113	33	25	0	58	66	22	0	88	259
Total	168	147	0	315	98	79	0	177	175	101	0	276	768
08:00 AM	96	70	0	166	18	29	0	47	28	24	0	52	265
08:15 AM	53	32	0	85	18	17	0	35	22	20	0	42	162
08:30 AM	37	22	0	59	19	26	0	45	28	18	0	46	150
08:45 AM	38	21	0	59	16	21	0	37	25	23	0	48	144
Total	224	145	0	369	71	93	0	164	103	85	0	188	721
Grand Total	392	292	0	684	169	172	0	341	278	186	0	464	1489
Apprch %	57.3	42.7	0		49.6	50.4	0		59.9	40.1	0		
Total %	26.3	19.6	0	45.9	11.3	11.6	0	22.9	18.7	12.5	0	31.2	

Start Time	Ellis Street Southbound				Avenue 16 Westbound				Avenue 16 Northbound				Int. Total
	Left	Thru	U-Turns	App. Total	Left	Right	U-Turns	App. Total	Thru	Right	U-Turns	App. Total	
Peak Hour Analysis From 07:15 AM to 08:00 AM - Peak 1 of 1													
Peak Hour for Entire Intersection Begins at 07:15 AM													
07:15 AM	36	25	0	61	19	24	0	43	46	24	0	70	174
07:30 AM	49	42	0	91	27	23	0	50	48	32	0	80	221
07:45 AM	58	55	0	113	33	25	0	58	66	22	0	88	259
08:00 AM	96	70	0	166	18	29	0	47	28	24	0	52	265
Total Volume	239	192	0	431	97	101	0	198	188	102	0	290	919
% App. Total	55.5	44.5	0		49	51	0		64.8	35.2	0		
PHF	.622	.686	.000	.649	.735	.871	.000	.853	.712	.797	.000	.824	.867

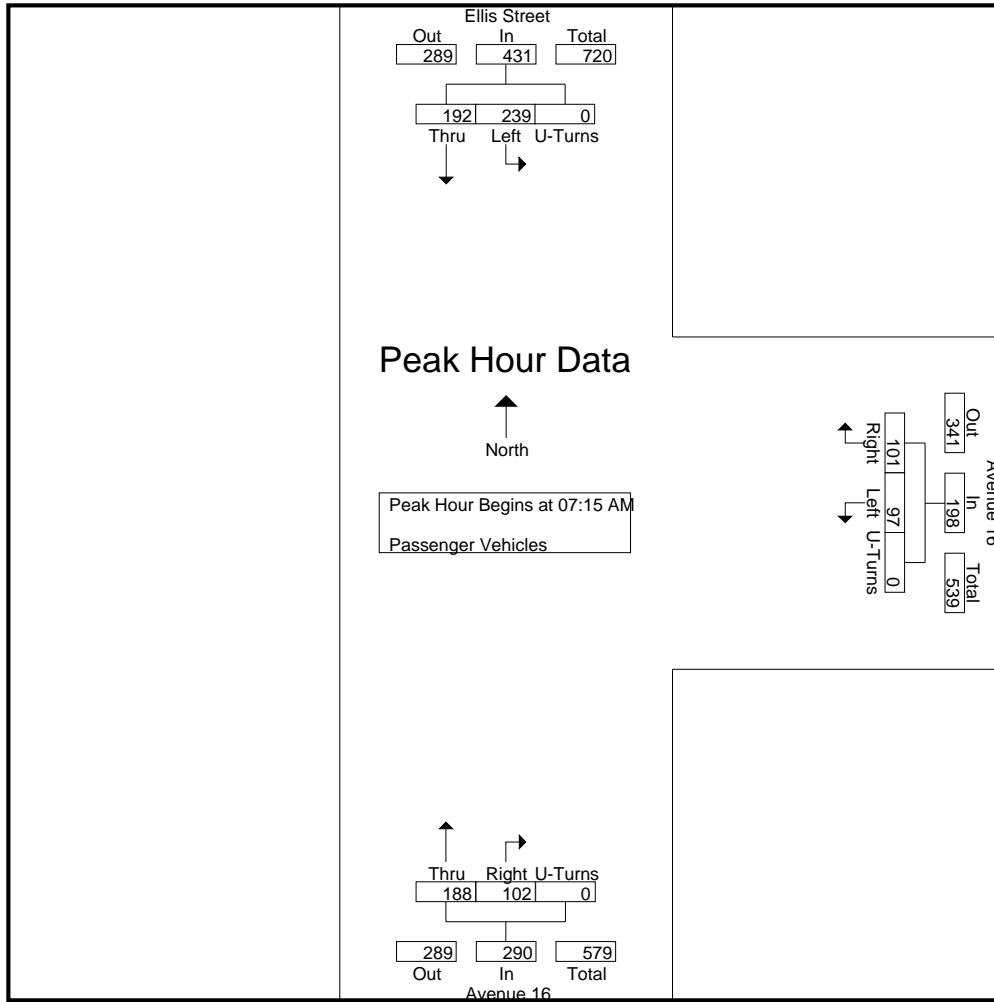

Peak Hour Analysis From 07:15 AM to 08:00 AM - Peak 1 of 1

Peak Hour for Each Approach Begins at:

	07:15 AM				07:15 AM				07:15 AM			
+0 mins.	36	25	0	61	19	24	0	43	46	24	0	70
+15 mins.	49	42	0	91	27	23	0	50	48	32	0	80
+30 mins.	58	55	0	113	33	25	0	58	66	22	0	88
+45 mins.	96	70	0	166	18	29	0	47	28	24	0	52
Total Volume	239	192	0	431	97	101	0	198	188	102	0	290
% App. Total	55.5	44.5	0		49	51	0		64.8	35.2	0	
PHF	.622	.686	.000	.649	.735	.871	.000	.853	.712	.797	.000	.824

City of Madera
 N/S: Ellis Street/Avenue 16
 E/W: Avenue 16
 Weather: Clear

File Name : 20_MDA_Ellis_Ave 16 AM
 Site Code : 00319628
 Start Date : 9/19/2019
 Page No : 1

Groups Printed- Large 2 Axle Vehicles

Start Time	Ellis Street Southbound				Avenue 16 Westbound				Avenue 16 Northbound				Int. Total
	Left	Thru	U-Turns	App. Total	Left	Right	U-Turns	App. Total	Thru	Right	U-Turns	App. Total	
07:00 AM	1	0	0	1	1	1	0	2	0	1	0	1	4
07:15 AM	0	0	0	0	0	1	0	1	1	0	0	1	2
07:30 AM	2	1	0	3	2	0	0	2	1	2	0	3	8
07:45 AM	2	0	0	2	1	0	0	1	1	1	0	2	5
Total	5	1	0	6	4	2	0	6	3	4	0	7	19
08:00 AM	1	1	0	2	0	0	0	0	0	3	0	3	5
08:15 AM	0	2	0	2	1	1	0	2	0	2	0	2	6
08:30 AM	1	0	0	1	1	0	0	1	0	1	0	1	3
08:45 AM	1	1	0	2	1	0	0	1	0	0	0	0	3
Total	3	4	0	7	3	1	0	4	0	6	0	6	17
Grand Total	8	5	0	13	7	3	0	10	3	10	0	13	36
Apprch %	61.5	38.5	0		70	30	0		23.1	76.9	0		
Total %	22.2	13.9	0	36.1	19.4	8.3	0	27.8	8.3	27.8	0	36.1	

Start Time	Ellis Street Southbound				Avenue 16 Westbound				Avenue 16 Northbound				Int. Total
	Left	Thru	U-Turns	App. Total	Left	Right	U-Turns	App. Total	Thru	Right	U-Turns	App. Total	
Peak Hour Analysis From 07:15 AM to 08:00 AM - Peak 1 of 1													
Peak Hour for Entire Intersection Begins at 07:15 AM													
07:15 AM	0	0	0	0	0	1	0	1	1	0	0	1	2
07:30 AM	2	1	0	3	2	0	0	2	1	2	0	3	8
07:45 AM	2	0	0	2	1	0	0	1	1	1	0	2	5
08:00 AM	1	1	0	2	0	0	0	0	0	3	0	3	5
Total Volume	5	2	0	7	3	1	0	4	3	6	0	9	20
% App. Total	71.4	28.6	0		75	25	0		33.3	66.7	0		
PHF	.625	.500	.000	.583	.375	.250	.000	.500	.750	.500	.000	.750	.625

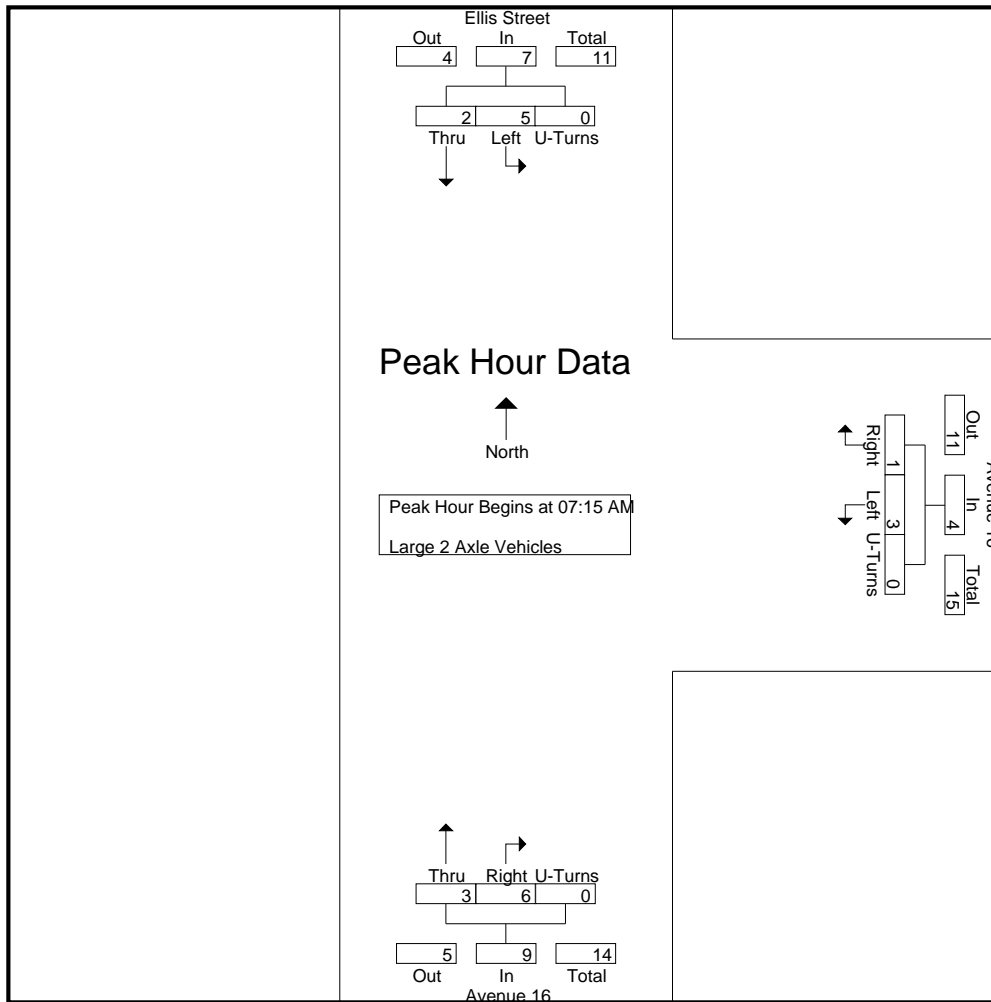

Peak Hour Analysis From 07:15 AM to 08:00 AM - Peak 1 of 1
 Peak Hour for Each Approach Begins at:

	07:15 AM				07:15 AM				07:15 AM			
+0 mins.	0	0	0	0	0	1	0	1	0	0	0	1
+15 mins.	2	1	0	3	2	0	0	2	1	2	0	3
+30 mins.	2	0	0	2	1	0	0	1	1	1	0	2
+45 mins.	1	1	0	2	0	0	0	0	0	3	0	3
Total Volume	5	2	0	7	3	1	0	4	3	6	0	9
% App. Total	71.4	28.6	0		75	25	0		33.3	66.7	0	
PHF	.625	.500	.000	.583	.375	.250	.000	.500	.750	.500	.000	.750

City of Madera
 N/S: Ellis Street/Avenue 16
 E/W: Avenue 16
 Weather: Clear

File Name : 20_MDA_Ellis_Ave 16 AM
 Site Code : 00319628
 Start Date : 9/19/2019
 Page No : 1

Groups Printed- 3 Axle Vehicles

Start Time	Ellis Street Southbound				Avenue 16 Westbound				Avenue 16 Northbound				Int. Total	
	Left	Thru	U-Turns	App. Total	Left	Right	U-Turns	App. Total	Thru	Right	U-Turns	App. Total		
07:00 AM	0	0	0	0	0	0	0	0	0	0	0	0	0	0
07:15 AM	0	0	0	0	0	0	0	0	0	0	0	0	0	0
07:30 AM	0	0	0	0	0	0	0	0	0	0	0	0	0	0
07:45 AM	0	0	0	0	0	0	0	0	0	0	0	0	0	0
Total	0	0	0	0	0	0	0	0	0	0	0	0	0	0
08:00 AM	0	0	0	0	0	0	0	0	0	0	1	0	1	1
08:15 AM	0	0	0	0	0	0	0	0	0	0	0	0	0	0
08:30 AM	0	0	0	0	0	0	0	0	0	0	0	0	0	0
08:45 AM	0	0	0	0	0	0	0	0	0	0	0	0	0	0
Total	0	0	0	0	0	0	0	0	0	0	1	0	1	1
Grand Total	0	0	0	0	0	0	0	0	0	0	1	0	1	1
Apprch %	0	0	0	0	0	0	0	0	0	0	100	0	0	0
Total %	0	0	0	0	0	0	0	0	0	0	100	0	100	0

Start Time	Ellis Street Southbound				Avenue 16 Westbound				Avenue 16 Northbound				Int. Total	
	Left	Thru	U-Turns	App. Total	Left	Right	U-Turns	App. Total	Thru	Right	U-Turns	App. Total		
07:15 AM	0	0	0	0	0	0	0	0	0	0	0	0	0	0
07:30 AM	0	0	0	0	0	0	0	0	0	0	0	0	0	0
07:45 AM	0	0	0	0	0	0	0	0	0	0	0	0	0	0
08:00 AM	0	0	0	0	0	0	0	0	0	0	1	0	1	1
Total Volume	0	0	0	0	0	0	0	0	0	0	1	0	1	1
% App. Total	0	0	0	0	0	0	0	0	0	0	100	0	0	0
PHF	.000	.000	.000	.000	.000	.000	.000	.000	.000	.000	.250	.000	.250	.250

Peak Hour Analysis From 07:15 AM to 08:00 AM - Peak 1 of 1

Peak Hour for Entire Intersection Begins at 07:15 AM

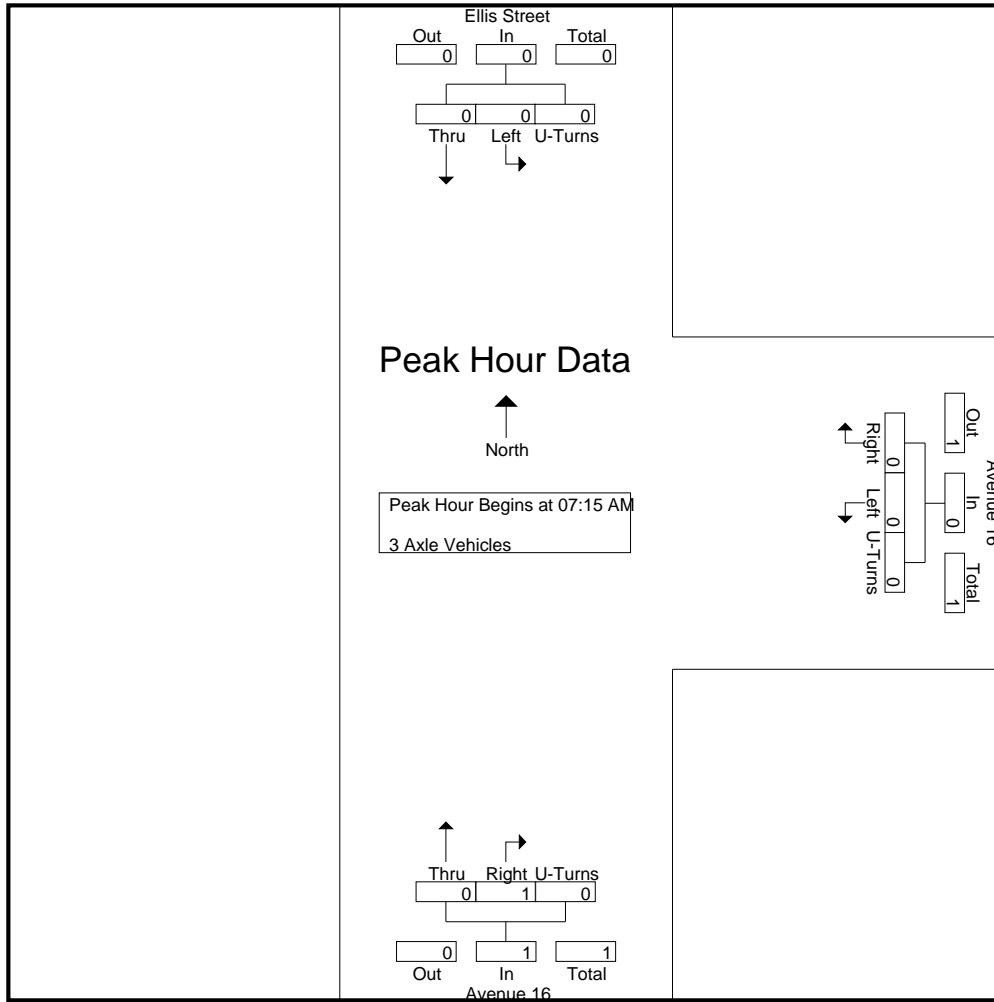

Peak Hour Analysis From 07:15 AM to 08:00 AM - Peak 1 of 1

Peak Hour for Each Approach Begins at:

	07:15 AM				07:15 AM				07:15 AM			
+0 mins.	0	0	0	0	0	0	0	0	0	0	0	0
+15 mins.	0	0	0	0	0	0	0	0	0	0	0	0
+30 mins.	0	0	0	0	0	0	0	0	0	0	0	0
+45 mins.	0	0	0	0	0	0	0	0	0	1	0	1
Total Volume	0	0	0	0	0	0	0	0	0	1	0	1
% App. Total	0	0	0	0	0	0	0	0	0	100	0	0
PHF	.000	.000	.000	.000	.000	.000	.000	.000	.000	.250	.000	.250

City of Madera
 N/S: Ellis Street/Avenue 16
 E/W: Avenue 16
 Weather: Clear

File Name : 20_MDA_Ellis_Ave 16 AM
 Site Code : 00319628
 Start Date : 9/19/2019
 Page No : 1

Groups Printed- 4+ Axle Trucks

Start Time	Ellis Street Southbound				Avenue 16 Westbound				Avenue 16 Northbound				Int. Total
	Left	Thru	U-Turns	App. Total	Left	Right	U-Turns	App. Total	Thru	Right	U-Turns	App. Total	
07:00 AM	0	0	0	0	0	3	0	3	0	0	0	0	3
07:15 AM	0	0	0	0	0	1	0	1	0	0	0	0	1
07:30 AM	0	0	0	0	1	0	0	1	0	1	0	1	2
07:45 AM	0	0	0	0	0	0	0	0	0	1	0	1	1
Total	0	0	0	0	1	4	0	5	0	2	0	2	7
08:00 AM	0	0	0	0	0	3	0	3	0	0	0	0	3
08:15 AM	2	1	0	3	3	1	0	4	0	1	0	1	8
08:30 AM	0	0	0	0	0	0	0	0	0	1	0	1	1
08:45 AM	1	0	0	1	0	0	0	0	0	0	0	0	1
Total	3	1	0	4	3	4	0	7	0	2	0	2	13
Grand Total	3	1	0	4	4	8	0	12	0	4	0	4	20
Apprch %	75	25	0		33.3	66.7	0		0	100	0		
Total %	15	5	0	20	20	40	0	60	0	20	0	20	

Start Time	Ellis Street Southbound				Avenue 16 Westbound				Avenue 16 Northbound				Int. Total
	Left	Thru	U-Turns	App. Total	Left	Right	U-Turns	App. Total	Thru	Right	U-Turns	App. Total	
Peak Hour Analysis From 07:15 AM to 08:00 AM - Peak 1 of 1													
Peak Hour for Entire Intersection Begins at 07:15 AM													
07:15 AM	0	0	0	0	0	1	0	1	0	0	0	0	1
07:30 AM	0	0	0	0	1	0	0	1	0	1	0	1	2
07:45 AM	0	0	0	0	0	0	0	0	0	1	0	1	1
08:00 AM	0	0	0	0	0	3	0	3	0	0	0	0	3
Total Volume	0	0	0	0	1	4	0	5	0	2	0	2	7
% App. Total	0	0	0		20	80	0		0	100	0		
PHF	.000	.000	.000	.000	.250	.333	.000	.417	.000	.500	.000	.500	.583

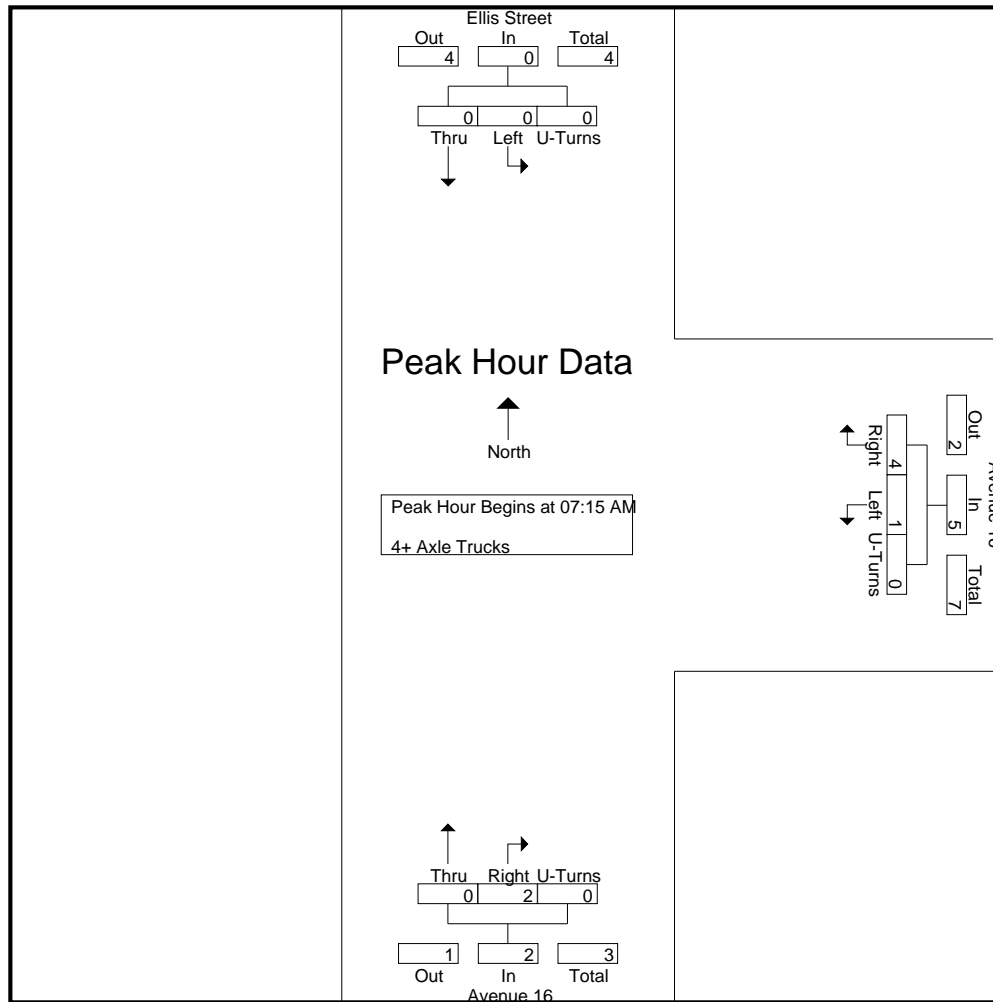

Peak Hour Analysis From 07:15 AM to 08:00 AM - Peak 1 of 1
 Peak Hour for Each Approach Begins at:

	07:15 AM				07:15 AM				07:15 AM			
+0 mins.	0	0	0	0	0	1	0	1	0	0	0	0
+15 mins.	0	0	0	0	1	0	0	1	0	1	0	1
+30 mins.	0	0	0	0	0	0	0	0	0	1	0	1
+45 mins.	0	0	0	0	0	3	0	3	0	0	0	0
Total Volume	0	0	0	0	1	4	0	5	0	2	0	2
% App. Total	0	0	0	0	20	80	0	0	0	100	0	0
PHF	.000	.000	.000	.000	.250	.333	.000	.417	.000	.500	.000	.500

City of Madera
 N/S: Ellis Street/Avenue 16
 E/W: Avenue 16
 Weather: Clear

File Name : 20_MDA_Ellis_Ave 16 PM
 Site Code : 00319628
 Start Date : 9/19/2019
 Page No : 1

Groups Printed- Passenger Vehicles - Large 2 Axle Vehicles - 3 Axle Vehicles - 4+ Axle Trucks

Start Time	Ellis Street Southbound				Avenue 16 Westbound				Avenue 16 Northbound				Int. Total
	Left	Thru	U-Turns	App. Total	Left	Right	U-Turns	App. Total	Thru	Right	U-Turns	App. Total	
04:00 PM	43	21	0	64	20	46	0	66	40	55	0	95	225
04:15 PM	42	25	0	67	22	55	0	77	36	29	0	65	209
04:30 PM	49	53	0	102	27	53	0	80	47	32	0	79	261
04:45 PM	48	40	0	88	25	39	0	64	28	30	0	58	210
Total	182	139	0	321	94	193	0	287	151	146	0	297	905
05:00 PM	44	51	1	96	26	57	0	83	33	32	0	65	244
05:15 PM	39	30	0	69	18	62	0	80	42	33	0	75	224
05:30 PM	48	37	0	85	35	67	0	102	41	13	0	54	241
05:45 PM	40	51	0	91	29	53	0	82	30	19	0	49	222
Total	171	169	1	341	108	239	0	347	146	97	0	243	931
Grand Total	353	308	1	662	202	432	0	634	297	243	0	540	1836
Apprch %	53.3	46.5	0.2		31.9	68.1	0		55	45	0		
Total %	19.2	16.8	0.1	36.1	11	23.5	0	34.5	16.2	13.2	0	29.4	
Passenger Vehicles	352	306	1	659	198	426	0	624	294	237	0	531	1814
% Passenger Vehicles	99.7	99.4	100	99.5	98	98.6	0	98.4	99	97.5	0	98.3	98.8
Large 2 Axle Vehicles	1	2	0	3	3	4	0	7	2	3	0	5	15
% Large 2 Axle Vehicles	0.3	0.6	0	0.5	1.5	0.9	0	1.1	0.7	1.2	0	0.9	0.8
3 Axle Vehicles	0	0	0	0	0	1	0	1	1	0	0	1	2
% 3 Axle Vehicles	0	0	0	0	0	0.2	0	0.2	0.3	0	0	0.2	0.1
4+ Axle Trucks	0	0	0	0	1	1	0	2	0	3	0	3	5
% 4+ Axle Trucks	0	0	0	0	0.5	0.2	0	0.3	0	1.2	0	0.6	0.3

Start Time	Ellis Street Southbound				Avenue 16 Westbound				Avenue 16 Northbound				Int. Total
	Left	Thru	U-Turns	App. Total	Left	Right	U-Turns	App. Total	Thru	Right	U-Turns	App. Total	
Peak Hour Analysis From 04:00 PM to 05:45 PM - Peak 1 of 1													
Peak Hour for Entire Intersection Begins at 04:30 PM													
04:30 PM	49	53	0	102	27	53	0	80	47	32	0	79	261
04:45 PM	48	40	0	88	25	39	0	64	28	30	0	58	210
05:00 PM	44	51	1	96	26	57	0	83	33	32	0	65	244
05:15 PM	39	30	0	69	18	62	0	80	42	33	0	75	224
Total Volume	180	174	1	355	96	211	0	307	150	127	0	277	939
% App. Total	50.7	49	0.3		31.3	68.7	0		54.2	45.8	0		
PHF	.918	.821	.250	.870	.889	.851	.000	.925	.798	.962	.000	.877	.899

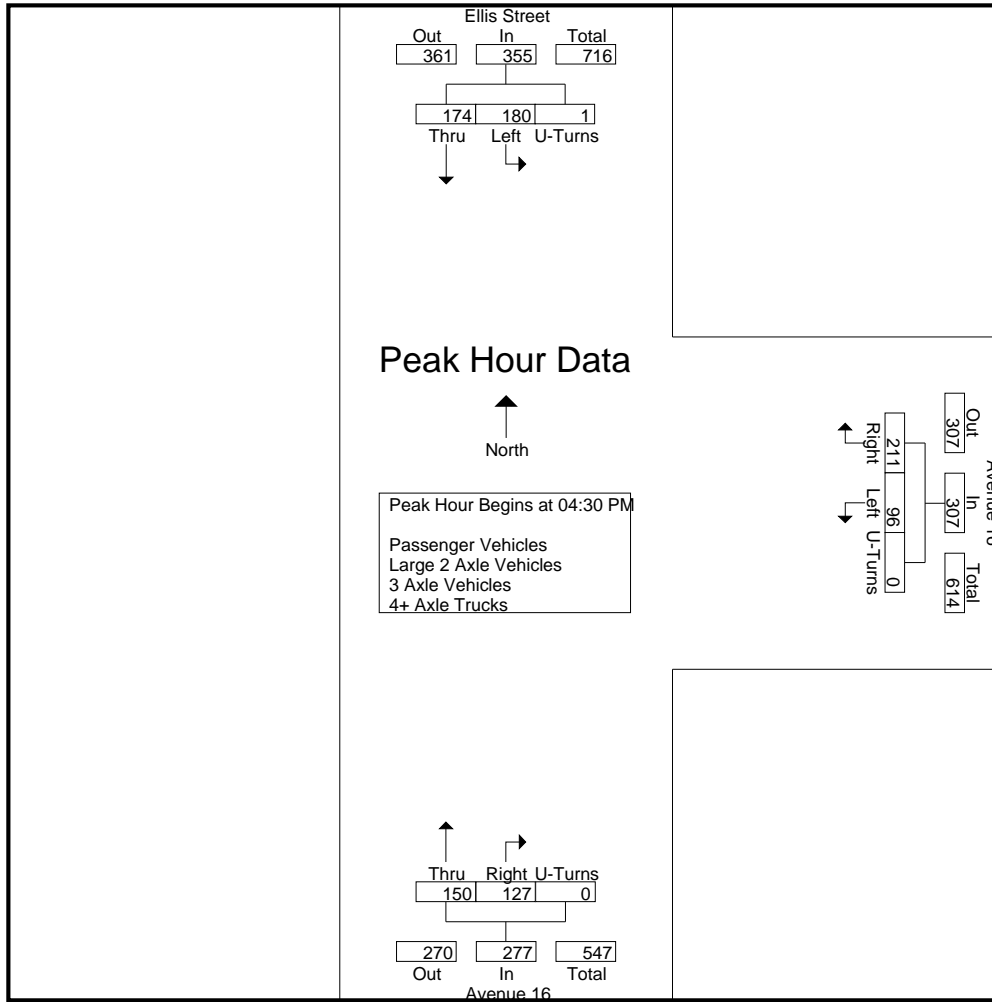

Peak Hour Analysis From 04:00 PM to 05:45 PM - Peak 1 of 1
 Peak Hour for Each Approach Begins at:

	04:30 PM				05:00 PM				04:00 PM			
+0 mins.	49	53	0	102	26	57	0	83	40	55	0	95
+15 mins.	48	40	0	88	18	62	0	80	36	29	0	65
+30 mins.	44	51	1	96	35	67	0	102	47	32	0	79
+45 mins.	39	30	0	69	29	53	0	82	28	30	0	58
Total Volume	180	174	1	355	108	239	0	347	151	146	0	297
% App. Total	50.7	49	0.3		31.1	68.9	0		50.8	49.2	0	
PHF	.918	.821	.250	.870	.771	.892	.000	.850	.803	.664	.000	.782

City of Madera
 N/S: Ellis Street/Avenue 16
 E/W: Avenue 16
 Weather: Clear

File Name : 20_MDA_Ellis_Ave 16 PM
 Site Code : 00319628
 Start Date : 9/19/2019
 Page No : 1

Groups Printed- Passenger Vehicles

Start Time	Ellis Street Southbound				Avenue 16 Westbound				Avenue 16 Northbound				Int. Total
	Left	Thru	U-Turns	App. Total	Left	Right	U-Turns	App. Total	Thru	Right	U-Turns	App. Total	
04:00 PM	43	21	0	64	20	45	0	65	39	53	0	92	221
04:15 PM	42	25	0	67	22	54	0	76	36	28	0	64	207
04:30 PM	49	52	0	101	25	53	0	78	46	31	0	77	256
04:45 PM	48	39	0	87	24	38	0	62	28	30	0	58	207
Total	182	137	0	319	91	190	0	281	149	142	0	291	891
05:00 PM	44	51	1	96	26	56	0	82	33	30	0	63	241
05:15 PM	39	30	0	69	18	61	0	79	42	33	0	75	223
05:30 PM	47	37	0	84	35	67	0	102	40	13	0	53	239
05:45 PM	40	51	0	91	28	52	0	80	30	19	0	49	220
Total	170	169	1	340	107	236	0	343	145	95	0	240	923
Grand Total	352	306	1	659	198	426	0	624	294	237	0	531	1814
Apprch %	53.4	46.4	0.2		31.7	68.3	0		55.4	44.6	0		
Total %	19.4	16.9	0.1	36.3	10.9	23.5	0	34.4	16.2	13.1	0	29.3	

Start Time	Ellis Street Southbound				Avenue 16 Westbound				Avenue 16 Northbound				Int. Total
	Left	Thru	U-Turns	App. Total	Left	Right	U-Turns	App. Total	Thru	Right	U-Turns	App. Total	
Peak Hour Analysis From 04:30 PM to 05:15 PM - Peak 1 of 1													
Peak Hour for Entire Intersection Begins at 04:30 PM													
04:30 PM	49	52	0	101	25	53	0	78	46	31	0	77	256
04:45 PM	48	39	0	87	24	38	0	62	28	30	0	58	207
05:00 PM	44	51	1	96	26	56	0	82	33	30	0	63	241
05:15 PM	39	30	0	69	18	61	0	79	42	33	0	75	223
Total Volume	180	172	1	353	93	208	0	301	149	124	0	273	927
% App. Total	51	48.7	0.3		30.9	69.1	0		54.6	45.4	0		
PHF	.918	.827	.250	.874	.894	.852	.000	.918	.810	.939	.000	.886	.905

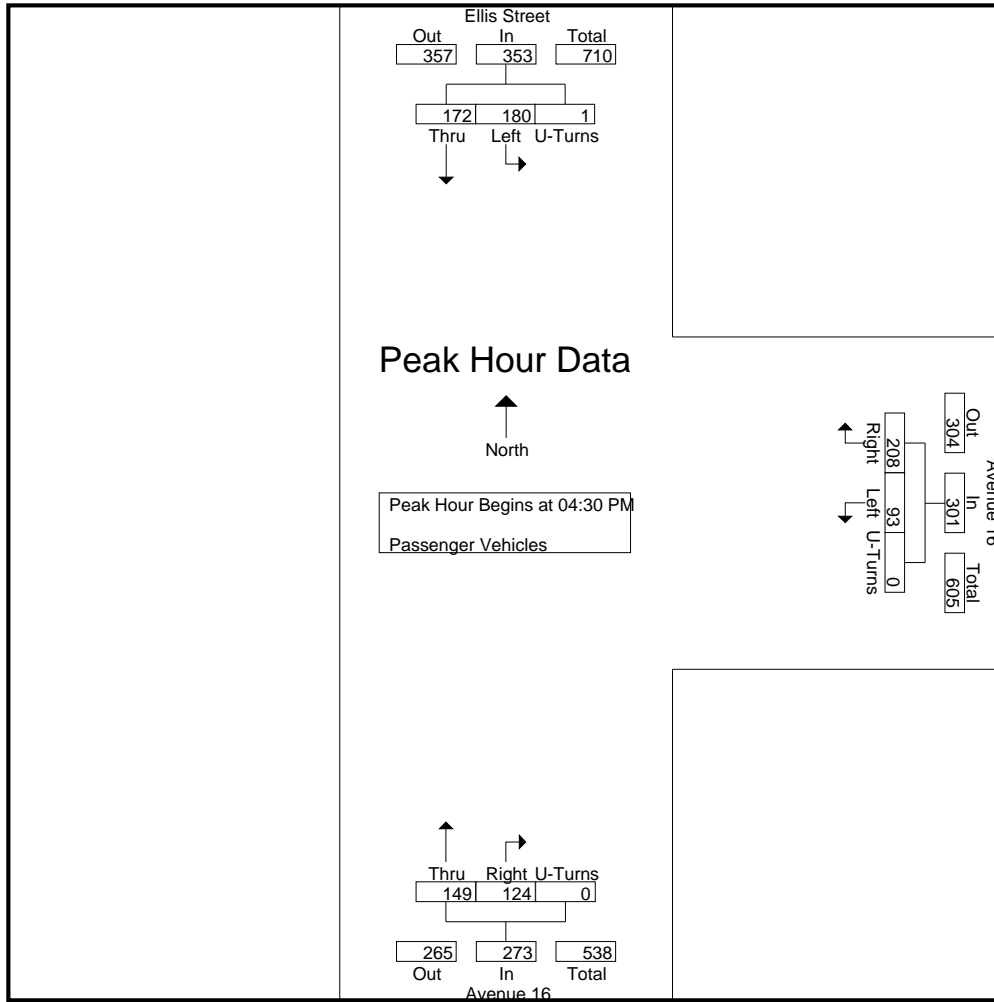

Peak Hour Analysis From 04:30 PM to 05:15 PM - Peak 1 of 1
 Peak Hour for Each Approach Begins at:

	04:30 PM				04:30 PM				04:30 PM			
+0 mins.	49	52	0	101	25	53	0	78	46	31	0	77
+15 mins.	48	39	0	87	24	38	0	62	28	30	0	58
+30 mins.	44	51	1	96	26	56	0	82	33	30	0	63
+45 mins.	39	30	0	69	18	61	0	79	42	33	0	75
Total Volume	180	172	1	353	93	208	0	301	149	124	0	273
% App. Total	51	48.7	0.3		30.9	69.1	0		54.6	45.4	0	
PHF	.918	.827	.250	.874	.894	.852	.000	.918	.810	.939	.000	.886

City of Madera
 N/S: Ellis Street/Avenue 16
 E/W: Avenue 16
 Weather: Clear

File Name : 20_MDA_Ellis_Ave 16 PM
 Site Code : 00319628
 Start Date : 9/19/2019
 Page No : 1

Groups Printed- Large 2 Axle Vehicles

Start Time	Ellis Street Southbound				Avenue 16 Westbound				Avenue 16 Northbound				Int. Total
	Left	Thru	U-Turns	App. Total	Left	Right	U-Turns	App. Total	Thru	Right	U-Turns	App. Total	
04:00 PM	0	0	0	0	0	0	0	0	1	2	0	3	3
04:15 PM	0	0	0	0	0	0	0	0	0	1	0	1	1
04:30 PM	0	1	0	1	2	0	0	2	1	0	0	1	4
04:45 PM	0	1	0	1	0	1	0	1	0	0	0	0	2
Total	0	2	0	2	2	1	0	3	2	3	0	5	10
05:00 PM	0	0	0	0	0	1	0	1	0	0	0	0	1
05:15 PM	0	0	0	0	0	1	0	1	0	0	0	0	1
05:30 PM	1	0	0	1	0	0	0	0	0	0	0	0	1
05:45 PM	0	0	0	0	1	1	0	2	0	0	0	0	2
Total	1	0	0	1	1	3	0	4	0	0	0	0	5
Grand Total	1	2	0	3	3	4	0	7	2	3	0	5	15
Apprch %	33.3	66.7	0		42.9	57.1	0		40	60	0		
Total %	6.7	13.3	0	20	20	26.7	0	46.7	13.3	20	0	33.3	

Start Time	Ellis Street Southbound				Avenue 16 Westbound				Avenue 16 Northbound				Int. Total
	Left	Thru	U-Turns	App. Total	Left	Right	U-Turns	App. Total	Thru	Right	U-Turns	App. Total	
04:30 PM	0	1	0	1	2	0	0	2	1	0	0	1	4
04:45 PM	0	1	0	1	0	1	0	1	0	0	0	0	2
05:00 PM	0	0	0	0	0	1	0	1	0	0	0	0	1
05:15 PM	0	0	0	0	0	1	0	1	0	0	0	0	1
Total Volume	0	2	0	2	2	3	0	5	1	0	0	1	8
% App. Total	0	100	0		40	60	0		100	0	0		
PHF	.000	.500	.000	.500	.250	.750	.000	.625	.250	.000	.000	.250	.500

Peak Hour Analysis From 04:30 PM to 05:15 PM - Peak 1 of 1

Peak Hour for Entire Intersection Begins at 04:30 PM

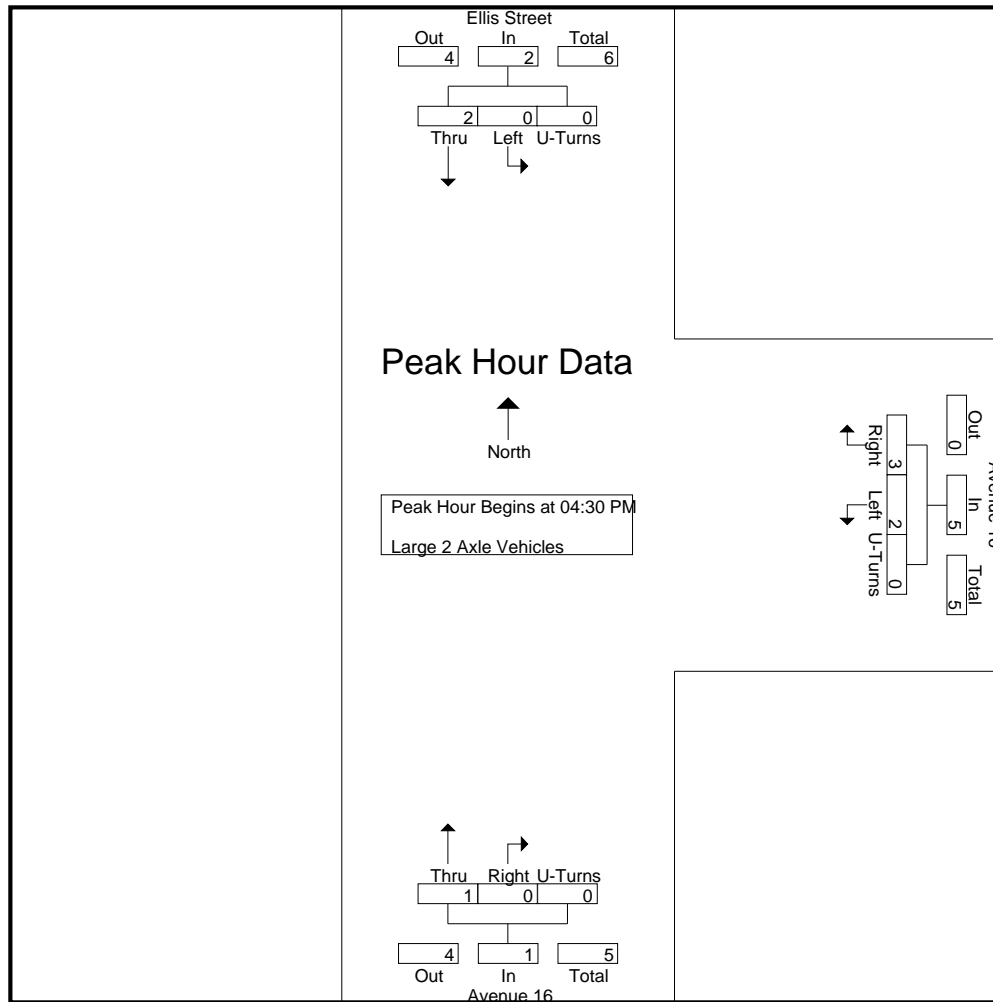

Peak Hour Analysis From 04:30 PM to 05:15 PM - Peak 1 of 1
 Peak Hour for Each Approach Begins at:

	04:30 PM				04:30 PM				04:30 PM			
+0 mins.	0	1	0	1	2	0	0	2	1	0	0	1
+15 mins.	0	1	0	1	0	1	0	1	0	0	0	0
+30 mins.	0	0	0	0	0	1	0	1	0	0	0	0
+45 mins.	0	0	0	0	0	1	0	1	0	0	0	0
Total Volume	0	2	0	2	2	3	0	5	1	0	0	1
% App. Total	0	100	0	0	40	60	0	0	100	0	0	0
PHF	.000	.500	.000	.500	.250	.750	.000	.625	.250	.000	.000	.250

City of Madera
 N/S: Ellis Street/Avenue 16
 E/W: Avenue 16
 Weather: Clear

File Name : 20_MDA_Ellis_Ave 16 PM
 Site Code : 00319628
 Start Date : 9/19/2019
 Page No : 1

Groups Printed- 3 Axle Vehicles

Start Time	Ellis Street Southbound				Avenue 16 Westbound				Avenue 16 Northbound				Int. Total
	Left	Thru	U-Turns	App. Total	Left	Right	U-Turns	App. Total	Thru	Right	U-Turns	App. Total	
04:00 PM	0	0	0	0	0	0	0	0	0	0	0	0	0
04:15 PM	0	0	0	0	0	1	0	1	0	0	0	0	1
04:30 PM	0	0	0	0	0	0	0	0	0	0	0	0	0
04:45 PM	0	0	0	0	0	0	0	0	0	0	0	0	0
Total	0	0	0	0	0	1	0	1	0	0	0	0	1
05:00 PM	0	0	0	0	0	0	0	0	0	0	0	0	0
05:15 PM	0	0	0	0	0	0	0	0	0	0	0	0	0
05:30 PM	0	0	0	0	0	0	0	0	1	0	0	1	1
05:45 PM	0	0	0	0	0	0	0	0	0	0	0	0	0
Total	0	0	0	0	0	0	0	0	1	0	0	1	1
Grand Total	0	0	0	0	0	1	0	1	1	0	0	1	2
Apprch %	0	0	0	0	0	100	0	0	100	0	0	0	0
Total %	0	0	0	0	0	50	0	50	50	0	0	50	0

Start Time	Ellis Street Southbound				Avenue 16 Westbound				Avenue 16 Northbound				Int. Total
	Left	Thru	U-Turns	App. Total	Left	Right	U-Turns	App. Total	Thru	Right	U-Turns	App. Total	
04:30 PM	0	0	0	0	0	0	0	0	0	0	0	0	0
04:45 PM	0	0	0	0	0	0	0	0	0	0	0	0	0
05:00 PM	0	0	0	0	0	0	0	0	0	0	0	0	0
05:15 PM	0	0	0	0	0	0	0	0	0	0	0	0	0
Total Volume	0	0	0	0	0	0	0	0	0	0	0	0	0
% App. Total	0	0	0	0	0	0	0	0	0	0	0	0	0
PHF	.000	.000	.000	.000	.000	.000	.000	.000	.000	.000	.000	.000	.000

Peak Hour Analysis From 04:30 PM to 05:15 PM - Peak 1 of 1
 Peak Hour for Entire Intersection Begins at 04:30 PM

City of Madera
 N/S: Ellis Street/Avenue 16
 E/W: Avenue 16
 Weather: Clear

File Name : 20_MDA_Ellis_Ave 16 PM
 Site Code : 00319628
 Start Date : 9/19/2019
 Page No : 2

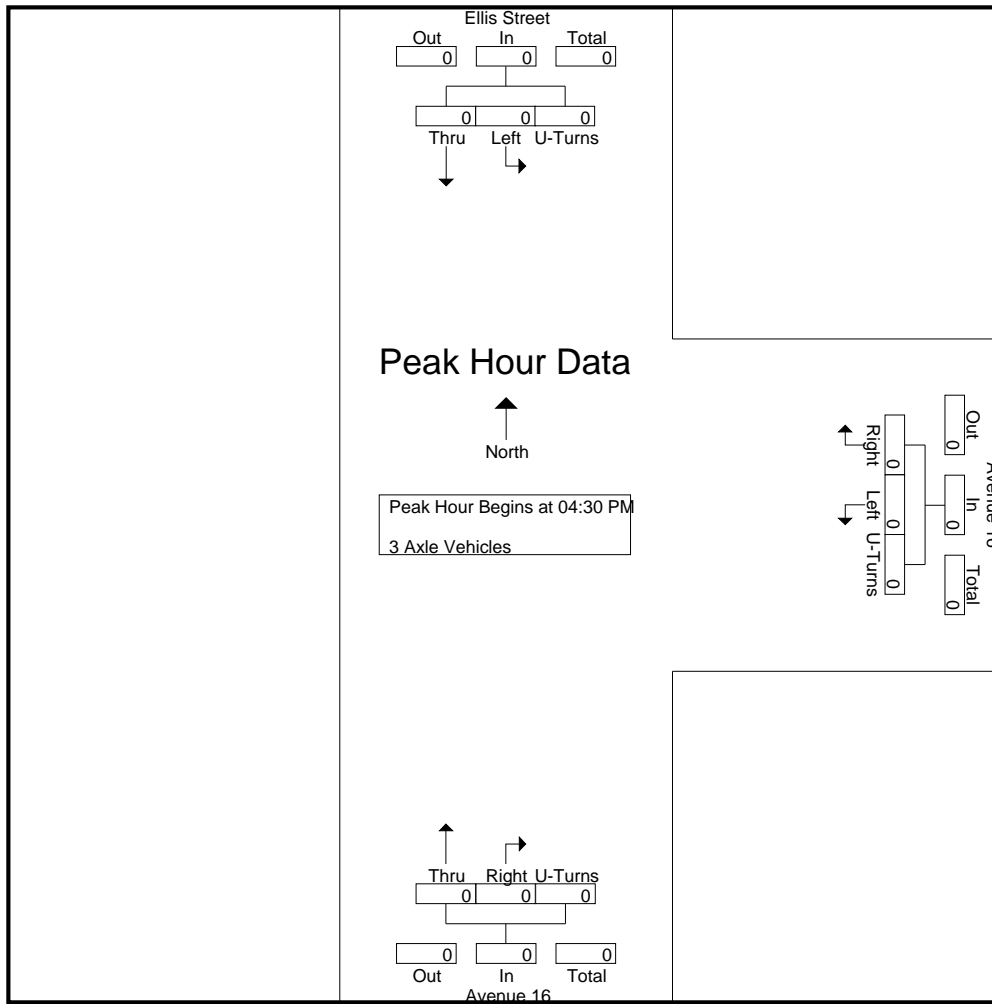

Peak Hour Analysis From 04:30 PM to 05:15 PM - Peak 1 of 1
 Peak Hour for Each Approach Begins at:

	04:30 PM				04:30 PM				04:30 PM			
+0 mins.	0	0	0	0	0	0	0	0	0	0	0	0
+15 mins.	0	0	0	0	0	0	0	0	0	0	0	0
+30 mins.	0	0	0	0	0	0	0	0	0	0	0	0
+45 mins.	0	0	0	0	0	0	0	0	0	0	0	0
Total Volume	0	0	0	0	0	0	0	0	0	0	0	0
% App. Total	0	0	0	0	0	0	0	0	0	0	0	0
PHF	.000	.000	.000	.000	.000	.000	.000	.000	.000	.000	.000	.000

City of Madera
 N/S: Ellis Street/Avenue 16
 E/W: Avenue 16
 Weather: Clear

File Name : 20_MDA_Ellis_Ave 16 PM
 Site Code : 00319628
 Start Date : 9/19/2019
 Page No : 1

Groups Printed- 4+ Axle Trucks

Start Time	Ellis Street Southbound				Avenue 16 Westbound				Avenue 16 Northbound				Int. Total
	Left	Thru	U-Turns	App. Total	Left	Right	U-Turns	App. Total	Thru	Right	U-Turns	App. Total	
04:00 PM	0	0	0	0	0	1	0	1	0	0	0	0	1
04:15 PM	0	0	0	0	0	0	0	0	0	0	0	0	0
04:30 PM	0	0	0	0	0	0	0	0	0	1	0	1	1
04:45 PM	0	0	0	0	1	0	0	1	0	0	0	0	1
Total	0	0	0	0	1	1	0	2	0	1	0	1	3
05:00 PM	0	0	0	0	0	0	0	0	0	2	0	2	2
05:15 PM	0	0	0	0	0	0	0	0	0	0	0	0	0
05:30 PM	0	0	0	0	0	0	0	0	0	0	0	0	0
05:45 PM	0	0	0	0	0	0	0	0	0	0	0	0	0
Total	0	0	0	0	0	0	0	0	0	2	0	2	2
Grand Total	0	0	0	0	1	1	0	2	0	3	0	3	5
Apprch %	0	0	0	0	50	50	0	40	0	100	0	60	
Total %	0	0	0	0	20	20	0	40	0	60	0	60	

Start Time	Ellis Street Southbound				Avenue 16 Westbound				Avenue 16 Northbound				Int. Total
	Left	Thru	U-Turns	App. Total	Left	Right	U-Turns	App. Total	Thru	Right	U-Turns	App. Total	
04:30 PM	0	0	0	0	0	0	0	0	0	1	0	1	1
04:45 PM	0	0	0	0	1	0	0	1	0	0	0	0	1
05:00 PM	0	0	0	0	0	0	0	0	0	2	0	2	2
05:15 PM	0	0	0	0	0	0	0	0	0	0	0	0	0
Total Volume	0	0	0	0	1	0	0	1	0	3	0	3	4
% App. Total	0	0	0	0	100	0	0	250	0	100	0	375	500
PHF	.000	.000	.000	.000	.250	.000	.000	.250	.000	.375	.000	.375	.500

Peak Hour Analysis From 04:30 PM to 05:15 PM - Peak 1 of 1

Peak Hour for Entire Intersection Begins at 04:30 PM

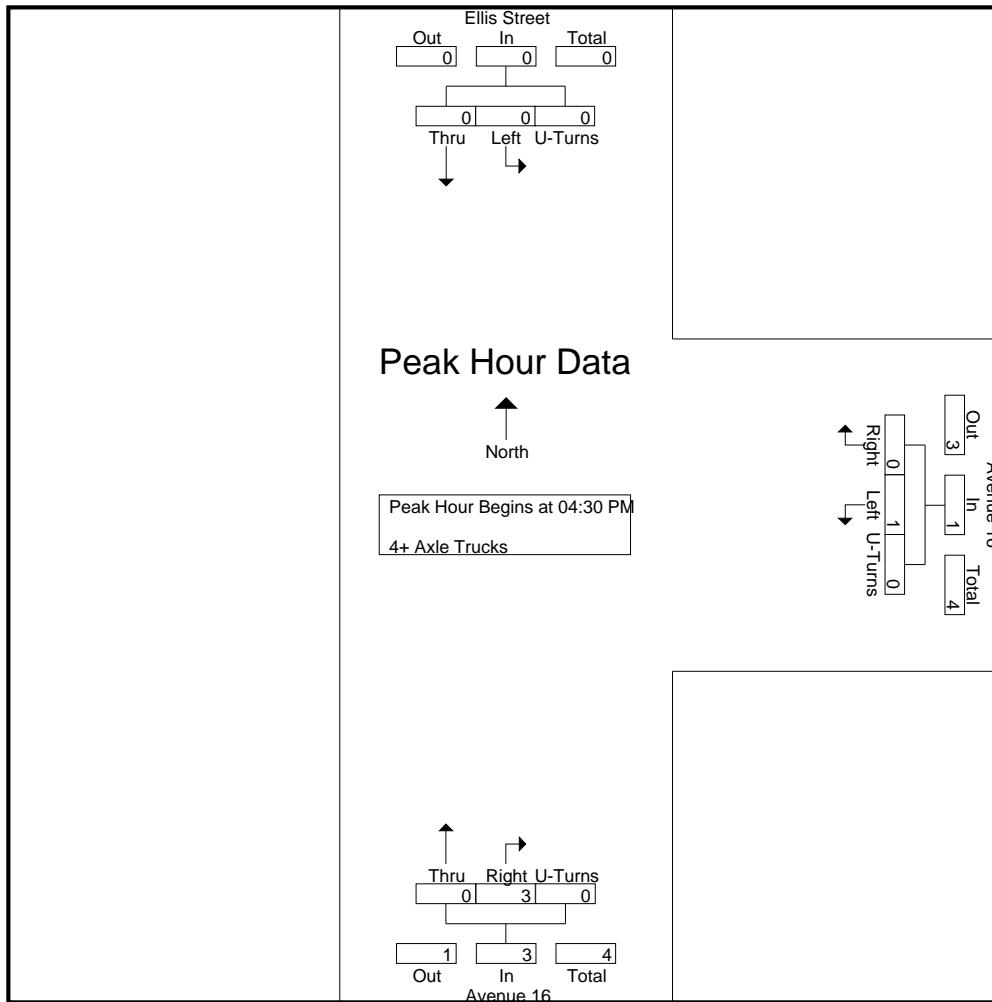

Peak Hour Analysis From 04:30 PM to 05:15 PM - Peak 1 of 1
 Peak Hour for Each Approach Begins at:

	04:30 PM				04:30 PM				04:30 PM			
+0 mins.	0	0	0	0	0	0	0	0	0	1	0	1
+15 mins.	0	0	0	0	1	0	0	1	0	0	0	0
+30 mins.	0	0	0	0	0	0	0	0	0	2	0	2
+45 mins.	0	0	0	0	0	0	0	0	0	0	0	0
Total Volume	0	0	0	0	1	0	0	1	0	3	0	3
% App. Total	0	0	0	0	100	0	0	0	0	100	0	0
PHF	.000	.000	.000	.000	.250	.000	.000	.250	.000	.375	.000	.375

Location: Madera
 N/S: Ellis Street/Avenue 16
 E/W: Avenue 16



PEDESTRIANS

	North Leg Ellis Street	East Leg Avenue 16	South Leg Avenue 16	West Leg Dead End	
	Pedestrians	Pedestrians	Pedestrians	Pedestrians	
7:00 AM	0	0	0	0	0
7:15 AM	0	1	0	0	1
7:30 AM	0	0	0	0	0
7:45 AM	0	0	0	0	0
8:00 AM	0	0	0	0	0
8:15 AM	0	0	0	0	0
8:30 AM	0	1	0	0	1
8:45 AM	0	1	0	0	1
TOTAL VOLUMES:	0	3	0	0	3

	North Leg Ellis Street	East Leg Avenue 16	South Leg Avenue 16	West Leg Dead End	
	Pedestrians	Pedestrians	Pedestrians	Pedestrians	
4:00 PM	0	0	0	0	0
4:15 PM	0	0	0	0	0
4:30 PM	0	0	1	0	1
4:45 PM	0	0	0	0	0
5:00 PM	0	0	0	0	0
5:15 PM	0	0	0	1	1
5:30 PM	0	0	0	1	1
5:45 PM	0	0	0	0	0
TOTAL VOLUMES:	0	0	1	2	3

Location: Madera
 N/S: Ellis Street/Avenue 16
 E/W: Avenue 16



BICYCLES

	Southbound Ellis Street			Westbound Avenue 16			Northbound Avenue 16			Eastbound Dead End			
	Left	Thru	Right	Left	Thru	Right	Left	Thru	Right	Left	Thru	Right	
7:00 AM	0	0	0	0	0	0	0	0	0	0	0	0	0
7:15 AM	0	0	0	0	0	0	0	0	0	0	0	0	0
7:30 AM	0	0	0	0	0	0	0	0	1	0	0	0	1
7:45 AM	0	0	0	0	0	0	0	0	0	0	0	0	0
8:00 AM	0	0	0	1	0	0	0	0	0	0	0	0	1
8:15 AM	0	0	0	0	0	0	0	0	0	0	0	0	0
8:30 AM	0	0	0	0	0	0	0	0	0	0	0	0	0
8:45 AM	0	0	0	0	0	0	0	0	0	0	0	0	0
TOTAL VOLUMES:	0	0	0	1	0	0	0	0	1	0	0	0	2

	Southbound Ellis Street			Westbound Avenue 16			Northbound Avenue 16			Eastbound Dead End			
	Left	Thru	Right	Left	Thru	Right	Left	Thru	Right	Left	Thru	Right	
4:00 PM	0	0	0	0	0	0	0	0	0	0	0	0	0
4:15 PM	0	0	0	0	0	0	0	0	0	0	0	0	0
4:30 PM	0	0	0	0	0	0	0	0	0	0	0	0	0
4:45 PM	0	0	0	0	0	0	0	0	0	0	0	0	0
5:00 PM	0	0	0	0	0	0	0	0	0	0	0	0	0
5:15 PM	0	0	0	0	0	0	0	0	0	0	0	0	0
5:30 PM	0	0	0	1	0	0	0	0	0	0	0	0	1
5:45 PM	0	0	0	0	0	0	0	0	0	0	0	0	0
TOTAL VOLUMES:	0	0	0	1	0	0	0	0	0	0	0	0	1

City of Madera
 N/S: Schnoor Street
 E/W: Avenue 16
 Weather: Clear

File Name : 21_MDA_Schnoor_Ave 16 AM
 Site Code : 00319628
 Start Date : 9/19/2019
 Page No : 1

Groups Printed- Passenger Vehicles - Large 2 Axle Vehicles - 3 Axle Vehicles - 4+ Axle Trucks

Start Time	Schnoor Street Southbound					Avenue 16 Westbound					Schnoor Street Northbound					Avenue 16 Eastbound					Int. Total
	Left	Thru	Right	U-Turns	App. Total	Left	Thru	Right	U-Turns	App. Total	Left	Thru	Right	U-Turns	App. Total	Left	Thru	Right	U-Turns	App. Total	
07:00 AM	1	0	0	0	1	22	23	0	1	46	10	1	35	0	46	0	38	14	0	52	145
07:15 AM	4	2	0	0	6	20	24	7	0	51	20	1	49	0	70	1	39	11	0	51	178
07:30 AM	3	0	1	0	4	19	35	4	0	58	23	0	46	1	70	5	50	29	1	85	217
07:45 AM	3	2	0	0	5	23	42	2	0	67	22	1	63	0	86	1	41	41	0	83	241
Total	11	4	1	0	16	84	124	13	1	222	75	3	193	1	272	7	168	95	1	271	781
08:00 AM	3	1	1	0	5	28	24	6	1	59	28	4	47	1	80	5	51	55	1	112	256
08:15 AM	6	3	2	0	11	38	20	2	1	61	21	0	49	0	70	2	32	37	0	71	213
08:30 AM	3	3	1	0	7	30	19	2	0	51	28	1	24	1	54	3	29	31	0	63	175
08:45 AM	2	1	1	0	4	32	20	5	0	57	23	2	37	0	62	4	29	26	0	59	182
Total	14	8	5	0	27	128	83	15	2	228	100	7	157	2	266	14	141	149	1	305	826
Grand Total	25	12	6	0	43	212	207	28	3	450	175	10	350	3	538	21	309	244	2	576	1607
Apprch %	58.1	27.9	14	0		47.1	46	6.2	0.7		32.5	1.9	65.1	0.6		3.6	53.6	42.4	0.3		
Total %	1.6	0.7	0.4	0	2.7	13.2	12.9	1.7	0.2	28	10.9	0.6	21.8	0.2	33.5	1.3	19.2	15.2	0.1	35.8	
Passenger Vehicles	56	91.7	83.3	0	69.8	97.6	89.4	82.1	100	92.9	99.4	100	98.6	100	98.9	85.7	95.5	97.5	100	96	95.4
Large 2 Axle Vehicles	12	8.3	16.7	0	11.6	1.4	4.8	7.1	0	3.3	0.6	0	1.1	0	0.9	14.3	2.3	2.5	0	2.8	2.6
3 Axle Vehicles	4	0	0	0	2.3	0	0	0	0	0	0	0	0	0	0	0	0.3	0	0	0.2	0.1
4+ Axle Trucks	7	0	0	0	7	2	12	3	0	17	0	0	1	0	1	0	6	0	0	6	31
% 4+ Axle Trucks																					

Start Time	Schnoor Street Southbound					Avenue 16 Westbound					Schnoor Street Northbound					Avenue 16 Eastbound					Int. Total
	Left	Thru	Right	U-Turns	App. Total	Left	Thru	Right	U-Turns	App. Total	Left	Thru	Right	U-Turns	App. Total	Left	Thru	Right	U-Turns	App. Total	
Peak Hour Analysis From 07:00 AM to 08:45 AM - Peak 1 of 1																					
Peak Hour for Entire Intersection Begins at 07:30 AM																					
07:30 AM	3	0	1	0	4	19	35	4	0	58	23	0	46	1	70	5	50	29	1	85	217
07:45 AM	3	2	0	0	5	23	42	2	0	67	22	1	63	0	86	1	41	41	0	83	241
08:00 AM	3	1	1	0	5	28	24	6	1	59	28	4	47	1	80	5	51	55	1	112	256
08:15 AM	6	3	2	0	11	38	20	2	1	61	21	0	49	0	70	2	32	37	0	71	213
Total Volume	15	6	4	0	25	108	121	14	2	245	94	5	205	2	306	13	174	162	2	351	927
% App. Total	60	24	16	0		44.1	49.4	5.7	0.8		30.7	1.6	67	0.7		3.7	49.6	46.2	0.6		
PHF	.625	.500	.500	.000	.568	.711	.720	.583	.500	.914	.839	.313	.813	.500	.890	.650	.853	.736	.500	.783	.905

City of Madera
 N/S: Schnoor Street
 E/W: Avenue 16
 Weather: Clear

File Name : 21_MDA_Schnoor_Ave 16 AM
 Site Code : 00319628
 Start Date : 9/19/2019
 Page No : 2

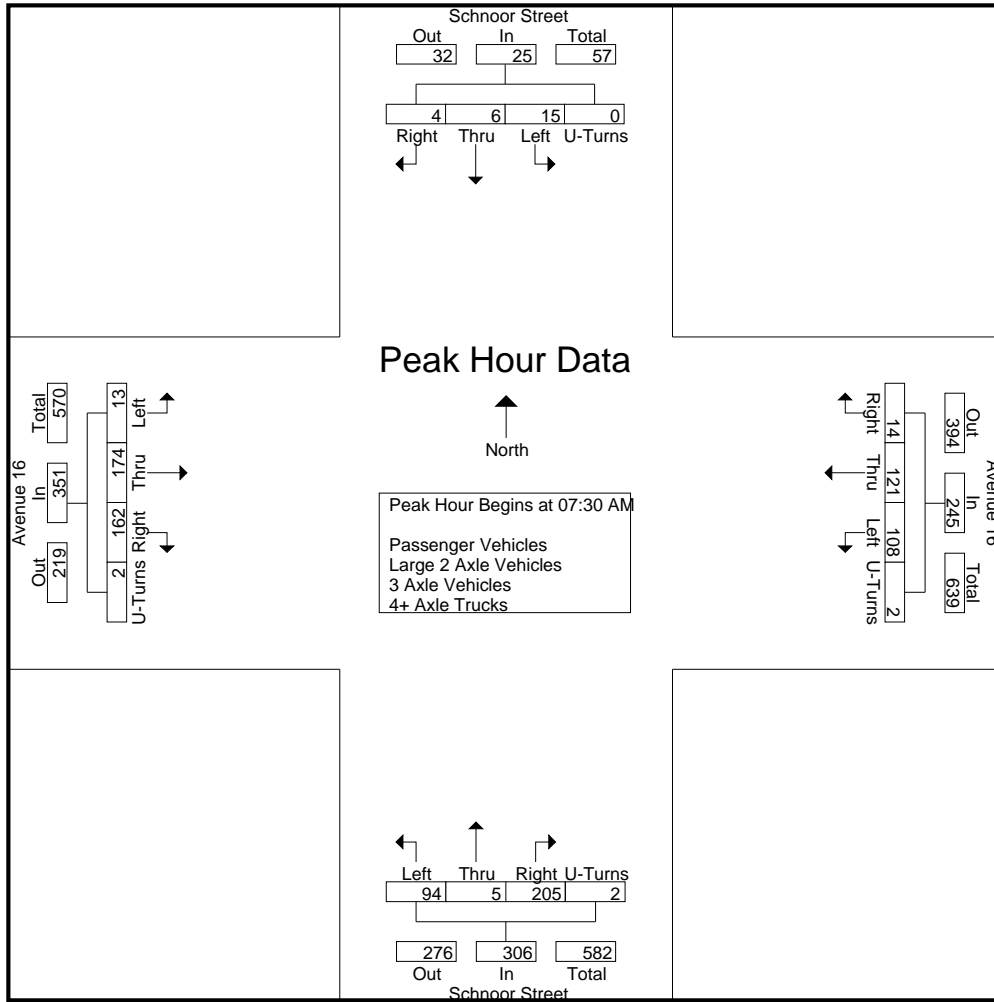

Peak Hour Analysis From 07:00 AM to 08:45 AM - Peak 1 of 1
 Peak Hour for Each Approach Begins at:

	07:45 AM					07:30 AM					07:15 AM					07:30 AM				
+0 mins.	3	2	0	0	5	19	35	4	0	58	20	1	49	0	70	5	50	29	1	85
+15 mins.	3	1	1	0	5	23	42	2	0	67	23	0	46	1	70	1	41	41	0	83
+30 mins.	6	3	2	0	11	28	24	6	1	59	22	1	63	0	86	5	51	55	1	112
+45 mins.	3	3	1	0	7	38	20	2	1	61	28	4	47	1	80	2	32	37	0	71
Total Volume	15	9	4	0	28	108	121	14	2	245	93	6	205	2	306	13	174	162	2	351
% App. Total	53.6	32.1	14.3	0		44.1	49.4	5.7	0.8		30.4	2	67	0.7		3.7	49.6	46.2	0.6	
PHF	.625	.750	.500	.000	.636	.711	.720	.583	.500	.914	.830	.375	.813	.500	.890	.650	.853	.736	.500	.783

City of Madera
 N/S: Schnoor Street
 E/W: Avenue 16
 Weather: Clear

File Name : 21_MDA_Schnoor_Ave 16 AM
 Site Code : 00319628
 Start Date : 9/19/2019
 Page No : 1

Groups Printed- Passenger Vehicles

Start Time	Schnoor Street Southbound					Avenue 16 Westbound					Schnoor Street Northbound					Avenue 16 Eastbound					Int. Total
	Left	Thru	Right	U-Turns	App. Total	Left	Thru	Right	U-Turns	App. Total	Left	Thru	Right	U-Turns	App. Total	Left	Thru	Right	U-Turns	App. Total	
07:00 AM	0	0	0	0	0	21	19	0	1	41	9	1	33	0	43	0	36	14	0	50	134
07:15 AM	2	2	0	0	4	18	21	6	0	45	20	1	49	0	70	1	39	10	0	50	169
07:30 AM	1	0	1	0	2	19	33	4	0	56	23	0	45	1	69	5	48	28	1	82	209
07:45 AM	1	2	0	0	3	23	41	2	0	66	22	1	63	0	86	0	40	40	0	80	235
Total	4	4	1	0	9	81	114	12	1	208	74	3	190	1	268	6	163	92	1	262	747
08:00 AM	3	0	1	0	4	28	21	6	1	56	28	4	47	1	80	4	48	54	1	107	247
08:15 AM	3	3	1	0	7	38	15	1	1	55	21	0	49	0	70	2	30	36	0	68	200
08:30 AM	2	3	1	0	6	28	19	1	0	48	28	1	23	1	53	2	27	30	0	59	166
08:45 AM	2	1	1	0	4	32	16	3	0	51	23	2	36	0	61	4	27	26	0	57	173
Total	10	7	4	0	21	126	71	11	2	210	100	7	155	2	264	12	132	146	1	291	786
Grand Total	14	11	5	0	30	207	185	23	3	418	174	10	345	3	532	18	295	238	2	553	1533
Apprch %	46.7	36.7	16.7	0		49.5	44.3	5.5	0.7		32.7	1.9	64.8	0.6		3.3	53.3	43	0.4		
Total %	0.9	0.7	0.3	0	2	13.5	12.1	1.5	0.2	27.3	11.4	0.7	22.5	0.2	34.7	1.2	19.2	15.5	0.1	36.1	

Start Time	Schnoor Street Southbound					Avenue 16 Westbound					Schnoor Street Northbound					Avenue 16 Eastbound					Int. Total
	Left	Thru	Right	U-Turns	App. Total	Thru	Right	U-Turns	App. Total	Thru	Right	U-Turns	App. Total	Thru	Right	U-Turns	App. Total				
Peak Hour Analysis From 07:30 AM to 08:15 AM - Peak 1 of 1																					
Peak Hour for Entire Intersection Begins at 07:30 AM																					
07:30 AM	1	0	1	0	2	19	33	4	0	56	23	0	45	1	69	5	48	28	1	82	209
07:45 AM	1	2	0	0	3	23	41	2	0	66	22	1	63	0	86	0	40	40	0	80	235
08:00 AM	3	0	1	0	4	28	21	6	1	56	28	4	47	1	80	4	48	54	1	107	247
08:15 AM	3	3	1	0	7	38	15	1	1	55	21	0	49	0	70	2	30	36	0	68	200
Total Volume	8	5	3	0	16	108	110	13	2	233	94	5	204	2	305	11	166	158	2	337	891
% App. Total	50	31.2	18.8	0		46.4	47.2	5.6	0.9		30.8	1.6	66.9	0.7		3.3	49.3	46.9	0.6		
PHF	.667	.417	.750	.000	.571	.711	.671	.542	.500	.883	.839	.313	.810	.500	.887	.550	.865	.731	.500	.787	.902

City of Madera
 N/S: Schnoor Street
 E/W: Avenue 16
 Weather: Clear

File Name : 21_MDA_Schnoor_Ave 16 AM
 Site Code : 00319628
 Start Date : 9/19/2019
 Page No : 2

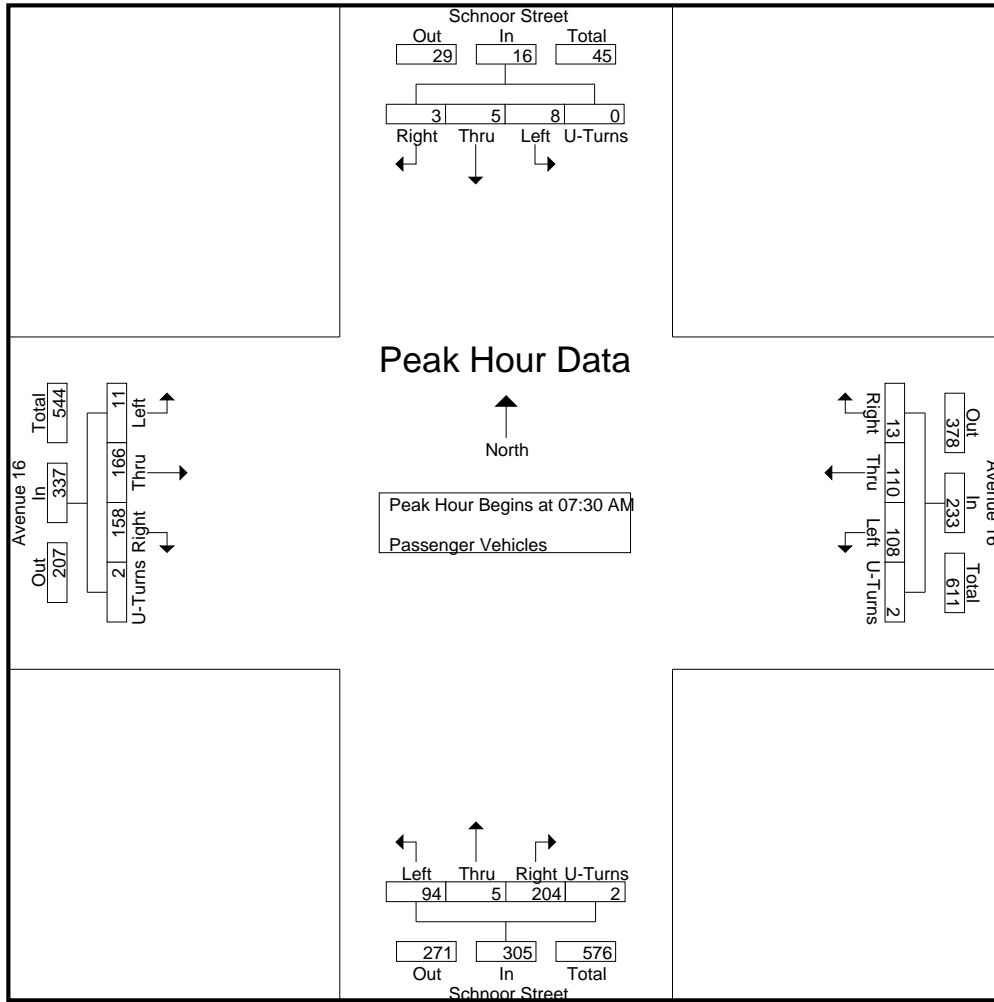

Peak Hour Analysis From 07:30 AM to 08:15 AM - Peak 1 of 1
 Peak Hour for Each Approach Begins at:

	07:30 AM					07:30 AM					07:30 AM									
+0 mins.	1	0	1	0	2	19	33	4	0	56	23	0	45	1	69	5	48	28	1	82
+15 mins.	1	2	0	0	3	23	41	2	0	66	22	1	63	0	86	0	40	40	0	80
+30 mins.	3	0	1	0	4	28	21	6	1	56	28	4	47	1	80	4	48	54	1	107
+45 mins.	3	3	1	0	7	38	15	1	1	55	21	0	49	0	70	2	30	36	0	68
Total Volume	8	5	3	0	16	108	110	13	2	233	94	5	204	2	305	11	166	158	2	337
% App. Total	50	31.2	18.8	0		46.4	47.2	5.6	0.9		30.8	1.6	66.9	0.7		3.3	49.3	46.9	0.6	
PHF	.667	.417	.750	.000	.571	.711	.671	.542	.500	.883	.839	.313	.810	.500	.887	.550	.865	.731	.500	.787

City of Madera
 N/S: Schnoor Street
 E/W: Avenue 16
 Weather: Clear

File Name : 21_MDA_Schnoor_Ave 16 AM
 Site Code : 00319628
 Start Date : 9/19/2019
 Page No : 1

Groups Printed- Large 2 Axle Vehicles

Start Time	Schnoor Street Southbound					Avenue 16 Westbound					Schnoor Street Northbound					Avenue 16 Eastbound					Int. Total
	Left	Thru	Right	U-Turns	App. Total	Left	Thru	Right	U-Turns	App. Total	Left	Thru	Right	U-Turns	App. Total	Left	Thru	Right	U-Turns	App. Total	
07:00 AM	0	0	0	0	0	0	1	0	0	1	1	0	2	0	3	0	2	0	0	2	6
07:15 AM	0	0	0	0	0	2	2	0	0	4	0	0	0	0	0	0	0	1	0	1	5
07:30 AM	1	0	0	0	1	0	1	0	0	1	0	0	0	0	0	0	1	1	0	2	4
07:45 AM	1	0	0	0	1	0	1	0	0	1	0	0	0	0	0	1	0	1	0	2	4
Total	2	0	0	0	2	2	5	0	0	7	1	0	2	0	3	1	3	3	0	7	19
08:00 AM	0	1	0	0	1	0	0	0	0	0	0	0	0	0	0	1	2	1	0	4	5
08:15 AM	1	0	1	0	2	0	1	0	0	1	0	0	0	0	0	0	0	1	0	1	4
08:30 AM	0	0	0	0	0	1	0	0	0	1	0	0	1	0	1	1	1	1	0	3	5
08:45 AM	0	0	0	0	0	0	4	2	0	6	0	0	1	0	1	0	1	0	0	1	8
Total	1	1	1	0	3	1	5	2	0	8	0	0	2	0	2	2	4	3	0	9	22
Grand Total	3	1	1	0	5	3	10	2	0	15	1	0	4	0	5	3	7	6	0	16	41
Apprch %	60	20	20	0		20	66.7	13.3	0		20	0	80	0		18.8	43.8	37.5	0		
Total %	7.3	2.4	2.4	0	12.2	7.3	24.4	4.9	0	36.6	2.4	0	9.8	0	12.2	7.3	17.1	14.6	0	39	

Start Time	Schnoor Street Southbound					Avenue 16 Westbound					Schnoor Street Northbound					Avenue 16 Eastbound					Int. Total
	Left	Thru	Right	U-Turns	App. Total	Thru	Right	U-Turns	App. Total	Thru	Right	U-Turns	App. Total	Thru	Right	U-Turns	App. Total				
Peak Hour Analysis From 07:30 AM to 08:15 AM - Peak 1 of 1																					
Peak Hour for Entire Intersection Begins at 07:30 AM																					
07:30 AM	1	0	0	0	1	0	1	0	0	1	0	0	0	0	0	0	1	1	0	2	4
07:45 AM	1	0	0	0	1	0	1	0	0	1	0	0	0	0	0	1	0	1	0	2	4
08:00 AM	0	1	0	0	1	0	0	0	0	0	0	0	0	0	0	1	2	1	0	4	5
08:15 AM	1	0	1	0	2	0	1	0	0	1	0	0	0	0	0	0	0	1	0	1	4
Total Volume	3	1	1	0	5	0	3	0	0	3	0	0	0	0	0	2	3	4	0	9	17
% App. Total	60	20	20	0		0	100	0	0		0	0	0	0		22.2	33.3	44.4	0		
PHF	.750	.250	.250	.000	.625	.000	.750	.000	.000	.750	.000	.000	.000	.000	.000	.500	.375	1.00	.000	.563	.850

City of Madera
 N/S: Schnoor Street
 E/W: Avenue 16
 Weather: Clear

File Name : 21_MDA_Schnoor_Ave 16 AM
 Site Code : 00319628
 Start Date : 9/19/2019
 Page No : 2

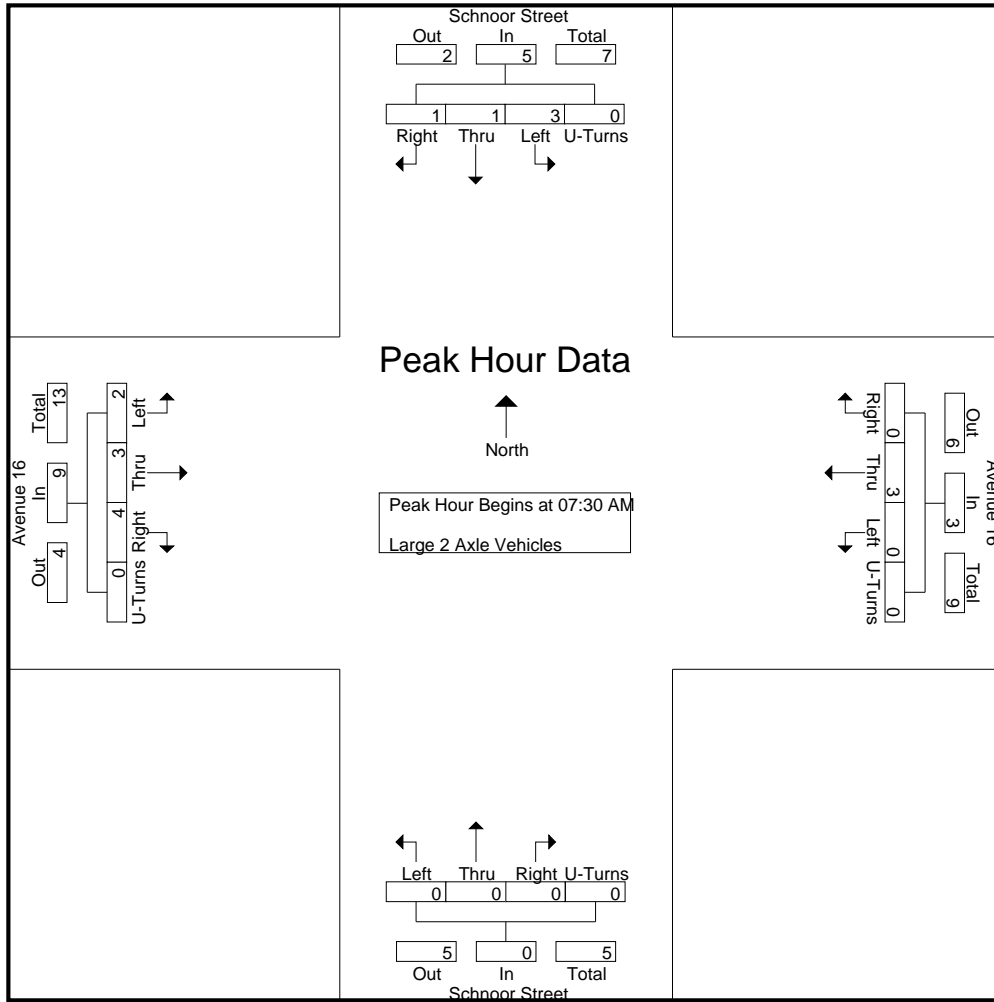

Peak Hour Analysis From 07:30 AM to 08:15 AM - Peak 1 of 1
 Peak Hour for Each Approach Begins at:

	07:30 AM					07:30 AM					07:30 AM					07:30 AM				
+0 mins.	1	0	0	0	1	0	1	0	0	1	0	0	0	0	0	0	1	1	0	2
+15 mins.	1	0	0	0	1	0	1	0	0	1	0	0	0	0	0	1	0	1	0	2
+30 mins.	0	1	0	0	1	0	0	0	0	0	0	0	0	0	0	1	2	1	0	4
+45 mins.	1	0	1	0	2	0	1	0	0	1	0	0	0	0	0	0	0	1	0	1
Total Volume	3	1	1	0	5	0	3	0	0	3	0	0	0	0	0	2	3	4	0	9
% App. Total	60	20	20	0		0	100	0	0		0	0	0	0		22.2	33.3	44.4	0	
PHF	.750	.250	.250	.000	.625	.000	.750	.000	.000	.750	.000	.000	.000	.000	.000	.500	.375	1.000	.000	.563

City of Madera
 N/S: Schnoor Street
 E/W: Avenue 16
 Weather: Clear

File Name : 21_MDA_Schnoor_Ave 16 AM
 Site Code : 00319628
 Start Date : 9/19/2019
 Page No : 1

Groups Printed- 3 Axle Vehicles

Start Time	Schnoor Street Southbound					Avenue 16 Westbound					Schnoor Street Northbound					Avenue 16 Eastbound					Int. Total	
	Left	Thru	Right	U-Turns	App. Total	Left	Thru	Right	U-Turns	App. Total	Left	Thru	Right	U-Turns	App. Total	Left	Thru	Right	U-Turns	App. Total		
07:00 AM	0	0	0	0	0	0	0	0	0	0	0	0	0	0	0	0	0	0	0	0	0	0
07:15 AM	1	0	0	0	1	0	0	0	0	0	0	0	0	0	0	0	0	0	0	0	0	0
07:30 AM	0	0	0	0	0	0	0	0	0	0	0	0	0	0	0	0	0	0	0	0	0	0
07:45 AM	0	0	0	0	0	0	0	0	0	0	0	0	0	0	0	0	0	0	0	0	0	0
Total	1	0	0	0	1	0	0	0	0	0	0	0	0	0	0	0	0	0	0	0	0	0
08:00 AM	0	0	0	0	0	0	0	0	0	0	0	0	0	0	0	0	1	0	0	0	1	1
08:15 AM	0	0	0	0	0	0	0	0	0	0	0	0	0	0	0	0	0	0	0	0	0	0
08:30 AM	0	0	0	0	0	0	0	0	0	0	0	0	0	0	0	0	0	0	0	0	0	0
08:45 AM	0	0	0	0	0	0	0	0	0	0	0	0	0	0	0	0	0	0	0	0	0	0
Total	0	0	0	0	0	0	0	0	0	0	0	0	0	0	0	0	1	0	0	0	1	1
Grand Total	1	0	0	0	1	0	0	0	0	0	0	0	0	0	0	0	1	0	0	0	1	2
Apprch %	100	0	0	0		0	0	0	0		0	0	0	0		0	100	0	0			
Total %	50	0	0	0	50	0	0	0	0	0	0	0	0	0	0	0	50	0	0	50		

Start Time	Schnoor Street Southbound					Avenue 16 Westbound					Schnoor Street Northbound					Avenue 16 Eastbound					Int. Total	
	Left	Thru	Right	U-Turns	App. Total	Left	Thru	Right	U-Turns	App. Total	Left	Thru	Right	U-Turns	App. Total	Left	Thru	Right	U-Turns	App. Total		
Peak Hour Analysis From 07:30 AM to 08:15 AM - Peak 1 of 1																						
Peak Hour for Entire Intersection Begins at 07:30 AM																						
07:30 AM	0	0	0	0	0	0	0	0	0	0	0	0	0	0	0	0	0	0	0	0	0	0
07:45 AM	0	0	0	0	0	0	0	0	0	0	0	0	0	0	0	0	0	0	0	0	0	0
08:00 AM	0	0	0	0	0	0	0	0	0	0	0	0	0	0	0	0	1	0	0	0	1	1
08:15 AM	0	0	0	0	0	0	0	0	0	0	0	0	0	0	0	0	0	0	0	0	0	0
Total Volume	0	0	0	0	0	0	0	0	0	0	0	0	0	0	0	0	1	0	0	0	1	1
% App. Total	0	0	0	0		0	0	0	0		0	0	0	0		0	100	0	0			
PHF	.000	.000	.000	.000	.000	.000	.000	.000	.000	.000	.000	.000	.000	.000	.000	.000	.250	.000	.000	.250	.250	.250

City of Madera
 N/S: Schnoor Street
 E/W: Avenue 16
 Weather: Clear

File Name : 21_MDA_Schnoor_Ave 16 AM
 Site Code : 00319628
 Start Date : 9/19/2019
 Page No : 2

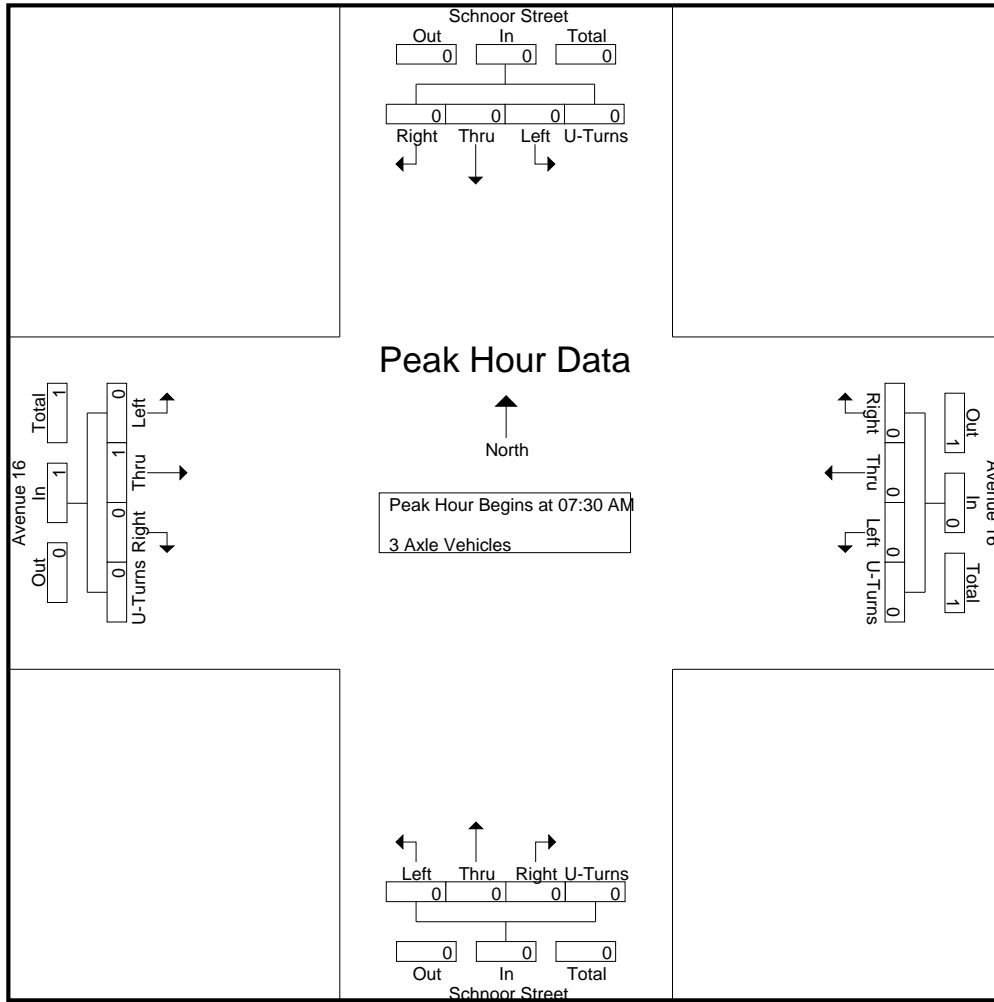

Peak Hour Analysis From 07:30 AM to 08:15 AM - Peak 1 of 1
 Peak Hour for Each Approach Begins at:

	07:30 AM					07:30 AM					07:30 AM					07:30 AM									
+0 mins.	0	0	0	0	0	0	0	0	0	0	0	0	0	0	0	0	0	0	0	0	0	0	0	0	0
+15 mins.	0	0	0	0	0	0	0	0	0	0	0	0	0	0	0	0	0	0	0	0	0	0	0	0	0
+30 mins.	0	0	0	0	0	0	0	0	0	0	0	0	0	0	0	0	1	0	0	0	0	0	0	0	1
+45 mins.	0	0	0	0	0	0	0	0	0	0	0	0	0	0	0	0	0	0	0	0	0	0	0	0	0
Total Volume	0	0	0	0	0	0	0	0	0	0	0	0	0	0	0	0	1	0	0	0	0	0	0	0	1
% App. Total	0	0	0	0	0	0	0	0	0	0	0	0	0	0	0	0	100	0	0	0	0	0	0	0	0
PHF	.000	.000	.000	.000	.000	.000	.000	.000	.000	.000	.000	.000	.000	.000	.000	.000	.250	.000	.000	.250					

City of Madera
 N/S: Schnoor Street
 E/W: Avenue 16
 Weather: Clear

File Name : 21_MDA_Schnoor_Ave 16 AM
 Site Code : 00319628
 Start Date : 9/19/2019
 Page No : 1

Groups Printed- 4+ Axle Trucks

Start Time	Schnoor Street Southbound					Avenue 16 Westbound					Schnoor Street Northbound					Avenue 16 Eastbound					Int. Total
	Left	Thru	Right	U-Turns	App. Total	Left	Thru	Right	U-Turns	App. Total	Left	Thru	Right	U-Turns	App. Total	Left	Thru	Right	U-Turns	App. Total	
07:00 AM	1	0	0	0	1	1	3	0	0	4	0	0	0	0	0	0	0	0	0	0	5
07:15 AM	1	0	0	0	1	0	1	1	0	2	0	0	0	0	0	0	0	0	0	0	3
07:30 AM	1	0	0	0	1	0	1	0	0	1	0	0	1	0	1	0	1	0	0	1	4
07:45 AM	1	0	0	0	1	0	0	0	0	0	0	0	0	0	0	0	1	0	0	1	2
Total	4	0	0	0	4	1	5	1	0	7	0	0	1	0	1	0	2	0	0	2	14
08:00 AM	0	0	0	0	0	0	3	0	0	3	0	0	0	0	0	0	0	0	0	0	3
08:15 AM	2	0	0	0	2	0	4	1	0	5	0	0	0	0	0	0	2	0	0	2	9
08:30 AM	1	0	0	0	1	1	0	1	0	2	0	0	0	0	0	0	1	0	0	1	4
08:45 AM	0	0	0	0	0	0	0	0	0	0	0	0	0	0	0	0	1	0	0	1	1
Total	3	0	0	0	3	1	7	2	0	10	0	0	0	0	0	0	4	0	0	4	17
Grand Total	7	0	0	0	7	2	12	3	0	17	0	0	1	0	1	0	6	0	0	6	31
Apprch %	100	0	0	0		11.8	70.6	17.6	0		0	0	100	0		0	100	0	0		
Total %	22.6	0	0	0	22.6	6.5	38.7	9.7	0	54.8	0	0	3.2	0	3.2	0	19.4	0	0	19.4	

Start Time	Schnoor Street Southbound					Avenue 16 Westbound					Schnoor Street Northbound					Avenue 16 Eastbound					Int. Total
	Left	Thru	Right	U-Turns	App. Total	Thru	Right	U-Turns	App. Total	Thru	Right	U-Turns	App. Total	Thru	Right	U-Turns	App. Total				
Peak Hour Analysis From 07:30 AM to 08:15 AM - Peak 1 of 1																					
Peak Hour for Entire Intersection Begins at 07:30 AM																					
07:30 AM	1	0	0	0	1	0	1	0	0	1	0	0	1	0	1	0	1	0	0	1	4
07:45 AM	1	0	0	0	1	0	0	0	0	0	0	0	0	0	0	0	1	0	0	1	2
08:00 AM	0	0	0	0	0	0	3	0	0	3	0	0	0	0	0	0	0	0	0	0	3
08:15 AM	2	0	0	0	2	0	4	1	0	5	0	0	0	0	0	0	2	0	0	2	9
Total Volume	4	0	0	0	4	0	8	1	0	9	0	0	1	0	1	0	4	0	0	4	18
% App. Total	100	0	0	0		0	88.9	11.1	0		0	0	100	0		0	100	0	0		
PHF	.500	.000	.000	.000	.500	.000	.500	.250	.000	.450	.000	.000	.250	.000	.250	.000	.500	.000	.000	.500	.500

City of Madera
 N/S: Schnoor Street
 E/W: Avenue 16
 Weather: Clear

File Name : 21_MDA_Schnoor_Ave 16 AM
 Site Code : 00319628
 Start Date : 9/19/2019
 Page No : 2

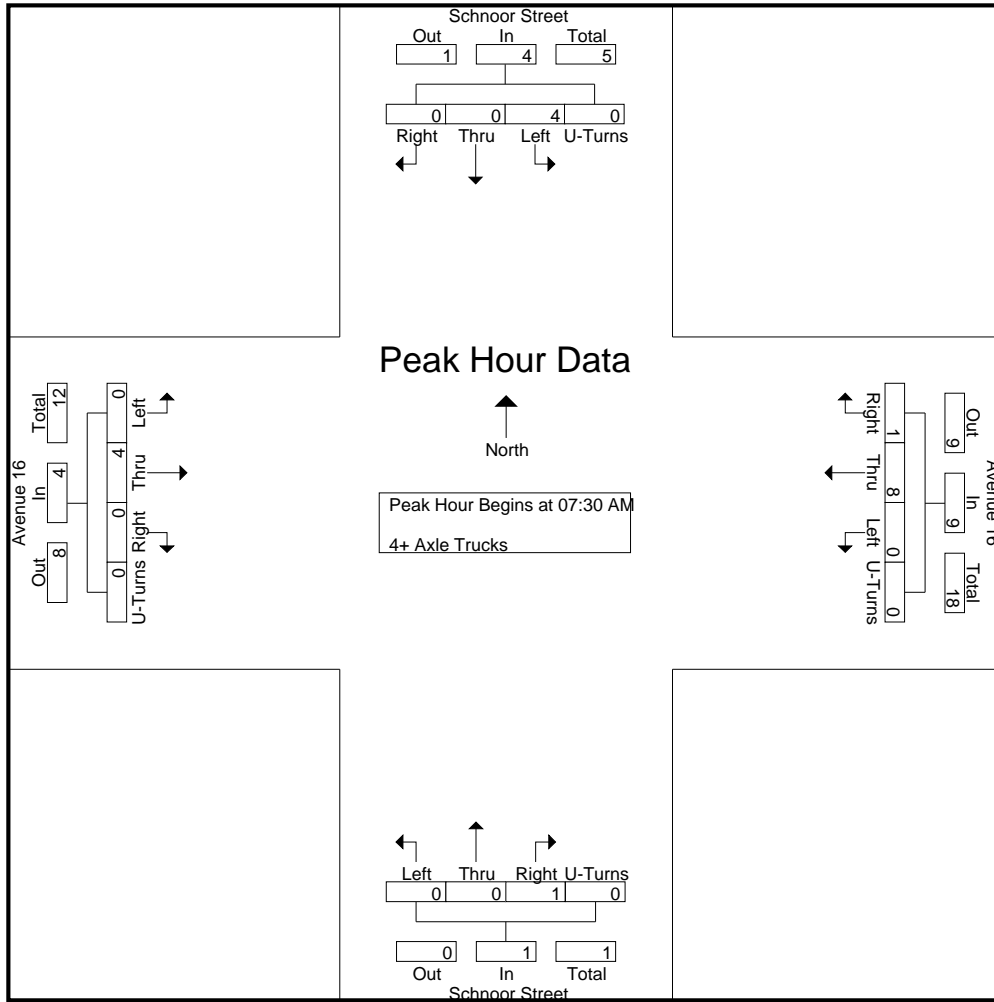

Peak Hour Analysis From 07:30 AM to 08:15 AM - Peak 1 of 1
 Peak Hour for Each Approach Begins at:

	07:30 AM					07:30 AM					07:30 AM					07:30 AM				
+0 mins.	1	0	0	0	1	0	1	0	0	1	0	0	1	0	1	0	1	0	0	1
+15 mins.	1	0	0	0	1	0	0	0	0	0	0	0	0	0	0	0	1	0	0	1
+30 mins.	0	0	0	0	0	0	3	0	0	3	0	0	0	0	0	0	0	0	0	0
+45 mins.	2	0	0	0	2	0	4	1	0	5	0	0	0	0	0	0	2	0	0	2
Total Volume	4	0	0	0	4	0	8	1	0	9	0	0	1	0	1	0	4	0	0	4
% App. Total	100	0	0	0	0	0	88.9	11.1	0	0	0	0	100	0	0	0	100	0	0	0
PHF	.500	.000	.000	.000	.500	.000	.500	.250	.000	.450	.000	.000	.250	.000	.250	.000	.500	.000	.000	.500

City of Madera
 N/S: Schnoor Street
 E/W: Avenue 16
 Weather: Clear

File Name : 21_MDA_Schnoor_Ave 16 PM
 Site Code : 00319628
 Start Date : 9/19/2019
 Page No : 1

Groups Printed- Passenger Vehicles - Large 2 Axle Vehicles - 3 Axle Vehicles - 4+ Axle Trucks

Start Time	Schnoor Street Southbound					Avenue 16 Westbound					Schnoor Street Northbound					Avenue 16 Eastbound					Int. Total
	Left	Thru	Right	U-Turns	App. Total	Left	Thru	Right	U-Turns	App. Total	Left	Thru	Right	U-Turns	App. Total	Left	Thru	Right	U-Turns	App. Total	
04:00 PM	5	1	1	0	7	44	24	6	0	74	41	0	43	1	85	3	56	42	1	102	268
04:15 PM	5	3	3	0	11	32	24	1	0	57	50	1	45	0	96	3	29	38	0	70	234
04:30 PM	5	1	1	0	7	31	36	6	0	73	44	2	43	0	89	0	39	40	0	79	248
04:45 PM	3	1	3	0	7	36	30	4	0	70	34	4	50	0	88	3	30	45	0	78	243
Total	18	6	8	0	32	143	114	17	0	274	169	7	181	1	358	9	154	165	1	329	993
05:00 PM	7	7	2	0	16	47	32	6	1	86	50	6	54	0	110	2	34	37	1	74	286
05:15 PM	9	6	2	0	17	49	24	5	0	78	49	1	47	0	97	2	29	46	0	77	269
05:30 PM	4	0	1	0	5	46	46	2	0	94	59	2	56	0	117	1	20	35	0	56	272
05:45 PM	5	3	0	0	8	37	33	2	0	72	49	0	39	0	88	1	28	34	0	63	231
Total	25	16	5	0	46	179	135	15	1	330	207	9	196	0	412	6	111	152	1	270	1058
Grand Total	43	22	13	0	78	322	249	32	1	604	376	16	377	1	770	15	265	317	2	599	2051
Apprch %	55.1	28.2	16.7	0		53.3	41.2	5.3	0.2		48.8	2.1	49	0.1		2.5	44.2	52.9	0.3		
Total %	2.1	1.1	0.6	0	3.8	15.7	12.1	1.6	0	29.4	18.3	0.8	18.4	0	37.5	0.7	12.9	15.5	0.1	29.2	
Passenger Vehicles																					
% Passenger Vehicles	81.4	95.5	84.6	0	85.9	100	94.8	71.9	100	96.4	98.9	87.5	98.9	100	98.7	93.3	97	98.4	100	97.7	97.2
Large 2 Axle Vehicles																					
% Large 2 Axle Vehicles	7	4.5	7.7	0	6.4	0	4	12.5	0	2.3	1.1	12.5	0.5	0	1	6.7	1.9	1.6	0	1.8	1.9
3 Axle Vehicles																					
% 3 Axle Vehicles	0	0	0	0	0	0	0.4	0	0	0.2	0	0	0	0	0	0	0	0	0	0	0
4+ Axle Trucks																					
% 4+ Axle Trucks	5	0	1	0	6	0	2	5	0	7	0	0	2	0	2	0	3	0	0	3	18

Start Time	Schnoor Street Southbound					Avenue 16 Westbound					Schnoor Street Northbound					Avenue 16 Eastbound					Int. Total
	Left	Thru	Right	U-Turns	App. Total	Left	Thru	Right	U-Turns	App. Total	Left	Thru	Right	U-Turns	App. Total	Left	Thru	Right	U-Turns	App. Total	
Peak Hour Analysis From 04:00 PM to 05:45 PM - Peak 1 of 1																					
Peak Hour for Entire Intersection Begins at 04:45 PM																					
04:45 PM	3	1	3	0	7	36	30	4	0	70	34	4	50	0	88	3	30	45	0	78	243
05:00 PM	7	7	2	0	16	47	32	6	1	86	50	6	54	0	110	2	34	37	1	74	286
05:15 PM	9	6	2	0	17	49	24	5	0	78	49	1	47	0	97	2	29	46	0	77	269
05:30 PM	4	0	1	0	5	46	46	2	0	94	59	2	56	0	117	1	20	35	0	56	272
Total Volume	23	14	8	0	45	178	132	17	1	328	192	13	207	0	412	8	113	163	1	285	1070
% App. Total	51.1	31.1	17.8	0		54.3	40.2	5.2	0.3		46.6	3.2	50.2	0		2.8	39.6	57.2	0.4		
PHF	.639	.500	.667	.000	.662	.908	.717	.708	.250	.872	.814	.542	.924	.000	.880	.667	.831	.886	.250	.913	.935

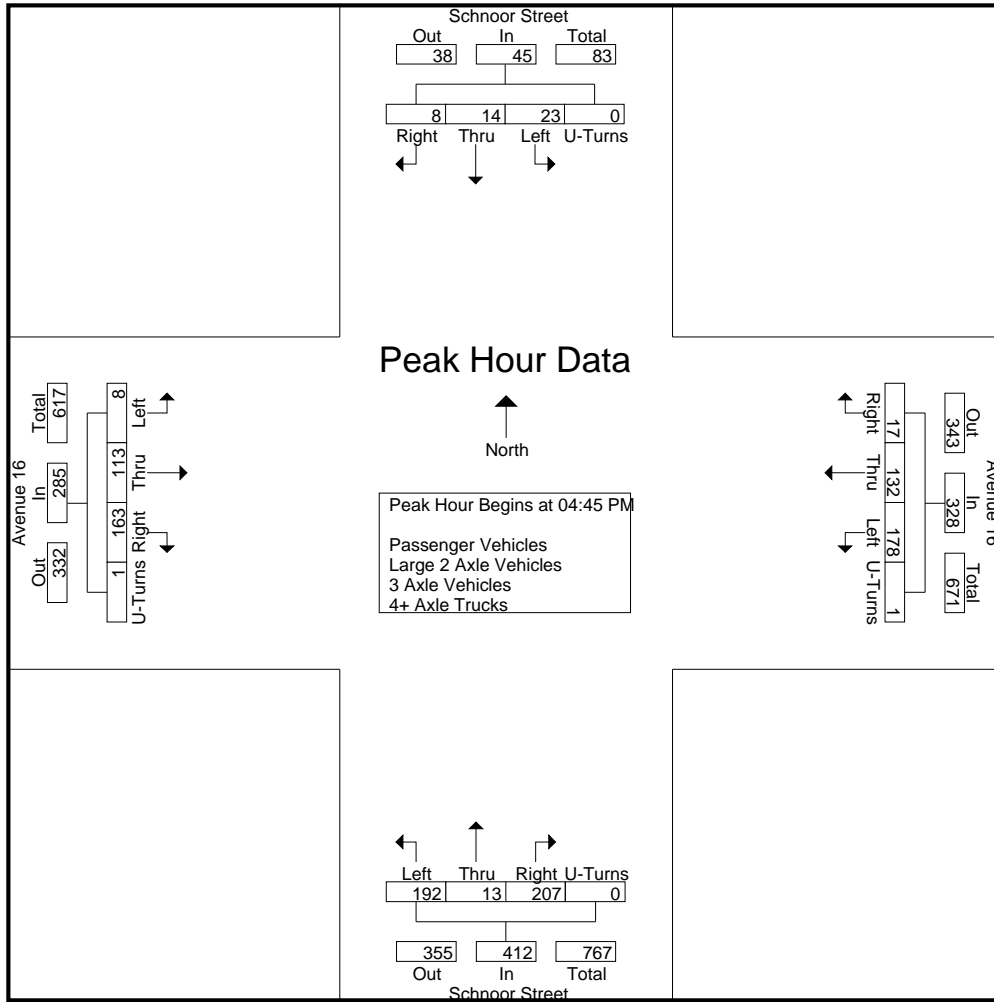

Peak Hour Analysis From 04:00 PM to 05:45 PM - Peak 1 of 1
 Peak Hour for Each Approach Begins at:

	04:30 PM					05:00 PM					04:45 PM					04:00 PM				
+0 mins.	5	1	1	0	7	47	32	6	1	86	34	4	50	0	88	3	56	42	1	102
+15 mins.	3	1	3	0	7	49	24	5	0	78	50	6	54	0	110	3	29	38	0	70
+30 mins.	7	7	2	0	16	46	46	2	0	94	49	1	47	0	97	0	39	40	0	79
+45 mins.	9	6	2	0	17	37	33	2	0	72	59	2	56	0	117	3	30	45	0	78
Total Volume	24	15	8	0	47	179	135	15	1	330	192	13	207	0	412	9	154	165	1	329
% App. Total	51.1	31.9	17	0		54.2	40.9	4.5	0.3		46.6	3.2	50.2	0		2.7	46.8	50.2	0.3	
PHF	.667	.536	.667	.000	.691	.913	.734	.625	.250	.878	.814	.542	.924	.000	.880	.750	.688	.917	.250	.806

City of Madera
 N/S: Schnoor Street
 E/W: Avenue 16
 Weather: Clear

File Name : 21_MDA_Schnoor_Ave 16 PM
 Site Code : 00319628
 Start Date : 9/19/2019
 Page No : 1

Groups Printed- Passenger Vehicles

Start Time	Schnoor Street Southbound					Avenue 16 Westbound					Schnoor Street Northbound					Avenue 16 Eastbound					Int. Total
	Left	Thru	Right	U-Turns	App. Total	Left	Thru	Right	U-Turns	App. Total	Left	Thru	Right	U-Turns	App. Total	Left	Thru	Right	U-Turns	App. Total	
04:00 PM	5	1	1	0	7	44	23	5	0	72	40	0	43	1	84	3	53	39	1	96	259
04:15 PM	4	3	2	0	9	32	23	1	0	56	49	1	42	0	92	3	29	37	0	69	226
04:30 PM	4	1	1	0	6	31	33	4	0	68	43	2	43	0	88	0	37	40	0	77	239
04:45 PM	2	1	3	0	6	36	28	3	0	67	34	4	50	0	88	3	30	45	0	78	239
Total	15	6	7	0	28	143	107	13	0	263	166	7	178	1	352	9	149	161	1	320	963
05:00 PM	5	6	1	0	12	47	32	3	1	83	50	4	54	0	108	2	32	37	1	72	275
05:15 PM	8	6	2	0	16	49	23	3	0	75	48	1	47	0	96	2	28	46	0	76	263
05:30 PM	2	0	1	0	3	46	46	2	0	94	59	2	55	0	116	0	20	34	0	54	267
05:45 PM	5	3	0	0	8	37	28	2	0	67	49	0	39	0	88	1	28	34	0	63	226
Total	20	15	4	0	39	179	129	10	1	319	206	7	195	0	408	5	108	151	1	265	1031
Grand Total	35	21	11	0	67	322	236	23	1	582	372	14	373	1	760	14	257	312	2	585	1994
Apprch %	52.2	31.3	16.4	0		55.3	40.5	4	0.2		48.9	1.8	49.1	0.1		2.4	43.9	53.3	0.3		
Total %	1.8	1.1	0.6	0	3.4	16.1	11.8	1.2	0.1	29.2	18.7	0.7	18.7	0.1	38.1	0.7	12.9	15.6	0.1	29.3	

Start Time	Schnoor Street Southbound					Avenue 16 Westbound					Schnoor Street Northbound					Avenue 16 Eastbound					Int. Total
	Left	Thru	Right	U-Turns	App. Total	Thru	Right	U-Turns	App. Total	Thru	Right	U-Turns	App. Total	Thru	Right	U-Turns	App. Total				
Peak Hour Analysis From 04:45 PM to 05:30 PM - Peak 1 of 1																					
Peak Hour for Entire Intersection Begins at 04:45 PM																					
04:45 PM	2	1	3	0	6	36	28	3	0	67	34	4	50	0	88	3	30	45	0	78	239
05:00 PM	5	6	1	0	12	47	32	3	1	83	50	4	54	0	108	2	32	37	1	72	275
05:15 PM	8	6	2	0	16	49	23	3	0	75	48	1	47	0	96	2	28	46	0	76	263
05:30 PM	2	0	1	0	3	46	46	2	0	94	59	2	55	0	116	0	20	34	0	54	267
Total Volume	17	13	7	0	37	178	129	11	1	319	191	11	206	0	408	7	110	162	1	280	1044
% App. Total	45.9	35.1	18.9	0		55.8	40.4	3.4	0.3		46.8	2.7	50.5	0		2.5	39.3	57.9	0.4		
PHF	.531	.542	.583	.000	.578	.908	.701	.917	.250	.848	.809	.688	.936	.000	.879	.583	.859	.880	.250	.897	.949

City of Madera
 N/S: Schnoor Street
 E/W: Avenue 16
 Weather: Clear

File Name : 21_MDA_Schnoor_Ave 16 PM
 Site Code : 00319628
 Start Date : 9/19/2019
 Page No : 2

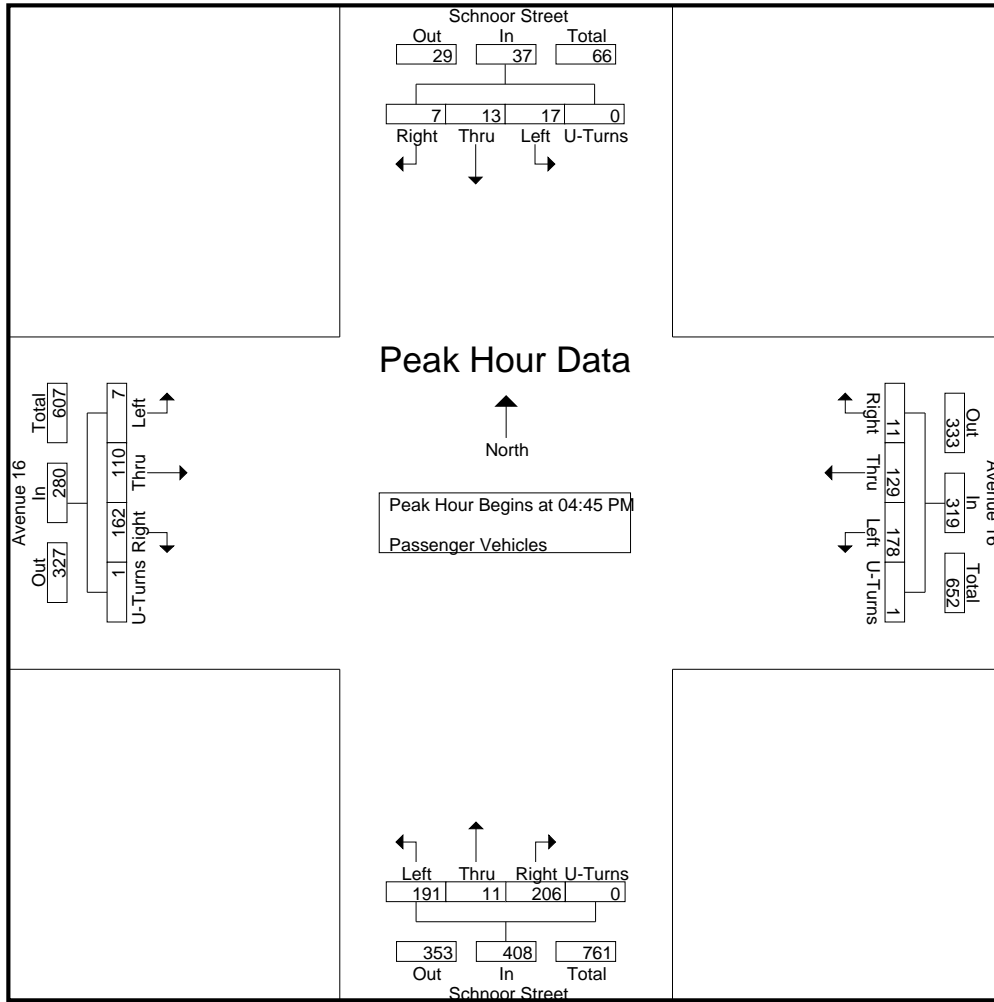

Peak Hour Analysis From 04:45 PM to 05:30 PM - Peak 1 of 1
 Peak Hour for Each Approach Begins at:

	04:45 PM					04:45 PM					04:45 PM					04:45 PM				
+0 mins.	2	1	3	0	6	36	28	3	0	67	34	4	50	0	88	3	30	45	0	78
+15 mins.	5	6	1	0	12	47	32	3	1	83	50	4	54	0	108	2	32	37	1	72
+30 mins.	8	6	2	0	16	49	23	3	0	75	48	1	47	0	96	2	28	46	0	76
+45 mins.	2	0	1	0	3	46	46	2	0	94	59	2	55	0	116	0	20	34	0	54
Total Volume	17	13	7	0	37	178	129	11	1	319	191	11	206	0	408	7	110	162	1	280
% App. Total	45.9	35.1	18.9	0		55.8	40.4	3.4	0.3		46.8	2.7	50.5	0		2.5	39.3	57.9	0.4	
PHF	.531	.542	.583	.000	.578	.908	.701	.917	.250	.848	.809	.688	.936	.000	.879	.583	.859	.880	.250	.897

City of Madera
 N/S: Schnoor Street
 E/W: Avenue 16
 Weather: Clear

File Name : 21_MDA_Schnoor_Ave 16 PM
 Site Code : 00319628
 Start Date : 9/19/2019
 Page No : 1

Groups Printed- Large 2 Axle Vehicles

Start Time	Schnoor Street Southbound					Avenue 16 Westbound					Schnoor Street Northbound					Avenue 16 Eastbound					Int. Total
	Left	Thru	Right	U-Turns	App. Total	Left	Thru	Right	U-Turns	App. Total	Left	Thru	Right	U-Turns	App. Total	Left	Thru	Right	U-Turns	App. Total	
04:00 PM	0	0	0	0	0	0	0	0	0	0	1	0	0	0	1	0	2	3	0	5	6
04:15 PM	0	0	0	0	0	0	1	0	0	1	1	0	2	0	3	0	0	1	0	1	5
04:30 PM	1	0	0	0	1	0	2	1	0	3	1	0	0	0	1	0	1	0	0	1	6
04:45 PM	1	0	0	0	1	0	1	0	0	1	0	0	0	0	0	0	0	0	0	0	2
Total	2	0	0	0	2	0	4	1	0	5	3	0	2	0	5	0	3	4	0	7	19
05:00 PM	1	1	1	0	3	0	0	2	0	2	0	2	0	0	2	0	1	0	0	1	8
05:15 PM	0	0	0	0	0	0	1	1	0	2	1	0	0	0	1	0	1	0	0	1	4
05:30 PM	0	0	0	0	0	0	0	0	0	0	0	0	0	0	0	1	0	1	0	2	2
05:45 PM	0	0	0	0	0	0	5	0	0	5	0	0	0	0	0	0	0	0	0	0	5
Total	1	1	1	0	3	0	6	3	0	9	1	2	0	0	3	1	2	1	0	4	19
Grand Total	3	1	1	0	5	0	10	4	0	14	4	2	2	0	8	1	5	5	0	11	38
Apprch %	60	20	20	0		0	71.4	28.6	0		50	25	25	0		9.1	45.5	45.5	0		
Total %	7.9	2.6	2.6	0	13.2	0	26.3	10.5	0	36.8	10.5	5.3	5.3	0	21.1	2.6	13.2	13.2	0	28.9	

Start Time	Schnoor Street Southbound					Avenue 16 Westbound					Schnoor Street Northbound					Avenue 16 Eastbound					Int. Total
	Left	Thru	Right	U-Turns	App. Total	Thru	Right	U-Turns	App. Total	Thru	Right	U-Turns	App. Total	Thru	Right	U-Turns	App. Total				
Peak Hour Analysis From 04:45 PM to 05:30 PM - Peak 1 of 1																					
Peak Hour for Entire Intersection Begins at 04:45 PM																					
04:45 PM	1	0	0	0	1	0	1	0	0	1	0	0	0	0	0	0	0	0	0	0	2
05:00 PM	1	1	1	0	3	0	0	2	0	2	0	2	0	0	2	0	1	0	0	1	8
05:15 PM	0	0	0	0	0	0	1	1	0	2	1	0	0	0	1	0	1	0	0	1	4
05:30 PM	0	0	0	0	0	0	0	0	0	0	0	0	0	0	0	1	0	1	0	2	2
Total Volume	2	1	1	0	4	0	2	3	0	5	1	2	0	0	3	1	2	1	0	4	16
% App. Total	50	25	25	0		0	40	60	0		33.3	66.7	0	0		25	50	25	0		
PHF	.500	.250	.250	.000	.333	.000	.500	.375	.000	.625	.250	.250	.000	.000	.375	.250	.500	.250	.000	.500	.500

City of Madera
 N/S: Schnoor Street
 E/W: Avenue 16
 Weather: Clear

File Name : 21_MDA_Schnoor_Ave 16 PM
 Site Code : 00319628
 Start Date : 9/19/2019
 Page No : 2

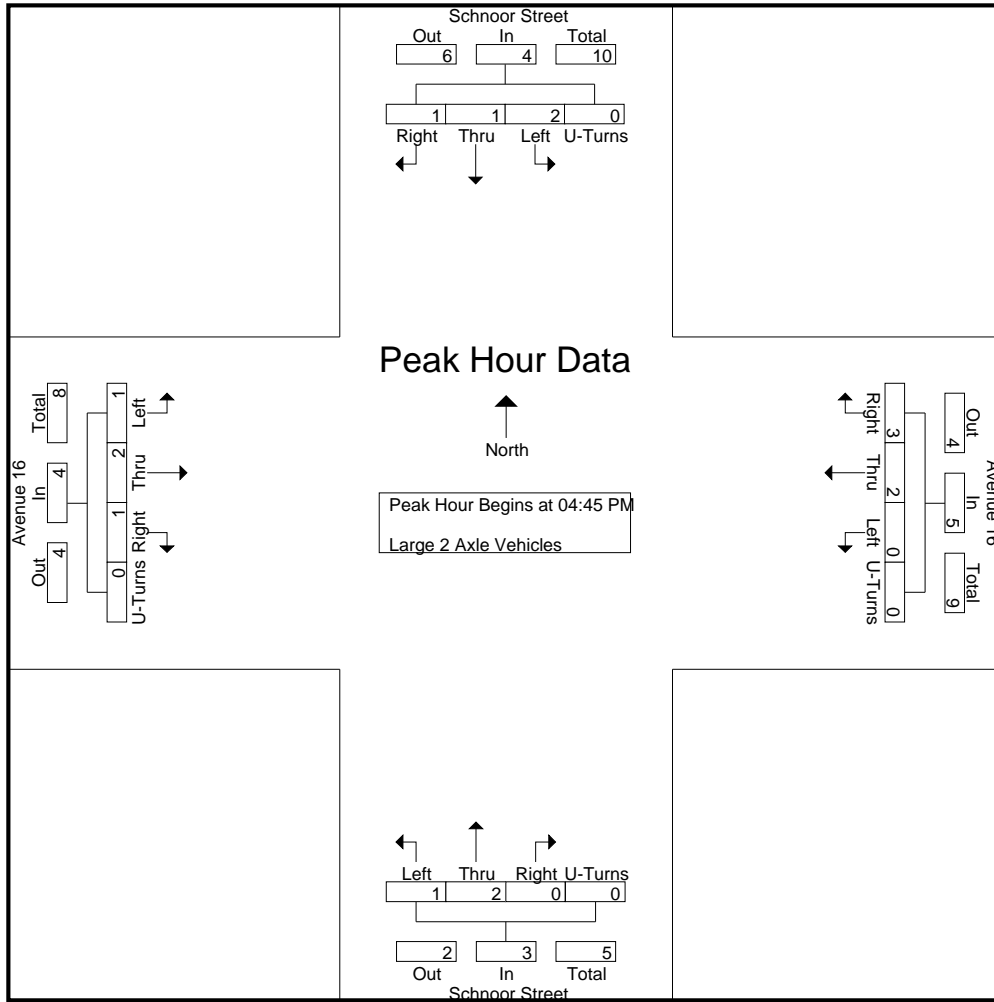

Peak Hour Analysis From 04:45 PM to 05:30 PM - Peak 1 of 1
 Peak Hour for Each Approach Begins at:

	04:45 PM					04:45 PM					04:45 PM					04:45 PM									
+0 mins.	1	0	0	0	1	0	1	0	0	1	0	0	0	0	0	0	0	0	0	0	0	0	0	0	0
+15 mins.	1	1	1	0	3	0	0	2	0	2	0	2	0	0	2	0	1	0	0	1	0	1	0	0	1
+30 mins.	0	0	0	0	0	0	1	1	0	2	1	0	0	0	1	0	1	0	0	1	0	1	0	0	1
+45 mins.	0	0	0	0	0	0	0	0	0	0	0	0	0	0	0	1	0	1	0	2	1	0	1	0	2
Total Volume	2	1	1	0	4	0	2	3	0	5	1	2	0	0	3	1	2	1	0	4	1	2	1	0	4
% App. Total	50	25	25	0		0	40	60	0		33.3	66.7	0	0		25	50	25	0		25	50	25	0	
PHF	.500	.250	.250	.000	.333	.000	.500	.375	.000	.625	.250	.250	.000	.000	.375	.250	.500	.250	.000	.500	.250	.500	.250	.000	.500

City of Madera
 N/S: Schnoor Street
 E/W: Avenue 16
 Weather: Clear

File Name : 21_MDA_Schnoor_Ave 16 PM
 Site Code : 00319628
 Start Date : 9/19/2019
 Page No : 1

Groups Printed- 3 Axle Vehicles

Start Time	Schnoor Street Southbound					Avenue 16 Westbound					Schnoor Street Northbound					Avenue 16 Eastbound					Int. Total
	Left	Thru	Right	U-Turns	App. Total	Left	Thru	Right	U-Turns	App. Total	Left	Thru	Right	U-Turns	App. Total	Left	Thru	Right	U-Turns	App. Total	
04:00 PM	0	0	0	0	0	0	0	0	0	0	0	0	0	0	0	0	0	0	0	0	0
04:15 PM	0	0	0	0	0	0	0	0	0	0	0	0	0	0	0	0	0	0	0	0	0
04:30 PM	0	0	0	0	0	0	0	1	0	0	0	0	0	0	0	0	0	0	0	0	1
04:45 PM	0	0	0	0	0	0	0	0	0	0	0	0	0	0	0	0	0	0	0	0	0
Total	0	0	0	0	0	0	1	0	0	1	0	0	0	0	0	0	0	0	0	0	1
05:00 PM	0	0	0	0	0	0	0	0	0	0	0	0	0	0	0	0	0	0	0	0	0
05:15 PM	0	0	0	0	0	0	0	0	0	0	0	0	0	0	0	0	0	0	0	0	0
05:30 PM	0	0	0	0	0	0	0	0	0	0	0	0	0	0	0	0	0	0	0	0	0
05:45 PM	0	0	0	0	0	0	0	0	0	0	0	0	0	0	0	0	0	0	0	0	0
Total	0	0	0	0	0	0	0	0	0	0	0	0	0	0	0	0	0	0	0	0	0
Grand Total	0	0	0	0	0	0	1	0	0	1	0	0	0	0	0	0	0	0	0	0	1
Apprch %	0	0	0	0		0	100	0	0		0	0	0	0		0	0	0	0		
Total %	0	0	0	0		0	100	0	0	100	0	0	0	0		0	0	0	0		

Start Time	Schnoor Street Southbound					Avenue 16 Westbound					Schnoor Street Northbound					Avenue 16 Eastbound					Int. Total
	Left	Thru	Right	U-Turns	App. Total	Left	Thru	Right	U-Turns	App. Total	Left	Thru	Right	U-Turns	App. Total	Left	Thru	Right	U-Turns	App. Total	
Peak Hour Analysis From 04:45 PM to 05:30 PM - Peak 1 of 1																					
Peak Hour for Entire Intersection Begins at 04:45 PM																					
04:45 PM	0	0	0	0	0	0	0	0	0	0	0	0	0	0	0	0	0	0	0	0	0
05:00 PM	0	0	0	0	0	0	0	0	0	0	0	0	0	0	0	0	0	0	0	0	0
05:15 PM	0	0	0	0	0	0	0	0	0	0	0	0	0	0	0	0	0	0	0	0	0
05:30 PM	0	0	0	0	0	0	0	0	0	0	0	0	0	0	0	0	0	0	0	0	0
Total Volume	0	0	0	0	0	0	0	0	0	0	0	0	0	0	0	0	0	0	0	0	0
% App. Total	0	0	0	0		0	0	0	0		0	0	0	0		0	0	0	0		
PHF	.000	.000	.000	.000	.000	.000	.000	.000	.000	.000	.000	.000	.000	.000	.000	.000	.000	.000	.000	.000	.000

City of Madera
 N/S: Schnoor Street
 E/W: Avenue 16
 Weather: Clear

File Name : 21_MDA_Schnoor_Ave 16 PM
 Site Code : 00319628
 Start Date : 9/19/2019
 Page No : 2

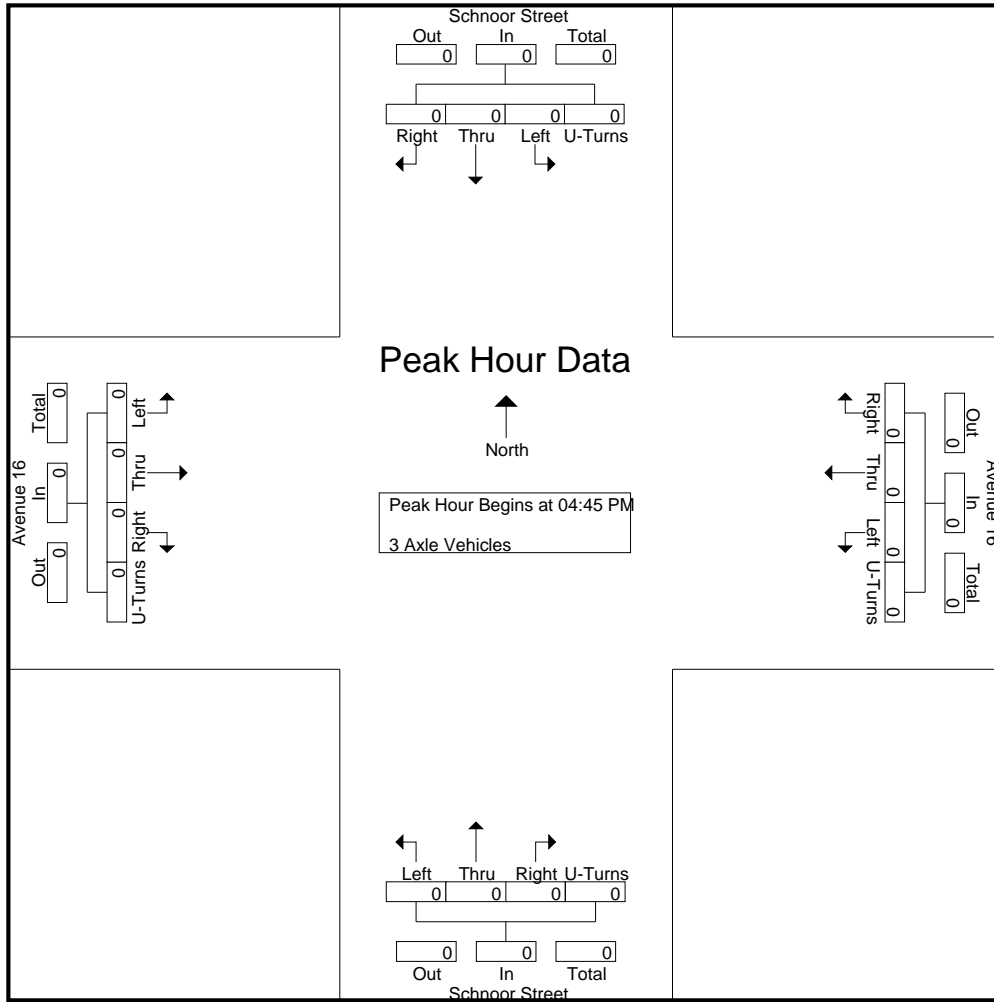

Peak Hour Analysis From 04:45 PM to 05:30 PM - Peak 1 of 1
 Peak Hour for Each Approach Begins at:

	04:45 PM					04:45 PM					04:45 PM					04:45 PM				
+0 mins.	0	0	0	0	0	0	0	0	0	0	0	0	0	0	0	0	0	0	0	0
+15 mins.	0	0	0	0	0	0	0	0	0	0	0	0	0	0	0	0	0	0	0	0
+30 mins.	0	0	0	0	0	0	0	0	0	0	0	0	0	0	0	0	0	0	0	0
+45 mins.	0	0	0	0	0	0	0	0	0	0	0	0	0	0	0	0	0	0	0	0
Total Volume	0	0	0	0	0	0	0	0	0	0	0	0	0	0	0	0	0	0	0	0
% App. Total	0	0	0	0	0	0	0	0	0	0	0	0	0	0	0	0	0	0	0	0
PHF	.000	.000	.000	.000	.000	.000	.000	.000	.000	.000	.000	.000	.000	.000	.000	.000	.000	.000	.000	.000

City of Madera
 N/S: Schnoor Street
 E/W: Avenue 16
 Weather: Clear

File Name : 21_MDA_Schnoor_Ave 16 PM
 Site Code : 00319628
 Start Date : 9/19/2019
 Page No : 1

Groups Printed- 4+ Axle Trucks

Start Time	Schnoor Street Southbound					Avenue 16 Westbound					Schnoor Street Northbound					Avenue 16 Eastbound					Int. Total
	Left	Thru	Right	U-Turns	App. Total	Left	Thru	Right	U-Turns	App. Total	Left	Thru	Right	U-Turns	App. Total	Left	Thru	Right	U-Turns	App. Total	
04:00 PM	0	0	0	0	0	0	1	1	0	2	0	0	0	0	0	0	1	0	0	1	3
04:15 PM	1	0	1	0	2	0	0	0	0	0	0	0	1	0	1	0	0	0	0	0	3
04:30 PM	0	0	0	0	0	0	0	1	0	1	0	0	0	0	0	0	1	0	0	1	2
04:45 PM	0	0	0	0	0	0	1	1	0	2	0	0	0	0	0	0	0	0	0	0	2
Total	1	0	1	0	2	0	2	3	0	5	0	0	1	0	1	0	2	0	0	2	10
05:00 PM	1	0	0	0	1	0	0	1	0	1	0	0	0	0	0	0	1	0	0	1	3
05:15 PM	1	0	0	0	1	0	0	1	0	1	0	0	0	0	0	0	0	0	0	0	2
05:30 PM	2	0	0	0	2	0	0	0	0	0	0	0	1	0	1	0	0	0	0	0	3
05:45 PM	0	0	0	0	0	0	0	0	0	0	0	0	0	0	0	0	0	0	0	0	0
Total	4	0	0	0	4	0	0	2	0	2	0	0	1	0	1	0	1	0	0	1	8
Grand Total	5	0	1	0	6	0	2	5	0	7	0	0	2	0	2	0	3	0	0	3	18
Apprch %	83.3	0	16.7	0		0	28.6	71.4	0		0	0	100	0		0	100	0	0		
Total %	27.8	0	5.6	0	33.3	0	11.1	27.8	0	38.9	0	0	11.1	0	11.1	0	16.7	0	0	16.7	

Start Time	Schnoor Street Southbound					Avenue 16 Westbound					Schnoor Street Northbound					Avenue 16 Eastbound					Int. Total
	Left	Thru	Right	U-Turns	App. Total	Thru	Right	U-Turns	App. Total	Thru	Right	U-Turns	App. Total	Thru	Right	U-Turns	App. Total				
Peak Hour Analysis From 04:45 PM to 05:30 PM - Peak 1 of 1																					
Peak Hour for Entire Intersection Begins at 04:45 PM																					
04:45 PM	0	0	0	0	0	0	1	1	0	2	0	0	0	0	0	0	0	0	0	0	2
05:00 PM	1	0	0	0	1	0	0	1	0	1	0	0	0	0	0	0	1	0	0	1	3
05:15 PM	1	0	0	0	1	0	0	1	0	1	0	0	0	0	0	0	0	0	0	0	2
05:30 PM	2	0	0	0	2	0	0	0	0	0	0	0	1	0	1	0	0	0	0	0	3
Total Volume	4	0	0	0	4	0	1	3	0	4	0	0	1	0	1	0	1	0	0	1	10
% App. Total	100	0	0	0		0	25	75	0		0	0	100	0		0	100	0	0		
PHF	.500	.000	.000	.000	.500	.000	.250	.750	.000	.500	.000	.000	.250	.000	.250	.000	.250	.000	.000	.250	.833

City of Madera
 N/S: Schnoor Street
 E/W: Avenue 16
 Weather: Clear

File Name : 21_MDA_Schnoor_Ave 16 PM
 Site Code : 00319628
 Start Date : 9/19/2019
 Page No : 2

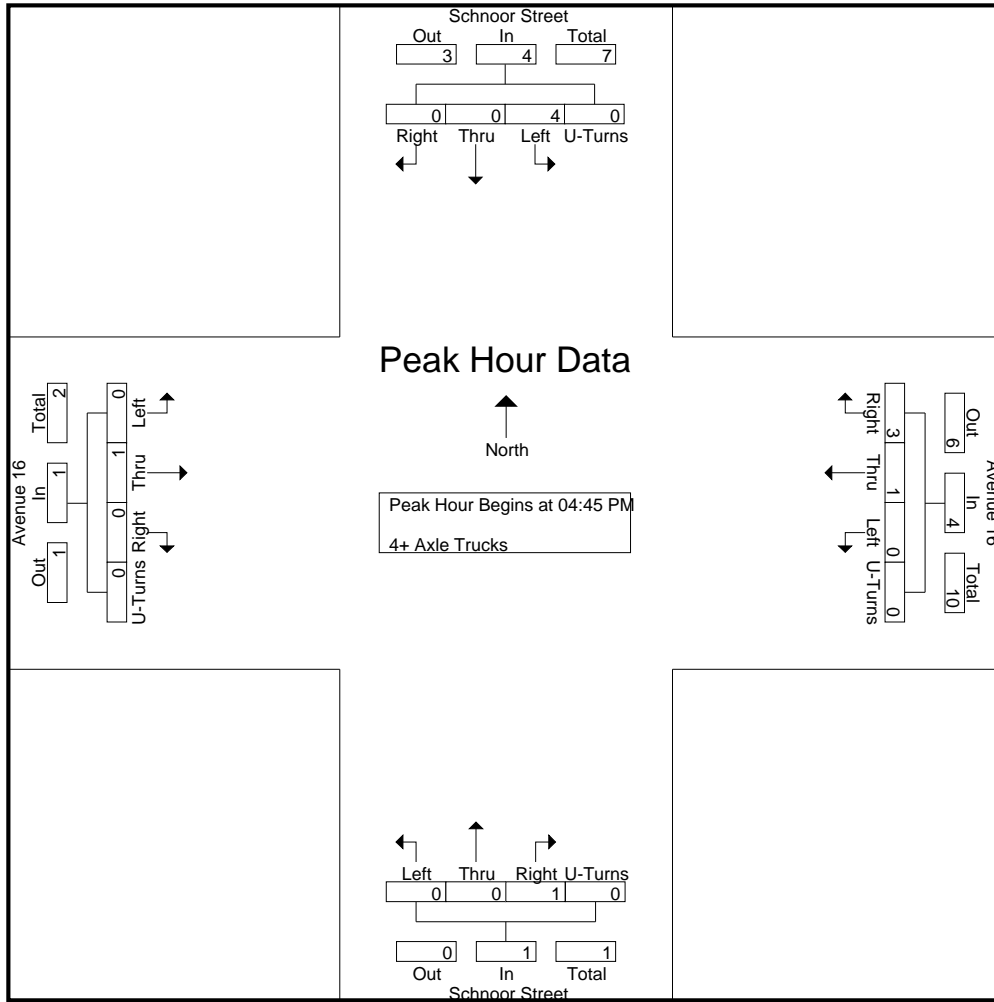

Peak Hour Analysis From 04:45 PM to 05:30 PM - Peak 1 of 1
 Peak Hour for Each Approach Begins at:

	04:45 PM					04:45 PM					04:45 PM					04:45 PM				
+0 mins.	0	0	0	0	0	0	1	1	0	2	0	0	0	0	0	0	0	0	0	0
+15 mins.	1	0	0	0	1	0	0	1	0	1	0	0	0	0	0	0	1	0	0	1
+30 mins.	1	0	0	0	1	0	0	1	0	1	0	0	0	0	0	0	0	0	0	0
+45 mins.	2	0	0	0	2	0	0	0	0	0	0	0	1	0	1	0	0	0	0	0
Total Volume	4	0	0	0	4	0	1	3	0	4	0	0	1	0	1	0	1	0	0	1
% App. Total	100	0	0	0	0	0	25	75	0	0	0	0	100	0	0	0	100	0	0	0
PHF	.500	.000	.000	.000	.500	.000	.250	.750	.000	.500	.000	.000	.250	.000	.250	.000	.250	.000	.000	.250

Location: Madera
 N/S: Schnoor Street
 E/W: Avenue 16



Date: 9/19/2019
 Day: Thursday

PEDESTRIANS

	North Leg Schnoor Street	East Leg Avenue 16	South Leg Schnoor Street	West Leg Avenue 16	
	Pedestrians	Pedestrians	Pedestrians	Pedestrians	
7:00 AM	0	0	0	0	0
7:15 AM	0	0	0	0	0
7:30 AM	0	0	0	0	0
7:45 AM	0	0	0	0	0
8:00 AM	0	2	0	0	2
8:15 AM	0	2	1	0	3
8:30 AM	0	0	0	0	0
8:45 AM	0	0	0	0	0
TOTAL VOLUMES:	0	4	1	0	5

	North Leg Schnoor Street	East Leg Avenue 16	South Leg Schnoor Street	West Leg Avenue 16	
	Pedestrians	Pedestrians	Pedestrians	Pedestrians	
4:00 PM	0	2	0	0	2
4:15 PM	0	1	0	0	1
4:30 PM	0	0	2	0	2
4:45 PM	0	0	4	0	4
5:00 PM	0	0	0	0	0
5:15 PM	0	0	0	0	0
5:30 PM	0	1	1	0	2
5:45 PM	1	0	0	0	1
TOTAL VOLUMES:	1	4	7	0	12

Location: Madera
 N/S: Schnoor Street
 E/W: Avenue 16



Date: 9/19/2019
 Day: Thursday

BICYCLES

	Southbound Schnoor Street			Westbound Avenue 16			Northbound Schnoor Street			Eastbound Avenue 16			
	Left	Thru	Right	Left	Thru	Right	Left	Thru	Right	Left	Thru	Right	
7:00 AM	0	0	0	0	0	0	0	0	0	0	0	0	0
7:15 AM	0	0	0	0	1	0	0	0	0	0	0	0	1
7:30 AM	0	0	0	0	0	0	0	0	0	0	0	0	0
7:45 AM	0	0	0	0	0	0	0	0	0	0	0	0	0
8:00 AM	0	0	0	0	0	0	0	0	0	0	0	0	0
8:15 AM	0	0	0	0	0	0	0	0	0	0	0	0	0
8:30 AM	0	0	0	0	0	0	0	0	0	0	0	0	0
8:45 AM	0	0	0	0	0	0	0	0	0	0	0	0	0
TOTAL VOLUMES:	0	0	0	0	1	0	0	0	0	0	0	0	1

	Southbound Schnoor Street			Westbound Avenue 16			Northbound Schnoor Street			Eastbound Avenue 16			
	Left	Thru	Right	Left	Thru	Right	Left	Thru	Right	Left	Thru	Right	
4:00 PM	0	0	0	0	0	0	0	0	0	0	0	0	0
4:15 PM	0	0	0	0	0	0	0	0	0	0	0	0	0
4:30 PM	0	0	0	0	0	0	0	0	0	0	0	0	0
4:45 PM	0	0	0	0	0	0	0	0	0	0	0	0	0
5:00 PM	0	0	0	0	0	0	0	0	0	0	0	0	0
5:15 PM	0	0	0	0	0	0	0	0	0	0	0	0	0
5:30 PM	0	0	0	0	0	0	0	0	0	0	0	0	0
5:45 PM	0	0	0	0	0	0	0	0	0	0	0	0	0
TOTAL VOLUMES:	0	0	0	0	0	0	0	0	0	0	0	0	0

City of Madera
 N/S: SR-99 Southbound Ramps
 E/W: Avenue 16/Gateway Drive
 Weather: Clear

File Name : 22_MDA_99S_Gateway AM
 Site Code : 00319628
 Start Date : 9/19/2019
 Page No : 1

Groups Printed- Passenger Vehicles - Large 2 Axle Vehicles - 3 Axle Vehicles - 4+ Axle Trucks

Start Time	SR-99 Southbound Ramps Southbound				Gateway Drive Westbound				Avenue 16 Eastbound				Int. Total
	Left	Right	U-Turns	App. Total	Thru	Right	U-Turns	App. Total	Left	Thru	U-Turns	App. Total	
07:00 AM	12	21	0	33	36	0	0	36	38	42	0	80	149
07:15 AM	8	20	0	28	35	1	0	36	50	38	0	88	152
07:30 AM	15	15	0	30	43	0	0	43	40	77	0	117	190
07:45 AM	26	39	0	65	50	1	0	51	49	55	0	104	220
Total	61	95	0	156	164	2	0	166	177	212	0	389	711
08:00 AM	13	30	0	43	41	0	0	41	54	46	0	100	184
08:15 AM	10	19	0	29	38	0	0	38	44	49	0	93	160
08:30 AM	10	24	0	34	39	1	0	40	32	43	0	75	149
08:45 AM	15	29	2	46	57	0	0	57	20	47	0	67	170
Total	48	102	2	152	175	1	0	176	150	185	0	335	663
Grand Total	109	197	2	308	339	3	0	342	327	397	0	724	1374
Apprch %	35.4	64	0.6		99.1	0.9	0		45.2	54.8	0		
Total %	7.9	14.3	0.1	22.4	24.7	0.2	0	24.9	23.8	28.9	0	52.7	
Passenger Vehicles	105	190	2	297	321	3	0	324	311	381	0	692	1313
% Passenger Vehicles	96.3	96.4	100	96.4	94.7	100	0	94.7	95.1	96	0	95.6	95.6
Large 2 Axle Vehicles	1	5	0	6	11	0	0	11	6	10	0	16	33
% Large 2 Axle Vehicles	0.9	2.5	0	1.9	3.2	0	0	3.2	1.8	2.5	0	2.2	2.4
3 Axle Vehicles	1	0	0	1	2	0	0	2	3	1	0	4	7
% 3 Axle Vehicles	0.9	0	0	0.3	0.6	0	0	0.6	0.9	0.3	0	0.6	0.5
4+ Axle Trucks	2	2	0	4	5	0	0	5	7	5	0	12	21
% 4+ Axle Trucks	1.8	1	0	1.3	1.5	0	0	1.5	2.1	1.3	0	1.7	1.5

Start Time	SR-99 Southbound Ramps Southbound				Gateway Drive Westbound				Avenue 16 Eastbound				Int. Total
	Left	Right	U-Turns	App. Total	Thru	Right	U-Turns	App. Total	Left	Thru	U-Turns	App. Total	
Peak Hour Analysis From 07:00 AM to 08:45 AM - Peak 1 of 1													
Peak Hour for Entire Intersection Begins at 07:30 AM													
07:30 AM	15	15	0	30	43	0	0	43	40	77	0	117	190
07:45 AM	26	39	0	65	50	1	0	51	49	55	0	104	220
08:00 AM	13	30	0	43	41	0	0	41	54	46	0	100	184
08:15 AM	10	19	0	29	38	0	0	38	44	49	0	93	160
Total Volume	64	103	0	167	172	1	0	173	187	227	0	414	754
% App. Total	38.3	61.7	0		99.4	0.6	0		45.2	54.8	0		
PHF	.615	.660	.000	.642	.860	.250	.000	.848	.866	.737	.000	.885	.857

City of Madera
 N/S: SR-99 Southbound Ramps
 E/W: Avenue 16/Gateway Drive
 Weather: Clear

File Name : 22_MDA_99S_Gateway AM
 Site Code : 00319628
 Start Date : 9/19/2019
 Page No : 2

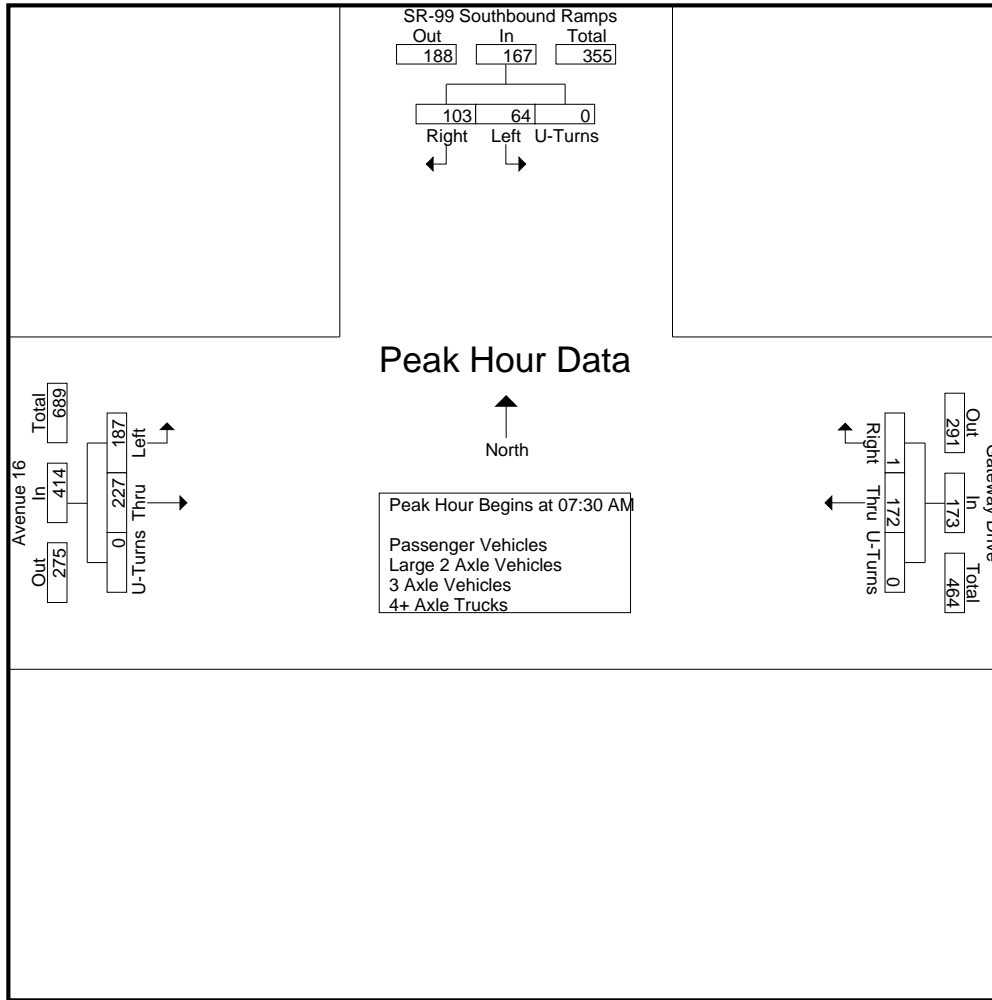

Peak Hour Analysis From 07:00 AM to 08:45 AM - Peak 1 of 1
 Peak Hour for Each Approach Begins at:

	07:45 AM				08:00 AM				07:30 AM			
+0 mins.	26	39	0	65	41	0	0	41	40	77	0	117
+15 mins.	13	30	0	43	38	0	0	38	49	55	0	104
+30 mins.	10	19	0	29	39	1	0	40	54	46	0	100
+45 mins.	10	24	0	34	57	0	0	57	44	49	0	93
Total Volume	59	112	0	171	175	1	0	176	187	227	0	414
% App. Total	34.5	65.5	0		99.4	0.6	0		45.2	54.8	0	
PHF	.567	.718	.000	.658	.768	.250	.000	.772	.866	.737	.000	.885

City of Madera
 N/S: SR-99 Southbound Ramps
 E/W: Avenue 16/Gateway Drive
 Weather: Clear

File Name : 22_MDA_99S_Gateway AM
 Site Code : 00319628
 Start Date : 9/19/2019
 Page No : 1

Groups Printed- Passenger Vehicles

Start Time	SR-99 Southbound Ramps Southbound				Gateway Drive Westbound				Avenue 16 Eastbound				Int. Total
	Left	Right	U-Turns	App. Total	Thru	Right	U-Turns	App. Total	Left	Thru	U-Turns	App. Total	
07:00 AM	11	21	0	32	33	0	0	33	32	38	0	70	135
07:15 AM	8	19	0	27	33	1	0	34	48	35	0	83	144
07:30 AM	15	15	0	30	39	0	0	39	38	76	0	114	183
07:45 AM	26	37	0	63	48	1	0	49	47	55	0	102	214
Total	60	92	0	152	153	2	0	155	165	204	0	369	676
08:00 AM	12	29	0	41	39	0	0	39	54	44	0	98	178
08:15 AM	9	17	0	26	35	0	0	35	43	47	0	90	151
08:30 AM	9	24	0	33	38	1	0	39	31	41	0	72	144
08:45 AM	15	28	2	45	56	0	0	56	18	45	0	63	164
Total	45	98	2	145	168	1	0	169	146	177	0	323	637
Grand Total	105	190	2	297	321	3	0	324	311	381	0	692	1313
Apprch %	35.4	64	0.7		99.1	0.9	0		44.9	55.1	0		
Total %	8	14.5	0.2	22.6	24.4	0.2	0	24.7	23.7	29	0	52.7	

Start Time	SR-99 Southbound Ramps Southbound				Gateway Drive Westbound				Avenue 16 Eastbound				Int. Total
	Left	Right	U-Turns	App. Total	Thru	Right	U-Turns	App. Total	Left	Thru	U-Turns	App. Total	
Peak Hour Analysis From 07:30 AM to 08:15 AM - Peak 1 of 1													
Peak Hour for Entire Intersection Begins at 07:30 AM													
07:30 AM	15	15	0	30	39	0	0	39	38	76	0	114	183
07:45 AM	26	37	0	63	48	1	0	49	47	55	0	102	214
08:00 AM	12	29	0	41	39	0	0	39	54	44	0	98	178
08:15 AM	9	17	0	26	35	0	0	35	43	47	0	90	151
Total Volume	62	98	0	160	161	1	0	162	182	222	0	404	726
% App. Total	38.8	61.2	0		99.4	0.6	0		45	55	0		
PHF	.596	.662	.000	.635	.839	.250	.000	.827	.843	.730	.000	.886	.848

City of Madera
 N/S: SR-99 Southbound Ramps
 E/W: Avenue 16/Gateway Drive
 Weather: Clear

File Name : 22_MDA_99S_Gateway AM
 Site Code : 00319628
 Start Date : 9/19/2019
 Page No : 2

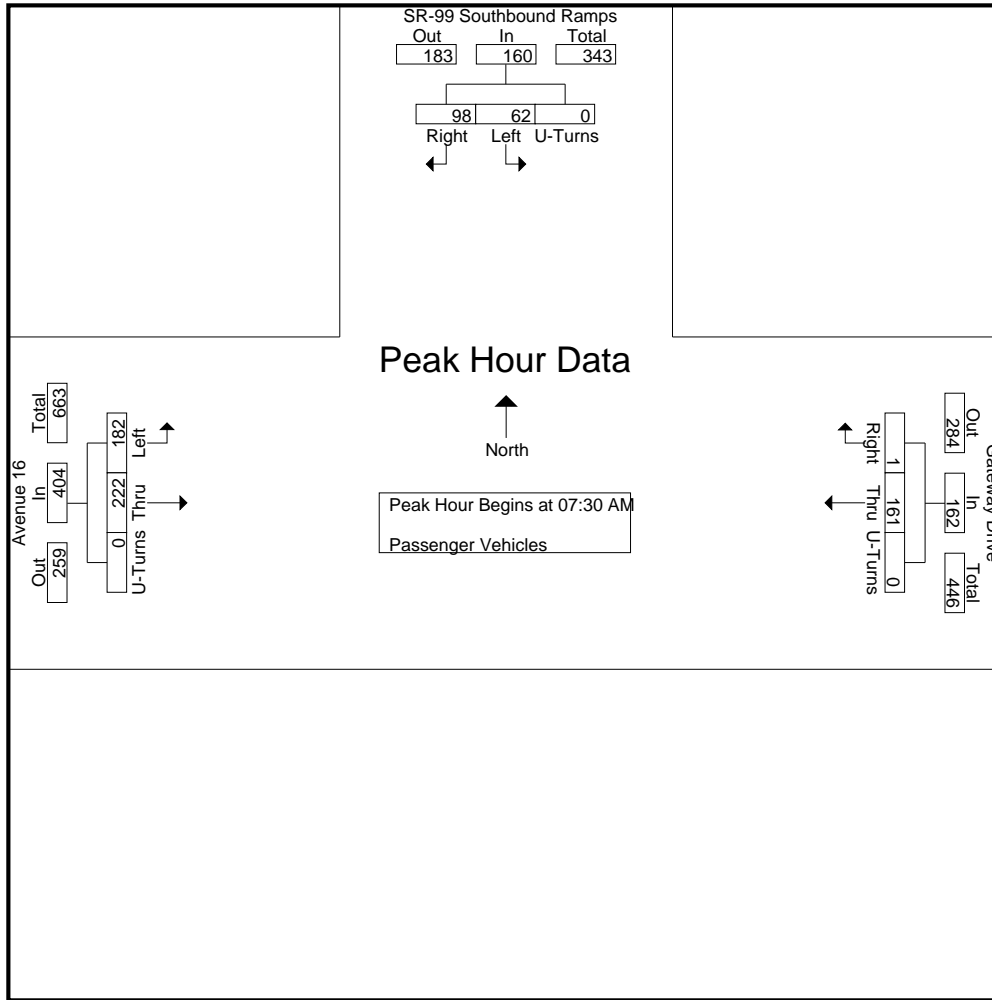

Peak Hour Analysis From 07:30 AM to 08:15 AM - Peak 1 of 1
 Peak Hour for Each Approach Begins at:

	07:30 AM				07:30 AM				07:30 AM			
+0 mins.	15	15	0	30	39	0	0	39	38	76	0	114
+15 mins.	26	37	0	63	48	1	0	49	47	55	0	102
+30 mins.	12	29	0	41	39	0	0	39	54	44	0	98
+45 mins.	9	17	0	26	35	0	0	35	43	47	0	90
Total Volume	62	98	0	160	161	1	0	162	182	222	0	404
% App. Total	38.8	61.2	0		99.4	0.6	0		45	55	0	
PHF	.596	.662	.000	.635	.839	.250	.000	.827	.843	.730	.000	.886

City of Madera
 N/S: SR-99 Southbound Ramps
 E/W: Avenue 16/Gateway Drive
 Weather: Clear

File Name : 22_MDA_99S_Gateway AM
 Site Code : 00319628
 Start Date : 9/19/2019
 Page No : 1

Groups Printed- Large 2 Axle Vehicles

Start Time	SR-99 Southbound Ramps Southbound				Gateway Drive Westbound				Avenue 16 Eastbound				Int. Total
	Left	Right	U-Turns	App. Total	Thru	Right	U-Turns	App. Total	Left	Thru	U-Turns	App. Total	
07:00 AM	0	0	0	0	3	0	0	3	3	2	0	5	8
07:15 AM	0	1	0	1	2	0	0	2	1	1	0	2	5
07:30 AM	0	0	0	0	2	0	0	2	1	0	0	1	3
07:45 AM	0	1	0	1	2	0	0	2	0	0	0	0	3
Total	0	2	0	2	9	0	0	9	5	3	0	8	19
08:00 AM	0	1	0	1	2	0	0	2	0	1	0	1	4
08:15 AM	1	1	0	2	0	0	0	0	0	2	0	2	4
08:30 AM	0	0	0	0	0	0	0	0	0	2	0	2	2
08:45 AM	0	1	0	1	0	0	0	0	1	2	0	3	4
Total	1	3	0	4	2	0	0	2	1	7	0	8	14
Grand Total	1	5	0	6	11	0	0	11	6	10	0	16	33
Apprch %	16.7	83.3	0		100	0	0		37.5	62.5	0		
Total %	3	15.2	0	18.2	33.3	0	0	33.3	18.2	30.3	0	48.5	

Start Time	SR-99 Southbound Ramps Southbound				Gateway Drive Westbound				Avenue 16 Eastbound				Int. Total
	Left	Right	U-Turns	App. Total	Thru	Right	U-Turns	App. Total	Left	Thru	U-Turns	App. Total	
07:30 AM	0	0	0	0	2	0	0	2	1	0	0	1	3
07:45 AM	0	1	0	1	2	0	0	2	0	0	0	0	3
08:00 AM	0	1	0	1	2	0	0	2	0	1	0	1	4
08:15 AM	1	1	0	2	0	0	0	0	0	2	0	2	4
Total Volume	1	3	0	4	6	0	0	6	1	3	0	4	14
% App. Total	25	75	0		100	0	0		25	75	0		
PHF	.250	.750	.000	.500	.750	.000	.000	.750	.250	.375	.000	.500	.875

Peak Hour Analysis From 07:30 AM to 08:15 AM - Peak 1 of 1

Peak Hour for Entire Intersection Begins at 07:30 AM

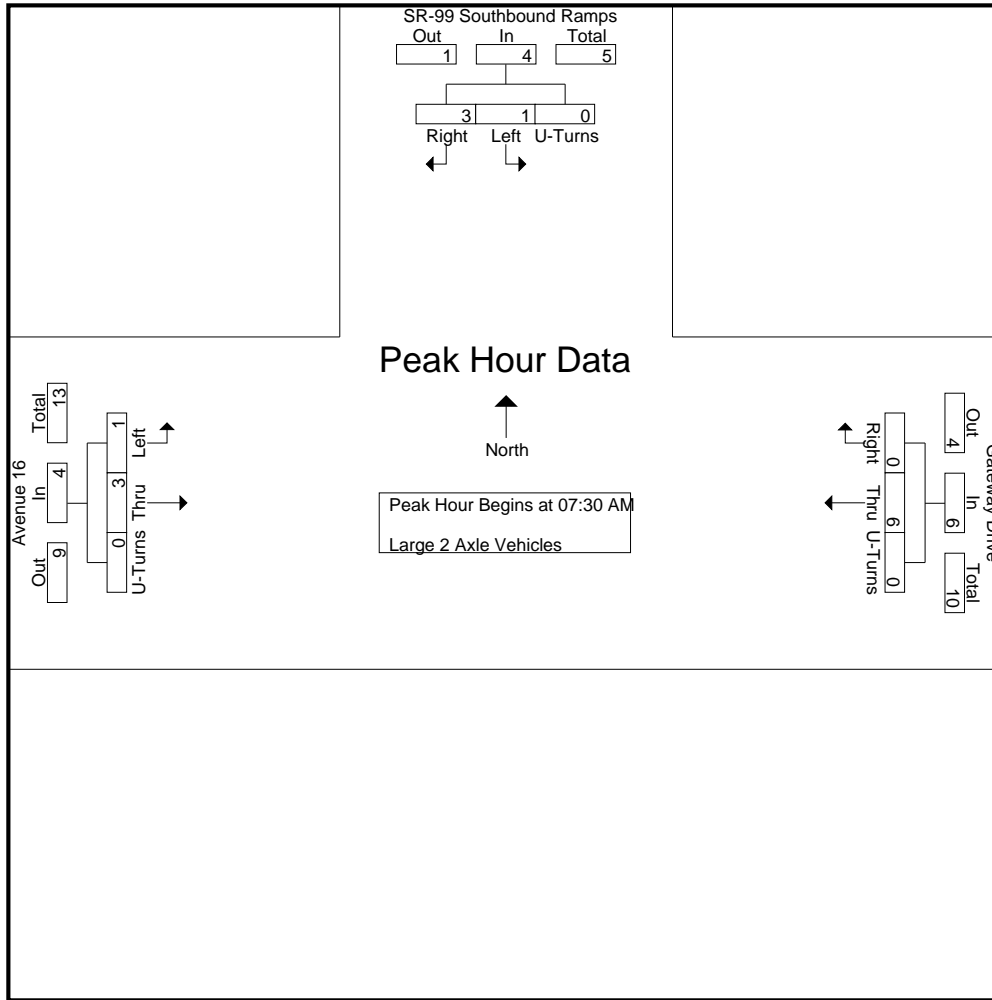

Peak Hour Analysis From 07:30 AM to 08:15 AM - Peak 1 of 1

Peak Hour for Each Approach Begins at:

	07:30 AM				07:30 AM				07:30 AM			
+0 mins.	0	0	0	0	2	0	0	2	1	0	0	1
+15 mins.	0	1	0	1	2	0	0	2	0	0	0	0
+30 mins.	0	1	0	1	2	0	0	2	0	1	0	1
+45 mins.	1	1	0	2	0	0	0	0	0	2	0	2
Total Volume	1	3	0	4	6	0	0	6	1	3	0	4
% App. Total	25	75	0		100	0	0		25	75	0	
PHF	.250	.750	.000	.500	.750	.000	.000	.750	.250	.375	.000	.500

City of Madera
 N/S: SR-99 Southbound Ramps
 E/W: Avenue 16/Gateway Drive
 Weather: Clear

File Name : 22_MDA_99S_Gateway AM
 Site Code : 00319628
 Start Date : 9/19/2019
 Page No : 1

Groups Printed- 3 Axle Vehicles

Start Time	SR-99 Southbound Ramps Southbound				Gateway Drive Westbound				Avenue 16 Eastbound				Int. Total
	Left	Right	U-Turns	App. Total	Thru	Right	U-Turns	App. Total	Left	Thru	U-Turns	App. Total	
07:00 AM	0	0	0	0	0	0	0	0	2	0	0	2	2
07:15 AM	0	0	0	0	0	0	0	0	1	0	0	1	1
07:30 AM	0	0	0	0	1	0	0	1	0	1	0	1	2
07:45 AM	0	0	0	0	0	0	0	0	0	0	0	0	0
Total	0	0	0	0	1	0	0	1	3	1	0	4	5
08:00 AM	1	0	0	1	0	0	0	0	0	0	0	0	1
08:15 AM	0	0	0	0	1	0	0	1	0	0	0	0	1
08:30 AM	0	0	0	0	0	0	0	0	0	0	0	0	0
08:45 AM	0	0	0	0	0	0	0	0	0	0	0	0	0
Total	1	0	0	1	1	0	0	1	0	0	0	0	2
Grand Total	1	0	0	1	2	0	0	2	3	1	0	4	7
Apprch %	100	0	0		100	0	0		75	25	0		
Total %	14.3	0	0	14.3	28.6	0	0	28.6	42.9	14.3	0	57.1	

Start Time	SR-99 Southbound Ramps Southbound				Gateway Drive Westbound				Avenue 16 Eastbound				Int. Total
	Left	Right	U-Turns	App. Total	Thru	Right	U-Turns	App. Total	Left	Thru	U-Turns	App. Total	
07:30 AM	0	0	0	0	1	0	0	1	0	1	0	1	2
07:45 AM	0	0	0	0	0	0	0	0	0	0	0	0	0
08:00 AM	1	0	0	1	0	0	0	0	0	0	0	0	1
08:15 AM	0	0	0	0	1	0	0	1	0	0	0	0	1
Total Volume	1	0	0	1	2	0	0	2	0	1	0	1	4
% App. Total	100	0	0		100	0	0		0	100	0		
PHF	.250	.000	.000	.250	.500	.000	.000	.500	.000	.250	.000	.250	.500

Peak Hour Analysis From 07:30 AM to 08:15 AM - Peak 1 of 1

Peak Hour for Entire Intersection Begins at 07:30 AM

City of Madera
 N/S: SR-99 Southbound Ramps
 E/W: Avenue 16/Gateway Drive
 Weather: Clear

File Name : 22_MDA_99S_Gateway AM
 Site Code : 00319628
 Start Date : 9/19/2019
 Page No : 2

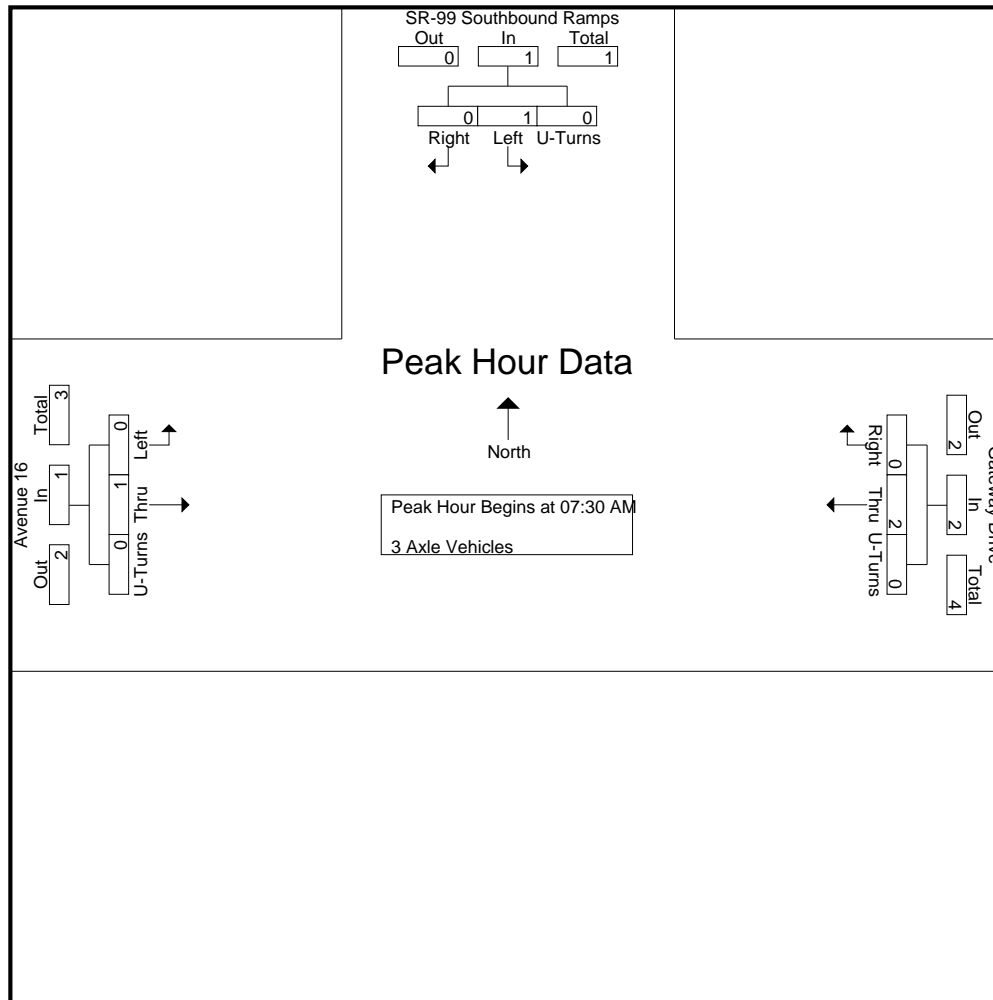

Peak Hour Analysis From 07:30 AM to 08:15 AM - Peak 1 of 1
 Peak Hour for Each Approach Begins at:

	07:30 AM				07:30 AM				07:30 AM			
+0 mins.	0	0	0	0	1	0	0	1	0	1	0	1
+15 mins.	0	0	0	0	0	0	0	0	0	0	0	0
+30 mins.	1	0	0	1	0	0	0	0	0	0	0	0
+45 mins.	0	0	0	0	1	0	0	1	0	0	0	0
Total Volume	1	0	0	1	2	0	0	2	0	1	0	1
% App. Total	100	0	0	0	100	0	0	0	0	100	0	0
PHF	.250	.000	.000	.250	.500	.000	.000	.500	.000	.250	.000	.250

City of Madera
 N/S: SR-99 Southbound Ramps
 E/W: Avenue 16/Gateway Drive
 Weather: Clear

File Name : 22_MDA_99S_Gateway AM
 Site Code : 00319628
 Start Date : 9/19/2019
 Page No : 1

Groups Printed- 4+ Axle Trucks

Start Time	SR-99 Southbound Ramps Southbound				Gateway Drive Westbound				Avenue 16 Eastbound				Int. Total
	Left	Right	U-Turns	App. Total	Thru	Right	U-Turns	App. Total	Left	Thru	U-Turns	App. Total	
07:00 AM	1	0	0	1	0	0	0	0	1	2	0	3	4
07:15 AM	0	0	0	0	0	0	0	0	0	2	0	2	2
07:30 AM	0	0	0	0	1	0	0	1	1	0	0	1	2
07:45 AM	0	1	0	1	0	0	0	0	2	0	0	2	3
Total	1	1	0	2	1	0	0	1	4	4	0	8	11
08:00 AM	0	0	0	0	0	0	0	0	0	1	0	1	1
08:15 AM	0	1	0	1	2	0	0	2	1	0	0	1	4
08:30 AM	1	0	0	1	1	0	0	1	1	0	0	1	3
08:45 AM	0	0	0	0	1	0	0	1	1	0	0	1	2
Total	1	1	0	2	4	0	0	4	3	1	0	4	10
Grand Total	2	2	0	4	5	0	0	5	7	5	0	12	21
Apprch %	50	50	0		100	0	0		58.3	41.7	0		
Total %	9.5	9.5	0	19	23.8	0	0	23.8	33.3	23.8	0	57.1	

Start Time	SR-99 Southbound Ramps Southbound				Gateway Drive Westbound				Avenue 16 Eastbound				Int. Total
	Left	Right	U-Turns	App. Total	Thru	Right	U-Turns	App. Total	Left	Thru	U-Turns	App. Total	
07:30 AM	0	0	0	0	1	0	0	1	1	0	0	1	2
07:45 AM	0	1	0	1	0	0	0	0	2	0	0	2	3
08:00 AM	0	0	0	0	0	0	0	0	0	1	0	1	1
08:15 AM	0	1	0	1	2	0	0	2	1	0	0	1	4
Total Volume	0	2	0	2	3	0	0	3	4	1	0	5	10
% App. Total	0	100	0		100	0	0		80	20	0		
PHF	.000	.500	.000	.500	.375	.000	.000	.375	.500	.250	.000	.625	.625

Peak Hour Analysis From 07:30 AM to 08:15 AM - Peak 1 of 1

Peak Hour for Entire Intersection Begins at 07:30 AM

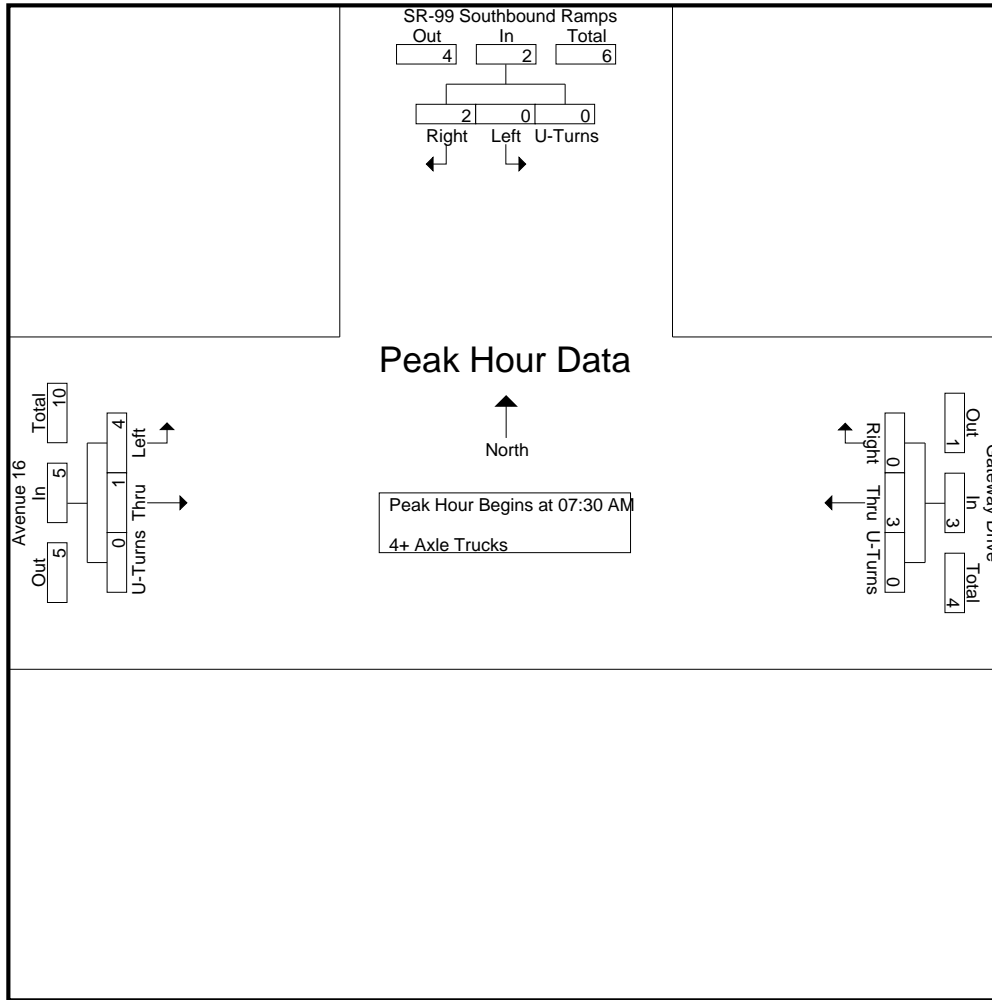

Peak Hour Analysis From 07:30 AM to 08:15 AM - Peak 1 of 1

Peak Hour for Each Approach Begins at:

	07:30 AM				07:30 AM				07:30 AM			
+0 mins.	0	0	0	0	1	0	0	1	1	0	0	1
+15 mins.	0	1	0	1	0	0	0	0	2	0	0	2
+30 mins.	0	0	0	0	0	0	0	0	0	1	0	1
+45 mins.	0	1	0	1	2	0	0	2	1	0	0	1
Total Volume	0	2	0	2	3	0	0	3	4	1	0	5
% App. Total	0	100	0	0	100	0	0	0	80	20	0	0
PHF	.000	.500	.000	.500	.375	.000	.000	.375	.500	.250	.000	.625

City of Madera
 N/S: SR-99 Southbound Ramps
 E/W: Avenue 16/Gateway Drive
 Weather: Clear

File Name : 22_MDA_99S_Gateway PM
 Site Code : 00319628
 Start Date : 9/19/2019
 Page No : 1

Groups Printed- Passenger Vehicles - Large 2 Axle Vehicles - 3 Axle Vehicles - 4+ Axle Trucks

Start Time	SR-99 Southbound Ramps Southbound				Gateway Drive Westbound				Avenue 16 Eastbound				Int. Total
	Left	Right	U-Turns	App. Total	Thru	Right	U-Turns	App. Total	Left	Thru	U-Turns	App. Total	
04:00 PM	16	41	0	57	51	2	0	53	28	68	0	96	206
04:15 PM	35	34	0	69	49	1	0	50	15	65	0	80	199
04:30 PM	29	38	0	67	56	0	0	56	30	63	0	93	216
04:45 PM	33	48	0	81	67	1	0	68	18	69	0	87	236
Total	113	161	0	274	223	4	0	227	91	265	0	356	857
05:00 PM	31	46	0	77	77	0	0	77	25	94	0	119	273
05:15 PM	25	26	0	51	61	0	0	61	29	62	0	91	203
05:30 PM	16	34	1	51	56	1	0	57	24	48	0	72	180
05:45 PM	13	33	0	46	40	1	0	41	21	52	0	73	160
Total	85	139	1	225	234	2	0	236	99	256	0	355	816
Grand Total	198	300	1	499	457	6	0	463	190	521	0	711	1673
Apprch %	39.7	60.1	0.2		98.7	1.3	0		26.7	73.3	0		
Total %	11.8	17.9	0.1	29.8	27.3	0.4	0	27.7	11.4	31.1	0	42.5	
Passenger Vehicles	190	289	0	479	446	5	0	451	178	513	0	691	1621
% Passenger Vehicles	96	96.3	0	96	97.6	83.3	0	97.4	93.7	98.5	0	97.2	96.9
Large 2 Axle Vehicles	2	5	1	8	2	1	0	3	5	4	0	9	20
% Large 2 Axle Vehicles	1	1.7	100	1.6	0.4	16.7	0	0.6	2.6	0.8	0	1.3	1.2
3 Axle Vehicles	0	1	0	1	2	0	0	2	3	0	0	3	6
% 3 Axle Vehicles	0	0.3	0	0.2	0.4	0	0	0.4	1.6	0	0	0.4	0.4
4+ Axle Trucks	6	5	0	11	7	0	0	7	4	4	0	8	26
% 4+ Axle Trucks	3	1.7	0	2.2	1.5	0	0	1.5	2.1	0.8	0	1.1	1.6

Start Time	SR-99 Southbound Ramps Southbound				Gateway Drive Westbound				Avenue 16 Eastbound				Int. Total
	Left	Right	U-Turns	App. Total	Thru	Right	U-Turns	App. Total	Left	Thru	U-Turns	App. Total	
Peak Hour Analysis From 04:00 PM to 05:45 PM - Peak 1 of 1													
Peak Hour for Entire Intersection Begins at 04:30 PM													
04:30 PM	29	38	0	67	56	0	0	56	30	63	0	93	216
04:45 PM	33	48	0	81	67	1	0	68	18	69	0	87	236
05:00 PM	31	46	0	77	77	0	0	77	25	94	0	119	273
05:15 PM	25	26	0	51	61	0	0	61	29	62	0	91	203
Total Volume	118	158	0	276	261	1	0	262	102	288	0	390	928
% App. Total	42.8	57.2	0		99.6	0.4	0		26.2	73.8	0		
PHF	.894	.823	.000	.852	.847	.250	.000	.851	.850	.766	.000	.819	.850

City of Madera
 N/S: SR-99 Southbound Ramps
 E/W: Avenue 16/Gateway Drive
 Weather: Clear

File Name : 22_MDA_99S_Gateway PM
 Site Code : 00319628
 Start Date : 9/19/2019
 Page No : 2

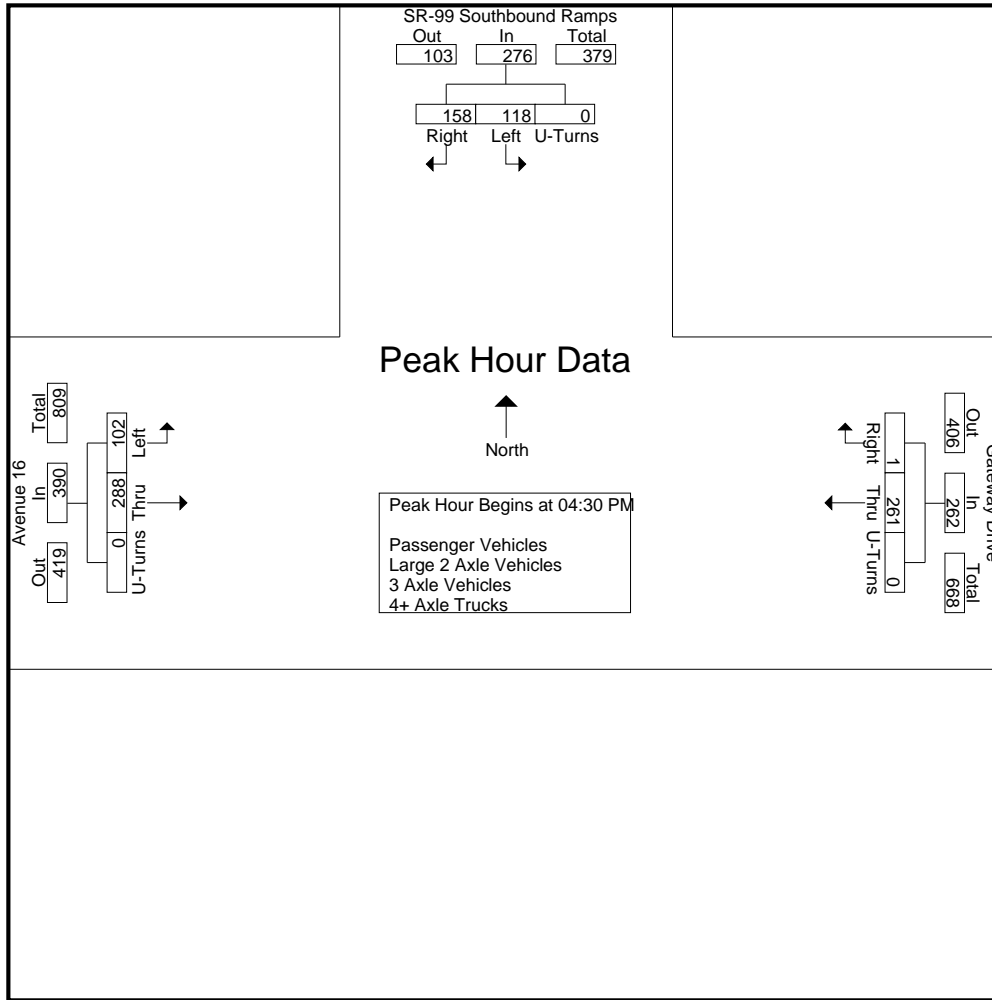

Peak Hour Analysis From 04:00 PM to 05:45 PM - Peak 1 of 1
 Peak Hour for Each Approach Begins at:

	04:15 PM				04:45 PM				04:30 PM			
+0 mins.	35	34	0	69	67	1	0	68	30	63	0	93
+15 mins.	29	38	0	67	77	0	0	77	18	69	0	87
+30 mins.	33	48	0	81	61	0	0	61	25	94	0	119
+45 mins.	31	46	0	77	56	1	0	57	29	62	0	91
Total Volume	128	166	0	294	261	2	0	263	102	288	0	390
% App. Total	43.5	56.5	0		99.2	0.8	0		26.2	73.8	0	
PHF	.914	.865	.000	.907	.847	.500	.000	.854	.850	.766	.000	.819

City of Madera
 N/S: SR-99 Southbound Ramps
 E/W: Avenue 16/Gateway Drive
 Weather: Clear

File Name : 22_MDA_99S_Gateway PM
 Site Code : 00319628
 Start Date : 9/19/2019
 Page No : 1

Groups Printed- Passenger Vehicles

Start Time	SR-99 Southbound Ramps Southbound				Gateway Drive Westbound				Avenue 16 Eastbound				Int. Total
	Left	Right	U-Turns	App. Total	Thru	Right	U-Turns	App. Total	Left	Thru	U-Turns	App. Total	
04:00 PM	16	38	0	54	49	2	0	51	24	67	0	91	196
04:15 PM	33	33	0	66	47	0	0	47	14	63	0	77	190
04:30 PM	28	37	0	65	54	0	0	54	28	61	0	89	208
04:45 PM	31	47	0	78	65	1	0	66	15	69	0	84	228
Total	108	155	0	263	215	3	0	218	81	260	0	341	822
05:00 PM	29	44	0	73	75	0	0	75	25	92	0	117	265
05:15 PM	25	25	0	50	60	0	0	60	28	62	0	90	200
05:30 PM	15	34	0	49	56	1	0	57	24	48	0	72	178
05:45 PM	13	31	0	44	40	1	0	41	20	51	0	71	156
Total	82	134	0	216	231	2	0	233	97	253	0	350	799
Grand Total	190	289	0	479	446	5	0	451	178	513	0	691	1621
Apprch %	39.7	60.3	0		98.9	1.1	0		25.8	74.2	0		
Total %	11.7	17.8	0	29.5	27.5	0.3	0	27.8	11	31.6	0	42.6	

Start Time	SR-99 Southbound Ramps Southbound				Gateway Drive Westbound				Avenue 16 Eastbound				Int. Total
	Left	Right	U-Turns	App. Total	Thru	Right	U-Turns	App. Total	Left	Thru	U-Turns	App. Total	
Peak Hour Analysis From 04:30 PM to 05:15 PM - Peak 1 of 1													
Peak Hour for Entire Intersection Begins at 04:30 PM													
04:30 PM	28	37	0	65	54	0	0	54	28	61	0	89	208
04:45 PM	31	47	0	78	65	1	0	66	15	69	0	84	228
05:00 PM	29	44	0	73	75	0	0	75	25	92	0	117	265
05:15 PM	25	25	0	50	60	0	0	60	28	62	0	90	200
Total Volume	113	153	0	266	254	1	0	255	96	284	0	380	901
% App. Total	42.5	57.5	0		99.6	0.4	0		25.3	74.7	0		
PHF	.911	.814	.000	.853	.847	.250	.000	.850	.857	.772	.000	.812	.850

City of Madera
 N/S: SR-99 Southbound Ramps
 E/W: Avenue 16/Gateway Drive
 Weather: Clear

File Name : 22_MDA_99S_Gateway PM
 Site Code : 00319628
 Start Date : 9/19/2019
 Page No : 2

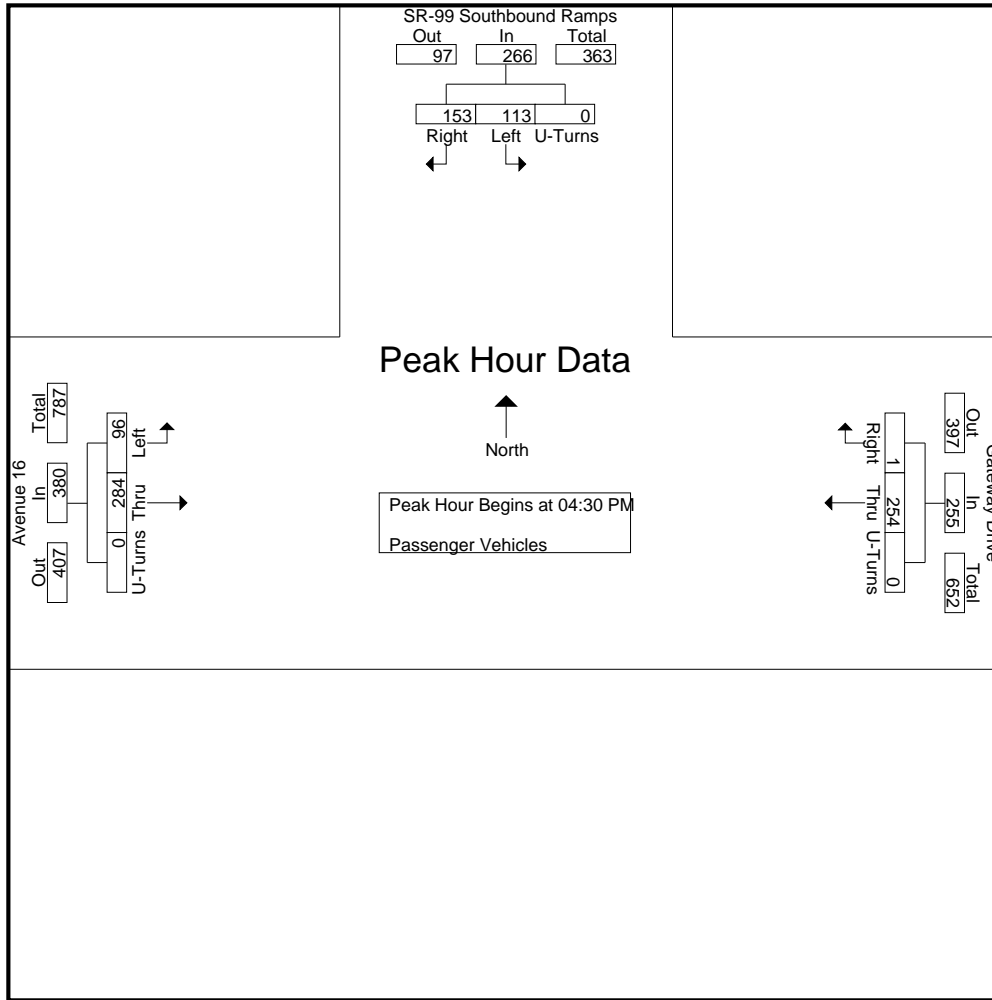

Peak Hour Analysis From 04:30 PM to 05:15 PM - Peak 1 of 1
 Peak Hour for Each Approach Begins at:

	04:30 PM				04:30 PM				04:30 PM			
+0 mins.	28	37	0	65	54	0	0	54	28	61	0	89
+15 mins.	31	47	0	78	65	1	0	66	15	69	0	84
+30 mins.	29	44	0	73	75	0	0	75	25	92	0	117
+45 mins.	25	25	0	50	60	0	0	60	28	62	0	90
Total Volume	113	153	0	266	254	1	0	255	96	284	0	380
% App. Total	42.5	57.5	0		99.6	0.4	0		25.3	74.7	0	
PHF	.911	.814	.000	.853	.847	.250	.000	.850	.857	.772	.000	.812

City of Madera
 N/S: SR-99 Southbound Ramps
 E/W: Avenue 16/Gateway Drive
 Weather: Clear

File Name : 22_MDA_99S_Gateway PM
 Site Code : 00319628
 Start Date : 9/19/2019
 Page No : 1

Groups Printed- Large 2 Axle Vehicles

Start Time	SR-99 Southbound Ramps Southbound				Gateway Drive Westbound				Avenue 16 Eastbound				Int. Total
	Left	Right	U-Turns	App. Total	Thru	Right	U-Turns	App. Total	Left	Thru	U-Turns	App. Total	
04:00 PM	0	1	0	1	0	0	0	0	1	0	0	1	2
04:15 PM	0	1	0	1	1	1	0	2	0	1	0	1	4
04:30 PM	1	1	0	2	1	0	0	1	2	2	0	4	7
04:45 PM	1	0	0	1	0	0	0	0	1	0	0	1	2
Total	2	3	0	5	2	1	0	3	4	3	0	7	15
05:00 PM	0	1	0	1	0	0	0	0	0	1	0	1	2
05:15 PM	0	0	0	0	0	0	0	0	1	0	0	1	1
05:30 PM	0	0	1	1	0	0	0	0	0	0	0	0	1
05:45 PM	0	1	0	1	0	0	0	0	0	0	0	0	1
Total	0	2	1	3	0	0	0	0	1	1	0	2	5
Grand Total	2	5	1	8	2	1	0	3	5	4	0	9	20
Apprch %	25	62.5	12.5		66.7	33.3	0		55.6	44.4	0		
Total %	10	25	5	40	10	5	0	15	25	20	0	45	

Start Time	SR-99 Southbound Ramps Southbound				Gateway Drive Westbound				Avenue 16 Eastbound				Int. Total
	Left	Right	U-Turns	App. Total	Thru	Right	U-Turns	App. Total	Left	Thru	U-Turns	App. Total	
04:30 PM	1	1	0	2	1	0	0	1	2	2	0	4	7
04:45 PM	1	0	0	1	0	0	0	0	1	0	0	1	2
05:00 PM	0	1	0	1	0	0	0	0	0	1	0	1	2
05:15 PM	0	0	0	0	0	0	0	0	1	0	0	1	1
Total Volume	2	2	0	4	1	0	0	1	4	3	0	7	12
% App. Total	50	50	0		100	0	0		57.1	42.9	0		
PHF	.500	.500	.000	.500	.250	.000	.000	.250	.500	.375	.000	.438	.429

Peak Hour Analysis From 04:30 PM to 05:15 PM - Peak 1 of 1

Peak Hour for Entire Intersection Begins at 04:30 PM

City of Madera
 N/S: SR-99 Southbound Ramps
 E/W: Avenue 16/Gateway Drive
 Weather: Clear

File Name : 22_MDA_99S_Gateway PM
 Site Code : 00319628
 Start Date : 9/19/2019
 Page No : 2

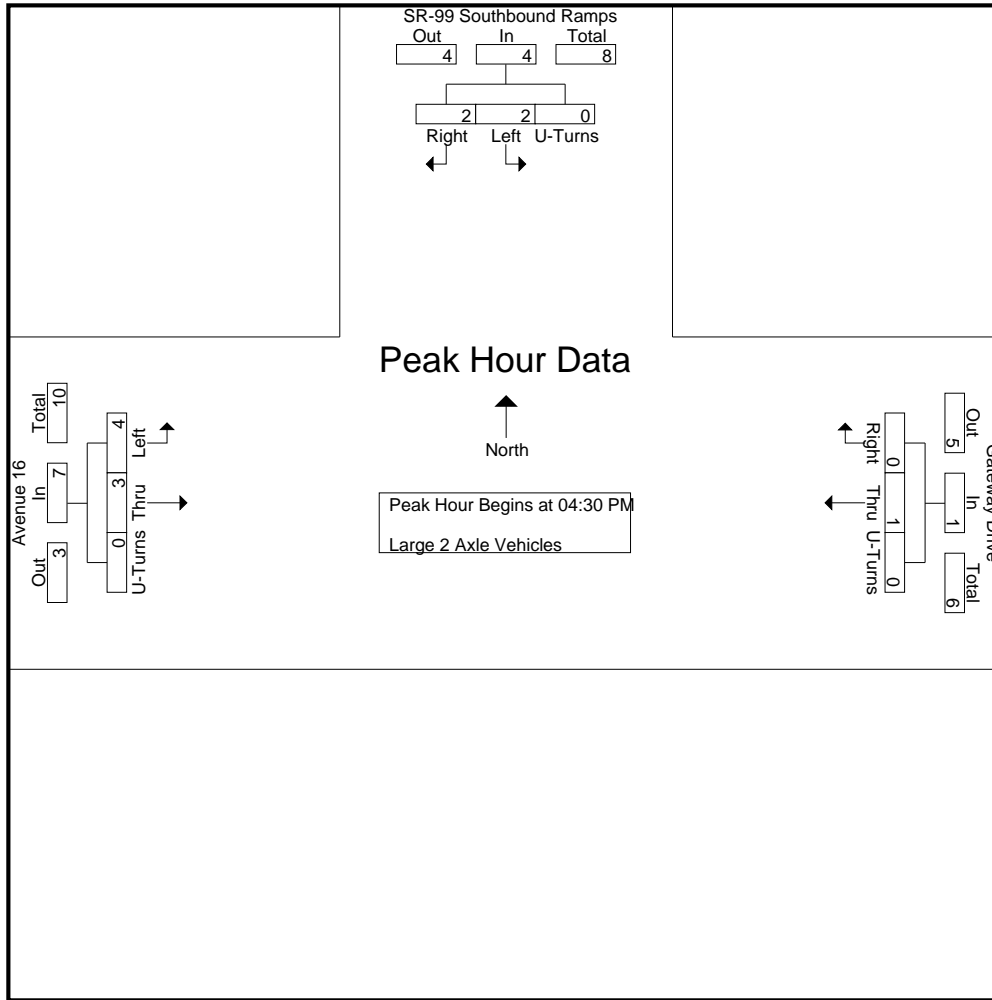

Peak Hour Analysis From 04:30 PM to 05:15 PM - Peak 1 of 1

Peak Hour for Each Approach Begins at:

	04:30 PM				04:30 PM				04:30 PM			
+0 mins.	1	1	0	2	1	0	0	1	2	2	0	4
+15 mins.	1	0	0	1	0	0	0	0	1	0	0	1
+30 mins.	0	1	0	1	0	0	0	0	0	1	0	1
+45 mins.	0	0	0	0	0	0	0	0	1	0	0	1
Total Volume	2	2	0	4	1	0	0	1	4	3	0	7
% App. Total	50	50	0		100	0	0		57.1	42.9	0	
PHF	.500	.500	.000	.500	.250	.000	.000	.250	.500	.375	.000	.438

City of Madera
 N/S: SR-99 Southbound Ramps
 E/W: Avenue 16/Gateway Drive
 Weather: Clear

File Name : 22_MDA_99S_Gateway PM
 Site Code : 00319628
 Start Date : 9/19/2019
 Page No : 1

Groups Printed- 3 Axle Vehicles

Start Time	SR-99 Southbound Ramps Southbound				Gateway Drive Westbound				Avenue 16 Eastbound				Int. Total
	Left	Right	U-Turns	App. Total	Thru	Right	U-Turns	App. Total	Left	Thru	U-Turns	App. Total	
04:00 PM	0	1	0	1	0	0	0	0	1	0	0	1	2
04:15 PM	0	0	0	0	1	0	0	1	1	0	0	1	2
04:30 PM	0	0	0	0	0	0	0	0	0	0	0	0	0
04:45 PM	0	0	0	0	0	0	0	0	0	0	0	0	0
Total	0	1	0	1	1	0	0	1	2	0	0	2	4
05:00 PM	0	0	0	0	0	0	0	0	0	0	0	0	0
05:15 PM	0	0	0	0	1	0	0	1	0	0	0	0	1
05:30 PM	0	0	0	0	0	0	0	0	0	0	0	0	0
05:45 PM	0	0	0	0	0	0	0	0	1	0	0	1	1
Total	0	0	0	0	1	0	0	1	1	0	0	1	2
Grand Total	0	1	0	1	2	0	0	2	3	0	0	3	6
Apprch %	0	100	0		100	0	0		100	0	0		
Total %	0	16.7	0	16.7	33.3	0	0	33.3	50	0	0	50	

Start Time	SR-99 Southbound Ramps Southbound				Gateway Drive Westbound				Avenue 16 Eastbound				Int. Total
	Left	Right	U-Turns	App. Total	Thru	Right	U-Turns	App. Total	Left	Thru	U-Turns	App. Total	
Peak Hour Analysis From 04:30 PM to 05:15 PM - Peak 1 of 1													
Peak Hour for Entire Intersection Begins at 04:30 PM													
04:30 PM	0	0	0	0	0	0	0	0	0	0	0	0	0
04:45 PM	0	0	0	0	0	0	0	0	0	0	0	0	0
05:00 PM	0	0	0	0	0	0	0	0	0	0	0	0	0
05:15 PM	0	0	0	0	1	0	0	1	0	0	0	0	1
Total Volume	0	0	0	0	1	0	0	1	0	0	0	0	1
% App. Total	0	0	0		100	0	0		0	0	0		
PHF	.000	.000	.000	.000	.250	.000	.000	.250	.000	.000	.000	.000	.250

City of Madera
 N/S: SR-99 Southbound Ramps
 E/W: Avenue 16/Gateway Drive
 Weather: Clear

File Name : 22_MDA_99S_Gateway PM
 Site Code : 00319628
 Start Date : 9/19/2019
 Page No : 2

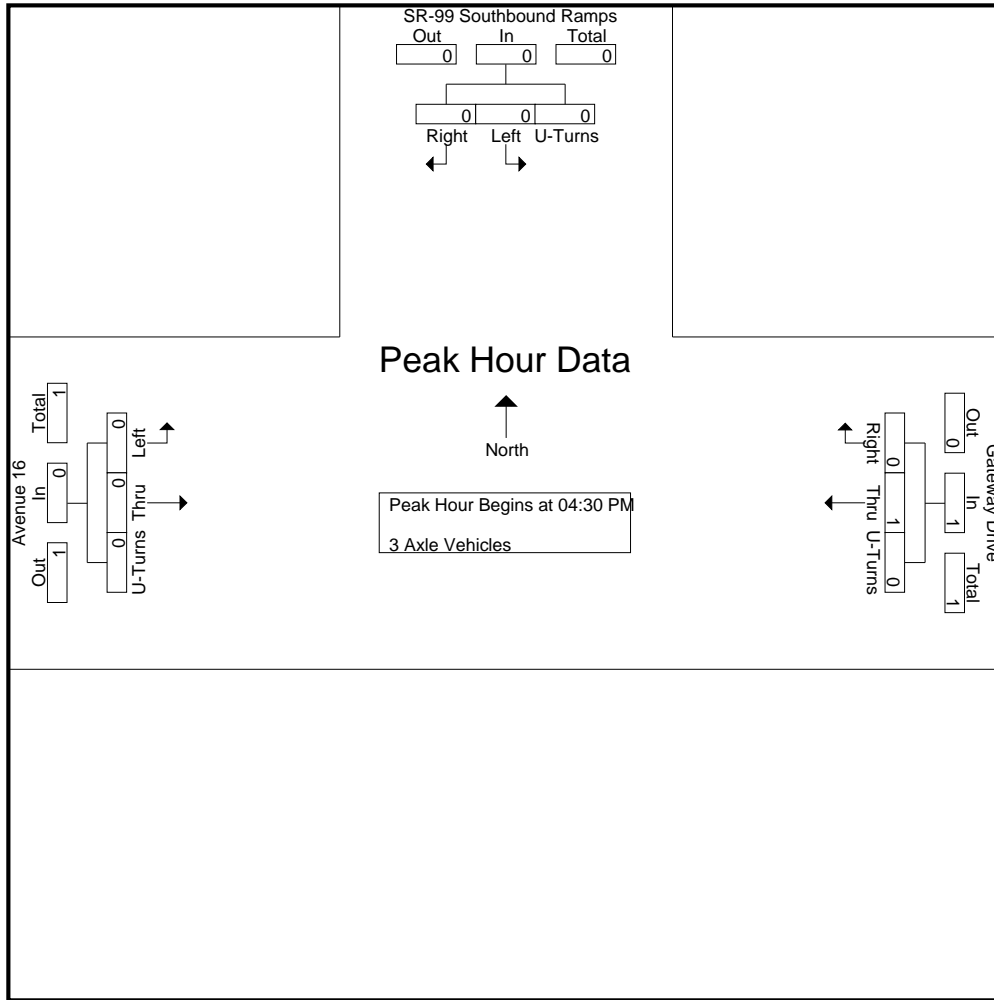

Peak Hour Analysis From 04:30 PM to 05:15 PM - Peak 1 of 1
 Peak Hour for Each Approach Begins at:

	04:30 PM				04:30 PM				04:30 PM			
+0 mins.	0	0	0	0	0	0	0	0	0	0	0	0
+15 mins.	0	0	0	0	0	0	0	0	0	0	0	0
+30 mins.	0	0	0	0	0	0	0	0	0	0	0	0
+45 mins.	0	0	0	0	1	0	0	1	0	0	0	0
Total Volume	0	0	0	0	1	0	0	1	0	0	0	0
% App. Total	0	0	0	0	100	0	0	0	0	0	0	0
PHF	.000	.000	.000	.000	.250	.000	.000	.250	.000	.000	.000	.000

City of Madera
 N/S: SR-99 Southbound Ramps
 E/W: Avenue 16/Gateway Drive
 Weather: Clear

File Name : 22_MDA_99S_Gateway PM
 Site Code : 00319628
 Start Date : 9/19/2019
 Page No : 1

Groups Printed- 4+ Axle Trucks

Start Time	SR-99 Southbound Ramps Southbound				Gateway Drive Westbound				Avenue 16 Eastbound				Int. Total
	Left	Right	U-Turns	App. Total	Thru	Right	U-Turns	App. Total	Left	Thru	U-Turns	App. Total	
04:00 PM	0	1	0	1	2	0	0	2	2	1	0	3	6
04:15 PM	2	0	0	2	0	0	0	0	0	1	0	1	3
04:30 PM	0	0	0	0	1	0	0	1	0	0	0	0	1
04:45 PM	1	1	0	2	2	0	0	2	2	0	0	2	6
Total	3	2	0	5	5	0	0	5	4	2	0	6	16
05:00 PM	2	1	0	3	2	0	0	2	0	1	0	1	6
05:15 PM	0	1	0	1	0	0	0	0	0	0	0	0	1
05:30 PM	1	0	0	1	0	0	0	0	0	0	0	0	1
05:45 PM	0	1	0	1	0	0	0	0	0	1	0	1	2
Total	3	3	0	6	2	0	0	2	0	2	0	2	10
Grand Total	6	5	0	11	7	0	0	7	4	4	0	8	26
Apprch %	54.5	45.5	0		100	0	0		50	50	0		
Total %	23.1	19.2	0	42.3	26.9	0	0	26.9	15.4	15.4	0	30.8	

Start Time	SR-99 Southbound Ramps Southbound				Gateway Drive Westbound				Avenue 16 Eastbound				Int. Total
	Left	Right	U-Turns	App. Total	Thru	Right	U-Turns	App. Total	Left	Thru	U-Turns	App. Total	
04:30 PM	0	0	0	0	1	0	0	1	0	0	0	0	1
04:45 PM	1	1	0	2	2	0	0	2	2	0	0	2	6
05:00 PM	2	1	0	3	2	0	0	2	0	1	0	1	6
05:15 PM	0	1	0	1	0	0	0	0	0	0	0	0	1
Total Volume	3	3	0	6	5	0	0	5	2	1	0	3	14
% App. Total	50	50	0		100	0	0		66.7	33.3	0		
PHF	.375	.750	.000	.500	.625	.000	.000	.625	.250	.250	.000	.375	.583

Peak Hour Analysis From 04:30 PM to 05:15 PM - Peak 1 of 1

Peak Hour for Entire Intersection Begins at 04:30 PM

City of Madera
 N/S: SR-99 Southbound Ramps
 E/W: Avenue 16/Gateway Drive
 Weather: Clear

File Name : 22_MDA_99S_Gateway PM
 Site Code : 00319628
 Start Date : 9/19/2019
 Page No : 2

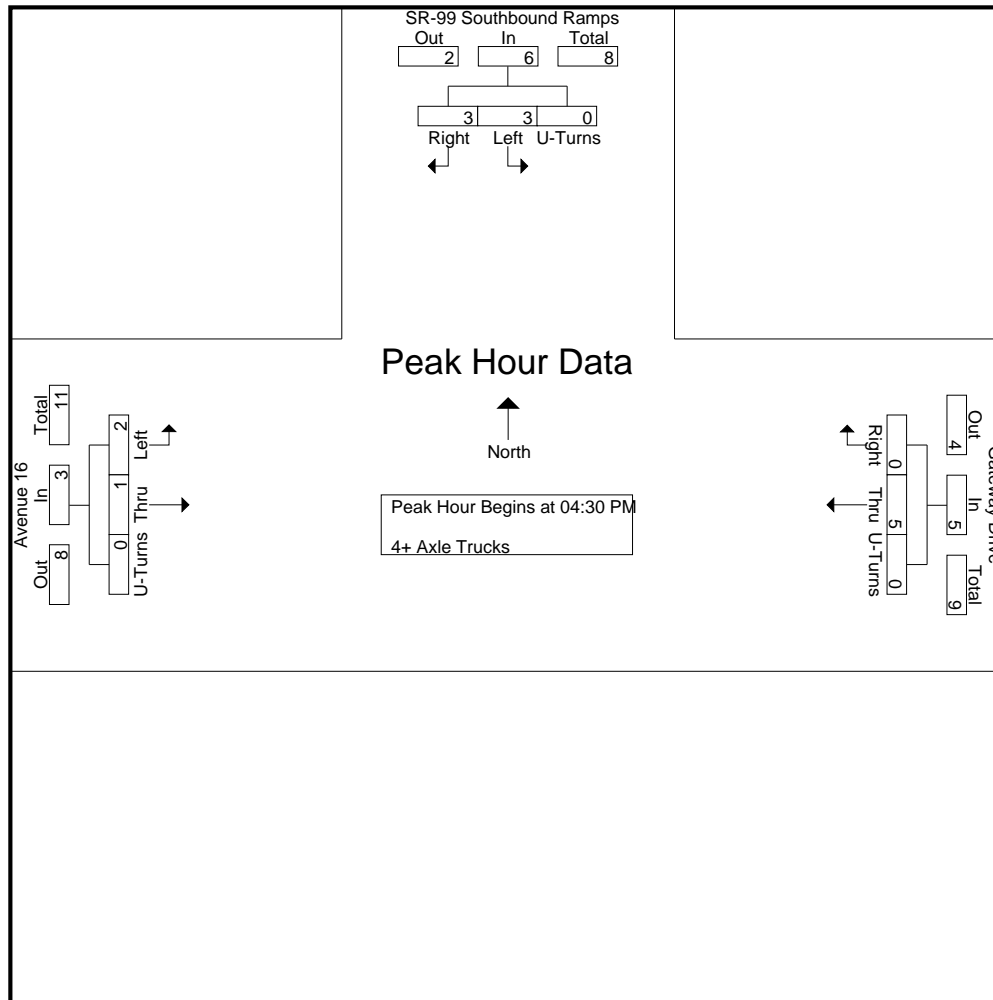

Peak Hour Analysis From 04:30 PM to 05:15 PM - Peak 1 of 1
 Peak Hour for Each Approach Begins at:

	04:30 PM				04:30 PM				04:30 PM			
+0 mins.	0	0	0	0	1	0	0	1	0	0	0	0
+15 mins.	1	1	0	2	2	0	0	2	2	0	0	2
+30 mins.	2	1	0	3	2	0	0	2	0	1	0	1
+45 mins.	0	1	0	1	0	0	0	0	0	0	0	0
Total Volume	3	3	0	6	5	0	0	5	2	1	0	3
% App. Total	50	50	0	100	100	0	0	100	66.7	33.3	0	100
PHF	.375	.750	.000	.500	.625	.000	.000	.625	.250	.250	.000	.375

Location: Madera
 N/S: SR-99 Southbound Ramps
 E/W: Avenue 16/Gateway Drive



Date: 9/19/2019
 Day: Thursday

PEDESTRIANS

	North Leg SR-99 Southbound Ramps	East Leg Gateway Drive	South Leg Dead End	West Leg Avenue 16	
	Pedestrians	Pedestrians	Pedestrians	Pedestrians	
7:00 AM	0	0	1	0	1
7:15 AM	0	0	0	0	0
7:30 AM	0	0	0	0	0
7:45 AM	0	0	0	0	0
8:00 AM	0	0	0	0	0
8:15 AM	0	0	0	0	0
8:30 AM	0	0	0	0	0
8:45 AM	0	0	0	0	0
TOTAL VOLUMES:	0	0	1	0	1

	North Leg SR-99 Southbound Ramps	East Leg Gateway Drive	South Leg Dead End	West Leg Avenue 16	
	Pedestrians	Pedestrians	Pedestrians	Pedestrians	
4:00 PM	0	0	0	0	0
4:15 PM	0	0	0	0	0
4:30 PM	0	0	0	0	0
4:45 PM	0	0	0	0	0
5:00 PM	0	0	0	0	0
5:15 PM	0	0	0	0	0
5:30 PM	0	0	0	0	0
5:45 PM	0	0	0	0	0
TOTAL VOLUMES:	0	0	0	0	0

Location: Madera
 N/S: SR-99 Southbound Ramps
 E/W: Avenue 16/Gateway Drive



Date: 9/19/2019
 Day: Thursday

BICYCLES

	Southbound SR-99 Southbound Ramps			Westbound Gateway Drive			Northbound Dead End			Eastbound Avenue 16			
	Left	Thru	Right	Left	Thru	Right	Left	Thru	Right	Left	Thru	Right	
7:00 AM	0	0	0	0	0	0	0	0	0	0	0	0	0
7:15 AM	0	0	0	0	0	0	0	0	0	0	0	0	0
7:30 AM	0	0	0	0	1	0	0	0	0	0	0	0	1
7:45 AM	0	0	0	0	0	0	0	0	0	0	0	0	0
8:00 AM	0	0	0	0	0	0	0	0	0	0	0	0	0
8:15 AM	0	0	0	0	0	0	0	0	0	0	0	0	0
8:30 AM	0	0	0	0	0	0	0	0	0	0	0	0	0
8:45 AM	0	0	0	0	0	0	0	0	0	0	0	0	0
TOTAL VOLUMES:	0	0	0	0	1	0	0	0	0	0	0	0	1

	Southbound SR-99 Southbound Ramps			Westbound Gateway Drive			Northbound Dead End			Eastbound Avenue 16			
	Left	Thru	Right	Left	Thru	Right	Left	Thru	Right	Left	Thru	Right	
4:00 PM	0	0	0	0	0	0	0	0	0	0	0	0	0
4:15 PM	0	0	0	0	0	0	0	0	0	0	0	0	0
4:30 PM	0	0	0	0	0	0	0	0	0	0	0	0	0
4:45 PM	0	0	0	0	0	0	0	0	0	0	0	0	0
5:00 PM	0	0	0	0	0	0	0	0	0	0	0	0	0
5:15 PM	0	0	0	0	0	0	0	0	0	0	0	0	0
5:30 PM	0	0	0	0	0	0	0	0	0	0	0	0	0
5:45 PM	0	0	0	0	0	0	0	0	0	0	0	0	0
TOTAL VOLUMES:	0	0	0	0	0	0	0	0	0	0	0	0	0

City of Madera
 N/S: SR-99 Northbound Ramps
 E/W: Gateway Drive
 Weather: Clear

File Name : 23A_MDA_99N Spur_Gateway AM
 Site Code : 00319628
 Start Date : 9/19/2019
 Page No : 1

Groups Printed- Passenger Vehicles - Large 2 Axle Vehicles - 3 Axle Vehicles - 4+ Axle Trucks

Start Time	SR-99 Northbound Ramps Southbound				Gateway Drive Westbound				Gateway Drive Eastbound				Int. Total
	Left	Right	U-Turns	App. Total	Thru	Right	U-Turns	App. Total	Left	Thru	U-Turns	App. Total	
07:00 AM	0	19	0	19	16	0	0	16	30	23	0	53	88
07:15 AM	0	19	0	19	17	0	0	17	28	24	0	52	88
07:30 AM	0	30	0	30	16	0	0	16	59	37	0	96	142
07:45 AM	0	26	0	26	23	0	0	23	36	45	0	81	130
Total	0	94	0	94	72	0	0	72	153	129	0	282	448
08:00 AM	0	23	0	23	12	0	0	12	34	22	0	56	91
08:15 AM	0	25	0	25	14	0	0	14	31	29	0	60	99
08:30 AM	0	28	0	28	16	0	0	16	26	29	0	55	99
08:45 AM	0	33	0	33	24	0	0	24	31	34	0	65	122
Total	0	109	0	109	66	0	0	66	122	114	0	236	411
Grand Total	0	203	0	203	138	0	0	138	275	243	0	518	859
Apprch %	0	100	0		100	0	0		53.1	46.9	0		
Total %	0	23.6	0	23.6	16.1	0	0	16.1	32	28.3	0	60.3	
Passenger Vehicles	0	191	0	191	131	0	0	131	263	232	0	495	817
% Passenger Vehicles	0	94.1	0	94.1	94.9	0	0	94.9	95.6	95.5	0	95.6	95.1
Large 2 Axle Vehicles	0	6	0	6	6	0	0	6	7	7	0	14	26
% Large 2 Axle Vehicles	0	3	0	3	4.3	0	0	4.3	2.5	2.9	0	2.7	3
3 Axle Vehicles	0	1	0	1	1	0	0	1	0	2	0	2	4
% 3 Axle Vehicles	0	0.5	0	0.5	0.7	0	0	0.7	0	0.8	0	0.4	0.5
4+ Axle Trucks	0	5	0	5	0	0	0	0	5	2	0	7	12
% 4+ Axle Trucks	0	2.5	0	2.5	0	0	0	0	1.8	0.8	0	1.4	1.4

Start Time	SR-99 Northbound Ramps Southbound				Gateway Drive Westbound				Gateway Drive Eastbound				Int. Total
	Left	Right	U-Turns	App. Total	Thru	Right	U-Turns	App. Total	Left	Thru	U-Turns	App. Total	
Peak Hour Analysis From 07:00 AM to 08:45 AM - Peak 1 of 1													
Peak Hour for Entire Intersection Begins at 07:30 AM													
07:30 AM	0	30	0	30	16	0	0	16	59	37	0	96	142
07:45 AM	0	26	0	26	23	0	0	23	36	45	0	81	130
08:00 AM	0	23	0	23	12	0	0	12	34	22	0	56	91
08:15 AM	0	25	0	25	14	0	0	14	31	29	0	60	99
Total Volume	0	104	0	104	65	0	0	65	160	133	0	293	462
% App. Total	0	100	0		100	0	0		54.6	45.4	0		
PHF	.000	.867	.000	.867	.707	.000	.000	.707	.678	.739	.000	.763	.813

City of Madera
 N/S: SR-99 Northbound Ramps
 E/W: Gateway Drive
 Weather: Clear

File Name : 23A_MDA_99N Spur_Gateway AM
 Site Code : 00319628
 Start Date : 9/19/2019
 Page No : 2

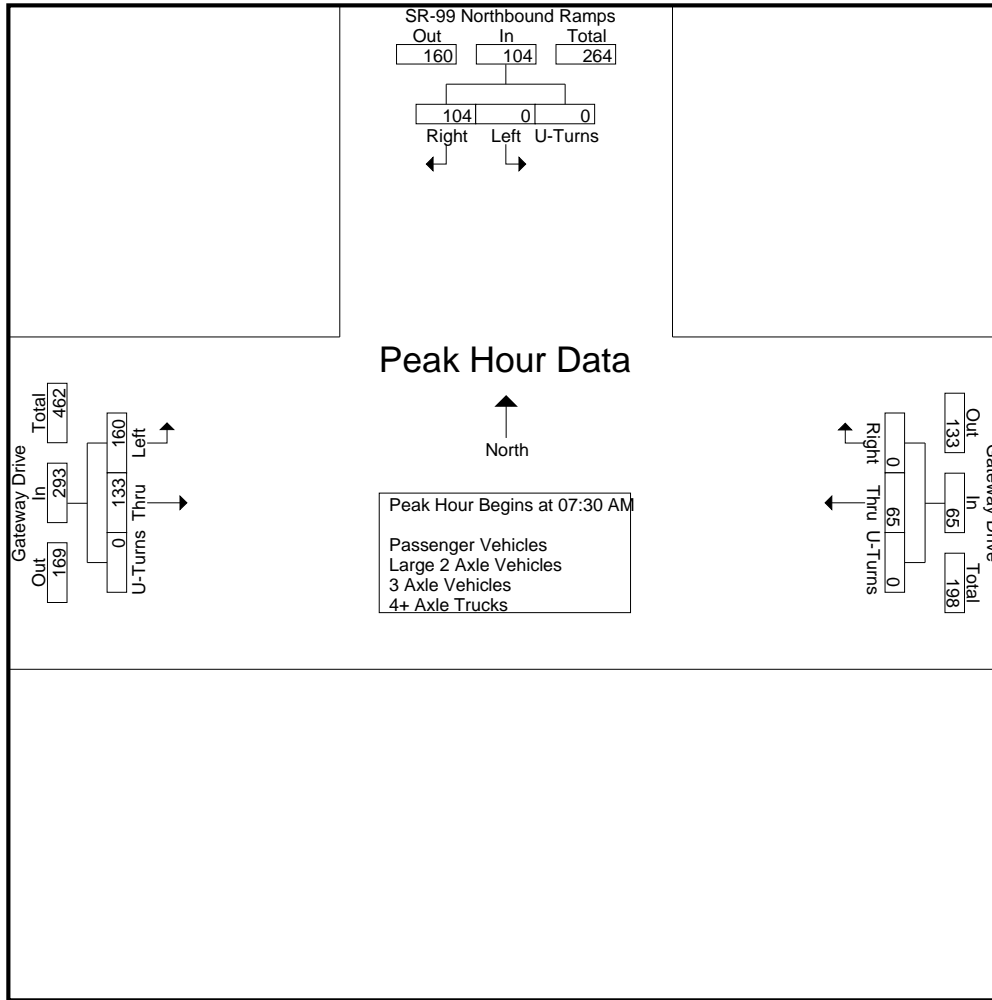

Peak Hour Analysis From 07:00 AM to 08:45 AM - Peak 1 of 1
 Peak Hour for Each Approach Begins at:

	08:00 AM				07:00 AM				07:30 AM			
+0 mins.	0	23	0	23	16	0	0	16	59	37	0	96
+15 mins.	0	25	0	25	17	0	0	17	36	45	0	81
+30 mins.	0	28	0	28	16	0	0	16	34	22	0	56
+45 mins.	0	33	0	33	23	0	0	23	31	29	0	60
Total Volume	0	109	0	109	72	0	0	72	160	133	0	293
% App. Total	0	100	0	100	100	0	0	100	54.6	45.4	0	100
PHF	.000	.826	.000	.826	.783	.000	.000	.783	.678	.739	.000	.763

City of Madera
 N/S: SR-99 Northbound Ramps
 E/W: Gateway Drive
 Weather: Clear

File Name : 23A_MDA_99N Spur_Gateway AM
 Site Code : 00319628
 Start Date : 9/19/2019
 Page No : 1

Groups Printed- Passenger Vehicles

Start Time	SR-99 Northbound Ramps Southbound				Gateway Drive Westbound				Gateway Drive Eastbound				Int. Total
	Left	Right	U-Turns	App. Total	Thru	Right	U-Turns	App. Total	Left	Thru	U-Turns	App. Total	
07:00 AM	0	18	0	18	14	0	0	14	27	21	0	48	80
07:15 AM	0	18	0	18	16	0	0	16	26	23	0	49	83
07:30 AM	0	28	0	28	14	0	0	14	56	37	0	93	135
07:45 AM	0	25	0	25	22	0	0	22	36	45	0	81	128
Total	0	89	0	89	66	0	0	66	145	126	0	271	426
08:00 AM	0	22	0	22	11	0	0	11	33	20	0	53	86
08:15 AM	0	22	0	22	14	0	0	14	30	26	0	56	92
08:30 AM	0	27	0	27	16	0	0	16	25	27	0	52	95
08:45 AM	0	31	0	31	24	0	0	24	30	33	0	63	118
Total	0	102	0	102	65	0	0	65	118	106	0	224	391
Grand Total	0	191	0	191	131	0	0	131	263	232	0	495	817
Apprch %	0	100	0		100	0	0		53.1	46.9	0		
Total %	0	23.4	0	23.4	16	0	0	16	32.2	28.4	0	60.6	

Start Time	SR-99 Northbound Ramps Southbound				Gateway Drive Westbound				Gateway Drive Eastbound				Int. Total
	Left	Right	U-Turns	App. Total	Thru	Right	U-Turns	App. Total	Left	Thru	U-Turns	App. Total	
Peak Hour Analysis From 07:30 AM to 08:15 AM - Peak 1 of 1													
Peak Hour for Entire Intersection Begins at 07:30 AM													
07:30 AM	0	28	0	28	14	0	0	14	56	37	0	93	135
07:45 AM	0	25	0	25	22	0	0	22	36	45	0	81	128
08:00 AM	0	22	0	22	11	0	0	11	33	20	0	53	86
08:15 AM	0	22	0	22	14	0	0	14	30	26	0	56	92
Total Volume	0	97	0	97	61	0	0	61	155	128	0	283	441
% App. Total	0	100	0		100	0	0		54.8	45.2	0		
PHF	.000	.866	.000	.866	.693	.000	.000	.693	.692	.711	.000	.761	.817

City of Madera
 N/S: SR-99 Northbound Ramps
 E/W: Gateway Drive
 Weather: Clear

File Name : 23A_MDA_99N Spur_Gateway AM
 Site Code : 00319628
 Start Date : 9/19/2019
 Page No : 2

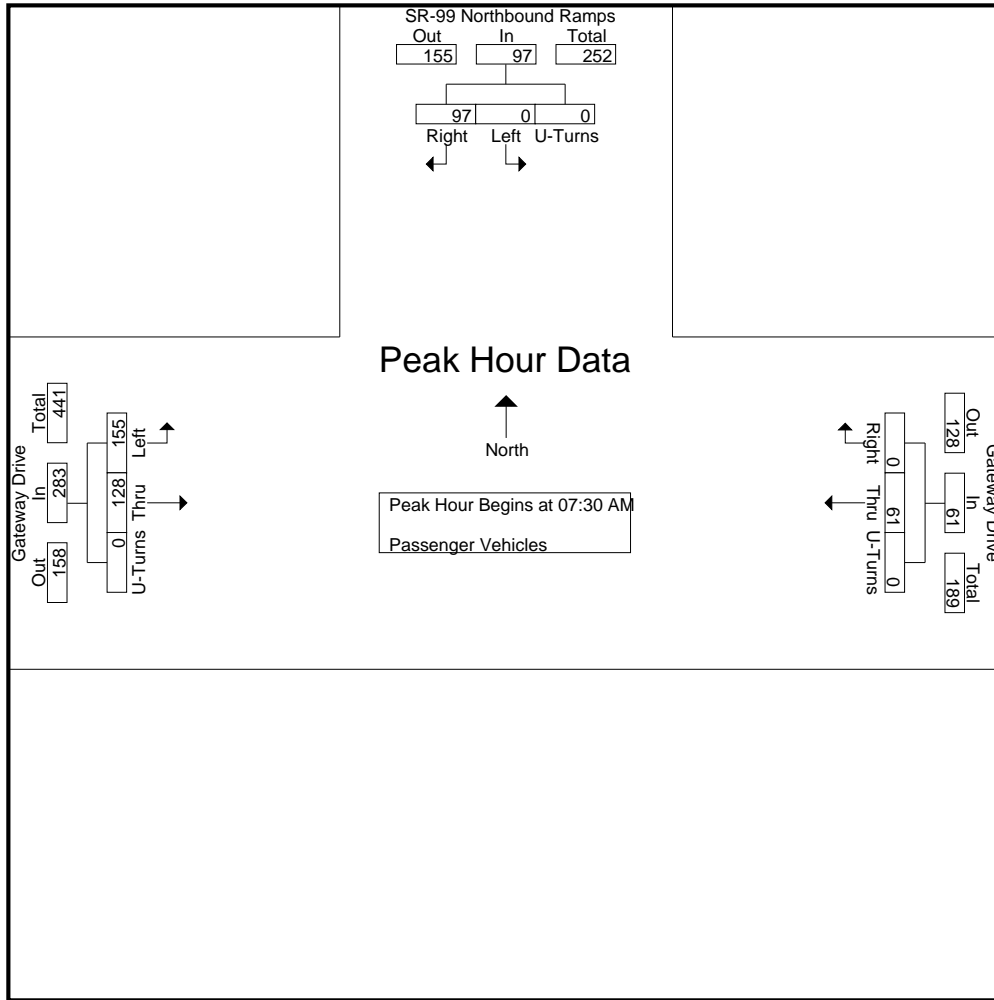

Peak Hour Analysis From 07:30 AM to 08:15 AM - Peak 1 of 1
 Peak Hour for Each Approach Begins at:

	07:30 AM				07:30 AM				07:30 AM			
+0 mins.	0	28	0	28	14	0	0	14	56	37	0	93
+15 mins.	0	25	0	25	22	0	0	22	36	45	0	81
+30 mins.	0	22	0	22	11	0	0	11	33	20	0	53
+45 mins.	0	22	0	22	14	0	0	14	30	26	0	56
Total Volume	0	97	0	97	61	0	0	61	155	128	0	283
% App. Total	0	100	0		100	0	0		54.8	45.2	0	
PHF	.000	.866	.000	.866	.693	.000	.000	.693	.692	.711	.000	.761

City of Madera
 N/S: SR-99 Northbound Ramps
 E/W: Gateway Drive
 Weather: Clear

File Name : 23A_MDA_99N Spur_Gateway AM
 Site Code : 00319628
 Start Date : 9/19/2019
 Page No : 1

Groups Printed- Large 2 Axle Vehicles

Start Time	SR-99 Northbound Ramps Southbound				Gateway Drive Westbound				Gateway Drive Eastbound				Int. Total
	Left	Right	U-Turns	App. Total	Thru	Right	U-Turns	App. Total	Left	Thru	U-Turns	App. Total	
07:00 AM	0	1	0	1	2	0	0	2	1	1	0	2	5
07:15 AM	0	1	0	1	1	0	0	1	0	1	0	1	3
07:30 AM	0	1	0	1	1	0	0	1	3	0	0	3	5
07:45 AM	0	1	0	1	1	0	0	1	0	0	0	0	2
Total	0	4	0	4	5	0	0	5	4	2	0	6	15
08:00 AM	0	1	0	1	1	0	0	1	0	1	0	1	3
08:15 AM	0	0	0	0	0	0	0	0	1	2	0	3	3
08:30 AM	0	0	0	0	0	0	0	0	1	1	0	2	2
08:45 AM	0	1	0	1	0	0	0	0	1	1	0	2	3
Total	0	2	0	2	1	0	0	1	3	5	0	8	11
Grand Total	0	6	0	6	6	0	0	6	7	7	0	14	26
Apprch %	0	100	0		100	0	0		50	50	0		
Total %	0	23.1	0	23.1	23.1	0	0	23.1	26.9	26.9	0	53.8	

Start Time	SR-99 Northbound Ramps Southbound				Gateway Drive Westbound				Gateway Drive Eastbound				Int. Total
	Left	Right	U-Turns	App. Total	Thru	Right	U-Turns	App. Total	Left	Thru	U-Turns	App. Total	
07:30 AM	0	1	0	1	1	0	0	1	3	0	0	3	5
07:45 AM	0	1	0	1	1	0	0	1	0	0	0	0	2
08:00 AM	0	1	0	1	1	0	0	1	0	1	0	1	3
08:15 AM	0	0	0	0	0	0	0	0	1	2	0	3	3
Total Volume	0	3	0	3	3	0	0	3	4	3	0	7	13
% App. Total	0	100	0		100	0	0		57.1	42.9	0		
PHF	.000	.750	.000	.750	.750	.000	.000	.750	.333	.375	.000	.583	.650

Peak Hour Analysis From 07:30 AM to 08:15 AM - Peak 1 of 1

Peak Hour for Entire Intersection Begins at 07:30 AM

City of Madera
 N/S: SR-99 Northbound Ramps
 E/W: Gateway Drive
 Weather: Clear

File Name : 23A_MDA_99N Spur_Gateway AM
 Site Code : 00319628
 Start Date : 9/19/2019
 Page No : 2

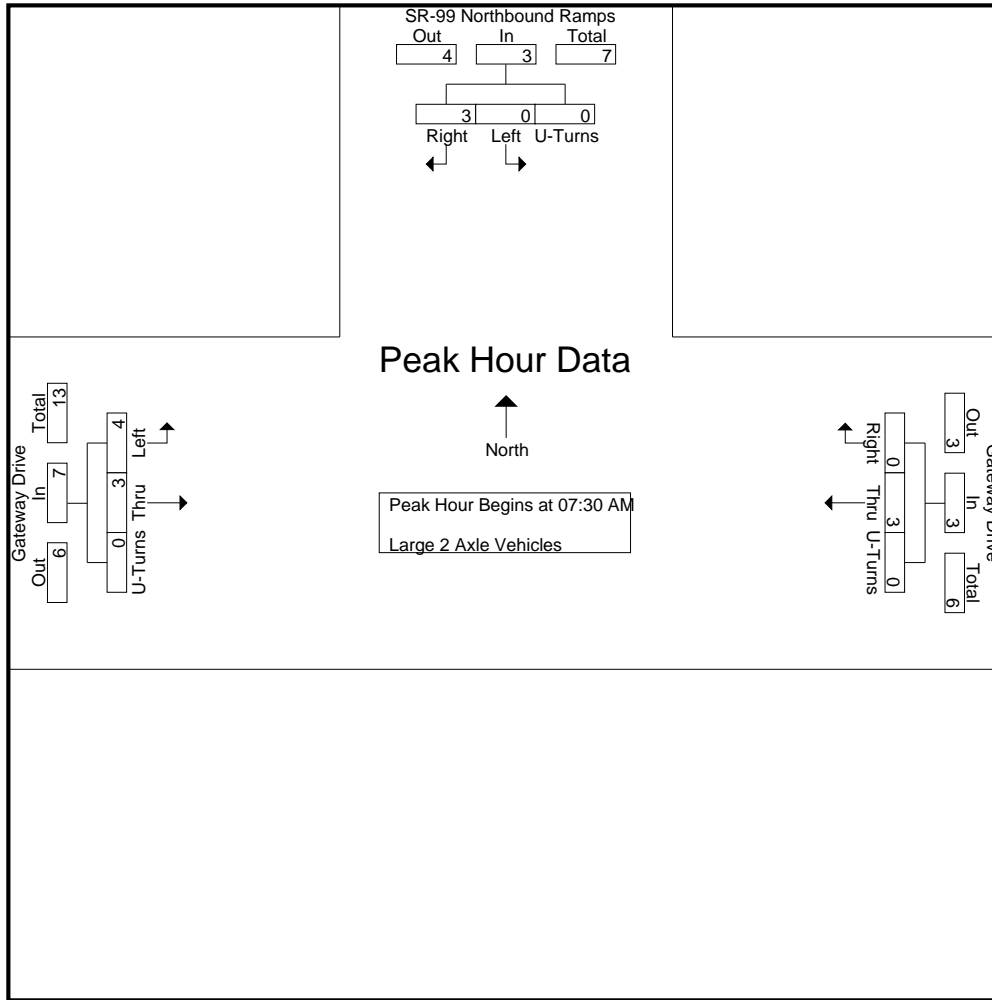

Peak Hour Analysis From 07:30 AM to 08:15 AM - Peak 1 of 1
 Peak Hour for Each Approach Begins at:

	07:30 AM				07:30 AM				07:30 AM				
+0 mins.	0	1	0	1	1	0	0	1	3	0	0	0	3
+15 mins.	0	1	0	1	1	0	0	1	0	0	0	0	0
+30 mins.	0	1	0	1	1	0	0	1	0	1	0	1	1
+45 mins.	0	0	0	0	0	0	0	0	1	2	0	3	3
Total Volume	0	3	0	3	3	0	0	3	4	3	0	7	7
% App. Total	0	100	0		100	0	0		57.1	42.9	0		
PHF	.000	.750	.000	.750	.750	.000	.000	.750	.333	.375	.000	.583	

City of Madera
 N/S: SR-99 Northbound Ramps
 E/W: Gateway Drive
 Weather: Clear

File Name : 23A_MDA_99N Spur_Gateway AM
 Site Code : 00319628
 Start Date : 9/19/2019
 Page No : 1

Groups Printed- 3 Axle Vehicles

Start Time	SR-99 Northbound Ramps Southbound				Gateway Drive Westbound				Gateway Drive Eastbound				Int. Total	
	Left	Right	U-Turns	App. Total	Thru	Right	U-Turns	App. Total	Left	Thru	U-Turns	App. Total		
07:00 AM	0	0	0	0	0	0	0	0	0	0	0	0	0	0
07:15 AM	0	0	0	0	0	0	0	0	0	0	0	0	0	0
07:30 AM	0	0	0	0	1	0	0	1	0	0	0	0	0	1
07:45 AM	0	0	0	0	0	0	0	0	0	0	0	0	0	0
Total	0	0	0	0	1	0	0	1	0	0	0	0	0	1
08:00 AM	0	0	0	0	0	0	0	0	0	1	0	1	0	1
08:15 AM	0	1	0	1	0	0	0	0	0	1	0	1	0	2
08:30 AM	0	0	0	0	0	0	0	0	0	0	0	0	0	0
08:45 AM	0	0	0	0	0	0	0	0	0	0	0	0	0	0
Total	0	1	0	1	0	0	0	0	0	2	0	2	0	3
Grand Total	0	1	0	1	1	0	0	1	0	2	0	2	0	4
Apprch %	0	100	0		100	0	0		0	100	0			
Total %	0	25	0	25	25	0	0	25	0	50	0	50		

Start Time	SR-99 Northbound Ramps Southbound				Gateway Drive Westbound				Gateway Drive Eastbound				Int. Total	
	Left	Right	U-Turns	App. Total	Thru	Right	U-Turns	App. Total	Left	Thru	U-Turns	App. Total		
07:30 AM	0	0	0	0	1	0	0	1	0	0	0	0	0	1
07:45 AM	0	0	0	0	0	0	0	0	0	0	0	0	0	0
08:00 AM	0	0	0	0	0	0	0	0	0	1	0	1	0	1
08:15 AM	0	1	0	1	0	0	0	0	0	1	0	1	0	2
Total Volume	0	1	0	1	1	0	0	1	0	2	0	2	0	4
% App. Total	0	100	0		100	0	0		0	100	0			
PHF	.000	.250	.000	.250	.250	.000	.000	.250	.000	.500	.000	.500		.500

Peak Hour Analysis From 07:30 AM to 08:15 AM - Peak 1 of 1

Peak Hour for Entire Intersection Begins at 07:30 AM

City of Madera
 N/S: SR-99 Northbound Ramps
 E/W: Gateway Drive
 Weather: Clear

File Name : 23A_MDA_99N Spur_Gateway AM
 Site Code : 00319628
 Start Date : 9/19/2019
 Page No : 2

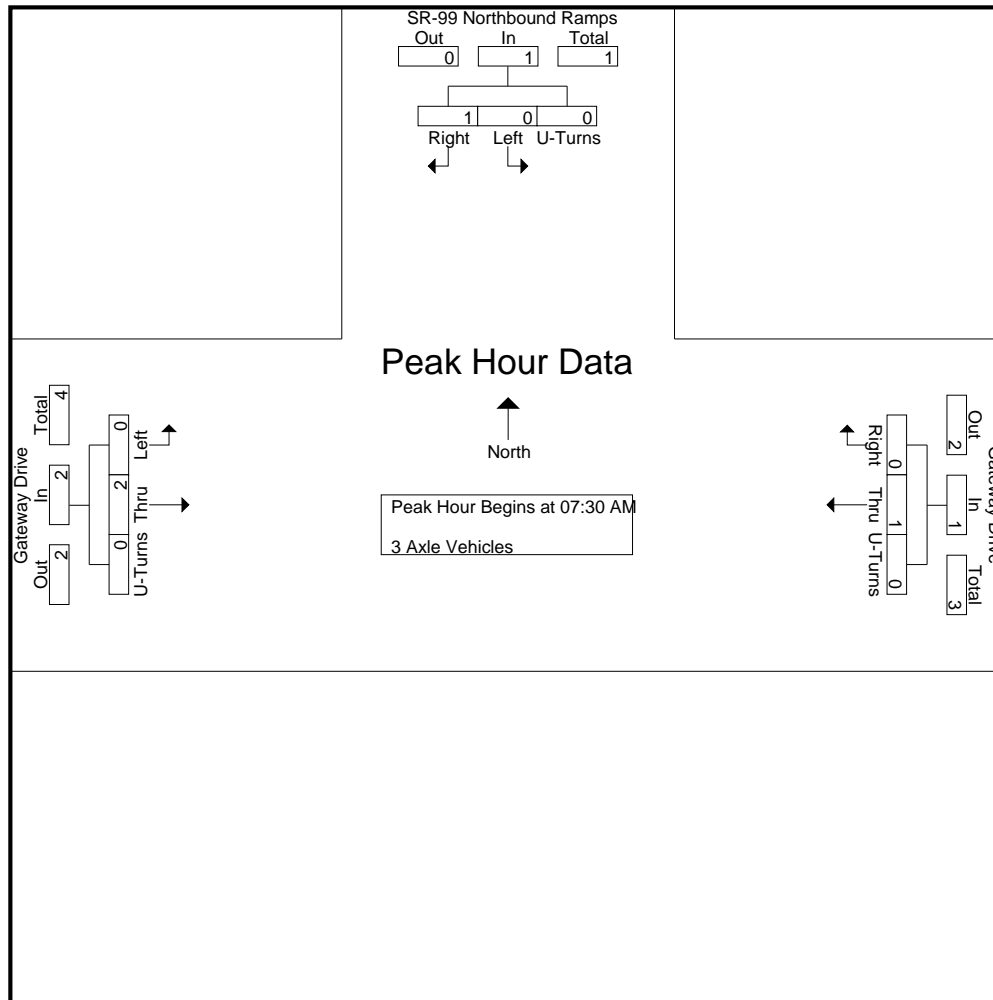

Peak Hour Analysis From 07:30 AM to 08:15 AM - Peak 1 of 1
 Peak Hour for Each Approach Begins at:

	07:30 AM				07:30 AM				07:30 AM			
+0 mins.	0	0	0	0	1	0	0	1	0	0	0	0
+15 mins.	0	0	0	0	0	0	0	0	0	0	0	0
+30 mins.	0	0	0	0	0	0	0	0	0	1	0	1
+45 mins.	0	1	0	1	0	0	0	0	0	1	0	1
Total Volume	0	1	0	1	1	0	0	1	0	2	0	2
% App. Total	0	100	0	0	100	0	0	0	0	100	0	0
PHF	.000	.250	.000	.250	.250	.000	.000	.250	.000	.500	.000	.500

City of Madera
 N/S: SR-99 Northbound Ramps
 E/W: Gateway Drive
 Weather: Clear

File Name : 23A_MDA_99N_Spur_Gateway AM
 Site Code : 00319628
 Start Date : 9/19/2019
 Page No : 1

Groups Printed- 4+ Axle Trucks

Start Time	SR-99 Northbound Ramps Southbound				Gateway Drive Westbound				Gateway Drive Eastbound				Int. Total
	Left	Right	U-Turns	App. Total	Thru	Right	U-Turns	App. Total	Left	Thru	U-Turns	App. Total	
07:00 AM	0	0	0	0	0	0	0	0	2	1	0	3	3
07:15 AM	0	0	0	0	0	0	0	0	2	0	0	2	2
07:30 AM	0	1	0	1	0	0	0	0	0	0	0	0	1
07:45 AM	0	0	0	0	0	0	0	0	0	0	0	0	0
Total	0	1	0	1	0	0	0	0	4	1	0	5	6
08:00 AM	0	0	0	0	0	0	0	0	1	0	0	1	1
08:15 AM	0	2	0	2	0	0	0	0	0	0	0	0	2
08:30 AM	0	1	0	1	0	0	0	0	0	1	0	1	2
08:45 AM	0	1	0	1	0	0	0	0	0	0	0	0	1
Total	0	4	0	4	0	0	0	0	1	1	0	2	6
Grand Total	0	5	0	5	0	0	0	0	5	2	0	7	12
Apprch %	0	100	0		0	0	0		71.4	28.6	0		
Total %	0	41.7	0	41.7	0	0	0	0	41.7	16.7	0	58.3	

Start Time	SR-99 Northbound Ramps Southbound				Gateway Drive Westbound				Gateway Drive Eastbound				Int. Total
	Left	Right	U-Turns	App. Total	Thru	Right	U-Turns	App. Total	Left	Thru	U-Turns	App. Total	
07:30 AM	0	1	0	1	0	0	0	0	0	0	0	0	1
07:45 AM	0	0	0	0	0	0	0	0	0	0	0	0	0
08:00 AM	0	0	0	0	0	0	0	0	1	0	0	1	1
08:15 AM	0	2	0	2	0	0	0	0	0	0	0	0	2
Total Volume	0	3	0	3	0	0	0	0	1	0	0	1	4
% App. Total	0	100	0		0	0	0		100	0	0		
PHF	.000	.375	.000	.375	.000	.000	.000	.000	.250	.000	.000	.250	.500

Peak Hour Analysis From 07:30 AM to 08:15 AM - Peak 1 of 1

Peak Hour for Entire Intersection Begins at 07:30 AM

City of Madera
 N/S: SR-99 Northbound Ramps
 E/W: Gateway Drive
 Weather: Clear

File Name : 23A_MDA_99N Spur_Gateway AM
 Site Code : 00319628
 Start Date : 9/19/2019
 Page No : 2

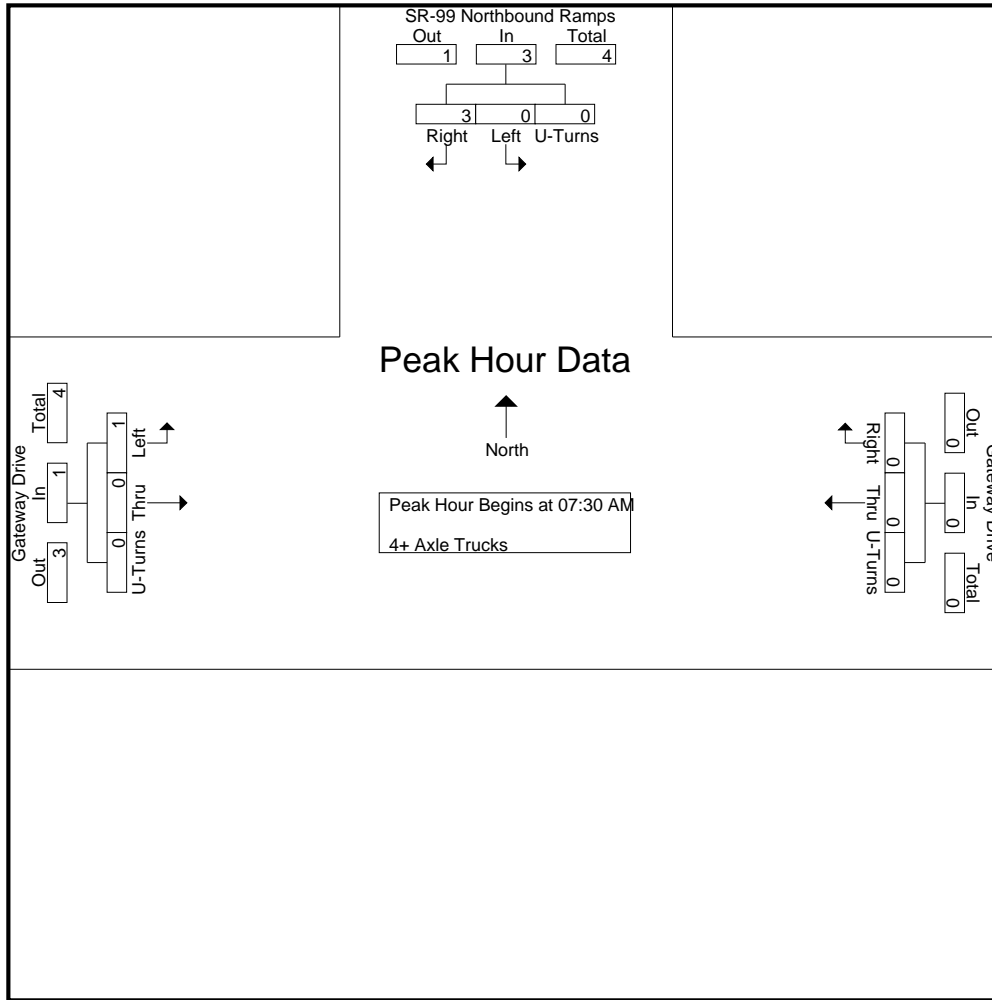

Peak Hour Analysis From 07:30 AM to 08:15 AM - Peak 1 of 1
 Peak Hour for Each Approach Begins at:

	07:30 AM				07:30 AM				07:30 AM			
+0 mins.	0	1	0	1	0	0	0	0	0	0	0	0
+15 mins.	0	0	0	0	0	0	0	0	0	0	0	0
+30 mins.	0	0	0	0	0	0	0	0	1	0	0	1
+45 mins.	0	2	0	2	0	0	0	0	0	0	0	0
Total Volume	0	3	0	3	0	0	0	0	1	0	0	1
% App. Total	0	100	0		0	0	0		100	0	0	
PHF	.000	.375	.000	.375	.000	.000	.000	.000	.250	.000	.000	.250

City of Madera
 N/S: SR-99 Northbound Ramps
 E/W: Gateway Drive
 Weather: Clear

File Name : 23A_MDA_99N Spur_Gateway PM
 Site Code : 00319628
 Start Date : 9/19/2019
 Page No : 1

Groups Printed- Passenger Vehicles - Large 2 Axle Vehicles - 3 Axle Vehicles - 4+ Axle Trucks

Start Time	SR-99 Northbound Ramps Southbound				Gateway Drive Westbound				Gateway Drive Eastbound				Int. Total
	Left	Right	U-Turns	App. Total	Thru	Right	U-Turns	App. Total	Left	Thru	U-Turns	App. Total	
04:00 PM	0	23	0	23	28	0	0	28	30	46	0	76	127
04:15 PM	0	32	0	32	32	0	0	32	41	85	0	126	190
04:30 PM	0	24	0	24	18	0	0	18	27	56	0	83	125
04:45 PM	0	39	0	39	29	0	0	29	27	73	0	100	168
Total	0	118	0	118	107	0	0	107	125	260	0	385	610
05:00 PM	0	40	0	40	39	0	0	39	58	74	0	132	211
05:15 PM	0	28	0	28	34	0	0	34	31	61	0	92	154
05:30 PM	0	34	0	34	24	0	0	24	27	37	0	64	122
05:45 PM	0	22	0	22	20	0	0	20	32	35	0	67	109
Total	0	124	0	124	117	0	0	117	148	207	0	355	596
Grand Total	0	242	0	242	224	0	0	224	273	467	0	740	1206
Apprch %	0	100	0		100	0	0		36.9	63.1	0		
Total %	0	20.1	0	20.1	18.6	0	0	18.6	22.6	38.7	0	61.4	
Passenger Vehicles	0	234	0	234	221	0	0	221	268	456	0	724	1179
% Passenger Vehicles	0	96.7	0	96.7	98.7	0	0	98.7	98.2	97.6	0	97.8	97.8
Large 2 Axle Vehicles	0	0	0	0	2	0	0	2	1	6	0	7	9
% Large 2 Axle Vehicles	0	0	0	0	0.9	0	0	0.9	0.4	1.3	0	0.9	0.7
3 Axle Vehicles	0	1	0	1	1	0	0	1	0	0	0	0	2
% 3 Axle Vehicles	0	0.4	0	0.4	0.4	0	0	0.4	0	0	0	0	0.2
4+ Axle Trucks	0	7	0	7	0	0	0	0	4	5	0	9	16
% 4+ Axle Trucks	0	2.9	0	2.9	0	0	0	0	1.5	1.1	0	1.2	1.3

Start Time	SR-99 Northbound Ramps Southbound				Gateway Drive Westbound				Gateway Drive Eastbound				Int. Total
	Left	Right	U-Turns	App. Total	Thru	Right	U-Turns	App. Total	Left	Thru	U-Turns	App. Total	
Peak Hour Analysis From 04:00 PM to 05:45 PM - Peak 1 of 1													
Peak Hour for Entire Intersection Begins at 04:15 PM													
04:15 PM	0	32	0	32	32	0	0	32	41	85	0	126	190
04:30 PM	0	24	0	24	18	0	0	18	27	56	0	83	125
04:45 PM	0	39	0	39	29	0	0	29	27	73	0	100	168
05:00 PM	0	40	0	40	39	0	0	39	58	74	0	132	211
Total Volume	0	135	0	135	118	0	0	118	153	288	0	441	694
% App. Total	0	100	0		100	0	0		34.7	65.3	0		
PHF	.000	.844	.000	.844	.756	.000	.000	.756	.659	.847	.000	.835	.822

City of Madera
 N/S: SR-99 Northbound Ramps
 E/W: Gateway Drive
 Weather: Clear

File Name : 23A_MDA_99N Spur_Gateway PM
 Site Code : 00319628
 Start Date : 9/19/2019
 Page No : 2

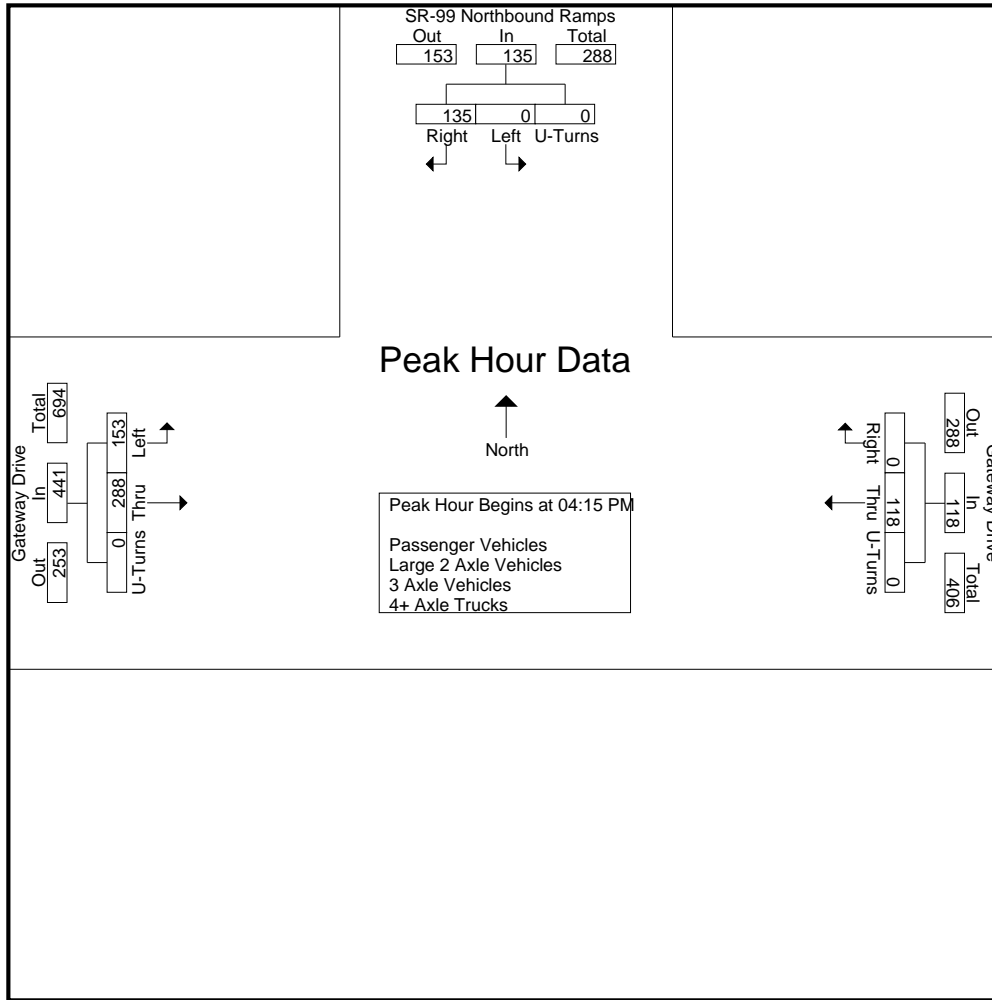

Peak Hour Analysis From 04:00 PM to 05:45 PM - Peak 1 of 1
 Peak Hour for Each Approach Begins at:

	04:45 PM				04:45 PM				04:15 PM			
+0 mins.	0	39	0	39	29	0	0	29	41	85	0	126
+15 mins.	0	40	0	40	39	0	0	39	27	56	0	83
+30 mins.	0	28	0	28	34	0	0	34	27	73	0	100
+45 mins.	0	34	0	34	24	0	0	24	58	74	0	132
Total Volume	0	141	0	141	126	0	0	126	153	288	0	441
% App. Total	0	100	0		100	0	0		34.7	65.3	0	
PHF	.000	.881	.000	.881	.808	.000	.000	.808	.659	.847	.000	.835

City of Madera
 N/S: SR-99 Northbound Ramps
 E/W: Gateway Drive
 Weather: Clear

File Name : 23A_MDA_99N Spur_Gateway PM
 Site Code : 00319628
 Start Date : 9/19/2019
 Page No : 1

Groups Printed- Passenger Vehicles

Start Time	SR-99 Northbound Ramps Southbound				Gateway Drive Westbound				Gateway Drive Eastbound				Int. Total
	Left	Right	U-Turns	App. Total	Thru	Right	U-Turns	App. Total	Left	Thru	U-Turns	App. Total	
04:00 PM	0	21	0	21	28	0	0	28	29	46	0	75	124
04:15 PM	0	32	0	32	29	0	0	29	39	82	0	121	182
04:30 PM	0	23	0	23	18	0	0	18	27	53	0	80	121
04:45 PM	0	37	0	37	29	0	0	29	27	71	0	98	164
Total	0	113	0	113	104	0	0	104	122	252	0	374	591
05:00 PM	0	38	0	38	39	0	0	39	57	72	0	129	206
05:15 PM	0	27	0	27	34	0	0	34	31	61	0	92	153
05:30 PM	0	34	0	34	24	0	0	24	27	36	0	63	121
05:45 PM	0	22	0	22	20	0	0	20	31	35	0	66	108
Total	0	121	0	121	117	0	0	117	146	204	0	350	588
Grand Total	0	234	0	234	221	0	0	221	268	456	0	724	1179
Apprch %	0	100	0		100	0	0		37	63	0		
Total %	0	19.8	0	19.8	18.7	0	0	18.7	22.7	38.7	0	61.4	

Start Time	SR-99 Northbound Ramps Southbound				Gateway Drive Westbound				Gateway Drive Eastbound				Int. Total
	Left	Right	U-Turns	App. Total	Thru	Right	U-Turns	App. Total	Left	Thru	U-Turns	App. Total	
Peak Hour Analysis From 04:15 PM to 05:00 PM - Peak 1 of 1													
Peak Hour for Entire Intersection Begins at 04:15 PM													
04:15 PM	0	32	0	32	29	0	0	29	39	82	0	121	182
04:30 PM	0	23	0	23	18	0	0	18	27	53	0	80	121
04:45 PM	0	37	0	37	29	0	0	29	27	71	0	98	164
05:00 PM	0	38	0	38	39	0	0	39	57	72	0	129	206
Total Volume	0	130	0	130	115	0	0	115	150	278	0	428	673
% App. Total	0	100	0		100	0	0		35	65	0		
PHF	.000	.855	.000	.855	.737	.000	.000	.737	.658	.848	.000	.829	.817

City of Madera
 N/S: SR-99 Northbound Ramps
 E/W: Gateway Drive
 Weather: Clear

File Name : 23A_MDA_99N Spur_Gateway PM
 Site Code : 00319628
 Start Date : 9/19/2019
 Page No : 2

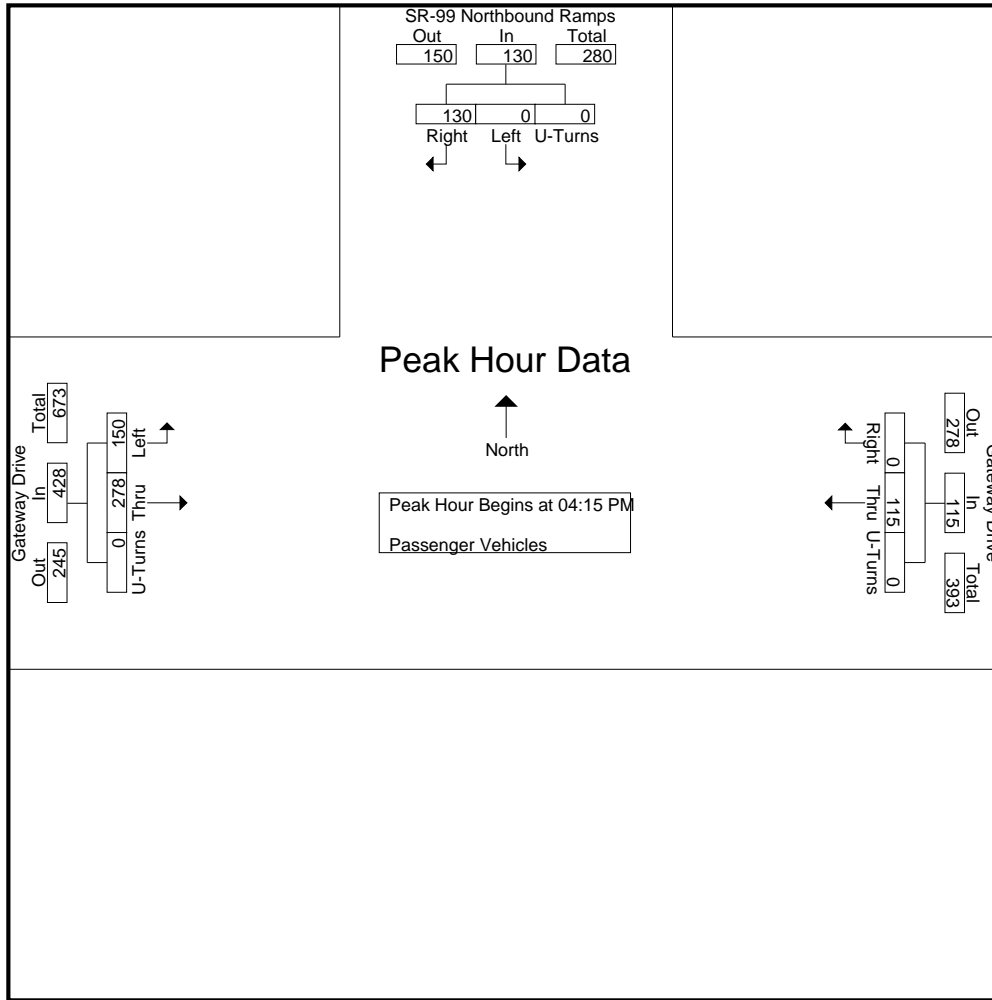

Peak Hour Analysis From 04:15 PM to 05:00 PM - Peak 1 of 1
 Peak Hour for Each Approach Begins at:

	04:15 PM				04:15 PM				04:15 PM			
+0 mins.	0	32	0	32	29	0	0	29	39	82	0	121
+15 mins.	0	23	0	23	18	0	0	18	27	53	0	80
+30 mins.	0	37	0	37	29	0	0	29	27	71	0	98
+45 mins.	0	38	0	38	39	0	0	39	57	72	0	129
Total Volume	0	130	0	130	115	0	0	115	150	278	0	428
% App. Total	0	100	0		100	0	0		35	65	0	
PHF	.000	.855	.000	.855	.737	.000	.000	.737	.658	.848	.000	.829

City of Madera
 N/S: SR-99 Northbound Ramps
 E/W: Gateway Drive
 Weather: Clear

File Name : 23A_MDA_99N Spur_Gateway PM
 Site Code : 00319628
 Start Date : 9/19/2019
 Page No : 1

Groups Printed- Large 2 Axle Vehicles

Start Time	SR-99 Northbound Ramps Southbound				Gateway Drive Westbound				Gateway Drive Eastbound				Int. Total	
	Left	Right	U-Turns	App. Total	Thru	Right	U-Turns	App. Total	Left	Thru	U-Turns	App. Total		
04:00 PM	0	0	0	0	0	0	0	0	0	0	0	0	0	0
04:15 PM	0	0	0	0	2	0	0	2	1	1	0	2	2	4
04:30 PM	0	0	0	0	0	0	0	0	0	3	0	3	3	3
04:45 PM	0	0	0	0	0	0	0	0	0	2	0	2	2	2
Total	0	0	0	0	2	0	0	2	1	6	0	7	7	9
05:00 PM	0	0	0	0	0	0	0	0	0	0	0	0	0	0
05:15 PM	0	0	0	0	0	0	0	0	0	0	0	0	0	0
05:30 PM	0	0	0	0	0	0	0	0	0	0	0	0	0	0
05:45 PM	0	0	0	0	0	0	0	0	0	0	0	0	0	0
Total	0	0	0	0	0	0	0	0	0	0	0	0	0	0
Grand Total	0	0	0	0	2	0	0	2	1	6	0	7	7	9
Apprch %	0	0	0	0	100	0	0	22.2	14.3	85.7	0	77.8	77.8	
Total %	0	0	0	0	22.2	0	0	22.2	11.1	66.7	0	77.8	77.8	

Start Time	SR-99 Northbound Ramps Southbound				Gateway Drive Westbound				Gateway Drive Eastbound				Int. Total	
	Left	Right	U-Turns	App. Total	Thru	Right	U-Turns	App. Total	Left	Thru	U-Turns	App. Total		
Peak Hour Analysis From 04:15 PM to 05:00 PM - Peak 1 of 1														
Peak Hour for Entire Intersection Begins at 04:15 PM														
04:15 PM	0	0	0	0	2	0	0	2	1	1	0	2	2	4
04:30 PM	0	0	0	0	0	0	0	0	0	3	0	3	3	3
04:45 PM	0	0	0	0	0	0	0	0	0	2	0	2	2	2
05:00 PM	0	0	0	0	0	0	0	0	0	0	0	0	0	0
Total Volume	0	0	0	0	2	0	0	2	1	6	0	7	7	9
% App. Total	0	0	0	0	100	0	0	22.2	14.3	85.7	0	77.8	77.8	
PHF	.000	.000	.000	.000	.250	.000	.000	.250	.250	.500	.000	.583	.583	.563

City of Madera
 N/S: SR-99 Northbound Ramps
 E/W: Gateway Drive
 Weather: Clear

File Name : 23A_MDA_99N Spur_Gateway PM
 Site Code : 00319628
 Start Date : 9/19/2019
 Page No : 2

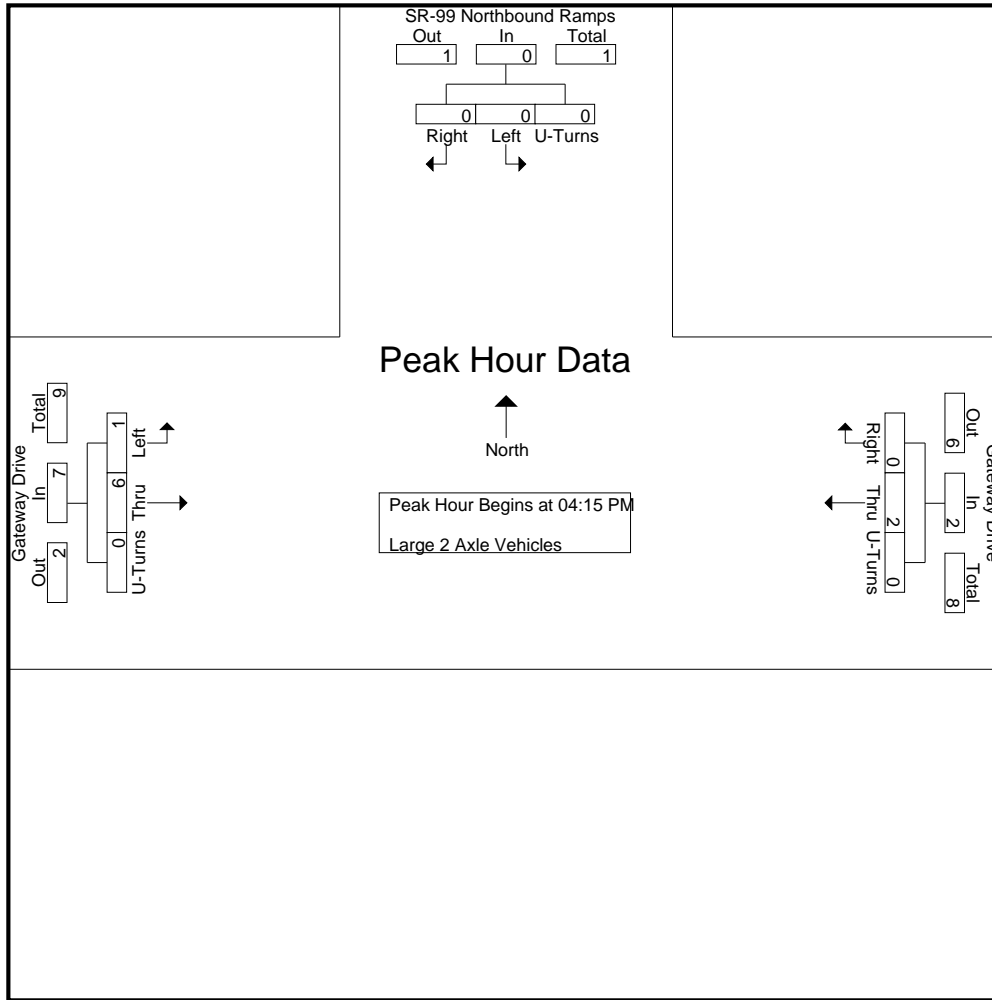

Peak Hour Analysis From 04:15 PM to 05:00 PM - Peak 1 of 1
 Peak Hour for Each Approach Begins at:

	04:15 PM				04:15 PM				04:15 PM			
+0 mins.	0	0	0	0	2	0	0	2	1	1	0	2
+15 mins.	0	0	0	0	0	0	0	0	0	3	0	3
+30 mins.	0	0	0	0	0	0	0	0	0	2	0	2
+45 mins.	0	0	0	0	0	0	0	0	0	0	0	0
Total Volume	0	0	0	0	2	0	0	2	1	6	0	7
% App. Total	0	0	0	0	100	0	0	0	14.3	85.7	0	0
PHF	.000	.000	.000	.000	.250	.000	.000	.250	.250	.500	.000	.583

City of Madera
 N/S: SR-99 Northbound Ramps
 E/W: Gateway Drive
 Weather: Clear

File Name : 23A_MDA_99N Spur_Gateway PM
 Site Code : 00319628
 Start Date : 9/19/2019
 Page No : 1

Groups Printed- 3 Axle Vehicles

Start Time	SR-99 Northbound Ramps Southbound				Gateway Drive Westbound				Gateway Drive Eastbound				Int. Total	
	Left	Right	U-Turns	App. Total	Thru	Right	U-Turns	App. Total	Left	Thru	U-Turns	App. Total		
04:00 PM	0	0	0	0	0	0	0	0	0	0	0	0	0	0
04:15 PM	0	0	0	0	1	0	0	1	0	0	0	0	0	1
04:30 PM	0	0	0	0	0	0	0	0	0	0	0	0	0	0
04:45 PM	0	0	0	0	0	0	0	0	0	0	0	0	0	0
Total	0	0	0	0	1	0	0	1	0	0	0	0	0	1
05:00 PM	0	0	0	0	0	0	0	0	0	0	0	0	0	0
05:15 PM	0	1	0	1	0	0	0	0	0	0	0	0	0	1
05:30 PM	0	0	0	0	0	0	0	0	0	0	0	0	0	0
05:45 PM	0	0	0	0	0	0	0	0	0	0	0	0	0	0
Total	0	1	0	1	0	0	0	0	0	0	0	0	0	1
Grand Total	0	1	0	1	1	0	0	1	0	0	0	0	0	2
Apprch %	0	100	0		100	0	0		0	0	0	0		
Total %	0	50	0	50	50	0	0	50	0	0	0	0		

Start Time	SR-99 Northbound Ramps Southbound				Gateway Drive Westbound				Gateway Drive Eastbound				Int. Total	
	Left	Right	U-Turns	App. Total	Thru	Right	U-Turns	App. Total	Left	Thru	U-Turns	App. Total		
04:15 PM	0	0	0	0	1	0	0	1	0	0	0	0	0	1
04:30 PM	0	0	0	0	0	0	0	0	0	0	0	0	0	0
04:45 PM	0	0	0	0	0	0	0	0	0	0	0	0	0	0
05:00 PM	0	0	0	0	0	0	0	0	0	0	0	0	0	0
Total Volume	0	0	0	0	1	0	0	1	0	0	0	0	0	1
% App. Total	0	0	0		100	0	0		0	0	0	0		
PHF	.000	.000	.000	.000	.250	.000	.000	.250	.000	.000	.000	.000	.000	.250

Peak Hour Analysis From 04:15 PM to 05:00 PM - Peak 1 of 1

Peak Hour for Entire Intersection Begins at 04:15 PM

City of Madera
 N/S: SR-99 Northbound Ramps
 E/W: Gateway Drive
 Weather: Clear

File Name : 23A_MDA_99N_Spur_Gateway PM
 Site Code : 00319628
 Start Date : 9/19/2019
 Page No : 2

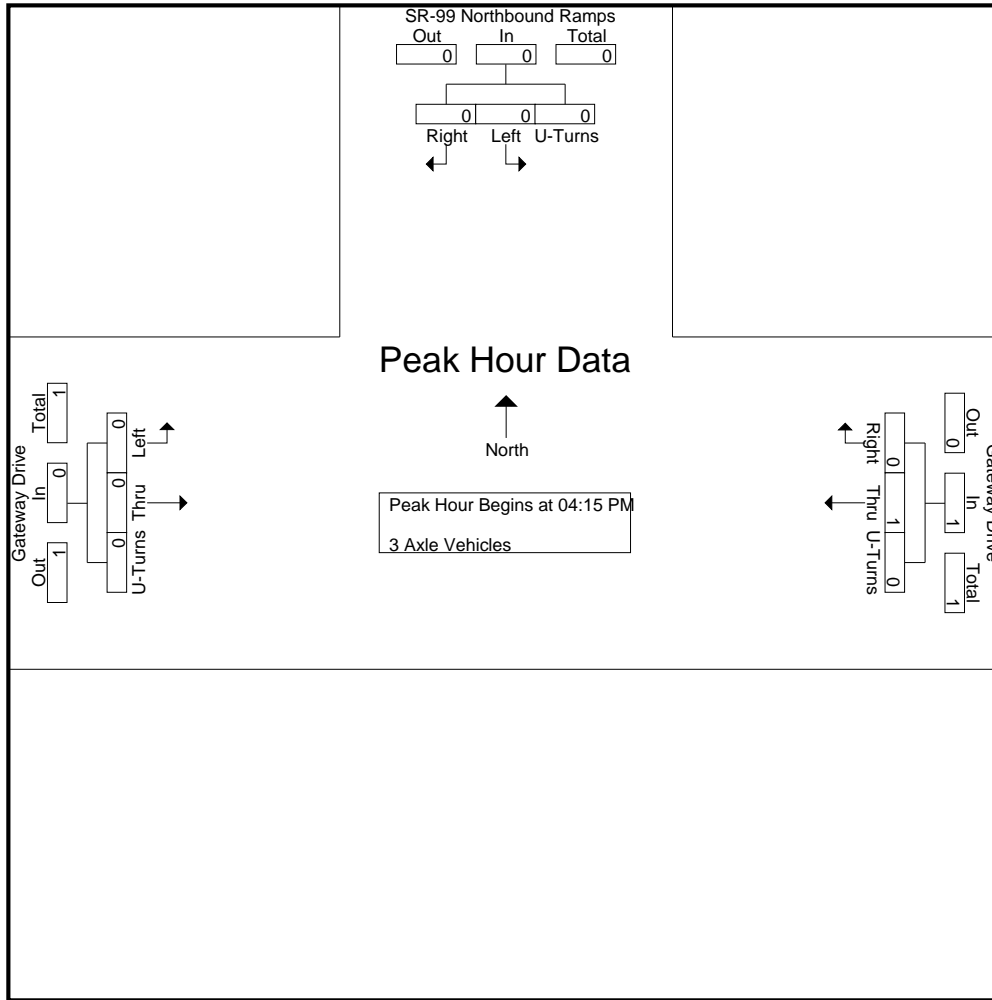

Peak Hour Analysis From 04:15 PM to 05:00 PM - Peak 1 of 1
 Peak Hour for Each Approach Begins at:

	04:15 PM				04:15 PM				04:15 PM			
+0 mins.	0	0	0	0	1	0	0	1	0	0	0	0
+15 mins.	0	0	0	0	0	0	0	0	0	0	0	0
+30 mins.	0	0	0	0	0	0	0	0	0	0	0	0
+45 mins.	0	0	0	0	0	0	0	0	0	0	0	0
Total Volume	0	0	0	0	1	0	0	1	0	0	0	0
% App. Total	0	0	0	0	100	0	0	0	0	0	0	0
PHF	.000	.000	.000	.000	.250	.000	.000	.250	.000	.000	.000	.000

City of Madera
 N/S: SR-99 Northbound Ramps
 E/W: Gateway Drive
 Weather: Clear

File Name : 23A_MDA_99N Spur_Gateway PM
 Site Code : 00319628
 Start Date : 9/19/2019
 Page No : 1

Groups Printed- 4+ Axle Trucks

Start Time	SR-99 Northbound Ramps Southbound				Gateway Drive Westbound				Gateway Drive Eastbound				Int. Total
	Left	Right	U-Turns	App. Total	Thru	Right	U-Turns	App. Total	Left	Thru	U-Turns	App. Total	
04:00 PM	0	2	0	2	0	0	0	0	1	0	0	1	3
04:15 PM	0	0	0	0	0	0	0	0	1	2	0	3	3
04:30 PM	0	1	0	1	0	0	0	0	0	0	0	0	1
04:45 PM	0	2	0	2	0	0	0	0	0	0	0	0	2
Total	0	5	0	5	0	0	0	0	2	2	0	4	9
05:00 PM	0	2	0	2	0	0	0	0	1	2	0	3	5
05:15 PM	0	0	0	0	0	0	0	0	0	0	0	0	0
05:30 PM	0	0	0	0	0	0	0	0	0	1	0	1	1
05:45 PM	0	0	0	0	0	0	0	0	1	0	0	1	1
Total	0	2	0	2	0	0	0	0	2	3	0	5	7
Grand Total	0	7	0	7	0	0	0	0	4	5	0	9	16
Apprch %	0	100	0		0	0	0		44.4	55.6	0		
Total %	0	43.8	0	43.8	0	0	0	0	25	31.2	0	56.2	

Start Time	SR-99 Northbound Ramps Southbound				Gateway Drive Westbound				Gateway Drive Eastbound				Int. Total
	Left	Right	U-Turns	App. Total	Thru	Right	U-Turns	App. Total	Left	Thru	U-Turns	App. Total	
04:15 PM	0	0	0	0	0	0	0	0	1	2	0	3	3
04:30 PM	0	1	0	1	0	0	0	0	0	0	0	0	1
04:45 PM	0	2	0	2	0	0	0	0	0	0	0	0	2
05:00 PM	0	2	0	2	0	0	0	0	1	2	0	3	5
Total Volume	0	5	0	5	0	0	0	0	2	4	0	6	11
% App. Total	0	100	0		0	0	0		33.3	66.7	0		
PHF	.000	.625	.000	.625	.000	.000	.000	.000	.500	.500	.000	.500	.550

Peak Hour Analysis From 04:15 PM to 05:00 PM - Peak 1 of 1

Peak Hour for Entire Intersection Begins at 04:15 PM

City of Madera
 N/S: SR-99 Northbound Ramps
 E/W: Gateway Drive
 Weather: Clear

File Name : 23A_MDA_99N Spur_Gateway PM
 Site Code : 00319628
 Start Date : 9/19/2019
 Page No : 2

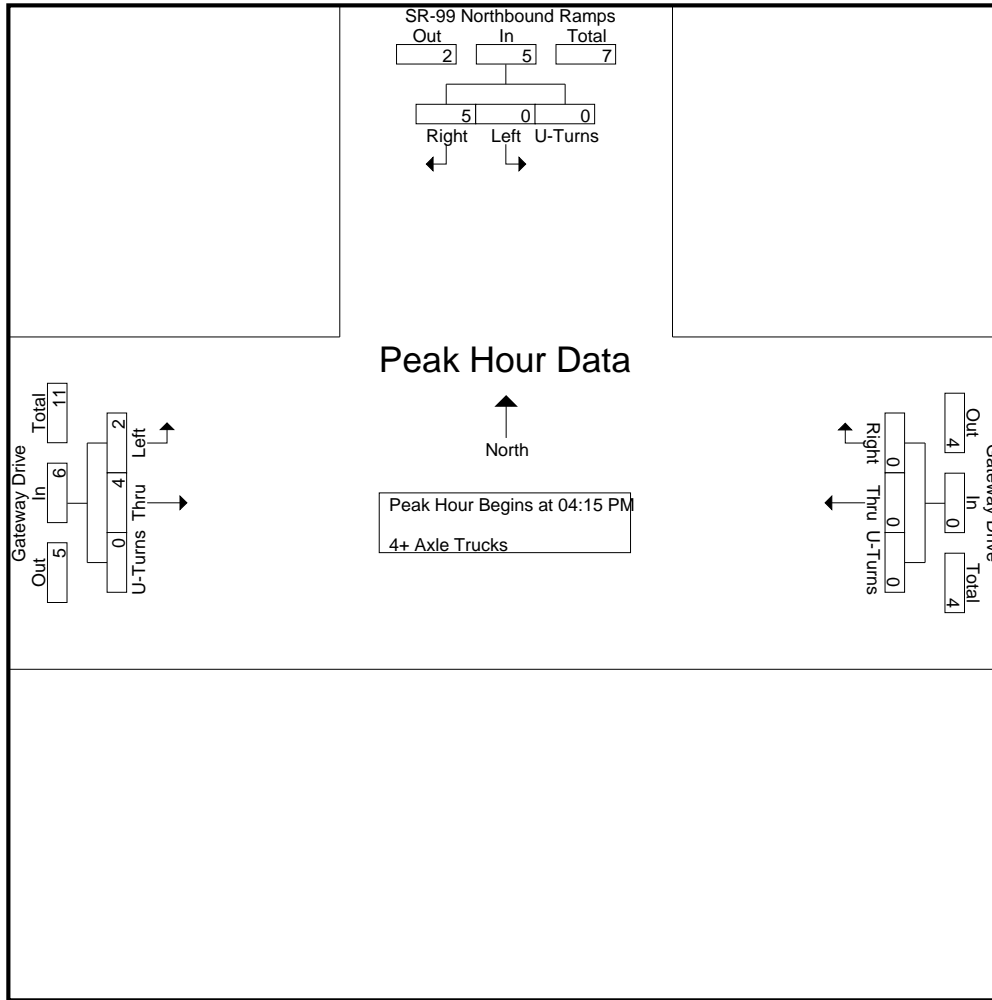

Peak Hour Analysis From 04:15 PM to 05:00 PM - Peak 1 of 1
 Peak Hour for Each Approach Begins at:

	04:15 PM				04:15 PM				04:15 PM			
+0 mins.	0	0	0	0	0	0	0	0	1	2	0	3
+15 mins.	0	1	0	1	0	0	0	0	0	0	0	0
+30 mins.	0	2	0	2	0	0	0	0	0	0	0	0
+45 mins.	0	2	0	2	0	0	0	0	1	2	0	3
Total Volume	0	5	0	5	0	0	0	0	2	4	0	6
% App. Total	0	100	0		0	0	0		33.3	66.7	0	
PHF	.000	.625	.000	.625	.000	.000	.000	.000	.500	.500	.000	.500

Location: Madera
 N/S: SR-99 Northbound Ramps
 E/W: Gateway Drive



Date: 9/19/2019
 Day: Thursday

PEDESTRIANS

	North Leg SR-99 Northbound Ramps	East Leg Gateway Drive	South Leg Dead End	West Leg Gateway Drive	
	Pedestrians	Pedestrians	Pedestrians	Pedestrians	
7:00 AM	0	0	0	0	0
7:15 AM	0	0	0	0	0
7:30 AM	0	0	0	0	0
7:45 AM	0	0	0	0	0
8:00 AM	0	0	0	0	0
8:15 AM	0	0	0	0	0
8:30 AM	0	0	0	0	0
8:45 AM	0	0	0	0	0
TOTAL VOLUMES:	0	0	0	0	0

	North Leg SR-99 Northbound Ramps	East Leg Gateway Drive	South Leg Dead End	West Leg Gateway Drive	
	Pedestrians	Pedestrians	Pedestrians	Pedestrians	
4:00 PM	0	0	0	0	0
4:15 PM	0	0	0	0	0
4:30 PM	0	0	0	0	0
4:45 PM	0	0	0	0	0
5:00 PM	0	0	0	0	0
5:15 PM	0	0	0	0	0
5:30 PM	0	0	0	0	0
5:45 PM	0	0	0	0	0
TOTAL VOLUMES:	0	0	0	0	0

Location: Madera
 N/S: SR-99 Northbound Ramps
 E/W: Gateway Drive



Date: 9/19/2019
 Day: Thursday

BICYCLES

	Southbound SR-99 Northbound Ramps			Westbound Gateway Drive			Northbound Dead End			Eastbound Gateway Drive			
	Left	Thru	Right	Left	Thru	Right	Left	Thru	Right	Left	Thru	Right	
7:00 AM	0	0	0	0	0	0	0	0	0	0	0	0	0
7:15 AM	0	0	0	0	0	0	0	0	0	0	0	0	0
7:30 AM	0	0	0	0	1	0	0	0	0	0	0	0	1
7:45 AM	0	0	0	0	0	0	0	0	0	0	0	0	0
8:00 AM	0	0	0	0	0	0	0	0	0	0	0	0	0
8:15 AM	0	0	0	0	0	0	0	0	0	0	0	0	0
8:30 AM	0	0	0	0	0	0	0	0	0	0	0	0	0
8:45 AM	0	0	0	0	0	0	0	0	0	0	0	0	0
TOTAL VOLUMES:	0	0	0	0	1	0	0	0	0	0	0	0	1

	Southbound SR-99 Northbound Ramps			Westbound Gateway Drive			Northbound Dead End			Eastbound Gateway Drive			
	Left	Thru	Right	Left	Thru	Right	Left	Thru	Right	Left	Thru	Right	
4:00 PM	0	0	0	0	0	0	0	0	0	0	0	0	0
4:15 PM	0	0	0	0	0	0	0	0	0	0	0	0	0
4:30 PM	0	0	0	0	0	0	0	0	0	0	0	0	0
4:45 PM	0	0	0	0	0	0	0	0	0	0	0	0	0
5:00 PM	0	0	0	0	0	0	0	0	0	0	0	0	0
5:15 PM	0	0	0	0	0	0	0	0	0	0	0	0	0
5:30 PM	0	0	0	0	0	0	0	0	0	0	0	0	0
5:45 PM	0	0	0	0	0	0	0	0	0	0	0	0	0
TOTAL VOLUMES:	0	0	0	0	0	0	0	0	0	0	0	0	0

City of Madera
 N/S: SR-99 Northbound Ramps
 E/W: SR-99 NB Spur
 Weather: Clear

File Name : 23_MDA_99N_Spur AM
 Site Code : 00319628
 Start Date : 9/19/2019
 Page No : 1

Groups Printed- Passenger Vehicles - Large 2 Axle Vehicles - 3 Axle Vehicles - 4+ Axle Trucks

Start Time	Spur to Gateway Westbound				Spur to Gateway Northbound				SR-99 Northbound Ramps Eastbound				Int. Total
	Left	Thru	U-Turns	App. Total	Left	Right	U-Turns	App. Total	Thru	Right	U-Turns	App. Total	
07:00 AM	0	10	0	10	30	0	0	30	0	19	0	19	59
07:15 AM	0	15	0	15	28	0	0	28	0	19	0	19	62
07:30 AM	0	13	0	13	59	0	0	59	0	30	0	30	102
07:45 AM	0	12	0	12	36	0	0	36	0	26	0	26	74
Total	0	50	0	50	153	0	0	153	0	94	0	94	297
08:00 AM	0	6	0	6	34	0	0	34	2	23	0	25	65
08:15 AM	0	11	0	11	31	0	0	31	1	25	0	26	68
08:30 AM	0	9	0	9	26	0	0	26	2	28	0	30	65
08:45 AM	0	11	0	11	31	0	0	31	0	33	0	33	75
Total	0	37	0	37	122	0	0	122	5	109	0	114	273
Grand Total	0	87	0	87	275	0	0	275	5	203	0	208	570
Apprch %	0	100	0		100	0	0		2.4	97.6	0		
Total %	0	15.3	0	15.3	48.2	0	0	48.2	0.9	35.6	0	36.5	
Passenger Vehicles	0	73	0	73	263	0	0	263	4	191	0	195	531
% Passenger Vehicles	0	83.9	0	83.9	95.6	0	0	95.6	80	94.1	0	93.8	93.2
Large 2 Axle Vehicles	0	4	0	4	7	0	0	7	1	6	0	7	18
% Large 2 Axle Vehicles	0	4.6	0	4.6	2.5	0	0	2.5	20	3	0	3.4	3.2
3 Axle Vehicles	0	3	0	3	0	0	0	0	0	1	0	1	4
% 3 Axle Vehicles	0	3.4	0	3.4	0	0	0	0	0	0.5	0	0.5	0.7
4+ Axle Trucks	0	7	0	7	5	0	0	5	0	5	0	5	17
% 4+ Axle Trucks	0	8	0	8	1.8	0	0	1.8	0	2.5	0	2.4	3

Start Time	Spur to Gateway Westbound				Spur to Gateway Northbound				SR-99 Northbound Ramps Eastbound				Int. Total
	Left	Thru	U-Turns	App. Total	Left	Right	U-Turns	App. Total	Thru	Right	U-Turns	App. Total	
Peak Hour Analysis From 07:00 AM to 08:45 AM - Peak 1 of 1													
Peak Hour for Entire Intersection Begins at 07:30 AM													
07:30 AM	0	13	0	13	59	0	0	59	0	30	0	30	102
07:45 AM	0	12	0	12	36	0	0	36	0	26	0	26	74
08:00 AM	0	6	0	6	34	0	0	34	2	23	0	25	65
08:15 AM	0	11	0	11	31	0	0	31	1	25	0	26	68
Total Volume	0	42	0	42	160	0	0	160	3	104	0	107	309
% App. Total	0	100	0		100	0	0		2.8	97.2	0		
PHF	.000	.808	.000	.808	.678	.000	.000	.678	.375	.867	.000	.892	.757

City of Madera
 N/S: SR-99 Northbound Ramps
 E/W: SR-99 NB Spur
 Weather: Clear

File Name : 23_MDA_99N_Spur AM
 Site Code : 00319628
 Start Date : 9/19/2019
 Page No : 2

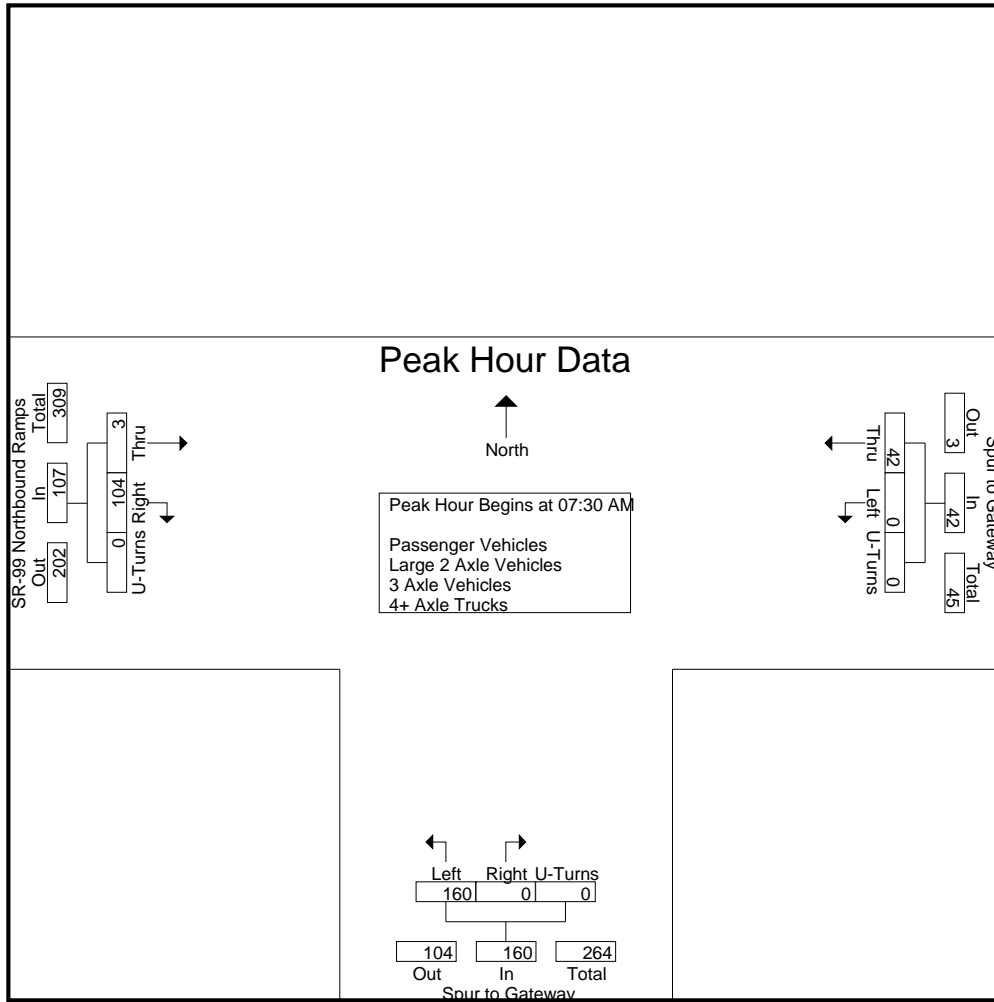

Peak Hour Analysis From 07:00 AM to 08:45 AM - Peak 1 of 1
 Peak Hour for Each Approach Begins at:

	07:00 AM			07:30 AM			08:00 AM					
+0 mins.	0	10	0	10	59	0	0	59	2	23	0	25
+15 mins.	0	15	0	15	36	0	0	36	1	25	0	26
+30 mins.	0	13	0	13	34	0	0	34	2	28	0	30
+45 mins.	0	12	0	12	31	0	0	31	0	33	0	33
Total Volume	0	50	0	50	160	0	0	160	5	109	0	114
% App. Total	0	100	0	100	100	0	0	100	4.4	95.6	0	100
PHF	.000	.833	.000	.833	.678	.000	.000	.678	.625	.826	.000	.864

City of Madera
 N/S: SR-99 Northbound Ramps
 E/W: SR-99 NB Spur
 Weather: Clear

File Name : 23_MDA_99N_Spur AM
 Site Code : 00319628
 Start Date : 9/19/2019
 Page No : 1

Groups Printed- Passenger Vehicles

Start Time	Spur to Gateway Westbound				Spur to Gateway Northbound				SR-99 Northbound Ramps Eastbound				Int. Total
	Left	Thru	U-Turns	App. Total	Left	Right	U-Turns	App. Total	Thru	Right	U-Turns	App. Total	
07:00 AM	0	7	0	7	27	0	0	27	0	18	0	18	52
07:15 AM	0	12	0	12	26	0	0	26	0	18	0	18	56
07:30 AM	0	10	0	10	56	0	0	56	0	28	0	28	94
07:45 AM	0	11	0	11	36	0	0	36	0	25	0	25	72
Total	0	40	0	40	145	0	0	145	0	89	0	89	274
08:00 AM	0	6	0	6	33	0	0	33	2	22	0	24	63
08:15 AM	0	11	0	11	30	0	0	30	1	22	0	23	64
08:30 AM	0	7	0	7	25	0	0	25	1	27	0	28	60
08:45 AM	0	9	0	9	30	0	0	30	0	31	0	31	70
Total	0	33	0	33	118	0	0	118	4	102	0	106	257
Grand Total	0	73	0	73	263	0	0	263	4	191	0	195	531
Apprch %	0	100	0		100	0	0		2.1	97.9	0		
Total %	0	13.7	0	13.7	49.5	0	0	49.5	0.8	36	0	36.7	

Start Time	Spur to Gateway Westbound				Spur to Gateway Northbound				SR-99 Northbound Ramps Eastbound				Int. Total
	Left	Thru	U-Turns	App. Total	Left	Right	U-Turns	App. Total	Thru	Right	U-Turns	App. Total	
Peak Hour Analysis From 07:30 AM to 08:15 AM - Peak 1 of 1													
Peak Hour for Entire Intersection Begins at 07:30 AM													
07:30 AM	0	10	0	10	56	0	0	56	0	28	0	28	94
07:45 AM	0	11	0	11	36	0	0	36	0	25	0	25	72
08:00 AM	0	6	0	6	33	0	0	33	2	22	0	24	63
08:15 AM	0	11	0	11	30	0	0	30	1	22	0	23	64
Total Volume	0	38	0	38	155	0	0	155	3	97	0	100	293
% App. Total	0	100	0		100	0	0		3	97	0		
PHF	.000	.864	.000	.864	.692	.000	.000	.692	.375	.866	.000	.893	.779

City of Madera
 N/S: SR-99 Northbound Ramps
 E/W: SR-99 NB Spur
 Weather: Clear

File Name : 23_MDA_99N_Spur AM
 Site Code : 00319628
 Start Date : 9/19/2019
 Page No : 2

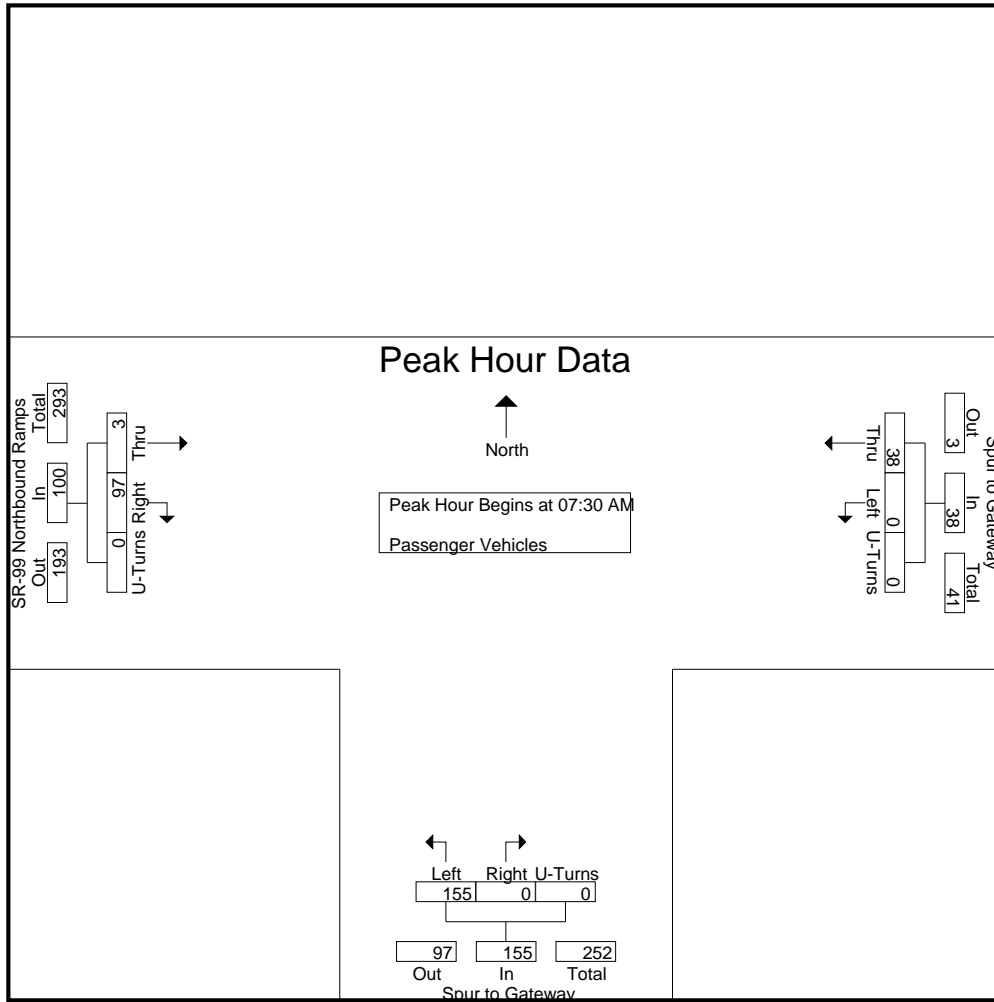

Peak Hour Analysis From 07:30 AM to 08:15 AM - Peak 1 of 1
 Peak Hour for Each Approach Begins at:

	07:30 AM				07:30 AM				07:30 AM			
+0 mins.	0	10	0	10	56	0	0	56	0	28	0	28
+15 mins.	0	11	0	11	36	0	0	36	0	25	0	25
+30 mins.	0	6	0	6	33	0	0	33	2	22	0	24
+45 mins.	0	11	0	11	30	0	0	30	1	22	0	23
Total Volume	0	38	0	38	155	0	0	155	3	97	0	100
% App. Total	0	100	0		100	0	0		3	97	0	
PHF	.000	.864	.000	.864	.692	.000	.000	.692	.375	.866	.000	.893

City of Madera
 N/S: SR-99 Northbound Ramps
 E/W: SR-99 NB Spur
 Weather: Clear

File Name : 23_MDA_99N_Spur AM
 Site Code : 00319628
 Start Date : 9/19/2019
 Page No : 1

Groups Printed- Large 2 Axle Vehicles

Start Time	Spur to Gateway Westbound				Spur to Gateway Northbound				SR-99 Northbound Ramps Eastbound				Int. Total
	Left	Thru	U-Turns	App. Total	Left	Right	U-Turns	App. Total	Thru	Right	U-Turns	App. Total	
07:00 AM	0	1	0	1	1	0	0	1	0	1	0	1	3
07:15 AM	0	1	0	1	0	0	0	0	0	1	0	1	2
07:30 AM	0	1	0	1	3	0	0	3	0	1	0	1	5
07:45 AM	0	0	0	0	0	0	0	0	0	1	0	1	1
Total	0	3	0	3	4	0	0	4	0	4	0	4	11
08:00 AM	0	0	0	0	0	0	0	0	0	1	0	1	1
08:15 AM	0	0	0	0	1	0	0	1	0	0	0	0	1
08:30 AM	0	1	0	1	1	0	0	1	1	0	0	1	3
08:45 AM	0	0	0	0	1	0	0	1	0	1	0	1	2
Total	0	1	0	1	3	0	0	3	1	2	0	3	7
Grand Total	0	4	0	4	7	0	0	7	1	6	0	7	18
Apprch %	0	100	0		100	0	0		14.3	85.7	0		
Total %	0	22.2	0	22.2	38.9	0	0	38.9	5.6	33.3	0	38.9	

Start Time	Spur to Gateway Westbound				Spur to Gateway Northbound				SR-99 Northbound Ramps Eastbound				Int. Total
	Left	Thru	U-Turns	App. Total	Left	Right	U-Turns	App. Total	Thru	Right	U-Turns	App. Total	
07:30 AM	0	1	0	1	3	0	0	3	0	1	0	1	5
07:45 AM	0	0	0	0	0	0	0	0	0	1	0	1	1
08:00 AM	0	0	0	0	0	0	0	0	0	1	0	1	1
08:15 AM	0	0	0	0	1	0	0	1	0	0	0	0	1
Total Volume	0	1	0	1	4	0	0	4	0	3	0	3	8
% App. Total	0	100	0		100	0	0		0	100	0		
PHF	.000	.250	.000	.250	.333	.000	.000	.333	.000	.750	.000	.750	.400

Peak Hour Analysis From 07:30 AM to 08:15 AM - Peak 1 of 1

Peak Hour for Entire Intersection Begins at 07:30 AM

City of Madera
 N/S: SR-99 Northbound Ramps
 E/W: SR-99 NB Spur
 Weather: Clear

File Name : 23_MDA_99N_Spur AM
 Site Code : 00319628
 Start Date : 9/19/2019
 Page No : 2

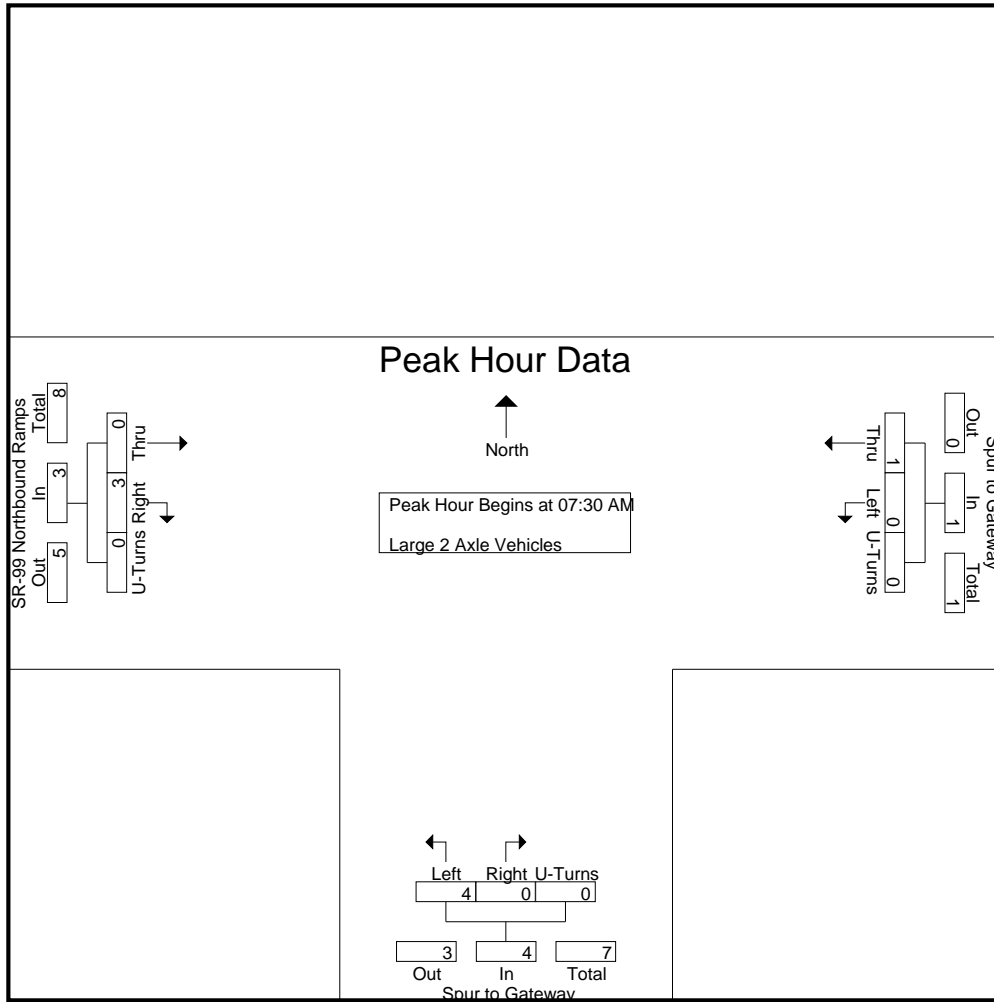

Peak Hour Analysis From 07:30 AM to 08:15 AM - Peak 1 of 1
 Peak Hour for Each Approach Begins at:

	07:30 AM				07:30 AM				07:30 AM			
+0 mins.	0	1	0	1	3	0	0	3	0	1	0	1
+15 mins.	0	0	0	0	0	0	0	0	0	1	0	1
+30 mins.	0	0	0	0	0	0	0	0	0	1	0	1
+45 mins.	0	0	0	0	1	0	0	1	0	0	0	0
Total Volume	0	1	0	1	4	0	0	4	0	3	0	3
% App. Total	0	100	0	0	100	0	0	0	0	100	0	0
PHF	.000	.250	.000	.250	.333	.000	.000	.333	.000	.750	.000	.750

City of Madera
 N/S: SR-99 Northbound Ramps
 E/W: SR-99 NB Spur
 Weather: Clear

File Name : 23_MDA_99N_Spur AM
 Site Code : 00319628
 Start Date : 9/19/2019
 Page No : 1

Groups Printed- 3 Axle Vehicles

Start Time	Spur to Gateway Westbound				Spur to Gateway Northbound				SR-99 Northbound Ramps Eastbound				Int. Total	
	Left	Thru	U-Turns	App. Total	Left	Right	U-Turns	App. Total	Thru	Right	U-Turns	App. Total		
07:00 AM	0	0	0	0	0	0	0	0	0	0	0	0	0	0
07:15 AM	0	1	0	1	0	0	0	0	0	0	0	0	0	1
07:30 AM	0	1	0	1	0	0	0	0	0	0	0	0	0	1
07:45 AM	0	0	0	0	0	0	0	0	0	0	0	0	0	0
Total	0	2	0	2	0	0	0	0	0	0	0	0	0	2
08:00 AM	0	0	0	0	0	0	0	0	0	0	0	0	0	0
08:15 AM	0	0	0	0	0	0	0	0	0	1	0	1	1	1
08:30 AM	0	0	0	0	0	0	0	0	0	0	0	0	0	0
08:45 AM	0	1	0	1	0	0	0	0	0	0	0	0	0	1
Total	0	1	0	1	0	0	0	0	0	1	0	1	1	2
Grand Total	0	3	0	3	0	0	0	0	0	1	0	1	1	4
Apprch %	0	100	0		0	0	0		0	100	0			
Total %	0	75	0	75	0	0	0	0	0	25	0	25		

Start Time	Spur to Gateway Westbound				Spur to Gateway Northbound				SR-99 Northbound Ramps Eastbound				Int. Total	
	Left	Thru	U-Turns	App. Total	Left	Right	U-Turns	App. Total	Thru	Right	U-Turns	App. Total		
07:30 AM	0	1	0	1	0	0	0	0	0	0	0	0	0	1
07:45 AM	0	0	0	0	0	0	0	0	0	0	0	0	0	0
08:00 AM	0	0	0	0	0	0	0	0	0	0	0	0	0	0
08:15 AM	0	0	0	0	0	0	0	0	0	1	0	1	1	1
Total Volume	0	1	0	1	0	0	0	0	0	1	0	1	1	2
% App. Total	0	100	0		0	0	0		0	100	0			
PHF	.000	.250	.000	.250	.000	.000	.000	.000	.000	.250	.000	.250		.500

Peak Hour Analysis From 07:30 AM to 08:15 AM - Peak 1 of 1

Peak Hour for Entire Intersection Begins at 07:30 AM

City of Madera
 N/S: SR-99 Northbound Ramps
 E/W: SR-99 NB Spur
 Weather: Clear

File Name : 23_MDA_99N_Spur AM
 Site Code : 00319628
 Start Date : 9/19/2019
 Page No : 2

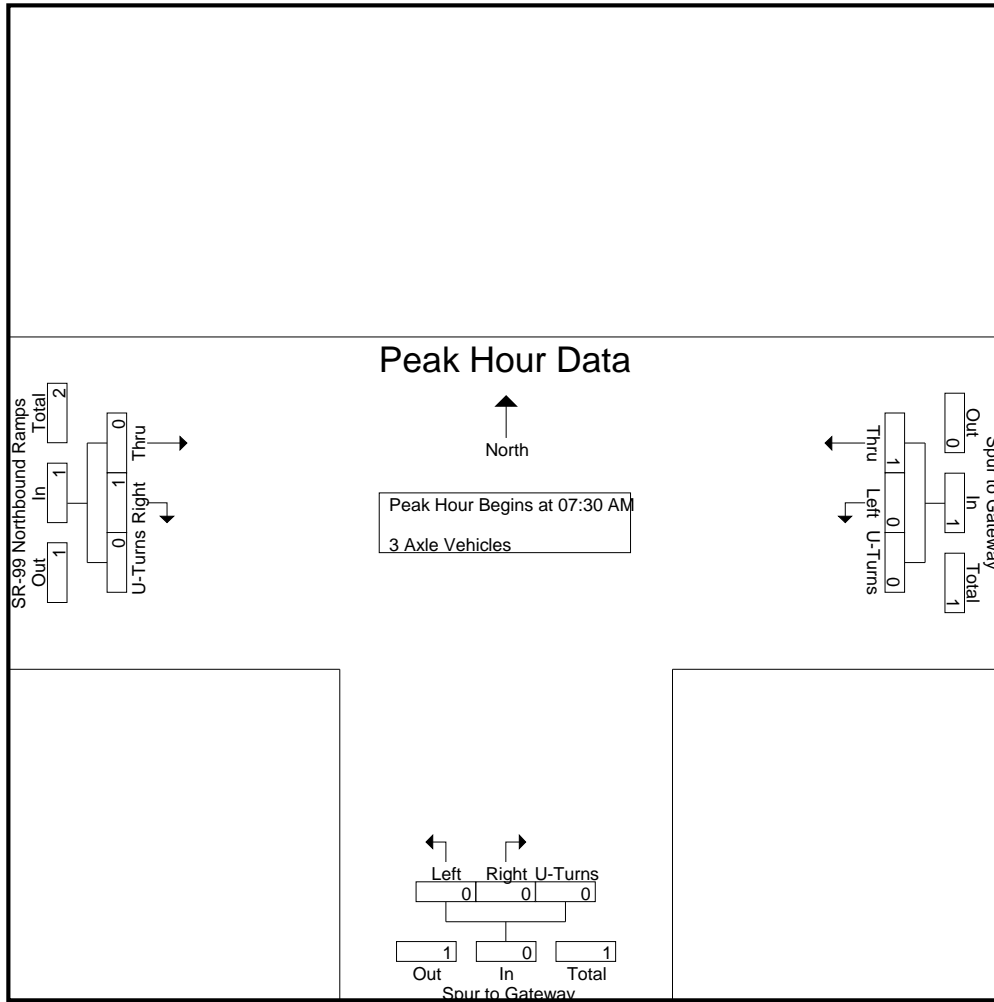

Peak Hour Analysis From 07:30 AM to 08:15 AM - Peak 1 of 1
 Peak Hour for Each Approach Begins at:

	07:30 AM				07:30 AM				07:30 AM			
+0 mins.	0	1	0	1	0	0	0	0	0	0	0	0
+15 mins.	0	0	0	0	0	0	0	0	0	0	0	0
+30 mins.	0	0	0	0	0	0	0	0	0	0	0	0
+45 mins.	0	0	0	0	0	0	0	0	0	1	0	1
Total Volume	0	1	0	1	0	0	0	0	0	1	0	1
% App. Total	0	100	0	0	0	0	0	0	0	100	0	0
PHF	.000	.250	.000	.250	.000	.000	.000	.000	.000	.250	.000	.250

City of Madera
 N/S: SR-99 Northbound Ramps
 E/W: SR-99 NB Spur
 Weather: Clear

File Name : 23_MDA_99N_Spur AM
 Site Code : 00319628
 Start Date : 9/19/2019
 Page No : 1

Groups Printed- 4+ Axle Trucks

Start Time	Spur to Gateway Westbound				Spur to Gateway Northbound				SR-99 Northbound Ramps Eastbound				Int. Total
	Left	Thru	U-Turns	App. Total	Left	Right	U-Turns	App. Total	Thru	Right	U-Turns	App. Total	
07:00 AM	0	2	0	2	2	0	0	2	0	0	0	0	4
07:15 AM	0	1	0	1	2	0	0	2	0	0	0	0	3
07:30 AM	0	1	0	1	0	0	0	0	0	1	0	1	2
07:45 AM	0	1	0	1	0	0	0	0	0	0	0	0	1
Total	0	5	0	5	4	0	0	4	0	1	0	1	10
08:00 AM	0	0	0	0	1	0	0	1	0	0	0	0	1
08:15 AM	0	0	0	0	0	0	0	0	0	2	0	2	2
08:30 AM	0	1	0	1	0	0	0	0	0	1	0	1	2
08:45 AM	0	1	0	1	0	0	0	0	0	1	0	1	2
Total	0	2	0	2	1	0	0	1	0	4	0	4	7
Grand Total	0	7	0	7	5	0	0	5	0	5	0	5	17
Apprch %	0	100	0		100	0	0		0	100	0		
Total %	0	41.2	0	41.2	29.4	0	0	29.4	0	29.4	0	29.4	

Start Time	Spur to Gateway Westbound				Spur to Gateway Northbound				SR-99 Northbound Ramps Eastbound				Int. Total
	Left	Thru	U-Turns	App. Total	Left	Right	U-Turns	App. Total	Thru	Right	U-Turns	App. Total	
07:30 AM	0	1	0	1	0	0	0	0	0	1	0	1	2
07:45 AM	0	1	0	1	0	0	0	0	0	0	0	0	1
08:00 AM	0	0	0	0	1	0	0	1	0	0	0	0	1
08:15 AM	0	0	0	0	0	0	0	0	0	2	0	2	2
Total Volume	0	2	0	2	1	0	0	1	0	3	0	3	6
% App. Total	0	100	0		100	0	0		0	100	0		
PHF	.000	.500	.000	.500	.250	.000	.000	.250	.000	.375	.000	.375	.750

Peak Hour Analysis From 07:30 AM to 08:15 AM - Peak 1 of 1

Peak Hour for Entire Intersection Begins at 07:30 AM

City of Madera
 N/S: SR-99 Northbound Ramps
 E/W: SR-99 NB Spur
 Weather: Clear

File Name : 23_MDA_99N_Spur AM
 Site Code : 00319628
 Start Date : 9/19/2019
 Page No : 2

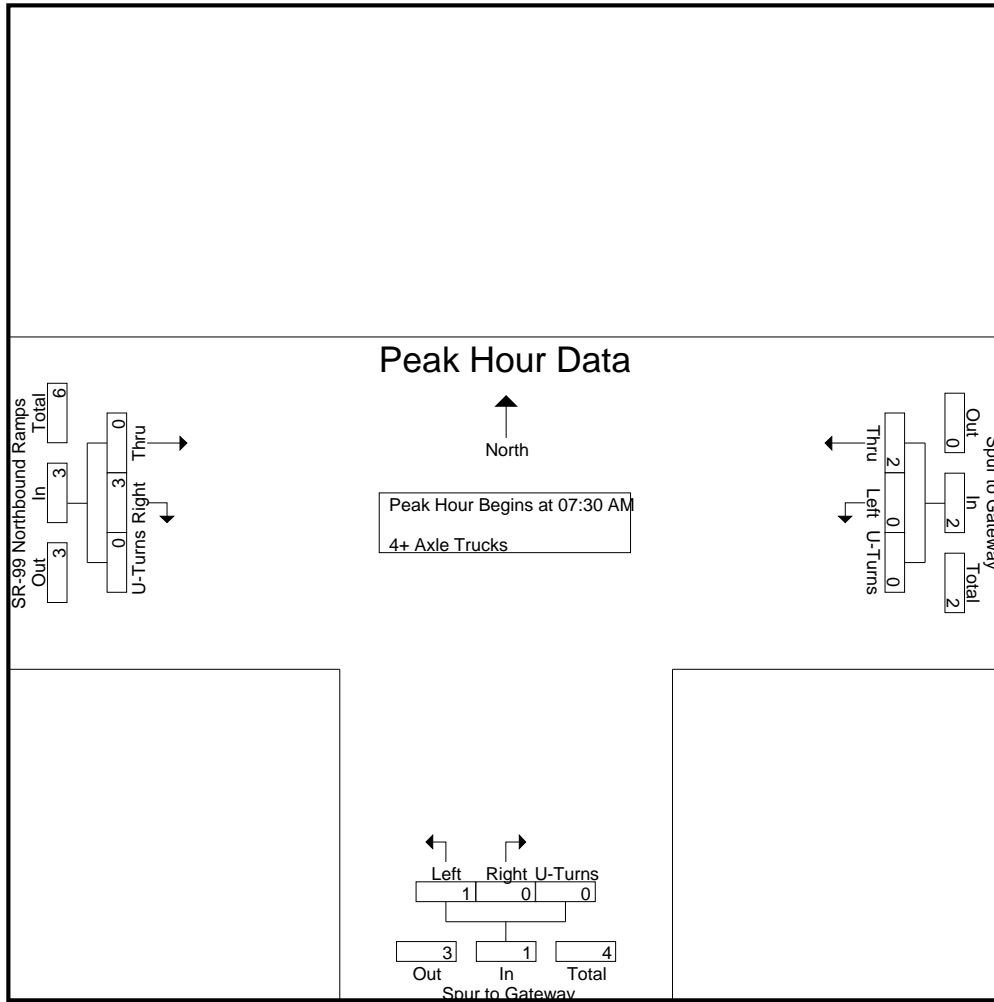

Peak Hour Analysis From 07:30 AM to 08:15 AM - Peak 1 of 1
 Peak Hour for Each Approach Begins at:

	07:30 AM				07:30 AM				07:30 AM			
+0 mins.	0	1	0	1	0	0	0	0	0	1	0	1
+15 mins.	0	1	0	1	0	0	0	0	0	0	0	0
+30 mins.	0	0	0	0	1	0	0	1	0	0	0	0
+45 mins.	0	0	0	0	0	0	0	0	0	2	0	2
Total Volume	0	2	0	2	1	0	0	1	0	3	0	3
% App. Total	0	100	0	0	100	0	0	0	0	100	0	0
PHF	.000	.500	.000	.500	.250	.000	.000	.250	.000	.375	.000	.375

City of Madera
 N/S: SR-99 Northbound Ramps
 E/W: SR-99 NB Spur
 Weather: Clear

File Name : 23_MDA_99N_Spur PM
 Site Code : 00319628
 Start Date : 9/19/2019
 Page No : 1

Groups Printed- Passenger Vehicles - Large 2 Axle Vehicles - 3 Axle Vehicles - 4+ Axle Trucks

Start Time	Spur to Gateway Westbound				Spur to Gateway Northbound				SR-99 Northbound Ramps Eastbound				Int. Total
	Left	Thru	U-Turns	App. Total	Left	Right	U-Turns	App. Total	Thru	Right	U-Turns	App. Total	
04:00 PM	0	18	0	18	30	0	0	30	3	23	0	26	74
04:15 PM	0	16	0	16	41	0	0	41	2	32	0	34	91
04:30 PM	0	20	0	20	27	0	0	27	0	24	0	24	71
04:45 PM	0	11	0	11	27	0	0	27	0	39	0	39	77
Total	0	65	0	65	125	0	0	125	5	118	0	123	313
05:00 PM	0	31	0	31	58	0	0	58	1	40	0	41	130
05:15 PM	0	26	0	26	31	0	0	31	0	28	0	28	85
05:30 PM	0	13	0	13	27	0	0	27	1	34	0	35	75
05:45 PM	0	11	0	11	32	0	0	32	1	22	0	23	66
Total	0	81	0	81	148	0	0	148	3	124	0	127	356
Grand Total	0	146	0	146	273	0	0	273	8	242	0	250	669
Apprch %	0	100	0		100	0	0		3.2	96.8	0		
Total %	0	21.8	0	21.8	40.8	0	0	40.8	1.2	36.2	0	37.4	
Passenger Vehicles	0	137	0	137	268	0	0	268	8	234	0	242	647
% Passenger Vehicles	0	93.8	0	93.8	98.2	0	0	98.2	100	96.7	0	96.8	96.7
Large 2 Axle Vehicles	0	2	0	2	1	0	0	1	0	0	0	0	3
% Large 2 Axle Vehicles	0	1.4	0	1.4	0.4	0	0	0.4	0	0	0	0	0.4
3 Axle Vehicles	0	0	0	0	0	0	0	0	0	1	0	1	1
% 3 Axle Vehicles	0	0	0	0	0	0	0	0	0	0.4	0	0.4	0.1
4+ Axle Trucks	0	7	0	7	4	0	0	4	0	7	0	7	18
% 4+ Axle Trucks	0	4.8	0	4.8	1.5	0	0	1.5	0	2.9	0	2.8	2.7

Start Time	Spur to Gateway Westbound				Spur to Gateway Northbound				SR-99 Northbound Ramps Eastbound				Int. Total
	Left	Thru	U-Turns	App. Total	Left	Right	U-Turns	App. Total	Thru	Right	U-Turns	App. Total	
Peak Hour Analysis From 04:00 PM to 05:45 PM - Peak 1 of 1													
Peak Hour for Entire Intersection Begins at 04:15 PM													
04:15 PM	0	16	0	16	41	0	0	41	2	32	0	34	91
04:30 PM	0	20	0	20	27	0	0	27	0	24	0	24	71
04:45 PM	0	11	0	11	27	0	0	27	0	39	0	39	77
05:00 PM	0	31	0	31	58	0	0	58	1	40	0	41	130
Total Volume	0	78	0	78	153	0	0	153	3	135	0	138	369
% App. Total	0	100	0		100	0	0		2.2	97.8	0		
PHF	.000	.629	.000	.629	.659	.000	.000	.659	.375	.844	.000	.841	.710

City of Madera
 N/S: SR-99 Northbound Ramps
 E/W: SR-99 NB Spur
 Weather: Clear

File Name : 23_MDA_99N_Spur PM
 Site Code : 00319628
 Start Date : 9/19/2019
 Page No : 2

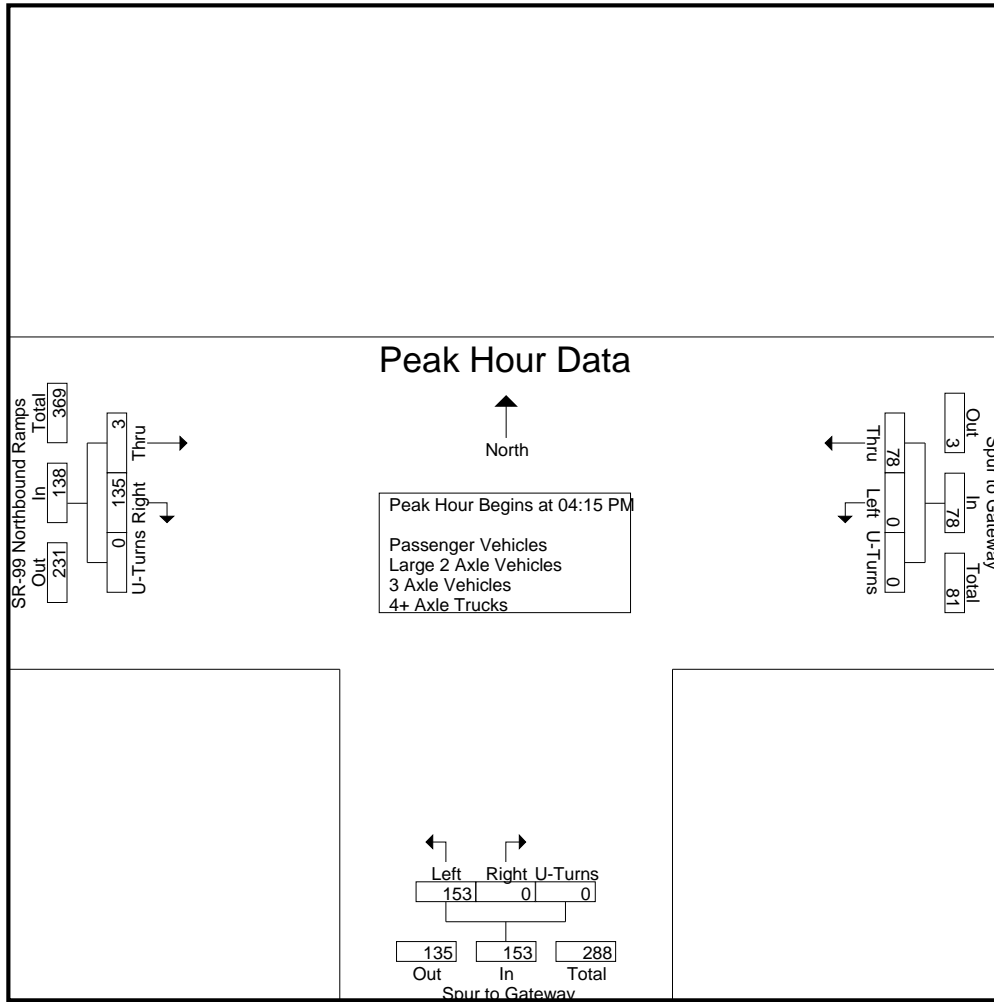

Peak Hour Analysis From 04:00 PM to 05:45 PM - Peak 1 of 1
 Peak Hour for Each Approach Begins at:

	04:30 PM				04:15 PM				04:45 PM			
+0 mins.	0	20	0	20	41	0	0	41	0	39	0	39
+15 mins.	0	11	0	11	27	0	0	27	1	40	0	41
+30 mins.	0	31	0	31	27	0	0	27	0	28	0	28
+45 mins.	0	26	0	26	58	0	0	58	1	34	0	35
Total Volume	0	88	0	88	153	0	0	153	2	141	0	143
% App. Total	0	100	0		100	0	0		1.4	98.6	0	
PHF	.000	.710	.000	.710	.659	.000	.000	.659	.500	.881	.000	.872

City of Madera
 N/S: SR-99 Northbound Ramps
 E/W: SR-99 NB Spur
 Weather: Clear

File Name : 23_MDA_99N_Spur PM
 Site Code : 00319628
 Start Date : 9/19/2019
 Page No : 1

Groups Printed- Passenger Vehicles

Start Time	Spur to Gateway Westbound				Spur to Gateway Northbound				SR-99 Northbound Ramps Eastbound				Int. Total
	Left	Thru	U-Turns	App. Total	Left	Right	U-Turns	App. Total	Thru	Right	U-Turns	App. Total	
04:00 PM	0	16	0	16	29	0	0	29	3	21	0	24	69
04:15 PM	0	16	0	16	39	0	0	39	2	32	0	34	89
04:30 PM	0	19	0	19	27	0	0	27	0	23	0	23	69
04:45 PM	0	9	0	9	27	0	0	27	0	37	0	37	73
Total	0	60	0	60	122	0	0	122	5	113	0	118	300
05:00 PM	0	27	0	27	57	0	0	57	1	38	0	39	123
05:15 PM	0	26	0	26	31	0	0	31	0	27	0	27	84
05:30 PM	0	13	0	13	27	0	0	27	1	34	0	35	75
05:45 PM	0	11	0	11	31	0	0	31	1	22	0	23	65
Total	0	77	0	77	146	0	0	146	3	121	0	124	347
Grand Total	0	137	0	137	268	0	0	268	8	234	0	242	647
Apprch %	0	100	0		100	0	0		3.3	96.7	0		
Total %	0	21.2	0	21.2	41.4	0	0	41.4	1.2	36.2	0	37.4	

Start Time	Spur to Gateway Westbound				Spur to Gateway Northbound				SR-99 Northbound Ramps Eastbound				Int. Total
	Left	Thru	U-Turns	App. Total	Left	Right	U-Turns	App. Total	Thru	Right	U-Turns	App. Total	
Peak Hour Analysis From 04:15 PM to 05:00 PM - Peak 1 of 1													
Peak Hour for Entire Intersection Begins at 04:15 PM													
04:15 PM	0	16	0	16	39	0	0	39	2	32	0	34	89
04:30 PM	0	19	0	19	27	0	0	27	0	23	0	23	69
04:45 PM	0	9	0	9	27	0	0	27	0	37	0	37	73
05:00 PM	0	27	0	27	57	0	0	57	1	38	0	39	123
Total Volume	0	71	0	71	150	0	0	150	3	130	0	133	354
% App. Total	0	100	0		100	0	0		2.3	97.7	0		
PHF	.000	.657	.000	.657	.658	.000	.000	.658	.375	.855	.000	.853	.720

City of Madera
 N/S: SR-99 Northbound Ramps
 E/W: SR-99 NB Spur
 Weather: Clear

File Name : 23_MDA_99N_Spur PM
 Site Code : 00319628
 Start Date : 9/19/2019
 Page No : 2

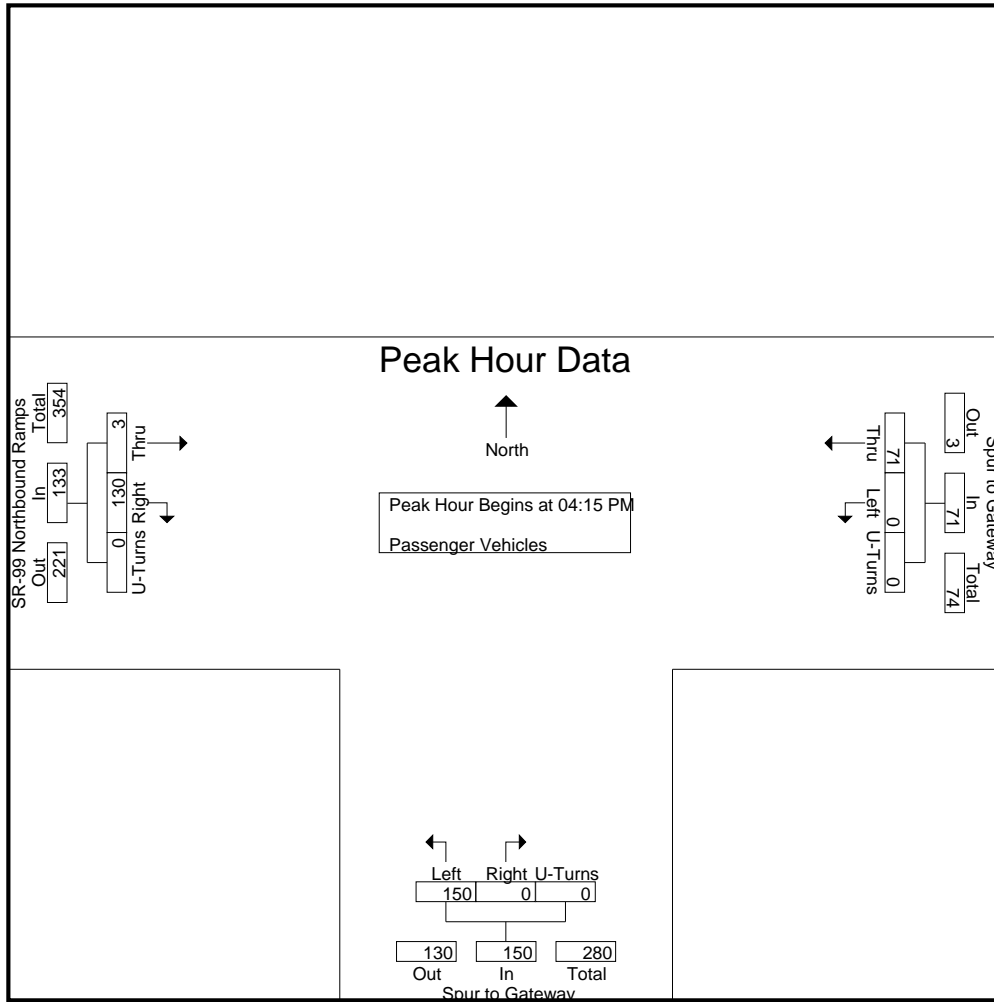

Peak Hour Analysis From 04:15 PM to 05:00 PM - Peak 1 of 1
 Peak Hour for Each Approach Begins at:

	04:15 PM				04:15 PM				04:15 PM			
+0 mins.	0	16	0	16	39	0	0	39	2	32	0	34
+15 mins.	0	19	0	19	27	0	0	27	0	23	0	23
+30 mins.	0	9	0	9	27	0	0	27	0	37	0	37
+45 mins.	0	27	0	27	57	0	0	57	1	38	0	39
Total Volume	0	71	0	71	150	0	0	150	3	130	0	133
% App. Total	0	100	0		100	0	0		2.3	97.7	0	
PHF	.000	.657	.000	.657	.658	.000	.000	.658	.375	.855	.000	.853

City of Madera
 N/S: SR-99 Northbound Ramps
 E/W: SR-99 NB Spur
 Weather: Clear

File Name : 23_MDA_99N_Spur PM
 Site Code : 00319628
 Start Date : 9/19/2019
 Page No : 2

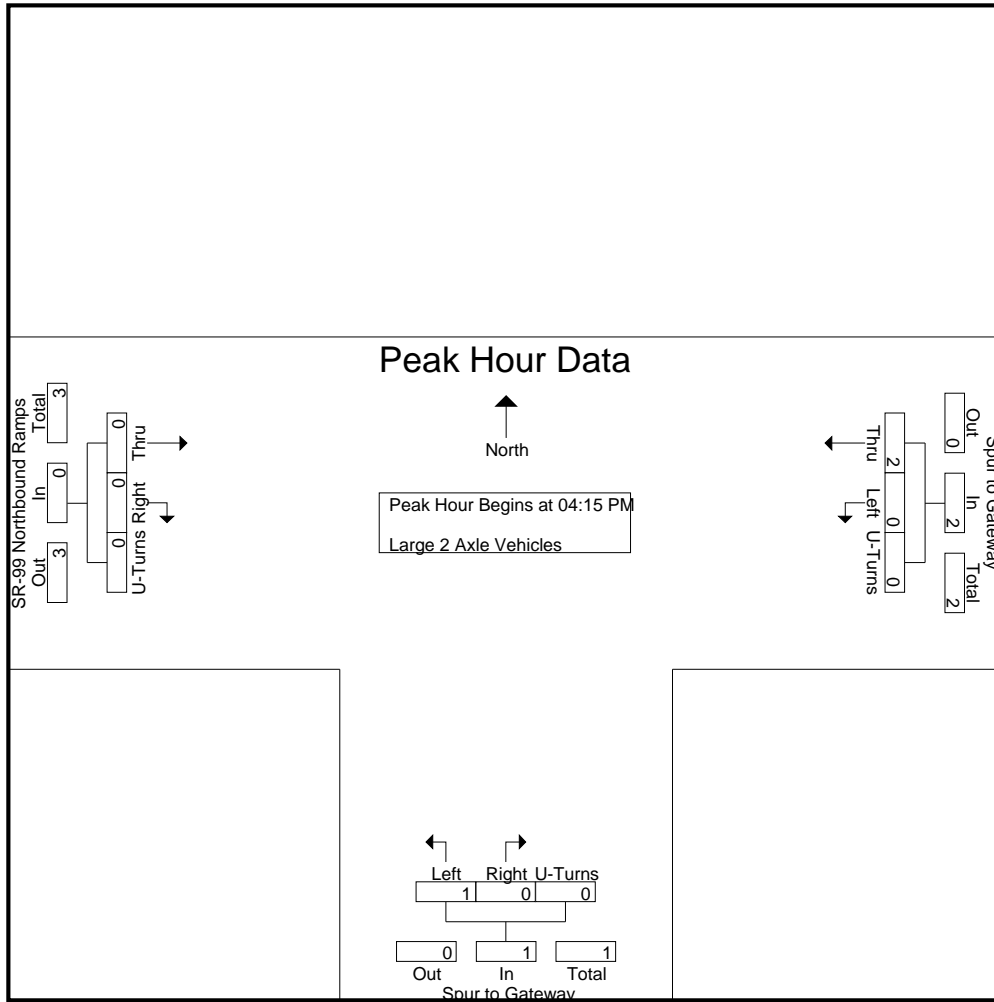

Peak Hour Analysis From 04:15 PM to 05:00 PM - Peak 1 of 1
 Peak Hour for Each Approach Begins at:

	04:15 PM				04:15 PM				04:15 PM			
+0 mins.	0	0	0	0	1	0	0	1	0	0	0	0
+15 mins.	0	0	0	0	0	0	0	0	0	0	0	0
+30 mins.	0	0	0	0	0	0	0	0	0	0	0	0
+45 mins.	0	2	0	2	0	0	0	0	0	0	0	0
Total Volume	0	2	0	2	1	0	0	1	0	0	0	0
% App. Total	0	100	0	0	100	0	0	0	0	0	0	0
PHF	.000	.250	.000	.250	.250	.000	.000	.250	.000	.000	.000	.000

City of Madera
 N/S: SR-99 Northbound Ramps
 E/W: SR-99 NB Spur
 Weather: Clear

File Name : 23_MDA_99N_Spur PM
 Site Code : 00319628
 Start Date : 9/19/2019
 Page No : 1

Groups Printed- 3 Axle Vehicles

Start Time	Spur to Gateway Westbound				Spur to Gateway Northbound				SR-99 Northbound Ramps Eastbound				Int. Total
	Left	Thru	U-Turns	App. Total	Left	Right	U-Turns	App. Total	Thru	Right	U-Turns	App. Total	
04:00 PM	0	0	0	0	0	0	0	0	0	0	0	0	0
04:15 PM	0	0	0	0	0	0	0	0	0	0	0	0	0
04:30 PM	0	0	0	0	0	0	0	0	0	0	0	0	0
04:45 PM	0	0	0	0	0	0	0	0	0	0	0	0	0
Total	0	0	0	0	0	0	0	0	0	0	0	0	0
05:00 PM	0	0	0	0	0	0	0	0	0	0	0	0	0
05:15 PM	0	0	0	0	0	0	0	0	0	1	0	1	1
05:30 PM	0	0	0	0	0	0	0	0	0	0	0	0	0
05:45 PM	0	0	0	0	0	0	0	0	0	0	0	0	0
Total	0	0	0	0	0	0	0	0	0	1	0	1	1
Grand Total	0	0	0	0	0	0	0	0	0	1	0	1	1
Apprch %	0	0	0	0	0	0	0	0	0	100	0	100	
Total %	0	0	0	0	0	0	0	0	0	100	0	100	

Start Time	Spur to Gateway Westbound				Spur to Gateway Northbound				SR-99 Northbound Ramps Eastbound				Int. Total
	Left	Thru	U-Turns	App. Total	Left	Right	U-Turns	App. Total	Thru	Right	U-Turns	App. Total	
04:15 PM	0	0	0	0	0	0	0	0	0	0	0	0	0
04:30 PM	0	0	0	0	0	0	0	0	0	0	0	0	0
04:45 PM	0	0	0	0	0	0	0	0	0	0	0	0	0
05:00 PM	0	0	0	0	0	0	0	0	0	0	0	0	0
Total Volume	0	0	0	0	0	0	0	0	0	0	0	0	0
% App. Total	0	0	0	0	0	0	0	0	0	0	0	0	
PHF	.000	.000	.000	.000	.000	.000	.000	.000	.000	.000	.000	.000	.000

Peak Hour Analysis From 04:15 PM to 05:00 PM - Peak 1 of 1

Peak Hour for Entire Intersection Begins at 04:15 PM

City of Madera
 N/S: SR-99 Northbound Ramps
 E/W: SR-99 NB Spur
 Weather: Clear

File Name : 23_MDA_99N_Spur PM
 Site Code : 00319628
 Start Date : 9/19/2019
 Page No : 2

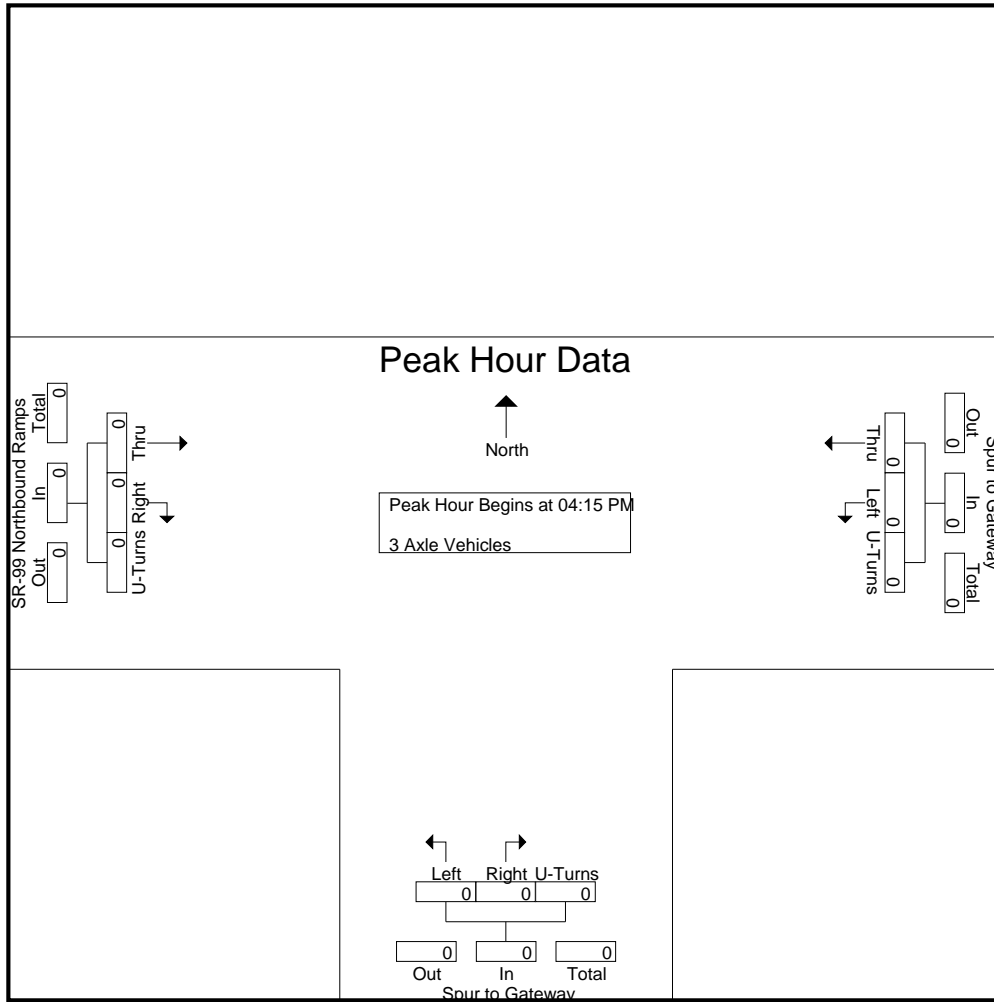

Peak Hour Analysis From 04:15 PM to 05:00 PM - Peak 1 of 1
 Peak Hour for Each Approach Begins at:

	04:15 PM				04:15 PM				04:15 PM			
+0 mins.	0	0	0	0	0	0	0	0	0	0	0	0
+15 mins.	0	0	0	0	0	0	0	0	0	0	0	0
+30 mins.	0	0	0	0	0	0	0	0	0	0	0	0
+45 mins.	0	0	0	0	0	0	0	0	0	0	0	0
Total Volume	0	0	0	0	0	0	0	0	0	0	0	0
% App. Total	0	0	0	0	0	0	0	0	0	0	0	0
PHF	.000	.000	.000	.000	.000	.000	.000	.000	.000	.000	.000	.000

City of Madera
 N/S: SR-99 Northbound Ramps
 E/W: SR-99 NB Spur
 Weather: Clear

File Name : 23_MDA_99N_Spur PM
 Site Code : 00319628
 Start Date : 9/19/2019
 Page No : 1

Groups Printed- 4+ Axle Trucks

Start Time	Spur to Gateway Westbound				Spur to Gateway Northbound				SR-99 Northbound Ramps Eastbound				Int. Total
	Left	Thru	U-Turns	App. Total	Left	Right	U-Turns	App. Total	Thru	Right	U-Turns	App. Total	
04:00 PM	0	2	0	2	1	0	0	1	0	2	0	2	5
04:15 PM	0	0	0	0	1	0	0	1	0	0	0	0	1
04:30 PM	0	1	0	1	0	0	0	0	0	1	0	1	2
04:45 PM	0	2	0	2	0	0	0	0	0	2	0	2	4
Total	0	5	0	5	2	0	0	2	0	5	0	5	12
05:00 PM	0	2	0	2	1	0	0	1	0	2	0	2	5
05:15 PM	0	0	0	0	0	0	0	0	0	0	0	0	0
05:30 PM	0	0	0	0	0	0	0	0	0	0	0	0	0
05:45 PM	0	0	0	0	1	0	0	1	0	0	0	0	1
Total	0	2	0	2	2	0	0	2	0	2	0	2	6
Grand Total	0	7	0	7	4	0	0	4	0	7	0	7	18
Apprch %	0	100	0		100	0	0		0	100	0		
Total %	0	38.9	0	38.9	22.2	0	0	22.2	0	38.9	0	38.9	

Start Time	Spur to Gateway Westbound				Spur to Gateway Northbound				SR-99 Northbound Ramps Eastbound				Int. Total
	Left	Thru	U-Turns	App. Total	Left	Right	U-Turns	App. Total	Thru	Right	U-Turns	App. Total	
04:15 PM	0	0	0	0	1	0	0	1	0	0	0	0	1
04:30 PM	0	1	0	1	0	0	0	0	0	1	0	1	2
04:45 PM	0	2	0	2	0	0	0	0	0	2	0	2	4
05:00 PM	0	2	0	2	1	0	0	1	0	2	0	2	5
Total Volume	0	5	0	5	2	0	0	2	0	5	0	5	12
% App. Total	0	100	0		100	0	0		0	100	0		
PHF	.000	.625	.000	.625	.500	.000	.000	.500	.000	.625	.000	.625	.600

Peak Hour Analysis From 04:15 PM to 05:00 PM - Peak 1 of 1

Peak Hour for Entire Intersection Begins at 04:15 PM

City of Madera
 N/S: SR-99 Northbound Ramps
 E/W: SR-99 NB Spur
 Weather: Clear

File Name : 23_MDA_99N_Spur PM
 Site Code : 00319628
 Start Date : 9/19/2019
 Page No : 2

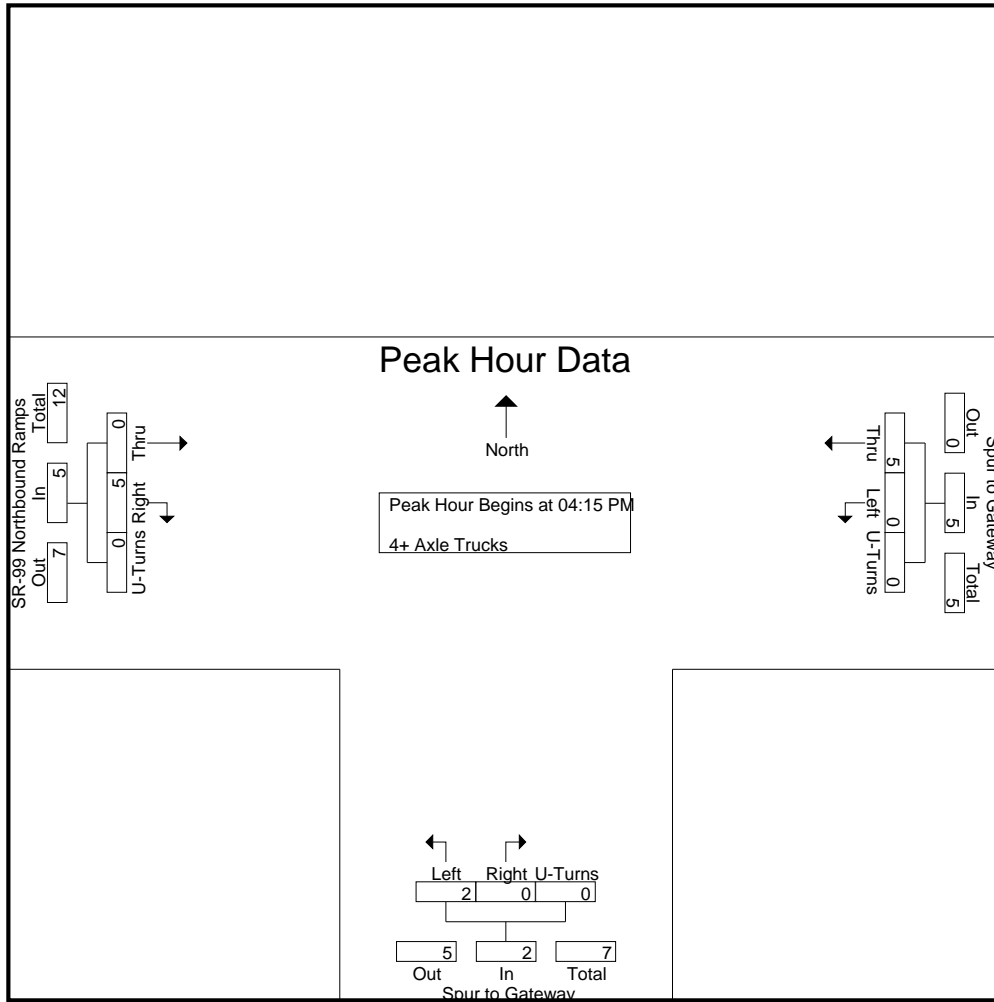

Peak Hour Analysis From 04:15 PM to 05:00 PM - Peak 1 of 1
 Peak Hour for Each Approach Begins at:

	04:15 PM				04:15 PM				04:15 PM			
+0 mins.	0	0	0	0	1	0	0	1	0	0	0	0
+15 mins.	0	1	0	1	0	0	0	0	0	1	0	1
+30 mins.	0	2	0	2	0	0	0	0	0	2	0	2
+45 mins.	0	2	0	2	1	0	0	1	0	2	0	2
Total Volume	0	5	0	5	2	0	0	2	0	5	0	5
% App. Total	0	100	0	100	100	0	0	100	0	100	0	100
PHF	.000	.625	.000	.625	.500	.000	.000	.500	.000	.625	.000	.625

Location: Madera
 N/S: SR-99 NB Ramps
 E/W: Spur to Gateway



Date: 9/19/2019
 Day: Thursday

PEDESTRIANS

	North Leg Dead End	East Leg Spur to Gateway	South Leg Spur To Gateway	West Leg SR-99 NB Ramps	
	Pedestrians	Pedestrians	Pedestrians	Pedestrians	
7:00 AM	0	0	0	0	0
7:15 AM	0	0	0	0	0
7:30 AM	0	0	0	0	0
7:45 AM	0	0	0	0	0
8:00 AM	0	0	0	0	0
8:15 AM	0	0	0	0	0
8:30 AM	0	0	0	0	0
8:45 AM	0	0	0	0	0
TOTAL VOLUMES:	0	0	0	0	0

	North Leg Dead End	East Leg Spur to Gateway	South Leg Spur To Gateway	West Leg SR-99 NB Ramps	
	Pedestrians	Pedestrians	Pedestrians	Pedestrians	
4:00 PM	0	0	0	0	0
4:15 PM	0	0	0	0	0
4:30 PM	0	0	0	0	0
4:45 PM	0	0	0	0	0
5:00 PM	0	0	0	0	0
5:15 PM	0	0	0	0	0
5:30 PM	0	0	0	0	0
5:45 PM	0	0	0	0	0
TOTAL VOLUMES:	0	0	0	0	0

Location: Madera
 N/S: SR-99 NB Ramps
 E/W: Spur to Gateway



Date: 9/19/2019
 Day: Thursday

BICYCLES

	Southbound Dead End			Westbound Spur to Gateway			Northbound Spur To Gateway			Eastbound SR-99 NB Ramps			
	Left	Thru	Right	Left	Thru	Right	Left	Thru	Right	Left	Thru	Right	
7:00 AM	0	0	0	0	0	0	0	0	0	0	0	0	0
7:15 AM	0	0	0	0	0	0	0	0	0	0	0	0	0
7:30 AM	0	0	0	0	0	0	0	0	0	0	0	0	0
7:45 AM	0	0	0	0	0	0	0	0	0	0	0	0	0
8:00 AM	0	0	0	0	0	0	0	0	0	0	0	0	0
8:15 AM	0	0	0	0	0	0	0	0	0	0	0	0	0
8:30 AM	0	0	0	0	0	0	0	0	0	0	0	0	0
8:45 AM	0	0	0	0	0	0	0	0	0	0	0	0	0
TOTAL VOLUMES:	0	0	0	0	0	0	0	0	0	0	0	0	0

	Southbound Dead End			Westbound Spur to Gateway			Northbound Spur To Gateway			Eastbound SR-99 NB Ramps			
	Left	Thru	Right	Left	Thru	Right	Left	Thru	Right	Left	Thru	Right	
4:00 PM	0	0	0	0	0	0	0	0	0	0	0	0	0
4:15 PM	0	0	0	0	0	0	0	0	0	0	0	0	0
4:30 PM	0	0	0	0	0	0	0	0	0	0	0	0	0
4:45 PM	0	0	0	0	0	0	0	0	0	0	0	0	0
5:00 PM	0	0	0	0	0	0	0	0	0	0	0	0	0
5:15 PM	0	0	0	0	0	0	0	0	0	0	0	0	0
5:30 PM	0	0	0	0	0	0	0	0	0	0	0	0	0
5:45 PM	0	0	0	0	0	0	0	0	0	0	0	0	0
TOTAL VOLUMES:	0	0	0	0	0	0	0	0	0	0	0	0	0

City of Madera
 N/S: SR-99 Northbound Ramps/Gateway Dr
 E/W: Gateway Drive
 Weather: Clear

File Name : 23B_MDA_99N Spur_Gateway AM
 Site Code : 00319628
 Start Date : 9/19/2019
 Page No : 1

Groups Printed- Passenger Vehicles - Large 2 Axle Vehicles - 3 Axle Vehicles - 4+ Axle Trucks

Start Time	SR-99 Northbound Ramps Southbound				Gateway Drive Westbound				Gateway Drive Eastbound				Int. Total
	Left	Right	U-Turns	App. Total	Thru	Right	U-Turns	App. Total	Left	Thru	U-Turns	App. Total	
07:00 AM	0	0	0	0	16	10	0	26	0	23	0	23	49
07:15 AM	0	0	0	0	17	15	0	32	0	24	0	24	56
07:30 AM	0	0	0	0	16	13	0	29	0	37	0	37	66
07:45 AM	0	0	0	0	23	12	0	35	0	45	0	45	80
Total	0	0	0	0	72	50	0	122	0	129	0	129	251
08:00 AM	2	0	0	2	12	6	0	18	0	22	0	22	42
08:15 AM	1	0	0	1	14	11	0	25	0	29	0	29	55
08:30 AM	2	0	0	2	16	9	0	25	0	29	0	29	56
08:45 AM	0	0	0	0	24	11	0	35	0	34	0	34	69
Total	5	0	0	5	66	37	0	103	0	114	0	114	222
Grand Total	5	0	0	5	138	87	0	225	0	243	0	243	473
Apprch %	100	0	0		61.3	38.7	0		0	100	0		
Total %	1.1	0	0	1.1	29.2	18.4	0	47.6	0	51.4	0	51.4	
Passenger Vehicles	4	0	0	4	131	73	0	204	0	232	0	232	440
% Passenger Vehicles	80	0	0	80	94.9	83.9	0	90.7	0	95.5	0	95.5	93
Large 2 Axle Vehicles	1	0	0	1	6	4	0	10	0	7	0	7	18
% Large 2 Axle Vehicles	20	0	0	20	4.3	4.6	0	4.4	0	2.9	0	2.9	3.8
3 Axle Vehicles	0	0	0	0	1	3	0	4	0	2	0	2	6
% 3 Axle Vehicles	0	0	0	0	0.7	3.4	0	1.8	0	0.8	0	0.8	1.3
4+ Axle Trucks	0	0	0	0	0	7	0	7	0	2	0	2	9
% 4+ Axle Trucks	0	0	0	0	0	8	0	3.1	0	0.8	0	0.8	1.9

Start Time	SR-99 Northbound Ramps Southbound				Gateway Drive Westbound				Gateway Drive Eastbound				Int. Total
	Left	Right	U-Turns	App. Total	Thru	Right	U-Turns	App. Total	Left	Thru	U-Turns	App. Total	
Peak Hour Analysis From 07:00 AM to 08:45 AM - Peak 1 of 1													
Peak Hour for Entire Intersection Begins at 07:00 AM													
07:00 AM	0	0	0	0	16	10	0	26	0	23	0	23	49
07:15 AM	0	0	0	0	17	15	0	32	0	24	0	24	56
07:30 AM	0	0	0	0	16	13	0	29	0	37	0	37	66
07:45 AM	0	0	0	0	23	12	0	35	0	45	0	45	80
Total Volume	0	0	0	0	72	50	0	122	0	129	0	129	251
% App. Total	0	0	0		59	41	0		0	100	0		
PHF	.000	.000	.000	.000	.783	.833	.000	.871	.000	.717	.000	.717	.784

City of Madera
 N/S: SR-99 Northbound Ramps/Gateway Dr
 E/W: Gateway Drive
 Weather: Clear

File Name : 23B_MDA_99N Spur_Gateway AM
 Site Code : 00319628
 Start Date : 9/19/2019
 Page No : 2

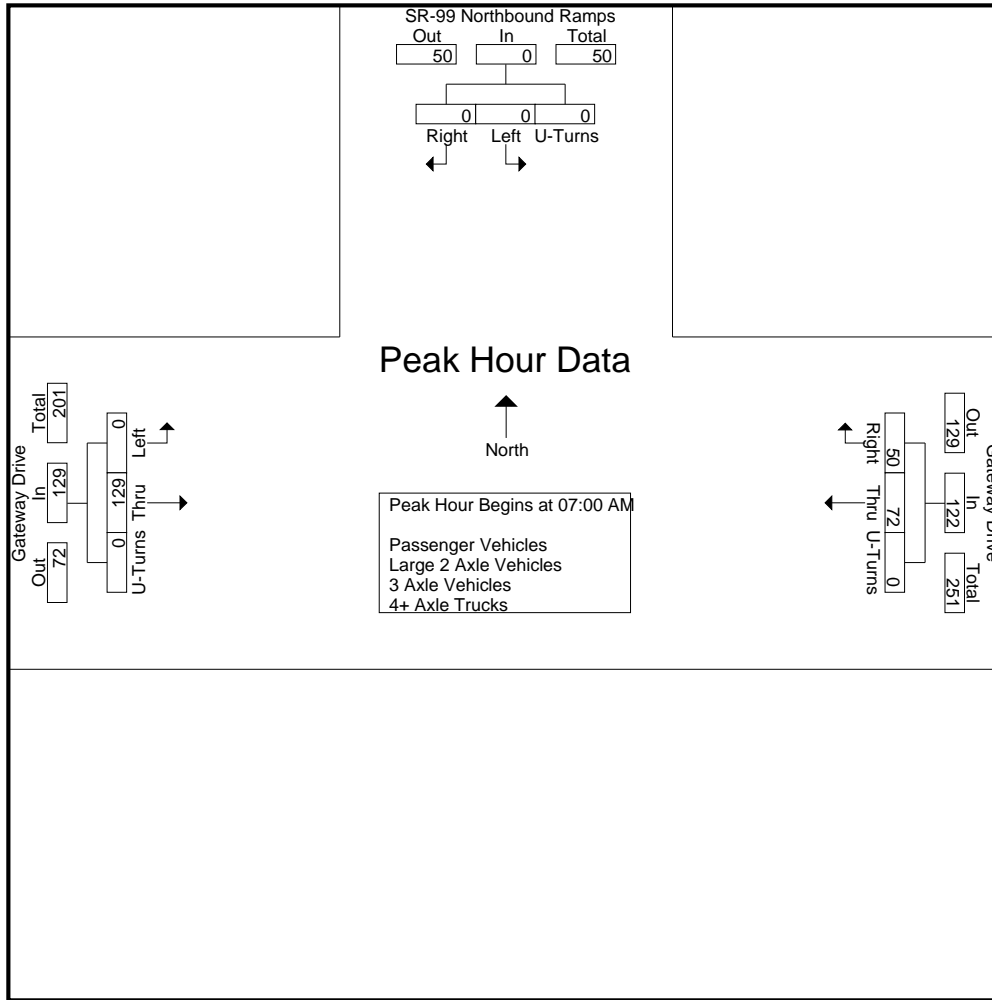

Peak Hour Analysis From 07:00 AM to 08:45 AM - Peak 1 of 1
 Peak Hour for Each Approach Begins at:

	07:45 AM				07:00 AM				07:30 AM			
+0 mins.	0	0	0	0	16	10	0	26	0	37	0	37
+15 mins.	2	0	0	2	17	15	0	32	0	45	0	45
+30 mins.	1	0	0	1	16	13	0	29	0	22	0	22
+45 mins.	2	0	0	2	23	12	0	35	0	29	0	29
Total Volume	5	0	0	5	72	50	0	122	0	133	0	133
% App. Total	100	0	0		59	41	0		0	100	0	
PHF	.625	.000	.000	.625	.783	.833	.000	.871	.000	.739	.000	.739

City of Madera
 N/S: SR-99 Northbound Ramps/Gateway Dr
 E/W: Gateway Drive
 Weather: Clear

File Name : 23B_MDA_99N Spur_Gateway AM
 Site Code : 00319628
 Start Date : 9/19/2019
 Page No : 1

Groups Printed- Passenger Vehicles

Start Time	SR-99 Northbound Ramps Southbound				Gateway Drive Westbound				Gateway Drive Eastbound				Int. Total
	Left	Right	U-Turns	App. Total	Thru	Right	U-Turns	App. Total	Left	Thru	U-Turns	App. Total	
07:00 AM	0	0	0	0	14	7	0	21	0	21	0	21	42
07:15 AM	0	0	0	0	16	12	0	28	0	23	0	23	51
07:30 AM	0	0	0	0	14	10	0	24	0	37	0	37	61
07:45 AM	0	0	0	0	22	11	0	33	0	45	0	45	78
Total	0	0	0	0	66	40	0	106	0	126	0	126	232
08:00 AM	2	0	0	2	11	6	0	17	0	20	0	20	39
08:15 AM	1	0	0	1	14	11	0	25	0	26	0	26	52
08:30 AM	1	0	0	1	16	7	0	23	0	27	0	27	51
08:45 AM	0	0	0	0	24	9	0	33	0	33	0	33	66
Total	4	0	0	4	65	33	0	98	0	106	0	106	208
Grand Total	4	0	0	4	131	73	0	204	0	232	0	232	440
Apprch %	100	0	0		64.2	35.8	0		0	100	0		
Total %	0.9	0	0	0.9	29.8	16.6	0	46.4	0	52.7	0	52.7	

Start Time	SR-99 Northbound Ramps Southbound				Gateway Drive Westbound				Gateway Drive Eastbound				Int. Total
	Left	Right	U-Turns	App. Total	Thru	Right	U-Turns	App. Total	Left	Thru	U-Turns	App. Total	
Peak Hour Analysis From 07:00 AM to 07:45 AM - Peak 1 of 1													
Peak Hour for Entire Intersection Begins at 07:00 AM													
07:00 AM	0	0	0	0	14	7	0	21	0	21	0	21	42
07:15 AM	0	0	0	0	16	12	0	28	0	23	0	23	51
07:30 AM	0	0	0	0	14	10	0	24	0	37	0	37	61
07:45 AM	0	0	0	0	22	11	0	33	0	45	0	45	78
Total Volume	0	0	0	0	66	40	0	106	0	126	0	126	232
% App. Total	0	0	0		62.3	37.7	0		0	100	0		
PHF	.000	.000	.000	.000	.750	.833	.000	.803	.000	.700	.000	.700	.744

City of Madera
 N/S: SR-99 Northbound Ramps/Gateway Dr
 E/W: Gateway Drive
 Weather: Clear

File Name : 23B_MDA_99N Spur_Gateway AM
 Site Code : 00319628
 Start Date : 9/19/2019
 Page No : 2

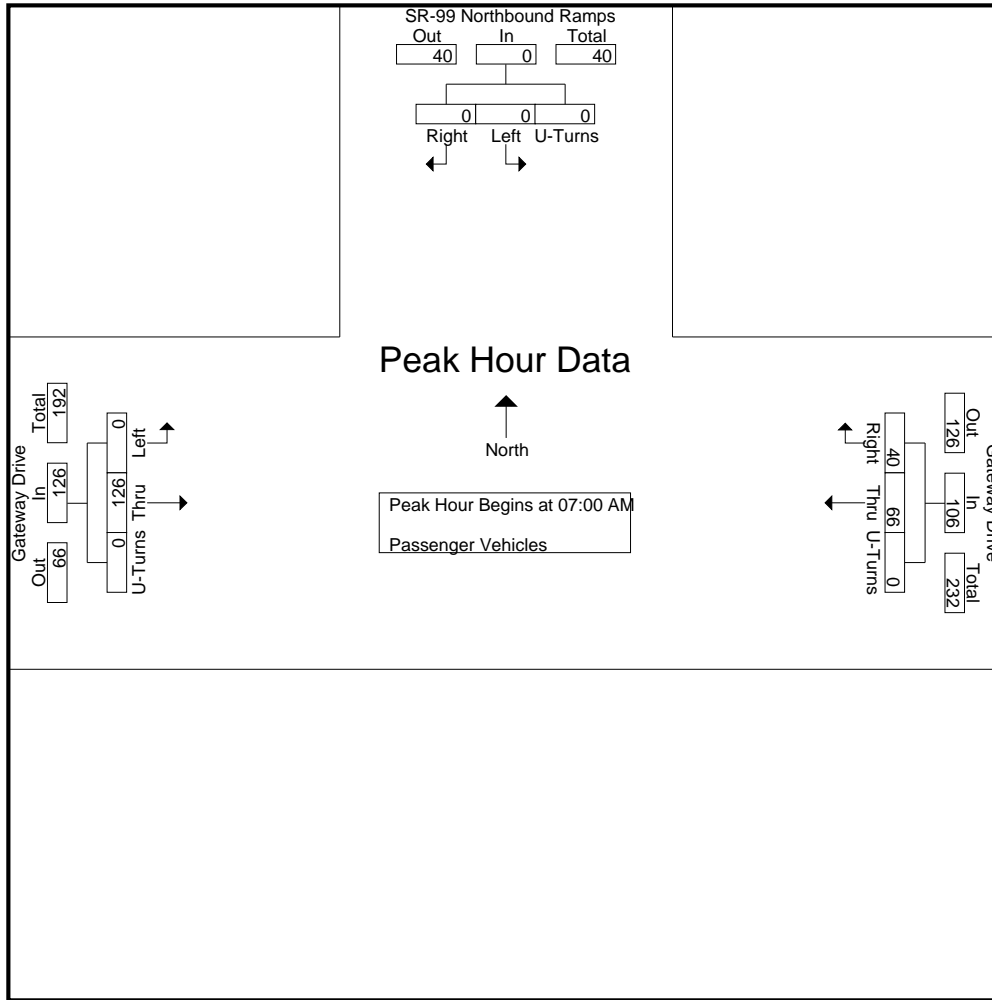

Peak Hour Analysis From 07:00 AM to 07:45 AM - Peak 1 of 1
 Peak Hour for Each Approach Begins at:

	07:00 AM				07:00 AM				07:00 AM			
+0 mins.	0	0	0	0	14	7	0	21	0	21	0	21
+15 mins.	0	0	0	0	16	12	0	28	0	23	0	23
+30 mins.	0	0	0	0	14	10	0	24	0	37	0	37
+45 mins.	0	0	0	0	22	11	0	33	0	45	0	45
Total Volume	0	0	0	0	66	40	0	106	0	126	0	126
% App. Total	0	0	0	0	62.3	37.7	0		0	100	0	
PHF	.000	.000	.000	.000	.750	.833	.000	.803	.000	.700	.000	.700

City of Madera
 N/S: SR-99 Northbound Ramps/Gateway Dr
 E/W: Gateway Drive
 Weather: Clear

File Name : 23B_MDA_99N_Spur_Gateway AM
 Site Code : 00319628
 Start Date : 9/19/2019
 Page No : 1

Groups Printed- Large 2 Axle Vehicles

Start Time	SR-99 Northbound Ramps Southbound				Gateway Drive Westbound				Gateway Drive Eastbound				Int. Total
	Left	Right	U-Turns	App. Total	Thru	Right	U-Turns	App. Total	Left	Thru	U-Turns	App. Total	
07:00 AM	0	0	0	0	2	1	0	3	0	1	0	1	4
07:15 AM	0	0	0	0	1	1	0	2	0	1	0	1	3
07:30 AM	0	0	0	0	1	1	0	2	0	0	0	0	2
07:45 AM	0	0	0	0	1	0	0	1	0	0	0	0	1
Total	0	0	0	0	5	3	0	8	0	2	0	2	10
08:00 AM	0	0	0	0	1	0	0	1	0	1	0	1	2
08:15 AM	0	0	0	0	0	0	0	0	0	2	0	2	2
08:30 AM	1	0	0	1	0	1	0	1	0	1	0	1	3
08:45 AM	0	0	0	0	0	0	0	0	0	1	0	1	1
Total	1	0	0	1	1	1	0	2	0	5	0	5	8
Grand Total	1	0	0	1	6	4	0	10	0	7	0	7	18
Apprch %	100	0	0		60	40	0		0	100	0		
Total %	5.6	0	0	5.6	33.3	22.2	0	55.6	0	38.9	0	38.9	

Start Time	SR-99 Northbound Ramps Southbound				Gateway Drive Westbound				Gateway Drive Eastbound				Int. Total
	Left	Right	U-Turns	App. Total	Thru	Right	U-Turns	App. Total	Left	Thru	U-Turns	App. Total	
07:00 AM	0	0	0	0	2	1	0	3	0	1	0	1	4
07:15 AM	0	0	0	0	1	1	0	2	0	1	0	1	3
07:30 AM	0	0	0	0	1	1	0	2	0	0	0	0	2
07:45 AM	0	0	0	0	1	0	0	1	0	0	0	0	1
Total Volume	0	0	0	0	5	3	0	8	0	2	0	2	10
% App. Total	0	0	0		62.5	37.5	0		0	100	0		
PHF	.000	.000	.000	.000	.625	.750	.000	.667	.000	.500	.000	.500	.625

Peak Hour Analysis From 07:00 AM to 07:45 AM - Peak 1 of 1

Peak Hour for Entire Intersection Begins at 07:00 AM

City of Madera
 N/S: SR-99 Northbound Ramps/Gateway Dr
 E/W: Gateway Drive
 Weather: Clear

File Name : 23B_MDA_99N Spur_Gateway AM
 Site Code : 00319628
 Start Date : 9/19/2019
 Page No : 2

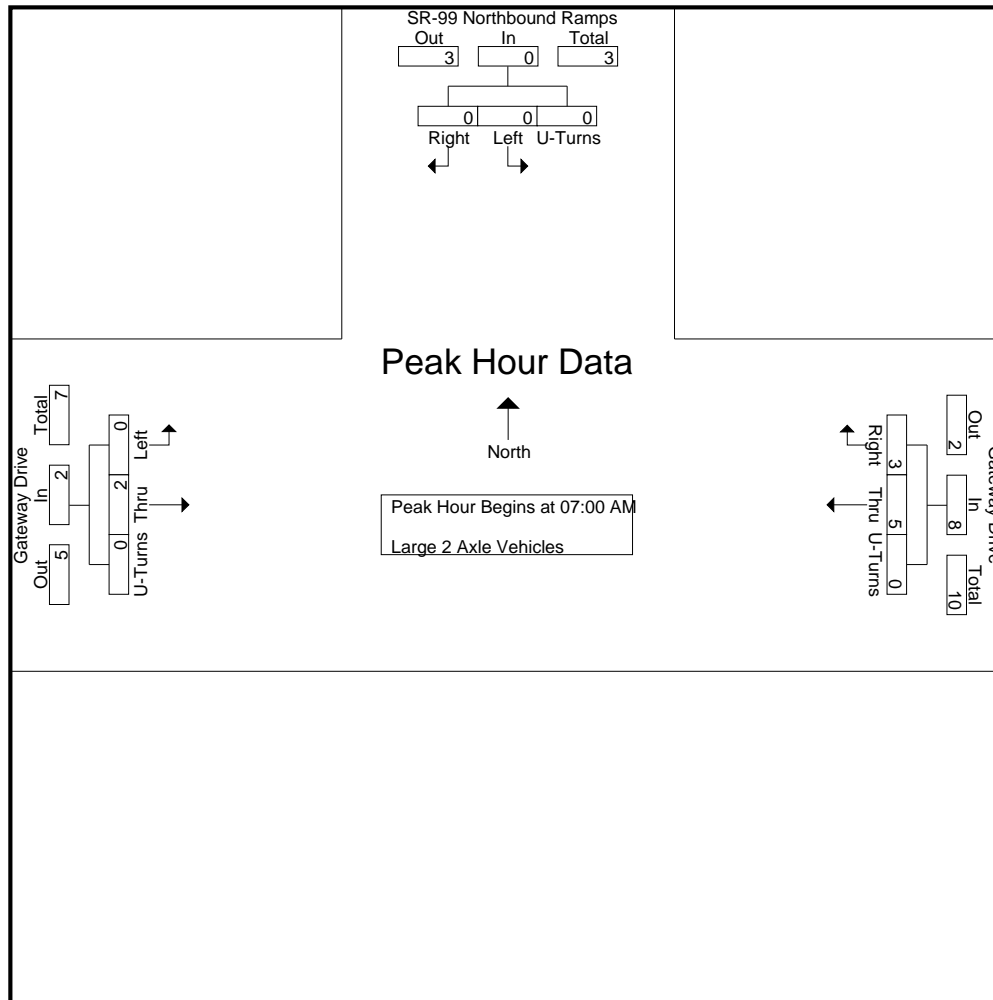

Peak Hour Analysis From 07:00 AM to 07:45 AM - Peak 1 of 1
 Peak Hour for Each Approach Begins at:

	07:00 AM				07:00 AM				07:00 AM			
+0 mins.	0	0	0	0	2	1	0	3	0	1	0	1
+15 mins.	0	0	0	0	1	1	0	2	0	1	0	1
+30 mins.	0	0	0	0	1	1	0	2	0	0	0	0
+45 mins.	0	0	0	0	1	0	0	1	0	0	0	0
Total Volume	0	0	0	0	5	3	0	8	0	2	0	2
% App. Total	0	0	0	0	62.5	37.5	0		0	100	0	
PHF	.000	.000	.000	.000	.625	.750	.000	.667	.000	.500	.000	.500

City of Madera
 N/S: SR-99 Northbound Ramps/Gateway Dr
 E/W: Gateway Drive
 Weather: Clear

File Name : 23B_MDA_99N_Spur_Gateway AM
 Site Code : 00319628
 Start Date : 9/19/2019
 Page No : 1

Groups Printed- 3 Axle Vehicles

Start Time	SR-99 Northbound Ramps Southbound				Gateway Drive Westbound				Gateway Drive Eastbound				Int. Total	
	Left	Right	U-Turns	App. Total	Thru	Right	U-Turns	App. Total	Left	Thru	U-Turns	App. Total		
07:00 AM	0	0	0	0	0	0	0	0	0	0	0	0	0	0
07:15 AM	0	0	0	0	0	1	0	1	0	0	0	0	0	1
07:30 AM	0	0	0	0	1	1	0	2	0	0	0	0	0	2
07:45 AM	0	0	0	0	0	0	0	0	0	0	0	0	0	0
Total	0	0	0	0	1	2	0	3	0	0	0	0	0	3
08:00 AM	0	0	0	0	0	0	0	0	0	1	0	1	0	1
08:15 AM	0	0	0	0	0	0	0	0	0	1	0	1	0	1
08:30 AM	0	0	0	0	0	0	0	0	0	0	0	0	0	0
08:45 AM	0	0	0	0	0	1	0	1	0	0	0	0	0	1
Total	0	0	0	0	0	1	0	1	0	2	0	2	0	3
Grand Total	0	0	0	0	1	3	0	4	0	2	0	2	0	6
Apprch %	0	0	0	0	25	75	0	100	0	100	0	100	0	100
Total %	0	0	0	0	16.7	50	0	66.7	0	33.3	0	33.3	0	33.3

Start Time	SR-99 Northbound Ramps Southbound				Gateway Drive Westbound				Gateway Drive Eastbound				Int. Total	
	Left	Right	U-Turns	App. Total	Thru	Right	U-Turns	App. Total	Left	Thru	U-Turns	App. Total		
07:00 AM	0	0	0	0	0	0	0	0	0	0	0	0	0	0
07:15 AM	0	0	0	0	0	1	0	1	0	0	0	0	0	1
07:30 AM	0	0	0	0	1	1	0	2	0	0	0	0	0	2
07:45 AM	0	0	0	0	0	0	0	0	0	0	0	0	0	0
Total Volume	0	0	0	0	1	2	0	3	0	0	0	0	0	3
% App. Total	0	0	0	0	33.3	66.7	0	100	0	0	0	0	0	100
PHF	.000	.000	.000	.000	.250	.500	.000	.375	.000	.000	.000	.000	.000	.375

Peak Hour Analysis From 07:00 AM to 07:45 AM - Peak 1 of 1
 Peak Hour for Entire Intersection Begins at 07:00 AM

City of Madera
 N/S: SR-99 Northbound Ramps/Gateway Dr
 E/W: Gateway Drive
 Weather: Clear

File Name : 23B_MDA_99N Spur_Gateway AM
 Site Code : 00319628
 Start Date : 9/19/2019
 Page No : 2

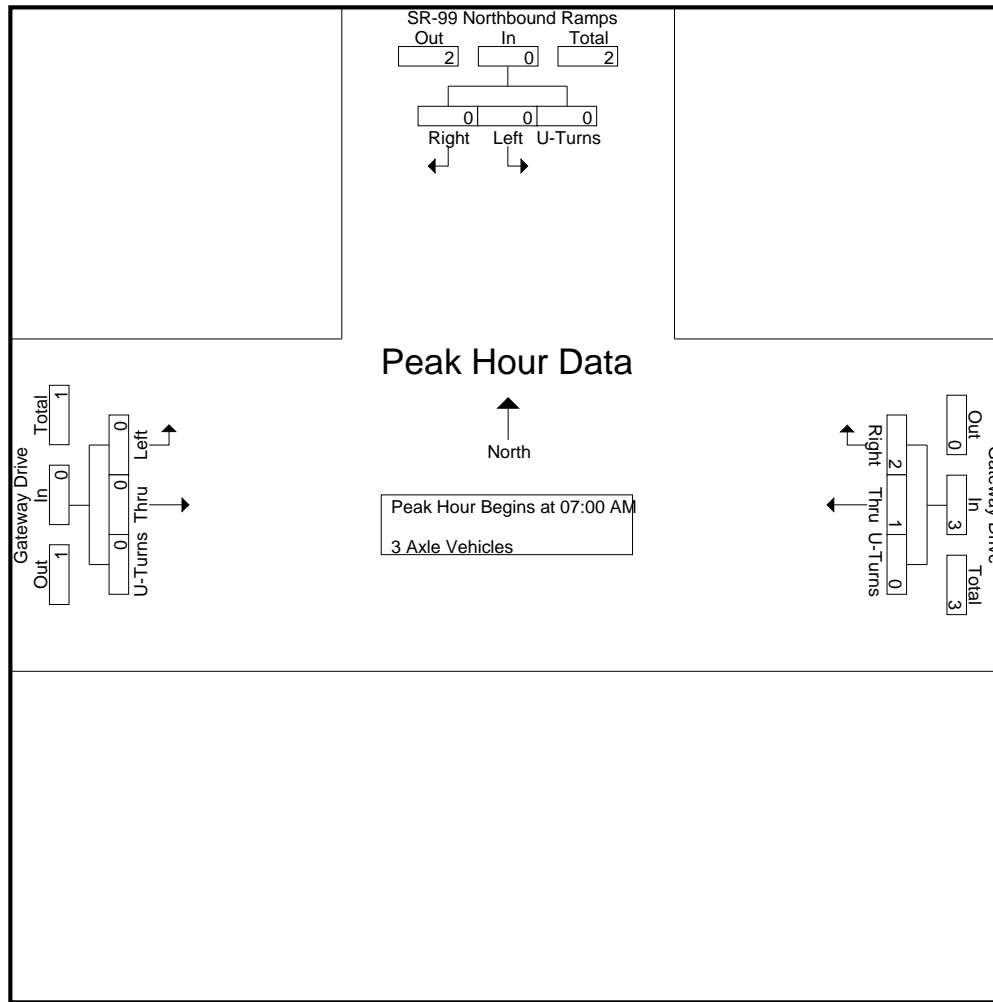

Peak Hour Analysis From 07:00 AM to 07:45 AM - Peak 1 of 1
 Peak Hour for Each Approach Begins at:

	07:00 AM				07:00 AM				07:00 AM			
+0 mins.	0	0	0	0	0	0	0	0	0	0	0	0
+15 mins.	0	0	0	0	0	1	0	1	0	0	0	0
+30 mins.	0	0	0	0	1	1	0	2	0	0	0	0
+45 mins.	0	0	0	0	0	0	0	0	0	0	0	0
Total Volume	0	0	0	0	1	2	0	3	0	0	0	0
% App. Total	0	0	0	0	33.3	66.7	0	0	0	0	0	0
PHF	.000	.000	.000	.000	.250	.500	.000	.375	.000	.000	.000	.000

City of Madera
 N/S: SR-99 Northbound Ramps/Gateway Dr
 E/W: Gateway Drive
 Weather: Clear

File Name : 23B_MDA_99N_Spur_Gateway AM
 Site Code : 00319628
 Start Date : 9/19/2019
 Page No : 1

Groups Printed- 4+ Axle Trucks

Start Time	SR-99 Northbound Ramps Southbound				Gateway Drive Westbound				Gateway Drive Eastbound				Int. Total
	Left	Right	U-Turns	App. Total	Thru	Right	U-Turns	App. Total	Left	Thru	U-Turns	App. Total	
07:00 AM	0	0	0	0	0	2	0	2	0	1	0	1	3
07:15 AM	0	0	0	0	0	1	0	1	0	0	0	0	1
07:30 AM	0	0	0	0	0	1	0	1	0	0	0	0	1
07:45 AM	0	0	0	0	0	1	0	1	0	0	0	0	1
Total	0	0	0	0	0	5	0	5	0	1	0	1	6
08:00 AM	0	0	0	0	0	0	0	0	0	0	0	0	0
08:15 AM	0	0	0	0	0	0	0	0	0	0	0	0	0
08:30 AM	0	0	0	0	0	1	0	1	0	1	0	1	2
08:45 AM	0	0	0	0	0	1	0	1	0	0	0	0	1
Total	0	0	0	0	0	2	0	2	0	1	0	1	3
Grand Total	0	0	0	0	0	7	0	7	0	2	0	2	9
Apprch %	0	0	0	0	0	100	0	0	0	100	0	0	0
Total %	0	0	0	0	0	77.8	0	77.8	0	22.2	0	22.2	0

Start Time	SR-99 Northbound Ramps Southbound				Gateway Drive Westbound				Gateway Drive Eastbound				Int. Total
	Left	Right	U-Turns	App. Total	Thru	Right	U-Turns	App. Total	Left	Thru	U-Turns	App. Total	
07:00 AM	0	0	0	0	0	2	0	2	0	1	0	1	3
07:15 AM	0	0	0	0	0	1	0	1	0	0	0	0	1
07:30 AM	0	0	0	0	0	1	0	1	0	0	0	0	1
07:45 AM	0	0	0	0	0	1	0	1	0	0	0	0	1
Total Volume	0	0	0	0	0	5	0	5	0	1	0	1	6
% App. Total	0	0	0	0	0	100	0	0	0	100	0	0	0
PHF	.000	.000	.000	.000	.000	.625	.000	.625	.000	.250	.000	.250	.500

Peak Hour Analysis From 07:00 AM to 07:45 AM - Peak 1 of 1

Peak Hour for Entire Intersection Begins at 07:00 AM

City of Madera
 N/S: SR-99 Northbound Ramps/Gateway Dr
 E/W: Gateway Drive
 Weather: Clear

File Name : 23B_MDA_99N Spur_Gateway AM
 Site Code : 00319628
 Start Date : 9/19/2019
 Page No : 2

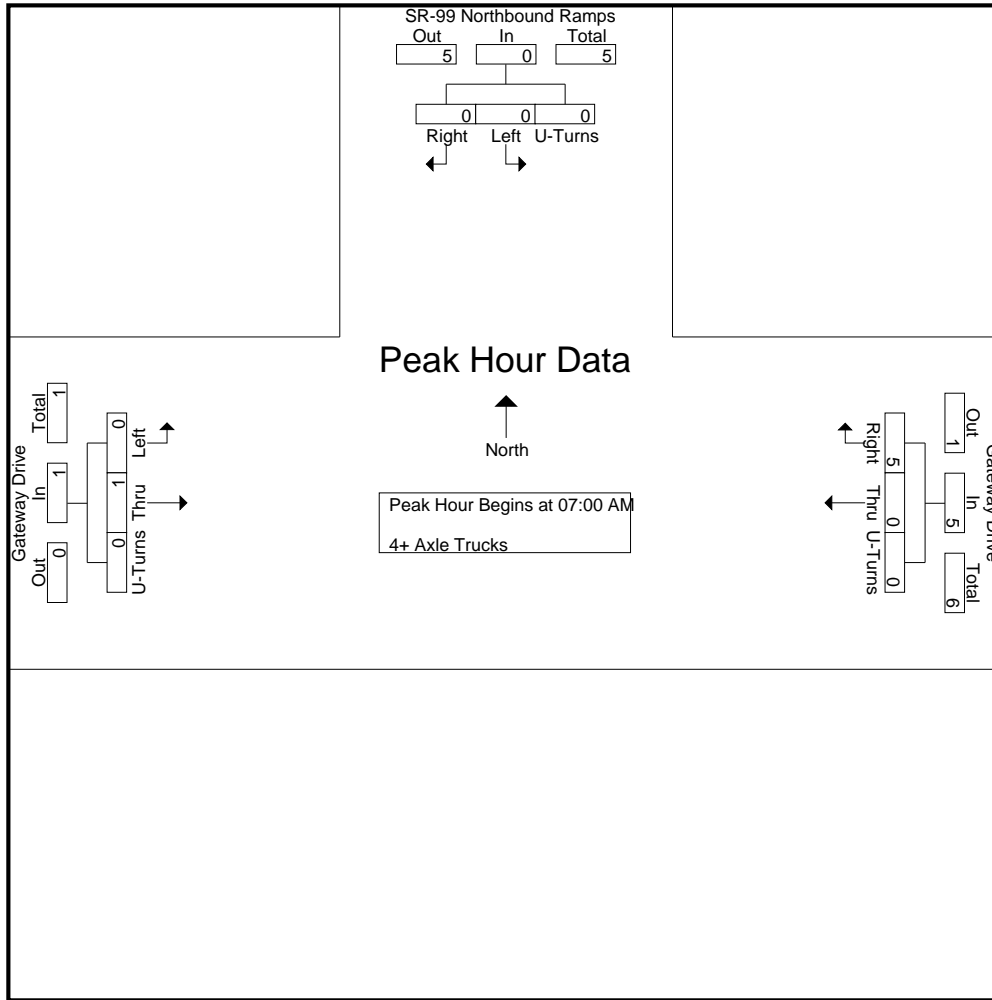

Peak Hour Analysis From 07:00 AM to 07:45 AM - Peak 1 of 1
 Peak Hour for Each Approach Begins at:

	07:00 AM				07:00 AM				07:00 AM			
+0 mins.	0	0	0	0	0	2	0	2	0	1	0	1
+15 mins.	0	0	0	0	0	1	0	1	0	0	0	0
+30 mins.	0	0	0	0	0	1	0	1	0	0	0	0
+45 mins.	0	0	0	0	0	1	0	1	0	0	0	0
Total Volume	0	0	0	0	0	5	0	5	0	1	0	1
% App. Total	0	0	0	0	0	100	0	0	0	100	0	0
PHF	.000	.000	.000	.000	.000	.625	.000	.625	.000	.250	.000	.250

City of Madera
 N/S: SR-99 Northbound Ramps/Gateway Dr
 E/W: Gateway Drive
 Weather: Clear

File Name : 23B_MDA_99N Spur_Gateway PM
 Site Code : 00319628
 Start Date : 9/19/2019
 Page No : 1

Groups Printed- Passenger Vehicles - Large 2 Axle Vehicles - 3 Axle Vehicles - 4+ Axle Trucks

Start Time	SR-99 Northbound Ramps Southbound				Gateway Drive Westbound				Gateway Drive Eastbound				Int. Total
	Left	Right	U-Turns	App. Total	Thru	Right	U-Turns	App. Total	Left	Thru	U-Turns	App. Total	
04:00 PM	3	0	0	3	28	16	0	44	0	46	0	46	93
04:15 PM	2	0	0	2	32	16	0	48	0	85	0	85	135
04:30 PM	0	0	0	0	18	19	0	37	0	56	0	56	93
04:45 PM	0	0	0	0	29	9	0	38	0	73	0	73	111
Total	5	0	0	5	107	60	0	167	0	260	0	260	432
05:00 PM	1	0	0	1	39	29	0	68	0	74	0	74	143
05:15 PM	0	0	0	0	34	26	0	60	0	61	0	61	121
05:30 PM	1	0	0	1	24	13	0	37	0	37	0	37	75
05:45 PM	1	0	0	1	20	11	0	31	0	35	0	35	67
Total	3	0	0	3	117	79	0	196	0	207	0	207	406
Grand Total	8	0	0	8	224	139	0	363	0	467	0	467	838
Apprch %	100	0	0		61.7	38.3	0		0	100	0		
Total %	1	0	0	1	26.7	16.6	0	43.3	0	55.7	0	55.7	
Passenger Vehicles	8	0	0	8	221	137	0	358	0	456	0	456	822
% Passenger Vehicles	100	0	0	100	98.7	98.6	0	98.6	0	97.6	0	97.6	98.1
Large 2 Axle Vehicles	0	0	0	0	2	2	0	4	0	6	0	6	10
% Large 2 Axle Vehicles	0	0	0	0	0.9	1.4	0	1.1	0	1.3	0	1.3	1.2
3 Axle Vehicles	0	0	0	0	1	0	0	1	0	0	0	0	1
% 3 Axle Vehicles	0	0	0	0	0.4	0	0	0.3	0	0	0	0	0.1
4+ Axle Trucks	0	0	0	0	0	0	0	0	0	5	0	5	5
% 4+ Axle Trucks	0	0	0	0	0	0	0	0	0	1.1	0	1.1	0.6

Start Time	SR-99 Northbound Ramps Southbound				Gateway Drive Westbound				Gateway Drive Eastbound				Int. Total
	Left	Right	U-Turns	App. Total	Thru	Right	U-Turns	App. Total	Left	Thru	U-Turns	App. Total	
Peak Hour Analysis From 04:00 PM to 05:45 PM - Peak 1 of 1													
Peak Hour for Entire Intersection Begins at 04:15 PM													
04:15 PM	2	0	0	2	32	16	0	48	0	85	0	85	135
04:30 PM	0	0	0	0	18	19	0	37	0	56	0	56	93
04:45 PM	0	0	0	0	29	9	0	38	0	73	0	73	111
05:00 PM	1	0	0	1	39	29	0	68	0	74	0	74	143
Total Volume	3	0	0	3	118	73	0	191	0	288	0	288	482
% App. Total	100	0	0		61.8	38.2	0		0	100	0		
PHF	.375	.000	.000	.375	.756	.629	.000	.702	.000	.847	.000	.847	.843

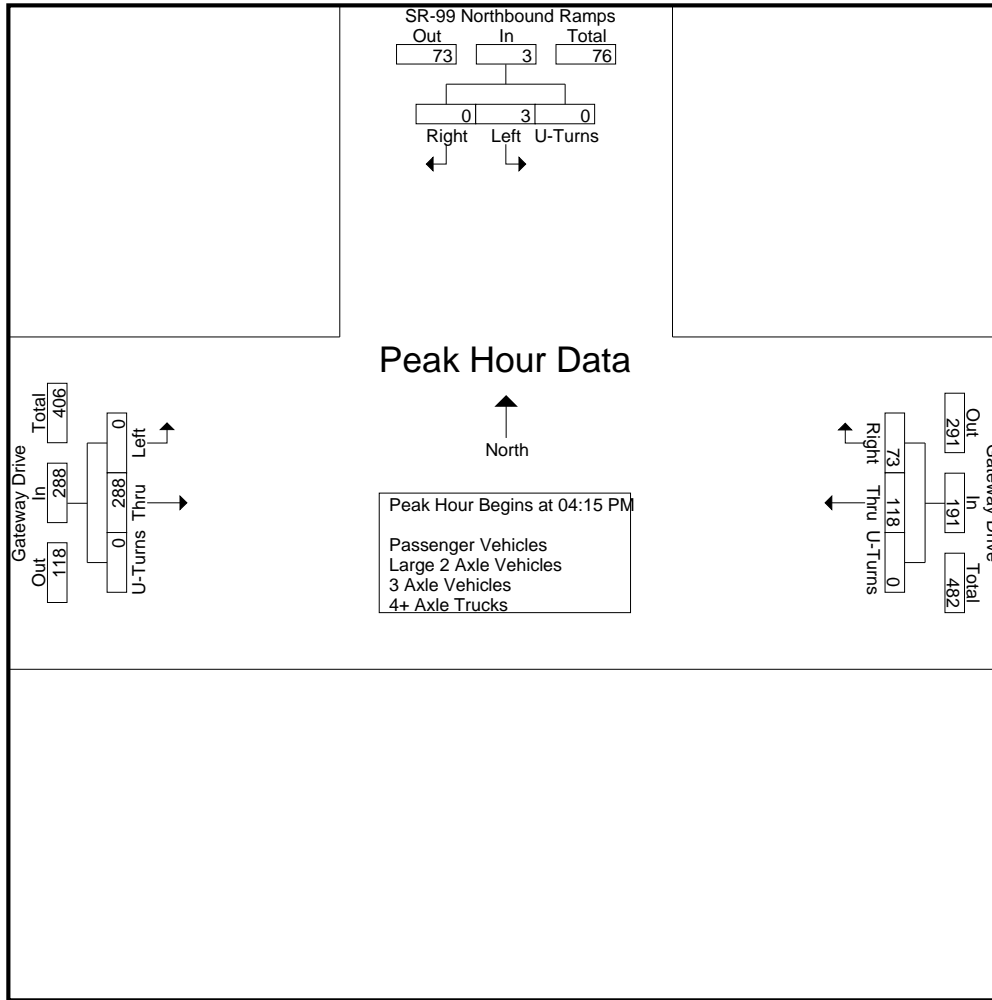

Peak Hour Analysis From 04:00 PM to 05:45 PM - Peak 1 of 1
 Peak Hour for Each Approach Begins at:

	04:00 PM				04:30 PM				04:15 PM			
+0 mins.	3	0	0	3	18	19	0	37	0	85	0	85
+15 mins.	2	0	0	2	29	9	0	38	0	56	0	56
+30 mins.	0	0	0	0	39	29	0	68	0	73	0	73
+45 mins.	0	0	0	0	34	26	0	60	0	74	0	74
Total Volume	5	0	0	5	120	83	0	203	0	288	0	288
% App. Total	100	0	0		59.1	40.9	0		0	100	0	
PHF	.417	.000	.000	.417	.769	.716	.000	.746	.000	.847	.000	.847

City of Madera
 N/S: SR-99 Northbound Ramps/Gateway Dr
 E/W: Gateway Drive
 Weather: Clear

File Name : 23B_MDA_99N Spur_Gateway PM
 Site Code : 00319628
 Start Date : 9/19/2019
 Page No : 1

Groups Printed- Passenger Vehicles

Start Time	SR-99 Northbound Ramps Southbound				Gateway Drive Westbound				Gateway Drive Eastbound				Int. Total
	Left	Right	U-Turns	App. Total	Thru	Right	U-Turns	App. Total	Left	Thru	U-Turns	App. Total	
04:00 PM	3	0	0	3	28	16	0	44	0	46	0	46	93
04:15 PM	2	0	0	2	29	16	0	45	0	82	0	82	129
04:30 PM	0	0	0	0	18	19	0	37	0	53	0	53	90
04:45 PM	0	0	0	0	29	9	0	38	0	71	0	71	109
Total	5	0	0	5	104	60	0	164	0	252	0	252	421
05:00 PM	1	0	0	1	39	27	0	66	0	72	0	72	139
05:15 PM	0	0	0	0	34	26	0	60	0	61	0	61	121
05:30 PM	1	0	0	1	24	13	0	37	0	36	0	36	74
05:45 PM	1	0	0	1	20	11	0	31	0	35	0	35	67
Total	3	0	0	3	117	77	0	194	0	204	0	204	401
Grand Total	8	0	0	8	221	137	0	358	0	456	0	456	822
Apprch %	100	0	0		61.7	38.3	0		0	100	0		
Total %	1	0	0	1	26.9	16.7	0	43.6	0	55.5	0	55.5	

Start Time	SR-99 Northbound Ramps Southbound				Gateway Drive Westbound				Gateway Drive Eastbound				Int. Total
	Left	Right	U-Turns	App. Total	Thru	Right	U-Turns	App. Total	Left	Thru	U-Turns	App. Total	
Peak Hour Analysis From 04:15 PM to 05:00 PM - Peak 1 of 1													
Peak Hour for Entire Intersection Begins at 04:15 PM													
04:15 PM	2	0	0	2	29	16	0	45	0	82	0	82	129
04:30 PM	0	0	0	0	18	19	0	37	0	53	0	53	90
04:45 PM	0	0	0	0	29	9	0	38	0	71	0	71	109
05:00 PM	1	0	0	1	39	27	0	66	0	72	0	72	139
Total Volume	3	0	0	3	115	71	0	186	0	278	0	278	467
% App. Total	100	0	0		61.8	38.2	0		0	100	0		
PHF	.375	.000	.000	.375	.737	.657	.000	.705	.000	.848	.000	.848	.840

City of Madera
 N/S: SR-99 Northbound Ramps/Gateway Dr
 E/W: Gateway Drive
 Weather: Clear

File Name : 23B_MDA_99N Spur_Gateway PM
 Site Code : 00319628
 Start Date : 9/19/2019
 Page No : 2

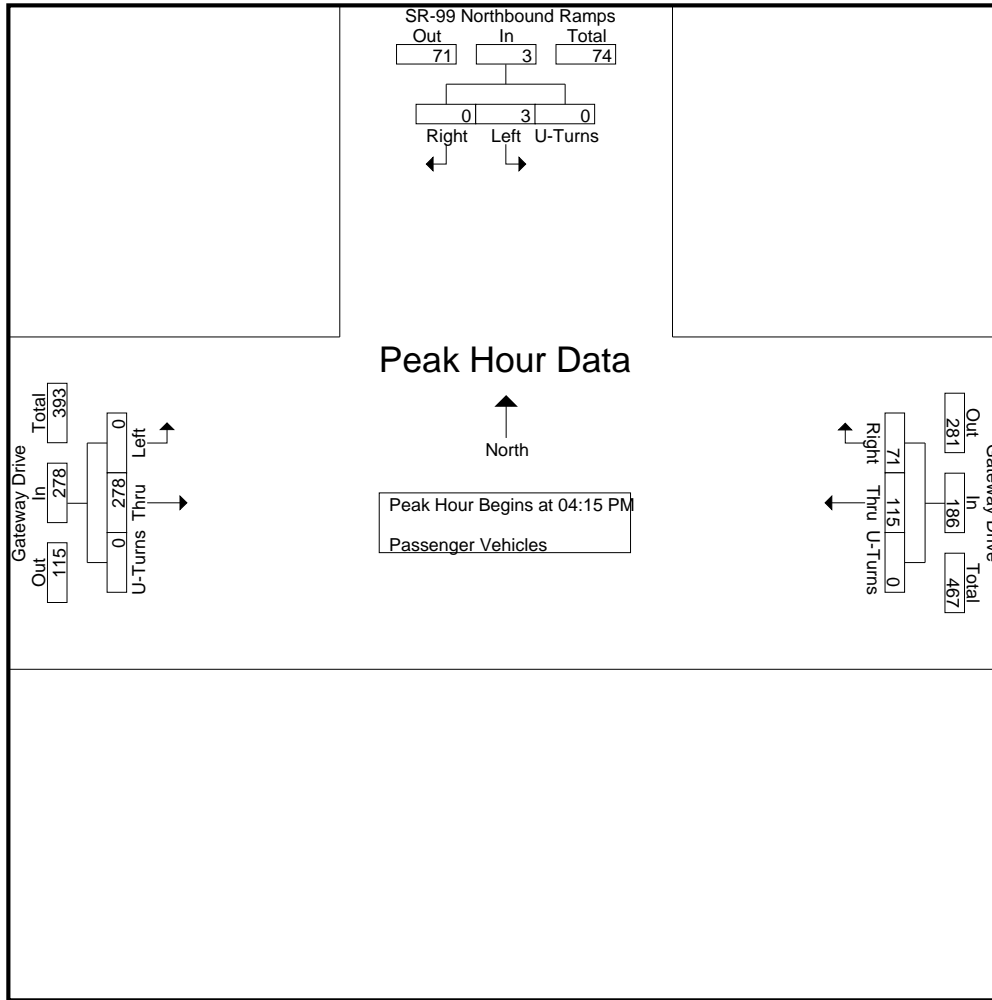

Peak Hour Analysis From 04:15 PM to 05:00 PM - Peak 1 of 1
 Peak Hour for Each Approach Begins at:

	04:15 PM				04:15 PM				04:15 PM			
+0 mins.	2	0	0	2	29	16	0	45	0	82	0	82
+15 mins.	0	0	0	0	18	19	0	37	0	53	0	53
+30 mins.	0	0	0	0	29	9	0	38	0	71	0	71
+45 mins.	1	0	0	1	39	27	0	66	0	72	0	72
Total Volume	3	0	0	3	115	71	0	186	0	278	0	278
% App. Total	100	0	0		61.8	38.2	0		0	100	0	
PHF	.375	.000	.000	.375	.737	.657	.000	.705	.000	.848	.000	.848

City of Madera
 N/S: SR-99 Northbound Ramps/Gateway Dr
 E/W: Gateway Drive
 Weather: Clear

File Name : 23B_MDA_99N Spur_Gateway PM
 Site Code : 00319628
 Start Date : 9/19/2019
 Page No : 1

Groups Printed- Large 2 Axle Vehicles

Start Time	SR-99 Northbound Ramps Southbound				Gateway Drive Westbound				Gateway Drive Eastbound				Int. Total	
	Left	Right	U-Turns	App. Total	Thru	Right	U-Turns	App. Total	Left	Thru	U-Turns	App. Total		
04:00 PM	0	0	0	0	0	0	0	0	0	0	0	0	0	0
04:15 PM	0	0	0	0	2	0	0	2	0	1	0	1	1	3
04:30 PM	0	0	0	0	0	0	0	0	0	3	0	3	3	3
04:45 PM	0	0	0	0	0	0	0	0	0	2	0	2	2	2
Total	0	0	0	0	2	0	0	2	0	6	0	6	6	8
05:00 PM	0	0	0	0	0	2	0	2	0	0	0	0	0	2
05:15 PM	0	0	0	0	0	0	0	0	0	0	0	0	0	0
05:30 PM	0	0	0	0	0	0	0	0	0	0	0	0	0	0
05:45 PM	0	0	0	0	0	0	0	0	0	0	0	0	0	0
Total	0	0	0	0	0	2	0	2	0	0	0	0	0	2
Grand Total	0	0	0	0	2	2	0	4	0	6	0	6	6	10
Apprch %	0	0	0	0	50	50	0	100	0	100	0	60	60	
Total %	0	0	0	0	20	20	0	40	0	60	0	60	60	

Start Time	SR-99 Northbound Ramps Southbound				Gateway Drive Westbound				Gateway Drive Eastbound				Int. Total
	Left	Right	U-Turns	App. Total	Thru	Right	U-Turns	App. Total	Left	Thru	U-Turns	App. Total	
04:15 PM	0	0	0	0	2	0	0	2	0	1	0	1	3
04:30 PM	0	0	0	0	0	0	0	0	0	3	0	3	3
04:45 PM	0	0	0	0	0	0	0	0	0	2	0	2	2
05:00 PM	0	0	0	0	0	2	0	2	0	0	0	0	2
Total Volume	0	0	0	0	2	2	0	4	0	6	0	6	10
% App. Total	0	0	0	0	50	50	0	100	0	100	0	60	60
PHF	.000	.000	.000	.000	.250	.250	.000	.500	.000	.500	.000	.500	.833

Peak Hour Analysis From 04:15 PM to 05:00 PM - Peak 1 of 1

Peak Hour for Entire Intersection Begins at 04:15 PM

City of Madera
 N/S: SR-99 Northbound Ramps/Gateway Dr
 E/W: Gateway Drive
 Weather: Clear

File Name : 23B_MDA_99N Spur_Gateway PM
 Site Code : 00319628
 Start Date : 9/19/2019
 Page No : 2

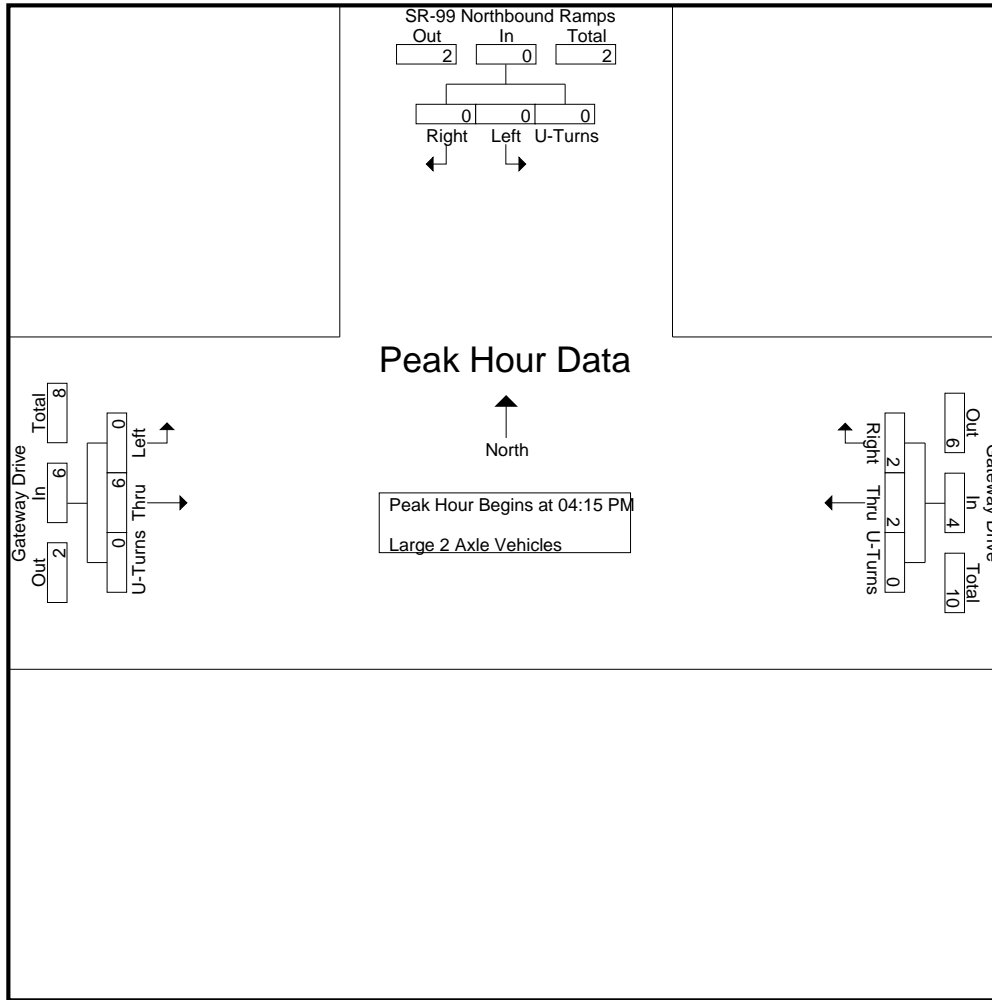

Peak Hour Analysis From 04:15 PM to 05:00 PM - Peak 1 of 1
 Peak Hour for Each Approach Begins at:

	04:15 PM				04:15 PM				04:15 PM			
+0 mins.	0	0	0	0	2	0	0	2	0	1	0	1
+15 mins.	0	0	0	0	0	0	0	0	0	3	0	3
+30 mins.	0	0	0	0	0	0	0	0	0	2	0	2
+45 mins.	0	0	0	0	0	2	0	2	0	0	0	0
Total Volume	0	0	0	0	2	2	0	4	0	6	0	6
% App. Total	0	0	0	0	50	50	0	50	0	100	0	100
PHF	.000	.000	.000	.000	.250	.250	.000	.500	.000	.500	.000	.500

City of Madera
 N/S: SR-99 Northbound Ramps/Gateway Dr
 E/W: Gateway Drive
 Weather: Clear

File Name : 23B_MDA_99N_Spur_Gateway PM
 Site Code : 00319628
 Start Date : 9/19/2019
 Page No : 2

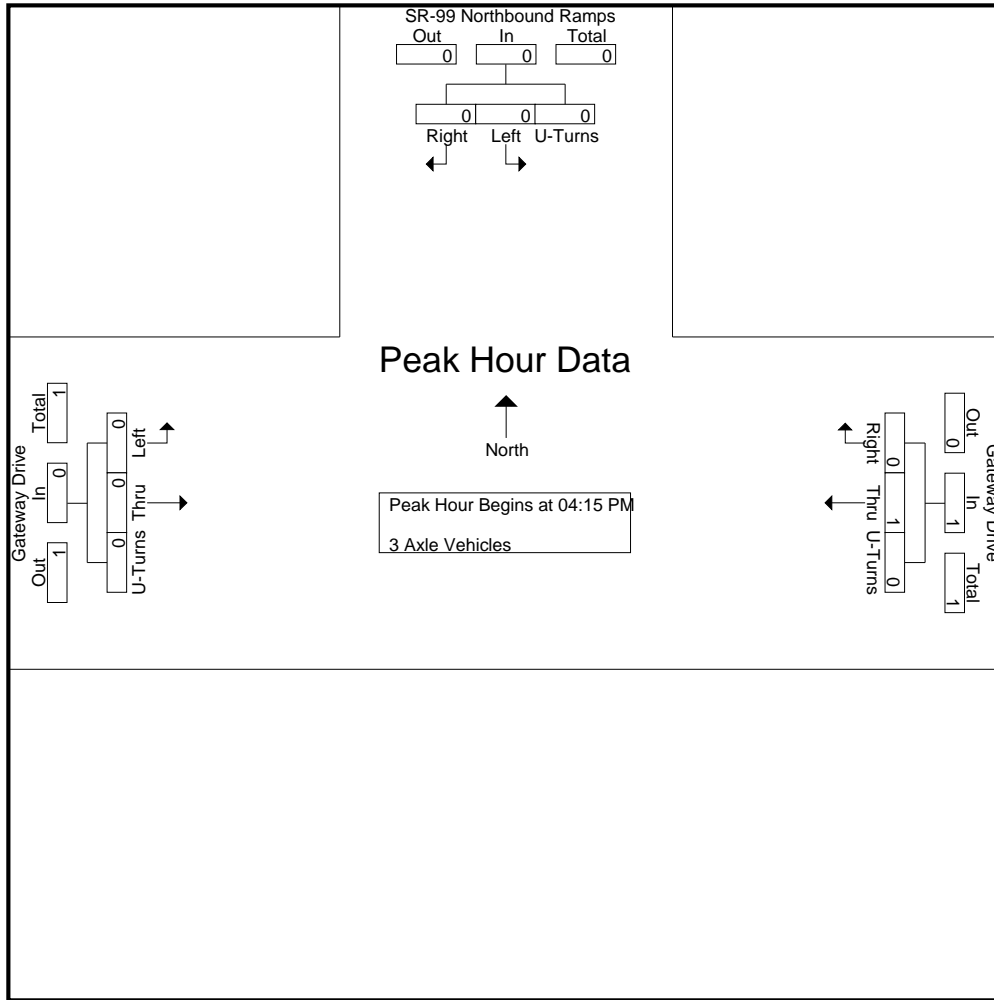

Peak Hour Analysis From 04:15 PM to 05:00 PM - Peak 1 of 1
 Peak Hour for Each Approach Begins at:

	04:15 PM				04:15 PM				04:15 PM			
+0 mins.	0	0	0	0	1	0	0	1	0	0	0	0
+15 mins.	0	0	0	0	0	0	0	0	0	0	0	0
+30 mins.	0	0	0	0	0	0	0	0	0	0	0	0
+45 mins.	0	0	0	0	0	0	0	0	0	0	0	0
Total Volume	0	0	0	0	1	0	0	1	0	0	0	0
% App. Total	0	0	0	0	100	0	0	0	0	0	0	0
PHF	.000	.000	.000	.000	.250	.000	.000	.250	.000	.000	.000	.000

City of Madera
 N/S: SR-99 Northbound Ramps/Gateway Dr
 E/W: Gateway Drive
 Weather: Clear

File Name : 23B_MDA_99N Spur_Gateway PM
 Site Code : 00319628
 Start Date : 9/19/2019
 Page No : 1

Groups Printed- 4+ Axle Trucks

Start Time	SR-99 Northbound Ramps Southbound				Gateway Drive Westbound				Gateway Drive Eastbound				Int. Total	
	Left	Right	U-Turns	App. Total	Thru	Right	U-Turns	App. Total	Left	Thru	U-Turns	App. Total		
04:00 PM	0	0	0	0	0	0	0	0	0	0	0	0	0	0
04:15 PM	0	0	0	0	0	0	0	0	0	2	0	0	2	2
04:30 PM	0	0	0	0	0	0	0	0	0	0	0	0	0	0
04:45 PM	0	0	0	0	0	0	0	0	0	0	0	0	0	0
Total	0	0	0	0	0	0	0	0	0	2	0	0	2	2
05:00 PM	0	0	0	0	0	0	0	0	0	2	0	0	2	2
05:15 PM	0	0	0	0	0	0	0	0	0	0	0	0	0	0
05:30 PM	0	0	0	0	0	0	0	0	0	1	0	0	1	1
05:45 PM	0	0	0	0	0	0	0	0	0	0	0	0	0	0
Total	0	0	0	0	0	0	0	0	0	3	0	0	3	3
Grand Total	0	0	0	0	0	0	0	0	0	5	0	0	5	5
Apprch %	0	0	0	0	0	0	0	0	0	100	0	0	100	
Total %	0	0	0	0	0	0	0	0	0	100	0	0	100	

Start Time	SR-99 Northbound Ramps Southbound				Gateway Drive Westbound				Gateway Drive Eastbound				Int. Total	
	Left	Right	U-Turns	App. Total	Thru	Right	U-Turns	App. Total	Left	Thru	U-Turns	App. Total		
Peak Hour Analysis From 04:15 PM to 05:00 PM - Peak 1 of 1														
Peak Hour for Entire Intersection Begins at 04:15 PM														
04:15 PM	0	0	0	0	0	0	0	0	0	2	0	0	2	2
04:30 PM	0	0	0	0	0	0	0	0	0	0	0	0	0	0
04:45 PM	0	0	0	0	0	0	0	0	0	0	0	0	0	0
05:00 PM	0	0	0	0	0	0	0	0	0	2	0	0	2	2
Total Volume	0	0	0	0	0	0	0	0	0	4	0	0	4	4
% App. Total	0	0	0	0	0	0	0	0	0	100	0	0	100	
PHF	.000	.000	.000	.000	.000	.000	.000	.000	.000	.500	.000	.000	.500	.500

City of Madera
 N/S: SR-99 Northbound Ramps/Gateway Dr
 E/W: Gateway Drive
 Weather: Clear

File Name : 23B_MDA_99N Spur_Gateway PM
 Site Code : 00319628
 Start Date : 9/19/2019
 Page No : 2

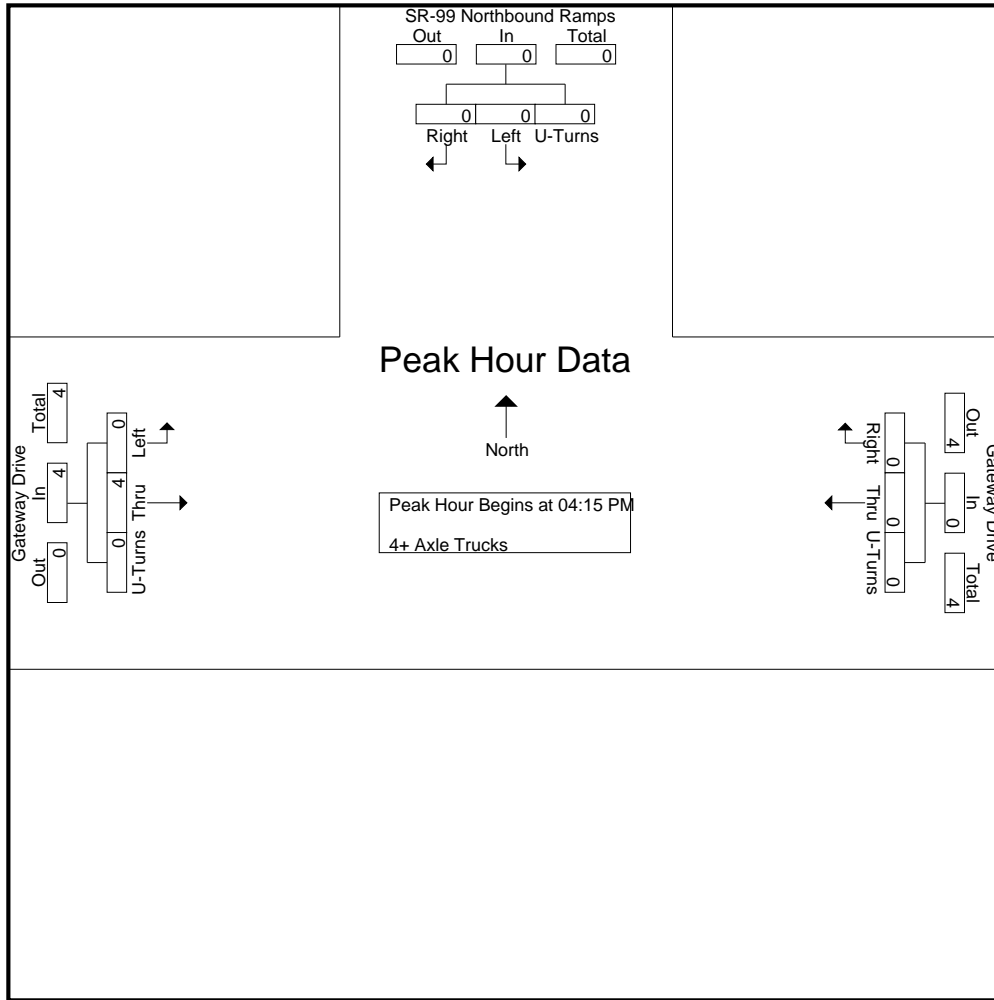

Peak Hour Analysis From 04:15 PM to 05:00 PM - Peak 1 of 1

Peak Hour for Each Approach Begins at:

	04:15 PM				04:15 PM				04:15 PM			
+0 mins.	0	0	0	0	0	0	0	0	0	2	0	2
+15 mins.	0	0	0	0	0	0	0	0	0	0	0	0
+30 mins.	0	0	0	0	0	0	0	0	0	0	0	0
+45 mins.	0	0	0	0	0	0	0	0	0	2	0	2
Total Volume	0	0	0	0	0	0	0	0	0	4	0	4
% App. Total	0	0	0	0	0	0	0	0	0	100	0	0
PHF	.000	.000	.000	.000	.000	.000	.000	.000	.000	.500	.000	.500

Location: Madera
 N/S: SR-99 NB Ramps/Gateway
 E/W: Gateway Drive



Date: 9/19/2019
 Day: Thursday

PEDESTRIANS

	North Leg SR-99 Northbound Ramps	East Leg Gateway Drive	South Leg Dead End	West Leg Gateway Drive	
	Pedestrians	Pedestrians	Pedestrians	Pedestrians	
7:00 AM	0	0	0	0	0
7:15 AM	0	0	0	0	0
7:30 AM	0	0	0	0	0
7:45 AM	0	0	0	0	0
8:00 AM	0	0	0	0	0
8:15 AM	0	0	0	0	0
8:30 AM	0	0	0	0	0
8:45 AM	0	0	0	0	0
TOTAL VOLUMES:	0	0	0	0	0

	North Leg SR-99 Northbound Ramps	East Leg Gateway Drive	South Leg Dead End	West Leg Gateway Drive	
	Pedestrians	Pedestrians	Pedestrians	Pedestrians	
4:00 PM	0	0	0	0	0
4:15 PM	0	0	0	0	0
4:30 PM	0	0	0	0	0
4:45 PM	0	0	0	0	0
5:00 PM	0	0	0	0	0
5:15 PM	0	0	0	0	0
5:30 PM	0	0	0	0	0
5:45 PM	0	0	0	0	0
TOTAL VOLUMES:	0	0	0	0	0

Location: Madera
 N/S: SR-99 NB Ramps/Gateway
 E/W: Gateway Drive



Date: 9/19/2019
 Day: Thursday

BICYCLES

	Southbound SR-99 Northbound Ramps			Westbound Gateway Drive			Northbound Dead End			Eastbound Gateway Drive			
	Left	Thru	Right	Left	Thru	Right	Left	Thru	Right	Left	Thru	Right	
7:00 AM	0	0	0	0	0	0	0	0	0	0	0	0	0
7:15 AM	0	0	0	0	0	0	0	0	0	0	0	0	0
7:30 AM	0	0	0	0	0	0	0	0	0	0	0	0	0
7:45 AM	0	0	0	0	0	0	0	0	0	0	0	0	0
8:00 AM	0	0	0	0	0	0	0	0	0	0	0	0	0
8:15 AM	0	0	0	0	0	0	0	0	0	0	0	0	0
8:30 AM	0	0	0	0	0	0	0	0	0	0	0	0	0
8:45 AM	0	0	0	0	0	0	0	0	0	0	0	0	0
TOTAL VOLUMES:	0	0	0	0	0	0	0	0	0	0	0	0	0

	Southbound SR-99 Northbound Ramps			Westbound Gateway Drive			Northbound Dead End			Eastbound Gateway Drive			
	Left	Thru	Right	Left	Thru	Right	Left	Thru	Right	Left	Thru	Right	
4:00 PM	0	0	0	0	0	0	0	0	0	0	0	0	0
4:15 PM	0	0	0	0	0	0	0	0	0	0	0	0	0
4:30 PM	0	0	0	0	0	0	0	0	0	0	0	0	0
4:45 PM	0	0	0	0	0	0	0	0	0	0	0	0	0
5:00 PM	0	0	0	0	0	0	0	0	0	0	0	0	0
5:15 PM	0	0	0	0	0	0	0	0	0	0	0	0	0
5:30 PM	0	0	0	0	0	0	0	0	0	0	0	0	0
5:45 PM	0	0	0	0	0	0	0	0	0	0	0	0	0
TOTAL VOLUMES:	0	0	0	0	0	0	0	0	0	0	0	0	0

City of Madera
 N/S: Schnoor Street
 E/W: Cleveland Avenue
 Weather: Clear

File Name : 24_MDA_Schnoor_Cleveland AM
 Site Code : 00319628
 Start Date : 9/19/2019
 Page No : 1

Groups Printed- Passenger Vehicles - Large 2 Axle Vehicles - 3 Axle Vehicles - 4+ Axle Trucks

Start Time	Schnoor Street Southbound					Cleveland Avenue Westbound					Schnoor Street Northbound					Cleveland Avenue Eastbound					Int. Total
	Left	Thru	Right	U-Turns	App. Total	Left	Thru	Right	U-Turns	App. Total	Left	Thru	Right	U-Turns	App. Total	Left	Thru	Right	U-Turns	App. Total	
07:00 AM	9	25	9	1	44	23	36	8	0	67	5	31	15	1	52	11	81	8	0	100	263
07:15 AM	16	17	8	1	42	17	34	9	0	60	6	30	36	0	72	9	81	5	0	95	269
07:30 AM	18	30	7	0	55	24	49	8	0	81	9	39	29	1	78	12	97	6	0	115	329
07:45 AM	13	39	17	1	70	34	62	14	0	110	13	60	45	0	118	18	105	4	0	127	425
Total	56	111	41	3	211	98	181	39	0	318	33	160	125	2	320	50	364	23	0	437	1286
08:00 AM	24	38	18	1	81	38	57	10	0	105	14	55	39	0	108	14	69	13	0	96	390
08:15 AM	23	44	14	0	81	45	42	13	0	100	15	48	39	0	102	17	72	5	0	94	377
08:30 AM	16	35	10	1	62	44	49	6	0	99	8	49	32	0	89	22	75	10	0	107	357
08:45 AM	8	32	8	0	48	41	72	12	0	125	7	44	32	0	83	7	65	9	0	81	337
Total	71	149	50	2	272	168	220	41	0	429	44	196	142	0	382	60	281	37	0	378	1461
Grand Total	127	260	91	5	483	266	401	80	0	747	77	356	267	2	702	110	645	60	0	815	2747
Apprch %	26.3	53.8	18.8	1		35.6	53.7	10.7	0		11	50.7	38	0.3		13.5	79.1	7.4	0		
Total %	4.6	9.5	3.3	0.2	17.6	9.7	14.6	2.9	0	27.2	2.8	13	9.7	0.1	25.6	4	23.5	2.2	0	29.7	
Passenger Vehicles	96.9	98.5	92.3	80	96.7	95.1	94.8	96.2	0	95	98.7	98.9	98.1	100	98.6	100	97.5	98.3	0	97.9	97.1
Large 2 Axle Vehicles	3.1	1.2	7.7	20	3.1	4.1	3.5	2.5	0	3.6	0	0.8	1.1	0	0.9	0	1.4	1.7	0	1.2	2.1
3 Axle Vehicles	0	1	0	0	1	0	4	0	0	4	1	1	0	0	2	0	5	0	0	5	12
% 3 Axle Vehicles	0	0.4	0	0	0.2	0	1	0	0	0.5	1.3	0.3	0	0	0.3	0	0.8	0	0	0.6	0.4
4+ Axle Trucks	0	0	0	0	0	2	3	1	0	6	0	0	2	0	2	0	2	0	0	2	10
% 4+ Axle Trucks																					

Start Time	Schnoor Street Southbound					Cleveland Avenue Westbound					Schnoor Street Northbound					Cleveland Avenue Eastbound					Int. Total
	Left	Thru	Right	U-Turns	App. Total	Left	Thru	Right	U-Turns	App. Total	Left	Thru	Right	U-Turns	App. Total	Left	Thru	Right	U-Turns	App. Total	
Peak Hour Analysis From 07:00 AM to 08:45 AM - Peak 1 of 1																					
Peak Hour for Entire Intersection Begins at 07:45 AM																					
07:45 AM	13	39	17	1	70	34	62	14	0	110	13	60	45	0	118	18	105	4	0	127	425
08:00 AM	24	38	18	1	81	38	57	10	0	105	14	55	39	0	108	14	69	13	0	96	390
08:15 AM	23	44	14	0	81	45	42	13	0	100	15	48	39	0	102	17	72	5	0	94	377
08:30 AM	16	35	10	1	62	44	49	6	0	99	8	49	32	0	89	22	75	10	0	107	357
Total Volume	76	156	59	3	294	161	210	43	0	414	50	212	155	0	417	71	321	32	0	424	1549
% App. Total	25.9	53.1	20.1	1		38.9	50.7	10.4	0		12	50.8	37.2	0		16.7	75.7	7.5	0		
PHF	.792	.886	.819	.750	.907	.894	.847	.768	.000	.941	.833	.883	.861	.000	.883	.807	.764	.615	.000	.835	.911

City of Madera
 N/S: Schnoor Street
 E/W: Cleveland Avenue
 Weather: Clear

File Name : 24_MDA_Schnoor_Cleveland AM
 Site Code : 00319628
 Start Date : 9/19/2019
 Page No : 2

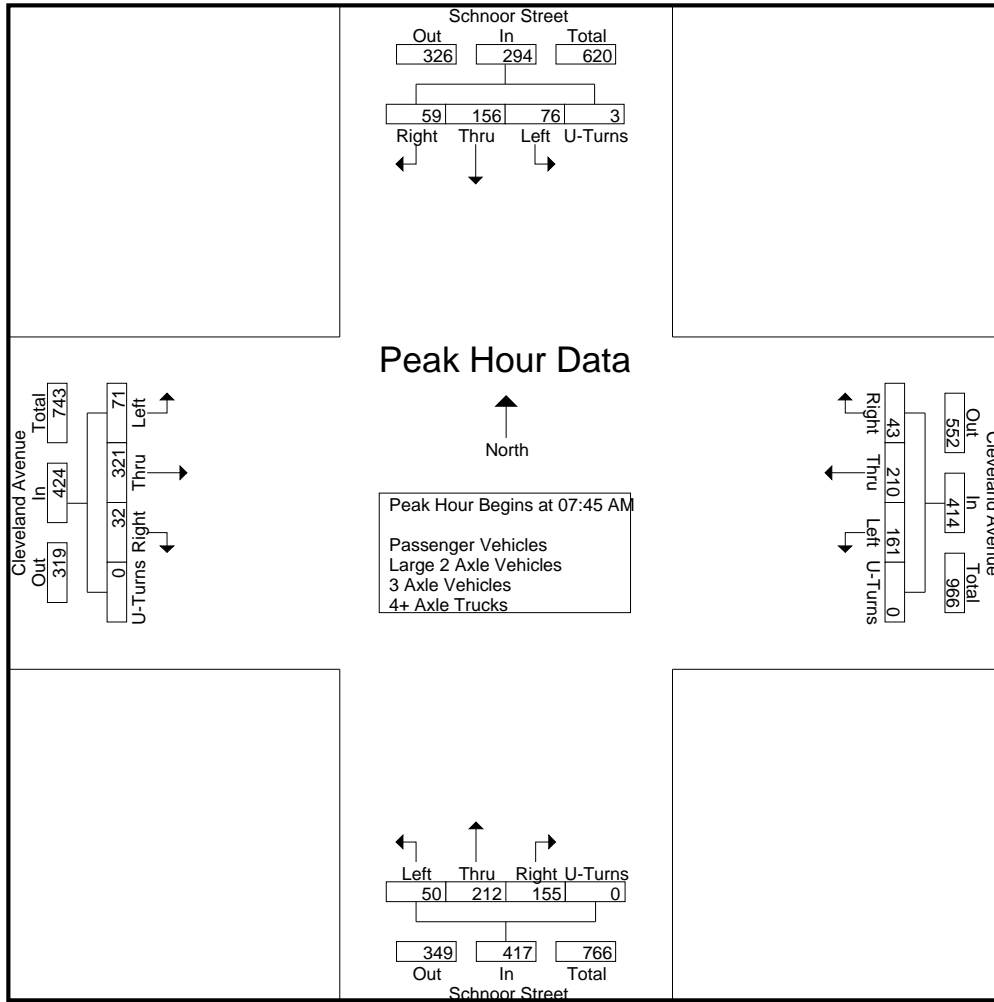

Peak Hour Analysis From 07:00 AM to 08:45 AM - Peak 1 of 1
 Peak Hour for Each Approach Begins at:

	07:45 AM					08:00 AM					07:45 AM					07:00 AM				
+0 mins.	13	39	17	1	70	38	57	10	0	105	13	60	45	0	118	11	81	8	0	100
+15 mins.	24	38	18	1	81	45	42	13	0	100	14	55	39	0	108	9	81	5	0	95
+30 mins.	23	44	14	0	81	44	49	6	0	99	15	48	39	0	102	12	97	6	0	115
+45 mins.	16	35	10	1	62	41	72	12	0	125	8	49	32	0	89	18	105	4	0	127
Total Volume	76	156	59	3	294	168	220	41	0	429	50	212	155	0	417	50	364	23	0	437
% App. Total	25.9	53.1	20.1	1		39.2	51.3	9.6	0		12	50.8	37.2	0		11.4	83.3	5.3	0	
PHF	.792	.886	.819	.750	.907	.933	.764	.788	.000	.858	.833	.883	.861	.000	.883	.694	.867	.719	.000	.860

City of Madera
 N/S: Schnoor Street
 E/W: Cleveland Avenue
 Weather: Clear

File Name : 24_MDA_Schnoor_Cleveland AM
 Site Code : 00319628
 Start Date : 9/19/2019
 Page No : 1

Groups Printed- Passenger Vehicles

Start Time	Schnoor Street Southbound					Cleveland Avenue Westbound					Schnoor Street Northbound					Cleveland Avenue Eastbound					Int. Total
	Left	Thru	Right	U-Turns	App. Total	Left	Thru	Right	U-Turns	App. Total	Left	Thru	Right	U-Turns	App. Total	Left	Thru	Right	U-Turns	App. Total	
07:00 AM	9	23	9	1	42	22	34	8	0	64	5	30	15	1	51	11	80	8	0	99	256
07:15 AM	15	16	5	1	37	15	31	9	0	55	5	30	36	0	71	9	80	5	0	94	257
07:30 AM	18	30	6	0	54	23	46	7	0	76	9	38	29	1	77	12	94	6	0	112	319
07:45 AM	12	38	17	0	67	34	61	14	0	109	13	60	45	0	118	18	102	4	0	124	418
Total	54	107	37	2	200	94	172	38	0	304	32	158	125	2	317	50	356	23	0	429	1250
08:00 AM	23	38	16	1	78	37	50	10	0	97	14	54	37	0	105	14	67	12	0	93	373
08:15 AM	22	44	13	0	79	44	38	12	0	94	15	48	38	0	101	17	71	5	0	93	367
08:30 AM	16	35	10	1	62	39	49	6	0	94	8	49	31	0	88	22	71	10	0	103	347
08:45 AM	8	32	8	0	48	39	71	11	0	121	7	43	31	0	81	7	64	9	0	80	330
Total	69	149	47	2	267	159	208	39	0	406	44	194	137	0	375	60	273	36	0	369	1417
Grand Total	123	256	84	4	467	253	380	77	0	710	76	352	262	2	692	110	629	59	0	798	2667
Apprch %	26.3	54.8	18	0.9		35.6	53.5	10.8	0		11	50.9	37.9	0.3		13.8	78.8	7.4	0		
Total %	4.6	9.6	3.1	0.1	17.5	9.5	14.2	2.9	0	26.6	2.8	13.2	9.8	0.1	25.9	4.1	23.6	2.2	0	29.9	

Start Time	Schnoor Street Southbound					Cleveland Avenue Westbound					Schnoor Street Northbound					Cleveland Avenue Eastbound					Int. Total
	Left	Thru	Right	U-Turns	App. Total	Thru	Right	U-Turns	App. Total	Thru	Right	U-Turns	App. Total	Thru	Right	U-Turns	App. Total				
Peak Hour Analysis From 07:45 AM to 08:30 AM - Peak 1 of 1																					
Peak Hour for Entire Intersection Begins at 07:45 AM																					
07:45 AM	12	38	17	0	67	34	61	14	0	109	13	60	45	0	118	18	102	4	0	124	418
08:00 AM	23	38	16	1	78	37	50	10	0	97	14	54	37	0	105	14	67	12	0	93	373
08:15 AM	22	44	13	0	79	44	38	12	0	94	15	48	38	0	101	17	71	5	0	93	367
08:30 AM	16	35	10	1	62	39	49	6	0	94	8	49	31	0	88	22	71	10	0	103	347
Total Volume	73	155	56	2	286	154	198	42	0	394	50	211	151	0	412	71	311	31	0	413	1505
% App. Total	25.5	54.2	19.6	0.7		39.1	50.3	10.7	0		12.1	51.2	36.7	0		17.2	75.3	7.5	0		
PHF	.793	.881	.824	.500	.905	.875	.811	.750	.000	.904	.833	.879	.839	.000	.873	.807	.762	.646	.000	.833	.900

City of Madera
 N/S: Schnoor Street
 E/W: Cleveland Avenue
 Weather: Clear

File Name : 24_MDA_Schnoor_Cleveland AM
 Site Code : 00319628
 Start Date : 9/19/2019
 Page No : 2

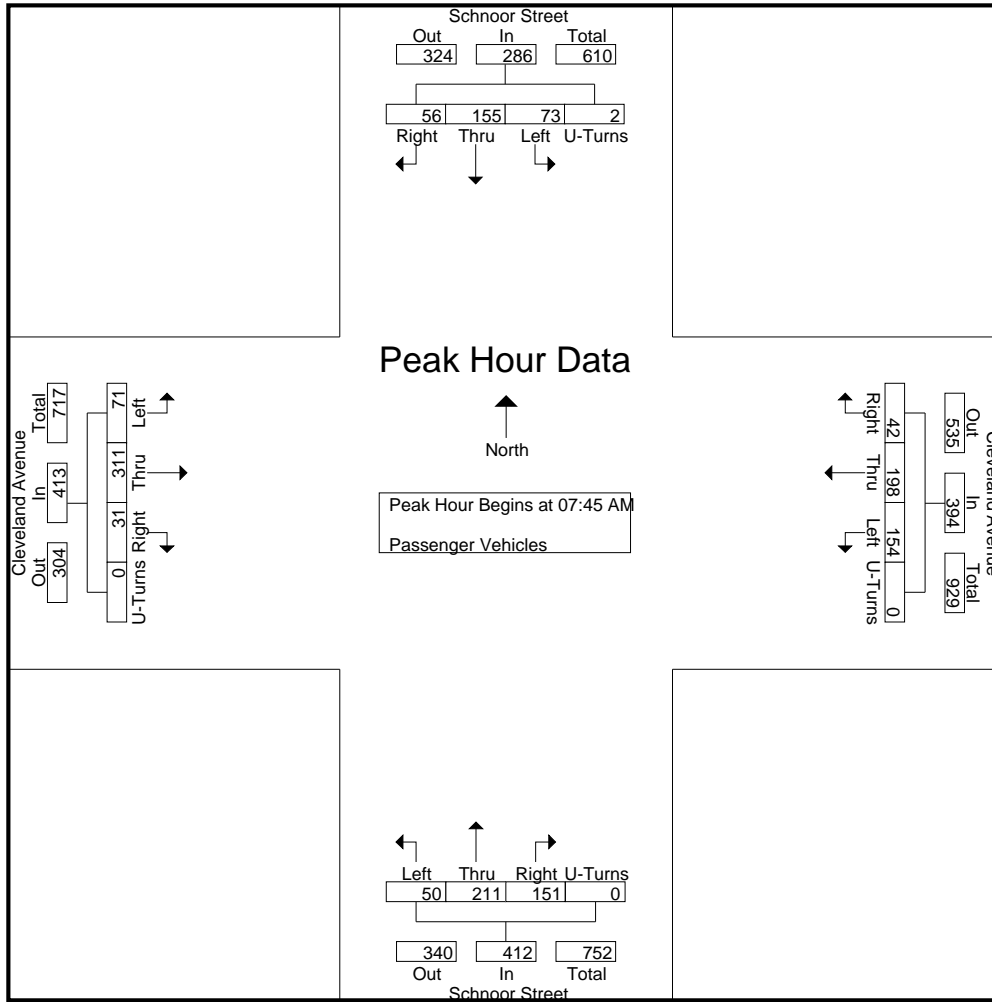

Peak Hour Analysis From 07:45 AM to 08:30 AM - Peak 1 of 1
 Peak Hour for Each Approach Begins at:

	07:45 AM					07:45 AM					07:45 AM									
+0 mins.	12	38	17	0	67	34	61	14	0	109	13	60	45	0	118	18	102	4	0	124
+15 mins.	23	38	16	1	78	37	50	10	0	97	14	54	37	0	105	14	67	12	0	93
+30 mins.	22	44	13	0	79	44	38	12	0	94	15	48	38	0	101	17	71	5	0	93
+45 mins.	16	35	10	1	62	39	49	6	0	94	8	49	31	0	88	22	71	10	0	103
Total Volume	73	155	56	2	286	154	198	42	0	394	50	211	151	0	412	71	311	31	0	413
% App. Total	25.5	54.2	19.6	0.7		39.1	50.3	10.7	0		12.1	51.2	36.7	0		17.2	75.3	7.5	0	
PHF	.793	.881	.824	.500	.905	.875	.811	.750	.000	.904	.833	.879	.839	.000	.873	.807	.762	.646	.000	.833

City of Madera
 N/S: Schnoor Street
 E/W: Cleveland Avenue
 Weather: Clear

File Name : 24_MDA_Schnoor_Cleveland AM
 Site Code : 00319628
 Start Date : 9/19/2019
 Page No : 1

Groups Printed- Large 2 Axle Vehicles

Start Time	Schnoor Street Southbound					Cleveland Avenue Westbound					Schnoor Street Northbound					Cleveland Avenue Eastbound					Int. Total
	Left	Thru	Right	U-Turns	App. Total	Left	Thru	Right	U-Turns	App. Total	Left	Thru	Right	U-Turns	App. Total	Left	Thru	Right	U-Turns	App. Total	
07:00 AM	0	1	0	0	1	1	1	0	0	2	0	1	0	0	1	0	1	0	0	1	5
07:15 AM	1	1	3	0	5	0	2	0	0	2	0	0	0	0	0	0	1	0	0	1	8
07:30 AM	0	0	1	0	1	1	2	0	0	3	0	1	0	0	1	0	1	0	0	1	6
07:45 AM	1	1	0	1	3	0	1	0	0	1	0	0	0	0	0	0	1	0	0	1	5
Total	2	3	4	1	10	2	6	0	0	8	0	2	0	0	2	0	4	0	0	4	24
08:00 AM	1	0	2	0	3	1	5	0	0	6	0	1	0	0	1	0	1	1	0	2	12
08:15 AM	1	0	1	0	2	1	3	1	0	5	0	0	1	0	1	0	1	0	0	1	9
08:30 AM	0	0	0	0	0	5	0	0	0	5	0	0	1	0	1	0	3	0	0	3	9
08:45 AM	0	0	0	0	0	2	0	1	0	3	0	0	1	0	1	0	0	0	0	0	4
Total	2	0	3	0	5	9	8	2	0	19	0	1	3	0	4	0	5	1	0	6	34
Grand Total	4	3	7	1	15	11	14	2	0	27	0	3	3	0	6	0	9	1	0	10	58
Apprch %	26.7	20	46.7	6.7		40.7	51.9	7.4	0		0	50	50	0		0	90	10	0		
Total %	6.9	5.2	12.1	1.7	25.9	19	24.1	3.4	0	46.6	0	5.2	5.2	0	10.3	0	15.5	1.7	0	17.2	

Start Time	Schnoor Street Southbound					Cleveland Avenue Westbound					Schnoor Street Northbound					Cleveland Avenue Eastbound					Int. Total
	Left	Thru	Right	U-Turns	App. Total	Thru	Right	U-Turns	App. Total	Thru	Right	U-Turns	App. Total	Thru	Right	U-Turns	App. Total				
Peak Hour Analysis From 07:45 AM to 08:30 AM - Peak 1 of 1																					
Peak Hour for Entire Intersection Begins at 07:45 AM																					
07:45 AM	1	1	0	1	3	0	1	0	0	1	0	0	0	0	0	0	1	0	0	1	5
08:00 AM	1	0	2	0	3	1	5	0	0	6	0	1	0	0	1	0	1	1	0	2	12
08:15 AM	1	0	1	0	2	1	3	1	0	5	0	0	1	0	1	0	1	0	0	1	9
08:30 AM	0	0	0	0	0	5	0	0	0	5	0	0	1	0	1	0	3	0	0	3	9
Total Volume	3	1	3	1	8	7	9	1	0	17	0	1	2	0	3	0	6	1	0	7	35
% App. Total	37.5	12.5	37.5	12.5		41.2	52.9	5.9	0		0	33.3	66.7	0		0	85.7	14.3	0		
PHF	.750	.250	.375	.250	.667	.350	.450	.250	.000	.708	.000	.250	.500	.000	.750	.000	.500	.250	.000	.583	.729

City of Madera
 N/S: Schnoor Street
 E/W: Cleveland Avenue
 Weather: Clear

File Name : 24_MDA_Schnoor_Cleveland AM
 Site Code : 00319628
 Start Date : 9/19/2019
 Page No : 2

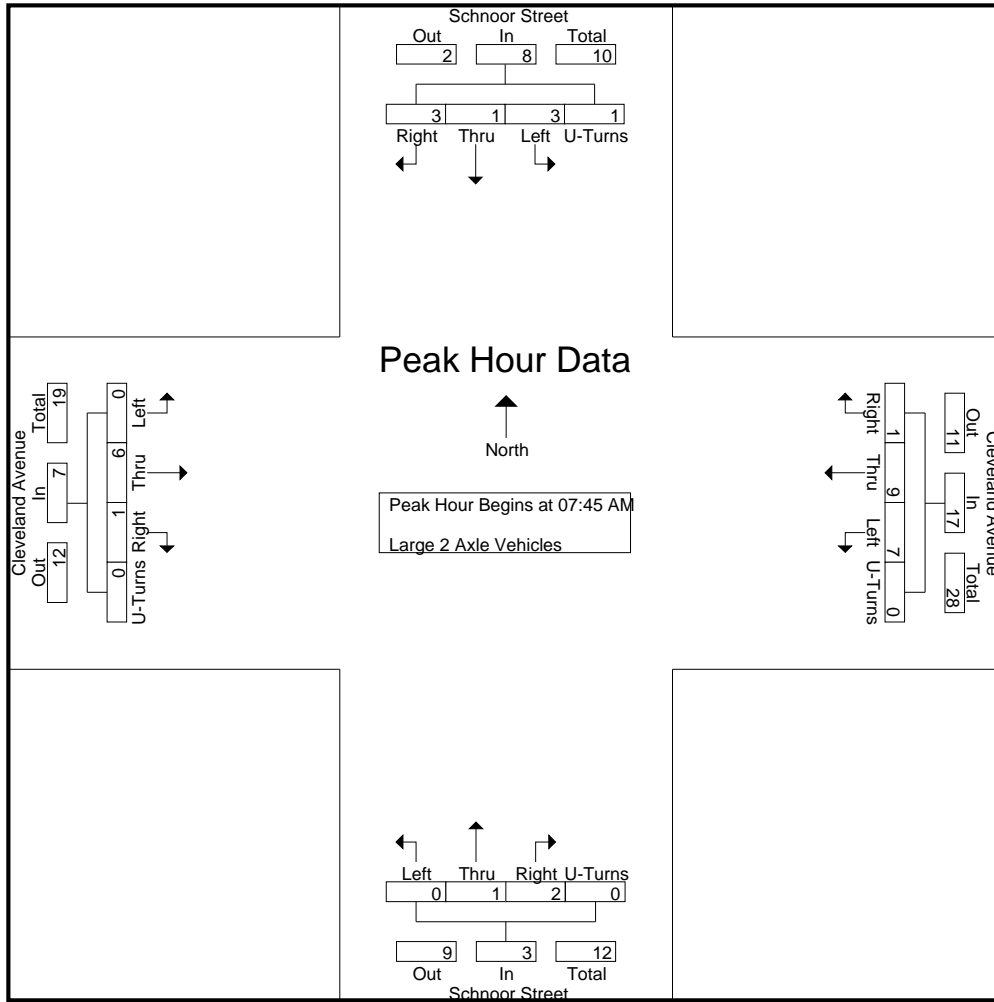

Peak Hour Analysis From 07:45 AM to 08:30 AM - Peak 1 of 1
 Peak Hour for Each Approach Begins at:

	07:45 AM					07:45 AM					07:45 AM									
+0 mins.	1	1	0	1	3	0	1	0	0	1	0	0	0	0	0	0	1	0	0	1
+15 mins.	1	0	2	0	3	1	5	0	0	6	0	1	0	0	1	0	1	1	0	2
+30 mins.	1	0	1	0	2	1	3	1	0	5	0	0	1	0	1	0	1	0	0	1
+45 mins.	0	0	0	0	0	5	0	0	0	5	0	0	1	0	1	0	3	0	0	3
Total Volume	3	1	3	1	8	7	9	1	0	17	0	1	2	0	3	0	6	1	0	7
% App. Total	37.5	12.5	37.5	12.5		41.2	52.9	5.9	0		0	33.3	66.7	0		0	85.7	14.3	0	
PHF	.750	.250	.375	.250	.667	.350	.450	.250	.000	.708	.000	.250	.500	.000	.750	.000	.500	.250	.000	.583

City of Madera
 N/S: Schnoor Street
 E/W: Cleveland Avenue
 Weather: Clear

File Name : 24_MDA_Schnoor_Cleveland AM
 Site Code : 00319628
 Start Date : 9/19/2019
 Page No : 1

Groups Printed- 3 Axle Vehicles

Start Time	Schnoor Street Southbound					Cleveland Avenue Westbound					Schnoor Street Northbound					Cleveland Avenue Eastbound					Int. Total
	Left	Thru	Right	U-Turns	App. Total	Left	Thru	Right	U-Turns	App. Total	Left	Thru	Right	U-Turns	App. Total	Left	Thru	Right	U-Turns	App. Total	
07:00 AM	0	1	0	0	1	0	1	0	0	1	0	0	0	0	0	0	0	0	0	0	2
07:15 AM	0	0	0	0	0	0	0	0	0	0	1	0	0	0	1	0	0	0	0	0	1
07:30 AM	0	0	0	0	0	0	1	0	0	1	0	0	0	0	0	0	2	0	0	2	3
07:45 AM	0	0	0	0	0	0	0	0	0	0	0	0	0	0	0	0	1	0	0	1	1
Total	0	1	0	0	1	0	2	0	0	2	1	0	0	0	1	0	3	0	0	3	7
08:00 AM	0	0	0	0	0	0	1	0	0	1	0	0	0	0	0	0	1	0	0	1	2
08:15 AM	0	0	0	0	0	0	1	0	0	1	0	0	0	0	0	0	0	0	0	0	1
08:30 AM	0	0	0	0	0	0	0	0	0	0	0	0	0	0	0	0	0	0	0	0	0
08:45 AM	0	0	0	0	0	0	0	0	0	0	0	1	0	0	1	0	1	0	0	1	2
Total	0	0	0	0	0	0	2	0	0	2	0	1	0	0	1	0	2	0	0	2	5
Grand Total	0	1	0	0	1	0	4	0	0	4	1	1	0	0	2	0	5	0	0	5	12
Apprch %	0	100	0	0		0	100	0	0		50	50	0	0		0	100	0	0		
Total %	0	8.3	0	0	8.3	0	33.3	0	0	33.3	8.3	8.3	0	0	16.7	0	41.7	0	0	41.7	

Start Time	Schnoor Street Southbound					Cleveland Avenue Westbound					Schnoor Street Northbound					Cleveland Avenue Eastbound					Int. Total
	Left	Thru	Right	U-Turns	App. Total	Thru	Right	U-Turns	App. Total	Thru	Right	U-Turns	App. Total	Thru	Right	U-Turns	App. Total				
Peak Hour Analysis From 07:45 AM to 08:30 AM - Peak 1 of 1																					
Peak Hour for Entire Intersection Begins at 07:45 AM																					
07:45 AM	0	0	0	0	0	0	0	0	0	0	0	0	0	0	0	0	1	0	0	1	1
08:00 AM	0	0	0	0	0	0	1	0	0	1	0	0	0	0	0	0	1	0	0	1	2
08:15 AM	0	0	0	0	0	0	1	0	0	1	0	0	0	0	0	0	0	0	0	0	1
08:30 AM	0	0	0	0	0	0	0	0	0	0	0	0	0	0	0	0	0	0	0	0	0
Total Volume	0	0	0	0	0	0	2	0	0	2	0	0	0	0	0	0	2	0	0	2	4
% App. Total	0	0	0	0		0	100	0	0		0	0	0	0		0	100	0	0		
PHF	.000	.000	.000	.000	.000	.000	.500	.000	.000	.500	.000	.000	.000	.000	.000	.000	.500	.000	.000	.500	.500

City of Madera
 N/S: Schnoor Street
 E/W: Cleveland Avenue
 Weather: Clear

File Name : 24_MDA_Schnoor_Cleveland AM
 Site Code : 00319628
 Start Date : 9/19/2019
 Page No : 2

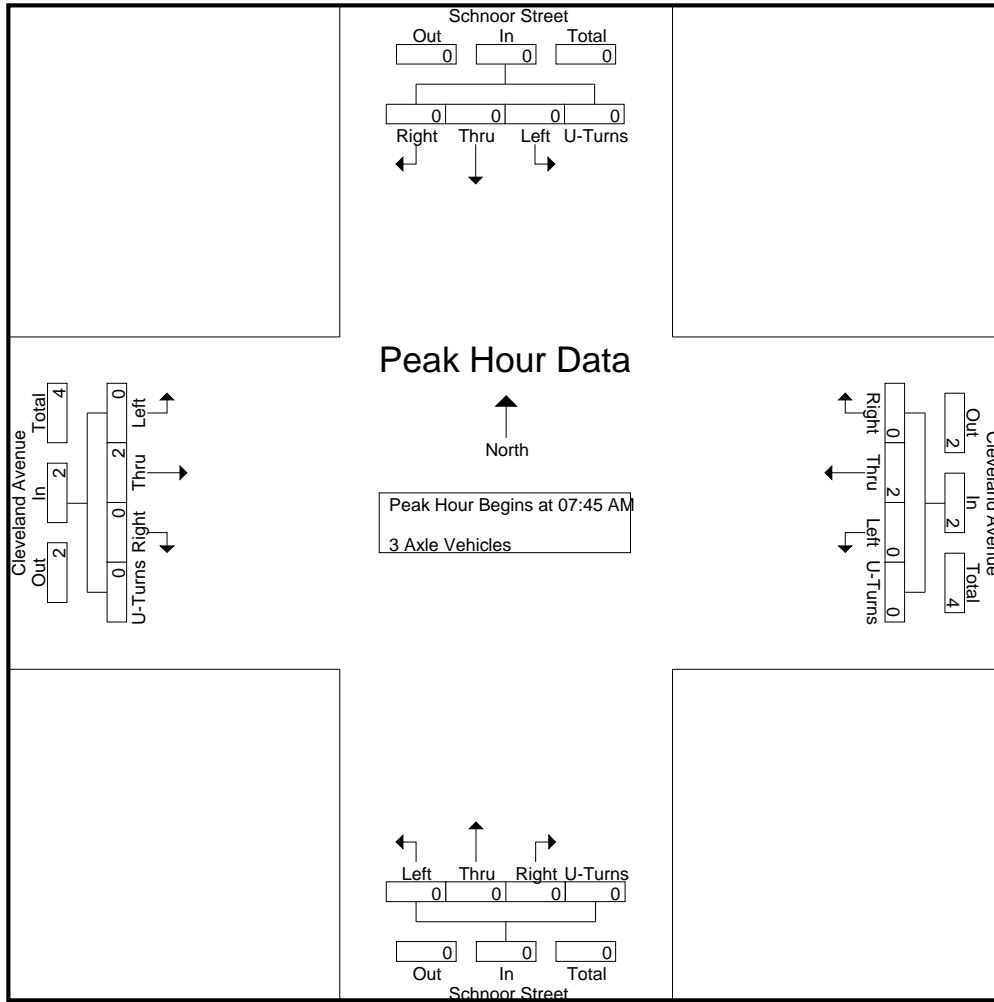

Peak Hour Analysis From 07:45 AM to 08:30 AM - Peak 1 of 1
 Peak Hour for Each Approach Begins at:

	07:45 AM					07:45 AM					07:45 AM									
+0 mins.	0	0	0	0	0	0	0	0	0	0	0	0	0	0	0	0	1	0	0	1
+15 mins.	0	0	0	0	0	0	1	0	0	1	0	0	0	0	0	0	1	0	0	1
+30 mins.	0	0	0	0	0	0	1	0	0	1	0	0	0	0	0	0	0	0	0	0
+45 mins.	0	0	0	0	0	0	0	0	0	0	0	0	0	0	0	0	0	0	0	0
Total Volume	0	0	0	0	0	0	2	0	0	2	0	0	0	0	0	0	2	0	0	2
% App. Total	0	0	0	0	0	0	100	0	0	0	0	0	0	0	0	0	100	0	0	0
PHF	.000	.000	.000	.000	.000	.000	.500	.000	.000	.500	.000	.000	.000	.000	.000	.000	.500	.000	.000	.500

City of Madera
 N/S: Schnoor Street
 E/W: Cleveland Avenue
 Weather: Clear

File Name : 24_MDA_Schnoor_Cleveland AM
 Site Code : 00319628
 Start Date : 9/19/2019
 Page No : 1

Groups Printed- 4+ Axle Trucks

Start Time	Schnoor Street Southbound					Cleveland Avenue Westbound					Schnoor Street Northbound					Cleveland Avenue Eastbound					Int. Total
	Left	Thru	Right	U-Turns	App. Total	Left	Thru	Right	U-Turns	App. Total	Left	Thru	Right	U-Turns	App. Total	Left	Thru	Right	U-Turns	App. Total	
07:00 AM	0	0	0	0	0	0	0	0	0	0	0	0	0	0	0	0	0	0	0	0	0
07:15 AM	0	0	0	0	0	2	1	0	0	3	0	0	0	0	0	0	0	0	0	0	0
07:30 AM	0	0	0	0	0	0	0	1	0	1	0	0	0	0	0	0	0	0	0	0	0
07:45 AM	0	0	0	0	0	0	0	0	0	0	0	0	0	0	0	0	1	0	0	0	1
Total	0	0	0	0	0	2	1	1	0	4	0	0	0	0	0	0	1	0	0	0	1
08:00 AM	0	0	0	0	0	0	1	0	0	1	0	0	2	0	2	0	0	0	0	0	0
08:15 AM	0	0	0	0	0	0	0	0	0	0	0	0	0	0	0	0	0	0	0	0	0
08:30 AM	0	0	0	0	0	0	0	0	0	0	0	0	0	0	0	0	1	0	0	0	1
08:45 AM	0	0	0	0	0	0	1	0	0	1	0	0	0	0	0	0	0	0	0	0	0
Total	0	0	0	0	0	0	2	0	0	2	0	0	2	0	2	0	1	0	0	0	1
Grand Total	0	0	0	0	0	2	3	1	0	6	0	0	2	0	2	0	2	0	0	0	2
Apprch %	0	0	0	0		33.3	50	16.7	0		0	0	100	0		0	100	0	0		
Total %	0	0	0	0	0	20	30	10	0	60	0	0	20	0	20	0	20	0	0	20	10

Start Time	Schnoor Street Southbound					Cleveland Avenue Westbound					Schnoor Street Northbound					Cleveland Avenue Eastbound					Int. Total
	Left	Thru	Right	U-Turns	App. Total	Thru	Right	U-Turns	App. Total	Thru	Right	U-Turns	App. Total	Thru	Right	U-Turns	App. Total				
Peak Hour Analysis From 07:45 AM to 08:30 AM - Peak 1 of 1																					
Peak Hour for Entire Intersection Begins at 07:45 AM																					
07:45 AM	0	0	0	0	0	0	0	0	0	0	0	0	0	0	0	0	1	0	0	0	1
08:00 AM	0	0	0	0	0	0	1	0	0	1	0	0	2	0	2	0	0	0	0	0	0
08:15 AM	0	0	0	0	0	0	0	0	0	0	0	0	0	0	0	0	0	0	0	0	0
08:30 AM	0	0	0	0	0	0	0	0	0	0	0	0	0	0	0	0	1	0	0	0	1
Total Volume	0	0	0	0	0	0	1	0	0	1	0	0	2	0	2	0	2	0	0	0	2
% App. Total	0	0	0	0	0	0	100	0	0		0	0	100	0		0	100	0	0		
PHF	.000	.000	.000	.000	.000	.000	.250	.000	.000	.250	.000	.000	.250	.000	.250	.000	.500	.000	.000	.500	.417

City of Madera
 N/S: Schnoor Street
 E/W: Cleveland Avenue
 Weather: Clear

File Name : 24_MDA_Schnoor_Cleveland AM
 Site Code : 00319628
 Start Date : 9/19/2019
 Page No : 2

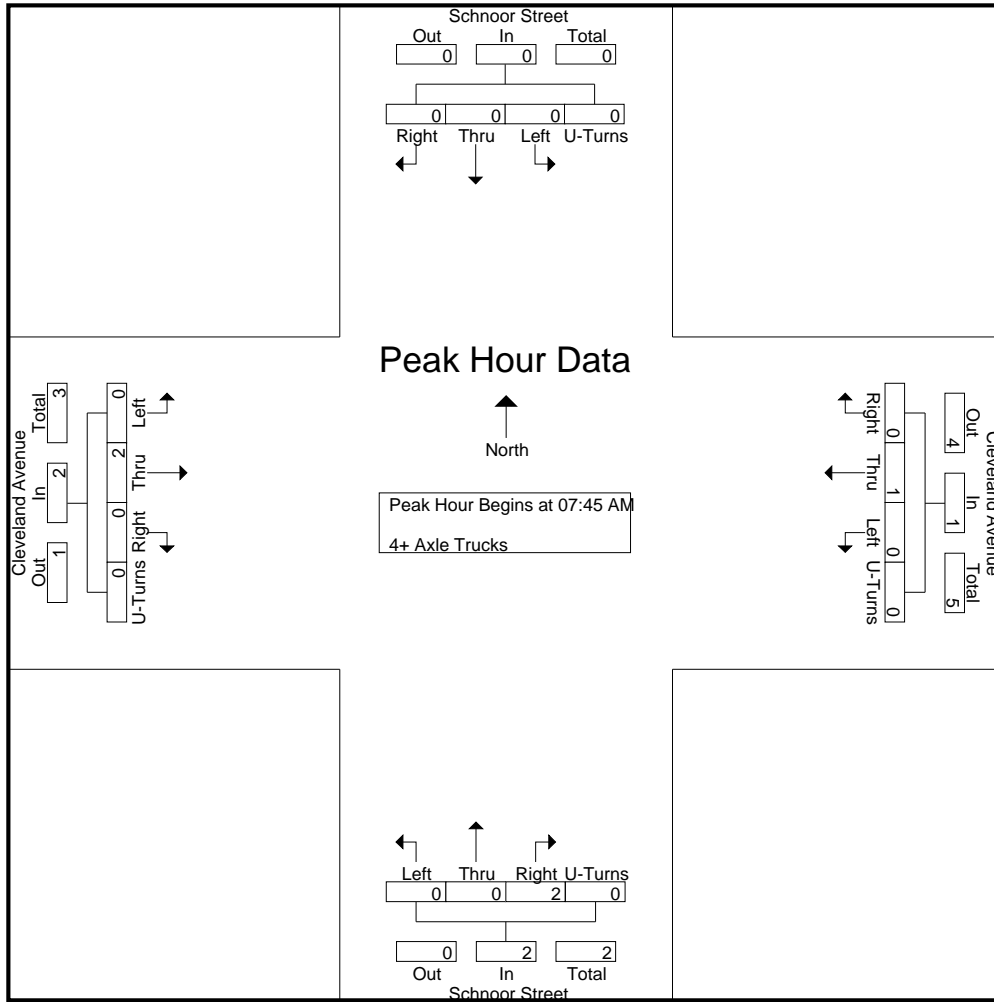

Peak Hour Analysis From 07:45 AM to 08:30 AM - Peak 1 of 1
 Peak Hour for Each Approach Begins at:

	07:45 AM					07:45 AM					07:45 AM									
+0 mins.	0	0	0	0	0	0	0	0	0	0	0	0	0	0	0	0	1	0	0	1
+15 mins.	0	0	0	0	0	0	1	0	0	1	0	0	2	0	2	0	0	0	0	0
+30 mins.	0	0	0	0	0	0	0	0	0	0	0	0	0	0	0	0	0	0	0	0
+45 mins.	0	0	0	0	0	0	0	0	0	0	0	0	0	0	0	0	1	0	0	1
Total Volume	0	0	0	0	0	0	1	0	0	1	0	0	2	0	2	0	2	0	0	2
% App. Total	0	0	0	0	0	0	100	0	0	0	0	0	100	0	0	0	100	0	0	0
PHF	.000	.000	.000	.000	.000	.000	.250	.000	.000	.250	.000	.000	.250	.000	.250	.000	.500	.000	.000	.500

City of Madera
 N/S: Schnoor Street
 E/W: Cleveland Avenue
 Weather: Clear

File Name : 24_MDA_Schnoor_Cleveland PM
 Site Code : 00319628
 Start Date : 9/19/2019
 Page No : 1

Groups Printed- Passenger Vehicles - Large 2 Axle Vehicles - 3 Axle Vehicles - 4+ Axle Trucks

Start Time	Schnoor Street Southbound					Cleveland Avenue Westbound					Schnoor Street Northbound					Cleveland Avenue Eastbound					Int. Total
	Left	Thru	Right	U-Turns	App. Total	Left	Thru	Right	U-Turns	App. Total	Left	Thru	Right	U-Turns	App. Total	Left	Thru	Right	U-Turns	App. Total	
04:00 PM	23	37	14	0	74	57	111	12	0	180	17	55	23	1	96	37	102	11	0	150	500
04:15 PM	20	41	18	0	79	61	95	26	0	182	15	50	28	0	93	28	95	8	0	131	485
04:30 PM	19	41	19	0	79	59	98	29	0	186	14	48	27	0	89	23	106	13	0	142	496
04:45 PM	29	40	16	1	86	58	84	24	0	166	10	44	30	2	86	29	86	12	0	127	465
Total	91	159	67	1	318	235	388	91	0	714	56	197	108	3	364	117	389	44	0	550	1946
05:00 PM	22	46	18	0	86	61	102	18	2	183	14	60	32	1	107	27	86	14	0	127	503
05:15 PM	28	53	18	0	99	65	119	23	0	207	15	45	41	2	103	27	97	10	0	134	543
05:30 PM	28	47	22	3	100	75	89	36	0	200	10	50	43	1	104	24	99	8	0	131	535
05:45 PM	27	49	16	2	94	61	110	26	0	197	9	45	32	0	86	30	101	9	0	140	517
Total	105	195	74	5	379	262	420	103	2	787	48	200	148	4	400	108	383	41	0	532	2098
Grand Total	196	354	141	6	697	497	808	194	2	1501	104	397	256	7	764	225	772	85	0	1082	4044
Apprch %	28.1	50.8	20.2	0.9		33.1	53.8	12.9	0.1		13.6	52	33.5	0.9		20.8	71.3	7.9	0		
Total %	4.8	8.8	3.5	0.1	17.2	12.3	20	4.8	0	37.1	2.6	9.8	6.3	0.2	18.9	5.6	19.1	2.1	0	26.8	
Passenger Vehicles	98.5	99.7	99.3	100	99.3	99.2	98.9	98.5	100	98.9	99	99.7	98.8	100	99.3	99.6	97.8	97.6	0	98.2	98.9
Large 2 Axle Vehicles	1.5	0.3	0.7	0	0.7	0.8	1	0.5	0	0.9	1	0.3	0.4	0	0.4	0.4	1.8	2.4	0	1.6	0.9
3 Axle Vehicles	0	0	0	0	0	0	0	0	0	0	0	0	0	0	0	0	1	0	0	1	1
% 3 Axle Vehicles	0	0	0	0	0	0	0	0	0	0	0	0	0	0	0	0	0.1	0	0	0.1	0
4+ Axle Trucks	0	0	0	0	0	0	1	2	0	3	0	0	2	0	2	0	2	0	0	2	7
% 4+ Axle Trucks																					

Start Time	Schnoor Street Southbound					Cleveland Avenue Westbound					Schnoor Street Northbound					Cleveland Avenue Eastbound					Int. Total
	Left	Thru	Right	U-Turns	App. Total	Left	Thru	Right	U-Turns	App. Total	Left	Thru	Right	U-Turns	App. Total	Left	Thru	Right	U-Turns	App. Total	
Peak Hour Analysis From 04:00 PM to 05:45 PM - Peak 1 of 1																					
Peak Hour for Entire Intersection Begins at 05:00 PM																					
05:00 PM	22	46	18	0	86	61	102	18	2	183	14	60	32	1	107	27	86	14	0	127	503
05:15 PM	28	53	18	0	99	65	119	23	0	207	15	45	41	2	103	27	97	10	0	134	543
05:30 PM	28	47	22	3	100	75	89	36	0	200	10	50	43	1	104	24	99	8	0	131	535
05:45 PM	27	49	16	2	94	61	110	26	0	197	9	45	32	0	86	30	101	9	0	140	517
Total Volume	105	195	74	5	379	262	420	103	2	787	48	200	148	4	400	108	383	41	0	532	2098
% App. Total	27.7	51.5	19.5	1.3		33.3	53.4	13.1	0.3		12	50	37	1		20.3	72	7.7	0		
PHF	.938	.920	.841	.417	.948	.873	.882	.715	.250	.950	.800	.833	.860	.500	.935	.900	.948	.732	.000	.950	.966

City of Madera
 N/S: Schnoor Street
 E/W: Cleveland Avenue
 Weather: Clear

File Name : 24_MDA_Schnoor_Cleveland PM
 Site Code : 00319628
 Start Date : 9/19/2019
 Page No : 2

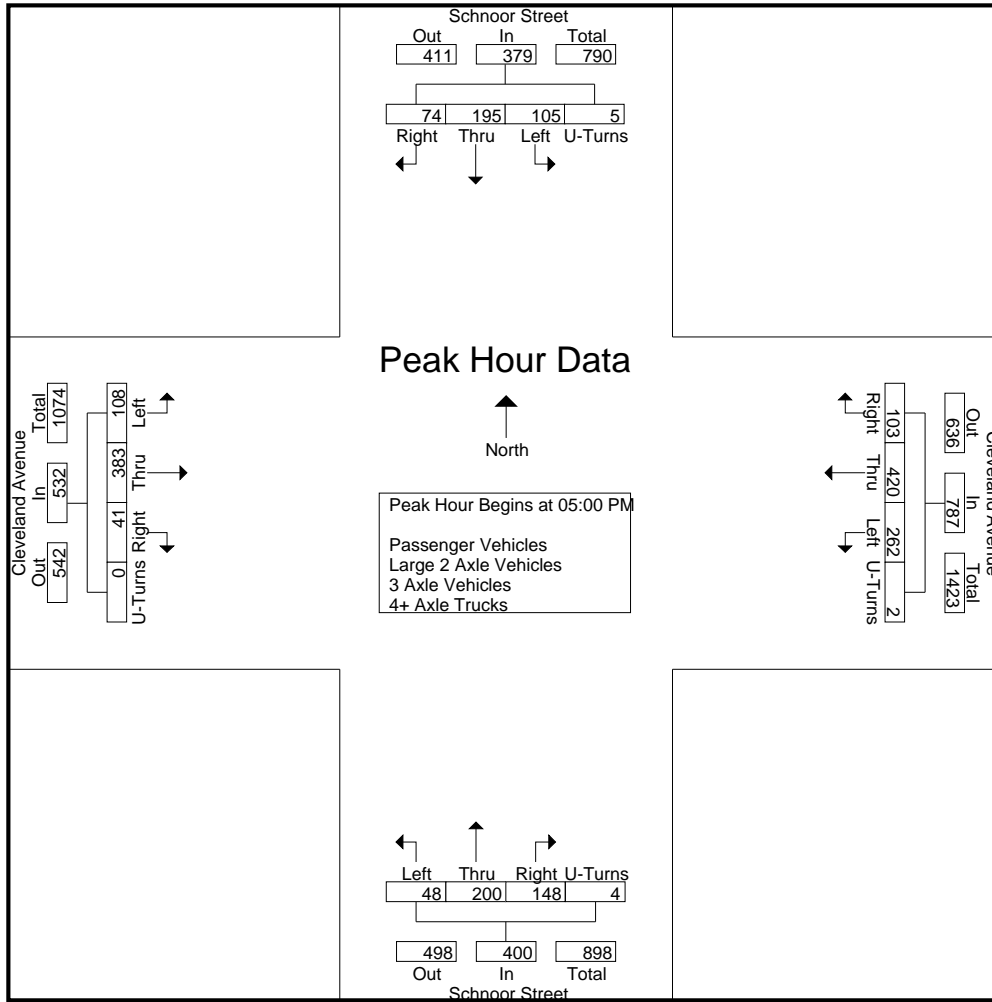

Peak Hour Analysis From 04:00 PM to 05:45 PM - Peak 1 of 1
 Peak Hour for Each Approach Begins at:

	05:00 PM					05:00 PM					04:45 PM					04:00 PM				
+0 mins.	22	46	18	0	86	61	102	18	2	183	10	44	30	2	86	37	102	11	0	150
+15 mins.	28	53	18	0	99	65	119	23	0	207	14	60	32	1	107	28	95	8	0	131
+30 mins.	28	47	22	3	100	75	89	36	0	200	15	45	41	2	103	23	106	13	0	142
+45 mins.	27	49	16	2	94	61	110	26	0	197	10	50	43	1	104	29	86	12	0	127
Total Volume	105	195	74	5	379	262	420	103	2	787	49	199	146	6	400	117	389	44	0	550
% App. Total	27.7	51.5	19.5	1.3		33.3	53.4	13.1	0.3		12.2	49.8	36.5	1.5		21.3	70.7	8	0	
PHF	.938	.920	.841	.417	.948	.873	.882	.715	.250	.950	.817	.829	.849	.750	.935	.791	.917	.846	.000	.917

City of Madera
 N/S: Schnoor Street
 E/W: Cleveland Avenue
 Weather: Clear

File Name : 24_MDA_Schnoor_Cleveland PM
 Site Code : 00319628
 Start Date : 9/19/2019
 Page No : 1

Groups Printed- Passenger Vehicles

Start Time	Schnoor Street Southbound					Cleveland Avenue Westbound					Schnoor Street Northbound					Cleveland Avenue Eastbound					Int. Total
	Left	Thru	Right	U-Turns	App. Total	Left	Thru	Right	U-Turns	App. Total	Left	Thru	Right	U-Turns	App. Total	Left	Thru	Right	U-Turns	App. Total	
04:00 PM	23	37	13	0	73	57	110	12	0	179	16	55	23	1	95	37	97	11	0	145	492
04:15 PM	20	41	18	0	79	61	93	25	0	179	15	50	26	0	91	27	94	7	0	128	477
04:30 PM	19	40	19	0	78	58	95	29	0	182	14	48	27	0	89	23	105	13	0	141	490
04:45 PM	29	40	16	1	86	58	84	24	0	166	10	44	30	2	86	29	82	12	0	123	461
Total	91	158	66	1	316	234	382	90	0	706	55	197	106	3	361	116	378	43	0	537	1920
05:00 PM	21	46	18	0	85	61	100	18	2	181	14	59	32	1	106	27	86	14	0	127	499
05:15 PM	27	53	18	0	98	64	119	22	0	205	15	45	40	2	102	27	96	10	0	133	538
05:30 PM	28	47	22	3	100	74	89	35	0	198	10	50	43	1	104	24	97	8	0	129	531
05:45 PM	26	49	16	2	93	60	109	26	0	195	9	45	32	0	86	30	98	8	0	136	510
Total	102	195	74	5	376	259	417	101	2	779	48	199	147	4	398	108	377	40	0	525	2078
Grand Total	193	353	140	6	692	493	799	191	2	1485	103	396	253	7	759	224	755	83	0	1062	3998
Apprch %	27.9	51	20.2	0.9		33.2	53.8	12.9	0.1		13.6	52.2	33.3	0.9		21.1	71.1	7.8	0		
Total %	4.8	8.8	3.5	0.2	17.3	12.3	20	4.8	0.1	37.1	2.6	9.9	6.3	0.2	19	5.6	18.9	2.1	0	26.6	

Start Time	Schnoor Street Southbound					Cleveland Avenue Westbound					Schnoor Street Northbound					Cleveland Avenue Eastbound					Int. Total
	Left	Thru	Right	U-Turns	App. Total	Thru	Right	U-Turns	App. Total	Thru	Right	U-Turns	App. Total	Thru	Right	U-Turns	App. Total				
Peak Hour Analysis From 05:00 PM to 05:45 PM - Peak 1 of 1																					
Peak Hour for Entire Intersection Begins at 05:00 PM																					
05:00 PM	21	46	18	0	85	61	100	18	2	181	14	59	32	1	106	27	86	14	0	127	499
05:15 PM	27	53	18	0	98	64	119	22	0	205	15	45	40	2	102	27	96	10	0	133	538
05:30 PM	28	47	22	3	100	74	89	35	0	198	10	50	43	1	104	24	97	8	0	129	531
05:45 PM	26	49	16	2	93	60	109	26	0	195	9	45	32	0	86	30	98	8	0	136	510
Total Volume	102	195	74	5	376	259	417	101	2	779	48	199	147	4	398	108	377	40	0	525	2078
% App. Total	27.1	51.9	19.7	1.3		33.2	53.5	13	0.3		12.1	50	36.9	1		20.6	71.8	7.6	0		
PHF	.911	.920	.841	.417	.940	.875	.876	.721	.250	.950	.800	.843	.855	.500	.939	.900	.962	.714	.000	.965	.966

City of Madera
 N/S: Schnoor Street
 E/W: Cleveland Avenue
 Weather: Clear

File Name : 24_MDA_Schnoor_Cleveland PM
 Site Code : 00319628
 Start Date : 9/19/2019
 Page No : 2

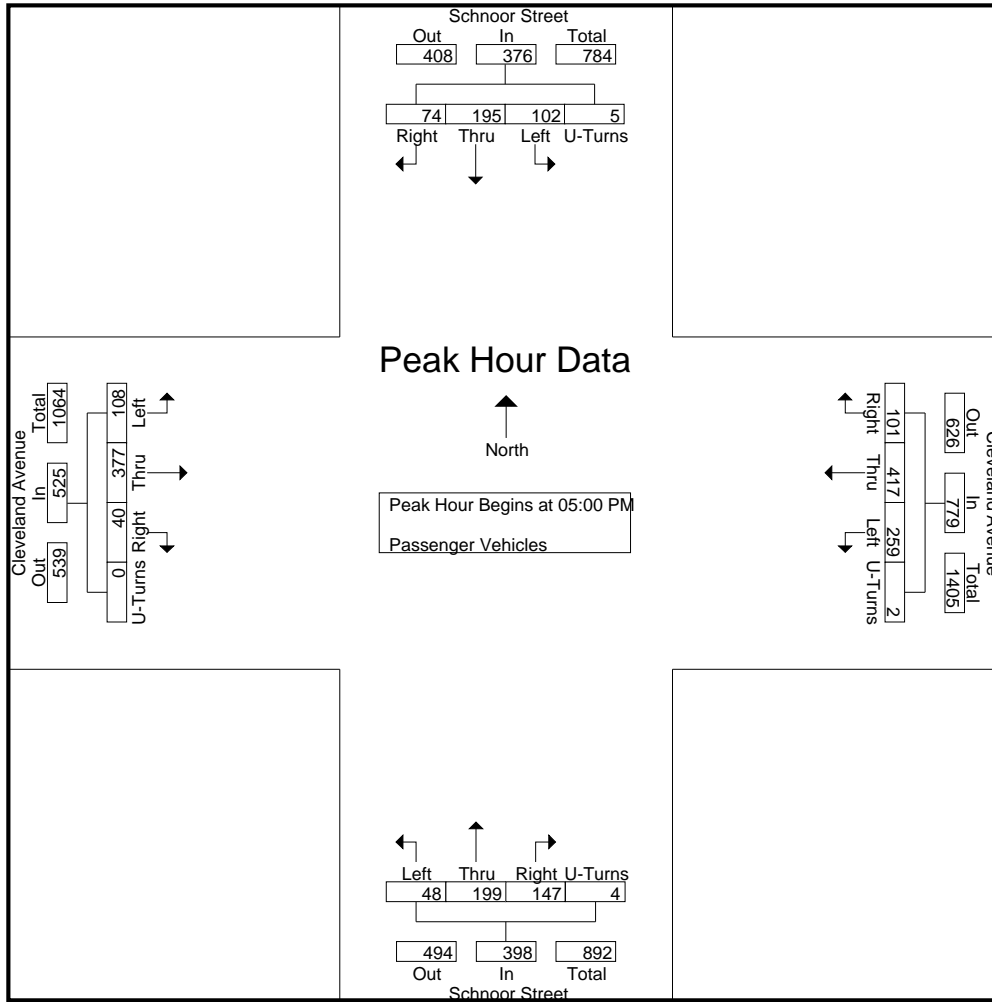

Peak Hour Analysis From 05:00 PM to 05:45 PM - Peak 1 of 1
 Peak Hour for Each Approach Begins at:

	05:00 PM					05:00 PM					05:00 PM									
+0 mins.	21	46	18	0	85	61	100	18	2	181	14	59	32	1	106	27	86	14	0	127
+15 mins.	27	53	18	0	98	64	119	22	0	205	15	45	40	2	102	27	96	10	0	133
+30 mins.	28	47	22	3	100	74	89	35	0	198	10	50	43	1	104	24	97	8	0	129
+45 mins.	26	49	16	2	93	60	109	26	0	195	9	45	32	0	86	30	98	8	0	136
Total Volume	102	195	74	5	376	259	417	101	2	779	48	199	147	4	398	108	377	40	0	525
% App. Total	27.1	51.9	19.7	1.3		33.2	53.5	13	0.3		12.1	50	36.9	1		20.6	71.8	7.6	0	
PHF	.911	.920	.841	.417	.940	.875	.876	.721	.250	.950	.800	.843	.855	.500	.939	.900	.962	.714	.000	.965

City of Madera
 N/S: Schnoor Street
 E/W: Cleveland Avenue
 Weather: Clear

File Name : 24_MDA_Schnoor_Cleveland PM
 Site Code : 00319628
 Start Date : 9/19/2019
 Page No : 1

Groups Printed- Large 2 Axle Vehicles

Start Time	Schnoor Street Southbound					Cleveland Avenue Westbound					Schnoor Street Northbound					Cleveland Avenue Eastbound					Int. Total
	Left	Thru	Right	U-Turns	App. Total	Left	Thru	Right	U-Turns	App. Total	Left	Thru	Right	U-Turns	App. Total	Left	Thru	Right	U-Turns	App. Total	
04:00 PM	0	0	1	0	1	0	1	0	0	1	1	0	0	0	1	0	3	0	0	3	6
04:15 PM	0	0	0	0	0	0	2	1	0	3	0	0	1	0	1	1	1	1	0	3	7
04:30 PM	0	1	0	0	1	1	3	0	0	4	0	0	0	0	0	0	1	0	0	1	6
04:45 PM	0	0	0	0	0	0	0	0	0	0	0	0	0	0	0	0	3	0	0	3	3
Total	0	1	1	0	2	1	6	1	0	8	1	0	1	0	2	1	8	1	0	10	22
05:00 PM	1	0	0	0	1	0	2	0	0	2	0	1	0	0	1	0	0	0	0	0	4
05:15 PM	1	0	0	0	1	1	0	0	0	1	0	0	0	0	0	0	1	0	0	1	3
05:30 PM	0	0	0	0	0	1	0	0	0	1	0	0	0	0	0	0	2	0	0	2	3
05:45 PM	1	0	0	0	1	1	0	0	0	1	0	0	0	0	0	0	3	1	0	4	6
Total	3	0	0	0	3	3	2	0	0	5	0	1	0	0	1	0	6	1	0	7	16
Grand Total	3	1	1	0	5	4	8	1	0	13	1	1	1	0	3	1	14	2	0	17	38
Apprch %	60	20	20	0		30.8	61.5	7.7	0		33.3	33.3	33.3	0		5.9	82.4	11.8	0		
Total %	7.9	2.6	2.6	0	13.2	10.5	21.1	2.6	0	34.2	2.6	2.6	2.6	0	7.9	2.6	36.8	5.3	0	44.7	

Start Time	Schnoor Street Southbound					Cleveland Avenue Westbound					Schnoor Street Northbound					Cleveland Avenue Eastbound					Int. Total
	Left	Thru	Right	U-Turns	App. Total	Thru	Right	U-Turns	App. Total	Thru	Right	U-Turns	App. Total	Thru	Right	U-Turns	App. Total				
Peak Hour Analysis From 05:00 PM to 05:45 PM - Peak 1 of 1																					
Peak Hour for Entire Intersection Begins at 05:00 PM																					
05:00 PM	1	0	0	0	1	0	2	0	0	2	0	1	0	0	1	0	0	0	0	0	4
05:15 PM	1	0	0	0	1	1	0	0	0	1	0	0	0	0	0	0	1	0	0	1	3
05:30 PM	0	0	0	0	0	1	0	0	0	1	0	0	0	0	0	0	2	0	0	2	3
05:45 PM	1	0	0	0	1	1	0	0	0	1	0	0	0	0	0	0	3	1	0	4	6
Total Volume	3	0	0	0	3	3	2	0	0	5	0	1	0	0	1	0	6	1	0	7	16
% App. Total	100	0	0	0		60	40	0	0		0	100	0	0		0	85.7	14.3	0		
PHF	.750	.000	.000	.000	.750	.750	.250	.000	.000	.625	.000	.250	.000	.000	.250	.000	.500	.250	.000	.438	.667

City of Madera
 N/S: Schnoor Street
 E/W: Cleveland Avenue
 Weather: Clear

File Name : 24_MDA_Schnoor_Cleveland PM
 Site Code : 00319628
 Start Date : 9/19/2019
 Page No : 2

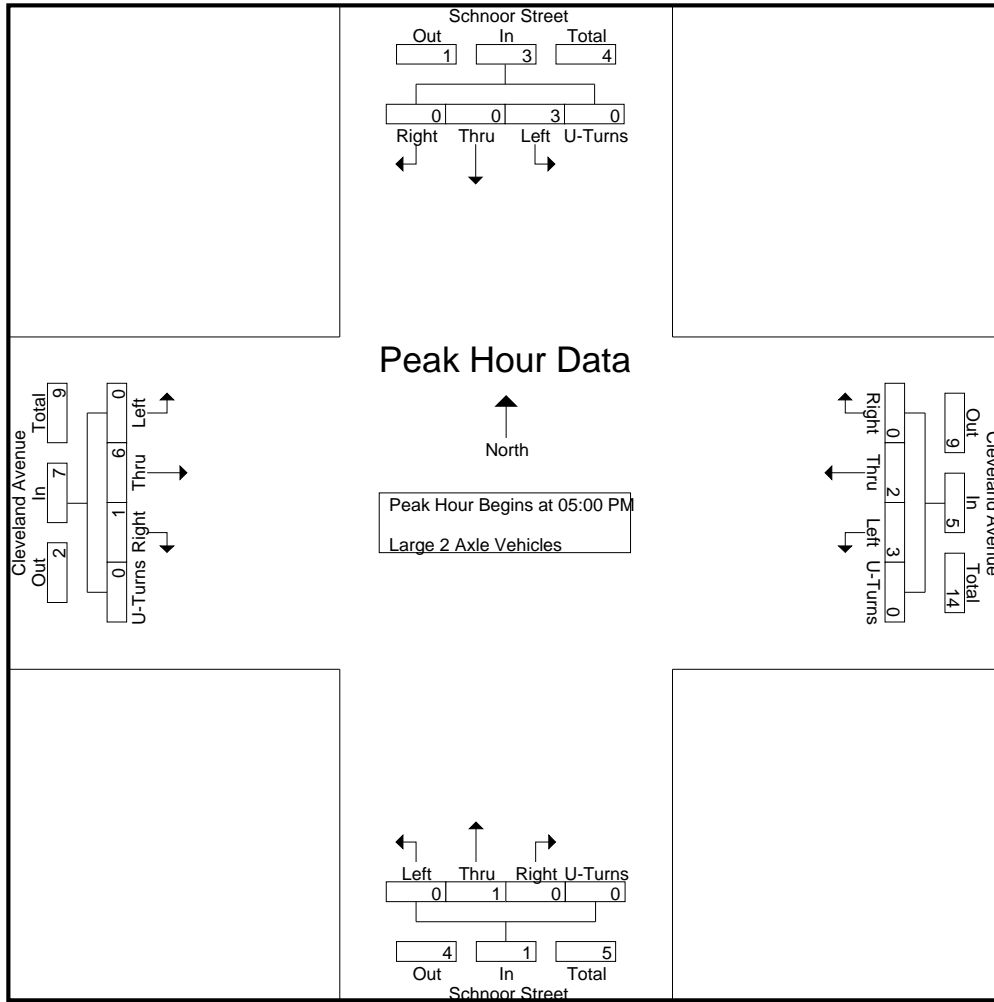

Peak Hour Analysis From 05:00 PM to 05:45 PM - Peak 1 of 1
 Peak Hour for Each Approach Begins at:

	05:00 PM					05:00 PM					05:00 PM									
+0 mins.	1	0	0	0	1	0	2	0	0	2	0	1	0	0	1	0	0	0	0	0
+15 mins.	1	0	0	0	1	1	0	0	0	1	0	0	0	0	0	0	1	0	0	1
+30 mins.	0	0	0	0	0	1	0	0	0	1	0	0	0	0	0	0	2	0	0	2
+45 mins.	1	0	0	0	1	1	0	0	0	1	0	0	0	0	0	0	3	1	0	4
Total Volume	3	0	0	0	3	3	2	0	0	5	0	1	0	0	1	0	6	1	0	7
% App. Total	100	0	0	0	0	60	40	0	0	0	0	100	0	0	0	0	85.7	14.3	0	0
PHF	.750	.000	.000	.000	.750	.750	.250	.000	.000	.625	.000	.250	.000	.000	.250	.000	.500	.250	.000	.438

City of Madera
 N/S: Schnoor Street
 E/W: Cleveland Avenue
 Weather: Clear

File Name : 24_MDA_Schnoor_Cleveland PM
 Site Code : 00319628
 Start Date : 9/19/2019
 Page No : 1

Groups Printed- 3 Axle Vehicles

Start Time	Schnoor Street Southbound					Cleveland Avenue Westbound					Schnoor Street Northbound					Cleveland Avenue Eastbound					Int. Total
	Left	Thru	Right	U-Turns	App. Total	Left	Thru	Right	U-Turns	App. Total	Left	Thru	Right	U-Turns	App. Total	Left	Thru	Right	U-Turns	App. Total	
04:00 PM	0	0	0	0	0	0	0	0	0	0	0	0	0	0	0	0	1	0	0	1	1
04:15 PM	0	0	0	0	0	0	0	0	0	0	0	0	0	0	0	0	0	0	0	0	0
04:30 PM	0	0	0	0	0	0	0	0	0	0	0	0	0	0	0	0	0	0	0	0	0
04:45 PM	0	0	0	0	0	0	0	0	0	0	0	0	0	0	0	0	0	0	0	0	0
Total	0	0	0	0	0	0	0	0	0	0	0	0	0	0	0	0	1	0	0	1	1
05:00 PM	0	0	0	0	0	0	0	0	0	0	0	0	0	0	0	0	0	0	0	0	0
05:15 PM	0	0	0	0	0	0	0	0	0	0	0	0	0	0	0	0	0	0	0	0	0
05:30 PM	0	0	0	0	0	0	0	0	0	0	0	0	0	0	0	0	0	0	0	0	0
05:45 PM	0	0	0	0	0	0	0	0	0	0	0	0	0	0	0	0	0	0	0	0	0
Total	0	0	0	0	0	0	0	0	0	0	0	0	0	0	0	0	0	0	0	0	0
Grand Total	0	0	0	0	0	0	0	0	0	0	0	0	0	0	0	0	1	0	0	1	1
Apprch %	0	0	0	0		0	0	0	0		0	0	0	0		0	100	0	0		
Total %	0	0	0	0	0	0	0	0	0	0	0	0	0	0	0	0	100	0	0	100	

Start Time	Schnoor Street Southbound					Cleveland Avenue Westbound					Schnoor Street Northbound					Cleveland Avenue Eastbound					Int. Total
	Left	Thru	Right	U-Turns	App. Total	Left	Thru	Right	U-Turns	App. Total	Left	Thru	Right	U-Turns	App. Total	Left	Thru	Right	U-Turns	App. Total	
Peak Hour Analysis From 05:00 PM to 05:45 PM - Peak 1 of 1																					
Peak Hour for Entire Intersection Begins at 05:00 PM																					
05:00 PM	0	0	0	0	0	0	0	0	0	0	0	0	0	0	0	0	0	0	0	0	0
05:15 PM	0	0	0	0	0	0	0	0	0	0	0	0	0	0	0	0	0	0	0	0	0
05:30 PM	0	0	0	0	0	0	0	0	0	0	0	0	0	0	0	0	0	0	0	0	0
05:45 PM	0	0	0	0	0	0	0	0	0	0	0	0	0	0	0	0	0	0	0	0	0
Total Volume	0	0	0	0	0	0	0	0	0	0	0	0	0	0	0	0	0	0	0	0	0
% App. Total	0	0	0	0		0	0	0	0		0	0	0	0		0	0	0	0		
PHF	.000	.000	.000	.000	.000	.000	.000	.000	.000	.000	.000	.000	.000	.000	.000	.000	.000	.000	.000	.000	.000

City of Madera
 N/S: Schnoor Street
 E/W: Cleveland Avenue
 Weather: Clear

File Name : 24_MDA_Schnoor_Cleveland PM
 Site Code : 00319628
 Start Date : 9/19/2019
 Page No : 2

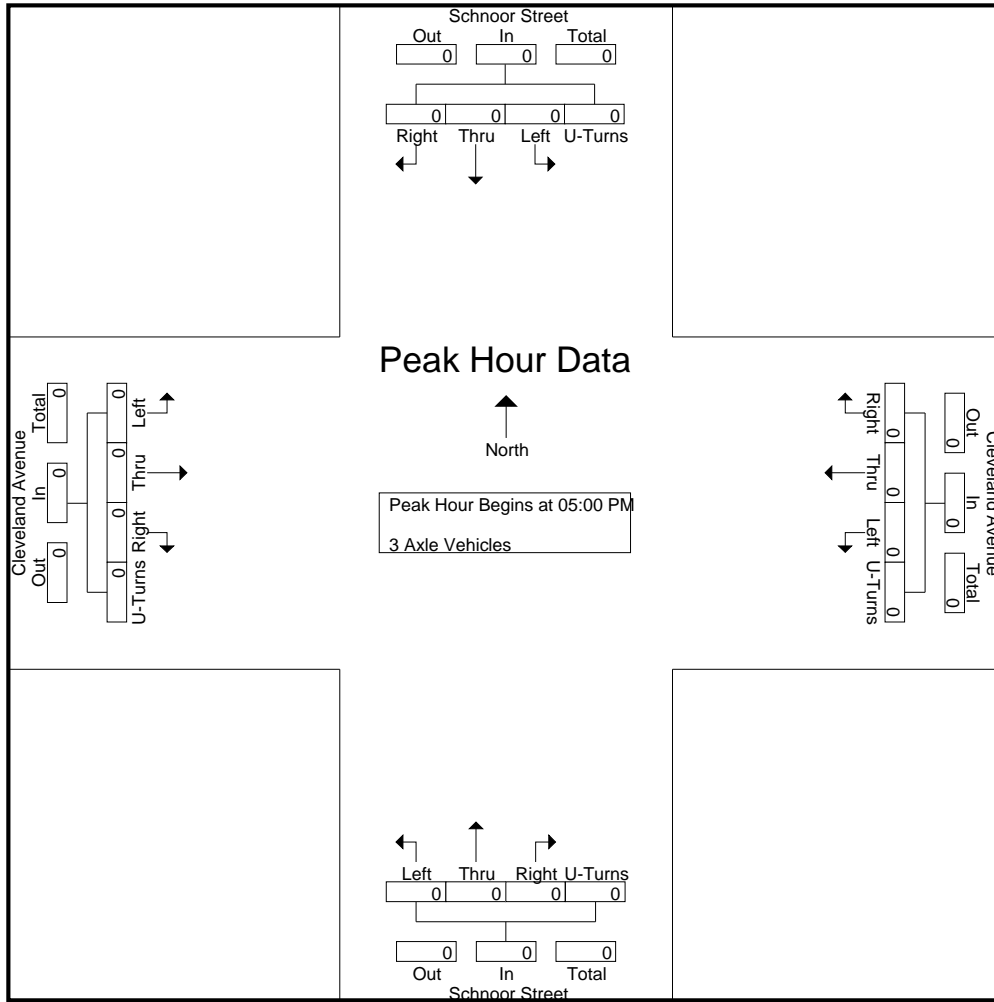

Peak Hour Analysis From 05:00 PM to 05:45 PM - Peak 1 of 1
 Peak Hour for Each Approach Begins at:

	05:00 PM					05:00 PM					05:00 PM					05:00 PM									
+0 mins.	0	0	0	0	0	0	0	0	0	0	0	0	0	0	0	0	0	0	0	0	0	0	0	0	0
+15 mins.	0	0	0	0	0	0	0	0	0	0	0	0	0	0	0	0	0	0	0	0	0	0	0	0	0
+30 mins.	0	0	0	0	0	0	0	0	0	0	0	0	0	0	0	0	0	0	0	0	0	0	0	0	0
+45 mins.	0	0	0	0	0	0	0	0	0	0	0	0	0	0	0	0	0	0	0	0	0	0	0	0	0
Total Volume	0	0	0	0	0	0	0	0	0	0	0	0	0	0	0	0	0	0	0	0	0	0	0	0	0
% App. Total	0	0	0	0	0	0	0	0	0	0	0	0	0	0	0	0	0	0	0	0	0	0	0	0	0
PHF	.000	.000	.000	.000	.000	.000	.000	.000	.000	.000	.000	.000	.000	.000	.000	.000	.000	.000	.000	.000	.000	.000	.000	.000	.000

City of Madera
 N/S: Schnoor Street
 E/W: Cleveland Avenue
 Weather: Clear

File Name : 24_MDA_Schnoor_Cleveland PM
 Site Code : 00319628
 Start Date : 9/19/2019
 Page No : 1

Groups Printed- 4+ Axle Trucks

Start Time	Schnoor Street Southbound					Cleveland Avenue Westbound					Schnoor Street Northbound					Cleveland Avenue Eastbound					Int. Total
	Left	Thru	Right	U-Turns	App. Total	Left	Thru	Right	U-Turns	App. Total	Left	Thru	Right	U-Turns	App. Total	Left	Thru	Right	U-Turns	App. Total	
04:00 PM	0	0	0	0	0	0	0	0	0	0	0	0	0	0	0	0	1	0	0	1	1
04:15 PM	0	0	0	0	0	0	0	0	0	0	0	0	1	0	1	0	0	0	0	0	0
04:30 PM	0	0	0	0	0	0	0	0	0	0	0	0	0	0	0	0	0	0	0	0	0
04:45 PM	0	0	0	0	0	0	0	0	0	0	0	0	0	0	0	0	1	0	0	1	1
Total	0	0	0	0	0	0	0	0	0	0	0	0	1	0	1	0	2	0	0	2	3
05:00 PM	0	0	0	0	0	0	0	0	0	0	0	0	0	0	0	0	0	0	0	0	0
05:15 PM	0	0	0	0	0	0	0	1	0	1	0	0	1	0	1	0	0	0	0	0	2
05:30 PM	0	0	0	0	0	0	0	1	0	1	0	0	0	0	0	0	0	0	0	0	1
05:45 PM	0	0	0	0	0	0	1	0	0	1	0	0	0	0	0	0	0	0	0	0	1
Total	0	0	0	0	0	0	1	2	0	3	0	0	1	0	1	0	0	0	0	0	4
Grand Total	0	0	0	0	0	0	1	2	0	3	0	0	2	0	2	0	2	0	0	2	7
Apprch %	0	0	0	0		0	33.3	66.7	0		0	0	100	0		0	100	0	0		
Total %	0	0	0	0		0	14.3	28.6	0	42.9	0	0	28.6	0	28.6	0	28.6	0	0	28.6	

Start Time	Schnoor Street Southbound					Cleveland Avenue Westbound					Schnoor Street Northbound					Cleveland Avenue Eastbound					Int. Total
	Left	Thru	Right	U-Turns	App. Total	Thru	Right	U-Turns	App. Total	Thru	Right	U-Turns	App. Total	Thru	Right	U-Turns	App. Total				
Peak Hour Analysis From 05:00 PM to 05:45 PM - Peak 1 of 1																					
Peak Hour for Entire Intersection Begins at 05:00 PM																					
05:00 PM	0	0	0	0	0	0	0	0	0	0	0	0	0	0	0	0	0	0	0	0	0
05:15 PM	0	0	0	0	0	0	0	1	0	1	0	0	1	0	1	0	0	0	0	0	2
05:30 PM	0	0	0	0	0	0	0	1	0	1	0	0	0	0	0	0	0	0	0	0	1
05:45 PM	0	0	0	0	0	0	1	0	0	1	0	0	0	0	0	0	0	0	0	0	1
Total Volume	0	0	0	0	0	0	1	2	0	3	0	0	1	0	1	0	0	0	0	0	4
% App. Total	0	0	0	0		0	33.3	66.7	0		0	0	100	0		0	0	0	0		
PHF	.000	.000	.000	.000	.000	.000	.250	.500	.000	.750	.000	.000	.250	.000	.250	.000	.000	.000	.000	.000	.500

City of Madera
 N/S: Schnoor Street
 E/W: Cleveland Avenue
 Weather: Clear

File Name : 24_MDA_Schnoor_Cleveland PM
 Site Code : 00319628
 Start Date : 9/19/2019
 Page No : 2

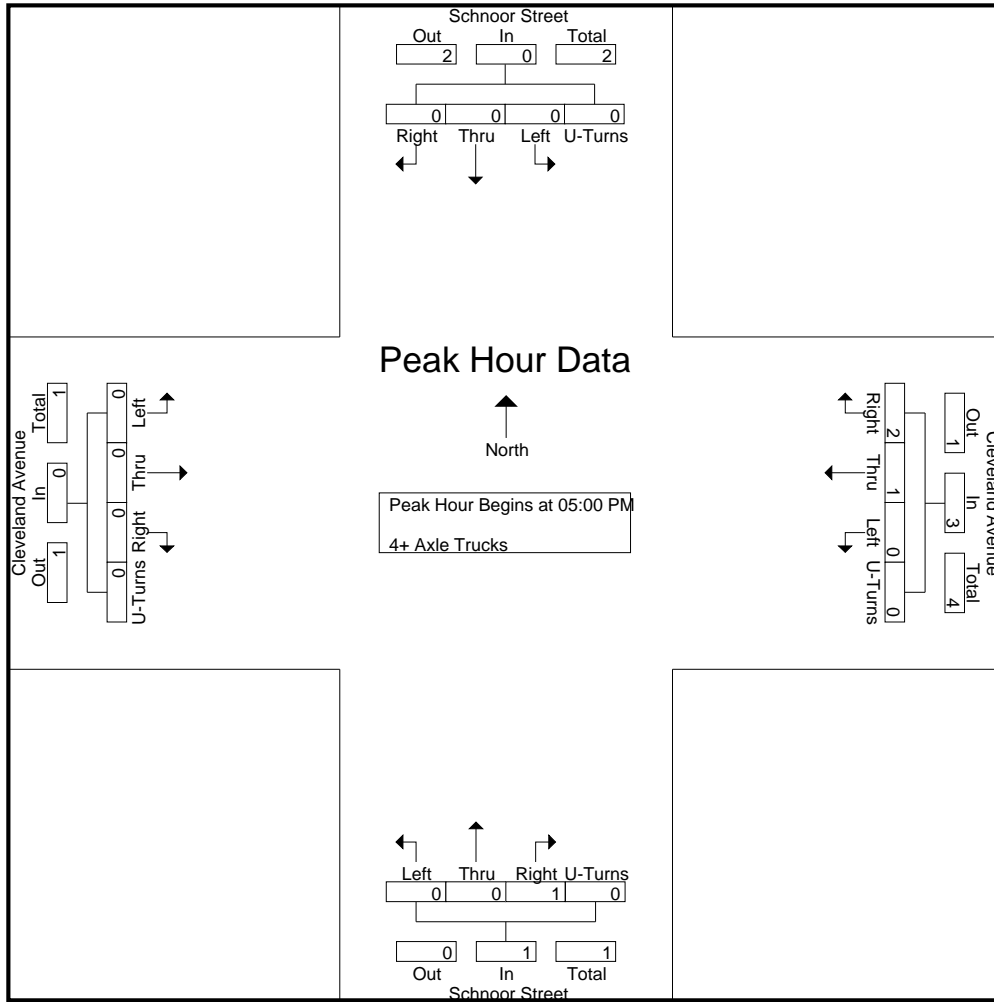

Peak Hour Analysis From 05:00 PM to 05:45 PM - Peak 1 of 1
 Peak Hour for Each Approach Begins at:

	05:00 PM					05:00 PM					05:00 PM									
+0 mins.	0	0	0	0	0	0	0	0	0	0	0	0	0	0	0	0	0	0	0	0
+15 mins.	0	0	0	0	0	0	0	1	0	1	0	0	1	0	1	0	0	0	0	0
+30 mins.	0	0	0	0	0	0	0	1	0	1	0	0	0	0	0	0	0	0	0	0
+45 mins.	0	0	0	0	0	0	1	0	0	1	0	0	0	0	0	0	0	0	0	0
Total Volume	0	0	0	0	0	0	1	2	0	3	0	0	1	0	1	0	0	0	0	0
% App. Total	0	0	0	0	0	0	33.3	66.7	0		0	0	100	0		0	0	0	0	0
PHF	.000	.000	.000	.000	.000	.000	.250	.500	.000	.750	.000	.000	.250	.000	.250	.000	.000	.000	.000	.000

Location: Madera
 N/S: Schnoor Street
 E/W: Cleveland Avenue



Date: 9/19/2019
 Day: Thursday

PEDESTRIANS

	North Leg Schnoor Street	East Leg Cleveland Avenue	South Leg Schnoor Street	West Leg Cleveland Avenue	
	Pedestrians	Pedestrians	Pedestrians	Pedestrians	
7:00 AM	0	0	0	0	0
7:15 AM	0	0	0	0	0
7:30 AM	0	0	0	0	0
7:45 AM	0	0	0	0	0
8:00 AM	0	0	0	0	0
8:15 AM	0	0	0	0	0
8:30 AM	2	0	0	0	2
8:45 AM	1	0	2	2	5
TOTAL VOLUMES:	3	0	2	2	7

	North Leg Schnoor Street	East Leg Cleveland Avenue	South Leg Schnoor Street	West Leg Cleveland Avenue	
	Pedestrians	Pedestrians	Pedestrians	Pedestrians	
4:00 PM	0	2	0	0	2
4:15 PM	3	4	0	0	7
4:30 PM	0	4	1	19	24
4:45 PM	3	5	17	21	46
5:00 PM	0	3	2	5	10
5:15 PM	0	0	3	0	3
5:30 PM	0	0	3	3	6
5:45 PM	0	0	0	0	0
TOTAL VOLUMES:	6	18	26	48	98

Location: Madera
 N/S: Schnoor Street
 E/W: Cleveland Avenue



Date: 9/19/2019
 Day: Thursday

BICYCLES

	Southbound Schnoor Street			Westbound Cleveland Avenue			Northbound Schnoor Street			Eastbound Cleveland Avenue			
	Left	Thru	Right	Left	Thru	Right	Left	Thru	Right	Left	Thru	Right	
7:00 AM	0	0	0	0	0	0	0	0	0	0	0	0	0
7:15 AM	0	0	0	0	0	0	0	0	0	0	0	0	0
7:30 AM	0	0	0	0	0	0	0	0	0	0	0	0	0
7:45 AM	0	0	0	0	0	0	0	0	0	0	0	0	0
8:00 AM	0	0	0	0	0	0	0	1	0	0	1	0	2
8:15 AM	0	1	0	0	0	0	0	0	0	0	0	0	1
8:30 AM	1	0	0	0	0	0	0	0	0	0	0	0	1
8:45 AM	0	0	0	0	0	0	0	0	1	0	0	0	1
TOTAL VOLUMES:	1	1	0	0	0	0	0	1	1	0	1	0	5

	Southbound Schnoor Street			Westbound Cleveland Avenue			Northbound Schnoor Street			Eastbound Cleveland Avenue			
	Left	Thru	Right	Left	Thru	Right	Left	Thru	Right	Left	Thru	Right	
4:00 PM	0	0	0	0	0	0	0	0	0	0	1	0	1
4:15 PM	0	0	0	0	0	0	0	0	0	0	0	0	0
4:30 PM	0	0	0	0	0	0	0	0	0	0	0	0	0
4:45 PM	0	0	0	0	0	0	0	1	0	0	0	0	1
5:00 PM	0	0	0	0	0	0	0	0	0	0	0	0	0
5:15 PM	0	0	0	0	0	0	0	0	0	0	0	0	0
5:30 PM	0	0	0	0	1	0	0	0	0	0	0	0	1
5:45 PM	0	2	0	0	0	0	0	2	0	0	0	0	4
TOTAL VOLUMES:	0	2	0	0	1	0	0	3	0	0	1	0	7

City of Madera
 N/S: Fairgrounds
 E/W: Cleveland Ave
 Weather: Clear

File Name : 25_MDA_Fairgrounds_Cleveland AM
 Site Code : 00319628
 Start Date : 9/19/2019
 Page No : 1

Groups Printed- Total Volume

Start Time	Fairgrounds Southbound					Cleveland Avenue Westbound					Fairgrounds Northbound					Cleveland Avenue Eastbound					Int. Total
	Left	Thru	Right	U-Turns	App. Total	Left	Thru	Right	U-Turns	App. Total	Left	Thru	Right	U-Turns	App. Total	Left	Thru	Right	U-Turns	App. Total	
07:00 AM	10	0	3	0	13	6	64	20	2	92	1	0	5	0	6	12	97	1	0	110	221
07:15 AM	13	0	6	0	19	5	50	6	2	63	2	0	2	0	4	11	129	3	0	143	229
07:30 AM	11	1	5	0	17	1	82	10	0	93	1	0	2	0	3	11	132	4	0	147	260
07:45 AM	15	0	4	0	19	6	108	14	2	130	0	0	1	0	1	12	160	4	0	176	326
Total	49	1	18	0	68	18	304	50	6	378	4	0	10	0	14	46	518	12	0	576	1036
08:00 AM	24	1	11	0	36	7	86	12	1	106	4	1	6	0	11	21	108	5	0	134	287
08:15 AM	36	1	9	0	46	8	88	21	1	118	4	1	8	0	13	30	119	7	0	156	333
08:30 AM	20	3	14	0	37	6	80	18	1	105	5	4	8	0	17	17	119	13	0	149	308
08:45 AM	30	3	10	0	43	12	102	28	2	144	6	3	4	0	13	28	91	7	0	126	326
Total	110	8	44	0	162	33	356	79	5	473	19	9	26	0	54	96	437	32	0	565	1254
Grand Total	159	9	62	0	230	51	660	129	11	851	23	9	36	0	68	142	955	44	0	1141	2290
Apprch %	69.1	3.9	27	0		6	77.6	15.2	1.3		33.8	13.2	52.9	0		12.4	83.7	3.9	0		
Total %	6.9	0.4	2.7	0	10	2.2	28.8	5.6	0.5	37.2	1	0.4	1.6	0	3	6.2	41.7	1.9	0	49.8	

Start Time	Fairgrounds Southbound					Cleveland Avenue Westbound					Fairgrounds Northbound					Cleveland Avenue Eastbound					Int. Total
	Left	Thru	Right	U-Turns	App. Total	Thru	Right	U-Turns	App. Total	Thru	Right	U-Turns	App. Total	Thru	Right	U-Turns	App. Total				
Peak Hour Analysis From 07:00 AM to 08:45 AM - Peak 1 of 1																					
Peak Hour for Entire Intersection Begins at 07:45 AM																					
07:45 AM	15	0	4	0	19	6	108	14	2	130	0	0	1	0	1	12	160	4	0	176	326
08:00 AM	24	1	11	0	36	7	86	12	1	106	4	1	6	0	11	21	108	5	0	134	287
08:15 AM	36	1	9	0	46	8	88	21	1	118	4	1	8	0	13	30	119	7	0	156	333
08:30 AM	20	3	14	0	37	6	80	18	1	105	5	4	8	0	17	17	119	13	0	149	308
Total Volume	95	5	38	0	138	27	362	65	5	459	13	6	23	0	42	80	506	29	0	615	1254
% App. Total	68.8	3.6	27.5	0		5.9	78.9	14.2	1.1		31	14.3	54.8	0		13	82.3	4.7	0		
PHF	.660	.417	.679	.000	.750	.844	.838	.774	.625	.883	.650	.375	.719	.000	.618	.667	.791	.558	.000	.874	.941

City of Madera
 N/S: Fairgrounds
 E/W: Cleveland Ave
 Weather: Clear

File Name : 25_MDA_Fairgrounds_Cleveland AM
 Site Code : 00319628
 Start Date : 9/19/2019
 Page No : 2

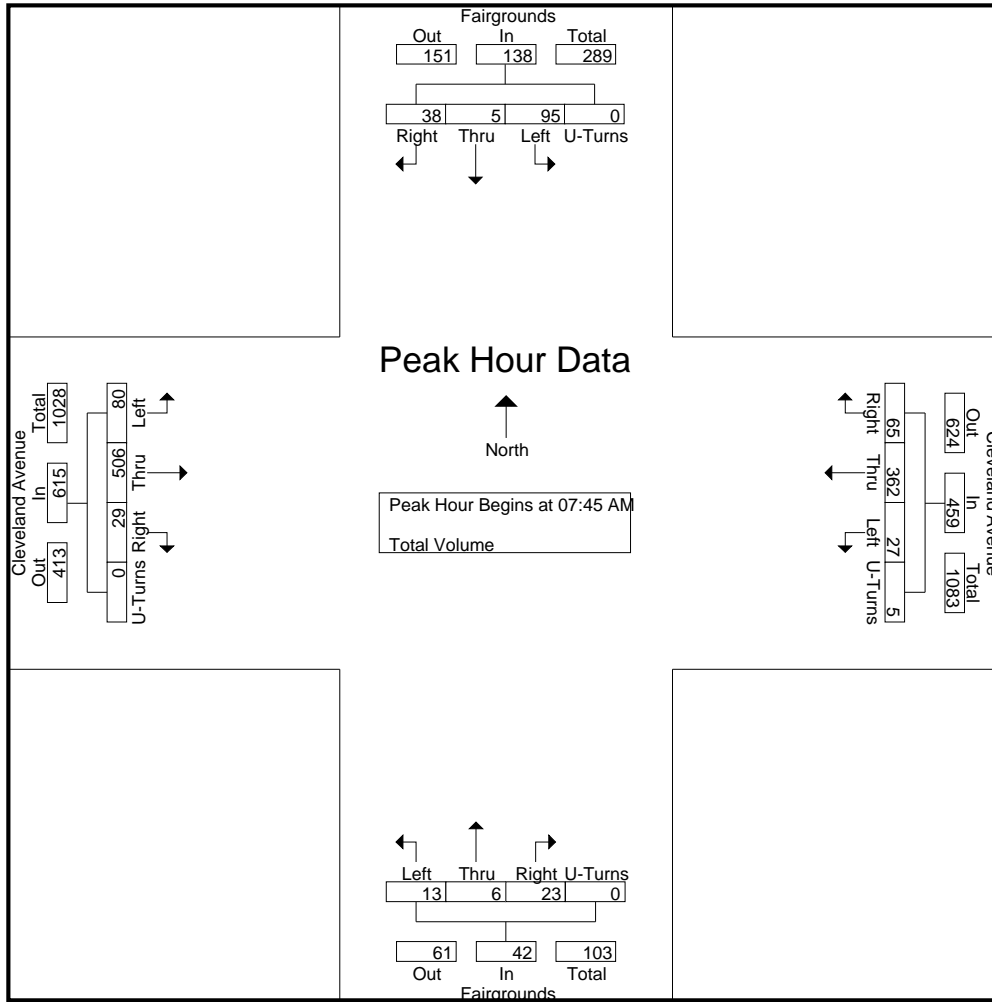

Peak Hour Analysis From 07:00 AM to 08:45 AM - Peak 1 of 1
 Peak Hour for Each Approach Begins at:

	08:00 AM					08:00 AM					08:00 AM					07:45 AM				
+0 mins.	24	1	11	0	36	7	86	12	1	106	4	1	6	0	11	12	160	4	0	176
+15 mins.	36	1	9	0	46	8	88	21	1	118	4	1	8	0	13	21	108	5	0	134
+30 mins.	20	3	14	0	37	6	80	18	1	105	5	4	8	0	17	30	119	7	0	156
+45 mins.	30	3	10	0	43	12	102	28	2	144	6	3	4	0	13	17	119	13	0	149
Total Volume	110	8	44	0	162	33	356	79	5	473	19	9	26	0	54	80	506	29	0	615
% App. Total	67.9	4.9	27.2	0		7	75.3	16.7	1.1		35.2	16.7	48.1	0		13	82.3	4.7	0	
PHF	.764	.667	.786	.000	.880	.688	.873	.705	.625	.821	.792	.563	.813	.000	.794	.667	.791	.558	.000	.874

City of Madera
 N/S: Fairgrounds
 E/W: Cleveland Ave
 Weather: Clear

File Name : 25_MDA_Fairgrounds_Cleveland PM
 Site Code : 00319628
 Start Date : 9/19/2019
 Page No : 1

Groups Printed- Total Volume

Start Time	Fairgrounds Southbound					Cleveland Avenue Westbound					Fairgrounds Northbound					Cleveland Avenue Eastbound					Int. Total
	Left	Thru	Right	U-Turns	App. Total	Left	Thru	Right	U-Turns	App. Total	Left	Thru	Right	U-Turns	App. Total	Left	Thru	Right	U-Turns	App. Total	
04:00 PM	47	7	19	0	73	34	132	23	16	205	10	3	22	0	35	15	108	22	0	145	458
04:15 PM	49	9	19	0	77	20	136	32	5	193	17	9	20	0	46	20	105	21	0	146	462
04:30 PM	61	6	13	0	80	17	121	25	5	168	31	3	21	0	55	21	125	18	0	164	467
04:45 PM	58	10	23	0	91	38	117	30	8	193	12	9	13	0	34	23	118	27	0	168	486
Total	215	32	74	0	321	109	506	110	34	759	70	24	76	0	170	79	456	88	0	623	1873
05:00 PM	60	16	20	0	96	28	132	39	3	202	17	9	25	0	51	16	105	20	0	141	490
05:15 PM	67	3	32	0	102	39	130	31	5	205	24	15	22	0	61	26	117	25	0	168	536
05:30 PM	52	10	26	0	88	33	121	28	9	191	22	11	34	0	67	24	135	21	0	180	526
05:45 PM	52	5	20	0	77	30	120	25	8	183	32	6	24	0	62	23	121	25	0	169	491
Total	231	34	98	0	363	130	503	123	25	781	95	41	105	0	241	89	478	91	0	658	2043
Grand Total	446	66	172	0	684	239	1009	233	59	1540	165	65	181	0	411	168	934	179	0	1281	3916
Apprch %	65.2	9.6	25.1	0		15.5	65.5	15.1	3.8		40.1	15.8	44	0		13.1	72.9	14	0		
Total %	11.4	1.7	4.4	0	17.5	6.1	25.8	5.9	1.5	39.3	4.2	1.7	4.6	0	10.5	4.3	23.9	4.6	0	32.7	

Start Time	Fairgrounds Southbound					Cleveland Avenue Westbound					Fairgrounds Northbound					Cleveland Avenue Eastbound					Int. Total
	Left	Thru	Right	U-Turns	App. Total	Left	Thru	Right	U-Turns	App. Total	Left	Thru	Right	U-Turns	App. Total	Left	Thru	Right	U-Turns	App. Total	
05:00 PM	60	16	20	0	96	28	132	39	3	202	17	9	25	0	51	16	105	20	0	141	490
05:15 PM	67	3	32	0	102	39	130	31	5	205	24	15	22	0	61	26	117	25	0	168	536
05:30 PM	52	10	26	0	88	33	121	28	9	191	22	11	34	0	67	24	135	21	0	180	526
05:45 PM	52	5	20	0	77	30	120	25	8	183	32	6	24	0	62	23	121	25	0	169	491
Total Volume	231	34	98	0	363	130	503	123	25	781	95	41	105	0	241	89	478	91	0	658	2043
% App. Total	63.6	9.4	27	0		16.6	64.4	15.7	3.2		39.4	17	43.6	0		13.5	72.6	13.8	0		
PHF	.862	.531	.766	.000	.890	.833	.953	.788	.694	.952	.742	.683	.772	.000	.899	.856	.885	.910	.000	.914	.953

Peak Hour Analysis From 04:00 PM to 05:45 PM - Peak 1 of 1

Peak Hour for Entire Intersection Begins at 05:00 PM

City of Madera
 N/S: Fairgrounds
 E/W: Cleveland Ave
 Weather: Clear

File Name : 25_MDA_Fairgrounds_Cleveland PM
 Site Code : 00319628
 Start Date : 9/19/2019
 Page No : 2

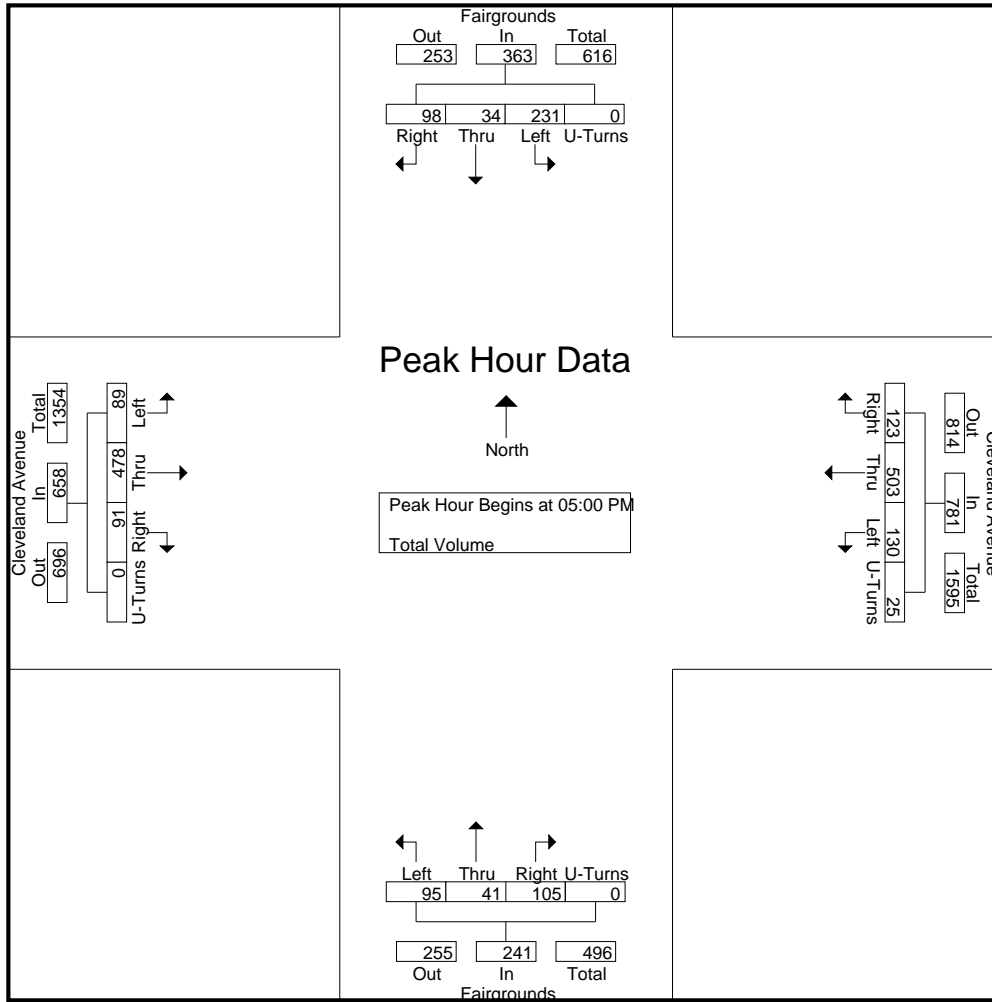

Peak Hour Analysis From 04:00 PM to 05:45 PM - Peak 1 of 1
 Peak Hour for Each Approach Begins at:

	04:45 PM					04:45 PM					05:00 PM					05:00 PM				
+0 mins.	58	10	23	0	91	38	117	30	8	193	17	9	25	0	51	16	105	20	0	141
+15 mins.	60	16	20	0	96	28	132	39	3	202	24	15	22	0	61	26	117	25	0	168
+30 mins.	67	3	32	0	102	39	130	31	5	205	22	11	34	0	67	24	135	21	0	180
+45 mins.	52	10	26	0	88	33	121	28	9	191	32	6	24	0	62	23	121	25	0	169
Total Volume	237	39	101	0	377	138	500	128	25	791	95	41	105	0	241	89	478	91	0	658
% App. Total	62.9	10.3	26.8	0		17.4	63.2	16.2	3.2		39.4	17	43.6	0		13.5	72.6	13.8	0	
PHF	.884	.609	.789	.000	.924	.885	.947	.821	.694	.965	.742	.683	.772	.000	.899	.856	.885	.910	.000	.914

Location: Madera
 N/S: Fairgrounds
 E/W: Cleveland Avenue



Date: 9/19/2019
 Day: Thursday

PEDESTRIANS

	North Leg Fairgrounds	East Leg Cleveland Avenue	South Leg Fairgrounds	West Leg Cleveland Avenue	
	Pedestrians	Pedestrians	Pedestrians	Pedestrians	
7:00 AM	0	0	0	0	0
7:15 AM	0	0	0	0	0
7:30 AM	0	0	0	0	0
7:45 AM	0	0	0	0	0
8:00 AM	0	0	0	1	1
8:15 AM	0	0	0	0	0
8:30 AM	0	0	0	0	0
8:45 AM	0	0	3	0	3
TOTAL VOLUMES:	0	0	3	1	4

	North Leg Fairgrounds	East Leg Cleveland Avenue	South Leg Fairgrounds	West Leg Cleveland Avenue	
	Pedestrians	Pedestrians	Pedestrians	Pedestrians	
4:00 PM	0	0	0	0	0
4:15 PM	1	0	0	4	5
4:30 PM	0	0	1	5	6
4:45 PM	1	0	0	2	3
5:00 PM	0	0	1	1	2
5:15 PM	0	0	0	2	2
5:30 PM	0	0	0	0	0
5:45 PM	0	0	0	0	0
TOTAL VOLUMES:	2	0	2	14	18

Location: Madera
 N/S: Fairgrounds
 E/W: Cleveland Avenue



Date: 9/19/2019
 Day: Thursday

BICYCLES

	Southbound Fairgrounds			Westbound Cleveland Avenue			Northbound Fairgrounds			Eastbound Cleveland Avenue			
	Left	Thru	Right	Left	Thru	Right	Left	Thru	Right	Left	Thru	Right	
7:00 AM	0	0	0	0	0	0	0	0	0	0	0	0	0
7:15 AM	0	0	0	0	0	0	0	0	0	0	0	0	0
7:30 AM	0	0	0	0	0	0	0	0	0	0	0	0	0
7:45 AM	0	0	0	0	0	0	0	0	0	0	0	0	0
8:00 AM	0	0	0	0	0	0	0	0	0	0	1	0	1
8:15 AM	0	0	0	0	0	0	0	0	0	0	0	0	0
8:30 AM	0	0	0	0	0	0	0	0	0	0	1	0	1
8:45 AM	0	0	0	0	0	0	0	0	0	0	0	0	0
TOTAL VOLUMES:	0	0	0	0	0	0	0	0	0	0	2	0	2

	Southbound Fairgrounds			Westbound Cleveland Avenue			Northbound Fairgrounds			Eastbound Cleveland Avenue			
	Left	Thru	Right	Left	Thru	Right	Left	Thru	Right	Left	Thru	Right	
4:00 PM	0	0	0	0	0	0	0	0	0	0	0	0	0
4:15 PM	0	0	0	0	0	0	0	0	0	0	0	0	0
4:30 PM	0	0	0	0	0	0	0	0	0	0	0	1	1
4:45 PM	0	0	0	0	0	0	0	0	0	0	0	0	0
5:00 PM	0	0	0	0	0	0	0	0	0	0	0	0	0
5:15 PM	0	0	0	0	0	0	0	1	0	0	0	0	1
5:30 PM	0	1	0	0	1	0	0	2	0	0	0	0	4
5:45 PM	0	0	0	0	0	0	0	0	0	0	0	0	0
TOTAL VOLUMES:	0	1	0	0	1	0	0	3	0	0	0	1	6

City of Madera
 N/S: SR-99 Southbound Ramps
 E/W: Cleveland Avenue
 Weather: Clear

File Name : 26_MDA_99S_Cleveland AM
 Site Code : 00319628
 Start Date : 9/19/2019
 Page No : 1

Groups Printed- Passenger Vehicles - Large 2 Axle Vehicles - 3 Axle Vehicles - 4+ Axle Trucks

Start Time	SR-99 Southbound Off Ramp Southbound					Cleveland Avenue Westbound					SR-99 Southbound On Ramp Northbound					Cleveland Avenue Eastbound					Int. Total
	Left	Thru	Right	U-Turns	App. Total	Left	Thru	Right	U-Turns	App. Total	Left	Thru	Right	U-Turns	App. Total	Left	Thru	Right	U-Turns	App. Total	
07:00 AM	7	0	7	0	14	61	93	0	0	154	0	0	0	0	0	0	50	65	0	115	283
07:15 AM	10	0	7	0	17	56	74	0	0	130	0	0	0	0	0	0	74	94	0	168	315
07:30 AM	13	0	6	0	19	84	120	0	0	204	0	0	0	0	0	0	93	68	0	161	384
07:45 AM	14	0	16	0	30	79	190	0	0	269	0	0	0	0	0	0	113	89	0	202	501
Total	44	0	36	0	80	280	477	0	0	757	0	0	0	0	0	0	330	316	0	646	1483
08:00 AM	14	0	8	0	22	74	141	0	0	215	0	0	0	0	0	0	93	64	0	157	394
08:15 AM	16	1	14	0	31	98	149	0	0	247	0	0	0	0	0	0	110	76	0	186	464
08:30 AM	11	0	8	0	19	55	157	0	0	212	0	0	0	0	0	0	84	77	0	161	392
08:45 AM	15	0	13	0	28	37	171	0	0	208	0	0	0	0	0	0	87	53	0	140	376
Total	56	1	43	0	100	264	618	0	0	882	0	0	0	0	0	0	374	270	0	644	1626
Grand Total	100	1	79	0	180	544	1095	0	0	1639	0	0	0	0	0	0	704	586	0	1290	3109
Apprch %	55.6	0.6	43.9	0		33.2	66.8	0	0		0	0	0	0	0	0	54.6	45.4	0		
Total %	3.2	0	2.5	0	5.8	17.5	35.2	0	0	52.7	0	0	0	0	0	0	22.6	18.8	0	41.5	
Passenger Vehicles	1044																				
% Passenger Vehicles	84	100	89.9	0	86.7	98.3	95.3	0	0	96.3	0	0	0	0	0	0	96.2	96.8	0	96.4	95.8
Large 2 Axle Vehicles	1044																				
% Large 2 Axle Vehicles	4	0	5.1	0	4.4	0.9	3.5	0	0	2.6	0	0	0	0	0	0	2.8	1.7	0	2.3	2.6
3 Axle Vehicles	0	0	1	0	1	2	7	0	0	9	0	0	0	0	0	0	4	3	0	7	17
% 3 Axle Vehicles	0	0	1.3	0	0.6	0.4	0.6	0	0	0.5	0	0	0	0	0	0	0.6	0.5	0	0.5	0.5
4+ Axle Trucks	12	0	3	0	15	2	6	0	0	8	0	0	0	0	0	0	3	6	0	9	32
% 4+ Axle Trucks																					

Start Time	SR-99 Southbound Off Ramp Southbound					Cleveland Avenue Westbound					SR-99 Southbound On Ramp Northbound					Cleveland Avenue Eastbound					Int. Total
	Left	Thru	Right	U-Turns	App. Total	Left	Thru	Right	U-Turns	App. Total	Left	Thru	Right	U-Turns	App. Total	Left	Thru	Right	U-Turns	App. Total	
Peak Hour Analysis From 07:00 AM to 08:45 AM - Peak 1 of 1																					
Peak Hour for Entire Intersection Begins at 07:45 AM																					
07:45 AM	14	0	16	0	30	79	190	0	0	269	0	0	0	0	0	0	113	89	0	202	501
08:00 AM	14	0	8	0	22	74	141	0	0	215	0	0	0	0	0	0	93	64	0	157	394
08:15 AM	16	1	14	0	31	98	149	0	0	247	0	0	0	0	0	0	110	76	0	186	464
08:30 AM	11	0	8	0	19	55	157	0	0	212	0	0	0	0	0	0	84	77	0	161	392
Total Volume	55	1	46	0	102	306	637	0	0	943	0	0	0	0	0	0	400	306	0	706	1751
% App. Total	53.9	1	45.1	0		32.4	67.6	0	0		0	0	0	0	0	0	56.7	43.3	0		
PHF	.859	.250	.719	.000	.823	.781	.838	.000	.000	.876	.000	.000	.000	.000	.000	.000	.885	.860	.000	.874	.874

City of Madera
 N/S: SR-99 Southbound Ramps
 E/W: Cleveland Avenue
 Weather: Clear

File Name : 26_MDA_99S_Cleveland AM
 Site Code : 00319628
 Start Date : 9/19/2019
 Page No : 2

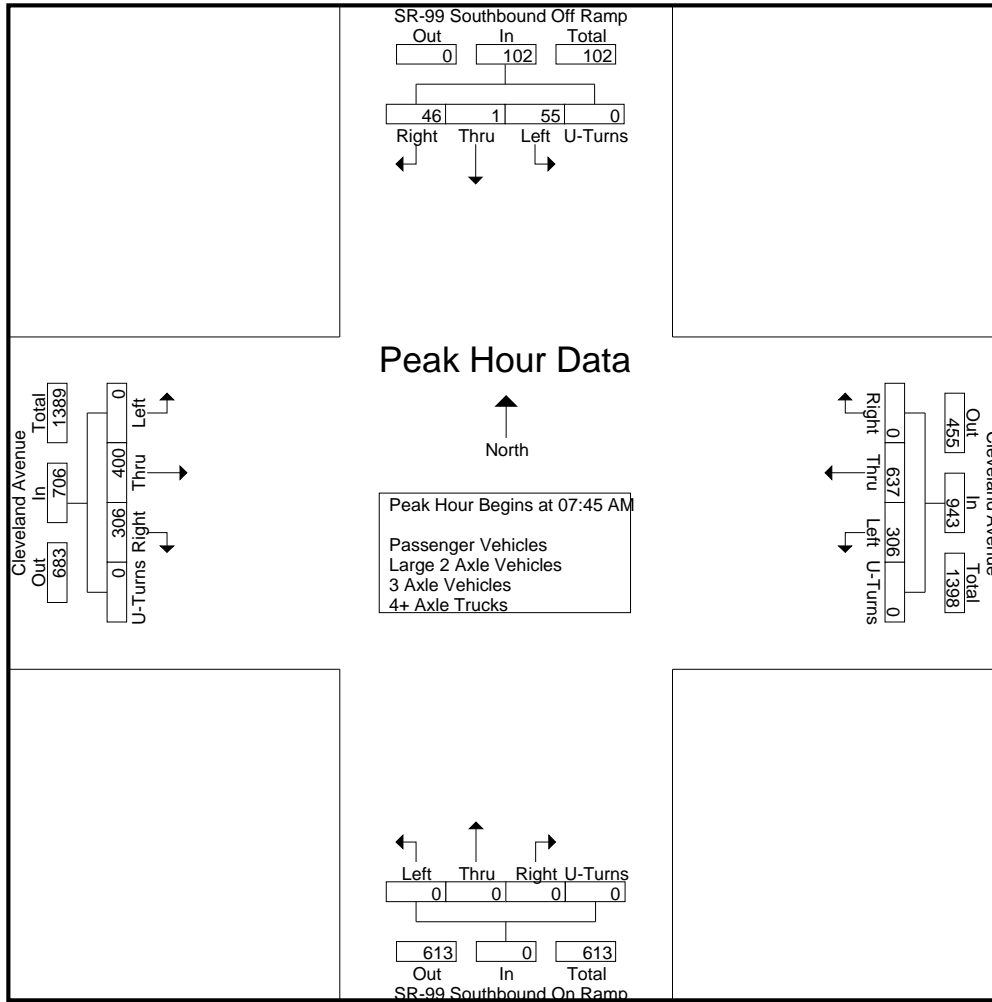

Peak Hour Analysis From 07:00 AM to 08:45 AM - Peak 1 of 1
 Peak Hour for Each Approach Begins at:

	07:30 AM					07:45 AM					07:00 AM					07:30 AM				
+0 mins.	13	0	6	0	19	79	190	0	0	269	0	0	0	0	0	0	93	68	0	161
+15 mins.	14	0	16	0	30	74	141	0	0	215	0	0	0	0	0	0	113	89	0	202
+30 mins.	14	0	8	0	22	98	149	0	0	247	0	0	0	0	0	0	93	64	0	157
+45 mins.	16	1	14	0	31	55	157	0	0	212	0	0	0	0	0	0	110	76	0	186
Total Volume	57	1	44	0	102	306	637	0	0	943	0	0	0	0	0	0	409	297	0	706
% App. Total	55.9	1	43.1	0		32.4	67.6	0	0		0	0	0	0	0	0	57.9	42.1	0	
PHF	.891	.250	.688	.000	.823	.781	.838	.000	.000	.876	.000	.000	.000	.000	.000	.000	.905	.834	.000	.874

City of Madera
 N/S: SR-99 Southbound Ramps
 E/W: Cleveland Avenue
 Weather: Clear

File Name : 26_MDA_99S_Cleveland AM
 Site Code : 00319628
 Start Date : 9/19/2019
 Page No : 1

Groups Printed- Passenger Vehicles

Start Time	SR-99 Southbound Off Ramp Southbound					Cleveland Avenue Westbound					SR-99 Southbound On Ramp Northbound					Cleveland Avenue Eastbound					Int. Total
	Left	Thru	Right	U-Turns	App. Total	Left	Thru	Right	U-Turns	App. Total	Left	Thru	Right	U-Turns	App. Total	Left	Thru	Right	U-Turns	App. Total	
07:00 AM	5	0	7	0	12	60	85	0	0	145	0	0	0	0	0	0	47	65	0	112	269
07:15 AM	8	0	6	0	14	56	67	0	0	123	0	0	0	0	0	0	73	93	0	166	303
07:30 AM	11	0	5	0	16	84	115	0	0	199	0	0	0	0	0	0	89	66	0	155	370
07:45 AM	11	0	16	0	27	78	182	0	0	260	0	0	0	0	0	0	112	85	0	197	484
Total	35	0	34	0	69	278	449	0	0	727	0	0	0	0	0	0	321	309	0	630	1426
08:00 AM	12	0	8	0	20	74	135	0	0	209	0	0	0	0	0	0	87	63	0	150	379
08:15 AM	14	1	12	0	27	97	142	0	0	239	0	0	0	0	0	0	106	72	0	178	444
08:30 AM	8	0	5	0	13	52	153	0	0	205	0	0	0	0	0	0	78	72	0	150	368
08:45 AM	15	0	12	0	27	34	165	0	0	199	0	0	0	0	0	0	85	51	0	136	362
Total	49	1	37	0	87	257	595	0	0	852	0	0	0	0	0	0	356	258	0	614	1553
Grand Total	84	1	71	0	156	535	1044	0	0	1579	0	0	0	0	0	0	677	567	0	1244	2979
Apprch %	53.8	0.6	45.5	0		33.9	66.1	0	0		0	0	0	0	0	0	54.4	45.6	0		
Total %	2.8	0	2.4	0	5.2	18	35	0	0	53	0	0	0	0	0	0	22.7	19	0	41.8	

Start Time	SR-99 Southbound Off Ramp Southbound					Cleveland Avenue Westbound					SR-99 Southbound On Ramp Northbound					Cleveland Avenue Eastbound					Int. Total
	Left	Thru	Right	U-Turns	App. Total	Thru	Right	U-Turns	App. Total	Thru	Right	U-Turns	App. Total	Thru	Right	U-Turns	App. Total				
Peak Hour Analysis From 07:45 AM to 08:30 AM - Peak 1 of 1																					
Peak Hour for Entire Intersection Begins at 07:45 AM																					
07:45 AM	11	0	16	0	27	78	182	0	0	260	0	0	0	0	0	0	112	85	0	197	484
08:00 AM	12	0	8	0	20	74	135	0	0	209	0	0	0	0	0	0	87	63	0	150	379
08:15 AM	14	1	12	0	27	97	142	0	0	239	0	0	0	0	0	0	106	72	0	178	444
08:30 AM	8	0	5	0	13	52	153	0	0	205	0	0	0	0	0	0	78	72	0	150	368
Total Volume	45	1	41	0	87	301	612	0	0	913	0	0	0	0	0	0	383	292	0	675	1675
% App. Total	51.7	1.1	47.1	0		33	67	0	0		0	0	0	0	0	0	56.7	43.3	0		
PHF	.804	.250	.641	.000	.806	.776	.841	.000	.000	.878	.000	.000	.000	.000	.000	.000	.855	.859	.000	.857	.865

City of Madera
 N/S: SR-99 Southbound Ramps
 E/W: Cleveland Avenue
 Weather: Clear

File Name : 26_MDA_99S_Cleveland AM
 Site Code : 00319628
 Start Date : 9/19/2019
 Page No : 2

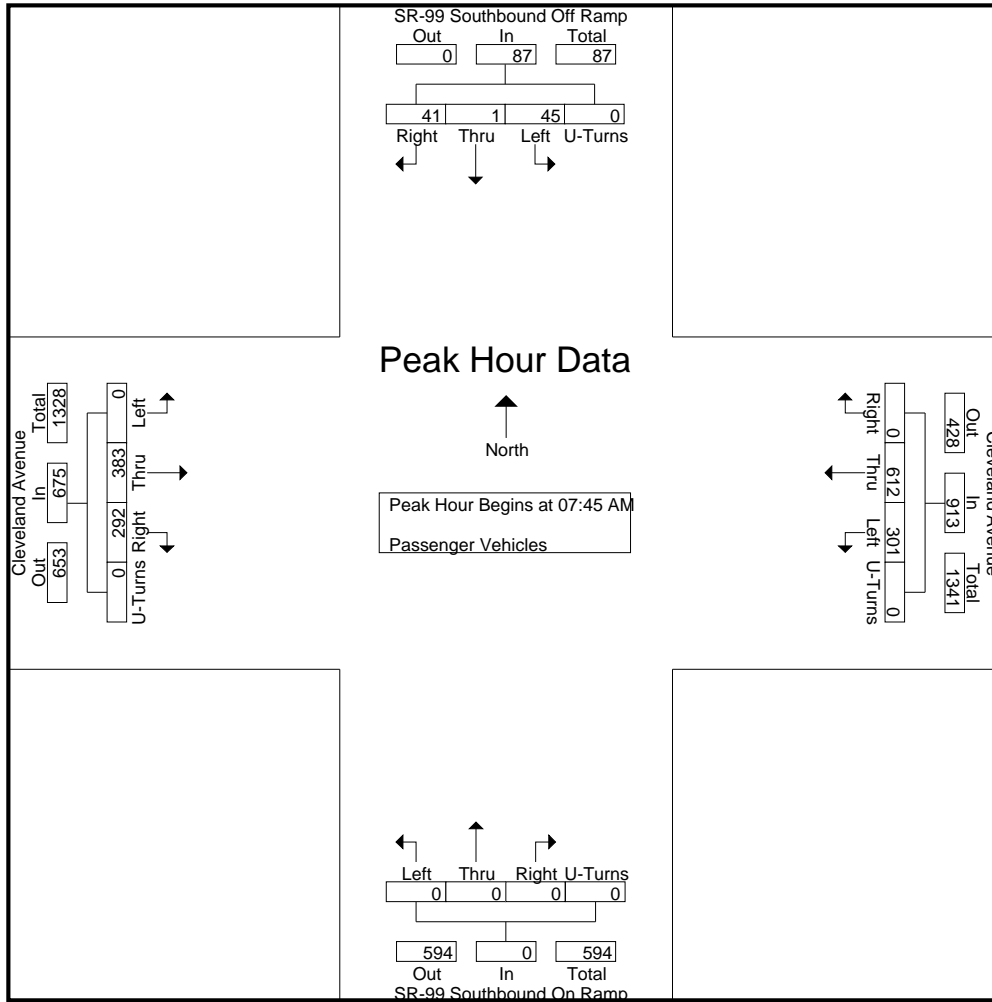

Peak Hour Analysis From 07:45 AM to 08:30 AM - Peak 1 of 1
 Peak Hour for Each Approach Begins at:

	07:45 AM					07:45 AM					07:45 AM									
+0 mins.	11	0	16	0	27	78	182	0	0	260	0	0	0	0	0	0	112	85	0	197
+15 mins.	12	0	8	0	20	74	135	0	0	209	0	0	0	0	0	0	87	63	0	150
+30 mins.	14	1	12	0	27	97	142	0	0	239	0	0	0	0	0	0	106	72	0	178
+45 mins.	8	0	5	0	13	52	153	0	0	205	0	0	0	0	0	0	78	72	0	150
Total Volume	45	1	41	0	87	301	612	0	0	913	0	0	0	0	0	0	383	292	0	675
% App. Total	51.7	1.1	47.1	0		33	67	0	0		0	0	0	0	0	0	56.7	43.3	0	
PHF	.804	.250	.641	.000	.806	.776	.841	.000	.000	.878	.000	.000	.000	.000	.000	.000	.855	.859	.000	.857

City of Madera
 N/S: SR-99 Southbound Ramps
 E/W: Cleveland Avenue
 Weather: Clear

File Name : 26_MDA_99S_Cleveland AM
 Site Code : 00319628
 Start Date : 9/19/2019
 Page No : 1

Groups Printed- Large 2 Axle Vehicles

Start Time	SR-99 Southbound Off Ramp Southbound					Cleveland Avenue Westbound					SR-99 Southbound On Ramp Northbound					Cleveland Avenue Eastbound					Int. Total
	Left	Thru	Right	U-Turns	App. Total	Left	Thru	Right	U-Turns	App. Total	Left	Thru	Right	U-Turns	App. Total	Left	Thru	Right	U-Turns	App. Total	
07:00 AM	1	0	0	0	1	1	6	0	0	7	0	0	0	0	0	0	2	0	0	2	10
07:15 AM	1	0	0	0	1	0	3	0	0	3	0	0	0	0	0	0	1	1	0	2	6
07:30 AM	1	0	0	0	1	0	4	0	0	4	0	0	0	0	0	0	3	0	0	3	8
07:45 AM	1	0	0	0	1	1	6	0	0	7	0	0	0	0	0	0	1	1	0	2	10
Total	4	0	0	0	4	2	19	0	0	21	0	0	0	0	0	0	7	2	0	9	34
08:00 AM	0	0	0	0	0	0	5	0	0	5	0	0	0	0	0	0	3	0	0	3	8
08:15 AM	0	0	1	0	1	0	6	0	0	6	0	0	0	0	0	0	3	4	0	7	14
08:30 AM	0	0	2	0	2	2	4	0	0	6	0	0	0	0	0	0	5	4	0	9	17
08:45 AM	0	0	1	0	1	1	4	0	0	5	0	0	0	0	0	0	2	0	0	2	8
Total	0	0	4	0	4	3	19	0	0	22	0	0	0	0	0	0	13	8	0	21	47
Grand Total	4	0	4	0	8	5	38	0	0	43	0	0	0	0	0	0	20	10	0	30	81
Apprch %	50	0	50	0		11.6	88.4	0	0		0	0	0	0		0	66.7	33.3	0		
Total %	4.9	0	4.9	0	9.9	6.2	46.9	0	0	53.1	0	0	0	0	0	0	24.7	12.3	0	37	

Start Time	SR-99 Southbound Off Ramp Southbound					Cleveland Avenue Westbound					SR-99 Southbound On Ramp Northbound					Cleveland Avenue Eastbound					Int. Total
	Left	Thru	Right	U-Turns	App. Total	Thru	Right	U-Turns	App. Total	Thru	Right	U-Turns	App. Total	Thru	Right	U-Turns	App. Total				
Peak Hour Analysis From 07:45 AM to 08:30 AM - Peak 1 of 1																					
Peak Hour for Entire Intersection Begins at 07:45 AM																					
07:45 AM	1	0	0	0	1	1	6	0	0	7	0	0	0	0	0	0	1	1	0	2	10
08:00 AM	0	0	0	0	0	0	5	0	0	5	0	0	0	0	0	0	3	0	0	3	8
08:15 AM	0	0	1	0	1	0	6	0	0	6	0	0	0	0	0	0	3	4	0	7	14
08:30 AM	0	0	2	0	2	2	4	0	0	6	0	0	0	0	0	0	5	4	0	9	17
Total Volume	1	0	3	0	4	3	21	0	0	24	0	0	0	0	0	0	12	9	0	21	49
% App. Total	25	0	75	0		12.5	87.5	0	0		0	0	0	0		0	57.1	42.9	0		
PHF	.250	.000	.375	.000	.500	.375	.875	.000	.000	.857	.000	.000	.000	.000	.000	.000	.600	.563	.000	.583	.721

City of Madera
 N/S: SR-99 Southbound Ramps
 E/W: Cleveland Avenue
 Weather: Clear

File Name : 26_MDA_99S_Cleveland AM
 Site Code : 00319628
 Start Date : 9/19/2019
 Page No : 2

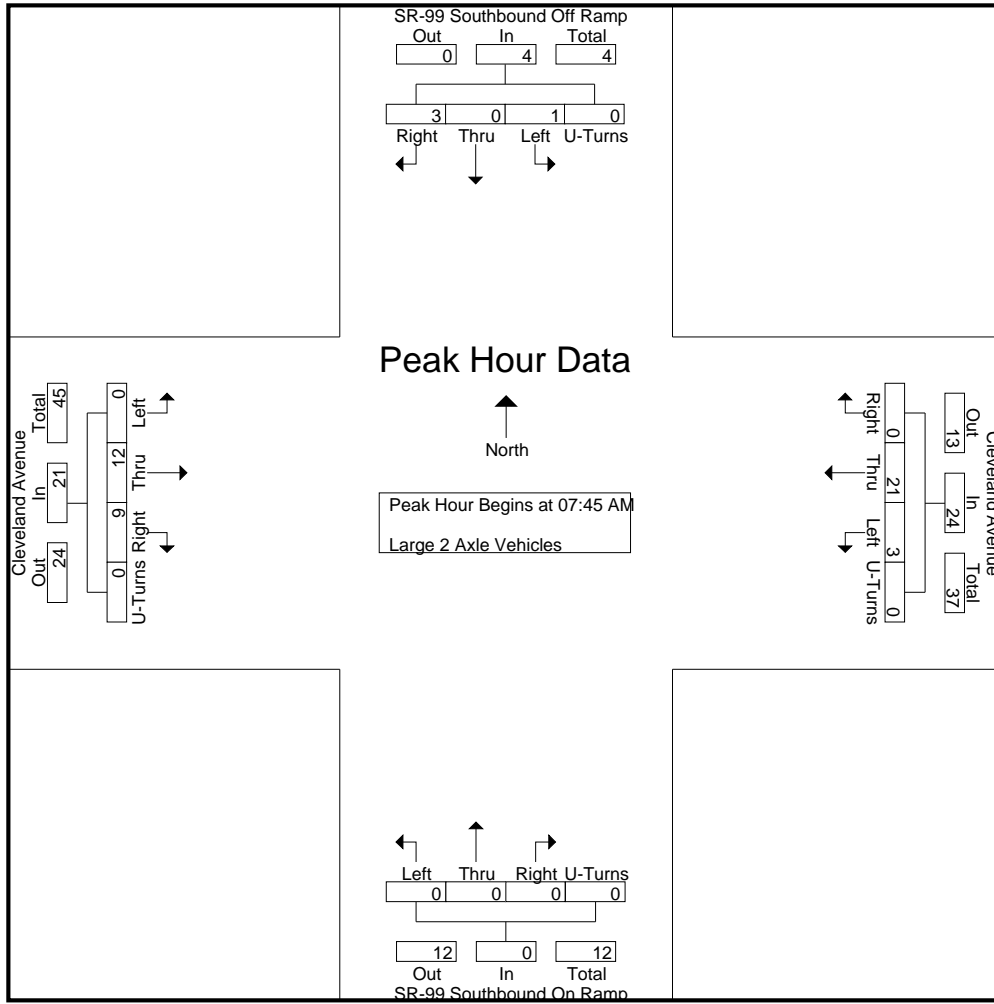

Peak Hour Analysis From 07:45 AM to 08:30 AM - Peak 1 of 1
 Peak Hour for Each Approach Begins at:

	07:45 AM					07:45 AM					07:45 AM									
+0 mins.	1	0	0	0	1	1	6	0	0	7	0	0	0	0	0	0	1	1	0	2
+15 mins.	0	0	0	0	0	0	5	0	0	5	0	0	0	0	0	0	3	0	0	3
+30 mins.	0	0	1	0	1	0	6	0	0	6	0	0	0	0	0	0	3	4	0	7
+45 mins.	0	0	2	0	2	2	4	0	0	6	0	0	0	0	0	0	5	4	0	9
Total Volume	1	0	3	0	4	3	21	0	0	24	0	0	0	0	0	0	12	9	0	21
% App. Total	25	0	75	0		12.5	87.5	0	0		0	0	0	0		0	57.1	42.9	0	
PHF	.250	.000	.375	.000	.500	.375	.875	.000	.000	.857	.000	.000	.000	.000	.000	.000	.600	.563	.000	.583

City of Madera
 N/S: SR-99 Southbound Ramps
 E/W: Cleveland Avenue
 Weather: Clear

File Name : 26_MDA_99S_Cleveland AM
 Site Code : 00319628
 Start Date : 9/19/2019
 Page No : 1

Groups Printed- 3 Axle Vehicles

Start Time	SR-99 Southbound Off Ramp Southbound					Cleveland Avenue Westbound					SR-99 Southbound On Ramp Northbound					Cleveland Avenue Eastbound					Int. Total
	Left	Thru	Right	U-Turns	App. Total	Left	Thru	Right	U-Turns	App. Total	Left	Thru	Right	U-Turns	App. Total	Left	Thru	Right	U-Turns	App. Total	
07:00 AM	0	0	0	0	0	0	1	0	0	1	0	0	0	0	0	0	0	0	0	0	1
07:15 AM	0	0	0	0	0	0	2	0	0	2	0	0	0	0	0	0	0	0	0	0	2
07:30 AM	0	0	1	0	1	0	0	0	0	0	0	0	0	0	0	0	1	2	0	3	4
07:45 AM	0	0	0	0	0	0	1	0	0	1	0	0	0	0	0	0	0	0	0	0	1
Total	0	0	1	0	1	0	4	0	0	4	0	0	0	0	0	0	1	2	0	3	8
08:00 AM	0	0	0	0	0	0	0	0	0	0	0	0	0	0	0	0	2	0	0	2	2
08:15 AM	0	0	0	0	0	0	1	0	0	1	0	0	0	0	0	0	1	0	0	1	2
08:30 AM	0	0	0	0	0	1	0	0	0	1	0	0	0	0	0	0	0	0	0	0	1
08:45 AM	0	0	0	0	0	1	2	0	0	3	0	0	0	0	0	0	0	1	0	1	4
Total	0	0	0	0	0	2	3	0	0	5	0	0	0	0	0	0	3	1	0	4	9
Grand Total	0	0	1	0	1	2	7	0	0	9	0	0	0	0	0	0	4	3	0	7	17
Apprch %	0	0	100	0		22.2	77.8	0	0		0	0	0	0		0	57.1	42.9	0		
Total %	0	0	5.9	0	5.9	11.8	41.2	0	0	52.9	0	0	0	0	0	0	23.5	17.6	0	41.2	

Start Time	SR-99 Southbound Off Ramp Southbound					Cleveland Avenue Westbound					SR-99 Southbound On Ramp Northbound					Cleveland Avenue Eastbound					Int. Total
	Left	Thru	Right	U-Turns	App. Total	Thru	Right	U-Turns	App. Total	Thru	Right	U-Turns	App. Total	Thru	Right	U-Turns	App. Total				
Peak Hour Analysis From 07:45 AM to 08:30 AM - Peak 1 of 1																					
Peak Hour for Entire Intersection Begins at 07:45 AM																					
07:45 AM	0	0	0	0	0	0	1	0	0	1	0	0	0	0	0	0	0	0	0	0	1
08:00 AM	0	0	0	0	0	0	0	0	0	0	0	0	0	0	0	0	2	0	0	2	2
08:15 AM	0	0	0	0	0	0	1	0	0	1	0	0	0	0	0	0	1	0	0	1	2
08:30 AM	0	0	0	0	0	1	0	0	0	1	0	0	0	0	0	0	0	0	0	0	1
Total Volume	0	0	0	0	0	1	2	0	0	3	0	0	0	0	0	0	3	0	0	3	6
% App. Total	0	0	0	0		33.3	66.7	0	0		0	0	0	0		0	100	0	0		
PHF	.000	.000	.000	.000	.000	.250	.500	.000	.000	.750	.000	.000	.000	.000	.000	.000	.375	.000	.000	.375	.750

City of Madera
 N/S: SR-99 Southbound Ramps
 E/W: Cleveland Avenue
 Weather: Clear

File Name : 26_MDA_99S_Cleveland AM
 Site Code : 00319628
 Start Date : 9/19/2019
 Page No : 2

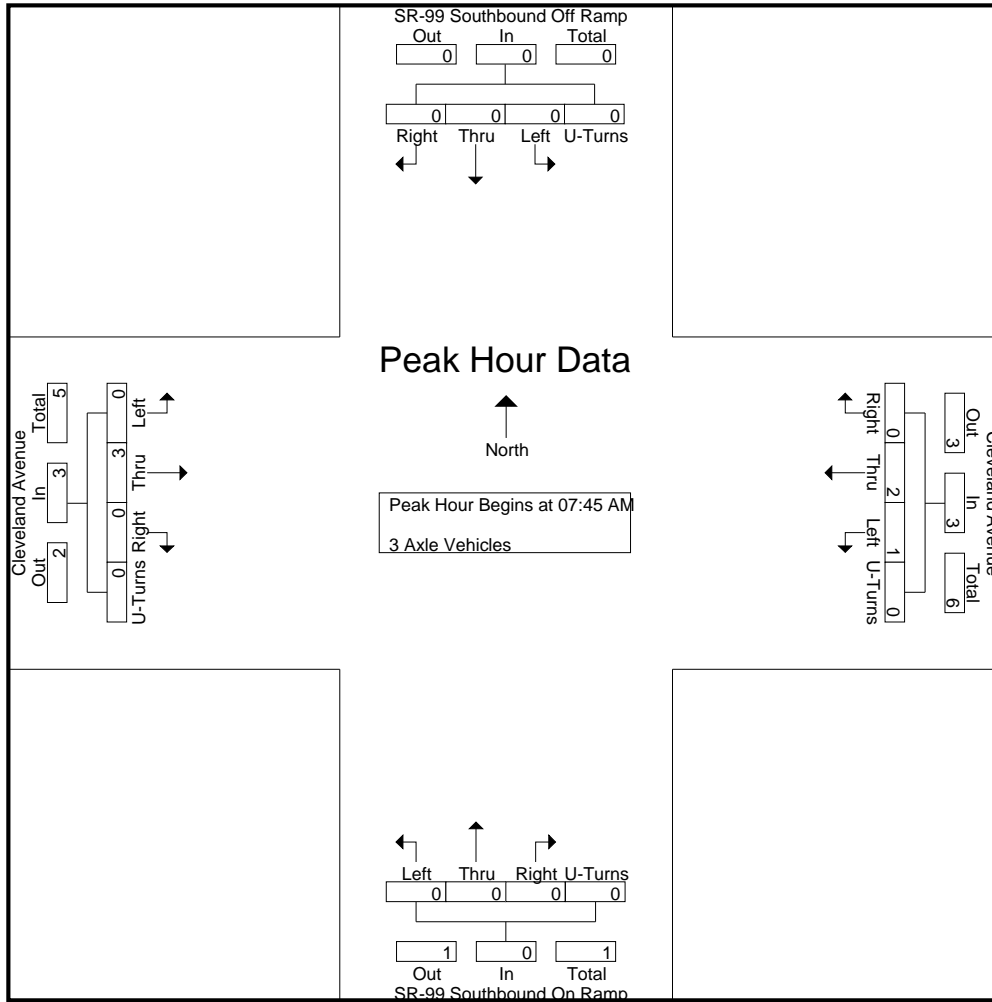

Peak Hour Analysis From 07:45 AM to 08:30 AM - Peak 1 of 1
 Peak Hour for Each Approach Begins at:

	07:45 AM					07:45 AM					07:45 AM									
+0 mins.	0	0	0	0	0	0	1	0	0	1	0	0	0	0	0	0	0	0	0	0
+15 mins.	0	0	0	0	0	0	0	0	0	0	0	0	0	0	0	0	2	0	0	2
+30 mins.	0	0	0	0	0	0	1	0	0	1	0	0	0	0	0	0	1	0	0	1
+45 mins.	0	0	0	0	0	1	0	0	0	1	0	0	0	0	0	0	0	0	0	0
Total Volume	0	0	0	0	0	1	2	0	0	3	0	0	0	0	0	0	3	0	0	3
% App. Total	0	0	0	0	0	33.3	66.7	0	0		0	0	0	0		0	100	0	0	
PHF	.000	.000	.000	.000	.000	.250	.500	.000	.000	.750	.000	.000	.000	.000	.000	.000	.375	.000	.000	.375

City of Madera
 N/S: SR-99 Southbound Ramps
 E/W: Cleveland Avenue
 Weather: Clear

File Name : 26_MDA_99S_Cleveland AM
 Site Code : 00319628
 Start Date : 9/19/2019
 Page No : 1

Groups Printed- 4+ Axle Trucks

Start Time	SR-99 Southbound Off Ramp Southbound					Cleveland Avenue Westbound					SR-99 Southbound On Ramp Northbound					Cleveland Avenue Eastbound					Int. Total
	Left	Thru	Right	U-Turns	App. Total	Left	Thru	Right	U-Turns	App. Total	Left	Thru	Right	U-Turns	App. Total	Left	Thru	Right	U-Turns	App. Total	
07:00 AM	1	0	0	0	1	0	1	0	0	1	0	0	0	0	0	0	1	0	0	1	3
07:15 AM	1	0	1	0	2	0	2	0	0	2	0	0	0	0	0	0	0	0	0	0	4
07:30 AM	1	0	0	0	1	0	1	0	0	1	0	0	0	0	0	0	0	0	0	0	2
07:45 AM	2	0	0	0	2	0	1	0	0	1	0	0	0	0	0	0	0	3	0	3	6
Total	5	0	1	0	6	0	5	0	0	5	0	0	0	0	0	0	1	3	0	4	15
08:00 AM	2	0	0	0	2	0	1	0	0	1	0	0	0	0	0	0	1	1	0	2	5
08:15 AM	2	0	1	0	3	1	0	0	0	1	0	0	0	0	0	0	0	0	0	0	4
08:30 AM	3	0	1	0	4	0	0	0	0	0	0	0	0	0	0	0	1	1	0	2	6
08:45 AM	0	0	0	0	0	1	0	0	0	1	0	0	0	0	0	0	0	1	0	1	2
Total	7	0	2	0	9	2	1	0	0	3	0	0	0	0	0	0	2	3	0	5	17
Grand Total	12	0	3	0	15	2	6	0	0	8	0	0	0	0	0	0	3	6	0	9	32
Apprch %	80	0	20	0		25	75	0	0		0	0	0	0		0	33.3	66.7	0		
Total %	37.5	0	9.4	0	46.9	6.2	18.8	0	0	25	0	0	0	0	0	0	9.4	18.8	0	28.1	

Start Time	SR-99 Southbound Off Ramp Southbound					Cleveland Avenue Westbound					SR-99 Southbound On Ramp Northbound					Cleveland Avenue Eastbound					Int. Total
	Left	Thru	Right	U-Turns	App. Total	Thru	Right	U-Turns	App. Total	Thru	Right	U-Turns	App. Total	Thru	Right	U-Turns	App. Total				
Peak Hour Analysis From 07:45 AM to 08:30 AM - Peak 1 of 1																					
Peak Hour for Entire Intersection Begins at 07:45 AM																					
07:45 AM	2	0	0	0	2	0	1	0	0	1	0	0	0	0	0	0	0	3	0	3	6
08:00 AM	2	0	0	0	2	0	1	0	0	1	0	0	0	0	0	0	1	1	0	2	5
08:15 AM	2	0	1	0	3	1	0	0	0	1	0	0	0	0	0	0	0	0	0	0	4
08:30 AM	3	0	1	0	4	0	0	0	0	0	0	0	0	0	0	0	1	1	0	2	6
Total Volume	9	0	2	0	11	1	2	0	0	3	0	0	0	0	0	0	2	5	0	7	21
% App. Total	81.8	0	18.2	0		33.3	66.7	0	0		0	0	0	0		0	28.6	71.4	0		
PHF	.750	.000	.500	.000	.688	.250	.500	.000	.000	.750	.000	.000	.000	.000	.000	.000	.500	.417	.000	.583	.875

City of Madera
 N/S: SR-99 Southbound Ramps
 E/W: Cleveland Avenue
 Weather: Clear

File Name : 26_MDA_99S_Cleveland AM
 Site Code : 00319628
 Start Date : 9/19/2019
 Page No : 2

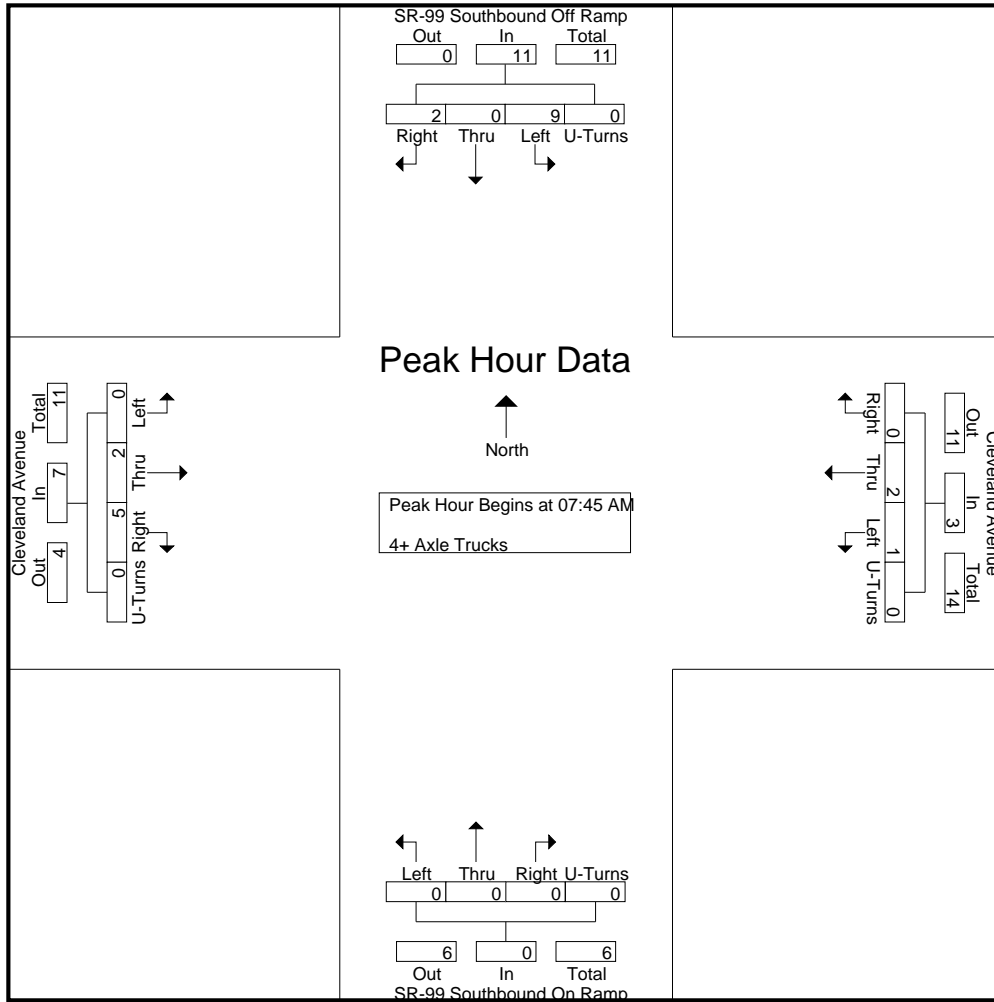

Peak Hour Analysis From 07:45 AM to 08:30 AM - Peak 1 of 1
 Peak Hour for Each Approach Begins at:

	07:45 AM					07:45 AM					07:45 AM					07:45 AM					
+0 mins.	2	0	0	0	2	0	1	0	0	1	0	0	0	0	0	0	0	0	3	0	3
+15 mins.	2	0	0	0	2	0	1	0	0	1	0	0	0	0	0	0	0	1	1	0	2
+30 mins.	2	0	1	0	3	1	0	0	0	1	0	0	0	0	0	0	0	0	0	0	0
+45 mins.	3	0	1	0	4	0	0	0	0	0	0	0	0	0	0	0	1	1	1	0	2
Total Volume	9	0	2	0	11	1	2	0	0	3	0	0	0	0	0	0	2	5	0	0	7
% App. Total	81.8	0	18.2	0		33.3	66.7	0	0		0	0	0	0		0	28.6	71.4	0		
PHF	.750	.000	.500	.000	.688	.250	.500	.000	.000	.750	.000	.000	.000	.000	.000	.000	.500	.417	.000	.583	

City of Madera
 N/S: SR-99 Southbound Ramps
 E/W: Cleveland Avenue
 Weather: Clear

File Name : 26_MDA_99S_Cleveland PM
 Site Code : 00319628
 Start Date : 9/19/2019
 Page No : 1

Groups Printed- Passenger Vehicles - Large 2 Axle Vehicles - 3 Axle Vehicles - 4+ Axle Trucks

Start Time	SR-99 Southbound Off Ramp Southbound					Cleveland Avenue Westbound					SR-99 Southbound On Ramp Northbound					Cleveland Avenue Eastbound					Int. Total
	Left	Thru	Right	U-Turns	App. Total	Left	Thru	Right	U-Turns	App. Total	Left	Thru	Right	U-Turns	App. Total	Left	Thru	Right	U-Turns	App. Total	
04:00 PM	25	0	15	0	40	62	249	0	0	311	0	0	0	0	0	0	150	79	0	229	580
04:15 PM	28	1	14	0	43	42	235	0	0	277	0	0	0	0	0	0	146	67	0	213	533
04:30 PM	30	1	14	0	45	55	208	0	0	263	0	0	0	0	0	0	171	76	0	247	555
04:45 PM	22	0	12	0	34	49	251	0	0	300	0	0	0	0	0	0	153	84	0	237	571
Total	105	2	55	0	162	208	943	0	0	1151	0	0	0	0	0	0	620	306	0	926	2239
05:00 PM	35	0	19	0	54	54	250	0	0	304	0	0	0	0	0	0	172	75	0	247	605
05:15 PM	30	0	20	0	50	45	267	0	0	312	0	0	0	0	0	0	161	89	0	250	612
05:30 PM	38	0	26	0	64	37	240	0	0	277	0	0	0	0	0	0	197	79	0	276	617
05:45 PM	17	0	16	0	33	50	230	0	0	280	0	0	0	0	0	0	162	85	0	247	560
Total	120	0	81	0	201	186	987	0	0	1173	0	0	0	0	0	0	692	328	0	1020	2394
Grand Total	225	2	136	0	363	394	1930	0	0	2324	0	0	0	0	0	0	1312	634	0	1946	4633
Apprch %	62	0.6	37.5	0		17	83	0	0		0	0	0	0	0	0	67.4	32.6	0		
Total %	4.9	0	2.9	0	7.8	8.5	41.7	0	0	50.2	0	0	0	0	0	0	28.3	13.7	0	42	
Passenger Vehicles						1916					1299										
% Passenger Vehicles	96	50	94.9	0	95.3	99	99.3	0	0	99.2	0	0	0	0	0	0	99	96.8	0	98.3	98.5
Large 2 Axle Vehicles																					
% Large 2 Axle Vehicles	3.1	0	3.7	0	3.3	1	0.6	0	0	0.7	0	0	0	0	0	0	0.9	2.5	0	1.4	1.2
3 Axle Vehicles	0	0	0	0	0	0	0	0	0	0	0	0	0	0	0	0	0	1	0	1	1
% 3 Axle Vehicles	0	0	0	0	0	0	0	0	0	0	0	0	0	0	0	0	0	0.2	0	0.1	0
4+ Axle Trucks	2	1	2	0	5	0	2	0	0	2	0	0	0	0	0	0	0	1	3	0	4
% 4+ Axle Trucks																					

Start Time	SR-99 Southbound Off Ramp Southbound					Cleveland Avenue Westbound					SR-99 Southbound On Ramp Northbound					Cleveland Avenue Eastbound					Int. Total
	Left	Thru	Right	U-Turns	App. Total	Left	Thru	Right	U-Turns	App. Total	Left	Thru	Right	U-Turns	App. Total	Left	Thru	Right	U-Turns	App. Total	
Peak Hour Analysis From 04:00 PM to 05:45 PM - Peak 1 of 1																					
Peak Hour for Entire Intersection Begins at 04:45 PM																					
04:45 PM	22	0	12	0	34	49	251	0	0	300	0	0	0	0	0	0	153	84	0	237	571
05:00 PM	35	0	19	0	54	54	250	0	0	304	0	0	0	0	0	0	172	75	0	247	605
05:15 PM	30	0	20	0	50	45	267	0	0	312	0	0	0	0	0	0	161	89	0	250	612
05:30 PM	38	0	26	0	64	37	240	0	0	277	0	0	0	0	0	0	197	79	0	276	617
Total Volume	125	0	77	0	202	185	1008	0	0	1193	0	0	0	0	0	0	683	327	0	1010	2405
% App. Total	61.9	0	38.1	0		15.5	84.5	0	0		0	0	0	0	0	0	67.6	32.4	0		
PHF	.822	.000	.740	.000	.789	.856	.944	.000	.000	.956	.000	.000	.000	.000	.000	.000	.867	.919	.000	.915	.974

City of Madera
 N/S: SR-99 Southbound Ramps
 E/W: Cleveland Avenue
 Weather: Clear

File Name : 26_MDA_99S_Cleveland PM
 Site Code : 00319628
 Start Date : 9/19/2019
 Page No : 2

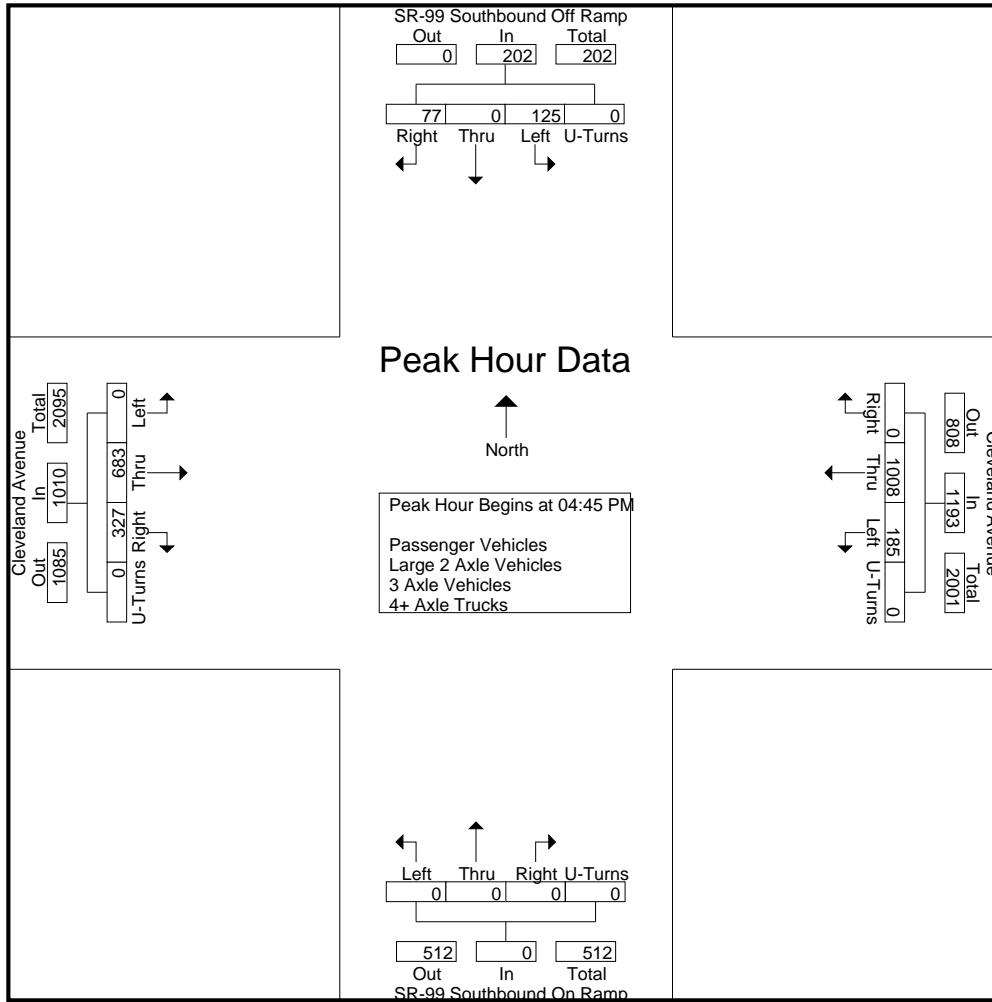

Peak Hour Analysis From 04:00 PM to 05:45 PM - Peak 1 of 1
 Peak Hour for Each Approach Begins at:

	04:45 PM					04:00 PM					05:00 PM									
+0 mins.	22	0	12	0	34	49	251	0	0	300	0	0	0	0	0	0	172	75	0	247
+15 mins.	35	0	19	0	54	54	250	0	0	304	0	0	0	0	0	0	161	89	0	250
+30 mins.	30	0	20	0	50	45	267	0	0	312	0	0	0	0	0	0	197	79	0	276
+45 mins.	38	0	26	0	64	37	240	0	0	277	0	0	0	0	0	0	162	85	0	247
Total Volume	125	0	77	0	202	185	1008	0	0	1193	0	0	0	0	0	0	692	328	0	1020
% App. Total	61.9	0	38.1	0		15.5	84.5	0	0		0	0	0	0		0	67.8	32.2	0	
PHF	.822	.000	.740	.000	.789	.856	.944	.000	.000	.956	.000	.000	.000	.000	.000	.000	.878	.921	.000	.924

City of Madera
 N/S: SR-99 Southbound Ramps
 E/W: Cleveland Avenue
 Weather: Clear

File Name : 26_MDA_99S_Cleveland PM
 Site Code : 00319628
 Start Date : 9/19/2019
 Page No : 1

Groups Printed- Passenger Vehicles

Start Time	SR-99 Southbound Off Ramp Southbound					Cleveland Avenue Westbound					SR-99 Southbound On Ramp Northbound					Cleveland Avenue Eastbound					Int. Total
	Left	Thru	Right	U-Turns	App. Total	Left	Thru	Right	U-Turns	App. Total	Left	Thru	Right	U-Turns	App. Total	Left	Thru	Right	U-Turns	App. Total	
04:00 PM	23	0	14	0	37	60	248	0	0	308	0	0	0	0	0	0	149	75	0	224	569
04:15 PM	27	0	13	0	40	42	233	0	0	275	0	0	0	0	0	0	145	65	0	210	525
04:30 PM	29	1	13	0	43	55	206	0	0	261	0	0	0	0	0	0	168	73	0	241	545
04:45 PM	21	0	12	0	33	49	250	0	0	299	0	0	0	0	0	0	153	80	0	233	565
Total	100	1	52	0	153	206	937	0	0	1143	0	0	0	0	0	0	615	293	0	908	2204
05:00 PM	34	0	19	0	53	54	249	0	0	303	0	0	0	0	0	0	171	74	0	245	601
05:15 PM	28	0	18	0	46	45	263	0	0	308	0	0	0	0	0	0	159	88	0	247	601
05:30 PM	38	0	24	0	62	37	240	0	0	277	0	0	0	0	0	0	194	77	0	271	610
05:45 PM	16	0	16	0	32	48	227	0	0	275	0	0	0	0	0	0	160	82	0	242	549
Total	116	0	77	0	193	184	979	0	0	1163	0	0	0	0	0	0	684	321	0	1005	2361
Grand Total	216	1	129	0	346	390	1916	0	0	2306	0	0	0	0	0	0	1299	614	0	1913	4565
Apprch %	62.4	0.3	37.3	0		16.9	83.1	0	0		0	0	0	0	0	0	67.9	32.1	0		
Total %	4.7	0	2.8	0	7.6	8.5	42	0	0	50.5	0	0	0	0	0	0	28.5	13.5	0	41.9	

Start Time	SR-99 Southbound Off Ramp Southbound					Cleveland Avenue Westbound					SR-99 Southbound On Ramp Northbound					Cleveland Avenue Eastbound					Int. Total
	Left	Thru	Right	U-Turns	App. Total	Thru	Right	U-Turns	App. Total	Thru	Right	U-Turns	App. Total	Thru	Right	U-Turns	App. Total				
Peak Hour Analysis From 04:45 PM to 05:30 PM - Peak 1 of 1																					
Peak Hour for Entire Intersection Begins at 04:45 PM																					
04:45 PM	21	0	12	0	33	49	250	0	0	299	0	0	0	0	0	0	153	80	0	233	565
05:00 PM	34	0	19	0	53	54	249	0	0	303	0	0	0	0	0	0	171	74	0	245	601
05:15 PM	28	0	18	0	46	45	263	0	0	308	0	0	0	0	0	0	159	88	0	247	601
05:30 PM	38	0	24	0	62	37	240	0	0	277	0	0	0	0	0	0	194	77	0	271	610
Total Volume	121	0	73	0	194	185	1002	0	0	1187	0	0	0	0	0	0	677	319	0	996	2377
% App. Total	62.4	0	37.6	0		15.6	84.4	0	0		0	0	0	0	0	0	68	32	0		
PHF	.796	.000	.760	.000	.782	.856	.952	.000	.000	.963	.000	.000	.000	.000	.000	.000	.872	.906	.000	.919	.974

City of Madera
 N/S: SR-99 Southbound Ramps
 E/W: Cleveland Avenue
 Weather: Clear

File Name : 26_MDA_99S_Cleveland PM
 Site Code : 00319628
 Start Date : 9/19/2019
 Page No : 2

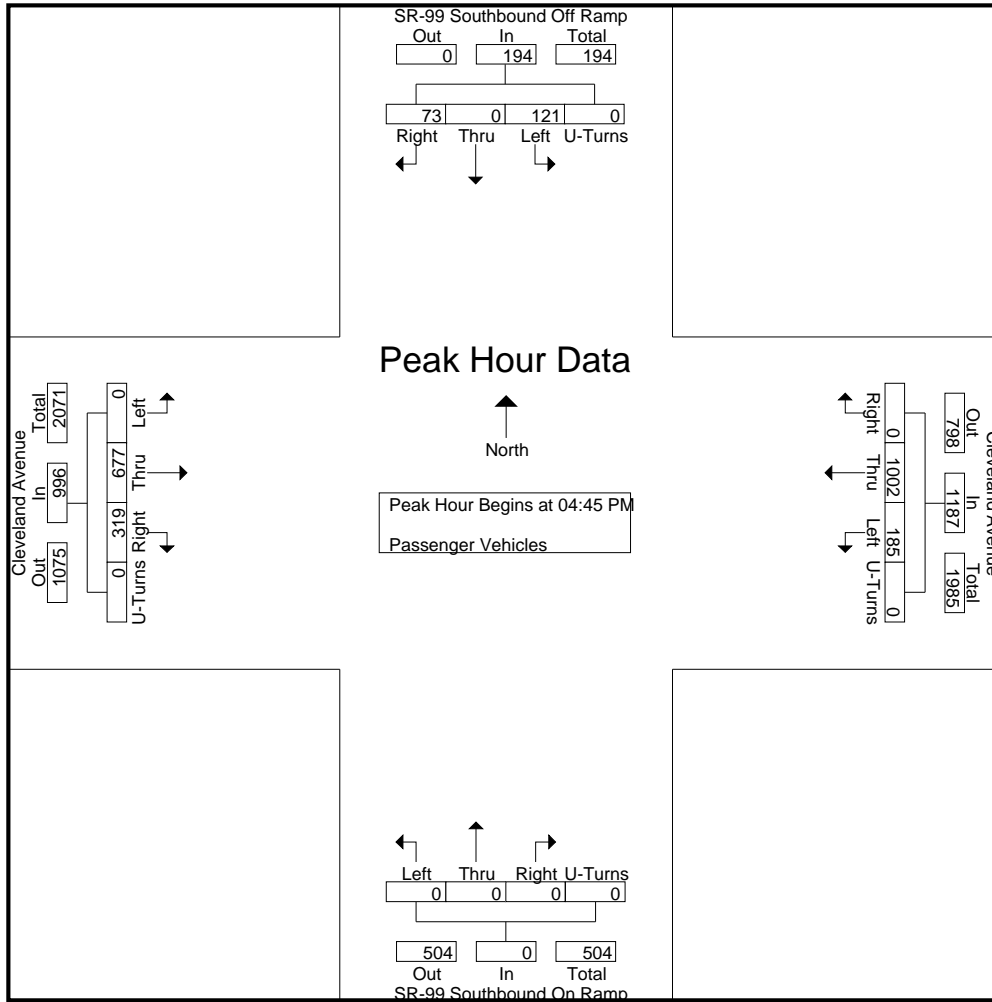

Peak Hour Analysis From 04:45 PM to 05:30 PM - Peak 1 of 1
 Peak Hour for Each Approach Begins at:

	04:45 PM					04:45 PM					04:45 PM									
+0 mins.	21	0	12	0	33	49	250	0	0	299	0	0	0	0	0	0	153	80	0	233
+15 mins.	34	0	19	0	53	54	249	0	0	303	0	0	0	0	0	0	171	74	0	245
+30 mins.	28	0	18	0	46	45	263	0	0	308	0	0	0	0	0	0	159	88	0	247
+45 mins.	38	0	24	0	62	37	240	0	0	277	0	0	0	0	0	0	194	77	0	271
Total Volume	121	0	73	0	194	185	1002	0	0	1187	0	0	0	0	0	0	677	319	0	996
% App. Total	62.4	0	37.6	0		15.6	84.4	0	0		0	0	0	0	0	0	68	32	0	
PHF	.796	.000	.760	.000	.782	.856	.952	.000	.000	.963	.000	.000	.000	.000	.000	.000	.872	.906	.000	.919

City of Madera
 N/S: SR-99 Southbound Ramps
 E/W: Cleveland Avenue
 Weather: Clear

File Name : 26_MDA_99S_Cleveland PM
 Site Code : 00319628
 Start Date : 9/19/2019
 Page No : 1

Groups Printed- Large 2 Axle Vehicles

Start Time	SR-99 Southbound Off Ramp Southbound					Cleveland Avenue Westbound					SR-99 Southbound On Ramp Northbound					Cleveland Avenue Eastbound					Int. Total
	Left	Thru	Right	U-Turns	App. Total	Left	Thru	Right	U-Turns	App. Total	Left	Thru	Right	U-Turns	App. Total	Left	Thru	Right	U-Turns	App. Total	
04:00 PM	2	0	1	0	3	2	1	0	0	3	0	0	0	0	0	0	1	2	0	3	9
04:15 PM	0	0	1	0	1	0	2	0	0	2	0	0	0	0	0	0	1	1	0	2	5
04:30 PM	1	0	1	0	2	0	2	0	0	2	0	0	0	0	0	0	3	3	0	6	10
04:45 PM	1	0	0	0	1	0	1	0	0	1	0	0	0	0	0	0	0	3	0	3	5
Total	4	0	3	0	7	2	6	0	0	8	0	0	0	0	0	0	5	9	0	14	29
05:00 PM	1	0	0	0	1	0	1	0	0	1	0	0	0	0	0	0	1	1	0	2	4
05:15 PM	1	0	1	0	2	0	2	0	0	2	0	0	0	0	0	0	2	1	0	3	7
05:30 PM	0	0	1	0	1	0	0	0	0	0	0	0	0	0	0	0	2	2	0	4	5
05:45 PM	1	0	0	0	1	2	3	0	0	5	0	0	0	0	0	0	2	3	0	5	11
Total	3	0	2	0	5	2	6	0	0	8	0	0	0	0	0	0	7	7	0	14	27
Grand Total	7	0	5	0	12	4	12	0	0	16	0	0	0	0	0	0	12	16	0	28	56
Apprch %	58.3	0	41.7	0		25	75	0	0		0	0	0	0	0	0	42.9	57.1	0		
Total %	12.5	0	8.9	0	21.4	7.1	21.4	0	0	28.6	0	0	0	0	0	0	21.4	28.6	0	50	

Start Time	SR-99 Southbound Off Ramp Southbound					Cleveland Avenue Westbound					SR-99 Southbound On Ramp Northbound					Cleveland Avenue Eastbound					Int. Total
	Left	Thru	Right	U-Turns	App. Total	Thru	Right	U-Turns	App. Total	Thru	Right	U-Turns	App. Total	Thru	Right	U-Turns	App. Total				
Peak Hour Analysis From 04:45 PM to 05:30 PM - Peak 1 of 1																					
Peak Hour for Entire Intersection Begins at 04:45 PM																					
04:45 PM	1	0	0	0	1	0	1	0	0	1	0	0	0	0	0	0	0	3	0	3	5
05:00 PM	1	0	0	0	1	0	1	0	0	1	0	0	0	0	0	0	1	1	0	2	4
05:15 PM	1	0	1	0	2	0	2	0	0	2	0	0	0	0	0	0	2	1	0	3	7
05:30 PM	0	0	1	0	1	0	0	0	0	0	0	0	0	0	0	0	2	2	0	4	5
Total Volume	3	0	2	0	5	0	4	0	0	4	0	0	0	0	0	0	5	7	0	12	21
% App. Total	60	0	40	0		0	100	0	0		0	0	0	0	0	0	41.7	58.3	0		
PHF	.750	.000	.500	.000	.625	.000	.500	.000	.000	.500	.000	.000	.000	.000	.000	.000	.625	.583	.000	.750	.750

City of Madera
 N/S: SR-99 Southbound Ramps
 E/W: Cleveland Avenue
 Weather: Clear

File Name : 26_MDA_99S_Cleveland PM
 Site Code : 00319628
 Start Date : 9/19/2019
 Page No : 2

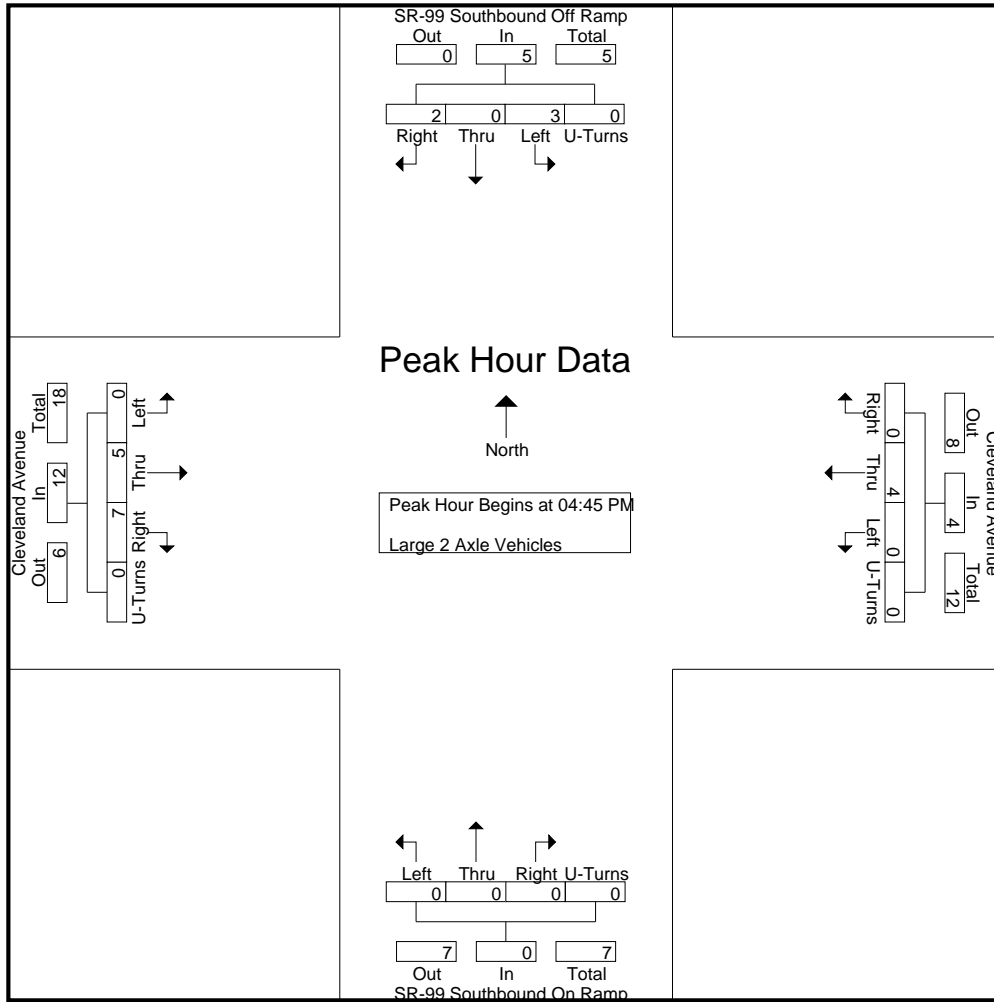

Peak Hour Analysis From 04:45 PM to 05:30 PM - Peak 1 of 1
 Peak Hour for Each Approach Begins at:

	04:45 PM					04:45 PM					04:45 PM									
+0 mins.	1	0	0	0	1	0	1	0	0	1	0	0	0	0	0	0	0	3	0	3
+15 mins.	1	0	0	0	1	0	1	0	0	1	0	0	0	0	0	0	1	1	0	2
+30 mins.	1	0	1	0	2	0	2	0	0	2	0	0	0	0	0	0	2	1	0	3
+45 mins.	0	0	1	0	1	0	0	0	0	0	0	0	0	0	0	0	2	2	0	4
Total Volume	3	0	2	0	5	0	4	0	0	4	0	0	0	0	0	0	5	7	0	12
% App. Total	60	0	40	0		0	100	0	0		0	0	0	0		0	41.7	58.3	0	
PHF	.750	.000	.500	.000	.625	.000	.500	.000	.000	.500	.000	.000	.000	.000	.000	.000	.625	.583	.000	.750

City of Madera
 N/S: SR-99 Southbound Ramps
 E/W: Cleveland Avenue
 Weather: Clear

File Name : 26_MDA_99S_Cleveland PM
 Site Code : 00319628
 Start Date : 9/19/2019
 Page No : 1

Groups Printed- 3 Axle Vehicles

Start Time	SR-99 Southbound Off Ramp Southbound					Cleveland Avenue Westbound					SR-99 Southbound On Ramp Northbound					Cleveland Avenue Eastbound					Int. Total
	Left	Thru	Right	U-Turns	App. Total	Left	Thru	Right	U-Turns	App. Total	Left	Thru	Right	U-Turns	App. Total	Left	Thru	Right	U-Turns	App. Total	
04:00 PM	0	0	0	0	0	0	0	0	0	0	0	0	0	0	0	0	0	1	0	1	1
04:15 PM	0	0	0	0	0	0	0	0	0	0	0	0	0	0	0	0	0	0	0	0	0
04:30 PM	0	0	0	0	0	0	0	0	0	0	0	0	0	0	0	0	0	0	0	0	0
04:45 PM	0	0	0	0	0	0	0	0	0	0	0	0	0	0	0	0	0	0	0	0	0
Total	0	0	0	0	0	0	0	0	0	0	0	0	0	0	0	0	0	1	0	1	1
05:00 PM	0	0	0	0	0	0	0	0	0	0	0	0	0	0	0	0	0	0	0	0	0
05:15 PM	0	0	0	0	0	0	0	0	0	0	0	0	0	0	0	0	0	0	0	0	0
05:30 PM	0	0	0	0	0	0	0	0	0	0	0	0	0	0	0	0	0	0	0	0	0
05:45 PM	0	0	0	0	0	0	0	0	0	0	0	0	0	0	0	0	0	0	0	0	0
Total	0	0	0	0	0	0	0	0	0	0	0	0	0	0	0	0	0	0	0	0	0
Grand Total	0	0	0	0	0	0	0	0	0	0	0	0	0	0	0	0	0	1	0	1	1
Apprch %	0	0	0	0		0	0	0	0		0	0	0	0		0	0	100	0		
Total %	0	0	0	0	0	0	0	0	0	0	0	0	0	0	0	0	0	100	0	100	

Start Time	SR-99 Southbound Off Ramp Southbound					Cleveland Avenue Westbound					SR-99 Southbound On Ramp Northbound					Cleveland Avenue Eastbound					Int. Total
	Left	Thru	Right	U-Turns	App. Total	Left	Thru	Right	U-Turns	App. Total	Left	Thru	Right	U-Turns	App. Total	Left	Thru	Right	U-Turns	App. Total	
Peak Hour Analysis From 04:45 PM to 05:30 PM - Peak 1 of 1																					
Peak Hour for Entire Intersection Begins at 04:45 PM																					
04:45 PM	0	0	0	0	0	0	0	0	0	0	0	0	0	0	0	0	0	0	0	0	0
05:00 PM	0	0	0	0	0	0	0	0	0	0	0	0	0	0	0	0	0	0	0	0	0
05:15 PM	0	0	0	0	0	0	0	0	0	0	0	0	0	0	0	0	0	0	0	0	0
05:30 PM	0	0	0	0	0	0	0	0	0	0	0	0	0	0	0	0	0	0	0	0	0
Total Volume	0	0	0	0	0	0	0	0	0	0	0	0	0	0	0	0	0	0	0	0	0
% App. Total	0	0	0	0		0	0	0	0		0	0	0	0		0	0	0	0		
PHF	.000	.000	.000	.000	.000	.000	.000	.000	.000	.000	.000	.000	.000	.000	.000	.000	.000	.000	.000	.000	.000

City of Madera
 N/S: SR-99 Southbound Ramps
 E/W: Cleveland Avenue
 Weather: Clear

File Name : 26_MDA_99S_Cleveland PM
 Site Code : 00319628
 Start Date : 9/19/2019
 Page No : 2

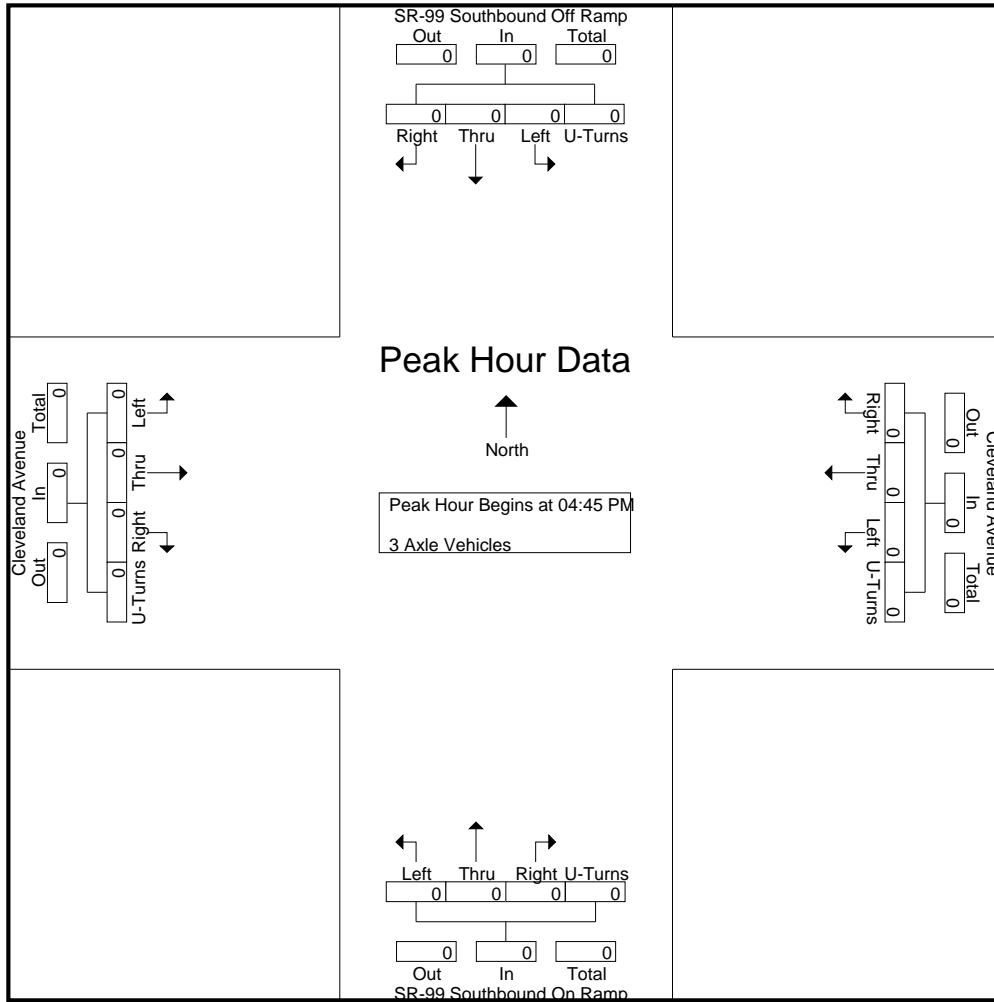

Peak Hour Analysis From 04:45 PM to 05:30 PM - Peak 1 of 1
 Peak Hour for Each Approach Begins at:

	04:45 PM					04:45 PM					04:45 PM					04:45 PM				
+0 mins.	0	0	0	0	0	0	0	0	0	0	0	0	0	0	0	0	0	0	0	0
+15 mins.	0	0	0	0	0	0	0	0	0	0	0	0	0	0	0	0	0	0	0	0
+30 mins.	0	0	0	0	0	0	0	0	0	0	0	0	0	0	0	0	0	0	0	0
+45 mins.	0	0	0	0	0	0	0	0	0	0	0	0	0	0	0	0	0	0	0	0
Total Volume	0	0	0	0	0	0	0	0	0	0	0	0	0	0	0	0	0	0	0	0
% App. Total	0	0	0	0	0	0	0	0	0	0	0	0	0	0	0	0	0	0	0	0
PHF	.000	.000	.000	.000	.000	.000	.000	.000	.000	.000	.000	.000	.000	.000	.000	.000	.000	.000	.000	.000

City of Madera
 N/S: SR-99 Southbound Ramps
 E/W: Cleveland Avenue
 Weather: Clear

File Name : 26_MDA_99S_Cleveland PM
 Site Code : 00319628
 Start Date : 9/19/2019
 Page No : 1

Groups Printed- 4+ Axle Trucks

Start Time	SR-99 Southbound Off Ramp Southbound					Cleveland Avenue Westbound					SR-99 Southbound On Ramp Northbound					Cleveland Avenue Eastbound					Int. Total
	Left	Thru	Right	U-Turns	App. Total	Left	Thru	Right	U-Turns	App. Total	Left	Thru	Right	U-Turns	App. Total	Left	Thru	Right	U-Turns	App. Total	
04:00 PM	0	0	0	0	0	0	0	0	0	0	0	0	0	0	0	0	0	1	0	1	1
04:15 PM	1	1	0	0	2	0	0	0	0	0	0	0	0	0	0	0	0	1	0	1	3
04:30 PM	0	0	0	0	0	0	0	0	0	0	0	0	0	0	0	0	0	0	0	0	0
04:45 PM	0	0	0	0	0	0	0	0	0	0	0	0	0	0	0	0	0	1	0	1	1
Total	1	1	0	0	2	0	0	0	0	0	0	0	0	0	0	0	0	3	0	3	5
05:00 PM	0	0	0	0	0	0	0	0	0	0	0	0	0	0	0	0	0	0	0	0	0
05:15 PM	1	0	1	0	2	0	2	0	0	2	0	0	0	0	0	0	0	0	0	0	4
05:30 PM	0	0	1	0	1	0	0	0	0	0	0	0	0	0	0	0	1	0	0	1	2
05:45 PM	0	0	0	0	0	0	0	0	0	0	0	0	0	0	0	0	0	0	0	0	0
Total	1	0	2	0	3	0	2	0	0	2	0	0	0	0	0	0	1	0	0	1	6
Grand Total	2	1	2	0	5	0	2	0	0	2	0	0	0	0	0	0	1	3	0	4	11
Apprch %	40	20	40	0		0	100	0	0		0	0	0	0		0	25	75	0		
Total %	18.2	9.1	18.2	0	45.5	0	18.2	0	0	18.2	0	0	0	0	0	0	9.1	27.3	0	36.4	

Start Time	SR-99 Southbound Off Ramp Southbound					Cleveland Avenue Westbound					SR-99 Southbound On Ramp Northbound					Cleveland Avenue Eastbound					Int. Total
	Left	Thru	Right	U-Turns	App. Total	Thru	Right	U-Turns	App. Total	Thru	Right	U-Turns	App. Total	Thru	Right	U-Turns	App. Total				
Peak Hour Analysis From 04:45 PM to 05:30 PM - Peak 1 of 1																					
Peak Hour for Entire Intersection Begins at 04:45 PM																					
04:45 PM	0	0	0	0	0	0	0	0	0	0	0	0	0	0	0	0	0	1	0	1	1
05:00 PM	0	0	0	0	0	0	0	0	0	0	0	0	0	0	0	0	0	0	0	0	0
05:15 PM	1	0	1	0	2	0	2	0	0	2	0	0	0	0	0	0	0	0	0	0	4
05:30 PM	0	0	1	0	1	0	0	0	0	0	0	0	0	0	0	0	1	0	0	1	2
Total Volume	1	0	2	0	3	0	2	0	0	2	0	0	0	0	0	0	1	1	0	2	7
% App. Total	33.3	0	66.7	0		0	100	0	0		0	0	0	0		0	50	50	0		
PHF	.250	.000	.500	.000	.375	.000	.250	.000	.000	.250	.000	.000	.000	.000	.000	.000	.250	.250	.000	.500	.438

City of Madera
 N/S: SR-99 Southbound Ramps
 E/W: Cleveland Avenue
 Weather: Clear

File Name : 26_MDA_99S_Cleveland PM
 Site Code : 00319628
 Start Date : 9/19/2019
 Page No : 2

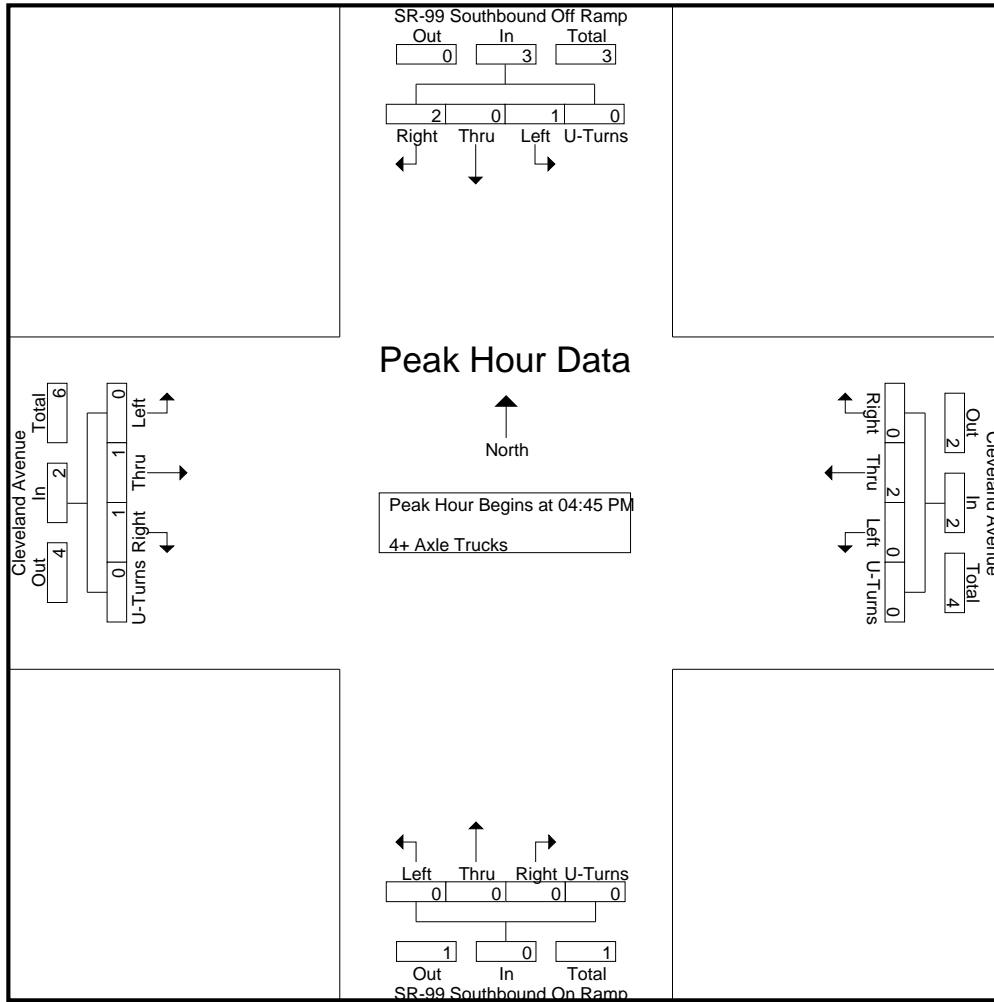

Peak Hour Analysis From 04:45 PM to 05:30 PM - Peak 1 of 1
 Peak Hour for Each Approach Begins at:

	04:45 PM					04:45 PM					04:45 PM					04:45 PM				
+0 mins.	0	0	0	0	0	0	0	0	0	0	0	0	0	0	0	0	0	1	0	1
+15 mins.	0	0	0	0	0	0	0	0	0	0	0	0	0	0	0	0	0	0	0	0
+30 mins.	1	0	1	0	2	0	2	0	0	2	0	0	0	0	0	0	0	0	0	0
+45 mins.	0	0	1	0	1	0	0	0	0	0	0	0	0	0	0	0	1	0	0	1
Total Volume	1	0	2	0	3	0	2	0	0	2	0	0	0	0	0	0	1	1	0	2
% App. Total	33.3	0	66.7	0		0	100	0	0		0	0	0	0		0	50	50	0	
PHF	.250	.000	.500	.000	.375	.000	.250	.000	.000	.250	.000	.000	.000	.000	.000	.000	.250	.250	.000	.500

Location: Madera
 N/S: SR-99 Southbound Ramps
 E/W: Cleveland Avenue



Date: 9/19/2019
 Day: Thursday

PEDESTRIANS

	North Leg SR-99 Southbound Ramps	East Leg Cleveland Avenue	South Leg SR-99 Southbound Ramps	West Leg Cleveland Avenue	
	Pedestrians	Pedestrians	Pedestrians	Pedestrians	
7:00 AM	0	0	0	0	0
7:15 AM	1	0	0	0	1
7:30 AM	0	0	0	0	0
7:45 AM	1	0	0	0	1
8:00 AM	3	0	0	0	3
8:15 AM	2	0	0	0	2
8:30 AM	0	0	0	0	0
8:45 AM	4	2	3	0	9
TOTAL VOLUMES:	11	2	3	0	16

	North Leg SR-99 Southbound Ramps	East Leg Cleveland Avenue	South Leg SR-99 Southbound Ramps	West Leg Cleveland Avenue	
	Pedestrians	Pedestrians	Pedestrians	Pedestrians	
4:00 PM	2	0	0	0	2
4:15 PM	0	0	1	0	1
4:30 PM	0	0	2	0	2
4:45 PM	3	0	0	0	3
5:00 PM	2	0	0	0	2
5:15 PM	1	0	1	0	2
5:30 PM	1	0	2	0	3
5:45 PM	1	0	0	0	1
TOTAL VOLUMES:	10	0	6	0	16

Location: Madera
 N/S: SR-99 Southbound Ramps
 E/W: Cleveland Avenue



Date: 9/19/2019
 Day: Thursday

BICYCLES

	Southbound SR-99 Southbound Ramps			Westbound Cleveland Avenue			Northbound SR-99 Southbound Ramps			Eastbound Cleveland Avenue			
	Left	Thru	Right	Left	Thru	Right	Left	Thru	Right	Left	Thru	Right	
7:00 AM	0	0	0	0	0	0	0	0	0	0	0	0	0
7:15 AM	0	0	0	0	0	0	0	0	0	0	0	0	0
7:30 AM	0	0	0	0	0	0	0	0	0	0	0	0	0
7:45 AM	0	0	0	0	0	0	0	0	0	0	0	0	0
8:00 AM	0	0	0	0	1	0	0	0	0	0	1	0	2
8:15 AM	0	0	0	0	0	0	0	0	0	0	0	0	0
8:30 AM	0	0	0	0	1	0	0	0	0	0	1	0	2
8:45 AM	0	0	0	0	0	0	0	0	0	0	0	0	0
TOTAL VOLUMES:	0	0	0	0	2	0	0	0	0	0	2	0	4

	Southbound SR-99 Southbound Ramps			Westbound Cleveland Avenue			Northbound SR-99 Southbound Ramps			Eastbound Cleveland Avenue			
	Left	Thru	Right	Left	Thru	Right	Left	Thru	Right	Left	Thru	Right	
4:00 PM	0	0	0	0	2	0	0	0	0	0	0	0	2
4:15 PM	0	0	0	0	0	0	0	0	0	0	0	0	0
4:30 PM	0	0	0	0	1	0	0	0	0	0	0	0	1
4:45 PM	0	0	0	0	0	0	0	0	0	0	2	0	2
5:00 PM	0	0	0	0	1	0	0	0	0	0	2	0	3
5:15 PM	0	0	0	0	1	0	0	0	0	0	0	0	1
5:30 PM	0	0	0	0	3	0	0	0	0	0	1	0	4
5:45 PM	0	0	0	0	0	0	0	0	0	0	0	0	0
TOTAL VOLUMES:	0	0	0	0	8	0	0	0	0	0	5	0	13

City of Madera
 N/S: SR-99 Northbound Ramps
 E/W: Cleveland Avenue
 Weather: Clear

File Name : 27_MDA_99N_Cleveland AM
 Site Code : 00319628
 Start Date : 9/24/2019
 Page No : 1

Groups Printed- Passenger Vehicles - Large 2 Axle Vehicles - 3 Axle Vehicles - 4+ Axle Trucks

Start Time	SR-99 Northbound On Ramp Southbound					Cleveland Avenue Westbound					SR-99 Northbound Off Ramp Northbound					Cleveland Avenue Eastbound					Int. Total
	Left	Thru	Right	U-Turns	App. Total	Left	Thru	Right	U-Turns	App. Total	Left	Thru	Right	U-Turns	App. Total	Left	Thru	Right	U-Turns	App. Total	
07:00 AM	0	0	0	0	0	0	106	12	0	118	45	0	46	0	91	10	52	0	0	62	271
07:15 AM	0	0	0	0	0	0	116	15	0	131	37	0	69	0	106	10	71	0	0	81	318
07:30 AM	0	0	0	0	0	0	149	12	0	161	56	0	82	0	138	5	104	0	0	109	408
07:45 AM	0	0	0	0	0	0	211	19	0	230	80	0	77	0	157	8	138	0	0	146	533
Total	0	0	0	0	0	0	582	58	0	640	218	0	274	0	492	33	365	0	0	398	1530
08:00 AM	0	0	0	0	0	0	191	17	0	208	43	0	45	0	88	18	86	0	0	104	400
08:15 AM	0	0	0	0	0	0	179	11	0	190	55	0	39	0	94	12	99	0	0	111	395
08:30 AM	0	0	0	0	0	0	170	17	0	187	39	0	52	0	91	10	89	0	0	99	377
08:45 AM	0	0	0	0	0	0	190	13	0	203	37	0	56	0	93	15	105	0	0	120	416
Total	0	0	0	0	0	0	730	58	0	788	174	0	192	0	366	55	379	0	0	434	1588
Grand Total	0	0	0	0	0	0	1312	116	0	1428	392	0	466	0	858	88	744	0	0	832	3118
Apprch %	0	0	0	0	0	0	91.9	8.1	0	45.7	0	54.3	0	27.5	10.6	89.4	0	0	26.7		
Total %	0	0	0	0	0	0	42.1	3.7	0	45.8	12.6	0	14.9	0	27.5	2.8	23.9	0	0	26.7	
Passenger Vehicles	0	0	0	0	0	0	1271	111	0	1382	371	0	434	0	805	84	704	0	0	788	2975
% Passenger Vehicles	0	0	0	0	0	0	96.9	95.7	0	96.8	94.6	0	93.1	0	93.8	95.5	94.6	0	0	94.7	95.4
Large 2 Axle Vehicles	0	0	0	0	0	0	29	1	0	30	15	0	24	0	39	0	27	0	0	27	96
% Large 2 Axle Vehicles	0	0	0	0	0	0	2.2	0.9	0	2.1	3.8	0	5.2	0	4.5	0	3.6	0	0	3.2	3.1
3 Axle Vehicles	0	0	0	0	0	0	5	1	0	6	4	0	3	0	7	0	4	0	0	4	17
% 3 Axle Vehicles	0	0	0	0	0	0	0.4	0.9	0	0.4	1	0	0.6	0	0.8	0	0.5	0	0	0.5	0.5
4+ Axle Trucks	0	0	0	0	0	0	7	3	0	10	2	0	5	0	7	4	9	0	0	13	30
% 4+ Axle Trucks	0	0	0	0	0	0	0.5	2.6	0	0.7	0.5	0	1.1	0	0.8	4.5	1.2	0	0	1.6	1

Start Time	SR-99 Northbound On Ramp Southbound					Cleveland Avenue Westbound					SR-99 Northbound Off Ramp Northbound					Cleveland Avenue Eastbound					Int. Total
	Left	Thru	Right	U-Turns	App. Total	Left	Thru	Right	U-Turns	App. Total	Left	Thru	Right	U-Turns	App. Total	Left	Thru	Right	U-Turns	App. Total	
Peak Hour Analysis From 07:00 AM to 08:45 AM - Peak 1 of 1																					
Peak Hour for Entire Intersection Begins at 07:30 AM																					
07:30 AM	0	0	0	0	0	0	149	12	0	161	56	0	82	0	138	5	104	0	0	109	408
07:45 AM	0	0	0	0	0	0	211	19	0	230	80	0	77	0	157	8	138	0	0	146	533
08:00 AM	0	0	0	0	0	0	191	17	0	208	43	0	45	0	88	18	86	0	0	104	400
08:15 AM	0	0	0	0	0	0	179	11	0	190	55	0	39	0	94	12	99	0	0	111	395
Total Volume	0	0	0	0	0	0	730	59	0	789	234	0	243	0	477	43	427	0	0	470	1736
% App. Total	0	0	0	0	0	0	92.5	7.5	0	49.1	0	50.9	0	0	9.1	90.9	0	0	0	0	
PHF	.000	.000	.000	.000	.000	.000	.865	.776	.000	.858	.731	.000	.741	.000	.760	.597	.774	.000	.000	.805	.814

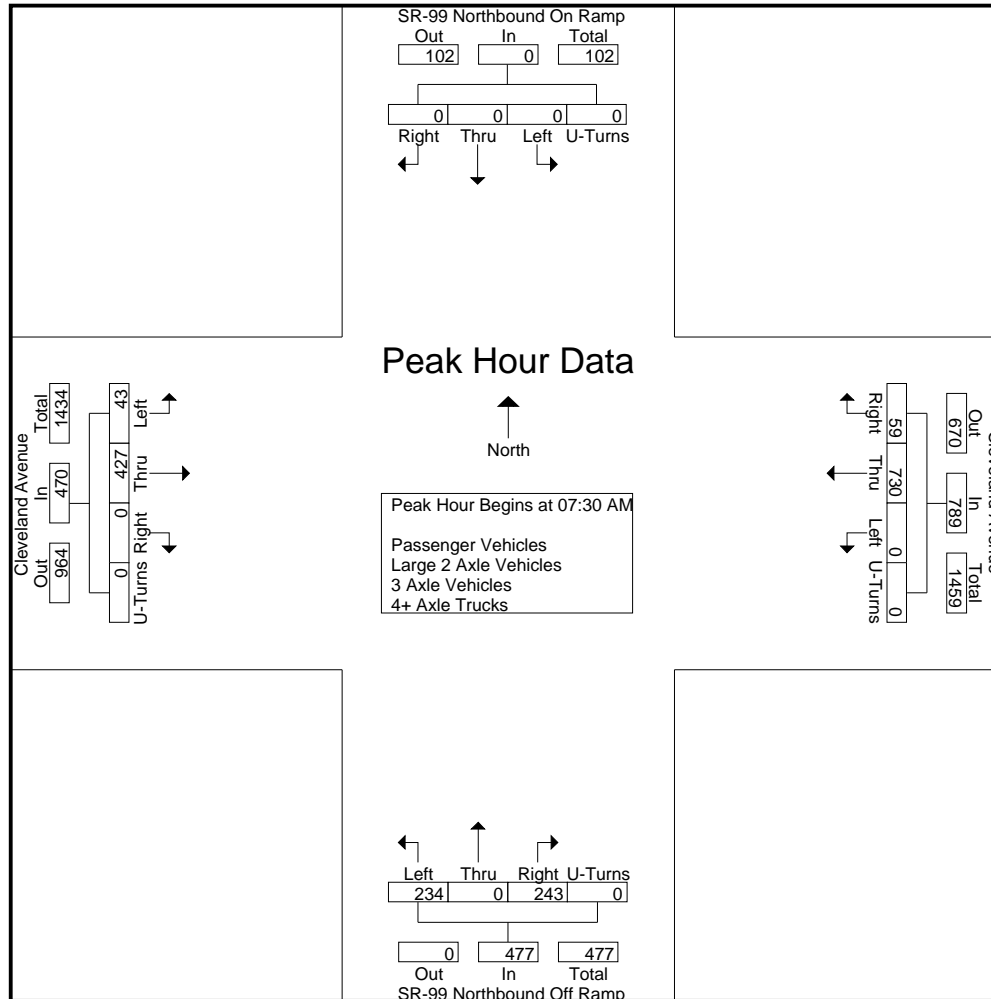

Counts Unlimited
 PO Box 1178
 Corona, CA 92878
 (951) 268-6268

City of Madera
 N/S: SR-99 Northbound Ramps
 E/W: Cleveland Avenue
 Weather: Clear

File Name : 27_MDA_99N_Cleveland AM
 Site Code : 00319628
 Start Date : 9/24/2019
 Page No : 3

Start Time	SR-99 Northbound On Ramp Southbound					Cleveland Avenue Westbound					SR-99 Northbound Off Ramp Northbound					Cleveland Avenue Eastbound					Int. Total
	Left	Thru	Right	U-Turns	App. Total	Left	Thru	Right	U-Turns	App. Total	Left	Thru	Right	U-Turns	App. Total	Left	Thru	Right	U-Turns	App. Total	

Peak Hour Analysis From 07:00 AM to 08:45 AM - Peak 1 of 1
 Peak Hour for Each Approach Begins at:

	07:00 AM					07:45 AM					07:00 AM					07:30 AM				
+0 mins.	0	0	0	0	0	0	211	19	0	230	45	0	46	0	91	5	104	0	0	109
+15 mins.	0	0	0	0	0	0	191	17	0	208	37	0	69	0	106	8	138	0	0	146
+30 mins.	0	0	0	0	0	0	179	11	0	190	56	0	82	0	138	18	86	0	0	104
+45 mins.	0	0	0	0	0	0	170	17	0	187	80	0	77	0	157	12	99	0	0	111
Total Volume	0	0	0	0	0	0	751	64	0	815	218	0	274	0	492	43	427	0	0	470
% App. Total	0	0	0	0	0	0	92.1	7.9	0		44.3	0	55.7	0		9.1	90.9	0	0	
PHF	.000	.000	.000	.000	.000	.000	.890	.842	.000	.886	.681	.000	.835	.000	.783	.597	.774	.000	.000	.805

City of Madera
 N/S: SR-99 Northbound Ramps
 E/W: Cleveland Avenue
 Weather: Clear

File Name : 27_MDA_99N_Cleveland AM
 Site Code : 00319628
 Start Date : 9/24/2019
 Page No : 1

Groups Printed- Passenger Vehicles

Start Time	SR-99 Northbound On Ramp Southbound					Cleveland Avenue Westbound					SR-99 Northbound Off Ramp Northbound					Cleveland Avenue Eastbound					Int. Total
	Left	Thru	Right	U-Turns	App. Total	Left	Thru	Right	U-Turns	App. Total	Left	Thru	Right	U-Turns	App. Total	Left	Thru	Right	U-Turns	App. Total	
07:00 AM	0	0	0	0	0	0	102	10	0	112	41	0	43	0	84	9	47	0	0	56	252
07:15 AM	0	0	0	0	0	0	112	14	0	126	33	0	64	0	97	10	68	0	0	78	301
07:30 AM	0	0	0	0	0	0	146	12	0	158	54	0	76	0	130	5	99	0	0	104	392
07:45 AM	0	0	0	0	0	0	202	19	0	221	77	0	72	0	149	7	133	0	0	140	510
Total	0	0	0	0	0	0	562	55	0	617	205	0	255	0	460	31	347	0	0	378	1455
08:00 AM	0	0	0	0	0	0	187	16	0	203	41	0	45	0	86	18	78	0	0	96	385
08:15 AM	0	0	0	0	0	0	173	11	0	184	53	0	37	0	90	11	95	0	0	106	380
08:30 AM	0	0	0	0	0	0	165	17	0	182	38	0	46	0	84	9	83	0	0	92	358
08:45 AM	0	0	0	0	0	0	184	12	0	196	34	0	51	0	85	15	101	0	0	116	397
Total	0	0	0	0	0	0	709	56	0	765	166	0	179	0	345	53	357	0	0	410	1520
Grand Total	0	0	0	0	0	0	1271	111	0	1382	371	0	434	0	805	84	704	0	0	788	2975
Apprch %	0	0	0	0	0	0	92	8	0	46.1	46.1	0	53.9	0	23.7	10.7	89.3	0	0	26.5	
Total %	0	0	0	0	0	0	42.7	3.7	0	46.5	12.5	0	14.6	0	27.1	2.8	23.7	0	0	26.5	

Start Time	SR-99 Northbound On Ramp Southbound					Cleveland Avenue Westbound					SR-99 Northbound Off Ramp Northbound					Cleveland Avenue Eastbound					Int. Total
	Left	Thru	Right	U-Turns	App. Total	Left	Thru	Right	U-Turns	App. Total	Left	Thru	Right	U-Turns	App. Total	Left	Thru	Right	U-Turns	App. Total	
Peak Hour Analysis From 07:30 AM to 08:15 AM - Peak 1 of 1																					
Peak Hour for Entire Intersection Begins at 07:30 AM																					
07:30 AM	0	0	0	0	0	0	146	12	0	158	54	0	76	0	130	5	99	0	0	104	392
07:45 AM	0	0	0	0	0	0	202	19	0	221	77	0	72	0	149	7	133	0	0	140	510
08:00 AM	0	0	0	0	0	0	187	16	0	203	41	0	45	0	86	18	78	0	0	96	385
08:15 AM	0	0	0	0	0	0	173	11	0	184	53	0	37	0	90	11	95	0	0	106	380
Total Volume	0	0	0	0	0	0	708	58	0	766	225	0	230	0	455	41	405	0	0	446	1667
% App. Total	0	0	0	0	0	0	92.4	7.6	0	46.1	49.5	0	50.5	0	23.7	9.2	90.8	0	0	26.5	
PHF	.000	.000	.000	.000	.000	.000	.876	.763	.000	.867	.731	.000	.757	.000	.763	.569	.761	.000	.000	.796	.817

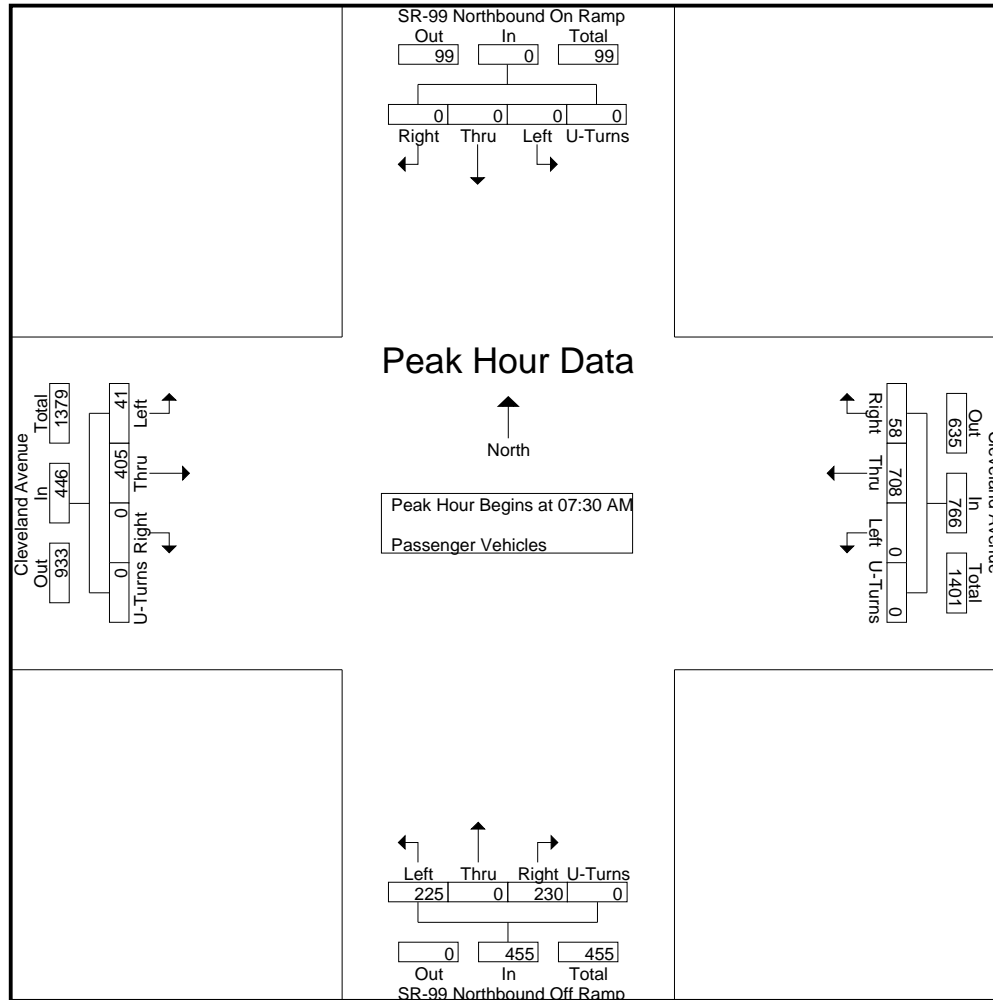

City of Madera
 N/S: SR-99 Northbound Ramps
 E/W: Cleveland Avenue
 Weather: Clear

File Name : 27_MDA_99N_Cleveland AM
 Site Code : 00319628
 Start Date : 9/24/2019
 Page No : 3

Start Time	SR-99 Northbound On Ramp Southbound					Cleveland Avenue Westbound					SR-99 Northbound Off Ramp Northbound					Cleveland Avenue Eastbound					Int. Total
	Left	Thru	Right	U-Turns	App. Total	Left	Thru	Right	U-Turns	App. Total	Left	Thru	Right	U-Turns	App. Total	Left	Thru	Right	U-Turns	App. Total	

Peak Hour Analysis From 07:30 AM to 08:15 AM - Peak 1 of 1
 Peak Hour for Each Approach Begins at:

	07:30 AM					07:30 AM					07:30 AM					07:30 AM				
+0 mins.	0	0	0	0	0	0	146	12	0	158	54	0	76	0	130	5	99	0	0	104
+15 mins.	0	0	0	0	0	0	202	19	0	221	77	0	72	0	149	7	133	0	0	140
+30 mins.	0	0	0	0	0	0	187	16	0	203	41	0	45	0	86	18	78	0	0	96
+45 mins.	0	0	0	0	0	0	173	11	0	184	53	0	37	0	90	11	95	0	0	106
Total Volume	0	0	0	0	0	0	708	58	0	766	225	0	230	0	455	41	405	0	0	446
% App. Total	0	0	0	0	0	0	92.4	7.6	0		49.5	0	50.5	0		9.2	90.8	0	0	
PHF	.000	.000	.000	.000	.000	.000	.876	.763	.000	.867	.731	.000	.757	.000	.763	.569	.761	.000	.000	.796

City of Madera
 N/S: SR-99 Northbound Ramps
 E/W: Cleveland Avenue
 Weather: Clear

File Name : 27_MDA_99N_Cleveland AM
 Site Code : 00319628
 Start Date : 9/24/2019
 Page No : 1

Groups Printed- Large 2 Axle Vehicles

Start Time	SR-99 Northbound On Ramp Southbound					Cleveland Avenue Westbound					SR-99 Northbound Off Ramp Northbound					Cleveland Avenue Eastbound					Int. Total
	Left	Thru	Right	U-Turns	App. Total	Left	Thru	Right	U-Turns	App. Total	Left	Thru	Right	U-Turns	App. Total	Left	Thru	Right	U-Turns	App. Total	
07:00 AM	0	0	0	0	0	0	4	0	0	4	2	0	1	0	3	0	4	0	0	4	11
07:15 AM	0	0	0	0	0	0	2	0	0	2	2	0	5	0	7	0	2	0	0	2	11
07:30 AM	0	0	0	0	0	0	2	0	0	2	2	0	4	0	6	0	4	0	0	4	12
07:45 AM	0	0	0	0	0	0	7	0	0	7	2	0	3	0	5	0	3	0	0	3	15
Total	0	0	0	0	0	0	15	0	0	15	8	0	13	0	21	0	13	0	0	13	49
08:00 AM	0	0	0	0	0	0	3	1	0	4	2	0	0	0	2	0	4	0	0	4	10
08:15 AM	0	0	0	0	0	0	4	0	0	4	2	0	2	0	4	0	3	0	0	3	11
08:30 AM	0	0	0	0	0	0	4	0	0	4	1	0	5	0	6	0	4	0	0	4	14
08:45 AM	0	0	0	0	0	0	3	0	0	3	2	0	4	0	6	0	3	0	0	3	12
Total	0	0	0	0	0	0	14	1	0	15	7	0	11	0	18	0	14	0	0	14	47
Grand Total	0	0	0	0	0	0	29	1	0	30	15	0	24	0	39	0	27	0	0	27	96
Apprch %	0	0	0	0	0	0	96.7	3.3	0	30.2	38.5	0	61.5	0	40.6	0	100	0	0	28.1	
Total %	0	0	0	0	0	0	30.2	1	0	31.2	15.6	0	25	0	40.6	0	28.1	0	0	28.1	

Start Time	SR-99 Northbound On Ramp Southbound					Cleveland Avenue Westbound					SR-99 Northbound Off Ramp Northbound					Cleveland Avenue Eastbound					Int. Total
	Left	Thru	Right	U-Turns	App. Total	Left	Thru	Right	U-Turns	App. Total	Left	Thru	Right	U-Turns	App. Total	Left	Thru	Right	U-Turns	App. Total	
Peak Hour Analysis From 07:30 AM to 08:15 AM - Peak 1 of 1																					
Peak Hour for Entire Intersection Begins at 07:30 AM																					
07:30 AM	0	0	0	0	0	0	2	0	0	2	2	0	4	0	6	0	4	0	0	4	12
07:45 AM	0	0	0	0	0	0	7	0	0	7	2	0	3	0	5	0	3	0	0	3	15
08:00 AM	0	0	0	0	0	0	3	1	0	4	2	0	0	0	2	0	4	0	0	4	10
08:15 AM	0	0	0	0	0	0	4	0	0	4	2	0	2	0	4	0	3	0	0	3	11
Total Volume	0	0	0	0	0	0	16	1	0	17	8	0	9	0	17	0	14	0	0	14	48
% App. Total	0	0	0	0	0	0	94.1	5.9	0	30.2	47.1	0	52.9	0	40.6	0	100	0	0	28.1	
PHF	.000	.000	.000	.000	.000	.000	.571	.250	.000	.607	1.00	.000	.563	.000	.708	.000	.875	.000	.000	.875	.800

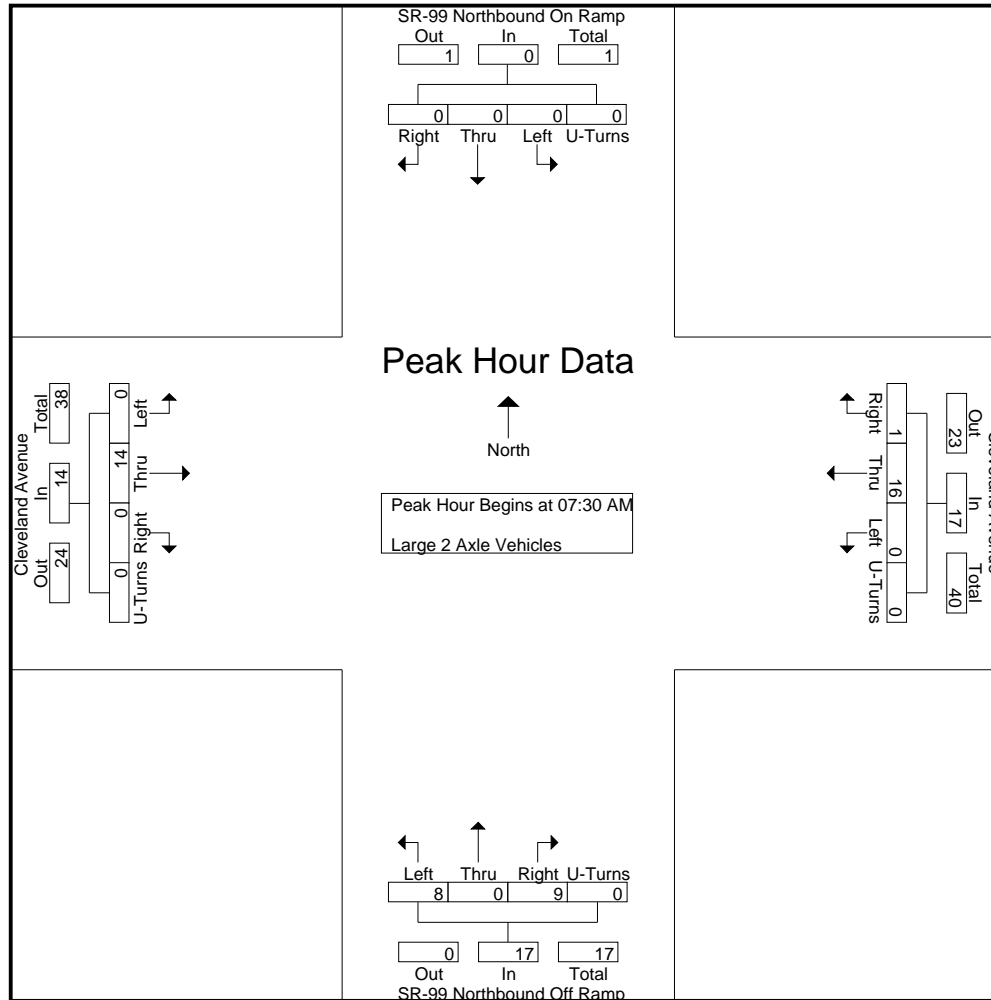

Counts Unlimited
 PO Box 1178
 Corona, CA 92878
 (951) 268-6268

City of Madera
 N/S: SR-99 Northbound Ramps
 E/W: Cleveland Avenue
 Weather: Clear

File Name : 27_MDA_99N_Cleveland AM
 Site Code : 00319628
 Start Date : 9/24/2019
 Page No : 3

Start Time	SR-99 Northbound On Ramp Southbound					Cleveland Avenue Westbound					SR-99 Northbound Off Ramp Northbound					Cleveland Avenue Eastbound					Int. Total
	Left	Thru	Right	U-Turns	App. Total	Left	Thru	Right	U-Turns	App. Total	Left	Thru	Right	U-Turns	App. Total	Left	Thru	Right	U-Turns	App. Total	

Peak Hour Analysis From 07:30 AM to 08:15 AM - Peak 1 of 1
 Peak Hour for Each Approach Begins at:

	07:30 AM					07:30 AM					07:30 AM					07:30 AM				
+0 mins.	0	0	0	0	0	0	2	0	0	2	2	0	4	0	6	0	4	0	0	4
+15 mins.	0	0	0	0	0	0	7	0	0	7	2	0	3	0	5	0	3	0	0	3
+30 mins.	0	0	0	0	0	0	3	1	0	4	2	0	0	0	2	0	4	0	0	4
+45 mins.	0	0	0	0	0	0	4	0	0	4	2	0	2	0	4	0	3	0	0	3
Total Volume	0	0	0	0	0	0	16	1	0	17	8	0	9	0	17	0	14	0	0	14
% App. Total	0	0	0	0	0	0	94.1	5.9	0		47.1	0	52.9	0		0	100	0	0	
PHF	.000	.000	.000	.000	.000	.000	.571	.250	.000	.607	1.000	.000	.563	.000	.708	.000	.875	.000	.000	.875

City of Madera
 N/S: SR-99 Northbound Ramps
 E/W: Cleveland Avenue
 Weather: Clear

File Name : 27_MDA_99N_Cleveland AM
 Site Code : 00319628
 Start Date : 9/24/2019
 Page No : 1

Groups Printed- 3 Axle Vehicles

Start Time	SR-99 Northbound On Ramp Southbound					Cleveland Avenue Westbound					SR-99 Northbound Off Ramp Northbound					Cleveland Avenue Eastbound					Int. Total	
	Left	Thru	Right	U-Turns	App. Total	Left	Thru	Right	U-Turns	App. Total	Left	Thru	Right	U-Turns	App. Total	Left	Thru	Right	U-Turns	App. Total		
07:00 AM	0	0	0	0	0	0	0	0	0	0	2	0	2	0	4	0	0	0	0	0	0	4
07:15 AM	0	0	0	0	0	0	1	1	0	2	1	0	0	0	1	0	0	0	0	0	0	3
07:30 AM	0	0	0	0	0	0	0	0	0	0	0	0	1	0	1	0	0	0	0	0	0	1
07:45 AM	0	0	0	0	0	0	1	0	0	1	0	0	0	0	0	0	1	0	0	0	1	2
Total	0	0	0	0	0	0	2	1	0	3	3	0	3	0	6	0	1	0	0	1	1	10
08:00 AM	0	0	0	0	0	0	0	0	0	0	0	0	0	0	0	0	2	0	0	2	2	2
08:15 AM	0	0	0	0	0	0	1	0	0	1	0	0	0	0	0	0	1	0	0	1	1	2
08:30 AM	0	0	0	0	0	0	0	0	0	0	0	0	0	0	0	0	0	0	0	0	0	0
08:45 AM	0	0	0	0	0	0	2	0	0	2	1	0	0	0	1	0	0	0	0	0	0	3
Total	0	0	0	0	0	0	3	0	0	3	1	0	0	0	1	0	3	0	0	3	3	7
Grand Total	0	0	0	0	0	0	5	1	0	6	4	0	3	0	7	0	4	0	0	4	4	17
Apprch %	0	0	0	0	0	0	83.3	16.7	0		57.1	0	42.9	0		0	100	0	0			
Total %	0	0	0	0	0	0	29.4	5.9	0	35.3	23.5	0	17.6	0	41.2	0	23.5	0	0	23.5		

Start Time	SR-99 Northbound On Ramp Southbound					Cleveland Avenue Westbound					SR-99 Northbound Off Ramp Northbound					Cleveland Avenue Eastbound					Int. Total	
	Left	Thru	Right	U-Turns	App. Total	Left	Thru	Right	U-Turns	App. Total	Left	Thru	Right	U-Turns	App. Total	Left	Thru	Right	U-Turns	App. Total		
Peak Hour Analysis From 07:30 AM to 08:15 AM - Peak 1 of 1																						
Peak Hour for Entire Intersection Begins at 07:30 AM																						
07:30 AM	0	0	0	0	0	0	0	0	0	0	0	0	1	0	1	0	0	0	0	0	0	1
07:45 AM	0	0	0	0	0	0	1	0	0	1	0	0	0	0	0	0	1	0	0	1	1	2
08:00 AM	0	0	0	0	0	0	0	0	0	0	0	0	0	0	0	0	2	0	0	2	2	2
08:15 AM	0	0	0	0	0	0	1	0	0	1	0	0	0	0	0	0	1	0	0	1	1	2
Total Volume	0	0	0	0	0	0	2	0	0	2	0	0	1	0	1	0	4	0	0	4	4	7
% App. Total	0	0	0	0	0	0	100	0	0		0	0	100	0		0	100	0	0			
PHF	.000	.000	.000	.000	.000	.000	.500	.000	.000	.500	.000	.000	.250	.000	.250	.000	.500	.000	.000	.500		.875

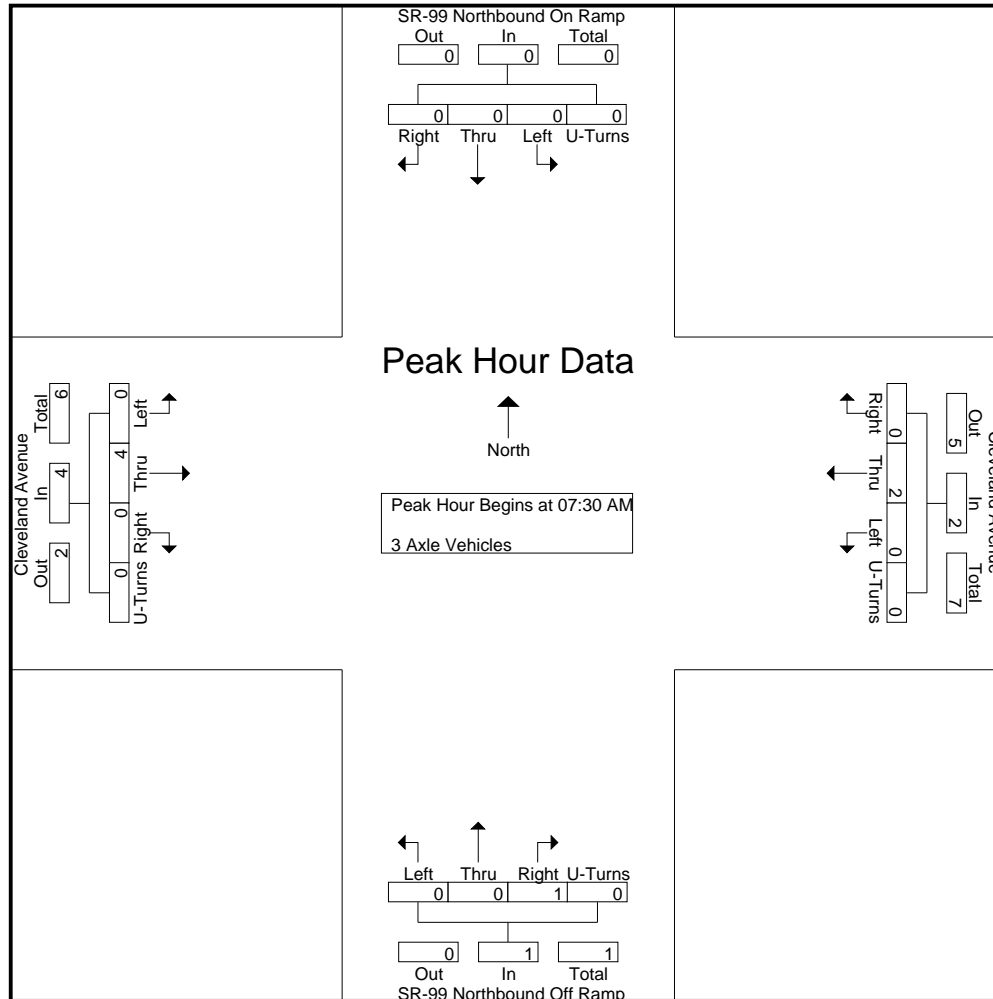

City of Madera
 N/S: SR-99 Northbound Ramps
 E/W: Cleveland Avenue
 Weather: Clear

File Name : 27_MDA_99N_Cleveland AM
 Site Code : 00319628
 Start Date : 9/24/2019
 Page No : 3

Start Time	SR-99 Northbound On Ramp Southbound					Cleveland Avenue Westbound					SR-99 Northbound Off Ramp Northbound					Cleveland Avenue Eastbound					Int. Total
	Left	Thru	Right	U-Turns	App. Total	Left	Thru	Right	U-Turns	App. Total	Left	Thru	Right	U-Turns	App. Total	Left	Thru	Right	U-Turns	App. Total	

Peak Hour Analysis From 07:30 AM to 08:15 AM - Peak 1 of 1
 Peak Hour for Each Approach Begins at:

	07:30 AM					07:30 AM					07:30 AM					07:30 AM									
+0 mins.	0	0	0	0	0	0	0	0	0	0	0	0	1	0	1	0	0	0	0	0	0	0	0	0	0
+15 mins.	0	0	0	0	0	0	1	0	0	1	0	0	0	0	0	0	1	0	0	1	0	1	0	0	1
+30 mins.	0	0	0	0	0	0	0	0	0	0	0	0	0	0	0	0	2	0	0	2	0	2	0	0	2
+45 mins.	0	0	0	0	0	0	1	0	0	1	0	0	0	0	0	0	1	0	0	1	0	1	0	0	1
Total Volume	0	0	0	0	0	0	2	0	0	2	0	0	1	0	1	0	4	0	0	4	0	4	0	0	4
% App. Total	0	0	0	0	0	0	100	0	0	100	0	0	100	0	100	0	100	0	0	100	0	100	0	0	100
PHF	.000	.000	.000	.000	.000	.000	.500	.000	.000	.500	.000	.000	.250	.000	.250	.000	.500	.000	.000	.500	.000	.500	.000	.000	.500

City of Madera
 N/S: SR-99 Northbound Ramps
 E/W: Cleveland Avenue
 Weather: Clear

File Name : 27_MDA_99N_Cleveland AM
 Site Code : 00319628
 Start Date : 9/24/2019
 Page No : 1

Groups Printed- 4+ Axle Trucks

Start Time	SR-99 Northbound On Ramp Southbound					Cleveland Avenue Westbound					SR-99 Northbound Off Ramp Northbound					Cleveland Avenue Eastbound					Int. Total
	Left	Thru	Right	U-Turns	App. Total	Left	Thru	Right	U-Turns	App. Total	Left	Thru	Right	U-Turns	App. Total	Left	Thru	Right	U-Turns	App. Total	
07:00 AM	0	0	0	0	0	0	0	2	0	2	0	0	0	0	0	1	1	0	0	2	4
07:15 AM	0	0	0	0	0	0	1	0	0	1	1	0	0	0	1	0	1	0	0	1	3
07:30 AM	0	0	0	0	0	0	1	0	0	1	0	0	1	0	1	0	1	0	0	1	3
07:45 AM	0	0	0	0	0	0	1	0	0	1	1	0	2	0	3	1	1	0	0	2	6
Total	0	0	0	0	0	0	3	2	0	5	2	0	3	0	5	2	4	0	0	6	16
08:00 AM	0	0	0	0	0	0	1	0	0	1	0	0	0	0	0	0	2	0	0	2	3
08:15 AM	0	0	0	0	0	0	1	0	0	1	0	0	0	0	0	1	0	0	0	1	2
08:30 AM	0	0	0	0	0	0	1	0	0	1	0	0	1	0	1	1	2	0	0	3	5
08:45 AM	0	0	0	0	0	0	1	1	0	2	0	0	1	0	1	0	1	0	0	1	4
Total	0	0	0	0	0	0	4	1	0	5	0	0	2	0	2	2	5	0	0	7	14
Grand Total	0	0	0	0	0	0	7	3	0	10	2	0	5	0	7	4	9	0	0	13	30
Apprch %	0	0	0	0	0	0	70	30	0		28.6	0	71.4	0		30.8	69.2	0	0		
Total %	0	0	0	0	0	0	23.3	10	0	33.3	6.7	0	16.7	0	23.3	13.3	30	0	0	43.3	

Start Time	SR-99 Northbound On Ramp Southbound					Cleveland Avenue Westbound					SR-99 Northbound Off Ramp Northbound					Cleveland Avenue Eastbound					Int. Total
	Left	Thru	Right	U-Turns	App. Total	Left	Thru	Right	U-Turns	App. Total	Left	Thru	Right	U-Turns	App. Total	Left	Thru	Right	U-Turns	App. Total	
Peak Hour Analysis From 07:30 AM to 08:15 AM - Peak 1 of 1																					
Peak Hour for Entire Intersection Begins at 07:30 AM																					
07:30 AM	0	0	0	0	0	0	1	0	0	1	0	0	1	0	1	0	1	0	0	1	3
07:45 AM	0	0	0	0	0	0	1	0	0	1	1	0	2	0	3	1	1	0	0	2	6
08:00 AM	0	0	0	0	0	0	1	0	0	1	0	0	0	0	0	0	2	0	0	2	3
08:15 AM	0	0	0	0	0	0	1	0	0	1	0	0	0	0	0	1	0	0	0	1	2
Total Volume	0	0	0	0	0	0	4	0	0	4	1	0	3	0	4	2	4	0	0	6	14
% App. Total	0	0	0	0	0	0	100	0	0		25	0	75	0		33.3	66.7	0	0		
PHF	.000	.000	.000	.000	.000	.000	1.00	.000	.000	1.00	.250	.000	.375	.000	.333	.500	.500	.000	.000	.750	.583

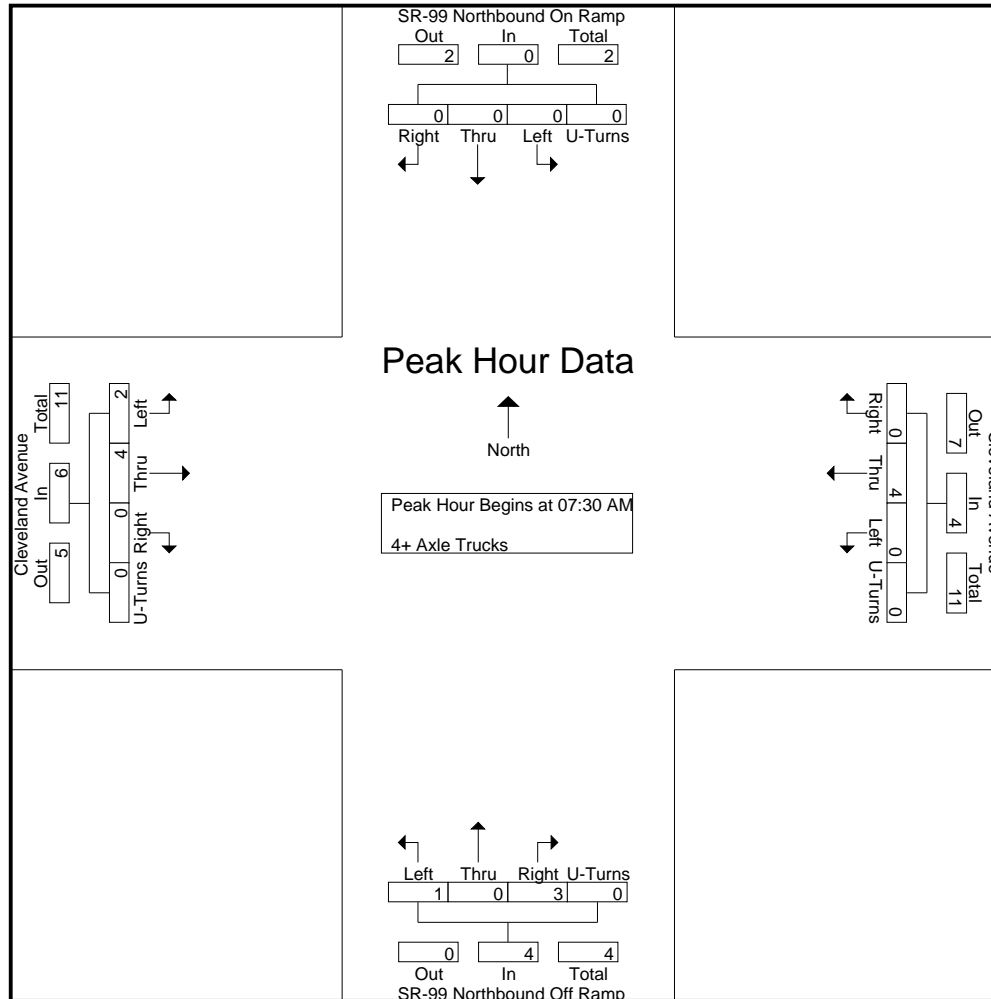

City of Madera
 N/S: SR-99 Northbound Ramps
 E/W: Cleveland Avenue
 Weather: Clear

File Name : 27_MDA_99N_Cleveland AM
 Site Code : 00319628
 Start Date : 9/24/2019
 Page No : 3

Start Time	SR-99 Northbound On Ramp Southbound					Cleveland Avenue Westbound					SR-99 Northbound Off Ramp Northbound					Cleveland Avenue Eastbound					Int. Total
	Left	Thru	Right	U-Turns	App. Total	Left	Thru	Right	U-Turns	App. Total	Left	Thru	Right	U-Turns	App. Total	Left	Thru	Right	U-Turns	App. Total	

Peak Hour Analysis From 07:30 AM to 08:15 AM - Peak 1 of 1
 Peak Hour for Each Approach Begins at:

	07:30 AM					07:30 AM					07:30 AM					07:30 AM				
+0 mins.	0	0	0	0	0	0	1	0	0	1	0	0	1	0	1	0	1	0	0	1
+15 mins.	0	0	0	0	0	0	1	0	0	1	1	0	2	0	3	1	1	0	0	2
+30 mins.	0	0	0	0	0	0	1	0	0	1	0	0	0	0	0	0	2	0	0	2
+45 mins.	0	0	0	0	0	0	1	0	0	1	0	0	0	0	0	1	0	0	0	1
Total Volume	0	0	0	0	0	0	4	0	0	4	1	0	3	0	4	2	4	0	0	6
% App. Total	0	0	0	0	0	0	100	0	0	100	25	0	75	0	100	33.3	66.7	0	0	100
PHF	.000	.000	.000	.000	.000	.000	1.000	.000	.000	1.000	.250	.000	.375	.000	.333	.500	.500	.000	.000	.750

City of Madera
 N/S: SR-99 Northbound Ramps
 E/W: Cleveland Avenue
 Weather: Clear

File Name : 27_MDA_99N_Cleveland PM
 Site Code : 00319628
 Start Date : 9/24/2019
 Page No : 1

Groups Printed- Passenger Vehicles - Large 2 Axle Vehicles - 3 Axle Vehicles - 4+ Axle Trucks

Start Time	SR-99 Northbound On Ramp Southbound					Cleveland Avenue Westbound					SR-99 Northbound Off Ramp Northbound					Cleveland Avenue Eastbound					Int. Total
	Left	Thru	Right	U-Turns	App. Total	Left	Thru	Right	U-Turns	App. Total	Left	Thru	Right	U-Turns	App. Total	Left	Thru	Right	U-Turns	App. Total	
04:00 PM	0	0	0	0	0	0	158	13	0	171	60	0	75	0	135	8	137	0	0	145	451
04:15 PM	0	0	0	0	0	0	185	19	0	204	93	0	80	0	173	9	148	0	0	157	534
04:30 PM	0	0	0	0	0	0	179	12	0	191	78	0	71	0	149	17	176	0	0	193	533
04:45 PM	0	0	0	0	0	0	219	14	0	233	91	0	58	0	149	15	167	0	0	182	564
Total	0	0	0	0	0	0	741	58	0	799	322	0	284	0	606	49	628	0	0	677	2082
05:00 PM	0	0	0	0	0	0	199	15	0	214	114	0	81	0	195	23	195	0	0	218	627
05:15 PM	0	0	0	0	0	0	222	17	0	239	93	0	74	0	167	13	177	0	0	190	596
05:30 PM	0	0	0	0	0	0	186	19	0	205	119	5	52	0	176	19	197	0	1	217	598
05:45 PM	0	0	0	0	0	0	175	15	0	190	69	2	71	0	142	14	147	0	0	161	493
Total	0	0	0	0	0	0	782	66	0	848	395	7	278	0	680	69	716	0	1	786	2314
Grand Total	0	0	0	0	0	0	1523	124	0	1647	717	7	562	0	1286	118	1344	0	1	1463	4396
Apprch %	0	0	0	0	0	0	92.5	7.5	0		55.8	0.5	43.7	0		8.1	91.9	0	0.1		
Total %	0	0	0	0	0	0	34.6	2.8	0	37.5	16.3	0.2	12.8	0	29.3	2.7	30.6	0	0	33.3	
Passenger Vehicles	0	0	0	0	0	0	1515	116	0	1631	714	7	555	0	1276	116	1332	0	1	1449	4356
% Passenger Vehicles	0	0	0	0	0	0	99.5	93.5	0	99	99.6	100	98.8	0	99.2	98.3	99.1	0	100	99	99.1
Large 2 Axle Vehicles	0	0	0	0	0	0	7	4	0	11	2	0	3	0	5	1	11	0	0	12	28
% Large 2 Axle Vehicles	0	0	0	0	0	0	0.5	3.2	0	0.7	0.3	0	0.5	0	0.4	0.8	0.8	0	0	0.8	0.6
3 Axle Vehicles	0	0	0	0	0	0	0	2	0	2	0	0	1	0	1	0	0	0	0	0	3
% 3 Axle Vehicles	0	0	0	0	0	0	0	1.6	0	0.1	0	0	0.2	0	0.1	0	0	0	0	0	0.1
4+ Axle Trucks	0	0	0	0	0	0	1	2	0	3	1	0	3	0	4	1	1	0	0	2	9
% 4+ Axle Trucks	0	0	0	0	0	0	0.1	1.6	0	0.2	0.1	0	0.5	0	0.3	0.8	0.1	0	0	0.1	0.2

Start Time	SR-99 Northbound On Ramp Southbound					Cleveland Avenue Westbound					SR-99 Northbound Off Ramp Northbound					Cleveland Avenue Eastbound					Int. Total
	Left	Thru	Right	U-Turns	App. Total	Left	Thru	Right	U-Turns	App. Total	Left	Thru	Right	U-Turns	App. Total	Left	Thru	Right	U-Turns	App. Total	
Peak Hour Analysis From 04:00 PM to 05:45 PM - Peak 1 of 1																					
Peak Hour for Entire Intersection Begins at 04:45 PM																					
04:45 PM	0	0	0	0	0	0	219	14	0	233	91	0	58	0	149	15	167	0	0	182	564
05:00 PM	0	0	0	0	0	0	199	15	0	214	114	0	81	0	195	23	195	0	0	218	627
05:15 PM	0	0	0	0	0	0	222	17	0	239	93	0	74	0	167	13	177	0	0	190	596
05:30 PM	0	0	0	0	0	0	186	19	0	205	119	5	52	0	176	19	197	0	1	217	598
Total Volume	0	0	0	0	0	0	826	65	0	891	417	5	265	0	687	70	736	0	1	807	2385
% App. Total	0	0	0	0	0	0	92.7	7.3	0		60.7	0.7	38.6	0		8.7	91.2	0	0.1		
PHF	.000	.000	.000	.000	.000	.000	.930	.855	.000	.932	.876	.250	.818	.000	.881	.761	.934	.000	.250	.925	.951

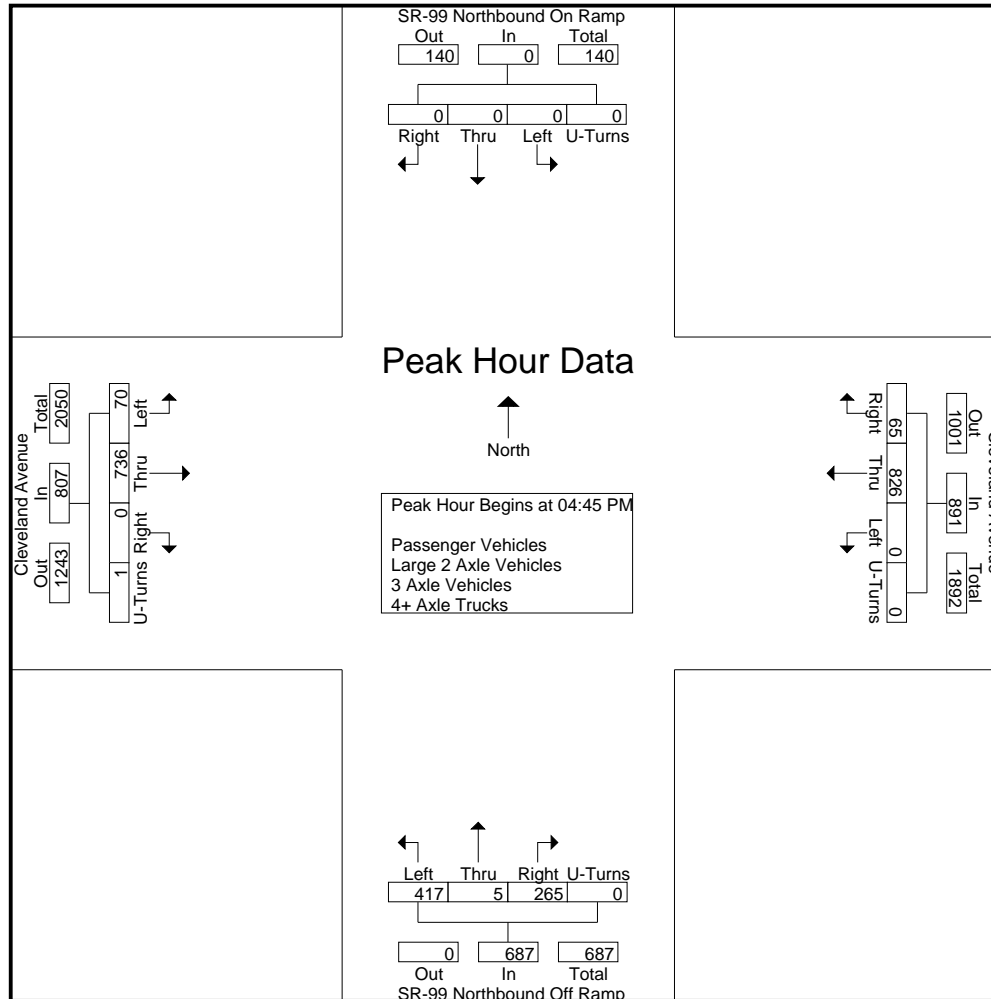

Counts Unlimited
 PO Box 1178
 Corona, CA 92878
 (951) 268-6268

City of Madera
 N/S: SR-99 Northbound Ramps
 E/W: Cleveland Avenue
 Weather: Clear

File Name : 27_MDA_99N_Cleveland PM
 Site Code : 00319628
 Start Date : 9/24/2019
 Page No : 3

Start Time	SR-99 Northbound On Ramp Southbound					Cleveland Avenue Westbound					SR-99 Northbound Off Ramp Northbound					Cleveland Avenue Eastbound					Int. Total
	Left	Thru	Right	U-Turns	App. Total	Left	Thru	Right	U-Turns	App. Total	Left	Thru	Right	U-Turns	App. Total	Left	Thru	Right	U-Turns	App. Total	

Peak Hour Analysis From 04:00 PM to 05:45 PM - Peak 1 of 1
 Peak Hour for Each Approach Begins at:

	04:00 PM					04:45 PM					04:45 PM					04:45 PM				
+0 mins.	0	0	0	0	0	0	219	14	0	233	91	0	58	0	149	15	167	0	0	182
+15 mins.	0	0	0	0	0	0	199	15	0	214	114	0	81	0	195	23	195	0	0	218
+30 mins.	0	0	0	0	0	0	222	17	0	239	93	0	74	0	167	13	177	0	0	190
+45 mins.	0	0	0	0	0	0	186	19	0	205	119	5	52	0	176	19	197	0	1	217
Total Volume	0	0	0	0	0	0	826	65	0	891	417	5	265	0	687	70	736	0	1	807
% App. Total	0	0	0	0	0	0	92.7	7.3	0		60.7	0.7	38.6	0		8.7	91.2	0	0.1	
PHF	.000	.000	.000	.000	.000	.000	.930	.855	.000	.932	.876	.250	.818	.000	.881	.761	.934	.000	.250	.925

City of Madera
 N/S: SR-99 Northbound Ramps
 E/W: Cleveland Avenue
 Weather: Clear

File Name : 27_MDA_99N_Cleveland PM
 Site Code : 00319628
 Start Date : 9/24/2019
 Page No : 1

Groups Printed- Passenger Vehicles

Start Time	SR-99 Northbound On Ramp Southbound					Cleveland Avenue Westbound					SR-99 Northbound Off Ramp Northbound					Cleveland Avenue Eastbound					Int. Total
	Left	Thru	Right	U-Turns	App. Total	Left	Thru	Right	U-Turns	App. Total	Left	Thru	Right	U-Turns	App. Total	Left	Thru	Right	U-Turns	App. Total	
04:00 PM	0	0	0	0	0	0	158	12	0	170	60	0	75	0	135	8	137	0	0	145	450
04:15 PM	0	0	0	0	0	0	185	19	0	204	93	0	80	0	173	9	148	0	0	157	534
04:30 PM	0	0	0	0	0	0	179	12	0	191	78	0	71	0	149	17	176	0	0	193	533
04:45 PM	0	0	0	0	0	0	219	13	0	232	91	0	58	0	149	15	167	0	0	182	563
Total	0	0	0	0	0	0	741	56	0	797	322	0	284	0	606	49	628	0	0	677	2080
05:00 PM	0	0	0	0	0	0	197	14	0	211	114	0	77	0	191	23	192	0	0	215	617
05:15 PM	0	0	0	0	0	0	220	17	0	237	91	0	73	0	164	12	173	0	0	185	586
05:30 PM	0	0	0	0	0	0	185	15	0	200	119	5	52	0	176	18	195	0	1	214	590
05:45 PM	0	0	0	0	0	0	172	14	0	186	68	2	69	0	139	14	144	0	0	158	483
Total	0	0	0	0	0	0	774	60	0	834	392	7	271	0	670	67	704	0	1	772	2276
Grand Total	0	0	0	0	0	0	1515	116	0	1631	714	7	555	0	1276	116	1332	0	1	1449	4356
Apprch %	0	0	0	0	0	0	92.9	7.1	0	37.4	56	0.5	43.5	0	29.3	8	91.9	0	0.1	33.3	
Total %	0	0	0	0	0	0	34.8	2.7	0	37.4	16.4	0.2	12.7	0	29.3	2.7	30.6	0	0	33.3	

Start Time	SR-99 Northbound On Ramp Southbound					Cleveland Avenue Westbound					SR-99 Northbound Off Ramp Northbound					Cleveland Avenue Eastbound					Int. Total
	Left	Thru	Right	U-Turns	App. Total	Left	Thru	Right	U-Turns	App. Total	Left	Thru	Right	U-Turns	App. Total	Left	Thru	Right	U-Turns	App. Total	
Peak Hour Analysis From 04:45 PM to 05:30 PM - Peak 1 of 1																					
Peak Hour for Entire Intersection Begins at 04:45 PM																					
04:45 PM	0	0	0	0	0	0	219	13	0	232	91	0	58	0	149	15	167	0	0	182	563
05:00 PM	0	0	0	0	0	0	197	14	0	211	114	0	77	0	191	23	192	0	0	215	617
05:15 PM	0	0	0	0	0	0	220	17	0	237	91	0	73	0	164	12	173	0	0	185	586
05:30 PM	0	0	0	0	0	0	185	15	0	200	119	5	52	0	176	18	195	0	1	214	590
Total Volume	0	0	0	0	0	0	821	59	0	880	415	5	260	0	680	68	727	0	1	796	2356
% App. Total	0	0	0	0	0	0	93.3	6.7	0	37.4	61	0.7	38.2	0	29.3	8.5	91.3	0	0.1	33.3	
PHF	.000	.000	.000	.000	.000	.000	.933	.868	.000	.928	.872	.250	.844	.000	.890	.739	.932	.000	.250	.926	.955

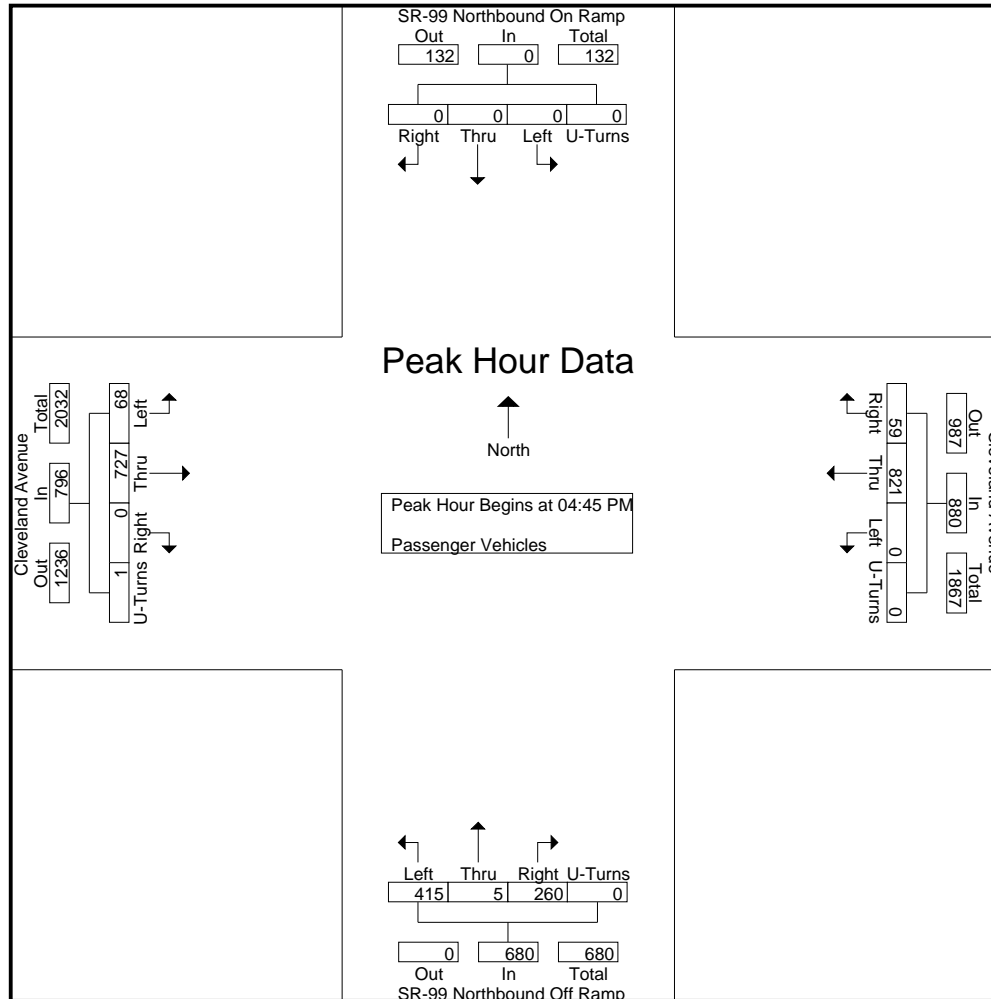

Counts Unlimited
 PO Box 1178
 Corona, CA 92878
 (951) 268-6268

City of Madera
 N/S: SR-99 Northbound Ramps
 E/W: Cleveland Avenue
 Weather: Clear

File Name : 27_MDA_99N_Cleveland PM
 Site Code : 00319628
 Start Date : 9/24/2019
 Page No : 3

Start Time	SR-99 Northbound On Ramp Southbound					Cleveland Avenue Westbound					SR-99 Northbound Off Ramp Northbound					Cleveland Avenue Eastbound					Int. Total
	Left	Thru	Right	U-Turns	App. Total	Left	Thru	Right	U-Turns	App. Total	Left	Thru	Right	U-Turns	App. Total	Left	Thru	Right	U-Turns	App. Total	

Peak Hour Analysis From 04:45 PM to 05:30 PM - Peak 1 of 1
 Peak Hour for Each Approach Begins at:

	04:45 PM					04:45 PM					04:45 PM					04:45 PM				
+0 mins.	0	0	0	0	0	0	219	13	0	232	91	0	58	0	149	15	167	0	0	182
+15 mins.	0	0	0	0	0	0	197	14	0	211	114	0	77	0	191	23	192	0	0	215
+30 mins.	0	0	0	0	0	0	220	17	0	237	91	0	73	0	164	12	173	0	0	185
+45 mins.	0	0	0	0	0	0	185	15	0	200	119	5	52	0	176	18	195	0	1	214
Total Volume	0	0	0	0	0	0	821	59	0	880	415	5	260	0	680	68	727	0	1	796
% App. Total	0	0	0	0	0	0	93.3	6.7	0		61	0.7	38.2	0		8.5	91.3	0	0.1	
PHF	.000	.000	.000	.000	.000	.000	.933	.868	.000	.928	.872	.250	.844	.000	.890	.739	.932	.000	.250	.926

City of Madera
 N/S: SR-99 Northbound Ramps
 E/W: Cleveland Avenue
 Weather: Clear

File Name : 27_MDA_99N_Cleveland PM
 Site Code : 00319628
 Start Date : 9/24/2019
 Page No : 1

Groups Printed- Large 2 Axle Vehicles

Start Time	SR-99 Northbound On Ramp Southbound					Cleveland Avenue Westbound					SR-99 Northbound Off Ramp Northbound					Cleveland Avenue Eastbound					Int. Total
	Left	Thru	Right	U-Turns	App. Total	Left	Thru	Right	U-Turns	App. Total	Left	Thru	Right	U-Turns	App. Total	Left	Thru	Right	U-Turns	App. Total	
04:00 PM	0	0	0	0	0	0	0	0	0	0	0	0	0	0	0	0	0	0	0	0	0
04:15 PM	0	0	0	0	0	0	0	0	0	0	0	0	0	0	0	0	0	0	0	0	0
04:30 PM	0	0	0	0	0	0	0	0	0	0	0	0	0	0	0	0	0	0	0	0	0
04:45 PM	0	0	0	0	0	0	0	0	0	0	0	0	0	0	0	0	0	0	0	0	0
Total	0	0	0	0	0	0	0	0	0	0	0	0	0	0	0	0	0	0	0	0	0
05:00 PM	0	0	0	0	0	0	2	1	0	3	0	0	2	0	2	0	3	0	0	3	8
05:15 PM	0	0	0	0	0	0	1	0	0	1	1	0	0	0	1	1	3	0	0	4	6
05:30 PM	0	0	0	0	0	0	1	2	0	3	0	0	0	0	0	0	2	0	0	2	5
05:45 PM	0	0	0	0	0	0	3	1	0	4	1	0	1	0	2	0	3	0	0	3	9
Total	0	0	0	0	0	0	7	4	0	11	2	0	3	0	5	1	11	0	0	12	28
Grand Total	0	0	0	0	0	0	7	4	0	11	2	0	3	0	5	1	11	0	0	12	28
Apprch %	0	0	0	0	0	0	63.6	36.4	0	39.3	40	0	60	0	17.9	8.3	91.7	0	0	42.9	
Total %	0	0	0	0	0	0	25	14.3	0	39.3	7.1	0	10.7	0	17.9	3.6	39.3	0	0	42.9	

Start Time	SR-99 Northbound On Ramp Southbound					Cleveland Avenue Westbound					SR-99 Northbound Off Ramp Northbound					Cleveland Avenue Eastbound					Int. Total
	Left	Thru	Right	U-Turns	App. Total	Left	Thru	Right	U-Turns	App. Total	Left	Thru	Right	U-Turns	App. Total	Left	Thru	Right	U-Turns	App. Total	
Peak Hour Analysis From 04:45 PM to 05:30 PM - Peak 1 of 1																					
Peak Hour for Entire Intersection Begins at 04:45 PM																					
04:45 PM	0	0	0	0	0	0	0	0	0	0	0	0	0	0	0	0	0	0	0	0	0
05:00 PM	0	0	0	0	0	0	2	1	0	3	0	0	2	0	2	0	3	0	0	3	8
05:15 PM	0	0	0	0	0	0	1	0	0	1	1	0	0	0	1	1	3	0	0	4	6
05:30 PM	0	0	0	0	0	0	1	2	0	3	0	0	0	0	0	0	2	0	0	2	5
Total Volume	0	0	0	0	0	0	4	3	0	7	1	0	2	0	3	1	8	0	0	9	19
% App. Total	0	0	0	0	0	0	57.1	42.9	0	39.3	33.3	0	66.7	0	17.9	11.1	88.9	0	0	42.9	
PHF	.000	.000	.000	.000	.000	.000	.500	.375	.000	.583	.250	.000	.250	.000	.375	.250	.667	.000	.000	.563	.594

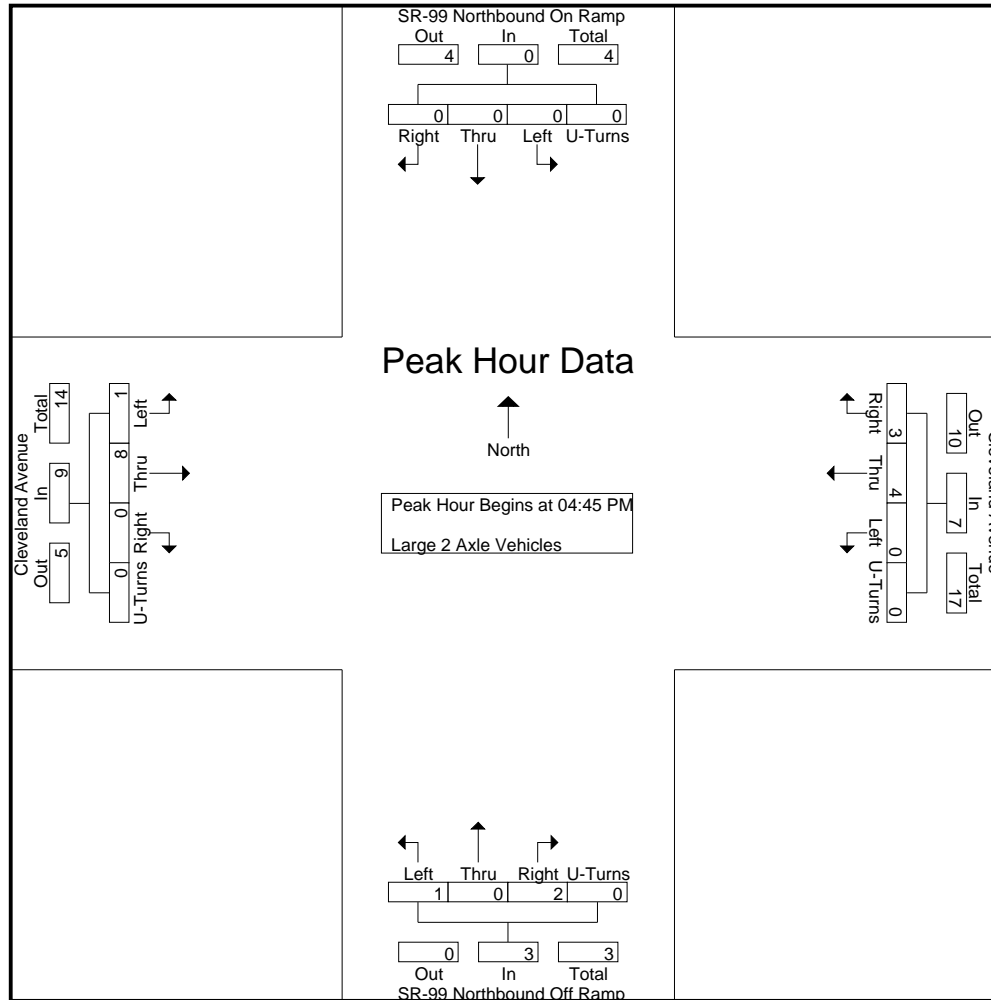

City of Madera
 N/S: SR-99 Northbound Ramps
 E/W: Cleveland Avenue
 Weather: Clear

File Name : 27_MDA_99N_Cleveland PM
 Site Code : 00319628
 Start Date : 9/24/2019
 Page No : 3

Start Time	SR-99 Northbound On Ramp Southbound					Cleveland Avenue Westbound					SR-99 Northbound Off Ramp Northbound					Cleveland Avenue Eastbound					Int. Total
	Left	Thru	Right	U-Turns	App. Total	Left	Thru	Right	U-Turns	App. Total	Left	Thru	Right	U-Turns	App. Total	Left	Thru	Right	U-Turns	App. Total	

Peak Hour Analysis From 04:45 PM to 05:30 PM - Peak 1 of 1
 Peak Hour for Each Approach Begins at:

	04:45 PM					04:45 PM					04:45 PM					04:45 PM									
+0 mins.	0	0	0	0	0	0	0	0	0	0	0	0	0	0	0	0	0	0	0	0	0	0	0	0	0
+15 mins.	0	0	0	0	0	0	2	1	0	3	0	0	2	0	2	0	3	0	0	3	0	3	0	0	3
+30 mins.	0	0	0	0	0	0	1	0	0	1	1	0	0	0	1	1	3	0	0	4	1	3	0	0	4
+45 mins.	0	0	0	0	0	0	1	2	0	3	0	0	0	0	0	0	2	0	0	2	0	2	0	0	2
Total Volume	0	0	0	0	0	0	4	3	0	7	1	0	2	0	3	1	8	0	0	9	1	8	0	0	9
% App. Total	0	0	0	0	0	0	57.1	42.9	0		33.3	0	66.7	0		11.1	88.9	0	0		11.1	88.9	0	0	
PHF	.000	.000	.000	.000	.000	.000	.500	.375	.000	.583	.250	.000	.250	.000	.375	.250	.667	.000	.000	.563	.250	.667	.000	.000	.563

City of Madera
 N/S: SR-99 Northbound Ramps
 E/W: Cleveland Avenue
 Weather: Clear

File Name : 27_MDA_99N_Cleveland PM
 Site Code : 00319628
 Start Date : 9/24/2019
 Page No : 1

Groups Printed- 3 Axle Vehicles

Start Time	SR-99 Northbound On Ramp Southbound					Cleveland Avenue Westbound					SR-99 Northbound Off Ramp Northbound					Cleveland Avenue Eastbound					Int. Total
	Left	Thru	Right	U-Turns	App. Total	Left	Thru	Right	U-Turns	App. Total	Left	Thru	Right	U-Turns	App. Total	Left	Thru	Right	U-Turns	App. Total	
04:00 PM	0	0	0	0	0	0	0	1	0	1	0	0	0	0	0	0	0	0	0	0	0
04:15 PM	0	0	0	0	0	0	0	0	0	0	0	0	0	0	0	0	0	0	0	0	0
04:30 PM	0	0	0	0	0	0	0	0	0	0	0	0	0	0	0	0	0	0	0	0	0
04:45 PM	0	0	0	0	0	0	0	1	0	1	0	0	0	0	0	0	0	0	0	0	0
Total	0	0	0	0	0	0	0	2	0	2	0	0	0	0	0	0	0	0	0	0	2
05:00 PM	0	0	0	0	0	0	0	0	0	0	0	0	0	0	0	0	0	0	0	0	0
05:15 PM	0	0	0	0	0	0	0	0	0	0	0	0	0	0	0	0	0	0	0	0	0
05:30 PM	0	0	0	0	0	0	0	0	0	0	0	0	0	0	0	0	0	0	0	0	0
05:45 PM	0	0	0	0	0	0	0	0	0	0	0	0	1	0	1	0	0	0	0	0	0
Total	0	0	0	0	0	0	0	0	0	0	0	0	1	0	1	0	0	0	0	0	1
Grand Total	0	0	0	0	0	0	0	2	0	2	0	0	1	0	1	0	0	0	0	0	3
Apprch %	0	0	0	0	0	0	0	100	0	0	0	0	100	0	0	0	0	0	0	0	
Total %	0	0	0	0	0	0	0	66.7	0	66.7	0	0	33.3	0	33.3	0	0	0	0	0	

Start Time	SR-99 Northbound On Ramp Southbound					Cleveland Avenue Westbound					SR-99 Northbound Off Ramp Northbound					Cleveland Avenue Eastbound					Int. Total
	Left	Thru	Right	U-Turns	App. Total	Left	Thru	Right	U-Turns	App. Total	Left	Thru	Right	U-Turns	App. Total	Left	Thru	Right	U-Turns	App. Total	
Peak Hour Analysis From 04:45 PM to 05:30 PM - Peak 1 of 1																					
Peak Hour for Entire Intersection Begins at 04:45 PM																					
04:45 PM	0	0	0	0	0	0	0	1	0	1	0	0	0	0	0	0	0	0	0	0	1
05:00 PM	0	0	0	0	0	0	0	0	0	0	0	0	0	0	0	0	0	0	0	0	0
05:15 PM	0	0	0	0	0	0	0	0	0	0	0	0	0	0	0	0	0	0	0	0	0
05:30 PM	0	0	0	0	0	0	0	0	0	0	0	0	0	0	0	0	0	0	0	0	0
Total Volume	0	0	0	0	0	0	0	1	0	1	0	0	0	0	0	0	0	0	0	0	1
% App. Total	0	0	0	0	0	0	0	100	0	0	0	0	0	0	0	0	0	0	0	0	
PHF	.000	.000	.000	.000	.000	.000	.000	.250	.000	.250	.000	.000	.000	.000	.000	.000	.000	.000	.000	.000	.250

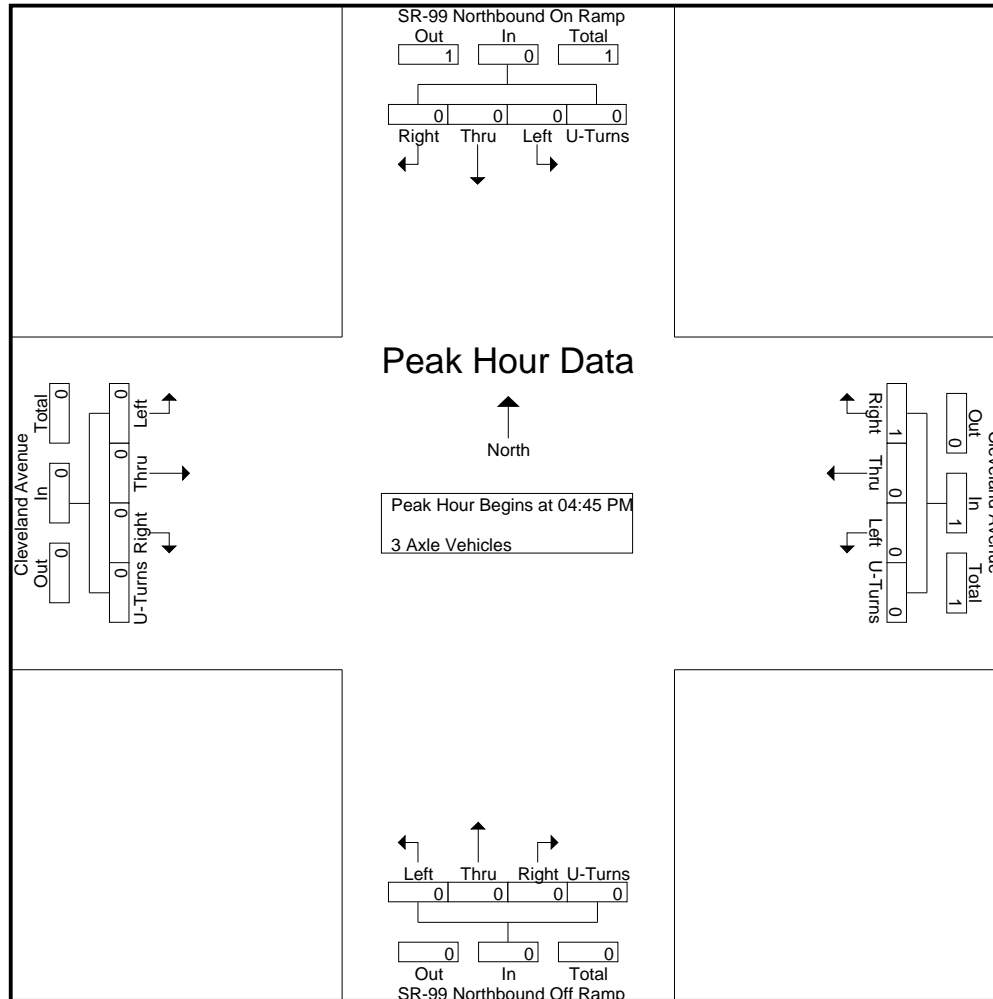

City of Madera
 N/S: SR-99 Northbound Ramps
 E/W: Cleveland Avenue
 Weather: Clear

File Name : 27_MDA_99N_Cleveland PM
 Site Code : 00319628
 Start Date : 9/24/2019
 Page No : 3

Start Time	SR-99 Northbound On Ramp Southbound					Cleveland Avenue Westbound					SR-99 Northbound Off Ramp Northbound					Cleveland Avenue Eastbound					Int. Total
	Left	Thru	Right	U-Turns	App. Total	Left	Thru	Right	U-Turns	App. Total	Left	Thru	Right	U-Turns	App. Total	Left	Thru	Right	U-Turns	App. Total	

Peak Hour Analysis From 04:45 PM to 05:30 PM - Peak 1 of 1
 Peak Hour for Each Approach Begins at:

	04:45 PM					04:45 PM					04:45 PM					04:45 PM				
+0 mins.	0	0	0	0	0	0	0	1	0	1	0	0	0	0	0	0	0	0	0	0
+15 mins.	0	0	0	0	0	0	0	0	0	0	0	0	0	0	0	0	0	0	0	0
+30 mins.	0	0	0	0	0	0	0	0	0	0	0	0	0	0	0	0	0	0	0	0
+45 mins.	0	0	0	0	0	0	0	0	0	0	0	0	0	0	0	0	0	0	0	0
Total Volume	0	0	0	0	0	0	0	1	0	1	0	0	0	0	0	0	0	0	0	0
% App. Total	0	0	0	0	0	0	0	100	0	0	0	0	0	0	0	0	0	0	0	0
PHF	.000	.000	.000	.000	.000	.000	.000	.250	.000	.250	.000	.000	.000	.000	.000	.000	.000	.000	.000	.000

City of Madera
 N/S: SR-99 Northbound Ramps
 E/W: Cleveland Avenue
 Weather: Clear

File Name : 27_MDA_99N_Cleveland PM
 Site Code : 00319628
 Start Date : 9/24/2019
 Page No : 1

Groups Printed- 4+ Axle Trucks

Start Time	SR-99 Northbound On Ramp Southbound					Cleveland Avenue Westbound					SR-99 Northbound Off Ramp Northbound					Cleveland Avenue Eastbound					Int. Total
	Left	Thru	Right	U-Turns	App. Total	Left	Thru	Right	U-Turns	App. Total	Left	Thru	Right	U-Turns	App. Total	Left	Thru	Right	U-Turns	App. Total	
04:00 PM	0	0	0	0	0	0	0	0	0	0	0	0	0	0	0	0	0	0	0	0	0
04:15 PM	0	0	0	0	0	0	0	0	0	0	0	0	0	0	0	0	0	0	0	0	0
04:30 PM	0	0	0	0	0	0	0	0	0	0	0	0	0	0	0	0	0	0	0	0	0
04:45 PM	0	0	0	0	0	0	0	0	0	0	0	0	0	0	0	0	0	0	0	0	0
Total	0	0	0	0	0	0	0	0	0	0	0	0	0	0	0	0	0	0	0	0	0
05:00 PM	0	0	0	0	0	0	0	0	0	0	0	0	2	0	2	0	0	0	0	0	2
05:15 PM	0	0	0	0	0	0	1	0	0	1	1	0	1	0	2	0	1	0	0	1	4
05:30 PM	0	0	0	0	0	0	0	2	0	2	0	0	0	0	0	1	0	0	0	1	3
05:45 PM	0	0	0	0	0	0	0	0	0	0	0	0	0	0	0	0	0	0	0	0	0
Total	0	0	0	0	0	0	1	2	0	3	1	0	3	0	4	1	1	0	0	2	9
Grand Total	0	0	0	0	0	0	1	2	0	3	1	0	3	0	4	1	1	0	0	2	9
Apprch %	0	0	0	0	0	0	33.3	66.7	0	33.3	25	0	75	0	44.4	50	50	0	0	22.2	
Total %	0	0	0	0	0	0	11.1	22.2	0	33.3	11.1	0	33.3	0	44.4	11.1	11.1	0	0	22.2	

Start Time	SR-99 Northbound On Ramp Southbound					Cleveland Avenue Westbound					SR-99 Northbound Off Ramp Northbound					Cleveland Avenue Eastbound					Int. Total
	Left	Thru	Right	U-Turns	App. Total	Left	Thru	Right	U-Turns	App. Total	Left	Thru	Right	U-Turns	App. Total	Left	Thru	Right	U-Turns	App. Total	
Peak Hour Analysis From 04:45 PM to 05:30 PM - Peak 1 of 1																					
Peak Hour for Entire Intersection Begins at 04:45 PM																					
04:45 PM	0	0	0	0	0	0	0	0	0	0	0	0	0	0	0	0	0	0	0	0	0
05:00 PM	0	0	0	0	0	0	0	0	0	0	0	0	2	0	2	0	0	0	0	0	2
05:15 PM	0	0	0	0	0	0	1	0	0	1	1	0	1	0	2	0	1	0	0	1	4
05:30 PM	0	0	0	0	0	0	0	2	0	2	0	0	0	0	0	1	0	0	0	1	3
Total Volume	0	0	0	0	0	0	1	2	0	3	1	0	3	0	4	1	1	0	0	2	9
% App. Total	0	0	0	0	0	0	33.3	66.7	0	33.3	25	0	75	0	44.4	50	50	0	0	22.2	
PHF	.000	.000	.000	.000	.000	.000	.250	.250	.000	.375	.250	.000	.375	.000	.500	.250	.250	.000	.000	.500	.563

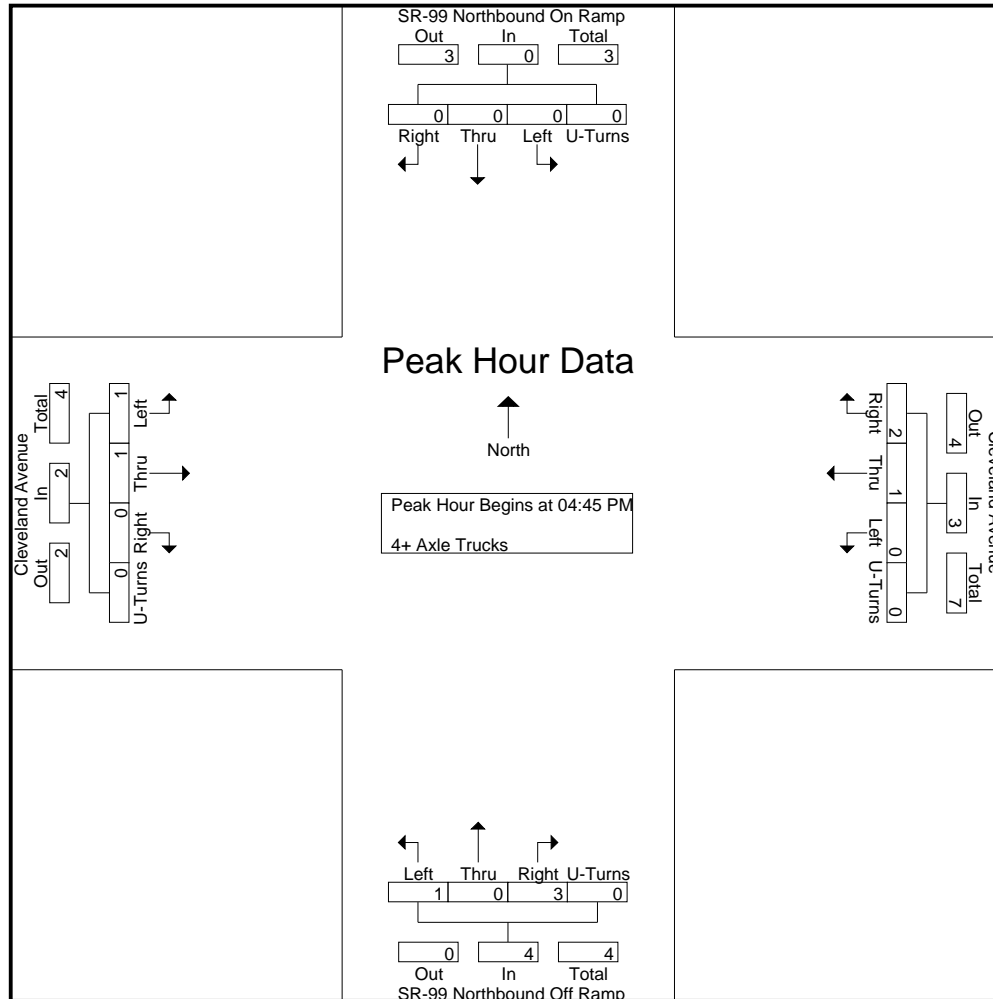

Counts Unlimited
 PO Box 1178
 Corona, CA 92878
 (951) 268-6268

City of Madera
 N/S: SR-99 Northbound Ramps
 E/W: Cleveland Avenue
 Weather: Clear

File Name : 27_MDA_99N_Cleveland PM
 Site Code : 00319628
 Start Date : 9/24/2019
 Page No : 3

Start Time	SR-99 Northbound On Ramp Southbound					Cleveland Avenue Westbound					SR-99 Northbound Off Ramp Northbound					Cleveland Avenue Eastbound					Int. Total
	Left	Thru	Right	U-Turns	App. Total	Left	Thru	Right	U-Turns	App. Total	Left	Thru	Right	U-Turns	App. Total	Left	Thru	Right	U-Turns	App. Total	

Peak Hour Analysis From 04:45 PM to 05:30 PM - Peak 1 of 1
 Peak Hour for Each Approach Begins at:

	04:45 PM					04:45 PM					04:45 PM					04:45 PM									
+0 mins.	0	0	0	0	0	0	0	0	0	0	0	0	0	0	0	0	0	0	0	0	0	0	0	0	0
+15 mins.	0	0	0	0	0	0	0	0	0	0	0	0	2	0	2	0	0	0	0	0	0	0	0	0	0
+30 mins.	0	0	0	0	0	0	1	0	0	1	1	0	1	0	2	0	1	0	0	1	0	1	0	0	1
+45 mins.	0	0	0	0	0	0	0	2	0	2	0	0	0	0	0	1	0	0	0	1	0	0	0	0	0
Total Volume	0	0	0	0	0	0	1	2	0	3	1	0	3	0	4	1	1	0	0	2	0	0	0	0	0
% App. Total	0	0	0	0	0	0	33.3	66.7	0	37.5	25	0	75	0	50	50	50	0	0	50	0	0	0	0	0
PHF	.000	.000	.000	.000	.000	.000	.250	.250	.000	.375	.250	.000	.375	.000	.500	.250	.250	.000	.000	.500	.000	.000	.000	.000	.000

Location: Madera
 N/S: SR-99 Northbound Ramps
 E/W: Cleveland Avenue



Date: 9/24/2019
 Day: Tuesday

PEDESTRIANS

	North Leg SR-99 Northbound Ramps	East Leg Cleveland Avenue	South Leg SR-99 Northbound Ramps	West Leg Cleveland Avenue	
	Pedestrians	Pedestrians	Pedestrians	Pedestrians	
7:00 AM	0	0	0	0	0
7:15 AM	1	0	1	0	2
7:30 AM	0	0	0	0	0
7:45 AM	0	0	0	0	0
8:00 AM	0	0	0	0	0
8:15 AM	0	0	0	0	0
8:30 AM	0	0	0	0	0
8:45 AM	0	0	0	0	0
TOTAL VOLUMES:	1	0	1	0	2

	North Leg SR-99 Northbound Ramps	East Leg Cleveland Avenue	South Leg SR-99 Northbound Ramps	West Leg Cleveland Avenue	
	Pedestrians	Pedestrians	Pedestrians	Pedestrians	
4:00 PM	0	0	0	0	0
4:15 PM	0	0	0	0	0
4:30 PM	0	0	0	0	0
4:45 PM	0	0	0	0	0
5:00 PM	5	0	0	0	5
5:15 PM	1	0	2	0	3
5:30 PM	0	0	1	0	1
5:45 PM	0	0	0	0	0
TOTAL VOLUMES:	6	0	3	0	9

Location: Madera
 N/S: SR-99 Northbound Ramps
 E/W: Cleveland Avenue



Date: 9/24/2019
 Day: Tuesday

BICYCLES

	Southbound SR-99 Northbound Ramps			Westbound Cleveland Avenue			Northbound SR-99 Northbound Ramps			Eastbound Cleveland Avenue			
	Left	Thru	Right	Left	Thru	Right	Left	Thru	Right	Left	Thru	Right	
7:00 AM	0	0	0	0	0	0	0	0	0	0	0	0	0
7:15 AM	0	0	0	0	0	0	0	0	0	0	0	0	0
7:30 AM	0	0	0	0	0	0	0	0	0	0	0	0	0
7:45 AM	0	0	0	0	0	0	0	0	0	0	0	0	0
8:00 AM	0	0	0	0	0	0	0	0	0	0	0	0	0
8:15 AM	0	0	0	0	0	0	0	0	0	0	0	0	0
8:30 AM	0	0	0	0	0	0	0	0	0	0	0	0	0
8:45 AM	0	0	0	0	0	0	0	0	0	0	0	0	0
TOTAL VOLUMES:	0	0	0	0	0	0	0	0	0	0	0	0	0

	Southbound SR-99 Northbound Ramps			Westbound Cleveland Avenue			Northbound SR-99 Northbound Ramps			Eastbound Cleveland Avenue			
	Left	Thru	Right	Left	Thru	Right	Left	Thru	Right	Left	Thru	Right	
4:00 PM	0	0	0	0	0	0	0	0	0	0	0	0	0
4:15 PM	0	0	0	0	0	0	0	0	0	0	0	0	0
4:30 PM	0	0	0	0	0	0	0	0	0	0	0	0	0
4:45 PM	0	0	0	0	0	0	0	0	0	0	0	0	0
5:00 PM	1	0	0	0	1	0	0	0	0	0	1	0	3
5:15 PM	0	0	0	0	1	0	0	0	0	0	0	0	1
5:30 PM	0	0	0	0	2	0	0	0	0	0	1	0	3
5:45 PM	0	0	0	0	0	0	0	0	0	0	0	0	0
TOTAL VOLUMES:	1	0	0	0	4	0	0	0	0	0	2	0	7

City of Madera
 N/S: Gateway Drive
 E/W: Cleveland Avenue
 Weather: Clear

File Name : 28_MDA_Gateway_Cleveland AM
 Site Code : 00319628
 Start Date : 9/24/2019
 Page No : 1

Groups Printed- Passenger Vehicles - Large 2 Axle Vehicles - 3 Axle Vehicles - 4+ Axle Trucks

Start Time	Gateway Drive Southbound					Cleveland Avenue Westbound					Gateway Drive Northbound					Cleveland Avenue Eastbound					Int. Total	
	Left	Thru	Right	U-Turns	App. Total	Left	Thru	Right	U-Turns	App. Total	Left	Thru	Right	U-Turns	App. Total	Left	Thru	Right	U-Turns	App. Total		
07:00 AM	13	10	1	0	24	11	114	20	0	145	15	10	11	0	36	1	73	19	0	93	298	
07:15 AM	13	8	2	0	23	26	112	19	0	157	17	13	22	0	52	1	108	31	0	140	372	
07:30 AM	14	23	1	0	38	28	136	15	0	179	24	13	27	0	64	0	158	35	0	193	474	
07:45 AM	19	30	0	0	49	33	202	22	0	257	36	13	29	0	78	1	167	54	0	222	606	
Total	59	71	4	0	134	98	564	76	0	738	92	49	89	0	230	3	506	139	0	648	1750	
08:00 AM	8	18	3	0	29	54	180	14	0	248	18	10	25	0	53	0	105	15	0	120	450	
08:15 AM	10	14	0	0	24	39	134	11	0	184	52	11	32	0	95	3	90	36	0	129	432	
08:30 AM	15	12	1	0	28	28	143	18	0	189	39	11	37	0	87	2	118	28	0	148	452	
08:45 AM	23	8	1	0	32	20	146	23	0	189	61	20	39	0	120	5	121	37	0	163	504	
Total	56	52	5	0	113	141	603	66	0	810	170	52	133	0	355	10	434	116	0	560	1838	
Grand Total	115	123	9	0	247	239	1167	142	0	1548	262	101	222	0	585	13	940	255	0	1208	3588	
Apprch %	46.6	49.8	3.6	0		15.4	75.4	9.2	0		44.8	17.3	37.9	0		1.1	77.8	21.1	0			
Total %	3.2	3.4	0.3	0	6.9	6.7	32.5	4	0	43.1	7.3	2.8	6.2	0	16.3	0.4	26.2	7.1	0	33.7		
Passenger Vehicles	1136																					
% Passenger Vehicles	92.2	95.9	100	0	94.3	98.3	97.3	88	0	96.6	93.5	89.1	96.4	0	93.8	100	94	94.9	0	94.3	95.2	
Large 2 Axle Vehicles	5.2																					
% Large 2 Axle Vehicles	5.2	4.1	0	0	4.5	1.7	1.8	4.2	0	2	6.1	8.9	3.2	0	5.5	0	4.8	4.3	0	4.6	3.6	
3 Axle Vehicles	1	0	0	0	1	0	2	3	0	5	0	1	0	0	1	0	1	0	0	0	1	8
% 3 Axle Vehicles	0.9	0	0	0	0.4	0	0.2	2.1	0	0.3	0	1	0	0	0.2	0	0.1	0	0	0	0.1	0.2
4+ Axle Trucks	2	0	0	0	2	0	8	8	0	16	1	1	1	0	3	0	10	2	0	12	33	
% 4+ Axle Trucks																						

Start Time	Gateway Drive Southbound					Cleveland Avenue Westbound					Gateway Drive Northbound					Cleveland Avenue Eastbound					Int. Total
	Left	Thru	Right	U-Turns	App. Total	Left	Thru	Right	U-Turns	App. Total	Left	Thru	Right	U-Turns	App. Total	Left	Thru	Right	U-Turns	App. Total	
Peak Hour Analysis From 07:00 AM to 08:45 AM - Peak 1 of 1																					
Peak Hour for Entire Intersection Begins at 07:30 AM																					
07:30 AM	14	23	1	0	38	28	136	15	0	179	24	13	27	0	64	0	158	35	0	193	474
07:45 AM	19	30	0	0	49	33	202	22	0	257	36	13	29	0	78	1	167	54	0	222	606
08:00 AM	8	18	3	0	29	54	180	14	0	248	18	10	25	0	53	0	105	15	0	120	450
08:15 AM	10	14	0	0	24	39	134	11	0	184	52	11	32	0	95	3	90	36	0	129	432
Total Volume	51	85	4	0	140	154	652	62	0	868	130	47	113	0	290	4	520	140	0	664	1962
% App. Total	36.4	60.7	2.9	0		17.7	75.1	7.1	0		44.8	16.2	39	0		0.6	78.3	21.1	0		
PHF	.671	.708	.333	.000	.714	.713	.807	.705	.000	.844	.625	.904	.883	.000	.763	.333	.778	.648	.000	.748	.809

City of Madera
 N/S: Gateway Drive
 E/W: Cleveland Avenue
 Weather: Clear

File Name : 28_MDA_Gateway_Cleveland AM
 Site Code : 00319628
 Start Date : 9/24/2019
 Page No : 2

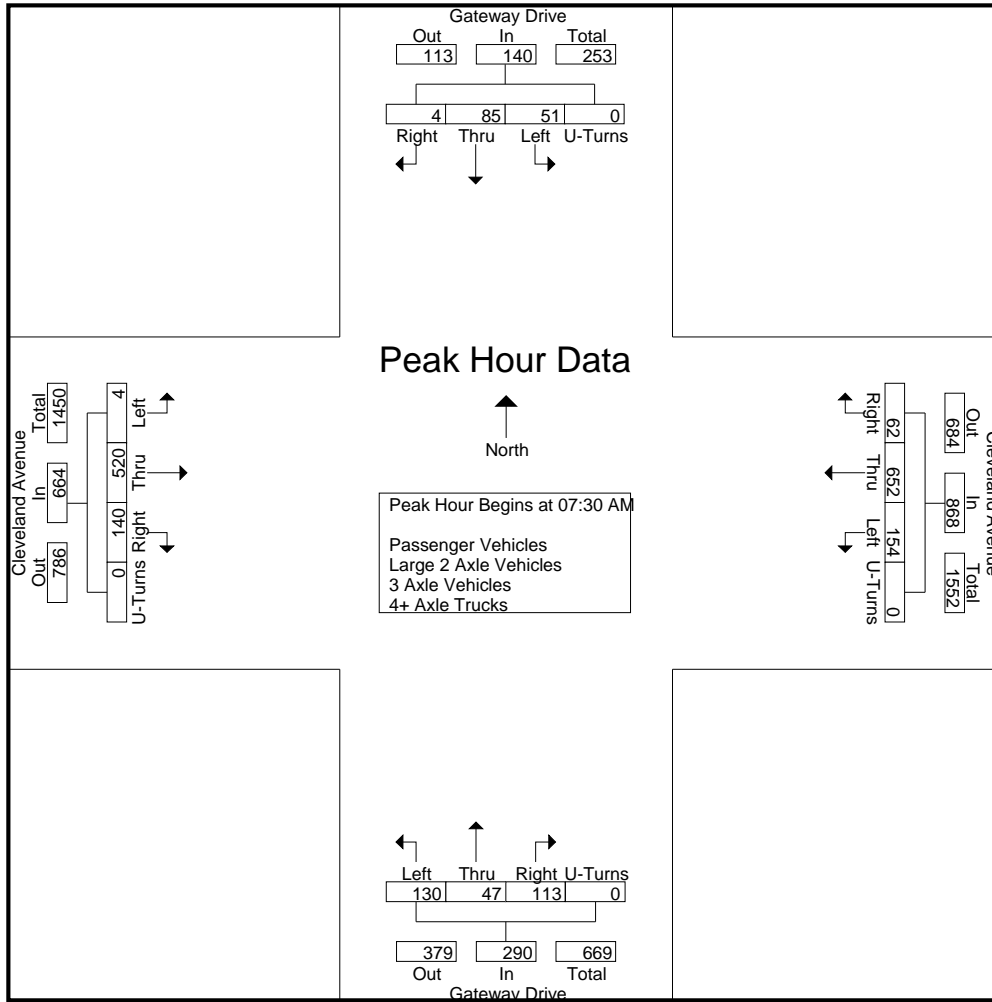

Peak Hour Analysis From 07:00 AM to 08:45 AM - Peak 1 of 1
 Peak Hour for Each Approach Begins at:

	07:30 AM					07:45 AM					08:00 AM					07:15 AM				
+0 mins.	14	23	1	0	38	33	202	22	0	257	18	10	25	0	53	1	108	31	0	140
+15 mins.	19	30	0	0	49	54	180	14	0	248	52	11	32	0	95	0	158	35	0	193
+30 mins.	8	18	3	0	29	39	134	11	0	184	39	11	37	0	87	1	167	54	0	222
+45 mins.	10	14	0	0	24	28	143	18	0	189	61	20	39	0	120	0	105	15	0	120
Total Volume	51	85	4	0	140	154	659	65	0	878	170	52	133	0	355	2	538	135	0	675
% App. Total	36.4	60.7	2.9	0		17.5	75.1	7.4	0		47.9	14.6	37.5	0		0.3	79.7	20	0	
PHF	.671	.708	.333	.000	.714	.713	.816	.739	.000	.854	.697	.650	.853	.000	.740	.500	.805	.625	.000	.760

City of Madera
 N/S: Gateway Drive
 E/W: Cleveland Avenue
 Weather: Clear

File Name : 28_MDA_Gateway_Cleveland AM
 Site Code : 00319628
 Start Date : 9/24/2019
 Page No : 1

Groups Printed- Passenger Vehicles

Start Time	Gateway Drive Southbound					Cleveland Avenue Westbound					Gateway Drive Northbound					Cleveland Avenue Eastbound					Int. Total
	Left	Thru	Right	U-Turns	App. Total	Left	Thru	Right	U-Turns	App. Total	Left	Thru	Right	U-Turns	App. Total	Left	Thru	Right	U-Turns	App. Total	
07:00 AM	12	9	1	0	22	11	105	17	0	133	15	9	10	0	34	1	66	17	0	84	273
07:15 AM	12	8	2	0	22	25	111	15	0	151	15	13	20	0	48	1	99	30	0	130	351
07:30 AM	14	23	1	0	38	28	134	11	0	173	21	10	27	0	58	0	148	35	0	183	452
07:45 AM	19	30	0	0	49	32	199	20	0	251	30	11	27	0	68	1	161	52	0	214	582
Total	57	70	4	0	131	96	549	63	0	708	81	43	84	0	208	3	474	134	0	611	1658
08:00 AM	6	17	3	0	26	54	176	12	0	242	17	8	25	0	50	0	101	14	0	115	433
08:15 AM	9	12	0	0	21	38	132	11	0	181	50	11	32	0	93	3	85	35	0	123	418
08:30 AM	14	11	1	0	26	27	139	17	0	183	38	10	36	0	84	2	108	27	0	137	430
08:45 AM	20	8	1	0	29	20	140	22	0	182	59	18	37	0	114	5	116	32	0	153	478
Total	49	48	5	0	102	139	587	62	0	788	164	47	130	0	341	10	410	108	0	528	1759
Grand Total	106	118	9	0	233	235	1136	125	0	1496	245	90	214	0	549	13	884	242	0	1139	3417
Apprch %	45.5	50.6	3.9	0		15.7	75.9	8.4	0		44.6	16.4	39	0		1.1	77.6	21.2	0		
Total %	3.1	3.5	0.3	0	6.8	6.9	33.2	3.7	0	43.8	7.2	2.6	6.3	0	16.1	0.4	25.9	7.1	0	33.3	

Start Time	Gateway Drive Southbound					Cleveland Avenue Westbound					Gateway Drive Northbound					Cleveland Avenue Eastbound					Int. Total
	Left	Thru	Right	U-Turns	App. Total	Thru	Right	U-Turns	App. Total	Thru	Right	U-Turns	App. Total	Thru	Right	U-Turns	App. Total				
Peak Hour Analysis From 07:30 AM to 08:15 AM - Peak 1 of 1																					
Peak Hour for Entire Intersection Begins at 07:30 AM																					
07:30 AM	14	23	1	0	38	28	134	11	0	173	21	10	27	0	58	0	148	35	0	183	452
07:45 AM	19	30	0	0	49	32	199	20	0	251	30	11	27	0	68	1	161	52	0	214	582
08:00 AM	6	17	3	0	26	54	176	12	0	242	17	8	25	0	50	0	101	14	0	115	433
08:15 AM	9	12	0	0	21	38	132	11	0	181	50	11	32	0	93	3	85	35	0	123	418
Total Volume	48	82	4	0	134	152	641	54	0	847	118	40	111	0	269	4	495	136	0	635	1885
% App. Total	35.8	61.2	3	0		17.9	75.7	6.4	0		43.9	14.9	41.3	0		0.6	78	21.4	0		
PHF	.632	.683	.333	.000	.684	.704	.805	.675	.000	.844	.590	.909	.867	.000	.723	.333	.769	.654	.000	.742	.810

City of Madera
 N/S: Gateway Drive
 E/W: Cleveland Avenue
 Weather: Clear

File Name : 28_MDA_Gateway_Cleveland AM
 Site Code : 00319628
 Start Date : 9/24/2019
 Page No : 2

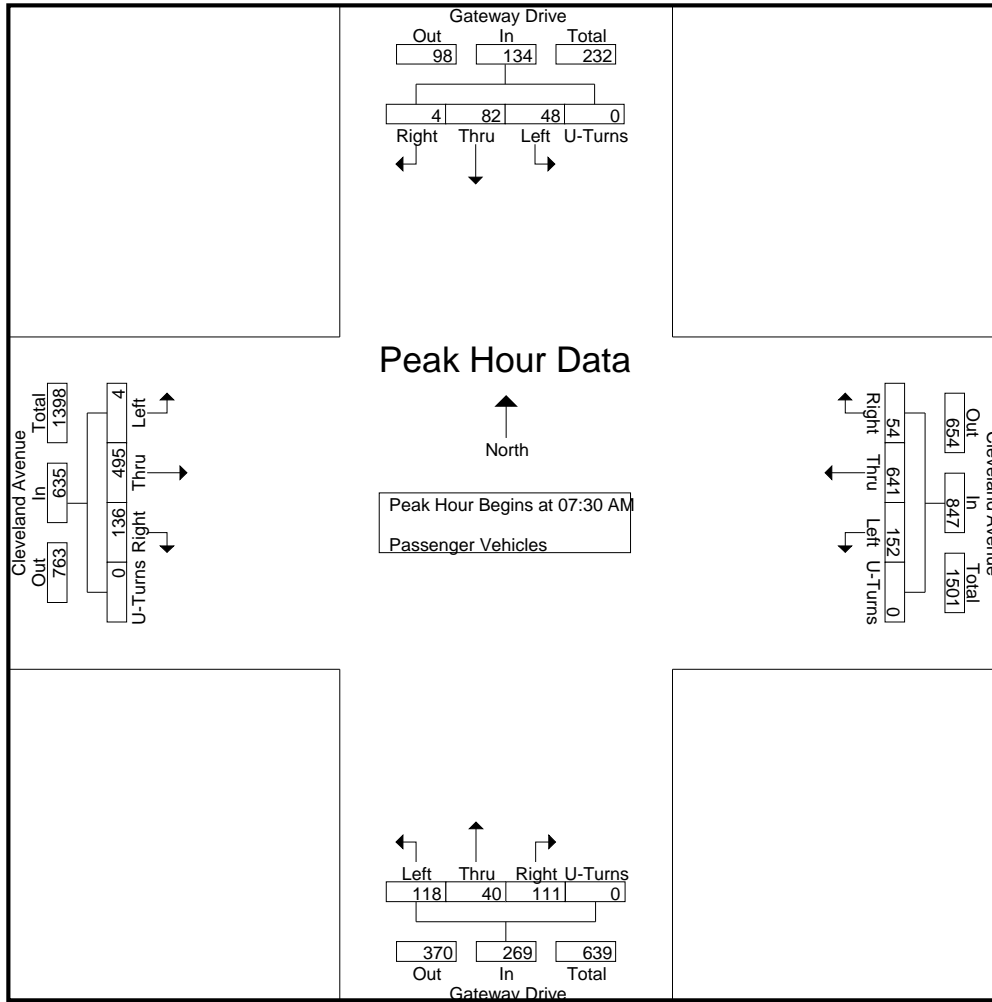

Peak Hour Analysis From 07:30 AM to 08:15 AM - Peak 1 of 1
 Peak Hour for Each Approach Begins at:

	07:30 AM					07:30 AM					07:30 AM									
+0 mins.	14	23	1	0	38	28	134	11	0	173	21	10	27	0	58	0	148	35	0	183
+15 mins.	19	30	0	0	49	32	199	20	0	251	30	11	27	0	68	1	161	52	0	214
+30 mins.	6	17	3	0	26	54	176	12	0	242	17	8	25	0	50	0	101	14	0	115
+45 mins.	9	12	0	0	21	38	132	11	0	181	50	11	32	0	93	3	85	35	0	123
Total Volume	48	82	4	0	134	152	641	54	0	847	118	40	111	0	269	4	495	136	0	635
% App. Total	35.8	61.2	3	0		17.9	75.7	6.4	0		43.9	14.9	41.3	0		0.6	78	21.4	0	
PHF	.632	.683	.333	.000	.684	.704	.805	.675	.000	.844	.590	.909	.867	.000	.723	.333	.769	.654	.000	.742

City of Madera
 N/S: Gateway Drive
 E/W: Cleveland Avenue
 Weather: Clear

File Name : 28_MDA_Gateway_Cleveland AM
 Site Code : 00319628
 Start Date : 9/24/2019
 Page No : 1

Groups Printed- Large 2 Axle Vehicles

Start Time	Gateway Drive Southbound					Cleveland Avenue Westbound					Gateway Drive Northbound					Cleveland Avenue Eastbound					Int. Total
	Left	Thru	Right	U-Turns	App. Total	Left	Thru	Right	U-Turns	App. Total	Left	Thru	Right	U-Turns	App. Total	Left	Thru	Right	U-Turns	App. Total	
07:00 AM	0	1	0	0	1	0	7	1	0	8	0	1	0	0	1	0	5	2	0	7	17
07:15 AM	1	0	0	0	1	1	1	2	0	4	2	0	2	0	4	0	8	1	0	9	18
07:30 AM	0	0	0	0	0	0	1	2	0	3	3	2	0	0	5	0	9	0	0	9	17
07:45 AM	0	0	0	0	0	1	2	0	0	3	6	2	2	0	10	0	4	2	0	6	19
Total	1	1	0	0	2	2	11	5	0	18	11	5	4	0	20	0	26	5	0	31	71
08:00 AM	1	1	0	0	2	0	4	1	0	5	0	2	0	0	2	0	2	1	0	3	12
08:15 AM	1	2	0	0	3	1	1	0	0	2	2	0	0	0	2	0	4	1	0	5	12
08:30 AM	1	1	0	0	2	1	3	0	0	4	1	1	1	0	3	0	9	1	0	10	19
08:45 AM	2	0	0	0	2	0	2	0	0	2	2	1	2	0	5	0	4	3	0	7	16
Total	5	4	0	0	9	2	10	1	0	13	5	4	3	0	12	0	19	6	0	25	59
Grand Total	6	5	0	0	11	4	21	6	0	31	16	9	7	0	32	0	45	11	0	56	130
Apprch %	54.5	45.5	0	0		12.9	67.7	19.4	0		50	28.1	21.9	0		0	80.4	19.6	0		
Total %	4.6	3.8	0	0	8.5	3.1	16.2	4.6	0	23.8	12.3	6.9	5.4	0	24.6	0	34.6	8.5	0	43.1	

Start Time	Gateway Drive Southbound					Cleveland Avenue Westbound					Gateway Drive Northbound					Cleveland Avenue Eastbound					Int. Total
	Left	Thru	Right	U-Turns	App. Total	Thru	Right	U-Turns	App. Total	Thru	Right	U-Turns	App. Total	Thru	Right	U-Turns	App. Total				
Peak Hour Analysis From 07:30 AM to 08:15 AM - Peak 1 of 1																					
Peak Hour for Entire Intersection Begins at 07:30 AM																					
07:30 AM	0	0	0	0	0	0	1	2	0	3	3	2	0	0	5	0	9	0	0	9	17
07:45 AM	0	0	0	0	0	1	2	0	0	3	6	2	2	0	10	0	4	2	0	6	19
08:00 AM	1	1	0	0	2	0	4	1	0	5	0	2	0	0	2	0	2	1	0	3	12
08:15 AM	1	2	0	0	3	1	1	0	0	2	2	0	0	0	2	0	4	1	0	5	12
Total Volume	2	3	0	0	5	2	8	3	0	13	11	6	2	0	19	0	19	4	0	23	60
% App. Total	40	60	0	0		15.4	61.5	23.1	0		57.9	31.6	10.5	0		0	82.6	17.4	0		
PHF	.500	.375	.000	.000	.417	.500	.500	.375	.000	.650	.458	.750	.250	.000	.475	.000	.528	.500	.000	.639	.789

City of Madera
 N/S: Gateway Drive
 E/W: Cleveland Avenue
 Weather: Clear

File Name : 28_MDA_Gateway_Cleveland AM
 Site Code : 00319628
 Start Date : 9/24/2019
 Page No : 2

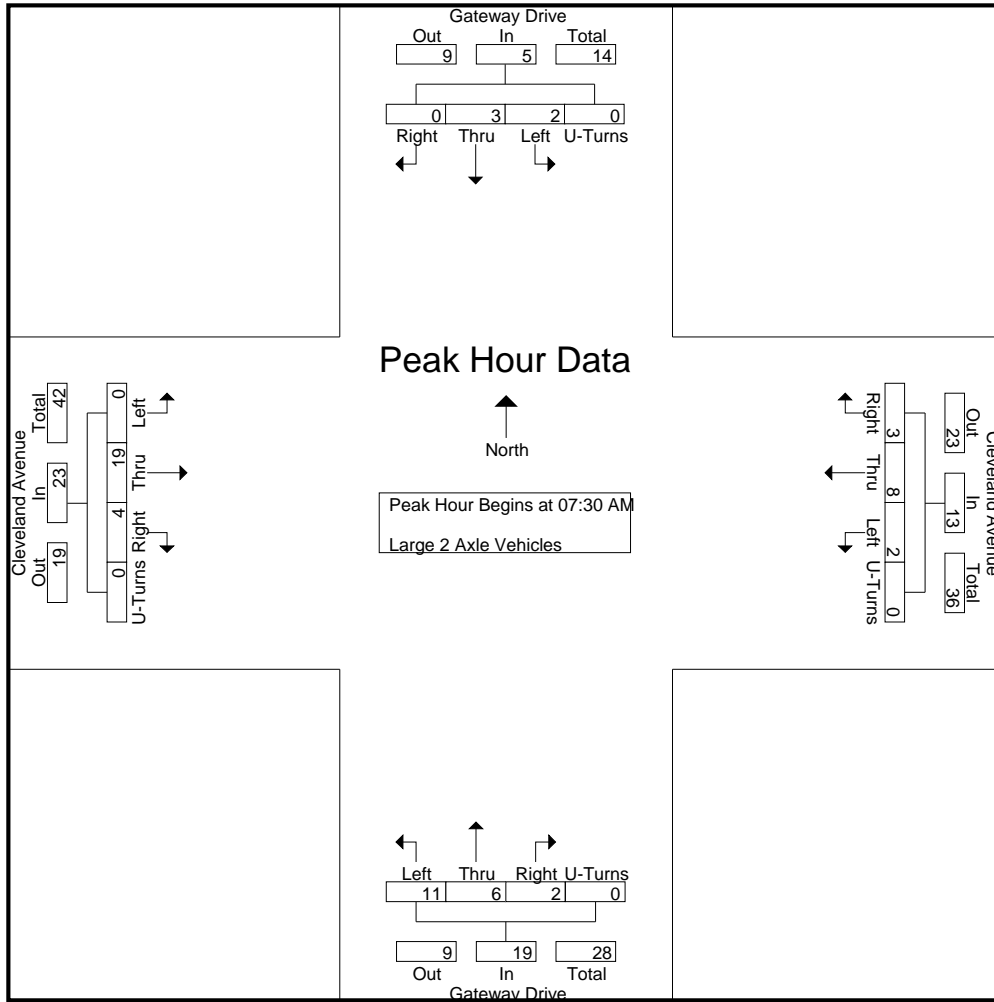

Peak Hour Analysis From 07:30 AM to 08:15 AM - Peak 1 of 1
 Peak Hour for Each Approach Begins at:

	07:30 AM					07:30 AM					07:30 AM									
+0 mins.	0	0	0	0	0	0	1	2	0	3	3	2	0	0	5	0	9	0	0	9
+15 mins.	0	0	0	0	0	1	2	0	0	3	6	2	2	0	10	0	4	2	0	6
+30 mins.	1	1	0	0	2	0	4	1	0	5	0	2	0	0	2	0	2	1	0	3
+45 mins.	1	2	0	0	3	1	1	0	0	2	2	0	0	0	2	0	4	1	0	5
Total Volume	2	3	0	0	5	2	8	3	0	13	11	6	2	0	19	0	19	4	0	23
% App. Total	40	60	0	0		15.4	61.5	23.1	0		57.9	31.6	10.5	0		0	82.6	17.4	0	
PHF	.500	.375	.000	.000	.417	.500	.500	.375	.000	.650	.458	.750	.250	.000	.475	.000	.528	.500	.000	.639

City of Madera
 N/S: Gateway Drive
 E/W: Cleveland Avenue
 Weather: Clear

File Name : 28_MDA_Gateway_Cleveland AM
 Site Code : 00319628
 Start Date : 9/24/2019
 Page No : 1

Groups Printed- 3 Axle Vehicles

Start Time	Gateway Drive Southbound					Cleveland Avenue Westbound					Gateway Drive Northbound					Cleveland Avenue Eastbound					Int. Total
	Left	Thru	Right	U-Turns	App. Total	Left	Thru	Right	U-Turns	App. Total	Left	Thru	Right	U-Turns	App. Total	Left	Thru	Right	U-Turns	App. Total	
07:00 AM	0	0	0	0	0	0	1	0	0	1	0	0	0	0	0	0	0	0	0	0	1
07:15 AM	0	0	0	0	0	0	0	1	0	1	0	0	0	0	0	0	0	0	0	0	1
07:30 AM	0	0	0	0	0	0	0	1	0	1	0	1	0	0	1	0	0	0	0	0	2
07:45 AM	0	0	0	0	0	0	0	0	0	0	0	0	0	0	0	0	0	0	0	0	0
Total	0	0	0	0	0	0	1	2	0	3	0	1	0	0	1	0	0	0	0	0	4
08:00 AM	1	0	0	0	1	0	0	0	0	0	0	0	0	0	0	0	0	0	0	0	1
08:15 AM	0	0	0	0	0	0	0	0	0	0	0	0	0	0	0	0	1	0	0	1	1
08:30 AM	0	0	0	0	0	0	0	0	0	0	0	0	0	0	0	0	0	0	0	0	0
08:45 AM	0	0	0	0	0	0	1	1	0	2	0	0	0	0	0	0	0	0	0	0	2
Total	1	0	0	0	1	0	1	1	0	2	0	0	0	0	0	0	1	0	0	1	4
Grand Total	1	0	0	0	1	0	2	3	0	5	0	1	0	0	1	0	1	0	0	1	8
Apprch %	100	0	0	0		0	40	60	0		0	100	0	0		0	100	0	0		
Total %	12.5	0	0	0	12.5	0	25	37.5	0	62.5	0	12.5	0	0	12.5	0	12.5	0	0	12.5	

Start Time	Gateway Drive Southbound					Cleveland Avenue Westbound					Gateway Drive Northbound					Cleveland Avenue Eastbound					Int. Total
	Left	Thru	Right	U-Turns	App. Total	Thru	Right	U-Turns	App. Total	Thru	Right	U-Turns	App. Total	Thru	Right	U-Turns	App. Total				
Peak Hour Analysis From 07:30 AM to 08:15 AM - Peak 1 of 1																					
Peak Hour for Entire Intersection Begins at 07:30 AM																					
07:30 AM	0	0	0	0	0	0	0	1	0	1	0	1	0	0	1	0	0	0	0	0	2
07:45 AM	0	0	0	0	0	0	0	0	0	0	0	0	0	0	0	0	0	0	0	0	0
08:00 AM	1	0	0	0	1	0	0	0	0	0	0	0	0	0	0	0	0	0	0	0	1
08:15 AM	0	0	0	0	0	0	0	0	0	0	0	0	0	0	0	0	1	0	0	1	1
Total Volume	1	0	0	0	1	0	0	1	0	1	0	1	0	0	1	0	1	0	0	1	4
% App. Total	100	0	0	0		0	0	100	0		0	100	0	0		0	100	0	0		
PHF	.250	.000	.000	.000	.250	.000	.000	.250	.000	.250	.000	.250	.000	.000	.250	.000	.250	.000	.000	.250	.500

City of Madera
 N/S: Gateway Drive
 E/W: Cleveland Avenue
 Weather: Clear

File Name : 28_MDA_Gateway_Cleveland AM
 Site Code : 00319628
 Start Date : 9/24/2019
 Page No : 2

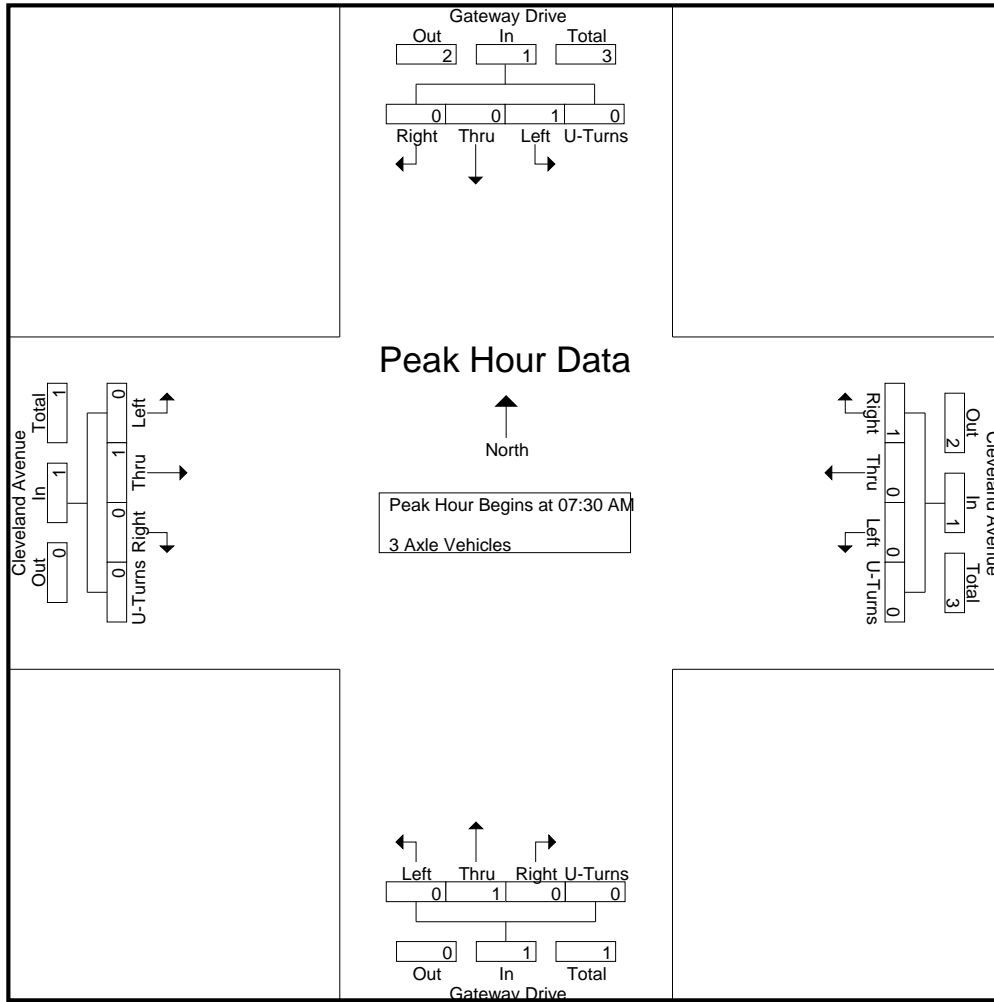

Peak Hour Analysis From 07:30 AM to 08:15 AM - Peak 1 of 1
 Peak Hour for Each Approach Begins at:

	07:30 AM					07:30 AM					07:30 AM					07:30 AM				
+0 mins.	0	0	0	0	0	0	0	1	0	1	0	1	0	0	1	0	0	0	0	0
+15 mins.	0	0	0	0	0	0	0	0	0	0	0	0	0	0	0	0	0	0	0	0
+30 mins.	1	0	0	0	1	0	0	0	0	0	0	0	0	0	0	0	0	0	0	0
+45 mins.	0	0	0	0	0	0	0	0	0	0	0	0	0	0	0	0	1	0	0	1
Total Volume	1	0	0	0	1	0	0	1	0	1	0	1	0	0	1	0	1	0	0	1
% App. Total	100	0	0	0	0	0	0	100	0	0	0	100	0	0	0	0	100	0	0	0
PHF	.250	.000	.000	.000	.250	.000	.000	.250	.000	.250	.000	.250	.000	.000	.250	.000	.250	.000	.000	.250

City of Madera
 N/S: Gateway Drive
 E/W: Cleveland Avenue
 Weather: Clear

File Name : 28_MDA_Gateway_Cleveland AM
 Site Code : 00319628
 Start Date : 9/24/2019
 Page No : 1

Groups Printed- 4+ Axle Trucks

Start Time	Gateway Drive Southbound					Cleveland Avenue Westbound					Gateway Drive Northbound					Cleveland Avenue Eastbound					Int. Total
	Left	Thru	Right	U-Turns	App. Total	Left	Thru	Right	U-Turns	App. Total	Left	Thru	Right	U-Turns	App. Total	Left	Thru	Right	U-Turns	App. Total	
07:00 AM	1	0	0	0	1	0	1	2	0	3	0	0	1	0	1	0	2	0	0	2	7
07:15 AM	0	0	0	0	0	0	0	1	0	1	0	0	0	0	0	0	1	0	0	1	2
07:30 AM	0	0	0	0	0	0	1	1	0	2	0	0	0	0	0	0	1	0	0	1	3
07:45 AM	0	0	0	0	0	0	1	2	0	3	0	0	0	0	0	0	2	0	0	2	5
Total	1	0	0	0	1	0	3	6	0	9	0	0	1	0	1	0	6	0	0	6	17
08:00 AM	0	0	0	0	0	0	0	1	0	1	1	0	0	0	1	0	2	0	0	2	4
08:15 AM	0	0	0	0	0	0	1	0	0	1	0	0	0	0	0	0	0	0	0	0	1
08:30 AM	0	0	0	0	0	0	1	1	0	2	0	0	0	0	0	0	1	0	0	1	3
08:45 AM	1	0	0	0	1	0	3	0	0	3	0	1	0	0	1	0	1	2	0	3	8
Total	1	0	0	0	1	0	5	2	0	7	1	1	0	0	2	0	4	2	0	6	16
Grand Total	2	0	0	0	2	0	8	8	0	16	1	1	1	0	3	0	10	2	0	12	33
Apprch %	100	0	0	0		0	50	50	0		33.3	33.3	33.3	0		0	83.3	16.7	0		
Total %	6.1	0	0	0	6.1	0	24.2	24.2	0	48.5	3	3	3	0	9.1	0	30.3	6.1	0	36.4	

Start Time	Gateway Drive Southbound					Cleveland Avenue Westbound					Gateway Drive Northbound					Cleveland Avenue Eastbound					Int. Total
	Left	Thru	Right	U-Turns	App. Total	Thru	Right	U-Turns	App. Total	Thru	Right	U-Turns	App. Total	Thru	Right	U-Turns	App. Total				
Peak Hour Analysis From 07:30 AM to 08:15 AM - Peak 1 of 1																					
Peak Hour for Entire Intersection Begins at 07:30 AM																					
07:30 AM	0	0	0	0	0	0	1	1	0	2	0	0	0	0	0	0	1	0	0	1	3
07:45 AM	0	0	0	0	0	0	1	2	0	3	0	0	0	0	0	0	2	0	0	2	5
08:00 AM	0	0	0	0	0	0	0	1	0	1	1	0	0	0	1	0	2	0	0	2	4
08:15 AM	0	0	0	0	0	0	1	0	0	1	0	0	0	0	0	0	0	0	0	0	1
Total Volume	0	0	0	0	0	0	3	4	0	7	1	0	0	0	1	0	5	0	0	5	13
% App. Total	0	0	0	0		0	42.9	57.1	0		100	0	0	0		0	100	0	0		
PHF	.000	.000	.000	.000	.000	.000	.750	.500	.000	.583	.250	.000	.000	.000	.250	.000	.625	.000	.000	.625	.650

City of Madera
 N/S: Gateway Drive
 E/W: Cleveland Avenue
 Weather: Clear

File Name : 28_MDA_Gateway_Cleveland AM
 Site Code : 00319628
 Start Date : 9/24/2019
 Page No : 2

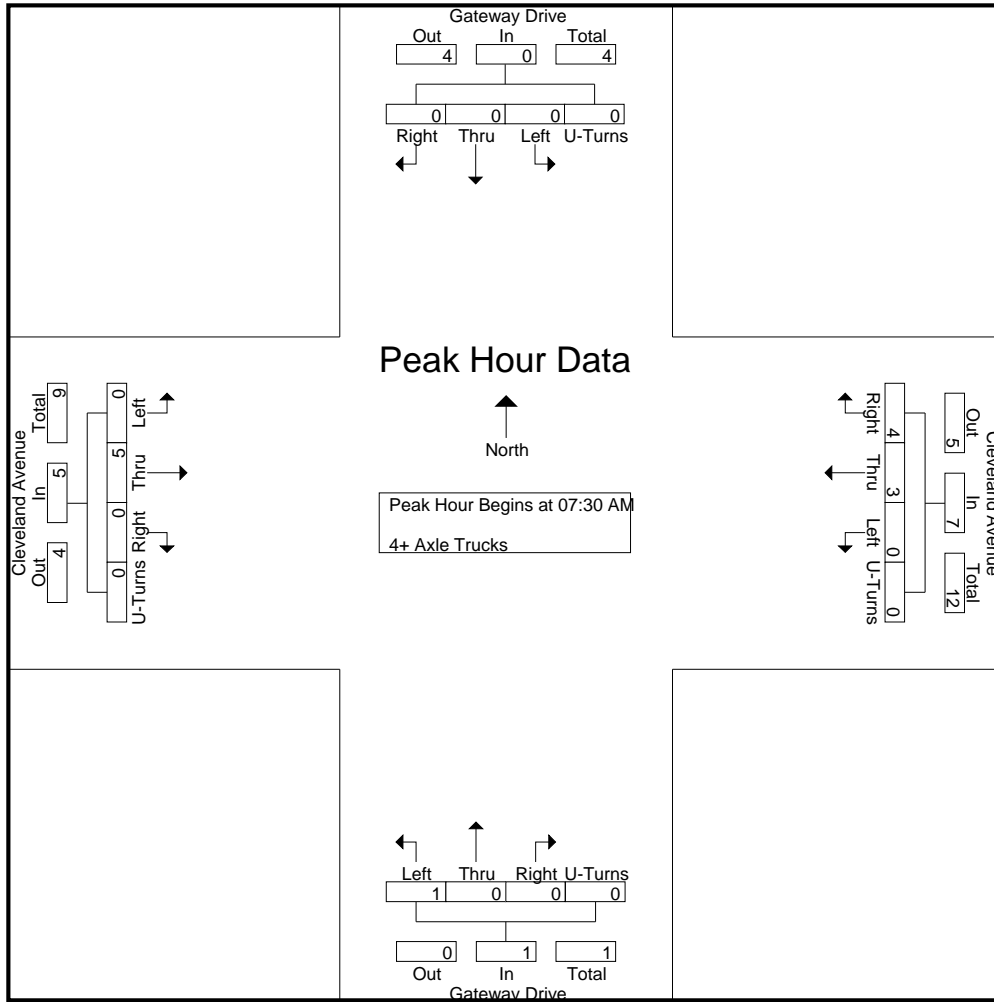

Peak Hour Analysis From 07:30 AM to 08:15 AM - Peak 1 of 1
 Peak Hour for Each Approach Begins at:

	07:30 AM					07:30 AM					07:30 AM									
+0 mins.	0	0	0	0	0	0	1	1	0	2	0	0	0	0	0	0	1	0	0	1
+15 mins.	0	0	0	0	0	0	1	2	0	3	0	0	0	0	0	0	2	0	0	2
+30 mins.	0	0	0	0	0	0	0	1	0	1	1	0	0	0	1	0	2	0	0	2
+45 mins.	0	0	0	0	0	0	1	0	0	1	0	0	0	0	0	0	0	0	0	0
Total Volume	0	0	0	0	0	0	3	4	0	7	1	0	0	0	1	0	5	0	0	5
% App. Total	0	0	0	0	0	0	42.9	57.1	0	0	100	0	0	0	0	0	100	0	0	0
PHF	.000	.000	.000	.000	.000	.000	.750	.500	.000	.583	.250	.000	.000	.000	.250	.000	.625	.000	.000	.625

City of Madera
 N/S: Gateway Drive
 E/W: Cleveland Avenue
 Weather: Clear

File Name : 28_MDA_Gateway_Cleveland PM
 Site Code : 00319628
 Start Date : 9/24/2019
 Page No : 1

Groups Printed- Passenger Vehicles - Large 2 Axle Vehicles - 3 Axle Vehicles - 4+ Axle Trucks

Start Time	Gateway Drive Southbound					Cleveland Avenue Westbound					Gateway Drive Northbound					Cleveland Avenue Eastbound					Int. Total
	Left	Thru	Right	U-Turns	App. Total	Left	Thru	Right	U-Turns	App. Total	Left	Thru	Right	U-Turns	App. Total	Left	Thru	Right	U-Turns	App. Total	
04:00 PM	33	22	7	0	62	42	131	39	0	212	46	22	66	0	134	2	191	33	0	226	634
04:15 PM	36	35	5	0	76	34	167	23	0	224	35	26	51	0	112	2	179	44	0	225	637
04:30 PM	41	20	9	0	70	41	131	22	0	194	49	17	50	0	116	6	182	55	0	243	623
04:45 PM	33	39	3	0	75	34	173	25	0	232	56	22	49	0	127	5	170	54	0	229	663
Total	143	116	24	0	283	151	602	109	0	862	186	87	216	0	489	15	722	186	0	923	2557
05:00 PM	43	34	1	0	78	27	159	30	0	216	53	44	49	0	146	3	201	63	0	267	707
05:15 PM	40	31	9	0	80	39	178	25	0	242	60	29	65	0	154	0	190	59	0	249	725
05:30 PM	22	16	5	0	43	37	162	15	0	214	35	23	40	0	98	4	206	34	1	245	600
05:45 PM	36	10	5	0	51	41	144	23	0	208	47	16	51	0	114	1	178	33	0	212	585
Total	141	91	20	0	252	144	643	93	0	880	195	112	205	0	512	8	775	189	1	973	2617
Grand Total	284	207	44	0	535	295	1245	202	0	1742	381	199	421	0	1001	23	1497	375	1	1896	5174
Apprch %	53.1	38.7	8.2	0		16.9	71.5	11.6	0		38.1	19.9	42.1	0		1.2	79	19.8	0.1		
Total %	5.5	4	0.9	0	10.3	5.7	24.1	3.9	0	33.7	7.4	3.8	8.1	0	19.3	0.4	28.9	7.2	0	36.6	
Passenger Vehicles						1213										1466					
% Passenger Vehicles	98.6	96.6	100	0	97.9	98.3	97.4	98	0	97.6	98.2	98.5	97.9	0	98.1	95.7	97.9	99.5	100	98.2	98
Large 2 Axle Vehicles																					
% Large 2 Axle Vehicles	1.1	1.4	0	0	1.1	1.4	1.8	1.5	0	1.7	1.3	1.5	1.9	0	1.6	4.3	1.6	0.3	0	1.4	1.5
3 Axle Vehicles	0	0	0	0	0	0	1	1	0	2	0	0	1	0	1	0	2	0	0	2	5
% 3 Axle Vehicles	0	0	0	0	0	0	0.1	0.5	0	0.1	0	0	0.2	0	0.1	0	0.1	0	0	0.1	0.1
4+ Axle Trucks	1	4	0	0	5	1	8	0	0	9	2	0	0	0	2	0	5	1	0	6	22
% 4+ Axle Trucks																					

Start Time	Gateway Drive Southbound					Cleveland Avenue Westbound					Gateway Drive Northbound					Cleveland Avenue Eastbound					Int. Total
	Left	Thru	Right	U-Turns	App. Total	Left	Thru	Right	U-Turns	App. Total	Left	Thru	Right	U-Turns	App. Total	Left	Thru	Right	U-Turns	App. Total	
Peak Hour Analysis From 04:00 PM to 05:45 PM - Peak 1 of 1																					
Peak Hour for Entire Intersection Begins at 04:30 PM																					
04:30 PM	41	20	9	0	70	41	131	22	0	194	49	17	50	0	116	6	182	55	0	243	623
04:45 PM	33	39	3	0	75	34	173	25	0	232	56	22	49	0	127	5	170	54	0	229	663
05:00 PM	43	34	1	0	78	27	159	30	0	216	53	44	49	0	146	3	201	63	0	267	707
05:15 PM	40	31	9	0	80	39	178	25	0	242	60	29	65	0	154	0	190	59	0	249	725
Total Volume	157	124	22	0	303	141	641	102	0	884	218	112	213	0	543	14	743	231	0	988	2718
% App. Total	51.8	40.9	7.3	0		16	72.5	11.5	0		40.1	20.6	39.2	0		1.4	75.2	23.4	0		
PHF	.913	.795	.611	.000	.947	.860	.900	.850	.000	.913	.908	.636	.819	.000	.881	.583	.924	.917	.000	.925	.937

City of Madera
 N/S: Gateway Drive
 E/W: Cleveland Avenue
 Weather: Clear

File Name : 28_MDA_Gateway_Cleveland PM
 Site Code : 00319628
 Start Date : 9/24/2019
 Page No : 2

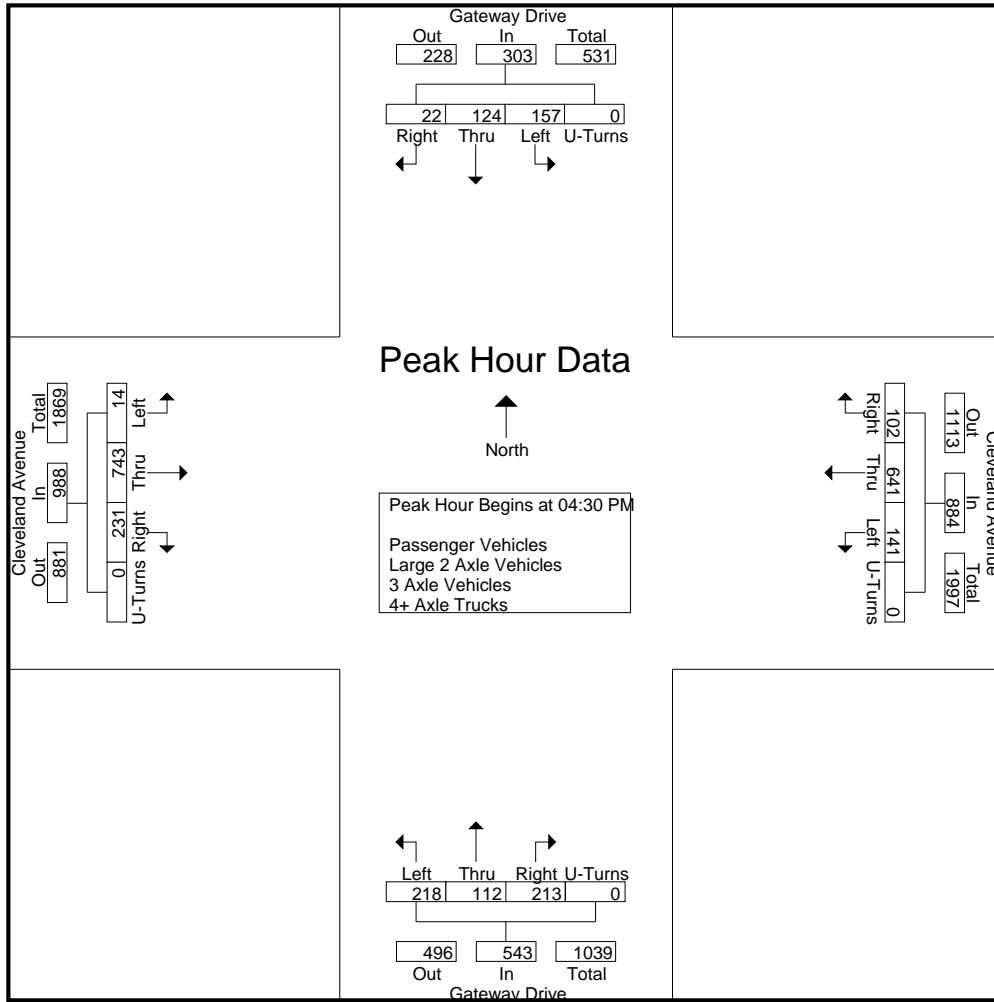

Peak Hour Analysis From 04:00 PM to 05:45 PM - Peak 1 of 1
 Peak Hour for Each Approach Begins at:

	04:30 PM					04:45 PM					04:30 PM					04:45 PM				
+0 mins.	41	20	9	0	70	34	173	25	0	232	49	17	50	0	116	5	170	54	0	229
+15 mins.	33	39	3	0	75	27	159	30	0	216	56	22	49	0	127	3	201	63	0	267
+30 mins.	43	34	1	0	78	39	178	25	0	242	53	44	49	0	146	0	190	59	0	249
+45 mins.	40	31	9	0	80	37	162	15	0	214	60	29	65	0	154	4	206	34	1	245
Total Volume	157	124	22	0	303	137	672	95	0	904	218	112	213	0	543	12	767	210	1	990
% App. Total	51.8	40.9	7.3	0		15.2	74.3	10.5	0		40.1	20.6	39.2	0		1.2	77.5	21.2	0.1	
PHF	.913	.795	.611	.000	.947	.878	.944	.792	.000	.934	.908	.636	.819	.000	.881	.600	.931	.833	.250	.927

City of Madera
 N/S: Gateway Drive
 E/W: Cleveland Avenue
 Weather: Clear

File Name : 28_MDA_Gateway_Cleveland PM
 Site Code : 00319628
 Start Date : 9/24/2019
 Page No : 1

Groups Printed- Passenger Vehicles

Start Time	Gateway Drive Southbound					Cleveland Avenue Westbound					Gateway Drive Northbound					Cleveland Avenue Eastbound					Int. Total
	Left	Thru	Right	U-Turns	App. Total	Left	Thru	Right	U-Turns	App. Total	Left	Thru	Right	U-Turns	App. Total	Left	Thru	Right	U-Turns	App. Total	
04:00 PM	33	22	7	0	62	41	125	38	0	204	45	21	64	0	130	2	185	33	0	220	616
04:15 PM	36	33	5	0	74	33	162	21	0	216	33	24	50	0	107	2	176	44	0	222	619
04:30 PM	40	20	9	0	69	40	127	22	0	189	49	17	50	0	116	6	179	55	0	240	614
04:45 PM	32	35	3	0	70	32	171	25	0	228	55	22	47	0	124	5	165	54	0	224	646
Total	141	110	24	0	275	146	585	106	0	837	182	84	211	0	477	15	705	186	0	906	2495
05:00 PM	42	33	1	0	76	27	155	29	0	211	51	44	48	0	143	3	195	63	0	261	691
05:15 PM	40	31	9	0	80	39	172	25	0	236	60	29	65	0	154	0	187	59	0	246	716
05:30 PM	21	16	5	0	42	37	159	15	0	211	35	23	38	0	96	3	203	32	1	239	588
05:45 PM	36	10	5	0	51	41	142	23	0	206	46	16	50	0	112	1	176	33	0	210	579
Total	139	90	20	0	249	144	628	92	0	864	192	112	201	0	505	7	761	187	1	956	2574
Grand Total	280	200	44	0	524	290	1213	198	0	1701	374	196	412	0	982	22	1466	373	1	1862	5069
Apprch %	53.4	38.2	8.4	0		17	71.3	11.6	0		38.1	20	42	0		1.2	78.7	20	0.1		
Total %	5.5	3.9	0.9	0	10.3	5.7	23.9	3.9	0	33.6	7.4	3.9	8.1	0	19.4	0.4	28.9	7.4	0	36.7	

Start Time	Gateway Drive Southbound					Cleveland Avenue Westbound					Gateway Drive Northbound					Cleveland Avenue Eastbound					Int. Total
	Left	Thru	Right	U-Turns	App. Total	Left	Thru	Right	U-Turns	App. Total	Left	Thru	Right	U-Turns	App. Total	Left	Thru	Right	U-Turns	App. Total	
Peak Hour Analysis From 04:30 PM to 05:15 PM - Peak 1 of 1																					
Peak Hour for Entire Intersection Begins at 04:30 PM																					
04:30 PM	40	20	9	0	69	40	127	22	0	189	49	17	50	0	116	6	179	55	0	240	614
04:45 PM	32	35	3	0	70	32	171	25	0	228	55	22	47	0	124	5	165	54	0	224	646
05:00 PM	42	33	1	0	76	27	155	29	0	211	51	44	48	0	143	3	195	63	0	261	691
05:15 PM	40	31	9	0	80	39	172	25	0	236	60	29	65	0	154	0	187	59	0	246	716
Total Volume	154	119	22	0	295	138	625	101	0	864	215	112	210	0	537	14	726	231	0	971	2667
% App. Total	52.2	40.3	7.5	0		16	72.3	11.7	0		40	20.9	39.1	0		1.4	74.8	23.8	0		
PHF	.917	.850	.611	.000	.922	.863	.908	.871	.000	.915	.896	.636	.808	.000	.872	.583	.931	.917	.000	.930	.931

City of Madera
 N/S: Gateway Drive
 E/W: Cleveland Avenue
 Weather: Clear

File Name : 28_MDA_Gateway_Cleveland PM
 Site Code : 00319628
 Start Date : 9/24/2019
 Page No : 2

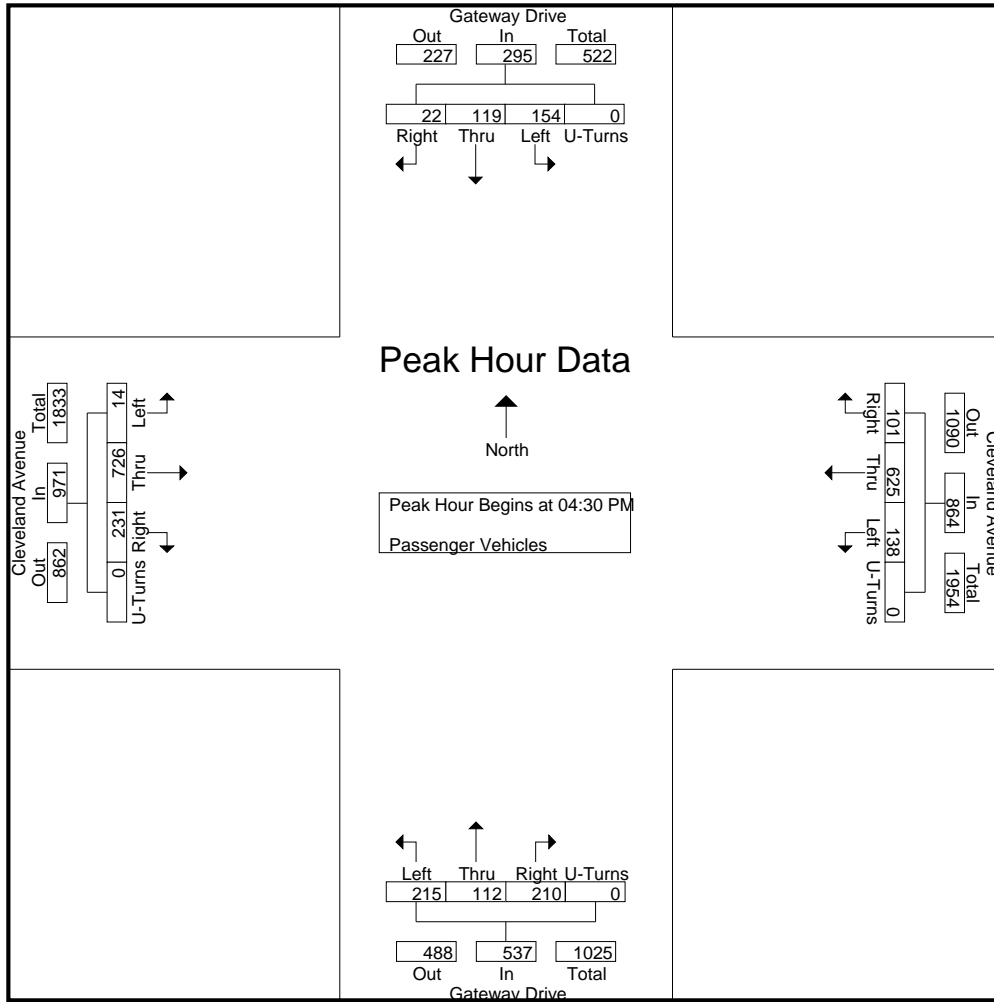

Peak Hour Analysis From 04:30 PM to 05:15 PM - Peak 1 of 1
 Peak Hour for Each Approach Begins at:

	04:30 PM					04:30 PM					04:30 PM									
+0 mins.	40	20	9	0	69	40	127	22	0	189	49	17	50	0	116	6	179	55	0	240
+15 mins.	32	35	3	0	70	32	171	25	0	228	55	22	47	0	124	5	165	54	0	224
+30 mins.	42	33	1	0	76	27	155	29	0	211	51	44	48	0	143	3	195	63	0	261
+45 mins.	40	31	9	0	80	39	172	25	0	236	60	29	65	0	154	0	187	59	0	246
Total Volume	154	119	22	0	295	138	625	101	0	864	215	112	210	0	537	14	726	231	0	971
% App. Total	52.2	40.3	7.5	0		16	72.3	11.7	0		40	20.9	39.1	0		1.4	74.8	23.8	0	
PHF	.917	.850	.611	.000	.922	.863	.908	.871	.000	.915	.896	.636	.808	.000	.872	.583	.931	.917	.000	.930

City of Madera
 N/S: Gateway Drive
 E/W: Cleveland Avenue
 Weather: Clear

File Name : 28_MDA_Gateway_Cleveland PM
 Site Code : 00319628
 Start Date : 9/24/2019
 Page No : 1

Groups Printed- Large 2 Axle Vehicles

Start Time	Gateway Drive Southbound					Cleveland Avenue Westbound					Gateway Drive Northbound					Cleveland Avenue Eastbound					Int. Total
	Left	Thru	Right	U-Turns	App. Total	Left	Thru	Right	U-Turns	App. Total	Left	Thru	Right	U-Turns	App. Total	Left	Thru	Right	U-Turns	App. Total	
04:00 PM	0	0	0	0	0	1	4	1	0	6	1	1	2	0	4	0	5	0	0	5	15
04:15 PM	0	0	0	0	0	0	3	1	0	4	1	2	1	0	4	0	3	0	0	3	11
04:30 PM	1	0	0	0	1	1	3	0	0	4	0	0	0	0	0	0	3	0	0	3	8
04:45 PM	1	3	0	0	4	2	2	0	0	4	1	0	2	0	3	0	4	0	0	4	15
Total	2	3	0	0	5	4	12	2	0	18	3	3	5	0	11	0	15	0	0	15	49
05:00 PM	1	0	0	0	1	0	3	1	0	4	1	0	1	0	2	0	4	0	0	4	11
05:15 PM	0	0	0	0	0	0	4	0	0	4	0	0	0	0	0	0	1	0	0	1	5
05:30 PM	0	0	0	0	0	0	3	0	0	3	0	0	1	0	1	1	2	1	0	4	8
05:45 PM	0	0	0	0	0	0	1	0	0	1	1	0	1	0	2	0	2	0	0	2	5
Total	1	0	0	0	1	0	11	1	0	12	2	0	3	0	5	1	9	1	0	11	29
Grand Total	3	3	0	0	6	4	23	3	0	30	5	3	8	0	16	1	24	1	0	26	78
Apprch %	50	50	0	0		13.3	76.7	10	0		31.2	18.8	50	0		3.8	92.3	3.8	0		
Total %	3.8	3.8	0	0	7.7	5.1	29.5	3.8	0	38.5	6.4	3.8	10.3	0	20.5	1.3	30.8	1.3	0	33.3	

Start Time	Gateway Drive Southbound					Cleveland Avenue Westbound					Gateway Drive Northbound					Cleveland Avenue Eastbound					Int. Total
	Left	Thru	Right	U-Turns	App. Total	Thru	Right	U-Turns	App. Total	Thru	Right	U-Turns	App. Total	Thru	Right	U-Turns	App. Total				
Peak Hour Analysis From 04:30 PM to 05:15 PM - Peak 1 of 1																					
Peak Hour for Entire Intersection Begins at 04:30 PM																					
04:30 PM	1	0	0	0	1	1	3	0	0	4	0	0	0	0	0	0	3	0	0	3	8
04:45 PM	1	3	0	0	4	2	2	0	0	4	1	0	2	0	3	0	4	0	0	4	15
05:00 PM	1	0	0	0	1	0	3	1	0	4	1	0	1	0	2	0	4	0	0	4	11
05:15 PM	0	0	0	0	0	0	4	0	0	4	0	0	0	0	0	0	1	0	0	1	5
Total Volume	3	3	0	0	6	3	12	1	0	16	2	0	3	0	5	0	12	0	0	12	39
% App. Total	50	50	0	0		18.8	75	6.2	0		40	0	60	0		0	100	0	0		
PHF	.750	.250	.000	.000	.375	.375	.750	.250	.000	1.00	.500	.000	.375	.000	.417	.000	.750	.000	.000	.750	.650

City of Madera
 N/S: Gateway Drive
 E/W: Cleveland Avenue
 Weather: Clear

File Name : 28_MDA_Gateway_Cleveland PM
 Site Code : 00319628
 Start Date : 9/24/2019
 Page No : 2

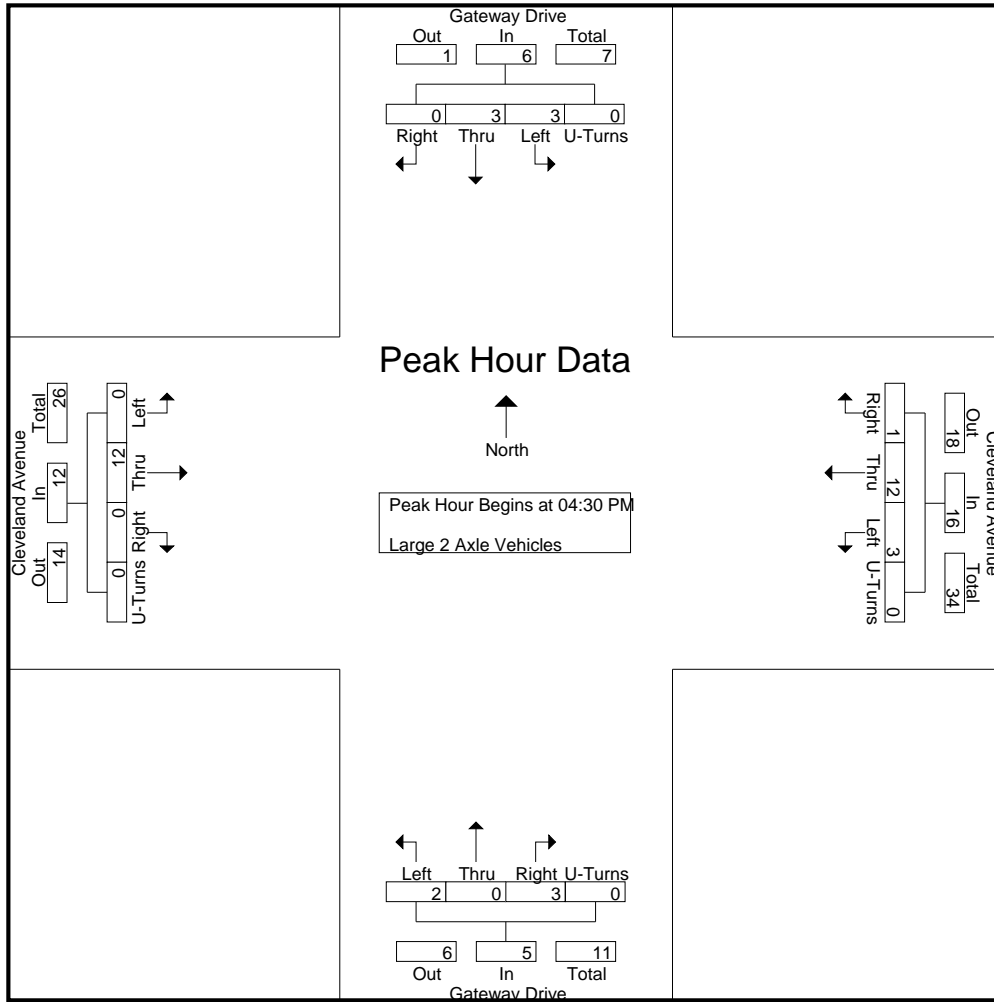

Peak Hour Analysis From 04:30 PM to 05:15 PM - Peak 1 of 1
 Peak Hour for Each Approach Begins at:

	04:30 PM					04:30 PM					04:30 PM									
+0 mins.	1	0	0	0	1	1	3	0	0	4	0	0	0	0	0	0	3	0	0	3
+15 mins.	1	3	0	0	4	2	2	0	0	4	1	0	2	0	3	0	4	0	0	4
+30 mins.	1	0	0	0	1	0	3	1	0	4	1	0	1	0	2	0	4	0	0	4
+45 mins.	0	0	0	0	0	0	4	0	0	4	0	0	0	0	0	0	1	0	0	1
Total Volume	3	3	0	0	6	3	12	1	0	16	2	0	3	0	5	0	12	0	0	12
% App. Total	50	50	0	0		18.8	75	6.2	0		40	0	60	0		0	100	0	0	
PHF	.750	.250	.000	.000	.375	.375	.750	.250	.000	1.000	.500	.000	.375	.000	.417	.000	.750	.000	.000	.750

City of Madera
 N/S: Gateway Drive
 E/W: Cleveland Avenue
 Weather: Clear

File Name : 28_MDA_Gateway_Cleveland PM
 Site Code : 00319628
 Start Date : 9/24/2019
 Page No : 1

Groups Printed- 3 Axle Vehicles

Start Time	Gateway Drive Southbound					Cleveland Avenue Westbound					Gateway Drive Northbound					Cleveland Avenue Eastbound					Int. Total
	Left	Thru	Right	U-Turns	App. Total	Left	Thru	Right	U-Turns	App. Total	Left	Thru	Right	U-Turns	App. Total	Left	Thru	Right	U-Turns	App. Total	
04:00 PM	0	0	0	0	0	0	0	0	0	0	0	0	0	0	0	0	0	0	0	0	0
04:15 PM	0	0	0	0	0	0	1	1	0	2	0	0	0	0	0	0	0	0	0	0	0
04:30 PM	0	0	0	0	0	0	0	0	0	0	0	0	0	0	0	0	0	0	0	0	0
04:45 PM	0	0	0	0	0	0	0	0	0	0	0	0	0	0	0	0	0	0	0	0	0
Total	0	0	0	0	0	0	1	1	0	2	0	0	0	0	0	0	0	0	0	0	2
05:00 PM	0	0	0	0	0	0	0	0	0	0	0	0	0	0	0	0	1	0	0	1	1
05:15 PM	0	0	0	0	0	0	0	0	0	0	0	0	0	0	0	0	1	0	0	1	1
05:30 PM	0	0	0	0	0	0	0	0	0	0	0	0	1	0	1	0	0	0	0	0	1
05:45 PM	0	0	0	0	0	0	0	0	0	0	0	0	0	0	0	0	0	0	0	0	0
Total	0	0	0	0	0	0	0	0	0	0	0	0	1	0	1	0	2	0	0	2	3
Grand Total	0	0	0	0	0	0	1	1	0	2	0	0	1	0	1	0	2	0	0	2	5
Apprch %	0	0	0	0		0	50	50	0		0	0	100	0		0	100	0	0		
Total %	0	0	0	0	0	0	20	20	0	40	0	0	20	0	20	0	40	0	0	40	

Start Time	Gateway Drive Southbound					Cleveland Avenue Westbound					Gateway Drive Northbound					Cleveland Avenue Eastbound					Int. Total
	Left	Thru	Right	U-Turns	App. Total	Left	Thru	Right	U-Turns	App. Total	Left	Thru	Right	U-Turns	App. Total	Left	Thru	Right	U-Turns	App. Total	
Peak Hour Analysis From 04:30 PM to 05:15 PM - Peak 1 of 1																					
Peak Hour for Entire Intersection Begins at 04:30 PM																					
04:30 PM	0	0	0	0	0	0	0	0	0	0	0	0	0	0	0	0	0	0	0	0	0
04:45 PM	0	0	0	0	0	0	0	0	0	0	0	0	0	0	0	0	0	0	0	0	0
05:00 PM	0	0	0	0	0	0	0	0	0	0	0	0	0	0	0	0	1	0	0	1	1
05:15 PM	0	0	0	0	0	0	0	0	0	0	0	0	0	0	0	0	1	0	0	1	1
Total Volume	0	0	0	0	0	0	0	0	0	0	0	0	0	0	0	0	2	0	0	2	2
% App. Total	0	0	0	0		0	0	0	0		0	0	0	0		0	100	0	0		
PHF	.000	.000	.000	.000	.000	.000	.000	.000	.000	.000	.000	.000	.000	.000	.000	.000	.500	.000	.000	.500	.500

City of Madera
 N/S: Gateway Drive
 E/W: Cleveland Avenue
 Weather: Clear

File Name : 28_MDA_Gateway_Cleveland PM
 Site Code : 00319628
 Start Date : 9/24/2019
 Page No : 2

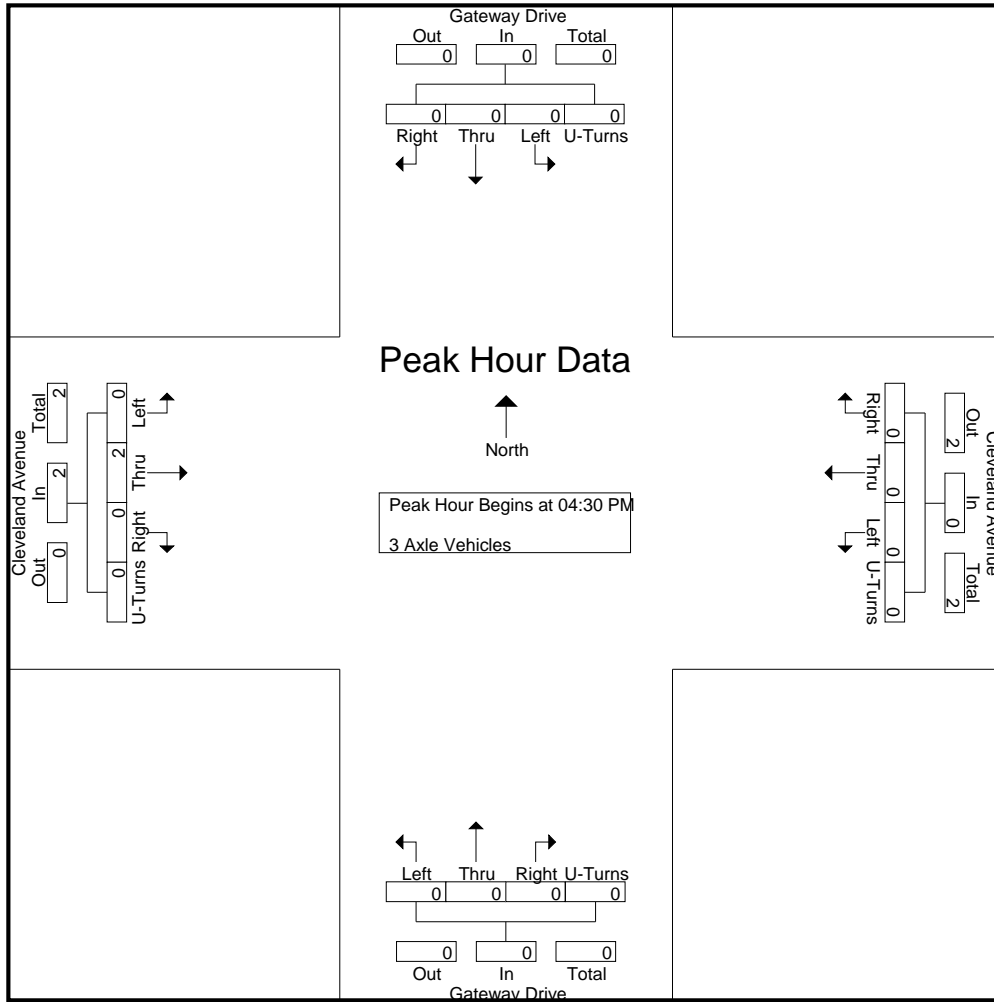

Peak Hour Analysis From 04:30 PM to 05:15 PM - Peak 1 of 1
 Peak Hour for Each Approach Begins at:

	04:30 PM					04:30 PM					04:30 PM					04:30 PM									
+0 mins.	0	0	0	0	0	0	0	0	0	0	0	0	0	0	0	0	0	0	0	0	0	0	0	0	0
+15 mins.	0	0	0	0	0	0	0	0	0	0	0	0	0	0	0	0	0	0	0	0	0	0	0	0	0
+30 mins.	0	0	0	0	0	0	0	0	0	0	0	0	0	0	0	0	1	0	0	0	0	1	0	0	0
+45 mins.	0	0	0	0	0	0	0	0	0	0	0	0	0	0	0	0	1	0	0	0	0	1	0	0	0
Total Volume	0	0	0	0	0	0	0	0	0	0	0	0	0	0	0	0	2	0	0	0	0	2	0	0	0
% App. Total	0	0	0	0	0	0	0	0	0	0	0	0	0	0	0	0	100	0	0	0	0	100	0	0	0
PHF	.000	.000	.000	.000	.000	.000	.000	.000	.000	.000	.000	.000	.000	.000	.000	.000	.500	.000	.000	.500	.000	.500	.000	.000	.500

City of Madera
 N/S: Gateway Drive
 E/W: Cleveland Avenue
 Weather: Clear

File Name : 28_MDA_Gateway_Cleveland PM
 Site Code : 00319628
 Start Date : 9/24/2019
 Page No : 1

Groups Printed- 4+ Axle Trucks

Start Time	Gateway Drive Southbound					Cleveland Avenue Westbound					Gateway Drive Northbound					Cleveland Avenue Eastbound					Int. Total
	Left	Thru	Right	U-Turns	App. Total	Left	Thru	Right	U-Turns	App. Total	Left	Thru	Right	U-Turns	App. Total	Left	Thru	Right	U-Turns	App. Total	
04:00 PM	0	0	0	0	0	0	2	0	0	2	0	0	0	0	0	0	1	0	0	1	3
04:15 PM	0	2	0	0	2	1	1	0	0	2	1	0	0	0	1	0	0	0	0	0	5
04:30 PM	0	0	0	0	0	0	1	0	0	1	0	0	0	0	0	0	0	0	0	0	1
04:45 PM	0	1	0	0	1	0	0	0	0	0	0	0	0	0	0	0	1	0	0	1	2
Total	0	3	0	0	3	1	4	0	0	5	1	0	0	0	1	0	2	0	0	2	11
05:00 PM	0	1	0	0	1	0	1	0	0	1	1	0	0	0	1	0	1	0	0	1	4
05:15 PM	0	0	0	0	0	0	2	0	0	2	0	0	0	0	0	0	1	0	0	1	3
05:30 PM	1	0	0	0	1	0	0	0	0	0	0	0	0	0	0	0	1	1	0	2	3
05:45 PM	0	0	0	0	0	0	1	0	0	1	0	0	0	0	0	0	0	0	0	0	1
Total	1	1	0	0	2	0	4	0	0	4	1	0	0	0	1	0	3	1	0	4	11
Grand Total	1	4	0	0	5	1	8	0	0	9	2	0	0	0	2	0	5	1	0	6	22
Apprch %	20	80	0	0		11.1	88.9	0	0		100	0	0	0		0	83.3	16.7	0		
Total %	4.5	18.2	0	0	22.7	4.5	36.4	0	0	40.9	9.1	0	0	0	9.1	0	22.7	4.5	0	27.3	

Start Time	Gateway Drive Southbound					Cleveland Avenue Westbound					Gateway Drive Northbound					Cleveland Avenue Eastbound					Int. Total
	Left	Thru	Right	U-Turns	App. Total	Thru	Right	U-Turns	App. Total	Thru	Right	U-Turns	App. Total	Thru	Right	U-Turns	App. Total				
Peak Hour Analysis From 04:30 PM to 05:15 PM - Peak 1 of 1																					
Peak Hour for Entire Intersection Begins at 04:30 PM																					
04:30 PM	0	0	0	0	0	0	1	0	0	1	0	0	0	0	0	0	0	0	0	0	1
04:45 PM	0	1	0	0	1	0	0	0	0	0	0	0	0	0	0	0	1	0	0	1	2
05:00 PM	0	1	0	0	1	0	1	0	0	1	1	0	0	0	1	0	1	0	0	1	4
05:15 PM	0	0	0	0	0	0	2	0	0	2	0	0	0	0	0	0	1	0	0	1	3
Total Volume	0	2	0	0	2	0	4	0	0	4	1	0	0	0	1	0	3	0	0	3	10
% App. Total	0	100	0	0		0	100	0	0		100	0	0	0		0	100	0	0		
PHF	.000	.500	.000	.000	.500	.000	.500	.000	.000	.500	.250	.000	.000	.000	.250	.000	.750	.000	.000	.750	.625

City of Madera
 N/S: Gateway Drive
 E/W: Cleveland Avenue
 Weather: Clear

File Name : 28_MDA_Gateway_Cleveland PM
 Site Code : 00319628
 Start Date : 9/24/2019
 Page No : 2

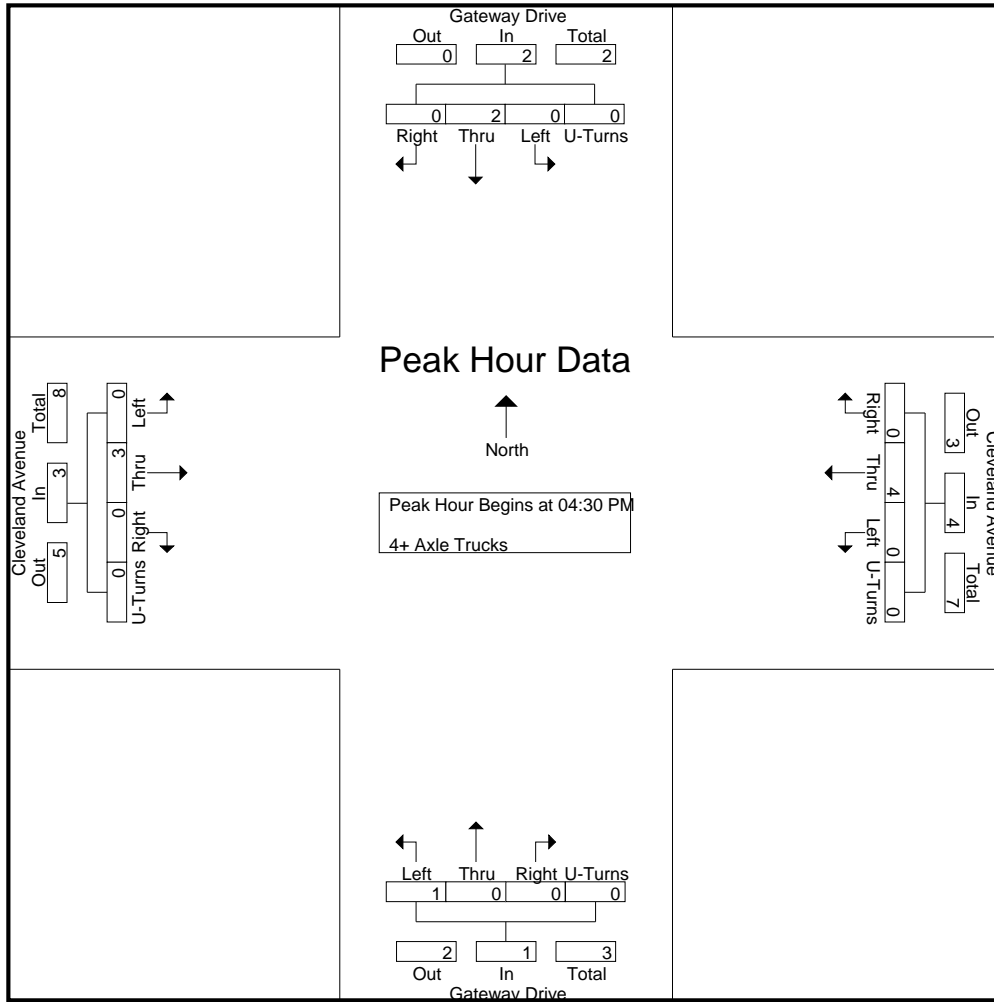

Peak Hour Analysis From 04:30 PM to 05:15 PM - Peak 1 of 1
 Peak Hour for Each Approach Begins at:

	04:30 PM					04:30 PM					04:30 PM									
+0 mins.	0	0	0	0	0	0	1	0	0	1	0	0	0	0	0	0	0	0	0	0
+15 mins.	0	1	0	0	1	0	0	0	0	0	0	0	0	0	0	0	1	0	0	1
+30 mins.	0	1	0	0	1	0	1	0	0	1	1	0	0	0	1	0	1	0	0	1
+45 mins.	0	0	0	0	0	0	2	0	0	2	0	0	0	0	0	0	1	0	0	1
Total Volume	0	2	0	0	2	0	4	0	0	4	1	0	0	0	1	0	3	0	0	3
% App. Total	0	100	0	0	0	0	100	0	0	0	100	0	0	0	0	0	100	0	0	0
PHF	.000	.500	.000	.000	.500	.000	.500	.000	.000	.500	.250	.000	.000	.000	.250	.000	.750	.000	.000	.750

Location: Madera
 N/S: Gateway Drive
 E/W: Cleveland Avenue



Date: 9/24/2019
 Day: Tuesday

PEDESTRIANS

	North Leg Gateway Drive	East Leg Cleveland Avenue	South Leg Gateway Drive	West Leg Cleveland Avenue	
	Pedestrians	Pedestrians	Pedestrians	Pedestrians	
7:00 AM	0	0	1	0	1
7:15 AM	0	0	0	0	0
7:30 AM	0	0	0	0	0
7:45 AM	0	0	0	0	0
8:00 AM	1	0	2	1	4
8:15 AM	0	0	1	1	2
8:30 AM	1	0	4	2	7
8:45 AM	2	0	1	1	4
TOTAL VOLUMES:	4	0	9	5	18

	North Leg Gateway Drive	East Leg Cleveland Avenue	South Leg Gateway Drive	West Leg Cleveland Avenue	
	Pedestrians	Pedestrians	Pedestrians	Pedestrians	
4:00 PM	1	0	0	1	2
4:15 PM	3	0	2	1	6
4:30 PM	0	0	0	3	3
4:45 PM	3	0	4	1	8
5:00 PM	1	0	0	1	2
5:15 PM	0	0	0	0	0
5:30 PM	3	0	0	0	3
5:45 PM	3	0	4	3	10
TOTAL VOLUMES:	14	0	10	10	34

Location: Madera
 N/S: Gateway Drive
 E/W: Cleveland Avenue



Date: 9/24/2019
 Day: Tuesday

BICYCLES

	Southbound Gateway Drive			Westbound Cleveland Avenue			Northbound Gateway Drive			Eastbound Cleveland Avenue			
	Left	Thru	Right	Left	Thru	Right	Left	Thru	Right	Left	Thru	Right	
7:00 AM	0	0	0	1	0	0	0	0	0	0	0	0	1
7:15 AM	0	0	0	0	0	1	0	0	0	0	0	0	1
7:30 AM	0	0	0	1	1	0	1	1	0	0	0	0	4
7:45 AM	0	0	0	0	1	0	0	0	0	0	0	0	1
8:00 AM	0	0	0	2	0	0	0	0	0	0	1	0	3
8:15 AM	0	0	0	1	2	0	0	0	0	0	0	0	3
8:30 AM	0	0	0	0	0	0	0	0	0	0	0	0	0
8:45 AM	0	0	0	1	0	0	0	0	0	0	0	0	1
TOTAL VOLUMES:	0	0	0	6	4	1	1	1	0	0	1	0	14

	Southbound Gateway Drive			Westbound Cleveland Avenue			Northbound Gateway Drive			Eastbound Cleveland Avenue			
	Left	Thru	Right	Left	Thru	Right	Left	Thru	Right	Left	Thru	Right	
4:00 PM	0	0	0	1	1	0	0	0	1	0	0	0	3
4:15 PM	0	0	0	0	0	0	0	0	0	0	0	0	0
4:30 PM	0	0	0	1	1	0	0	0	0	0	1	0	3
4:45 PM	0	0	0	0	1	0	1	0	0	0	1	0	3
5:00 PM	0	0	0	2	0	0	0	0	0	0	0	0	2
5:15 PM	0	0	0	0	0	0	0	0	0	0	0	0	0
5:30 PM	0	0	0	0	0	0	0	0	0	0	0	0	0
5:45 PM	0	0	0	0	0	0	0	0	0	0	0	0	0
TOTAL VOLUMES:	0	0	0	4	3	0	1	0	1	0	2	0	11

City of Madera
 N/S: Country Club Drive/Cleveland Ave
 E/W: Cleveland Ave
 Weather: Clear

File Name : 29_MDA_Country Club_Cleveland AM
 Site Code : 00319628
 Start Date : 9/24/2019
 Page No : 1

Groups Printed- Total Volume

Start Time	Country Club Drive Southbound				Cleveland Avenue Westbound				Cleveland Avenue Northbound				Int. Total
	Left	Thru	U-Turns	App. Total	Left	Right	U-Turns	App. Total	Thru	Right	U-Turns	App. Total	
07:00 AM	7	74	0	81	59	3	0	62	57	31	0	88	231
07:15 AM	11	89	0	100	59	0	0	59	92	40	0	132	291
07:30 AM	20	99	0	119	75	7	0	82	139	57	0	196	397
07:45 AM	25	175	0	200	79	6	0	85	147	58	0	205	490
Total	63	437	0	500	272	16	0	288	435	186	0	621	1409
08:00 AM	17	177	0	194	65	1	0	66	98	43	0	141	401
08:15 AM	14	132	0	146	52	5	0	57	97	35	0	132	335
08:30 AM	6	111	0	117	73	8	0	81	109	52	0	161	359
08:45 AM	12	101	0	113	81	1	0	82	116	62	0	178	373
Total	49	521	0	570	271	15	0	286	420	192	0	612	1468
Grand Total	112	958	0	1070	543	31	0	574	855	378	0	1233	2877
Apprch %	10.5	89.5	0		94.6	5.4	0		69.3	30.7	0		
Total %	3.9	33.3	0	37.2	18.9	1.1	0	20	29.7	13.1	0	42.9	

Start Time	Country Club Drive Southbound				Cleveland Avenue Westbound				Cleveland Avenue Northbound				Int. Total
	Left	Thru	U-Turns	App. Total	Left	Right	U-Turns	App. Total	Thru	Right	U-Turns	App. Total	
Peak Hour Analysis From 07:00 AM to 08:45 AM - Peak 1 of 1													
Peak Hour for Entire Intersection Begins at 07:30 AM													
07:30 AM	20	99	0	119	75	7	0	82	139	57	0	196	397
07:45 AM	25	175	0	200	79	6	0	85	147	58	0	205	490
08:00 AM	17	177	0	194	65	1	0	66	98	43	0	141	401
08:15 AM	14	132	0	146	52	5	0	57	97	35	0	132	335
Total Volume	76	583	0	659	271	19	0	290	481	193	0	674	1623
% App. Total	11.5	88.5	0		93.4	6.6	0		71.4	28.6	0		
PHF	.760	.823	.000	.824	.858	.679	.000	.853	.818	.832	.000	.822	.828

City of Madera
 N/S: Country Club Drive/Cleveland Ave
 E/W: Cleveland Ave
 Weather: Clear

File Name : 29_MDA_Country Club_Cleveland AM
 Site Code : 00319628
 Start Date : 9/24/2019
 Page No : 2

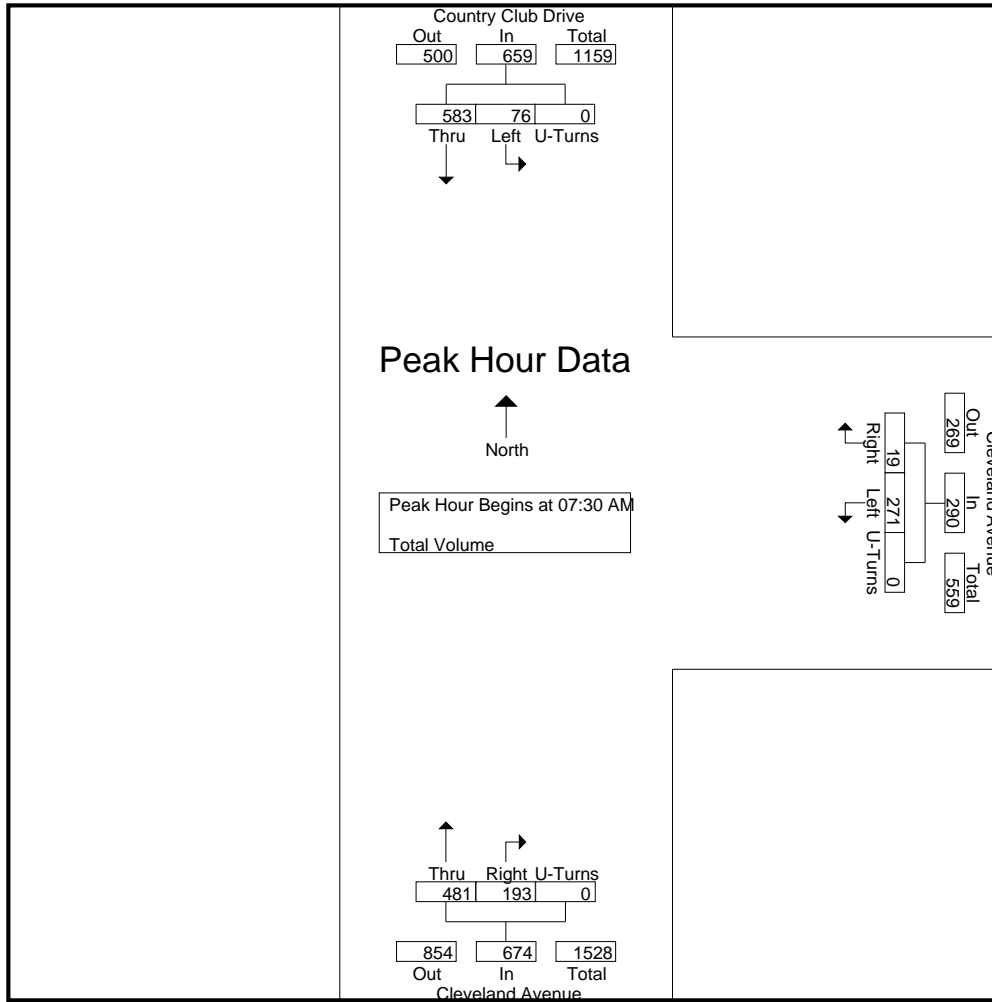

Peak Hour Analysis From 07:00 AM to 08:45 AM - Peak 1 of 1

Peak Hour for Each Approach Begins at:

	07:30 AM				07:15 AM				07:15 AM			
+0 mins.	20	99	0	119	59	0	0	59	92	40	0	132
+15 mins.	25	175	0	200	75	7	0	82	139	57	0	196
+30 mins.	17	177	0	194	79	6	0	85	147	58	0	205
+45 mins.	14	132	0	146	65	1	0	66	98	43	0	141
Total Volume	76	583	0	659	278	14	0	292	476	198	0	674
% App. Total	11.5	88.5	0		95.2	4.8	0		70.6	29.4	0	
PHF	.760	.823	.000	.824	.880	.500	.000	.859	.810	.853	.000	.822

City of Madera
 N/S: Country Club Drive/Cleveland Ave
 E/W: Cleveland Ave
 Weather: Clear

File Name : 29_MDA_Country Club_Cleveland PM
 Site Code : 00319628
 Start Date : 9/24/2019
 Page No : 1

Groups Printed- Total Volume

Start Time	Country Club Drive Southbound				Cleveland Avenue Westbound				Cleveland Avenue Northbound				Int. Total
	Left	Thru	U-Turns	App. Total	Left	Right	U-Turns	App. Total	Thru	Right	U-Turns	App. Total	
04:00 PM	21	144	0	165	65	13	0	78	181	105	0	286	529
04:15 PM	28	136	0	164	80	9	0	89	165	99	0	264	517
04:30 PM	18	112	0	130	68	6	0	74	177	97	0	274	478
04:45 PM	22	152	0	174	85	8	0	93	157	94	0	251	518
Total	89	544	0	633	298	36	0	334	680	395	0	1075	2042
05:00 PM	21	133	0	154	75	5	0	80	181	104	0	285	519
05:15 PM	14	153	0	167	84	8	0	92	185	111	0	296	555
05:30 PM	18	137	0	155	83	5	0	88	186	81	0	267	510
05:45 PM	23	132	0	155	77	9	0	86	179	85	0	264	505
Total	76	555	0	631	319	27	0	346	731	381	0	1112	2089
Grand Total	165	1099	0	1264	617	63	0	680	1411	776	0	2187	4131
Apprch %	13.1	86.9	0		90.7	9.3	0		64.5	35.5	0		
Total %	4	26.6	0	30.6	14.9	1.5	0	16.5	34.2	18.8	0	52.9	

Start Time	Country Club Drive Southbound				Cleveland Avenue Westbound				Cleveland Avenue Northbound				Int. Total
	Left	Thru	U-Turns	App. Total	Left	Right	U-Turns	App. Total	Thru	Right	U-Turns	App. Total	
Peak Hour Analysis From 04:00 PM to 05:45 PM - Peak 1 of 1													
Peak Hour for Entire Intersection Begins at 04:45 PM													
04:45 PM	22	152	0	174	85	8	0	93	157	94	0	251	518
05:00 PM	21	133	0	154	75	5	0	80	181	104	0	285	519
05:15 PM	14	153	0	167	84	8	0	92	185	111	0	296	555
05:30 PM	18	137	0	155	83	5	0	88	186	81	0	267	510
Total Volume	75	575	0	650	327	26	0	353	709	390	0	1099	2102
% App. Total	11.5	88.5	0		92.6	7.4	0		64.5	35.5	0		
PHF	.852	.940	.000	.934	.962	.813	.000	.949	.953	.878	.000	.928	.947

City of Madera
 N/S: Country Club Drive/Cleveland Ave
 E/W: Cleveland Ave
 Weather: Clear

File Name : 29_MDA_Country Club_Cleveland PM
 Site Code : 00319628
 Start Date : 9/24/2019
 Page No : 2

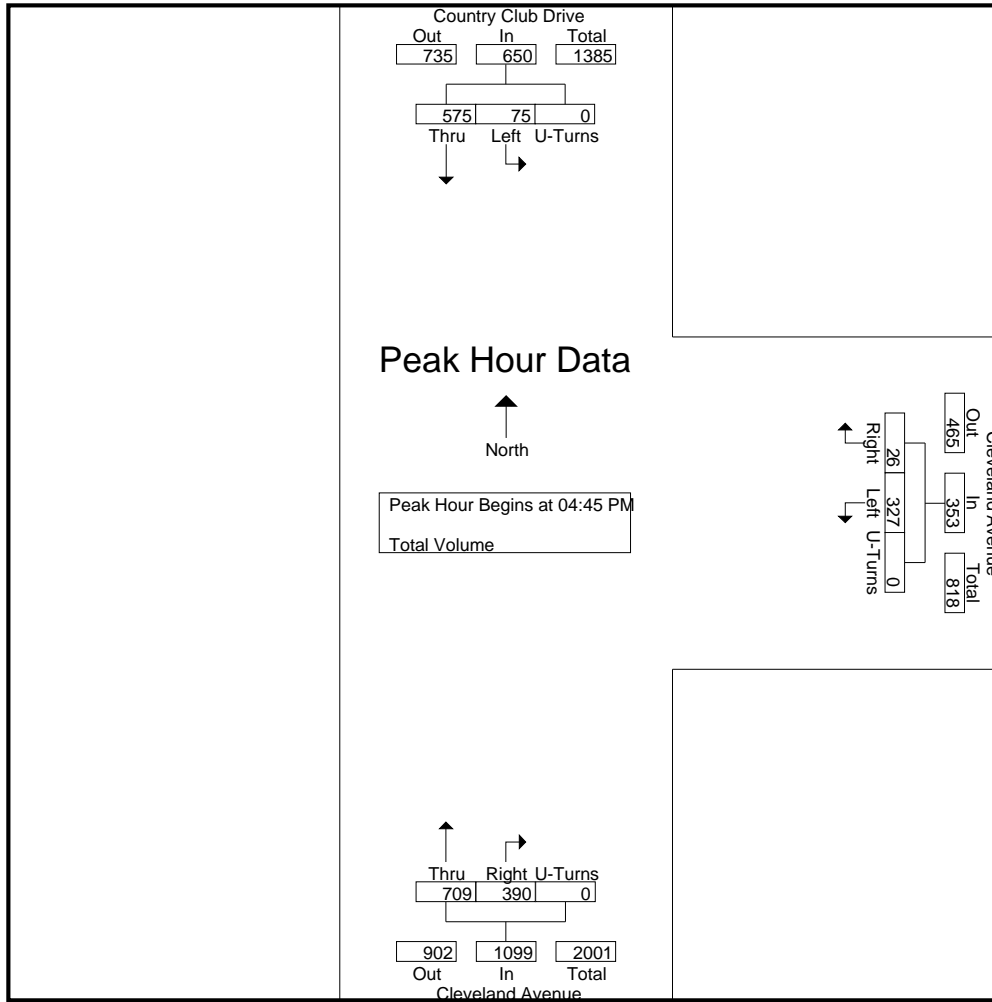

Peak Hour Analysis From 04:00 PM to 05:45 PM - Peak 1 of 1

Peak Hour for Each Approach Begins at:

	04:45 PM				04:45 PM				05:00 PM			
+0 mins.	22	152	0	174	85	8	0	93	181	104	0	285
+15 mins.	21	133	0	154	75	5	0	80	185	111	0	296
+30 mins.	14	153	0	167	84	8	0	92	186	81	0	267
+45 mins.	18	137	0	155	83	5	0	88	179	85	0	264
Total Volume	75	575	0	650	327	26	0	353	731	381	0	1112
% App. Total	11.5	88.5	0		92.6	7.4	0		65.7	34.3	0	
PHF	.852	.940	.000	.934	.962	.813	.000	.949	.983	.858	.000	.939

Location: Madera
 N/S: Country Club Drive/Cleveland Ave
 E/W: Cleveland Avenue



Date: 9/24/2019
 Day: Tuesday

PEDESTRIANS

	North Leg Country Club Drive	East Leg Cleveland Avenue	South Leg Cleveland Avenue	West Leg Dead End	
	Pedestrians	Pedestrians	Pedestrians	Pedestrians	
7:00 AM	0	0	0	0	0
7:15 AM	0	0	0	0	0
7:30 AM	0	0	0	0	0
7:45 AM	1	0	0	0	1
8:00 AM	2	0	0	0	2
8:15 AM	0	0	0	0	0
8:30 AM	1	0	0	0	1
8:45 AM	1	0	0	0	1
TOTAL VOLUMES:	5	0	0	0	5

	North Leg Country Club Drive	East Leg Cleveland Avenue	South Leg Cleveland Avenue	West Leg Dead End	
	Pedestrians	Pedestrians	Pedestrians	Pedestrians	
4:00 PM	4	1	0	0	5
4:15 PM	0	1	0	0	1
4:30 PM	0	0	0	0	0
4:45 PM	2	2	0	0	4
5:00 PM	2	0	0	0	2
5:15 PM	1	1	0	0	2
5:30 PM	1	0	0	0	1
5:45 PM	0	0	0	0	0
TOTAL VOLUMES:	10	5	0	0	15

Location: Madera
 N/S: Country Club Drive/Cleveland Ave
 E/W: Cleveland Avenue



Date: 9/24/2019
 Day: Tuesday

BICYCLES

	Southbound Country Club Drive			Westbound Cleveland Avenue			Northbound Cleveland Avenue			Eastbound Dead End			
	Left	Thru	Right	Left	Thru	Right	Left	Thru	Right	Left	Thru	Right	
7:00 AM	0	0	0	1	0	0	0	0	0	0	0	0	1
7:15 AM	0	1	0	0	0	0	0	0	0	0	0	0	1
7:30 AM	0	1	0	0	0	0	0	0	0	0	0	0	1
7:45 AM	0	0	0	1	0	0	0	0	0	0	0	0	1
8:00 AM	0	2	0	0	0	0	0	1	0	0	0	0	3
8:15 AM	0	0	0	0	0	0	0	0	0	0	0	0	0
8:30 AM	0	0	0	0	0	1	0	3	1	0	0	0	5
8:45 AM	0	0	0	0	0	0	0	0	0	0	0	0	0
TOTAL VOLUMES:	0	4	0	2	0	1	0	4	1	0	0	0	12

	Southbound Country Club Drive			Westbound Cleveland Avenue			Northbound Cleveland Avenue			Eastbound Dead End			
	Left	Thru	Right	Left	Thru	Right	Left	Thru	Right	Left	Thru	Right	
4:00 PM	0	2	0	0	0	0	0	0	1	0	0	0	3
4:15 PM	0	0	0	0	0	0	0	0	0	0	0	0	0
4:30 PM	0	1	0	0	0	0	0	3	0	0	0	0	4
4:45 PM	0	1	0	0	0	0	0	1	1	0	0	0	3
5:00 PM	0	1	0	0	0	0	0	0	0	0	0	0	1
5:15 PM	0	0	0	1	0	0	0	0	0	0	0	0	1
5:30 PM	0	0	0	0	0	0	0	0	0	0	0	0	0
5:45 PM	0	0	0	0	0	0	0	0	0	0	0	0	0
TOTAL VOLUMES:	0	5	0	1	0	0	0	4	2	0	0	0	12

City of Madera
 N/S: Country Club Drive
 E/W: Sharon Boulevard
 Weather: Clear

File Name : 51_MDA_Country Club_Sharon AM
 Site Code : 00319628
 Start Date : 9/26/2019
 Page No : 1

Groups Printed- Passenger Vehicles - Large 2 Axle Vehicles - 3 Axle Vehicles - 4+ Axle Trucks

Start Time	Country Club Drive Southbound					Rent-A-Center Driveway Westbound					Country Club Drive Northbound					Sharon Boulevard Eastbound					Int. Total
	Left	Thru	Right	U-Turns	App. Total	Left	Thru	Right	U-Turns	App. Total	Left	Thru	Right	U-Turns	App. Total	Left	Thru	Right	U-Turns	App. Total	
07:00 AM	0	97	0	0	97	0	0	0	0	0	2	61	0	0	63	0	0	2	0	2	162
07:15 AM	0	86	0	0	86	0	0	0	0	0	1	97	0	0	98	0	0	1	0	1	185
07:30 AM	0	149	1	0	150	0	0	0	0	0	0	122	0	0	122	0	0	5	0	5	277
07:45 AM	0	172	0	0	172	0	0	1	0	1	0	163	0	0	163	0	0	5	0	5	341
Total	0	504	1	0	505	0	0	1	0	1	3	443	0	0	446	0	0	13	0	13	965
08:00 AM	0	169	0	0	169	0	0	0	0	0	1	103	0	0	104	1	0	0	0	1	274
08:15 AM	1	144	0	0	145	0	0	0	0	0	0	110	0	0	110	1	0	2	0	3	258
08:30 AM	1	128	0	0	129	0	0	0	0	0	1	126	0	0	127	0	0	0	0	0	256
08:45 AM	0	113	0	0	113	0	0	0	0	0	0	119	0	0	119	0	0	0	0	0	232
Total	2	554	0	0	556	0	0	0	0	0	2	458	0	0	460	2	0	2	0	4	1020
Grand Total	2	1058	1	0	1061	0	0	1	0	1	5	901	0	0	906	2	0	15	0	17	1985
Apprch %	0.2	99.7	0.1	0		0	0	100	0		0.6	99.4	0	0		11.8	0	88.2	0		
Total %	0.1	53.3	0.1	0	53.5	0	0	0.1	0	0.1	0.3	45.4	0	0	45.6	0.1	0	0.8	0	0.9	
Passenger Vehicles	1015																				
% Passenger Vehicles	100	95.9	100	0	95.9	0	0	100	0	100	100	94.9	0	0	94.9	100	0	86.7	0	88.2	95.4
Large 2 Axle Vehicles																					
% Large 2 Axle Vehicles	0	2.6	0	0	2.6	0	0	0	0	0	0	3.1	0	0	3.1	0	0	13.3	0	11.8	2.9
3 Axle Vehicles																					
% 3 Axle Vehicles	0	0.1	0	0	0.1	0	0	0	0	0	0	0.6	0	0	0.6	0	0	0	0	0	0.3
4+ Axle Trucks																					
% 4+ Axle Trucks	0	14	0	0	14	0	0	0	0	0	0	13	0	0	13	0	0	0	0	0	27

Start Time	Country Club Drive Southbound					Rent-A-Center Driveway Westbound					Country Club Drive Northbound					Sharon Boulevard Eastbound					Int. Total
	Left	Thru	Right	U-Turns	App. Total	Left	Thru	Right	U-Turns	App. Total	Left	Thru	Right	U-Turns	App. Total	Left	Thru	Right	U-Turns	App. Total	
Peak Hour Analysis From 07:00 AM to 08:45 AM - Peak 1 of 1																					
Peak Hour for Entire Intersection Begins at 07:30 AM																					
07:30 AM	0	149	1	0	150	0	0	0	0	0	0	122	0	0	122	0	0	5	0	5	277
07:45 AM	0	172	0	0	172	0	0	1	0	1	0	163	0	0	163	0	0	5	0	5	341
08:00 AM	0	169	0	0	169	0	0	0	0	0	1	103	0	0	104	1	0	0	0	1	274
08:15 AM	1	144	0	0	145	0	0	0	0	0	0	110	0	0	110	1	0	2	0	3	258
Total Volume	1	634	1	0	636	0	0	1	0	1	1	498	0	0	499	2	0	12	0	14	1150
% App. Total	0.2	99.7	0.2	0		0	0	100	0		0.2	99.8	0	0		14.3	0	85.7	0		
PHF	.250	.922	.250	.000	.924	.000	.000	.250	.000	.250	.250	.764	.000	.000	.765	.500	.000	.600	.000	.700	.843

City of Madera
 N/S: Country Club Drive
 E/W: Sharon Boulevard
 Weather: Clear

File Name : 51_MDA_Country Club_Sharon AM
 Site Code : 00319628
 Start Date : 9/26/2019
 Page No : 2

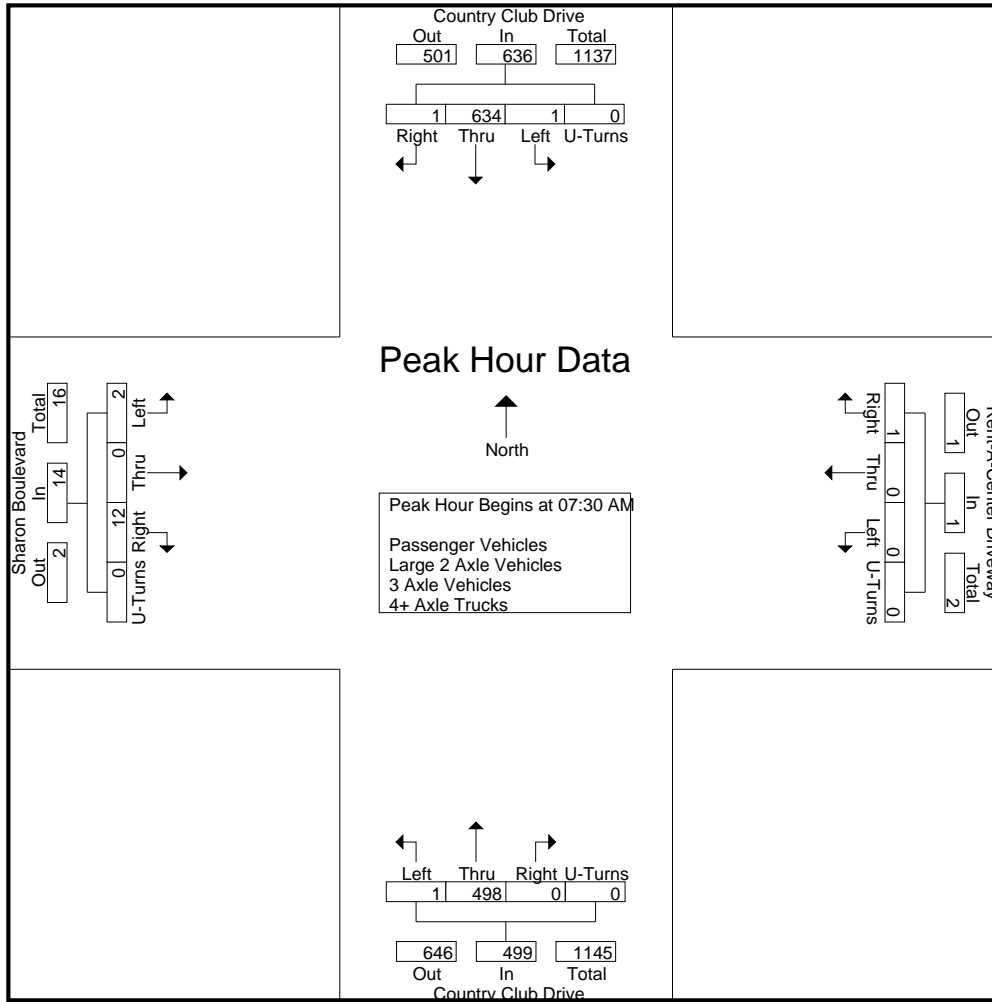

Peak Hour Analysis From 07:00 AM to 08:45 AM - Peak 1 of 1
 Peak Hour for Each Approach Begins at:

	07:30 AM					07:00 AM					07:45 AM					07:30 AM				
+0 mins.	0	149	1	0	150	0	0	0	0	0	0	163	0	0	163	0	0	5	0	5
+15 mins.	0	172	0	0	172	0	0	0	0	0	1	103	0	0	104	0	0	5	0	5
+30 mins.	0	169	0	0	169	0	0	0	0	0	0	110	0	0	110	1	0	0	0	1
+45 mins.	1	144	0	0	145	0	0	1	0	1	1	126	0	0	127	1	0	2	0	3
Total Volume	1	634	1	0	636	0	0	1	0	1	2	502	0	0	504	2	0	12	0	14
% App. Total	0.2	99.7	0.2	0		0	0	100	0		0.4	99.6	0	0		14.3	0	85.7	0	
PHF	.250	.922	.250	.000	.924	.000	.000	.250	.000	.250	.500	.770	.000	.000	.773	.500	.000	.600	.000	.700

City of Madera
 N/S: Country Club Drive
 E/W: Sharon Boulevard
 Weather: Clear

File Name : 51_MDA_Country Club_Sharon AM
 Site Code : 00319628
 Start Date : 9/26/2019
 Page No : 1

Groups Printed- Passenger Vehicles

Start Time	Country Club Drive Southbound					Rent-A-Center Driveway Westbound					Country Club Drive Northbound					Sharon Boulevard Eastbound					Int. Total
	Left	Thru	Right	U-Turns	App. Total	Left	Thru	Right	U-Turns	App. Total	Left	Thru	Right	U-Turns	App. Total	Left	Thru	Right	U-Turns	App. Total	
07:00 AM	0	93	0	0	93	0	0	0	0	0	2	57	0	0	59	0	0	1	0	1	153
07:15 AM	0	84	0	0	84	0	0	0	0	0	1	96	0	0	97	0	0	1	0	1	182
07:30 AM	0	144	1	0	145	0	0	0	0	0	0	115	0	0	115	0	0	5	0	5	265
07:45 AM	0	167	0	0	167	0	0	1	0	1	0	152	0	0	152	0	0	4	0	4	324
Total	0	488	1	0	489	0	0	1	0	1	3	420	0	0	423	0	0	11	0	11	924
08:00 AM	0	166	0	0	166	0	0	0	0	0	1	100	0	0	101	1	0	0	0	1	268
08:15 AM	1	134	0	0	135	0	0	0	0	0	0	106	0	0	106	1	0	2	0	3	244
08:30 AM	1	123	0	0	124	0	0	0	0	0	1	119	0	0	120	0	0	0	0	0	244
08:45 AM	0	104	0	0	104	0	0	0	0	0	0	110	0	0	110	0	0	0	0	0	214
Total	2	527	0	0	529	0	0	0	0	0	2	435	0	0	437	2	0	2	0	4	970
Grand Total	2	1015	1	0	1018	0	0	1	0	1	5	855	0	0	860	2	0	13	0	15	1894
Apprch %	0.2	99.7	0.1	0		0	0	100	0		0.6	99.4	0	0		13.3	0	86.7	0		
Total %	0.1	53.6	0.1	0	53.7	0	0	0.1	0	0.1	0.3	45.1	0	0	45.4	0.1	0	0.7	0	0.8	

Start Time	Country Club Drive Southbound					Rent-A-Center Driveway Westbound					Country Club Drive Northbound					Sharon Boulevard Eastbound					Int. Total
	Left	Thru	Right	U-Turns	App. Total	Left	Thru	Right	U-Turns	App. Total	Left	Thru	Right	U-Turns	App. Total	Left	Thru	Right	U-Turns	App. Total	
07:30 AM	0	144	1	0	145	0	0	0	0	0	0	115	0	0	115	0	0	5	0	5	265
07:45 AM	0	167	0	0	167	0	0	1	0	1	0	152	0	0	152	0	0	4	0	4	324
08:00 AM	0	166	0	0	166	0	0	0	0	0	1	100	0	0	101	1	0	0	0	1	268
08:15 AM	1	134	0	0	135	0	0	0	0	0	0	106	0	0	106	1	0	2	0	3	244
Total Volume	1	611	1	0	613	0	0	1	0	1	1	473	0	0	474	2	0	11	0	13	1101
% App. Total	0.2	99.7	0.2	0		0	0	100	0		0.2	99.8	0	0		15.4	0	84.6	0		
PHF	.250	.915	.250	.000	.918	.000	.000	.250	.000	.250	.250	.778	.000	.000	.780	.500	.000	.550	.000	.650	.850

Peak Hour Analysis From 07:30 AM to 08:15 AM - Peak 1 of 1

Peak Hour for Entire Intersection Begins at 07:30 AM

City of Madera
 N/S: Country Club Drive
 E/W: Sharon Boulevard
 Weather: Clear

File Name : 51_MDA_Country Club_Sharon AM
 Site Code : 00319628
 Start Date : 9/26/2019
 Page No : 2

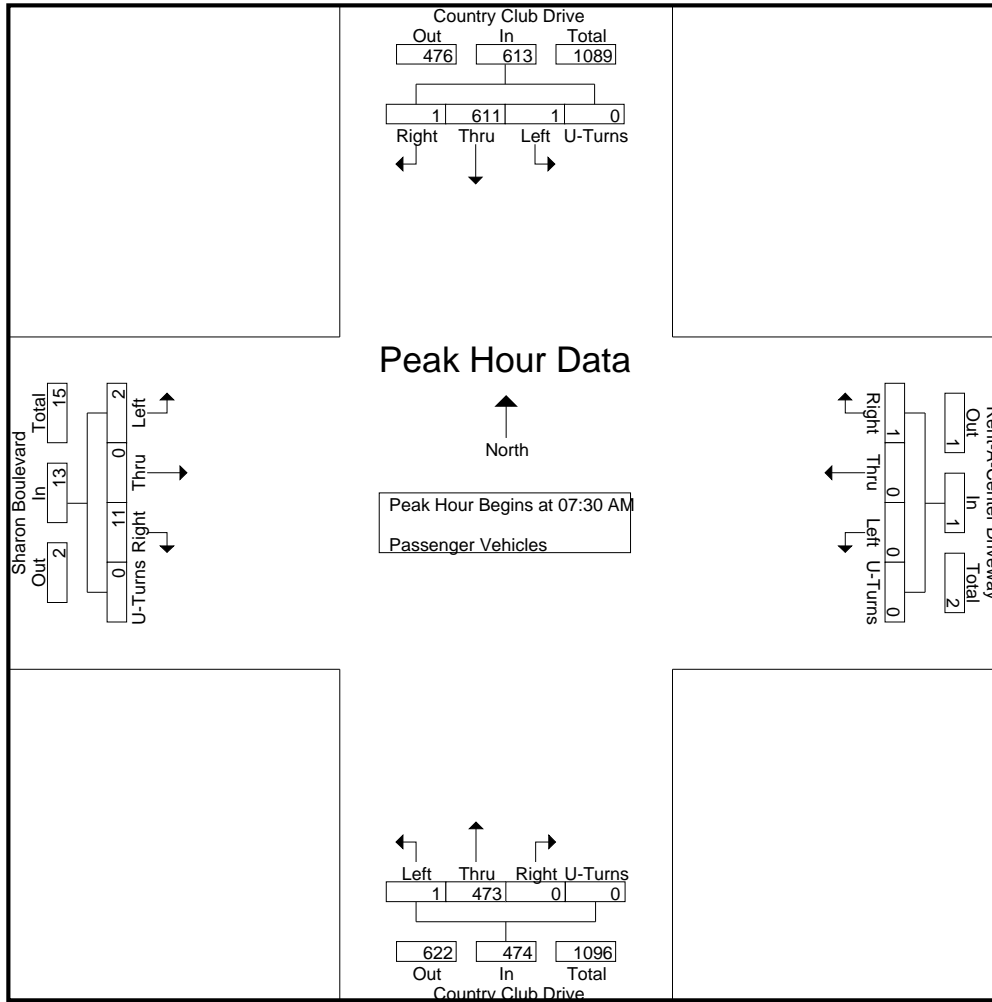

Peak Hour Analysis From 07:30 AM to 08:15 AM - Peak 1 of 1
 Peak Hour for Each Approach Begins at:

	07:30 AM					07:30 AM					07:30 AM									
+0 mins.	0	144	1	0	145	0	0	0	0	0	0	115	0	0	115	0	0	5	0	5
+15 mins.	0	167	0	0	167	0	0	1	0	1	0	152	0	0	152	0	0	4	0	4
+30 mins.	0	166	0	0	166	0	0	0	0	0	1	100	0	0	101	1	0	0	0	1
+45 mins.	1	134	0	0	135	0	0	0	0	0	0	106	0	0	106	1	0	2	0	3
Total Volume	1	611	1	0	613	0	0	1	0	1	1	473	0	0	474	2	0	11	0	13
% App. Total	0.2	99.7	0.2	0		0	0	100	0		0.2	99.8	0	0		15.4	0	84.6	0	
PHF	.250	.915	.250	.000	.918	.000	.000	.250	.000	.250	.250	.778	.000	.000	.780	.500	.000	.550	.000	.650

City of Madera
 N/S: Country Club Drive
 E/W: Sharon Boulevard
 Weather: Clear

File Name : 51_MDA_Country Club_Sharon AM
 Site Code : 00319628
 Start Date : 9/26/2019
 Page No : 1

Groups Printed- Large 2 Axle Vehicles

Start Time	Country Club Drive Southbound					Rent-A-Center Driveway Westbound					Country Club Drive Northbound					Sharon Boulevard Eastbound					Int. Total
	Left	Thru	Right	U-Turns	App. Total	Left	Thru	Right	U-Turns	App. Total	Left	Thru	Right	U-Turns	App. Total	Left	Thru	Right	U-Turns	App. Total	
07:00 AM	0	3	0	0	3	0	0	0	0	0	0	4	0	0	4	0	0	1	0	1	8
07:15 AM	0	2	0	0	2	0	0	0	0	0	0	1	0	0	1	0	0	0	0	0	3
07:30 AM	0	5	0	0	5	0	0	0	0	0	0	5	0	0	5	0	0	0	0	0	10
07:45 AM	0	2	0	0	2	0	0	0	0	0	0	3	0	0	3	0	0	1	0	1	6
Total	0	12	0	0	12	0	0	0	0	0	0	13	0	0	13	0	0	2	0	2	27
08:00 AM	0	1	0	0	1	0	0	0	0	0	0	1	0	0	1	0	0	0	0	0	2
08:15 AM	0	7	0	0	7	0	0	0	0	0	0	4	0	0	4	0	0	0	0	0	11
08:30 AM	0	3	0	0	3	0	0	0	0	0	0	5	0	0	5	0	0	0	0	0	8
08:45 AM	0	5	0	0	5	0	0	0	0	0	0	5	0	0	5	0	0	0	0	0	10
Total	0	16	0	0	16	0	0	0	0	0	0	15	0	0	15	0	0	0	0	0	31
Grand Total	0	28	0	0	28	0	0	0	0	0	0	28	0	0	28	0	0	2	0	2	58
Apprch %	0	100	0	0		0	0	0	0		0	100	0	0		0	0	100	0		
Total %	0	48.3	0	0	48.3	0	0	0	0	0	0	48.3	0	0	48.3	0	0	3.4	0	3.4	

Start Time	Country Club Drive Southbound					Rent-A-Center Driveway Westbound					Country Club Drive Northbound					Sharon Boulevard Eastbound					Int. Total
	Left	Thru	Right	U-Turns	App. Total	Thru	Right	U-Turns	App. Total	Thru	Right	U-Turns	App. Total	Thru	Right	U-Turns	App. Total				
Peak Hour Analysis From 07:30 AM to 08:15 AM - Peak 1 of 1																					
Peak Hour for Entire Intersection Begins at 07:30 AM																					
07:30 AM	0	5	0	0	5	0	0	0	0	0	0	5	0	0	5	0	0	0	0	0	10
07:45 AM	0	2	0	0	2	0	0	0	0	0	0	3	0	0	3	0	0	1	0	1	6
08:00 AM	0	1	0	0	1	0	0	0	0	0	0	1	0	0	1	0	0	0	0	0	2
08:15 AM	0	7	0	0	7	0	0	0	0	0	0	4	0	0	4	0	0	0	0	0	11
Total Volume	0	15	0	0	15	0	0	0	0	0	0	13	0	0	13	0	0	1	0	1	29
% App. Total	0	100	0	0		0	0	0	0		0	100	0	0		0	0	100	0		
PHF	.000	.536	.000	.000	.536	.000	.000	.000	.000	.000	.000	.650	.000	.000	.650	.000	.000	.250	.000	.250	.659

City of Madera
 N/S: Country Club Drive
 E/W: Sharon Boulevard
 Weather: Clear

File Name : 51_MDA_Country Club_Sharon AM
 Site Code : 00319628
 Start Date : 9/26/2019
 Page No : 2

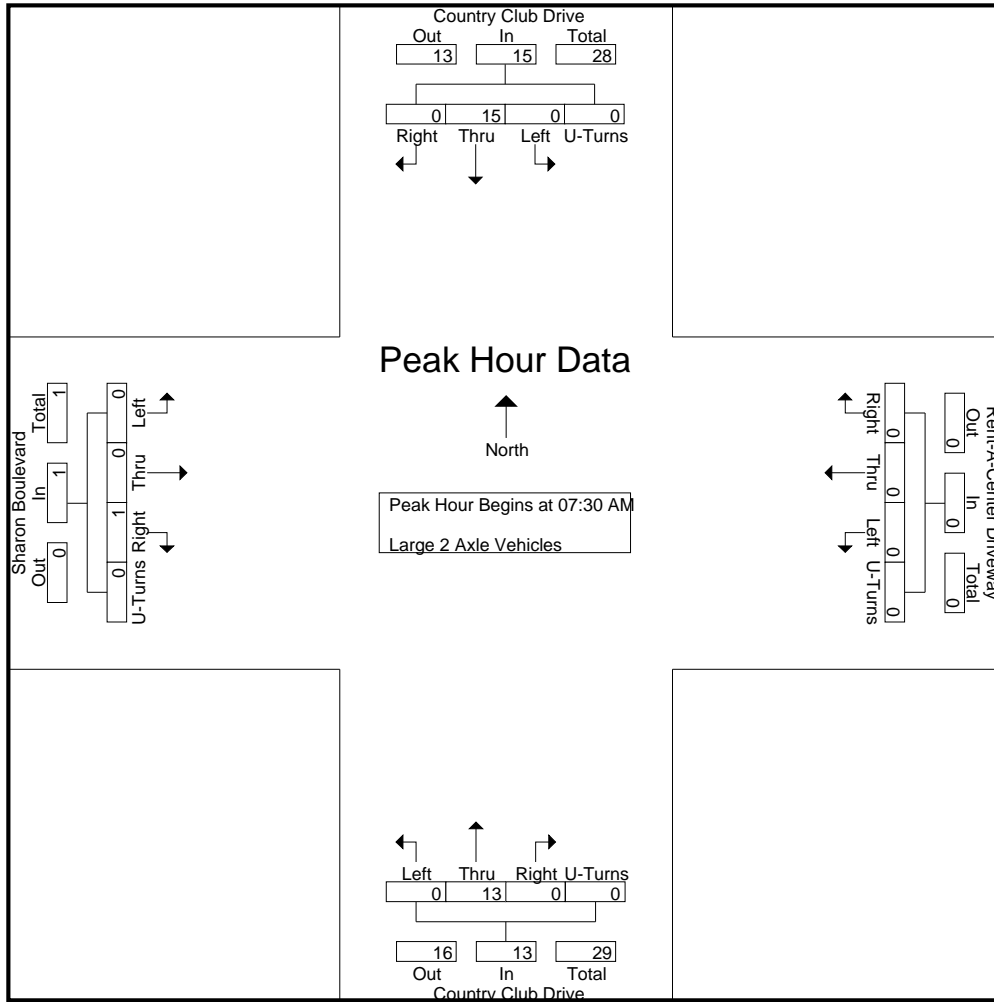

Peak Hour Analysis From 07:30 AM to 08:15 AM - Peak 1 of 1
 Peak Hour for Each Approach Begins at:

	07:30 AM					07:30 AM					07:30 AM									
+0 mins.	0	5	0	0	5	0	0	0	0	0	0	5	0	0	5	0	0	0	0	0
+15 mins.	0	2	0	0	2	0	0	0	0	0	0	3	0	0	3	0	0	1	0	1
+30 mins.	0	1	0	0	1	0	0	0	0	0	0	1	0	0	1	0	0	0	0	0
+45 mins.	0	7	0	0	7	0	0	0	0	0	0	4	0	0	4	0	0	0	0	0
Total Volume	0	15	0	0	15	0	0	0	0	0	0	13	0	0	13	0	0	1	0	1
% App. Total	0	100	0	0	0	0	0	0	0	0	0	100	0	0	0	0	0	100	0	0
PHF	.000	.536	.000	.000	.536	.000	.000	.000	.000	.000	.000	.650	.000	.000	.650	.000	.000	.250	.000	.250

City of Madera
 N/S: Country Club Drive
 E/W: Sharon Boulevard
 Weather: Clear

File Name : 51_MDA_Country Club_Sharon AM
 Site Code : 00319628
 Start Date : 9/26/2019
 Page No : 1

Groups Printed- 3 Axle Vehicles

Start Time	Country Club Drive Southbound					Rent-A-Center Driveway Westbound					Country Club Drive Northbound					Sharon Boulevard Eastbound					Int. Total
	Left	Thru	Right	U-Turns	App. Total	Left	Thru	Right	U-Turns	App. Total	Left	Thru	Right	U-Turns	App. Total	Left	Thru	Right	U-Turns	App. Total	
07:00 AM	0	0	0	0	0	0	0	0	0	0	0	0	0	0	0	0	0	0	0	0	0
07:15 AM	0	0	0	0	0	0	0	0	0	0	0	0	0	0	0	0	0	0	0	0	0
07:30 AM	0	0	0	0	0	0	0	0	0	0	0	0	0	0	0	0	0	0	0	0	0
07:45 AM	0	0	0	0	0	0	0	0	0	0	0	2	0	0	2	0	0	0	0	0	2
Total	0	0	0	0	0	0	0	0	0	0	0	2	0	0	2	0	0	0	0	0	2
08:00 AM	0	1	0	0	1	0	0	0	0	0	0	1	0	0	1	0	0	0	0	0	2
08:15 AM	0	0	0	0	0	0	0	0	0	0	0	0	0	0	0	0	0	0	0	0	0
08:30 AM	0	0	0	0	0	0	0	0	0	0	0	1	0	0	1	0	0	0	0	0	1
08:45 AM	0	0	0	0	0	0	0	0	0	0	0	1	0	0	1	0	0	0	0	0	1
Total	0	1	0	0	1	0	0	0	0	0	0	3	0	0	3	0	0	0	0	0	4
Grand Total	0	1	0	0	1	0	0	0	0	0	0	5	0	0	5	0	0	0	0	0	6
Apprch %	0	100	0	0		0	0	0	0		0	100	0	0		0	0	0	0		
Total %	0	16.7	0	0	16.7	0	0	0	0	0	0	83.3	0	0	83.3	0	0	0	0	0	

Start Time	Country Club Drive Southbound					Rent-A-Center Driveway Westbound					Country Club Drive Northbound					Sharon Boulevard Eastbound					Int. Total
	Left	Thru	Right	U-Turns	App. Total	Left	Thru	Right	U-Turns	App. Total	Left	Thru	Right	U-Turns	App. Total	Left	Thru	Right	U-Turns	App. Total	
07:30 AM	0	0	0	0	0	0	0	0	0	0	0	0	0	0	0	0	0	0	0	0	0
07:45 AM	0	0	0	0	0	0	0	0	0	0	0	2	0	0	2	0	0	0	0	0	2
08:00 AM	0	1	0	0	1	0	0	0	0	0	0	1	0	0	1	0	0	0	0	0	2
08:15 AM	0	0	0	0	0	0	0	0	0	0	0	0	0	0	0	0	0	0	0	0	0
Total Volume	0	1	0	0	1	0	0	0	0	0	0	3	0	0	3	0	0	0	0	0	4
% App. Total	0	100	0	0		0	0	0	0		0	100	0	0		0	0	0	0		
PHF	.000	.250	.000	.000	.250	.000	.000	.000	.000	.000	.000	.375	.000	.000	.375	.000	.000	.000	.000	.000	.500

Peak Hour Analysis From 07:30 AM to 08:15 AM - Peak 1 of 1

Peak Hour for Entire Intersection Begins at 07:30 AM

City of Madera
 N/S: Country Club Drive
 E/W: Sharon Boulevard
 Weather: Clear

File Name : 51_MDA_Country Club_Sharon AM
 Site Code : 00319628
 Start Date : 9/26/2019
 Page No : 2

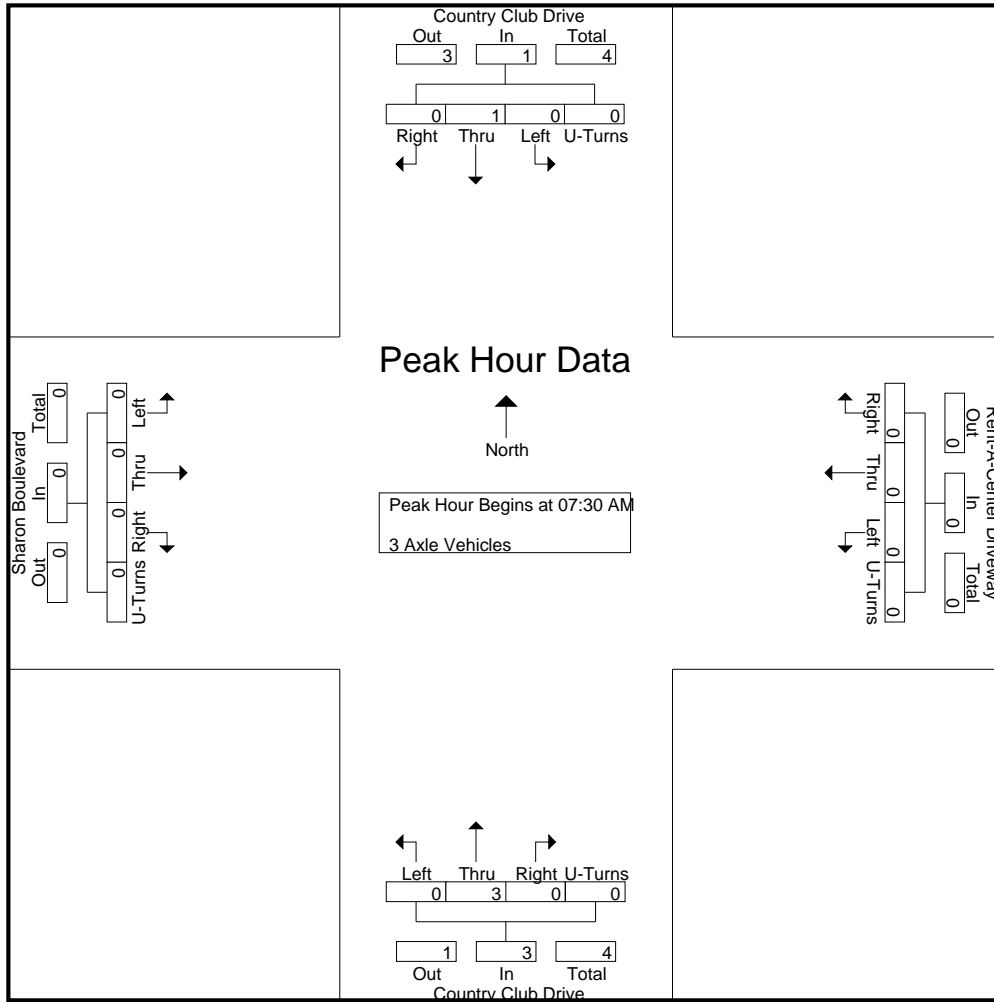

Peak Hour Analysis From 07:30 AM to 08:15 AM - Peak 1 of 1
 Peak Hour for Each Approach Begins at:

	07:30 AM					07:30 AM					07:30 AM					07:30 AM				
+0 mins.	0	0	0	0	0	0	0	0	0	0	0	0	0	0	0	0	0	0	0	0
+15 mins.	0	0	0	0	0	0	0	0	0	0	0	2	0	0	2	0	0	0	0	0
+30 mins.	0	1	0	0	1	0	0	0	0	0	0	1	0	0	1	0	0	0	0	0
+45 mins.	0	0	0	0	0	0	0	0	0	0	0	0	0	0	0	0	0	0	0	0
Total Volume	0	1	0	0	1	0	0	0	0	0	0	3	0	0	3	0	0	0	0	0
% App. Total	0	100	0	0	0	0	0	0	0	0	0	100	0	0	0	0	0	0	0	0
PHF	.000	.250	.000	.000	.250	.000	.000	.000	.000	.000	.000	.375	.000	.000	.375	.000	.000	.000	.000	.000

City of Madera
 N/S: Country Club Drive
 E/W: Sharon Boulevard
 Weather: Clear

File Name : 51_MDA_Country Club_Sharon AM
 Site Code : 00319628
 Start Date : 9/26/2019
 Page No : 1

Groups Printed- 4+ Axle Trucks

Start Time	Country Club Drive Southbound					Rent-A-Center Driveway Westbound					Country Club Drive Northbound					Sharon Boulevard Eastbound					Int. Total
	Left	Thru	Right	U-Turns	App. Total	Left	Thru	Right	U-Turns	App. Total	Left	Thru	Right	U-Turns	App. Total	Left	Thru	Right	U-Turns	App. Total	
07:00 AM	0	1	0	0	1	0	0	0	0	0	0	0	0	0	0	0	0	0	0	0	0
07:15 AM	0	0	0	0	0	0	0	0	0	0	0	0	0	0	0	0	0	0	0	0	0
07:30 AM	0	0	0	0	0	0	0	0	0	0	0	2	0	0	2	0	0	0	0	0	2
07:45 AM	0	3	0	0	3	0	0	0	0	0	0	6	0	0	6	0	0	0	0	0	9
Total	0	4	0	0	4	0	0	0	0	0	0	8	0	0	8	0	0	0	0	0	12
08:00 AM	0	1	0	0	1	0	0	0	0	0	0	1	0	0	1	0	0	0	0	0	2
08:15 AM	0	3	0	0	3	0	0	0	0	0	0	0	0	0	0	0	0	0	0	0	3
08:30 AM	0	2	0	0	2	0	0	0	0	0	0	1	0	0	1	0	0	0	0	0	3
08:45 AM	0	4	0	0	4	0	0	0	0	0	0	3	0	0	3	0	0	0	0	0	7
Total	0	10	0	0	10	0	0	0	0	0	0	5	0	0	5	0	0	0	0	0	15
Grand Total	0	14	0	0	14	0	0	0	0	0	0	13	0	0	13	0	0	0	0	0	27
Apprch %	0	100	0	0		0	0	0	0		0	100	0	0		0	0	0	0		
Total %	0	51.9	0	0	51.9	0	0	0	0	0	0	48.1	0	0	48.1	0	0	0	0	0	0

Start Time	Country Club Drive Southbound					Rent-A-Center Driveway Westbound					Country Club Drive Northbound					Sharon Boulevard Eastbound					Int. Total
	Left	Thru	Right	U-Turns	App. Total	Thru	Right	U-Turns	App. Total	Thru	Right	U-Turns	App. Total	Thru	Right	U-Turns	App. Total				
Peak Hour Analysis From 07:30 AM to 08:15 AM - Peak 1 of 1																					
Peak Hour for Entire Intersection Begins at 07:30 AM																					
07:30 AM	0	0	0	0	0	0	0	0	0	0	0	2	0	0	2	0	0	0	0	0	2
07:45 AM	0	3	0	0	3	0	0	0	0	0	0	6	0	0	6	0	0	0	0	0	9
08:00 AM	0	1	0	0	1	0	0	0	0	0	0	1	0	0	1	0	0	0	0	0	2
08:15 AM	0	3	0	0	3	0	0	0	0	0	0	0	0	0	0	0	0	0	0	0	3
Total Volume	0	7	0	0	7	0	0	0	0	0	0	9	0	0	9	0	0	0	0	0	16
% App. Total	0	100	0	0		0	0	0	0		0	100	0	0		0	0	0	0		
PHF	.000	.583	.000	.000	.583	.000	.000	.000	.000	.000	.000	.375	.000	.000	.375	.000	.000	.000	.000	.000	.444

City of Madera
 N/S: Country Club Drive
 E/W: Sharon Boulevard
 Weather: Clear

File Name : 51_MDA_Country Club_Sharon AM
 Site Code : 00319628
 Start Date : 9/26/2019
 Page No : 2

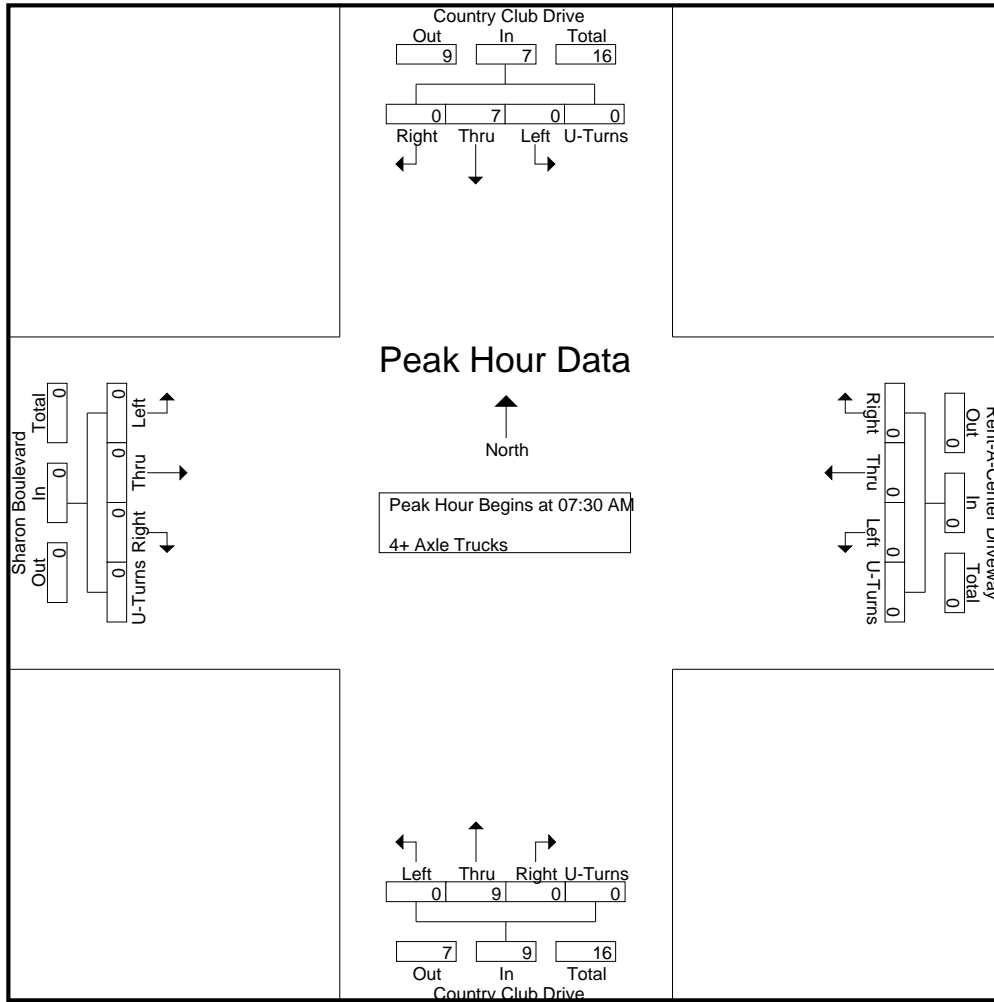

Peak Hour Analysis From 07:30 AM to 08:15 AM - Peak 1 of 1
 Peak Hour for Each Approach Begins at:

	07:30 AM					07:30 AM					07:30 AM									
+0 mins.	0	0	0	0	0	0	0	0	0	0	0	2	0	0	2	0	0	0	0	0
+15 mins.	0	3	0	0	3	0	0	0	0	0	0	6	0	0	6	0	0	0	0	0
+30 mins.	0	1	0	0	1	0	0	0	0	0	0	1	0	0	1	0	0	0	0	0
+45 mins.	0	3	0	0	3	0	0	0	0	0	0	0	0	0	0	0	0	0	0	0
Total Volume	0	7	0	0	7	0	0	0	0	0	0	9	0	0	9	0	0	0	0	0
% App. Total	0	100	0	0	0	0	0	0	0	0	0	100	0	0	0	0	0	0	0	0
PHF	.000	.583	.000	.000	.583	.000	.000	.000	.000	.000	.000	.375	.000	.000	.375	.000	.000	.000	.000	.000

City of Madera
 N/S: Country Club Drive
 E/W: Sharon Boulevard
 Weather: Clear

File Name : 51_MDA_Country Club_Sharon PM
 Site Code : 00319628
 Start Date : 9/26/2019
 Page No : 1

Groups Printed- Passenger Vehicles - Large 2 Axle Vehicles - 3 Axle Vehicles - 4+ Axle Trucks

Start Time	Country Club Drive Southbound					Rent-A-Center Driveway Westbound					Country Club Drive Northbound					Sharon Boulevard Eastbound					Int. Total
	Left	Thru	Right	U-Turns	App. Total	Left	Thru	Right	U-Turns	App. Total	Left	Thru	Right	U-Turns	App. Total	Left	Thru	Right	U-Turns	App. Total	
04:00 PM	0	163	0	0	163	0	0	0	0	0	1	166	0	0	167	0	0	2	0	2	332
04:15 PM	0	152	1	0	153	0	0	0	0	0	2	146	1	1	150	0	0	0	0	0	303
04:30 PM	0	151	0	0	151	0	0	0	0	0	1	147	0	0	148	0	0	1	0	1	300
04:45 PM	1	146	1	1	149	0	0	0	0	0	1	156	0	1	158	1	0	5	0	6	313
Total	1	612	2	1	616	0	0	0	0	0	5	615	1	2	623	1	0	8	0	9	1248
05:00 PM	0	153	0	0	153	0	0	0	0	0	0	194	0	0	194	0	0	5	0	5	352
05:15 PM	0	139	0	0	139	0	0	0	0	0	1	168	0	0	169	0	0	3	0	3	311
05:30 PM	0	154	0	0	154	0	0	0	0	0	2	189	1	0	192	1	0	3	0	4	350
05:45 PM	0	127	0	0	127	0	0	0	0	0	1	160	0	0	161	0	0	1	0	1	289
Total	0	573	0	0	573	0	0	0	0	0	4	711	1	0	716	1	0	12	0	13	1302
Grand Total	1	1185	2	1	1189	0	0	0	0	0	9	1326	2	2	1339	2	0	20	0	22	2550
Apprch %	0.1	99.7	0.2	0.1		0	0	0	0		0.7	99	0.1	0.1		9.1	0	90.9	0		
Total %	0	46.5	0.1	0	46.6	0	0	0	0	0	0.4	52	0.1	0.1	52.5	0.1	0	0.8	0	0.9	
Passenger Vehicles	1166										1305										
% Passenger Vehicles	100	98.4	100	100	98.4	0	0	0	0	0	100	98.4	100	100	98.4	100	0	100	0	100	98.4
Large 2 Axle Vehicles	0					0					0					0					
% Large 2 Axle Vehicles	0	1.4	0	0	1.3	0	0	0	0	0	0	1.1	0	0	1.1	0	0	0	0	0	1.2
3 Axle Vehicles	0	2	0	0	2	0	0	0	0	0	0	4	0	0	4	0	0	0	0	0	6
% 3 Axle Vehicles	0	0.2	0	0	0.2	0	0	0	0	0	0	0.3	0	0	0.3	0	0	0	0	0	0.2
4+ Axle Trucks	0	1	0	0	1	0	0	0	0	0	0	2	0	0	2	0	0	0	0	0	3
% 4+ Axle Trucks																					

Start Time	Country Club Drive Southbound					Rent-A-Center Driveway Westbound					Country Club Drive Northbound					Sharon Boulevard Eastbound					Int. Total
	Left	Thru	Right	U-Turns	App. Total	Left	Thru	Right	U-Turns	App. Total	Left	Thru	Right	U-Turns	App. Total	Left	Thru	Right	U-Turns	App. Total	
Peak Hour Analysis From 04:00 PM to 05:45 PM - Peak 1 of 1																					
Peak Hour for Entire Intersection Begins at 04:45 PM																					
04:45 PM	1	146	1	1	149	0	0	0	0	0	1	156	0	1	158	1	0	5	0	6	313
05:00 PM	0	153	0	0	153	0	0	0	0	0	0	194	0	0	194	0	0	5	0	5	352
05:15 PM	0	139	0	0	139	0	0	0	0	0	1	168	0	0	169	0	0	3	0	3	311
05:30 PM	0	154	0	0	154	0	0	0	0	0	2	189	1	0	192	1	0	3	0	4	350
Total Volume	1	592	1	1	595	0	0	0	0	0	4	707	1	1	713	2	0	16	0	18	1326
% App. Total	0.2	99.5	0.2	0.2		0	0	0	0		0.6	99.2	0.1	0.1		11.1	0	88.9	0		
PHF	.250	.961	.250	.250	.966	.000	.000	.000	.000	.000	.500	.911	.250	.250	.919	.500	.000	.800	.000	.750	.942

City of Madera
 N/S: Country Club Drive
 E/W: Sharon Boulevard
 Weather: Clear

File Name : 51_MDA_Country Club_Sharon PM
 Site Code : 00319628
 Start Date : 9/26/2019
 Page No : 2

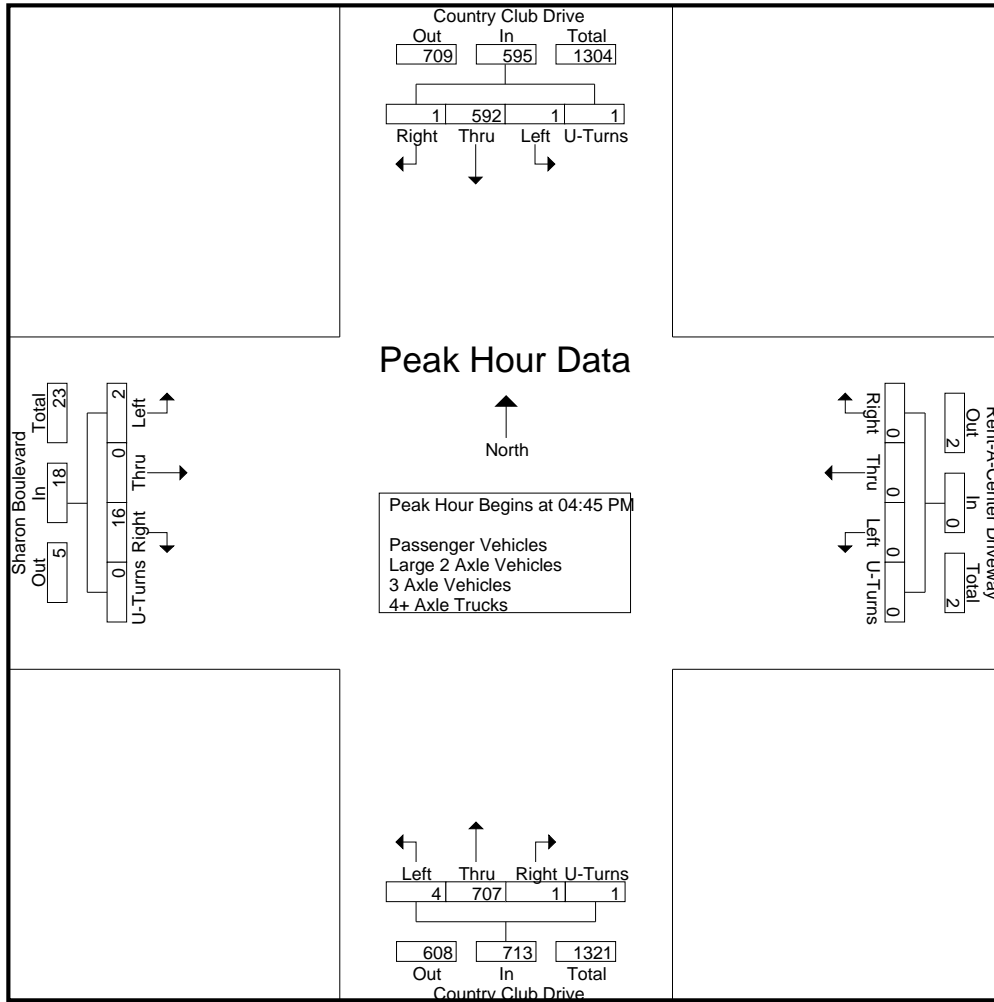

Peak Hour Analysis From 04:00 PM to 05:45 PM - Peak 1 of 1
 Peak Hour for Each Approach Begins at:

	04:00 PM					04:00 PM					05:00 PM					04:45 PM				
+0 mins.	0	163	0	0	163	0	0	0	0	0	0	194	0	0	194	1	0	5	0	6
+15 mins.	0	152	1	0	153	0	0	0	0	0	1	168	0	0	169	0	0	5	0	5
+30 mins.	0	151	0	0	151	0	0	0	0	0	2	189	1	0	192	0	0	3	0	3
+45 mins.	1	146	1	1	149	0	0	0	0	0	1	160	0	0	161	1	0	3	0	4
Total Volume	1	612	2	1	616	0	0	0	0	0	4	711	1	0	716	2	0	16	0	18
% App. Total	0.2	99.4	0.3	0.2		0	0	0	0	0	0.6	99.3	0.1	0		11.1	0	88.9	0	
PHF	.250	.939	.500	.250	.945	.000	.000	.000	.000	.000	.500	.916	.250	.000	.923	.500	.000	.800	.000	.750

City of Madera
 N/S: Country Club Drive
 E/W: Sharon Boulevard
 Weather: Clear

File Name : 51_MDA_Country Club_Sharon PM
 Site Code : 00319628
 Start Date : 9/26/2019
 Page No : 1

Groups Printed- Passenger Vehicles

Start Time	Country Club Drive Southbound					Rent-A-Center Driveway Westbound					Country Club Drive Northbound					Sharon Boulevard Eastbound					Int. Total
	Left	Thru	Right	U-Turns	App. Total	Left	Thru	Right	U-Turns	App. Total	Left	Thru	Right	U-Turns	App. Total	Left	Thru	Right	U-Turns	App. Total	
04:00 PM	0	158	0	0	158	0	0	0	0	0	1	164	0	0	165	0	0	2	0	2	325
04:15 PM	0	151	1	0	152	0	0	0	0	0	2	144	1	1	148	0	0	0	0	0	300
04:30 PM	0	148	0	0	148	0	0	0	0	0	1	143	0	0	144	0	0	1	0	1	293
04:45 PM	1	145	1	1	148	0	0	0	0	0	1	156	0	1	158	1	0	5	0	6	312
Total	1	602	2	1	606	0	0	0	0	0	5	607	1	2	615	1	0	8	0	9	1230
05:00 PM	0	149	0	0	149	0	0	0	0	0	0	192	0	0	192	0	0	5	0	5	346
05:15 PM	0	139	0	0	139	0	0	0	0	0	1	165	0	0	166	0	0	3	0	3	308
05:30 PM	0	151	0	0	151	0	0	0	0	0	2	184	1	0	187	1	0	3	0	4	342
05:45 PM	0	125	0	0	125	0	0	0	0	0	1	157	0	0	158	0	0	1	0	1	284
Total	0	564	0	0	564	0	0	0	0	0	4	698	1	0	703	1	0	12	0	13	1280
Grand Total	1	1166	2	1	1170	0	0	0	0	0	9	1305	2	2	1318	2	0	20	0	22	2510
Apprch %	0.1	99.7	0.2	0.1		0	0	0	0		0.7	99	0.2	0.2		9.1	0	90.9	0		
Total %	0	46.5	0.1	0	46.6	0	0	0	0	0	0.4	52	0.1	0.1	52.5	0.1	0	0.8	0	0.9	

Start Time	Country Club Drive Southbound					Rent-A-Center Driveway Westbound					Country Club Drive Northbound					Sharon Boulevard Eastbound					Int. Total
	Left	Thru	Right	U-Turns	App. Total	Thru	Right	U-Turns	App. Total	Thru	Right	U-Turns	App. Total	Thru	Right	U-Turns	App. Total				
Peak Hour Analysis From 04:45 PM to 05:30 PM - Peak 1 of 1																					
Peak Hour for Entire Intersection Begins at 04:45 PM																					
04:45 PM	1	145	1	1	148	0	0	0	0	0	1	156	0	1	158	1	0	5	0	6	312
05:00 PM	0	149	0	0	149	0	0	0	0	0	0	192	0	0	192	0	0	5	0	5	346
05:15 PM	0	139	0	0	139	0	0	0	0	0	1	165	0	0	166	0	0	3	0	3	308
05:30 PM	0	151	0	0	151	0	0	0	0	0	2	184	1	0	187	1	0	3	0	4	342
Total Volume	1	584	1	1	587	0	0	0	0	0	4	697	1	1	703	2	0	16	0	18	1308
% App. Total	0.2	99.5	0.2	0.2		0	0	0	0		0.6	99.1	0.1	0.1		11.1	0	88.9	0		
PHF	.250	.967	.250	.250	.972	.000	.000	.000	.000	.000	.500	.908	.250	.250	.915	.500	.000	.800	.000	.750	.945

City of Madera
 N/S: Country Club Drive
 E/W: Sharon Boulevard
 Weather: Clear

File Name : 51_MDA_Country Club_Sharon PM
 Site Code : 00319628
 Start Date : 9/26/2019
 Page No : 2

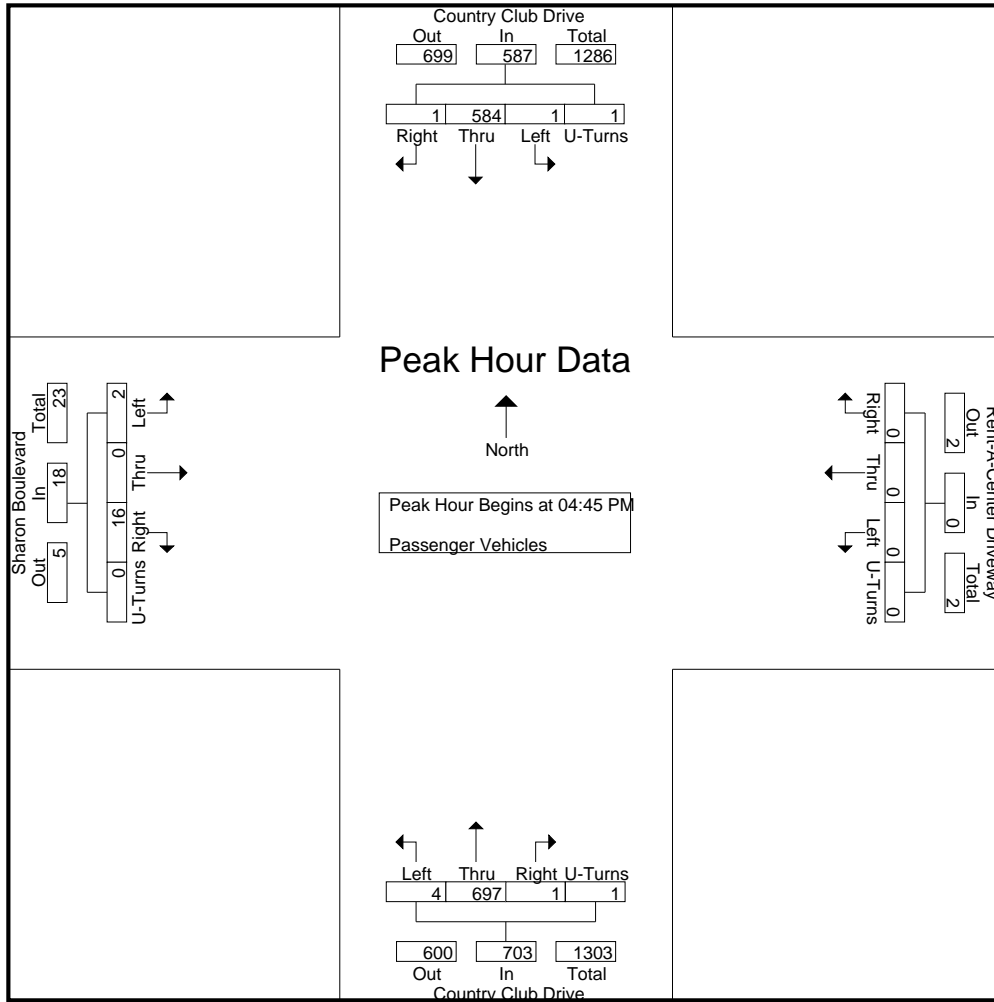

Peak Hour Analysis From 04:45 PM to 05:30 PM - Peak 1 of 1
 Peak Hour for Each Approach Begins at:

	04:45 PM				04:45 PM				04:45 PM				04:45 PM							
+0 mins.	1	145	1	1	148	0	0	0	0	0	1	156	0	1	158	1	0	5	0	6
+15 mins.	0	149	0	0	149	0	0	0	0	0	0	192	0	0	192	0	0	5	0	5
+30 mins.	0	139	0	0	139	0	0	0	0	0	1	165	0	0	166	0	0	3	0	3
+45 mins.	0	151	0	0	151	0	0	0	0	0	2	184	1	0	187	1	0	3	0	4
Total Volume	1	584	1	1	587	0	0	0	0	0	4	697	1	1	703	2	0	16	0	18
% App. Total	0.2	99.5	0.2	0.2		0	0	0	0		0.6	99.1	0.1	0.1		11.1	0	88.9	0	
PHF	.250	.967	.250	.250	.972	.000	.000	.000	.000	.000	.500	.908	.250	.250	.915	.500	.000	.800	.000	.750

City of Madera
 N/S: Country Club Drive
 E/W: Sharon Boulevard
 Weather: Clear

File Name : 51_MDA_Country Club_Sharon PM
 Site Code : 00319628
 Start Date : 9/26/2019
 Page No : 1

Groups Printed- Large 2 Axle Vehicles

Start Time	Country Club Drive Southbound					Rent-A-Center Driveway Westbound					Country Club Drive Northbound					Sharon Boulevard Eastbound					Int. Total
	Left	Thru	Right	U-Turns	App. Total	Left	Thru	Right	U-Turns	App. Total	Left	Thru	Right	U-Turns	App. Total	Left	Thru	Right	U-Turns	App. Total	
04:00 PM	0	4	0	0	4	0	0	0	0	0	0	2	0	0	2	0	0	0	0	0	6
04:15 PM	0	1	0	0	1	0	0	0	0	0	0	2	0	0	2	0	0	0	0	0	3
04:30 PM	0	2	0	0	2	0	0	0	0	0	0	3	0	0	3	0	0	0	0	0	5
04:45 PM	0	1	0	0	1	0	0	0	0	0	0	0	0	0	0	0	0	0	0	0	1
Total	0	8	0	0	8	0	0	0	0	0	0	7	0	0	7	0	0	0	0	0	15
05:00 PM	0	4	0	0	4	0	0	0	0	0	0	1	0	0	1	0	0	0	0	0	5
05:15 PM	0	0	0	0	0	0	0	0	0	0	0	2	0	0	2	0	0	0	0	0	2
05:30 PM	0	2	0	0	2	0	0	0	0	0	0	3	0	0	3	0	0	0	0	0	5
05:45 PM	0	2	0	0	2	0	0	0	0	0	0	2	0	0	2	0	0	0	0	0	4
Total	0	8	0	0	8	0	0	0	0	0	0	8	0	0	8	0	0	0	0	0	16
Grand Total	0	16	0	0	16	0	0	0	0	0	0	15	0	0	15	0	0	0	0	0	31
Apprch %	0	100	0	0		0	0	0	0		0	100	0	0		0	0	0	0		
Total %	0	51.6	0	0	51.6	0	0	0	0	0	0	48.4	0	0	48.4	0	0	0	0	0	

Start Time	Country Club Drive Southbound					Rent-A-Center Driveway Westbound					Country Club Drive Northbound					Sharon Boulevard Eastbound					Int. Total
	Left	Thru	Right	U-Turns	App. Total	Left	Thru	Right	U-Turns	App. Total	Left	Thru	Right	U-Turns	App. Total	Left	Thru	Right	U-Turns	App. Total	
Peak Hour Analysis From 04:45 PM to 05:30 PM - Peak 1 of 1																					
Peak Hour for Entire Intersection Begins at 04:45 PM																					
04:45 PM	0	1	0	0	1	0	0	0	0	0	0	0	0	0	0	0	0	0	0	0	1
05:00 PM	0	4	0	0	4	0	0	0	0	0	0	1	0	0	1	0	0	0	0	0	5
05:15 PM	0	0	0	0	0	0	0	0	0	0	0	2	0	0	2	0	0	0	0	0	2
05:30 PM	0	2	0	0	2	0	0	0	0	0	0	3	0	0	3	0	0	0	0	0	5
Total Volume	0	7	0	0	7	0	0	0	0	0	0	6	0	0	6	0	0	0	0	0	13
% App. Total	0	100	0	0		0	0	0	0		0	100	0	0		0	0	0	0		
PHF	.000	.438	.000	.000	.438	.000	.000	.000	.000	.000	.000	.500	.000	.000	.500	.000	.000	.000	.000	.000	.650

City of Madera
 N/S: Country Club Drive
 E/W: Sharon Boulevard
 Weather: Clear

File Name : 51_MDA_Country Club_Sharon PM
 Site Code : 00319628
 Start Date : 9/26/2019
 Page No : 2

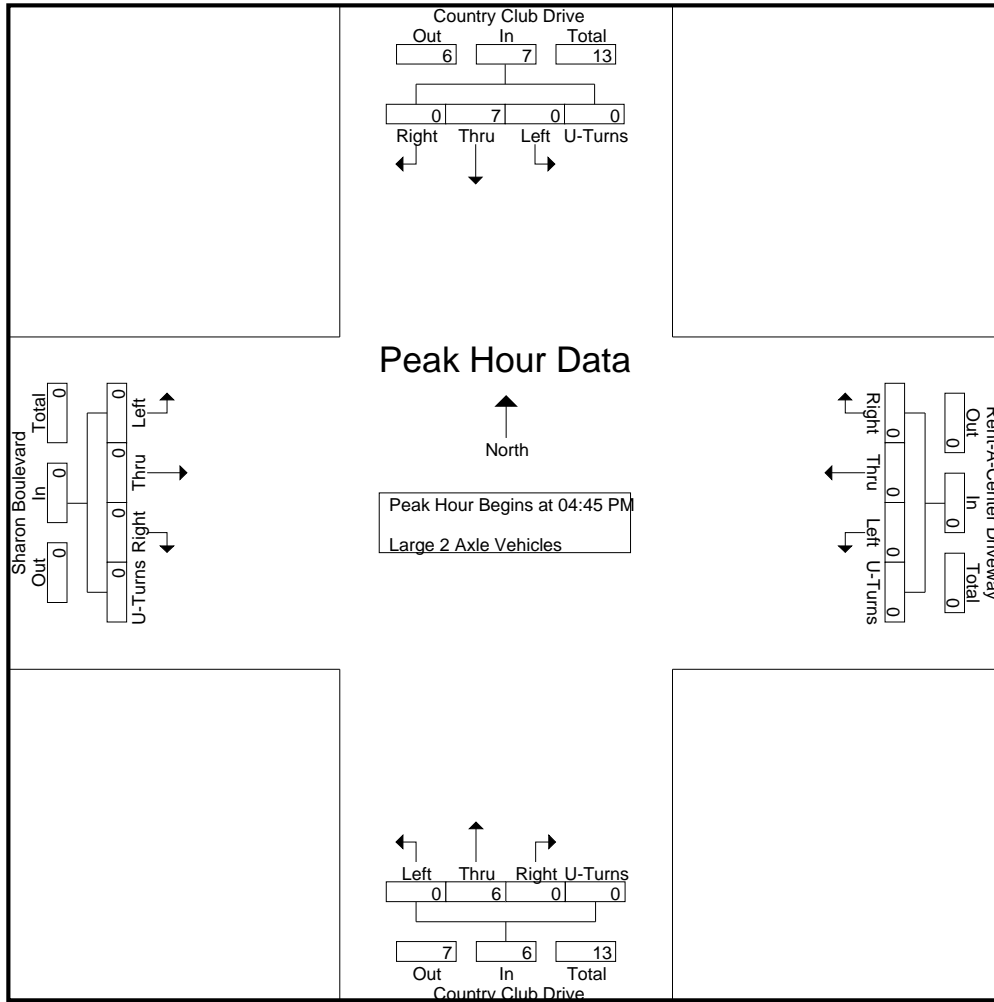

Peak Hour Analysis From 04:45 PM to 05:30 PM - Peak 1 of 1
 Peak Hour for Each Approach Begins at:

	04:45 PM					04:45 PM					04:45 PM									
+0 mins.	0	1	0	0	1	0	0	0	0	0	0	0	0	0	0	0	0	0	0	0
+15 mins.	0	4	0	0	4	0	0	0	0	0	0	1	0	0	1	0	0	0	0	0
+30 mins.	0	0	0	0	0	0	0	0	0	0	0	2	0	0	2	0	0	0	0	0
+45 mins.	0	2	0	0	2	0	0	0	0	0	0	3	0	0	3	0	0	0	0	0
Total Volume	0	7	0	0	7	0	0	0	0	0	0	6	0	0	6	0	0	0	0	0
% App. Total	0	100	0	0	0	0	0	0	0	0	0	100	0	0	0	0	0	0	0	0
PHF	.000	.438	.000	.000	.438	.000	.000	.000	.000	.000	.000	.500	.000	.000	.500	.000	.000	.000	.000	.000

City of Madera
 N/S: Country Club Drive
 E/W: Sharon Boulevard
 Weather: Clear

File Name : 51_MDA_Country Club_Sharon PM
 Site Code : 00319628
 Start Date : 9/26/2019
 Page No : 1

Groups Printed- 3 Axle Vehicles

Start Time	Country Club Drive Southbound					Rent-A-Center Driveway Westbound					Country Club Drive Northbound					Sharon Boulevard Eastbound					Int. Total					
	Left	Thru	Right	U-Turns	App. Total	Left	Thru	Right	U-Turns	App. Total	Left	Thru	Right	U-Turns	App. Total	Left	Thru	Right	U-Turns	App. Total						
04:00 PM	0	1	0	0	1	0	0	0	0	0	0	0	0	0	0	0	0	0	0	0	0	0	0	0	0	1
04:15 PM	0	0	0	0	0	0	0	0	0	0	0	0	0	0	0	0	0	0	0	0	0	0	0	0	0	0
04:30 PM	0	0	0	0	0	0	0	0	0	0	0	1	0	0	1	0	0	0	0	0	0	0	0	0	0	1
04:45 PM	0	0	0	0	0	0	0	0	0	0	0	0	0	0	0	0	0	0	0	0	0	0	0	0	0	0
Total	0	1	0	0	1	0	0	0	0	0	0	1	0	0	1	0	0	0	0	0	0	0	0	0	0	2
05:00 PM	0	0	0	0	0	0	0	0	0	0	0	1	0	0	1	0	0	0	0	0	0	0	0	0	0	1
05:15 PM	0	0	0	0	0	0	0	0	0	0	0	1	0	0	1	0	0	0	0	0	0	0	0	0	0	1
05:30 PM	0	1	0	0	1	0	0	0	0	0	0	1	0	0	1	0	0	0	0	0	0	0	0	0	0	2
05:45 PM	0	0	0	0	0	0	0	0	0	0	0	0	0	0	0	0	0	0	0	0	0	0	0	0	0	0
Total	0	1	0	0	1	0	0	0	0	0	0	3	0	0	3	0	0	0	0	0	0	0	0	0	0	4
Grand Total	0	2	0	0	2	0	0	0	0	0	0	4	0	0	4	0	0	0	0	0	0	0	0	0	0	6
Apprch %	0	100	0	0		0	0	0	0		0	100	0	0		0	0	0	0		0	0	0	0		
Total %	0	33.3	0	0	33.3	0	0	0	0	0	0	66.7	0	0	66.7	0	0	0	0	0	0	0	0	0	0	

Start Time	Country Club Drive Southbound					Rent-A-Center Driveway Westbound					Country Club Drive Northbound					Sharon Boulevard Eastbound					Int. Total					
	Left	Thru	Right	U-Turns	App. Total	Thru	Right	U-Turns	App. Total	Thru	Right	U-Turns	App. Total	Thru	Right	U-Turns	App. Total									
Peak Hour Analysis From 04:45 PM to 05:30 PM - Peak 1 of 1																										
Peak Hour for Entire Intersection Begins at 04:45 PM																										
04:45 PM	0	0	0	0	0	0	0	0	0	0	0	0	0	0	0	0	0	0	0	0	0	0	0	0	0	0
05:00 PM	0	0	0	0	0	0	0	0	0	0	0	1	0	0	1	0	0	0	0	0	0	0	0	0	0	1
05:15 PM	0	0	0	0	0	0	0	0	0	0	0	1	0	0	1	0	0	0	0	0	0	0	0	0	0	1
05:30 PM	0	1	0	0	1	0	0	0	0	0	0	1	0	0	1	0	0	0	0	0	0	0	0	0	0	2
Total Volume	0	1	0	0	1	0	0	0	0	0	0	3	0	0	3	0	0	0	0	0	0	0	0	0	0	4
% App. Total	0	100	0	0		0	0	0	0		0	100	0	0		0	0	0	0		0	0	0	0		
PHF	.000	.250	.000	.000	.250	.000	.000	.000	.000	.000	.000	.750	.000	.000	.750	.000	.000	.000	.000	.000	.000	.000	.000	.000	.500	

City of Madera
 N/S: Country Club Drive
 E/W: Sharon Boulevard
 Weather: Clear

File Name : 51_MDA_Country Club_Sharon PM
 Site Code : 00319628
 Start Date : 9/26/2019
 Page No : 2

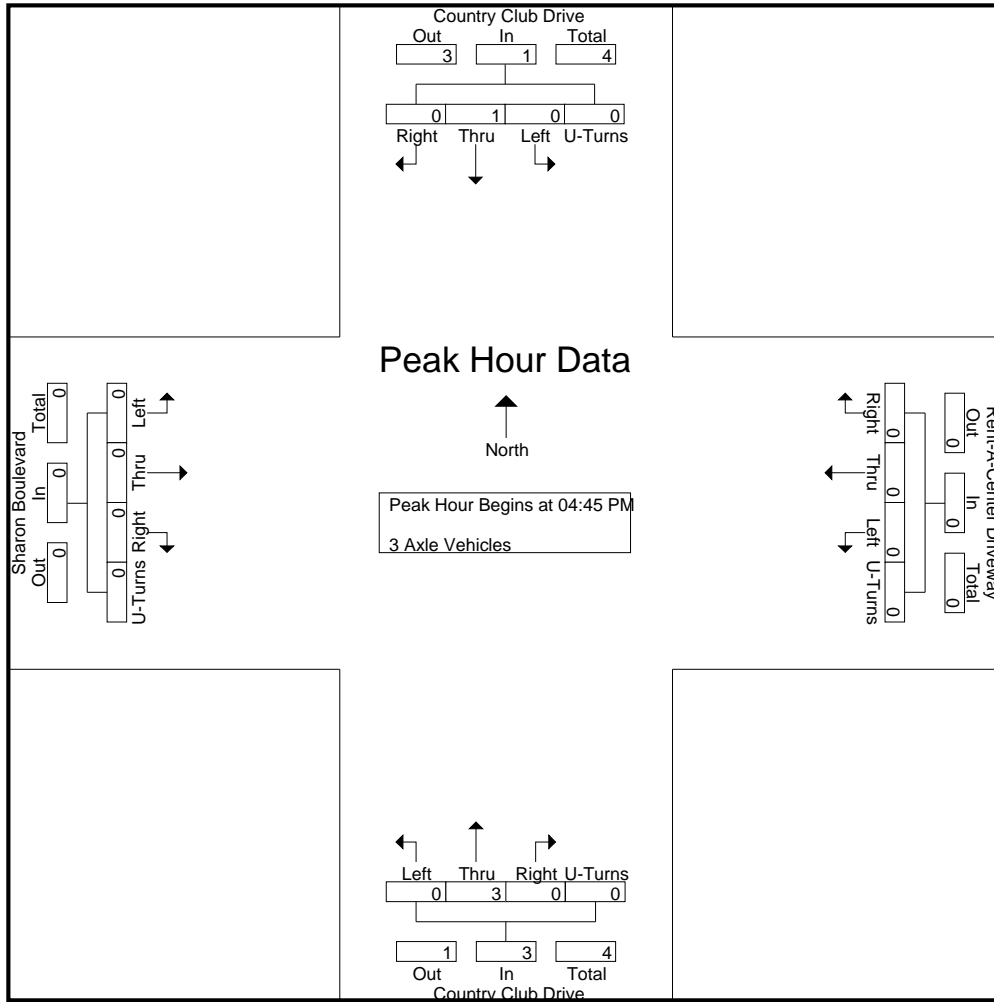

Peak Hour Analysis From 04:45 PM to 05:30 PM - Peak 1 of 1
 Peak Hour for Each Approach Begins at:

	04:45 PM					04:45 PM					04:45 PM					04:45 PM				
+0 mins.	0	0	0	0	0	0	0	0	0	0	0	0	0	0	0	0	0	0	0	0
+15 mins.	0	0	0	0	0	0	0	0	0	0	0	1	0	0	1	0	0	0	0	0
+30 mins.	0	0	0	0	0	0	0	0	0	0	0	1	0	0	1	0	0	0	0	0
+45 mins.	0	1	0	0	1	0	0	0	0	0	0	1	0	0	1	0	0	0	0	0
Total Volume	0	1	0	0	1	0	0	0	0	0	0	3	0	0	3	0	0	0	0	0
% App. Total	0	100	0	0	0	0	0	0	0	0	0	100	0	0	0	0	0	0	0	0
PHF	.000	.250	.000	.000	.250	.000	.000	.000	.000	.000	.000	.750	.000	.000	.750	.000	.000	.000	.000	.000

City of Madera
 N/S: Country Club Drive
 E/W: Sharon Boulevard
 Weather: Clear

File Name : 51_MDA_Country Club_Sharon PM
 Site Code : 00319628
 Start Date : 9/26/2019
 Page No : 1

Groups Printed- 4+ Axle Trucks

Start Time	Country Club Drive Southbound					Rent-A-Center Driveway Westbound					Country Club Drive Northbound					Sharon Boulevard Eastbound					Int. Total
	Left	Thru	Right	U-Turns	App. Total	Left	Thru	Right	U-Turns	App. Total	Left	Thru	Right	U-Turns	App. Total	Left	Thru	Right	U-Turns	App. Total	
04:00 PM	0	0	0	0	0	0	0	0	0	0	0	0	0	0	0	0	0	0	0	0	0
04:15 PM	0	0	0	0	0	0	0	0	0	0	0	0	0	0	0	0	0	0	0	0	0
04:30 PM	0	1	0	0	1	0	0	0	0	0	0	0	0	0	0	0	0	0	0	0	1
04:45 PM	0	0	0	0	0	0	0	0	0	0	0	0	0	0	0	0	0	0	0	0	0
Total	0	1	0	0	1	0	0	0	0	0	0	0	0	0	0	0	0	0	0	0	1
05:00 PM	0	0	0	0	0	0	0	0	0	0	0	0	0	0	0	0	0	0	0	0	0
05:15 PM	0	0	0	0	0	0	0	0	0	0	0	0	0	0	0	0	0	0	0	0	0
05:30 PM	0	0	0	0	0	0	0	0	0	0	0	1	0	0	1	0	0	0	0	0	1
05:45 PM	0	0	0	0	0	0	0	0	0	0	0	1	0	0	1	0	0	0	0	0	1
Total	0	0	0	0	0	0	0	0	0	0	0	2	0	0	2	0	0	0	0	0	2
Grand Total	0	1	0	0	1	0	0	0	0	0	0	2	0	0	2	0	0	0	0	0	3
Apprch %	0	100	0	0		0	0	0	0		0	100	0	0		0	0	0	0		
Total %	0	33.3	0	0	33.3	0	0	0	0	0	0	66.7	0	0	66.7	0	0	0	0	0	0

Start Time	Country Club Drive Southbound					Rent-A-Center Driveway Westbound					Country Club Drive Northbound					Sharon Boulevard Eastbound					Int. Total
	Left	Thru	Right	U-Turns	App. Total	Thru	Right	U-Turns	App. Total	Thru	Right	U-Turns	App. Total	Thru	Right	U-Turns	App. Total				
Peak Hour Analysis From 04:45 PM to 05:30 PM - Peak 1 of 1																					
Peak Hour for Entire Intersection Begins at 04:45 PM																					
04:45 PM	0	0	0	0	0	0	0	0	0	0	0	0	0	0	0	0	0	0	0	0	0
05:00 PM	0	0	0	0	0	0	0	0	0	0	0	0	0	0	0	0	0	0	0	0	0
05:15 PM	0	0	0	0	0	0	0	0	0	0	0	0	0	0	0	0	0	0	0	0	0
05:30 PM	0	0	0	0	0	0	0	0	0	0	0	1	0	0	1	0	0	0	0	0	1
Total Volume	0	0	0	0	0	0	0	0	0	0	0	1	0	0	1	0	0	0	0	0	1
% App. Total	0	0	0	0		0	0	0	0		0	100	0	0		0	0	0	0		
PHF	.000	.000	.000	.000	.000	.000	.000	.000	.000	.000	.000	.250	.000	.000	.250	.000	.000	.000	.000	.000	.250

City of Madera
 N/S: Country Club Drive
 E/W: Sharon Boulevard
 Weather: Clear

File Name : 51_MDA_Country Club_Sharon PM
 Site Code : 00319628
 Start Date : 9/26/2019
 Page No : 2

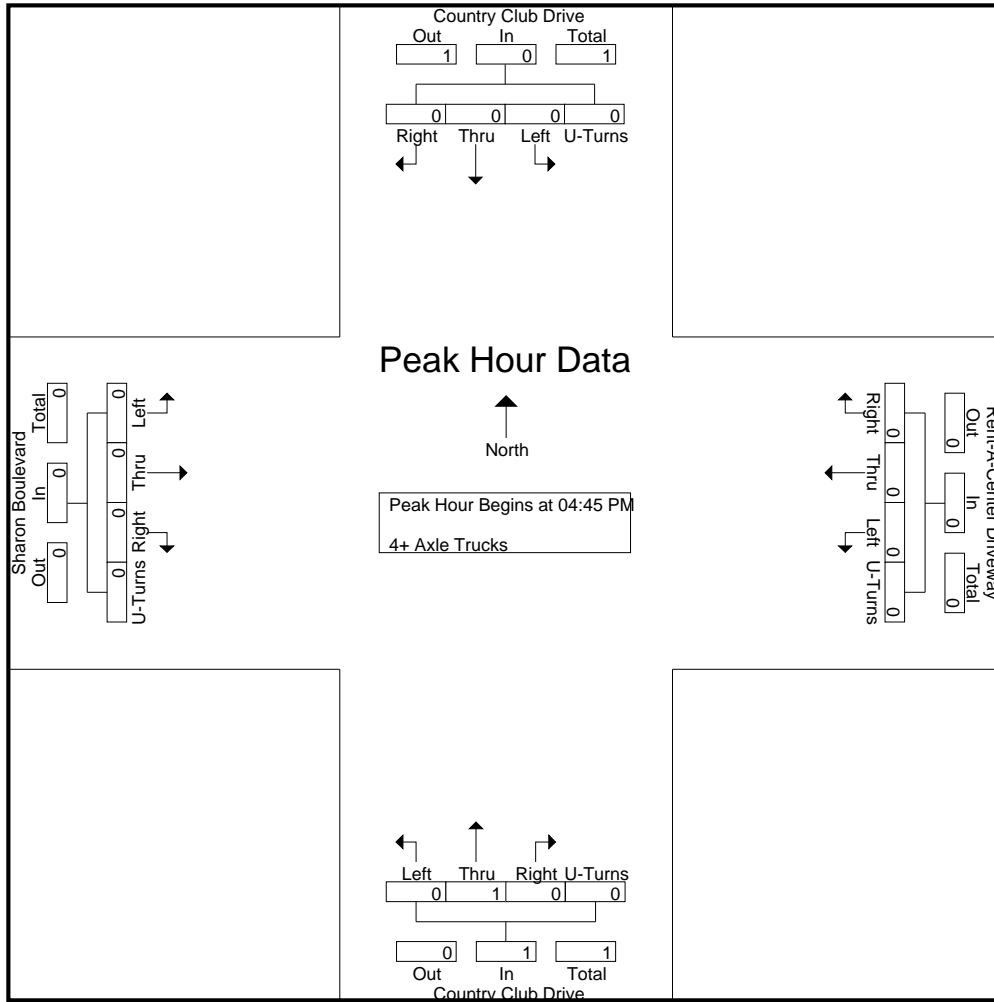

Peak Hour Analysis From 04:45 PM to 05:30 PM - Peak 1 of 1
 Peak Hour for Each Approach Begins at:

	04:45 PM					04:45 PM					04:45 PM					04:45 PM				
+0 mins.	0	0	0	0	0	0	0	0	0	0	0	0	0	0	0	0	0	0	0	0
+15 mins.	0	0	0	0	0	0	0	0	0	0	0	0	0	0	0	0	0	0	0	0
+30 mins.	0	0	0	0	0	0	0	0	0	0	0	0	0	0	0	0	0	0	0	0
+45 mins.	0	0	0	0	0	0	0	0	0	0	0	1	0	0	1	0	0	0	0	0
Total Volume	0	0	0	0	0	0	0	0	0	0	0	1	0	0	1	0	0	0	0	0
% App. Total	0	0	0	0	0	0	0	0	0	0	0	100	0	0	0	0	0	0	0	0
PHF	.000	.000	.000	.000	.000	.000	.000	.000	.000	.000	.000	.250	.000	.000	.250	.000	.000	.000	.000	.000

Location: Madera
 N/S: Country Club Drive
 E/W: Sharon Boulevard



Date: 9/26/2019
 Day: Thursday

PEDESTRIANS

	North Leg Country Club Drive	East Leg Rent-A-Center DW	South Leg Country Club Drive	West Leg Sharon Boulevard	
	Pedestrians	Pedestrians	Pedestrians	Pedestrians	
7:00 AM	0	0	0	0	0
7:15 AM	0	0	0	0	0
7:30 AM	0	0	0	1	1
7:45 AM	0	0	0	0	0
8:00 AM	0	0	0	1	1
8:15 AM	0	0	0	0	0
8:30 AM	0	0	0	0	0
8:45 AM	0	0	0	0	0
TOTAL VOLUMES:	0	0	0	2	2

	North Leg Country Club Drive	East Leg Rent-A-Center DW	South Leg Country Club Drive	West Leg Sharon Boulevard	
	Pedestrians	Pedestrians	Pedestrians	Pedestrians	
4:00 PM	0	0	0	1	1
4:15 PM	0	0	0	1	1
4:30 PM	0	0	0	1	1
4:45 PM	0	0	0	0	0
5:00 PM	0	0	0	0	0
5:15 PM	0	0	0	0	0
5:30 PM	0	0	0	0	0
5:45 PM	0	0	0	0	0
TOTAL VOLUMES:	0	0	0	3	3

Location: Madera
 N/S: Country Club Drive
 E/W: Sharon Boulevard



Date: 9/26/2019
 Day: Thursday

BICYCLES

	Southbound Country Club Drive			Westbound Rent-A-Center DW			Northbound Country Club Drive			Eastbound Sharon Boulevard			
	Left	Thru	Right	Left	Thru	Right	Left	Thru	Right	Left	Thru	Right	
7:00 AM	0	0	0	0	0	0	0	0	0	0	1	0	1
7:15 AM	0	0	0	0	0	0	0	1	0	0	0	0	1
7:30 AM	0	1	0	0	0	0	0	0	0	0	0	0	1
7:45 AM	0	0	0	0	0	0	0	1	0	0	0	0	1
8:00 AM	0	0	0	0	0	0	0	0	0	0	0	2	2
8:15 AM	0	0	0	0	0	0	0	0	0	0	0	0	0
8:30 AM	0	0	0	0	0	0	0	0	0	0	0	0	0
8:45 AM	0	0	0	0	0	0	0	0	0	0	0	0	0
TOTAL VOLUMES:	0	1	0	0	0	0	0	2	0	0	1	2	6

	Southbound Country Club Drive			Westbound Rent-A-Center DW			Northbound Country Club Drive			Eastbound Sharon Boulevard			
	Left	Thru	Right	Left	Thru	Right	Left	Thru	Right	Left	Thru	Right	
4:00 PM	0	1	0	0	0	0	0	0	0	0	0	0	1
4:15 PM	0	0	0	0	0	0	0	1	0	0	2	0	3
4:30 PM	0	0	0	0	0	0	0	0	0	0	0	0	0
4:45 PM	0	0	0	0	0	0	0	0	0	0	0	0	0
5:00 PM	0	0	0	0	0	0	0	1	0	0	0	0	1
5:15 PM	0	0	0	0	0	0	0	1	0	0	0	0	1
5:30 PM	0	1	0	0	0	0	0	0	0	0	0	0	1
5:45 PM	0	0	0	0	0	0	0	1	0	0	0	0	1
TOTAL VOLUMES:	0	2	0	0	0	0	0	4	0	0	2	0	8

City of Madera
 N/S: Pine Street
 E/W: Howard Road
 Weather: Clear

File Name : 30_MDA_Pine_Howard AM
 Site Code : 00319628
 Start Date : 9/24/2019
 Page No : 1

Groups Printed- Passenger Vehicles - Large 2 Axle Vehicles - 3 Axle Vehicles - 4+ Axle Trucks

Start Time	Pine Street Southbound					Howard Road Westbound					Pine Street Northbound					Howard Road Eastbound					Int. Total	
	Left	Thru	Right	U-Turns	App. Total	Left	Thru	Right	U-Turns	App. Total	Left	Thru	Right	U-Turns	App. Total	Left	Thru	Right	U-Turns	App. Total		
07:00 AM	4	25	15	0	44	20	53	1	0	74	9	17	23	0	49	5	107	20	0	132	299	
07:15 AM	4	65	21	0	90	32	93	0	0	125	13	36	60	0	109	9	165	13	0	187	511	
07:30 AM	2	83	25	0	110	43	129	2	0	174	27	47	63	0	137	7	199	13	0	219	640	
07:45 AM	2	49	29	0	80	38	134	2	0	174	36	36	54	0	126	11	184	27	0	222	602	
Total	12	222	90	0	324	133	409	5	0	547	85	136	200	0	421	32	655	73	0	760	2052	
08:00 AM	8	42	22	0	72	13	77	2	0	92	39	32	45	0	116	6	119	19	0	144	424	
08:15 AM	6	25	18	0	49	13	69	2	0	84	33	23	20	0	76	7	111	19	0	137	346	
08:30 AM	2	27	31	0	60	16	54	1	0	71	26	21	14	0	61	5	102	31	0	138	330	
08:45 AM	1	29	27	0	57	18	75	1	0	94	24	21	27	0	72	11	93	13	0	117	340	
Total	17	123	98	0	238	60	275	6	0	341	122	97	106	0	325	29	425	82	0	536	1440	
Grand Total	29	345	188	0	562	193	684	11	0	888	207	233	306	0	746	61	1080	155	0	1296	3492	
Apprch %	5.2	61.4	33.5	0		21.7	77	1.2	0		27.7	31.2	41	0		4.7	83.3	12	0			
Total %	0.8	9.9	5.4	0	16.1	5.5	19.6	0.3	0	25.4	5.9	6.7	8.8	0	21.4	1.7	30.9	4.4	0	37.1		
Passenger Vehicles	1055																					
% Passenger Vehicles	96.6	92.2	96.8	0	94	93.3	97.2	100	0	96.4	95.7	93.6	89.9	0	92.6	100	97.7	94.2	0	97.4	95.6	
Large 2 Axle Vehicles	0																					
% Large 2 Axle Vehicles	0	7.8	2.7	0	5.7	3.1	1.8	0	0	2	2.9	4.7	6.5	0	5	0	1.7	5.8	0	2.1	3.3	
3 Axle Vehicles	1	0	0	0	1	0	1	0	0	1	0	1	2	0	3	0	0	0	0	0	0	5
% 3 Axle Vehicles	3.4	0	0	0	0.2	0	0.1	0	0	0.1	0	0.4	0.7	0	0.4	0	0	0	0	0	0.1	
4+ Axle Trucks	0	0	1	0	1	7	6	0	0	13	3	3	9	0	15	0	7	0	0	7	36	
% 4+ Axle Trucks																						

Start Time	Pine Street Southbound					Howard Road Westbound					Pine Street Northbound					Howard Road Eastbound					Int. Total
	Left	Thru	Right	U-Turns	App. Total	Left	Thru	Right	U-Turns	App. Total	Left	Thru	Right	U-Turns	App. Total	Left	Thru	Right	U-Turns	App. Total	
Peak Hour Analysis From 07:00 AM to 08:45 AM - Peak 1 of 1																					
Peak Hour for Entire Intersection Begins at 07:15 AM																					
07:15 AM	4	65	21	0	90	32	93	0	0	125	13	36	60	0	109	9	165	13	0	187	511
07:30 AM	2	83	25	0	110	43	129	2	0	174	27	47	63	0	137	7	199	13	0	219	640
07:45 AM	2	49	29	0	80	38	134	2	0	174	36	36	54	0	126	11	184	27	0	222	602
08:00 AM	8	42	22	0	72	13	77	2	0	92	39	32	45	0	116	6	119	19	0	144	424
Total Volume	16	239	97	0	352	126	433	6	0	565	115	151	222	0	488	33	667	72	0	772	2177
% App. Total	4.5	67.9	27.6	0		22.3	76.6	1.1	0		23.6	30.9	45.5	0		4.3	86.4	9.3	0		
PHF	.500	.720	.836	.000	.800	.733	.808	.750	.000	.812	.737	.803	.881	.000	.891	.750	.838	.667	.000	.869	.850

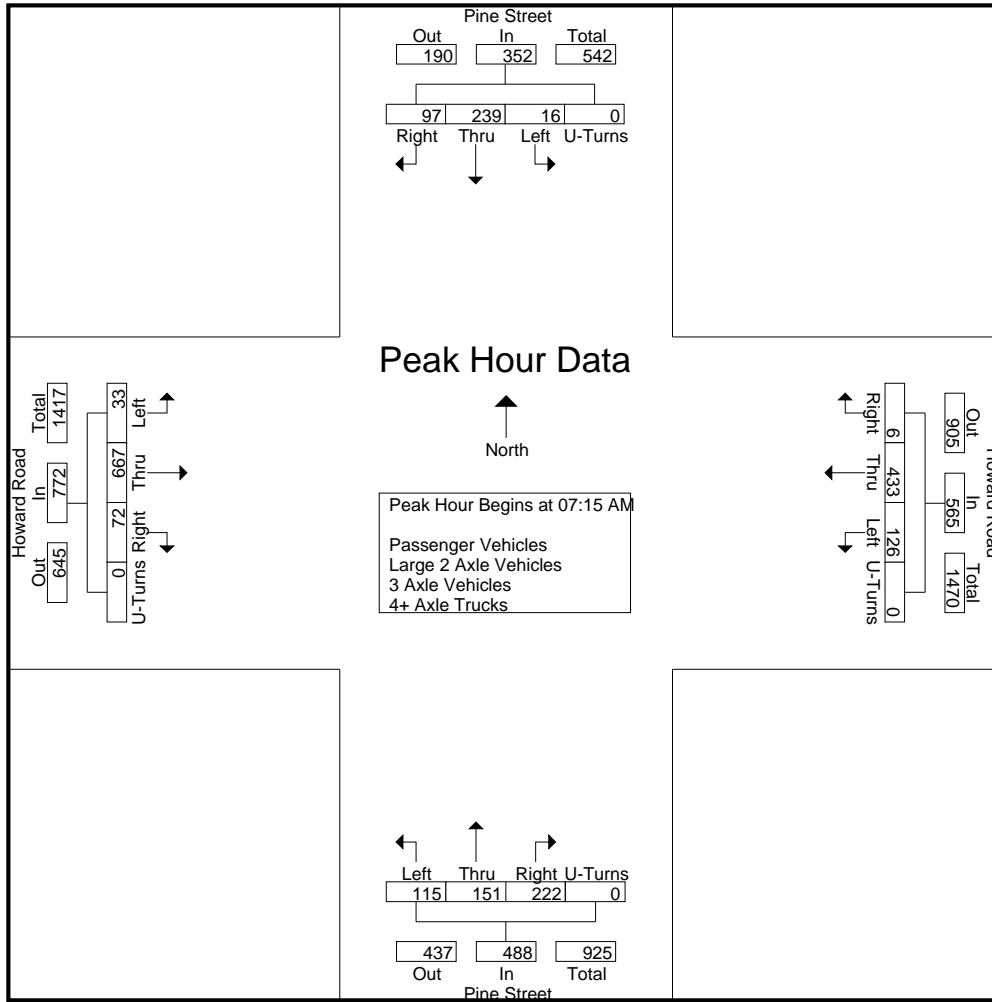

Peak Hour Analysis From 07:00 AM to 08:45 AM - Peak 1 of 1
 Peak Hour for Each Approach Begins at:

	07:15 AM					07:15 AM					07:15 AM									
+0 mins.	4	65	21	0	90	32	93	0	0	125	13	36	60	0	109	9	165	13	0	187
+15 mins.	2	83	25	0	110	43	129	2	0	174	27	47	63	0	137	7	199	13	0	219
+30 mins.	2	49	29	0	80	38	134	2	0	174	36	36	54	0	126	11	184	27	0	222
+45 mins.	8	42	22	0	72	13	77	2	0	92	39	32	45	0	116	6	119	19	0	144
Total Volume	16	239	97	0	352	126	433	6	0	565	115	151	222	0	488	33	667	72	0	772
% App. Total	4.5	67.9	27.6	0		22.3	76.6	1.1	0		23.6	30.9	45.5	0		4.3	86.4	9.3	0	
PHF	.500	.720	.836	.000	.800	.733	.808	.750	.000	.812	.737	.803	.881	.000	.891	.750	.838	.667	.000	.869

City of Madera
 N/S: Pine Street
 E/W: Howard Road
 Weather: Clear

File Name : 30_MDA_Pine_Howard AM
 Site Code : 00319628
 Start Date : 9/24/2019
 Page No : 1

Groups Printed- Passenger Vehicles

Start Time	Pine Street Southbound					Howard Road Westbound					Pine Street Northbound					Howard Road Eastbound					Int. Total
	Left	Thru	Right	U-Turns	App. Total	Left	Thru	Right	U-Turns	App. Total	Left	Thru	Right	U-Turns	App. Total	Left	Thru	Right	U-Turns	App. Total	
07:00 AM	4	23	14	0	41	19	50	1	0	70	9	16	16	0	41	5	101	20	0	126	278
07:15 AM	4	65	21	0	90	29	89	0	0	118	13	33	52	0	98	9	162	13	0	184	490
07:30 AM	2	81	23	0	106	43	128	2	0	173	24	47	60	0	131	7	197	13	0	217	627
07:45 AM	2	47	28	0	77	36	133	2	0	171	35	35	51	0	121	11	181	26	0	218	587
Total	12	216	86	0	314	127	400	5	0	532	81	131	179	0	391	32	641	72	0	745	1982
08:00 AM	7	37	21	0	65	11	75	2	0	88	38	30	40	0	108	6	115	16	0	137	398
08:15 AM	6	20	18	0	44	11	65	2	0	78	32	19	17	0	68	7	107	15	0	129	319
08:30 AM	2	20	31	0	53	13	53	1	0	67	25	19	14	0	58	5	100	30	0	135	313
08:45 AM	1	25	26	0	52	18	72	1	0	91	22	19	25	0	66	11	92	13	0	116	325
Total	16	102	96	0	214	53	265	6	0	324	117	87	96	0	300	29	414	74	0	517	1355
Grand Total	28	318	182	0	528	180	665	11	0	856	198	218	275	0	691	61	1055	146	0	1262	3337
Apprch %	5.3	60.2	34.5	0		21	77.7	1.3	0		28.7	31.5	39.8	0		4.8	83.6	11.6	0		
Total %	0.8	9.5	5.5	0	15.8	5.4	19.9	0.3	0	25.7	5.9	6.5	8.2	0	20.7	1.8	31.6	4.4	0	37.8	

Start Time	Pine Street Southbound					Howard Road Westbound					Pine Street Northbound					Howard Road Eastbound					Int. Total
	Left	Thru	Right	U-Turns	App. Total	Left	Thru	Right	U-Turns	App. Total	Left	Thru	Right	U-Turns	App. Total	Left	Thru	Right	U-Turns	App. Total	
Peak Hour Analysis From 07:15 AM to 08:00 AM - Peak 1 of 1																					
Peak Hour for Entire Intersection Begins at 07:15 AM																					
07:15 AM	4	65	21	0	90	29	89	0	0	118	13	33	52	0	98	9	162	13	0	184	490
07:30 AM	2	81	23	0	106	43	128	2	0	173	24	47	60	0	131	7	197	13	0	217	627
07:45 AM	2	47	28	0	77	36	133	2	0	171	35	35	51	0	121	11	181	26	0	218	587
08:00 AM	7	37	21	0	65	11	75	2	0	88	38	30	40	0	108	6	115	16	0	137	398
Total Volume	15	230	93	0	338	119	425	6	0	550	110	145	203	0	458	33	655	68	0	756	2102
% App. Total	4.4	68	27.5	0		21.6	77.3	1.1	0		24	31.7	44.3	0		4.4	86.6	9	0		
PHF	.536	.710	.830	.000	.797	.692	.799	.750	.000	.795	.724	.771	.846	.000	.874	.750	.831	.654	.000	.867	.838

City of Madera
 N/S: Pine Street
 E/W: Howard Road
 Weather: Clear

File Name : 30_MDA_Pine_Howard AM
 Site Code : 00319628
 Start Date : 9/24/2019
 Page No : 2

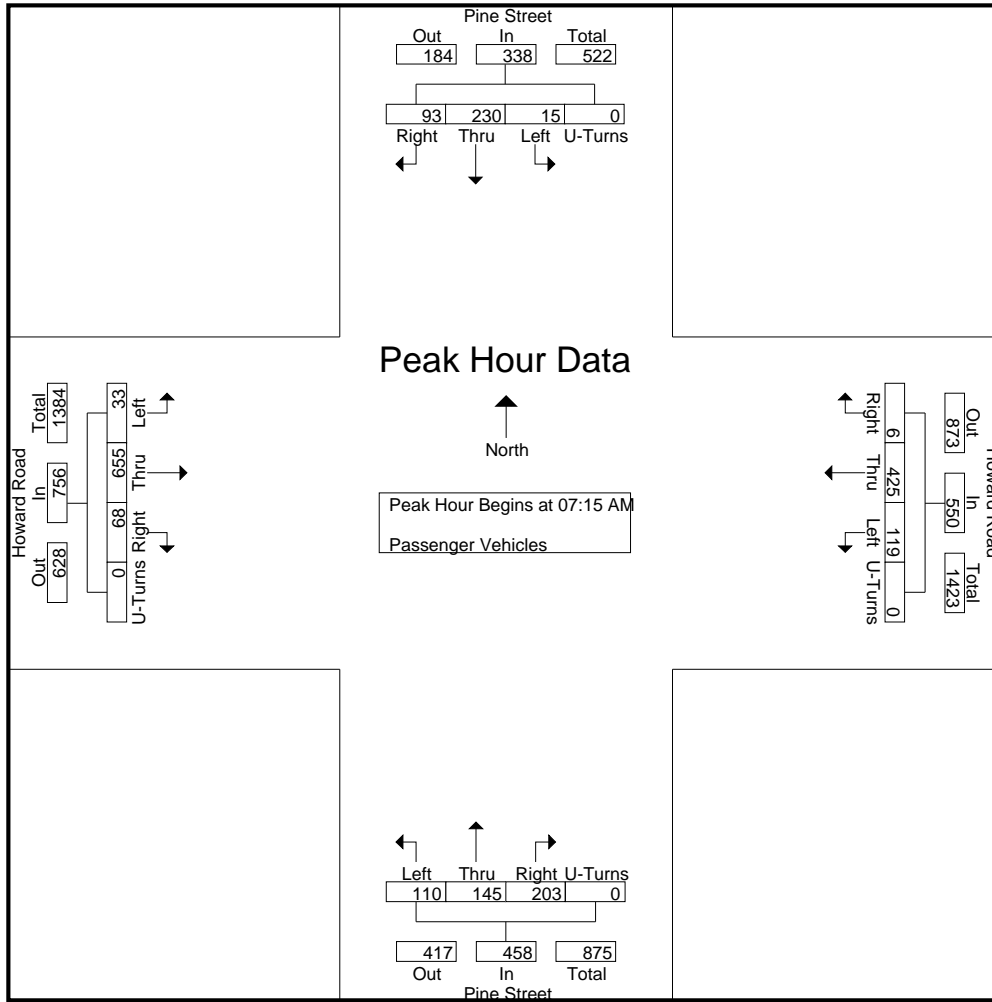

Peak Hour Analysis From 07:15 AM to 08:00 AM - Peak 1 of 1
 Peak Hour for Each Approach Begins at:

	07:15 AM					07:15 AM					07:15 AM									
+0 mins.	4	65	21	0	90	29	89	0	0	118	13	33	52	0	98	9	162	13	0	184
+15 mins.	2	81	23	0	106	43	128	2	0	173	24	47	60	0	131	7	197	13	0	217
+30 mins.	2	47	28	0	77	36	133	2	0	171	35	35	51	0	121	11	181	26	0	218
+45 mins.	7	37	21	0	65	11	75	2	0	88	38	30	40	0	108	6	115	16	0	137
Total Volume	15	230	93	0	338	119	425	6	0	550	110	145	203	0	458	33	655	68	0	756
% App. Total	4.4	68	27.5	0		21.6	77.3	1.1	0		24	31.7	44.3	0		4.4	86.6	9	0	
PHF	.536	.710	.830	.000	.797	.692	.799	.750	.000	.795	.724	.771	.846	.000	.874	.750	.831	.654	.000	.867

City of Madera
 N/S: Pine Street
 E/W: Howard Road
 Weather: Clear

File Name : 30_MDA_Pine_Howard AM
 Site Code : 00319628
 Start Date : 9/24/2019
 Page No : 1

Groups Printed- Large 2 Axle Vehicles

Start Time	Pine Street Southbound					Howard Road Westbound					Pine Street Northbound					Howard Road Eastbound					Int. Total
	Left	Thru	Right	U-Turns	App. Total	Left	Thru	Right	U-Turns	App. Total	Left	Thru	Right	U-Turns	App. Total	Left	Thru	Right	U-Turns	App. Total	
07:00 AM	0	2	1	0	3	1	1	0	0	2	0	1	5	0	6	0	4	0	0	4	15
07:15 AM	0	0	0	0	0	2	3	0	0	5	0	2	4	0	6	0	3	0	0	3	14
07:30 AM	0	2	2	0	4	0	0	0	0	0	3	0	2	0	5	0	2	0	0	2	11
07:45 AM	0	2	1	0	3	0	1	0	0	1	0	1	2	0	3	0	1	1	0	2	9
Total	0	6	4	0	10	3	5	0	0	8	3	4	13	0	20	0	10	1	0	11	49
08:00 AM	0	5	1	0	6	1	2	0	0	3	1	1	2	0	4	0	3	3	0	6	19
08:15 AM	0	5	0	0	5	1	1	0	0	2	0	3	3	0	6	0	3	4	0	7	20
08:30 AM	0	7	0	0	7	1	1	0	0	2	1	2	0	0	3	0	1	1	0	2	14
08:45 AM	0	4	0	0	4	0	3	0	0	3	1	1	2	0	4	0	1	0	0	1	12
Total	0	21	1	0	22	3	7	0	0	10	3	7	7	0	17	0	8	8	0	16	65
Grand Total	0	27	5	0	32	6	12	0	0	18	6	11	20	0	37	0	18	9	0	27	114
Apprch %	0	84.4	15.6	0		33.3	66.7	0	0		16.2	29.7	54.1	0		0	66.7	33.3	0		
Total %	0	23.7	4.4	0	28.1	5.3	10.5	0	0	15.8	5.3	9.6	17.5	0	32.5	0	15.8	7.9	0	23.7	

Start Time	Pine Street Southbound					Howard Road Westbound					Pine Street Northbound					Howard Road Eastbound					Int. Total
	Left	Thru	Right	U-Turns	App. Total	Thru	Right	U-Turns	App. Total	Thru	Right	U-Turns	App. Total	Thru	Right	U-Turns	App. Total				
Peak Hour Analysis From 07:15 AM to 08:00 AM - Peak 1 of 1																					
Peak Hour for Entire Intersection Begins at 07:15 AM																					
07:15 AM	0	0	0	0	0	2	3	0	0	5	0	2	4	0	6	0	3	0	0	3	14
07:30 AM	0	2	2	0	4	0	0	0	0	0	3	0	2	0	5	0	2	0	0	2	11
07:45 AM	0	2	1	0	3	0	1	0	0	1	0	1	2	0	3	0	1	1	0	2	9
08:00 AM	0	5	1	0	6	1	2	0	0	3	1	1	2	0	4	0	3	3	0	6	19
Total Volume	0	9	4	0	13	3	6	0	0	9	4	4	10	0	18	0	9	4	0	13	53
% App. Total	0	69.2	30.8	0		33.3	66.7	0	0		22.2	22.2	55.6	0		0	69.2	30.8	0		
PHF	.000	.450	.500	.000	.542	.375	.500	.000	.000	.450	.333	.500	.625	.000	.750	.000	.750	.333	.000	.542	.697

City of Madera
 N/S: Pine Street
 E/W: Howard Road
 Weather: Clear

File Name : 30_MDA_Pine_Howard AM
 Site Code : 00319628
 Start Date : 9/24/2019
 Page No : 2

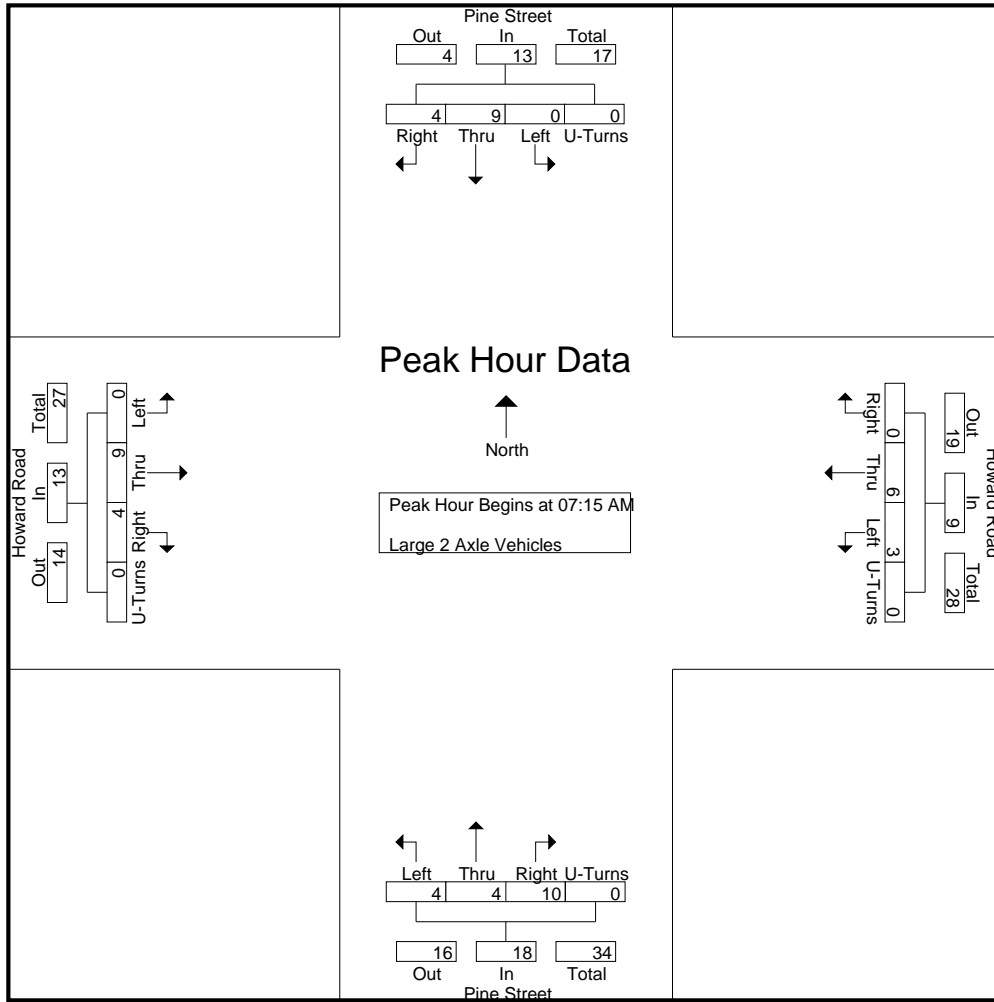

Peak Hour Analysis From 07:15 AM to 08:00 AM - Peak 1 of 1
 Peak Hour for Each Approach Begins at:

	07:15 AM					07:15 AM					07:15 AM									
+0 mins.	0	0	0	0	0	2	3	0	0	5	0	2	4	0	6	0	3	0	0	3
+15 mins.	0	2	2	0	4	0	0	0	0	0	3	0	2	0	5	0	2	0	0	2
+30 mins.	0	2	1	0	3	0	1	0	0	1	0	1	2	0	3	0	1	1	0	2
+45 mins.	0	5	1	0	6	1	2	0	0	3	1	1	2	0	4	0	3	3	0	6
Total Volume	0	9	4	0	13	3	6	0	0	9	4	4	10	0	18	0	9	4	0	13
% App. Total	0	69.2	30.8	0		33.3	66.7	0	0		22.2	22.2	55.6	0		0	69.2	30.8	0	
PHF	.000	.450	.500	.000	.542	.375	.500	.000	.000	.450	.333	.500	.625	.000	.750	.000	.750	.333	.000	.542

City of Madera
 N/S: Pine Street
 E/W: Howard Road
 Weather: Clear

File Name : 30_MDA_Pine_Howard AM
 Site Code : 00319628
 Start Date : 9/24/2019
 Page No : 1

Groups Printed- 3 Axle Vehicles

Start Time	Pine Street Southbound					Howard Road Westbound					Pine Street Northbound					Howard Road Eastbound					Int. Total					
	Left	Thru	Right	U-Turns	App. Total	Left	Thru	Right	U-Turns	App. Total	Left	Thru	Right	U-Turns	App. Total	Left	Thru	Right	U-Turns	App. Total						
07:00 AM	0	0	0	0	0	0	0	0	0	0	0	0	0	0	0	0	0	0	0	0	0	0	0	0	0	0
07:15 AM	0	0	0	0	0	0	0	0	0	0	0	0	1	0	1	0	0	0	0	0	0	0	0	0	0	1
07:30 AM	0	0	0	0	0	0	0	0	0	0	0	0	0	0	0	0	0	0	0	0	0	0	0	0	0	0
07:45 AM	0	0	0	0	0	0	0	0	0	0	0	0	1	0	1	0	0	0	0	0	0	0	0	0	0	1
Total	0	0	0	0	0	0	0	0	0	0	0	0	2	0	2	0	0	0	0	0	0	0	0	0	0	2
08:00 AM	1	0	0	0	1	0	0	0	0	0	0	0	0	0	0	0	0	0	0	0	0	0	0	0	0	1
08:15 AM	0	0	0	0	0	0	1	0	0	1	0	0	0	0	0	0	0	0	0	0	0	0	0	0	0	1
08:30 AM	0	0	0	0	0	0	0	0	0	0	0	0	0	0	0	0	0	0	0	0	0	0	0	0	0	0
08:45 AM	0	0	0	0	0	0	0	0	0	0	0	1	0	0	1	0	0	0	0	0	0	0	0	0	0	1
Total	1	0	0	0	1	0	1	0	0	1	0	1	0	0	1	0	0	0	0	0	0	0	0	0	0	3
Grand Total	1	0	0	0	1	0	1	0	0	1	0	1	2	0	3	0	0	0	0	0	0	0	0	0	0	5
Apprch %	100	0	0	0		0	100	0	0		0	33.3	66.7	0		0	0	0	0	0	0	0	0	0	0	
Total %	20	0	0	0	20	0	20	0	0	20	0	20	40	0	60	0	0	0	0	0	0	0	0	0	0	

Start Time	Pine Street Southbound					Howard Road Westbound					Pine Street Northbound					Howard Road Eastbound					Int. Total					
	Left	Thru	Right	U-Turns	App. Total	Thru	Right	U-Turns	App. Total	Thru	Right	U-Turns	App. Total	Thru	Right	U-Turns	App. Total									
Peak Hour Analysis From 07:15 AM to 08:00 AM - Peak 1 of 1																										
Peak Hour for Entire Intersection Begins at 07:15 AM																										
07:15 AM	0	0	0	0	0	0	0	0	0	0	0	0	1	0	1	0	0	0	0	0	0	0	0	0	0	1
07:30 AM	0	0	0	0	0	0	0	0	0	0	0	0	0	0	0	0	0	0	0	0	0	0	0	0	0	0
07:45 AM	0	0	0	0	0	0	0	0	0	0	0	0	1	0	1	0	0	0	0	0	0	0	0	0	0	1
08:00 AM	1	0	0	0	1	0	0	0	0	0	0	0	0	0	0	0	0	0	0	0	0	0	0	0	0	1
Total Volume	1	0	0	0	1	0	0	0	0	0	0	0	2	0	2	0	0	0	0	0	0	0	0	0	0	3
% App. Total	100	0	0	0		0	0	0	0		0	0	100	0		0	0	0	0	0	0	0	0	0	0	
PHF	.250	.000	.000	.000	.250	.000	.000	.000	.000	.000	.000	.000	.500	.000	.500	.000	.000	.000	.000	.000	.000	.000	.000	.000	.750	

City of Madera
 N/S: Pine Street
 E/W: Howard Road
 Weather: Clear

File Name : 30_MDA_Pine_Howard AM
 Site Code : 00319628
 Start Date : 9/24/2019
 Page No : 2

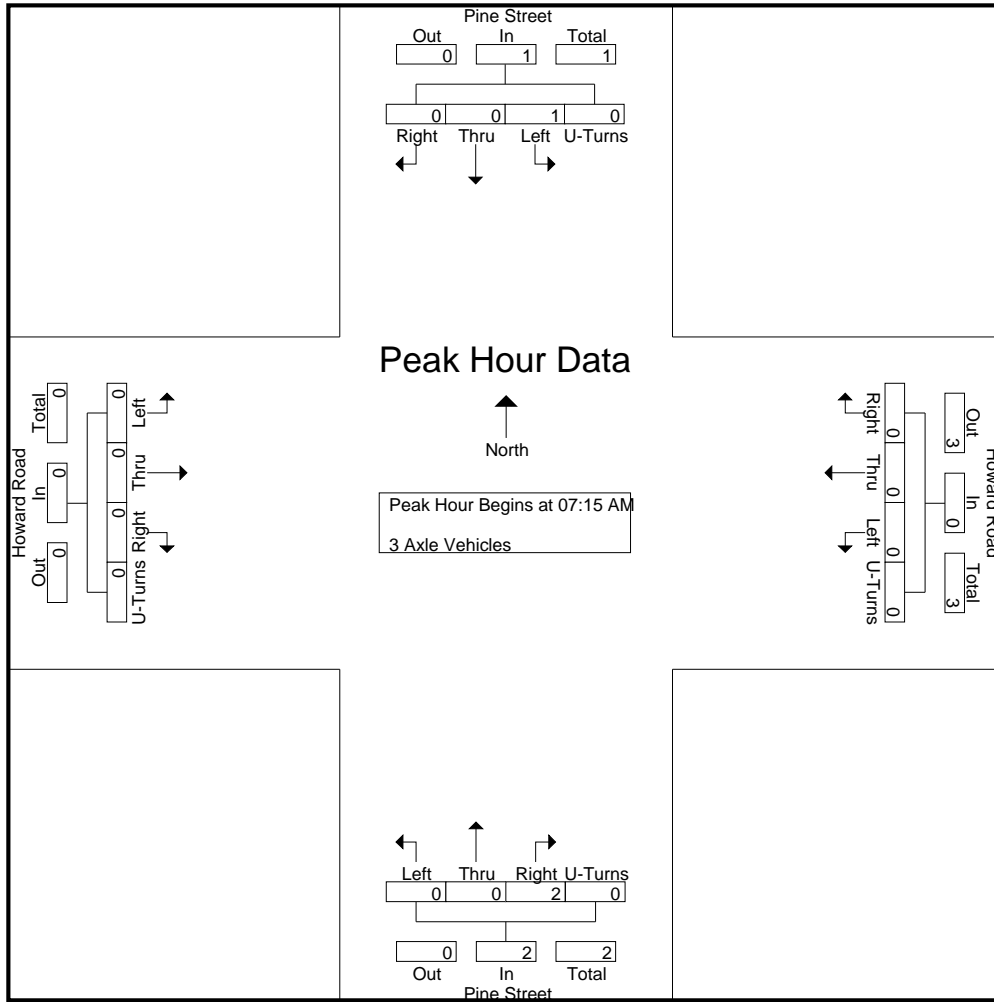

Peak Hour Analysis From 07:15 AM to 08:00 AM - Peak 1 of 1
 Peak Hour for Each Approach Begins at:

	07:15 AM					07:15 AM					07:15 AM									
+0 mins.	0	0	0	0	0	0	0	0	0	0	0	0	1	0	1	0	0	0	0	0
+15 mins.	0	0	0	0	0	0	0	0	0	0	0	0	0	0	0	0	0	0	0	0
+30 mins.	0	0	0	0	0	0	0	0	0	0	0	0	1	0	1	0	0	0	0	0
+45 mins.	1	0	0	0	1	0	0	0	0	0	0	0	0	0	0	0	0	0	0	0
Total Volume	1	0	0	0	1	0	0	0	0	0	0	0	2	0	2	0	0	0	0	0
% App. Total	100	0	0	0	0	0	0	0	0	0	0	0	100	0	0	0	0	0	0	0
PHF	.250	.000	.000	.000	.250	.000	.000	.000	.000	.000	.000	.000	.500	.000	.500	.000	.000	.000	.000	.000

City of Madera
 N/S: Pine Street
 E/W: Howard Road
 Weather: Clear

File Name : 30_MDA_Pine_Howard AM
 Site Code : 00319628
 Start Date : 9/24/2019
 Page No : 1

Groups Printed- 4+ Axle Trucks

Start Time	Pine Street Southbound					Howard Road Westbound					Pine Street Northbound					Howard Road Eastbound					Int. Total
	Left	Thru	Right	U-Turns	App. Total	Left	Thru	Right	U-Turns	App. Total	Left	Thru	Right	U-Turns	App. Total	Left	Thru	Right	U-Turns	App. Total	
07:00 AM	0	0	0	0	0	0	2	0	0	2	0	0	2	0	2	0	2	0	0	2	6
07:15 AM	0	0	0	0	0	1	1	0	0	2	0	1	3	0	4	0	0	0	0	0	6
07:30 AM	0	0	0	0	0	0	1	0	0	1	0	0	1	0	1	0	0	0	0	0	2
07:45 AM	0	0	0	0	0	2	0	0	0	2	1	0	0	0	1	0	2	0	0	2	5
Total	0	0	0	0	0	3	4	0	0	7	1	1	6	0	8	0	4	0	0	4	19
08:00 AM	0	0	0	0	0	1	0	0	0	1	0	1	3	0	4	0	1	0	0	1	6
08:15 AM	0	0	0	0	0	1	2	0	0	3	1	1	0	0	2	0	1	0	0	1	6
08:30 AM	0	0	0	0	0	2	0	0	0	2	0	0	0	0	0	0	1	0	0	1	3
08:45 AM	0	0	1	0	1	0	0	0	0	0	1	0	0	0	1	0	0	0	0	0	2
Total	0	0	1	0	1	4	2	0	0	6	2	2	3	0	7	0	3	0	0	3	17
Grand Total	0	0	1	0	1	7	6	0	0	13	3	3	9	0	15	0	7	0	0	7	36
Apprch %	0	0	100	0		53.8	46.2	0	0		20	20	60	0		0	100	0	0		
Total %	0	0	2.8	0	2.8	19.4	16.7	0	0	36.1	8.3	8.3	25	0	41.7	0	19.4	0	0	19.4	

Start Time	Pine Street Southbound					Howard Road Westbound					Pine Street Northbound					Howard Road Eastbound					Int. Total
	Left	Thru	Right	U-Turns	App. Total	Thru	Right	U-Turns	App. Total	Thru	Right	U-Turns	App. Total	Thru	Right	U-Turns	App. Total				
Peak Hour Analysis From 07:15 AM to 08:00 AM - Peak 1 of 1																					
Peak Hour for Entire Intersection Begins at 07:15 AM																					
07:15 AM	0	0	0	0	0	1	1	0	0	2	0	1	3	0	4	0	0	0	0	0	6
07:30 AM	0	0	0	0	0	0	1	0	0	1	0	0	1	0	1	0	0	0	0	0	2
07:45 AM	0	0	0	0	0	2	0	0	0	2	1	0	0	0	1	0	2	0	0	2	5
08:00 AM	0	0	0	0	0	1	0	0	0	1	0	1	3	0	4	0	1	0	0	1	6
Total Volume	0	0	0	0	0	4	2	0	0	6	1	2	7	0	10	0	3	0	0	3	19
% App. Total	0	0	0	0	0	66.7	33.3	0	0		10	20	70	0		0	100	0	0		
PHF	.000	.000	.000	.000	.000	.500	.500	.000	.000	.750	.250	.500	.583	.000	.625	.000	.375	.000	.000	.375	.792

City of Madera
 N/S: Pine Street
 E/W: Howard Road
 Weather: Clear

File Name : 30_MDA_Pine_Howard AM
 Site Code : 00319628
 Start Date : 9/24/2019
 Page No : 2

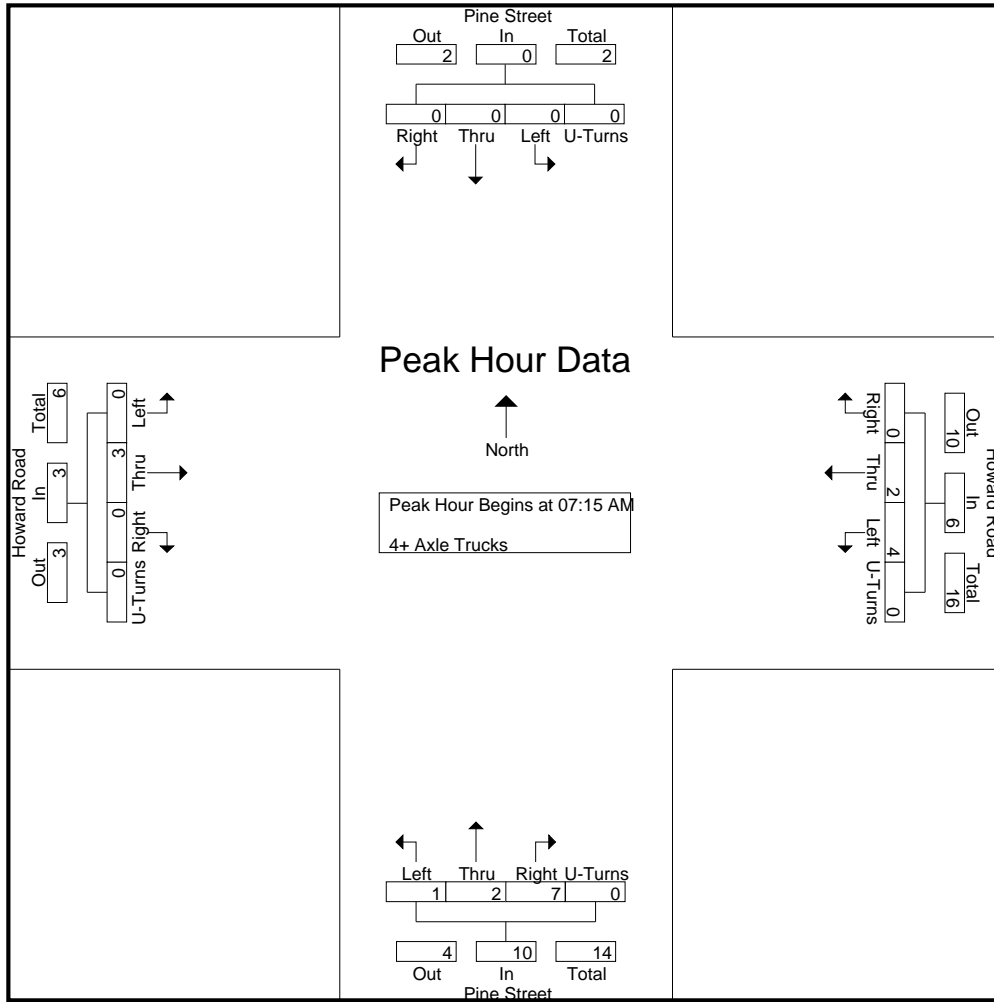

Peak Hour Analysis From 07:15 AM to 08:00 AM - Peak 1 of 1
 Peak Hour for Each Approach Begins at:

	07:15 AM					07:15 AM					07:15 AM									
+0 mins.	0	0	0	0	0	1	1	0	0	2	0	1	3	0	4	0	0	0	0	0
+15 mins.	0	0	0	0	0	0	1	0	0	1	0	0	1	0	1	0	0	0	0	0
+30 mins.	0	0	0	0	0	2	0	0	0	2	1	0	0	0	1	0	2	0	0	2
+45 mins.	0	0	0	0	0	1	0	0	0	1	0	1	3	0	4	0	1	0	0	1
Total Volume	0	0	0	0	0	4	2	0	0	6	1	2	7	0	10	0	3	0	0	3
% App. Total	0	0	0	0	0	66.7	33.3	0	0		10	20	70	0		0	100	0	0	
PHF	.000	.000	.000	.000	.000	.500	.500	.000	.750		.250	.500	.583	.000	.625	.000	.375	.000	.000	.375

City of Madera
 N/S: Pine Street
 E/W: Howard Road
 Weather: Clear

File Name : 30_MDA_Pine_Howard PM
 Site Code : 00319628
 Start Date : 9/24/2019
 Page No : 1

Groups Printed- Passenger Vehicles - Large 2 Axle Vehicles - 3 Axle Vehicles - 4+ Axle Trucks

Start Time	Pine Street Southbound					Howard Road Westbound					Pine Street Northbound					Howard Road Eastbound					Int. Total
	Left	Thru	Right	U-Turns	App. Total	Left	Thru	Right	U-Turns	App. Total	Left	Thru	Right	U-Turns	App. Total	Left	Thru	Right	U-Turns	App. Total	
04:00 PM	1	32	32	0	65	17	94	0	0	111	36	39	31	0	106	22	130	25	0	177	459
04:15 PM	3	37	38	0	78	22	91	2	0	115	40	38	28	0	106	17	117	23	0	157	456
04:30 PM	4	24	33	0	61	21	118	0	0	139	33	38	38	0	109	35	129	20	0	184	493
04:45 PM	7	33	15	0	55	25	102	0	0	127	32	35	29	0	96	19	128	26	0	173	451
Total	15	126	118	0	259	85	405	2	0	492	141	150	126	0	417	93	504	94	0	691	1859
05:00 PM	3	41	39	0	83	16	147	1	0	164	36	36	35	0	107	16	135	26	0	177	531
05:15 PM	1	33	32	0	66	24	119	2	0	145	41	46	36	0	123	15	136	24	0	175	509
05:30 PM	4	28	26	0	58	17	97	1	0	115	36	24	28	0	88	27	141	22	1	191	452
05:45 PM	5	23	28	0	56	19	97	1	0	117	25	30	32	0	87	15	109	12	0	136	396
Total	13	125	125	0	263	76	460	5	0	541	138	136	131	0	405	73	521	84	1	679	1888
Grand Total	28	251	243	0	522	161	865	7	0	1033	279	286	257	0	822	166	1025	178	1	1370	3747
Apprch %	5.4	48.1	46.6	0		15.6	83.7	0.7	0		33.9	34.8	31.3	0		12.1	74.8	13	0.1		
Total %	0.7	6.7	6.5	0	13.9	4.3	23.1	0.2	0	27.6	7.4	7.6	6.9	0	21.9	4.4	27.4	4.8	0	36.6	
Passenger Vehicles	1004																				
% Passenger Vehicles	96.4	95.2	100	0	97.5	95.7	98.8	100	0	98.4	99.6	97.6	96.9	0	98.1	98.8	98	94.4	100	97.6	97.9
Large 2 Axle Vehicles	3.6 4.8 0 0 2.5 3.1 1.2 0 0 1.5 0.4 2.1 1.9 0 1.5 1.2 1.8 5.6 0 2.2 1.9																				
% Large 2 Axle Vehicles	3.6	4.8	0	0	2.5	3.1	1.2	0	0	1.5	0.4	2.1	1.9	0	1.5	1.2	1.8	5.6	0	2.2	1.9
3 Axle Vehicles	0	0	0	0	0	0	0	0	0	0	0	0	1	0	1	0	2	0	0	2	3
% 3 Axle Vehicles	0	0	0	0	0	0	0	0	0	0	0	0	0.4	0	0.1	0	0.2	0	0	0.1	0.1
4+ Axle Trucks	0	0	0	0	0	2	0	0	0	2	0	1	2	0	3	0	1	0	0	1	6
% 4+ Axle Trucks																					

Start Time	Pine Street Southbound					Howard Road Westbound					Pine Street Northbound					Howard Road Eastbound					Int. Total
	Left	Thru	Right	U-Turns	App. Total	Left	Thru	Right	U-Turns	App. Total	Left	Thru	Right	U-Turns	App. Total	Left	Thru	Right	U-Turns	App. Total	
Peak Hour Analysis From 04:00 PM to 05:45 PM - Peak 1 of 1																					
Peak Hour for Entire Intersection Begins at 04:30 PM																					
04:30 PM	4	24	33	0	61	21	118	0	0	139	33	38	38	0	109	35	129	20	0	184	493
04:45 PM	7	33	15	0	55	25	102	0	0	127	32	35	29	0	96	19	128	26	0	173	451
05:00 PM	3	41	39	0	83	16	147	1	0	164	36	36	35	0	107	16	135	26	0	177	531
05:15 PM	1	33	32	0	66	24	119	2	0	145	41	46	36	0	123	15	136	24	0	175	509
Total Volume	15	131	119	0	265	86	486	3	0	575	142	155	138	0	435	85	528	96	0	709	1984
% App. Total	5.7	49.4	44.9	0		15	84.5	0.5	0		32.6	35.6	31.7	0		12	74.5	13.5	0		
PHF	.536	.799	.763	.000	.798	.860	.827	.375	.000	.877	.866	.842	.908	.000	.884	.607	.971	.923	.000	.963	.934

City of Madera
 N/S: Pine Street
 E/W: Howard Road
 Weather: Clear

File Name : 30_MDA_Pine_Howard PM
 Site Code : 00319628
 Start Date : 9/24/2019
 Page No : 2

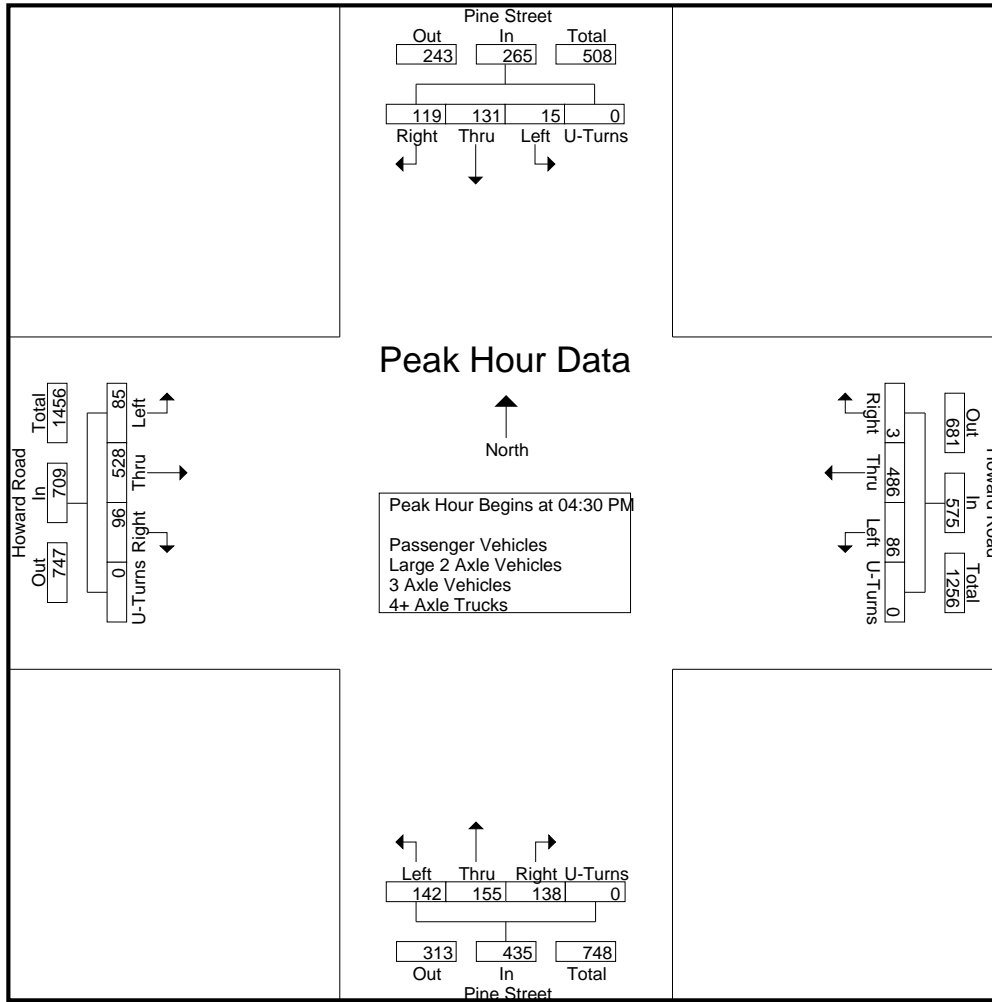

Peak Hour Analysis From 04:00 PM to 05:45 PM - Peak 1 of 1
 Peak Hour for Each Approach Begins at:

	04:15 PM					04:30 PM					04:45 PM									
+0 mins.	3	37	38	0	78	21	118	0	0	139	33	38	38	0	109	19	128	26	0	173
+15 mins.	4	24	33	0	61	25	102	0	0	127	32	35	29	0	96	16	135	26	0	177
+30 mins.	7	33	15	0	55	16	147	1	0	164	36	36	35	0	107	15	136	24	0	175
+45 mins.	3	41	39	0	83	24	119	2	0	145	41	46	36	0	123	27	141	22	1	191
Total Volume	17	135	125	0	277	86	486	3	0	575	142	155	138	0	435	77	540	98	1	716
% App. Total	6.1	48.7	45.1	0		15	84.5	0.5	0		32.6	35.6	31.7	0		10.8	75.4	13.7	0.1	
PHF	.607	.823	.801	.000	.834	.860	.827	.375	.000	.877	.866	.842	.908	.000	.884	.713	.957	.942	.250	.937

City of Madera
 N/S: Pine Street
 E/W: Howard Road
 Weather: Clear

File Name : 30_MDA_Pine_Howard PM
 Site Code : 00319628
 Start Date : 9/24/2019
 Page No : 1

Groups Printed- Passenger Vehicles

Start Time	Pine Street Southbound					Howard Road Westbound					Pine Street Northbound					Howard Road Eastbound					Int. Total
	Left	Thru	Right	U-Turns	App. Total	Left	Thru	Right	U-Turns	App. Total	Left	Thru	Right	U-Turns	App. Total	Left	Thru	Right	U-Turns	App. Total	
04:00 PM	1	29	32	0	62	16	92	0	0	108	36	39	28	0	103	21	123	23	0	167	440
04:15 PM	3	34	38	0	75	19	89	2	0	110	40	37	27	0	104	17	116	22	0	155	444
04:30 PM	4	22	33	0	59	20	118	0	0	138	32	35	38	0	105	35	123	20	0	178	480
04:45 PM	6	32	15	0	53	25	102	0	0	127	32	35	29	0	96	19	127	24	0	170	446
Total	14	117	118	0	249	80	401	2	0	483	140	146	122	0	408	92	489	89	0	670	1810
05:00 PM	3	40	39	0	82	16	144	1	0	161	36	36	34	0	106	16	133	25	0	174	523
05:15 PM	1	32	32	0	65	23	117	2	0	142	41	45	35	0	121	14	135	22	0	171	499
05:30 PM	4	27	26	0	57	17	97	1	0	115	36	24	28	0	88	27	139	21	1	188	448
05:45 PM	5	23	28	0	56	18	96	1	0	115	25	28	30	0	83	15	108	11	0	134	388
Total	13	122	125	0	260	74	454	5	0	533	138	133	127	0	398	72	515	79	1	667	1858
Grand Total	27	239	243	0	509	154	855	7	0	1016	278	279	249	0	806	164	1004	168	1	1337	3668
Apprch %	5.3	47	47.7	0		15.2	84.2	0.7	0		34.5	34.6	30.9	0		12.3	75.1	12.6	0.1		
Total %	0.7	6.5	6.6	0	13.9	4.2	23.3	0.2	0	27.7	7.6	7.6	6.8	0	22	4.5	27.4	4.6	0	36.5	

Start Time	Pine Street Southbound					Howard Road Westbound					Pine Street Northbound					Howard Road Eastbound					Int. Total
	Left	Thru	Right	U-Turns	App. Total	Left	Thru	Right	U-Turns	App. Total	Left	Thru	Right	U-Turns	App. Total	Left	Thru	Right	U-Turns	App. Total	
Peak Hour Analysis From 04:30 PM to 05:15 PM - Peak 1 of 1																					
Peak Hour for Entire Intersection Begins at 04:30 PM																					
04:30 PM	4	22	33	0	59	20	118	0	0	138	32	35	38	0	105	35	123	20	0	178	480
04:45 PM	6	32	15	0	53	25	102	0	0	127	32	35	29	0	96	19	127	24	0	170	446
05:00 PM	3	40	39	0	82	16	144	1	0	161	36	36	34	0	106	16	133	25	0	174	523
05:15 PM	1	32	32	0	65	23	117	2	0	142	41	45	35	0	121	14	135	22	0	171	499
Total Volume	14	126	119	0	259	84	481	3	0	568	141	151	136	0	428	84	518	91	0	693	1948
% App. Total	5.4	48.6	45.9	0		14.8	84.7	0.5	0		32.9	35.3	31.8	0		12.1	74.7	13.1	0		
PHF	.583	.788	.763	.000	.790	.840	.835	.375	.000	.882	.860	.839	.895	.000	.884	.600	.959	.910	.000	.973	.931

City of Madera
 N/S: Pine Street
 E/W: Howard Road
 Weather: Clear

File Name : 30_MDA_Pine_Howard PM
 Site Code : 00319628
 Start Date : 9/24/2019
 Page No : 2

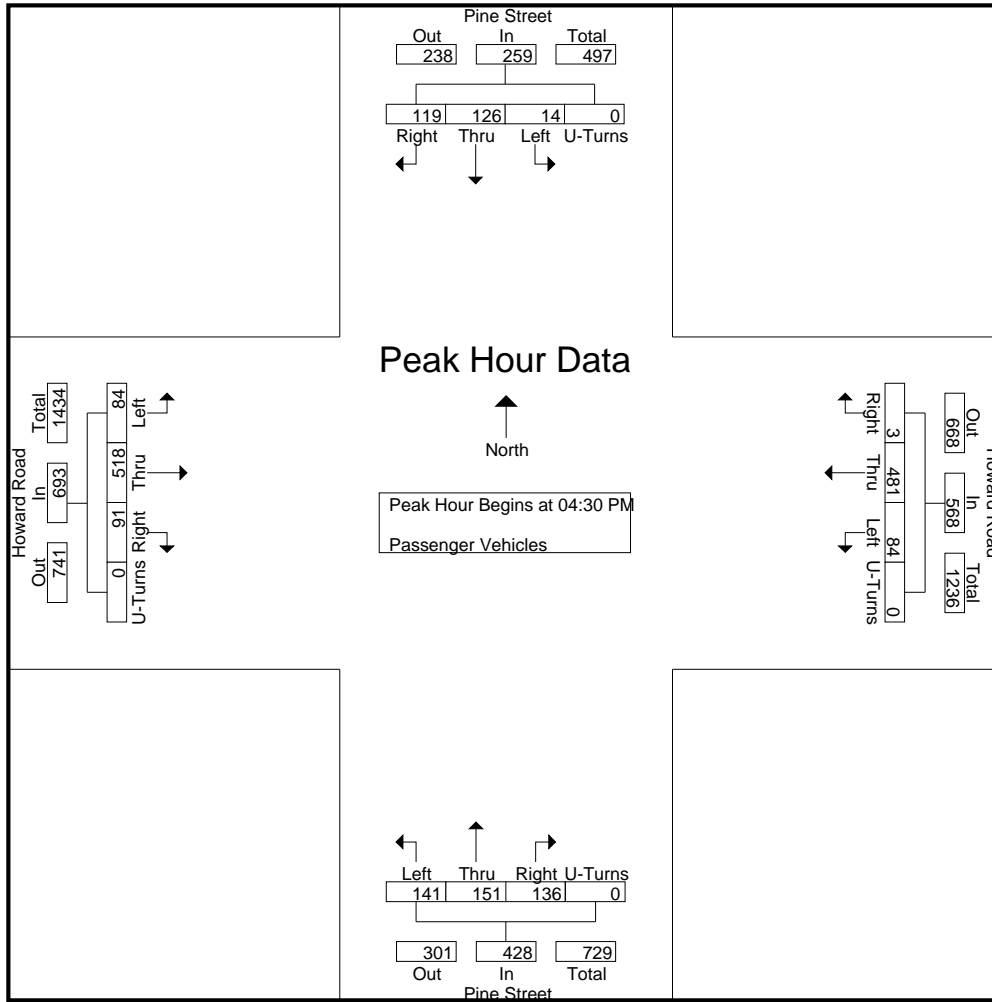

Peak Hour Analysis From 04:30 PM to 05:15 PM - Peak 1 of 1
 Peak Hour for Each Approach Begins at:

	04:30 PM					04:30 PM					04:30 PM									
+0 mins.	4	22	33	0	59	20	118	0	0	138	32	35	38	0	105	35	123	20	0	178
+15 mins.	6	32	15	0	53	25	102	0	0	127	32	35	29	0	96	19	127	24	0	170
+30 mins.	3	40	39	0	82	16	144	1	0	161	36	36	34	0	106	16	133	25	0	174
+45 mins.	1	32	32	0	65	23	117	2	0	142	41	45	35	0	121	14	135	22	0	171
Total Volume	14	126	119	0	259	84	481	3	0	568	141	151	136	0	428	84	518	91	0	693
% App. Total	5.4	48.6	45.9	0		14.8	84.7	0.5	0		32.9	35.3	31.8	0		12.1	74.7	13.1	0	
PHF	.583	.788	.763	.000	.790	.840	.835	.375	.000	.882	.860	.839	.895	.000	.884	.600	.959	.910	.000	.973

City of Madera
 N/S: Pine Street
 E/W: Howard Road
 Weather: Clear

File Name : 30_MDA_Pine_Howard PM
 Site Code : 00319628
 Start Date : 9/24/2019
 Page No : 1

Groups Printed- Large 2 Axle Vehicles

Start Time	Pine Street Southbound					Howard Road Westbound					Pine Street Northbound					Howard Road Eastbound					Int. Total
	Left	Thru	Right	U-Turns	App. Total	Left	Thru	Right	U-Turns	App. Total	Left	Thru	Right	U-Turns	App. Total	Left	Thru	Right	U-Turns	App. Total	
04:00 PM	0	3	0	0	3	1	2	0	0	3	0	0	3	0	3	1	7	2	0	10	19
04:15 PM	0	3	0	0	3	3	2	0	0	5	0	1	0	0	1	0	1	1	0	2	11
04:30 PM	0	2	0	0	2	0	0	0	0	0	1	3	0	0	4	0	4	0	0	4	10
04:45 PM	1	1	0	0	2	0	0	0	0	0	0	0	0	0	0	0	1	2	0	3	5
Total	1	9	0	0	10	4	4	0	0	8	1	4	3	0	8	1	13	5	0	19	45
05:00 PM	0	1	0	0	1	0	3	0	0	3	0	0	1	0	1	0	1	1	0	2	7
05:15 PM	0	1	0	0	1	0	2	0	0	2	0	1	1	0	2	1	1	2	0	4	9
05:30 PM	0	1	0	0	1	0	0	0	0	0	0	0	0	0	0	0	2	1	0	3	4
05:45 PM	0	0	0	0	0	1	1	0	0	2	0	1	0	0	1	0	1	1	0	2	5
Total	0	3	0	0	3	1	6	0	0	7	0	2	2	0	4	1	5	5	0	11	25
Grand Total	1	12	0	0	13	5	10	0	0	15	1	6	5	0	12	2	18	10	0	30	70
Apprch %	7.7	92.3	0	0		33.3	66.7	0	0		8.3	50	41.7	0		6.7	60	33.3	0		
Total %	1.4	17.1	0	0	18.6	7.1	14.3	0	0	21.4	1.4	8.6	7.1	0	17.1	2.9	25.7	14.3	0	42.9	

Start Time	Pine Street Southbound					Howard Road Westbound					Pine Street Northbound					Howard Road Eastbound					Int. Total
	Left	Thru	Right	U-Turns	App. Total	Thru	Right	U-Turns	App. Total	Thru	Right	U-Turns	App. Total	Thru	Right	U-Turns	App. Total				
Peak Hour Analysis From 04:30 PM to 05:15 PM - Peak 1 of 1																					
Peak Hour for Entire Intersection Begins at 04:30 PM																					
04:30 PM	0	2	0	0	2	0	0	0	0	0	1	3	0	0	4	0	4	0	0	4	10
04:45 PM	1	1	0	0	2	0	0	0	0	0	0	0	0	0	0	0	1	2	0	3	5
05:00 PM	0	1	0	0	1	0	3	0	0	3	0	0	1	0	1	0	1	1	0	2	7
05:15 PM	0	1	0	0	1	0	2	0	0	2	0	1	1	0	2	1	1	2	0	4	9
Total Volume	1	5	0	0	6	0	5	0	0	5	1	4	2	0	7	1	7	5	0	13	31
% App. Total	16.7	83.3	0	0		0	100	0	0		14.3	57.1	28.6	0		7.7	53.8	38.5	0		
PHF	.250	.625	.000	.000	.750	.000	.417	.000	.000	.417	.250	.333	.500	.000	.438	.250	.438	.625	.000	.813	.775

City of Madera
 N/S: Pine Street
 E/W: Howard Road
 Weather: Clear

File Name : 30_MDA_Pine_Howard PM
 Site Code : 00319628
 Start Date : 9/24/2019
 Page No : 2

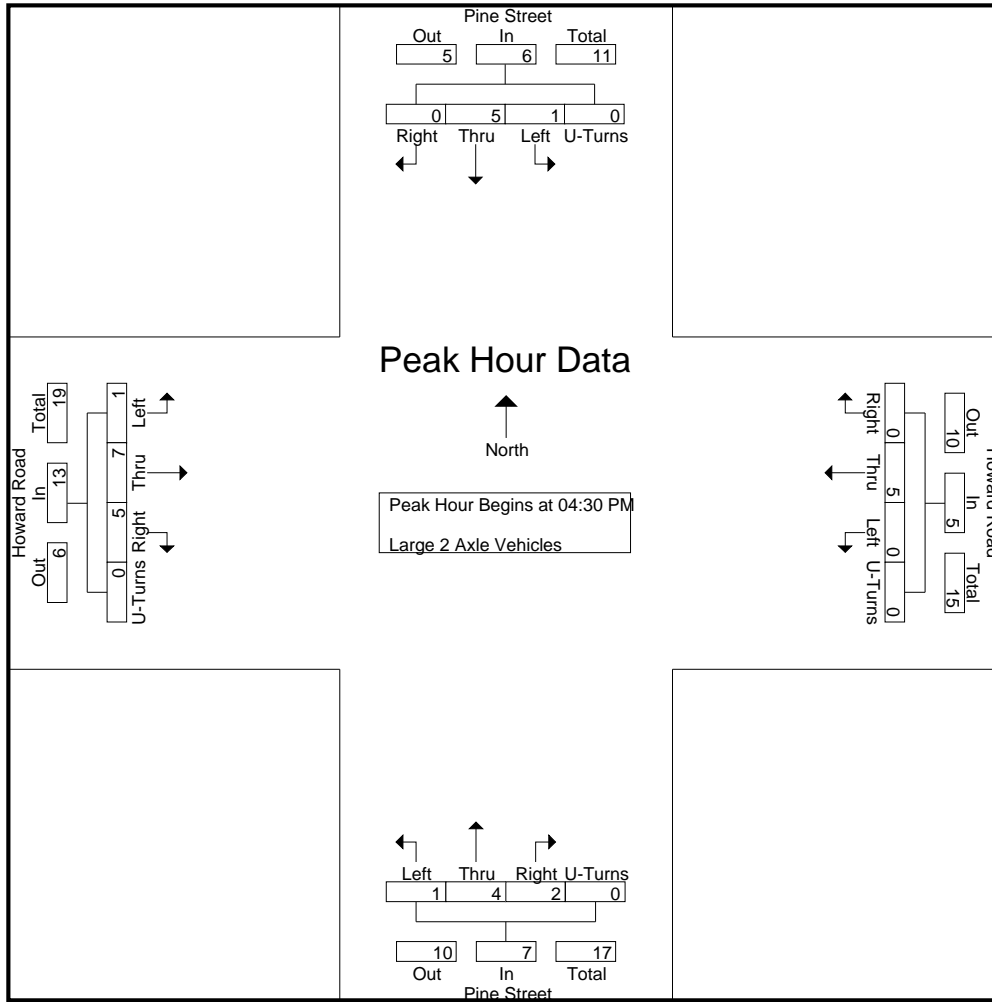

Peak Hour Analysis From 04:30 PM to 05:15 PM - Peak 1 of 1
 Peak Hour for Each Approach Begins at:

	04:30 PM					04:30 PM					04:30 PM									
+0 mins.	0	2	0	0	2	0	0	0	0	0	1	3	0	0	4	0	4	0	0	4
+15 mins.	1	1	0	0	2	0	0	0	0	0	0	0	0	0	0	0	1	2	0	3
+30 mins.	0	1	0	0	1	0	3	0	0	3	0	0	1	0	1	0	1	1	0	2
+45 mins.	0	1	0	0	1	0	2	0	0	2	0	1	1	0	2	1	1	2	0	4
Total Volume	1	5	0	0	6	0	5	0	0	5	1	4	2	0	7	1	7	5	0	13
% App. Total	16.7	83.3	0	0		0	100	0	0		14.3	57.1	28.6	0		7.7	53.8	38.5	0	
PHF	.250	.625	.000	.000	.750	.000	.417	.000	.000	.417	.250	.333	.500	.000	.438	.250	.438	.625	.000	.813

City of Madera
 N/S: Pine Street
 E/W: Howard Road
 Weather: Clear

File Name : 30_MDA_Pine_Howard PM
 Site Code : 00319628
 Start Date : 9/24/2019
 Page No : 1

Groups Printed- 3 Axle Vehicles

Start Time	Pine Street Southbound					Howard Road Westbound					Pine Street Northbound					Howard Road Eastbound					Int. Total	
	Left	Thru	Right	U-Turns	App. Total	Left	Thru	Right	U-Turns	App. Total	Left	Thru	Right	U-Turns	App. Total	Left	Thru	Right	U-Turns	App. Total		
04:00 PM	0	0	0	0	0	0	0	0	0	0	0	0	0	0	0	0	0	0	0	0	0	0
04:15 PM	0	0	0	0	0	0	0	0	0	0	0	0	0	0	0	0	0	0	0	0	0	0
04:30 PM	0	0	0	0	0	0	0	0	0	0	0	0	0	0	0	0	1	0	0	0	1	1
04:45 PM	0	0	0	0	0	0	0	0	0	0	0	0	0	0	0	0	0	0	0	0	0	0
Total	0	0	0	0	0	0	0	0	0	0	0	0	0	0	0	0	1	0	0	0	1	1
05:00 PM	0	0	0	0	0	0	0	0	0	0	0	0	0	0	0	0	1	0	0	0	1	1
05:15 PM	0	0	0	0	0	0	0	0	0	0	0	0	0	0	0	0	0	0	0	0	0	0
05:30 PM	0	0	0	0	0	0	0	0	0	0	0	0	0	0	0	0	0	0	0	0	0	0
05:45 PM	0	0	0	0	0	0	0	0	0	0	0	0	1	0	1	0	0	0	0	0	0	1
Total	0	0	0	0	0	0	0	0	0	0	0	0	1	0	1	0	1	0	0	0	1	2
Grand Total	0	0	0	0	0	0	0	0	0	0	0	0	1	0	1	0	2	0	0	0	2	3
Apprch %	0	0	0	0		0	0	0	0		0	0	100	0		0	100	0	0			
Total %	0	0	0	0	0	0	0	0	0	0	0	0	33.3	0	33.3	0	66.7	0	0	66.7		

Start Time	Pine Street Southbound					Howard Road Westbound					Pine Street Northbound					Howard Road Eastbound					Int. Total	
	Left	Thru	Right	U-Turns	App. Total	Thru	Right	U-Turns	App. Total	Thru	Right	U-Turns	App. Total	Thru	Right	U-Turns	App. Total					
Peak Hour Analysis From 04:30 PM to 05:15 PM - Peak 1 of 1																						
Peak Hour for Entire Intersection Begins at 04:30 PM																						
04:30 PM	0	0	0	0	0	0	0	0	0	0	0	0	0	0	0	0	1	0	0	0	1	1
04:45 PM	0	0	0	0	0	0	0	0	0	0	0	0	0	0	0	0	0	0	0	0	0	0
05:00 PM	0	0	0	0	0	0	0	0	0	0	0	0	0	0	0	0	1	0	0	0	1	1
05:15 PM	0	0	0	0	0	0	0	0	0	0	0	0	0	0	0	0	0	0	0	0	0	0
Total Volume	0	0	0	0	0	0	0	0	0	0	0	0	0	0	0	0	2	0	0	0	2	2
% App. Total	0	0	0	0	0	0	0	0	0	0	0	0	0	0	0	0	100	0	0	0		
PHF	.000	.000	.000	.000	.000	.000	.000	.000	.000	.000	.000	.000	.000	.000	.000	.000	.500	.000	.000	.500		.500

City of Madera
 N/S: Pine Street
 E/W: Howard Road
 Weather: Clear

File Name : 30_MDA_Pine_Howard PM
 Site Code : 00319628
 Start Date : 9/24/2019
 Page No : 2

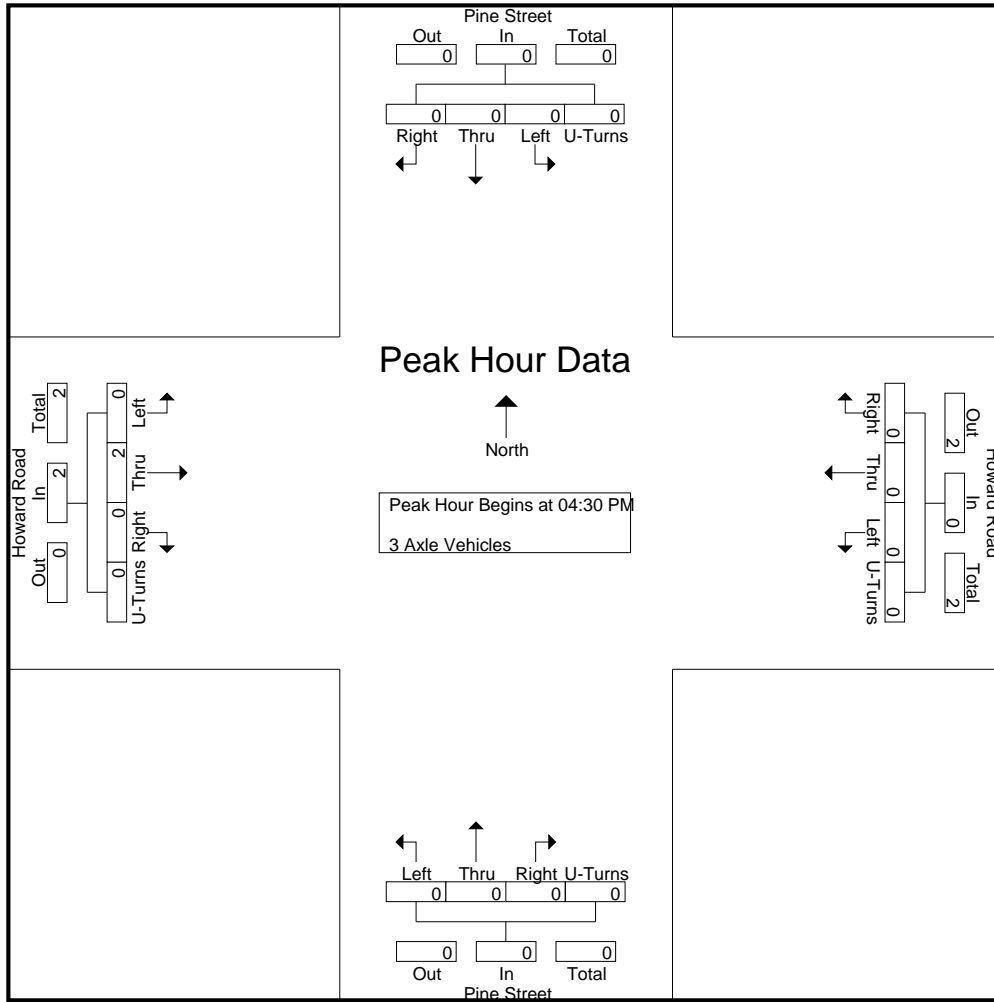

Peak Hour Analysis From 04:30 PM to 05:15 PM - Peak 1 of 1
 Peak Hour for Each Approach Begins at:

	04:30 PM					04:30 PM					04:30 PM					04:30 PM				
+0 mins.	0	0	0	0	0	0	0	0	0	0	0	0	0	0	0	0	1	0	0	1
+15 mins.	0	0	0	0	0	0	0	0	0	0	0	0	0	0	0	0	0	0	0	0
+30 mins.	0	0	0	0	0	0	0	0	0	0	0	0	0	0	0	0	1	0	0	1
+45 mins.	0	0	0	0	0	0	0	0	0	0	0	0	0	0	0	0	0	0	0	0
Total Volume	0	0	0	0	0	0	0	0	0	0	0	0	0	0	0	0	2	0	0	2
% App. Total	0	0	0	0	0	0	0	0	0	0	0	0	0	0	0	0	100	0	0	0
PHF	.000	.000	.000	.000	.000	.000	.000	.000	.000	.000	.000	.000	.000	.000	.000	.000	.500	.000	.000	.500

City of Madera
 N/S: Pine Street
 E/W: Howard Road
 Weather: Clear

File Name : 30_MDA_Pine_Howard PM
 Site Code : 00319628
 Start Date : 9/24/2019
 Page No : 1

Groups Printed- 4+ Axle Trucks

Start Time	Pine Street Southbound					Howard Road Westbound					Pine Street Northbound					Howard Road Eastbound					Int. Total
	Left	Thru	Right	U-Turns	App. Total	Left	Thru	Right	U-Turns	App. Total	Left	Thru	Right	U-Turns	App. Total	Left	Thru	Right	U-Turns	App. Total	
04:00 PM	0	0	0	0	0	0	0	0	0	0	0	0	0	0	0	0	0	0	0	0	0
04:15 PM	0	0	0	0	0	0	0	0	0	0	0	0	1	0	1	0	0	0	0	0	0
04:30 PM	0	0	0	0	0	1	0	0	0	1	0	0	0	0	0	0	1	0	0	1	2
04:45 PM	0	0	0	0	0	0	0	0	0	0	0	0	0	0	0	0	0	0	0	0	0
Total	0	0	0	0	0	1	0	0	0	1	0	0	1	0	1	0	1	0	0	1	3
05:00 PM	0	0	0	0	0	0	0	0	0	0	0	0	0	0	0	0	0	0	0	0	0
05:15 PM	0	0	0	0	0	1	0	0	0	1	0	0	0	0	0	0	0	0	0	0	1
05:30 PM	0	0	0	0	0	0	0	0	0	0	0	0	0	0	0	0	0	0	0	0	0
05:45 PM	0	0	0	0	0	0	0	0	0	0	0	1	1	0	2	0	0	0	0	0	2
Total	0	0	0	0	0	1	0	0	0	1	0	1	1	0	2	0	0	0	0	0	3
Grand Total	0	0	0	0	0	2	0	0	0	2	0	1	2	0	3	0	1	0	0	1	6
Apprch %	0	0	0	0		100	0	0	0		0	33.3	66.7	0		0	100	0	0		
Total %	0	0	0	0	0	33.3	0	0	0	33.3	0	16.7	33.3	0	50	0	16.7	0	0	16.7	

Start Time	Pine Street Southbound					Howard Road Westbound					Pine Street Northbound					Howard Road Eastbound					Int. Total
	Left	Thru	Right	U-Turns	App. Total	Thru	Right	U-Turns	App. Total	Thru	Right	U-Turns	App. Total	Thru	Right	U-Turns	App. Total				
Peak Hour Analysis From 04:30 PM to 05:15 PM - Peak 1 of 1																					
Peak Hour for Entire Intersection Begins at 04:30 PM																					
04:30 PM	0	0	0	0	0	1	0	0	0	1	0	0	0	0	0	0	1	0	0	1	2
04:45 PM	0	0	0	0	0	0	0	0	0	0	0	0	0	0	0	0	0	0	0	0	0
05:00 PM	0	0	0	0	0	0	0	0	0	0	0	0	0	0	0	0	0	0	0	0	0
05:15 PM	0	0	0	0	0	1	0	0	0	1	0	0	0	0	0	0	0	0	0	0	1
Total Volume	0	0	0	0	0	2	0	0	0	2	0	0	0	0	0	0	1	0	0	1	3
% App. Total	0	0	0	0	0	100	0	0	0		0	0	0	0		0	100	0	0		
PHF	.000	.000	.000	.000	.000	.500	.000	.000	.000	.500	.000	.000	.000	.000	.000	.000	.250	.000	.000	.250	.375

City of Madera
 N/S: Pine Street
 E/W: Howard Road
 Weather: Clear

File Name : 30_MDA_Pine_Howard PM
 Site Code : 00319628
 Start Date : 9/24/2019
 Page No : 2

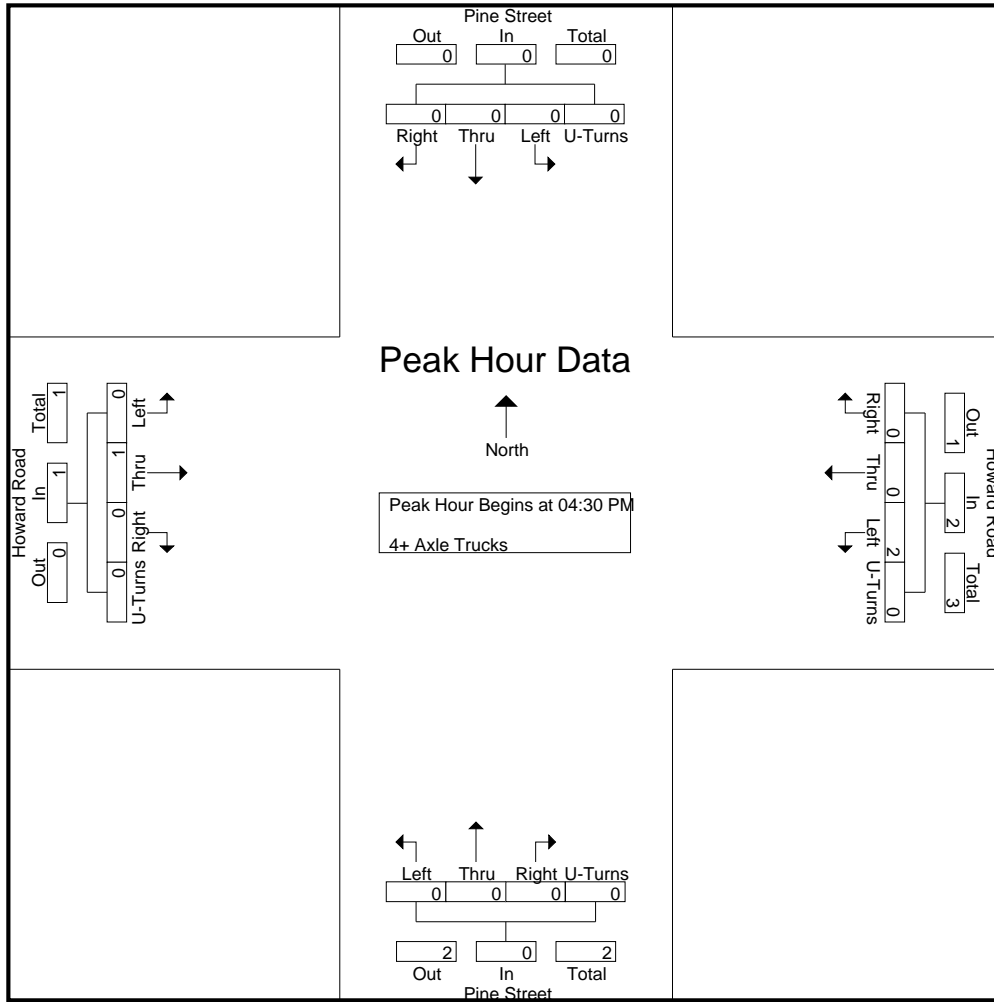

Peak Hour Analysis From 04:30 PM to 05:15 PM - Peak 1 of 1
 Peak Hour for Each Approach Begins at:

	04:30 PM					04:30 PM					04:30 PM									
+0 mins.	0	0	0	0	0	1	0	0	0	1	0	0	0	0	0	0	1	0	0	1
+15 mins.	0	0	0	0	0	0	0	0	0	0	0	0	0	0	0	0	0	0	0	0
+30 mins.	0	0	0	0	0	0	0	0	0	0	0	0	0	0	0	0	0	0	0	0
+45 mins.	0	0	0	0	0	1	0	0	0	1	0	0	0	0	0	0	0	0	0	0
Total Volume	0	0	0	0	0	2	0	0	0	2	0	0	0	0	0	0	1	0	0	1
% App. Total	0	0	0	0	0	100	0	0	0	0	0	0	0	0	0	0	100	0	0	0
PHF	.000	.000	.000	.000	.000	.500	.000	.000	.000	.500	.000	.000	.000	.000	.000	.000	.250	.000	.000	.250

Location: Madera
 N/S: Pine Street
 E/W: Howard Road



Date: 9/24/2019
 Day: Tuesday

PEDESTRIANS

	North Leg Pine Street	East Leg Howard Road	South Leg Pine Street	West Leg Howard Road	
	Pedestrians	Pedestrians	Pedestrians	Pedestrians	
7:00 AM	2	3	3	0	8
7:15 AM	0	0	3	0	3
7:30 AM	2	3	1	0	6
7:45 AM	0	0	8	0	8
8:00 AM	0	0	3	0	3
8:15 AM	0	0	2	0	2
8:30 AM	0	0	1	0	1
8:45 AM	0	1	1	0	2
TOTAL VOLUMES:	4	7	22	0	33

	North Leg Pine Street	East Leg Howard Road	South Leg Pine Street	West Leg Howard Road	
	Pedestrians	Pedestrians	Pedestrians	Pedestrians	
4:00 PM	1	0	1	0	2
4:15 PM	0	0	6	0	6
4:30 PM	0	0	4	0	4
4:45 PM	0	0	3	0	3
5:00 PM	0	0	12	0	12
5:15 PM	0	0	10	0	10
5:30 PM	0	0	1	0	1
5:45 PM	0	0	0	0	0
TOTAL VOLUMES:	1	0	37	0	38

Location: Madera
 N/S: Pine Street
 E/W: Howard Road



Date: 9/24/2019
 Day: Tuesday

BICYCLES

	Southbound Pine Street			Westbound Howard Road			Northbound Pine Street			Eastbound Howard Road			
	Left	Thru	Right	Left	Thru	Right	Left	Thru	Right	Left	Thru	Right	
7:00 AM	0	0	0	0	0	0	0	0	0	0	0	0	0
7:15 AM	0	0	0	0	0	0	0	0	0	0	4	0	4
7:30 AM	0	0	0	0	0	0	0	0	0	0	1	0	1
7:45 AM	0	0	0	0	0	0	0	0	0	0	1	0	1
8:00 AM	0	0	0	0	0	0	0	0	0	0	0	0	0
8:15 AM	0	0	0	0	0	0	0	0	0	0	0	0	0
8:30 AM	0	0	0	0	0	0	0	0	0	0	1	0	1
8:45 AM	0	0	0	0	0	0	0	0	0	0	0	0	0
TOTAL VOLUMES:	0	0	0	0	0	0	0	0	0	0	7	0	7

	Southbound Pine Street			Westbound Howard Road			Northbound Pine Street			Eastbound Howard Road			
	Left	Thru	Right	Left	Thru	Right	Left	Thru	Right	Left	Thru	Right	
4:00 PM	0	0	0	0	0	0	0	0	0	0	1	0	1
4:15 PM	0	0	0	0	0	0	0	0	0	0	0	0	0
4:30 PM	0	0	0	0	0	0	0	0	0	0	0	0	0
4:45 PM	0	0	0	0	0	0	0	0	0	0	0	0	0
5:00 PM	0	0	0	0	1	0	0	0	0	0	0	0	1
5:15 PM	0	0	0	0	0	0	0	0	0	0	0	0	0
5:30 PM	0	0	0	0	0	0	0	0	0	0	1	0	1
5:45 PM	0	0	0	0	0	0	0	0	0	0	0	0	0
TOTAL VOLUMES:	0	0	0	0	1	0	0	0	0	0	2	0	3

City of Madera
 N/S: Q Street
 E/W: Howard Road/Yosemite Avenue
 Weather: Clear

File Name : 31_MDA_Q St_Yosemite AM
 Site Code : 00319628
 Start Date : 9/24/2019
 Page No : 1

Groups Printed- Passenger Vehicles - Large 2 Axle Vehicles - 3 Axle Vehicles - 4+ Axle Trucks

Start Time	Q Street Southbound					Yosemite Avenue Westbound					Q Street Northbound					Howard Road Eastbound					Int. Total
	Left	Thru	Right	U-Turns	App. Total	Left	Thru	Right	U-Turns	App. Total	Left	Thru	Right	U-Turns	App. Total	Left	Thru	Right	U-Turns	App. Total	
07:00 AM	2	11	1	0	14	3	54	4	0	61	27	6	0	0	33	2	68	51	0	121	229
07:15 AM	21	30	3	0	54	8	93	1	0	102	50	12	4	0	66	3	127	78	0	208	430
07:30 AM	45	61	2	0	108	13	98	7	0	118	101	29	5	0	135	3	176	91	0	270	631
07:45 AM	26	39	4	0	69	5	96	9	0	110	83	30	7	0	120	0	136	83	0	219	518
Total	94	141	10	0	245	29	341	21	0	391	261	77	16	0	354	8	507	303	0	818	1808
08:00 AM	7	17	3	0	27	0	45	2	0	47	58	17	4	0	79	0	102	56	0	158	311
08:15 AM	10	24	1	0	35	5	47	3	0	55	40	13	5	0	58	1	86	43	0	130	278
08:30 AM	3	24	4	0	31	0	40	1	0	41	37	16	2	0	55	2	60	33	0	95	222
08:45 AM	5	8	2	0	15	0	63	3	0	66	38	8	1	0	47	2	81	38	0	121	249
Total	25	73	10	0	108	5	195	9	0	209	173	54	12	0	239	5	329	170	0	504	1060
Grand Total	119	214	20	0	353	34	536	30	0	600	434	131	28	0	593	13	836	473	0	1322	2868
Apprch %	33.7	60.6	5.7	0		5.7	89.3	5	0		73.2	22.1	4.7	0		1	63.2	35.8	0		
Total %	4.1	7.5	0.7	0	12.3	1.2	18.7	1	0	20.9	15.1	4.6	1	0	20.7	0.5	29.1	16.5	0	46.1	
Passenger Vehicles																					
% Passenger Vehicles	99.2	97.2	100	0	98	97.1	96.5	100	0	96.7	97.2	96.2	85.7	0	96.5	92.3	97.8	94.7	0	96.7	96.8
Large 2 Axle Vehicles																					
% Large 2 Axle Vehicles	0	2.8	0	0	1.7	2.9	2.1	0	0	2	1.2	3.1	14.3	0	2.2	7.7	1.6	3.2	0	2.2	2.1
3 Axle Vehicles																					
% 3 Axle Vehicles	0.8	0	0	0	0.3	0	0.6	0	0	0.5	0	0.8	0	0	0.2	0	0.1	0	0	0.1	0.2
4+ Axle Trucks																					
% 4+ Axle Trucks	0	0	0	0	0	0	5	0	0	5	7	0	0	0	7	0	4	10	0	14	26

Start Time	Q Street Southbound					Yosemite Avenue Westbound					Q Street Northbound					Howard Road Eastbound					Int. Total
	Left	Thru	Right	U-Turns	App. Total	Left	Thru	Right	U-Turns	App. Total	Left	Thru	Right	U-Turns	App. Total	Left	Thru	Right	U-Turns	App. Total	
Peak Hour Analysis From 07:00 AM to 08:45 AM - Peak 1 of 1																					
Peak Hour for Entire Intersection Begins at 07:15 AM																					
07:15 AM	21	30	3	0	54	8	93	1	0	102	50	12	4	0	66	3	127	78	0	208	430
07:30 AM	45	61	2	0	108	13	98	7	0	118	101	29	5	0	135	3	176	91	0	270	631
07:45 AM	26	39	4	0	69	5	96	9	0	110	83	30	7	0	120	0	136	83	0	219	518
08:00 AM	7	17	3	0	27	0	45	2	0	47	58	17	4	0	79	0	102	56	0	158	311
Total Volume	99	147	12	0	258	26	332	19	0	377	292	88	20	0	400	6	541	308	0	855	1890
% App. Total	38.4	57	4.7	0		6.9	88.1	5	0		73	22	5	0		0.7	63.3	36	0		
PHF	.550	.602	.750	.000	.597	.500	.847	.528	.000	.799	.723	.733	.714	.000	.741	.500	.768	.846	.000	.792	.749

City of Madera
 N/S: Q Street
 E/W: Howard Road/Yosemite Avenue
 Weather: Clear

File Name : 31_MDA_Q St_Yosemite AM
 Site Code : 00319628
 Start Date : 9/24/2019
 Page No : 2

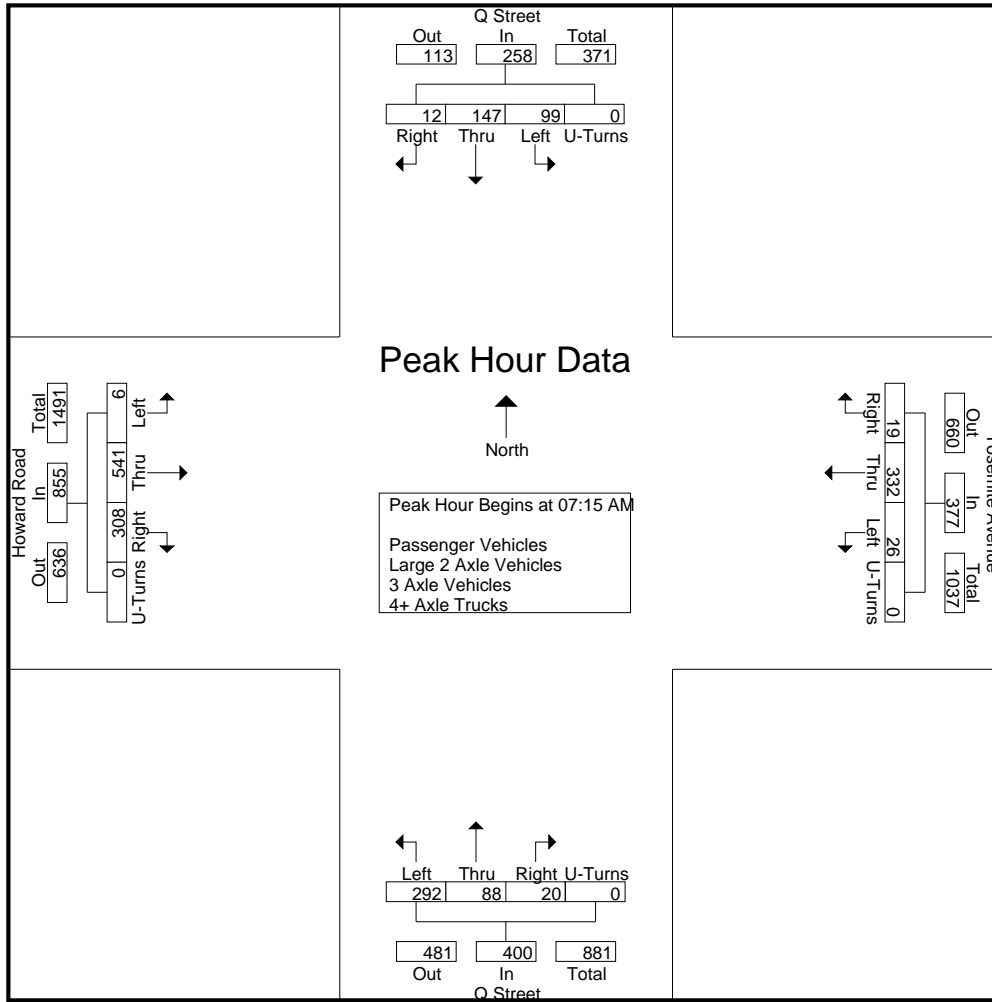

Peak Hour Analysis From 07:00 AM to 08:45 AM - Peak 1 of 1
 Peak Hour for Each Approach Begins at:

	07:15 AM					07:00 AM					07:15 AM					07:15 AM				
+0 mins.	21	30	3	0	54	3	54	4	0	61	50	12	4	0	66	3	127	78	0	208
+15 mins.	45	61	2	0	108	8	93	1	0	102	101	29	5	0	135	3	176	91	0	270
+30 mins.	26	39	4	0	69	13	98	7	0	118	83	30	7	0	120	0	136	83	0	219
+45 mins.	7	17	3	0	27	5	96	9	0	110	58	17	4	0	79	0	102	56	0	158
Total Volume	99	147	12	0	258	29	341	21	0	391	292	88	20	0	400	6	541	308	0	855
% App. Total	38.4	57	4.7	0		7.4	87.2	5.4	0		73	22	5	0		0.7	63.3	36	0	
PHF	.550	.602	.750	.000	.597	.558	.870	.583	.000	.828	.723	.733	.714	.000	.741	.500	.768	.846	.000	.792

City of Madera
 N/S: Q Street
 E/W: Howard Road/Yosemite Avenue
 Weather: Clear

File Name : 31_MDA_Q St_Yosemite AM
 Site Code : 00319628
 Start Date : 9/24/2019
 Page No : 1

Groups Printed- Passenger Vehicles

Start Time	Q Street Southbound					Yosemite Avenue Westbound					Q Street Northbound					Howard Road Eastbound					Int. Total
	Left	Thru	Right	U-Turns	App. Total	Left	Thru	Right	U-Turns	App. Total	Left	Thru	Right	U-Turns	App. Total	Left	Thru	Right	U-Turns	App. Total	
07:00 AM	2	11	1	0	14	3	50	4	0	57	27	6	0	0	33	2	64	45	0	111	215
07:15 AM	21	30	3	0	54	8	91	1	0	100	45	10	2	0	57	2	125	70	0	197	408
07:30 AM	45	58	2	0	105	12	97	7	0	116	101	27	5	0	133	3	174	89	0	266	620
07:45 AM	26	38	4	0	68	5	94	9	0	108	81	30	7	0	118	0	136	81	0	217	511
Total	94	137	10	0	241	28	332	21	0	381	254	73	14	0	341	7	499	285	0	791	1754
08:00 AM	7	15	3	0	25	0	43	2	0	45	55	16	3	0	74	0	101	51	0	152	296
08:15 AM	10	24	1	0	35	5	45	3	0	53	38	13	4	0	55	1	82	41	0	124	267
08:30 AM	3	24	4	0	31	0	36	1	0	37	37	16	2	0	55	2	59	33	0	94	217
08:45 AM	4	8	2	0	14	0	61	3	0	64	38	8	1	0	47	2	77	38	0	117	242
Total	24	71	10	0	105	5	185	9	0	199	168	53	10	0	231	5	319	163	0	487	1022
Grand Total	118	208	20	0	346	33	517	30	0	580	422	126	24	0	572	12	818	448	0	1278	2776
Apprch %	34.1	60.1	5.8	0		5.7	89.1	5.2	0		73.8	22	4.2	0		0.9	64	35.1	0		
Total %	4.3	7.5	0.7	0	12.5	1.2	18.6	1.1	0	20.9	15.2	4.5	0.9	0	20.6	0.4	29.5	16.1	0	46	

Start Time	Q Street Southbound					Yosemite Avenue Westbound					Q Street Northbound					Howard Road Eastbound					Int. Total
	Left	Thru	Right	U-Turns	App. Total	Left	Thru	Right	U-Turns	App. Total	Left	Thru	Right	U-Turns	App. Total	Left	Thru	Right	U-Turns	App. Total	
Peak Hour Analysis From 07:15 AM to 08:00 AM - Peak 1 of 1																					
Peak Hour for Entire Intersection Begins at 07:15 AM																					
07:15 AM	21	30	3	0	54	8	91	1	0	100	45	10	2	0	57	2	125	70	0	197	408
07:30 AM	45	58	2	0	105	12	97	7	0	116	101	27	5	0	133	3	174	89	0	266	620
07:45 AM	26	38	4	0	68	5	94	9	0	108	81	30	7	0	118	0	136	81	0	217	511
08:00 AM	7	15	3	0	25	0	43	2	0	45	55	16	3	0	74	0	101	51	0	152	296
Total Volume	99	141	12	0	252	25	325	19	0	369	282	83	17	0	382	5	536	291	0	832	1835
% App. Total	39.3	56	4.8	0		6.8	88.1	5.1	0		73.8	21.7	4.5	0		0.6	64.4	35	0		
PHF	.550	.608	.750	.000	.600	.521	.838	.528	.000	.795	.698	.692	.607	.000	.718	.417	.770	.817	.000	.782	.740

City of Madera
 N/S: Q Street
 E/W: Howard Road/Yosemite Avenue
 Weather: Clear

File Name : 31_MDA_Q St_Yosemite AM
 Site Code : 00319628
 Start Date : 9/24/2019
 Page No : 2

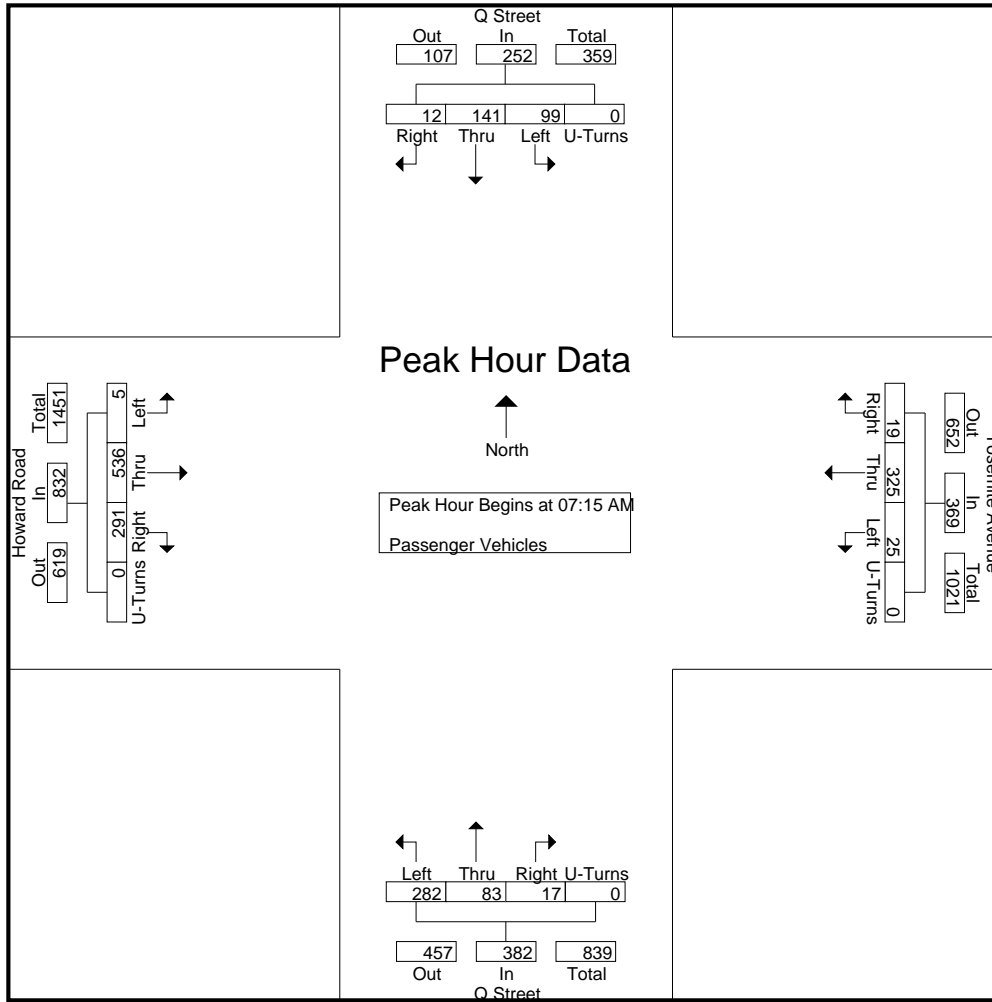

Peak Hour Analysis From 07:15 AM to 08:00 AM - Peak 1 of 1
 Peak Hour for Each Approach Begins at:

	07:15 AM					07:15 AM					07:15 AM									
+0 mins.	21	30	3	0	54	8	91	1	0	100	45	10	2	0	57	2	125	70	0	197
+15 mins.	45	58	2	0	105	12	97	7	0	116	101	27	5	0	133	3	174	89	0	266
+30 mins.	26	38	4	0	68	5	94	9	0	108	81	30	7	0	118	0	136	81	0	217
+45 mins.	7	15	3	0	25	0	43	2	0	45	55	16	3	0	74	0	101	51	0	152
Total Volume	99	141	12	0	252	25	325	19	0	369	282	83	17	0	382	5	536	291	0	832
% App. Total	39.3	56	4.8	0		6.8	88.1	5.1	0		73.8	21.7	4.5	0		0.6	64.4	35	0	
PHF	.550	.608	.750	.000	.600	.521	.838	.528	.000	.795	.698	.692	.607	.000	.718	.417	.770	.817	.000	.782

City of Madera
 N/S: Q Street
 E/W: Howard Road/Yosemite Avenue
 Weather: Clear

File Name : 31_MDA_Q St_Yosemite AM
 Site Code : 00319628
 Start Date : 9/24/2019
 Page No : 1

Groups Printed- Large 2 Axle Vehicles

Start Time	Q Street Southbound					Yosemite Avenue Westbound					Q Street Northbound					Howard Road Eastbound					Int. Total
	Left	Thru	Right	U-Turns	App. Total	Left	Thru	Right	U-Turns	App. Total	Left	Thru	Right	U-Turns	App. Total	Left	Thru	Right	U-Turns	App. Total	
07:00 AM	0	0	0	0	0	0	1	0	0	1	0	0	0	0	0	0	1	5	0	6	7
07:15 AM	0	0	0	0	0	0	2	0	0	2	3	2	2	0	7	1	1	6	0	8	17
07:30 AM	0	3	0	0	3	1	0	0	0	1	0	1	0	0	1	0	1	2	0	3	8
07:45 AM	0	1	0	0	1	0	2	0	0	2	0	0	0	0	0	0	0	0	0	0	3
Total	0	4	0	0	4	1	5	0	0	6	3	3	2	0	8	1	3	13	0	17	35
08:00 AM	0	2	0	0	2	0	1	0	0	1	2	1	1	0	4	0	1	1	0	2	9
08:15 AM	0	0	0	0	0	0	1	0	0	1	0	0	1	0	1	0	4	1	0	5	7
08:30 AM	0	0	0	0	0	0	2	0	0	2	0	0	0	0	0	0	1	0	0	1	3
08:45 AM	0	0	0	0	0	0	2	0	0	2	0	0	0	0	0	0	4	0	0	4	6
Total	0	2	0	0	2	0	6	0	0	6	2	1	2	0	5	0	10	2	0	12	25
Grand Total	0	6	0	0	6	1	11	0	0	12	5	4	4	0	13	1	13	15	0	29	60
Apprch %	0	100	0	0		8.3	91.7	0	0		38.5	30.8	30.8	0		3.4	44.8	51.7	0		
Total %	0	10	0	0	10	1.7	18.3	0	0	20	8.3	6.7	6.7	0	21.7	1.7	21.7	25	0	48.3	

Start Time	Q Street Southbound					Yosemite Avenue Westbound					Q Street Northbound					Howard Road Eastbound					Int. Total
	Left	Thru	Right	U-Turns	App. Total	Left	Thru	Right	U-Turns	App. Total	Left	Thru	Right	U-Turns	App. Total	Left	Thru	Right	U-Turns	App. Total	
Peak Hour Analysis From 07:15 AM to 08:00 AM - Peak 1 of 1																					
Peak Hour for Entire Intersection Begins at 07:15 AM																					
07:15 AM	0	0	0	0	0	0	2	0	0	2	3	2	2	0	7	1	1	6	0	8	17
07:30 AM	0	3	0	0	3	1	0	0	0	1	0	1	0	0	1	0	1	2	0	3	8
07:45 AM	0	1	0	0	1	0	2	0	0	2	0	0	0	0	0	0	0	0	0	0	3
08:00 AM	0	2	0	0	2	0	1	0	0	1	2	1	1	0	4	0	1	1	0	2	9
Total Volume	0	6	0	0	6	1	5	0	0	6	5	4	3	0	12	1	3	9	0	13	37
% App. Total	0	100	0	0		16.7	83.3	0	0		41.7	33.3	25	0		7.7	23.1	69.2	0		
PHF	.000	.500	.000	.000	.500	.250	.625	.000	.000	.750	.417	.500	.375	.000	.429	.250	.750	.375	.000	.406	.544

City of Madera
 N/S: Q Street
 E/W: Howard Road/Yosemite Avenue
 Weather: Clear

File Name : 31_MDA_Q St_Yosemite AM
 Site Code : 00319628
 Start Date : 9/24/2019
 Page No : 2

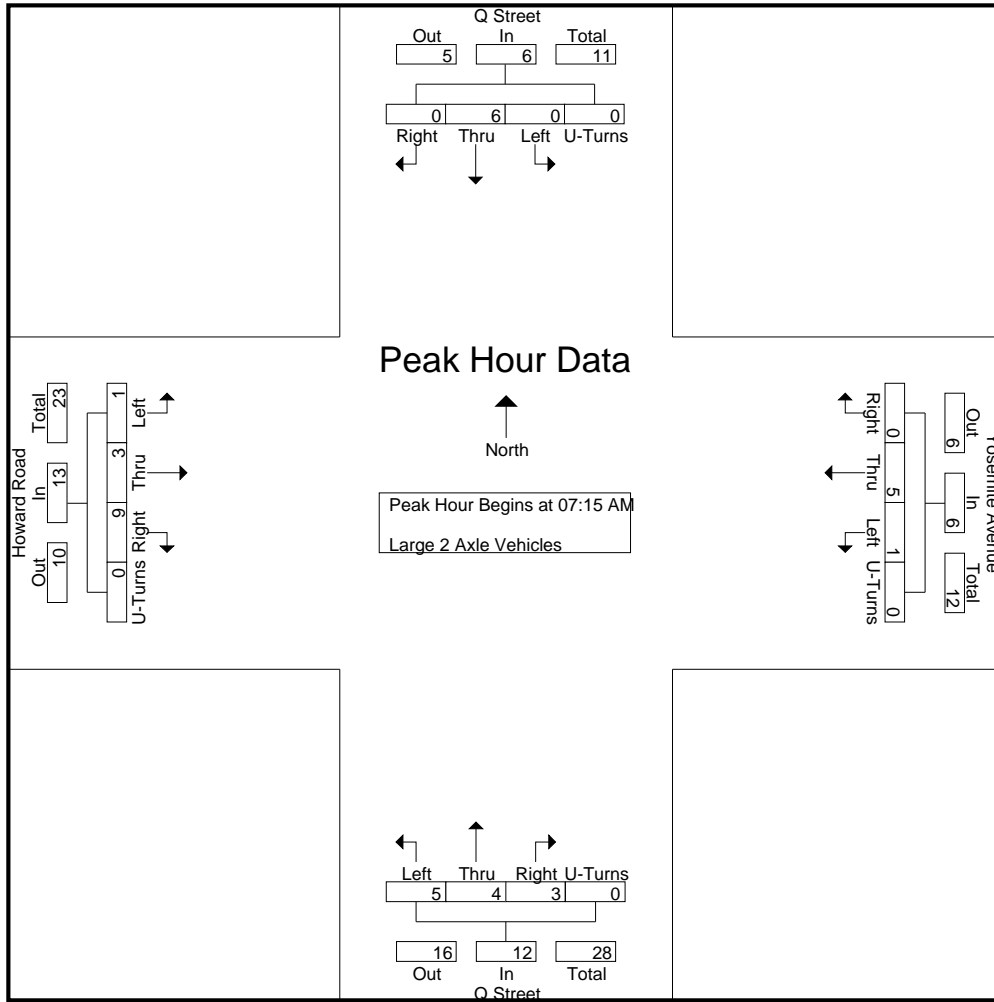

Peak Hour Analysis From 07:15 AM to 08:00 AM - Peak 1 of 1
 Peak Hour for Each Approach Begins at:

	07:15 AM					07:15 AM					07:15 AM									
+0 mins.	0	0	0	0	0	0	2	0	0	2	3	2	2	0	7	1	1	6	0	8
+15 mins.	0	3	0	0	3	1	0	0	0	1	0	1	0	0	1	0	1	2	0	3
+30 mins.	0	1	0	0	1	0	2	0	0	2	0	0	0	0	0	0	0	0	0	0
+45 mins.	0	2	0	0	2	0	1	0	0	1	2	1	1	0	4	0	1	1	0	2
Total Volume	0	6	0	0	6	1	5	0	0	6	5	4	3	0	12	1	3	9	0	13
% App. Total	0	100	0	0	0	16.7	83.3	0	0	0	41.7	33.3	25	0	0	7.7	23.1	69.2	0	0
PHF	.000	.500	.000	.000	.500	.250	.625	.000	.000	.750	.417	.500	.375	.000	.429	.250	.750	.375	.000	.406

City of Madera
 N/S: Q Street
 E/W: Howard Road/Yosemite Avenue
 Weather: Clear

File Name : 31_MDA_Q St_Yosemite AM
 Site Code : 00319628
 Start Date : 9/24/2019
 Page No : 1

Groups Printed- 3 Axle Vehicles

Start Time	Q Street Southbound					Yosemite Avenue Westbound					Q Street Northbound					Howard Road Eastbound					Int. Total
	Left	Thru	Right	U-Turns	App. Total	Left	Thru	Right	U-Turns	App. Total	Left	Thru	Right	U-Turns	App. Total	Left	Thru	Right	U-Turns	App. Total	
07:00 AM	0	0	0	0	0	0	1	0	0	1	0	0	0	0	0	0	0	0	0	0	1
07:15 AM	0	0	0	0	0	0	0	0	0	0	0	0	0	0	0	0	1	0	0	0	1
07:30 AM	0	0	0	0	0	0	1	0	0	1	0	1	0	0	1	0	0	0	0	0	2
07:45 AM	0	0	0	0	0	0	0	0	0	0	0	0	0	0	0	0	0	0	0	0	0
Total	0	0	0	0	0	0	2	0	0	2	0	1	0	0	1	0	1	0	0	0	4
08:00 AM	0	0	0	0	0	0	0	0	0	0	0	0	0	0	0	0	0	0	0	0	0
08:15 AM	0	0	0	0	0	0	1	0	0	1	0	0	0	0	0	0	0	0	0	0	1
08:30 AM	0	0	0	0	0	0	0	0	0	0	0	0	0	0	0	0	0	0	0	0	0
08:45 AM	1	0	0	0	1	0	0	0	0	0	0	0	0	0	0	0	0	0	0	0	1
Total	1	0	0	0	1	0	1	0	0	1	0	0	0	0	0	0	0	0	0	0	2
Grand Total	1	0	0	0	1	0	3	0	0	3	0	1	0	0	1	0	1	0	0	0	6
Apprch %	100	0	0	0		0	100	0	0		0	100	0	0		0	100	0	0		
Total %	16.7	0	0	0	16.7	0	50	0	0	50	0	16.7	0	0	16.7	0	16.7	0	0	16.7	

Start Time	Q Street Southbound					Yosemite Avenue Westbound					Q Street Northbound					Howard Road Eastbound					Int. Total
	Left	Thru	Right	U-Turns	App. Total	Thru	Right	U-Turns	App. Total	Thru	Right	U-Turns	App. Total	Thru	Right	U-Turns	App. Total				
Peak Hour Analysis From 07:15 AM to 08:00 AM - Peak 1 of 1																					
Peak Hour for Entire Intersection Begins at 07:15 AM																					
07:15 AM	0	0	0	0	0	0	0	0	0	0	0	0	0	0	0	0	1	0	0	0	1
07:30 AM	0	0	0	0	0	0	1	0	0	1	0	1	0	0	1	0	0	0	0	0	2
07:45 AM	0	0	0	0	0	0	0	0	0	0	0	0	0	0	0	0	0	0	0	0	0
08:00 AM	0	0	0	0	0	0	0	0	0	0	0	0	0	0	0	0	0	0	0	0	0
Total Volume	0	0	0	0	0	0	1	0	0	1	0	1	0	0	1	0	1	0	0	0	3
% App. Total	0	0	0	0		0	100	0	0		0	100	0	0		0	100	0	0		
PHF	.000	.000	.000	.000	.000	.000	.250	.000	.000	.250	.000	.250	.000	.000	.250	.000	.250	.000	.000	.250	.375

City of Madera
 N/S: Q Street
 E/W: Howard Road/Yosemite Avenue
 Weather: Clear

File Name : 31_MDA_Q St_Yosemite AM
 Site Code : 00319628
 Start Date : 9/24/2019
 Page No : 2

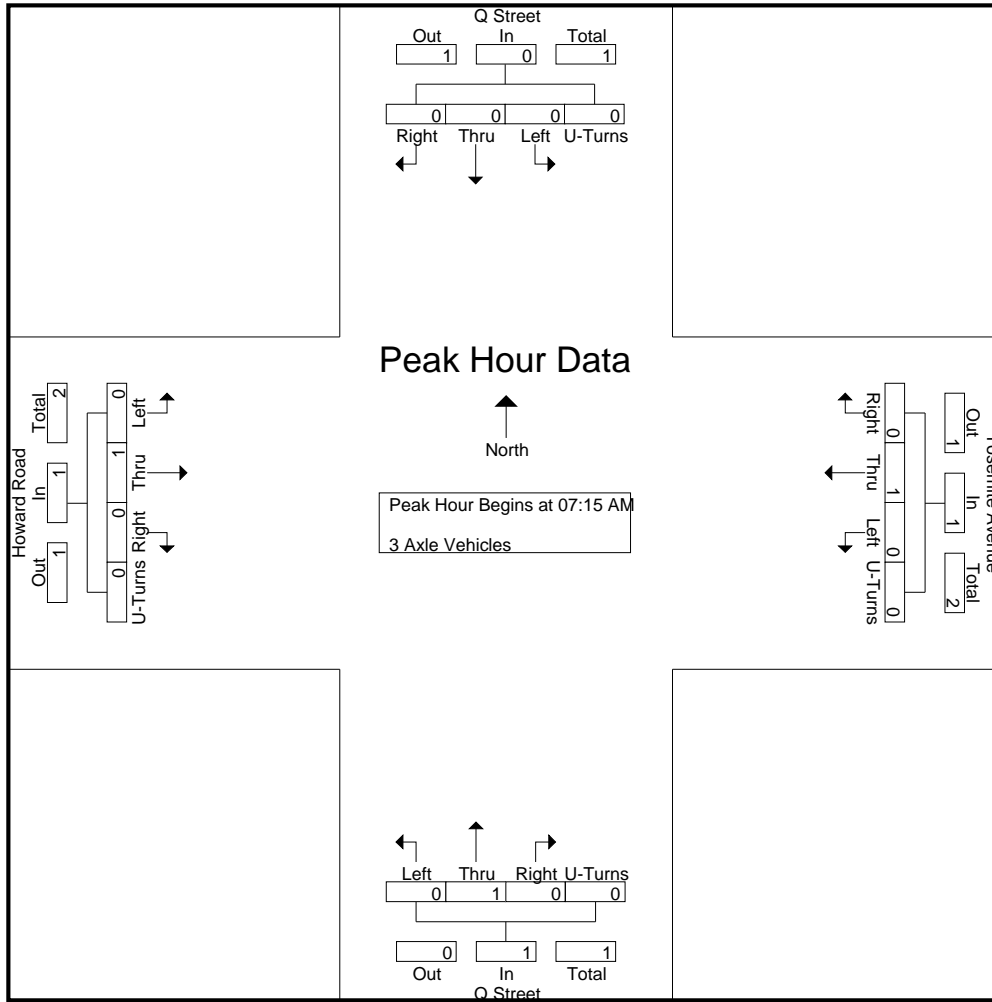

Peak Hour Analysis From 07:15 AM to 08:00 AM - Peak 1 of 1
 Peak Hour for Each Approach Begins at:

	07:15 AM					07:15 AM					07:15 AM									
+0 mins.	0	0	0	0	0	0	0	0	0	0	0	0	0	0	0	0	1	0	0	1
+15 mins.	0	0	0	0	0	0	1	0	0	1	0	1	0	0	1	0	0	0	0	0
+30 mins.	0	0	0	0	0	0	0	0	0	0	0	0	0	0	0	0	0	0	0	0
+45 mins.	0	0	0	0	0	0	0	0	0	0	0	0	0	0	0	0	0	0	0	0
Total Volume	0	0	0	0	0	0	1	0	0	1	0	1	0	0	1	0	1	0	0	1
% App. Total	0	0	0	0	0	0	100	0	0	0	0	100	0	0	0	0	100	0	0	0
PHF	.000	.000	.000	.000	.000	.000	.250	.000	.000	.250	.000	.250	.000	.000	.250	.000	.250	.000	.000	.250

City of Madera
 N/S: Q Street
 E/W: Howard Road/Yosemite Avenue
 Weather: Clear

File Name : 31_MDA_Q St_Yosemite AM
 Site Code : 00319628
 Start Date : 9/24/2019
 Page No : 1

Groups Printed- 4+ Axle Trucks

Start Time	Q Street Southbound					Yosemite Avenue Westbound					Q Street Northbound					Howard Road Eastbound					Int. Total
	Left	Thru	Right	U-Turns	App. Total	Left	Thru	Right	U-Turns	App. Total	Left	Thru	Right	U-Turns	App. Total	Left	Thru	Right	U-Turns	App. Total	
07:00 AM	0	0	0	0	0	0	2	0	0	2	0	0	0	0	0	0	3	1	0	4	6
07:15 AM	0	0	0	0	0	0	0	0	0	0	2	0	0	0	2	0	0	2	0	2	4
07:30 AM	0	0	0	0	0	0	0	0	0	0	0	0	0	0	0	0	1	0	0	1	1
07:45 AM	0	0	0	0	0	0	0	0	0	0	2	0	0	0	2	0	0	2	0	2	4
Total	0	0	0	0	0	0	2	0	0	2	4	0	0	0	4	0	4	5	0	9	15
08:00 AM	0	0	0	0	0	0	1	0	0	1	1	0	0	0	1	0	0	4	0	4	6
08:15 AM	0	0	0	0	0	0	0	0	0	0	2	0	0	0	2	0	0	1	0	1	3
08:30 AM	0	0	0	0	0	0	2	0	0	2	0	0	0	0	0	0	0	0	0	0	2
08:45 AM	0	0	0	0	0	0	0	0	0	0	0	0	0	0	0	0	0	0	0	0	0
Total	0	0	0	0	0	0	3	0	0	3	3	0	0	0	3	0	0	5	0	5	11
Grand Total	0	0	0	0	0	0	5	0	0	5	7	0	0	0	7	0	4	10	0	14	26
Apprch %	0	0	0	0	0	0	100	0	0	0	100	0	0	0	0	0	28.6	71.4	0	0	
Total %	0	0	0	0	0	0	19.2	0	0	19.2	26.9	0	0	0	26.9	0	15.4	38.5	0	53.8	

Start Time	Q Street Southbound					Yosemite Avenue Westbound					Q Street Northbound					Howard Road Eastbound					Int. Total
	Left	Thru	Right	U-Turns	App. Total	Thru	Right	U-Turns	App. Total	Thru	Right	U-Turns	App. Total	Thru	Right	U-Turns	App. Total				
Peak Hour Analysis From 07:15 AM to 08:00 AM - Peak 1 of 1																					
Peak Hour for Entire Intersection Begins at 07:15 AM																					
07:15 AM	0	0	0	0	0	0	0	0	0	0	2	0	0	0	2	0	0	2	0	2	4
07:30 AM	0	0	0	0	0	0	0	0	0	0	0	0	0	0	0	0	1	0	0	1	1
07:45 AM	0	0	0	0	0	0	0	0	0	0	2	0	0	0	2	0	0	2	0	2	4
08:00 AM	0	0	0	0	0	0	1	0	0	1	1	0	0	0	1	0	0	4	0	4	6
Total Volume	0	0	0	0	0	0	1	0	0	1	5	0	0	0	5	0	1	8	0	9	15
% App. Total	0	0	0	0	0	0	100	0	0	0	100	0	0	0	0	0	11.1	88.9	0	0	
PHF	.000	.000	.000	.000	.000	.000	.250	.000	.000	.250	.625	.000	.000	.000	.625	.000	.250	.500	.000	.563	.625

City of Madera
 N/S: Q Street
 E/W: Howard Road/Yosemite Avenue
 Weather: Clear

File Name : 31_MDA_Q St_Yosemite AM
 Site Code : 00319628
 Start Date : 9/24/2019
 Page No : 2

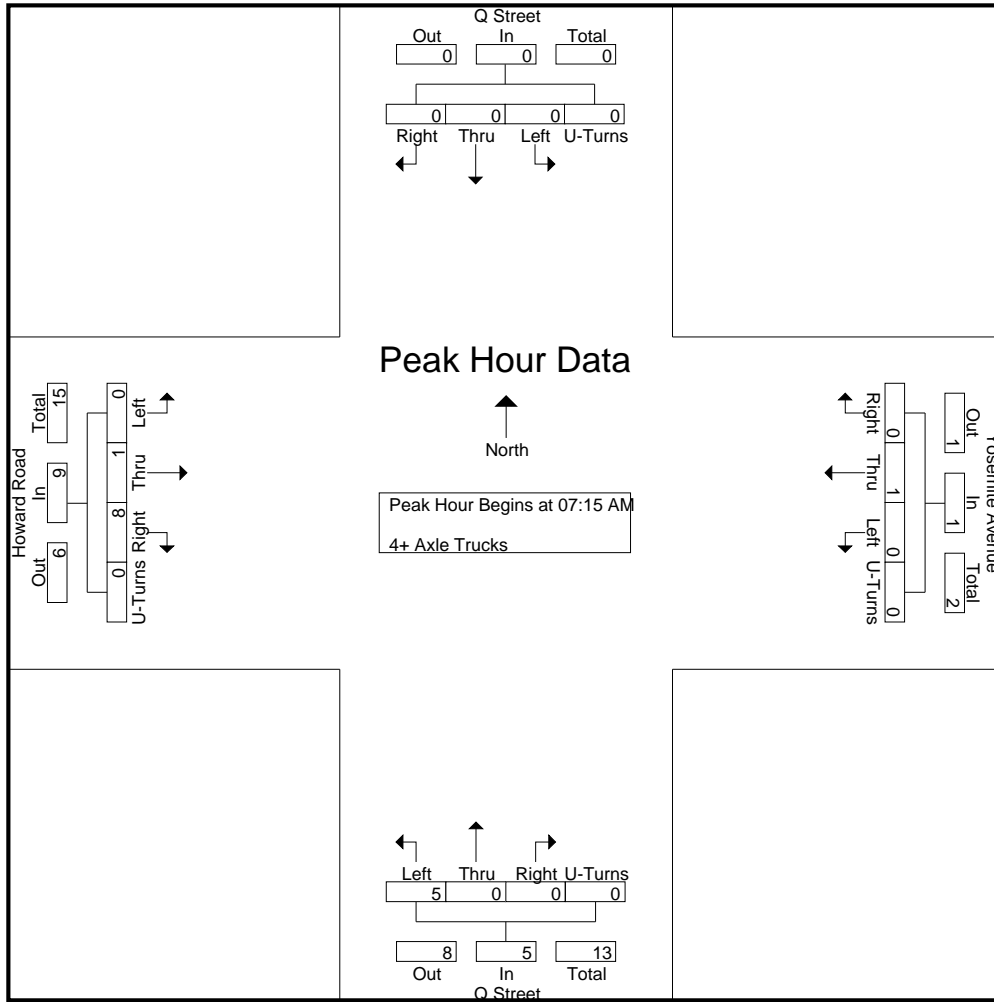

Peak Hour Analysis From 07:15 AM to 08:00 AM - Peak 1 of 1
 Peak Hour for Each Approach Begins at:

	07:15 AM					07:15 AM					07:15 AM										
+0 mins.	0	0	0	0	0	0	0	0	0	0	2	0	0	0	0	2	0	0	2	0	2
+15 mins.	0	0	0	0	0	0	0	0	0	0	0	0	0	0	0	0	0	1	0	0	1
+30 mins.	0	0	0	0	0	0	0	0	0	0	2	0	0	0	0	2	0	0	2	0	2
+45 mins.	0	0	0	0	0	0	1	0	0	1	1	0	0	0	0	1	0	0	4	0	4
Total Volume	0	0	0	0	0	0	1	0	0	1	5	0	0	0	0	5	0	1	8	0	9
% App. Total	0	0	0	0	0	0	100	0	0	0	100	0	0	0	0	0	11.1	88.9	0	0	0
PHF	.000	.000	.000	.000	.000	.000	.250	.000	.000	.250	.625	.000	.000	.000	.625	.000	.250	.500	.000	.563	

City of Madera
 N/S: Q Street
 E/W: Howard Road/Yosemite Avenue
 Weather: Clear

File Name : 31_MDA_Q St_Yosemite PM
 Site Code : 00319628
 Start Date : 9/24/2019
 Page No : 1

Groups Printed- Passenger Vehicles - Large 2 Axle Vehicles - 3 Axle Vehicles - 4+ Axle Trucks

Start Time	Q Street Southbound					Yosemite Avenue Westbound					Q Street Northbound					Howard Road Eastbound					Int. Total
	Left	Thru	Right	U-Turns	App. Total	Left	Thru	Right	U-Turns	App. Total	Left	Thru	Right	U-Turns	App. Total	Left	Thru	Right	U-Turns	App. Total	
04:00 PM	6	12	3	0	21	2	60	5	0	67	56	8	2	0	66	3	113	49	0	165	319
04:15 PM	3	10	1	0	14	7	72	8	0	87	54	11	2	0	67	1	98	34	0	133	301
04:30 PM	3	14	1	0	18	3	92	5	0	100	65	14	4	0	83	2	117	47	0	166	367
04:45 PM	4	12	0	0	16	2	80	2	0	84	53	13	2	0	68	1	102	52	0	155	323
Total	16	48	5	0	69	14	304	20	0	338	228	46	10	0	284	7	430	182	0	619	1310
05:00 PM	4	19	1	0	24	2	105	4	1	112	86	30	4	0	120	1	105	58	0	164	420
05:15 PM	5	10	0	0	15	4	80	3	0	87	74	17	2	0	93	3	118	54	0	175	370
05:30 PM	0	26	1	0	27	3	71	4	0	78	68	14	2	0	84	6	106	60	0	172	361
05:45 PM	5	9	1	0	15	1	79	2	0	82	51	19	2	0	72	1	91	38	0	130	299
Total	14	64	3	0	81	10	335	13	1	359	279	80	10	0	369	11	420	210	0	641	1450
Grand Total	30	112	8	0	150	24	639	33	1	697	507	126	20	0	653	18	850	392	0	1260	2760
Apprch %	20	74.7	5.3	0		3.4	91.7	4.7	0.1		77.6	19.3	3.1	0		1.4	67.5	31.1	0		
Total %	1.1	4.1	0.3	0	5.4	0.9	23.2	1.2	0	25.3	18.4	4.6	0.7	0	23.7	0.7	30.8	14.2	0	45.7	
Passenger Vehicles	100	99.1	100	0	99.3	95.8	98.1	100	100	98.1	99.2	100	80	0	98.8	100	97.6	98	0	97.8	98.2
Large 2 Axle Vehicles	0	0.9	0	0	0.7	4.2	1.6	0	0	1.6	0.8	0	20	0	1.2	0	2	1	0	1.7	1.5
3 Axle Vehicles	0	0	0	0	0	0	0	0	0	0	0	0	0	0	0	0	3	1	0	4	4
% 3 Axle Vehicles	0	0	0	0	0	0	0	0	0	0	0	0	0	0	0	0	0.4	0.3	0	0.3	0.1
4+ Axle Trucks	0	0	0	0	0	0	2	0	0	2	0	0	0	0	0	0	0	3	0	3	5
% 4+ Axle Trucks																					

Start Time	Q Street Southbound					Yosemite Avenue Westbound					Q Street Northbound					Howard Road Eastbound					Int. Total
	Left	Thru	Right	U-Turns	App. Total	Left	Thru	Right	U-Turns	App. Total	Left	Thru	Right	U-Turns	App. Total	Left	Thru	Right	U-Turns	App. Total	
Peak Hour Analysis From 04:00 PM to 05:45 PM - Peak 1 of 1																					
Peak Hour for Entire Intersection Begins at 04:30 PM																					
04:30 PM	3	14	1	0	18	3	92	5	0	100	65	14	4	0	83	2	117	47	0	166	367
04:45 PM	4	12	0	0	16	2	80	2	0	84	53	13	2	0	68	1	102	52	0	155	323
05:00 PM	4	19	1	0	24	2	105	4	1	112	86	30	4	0	120	1	105	58	0	164	420
05:15 PM	5	10	0	0	15	4	80	3	0	87	74	17	2	0	93	3	118	54	0	175	370
Total Volume	16	55	2	0	73	11	357	14	1	383	278	74	12	0	364	7	442	211	0	660	1480
% App. Total	21.9	75.3	2.7	0		2.9	93.2	3.7	0.3		76.4	20.3	3.3	0		1.1	67	32	0		
PHF	.800	.724	.500	.000	.760	.688	.850	.700	.250	.855	.808	.617	.750	.000	.758	.583	.936	.909	.000	.943	.881

City of Madera
 N/S: Q Street
 E/W: Howard Road/Yosemite Avenue
 Weather: Clear

File Name : 31_MDA_Q St_Yosemite PM
 Site Code : 00319628
 Start Date : 9/24/2019
 Page No : 2

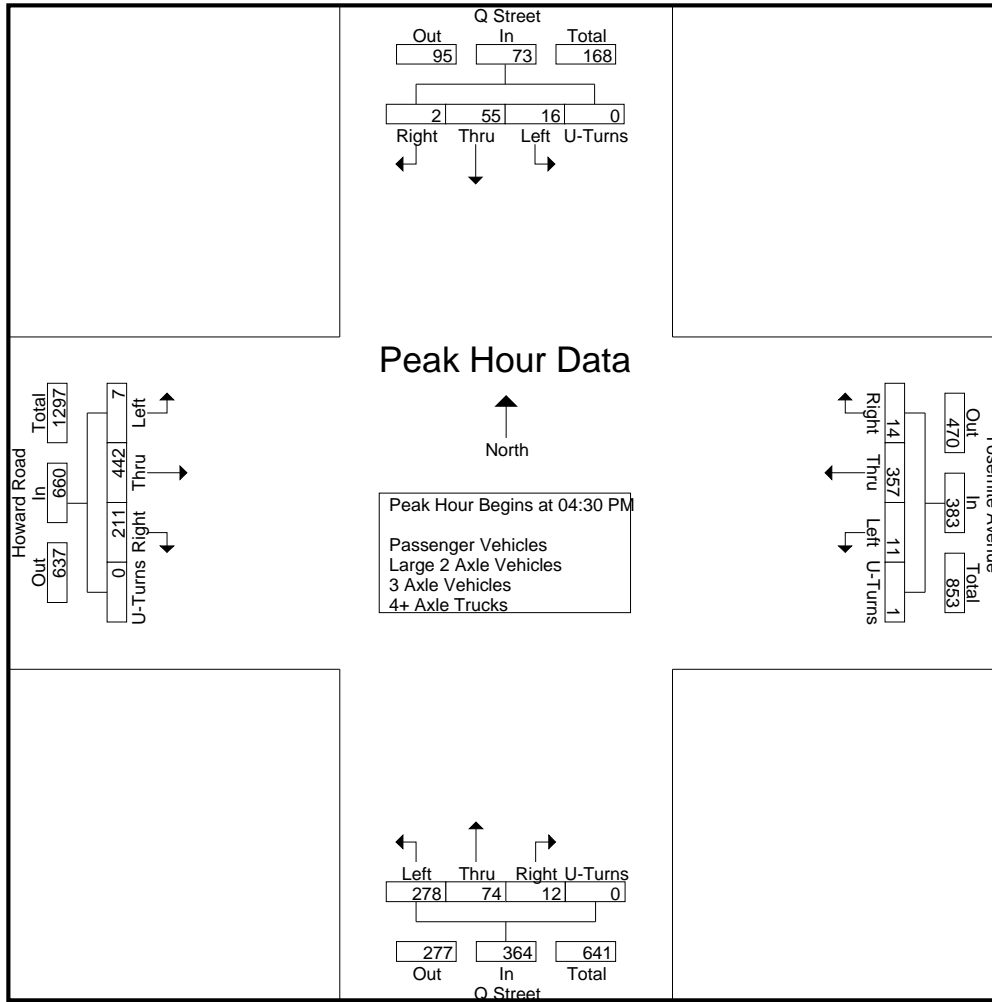

Peak Hour Analysis From 04:00 PM to 05:45 PM - Peak 1 of 1
 Peak Hour for Each Approach Begins at:

	04:45 PM					04:15 PM					05:00 PM					04:45 PM				
+0 mins.	4	12	0	0	16	7	72	8	0	87	86	30	4	0	120	1	102	52	0	155
+15 mins.	4	19	1	0	24	3	92	5	0	100	74	17	2	0	93	1	105	58	0	164
+30 mins.	5	10	0	0	15	2	80	2	0	84	68	14	2	0	84	3	118	54	0	175
+45 mins.	0	26	1	0	27	2	105	4	1	112	51	19	2	0	72	6	106	60	0	172
Total Volume	13	67	2	0	82	14	349	19	1	383	279	80	10	0	369	11	431	224	0	666
% App. Total	15.9	81.7	2.4	0		3.7	91.1	5	0.3		75.6	21.7	2.7	0		1.7	64.7	33.6	0	
PHF	.650	.644	.500	.000	.759	.500	.831	.594	.250	.855	.811	.667	.625	.000	.769	.458	.913	.933	.000	.951

City of Madera
 N/S: Q Street
 E/W: Howard Road/Yosemite Avenue
 Weather: Clear

File Name : 31_MDA_Q St_Yosemite PM
 Site Code : 00319628
 Start Date : 9/24/2019
 Page No : 1

Groups Printed- Passenger Vehicles

Start Time	Q Street Southbound					Yosemite Avenue Westbound					Q Street Northbound					Howard Road Eastbound					Int. Total
	Left	Thru	Right	U-Turns	App. Total	Left	Thru	Right	U-Turns	App. Total	Left	Thru	Right	U-Turns	App. Total	Left	Thru	Right	U-Turns	App. Total	
04:00 PM	6	12	3	0	21	2	59	5	0	66	53	8	2	0	63	3	106	47	0	156	306
04:15 PM	3	10	1	0	14	6	67	8	0	81	54	11	1	0	66	1	97	33	0	131	292
04:30 PM	3	14	1	0	18	3	91	5	0	99	65	14	3	0	82	2	113	44	0	159	358
04:45 PM	4	12	0	0	16	2	80	2	0	84	53	13	2	0	68	1	102	51	0	154	322
Total	16	48	5	0	69	13	297	20	0	330	225	46	8	0	279	7	418	175	0	600	1278
05:00 PM	4	19	1	0	24	2	104	4	1	111	85	30	3	0	118	1	104	58	0	163	416
05:15 PM	5	9	0	0	14	4	78	3	0	85	74	17	2	0	93	3	116	54	0	173	365
05:30 PM	0	26	1	0	27	3	71	4	0	78	68	14	1	0	83	6	103	60	0	169	357
05:45 PM	5	9	1	0	15	1	77	2	0	80	51	19	2	0	72	1	89	37	0	127	294
Total	14	63	3	0	80	10	330	13	1	354	278	80	8	0	366	11	412	209	0	632	1432
Grand Total	30	111	8	0	149	23	627	33	1	684	503	126	16	0	645	18	830	384	0	1232	2710
Apprch %	20.1	74.5	5.4	0		3.4	91.7	4.8	0.1		78	19.5	2.5	0		1.5	67.4	31.2	0		
Total %	1.1	4.1	0.3	0	5.5	0.8	23.1	1.2	0	25.2	18.6	4.6	0.6	0	23.8	0.7	30.6	14.2	0	45.5	

Start Time	Q Street Southbound					Yosemite Avenue Westbound					Q Street Northbound					Howard Road Eastbound					Int. Total
	Left	Thru	Right	U-Turns	App. Total	Thru	Right	U-Turns	App. Total	Thru	Right	U-Turns	App. Total	Thru	Right	U-Turns	App. Total				
Peak Hour Analysis From 04:30 PM to 05:15 PM - Peak 1 of 1																					
Peak Hour for Entire Intersection Begins at 04:30 PM																					
04:30 PM	3	14	1	0	18	3	91	5	0	99	65	14	3	0	82	2	113	44	0	159	358
04:45 PM	4	12	0	0	16	2	80	2	0	84	53	13	2	0	68	1	102	51	0	154	322
05:00 PM	4	19	1	0	24	2	104	4	1	111	85	30	3	0	118	1	104	58	0	163	416
05:15 PM	5	9	0	0	14	4	78	3	0	85	74	17	2	0	93	3	116	54	0	173	365
Total Volume	16	54	2	0	72	11	353	14	1	379	277	74	10	0	361	7	435	207	0	649	1461
% App. Total	22.2	75	2.8	0		2.9	93.1	3.7	0.3		76.7	20.5	2.8	0		1.1	67	31.9	0		
PHF	.800	.711	.500	.000	.750	.688	.849	.700	.250	.854	.815	.617	.833	.000	.765	.583	.938	.892	.000	.938	.878

City of Madera
 N/S: Q Street
 E/W: Howard Road/Yosemite Avenue
 Weather: Clear

File Name : 31_MDA_Q St_Yosemite PM
 Site Code : 00319628
 Start Date : 9/24/2019
 Page No : 2

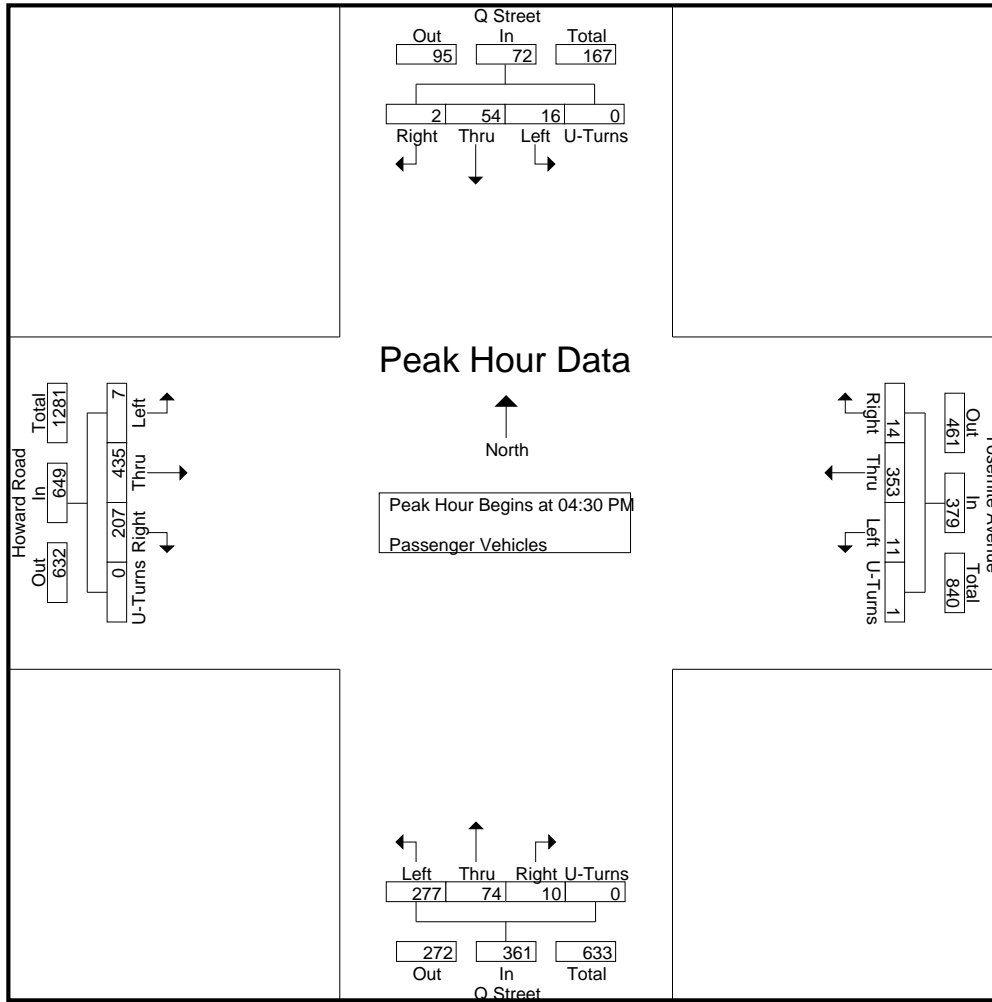

Peak Hour Analysis From 04:30 PM to 05:15 PM - Peak 1 of 1
 Peak Hour for Each Approach Begins at:

	04:30 PM					04:30 PM					04:30 PM									
+0 mins.	3	14	1	0	18	3	91	5	0	99	65	14	3	0	82	2	113	44	0	159
+15 mins.	4	12	0	0	16	2	80	2	0	84	53	13	2	0	68	1	102	51	0	154
+30 mins.	4	19	1	0	24	2	104	4	1	111	85	30	3	0	118	1	104	58	0	163
+45 mins.	5	9	0	0	14	4	78	3	0	85	74	17	2	0	93	3	116	54	0	173
Total Volume	16	54	2	0	72	11	353	14	1	379	277	74	10	0	361	7	435	207	0	649
% App. Total	22.2	75	2.8	0		2.9	93.1	3.7	0.3		76.7	20.5	2.8	0		1.1	67	31.9	0	
PHF	.800	.711	.500	.000	.750	.688	.849	.700	.250	.854	.815	.617	.833	.000	.765	.583	.938	.892	.000	.938

City of Madera
 N/S: Q Street
 E/W: Howard Road/Yosemite Avenue
 Weather: Clear

File Name : 31_MDA_Q St_Yosemite PM
 Site Code : 00319628
 Start Date : 9/24/2019
 Page No : 1

Groups Printed- Large 2 Axle Vehicles

Start Time	Q Street Southbound					Yosemite Avenue Westbound					Q Street Northbound					Howard Road Eastbound					Int. Total
	Left	Thru	Right	U-Turns	App. Total	Left	Thru	Right	U-Turns	App. Total	Left	Thru	Right	U-Turns	App. Total	Left	Thru	Right	U-Turns	App. Total	
04:00 PM	0	0	0	0	0	0	1	0	0	1	3	0	0	0	3	0	7	2	0	9	13
04:15 PM	0	0	0	0	0	1	5	0	0	6	0	0	1	0	1	0	1	0	0	1	8
04:30 PM	0	0	0	0	0	0	0	0	0	0	0	0	1	0	1	0	3	1	0	4	5
04:45 PM	0	0	0	0	0	0	0	0	0	0	0	0	0	0	0	0	0	1	0	1	1
Total	0	0	0	0	0	1	6	0	0	7	3	0	2	0	5	0	11	4	0	15	27
05:00 PM	0	0	0	0	0	0	1	0	0	1	1	0	1	0	2	0	0	0	0	0	3
05:15 PM	0	1	0	0	1	0	1	0	0	1	0	0	0	0	0	0	2	0	0	2	4
05:30 PM	0	0	0	0	0	0	0	0	0	0	0	0	1	0	1	0	3	0	0	3	4
05:45 PM	0	0	0	0	0	0	2	0	0	2	0	0	0	0	0	0	1	0	0	1	3
Total	0	1	0	0	1	0	4	0	0	4	1	0	2	0	3	0	6	0	0	6	14
Grand Total	0	1	0	0	1	1	10	0	0	11	4	0	4	0	8	0	17	4	0	21	41
Apprch %	0	100	0	0		9.1	90.9	0	0		50	0	50	0		0	81	19	0		
Total %	0	2.4	0	0	2.4	2.4	24.4	0	0	26.8	9.8	0	9.8	0	19.5	0	41.5	9.8	0	51.2	

Start Time	Q Street Southbound					Yosemite Avenue Westbound					Q Street Northbound					Howard Road Eastbound					Int. Total
	Left	Thru	Right	U-Turns	App. Total	Thru	Right	U-Turns	App. Total	Thru	Right	U-Turns	App. Total	Thru	Right	U-Turns	App. Total				
Peak Hour Analysis From 04:30 PM to 05:15 PM - Peak 1 of 1																					
Peak Hour for Entire Intersection Begins at 04:30 PM																					
04:30 PM	0	0	0	0	0	0	0	0	0	0	0	0	1	0	1	0	3	1	0	4	5
04:45 PM	0	0	0	0	0	0	0	0	0	0	0	0	0	0	0	0	0	1	0	1	1
05:00 PM	0	0	0	0	0	0	1	0	0	1	1	0	1	0	2	0	0	0	0	0	3
05:15 PM	0	1	0	0	1	0	1	0	0	1	0	0	0	0	0	0	2	0	0	2	4
Total Volume	0	1	0	0	1	0	2	0	0	2	1	0	2	0	3	0	5	2	0	7	13
% App. Total	0	100	0	0		0	100	0	0		33.3	0	66.7	0		0	71.4	28.6	0		
PHF	.000	.250	.000	.000	.250	.000	.500	.000	.000	.500	.250	.000	.500	.000	.375	.000	.417	.500	.000	.438	.650

City of Madera
 N/S: Q Street
 E/W: Howard Road/Yosemite Avenue
 Weather: Clear

File Name : 31_MDA_Q St_Yosemite PM
 Site Code : 00319628
 Start Date : 9/24/2019
 Page No : 2

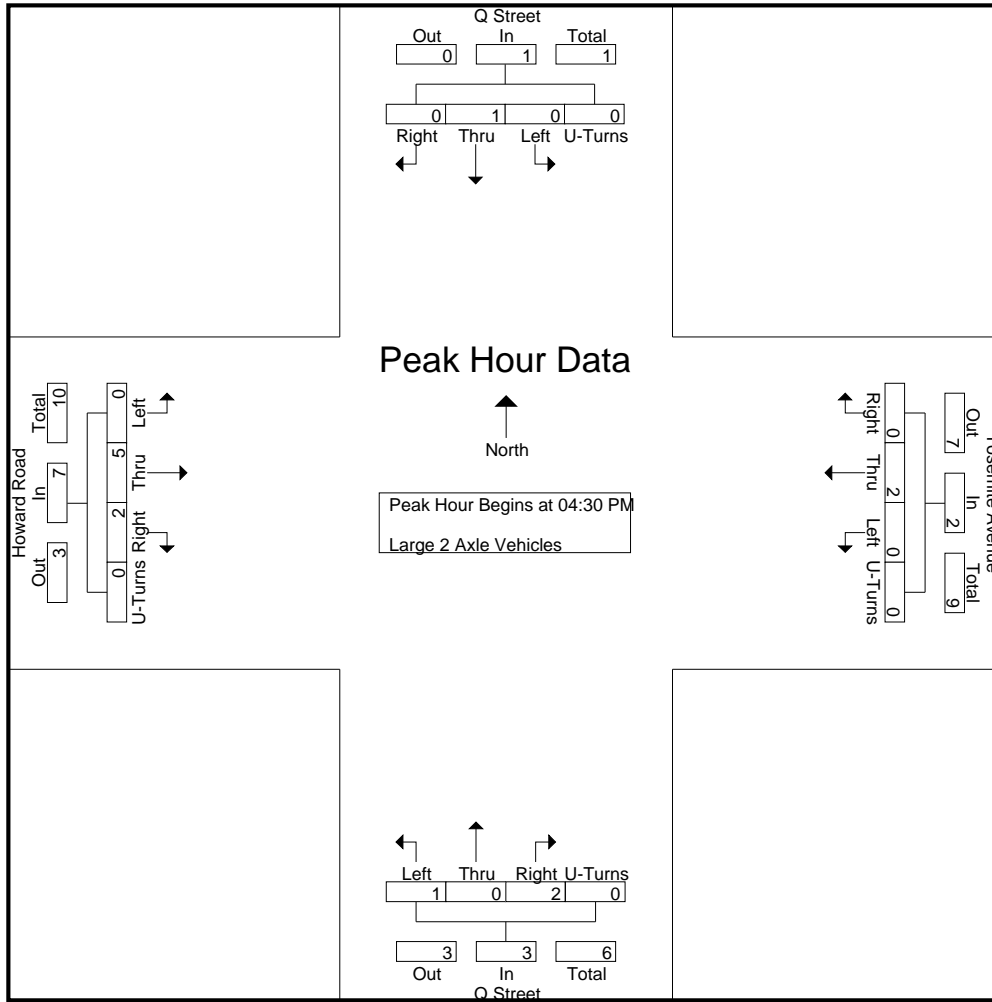

Peak Hour Analysis From 04:30 PM to 05:15 PM - Peak 1 of 1
 Peak Hour for Each Approach Begins at:

	04:30 PM					04:30 PM					04:30 PM									
+0 mins.	0	0	0	0	0	0	0	0	0	0	0	0	1	0	1	0	3	1	0	4
+15 mins.	0	0	0	0	0	0	0	0	0	0	0	0	0	0	0	0	0	1	0	1
+30 mins.	0	0	0	0	0	0	1	0	0	1	1	0	1	0	2	0	0	0	0	0
+45 mins.	0	1	0	0	1	0	1	0	0	1	0	0	0	0	0	0	2	0	0	2
Total Volume	0	1	0	0	1	0	2	0	0	2	1	0	2	0	3	0	5	2	0	7
% App. Total	0	100	0	0	0	0	100	0	0	0	33.3	0	66.7	0	0	0	71.4	28.6	0	0
PHF	.000	.250	.000	.000	.250	.000	.500	.000	.000	.500	.250	.000	.500	.000	.375	.000	.417	.500	.000	.438

City of Madera
 N/S: Q Street
 E/W: Howard Road/Yosemite Avenue
 Weather: Clear

File Name : 31_MDA_Q St_Yosemite PM
 Site Code : 00319628
 Start Date : 9/24/2019
 Page No : 1

Groups Printed- 3 Axle Vehicles

Start Time	Q Street Southbound					Yosemite Avenue Westbound					Q Street Northbound					Howard Road Eastbound					Int. Total
	Left	Thru	Right	U-Turns	App. Total	Left	Thru	Right	U-Turns	App. Total	Left	Thru	Right	U-Turns	App. Total	Left	Thru	Right	U-Turns	App. Total	
04:00 PM	0	0	0	0	0	0	0	0	0	0	0	0	0	0	0	0	0	0	0	0	0
04:15 PM	0	0	0	0	0	0	0	0	0	0	0	0	0	0	0	0	0	0	0	0	0
04:30 PM	0	0	0	0	0	0	0	0	0	0	0	0	0	0	0	0	1	1	0	0	2
04:45 PM	0	0	0	0	0	0	0	0	0	0	0	0	0	0	0	0	0	0	0	0	0
Total	0	0	0	0	0	0	0	0	0	0	0	0	0	0	0	0	1	1	0	0	2
05:00 PM	0	0	0	0	0	0	0	0	0	0	0	0	0	0	0	0	1	0	0	0	1
05:15 PM	0	0	0	0	0	0	0	0	0	0	0	0	0	0	0	0	0	0	0	0	0
05:30 PM	0	0	0	0	0	0	0	0	0	0	0	0	0	0	0	0	0	0	0	0	0
05:45 PM	0	0	0	0	0	0	0	0	0	0	0	0	0	0	0	0	1	0	0	0	1
Total	0	0	0	0	0	0	0	0	0	0	0	0	0	0	0	0	2	0	0	0	2
Grand Total	0	0	0	0	0	0	0	0	0	0	0	0	0	0	0	0	3	1	0	0	4
Apprch %	0	0	0	0		0	0	0	0		0	0	0	0		0	75	25	0		
Total %	0	0	0	0	0	0	0	0	0	0	0	0	0	0	0	0	75	25	0	100	

Start Time	Q Street Southbound					Yosemite Avenue Westbound					Q Street Northbound					Howard Road Eastbound					Int. Total
	Left	Thru	Right	U-Turns	App. Total	Left	Thru	Right	U-Turns	App. Total	Left	Thru	Right	U-Turns	App. Total	Left	Thru	Right	U-Turns	App. Total	
Peak Hour Analysis From 04:30 PM to 05:15 PM - Peak 1 of 1																					
Peak Hour for Entire Intersection Begins at 04:30 PM																					
04:30 PM	0	0	0	0	0	0	0	0	0	0	0	0	0	0	0	0	1	1	0	0	2
04:45 PM	0	0	0	0	0	0	0	0	0	0	0	0	0	0	0	0	0	0	0	0	0
05:00 PM	0	0	0	0	0	0	0	0	0	0	0	0	0	0	0	0	1	0	0	0	1
05:15 PM	0	0	0	0	0	0	0	0	0	0	0	0	0	0	0	0	0	0	0	0	0
Total Volume	0	0	0	0	0	0	0	0	0	0	0	0	0	0	0	0	2	1	0	0	3
% App. Total	0	0	0	0	0	0	0	0	0	0	0	0	0	0	0	0	66.7	33.3	0	0	
PHF	.000	.000	.000	.000	.000	.000	.000	.000	.000	.000	.000	.000	.000	.000	.000	.000	.500	.250	.000	.375	.375

City of Madera
 N/S: Q Street
 E/W: Howard Road/Yosemite Avenue
 Weather: Clear

File Name : 31_MDA_Q St_Yosemite PM
 Site Code : 00319628
 Start Date : 9/24/2019
 Page No : 2

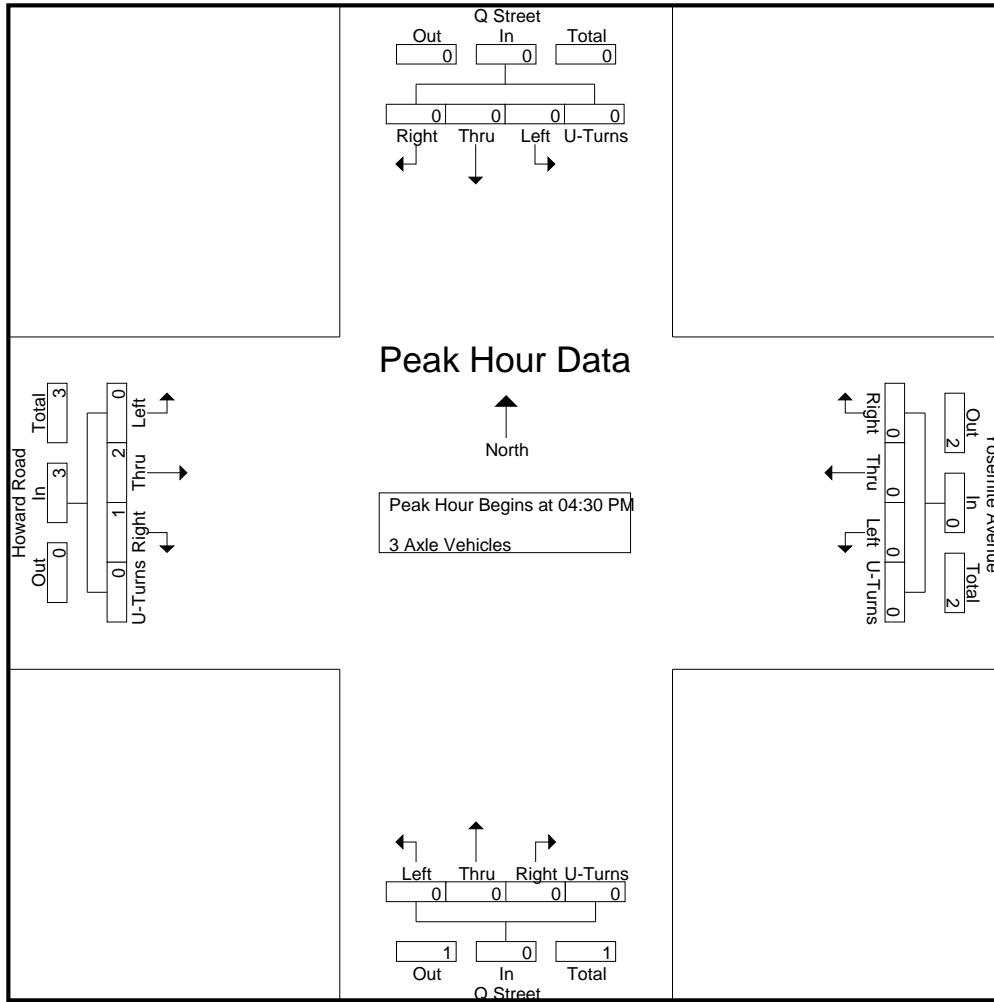

Peak Hour Analysis From 04:30 PM to 05:15 PM - Peak 1 of 1
 Peak Hour for Each Approach Begins at:

	04:30 PM					04:30 PM					04:30 PM									
+0 mins.	0	0	0	0	0	0	0	0	0	0	0	0	0	0	0	0	1	1	0	2
+15 mins.	0	0	0	0	0	0	0	0	0	0	0	0	0	0	0	0	0	0	0	0
+30 mins.	0	0	0	0	0	0	0	0	0	0	0	0	0	0	0	0	1	0	0	1
+45 mins.	0	0	0	0	0	0	0	0	0	0	0	0	0	0	0	0	0	0	0	0
Total Volume	0	0	0	0	0	0	0	0	0	0	0	0	0	0	0	0	2	1	0	3
% App. Total	0	0	0	0	0	0	0	0	0	0	0	0	0	0	0	0	66.7	33.3	0	0
PHF	.000	.000	.000	.000	.000	.000	.000	.000	.000	.000	.000	.000	.000	.000	.000	.000	.500	.250	.000	.375

City of Madera
 N/S: Q Street
 E/W: Howard Road/Yosemite Avenue
 Weather: Clear

File Name : 31_MDA_Q St_Yosemite PM
 Site Code : 00319628
 Start Date : 9/24/2019
 Page No : 1

Groups Printed- 4+ Axle Trucks

Start Time	Q Street Southbound					Yosemite Avenue Westbound					Q Street Northbound					Howard Road Eastbound					Int. Total
	Left	Thru	Right	U-Turns	App. Total	Left	Thru	Right	U-Turns	App. Total	Left	Thru	Right	U-Turns	App. Total	Left	Thru	Right	U-Turns	App. Total	
04:00 PM	0	0	0	0	0	0	0	0	0	0	0	0	0	0	0	0	0	0	0	0	0
04:15 PM	0	0	0	0	0	0	0	0	0	0	0	0	0	0	0	0	0	1	0	0	1
04:30 PM	0	0	0	0	0	0	1	0	0	1	0	0	0	0	0	0	0	1	0	0	1
04:45 PM	0	0	0	0	0	0	0	0	0	0	0	0	0	0	0	0	0	0	0	0	0
Total	0	0	0	0	0	0	1	0	0	1	0	0	0	0	0	0	0	2	0	0	2
05:00 PM	0	0	0	0	0	0	0	0	0	0	0	0	0	0	0	0	0	0	0	0	0
05:15 PM	0	0	0	0	0	0	1	0	0	1	0	0	0	0	0	0	0	0	0	0	0
05:30 PM	0	0	0	0	0	0	0	0	0	0	0	0	0	0	0	0	0	0	0	0	0
05:45 PM	0	0	0	0	0	0	0	0	0	0	0	0	0	0	0	0	0	1	0	0	1
Total	0	0	0	0	0	0	1	0	0	1	0	0	0	0	0	0	0	1	0	0	1
Grand Total	0	0	0	0	0	0	2	0	0	2	0	0	0	0	0	0	0	3	0	0	3
Apprch %	0	0	0	0	0	0	100	0	0	0	0	0	0	0	0	0	0	100	0	0	0
Total %	0	0	0	0	0	0	40	0	0	40	0	0	0	0	0	0	0	60	0	60	60

Start Time	Q Street Southbound					Yosemite Avenue Westbound					Q Street Northbound					Howard Road Eastbound					Int. Total
	Left	Thru	Right	U-Turns	App. Total	Left	Thru	Right	U-Turns	App. Total	Left	Thru	Right	U-Turns	App. Total	Left	Thru	Right	U-Turns	App. Total	
Peak Hour Analysis From 04:30 PM to 05:15 PM - Peak 1 of 1																					
Peak Hour for Entire Intersection Begins at 04:30 PM																					
04:30 PM	0	0	0	0	0	0	1	0	0	1	0	0	0	0	0	0	0	1	0	0	1
04:45 PM	0	0	0	0	0	0	0	0	0	0	0	0	0	0	0	0	0	0	0	0	0
05:00 PM	0	0	0	0	0	0	0	0	0	0	0	0	0	0	0	0	0	0	0	0	0
05:15 PM	0	0	0	0	0	0	1	0	0	1	0	0	0	0	0	0	0	0	0	0	0
Total Volume	0	0	0	0	0	0	2	0	0	2	0	0	0	0	0	0	0	1	0	0	1
% App. Total	0	0	0	0	0	0	100	0	0	0	0	0	0	0	0	0	0	100	0	0	0
PHF	.000	.000	.000	.000	.000	.000	.500	.000	.000	.500	.000	.000	.000	.000	.000	.000	.000	.250	.000	.250	.375

City of Madera
 N/S: Q Street
 E/W: Howard Road/Yosemite Avenue
 Weather: Clear

File Name : 31_MDA_Q St_Yosemite PM
 Site Code : 00319628
 Start Date : 9/24/2019
 Page No : 2

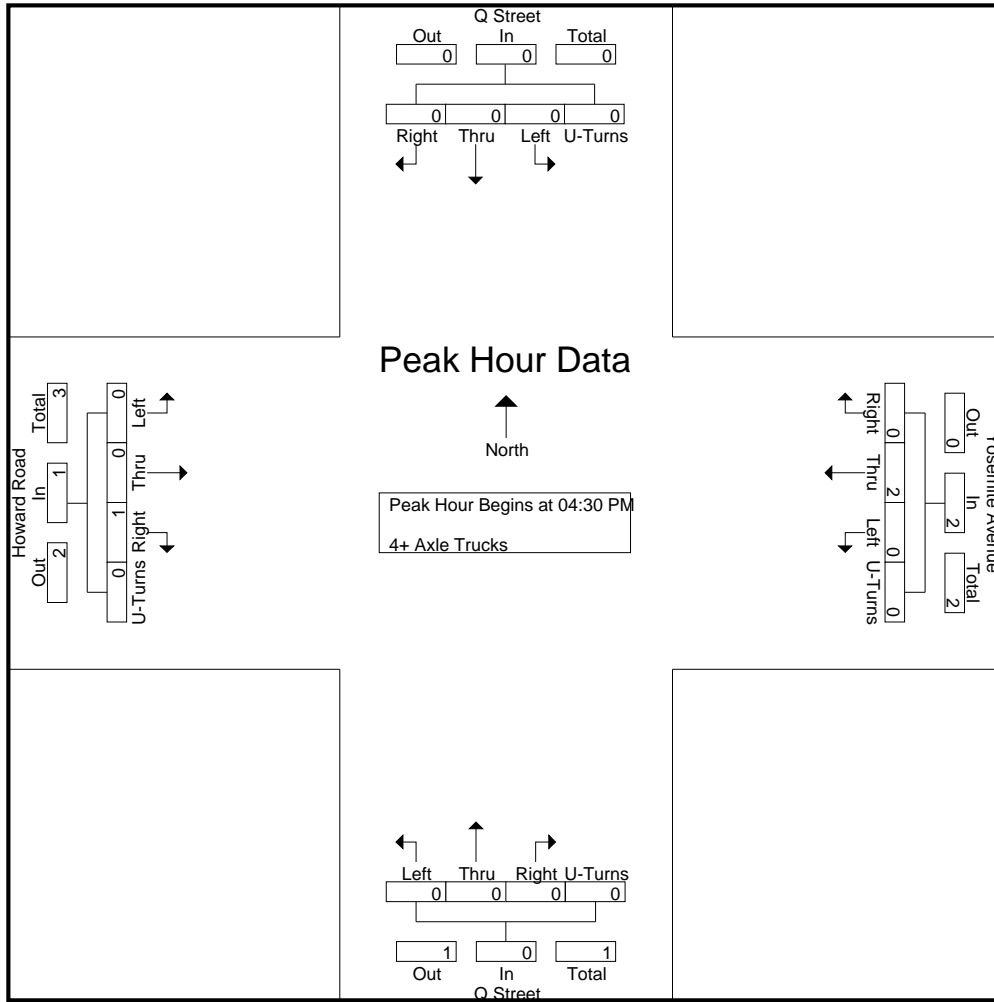

Peak Hour Analysis From 04:30 PM to 05:15 PM - Peak 1 of 1
 Peak Hour for Each Approach Begins at:

	04:30 PM					04:30 PM					04:30 PM					04:30 PM				
+0 mins.	0	0	0	0	0	0	1	0	0	1	0	0	0	0	0	0	0	1	0	1
+15 mins.	0	0	0	0	0	0	0	0	0	0	0	0	0	0	0	0	0	0	0	0
+30 mins.	0	0	0	0	0	0	0	0	0	0	0	0	0	0	0	0	0	0	0	0
+45 mins.	0	0	0	0	0	0	1	0	0	1	0	0	0	0	0	0	0	0	0	0
Total Volume	0	0	0	0	0	0	2	0	0	2	0	0	0	0	0	0	0	1	0	1
% App. Total	0	0	0	0	0	0	100	0	0	0	0	0	0	0	0	0	0	100	0	0
PHF	.000	.000	.000	.000	.000	.000	.500	.000	.000	.500	.000	.000	.000	.000	.000	.000	.000	.250	.000	.250

Location: Madera
 N/S: Q Street
 E/W: Howard Road/Yosemite Avenue



Date: 9/24/2019
 Day: Tuesday

PEDESTRIANS

	North Leg Q Street	East Leg Howard Road/Yosemite Avenue	South Leg Q Street	West Leg Howard Road/Yosemite Avenue	
	Pedestrians	Pedestrians	Pedestrians	Pedestrians	
7:00 AM	1	2	1	0	4
7:15 AM	0	3	2	0	5
7:30 AM	0	6	4	0	10
7:45 AM	0	5	2	0	7
8:00 AM	0	1	3	0	4
8:15 AM	0	3	4	0	7
8:30 AM	0	0	0	0	0
8:45 AM	0	0	1	0	1
TOTAL VOLUMES:	1	20	17	0	38

	North Leg Q Street	East Leg Howard Road/Yosemite Avenue	South Leg Q Street	West Leg Howard Road/Yosemite Avenue	
	Pedestrians	Pedestrians	Pedestrians	Pedestrians	
4:00 PM	1	1	2	1	5
4:15 PM	0	0	4	0	4
4:30 PM	0	1	1	0	2
4:45 PM	1	1	1	0	3
5:00 PM	0	0	0	0	0
5:15 PM	0	0	0	0	0
5:30 PM	0	0	3	0	3
5:45 PM	0	0	1	0	1
TOTAL VOLUMES:	2	3	12	1	18

Location: Madera
 N/S: Q Street
 E/W: Howard Road/Yosemite Avenue



Date: 9/24/2019
 Day: Tuesday

BICYCLES

	Southbound Q Street			Westbound Howard Road/Yosemite Avenue			Northbound Q Street			Eastbound Howard Road/Yosemite Avenue			
	Left	Thru	Right	Left	Thru	Right	Left	Thru	Right	Left	Thru	Right	
7:00 AM	0	0	0	0	0	0	0	0	0	0	0	0	0
7:15 AM	0	0	0	0	0	0	0	0	0	0	0	0	0
7:30 AM	0	0	0	0	0	0	0	0	0	0	0	0	0
7:45 AM	0	0	0	0	0	0	0	0	0	0	0	0	0
8:00 AM	0	0	0	0	0	0	0	1	0	0	0	1	2
8:15 AM	0	0	0	0	0	0	0	0	0	0	0	0	0
8:30 AM	0	0	0	0	1	0	0	1	0	0	1	0	3
8:45 AM	0	0	0	0	0	0	0	0	0	0	0	0	0
TOTAL VOLUMES:	0	0	0	0	1	0	0	2	0	0	1	1	5

	Southbound Q Street			Westbound Howard Road/Yosemite Avenue			Northbound Q Street			Eastbound Howard Road/Yosemite Avenue			
	Left	Thru	Right	Left	Thru	Right	Left	Thru	Right	Left	Thru	Right	
4:00 PM	0	0	0	0	0	0	0	0	0	0	0	0	0
4:15 PM	0	0	0	0	0	0	0	0	0	0	0	0	0
4:30 PM	0	0	0	0	0	0	0	0	0	0	0	0	0
4:45 PM	0	0	0	0	0	0	0	0	0	0	0	0	0
5:00 PM	0	0	0	0	1	0	0	0	0	0	0	0	1
5:15 PM	0	0	0	0	0	0	0	0	0	0	0	0	0
5:30 PM	0	0	0	0	0	0	0	0	0	0	1	0	1
5:45 PM	0	0	0	0	0	0	0	0	0	0	0	0	0
TOTAL VOLUMES:	0	0	0	0	1	0	0	0	0	0	1	0	2

City of Madera
 N/S: I Street
 E/W: 2nd St/SR-99 SB Off Ramp
 Weather: Clear

File Name : 33A_MDA_I St_4th St 99S Off Ramp AM
 Site Code : 00319628
 Start Date : 9/24/2019
 Page No : 1

Groups Printed- Passenger Vehicles - Large 2 Axle Vehicles - 3 Axle Vehicles - 4+ Axle Trucks

Start Time	I Street Southbound					SR-99 Southbound Off Ramp Westbound					I Street Northbound					2nd Street Eastbound					Int. Total
	Left	Thru	Right	U-Turns	App. Total	Left	Thru	Right	U-Turns	App. Total	Left	Thru	Right	U-Turns	App. Total	Left	Thru	Right	U-Turns	App. Total	
07:00 AM	0	32	0	0	32	38	1	0	0	39	1	17	0	0	18	0	0	8	0	8	97
07:15 AM	0	30	1	0	31	56	4	1	0	61	0	13	0	0	13	0	0	13	0	13	118
07:30 AM	0	31	0	0	31	80	6	2	0	88	4	15	0	0	19	1	0	14	0	15	153
07:45 AM	0	43	2	0	45	92	2	2	0	96	3	30	0	0	33	0	0	17	0	17	191
Total	0	136	3	0	139	266	13	5	0	284	8	75	0	0	83	1	0	52	0	53	559
08:00 AM	0	28	0	0	28	91	2	2	0	95	2	17	0	0	19	1	0	8	0	9	151
08:15 AM	0	30	0	0	30	100	7	5	0	112	6	20	0	0	26	0	0	14	0	14	182
08:30 AM	0	20	2	0	22	72	6	2	0	80	4	30	0	0	34	0	0	14	0	14	150
08:45 AM	0	31	0	0	31	65	2	4	0	71	7	28	0	0	35	0	0	8	0	8	145
Total	0	109	2	0	111	328	17	13	0	358	19	95	0	0	114	1	0	44	0	45	628
Grand Total	0	245	5	0	250	594	30	18	0	642	27	170	0	0	197	2	0	96	0	98	1187
Apprch %	0	98	2	0		92.5	4.7	2.8	0		13.7	86.3	0	0		2	0	98	0		
Total %	0	20.6	0.4	0	21.1	50	2.5	1.5	0	54.1	2.3	14.3	0	0	16.6	0.2	0	8.1	0	8.3	
Passenger Vehicles	0	99.6	100	0	99.6	96.1	96.7	100	0	96.3	92.6	98.2	0	0	97.5	100	0	100	0	100	97.5
Large 2 Axle Vehicles	0	0.4	0	0	0.4	1.7	3.3	0	0	1.7	3.7	1.8	0	0	2	0	0	0	0	0	1.3
3 Axle Vehicles	0	0	0	0	0	3	0	0	0	3	1	0	0	0	1	0	0	0	0	0	4
% 3 Axle Vehicles	0	0	0	0	0	0.5	0	0	0	0.5	3.7	0	0	0	0.5	0	0	0	0	0	0.3
4+ Axle Trucks	0	0	0	0	0	10	0	0	0	10	0	0	0	0	0	0	0	0	0	0	10
% 4+ Axle Trucks																					

Start Time	I Street Southbound					SR-99 Southbound Off Ramp Westbound					I Street Northbound					2nd Street Eastbound					Int. Total
	Left	Thru	Right	U-Turns	App. Total	Left	Thru	Right	U-Turns	App. Total	Left	Thru	Right	U-Turns	App. Total	Left	Thru	Right	U-Turns	App. Total	
Peak Hour Analysis From 07:00 AM to 08:45 AM - Peak 1 of 1																					
Peak Hour for Entire Intersection Begins at 07:30 AM																					
07:30 AM	0	31	0	0	31	80	6	2	0	88	4	15	0	0	19	1	0	14	0	15	153
07:45 AM	0	43	2	0	45	92	2	2	0	96	3	30	0	0	33	0	0	17	0	17	191
08:00 AM	0	28	0	0	28	91	2	2	0	95	2	17	0	0	19	1	0	8	0	9	151
08:15 AM	0	30	0	0	30	100	7	5	0	112	6	20	0	0	26	0	0	14	0	14	182
Total Volume	0	132	2	0	134	363	17	11	0	391	15	82	0	0	97	2	0	53	0	55	677
% App. Total	0	98.5	1.5	0		92.8	4.3	2.8	0		15.5	84.5	0	0		3.6	0	96.4	0		
PHF	.000	.767	.250	.000	.744	.908	.607	.550	.000	.873	.625	.683	.000	.000	.735	.500	.000	.779	.000	.809	.886

City of Madera
 N/S: I Street
 E/W: 2nd St/SR-99 SB Off Ramp
 Weather: Clear

File Name : 33A_MDA_I St_4th St 99S Off Ramp AM
 Site Code : 00319628
 Start Date : 9/24/2019
 Page No : 2

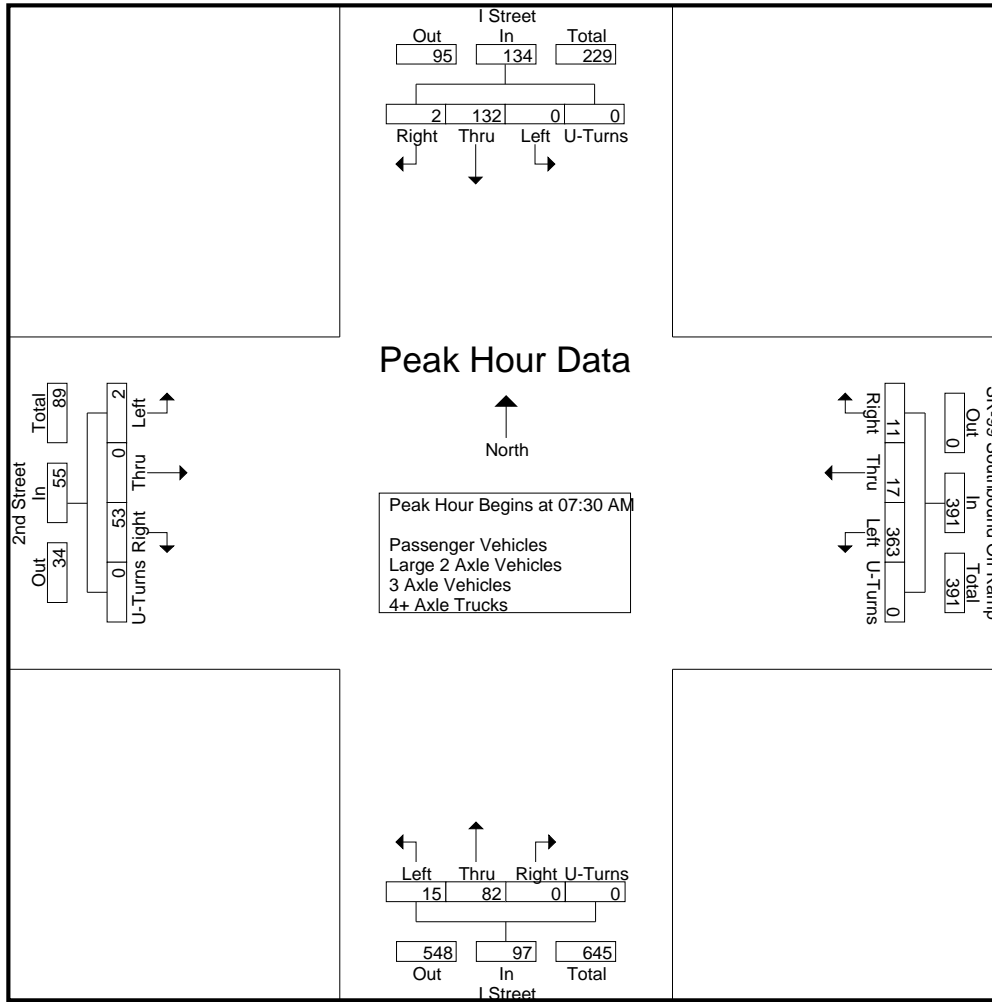

Peak Hour Analysis From 07:00 AM to 08:45 AM - Peak 1 of 1
 Peak Hour for Each Approach Begins at:

	07:00 AM					07:30 AM					08:00 AM					07:30 AM				
+0 mins.	0	32	0	0	32	80	6	2	0	88	2	17	0	0	19	1	0	14	0	15
+15 mins.	0	30	1	0	31	92	2	2	0	96	6	20	0	0	26	0	0	17	0	17
+30 mins.	0	31	0	0	31	91	2	2	0	95	4	30	0	0	34	1	0	8	0	9
+45 mins.	0	43	2	0	45	100	7	5	0	112	7	28	0	0	35	0	0	14	0	14
Total Volume	0	136	3	0	139	363	17	11	0	391	19	95	0	0	114	2	0	53	0	55
% App. Total	0	97.8	2.2	0		92.8	4.3	2.8	0		16.7	83.3	0	0		3.6	0	96.4	0	
PHF	.000	.791	.375	.000	.772	.908	.607	.550	.000	.873	.679	.792	.000	.000	.814	.500	.000	.779	.000	.809

City of Madera
 N/S: I Street
 E/W: 2nd St/SR-99 SB Off Ramp
 Weather: Clear

File Name : 33A_MDA_I St_4th St 99S Off Ramp AM
 Site Code : 00319628
 Start Date : 9/24/2019
 Page No : 1

Groups Printed- Passenger Vehicles

Start Time	I Street Southbound					SR-99 Southbound Off Ramp Westbound					I Street Northbound					2nd Street Eastbound					Int. Total
	Left	Thru	Right	U-Turns	App. Total	Left	Thru	Right	U-Turns	App. Total	Left	Thru	Right	U-Turns	App. Total	Left	Thru	Right	U-Turns	App. Total	
07:00 AM	0	32	0	0	32	36	1	0	0	37	0	17	0	0	17	0	0	8	0	8	94
07:15 AM	0	30	1	0	31	53	3	1	0	57	0	13	0	0	13	0	0	13	0	13	114
07:30 AM	0	31	0	0	31	75	6	2	0	83	3	13	0	0	16	1	0	14	0	15	145
07:45 AM	0	42	2	0	44	88	2	2	0	92	3	30	0	0	33	0	0	17	0	17	186
Total	0	135	3	0	138	252	12	5	0	269	6	73	0	0	79	1	0	52	0	53	539
08:00 AM	0	28	0	0	28	88	2	2	0	92	2	17	0	0	19	1	0	8	0	9	148
08:15 AM	0	30	0	0	30	99	7	5	0	111	6	19	0	0	25	0	0	14	0	14	180
08:30 AM	0	20	2	0	22	70	6	2	0	78	4	30	0	0	34	0	0	14	0	14	148
08:45 AM	0	31	0	0	31	62	2	4	0	68	7	28	0	0	35	0	0	8	0	8	142
Total	0	109	2	0	111	319	17	13	0	349	19	94	0	0	113	1	0	44	0	45	618
Grand Total	0	244	5	0	249	571	29	18	0	618	25	167	0	0	192	2	0	96	0	98	1157
Apprch %	0	98	2	0		92.4	4.7	2.9	0		13	87	0	0		2	0	98	0		
Total %	0	21.1	0.4	0	21.5	49.4	2.5	1.6	0	53.4	2.2	14.4	0	0	16.6	0.2	0	8.3	0	8.5	

Start Time	I Street Southbound					SR-99 Southbound Off Ramp Westbound					I Street Northbound					2nd Street Eastbound					Int. Total
	Left	Thru	Right	U-Turns	App. Total	Left	Thru	Right	U-Turns	App. Total	Left	Thru	Right	U-Turns	App. Total	Left	Thru	Right	U-Turns	App. Total	
07:30 AM	0	31	0	0	31	75	6	2	0	83	3	13	0	0	16	1	0	14	0	15	145
07:45 AM	0	42	2	0	44	88	2	2	0	92	3	30	0	0	33	0	0	17	0	17	186
08:00 AM	0	28	0	0	28	88	2	2	0	92	2	17	0	0	19	1	0	8	0	9	148
08:15 AM	0	30	0	0	30	99	7	5	0	111	6	19	0	0	25	0	0	14	0	14	180
Total Volume	0	131	2	0	133	350	17	11	0	378	14	79	0	0	93	2	0	53	0	55	659
% App. Total	0	98.5	1.5	0		92.6	4.5	2.9	0		15.1	84.9	0	0		3.6	0	96.4	0		
PHF	.000	.780	.250	.000	.756	.884	.607	.550	.000	.851	.583	.658	.000	.000	.705	.500	.000	.779	.000	.809	.886

Peak Hour Analysis From 07:30 AM to 08:15 AM - Peak 1 of 1

Peak Hour for Entire Intersection Begins at 07:30 AM

City of Madera
 N/S: I Street
 E/W: 2nd St/SR-99 SB Off Ramp
 Weather: Clear

File Name : 33A_MDA_I St_4th St 99S Off Ramp AM
 Site Code : 00319628
 Start Date : 9/24/2019
 Page No : 2

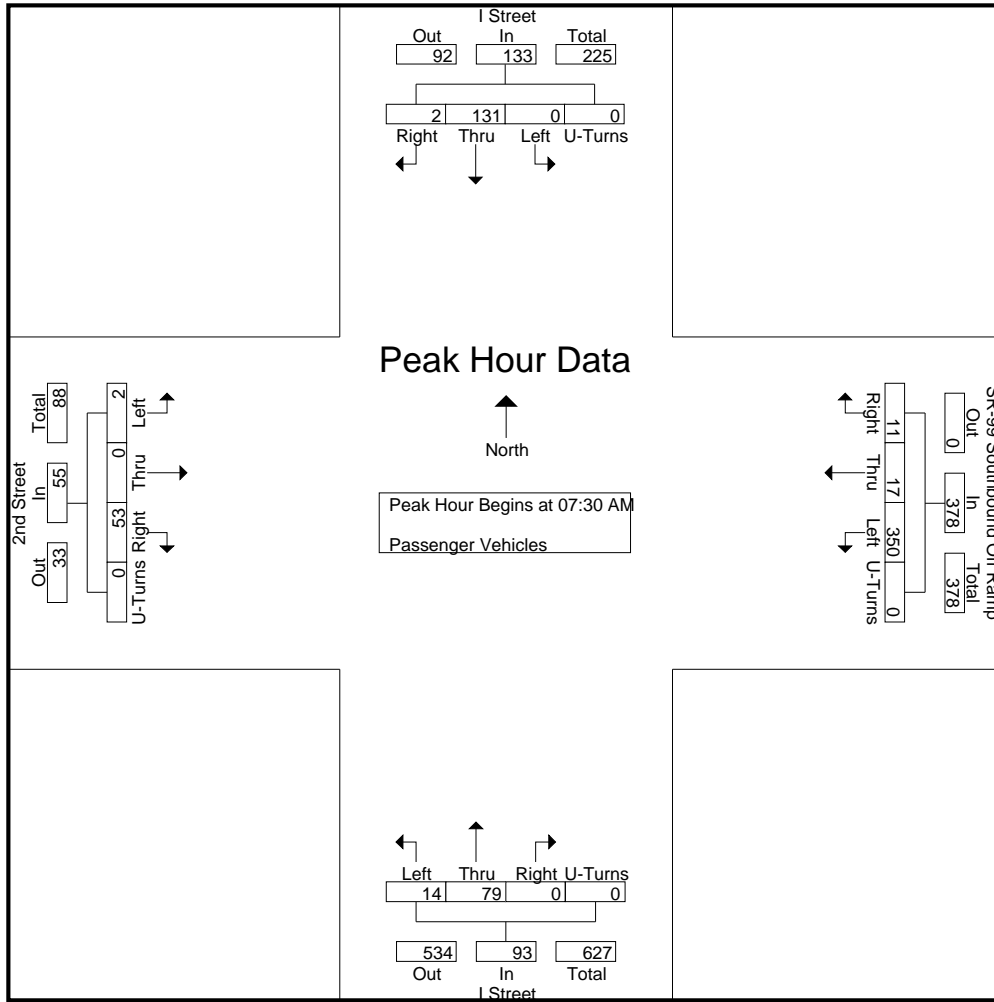

Peak Hour Analysis From 07:30 AM to 08:15 AM - Peak 1 of 1
 Peak Hour for Each Approach Begins at:

	07:30 AM					07:30 AM					07:30 AM									
+0 mins.	0	31	0	0	31	75	6	2	0	83	3	13	0	0	16	1	0	14	0	15
+15 mins.	0	42	2	0	44	88	2	2	0	92	3	30	0	0	33	0	0	17	0	17
+30 mins.	0	28	0	0	28	88	2	2	0	92	2	17	0	0	19	1	0	8	0	9
+45 mins.	0	30	0	0	30	99	7	5	0	111	6	19	0	0	25	0	0	14	0	14
Total Volume	0	131	2	0	133	350	17	11	0	378	14	79	0	0	93	2	0	53	0	55
% App. Total	0	98.5	1.5	0		92.6	4.5	2.9	0		15.1	84.9	0	0		3.6	0	96.4	0	
PHF	.000	.780	.250	.000	.756	.884	.607	.550	.000	.851	.583	.658	.000	.000	.705	.500	.000	.779	.000	.809

City of Madera
 N/S: I Street
 E/W: 2nd St/SR-99 SB Off Ramp
 Weather: Clear

File Name : 33A_MDA_I St_4th St 99S Off Ramp AM
 Site Code : 00319628
 Start Date : 9/24/2019
 Page No : 1

Groups Printed- Large 2 Axle Vehicles

Start Time	I Street Southbound					SR-99 Southbound Off Ramp Westbound					I Street Northbound					2nd Street Eastbound					Int. Total
	Left	Thru	Right	U-Turns	App. Total	Left	Thru	Right	U-Turns	App. Total	Left	Thru	Right	U-Turns	App. Total	Left	Thru	Right	U-Turns	App. Total	
07:00 AM	0	0	0	0	0	0	0	0	0	0	0	0	0	0	0	0	0	0	0	0	0
07:15 AM	0	0	0	0	0	1	1	0	0	2	0	0	0	0	0	0	0	0	0	0	0
07:30 AM	0	0	0	0	0	2	0	0	0	2	1	2	0	0	3	0	0	0	0	0	5
07:45 AM	0	1	0	0	1	1	0	0	0	1	0	0	0	0	0	0	0	0	0	0	2
Total	0	1	0	0	1	4	1	0	0	5	1	2	0	0	3	0	0	0	0	0	9
08:00 AM	0	0	0	0	0	2	0	0	0	2	0	0	0	0	0	0	0	0	0	0	2
08:15 AM	0	0	0	0	0	1	0	0	0	1	0	1	0	0	1	0	0	0	0	0	2
08:30 AM	0	0	0	0	0	2	0	0	0	2	0	0	0	0	0	0	0	0	0	0	2
08:45 AM	0	0	0	0	0	1	0	0	0	1	0	0	0	0	0	0	0	0	0	0	1
Total	0	0	0	0	0	6	0	0	0	6	0	1	0	0	1	0	0	0	0	0	7
Grand Total	0	1	0	0	1	10	1	0	0	11	1	3	0	0	4	0	0	0	0	0	16
Apprch %	0	100	0	0		90.9	9.1	0	0		25	75	0	0		0	0	0	0		
Total %	0	6.2	0	0	6.2	62.5	6.2	0	0	68.8	6.2	18.8	0	0	25	0	0	0	0	0	

Start Time	I Street Southbound					SR-99 Southbound Off Ramp Westbound					I Street Northbound					2nd Street Eastbound					Int. Total
	Left	Thru	Right	U-Turns	App. Total	Left	Thru	Right	U-Turns	App. Total	Left	Thru	Right	U-Turns	App. Total	Left	Thru	Right	U-Turns	App. Total	
07:30 AM	0	0	0	0	0	2	0	0	0	2	1	2	0	0	3	0	0	0	0	0	5
07:45 AM	0	1	0	0	1	1	0	0	0	1	0	0	0	0	0	0	0	0	0	0	2
08:00 AM	0	0	0	0	0	2	0	0	0	2	0	0	0	0	0	0	0	0	0	0	2
08:15 AM	0	0	0	0	0	1	0	0	0	1	0	1	0	0	1	0	0	0	0	0	2
Total Volume	0	1	0	0	1	6	0	0	0	6	1	3	0	0	4	0	0	0	0	0	11
% App. Total	0	100	0	0		100	0	0	0		25	75	0	0		0	0	0	0		
PHF	.000	.250	.000	.000	.250	.750	.000	.000	.000	.750	.250	.375	.000	.000	.333	.000	.000	.000	.000	.000	.550

Peak Hour Analysis From 07:30 AM to 08:15 AM - Peak 1 of 1

Peak Hour for Entire Intersection Begins at 07:30 AM

City of Madera
 N/S: I Street
 E/W: 2nd St/SR-99 SB Off Ramp
 Weather: Clear

File Name : 33A_MDA_I St_4th St 99S Off Ramp AM
 Site Code : 00319628
 Start Date : 9/24/2019
 Page No : 2

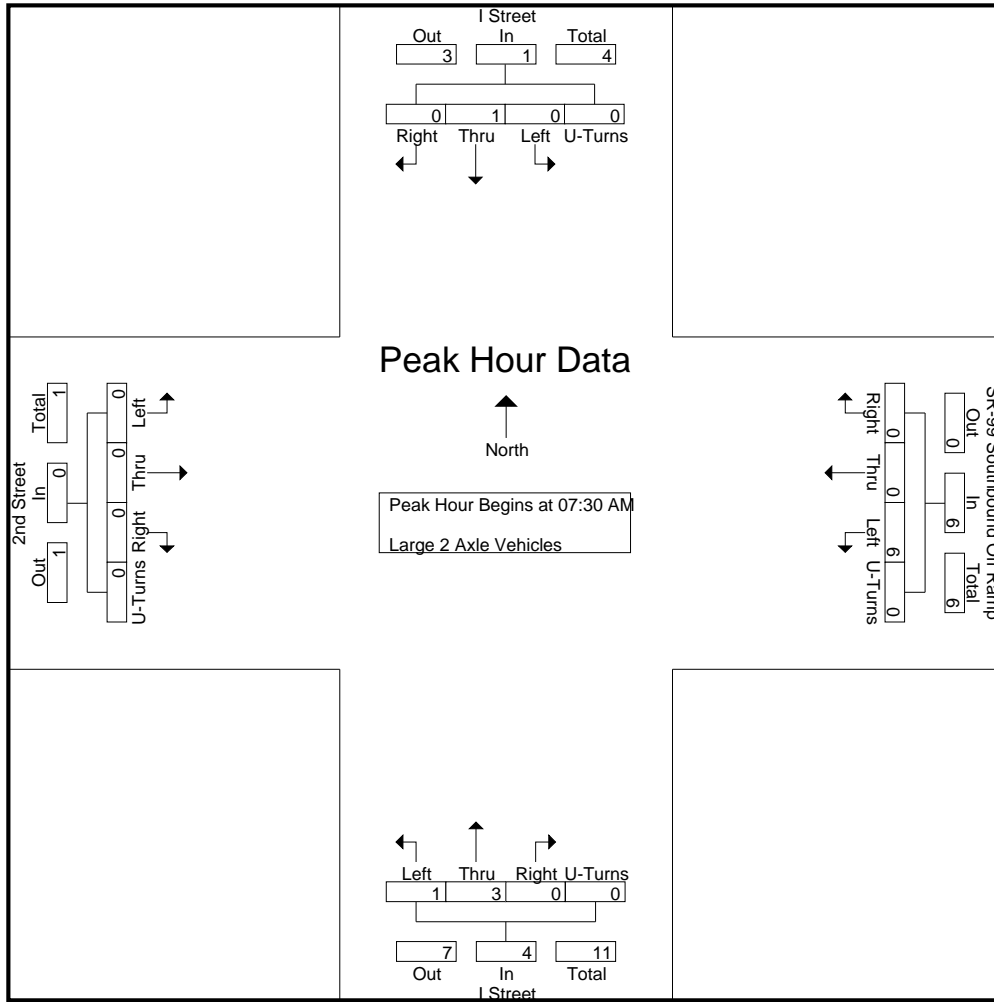

Peak Hour Analysis From 07:30 AM to 08:15 AM - Peak 1 of 1
 Peak Hour for Each Approach Begins at:

	07:30 AM					07:30 AM					07:30 AM									
+0 mins.	0	0	0	0	0	2	0	0	0	2	1	2	0	0	3	0	0	0	0	0
+15 mins.	0	1	0	0	1	1	0	0	0	1	0	0	0	0	0	0	0	0	0	0
+30 mins.	0	0	0	0	0	2	0	0	0	2	0	0	0	0	0	0	0	0	0	0
+45 mins.	0	0	0	0	0	1	0	0	0	1	0	1	0	0	1	0	0	0	0	0
Total Volume	0	1	0	0	1	6	0	0	0	6	1	3	0	0	4	0	0	0	0	0
% App. Total	0	100	0	0	0	100	0	0	0	0	25	75	0	0	0	0	0	0	0	0
PHF	.000	.250	.000	.000	.250	.750	.000	.000	.000	.750	.250	.375	.000	.000	.333	.000	.000	.000	.000	.000

City of Madera
 N/S: I Street
 E/W: 2nd St/SR-99 SB Off Ramp
 Weather: Clear

File Name : 33A_MDA_I St_4th St 99S Off Ramp AM
 Site Code : 00319628
 Start Date : 9/24/2019
 Page No : 1

Groups Printed- 3 Axle Vehicles

Start Time	I Street Southbound					SR-99 Southbound Off Ramp Westbound					I Street Northbound					2nd Street Eastbound					Int. Total
	Left	Thru	Right	U-Turns	App. Total	Left	Thru	Right	U-Turns	App. Total	Left	Thru	Right	U-Turns	App. Total	Left	Thru	Right	U-Turns	App. Total	
07:00 AM	0	0	0	0	0	1	0	0	0	1	1	0	0	0	1	0	0	0	0	0	2
07:15 AM	0	0	0	0	0	0	0	0	0	0	0	0	0	0	0	0	0	0	0	0	0
07:30 AM	0	0	0	0	0	0	0	0	0	0	0	0	0	0	0	0	0	0	0	0	0
07:45 AM	0	0	0	0	0	0	0	0	0	0	0	0	0	0	0	0	0	0	0	0	0
Total	0	0	0	0	0	1	0	0	0	1	1	0	0	0	1	0	0	0	0	0	2
08:00 AM	0	0	0	0	0	1	0	0	0	1	0	0	0	0	0	0	0	0	0	0	1
08:15 AM	0	0	0	0	0	0	0	0	0	0	0	0	0	0	0	0	0	0	0	0	0
08:30 AM	0	0	0	0	0	0	0	0	0	0	0	0	0	0	0	0	0	0	0	0	0
08:45 AM	0	0	0	0	0	1	0	0	0	1	0	0	0	0	0	0	0	0	0	0	1
Total	0	0	0	0	0	2	0	0	0	2	0	0	0	0	0	0	0	0	0	0	2
Grand Total	0	0	0	0	0	3	0	0	0	3	1	0	0	0	1	0	0	0	0	0	4
Apprch %	0	0	0	0		100	0	0	0		100	0	0	0		0	0	0	0		
Total %	0	0	0	0	0	75	0	0	0	75	25	0	0	0	25	0	0	0	0	0	0

Start Time	I Street Southbound					SR-99 Southbound Off Ramp Westbound					I Street Northbound					2nd Street Eastbound					Int. Total
	Left	Thru	Right	U-Turns	App. Total	Left	Thru	Right	U-Turns	App. Total	Left	Thru	Right	U-Turns	App. Total	Left	Thru	Right	U-Turns	App. Total	
Peak Hour Analysis From 07:30 AM to 08:15 AM - Peak 1 of 1																					
Peak Hour for Entire Intersection Begins at 07:30 AM																					
07:30 AM	0	0	0	0	0	0	0	0	0	0	0	0	0	0	0	0	0	0	0	0	0
07:45 AM	0	0	0	0	0	0	0	0	0	0	0	0	0	0	0	0	0	0	0	0	0
08:00 AM	0	0	0	0	0	1	0	0	0	1	0	0	0	0	0	0	0	0	0	0	1
08:15 AM	0	0	0	0	0	0	0	0	0	0	0	0	0	0	0	0	0	0	0	0	0
Total Volume	0	0	0	0	0	1	0	0	0	1	0	0	0	0	0	0	0	0	0	0	1
% App. Total	0	0	0	0		100	0	0	0		0	0	0	0		0	0	0	0		
PHF	.000	.000	.000	.000	.000	.250	.000	.000	.000	.250	.000	.000	.000	.000	.000	.000	.000	.000	.000	.000	.250

City of Madera
 N/S: I Street
 E/W: 2nd St/SR-99 SB Off Ramp
 Weather: Clear

File Name : 33A_MDA_I St_4th St 99S Off Ramp AM
 Site Code : 00319628
 Start Date : 9/24/2019
 Page No : 2

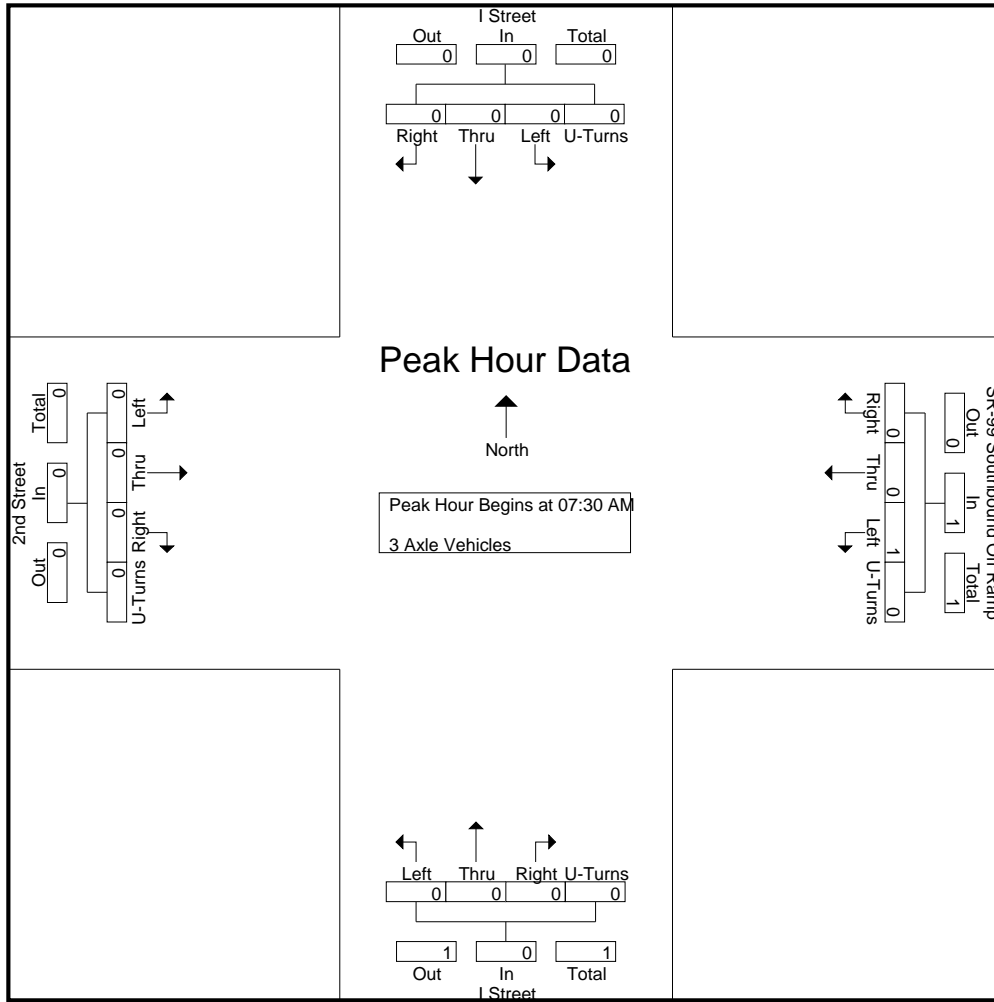

Peak Hour Analysis From 07:30 AM to 08:15 AM - Peak 1 of 1
 Peak Hour for Each Approach Begins at:

	07:30 AM					07:30 AM					07:30 AM					07:30 AM				
+0 mins.	0	0	0	0	0	0	0	0	0	0	0	0	0	0	0	0	0	0	0	0
+15 mins.	0	0	0	0	0	0	0	0	0	0	0	0	0	0	0	0	0	0	0	0
+30 mins.	0	0	0	0	0	1	0	0	0	1	0	0	0	0	0	0	0	0	0	0
+45 mins.	0	0	0	0	0	0	0	0	0	0	0	0	0	0	0	0	0	0	0	0
Total Volume	0	0	0	0	0	1	0	0	0	1	0	0	0	0	0	0	0	0	0	0
% App. Total	0	0	0	0	0	100	0	0	0	0	0	0	0	0	0	0	0	0	0	0
PHF	.000	.000	.000	.000	.000	.250	.000	.000	.000	.250	.000	.000	.000	.000	.000	.000	.000	.000	.000	.000

City of Madera
 N/S: I Street
 E/W: 2nd St/SR-99 SB Off Ramp
 Weather: Clear

File Name : 33A_MDA_I St_4th St 99S Off Ramp AM
 Site Code : 00319628
 Start Date : 9/24/2019
 Page No : 1

Groups Printed- 4+ Axle Trucks

Start Time	I Street Southbound					SR-99 Southbound Off Ramp Westbound					I Street Northbound					2nd Street Eastbound					Int. Total
	Left	Thru	Right	U-Turns	App. Total	Left	Thru	Right	U-Turns	App. Total	Left	Thru	Right	U-Turns	App. Total	Left	Thru	Right	U-Turns	App. Total	
07:00 AM	0	0	0	0	0	1	0	0	0	1	0	0	0	0	0	0	0	0	0	0	1
07:15 AM	0	0	0	0	0	2	0	0	0	2	0	0	0	0	0	0	0	0	0	0	2
07:30 AM	0	0	0	0	0	3	0	0	0	3	0	0	0	0	0	0	0	0	0	0	3
07:45 AM	0	0	0	0	0	3	0	0	0	3	0	0	0	0	0	0	0	0	0	0	3
Total	0	0	0	0	0	9	0	0	0	9	0	0	0	0	0	0	0	0	0	0	9
08:00 AM	0	0	0	0	0	0	0	0	0	0	0	0	0	0	0	0	0	0	0	0	0
08:15 AM	0	0	0	0	0	0	0	0	0	0	0	0	0	0	0	0	0	0	0	0	0
08:30 AM	0	0	0	0	0	0	0	0	0	0	0	0	0	0	0	0	0	0	0	0	0
08:45 AM	0	0	0	0	0	1	0	0	0	1	0	0	0	0	0	0	0	0	0	0	1
Total	0	0	0	0	0	1	0	0	0	1	0	0	0	0	0	0	0	0	0	0	1
Grand Total	0	0	0	0	0	10	0	0	0	10	0	0	0	0	0	0	0	0	0	0	10
Apprch %	0	0	0	0		100	0	0	0		0	0	0	0		0	0	0	0		
Total %	0	0	0	0	0	100	0	0	0	100	0	0	0	0	0	0	0	0	0	0	0

Start Time	I Street Southbound					SR-99 Southbound Off Ramp Westbound					I Street Northbound					2nd Street Eastbound					Int. Total
	Left	Thru	Right	U-Turns	App. Total	Left	Thru	Right	U-Turns	App. Total	Left	Thru	Right	U-Turns	App. Total	Left	Thru	Right	U-Turns	App. Total	
Peak Hour Analysis From 07:30 AM to 08:15 AM - Peak 1 of 1																					
Peak Hour for Entire Intersection Begins at 07:30 AM																					
07:30 AM	0	0	0	0	0	3	0	0	0	3	0	0	0	0	0	0	0	0	0	0	3
07:45 AM	0	0	0	0	0	3	0	0	0	3	0	0	0	0	0	0	0	0	0	0	3
08:00 AM	0	0	0	0	0	0	0	0	0	0	0	0	0	0	0	0	0	0	0	0	0
08:15 AM	0	0	0	0	0	0	0	0	0	0	0	0	0	0	0	0	0	0	0	0	0
Total Volume	0	0	0	0	0	6	0	0	0	6	0	0	0	0	0	0	0	0	0	0	6
% App. Total	0	0	0	0		100	0	0	0		0	0	0	0		0	0	0	0		
PHF	.000	.000	.000	.000	.000	.500	.000	.000	.000	.500	.000	.000	.000	.000	.000	.000	.000	.000	.000	.000	.500

City of Madera
 N/S: I Street
 E/W: 2nd St/SR-99 SB Off Ramp
 Weather: Clear

File Name : 33A_MDA_I St_4th St 99S Off Ramp AM
 Site Code : 00319628
 Start Date : 9/24/2019
 Page No : 2

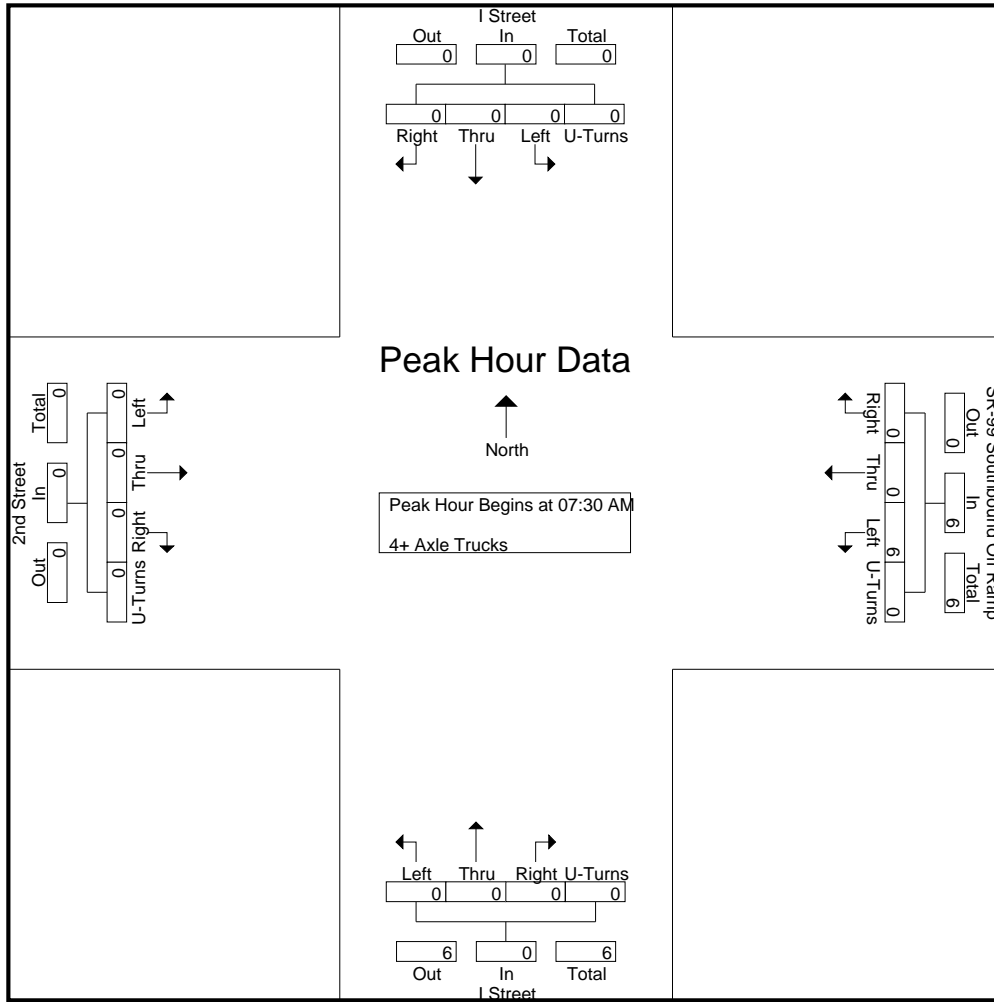

Peak Hour Analysis From 07:30 AM to 08:15 AM - Peak 1 of 1
 Peak Hour for Each Approach Begins at:

	07:30 AM					07:30 AM					07:30 AM					07:30 AM				
+0 mins.	0	0	0	0	0	3	0	0	0	3	0	0	0	0	0	0	0	0	0	0
+15 mins.	0	0	0	0	0	3	0	0	0	3	0	0	0	0	0	0	0	0	0	0
+30 mins.	0	0	0	0	0	0	0	0	0	0	0	0	0	0	0	0	0	0	0	0
+45 mins.	0	0	0	0	0	0	0	0	0	0	0	0	0	0	0	0	0	0	0	0
Total Volume	0	0	0	0	0	6	0	0	0	6	0	0	0	0	0	0	0	0	0	0
% App. Total	0	0	0	0	0	100	0	0	0	100	0	0	0	0	0	0	0	0	0	0
PHF	.000	.000	.000	.000	.000	.500	.000	.000	.500	.000	.000	.000	.000	.000	.000	.000	.000	.000	.000	

City of Madera
 N/S: I Street
 E/W: 2nd St/SR-99 SB Off Ramp
 Weather: Clear

File Name : 33A_MDA_I St_4th St 99S Off Ramp PM
 Site Code : 00319628
 Start Date : 9/24/2019
 Page No : 1

Groups Printed- Passenger Vehicles - Large 2 Axle Vehicles - 3 Axle Vehicles - 4+ Axle Trucks

Start Time	I Street Southbound					SR-99 Southbound Off Ramp Westbound					I Street Northbound					2nd Street Eastbound					Int. Total
	Left	Thru	Right	U-Turns	App. Total	Left	Thru	Right	U-Turns	App. Total	Left	Thru	Right	U-Turns	App. Total	Left	Thru	Right	U-Turns	App. Total	
04:00 PM	0	16	0	0	16	69	1	0	0	70	12	32	0	0	44	0	1	6	0	7	137
04:15 PM	0	32	0	0	32	48	6	2	0	56	7	22	0	0	29	0	0	6	0	6	123
04:30 PM	0	23	0	0	23	64	4	2	0	70	7	34	0	0	41	1	0	5	0	6	140
04:45 PM	0	27	1	0	28	58	7	0	0	65	5	25	0	0	30	0	0	14	0	14	137
Total	0	98	1	0	99	239	18	4	0	261	31	113	0	0	144	1	1	31	0	33	537
05:00 PM	0	31	0	0	31	53	4	1	0	58	10	41	0	0	51	0	0	7	0	7	147
05:15 PM	0	28	0	0	28	56	1	0	0	57	15	36	0	0	51	0	0	8	0	8	144
05:30 PM	0	33	0	0	33	62	4	1	0	67	6	27	0	0	33	0	0	12	0	12	145
05:45 PM	0	20	0	0	20	65	1	2	0	68	11	37	0	0	48	0	0	5	0	5	141
Total	0	112	0	0	112	236	10	4	0	250	42	141	0	0	183	0	0	32	0	32	577
Grand Total	0	210	1	0	211	475	28	8	0	511	73	254	0	0	327	1	1	63	0	65	1114
Apprch %	0	99.5	0.5	0		93	5.5	1.6	0		22.3	77.7	0	0		1.5	1.5	96.9	0		
Total %	0	18.9	0.1	0	18.9	42.6	2.5	0.7	0	45.9	6.6	22.8	0	0	29.4	0.1	0.1	5.7	0	5.8	
Passenger Vehicles	0	99.5	100	0	99.5	96.8	100	100	0	97.1	98.6	99.6	0	0	99.4	100	0	100	0	98.5	98.3
Large 2 Axle Vehicles	0	0.5	0	0	0.5	2.1	0	0	0	2	1.4	0.4	0	0	0.6	0	0	0	0	0	1.2
3 Axle Vehicles	0	0	0	0	0	0	0	0	0	0	0	0	0	0	0	0	1	0	0	1	1
% 3 Axle Vehicles	0	0	0	0	0	0	0	0	0	0	0	0	0	0	0	0	100	0	0	1.5	0.1
4+ Axle Trucks	0	0	0	0	0	5	0	0	0	5	0	0	0	0	0	0	0	0	0	0	5
% 4+ Axle Trucks																					

Start Time	I Street Southbound					SR-99 Southbound Off Ramp Westbound					I Street Northbound					2nd Street Eastbound					Int. Total
	Left	Thru	Right	U-Turns	App. Total	Left	Thru	Right	U-Turns	App. Total	Left	Thru	Right	U-Turns	App. Total	Left	Thru	Right	U-Turns	App. Total	
Peak Hour Analysis From 04:00 PM to 05:45 PM - Peak 1 of 1																					
Peak Hour for Entire Intersection Begins at 05:00 PM																					
05:00 PM	0	31	0	0	31	53	4	1	0	58	10	41	0	0	51	0	0	7	0	7	147
05:15 PM	0	28	0	0	28	56	1	0	0	57	15	36	0	0	51	0	0	8	0	8	144
05:30 PM	0	33	0	0	33	62	4	1	0	67	6	27	0	0	33	0	0	12	0	12	145
05:45 PM	0	20	0	0	20	65	1	2	0	68	11	37	0	0	48	0	0	5	0	5	141
Total Volume	0	112	0	0	112	236	10	4	0	250	42	141	0	0	183	0	0	32	0	32	577
% App. Total	0	100	0	0		94.4	4	1.6	0		23	77	0	0		0	0	100	0		
PHF	.000	.848	.000	.000	.848	.908	.625	.500	.000	.919	.700	.860	.000	.000	.897	.000	.000	.667	.000	.667	.981

City of Madera
 N/S: I Street
 E/W: 2nd St/SR-99 SB Off Ramp
 Weather: Clear

File Name : 33A_MDA_I St_4th St 99S Off Ramp PM
 Site Code : 00319628
 Start Date : 9/24/2019
 Page No : 2

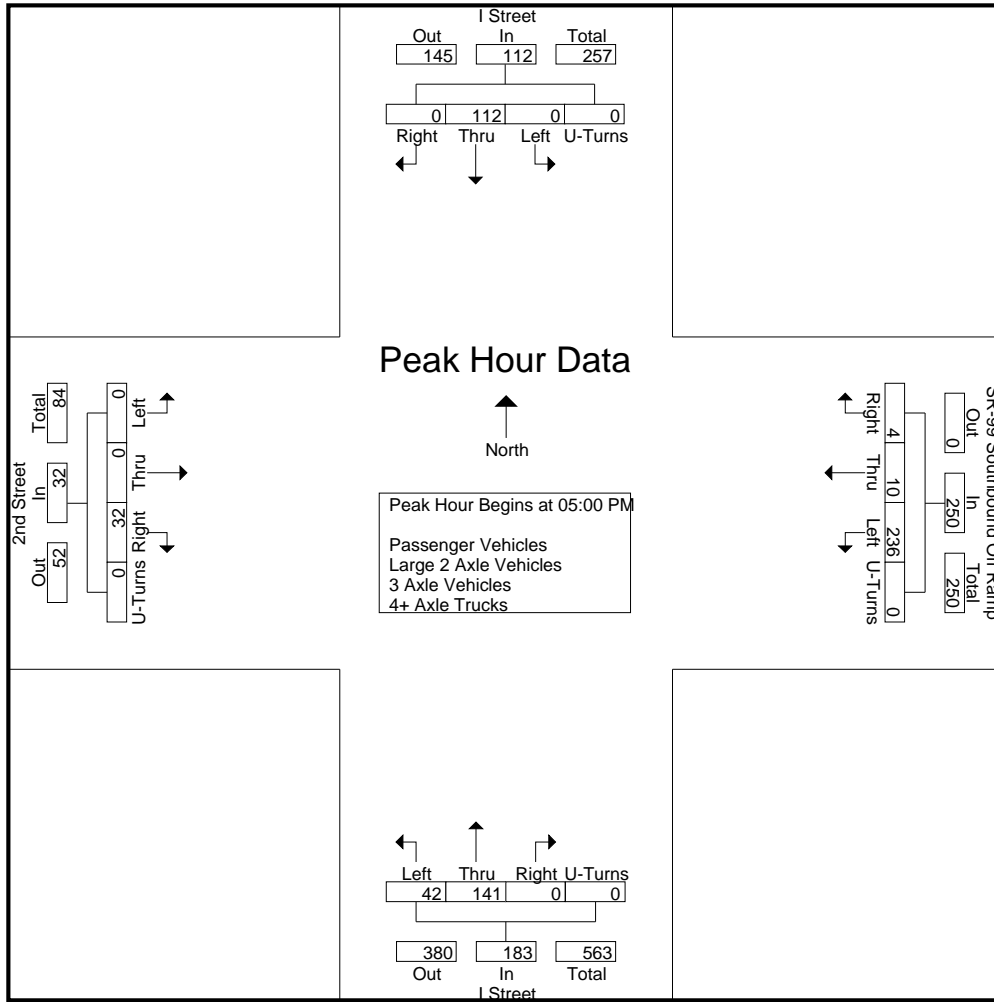

Peak Hour Analysis From 04:00 PM to 05:45 PM - Peak 1 of 1
 Peak Hour for Each Approach Begins at:

	04:45 PM					04:00 PM					05:00 PM					04:45 PM				
+0 mins.	0	27	1	0	28	69	1	0	0	70	10	41	0	0	51	0	0	14	0	14
+15 mins.	0	31	0	0	31	48	6	2	0	56	15	36	0	0	51	0	0	7	0	7
+30 mins.	0	28	0	0	28	64	4	2	0	70	6	27	0	0	33	0	0	8	0	8
+45 mins.	0	33	0	0	33	58	7	0	0	65	11	37	0	0	48	0	0	12	0	12
Total Volume	0	119	1	0	120	239	18	4	0	261	42	141	0	0	183	0	0	41	0	41
% App. Total	0	99.2	0.8	0		91.6	6.9	1.5	0		23	77	0	0		0	0	100	0	
PHF	.000	.902	.250	.000	.909	.866	.643	.500	.000	.932	.700	.860	.000	.000	.897	.000	.000	.732	.000	.732

City of Madera
 N/S: I Street
 E/W: 2nd St/SR-99 SB Off Ramp
 Weather: Clear

File Name : 33A_MDA_I St_4th St 99S Off Ramp PM
 Site Code : 00319628
 Start Date : 9/24/2019
 Page No : 1

Groups Printed- Passenger Vehicles

Start Time	I Street Southbound					SR-99 Southbound Off Ramp Westbound					I Street Northbound					2nd Street Eastbound					Int. Total
	Left	Thru	Right	U-Turns	App. Total	Left	Thru	Right	U-Turns	App. Total	Left	Thru	Right	U-Turns	App. Total	Left	Thru	Right	U-Turns	App. Total	
04:00 PM	0	16	0	0	16	67	1	0	0	68	11	32	0	0	43	0	0	6	0	6	133
04:15 PM	0	32	0	0	32	47	6	2	0	55	7	22	0	0	29	0	0	6	0	6	122
04:30 PM	0	22	0	0	22	63	4	2	0	69	7	33	0	0	40	1	0	5	0	6	137
04:45 PM	0	27	1	0	28	54	7	0	0	61	5	25	0	0	30	0	0	14	0	14	133
Total	0	97	1	0	98	231	18	4	0	253	30	112	0	0	142	1	0	31	0	32	525
05:00 PM	0	31	0	0	31	53	4	1	0	58	10	41	0	0	51	0	0	7	0	7	147
05:15 PM	0	28	0	0	28	55	1	0	0	56	15	36	0	0	51	0	0	8	0	8	143
05:30 PM	0	33	0	0	33	58	4	1	0	63	6	27	0	0	33	0	0	12	0	12	141
05:45 PM	0	20	0	0	20	63	1	2	0	66	11	37	0	0	48	0	0	5	0	5	139
Total	0	112	0	0	112	229	10	4	0	243	42	141	0	0	183	0	0	32	0	32	570
Grand Total	0	209	1	0	210	460	28	8	0	496	72	253	0	0	325	1	0	63	0	64	1095
Apprch %	0	99.5	0.5	0		92.7	5.6	1.6	0		22.2	77.8	0	0		1.6	0	98.4	0		
Total %	0	19.1	0.1	0	19.2	42	2.6	0.7	0	45.3	6.6	23.1	0	0	29.7	0.1	0	5.8	0	5.8	

Start Time	I Street Southbound					SR-99 Southbound Off Ramp Westbound					I Street Northbound					2nd Street Eastbound					Int. Total
	Left	Thru	Right	U-Turns	App. Total	Left	Thru	Right	U-Turns	App. Total	Left	Thru	Right	U-Turns	App. Total	Left	Thru	Right	U-Turns	App. Total	
Peak Hour Analysis From 05:00 PM to 05:45 PM - Peak 1 of 1																					
Peak Hour for Entire Intersection Begins at 05:00 PM																					
05:00 PM	0	31	0	0	31	53	4	1	0	58	10	41	0	0	51	0	0	7	0	7	147
05:15 PM	0	28	0	0	28	55	1	0	0	56	15	36	0	0	51	0	0	8	0	8	143
05:30 PM	0	33	0	0	33	58	4	1	0	63	6	27	0	0	33	0	0	12	0	12	141
05:45 PM	0	20	0	0	20	63	1	2	0	66	11	37	0	0	48	0	0	5	0	5	139
Total Volume	0	112	0	0	112	229	10	4	0	243	42	141	0	0	183	0	0	32	0	32	570
% App. Total	0	100	0	0		94.2	4.1	1.6	0		23	77	0	0		0	0	100	0		
PHF	.000	.848	.000	.000	.848	.909	.625	.500	.000	.920	.700	.860	.000	.000	.897	.000	.000	.667	.000	.667	.969

City of Madera
 N/S: I Street
 E/W: 2nd St/SR-99 SB Off Ramp
 Weather: Clear

File Name : 33A_MDA_I St_4th St 99S Off Ramp PM
 Site Code : 00319628
 Start Date : 9/24/2019
 Page No : 2

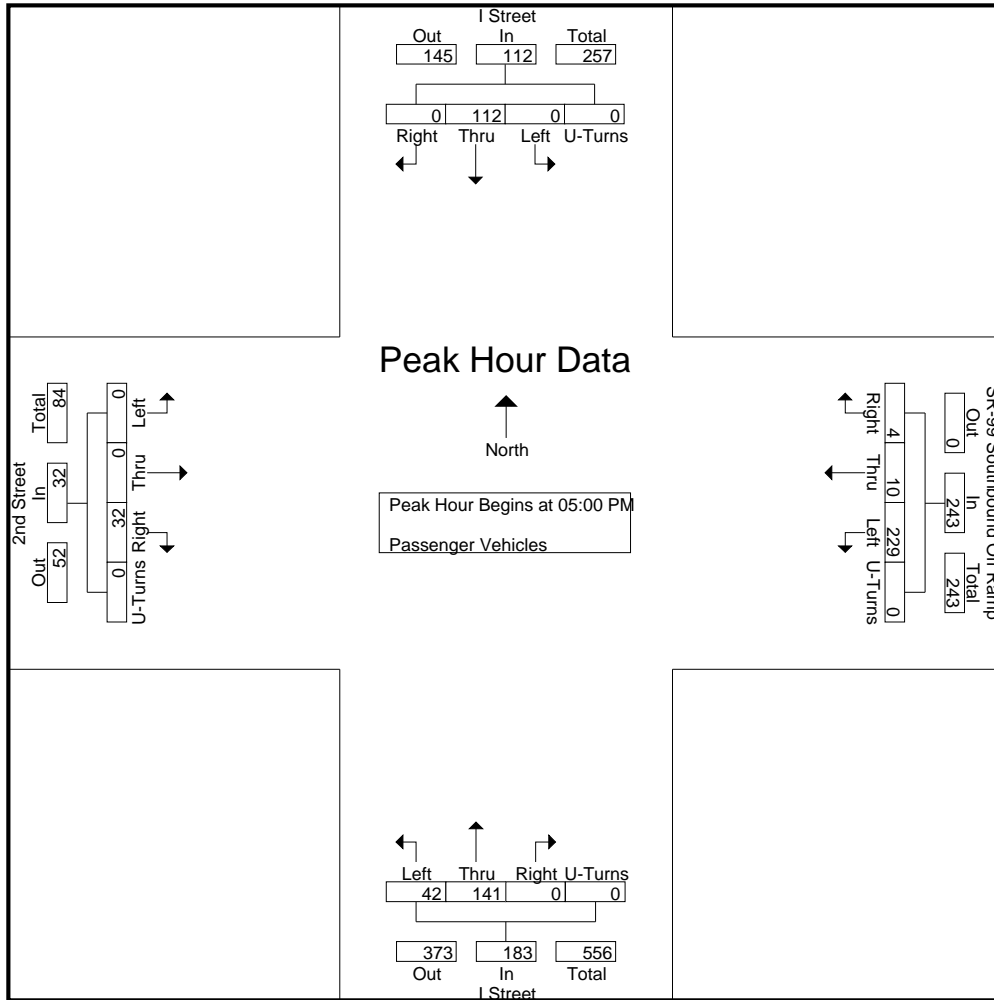

Peak Hour Analysis From 05:00 PM to 05:45 PM - Peak 1 of 1
 Peak Hour for Each Approach Begins at:

	05:00 PM					05:00 PM					05:00 PM									
+0 mins.	0	31	0	0	31	53	4	1	0	58	10	41	0	0	51	0	0	7	0	7
+15 mins.	0	28	0	0	28	55	1	0	0	56	15	36	0	0	51	0	0	8	0	8
+30 mins.	0	33	0	0	33	58	4	1	0	63	6	27	0	0	33	0	0	12	0	12
+45 mins.	0	20	0	0	20	63	1	2	0	66	11	37	0	0	48	0	0	5	0	5
Total Volume	0	112	0	0	112	229	10	4	0	243	42	141	0	0	183	0	0	32	0	32
% App. Total	0	100	0	0	0	94.2	4.1	1.6	0	0	23	77	0	0	0	0	0	100	0	0
PHF	.000	.848	.000	.000	.848	.909	.625	.500	.000	.920	.700	.860	.000	.000	.897	.000	.000	.667	.000	.667

City of Madera
 N/S: I Street
 E/W: 2nd St/SR-99 SB Off Ramp
 Weather: Clear

File Name : 33A_MDA_I St_4th St 99S Off Ramp PM
 Site Code : 00319628
 Start Date : 9/24/2019
 Page No : 1

Groups Printed- Large 2 Axle Vehicles

Start Time	I Street Southbound					SR-99 Southbound Off Ramp Westbound					I Street Northbound					2nd Street Eastbound					Int. Total
	Left	Thru	Right	U-Turns	App. Total	Left	Thru	Right	U-Turns	App. Total	Left	Thru	Right	U-Turns	App. Total	Left	Thru	Right	U-Turns	App. Total	
04:00 PM	0	0	0	0	0	2	0	0	0	2	1	0	0	0	1	0	0	0	0	0	3
04:15 PM	0	0	0	0	0	1	0	0	0	1	0	0	0	0	0	0	0	0	0	0	1
04:30 PM	0	1	0	0	1	1	0	0	0	1	0	1	0	0	1	0	0	0	0	0	3
04:45 PM	0	0	0	0	0	2	0	0	0	2	0	0	0	0	0	0	0	0	0	0	2
Total	0	1	0	0	1	6	0	0	0	6	1	1	0	0	2	0	0	0	0	0	9
05:00 PM	0	0	0	0	0	0	0	0	0	0	0	0	0	0	0	0	0	0	0	0	0
05:15 PM	0	0	0	0	0	1	0	0	0	1	0	0	0	0	0	0	0	0	0	0	1
05:30 PM	0	0	0	0	0	1	0	0	0	1	0	0	0	0	0	0	0	0	0	0	1
05:45 PM	0	0	0	0	0	2	0	0	0	2	0	0	0	0	0	0	0	0	0	0	2
Total	0	0	0	0	0	4	0	0	0	4	0	0	0	0	0	0	0	0	0	0	4
Grand Total	0	1	0	0	1	10	0	0	0	10	1	1	0	0	2	0	0	0	0	0	13
Apprch %	0	100	0	0		100	0	0	0		50	50	0	0		0	0	0	0		
Total %	0	7.7	0	0	7.7	76.9	0	0	0	76.9	7.7	7.7	0	0	15.4	0	0	0	0	0	

Start Time	I Street Southbound					SR-99 Southbound Off Ramp Westbound					I Street Northbound					2nd Street Eastbound					Int. Total
	Left	Thru	Right	U-Turns	App. Total	Left	Thru	Right	U-Turns	App. Total	Left	Thru	Right	U-Turns	App. Total	Left	Thru	Right	U-Turns	App. Total	
05:00 PM	0	0	0	0	0	0	0	0	0	0	0	0	0	0	0	0	0	0	0	0	0
05:15 PM	0	0	0	0	0	1	0	0	0	1	0	0	0	0	0	0	0	0	0	0	1
05:30 PM	0	0	0	0	0	1	0	0	0	1	0	0	0	0	0	0	0	0	0	0	1
05:45 PM	0	0	0	0	0	2	0	0	0	2	0	0	0	0	0	0	0	0	0	0	2
Total Volume	0	0	0	0	0	4	0	0	0	4	0	0	0	0	0	0	0	0	0	0	4
% App. Total	0	0	0	0		100	0	0	0		0	0	0	0		0	0	0	0		
PHF	.000	.000	.000	.000	.000	.500	.000	.000	.000	.500	.000	.000	.000	.000	.000	.000	.000	.000	.000	.000	.500

Peak Hour Analysis From 05:00 PM to 05:45 PM - Peak 1 of 1

Peak Hour for Entire Intersection Begins at 05:00 PM

City of Madera
 N/S: I Street
 E/W: 2nd St/SR-99 SB Off Ramp
 Weather: Clear

File Name : 33A_MDA_I St_4th St 99S Off Ramp PM
 Site Code : 00319628
 Start Date : 9/24/2019
 Page No : 2

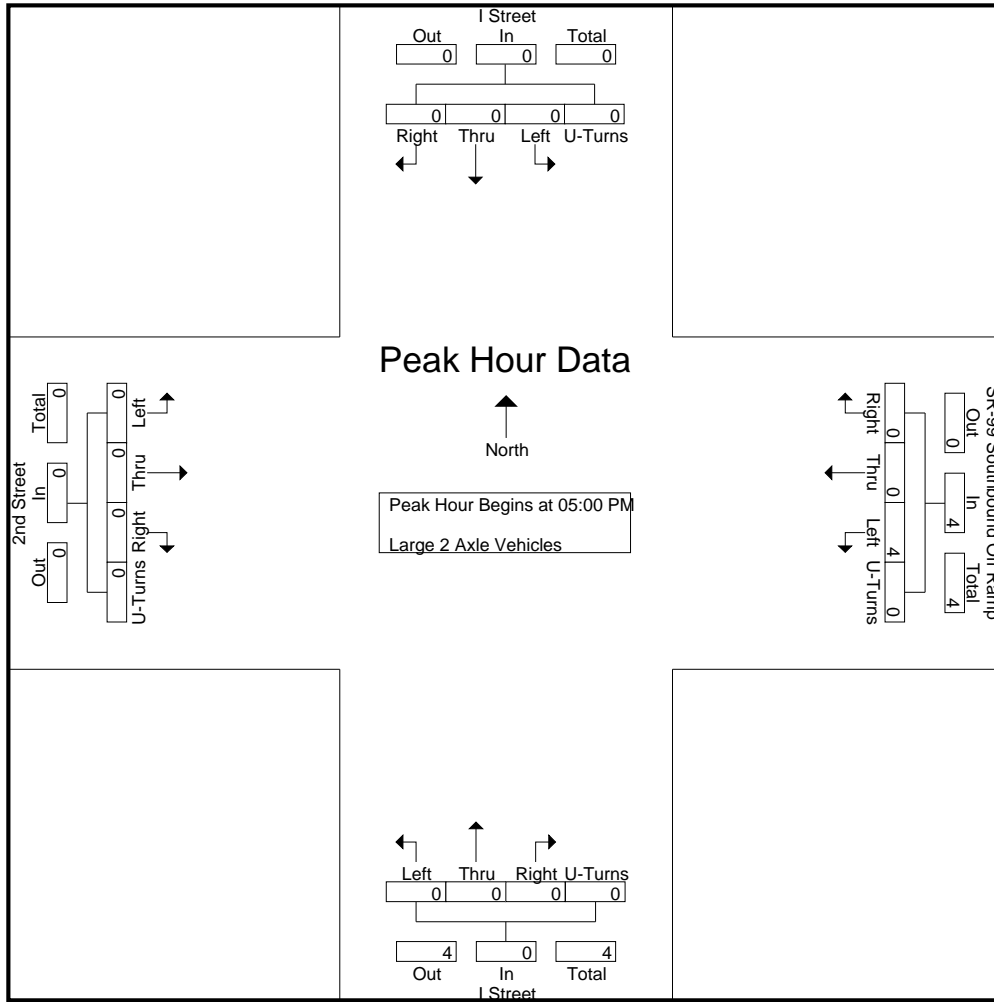

Peak Hour Analysis From 05:00 PM to 05:45 PM - Peak 1 of 1
 Peak Hour for Each Approach Begins at:

	05:00 PM					05:00 PM					05:00 PM									
+0 mins.	0	0	0	0	0	0	0	0	0	0	0	0	0	0	0	0	0	0	0	0
+15 mins.	0	0	0	0	0	1	0	0	0	1	0	0	0	0	0	0	0	0	0	0
+30 mins.	0	0	0	0	0	1	0	0	0	1	0	0	0	0	0	0	0	0	0	0
+45 mins.	0	0	0	0	0	2	0	0	0	2	0	0	0	0	0	0	0	0	0	0
Total Volume	0	0	0	0	0	4	0	0	0	4	0	0	0	0	0	0	0	0	0	0
% App. Total	0	0	0	0	0	100	0	0	0	0	0	0	0	0	0	0	0	0	0	0
PHF	.000	.000	.000	.000	.000	.500	.000	.000	.000	.500	.000	.000	.000	.000	.000	.000	.000	.000	.000	.000

City of Madera
 N/S: I Street
 E/W: 2nd St/SR-99 SB Off Ramp
 Weather: Clear

File Name : 33A_MDA_I St_4th St 99S Off Ramp PM
 Site Code : 00319628
 Start Date : 9/24/2019
 Page No : 1

Groups Printed- 3 Axle Vehicles

Start Time	I Street Southbound					SR-99 Southbound Off Ramp Westbound					I Street Northbound					2nd Street Eastbound					Int. Total
	Left	Thru	Right	U-Turns	App. Total	Left	Thru	Right	U-Turns	App. Total	Left	Thru	Right	U-Turns	App. Total	Left	Thru	Right	U-Turns	App. Total	
04:00 PM	0	0	0	0	0	0	0	0	0	0	0	0	0	0	0	0	1	0	0	1	1
04:15 PM	0	0	0	0	0	0	0	0	0	0	0	0	0	0	0	0	0	0	0	0	0
04:30 PM	0	0	0	0	0	0	0	0	0	0	0	0	0	0	0	0	0	0	0	0	0
04:45 PM	0	0	0	0	0	0	0	0	0	0	0	0	0	0	0	0	0	0	0	0	0
Total	0	0	0	0	0	0	0	0	0	0	0	0	0	0	0	0	1	0	0	1	1
05:00 PM	0	0	0	0	0	0	0	0	0	0	0	0	0	0	0	0	0	0	0	0	0
05:15 PM	0	0	0	0	0	0	0	0	0	0	0	0	0	0	0	0	0	0	0	0	0
05:30 PM	0	0	0	0	0	0	0	0	0	0	0	0	0	0	0	0	0	0	0	0	0
05:45 PM	0	0	0	0	0	0	0	0	0	0	0	0	0	0	0	0	0	0	0	0	0
Total	0	0	0	0	0	0	0	0	0	0	0	0	0	0	0	0	0	0	0	0	0
Grand Total	0	0	0	0	0	0	0	0	0	0	0	0	0	0	0	0	1	0	0	1	1
Apprch %	0	0	0	0		0	0	0	0		0	0	0	0		0	100	0	0		
Total %	0	0	0	0	0	0	0	0	0	0	0	0	0	0	0	0	100	0	0	100	

Start Time	I Street Southbound					SR-99 Southbound Off Ramp Westbound					I Street Northbound					2nd Street Eastbound					Int. Total
	Left	Thru	Right	U-Turns	App. Total	Left	Thru	Right	U-Turns	App. Total	Left	Thru	Right	U-Turns	App. Total	Left	Thru	Right	U-Turns	App. Total	
Peak Hour Analysis From 05:00 PM to 05:45 PM - Peak 1 of 1																					
Peak Hour for Entire Intersection Begins at 05:00 PM																					
05:00 PM	0	0	0	0	0	0	0	0	0	0	0	0	0	0	0	0	0	0	0	0	0
05:15 PM	0	0	0	0	0	0	0	0	0	0	0	0	0	0	0	0	0	0	0	0	0
05:30 PM	0	0	0	0	0	0	0	0	0	0	0	0	0	0	0	0	0	0	0	0	0
05:45 PM	0	0	0	0	0	0	0	0	0	0	0	0	0	0	0	0	0	0	0	0	0
Total Volume	0	0	0	0	0	0	0	0	0	0	0	0	0	0	0	0	0	0	0	0	0
% App. Total	0	0	0	0		0	0	0	0		0	0	0	0		0	0	0	0		
PHF	.000	.000	.000	.000	.000	.000	.000	.000	.000	.000	.000	.000	.000	.000	.000	.000	.000	.000	.000	.000	.000

City of Madera
 N/S: I Street
 E/W: 2nd St/SR-99 SB Off Ramp
 Weather: Clear

File Name : 33A_MDA_I St_4th St 99S Off Ramp PM
 Site Code : 00319628
 Start Date : 9/24/2019
 Page No : 2

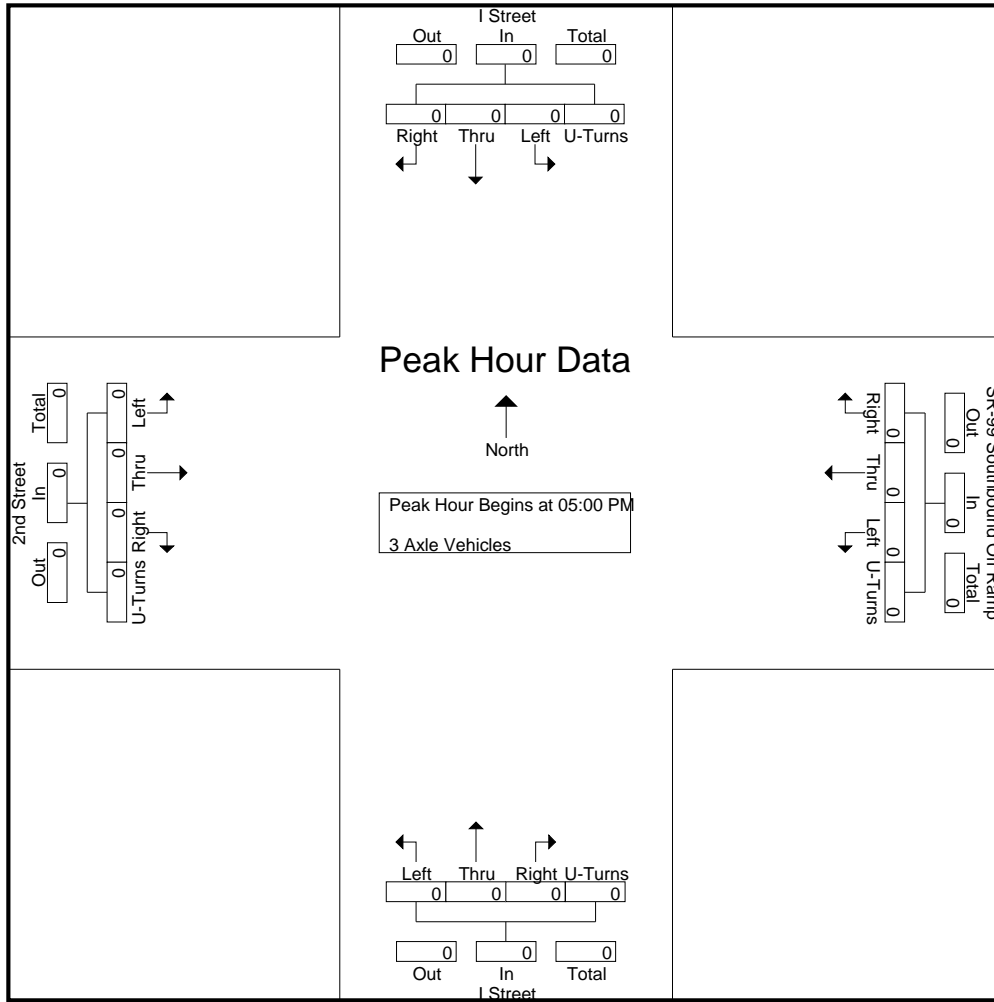

Peak Hour Analysis From 05:00 PM to 05:45 PM - Peak 1 of 1
 Peak Hour for Each Approach Begins at:

	05:00 PM					05:00 PM					05:00 PM					05:00 PM				
+0 mins.	0	0	0	0	0	0	0	0	0	0	0	0	0	0	0	0	0	0	0	0
+15 mins.	0	0	0	0	0	0	0	0	0	0	0	0	0	0	0	0	0	0	0	0
+30 mins.	0	0	0	0	0	0	0	0	0	0	0	0	0	0	0	0	0	0	0	0
+45 mins.	0	0	0	0	0	0	0	0	0	0	0	0	0	0	0	0	0	0	0	0
Total Volume	0	0	0	0	0	0	0	0	0	0	0	0	0	0	0	0	0	0	0	0
% App. Total	0	0	0	0	0	0	0	0	0	0	0	0	0	0	0	0	0	0	0	0
PHF	.000	.000	.000	.000	.000	.000	.000	.000	.000	.000	.000	.000	.000	.000	.000	.000	.000	.000	.000	.000

City of Madera
 N/S: I Street
 E/W: 2nd St/SR-99 SB Off Ramp
 Weather: Clear

File Name : 33A_MDA_I St_4th St 99S Off Ramp PM
 Site Code : 00319628
 Start Date : 9/24/2019
 Page No : 1

Groups Printed- 4+ Axle Trucks

Start Time	I Street Southbound					SR-99 Southbound Off Ramp Westbound					I Street Northbound					2nd Street Eastbound					Int. Total
	Left	Thru	Right	U-Turns	App. Total	Left	Thru	Right	U-Turns	App. Total	Left	Thru	Right	U-Turns	App. Total	Left	Thru	Right	U-Turns	App. Total	
04:00 PM	0	0	0	0	0	0	0	0	0	0	0	0	0	0	0	0	0	0	0	0	0
04:15 PM	0	0	0	0	0	0	0	0	0	0	0	0	0	0	0	0	0	0	0	0	0
04:30 PM	0	0	0	0	0	0	0	0	0	0	0	0	0	0	0	0	0	0	0	0	0
04:45 PM	0	0	0	0	0	2	0	0	0	2	0	0	0	0	0	0	0	0	0	0	2
Total	0	0	0	0	0	2	0	0	0	2	0	0	0	0	0	0	0	0	0	0	2
05:00 PM	0	0	0	0	0	0	0	0	0	0	0	0	0	0	0	0	0	0	0	0	0
05:15 PM	0	0	0	0	0	0	0	0	0	0	0	0	0	0	0	0	0	0	0	0	0
05:30 PM	0	0	0	0	0	3	0	0	0	3	0	0	0	0	0	0	0	0	0	0	3
05:45 PM	0	0	0	0	0	0	0	0	0	0	0	0	0	0	0	0	0	0	0	0	0
Total	0	0	0	0	0	3	0	0	0	3	0	0	0	0	0	0	0	0	0	0	3
Grand Total	0	0	0	0	0	5	0	0	0	5	0	0	0	0	0	0	0	0	0	0	5
Apprch %	0	0	0	0		100	0	0	0		0	0	0	0		0	0	0	0		
Total %	0	0	0	0	0	100	0	0	0	100	0	0	0	0	0	0	0	0	0	0	0

Start Time	I Street Southbound					SR-99 Southbound Off Ramp Westbound					I Street Northbound					2nd Street Eastbound					Int. Total
	Left	Thru	Right	U-Turns	App. Total	Left	Thru	Right	U-Turns	App. Total	Left	Thru	Right	U-Turns	App. Total	Left	Thru	Right	U-Turns	App. Total	
Peak Hour Analysis From 05:00 PM to 05:45 PM - Peak 1 of 1																					
Peak Hour for Entire Intersection Begins at 05:00 PM																					
05:00 PM	0	0	0	0	0	0	0	0	0	0	0	0	0	0	0	0	0	0	0	0	0
05:15 PM	0	0	0	0	0	0	0	0	0	0	0	0	0	0	0	0	0	0	0	0	0
05:30 PM	0	0	0	0	0	3	0	0	0	3	0	0	0	0	0	0	0	0	0	0	3
05:45 PM	0	0	0	0	0	0	0	0	0	0	0	0	0	0	0	0	0	0	0	0	0
Total Volume	0	0	0	0	0	3	0	0	0	3	0	0	0	0	0	0	0	0	0	0	3
% App. Total	0	0	0	0		100	0	0	0		0	0	0	0		0	0	0	0		
PHF	.000	.000	.000	.000	.000	.250	.000	.000	.000	.250	.000	.000	.000	.000	.000	.000	.000	.000	.000	.000	.250

City of Madera
 N/S: I Street
 E/W: 2nd St/SR-99 SB Off Ramp
 Weather: Clear

File Name : 33A_MDA_I St_4th St 99S Off Ramp PM
 Site Code : 00319628
 Start Date : 9/24/2019
 Page No : 2

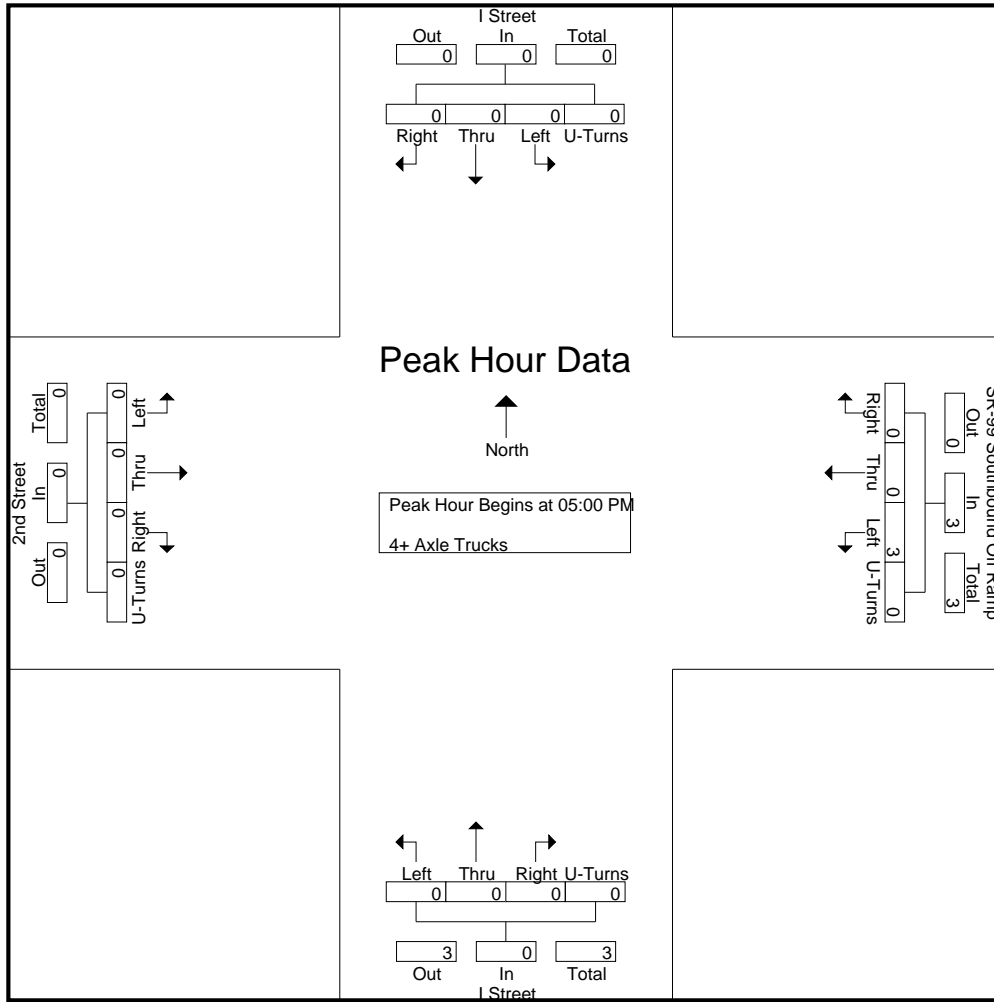

Peak Hour Analysis From 05:00 PM to 05:45 PM - Peak 1 of 1
 Peak Hour for Each Approach Begins at:

	05:00 PM					05:00 PM					05:00 PM					05:00 PM				
+0 mins.	0	0	0	0	0	0	0	0	0	0	0	0	0	0	0	0	0	0	0	0
+15 mins.	0	0	0	0	0	0	0	0	0	0	0	0	0	0	0	0	0	0	0	0
+30 mins.	0	0	0	0	0	3	0	0	0	3	0	0	0	0	0	0	0	0	0	0
+45 mins.	0	0	0	0	0	0	0	0	0	0	0	0	0	0	0	0	0	0	0	0
Total Volume	0	0	0	0	0	3	0	0	0	3	0	0	0	0	0	0	0	0	0	0
% App. Total	0	0	0	0	0	100	0	0	0	0	0	0	0	0	0	0	0	0	0	0
PHF	.000	.000	.000	.000	.000	.250	.000	.000	.000	.250	.000	.000	.000	.000	.000	.000	.000	.000	.000	.000

Location: Madera
 N/S: I Street
 E/W: 2nd St/SR-99 SB Off Ramp



Date: 9/24/2019
 Day: Tuesday

PEDESTRIANS

	North Leg I Street	East Leg SR-99 SB Off Ramp	South Leg I Street	West Leg 2nd Street	
	Pedestrians	Pedestrians	Pedestrians	Pedestrians	
7:00 AM	0	0	0	0	0
7:15 AM	0	0	0	1	1
7:30 AM	0	0	0	0	0
7:45 AM	0	0	0	0	0
8:00 AM	0	0	1	0	1
8:15 AM	0	0	0	0	0
8:30 AM	0	0	0	0	0
8:45 AM	0	0	0	0	0
TOTAL VOLUMES:	0	0	1	1	2

	North Leg I Street	East Leg SR-99 SB Off Ramp	South Leg I Street	West Leg 2nd Street	
	Pedestrians	Pedestrians	Pedestrians	Pedestrians	
4:00 PM	0	0	0	0	0
4:15 PM	0	0	0	0	0
4:30 PM	0	0	0	0	0
4:45 PM	0	0	0	0	0
5:00 PM	0	0	0	0	0
5:15 PM	0	1	0	0	1
5:30 PM	0	0	0	0	0
5:45 PM	0	0	0	1	1
TOTAL VOLUMES:	0	1	0	1	2

Location: Madera
 N/S: I Street
 E/W: 2nd St/SR-99 SB Off Ramp



Date: 9/24/2019
 Day: Tuesday

BICYCLES

	Southbound I Street			Westbound SR-99 SB Off Ramp			Northbound I Street			Eastbound 2nd Street			
	Left	Thru	Right	Left	Thru	Right	Left	Thru	Right	Left	Thru	Right	
7:00 AM	0	0	0	0	0	0	0	0	0	0	0	0	0
7:15 AM	0	0	0	0	0	0	0	0	0	0	0	0	0
7:30 AM	0	0	0	0	0	0	0	0	0	0	0	0	0
7:45 AM	0	0	0	0	0	0	0	0	0	0	0	0	0
8:00 AM	0	1	0	0	0	0	0	0	0	0	0	0	1
8:15 AM	0	1	0	0	0	0	0	0	0	0	0	0	1
8:30 AM	0	0	0	0	0	0	0	0	0	0	0	0	0
8:45 AM	0	0	0	0	0	0	1	0	0	0	0	0	1
TOTAL VOLUMES:	0	2	0	0	0	0	1	0	0	0	0	0	3

	Southbound I Street			Westbound SR-99 SB Off Ramp			Northbound I Street			Eastbound 2nd Street			
	Left	Thru	Right	Left	Thru	Right	Left	Thru	Right	Left	Thru	Right	
4:00 PM	0	0	0	0	0	0	0	0	0	0	0	0	0
4:15 PM	0	0	0	0	0	0	0	0	0	0	0	0	0
4:30 PM	0	0	0	0	0	0	0	0	0	0	0	0	0
4:45 PM	0	0	0	0	0	0	0	0	0	0	0	0	0
5:00 PM	0	0	0	0	0	0	0	0	0	0	0	0	0
5:15 PM	0	0	0	0	0	0	0	0	0	0	0	0	0
5:30 PM	0	0	0	0	0	0	1	0	0	0	0	0	1
5:45 PM	0	0	0	0	0	0	0	0	0	0	0	0	0
TOTAL VOLUMES:	0	0	0	0	0	0	1	0	0	0	0	0	1

City of Madera
 N/S: 4th Street
 E/W: Sunset Avenue
 Weather: Clear

File Name : 32_MDA_4th St_Sunset AM
 Site Code : 00319628
 Start Date : 9/24/2019
 Page No : 1

Groups Printed- Total Volume

Start Time	4th Street Southbound				4th Street Northbound				Sunset Avenue Eastbound				Int. Total
	Thru	Right	U-Turns	App. Total	Left	Thru	U-Turns	App. Total	Left	Right	U-Turns	App. Total	
07:00 AM	52	38	0	90	1	35	0	36	67	0	0	67	193
07:15 AM	116	44	0	160	3	60	0	63	86	8	0	94	317
07:30 AM	112	71	0	183	13	93	0	106	80	6	0	86	375
07:45 AM	96	79	0	175	10	80	0	90	107	6	0	113	378
Total	376	232	0	608	27	268	0	295	340	20	0	360	1263
08:00 AM	76	73	0	149	5	58	0	63	108	2	0	110	322
08:15 AM	58	68	0	126	9	41	0	50	74	5	0	79	255
08:30 AM	47	59	0	106	10	42	0	52	69	4	0	73	231
08:45 AM	56	28	0	84	2	39	0	41	59	3	0	62	187
Total	237	228	0	465	26	180	0	206	310	14	0	324	995
Grand Total	613	460	0	1073	53	448	0	501	650	34	0	684	2258
Apprch %	57.1	42.9	0		10.6	89.4	0		95	5	0		
Total %	27.1	20.4	0	47.5	2.3	19.8	0	22.2	28.8	1.5	0	30.3	

Start Time	4th Street Southbound				4th Street Northbound				Sunset Avenue Eastbound				Int. Total
	Thru	Right	U-Turns	App. Total	Left	Thru	U-Turns	App. Total	Left	Right	U-Turns	App. Total	
Peak Hour Analysis From 07:00 AM to 08:45 AM - Peak 1 of 1													
Peak Hour for Entire Intersection Begins at 07:15 AM													
07:15 AM	116	44	0	160	3	60	0	63	86	8	0	94	317
07:30 AM	112	71	0	183	13	93	0	106	80	6	0	86	375
07:45 AM	96	79	0	175	10	80	0	90	107	6	0	113	378
08:00 AM	76	73	0	149	5	58	0	63	108	2	0	110	322
Total Volume	400	267	0	667	31	291	0	322	381	22	0	403	1392
% App. Total	60	40	0		9.6	90.4	0		94.5	5.5	0		
PHF	.862	.845	.000	.911	.596	.782	.000	.759	.882	.688	.000	.892	.921

City of Madera
 N/S: 4th Street
 E/W: Sunset Avenue
 Weather: Clear

File Name : 32_MDA_4th St_Sunset AM
 Site Code : 00319628
 Start Date : 9/24/2019
 Page No : 2

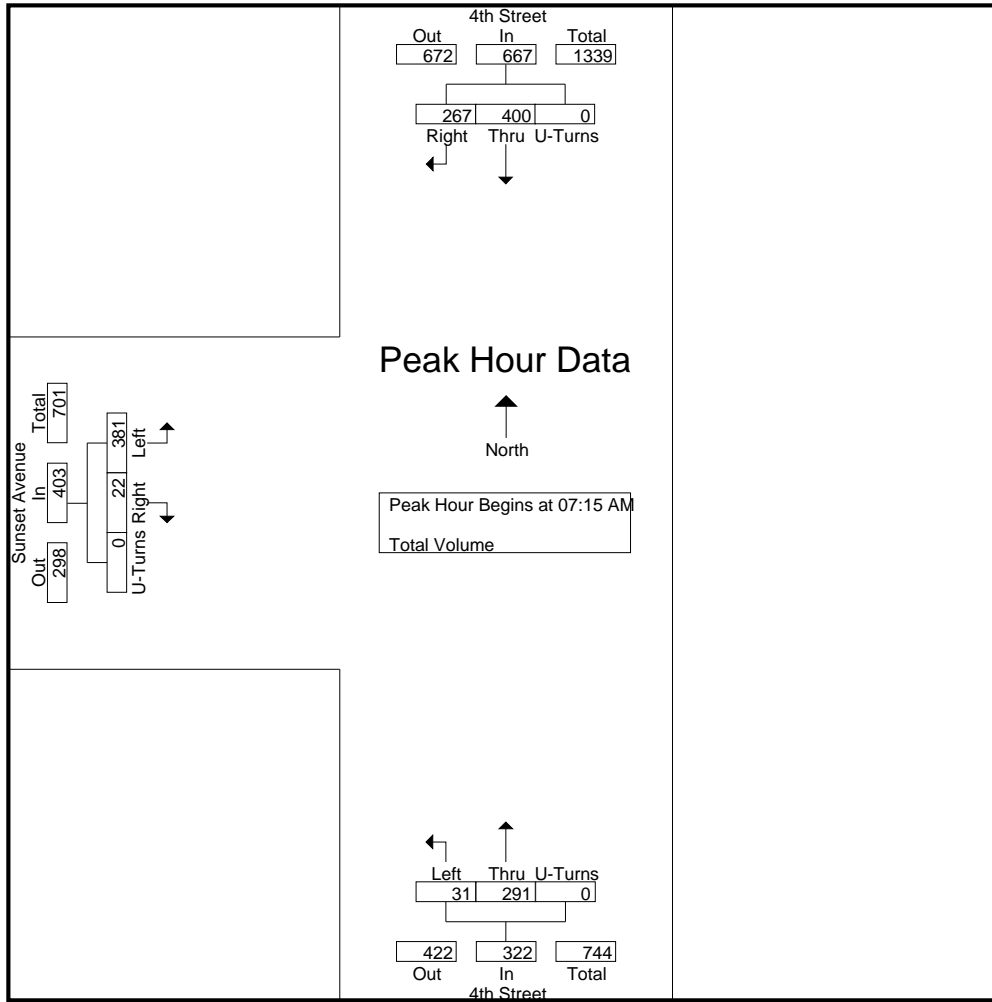

Peak Hour Analysis From 07:00 AM to 08:45 AM - Peak 1 of 1
 Peak Hour for Each Approach Begins at:

	07:15 AM				07:15 AM				07:15 AM			
+0 mins.	116	44	0	160	3	60	0	63	86	8	0	94
+15 mins.	112	71	0	183	13	93	0	106	80	6	0	86
+30 mins.	96	79	0	175	10	80	0	90	107	6	0	113
+45 mins.	76	73	0	149	5	58	0	63	108	2	0	110
Total Volume	400	267	0	667	31	291	0	322	381	22	0	403
% App. Total	60	40	0		9.6	90.4	0		94.5	5.5	0	
PHF	.862	.845	.000	.911	.596	.782	.000	.759	.882	.688	.000	.892

City of Madera
 N/S: 4th Street
 E/W: Sunset Avenue
 Weather: Clear

File Name : 32_MDA_4th St_Sunset PM
 Site Code : 00319628
 Start Date : 9/24/2019
 Page No : 1

Groups Printed- Total Volume

Start Time	4th Street Southbound				4th Street Northbound				Sunset Avenue Eastbound				Int. Total
	Thru	Right	U-Turns	App. Total	Left	Thru	U-Turns	App. Total	Left	Right	U-Turns	App. Total	
04:00 PM	85	76	0	161	1	84	0	85	54	1	0	55	301
04:15 PM	82	60	0	142	2	55	0	57	46	0	0	46	245
04:30 PM	82	62	0	144	3	86	0	89	51	5	0	56	289
04:45 PM	70	74	0	144	0	55	0	55	62	3	0	65	264
Total	319	272	0	591	6	280	0	286	213	9	0	222	1099
05:00 PM	97	114	0	211	2	73	0	75	51	3	0	54	340
05:15 PM	70	110	0	180	8	64	0	72	60	1	0	61	313
05:30 PM	67	84	0	151	1	57	0	58	49	3	0	52	261
05:45 PM	70	80	0	150	6	50	0	56	49	7	0	56	262
Total	304	388	0	692	17	244	0	261	209	14	0	223	1176
Grand Total	623	660	0	1283	23	524	0	547	422	23	0	445	2275
Apprch %	48.6	51.4	0		4.2	95.8	0		94.8	5.2	0		
Total %	27.4	29	0	56.4	1	23	0	24	18.5	1	0	19.6	

Start Time	4th Street Southbound				4th Street Northbound				Sunset Avenue Eastbound				Int. Total
	Thru	Right	U-Turns	App. Total	Left	Thru	U-Turns	App. Total	Left	Right	U-Turns	App. Total	
04:30 PM	82	62	0	144	3	86	0	89	51	5	0	56	289
04:45 PM	70	74	0	144	0	55	0	55	62	3	0	65	264
05:00 PM	97	114	0	211	2	73	0	75	51	3	0	54	340
05:15 PM	70	110	0	180	8	64	0	72	60	1	0	61	313
Total Volume	319	360	0	679	13	278	0	291	224	12	0	236	1206
% App. Total	47	53	0		4.5	95.5	0		94.9	5.1	0		
PHF	.822	.789	.000	.805	.406	.808	.000	.817	.903	.600	.000	.908	.887

Peak Hour Analysis From 04:00 PM to 05:45 PM - Peak 1 of 1

Peak Hour for Entire Intersection Begins at 04:30 PM

City of Madera
 N/S: 4th Street
 E/W: Sunset Avenue
 Weather: Clear

File Name : 32_MDA_4th St_Sunset PM
 Site Code : 00319628
 Start Date : 9/24/2019
 Page No : 2

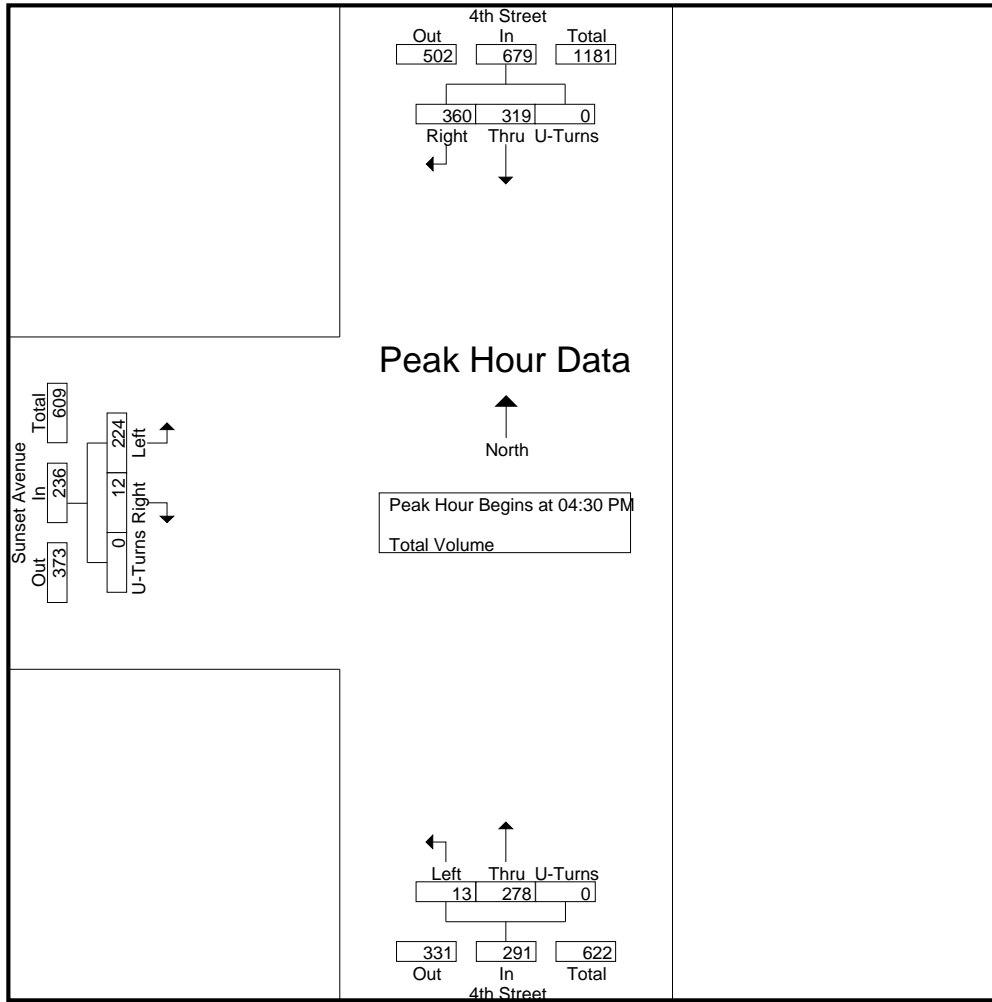

Peak Hour Analysis From 04:00 PM to 05:45 PM - Peak 1 of 1
 Peak Hour for Each Approach Begins at:

	05:00 PM				04:30 PM				04:30 PM			
+0 mins.	97	114	0	211	3	86	0	89	51	5	0	56
+15 mins.	70	110	0	180	0	55	0	55	62	3	0	65
+30 mins.	67	84	0	151	2	73	0	75	51	3	0	54
+45 mins.	70	80	0	150	8	64	0	72	60	1	0	61
Total Volume	304	388	0	692	13	278	0	291	224	12	0	236
% App. Total	43.9	56.1	0		4.5	95.5	0		94.9	5.1	0	
PHF	.784	.851	.000	.820	.406	.808	.000	.817	.903	.600	.000	.908

Location: Madera
 N/S: 4th Street
 E/W: Sunset Avenue



Date: 9/24/2019
 Day: Tuesday

PEDESTRIANS

	North Leg 4th Street	East Leg Dead End	South Leg 4th Street	West Leg Sunset Avenue	
	Pedestrians	Pedestrians	Pedestrians	Pedestrians	
7:00 AM	2	0	0	1	3
7:15 AM	1	0	0	0	1
7:30 AM	2	0	2	1	5
7:45 AM	3	0	1	1	5
8:00 AM	4	0	2	0	6
8:15 AM	9	0	3	0	12
8:30 AM	3	0	0	0	3
8:45 AM	1	0	0	0	1
TOTAL VOLUMES:	25	0	8	3	36

	North Leg 4th Street	East Leg Dead End	South Leg 4th Street	West Leg Sunset Avenue	
	Pedestrians	Pedestrians	Pedestrians	Pedestrians	
4:00 PM	0	0	0	0	0
4:15 PM	0	0	0	0	0
4:30 PM	0	0	7	0	7
4:45 PM	0	0	0	0	0
5:00 PM	1	0	0	0	1
5:15 PM	1	0	0	1	2
5:30 PM	0	0	0	0	0
5:45 PM	0	0	0	0	0
TOTAL VOLUMES:	2	0	7	1	10

Location: Madera
 N/S: 4th Street
 E/W: Sunset Avenue



Date: 9/24/2019
 Day: Tuesday

BICYCLES

	Southbound 4th Street			Westbound Dead End			Northbound 4th Street			Eastbound Sunset Avenue			
	Left	Thru	Right	Left	Thru	Right	Left	Thru	Right	Left	Thru	Right	
7:00 AM	0	0	0	0	0	0	0	0	0	2	0	0	2
7:15 AM	0	0	0	0	0	0	0	0	0	2	0	0	2
7:30 AM	0	0	0	0	0	0	0	0	0	1	0	1	2
7:45 AM	0	0	1	0	0	0	0	0	0	0	0	0	1
8:00 AM	0	0	0	0	0	0	0	0	0	0	0	0	0
8:15 AM	0	1	1	0	0	0	0	0	0	0	0	0	2
8:30 AM	0	0	0	0	0	0	0	0	0	0	0	0	0
8:45 AM	0	0	0	0	0	0	0	0	0	0	0	0	0
TOTAL VOLUMES:	0	1	2	0	0	0	0	0	0	5	0	1	9

	Southbound 4th Street			Westbound Dead End			Northbound 4th Street			Eastbound Sunset Avenue			
	Left	Thru	Right	Left	Thru	Right	Left	Thru	Right	Left	Thru	Right	
4:00 PM	0	0	0	0	0	0	0	0	0	0	0	0	0
4:15 PM	0	0	0	0	0	0	0	0	0	0	0	0	0
4:30 PM	0	0	0	0	0	0	0	0	0	0	0	0	0
4:45 PM	0	0	1	0	0	0	0	0	0	0	0	0	1
5:00 PM	0	0	0	0	1	0	0	1	0	0	0	0	2
5:15 PM	0	0	0	0	0	0	0	0	0	0	0	0	0
5:30 PM	0	0	0	0	0	0	0	0	0	0	0	0	0
5:45 PM	0	0	0	0	0	0	0	0	0	0	0	0	0
TOTAL VOLUMES:	0	0	1	0	1	0	0	1	0	0	0	0	3

City of Madera
 N/S: H Street
 E/W: SR-99 NB On Ramp/2nd Street
 Weather: Clear

File Name : 34A_MDA_H St_99N On Ramp AM
 Site Code : 00319628
 Start Date : 9/24/2019
 Page No : 1

Groups Printed- Passenger Vehicles - Large 2 Axle Vehicles - 3 Axle Vehicles - 4+ Axle Trucks

Start Time	H Street Southbound					2nd Street Westbound					H Street Northbound					SR-99 Northbound On Ramp Eastbound					Int. Total
	Left	Thru	Right	U-Turns	App. Total	Left	Thru	Right	U-Turns	App. Total	Left	Thru	Right	U-Turns	App. Total	Left	Thru	Right	U-Turns	App. Total	
07:00 AM	0	5	1	0	6	2	3	0	0	5	38	0	3	0	41	0	0	0	0	0	52
07:15 AM	0	8	0	0	8	3	3	0	0	6	48	5	1	0	54	0	0	0	0	0	68
07:30 AM	0	16	0	0	16	4	3	0	0	7	57	8	2	0	67	0	0	0	0	0	90
07:45 AM	0	6	1	0	7	8	7	0	0	15	84	5	2	0	91	0	0	0	0	0	113
Total	0	35	2	0	37	17	16	0	0	33	227	18	8	0	253	0	0	0	0	0	323
08:00 AM	0	7	1	0	8	0	3	0	0	3	57	7	2	0	66	0	0	0	0	0	77
08:15 AM	0	5	1	0	6	1	8	2	0	11	55	4	3	0	62	0	0	0	0	0	79
08:30 AM	1	7	0	0	8	1	3	0	0	4	40	5	1	0	46	0	0	0	0	0	58
08:45 AM	0	4	1	0	5	1	4	1	0	6	39	4	4	0	47	0	0	0	0	0	58
Total	1	23	3	0	27	3	18	3	0	24	191	20	10	0	221	0	0	0	0	0	272
Grand Total	1	58	5	0	64	20	34	3	0	57	418	38	18	0	474	0	0	0	0	0	595
Apprch %	1.6	90.6	7.8	0		35.1	59.6	5.3	0		88.2	8	3.8	0		0	0	0	0		
Total %	0.2	9.7	0.8	0	10.8	3.4	5.7	0.5	0	9.6	70.3	6.4	3	0	79.7	0	0	0	0	0	
Passenger Vehicles	100	100	100	0	100	100	97.1	100	0	98.2	94.3	94.7	100	0	94.5	0	0	0	0	0	95.5
Large 2 Axle Vehicles	0	0	0	0	0	0	2.9	0	0	1.8	4.3	5.3	0	0	4.2	0	0	0	0	0	3.5
3 Axle Vehicles	0	0	0	0	0	0	0	0	0	0	1	0	0	0	1	0	0	0	0	0	1
% 3 Axle Vehicles	0	0	0	0	0	0	0	0	0	0	0.2	0	0	0	0.2	0	0	0	0	0	0.2
4+ Axle Trucks	0	0	0	0	0	0	0	0	0	0	5	0	0	0	5	0	0	0	0	0	5
% 4+ Axle Trucks																					

Start Time	H Street Southbound					2nd Street Westbound					H Street Northbound					SR-99 Northbound On Ramp Eastbound					Int. Total
	Left	Thru	Right	U-Turns	App. Total	Left	Thru	Right	U-Turns	App. Total	Left	Thru	Right	U-Turns	App. Total	Left	Thru	Right	U-Turns	App. Total	
07:30 AM	0	16	0	0	16	4	3	0	0	7	57	8	2	0	67	0	0	0	0	0	90
07:45 AM	0	6	1	0	7	8	7	0	0	15	84	5	2	0	91	0	0	0	0	0	113
08:00 AM	0	7	1	0	8	0	3	0	0	3	57	7	2	0	66	0	0	0	0	0	77
08:15 AM	0	5	1	0	6	1	8	2	0	11	55	4	3	0	62	0	0	0	0	0	79
Total Volume	0	34	3	0	37	13	21	2	0	36	253	24	9	0	286	0	0	0	0	0	359
% App. Total	0	91.9	8.1	0		36.1	58.3	5.6	0		88.5	8.4	3.1	0		0	0	0	0		
PHF	.000	.531	.750	.000	.578	.406	.656	.250	.000	.600	.753	.750	.750	.000	.786	.000	.000	.000	.000	.000	.794

Peak Hour Analysis From 07:00 AM to 08:45 AM - Peak 1 of 1
 Peak Hour for Entire Intersection Begins at 07:30 AM

City of Madera
 N/S: H Street
 E/W: SR-99 NB On Ramp/2nd Street
 Weather: Clear

File Name : 34A_MDA_H St_99N On Ramp AM
 Site Code : 00319628
 Start Date : 9/24/2019
 Page No : 2

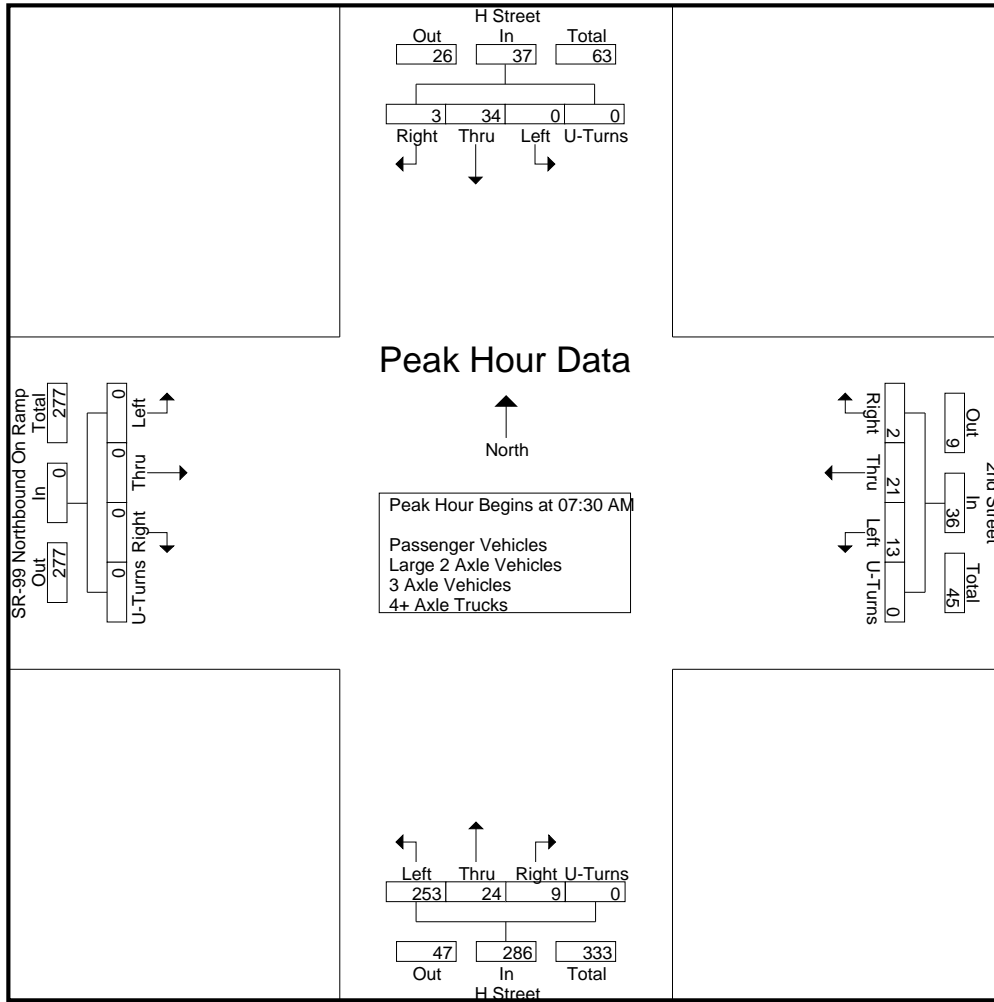

Peak Hour Analysis From 07:00 AM to 08:45 AM - Peak 1 of 1
 Peak Hour for Each Approach Begins at:

	07:15 AM					07:30 AM					07:45 AM					07:00 AM				
+0 mins.	0	8	0	0	8	4	3	0	0	7	57	8	2	0	67	0	0	0	0	0
+15 mins.	0	16	0	0	16	8	7	0	0	15	84	5	2	0	91	0	0	0	0	0
+30 mins.	0	6	1	0	7	0	3	0	0	3	57	7	2	0	66	0	0	0	0	0
+45 mins.	0	7	1	0	8	1	8	2	0	11	55	4	3	0	62	0	0	0	0	0
Total Volume	0	37	2	0	39	13	21	2	0	36	253	24	9	0	286	0	0	0	0	0
% App. Total	0	94.9	5.1	0		36.1	58.3	5.6	0		88.5	8.4	3.1	0		0	0	0	0	0
PHF	.000	.578	.500	.000	.609	.406	.656	.250	.000	.600	.753	.750	.750	.000	.786	.000	.000	.000	.000	.000

City of Madera
 N/S: H Street
 E/W: SR-99 NB On Ramp/2nd Street
 Weather: Clear

File Name : 34A_MDA_H St_99N On Ramp AM
 Site Code : 00319628
 Start Date : 9/24/2019
 Page No : 2

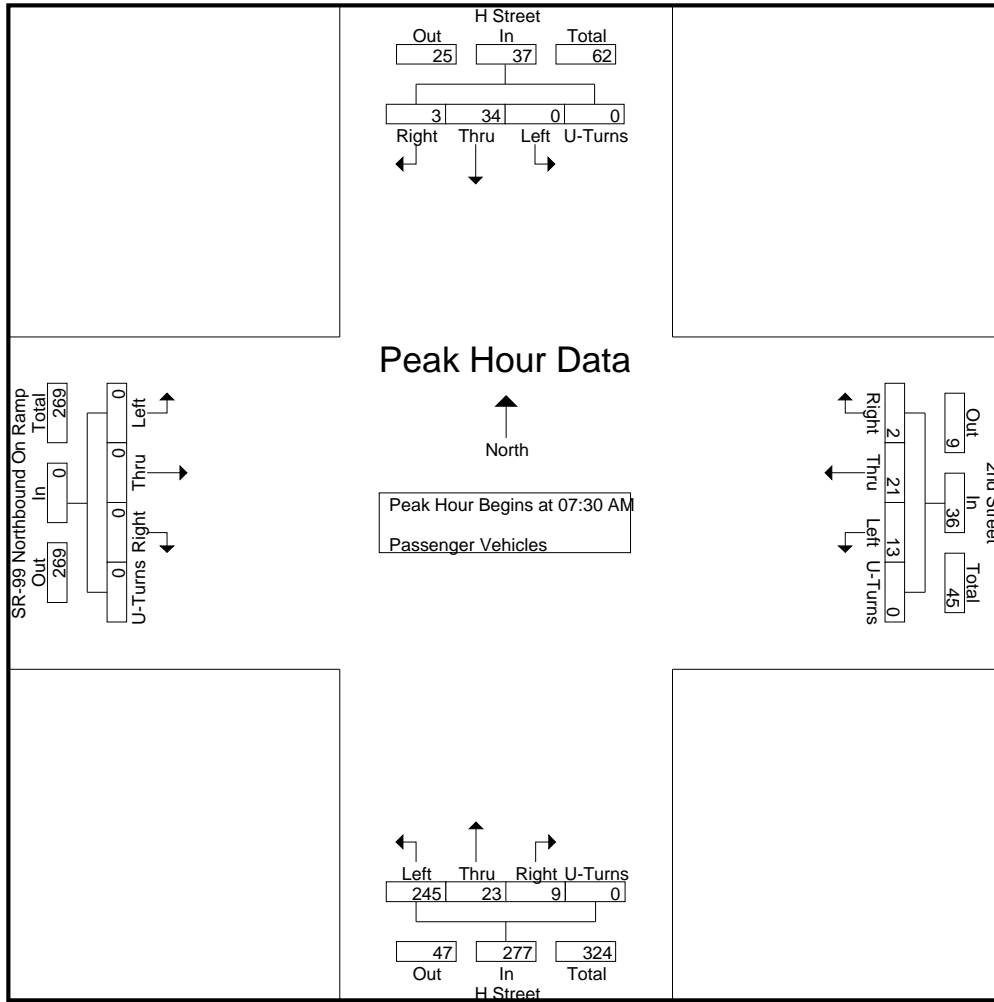

Peak Hour Analysis From 07:30 AM to 08:15 AM - Peak 1 of 1
 Peak Hour for Each Approach Begins at:

	07:30 AM					07:30 AM					07:30 AM									
+0 mins.	0	16	0	0	16	4	3	0	0	7	53	7	2	0	62	0	0	0	0	0
+15 mins.	0	6	1	0	7	8	7	0	0	15	83	5	2	0	90	0	0	0	0	0
+30 mins.	0	7	1	0	8	0	3	0	0	3	55	7	2	0	64	0	0	0	0	0
+45 mins.	0	5	1	0	6	1	8	2	0	11	54	4	3	0	61	0	0	0	0	0
Total Volume	0	34	3	0	37	13	21	2	0	36	245	23	9	0	277	0	0	0	0	0
% App. Total	0	91.9	8.1	0		36.1	58.3	5.6	0		88.4	8.3	3.2	0		0	0	0	0	
PHF	.000	.531	.750	.000	.578	.406	.656	.250	.000	.600	.738	.821	.750	.000	.769	.000	.000	.000	.000	.000

City of Madera
 N/S: H Street
 E/W: SR-99 NB On Ramp/2nd Street
 Weather: Clear

File Name : 34A_MDA_H St_99N On Ramp AM
 Site Code : 00319628
 Start Date : 9/24/2019
 Page No : 1

Groups Printed- Large 2 Axle Vehicles

Start Time	H Street Southbound					2nd Street Westbound					H Street Northbound					SR-99 Northbound On Ramp Eastbound					Int. Total
	Left	Thru	Right	U-Turns	App. Total	Left	Thru	Right	U-Turns	App. Total	Left	Thru	Right	U-Turns	App. Total	Left	Thru	Right	U-Turns	App. Total	
07:00 AM	0	0	0	0	0	0	0	0	0	0	6	0	0	0	6	0	0	0	0	0	6
07:15 AM	0	0	0	0	0	0	1	0	0	1	2	1	0	0	3	0	0	0	0	0	4
07:30 AM	0	0	0	0	0	0	0	0	0	0	4	1	0	0	5	0	0	0	0	0	5
07:45 AM	0	0	0	0	0	0	0	0	0	0	0	0	0	0	0	0	0	0	0	0	0
Total	0	0	0	0	0	0	1	0	0	1	12	2	0	0	14	0	0	0	0	0	15
08:00 AM	0	0	0	0	0	0	0	0	0	0	1	0	0	0	1	0	0	0	0	0	1
08:15 AM	0	0	0	0	0	0	0	0	0	0	0	0	0	0	0	0	0	0	0	0	0
08:30 AM	0	0	0	0	0	0	0	0	0	0	3	0	0	0	3	0	0	0	0	0	3
08:45 AM	0	0	0	0	0	0	0	0	0	0	2	0	0	0	2	0	0	0	0	0	2
Total	0	0	0	0	0	0	0	0	0	0	6	0	0	0	6	0	0	0	0	0	6
Grand Total	0	0	0	0	0	0	1	0	0	1	18	2	0	0	20	0	0	0	0	0	21
Apprch %	0	0	0	0		0	100	0	0		90	10	0	0		0	0	0	0		
Total %	0	0	0	0		0	4.8	0	0	4.8	85.7	9.5	0	0	95.2	0	0	0	0		

Start Time	H Street Southbound					2nd Street Westbound					H Street Northbound					SR-99 Northbound On Ramp Eastbound					Int. Total
	Left	Thru	Right	U-Turns	App. Total	Left	Thru	Right	U-Turns	App. Total	Left	Thru	Right	U-Turns	App. Total	Left	Thru	Right	U-Turns	App. Total	
Peak Hour Analysis From 07:30 AM to 08:15 AM - Peak 1 of 1																					
Peak Hour for Entire Intersection Begins at 07:30 AM																					
07:30 AM	0	0	0	0	0	0	0	0	0	0	4	1	0	0	5	0	0	0	0	0	5
07:45 AM	0	0	0	0	0	0	0	0	0	0	0	0	0	0	0	0	0	0	0	0	0
08:00 AM	0	0	0	0	0	0	0	0	0	0	1	0	0	0	1	0	0	0	0	0	1
08:15 AM	0	0	0	0	0	0	0	0	0	0	0	0	0	0	0	0	0	0	0	0	0
Total Volume	0	0	0	0	0	0	0	0	0	0	5	1	0	0	6	0	0	0	0	0	6
% App. Total	0	0	0	0		0	0	0	0		83.3	16.7	0	0		0	0	0	0		
PHF	.000	.000	.000	.000	.000	.000	.000	.000	.000	.000	.313	.250	.000	.000	.300	.000	.000	.000	.000	.000	.300

City of Madera
 N/S: H Street
 E/W: SR-99 NB On Ramp/2nd Street
 Weather: Clear

File Name : 34A_MDA_H St_99N On Ramp AM
 Site Code : 00319628
 Start Date : 9/24/2019
 Page No : 2

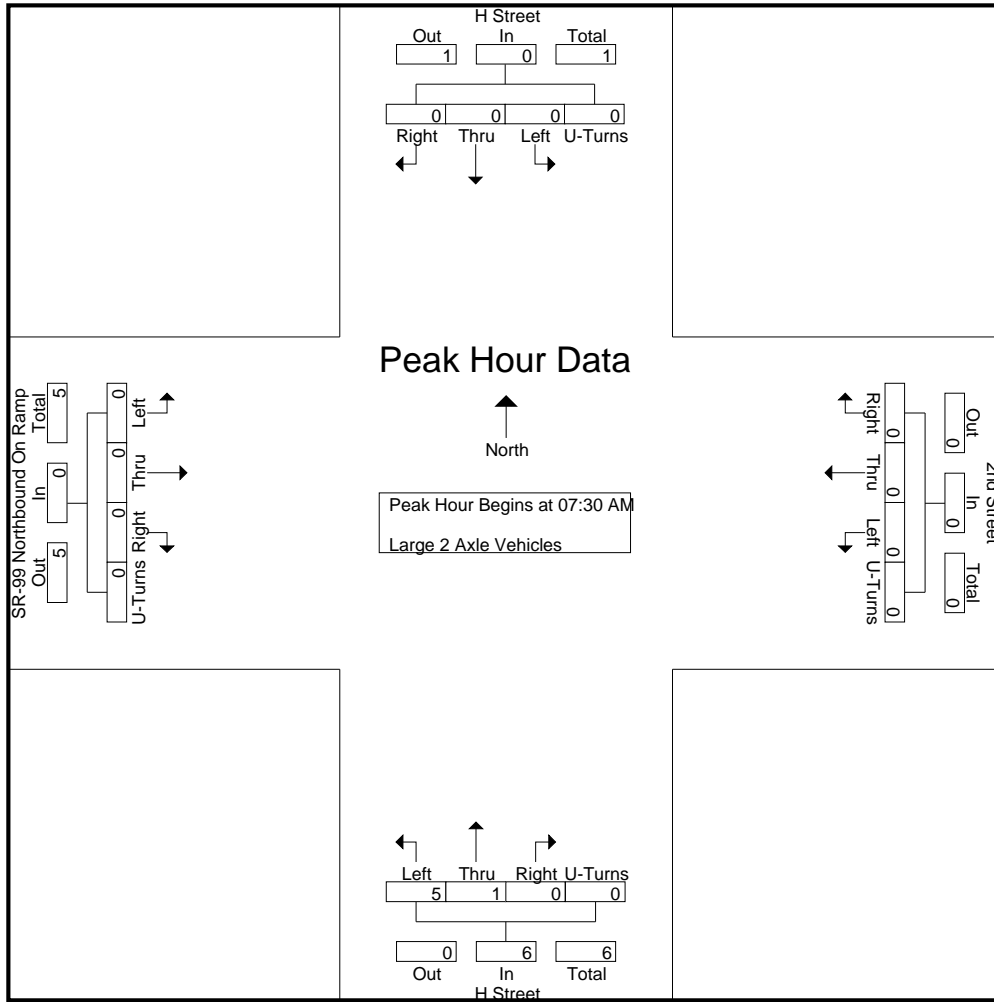

Peak Hour Analysis From 07:30 AM to 08:15 AM - Peak 1 of 1
 Peak Hour for Each Approach Begins at:

	07:30 AM					07:30 AM					07:30 AM									
+0 mins.	0	0	0	0	0	0	0	0	0	0	4	1	0	0	5	0	0	0	0	0
+15 mins.	0	0	0	0	0	0	0	0	0	0	0	0	0	0	0	0	0	0	0	0
+30 mins.	0	0	0	0	0	0	0	0	0	0	1	0	0	0	1	0	0	0	0	0
+45 mins.	0	0	0	0	0	0	0	0	0	0	0	0	0	0	0	0	0	0	0	0
Total Volume	0	0	0	0	0	0	0	0	0	0	5	1	0	0	6	0	0	0	0	0
% App. Total	0	0	0	0	0	0	0	0	0	0	83.3	16.7	0	0	0	0	0	0	0	0
PHF	.000	.000	.000	.000	.000	.000	.000	.000	.000	.000	.313	.250	.000	.000	.300	.000	.000	.000	.000	.000

City of Madera
 N/S: H Street
 E/W: SR-99 NB On Ramp/2nd Street
 Weather: Clear

File Name : 34A_MDA_H St_99N On Ramp AM
 Site Code : 00319628
 Start Date : 9/24/2019
 Page No : 1

Groups Printed- 3 Axle Vehicles

Start Time	H Street Southbound					2nd Street Westbound					H Street Northbound					SR-99 Northbound On Ramp Eastbound					Int. Total
	Left	Thru	Right	U-Turns	App. Total	Left	Thru	Right	U-Turns	App. Total	Left	Thru	Right	U-Turns	App. Total	Left	Thru	Right	U-Turns	App. Total	
07:00 AM	0	0	0	0	0	0	0	0	0	0	1	0	0	0	1	0	0	0	0	0	1
07:15 AM	0	0	0	0	0	0	0	0	0	0	0	0	0	0	0	0	0	0	0	0	0
07:30 AM	0	0	0	0	0	0	0	0	0	0	0	0	0	0	0	0	0	0	0	0	0
07:45 AM	0	0	0	0	0	0	0	0	0	0	0	0	0	0	0	0	0	0	0	0	0
Total	0	0	0	0	0	0	0	0	0	0	1	0	0	0	1	0	0	0	0	0	1
08:00 AM	0	0	0	0	0	0	0	0	0	0	0	0	0	0	0	0	0	0	0	0	0
08:15 AM	0	0	0	0	0	0	0	0	0	0	0	0	0	0	0	0	0	0	0	0	0
08:30 AM	0	0	0	0	0	0	0	0	0	0	0	0	0	0	0	0	0	0	0	0	0
08:45 AM	0	0	0	0	0	0	0	0	0	0	0	0	0	0	0	0	0	0	0	0	0
Total	0	0	0	0	0	0	0	0	0	0	0	0	0	0	0	0	0	0	0	0	0
Grand Total	0	0	0	0	0	0	0	0	0	0	1	0	0	0	1	0	0	0	0	0	1
Apprch %	0	0	0	0		0	0	0	0		100	0	0	0		0	0	0	0		
Total %	0	0	0	0	0	0	0	0	0	0	100	0	0	0	100	0	0	0	0	0	0

Start Time	H Street Southbound					2nd Street Westbound					H Street Northbound					SR-99 Northbound On Ramp Eastbound					Int. Total
	Left	Thru	Right	U-Turns	App. Total	Left	Thru	Right	U-Turns	App. Total	Left	Thru	Right	U-Turns	App. Total	Left	Thru	Right	U-Turns	App. Total	
Peak Hour Analysis From 07:30 AM to 08:15 AM - Peak 1 of 1																					
Peak Hour for Entire Intersection Begins at 07:30 AM																					
07:30 AM	0	0	0	0	0	0	0	0	0	0	0	0	0	0	0	0	0	0	0	0	0
07:45 AM	0	0	0	0	0	0	0	0	0	0	0	0	0	0	0	0	0	0	0	0	0
08:00 AM	0	0	0	0	0	0	0	0	0	0	0	0	0	0	0	0	0	0	0	0	0
08:15 AM	0	0	0	0	0	0	0	0	0	0	0	0	0	0	0	0	0	0	0	0	0
Total Volume	0	0	0	0	0	0	0	0	0	0	0	0	0	0	0	0	0	0	0	0	0
% App. Total	0	0	0	0		0	0	0	0		0	0	0	0		0	0	0	0		
PHF	.000	.000	.000	.000	.000	.000	.000	.000	.000	.000	.000	.000	.000	.000	.000	.000	.000	.000	.000	.000	.000

City of Madera
 N/S: H Street
 E/W: SR-99 NB On Ramp/2nd Street
 Weather: Clear

File Name : 34A_MDA_H St_99N On Ramp AM
 Site Code : 00319628
 Start Date : 9/24/2019
 Page No : 2

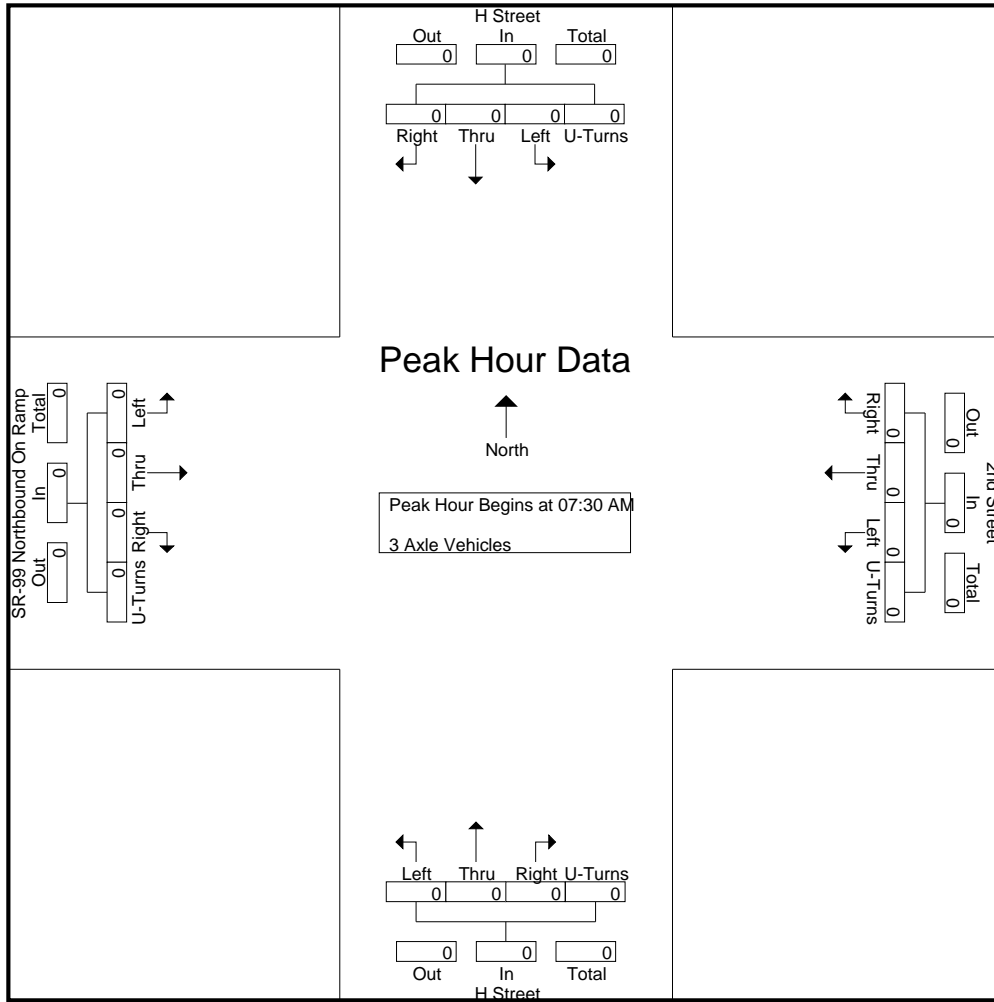

Peak Hour Analysis From 07:30 AM to 08:15 AM - Peak 1 of 1
 Peak Hour for Each Approach Begins at:

	07:30 AM					07:30 AM					07:30 AM					07:30 AM									
+0 mins.	0	0	0	0	0	0	0	0	0	0	0	0	0	0	0	0	0	0	0	0	0	0	0	0	0
+15 mins.	0	0	0	0	0	0	0	0	0	0	0	0	0	0	0	0	0	0	0	0	0	0	0	0	0
+30 mins.	0	0	0	0	0	0	0	0	0	0	0	0	0	0	0	0	0	0	0	0	0	0	0	0	0
+45 mins.	0	0	0	0	0	0	0	0	0	0	0	0	0	0	0	0	0	0	0	0	0	0	0	0	0
Total Volume	0	0	0	0	0	0	0	0	0	0	0	0	0	0	0	0	0	0	0	0	0	0	0	0	0
% App. Total	0	0	0	0	0	0	0	0	0	0	0	0	0	0	0	0	0	0	0	0	0	0	0	0	0
PHF	.000	.000	.000	.000	.000	.000	.000	.000	.000	.000	.000	.000	.000	.000	.000	.000	.000	.000	.000	.000	.000	.000	.000	.000	.000

City of Madera
 N/S: H Street
 E/W: SR-99 NB On Ramp/2nd Street
 Weather: Clear

File Name : 34A_MDA_H St_99N On Ramp AM
 Site Code : 00319628
 Start Date : 9/24/2019
 Page No : 1

Groups Printed- 4+ Axle Trucks

Start Time	H Street Southbound					2nd Street Westbound					H Street Northbound					SR-99 Northbound On Ramp Eastbound					Int. Total
	Left	Thru	Right	U-Turns	App. Total	Left	Thru	Right	U-Turns	App. Total	Left	Thru	Right	U-Turns	App. Total	Left	Thru	Right	U-Turns	App. Total	
07:00 AM	0	0	0	0	0	0	0	0	0	0	0	0	0	0	0	0	0	0	0	0	0
07:15 AM	0	0	0	0	0	0	0	0	0	0	1	0	0	0	1	0	0	0	0	0	0
07:30 AM	0	0	0	0	0	0	0	0	0	0	0	0	0	0	0	0	0	0	0	0	0
07:45 AM	0	0	0	0	0	0	0	0	0	0	1	0	0	0	1	0	0	0	0	0	0
Total	0	0	0	0	0	0	0	0	0	0	2	0	0	0	2	0	0	0	0	0	2
08:00 AM	0	0	0	0	0	0	0	0	0	0	1	0	0	0	1	0	0	0	0	0	0
08:15 AM	0	0	0	0	0	0	0	0	0	0	1	0	0	0	1	0	0	0	0	0	0
08:30 AM	0	0	0	0	0	0	0	0	0	0	0	0	0	0	0	0	0	0	0	0	0
08:45 AM	0	0	0	0	0	0	0	0	0	0	1	0	0	0	1	0	0	0	0	0	0
Total	0	0	0	0	0	0	0	0	0	0	3	0	0	0	3	0	0	0	0	0	3
Grand Total	0	0	0	0	0	0	0	0	0	0	5	0	0	0	5	0	0	0	0	0	5
Apprch %	0	0	0	0		0	0	0	0		100	0	0	0		0	0	0	0		
Total %	0	0	0	0	0	0	0	0	0	0	100	0	0	0	100	0	0	0	0	0	0

Start Time	H Street Southbound					2nd Street Westbound					H Street Northbound					SR-99 Northbound On Ramp Eastbound					Int. Total
	Left	Thru	Right	U-Turns	App. Total	Left	Thru	Right	U-Turns	App. Total	Left	Thru	Right	U-Turns	App. Total	Left	Thru	Right	U-Turns	App. Total	
Peak Hour Analysis From 07:30 AM to 08:15 AM - Peak 1 of 1																					
Peak Hour for Entire Intersection Begins at 07:30 AM																					
07:30 AM	0	0	0	0	0	0	0	0	0	0	0	0	0	0	0	0	0	0	0	0	0
07:45 AM	0	0	0	0	0	0	0	0	0	0	1	0	0	0	1	0	0	0	0	0	0
08:00 AM	0	0	0	0	0	0	0	0	0	0	1	0	0	0	1	0	0	0	0	0	0
08:15 AM	0	0	0	0	0	0	0	0	0	0	1	0	0	0	1	0	0	0	0	0	0
Total Volume	0	0	0	0	0	0	0	0	0	0	3	0	0	0	3	0	0	0	0	0	3
% App. Total	0	0	0	0		0	0	0	0		100	0	0	0		0	0	0	0		
PHF	.000	.000	.000	.000	.000	.000	.000	.000	.000	.000	.750	.000	.000	.000	.750	.000	.000	.000	.000	.000	.750

City of Madera
 N/S: H Street
 E/W: SR-99 NB On Ramp/2nd Street
 Weather: Clear

File Name : 34A_MDA_H St_99N On Ramp AM
 Site Code : 00319628
 Start Date : 9/24/2019
 Page No : 2

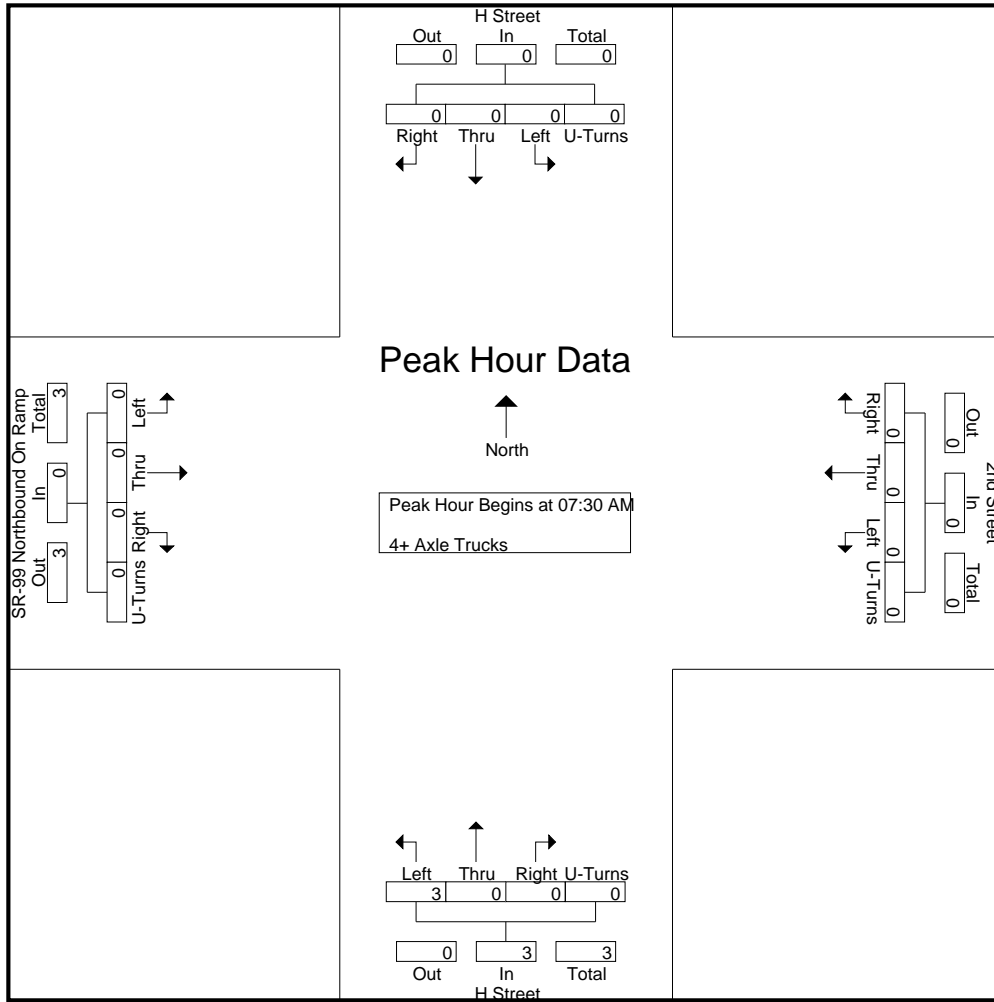

Peak Hour Analysis From 07:30 AM to 08:15 AM - Peak 1 of 1
 Peak Hour for Each Approach Begins at:

	07:30 AM					07:30 AM					07:30 AM									
+0 mins.	0	0	0	0	0	0	0	0	0	0	0	0	0	0	0	0	0	0	0	0
+15 mins.	0	0	0	0	0	0	0	0	0	0	1	0	0	0	1	0	0	0	0	0
+30 mins.	0	0	0	0	0	0	0	0	0	0	1	0	0	0	1	0	0	0	0	0
+45 mins.	0	0	0	0	0	0	0	0	0	0	1	0	0	0	1	0	0	0	0	0
Total Volume	0	0	0	0	0	0	0	0	0	0	3	0	0	0	3	0	0	0	0	0
% App. Total	0	0	0	0	0	0	0	0	0	0	100	0	0	0	0	0	0	0	0	0
PHF	.000	.000	.000	.000	.000	.000	.000	.000	.000	.000	.750	.000	.000	.000	.750	.000	.000	.000	.000	.000

City of Madera
 N/S: H Street
 E/W: SR-99 NB On Ramp/2nd Street
 Weather: Clear

File Name : 34A_MDA_H St_99N On Ramp PM
 Site Code : 00319628
 Start Date : 9/24/2019
 Page No : 1

Groups Printed- Passenger Vehicles - Large 2 Axle Vehicles - 3 Axle Vehicles - 4+ Axle Trucks

Start Time	H Street Southbound					2nd Street Westbound					H Street Northbound					SR-99 Northbound On Ramp Eastbound					Int. Total
	Left	Thru	Right	U-Turns	App. Total	Left	Thru	Right	U-Turns	App. Total	Left	Thru	Right	U-Turns	App. Total	Left	Thru	Right	U-Turns	App. Total	
04:00 PM	0	8	0	0	8	2	4	1	0	7	75	8	3	0	86	0	0	0	0	0	101
04:15 PM	0	6	0	0	6	1	8	0	0	9	53	9	6	0	68	0	0	0	0	0	83
04:30 PM	0	4	0	0	4	1	6	0	0	7	61	9	4	0	74	0	0	0	0	0	85
04:45 PM	0	6	0	0	6	2	8	0	0	10	67	5	5	0	77	0	0	0	0	0	93
Total	0	24	0	0	24	6	26	1	0	33	256	31	18	0	305	0	0	0	0	0	362
05:00 PM	2	3	0	0	5	0	26	1	0	27	82	5	3	0	90	0	0	0	0	0	122
05:15 PM	0	7	0	0	7	7	7	1	0	15	62	6	3	0	71	0	0	0	0	0	93
05:30 PM	0	8	0	0	8	2	11	2	0	15	51	11	1	0	63	0	0	0	0	0	86
05:45 PM	1	11	0	0	12	2	2	0	0	4	46	8	2	0	56	0	0	0	0	0	72
Total	3	29	0	0	32	11	46	4	0	61	241	30	9	0	280	0	0	0	0	0	373
Grand Total	3	53	0	0	56	17	72	5	0	94	497	61	27	0	585	0	0	0	0	0	735
Apprch %	5.4	94.6	0	0		18.1	76.6	5.3	0		85	10.4	4.6	0		0	0	0	0		
Total %	0.4	7.2	0	0	7.6	2.3	9.8	0.7	0	12.8	67.6	8.3	3.7	0	79.6	0	0	0	0	0	
Passenger Vehicles	100	98.1	0	0	98.2	100	100	100	0	100	96.6	96.7	100	0	96.8	0	0	0	0	0	97.3
Large 2 Axle Vehicles	0	1.9	0	0	1.8	0	0	0	0	0	2.2	3.3	0	0	2.2	0	0	0	0	0	1.9
3 Axle Vehicles	0	0	0	0	0	0	0	0	0	0	1	0	0	0	1	0	0	0	0	0	1
% 3 Axle Vehicles	0	0	0	0	0	0	0	0	0	0	0.2	0	0	0	0.2	0	0	0	0	0	0.1
4+ Axle Trucks	0	0	0	0	0	0	0	0	0	0	5	0	0	0	5	0	0	0	0	0	5
% 4+ Axle Trucks																					

Start Time	H Street Southbound					2nd Street Westbound					H Street Northbound					SR-99 Northbound On Ramp Eastbound					Int. Total
	Left	Thru	Right	U-Turns	App. Total	Left	Thru	Right	U-Turns	App. Total	Left	Thru	Right	U-Turns	App. Total	Left	Thru	Right	U-Turns	App. Total	
Peak Hour Analysis From 04:00 PM to 05:45 PM - Peak 1 of 1																					
Peak Hour for Entire Intersection Begins at 04:45 PM																					
04:45 PM	0	6	0	0	6	2	8	0	0	10	67	5	5	0	77	0	0	0	0	0	93
05:00 PM	2	3	0	0	5	0	26	1	0	27	82	5	3	0	90	0	0	0	0	0	122
05:15 PM	0	7	0	0	7	7	7	1	0	15	62	6	3	0	71	0	0	0	0	0	93
05:30 PM	0	8	0	0	8	2	11	2	0	15	51	11	1	0	63	0	0	0	0	0	86
Total Volume	2	24	0	0	26	11	52	4	0	67	262	27	12	0	301	0	0	0	0	0	394
% App. Total	7.7	92.3	0	0		16.4	77.6	6	0		87	9	4	0		0	0	0	0		
PHF	.250	.750	.000	.000	.813	.393	.500	.500	.000	.620	.799	.614	.600	.000	.836	.000	.000	.000	.000	.000	.807

City of Madera
 N/S: H Street
 E/W: SR-99 NB On Ramp/2nd Street
 Weather: Clear

File Name : 34A_MDA_H St_99N On Ramp PM
 Site Code : 00319628
 Start Date : 9/24/2019
 Page No : 2

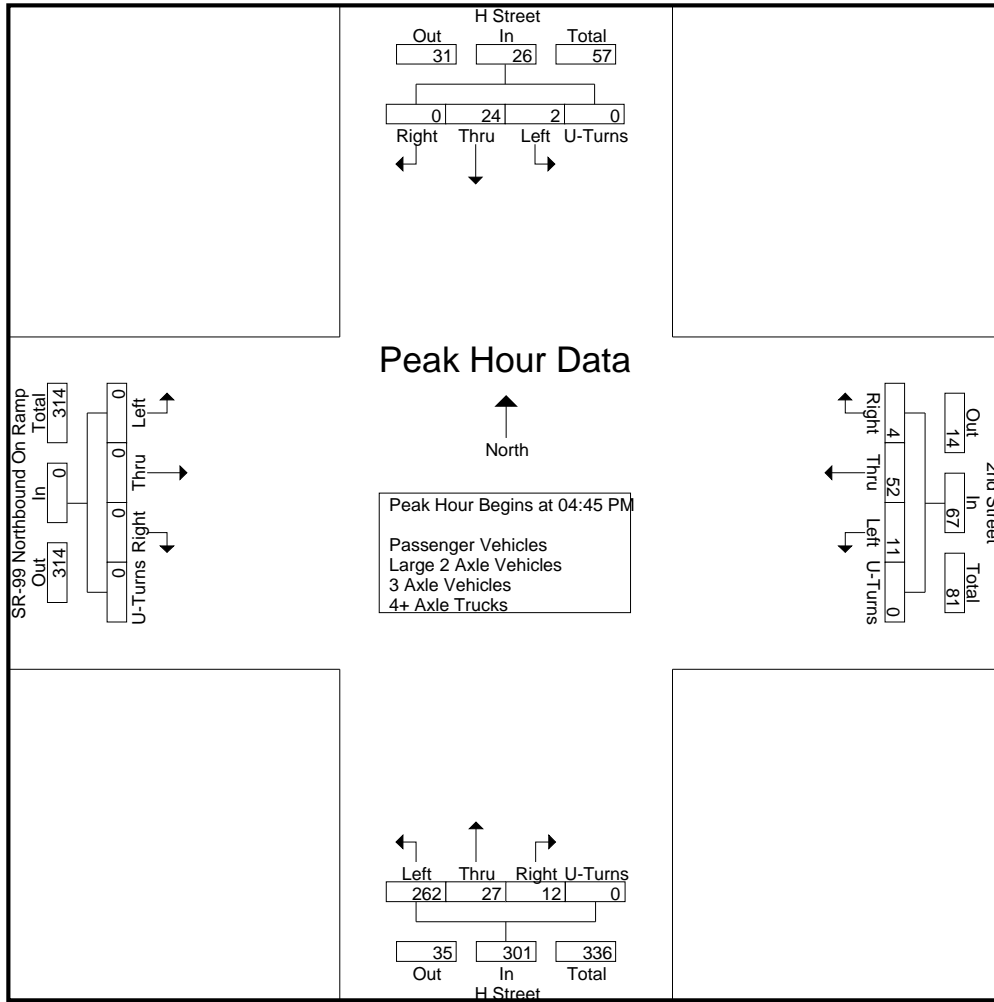

Peak Hour Analysis From 04:00 PM to 05:45 PM - Peak 1 of 1
 Peak Hour for Each Approach Begins at:

	05:00 PM					04:45 PM					04:30 PM					04:00 PM				
+0 mins.	2	3	0	0	5	2	8	0	0	10	61	9	4	0	74	0	0	0	0	0
+15 mins.	0	7	0	0	7	0	26	1	0	27	67	5	5	0	77	0	0	0	0	0
+30 mins.	0	8	0	0	8	7	7	1	0	15	82	5	3	0	90	0	0	0	0	0
+45 mins.	1	11	0	0	12	2	11	2	0	15	62	6	3	0	71	0	0	0	0	0
Total Volume	3	29	0	0	32	11	52	4	0	67	272	25	15	0	312	0	0	0	0	0
% App. Total	9.4	90.6	0	0		16.4	77.6	6	0		87.2	8	4.8	0		0	0	0	0	
PHF	.375	.659	.000	.000	.667	.393	.500	.500	.000	.620	.829	.694	.750	.000	.867	.000	.000	.000	.000	.000

City of Madera
 N/S: H Street
 E/W: SR-99 NB On Ramp/2nd Street
 Weather: Clear

File Name : 34A_MDA_H St_99N On Ramp PM
 Site Code : 00319628
 Start Date : 9/24/2019
 Page No : 2

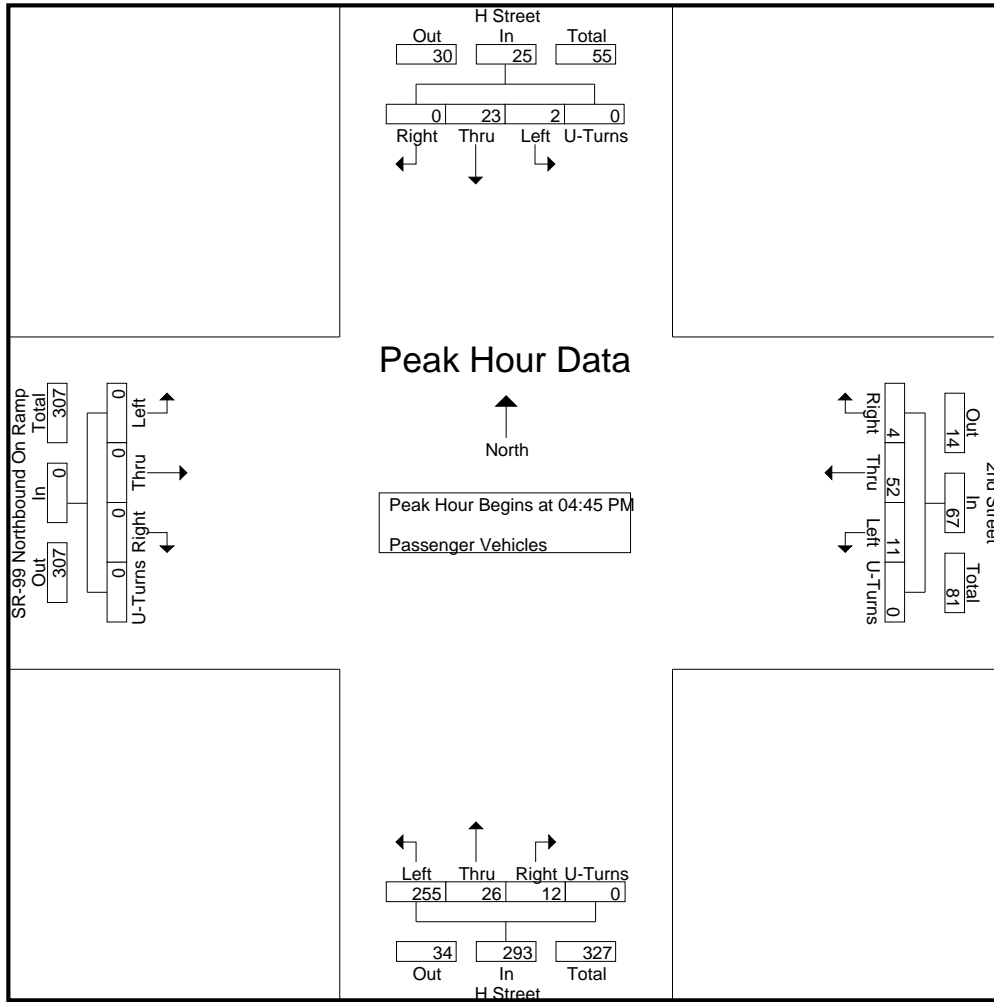

Peak Hour Analysis From 04:45 PM to 05:30 PM - Peak 1 of 1
 Peak Hour for Each Approach Begins at:

	04:45 PM					04:45 PM					04:45 PM					04:45 PM				
+0 mins.	0	6	0	0	6	2	8	0	0	10	65	5	5	0	75	0	0	0	0	0
+15 mins.	2	3	0	0	5	0	26	1	0	27	82	5	3	0	90	0	0	0	0	0
+30 mins.	0	7	0	0	7	7	7	1	0	15	58	6	3	0	67	0	0	0	0	0
+45 mins.	0	7	0	0	7	2	11	2	0	15	50	10	1	0	61	0	0	0	0	0
Total Volume	2	23	0	0	25	11	52	4	0	67	255	26	12	0	293	0	0	0	0	0
% App. Total	8	92	0	0		16.4	77.6	6	0		87	8.9	4.1	0		0	0	0	0	
PHF	.250	.821	.000	.000	.893	.393	.500	.500	.000	.620	.777	.650	.600	.000	.814	.000	.000	.000	.000	.000

City of Madera
 N/S: H Street
 E/W: SR-99 NB On Ramp/2nd Street
 Weather: Clear

File Name : 34A_MDA_H St_99N On Ramp PM
 Site Code : 00319628
 Start Date : 9/24/2019
 Page No : 1

Groups Printed- Large 2 Axle Vehicles

Start Time	H Street Southbound					2nd Street Westbound					H Street Northbound					SR-99 Northbound On Ramp Eastbound					Int. Total
	Left	Thru	Right	U-Turns	App. Total	Left	Thru	Right	U-Turns	App. Total	Left	Thru	Right	U-Turns	App. Total	Left	Thru	Right	U-Turns	App. Total	
04:00 PM	0	0	0	0	0	0	0	0	0	0	1	1	0	0	2	0	0	0	0	0	2
04:15 PM	0	0	0	0	0	0	0	0	0	0	0	0	0	0	0	0	0	0	0	0	0
04:30 PM	0	0	0	0	0	0	0	0	0	0	4	0	0	0	4	0	0	0	0	0	4
04:45 PM	0	0	0	0	0	0	0	0	0	0	2	0	0	0	2	0	0	0	0	0	2
Total	0	0	0	0	0	0	0	0	0	0	7	1	0	0	8	0	0	0	0	0	8
05:00 PM	0	0	0	0	0	0	0	0	0	0	0	0	0	0	0	0	0	0	0	0	0
05:15 PM	0	0	0	0	0	0	0	0	0	0	4	0	0	0	4	0	0	0	0	0	4
05:30 PM	0	1	0	0	1	0	0	0	0	0	0	1	0	0	1	0	0	0	0	0	2
05:45 PM	0	0	0	0	0	0	0	0	0	0	0	0	0	0	0	0	0	0	0	0	0
Total	0	1	0	0	1	0	0	0	0	0	4	1	0	0	5	0	0	0	0	0	6
Grand Total	0	1	0	0	1	0	0	0	0	0	11	2	0	0	13	0	0	0	0	0	14
Apprch %	0	100	0	0		0	0	0	0		84.6	15.4	0	0		0	0	0	0		
Total %	0	7.1	0	0	7.1	0	0	0	0	0	78.6	14.3	0	0	92.9	0	0	0	0	0	

Start Time	H Street Southbound					2nd Street Westbound					H Street Northbound					SR-99 Northbound On Ramp Eastbound					Int. Total
	Left	Thru	Right	U-Turns	App. Total	Left	Thru	Right	U-Turns	App. Total	Left	Thru	Right	U-Turns	App. Total	Left	Thru	Right	U-Turns	App. Total	
Peak Hour Analysis From 04:45 PM to 05:30 PM - Peak 1 of 1																					
Peak Hour for Entire Intersection Begins at 04:45 PM																					
04:45 PM	0	0	0	0	0	0	0	0	0	0	2	0	0	0	2	0	0	0	0	0	2
05:00 PM	0	0	0	0	0	0	0	0	0	0	0	0	0	0	0	0	0	0	0	0	0
05:15 PM	0	0	0	0	0	0	0	0	0	0	4	0	0	0	4	0	0	0	0	0	4
05:30 PM	0	1	0	0	1	0	0	0	0	0	0	1	0	0	1	0	0	0	0	0	2
Total Volume	0	1	0	0	1	0	0	0	0	0	6	1	0	0	7	0	0	0	0	0	8
% App. Total	0	100	0	0		0	0	0	0		85.7	14.3	0	0		0	0	0	0		
PHF	.000	.250	.000	.000	.250	.000	.000	.000	.000	.000	.375	.250	.000	.000	.438	.000	.000	.000	.000	.000	.500

City of Madera
 N/S: H Street
 E/W: SR-99 NB On Ramp/2nd Street
 Weather: Clear

File Name : 34A_MDA_H St_99N On Ramp PM
 Site Code : 00319628
 Start Date : 9/24/2019
 Page No : 2

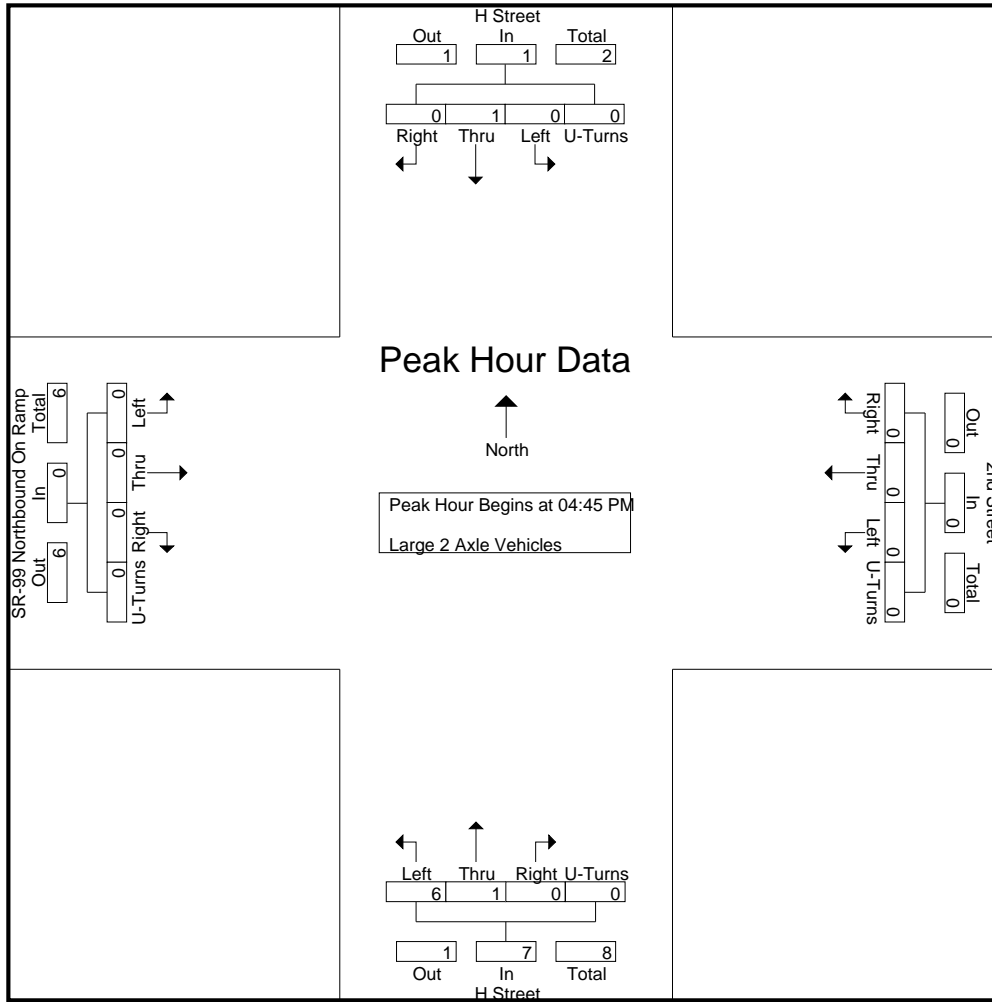

Peak Hour Analysis From 04:45 PM to 05:30 PM - Peak 1 of 1
 Peak Hour for Each Approach Begins at:

	04:45 PM					04:45 PM					04:45 PM									
+0 mins.	0	0	0	0	0	0	0	0	0	0	2	0	0	0	0	0	0	0	0	0
+15 mins.	0	0	0	0	0	0	0	0	0	0	0	0	0	0	0	0	0	0	0	0
+30 mins.	0	0	0	0	0	0	0	0	0	0	4	0	0	0	0	0	0	0	0	0
+45 mins.	0	1	0	0	1	0	0	0	0	0	0	1	0	0	1	0	0	0	0	0
Total Volume	0	1	0	0	1	0	0	0	0	0	6	1	0	0	7	0	0	0	0	0
% App. Total	0	100	0	0	0	0	0	0	0	0	85.7	14.3	0	0	0	0	0	0	0	0
PHF	.000	.250	.000	.000	.250	.000	.000	.000	.000	.000	.375	.250	.000	.000	.438	.000	.000	.000	.000	.000

City of Madera
 N/S: H Street
 E/W: SR-99 NB On Ramp/2nd Street
 Weather: Clear

File Name : 34A_MDA_H St_99N On Ramp PM
 Site Code : 00319628
 Start Date : 9/24/2019
 Page No : 1

Groups Printed- 3 Axle Vehicles

Start Time	H Street Southbound					2nd Street Westbound					H Street Northbound					SR-99 Northbound On Ramp Eastbound					Int. Total
	Left	Thru	Right	U-Turns	App. Total	Left	Thru	Right	U-Turns	App. Total	Left	Thru	Right	U-Turns	App. Total	Left	Thru	Right	U-Turns	App. Total	
04:00 PM	0	0	0	0	0	0	0	0	0	0	1	0	0	0	1	0	0	0	0	0	1
04:15 PM	0	0	0	0	0	0	0	0	0	0	0	0	0	0	0	0	0	0	0	0	0
04:30 PM	0	0	0	0	0	0	0	0	0	0	0	0	0	0	0	0	0	0	0	0	0
04:45 PM	0	0	0	0	0	0	0	0	0	0	0	0	0	0	0	0	0	0	0	0	0
Total	0	0	0	0	0	0	0	0	0	0	1	0	0	0	1	0	0	0	0	0	1
05:00 PM	0	0	0	0	0	0	0	0	0	0	0	0	0	0	0	0	0	0	0	0	0
05:15 PM	0	0	0	0	0	0	0	0	0	0	0	0	0	0	0	0	0	0	0	0	0
05:30 PM	0	0	0	0	0	0	0	0	0	0	0	0	0	0	0	0	0	0	0	0	0
05:45 PM	0	0	0	0	0	0	0	0	0	0	0	0	0	0	0	0	0	0	0	0	0
Total	0	0	0	0	0	0	0	0	0	0	0	0	0	0	0	0	0	0	0	0	0
Grand Total	0	0	0	0	0	0	0	0	0	0	1	0	0	0	1	0	0	0	0	0	1
Apprch %	0	0	0	0		0	0	0	0		100	0	0	0		0	0	0	0		
Total %	0	0	0	0	0	0	0	0	0	0	100	0	0	0	100	0	0	0	0	0	0

Start Time	H Street Southbound					2nd Street Westbound					H Street Northbound					SR-99 Northbound On Ramp Eastbound					Int. Total
	Left	Thru	Right	U-Turns	App. Total	Left	Thru	Right	U-Turns	App. Total	Left	Thru	Right	U-Turns	App. Total	Left	Thru	Right	U-Turns	App. Total	
Peak Hour Analysis From 04:45 PM to 05:30 PM - Peak 1 of 1																					
Peak Hour for Entire Intersection Begins at 04:45 PM																					
04:45 PM	0	0	0	0	0	0	0	0	0	0	0	0	0	0	0	0	0	0	0	0	0
05:00 PM	0	0	0	0	0	0	0	0	0	0	0	0	0	0	0	0	0	0	0	0	0
05:15 PM	0	0	0	0	0	0	0	0	0	0	0	0	0	0	0	0	0	0	0	0	0
05:30 PM	0	0	0	0	0	0	0	0	0	0	0	0	0	0	0	0	0	0	0	0	0
Total Volume	0	0	0	0	0	0	0	0	0	0	0	0	0	0	0	0	0	0	0	0	0
% App. Total	0	0	0	0		0	0	0	0		0	0	0	0		0	0	0	0		
PHF	.000	.000	.000	.000	.000	.000	.000	.000	.000	.000	.000	.000	.000	.000	.000	.000	.000	.000	.000	.000	.000

City of Madera
 N/S: H Street
 E/W: SR-99 NB On Ramp/2nd Street
 Weather: Clear

File Name : 34A_MDA_H St_99N On Ramp PM
 Site Code : 00319628
 Start Date : 9/24/2019
 Page No : 2

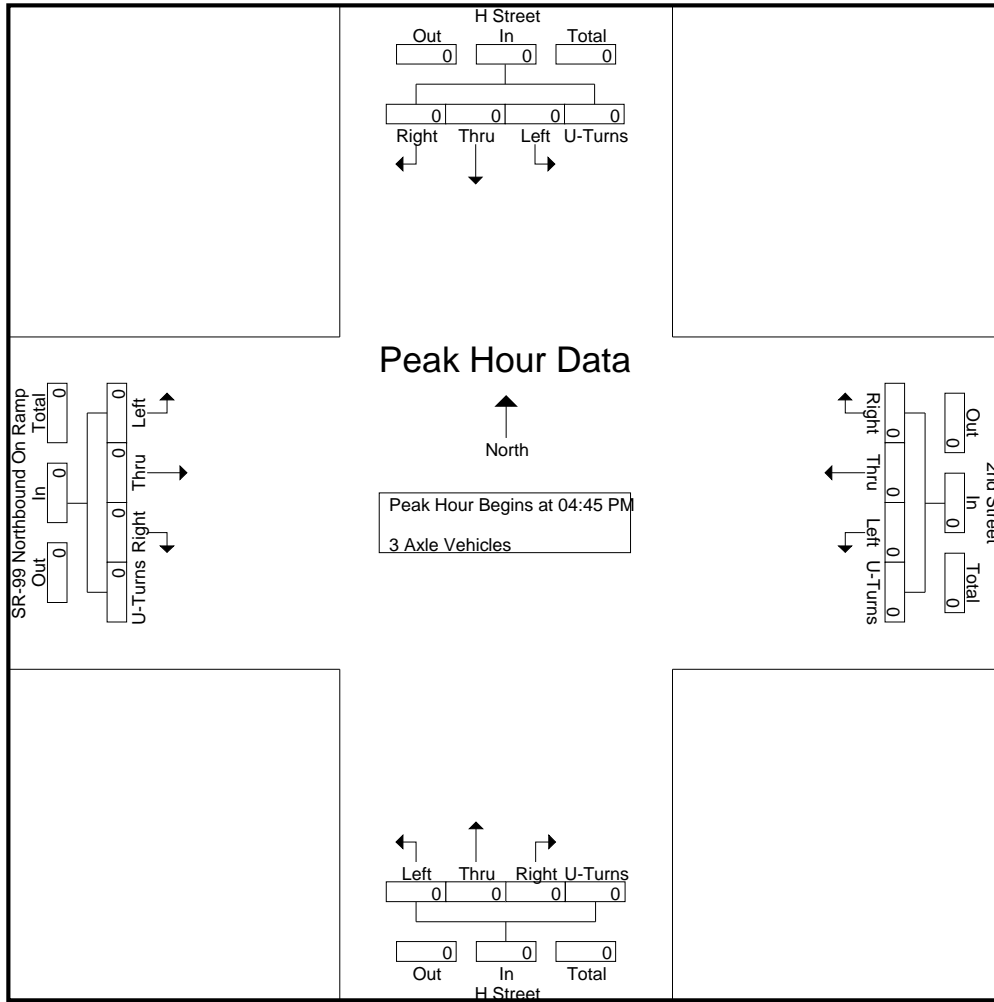

Peak Hour Analysis From 04:45 PM to 05:30 PM - Peak 1 of 1
 Peak Hour for Each Approach Begins at:

	04:45 PM					04:45 PM					04:45 PM					04:45 PM				
+0 mins.	0	0	0	0	0	0	0	0	0	0	0	0	0	0	0	0	0	0	0	0
+15 mins.	0	0	0	0	0	0	0	0	0	0	0	0	0	0	0	0	0	0	0	0
+30 mins.	0	0	0	0	0	0	0	0	0	0	0	0	0	0	0	0	0	0	0	0
+45 mins.	0	0	0	0	0	0	0	0	0	0	0	0	0	0	0	0	0	0	0	0
Total Volume	0	0	0	0	0	0	0	0	0	0	0	0	0	0	0	0	0	0	0	0
% App. Total	0	0	0	0	0	0	0	0	0	0	0	0	0	0	0	0	0	0	0	0
PHF	.000	.000	.000	.000	.000	.000	.000	.000	.000	.000	.000	.000	.000	.000	.000	.000	.000	.000	.000	.000

City of Madera
 N/S: H Street
 E/W: SR-99 NB On Ramp/2nd Street
 Weather: Clear

File Name : 34A_MDA_H St_99N On Ramp PM
 Site Code : 00319628
 Start Date : 9/24/2019
 Page No : 1

Groups Printed- 4+ Axle Trucks

Start Time	H Street Southbound					2nd Street Westbound					H Street Northbound					SR-99 Northbound On Ramp Eastbound					Int. Total
	Left	Thru	Right	U-Turns	App. Total	Left	Thru	Right	U-Turns	App. Total	Left	Thru	Right	U-Turns	App. Total	Left	Thru	Right	U-Turns	App. Total	
04:00 PM	0	0	0	0	0	0	0	0	0	0	2	0	0	0	2	0	0	0	0	0	2
04:15 PM	0	0	0	0	0	0	0	0	0	0	1	0	0	0	1	0	0	0	0	0	1
04:30 PM	0	0	0	0	0	0	0	0	0	0	0	0	0	0	0	0	0	0	0	0	0
04:45 PM	0	0	0	0	0	0	0	0	0	0	0	0	0	0	0	0	0	0	0	0	0
Total	0	0	0	0	0	0	0	0	0	0	3	0	0	0	3	0	0	0	0	0	3
05:00 PM	0	0	0	0	0	0	0	0	0	0	0	0	0	0	0	0	0	0	0	0	0
05:15 PM	0	0	0	0	0	0	0	0	0	0	0	0	0	0	0	0	0	0	0	0	0
05:30 PM	0	0	0	0	0	0	0	0	0	0	1	0	0	0	1	0	0	0	0	0	1
05:45 PM	0	0	0	0	0	0	0	0	0	0	1	0	0	0	1	0	0	0	0	0	1
Total	0	0	0	0	0	0	0	0	0	0	2	0	0	0	2	0	0	0	0	0	2
Grand Total	0	0	0	0	0	0	0	0	0	0	5	0	0	0	5	0	0	0	0	0	5
Apprch %	0	0	0	0		0	0	0	0		100	0	0	0		0	0	0	0		
Total %	0	0	0	0	0	0	0	0	0	0	100	0	0	0	100	0	0	0	0	0	0

Start Time	H Street Southbound					2nd Street Westbound					H Street Northbound					SR-99 Northbound On Ramp Eastbound					Int. Total
	Left	Thru	Right	U-Turns	App. Total	Left	Thru	Right	U-Turns	App. Total	Left	Thru	Right	U-Turns	App. Total	Left	Thru	Right	U-Turns	App. Total	
Peak Hour Analysis From 04:45 PM to 05:30 PM - Peak 1 of 1																					
Peak Hour for Entire Intersection Begins at 04:45 PM																					
04:45 PM	0	0	0	0	0	0	0	0	0	0	0	0	0	0	0	0	0	0	0	0	0
05:00 PM	0	0	0	0	0	0	0	0	0	0	0	0	0	0	0	0	0	0	0	0	0
05:15 PM	0	0	0	0	0	0	0	0	0	0	0	0	0	0	0	0	0	0	0	0	0
05:30 PM	0	0	0	0	0	0	0	0	0	0	1	0	0	0	1	0	0	0	0	0	1
Total Volume	0	0	0	0	0	0	0	0	0	0	1	0	0	0	1	0	0	0	0	0	1
% App. Total	0	0	0	0		0	0	0	0		100	0	0	0		0	0	0	0		
PHF	.000	.000	.000	.000	.000	.000	.000	.000	.000	.000	.250	.000	.000	.000	.250	.000	.000	.000	.000	.000	.250

City of Madera
 N/S: H Street
 E/W: SR-99 NB On Ramp/2nd Street
 Weather: Clear

File Name : 34A_MDA_H St_99N On Ramp PM
 Site Code : 00319628
 Start Date : 9/24/2019
 Page No : 2

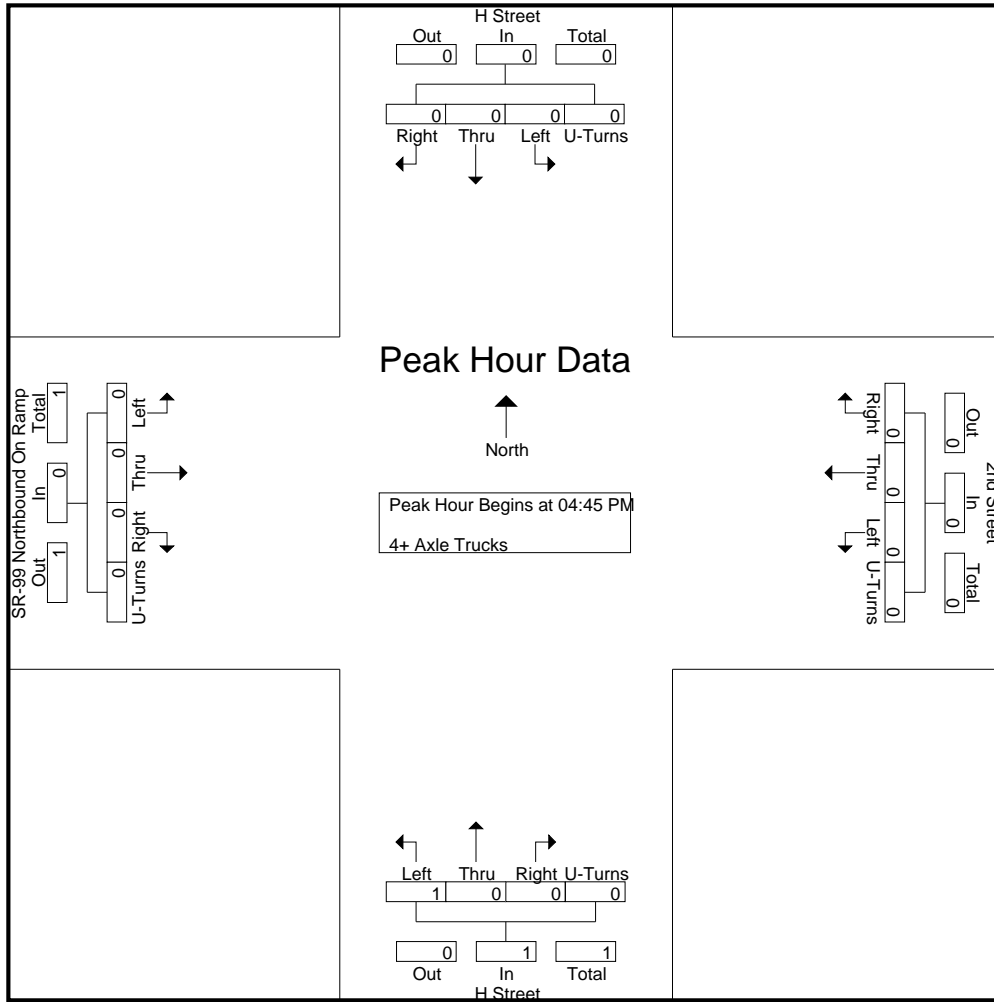

Peak Hour Analysis From 04:45 PM to 05:30 PM - Peak 1 of 1
 Peak Hour for Each Approach Begins at:

	04:45 PM					04:45 PM					04:45 PM					04:45 PM									
+0 mins.	0	0	0	0	0	0	0	0	0	0	0	0	0	0	0	0	0	0	0	0	0	0	0	0	0
+15 mins.	0	0	0	0	0	0	0	0	0	0	0	0	0	0	0	0	0	0	0	0	0	0	0	0	0
+30 mins.	0	0	0	0	0	0	0	0	0	0	0	0	0	0	0	0	0	0	0	0	0	0	0	0	0
+45 mins.	0	0	0	0	0	0	0	0	0	0	1	0	0	0	1	0	0	0	0	0	0	0	0	0	0
Total Volume	0	0	0	0	0	0	0	0	0	0	1	0	0	0	1	0	0	0	0	0	0	0	0	0	0
% App. Total	0	0	0	0	0	0	0	0	0	0	100	0	0	0	0	0	0	0	0	0	0	0	0	0	0
PHF	.000	.000	.000	.000	.000	.000	.000	.000	.000	.000	.250	.000	.000	.000	.250	.000	.000	.000	.000	.000	.000	.000	.000	.000	.000

Location: Madera
 N/S: H Street
 E/W: SR-99 NB On Ramp/2nd Street



Date: 9/24/2019
 Day: Tuesday

PEDESTRIANS

	North Leg H Street	East Leg 2nd Street	South Leg H Street	West Leg SR-99 NB On Ramp	
	Pedestrians	Pedestrians	Pedestrians	Pedestrians	
7:00 AM	0	3	0	0	3
7:15 AM	0	5	0	0	5
7:30 AM	0	0	0	0	0
7:45 AM	0	1	0	0	1
8:00 AM	0	3	0	0	3
8:15 AM	0	1	0	0	1
8:30 AM	0	0	0	0	0
8:45 AM	0	1	0	0	1
TOTAL VOLUMES:	0	14	0	0	14

	North Leg H Street	East Leg 2nd Street	South Leg H Street	West Leg SR-99 NB On Ramp	
	Pedestrians	Pedestrians	Pedestrians	Pedestrians	
4:00 PM	0	0	0	0	0
4:15 PM	0	0	0	0	0
4:30 PM	0	0	0	0	0
4:45 PM	0	0	0	0	0
5:00 PM	0	1	0	0	1
5:15 PM	0	1	0	0	1
5:30 PM	0	0	0	0	0
5:45 PM	0	0	0	0	0
TOTAL VOLUMES:	0	2	0	0	2

Location: Madera
 N/S: H Street
 E/W: SR-99 NB On Ramp/2nd Street



Date: 9/24/2019
 Day: Tuesday

BICYCLES

	Southbound H Street			Westbound 2nd Street			Northbound H Street			Eastbound SR-99 NB On Ramp			
	Left	Thru	Right	Left	Thru	Right	Left	Thru	Right	Left	Thru	Right	
7:00 AM	0	0	0	0	0	0	0	0	0	0	0	0	0
7:15 AM	0	0	0	1	0	0	0	0	0	0	0	0	1
7:30 AM	0	0	0	0	0	0	0	0	0	0	0	0	0
7:45 AM	0	0	0	0	0	0	0	0	0	0	0	0	0
8:00 AM	0	0	0	0	0	0	0	0	0	0	0	0	0
8:15 AM	0	0	0	0	0	0	0	0	0	0	0	0	0
8:30 AM	0	0	0	0	0	0	0	0	0	0	0	0	0
8:45 AM	0	0	0	0	0	0	0	0	0	0	0	0	0
TOTAL VOLUMES:	0	0	0	1	0	0	0	0	0	0	0	0	1

	Southbound H Street			Westbound 2nd Street			Northbound H Street			Eastbound SR-99 NB On Ramp			
	Left	Thru	Right	Left	Thru	Right	Left	Thru	Right	Left	Thru	Right	
4:00 PM	0	0	0	0	0	0	0	0	0	0	0	0	0
4:15 PM	0	0	0	0	0	0	0	0	0	0	0	0	0
4:30 PM	0	0	0	0	0	0	0	0	0	0	0	0	0
4:45 PM	0	0	0	0	0	0	0	0	0	0	0	0	0
5:00 PM	0	0	0	0	0	0	0	0	0	0	0	0	0
5:15 PM	0	0	0	0	0	0	0	0	0	0	0	0	0
5:30 PM	0	0	0	0	0	0	0	0	0	0	0	0	0
5:45 PM	0	0	0	0	0	0	0	0	0	0	0	0	0
TOTAL VOLUMES:	0	0	0	0	0	0	0	0	0	0	0	0	0

City of Madera
 N/S: I Street
 E/W: 4th Street
 Weather: Clear

File Name : 33_MDA_I St_4th St AM
 Site Code : 00319628
 Start Date : 9/24/2019
 Page No : 1

Groups Printed- Passenger Vehicles - Large 2 Axle Vehicles - 3 Axle Vehicles - 4+ Axle Trucks

Start Time	I Street Southbound					4th Street Westbound					I Street Northbound					4th Street Eastbound					Int. Total
	Left	Thru	Right	U-Turns	App. Total	Left	Thru	Right	U-Turns	App. Total	Left	Thru	Right	U-Turns	App. Total	Left	Thru	Right	U-Turns	App. Total	
07:00 AM	40	22	19	0	81	4	68	11	0	83	11	12	22	0	45	2	91	6	0	99	308
07:15 AM	40	39	26	0	105	6	105	18	0	129	9	6	23	0	38	5	149	8	0	162	434
07:30 AM	54	62	27	0	143	19	147	15	0	181	5	10	34	0	49	8	148	9	0	165	538
07:45 AM	68	73	20	0	161	26	122	14	0	162	21	20	45	0	86	14	180	17	0	211	620
Total	202	196	92	0	490	55	442	58	0	555	46	48	124	0	218	29	568	40	0	637	1900
08:00 AM	49	67	34	0	150	18	98	18	0	134	10	10	44	0	64	1	155	22	0	178	526
08:15 AM	30	75	40	0	145	20	81	13	0	114	15	15	31	0	61	2	115	19	0	136	456
08:30 AM	31	56	28	0	115	13	79	8	0	100	27	29	31	0	87	6	96	15	0	117	419
08:45 AM	29	37	25	0	91	8	58	10	0	76	11	16	26	0	53	5	95	13	0	113	333
Total	139	235	127	0	501	59	316	49	0	424	63	70	132	0	265	14	461	69	0	544	1734
Grand Total	341	431	219	0	991	114	758	107	0	979	109	118	256	0	483	43	1029	109	0	1181	3634
Apprch %	34.4	43.5	22.1	0		11.6	77.4	10.9	0		22.6	24.4	53	0		3.6	87.1	9.2	0		
Total %	9.4	11.9	6	0	27.3	3.1	20.9	2.9	0	26.9	3	3.2	7	0	13.3	1.2	28.3	3	0	32.5	
Passenger Vehicles	98.2	95.6	97.3	0	96.9	97.4	94.7	98.1	0	95.4	97.2	95.8	96.5	0	96.5	95.3	96.9	99.1	0	97	96.5
Large 2 Axle Vehicles	1.2	2.6	2.3	0	2	1.8	5	1.9	0	4.3	2.8	4.2	2	0	2.7	2.3	2.8	0.9	0	2.6	2.9
% Large 2 Axle Vehicles	1	1	1	0	3	0	1	0	0	1	0	0	2	0	2	1	2	0	0	3	9
3 Axle Vehicles	0.3	0.2	0.5	0	0.3	0	0.1	0	0	0.1	0	0	0.8	0	0.4	2.3	0.2	0	0	0.3	0.2
% 3 Axle Vehicles	1	7	0	0	8	1	1	0	0	2	0	0	2	0	2	0	1	0	0	1	13
4+ Axle Trucks																					
% 4+ Axle Trucks																					

Start Time	I Street Southbound					4th Street Westbound					I Street Northbound					4th Street Eastbound					Int. Total
	Left	Thru	Right	U-Turns	App. Total	Left	Thru	Right	U-Turns	App. Total	Left	Thru	Right	U-Turns	App. Total	Left	Thru	Right	U-Turns	App. Total	
Peak Hour Analysis From 07:00 AM to 08:45 AM - Peak 1 of 1																					
Peak Hour for Entire Intersection Begins at 07:30 AM																					
07:30 AM	54	62	27	0	143	19	147	15	0	181	5	10	34	0	49	8	148	9	0	165	538
07:45 AM	68	73	20	0	161	26	122	14	0	162	21	20	45	0	86	14	180	17	0	211	620
08:00 AM	49	67	34	0	150	18	98	18	0	134	10	10	44	0	64	1	155	22	0	178	526
08:15 AM	30	75	40	0	145	20	81	13	0	114	15	15	31	0	61	2	115	19	0	136	456
Total Volume	201	277	121	0	599	83	448	60	0	591	51	55	154	0	260	25	598	67	0	690	2140
% App. Total	33.6	46.2	20.2	0		14	75.8	10.2	0		19.6	21.2	59.2	0		3.6	86.7	9.7	0		
PHF	.739	.923	.756	.000	.930	.798	.762	.833	.000	.816	.607	.688	.856	.000	.756	.446	.831	.761	.000	.818	.863

City of Madera
 N/S: I Street
 E/W: 4th Street
 Weather: Clear

File Name : 33_MDA_I St_4th St AM
 Site Code : 00319628
 Start Date : 9/24/2019
 Page No : 2

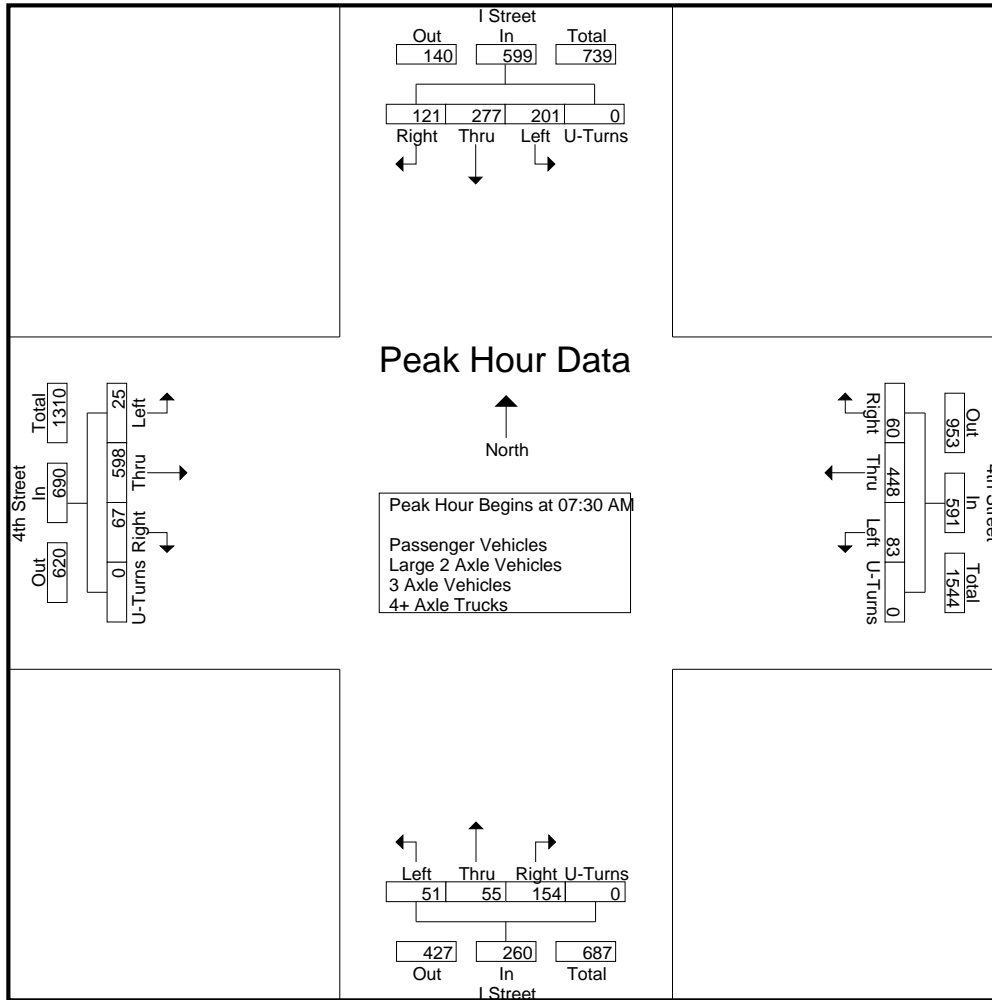

Peak Hour Analysis From 07:00 AM to 08:45 AM - Peak 1 of 1
 Peak Hour for Each Approach Begins at:

	07:30 AM					07:15 AM					07:45 AM					07:15 AM				
+0 mins.	54	62	27	0	143	6	105	18	0	129	21	20	45	0	86	5	149	8	0	162
+15 mins.	68	73	20	0	161	19	147	15	0	181	10	10	44	0	64	8	148	9	0	165
+30 mins.	49	67	34	0	150	26	122	14	0	162	15	15	31	0	61	14	180	17	0	211
+45 mins.	30	75	40	0	145	18	98	18	0	134	27	29	31	0	87	1	155	22	0	178
Total Volume	201	277	121	0	599	69	472	65	0	606	73	74	151	0	298	28	632	56	0	716
% App. Total	33.6	46.2	20.2	0		11.4	77.9	10.7	0		24.5	24.8	50.7	0		3.9	88.3	7.8	0	
PHF	.739	.923	.756	.000	.930	.663	.803	.903	.000	.837	.676	.638	.839	.000	.856	.500	.878	.636	.000	.848

City of Madera
 N/S: I Street
 E/W: 4th Street
 Weather: Clear

File Name : 33_MDA_I St_4th St AM
 Site Code : 00319628
 Start Date : 9/24/2019
 Page No : 1

Groups Printed- Passenger Vehicles

Start Time	I Street Southbound					4th Street Westbound					I Street Northbound					4th Street Eastbound					Int. Total
	Left	Thru	Right	U-Turns	App. Total	Left	Thru	Right	U-Turns	App. Total	Left	Thru	Right	U-Turns	App. Total	Left	Thru	Right	U-Turns	App. Total	
07:00 AM	40	21	18	0	79	4	63	11	0	78	10	12	20	0	42	1	86	6	0	93	292
07:15 AM	40	36	26	0	102	6	104	18	0	128	9	6	22	0	37	5	138	8	0	151	418
07:30 AM	54	58	26	0	138	18	145	15	0	178	4	7	34	0	45	8	147	9	0	164	525
07:45 AM	66	71	20	0	157	25	118	14	0	157	20	20	45	0	85	13	178	17	0	208	607
Total	200	186	90	0	476	53	430	58	0	541	43	45	121	0	209	27	549	40	0	616	1842
08:00 AM	47	65	33	0	145	18	96	17	0	131	10	10	44	0	64	1	151	22	0	174	514
08:15 AM	30	73	40	0	143	19	74	13	0	106	15	14	29	0	58	2	112	19	0	133	440
08:30 AM	31	54	26	0	111	13	65	8	0	86	27	28	28	0	83	6	94	15	0	115	395
08:45 AM	27	34	24	0	85	8	53	9	0	70	11	16	25	0	52	5	91	12	0	108	315
Total	135	226	123	0	484	58	288	47	0	393	63	68	126	0	257	14	448	68	0	530	1664
Grand Total	335	412	213	0	960	111	718	105	0	934	106	113	247	0	466	41	997	108	0	1146	3506
Apprch %	34.9	42.9	22.2	0		11.9	76.9	11.2	0		22.7	24.2	53	0		3.6	87	9.4	0		
Total %	9.6	11.8	6.1	0	27.4	3.2	20.5	3	0	26.6	3	3.2	7	0	13.3	1.2	28.4	3.1	0	32.7	

Start Time	I Street Southbound					4th Street Westbound					I Street Northbound					4th Street Eastbound					Int. Total
	Left	Thru	Right	U-Turns	App. Total	Thru	Right	U-Turns	App. Total	Thru	Right	U-Turns	App. Total	Thru	Right	U-Turns	App. Total				
Peak Hour Analysis From 07:30 AM to 08:15 AM - Peak 1 of 1																					
Peak Hour for Entire Intersection Begins at 07:30 AM																					
07:30 AM	54	58	26	0	138	18	145	15	0	178	4	7	34	0	45	8	147	9	0	164	525
07:45 AM	66	71	20	0	157	25	118	14	0	157	20	20	45	0	85	13	178	17	0	208	607
08:00 AM	47	65	33	0	145	18	96	17	0	131	10	10	44	0	64	1	151	22	0	174	514
08:15 AM	30	73	40	0	143	19	74	13	0	106	15	14	29	0	58	2	112	19	0	133	440
Total Volume	197	267	119	0	583	80	433	59	0	572	49	51	152	0	252	24	588	67	0	679	2086
% App. Total	33.8	45.8	20.4	0		14	75.7	10.3	0		19.4	20.2	60.3	0		3.5	86.6	9.9	0		
PHF	.746	.914	.744	.000	.928	.800	.747	.868	.000	.803	.613	.638	.844	.000	.741	.462	.826	.761	.000	.816	.859

City of Madera
 N/S: I Street
 E/W: 4th Street
 Weather: Clear

File Name : 33_MDA_I St_4th St AM
 Site Code : 00319628
 Start Date : 9/24/2019
 Page No : 2

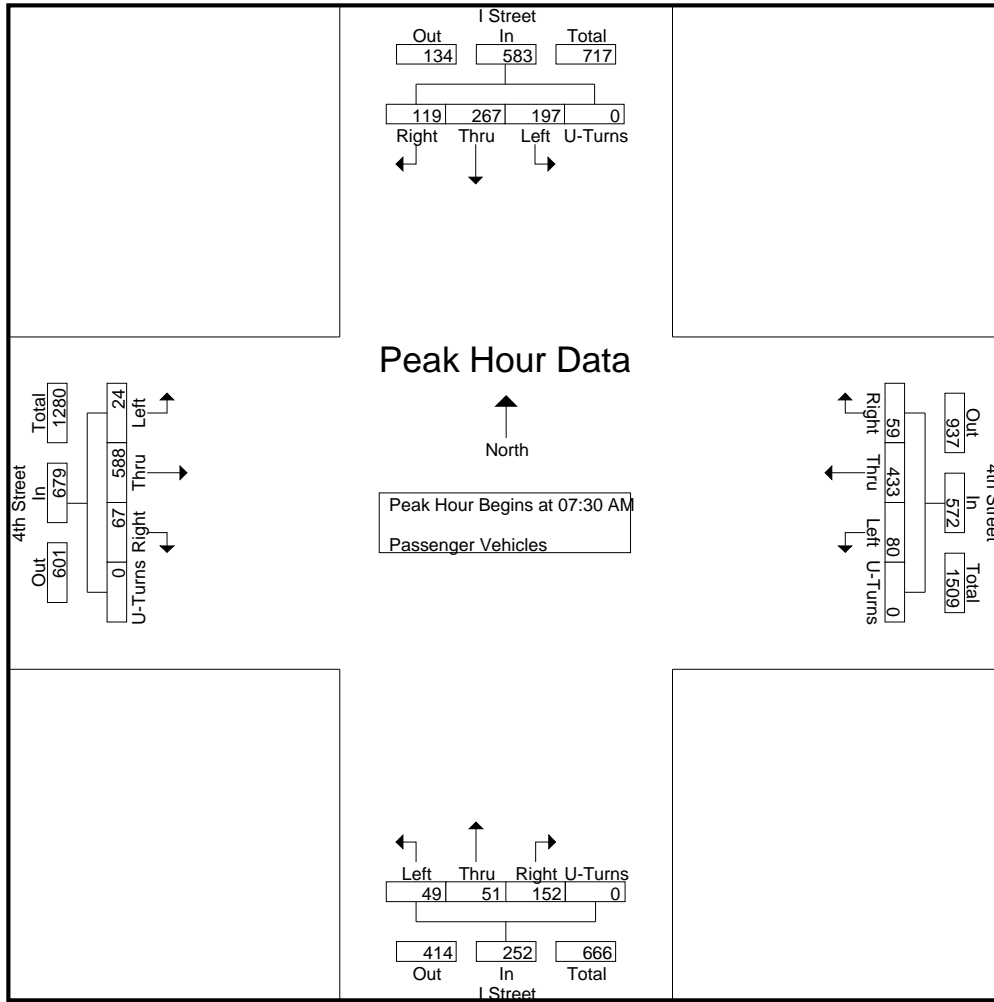

Peak Hour Analysis From 07:30 AM to 08:15 AM - Peak 1 of 1
 Peak Hour for Each Approach Begins at:

	07:30 AM					07:30 AM					07:30 AM									
+0 mins.	54	58	26	0	138	18	145	15	0	178	4	7	34	0	45	8	147	9	0	164
+15 mins.	66	71	20	0	157	25	118	14	0	157	20	20	45	0	85	13	178	17	0	208
+30 mins.	47	65	33	0	145	18	96	17	0	131	10	10	44	0	64	1	151	22	0	174
+45 mins.	30	73	40	0	143	19	74	13	0	106	15	14	29	0	58	2	112	19	0	133
Total Volume	197	267	119	0	583	80	433	59	0	572	49	51	152	0	252	24	588	67	0	679
% App. Total	33.8	45.8	20.4	0		14	75.7	10.3	0		19.4	20.2	60.3	0		3.5	86.6	9.9	0	
PHF	.746	.914	.744	.000	.928	.800	.747	.868	.000	.803	.613	.638	.844	.000	.741	.462	.826	.761	.000	.816

City of Madera
 N/S: I Street
 E/W: 4th Street
 Weather: Clear

File Name : 33_MDA_I St_4th St AM
 Site Code : 00319628
 Start Date : 9/24/2019
 Page No : 1

Groups Printed- Large 2 Axle Vehicles

Start Time	I Street Southbound					4th Street Westbound					I Street Northbound					4th Street Eastbound					Int. Total
	Left	Thru	Right	U-Turns	App. Total	Left	Thru	Right	U-Turns	App. Total	Left	Thru	Right	U-Turns	App. Total	Left	Thru	Right	U-Turns	App. Total	
07:00 AM	0	0	1	0	1	0	4	0	0	4	1	0	0	0	1	0	5	0	0	5	11
07:15 AM	0	1	0	0	1	0	1	0	0	1	0	0	0	0	0	0	10	0	0	10	12
07:30 AM	0	1	1	0	2	1	2	0	0	3	1	3	0	0	4	0	1	0	0	1	10
07:45 AM	1	1	0	0	2	0	4	0	0	4	1	0	0	0	1	1	2	0	0	3	10
Total	1	3	2	0	6	1	11	0	0	12	3	3	0	0	6	1	18	0	0	19	43
08:00 AM	2	2	0	0	4	0	2	1	0	3	0	0	0	0	0	0	4	0	0	4	11
08:15 AM	0	2	0	0	2	1	6	0	0	7	0	1	2	0	3	0	3	0	0	3	15
08:30 AM	0	2	2	0	4	0	14	0	0	14	0	1	2	0	3	0	1	0	0	1	22
08:45 AM	1	2	1	0	4	0	5	1	0	6	0	0	1	0	1	0	3	1	0	4	15
Total	3	8	3	0	14	1	27	2	0	30	0	2	5	0	7	0	11	1	0	12	63
Grand Total	4	11	5	0	20	2	38	2	0	42	3	5	5	0	13	1	29	1	0	31	106
Apprch %	20	55	25	0		4.8	90.5	4.8	0		23.1	38.5	38.5	0		3.2	93.5	3.2	0		
Total %	3.8	10.4	4.7	0	18.9	1.9	35.8	1.9	0	39.6	2.8	4.7	4.7	0	12.3	0.9	27.4	0.9	0	29.2	

Start Time	I Street Southbound					4th Street Westbound					I Street Northbound					4th Street Eastbound					Int. Total
	Left	Thru	Right	U-Turns	App. Total	Left	Thru	Right	U-Turns	App. Total	Left	Thru	Right	U-Turns	App. Total	Left	Thru	Right	U-Turns	App. Total	
Peak Hour Analysis From 07:30 AM to 08:15 AM - Peak 1 of 1																					
Peak Hour for Entire Intersection Begins at 07:30 AM																					
07:30 AM	0	1	1	0	2	1	2	0	0	3	1	3	0	0	4	0	1	0	0	1	10
07:45 AM	1	1	0	0	2	0	4	0	0	4	1	0	0	0	1	1	2	0	0	3	10
08:00 AM	2	2	0	0	4	0	2	1	0	3	0	0	0	0	0	0	4	0	0	4	11
08:15 AM	0	2	0	0	2	1	6	0	0	7	0	1	2	0	3	0	3	0	0	3	15
Total Volume	3	6	1	0	10	2	14	1	0	17	2	4	2	0	8	1	10	0	0	11	46
% App. Total	30	60	10	0		11.8	82.4	5.9	0		25	50	25	0		9.1	90.9	0	0		
PHF	.375	.750	.250	.000	.625	.500	.583	.250	.000	.607	.500	.333	.250	.000	.500	.250	.625	.000	.000	.688	.767

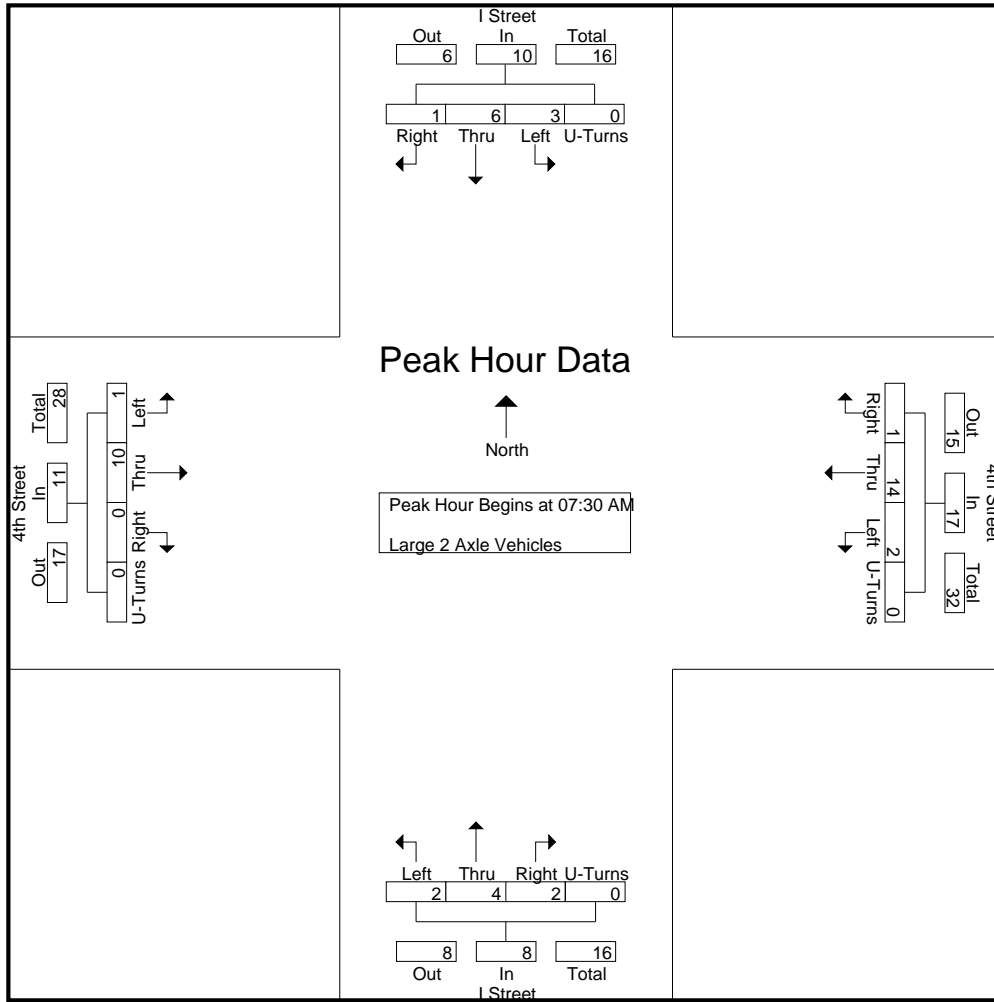

Peak Hour Analysis From 07:30 AM to 08:15 AM - Peak 1 of 1
 Peak Hour for Each Approach Begins at:

	07:30 AM					07:30 AM					07:30 AM									
+0 mins.	0	1	1	0	2	1	2	0	0	3	1	3	0	0	4	0	1	0	0	1
+15 mins.	1	1	0	0	2	0	4	0	0	4	1	0	0	0	1	1	2	0	0	3
+30 mins.	2	2	0	0	4	0	2	1	0	3	0	0	0	0	0	0	4	0	0	4
+45 mins.	0	2	0	0	2	1	6	0	0	7	0	1	2	0	3	0	3	0	0	3
Total Volume	3	6	1	0	10	2	14	1	0	17	2	4	2	0	8	1	10	0	0	11
% App. Total	30	60	10	0		11.8	82.4	5.9	0		25	50	25	0		9.1	90.9	0	0	
PHF	.375	.750	.250	.000	.625	.500	.583	.250	.000	.607	.500	.333	.250	.000	.500	.250	.625	.000	.000	.688

City of Madera
 N/S: I Street
 E/W: 4th Street
 Weather: Clear

File Name : 33_MDA_I St_4th St AM
 Site Code : 00319628
 Start Date : 9/24/2019
 Page No : 1

Groups Printed- 3 Axle Vehicles

Start Time	I Street Southbound					4th Street Westbound					I Street Northbound					4th Street Eastbound					Int. Total
	Left	Thru	Right	U-Turns	App. Total	Left	Thru	Right	U-Turns	App. Total	Left	Thru	Right	U-Turns	App. Total	Left	Thru	Right	U-Turns	App. Total	
07:00 AM	0	0	0	0	0	0	0	0	0	0	0	0	1	0	1	1	0	0	0	1	2
07:15 AM	0	0	0	0	0	0	0	0	0	0	0	0	1	0	1	0	1	0	0	1	2
07:30 AM	0	0	0	0	0	0	0	0	0	0	0	0	0	0	0	0	0	0	0	0	0
07:45 AM	0	0	0	0	0	0	0	0	0	0	0	0	0	0	0	0	0	0	0	0	0
Total	0	0	0	0	0	0	0	0	0	0	0	0	2	0	2	1	1	0	0	2	4
08:00 AM	0	0	1	0	1	0	0	0	0	0	0	0	0	0	0	0	0	0	0	0	1
08:15 AM	0	0	0	0	0	0	1	0	0	1	0	0	0	0	0	0	0	0	0	0	1
08:30 AM	0	0	0	0	0	0	0	0	0	0	0	0	0	0	0	0	0	0	0	0	0
08:45 AM	1	1	0	0	2	0	0	0	0	0	0	0	0	0	0	0	1	0	0	1	3
Total	1	1	1	0	3	0	1	0	0	1	0	0	0	0	0	0	1	0	0	1	5
Grand Total	1	1	1	0	3	0	1	0	0	1	0	0	2	0	2	1	2	0	0	3	9
Apprch %	33.3	33.3	33.3	0		0	100	0	0		0	0	100	0		33.3	66.7	0	0		
Total %	11.1	11.1	11.1	0	33.3	0	11.1	0	0	11.1	0	0	22.2	0	22.2	11.1	22.2	0	0	33.3	

Start Time	I Street Southbound					4th Street Westbound					I Street Northbound					4th Street Eastbound					Int. Total
	Left	Thru	Right	U-Turns	App. Total	Thru	Right	U-Turns	App. Total	Thru	Right	U-Turns	App. Total	Thru	Right	U-Turns	App. Total				
Peak Hour Analysis From 07:30 AM to 08:15 AM - Peak 1 of 1																					
Peak Hour for Entire Intersection Begins at 07:30 AM																					
07:30 AM	0	0	0	0	0	0	0	0	0	0	0	0	0	0	0	0	0	0	0	0	0
07:45 AM	0	0	0	0	0	0	0	0	0	0	0	0	0	0	0	0	0	0	0	0	0
08:00 AM	0	0	1	0	1	0	0	0	0	0	0	0	0	0	0	0	0	0	0	0	1
08:15 AM	0	0	0	0	0	0	1	0	0	1	0	0	0	0	0	0	0	0	0	0	1
Total Volume	0	0	1	0	1	0	1	0	0	1	0	0	0	0	0	0	0	0	0	0	2
% App. Total	0	0	100	0		0	100	0	0		0	0	0	0		0	0	0	0		
PHF	.000	.000	.250	.000	.250	.000	.250	.000	.000	.250	.000	.000	.000	.000	.000	.000	.000	.000	.000	.000	.500

City of Madera
 N/S: I Street
 E/W: 4th Street
 Weather: Clear

File Name : 33_MDA_I St_4th St AM
 Site Code : 00319628
 Start Date : 9/24/2019
 Page No : 2

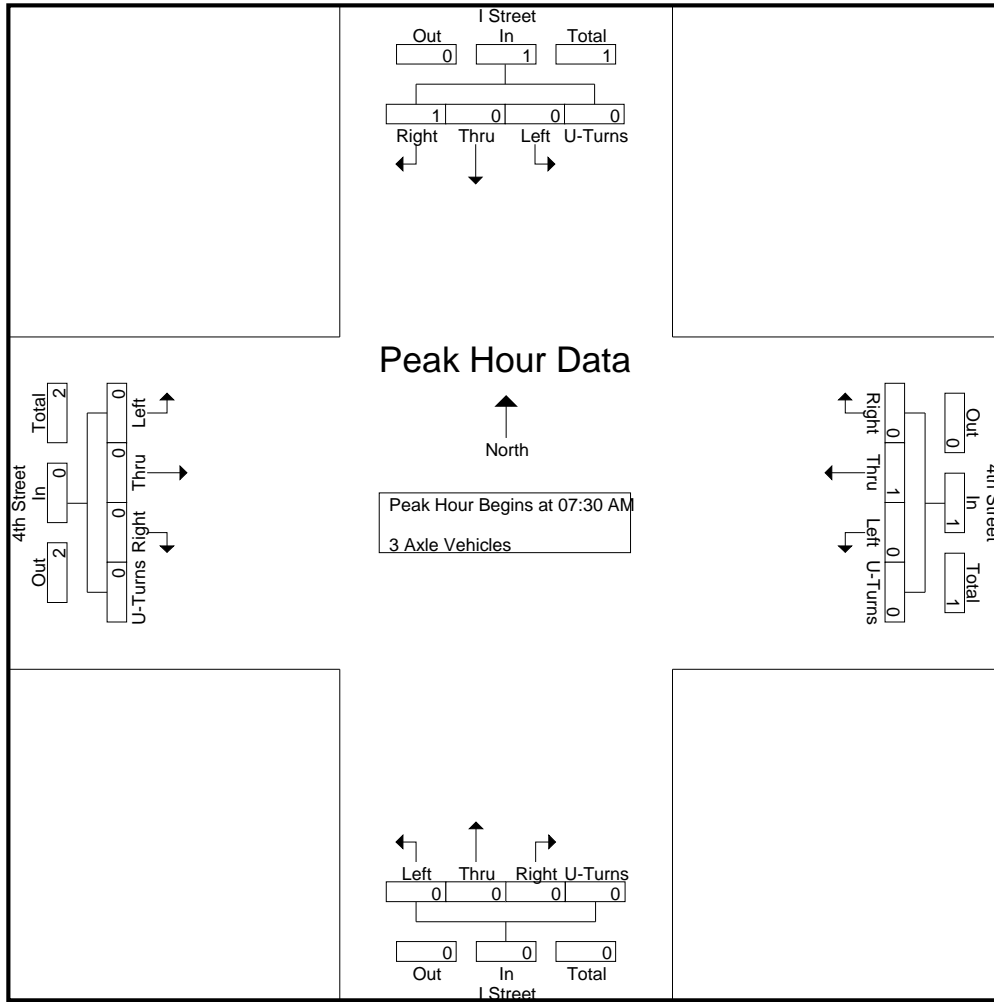

Peak Hour Analysis From 07:30 AM to 08:15 AM - Peak 1 of 1
 Peak Hour for Each Approach Begins at:

	07:30 AM					07:30 AM					07:30 AM					07:30 AM									
+0 mins.	0	0	0	0	0	0	0	0	0	0	0	0	0	0	0	0	0	0	0	0	0	0	0	0	0
+15 mins.	0	0	0	0	0	0	0	0	0	0	0	0	0	0	0	0	0	0	0	0	0	0	0	0	0
+30 mins.	0	0	1	0	1	0	0	0	0	0	0	0	0	0	0	0	0	0	0	0	0	0	0	0	0
+45 mins.	0	0	0	0	0	0	1	0	0	1	0	0	0	0	0	0	0	0	0	0	0	0	0	0	0
Total Volume	0	0	1	0	1	0	1	0	0	1	0	0	0	0	0	0	0	0	0	0	0	0	0	0	0
% App. Total	0	0	100	0	0	0	100	0	0	0	0	0	0	0	0	0	0	0	0	0	0	0	0	0	0
PHF	.000	.000	.250	.000	.250	.000	.250	.000	.000	.250	.000	.000	.000	.000	.000	.000	.000	.000	.000	.000	.000	.000	.000	.000	.000

City of Madera
 N/S: I Street
 E/W: 4th Street
 Weather: Clear

File Name : 33_MDA_I St_4th St AM
 Site Code : 00319628
 Start Date : 9/24/2019
 Page No : 1

Groups Printed- 4+ Axle Trucks

Start Time	I Street Southbound					4th Street Westbound					I Street Northbound					4th Street Eastbound					Int. Total
	Left	Thru	Right	U-Turns	App. Total	Left	Thru	Right	U-Turns	App. Total	Left	Thru	Right	U-Turns	App. Total	Left	Thru	Right	U-Turns	App. Total	
07:00 AM	0	1	0	0	1	0	1	0	0	1	0	0	1	0	1	0	0	0	0	0	3
07:15 AM	0	2	0	0	2	0	0	0	0	0	0	0	0	0	0	0	0	0	0	0	2
07:30 AM	0	3	0	0	3	0	0	0	0	0	0	0	0	0	0	0	0	0	0	0	3
07:45 AM	1	1	0	0	2	1	0	0	0	1	0	0	0	0	0	0	0	0	0	0	3
Total	1	7	0	0	8	1	1	0	0	2	0	0	1	0	1	0	0	0	0	0	11
08:00 AM	0	0	0	0	0	0	0	0	0	0	0	0	0	0	0	0	0	0	0	0	0
08:15 AM	0	0	0	0	0	0	0	0	0	0	0	0	0	0	0	0	0	0	0	0	0
08:30 AM	0	0	0	0	0	0	0	0	0	0	0	0	1	0	1	0	1	0	0	1	2
08:45 AM	0	0	0	0	0	0	0	0	0	0	0	0	0	0	0	0	0	0	0	0	0
Total	0	0	0	0	0	0	0	0	0	0	0	0	1	0	1	0	1	0	0	1	2
Grand Total	1	7	0	0	8	1	1	0	0	2	0	0	2	0	2	0	1	0	0	1	13
Apprch %	12.5	87.5	0	0		50	50	0	0		0	0	100	0		0	100	0	0		
Total %	7.7	53.8	0	0	61.5	7.7	7.7	0	0	15.4	0	0	15.4	0	15.4	0	7.7	0	0	7.7	

Start Time	I Street Southbound					4th Street Westbound					I Street Northbound					4th Street Eastbound					Int. Total
	Left	Thru	Right	U-Turns	App. Total	Thru	Right	U-Turns	App. Total	Thru	Right	U-Turns	App. Total	Thru	Right	U-Turns	App. Total				
Peak Hour Analysis From 07:30 AM to 08:15 AM - Peak 1 of 1																					
Peak Hour for Entire Intersection Begins at 07:30 AM																					
07:30 AM	0	3	0	0	3	0	0	0	0	0	0	0	0	0	0	0	0	0	0	0	3
07:45 AM	1	1	0	0	2	1	0	0	0	1	0	0	0	0	0	0	0	0	0	0	3
08:00 AM	0	0	0	0	0	0	0	0	0	0	0	0	0	0	0	0	0	0	0	0	0
08:15 AM	0	0	0	0	0	0	0	0	0	0	0	0	0	0	0	0	0	0	0	0	0
Total Volume	1	4	0	0	5	1	0	0	0	1	0	0	0	0	0	0	0	0	0	0	6
% App. Total	20	80	0	0		100	0	0	0		0	0	0	0		0	0	0	0		
PHF	.250	.333	.000	.000	.417	.250	.000	.000	.000	.250	.000	.000	.000	.000	.000	.000	.000	.000	.000	.000	.500

City of Madera
 N/S: I Street
 E/W: 4th Street
 Weather: Clear

File Name : 33_MDA_I St_4th St AM
 Site Code : 00319628
 Start Date : 9/24/2019
 Page No : 2

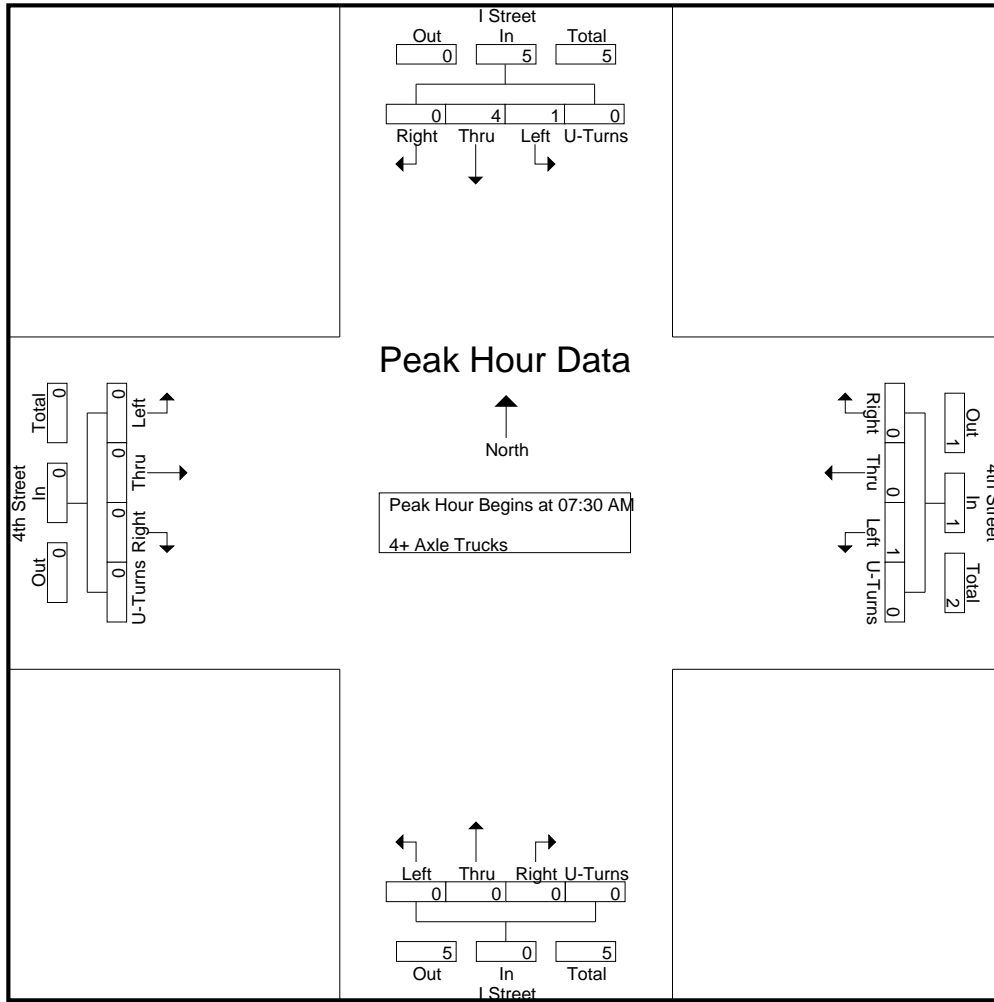

Peak Hour Analysis From 07:30 AM to 08:15 AM - Peak 1 of 1
 Peak Hour for Each Approach Begins at:

	07:30 AM					07:30 AM					07:30 AM									
+0 mins.	0	3	0	0	3	0	0	0	0	0	0	0	0	0	0	0	0	0	0	0
+15 mins.	1	1	0	0	2	1	0	0	0	1	0	0	0	0	0	0	0	0	0	0
+30 mins.	0	0	0	0	0	0	0	0	0	0	0	0	0	0	0	0	0	0	0	0
+45 mins.	0	0	0	0	0	0	0	0	0	0	0	0	0	0	0	0	0	0	0	0
Total Volume	1	4	0	0	5	1	0	0	0	1	0	0	0	0	0	0	0	0	0	0
% App. Total	20	80	0	0		100	0	0	0		0	0	0	0		0	0	0	0	
PHF	.250	.333	.000	.000	.417	.250	.000	.000	.000	.250	.000	.000	.000	.000	.000	.000	.000	.000	.000	.000

City of Madera
 N/S: I Street
 E/W: 4th Street
 Weather: Clear

File Name : 33_MDA_I St_4th St PM
 Site Code : 00319628
 Start Date : 9/24/2019
 Page No : 1

Groups Printed- Passenger Vehicles - Large 2 Axle Vehicles - 3 Axle Vehicles - 4+ Axle Trucks

Start Time	I Street Southbound					4th Street Westbound					I Street Northbound					4th Street Eastbound					Int. Total
	Left	Thru	Right	U-Turns	App. Total	Left	Thru	Right	U-Turns	App. Total	Left	Thru	Right	U-Turns	App. Total	Left	Thru	Right	U-Turns	App. Total	
04:00 PM	36	43	24	0	103	22	110	22	0	154	20	19	48	0	87	6	127	12	0	145	489
04:15 PM	43	33	15	0	91	19	106	21	0	146	16	10	39	0	65	10	93	12	0	115	417
04:30 PM	42	41	25	0	108	8	112	26	0	146	17	19	49	0	85	7	115	12	0	134	473
04:45 PM	38	39	26	0	103	16	122	21	0	159	21	9	48	0	78	6	115	17	0	138	478
Total	159	156	90	0	405	65	450	90	0	605	74	57	184	0	315	29	450	53	0	532	1857
05:00 PM	43	42	21	0	106	14	133	28	0	175	31	28	87	0	146	9	131	4	0	144	571
05:15 PM	36	41	21	0	98	21	123	31	0	175	27	12	60	0	99	9	110	28	0	147	519
05:30 PM	35	47	17	0	99	18	112	17	0	147	22	14	40	0	76	4	99	14	0	117	439
05:45 PM	25	41	28	0	94	14	114	15	0	143	20	15	36	0	71	4	85	19	0	108	416
Total	139	171	87	0	397	67	482	91	0	640	100	69	223	0	392	26	425	65	0	516	1945
Grand Total	298	327	177	0	802	132	932	181	0	1245	174	126	407	0	707	55	875	118	0	1048	3802
Apprch %	37.2	40.8	22.1	0		10.6	74.9	14.5	0		24.6	17.8	57.6	0		5.2	83.5	11.3	0		
Total %	7.8	8.6	4.7	0	21.1	3.5	24.5	4.8	0	32.7	4.6	3.3	10.7	0	18.6	1.4	23	3.1	0	27.6	
Passenger Vehicles	98.7	96.9	94.4	0	97	98.5	98.1	98.9	0	98.2	98.9	100	98.8	0	99	100	96.9	99.2	0	97.3	97.9
Large 2 Axle Vehicles	1.3	2.1	4	0	2.2	1.5	1.9	1.1	0	1.8	1.1	0	1.2	0	1	0	2.9	0.8	0	2.5	1.9
3 Axle Vehicles	0	0	0	0	0	0	0	0	0	0	0	0	0	0	0	0	1	0	0	1	1
% 3 Axle Vehicles	0	0	0	0	0	0	0	0	0	0	0	0	0	0	0	0	0.1	0	0	0.1	0
4+ Axle Trucks	0	3	3	0	6	0	0	0	0	0	0	0	0	0	0	0	1	0	0	1	7
% 4+ Axle Trucks																					

Start Time	I Street Southbound					4th Street Westbound					I Street Northbound					4th Street Eastbound					Int. Total
	Left	Thru	Right	U-Turns	App. Total	Left	Thru	Right	U-Turns	App. Total	Left	Thru	Right	U-Turns	App. Total	Left	Thru	Right	U-Turns	App. Total	
Peak Hour Analysis From 04:00 PM to 05:45 PM - Peak 1 of 1																					
Peak Hour for Entire Intersection Begins at 04:30 PM																					
04:30 PM	42	41	25	0	108	8	112	26	0	146	17	19	49	0	85	7	115	12	0	134	473
04:45 PM	38	39	26	0	103	16	122	21	0	159	21	9	48	0	78	6	115	17	0	138	478
05:00 PM	43	42	21	0	106	14	133	28	0	175	31	28	87	0	146	9	131	4	0	144	571
05:15 PM	36	41	21	0	98	21	123	31	0	175	27	12	60	0	99	9	110	28	0	147	519
Total Volume	159	163	93	0	415	59	490	106	0	655	96	68	244	0	408	31	471	61	0	563	2041
% App. Total	38.3	39.3	22.4	0		9	74.8	16.2	0		23.5	16.7	59.8	0		5.5	83.7	10.8	0		
PHF	.924	.970	.894	.000	.961	.702	.921	.855	.000	.936	.774	.607	.701	.000	.699	.861	.899	.545	.000	.957	.894

City of Madera
 N/S: I Street
 E/W: 4th Street
 Weather: Clear

File Name : 33_MDA_I St_4th St PM
 Site Code : 00319628
 Start Date : 9/24/2019
 Page No : 2

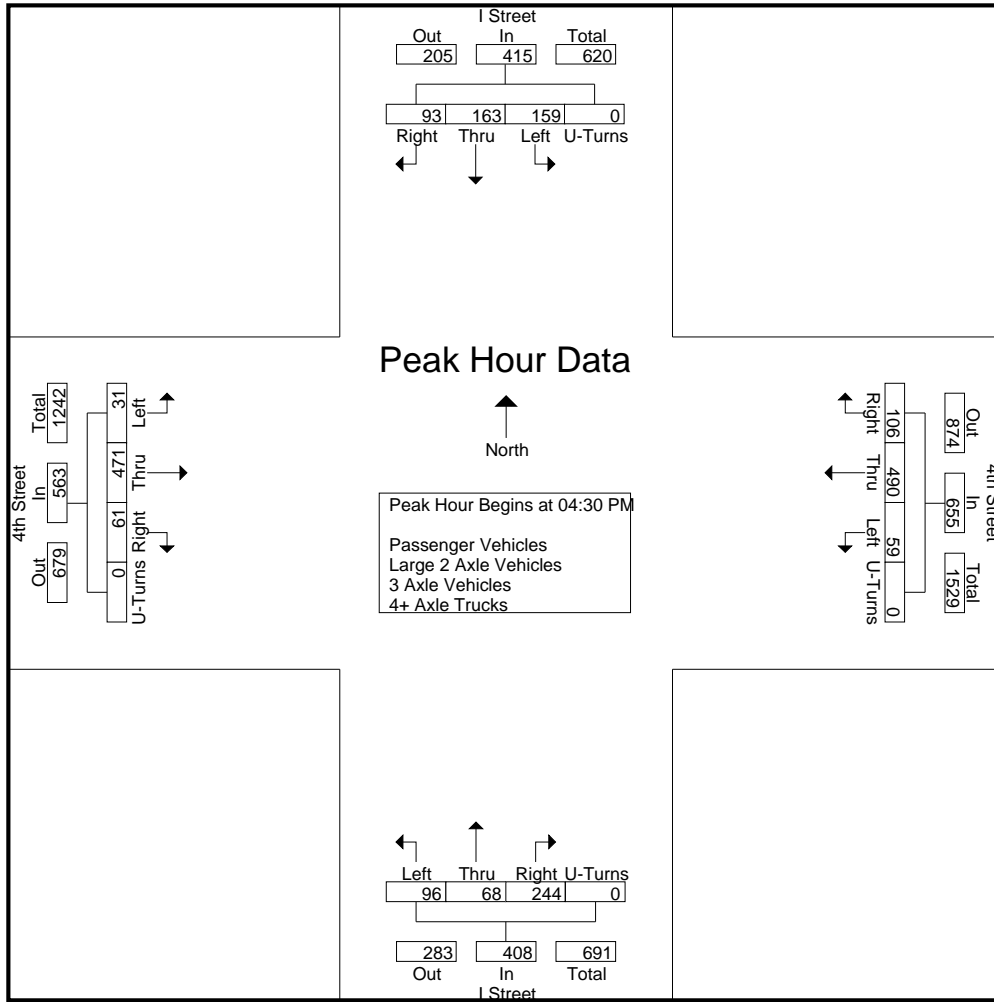

Peak Hour Analysis From 04:00 PM to 05:45 PM - Peak 1 of 1
 Peak Hour for Each Approach Begins at:

	04:30 PM					04:45 PM					04:30 PM									
+0 mins.	42	41	25	0	108	16	122	21	0	159	17	19	49	0	85	7	115	12	0	134
+15 mins.	38	39	26	0	103	14	133	28	0	175	21	9	48	0	78	6	115	17	0	138
+30 mins.	43	42	21	0	106	21	123	31	0	175	31	28	87	0	146	9	131	4	0	144
+45 mins.	36	41	21	0	98	18	112	17	0	147	27	12	60	0	99	9	110	28	0	147
Total Volume	159	163	93	0	415	69	490	97	0	656	96	68	244	0	408	31	471	61	0	563
% App. Total	38.3	39.3	22.4	0		10.5	74.7	14.8	0		23.5	16.7	59.8	0		5.5	83.7	10.8	0	
PHF	.924	.970	.894	.000	.961	.821	.921	.782	.000	.937	.774	.607	.701	.000	.699	.861	.899	.545	.000	.957

City of Madera
 N/S: I Street
 E/W: 4th Street
 Weather: Clear

File Name : 33_MDA_I St_4th St PM
 Site Code : 00319628
 Start Date : 9/24/2019
 Page No : 1

Groups Printed- Passenger Vehicles

Start Time	I Street Southbound					4th Street Westbound					I Street Northbound					4th Street Eastbound					Int. Total
	Left	Thru	Right	U-Turns	App. Total	Left	Thru	Right	U-Turns	App. Total	Left	Thru	Right	U-Turns	App. Total	Left	Thru	Right	U-Turns	App. Total	
04:00 PM	35	38	21	0	94	22	108	22	0	152	20	19	46	0	85	6	125	11	0	142	473
04:15 PM	42	33	15	0	90	19	100	20	0	139	16	10	39	0	65	10	93	12	0	115	409
04:30 PM	42	41	23	0	106	8	109	25	0	142	16	19	47	0	82	7	111	12	0	130	460
04:45 PM	37	38	24	0	99	16	120	21	0	157	20	9	48	0	77	6	112	17	0	135	468
Total	156	150	83	0	389	65	437	88	0	590	72	57	180	0	309	29	441	52	0	522	1810
05:00 PM	43	42	21	0	106	14	133	28	0	175	31	28	87	0	146	9	125	4	0	138	565
05:15 PM	36	41	20	0	97	21	122	31	0	174	27	12	60	0	99	9	104	28	0	141	511
05:30 PM	35	45	16	0	96	16	110	17	0	143	22	14	40	0	76	4	96	14	0	114	429
05:45 PM	24	39	27	0	90	14	112	15	0	141	20	15	35	0	70	4	82	19	0	105	406
Total	138	167	84	0	389	65	477	91	0	633	100	69	222	0	391	26	407	65	0	498	1911
Grand Total	294	317	167	0	778	130	914	179	0	1223	172	126	402	0	700	55	848	117	0	1020	3721
Apprch %	37.8	40.7	21.5	0		10.6	74.7	14.6	0		24.6	18	57.4	0		5.4	83.1	11.5	0		
Total %	7.9	8.5	4.5	0	20.9	3.5	24.6	4.8	0	32.9	4.6	3.4	10.8	0	18.8	1.5	22.8	3.1	0	27.4	

Start Time	I Street Southbound					4th Street Westbound					I Street Northbound					4th Street Eastbound					Int. Total
	Left	Thru	Right	U-Turns	App. Total	Thru	Right	U-Turns	App. Total	Thru	Right	U-Turns	App. Total	Thru	Right	U-Turns	App. Total				
Peak Hour Analysis From 04:30 PM to 05:15 PM - Peak 1 of 1																					
Peak Hour for Entire Intersection Begins at 04:30 PM																					
04:30 PM	42	41	23	0	106	8	109	25	0	142	16	19	47	0	82	7	111	12	0	130	460
04:45 PM	37	38	24	0	99	16	120	21	0	157	20	9	48	0	77	6	112	17	0	135	468
05:00 PM	43	42	21	0	106	14	133	28	0	175	31	28	87	0	146	9	125	4	0	138	565
05:15 PM	36	41	20	0	97	21	122	31	0	174	27	12	60	0	99	9	104	28	0	141	511
Total Volume	158	162	88	0	408	59	484	105	0	648	94	68	242	0	404	31	452	61	0	544	2004
% App. Total	38.7	39.7	21.6	0		9.1	74.7	16.2	0		23.3	16.8	59.9	0		5.7	83.1	11.2	0		
PHF	.919	.964	.917	.000	.962	.702	.910	.847	.000	.926	.758	.607	.695	.000	.692	.861	.904	.545	.000	.965	.887

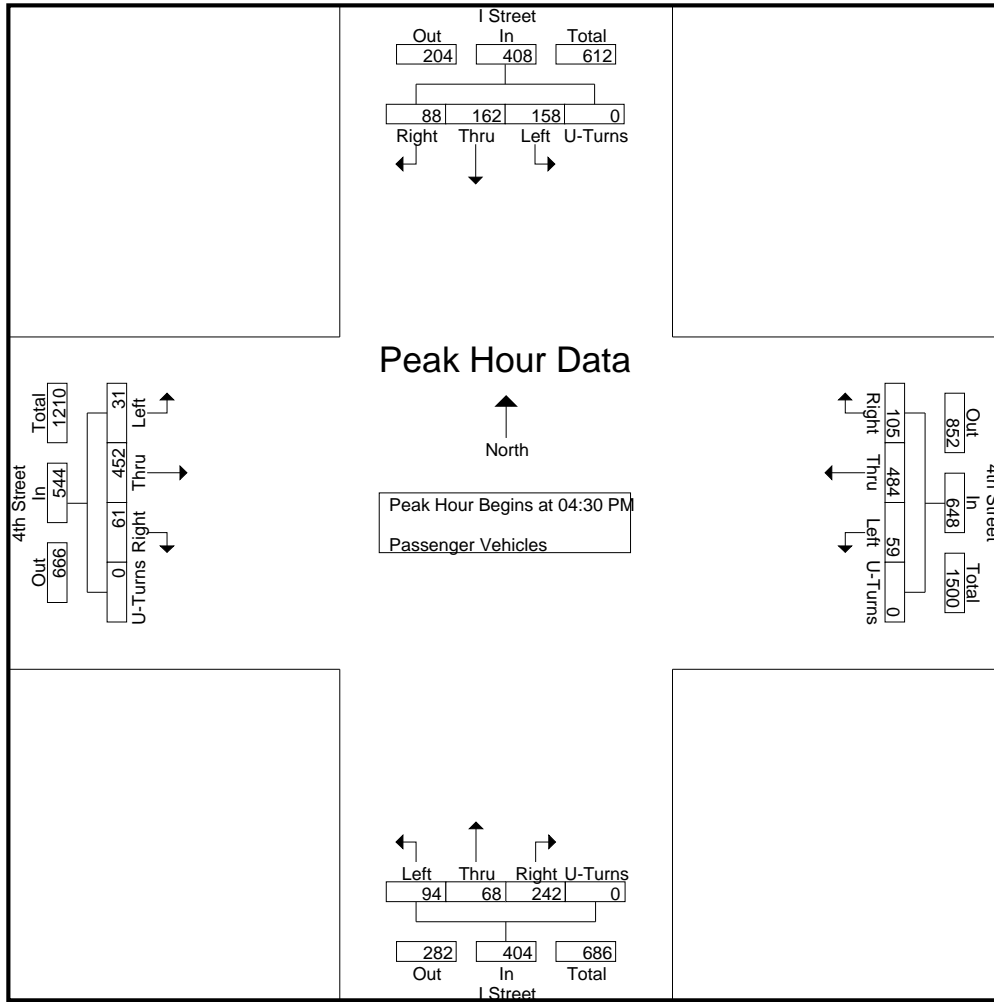

Peak Hour Analysis From 04:30 PM to 05:15 PM - Peak 1 of 1
 Peak Hour for Each Approach Begins at:

	04:30 PM					04:30 PM					04:30 PM									
+0 mins.	42	41	23	0	106	8	109	25	0	142	16	19	47	0	82	7	111	12	0	130
+15 mins.	37	38	24	0	99	16	120	21	0	157	20	9	48	0	77	6	112	17	0	135
+30 mins.	43	42	21	0	106	14	133	28	0	175	31	28	87	0	146	9	125	4	0	138
+45 mins.	36	41	20	0	97	21	122	31	0	174	27	12	60	0	99	9	104	28	0	141
Total Volume	158	162	88	0	408	59	484	105	0	648	94	68	242	0	404	31	452	61	0	544
% App. Total	38.7	39.7	21.6	0		9.1	74.7	16.2	0		23.3	16.8	59.9	0		5.7	83.1	11.2	0	
PHF	.919	.964	.917	.000	.962	.702	.910	.847	.000	.926	.758	.607	.695	.000	.692	.861	.904	.545	.000	.965

City of Madera
 N/S: I Street
 E/W: 4th Street
 Weather: Clear

File Name : 33_MDA_I St_4th St PM
 Site Code : 00319628
 Start Date : 9/24/2019
 Page No : 1

Groups Printed- Large 2 Axle Vehicles

Start Time	I Street Southbound					4th Street Westbound					I Street Northbound					4th Street Eastbound					Int. Total
	Left	Thru	Right	U-Turns	App. Total	Left	Thru	Right	U-Turns	App. Total	Left	Thru	Right	U-Turns	App. Total	Left	Thru	Right	U-Turns	App. Total	
04:00 PM	1	5	2	0	8	0	2	0	0	2	0	0	2	0	2	0	1	1	0	2	14
04:15 PM	1	0	0	0	1	0	6	1	0	7	0	0	0	0	0	0	0	0	0	0	8
04:30 PM	0	0	2	0	2	0	3	1	0	4	1	0	2	0	3	0	4	0	0	4	13
04:45 PM	1	0	1	0	2	0	2	0	0	2	1	0	0	0	1	0	3	0	0	3	8
Total	3	5	5	0	13	0	13	2	0	15	2	0	4	0	6	0	8	1	0	9	43
05:00 PM	0	0	0	0	0	0	0	0	0	0	0	0	0	0	0	0	6	0	0	6	6
05:15 PM	0	0	1	0	1	0	1	0	0	1	0	0	0	0	0	0	6	0	0	6	8
05:30 PM	0	1	0	0	1	2	2	0	0	4	0	0	0	0	0	0	3	0	0	3	8
05:45 PM	1	1	1	0	3	0	2	0	0	2	0	0	1	0	1	0	2	0	0	2	8
Total	1	2	2	0	5	2	5	0	0	7	0	0	1	0	1	0	17	0	0	17	30
Grand Total	4	7	7	0	18	2	18	2	0	22	2	0	5	0	7	0	25	1	0	26	73
Apprch %	22.2	38.9	38.9	0		9.1	81.8	9.1	0		28.6	0	71.4	0		0	96.2	3.8	0		
Total %	5.5	9.6	9.6	0	24.7	2.7	24.7	2.7	0	30.1	2.7	0	6.8	0	9.6	0	34.2	1.4	0	35.6	

Start Time	I Street Southbound					4th Street Westbound					I Street Northbound					4th Street Eastbound					Int. Total
	Left	Thru	Right	U-Turns	App. Total	Thru	Right	U-Turns	App. Total	Thru	Right	U-Turns	App. Total	Thru	Right	U-Turns	App. Total				
Peak Hour Analysis From 04:30 PM to 05:15 PM - Peak 1 of 1																					
Peak Hour for Entire Intersection Begins at 04:30 PM																					
04:30 PM	0	0	2	0	2	0	3	1	0	4	1	0	2	0	3	0	4	0	0	4	13
04:45 PM	1	0	1	0	2	0	2	0	0	2	1	0	0	0	1	0	3	0	0	3	8
05:00 PM	0	0	0	0	0	0	0	0	0	0	0	0	0	0	0	0	6	0	0	6	6
05:15 PM	0	0	1	0	1	0	1	0	0	1	0	0	0	0	0	0	6	0	0	6	8
Total Volume	1	0	4	0	5	0	6	1	0	7	2	0	2	0	4	0	19	0	0	19	35
% App. Total	20	0	80	0		0	85.7	14.3	0		50	0	50	0		0	100	0	0		
PHF	.250	.000	.500	.000	.625	.000	.500	.250	.000	.438	.500	.000	.250	.000	.333	.000	.792	.000	.000	.792	.673

City of Madera
 N/S: I Street
 E/W: 4th Street
 Weather: Clear

File Name : 33_MDA_I St_4th St PM
 Site Code : 00319628
 Start Date : 9/24/2019
 Page No : 2

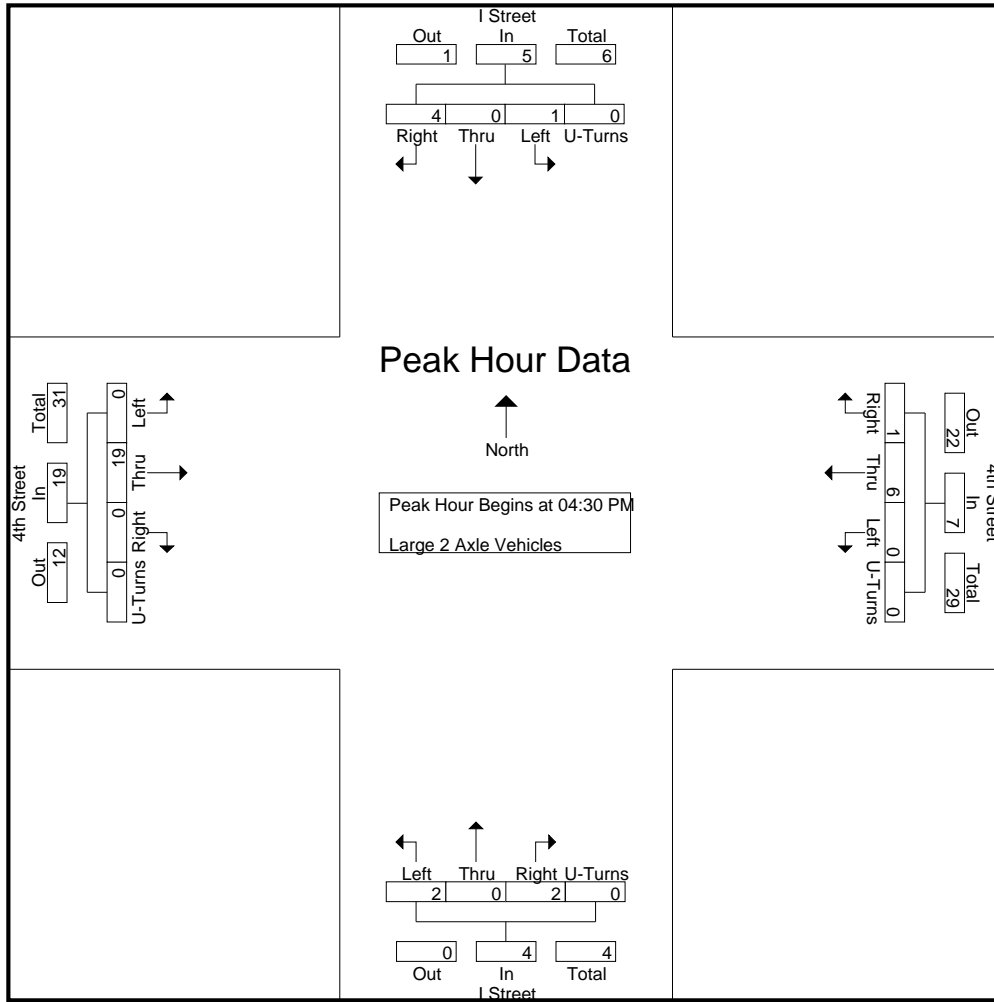

Peak Hour Analysis From 04:30 PM to 05:15 PM - Peak 1 of 1
 Peak Hour for Each Approach Begins at:

	04:30 PM					04:30 PM					04:30 PM									
+0 mins.	0	0	2	0	2	0	3	1	0	4	1	0	2	0	3	0	4	0	0	4
+15 mins.	1	0	1	0	2	0	2	0	0	2	1	0	0	0	1	0	3	0	0	3
+30 mins.	0	0	0	0	0	0	0	0	0	0	0	0	0	0	0	0	6	0	0	6
+45 mins.	0	0	1	0	1	0	1	0	0	1	0	0	0	0	0	0	6	0	0	6
Total Volume	1	0	4	0	5	0	6	1	0	7	2	0	2	0	4	0	19	0	0	19
% App. Total	20	0	80	0		0	85.7	14.3	0		50	0	50	0		0	100	0	0	
PHF	.250	.000	.500	.000	.625	.000	.500	.250	.000	.438	.500	.000	.250	.000	.333	.000	.792	.000	.000	.792

City of Madera
 N/S: I Street
 E/W: 4th Street
 Weather: Clear

File Name : 33_MDA_I St_4th St PM
 Site Code : 00319628
 Start Date : 9/24/2019
 Page No : 1

Groups Printed- 3 Axle Vehicles

Start Time	I Street Southbound					4th Street Westbound					I Street Northbound					4th Street Eastbound					Int. Total
	Left	Thru	Right	U-Turns	App. Total	Left	Thru	Right	U-Turns	App. Total	Left	Thru	Right	U-Turns	App. Total	Left	Thru	Right	U-Turns	App. Total	
04:00 PM	0	0	0	0	0	0	0	0	0	0	0	0	0	0	0	0	1	0	0	1	1
04:15 PM	0	0	0	0	0	0	0	0	0	0	0	0	0	0	0	0	0	0	0	0	0
04:30 PM	0	0	0	0	0	0	0	0	0	0	0	0	0	0	0	0	0	0	0	0	0
04:45 PM	0	0	0	0	0	0	0	0	0	0	0	0	0	0	0	0	0	0	0	0	0
Total	0	0	0	0	0	0	0	0	0	0	0	0	0	0	0	0	1	0	0	1	1
05:00 PM	0	0	0	0	0	0	0	0	0	0	0	0	0	0	0	0	0	0	0	0	0
05:15 PM	0	0	0	0	0	0	0	0	0	0	0	0	0	0	0	0	0	0	0	0	0
05:30 PM	0	0	0	0	0	0	0	0	0	0	0	0	0	0	0	0	0	0	0	0	0
05:45 PM	0	0	0	0	0	0	0	0	0	0	0	0	0	0	0	0	0	0	0	0	0
Total	0	0	0	0	0	0	0	0	0	0	0	0	0	0	0	0	0	0	0	0	0
Grand Total	0	0	0	0	0	0	0	0	0	0	0	0	0	0	0	0	1	0	0	1	1
Apprch %	0	0	0	0		0	0	0	0		0	0	0	0		0	100	0	0		
Total %	0	0	0	0	0	0	0	0	0	0	0	0	0	0	0	0	100	0	0	100	

Start Time	I Street Southbound					4th Street Westbound					I Street Northbound					4th Street Eastbound					Int. Total
	Left	Thru	Right	U-Turns	App. Total	Left	Thru	Right	U-Turns	App. Total	Left	Thru	Right	U-Turns	App. Total	Left	Thru	Right	U-Turns	App. Total	
Peak Hour Analysis From 04:30 PM to 05:15 PM - Peak 1 of 1																					
Peak Hour for Entire Intersection Begins at 04:30 PM																					
04:30 PM	0	0	0	0	0	0	0	0	0	0	0	0	0	0	0	0	0	0	0	0	0
04:45 PM	0	0	0	0	0	0	0	0	0	0	0	0	0	0	0	0	0	0	0	0	0
05:00 PM	0	0	0	0	0	0	0	0	0	0	0	0	0	0	0	0	0	0	0	0	0
05:15 PM	0	0	0	0	0	0	0	0	0	0	0	0	0	0	0	0	0	0	0	0	0
Total Volume	0	0	0	0	0	0	0	0	0	0	0	0	0	0	0	0	0	0	0	0	0
% App. Total	0	0	0	0		0	0	0	0		0	0	0	0		0	0	0	0		
PHF	.000	.000	.000	.000	.000	.000	.000	.000	.000	.000	.000	.000	.000	.000	.000	.000	.000	.000	.000	.000	.000

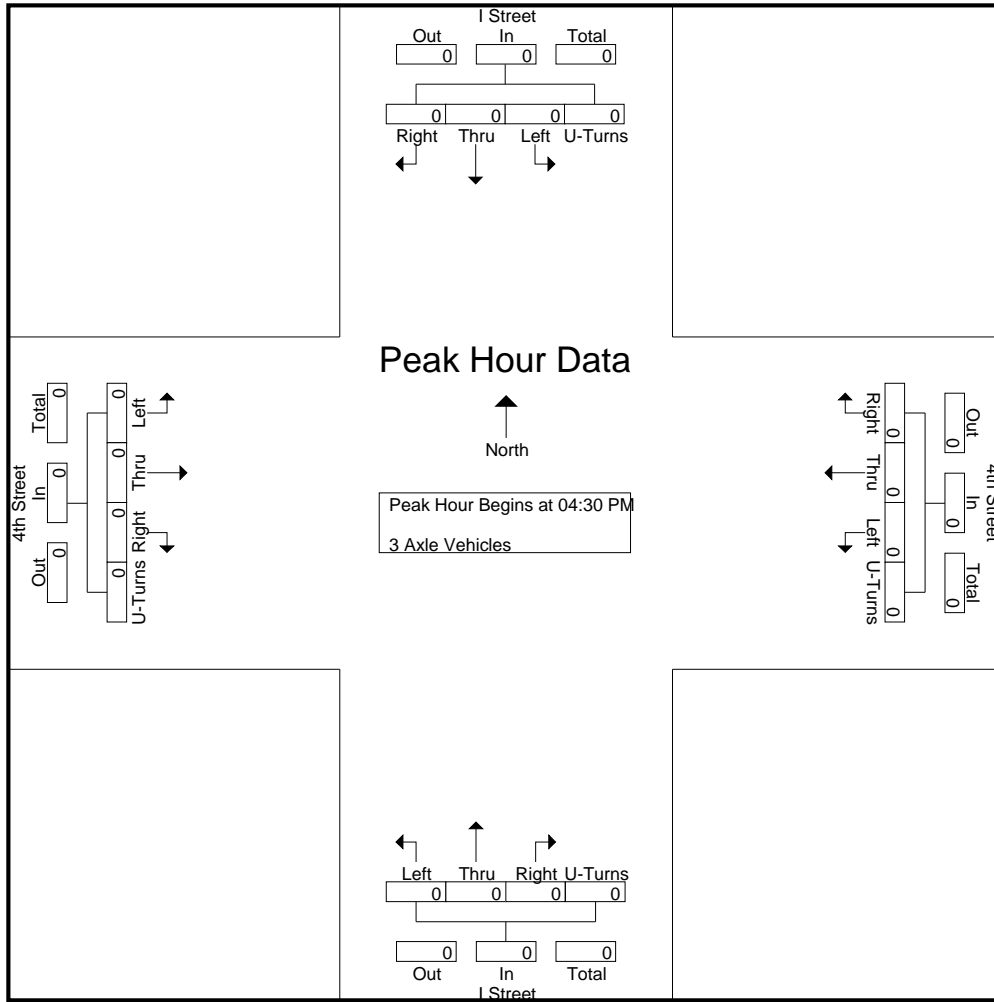

Peak Hour Analysis From 04:30 PM to 05:15 PM - Peak 1 of 1
 Peak Hour for Each Approach Begins at:

	04:30 PM					04:30 PM					04:30 PM					04:30 PM									
+0 mins.	0	0	0	0	0	0	0	0	0	0	0	0	0	0	0	0	0	0	0	0	0	0	0	0	0
+15 mins.	0	0	0	0	0	0	0	0	0	0	0	0	0	0	0	0	0	0	0	0	0	0	0	0	0
+30 mins.	0	0	0	0	0	0	0	0	0	0	0	0	0	0	0	0	0	0	0	0	0	0	0	0	0
+45 mins.	0	0	0	0	0	0	0	0	0	0	0	0	0	0	0	0	0	0	0	0	0	0	0	0	0
Total Volume	0	0	0	0	0	0	0	0	0	0	0	0	0	0	0	0	0	0	0	0	0	0	0	0	0
% App. Total	0	0	0	0	0	0	0	0	0	0	0	0	0	0	0	0	0	0	0	0	0	0	0	0	0
PHF	.000	.000	.000	.000	.000	.000	.000	.000	.000	.000	.000	.000	.000	.000	.000	.000	.000	.000	.000	.000	.000	.000	.000	.000	.000

City of Madera
 N/S: I Street
 E/W: 4th Street
 Weather: Clear

File Name : 33_MDA_I St_4th St PM
 Site Code : 00319628
 Start Date : 9/24/2019
 Page No : 1

Groups Printed- 4+ Axle Trucks

Start Time	I Street Southbound					4th Street Westbound					I Street Northbound					4th Street Eastbound					Int. Total					
	Left	Thru	Right	U-Turns	App. Total	Left	Thru	Right	U-Turns	App. Total	Left	Thru	Right	U-Turns	App. Total	Left	Thru	Right	U-Turns	App. Total						
04:00 PM	0	0	1	0	1	0	0	0	0	0	0	0	0	0	0	0	0	0	0	0	0	0	0	0	0	1
04:15 PM	0	0	0	0	0	0	0	0	0	0	0	0	0	0	0	0	0	0	0	0	0	0	0	0	0	0
04:30 PM	0	0	0	0	0	0	0	0	0	0	0	0	0	0	0	0	0	0	0	0	0	0	0	0	0	0
04:45 PM	0	1	1	0	2	0	0	0	0	0	0	0	0	0	0	0	0	0	0	0	0	0	0	0	0	2
Total	0	1	2	0	3	0	0	0	0	0	0	0	0	0	0	0	0	0	0	0	0	0	0	0	0	3
05:00 PM	0	0	0	0	0	0	0	0	0	0	0	0	0	0	0	0	0	0	0	0	0	0	0	0	0	0
05:15 PM	0	0	0	0	0	0	0	0	0	0	0	0	0	0	0	0	0	0	0	0	0	0	0	0	0	0
05:30 PM	0	1	1	0	2	0	0	0	0	0	0	0	0	0	0	0	0	0	0	0	0	0	0	0	0	2
05:45 PM	0	1	0	0	1	0	0	0	0	0	0	0	0	0	0	0	1	0	0	0	0	1	0	0	1	2
Total	0	2	1	0	3	0	0	0	0	0	0	0	0	0	0	0	1	0	0	0	0	1	0	0	1	4
Grand Total	0	3	3	0	6	0	0	0	0	0	0	0	0	0	0	0	1	0	0	0	0	1	0	0	1	7
Apprch %	0	50	50	0		0	0	0	0		0	0	0	0		0	100	0	0		0	100	0	0		
Total %	0	42.9	42.9	0	85.7	0	0	0	0	0	0	0	0	0	0	0	14.3	0	0	14.3	0	14.3	0	0	14.3	

Start Time	I Street Southbound					4th Street Westbound					I Street Northbound					4th Street Eastbound					Int. Total					
	Left	Thru	Right	U-Turns	App. Total	Thru	Right	U-Turns	App. Total	Thru	Right	U-Turns	App. Total	Thru	Right	U-Turns	App. Total									
Peak Hour Analysis From 04:30 PM to 05:15 PM - Peak 1 of 1																										
Peak Hour for Entire Intersection Begins at 04:30 PM																										
04:30 PM	0	0	0	0	0	0	0	0	0	0	0	0	0	0	0	0	0	0	0	0	0	0	0	0	0	0
04:45 PM	0	1	1	0	2	0	0	0	0	0	0	0	0	0	0	0	0	0	0	0	0	0	0	0	0	2
05:00 PM	0	0	0	0	0	0	0	0	0	0	0	0	0	0	0	0	0	0	0	0	0	0	0	0	0	0
05:15 PM	0	0	0	0	0	0	0	0	0	0	0	0	0	0	0	0	0	0	0	0	0	0	0	0	0	0
Total Volume	0	1	1	0	2	0	0	0	0	0	0	0	0	0	0	0	0	0	0	0	0	0	0	0	0	2
% App. Total	0	50	50	0		0	0	0	0		0	0	0	0		0	0	0	0		0	0	0	0		
PHF	.000	.250	.250	.000	.250	.000	.000	.000	.000	.000	.000	.000	.000	.000	.000	.000	.000	.000	.000	.000	.000	.000	.000	.000	.250	

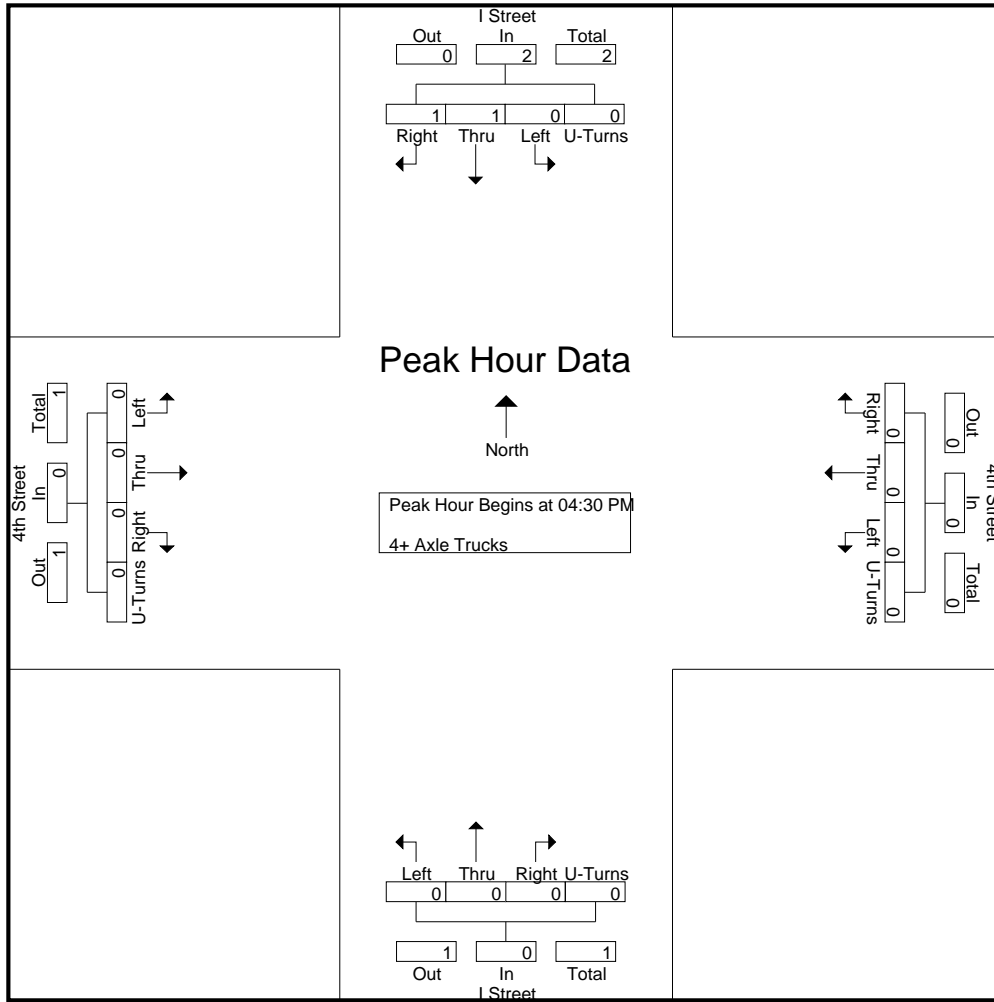

Peak Hour Analysis From 04:30 PM to 05:15 PM - Peak 1 of 1
 Peak Hour for Each Approach Begins at:

	04:30 PM					04:30 PM					04:30 PM					04:30 PM				
+0 mins.	0	0	0	0	0	0	0	0	0	0	0	0	0	0	0	0	0	0	0	0
+15 mins.	0	1	1	0	2	0	0	0	0	0	0	0	0	0	0	0	0	0	0	0
+30 mins.	0	0	0	0	0	0	0	0	0	0	0	0	0	0	0	0	0	0	0	0
+45 mins.	0	0	0	0	0	0	0	0	0	0	0	0	0	0	0	0	0	0	0	0
Total Volume	0	1	1	0	2	0	0	0	0	0	0	0	0	0	0	0	0	0	0	0
% App. Total	0	50	50	0		0	0	0	0		0	0	0	0		0	0	0	0	
PHF	.000	.250	.250	.000	.250	.000	.000	.000	.000	.000	.000	.000	.000	.000	.000	.000	.000	.000	.000	.000

Location: Madera
 N/S: I Street
 E/W: 4th Street



Date: 9/24/2019
 Day: Tuesday

PEDESTRIANS

	North Leg I Street	East Leg 4th Street	South Leg I Street	West Leg 4th Street	
	Pedestrians	Pedestrians	Pedestrians	Pedestrians	
7:00 AM	13	0	1	3	17
7:15 AM	2	0	1	1	4
7:30 AM	2	0	2	2	6
7:45 AM	9	0	1	0	10
8:00 AM	5	0	1	8	14
8:15 AM	5	0	0	4	9
8:30 AM	2	0	2	1	5
8:45 AM	0	0	1	0	1
TOTAL VOLUMES:	38	0	9	19	66

	North Leg I Street	East Leg 4th Street	South Leg I Street	West Leg 4th Street	
	Pedestrians	Pedestrians	Pedestrians	Pedestrians	
4:00 PM	0	0	0	2	2
4:15 PM	3	0	0	0	3
4:30 PM	2	0	0	0	2
4:45 PM	0	0	0	0	0
5:00 PM	1	0	2	0	3
5:15 PM	1	0	0	0	1
5:30 PM	0	0	0	0	0
5:45 PM	1	0	1	1	3
TOTAL VOLUMES:	8	0	3	3	14

Location: Madera
 N/S: I Street
 E/W: 4th Street



Date: 9/24/2019
 Day: Tuesday

BICYCLES

	Southbound I Street			Westbound 4th Street			Northbound I Street			Eastbound 4th Street			
	Left	Thru	Right	Left	Thru	Right	Left	Thru	Right	Left	Thru	Right	
7:00 AM	0	0	0	0	0	0	0	0	0	0	0	0	0
7:15 AM	0	0	0	0	1	0	0	0	0	0	1	0	2
7:30 AM	0	0	0	0	0	0	0	0	0	0	0	0	0
7:45 AM	0	0	0	0	2	0	0	0	0	0	0	0	2
8:00 AM	0	0	1	0	0	0	0	0	0	0	1	0	2
8:15 AM	0	0	0	0	0	0	0	0	0	0	1	0	1
8:30 AM	0	0	0	0	0	0	0	0	0	0	0	0	0
8:45 AM	0	0	0	0	0	1	0	0	0	0	0	0	1
TOTAL VOLUMES:	0	0	1	0	3	1	0	0	0	0	3	0	8

	Southbound I Street			Westbound 4th Street			Northbound I Street			Eastbound 4th Street			
	Left	Thru	Right	Left	Thru	Right	Left	Thru	Right	Left	Thru	Right	
4:00 PM	0	0	0	0	0	0	0	0	0	0	0	0	0
4:15 PM	0	0	0	0	1	0	0	0	0	0	1	0	2
4:30 PM	0	0	0	0	0	0	0	1	0	0	1	0	2
4:45 PM	0	0	0	0	0	0	1	0	0	0	0	0	1
5:00 PM	0	0	0	0	0	0	1	0	0	0	1	0	2
5:15 PM	0	0	0	0	0	0	0	0	0	0	0	0	0
5:30 PM	0	0	0	0	0	1	0	0	0	0	0	0	1
5:45 PM	0	0	0	0	2	0	0	0	0	0	0	0	2
TOTAL VOLUMES:	0	0	0	0	3	1	2	1	0	0	3	0	10

City of Madera
 N/S: SR-99 Southbound On Ramp
 E/W: 4th Street
 Weather: Clear

File Name : 33B_MDA_99S On Ramp_4th St AM
 Site Code : 00319628
 Start Date : 9/24/2019
 Page No : 1

Groups Printed- Passenger Vehicles - Large 2 Axle Vehicles - 3 Axle Vehicles - 4+ Axle Trucks

Start Time	4th Street Westbound				SR-99 Southbound On Ramp Northbound				4th Street Eastbound				Int. Total
	Left	Thru	U-Turns	App. Total	Left	Right	U-Turns	App. Total	Thru	Right	U-Turns	App. Total	
07:00 AM	54	88	0	142	0	0	0	0	77	76	0	153	295
07:15 AM	33	131	0	164	0	0	0	0	109	98	0	207	371
07:30 AM	54	182	0	236	0	0	0	0	163	74	0	237	473
07:45 AM	30	158	0	188	0	0	0	0	221	74	0	295	483
Total	171	559	0	730	0	0	0	0	570	322	0	892	1622
08:00 AM	35	134	0	169	0	0	1	1	174	77	0	251	421
08:15 AM	35	113	0	148	0	0	0	0	117	60	0	177	325
08:30 AM	38	88	0	126	0	0	0	0	113	44	0	157	283
08:45 AM	44	74	0	118	0	0	0	0	102	43	0	145	263
Total	152	409	0	561	0	0	1	1	506	224	0	730	1292
Grand Total	323	968	0	1291	0	0	1	1	1076	546	0	1622	2914
Apprch %	25	75	0		0	0	100		66.3	33.7	0		
Total %	11.1	33.2	0	44.3	0	0	0	0	36.9	18.7	0	55.7	
Passenger Vehicles	314	934	0	1248	0	0	0	0	1048	542	0	1590	2838
% Passenger Vehicles	97.2	96.5	0	96.7	0	0	0	0	97.4	99.3	0	98	97.4
Large 2 Axle Vehicles	8	33	0	41	0	0	1	1	22	3	0	25	67
% Large 2 Axle Vehicles	2.5	3.4	0	3.2	0	0	100	100	2	0.5	0	1.5	2.3
3 Axle Vehicles	0	1	0	1	0	0	0	0	1	0	0	1	2
% 3 Axle Vehicles	0	0.1	0	0.1	0	0	0	0	0.1	0	0	0.1	0.1
4+ Axle Trucks	1	0	0	1	0	0	0	0	5	1	0	6	7
% 4+ Axle Trucks	0.3	0	0	0.1	0	0	0	0	0.5	0.2	0	0.4	0.2

Start Time	4th Street Westbound				SR-99 Southbound On Ramp Northbound				4th Street Eastbound				Int. Total
	Left	Thru	U-Turns	App. Total	Left	Right	U-Turns	App. Total	Thru	Right	U-Turns	App. Total	
Peak Hour Analysis From 07:00 AM to 08:45 AM - Peak 1 of 1													
Peak Hour for Entire Intersection Begins at 07:15 AM													
07:15 AM	33	131	0	164	0	0	0	0	109	98	0	207	371
07:30 AM	54	182	0	236	0	0	0	0	163	74	0	237	473
07:45 AM	30	158	0	188	0	0	0	0	221	74	0	295	483
08:00 AM	35	134	0	169	0	0	1	1	174	77	0	251	421
Total Volume	152	605	0	757	0	0	1	1	667	323	0	990	1748
% App. Total	20.1	79.9	0		0	0	100		67.4	32.6	0		
PHF	.704	.831	.000	.802	.000	.000	.250	.250	.755	.824	.000	.839	.905

City of Madera
 N/S: SR-99 Southbound On Ramp
 E/W: 4th Street
 Weather: Clear

File Name : 33B_MDA_99S On Ramp_4th St AM
 Site Code : 00319628
 Start Date : 9/24/2019
 Page No : 2

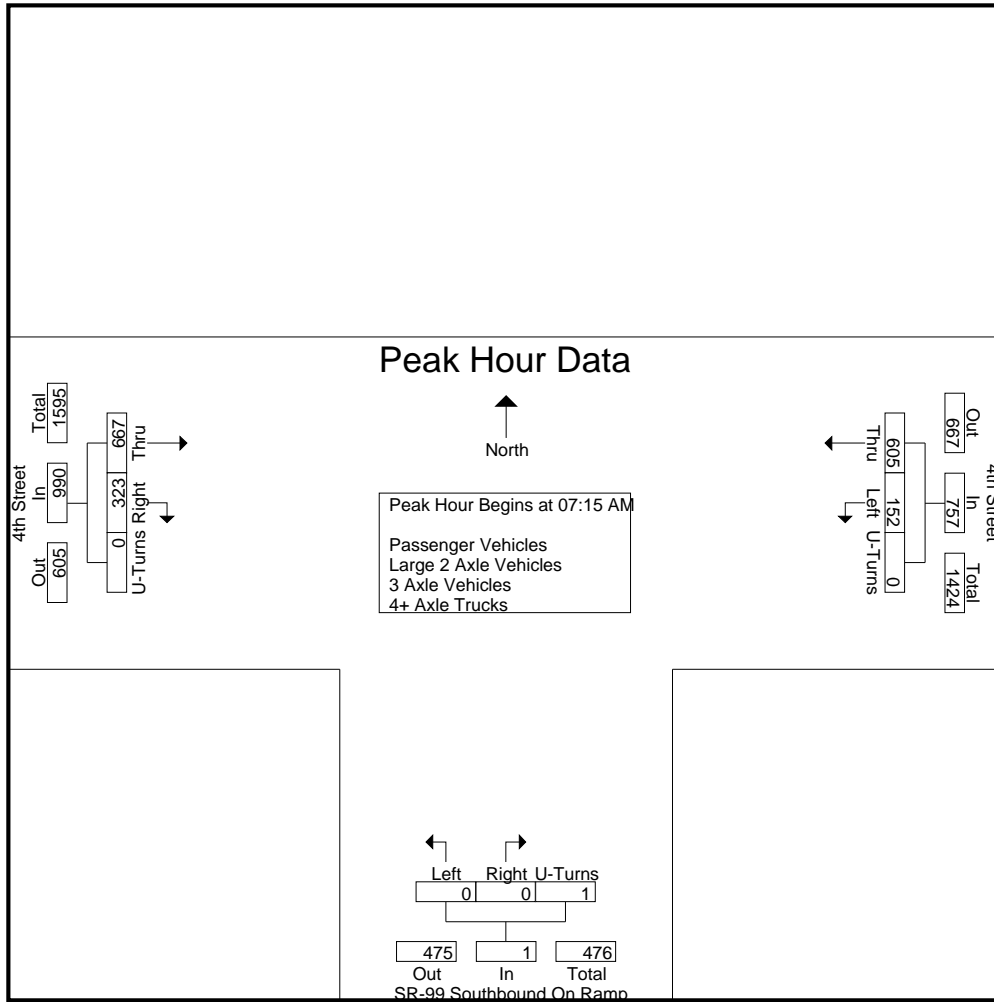

Peak Hour Analysis From 07:00 AM to 08:45 AM - Peak 1 of 1
 Peak Hour for Each Approach Begins at:

	07:15 AM				07:15 AM				07:15 AM			
+0 mins.	33	131	0	164	0	0	0	0	109	98	0	207
+15 mins.	54	182	0	236	0	0	0	0	163	74	0	237
+30 mins.	30	158	0	188	0	0	0	0	221	74	0	295
+45 mins.	35	134	0	169	0	0	1	1	174	77	0	251
Total Volume	152	605	0	757	0	0	1	1	667	323	0	990
% App. Total	20.1	79.9	0		0	0	100		67.4	32.6	0	
PHF	.704	.831	.000	.802	.000	.000	.250	.250	.755	.824	.000	.839

City of Madera
 N/S: SR-99 Southbound On Ramp
 E/W: 4th Street
 Weather: Clear

File Name : 33B_MDA_99S On Ramp_4th St AM
 Site Code : 00319628
 Start Date : 9/24/2019
 Page No : 1

Groups Printed- Passenger Vehicles

Start Time	4th Street Westbound				SR-99 Southbound On Ramp Northbound				4th Street Eastbound				Int. Total
	Left	Thru	U-Turns	App. Total	Left	Right	U-Turns	App. Total	Thru	Right	U-Turns	App. Total	
07:00 AM	54	82	0	136	0	0	0	0	70	75	0	145	281
07:15 AM	33	130	0	163	0	0	0	0	105	98	0	203	366
07:30 AM	53	180	0	233	0	0	0	0	162	73	0	235	468
07:45 AM	29	157	0	186	0	0	0	0	218	74	0	292	478
Total	169	549	0	718	0	0	0	0	555	320	0	875	1593
08:00 AM	35	128	0	163	0	0	0	0	171	76	0	247	410
08:15 AM	33	108	0	141	0	0	0	0	111	60	0	171	312
08:30 AM	34	83	0	117	0	0	0	0	112	44	0	156	273
08:45 AM	43	66	0	109	0	0	0	0	99	42	0	141	250
Total	145	385	0	530	0	0	0	0	493	222	0	715	1245
Grand Total	314	934	0	1248	0	0	0	0	1048	542	0	1590	2838
Apprch %	25.2	74.8	0		0	0	0	0	65.9	34.1	0		
Total %	11.1	32.9	0	44	0	0	0	0	36.9	19.1	0	56	

Start Time	4th Street Westbound				SR-99 Southbound On Ramp Northbound				4th Street Eastbound				Int. Total
	Left	Thru	U-Turns	App. Total	Left	Right	U-Turns	App. Total	Thru	Right	U-Turns	App. Total	
Peak Hour Analysis From 07:15 AM to 08:00 AM - Peak 1 of 1													
Peak Hour for Entire Intersection Begins at 07:15 AM													
07:15 AM	33	130	0	163	0	0	0	0	105	98	0	203	366
07:30 AM	53	180	0	233	0	0	0	0	162	73	0	235	468
07:45 AM	29	157	0	186	0	0	0	0	218	74	0	292	478
08:00 AM	35	128	0	163	0	0	0	0	171	76	0	247	410
Total Volume	150	595	0	745	0	0	0	0	656	321	0	977	1722
% App. Total	20.1	79.9	0		0	0	0	0	67.1	32.9	0		
PHF	.708	.826	.000	.799	.000	.000	.000	.000	.752	.819	.000	.836	.901

City of Madera
 N/S: SR-99 Southbound On Ramp
 E/W: 4th Street
 Weather: Clear

File Name : 33B_MDA_99S On Ramp_4th St AM
 Site Code : 00319628
 Start Date : 9/24/2019
 Page No : 2

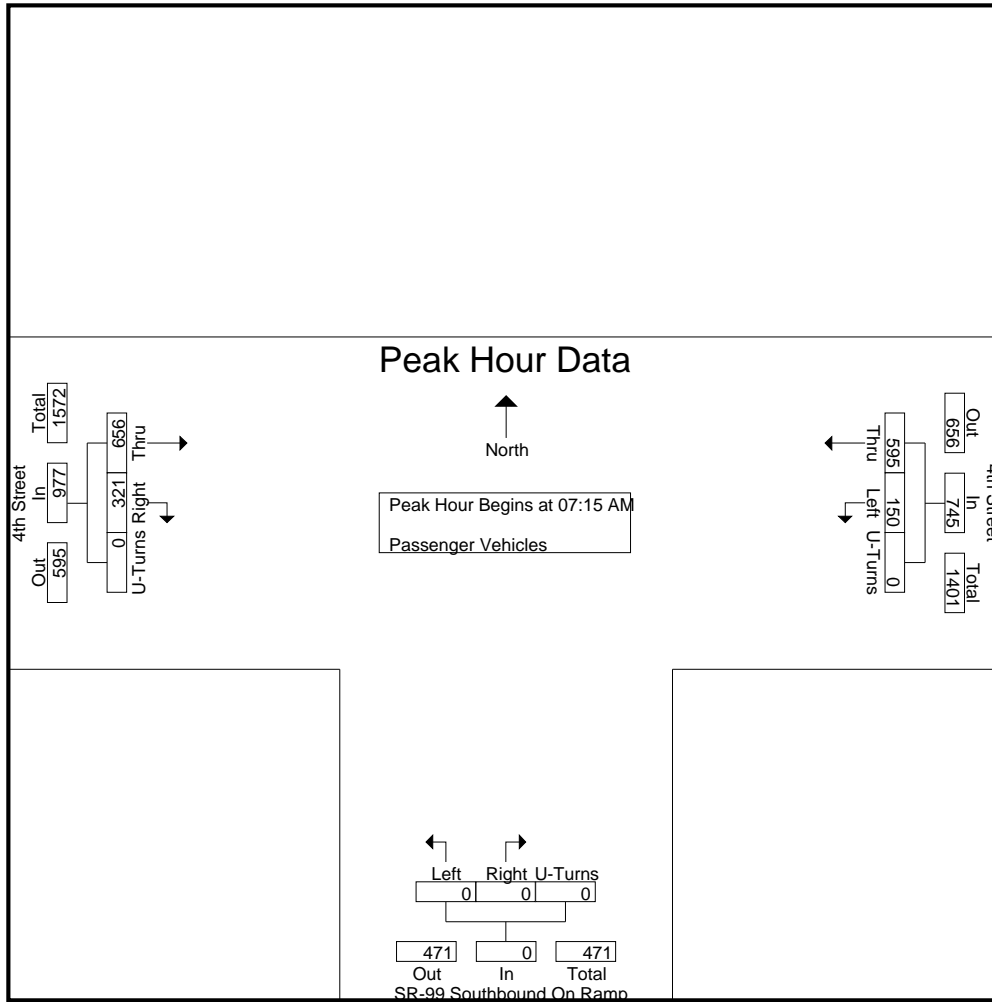

Peak Hour Analysis From 07:15 AM to 08:00 AM - Peak 1 of 1
 Peak Hour for Each Approach Begins at:

	07:15 AM				07:15 AM				07:15 AM			
+0 mins.	33	130	0	163	0	0	0	0	105	98	0	203
+15 mins.	53	180	0	233	0	0	0	0	162	73	0	235
+30 mins.	29	157	0	186	0	0	0	0	218	74	0	292
+45 mins.	35	128	0	163	0	0	0	0	171	76	0	247
Total Volume	150	595	0	745	0	0	0	0	656	321	0	977
% App. Total	20.1	79.9	0		0	0	0	0	67.1	32.9	0	
PHF	.708	.826	.000	.799	.000	.000	.000	.000	.752	.819	.000	.836

City of Madera
 N/S: SR-99 Southbound On Ramp
 E/W: 4th Street
 Weather: Clear

File Name : 33B_MDA_99S On Ramp_4th St AM
 Site Code : 00319628
 Start Date : 9/24/2019
 Page No : 1

Groups Printed- Large 2 Axle Vehicles

Start Time	4th Street Westbound				SR-99 Southbound On Ramp Northbound				4th Street Eastbound				Int. Total
	Left	Thru	U-Turns	App. Total	Left	Right	U-Turns	App. Total	Thru	Right	U-Turns	App. Total	
07:00 AM	0	6	0	6	0	0	0	0	6	1	0	7	13
07:15 AM	0	1	0	1	0	0	0	0	2	0	0	2	3
07:30 AM	1	2	0	3	0	0	0	0	1	0	0	1	4
07:45 AM	1	1	0	2	0	0	0	0	2	0	0	2	4
Total	2	10	0	12	0	0	0	0	11	1	0	12	24
08:00 AM	0	6	0	6	0	0	1	1	2	1	0	3	10
08:15 AM	2	5	0	7	0	0	0	0	5	0	0	5	12
08:30 AM	3	5	0	8	0	0	0	0	1	0	0	1	9
08:45 AM	1	7	0	8	0	0	0	0	3	1	0	4	12
Total	6	23	0	29	0	0	1	1	11	2	0	13	43
Grand Total	8	33	0	41	0	0	1	1	22	3	0	25	67
Apprch %	19.5	80.5	0		0	0	100		88	12	0		
Total %	11.9	49.3	0	61.2	0	0	1.5	1.5	32.8	4.5	0	37.3	

Start Time	4th Street Westbound				SR-99 Southbound On Ramp Northbound				4th Street Eastbound				Int. Total
	Left	Thru	U-Turns	App. Total	Left	Right	U-Turns	App. Total	Thru	Right	U-Turns	App. Total	
Peak Hour Analysis From 07:15 AM to 08:00 AM - Peak 1 of 1													
Peak Hour for Entire Intersection Begins at 07:15 AM													
07:15 AM	0	1	0	1	0	0	0	0	2	0	0	2	3
07:30 AM	1	2	0	3	0	0	0	0	1	0	0	1	4
07:45 AM	1	1	0	2	0	0	0	0	2	0	0	2	4
08:00 AM	0	6	0	6	0	0	1	1	2	1	0	3	10
Total Volume	2	10	0	12	0	0	1	1	7	1	0	8	21
% App. Total	16.7	83.3	0		0	0	100		87.5	12.5	0		
PHF	.500	.417	.000	.500	.000	.000	.250	.250	.875	.250	.000	.667	.525

City of Madera
 N/S: SR-99 Southbound On Ramp
 E/W: 4th Street
 Weather: Clear

File Name : 33B_MDA_99S On Ramp_4th St AM
 Site Code : 00319628
 Start Date : 9/24/2019
 Page No : 2

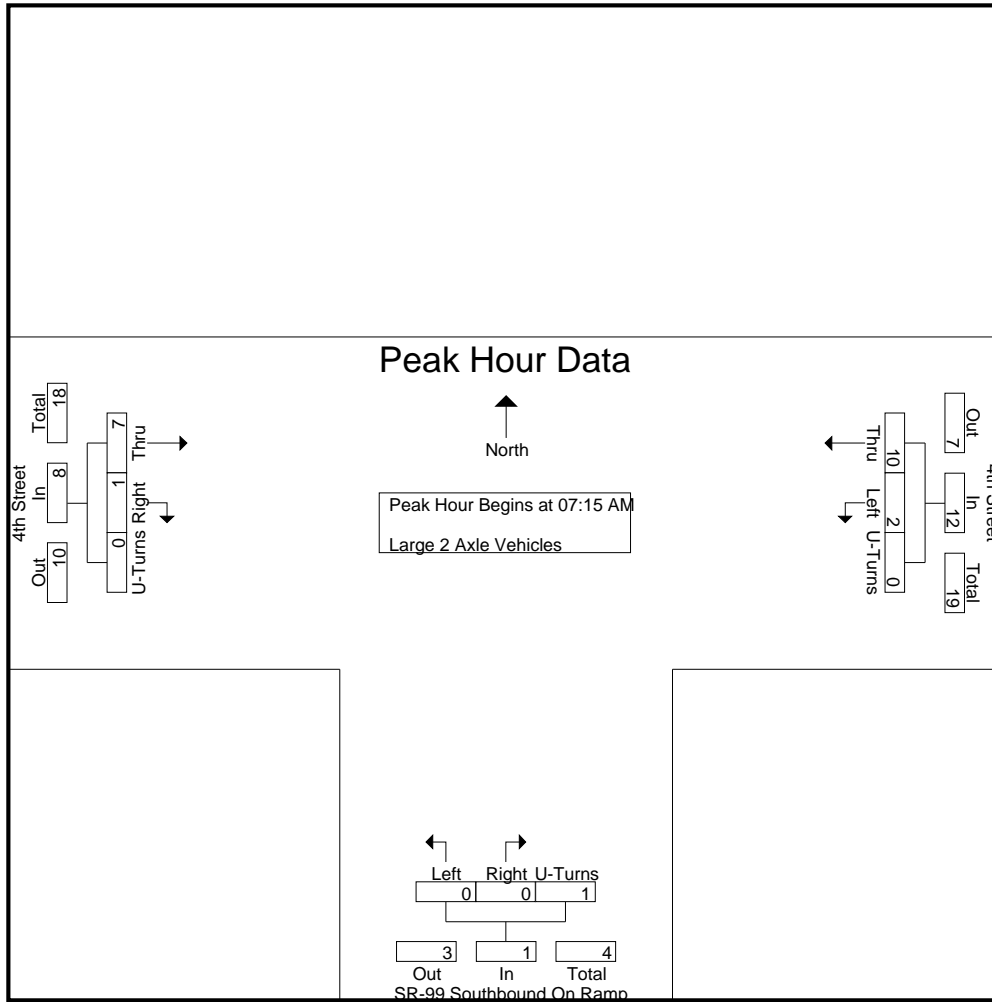

Peak Hour Analysis From 07:15 AM to 08:00 AM - Peak 1 of 1
 Peak Hour for Each Approach Begins at:

	07:15 AM				07:15 AM				07:15 AM			
+0 mins.	0	1	0	1	0	0	0	0	2	0	0	2
+15 mins.	1	2	0	3	0	0	0	0	1	0	0	1
+30 mins.	1	1	0	2	0	0	0	0	2	0	0	2
+45 mins.	0	6	0	6	0	0	1	1	2	1	0	3
Total Volume	2	10	0	12	0	0	1	1	7	1	0	8
% App. Total	16.7	83.3	0		0	0	100		87.5	12.5	0	
PHF	.500	.417	.000	.500	.000	.000	.250	.250	.875	.250	.000	.667

City of Madera
 N/S: SR-99 Southbound On Ramp
 E/W: 4th Street
 Weather: Clear

File Name : 33B_MDA_99S On Ramp_4th St AM
 Site Code : 00319628
 Start Date : 9/24/2019
 Page No : 1

Groups Printed- 3 Axle Vehicles

Start Time	4th Street Westbound				SR-99 Southbound On Ramp Northbound				4th Street Eastbound				Int. Total	
	Left	Thru	U-Turns	App. Total	Left	Right	U-Turns	App. Total	Thru	Right	U-Turns	App. Total		
07:00 AM	0	0	0	0	0	0	0	0	0	0	0	0	0	0
07:15 AM	0	0	0	0	0	0	0	0	0	1	0	0	1	1
07:30 AM	0	0	0	0	0	0	0	0	0	0	0	0	0	0
07:45 AM	0	0	0	0	0	0	0	0	0	0	0	0	0	0
Total	0	0	0	0	0	0	0	0	0	1	0	0	1	1
08:00 AM	0	0	0	0	0	0	0	0	0	0	0	0	0	0
08:15 AM	0	0	0	0	0	0	0	0	0	0	0	0	0	0
08:30 AM	0	0	0	0	0	0	0	0	0	0	0	0	0	0
08:45 AM	0	1	0	1	0	0	0	0	0	0	0	0	0	1
Total	0	1	0	1	0	0	0	0	0	0	0	0	0	1
Grand Total	0	1	0	1	0	0	0	0	0	1	0	0	1	2
Apprch %	0	100	0		0	0	0		0	100	0	0		
Total %	0	50	0	50	0	0	0	0	0	50	0	0	50	

Start Time	4th Street Westbound				SR-99 Southbound On Ramp Northbound				4th Street Eastbound				Int. Total	
	Left	Thru	U-Turns	App. Total	Left	Right	U-Turns	App. Total	Thru	Right	U-Turns	App. Total		
Peak Hour Analysis From 07:15 AM to 08:00 AM - Peak 1 of 1														
Peak Hour for Entire Intersection Begins at 07:15 AM														
07:15 AM	0	0	0	0	0	0	0	0	0	1	0	0	1	1
07:30 AM	0	0	0	0	0	0	0	0	0	0	0	0	0	0
07:45 AM	0	0	0	0	0	0	0	0	0	0	0	0	0	0
08:00 AM	0	0	0	0	0	0	0	0	0	0	0	0	0	0
Total Volume	0	0	0	0	0	0	0	0	0	1	0	0	1	1
% App. Total	0	0	0		0	0	0		0	100	0	0		
PHF	.000	.000	.000	.000	.000	.000	.000	.000	.000	.250	.000	.000	.250	.250

City of Madera
 N/S: SR-99 Southbound On Ramp
 E/W: 4th Street
 Weather: Clear

File Name : 33B_MDA_99S On Ramp_4th St AM
 Site Code : 00319628
 Start Date : 9/24/2019
 Page No : 2

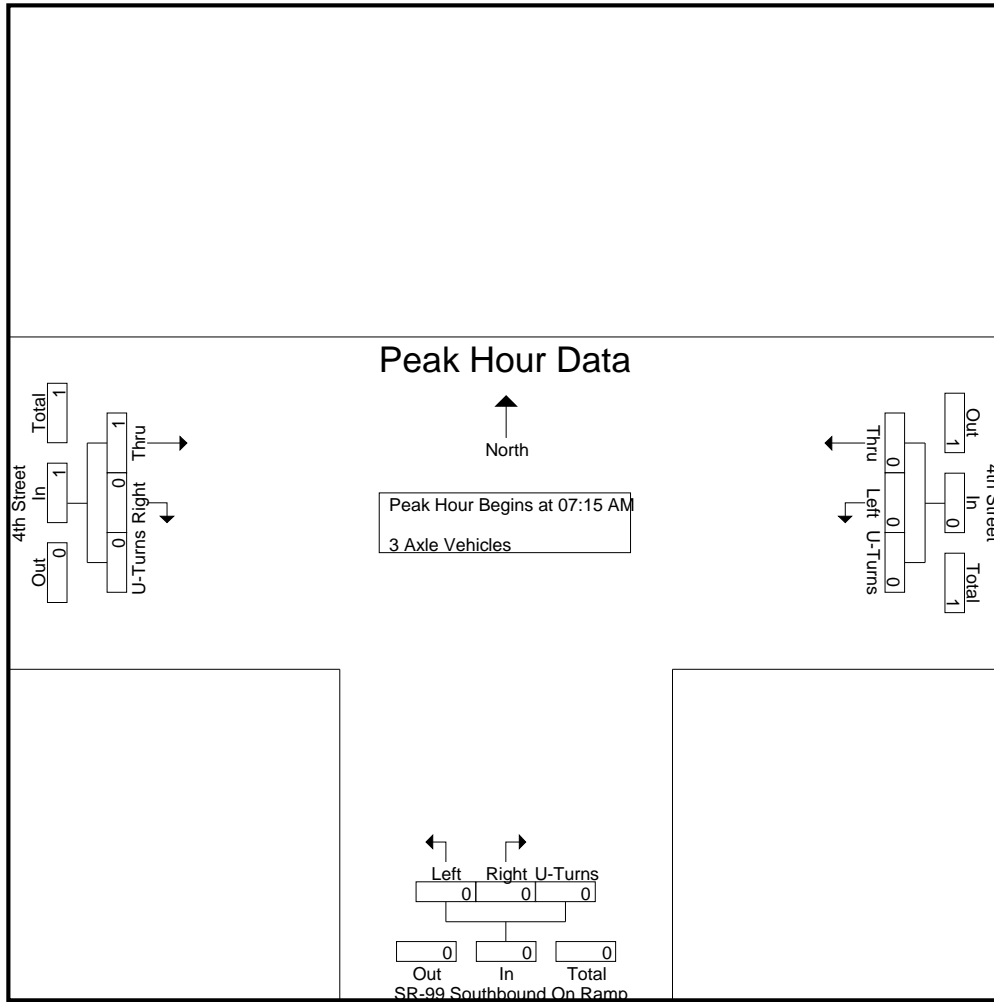

Peak Hour Analysis From 07:15 AM to 08:00 AM - Peak 1 of 1
 Peak Hour for Each Approach Begins at:

	07:15 AM				07:15 AM				07:15 AM			
+0 mins.	0	0	0	0	0	0	0	0	1	0	0	1
+15 mins.	0	0	0	0	0	0	0	0	0	0	0	0
+30 mins.	0	0	0	0	0	0	0	0	0	0	0	0
+45 mins.	0	0	0	0	0	0	0	0	0	0	0	0
Total Volume	0	0	0	0	0	0	0	0	1	0	0	1
% App. Total	0	0	0	0	0	0	0	0	100	0	0	0
PHF	.000	.000	.000	.000	.000	.000	.000	.000	.250	.000	.000	.250

City of Madera
 N/S: SR-99 Southbound On Ramp
 E/W: 4th Street
 Weather: Clear

File Name : 33B_MDA_99S On Ramp_4th St AM
 Site Code : 00319628
 Start Date : 9/24/2019
 Page No : 1

Groups Printed- 4+ Axle Trucks

Start Time	4th Street Westbound				SR-99 Southbound On Ramp Northbound				4th Street Eastbound				Int. Total
	Left	Thru	U-Turns	App. Total	Left	Right	U-Turns	App. Total	Thru	Right	U-Turns	App. Total	
07:00 AM	0	0	0	0	0	0	0	0	1	0	0	1	1
07:15 AM	0	0	0	0	0	0	0	0	1	0	0	1	1
07:30 AM	0	0	0	0	0	0	0	0	0	1	0	1	1
07:45 AM	0	0	0	0	0	0	0	0	1	0	0	1	1
Total	0	0	0	0	0	0	0	0	3	1	0	4	4
08:00 AM	0	0	0	0	0	0	0	0	1	0	0	1	1
08:15 AM	0	0	0	0	0	0	0	0	1	0	0	1	1
08:30 AM	1	0	0	1	0	0	0	0	0	0	0	0	1
08:45 AM	0	0	0	0	0	0	0	0	0	0	0	0	0
Total	1	0	0	1	0	0	0	0	2	0	0	2	3
Grand Total	1	0	0	1	0	0	0	0	5	1	0	6	7
Apprch %	100	0	0		0	0	0		83.3	16.7	0		
Total %	14.3	0	0	14.3	0	0	0	0	71.4	14.3	0	85.7	

Start Time	4th Street Westbound				SR-99 Southbound On Ramp Northbound				4th Street Eastbound				Int. Total
	Left	Thru	U-Turns	App. Total	Left	Right	U-Turns	App. Total	Thru	Right	U-Turns	App. Total	
Peak Hour Analysis From 07:15 AM to 08:00 AM - Peak 1 of 1													
Peak Hour for Entire Intersection Begins at 07:15 AM													
07:15 AM	0	0	0	0	0	0	0	0	1	0	0	1	1
07:30 AM	0	0	0	0	0	0	0	0	0	1	0	1	1
07:45 AM	0	0	0	0	0	0	0	0	1	0	0	1	1
08:00 AM	0	0	0	0	0	0	0	0	1	0	0	1	1
Total Volume	0	0	0	0	0	0	0	0	3	1	0	4	4
% App. Total	0	0	0		0	0	0		75	25	0		
PHF	.000	.000	.000	.000	.000	.000	.000	.000	.750	.250	.000	1.00	1.00

City of Madera
 N/S: SR-99 Southbound On Ramp
 E/W: 4th Street
 Weather: Clear

File Name : 33B_MDA_99S On Ramp_4th St AM
 Site Code : 00319628
 Start Date : 9/24/2019
 Page No : 2

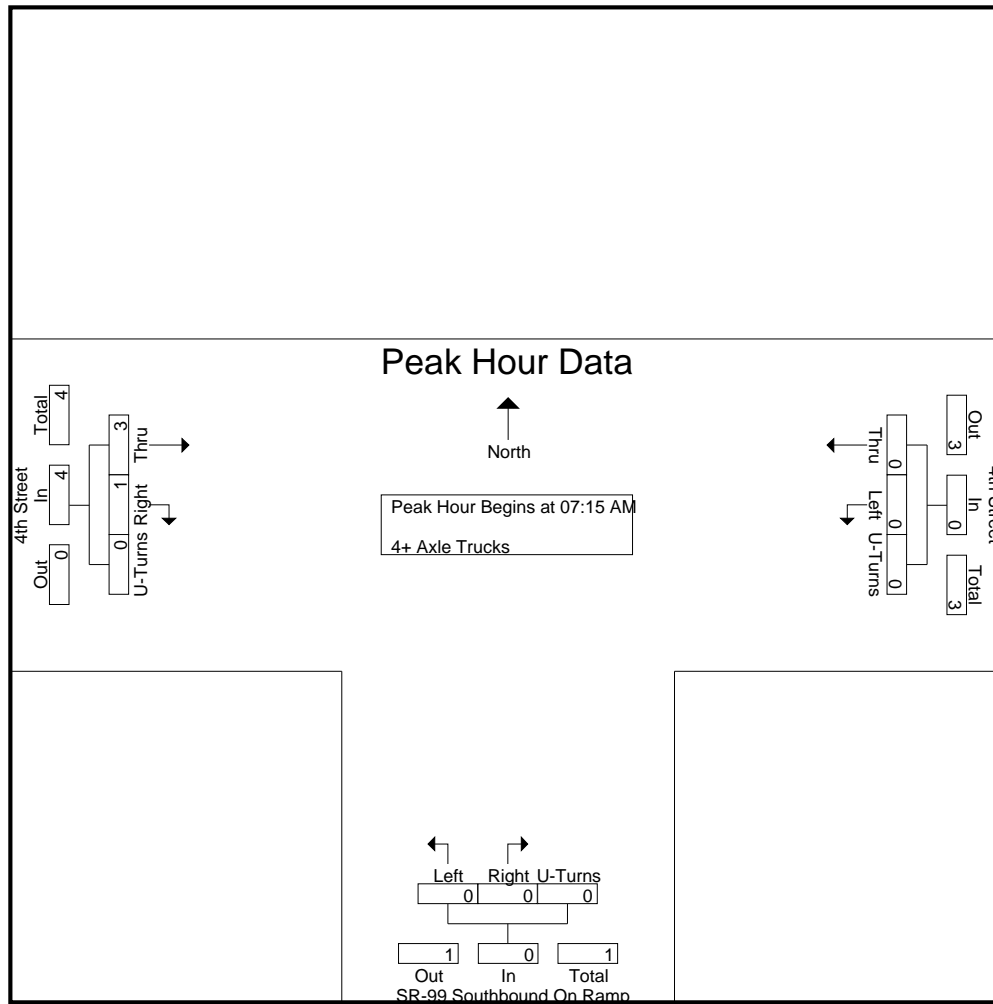

Peak Hour Analysis From 07:15 AM to 08:00 AM - Peak 1 of 1
 Peak Hour for Each Approach Begins at:

	07:15 AM				07:15 AM				07:15 AM			
+0 mins.	0	0	0	0	0	0	0	0	1	0	0	1
+15 mins.	0	0	0	0	0	0	0	0	0	1	0	1
+30 mins.	0	0	0	0	0	0	0	0	1	0	0	1
+45 mins.	0	0	0	0	0	0	0	0	1	0	0	1
Total Volume	0	0	0	0	0	0	0	0	3	1	0	4
% App. Total	0	0	0	0	0	0	0	0	.75	.25	0	1.000
PHF	.000	.000	.000	.000	.000	.000	.000	.000	.750	.250	.000	1.000

City of Madera
 N/S: SR-99 Southbound On Ramp
 E/W: 4th Street
 Weather: Clear

File Name : 33B_MDA_99S On Ramp_4th St PM
 Site Code : 00319628
 Start Date : 9/24/2019
 Page No : 1

Groups Printed- Passenger Vehicles - Large 2 Axle Vehicles - 3 Axle Vehicles - 4+ Axle Trucks

Start Time	4th Street Westbound				SR-99 Southbound On Ramp Northbound				4th Street Eastbound				Int. Total
	Left	Thru	U-Turns	App. Total	Left	Right	U-Turns	App. Total	Thru	Right	U-Turns	App. Total	
04:00 PM	50	156	0	206	0	0	0	0	166	40	0	206	412
04:15 PM	39	139	0	178	0	0	0	0	133	38	0	171	349
04:30 PM	38	149	0	187	0	0	0	0	153	53	0	206	393
04:45 PM	27	154	0	181	0	0	0	0	139	61	0	200	381
Total	154	598	0	752	0	0	0	0	591	192	0	783	1535
05:00 PM	44	171	0	215	0	0	0	0	164	96	0	260	475
05:15 PM	42	178	0	220	0	0	0	0	138	63	0	201	421
05:30 PM	36	136	0	172	0	0	0	0	134	41	0	175	347
05:45 PM	38	139	0	177	0	0	0	0	112	27	0	139	316
Total	160	624	0	784	0	0	0	0	548	227	0	775	1559
Grand Total	314	1222	0	1536	0	0	0	0	1139	419	0	1558	3094
Apprch %	20.4	79.6	0		0	0	0		73.1	26.9	0		
Total %	10.1	39.5	0	49.6	0	0	0	0	36.8	13.5	0	50.4	
Passenger Vehicles	310	1209	0	1519	0	0	0	0	1120	416	0	1536	3055
% Passenger Vehicles	98.7	98.9	0	98.9	0	0	0	0	98.3	99.3	0	98.6	98.7
Large 2 Axle Vehicles	4	12	0	16	0	0	0	0	16	3	0	19	35
% Large 2 Axle Vehicles	1.3	1	0	1	0	0	0	0	1.4	0.7	0	1.2	1.1
3 Axle Vehicles	0	1	0	1	0	0	0	0	1	0	0	1	2
% 3 Axle Vehicles	0	0.1	0	0.1	0	0	0	0	0.1	0	0	0.1	0.1
4+ Axle Trucks	0	0	0	0	0	0	0	0	2	0	0	2	2
% 4+ Axle Trucks	0	0	0	0	0	0	0	0	0.2	0	0	0.1	0.1

Start Time	4th Street Westbound				SR-99 Southbound On Ramp Northbound				4th Street Eastbound				Int. Total
	Left	Thru	U-Turns	App. Total	Left	Right	U-Turns	App. Total	Thru	Right	U-Turns	App. Total	
Peak Hour Analysis From 04:00 PM to 05:45 PM - Peak 1 of 1													
Peak Hour for Entire Intersection Begins at 04:30 PM													
04:30 PM	38	149	0	187	0	0	0	0	153	53	0	206	393
04:45 PM	27	154	0	181	0	0	0	0	139	61	0	200	381
05:00 PM	44	171	0	215	0	0	0	0	164	96	0	260	475
05:15 PM	42	178	0	220	0	0	0	0	138	63	0	201	421
Total Volume	151	652	0	803	0	0	0	0	594	273	0	867	1670
% App. Total	18.8	81.2	0		0	0	0		68.5	31.5	0		
PHF	.858	.916	.000	.913	.000	.000	.000	.000	.905	.711	.000	.834	.879

City of Madera
 N/S: SR-99 Southbound On Ramp
 E/W: 4th Street
 Weather: Clear

File Name : 33B_MDA_99S On Ramp_4th St PM
 Site Code : 00319628
 Start Date : 9/24/2019
 Page No : 2

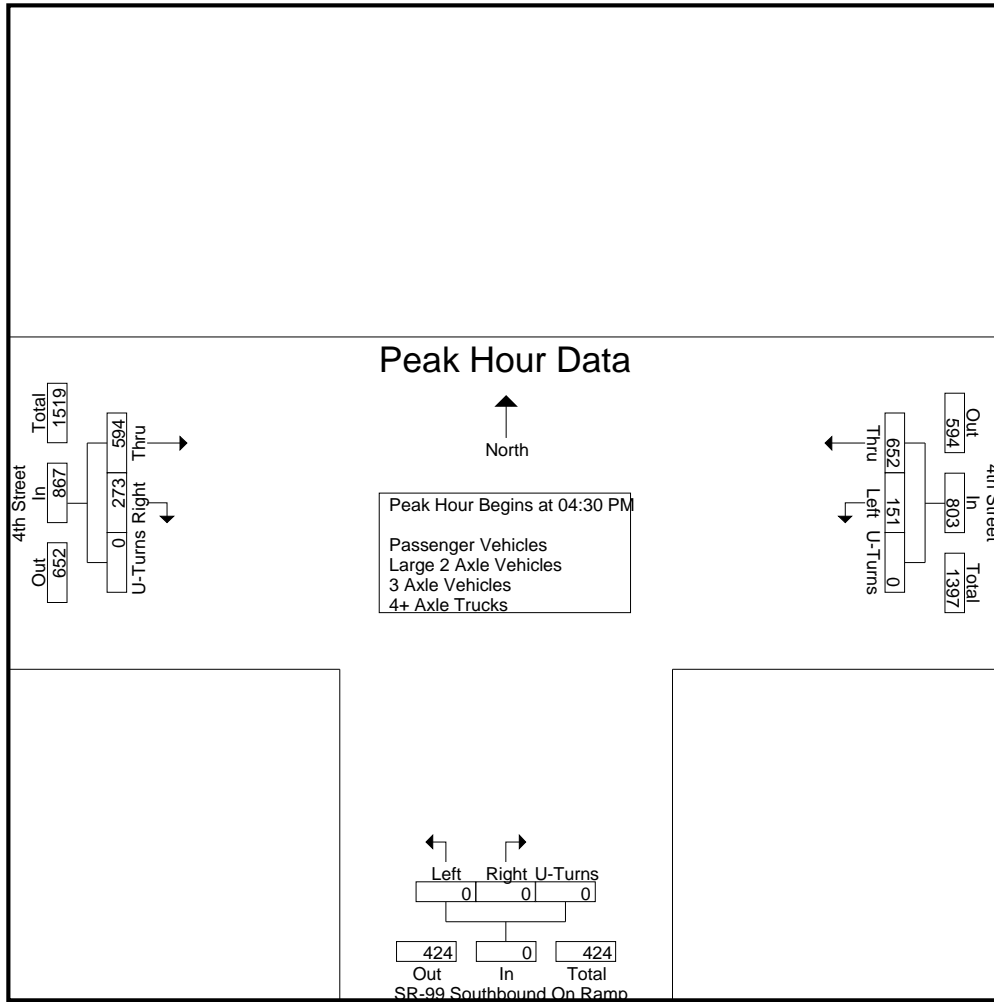

Peak Hour Analysis From 04:00 PM to 05:45 PM - Peak 1 of 1
 Peak Hour for Each Approach Begins at:

	04:30 PM				04:00 PM				04:30 PM			
+0 mins.	38	149	0	187	0	0	0	0	153	53	0	206
+15 mins.	27	154	0	181	0	0	0	0	139	61	0	200
+30 mins.	44	171	0	215	0	0	0	0	164	96	0	260
+45 mins.	42	178	0	220	0	0	0	0	138	63	0	201
Total Volume	151	652	0	803	0	0	0	0	594	273	0	867
% App. Total	18.8	81.2	0		0	0	0	0	68.5	31.5	0	
PHF	.858	.916	.000	.913	.000	.000	.000	.000	.905	.711	.000	.834

City of Madera
 N/S: SR-99 Southbound On Ramp
 E/W: 4th Street
 Weather: Clear

File Name : 33B_MDA_99S On Ramp_4th St PM
 Site Code : 00319628
 Start Date : 9/24/2019
 Page No : 1

Groups Printed- Passenger Vehicles

Start Time	4th Street Westbound				SR-99 Southbound On Ramp Northbound				4th Street Eastbound				Int. Total
	Left	Thru	U-Turns	App. Total	Left	Right	U-Turns	App. Total	Thru	Right	U-Turns	App. Total	
04:00 PM	50	152	0	202	0	0	0	0	162	39	0	201	403
04:15 PM	38	137	0	175	0	0	0	0	132	38	0	170	345
04:30 PM	37	147	0	184	0	0	0	0	150	53	0	203	387
04:45 PM	26	153	0	179	0	0	0	0	137	60	0	197	376
Total	151	589	0	740	0	0	0	0	581	190	0	771	1511
05:00 PM	44	169	0	213	0	0	0	0	163	95	0	258	471
05:15 PM	41	178	0	219	0	0	0	0	133	63	0	196	415
05:30 PM	36	134	0	170	0	0	0	0	132	41	0	173	343
05:45 PM	38	139	0	177	0	0	0	0	111	27	0	138	315
Total	159	620	0	779	0	0	0	0	539	226	0	765	1544
Grand Total	310	1209	0	1519	0	0	0	0	1120	416	0	1536	3055
Apprch %	20.4	79.6	0		0	0	0		72.9	27.1	0		
Total %	10.1	39.6	0	49.7	0	0	0	0	36.7	13.6	0	50.3	

Start Time	4th Street Westbound				SR-99 Southbound On Ramp Northbound				4th Street Eastbound				Int. Total
	Left	Thru	U-Turns	App. Total	Left	Right	U-Turns	App. Total	Thru	Right	U-Turns	App. Total	
Peak Hour Analysis From 04:30 PM to 05:15 PM - Peak 1 of 1													
Peak Hour for Entire Intersection Begins at 04:30 PM													
04:30 PM	37	147	0	184	0	0	0	0	150	53	0	203	387
04:45 PM	26	153	0	179	0	0	0	0	137	60	0	197	376
05:00 PM	44	169	0	213	0	0	0	0	163	95	0	258	471
05:15 PM	41	178	0	219	0	0	0	0	133	63	0	196	415
Total Volume	148	647	0	795	0	0	0	0	583	271	0	854	1649
% App. Total	18.6	81.4	0		0	0	0		68.3	31.7	0		
PHF	.841	.909	.000	.908	.000	.000	.000	.000	.894	.713	.000	.828	.875

City of Madera
 N/S: SR-99 Southbound On Ramp
 E/W: 4th Street
 Weather: Clear

File Name : 33B_MDA_99S On Ramp_4th St PM
 Site Code : 00319628
 Start Date : 9/24/2019
 Page No : 2

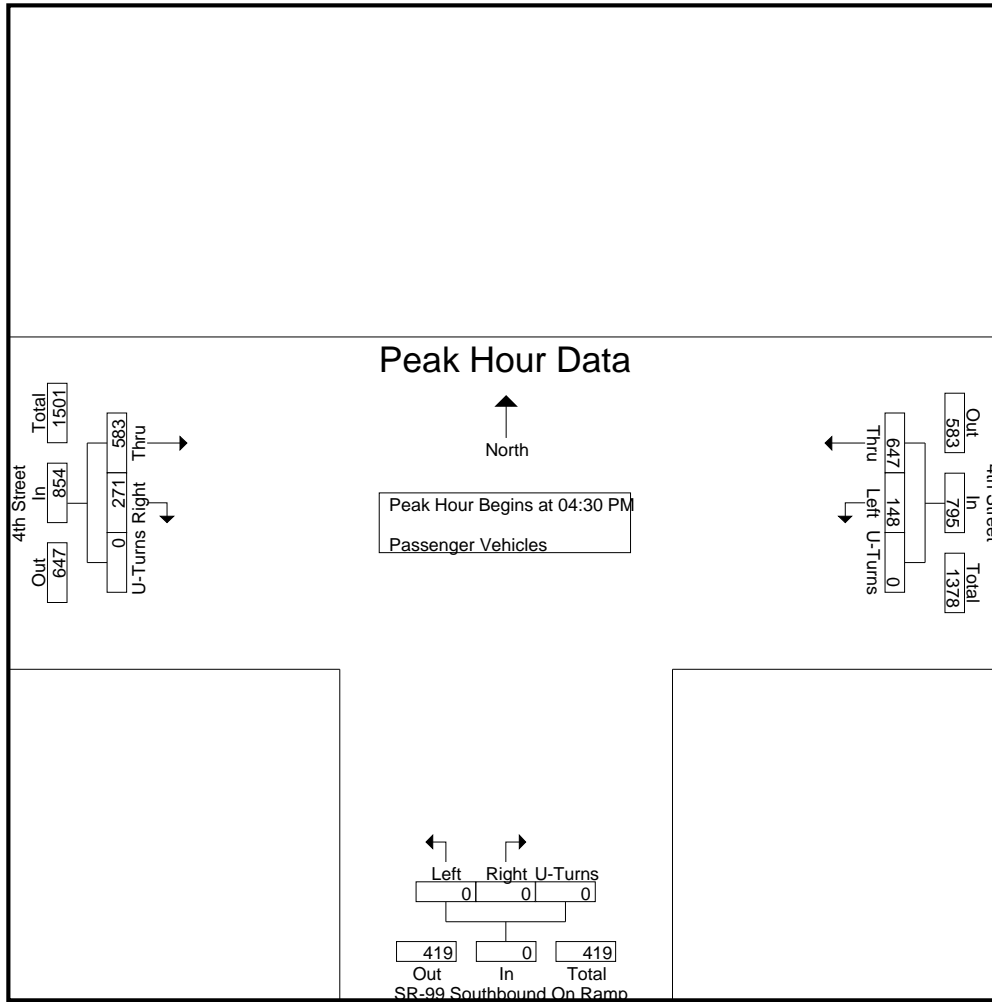

Peak Hour Analysis From 04:30 PM to 05:15 PM - Peak 1 of 1
 Peak Hour for Each Approach Begins at:

	04:30 PM				04:30 PM				04:30 PM			
+0 mins.	37	147	0	184	0	0	0	0	150	53	0	203
+15 mins.	26	153	0	179	0	0	0	0	137	60	0	197
+30 mins.	44	169	0	213	0	0	0	0	163	95	0	258
+45 mins.	41	178	0	219	0	0	0	0	133	63	0	196
Total Volume	148	647	0	795	0	0	0	0	583	271	0	854
% App. Total	18.6	81.4	0		0	0	0	0	68.3	31.7	0	
PHF	.841	.909	.000	.908	.000	.000	.000	.000	.894	.713	.000	.828

City of Madera
 N/S: SR-99 Southbound On Ramp
 E/W: 4th Street
 Weather: Clear

File Name : 33B_MDA_99S On Ramp_4th St PM
 Site Code : 00319628
 Start Date : 9/24/2019
 Page No : 1

Groups Printed- Large 2 Axle Vehicles

Start Time	4th Street Westbound				SR-99 Southbound On Ramp Northbound				4th Street Eastbound				Int. Total
	Left	Thru	U-Turns	App. Total	Left	Right	U-Turns	App. Total	Thru	Right	U-Turns	App. Total	
04:00 PM	0	4	0	4	0	0	0	0	3	1	0	4	8
04:15 PM	1	2	0	3	0	0	0	0	0	0	0	0	3
04:30 PM	1	1	0	2	0	0	0	0	3	0	0	3	5
04:45 PM	1	1	0	2	0	0	0	0	2	1	0	3	5
Total	3	8	0	11	0	0	0	0	8	2	0	10	21
05:00 PM	0	2	0	2	0	0	0	0	1	1	0	2	4
05:15 PM	1	0	0	1	0	0	0	0	5	0	0	5	6
05:30 PM	0	2	0	2	0	0	0	0	2	0	0	2	4
05:45 PM	0	0	0	0	0	0	0	0	0	0	0	0	0
Total	1	4	0	5	0	0	0	0	8	1	0	9	14
Grand Total	4	12	0	16	0	0	0	0	16	3	0	19	35
Apprch %	25	75	0		0	0	0		84.2	15.8	0		
Total %	11.4	34.3	0	45.7	0	0	0	0	45.7	8.6	0	54.3	

Start Time	4th Street Westbound				SR-99 Southbound On Ramp Northbound				4th Street Eastbound				Int. Total
	Left	Thru	U-Turns	App. Total	Left	Right	U-Turns	App. Total	Thru	Right	U-Turns	App. Total	
04:30 PM	1	1	0	2	0	0	0	0	3	0	0	3	5
04:45 PM	1	1	0	2	0	0	0	0	2	1	0	3	5
05:00 PM	0	2	0	2	0	0	0	0	1	1	0	2	4
05:15 PM	1	0	0	1	0	0	0	0	5	0	0	5	6
Total Volume	3	4	0	7	0	0	0	0	11	2	0	13	20
% App. Total	42.9	57.1	0		0	0	0		84.6	15.4	0		
PHF	.750	.500	.000	.875	.000	.000	.000	.000	.550	.500	.000	.650	.833

Peak Hour Analysis From 04:30 PM to 05:15 PM - Peak 1 of 1

Peak Hour for Entire Intersection Begins at 04:30 PM

City of Madera
 N/S: SR-99 Southbound On Ramp
 E/W: 4th Street
 Weather: Clear

File Name : 33B_MDA_99S On Ramp_4th St PM
 Site Code : 00319628
 Start Date : 9/24/2019
 Page No : 2

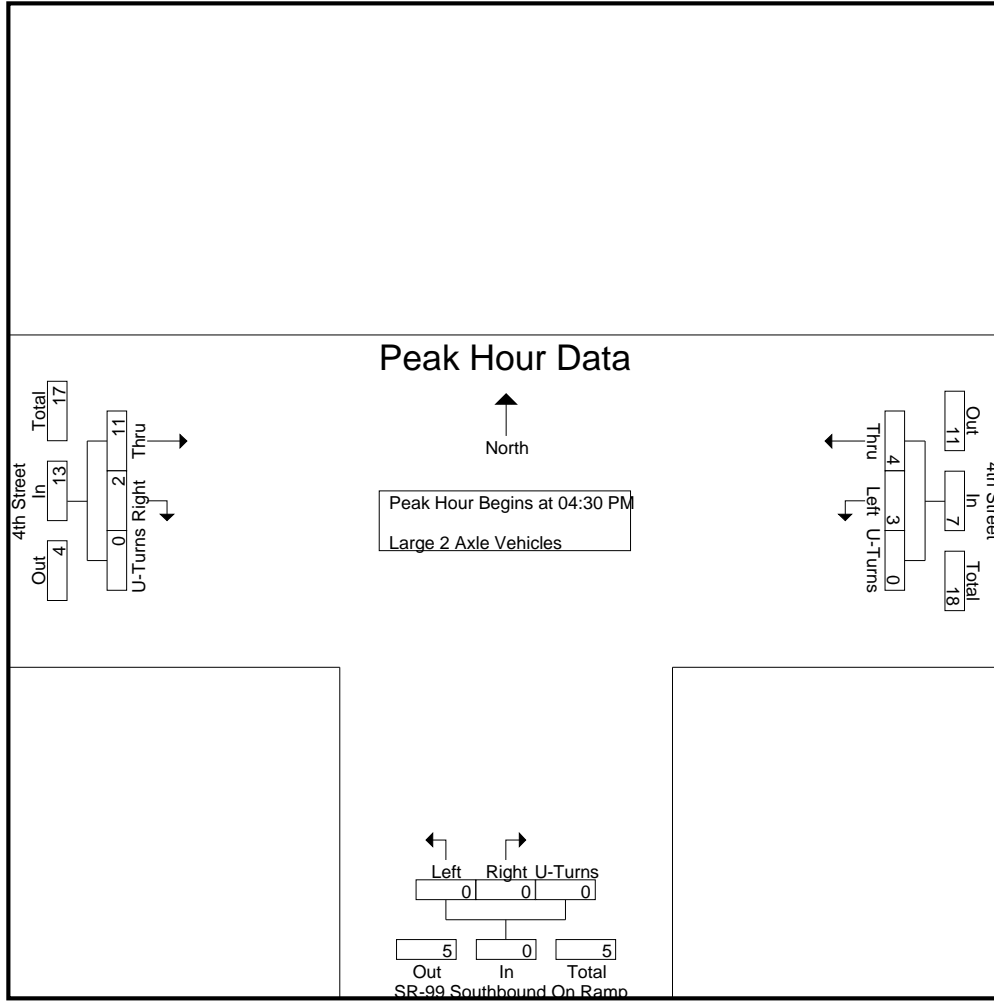

Peak Hour Analysis From 04:30 PM to 05:15 PM - Peak 1 of 1
 Peak Hour for Each Approach Begins at:

	04:30 PM				04:30 PM				04:30 PM			
+0 mins.	1	1	0	2	0	0	0	0	3	0	0	3
+15 mins.	1	1	0	2	0	0	0	0	2	1	0	3
+30 mins.	0	2	0	2	0	0	0	0	1	1	0	2
+45 mins.	1	0	0	1	0	0	0	0	5	0	0	5
Total Volume	3	4	0	7	0	0	0	0	11	2	0	13
% App. Total	42.9	57.1	0		0	0	0		84.6	15.4	0	
PHF	.750	.500	.000	.875	.000	.000	.000	.000	.550	.500	.000	.650

City of Madera
 N/S: SR-99 Southbound On Ramp
 E/W: 4th Street
 Weather: Clear

File Name : 33B_MDA_99S On Ramp_4th St PM
 Site Code : 00319628
 Start Date : 9/24/2019
 Page No : 1

Groups Printed- 3 Axle Vehicles

Start Time	4th Street Westbound				SR-99 Southbound On Ramp Northbound				4th Street Eastbound				Int. Total
	Left	Thru	U-Turns	App. Total	Left	Right	U-Turns	App. Total	Thru	Right	U-Turns	App. Total	
04:00 PM	0	0	0	0	0	0	0	0	1	0	0	1	1
04:15 PM	0	0	0	0	0	0	0	0	0	0	0	0	0
04:30 PM	0	1	0	1	0	0	0	0	0	0	0	0	1
04:45 PM	0	0	0	0	0	0	0	0	0	0	0	0	0
Total	0	1	0	1	0	0	0	0	1	0	0	1	2
05:00 PM	0	0	0	0	0	0	0	0	0	0	0	0	0
05:15 PM	0	0	0	0	0	0	0	0	0	0	0	0	0
05:30 PM	0	0	0	0	0	0	0	0	0	0	0	0	0
05:45 PM	0	0	0	0	0	0	0	0	0	0	0	0	0
Total	0	0	0	0	0	0	0	0	0	0	0	0	0
Grand Total	0	1	0	1	0	0	0	0	1	0	0	1	2
Apprch %	0	100	0		0	0	0		100	0	0		
Total %	0	50	0	50	0	0	0	0	50	0	0	50	

Start Time	4th Street Westbound				SR-99 Southbound On Ramp Northbound				4th Street Eastbound				Int. Total
	Left	Thru	U-Turns	App. Total	Left	Right	U-Turns	App. Total	Thru	Right	U-Turns	App. Total	
04:30 PM	0	1	0	1	0	0	0	0	0	0	0	0	1
04:45 PM	0	0	0	0	0	0	0	0	0	0	0	0	0
05:00 PM	0	0	0	0	0	0	0	0	0	0	0	0	0
05:15 PM	0	0	0	0	0	0	0	0	0	0	0	0	0
Total Volume	0	1	0	1	0	0	0	0	0	0	0	0	1
% App. Total	0	100	0		0	0	0		0	0	0		
PHF	.000	.250	.000	.250	.000	.000	.000	.000	.000	.000	.000	.000	.250

Peak Hour Analysis From 04:30 PM to 05:15 PM - Peak 1 of 1

Peak Hour for Entire Intersection Begins at 04:30 PM

City of Madera
 N/S: SR-99 Southbound On Ramp
 E/W: 4th Street
 Weather: Clear

File Name : 33B_MDA_99S On Ramp_4th St PM
 Site Code : 00319628
 Start Date : 9/24/2019
 Page No : 1

Groups Printed- 4+ Axle Trucks

Start Time	4th Street Westbound				SR-99 Southbound On Ramp Northbound				4th Street Eastbound				Int. Total	
	Left	Thru	U-Turns	App. Total	Left	Right	U-Turns	App. Total	Thru	Right	U-Turns	App. Total		
04:00 PM	0	0	0	0	0	0	0	0	0	0	0	0	0	0
04:15 PM	0	0	0	0	0	0	0	0	0	1	0	0	1	1
04:30 PM	0	0	0	0	0	0	0	0	0	0	0	0	0	0
04:45 PM	0	0	0	0	0	0	0	0	0	0	0	0	0	0
Total	0	0	0	0	0	0	0	0	0	1	0	0	1	1
05:00 PM	0	0	0	0	0	0	0	0	0	0	0	0	0	0
05:15 PM	0	0	0	0	0	0	0	0	0	0	0	0	0	0
05:30 PM	0	0	0	0	0	0	0	0	0	0	0	0	0	0
05:45 PM	0	0	0	0	0	0	0	0	0	1	0	0	1	1
Total	0	0	0	0	0	0	0	0	0	1	0	0	1	1
Grand Total	0	0	0	0	0	0	0	0	0	2	0	0	2	2
Apprch %	0	0	0	0	0	0	0	0	0	100	0	0	100	
Total %	0	0	0	0	0	0	0	0	0	100	0	0	100	

Start Time	4th Street Westbound				SR-99 Southbound On Ramp Northbound				4th Street Eastbound				Int. Total	
	Left	Thru	U-Turns	App. Total	Left	Right	U-Turns	App. Total	Thru	Right	U-Turns	App. Total		
04:30 PM	0	0	0	0	0	0	0	0	0	0	0	0	0	0
04:45 PM	0	0	0	0	0	0	0	0	0	0	0	0	0	0
05:00 PM	0	0	0	0	0	0	0	0	0	0	0	0	0	0
05:15 PM	0	0	0	0	0	0	0	0	0	0	0	0	0	0
Total Volume	0	0	0	0	0	0	0	0	0	0	0	0	0	0
% App. Total	0	0	0	0	0	0	0	0	0	0	0	0	0	0
PHF	.000	.000	.000	.000	.000	.000	.000	.000	.000	.000	.000	.000	.000	.000

Peak Hour Analysis From 04:30 PM to 05:15 PM - Peak 1 of 1
 Peak Hour for Entire Intersection Begins at 04:30 PM

City of Madera
 N/S: SR-99 Southbound On Ramp
 E/W: 4th Street
 Weather: Clear

File Name : 33B_MDA_99S On Ramp_4th St PM
 Site Code : 00319628
 Start Date : 9/24/2019
 Page No : 2

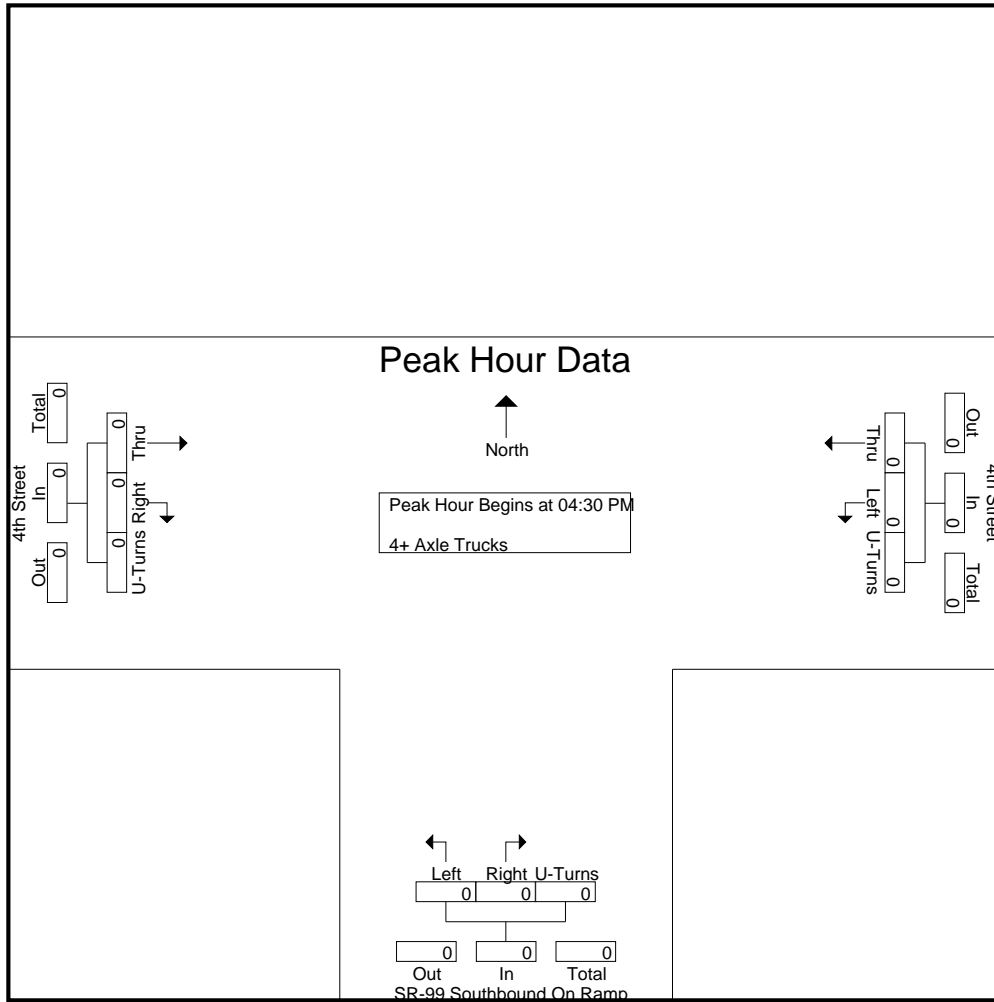

Peak Hour Analysis From 04:30 PM to 05:15 PM - Peak 1 of 1
 Peak Hour for Each Approach Begins at:

	04:30 PM				04:30 PM				04:30 PM			
+0 mins.	0	0	0	0	0	0	0	0	0	0	0	0
+15 mins.	0	0	0	0	0	0	0	0	0	0	0	0
+30 mins.	0	0	0	0	0	0	0	0	0	0	0	0
+45 mins.	0	0	0	0	0	0	0	0	0	0	0	0
Total Volume	0	0	0	0	0	0	0	0	0	0	0	0
% App. Total	0	0	0	0	0	0	0	0	0	0	0	0
PHF	.000	.000	.000	.000	.000	.000	.000	.000	.000	.000	.000	.000

Location: Madera
 N/S: SR-99 SB On Ramp
 E/W: 4th Street



Date: 9/24/2019
 Day: Tuesday

PEDESTRIANS

	North Leg Dead End	East Leg 4th Street	South Leg SR-99 SB On Ramp	West Leg 4th Street	
	Pedestrians	Pedestrians	Pedestrians	Pedestrians	
7:00 AM	0	0	0	0	0
7:15 AM	0	0	0	0	0
7:30 AM	0	0	0	0	0
7:45 AM	0	0	1	0	1
8:00 AM	0	0	1	0	1
8:15 AM	0	0	1	0	1
8:30 AM	0	0	2	0	2
8:45 AM	0	0	2	0	2
TOTAL VOLUMES:	0	0	7	0	7

	North Leg Dead End	East Leg 4th Street	South Leg SR-99 SB On Ramp	West Leg 4th Street	
	Pedestrians	Pedestrians	Pedestrians	Pedestrians	
4:00 PM	0	0	1	0	1
4:15 PM	0	0	0	0	0
4:30 PM	0	0	4	0	4
4:45 PM	0	0	0	0	0
5:00 PM	0	0	0	0	0
5:15 PM	0	0	2	0	2
5:30 PM	0	0	0	0	0
5:45 PM	0	0	1	0	1
TOTAL VOLUMES:	0	0	8	0	8

Location: Madera
 N/S: SR-99 SB On Ramp
 E/W: 4th Street



Date: 9/24/2019
 Day: Tuesday

BICYCLES

	Southbound Dead End			Westbound 4th Street			Northbound SR-99 SB On Ramp			Eastbound 4th Street			
	Left	Thru	Right	Left	Thru	Right	Left	Thru	Right	Left	Thru	Right	
7:00 AM	0	0	0	0	0	0	0	0	0	0	0	0	0
7:15 AM	0	0	0	0	2	0	0	0	0	0	1	0	3
7:30 AM	0	0	0	0	0	0	0	0	0	0	0	0	0
7:45 AM	0	0	0	0	2	0	0	0	0	0	0	0	2
8:00 AM	0	0	0	0	0	0	0	0	0	0	1	0	1
8:15 AM	0	0	0	0	1	0	0	0	0	0	0	0	1
8:30 AM	0	0	0	0	1	0	0	0	0	0	0	0	1
8:45 AM	0	0	0	0	0	0	0	0	0	0	1	0	1
TOTAL VOLUMES:	0	0	0	0	6	0	0	0	0	0	3	0	9

	Southbound Dead End			Westbound 4th Street			Northbound SR-99 SB On Ramp			Eastbound 4th Street			
	Left	Thru	Right	Left	Thru	Right	Left	Thru	Right	Left	Thru	Right	
4:00 PM	0	0	0	0	0	0	0	0	0	0	0	0	0
4:15 PM	0	0	0	0	0	0	0	0	0	0	0	0	0
4:30 PM	0	0	0	0	1	0	0	0	0	0	0	0	1
4:45 PM	0	0	0	0	1	0	0	0	0	0	0	0	1
5:00 PM	0	0	0	0	0	0	0	0	0	0	1	0	1
5:15 PM	0	0	0	0	0	0	0	0	0	0	0	0	0
5:30 PM	0	0	0	0	0	0	0	0	0	0	0	0	0
5:45 PM	0	0	0	0	0	0	0	0	0	0	0	0	0
TOTAL VOLUMES:	0	0	0	0	2	0	0	0	0	0	1	0	3

City of Madera
 N/S: H Street/SR-99 Northbound Off Ramp
 E/W: 4th Street
 Weather: Clear

File Name : 34_MDA_99N_4th St AM
 Site Code : 00319628
 Start Date : 9/24/2019
 Page No : 1

Groups Printed- Passenger Vehicles - Large 2 Axle Vehicles - 3 Axle Vehicles - 4+ Axle Trucks

Start Time	H Street Southbound					4th Street Westbound					SR-99 Northbound Off Ramp Northbound					4th Street Eastbound					Int. Total
	Left	Thru	Right	U-Turns	App. Total	Left	Thru	Right	U-Turns	App. Total	Left	Thru	Right	U-Turns	App. Total	Left	Thru	Right	U-Turns	App. Total	
07:00 AM	0	0	8	0	8	0	91	12	0	103	42	3	26	0	71	31	46	0	0	77	259
07:15 AM	0	0	12	0	12	0	105	10	0	115	42	2	33	0	77	43	62	0	0	105	309
07:30 AM	1	0	18	0	19	0	140	13	0	153	82	5	56	0	143	51	111	0	0	162	477
07:45 AM	0	0	16	0	16	0	110	9	0	119	61	5	67	0	133	79	142	0	0	221	489
Total	1	0	54	0	55	0	446	44	0	490	227	15	182	0	424	204	361	0	0	565	1534
08:00 AM	0	0	9	0	9	0	90	14	0	104	60	10	50	0	120	46	127	0	0	173	406
08:15 AM	4	0	13	0	17	0	110	16	0	126	30	4	22	0	56	39	79	0	0	118	317
08:30 AM	3	0	11	0	14	0	95	11	0	106	20	1	20	0	41	33	87	0	0	120	281
08:45 AM	1	0	6	0	7	0	81	8	0	89	29	1	25	0	55	27	76	0	0	103	254
Total	8	0	39	0	47	0	376	49	0	425	139	16	117	0	272	145	369	0	0	514	1258
Grand Total	9	0	93	0	102	0	822	93	0	915	366	31	299	0	696	349	730	0	0	1079	2792
Apprch %	8.8	0	91.2	0		0	89.8	10.2	0		52.6	4.5	43	0		32.3	67.7	0	0		
Total %	0.3	0	3.3	0	3.7	0	29.4	3.3	0	32.8	13.1	1.1	10.7	0	24.9	12.5	26.1	0	0	38.6	
Passenger Vehicles	100	0	100	0	100	0	96.4	88.2	0	95.5	97.3	93.5	97	0	97	96.6	98.4	0	0	97.8	96.9
Large 2 Axle Vehicles	0	0	0	0	0	0	3.5	10.8	0	4.3	2.5	6.5	1.7	0	2.3	2.3	1.4	0	0	1.7	2.6
3 Axle Vehicles	0	0	0	0	0	0	0	0	0	0	0.3	0	1.3	0	0.7	0	0.1	0	0	0.1	0.2
4+ Axle Trucks	0	0	0	0	0	0	1	1	0	2	0	0	0	0	0	4	1	0	0	5	7
% 4+ Axle Trucks																					

Start Time	H Street Southbound					4th Street Westbound					SR-99 Northbound Off Ramp Northbound					4th Street Eastbound					Int. Total
	Left	Thru	Right	U-Turns	App. Total	Left	Thru	Right	U-Turns	App. Total	Left	Thru	Right	U-Turns	App. Total	Left	Thru	Right	U-Turns	App. Total	
Peak Hour Analysis From 07:00 AM to 08:45 AM - Peak 1 of 1																					
Peak Hour for Entire Intersection Begins at 07:30 AM																					
07:30 AM	1	0	18	0	19	0	140	13	0	153	82	5	56	0	143	51	111	0	0	162	477
07:45 AM	0	0	16	0	16	0	110	9	0	119	61	5	67	0	133	79	142	0	0	221	489
08:00 AM	0	0	9	0	9	0	90	14	0	104	60	10	50	0	120	46	127	0	0	173	406
08:15 AM	4	0	13	0	17	0	110	16	0	126	30	4	22	0	56	39	79	0	0	118	317
Total Volume	5	0	56	0	61	0	450	52	0	502	233	24	195	0	452	215	459	0	0	674	1689
% App. Total	8.2	0	91.8	0		0	89.6	10.4	0		51.5	5.3	43.1	0		31.9	68.1	0	0		
PHF	.313	.000	.778	.000	.803	.000	.804	.813	.000	.820	.710	.600	.728	.000	.790	.680	.808	.000	.000	.762	.863

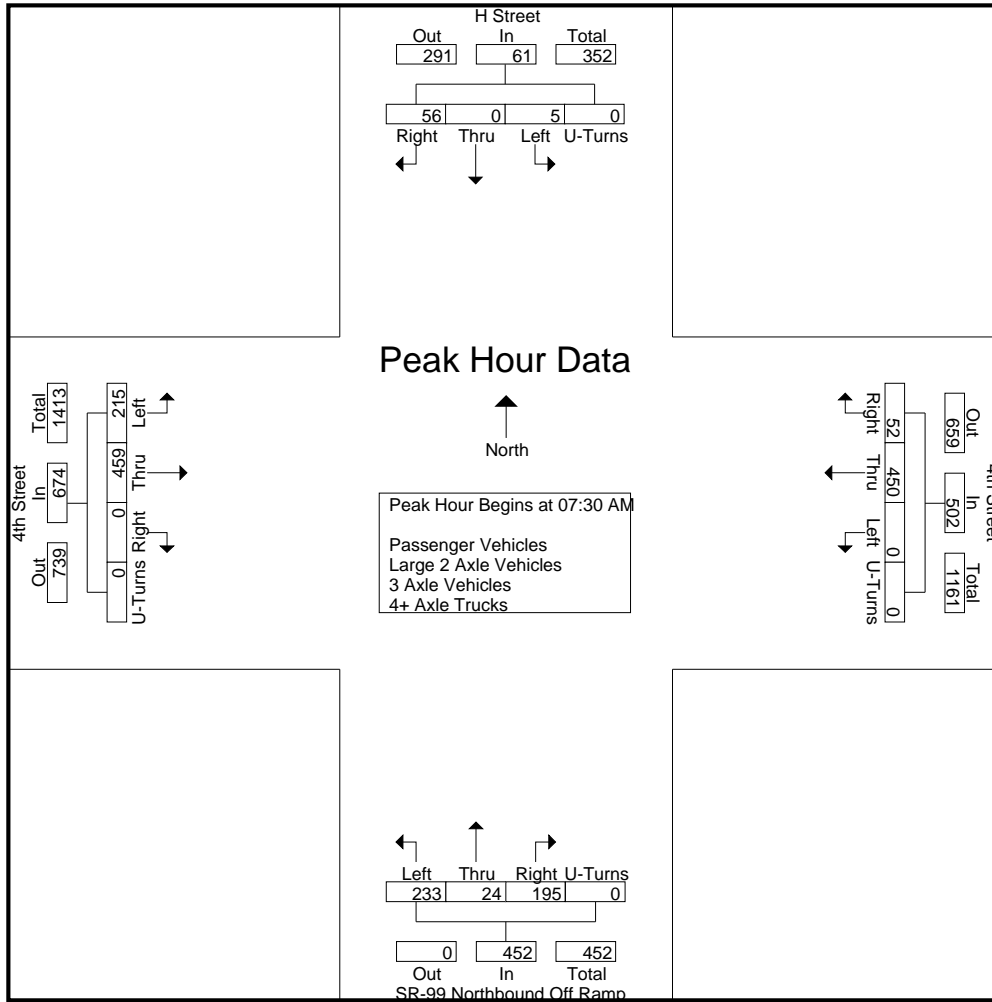

Peak Hour Analysis From 07:00 AM to 08:45 AM - Peak 1 of 1
 Peak Hour for Each Approach Begins at:

	07:30 AM					07:30 AM					07:15 AM					07:30 AM				
+0 mins.	1	0	18	0	19	0	140	13	0	153	42	2	33	0	77	51	111	0	0	162
+15 mins.	0	0	16	0	16	0	110	9	0	119	82	5	56	0	143	79	142	0	0	221
+30 mins.	0	0	9	0	9	0	90	14	0	104	61	5	67	0	133	46	127	0	0	173
+45 mins.	4	0	13	0	17	0	110	16	0	126	60	10	50	0	120	39	79	0	0	118
Total Volume	5	0	56	0	61	0	450	52	0	502	245	22	206	0	473	215	459	0	0	674
% App. Total	8.2	0	91.8	0		0	89.6	10.4	0		51.8	4.7	43.6	0		31.9	68.1	0	0	
PHF	.313	.000	.778	.000	.803	.000	.804	.813	.000	.820	.747	.550	.769	.000	.827	.680	.808	.000	.000	.762

City of Madera
 N/S: H Street/SR-99 Northbound Off Ramp
 E/W: 4th Street
 Weather: Clear

File Name : 34_MDA_99N_4th St AM
 Site Code : 00319628
 Start Date : 9/24/2019
 Page No : 1

Groups Printed- Passenger Vehicles

Start Time	H Street Southbound					4th Street Westbound					SR-99 Northbound Off Ramp Northbound					4th Street Eastbound					Int. Total
	Left	Thru	Right	U-Turns	App. Total	Left	Thru	Right	U-Turns	App. Total	Left	Thru	Right	U-Turns	App. Total	Left	Thru	Right	U-Turns	App. Total	
07:00 AM	0	0	8	0	8	0	88	9	0	97	40	2	25	0	67	28	43	0	0	71	243
07:15 AM	0	0	12	0	12	0	105	9	0	114	41	2	31	0	74	41	59	0	0	100	300
07:30 AM	1	0	18	0	19	0	137	9	0	146	82	5	55	0	142	50	111	0	0	161	468
07:45 AM	0	0	16	0	16	0	107	9	0	116	60	5	67	0	132	78	142	0	0	220	484
Total	1	0	54	0	55	0	437	36	0	473	223	14	178	0	415	197	355	0	0	552	1495
08:00 AM	0	0	9	0	9	0	87	14	0	101	58	9	48	0	115	45	126	0	0	171	396
08:15 AM	4	0	13	0	17	0	105	16	0	121	30	4	21	0	55	37	75	0	0	112	305
08:30 AM	3	0	11	0	14	0	86	9	0	95	20	1	20	0	41	32	86	0	0	118	268
08:45 AM	1	0	6	0	7	0	77	7	0	84	25	1	23	0	49	26	76	0	0	102	242
Total	8	0	39	0	47	0	355	46	0	401	133	15	112	0	260	140	363	0	0	503	1211
Grand Total	9	0	93	0	102	0	792	82	0	874	356	29	290	0	675	337	718	0	0	1055	2706
Apprch %	8.8	0	91.2	0		0	90.6	9.4	0		52.7	4.3	43	0		31.9	68.1	0	0		
Total %	0.3	0	3.4	0	3.8	0	29.3	3	0	32.3	13.2	1.1	10.7	0	24.9	12.5	26.5	0	0	39	

Start Time	H Street Southbound					4th Street Westbound					SR-99 Northbound Off Ramp Northbound					4th Street Eastbound					Int. Total
	Left	Thru	Right	U-Turns	App. Total	Left	Thru	Right	U-Turns	App. Total	Left	Thru	Right	U-Turns	App. Total	Left	Thru	Right	U-Turns	App. Total	
Peak Hour Analysis From 07:30 AM to 08:15 AM - Peak 1 of 1																					
Peak Hour for Entire Intersection Begins at 07:30 AM																					
07:30 AM	1	0	18	0	19	0	137	9	0	146	82	5	55	0	142	50	111	0	0	161	468
07:45 AM	0	0	16	0	16	0	107	9	0	116	60	5	67	0	132	78	142	0	0	220	484
08:00 AM	0	0	9	0	9	0	87	14	0	101	58	9	48	0	115	45	126	0	0	171	396
08:15 AM	4	0	13	0	17	0	105	16	0	121	30	4	21	0	55	37	75	0	0	112	305
Total Volume	5	0	56	0	61	0	436	48	0	484	230	23	191	0	444	210	454	0	0	664	1653
% App. Total	8.2	0	91.8	0		0	90.1	9.9	0		51.8	5.2	43	0		31.6	68.4	0	0		
PHF	.313	.000	.778	.000	.803	.000	.796	.750	.000	.829	.701	.639	.713	.000	.782	.673	.799	.000	.000	.755	.854

City of Madera
 N/S: H Street/SR-99 Northbound Off Ramp
 E/W: 4th Street
 Weather: Clear

File Name : 34_MDA_99N_4th St AM
 Site Code : 00319628
 Start Date : 9/24/2019
 Page No : 2

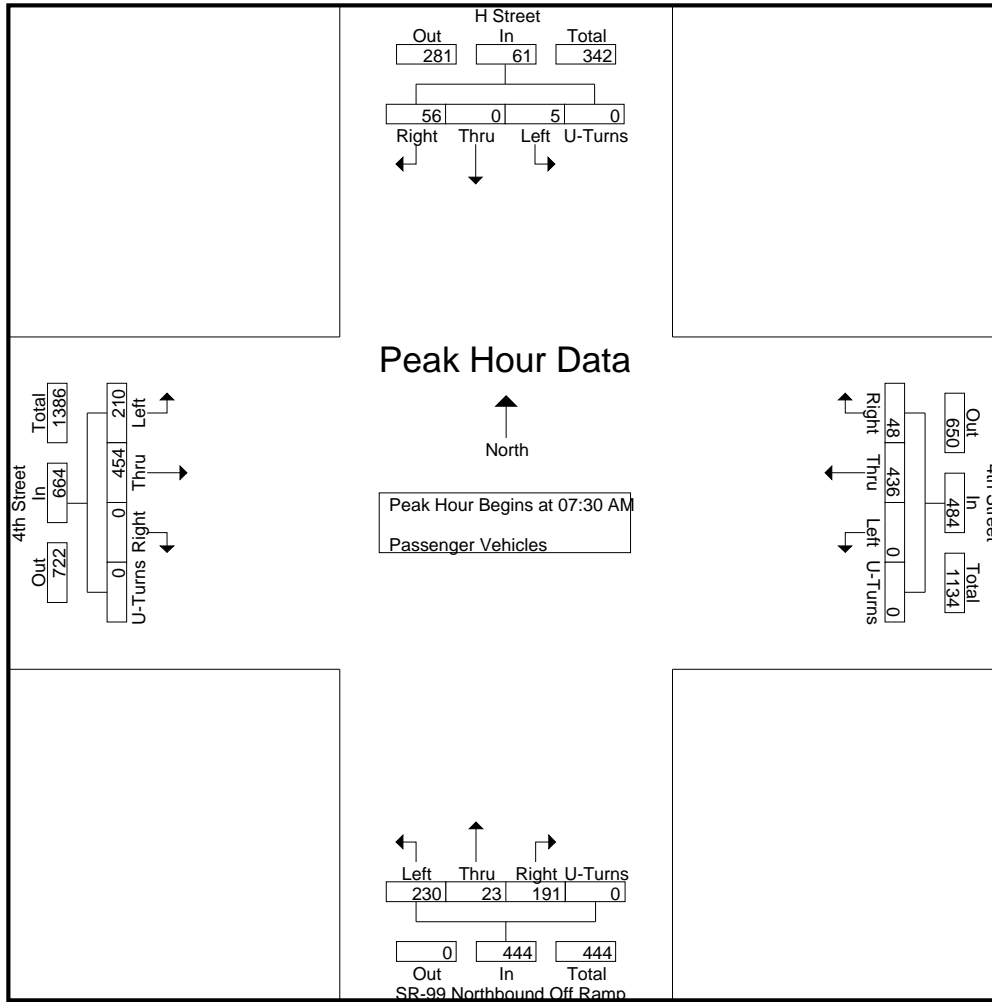

Peak Hour Analysis From 07:30 AM to 08:15 AM - Peak 1 of 1
 Peak Hour for Each Approach Begins at:

	07:30 AM					07:30 AM					07:30 AM									
+0 mins.	1	0	18	0	19	0	137	9	0	146	82	5	55	0	142	50	111	0	0	161
+15 mins.	0	0	16	0	16	0	107	9	0	116	60	5	67	0	132	78	142	0	0	220
+30 mins.	0	0	9	0	9	0	87	14	0	101	58	9	48	0	115	45	126	0	0	171
+45 mins.	4	0	13	0	17	0	105	16	0	121	30	4	21	0	55	37	75	0	0	112
Total Volume	5	0	56	0	61	0	436	48	0	484	230	23	191	0	444	210	454	0	0	664
% App. Total	8.2	0	91.8	0		0	90.1	9.9	0		51.8	5.2	43	0		31.6	68.4	0	0	
PHF	.313	.000	.778	.000	.803	.000	.796	.750	.000	.829	.701	.639	.713	.000	.782	.673	.799	.000	.000	.755

City of Madera
 N/S: H Street/SR-99 Northbound Off Ramp
 E/W: 4th Street
 Weather: Clear

File Name : 34_MDA_99N_4th St AM
 Site Code : 00319628
 Start Date : 9/24/2019
 Page No : 1

Groups Printed- Large 2 Axle Vehicles

Start Time	H Street Southbound					4th Street Westbound					SR-99 Northbound Off Ramp Northbound					4th Street Eastbound					Int. Total
	Left	Thru	Right	U-Turns	App. Total	Left	Thru	Right	U-Turns	App. Total	Left	Thru	Right	U-Turns	App. Total	Left	Thru	Right	U-Turns	App. Total	
07:00 AM	0	0	0	0	0	0	3	3	0	6	2	1	0	0	3	3	2	0	0	5	14
07:15 AM	0	0	0	0	0	0	0	1	0	1	1	0	2	0	3	1	2	0	0	3	7
07:30 AM	0	0	0	0	0	0	3	4	0	7	0	0	0	0	0	1	0	0	0	1	8
07:45 AM	0	0	0	0	0	0	3	0	0	3	1	0	0	0	1	0	0	0	0	0	4
Total	0	0	0	0	0	0	9	8	0	17	4	1	2	0	7	5	4	0	0	9	33
08:00 AM	0	0	0	0	0	0	3	0	0	3	2	1	1	0	4	0	1	0	0	1	8
08:15 AM	0	0	0	0	0	0	5	0	0	5	0	0	0	0	0	1	4	0	0	5	10
08:30 AM	0	0	0	0	0	0	8	2	0	10	0	0	0	0	0	1	1	0	0	2	12
08:45 AM	0	0	0	0	0	0	4	0	0	4	3	0	2	0	5	1	0	0	0	1	10
Total	0	0	0	0	0	0	20	2	0	22	5	1	3	0	9	3	6	0	0	9	40
Grand Total	0	0	0	0	0	0	29	10	0	39	9	2	5	0	16	8	10	0	0	18	73
Apprch %	0	0	0	0	0	0	74.4	25.6	0		56.2	12.5	31.2	0		44.4	55.6	0	0		
Total %	0	0	0	0	0	0	39.7	13.7	0	53.4	12.3	2.7	6.8	0	21.9	11	13.7	0	0	24.7	

Start Time	H Street Southbound					4th Street Westbound					SR-99 Northbound Off Ramp Northbound					4th Street Eastbound					Int. Total
	Left	Thru	Right	U-Turns	App. Total	Thru	Right	U-Turns	App. Total	Thru	Right	U-Turns	App. Total	Thru	Right	U-Turns	App. Total				
Peak Hour Analysis From 07:30 AM to 08:15 AM - Peak 1 of 1																					
Peak Hour for Entire Intersection Begins at 07:30 AM																					
07:30 AM	0	0	0	0	0	0	3	4	0	7	0	0	0	0	0	1	0	0	0	1	8
07:45 AM	0	0	0	0	0	0	3	0	0	3	1	0	0	0	1	0	0	0	0	0	4
08:00 AM	0	0	0	0	0	0	3	0	0	3	2	1	1	0	4	0	1	0	0	1	8
08:15 AM	0	0	0	0	0	0	5	0	0	5	0	0	0	0	0	1	4	0	0	5	10
Total Volume	0	0	0	0	0	0	14	4	0	18	3	1	1	0	5	2	5	0	0	7	30
% App. Total	0	0	0	0	0	0	77.8	22.2	0		60	20	20	0		28.6	71.4	0	0		
PHF	.000	.000	.000	.000	.000	.000	.700	.250	.000	.643	.375	.250	.250	.000	.313	.500	.313	.000	.000	.350	.750

City of Madera
 N/S: H Street/SR-99 Northbound Off Ramp
 E/W: 4th Street
 Weather: Clear

File Name : 34_MDA_99N_4th St AM
 Site Code : 00319628
 Start Date : 9/24/2019
 Page No : 2

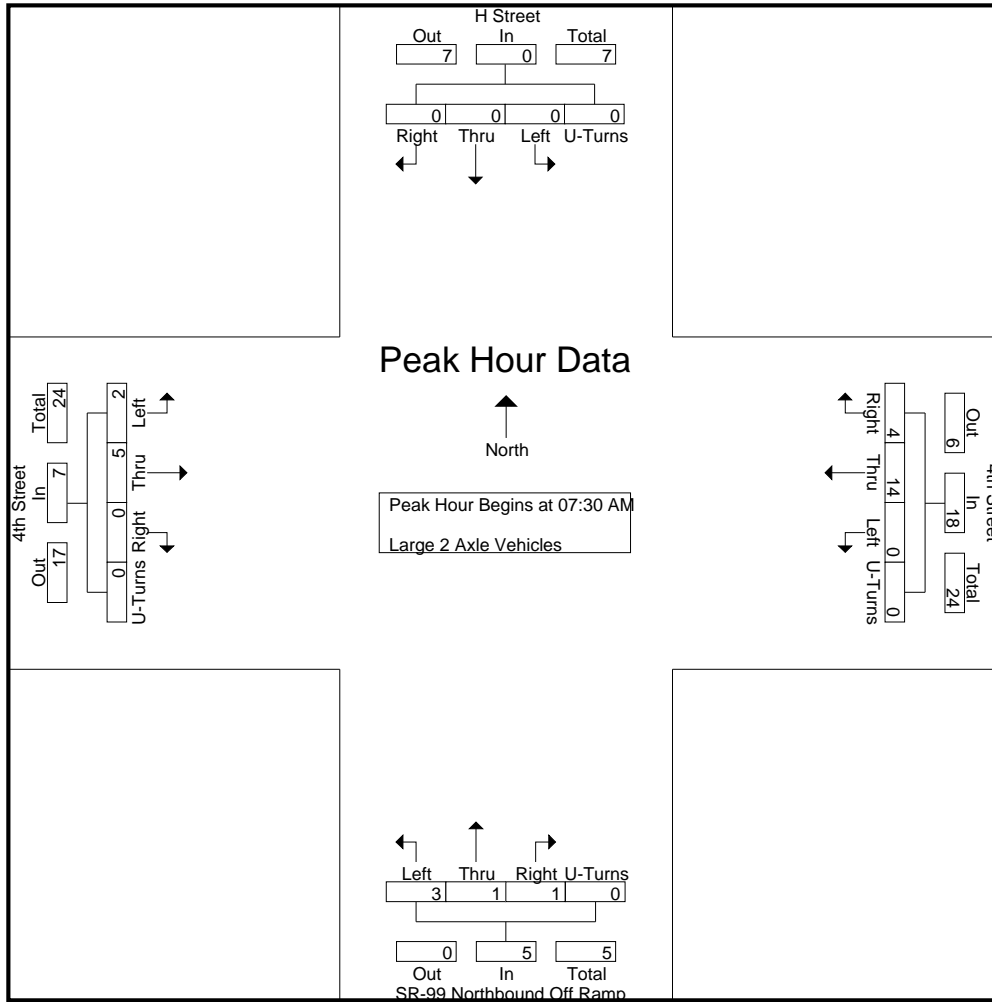

Peak Hour Analysis From 07:30 AM to 08:15 AM - Peak 1 of 1
 Peak Hour for Each Approach Begins at:

	07:30 AM					07:30 AM					07:30 AM										
+0 mins.	0	0	0	0	0	0	3	4	0	7	0	0	0	0	0	1	0	0	0	0	1
+15 mins.	0	0	0	0	0	0	3	0	0	3	1	0	0	0	1	0	0	0	0	0	0
+30 mins.	0	0	0	0	0	0	3	0	0	3	2	1	1	0	4	0	1	0	0	0	1
+45 mins.	0	0	0	0	0	0	5	0	0	5	0	0	0	0	0	1	4	0	0	0	5
Total Volume	0	0	0	0	0	0	14	4	0	18	3	1	1	0	5	2	5	0	0	0	7
% App. Total	0	0	0	0	0	0	77.8	22.2	0	0	60	20	20	0	0	28.6	71.4	0	0	0	0
PHF	.000	.000	.000	.000	.000	.000	.700	.250	.000	.643	.375	.250	.250	.000	.313	.500	.313	.000	.000	.350	

City of Madera
 N/S: H Street/SR-99 Northbound Off Ramp
 E/W: 4th Street
 Weather: Clear

File Name : 34_MDA_99N_4th St AM
 Site Code : 00319628
 Start Date : 9/24/2019
 Page No : 1

Groups Printed- 3 Axle Vehicles

Start Time	H Street Southbound					4th Street Westbound					SR-99 Northbound Off Ramp Northbound					4th Street Eastbound					Int. Total
	Left	Thru	Right	U-Turns	App. Total	Left	Thru	Right	U-Turns	App. Total	Left	Thru	Right	U-Turns	App. Total	Left	Thru	Right	U-Turns	App. Total	
07:00 AM	0	0	0	0	0	0	0	0	0	0	0	0	1	0	1	0	0	0	0	0	1
07:15 AM	0	0	0	0	0	0	0	0	0	0	0	0	0	0	0	0	1	0	0	0	1
07:30 AM	0	0	0	0	0	0	0	0	0	0	0	0	1	0	1	0	0	0	0	0	1
07:45 AM	0	0	0	0	0	0	0	0	0	0	0	0	0	0	0	0	0	0	0	0	0
Total	0	0	0	0	0	0	0	0	0	0	0	0	2	0	2	0	1	0	0	0	1
08:00 AM	0	0	0	0	0	0	0	0	0	0	0	0	1	0	1	0	0	0	0	0	1
08:15 AM	0	0	0	0	0	0	0	0	0	0	0	0	1	0	1	0	0	0	0	0	1
08:30 AM	0	0	0	0	0	0	0	0	0	0	0	0	0	0	0	0	0	0	0	0	0
08:45 AM	0	0	0	0	0	0	0	0	0	0	1	0	0	0	1	0	0	0	0	0	1
Total	0	0	0	0	0	0	0	0	0	0	1	0	2	0	3	0	0	0	0	0	3
Grand Total	0	0	0	0	0	0	0	0	0	0	1	0	4	0	5	0	1	0	0	0	1
Apprch %	0	0	0	0		0	0	0	0		20	0	80	0		0	100	0	0		
Total %	0	0	0	0	0	0	0	0	0	0	16.7	0	66.7	0	83.3	0	16.7	0	0	16.7	

Start Time	H Street Southbound					4th Street Westbound					SR-99 Northbound Off Ramp Northbound					4th Street Eastbound					Int. Total
	Left	Thru	Right	U-Turns	App. Total	Left	Thru	Right	U-Turns	App. Total	Left	Thru	Right	U-Turns	App. Total	Left	Thru	Right	U-Turns	App. Total	
07:30 AM	0	0	0	0	0	0	0	0	0	0	0	0	1	0	1	0	0	0	0	0	1
07:45 AM	0	0	0	0	0	0	0	0	0	0	0	0	0	0	0	0	0	0	0	0	0
08:00 AM	0	0	0	0	0	0	0	0	0	0	0	0	1	0	1	0	0	0	0	0	1
08:15 AM	0	0	0	0	0	0	0	0	0	0	0	0	1	0	1	0	0	0	0	0	1
Total Volume	0	0	0	0	0	0	0	0	0	0	0	0	3	0	3	0	0	0	0	0	3
% App. Total	0	0	0	0		0	0	0	0		0	0	100	0		0	0	0	0		
PHF	.000	.000	.000	.000	.000	.000	.000	.000	.000	.000	.000	.000	.750	.000	.750	.000	.000	.000	.000	.000	.750

Peak Hour Analysis From 07:30 AM to 08:15 AM - Peak 1 of 1

Peak Hour for Entire Intersection Begins at 07:30 AM

City of Madera
 N/S: H Street/SR-99 Northbound Off Ramp
 E/W: 4th Street
 Weather: Clear

File Name : 34_MDA_99N_4th St AM
 Site Code : 00319628
 Start Date : 9/24/2019
 Page No : 2

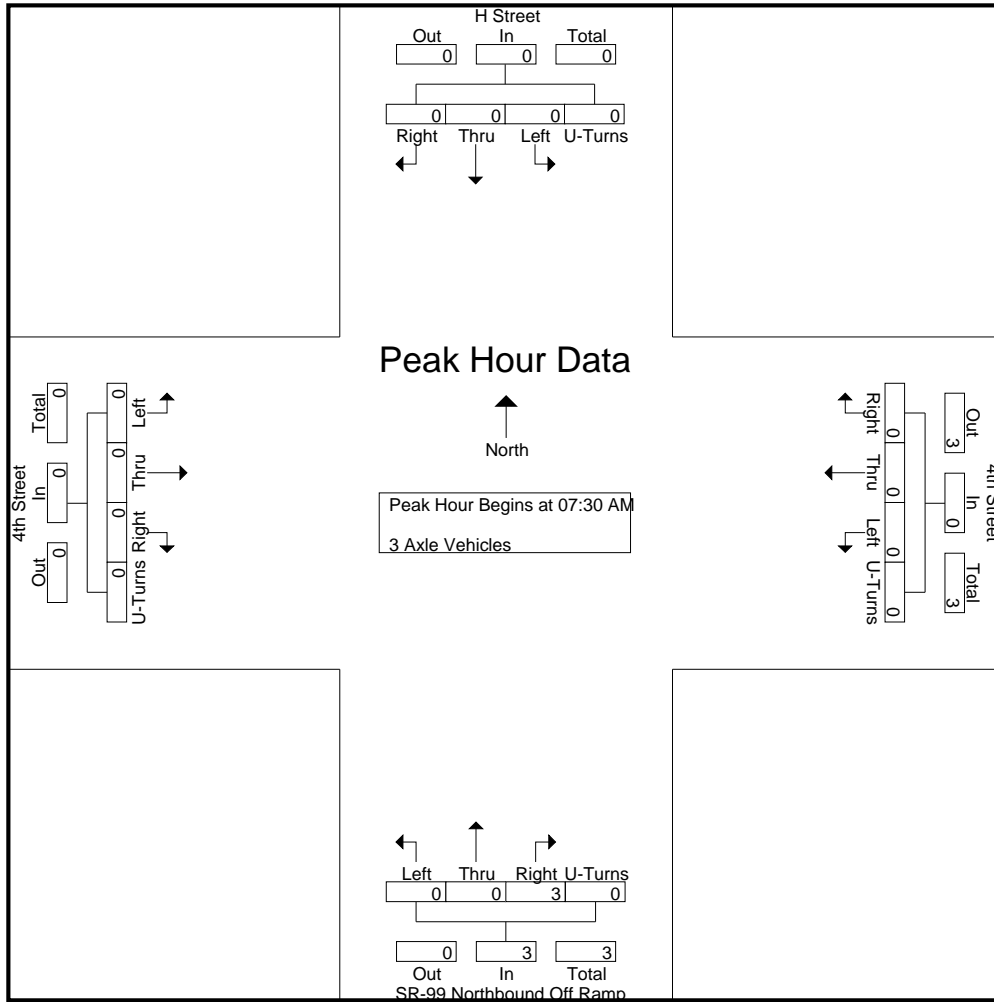

Peak Hour Analysis From 07:30 AM to 08:15 AM - Peak 1 of 1
 Peak Hour for Each Approach Begins at:

	07:30 AM					07:30 AM					07:30 AM									
+0 mins.	0	0	0	0	0	0	0	0	0	0	0	0	1	0	1	0	0	0	0	0
+15 mins.	0	0	0	0	0	0	0	0	0	0	0	0	0	0	0	0	0	0	0	0
+30 mins.	0	0	0	0	0	0	0	0	0	0	0	0	1	0	1	0	0	0	0	0
+45 mins.	0	0	0	0	0	0	0	0	0	0	0	0	1	0	1	0	0	0	0	0
Total Volume	0	0	0	0	0	0	0	0	0	0	0	0	3	0	3	0	0	0	0	0
% App. Total	0	0	0	0	0	0	0	0	0	0	0	0	100	0	0	0	0	0	0	0
PHF	.000	.000	.000	.000	.000	.000	.000	.000	.000	.000	.000	.000	.750	.000	.750	.000	.000	.000	.000	.000

City of Madera
 N/S: H Street/SR-99 Northbound Off Ramp
 E/W: 4th Street
 Weather: Clear

File Name : 34_MDA_99N_4th St AM
 Site Code : 00319628
 Start Date : 9/24/2019
 Page No : 1

Groups Printed- 4+ Axle Trucks

Start Time	H Street Southbound					4th Street Westbound					SR-99 Northbound Off Ramp Northbound					4th Street Eastbound					Int. Total
	Left	Thru	Right	U-Turns	App. Total	Left	Thru	Right	U-Turns	App. Total	Left	Thru	Right	U-Turns	App. Total	Left	Thru	Right	U-Turns	App. Total	
07:00 AM	0	0	0	0	0	0	0	0	0	0	0	0	0	0	0	0	1	0	0	1	1
07:15 AM	0	0	0	0	0	0	0	0	0	0	0	0	0	0	0	1	0	0	0	1	1
07:30 AM	0	0	0	0	0	0	0	0	0	0	0	0	0	0	0	0	0	0	0	0	0
07:45 AM	0	0	0	0	0	0	0	0	0	0	0	0	0	0	0	1	0	0	0	1	1
Total	0	0	0	0	0	0	0	0	0	0	0	0	0	0	0	2	1	0	0	3	3
08:00 AM	0	0	0	0	0	0	0	0	0	0	0	0	0	0	0	1	0	0	0	1	1
08:15 AM	0	0	0	0	0	0	0	0	0	0	0	0	0	0	0	1	0	0	0	1	1
08:30 AM	0	0	0	0	0	0	1	0	0	1	0	0	0	0	0	0	0	0	0	0	1
08:45 AM	0	0	0	0	0	0	0	1	0	1	0	0	0	0	0	0	0	0	0	0	1
Total	0	0	0	0	0	0	1	1	0	2	0	0	0	0	0	2	0	0	0	2	4
Grand Total	0	0	0	0	0	0	1	1	0	2	0	0	0	0	0	4	1	0	0	5	7
Apprch %	0	0	0	0		0	50	50	0		0	0	0	0		80	20	0	0		
Total %	0	0	0	0		0	14.3	14.3	0	28.6	0	0	0	0		57.1	14.3	0	0	71.4	

Start Time	H Street Southbound					4th Street Westbound					SR-99 Northbound Off Ramp Northbound					4th Street Eastbound					Int. Total
	Left	Thru	Right	U-Turns	App. Total	Thru	Right	U-Turns	App. Total	Thru	Right	U-Turns	App. Total	Thru	Right	U-Turns	App. Total				
Peak Hour Analysis From 07:30 AM to 08:15 AM - Peak 1 of 1																					
Peak Hour for Entire Intersection Begins at 07:30 AM																					
07:30 AM	0	0	0	0	0	0	0	0	0	0	0	0	0	0	0	0	0	0	0	0	0
07:45 AM	0	0	0	0	0	0	0	0	0	0	0	0	0	0	0	1	0	0	0	1	1
08:00 AM	0	0	0	0	0	0	0	0	0	0	0	0	0	0	0	1	0	0	0	1	1
08:15 AM	0	0	0	0	0	0	0	0	0	0	0	0	0	0	0	1	0	0	0	1	1
Total Volume	0	0	0	0	0	0	0	0	0	0	0	0	0	0	0	3	0	0	0	3	3
% App. Total	0	0	0	0		0	0	0	0		0	0	0	0		100	0	0	0		
PHF	.000	.000	.000	.000	.000	.000	.000	.000	.000	.000	.000	.000	.000	.000	.000	.750	.000	.000	.000	.750	.750

City of Madera
 N/S: H Street/SR-99 Northbound Off Ramp
 E/W: 4th Street
 Weather: Clear

File Name : 34_MDA_99N_4th St AM
 Site Code : 00319628
 Start Date : 9/24/2019
 Page No : 2

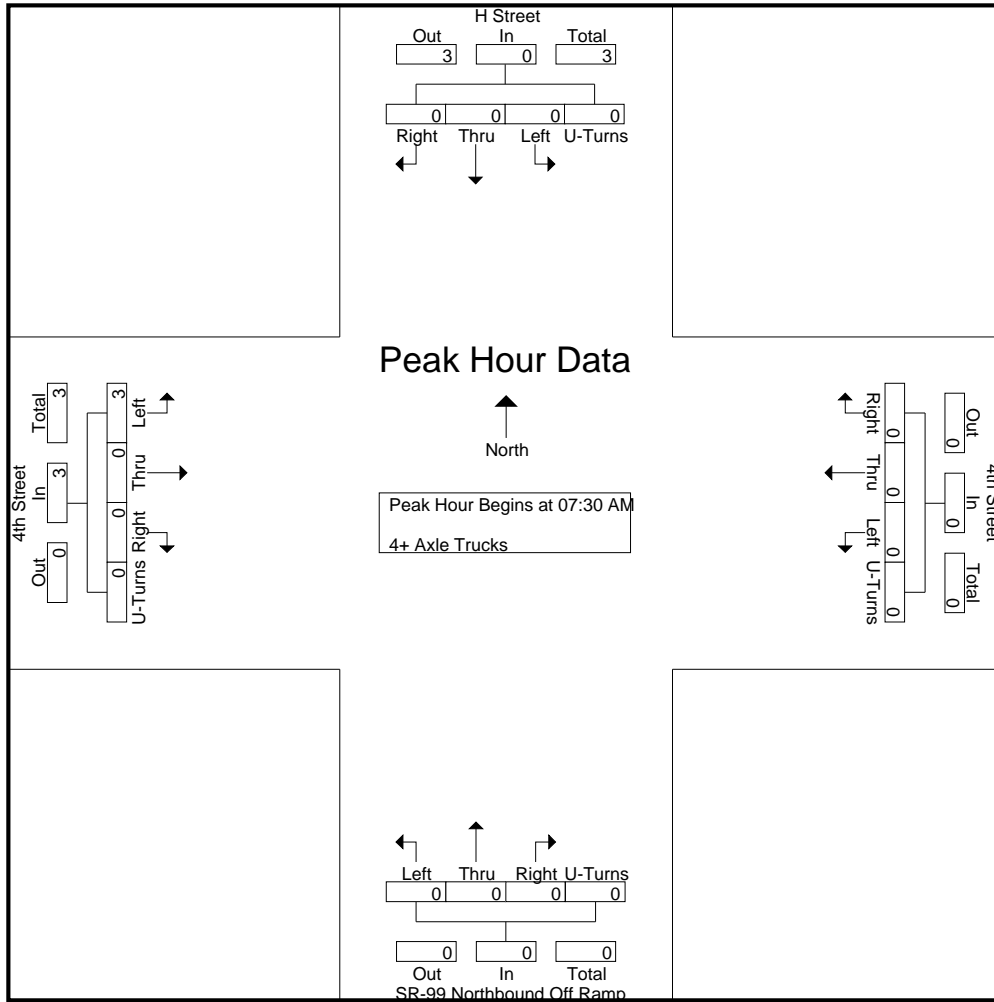

Peak Hour Analysis From 07:30 AM to 08:15 AM - Peak 1 of 1
 Peak Hour for Each Approach Begins at:

	07:30 AM					07:30 AM					07:30 AM									
+0 mins.	0	0	0	0	0	0	0	0	0	0	0	0	0	0	0	0	0	0	0	0
+15 mins.	0	0	0	0	0	0	0	0	0	0	0	0	0	0	0	1	0	0	0	1
+30 mins.	0	0	0	0	0	0	0	0	0	0	0	0	0	0	0	1	0	0	0	1
+45 mins.	0	0	0	0	0	0	0	0	0	0	0	0	0	0	0	1	0	0	0	1
Total Volume	0	0	0	0	0	0	0	0	0	0	0	0	0	0	0	3	0	0	0	3
% App. Total	0	0	0	0	0	0	0	0	0	0	0	0	0	0	0	100	0	0	0	0
PHF	.000	.000	.000	.000	.000	.000	.000	.000	.000	.000	.000	.000	.000	.000	.000	.750	.000	.000	.000	.750

City of Madera
 N/S: H Street/SR-99 Northbound Off Ramp
 E/W: 4th Street
 Weather: Clear

File Name : 34_MDA_99N_4th St PM
 Site Code : 00319628
 Start Date : 9/24/2019
 Page No : 1

Groups Printed- Passenger Vehicles - Large 2 Axle Vehicles - 3 Axle Vehicles - 4+ Axle Trucks

Start Time	H Street Southbound					4th Street Westbound					SR-99 Northbound Off Ramp Northbound					4th Street Eastbound					Int. Total
	Left	Thru	Right	U-Turns	App. Total	Left	Thru	Right	U-Turns	App. Total	Left	Thru	Right	U-Turns	App. Total	Left	Thru	Right	U-Turns	App. Total	
04:00 PM	8	0	16	0	24	0	123	24	0	147	67	3	41	0	111	49	117	0	0	166	448
04:15 PM	6	0	17	0	23	0	95	19	0	114	60	3	33	0	96	35	93	0	0	128	361
04:30 PM	6	0	22	0	28	0	127	20	0	147	44	7	34	0	85	50	111	0	0	161	421
04:45 PM	11	0	14	0	25	0	113	21	0	134	58	5	35	0	98	47	86	0	0	133	390
Total	31	0	69	0	100	0	458	84	0	542	229	18	143	0	390	181	407	0	0	588	1620
05:00 PM	3	0	12	0	15	0	145	22	0	167	60	3	34	0	97	61	104	0	0	165	444
05:15 PM	0	0	18	0	18	0	120	24	0	144	79	4	41	0	124	39	92	0	0	131	417
05:30 PM	0	0	11	0	11	0	94	18	0	112	73	4	34	0	111	46	87	0	0	133	367
05:45 PM	0	0	14	0	14	0	111	15	0	126	55	2	34	0	91	34	80	0	0	114	345
Total	3	0	55	0	58	0	470	79	0	549	267	13	143	0	423	180	363	0	0	543	1573
Grand Total	34	0	124	0	158	0	928	163	0	1091	496	31	286	0	813	361	770	0	0	1131	3193
Apprch %	21.5	0	78.5	0		0	85.1	14.9	0		61	3.8	35.2	0		31.9	68.1	0	0		
Total %	1.1	0	3.9	0	4.9	0	29.1	5.1	0	34.2	15.5	1	9	0	25.5	11.3	24.1	0	0	35.4	
Passenger Vehicles	97.1	0	99.2	0	98.7	0	99	95.1	0	98.4	99.4	96.8	97.2	0	98.5	97.8	99.6	0	0	99	98.7
Large 2 Axle Vehicles	2.9	0	0.8	0	1.3	0	0.9	3.1	0	1.2	0.6	3.2	2.1	0	1.2	1.4	0.4	0	0	0.7	1
3 Axle Vehicles	0	0	0	0	0	0	1	1	0	2	0	0	1	0	1	0	0	0	0	0	3
% 3 Axle Vehicles	0	0	0	0	0	0	0.1	0.6	0	0.2	0	0	0.3	0	0.1	0	0	0	0	0	0.1
4+ Axle Trucks	0	0	0	0	0	0	0	2	0	2	0	0	1	0	1	3	0	0	0	3	6
% 4+ Axle Trucks																					

Start Time	H Street Southbound					4th Street Westbound					SR-99 Northbound Off Ramp Northbound					4th Street Eastbound					Int. Total
	Left	Thru	Right	U-Turns	App. Total	Left	Thru	Right	U-Turns	App. Total	Left	Thru	Right	U-Turns	App. Total	Left	Thru	Right	U-Turns	App. Total	
04:30 PM	6	0	22	0	28	0	127	20	0	147	44	7	34	0	85	50	111	0	0	161	421
04:45 PM	11	0	14	0	25	0	113	21	0	134	58	5	35	0	98	47	86	0	0	133	390
05:00 PM	3	0	12	0	15	0	145	22	0	167	60	3	34	0	97	61	104	0	0	165	444
05:15 PM	0	0	18	0	18	0	120	24	0	144	79	4	41	0	124	39	92	0	0	131	417
Total Volume	20	0	66	0	86	0	505	87	0	592	241	19	144	0	404	197	393	0	0	590	1672
% App. Total	23.3	0	76.7	0		0	85.3	14.7	0		59.7	4.7	35.6	0		33.4	66.6	0	0		
PHF	.455	.000	.750	.000	.768	.000	.871	.906	.000	.886	.763	.679	.878	.000	.815	.807	.885	.000	.000	.894	.941

Peak Hour Analysis From 04:00 PM to 05:45 PM - Peak 1 of 1
 Peak Hour for Entire Intersection Begins at 04:30 PM

City of Madera
 N/S: H Street/SR-99 Northbound Off Ramp
 E/W: 4th Street
 Weather: Clear

File Name : 34_MDA_99N_4th St PM
 Site Code : 00319628
 Start Date : 9/24/2019
 Page No : 2

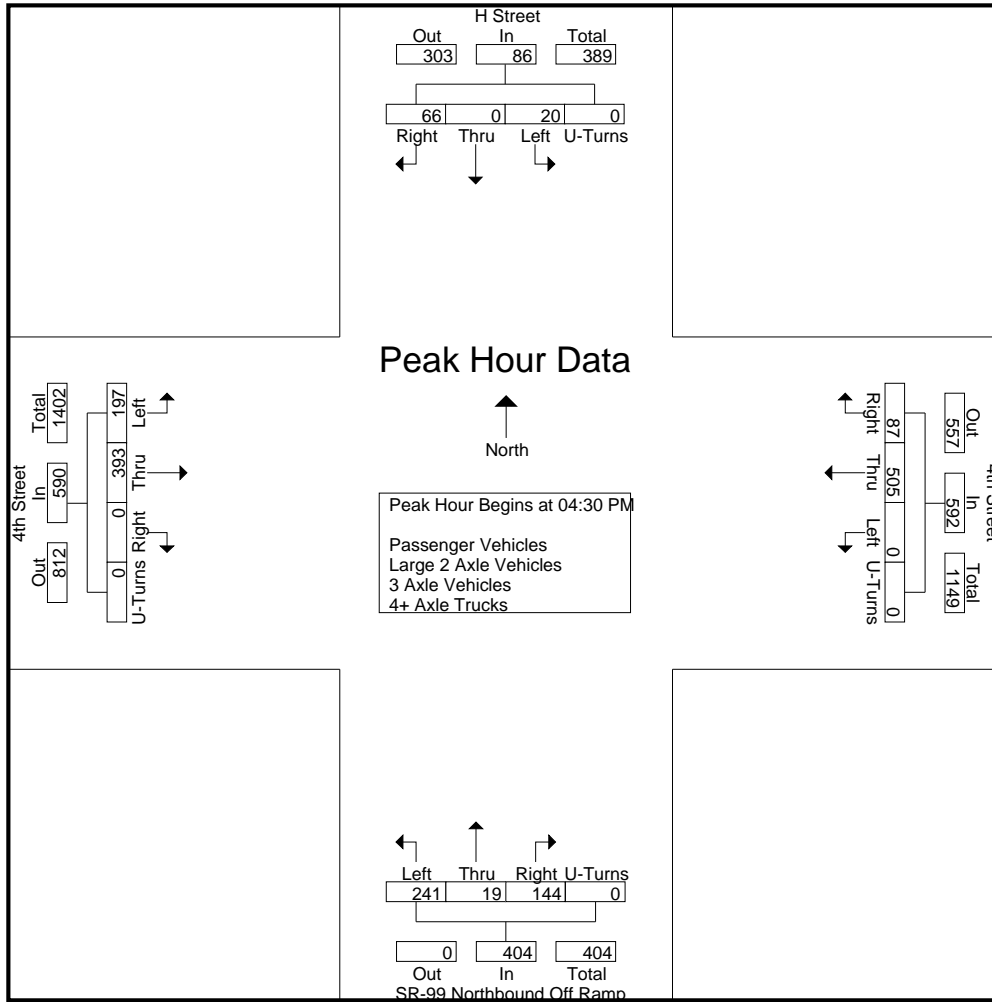

Peak Hour Analysis From 04:00 PM to 05:45 PM - Peak 1 of 1
 Peak Hour for Each Approach Begins at:

	04:00 PM					04:30 PM					04:45 PM					04:30 PM				
+0 mins.	8	0	16	0	24	0	127	20	0	147	58	5	35	0	98	50	111	0	0	161
+15 mins.	6	0	17	0	23	0	113	21	0	134	60	3	34	0	97	47	86	0	0	133
+30 mins.	6	0	22	0	28	0	145	22	0	167	79	4	41	0	124	61	104	0	0	165
+45 mins.	11	0	14	0	25	0	120	24	0	144	73	4	34	0	111	39	92	0	0	131
Total Volume	31	0	69	0	100	0	505	87	0	592	270	16	144	0	430	197	393	0	0	590
% App. Total	31	0	69	0		0	85.3	14.7	0		62.8	3.7	33.5	0		33.4	66.6	0	0	
PHF	.705	.000	.784	.000	.893	.000	.871	.906	.000	.886	.854	.800	.878	.000	.867	.807	.885	.000	.000	.894

City of Madera
 N/S: H Street/SR-99 Northbound Off Ramp
 E/W: 4th Street
 Weather: Clear

File Name : 34_MDA_99N_4th St PM
 Site Code : 00319628
 Start Date : 9/24/2019
 Page No : 1

Groups Printed- Passenger Vehicles

Start Time	H Street Southbound					4th Street Westbound					SR-99 Northbound Off Ramp Northbound					4th Street Eastbound					Int. Total
	Left	Thru	Right	U-Turns	App. Total	Left	Thru	Right	U-Turns	App. Total	Left	Thru	Right	U-Turns	App. Total	Left	Thru	Right	U-Turns	App. Total	
04:00 PM	8	0	16	0	24	0	122	21	0	143	65	3	39	0	107	47	117	0	0	164	438
04:15 PM	5	0	17	0	22	0	93	18	0	111	60	3	32	0	95	34	93	0	0	127	355
04:30 PM	6	0	22	0	28	0	125	19	0	144	44	7	32	0	83	48	111	0	0	159	414
04:45 PM	11	0	14	0	25	0	112	20	0	132	57	5	35	0	97	46	86	0	0	132	386
Total	30	0	69	0	99	0	452	78	0	530	226	18	138	0	382	175	407	0	0	582	1593
05:00 PM	3	0	12	0	15	0	144	22	0	166	60	3	33	0	96	61	104	0	0	165	442
05:15 PM	0	0	18	0	18	0	119	23	0	142	79	4	40	0	123	39	89	0	0	128	411
05:30 PM	0	0	10	0	10	0	94	17	0	111	73	3	33	0	109	45	87	0	0	132	362
05:45 PM	0	0	14	0	14	0	110	15	0	125	55	2	34	0	91	33	80	0	0	113	343
Total	3	0	54	0	57	0	467	77	0	544	267	12	140	0	419	178	360	0	0	538	1558
Grand Total	33	0	123	0	156	0	919	155	0	1074	493	30	278	0	801	353	767	0	0	1120	3151
Apprch %	21.2	0	78.8	0		0	85.6	14.4	0		61.5	3.7	34.7	0		31.5	68.5	0	0		
Total %	1	0	3.9	0	5	0	29.2	4.9	0	34.1	15.6	1	8.8	0	25.4	11.2	24.3	0	0	35.5	

Start Time	H Street Southbound					4th Street Westbound					SR-99 Northbound Off Ramp Northbound					4th Street Eastbound					Int. Total
	Left	Thru	Right	U-Turns	App. Total	Left	Thru	Right	U-Turns	App. Total	Left	Thru	Right	U-Turns	App. Total	Left	Thru	Right	U-Turns	App. Total	
Peak Hour Analysis From 04:30 PM to 05:15 PM - Peak 1 of 1																					
Peak Hour for Entire Intersection Begins at 04:30 PM																					
04:30 PM	6	0	22	0	28	0	125	19	0	144	44	7	32	0	83	48	111	0	0	159	414
04:45 PM	11	0	14	0	25	0	112	20	0	132	57	5	35	0	97	46	86	0	0	132	386
05:00 PM	3	0	12	0	15	0	144	22	0	166	60	3	33	0	96	61	104	0	0	165	442
05:15 PM	0	0	18	0	18	0	119	23	0	142	79	4	40	0	123	39	89	0	0	128	411
Total Volume	20	0	66	0	86	0	500	84	0	584	240	19	140	0	399	194	390	0	0	584	1653
% App. Total	23.3	0	76.7	0		0	85.6	14.4	0		60.2	4.8	35.1	0		33.2	66.8	0	0		
PHF	.455	.000	.750	.000	.768	.000	.868	.913	.000	.880	.759	.679	.875	.000	.811	.795	.878	.000	.000	.885	.935

City of Madera
 N/S: H Street/SR-99 Northbound Off Ramp
 E/W: 4th Street
 Weather: Clear

File Name : 34_MDA_99N_4th St PM
 Site Code : 00319628
 Start Date : 9/24/2019
 Page No : 2

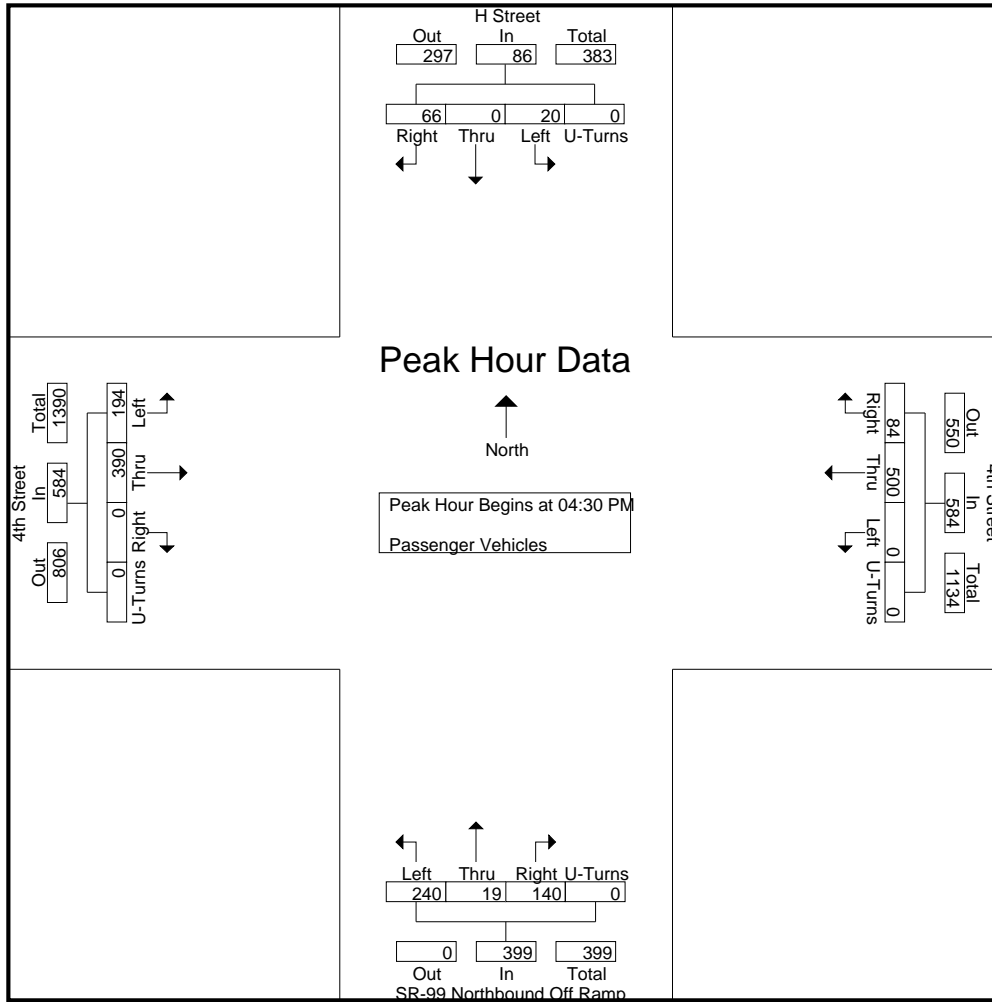

Peak Hour Analysis From 04:30 PM to 05:15 PM - Peak 1 of 1
 Peak Hour for Each Approach Begins at:

	04:30 PM					04:30 PM					04:30 PM									
+0 mins.	6	0	22	0	28	0	125	19	0	144	44	7	32	0	83	48	111	0	0	159
+15 mins.	11	0	14	0	25	0	112	20	0	132	57	5	35	0	97	46	86	0	0	132
+30 mins.	3	0	12	0	15	0	144	22	0	166	60	3	33	0	96	61	104	0	0	165
+45 mins.	0	0	18	0	18	0	119	23	0	142	79	4	40	0	123	39	89	0	0	128
Total Volume	20	0	66	0	86	0	500	84	0	584	240	19	140	0	399	194	390	0	0	584
% App. Total	23.3	0	76.7	0		0	85.6	14.4	0		60.2	4.8	35.1	0		33.2	66.8	0	0	
PHF	.455	.000	.750	.000	.768	.000	.868	.913	.000	.880	.759	.679	.875	.000	.811	.795	.878	.000	.000	.885

City of Madera
 N/S: H Street/SR-99 Northbound Off Ramp
 E/W: 4th Street
 Weather: Clear

File Name : 34_MDA_99N_4th St PM
 Site Code : 00319628
 Start Date : 9/24/2019
 Page No : 1

Groups Printed- Large 2 Axle Vehicles

Start Time	H Street Southbound					4th Street Westbound					SR-99 Northbound Off Ramp Northbound					4th Street Eastbound					Int. Total
	Left	Thru	Right	U-Turns	App. Total	Left	Thru	Right	U-Turns	App. Total	Left	Thru	Right	U-Turns	App. Total	Left	Thru	Right	U-Turns	App. Total	
04:00 PM	0	0	0	0	0	0	1	1	0	2	2	0	2	0	4	1	0	0	0	1	7
04:15 PM	1	0	0	0	1	0	2	1	0	3	0	0	0	0	0	0	0	0	0	0	4
04:30 PM	0	0	0	0	0	0	1	1	0	2	0	0	1	0	1	2	0	0	0	2	5
04:45 PM	0	0	0	0	0	0	1	1	0	2	1	0	0	0	1	1	0	0	0	1	4
Total	1	0	0	0	1	0	5	4	0	9	3	0	3	0	6	4	0	0	0	4	20
05:00 PM	0	0	0	0	0	0	1	0	0	1	0	0	1	0	1	0	0	0	0	0	2
05:15 PM	0	0	0	0	0	0	1	1	0	2	0	0	1	0	1	0	3	0	0	3	6
05:30 PM	0	0	1	0	1	0	0	0	0	0	0	1	1	0	2	1	0	0	0	1	4
05:45 PM	0	0	0	0	0	0	1	0	0	1	0	0	0	0	0	0	0	0	0	0	1
Total	0	0	1	0	1	0	3	1	0	4	0	1	3	0	4	1	3	0	0	4	13
Grand Total	1	0	1	0	2	0	8	5	0	13	3	1	6	0	10	5	3	0	0	8	33
Apprch %	50	0	50	0		0	61.5	38.5	0		30	10	60	0		62.5	37.5	0	0		
Total %	3	0	3	0	6.1	0	24.2	15.2	0	39.4	9.1	3	18.2	0	30.3	15.2	9.1	0	0	24.2	

Start Time	H Street Southbound					4th Street Westbound					SR-99 Northbound Off Ramp Northbound					4th Street Eastbound					Int. Total
	Left	Thru	Right	U-Turns	App. Total	Thru	Right	U-Turns	App. Total	Thru	Right	U-Turns	App. Total	Thru	Right	U-Turns	App. Total				
Peak Hour Analysis From 04:30 PM to 05:15 PM - Peak 1 of 1																					
Peak Hour for Entire Intersection Begins at 04:30 PM																					
04:30 PM	0	0	0	0	0	0	1	1	0	2	0	0	1	0	1	2	0	0	0	2	5
04:45 PM	0	0	0	0	0	0	1	1	0	2	1	0	0	0	1	1	0	0	0	1	4
05:00 PM	0	0	0	0	0	0	1	0	0	1	0	0	1	0	1	0	0	0	0	0	2
05:15 PM	0	0	0	0	0	0	1	1	0	2	0	0	1	0	1	0	3	0	0	3	6
Total Volume	0	0	0	0	0	0	4	3	0	7	1	0	3	0	4	3	3	0	0	6	17
% App. Total	0	0	0	0		0	57.1	42.9	0		25	0	75	0		50	50	0	0		
PHF	.000	.000	.000	.000	.000	.000	1.00	.750	.000	.875	.250	.000	.750	.000	1.00	.375	.250	.000	.000	.500	.708

City of Madera
 N/S: H Street/SR-99 Northbound Off Ramp
 E/W: 4th Street
 Weather: Clear

File Name : 34_MDA_99N_4th St PM
 Site Code : 00319628
 Start Date : 9/24/2019
 Page No : 2

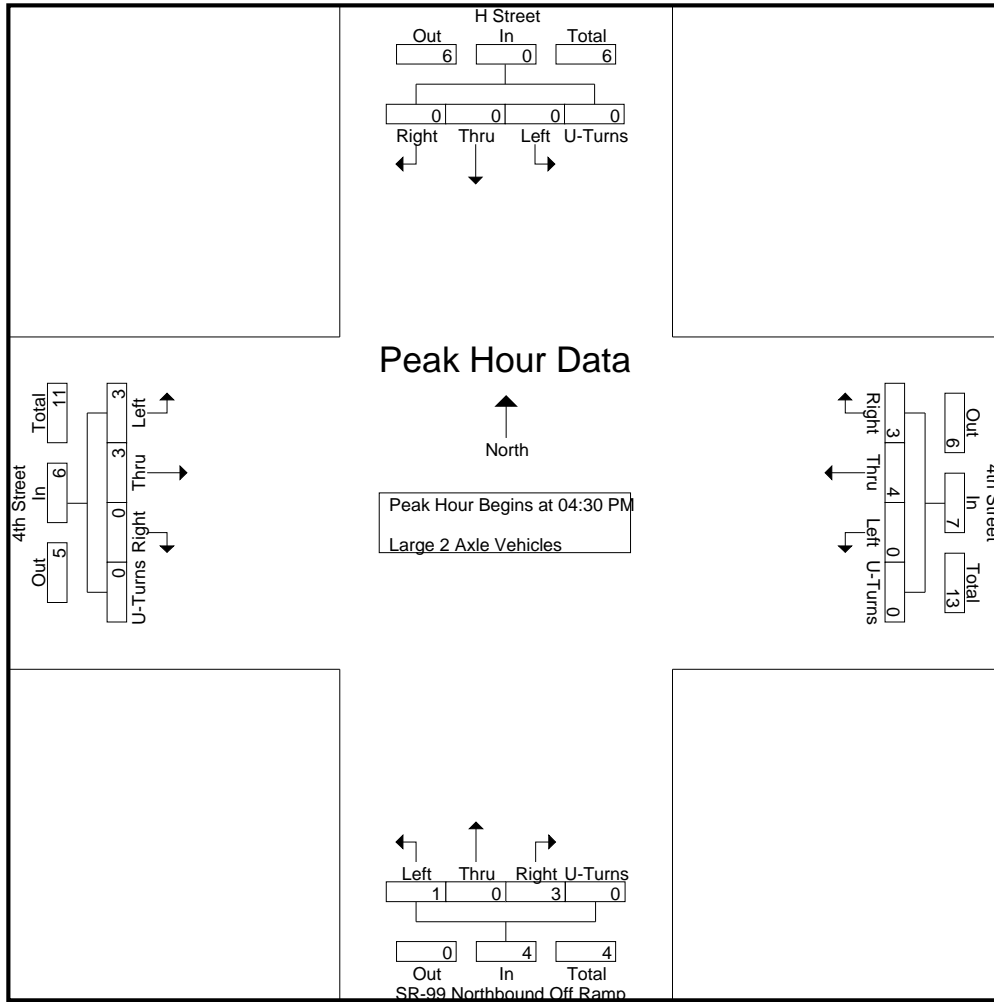

Peak Hour Analysis From 04:30 PM to 05:15 PM - Peak 1 of 1
 Peak Hour for Each Approach Begins at:

	04:30 PM					04:30 PM					04:30 PM									
+0 mins.	0	0	0	0	0	0	1	1	0	2	0	0	1	0	1	2	0	0	0	2
+15 mins.	0	0	0	0	0	0	1	1	0	2	1	0	0	0	1	1	0	0	0	1
+30 mins.	0	0	0	0	0	0	1	0	0	1	0	0	1	0	1	0	0	0	0	0
+45 mins.	0	0	0	0	0	0	1	1	0	2	0	0	1	0	1	0	3	0	0	3
Total Volume	0	0	0	0	0	0	4	3	0	7	1	0	3	0	4	3	3	0	0	6
% App. Total	0	0	0	0	0	0	57.1	42.9	0	0	25	0	75	0	0	50	50	0	0	0
PHF	.000	.000	.000	.000	.000	.000	1.000	.750	.000	.875	.250	.000	.750	.000	1.000	.375	.250	.000	.000	.500

City of Madera
 N/S: H Street/SR-99 Northbound Off Ramp
 E/W: 4th Street
 Weather: Clear

File Name : 34_MDA_99N_4th St PM
 Site Code : 00319628
 Start Date : 9/24/2019
 Page No : 1

Groups Printed- 3 Axle Vehicles

Start Time	H Street Southbound					4th Street Westbound					SR-99 Northbound Off Ramp Northbound					4th Street Eastbound					Int. Total
	Left	Thru	Right	U-Turns	App. Total	Left	Thru	Right	U-Turns	App. Total	Left	Thru	Right	U-Turns	App. Total	Left	Thru	Right	U-Turns	App. Total	
04:00 PM	0	0	0	0	0	0	0	1	0	1	0	0	0	0	0	0	0	0	0	0	1
04:15 PM	0	0	0	0	0	0	0	0	0	0	0	0	1	0	1	0	0	0	0	0	1
04:30 PM	0	0	0	0	0	0	1	0	0	1	0	0	0	0	0	0	0	0	0	0	1
04:45 PM	0	0	0	0	0	0	0	0	0	0	0	0	0	0	0	0	0	0	0	0	0
Total	0	0	0	0	0	0	1	1	0	2	0	0	1	0	1	0	0	0	0	0	3
05:00 PM	0	0	0	0	0	0	0	0	0	0	0	0	0	0	0	0	0	0	0	0	0
05:15 PM	0	0	0	0	0	0	0	0	0	0	0	0	0	0	0	0	0	0	0	0	0
05:30 PM	0	0	0	0	0	0	0	0	0	0	0	0	0	0	0	0	0	0	0	0	0
05:45 PM	0	0	0	0	0	0	0	0	0	0	0	0	0	0	0	0	0	0	0	0	0
Total	0	0	0	0	0	0	0	0	0	0	0	0	0	0	0	0	0	0	0	0	0
Grand Total	0	0	0	0	0	0	1	1	0	2	0	0	1	0	1	0	0	0	0	0	3
Apprch %	0	0	0	0		0	50	50	0		0	0	100	0		0	0	0	0		
Total %	0	0	0	0		0	33.3	33.3	0	66.7	0	0	33.3	0	33.3	0	0	0	0		

Start Time	H Street Southbound					4th Street Westbound					SR-99 Northbound Off Ramp Northbound					4th Street Eastbound					Int. Total
	Left	Thru	Right	U-Turns	App. Total	Thru	Right	U-Turns	App. Total	Thru	Right	U-Turns	App. Total	Thru	Right	U-Turns	App. Total				
Peak Hour Analysis From 04:30 PM to 05:15 PM - Peak 1 of 1																					
Peak Hour for Entire Intersection Begins at 04:30 PM																					
04:30 PM	0	0	0	0	0	0	1	0	0	1	0	0	0	0	0	0	0	0	0	0	1
04:45 PM	0	0	0	0	0	0	0	0	0	0	0	0	0	0	0	0	0	0	0	0	0
05:00 PM	0	0	0	0	0	0	0	0	0	0	0	0	0	0	0	0	0	0	0	0	0
05:15 PM	0	0	0	0	0	0	0	0	0	0	0	0	0	0	0	0	0	0	0	0	0
Total Volume	0	0	0	0	0	0	1	0	0	1	0	0	0	0	0	0	0	0	0	0	1
% App. Total	0	0	0	0		0	100	0	0		0	0	0	0		0	0	0	0		
PHF	.000	.000	.000	.000	.000	.000	.250	.000	.000	.250	.000	.000	.000	.000	.000	.000	.000	.000	.000	.000	.250

City of Madera
 N/S: H Street/SR-99 Northbound Off Ramp
 E/W: 4th Street
 Weather: Clear

File Name : 34_MDA_99N_4th St PM
 Site Code : 00319628
 Start Date : 9/24/2019
 Page No : 2

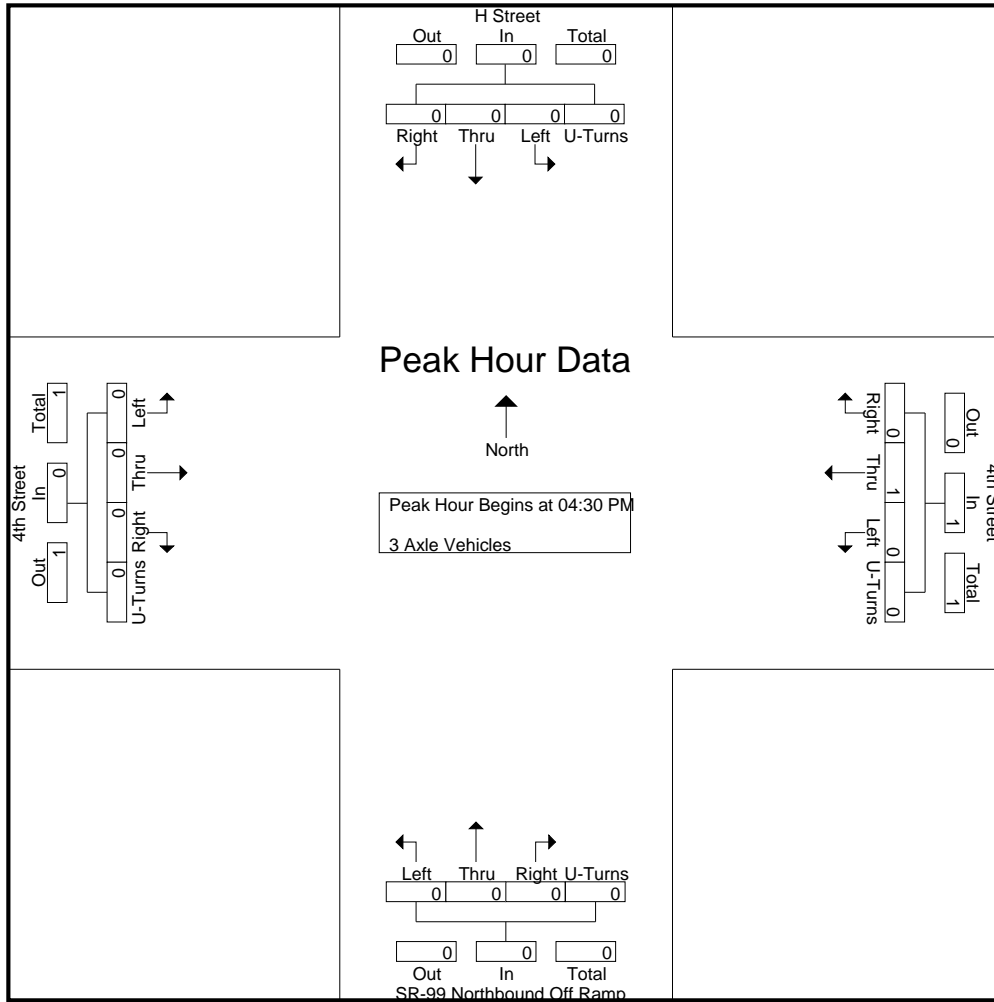

Peak Hour Analysis From 04:30 PM to 05:15 PM - Peak 1 of 1
 Peak Hour for Each Approach Begins at:

	04:30 PM					04:30 PM					04:30 PM					04:30 PM				
+0 mins.	0	0	0	0	0	0	1	0	0	1	0	0	0	0	0	0	0	0	0	0
+15 mins.	0	0	0	0	0	0	0	0	0	0	0	0	0	0	0	0	0	0	0	0
+30 mins.	0	0	0	0	0	0	0	0	0	0	0	0	0	0	0	0	0	0	0	0
+45 mins.	0	0	0	0	0	0	0	0	0	0	0	0	0	0	0	0	0	0	0	0
Total Volume	0	0	0	0	0	0	1	0	0	1	0	0	0	0	0	0	0	0	0	0
% App. Total	0	0	0	0	0	0	100	0	0	0	0	0	0	0	0	0	0	0	0	0
PHF	.000	.000	.000	.000	.000	.000	.250	.000	.000	.250	.000	.000	.000	.000	.000	.000	.000	.000	.000	.000

City of Madera
 N/S: H Street/SR-99 Northbound Off Ramp
 E/W: 4th Street
 Weather: Clear

File Name : 34_MDA_99N_4th St PM
 Site Code : 00319628
 Start Date : 9/24/2019
 Page No : 1

Groups Printed- 4+ Axle Trucks

Start Time	H Street Southbound					4th Street Westbound					SR-99 Northbound Off Ramp Northbound					4th Street Eastbound					Int. Total
	Left	Thru	Right	U-Turns	App. Total	Left	Thru	Right	U-Turns	App. Total	Left	Thru	Right	U-Turns	App. Total	Left	Thru	Right	U-Turns	App. Total	
04:00 PM	0	0	0	0	0	0	0	1	0	1	0	0	0	0	0	1	0	0	0	1	2
04:15 PM	0	0	0	0	0	0	0	0	0	0	0	0	0	0	0	1	0	0	0	1	1
04:30 PM	0	0	0	0	0	0	0	0	0	0	0	0	1	0	1	0	0	0	0	0	1
04:45 PM	0	0	0	0	0	0	0	0	0	0	0	0	0	0	0	0	0	0	0	0	0
Total	0	0	0	0	0	0	0	1	0	1	0	0	1	0	1	2	0	0	0	2	4
05:00 PM	0	0	0	0	0	0	0	0	0	0	0	0	0	0	0	0	0	0	0	0	0
05:15 PM	0	0	0	0	0	0	0	0	0	0	0	0	0	0	0	0	0	0	0	0	0
05:30 PM	0	0	0	0	0	0	0	1	0	1	0	0	0	0	0	0	0	0	0	0	1
05:45 PM	0	0	0	0	0	0	0	0	0	0	0	0	0	0	0	1	0	0	0	1	1
Total	0	0	0	0	0	0	0	1	0	1	0	0	0	0	0	1	0	0	0	1	2
Grand Total	0	0	0	0	0	0	0	2	0	2	0	0	1	0	1	3	0	0	0	3	6
Apprch %	0	0	0	0		0	0	100	0		0	0	100	0		100	0	0	0		
Total %	0	0	0	0	0	0	0	33.3	0	33.3	0	0	16.7	0	16.7	50	0	0	0	50	

Start Time	H Street Southbound					4th Street Westbound					SR-99 Northbound Off Ramp Northbound					4th Street Eastbound					Int. Total
	Left	Thru	Right	U-Turns	App. Total	Left	Thru	Right	U-Turns	App. Total	Left	Thru	Right	U-Turns	App. Total	Left	Thru	Right	U-Turns	App. Total	
Peak Hour Analysis From 04:30 PM to 05:15 PM - Peak 1 of 1																					
Peak Hour for Entire Intersection Begins at 04:30 PM																					
04:30 PM	0	0	0	0	0	0	0	0	0	0	0	0	1	0	1	0	0	0	0	0	1
04:45 PM	0	0	0	0	0	0	0	0	0	0	0	0	0	0	0	0	0	0	0	0	0
05:00 PM	0	0	0	0	0	0	0	0	0	0	0	0	0	0	0	0	0	0	0	0	0
05:15 PM	0	0	0	0	0	0	0	0	0	0	0	0	0	0	0	0	0	0	0	0	0
Total Volume	0	0	0	0	0	0	0	0	0	0	0	0	1	0	1	0	0	0	0	0	1
% App. Total	0	0	0	0		0	0	0	0		0	0	100	0		0	0	0	0		
PHF	.000	.000	.000	.000	.000	.000	.000	.000	.000	.000	.000	.000	.250	.000	.250	.000	.000	.000	.000	.000	.250

City of Madera
 N/S: H Street/SR-99 Northbound Off Ramp
 E/W: 4th Street
 Weather: Clear

File Name : 34_MDA_99N_4th St PM
 Site Code : 00319628
 Start Date : 9/24/2019
 Page No : 2

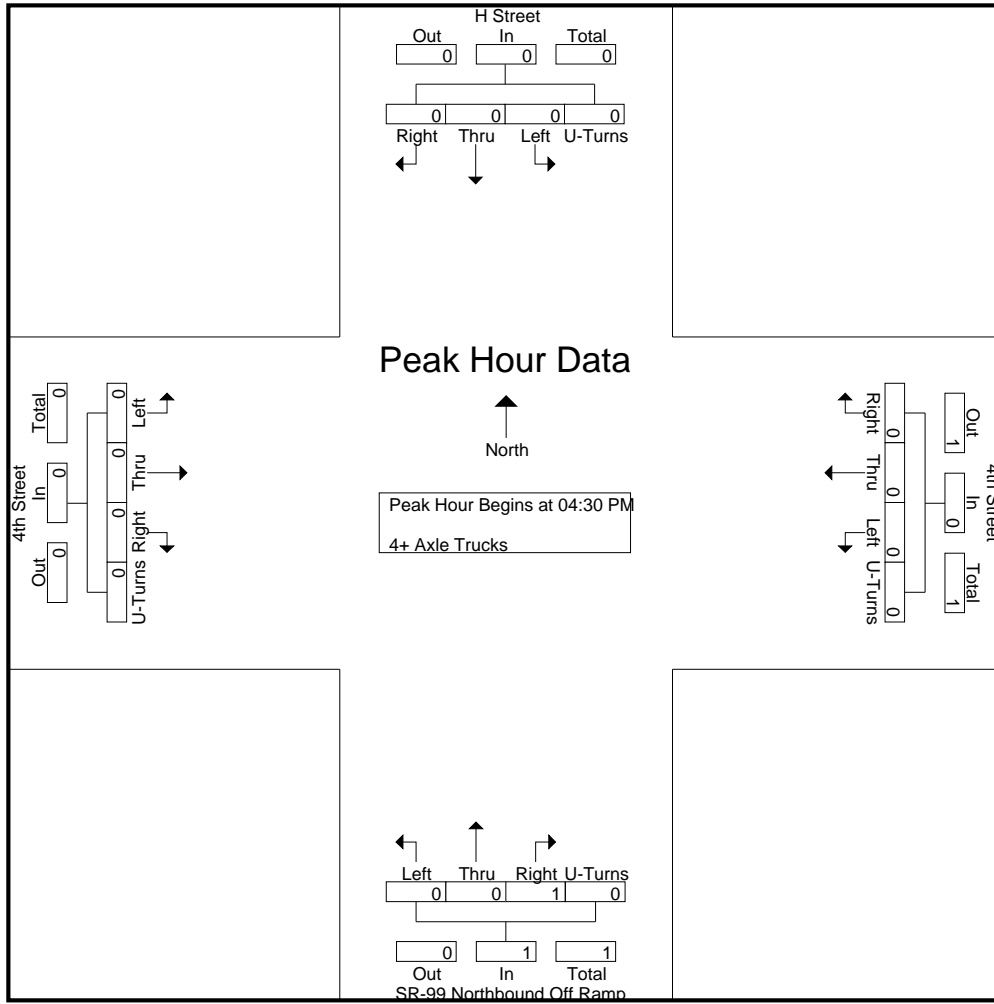

Peak Hour Analysis From 04:30 PM to 05:15 PM - Peak 1 of 1
 Peak Hour for Each Approach Begins at:

	04:30 PM					04:30 PM					04:30 PM									
+0 mins.	0	0	0	0	0	0	0	0	0	0	0	0	1	0	1	0	0	0	0	0
+15 mins.	0	0	0	0	0	0	0	0	0	0	0	0	0	0	0	0	0	0	0	0
+30 mins.	0	0	0	0	0	0	0	0	0	0	0	0	0	0	0	0	0	0	0	0
+45 mins.	0	0	0	0	0	0	0	0	0	0	0	0	0	0	0	0	0	0	0	0
Total Volume	0	0	0	0	0	0	0	0	0	0	0	0	1	0	1	0	0	0	0	0
% App. Total	0	0	0	0	0	0	0	0	0	0	0	0	100	0	0	0	0	0	0	0
PHF	.000	.000	.000	.000	.000	.000	.000	.000	.000	.000	.000	.000	.250	.000	.250	.000	.000	.000	.000	.000

Location: Madera
 N/S: H Street/SR-99 NB Off Ramp
 E/W: 4th Street



Date: 9/24/2019
 Day: Tuesday

PEDESTRIANS

	North Leg H Street	East Leg 4th Street	South Leg SR-99 NB Off Ramp	West Leg 4th Street	
	Pedestrians	Pedestrians	Pedestrians	Pedestrians	
7:00 AM	4	0	0	0	4
7:15 AM	2	0	0	0	2
7:30 AM	9	0	0	0	9
7:45 AM	1	0	0	0	1
8:00 AM	10	0	1	0	11
8:15 AM	3	0	1	0	4
8:30 AM	1	0	3	0	4
8:45 AM	0	0	3	0	3
TOTAL VOLUMES:	30	0	8	0	38

	North Leg H Street	East Leg 4th Street	South Leg SR-99 NB Off Ramp	West Leg 4th Street	
	Pedestrians	Pedestrians	Pedestrians	Pedestrians	
4:00 PM	1	0	1	0	2
4:15 PM	0	0	0	0	0
4:30 PM	2	0	4	0	6
4:45 PM	0	0	0	0	0
5:00 PM	3	0	0	0	3
5:15 PM	0	0	2	0	2
5:30 PM	0	0	0	0	0
5:45 PM	1	0	1	0	2
TOTAL VOLUMES:	7	0	8	0	15

Location: Madera
 N/S: H Street/SR-99 NB Off Ramp
 E/W: 4th Street



Date: 9/24/2019
 Day: Tuesday

BICYCLES

	Southbound H Street			Westbound 4th Street			Northbound SR-99 NB Off Ramp			Eastbound 4th Street			
	Left	Thru	Right	Left	Thru	Right	Left	Thru	Right	Left	Thru	Right	
7:00 AM	0	0	0	0	0	0	0	0	0	0	1	0	1
7:15 AM	0	0	2	0	0	0	0	0	0	0	1	0	3
7:30 AM	0	0	0	0	0	0	0	0	0	0	0	0	0
7:45 AM	0	0	1	0	0	0	0	0	0	0	0	0	1
8:00 AM	0	0	0	0	0	0	0	0	0	0	1	0	1
8:15 AM	0	0	0	0	0	0	0	0	0	0	0	0	0
8:30 AM	0	0	0	0	1	0	0	0	0	0	0	0	1
8:45 AM	0	0	0	0	0	0	0	0	0	1	0	0	1
TOTAL VOLUMES:	0	0	3	0	1	0	0	0	0	1	3	0	8

	Southbound H Street			Westbound 4th Street			Northbound SR-99 NB Off Ramp			Eastbound 4th Street			
	Left	Thru	Right	Left	Thru	Right	Left	Thru	Right	Left	Thru	Right	
4:00 PM	0	0	0	0	0	0	0	0	0	0	0	0	0
4:15 PM	0	0	0	0	0	0	0	0	0	0	0	0	0
4:30 PM	0	0	0	0	1	0	0	0	0	0	0	0	1
4:45 PM	0	0	0	0	2	0	0	0	0	0	0	0	2
5:00 PM	0	0	0	0	0	0	0	0	0	0	1	0	1
5:15 PM	0	0	0	0	0	0	0	0	0	0	0	0	0
5:30 PM	0	0	0	0	0	0	0	0	0	0	0	0	0
5:45 PM	0	0	0	0	0	0	0	0	0	0	0	0	0
TOTAL VOLUMES:	0	0	0	0	3	0	0	0	0	0	1	0	4

City of Madera
 N/S: I Street
 E/W: Olive Avenue
 Weather: Clear

File Name : 55_MDA_I St_Olive AM
 Site Code : 00319628
 Start Date : 9/26/2019
 Page No : 1

Groups Printed- Passenger Vehicles - Large 2 Axle Vehicles - 3 Axle Vehicles - 4+ Axle Trucks

Start Time	I Street Southbound					Olive Avenue Westbound					Praxair Store Driveway Northbound					Olive Avenue Eastbound					Int. Total
	Left	Thru	Right	U-Turns	App. Total	Left	Thru	Right	U-Turns	App. Total	Left	Thru	Right	U-Turns	App. Total	Left	Thru	Right	U-Turns	App. Total	
07:00 AM	7	0	6	0	13	0	61	4	0	65	0	0	0	0	0	3	71	0	0	74	152
07:15 AM	11	0	8	0	19	1	96	15	1	113	0	0	0	0	0	9	83	0	0	92	224
07:30 AM	9	0	17	0	26	0	110	14	0	124	0	0	0	0	0	26	99	0	0	125	275
07:45 AM	12	0	30	0	42	0	120	30	0	150	0	0	0	0	0	32	85	0	0	117	309
Total	39	0	61	0	100	1	387	63	1	452	0	0	0	0	0	70	338	0	0	408	960
08:00 AM	11	0	26	0	37	0	100	27	0	127	0	0	0	0	0	33	95	0	0	128	292
08:15 AM	13	0	27	1	41	1	133	20	1	155	0	0	0	0	0	32	84	0	0	116	312
08:30 AM	12	0	16	0	28	0	130	13	0	143	0	0	0	0	0	30	104	0	1	135	306
08:45 AM	18	0	7	0	25	2	73	25	2	102	0	0	0	0	0	18	87	0	0	105	232
Total	54	0	76	1	131	3	436	85	3	527	0	0	0	0	0	113	370	0	1	484	1142
Grand Total	93	0	137	1	231	4	823	148	4	979	0	0	0	0	0	183	708	0	1	892	2102
Apprch %	40.3	0	59.3	0.4		0.4	84.1	15.1	0.4		0	0	0	0	0	20.5	79.4	0	0.1		
Total %	4.4	0	6.5	0	11	0.2	39.2	7	0.2	46.6	0	0	0	0	0	8.7	33.7	0	0	42.4	
Passenger Vehicles	96.8	0	96.4	100	96.5	100	95.7	98	100	96.1	0	0	0	0	0	97.8	95.5	0	100	96	96.1
Large 2 Axle Vehicles																					
% Large 2 Axle Vehicles	1.1	0	3.6	0	2.6	0	3.5	1.4	0	3.2	0	0	0	0	0	2.2	3.7	0	0	3.4	3.2
3 Axle Vehicles	1	0	0	0	1	0	0	0	0	0	0	0	0	0	0	0	3	0	0	3	4
% 3 Axle Vehicles	1.1	0	0	0	0.4	0	0	0	0	0	0	0	0	0	0	0	0.4	0	0	0.3	0.2
4+ Axle Trucks	1	0	0	0	1	0	6	1	0	7	0	0	0	0	0	0	3	0	0	3	11
% 4+ Axle Trucks																					

Start Time	I Street Southbound					Olive Avenue Westbound					Praxair Store Driveway Northbound					Olive Avenue Eastbound					Int. Total
	Left	Thru	Right	U-Turns	App. Total	Left	Thru	Right	U-Turns	App. Total	Left	Thru	Right	U-Turns	App. Total	Left	Thru	Right	U-Turns	App. Total	
Peak Hour Analysis From 07:00 AM to 08:45 AM - Peak 1 of 1																					
Peak Hour for Entire Intersection Begins at 07:45 AM																					
07:45 AM	12	0	30	0	42	0	120	30	0	150	0	0	0	0	0	32	85	0	0	117	309
08:00 AM	11	0	26	0	37	0	100	27	0	127	0	0	0	0	0	33	95	0	0	128	292
08:15 AM	13	0	27	1	41	1	133	20	1	155	0	0	0	0	0	32	84	0	0	116	312
08:30 AM	12	0	16	0	28	0	130	13	0	143	0	0	0	0	0	30	104	0	1	135	306
Total Volume	48	0	99	1	148	1	483	90	1	575	0	0	0	0	0	127	368	0	1	496	1219
% App. Total	32.4	0	66.9	0.7		0.2	84	15.7	0.2		0	0	0	0	0	25.6	74.2	0	0.2		
PHF	.923	.000	.825	.250	.881	.250	.908	.750	.250	.927	.000	.000	.000	.000	.000	.962	.885	.000	.250	.919	.977

City of Madera
 N/S: I Street
 E/W: Olive Avenue
 Weather: Clear

File Name : 55_MDA_I St_Olive AM
 Site Code : 00319628
 Start Date : 9/26/2019
 Page No : 2

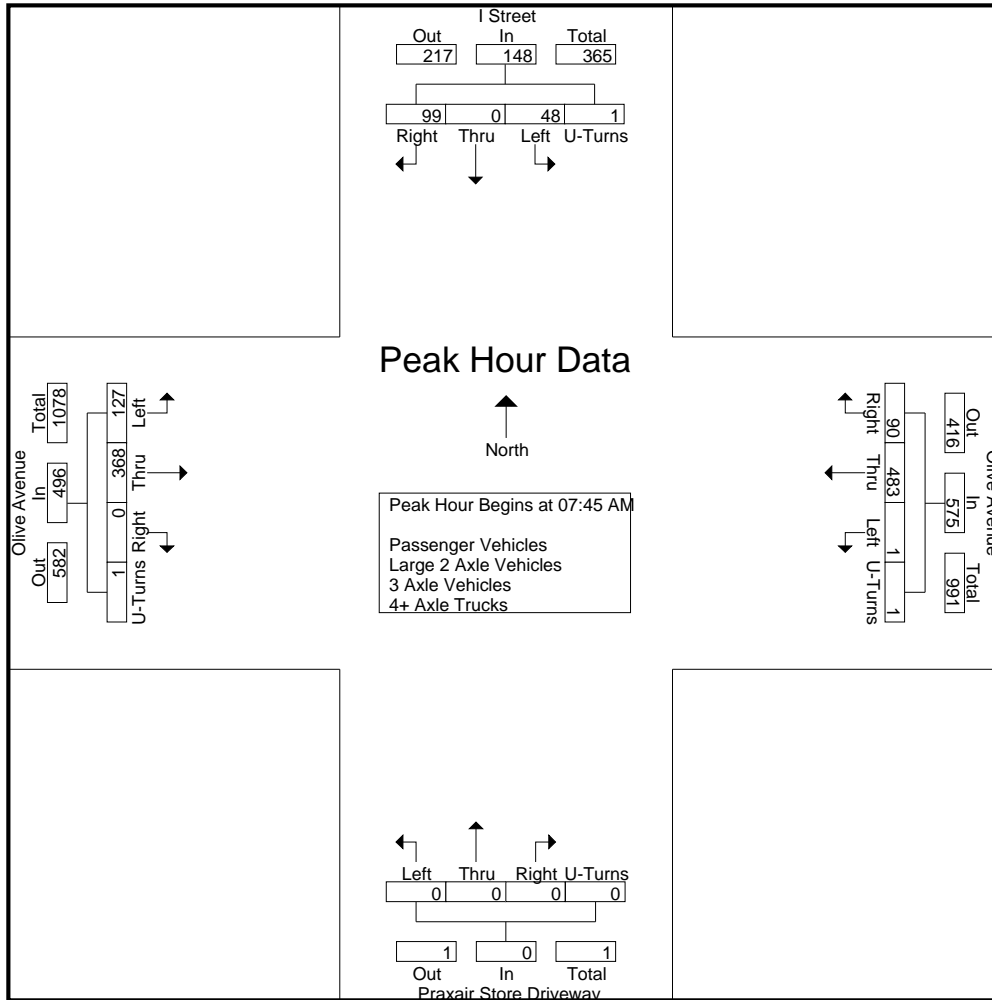

Peak Hour Analysis From 07:00 AM to 08:45 AM - Peak 1 of 1
 Peak Hour for Each Approach Begins at:

	07:45 AM					07:00 AM					07:45 AM									
+0 mins.	12	0	30	0	42	0	120	30	0	150	0	0	0	0	0	32	85	0	0	117
+15 mins.	11	0	26	0	37	0	100	27	0	127	0	0	0	0	0	33	95	0	0	128
+30 mins.	13	0	27	1	41	1	133	20	1	155	0	0	0	0	0	32	84	0	0	116
+45 mins.	12	0	16	0	28	0	130	13	0	143	0	0	0	0	0	30	104	0	1	135
Total Volume	48	0	99	1	148	1	483	90	1	575	0	0	0	0	0	127	368	0	1	496
% App. Total	32.4	0	66.9	0.7		0.2	84	15.7	0.2		0	0	0	0		25.6	74.2	0	0.2	
PHF	.923	.000	.825	.250	.881	.250	.908	.750	.250	.927	.000	.000	.000	.000	.000	.962	.885	.000	.250	.919

City of Madera
 N/S: I Street
 E/W: Olive Avenue
 Weather: Clear

File Name : 55_MDA_I St_Olive AM
 Site Code : 00319628
 Start Date : 9/26/2019
 Page No : 1

Groups Printed- Passenger Vehicles

Start Time	I Street Southbound					Olive Avenue Westbound					Praxair Store Driveway Northbound					Olive Avenue Eastbound					Int. Total
	Left	Thru	Right	U-Turns	App. Total	Left	Thru	Right	U-Turns	App. Total	Left	Thru	Right	U-Turns	App. Total	Left	Thru	Right	U-Turns	App. Total	
07:00 AM	7	0	6	0	13	0	57	4	0	61	0	0	0	0	0	3	67	0	0	70	144
07:15 AM	11	0	8	0	19	1	94	14	1	110	0	0	0	0	0	9	81	0	0	90	219
07:30 AM	9	0	16	0	25	0	106	13	0	119	0	0	0	0	0	26	96	0	0	122	266
07:45 AM	12	0	28	0	40	0	113	30	0	143	0	0	0	0	0	32	81	0	0	113	296
Total	39	0	58	0	97	1	370	61	1	433	0	0	0	0	0	70	325	0	0	395	925
08:00 AM	9	0	25	0	34	0	93	26	0	119	0	0	0	0	0	31	89	0	0	120	273
08:15 AM	12	0	27	1	40	1	128	20	1	150	0	0	0	0	0	32	79	0	0	111	301
08:30 AM	12	0	15	0	27	0	125	13	0	138	0	0	0	0	0	29	99	0	1	129	294
08:45 AM	18	0	7	0	25	2	72	25	2	101	0	0	0	0	0	17	84	0	0	101	227
Total	51	0	74	1	126	3	418	84	3	508	0	0	0	0	0	109	351	0	1	461	1095
Grand Total	90	0	132	1	223	4	788	145	4	941	0	0	0	0	0	179	676	0	1	856	2020
Apprch %	40.4	0	59.2	0.4		0.4	83.7	15.4	0.4		0	0	0	0		20.9	79	0	0.1		
Total %	4.5	0	6.5	0	11	0.2	39	7.2	0.2	46.6	0	0	0	0	0	8.9	33.5	0	0	42.4	

Start Time	I Street Southbound					Olive Avenue Westbound					Praxair Store Driveway Northbound					Olive Avenue Eastbound					Int. Total
	Left	Thru	Right	U-Turns	App. Total	Thru	Right	U-Turns	App. Total	Thru	Right	U-Turns	App. Total	Thru	Right	U-Turns	App. Total				
Peak Hour Analysis From 07:45 AM to 08:30 AM - Peak 1 of 1																					
Peak Hour for Entire Intersection Begins at 07:45 AM																					
07:45 AM	12	0	28	0	40	0	113	30	0	143	0	0	0	0	0	32	81	0	0	113	296
08:00 AM	9	0	25	0	34	0	93	26	0	119	0	0	0	0	0	31	89	0	0	120	273
08:15 AM	12	0	27	1	40	1	128	20	1	150	0	0	0	0	0	32	79	0	0	111	301
08:30 AM	12	0	15	0	27	0	125	13	0	138	0	0	0	0	0	29	99	0	1	129	294
Total Volume	45	0	95	1	141	1	459	89	1	550	0	0	0	0	0	124	348	0	1	473	1164
% App. Total	31.9	0	67.4	0.7		0.2	83.5	16.2	0.2		0	0	0	0		26.2	73.6	0	0.2		
PHF	.938	.000	.848	.250	.881	.250	.896	.742	.250	.917	.000	.000	.000	.000	.000	.969	.879	.000	.250	.917	.967

City of Madera
 N/S: I Street
 E/W: Olive Avenue
 Weather: Clear

File Name : 55_MDA_I St_Olive AM
 Site Code : 00319628
 Start Date : 9/26/2019
 Page No : 2

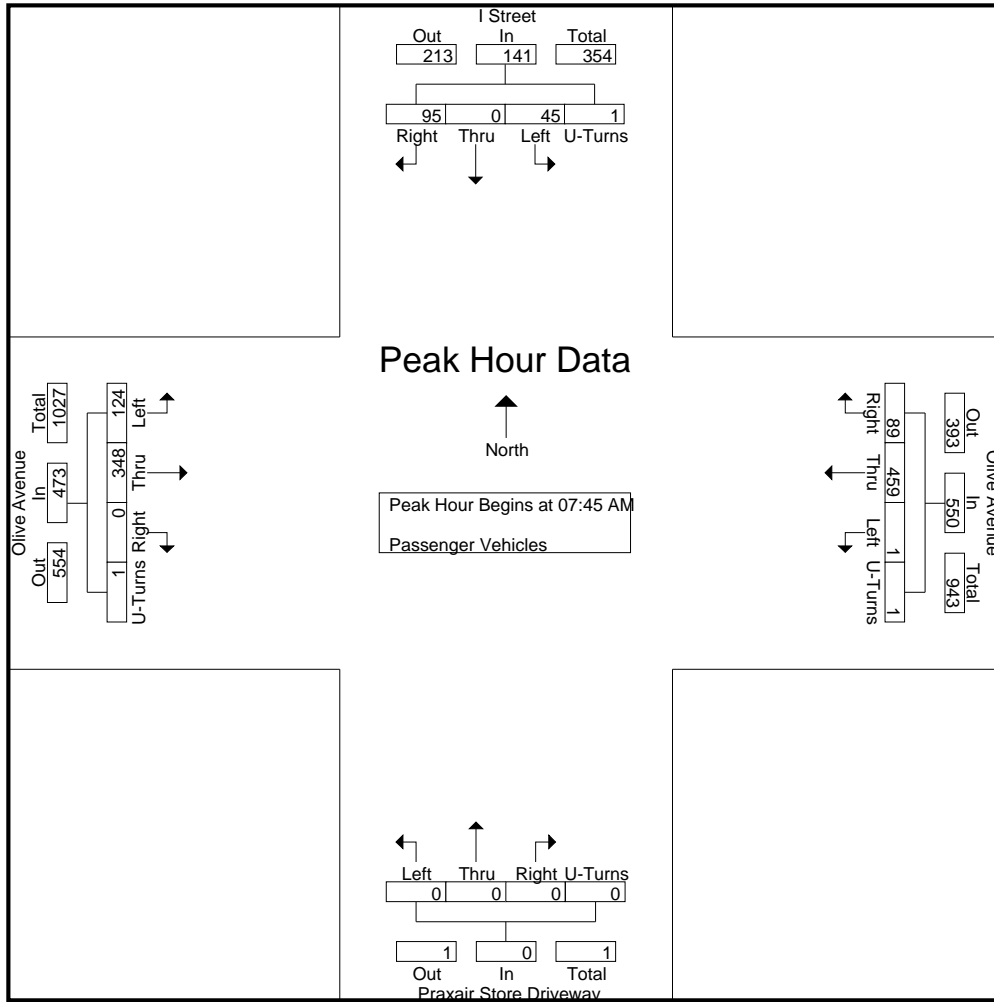

Peak Hour Analysis From 07:45 AM to 08:30 AM - Peak 1 of 1
 Peak Hour for Each Approach Begins at:

	07:45 AM					07:45 AM					07:45 AM					07:45 AM				
+0 mins.	12	0	28	0	40	0	113	30	0	143	0	0	0	0	0	32	81	0	0	113
+15 mins.	9	0	25	0	34	0	93	26	0	119	0	0	0	0	0	31	89	0	0	120
+30 mins.	12	0	27	1	40	1	128	20	1	150	0	0	0	0	0	32	79	0	0	111
+45 mins.	12	0	15	0	27	0	125	13	0	138	0	0	0	0	0	29	99	0	1	129
Total Volume	45	0	95	1	141	1	459	89	1	550	0	0	0	0	0	124	348	0	1	473
% App. Total	31.9	0	67.4	0.7		0.2	83.5	16.2	0.2		0	0	0	0	0	26.2	73.6	0	0.2	
PHF	.938	.000	.848	.250	.881	.250	.896	.742	.250	.917	.000	.000	.000	.000	.000	.969	.879	.000	.250	.917

City of Madera
 N/S: I Street
 E/W: Olive Avenue
 Weather: Clear

File Name : 55_MDA_I St_Olive AM
 Site Code : 00319628
 Start Date : 9/26/2019
 Page No : 1

Groups Printed- Large 2 Axle Vehicles

Start Time	I Street Southbound					Olive Avenue Westbound					Praxair Store Driveway Northbound					Olive Avenue Eastbound					Int. Total
	Left	Thru	Right	U-Turns	App. Total	Left	Thru	Right	U-Turns	App. Total	Left	Thru	Right	U-Turns	App. Total	Left	Thru	Right	U-Turns	App. Total	
07:00 AM	0	0	0	0	0	0	3	0	0	3	0	0	0	0	0	0	3	0	0	3	6
07:15 AM	0	0	0	0	0	0	2	1	0	3	0	0	0	0	0	0	2	0	0	2	5
07:30 AM	0	0	1	0	1	0	4	0	0	4	0	0	0	0	0	0	3	0	0	3	8
07:45 AM	0	0	2	0	2	0	6	0	0	6	0	0	0	0	0	0	3	0	0	3	11
Total	0	0	3	0	3	0	15	1	0	16	0	0	0	0	0	0	11	0	0	11	30
08:00 AM	1	0	1	0	2	0	5	1	0	6	0	0	0	0	0	2	5	0	0	7	15
08:15 AM	0	0	0	0	0	0	5	0	0	5	0	0	0	0	0	0	3	0	0	3	8
08:30 AM	0	0	1	0	1	0	3	0	0	3	0	0	0	0	0	1	5	0	0	6	10
08:45 AM	0	0	0	0	0	0	1	0	0	1	0	0	0	0	0	1	2	0	0	3	4
Total	1	0	2	0	3	0	14	1	0	15	0	0	0	0	0	4	15	0	0	19	37
Grand Total	1	0	5	0	6	0	29	2	0	31	0	0	0	0	0	4	26	0	0	30	67
Apprch %	16.7	0	83.3	0		0	93.5	6.5	0		0	0	0	0		13.3	86.7	0	0		
Total %	1.5	0	7.5	0	9	0	43.3	3	0	46.3	0	0	0	0	0	6	38.8	0	0	44.8	

Start Time	I Street Southbound					Olive Avenue Westbound					Praxair Store Driveway Northbound					Olive Avenue Eastbound					Int. Total
	Left	Thru	Right	U-Turns	App. Total	Thru	Right	U-Turns	App. Total	Thru	Right	U-Turns	App. Total	Thru	Right	U-Turns	App. Total				
Peak Hour Analysis From 07:45 AM to 08:30 AM - Peak 1 of 1																					
Peak Hour for Entire Intersection Begins at 07:45 AM																					
07:45 AM	0	0	2	0	2	0	6	0	0	6	0	0	0	0	0	0	3	0	0	3	11
08:00 AM	1	0	1	0	2	0	5	1	0	6	0	0	0	0	0	2	5	0	0	7	15
08:15 AM	0	0	0	0	0	0	5	0	0	5	0	0	0	0	0	0	3	0	0	3	8
08:30 AM	0	0	1	0	1	0	3	0	0	3	0	0	0	0	0	1	5	0	0	6	10
Total Volume	1	0	4	0	5	0	19	1	0	20	0	0	0	0	0	3	16	0	0	19	44
% App. Total	20	0	80	0		0	95	5	0		0	0	0	0		15.8	84.2	0	0		
PHF	.250	.000	.500	.000	.625	.000	.792	.250	.000	.833	.000	.000	.000	.000	.000	.375	.800	.000	.000	.679	.733

City of Madera
 N/S: I Street
 E/W: Olive Avenue
 Weather: Clear

File Name : 55_MDA_I St_Olive AM
 Site Code : 00319628
 Start Date : 9/26/2019
 Page No : 2

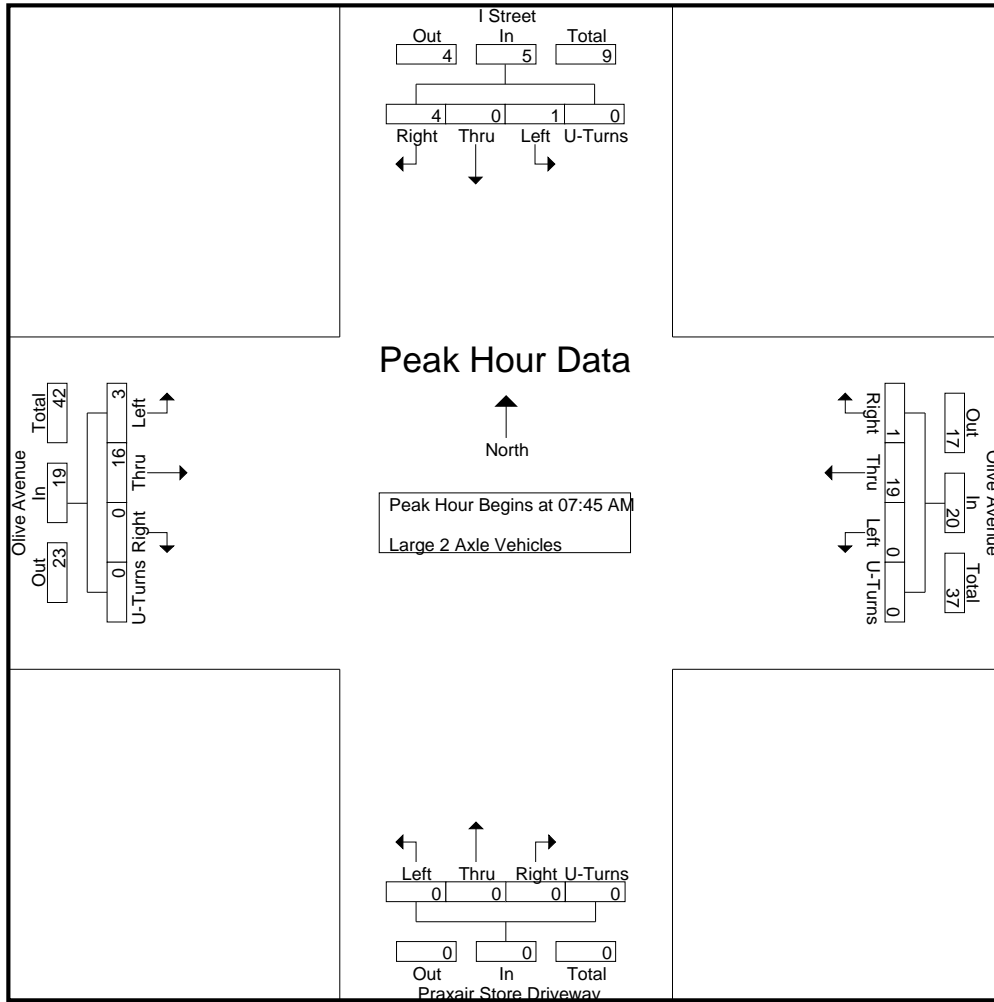

Peak Hour Analysis From 07:45 AM to 08:30 AM - Peak 1 of 1
 Peak Hour for Each Approach Begins at:

	07:45 AM					07:45 AM					07:45 AM					07:45 AM				
+0 mins.	0	0	2	0	2	0	6	0	0	6	0	0	0	0	0	0	3	0	0	3
+15 mins.	1	0	1	0	2	0	5	1	0	6	0	0	0	0	0	2	5	0	0	7
+30 mins.	0	0	0	0	0	0	5	0	0	5	0	0	0	0	0	0	3	0	0	3
+45 mins.	0	0	1	0	1	0	3	0	0	3	0	0	0	0	0	1	5	0	0	6
Total Volume	1	0	4	0	5	0	19	1	0	20	0	0	0	0	0	3	16	0	0	19
% App. Total	20	0	80	0		0	95	5	0		0	0	0	0		15.8	84.2	0	0	
PHF	.250	.000	.500	.000	.625	.000	.792	.250	.000	.833	.000	.000	.000	.000	.000	.375	.800	.000	.000	.679

City of Madera
 N/S: I Street
 E/W: Olive Avenue
 Weather: Clear

File Name : 55_MDA_I St_Olive AM
 Site Code : 00319628
 Start Date : 9/26/2019
 Page No : 1

Groups Printed- 3 Axle Vehicles

Start Time	I Street Southbound					Olive Avenue Westbound					Praxair Store Driveway Northbound					Olive Avenue Eastbound					Int. Total
	Left	Thru	Right	U-Turns	App. Total	Left	Thru	Right	U-Turns	App. Total	Left	Thru	Right	U-Turns	App. Total	Left	Thru	Right	U-Turns	App. Total	
07:00 AM	0	0	0	0	0	0	0	0	0	0	0	0	0	0	0	0	0	0	0	0	0
07:15 AM	0	0	0	0	0	0	0	0	0	0	0	0	0	0	0	0	0	0	0	0	0
07:30 AM	0	0	0	0	0	0	0	0	0	0	0	0	0	0	0	0	0	0	0	0	0
07:45 AM	0	0	0	0	0	0	0	0	0	0	0	0	0	0	0	0	0	0	0	0	0
Total	0	0	0	0	0	0	0	0	0	0	0	0	0	0	0	0	0	0	0	0	0
08:00 AM	0	0	0	0	0	0	0	0	0	0	0	0	0	0	0	0	0	0	0	0	0
08:15 AM	1	0	0	0	1	0	0	0	0	0	0	0	0	0	0	0	2	0	0	2	3
08:30 AM	0	0	0	0	0	0	0	0	0	0	0	0	0	0	0	0	0	0	0	0	0
08:45 AM	0	0	0	0	0	0	0	0	0	0	0	0	0	0	0	0	1	0	0	1	1
Total	1	0	0	0	1	0	0	0	0	0	0	0	0	0	0	0	3	0	0	3	4
Grand Total	1	0	0	0	1	0	0	0	0	0	0	0	0	0	0	0	3	0	0	3	4
Apprch %	100	0	0	0		0	0	0	0		0	0	0	0		0	100	0	0		
Total %	25	0	0	0	25	0	0	0	0	0	0	0	0	0	0	0	75	0	0	75	

Start Time	I Street Southbound					Olive Avenue Westbound					Praxair Store Driveway Northbound					Olive Avenue Eastbound					Int. Total
	Left	Thru	Right	U-Turns	App. Total	Left	Thru	Right	U-Turns	App. Total	Left	Thru	Right	U-Turns	App. Total	Left	Thru	Right	U-Turns	App. Total	
Peak Hour Analysis From 07:45 AM to 08:30 AM - Peak 1 of 1																					
Peak Hour for Entire Intersection Begins at 07:45 AM																					
07:45 AM	0	0	0	0	0	0	0	0	0	0	0	0	0	0	0	0	0	0	0	0	0
08:00 AM	0	0	0	0	0	0	0	0	0	0	0	0	0	0	0	0	0	0	0	0	0
08:15 AM	1	0	0	0	1	0	0	0	0	0	0	0	0	0	0	0	2	0	0	2	3
08:30 AM	0	0	0	0	0	0	0	0	0	0	0	0	0	0	0	0	0	0	0	0	0
Total Volume	1	0	0	0	1	0	0	0	0	0	0	0	0	0	0	0	2	0	0	2	3
% App. Total	100	0	0	0		0	0	0	0		0	0	0	0		0	100	0	0		
PHF	.250	.000	.000	.000	.250	.000	.000	.000	.000	.000	.000	.000	.000	.000	.000	.000	.250	.000	.000	.250	.250

City of Madera
 N/S: I Street
 E/W: Olive Avenue
 Weather: Clear

File Name : 55_MDA_I St_Olive AM
 Site Code : 00319628
 Start Date : 9/26/2019
 Page No : 2

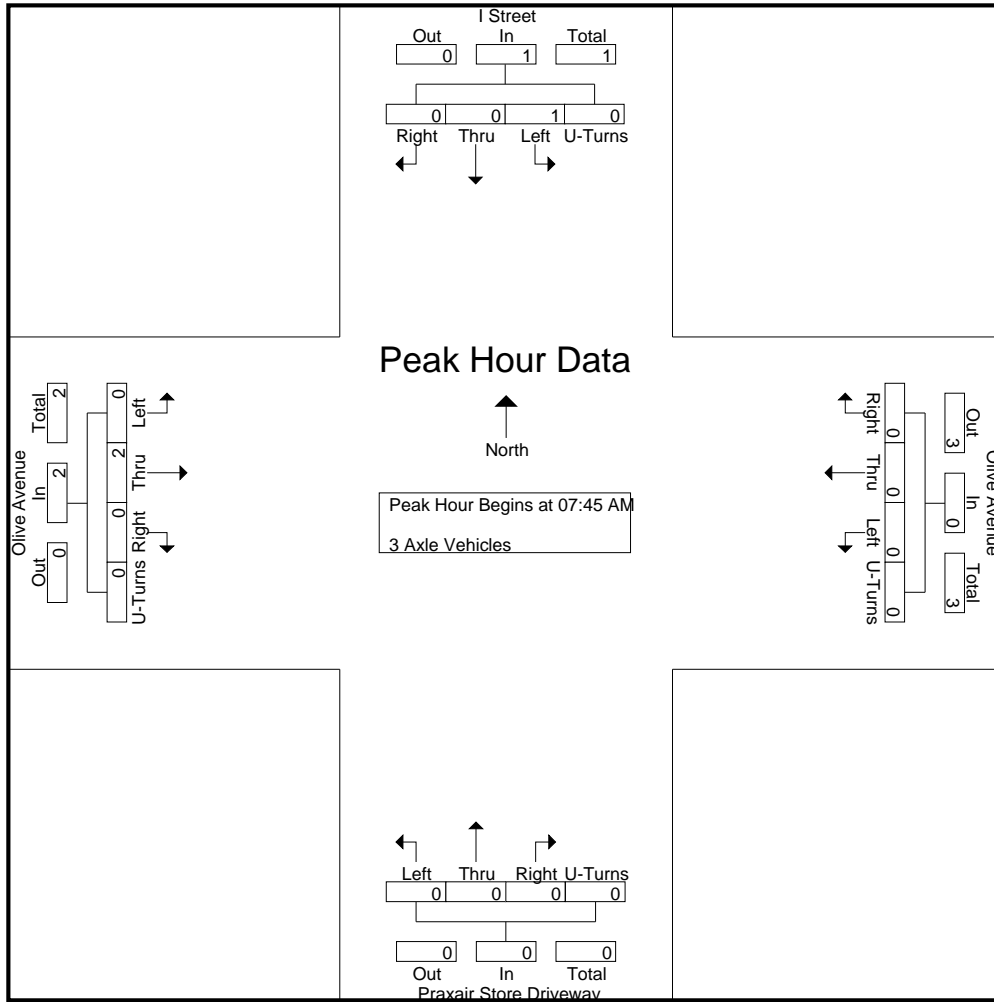

Peak Hour Analysis From 07:45 AM to 08:30 AM - Peak 1 of 1
 Peak Hour for Each Approach Begins at:

	07:45 AM					07:45 AM					07:45 AM									
+0 mins.	0	0	0	0	0	0	0	0	0	0	0	0	0	0	0	0	0	0	0	0
+15 mins.	0	0	0	0	0	0	0	0	0	0	0	0	0	0	0	0	0	0	0	0
+30 mins.	1	0	0	0	1	0	0	0	0	0	0	0	0	0	0	0	2	0	0	2
+45 mins.	0	0	0	0	0	0	0	0	0	0	0	0	0	0	0	0	0	0	0	0
Total Volume	1	0	0	0	1	0	0	0	0	0	0	0	0	0	0	0	2	0	0	2
% App. Total	100	0	0	0	0	0	0	0	0	0	0	0	0	0	0	0	100	0	0	0
PHF	.250	.000	.000	.000	.250	.000	.000	.000	.000	.000	.000	.000	.000	.000	.000	.000	.250	.000	.000	.250

City of Madera
 N/S: I Street
 E/W: Olive Avenue
 Weather: Clear

File Name : 55_MDA_I St_Olive AM
 Site Code : 00319628
 Start Date : 9/26/2019
 Page No : 1

Groups Printed- 4+ Axle Trucks

Start Time	I Street Southbound					Olive Avenue Westbound					Praxair Store Driveway Northbound					Olive Avenue Eastbound					Int. Total
	Left	Thru	Right	U-Turns	App. Total	Left	Thru	Right	U-Turns	App. Total	Left	Thru	Right	U-Turns	App. Total	Left	Thru	Right	U-Turns	App. Total	
07:00 AM	0	0	0	0	0	0	1	0	0	1	0	0	0	0	0	0	1	0	0	1	2
07:15 AM	0	0	0	0	0	0	0	0	0	0	0	0	0	0	0	0	0	0	0	0	0
07:30 AM	0	0	0	0	0	0	0	1	0	1	0	0	0	0	0	0	0	0	0	0	1
07:45 AM	0	0	0	0	0	0	1	0	0	1	0	0	0	0	0	0	1	0	0	1	2
Total	0	0	0	0	0	0	2	1	0	3	0	0	0	0	0	0	2	0	0	2	5
08:00 AM	1	0	0	0	1	0	2	0	0	2	0	0	0	0	0	0	1	0	0	1	4
08:15 AM	0	0	0	0	0	0	0	0	0	0	0	0	0	0	0	0	0	0	0	0	0
08:30 AM	0	0	0	0	0	0	2	0	0	2	0	0	0	0	0	0	0	0	0	0	2
08:45 AM	0	0	0	0	0	0	0	0	0	0	0	0	0	0	0	0	0	0	0	0	0
Total	1	0	0	0	1	0	4	0	0	4	0	0	0	0	0	0	1	0	0	1	6
Grand Total	1	0	0	0	1	0	6	1	0	7	0	0	0	0	0	0	3	0	0	3	11
Apprch %	100	0	0	0		0	85.7	14.3	0		0	0	0	0		0	100	0	0		
Total %	9.1	0	0	0	9.1	0	54.5	9.1	0	63.6	0	0	0	0	0	0	27.3	0	0	27.3	

Start Time	I Street Southbound					Olive Avenue Westbound					Praxair Store Driveway Northbound					Olive Avenue Eastbound					Int. Total
	Left	Thru	Right	U-Turns	App. Total	Thru	Right	U-Turns	App. Total	Thru	Right	U-Turns	App. Total	Thru	Right	U-Turns	App. Total				
Peak Hour Analysis From 07:45 AM to 08:30 AM - Peak 1 of 1																					
Peak Hour for Entire Intersection Begins at 07:45 AM																					
07:45 AM	0	0	0	0	0	0	1	0	0	1	0	0	0	0	0	0	1	0	0	1	2
08:00 AM	1	0	0	0	1	0	2	0	0	2	0	0	0	0	0	0	1	0	0	1	4
08:15 AM	0	0	0	0	0	0	0	0	0	0	0	0	0	0	0	0	0	0	0	0	0
08:30 AM	0	0	0	0	0	0	2	0	0	2	0	0	0	0	0	0	0	0	0	0	2
Total Volume	1	0	0	0	1	0	5	0	0	5	0	0	0	0	0	0	2	0	0	2	8
% App. Total	100	0	0	0		0	100	0	0		0	0	0	0		0	100	0	0		
PHF	.250	.000	.000	.000	.250	.000	.625	.000	.000	.625	.000	.000	.000	.000	.000	.000	.500	.000	.000	.500	.500

City of Madera
 N/S: I Street
 E/W: Olive Avenue
 Weather: Clear

File Name : 55_MDA_I St_Olive AM
 Site Code : 00319628
 Start Date : 9/26/2019
 Page No : 2

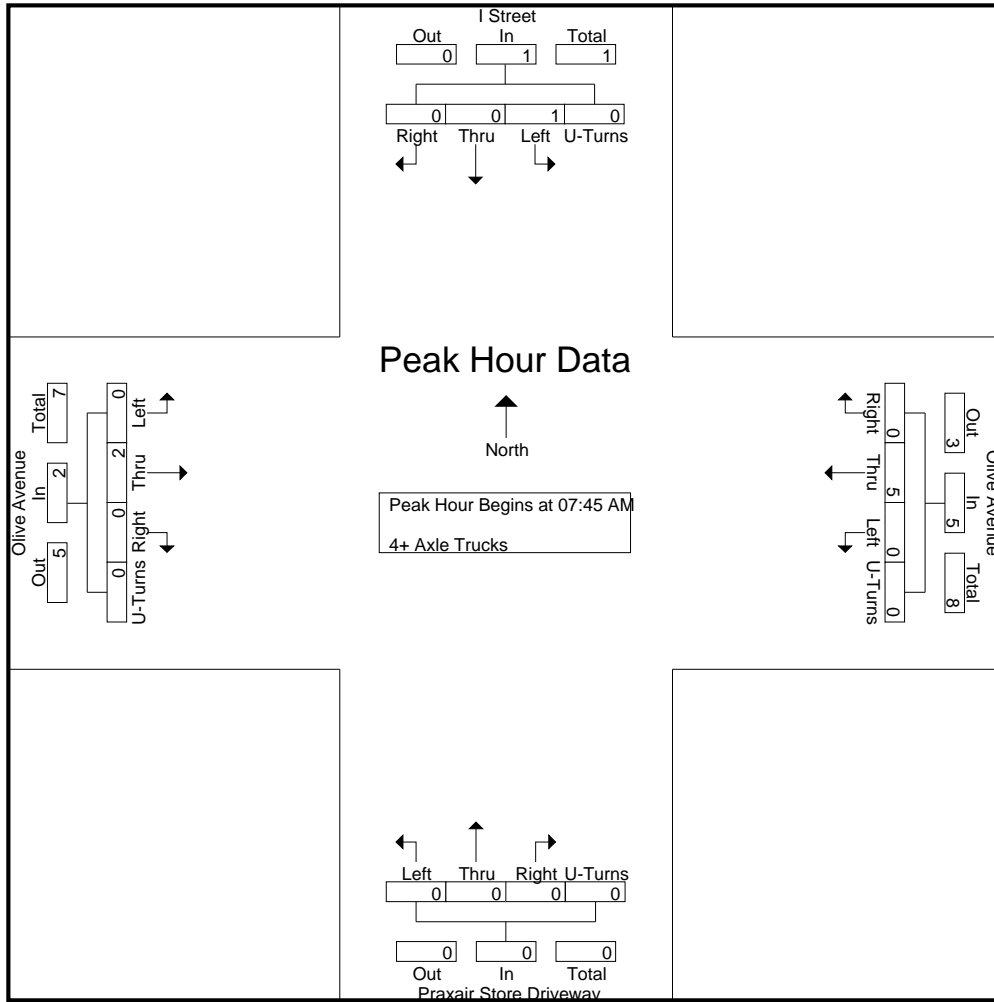

Peak Hour Analysis From 07:45 AM to 08:30 AM - Peak 1 of 1
 Peak Hour for Each Approach Begins at:

	07:45 AM					07:45 AM					07:45 AM					07:45 AM				
+0 mins.	0	0	0	0	0	0	1	0	0	1	0	0	0	0	0	0	1	0	0	1
+15 mins.	1	0	0	0	1	0	2	0	0	2	0	0	0	0	0	0	1	0	0	1
+30 mins.	0	0	0	0	0	0	0	0	0	0	0	0	0	0	0	0	0	0	0	0
+45 mins.	0	0	0	0	0	0	2	0	0	2	0	0	0	0	0	0	0	0	0	0
Total Volume	1	0	0	0	1	0	5	0	0	5	0	0	0	0	0	0	2	0	0	2
% App. Total	100	0	0	0	0	0	100	0	0	0	0	0	0	0	0	0	100	0	0	0
PHF	.250	.000	.000	.000	.250	.000	.625	.000	.000	.625	.000	.000	.000	.000	.000	.000	.500	.000	.000	.500

City of Madera
 N/S: I Street
 E/W: Olive Avenue
 Weather: Clear

File Name : 55_MDA_I St_Olive PM
 Site Code : 00319628
 Start Date : 9/26/2019
 Page No : 1

Groups Printed- Passenger Vehicles - Large 2 Axle Vehicles - 3 Axle Vehicles - 4+ Axle Trucks

Start Time	I Street Southbound					Olive Avenue Westbound					Praxair Store Driveway Northbound					Olive Avenue Eastbound					Int. Total
	Left	Thru	Right	U-Turns	App. Total	Left	Thru	Right	U-Turns	App. Total	Left	Thru	Right	U-Turns	App. Total	Left	Thru	Right	U-Turns	App. Total	
04:00 PM	38	0	23	0	61	0	85	22	0	107	0	0	0	0	0	26	82	0	0	108	276
04:15 PM	25	0	22	0	47	0	81	23	0	104	0	0	0	0	0	18	82	0	0	100	251
04:30 PM	27	0	23	0	50	0	80	25	0	105	0	0	0	0	0	25	95	0	0	120	275
04:45 PM	33	0	14	0	47	0	90	25	0	115	0	0	0	0	0	18	85	0	0	103	265
Total	123	0	82	0	205	0	336	95	0	431	0	0	0	0	0	87	344	0	0	431	1067
05:00 PM	40	0	27	0	67	0	97	19	0	116	0	0	0	0	0	19	107	0	0	126	309
05:15 PM	38	0	32	0	70	0	82	26	0	108	0	1	0	0	1	23	93	0	0	116	295
05:30 PM	49	0	30	0	79	0	77	22	0	99	0	0	0	0	0	27	86	0	1	114	292
05:45 PM	22	0	17	0	39	0	106	38	0	144	0	0	0	0	0	16	81	0	0	97	280
Total	149	0	106	0	255	0	362	105	0	467	0	1	0	0	1	85	367	0	1	453	1176
Grand Total	272	0	188	0	460	0	698	200	0	898	0	1	0	0	1	172	711	0	1	884	2243
Apprch %	59.1	0	40.9	0		0	77.7	22.3	0		0	100	0	0		19.5	80.4	0	0.1		
Total %	12.1	0	8.4	0	20.5	0	31.1	8.9	0	40	0	0	0	0	0	7.7	31.7	0	0	39.4	
Passenger Vehicles	99.3	0	99.5	0	99.3	0	97.9	99.5	0	98.2	0	100	0	0	100	98.3	98	0	100	98.1	98.4
Large 2 Axle Vehicles	0.7	0	0.5	0	0.7	0	2	0.5	0	1.7	0	0	0	0	0	1.7	1.3	0	0	1.4	1.3
3 Axle Vehicles	0	0	0	0	0	0	0	0	0	0	0	0	0	0	0	0	1	0	0	1	1
% 3 Axle Vehicles	0	0	0	0	0	0	0	0	0	0	0	0	0	0	0	0	0.1	0	0	0.1	0
4+ Axle Trucks	0	0	0	0	0	0	1	0	0	1	0	0	0	0	0	0	4	0	0	4	5
% 4+ Axle Trucks																					

Start Time	I Street Southbound					Olive Avenue Westbound					Praxair Store Driveway Northbound					Olive Avenue Eastbound					Int. Total
	Left	Thru	Right	U-Turns	App. Total	Left	Thru	Right	U-Turns	App. Total	Left	Thru	Right	U-Turns	App. Total	Left	Thru	Right	U-Turns	App. Total	
Peak Hour Analysis From 04:00 PM to 05:45 PM - Peak 1 of 1																					
Peak Hour for Entire Intersection Begins at 05:00 PM																					
05:00 PM	40	0	27	0	67	0	97	19	0	116	0	0	0	0	0	19	107	0	0	126	309
05:15 PM	38	0	32	0	70	0	82	26	0	108	0	1	0	0	1	23	93	0	0	116	295
05:30 PM	49	0	30	0	79	0	77	22	0	99	0	0	0	0	0	27	86	0	1	114	292
05:45 PM	22	0	17	0	39	0	106	38	0	144	0	0	0	0	0	16	81	0	0	97	280
Total Volume	149	0	106	0	255	0	362	105	0	467	0	1	0	0	1	85	367	0	1	453	1176
% App. Total	58.4	0	41.6	0		0	77.5	22.5	0		0	100	0	0		18.8	81	0	0.2		
PHF	.760	.000	.828	.000	.807	.000	.854	.691	.000	.811	.000	.250	.000	.000	.250	.787	.857	.000	.250	.899	.951

City of Madera
 N/S: I Street
 E/W: Olive Avenue
 Weather: Clear

File Name : 55_MDA_I St_Olive PM
 Site Code : 00319628
 Start Date : 9/26/2019
 Page No : 2

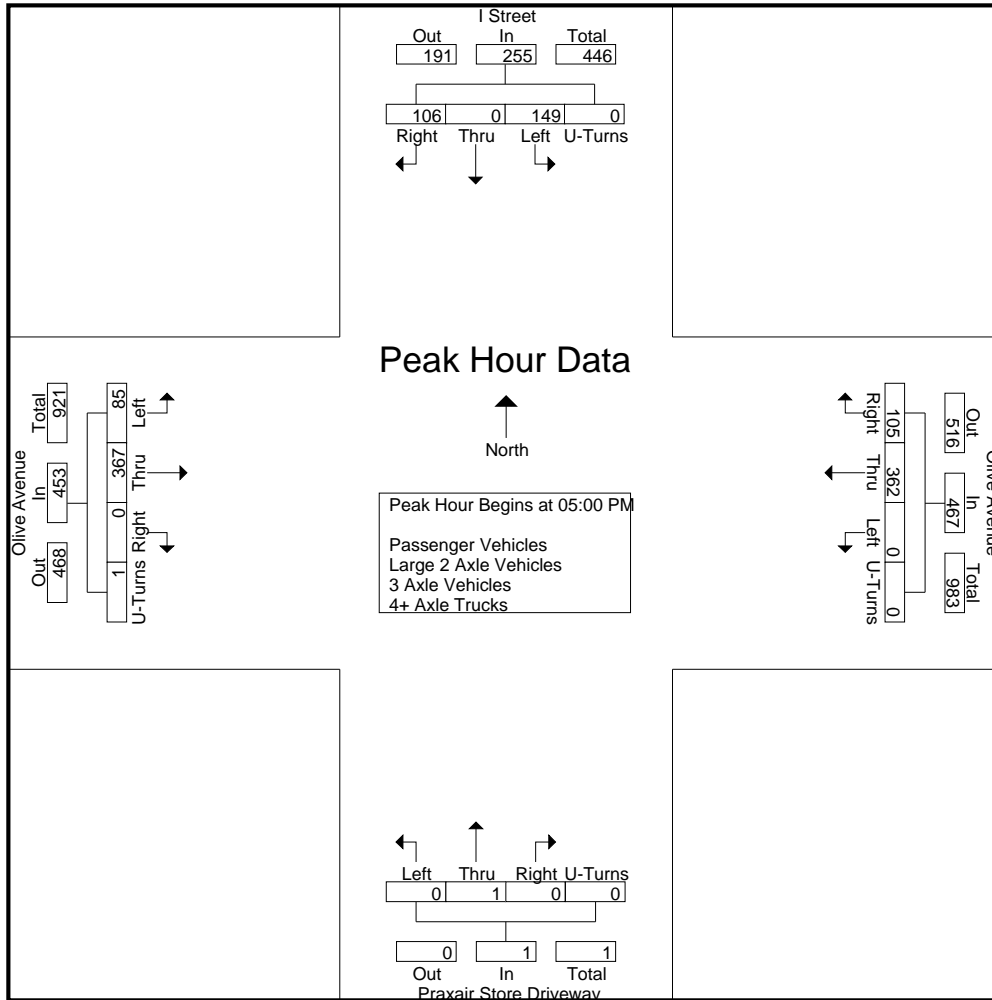

Peak Hour Analysis From 04:00 PM to 05:45 PM - Peak 1 of 1
 Peak Hour for Each Approach Begins at:

	04:45 PM					05:00 PM					04:30 PM					04:30 PM				
+0 mins.	33	0	14	0	47	0	97	19	0	116	0	0	0	0	0	25	95	0	0	120
+15 mins.	40	0	27	0	67	0	82	26	0	108	0	0	0	0	0	18	85	0	0	103
+30 mins.	38	0	32	0	70	0	77	22	0	99	0	0	0	0	0	19	107	0	0	126
+45 mins.	49	0	30	0	79	0	106	38	0	144	0	1	0	0	1	23	93	0	0	116
Total Volume	160	0	103	0	263	0	362	105	0	467	0	1	0	0	1	85	380	0	0	465
% App. Total	60.8	0	39.2	0		0	77.5	22.5	0		0	100	0	0		18.3	81.7	0	0	
PHF	.816	.000	.805	.000	.832	.000	.854	.691	.000	.811	.000	.250	.000	.000	.250	.850	.888	.000	.000	.923

City of Madera
 N/S: I Street
 E/W: Olive Avenue
 Weather: Clear

File Name : 55_MDA_I St_Olive PM
 Site Code : 00319628
 Start Date : 9/26/2019
 Page No : 1

Groups Printed- Passenger Vehicles

Start Time	I Street Southbound					Olive Avenue Westbound					Praxair Store Driveway Northbound					Olive Avenue Eastbound					Int. Total
	Left	Thru	Right	U-Turns	App. Total	Left	Thru	Right	U-Turns	App. Total	Left	Thru	Right	U-Turns	App. Total	Left	Thru	Right	U-Turns	App. Total	
04:00 PM	38	0	23	0	61	0	79	21	0	100	0	0	0	0	0	25	76	0	0	101	262
04:15 PM	24	0	22	0	46	0	80	23	0	103	0	0	0	0	0	17	82	0	0	99	248
04:30 PM	27	0	23	0	50	0	77	25	0	102	0	0	0	0	0	25	95	0	0	120	272
04:45 PM	33	0	14	0	47	0	90	25	0	115	0	0	0	0	0	18	84	0	0	102	264
Total	122	0	82	0	204	0	326	94	0	420	0	0	0	0	0	85	337	0	0	422	1046
05:00 PM	40	0	27	0	67	0	96	19	0	115	0	0	0	0	0	19	106	0	0	125	307
05:15 PM	38	0	31	0	69	0	80	26	0	106	0	1	0	0	1	23	91	0	0	114	290
05:30 PM	49	0	30	0	79	0	76	22	0	98	0	0	0	0	0	26	82	0	1	109	286
05:45 PM	21	0	17	0	38	0	105	38	0	143	0	0	0	0	0	16	81	0	0	97	278
Total	148	0	105	0	253	0	357	105	0	462	0	1	0	0	1	84	360	0	1	445	1161
Grand Total	270	0	187	0	457	0	683	199	0	882	0	1	0	0	1	169	697	0	1	867	2207
Apprch %	59.1	0	40.9	0		0	77.4	22.6	0		0	100	0	0		19.5	80.4	0	0.1		
Total %	12.2	0	8.5	0	20.7	0	30.9	9	0	40	0	0	0	0	0	7.7	31.6	0	0	39.3	

Start Time	I Street Southbound					Olive Avenue Westbound					Praxair Store Driveway Northbound					Olive Avenue Eastbound					Int. Total
	Left	Thru	Right	U-Turns	App. Total	Thru	Right	U-Turns	App. Total	Thru	Right	U-Turns	App. Total	Thru	Right	U-Turns	App. Total				
Peak Hour Analysis From 05:00 PM to 05:45 PM - Peak 1 of 1																					
Peak Hour for Entire Intersection Begins at 05:00 PM																					
05:00 PM	40	0	27	0	67	0	96	19	0	115	0	0	0	0	0	19	106	0	0	125	307
05:15 PM	38	0	31	0	69	0	80	26	0	106	0	1	0	0	1	23	91	0	0	114	290
05:30 PM	49	0	30	0	79	0	76	22	0	98	0	0	0	0	0	26	82	0	1	109	286
05:45 PM	21	0	17	0	38	0	105	38	0	143	0	0	0	0	0	16	81	0	0	97	278
Total Volume	148	0	105	0	253	0	357	105	0	462	0	1	0	0	1	84	360	0	1	445	1161
% App. Total	58.5	0	41.5	0		0	77.3	22.7	0		0	100	0	0		18.9	80.9	0	0.2		
PHF	.755	.000	.847	.000	.801	.000	.850	.691	.000	.808	.000	.250	.000	.000	.250	.808	.849	.000	.250	.890	.945

City of Madera
 N/S: I Street
 E/W: Olive Avenue
 Weather: Clear

File Name : 55_MDA_I St_Olive PM
 Site Code : 00319628
 Start Date : 9/26/2019
 Page No : 2

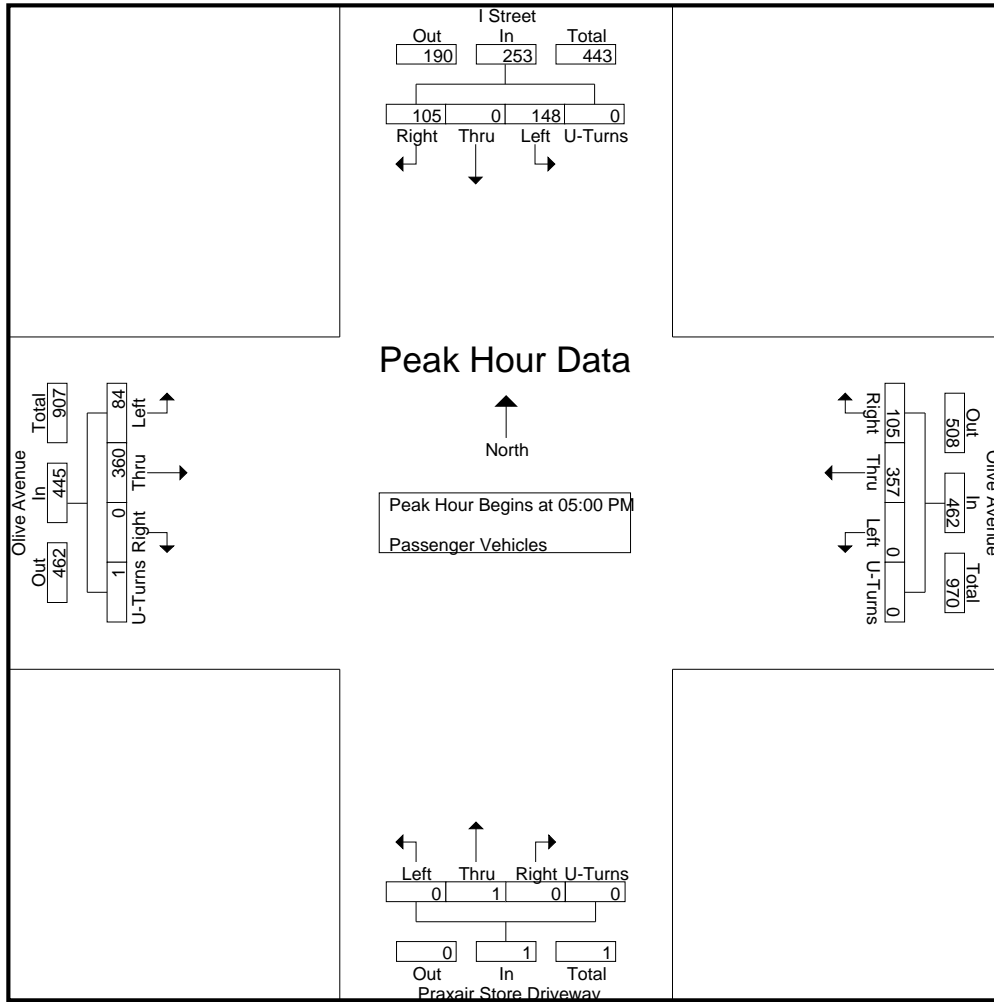

Peak Hour Analysis From 05:00 PM to 05:45 PM - Peak 1 of 1
 Peak Hour for Each Approach Begins at:

	05:00 PM					05:00 PM					05:00 PM					05:00 PM				
+0 mins.	40	0	27	0	67	0	96	19	0	115	0	0	0	0	0	19	106	0	0	125
+15 mins.	38	0	31	0	69	0	80	26	0	106	0	1	0	0	1	23	91	0	0	114
+30 mins.	49	0	30	0	79	0	76	22	0	98	0	0	0	0	0	26	82	0	1	109
+45 mins.	21	0	17	0	38	0	105	38	0	143	0	0	0	0	0	16	81	0	0	97
Total Volume	148	0	105	0	253	0	357	105	0	462	0	1	0	0	1	84	360	0	1	445
% App. Total	58.5	0	41.5	0		0	77.3	22.7	0		0	100	0	0		18.9	80.9	0	0.2	
PHF	.755	.000	.847	.000	.801	.000	.850	.691	.000	.808	.000	.250	.000	.000	.250	.808	.849	.000	.250	.890

City of Madera
 N/S: I Street
 E/W: Olive Avenue
 Weather: Clear

File Name : 55_MDA_I St_Olive PM
 Site Code : 00319628
 Start Date : 9/26/2019
 Page No : 1

Groups Printed- Large 2 Axle Vehicles

Start Time	I Street Southbound					Olive Avenue Westbound					Praxair Store Driveway Northbound					Olive Avenue Eastbound					Int. Total
	Left	Thru	Right	U-Turns	App. Total	Left	Thru	Right	U-Turns	App. Total	Left	Thru	Right	U-Turns	App. Total	Left	Thru	Right	U-Turns	App. Total	
04:00 PM	0	0	0	0	0	0	6	1	0	7	0	0	0	0	0	1	3	0	0	4	11
04:15 PM	1	0	0	0	1	0	1	0	0	1	0	0	0	0	0	1	0	0	0	1	3
04:30 PM	0	0	0	0	0	0	2	0	0	2	0	0	0	0	0	0	0	0	0	0	2
04:45 PM	0	0	0	0	0	0	0	0	0	0	0	0	0	0	0	0	1	0	0	1	1
Total	1	0	0	0	1	0	9	1	0	10	0	0	0	0	0	2	4	0	0	6	17
05:00 PM	0	0	0	0	0	0	1	0	0	1	0	0	0	0	0	0	1	0	0	1	2
05:15 PM	0	0	1	0	1	0	2	0	0	2	0	0	0	0	0	0	2	0	0	2	5
05:30 PM	0	0	0	0	0	0	1	0	0	1	0	0	0	0	0	1	2	0	0	3	4
05:45 PM	1	0	0	0	1	0	1	0	0	1	0	0	0	0	0	0	0	0	0	0	2
Total	1	0	1	0	2	0	5	0	0	5	0	0	0	0	0	1	5	0	0	6	13
Grand Total	2	0	1	0	3	0	14	1	0	15	0	0	0	0	0	3	9	0	0	12	30
Apprch %	66.7	0	33.3	0		0	93.3	6.7	0		0	0	0	0		25	75	0	0		
Total %	6.7	0	3.3	0	10	0	46.7	3.3	0	50	0	0	0	0	0	10	30	0	0	40	

Start Time	I Street Southbound					Olive Avenue Westbound					Praxair Store Driveway Northbound					Olive Avenue Eastbound					Int. Total
	Left	Thru	Right	U-Turns	App. Total	Thru	Right	U-Turns	App. Total	Thru	Right	U-Turns	App. Total	Thru	Right	U-Turns	App. Total				
Peak Hour Analysis From 05:00 PM to 05:45 PM - Peak 1 of 1																					
Peak Hour for Entire Intersection Begins at 05:00 PM																					
05:00 PM	0	0	0	0	0	0	1	0	0	1	0	0	0	0	0	0	1	0	0	1	2
05:15 PM	0	0	1	0	1	0	2	0	0	2	0	0	0	0	0	0	2	0	0	2	5
05:30 PM	0	0	0	0	0	0	1	0	0	1	0	0	0	0	0	1	2	0	0	3	4
05:45 PM	1	0	0	0	1	0	1	0	0	1	0	0	0	0	0	0	0	0	0	0	2
Total Volume	1	0	1	0	2	0	5	0	0	5	0	0	0	0	0	1	5	0	0	6	13
% App. Total	50	0	50	0		0	100	0	0		0	0	0	0		16.7	83.3	0	0		
PHF	.250	.000	.250	.000	.500	.000	.625	.000	.000	.625	.000	.000	.000	.000	.000	.250	.625	.000	.000	.500	.650

City of Madera
 N/S: I Street
 E/W: Olive Avenue
 Weather: Clear

File Name : 55_MDA_I St_Olive PM
 Site Code : 00319628
 Start Date : 9/26/2019
 Page No : 2

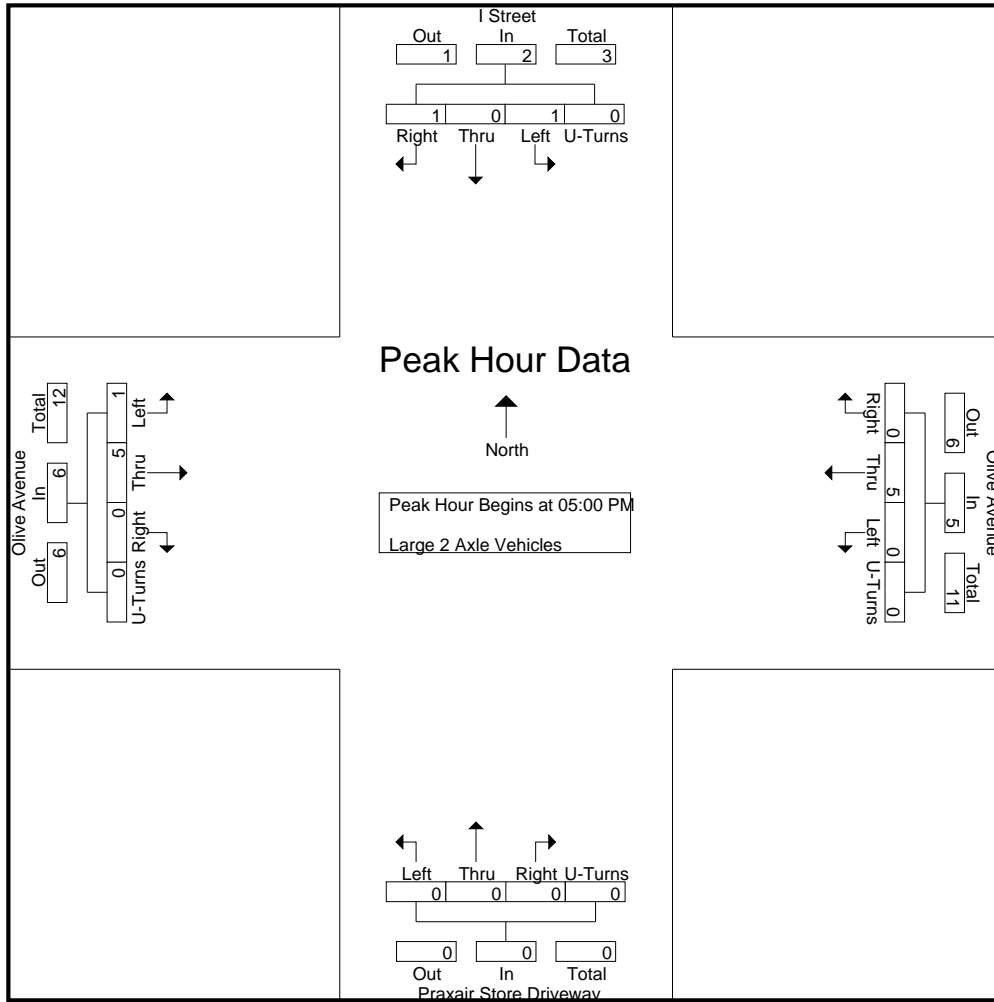

Peak Hour Analysis From 05:00 PM to 05:45 PM - Peak 1 of 1
 Peak Hour for Each Approach Begins at:

	05:00 PM					05:00 PM					05:00 PM					05:00 PM				
+0 mins.	0	0	0	0	0	0	1	0	0	1	0	0	0	0	0	0	1	0	0	1
+15 mins.	0	0	1	0	1	0	2	0	0	2	0	0	0	0	0	0	2	0	0	2
+30 mins.	0	0	0	0	0	0	1	0	0	1	0	0	0	0	0	1	2	0	0	3
+45 mins.	1	0	0	0	1	0	1	0	0	1	0	0	0	0	0	0	0	0	0	0
Total Volume	1	0	1	0	2	0	5	0	0	5	0	0	0	0	0	1	5	0	0	6
% App. Total	50	0	50	0		0	100	0	0		0	0	0	0		16.7	83.3	0	0	
PHF	.250	.000	.250	.000	.500	.000	.625	.000	.000	.625	.000	.000	.000	.000	.000	.250	.625	.000	.000	.500

City of Madera
 N/S: I Street
 E/W: Olive Avenue
 Weather: Clear

File Name : 55_MDA_I St_Olive PM
 Site Code : 00319628
 Start Date : 9/26/2019
 Page No : 1

Groups Printed- 3 Axle Vehicles

Start Time	I Street Southbound					Olive Avenue Westbound					Praxair Store Driveway Northbound					Olive Avenue Eastbound					Int. Total
	Left	Thru	Right	U-Turns	App. Total	Left	Thru	Right	U-Turns	App. Total	Left	Thru	Right	U-Turns	App. Total	Left	Thru	Right	U-Turns	App. Total	
04:00 PM	0	0	0	0	0	0	0	0	0	0	0	0	0	0	0	0	1	0	0	1	1
04:15 PM	0	0	0	0	0	0	0	0	0	0	0	0	0	0	0	0	0	0	0	0	0
04:30 PM	0	0	0	0	0	0	0	0	0	0	0	0	0	0	0	0	0	0	0	0	0
04:45 PM	0	0	0	0	0	0	0	0	0	0	0	0	0	0	0	0	0	0	0	0	0
Total	0	0	0	0	0	0	0	0	0	0	0	0	0	0	0	0	1	0	0	1	1
05:00 PM	0	0	0	0	0	0	0	0	0	0	0	0	0	0	0	0	0	0	0	0	0
05:15 PM	0	0	0	0	0	0	0	0	0	0	0	0	0	0	0	0	0	0	0	0	0
05:30 PM	0	0	0	0	0	0	0	0	0	0	0	0	0	0	0	0	0	0	0	0	0
05:45 PM	0	0	0	0	0	0	0	0	0	0	0	0	0	0	0	0	0	0	0	0	0
Total	0	0	0	0	0	0	0	0	0	0	0	0	0	0	0	0	0	0	0	0	0
Grand Total	0	0	0	0	0	0	0	0	0	0	0	0	0	0	0	0	1	0	0	1	1
Apprch %	0	0	0	0		0	0	0	0		0	0	0	0		0	100	0	0		
Total %	0	0	0	0	0	0	0	0	0	0	0	0	0	0	0	0	100	0	0	100	

Start Time	I Street Southbound					Olive Avenue Westbound					Praxair Store Driveway Northbound					Olive Avenue Eastbound					Int. Total
	Left	Thru	Right	U-Turns	App. Total	Left	Thru	Right	U-Turns	App. Total	Left	Thru	Right	U-Turns	App. Total	Left	Thru	Right	U-Turns	App. Total	
Peak Hour Analysis From 05:00 PM to 05:45 PM - Peak 1 of 1																					
Peak Hour for Entire Intersection Begins at 05:00 PM																					
05:00 PM	0	0	0	0	0	0	0	0	0	0	0	0	0	0	0	0	0	0	0	0	0
05:15 PM	0	0	0	0	0	0	0	0	0	0	0	0	0	0	0	0	0	0	0	0	0
05:30 PM	0	0	0	0	0	0	0	0	0	0	0	0	0	0	0	0	0	0	0	0	0
05:45 PM	0	0	0	0	0	0	0	0	0	0	0	0	0	0	0	0	0	0	0	0	0
Total Volume	0	0	0	0	0	0	0	0	0	0	0	0	0	0	0	0	0	0	0	0	0
% App. Total	0	0	0	0		0	0	0	0		0	0	0	0		0	0	0	0		
PHF	.000	.000	.000	.000	.000	.000	.000	.000	.000	.000	.000	.000	.000	.000	.000	.000	.000	.000	.000	.000	.000

City of Madera
 N/S: I Street
 E/W: Olive Avenue
 Weather: Clear

File Name : 55_MDA_I St_Olive PM
 Site Code : 00319628
 Start Date : 9/26/2019
 Page No : 2

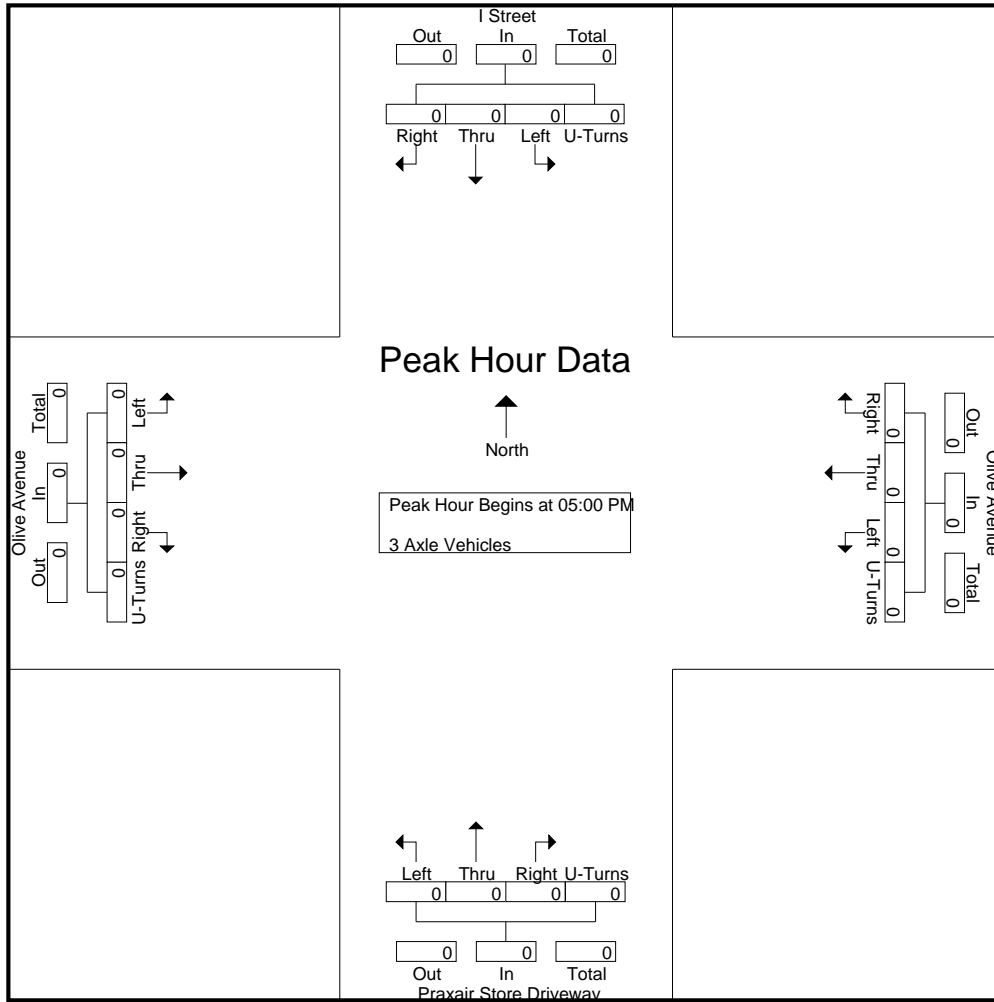

Peak Hour Analysis From 05:00 PM to 05:45 PM - Peak 1 of 1
 Peak Hour for Each Approach Begins at:

	05:00 PM					05:00 PM					05:00 PM					05:00 PM									
+0 mins.	0	0	0	0	0	0	0	0	0	0	0	0	0	0	0	0	0	0	0	0	0	0	0	0	0
+15 mins.	0	0	0	0	0	0	0	0	0	0	0	0	0	0	0	0	0	0	0	0	0	0	0	0	0
+30 mins.	0	0	0	0	0	0	0	0	0	0	0	0	0	0	0	0	0	0	0	0	0	0	0	0	0
+45 mins.	0	0	0	0	0	0	0	0	0	0	0	0	0	0	0	0	0	0	0	0	0	0	0	0	0
Total Volume	0	0	0	0	0	0	0	0	0	0	0	0	0	0	0	0	0	0	0	0	0	0	0	0	0
% App. Total	0	0	0	0	0	0	0	0	0	0	0	0	0	0	0	0	0	0	0	0	0	0	0	0	0
PHF	.000	.000	.000	.000	.000	.000	.000	.000	.000	.000	.000	.000	.000	.000	.000	.000	.000	.000	.000	.000	.000	.000	.000	.000	.000

City of Madera
 N/S: I Street
 E/W: Olive Avenue
 Weather: Clear

File Name : 55_MDA_I St_Olive PM
 Site Code : 00319628
 Start Date : 9/26/2019
 Page No : 1

Groups Printed- 4+ Axle Trucks

Start Time	I Street Southbound					Olive Avenue Westbound					Praxair Store Driveway Northbound					Olive Avenue Eastbound					Int. Total
	Left	Thru	Right	U-Turns	App. Total	Left	Thru	Right	U-Turns	App. Total	Left	Thru	Right	U-Turns	App. Total	Left	Thru	Right	U-Turns	App. Total	
04:00 PM	0	0	0	0	0	0	0	0	0	0	0	0	0	0	0	0	2	0	0	2	2
04:15 PM	0	0	0	0	0	0	0	0	0	0	0	0	0	0	0	0	0	0	0	0	0
04:30 PM	0	0	0	0	0	0	1	0	0	1	0	0	0	0	0	0	0	0	0	0	1
04:45 PM	0	0	0	0	0	0	0	0	0	0	0	0	0	0	0	0	0	0	0	0	0
Total	0	0	0	0	0	0	1	0	0	1	0	0	0	0	0	0	2	0	0	2	3
05:00 PM	0	0	0	0	0	0	0	0	0	0	0	0	0	0	0	0	0	0	0	0	0
05:15 PM	0	0	0	0	0	0	0	0	0	0	0	0	0	0	0	0	0	0	0	0	0
05:30 PM	0	0	0	0	0	0	0	0	0	0	0	0	0	0	0	0	2	0	0	2	2
05:45 PM	0	0	0	0	0	0	0	0	0	0	0	0	0	0	0	0	0	0	0	0	0
Total	0	0	0	0	0	0	0	0	0	0	0	0	0	0	0	0	2	0	0	2	2
Grand Total	0	0	0	0	0	0	1	0	0	1	0	0	0	0	0	0	4	0	0	4	5
Apprch %	0	0	0	0		0	100	0	0		0	0	0	0		0	100	0	0		
Total %	0	0	0	0	0	0	20	0	0	20	0	0	0	0	0	0	80	0	0	80	

Start Time	I Street Southbound					Olive Avenue Westbound					Praxair Store Driveway Northbound					Olive Avenue Eastbound					Int. Total
	Left	Thru	Right	U-Turns	App. Total	Left	Thru	Right	U-Turns	App. Total	Left	Thru	Right	U-Turns	App. Total	Left	Thru	Right	U-Turns	App. Total	
Peak Hour Analysis From 05:00 PM to 05:45 PM - Peak 1 of 1																					
Peak Hour for Entire Intersection Begins at 05:00 PM																					
05:00 PM	0	0	0	0	0	0	0	0	0	0	0	0	0	0	0	0	0	0	0	0	0
05:15 PM	0	0	0	0	0	0	0	0	0	0	0	0	0	0	0	0	0	0	0	0	0
05:30 PM	0	0	0	0	0	0	0	0	0	0	0	0	0	0	0	0	2	0	0	2	2
05:45 PM	0	0	0	0	0	0	0	0	0	0	0	0	0	0	0	0	0	0	0	0	0
Total Volume	0	0	0	0	0	0	0	0	0	0	0	0	0	0	0	0	2	0	0	2	2
% App. Total	0	0	0	0		0	0	0	0		0	0	0	0		0	100	0	0		
PHF	.000	.000	.000	.000	.000	.000	.000	.000	.000	.000	.000	.000	.000	.000	.000	.000	.250	.000	.000	.250	.250

City of Madera
 N/S: I Street
 E/W: Olive Avenue
 Weather: Clear

File Name : 55_MDA_I St_Olive PM
 Site Code : 00319628
 Start Date : 9/26/2019
 Page No : 2

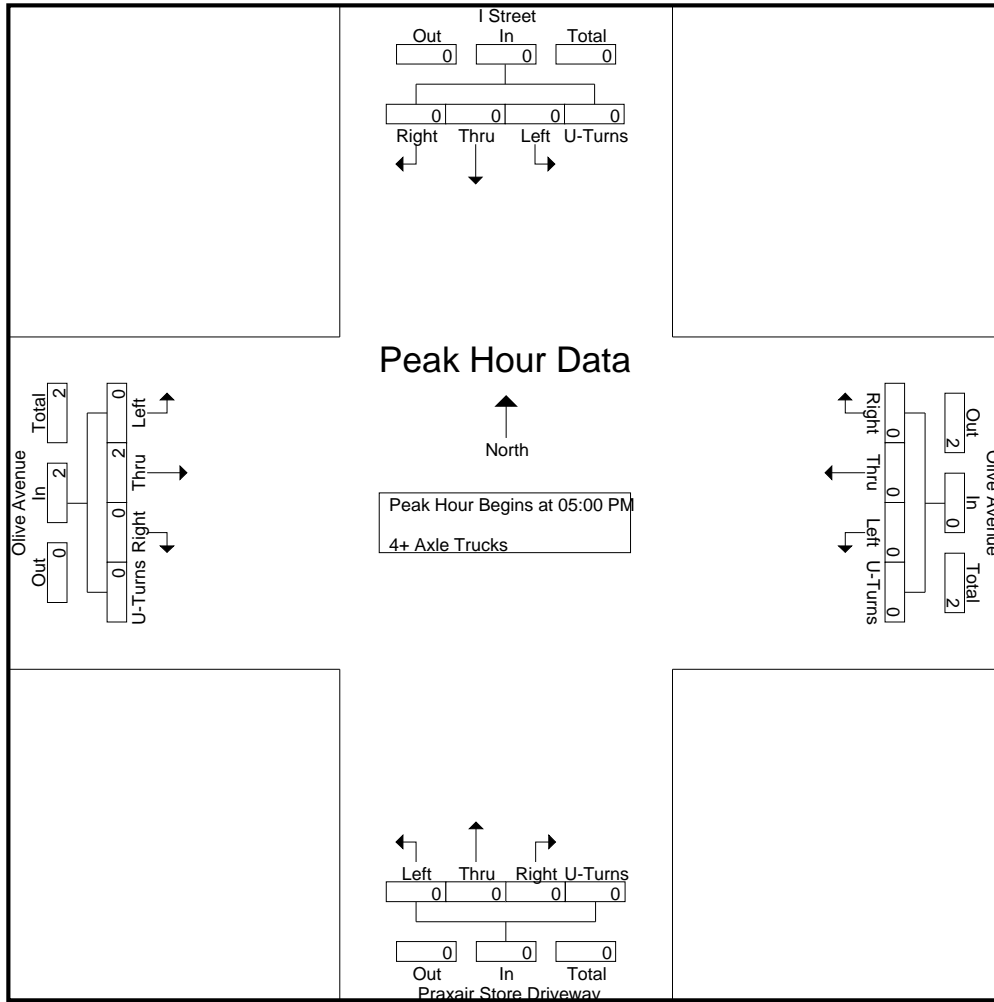

Peak Hour Analysis From 05:00 PM to 05:45 PM - Peak 1 of 1
 Peak Hour for Each Approach Begins at:

	05:00 PM					05:00 PM					05:00 PM					05:00 PM									
+0 mins.	0	0	0	0	0	0	0	0	0	0	0	0	0	0	0	0	0	0	0	0	0	0	0	0	0
+15 mins.	0	0	0	0	0	0	0	0	0	0	0	0	0	0	0	0	0	0	0	0	0	0	0	0	0
+30 mins.	0	0	0	0	0	0	0	0	0	0	0	0	0	0	0	0	0	2	0	0	2	0	0	0	0
+45 mins.	0	0	0	0	0	0	0	0	0	0	0	0	0	0	0	0	0	0	0	0	0	0	0	0	0
Total Volume	0	0	0	0	0	0	0	0	0	0	0	0	0	0	0	0	2	0	0	0	2	0	0	0	0
% App. Total	0	0	0	0	0	0	0	0	0	0	0	0	0	0	0	0	100	0	0	0	0	0	0	0	0
PHF	.000	.000	.000	.000	.000	.000	.000	.000	.000	.000	.000	.000	.000	.000	.000	.000	.250	.000	.000	.250					

Location: Madera
 N/S: I Street
 E/W: Olive Avenue



Date: 9/26/2019
 Day: Thursday

PEDESTRIANS

	North Leg I Street	East Leg Olive Avenue	South Leg Prexair Store Driveway	West Leg Olive Avenue	
	Pedestrians	Pedestrians	Pedestrians	Pedestrians	
7:00 AM	1	0	0	0	1
7:15 AM	2	0	0	0	2
7:30 AM	1	0	0	0	1
7:45 AM	5	0	0	0	5
8:00 AM	4	0	0	0	4
8:15 AM	6	0	0	0	6
8:30 AM	1	0	0	0	1
8:45 AM	1	0	0	0	1
TOTAL VOLUMES:	21	0	0	0	21

	North Leg I Street	East Leg Olive Avenue	South Leg Prexair Store Driveway	West Leg Olive Avenue	
	Pedestrians	Pedestrians	Pedestrians	Pedestrians	
4:00 PM	2	0	0	0	2
4:15 PM	0	0	0	0	0
4:30 PM	0	0	0	0	0
4:45 PM	0	0	0	0	0
5:00 PM	0	0	0	0	0
5:15 PM	0	0	0	0	0
5:30 PM	0	0	0	0	0
5:45 PM	0	0	0	0	0
TOTAL VOLUMES:	2	0	0	0	2

Location: Madera
 N/S: I Street
 E/W: Olive Avenue



Date: 9/26/2019
 Day: Thursday

BICYCLES

	Southbound I Street			Westbound Olive Avenue			Northbound Prexair Store Driveway			Eastbound Olive Avenue			
	Left	Thru	Right	Left	Thru	Right	Left	Thru	Right	Left	Thru	Right	
7:00 AM	0	0	0	0	0	0	0	0	0	0	0	0	0
7:15 AM	0	0	0	0	0	0	0	0	0	0	0	0	0
7:30 AM	0	0	0	0	0	0	0	0	0	0	0	0	0
7:45 AM	0	0	0	0	0	0	0	0	0	0	0	0	0
8:00 AM	0	0	0	0	0	0	0	0	0	0	0	0	0
8:15 AM	0	0	0	0	0	0	0	0	0	0	0	0	0
8:30 AM	0	0	0	0	0	0	0	0	0	0	0	0	0
8:45 AM	1	0	0	0	0	1	0	0	0	0	0	0	2
TOTAL VOLUMES:	1	0	0	0	0	1	0	0	0	0	0	0	2

	Southbound I Street			Westbound Olive Avenue			Northbound Prexair Store Driveway			Eastbound Olive Avenue			
	Left	Thru	Right	Left	Thru	Right	Left	Thru	Right	Left	Thru	Right	
4:00 PM	0	0	0	0	0	0	0	0	0	0	1	0	1
4:15 PM	1	0	0	0	0	0	0	0	0	0	0	0	1
4:30 PM	0	0	0	0	0	0	0	0	0	0	0	0	0
4:45 PM	0	0	0	0	0	0	0	0	0	0	0	0	0
5:00 PM	0	0	0	0	0	2	0	0	0	0	0	0	2
5:15 PM	0	0	0	0	0	0	0	0	0	0	0	0	0
5:30 PM	1	0	0	0	0	0	0	0	0	0	1	0	2
5:45 PM	0	0	0	0	0	0	0	0	0	0	0	0	0
TOTAL VOLUMES:	2	0	0	0	0	2	0	0	0	0	2	0	6

City of Madera
 N/S: SR-99 Southbound Off Ramp
 E/W: Olive Avenue
 Weather: Clear

File Name : 35_MDA_99S Off_Olive AM
 Site Code : 00319628
 Start Date : 9/24/2019
 Page No : 1

Groups Printed- Passenger Vehicles - Large 2 Axle Vehicles - 3 Axle Vehicles - 4+ Axle Trucks

Start Time	SR-99 Southbound Off Ramp Southbound				Olive Avenue Westbound				Olive Avenue Eastbound				Int. Total
	Left	Right	U-Turns	App. Total	Thru	Right	U-Turns	App. Total	Left	Thru	U-Turns	App. Total	
07:00 AM	45	21	0	66	73	0	0	73	0	68	0	68	207
07:15 AM	52	39	0	91	66	0	0	66	0	96	0	96	253
07:30 AM	94	24	0	118	100	1	0	101	0	97	0	97	316
07:45 AM	83	13	0	96	101	0	0	101	0	149	0	149	346
Total	274	97	0	371	340	1	0	341	0	410	0	410	1122
08:00 AM	55	20	0	75	92	0	0	92	0	149	0	149	316
08:15 AM	71	42	0	113	96	0	0	96	0	109	0	109	318
08:30 AM	59	45	0	104	98	0	0	98	0	112	0	112	314
08:45 AM	51	22	0	73	79	0	0	79	0	100	0	100	252
Total	236	129	0	365	365	0	0	365	0	470	0	470	1200
Grand Total	510	226	0	736	705	1	0	706	0	880	0	880	2322
Apprch %	69.3	30.7	0		99.9	0.1	0		0	100	0		
Total %	22	9.7	0	31.7	30.4	0	0	30.4	0	37.9	0	37.9	
Passenger Vehicles	449	213	0	662	674	1	0	675	0	837	0	837	2174
% Passenger Vehicles	88	94.2	0	89.9	95.6	100	0	95.6	0	95.1	0	95.1	93.6
Large 2 Axle Vehicles	26	9	0	35	29	0	0	29	0	30	0	30	94
% Large 2 Axle Vehicles	5.1	4	0	4.8	4.1	0	0	4.1	0	3.4	0	3.4	4
3 Axle Vehicles	5	2	0	7	1	0	0	1	0	1	0	1	9
% 3 Axle Vehicles	1	0.9	0	1	0.1	0	0	0.1	0	0.1	0	0.1	0.4
4+ Axle Trucks	30	2	0	32	1	0	0	1	0	12	0	12	45
% 4+ Axle Trucks	5.9	0.9	0	4.3	0.1	0	0	0.1	0	1.4	0	1.4	1.9

Start Time	SR-99 Southbound Off Ramp Southbound				Olive Avenue Westbound				Olive Avenue Eastbound				Int. Total
	Left	Right	U-Turns	App. Total	Thru	Right	U-Turns	App. Total	Left	Thru	U-Turns	App. Total	
Peak Hour Analysis From 07:00 AM to 08:45 AM - Peak 1 of 1													
Peak Hour for Entire Intersection Begins at 07:30 AM													
07:30 AM	94	24	0	118	100	1	0	101	0	97	0	97	316
07:45 AM	83	13	0	96	101	0	0	101	0	149	0	149	346
08:00 AM	55	20	0	75	92	0	0	92	0	149	0	149	316
08:15 AM	71	42	0	113	96	0	0	96	0	109	0	109	318
Total Volume	303	99	0	402	389	1	0	390	0	504	0	504	1296
% App. Total	75.4	24.6	0		99.7	0.3	0		0	100	0		
PHF	.806	.589	.000	.852	.963	.250	.000	.965	.000	.846	.000	.846	.936

City of Madera
 N/S: SR-99 Southbound Off Ramp
 E/W: Olive Avenue
 Weather: Clear

File Name : 35_MDA_99S Off_Olive AM
 Site Code : 00319628
 Start Date : 9/24/2019
 Page No : 2

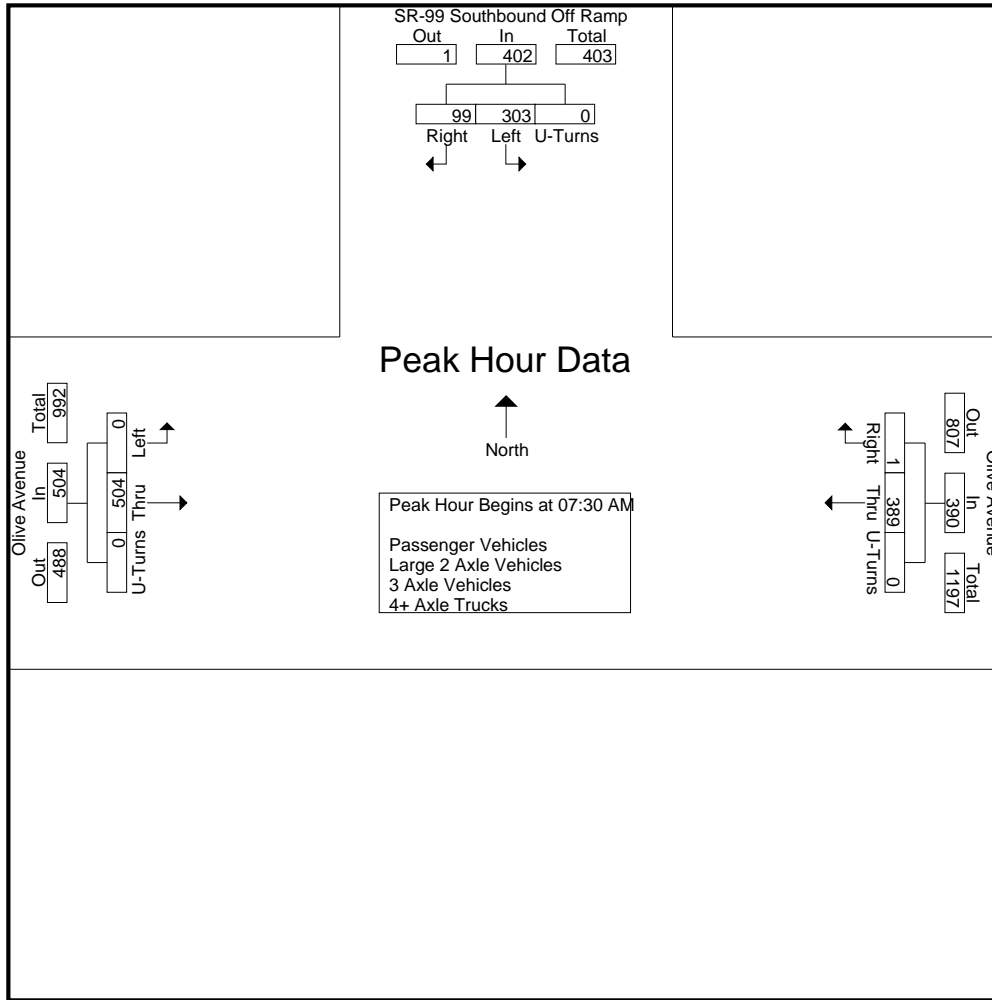

Peak Hour Analysis From 07:00 AM to 08:45 AM - Peak 1 of 1
 Peak Hour for Each Approach Begins at:

	07:30 AM				07:30 AM				07:45 AM			
+0 mins.	94	24	0	118	100	1	0	101	0	149	0	149
+15 mins.	83	13	0	96	101	0	0	101	0	149	0	149
+30 mins.	55	20	0	75	92	0	0	92	0	109	0	109
+45 mins.	71	42	0	113	96	0	0	96	0	112	0	112
Total Volume	303	99	0	402	389	1	0	390	0	519	0	519
% App. Total	75.4	24.6	0		99.7	0.3	0		0	100	0	
PHF	.806	.589	.000	.852	.963	.250	.000	.965	.000	.871	.000	.871

City of Madera
 N/S: SR-99 Southbound Off Ramp
 E/W: Olive Avenue
 Weather: Clear

File Name : 35_MDA_99S Off_Olive AM
 Site Code : 00319628
 Start Date : 9/24/2019
 Page No : 1

Groups Printed- Passenger Vehicles

Start Time	SR-99 Southbound Off Ramp Southbound				Olive Avenue Westbound				Olive Avenue Eastbound				Int. Total
	Left	Right	U-Turns	App. Total	Thru	Right	U-Turns	App. Total	Left	Thru	U-Turns	App. Total	
07:00 AM	36	18	0	54	69	0	0	69	0	65	0	65	188
07:15 AM	47	37	0	84	63	0	0	63	0	94	0	94	241
07:30 AM	85	23	0	108	94	1	0	95	0	94	0	94	297
07:45 AM	76	13	0	89	94	0	0	94	0	142	0	142	325
Total	244	91	0	335	320	1	0	321	0	395	0	395	1051
08:00 AM	49	19	0	68	92	0	0	92	0	145	0	145	305
08:15 AM	61	37	0	98	90	0	0	90	0	100	0	100	288
08:30 AM	50	45	0	95	94	0	0	94	0	107	0	107	296
08:45 AM	45	21	0	66	78	0	0	78	0	90	0	90	234
Total	205	122	0	327	354	0	0	354	0	442	0	442	1123
Grand Total	449	213	0	662	674	1	0	675	0	837	0	837	2174
Apprch %	67.8	32.2	0		99.9	0.1	0		0	100	0		
Total %	20.7	9.8	0	30.5	31	0	0	31	0	38.5	0	38.5	

Start Time	SR-99 Southbound Off Ramp Southbound				Olive Avenue Westbound				Olive Avenue Eastbound				Int. Total
	Left	Right	U-Turns	App. Total	Thru	Right	U-Turns	App. Total	Left	Thru	U-Turns	App. Total	
Peak Hour Analysis From 07:30 AM to 08:15 AM - Peak 1 of 1													
Peak Hour for Entire Intersection Begins at 07:30 AM													
07:30 AM	85	23	0	108	94	1	0	95	0	94	0	94	297
07:45 AM	76	13	0	89	94	0	0	94	0	142	0	142	325
08:00 AM	49	19	0	68	92	0	0	92	0	145	0	145	305
08:15 AM	61	37	0	98	90	0	0	90	0	100	0	100	288
Total Volume	271	92	0	363	370	1	0	371	0	481	0	481	1215
% App. Total	74.7	25.3	0		99.7	0.3	0		0	100	0		
PHF	.797	.622	.000	.840	.984	.250	.000	.976	.000	.829	.000	.829	.935

City of Madera
 N/S: SR-99 Southbound Off Ramp
 E/W: Olive Avenue
 Weather: Clear

File Name : 35_MDA_99S Off_Olive AM
 Site Code : 00319628
 Start Date : 9/24/2019
 Page No : 2

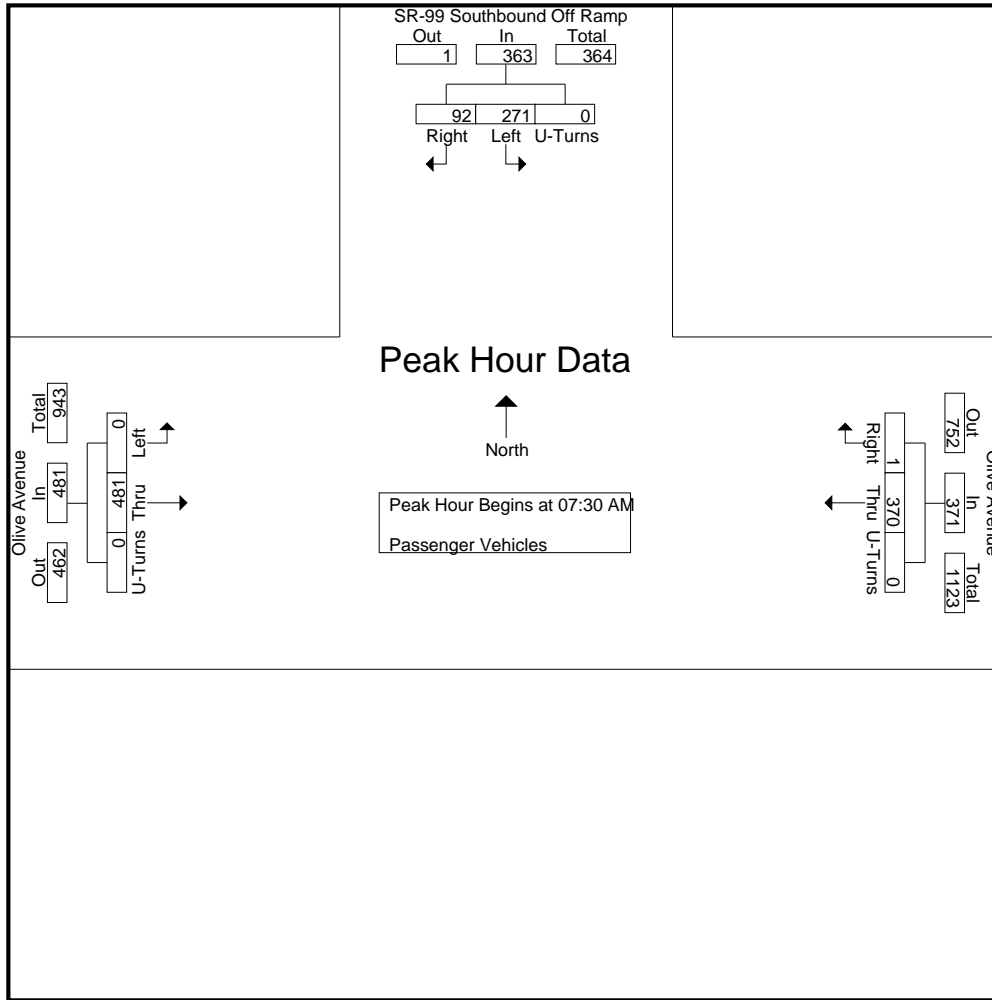

Peak Hour Analysis From 07:30 AM to 08:15 AM - Peak 1 of 1
 Peak Hour for Each Approach Begins at:

	07:30 AM				07:30 AM				07:30 AM			
+0 mins.	85	23	0	108	94	1	0	95	0	94	0	94
+15 mins.	76	13	0	89	94	0	0	94	0	142	0	142
+30 mins.	49	19	0	68	92	0	0	92	0	145	0	145
+45 mins.	61	37	0	98	90	0	0	90	0	100	0	100
Total Volume	271	92	0	363	370	1	0	371	0	481	0	481
% App. Total	74.7	25.3	0		99.7	0.3	0		0	100	0	
PHF	.797	.622	.000	.840	.984	.250	.000	.976	.000	.829	.000	.829

City of Madera
 N/S: SR-99 Southbound Off Ramp
 E/W: Olive Avenue
 Weather: Clear

File Name : 35_MDA_99S Off_Olive AM
 Site Code : 00319628
 Start Date : 9/24/2019
 Page No : 1

Groups Printed- Large 2 Axle Vehicles

Start Time	SR-99 Southbound Off Ramp Southbound				Olive Avenue Westbound				Olive Avenue Eastbound				Int. Total
	Left	Right	U-Turns	App. Total	Thru	Right	U-Turns	App. Total	Left	Thru	U-Turns	App. Total	
07:00 AM	4	3	0	7	3	0	0	3	0	2	0	2	12
07:15 AM	2	0	0	2	3	0	0	3	0	2	0	2	7
07:30 AM	5	0	0	5	6	0	0	6	0	1	0	1	12
07:45 AM	1	0	0	1	6	0	0	6	0	5	0	5	12
Total	12	3	0	15	18	0	0	18	0	10	0	10	43
08:00 AM	4	1	0	5	0	0	0	0	0	1	0	1	6
08:15 AM	6	4	0	10	6	0	0	6	0	7	0	7	23
08:30 AM	3	0	0	3	4	0	0	4	0	4	0	4	11
08:45 AM	1	1	0	2	1	0	0	1	0	8	0	8	11
Total	14	6	0	20	11	0	0	11	0	20	0	20	51
Grand Total	26	9	0	35	29	0	0	29	0	30	0	30	94
Apprch %	74.3	25.7	0		100	0	0		0	100	0		
Total %	27.7	9.6	0	37.2	30.9	0	0	30.9	0	31.9	0	31.9	

Start Time	SR-99 Southbound Off Ramp Southbound				Olive Avenue Westbound				Olive Avenue Eastbound				Int. Total
	Left	Right	U-Turns	App. Total	Thru	Right	U-Turns	App. Total	Left	Thru	U-Turns	App. Total	
07:30 AM	5	0	0	5	6	0	0	6	0	1	0	1	12
07:45 AM	1	0	0	1	6	0	0	6	0	5	0	5	12
08:00 AM	4	1	0	5	0	0	0	0	0	1	0	1	6
08:15 AM	6	4	0	10	6	0	0	6	0	7	0	7	23
Total Volume	16	5	0	21	18	0	0	18	0	14	0	14	53
% App. Total	76.2	23.8	0		100	0	0		0	100	0		
PHF	.667	.313	.000	.525	.750	.000	.000	.750	.000	.500	.000	.500	.576

Peak Hour Analysis From 07:30 AM to 08:15 AM - Peak 1 of 1

Peak Hour for Entire Intersection Begins at 07:30 AM

City of Madera
 N/S: SR-99 Southbound Off Ramp
 E/W: Olive Avenue
 Weather: Clear

File Name : 35_MDA_99S Off_Olive AM
 Site Code : 00319628
 Start Date : 9/24/2019
 Page No : 2

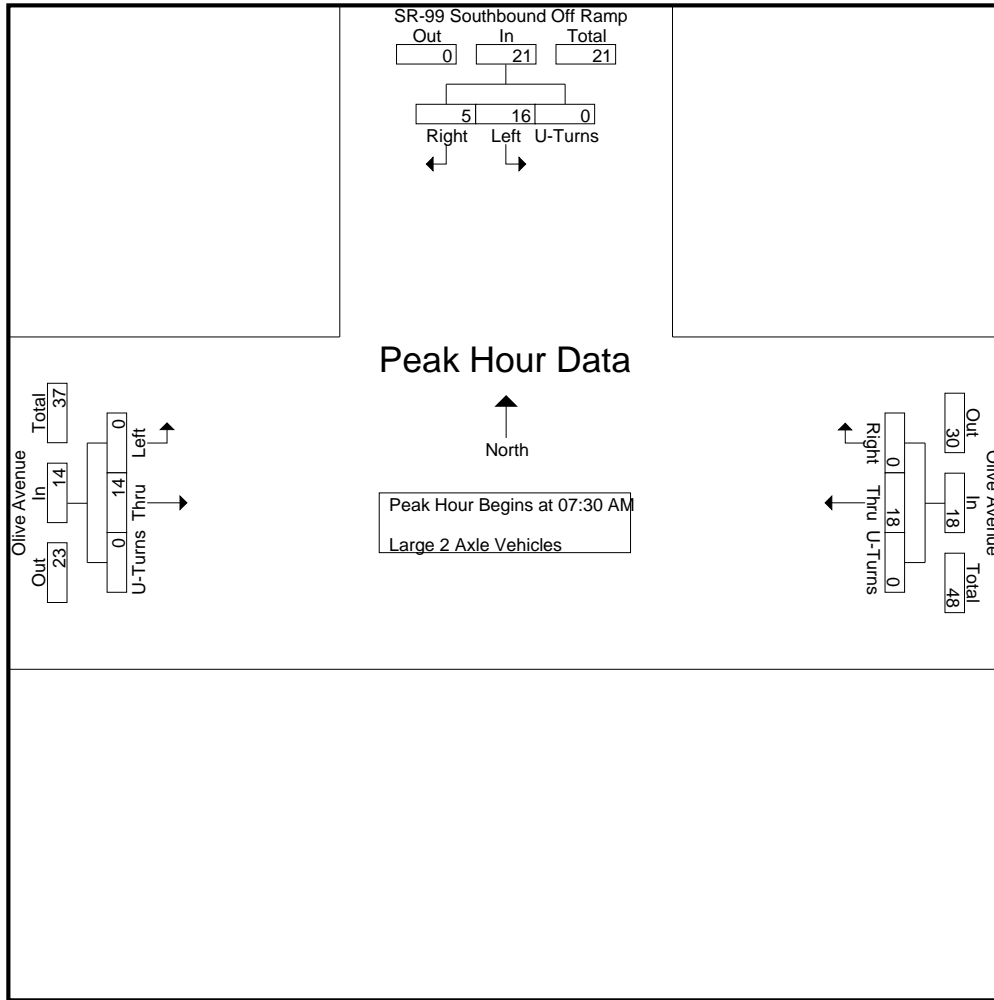

Peak Hour Analysis From 07:30 AM to 08:15 AM - Peak 1 of 1
 Peak Hour for Each Approach Begins at:

	07:30 AM				07:30 AM				07:30 AM			
+0 mins.	5	0	0	5	6	0	0	6	0	1	0	1
+15 mins.	1	0	0	1	6	0	0	6	0	5	0	5
+30 mins.	4	1	0	5	0	0	0	0	0	1	0	1
+45 mins.	6	4	0	10	6	0	0	6	0	7	0	7
Total Volume	16	5	0	21	18	0	0	18	0	14	0	14
% App. Total	76.2	23.8	0	100	100	0	0	100	0	100	0	100
PHF	.667	.313	.000	.525	.750	.000	.000	.750	.000	.500	.000	.500

City of Madera
 N/S: SR-99 Southbound Off Ramp
 E/W: Olive Avenue
 Weather: Clear

File Name : 35_MDA_99S Off_Olive AM
 Site Code : 00319628
 Start Date : 9/24/2019
 Page No : 1

Groups Printed- 3 Axle Vehicles

Start Time	SR-99 Southbound Off Ramp Southbound				Olive Avenue Westbound				Olive Avenue Eastbound				Int. Total
	Left	Right	U-Turns	App. Total	Thru	Right	U-Turns	App. Total	Left	Thru	U-Turns	App. Total	
07:00 AM	2	0	0	2	1	0	0	1	0	0	0	0	3
07:15 AM	0	1	0	1	0	0	0	0	0	0	0	0	1
07:30 AM	0	0	0	0	0	0	0	0	0	0	0	0	0
07:45 AM	1	0	0	1	0	0	0	0	0	0	0	0	1
Total	3	1	0	4	1	0	0	1	0	0	0	0	5
08:00 AM	0	0	0	0	0	0	0	0	0	0	0	0	0
08:15 AM	0	1	0	1	0	0	0	0	0	0	0	0	1
08:30 AM	1	0	0	1	0	0	0	0	0	0	0	0	1
08:45 AM	1	0	0	1	0	0	0	0	0	1	0	1	2
Total	2	1	0	3	0	0	0	0	0	1	0	1	4
Grand Total	5	2	0	7	1	0	0	1	0	1	0	1	9
Apprch %	71.4	28.6	0		100	0	0		0	100	0		
Total %	55.6	22.2	0	77.8	11.1	0	0	11.1	0	11.1	0	11.1	

Start Time	SR-99 Southbound Off Ramp Southbound				Olive Avenue Westbound				Olive Avenue Eastbound				Int. Total
	Left	Right	U-Turns	App. Total	Thru	Right	U-Turns	App. Total	Left	Thru	U-Turns	App. Total	
07:30 AM	0	0	0	0	0	0	0	0	0	0	0	0	0
07:45 AM	1	0	0	1	0	0	0	0	0	0	0	0	1
08:00 AM	0	0	0	0	0	0	0	0	0	0	0	0	0
08:15 AM	0	1	0	1	0	0	0	0	0	0	0	0	1
Total Volume	1	1	0	2	0	0	0	0	0	0	0	0	2
% App. Total	50	50	0		0	0	0		0	0	0		
PHF	.250	.250	.000	.500	.000	.000	.000	.000	.000	.000	.000	.000	.500

Peak Hour Analysis From 07:30 AM to 08:15 AM - Peak 1 of 1

Peak Hour for Entire Intersection Begins at 07:30 AM

City of Madera
 N/S: SR-99 Southbound Off Ramp
 E/W: Olive Avenue
 Weather: Clear

File Name : 35_MDA_99S Off_Olive AM
 Site Code : 00319628
 Start Date : 9/24/2019
 Page No : 2

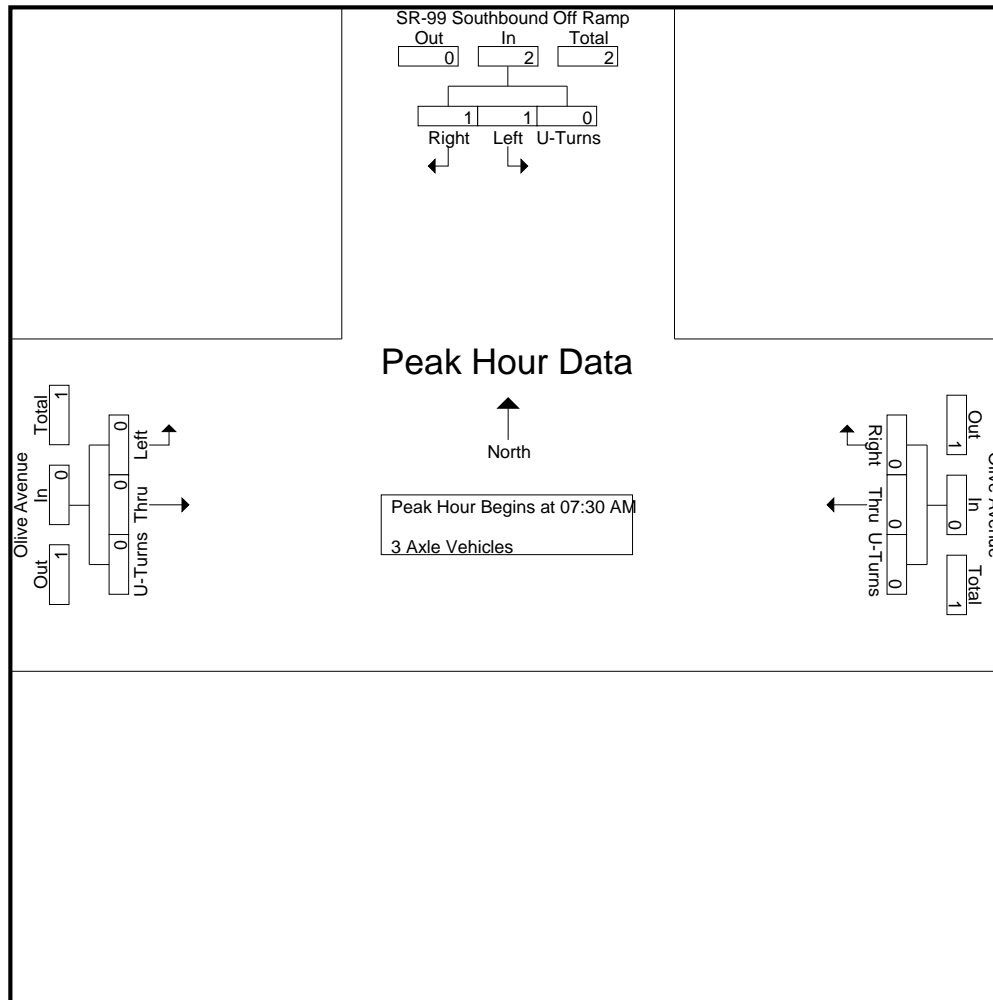

Peak Hour Analysis From 07:30 AM to 08:15 AM - Peak 1 of 1
 Peak Hour for Each Approach Begins at:

	07:30 AM				07:30 AM				07:30 AM			
+0 mins.	0	0	0	0	0	0	0	0	0	0	0	0
+15 mins.	1	0	0	1	0	0	0	0	0	0	0	0
+30 mins.	0	0	0	0	0	0	0	0	0	0	0	0
+45 mins.	0	1	0	1	0	0	0	0	0	0	0	0
Total Volume	1	1	0	2	0	0	0	0	0	0	0	0
% App. Total	50	50	0		0	0	0		0	0	0	
PHF	.250	.250	.000	.500	.000	.000	.000	.000	.000	.000	.000	.000

City of Madera
 N/S: SR-99 Southbound Off Ramp
 E/W: Olive Avenue
 Weather: Clear

File Name : 35_MDA_99S Off_Olive AM
 Site Code : 00319628
 Start Date : 9/24/2019
 Page No : 1

Groups Printed- 4+ Axle Trucks

Start Time	SR-99 Southbound Off Ramp Southbound				Olive Avenue Westbound				Olive Avenue Eastbound				Int. Total
	Left	Right	U-Turns	App. Total	Thru	Right	U-Turns	App. Total	Left	Thru	U-Turns	App. Total	
07:00 AM	3	0	0	3	0	0	0	0	0	1	0	1	4
07:15 AM	3	1	0	4	0	0	0	0	0	0	0	0	4
07:30 AM	4	1	0	5	0	0	0	0	0	2	0	2	7
07:45 AM	5	0	0	5	1	0	0	1	0	2	0	2	8
Total	15	2	0	17	1	0	0	1	0	5	0	5	23
08:00 AM	2	0	0	2	0	0	0	0	0	3	0	3	5
08:15 AM	4	0	0	4	0	0	0	0	0	2	0	2	6
08:30 AM	5	0	0	5	0	0	0	0	0	1	0	1	6
08:45 AM	4	0	0	4	0	0	0	0	0	1	0	1	5
Total	15	0	0	15	0	0	0	0	0	7	0	7	22
Grand Total	30	2	0	32	1	0	0	1	0	12	0	12	45
Apprch %	93.8	6.2	0		100	0	0		0	100	0		
Total %	66.7	4.4	0	71.1	2.2	0	0	2.2	0	26.7	0	26.7	

Start Time	SR-99 Southbound Off Ramp Southbound				Olive Avenue Westbound				Olive Avenue Eastbound				Int. Total
	Left	Right	U-Turns	App. Total	Thru	Right	U-Turns	App. Total	Left	Thru	U-Turns	App. Total	
07:30 AM	4	1	0	5	0	0	0	0	0	2	0	2	7
07:45 AM	5	0	0	5	1	0	0	1	0	2	0	2	8
08:00 AM	2	0	0	2	0	0	0	0	0	3	0	3	5
08:15 AM	4	0	0	4	0	0	0	0	0	2	0	2	6
Total Volume	15	1	0	16	1	0	0	1	0	9	0	9	26
% App. Total	93.8	6.2	0		100	0	0		0	100	0		
PHF	.750	.250	.000	.800	.250	.000	.000	.250	.000	.750	.000	.750	.813

Peak Hour Analysis From 07:30 AM to 08:15 AM - Peak 1 of 1

Peak Hour for Entire Intersection Begins at 07:30 AM

City of Madera
 N/S: SR-99 Southbound Off Ramp
 E/W: Olive Avenue
 Weather: Clear

File Name : 35_MDA_99S Off_Olive AM
 Site Code : 00319628
 Start Date : 9/24/2019
 Page No : 2

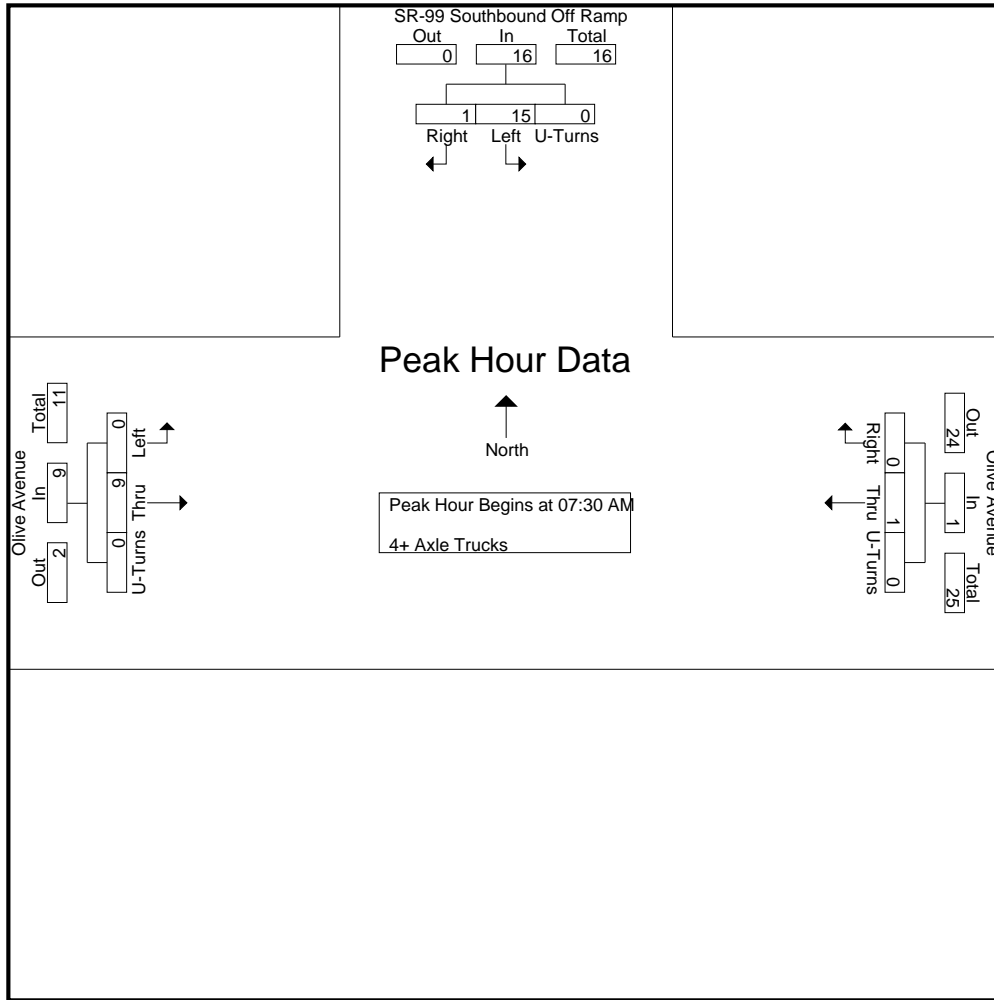

Peak Hour Analysis From 07:30 AM to 08:15 AM - Peak 1 of 1
 Peak Hour for Each Approach Begins at:

	07:30 AM				07:30 AM				07:30 AM			
+0 mins.	4	1	0	5	0	0	0	0	0	2	0	2
+15 mins.	5	0	0	5	1	0	0	1	0	2	0	2
+30 mins.	2	0	0	2	0	0	0	0	0	3	0	3
+45 mins.	4	0	0	4	0	0	0	0	0	2	0	2
Total Volume	15	1	0	16	1	0	0	1	0	9	0	9
% App. Total	93.8	6.2	0	100	100	0	0	100	0	100	0	100
PHF	.750	.250	.000	.800	.250	.000	.000	.250	.000	.750	.000	.750

City of Madera
 N/S: SR-99 Southbound Off Ramp
 E/W: Olive Avenue
 Weather: Clear

File Name : 35_MDA_99S Off_Olive PM
 Site Code : 00319628
 Start Date : 9/24/2019
 Page No : 1

Groups Printed- Passenger Vehicles - Large 2 Axle Vehicles - 3 Axle Vehicles - 4+ Axle Trucks

Start Time	SR-99 Southbound Off Ramp Southbound				Olive Avenue Westbound				Olive Avenue Eastbound				Int. Total
	Left	Right	U-Turns	App. Total	Thru	Right	U-Turns	App. Total	Left	Thru	U-Turns	App. Total	
04:00 PM	64	21	0	85	89	0	0	89	0	139	0	139	313
04:15 PM	53	13	0	66	55	0	0	55	0	125	0	125	246
04:30 PM	60	19	0	79	94	0	0	94	0	132	0	132	305
04:45 PM	65	18	0	83	103	0	0	103	0	115	0	115	301
Total	242	71	0	313	341	0	0	341	0	511	0	511	1165
05:00 PM	59	13	0	72	84	0	0	84	0	135	0	135	291
05:15 PM	43	15	0	58	120	0	0	120	0	140	0	140	318
05:30 PM	56	12	0	68	94	0	0	94	0	104	0	104	266
05:45 PM	49	13	0	62	93	0	0	93	0	121	0	121	276
Total	207	53	0	260	391	0	0	391	0	500	0	500	1151
Grand Total	449	124	0	573	732	0	0	732	0	1011	0	1011	2316
Apprch %	78.4	21.6	0		100	0	0		0	100	0		
Total %	19.4	5.4	0	24.7	31.6	0	0	31.6	0	43.7	0	43.7	
Passenger Vehicles	419	118	0	537	720	0	0	720	0	997	0	997	2254
% Passenger Vehicles	93.3	95.2	0	93.7	98.4	0	0	98.4	0	98.6	0	98.6	97.3
Large 2 Axle Vehicles	9	4	0	13	12	0	0	12	0	13	0	13	38
% Large 2 Axle Vehicles	2	3.2	0	2.3	1.6	0	0	1.6	0	1.3	0	1.3	1.6
3 Axle Vehicles	1	1	0	2	0	0	0	0	0	0	0	0	2
% 3 Axle Vehicles	0.2	0.8	0	0.3	0	0	0	0	0	0	0	0	0.1
4+ Axle Trucks	20	1	0	21	0	0	0	0	0	1	0	1	22
% 4+ Axle Trucks	4.5	0.8	0	3.7	0	0	0	0	0	0.1	0	0.1	0.9

Start Time	SR-99 Southbound Off Ramp Southbound				Olive Avenue Westbound				Olive Avenue Eastbound				Int. Total
	Left	Right	U-Turns	App. Total	Thru	Right	U-Turns	App. Total	Left	Thru	U-Turns	App. Total	
Peak Hour Analysis From 04:00 PM to 05:45 PM - Peak 1 of 1													
Peak Hour for Entire Intersection Begins at 04:30 PM													
04:30 PM	60	19	0	79	94	0	0	94	0	132	0	132	305
04:45 PM	65	18	0	83	103	0	0	103	0	115	0	115	301
05:00 PM	59	13	0	72	84	0	0	84	0	135	0	135	291
05:15 PM	43	15	0	58	120	0	0	120	0	140	0	140	318
Total Volume	227	65	0	292	401	0	0	401	0	522	0	522	1215
% App. Total	77.7	22.3	0		100	0	0		0	100	0		
PHF	.873	.855	.000	.880	.835	.000	.000	.835	.000	.932	.000	.932	.955

City of Madera
 N/S: SR-99 Southbound Off Ramp
 E/W: Olive Avenue
 Weather: Clear

File Name : 35_MDA_99S Off_Olive PM
 Site Code : 00319628
 Start Date : 9/24/2019
 Page No : 2

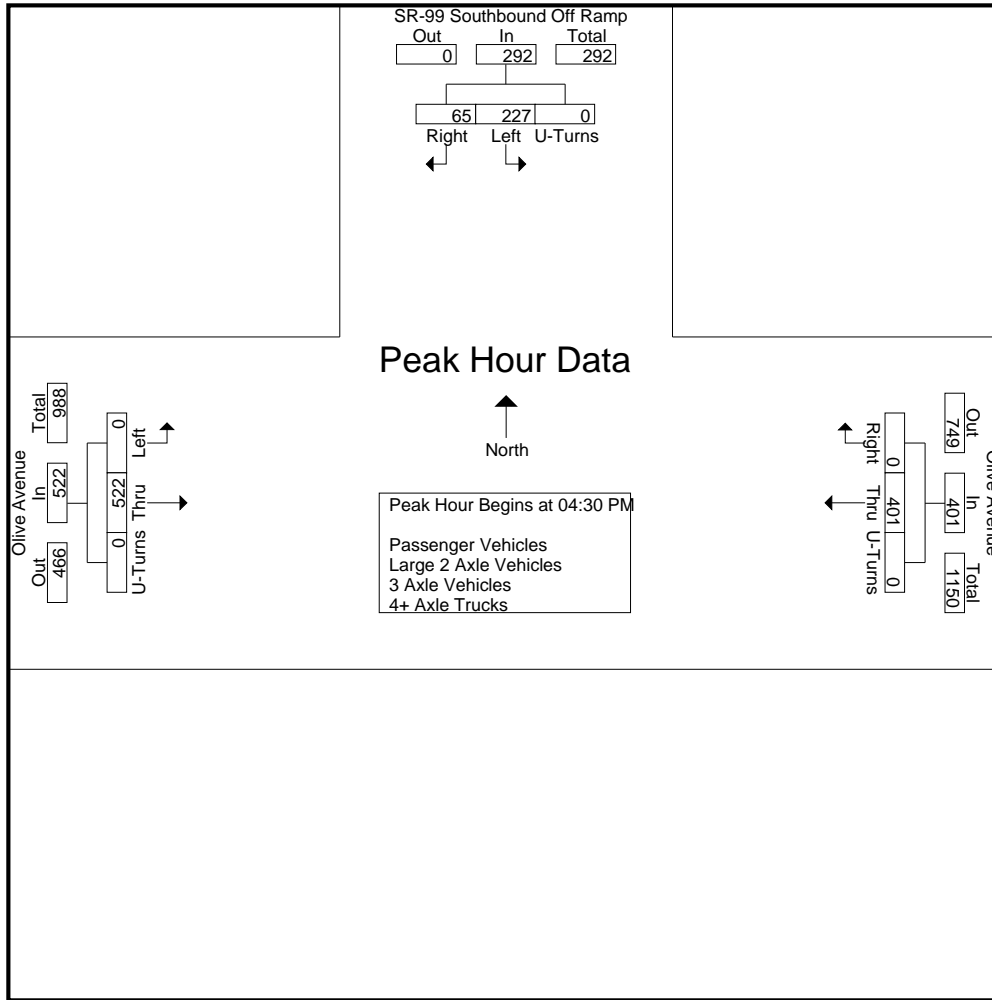

Peak Hour Analysis From 04:00 PM to 05:45 PM - Peak 1 of 1
 Peak Hour for Each Approach Begins at:

	04:00 PM				04:30 PM				04:30 PM			
+0 mins.	64	21	0	85	94	0	0	94	0	132	0	132
+15 mins.	53	13	0	66	103	0	0	103	0	115	0	115
+30 mins.	60	19	0	79	84	0	0	84	0	135	0	135
+45 mins.	65	18	0	83	120	0	0	120	0	140	0	140
Total Volume	242	71	0	313	401	0	0	401	0	522	0	522
% App. Total	77.3	22.7	0		100	0	0		0	100	0	
PHF	.931	.845	.000	.921	.835	.000	.000	.835	.000	.932	.000	.932

City of Madera
 N/S: SR-99 Southbound Off Ramp
 E/W: Olive Avenue
 Weather: Clear

File Name : 35_MDA_99S Off_Olive PM
 Site Code : 00319628
 Start Date : 9/24/2019
 Page No : 1

Groups Printed- Passenger Vehicles

Start Time	SR-99 Southbound Off Ramp Southbound				Olive Avenue Westbound				Olive Avenue Eastbound				Int. Total
	Left	Right	U-Turns	App. Total	Thru	Right	U-Turns	App. Total	Left	Thru	U-Turns	App. Total	
04:00 PM	57	20	0	77	87	0	0	87	0	135	0	135	299
04:15 PM	49	11	0	60	53	0	0	53	0	124	0	124	237
04:30 PM	57	19	0	76	91	0	0	91	0	130	0	130	297
04:45 PM	62	17	0	79	102	0	0	102	0	114	0	114	295
Total	225	67	0	292	333	0	0	333	0	503	0	503	1128
05:00 PM	55	12	0	67	84	0	0	84	0	133	0	133	284
05:15 PM	42	15	0	57	120	0	0	120	0	137	0	137	314
05:30 PM	51	11	0	62	93	0	0	93	0	104	0	104	259
05:45 PM	46	13	0	59	90	0	0	90	0	120	0	120	269
Total	194	51	0	245	387	0	0	387	0	494	0	494	1126
Grand Total	419	118	0	537	720	0	0	720	0	997	0	997	2254
Apprch %	78	22	0		100	0	0		0	100	0		
Total %	18.6	5.2	0	23.8	31.9	0	0	31.9	0	44.2	0	44.2	

Start Time	SR-99 Southbound Off Ramp Southbound				Olive Avenue Westbound				Olive Avenue Eastbound				Int. Total
	Left	Right	U-Turns	App. Total	Thru	Right	U-Turns	App. Total	Left	Thru	U-Turns	App. Total	
Peak Hour Analysis From 04:30 PM to 05:15 PM - Peak 1 of 1													
Peak Hour for Entire Intersection Begins at 04:30 PM													
04:30 PM	57	19	0	76	91	0	0	91	0	130	0	130	297
04:45 PM	62	17	0	79	102	0	0	102	0	114	0	114	295
05:00 PM	55	12	0	67	84	0	0	84	0	133	0	133	284
05:15 PM	42	15	0	57	120	0	0	120	0	137	0	137	314
Total Volume	216	63	0	279	397	0	0	397	0	514	0	514	1190
% App. Total	77.4	22.6	0		100	0	0		0	100	0		
PHF	.871	.829	.000	.883	.827	.000	.000	.827	.000	.938	.000	.938	.947

City of Madera
 N/S: SR-99 Southbound Off Ramp
 E/W: Olive Avenue
 Weather: Clear

File Name : 35_MDA_99S Off_Olive PM
 Site Code : 00319628
 Start Date : 9/24/2019
 Page No : 2

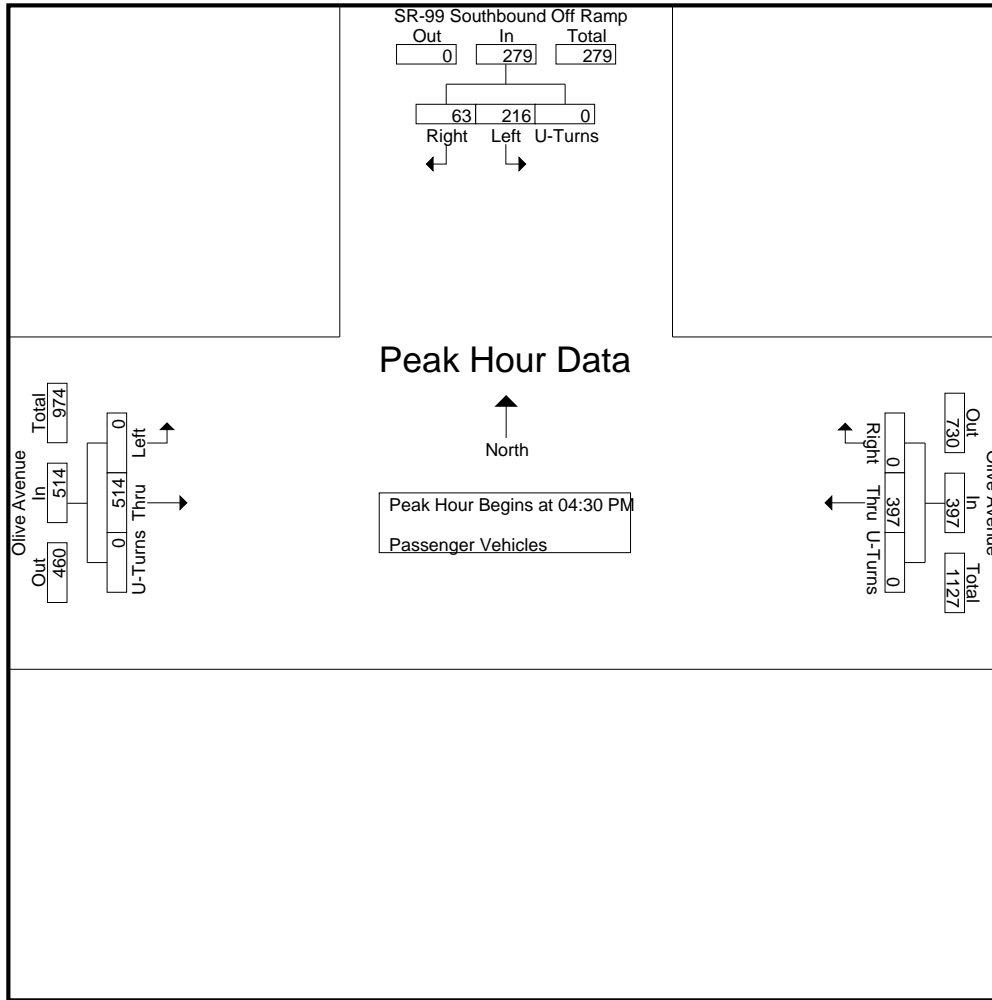

Peak Hour Analysis From 04:30 PM to 05:15 PM - Peak 1 of 1
 Peak Hour for Each Approach Begins at:

	04:30 PM				04:30 PM				04:30 PM			
+0 mins.	57	19	0	76	91	0	0	91	0	130	0	130
+15 mins.	62	17	0	79	102	0	0	102	0	114	0	114
+30 mins.	55	12	0	67	84	0	0	84	0	133	0	133
+45 mins.	42	15	0	57	120	0	0	120	0	137	0	137
Total Volume	216	63	0	279	397	0	0	397	0	514	0	514
% App. Total	77.4	22.6	0		100	0	0		0	100	0	
PHF	.871	.829	.000	.883	.827	.000	.000	.827	.000	.938	.000	.938

City of Madera
 N/S: SR-99 Southbound Off Ramp
 E/W: Olive Avenue
 Weather: Clear

File Name : 35_MDA_99S Off_Olive PM
 Site Code : 00319628
 Start Date : 9/24/2019
 Page No : 1

Groups Printed- Large 2 Axle Vehicles

Start Time	SR-99 Southbound Off Ramp Southbound				Olive Avenue Westbound				Olive Avenue Eastbound				Int. Total
	Left	Right	U-Turns	App. Total	Thru	Right	U-Turns	App. Total	Left	Thru	U-Turns	App. Total	
04:00 PM	3	1	0	4	2	0	0	2	0	4	0	4	10
04:15 PM	0	2	0	2	2	0	0	2	0	1	0	1	5
04:30 PM	0	0	0	0	3	0	0	3	0	2	0	2	5
04:45 PM	1	0	0	1	1	0	0	1	0	1	0	1	3
Total	4	3	0	7	8	0	0	8	0	8	0	8	23
05:00 PM	3	1	0	4	0	0	0	0	0	1	0	1	5
05:15 PM	1	0	0	1	0	0	0	0	0	3	0	3	4
05:30 PM	1	0	0	1	1	0	0	1	0	0	0	0	2
05:45 PM	0	0	0	0	3	0	0	3	0	1	0	1	4
Total	5	1	0	6	4	0	0	4	0	5	0	5	15
Grand Total	9	4	0	13	12	0	0	12	0	13	0	13	38
Apprch %	69.2	30.8	0		100	0	0		0	100	0		
Total %	23.7	10.5	0	34.2	31.6	0	0	31.6	0	34.2	0	34.2	

Start Time	SR-99 Southbound Off Ramp Southbound				Olive Avenue Westbound				Olive Avenue Eastbound				Int. Total
	Left	Right	U-Turns	App. Total	Thru	Right	U-Turns	App. Total	Left	Thru	U-Turns	App. Total	
04:30 PM	0	0	0	0	3	0	0	3	0	2	0	2	5
04:45 PM	1	0	0	1	1	0	0	1	0	1	0	1	3
05:00 PM	3	1	0	4	0	0	0	0	0	1	0	1	5
05:15 PM	1	0	0	1	0	0	0	0	0	3	0	3	4
Total Volume	5	1	0	6	4	0	0	4	0	7	0	7	17
% App. Total	83.3	16.7	0		100	0	0		0	100	0		
PHF	.417	.250	.000	.375	.333	.000	.000	.333	.000	.583	.000	.583	.850

Peak Hour Analysis From 04:30 PM to 05:15 PM - Peak 1 of 1

Peak Hour for Entire Intersection Begins at 04:30 PM

City of Madera
 N/S: SR-99 Southbound Off Ramp
 E/W: Olive Avenue
 Weather: Clear

File Name : 35_MDA_99S Off_Olive PM
 Site Code : 00319628
 Start Date : 9/24/2019
 Page No : 2

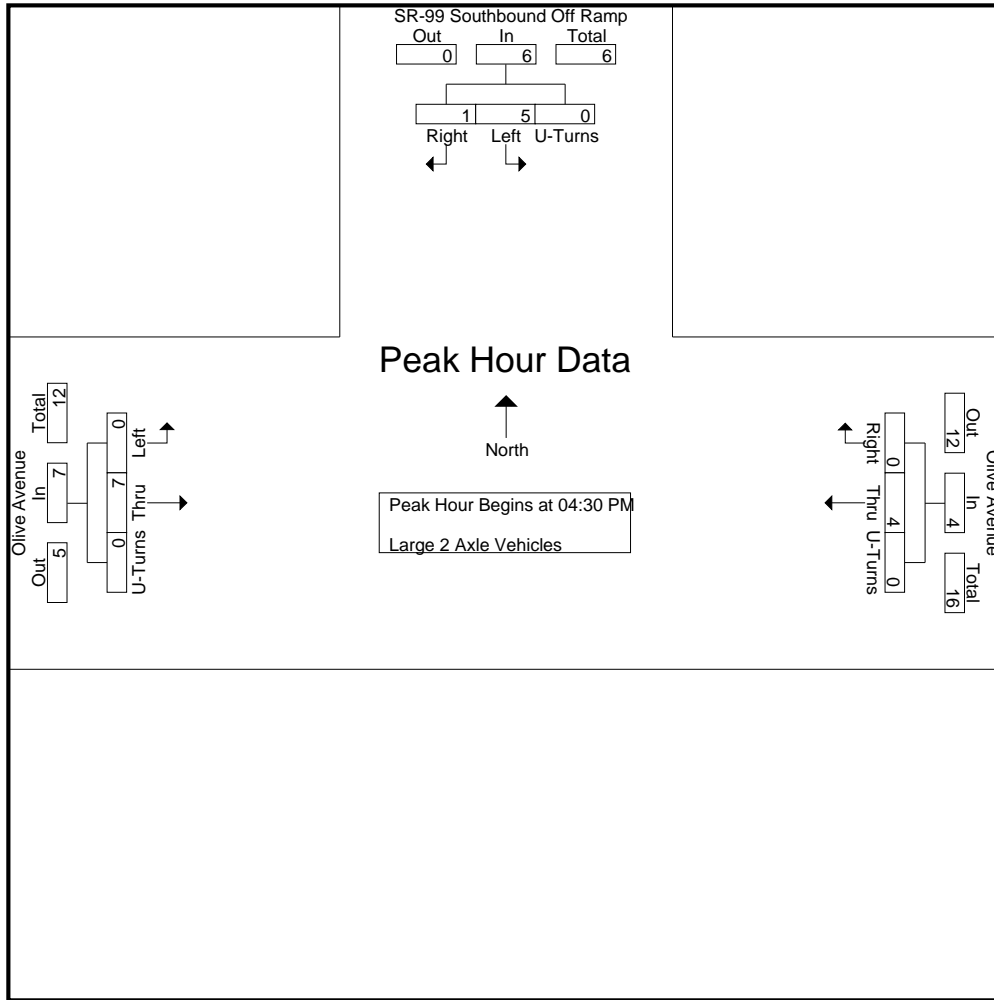

Peak Hour Analysis From 04:30 PM to 05:15 PM - Peak 1 of 1
 Peak Hour for Each Approach Begins at:

	04:30 PM				04:30 PM				04:30 PM			
+0 mins.	0	0	0	0	3	0	0	3	0	2	0	2
+15 mins.	1	0	0	1	1	0	0	1	0	1	0	1
+30 mins.	3	1	0	4	0	0	0	0	0	1	0	1
+45 mins.	1	0	0	1	0	0	0	0	0	3	0	3
Total Volume	5	1	0	6	4	0	0	4	0	7	0	7
% App. Total	83.3	16.7	0		100	0	0		0	100	0	
PHF	.417	.250	.000	.375	.333	.000	.000	.333	.000	.583	.000	.583

City of Madera
 N/S: SR-99 Southbound Off Ramp
 E/W: Olive Avenue
 Weather: Clear

File Name : 35_MDA_99S Off_Olive PM
 Site Code : 00319628
 Start Date : 9/24/2019
 Page No : 1

Groups Printed- 3 Axle Vehicles

Start Time	SR-99 Southbound Off Ramp Southbound				Olive Avenue Westbound				Olive Avenue Eastbound				Int. Total	
	Left	Right	U-Turns	App. Total	Thru	Right	U-Turns	App. Total	Left	Thru	U-Turns	App. Total		
04:00 PM	0	0	0	0	0	0	0	0	0	0	0	0	0	0
04:15 PM	0	0	0	0	0	0	0	0	0	0	0	0	0	0
04:30 PM	0	0	0	0	0	0	0	0	0	0	0	0	0	0
04:45 PM	1	1	0	2	0	0	0	0	0	0	0	0	0	2
Total	1	1	0	2	0	0	0	0	0	0	0	0	0	2
05:00 PM	0	0	0	0	0	0	0	0	0	0	0	0	0	0
05:15 PM	0	0	0	0	0	0	0	0	0	0	0	0	0	0
05:30 PM	0	0	0	0	0	0	0	0	0	0	0	0	0	0
05:45 PM	0	0	0	0	0	0	0	0	0	0	0	0	0	0
Total	0	0	0	0	0	0	0	0	0	0	0	0	0	0
Grand Total	1	1	0	2	0	0	0	0	0	0	0	0	0	2
Apprch %	50	50	0		0	0	0		0	0	0			
Total %	50	50	0	100	0	0	0	0	0	0	0	0		

Start Time	SR-99 Southbound Off Ramp Southbound				Olive Avenue Westbound				Olive Avenue Eastbound				Int. Total	
	Left	Right	U-Turns	App. Total	Thru	Right	U-Turns	App. Total	Left	Thru	U-Turns	App. Total		
04:30 PM	0	0	0	0	0	0	0	0	0	0	0	0	0	0
04:45 PM	1	1	0	2	0	0	0	0	0	0	0	0	0	2
05:00 PM	0	0	0	0	0	0	0	0	0	0	0	0	0	0
05:15 PM	0	0	0	0	0	0	0	0	0	0	0	0	0	0
Total Volume	1	1	0	2	0	0	0	0	0	0	0	0	0	2
% App. Total	50	50	0		0	0	0		0	0	0			
PHF	.250	.250	.000	.250	.000	.000	.000	.000	.000	.000	.000	.000	.000	.250

Peak Hour Analysis From 04:30 PM to 05:15 PM - Peak 1 of 1

Peak Hour for Entire Intersection Begins at 04:30 PM

City of Madera
 N/S: SR-99 Southbound Off Ramp
 E/W: Olive Avenue
 Weather: Clear

File Name : 35_MDA_99S Off_Olive PM
 Site Code : 00319628
 Start Date : 9/24/2019
 Page No : 2

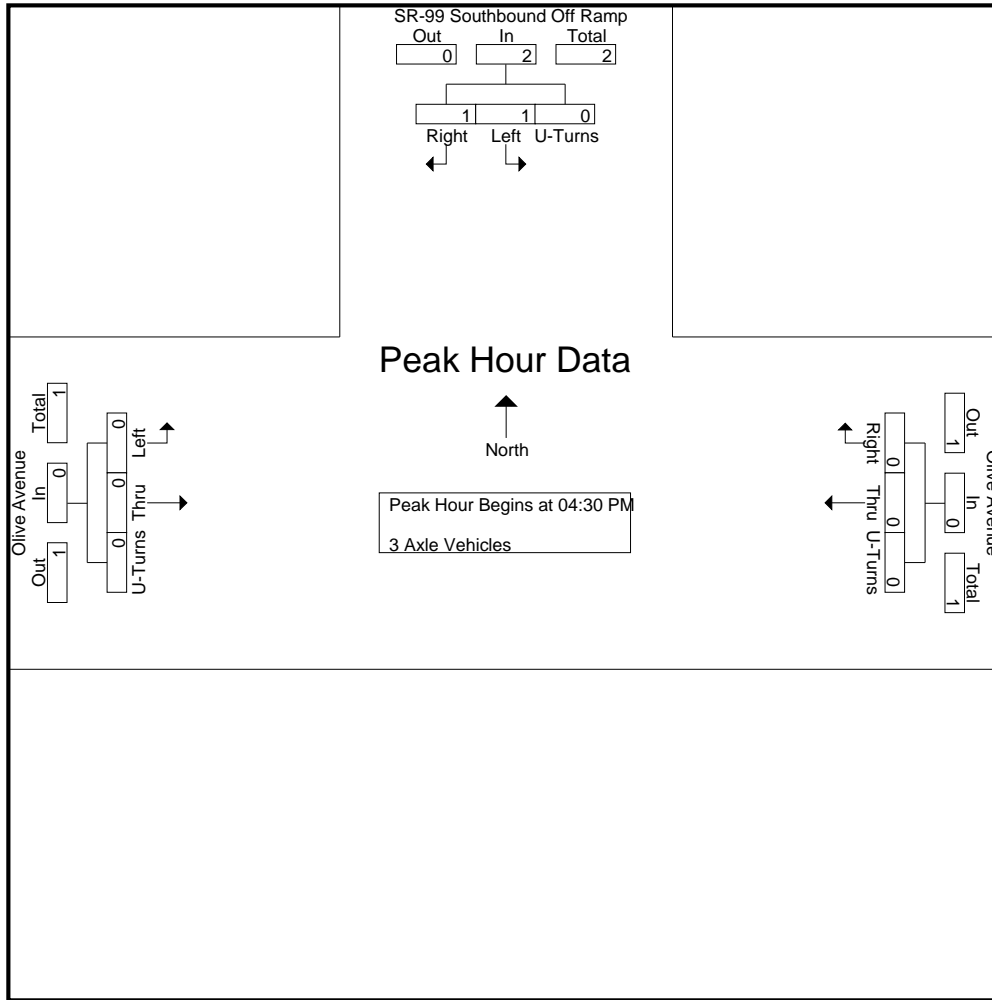

Peak Hour Analysis From 04:30 PM to 05:15 PM - Peak 1 of 1
 Peak Hour for Each Approach Begins at:

	04:30 PM				04:30 PM				04:30 PM			
+0 mins.	0	0	0	0	0	0	0	0	0	0	0	0
+15 mins.	1	1	0	2	0	0	0	0	0	0	0	0
+30 mins.	0	0	0	0	0	0	0	0	0	0	0	0
+45 mins.	0	0	0	0	0	0	0	0	0	0	0	0
Total Volume	1	1	0	2	0	0	0	0	0	0	0	0
% App. Total	50	50	0		0	0	0		0	0	0	
PHF	.250	.250	.000	.250	.000	.000	.000	.000	.000	.000	.000	.000

City of Madera
 N/S: SR-99 Southbound Off Ramp
 E/W: Olive Avenue
 Weather: Clear

File Name : 35_MDA_99S Off_Olive PM
 Site Code : 00319628
 Start Date : 9/24/2019
 Page No : 1

Groups Printed- 4+ Axle Trucks

Start Time	SR-99 Southbound Off Ramp Southbound				Olive Avenue Westbound				Olive Avenue Eastbound				Int. Total	
	Left	Right	U-Turns	App. Total	Thru	Right	U-Turns	App. Total	Left	Thru	U-Turns	App. Total		
04:00 PM	4	0	0	4	0	0	0	0	0	0	0	0	0	4
04:15 PM	4	0	0	4	0	0	0	0	0	0	0	0	0	4
04:30 PM	3	0	0	3	0	0	0	0	0	0	0	0	0	3
04:45 PM	1	0	0	1	0	0	0	0	0	0	0	0	0	1
Total	12	0	0	12	0	0	0	0	0	0	0	0	0	12
05:00 PM	1	0	0	1	0	0	0	0	0	0	1	0	1	2
05:15 PM	0	0	0	0	0	0	0	0	0	0	0	0	0	0
05:30 PM	4	1	0	5	0	0	0	0	0	0	0	0	0	5
05:45 PM	3	0	0	3	0	0	0	0	0	0	0	0	0	3
Total	8	1	0	9	0	0	0	0	0	0	1	0	1	10
Grand Total	20	1	0	21	0	0	0	0	0	0	1	0	1	22
Apprch %	95.2	4.8	0		0	0	0		0	100	0			
Total %	90.9	4.5	0	95.5	0	0	0	0	0	0	4.5	0	4.5	

Start Time	SR-99 Southbound Off Ramp Southbound				Olive Avenue Westbound				Olive Avenue Eastbound				Int. Total	
	Left	Right	U-Turns	App. Total	Thru	Right	U-Turns	App. Total	Left	Thru	U-Turns	App. Total		
Peak Hour Analysis From 04:30 PM to 05:15 PM - Peak 1 of 1														
Peak Hour for Entire Intersection Begins at 04:30 PM														
04:30 PM	3	0	0	3	0	0	0	0	0	0	0	0	0	3
04:45 PM	1	0	0	1	0	0	0	0	0	0	0	0	0	1
05:00 PM	1	0	0	1	0	0	0	0	0	0	1	0	1	2
05:15 PM	0	0	0	0	0	0	0	0	0	0	0	0	0	0
Total Volume	5	0	0	5	0	0	0	0	0	0	1	0	1	6
% App. Total	100	0	0		0	0	0		0	100	0			
PHF	.417	.000	.000	.417	.000	.000	.000	.000	.000	.000	.250	.000	.250	.500

City of Madera
 N/S: SR-99 Southbound Off Ramp
 E/W: Olive Avenue
 Weather: Clear

File Name : 35_MDA_99S Off_Olive PM
 Site Code : 00319628
 Start Date : 9/24/2019
 Page No : 2

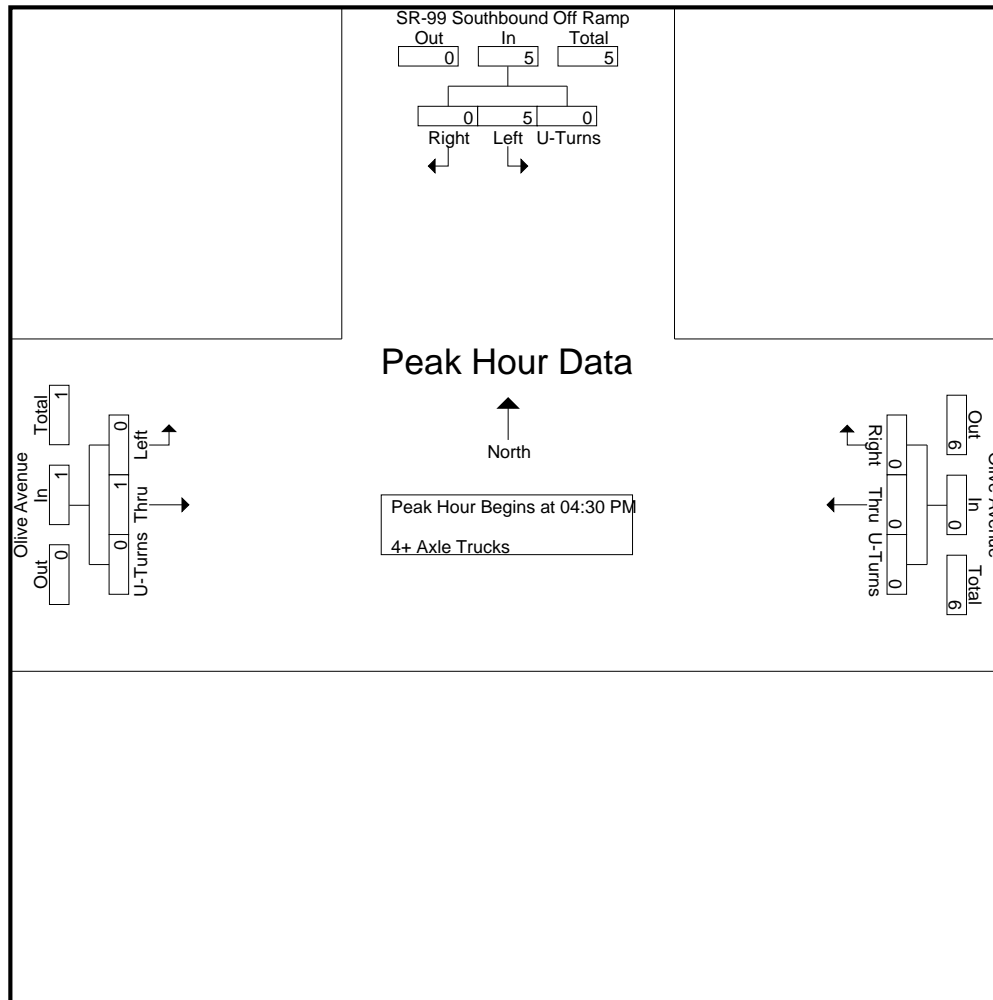

Peak Hour Analysis From 04:30 PM to 05:15 PM - Peak 1 of 1
 Peak Hour for Each Approach Begins at:

	04:30 PM				04:30 PM				04:30 PM			
+0 mins.	3	0	0	3	0	0	0	0	0	0	0	0
+15 mins.	1	0	0	1	0	0	0	0	0	0	0	0
+30 mins.	1	0	0	1	0	0	0	0	0	1	0	1
+45 mins.	0	0	0	0	0	0	0	0	0	0	0	0
Total Volume	5	0	0	5	0	0	0	0	0	1	0	1
% App. Total	100	0	0		0	0	0		0	100	0	
PHF	.417	.000	.000	.417	.000	.000	.000	.000	.000	.250	.000	.250

Location: Madera
 N/S: SR-99 SB Off Ramp
 E/W: Olive Avenue



Date: 9/24/2019
 Day: Tuesday

PEDESTRIANS

	North Leg SR-99 SB Off Ramp	East Leg Olive Avenue	South Leg SR-99 SB Off Ramp	West Leg Olive Avenue	
	Pedestrians	Pedestrians	Pedestrians	Pedestrians	
7:00 AM	1	0	0	0	1
7:15 AM	3	0	0	0	3
7:30 AM	2	0	0	0	2
7:45 AM	11	0	0	0	11
8:00 AM	5	0	0	0	5
8:15 AM	5	0	0	0	5
8:30 AM	4	0	0	0	4
8:45 AM	0	0	0	0	0
TOTAL VOLUMES:	31	0	0	0	31

	North Leg SR-99 SB Off Ramp	East Leg Olive Avenue	South Leg SR-99 SB Off Ramp	West Leg Olive Avenue	
	Pedestrians	Pedestrians	Pedestrians	Pedestrians	
4:00 PM	4	0	0	0	4
4:15 PM	2	0	0	0	2
4:30 PM	1	0	0	0	1
4:45 PM	1	0	0	0	1
5:00 PM	0	0	0	0	0
5:15 PM	1	0	0	0	1
5:30 PM	3	0	0	0	3
5:45 PM	5	0	0	0	5
TOTAL VOLUMES:	17	0	0	0	17

Location: Madera
 N/S: SR-99 SB Off Ramp
 E/W: Olive Avenue



Date: 9/24/2019
 Day: Tuesday

BICYCLES

	Southbound SR-99 SB Off Ramp			Westbound Olive Avenue			Northbound SR-99 SB Off Ramp			Eastbound Olive Avenue			
	Left	Thru	Right	Left	Thru	Right	Left	Thru	Right	Left	Thru	Right	
7:00 AM	0	0	0	0	0	0	0	0	0	0	0	0	0
7:15 AM	0	0	0	0	0	0	0	0	0	0	0	0	0
7:30 AM	0	0	0	0	0	0	0	0	0	0	0	0	0
7:45 AM	0	0	0	0	1	0	0	0	0	0	0	0	1
8:00 AM	0	0	0	0	0	0	0	0	0	0	0	0	0
8:15 AM	0	0	0	0	0	0	0	0	0	0	0	0	0
8:30 AM	0	0	0	0	0	0	0	0	0	0	0	0	0
8:45 AM	0	0	0	0	0	0	0	0	0	0	0	0	0
TOTAL VOLUMES:	0	0	0	0	1	0	0	0	0	0	0	0	1

	Southbound SR-99 SB Off Ramp			Westbound Olive Avenue			Northbound SR-99 SB Off Ramp			Eastbound Olive Avenue			
	Left	Thru	Right	Left	Thru	Right	Left	Thru	Right	Left	Thru	Right	
4:00 PM	0	0	0	0	0	0	0	0	0	0	0	0	0
4:15 PM	0	0	0	0	0	0	0	0	0	0	0	0	0
4:30 PM	0	0	0	0	0	0	0	0	0	0	0	0	0
4:45 PM	0	0	0	0	0	0	0	0	0	0	0	0	0
5:00 PM	0	0	0	0	0	0	0	0	0	0	1	0	1
5:15 PM	0	0	0	0	0	0	0	0	0	0	0	0	0
5:30 PM	0	0	0	0	0	0	0	0	0	0	0	0	0
5:45 PM	0	0	0	0	0	0	0	0	0	0	0	0	0
TOTAL VOLUMES:	0	0	0	0	0	0	0	0	0	0	1	0	1

City of Madera
 N/S: Madera Avenue
 E/W: SR-99 Northbound Ramps
 Weather: Clear

File Name : 36_MDA_Madera_99N AM
 Site Code : 00319628
 Start Date : 9/24/2019
 Page No : 1

Groups Printed- Passenger Vehicles - Large 2 Axle Vehicles - 3 Axle Vehicles - 4+ Axle Trucks

Start Time	Madera Avenue Southbound					SR-99 Northbound Off Ramp Westbound					Madera Avenue Northbound					SR-99 Northbound On Ramp Eastbound					Int. Total
	Left	Thru	Right	U-Turns	App. Total	Left	Thru	Right	U-Turns	App. Total	Left	Thru	Right	U-Turns	App. Total	Left	Thru	Right	U-Turns	App. Total	
07:00 AM	0	65	40	0	105	39	0	9	0	48	59	44	0	0	103	0	0	0	0	0	256
07:15 AM	0	85	32	0	117	37	0	11	0	48	98	68	0	0	166	0	0	0	0	0	331
07:30 AM	0	116	48	0	164	47	1	20	0	68	90	82	0	0	172	0	0	0	0	0	404
07:45 AM	0	124	39	0	163	37	0	30	0	67	102	115	0	0	217	0	0	0	0	0	447
Total	0	390	159	0	549	160	1	70	0	231	349	309	0	0	658	0	0	0	0	0	1438
08:00 AM	0	136	32	0	168	34	0	12	0	46	88	91	0	0	179	0	0	0	0	0	393
08:15 AM	0	175	29	0	204	21	0	13	0	34	64	96	0	0	160	0	0	0	0	0	398
08:30 AM	0	142	23	0	165	22	1	18	0	41	63	121	0	0	184	0	0	0	0	0	390
08:45 AM	0	97	32	0	129	33	0	15	0	48	62	110	0	0	172	0	0	0	0	0	349
Total	0	550	116	0	666	110	1	58	0	169	277	418	0	0	695	0	0	0	0	0	1530
Grand Total	0	940	275	0	1215	270	2	128	0	400	626	727	0	0	1353	0	0	0	0	0	2968
Apprch %	0	77.4	22.6	0		67.5	0.5	32	0		46.3	53.7	0	0		0	0	0	0		
Total %	0	31.7	9.3	0	40.9	9.1	0.1	4.3	0	13.5	21.1	24.5	0	0	45.6	0	0	0	0	0	
Passenger Vehicles	0	95.6	93.1	0	95.1	95.9	50	96.1	0	95.8	89	97.1	0	0	93.3	0	0	0	0	0	94.4
Large 2 Axle Vehicles	0	4	3.3	0	3.9	2.2	50	3.1	0	2.8	3.8	2.6	0	0	3.2	0	0	0	0	0	3.4
3 Axle Vehicles	0	0	2	0	2	1	0	0	0	1	2	1	0	0	3	0	0	0	0	0	6
% 3 Axle Vehicles	0	0	0.7	0	0.2	0.4	0	0	0	0.2	0.3	0.1	0	0	0.2	0	0	0	0	0	0.2
4+ Axle Trucks	0	3	8	0	11	4	0	1	0	5	43	1	0	0	44	0	0	0	0	0	60
% 4+ Axle Trucks																					

Start Time	Madera Avenue Southbound					SR-99 Northbound Off Ramp Westbound					Madera Avenue Northbound					SR-99 Northbound On Ramp Eastbound					Int. Total
	Left	Thru	Right	U-Turns	App. Total	Left	Thru	Right	U-Turns	App. Total	Left	Thru	Right	U-Turns	App. Total	Left	Thru	Right	U-Turns	App. Total	
Peak Hour Analysis From 07:00 AM to 08:45 AM - Peak 1 of 1																					
Peak Hour for Entire Intersection Begins at 07:30 AM																					
07:30 AM	0	116	48	0	164	47	1	20	0	68	90	82	0	0	172	0	0	0	0	0	404
07:45 AM	0	124	39	0	163	37	0	30	0	67	102	115	0	0	217	0	0	0	0	0	447
08:00 AM	0	136	32	0	168	34	0	12	0	46	88	91	0	0	179	0	0	0	0	0	393
08:15 AM	0	175	29	0	204	21	0	13	0	34	64	96	0	0	160	0	0	0	0	0	398
Total Volume	0	551	148	0	699	139	1	75	0	215	344	384	0	0	728	0	0	0	0	0	1642
% App. Total	0	78.8	21.2	0		64.7	0.5	34.9	0		47.3	52.7	0	0		0	0	0	0		
PHF	.000	.787	.771	.000	.857	.739	.250	.625	.000	.790	.843	.835	.000	.000	.839	.000	.000	.000	.000	.000	.918

City of Madera
 N/S: Madera Avenue
 E/W: SR-99 Northbound Ramps
 Weather: Clear

File Name : 36_MDA_Madera_99N AM
 Site Code : 00319628
 Start Date : 9/24/2019
 Page No : 2

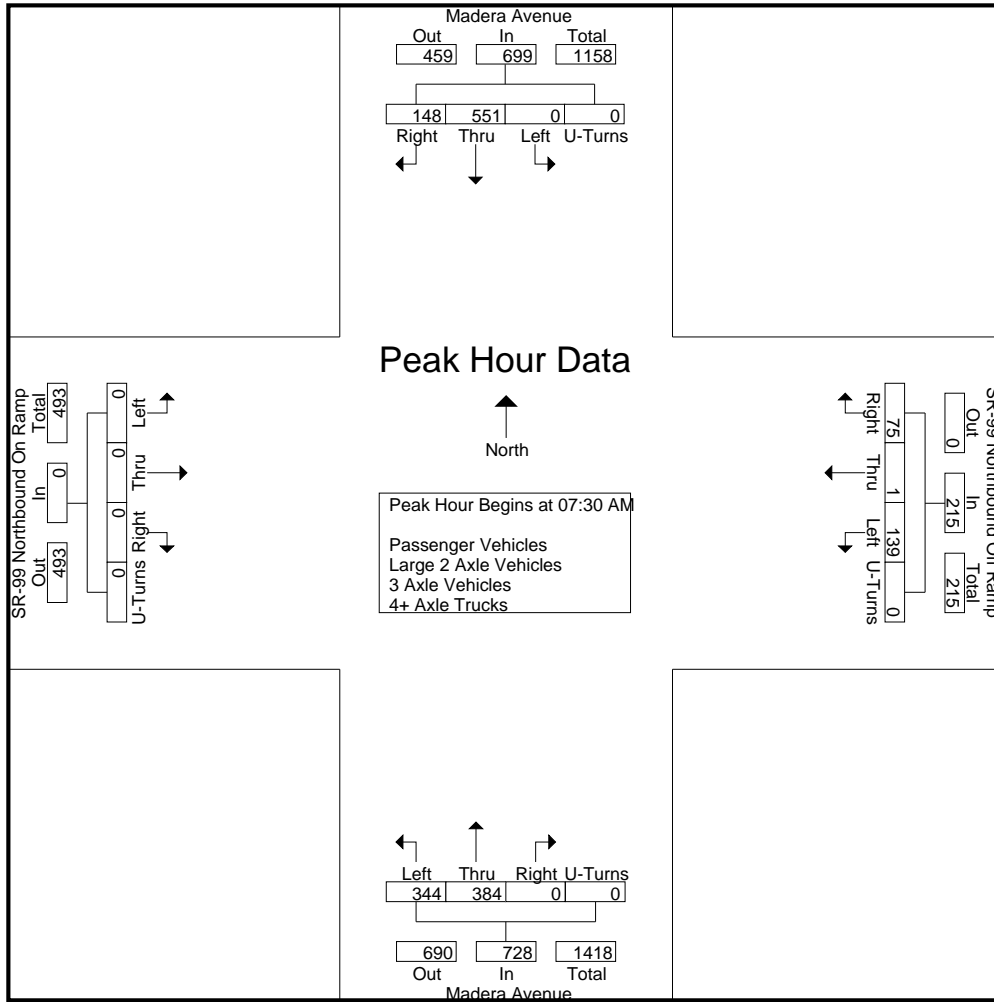

Peak Hour Analysis From 07:00 AM to 08:45 AM - Peak 1 of 1
 Peak Hour for Each Approach Begins at:

	07:45 AM				07:00 AM				07:45 AM				07:00 AM							
+0 mins.	0	124	39	0	163	39	0	9	0	48	102	115	0	0	217	0	0	0	0	0
+15 mins.	0	136	32	0	168	37	0	11	0	48	88	91	0	0	179	0	0	0	0	0
+30 mins.	0	175	29	0	204	47	1	20	0	68	64	96	0	0	160	0	0	0	0	0
+45 mins.	0	142	23	0	165	37	0	30	0	67	63	121	0	0	184	0	0	0	0	0
Total Volume	0	577	123	0	700	160	1	70	0	231	317	423	0	0	740	0	0	0	0	0
% App. Total	0	82.4	17.6	0		69.3	0.4	30.3	0		42.8	57.2	0	0		0	0	0	0	
PHF	.000	.824	.788	.000	.858	.851	.250	.583	.000	.849	.777	.874	.000	.000	.853	.000	.000	.000	.000	.000

City of Madera
 N/S: Madera Avenue
 E/W: SR-99 Northbound Ramps
 Weather: Clear

File Name : 36_MDA_Madera_99N AM
 Site Code : 00319628
 Start Date : 9/24/2019
 Page No : 1

Groups Printed- Passenger Vehicles

Start Time	Madera Avenue Southbound					SR-99 Northbound Off Ramp Westbound					Madera Avenue Northbound					SR-99 Northbound On Ramp Eastbound					Int. Total
	Left	Thru	Right	U-Turns	App. Total	Left	Thru	Right	U-Turns	App. Total	Left	Thru	Right	U-Turns	App. Total	Left	Thru	Right	U-Turns	App. Total	
07:00 AM	0	60	38	0	98	38	0	9	0	47	51	41	0	0	92	0	0	0	0	0	237
07:15 AM	0	80	29	0	109	36	0	11	0	47	95	66	0	0	161	0	0	0	0	0	317
07:30 AM	0	109	44	0	153	45	1	19	0	65	77	81	0	0	158	0	0	0	0	0	376
07:45 AM	0	117	39	0	156	36	0	28	0	64	92	114	0	0	206	0	0	0	0	0	426
Total	0	366	150	0	516	155	1	67	0	223	315	302	0	0	617	0	0	0	0	0	1356
08:00 AM	0	132	30	0	162	32	0	12	0	44	80	89	0	0	169	0	0	0	0	0	375
08:15 AM	0	171	27	0	198	19	0	13	0	32	54	93	0	0	147	0	0	0	0	0	377
08:30 AM	0	135	20	0	155	22	0	16	0	38	54	116	0	0	170	0	0	0	0	0	363
08:45 AM	0	95	29	0	124	31	0	15	0	46	54	106	0	0	160	0	0	0	0	0	330
Total	0	533	106	0	639	104	0	56	0	160	242	404	0	0	646	0	0	0	0	0	1445
Grand Total	0	899	256	0	1155	259	1	123	0	383	557	706	0	0	1263	0	0	0	0	0	2801
Apprch %	0	77.8	22.2	0		67.6	0.3	32.1	0		44.1	55.9	0	0		0	0	0	0		
Total %	0	32.1	9.1	0	41.2	9.2	0	4.4	0	13.7	19.9	25.2	0	0	45.1	0	0	0	0	0	

Start Time	Madera Avenue Southbound					SR-99 Northbound Off Ramp Westbound					Madera Avenue Northbound					SR-99 Northbound On Ramp Eastbound					Int. Total
	Left	Thru	Right	U-Turns	App. Total	Left	Thru	Right	U-Turns	App. Total	Left	Thru	Right	U-Turns	App. Total	Left	Thru	Right	U-Turns	App. Total	
07:30 AM	0	109	44	0	153	45	1	19	0	65	77	81	0	0	158	0	0	0	0	0	376
07:45 AM	0	117	39	0	156	36	0	28	0	64	92	114	0	0	206	0	0	0	0	0	426
08:00 AM	0	132	30	0	162	32	0	12	0	44	80	89	0	0	169	0	0	0	0	0	375
08:15 AM	0	171	27	0	198	19	0	13	0	32	54	93	0	0	147	0	0	0	0	0	377
Total Volume	0	529	140	0	669	132	1	72	0	205	303	377	0	0	680	0	0	0	0	0	1554
% App. Total	0	79.1	20.9	0		64.4	0.5	35.1	0		44.6	55.4	0	0		0	0	0	0		
PHF	.000	.773	.795	.000	.845	.733	.250	.643	.000	.788	.823	.827	.000	.000	.825	.000	.000	.000	.000	.000	.912

Peak Hour Analysis From 07:30 AM to 08:15 AM - Peak 1 of 1

Peak Hour for Entire Intersection Begins at 07:30 AM

City of Madera
 N/S: Madera Avenue
 E/W: SR-99 Northbound Ramps
 Weather: Clear

File Name : 36_MDA_Madera_99N AM
 Site Code : 00319628
 Start Date : 9/24/2019
 Page No : 2

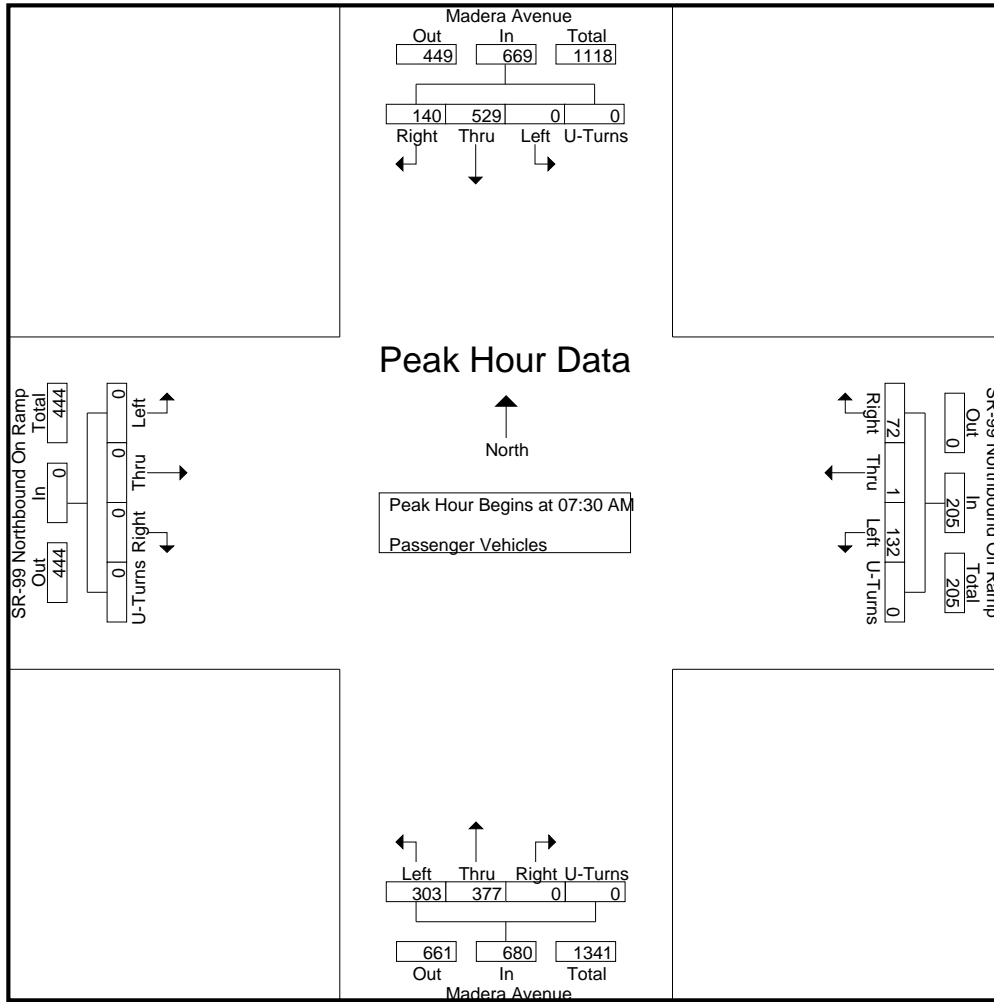

Peak Hour Analysis From 07:30 AM to 08:15 AM - Peak 1 of 1
 Peak Hour for Each Approach Begins at:

	07:30 AM					07:30 AM					07:30 AM									
+0 mins.	0	109	44	0	153	45	1	19	0	65	77	81	0	0	158	0	0	0	0	0
+15 mins.	0	117	39	0	156	36	0	28	0	64	92	114	0	0	206	0	0	0	0	0
+30 mins.	0	132	30	0	162	32	0	12	0	44	80	89	0	0	169	0	0	0	0	0
+45 mins.	0	171	27	0	198	19	0	13	0	32	54	93	0	0	147	0	0	0	0	0
Total Volume	0	529	140	0	669	132	1	72	0	205	303	377	0	0	680	0	0	0	0	0
% App. Total	0	79.1	20.9	0		64.4	0.5	35.1	0		44.6	55.4	0	0		0	0	0	0	0
PHF	.000	.773	.795	.000	.845	.733	.250	.643	.000	.788	.823	.827	.000	.000	.825	.000	.000	.000	.000	.000

City of Madera
 N/S: Madera Avenue
 E/W: SR-99 Northbound Ramps
 Weather: Clear

File Name : 36_MDA_Madera_99N AM
 Site Code : 00319628
 Start Date : 9/24/2019
 Page No : 1

Groups Printed- Large 2 Axle Vehicles

Start Time	Madera Avenue Southbound					SR-99 Northbound Off Ramp Westbound					Madera Avenue Northbound					SR-99 Northbound On Ramp Eastbound					Int. Total
	Left	Thru	Right	U-Turns	App. Total	Left	Thru	Right	U-Turns	App. Total	Left	Thru	Right	U-Turns	App. Total	Left	Thru	Right	U-Turns	App. Total	
07:00 AM	0	4	0	0	4	0	0	0	0	0	3	2	0	0	5	0	0	0	0	0	9
07:15 AM	0	5	2	0	7	1	0	0	0	1	2	2	0	0	4	0	0	0	0	0	12
07:30 AM	0	7	1	0	8	1	0	1	0	2	2	1	0	0	3	0	0	0	0	0	13
07:45 AM	0	6	0	0	6	1	0	2	0	3	5	1	0	0	6	0	0	0	0	0	15
Total	0	22	3	0	25	3	0	3	0	6	12	6	0	0	18	0	0	0	0	0	49
08:00 AM	0	4	1	0	5	2	0	0	0	2	1	2	0	0	3	0	0	0	0	0	10
08:15 AM	0	4	1	0	5	0	0	0	0	0	4	2	0	0	6	0	0	0	0	0	11
08:30 AM	0	6	3	0	9	0	1	1	0	2	3	5	0	0	8	0	0	0	0	0	19
08:45 AM	0	2	1	0	3	1	0	0	0	1	4	4	0	0	8	0	0	0	0	0	12
Total	0	16	6	0	22	3	1	1	0	5	12	13	0	0	25	0	0	0	0	0	52
Grand Total	0	38	9	0	47	6	1	4	0	11	24	19	0	0	43	0	0	0	0	0	101
Apprch %	0	80.9	19.1	0		54.5	9.1	36.4	0		55.8	44.2	0	0		0	0	0	0		
Total %	0	37.6	8.9	0	46.5	5.9	1	4	0	10.9	23.8	18.8	0	0	42.6	0	0	0	0	0	

Start Time	Madera Avenue Southbound					SR-99 Northbound Off Ramp Westbound					Madera Avenue Northbound					SR-99 Northbound On Ramp Eastbound					Int. Total
	Left	Thru	Right	U-Turns	App. Total	Left	Thru	Right	U-Turns	App. Total	Left	Thru	Right	U-Turns	App. Total	Left	Thru	Right	U-Turns	App. Total	
Peak Hour Analysis From 07:30 AM to 08:15 AM - Peak 1 of 1																					
Peak Hour for Entire Intersection Begins at 07:30 AM																					
07:30 AM	0	7	1	0	8	1	0	1	0	2	2	1	0	0	3	0	0	0	0	0	13
07:45 AM	0	6	0	0	6	1	0	2	0	3	5	1	0	0	6	0	0	0	0	0	15
08:00 AM	0	4	1	0	5	2	0	0	0	2	1	2	0	0	3	0	0	0	0	0	10
08:15 AM	0	4	1	0	5	0	0	0	0	0	4	2	0	0	6	0	0	0	0	0	11
Total Volume	0	21	3	0	24	4	0	3	0	7	12	6	0	0	18	0	0	0	0	0	49
% App. Total	0	87.5	12.5	0		57.1	0	42.9	0		66.7	33.3	0	0		0	0	0	0		
PHF	.000	.750	.750	.000	.750	.500	.000	.375	.000	.583	.600	.750	.000	.000	.750	.000	.000	.000	.000	.000	.817

City of Madera
 N/S: Madera Avenue
 E/W: SR-99 Northbound Ramps
 Weather: Clear

File Name : 36_MDA_Madera_99N AM
 Site Code : 00319628
 Start Date : 9/24/2019
 Page No : 2

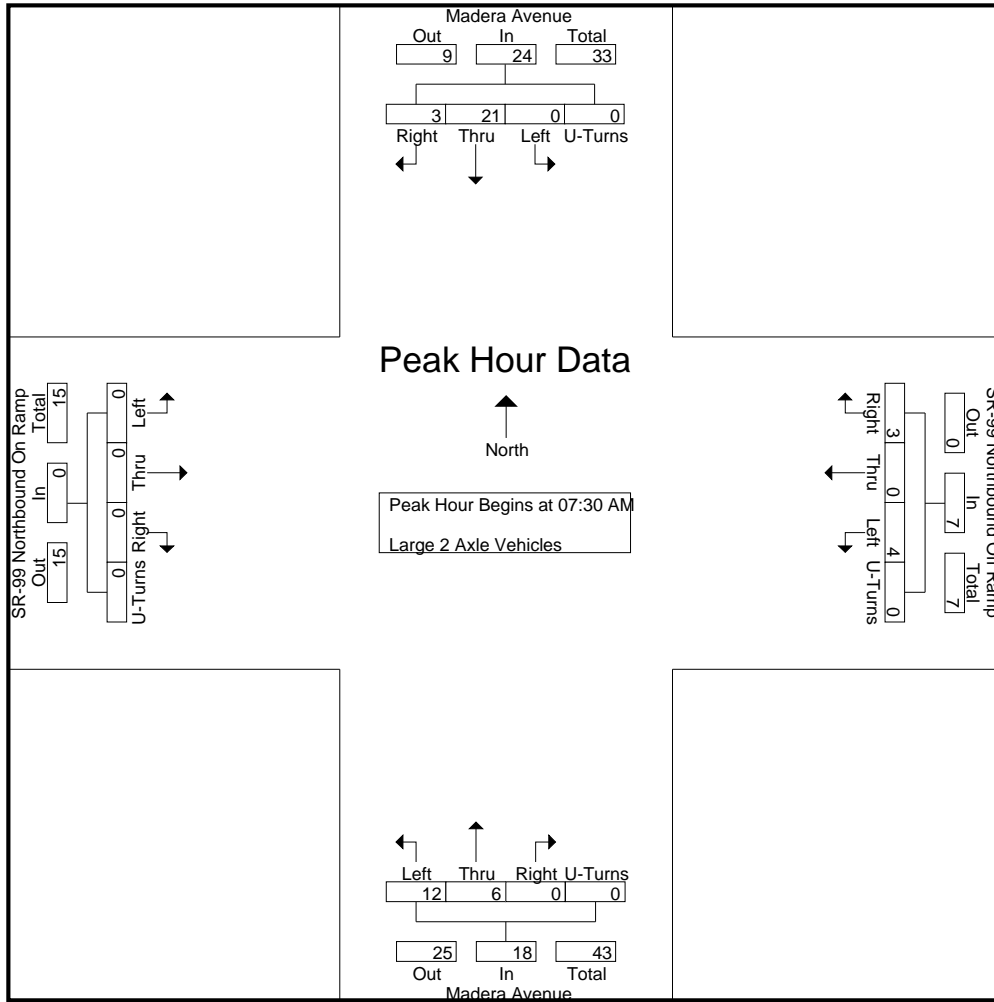

Peak Hour Analysis From 07:30 AM to 08:15 AM - Peak 1 of 1
 Peak Hour for Each Approach Begins at:

	07:30 AM					07:30 AM					07:30 AM									
+0 mins.	0	7	1	0	8	1	0	1	0	2	2	1	0	0	3	0	0	0	0	0
+15 mins.	0	6	0	0	6	1	0	2	0	3	5	1	0	0	6	0	0	0	0	0
+30 mins.	0	4	1	0	5	2	0	0	0	2	1	2	0	0	3	0	0	0	0	0
+45 mins.	0	4	1	0	5	0	0	0	0	0	4	2	0	0	6	0	0	0	0	0
Total Volume	0	21	3	0	24	4	0	3	0	7	12	6	0	0	18	0	0	0	0	0
% App. Total	0	87.5	12.5	0		57.1	0	42.9	0		66.7	33.3	0	0		0	0	0	0	
PHF	.000	.750	.750	.000	.750	.500	.000	.375	.000	.583	.600	.750	.000	.000	.750	.000	.000	.000	.000	.000

City of Madera
 N/S: Madera Avenue
 E/W: SR-99 Northbound Ramps
 Weather: Clear

File Name : 36_MDA_Madera_99N AM
 Site Code : 00319628
 Start Date : 9/24/2019
 Page No : 1

Groups Printed- 3 Axle Vehicles

Start Time	Madera Avenue Southbound					SR-99 Northbound Off Ramp Westbound					Madera Avenue Northbound					SR-99 Northbound On Ramp Eastbound					Int. Total
	Left	Thru	Right	U-Turns	App. Total	Left	Thru	Right	U-Turns	App. Total	Left	Thru	Right	U-Turns	App. Total	Left	Thru	Right	U-Turns	App. Total	
07:00 AM	0	0	0	0	0	1	0	0	0	1	1	1	0	0	2	0	0	0	0	0	3
07:15 AM	0	0	0	0	0	0	0	0	0	0	0	0	0	0	0	0	0	0	0	0	0
07:30 AM	0	0	1	0	1	0	0	0	0	0	0	0	0	0	0	0	0	0	0	0	1
07:45 AM	0	0	0	0	0	0	0	0	0	0	0	0	0	0	0	0	0	0	0	0	0
Total	0	0	1	0	1	1	0	0	0	1	1	1	0	0	2	0	0	0	0	0	4
08:00 AM	0	0	1	0	1	0	0	0	0	0	0	0	0	0	0	0	0	0	0	0	1
08:15 AM	0	0	0	0	0	0	0	0	0	0	1	0	0	0	1	0	0	0	0	0	1
08:30 AM	0	0	0	0	0	0	0	0	0	0	0	0	0	0	0	0	0	0	0	0	0
08:45 AM	0	0	0	0	0	0	0	0	0	0	0	0	0	0	0	0	0	0	0	0	0
Total	0	0	1	0	1	0	0	0	0	0	1	0	0	0	1	0	0	0	0	0	2
Grand Total	0	0	2	0	2	1	0	0	0	1	2	1	0	0	3	0	0	0	0	0	6
Apprch %	0	0	100	0		100	0	0	0		66.7	33.3	0	0		0	0	0	0		
Total %	0	0	33.3	0	33.3	16.7	0	0	0	16.7	33.3	16.7	0	0	50	0	0	0	0	0	

Start Time	Madera Avenue Southbound					SR-99 Northbound Off Ramp Westbound					Madera Avenue Northbound					SR-99 Northbound On Ramp Eastbound					Int. Total
	Left	Thru	Right	U-Turns	App. Total	Left	Thru	Right	U-Turns	App. Total	Left	Thru	Right	U-Turns	App. Total	Left	Thru	Right	U-Turns	App. Total	
07:30 AM	0	0	1	0	1	0	0	0	0	0	0	0	0	0	0	0	0	0	0	0	1
07:45 AM	0	0	0	0	0	0	0	0	0	0	0	0	0	0	0	0	0	0	0	0	0
08:00 AM	0	0	1	0	1	0	0	0	0	0	0	0	0	0	0	0	0	0	0	0	1
08:15 AM	0	0	0	0	0	0	0	0	0	0	1	0	0	0	1	0	0	0	0	0	1
Total Volume	0	0	2	0	2	0	0	0	0	0	1	0	0	0	1	0	0	0	0	0	3
% App. Total	0	0	100	0		0	0	0	0		100	0	0	0		0	0	0	0		
PHF	.000	.000	.500	.000	.500	.000	.000	.000	.000	.000	.250	.000	.000	.000	.250	.000	.000	.000	.000	.000	.750

Peak Hour Analysis From 07:30 AM to 08:15 AM - Peak 1 of 1

Peak Hour for Entire Intersection Begins at 07:30 AM

City of Madera
 N/S: Madera Avenue
 E/W: SR-99 Northbound Ramps
 Weather: Clear

File Name : 36_MDA_Madera_99N AM
 Site Code : 00319628
 Start Date : 9/24/2019
 Page No : 2

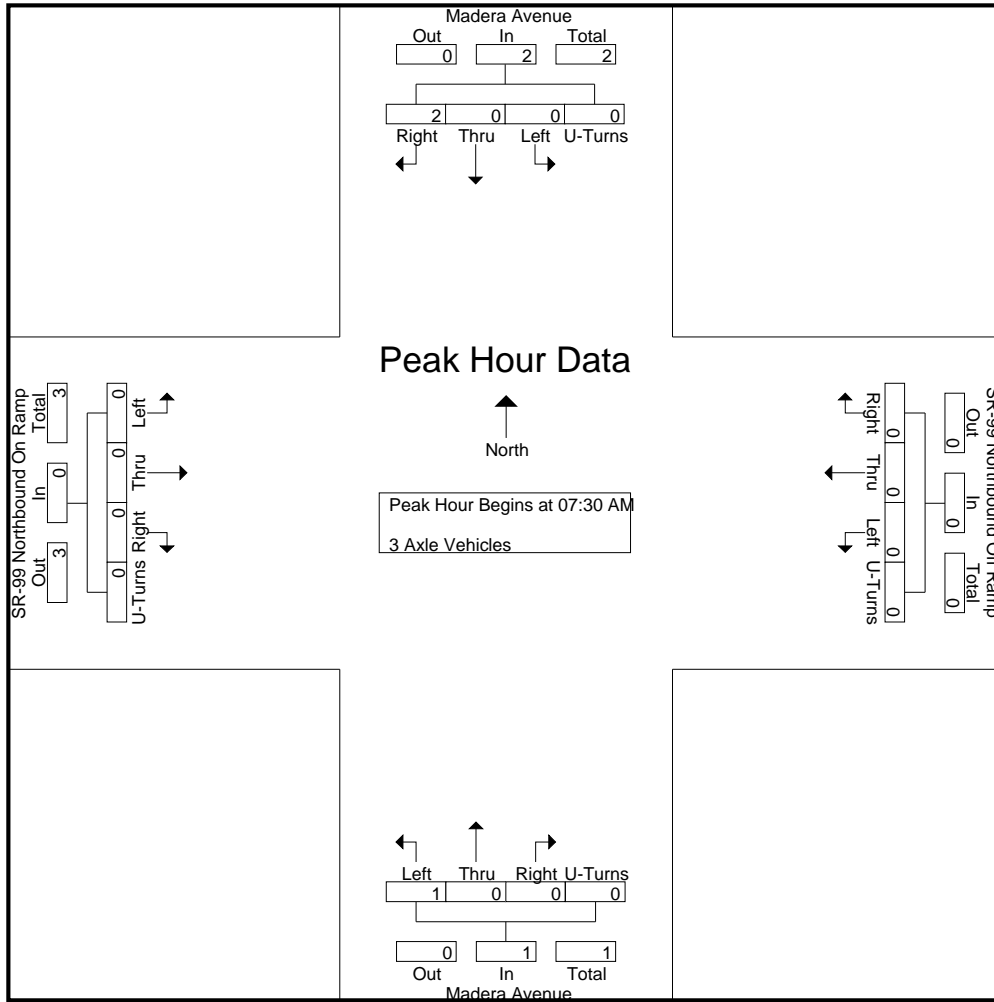

Peak Hour Analysis From 07:30 AM to 08:15 AM - Peak 1 of 1
 Peak Hour for Each Approach Begins at:

	07:30 AM					07:30 AM					07:30 AM									
+0 mins.	0	0	1	0	1	0	0	0	0	0	0	0	0	0	0	0	0	0	0	0
+15 mins.	0	0	0	0	0	0	0	0	0	0	0	0	0	0	0	0	0	0	0	0
+30 mins.	0	0	1	0	1	0	0	0	0	0	0	0	0	0	0	0	0	0	0	0
+45 mins.	0	0	0	0	0	0	0	0	0	0	1	0	0	0	1	0	0	0	0	0
Total Volume	0	0	2	0	2	0	0	0	0	0	1	0	0	0	1	0	0	0	0	0
% App. Total	0	0	100	0	0	0	0	0	0	0	100	0	0	0	0	0	0	0	0	0
PHF	.000	.000	.500	.000	.500	.000	.000	.000	.000	.000	.250	.000	.000	.000	.250	.000	.000	.000	.000	.000

City of Madera
 N/S: Madera Avenue
 E/W: SR-99 Northbound Ramps
 Weather: Clear

File Name : 36_MDA_Madera_99N AM
 Site Code : 00319628
 Start Date : 9/24/2019
 Page No : 1

Groups Printed- 4+ Axle Trucks

Start Time	Madera Avenue Southbound					SR-99 Northbound Off Ramp Westbound					Madera Avenue Northbound					SR-99 Northbound On Ramp Eastbound					Int. Total
	Left	Thru	Right	U-Turns	App. Total	Left	Thru	Right	U-Turns	App. Total	Left	Thru	Right	U-Turns	App. Total	Left	Thru	Right	U-Turns	App. Total	
07:00 AM	0	1	2	0	3	0	0	0	0	0	4	0	0	0	4	0	0	0	0	0	7
07:15 AM	0	0	1	0	1	0	0	0	0	0	1	0	0	0	1	0	0	0	0	0	2
07:30 AM	0	0	2	0	2	1	0	0	0	1	11	0	0	0	11	0	0	0	0	0	14
07:45 AM	0	1	0	0	1	0	0	0	0	0	5	0	0	0	5	0	0	0	0	0	6
Total	0	2	5	0	7	1	0	0	0	1	21	0	0	0	21	0	0	0	0	0	29
08:00 AM	0	0	0	0	0	0	0	0	0	0	7	0	0	0	7	0	0	0	0	0	7
08:15 AM	0	0	1	0	1	2	0	0	0	2	5	1	0	0	6	0	0	0	0	0	9
08:30 AM	0	1	0	0	1	0	0	1	0	1	6	0	0	0	6	0	0	0	0	0	8
08:45 AM	0	0	2	0	2	1	0	0	0	1	4	0	0	0	4	0	0	0	0	0	7
Total	0	1	3	0	4	3	0	1	0	4	22	1	0	0	23	0	0	0	0	0	31
Grand Total	0	3	8	0	11	4	0	1	0	5	43	1	0	0	44	0	0	0	0	0	60
Apprch %	0	27.3	72.7	0		80	0	20	0		97.7	2.3	0	0		0	0	0	0		
Total %	0	5	13.3	0	18.3	6.7	0	1.7	0	8.3	71.7	1.7	0	0	73.3	0	0	0	0	0	

Start Time	Madera Avenue Southbound					SR-99 Northbound Off Ramp Westbound					Madera Avenue Northbound					SR-99 Northbound On Ramp Eastbound					Int. Total
	Left	Thru	Right	U-Turns	App. Total	Left	Thru	Right	U-Turns	App. Total	Left	Thru	Right	U-Turns	App. Total	Left	Thru	Right	U-Turns	App. Total	
Peak Hour Analysis From 07:30 AM to 08:15 AM - Peak 1 of 1																					
Peak Hour for Entire Intersection Begins at 07:30 AM																					
07:30 AM	0	0	2	0	2	1	0	0	0	1	11	0	0	0	11	0	0	0	0	0	14
07:45 AM	0	1	0	0	1	0	0	0	0	0	5	0	0	0	5	0	0	0	0	0	6
08:00 AM	0	0	0	0	0	0	0	0	0	0	7	0	0	0	7	0	0	0	0	0	7
08:15 AM	0	0	1	0	1	2	0	0	0	2	5	1	0	0	6	0	0	0	0	0	9
Total Volume	0	1	3	0	4	3	0	0	0	3	28	1	0	0	29	0	0	0	0	0	36
% App. Total	0	25	75	0		100	0	0	0		96.6	3.4	0	0		0	0	0	0		
PHF	.000	.250	.375	.000	.500	.375	.000	.000	.000	.375	.636	.250	.000	.000	.659	.000	.000	.000	.000	.000	.643

City of Madera
 N/S: Madera Avenue
 E/W: SR-99 Northbound Ramps
 Weather: Clear

File Name : 36_MDA_Madera_99N AM
 Site Code : 00319628
 Start Date : 9/24/2019
 Page No : 2

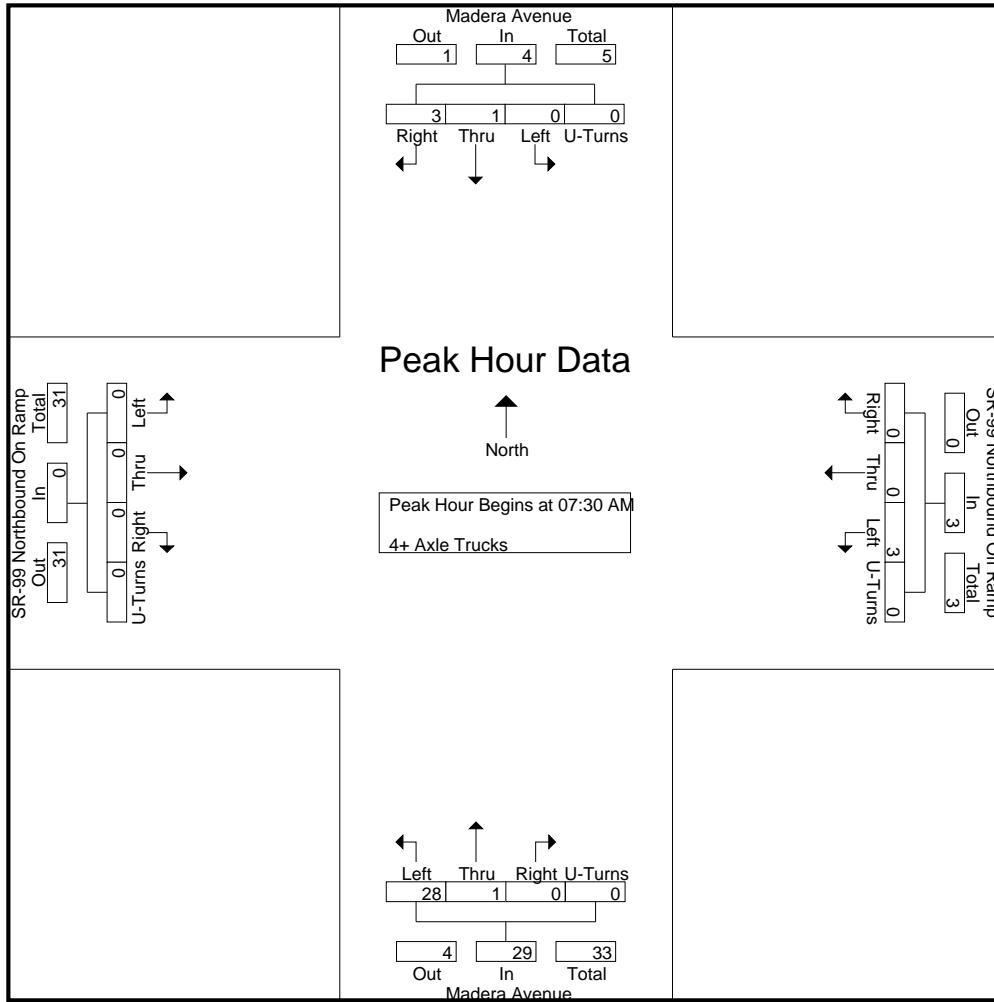

Peak Hour Analysis From 07:30 AM to 08:15 AM - Peak 1 of 1
 Peak Hour for Each Approach Begins at:

	07:30 AM					07:30 AM					07:30 AM									
+0 mins.	0	0	2	0	2	1	0	0	0	1	11	0	0	0	11	0	0	0	0	0
+15 mins.	0	1	0	0	1	0	0	0	0	0	5	0	0	0	5	0	0	0	0	0
+30 mins.	0	0	0	0	0	0	0	0	0	0	7	0	0	0	7	0	0	0	0	0
+45 mins.	0	0	1	0	1	2	0	0	0	2	5	1	0	0	6	0	0	0	0	0
Total Volume	0	1	3	0	4	3	0	0	0	3	28	1	0	0	29	0	0	0	0	0
% App. Total	0	25	75	0		100	0	0	0		96.6	3.4	0	0		0	0	0	0	
PHF	.000	.250	.375	.000	.500	.375	.000	.000	.000	.375	.636	.250	.000	.000	.659	.000	.000	.000	.000	.000

City of Madera
 N/S: Madera Avenue
 E/W: SR-99 Northbound Ramps
 Weather: Clear

File Name : 36_MDA_Madera_99N PM
 Site Code : 00319628
 Start Date : 9/24/2019
 Page No : 1

Groups Printed- Passenger Vehicles - Large 2 Axle Vehicles - 3 Axle Vehicles - 4+ Axle Trucks

Start Time	Madera Avenue Southbound					SR-99 Northbound Off Ramp Westbound					Madera Avenue Northbound					SR-99 Northbound On Ramp Eastbound					Int. Total
	Left	Thru	Right	U-Turns	App. Total	Left	Thru	Right	U-Turns	App. Total	Left	Thru	Right	U-Turns	App. Total	Left	Thru	Right	U-Turns	App. Total	
04:00 PM	0	126	36	0	162	33	0	15	0	48	81	154	0	0	235	0	0	0	0	0	445
04:15 PM	0	109	33	0	142	28	0	8	0	36	80	130	0	0	210	0	0	0	0	0	388
04:30 PM	0	128	43	0	171	45	0	11	0	56	98	135	0	0	233	0	0	0	0	0	460
04:45 PM	0	130	29	0	159	44	0	8	0	52	79	124	0	0	203	0	0	0	0	0	414
Total	0	493	141	0	634	150	0	42	0	192	338	543	0	0	881	0	0	0	0	0	1707
05:00 PM	0	167	64	0	231	35	1	6	0	42	101	134	0	0	235	0	0	0	0	0	508
05:15 PM	0	154	35	0	189	46	0	7	0	53	96	122	0	0	218	0	0	0	0	0	460
05:30 PM	0	138	33	0	171	47	1	13	0	61	78	120	0	0	198	0	0	0	0	0	430
05:45 PM	0	112	26	0	138	38	1	6	0	45	84	115	0	0	199	0	0	0	0	0	382
Total	0	571	158	0	729	166	3	32	0	201	359	491	0	0	850	0	0	0	0	0	1780
Grand Total	0	1064	299	0	1363	316	3	74	0	393	697	1034	0	0	1731	0	0	0	0	0	3487
Apprch %	0	78.1	21.9	0		80.4	0.8	18.8	0		40.3	59.7	0	0		0	0	0	0		
Total %	0	30.5	8.6	0	39.1	9.1	0.1	2.1	0	11.3	20	29.7	0	0	49.6	0	0	0	0	0	
Passenger Vehicles	1047										1020										
% Passenger Vehicles	0	98.4	96.3	0	97.9	98.4	100	98.6	0	98.5	96.7	98.6	0	0	97.9	0	0	0	0	0	98
Large 2 Axle Vehicles																					
% Large 2 Axle Vehicles	0	1.4	1.7	0	1.5	1.3	0	0	0	1	1.3	1.3	0	0	1.3	0	0	0	0	0	1.3
3 Axle Vehicles	0	1	0	0	1	0	0	0	0	0	0	0	0	0	0	0	0	0	0	0	1
% 3 Axle Vehicles	0	0.1	0	0	0.1	0	0	0	0	0	0	0	0	0	0	0	0	0	0	0	0
4+ Axle Trucks	0	1	6	0	7	1	0	1	0	2	14	1	0	0	15	0	0	0	0	0	24
% 4+ Axle Trucks																					

Start Time	Madera Avenue Southbound					SR-99 Northbound Off Ramp Westbound					Madera Avenue Northbound					SR-99 Northbound On Ramp Eastbound					Int. Total
	Left	Thru	Right	U-Turns	App. Total	Left	Thru	Right	U-Turns	App. Total	Left	Thru	Right	U-Turns	App. Total	Left	Thru	Right	U-Turns	App. Total	
Peak Hour Analysis From 04:00 PM to 05:45 PM - Peak 1 of 1																					
Peak Hour for Entire Intersection Begins at 04:30 PM																					
04:30 PM	0	128	43	0	171	45	0	11	0	56	98	135	0	0	233	0	0	0	0	0	460
04:45 PM	0	130	29	0	159	44	0	8	0	52	79	124	0	0	203	0	0	0	0	0	414
05:00 PM	0	167	64	0	231	35	1	6	0	42	101	134	0	0	235	0	0	0	0	0	508
05:15 PM	0	154	35	0	189	46	0	7	0	53	96	122	0	0	218	0	0	0	0	0	460
Total Volume	0	579	171	0	750	170	1	32	0	203	374	515	0	0	889	0	0	0	0	0	1842
% App. Total	0	77.2	22.8	0		83.7	0.5	15.8	0		42.1	57.9	0	0		0	0	0	0		
PHF	.000	.867	.668	.000	.812	.924	.250	.727	.000	.906	.926	.954	.000	.000	.946	.000	.000	.000	.000	.000	.906

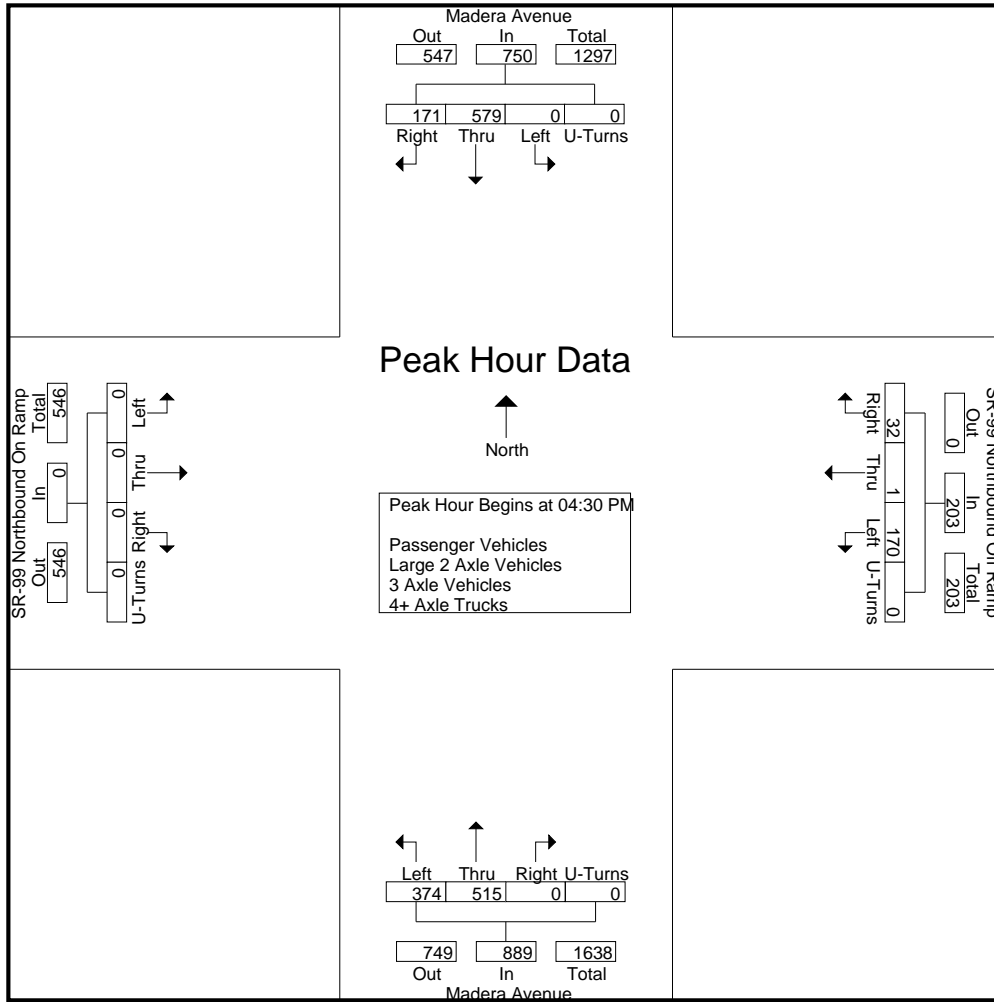

Peak Hour Analysis From 04:00 PM to 05:45 PM - Peak 1 of 1
 Peak Hour for Each Approach Begins at:

	04:30 PM					04:45 PM					04:30 PM					04:00 PM				
+0 mins.	0	128	43	0	171	44	0	8	0	52	98	135	0	0	233	0	0	0	0	0
+15 mins.	0	130	29	0	159	35	1	6	0	42	79	124	0	0	203	0	0	0	0	0
+30 mins.	0	167	64	0	231	46	0	7	0	53	101	134	0	0	235	0	0	0	0	0
+45 mins.	0	154	35	0	189	47	1	13	0	61	96	122	0	0	218	0	0	0	0	0
Total Volume	0	579	171	0	750	172	2	34	0	208	374	515	0	0	889	0	0	0	0	0
% App. Total	0	77.2	22.8	0		82.7	1	16.3	0		42.1	57.9	0	0		0	0	0	0	0
PHF	.000	.867	.668	.000	.812	.915	.500	.654	.000	.852	.926	.954	.000	.000	.946	.000	.000	.000	.000	.000

City of Madera
 N/S: Madera Avenue
 E/W: SR-99 Northbound Ramps
 Weather: Clear

File Name : 36_MDA_Madera_99N PM
 Site Code : 00319628
 Start Date : 9/24/2019
 Page No : 1

Groups Printed- Passenger Vehicles

Start Time	Madera Avenue Southbound					SR-99 Northbound Off Ramp Westbound					Madera Avenue Northbound					SR-99 Northbound On Ramp Eastbound					Int. Total
	Left	Thru	Right	U-Turns	App. Total	Left	Thru	Right	U-Turns	App. Total	Left	Thru	Right	U-Turns	App. Total	Left	Thru	Right	U-Turns	App. Total	
04:00 PM	0	123	36	0	159	32	0	15	0	47	80	149	0	0	229	0	0	0	0	0	435
04:15 PM	0	106	29	0	135	27	0	8	0	35	76	127	0	0	203	0	0	0	0	0	373
04:30 PM	0	126	42	0	168	44	0	11	0	55	96	132	0	0	228	0	0	0	0	0	451
04:45 PM	0	127	29	0	156	43	0	8	0	51	78	124	0	0	202	0	0	0	0	0	409
Total	0	482	136	0	618	146	0	42	0	188	330	532	0	0	862	0	0	0	0	0	1668
05:00 PM	0	166	61	0	227	35	1	6	0	42	98	133	0	0	231	0	0	0	0	0	500
05:15 PM	0	153	33	0	186	46	0	7	0	53	93	120	0	0	213	0	0	0	0	0	452
05:30 PM	0	136	33	0	169	46	1	13	0	60	74	120	0	0	194	0	0	0	0	0	423
05:45 PM	0	110	25	0	135	38	1	5	0	44	79	115	0	0	194	0	0	0	0	0	373
Total	0	565	152	0	717	165	3	31	0	199	344	488	0	0	832	0	0	0	0	0	1748
Grand Total	0	1047	288	0	1335	311	3	73	0	387	674	1020	0	0	1694	0	0	0	0	0	3416
Apprch %	0	78.4	21.6	0		80.4	0.8	18.9	0		39.8	60.2	0	0		0	0	0	0		
Total %	0	30.6	8.4	0	39.1	9.1	0.1	2.1	0	11.3	19.7	29.9	0	0	49.6	0	0	0	0	0	

Start Time	Madera Avenue Southbound					SR-99 Northbound Off Ramp Westbound					Madera Avenue Northbound					SR-99 Northbound On Ramp Eastbound					Int. Total
	Left	Thru	Right	U-Turns	App. Total	Left	Thru	Right	U-Turns	App. Total	Left	Thru	Right	U-Turns	App. Total	Left	Thru	Right	U-Turns	App. Total	
Peak Hour Analysis From 04:30 PM to 05:15 PM - Peak 1 of 1																					
Peak Hour for Entire Intersection Begins at 04:30 PM																					
04:30 PM	0	126	42	0	168	44	0	11	0	55	96	132	0	0	228	0	0	0	0	0	451
04:45 PM	0	127	29	0	156	43	0	8	0	51	78	124	0	0	202	0	0	0	0	0	409
05:00 PM	0	166	61	0	227	35	1	6	0	42	98	133	0	0	231	0	0	0	0	0	500
05:15 PM	0	153	33	0	186	46	0	7	0	53	93	120	0	0	213	0	0	0	0	0	452
Total Volume	0	572	165	0	737	168	1	32	0	201	365	509	0	0	874	0	0	0	0	0	1812
% App. Total	0	77.6	22.4	0		83.6	0.5	15.9	0		41.8	58.2	0	0		0	0	0	0		
PHF	.000	.861	.676	.000	.812	.913	.250	.727	.000	.914	.931	.957	.000	.000	.946	.000	.000	.000	.000	.000	.906

City of Madera
 N/S: Madera Avenue
 E/W: SR-99 Northbound Ramps
 Weather: Clear

File Name : 36_MDA_Madera_99N PM
 Site Code : 00319628
 Start Date : 9/24/2019
 Page No : 2

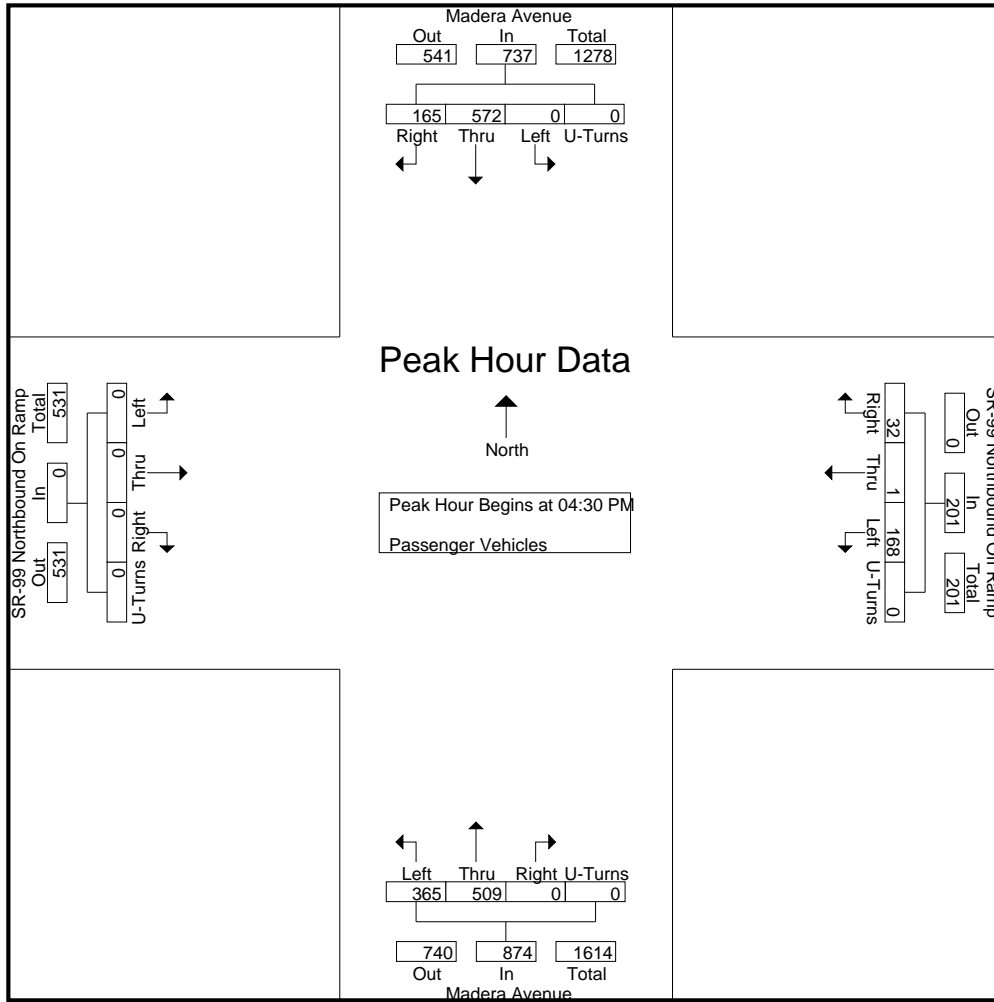

Peak Hour Analysis From 04:30 PM to 05:15 PM - Peak 1 of 1
 Peak Hour for Each Approach Begins at:

	04:30 PM					04:30 PM					04:30 PM									
+0 mins.	0	126	42	0	168	44	0	11	0	55	96	132	0	0	228	0	0	0	0	0
+15 mins.	0	127	29	0	156	43	0	8	0	51	78	124	0	0	202	0	0	0	0	0
+30 mins.	0	166	61	0	227	35	1	6	0	42	98	133	0	0	231	0	0	0	0	0
+45 mins.	0	153	33	0	186	46	0	7	0	53	93	120	0	0	213	0	0	0	0	0
Total Volume	0	572	165	0	737	168	1	32	0	201	365	509	0	0	874	0	0	0	0	0
% App. Total	0	77.6	22.4	0		83.6	0.5	15.9	0		41.8	58.2	0	0		0	0	0	0	0
PHF	.000	.861	.676	.000	.812	.913	.250	.727	.000	.914	.931	.957	.000	.000	.946	.000	.000	.000	.000	.000

City of Madera
 N/S: Madera Avenue
 E/W: SR-99 Northbound Ramps
 Weather: Clear

File Name : 36_MDA_Madera_99N PM
 Site Code : 00319628
 Start Date : 9/24/2019
 Page No : 2

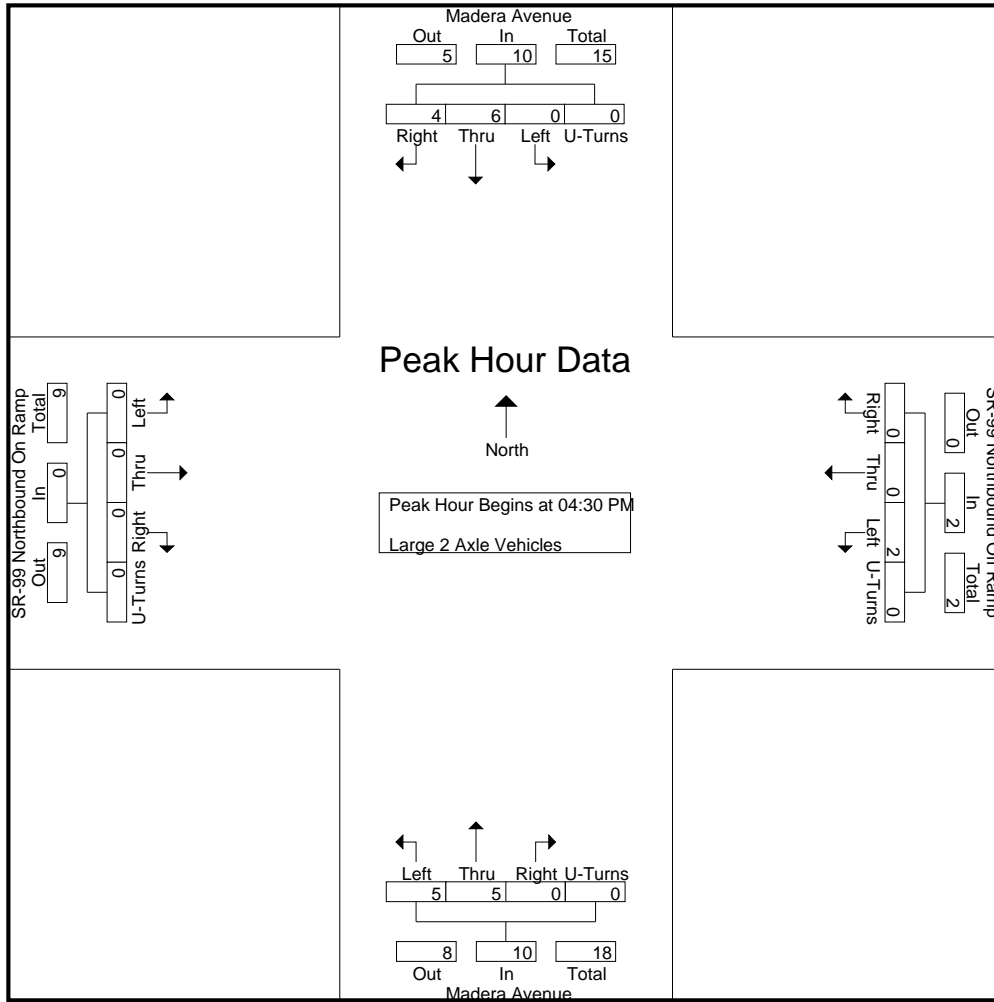

Peak Hour Analysis From 04:30 PM to 05:15 PM - Peak 1 of 1
 Peak Hour for Each Approach Begins at:

	04:30 PM					04:30 PM					04:30 PM									
+0 mins.	0	1	1	0	2	1	0	0	0	1	0	2	0	0	2	0	0	0	0	0
+15 mins.	0	3	0	0	3	1	0	0	0	1	1	0	0	0	1	0	0	0	0	0
+30 mins.	0	1	1	0	2	0	0	0	0	0	2	1	0	0	3	0	0	0	0	0
+45 mins.	0	1	2	0	3	0	0	0	0	0	2	2	0	0	4	0	0	0	0	0
Total Volume	0	6	4	0	10	2	0	0	0	2	5	5	0	0	10	0	0	0	0	0
% App. Total	0	60	40	0		100	0	0	0		50	50	0	0		0	0	0	0	
PHF	.000	.500	.500	.000	.833	.500	.000	.000	.000	.500	.625	.625	.000	.000	.625	.000	.000	.000	.000	.000

City of Madera
 N/S: Madera Avenue
 E/W: SR-99 Northbound Ramps
 Weather: Clear

File Name : 36_MDA_Madera_99N PM
 Site Code : 00319628
 Start Date : 9/24/2019
 Page No : 1

Groups Printed- 3 Axle Vehicles

Start Time	Madera Avenue Southbound					SR-99 Northbound Off Ramp Westbound					Madera Avenue Northbound					SR-99 Northbound On Ramp Eastbound					Int. Total
	Left	Thru	Right	U-Turns	App. Total	Left	Thru	Right	U-Turns	App. Total	Left	Thru	Right	U-Turns	App. Total	Left	Thru	Right	U-Turns	App. Total	
04:00 PM	0	0	0	0	0	0	0	0	0	0	0	0	0	0	0	0	0	0	0	0	0
04:15 PM	0	0	0	0	0	0	0	0	0	0	0	0	0	0	0	0	0	0	0	0	0
04:30 PM	0	1	0	0	1	0	0	0	0	0	0	0	0	0	0	0	0	0	0	0	1
04:45 PM	0	0	0	0	0	0	0	0	0	0	0	0	0	0	0	0	0	0	0	0	0
Total	0	1	0	0	1	0	0	0	0	0	0	0	0	0	0	0	0	0	0	0	1
05:00 PM	0	0	0	0	0	0	0	0	0	0	0	0	0	0	0	0	0	0	0	0	0
05:15 PM	0	0	0	0	0	0	0	0	0	0	0	0	0	0	0	0	0	0	0	0	0
05:30 PM	0	0	0	0	0	0	0	0	0	0	0	0	0	0	0	0	0	0	0	0	0
05:45 PM	0	0	0	0	0	0	0	0	0	0	0	0	0	0	0	0	0	0	0	0	0
Total	0	0	0	0	0	0	0	0	0	0	0	0	0	0	0	0	0	0	0	0	0
Grand Total	0	1	0	0	1	0	0	0	0	0	0	0	0	0	0	0	0	0	0	0	1
Apprch %	0	100	0	0		0	0	0	0		0	0	0	0		0	0	0	0		
Total %	0	100	0	0	100	0	0	0	0	0	0	0	0	0	0	0	0	0	0	0	

Start Time	Madera Avenue Southbound					SR-99 Northbound Off Ramp Westbound					Madera Avenue Northbound					SR-99 Northbound On Ramp Eastbound					Int. Total
	Left	Thru	Right	U-Turns	App. Total	Left	Thru	Right	U-Turns	App. Total	Left	Thru	Right	U-Turns	App. Total	Left	Thru	Right	U-Turns	App. Total	
Peak Hour Analysis From 04:30 PM to 05:15 PM - Peak 1 of 1																					
Peak Hour for Entire Intersection Begins at 04:30 PM																					
04:30 PM	0	1	0	0	1	0	0	0	0	0	0	0	0	0	0	0	0	0	0	0	1
04:45 PM	0	0	0	0	0	0	0	0	0	0	0	0	0	0	0	0	0	0	0	0	0
05:00 PM	0	0	0	0	0	0	0	0	0	0	0	0	0	0	0	0	0	0	0	0	0
05:15 PM	0	0	0	0	0	0	0	0	0	0	0	0	0	0	0	0	0	0	0	0	0
Total Volume	0	1	0	0	1	0	0	0	0	0	0	0	0	0	0	0	0	0	0	0	1
% App. Total	0	100	0	0		0	0	0	0		0	0	0	0		0	0	0	0		
PHF	.000	.250	.000	.000	.250	.000	.000	.000	.000	.000	.000	.000	.000	.000	.000	.000	.000	.000	.000	.000	.250

City of Madera
 N/S: Madera Avenue
 E/W: SR-99 Northbound Ramps
 Weather: Clear

File Name : 36_MDA_Madera_99N PM
 Site Code : 00319628
 Start Date : 9/24/2019
 Page No : 2

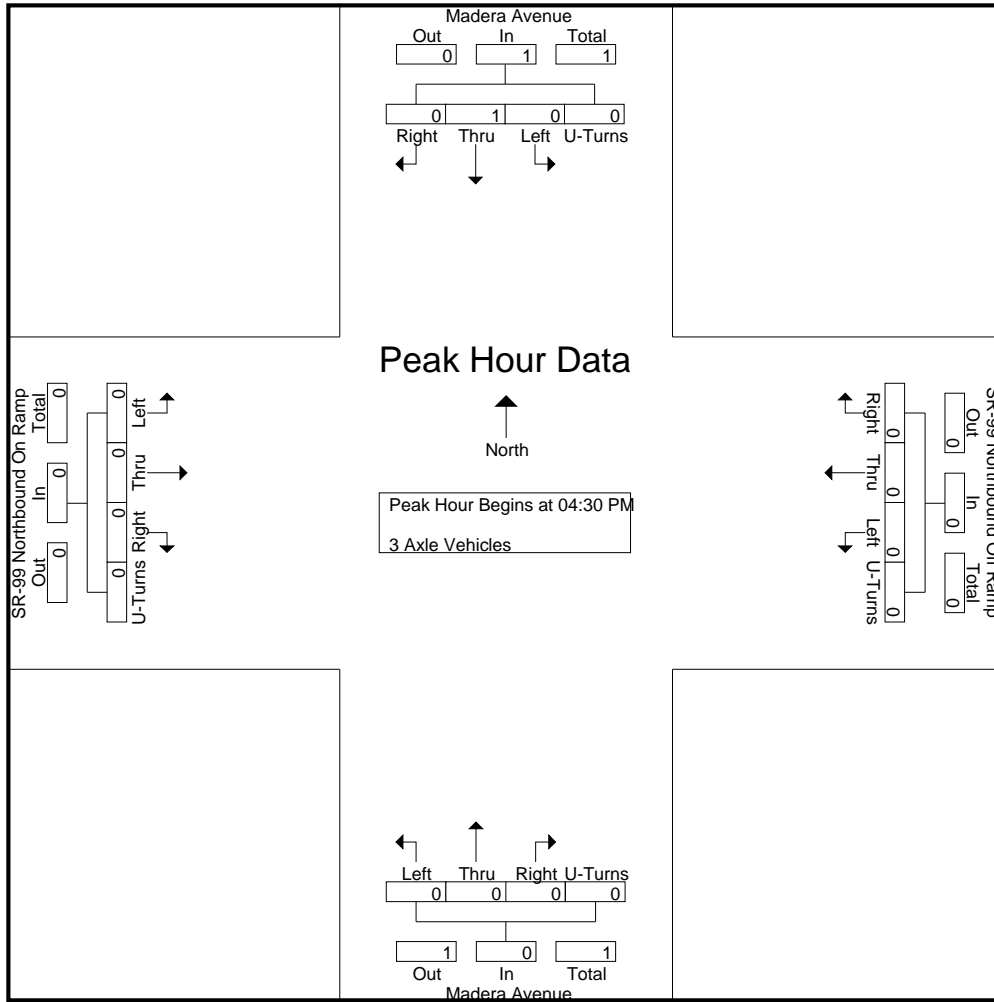

Peak Hour Analysis From 04:30 PM to 05:15 PM - Peak 1 of 1
 Peak Hour for Each Approach Begins at:

	04:30 PM					04:30 PM					04:30 PM									
+0 mins.	0	1	0	0	1	0	0	0	0	0	0	0	0	0	0	0	0	0	0	0
+15 mins.	0	0	0	0	0	0	0	0	0	0	0	0	0	0	0	0	0	0	0	0
+30 mins.	0	0	0	0	0	0	0	0	0	0	0	0	0	0	0	0	0	0	0	0
+45 mins.	0	0	0	0	0	0	0	0	0	0	0	0	0	0	0	0	0	0	0	0
Total Volume	0	1	0	0	1	0	0	0	0	0	0	0	0	0	0	0	0	0	0	0
% App. Total	0	100	0	0	0	0	0	0	0	0	0	0	0	0	0	0	0	0	0	0
PHF	.000	.250	.000	.000	.250	.000	.000	.000	.000	.000	.000	.000	.000	.000	.000	.000	.000	.000	.000	.000

City of Madera
 N/S: Madera Avenue
 E/W: SR-99 Northbound Ramps
 Weather: Clear

File Name : 36_MDA_Madera_99N PM
 Site Code : 00319628
 Start Date : 9/24/2019
 Page No : 1

Groups Printed- 4+ Axle Trucks

Start Time	Madera Avenue Southbound					SR-99 Northbound Off Ramp Westbound					Madera Avenue Northbound					SR-99 Northbound On Ramp Eastbound					Int. Total
	Left	Thru	Right	U-Turns	App. Total	Left	Thru	Right	U-Turns	App. Total	Left	Thru	Right	U-Turns	App. Total	Left	Thru	Right	U-Turns	App. Total	
04:00 PM	0	0	0	0	0	0	0	0	0	0	1	0	0	0	1	0	0	0	0	0	1
04:15 PM	0	1	4	0	5	0	0	0	0	0	2	0	0	0	2	0	0	0	0	0	2
04:30 PM	0	0	0	0	0	0	0	0	0	0	2	1	0	0	3	0	0	0	0	0	3
04:45 PM	0	0	0	0	0	0	0	0	0	0	0	0	0	0	0	0	0	0	0	0	0
Total	0	1	4	0	5	0	0	0	0	0	5	1	0	0	6	0	0	0	0	0	11
05:00 PM	0	0	2	0	2	0	0	0	0	0	1	0	0	0	1	0	0	0	0	0	3
05:15 PM	0	0	0	0	0	0	0	0	0	0	1	0	0	0	1	0	0	0	0	0	1
05:30 PM	0	0	0	0	0	1	0	0	0	1	2	0	0	0	2	0	0	0	0	0	3
05:45 PM	0	0	0	0	0	0	0	1	0	1	5	0	0	0	5	0	0	0	0	0	6
Total	0	0	2	0	2	1	0	1	0	2	9	0	0	0	9	0	0	0	0	0	13
Grand Total	0	1	6	0	7	1	0	1	0	2	14	1	0	0	15	0	0	0	0	0	24
Apprch %	0	14.3	85.7	0		50	0	50	0		93.3	6.7	0	0		0	0	0	0		
Total %	0	4.2	25	0	29.2	4.2	0	4.2	0	8.3	58.3	4.2	0	0	62.5	0	0	0	0	0	

Start Time	Madera Avenue Southbound					SR-99 Northbound Off Ramp Westbound					Madera Avenue Northbound					SR-99 Northbound On Ramp Eastbound					Int. Total
	Left	Thru	Right	U-Turns	App. Total	Left	Thru	Right	U-Turns	App. Total	Left	Thru	Right	U-Turns	App. Total	Left	Thru	Right	U-Turns	App. Total	
Peak Hour Analysis From 04:30 PM to 05:15 PM - Peak 1 of 1																					
Peak Hour for Entire Intersection Begins at 04:30 PM																					
04:30 PM	0	0	0	0	0	0	0	0	0	0	2	1	0	0	3	0	0	0	0	0	3
04:45 PM	0	0	0	0	0	0	0	0	0	0	0	0	0	0	0	0	0	0	0	0	0
05:00 PM	0	0	2	0	2	0	0	0	0	0	1	0	0	0	1	0	0	0	0	0	3
05:15 PM	0	0	0	0	0	0	0	0	0	0	1	0	0	0	1	0	0	0	0	0	1
Total Volume	0	0	2	0	2	0	0	0	0	0	4	1	0	0	5	0	0	0	0	0	7
% App. Total	0	0	100	0		0	0	0	0		80	20	0	0		0	0	0	0		
PHF	.000	.000	.250	.000	.250	.000	.000	.000	.000	.000	.500	.250	.000	.000	.417	.000	.000	.000	.000	.000	.583

City of Madera
 N/S: Madera Avenue
 E/W: SR-99 Northbound Ramps
 Weather: Clear

File Name : 36_MDA_Madera_99N PM
 Site Code : 00319628
 Start Date : 9/24/2019
 Page No : 2

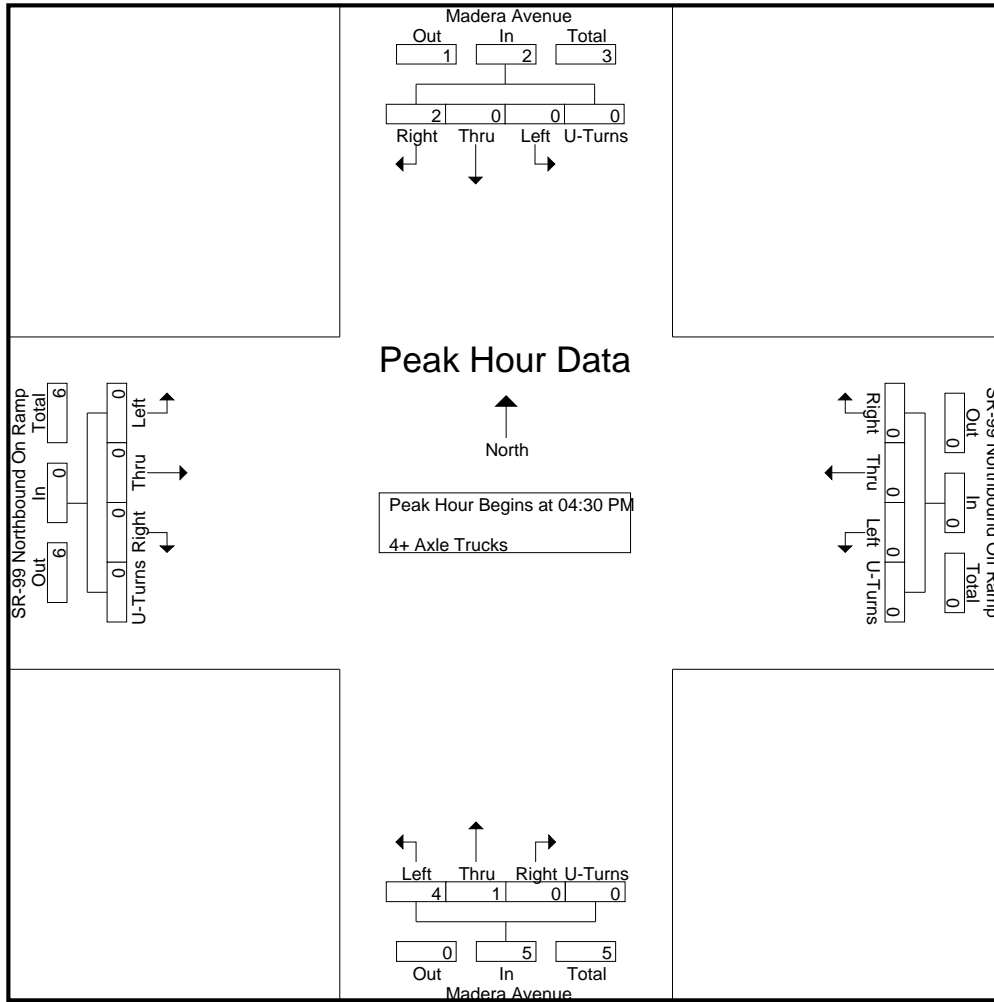

Peak Hour Analysis From 04:30 PM to 05:15 PM - Peak 1 of 1
 Peak Hour for Each Approach Begins at:

	04:30 PM					04:30 PM					04:30 PM					04:30 PM				
+0 mins.	0	0	0	0	0	0	0	0	0	0	2	1	0	0	3	0	0	0	0	0
+15 mins.	0	0	0	0	0	0	0	0	0	0	0	0	0	0	0	0	0	0	0	0
+30 mins.	0	0	2	0	2	0	0	0	0	0	1	0	0	0	1	0	0	0	0	0
+45 mins.	0	0	0	0	0	0	0	0	0	0	1	0	0	0	1	0	0	0	0	0
Total Volume	0	0	2	0	2	0	0	0	0	0	4	1	0	0	5	0	0	0	0	0
% App. Total	0	0	100	0	0	0	0	0	0	0	80	20	0	0	0	0	0	0	0	0
PHF	.000	.000	.250	.000	.250	.000	.000	.000	.000	.000	.500	.250	.000	.000	.417	.000	.000	.000	.000	.000

Location: Madera
 N/S: Madera Avenue
 E/W: SR-99 Northbound Ramps



Date: 9/24/2019
 Day: Tuesday

PEDESTRIANS

	North Leg Madera Avenue Pedestrians	East Leg SR-99 Northbound Ramps Pedestrians	South Leg Madera Avenue Pedestrians	West Leg SR-99 Northbound Ramps Pedestrians	
7:00 AM	0	0	0	1	1
7:15 AM	0	1	0	3	4
7:30 AM	0	1	0	7	8
7:45 AM	0	0	0	21	21
8:00 AM	0	2	0	3	5
8:15 AM	0	0	0	11	11
8:30 AM	0	0	0	0	0
8:45 AM	0	3	0	0	3
TOTAL VOLUMES:	0	7	0	46	53

	North Leg Madera Avenue Pedestrians	East Leg SR-99 Northbound Ramps Pedestrians	South Leg Madera Avenue Pedestrians	West Leg SR-99 Northbound Ramps Pedestrians	
4:00 PM	0	0	0	4	4
4:15 PM	0	0	0	2	2
4:30 PM	0	1	0	2	3
4:45 PM	0	1	0	1	2
5:00 PM	0	1	0	0	1
5:15 PM	0	1	0	1	2
5:30 PM	0	1	0	2	3
5:45 PM	1	2	0	3	6
TOTAL VOLUMES:	1	7	0	15	23

Location: Madera
 N/S: Madera Avenue
 E/W: SR-99 Northbound Ramps



Date: 9/24/2019
 Day: Tuesday

BICYCLES

	Southbound Madera Avenue			Westbound SR-99 Northbound Ramps			Northbound Madera Avenue			Eastbound SR-99 Northbound Ramps			
	Left	Thru	Right	Left	Thru	Right	Left	Thru	Right	Left	Thru	Right	
7:00 AM	0	0	0	0	0	0	0	0	0	0	0	0	0
7:15 AM	0	1	0	0	0	0	0	0	0	0	0	0	1
7:30 AM	0	0	0	0	0	0	0	0	0	0	0	0	0
7:45 AM	0	1	0	0	0	0	0	0	0	0	0	0	1
8:00 AM	0	0	0	0	0	0	0	0	0	0	0	0	0
8:15 AM	0	2	0	0	0	0	0	0	0	0	0	0	2
8:30 AM	0	0	0	0	0	0	0	0	0	0	0	0	0
8:45 AM	0	0	0	0	0	0	0	0	0	0	0	0	0
TOTAL VOLUMES:	0	4	0	0	0	0	0	0	0	0	0	0	4

	Southbound Madera Avenue			Westbound SR-99 Northbound Ramps			Northbound Madera Avenue			Eastbound SR-99 Northbound Ramps			
	Left	Thru	Right	Left	Thru	Right	Left	Thru	Right	Left	Thru	Right	
4:00 PM	0	0	0	0	0	0	0	0	0	0	0	0	0
4:15 PM	0	0	0	0	0	0	0	0	0	0	0	0	0
4:30 PM	0	0	0	0	0	0	0	0	0	0	0	0	0
4:45 PM	0	0	0	0	0	0	0	0	0	0	0	0	0
5:00 PM	0	0	0	0	0	0	0	0	0	0	0	0	0
5:15 PM	0	1	0	0	0	0	0	0	0	0	0	0	1
5:30 PM	0	0	0	0	0	0	0	1	0	0	0	0	1
5:45 PM	0	1	0	0	0	0	0	0	0	0	0	0	1
TOTAL VOLUMES:	0	2	0	0	0	0	0	1	0	0	0	0	3

City of Madera
 N/S: Madera Avenue
 E/W: Olive Ave/SR-99 SB On Ramp
 Weather: Clear

File Name : 37_MDA_Madera_Olive AM
 Site Code : 00319628
 Start Date : 9/24/2019
 Page No : 1

Groups Printed- Passenger Vehicles - Large 2 Axle Vehicles - 3 Axle Vehicles - 4+ Axle Trucks

Start Time	Madera Avenue Southbound					SR-99 Southbound On Ramp Westbound					Madera Avenue Northbound					Olive Avenue Eastbound					Int. Total	
	Left	Thru	Right	U-Turns	App. Total	Left	Thru	Right	U-Turns	App. Total	Left	Thru	Right	U-Turns	App. Total	Left	Thru	Right	U-Turns	App. Total		
07:00 AM	15	31	54	0	100	0	0	0	0	0	10	71	4	0	85	34	42	38	0	114	299	
07:15 AM	16	60	45	0	121	0	0	0	0	0	18	117	7	0	142	56	33	63	0	152	415	
07:30 AM	18	66	72	0	156	0	0	0	0	0	28	101	10	0	139	70	35	85	0	190	485	
07:45 AM	18	74	68	0	160	0	0	0	0	0	25	122	10	0	157	103	40	85	0	228	545	
Total	67	231	239	0	537	0	0	0	0	0	81	411	31	0	523	263	150	271	0	684	1744	
08:00 AM	19	83	70	0	172	0	0	0	0	0	25	122	6	0	153	73	56	75	0	204	529	
08:15 AM	29	103	68	0	200	0	0	0	0	0	27	107	12	0	146	50	58	65	0	173	519	
08:30 AM	25	76	67	0	168	0	0	0	0	0	27	121	1	0	149	46	48	63	0	157	474	
08:45 AM	22	52	64	0	138	0	0	0	0	0	15	130	8	0	153	38	34	76	0	148	439	
Total	95	314	269	0	678	0	0	0	0	0	94	480	27	0	601	207	196	279	0	682	1961	
Grand Total	162	545	508	0	1215	0	0	0	0	0	175	891	58	0	1124	470	346	550	0	1366	3705	
Apprch %	13.3	44.9	41.8	0		0	0	0	0	0	15.6	79.3	5.2	0		34.4	25.3	40.3	0			
Total %	4.4	14.7	13.7	0	32.8	0	0	0	0	0	4.7	24	1.6	0	30.3	12.7	9.3	14.8	0	36.9		
Passenger Vehicles																						
% Passenger Vehicles	96.3	96.3	94.3	0	95.5	0	0	0	0	0	98.9	92.3	96.6	0	93.5	94	96.8	90.5	0	93.3	94.1	
Large 2 Axle Vehicles																						
% Large 2 Axle Vehicles	0.6	3.7	5.1	0	3.9	0	0	0	0	0	1.1	3.5	3.4	0	3.1	4.7	1.7	4	0	3.7	3.6	
3 Axle Vehicles	0	0	1	0	1	0	0	0	0	0	0	1	0	1	0	0	2	0	0	2	4	
% 3 Axle Vehicles	0	0	0.2	0	0.1	0	0	0	0	0	0	0.1	0	0.1	0	0	0.4	0	0	0.1	0.1	
4+ Axle Trucks	5	0	2	0	7	0	0	0	0	0	0	37	0	37	6	5	28	0	39	83		
% 4+ Axle Trucks																						

Start Time	Madera Avenue Southbound					SR-99 Southbound On Ramp Westbound					Madera Avenue Northbound					Olive Avenue Eastbound					Int. Total
	Left	Thru	Right	U-Turns	App. Total	Left	Thru	Right	U-Turns	App. Total	Left	Thru	Right	U-Turns	App. Total	Left	Thru	Right	U-Turns	App. Total	
Peak Hour Analysis From 07:00 AM to 08:45 AM - Peak 1 of 1																					
Peak Hour for Entire Intersection Begins at 07:30 AM																					
07:30 AM	18	66	72	0	156	0	0	0	0	0	28	101	10	0	139	70	35	85	0	190	485
07:45 AM	18	74	68	0	160	0	0	0	0	0	25	122	10	0	157	103	40	85	0	228	545
08:00 AM	19	83	70	0	172	0	0	0	0	0	25	122	6	0	153	73	56	75	0	204	529
08:15 AM	29	103	68	0	200	0	0	0	0	0	27	107	12	0	146	50	58	65	0	173	519
Total Volume	84	326	278	0	688	0	0	0	0	0	105	452	38	0	595	296	189	310	0	795	2078
% App. Total	12.2	47.4	40.4	0		0	0	0	0	0	17.6	76	6.4	0		37.2	23.8	39	0		
PHF	.724	.791	.965	.000	.860	.000	.000	.000	.000	.000	.938	.926	.792	.000	.947	.718	.815	.912	.000	.872	.953

City of Madera
 N/S: Madera Avenue
 E/W: Olive Ave/SR-99 SB On Ramp
 Weather: Clear

File Name : 37_MDA_Madera_Olive AM
 Site Code : 00319628
 Start Date : 9/24/2019
 Page No : 2

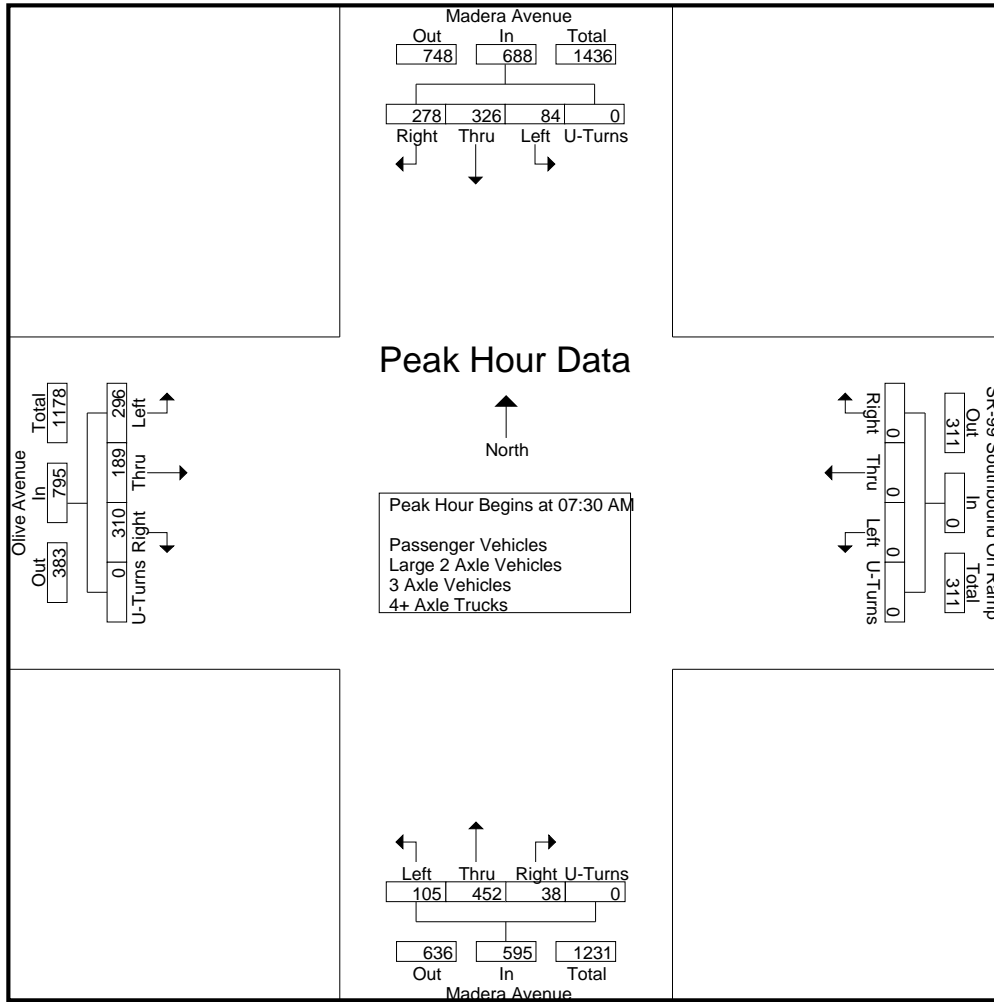

Peak Hour Analysis From 07:00 AM to 08:45 AM - Peak 1 of 1
 Peak Hour for Each Approach Begins at:

	07:45 AM					07:00 AM					07:45 AM					07:30 AM				
+0 mins.	18	74	68	0	160	0	0	0	0	0	25	122	10	0	157	70	35	85	0	190
+15 mins.	19	83	70	0	172	0	0	0	0	0	25	122	6	0	153	103	40	85	0	228
+30 mins.	29	103	68	0	200	0	0	0	0	0	27	107	12	0	146	73	56	75	0	204
+45 mins.	25	76	67	0	168	0	0	0	0	0	27	121	1	0	149	50	58	65	0	173
Total Volume	91	336	273	0	700	0	0	0	0	0	104	472	29	0	605	296	189	310	0	795
% App. Total	13	48	39	0		0	0	0	0		17.2	78	4.8	0		37.2	23.8	39	0	
PHF	.784	.816	.975	.000	.875	.000	.000	.000	.000	.000	.963	.967	.604	.000	.963	.718	.815	.912	.000	.872

City of Madera
 N/S: Madera Avenue
 E/W: Olive Ave/SR-99 SB On Ramp
 Weather: Clear

File Name : 37_MDA_Madera_Olive AM
 Site Code : 00319628
 Start Date : 9/24/2019
 Page No : 1

Groups Printed- Passenger Vehicles

Start Time	Madera Avenue Southbound					SR-99 Southbound On Ramp Westbound					Madera Avenue Northbound					Olive Avenue Eastbound					Int. Total
	Left	Thru	Right	U-Turns	App. Total	Left	Thru	Right	U-Turns	App. Total	Left	Thru	Right	U-Turns	App. Total	Left	Thru	Right	U-Turns	App. Total	
07:00 AM	15	27	52	0	94	0	0	0	0	0	10	68	4	0	82	29	40	33	0	102	278
07:15 AM	15	56	44	0	115	0	0	0	0	0	18	106	6	0	130	53	32	57	0	142	387
07:30 AM	18	63	69	0	150	0	0	0	0	0	28	95	9	0	132	69	34	80	0	183	465
07:45 AM	17	73	66	0	156	0	0	0	0	0	23	108	10	0	141	98	40	79	0	217	514
Total	65	219	231	0	515	0	0	0	0	0	79	377	29	0	485	249	146	249	0	644	1644
08:00 AM	19	81	65	0	165	0	0	0	0	0	25	109	6	0	140	66	54	66	0	186	491
08:15 AM	29	102	58	0	189	0	0	0	0	0	27	97	12	0	136	45	55	59	0	159	484
08:30 AM	23	73	64	0	160	0	0	0	0	0	27	118	1	0	146	45	47	60	0	152	458
08:45 AM	20	50	61	0	131	0	0	0	0	0	15	121	8	0	144	37	33	64	0	134	409
Total	91	306	248	0	645	0	0	0	0	0	94	445	27	0	566	193	189	249	0	631	1842
Grand Total	156	525	479	0	1160	0	0	0	0	0	173	822	56	0	1051	442	335	498	0	1275	3486
Apprch %	13.4	45.3	41.3	0		0	0	0	0	0	16.5	78.2	5.3	0		34.7	26.3	39.1	0		
Total %	4.5	15.1	13.7	0	33.3	0	0	0	0	0	5	23.6	1.6	0	30.1	12.7	9.6	14.3	0	36.6	

Start Time	Madera Avenue Southbound					SR-99 Southbound On Ramp Westbound					Madera Avenue Northbound					Olive Avenue Eastbound					Int. Total
	Left	Thru	Right	U-Turns	App. Total	Left	Thru	Right	U-Turns	App. Total	Left	Thru	Right	U-Turns	App. Total	Left	Thru	Right	U-Turns	App. Total	
Peak Hour Analysis From 07:30 AM to 08:15 AM - Peak 1 of 1																					
Peak Hour for Entire Intersection Begins at 07:30 AM																					
07:30 AM	18	63	69	0	150	0	0	0	0	0	28	95	9	0	132	69	34	80	0	183	465
07:45 AM	17	73	66	0	156	0	0	0	0	0	23	108	10	0	141	98	40	79	0	217	514
08:00 AM	19	81	65	0	165	0	0	0	0	0	25	109	6	0	140	66	54	66	0	186	491
08:15 AM	29	102	58	0	189	0	0	0	0	0	27	97	12	0	136	45	55	59	0	159	484
Total Volume	83	319	258	0	660	0	0	0	0	0	103	409	37	0	549	278	183	284	0	745	1954
% App. Total	12.6	48.3	39.1	0		0	0	0	0	0	18.8	74.5	6.7	0		37.3	24.6	38.1	0		
PHF	.716	.782	.935	.000	.873	.000	.000	.000	.000	.000	.920	.938	.771	.000	.973	.709	.832	.888	.000	.858	.950

City of Madera
 N/S: Madera Avenue
 E/W: Olive Ave/SR-99 SB On Ramp
 Weather: Clear

File Name : 37_MDA_Madera_Olive AM
 Site Code : 00319628
 Start Date : 9/24/2019
 Page No : 2

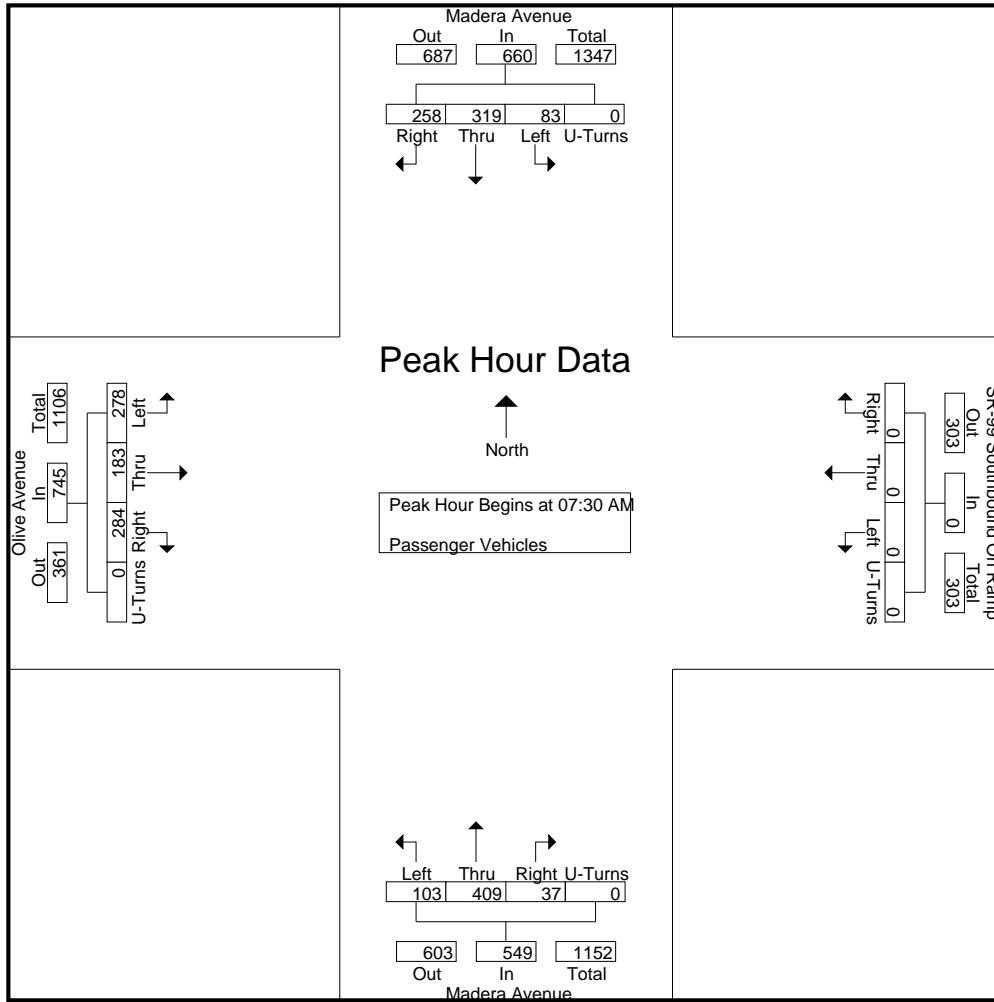

Peak Hour Analysis From 07:30 AM to 08:15 AM - Peak 1 of 1
 Peak Hour for Each Approach Begins at:

	07:30 AM					07:30 AM					07:30 AM									
+0 mins.	18	63	69	0	150	0	0	0	0	0	28	95	9	0	132	69	34	80	0	183
+15 mins.	17	73	66	0	156	0	0	0	0	0	23	108	10	0	141	98	40	79	0	217
+30 mins.	19	81	65	0	165	0	0	0	0	0	25	109	6	0	140	66	54	66	0	186
+45 mins.	29	102	58	0	189	0	0	0	0	0	27	97	12	0	136	45	55	59	0	159
Total Volume	83	319	258	0	660	0	0	0	0	0	103	409	37	0	549	278	183	284	0	745
% App. Total	12.6	48.3	39.1	0		0	0	0	0	0	18.8	74.5	6.7	0		37.3	24.6	38.1	0	
PHF	.716	.782	.935	.000	.873	.000	.000	.000	.000	.000	.920	.938	.771	.000	.973	.709	.832	.888	.000	.858

City of Madera
 N/S: Madera Avenue
 E/W: Olive Ave/SR-99 SB On Ramp
 Weather: Clear

File Name : 37_MDA_Madera_Olive AM
 Site Code : 00319628
 Start Date : 9/24/2019
 Page No : 1

Groups Printed- Large 2 Axle Vehicles

Start Time	Madera Avenue Southbound					SR-99 Southbound On Ramp Westbound					Madera Avenue Northbound					Olive Avenue Eastbound					Int. Total
	Left	Thru	Right	U-Turns	App. Total	Left	Thru	Right	U-Turns	App. Total	Left	Thru	Right	U-Turns	App. Total	Left	Thru	Right	U-Turns	App. Total	
07:00 AM	0	4	2	0	6	0	0	0	0	0	0	0	0	0	0	4	1	2	0	7	13
07:15 AM	0	4	1	0	5	0	0	0	0	0	0	8	1	0	9	3	1	2	0	6	20
07:30 AM	0	3	3	0	6	0	0	0	0	0	0	2	1	0	3	0	0	3	0	3	12
07:45 AM	1	1	2	0	4	0	0	0	0	0	2	4	0	0	6	5	0	3	0	8	18
Total	1	12	8	0	21	0	0	0	0	0	2	14	2	0	18	12	2	10	0	24	63
08:00 AM	0	2	4	0	6	0	0	0	0	0	0	3	0	0	3	5	1	3	0	9	18
08:15 AM	0	1	8	0	9	0	0	0	0	0	0	6	0	0	6	4	2	4	0	10	25
08:30 AM	0	3	3	0	6	0	0	0	0	0	0	2	0	0	2	1	0	0	0	1	9
08:45 AM	0	2	3	0	5	0	0	0	0	0	0	6	0	0	6	0	1	5	0	6	17
Total	0	8	18	0	26	0	0	0	0	0	0	17	0	0	17	10	4	12	0	26	69
Grand Total	1	20	26	0	47	0	0	0	0	0	2	31	2	0	35	22	6	22	0	50	132
Apprch %	2.1	42.6	55.3	0		0	0	0	0		5.7	88.6	5.7	0		44	12	44	0		
Total %	0.8	15.2	19.7	0	35.6	0	0	0	0	0	1.5	23.5	1.5	0	26.5	16.7	4.5	16.7	0	37.9	

Start Time	Madera Avenue Southbound					SR-99 Southbound On Ramp Westbound					Madera Avenue Northbound					Olive Avenue Eastbound					Int. Total
	Left	Thru	Right	U-Turns	App. Total	Left	Thru	Right	U-Turns	App. Total	Left	Thru	Right	U-Turns	App. Total	Left	Thru	Right	U-Turns	App. Total	
Peak Hour Analysis From 07:30 AM to 08:15 AM - Peak 1 of 1																					
Peak Hour for Entire Intersection Begins at 07:30 AM																					
07:30 AM	0	3	3	0	6	0	0	0	0	0	0	2	1	0	3	0	0	3	0	3	12
07:45 AM	1	1	2	0	4	0	0	0	0	0	2	4	0	0	6	5	0	3	0	8	18
08:00 AM	0	2	4	0	6	0	0	0	0	0	0	3	0	0	3	5	1	3	0	9	18
08:15 AM	0	1	8	0	9	0	0	0	0	0	0	6	0	0	6	4	2	4	0	10	25
Total Volume	1	7	17	0	25	0	0	0	0	0	2	15	1	0	18	14	3	13	0	30	73
% App. Total	4	28	68	0		0	0	0	0		11.1	83.3	5.6	0		46.7	10	43.3	0		
PHF	.250	.583	.531	.000	.694	.000	.000	.000	.000	.000	.250	.625	.250	.000	.750	.700	.375	.813	.000	.750	.730

City of Madera
 N/S: Madera Avenue
 E/W: Olive Ave/SR-99 SB On Ramp
 Weather: Clear

File Name : 37_MDA_Madera_Olive AM
 Site Code : 00319628
 Start Date : 9/24/2019
 Page No : 2

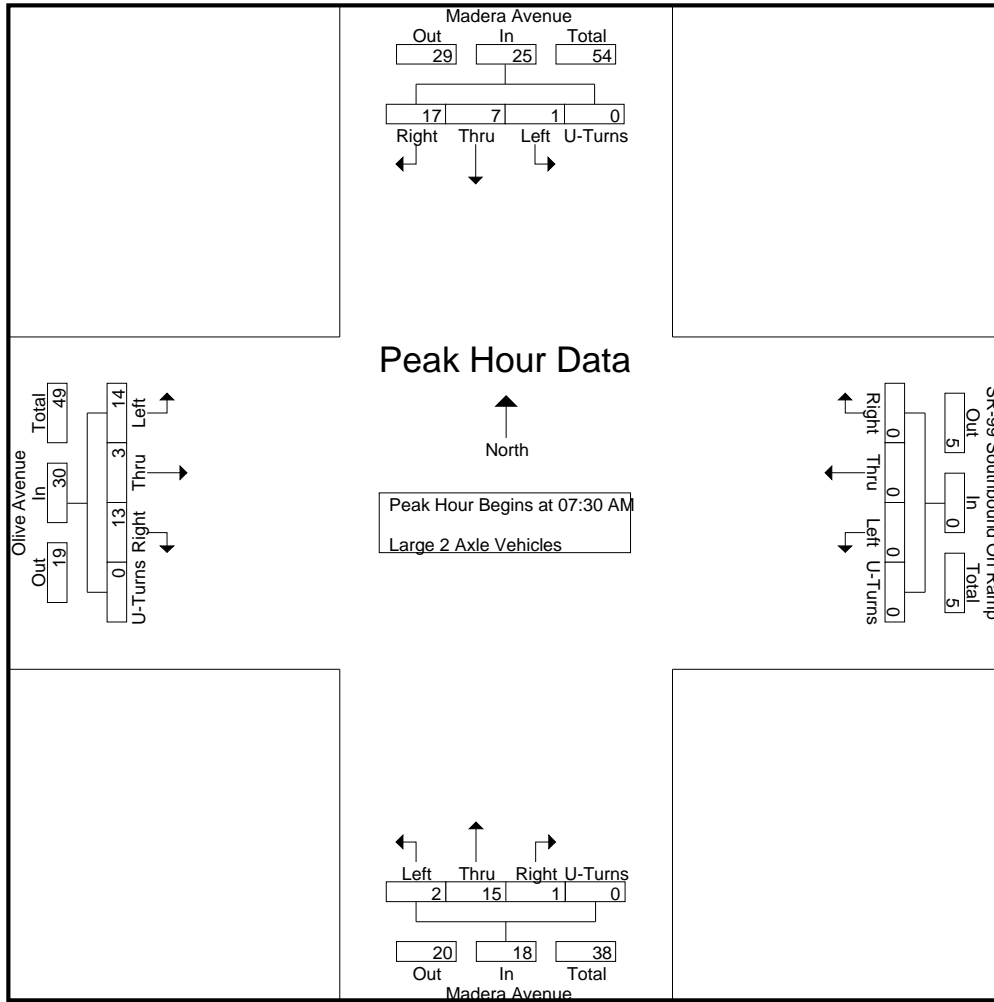

Peak Hour Analysis From 07:30 AM to 08:15 AM - Peak 1 of 1
 Peak Hour for Each Approach Begins at:

	07:30 AM					07:30 AM					07:30 AM									
+0 mins.	0	3	3	0	6	0	0	0	0	0	0	2	1	0	3	0	0	3	0	3
+15 mins.	1	1	2	0	4	0	0	0	0	0	2	4	0	0	6	5	0	3	0	8
+30 mins.	0	2	4	0	6	0	0	0	0	0	0	3	0	0	3	5	1	3	0	9
+45 mins.	0	1	8	0	9	0	0	0	0	0	0	6	0	0	6	4	2	4	0	10
Total Volume	1	7	17	0	25	0	0	0	0	0	2	15	1	0	18	14	3	13	0	30
% App. Total	4	28	68	0		0	0	0	0		11.1	83.3	5.6	0		46.7	10	43.3	0	
PHF	.250	.583	.531	.000	.694	.000	.000	.000	.000	.000	.250	.625	.250	.000	.750	.700	.375	.813	.000	.750

City of Madera
 N/S: Madera Avenue
 E/W: Olive Ave/SR-99 SB On Ramp
 Weather: Clear

File Name : 37_MDA_Madera_Olive AM
 Site Code : 00319628
 Start Date : 9/24/2019
 Page No : 1

Groups Printed- 3 Axle Vehicles

Start Time	Madera Avenue Southbound					SR-99 Southbound On Ramp Westbound					Madera Avenue Northbound					Olive Avenue Eastbound					Int. Total
	Left	Thru	Right	U-Turns	App. Total	Left	Thru	Right	U-Turns	App. Total	Left	Thru	Right	U-Turns	App. Total	Left	Thru	Right	U-Turns	App. Total	
07:00 AM	0	0	0	0	0	0	0	0	0	0	0	0	0	0	0	0	0	0	0	0	0
07:15 AM	0	0	0	0	0	0	0	0	0	0	0	0	0	0	0	0	0	0	0	0	0
07:30 AM	0	0	0	0	0	0	0	0	0	0	0	0	0	0	0	0	0	0	0	0	0
07:45 AM	0	0	0	0	0	0	0	0	0	0	0	1	0	0	1	0	0	0	0	0	1
Total	0	0	0	0	0	0	0	0	0	0	0	1	0	0	1	0	0	0	0	0	1
08:00 AM	0	0	0	0	0	0	0	0	0	0	0	0	0	0	0	0	0	0	0	0	0
08:15 AM	0	0	1	0	1	0	0	0	0	0	0	0	0	0	0	0	0	0	0	0	1
08:30 AM	0	0	0	0	0	0	0	0	0	0	0	0	0	0	0	0	0	0	0	0	0
08:45 AM	0	0	0	0	0	0	0	0	0	0	0	0	0	0	0	0	0	2	0	2	2
Total	0	0	1	0	1	0	0	0	0	0	0	0	0	0	0	0	0	2	0	2	3
Grand Total	0	0	1	0	1	0	0	0	0	0	0	1	0	0	1	0	0	2	0	2	4
Apprch %	0	0	100	0		0	0	0	0		0	100	0	0		0	0	100	0		
Total %	0	0	25	0	25	0	0	0	0	0	0	25	0	0	25	0	0	50	0	50	

Start Time	Madera Avenue Southbound					SR-99 Southbound On Ramp Westbound					Madera Avenue Northbound					Olive Avenue Eastbound					Int. Total
	Left	Thru	Right	U-Turns	App. Total	Left	Thru	Right	U-Turns	App. Total	Left	Thru	Right	U-Turns	App. Total	Left	Thru	Right	U-Turns	App. Total	
Peak Hour Analysis From 07:30 AM to 08:15 AM - Peak 1 of 1																					
Peak Hour for Entire Intersection Begins at 07:30 AM																					
07:30 AM	0	0	0	0	0	0	0	0	0	0	0	0	0	0	0	0	0	0	0	0	0
07:45 AM	0	0	0	0	0	0	0	0	0	0	0	1	0	0	1	0	0	0	0	0	1
08:00 AM	0	0	0	0	0	0	0	0	0	0	0	0	0	0	0	0	0	0	0	0	0
08:15 AM	0	0	1	0	1	0	0	0	0	0	0	0	0	0	0	0	0	0	0	0	1
Total Volume	0	0	1	0	1	0	0	0	0	0	0	1	0	0	1	0	0	0	0	0	2
% App. Total	0	0	100	0		0	0	0	0		0	100	0	0		0	0	0	0		
PHF	.000	.000	.250	.000	.250	.000	.000	.000	.000	.000	.000	.250	.000	.000	.250	.000	.000	.000	.000	.000	.500

City of Madera
 N/S: Madera Avenue
 E/W: Olive Ave/SR-99 SB On Ramp
 Weather: Clear

File Name : 37_MDA_Madera_Olive AM
 Site Code : 00319628
 Start Date : 9/24/2019
 Page No : 2

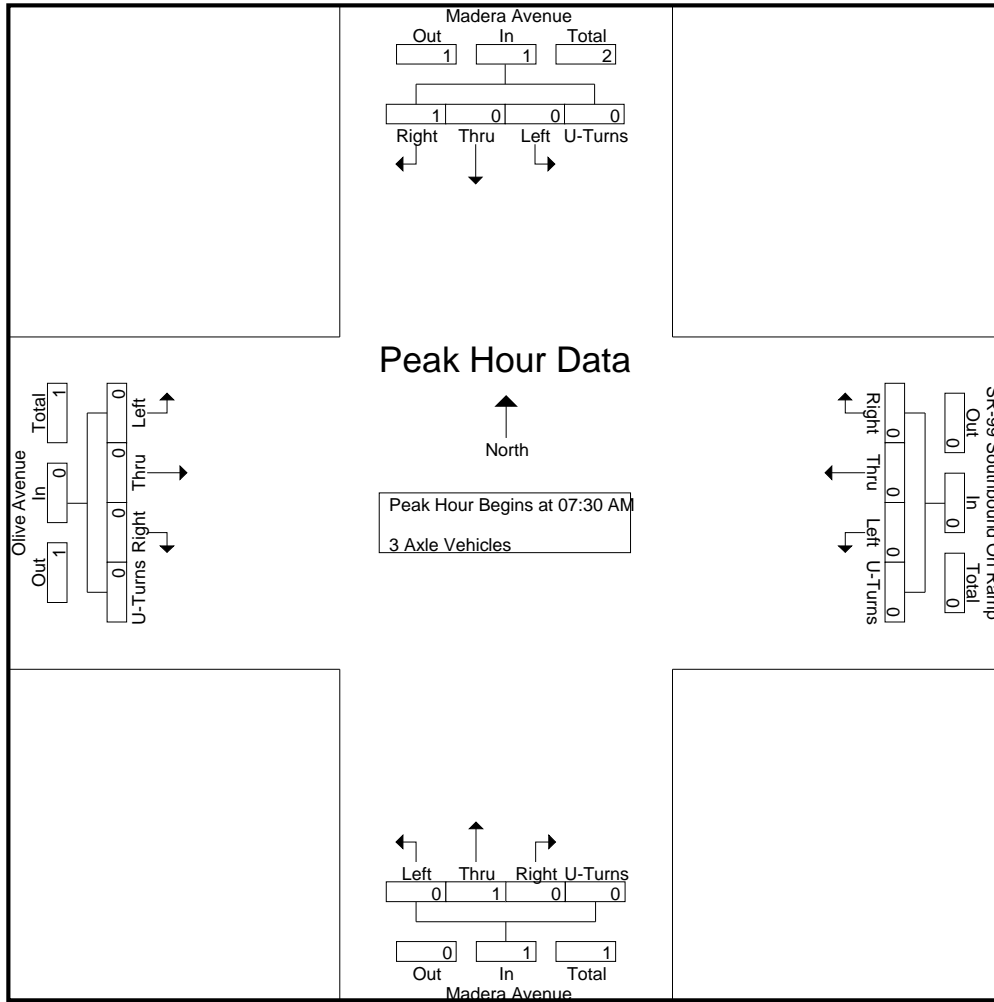

Peak Hour Analysis From 07:30 AM to 08:15 AM - Peak 1 of 1
 Peak Hour for Each Approach Begins at:

	07:30 AM					07:30 AM					07:30 AM									
+0 mins.	0	0	0	0	0	0	0	0	0	0	0	0	0	0	0	0	0	0	0	0
+15 mins.	0	0	0	0	0	0	0	0	0	0	0	1	0	0	1	0	0	0	0	0
+30 mins.	0	0	0	0	0	0	0	0	0	0	0	0	0	0	0	0	0	0	0	0
+45 mins.	0	0	1	0	1	0	0	0	0	0	0	0	0	0	0	0	0	0	0	0
Total Volume	0	0	1	0	1	0	0	0	0	0	0	1	0	0	1	0	0	0	0	0
% App. Total	0	0	100	0	0	0	0	0	0	0	0	100	0	0	0	0	0	0	0	0
PHF	.000	.000	.250	.000	.250	.000	.000	.000	.000	.000	.000	.250	.000	.000	.250	.000	.000	.000	.000	.000

City of Madera
 N/S: Madera Avenue
 E/W: Olive Ave/SR-99 SB On Ramp
 Weather: Clear

File Name : 37_MDA_Madera_Olive AM
 Site Code : 00319628
 Start Date : 9/24/2019
 Page No : 1

Groups Printed- 4+ Axle Trucks

Start Time	Madera Avenue Southbound					SR-99 Southbound On Ramp Westbound					Madera Avenue Northbound					Olive Avenue Eastbound					Int. Total
	Left	Thru	Right	U-Turns	App. Total	Left	Thru	Right	U-Turns	App. Total	Left	Thru	Right	U-Turns	App. Total	Left	Thru	Right	U-Turns	App. Total	
07:00 AM	0	0	0	0	0	0	0	0	0	0	0	3	0	0	3	1	1	3	0	5	8
07:15 AM	1	0	0	0	1	0	0	0	0	0	0	3	0	0	3	0	0	4	0	4	8
07:30 AM	0	0	0	0	0	0	0	0	0	0	0	4	0	0	4	1	1	2	0	4	8
07:45 AM	0	0	0	0	0	0	0	0	0	0	0	9	0	0	9	0	0	3	0	3	12
Total	1	0	0	0	1	0	0	0	0	0	0	19	0	0	19	2	2	12	0	16	36
08:00 AM	0	0	1	0	1	0	0	0	0	0	0	10	0	0	10	2	1	6	0	9	20
08:15 AM	0	0	1	0	1	0	0	0	0	0	0	4	0	0	4	1	1	2	0	4	9
08:30 AM	2	0	0	0	2	0	0	0	0	0	0	1	0	0	1	0	1	3	0	4	7
08:45 AM	2	0	0	0	2	0	0	0	0	0	0	3	0	0	3	1	0	5	0	6	11
Total	4	0	2	0	6	0	0	0	0	0	0	18	0	0	18	4	3	16	0	23	47
Grand Total	5	0	2	0	7	0	0	0	0	0	0	37	0	0	37	6	5	28	0	39	83
Apprch %	71.4	0	28.6	0		0	0	0	0		0	100	0	0		15.4	12.8	71.8	0		
Total %	6	0	2.4	0	8.4	0	0	0	0	0	0	44.6	0	0	44.6	7.2	6	33.7	0	47	

Start Time	Madera Avenue Southbound					SR-99 Southbound On Ramp Westbound					Madera Avenue Northbound					Olive Avenue Eastbound					Int. Total
	Left	Thru	Right	U-Turns	App. Total	Left	Thru	Right	U-Turns	App. Total	Left	Thru	Right	U-Turns	App. Total	Left	Thru	Right	U-Turns	App. Total	
Peak Hour Analysis From 07:30 AM to 08:15 AM - Peak 1 of 1																					
Peak Hour for Entire Intersection Begins at 07:30 AM																					
07:30 AM	0	0	0	0	0	0	0	0	0	0	0	4	0	0	4	1	1	2	0	4	8
07:45 AM	0	0	0	0	0	0	0	0	0	0	0	9	0	0	9	0	0	3	0	3	12
08:00 AM	0	0	1	0	1	0	0	0	0	0	0	10	0	0	10	2	1	6	0	9	20
08:15 AM	0	0	1	0	1	0	0	0	0	0	0	4	0	0	4	1	1	2	0	4	9
Total Volume	0	0	2	0	2	0	0	0	0	0	0	27	0	0	27	4	3	13	0	20	49
% App. Total	0	0	100	0		0	0	0	0		0	100	0	0		20	15	65	0		
PHF	.000	.000	.500	.000	.500	.000	.000	.000	.000	.000	.000	.675	.000	.000	.675	.500	.750	.542	.000	.556	.613

City of Madera
 N/S: Madera Avenue
 E/W: Olive Ave/SR-99 SB On Ramp
 Weather: Clear

File Name : 37_MDA_Madera_Olive AM
 Site Code : 00319628
 Start Date : 9/24/2019
 Page No : 2

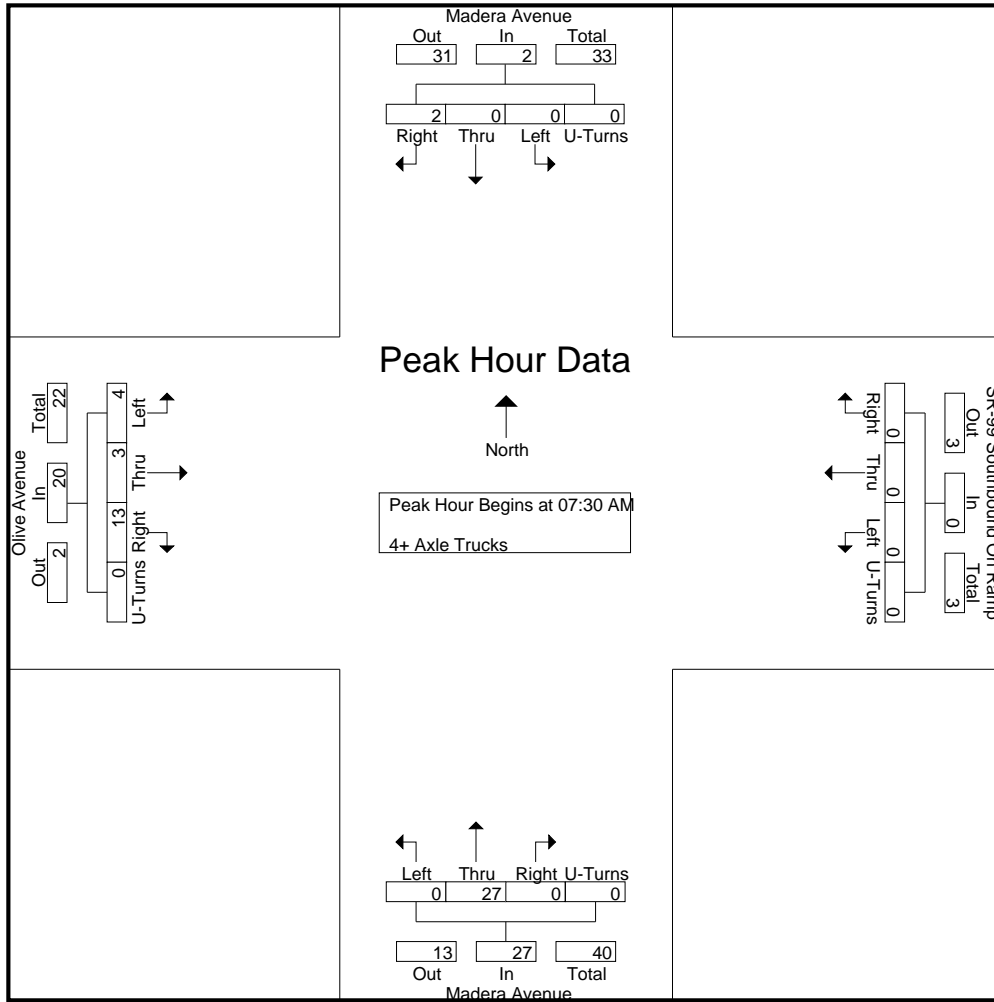

Peak Hour Analysis From 07:30 AM to 08:15 AM - Peak 1 of 1
 Peak Hour for Each Approach Begins at:

	07:30 AM					07:30 AM					07:30 AM									
+0 mins.	0	0	0	0	0	0	0	0	0	0	0	4	0	0	4	1	1	2	0	4
+15 mins.	0	0	0	0	0	0	0	0	0	0	0	9	0	0	9	0	0	3	0	3
+30 mins.	0	0	1	0	1	0	0	0	0	0	0	10	0	0	10	2	1	6	0	9
+45 mins.	0	0	1	0	1	0	0	0	0	0	0	4	0	0	4	1	1	2	0	4
Total Volume	0	0	2	0	2	0	0	0	0	0	0	27	0	0	27	4	3	13	0	20
% App. Total	0	0	100	0	0	0	0	0	0	0	0	100	0	0	0	20	15	65	0	0
PHF	.000	.000	.500	.000	.500	.000	.000	.000	.000	.000	.000	.675	.000	.000	.675	.500	.750	.542	.000	.556

City of Madera
 N/S: Madera Avenue
 E/W: Olive Ave/SR-99 SB On Ramp
 Weather: Clear

File Name : 37_MDA_Madera_Olive PM
 Site Code : 00319628
 Start Date : 9/24/2019
 Page No : 1

Groups Printed- Passenger Vehicles - Large 2 Axle Vehicles - 3 Axle Vehicles - 4+ Axle Trucks

Start Time	Madera Avenue Southbound					SR-99 Southbound On Ramp Westbound					Madera Avenue Northbound					Olive Avenue Eastbound					Int. Total
	Left	Thru	Right	U-Turns	App. Total	Left	Thru	Right	U-Turns	App. Total	Left	Thru	Right	U-Turns	App. Total	Left	Thru	Right	U-Turns	App. Total	
04:00 PM	32	78	44	0	154	0	0	0	0	0	35	141	9	0	185	93	46	65	0	204	543
04:15 PM	19	78	45	0	142	0	0	0	0	0	16	141	5	0	162	77	26	75	0	178	482
04:30 PM	26	88	55	0	169	0	0	0	0	0	32	155	7	0	194	71	43	80	0	194	557
04:45 PM	21	71	80	0	172	0	0	0	0	0	23	135	4	0	162	80	33	75	0	188	522
Total	98	315	224	0	637	0	0	0	0	0	106	572	25	0	703	321	148	295	0	764	2104
05:00 PM	45	92	65	0	202	0	0	0	0	0	20	143	12	0	175	88	30	72	0	190	567
05:15 PM	38	80	91	0	209	0	0	0	0	0	29	140	6	0	175	85	29	71	0	185	569
05:30 PM	34	85	66	0	185	0	0	0	0	0	25	125	8	0	158	81	26	52	0	159	502
05:45 PM	22	64	65	0	151	0	0	0	0	0	30	123	10	0	163	73	37	54	0	164	478
Total	139	321	287	0	747	0	0	0	0	0	104	531	36	0	671	327	122	249	0	698	2116
Grand Total	237	636	511	0	1384	0	0	0	0	0	210	1103	61	0	1374	648	270	544	0	1462	4220
Apprch %	17.1	46	36.9	0		0	0	0	0	0	15.3	80.3	4.4	0		44.3	18.5	37.2	0		
Total %	5.6	15.1	12.1	0	32.8	0	0	0	0	0	5	26.1	1.4	0	32.6	15.4	6.4	12.9	0	34.6	
Passenger Vehicles											1072										
% Passenger Vehicles	97.5	99.1	98.4	0	98.6	0	0	0	0	0	100	97.2	100	0	97.7	97.8	97.4	95	0	96.7	97.7
Large 2 Axle Vehicles																					
% Large 2 Axle Vehicles	2.1	0.8	1.2	0	1.2	0	0	0	0	0	0	1.4	0	0	1.1	1.7	1.1	1.3	0	1.4	1.2
3 Axle Vehicles	0	0	1	0	1	0	0	0	0	0	0	1	0	0	1	0	1	1	0	2	4
% 3 Axle Vehicles	0	0	0.2	0	0.1	0	0	0	0	0	0	0.1	0	0	0.1	0	0.4	0.2	0	0.1	0.1
4+ Axle Trucks	1	1	1	0	3	0	0	0	0	0	0	15	0	0	15	3	3	19	0	25	43
% 4+ Axle Trucks												1.4	0	0	1.1	0.5	0.5	3.5	0	1.4	1.0

Start Time	Madera Avenue Southbound					SR-99 Southbound On Ramp Westbound					Madera Avenue Northbound					Olive Avenue Eastbound					Int. Total
	Left	Thru	Right	U-Turns	App. Total	Left	Thru	Right	U-Turns	App. Total	Left	Thru	Right	U-Turns	App. Total	Left	Thru	Right	U-Turns	App. Total	
Peak Hour Analysis From 04:00 PM to 05:45 PM - Peak 1 of 1																					
Peak Hour for Entire Intersection Begins at 04:30 PM																					
04:30 PM	26	88	55	0	169	0	0	0	0	0	32	155	7	0	194	71	43	80	0	194	557
04:45 PM	21	71	80	0	172	0	0	0	0	0	23	135	4	0	162	80	33	75	0	188	522
05:00 PM	45	92	65	0	202	0	0	0	0	0	20	143	12	0	175	88	30	72	0	190	567
05:15 PM	38	80	91	0	209	0	0	0	0	0	29	140	6	0	175	85	29	71	0	185	569
Total Volume	130	331	291	0	752	0	0	0	0	0	104	573	29	0	706	324	135	298	0	757	2215
% App. Total	17.3	44	38.7	0		0	0	0	0	0	14.7	81.2	4.1	0		42.8	17.8	39.4	0		
PHF	.722	.899	.799	.000	.900	.000	.000	.000	.000	.000	.813	.924	.604	.000	.910	.920	.785	.931	.000	.976	.973

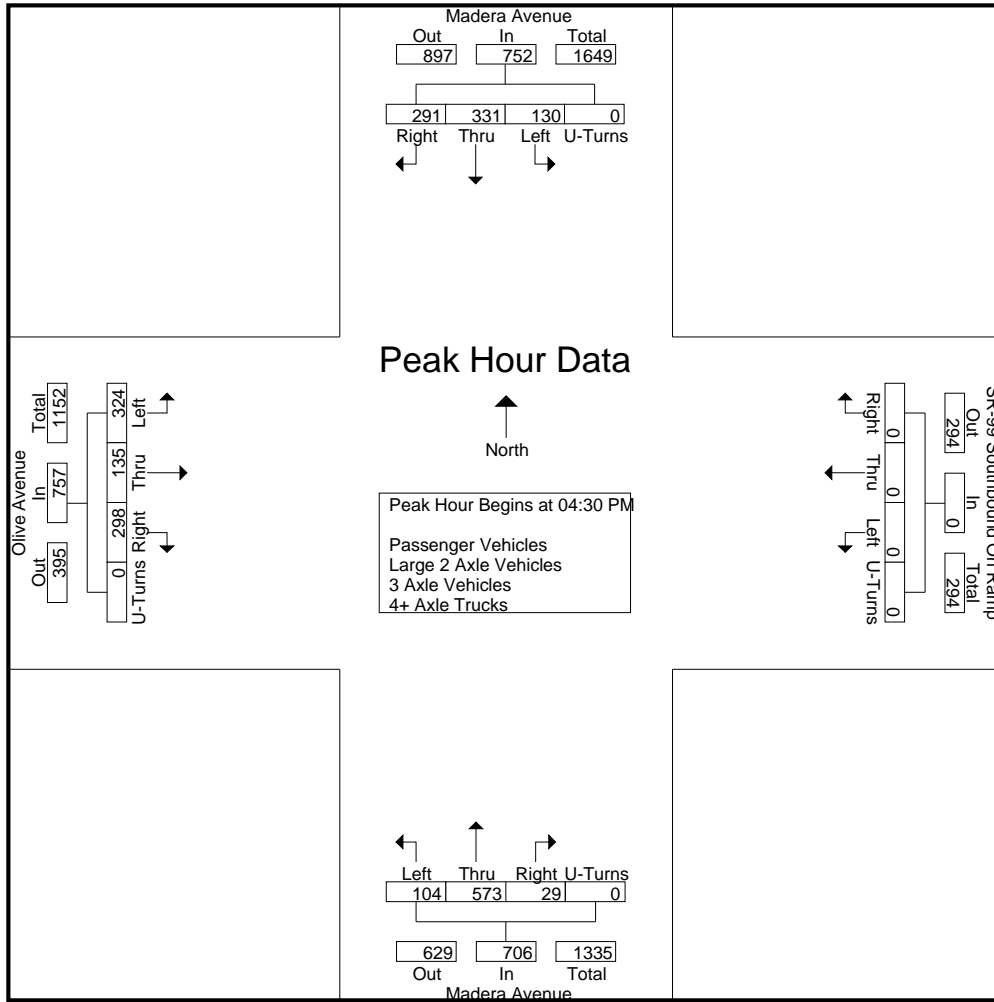

Peak Hour Analysis From 04:00 PM to 05:45 PM - Peak 1 of 1
 Peak Hour for Each Approach Begins at:

	04:45 PM					04:00 PM					04:30 PM					04:00 PM				
+0 mins.	21	71	80	0	172	0	0	0	0	0	32	155	7	0	194	93	46	65	0	204
+15 mins.	45	92	65	0	202	0	0	0	0	0	23	135	4	0	162	77	26	75	0	178
+30 mins.	38	80	91	0	209	0	0	0	0	0	20	143	12	0	175	71	43	80	0	194
+45 mins.	34	85	66	0	185	0	0	0	0	0	29	140	6	0	175	80	33	75	0	188
Total Volume	138	328	302	0	768	0	0	0	0	0	104	573	29	0	706	321	148	295	0	764
% App. Total	18	42.7	39.3	0		0	0	0	0	0	14.7	81.2	4.1	0		42	19.4	38.6	0	
PHF	.767	.891	.830	.000	.919	.000	.000	.000	.000	.000	.813	.924	.604	.000	.910	.863	.804	.922	.000	.936

City of Madera
 N/S: Madera Avenue
 E/W: Olive Ave/SR-99 SB On Ramp
 Weather: Clear

File Name : 37_MDA_Madera_Olive PM
 Site Code : 00319628
 Start Date : 9/24/2019
 Page No : 1

Groups Printed- Passenger Vehicles

Start Time	Madera Avenue Southbound					SR-99 Southbound On Ramp Westbound					Madera Avenue Northbound					Olive Avenue Eastbound					Int. Total
	Left	Thru	Right	U-Turns	App. Total	Left	Thru	Right	U-Turns	App. Total	Left	Thru	Right	U-Turns	App. Total	Left	Thru	Right	U-Turns	App. Total	
04:00 PM	31	77	43	0	151	0	0	0	0	0	35	137	9	0	181	90	44	62	0	196	528
04:15 PM	18	78	44	0	140	0	0	0	0	0	16	136	5	0	157	75	26	72	0	173	470
04:30 PM	26	88	54	0	168	0	0	0	0	0	32	150	7	0	189	70	42	77	0	189	546
04:45 PM	21	69	80	0	170	0	0	0	0	0	23	131	4	0	158	78	33	69	0	180	508
Total	96	312	221	0	629	0	0	0	0	0	106	554	25	0	685	313	145	280	0	738	2052
05:00 PM	44	91	65	0	200	0	0	0	0	0	20	141	12	0	173	84	29	71	0	184	557
05:15 PM	37	80	89	0	206	0	0	0	0	0	29	136	6	0	171	83	28	67	0	178	555
05:30 PM	32	85	65	0	182	0	0	0	0	0	25	121	8	0	154	81	25	48	0	154	490
05:45 PM	22	62	63	0	147	0	0	0	0	0	30	120	10	0	160	73	36	51	0	160	467
Total	135	318	282	0	735	0	0	0	0	0	104	518	36	0	658	321	118	237	0	676	2069
Grand Total	231	630	503	0	1364	0	0	0	0	0	210	1072	61	0	1343	634	263	517	0	1414	4121
Apprch %	16.9	46.2	36.9	0		0	0	0	0		15.6	79.8	4.5	0		44.8	18.6	36.6	0		
Total %	5.6	15.3	12.2	0	33.1	0	0	0	0	0	5.1	26	1.5	0	32.6	15.4	6.4	12.5	0	34.3	

Start Time	Madera Avenue Southbound					SR-99 Southbound On Ramp Westbound					Madera Avenue Northbound					Olive Avenue Eastbound					Int. Total
	Left	Thru	Right	U-Turns	App. Total	Left	Thru	Right	U-Turns	App. Total	Left	Thru	Right	U-Turns	App. Total	Left	Thru	Right	U-Turns	App. Total	
Peak Hour Analysis From 04:30 PM to 05:15 PM - Peak 1 of 1																					
Peak Hour for Entire Intersection Begins at 04:30 PM																					
04:30 PM	26	88	54	0	168	0	0	0	0	0	32	150	7	0	189	70	42	77	0	189	546
04:45 PM	21	69	80	0	170	0	0	0	0	0	23	131	4	0	158	78	33	69	0	180	508
05:00 PM	44	91	65	0	200	0	0	0	0	0	20	141	12	0	173	84	29	71	0	184	557
05:15 PM	37	80	89	0	206	0	0	0	0	0	29	136	6	0	171	83	28	67	0	178	555
Total Volume	128	328	288	0	744	0	0	0	0	0	104	558	29	0	691	315	132	284	0	731	2166
% App. Total	17.2	44.1	38.7	0		0	0	0	0	0	15.1	80.8	4.2	0		43.1	18.1	38.9	0		
PHF	.727	.901	.809	.000	.903	.000	.000	.000	.000	.000	.813	.930	.604	.000	.914	.938	.786	.922	.000	.967	.972

City of Madera
 N/S: Madera Avenue
 E/W: Olive Ave/SR-99 SB On Ramp
 Weather: Clear

File Name : 37_MDA_Madera_Olive PM
 Site Code : 00319628
 Start Date : 9/24/2019
 Page No : 2

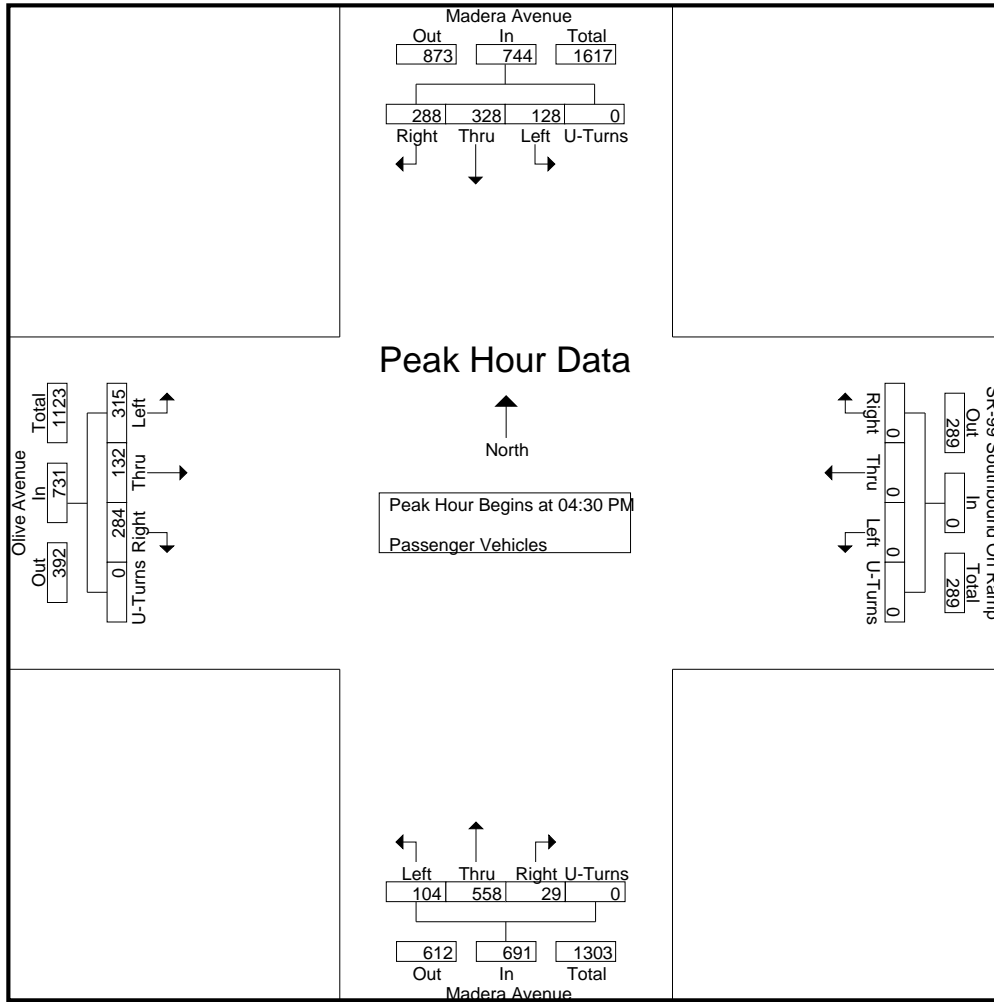

Peak Hour Analysis From 04:30 PM to 05:15 PM - Peak 1 of 1
 Peak Hour for Each Approach Begins at:

	04:30 PM					04:30 PM					04:30 PM									
+0 mins.	26	88	54	0	168	0	0	0	0	0	32	150	7	0	189	70	42	77	0	189
+15 mins.	21	69	80	0	170	0	0	0	0	0	23	131	4	0	158	78	33	69	0	180
+30 mins.	44	91	65	0	200	0	0	0	0	0	20	141	12	0	173	84	29	71	0	184
+45 mins.	37	80	89	0	206	0	0	0	0	0	29	136	6	0	171	83	28	67	0	178
Total Volume	128	328	288	0	744	0	0	0	0	0	104	558	29	0	691	315	132	284	0	731
% App. Total	17.2	44.1	38.7	0		0	0	0	0		15.1	80.8	4.2	0		43.1	18.1	38.9	0	
PHF	.727	.901	.809	.000	.903	.000	.000	.000	.000	.000	.813	.930	.604	.000	.914	.938	.786	.922	.000	.967

City of Madera
 N/S: Madera Avenue
 E/W: Olive Ave/SR-99 SB On Ramp
 Weather: Clear

File Name : 37_MDA_Madera_Olive PM
 Site Code : 00319628
 Start Date : 9/24/2019
 Page No : 1

Groups Printed- Large 2 Axle Vehicles

Start Time	Madera Avenue Southbound					SR-99 Southbound On Ramp Westbound					Madera Avenue Northbound					Olive Avenue Eastbound					Int. Total
	Left	Thru	Right	U-Turns	App. Total	Left	Thru	Right	U-Turns	App. Total	Left	Thru	Right	U-Turns	App. Total	Left	Thru	Right	U-Turns	App. Total	
04:00 PM	1	1	1	0	3	0	0	0	0	0	0	2	0	0	2	2	2	1	0	5	10
04:15 PM	1	0	1	0	2	0	0	0	0	0	0	3	0	0	3	1	0	0	0	1	6
04:30 PM	0	0	1	0	1	0	0	0	0	0	0	4	0	0	4	1	0	0	0	1	6
04:45 PM	0	2	0	0	2	0	0	0	0	0	0	2	0	0	2	2	0	3	0	5	9
Total	2	3	3	0	8	0	0	0	0	0	0	11	0	0	11	6	2	4	0	12	31
05:00 PM	0	1	0	0	1	0	0	0	0	0	0	0	0	0	0	3	1	1	0	5	6
05:15 PM	1	0	1	0	2	0	0	0	0	0	0	1	0	0	1	2	0	1	0	3	6
05:30 PM	2	0	1	0	3	0	0	0	0	0	0	1	0	0	1	0	0	0	0	0	4
05:45 PM	0	1	1	0	2	0	0	0	0	0	0	2	0	0	2	0	0	1	0	1	5
Total	3	2	3	0	8	0	0	0	0	0	0	4	0	0	4	5	1	3	0	9	21
Grand Total	5	5	6	0	16	0	0	0	0	0	0	15	0	0	15	11	3	7	0	21	52
Apprch %	31.2	31.2	37.5	0		0	0	0	0		0	100	0	0		52.4	14.3	33.3	0		
Total %	9.6	9.6	11.5	0	30.8	0	0	0	0	0	0	28.8	0	0	28.8	21.2	5.8	13.5	0	40.4	

Start Time	Madera Avenue Southbound					SR-99 Southbound On Ramp Westbound					Madera Avenue Northbound					Olive Avenue Eastbound					Int. Total
	Left	Thru	Right	U-Turns	App. Total	Left	Thru	Right	U-Turns	App. Total	Left	Thru	Right	U-Turns	App. Total	Left	Thru	Right	U-Turns	App. Total	
04:30 PM	0	0	1	0	1	0	0	0	0	0	0	4	0	0	4	1	0	0	0	1	6
04:45 PM	0	2	0	0	2	0	0	0	0	0	0	2	0	0	2	2	0	3	0	5	9
05:00 PM	0	1	0	0	1	0	0	0	0	0	0	0	0	0	0	3	1	1	0	5	6
05:15 PM	1	0	1	0	2	0	0	0	0	0	0	1	0	0	1	2	0	1	0	3	6
Total Volume	1	3	2	0	6	0	0	0	0	0	0	7	0	0	7	8	1	5	0	14	27
% App. Total	16.7	50	33.3	0		0	0	0	0		0	100	0	0		57.1	7.1	35.7	0		
PHF	.250	.375	.500	.000	.750	.000	.000	.000	.000	.000	.000	.438	.000	.000	.438	.667	.250	.417	.000	.700	.750

Peak Hour Analysis From 04:30 PM to 05:15 PM - Peak 1 of 1

Peak Hour for Entire Intersection Begins at 04:30 PM

City of Madera
 N/S: Madera Avenue
 E/W: Olive Ave/SR-99 SB On Ramp
 Weather: Clear

File Name : 37_MDA_Madera_Olive PM
 Site Code : 00319628
 Start Date : 9/24/2019
 Page No : 2

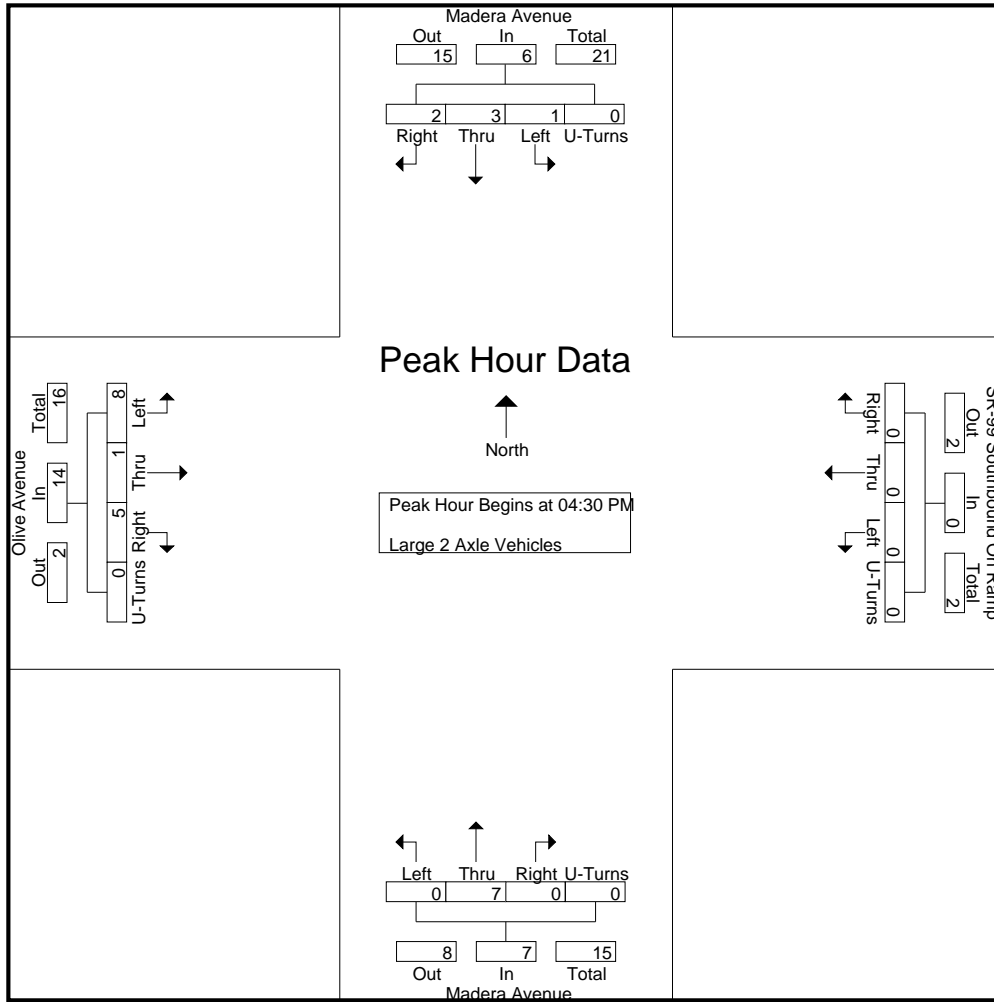

Peak Hour Analysis From 04:30 PM to 05:15 PM - Peak 1 of 1
 Peak Hour for Each Approach Begins at:

	04:30 PM					04:30 PM					04:30 PM									
+0 mins.	0	0	1	0	1	0	0	0	0	0	0	4	0	0	4	1	0	0	0	1
+15 mins.	0	2	0	0	2	0	0	0	0	0	0	2	0	0	2	2	0	3	0	5
+30 mins.	0	1	0	0	1	0	0	0	0	0	0	0	0	0	0	3	1	1	0	5
+45 mins.	1	0	1	0	2	0	0	0	0	0	0	1	0	0	1	2	0	1	0	3
Total Volume	1	3	2	0	6	0	0	0	0	0	0	7	0	0	7	8	1	5	0	14
% App. Total	16.7	50	33.3	0		0	0	0	0		0	100	0	0		57.1	7.1	35.7	0	
PHF	.250	.375	.500	.000	.750	.000	.000	.000	.000	.000	.000	.438	.000	.000	.438	.667	.250	.417	.000	.700

City of Madera
 N/S: Madera Avenue
 E/W: Olive Ave/SR-99 SB On Ramp
 Weather: Clear

File Name : 37_MDA_Madera_Olive PM
 Site Code : 00319628
 Start Date : 9/24/2019
 Page No : 1

Groups Printed- 3 Axle Vehicles

Start Time	Madera Avenue Southbound					SR-99 Southbound On Ramp Westbound					Madera Avenue Northbound					Olive Avenue Eastbound					Int. Total
	Left	Thru	Right	U-Turns	App. Total	Left	Thru	Right	U-Turns	App. Total	Left	Thru	Right	U-Turns	App. Total	Left	Thru	Right	U-Turns	App. Total	
04:00 PM	0	0	0	0	0	0	0	0	0	0	0	0	0	0	0	0	0	0	0	0	0
04:15 PM	0	0	0	0	0	0	0	0	0	0	0	0	0	0	0	0	0	0	0	0	0
04:30 PM	0	0	0	0	0	0	0	0	0	0	0	0	0	0	0	0	0	0	0	0	0
04:45 PM	0	0	0	0	0	0	0	0	0	0	0	1	0	0	1	0	0	0	0	0	1
Total	0	0	0	0	0	0	0	0	0	0	0	1	0	0	1	0	0	0	0	0	1
05:00 PM	0	0	0	0	0	0	0	0	0	0	0	0	0	0	0	0	0	0	0	0	0
05:15 PM	0	0	1	0	1	0	0	0	0	0	0	0	0	0	0	0	0	0	0	0	1
05:30 PM	0	0	0	0	0	0	0	0	0	0	0	0	0	0	0	0	1	1	0	2	2
05:45 PM	0	0	0	0	0	0	0	0	0	0	0	0	0	0	0	0	0	0	0	0	0
Total	0	0	1	0	1	0	0	0	0	0	0	0	0	0	0	0	1	1	0	2	3
Grand Total	0	0	1	0	1	0	0	0	0	0	0	1	0	0	1	0	1	1	0	2	4
Apprch %	0	0	100	0		0	0	0	0		0	100	0	0		0	50	50	0		
Total %	0	0	25	0	25	0	0	0	0	0	0	25	0	0	25	0	25	25	0	50	

Start Time	Madera Avenue Southbound					SR-99 Southbound On Ramp Westbound					Madera Avenue Northbound					Olive Avenue Eastbound					Int. Total
	Left	Thru	Right	U-Turns	App. Total	Left	Thru	Right	U-Turns	App. Total	Left	Thru	Right	U-Turns	App. Total	Left	Thru	Right	U-Turns	App. Total	
Peak Hour Analysis From 04:30 PM to 05:15 PM - Peak 1 of 1																					
Peak Hour for Entire Intersection Begins at 04:30 PM																					
04:30 PM	0	0	0	0	0	0	0	0	0	0	0	0	0	0	0	0	0	0	0	0	0
04:45 PM	0	0	0	0	0	0	0	0	0	0	0	1	0	0	1	0	0	0	0	0	1
05:00 PM	0	0	0	0	0	0	0	0	0	0	0	0	0	0	0	0	0	0	0	0	0
05:15 PM	0	0	1	0	1	0	0	0	0	0	0	0	0	0	0	0	0	0	0	0	1
Total Volume	0	0	1	0	1	0	0	0	0	0	0	1	0	0	1	0	0	0	0	0	2
% App. Total	0	0	100	0		0	0	0	0		0	100	0	0		0	0	0	0		
PHF	.000	.000	.250	.000	.250	.000	.000	.000	.000	.000	.000	.250	.000	.000	.250	.000	.000	.000	.000	.000	.500

City of Madera
 N/S: Madera Avenue
 E/W: Olive Ave/SR-99 SB On Ramp
 Weather: Clear

File Name : 37_MDA_Madera_Olive PM
 Site Code : 00319628
 Start Date : 9/24/2019
 Page No : 2

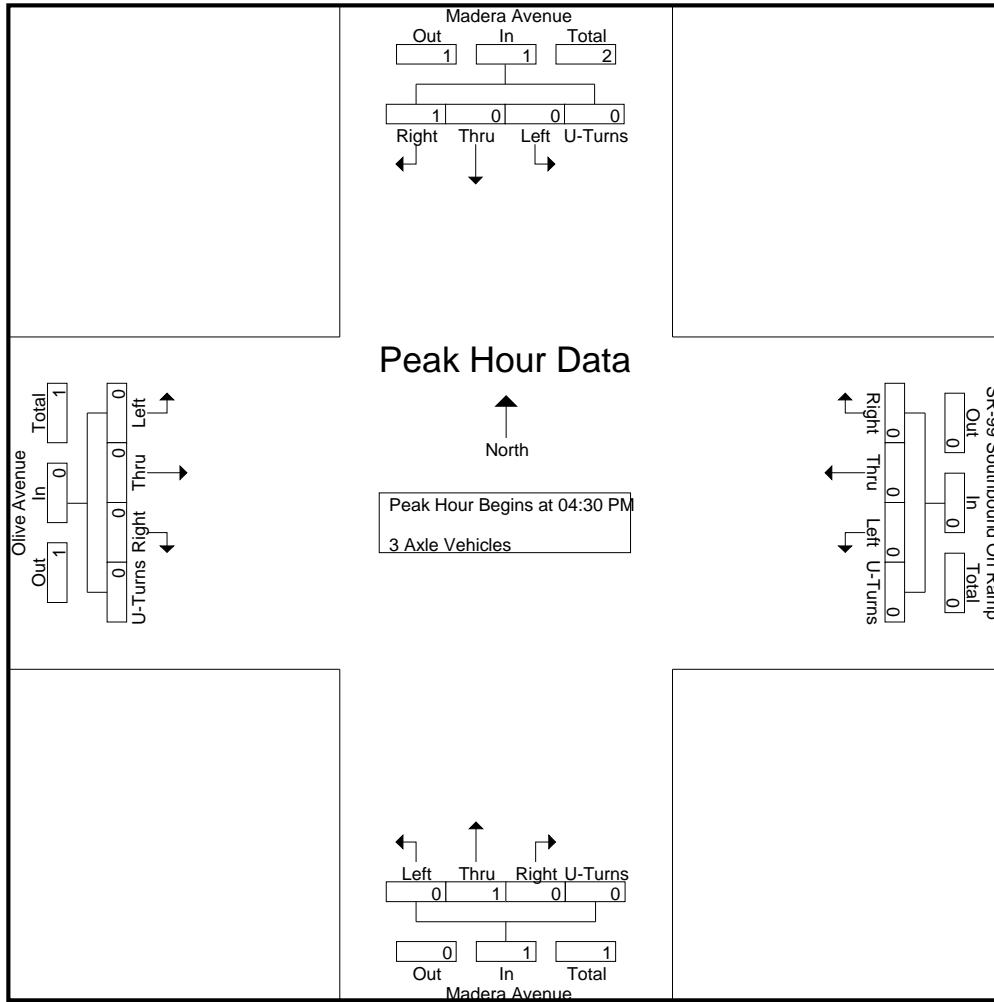

Peak Hour Analysis From 04:30 PM to 05:15 PM - Peak 1 of 1
 Peak Hour for Each Approach Begins at:

	04:30 PM					04:30 PM					04:30 PM					04:30 PM				
+0 mins.	0	0	0	0	0	0	0	0	0	0	0	0	0	0	0	0	0	0	0	0
+15 mins.	0	0	0	0	0	0	0	0	0	0	0	1	0	0	1	0	0	0	0	0
+30 mins.	0	0	0	0	0	0	0	0	0	0	0	0	0	0	0	0	0	0	0	0
+45 mins.	0	0	1	0	1	0	0	0	0	0	0	0	0	0	0	0	0	0	0	0
Total Volume	0	0	1	0	1	0	0	0	0	0	0	1	0	0	1	0	0	0	0	0
% App. Total	0	0	100	0	0	0	0	0	0	0	0	100	0	0	0	0	0	0	0	0
PHF	.000	.000	.250	.000	.250	.000	.000	.000	.000	.000	.000	.250	.000	.000	.250	.000	.000	.000	.000	.000

City of Madera
 N/S: Madera Avenue
 E/W: Olive Ave/SR-99 SB On Ramp
 Weather: Clear

File Name : 37_MDA_Madera_Olive PM
 Site Code : 00319628
 Start Date : 9/24/2019
 Page No : 1

Groups Printed- 4+ Axle Trucks

Start Time	Madera Avenue Southbound					SR-99 Southbound On Ramp Westbound					Madera Avenue Northbound					Olive Avenue Eastbound					Int. Total
	Left	Thru	Right	U-Turns	App. Total	Left	Thru	Right	U-Turns	App. Total	Left	Thru	Right	U-Turns	App. Total	Left	Thru	Right	U-Turns	App. Total	
04:00 PM	0	0	0	0	0	0	0	0	0	0	0	2	0	0	2	1	0	2	0	3	5
04:15 PM	0	0	0	0	0	0	0	0	0	0	0	2	0	0	2	1	0	3	0	4	6
04:30 PM	0	0	0	0	0	0	0	0	0	0	0	1	0	0	1	0	1	3	0	4	5
04:45 PM	0	0	0	0	0	0	0	0	0	0	0	1	0	0	1	0	0	3	0	3	4
Total	0	0	0	0	0	0	0	0	0	0	0	6	0	0	6	2	1	11	0	14	20
05:00 PM	1	0	0	0	1	0	0	0	0	0	0	2	0	0	2	1	0	0	0	1	4
05:15 PM	0	0	0	0	0	0	0	0	0	0	0	3	0	0	3	0	1	3	0	4	7
05:30 PM	0	0	0	0	0	0	0	0	0	0	0	3	0	0	3	0	0	3	0	3	6
05:45 PM	0	1	1	0	2	0	0	0	0	0	0	1	0	0	1	0	1	2	0	3	6
Total	1	1	1	0	3	0	0	0	0	0	0	9	0	0	9	1	2	8	0	11	23
Grand Total	1	1	1	0	3	0	0	0	0	0	0	15	0	0	15	3	3	19	0	25	43
Apprch %	33.3	33.3	33.3	0		0	0	0	0		0	100	0	0		12	12	76	0		
Total %	2.3	2.3	2.3	0	7	0	0	0	0	0	0	34.9	0	0	34.9	7	7	44.2	0	58.1	

Start Time	Madera Avenue Southbound					SR-99 Southbound On Ramp Westbound					Madera Avenue Northbound					Olive Avenue Eastbound					Int. Total
	Left	Thru	Right	U-Turns	App. Total	Left	Thru	Right	U-Turns	App. Total	Left	Thru	Right	U-Turns	App. Total	Left	Thru	Right	U-Turns	App. Total	
Peak Hour Analysis From 04:30 PM to 05:15 PM - Peak 1 of 1																					
Peak Hour for Entire Intersection Begins at 04:30 PM																					
04:30 PM	0	0	0	0	0	0	0	0	0	0	0	1	0	0	1	0	1	3	0	4	5
04:45 PM	0	0	0	0	0	0	0	0	0	0	0	1	0	0	1	0	0	3	0	3	4
05:00 PM	1	0	0	0	1	0	0	0	0	0	0	2	0	0	2	1	0	0	0	1	4
05:15 PM	0	0	0	0	0	0	0	0	0	0	0	3	0	0	3	0	1	3	0	4	7
Total Volume	1	0	0	0	1	0	0	0	0	0	0	7	0	0	7	1	2	9	0	12	20
% App. Total	100	0	0	0		0	0	0	0		0	100	0	0		8.3	16.7	75	0		
PHF	.250	.000	.000	.000	.250	.000	.000	.000	.000	.000	.000	.583	.000	.000	.583	.250	.500	.750	.000	.750	.714

City of Madera
 N/S: Madera Avenue
 E/W: Olive Ave/SR-99 SB On Ramp
 Weather: Clear

File Name : 37_MDA_Madera_Olive PM
 Site Code : 00319628
 Start Date : 9/24/2019
 Page No : 2

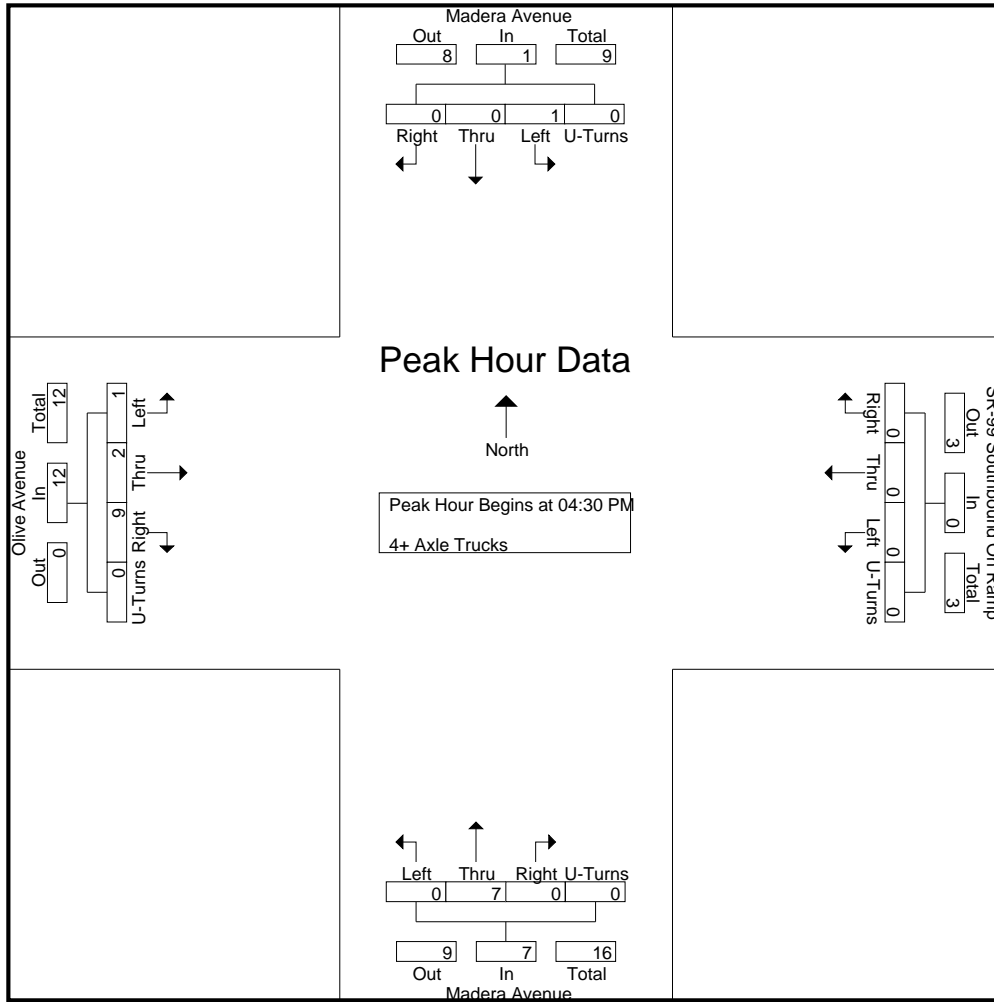

Peak Hour Analysis From 04:30 PM to 05:15 PM - Peak 1 of 1
 Peak Hour for Each Approach Begins at:

	04:30 PM					04:30 PM					04:30 PM									
+0 mins.	0	0	0	0	0	0	0	0	0	0	0	1	0	0	1	0	1	3	0	4
+15 mins.	0	0	0	0	0	0	0	0	0	0	0	1	0	0	1	0	0	3	0	3
+30 mins.	1	0	0	0	1	0	0	0	0	0	0	2	0	0	2	1	0	0	0	1
+45 mins.	0	0	0	0	0	0	0	0	0	0	0	3	0	0	3	0	1	3	0	4
Total Volume	1	0	0	0	1	0	0	0	0	0	0	7	0	0	7	1	2	9	0	12
% App. Total	100	0	0	0	0	0	0	0	0	0	0	100	0	0	0	8.3	16.7	75	0	0
PHF	.250	.000	.000	.000	.250	.000	.000	.000	.000	.000	.000	.583	.000	.000	.583	.250	.500	.750	.000	.750

Location: Madera
 N/S: Madera Avenue
 E/W: Olive Ave/SR-99 SB On Ramp



Date: 9/24/2019
 Day: Tuesday

PEDESTRIANS

	North Leg Madera Avenue Pedestrians	East Leg SR-99 SB ON Ramp Pedestrians	South Leg Madera Avenue Pedestrians	West Leg Olive Avenue Pedestrians	
7:00 AM	0	1	0	1	2
7:15 AM	0	3	3	3	9
7:30 AM	0	0	0	2	2
7:45 AM	0	0	0	6	6
8:00 AM	0	2	0	0	2
8:15 AM	0	0	0	2	2
8:30 AM	0	0	0	1	1
8:45 AM	0	0	1	2	3
TOTAL VOLUMES:	0	6	4	17	27

	North Leg Madera Avenue Pedestrians	East Leg SR-99 SB ON Ramp Pedestrians	South Leg Madera Avenue Pedestrians	West Leg Olive Avenue Pedestrians	
4:00 PM	0	0	0	2	2
4:15 PM	0	1	1	1	3
4:30 PM	0	0	0	0	0
4:45 PM	0	0	1	0	1
5:00 PM	0	0	0	1	1
5:15 PM	0	0	0	0	0
5:30 PM	0	0	0	0	0
5:45 PM	0	0	0	0	0
TOTAL VOLUMES:	0	1	2	4	7

Location: Madera
 N/S: Madera Avenue
 E/W: Olive Ave/SR-99 SB On Ramp



Date: 9/24/2019
 Day: Tuesday

BICYCLES

	Southbound Madera Avenue			Westbound SR-99 SB ON Ramp			Northbound Madera Avenue			Eastbound Olive Avenue			
	Left	Thru	Right	Left	Thru	Right	Left	Thru	Right	Left	Thru	Right	
7:00 AM	0	0	0	0	0	0	0	0	0	0	0	0	0
7:15 AM	0	0	0	0	0	0	0	0	0	0	0	0	0
7:30 AM	0	1	0	0	0	0	0	0	0	0	0	0	1
7:45 AM	0	0	0	0	0	0	0	0	0	0	0	0	0
8:00 AM	0	0	0	0	0	0	0	0	0	0	0	0	0
8:15 AM	0	1	0	0	0	0	0	0	0	0	0	0	1
8:30 AM	0	0	0	0	0	0	0	0	0	0	0	0	0
8:45 AM	0	1	0	0	0	0	0	0	0	0	0	0	1
TOTAL VOLUMES:	0	3	0	0	0	0	0	0	0	0	0	0	3

	Southbound Madera Avenue			Westbound SR-99 SB ON Ramp			Northbound Madera Avenue			Eastbound Olive Avenue			
	Left	Thru	Right	Left	Thru	Right	Left	Thru	Right	Left	Thru	Right	
4:00 PM	0	0	0	0	0	0	0	0	0	0	0	0	0
4:15 PM	0	0	0	0	0	0	0	0	0	0	0	0	0
4:30 PM	0	0	0	0	0	0	0	0	0	0	0	0	0
4:45 PM	0	0	0	0	0	0	0	0	0	0	0	0	0
5:00 PM	0	0	0	0	0	0	0	0	0	0	0	0	0
5:15 PM	0	0	0	0	0	0	0	0	0	0	0	0	0
5:30 PM	0	0	0	0	0	0	0	0	0	0	0	0	0
5:45 PM	0	0	0	0	0	0	0	1	0	0	0	0	1
TOTAL VOLUMES:	0	0	0	0	0	0	0	1	0	0	0	0	1

City of Madera
 N/S: Madera Avenue
 E/W: East Lewis Street
 Weather: Clear

File Name : 56_MDA_Madera_E Lewis AM
 Site Code : 00319628
 Start Date : 9/26/2019
 Page No : 1

Groups Printed- Passenger Vehicles - Large 2 Axle Vehicles - 3 Axle Vehicles - 4+ Axle Trucks

Start Time	Madera Avenue Southbound				East Lewis Street Westbound				Madera Avenue Northbound				Int. Total
	Left	Thru	U-Turns	App. Total	Left	Right	U-Turns	App. Total	Thru	Right	U-Turns	App. Total	
07:00 AM	1	77	2	80	0	0	0	0	99	0	0	99	179
07:15 AM	4	101	0	105	2	1	0	3	135	1	0	136	244
07:30 AM	5	177	0	182	3	0	0	3	159	2	0	161	346
07:45 AM	4	198	3	205	3	2	0	5	153	2	0	155	365
Total	14	553	5	572	8	3	0	11	546	5	0	551	1134
08:00 AM	7	178	2	187	2	2	0	4	145	2	0	147	338
08:15 AM	9	211	0	220	4	2	0	6	135	3	0	138	364
08:30 AM	6	177	0	183	0	2	0	2	186	1	0	187	372
08:45 AM	6	143	0	149	3	1	0	4	142	2	0	144	297
Total	28	709	2	739	9	7	0	16	608	8	0	616	1371
Grand Total	42	1262	7	1311	17	10	0	27	1154	13	0	1167	2505
Apprch %	3.2	96.3	0.5		63	37	0		98.9	1.1	0		
Total %	1.7	50.4	0.3	52.3	0.7	0.4	0	1.1	46.1	0.5	0	46.6	
Passenger Vehicles	38	1184	6	1228	15	9	0	24	1079	11	0	1090	2342
% Passenger Vehicles	90.5	93.8	85.7	93.7	88.2	90	0	88.9	93.5	84.6	0	93.4	93.5
Large 2 Axle Vehicles	3	40	1	44	1	1	0	2	35	2	0	37	83
% Large 2 Axle Vehicles	7.1	3.2	14.3	3.4	5.9	10	0	7.4	3	15.4	0	3.2	3.3
3 Axle Vehicles	0	4	0	4	0	0	0	0	2	0	0	2	6
% 3 Axle Vehicles	0	0.3	0	0.3	0	0	0	0	0.2	0	0	0.2	0.2
4+ Axle Trucks	1	34	0	35	1	0	0	1	38	0	0	38	74
% 4+ Axle Trucks	2.4	2.7	0	2.7	5.9	0	0	3.7	3.3	0	0	3.3	3

Start Time	Madera Avenue Southbound				East Lewis Street Westbound				Madera Avenue Northbound				Int. Total
	Left	Thru	U-Turns	App. Total	Left	Right	U-Turns	App. Total	Thru	Right	U-Turns	App. Total	
Peak Hour Analysis From 07:00 AM to 08:45 AM - Peak 1 of 1													
Peak Hour for Entire Intersection Begins at 07:45 AM													
07:45 AM	4	198	3	205	3	2	0	5	153	2	0	155	365
08:00 AM	7	178	2	187	2	2	0	4	145	2	0	147	338
08:15 AM	9	211	0	220	4	2	0	6	135	3	0	138	364
08:30 AM	6	177	0	183	0	2	0	2	186	1	0	187	372
Total Volume	26	764	5	795	9	8	0	17	619	8	0	627	1439
% App. Total	3.3	96.1	0.6		52.9	47.1	0		98.7	1.3	0		
PHF	.722	.905	.417	.903	.563	1.00	.000	.708	.832	.667	.000	.838	.967

City of Madera
 N/S: Madera Avenue
 E/W: East Lewis Street
 Weather: Clear

File Name : 56_MDA_Madera_E Lewis AM
 Site Code : 00319628
 Start Date : 9/26/2019
 Page No : 2

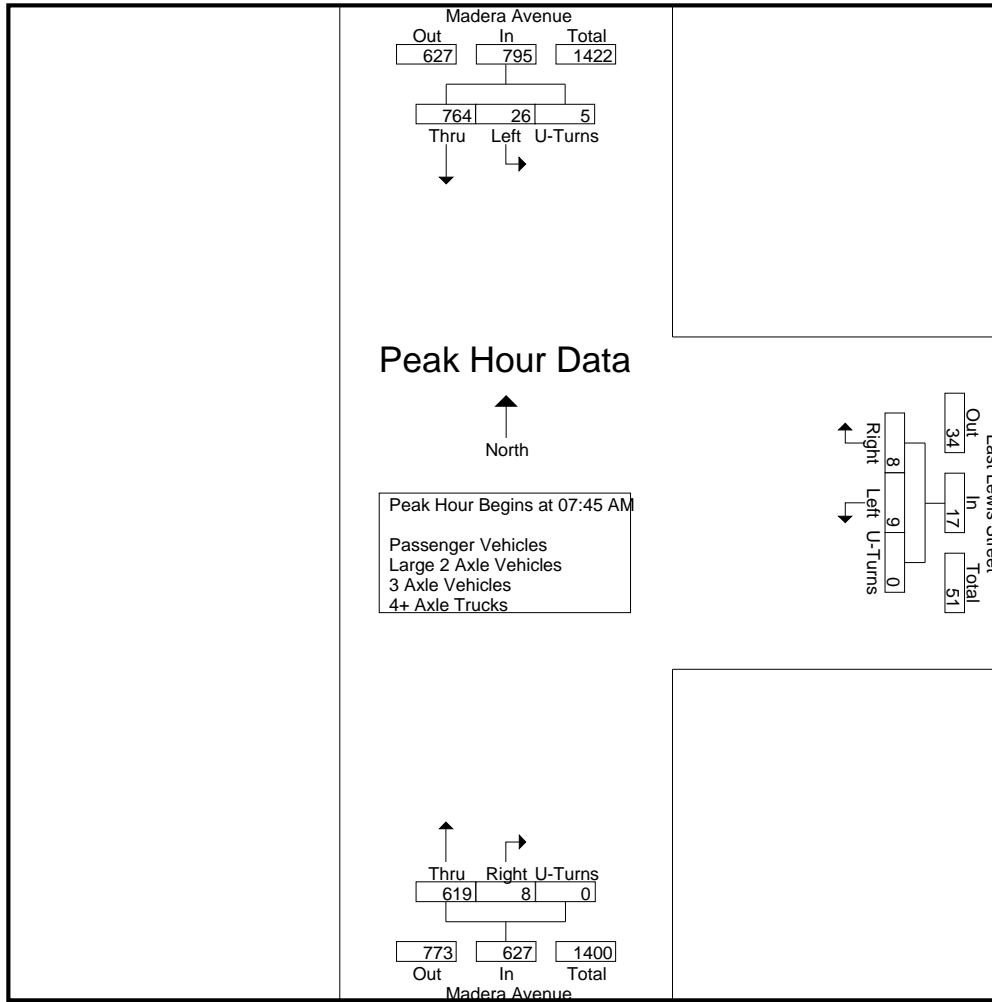

Peak Hour Analysis From 07:00 AM to 08:45 AM - Peak 1 of 1
 Peak Hour for Each Approach Begins at:

	07:30 AM				07:45 AM							
+0 mins.	4	198	3	205	3	0	0	3	153	2	0	155
+15 mins.	7	178	2	187	3	2	0	5	145	2	0	147
+30 mins.	9	211	0	220	2	2	0	4	135	3	0	138
+45 mins.	6	177	0	183	4	2	0	6	186	1	0	187
Total Volume	26	764	5	795	12	6	0	18	619	8	0	627
% App. Total	3.3	96.1	0.6		66.7	33.3	0		98.7	1.3	0	
PHF	.722	.905	.417	.903	.750	.750	.000	.750	.832	.667	.000	.838

City of Madera
 N/S: Madera Avenue
 E/W: East Lewis Street
 Weather: Clear

File Name : 56_MDA_Madera_E Lewis AM
 Site Code : 00319628
 Start Date : 9/26/2019
 Page No : 1

Groups Printed- Passenger Vehicles

Start Time	Madera Avenue Southbound				East Lewis Street Westbound				Madera Avenue Northbound				Int. Total
	Left	Thru	U-Turns	App. Total	Left	Right	U-Turns	App. Total	Thru	Right	U-Turns	App. Total	
07:00 AM	1	70	2	73	0	0	0	0	94	0	0	94	167
07:15 AM	3	94	0	97	2	1	0	3	124	1	0	125	225
07:30 AM	5	165	0	170	2	0	0	2	147	2	0	149	321
07:45 AM	3	188	2	193	3	2	0	5	144	2	0	146	344
Total	12	517	4	533	7	3	0	10	509	5	0	514	1057
08:00 AM	7	169	2	178	2	2	0	4	136	1	0	137	319
08:15 AM	8	201	0	209	3	1	0	4	127	2	0	129	342
08:30 AM	6	162	0	168	0	2	0	2	174	1	0	175	345
08:45 AM	5	135	0	140	3	1	0	4	133	2	0	135	279
Total	26	667	2	695	8	6	0	14	570	6	0	576	1285
Grand Total	38	1184	6	1228	15	9	0	24	1079	11	0	1090	2342
Apprch %	3.1	96.4	0.5		62.5	37.5	0		99	1	0		
Total %	1.6	50.6	0.3	52.4	0.6	0.4	0	1	46.1	0.5	0	46.5	

Start Time	Madera Avenue Southbound				East Lewis Street Westbound				Madera Avenue Northbound				Int. Total
	Left	Thru	U-Turns	App. Total	Left	Right	U-Turns	App. Total	Thru	Right	U-Turns	App. Total	
Peak Hour Analysis From 07:45 AM to 08:30 AM - Peak 1 of 1													
Peak Hour for Entire Intersection Begins at 07:45 AM													
07:45 AM	3	188	2	193	3	2	0	5	144	2	0	146	344
08:00 AM	7	169	2	178	2	2	0	4	136	1	0	137	319
08:15 AM	8	201	0	209	3	1	0	4	127	2	0	129	342
08:30 AM	6	162	0	168	0	2	0	2	174	1	0	175	345
Total Volume	24	720	4	748	8	7	0	15	581	6	0	587	1350
% App. Total	3.2	96.3	0.5		53.3	46.7	0		99	1	0		
PHF	.750	.896	.500	.895	.667	.875	.000	.750	.835	.750	.000	.839	.978

City of Madera
 N/S: Madera Avenue
 E/W: East Lewis Street
 Weather: Clear

File Name : 56_MDA_Madera_E Lewis AM
 Site Code : 00319628
 Start Date : 9/26/2019
 Page No : 2

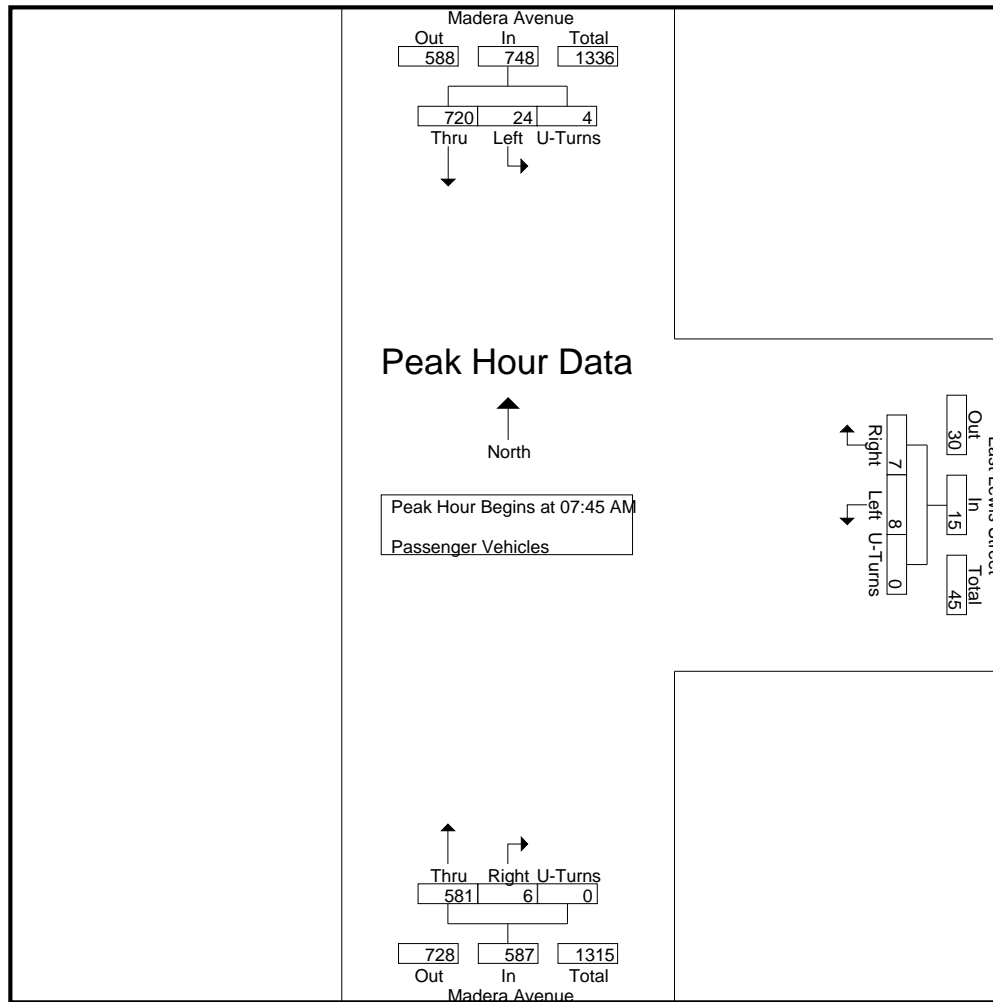

Peak Hour Analysis From 07:45 AM to 08:30 AM - Peak 1 of 1
 Peak Hour for Each Approach Begins at:

	07:45 AM				07:45 AM				07:45 AM			
+0 mins.	3	188	2	193	3	2	0	5	144	2	0	146
+15 mins.	7	169	2	178	2	2	0	4	136	1	0	137
+30 mins.	8	201	0	209	3	1	0	4	127	2	0	129
+45 mins.	6	162	0	168	0	2	0	2	174	1	0	175
Total Volume	24	720	4	748	8	7	0	15	581	6	0	587
% App. Total	3.2	96.3	0.5		53.3	46.7	0		99	1	0	
PHF	.750	.896	.500	.895	.667	.875	.000	.750	.835	.750	.000	.839

City of Madera
 N/S: Madera Avenue
 E/W: East Lewis Street
 Weather: Clear

File Name : 56_MDA_Madera_E Lewis AM
 Site Code : 00319628
 Start Date : 9/26/2019
 Page No : 1

Groups Printed- Large 2 Axle Vehicles

Start Time	Madera Avenue Southbound				East Lewis Street Westbound				Madera Avenue Northbound				Int. Total	
	Left	Thru	U-Turns	App. Total	Left	Right	U-Turns	App. Total	Thru	Right	U-Turns	App. Total		
07:00 AM	0	3	0	3	0	0	0	0	0	0	0	0	0	3
07:15 AM	1	4	0	5	0	0	0	0	6	0	0	6	0	11
07:30 AM	0	7	0	7	1	0	0	1	5	0	0	5	0	13
07:45 AM	1	3	1	5	0	0	0	0	5	0	0	5	0	10
Total	2	17	1	20	1	0	0	1	16	0	0	16	0	37
08:00 AM	0	8	0	8	0	0	0	0	4	1	0	5	0	13
08:15 AM	0	5	0	5	0	1	0	1	3	1	0	4	0	10
08:30 AM	0	8	0	8	0	0	0	0	5	0	0	5	0	13
08:45 AM	1	2	0	3	0	0	0	0	7	0	0	7	0	10
Total	1	23	0	24	0	1	0	1	19	2	0	21	0	46
Grand Total	3	40	1	44	1	1	0	2	35	2	0	37	0	83
Apprch %	6.8	90.9	2.3		50	50	0		94.6	5.4	0			
Total %	3.6	48.2	1.2	53	1.2	1.2	0	2.4	42.2	2.4	0	44.6		

Start Time	Madera Avenue Southbound				East Lewis Street Westbound				Madera Avenue Northbound				Int. Total	
	Left	Thru	U-Turns	App. Total	Left	Right	U-Turns	App. Total	Thru	Right	U-Turns	App. Total		
Peak Hour Analysis From 07:45 AM to 08:30 AM - Peak 1 of 1														
Peak Hour for Entire Intersection Begins at 07:45 AM														
07:45 AM	1	3	1	5	0	0	0	0	5	0	0	5	0	10
08:00 AM	0	8	0	8	0	0	0	0	4	1	0	5	0	13
08:15 AM	0	5	0	5	0	1	0	1	3	1	0	4	0	10
08:30 AM	0	8	0	8	0	0	0	0	5	0	0	5	0	13
Total Volume	1	24	1	26	0	1	0	1	17	2	0	19	0	46
% App. Total	3.8	92.3	3.8		0	100	0		89.5	10.5	0			
PHF	.250	.750	.250	.813	.000	.250	.000	.250	.850	.500	.000	.950		.885

City of Madera
 N/S: Madera Avenue
 E/W: East Lewis Street
 Weather: Clear

File Name : 56_MDA_Madera_E Lewis AM
 Site Code : 00319628
 Start Date : 9/26/2019
 Page No : 2

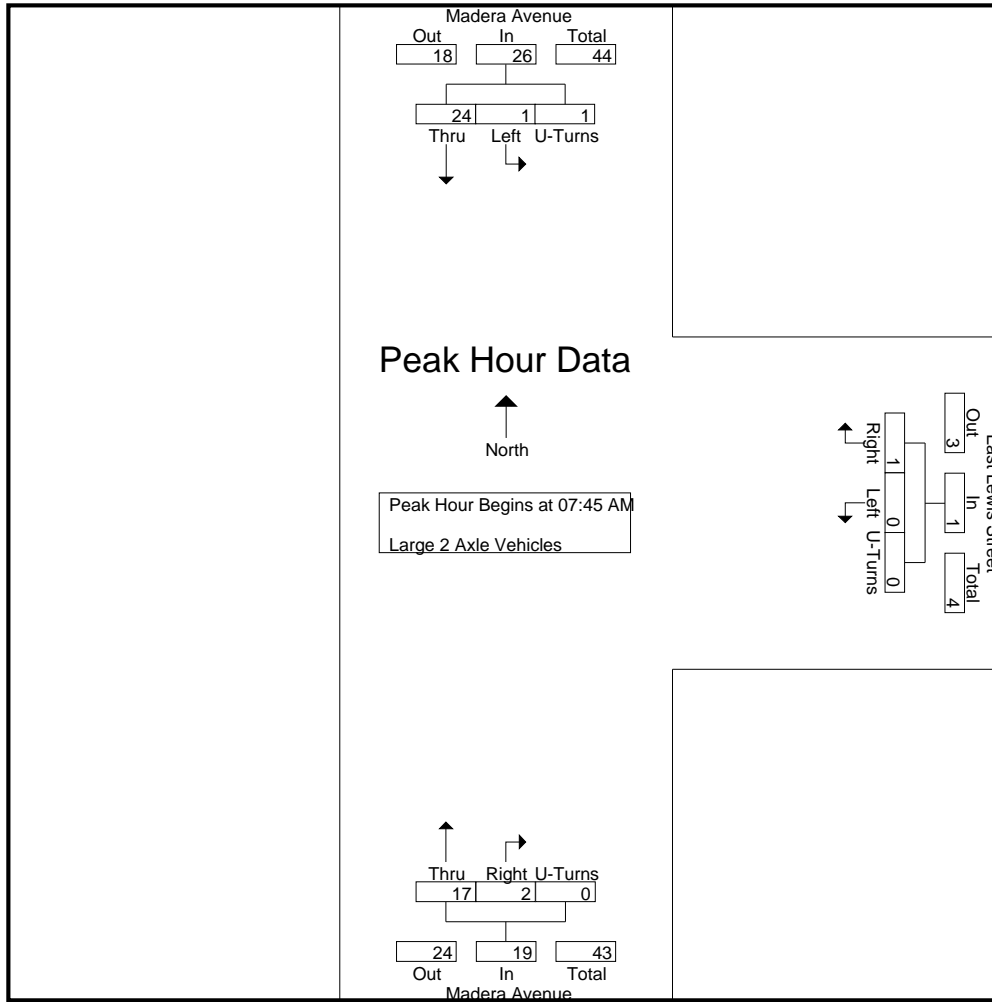

Peak Hour Analysis From 07:45 AM to 08:30 AM - Peak 1 of 1
 Peak Hour for Each Approach Begins at:

	07:45 AM				07:45 AM				07:45 AM			
+0 mins.	1	3	1	5	0	0	0	0	5	0	0	5
+15 mins.	0	8	0	8	0	0	0	0	4	1	0	5
+30 mins.	0	5	0	5	0	1	0	1	3	1	0	4
+45 mins.	0	8	0	8	0	0	0	0	5	0	0	5
Total Volume	1	24	1	26	0	1	0	1	17	2	0	19
% App. Total	3.8	92.3	3.8		0	100	0		89.5	10.5	0	
PHF	.250	.750	.250	.813	.000	.250	.000	.250	.850	.500	.000	.950

City of Madera
 N/S: Madera Avenue
 E/W: East Lewis Street
 Weather: Clear

File Name : 56_MDA_Madera_E Lewis AM
 Site Code : 00319628
 Start Date : 9/26/2019
 Page No : 1

Groups Printed- 3 Axle Vehicles

Start Time	Madera Avenue Southbound				East Lewis Street Westbound				Madera Avenue Northbound				Int. Total
	Left	Thru	U-Turns	App. Total	Left	Right	U-Turns	App. Total	Thru	Right	U-Turns	App. Total	
07:00 AM	0	1	0	1	0	0	0	0	1	0	0	1	2
07:15 AM	0	0	0	0	0	0	0	0	0	0	0	0	0
07:30 AM	0	0	0	0	0	0	0	0	0	0	0	0	0
07:45 AM	0	1	0	1	0	0	0	0	0	0	0	0	1
Total	0	2	0	2	0	0	0	0	1	0	0	1	3
08:00 AM	0	0	0	0	0	0	0	0	0	0	0	0	0
08:15 AM	0	0	0	0	0	0	0	0	1	0	0	1	1
08:30 AM	0	0	0	0	0	0	0	0	0	0	0	0	0
08:45 AM	0	2	0	2	0	0	0	0	0	0	0	0	2
Total	0	2	0	2	0	0	0	0	1	0	0	1	3
Grand Total	0	4	0	4	0	0	0	0	2	0	0	2	6
Apprch %	0	100	0		0	0	0		100	0	0		
Total %	0	66.7	0	66.7	0	0	0	0	33.3	0	0	33.3	

Start Time	Madera Avenue Southbound				East Lewis Street Westbound				Madera Avenue Northbound				Int. Total
	Left	Thru	U-Turns	App. Total	Left	Right	U-Turns	App. Total	Thru	Right	U-Turns	App. Total	
07:45 AM	0	1	0	1	0	0	0	0	0	0	0	0	1
08:00 AM	0	0	0	0	0	0	0	0	0	0	0	0	0
08:15 AM	0	0	0	0	0	0	0	0	1	0	0	1	1
08:30 AM	0	0	0	0	0	0	0	0	0	0	0	0	0
Total Volume	0	1	0	1	0	0	0	0	1	0	0	1	2
% App. Total	0	100	0		0	0	0		100	0	0		
PHF	.000	.250	.000	.250	.000	.000	.000	.000	.250	.000	.000	.250	.500

Peak Hour Analysis From 07:45 AM to 08:30 AM - Peak 1 of 1

Peak Hour for Entire Intersection Begins at 07:45 AM

City of Madera
 N/S: Madera Avenue
 E/W: East Lewis Street
 Weather: Clear

File Name : 56_MDA_Madera_E Lewis AM
 Site Code : 00319628
 Start Date : 9/26/2019
 Page No : 2

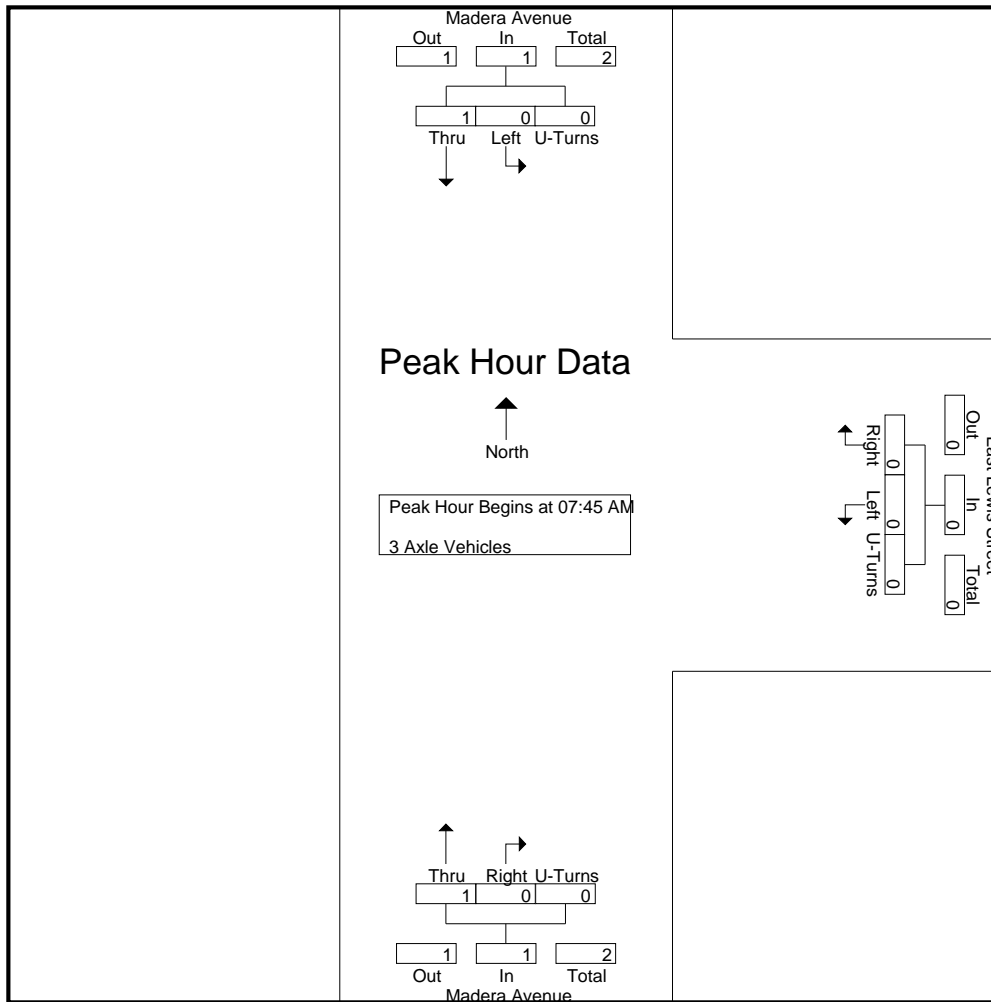

Peak Hour Analysis From 07:45 AM to 08:30 AM - Peak 1 of 1
 Peak Hour for Each Approach Begins at:

	07:45 AM				07:45 AM				07:45 AM			
+0 mins.	0	1	0	1	0	0	0	0	0	0	0	0
+15 mins.	0	0	0	0	0	0	0	0	0	0	0	0
+30 mins.	0	0	0	0	0	0	0	0	1	0	0	1
+45 mins.	0	0	0	0	0	0	0	0	0	0	0	0
Total Volume	0	1	0	1	0	0	0	0	1	0	0	1
% App. Total	0	100	0	0	0	0	0	0	100	0	0	0
PHF	.000	.250	.000	.250	.000	.000	.000	.000	.250	.000	.000	.250

City of Madera
 N/S: Madera Avenue
 E/W: East Lewis Street
 Weather: Clear

File Name : 56_MDA_Madera_E Lewis AM
 Site Code : 00319628
 Start Date : 9/26/2019
 Page No : 1

Groups Printed- 4+ Axle Trucks

Start Time	Madera Avenue Southbound				East Lewis Street Westbound				Madera Avenue Northbound				Int. Total
	Left	Thru	U-Turns	App. Total	Left	Right	U-Turns	App. Total	Thru	Right	U-Turns	App. Total	
07:00 AM	0	3	0	3	0	0	0	0	4	0	0	4	7
07:15 AM	0	3	0	3	0	0	0	0	5	0	0	5	8
07:30 AM	0	5	0	5	0	0	0	0	7	0	0	7	12
07:45 AM	0	6	0	6	0	0	0	0	4	0	0	4	10
Total	0	17	0	17	0	0	0	0	20	0	0	20	37
08:00 AM	0	1	0	1	0	0	0	0	5	0	0	5	6
08:15 AM	1	5	0	6	1	0	0	1	4	0	0	4	11
08:30 AM	0	7	0	7	0	0	0	0	7	0	0	7	14
08:45 AM	0	4	0	4	0	0	0	0	2	0	0	2	6
Total	1	17	0	18	1	0	0	1	18	0	0	18	37
Grand Total	1	34	0	35	1	0	0	1	38	0	0	38	74
Apprch %	2.9	97.1	0		100	0	0		100	0	0		
Total %	1.4	45.9	0	47.3	1.4	0	0	1.4	51.4	0	0	51.4	

Start Time	Madera Avenue Southbound				East Lewis Street Westbound				Madera Avenue Northbound				Int. Total
	Left	Thru	U-Turns	App. Total	Left	Right	U-Turns	App. Total	Thru	Right	U-Turns	App. Total	
Peak Hour Analysis From 07:45 AM to 08:30 AM - Peak 1 of 1													
Peak Hour for Entire Intersection Begins at 07:45 AM													
07:45 AM	0	6	0	6	0	0	0	0	4	0	0	4	10
08:00 AM	0	1	0	1	0	0	0	0	5	0	0	5	6
08:15 AM	1	5	0	6	1	0	0	1	4	0	0	4	11
08:30 AM	0	7	0	7	0	0	0	0	7	0	0	7	14
Total Volume	1	19	0	20	1	0	0	1	20	0	0	20	41
% App. Total	5	95	0		100	0	0		100	0	0		
PHF	.250	.679	.000	.714	.250	.000	.000	.250	.714	.000	.000	.714	.732

City of Madera
 N/S: Madera Avenue
 E/W: East Lewis Street
 Weather: Clear

File Name : 56_MDA_Madera_E Lewis AM
 Site Code : 00319628
 Start Date : 9/26/2019
 Page No : 2

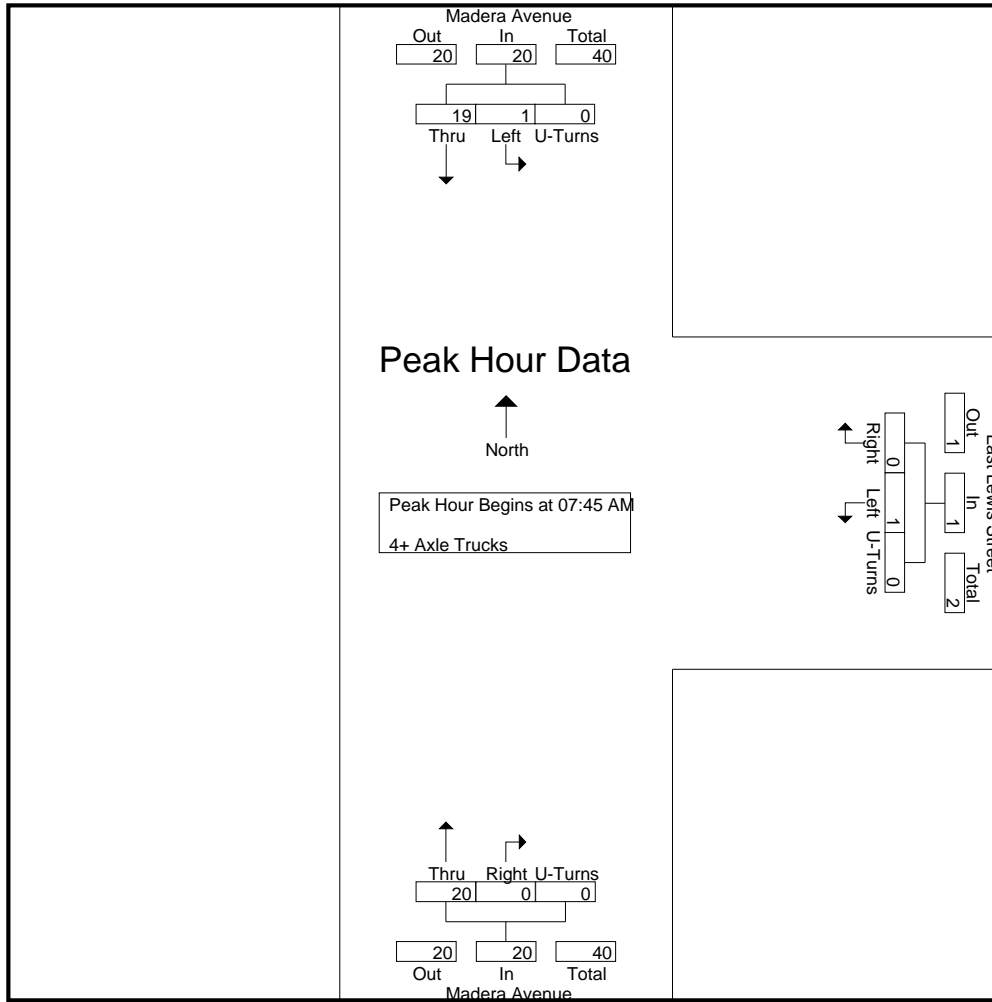

Peak Hour Analysis From 07:45 AM to 08:30 AM - Peak 1 of 1
 Peak Hour for Each Approach Begins at:

	07:45 AM				07:45 AM				07:45 AM			
+0 mins.	0	6	0	6	0	0	0	0	4	0	0	4
+15 mins.	0	1	0	1	0	0	0	0	5	0	0	5
+30 mins.	1	5	0	6	1	0	0	1	4	0	0	4
+45 mins.	0	7	0	7	0	0	0	0	7	0	0	7
Total Volume	1	19	0	20	1	0	0	1	20	0	0	20
% App. Total	5	95	0		100	0	0		100	0	0	
PHF	.250	.679	.000	.714	.250	.000	.000	.250	.714	.000	.000	.714

City of Madera
 N/S: Madera Avenue
 E/W: East Lewis Street
 Weather: Clear

File Name : 56_MDA_Madera_E Lewis PM
 Site Code : 00319628
 Start Date : 9/26/2019
 Page No : 1

Groups Printed- Passenger Vehicles - Large 2 Axle Vehicles - 3 Axle Vehicles - 4+ Axle Trucks

Start Time	Madera Avenue Southbound				East Lewis Street Westbound				Madera Avenue Northbound				Int. Total
	Left	Thru	U-Turns	App. Total	Left	Right	U-Turns	App. Total	Thru	Right	U-Turns	App. Total	
04:00 PM	7	152	1	160	6	4	0	10	178	0	0	178	348
04:15 PM	6	175	1	182	1	0	0	1	162	4	0	166	349
04:30 PM	8	176	1	185	1	3	0	4	196	0	0	196	385
04:45 PM	6	168	1	175	4	2	0	6	160	3	0	163	344
Total	27	671	4	702	12	9	0	21	696	7	0	703	1426
05:00 PM	4	172	0	176	0	1	0	1	210	3	0	213	390
05:15 PM	10	174	1	185	2	3	0	5	173	0	0	173	363
05:30 PM	8	157	0	165	5	2	0	7	167	3	0	170	342
05:45 PM	7	153	0	160	2	1	0	3	156	4	0	160	323
Total	29	656	1	686	9	7	0	16	706	10	0	716	1418
Grand Total	56	1327	5	1388	21	16	0	37	1402	17	0	1419	2844
Apprch %	4	95.6	0.4		56.8	43.2	0		98.8	1.2	0		
Total %	2	46.7	0.2	48.8	0.7	0.6	0	1.3	49.3	0.6	0	49.9	
Passenger Vehicles	55	1287	5	1347	20	16	0	36	1368	17	0	1385	2768
% Passenger Vehicles	98.2	97	100	97	95.2	100	0	97.3	97.6	100	0	97.6	97.3
Large 2 Axle Vehicles	1	14	0	15	1	0	0	1	17	0	0	17	33
% Large 2 Axle Vehicles	1.8	1.1	0	1.1	4.8	0	0	2.7	1.2	0	0	1.2	1.2
3 Axle Vehicles	0	2	0	2	0	0	0	0	0	0	0	0	2
% 3 Axle Vehicles	0	0.2	0	0.1	0	0	0	0	0	0	0	0	0.1
4+ Axle Trucks	0	24	0	24	0	0	0	0	17	0	0	17	41
% 4+ Axle Trucks	0	1.8	0	1.7	0	0	0	0	1.2	0	0	1.2	1.4

Start Time	Madera Avenue Southbound				East Lewis Street Westbound				Madera Avenue Northbound				Int. Total
	Left	Thru	U-Turns	App. Total	Left	Right	U-Turns	App. Total	Thru	Right	U-Turns	App. Total	
Peak Hour Analysis From 04:00 PM to 05:45 PM - Peak 1 of 1													
Peak Hour for Entire Intersection Begins at 04:30 PM													
04:30 PM	8	176	1	185	1	3	0	4	196	0	0	196	385
04:45 PM	6	168	1	175	4	2	0	6	160	3	0	163	344
05:00 PM	4	172	0	176	0	1	0	1	210	3	0	213	390
05:15 PM	10	174	1	185	2	3	0	5	173	0	0	173	363
Total Volume	28	690	3	721	7	9	0	16	739	6	0	745	1482
% App. Total	3.9	95.7	0.4		43.8	56.2	0		99.2	0.8	0		
PHF	.700	.980	.750	.974	.438	.750	.000	.667	.880	.500	.000	.874	.950

City of Madera
 N/S: Madera Avenue
 E/W: East Lewis Street
 Weather: Clear

File Name : 56_MDA_Madera_E Lewis PM
 Site Code : 00319628
 Start Date : 9/26/2019
 Page No : 2

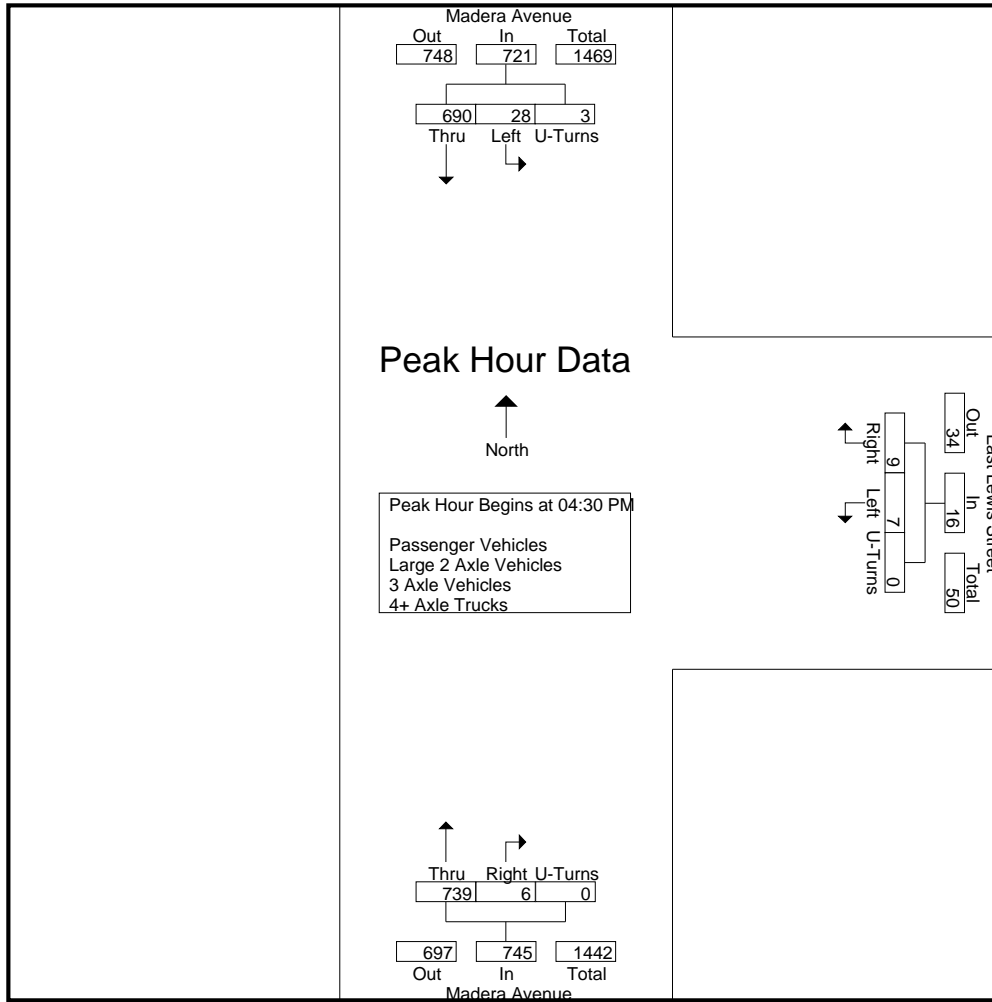

Peak Hour Analysis From 04:00 PM to 05:45 PM - Peak 1 of 1

Peak Hour for Each Approach Begins at:

	04:30 PM				04:00 PM				04:30 PM			
+0 mins.	8	176	1	185	6	4	0	10	196	0	0	196
+15 mins.	6	168	1	175	1	0	0	1	160	3	0	163
+30 mins.	4	172	0	176	1	3	0	4	210	3	0	213
+45 mins.	10	174	1	185	4	2	0	6	173	0	0	173
Total Volume	28	690	3	721	12	9	0	21	739	6	0	745
% App. Total	3.9	95.7	0.4		57.1	42.9	0		99.2	0.8	0	
PHF	.700	.980	.750	.974	.500	.563	.000	.525	.880	.500	.000	.874

City of Madera
 N/S: Madera Avenue
 E/W: East Lewis Street
 Weather: Clear

File Name : 56_MDA_Madera_E Lewis PM
 Site Code : 00319628
 Start Date : 9/26/2019
 Page No : 1

Groups Printed- Passenger Vehicles

Start Time	Madera Avenue Southbound				East Lewis Street Westbound				Madera Avenue Northbound				Int. Total
	Left	Thru	U-Turns	App. Total	Left	Right	U-Turns	App. Total	Thru	Right	U-Turns	App. Total	
04:00 PM	7	144	1	152	6	4	0	10	171	0	0	171	333
04:15 PM	6	170	1	177	1	0	0	1	159	4	0	163	341
04:30 PM	8	172	1	181	1	3	0	4	189	0	0	189	374
04:45 PM	5	163	1	169	3	2	0	5	159	3	0	162	336
Total	26	649	4	679	11	9	0	20	678	7	0	685	1384
05:00 PM	4	168	0	172	0	1	0	1	207	3	0	210	383
05:15 PM	10	172	1	183	2	3	0	5	170	0	0	170	358
05:30 PM	8	151	0	159	5	2	0	7	163	3	0	166	332
05:45 PM	7	147	0	154	2	1	0	3	150	4	0	154	311
Total	29	638	1	668	9	7	0	16	690	10	0	700	1384
Grand Total	55	1287	5	1347	20	16	0	36	1368	17	0	1385	2768
Apprch %	4.1	95.5	0.4		55.6	44.4	0		98.8	1.2	0		
Total %	2	46.5	0.2	48.7	0.7	0.6	0	1.3	49.4	0.6	0	50	

Start Time	Madera Avenue Southbound				East Lewis Street Westbound				Madera Avenue Northbound				Int. Total
	Left	Thru	U-Turns	App. Total	Left	Right	U-Turns	App. Total	Thru	Right	U-Turns	App. Total	
Peak Hour Analysis From 04:30 PM to 05:15 PM - Peak 1 of 1													
Peak Hour for Entire Intersection Begins at 04:30 PM													
04:30 PM	8	172	1	181	1	3	0	4	189	0	0	189	374
04:45 PM	5	163	1	169	3	2	0	5	159	3	0	162	336
05:00 PM	4	168	0	172	0	1	0	1	207	3	0	210	383
05:15 PM	10	172	1	183	2	3	0	5	170	0	0	170	358
Total Volume	27	675	3	705	6	9	0	15	725	6	0	731	1451
% App. Total	3.8	95.7	0.4		40	60	0		99.2	0.8	0		
PHF	.675	.981	.750	.963	.500	.750	.000	.750	.876	.500	.000	.870	.947

City of Madera
 N/S: Madera Avenue
 E/W: East Lewis Street
 Weather: Clear

File Name : 56_MDA_Madera_E Lewis PM
 Site Code : 00319628
 Start Date : 9/26/2019
 Page No : 2

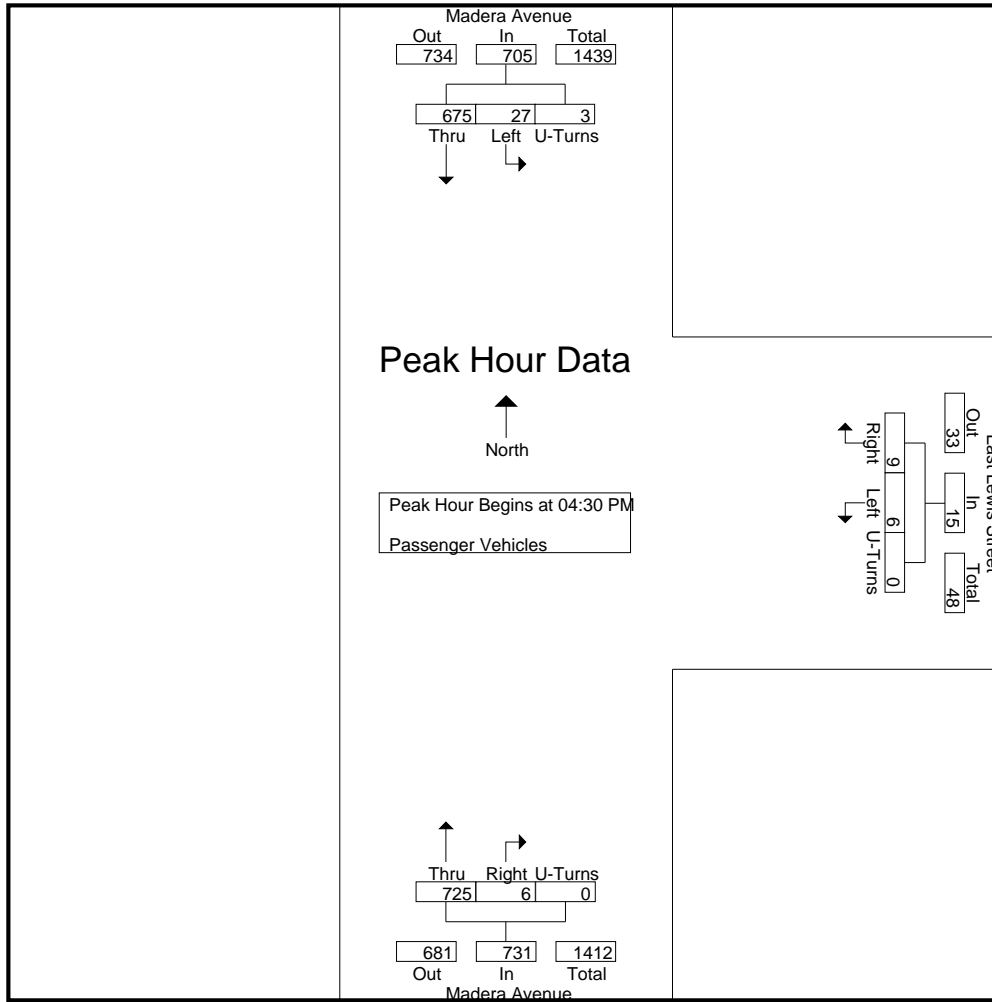

Peak Hour Analysis From 04:30 PM to 05:15 PM - Peak 1 of 1
 Peak Hour for Each Approach Begins at:

	04:30 PM				04:30 PM				04:30 PM			
+0 mins.	8	172	1	181	1	3	0	4	189	0	0	189
+15 mins.	5	163	1	169	3	2	0	5	159	3	0	162
+30 mins.	4	168	0	172	0	1	0	1	207	3	0	210
+45 mins.	10	172	1	183	2	3	0	5	170	0	0	170
Total Volume	27	675	3	705	6	9	0	15	725	6	0	731
% App. Total	3.8	95.7	0.4		40	60	0		99.2	0.8	0	
PHF	.675	.981	.750	.963	.500	.750	.000	.750	.876	.500	.000	.870

City of Madera
 N/S: Madera Avenue
 E/W: East Lewis Street
 Weather: Clear

File Name : 56_MDA_Madera_E Lewis PM
 Site Code : 00319628
 Start Date : 9/26/2019
 Page No : 1

Groups Printed- Large 2 Axle Vehicles

Start Time	Madera Avenue Southbound				East Lewis Street Westbound				Madera Avenue Northbound				Int. Total
	Left	Thru	U-Turns	App. Total	Left	Right	U-Turns	App. Total	Thru	Right	U-Turns	App. Total	
04:00 PM	0	3	0	3	0	0	0	0	6	0	0	6	9
04:15 PM	0	0	0	0	0	0	0	0	0	0	0	0	0
04:30 PM	0	0	0	0	0	0	0	0	2	0	0	2	2
04:45 PM	1	2	0	3	1	0	0	1	1	0	0	1	5
Total	1	5	0	6	1	0	0	1	9	0	0	9	16
05:00 PM	0	3	0	3	0	0	0	0	2	0	0	2	5
05:15 PM	0	2	0	2	0	0	0	0	2	0	0	2	4
05:30 PM	0	1	0	1	0	0	0	0	3	0	0	3	4
05:45 PM	0	3	0	3	0	0	0	0	1	0	0	1	4
Total	0	9	0	9	0	0	0	0	8	0	0	8	17
Grand Total	1	14	0	15	1	0	0	1	17	0	0	17	33
Aprch %	6.7	93.3	0		100	0	0		100	0	0		
Total %	3	42.4	0	45.5	3	0	0	3	51.5	0	0	51.5	

Start Time	Madera Avenue Southbound				East Lewis Street Westbound				Madera Avenue Northbound				Int. Total
	Left	Thru	U-Turns	App. Total	Left	Right	U-Turns	App. Total	Thru	Right	U-Turns	App. Total	
Peak Hour Analysis From 04:30 PM to 05:15 PM - Peak 1 of 1													
Peak Hour for Entire Intersection Begins at 04:30 PM													
04:30 PM	0	0	0	0	0	0	0	0	2	0	0	2	2
04:45 PM	1	2	0	3	1	0	0	1	1	0	0	1	5
05:00 PM	0	3	0	3	0	0	0	0	2	0	0	2	5
05:15 PM	0	2	0	2	0	0	0	0	2	0	0	2	4
Total Volume	1	7	0	8	1	0	0	1	7	0	0	7	16
% App. Total	12.5	87.5	0		100	0	0		100	0	0		
PHF	.250	.583	.000	.667	.250	.000	.000	.250	.875	.000	.000	.875	.800

City of Madera
 N/S: Madera Avenue
 E/W: East Lewis Street
 Weather: Clear

File Name : 56_MDA_Madera_E Lewis PM
 Site Code : 00319628
 Start Date : 9/26/2019
 Page No : 2

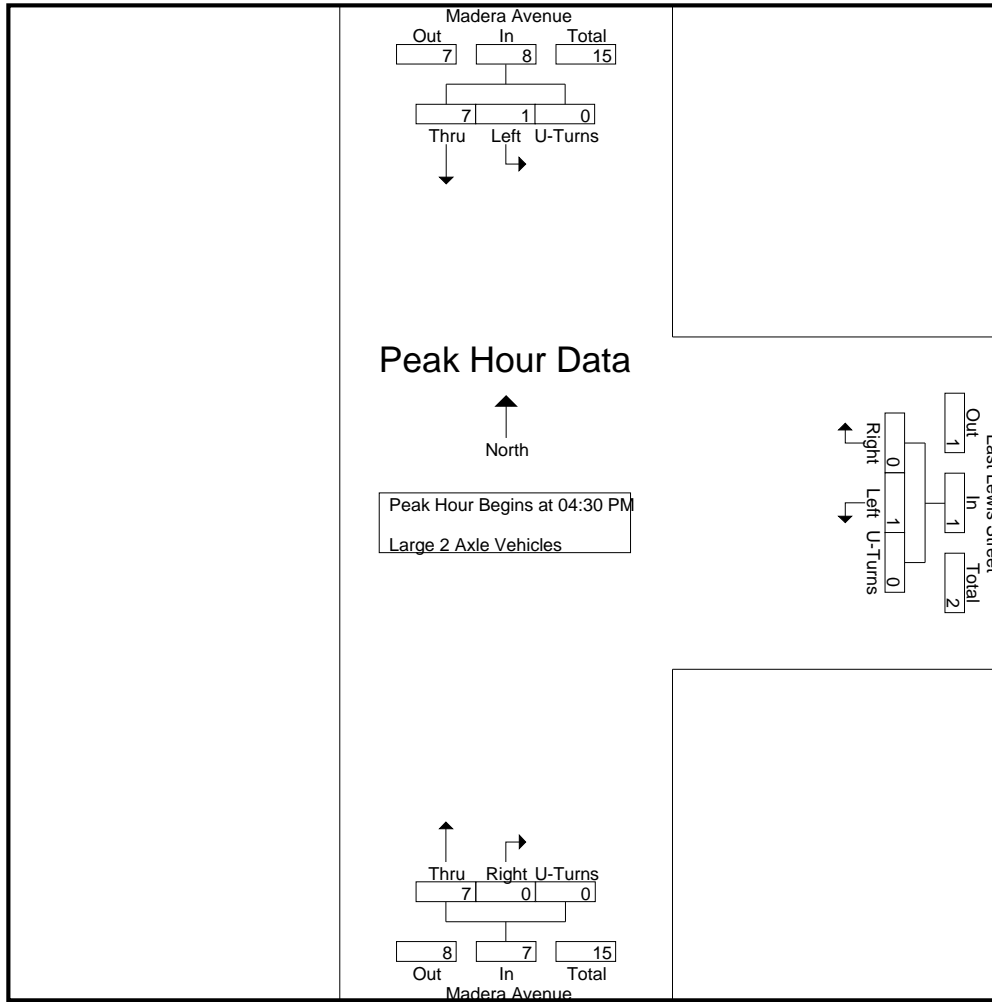

Peak Hour Analysis From 04:30 PM to 05:15 PM - Peak 1 of 1

Peak Hour for Each Approach Begins at:

	04:30 PM				04:30 PM				04:30 PM			
+0 mins.	0	0	0	0	0	0	0	0	2	0	0	2
+15 mins.	1	2	0	3	1	0	0	1	1	0	0	1
+30 mins.	0	3	0	3	0	0	0	0	2	0	0	2
+45 mins.	0	2	0	2	0	0	0	0	2	0	0	2
Total Volume	1	7	0	8	1	0	0	1	7	0	0	7
% App. Total	12.5	87.5	0		100	0	0		100	0	0	
PHF	.250	.583	.000	.667	.250	.000	.000	.250	.875	.000	.000	.875

City of Madera
 N/S: Madera Avenue
 E/W: East Lewis Street
 Weather: Clear

File Name : 56_MDA_Madera_E Lewis PM
 Site Code : 00319628
 Start Date : 9/26/2019
 Page No : 1

Groups Printed- 3 Axle Vehicles

Start Time	Madera Avenue Southbound				East Lewis Street Westbound				Madera Avenue Northbound				Int. Total	
	Left	Thru	U-Turns	App. Total	Left	Right	U-Turns	App. Total	Thru	Right	U-Turns	App. Total		
04:00 PM	0	0	0	0	0	0	0	0	0	0	0	0	0	0
04:15 PM	0	0	0	0	0	0	0	0	0	0	0	0	0	0
04:30 PM	0	1	0	1	0	0	0	0	0	0	0	0	0	1
04:45 PM	0	1	0	1	0	0	0	0	0	0	0	0	0	1
Total	0	2	0	2	0	0	0	0	0	0	0	0	0	2
05:00 PM	0	0	0	0	0	0	0	0	0	0	0	0	0	0
05:15 PM	0	0	0	0	0	0	0	0	0	0	0	0	0	0
05:30 PM	0	0	0	0	0	0	0	0	0	0	0	0	0	0
05:45 PM	0	0	0	0	0	0	0	0	0	0	0	0	0	0
Total	0	0	0	0	0	0	0	0	0	0	0	0	0	0
Grand Total	0	2	0	2	0	0	0	0	0	0	0	0	0	2
Apprch %	0	100	0		0	0	0		0	0	0			
Total %	0	100	0	100	0	0	0	0	0	0	0	0		

Start Time	Madera Avenue Southbound				East Lewis Street Westbound				Madera Avenue Northbound				Int. Total	
	Left	Thru	U-Turns	App. Total	Left	Right	U-Turns	App. Total	Thru	Right	U-Turns	App. Total		
04:30 PM	0	1	0	1	0	0	0	0	0	0	0	0	0	1
04:45 PM	0	1	0	1	0	0	0	0	0	0	0	0	0	1
05:00 PM	0	0	0	0	0	0	0	0	0	0	0	0	0	0
05:15 PM	0	0	0	0	0	0	0	0	0	0	0	0	0	0
Total Volume	0	2	0	2	0	0	0	0	0	0	0	0	0	2
% App. Total	0	100	0		0	0	0		0	0	0			
PHF	.000	.500	.000	.500	.000	.000	.000	.000	.000	.000	.000	.000	.000	.500

Peak Hour Analysis From 04:30 PM to 05:15 PM - Peak 1 of 1

Peak Hour for Entire Intersection Begins at 04:30 PM

City of Madera
 N/S: Madera Avenue
 E/W: East Lewis Street
 Weather: Clear

File Name : 56_MDA_Madera_E Lewis PM
 Site Code : 00319628
 Start Date : 9/26/2019
 Page No : 2

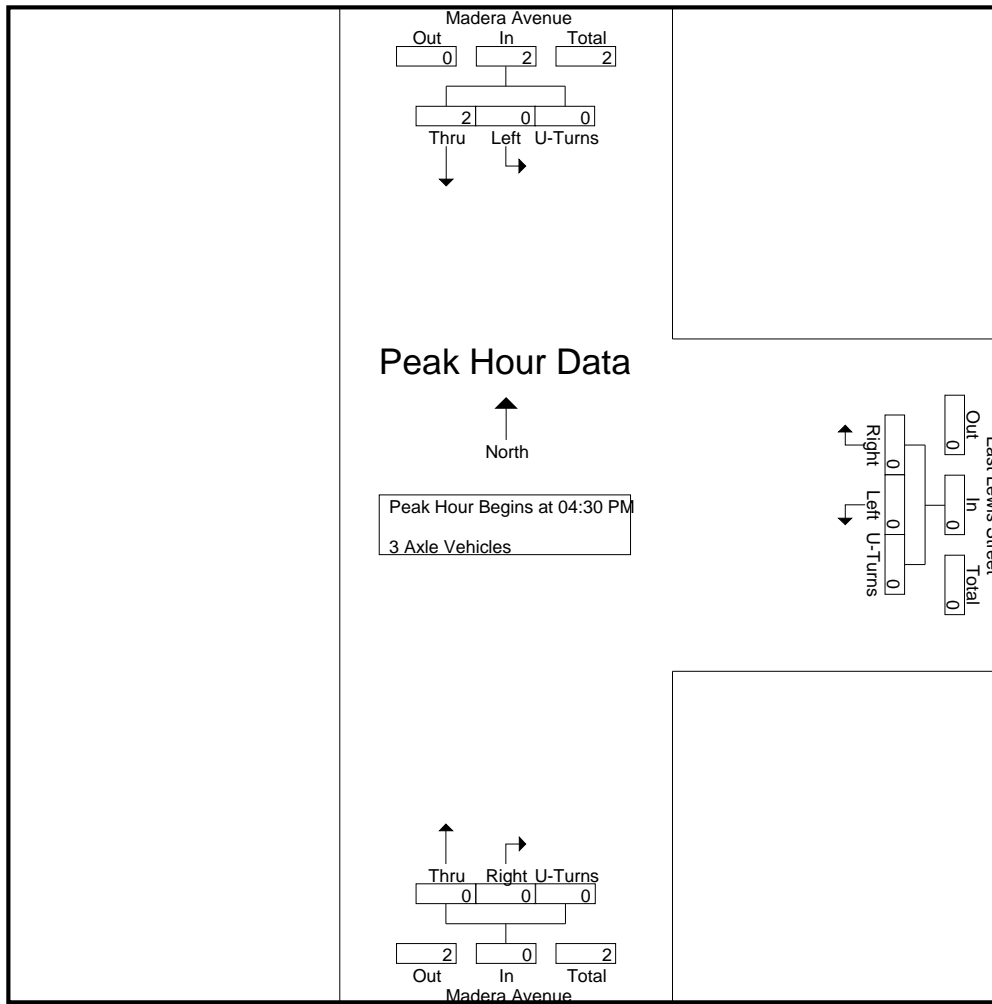

Peak Hour Analysis From 04:30 PM to 05:15 PM - Peak 1 of 1
 Peak Hour for Each Approach Begins at:

	04:30 PM				04:30 PM				04:30 PM			
+0 mins.	0	1	0	1	0	0	0	0	0	0	0	0
+15 mins.	0	1	0	1	0	0	0	0	0	0	0	0
+30 mins.	0	0	0	0	0	0	0	0	0	0	0	0
+45 mins.	0	0	0	0	0	0	0	0	0	0	0	0
Total Volume	0	2	0	2	0	0	0	0	0	0	0	0
% App. Total	0	100	0	0	0	0	0	0	0	0	0	0
PHF	.000	.500	.000	.500	.000	.000	.000	.000	.000	.000	.000	.000

City of Madera
 N/S: Madera Avenue
 E/W: East Lewis Street
 Weather: Clear

File Name : 56_MDA_Madera_E Lewis PM
 Site Code : 00319628
 Start Date : 9/26/2019
 Page No : 1

Groups Printed- 4+ Axle Trucks

Start Time	Madera Avenue Southbound				East Lewis Street Westbound				Madera Avenue Northbound				Int. Total
	Left	Thru	U-Turns	App. Total	Left	Right	U-Turns	App. Total	Thru	Right	U-Turns	App. Total	
04:00 PM	0	5	0	5	0	0	0	0	1	0	0	1	6
04:15 PM	0	5	0	5	0	0	0	0	3	0	0	3	8
04:30 PM	0	3	0	3	0	0	0	0	5	0	0	5	8
04:45 PM	0	2	0	2	0	0	0	0	0	0	0	0	2
Total	0	15	0	15	0	0	0	0	9	0	0	9	24
05:00 PM	0	1	0	1	0	0	0	0	1	0	0	1	2
05:15 PM	0	0	0	0	0	0	0	0	1	0	0	1	1
05:30 PM	0	5	0	5	0	0	0	0	1	0	0	1	6
05:45 PM	0	3	0	3	0	0	0	0	5	0	0	5	8
Total	0	9	0	9	0	0	0	0	8	0	0	8	17
Grand Total	0	24	0	24	0	0	0	0	17	0	0	17	41
Apprch %	0	100	0		0	0	0		100	0	0		
Total %	0	58.5	0	58.5	0	0	0	0	41.5	0	0	41.5	

Start Time	Madera Avenue Southbound				East Lewis Street Westbound				Madera Avenue Northbound				Int. Total
	Left	Thru	U-Turns	App. Total	Left	Right	U-Turns	App. Total	Thru	Right	U-Turns	App. Total	
Peak Hour Analysis From 04:30 PM to 05:15 PM - Peak 1 of 1													
Peak Hour for Entire Intersection Begins at 04:30 PM													
04:30 PM	0	3	0	3	0	0	0	0	5	0	0	5	8
04:45 PM	0	2	0	2	0	0	0	0	0	0	0	0	2
05:00 PM	0	1	0	1	0	0	0	0	1	0	0	1	2
05:15 PM	0	0	0	0	0	0	0	0	1	0	0	1	1
Total Volume	0	6	0	6	0	0	0	0	7	0	0	7	13
% App. Total	0	100	0		0	0	0		100	0	0		
PHF	.000	.500	.000	.500	.000	.000	.000	.000	.350	.000	.000	.350	.406

City of Madera
 N/S: Madera Avenue
 E/W: East Lewis Street
 Weather: Clear

File Name : 56_MDA_Madera_E Lewis PM
 Site Code : 00319628
 Start Date : 9/26/2019
 Page No : 2

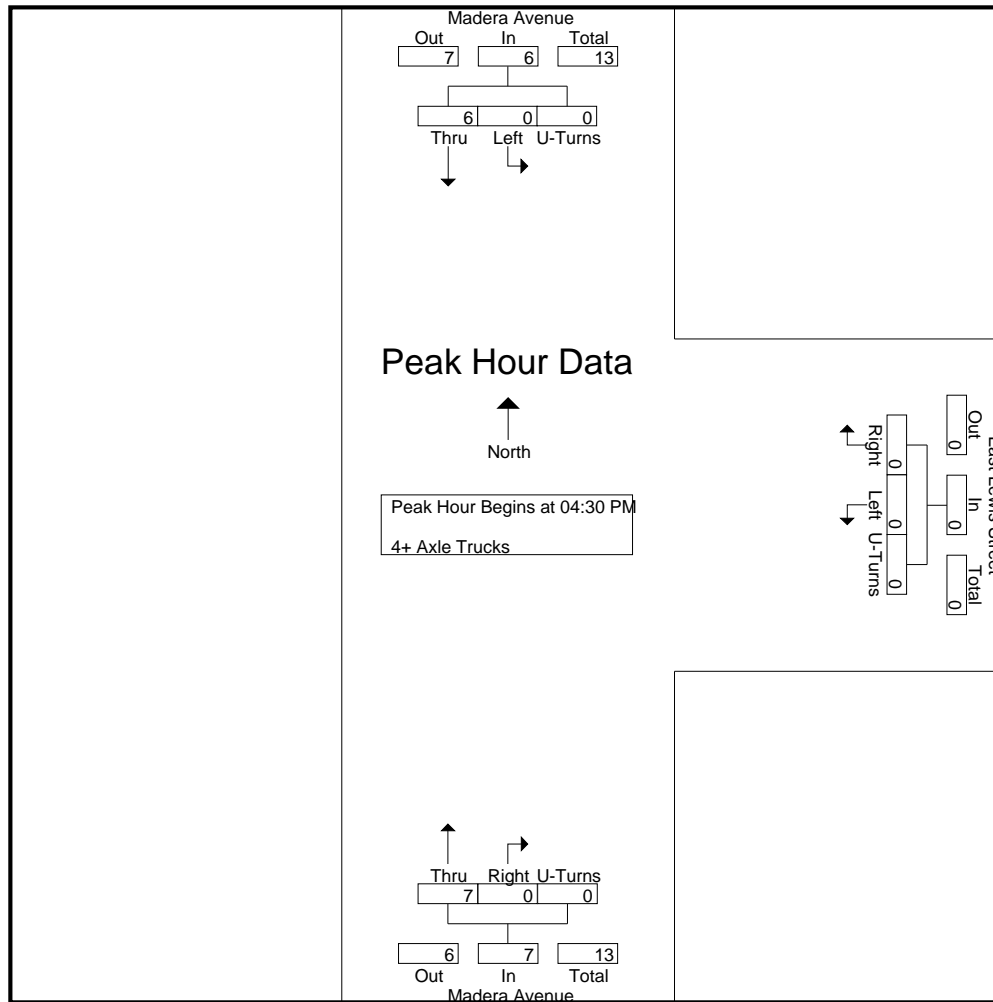

Peak Hour Analysis From 04:30 PM to 05:15 PM - Peak 1 of 1
 Peak Hour for Each Approach Begins at:

	04:30 PM				04:30 PM				04:30 PM			
+0 mins.	0	3	0	3	0	0	0	0	5	0	0	5
+15 mins.	0	2	0	2	0	0	0	0	0	0	0	0
+30 mins.	0	1	0	1	0	0	0	0	1	0	0	1
+45 mins.	0	0	0	0	0	0	0	0	1	0	0	1
Total Volume	0	6	0	6	0	0	0	0	7	0	0	7
% App. Total	0	100	0		0	0	0		100	0	0	
PHF	.000	.500	.000	.500	.000	.000	.000	.000	.350	.000	.000	.350

Location: Madera
 N/S: Madera Avenue
 E/W: East Lewis Street



Date: 9/26/2019
 Day: Thursday

PEDESTRIANS

	North Leg Madera Avenue	East Leg East Lewis Street	South Leg Prexair Store Driveway	West Leg Dead End	
	Pedestrians	Pedestrians	Pedestrians	Pedestrians	
7:00 AM	0	0	0	0	0
7:15 AM	0	1	0	0	1
7:30 AM	0	0	0	0	0
7:45 AM	0	0	0	0	0
8:00 AM	0	2	0	0	2
8:15 AM	0	1	0	0	1
8:30 AM	0	5	0	0	5
8:45 AM	0	0	0	0	0
TOTAL VOLUMES:	0	9	0	0	9

	North Leg Madera Avenue	East Leg East Lewis Street	South Leg Prexair Store Driveway	West Leg Dead End	
	Pedestrians	Pedestrians	Pedestrians	Pedestrians	
4:00 PM	0	2	0	0	2
4:15 PM	0	0	0	0	0
4:30 PM	0	0	0	0	0
4:45 PM	0	1	0	0	1
5:00 PM	0	0	0	0	0
5:15 PM	0	1	0	0	1
5:30 PM	0	1	0	0	1
5:45 PM	0	1	0	0	1
TOTAL VOLUMES:	0	6	0	0	6

Location: Madera
 N/S: Madera Avenue
 E/W: East Lewis Street



Date: 9/26/2019
 Day: Thursday

BICYCLES

	Southbound Madera Avenue			Westbound East Lewis Street			Northbound Prexair Store Driveway			Eastbound Dead End			
	Left	Thru	Right	Left	Thru	Right	Left	Thru	Right	Left	Thru	Right	
7:00 AM	0	0	0	0	0	0	0	0	0	0	0	0	0
7:15 AM	1	0	0	0	0	0	0	0	0	0	0	0	1
7:30 AM	0	0	0	0	0	0	0	1	0	0	0	0	1
7:45 AM	0	1	0	0	0	0	0	0	0	0	0	0	1
8:00 AM	0	0	0	0	0	0	0	0	0	0	0	0	0
8:15 AM	0	0	0	0	0	0	0	0	0	0	0	0	0
8:30 AM	0	2	0	0	0	0	0	0	0	0	0	0	2
8:45 AM	0	0	0	0	0	0	0	0	0	0	0	0	0
TOTAL VOLUMES:	1	3	0	0	0	0	0	1	0	0	0	0	5

	Southbound Madera Avenue			Westbound East Lewis Street			Northbound Prexair Store Driveway			Eastbound Dead End			
	Left	Thru	Right	Left	Thru	Right	Left	Thru	Right	Left	Thru	Right	
4:00 PM	0	0	0	0	0	0	0	0	0	0	0	0	0
4:15 PM	0	1	0	0	0	0	0	1	0	0	0	0	2
4:30 PM	0	0	0	0	0	0	0	0	0	0	0	0	0
4:45 PM	0	0	0	0	0	0	0	0	0	0	0	0	0
5:00 PM	0	1	0	0	0	0	0	1	0	0	0	0	2
5:15 PM	0	1	0	0	0	0	0	0	0	0	0	0	1
5:30 PM	0	0	0	0	0	0	0	1	0	0	0	0	1
5:45 PM	0	0	0	0	0	0	0	0	0	0	0	0	0
TOTAL VOLUMES:	0	3	0	0	0	0	0	3	0	0	0	0	6

City of Madera
 N/S: Tozer Street
 E/W: Yosemite Avenue
 Weather: Clear

File Name : 38_MDA_Tozer_Yosemite AM
 Site Code : 00319628
 Start Date : 9/24/2019
 Page No : 1

Groups Printed- Passenger Vehicles - Large 2 Axle Vehicles - 3 Axle Vehicles - 4+ Axle Trucks

Start Time	Tozer Street Southbound					Yosemite Avenue Westbound					Tozer Street Northbound					Yosemite Avenue Eastbound					Int. Total
	Left	Thru	Right	U-Turns	App. Total	Left	Thru	Right	U-Turns	App. Total	Left	Thru	Right	U-Turns	App. Total	Left	Thru	Right	U-Turns	App. Total	
07:00 AM	11	41	35	0	87	8	18	6	0	32	26	23	12	0	61	35	83	51	0	169	349
07:15 AM	15	50	38	0	103	19	61	6	0	86	20	21	9	0	50	47	126	75	0	248	487
07:30 AM	22	56	57	0	135	37	55	10	0	102	28	21	26	0	75	56	135	64	0	255	567
07:45 AM	14	81	39	0	134	38	98	13	0	149	48	31	23	0	102	31	148	69	0	248	633
Total	62	228	169	0	459	102	232	35	0	369	122	96	70	0	288	169	492	259	0	920	2036
08:00 AM	9	42	34	0	85	16	75	12	0	103	35	32	16	0	83	30	105	40	0	175	446
08:15 AM	9	31	29	0	69	6	59	12	0	77	39	38	12	0	89	35	68	35	0	138	373
08:30 AM	15	33	33	0	81	11	48	6	0	65	34	20	8	0	62	25	71	31	0	127	335
08:45 AM	12	49	41	0	102	4	39	3	0	46	38	24	8	0	70	30	53	26	0	109	327
Total	45	155	137	0	337	37	221	33	0	291	146	114	44	0	304	120	297	132	0	549	1481
Grand Total	107	383	306	0	796	139	453	68	0	660	268	210	114	0	592	289	789	391	0	1469	3517
Apprch %	13.4	48.1	38.4	0		21.1	68.6	10.3	0		45.3	35.5	19.3	0		19.7	53.7	26.6	0		
Total %	3	10.9	8.7	0	22.6	4	12.9	1.9	0	18.8	7.6	6	3.2	0	16.8	8.2	22.4	11.1	0	41.8	
Passenger Vehicles	98.1	98.7	91.5	0	95.9	97.8	94.9	94.1	0	95.5	96.3	96.2	93	0	95.6	92.4	95.8	98	0	95.7	95.7
Large 2 Axle Vehicles	1.9	1	4.2	0	2.4	2.2	3.8	5.9	0	3.6	2.6	2.9	6.1	0	3.4	2.4	3.3	1.5	0	2.7	2.9
% Large 2 Axle Vehicles	0	0	2	0	2	0	2	0	0	2	1	0	1	0	2	4	0	2	0	6	12
3 Axle Vehicles	0	0	0.7	0	0.3	0	0.4	0	0	0.3	0.4	0	0.9	0	0.3	1.4	0	0.5	0	0.4	0.3
% 3 Axle Vehicles	0	1	11	0	12	0	4	0	0	4	2	2	0	0	4	11	7	0	0	18	38
4+ Axle Trucks	0	1	11	0	12	0	4	0	0	4	2	2	0	0	4	11	7	0	0	18	38
% 4+ Axle Trucks																					

Start Time	Tozer Street Southbound					Yosemite Avenue Westbound					Tozer Street Northbound					Yosemite Avenue Eastbound					Int. Total
	Left	Thru	Right	U-Turns	App. Total	Left	Thru	Right	U-Turns	App. Total	Left	Thru	Right	U-Turns	App. Total	Left	Thru	Right	U-Turns	App. Total	
Peak Hour Analysis From 07:00 AM to 08:45 AM - Peak 1 of 1																					
Peak Hour for Entire Intersection Begins at 07:15 AM																					
07:15 AM	15	50	38	0	103	19	61	6	0	86	20	21	9	0	50	47	126	75	0	248	487
07:30 AM	22	56	57	0	135	37	55	10	0	102	28	21	26	0	75	56	135	64	0	255	567
07:45 AM	14	81	39	0	134	38	98	13	0	149	48	31	23	0	102	31	148	69	0	248	633
08:00 AM	9	42	34	0	85	16	75	12	0	103	35	32	16	0	83	30	105	40	0	175	446
Total Volume	60	229	168	0	457	110	289	41	0	440	131	105	74	0	310	164	514	248	0	926	2133
% App. Total	13.1	50.1	36.8	0		25	65.7	9.3	0		42.3	33.9	23.9	0		17.7	55.5	26.8	0		
PHF	.682	.707	.737	.000	.846	.724	.737	.788	.000	.738	.682	.820	.712	.000	.760	.732	.868	.827	.000	.908	.842

City of Madera
 N/S: Tozer Street
 E/W: Yosemite Avenue
 Weather: Clear

File Name : 38_MDA_Tozer_Yosemite AM
 Site Code : 00319628
 Start Date : 9/24/2019
 Page No : 2

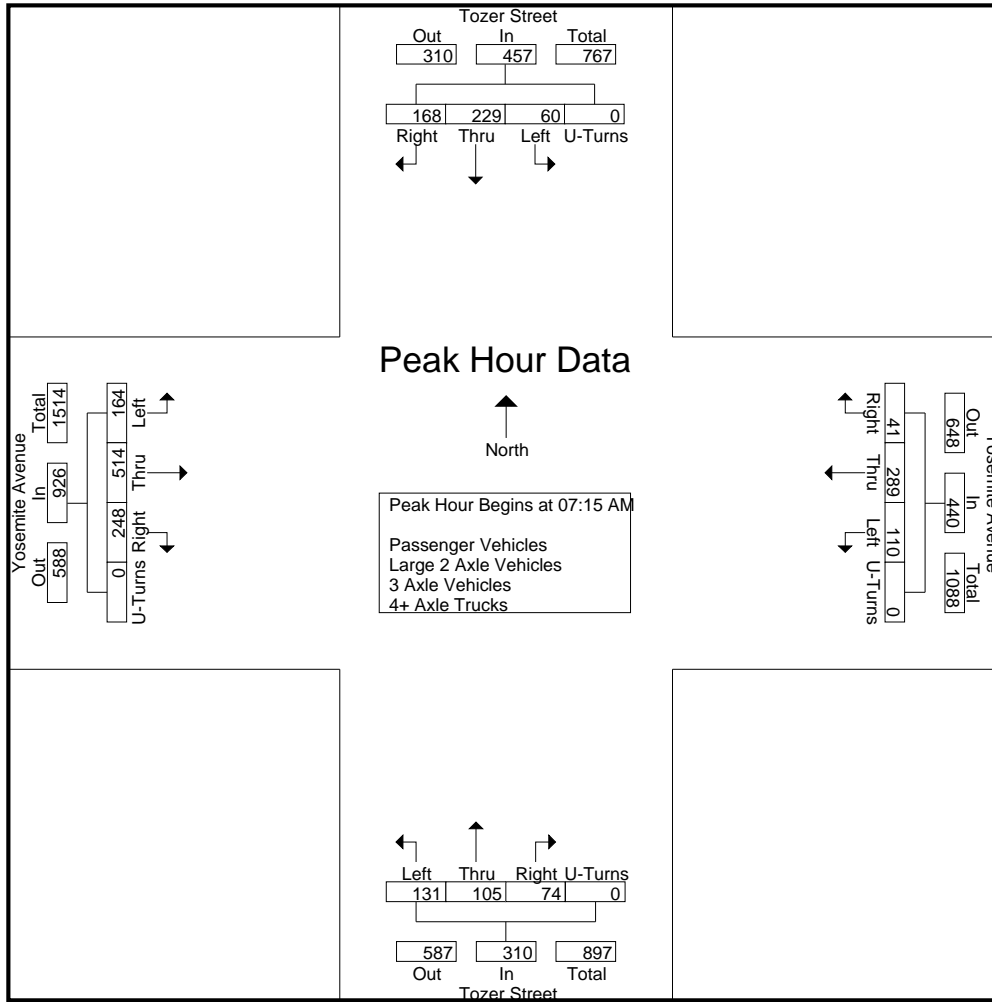

Peak Hour Analysis From 07:00 AM to 08:45 AM - Peak 1 of 1
 Peak Hour for Each Approach Begins at:

	07:00 AM					07:15 AM					07:30 AM					07:45 AM				
+0 mins.	11	41	35	0	87	19	61	6	0	86	28	21	26	0	75	47	126	75	0	248
+15 mins.	15	50	38	0	103	37	55	10	0	102	48	31	23	0	102	56	135	64	0	255
+30 mins.	22	56	57	0	135	38	98	13	0	149	35	32	16	0	83	31	148	69	0	248
+45 mins.	14	81	39	0	134	16	75	12	0	103	39	38	12	0	89	30	105	40	0	175
Total Volume	62	228	169	0	459	110	289	41	0	440	150	122	77	0	349	164	514	248	0	926
% App. Total	13.5	49.7	36.8	0		25	65.7	9.3	0		43	35	22.1	0		17.7	55.5	26.8	0	
PHF	.705	.704	.741	.000	.850	.724	.737	.788	.000	.738	.781	.803	.740	.000	.855	.732	.868	.827	.000	.908

City of Madera
 N/S: Tozer Street
 E/W: Yosemite Avenue
 Weather: Clear

File Name : 38_MDA_Tozer_Yosemite AM
 Site Code : 00319628
 Start Date : 9/24/2019
 Page No : 1

Groups Printed- Passenger Vehicles

Start Time	Tozer Street Southbound					Yosemite Avenue Westbound					Tozer Street Northbound					Yosemite Avenue Eastbound					Int. Total
	Left	Thru	Right	U-Turns	App. Total	Left	Thru	Right	U-Turns	App. Total	Left	Thru	Right	U-Turns	App. Total	Left	Thru	Right	U-Turns	App. Total	
07:00 AM	11	39	31	0	81	8	17	6	0	31	22	22	7	0	51	33	75	50	0	158	321
07:15 AM	15	50	36	0	101	17	58	6	0	81	19	20	9	0	48	45	120	74	0	239	469
07:30 AM	21	56	56	0	133	37	52	9	0	98	28	21	25	0	74	54	130	63	0	247	552
07:45 AM	14	81	37	0	132	38	97	12	0	147	48	29	22	0	99	27	143	69	0	239	617
Total	61	226	160	0	447	100	224	33	0	357	117	92	63	0	272	159	468	256	0	883	1959
08:00 AM	9	42	30	0	81	15	70	12	0	97	33	32	16	0	81	27	103	40	0	170	429
08:15 AM	9	30	25	0	64	6	55	12	0	73	38	38	12	0	88	34	65	35	0	134	359
08:30 AM	15	32	29	0	76	11	45	4	0	60	33	19	7	0	59	20	69	30	0	119	314
08:45 AM	11	48	36	0	95	4	36	3	0	43	37	21	8	0	66	27	51	22	0	100	304
Total	44	152	120	0	316	36	206	31	0	273	141	110	43	0	294	108	288	127	0	523	1406
Grand Total	105	378	280	0	763	136	430	64	0	630	258	202	106	0	566	267	756	383	0	1406	3365
Apprch %	13.8	49.5	36.7	0		21.6	68.3	10.2	0		45.6	35.7	18.7	0		19	53.8	27.2	0		
Total %	3.1	11.2	8.3	0	22.7	4	12.8	1.9	0	18.7	7.7	6	3.2	0	16.8	7.9	22.5	11.4	0	41.8	

Start Time	Tozer Street Southbound					Yosemite Avenue Westbound					Tozer Street Northbound					Yosemite Avenue Eastbound					Int. Total
	Left	Thru	Right	U-Turns	App. Total	Thru	Right	U-Turns	App. Total	Thru	Right	U-Turns	App. Total	Thru	Right	U-Turns	App. Total				
Peak Hour Analysis From 07:15 AM to 08:00 AM - Peak 1 of 1																					
Peak Hour for Entire Intersection Begins at 07:15 AM																					
07:15 AM	15	50	36	0	101	17	58	6	0	81	19	20	9	0	48	45	120	74	0	239	469
07:30 AM	21	56	56	0	133	37	52	9	0	98	28	21	25	0	74	54	130	63	0	247	552
07:45 AM	14	81	37	0	132	38	97	12	0	147	48	29	22	0	99	27	143	69	0	239	617
08:00 AM	9	42	30	0	81	15	70	12	0	97	33	32	16	0	81	27	103	40	0	170	429
Total Volume	59	229	159	0	447	107	277	39	0	423	128	102	72	0	302	153	496	246	0	895	2067
% App. Total	13.2	51.2	35.6	0		25.3	65.5	9.2	0		42.4	33.8	23.8	0		17.1	55.4	27.5	0		
PHF	.702	.707	.710	.000	.840	.704	.714	.813	.000	.719	.667	.797	.720	.000	.763	.708	.867	.831	.000	.906	.838

City of Madera
 N/S: Tozer Street
 E/W: Yosemite Avenue
 Weather: Clear

File Name : 38_MDA_Tozer_Yosemite AM
 Site Code : 00319628
 Start Date : 9/24/2019
 Page No : 2

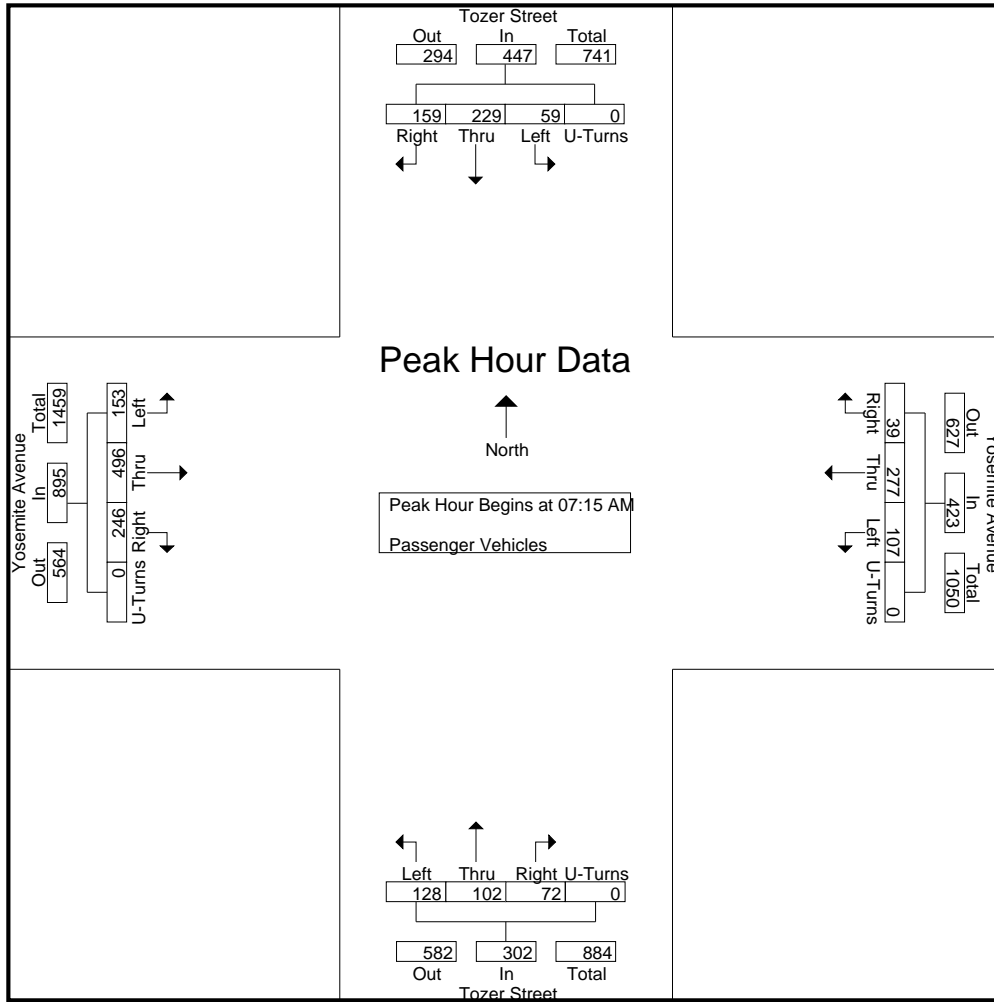

Peak Hour Analysis From 07:15 AM to 08:00 AM - Peak 1 of 1
 Peak Hour for Each Approach Begins at:

	07:15 AM					07:15 AM					07:15 AM									
+0 mins.	15	50	36	0	101	17	58	6	0	81	19	20	9	0	48	45	120	74	0	239
+15 mins.	21	56	56	0	133	37	52	9	0	98	28	21	25	0	74	54	130	63	0	247
+30 mins.	14	81	37	0	132	38	97	12	0	147	48	29	22	0	99	27	143	69	0	239
+45 mins.	9	42	30	0	81	15	70	12	0	97	33	32	16	0	81	27	103	40	0	170
Total Volume	59	229	159	0	447	107	277	39	0	423	128	102	72	0	302	153	496	246	0	895
% App. Total	13.2	51.2	35.6	0		25.3	65.5	9.2	0		42.4	33.8	23.8	0		17.1	55.4	27.5	0	
PHF	.702	.707	.710	.000	.840	.704	.714	.813	.000	.719	.667	.797	.720	.000	.763	.708	.867	.831	.000	.906

City of Madera
 N/S: Tozer Street
 E/W: Yosemite Avenue
 Weather: Clear

File Name : 38_MDA_Tozer_Yosemite AM
 Site Code : 00319628
 Start Date : 9/24/2019
 Page No : 1

Groups Printed- Large 2 Axle Vehicles

Start Time	Tozer Street Southbound					Yosemite Avenue Westbound					Tozer Street Northbound					Yosemite Avenue Eastbound					Int. Total
	Left	Thru	Right	U-Turns	App. Total	Left	Thru	Right	U-Turns	App. Total	Left	Thru	Right	U-Turns	App. Total	Left	Thru	Right	U-Turns	App. Total	
07:00 AM	0	2	4	0	6	0	1	0	0	1	3	1	4	0	8	1	8	1	0	10	25
07:15 AM	0	0	1	0	1	2	3	0	0	5	0	0	0	0	0	0	6	1	0	7	13
07:30 AM	1	0	1	0	2	0	3	1	0	4	0	0	1	0	1	0	2	1	0	3	10
07:45 AM	0	0	0	0	0	0	1	1	0	2	0	2	1	0	3	2	4	0	0	6	11
Total	1	2	6	0	9	2	8	2	0	12	3	3	6	0	12	3	20	3	0	26	59
08:00 AM	0	0	1	0	1	1	4	0	0	5	1	0	0	0	1	1	1	0	0	2	9
08:15 AM	0	1	3	0	4	0	4	0	0	4	1	0	0	0	1	0	2	0	0	2	11
08:30 AM	0	0	1	0	1	0	1	2	0	3	1	0	1	0	2	3	1	1	0	5	11
08:45 AM	1	1	2	0	4	0	0	0	0	0	1	3	0	0	4	0	2	2	0	4	12
Total	1	2	7	0	10	1	9	2	0	12	4	3	1	0	8	4	6	3	0	13	43
Grand Total	2	4	13	0	19	3	17	4	0	24	7	6	7	0	20	7	26	6	0	39	102
Apprch %	10.5	21.1	68.4	0		12.5	70.8	16.7	0		35	30	35	0		17.9	66.7	15.4	0		
Total %	2	3.9	12.7	0	18.6	2.9	16.7	3.9	0	23.5	6.9	5.9	6.9	0	19.6	6.9	25.5	5.9	0	38.2	

Start Time	Tozer Street Southbound					Yosemite Avenue Westbound					Tozer Street Northbound					Yosemite Avenue Eastbound					Int. Total
	Left	Thru	Right	U-Turns	App. Total	Thru	Right	U-Turns	App. Total	Thru	Right	U-Turns	App. Total	Thru	Right	U-Turns	App. Total				
Peak Hour Analysis From 07:15 AM to 08:00 AM - Peak 1 of 1																					
Peak Hour for Entire Intersection Begins at 07:15 AM																					
07:15 AM	0	0	1	0	1	2	3	0	0	5	0	0	0	0	0	0	6	1	0	7	13
07:30 AM	1	0	1	0	2	0	3	1	0	4	0	0	1	0	1	0	2	1	0	3	10
07:45 AM	0	0	0	0	0	0	1	1	0	2	0	2	1	0	3	2	4	0	0	6	11
08:00 AM	0	0	1	0	1	1	4	0	0	5	1	0	0	0	1	1	1	0	0	2	9
Total Volume	1	0	3	0	4	3	11	2	0	16	1	2	2	0	5	3	13	2	0	18	43
% App. Total	25	0	75	0		18.8	68.8	12.5	0		20	40	40	0		16.7	72.2	11.1	0		
PHF	.250	.000	.750	.000	.500	.375	.688	.500	.000	.800	.250	.250	.500	.000	.417	.375	.542	.500	.000	.643	.827

City of Madera
 N/S: Tozer Street
 E/W: Yosemite Avenue
 Weather: Clear

File Name : 38_MDA_Tozer_Yosemite AM
 Site Code : 00319628
 Start Date : 9/24/2019
 Page No : 2

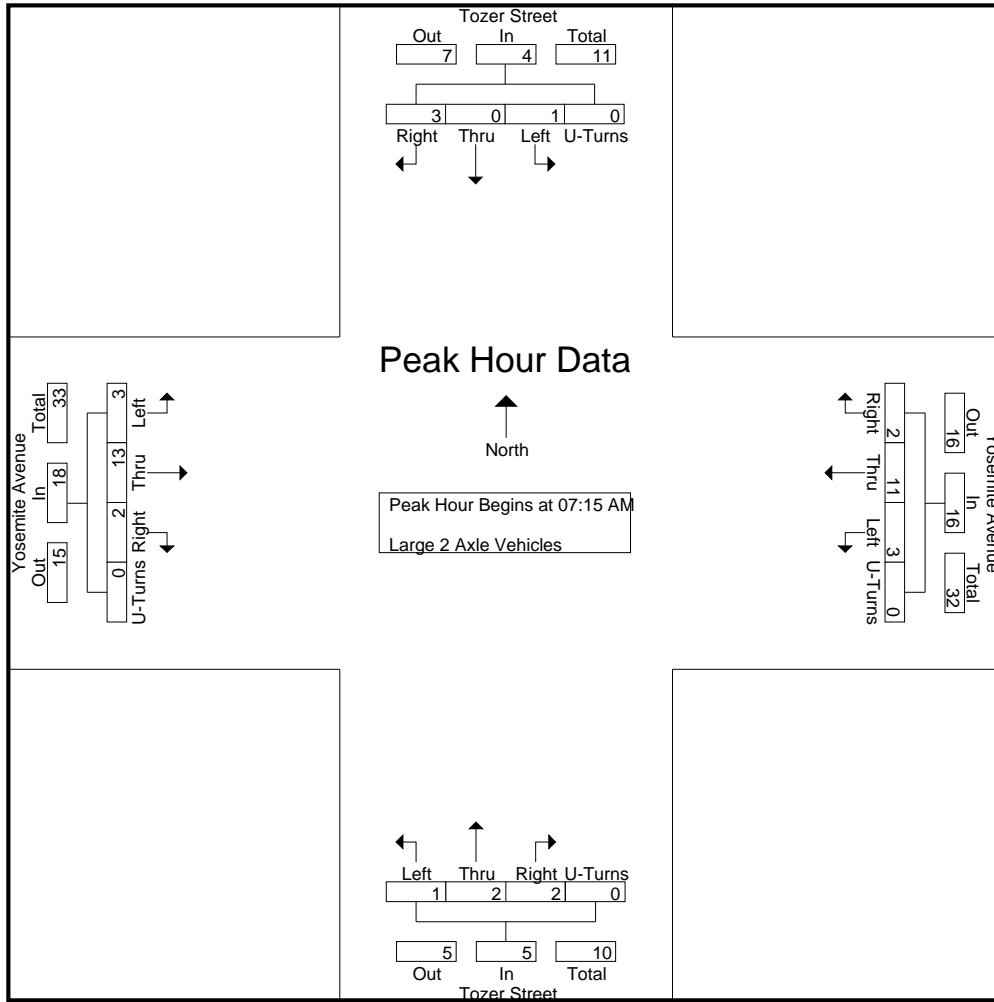

Peak Hour Analysis From 07:15 AM to 08:00 AM - Peak 1 of 1
 Peak Hour for Each Approach Begins at:

	07:15 AM					07:15 AM					07:15 AM					07:15 AM				
+0 mins.	0	0	1	0	1	2	3	0	0	5	0	0	0	0	0	0	6	1	0	7
+15 mins.	1	0	1	0	2	0	3	1	0	4	0	0	1	0	1	0	2	1	0	3
+30 mins.	0	0	0	0	0	0	1	1	0	2	0	2	1	0	3	2	4	0	0	6
+45 mins.	0	0	1	0	1	1	4	0	0	5	1	0	0	0	1	1	1	0	0	2
Total Volume	1	0	3	0	4	3	11	2	0	16	1	2	2	0	5	3	13	2	0	18
% App. Total	25	0	75	0		18.8	68.8	12.5	0		20	40	40	0		16.7	72.2	11.1	0	
PHF	.250	.000	.750	.000	.500	.375	.688	.500	.000	.800	.250	.250	.500	.000	.417	.375	.542	.500	.000	.643

City of Madera
 N/S: Tozer Street
 E/W: Yosemite Avenue
 Weather: Clear

File Name : 38_MDA_Tozer_Yosemite AM
 Site Code : 00319628
 Start Date : 9/24/2019
 Page No : 1

Groups Printed- 3 Axle Vehicles

Start Time	Tozer Street Southbound					Yosemite Avenue Westbound					Tozer Street Northbound					Yosemite Avenue Eastbound					Int. Total
	Left	Thru	Right	U-Turns	App. Total	Left	Thru	Right	U-Turns	App. Total	Left	Thru	Right	U-Turns	App. Total	Left	Thru	Right	U-Turns	App. Total	
07:00 AM	0	0	0	0	0	0	0	0	0	0	0	0	1	0	1	0	0	0	0	0	1
07:15 AM	0	0	0	0	0	0	0	0	0	0	1	0	0	0	1	1	0	0	0	0	1
07:30 AM	0	0	0	0	0	0	0	0	0	0	0	0	0	0	0	1	0	0	0	0	1
07:45 AM	0	0	0	0	0	0	0	0	0	0	0	0	0	0	0	0	0	0	0	0	0
Total	0	0	0	0	0	0	0	0	0	0	1	0	1	0	2	2	0	0	0	0	2
08:00 AM	0	0	0	0	0	0	0	0	0	0	0	0	0	0	0	1	0	0	0	0	1
08:15 AM	0	0	0	0	0	0	0	0	0	0	0	0	0	0	0	0	0	0	0	0	0
08:30 AM	0	0	2	0	2	0	2	0	0	2	0	0	0	0	0	0	0	0	0	0	0
08:45 AM	0	0	0	0	0	0	0	0	0	0	0	0	0	0	0	1	0	2	0	0	3
Total	0	0	2	0	2	0	2	0	0	2	0	0	0	0	0	2	0	2	0	0	4
Grand Total	0	0	2	0	2	0	2	0	0	2	1	0	1	0	2	4	0	2	0	0	6
Apprch %	0	0	100	0		0	100	0	0		50	0	50	0		66.7	0	33.3	0		
Total %	0	0	16.7	0	16.7	0	16.7	0	0	16.7	8.3	0	8.3	0	16.7	33.3	0	16.7	0	50	

Start Time	Tozer Street Southbound					Yosemite Avenue Westbound					Tozer Street Northbound					Yosemite Avenue Eastbound					Int. Total
	Left	Thru	Right	U-Turns	App. Total	Thru	Right	U-Turns	App. Total	Thru	Right	U-Turns	App. Total	Thru	Right	U-Turns	App. Total				
Peak Hour Analysis From 07:15 AM to 08:00 AM - Peak 1 of 1																					
Peak Hour for Entire Intersection Begins at 07:15 AM																					
07:15 AM	0	0	0	0	0	0	0	0	0	0	1	0	0	0	1	1	0	0	0	0	1
07:30 AM	0	0	0	0	0	0	0	0	0	0	0	0	0	0	0	1	0	0	0	0	1
07:45 AM	0	0	0	0	0	0	0	0	0	0	0	0	0	0	0	0	0	0	0	0	0
08:00 AM	0	0	0	0	0	0	0	0	0	0	0	0	0	0	0	1	0	0	0	0	1
Total Volume	0	0	0	0	0	0	0	0	0	0	1	0	0	0	1	3	0	0	0	0	4
% App. Total	0	0	0	0		0	0	0	0		100	0	0	0		100	0	0	0		
PHF	.000	.000	.000	.000	.000	.000	.000	.000	.000	.000	.250	.000	.000	.000	.250	.750	.000	.000	.000	.750	.500

City of Madera
 N/S: Tozer Street
 E/W: Yosemite Avenue
 Weather: Clear

File Name : 38_MDA_Tozer_Yosemite AM
 Site Code : 00319628
 Start Date : 9/24/2019
 Page No : 2

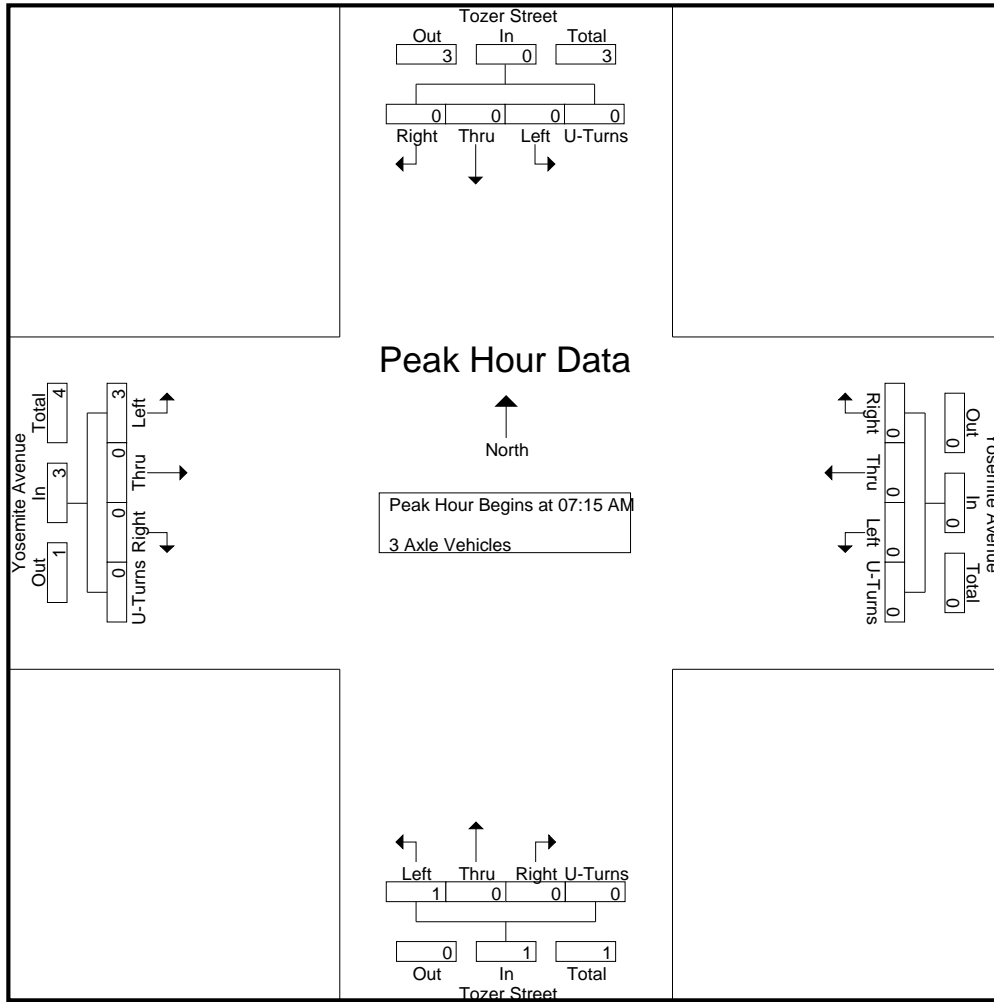

Peak Hour Analysis From 07:15 AM to 08:00 AM - Peak 1 of 1
 Peak Hour for Each Approach Begins at:

	07:15 AM					07:15 AM					07:15 AM										
+0 mins.	0	0	0	0	0	0	0	0	0	0	1	0	0	0	0	1	1	0	0	0	0
+15 mins.	0	0	0	0	0	0	0	0	0	0	0	0	0	0	0	0	1	0	0	0	0
+30 mins.	0	0	0	0	0	0	0	0	0	0	0	0	0	0	0	0	0	0	0	0	0
+45 mins.	0	0	0	0	0	0	0	0	0	0	0	0	0	0	0	0	1	0	0	0	0
Total Volume	0	0	0	0	0	0	0	0	0	0	1	0	0	0	0	1	3	0	0	0	0
% App. Total	0	0	0	0	0	0	0	0	0	0	100	0	0	0	0	100	0	0	0	0	0
PHF	.000	.000	.000	.000	.000	.000	.000	.000	.000	.000	.250	.000	.000	.000	.250	.750	.000	.000	.000	.000	.750

City of Madera
 N/S: Tozer Street
 E/W: Yosemite Avenue
 Weather: Clear

File Name : 38_MDA_Tozer_Yosemite AM
 Site Code : 00319628
 Start Date : 9/24/2019
 Page No : 1

Groups Printed- 4+ Axle Trucks

Start Time	Tozer Street Southbound					Yosemite Avenue Westbound					Tozer Street Northbound					Yosemite Avenue Eastbound					Int. Total
	Left	Thru	Right	U-Turns	App. Total	Left	Thru	Right	U-Turns	App. Total	Left	Thru	Right	U-Turns	App. Total	Left	Thru	Right	U-Turns	App. Total	
07:00 AM	0	0	0	0	0	0	0	0	0	0	1	0	0	0	1	1	0	0	0	1	2
07:15 AM	0	0	1	0	1	0	0	0	0	0	0	1	0	0	1	1	0	0	0	1	3
07:30 AM	0	0	0	0	0	0	0	0	0	0	0	0	0	0	0	1	3	0	0	4	4
07:45 AM	0	0	2	0	2	0	0	0	0	0	0	0	0	0	0	2	1	0	0	3	5
Total	0	0	3	0	3	0	0	0	0	0	1	1	0	0	2	5	4	0	0	9	14
08:00 AM	0	0	3	0	3	0	1	0	0	1	1	0	0	0	1	1	1	0	0	2	7
08:15 AM	0	0	1	0	1	0	0	0	0	0	0	0	0	0	0	1	1	0	0	2	3
08:30 AM	0	1	1	0	2	0	0	0	0	0	0	1	0	0	1	2	1	0	0	3	6
08:45 AM	0	0	3	0	3	0	3	0	0	3	0	0	0	0	0	2	0	0	0	2	8
Total	0	1	8	0	9	0	4	0	0	4	1	1	0	0	2	6	3	0	0	9	24
Grand Total	0	1	11	0	12	0	4	0	0	4	2	2	0	0	4	11	7	0	0	18	38
Apprch %	0	8.3	91.7	0		0	100	0	0		50	50	0	0		61.1	38.9	0	0		
Total %	0	2.6	28.9	0	31.6	0	10.5	0	0	10.5	5.3	5.3	0	0	10.5	28.9	18.4	0	0	47.4	

Start Time	Tozer Street Southbound					Yosemite Avenue Westbound					Tozer Street Northbound					Yosemite Avenue Eastbound					Int. Total
	Left	Thru	Right	U-Turns	App. Total	Thru	Right	U-Turns	App. Total	Thru	Right	U-Turns	App. Total	Thru	Right	U-Turns	App. Total				
Peak Hour Analysis From 07:15 AM to 08:00 AM - Peak 1 of 1																					
Peak Hour for Entire Intersection Begins at 07:15 AM																					
07:15 AM	0	0	1	0	1	0	0	0	0	0	0	1	0	0	1	1	0	0	0	1	3
07:30 AM	0	0	0	0	0	0	0	0	0	0	0	0	0	0	0	1	3	0	0	4	4
07:45 AM	0	0	2	0	2	0	0	0	0	0	0	0	0	0	0	2	1	0	0	3	5
08:00 AM	0	0	3	0	3	0	1	0	0	1	1	0	0	0	1	1	1	0	0	2	7
Total Volume	0	0	6	0	6	0	1	0	0	1	1	1	0	0	2	5	5	0	0	10	19
% App. Total	0	0	100	0		0	100	0	0		50	50	0	0		50	50	0	0		
PHF	.000	.000	.500	.000	.500	.000	.250	.000	.000	.250	.250	.250	.000	.000	.500	.625	.417	.000	.000	.625	.679

City of Madera
 N/S: Tozer Street
 E/W: Yosemite Avenue
 Weather: Clear

File Name : 38_MDA_Tozer_Yosemite AM
 Site Code : 00319628
 Start Date : 9/24/2019
 Page No : 2

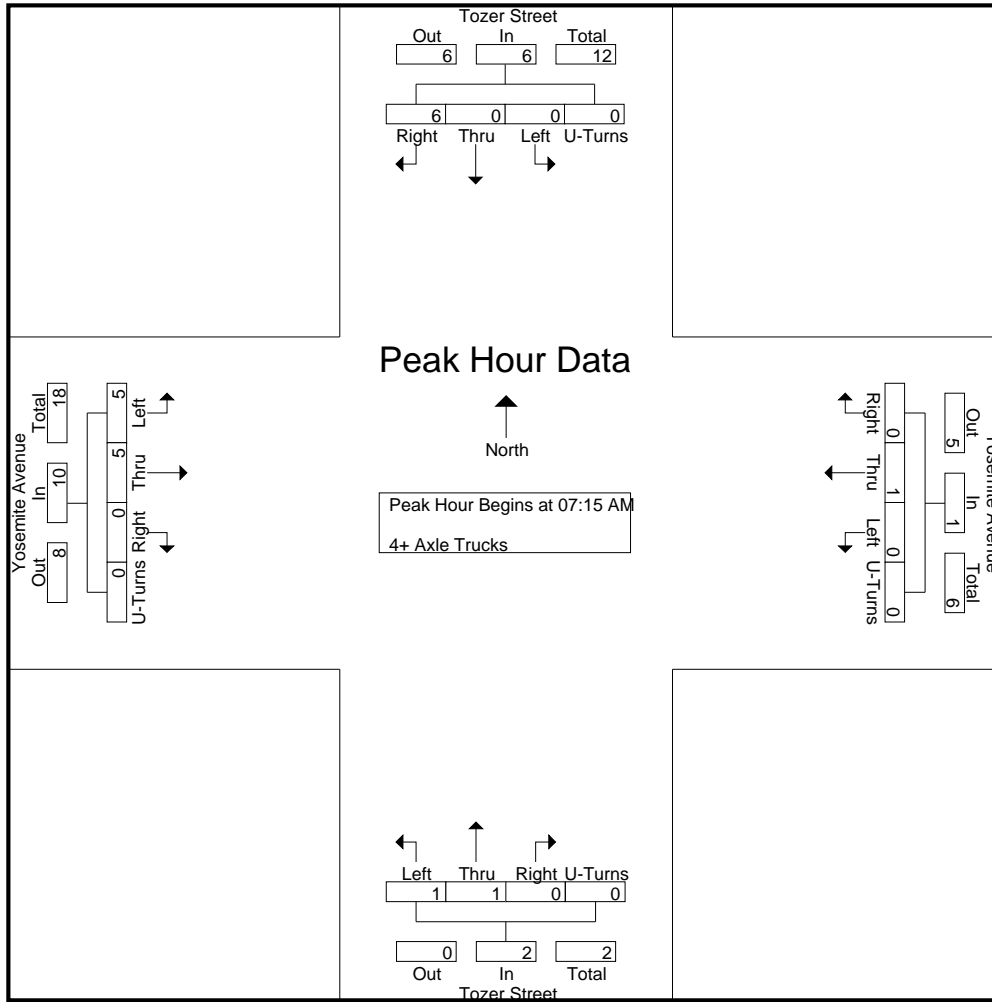

Peak Hour Analysis From 07:15 AM to 08:00 AM - Peak 1 of 1
 Peak Hour for Each Approach Begins at:

	07:15 AM					07:15 AM					07:15 AM									
+0 mins.	0	0	1	0	1	0	0	0	0	0	0	1	0	0	1	1	0	0	0	1
+15 mins.	0	0	0	0	0	0	0	0	0	0	0	0	0	0	0	1	3	0	0	4
+30 mins.	0	0	2	0	2	0	0	0	0	0	0	0	0	0	0	2	1	0	0	3
+45 mins.	0	0	3	0	3	0	1	0	0	1	1	0	0	0	1	1	1	0	0	2
Total Volume	0	0	6	0	6	0	1	0	0	1	1	1	0	0	2	5	5	0	0	10
% App. Total	0	0	100	0	0	0	100	0	0	0	50	50	0	0	0	50	50	0	0	0
PHF	.000	.000	.500	.000	.500	.000	.250	.000	.000	.250	.250	.250	.000	.000	.500	.625	.417	.000	.000	.625

City of Madera
 N/S: Tozer Street
 E/W: Yosemite Avenue
 Weather: Clear

File Name : 38_MDA_Tozer_Yosemite PM
 Site Code : 00319628
 Start Date : 9/24/2019
 Page No : 1

Groups Printed- Passenger Vehicles - Large 2 Axle Vehicles - 3 Axle Vehicles - 4+ Axle Trucks

Start Time	Tozer Street Southbound					Yosemite Avenue Westbound					Tozer Street Northbound					Yosemite Avenue Eastbound					Int. Total
	Left	Thru	Right	U-Turns	App. Total	Left	Thru	Right	U-Turns	App. Total	Left	Thru	Right	U-Turns	App. Total	Left	Thru	Right	U-Turns	App. Total	
04:00 PM	16	50	57	0	123	15	106	6	1	128	85	66	15	0	166	51	106	40	0	197	614
04:15 PM	11	33	65	0	109	17	99	12	0	128	63	49	13	0	125	56	93	43	0	192	554
04:30 PM	15	56	68	0	139	10	113	12	0	135	74	88	17	0	179	33	76	47	0	156	609
04:45 PM	19	36	56	0	111	17	111	7	0	135	64	48	19	0	131	56	127	55	0	238	615
Total	61	175	246	0	482	59	429	37	1	526	286	251	64	0	601	196	402	185	0	783	2392
05:00 PM	15	39	44	0	98	14	129	12	0	155	81	91	32	0	204	59	105	46	0	210	667
05:15 PM	18	36	41	0	95	7	94	4	0	105	86	56	27	0	169	39	100	47	0	186	555
05:30 PM	16	41	47	0	104	16	120	15	0	151	75	56	21	1	153	45	104	51	0	200	608
05:45 PM	14	31	68	0	113	12	95	14	0	121	75	40	29	0	144	38	111	41	0	190	568
Total	63	147	200	0	410	49	438	45	0	532	317	243	109	1	670	181	420	185	0	786	2398
Grand Total	124	322	446	0	892	108	867	82	1	1058	603	494	173	1	1271	377	822	370	0	1569	4790
Apprch %	13.9	36.1	50	0		10.2	81.9	7.8	0.1		47.4	38.9	13.6	0.1		24	52.4	23.6	0		
Total %	2.6	6.7	9.3	0	18.6	2.3	18.1	1.7	0	22.1	12.6	10.3	3.6	0	26.5	7.9	17.2	7.7	0	32.8	
Passenger Vehicles	96.8	97.2	93.7	0	95.4	100	99.1	97.6	100	99.1	98.2	97.8	99.4	100	98.2	97.6	97.9	97.8	0	97.8	97.7
Large 2 Axle Vehicles	2.4	2.2	4.7	0	3.5	0	0.7	2.4	0	0.8	1.8	2	0.6	0	1.7	1.3	1.8	2.2	0	1.8	1.9
% Large 2 Axle Vehicles	1	1	4	0	6	0	1	0	0	1	0	1	0	0	1	1	0	0	0	1	9
3 Axle Vehicles	0.8	0.3	0.9	0	0.7	0	0.1	0	0	0.1	0	0.2	0	0	0.1	0.3	0	0	0	0.1	0.2
% 3 Axle Vehicles	0	1	3	0	4	0	1	0	0	1	0	0	0	0	0	3	2	0	0	5	10
4+ Axle Trucks																					
% 4+ Axle Trucks																					

Start Time	Tozer Street Southbound					Yosemite Avenue Westbound					Tozer Street Northbound					Yosemite Avenue Eastbound					Int. Total
	Left	Thru	Right	U-Turns	App. Total	Left	Thru	Right	U-Turns	App. Total	Left	Thru	Right	U-Turns	App. Total	Left	Thru	Right	U-Turns	App. Total	
Peak Hour Analysis From 04:00 PM to 05:45 PM - Peak 1 of 1																					
Peak Hour for Entire Intersection Begins at 04:30 PM																					
04:30 PM	15	56	68	0	139	10	113	12	0	135	74	88	17	0	179	33	76	47	0	156	609
04:45 PM	19	36	56	0	111	17	111	7	0	135	64	48	19	0	131	56	127	55	0	238	615
05:00 PM	15	39	44	0	98	14	129	12	0	155	81	91	32	0	204	59	105	46	0	210	667
05:15 PM	18	36	41	0	95	7	94	4	0	105	86	56	27	0	169	39	100	47	0	186	555
Total Volume	67	167	209	0	443	48	447	35	0	530	305	283	95	0	683	187	408	195	0	790	2446
% App. Total	15.1	37.7	47.2	0		9.1	84.3	6.6	0		44.7	41.4	13.9	0		23.7	51.6	24.7	0		
PHF	.882	.746	.768	.000	.797	.706	.866	.729	.000	.855	.887	.777	.742	.000	.837	.792	.803	.886	.000	.830	.917

City of Madera
 N/S: Tozer Street
 E/W: Yosemite Avenue
 Weather: Clear

File Name : 38_MDA_Tozer_Yosemite PM
 Site Code : 00319628
 Start Date : 9/24/2019
 Page No : 2

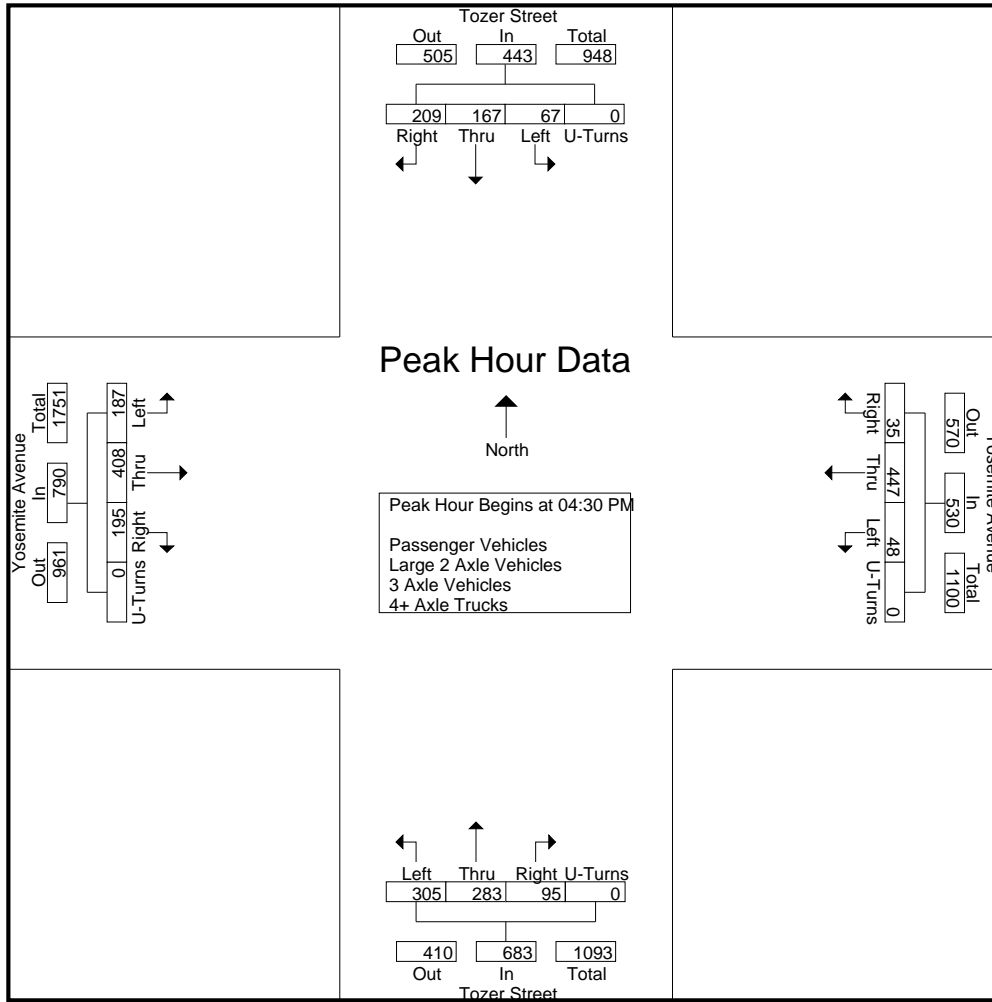

Peak Hour Analysis From 04:00 PM to 05:45 PM - Peak 1 of 1
 Peak Hour for Each Approach Begins at:

	04:00 PM					04:15 PM					04:30 PM					04:45 PM				
+0 mins.	16	50	57	0	123	17	99	12	0	128	74	88	17	0	179	56	127	55	0	238
+15 mins.	11	33	65	0	109	10	113	12	0	135	64	48	19	0	131	59	105	46	0	210
+30 mins.	15	56	68	0	139	17	111	7	0	135	81	91	32	0	204	39	100	47	0	186
+45 mins.	19	36	56	0	111	14	129	12	0	155	86	56	27	0	169	45	104	51	0	200
Total Volume	61	175	246	0	482	58	452	43	0	553	305	283	95	0	683	199	436	199	0	834
% App. Total	12.7	36.3	51	0		10.5	81.7	7.8	0		44.7	41.4	13.9	0		23.9	52.3	23.9	0	
PHF	.803	.781	.904	.000	.867	.853	.876	.896	.000	.892	.887	.777	.742	.000	.837	.843	.858	.905	.000	.876

City of Madera
 N/S: Tozer Street
 E/W: Yosemite Avenue
 Weather: Clear

File Name : 38_MDA_Tozer_Yosemite PM
 Site Code : 00319628
 Start Date : 9/24/2019
 Page No : 1

Groups Printed- Passenger Vehicles

Start Time	Tozer Street Southbound					Yosemite Avenue Westbound					Tozer Street Northbound					Yosemite Avenue Eastbound					Int. Total
	Left	Thru	Right	U-Turns	App. Total	Left	Thru	Right	U-Turns	App. Total	Left	Thru	Right	U-Turns	App. Total	Left	Thru	Right	U-Turns	App. Total	
04:00 PM	16	48	50	0	114	15	106	6	1	128	83	64	15	0	162	47	102	39	0	188	592
04:15 PM	10	31	50	0	91	17	98	11	0	126	60	47	13	0	120	56	88	41	0	185	522
04:30 PM	14	53	67	0	134	10	113	12	0	135	72	84	17	0	173	32	73	46	0	151	593
04:45 PM	18	36	53	0	107	17	111	7	0	135	63	47	19	0	129	56	125	53	0	234	605
Total	58	168	220	0	446	59	428	36	1	524	278	242	64	0	584	191	388	179	0	758	2312
05:00 PM	15	39	44	0	98	14	127	12	0	153	81	89	32	0	202	57	105	45	0	207	660
05:15 PM	17	36	41	0	94	7	94	4	0	105	86	56	26	0	168	38	99	47	0	184	551
05:30 PM	16	40	47	0	103	16	118	14	0	148	74	56	21	1	152	45	103	51	0	199	602
05:45 PM	14	30	66	0	110	12	92	14	0	118	73	40	29	0	142	37	110	40	0	187	557
Total	62	145	198	0	405	49	431	44	0	524	314	241	108	1	664	177	417	183	0	777	2370
Grand Total	120	313	418	0	851	108	859	80	1	1048	592	483	172	1	1248	368	805	362	0	1535	4682
Apprch %	14.1	36.8	49.1	0		10.3	82	7.6	0.1		47.4	38.7	13.8	0.1		24	52.4	23.6	0		
Total %	2.6	6.7	8.9	0	18.2	2.3	18.3	1.7	0	22.4	12.6	10.3	3.7	0	26.7	7.9	17.2	7.7	0	32.8	

Start Time	Tozer Street Southbound					Yosemite Avenue Westbound					Tozer Street Northbound					Yosemite Avenue Eastbound					Int. Total
	Left	Thru	Right	U-Turns	App. Total	Thru	Right	U-Turns	App. Total	Thru	Right	U-Turns	App. Total	Thru	Right	U-Turns	App. Total				
Peak Hour Analysis From 04:30 PM to 05:15 PM - Peak 1 of 1																					
Peak Hour for Entire Intersection Begins at 04:30 PM																					
04:30 PM	14	53	67	0	134	10	113	12	0	135	72	84	17	0	173	32	73	46	0	151	593
04:45 PM	18	36	53	0	107	17	111	7	0	135	63	47	19	0	129	56	125	53	0	234	605
05:00 PM	15	39	44	0	98	14	127	12	0	153	81	89	32	0	202	57	105	45	0	207	660
05:15 PM	17	36	41	0	94	7	94	4	0	105	86	56	26	0	168	38	99	47	0	184	551
Total Volume	64	164	205	0	433	48	445	35	0	528	302	276	94	0	672	183	402	191	0	776	2409
% App. Total	14.8	37.9	47.3	0		9.1	84.3	6.6	0		44.9	41.1	14	0		23.6	51.8	24.6	0		
PHF	.889	.774	.765	.000	.808	.706	.876	.729	.000	.863	.878	.775	.734	.000	.832	.803	.804	.901	.000	.829	.913

City of Madera
 N/S: Tozer Street
 E/W: Yosemite Avenue
 Weather: Clear

File Name : 38_MDA_Tozer_Yosemite PM
 Site Code : 00319628
 Start Date : 9/24/2019
 Page No : 2

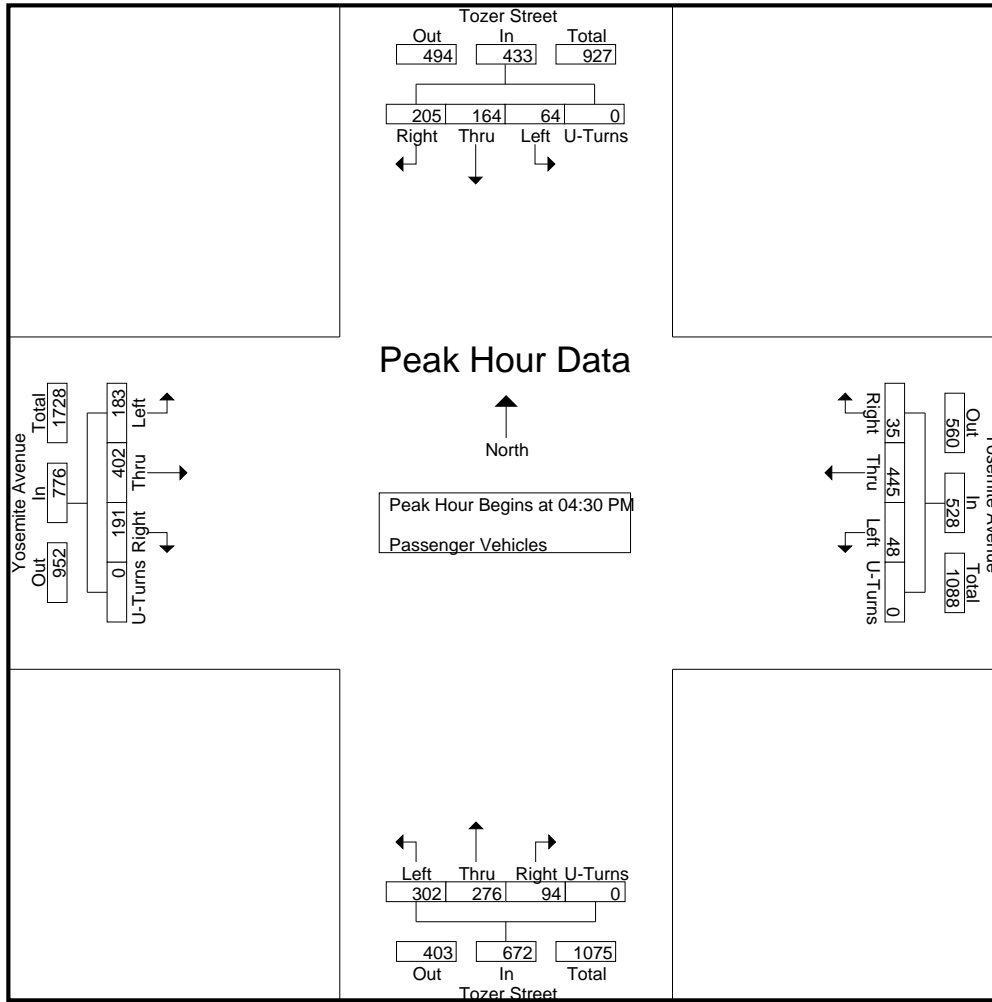

Peak Hour Analysis From 04:30 PM to 05:15 PM - Peak 1 of 1
 Peak Hour for Each Approach Begins at:

	04:30 PM					04:30 PM					04:30 PM									
+0 mins.	14	53	67	0	134	10	113	12	0	135	72	84	17	0	173	32	73	46	0	151
+15 mins.	18	36	53	0	107	17	111	7	0	135	63	47	19	0	129	56	125	53	0	234
+30 mins.	15	39	44	0	98	14	127	12	0	153	81	89	32	0	202	57	105	45	0	207
+45 mins.	17	36	41	0	94	7	94	4	0	105	86	56	26	0	168	38	99	47	0	184
Total Volume	64	164	205	0	433	48	445	35	0	528	302	276	94	0	672	183	402	191	0	776
% App. Total	14.8	37.9	47.3	0		9.1	84.3	6.6	0		44.9	41.1	14	0		23.6	51.8	24.6	0	
PHF	.889	.774	.765	.000	.808	.706	.876	.729	.000	.863	.878	.775	.734	.000	.832	.803	.804	.901	.000	.829

City of Madera
 N/S: Tozer Street
 E/W: Yosemite Avenue
 Weather: Clear

File Name : 38_MDA_Tozer_Yosemite PM
 Site Code : 00319628
 Start Date : 9/24/2019
 Page No : 1

Groups Printed- Large 2 Axle Vehicles

Start Time	Tozer Street Southbound					Yosemite Avenue Westbound					Tozer Street Northbound					Yosemite Avenue Eastbound					Int. Total
	Left	Thru	Right	U-Turns	App. Total	Left	Thru	Right	U-Turns	App. Total	Left	Thru	Right	U-Turns	App. Total	Left	Thru	Right	U-Turns	App. Total	
04:00 PM	0	2	3	0	5	0	0	0	0	0	2	2	0	0	4	2	4	1	0	7	16
04:15 PM	1	1	13	0	15	0	1	1	0	2	3	2	0	0	5	0	5	2	0	7	29
04:30 PM	1	2	1	0	4	0	0	0	0	0	2	3	0	0	5	0	1	1	0	2	11
04:45 PM	0	0	2	0	2	0	0	0	0	0	1	1	0	0	2	0	2	2	0	4	8
Total	2	5	19	0	26	0	1	1	0	2	8	8	0	0	16	2	12	6	0	20	64
05:00 PM	0	0	0	0	0	0	1	0	0	1	0	2	0	0	2	1	0	1	0	2	5
05:15 PM	1	0	0	0	1	0	0	0	0	0	0	0	1	0	1	1	1	0	0	2	4
05:30 PM	0	1	0	0	1	0	2	1	0	3	1	0	0	0	1	0	1	0	0	1	6
05:45 PM	0	1	2	0	3	0	2	0	0	2	2	0	0	0	2	1	1	1	0	3	10
Total	1	2	2	0	5	0	5	1	0	6	3	2	1	0	6	3	3	2	0	8	25
Grand Total	3	7	21	0	31	0	6	2	0	8	11	10	1	0	22	5	15	8	0	28	89
Apprch %	9.7	22.6	67.7	0		0	75	25	0		50	45.5	4.5	0		17.9	53.6	28.6	0		
Total %	3.4	7.9	23.6	0	34.8	0	6.7	2.2	0	9	12.4	11.2	1.1	0	24.7	5.6	16.9	9	0	31.5	

Start Time	Tozer Street Southbound					Yosemite Avenue Westbound					Tozer Street Northbound					Yosemite Avenue Eastbound					Int. Total
	Left	Thru	Right	U-Turns	App. Total	Thru	Right	U-Turns	App. Total	Thru	Right	U-Turns	App. Total	Thru	Right	U-Turns	App. Total				
Peak Hour Analysis From 04:30 PM to 05:15 PM - Peak 1 of 1																					
Peak Hour for Entire Intersection Begins at 04:30 PM																					
04:30 PM	1	2	1	0	4	0	0	0	0	0	2	3	0	0	5	0	1	1	0	2	11
04:45 PM	0	0	2	0	2	0	0	0	0	0	1	1	0	0	2	0	2	2	0	4	8
05:00 PM	0	0	0	0	0	0	1	0	0	1	0	2	0	0	2	1	0	1	0	2	5
05:15 PM	1	0	0	0	1	0	0	0	0	0	0	0	1	0	1	1	1	0	0	2	4
Total Volume	2	2	3	0	7	0	1	0	0	1	3	6	1	0	10	2	4	4	0	10	28
% App. Total	28.6	28.6	42.9	0		0	100	0	0		30	60	10	0		20	40	40	0		
PHF	.500	.250	.375	.000	.438	.000	.250	.000	.000	.250	.375	.500	.250	.000	.500	.500	.500	.500	.000	.625	.636

City of Madera
 N/S: Tozer Street
 E/W: Yosemite Avenue
 Weather: Clear

File Name : 38_MDA_Tozer_Yosemite PM
 Site Code : 00319628
 Start Date : 9/24/2019
 Page No : 2

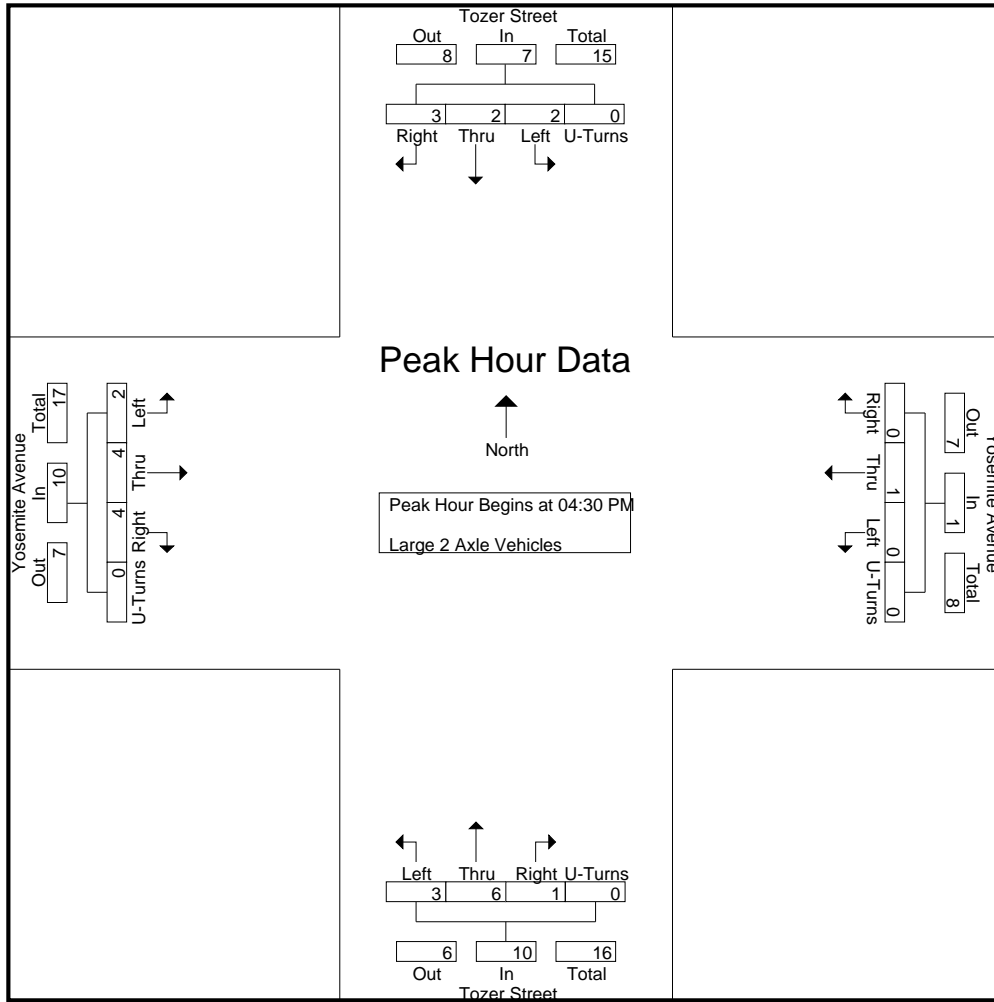

Peak Hour Analysis From 04:30 PM to 05:15 PM - Peak 1 of 1
 Peak Hour for Each Approach Begins at:

	04:30 PM					04:30 PM					04:30 PM									
+0 mins.	1	2	1	0	4	0	0	0	0	0	2	3	0	0	5	0	1	1	0	2
+15 mins.	0	0	2	0	2	0	0	0	0	0	1	1	0	0	2	0	2	2	0	4
+30 mins.	0	0	0	0	0	0	1	0	0	1	0	2	0	0	2	1	0	1	0	2
+45 mins.	1	0	0	0	1	0	0	0	0	0	0	0	1	0	1	1	1	0	0	2
Total Volume	2	2	3	0	7	0	1	0	0	1	3	6	1	0	10	2	4	4	0	10
% App. Total	28.6	28.6	42.9	0		0	100	0	0		30	60	10	0		20	40	40	0	
PHF	.500	.250	.375	.000	.438	.000	.250	.000	.000	.250	.375	.500	.250	.000	.500	.500	.500	.500	.000	.625

City of Madera
 N/S: Tozer Street
 E/W: Yosemite Avenue
 Weather: Clear

File Name : 38_MDA_Tozer_Yosemite PM
 Site Code : 00319628
 Start Date : 9/24/2019
 Page No : 1

Groups Printed- 3 Axle Vehicles

Start Time	Tozer Street Southbound					Yosemite Avenue Westbound					Tozer Street Northbound					Yosemite Avenue Eastbound					Int. Total
	Left	Thru	Right	U-Turns	App. Total	Left	Thru	Right	U-Turns	App. Total	Left	Thru	Right	U-Turns	App. Total	Left	Thru	Right	U-Turns	App. Total	
04:00 PM	0	0	3	0	3	0	0	0	0	0	0	0	0	0	0	1	0	0	0	1	4
04:15 PM	0	1	0	0	1	0	0	0	0	0	0	0	0	0	0	0	0	0	0	0	1
04:30 PM	0	0	0	0	0	0	0	0	0	0	0	1	0	0	1	0	0	0	0	0	1
04:45 PM	1	0	1	0	2	0	0	0	0	0	0	0	0	0	0	0	0	0	0	0	2
Total	1	1	4	0	6	0	0	0	0	0	0	1	0	0	1	1	0	0	0	1	8
05:00 PM	0	0	0	0	0	0	1	0	0	1	0	0	0	0	0	0	0	0	0	0	1
05:15 PM	0	0	0	0	0	0	0	0	0	0	0	0	0	0	0	0	0	0	0	0	0
05:30 PM	0	0	0	0	0	0	0	0	0	0	0	0	0	0	0	0	0	0	0	0	0
05:45 PM	0	0	0	0	0	0	0	0	0	0	0	0	0	0	0	0	0	0	0	0	0
Total	0	0	0	0	0	0	1	0	0	1	0	0	0	0	0	0	0	0	0	0	1
Grand Total	1	1	4	0	6	0	1	0	0	1	0	1	0	0	1	1	0	0	0	1	9
Apprch %	16.7	16.7	66.7	0		0	100	0	0		0	100	0	0		100	0	0	0		
Total %	11.1	11.1	44.4	0	66.7	0	11.1	0	0	11.1	0	11.1	0	0	11.1	11.1	0	0	0	11.1	

Start Time	Tozer Street Southbound					Yosemite Avenue Westbound					Tozer Street Northbound					Yosemite Avenue Eastbound					Int. Total
	Left	Thru	Right	U-Turns	App. Total	Thru	Right	U-Turns	App. Total	Thru	Right	U-Turns	App. Total	Thru	Right	U-Turns	App. Total				
Peak Hour Analysis From 04:30 PM to 05:15 PM - Peak 1 of 1																					
Peak Hour for Entire Intersection Begins at 04:30 PM																					
04:30 PM	0	0	0	0	0	0	0	0	0	0	0	1	0	0	1	0	0	0	0	0	1
04:45 PM	1	0	1	0	2	0	0	0	0	0	0	0	0	0	0	0	0	0	0	0	2
05:00 PM	0	0	0	0	0	0	1	0	0	1	0	0	0	0	0	0	0	0	0	0	1
05:15 PM	0	0	0	0	0	0	0	0	0	0	0	0	0	0	0	0	0	0	0	0	0
Total Volume	1	0	1	0	2	0	1	0	0	1	0	1	0	0	1	0	0	0	0	0	4
% App. Total	50	0	50	0		0	100	0	0		0	100	0	0		0	0	0	0		
PHF	.250	.000	.250	.000	.250	.000	.250	.000	.000	.250	.000	.250	.000	.000	.250	.000	.000	.000	.000	.000	.500

City of Madera
 N/S: Tozer Street
 E/W: Yosemite Avenue
 Weather: Clear

File Name : 38_MDA_Tozer_Yosemite PM
 Site Code : 00319628
 Start Date : 9/24/2019
 Page No : 2

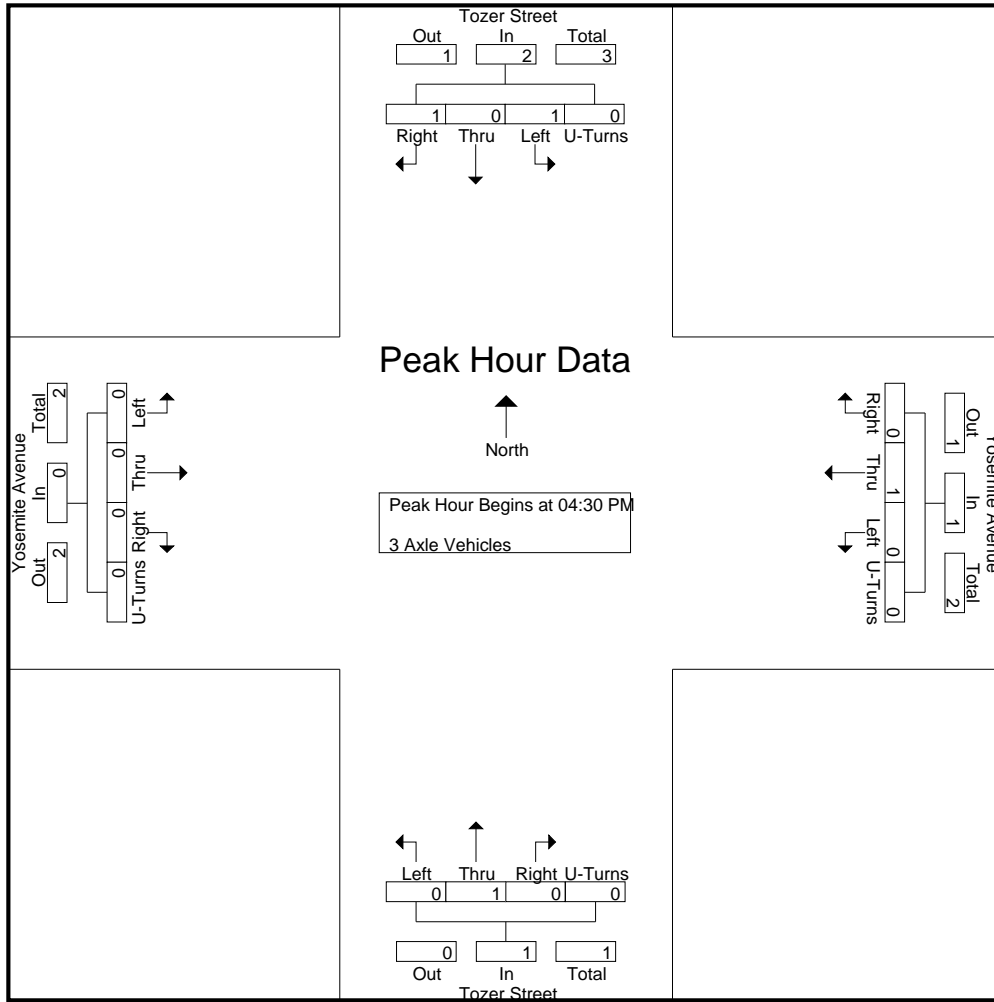

Peak Hour Analysis From 04:30 PM to 05:15 PM - Peak 1 of 1
 Peak Hour for Each Approach Begins at:

	04:30 PM					04:30 PM					04:30 PM					04:30 PM				
+0 mins.	0	0	0	0	0	0	0	0	0	0	0	1	0	0	1	0	0	0	0	0
+15 mins.	1	0	1	0	2	0	0	0	0	0	0	0	0	0	0	0	0	0	0	0
+30 mins.	0	0	0	0	0	0	1	0	0	1	0	0	0	0	0	0	0	0	0	0
+45 mins.	0	0	0	0	0	0	0	0	0	0	0	0	0	0	0	0	0	0	0	0
Total Volume	1	0	1	0	2	0	1	0	0	1	0	1	0	0	1	0	0	0	0	0
% App. Total	50	0	50	0		0	100	0	0		0	100	0	0		0	0	0	0	
PHF	.250	.000	.250	.000	.250	.000	.250	.000	.000	.250	.000	.250	.000	.000	.250	.000	.000	.000	.000	.000

City of Madera
 N/S: Tozer Street
 E/W: Yosemite Avenue
 Weather: Clear

File Name : 38_MDA_Tozer_Yosemite PM
 Site Code : 00319628
 Start Date : 9/24/2019
 Page No : 1

Groups Printed- 4+ Axle Trucks

Start Time	Tozer Street Southbound					Yosemite Avenue Westbound					Tozer Street Northbound					Yosemite Avenue Eastbound					Int. Total
	Left	Thru	Right	U-Turns	App. Total	Left	Thru	Right	U-Turns	App. Total	Left	Thru	Right	U-Turns	App. Total	Left	Thru	Right	U-Turns	App. Total	
04:00 PM	0	0	1	0	1	0	0	0	0	0	0	0	0	0	0	1	0	0	0	1	2
04:15 PM	0	0	2	0	2	0	0	0	0	0	0	0	0	0	0	0	0	0	0	0	2
04:30 PM	0	1	0	0	1	0	0	0	0	0	0	0	0	0	0	1	2	0	0	3	4
04:45 PM	0	0	0	0	0	0	0	0	0	0	0	0	0	0	0	0	0	0	0	0	0
Total	0	1	3	0	4	0	0	0	0	0	0	0	0	0	0	2	2	0	0	4	8
05:00 PM	0	0	0	0	0	0	0	0	0	0	0	0	0	0	0	1	0	0	0	1	1
05:15 PM	0	0	0	0	0	0	0	0	0	0	0	0	0	0	0	0	0	0	0	0	0
05:30 PM	0	0	0	0	0	0	0	0	0	0	0	0	0	0	0	0	0	0	0	0	0
05:45 PM	0	0	0	0	0	0	1	0	0	1	0	0	0	0	0	0	0	0	0	0	1
Total	0	0	0	0	0	0	1	0	0	1	0	0	0	0	0	1	0	0	0	1	2
Grand Total	0	1	3	0	4	0	1	0	0	1	0	0	0	0	0	3	2	0	0	5	10
Apprch %	0	25	75	0		0	100	0	0		0	0	0	0		60	40	0	0		
Total %	0	10	30	0	40	0	10	0	0	10	0	0	0	0	0	30	20	0	0	50	

Start Time	Tozer Street Southbound					Yosemite Avenue Westbound					Tozer Street Northbound					Yosemite Avenue Eastbound					Int. Total
	Left	Thru	Right	U-Turns	App. Total	Left	Thru	Right	U-Turns	App. Total	Left	Thru	Right	U-Turns	App. Total	Left	Thru	Right	U-Turns	App. Total	
Peak Hour Analysis From 04:30 PM to 05:15 PM - Peak 1 of 1																					
Peak Hour for Entire Intersection Begins at 04:30 PM																					
04:30 PM	0	1	0	0	1	0	0	0	0	0	0	0	0	0	0	1	2	0	0	3	4
04:45 PM	0	0	0	0	0	0	0	0	0	0	0	0	0	0	0	0	0	0	0	0	0
05:00 PM	0	0	0	0	0	0	0	0	0	0	0	0	0	0	0	1	0	0	0	1	1
05:15 PM	0	0	0	0	0	0	0	0	0	0	0	0	0	0	0	0	0	0	0	0	0
Total Volume	0	1	0	0	1	0	0	0	0	0	0	0	0	0	0	2	2	0	0	4	5
% App. Total	0	100	0	0		0	0	0	0		0	0	0	0		50	50	0	0		
PHF	.000	.250	.000	.000	.250	.000	.000	.000	.000	.000	.000	.000	.000	.000	.000	.500	.250	.000	.000	.333	.313

City of Madera
 N/S: Tozer Street
 E/W: Yosemite Avenue
 Weather: Clear

File Name : 38_MDA_Tozer_Yosemite PM
 Site Code : 00319628
 Start Date : 9/24/2019
 Page No : 2

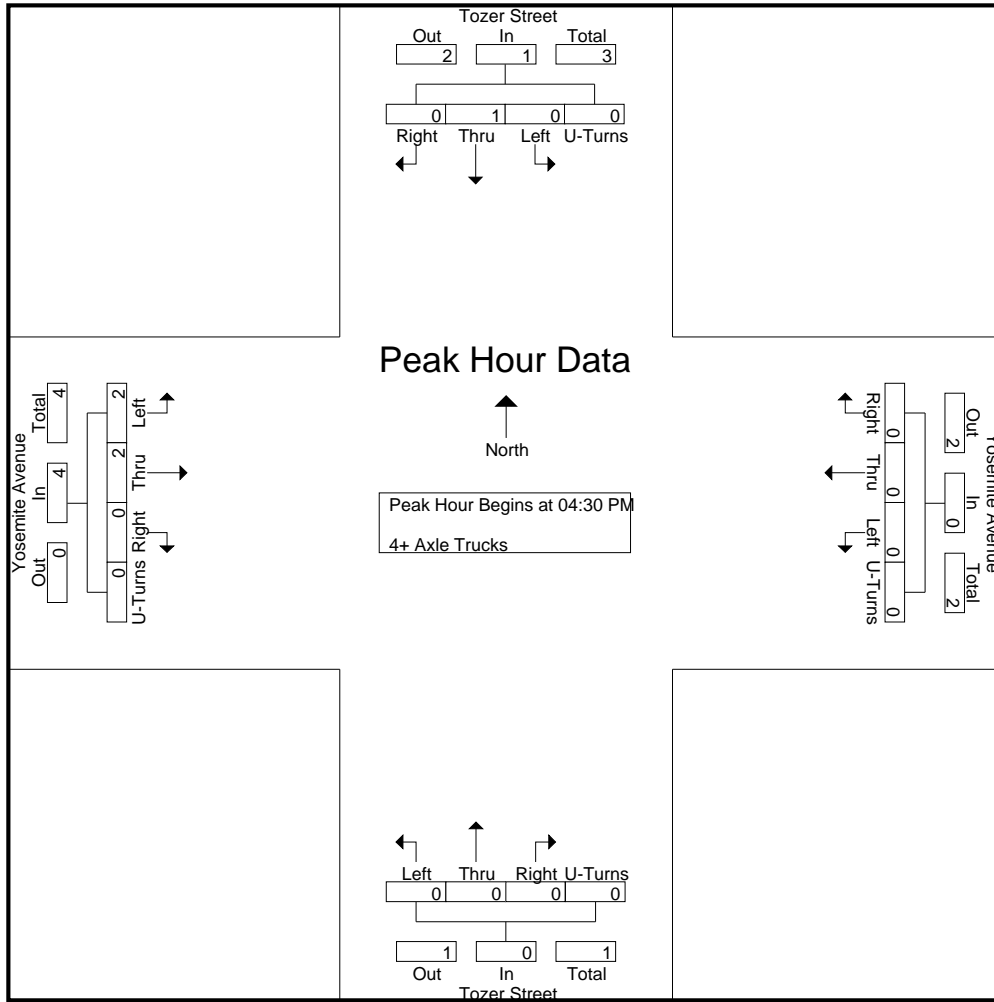

Peak Hour Analysis From 04:30 PM to 05:15 PM - Peak 1 of 1
 Peak Hour for Each Approach Begins at:

	04:30 PM					04:30 PM					04:30 PM					04:30 PM									
+0 mins.	0	1	0	0	1	0	0	0	0	0	0	0	0	0	0	1	2	0	0	3	0	0	0	0	0
+15 mins.	0	0	0	0	0	0	0	0	0	0	0	0	0	0	0	0	0	0	0	0	0	0	0	0	0
+30 mins.	0	0	0	0	0	0	0	0	0	0	0	0	0	0	0	1	0	0	0	1	0	0	0	0	0
+45 mins.	0	0	0	0	0	0	0	0	0	0	0	0	0	0	0	0	0	0	0	0	0	0	0	0	0
Total Volume	0	1	0	0	1	0	0	0	0	0	0	0	0	0	0	2	2	0	0	4	0	0	0	0	0
% App. Total	0	100	0	0	0	0	0	0	0	0	0	0	0	0	0	50	50	0	0	0	0	0	0	0	0
PHF	.000	.250	.000	.000	.250	.000	.000	.000	.000	.000	.000	.000	.000	.000	.000	.500	.250	.000	.000	.333					

Location: Madera
 N/S: Tozer Street
 E/W: Yosemite Avenue



Date: 9/24/2019
 Day: Tuesday

PEDESTRIANS

	North Leg Tozer Street	East Leg Yosemite Avenue	South Leg Tozer Street	West Leg Yosemite Avenue	
	Pedestrians	Pedestrians	Pedestrians	Pedestrians	
7:00 AM	0	1	0	1	2
7:15 AM	17	0	2	0	19
7:30 AM	14	2	6	0	22
7:45 AM	3	0	1	0	4
8:00 AM	6	1	3	1	11
8:15 AM	0	0	0	1	1
8:30 AM	0	1	2	0	3
8:45 AM	2	0	1	1	4
TOTAL VOLUMES:	42	5	15	4	66

	North Leg Tozer Street	East Leg Yosemite Avenue	South Leg Tozer Street	West Leg Yosemite Avenue	
	Pedestrians	Pedestrians	Pedestrians	Pedestrians	
4:00 PM	3	0	1	0	4
4:15 PM	2	0	0	1	3
4:30 PM	0	0	0	0	0
4:45 PM	1	0	2	0	3
5:00 PM	0	0	1	0	1
5:15 PM	0	0	5	4	9
5:30 PM	2	1	4	1	8
5:45 PM	1	0	2	0	3
TOTAL VOLUMES:	9	1	15	6	31

Location: Madera
 N/S: Tozer Street
 E/W: Yosemite Avenue



Date: 9/24/2019
 Day: Tuesday

BICYCLES

	Southbound Tozer Street			Westbound Yosemite Avenue			Northbound Tozer Street			Eastbound Yosemite Avenue			
	Left	Thru	Right	Left	Thru	Right	Left	Thru	Right	Left	Thru	Right	
7:00 AM	0	1	0	0	0	0	1	0	0	0	0	0	2
7:15 AM	0	0	0	0	0	0	0	0	0	0	0	0	0
7:30 AM	0	0	0	0	0	0	0	0	0	0	0	0	0
7:45 AM	0	0	0	0	0	0	0	1	0	0	0	0	1
8:00 AM	0	0	0	0	0	0	0	0	0	0	0	0	0
8:15 AM	0	3	0	0	0	0	0	0	0	0	0	0	3
8:30 AM	0	0	0	0	0	0	0	0	1	0	0	0	1
8:45 AM	0	1	0	0	1	0	0	0	0	0	0	0	2
TOTAL VOLUMES:	0	5	0	0	1	0	1	1	1	0	0	0	9

	Southbound Tozer Street			Westbound Yosemite Avenue			Northbound Tozer Street			Eastbound Yosemite Avenue			
	Left	Thru	Right	Left	Thru	Right	Left	Thru	Right	Left	Thru	Right	
4:00 PM	0	1	0	0	0	0	0	0	0	0	1	0	2
4:15 PM	0	0	0	0	1	0	0	0	0	0	0	0	1
4:30 PM	0	0	0	0	0	0	0	0	0	0	3	0	3
4:45 PM	0	1	0	0	0	0	0	0	0	0	0	0	1
5:00 PM	0	0	0	0	0	0	0	0	0	0	1	0	1
5:15 PM	0	0	0	0	0	0	0	0	0	0	0	0	0
5:30 PM	0	0	0	0	0	0	0	0	0	0	1	0	1
5:45 PM	0	0	0	0	0	0	1	0	0	0	0	0	1
TOTAL VOLUMES:	0	2	0	0	1	0	1	0	0	0	6	0	10

City of Madera
 N/S: Project Driveway 1
 E/W: Avenue 17
 Weather: Clear

File Name : 39_MDA_Project DW1_Ave 17 AM
 Site Code : 00319628
 Start Date : 9/24/2019
 Page No : 1

Groups Printed- Total Volume

Start Time	Project Driveway 1 Southbound				Avenue 17 Westbound				Avenue 17 Eastbound				Int. Total
	Left	Right	U-Turns	App. Total	Thru	Right	U-Turns	App. Total	Left	Thru	U-Turns	App. Total	
07:00 AM	0	0	0	0	4	0	0	4	0	6	0	6	10
07:15 AM	0	0	0	0	5	0	0	5	0	11	0	11	16
07:30 AM	0	0	0	0	7	0	0	7	0	4	0	4	11
07:45 AM	0	0	0	0	9	0	0	9	0	10	0	10	19
Total	0	0	0	0	25	0	0	25	0	31	0	31	56
08:00 AM	0	0	0	0	6	0	0	6	0	6	0	6	12
08:15 AM	0	0	0	0	8	0	0	8	0	5	0	5	13
08:30 AM	0	0	0	0	6	0	0	6	0	3	0	3	9
08:45 AM	0	0	0	0	5	0	0	5	0	3	0	3	8
Total	0	0	0	0	25	0	0	25	0	17	0	17	42
Grand Total	0	0	0	0	50	0	0	50	0	48	0	48	98
Apprch %	0	0	0	0	100	0	0	100	0	100	0	100	
Total %	0	0	0	0	51	0	0	51	0	49	0	49	

Start Time	Project Driveway 1 Southbound				Avenue 17 Westbound				Avenue 17 Eastbound				Int. Total
	Left	Right	U-Turns	App. Total	Thru	Right	U-Turns	App. Total	Left	Thru	U-Turns	App. Total	
07:15 AM	0	0	0	0	5	0	0	5	0	11	0	11	16
07:30 AM	0	0	0	0	7	0	0	7	0	4	0	4	11
07:45 AM	0	0	0	0	9	0	0	9	0	10	0	10	19
08:00 AM	0	0	0	0	6	0	0	6	0	6	0	6	12
Total Volume	0	0	0	0	27	0	0	27	0	31	0	31	58
% App. Total	0	0	0	0	100	0	0	100	0	100	0	100	
PHF	.000	.000	.000	.000	.750	.000	.000	.750	.000	.705	.000	.705	.763

Peak Hour Analysis From 07:00 AM to 08:45 AM - Peak 1 of 1

Peak Hour for Entire Intersection Begins at 07:15 AM

City of Madera
 N/S: Project Driveway 1
 E/W: Avenue 17
 Weather: Clear

File Name : 39_MDA_Project DW1_Ave 17 AM
 Site Code : 00319628
 Start Date : 9/24/2019
 Page No : 2

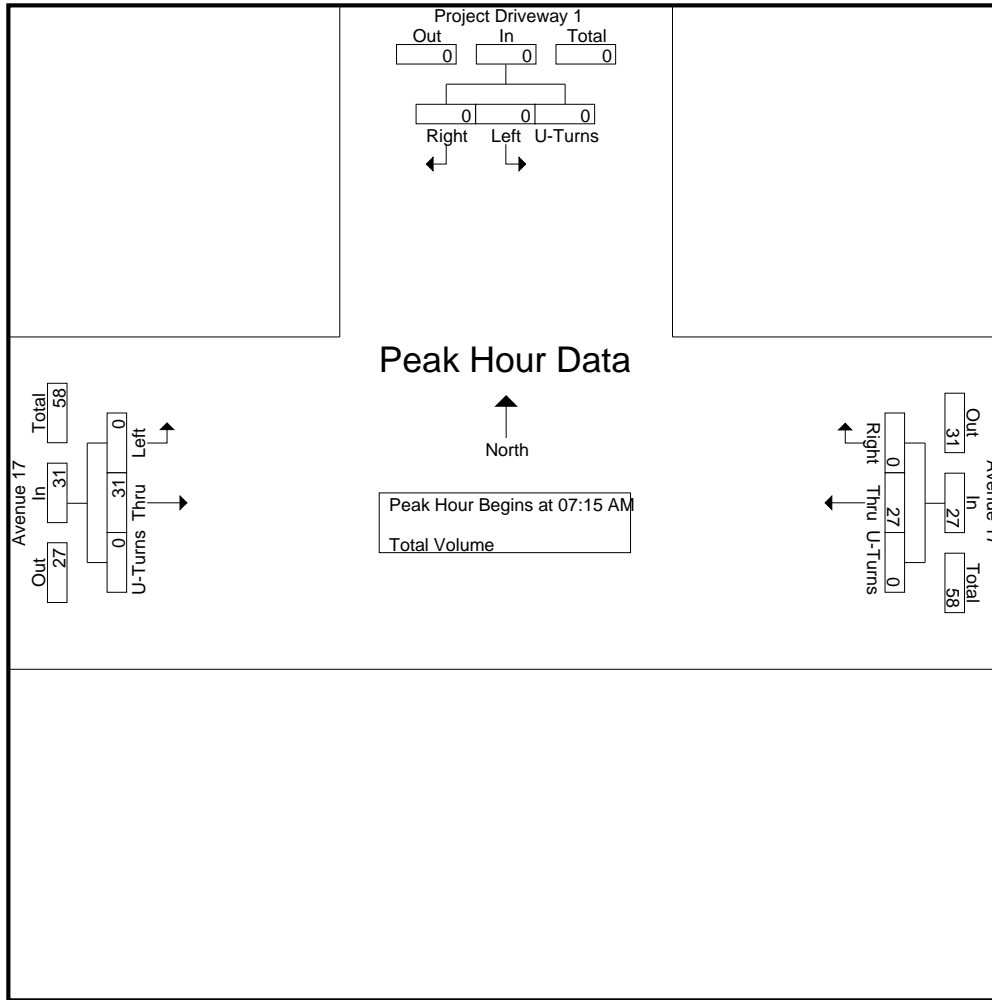

Peak Hour Analysis From 07:00 AM to 08:45 AM - Peak 1 of 1
 Peak Hour for Each Approach Begins at:

	07:00 AM				07:30 AM				07:00 AM			
+0 mins.	0	0	0	0	7	0	0	7	0	6	0	6
+15 mins.	0	0	0	0	9	0	0	9	0	11	0	11
+30 mins.	0	0	0	0	6	0	0	6	0	4	0	4
+45 mins.	0	0	0	0	8	0	0	8	0	10	0	10
Total Volume	0	0	0	0	30	0	0	30	0	31	0	31
% App. Total	0	0	0	0	100	0	0	100	0	100	0	100
PHF	.000	.000	.000	.000	.833	.000	.000	.833	.000	.705	.000	.705

City of Madera
 N/S: Project Driveway 1
 E/W: Avenue 17
 Weather: Clear

File Name : 39_MDA_Project DW1_Ave 17 PM
 Site Code : 00319628
 Start Date : 9/24/2019
 Page No : 1

Groups Printed- Total Volume

Start Time	Project Driveway 1 Southbound				Avenue 17 Westbound				Avenue 17 Eastbound				Int. Total
	Left	Right	U-Turns	App. Total	Thru	Right	U-Turns	App. Total	Left	Thru	U-Turns	App. Total	
04:00 PM	0	0	0	0	4	0	0	4	0	20	0	20	24
04:15 PM	0	0	0	0	9	0	0	9	0	11	0	11	20
04:30 PM	0	0	0	0	6	0	0	6	0	4	0	4	10
04:45 PM	0	0	0	0	7	0	0	7	0	7	0	7	14
Total	0	0	0	0	26	0	0	26	0	42	0	42	68
05:00 PM	0	0	0	0	7	0	0	7	0	13	0	13	20
05:15 PM	0	0	0	0	8	0	0	8	0	5	0	5	13
05:30 PM	0	0	0	0	8	0	0	8	0	12	0	12	20
05:45 PM	0	0	0	0	2	0	0	2	0	5	0	5	7
Total	0	0	0	0	25	0	0	25	0	35	0	35	60
Grand Total	0	0	0	0	51	0	0	51	0	77	0	77	128
Apprch %	0	0	0	0	100	0	0	100	0	100	0	100	
Total %	0	0	0	0	39.8	0	0	39.8	0	60.2	0	60.2	

Start Time	Project Driveway 1 Southbound				Avenue 17 Westbound				Avenue 17 Eastbound				Int. Total
	Left	Right	U-Turns	App. Total	Thru	Right	U-Turns	App. Total	Left	Thru	U-Turns	App. Total	
04:00 PM	0	0	0	0	4	0	0	4	0	20	0	20	24
04:15 PM	0	0	0	0	9	0	0	9	0	11	0	11	20
04:30 PM	0	0	0	0	6	0	0	6	0	4	0	4	10
04:45 PM	0	0	0	0	7	0	0	7	0	7	0	7	14
Total Volume	0	0	0	0	26	0	0	26	0	42	0	42	68
% App. Total	0	0	0	0	100	0	0	100	0	100	0	100	
PHF	.000	.000	.000	.000	.722	.000	.000	.722	.000	.525	.000	.525	.708

Peak Hour Analysis From 04:00 PM to 05:45 PM - Peak 1 of 1

Peak Hour for Entire Intersection Begins at 04:00 PM

City of Madera
 N/S: Project Driveway 1
 E/W: Avenue 17
 Weather: Clear

File Name : 39_MDA_Project DW1_Ave 17 PM
 Site Code : 00319628
 Start Date : 9/24/2019
 Page No : 2

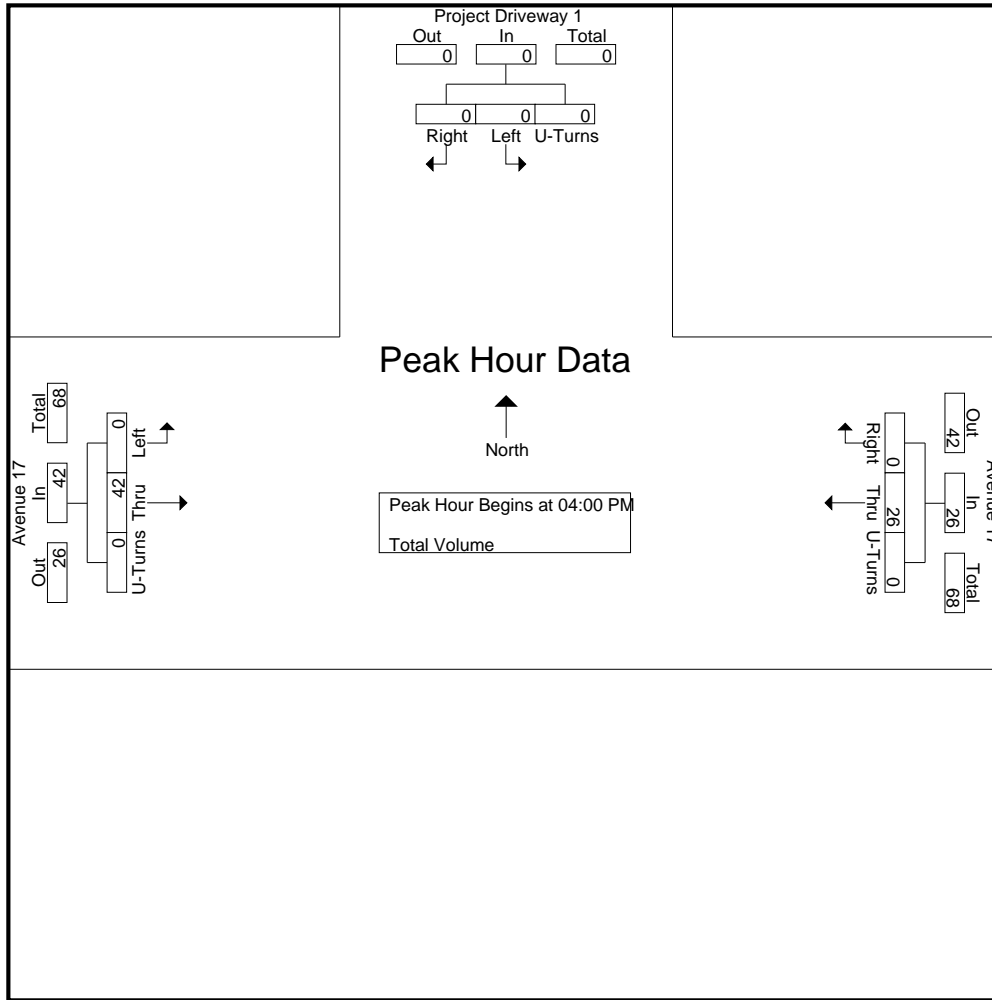

Peak Hour Analysis From 04:00 PM to 05:45 PM - Peak 1 of 1
 Peak Hour for Each Approach Begins at:

	04:00 PM				04:45 PM				04:00 PM			
+0 mins.	0	0	0	0	7	0	0	7	0	20	0	20
+15 mins.	0	0	0	0	7	0	0	7	0	11	0	11
+30 mins.	0	0	0	0	8	0	0	8	0	4	0	4
+45 mins.	0	0	0	0	8	0	0	8	0	7	0	7
Total Volume	0	0	0	0	30	0	0	30	0	42	0	42
% App. Total	0	0	0	0	100	0	0	100	0	100	0	100
PHF	.000	.000	.000	.000	.938	.000	.000	.938	.000	.525	.000	.525

Location: Madera
 N/S: Project Driveway 1
 E/W: Avenue 17



Date: 9/24/2019
 Day: Tuesday

PEDESTRIANS

	North Leg Project Driveway 1	East Leg Avenue 17	South Leg Dead End	West Leg Avenue 17	
	Pedestrians	Pedestrians	Pedestrians	Pedestrians	
7:00 AM	0	0	0	0	0
7:15 AM	0	0	0	0	0
7:30 AM	0	0	0	0	0
7:45 AM	0	0	0	0	0
8:00 AM	0	0	0	0	0
8:15 AM	0	0	0	0	0
8:30 AM	0	0	0	0	0
8:45 AM	0	0	0	0	0
TOTAL VOLUMES:	0	0	0	0	0

	North Leg Project Driveway 1	East Leg Avenue 17	South Leg Dead End	West Leg Avenue 17	
	Pedestrians	Pedestrians	Pedestrians	Pedestrians	
4:00 PM	0	0	0	0	0
4:15 PM	0	0	0	0	0
4:30 PM	0	0	0	0	0
4:45 PM	0	0	0	0	0
5:00 PM	0	0	0	0	0
5:15 PM	0	0	0	0	0
5:30 PM	0	0	0	0	0
5:45 PM	0	0	0	0	0
TOTAL VOLUMES:	0	0	0	0	0

Location: Madera
 N/S: Project Driveway 1
 E/W: Avenue 17



Date: 9/24/2019
 Day: Tuesday

BICYCLES

	Southbound Project Driveway 1			Westbound Avenue 17			Northbound Dead End			Eastbound Avenue 17			
	Left	Thru	Right	Left	Thru	Right	Left	Thru	Right	Left	Thru	Right	
7:00 AM	0	0	0	0	0	0	0	0	0	0	0	0	0
7:15 AM	0	0	0	0	0	0	0	0	0	0	0	0	0
7:30 AM	0	0	0	0	0	0	0	0	0	0	0	0	0
7:45 AM	0	0	0	0	0	0	0	0	0	0	0	0	0
8:00 AM	0	0	0	0	0	0	0	0	0	0	0	0	0
8:15 AM	0	0	0	0	0	0	0	0	0	0	0	0	0
8:30 AM	0	0	0	0	0	0	0	0	0	0	0	0	0
8:45 AM	0	0	0	0	0	0	0	0	0	0	0	0	0
TOTAL VOLUMES:	0	0	0	0	0	0	0	0	0	0	0	0	0

	Southbound Project Driveway 1			Westbound Avenue 17			Northbound Dead End			Eastbound Avenue 17			
	Left	Thru	Right	Left	Thru	Right	Left	Thru	Right	Left	Thru	Right	
4:00 PM	0	0	0	0	0	0	0	0	0	0	0	0	0
4:15 PM	0	0	0	0	0	0	0	0	0	0	0	0	0
4:30 PM	0	0	0	0	0	0	0	0	0	0	0	0	0
4:45 PM	0	0	0	0	0	0	0	0	0	0	0	0	0
5:00 PM	0	0	0	0	0	0	0	0	0	0	0	0	0
5:15 PM	0	0	0	0	0	0	0	0	0	0	0	0	0
5:30 PM	0	0	0	0	0	0	0	0	0	0	0	0	0
5:45 PM	0	0	0	0	0	0	0	0	0	0	0	0	0
TOTAL VOLUMES:	0	0	0	0	0	0	0	0	0	0	0	0	0

City of Madera
 N/S: Project Driveway 1/Road 22 1/2
 E/W: Avenue 16
 Weather: Clear

File Name : 40_MDA_Project DW1_Ave 16 AM
 Site Code : 00319628
 Start Date : 9/24/2019
 Page No : 1

Groups Printed- Total Volume

Start Time	Project Driveway 1 Southbound					Avenue 16 Westbound					Road 22 1/2 Northbound					Avenue 16 Eastbound					Int. Total	
	Left	Thru	Right	U-Turns	App. Total	Left	Thru	Right	U-Turns	App. Total	Left	Thru	Right	U-Turns	App. Total	Left	Thru	Right	U-Turns	App. Total		
07:00 AM	1	0	0	0	1	0	5	0	0	5	0	0	0	0	0	0	1	1	0	0	2	8
07:15 AM	0	0	0	0	0	0	4	0	0	4	0	0	0	0	0	0	2	0	0	0	2	6
07:30 AM	0	0	0	0	0	0	10	0	0	10	0	0	1	0	1	0	2	0	0	0	2	13
07:45 AM	0	0	0	0	0	0	15	0	0	15	0	0	0	0	0	0	2	0	0	0	2	17
Total	1	0	0	0	1	0	34	0	0	34	0	0	1	0	1	0	7	1	0	0	8	44
08:00 AM	0	0	0	0	0	0	3	0	0	3	0	0	0	0	0	0	1	0	0	0	1	4
08:15 AM	1	0	0	0	1	0	2	0	0	2	0	0	0	0	0	1	2	1	0	0	4	7
08:30 AM	0	0	0	0	0	0	7	0	0	7	0	0	0	0	0	0	2	0	0	0	2	9
08:45 AM	0	0	0	0	0	0	3	0	0	3	1	0	0	0	1	0	5	0	0	0	5	9
Total	1	0	0	0	1	0	15	0	0	15	1	0	0	0	1	1	10	1	0	0	12	29
Grand Total	2	0	0	0	2	0	49	0	0	49	1	0	1	0	2	1	17	2	0	0	20	73
Apprch %	100	0	0	0		0	100	0	0		50	0	50	0		5	85	10	0			
Total %	2.7	0	0	0	2.7	0	67.1	0	0	67.1	1.4	0	1.4	0	2.7	1.4	23.3	2.7	0	0	27.4	

Start Time	Project Driveway 1 Southbound					Avenue 16 Westbound					Road 22 1/2 Northbound					Avenue 16 Eastbound					Int. Total	
	Left	Thru	Right	U-Turns	App. Total	Thru	Right	U-Turns	App. Total	Thru	Right	U-Turns	App. Total	Thru	Right	U-Turns	App. Total					
Peak Hour Analysis From 07:00 AM to 08:45 AM - Peak 1 of 1																						
Peak Hour for Entire Intersection Begins at 07:00 AM																						
07:00 AM	1	0	0	0	1	0	5	0	0	5	0	0	0	0	0	0	1	1	0	0	2	8
07:15 AM	0	0	0	0	0	0	4	0	0	4	0	0	0	0	0	0	2	0	0	0	2	6
07:30 AM	0	0	0	0	0	0	10	0	0	10	0	0	1	0	1	0	2	0	0	0	2	13
07:45 AM	0	0	0	0	0	0	15	0	0	15	0	0	0	0	0	0	2	0	0	0	2	17
Total Volume	1	0	0	0	1	0	34	0	0	34	0	0	1	0	1	0	7	1	0	0	8	44
% App. Total	100	0	0	0		0	100	0	0		0	0	100	0		0	87.5	12.5	0			
PHF	.250	.000	.000	.000	.250	.000	.567	.000	.000	.567	.000	.000	.250	.000	.250	.000	.875	.250	.000	1.00	.647	

City of Madera
 N/S: Project Driveway 1/Road 22 1/2
 E/W: Avenue 16
 Weather: Clear

File Name : 40_MDA_Project DW1_Ave 16 AM
 Site Code : 00319628
 Start Date : 9/24/2019
 Page No : 2

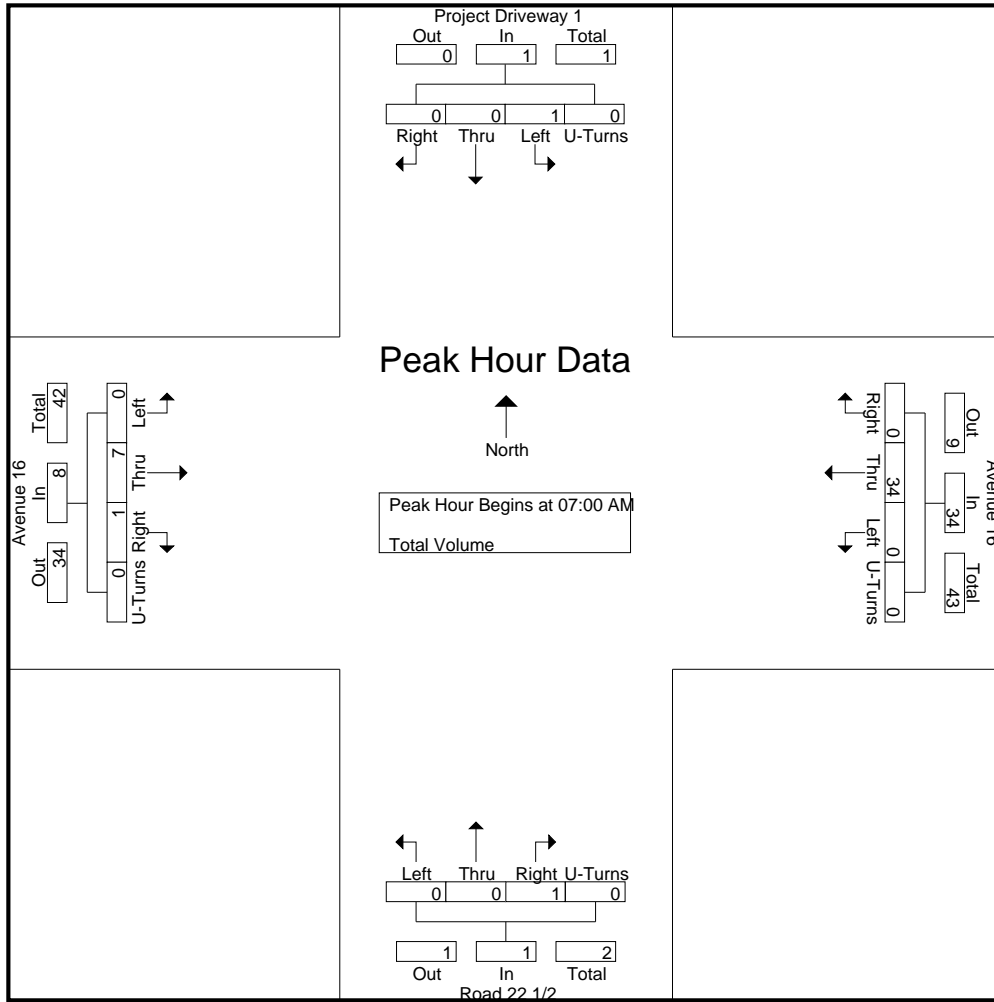

Peak Hour Analysis From 07:00 AM to 08:45 AM - Peak 1 of 1
 Peak Hour for Each Approach Begins at:

	07:00 AM					07:00 AM					07:00 AM					08:00 AM				
+0 mins.	1	0	0	0	1	0	5	0	0	5	0	0	0	0	0	0	1	0	0	1
+15 mins.	0	0	0	0	0	0	4	0	0	4	0	0	0	0	0	1	2	1	0	4
+30 mins.	0	0	0	0	0	0	10	0	0	10	0	0	1	0	1	0	2	0	0	2
+45 mins.	0	0	0	0	0	0	15	0	0	15	0	0	0	0	0	0	5	0	0	5
Total Volume	1	0	0	0	1	0	34	0	0	34	0	0	1	0	1	1	10	1	0	12
% App. Total	100	0	0	0	0	0	100	0	0	0	0	0	100	0	0	8.3	83.3	8.3	0	0
PHF	.250	.000	.000	.000	.250	.000	.567	.000	.000	.567	.000	.000	.250	.000	.250	.250	.500	.250	.000	.600

City of Madera
 N/S: Project Driveway 1/Road 22 1/2
 E/W: Avenue 16
 Weather: Clear

File Name : 40_MDA_Project DW1_Ave 16 PM
 Site Code : 00319628
 Start Date : 9/24/2019
 Page No : 1

Groups Printed- Total Volume

Start Time	Project Driveway 1 Southbound					Avenue 16 Westbound					Road 22 1/2 Northbound					Avenue 16 Eastbound					Int. Total
	Left	Thru	Right	U-Turns	App. Total	Left	Thru	Right	U-Turns	App. Total	Left	Thru	Right	U-Turns	App. Total	Left	Thru	Right	U-Turns	App. Total	
04:00 PM	1	0	0	0	1	0	2	0	0	2	0	0	0	0	0	0	7	0	0	7	10
04:15 PM	0	0	0	0	0	0	3	0	0	3	0	0	0	0	0	0	8	0	0	8	11
04:30 PM	0	0	0	0	0	0	5	0	0	5	0	0	0	0	0	0	26	0	0	26	31
04:45 PM	0	0	0	0	0	0	4	0	0	4	0	0	0	0	0	0	8	0	0	8	12
Total	1	0	0	0	1	0	14	0	0	14	0	0	0	0	0	0	49	0	0	49	64
05:00 PM	0	0	0	0	0	0	4	0	0	4	0	0	0	0	0	0	4	0	0	4	8
05:15 PM	0	0	0	0	0	0	9	0	0	9	0	0	0	0	0	0	2	0	0	2	11
05:30 PM	0	0	0	0	0	0	2	0	0	2	0	0	0	0	0	0	7	0	0	7	9
05:45 PM	0	0	0	0	0	0	3	0	0	3	0	0	0	0	0	0	5	0	0	5	8
Total	0	0	0	0	0	0	18	0	0	18	0	0	0	0	0	0	18	0	0	18	36
Grand Total	1	0	0	0	1	0	32	0	0	32	0	0	0	0	0	0	67	0	0	67	100
Apprch %	100	0	0	0		0	100	0	0		0	0	0	0		0	100	0	0		
Total %	1	0	0	0	1	0	32	0	0	32	0	0	0	0	0	0	67	0	0	67	

Start Time	Project Driveway 1 Southbound					Avenue 16 Westbound					Road 22 1/2 Northbound					Avenue 16 Eastbound					Int. Total
	Left	Thru	Right	U-Turns	App. Total	Left	Thru	Right	U-Turns	App. Total	Left	Thru	Right	U-Turns	App. Total	Left	Thru	Right	U-Turns	App. Total	
Peak Hour Analysis From 04:00 PM to 05:45 PM - Peak 1 of 1																					
Peak Hour for Entire Intersection Begins at 04:00 PM																					
04:00 PM	1	0	0	0	1	0	2	0	0	2	0	0	0	0	0	0	7	0	0	7	10
04:15 PM	0	0	0	0	0	0	3	0	0	3	0	0	0	0	0	0	8	0	0	8	11
04:30 PM	0	0	0	0	0	0	5	0	0	5	0	0	0	0	0	0	26	0	0	26	31
04:45 PM	0	0	0	0	0	0	4	0	0	4	0	0	0	0	0	0	8	0	0	8	12
Total Volume	1	0	0	0	1	0	14	0	0	14	0	0	0	0	0	0	49	0	0	49	64
% App. Total	100	0	0	0		0	100	0	0		0	0	0	0		0	100	0	0		
PHF	.250	.000	.000	.000	.250	.000	.700	.000	.000	.700	.000	.000	.000	.000	.000	.000	.471	.000	.000	.471	.516

City of Madera
 N/S: Project Driveway 1/Road 22 1/2
 E/W: Avenue 16
 Weather: Clear

File Name : 40_MDA_Project DW1_Ave 16 PM
 Site Code : 00319628
 Start Date : 9/24/2019
 Page No : 2

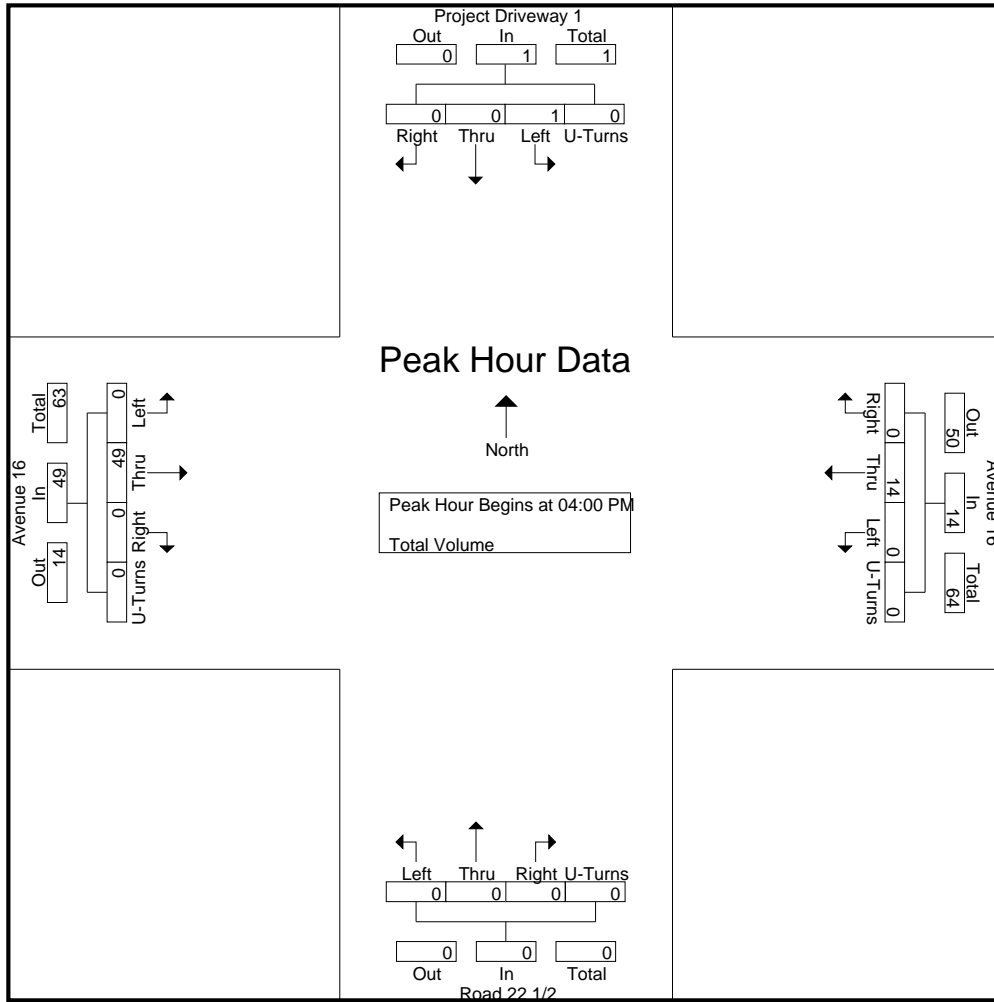

Peak Hour Analysis From 04:00 PM to 05:45 PM - Peak 1 of 1
 Peak Hour for Each Approach Begins at:

	04:00 PM					04:30 PM					04:00 PM					04:00 PM				
+0 mins.	1	0	0	0	1	0	5	0	0	5	0	0	0	0	0	0	7	0	0	7
+15 mins.	0	0	0	0	0	0	4	0	0	4	0	0	0	0	0	0	8	0	0	8
+30 mins.	0	0	0	0	0	0	4	0	0	4	0	0	0	0	0	0	26	0	0	26
+45 mins.	0	0	0	0	0	0	9	0	0	9	0	0	0	0	0	0	8	0	0	8
Total Volume	1	0	0	0	1	0	22	0	0	22	0	0	0	0	0	0	49	0	0	49
% App. Total	100	0	0	0	0	0	100	0	0	0	0	0	0	0	0	0	100	0	0	0
PHF	.250	.000	.000	.000	.250	.000	.611	.000	.000	.611	.000	.000	.000	.000	.000	.000	.471	.000	.000	.471

Location: Madera
 N/S: Project DW 1/Road 22 1/2
 E/W: Avenue 16



Date: 9/24/2019
 Day: Tuesday

PEDESTRIANS

	North Leg Project DW 1	East Leg Avenue 16	South Leg Road 22 1/2	West Leg Avenue 16	
	Pedestrians	Pedestrians	Pedestrians	Pedestrians	
7:00 AM	0	0	0	0	0
7:15 AM	0	0	0	0	0
7:30 AM	0	0	0	0	0
7:45 AM	0	0	0	0	0
8:00 AM	0	0	0	0	0
8:15 AM	0	0	0	0	0
8:30 AM	0	0	0	0	0
8:45 AM	0	0	0	0	0
TOTAL VOLUMES:	0	0	0	0	0

	North Leg Project DW 1	East Leg Avenue 16	South Leg Road 22 1/2	West Leg Avenue 16	
	Pedestrians	Pedestrians	Pedestrians	Pedestrians	
4:00 PM	0	0	0	0	0
4:15 PM	0	0	0	0	0
4:30 PM	0	0	0	0	0
4:45 PM	0	0	0	0	0
5:00 PM	0	0	0	0	0
5:15 PM	0	0	0	0	0
5:30 PM	0	0	0	0	0
5:45 PM	0	0	0	0	0
TOTAL VOLUMES:	0	0	0	0	0

Location: Madera
 N/S: Project DW 1/Road 22 1/2
 E/W: Avenue 16



Date: 9/24/2019
 Day: Tuesday

BICYCLES

	Southbound Project DW 1			Westbound Avenue 16			Northbound Road 22 1/2			Eastbound Avenue 16			
	Left	Thru	Right	Left	Thru	Right	Left	Thru	Right	Left	Thru	Right	
7:00 AM	0	0	0	0	0	0	0	0	0	0	0	0	0
7:15 AM	0	0	0	0	0	0	0	0	0	0	1	0	1
7:30 AM	0	0	0	0	0	0	0	0	0	0	0	0	0
7:45 AM	0	0	0	0	0	0	0	0	0	0	0	0	0
8:00 AM	0	0	0	0	0	0	0	0	0	0	0	0	0
8:15 AM	0	0	0	0	0	0	0	0	0	0	0	0	0
8:30 AM	0	0	0	0	0	0	0	0	0	0	0	0	0
8:45 AM	0	0	0	0	0	0	0	0	0	0	0	0	0
TOTAL VOLUMES:	0	0	0	0	0	0	0	0	0	0	1	0	1

	Southbound Project DW 1			Westbound Avenue 16			Northbound Road 22 1/2			Eastbound Avenue 16			
	Left	Thru	Right	Left	Thru	Right	Left	Thru	Right	Left	Thru	Right	
4:00 PM	0	0	0	0	0	0	0	0	0	0	0	0	0
4:15 PM	0	0	0	0	0	0	0	0	0	0	0	0	0
4:30 PM	0	0	0	0	0	0	0	0	0	0	0	0	0
4:45 PM	0	0	0	0	0	0	0	0	0	0	0	0	0
5:00 PM	0	0	0	0	0	0	0	0	0	0	0	0	0
5:15 PM	0	0	0	0	0	0	0	0	0	0	0	0	0
5:30 PM	0	0	0	0	0	0	0	0	0	0	0	0	0
5:45 PM	0	0	0	0	0	0	0	0	0	0	0	0	0
TOTAL VOLUMES:	0	0	0	0	0	0	0	0	0	0	0	0	0

City of Madera
 N/S: Road 22 1/2
 E/W: Avenue 15 1/2
 Weather: Clear

File Name : 46_MDA_Road 22 1-2_Ave 15 1-2 AM
 Site Code : 00319628
 Start Date : 9/24/2019
 Page No : 1

Groups Printed- Total Volume

Start Time	Road 22 1/2 Southbound					Avenue 15 1/2 Westbound					Road 22 1/2 Northbound					Avenue 15 1/2 Eastbound					Int. Total
	Left	Thru	Right	U-Turns	App. Total	Left	Thru	Right	U-Turns	App. Total	Left	Thru	Right	U-Turns	App. Total	Left	Thru	Right	U-Turns	App. Total	
07:00 AM	0	0	0	0	0	1	0	0	0	1	0	0	0	0	0	0	0	0	0	0	1
07:15 AM	0	0	0	0	0	0	0	0	0	0	0	0	0	0	0	0	0	0	0	0	0
07:30 AM	0	0	0	0	0	1	0	0	0	1	0	0	0	0	0	0	0	0	0	0	1
07:45 AM	0	0	0	0	0	0	0	0	0	0	0	0	0	0	0	0	0	0	0	0	0
Total	0	0	0	0	0	2	0	0	0	2	0	0	0	0	0	0	0	0	0	0	2
08:00 AM	0	0	0	0	0	0	0	0	0	0	0	0	0	0	0	0	0	0	0	0	0
08:15 AM	0	0	0	0	0	1	0	0	0	1	0	0	1	0	1	0	0	0	0	0	2
08:30 AM	1	0	0	0	1	0	0	1	0	1	0	0	1	0	1	0	0	0	0	0	3
08:45 AM	0	0	0	0	0	0	0	0	0	0	0	0	0	1	1	0	0	0	0	0	1
Total	1	0	0	0	1	1	0	1	0	2	0	0	2	1	3	0	0	0	0	0	6
Grand Total	1	0	0	0	1	3	0	1	0	4	0	0	2	1	3	0	0	0	0	0	8
Apprch %	100	0	0	0		75	0	25	0		0	0	66.7	33.3		0	0	0	0		
Total %	12.5	0	0	0	12.5	37.5	0	12.5	0	50	0	0	25	12.5	37.5	0	0	0	0	0	

Start Time	Road 22 1/2 Southbound					Avenue 15 1/2 Westbound					Road 22 1/2 Northbound					Avenue 15 1/2 Eastbound					Int. Total
	Left	Thru	Right	U-Turns	App. Total	Left	Thru	Right	U-Turns	App. Total	Left	Thru	Right	U-Turns	App. Total	Left	Thru	Right	U-Turns	App. Total	
Peak Hour Analysis From 07:00 AM to 08:45 AM - Peak 1 of 1																					
Peak Hour for Entire Intersection Begins at 08:00 AM																					
08:00 AM	0	0	0	0	0	0	0	0	0	0	0	0	0	0	0	0	0	0	0	0	0
08:15 AM	0	0	0	0	0	1	0	0	0	1	0	0	1	0	1	0	0	0	0	0	2
08:30 AM	1	0	0	0	1	0	0	1	0	1	0	0	1	0	1	0	0	0	0	0	3
08:45 AM	0	0	0	0	0	0	0	0	0	0	0	0	0	1	1	0	0	0	0	0	1
Total Volume	1	0	0	0	1	1	0	1	0	2	0	0	2	1	3	0	0	0	0	0	6
% App. Total	100	0	0	0		50	0	50	0		0	0	66.7	33.3		0	0	0	0		
PHF	.250	.000	.000	.000	.250	.250	.000	.250	.000	.500	.000	.000	.500	.250	.750	.000	.000	.000	.000	.000	.500

City of Madera
 N/S: Road 22 1/2
 E/W: Avenue 15 1/2
 Weather: Clear

File Name : 46_MDA_Road 22 1-2_Ave 15 1-2 AM
 Site Code : 00319628
 Start Date : 9/24/2019
 Page No : 2

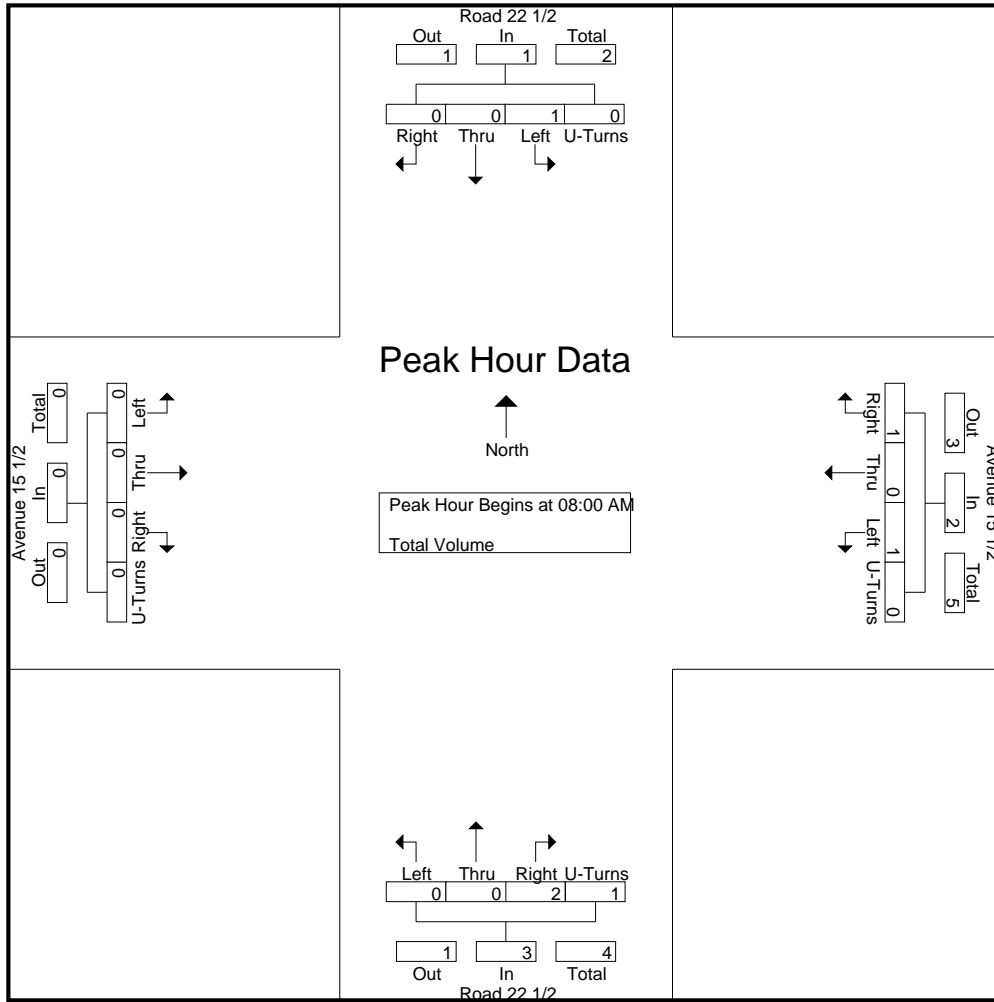

Peak Hour Analysis From 07:00 AM to 08:45 AM - Peak 1 of 1
 Peak Hour for Each Approach Begins at:

	07:45 AM					07:00 AM					08:00 AM					07:00 AM				
+0 mins.	0	0	0	0	0	1	0	0	0	1	0	0	0	0	0	0	0	0	0	0
+15 mins.	0	0	0	0	0	0	0	0	0	0	0	0	1	0	1	0	0	0	0	0
+30 mins.	0	0	0	0	0	1	0	0	0	1	0	0	1	0	1	0	0	0	0	0
+45 mins.	1	0	0	0	1	0	0	0	0	0	0	0	0	1	1	0	0	0	0	0
Total Volume	1	0	0	0	1	2	0	0	0	2	0	0	2	1	3	0	0	0	0	0
% App. Total	100	0	0	0	0	100	0	0	0	0	0	0	66.7	33.3		0	0	0	0	0
PHF	.250	.000	.000	.000	.250	.500	.000	.000	.000	.500	.000	.000	.500	.250	.750	.000	.000	.000	.000	.000

City of Madera
 N/S: Road 22 1/2
 E/W: Avenue 15 1/2
 Weather: Clear

File Name : 46_MDA_Road 22 1-2_Ave 15 1-2 PM
 Site Code : 00319628
 Start Date : 9/24/2019
 Page No : 1

Groups Printed- Total Volume

Start Time	Road 22 1/2 Southbound					Avenue 15 1/2 Westbound					Road 22 1/2 Northbound					Avenue 15 1/2 Eastbound					Int. Total
	Left	Thru	Right	U-Turns	App. Total	Left	Thru	Right	U-Turns	App. Total	Left	Thru	Right	U-Turns	App. Total	Left	Thru	Right	U-Turns	App. Total	
07:00 AM	0	0	0	0	0	0	0	0	0	0	0	0	0	0	0	0	0	0	0	0	0
07:15 AM	1	0	0	0	1	0	0	0	0	0	0	0	0	0	0	0	0	0	0	0	1
07:30 AM	0	0	0	0	0	0	0	0	0	0	0	0	0	0	0	0	0	0	0	0	0
07:45 AM	0	0	0	0	0	0	0	0	0	0	0	0	0	0	0	0	0	0	0	0	0
Total	1	0	0	0	1	0	0	0	0	0	0	0	0	0	0	0	0	0	0	0	1
08:00 AM	0	0	0	0	0	0	0	0	0	0	0	0	0	0	0	0	0	0	0	0	0
08:15 AM	0	0	0	0	0	0	0	0	0	0	0	0	0	0	0	0	0	0	0	0	0
08:30 AM	0	0	0	0	0	0	0	0	0	0	0	0	0	0	0	0	0	0	0	0	0
08:45 AM	1	0	0	0	1	0	0	0	0	0	0	0	0	0	0	0	0	0	0	0	1
Total	1	0	0	0	1	0	0	0	0	0	0	0	0	0	0	0	0	0	0	0	1
Grand Total	2	0	0	0	2	0	0	0	0	0	0	0	0	0	0	0	0	0	0	0	2
Apprch %	100	0	0	0		0	0	0	0		0	0	0	0		0	0	0	0		
Total %	100	0	0	0	100	0	0	0	0	0	0	0	0	0	0	0	0	0	0	0	0

Start Time	Road 22 1/2 Southbound					Avenue 15 1/2 Westbound					Road 22 1/2 Northbound					Avenue 15 1/2 Eastbound					Int. Total
	Left	Thru	Right	U-Turns	App. Total	Left	Thru	Right	U-Turns	App. Total	Left	Thru	Right	U-Turns	App. Total	Left	Thru	Right	U-Turns	App. Total	
Peak Hour Analysis From 07:00 AM to 08:45 AM - Peak 1 of 1																					
Peak Hour for Entire Intersection Begins at 07:00 AM																					
07:00 AM	0	0	0	0	0	0	0	0	0	0	0	0	0	0	0	0	0	0	0	0	0
07:15 AM	1	0	0	0	1	0	0	0	0	0	0	0	0	0	0	0	0	0	0	0	1
07:30 AM	0	0	0	0	0	0	0	0	0	0	0	0	0	0	0	0	0	0	0	0	0
07:45 AM	0	0	0	0	0	0	0	0	0	0	0	0	0	0	0	0	0	0	0	0	0
Total Volume	1	0	0	0	1	0	0	0	0	0	0	0	0	0	0	0	0	0	0	0	1
% App. Total	100	0	0	0		0	0	0	0		0	0	0	0		0	0	0	0		
PHF	.250	.000	.000	.000	.250	.000	.000	.000	.000	.000	.000	.000	.000	.000	.000	.000	.000	.000	.000	.000	.250

City of Madera
 N/S: Road 22 1/2
 E/W: Avenue 15 1/2
 Weather: Clear

File Name : 46_MDA_Road 22 1-2_Ave 15 1-2 PM
 Site Code : 00319628
 Start Date : 9/24/2019
 Page No : 2

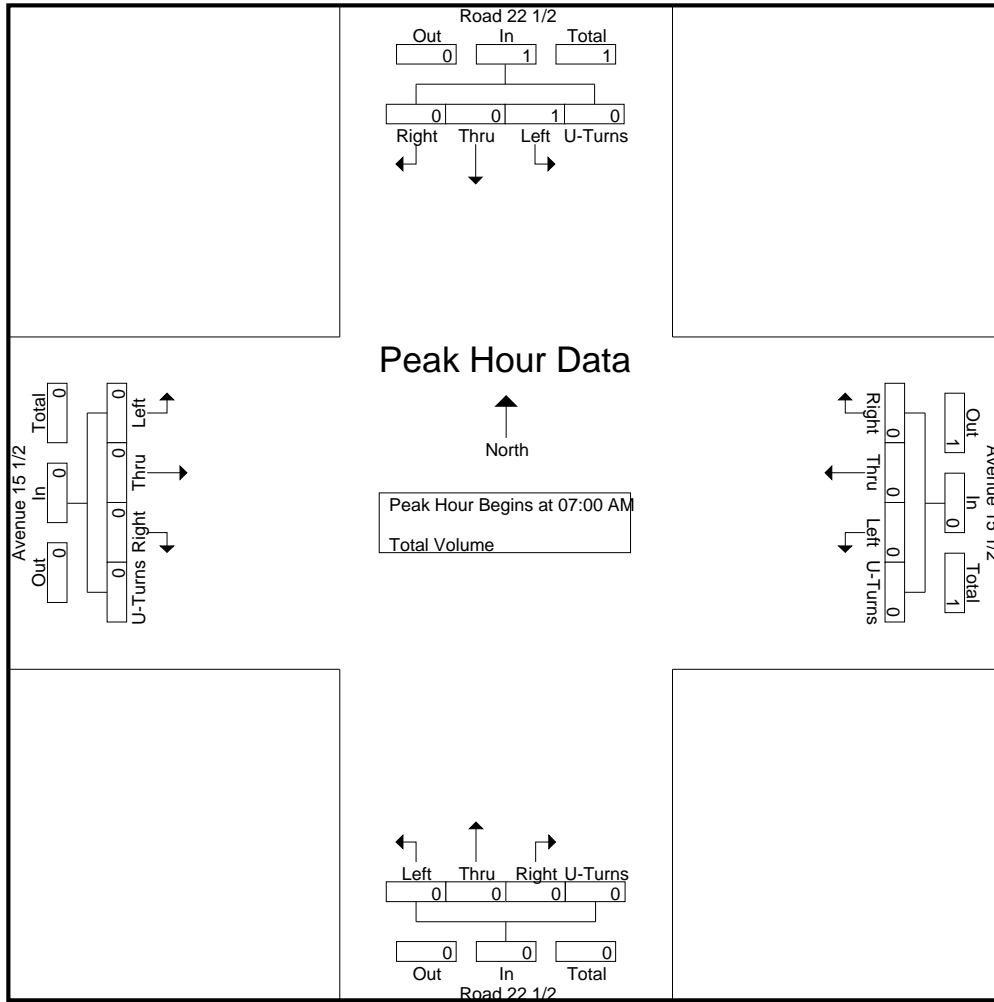

Peak Hour Analysis From 07:00 AM to 08:45 AM - Peak 1 of 1
 Peak Hour for Each Approach Begins at:

	07:00 AM					07:00 AM					07:00 AM				
+0 mins.	0	0	0	0	0	0	0	0	0	0	0	0	0	0	0
+15 mins.	1	0	0	0	1	0	0	0	0	0	0	0	0	0	0
+30 mins.	0	0	0	0	0	0	0	0	0	0	0	0	0	0	0
+45 mins.	0	0	0	0	0	0	0	0	0	0	0	0	0	0	0
Total Volume	1	0	0	0	1	0	0	0	0	0	0	0	0	0	0
% App. Total	100	0	0	0	0	0	0	0	0	0	0	0	0	0	0
PHF	.250	.000	.000	.000	.250	.000	.000	.000	.000	.000	.000	.000	.000	.000	.000

Location: Madera
 N/S: Road 22 1/2
 E/W: Avenue 15 1/2



Date: 9/24/2019
 Day: Tuesday

PEDESTRIANS

	North Leg Road 22 1/2	East Leg Avenue 15 1/2	South Leg Road 22 1/2	West Leg Avenue 15 1/2	
	Pedestrians	Pedestrians	Pedestrians	Pedestrians	
7:00 AM	0	0	0	0	0
7:15 AM	0	0	0	0	0
7:30 AM	0	0	0	0	0
7:45 AM	0	0	0	0	0
8:00 AM	0	0	0	0	0
8:15 AM	0	0	0	0	0
8:30 AM	0	0	0	0	0
8:45 AM	0	0	0	0	0
TOTAL VOLUMES:	0	0	0	0	0

	North Leg Road 22 1/2	East Leg Avenue 15 1/2	South Leg Road 22 1/2	West Leg Avenue 15 1/2	
	Pedestrians	Pedestrians	Pedestrians	Pedestrians	
4:00 PM	0	0	0	0	0
4:15 PM	0	0	0	0	0
4:30 PM	0	0	0	0	0
4:45 PM	0	0	0	0	0
5:00 PM	0	0	0	0	0
5:15 PM	0	0	0	0	0
5:30 PM	0	0	0	0	0
5:45 PM	0	0	0	0	0
TOTAL VOLUMES:	0	0	0	0	0

Location: Madera
 N/S: Road 22 1/2
 E/W: Avenue 15 1/2



Date: 9/24/2019
 Day: Tuesday

BICYCLES

	Southbound Road 22 1/2			Westbound Avenue 15 1/2			Northbound Road 22 1/2			Eastbound Avenue 15 1/2			
	Left	Thru	Right	Left	Thru	Right	Left	Thru	Right	Left	Thru	Right	
7:00 AM	0	0	0	0	0	0	0	0	0	0	0	0	0
7:15 AM	0	0	0	0	0	0	0	0	0	0	0	0	0
7:30 AM	0	0	0	0	0	0	0	0	0	0	0	0	0
7:45 AM	0	0	0	0	0	0	0	0	0	0	0	0	0
8:00 AM	0	0	0	0	0	0	0	0	0	0	0	0	0
8:15 AM	0	0	0	0	0	0	0	0	0	0	0	0	0
8:30 AM	0	0	0	0	0	0	0	0	0	0	0	0	0
8:45 AM	0	0	0	0	0	0	0	0	0	0	0	0	0
TOTAL VOLUMES:	0	0	0	0	0	0	0	0	0	0	0	0	0

	Southbound Road 22 1/2			Westbound Avenue 15 1/2			Northbound Road 22 1/2			Eastbound Avenue 15 1/2			
	Left	Thru	Right	Left	Thru	Right	Left	Thru	Right	Left	Thru	Right	
4:00 PM	0	0	0	0	0	0	0	0	0	0	0	0	0
4:15 PM	0	0	0	0	0	0	0	0	0	0	0	0	0
4:30 PM	0	0	0	0	0	0	0	0	0	0	0	0	0
4:45 PM	0	0	0	0	0	0	0	0	0	0	0	0	0
5:00 PM	0	0	0	0	0	0	0	0	0	0	0	0	0
5:15 PM	0	0	0	0	0	0	0	0	0	0	0	0	0
5:30 PM	0	0	0	0	0	0	0	0	0	0	0	0	0
5:45 PM	0	0	0	0	0	0	0	0	0	0	0	0	0
TOTAL VOLUMES:	0	0	0	0	0	0	0	0	0	0	0	0	0

City of Madera
 N/S: Road 23
 E/W: Project Driveway 3
 Weather: Clear

File Name : 41_MDA_Road 23_Project DW 3 AM
 Site Code : 00319628
 Start Date : 9/24/2019
 Page No : 1

Groups Printed- Total Volume

Start Time	Road 23 Southbound				Road 23 Northbound				Project Driveway 3 Eastbound				Int. Total
	Thru	Right	U-Turns	App. Total	Left	Thru	U-Turns	App. Total	Left	Right	U-Turns	App. Total	
07:00 AM	34	0	0	34	0	43	0	43	0	0	0	0	77
07:15 AM	45	0	0	45	0	48	0	48	0	0	0	0	93
07:30 AM	44	0	0	44	0	75	0	75	0	0	0	0	119
07:45 AM	42	0	0	42	0	54	0	54	0	0	0	0	96
Total	165	0	0	165	0	220	0	220	0	0	0	0	385
08:00 AM	29	0	0	29	0	55	0	55	0	0	0	0	84
08:15 AM	30	0	0	30	0	40	0	40	0	0	0	0	70
08:30 AM	16	0	0	16	0	35	0	35	0	0	0	0	51
08:45 AM	21	0	0	21	0	37	0	37	0	0	0	0	58
Total	96	0	0	96	0	167	0	167	0	0	0	0	263
Grand Total	261	0	0	261	0	387	0	387	0	0	0	0	648
Apprch %	100	0	0		0	100	0		0	0	0	0	
Total %	40.3	0	0	40.3	0	59.7	0	59.7	0	0	0	0	

Start Time	Road 23 Southbound				Road 23 Northbound				Project Driveway 3 Eastbound				Int. Total
	Thru	Right	U-Turns	App. Total	Left	Thru	U-Turns	App. Total	Left	Right	U-Turns	App. Total	
Peak Hour Analysis From 07:00 AM to 08:45 AM - Peak 1 of 1													
Peak Hour for Entire Intersection Begins at 07:15 AM													
07:15 AM	45	0	0	45	0	48	0	48	0	0	0	0	93
07:30 AM	44	0	0	44	0	75	0	75	0	0	0	0	119
07:45 AM	42	0	0	42	0	54	0	54	0	0	0	0	96
08:00 AM	29	0	0	29	0	55	0	55	0	0	0	0	84
Total Volume	160	0	0	160	0	232	0	232	0	0	0	0	392
% App. Total	100	0	0		0	100	0		0	0	0	0	
PHF	.889	.000	.000	.889	.000	.773	.000	.773	.000	.000	.000	.000	.824

City of Madera
 N/S: Road 23
 E/W: Project Driveway 3
 Weather: Clear

File Name : 41_MDA_Road 23_Project DW 3 AM
 Site Code : 00319628
 Start Date : 9/24/2019
 Page No : 2

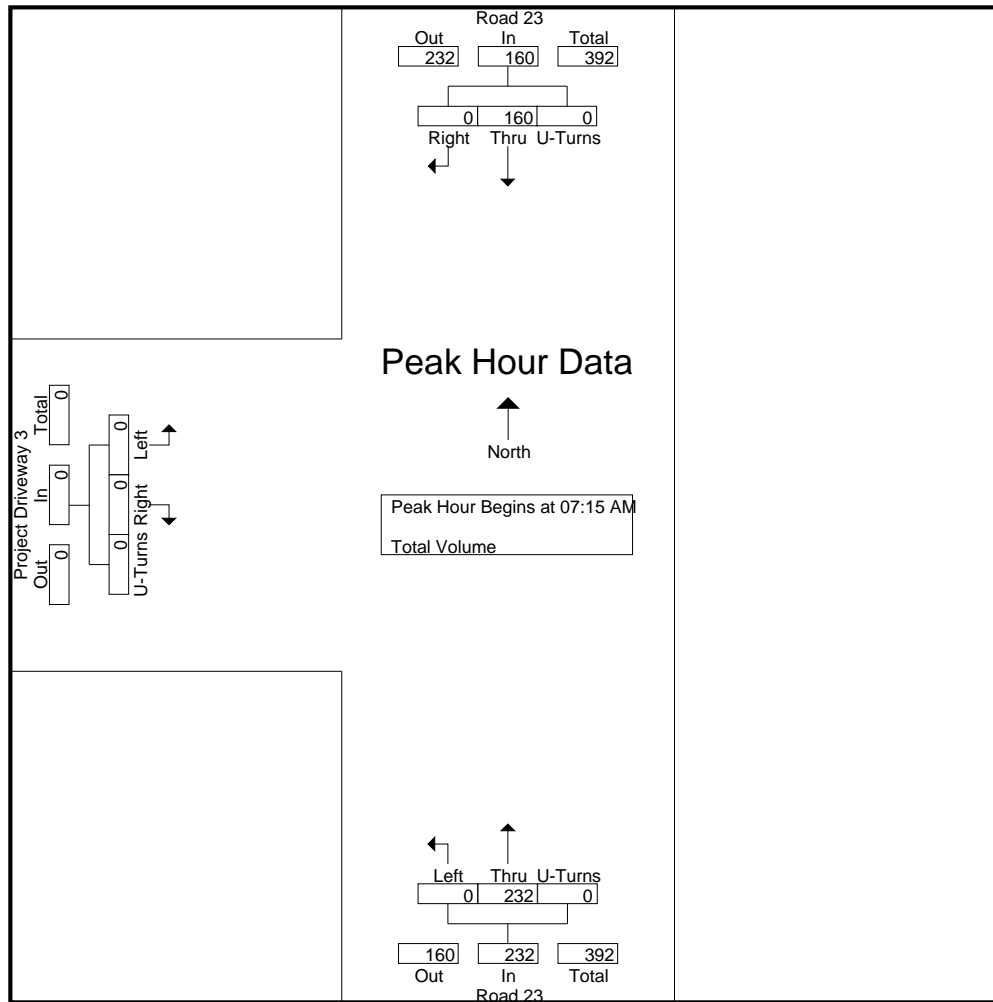

Peak Hour Analysis From 07:00 AM to 08:45 AM - Peak 1 of 1
 Peak Hour for Each Approach Begins at:

	07:00 AM				07:15 AM				07:00 AM			
+0 mins.	34	0	0	34	0	48	0	48	0	0	0	0
+15 mins.	45	0	0	45	0	75	0	75	0	0	0	0
+30 mins.	44	0	0	44	0	54	0	54	0	0	0	0
+45 mins.	42	0	0	42	0	55	0	55	0	0	0	0
Total Volume	165	0	0	165	0	232	0	232	0	0	0	0
% App. Total	100	0	0		0	100	0		0	0	0	
PHF	.917	.000	.000	.917	.000	.773	.000	.773	.000	.000	.000	.000

City of Madera
 N/S: Road 23
 E/W: Project Driveway 3
 Weather: Clear

File Name : 41_MDA_Road 23_Project DW 3 PM
 Site Code : 00319628
 Start Date : 9/24/2019
 Page No : 1

Groups Printed- Total Volume

Start Time	Road 23 Southbound				Road 23 Northbound				Project Driveway 3 Eastbound				Int. Total
	Thru	Right	U-Turns	App. Total	Left	Thru	U-Turns	App. Total	Left	Right	U-Turns	App. Total	
04:00 PM	73	0	0	73	0	36	0	36	0	1	0	1	110
04:15 PM	56	0	0	56	0	43	0	43	0	0	0	0	99
04:30 PM	62	0	0	62	0	42	0	42	0	1	0	1	105
04:45 PM	51	0	0	51	0	31	0	31	0	0	0	0	82
Total	242	0	0	242	0	152	0	152	0	2	0	2	396
05:00 PM	55	0	0	55	0	36	0	36	0	0	0	0	91
05:15 PM	58	0	0	58	0	33	0	33	0	0	0	0	91
05:30 PM	51	0	0	51	0	36	0	36	0	0	0	0	87
05:45 PM	26	0	0	26	1	19	0	20	0	0	0	0	46
Total	190	0	0	190	1	124	0	125	0	0	0	0	315
Grand Total	432	0	0	432	1	276	0	277	0	2	0	2	711
Apprch %	100	0	0		0.4	99.6	0		0	100	0		
Total %	60.8	0	0	60.8	0.1	38.8	0	39	0	0.3	0	0.3	

Start Time	Road 23 Southbound				Road 23 Northbound				Project Driveway 3 Eastbound				Int. Total
	Thru	Right	U-Turns	App. Total	Left	Thru	U-Turns	App. Total	Left	Right	U-Turns	App. Total	
Peak Hour Analysis From 04:00 PM to 05:45 PM - Peak 1 of 1													
Peak Hour for Entire Intersection Begins at 04:00 PM													
04:00 PM	73	0	0	73	0	36	0	36	0	1	0	1	110
04:15 PM	56	0	0	56	0	43	0	43	0	0	0	0	99
04:30 PM	62	0	0	62	0	42	0	42	0	1	0	1	105
04:45 PM	51	0	0	51	0	31	0	31	0	0	0	0	82
Total Volume	242	0	0	242	0	152	0	152	0	2	0	2	396
% App. Total	100	0	0		0	100	0		0	100	0		
PHF	.829	.000	.000	.829	.000	.884	.000	.884	.000	.500	.000	.500	.900

City of Madera
 N/S: Road 23
 E/W: Project Driveway 3
 Weather: Clear

File Name : 41_MDA_Road 23_Project DW 3 PM
 Site Code : 00319628
 Start Date : 9/24/2019
 Page No : 2

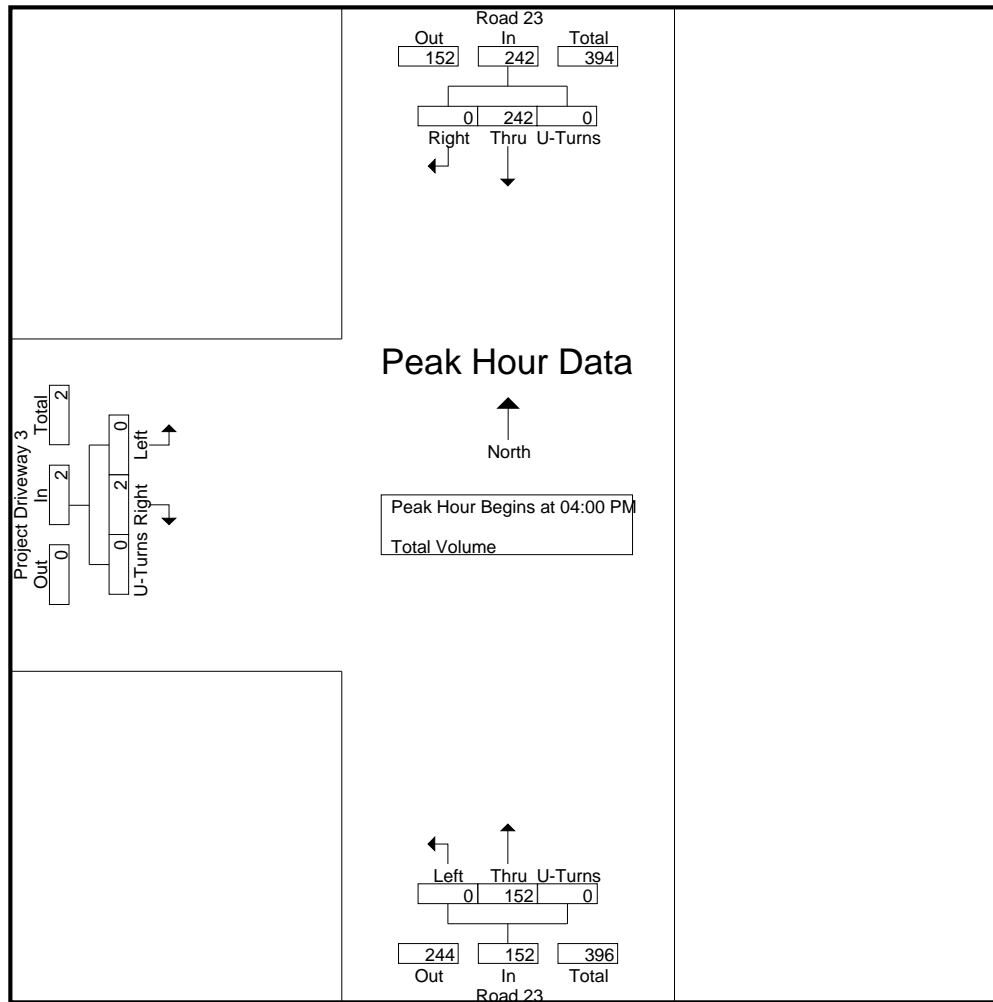

Peak Hour Analysis From 04:00 PM to 05:45 PM - Peak 1 of 1
 Peak Hour for Each Approach Begins at:

	04:00 PM				04:00 PM				04:00 PM			
+0 mins.	73	0	0	73	0	36	0	36	0	1	0	1
+15 mins.	56	0	0	56	0	43	0	43	0	0	0	0
+30 mins.	62	0	0	62	0	42	0	42	0	1	0	1
+45 mins.	51	0	0	51	0	31	0	31	0	0	0	0
Total Volume	242	0	0	242	0	152	0	152	0	2	0	2
% App. Total	100	0	0		0	100	0		0	100	0	
PHF	.829	.000	.000	.829	.000	.884	.000	.884	.000	.500	.000	.500

Location: Madera
 N/S: Road 23
 E/W: Project Driveway 3



Date: 9/24/2019
 Day: Tuesday

PEDESTRIANS

	North Leg Road 23	East Leg Project Driveway 3	South Leg Road 22 1/2	West Leg Project Driveway 3	
	Pedestrians	Pedestrians	Pedestrians	Pedestrians	
7:00 AM	0	0	0	0	0
7:15 AM	0	0	0	0	0
7:30 AM	0	0	0	0	0
7:45 AM	0	0	0	0	0
8:00 AM	0	0	0	0	0
8:15 AM	0	0	0	0	0
8:30 AM	0	0	0	0	0
8:45 AM	0	0	0	0	0
TOTAL VOLUMES:	0	0	0	0	0

	North Leg Road 23	East Leg Project Driveway 3	South Leg Road 22 1/2	West Leg Project Driveway 3	
	Pedestrians	Pedestrians	Pedestrians	Pedestrians	
4:00 PM	0	0	0	0	0
4:15 PM	0	0	0	0	0
4:30 PM	0	0	0	0	0
4:45 PM	0	0	0	0	0
5:00 PM	0	0	0	0	0
5:15 PM	0	0	0	0	0
5:30 PM	0	0	0	0	0
5:45 PM	0	0	0	0	0
TOTAL VOLUMES:	0	0	0	0	0

Location: Madera
 N/S: Road 23
 E/W: Project Driveway 3



Date: 9/24/2019
 Day: Tuesday

BICYCLES

	Southbound Road 23			Westbound Project Driveway 3			Northbound Road 22 1/2			Eastbound Project Driveway 3			
	Left	Thru	Right	Left	Thru	Right	Left	Thru	Right	Left	Thru	Right	
7:00 AM	0	0	0	0	0	0	0	0	0	0	0	0	0
7:15 AM	0	0	0	0	0	0	0	0	0	0	0	0	0
7:30 AM	0	0	0	0	0	0	0	0	0	0	0	0	0
7:45 AM	0	0	0	0	0	0	0	0	0	0	0	0	0
8:00 AM	0	0	0	0	0	0	0	0	0	0	0	0	0
8:15 AM	0	0	0	0	0	0	0	0	0	0	0	0	0
8:30 AM	0	0	0	0	0	0	0	0	0	0	0	0	0
8:45 AM	0	0	0	0	0	0	0	0	0	0	0	0	0
TOTAL VOLUMES:	0	0	0	0	0	0	0	0	0	0	0	0	0

	Southbound Road 23			Westbound Project Driveway 3			Northbound Road 22 1/2			Eastbound Project Driveway 3			
	Left	Thru	Right	Left	Thru	Right	Left	Thru	Right	Left	Thru	Right	
4:00 PM	0	0	0	0	0	0	0	0	0	0	0	0	0
4:15 PM	0	0	0	0	0	0	0	0	0	0	0	0	0
4:30 PM	0	0	0	0	0	0	0	0	0	0	0	0	0
4:45 PM	0	0	0	0	0	0	0	0	0	0	0	0	0
5:00 PM	0	0	0	0	0	0	0	0	0	0	0	0	0
5:15 PM	0	0	0	0	0	0	0	0	0	0	0	0	0
5:30 PM	0	0	0	0	0	0	0	0	0	0	0	0	0
5:45 PM	0	0	0	0	0	0	0	0	0	0	0	0	0
TOTAL VOLUMES:	0	0	0	0	0	0	0	0	0	0	0	0	0

City of Madera
 N/S: Road 23
 E/W: Project Driveway 5
 Weather: Clear

File Name : MDA_Rd 23_DW5 AM
 Site Code : 00319773
 Start Date : 11/12/2019
 Page No : 1

Groups Printed- Total Volume

Start Time	Road 23 Southbound			Road 23 Northbound			Project Driveway 5 Eastbound			Int. Total
	Thru	Right	App. Total	Left	Thru	App. Total	Left	Right	App. Total	
07:00 AM	33	0	33	0	36	36	0	0	0	69
07:15 AM	72	0	72	0	62	62	0	1	1	135
07:30 AM	61	0	61	0	73	73	0	0	0	134
07:45 AM	47	0	47	1	85	86	0	0	0	133
Total	213	0	213	1	256	257	0	1	1	471
08:00 AM	29	0	29	0	46	46	0	0	0	75
08:15 AM	18	0	18	0	40	40	0	0	0	58
08:30 AM	26	0	26	0	38	38	0	0	0	64
08:45 AM	20	0	20	0	26	26	0	0	0	46
Total	93	0	93	0	150	150	0	0	0	243
Grand Total	306	0	306	1	406	407	0	1	1	714
Apprch %	100	0		0.2	99.8		0	100		
Total %	42.9	0	42.9	0.1	56.9	57	0	0.1	0.1	

Start Time	Road 23 Southbound			Road 23 Northbound			Project Driveway 5 Eastbound			Int. Total
	Thru	Right	App. Total	Left	Thru	App. Total	Left	Right	App. Total	
07:15 AM	72	0	72	0	62	62	0	1	1	135
07:30 AM	61	0	61	0	73	73	0	0	0	134
07:45 AM	47	0	47	1	85	86	0	0	0	133
08:00 AM	29	0	29	0	46	46	0	0	0	75
Total Volume	209	0	209	1	266	267	0	1	1	477
% App. Total	100	0		0.4	99.6		0	100		
PHF	.726	.000	.726	.250	.782	.776	.000	.250	.250	.883

Peak Hour Analysis From 07:00 AM to 08:45 AM - Peak 1 of 1

Peak Hour for Entire Intersection Begins at 07:15 AM

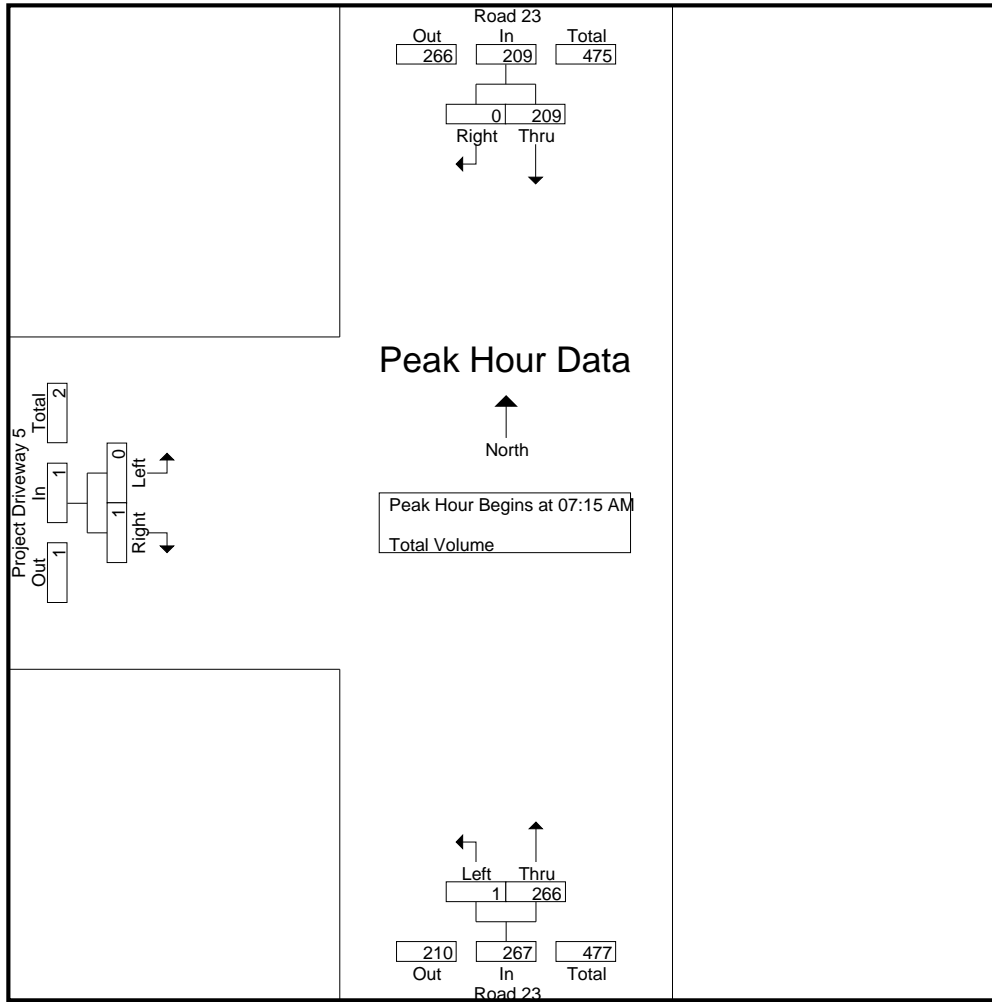

Peak Hour Analysis From 07:00 AM to 08:45 AM - Peak 1 of 1
 Peak Hour for Each Approach Begins at:

	07:00 AM			07:15 AM			07:00 AM		
+0 mins.	33	0	33	0	62	62	0	0	0
+15 mins.	72	0	72	0	73	73	0	1	1
+30 mins.	61	0	61	1	85	86	0	0	0
+45 mins.	47	0	47	0	46	46	0	0	0
Total Volume	213	0	213	1	266	267	0	1	1
% App. Total	100	0		0.4	99.6		0	100	
PHF	.740	.000	.740	.250	.782	.776	.000	.250	.250

City of Madera
 N/S: Road 23
 E/W: Project Driveway 5
 Weather: Clear

File Name : MDA_Rd 23_DW5 PM
 Site Code : 00319773
 Start Date : 11/12/2019
 Page No : 1

Groups Printed- Total Volume

Start Time	Road 23 Southbound			Road 23 Northbound			Project Driveway 5 Eastbound			Int. Total
	Thru	Right	App. Total	Left	Thru	App. Total	Left	Right	App. Total	
04:00 PM	120	0	120	0	97	97	1	1	2	219
04:15 PM	75	1	76	0	45	45	0	0	0	121
04:30 PM	62	0	62	0	42	42	0	0	0	104
04:45 PM	73	0	73	0	56	56	0	1	1	130
Total	330	1	331	0	240	240	1	2	3	574
05:00 PM	56	1	57	0	55	55	0	0	0	112
05:15 PM	48	1	49	1	48	49	1	1	2	100
05:30 PM	33	0	33	0	28	28	0	1	1	62
05:45 PM	40	0	40	0	23	23	0	0	0	63
Total	177	2	179	1	154	155	1	2	3	337
Grand Total	507	3	510	1	394	395	2	4	6	911
Apprch %	99.4	0.6		0.3	99.7		33.3	66.7		
Total %	55.7	0.3	56	0.1	43.2	43.4	0.2	0.4	0.7	

Start Time	Road 23 Southbound			Road 23 Northbound			Project Driveway 5 Eastbound			Int. Total
	Thru	Right	App. Total	Left	Thru	App. Total	Left	Right	App. Total	
04:00 PM	120	0	120	0	97	97	1	1	2	219
04:15 PM	75	1	76	0	45	45	0	0	0	121
04:30 PM	62	0	62	0	42	42	0	0	0	104
04:45 PM	73	0	73	0	56	56	0	1	1	130
Total Volume	330	1	331	0	240	240	1	2	3	574
% App. Total	99.7	0.3		0	100		33.3	66.7		
PHF	.688	.250	.690	.000	.619	.619	.250	.500	.375	.655

Peak Hour Analysis From 04:00 PM to 05:45 PM - Peak 1 of 1

Peak Hour for Entire Intersection Begins at 04:00 PM

City of Madera
 N/S: Road 23
 E/W: Project Driveway 5
 Weather: Clear

File Name : MDA_Rd 23_DW5 PM
 Site Code : 00319773
 Start Date : 11/12/2019
 Page No : 2

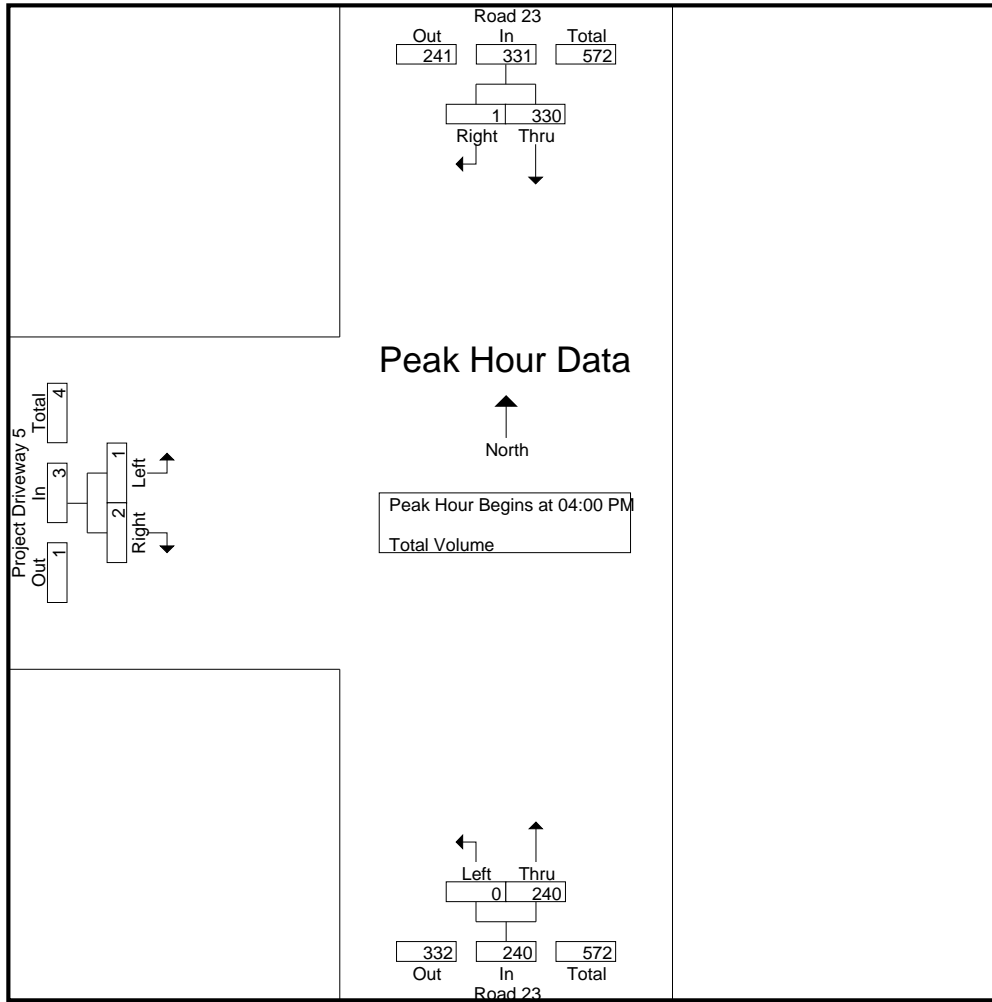

Peak Hour Analysis From 04:00 PM to 05:45 PM - Peak 1 of 1
 Peak Hour for Each Approach Begins at:

	04:00 PM			04:00 PM			04:45 PM		
+0 mins.	120	0	120	0	97	97	0	1	1
+15 mins.	75	1	76	0	45	45	0	0	0
+30 mins.	62	0	62	0	42	42	1	1	2
+45 mins.	73	0	73	0	56	56	0	1	1
Total Volume	330	1	331	0	240	240	1	3	4
% App. Total	99.7	0.3		0	100		25	75	
PHF	.688	.250	.690	.000	.619	.619	.250	.750	.500

Location: Madera
 N/S: Road 23
 E/W: Project DW 5



Date: 11/12/2019
 Date: Tuesday

PEDESTRIANS

	North Leg Road 23	East Leg Dead End	South Leg Road 23	West Leg Project DW 5	
	Pedestrians	Pedestrians	Pedestrians	Pedestrians	
7:00 AM	0	0	0	0	0
7:15 AM	0	0	0	0	0
7:30 AM	0	0	0	0	0
7:45 AM	0	0	0	0	0
8:00 AM	0	0	0	0	0
8:15 AM	0	0	0	0	0
8:30 AM	0	0	0	0	0
8:45 AM	0	0	0	0	0
TOTAL VOLUMES:	0	0	0	0	0

	North Leg Road 23	East Leg Dead End	South Leg Road 23	West Leg Project DW 5	
	Pedestrians	Pedestrians	Pedestrians	Pedestrians	
4:00 PM	0	0	0	0	0
4:15 PM	0	0	0	0	0
4:30 PM	0	0	0	0	0
4:45 PM	0	0	0	0	0
5:00 PM	0	0	0	0	0
5:15 PM	0	0	0	0	0
5:30 PM	0	0	0	0	0
5:45 PM	0	0	0	0	0
TOTAL VOLUMES:	0	0	0	0	0

Location: Madera
 N/S: Road 23
 E/W: Project DW 5



Date: 11/12/2019
 Date: Tuesday

BICYCLES

	Southbound Road 23			Westbound Dead End			Northbound Road 23			Eastbound Project DW 5			
	Left	Thru	Right	Left	Thru	Right	Left	Thru	Right	Left	Thru	Right	
7:00 AM	0	0	0	0	0	0	0	0	0	0	0	0	0
7:15 AM	0	0	0	0	0	0	0	0	0	0	0	0	0
7:30 AM	0	0	0	0	0	0	0	0	0	0	0	0	0
7:45 AM	0	0	0	0	0	0	0	0	0	0	0	0	0
8:00 AM	0	0	0	0	0	0	0	0	0	0	0	0	0
8:15 AM	0	0	0	0	0	0	0	0	0	0	0	0	0
8:30 AM	0	0	0	0	0	0	0	0	0	0	0	0	0
8:45 AM	0	0	0	0	0	0	0	0	0	0	0	0	0
TOTAL VOLUMES:	0	0	0	0	0	0	0	0	0	0	0	0	0

	Southbound Road 23			Westbound Dead End			Northbound Road 23			Eastbound Project DW 5			
	Left	Thru	Right	Left	Thru	Right	Left	Thru	Right	Left	Thru	Right	
4:00 PM	0	0	0	0	0	0	0	0	0	0	0	0	0
4:15 PM	0	0	0	0	0	0	0	0	0	0	0	0	0
4:30 PM	0	0	0	0	0	0	0	0	0	0	0	0	0
4:45 PM	0	0	0	0	0	0	0	0	0	0	0	0	0
5:00 PM	0	0	0	0	0	0	0	0	0	0	0	0	0
5:15 PM	0	0	0	0	0	0	0	0	0	0	0	0	0
5:30 PM	0	0	0	0	0	0	0	0	0	0	0	0	0
5:45 PM	0	0	0	0	0	0	0	0	0	0	0	0	0
TOTAL VOLUMES:	0	0	0	0	0	0	0	0	0	0	0	0	0

City of Madera
 N/S: SR-99 Southbound Ramps
 E/W: Avenue 18 1/2
 Weather: Clear

File Name : 03A_MDA_99S_Ave 18 1-2 AM
 Site Code : 00319628
 Start Date : 9/18/2019
 Page No : 1

Groups Printed- Passenger Vehicles - Large 2 Axle Vehicles - 3 Axle Vehicles - 4+ Axle Trucks

Start Time	SR-99 Southbound On Ramp Southbound					Avenue 18 1/2 Westbound					SR-99 Southbound Off Ramp Northbound					Avenue 18 1/2 Eastbound					Int. Total
	Left	Thru	Right	U-Turns	App. Total	Left	Thru	Right	U-Turns	App. Total	Left	Thru	Right	U-Turns	App. Total	Left	Thru	Right	U-Turns	App. Total	
07:00 AM	0	0	0	0	0	0	50	11	0	61	0	0	0	0	0	0	40	42	0	82	143
07:15 AM	0	0	0	0	0	0	69	9	0	78	0	0	0	0	0	0	51	54	0	105	183
07:30 AM	0	0	0	0	0	0	93	13	0	106	0	0	0	0	0	0	72	40	0	112	218
07:45 AM	0	0	0	0	0	0	90	10	0	100	0	0	0	0	0	0	76	43	0	119	219
Total	0	0	0	0	0	0	302	43	0	345	0	0	0	0	0	0	239	179	0	418	763
08:00 AM	0	0	0	0	0	0	59	4	0	63	0	0	0	0	0	0	65	47	0	112	175
08:15 AM	0	0	0	0	0	0	58	8	0	66	0	0	0	0	0	0	57	38	0	95	161
08:30 AM	0	0	0	0	0	0	71	9	0	80	0	0	0	0	0	0	51	44	0	95	175
08:45 AM	0	0	0	0	0	0	63	7	0	70	0	0	0	0	0	0	53	46	0	99	169
Total	0	0	0	0	0	0	251	28	0	279	0	0	0	0	0	0	226	175	0	401	680
Grand Total	0	0	0	0	0	0	553	71	0	624	0	0	0	0	0	0	465	354	0	819	1443
Apprch %	0	0	0	0	0	0	88.6	11.4	0		0	0	0	0	0	0	56.8	43.2	0		
Total %	0	0	0	0	0	0	38.3	4.9	0	43.2	0	0	0	0	0	0	32.2	24.5	0	56.8	
Passenger Vehicles	0	0	0	0	0	0	407	59	0	466	0	0	0	0	0	0	322	245	0	567	1033
% Passenger Vehicles	0	0	0	0	0	0	73.6	83.1	0	74.7	0	0	0	0	0	0	69.2	69.2	0	69.2	71.6
Large 2 Axle Vehicles	0	0	0	0	0	0	35	1	0	36	0	0	0	0	0	0	28	16	0	44	80
% Large 2 Axle Vehicles	0	0	0	0	0	0	6.3	1.4	0	5.8	0	0	0	0	0	0	6	4.5	0	5.4	5.5
3 Axle Vehicles	0	0	0	0	0	0	3	1	0	4	0	0	0	0	0	0	3	4	0	7	11
% 3 Axle Vehicles	0	0	0	0	0	0	0.5	1.4	0	0.6	0	0	0	0	0	0	0.6	1.1	0	0.9	0.8
4+ Axle Trucks	0	0	0	0	0	0	108	10	0	118	0	0	0	0	0	0	112	89	0	201	319
% 4+ Axle Trucks	0	0	0	0	0	0	19.5	14.1	0	18.9	0	0	0	0	0	0	24.1	25.1	0	24.5	22.1

Start Time	SR-99 Southbound On Ramp Southbound					Avenue 18 1/2 Westbound					SR-99 Southbound Off Ramp Northbound					Avenue 18 1/2 Eastbound					Int. Total
	Left	Thru	Right	U-Turns	App. Total	Left	Thru	Right	U-Turns	App. Total	Left	Thru	Right	U-Turns	App. Total	Left	Thru	Right	U-Turns	App. Total	
Peak Hour Analysis From 07:00 AM to 08:45 AM - Peak 1 of 1																					
Peak Hour for Entire Intersection Begins at 07:15 AM																					
07:15 AM	0	0	0	0	0	0	69	9	0	78	0	0	0	0	0	0	51	54	0	105	183
07:30 AM	0	0	0	0	0	0	93	13	0	106	0	0	0	0	0	0	72	40	0	112	218
07:45 AM	0	0	0	0	0	0	90	10	0	100	0	0	0	0	0	0	76	43	0	119	219
08:00 AM	0	0	0	0	0	0	59	4	0	63	0	0	0	0	0	0	65	47	0	112	175
Total Volume	0	0	0	0	0	0	311	36	0	347	0	0	0	0	0	0	264	184	0	448	795
% App. Total	0	0	0	0	0	0	89.6	10.4	0		0	0	0	0	0	0	58.9	41.1	0		
PHF	.000	.000	.000	.000	.000	.000	.836	.692	.000	.818	.000	.000	.000	.000	.000	.000	.868	.852	.000	.941	.908

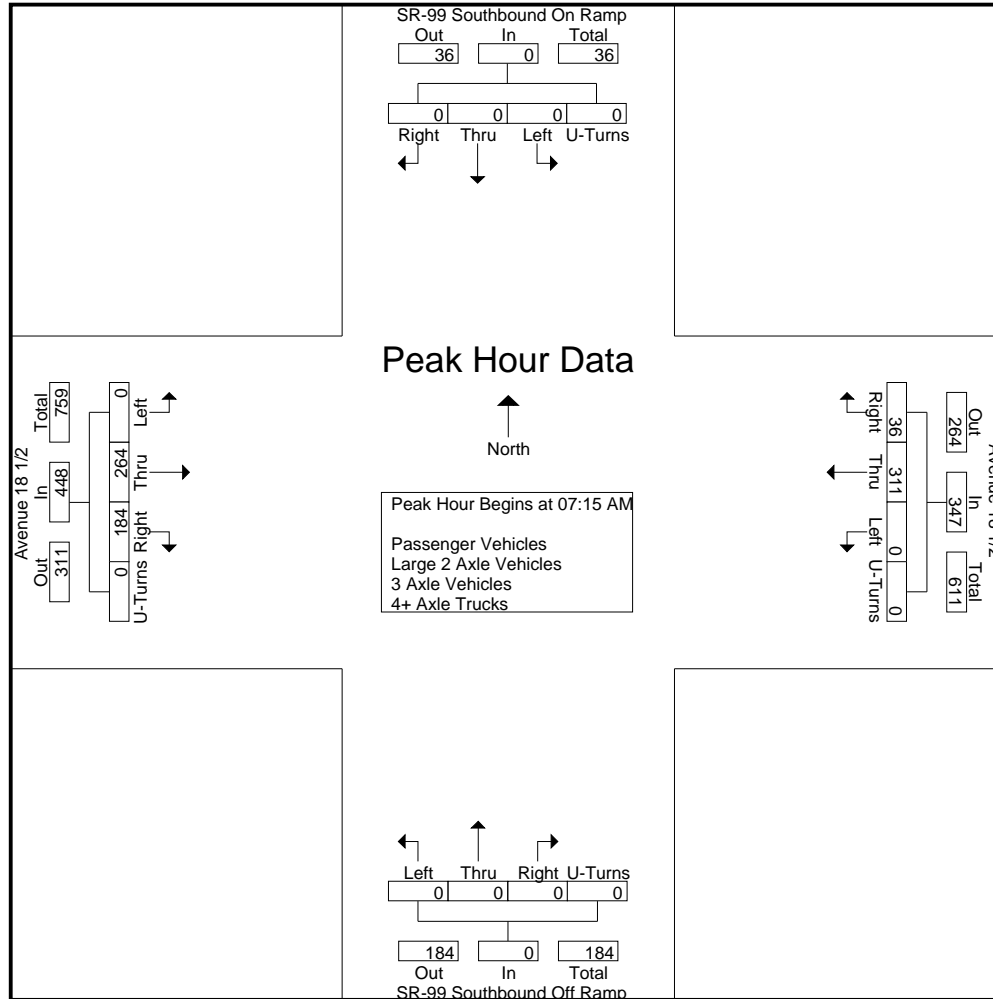

City of Madera
 N/S: SR-99 Southbound Ramps
 E/W: Avenue 18 1/2
 Weather: Clear

File Name : 03A_MDA_99S_Ave 18 1-2 AM
 Site Code : 00319628
 Start Date : 9/18/2019
 Page No : 3

Start Time	SR-99 Southbound On Ramp Southbound					Avenue 18 1/2 Westbound					SR-99 Southbound Off Ramp Northbound					Avenue 18 1/2 Eastbound					Int. Total
	Left	Thru	Right	U-Turns	App. Total	Left	Thru	Right	U-Turns	App. Total	Left	Thru	Right	U-Turns	App. Total	Left	Thru	Right	U-Turns	App. Total	

Peak Hour Analysis From 07:00 AM to 08:45 AM - Peak 1 of 1
 Peak Hour for Each Approach Begins at:

	07:00 AM					07:15 AM					07:00 AM					07:15 AM				
+0 mins.	0	0	0	0	0	0	69	9	0	78	0	0	0	0	0	0	51	54	0	105
+15 mins.	0	0	0	0	0	0	93	13	0	106	0	0	0	0	0	0	72	40	0	112
+30 mins.	0	0	0	0	0	0	90	10	0	100	0	0	0	0	0	0	76	43	0	119
+45 mins.	0	0	0	0	0	0	59	4	0	63	0	0	0	0	0	0	65	47	0	112
Total Volume	0	0	0	0	0	0	311	36	0	347	0	0	0	0	0	0	264	184	0	448
% App. Total	0	0	0	0	0	0	89.6	10.4	0		0	0	0	0	0	0	58.9	41.1	0	
PHF	.000	.000	.000	.000	.000	.000	.836	.692	.000	.818	.000	.000	.000	.000	.000	.000	.868	.852	.000	.941

City of Madera
 N/S: SR-99 Southbound Ramps
 E/W: Avenue 18 1/2
 Weather: Clear

File Name : 03A_MDA_99S_Ave 18 1-2 AM
 Site Code : 00319628
 Start Date : 9/18/2019
 Page No : 1

Groups Printed- Passenger Vehicles

Start Time	SR-99 Southbound On Ramp Southbound					Avenue 18 1/2 Westbound					SR-99 Southbound Off Ramp Northbound					Avenue 18 1/2 Eastbound					Int. Total
	Left	Thru	Right	U-Turns	App. Total	Left	Thru	Right	U-Turns	App. Total	Left	Thru	Right	U-Turns	App. Total	Left	Thru	Right	U-Turns	App. Total	
07:00 AM	0	0	0	0	0	0	38	8	0	46	0	0	0	0	0	0	26	25	0	51	97
07:15 AM	0	0	0	0	0	0	49	9	0	58	0	0	0	0	0	0	33	32	0	65	123
07:30 AM	0	0	0	0	0	0	69	11	0	80	0	0	0	0	0	0	52	27	0	79	159
07:45 AM	0	0	0	0	0	0	73	7	0	80	0	0	0	0	0	0	49	33	0	82	162
Total	0	0	0	0	0	0	229	35	0	264	0	0	0	0	0	0	160	117	0	277	541
08:00 AM	0	0	0	0	0	0	41	4	0	45	0	0	0	0	0	0	48	33	0	81	126
08:15 AM	0	0	0	0	0	0	46	7	0	53	0	0	0	0	0	0	41	29	0	70	123
08:30 AM	0	0	0	0	0	0	48	6	0	54	0	0	0	0	0	0	35	32	0	67	121
08:45 AM	0	0	0	0	0	0	43	7	0	50	0	0	0	0	0	0	38	34	0	72	122
Total	0	0	0	0	0	0	178	24	0	202	0	0	0	0	0	0	162	128	0	290	492
Grand Total	0	0	0	0	0	0	407	59	0	466	0	0	0	0	0	0	322	245	0	567	1033
Apprch %	0	0	0	0	0	0	87.3	12.7	0		0	0	0	0	0	0	56.8	43.2	0		
Total %	0	0	0	0	0	0	39.4	5.7	0	45.1	0	0	0	0	0	0	31.2	23.7	0	54.9	

Start Time	SR-99 Southbound On Ramp Southbound					Avenue 18 1/2 Westbound					SR-99 Southbound Off Ramp Northbound					Avenue 18 1/2 Eastbound					Int. Total
	Left	Thru	Right	U-Turns	App. Total	Left	Thru	Right	U-Turns	App. Total	Left	Thru	Right	U-Turns	App. Total	Left	Thru	Right	U-Turns	App. Total	
Peak Hour Analysis From 07:15 AM to 08:00 AM - Peak 1 of 1																					
Peak Hour for Entire Intersection Begins at 07:15 AM																					
07:15 AM	0	0	0	0	0	0	49	9	0	58	0	0	0	0	0	0	33	32	0	65	123
07:30 AM	0	0	0	0	0	0	69	11	0	80	0	0	0	0	0	0	52	27	0	79	159
07:45 AM	0	0	0	0	0	0	73	7	0	80	0	0	0	0	0	0	49	33	0	82	162
08:00 AM	0	0	0	0	0	0	41	4	0	45	0	0	0	0	0	0	48	33	0	81	126
Total Volume	0	0	0	0	0	0	232	31	0	263	0	0	0	0	0	0	182	125	0	307	570
% App. Total	0	0	0	0	0	0	88.2	11.8	0		0	0	0	0	0	0	59.3	40.7	0		
PHF	.000	.000	.000	.000	.000	.000	.795	.705	.000	.822	.000	.000	.000	.000	.000	.000	.875	.947	.000	.936	.880

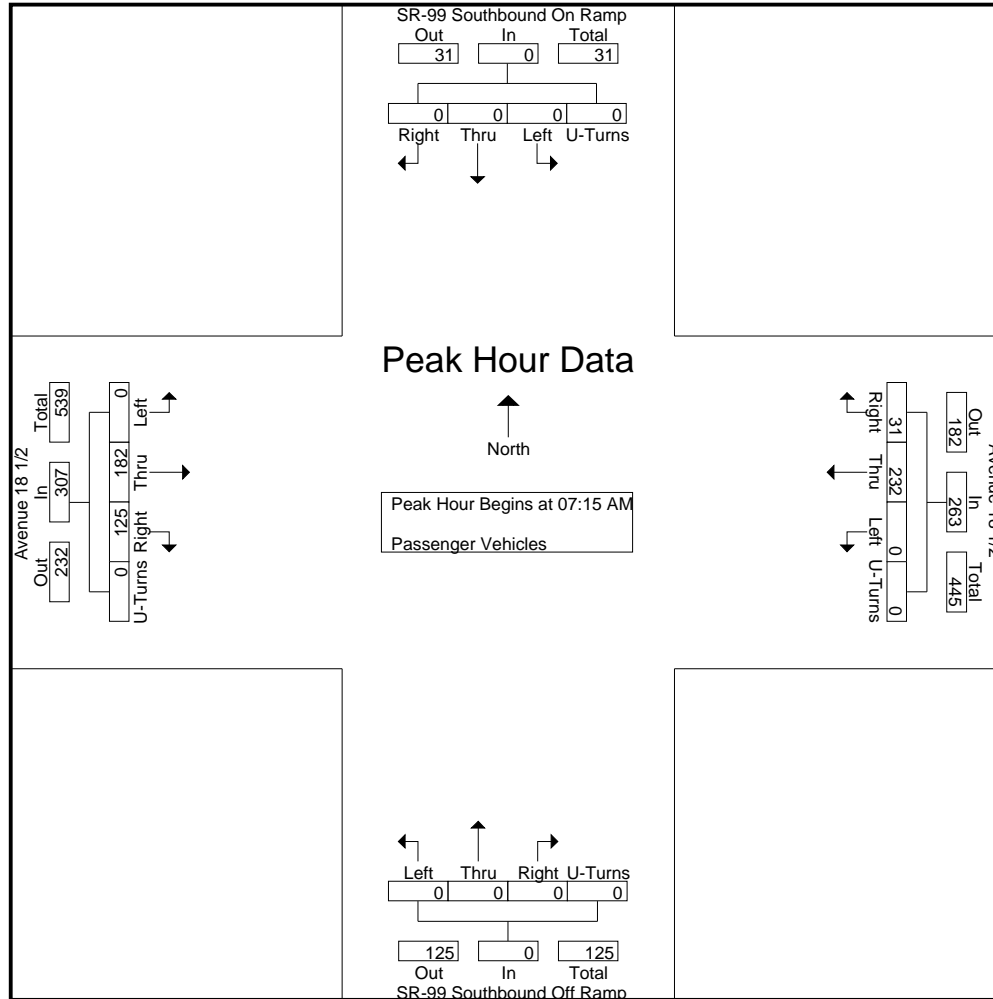

City of Madera
 N/S: SR-99 Southbound Ramps
 E/W: Avenue 18 1/2
 Weather: Clear

File Name : 03A_MDA_99S_Ave 18 1-2 AM
 Site Code : 00319628
 Start Date : 9/18/2019
 Page No : 3

Start Time	SR-99 Southbound On Ramp Southbound					Avenue 18 1/2 Westbound					SR-99 Southbound Off Ramp Northbound					Avenue 18 1/2 Eastbound					Int. Total
	Left	Thru	Right	U-Turns	App. Total	Left	Thru	Right	U-Turns	App. Total	Left	Thru	Right	U-Turns	App. Total	Left	Thru	Right	U-Turns	App. Total	

Peak Hour Analysis From 07:15 AM to 08:00 AM - Peak 1 of 1
 Peak Hour for Each Approach Begins at:

	07:15 AM					07:15 AM					07:15 AM					07:15 AM				
+0 mins.	0	0	0	0	0	0	49	9	0	58	0	0	0	0	0	0	33	32	0	65
+15 mins.	0	0	0	0	0	0	69	11	0	80	0	0	0	0	0	0	52	27	0	79
+30 mins.	0	0	0	0	0	0	73	7	0	80	0	0	0	0	0	0	49	33	0	82
+45 mins.	0	0	0	0	0	0	41	4	0	45	0	0	0	0	0	0	48	33	0	81
Total Volume	0	0	0	0	0	0	232	31	0	263	0	0	0	0	0	0	182	125	0	307
% App. Total	0	0	0	0	0	0	88.2	11.8	0		0	0	0	0	0	0	59.3	40.7	0	
PHF	.000	.000	.000	.000	.000	.000	.795	.705	.000	.822	.000	.000	.000	.000	.000	.000	.875	.947	.000	.936

City of Madera
 N/S: SR-99 Southbound Ramps
 E/W: Avenue 18 1/2
 Weather: Clear

File Name : 03A_MDA_99S_Ave 18 1-2 AM
 Site Code : 00319628
 Start Date : 9/18/2019
 Page No : 1

Groups Printed- Large 2 Axle Vehicles

Start Time	SR-99 Southbound On Ramp Southbound					Avenue 18 1/2 Westbound					SR-99 Southbound Off Ramp Northbound					Avenue 18 1/2 Eastbound					Int. Total
	Left	Thru	Right	U-Turns	App. Total	Left	Thru	Right	U-Turns	App. Total	Left	Thru	Right	U-Turns	App. Total	Left	Thru	Right	U-Turns	App. Total	
07:00 AM	0	0	0	0	0	0	4	0	0	4	0	0	0	0	0	0	3	2	0	5	9
07:15 AM	0	0	0	0	0	0	3	0	0	3	0	0	0	0	0	0	2	2	0	4	7
07:30 AM	0	0	0	0	0	0	7	0	0	7	0	0	0	0	0	0	4	3	0	7	14
07:45 AM	0	0	0	0	0	0	7	1	0	8	0	0	0	0	0	0	5	1	0	6	14
Total	0	0	0	0	0	0	21	1	0	22	0	0	0	0	0	0	14	8	0	22	44
08:00 AM	0	0	0	0	0	0	3	0	0	3	0	0	0	0	0	0	4	3	0	7	10
08:15 AM	0	0	0	0	0	0	2	0	0	2	0	0	0	0	0	0	2	2	0	4	6
08:30 AM	0	0	0	0	0	0	6	0	0	6	0	0	0	0	0	0	3	2	0	5	11
08:45 AM	0	0	0	0	0	0	3	0	0	3	0	0	0	0	0	0	5	1	0	6	9
Total	0	0	0	0	0	0	14	0	0	14	0	0	0	0	0	0	14	8	0	22	36
Grand Total	0	0	0	0	0	0	35	1	0	36	0	0	0	0	0	0	28	16	0	44	80
Apprch %	0	0	0	0	0	0	97.2	2.8	0	0	0	0	0	0	0	0	63.6	36.4	0	0	0
Total %	0	0	0	0	0	0	43.8	1.2	0	45	0	0	0	0	0	0	35	20	0	55	0

Start Time	SR-99 Southbound On Ramp Southbound					Avenue 18 1/2 Westbound					SR-99 Southbound Off Ramp Northbound					Avenue 18 1/2 Eastbound					Int. Total
	Left	Thru	Right	U-Turns	App. Total	Left	Thru	Right	U-Turns	App. Total	Left	Thru	Right	U-Turns	App. Total	Left	Thru	Right	U-Turns	App. Total	
Peak Hour Analysis From 07:15 AM to 08:00 AM - Peak 1 of 1																					
Peak Hour for Entire Intersection Begins at 07:15 AM																					
07:15 AM	0	0	0	0	0	0	3	0	0	3	0	0	0	0	0	0	2	2	0	4	7
07:30 AM	0	0	0	0	0	0	7	0	0	7	0	0	0	0	0	0	4	3	0	7	14
07:45 AM	0	0	0	0	0	0	7	1	0	8	0	0	0	0	0	0	5	1	0	6	14
08:00 AM	0	0	0	0	0	0	3	0	0	3	0	0	0	0	0	0	4	3	0	7	10
Total Volume	0	0	0	0	0	0	20	1	0	21	0	0	0	0	0	0	15	9	0	24	45
% App. Total	0	0	0	0	0	0	95.2	4.8	0	0	0	0	0	0	0	0	62.5	37.5	0	0	0
PHF	.000	.000	.000	.000	.000	.000	.714	.250	.000	.656	.000	.000	.000	.000	.000	.000	.750	.750	.000	.857	.804

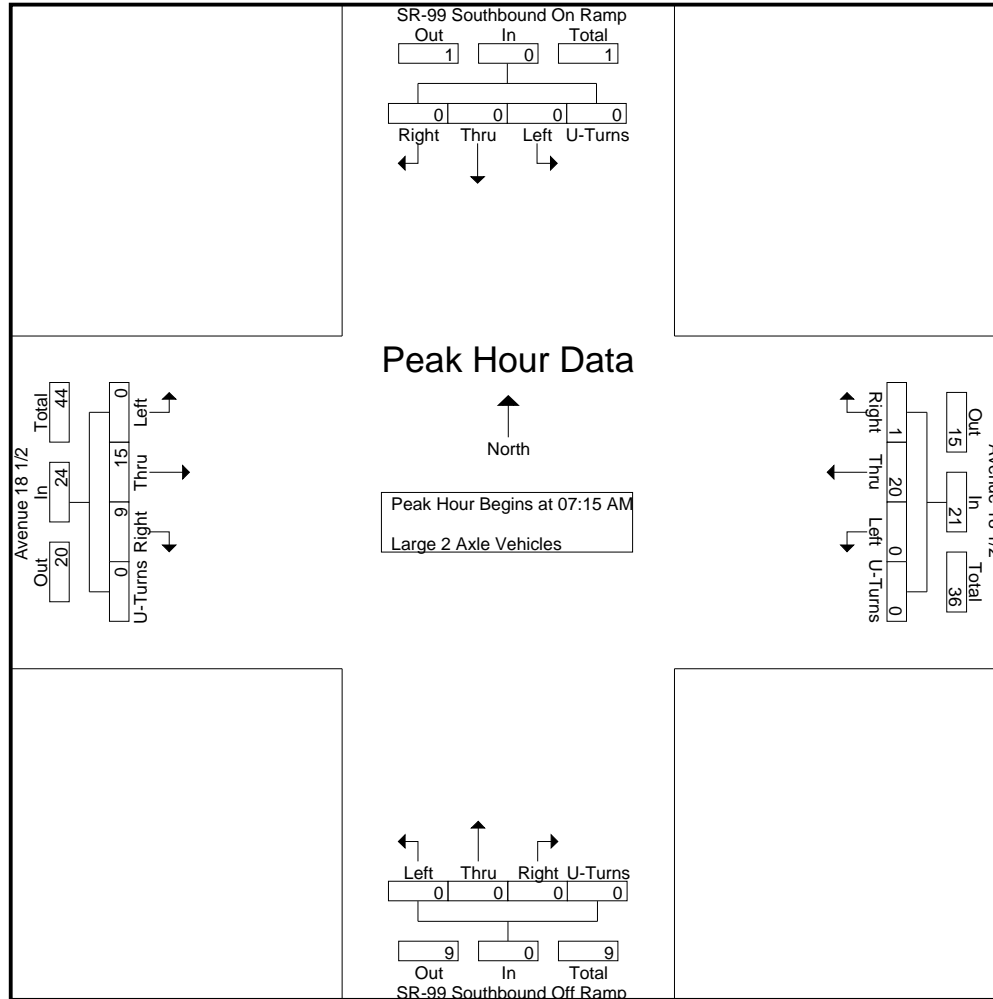

City of Madera
 N/S: SR-99 Southbound Ramps
 E/W: Avenue 18 1/2
 Weather: Clear

File Name : 03A_MDA_99S_Ave 18 1-2 AM
 Site Code : 00319628
 Start Date : 9/18/2019
 Page No : 3

Start Time	SR-99 Southbound On Ramp Southbound					Avenue 18 1/2 Westbound					SR-99 Southbound Off Ramp Northbound					Avenue 18 1/2 Eastbound					Int. Total
	Left	Thru	Right	U-Turns	App. Total	Left	Thru	Right	U-Turns	App. Total	Left	Thru	Right	U-Turns	App. Total	Left	Thru	Right	U-Turns	App. Total	

Peak Hour Analysis From 07:15 AM to 08:00 AM - Peak 1 of 1
 Peak Hour for Each Approach Begins at:

	07:15 AM					07:15 AM					07:15 AM					07:15 AM				
+0 mins.	0	0	0	0	0	0	3	0	0	3	0	0	0	0	0	0	2	2	0	4
+15 mins.	0	0	0	0	0	0	7	0	0	7	0	0	0	0	0	0	4	3	0	7
+30 mins.	0	0	0	0	0	0	7	1	0	8	0	0	0	0	0	0	5	1	0	6
+45 mins.	0	0	0	0	0	0	3	0	0	3	0	0	0	0	0	0	4	3	0	7
Total Volume	0	0	0	0	0	0	20	1	0	21	0	0	0	0	0	0	15	9	0	24
% App. Total	0	0	0	0	0	0	95.2	4.8	0		0	0	0	0	0	0	62.5	37.5	0	
PHF	.000	.000	.000	.000	.000	.000	.714	.250	.000	.656	.000	.000	.000	.000	.000	.000	.750	.750	.000	.857

City of Madera
 N/S: SR-99 Southbound Ramps
 E/W: Avenue 18 1/2
 Weather: Clear

File Name : 03A_MDA_99S_Ave 18 1-2 AM
 Site Code : 00319628
 Start Date : 9/18/2019
 Page No : 1

Groups Printed- 3 Axle Vehicles

Start Time	SR-99 Southbound On Ramp Southbound					Avenue 18 1/2 Westbound					SR-99 Southbound Off Ramp Northbound					Avenue 18 1/2 Eastbound					Int. Total
	Left	Thru	Right	U-Turns	App. Total	Left	Thru	Right	U-Turns	App. Total	Left	Thru	Right	U-Turns	App. Total	Left	Thru	Right	U-Turns	App. Total	
07:00 AM	0	0	0	0	0	0	0	0	0	0	0	0	0	0	0	0	1	0	0	1	1
07:15 AM	0	0	0	0	0	0	0	0	0	0	0	0	0	0	0	0	0	2	0	2	2
07:30 AM	0	0	0	0	0	0	0	0	0	0	0	0	0	0	0	0	1	0	0	1	1
07:45 AM	0	0	0	0	0	0	0	0	0	0	0	0	0	0	0	0	0	0	0	0	0
Total	0	0	0	0	0	0	0	0	0	0	0	0	0	0	0	0	2	2	0	4	4
08:00 AM	0	0	0	0	0	0	0	0	0	0	0	0	0	0	0	0	0	1	0	1	1
08:15 AM	0	0	0	0	0	0	1	0	0	1	0	0	0	0	0	0	1	0	0	1	2
08:30 AM	0	0	0	0	0	0	0	1	0	1	0	0	0	0	0	0	0	0	0	0	1
08:45 AM	0	0	0	0	0	0	2	0	0	2	0	0	0	0	0	0	0	1	0	1	3
Total	0	0	0	0	0	0	3	1	0	4	0	0	0	0	0	0	1	2	0	3	7
Grand Total	0	0	0	0	0	0	3	1	0	4	0	0	0	0	0	0	3	4	0	7	11
Apprch %	0	0	0	0	0	0	75	25	0	36.4	0	0	0	0	0	0	42.9	57.1	0	63.6	
Total %	0	0	0	0	0	0	27.3	9.1	0	36.4	0	0	0	0	0	0	27.3	36.4	0	63.6	

Start Time	SR-99 Southbound On Ramp Southbound					Avenue 18 1/2 Westbound					SR-99 Southbound Off Ramp Northbound					Avenue 18 1/2 Eastbound					Int. Total
	Left	Thru	Right	U-Turns	App. Total	Left	Thru	Right	U-Turns	App. Total	Left	Thru	Right	U-Turns	App. Total	Left	Thru	Right	U-Turns	App. Total	
Peak Hour Analysis From 07:15 AM to 08:00 AM - Peak 1 of 1																					
Peak Hour for Entire Intersection Begins at 07:15 AM																					
07:15 AM	0	0	0	0	0	0	0	0	0	0	0	0	0	0	0	0	0	2	0	2	2
07:30 AM	0	0	0	0	0	0	0	0	0	0	0	0	0	0	0	0	1	0	0	1	1
07:45 AM	0	0	0	0	0	0	0	0	0	0	0	0	0	0	0	0	0	0	0	0	0
08:00 AM	0	0	0	0	0	0	0	0	0	0	0	0	0	0	0	0	0	1	0	1	1
Total Volume	0	0	0	0	0	0	0	0	0	0	0	0	0	0	0	0	1	3	0	4	4
% App. Total	0	0	0	0	0	0	0	0	0	0	0	0	0	0	0	0	25	75	0		
PHF	.000	.000	.000	.000	.000	.000	.000	.000	.000	.000	.000	.000	.000	.000	.000	.000	.250	.375	.000	.500	.500

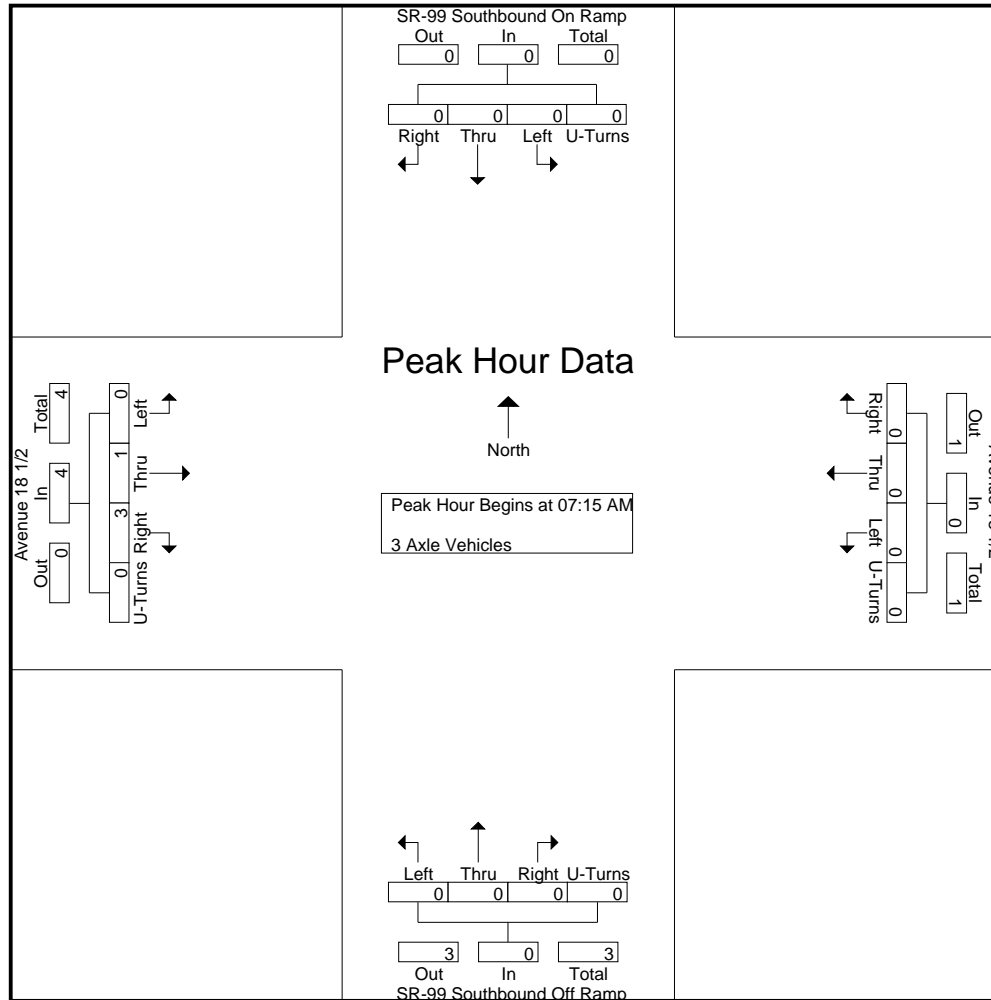

City of Madera
 N/S: SR-99 Southbound Ramps
 E/W: Avenue 18 1/2
 Weather: Clear

File Name : 03A_MDA_99S_Ave 18 1-2 AM
 Site Code : 00319628
 Start Date : 9/18/2019
 Page No : 3

Start Time	SR-99 Southbound On Ramp Southbound					Avenue 18 1/2 Westbound					SR-99 Southbound Off Ramp Northbound					Avenue 18 1/2 Eastbound					Int. Total
	Left	Thru	Right	U-Turns	App. Total	Left	Thru	Right	U-Turns	App. Total	Left	Thru	Right	U-Turns	App. Total	Left	Thru	Right	U-Turns	App. Total	

Peak Hour Analysis From 07:15 AM to 08:00 AM - Peak 1 of 1
 Peak Hour for Each Approach Begins at:

	07:15 AM					07:15 AM					07:15 AM					07:15 AM									
+0 mins.	0	0	0	0	0	0	0	0	0	0	0	0	0	0	0	0	0	0	2	0	0	0	0	0	2
+15 mins.	0	0	0	0	0	0	0	0	0	0	0	0	0	0	0	0	1	0	0	0	0	0	0	0	1
+30 mins.	0	0	0	0	0	0	0	0	0	0	0	0	0	0	0	0	0	0	0	0	0	0	0	0	0
+45 mins.	0	0	0	0	0	0	0	0	0	0	0	0	0	0	0	0	0	1	0	0	0	0	1	0	1
Total Volume	0	0	0	0	0	0	0	0	0	0	0	0	0	0	0	0	1	3	0	0	0	0	0	0	4
% App. Total	0	0	0	0	0	0	0	0	0	0	0	0	0	0	0	0	25	75	0	0	0	0	0	0	0
PHF	.000	.000	.000	.000	.000	.000	.000	.000	.000	.000	.000	.000	.000	.000	.000	.000	.250	.375	.000	.500					

City of Madera
 N/S: SR-99 Southbound Ramps
 E/W: Avenue 18 1/2
 Weather: Clear

File Name : 03A_MDA_99S_Ave 18 1-2 AM
 Site Code : 00319628
 Start Date : 9/18/2019
 Page No : 1

Groups Printed- 4+ Axle Trucks

Start Time	SR-99 Southbound On Ramp Southbound					Avenue 18 1/2 Westbound					SR-99 Southbound Off Ramp Northbound					Avenue 18 1/2 Eastbound					Int. Total
	Left	Thru	Right	U-Turns	App. Total	Left	Thru	Right	U-Turns	App. Total	Left	Thru	Right	U-Turns	App. Total	Left	Thru	Right	U-Turns	App. Total	
07:00 AM	0	0	0	0	0	0	8	3	0	11	0	0	0	0	0	0	10	15	0	25	36
07:15 AM	0	0	0	0	0	0	17	0	0	17	0	0	0	0	0	0	16	18	0	34	51
07:30 AM	0	0	0	0	0	0	17	2	0	19	0	0	0	0	0	0	15	10	0	25	44
07:45 AM	0	0	0	0	0	0	10	2	0	12	0	0	0	0	0	0	22	9	0	31	43
Total	0	0	0	0	0	0	52	7	0	59	0	0	0	0	0	0	63	52	0	115	174
08:00 AM	0	0	0	0	0	0	15	0	0	15	0	0	0	0	0	0	13	10	0	23	38
08:15 AM	0	0	0	0	0	0	9	1	0	10	0	0	0	0	0	0	13	7	0	20	30
08:30 AM	0	0	0	0	0	0	17	2	0	19	0	0	0	0	0	0	13	10	0	23	42
08:45 AM	0	0	0	0	0	0	15	0	0	15	0	0	0	0	0	0	10	10	0	20	35
Total	0	0	0	0	0	0	56	3	0	59	0	0	0	0	0	0	49	37	0	86	145
Grand Total	0	0	0	0	0	0	108	10	0	118	0	0	0	0	0	0	112	89	0	201	319
Apprch %	0	0	0	0	0	0	91.5	8.5	0	37	0	0	0	0	0	0	55.7	44.3	0	63	
Total %	0	0	0	0	0	0	33.9	3.1	0	37	0	0	0	0	0	0	35.1	27.9	0	63	

Start Time	SR-99 Southbound On Ramp Southbound					Avenue 18 1/2 Westbound					SR-99 Southbound Off Ramp Northbound					Avenue 18 1/2 Eastbound					Int. Total
	Left	Thru	Right	U-Turns	App. Total	Left	Thru	Right	U-Turns	App. Total	Left	Thru	Right	U-Turns	App. Total	Left	Thru	Right	U-Turns	App. Total	
Peak Hour Analysis From 07:15 AM to 08:00 AM - Peak 1 of 1																					
Peak Hour for Entire Intersection Begins at 07:15 AM																					
07:15 AM	0	0	0	0	0	0	17	0	0	17	0	0	0	0	0	0	16	18	0	34	51
07:30 AM	0	0	0	0	0	0	17	2	0	19	0	0	0	0	0	0	15	10	0	25	44
07:45 AM	0	0	0	0	0	0	10	2	0	12	0	0	0	0	0	0	22	9	0	31	43
08:00 AM	0	0	0	0	0	0	15	0	0	15	0	0	0	0	0	0	13	10	0	23	38
Total Volume	0	0	0	0	0	0	59	4	0	63	0	0	0	0	0	0	66	47	0	113	176
% App. Total	0	0	0	0	0	0	93.7	6.3	0	829	0	0	0	0	0	0	58.4	41.6	0	863	
PHF	.000	.000	.000	.000	.000	.000	.868	.500	.000	.829	.000	.000	.000	.000	.000	.000	.750	.653	.000	.831	.863

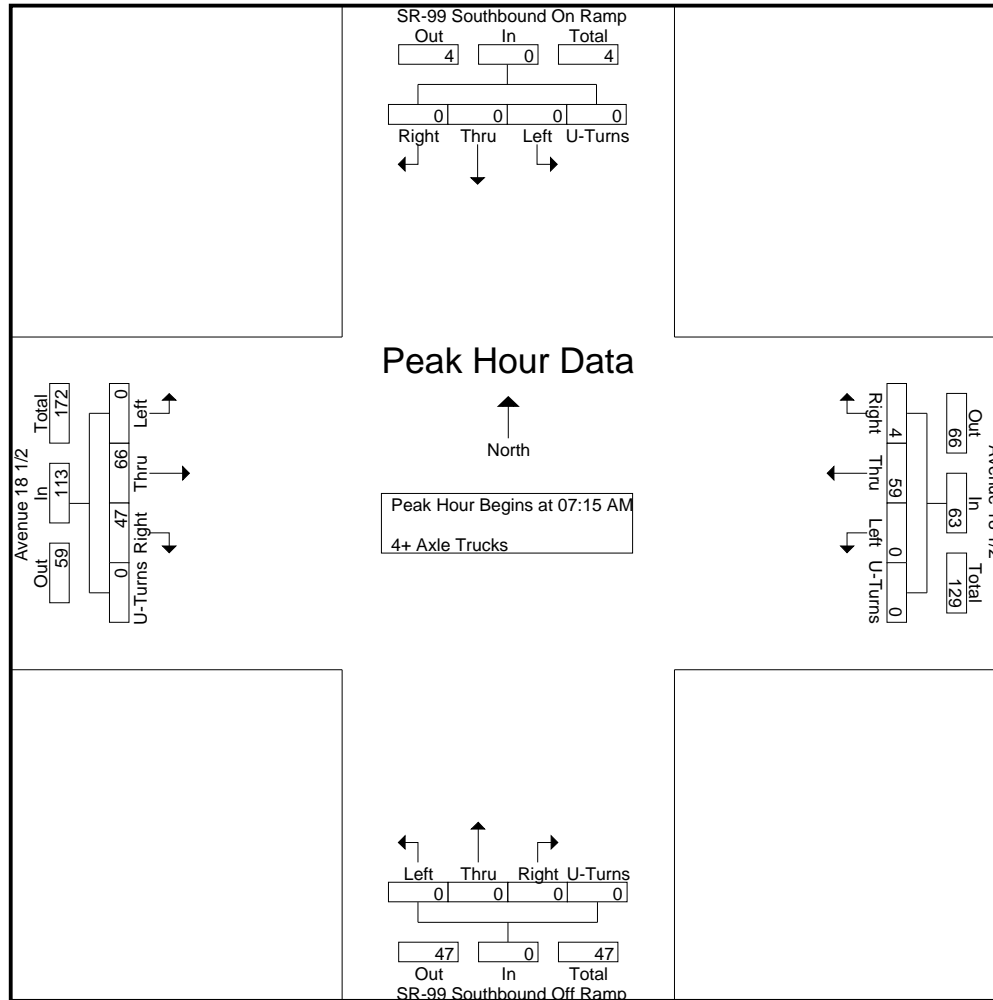

City of Madera
 N/S: SR-99 Southbound Ramps
 E/W: Avenue 18 1/2
 Weather: Clear

File Name : 03A_MDA_99S_Ave 18 1-2 AM
 Site Code : 00319628
 Start Date : 9/18/2019
 Page No : 3

Start Time	SR-99 Southbound On Ramp Southbound					Avenue 18 1/2 Westbound					SR-99 Southbound Off Ramp Northbound					Avenue 18 1/2 Eastbound					Int. Total
	Left	Thru	Right	U-Turns	App. Total	Left	Thru	Right	U-Turns	App. Total	Left	Thru	Right	U-Turns	App. Total	Left	Thru	Right	U-Turns	App. Total	

Peak Hour Analysis From 07:15 AM to 08:00 AM - Peak 1 of 1
 Peak Hour for Each Approach Begins at:

	07:15 AM					07:15 AM					07:15 AM					07:15 AM				
+0 mins.	0	0	0	0	0	0	17	0	0	17	0	0	0	0	0	0	16	18	0	34
+15 mins.	0	0	0	0	0	0	17	2	0	19	0	0	0	0	0	0	15	10	0	25
+30 mins.	0	0	0	0	0	0	10	2	0	12	0	0	0	0	0	0	22	9	0	31
+45 mins.	0	0	0	0	0	0	15	0	0	15	0	0	0	0	0	0	13	10	0	23
Total Volume	0	0	0	0	0	0	59	4	0	63	0	0	0	0	0	0	66	47	0	113
% App. Total	0	0	0	0	0	0	93.7	6.3	0		0	0	0	0	0	0	58.4	41.6	0	
PHF	.000	.000	.000	.000	.000	.000	.868	.500	.000	.829	.000	.000	.000	.000	.000	.000	.750	.653	.000	.831

City of Madera
 N/S: SR-99 Southbound Ramps
 E/W: Avenue 18 1/2
 Weather: Clear

File Name : 03A_MDA_99S_Ave 18 1-2 PM
 Site Code : 00319628
 Start Date : 9/18/2019
 Page No : 1

Groups Printed- Passenger Vehicles - Large 2 Axle Vehicles - 3 Axle Vehicles - 4+ Axle Trucks

Start Time	SR-99 Southbound On Ramp Southbound					Avenue 18 1/2 Westbound					SR-99 Southbound Off Ramp Northbound					Avenue 18 1/2 Eastbound					Int. Total
	Left	Thru	Right	U-Turns	App. Total	Left	Thru	Right	U-Turns	App. Total	Left	Thru	Right	U-Turns	App. Total	Left	Thru	Right	U-Turns	App. Total	
04:00 PM	0	0	0	0	0	0	57	8	0	65	0	0	0	0	0	0	56	57	0	113	178
04:15 PM	0	0	0	0	0	0	63	6	0	69	0	0	0	0	0	0	51	46	0	97	166
04:30 PM	0	0	0	0	0	0	60	2	0	62	0	0	0	0	0	0	60	51	0	111	173
04:45 PM	0	0	0	0	0	0	69	7	0	76	0	0	0	0	0	0	44	47	0	91	167
Total	0	0	0	0	0	0	249	23	0	272	0	0	0	0	0	0	211	201	0	412	684
05:00 PM	0	0	0	0	0	0	55	8	0	63	0	0	0	0	0	0	60	47	0	107	170
05:15 PM	0	0	0	0	0	0	69	10	0	79	0	0	0	0	0	0	58	51	0	109	188
05:30 PM	0	0	0	0	0	0	57	11	0	68	0	0	0	0	0	0	58	37	0	95	163
05:45 PM	0	0	0	0	0	0	54	2	0	56	0	0	0	0	0	0	44	52	0	96	152
Total	0	0	0	0	0	0	235	31	0	266	0	0	0	0	0	0	220	187	0	407	673
Grand Total	0	0	0	0	0	0	484	54	0	538	0	0	0	0	0	0	431	388	0	819	1357
Apprch %	0	0	0	0	0	0	90	10	0	0	0	0	0	0	0	0	52.6	47.4	0	0	
Total %	0	0	0	0	0	0	35.7	4	0	39.6	0	0	0	0	0	0	31.8	28.6	0	60.4	
Passenger Vehicles	0	0	0	0	0	0	369	48	0	417	0	0	0	0	0	0	340	292	0	632	1049
% Passenger Vehicles	0	0	0	0	0	0	76.2	88.9	0	77.5	0	0	0	0	0	0	78.9	75.3	0	77.2	77.3
Large 2 Axle Vehicles	0	0	0	0	0	0	22	1	0	23	0	0	0	0	0	0	19	11	0	30	53
% Large 2 Axle Vehicles	0	0	0	0	0	0	4.5	1.9	0	4.3	0	0	0	0	0	0	4.4	2.8	0	3.7	3.9
3 Axle Vehicles	0	0	0	0	0	0	7	1	0	8	0	0	0	0	0	0	5	5	0	10	18
% 3 Axle Vehicles	0	0	0	0	0	0	1.4	1.9	0	1.5	0	0	0	0	0	0	1.2	1.3	0	1.2	1.3
4+ Axle Trucks	0	0	0	0	0	0	86	4	0	90	0	0	0	0	0	0	67	80	0	147	237
% 4+ Axle Trucks	0	0	0	0	0	0	17.8	7.4	0	16.7	0	0	0	0	0	0	15.5	20.6	0	17.9	17.5

Start Time	SR-99 Southbound On Ramp Southbound					Avenue 18 1/2 Westbound					SR-99 Southbound Off Ramp Northbound					Avenue 18 1/2 Eastbound					Int. Total
	Left	Thru	Right	U-Turns	App. Total	Left	Thru	Right	U-Turns	App. Total	Left	Thru	Right	U-Turns	App. Total	Left	Thru	Right	U-Turns	App. Total	
Peak Hour Analysis From 04:00 PM to 05:45 PM - Peak 1 of 1																					
Peak Hour for Entire Intersection Begins at 04:30 PM																					
04:30 PM	0	0	0	0	0	0	60	2	0	62	0	0	0	0	0	0	60	51	0	111	173
04:45 PM	0	0	0	0	0	0	69	7	0	76	0	0	0	0	0	0	44	47	0	91	167
05:00 PM	0	0	0	0	0	0	55	8	0	63	0	0	0	0	0	0	60	47	0	107	170
05:15 PM	0	0	0	0	0	0	69	10	0	79	0	0	0	0	0	0	58	51	0	109	188
Total Volume	0	0	0	0	0	0	253	27	0	280	0	0	0	0	0	0	222	196	0	418	698
% App. Total	0	0	0	0	0	0	90.4	9.6	0	0	0	0	0	0	0	0	53.1	46.9	0	0	
PHF	.000	.000	.000	.000	.000	.000	.917	.675	.000	.886	.000	.000	.000	.000	.000	.000	.925	.961	.000	.941	.928

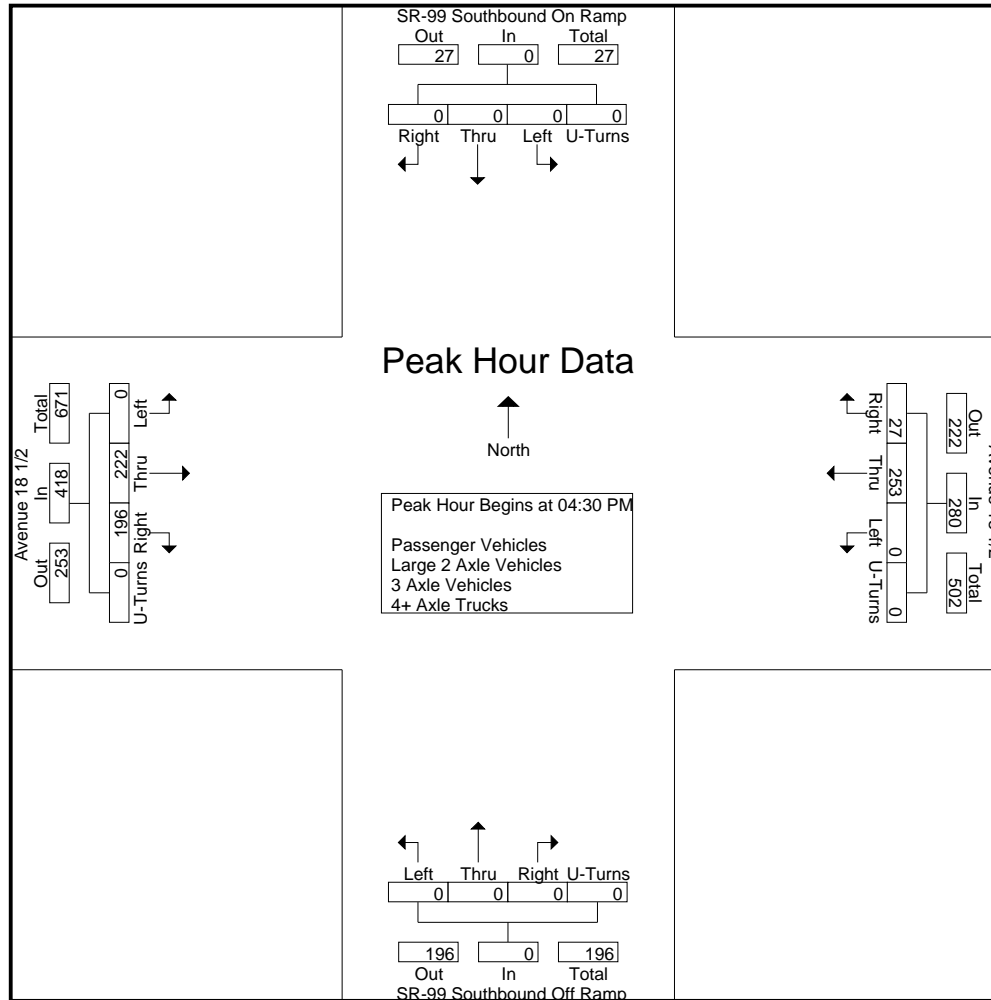

City of Madera
 N/S: SR-99 Southbound Ramps
 E/W: Avenue 18 1/2
 Weather: Clear

File Name : 03A_MDA_99S_Ave 18 1-2 PM
 Site Code : 00319628
 Start Date : 9/18/2019
 Page No : 3

Start Time	SR-99 Southbound On Ramp Southbound					Avenue 18 1/2 Westbound					SR-99 Southbound Off Ramp Northbound					Avenue 18 1/2 Eastbound					Int. Total
	Left	Thru	Right	U-Turns	App. Total	Left	Thru	Right	U-Turns	App. Total	Left	Thru	Right	U-Turns	App. Total	Left	Thru	Right	U-Turns	App. Total	

Peak Hour Analysis From 04:00 PM to 05:45 PM - Peak 1 of 1
 Peak Hour for Each Approach Begins at:

	04:00 PM					04:45 PM					04:00 PM					04:30 PM				
+0 mins.	0	0	0	0	0	0	69	7	0	76	0	0	0	0	0	0	60	51	0	111
+15 mins.	0	0	0	0	0	0	55	8	0	63	0	0	0	0	0	0	44	47	0	91
+30 mins.	0	0	0	0	0	0	69	10	0	79	0	0	0	0	0	0	60	47	0	107
+45 mins.	0	0	0	0	0	0	57	11	0	68	0	0	0	0	0	0	58	51	0	109
Total Volume	0	0	0	0	0	0	250	36	0	286	0	0	0	0	0	0	222	196	0	418
% App. Total	0	0	0	0	0	0	87.4	12.6	0		0	0	0	0	0	0	53.1	46.9	0	
PHF	.000	.000	.000	.000	.000	.000	.906	.818	.000	.905	.000	.000	.000	.000	.000	.000	.925	.961	.000	.941

City of Madera
 N/S: SR-99 Southbound Ramps
 E/W: Avenue 18 1/2
 Weather: Clear

File Name : 03A_MDA_99S_Ave 18 1-2 PM
 Site Code : 00319628
 Start Date : 9/18/2019
 Page No : 1

Groups Printed- Passenger Vehicles

Start Time	SR-99 Southbound On Ramp Southbound					Avenue 18 1/2 Westbound					SR-99 Southbound Off Ramp Northbound					Avenue 18 1/2 Eastbound					Int. Total
	Left	Thru	Right	U-Turns	App. Total	Left	Thru	Right	U-Turns	App. Total	Left	Thru	Right	U-Turns	App. Total	Left	Thru	Right	U-Turns	App. Total	
04:00 PM	0	0	0	0	0	0	38	7	0	45	0	0	0	0	0	0	38	45	0	83	128
04:15 PM	0	0	0	0	0	0	43	5	0	48	0	0	0	0	0	0	41	30	0	71	119
04:30 PM	0	0	0	0	0	0	45	2	0	47	0	0	0	0	0	0	42	39	0	81	128
04:45 PM	0	0	0	0	0	0	51	7	0	58	0	0	0	0	0	0	37	38	0	75	133
Total	0	0	0	0	0	0	177	21	0	198	0	0	0	0	0	0	158	152	0	310	508
05:00 PM	0	0	0	0	0	0	48	8	0	56	0	0	0	0	0	0	45	38	0	83	139
05:15 PM	0	0	0	0	0	0	53	8	0	61	0	0	0	0	0	0	51	38	0	89	150
05:30 PM	0	0	0	0	0	0	48	9	0	57	0	0	0	0	0	0	50	25	0	75	132
05:45 PM	0	0	0	0	0	0	43	2	0	45	0	0	0	0	0	0	36	39	0	75	120
Total	0	0	0	0	0	0	192	27	0	219	0	0	0	0	0	0	182	140	0	322	541
Grand Total	0	0	0	0	0	0	369	48	0	417	0	0	0	0	0	0	340	292	0	632	1049
Apprch %	0	0	0	0	0	0	88.5	11.5	0		0	0	0	0	0	0	53.8	46.2	0		
Total %	0	0	0	0	0	0	35.2	4.6	0	39.8	0	0	0	0	0	0	32.4	27.8	0	60.2	

Start Time	SR-99 Southbound On Ramp Southbound					Avenue 18 1/2 Westbound					SR-99 Southbound Off Ramp Northbound					Avenue 18 1/2 Eastbound					Int. Total
	Left	Thru	Right	U-Turns	App. Total	Left	Thru	Right	U-Turns	App. Total	Left	Thru	Right	U-Turns	App. Total	Left	Thru	Right	U-Turns	App. Total	
Peak Hour Analysis From 04:30 PM to 05:15 PM - Peak 1 of 1																					
Peak Hour for Entire Intersection Begins at 04:30 PM																					
04:30 PM	0	0	0	0	0	0	45	2	0	47	0	0	0	0	0	0	42	39	0	81	128
04:45 PM	0	0	0	0	0	0	51	7	0	58	0	0	0	0	0	0	37	38	0	75	133
05:00 PM	0	0	0	0	0	0	48	8	0	56	0	0	0	0	0	0	45	38	0	83	139
05:15 PM	0	0	0	0	0	0	53	8	0	61	0	0	0	0	0	0	51	38	0	89	150
Total Volume	0	0	0	0	0	0	197	25	0	222	0	0	0	0	0	0	175	153	0	328	550
% App. Total	0	0	0	0	0	0	88.7	11.3	0		0	0	0	0	0	0	53.4	46.6	0		
PHF	.000	.000	.000	.000	.000	.000	.929	.781	.000	.910	.000	.000	.000	.000	.000	.000	.858	.981	.000	.921	.917

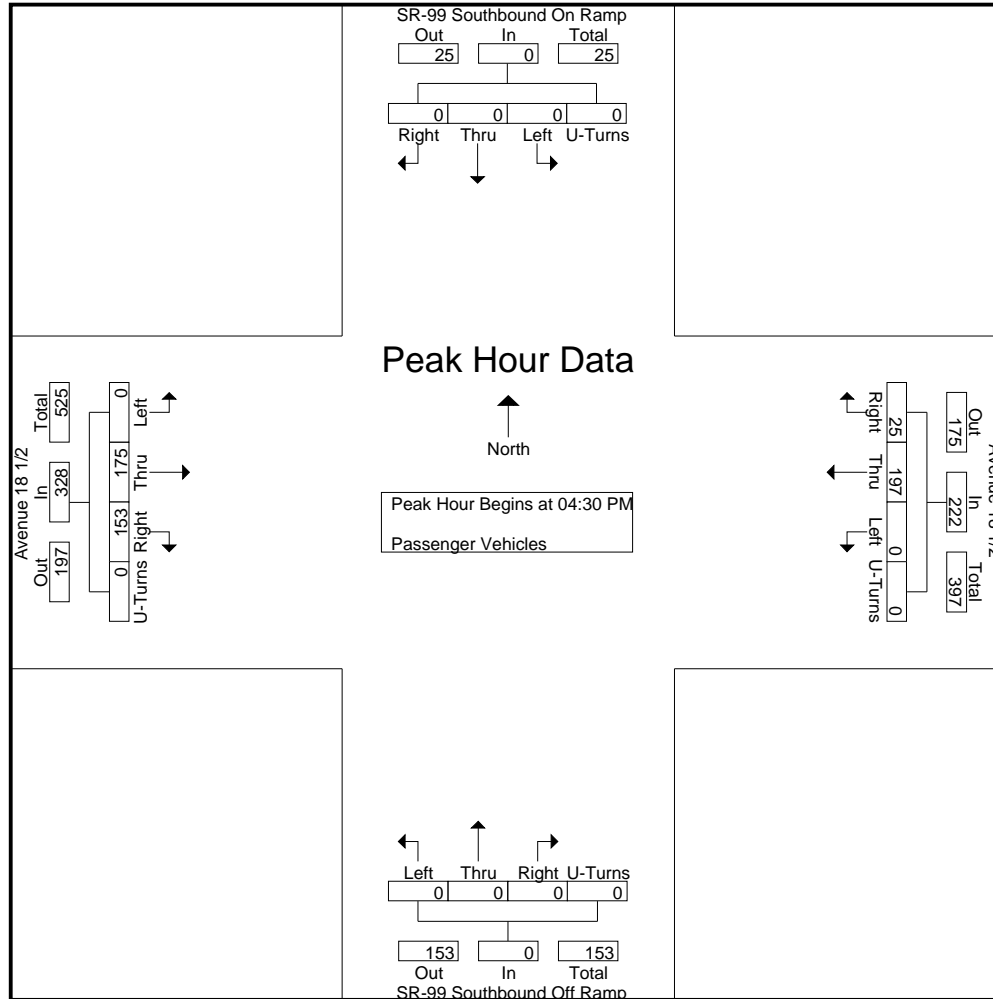

City of Madera
 N/S: SR-99 Southbound Ramps
 E/W: Avenue 18 1/2
 Weather: Clear

File Name : 03A_MDA_99S_Ave 18 1-2 PM
 Site Code : 00319628
 Start Date : 9/18/2019
 Page No : 3

Start Time	SR-99 Southbound On Ramp Southbound					Avenue 18 1/2 Westbound					SR-99 Southbound Off Ramp Northbound					Avenue 18 1/2 Eastbound					Int. Total
	Left	Thru	Right	U-Turns	App. Total	Left	Thru	Right	U-Turns	App. Total	Left	Thru	Right	U-Turns	App. Total	Left	Thru	Right	U-Turns	App. Total	

Peak Hour Analysis From 04:30 PM to 05:15 PM - Peak 1 of 1
 Peak Hour for Each Approach Begins at:

	04:30 PM					04:30 PM					04:30 PM					04:30 PM				
+0 mins.	0	0	0	0	0	0	45	2	0	47	0	0	0	0	0	0	42	39	0	81
+15 mins.	0	0	0	0	0	0	51	7	0	58	0	0	0	0	0	0	37	38	0	75
+30 mins.	0	0	0	0	0	0	48	8	0	56	0	0	0	0	0	0	45	38	0	83
+45 mins.	0	0	0	0	0	0	53	8	0	61	0	0	0	0	0	0	51	38	0	89
Total Volume	0	0	0	0	0	0	197	25	0	222	0	0	0	0	0	0	175	153	0	328
% App. Total	0	0	0	0	0	0	88.7	11.3	0		0	0	0	0	0	0	53.4	46.6	0	
PHF	.000	.000	.000	.000	.000	.000	.929	.781	.000	.910	.000	.000	.000	.000	.000	.000	.858	.981	.000	.921

City of Madera
 N/S: SR-99 Southbound Ramps
 E/W: Avenue 18 1/2
 Weather: Clear

File Name : 03A_MDA_99S_Ave 18 1-2 PM
 Site Code : 00319628
 Start Date : 9/18/2019
 Page No : 1

Groups Printed- Large 2 Axle Vehicles

Start Time	SR-99 Southbound On Ramp Southbound					Avenue 18 1/2 Westbound					SR-99 Southbound Off Ramp Northbound					Avenue 18 1/2 Eastbound					Int. Total
	Left	Thru	Right	U-Turns	App. Total	Left	Thru	Right	U-Turns	App. Total	Left	Thru	Right	U-Turns	App. Total	Left	Thru	Right	U-Turns	App. Total	
04:00 PM	0	0	0	0	0	0	2	1	0	3	0	0	0	0	0	0	3	0	0	3	6
04:15 PM	0	0	0	0	0	0	2	0	0	2	0	0	0	0	0	0	2	2	0	4	6
04:30 PM	0	0	0	0	0	0	5	0	0	5	0	0	0	0	0	0	1	3	0	4	9
04:45 PM	0	0	0	0	0	0	5	0	0	5	0	0	0	0	0	0	2	0	0	2	7
Total	0	0	0	0	0	0	14	1	0	15	0	0	0	0	0	0	8	5	0	13	28
05:00 PM	0	0	0	0	0	0	3	0	0	3	0	0	0	0	0	0	3	0	0	3	6
05:15 PM	0	0	0	0	0	0	1	0	0	1	0	0	0	0	0	0	4	2	0	6	7
05:30 PM	0	0	0	0	0	0	2	0	0	2	0	0	0	0	0	0	4	2	0	6	8
05:45 PM	0	0	0	0	0	0	2	0	0	2	0	0	0	0	0	0	0	2	0	2	4
Total	0	0	0	0	0	0	8	0	0	8	0	0	0	0	0	0	11	6	0	17	25
Grand Total	0	0	0	0	0	0	22	1	0	23	0	0	0	0	0	0	19	11	0	30	53
Apprch %	0	0	0	0	0	0	95.7	4.3	0	43.4	0	0	0	0	0	0	63.3	36.7	0	56.6	
Total %	0	0	0	0	0	0	41.5	1.9	0	43.4	0	0	0	0	0	0	35.8	20.8	0	56.6	

Start Time	SR-99 Southbound On Ramp Southbound					Avenue 18 1/2 Westbound					SR-99 Southbound Off Ramp Northbound					Avenue 18 1/2 Eastbound					Int. Total
	Left	Thru	Right	U-Turns	App. Total	Left	Thru	Right	U-Turns	App. Total	Left	Thru	Right	U-Turns	App. Total	Left	Thru	Right	U-Turns	App. Total	
Peak Hour Analysis From 04:30 PM to 05:15 PM - Peak 1 of 1																					
Peak Hour for Entire Intersection Begins at 04:30 PM																					
04:30 PM	0	0	0	0	0	0	5	0	0	5	0	0	0	0	0	0	1	3	0	4	9
04:45 PM	0	0	0	0	0	0	5	0	0	5	0	0	0	0	0	0	2	0	0	2	7
05:00 PM	0	0	0	0	0	0	3	0	0	3	0	0	0	0	0	0	3	0	0	3	6
05:15 PM	0	0	0	0	0	0	1	0	0	1	0	0	0	0	0	0	4	2	0	6	7
Total Volume	0	0	0	0	0	0	14	0	0	14	0	0	0	0	0	0	10	5	0	15	29
% App. Total	0	0	0	0	0	0	100	0	0	100	0	0	0	0	0	0	66.7	33.3	0	100	
PHF	.000	.000	.000	.000	.000	.000	.700	.000	.000	.700	.000	.000	.000	.000	.000	.000	.625	.417	.000	.625	.806

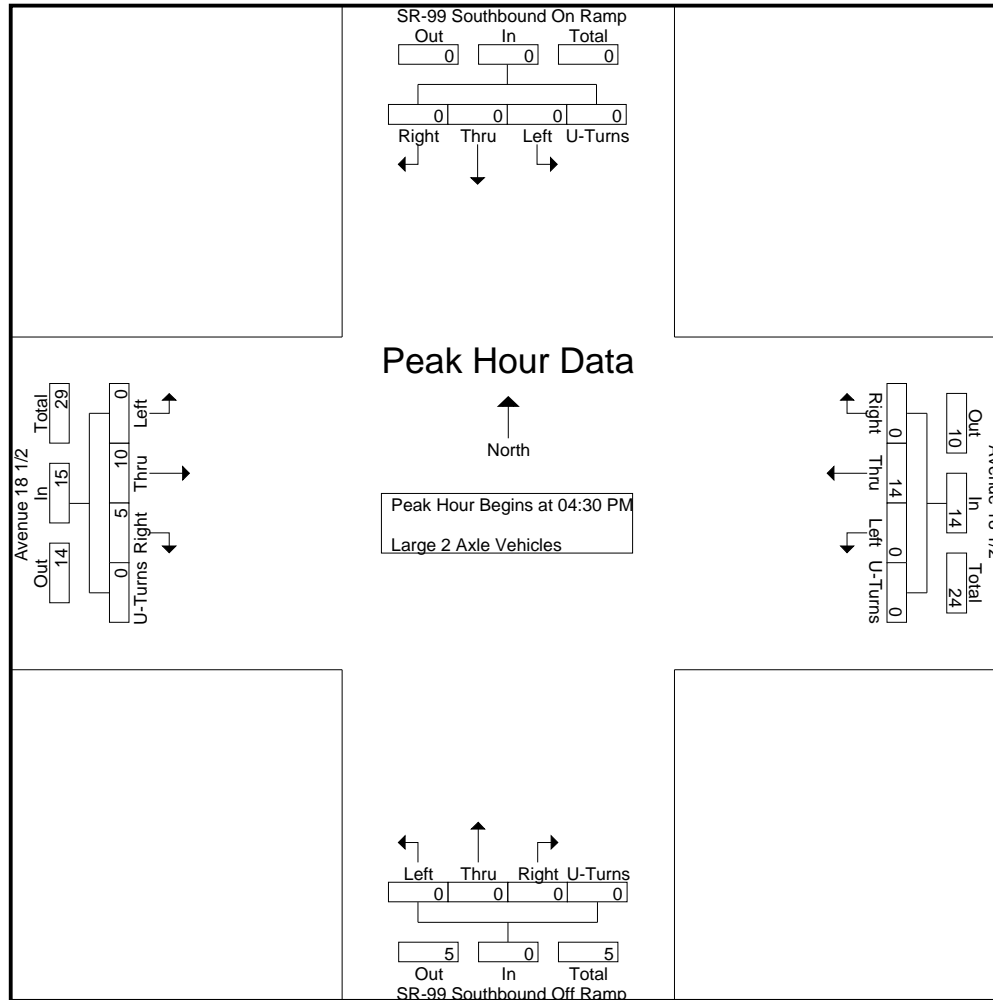

City of Madera
 N/S: SR-99 Southbound Ramps
 E/W: Avenue 18 1/2
 Weather: Clear

File Name : 03A_MDA_99S_Ave 18 1-2 PM
 Site Code : 00319628
 Start Date : 9/18/2019
 Page No : 3

Start Time	SR-99 Southbound On Ramp Southbound					Avenue 18 1/2 Westbound					SR-99 Southbound Off Ramp Northbound					Avenue 18 1/2 Eastbound					Int. Total
	Left	Thru	Right	U-Turns	App. Total	Left	Thru	Right	U-Turns	App. Total	Left	Thru	Right	U-Turns	App. Total	Left	Thru	Right	U-Turns	App. Total	

Peak Hour Analysis From 04:30 PM to 05:15 PM - Peak 1 of 1
 Peak Hour for Each Approach Begins at:

	04:30 PM					04:30 PM					04:30 PM					04:30 PM				
+0 mins.	0	0	0	0	0	0	5	0	0	5	0	0	0	0	0	0	1	3	0	4
+15 mins.	0	0	0	0	0	0	5	0	0	5	0	0	0	0	0	0	2	0	0	2
+30 mins.	0	0	0	0	0	0	3	0	0	3	0	0	0	0	0	0	3	0	0	3
+45 mins.	0	0	0	0	0	0	1	0	0	1	0	0	0	0	0	0	4	2	0	6
Total Volume	0	0	0	0	0	0	14	0	0	14	0	0	0	0	0	0	10	5	0	15
% App. Total	0	0	0	0	0	0	100	0	0	100	0	0	0	0	0	0	66.7	33.3	0	100
PHF	.000	.000	.000	.000	.000	.000	.700	.000	.000	.700	.000	.000	.000	.000	.000	.000	.625	.417	.000	.625

City of Madera
 N/S: SR-99 Southbound Ramps
 E/W: Avenue 18 1/2
 Weather: Clear

File Name : 03A_MDA_99S_Ave 18 1-2 PM
 Site Code : 00319628
 Start Date : 9/18/2019
 Page No : 1

Groups Printed- 3 Axle Vehicles

Start Time	SR-99 Southbound On Ramp Southbound					Avenue 18 1/2 Westbound					SR-99 Southbound Off Ramp Northbound					Avenue 18 1/2 Eastbound					Int. Total
	Left	Thru	Right	U-Turns	App. Total	Left	Thru	Right	U-Turns	App. Total	Left	Thru	Right	U-Turns	App. Total	Left	Thru	Right	U-Turns	App. Total	
04:00 PM	0	0	0	0	0	0	2	0	0	2	0	0	0	0	0	0	1	0	0	1	3
04:15 PM	0	0	0	0	0	0	1	1	0	2	0	0	0	0	0	0	0	0	0	0	2
04:30 PM	0	0	0	0	0	0	0	0	0	0	0	0	0	0	0	0	2	1	0	3	3
04:45 PM	0	0	0	0	0	0	0	0	0	0	0	0	0	0	0	0	0	1	0	1	1
Total	0	0	0	0	0	0	3	1	0	4	0	0	0	0	0	0	3	2	0	5	9
05:00 PM	0	0	0	0	0	0	0	0	0	0	0	0	0	0	0	0	0	0	0	0	0
05:15 PM	0	0	0	0	0	0	1	0	0	1	0	0	0	0	0	0	0	1	0	1	2
05:30 PM	0	0	0	0	0	0	1	0	0	1	0	0	0	0	0	0	0	2	0	2	3
05:45 PM	0	0	0	0	0	0	2	0	0	2	0	0	0	0	0	0	2	0	0	2	4
Total	0	0	0	0	0	0	4	0	0	4	0	0	0	0	0	0	2	3	0	5	9
Grand Total	0	0	0	0	0	0	7	1	0	8	0	0	0	0	0	0	5	5	0	10	18
Apprch %	0	0	0	0	0	0	87.5	12.5	0	0	0	0	0	0	0	0	50	50	0	0	
Total %	0	0	0	0	0	0	38.9	5.6	0	44.4	0	0	0	0	0	0	27.8	27.8	0	55.6	

Start Time	SR-99 Southbound On Ramp Southbound					Avenue 18 1/2 Westbound					SR-99 Southbound Off Ramp Northbound					Avenue 18 1/2 Eastbound					Int. Total
	Left	Thru	Right	U-Turns	App. Total	Left	Thru	Right	U-Turns	App. Total	Left	Thru	Right	U-Turns	App. Total	Left	Thru	Right	U-Turns	App. Total	
Peak Hour Analysis From 04:30 PM to 05:15 PM - Peak 1 of 1																					
Peak Hour for Entire Intersection Begins at 04:30 PM																					
04:30 PM	0	0	0	0	0	0	0	0	0	0	0	0	0	0	0	0	2	1	0	3	3
04:45 PM	0	0	0	0	0	0	0	0	0	0	0	0	0	0	0	0	0	1	0	1	1
05:00 PM	0	0	0	0	0	0	0	0	0	0	0	0	0	0	0	0	0	0	0	0	0
05:15 PM	0	0	0	0	0	0	1	0	0	1	0	0	0	0	0	0	0	1	0	1	2
Total Volume	0	0	0	0	0	0	1	0	0	1	0	0	0	0	0	0	2	3	0	5	6
% App. Total	0	0	0	0	0	0	100	0	0	0	0	0	0	0	0	0	40	60	0	0	
PHF	.000	.000	.000	.000	.000	.000	.250	.000	.000	.250	.000	.000	.000	.000	.000	.000	.250	.750	.000	.417	.500

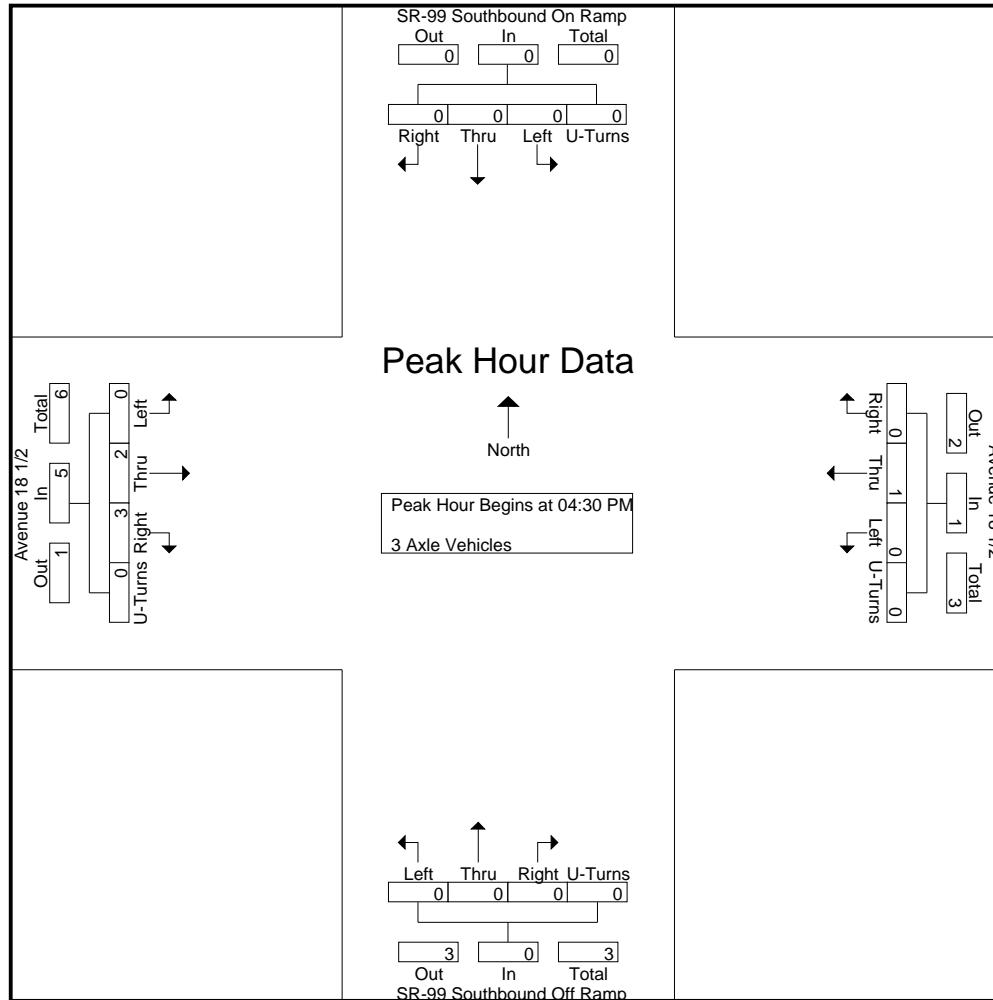

City of Madera
 N/S: SR-99 Southbound Ramps
 E/W: Avenue 18 1/2
 Weather: Clear

File Name : 03A_MDA_99S_Ave 18 1-2 PM
 Site Code : 00319628
 Start Date : 9/18/2019
 Page No : 3

Start Time	SR-99 Southbound On Ramp Southbound					Avenue 18 1/2 Westbound					SR-99 Southbound Off Ramp Northbound					Avenue 18 1/2 Eastbound					Int. Total
	Left	Thru	Right	U-Turns	App. Total	Left	Thru	Right	U-Turns	App. Total	Left	Thru	Right	U-Turns	App. Total	Left	Thru	Right	U-Turns	App. Total	

Peak Hour Analysis From 04:30 PM to 05:15 PM - Peak 1 of 1
 Peak Hour for Each Approach Begins at:

	04:30 PM					04:30 PM					04:30 PM					04:30 PM				
+0 mins.	0	0	0	0	0	0	0	0	0	0	0	0	0	0	0	0	2	1	0	3
+15 mins.	0	0	0	0	0	0	0	0	0	0	0	0	0	0	0	0	0	1	0	1
+30 mins.	0	0	0	0	0	0	0	0	0	0	0	0	0	0	0	0	0	0	0	0
+45 mins.	0	0	0	0	0	0	1	0	0	1	0	0	0	0	0	0	0	1	0	1
Total Volume	0	0	0	0	0	0	1	0	0	1	0	0	0	0	0	0	2	3	0	5
% App. Total	0	0	0	0	0	0	100	0	0	0	0	0	0	0	0	0	40	60	0	0
PHF	.000	.000	.000	.000	.000	.000	.250	.000	.000	.250	.000	.000	.000	.000	.000	.000	.250	.750	.000	.417

City of Madera
 N/S: SR-99 Southbound Ramps
 E/W: Avenue 18 1/2
 Weather: Clear

File Name : 03A_MDA_99S_Ave 18 1-2 PM
 Site Code : 00319628
 Start Date : 9/18/2019
 Page No : 1

Groups Printed- 4+ Axle Trucks

Start Time	SR-99 Southbound On Ramp Southbound					Avenue 18 1/2 Westbound					SR-99 Southbound Off Ramp Northbound					Avenue 18 1/2 Eastbound					Int. Total
	Left	Thru	Right	U-Turns	App. Total	Left	Thru	Right	U-Turns	App. Total	Left	Thru	Right	U-Turns	App. Total	Left	Thru	Right	U-Turns	App. Total	
04:00 PM	0	0	0	0	0	0	15	0	0	15	0	0	0	0	0	0	14	12	0	26	41
04:15 PM	0	0	0	0	0	0	17	0	0	17	0	0	0	0	0	0	8	14	0	22	39
04:30 PM	0	0	0	0	0	0	10	0	0	10	0	0	0	0	0	0	15	8	0	23	33
04:45 PM	0	0	0	0	0	0	13	0	0	13	0	0	0	0	0	0	5	8	0	13	26
Total	0	0	0	0	0	0	55	0	0	55	0	0	0	0	0	0	42	42	0	84	139
05:00 PM	0	0	0	0	0	0	4	0	0	4	0	0	0	0	0	0	12	9	0	21	25
05:15 PM	0	0	0	0	0	0	14	2	0	16	0	0	0	0	0	0	3	10	0	13	29
05:30 PM	0	0	0	0	0	0	6	2	0	8	0	0	0	0	0	0	4	8	0	12	20
05:45 PM	0	0	0	0	0	0	7	0	0	7	0	0	0	0	0	0	6	11	0	17	24
Total	0	0	0	0	0	0	31	4	0	35	0	0	0	0	0	0	25	38	0	63	98
Grand Total	0	0	0	0	0	0	86	4	0	90	0	0	0	0	0	0	67	80	0	147	237
Apprch %	0	0	0	0	0	0	95.6	4.4	0		0	0	0	0	0	0	45.6	54.4	0		
Total %	0	0	0	0	0	0	36.3	1.7	0	38	0	0	0	0	0	0	28.3	33.8	0	62	

Start Time	SR-99 Southbound On Ramp Southbound					Avenue 18 1/2 Westbound					SR-99 Southbound Off Ramp Northbound					Avenue 18 1/2 Eastbound					Int. Total
	Left	Thru	Right	U-Turns	App. Total	Left	Thru	Right	U-Turns	App. Total	Left	Thru	Right	U-Turns	App. Total	Left	Thru	Right	U-Turns	App. Total	
Peak Hour Analysis From 04:30 PM to 05:15 PM - Peak 1 of 1																					
Peak Hour for Entire Intersection Begins at 04:30 PM																					
04:30 PM	0	0	0	0	0	0	10	0	0	10	0	0	0	0	0	0	15	8	0	23	33
04:45 PM	0	0	0	0	0	0	13	0	0	13	0	0	0	0	0	0	5	8	0	13	26
05:00 PM	0	0	0	0	0	0	4	0	0	4	0	0	0	0	0	0	12	9	0	21	25
05:15 PM	0	0	0	0	0	0	14	2	0	16	0	0	0	0	0	0	3	10	0	13	29
Total Volume	0	0	0	0	0	0	41	2	0	43	0	0	0	0	0	0	35	35	0	70	113
% App. Total	0	0	0	0	0	0	95.3	4.7	0		0	0	0	0	0	0	50	50	0		
PHF	.000	.000	.000	.000	.000	.000	.732	.250	.000	.672	.000	.000	.000	.000	.000	.000	.583	.875	.000	.761	.856

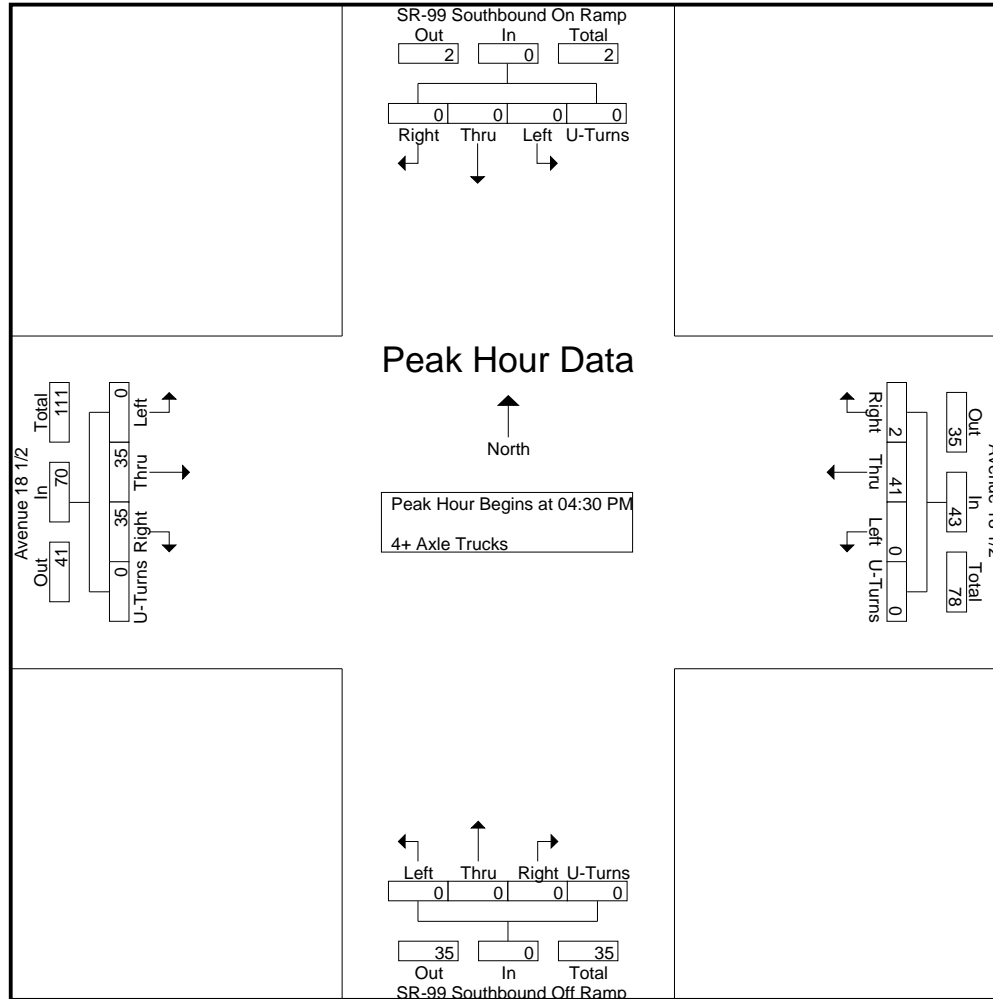

City of Madera
 N/S: SR-99 Southbound Ramps
 E/W: Avenue 18 1/2
 Weather: Clear

File Name : 03A_MDA_99S_Ave 18 1-2 PM
 Site Code : 00319628
 Start Date : 9/18/2019
 Page No : 3

Start Time	SR-99 Southbound On Ramp Southbound					Avenue 18 1/2 Westbound					SR-99 Southbound Off Ramp Northbound					Avenue 18 1/2 Eastbound					Int. Total
	Left	Thru	Right	U-Turns	App. Total	Left	Thru	Right	U-Turns	App. Total	Left	Thru	Right	U-Turns	App. Total	Left	Thru	Right	U-Turns	App. Total	

Peak Hour Analysis From 04:30 PM to 05:15 PM - Peak 1 of 1
 Peak Hour for Each Approach Begins at:

	04:30 PM					04:30 PM					04:30 PM					04:30 PM				
+0 mins.	0	0	0	0	0	0	10	0	0	10	0	0	0	0	0	0	15	8	0	23
+15 mins.	0	0	0	0	0	0	13	0	0	13	0	0	0	0	0	0	5	8	0	13
+30 mins.	0	0	0	0	0	0	4	0	0	4	0	0	0	0	0	0	12	9	0	21
+45 mins.	0	0	0	0	0	0	14	2	0	16	0	0	0	0	0	0	3	10	0	13
Total Volume	0	0	0	0	0	0	41	2	0	43	0	0	0	0	0	0	35	35	0	70
% App. Total	0	0	0	0	0	0	95.3	4.7	0		0	0	0	0	0	0	50	50	0	
PHF	.000	.000	.000	.000	.000	.000	.732	.250	.000	.672	.000	.000	.000	.000	.000	.000	.583	.875	.000	.761

Location: Madera
 N/S: SR-99 Southbound Ramps
 E/W: Avenue 18 1/2



PEDESTRIANS

	North Leg SR-99 Southbound Ramps	East Leg Avenue 18 1/2	South Leg SR-99 Southbound Ramps	West Leg Avenue 18 1/2	
	Pedestrians	Pedestrians	Pedestrians	Pedestrians	
7:00 AM	0	0	0	0	0
7:15 AM	0	0	0	0	0
7:30 AM	0	0	0	0	0
7:45 AM	0	0	0	0	0
8:00 AM	0	0	0	0	0
8:15 AM	0	0	0	0	0
8:30 AM	0	0	0	0	0
8:45 AM	0	0	0	0	0
TOTAL VOLUMES:	0	0	0	0	0

	North Leg SR-99 Southbound Ramps	East Leg Avenue 18 1/2	South Leg SR-99 Southbound Ramps	West Leg Avenue 18 1/2	
	Pedestrians	Pedestrians	Pedestrians	Pedestrians	
4:00 PM	0	0	0	0	0
4:15 PM	0	0	0	0	0
4:30 PM	0	0	0	0	0
4:45 PM	0	0	0	0	0
5:00 PM	1	0	0	0	1
5:15 PM	1	0	0	0	1
5:30 PM	0	0	0	0	0
5:45 PM	0	0	0	0	0
TOTAL VOLUMES:	2	0	0	0	2

Location: Madera
 N/S: SR-99 Southbound Ramps
 E/W: Avenue 18 1/2



BICYCLES

	Southbound SR-99 Southbound Ramps			Westbound Avenue 18 1/2			Northbound SR-99 Southbound Ramps			Eastbound Avenue 18 1/2			
	Left	Thru	Right	Left	Thru	Right	Left	Thru	Right	Left	Thru	Right	
7:00 AM	0	0	0	0	0	0	0	0	0	0	0	0	0
7:15 AM	0	0	0	0	0	0	0	0	0	0	0	0	0
7:30 AM	0	0	0	0	0	0	0	0	0	0	0	0	0
7:45 AM	0	0	0	0	0	0	0	0	0	0	0	0	0
8:00 AM	0	0	0	0	0	0	0	0	0	0	0	0	0
8:15 AM	0	0	0	0	0	0	0	0	0	0	0	0	0
8:30 AM	0	0	0	0	0	0	0	0	0	0	0	0	0
8:45 AM	0	0	0	0	0	0	0	0	0	0	0	0	0
TOTAL VOLUMES:	0	0	0	0	0	0	0	0	0	0	0	0	0

	Southbound SR-99 Southbound Ramps			Westbound Avenue 18 1/2			Northbound SR-99 Southbound Ramps			Eastbound Avenue 18 1/2			
	Left	Thru	Right	Left	Thru	Right	Left	Thru	Right	Left	Thru	Right	
4:00 PM	0	0	0	0	0	0	0	0	0	0	1	0	1
4:15 PM	0	0	0	0	0	0	0	0	0	0	0	0	0
4:30 PM	0	0	0	0	0	0	0	0	0	0	0	0	0
4:45 PM	0	0	0	0	0	0	0	0	0	0	0	0	0
5:00 PM	0	0	0	0	0	0	0	0	0	0	0	0	0
5:15 PM	0	0	0	0	0	0	0	0	0	0	0	0	0
5:30 PM	0	0	0	0	0	0	0	0	0	0	0	0	0
5:45 PM	0	0	0	0	0	0	0	0	0	0	0	0	0
TOTAL VOLUMES:	0	0	0	0	0	0	0	0	0	0	1	0	1

City of Madera
 N/S: SR-99 Southbound On Ramps
 E/W: Avenue 17
 Weather: Clear

File Name : 12A_MDA_99S_Ave 17 AM
 Site Code : 00319628
 Start Date : 9/18/2019
 Page No : 1

Groups Printed- Passenger Vehicles - Large 2 Axle Vehicles - 3 Axle Vehicles - 4+ Axle Trucks

Start Time	SR-99 Southbound On Ramp Southbound					Avenue 17 Westbound					SR-99 Southbound On Ramp Northbound					Avenue 17 Eastbound					Int. Total
	Left	Thru	Right	U-Turns	App. Total	Left	Thru	Right	U-Turns	App. Total	Left	Thru	Right	U-Turns	App. Total	Left	Thru	Right	U-Turns	App. Total	
07:00 AM	0	0	0	0	0	0	43	124	0	167	0	0	0	0	0	0	45	14	0	59	226
07:15 AM	0	0	0	0	0	0	58	136	0	194	0	0	0	0	0	0	45	20	0	65	259
07:30 AM	0	0	0	0	0	0	45	134	0	179	0	0	0	0	0	0	44	15	0	59	238
07:45 AM	0	0	0	0	0	0	71	117	0	188	0	0	0	0	0	0	53	15	0	68	256
Total	0	0	0	0	0	0	217	511	0	728	0	0	0	0	0	0	187	64	0	251	979
08:00 AM	0	0	0	0	0	0	56	107	0	163	0	0	0	0	0	0	48	25	0	73	236
08:15 AM	0	0	0	0	0	0	40	107	0	147	0	0	0	0	0	0	58	19	0	77	224
08:30 AM	0	0	0	0	0	0	33	81	0	114	0	0	0	0	0	0	38	22	0	60	174
08:45 AM	0	0	0	0	0	0	33	66	0	99	0	0	0	0	0	0	35	10	0	45	144
Total	0	0	0	0	0	0	162	361	0	523	0	0	0	0	0	0	179	76	0	255	778
Grand Total	0	0	0	0	0	0	379	872	0	1251	0	0	0	0	0	0	366	140	0	506	1757
Apprch %	0	0	0	0	0	0	30.3	69.7	0		0	0	0	0	0	0	72.3	27.7	0		
Total %	0	0	0	0	0	0	21.6	49.6	0	71.2	0	0	0	0	0	0	20.8	8	0	28.8	
Passenger Vehicles	0	0	0	0	0	0	92.9	96.1	0	95.1	0	0	0	0	0	0	86.3	85	0	86	92.5
Large 2 Axle Vehicles	0	0	0	0	0	0	4.5	1.7	0	2.6	0	0	0	0	0	0	5.2	8.6	0	6.1	3.6
3 Axle Vehicles	0	0	0	0	0	0	0	0	0	0	0	0	0	0	0	0	4	4	0	8	8
% 3 Axle Vehicles	0	0	0	0	0	0	0	0	0	0	0	0	0	0	0	0	1.1	2.9	0	1.6	0.5
4+ Axle Trucks	0	0	0	0	0	0	10	19	0	29	0	0	0	0	0	0	27	5	0	32	61
% 4+ Axle Trucks																					

Start Time	SR-99 Southbound On Ramp Southbound					Avenue 17 Westbound					SR-99 Southbound On Ramp Northbound					Avenue 17 Eastbound					Int. Total
	Left	Thru	Right	U-Turns	App. Total	Left	Thru	Right	U-Turns	App. Total	Left	Thru	Right	U-Turns	App. Total	Left	Thru	Right	U-Turns	App. Total	
Peak Hour Analysis From 07:00 AM to 08:45 AM - Peak 1 of 1																					
Peak Hour for Entire Intersection Begins at 07:15 AM																					
07:15 AM	0	0	0	0	0	0	58	136	0	194	0	0	0	0	0	0	45	20	0	65	259
07:30 AM	0	0	0	0	0	0	45	134	0	179	0	0	0	0	0	0	44	15	0	59	238
07:45 AM	0	0	0	0	0	0	71	117	0	188	0	0	0	0	0	0	53	15	0	68	256
08:00 AM	0	0	0	0	0	0	56	107	0	163	0	0	0	0	0	0	48	25	0	73	236
Total Volume	0	0	0	0	0	0	230	494	0	724	0	0	0	0	0	0	190	75	0	265	989
% App. Total	0	0	0	0	0	0	31.8	68.2	0		0	0	0	0	0	0	71.7	28.3	0		
PHF	.000	.000	.000	.000	.000	.000	.810	.908	.000	.933	.000	.000	.000	.000	.000	.000	.896	.750	.000	.908	.955

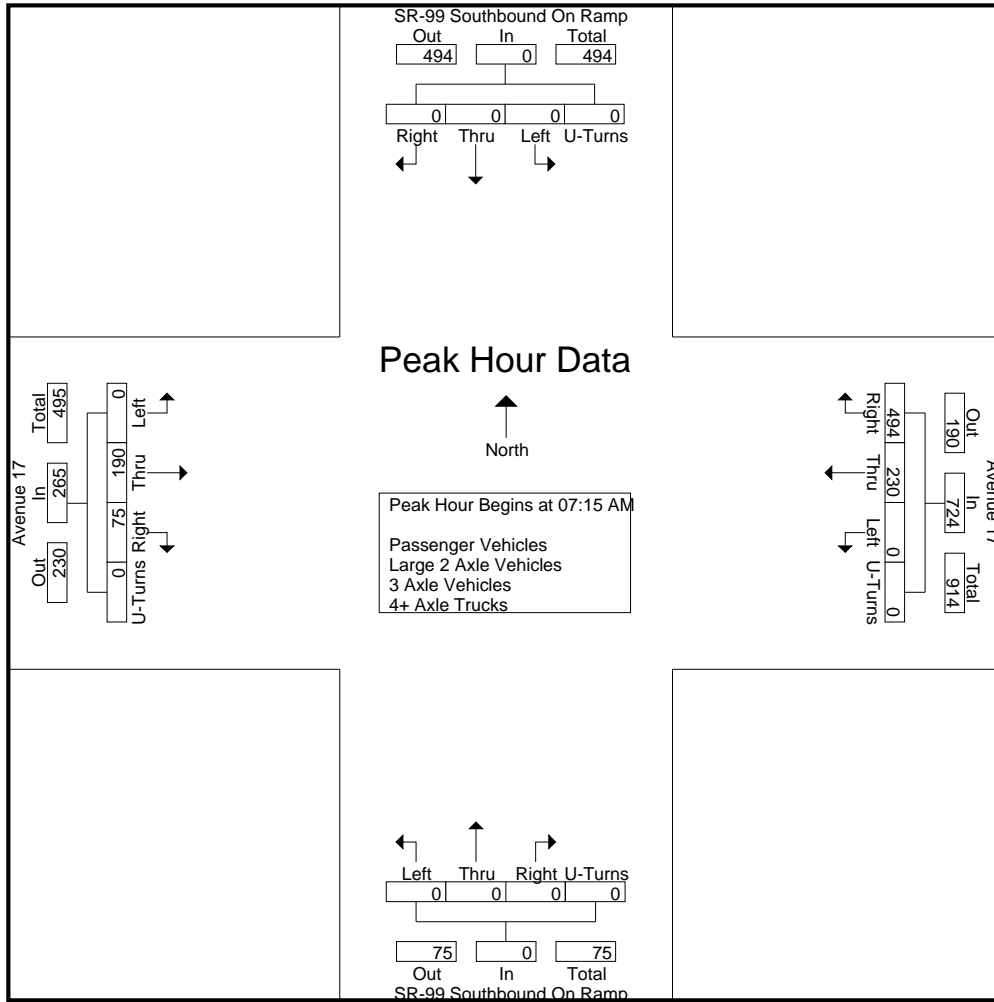

Peak Hour Analysis From 07:00 AM to 08:45 AM - Peak 1 of 1
 Peak Hour for Each Approach Begins at:

	07:00 AM					07:00 AM					07:45 AM									
+0 mins.	0	0	0	0	0	0	43	124	0	167	0	0	0	0	0	0	53	15	0	68
+15 mins.	0	0	0	0	0	0	58	136	0	194	0	0	0	0	0	0	48	25	0	73
+30 mins.	0	0	0	0	0	0	45	134	0	179	0	0	0	0	0	0	58	19	0	77
+45 mins.	0	0	0	0	0	0	71	117	0	188	0	0	0	0	0	0	38	22	0	60
Total Volume	0	0	0	0	0	0	217	511	0	728	0	0	0	0	0	0	197	81	0	278
% App. Total	0	0	0	0	0	0	29.8	70.2	0		0	0	0	0	0	0	70.9	29.1	0	
PHF	.000	.000	.000	.000	.000	.000	.764	.939	.000	.938	.000	.000	.000	.000	.000	.000	.849	.810	.000	.903

City of Madera
 N/S: SR-99 Southbound On Ramps
 E/W: Avenue 17
 Weather: Clear

File Name : 12A_MDA_99S_Ave 17 AM
 Site Code : 00319628
 Start Date : 9/18/2019
 Page No : 1

Groups Printed- Passenger Vehicles

Start Time	SR-99 Southbound On Ramp Southbound					Avenue 17 Westbound					SR-99 Southbound On Ramp Northbound					Avenue 17 Eastbound					Int. Total
	Left	Thru	Right	U-Turns	App. Total	Left	Thru	Right	U-Turns	App. Total	Left	Thru	Right	U-Turns	App. Total	Left	Thru	Right	U-Turns	App. Total	
07:00 AM	0	0	0	0	0	0	38	124	0	162	0	0	0	0	0	0	36	13	0	49	211
07:15 AM	0	0	0	0	0	0	53	130	0	183	0	0	0	0	0	0	42	17	0	59	242
07:30 AM	0	0	0	0	0	0	43	130	0	173	0	0	0	0	0	0	40	11	0	51	224
07:45 AM	0	0	0	0	0	0	64	115	0	179	0	0	0	0	0	0	49	15	0	64	243
Total	0	0	0	0	0	0	198	499	0	697	0	0	0	0	0	0	167	56	0	223	920
08:00 AM	0	0	0	0	0	0	54	99	0	153	0	0	0	0	0	0	39	21	0	60	213
08:15 AM	0	0	0	0	0	0	39	99	0	138	0	0	0	0	0	0	49	16	0	65	203
08:30 AM	0	0	0	0	0	0	31	76	0	107	0	0	0	0	0	0	31	19	0	50	157
08:45 AM	0	0	0	0	0	0	30	65	0	95	0	0	0	0	0	0	30	7	0	37	132
Total	0	0	0	0	0	0	154	339	0	493	0	0	0	0	0	0	149	63	0	212	705
Grand Total	0	0	0	0	0	0	352	838	0	1190	0	0	0	0	0	0	316	119	0	435	1625
Apprch %	0	0	0	0	0	0	29.6	70.4	0		0	0	0	0	0	0	72.6	27.4	0		
Total %	0	0	0	0	0	0	21.7	51.6	0	73.2	0	0	0	0	0	0	19.4	7.3	0	26.8	

Start Time	SR-99 Southbound On Ramp Southbound					Avenue 17 Westbound					SR-99 Southbound On Ramp Northbound					Avenue 17 Eastbound					Int. Total
	Left	Thru	Right	U-Turns	App. Total	Thru	Right	U-Turns	App. Total	Thru	Right	U-Turns	App. Total	Thru	Right	U-Turns	App. Total				
Peak Hour Analysis From 07:15 AM to 08:00 AM - Peak 1 of 1																					
Peak Hour for Entire Intersection Begins at 07:15 AM																					
07:15 AM	0	0	0	0	0	0	53	130	0	183	0	0	0	0	0	0	42	17	0	59	242
07:30 AM	0	0	0	0	0	0	43	130	0	173	0	0	0	0	0	0	40	11	0	51	224
07:45 AM	0	0	0	0	0	0	64	115	0	179	0	0	0	0	0	0	49	15	0	64	243
08:00 AM	0	0	0	0	0	0	54	99	0	153	0	0	0	0	0	0	39	21	0	60	213
Total Volume	0	0	0	0	0	0	214	474	0	688	0	0	0	0	0	0	170	64	0	234	922
% App. Total	0	0	0	0	0	0	31.1	68.9	0		0	0	0	0	0	0	72.6	27.4	0		
PHF	.000	.000	.000	.000	.000	.000	.836	.912	.000	.940	.000	.000	.000	.000	.000	.000	.867	.762	.000	.914	.949

City of Madera
 N/S: SR-99 Southbound On Ramps
 E/W: Avenue 17
 Weather: Clear

File Name : 12A_MDA_99S_Ave 17 AM
 Site Code : 00319628
 Start Date : 9/18/2019
 Page No : 2

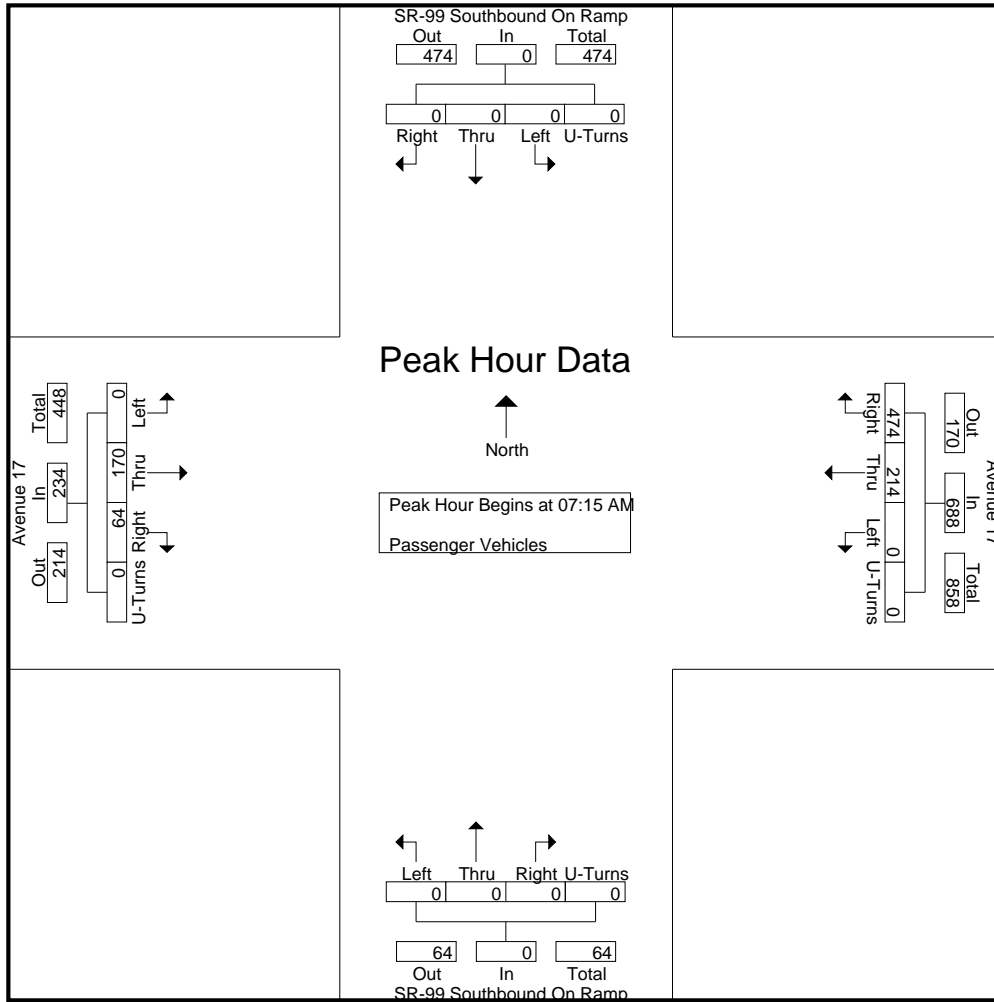

Peak Hour Analysis From 07:15 AM to 08:00 AM - Peak 1 of 1
 Peak Hour for Each Approach Begins at:

	07:15 AM					07:15 AM					07:15 AM									
+0 mins.	0	0	0	0	0	0	53	130	0	183	0	0	0	0	0	0	42	17	0	59
+15 mins.	0	0	0	0	0	0	43	130	0	173	0	0	0	0	0	0	40	11	0	51
+30 mins.	0	0	0	0	0	0	64	115	0	179	0	0	0	0	0	0	49	15	0	64
+45 mins.	0	0	0	0	0	0	54	99	0	153	0	0	0	0	0	0	39	21	0	60
Total Volume	0	0	0	0	0	0	214	474	0	688	0	0	0	0	0	0	170	64	0	234
% App. Total	0	0	0	0	0	0	31.1	68.9	0		0	0	0	0	0	0	72.6	27.4	0	
PHF	.000	.000	.000	.000	.000	.000	.836	.912	.000	.940	.000	.000	.000	.000	.000	.000	.867	.762	.000	.914

City of Madera
 N/S: SR-99 Southbound On Ramps
 E/W: Avenue 17
 Weather: Clear

File Name : 12A_MDA_99S_Ave 17 AM
 Site Code : 00319628
 Start Date : 9/18/2019
 Page No : 1

Groups Printed- Large 2 Axle Vehicles

Start Time	SR-99 Southbound On Ramp Southbound					Avenue 17 Westbound					SR-99 Southbound On Ramp Northbound					Avenue 17 Eastbound					Int. Total
	Left	Thru	Right	U-Turns	App. Total	Left	Thru	Right	U-Turns	App. Total	Left	Thru	Right	U-Turns	App. Total	Left	Thru	Right	U-Turns	App. Total	
07:00 AM	0	0	0	0	0	0	3	0	0	3	0	0	0	0	0	0	3	0	0	3	6
07:15 AM	0	0	0	0	0	0	3	0	0	3	0	0	0	0	0	0	0	2	0	2	5
07:30 AM	0	0	0	0	0	0	1	2	0	3	0	0	0	0	0	0	2	1	0	3	6
07:45 AM	0	0	0	0	0	0	5	1	0	6	0	0	0	0	0	0	2	0	0	2	8
Total	0	0	0	0	0	0	12	3	0	15	0	0	0	0	0	0	7	3	0	10	25
08:00 AM	0	0	0	0	0	0	1	2	0	3	0	0	0	0	0	0	4	2	0	6	9
08:15 AM	0	0	0	0	0	0	0	7	0	7	0	0	0	0	0	0	4	3	0	7	14
08:30 AM	0	0	0	0	0	0	2	2	0	4	0	0	0	0	0	0	1	2	0	3	7
08:45 AM	0	0	0	0	0	0	2	1	0	3	0	0	0	0	0	0	3	2	0	5	8
Total	0	0	0	0	0	0	5	12	0	17	0	0	0	0	0	0	12	9	0	21	38
Grand Total	0	0	0	0	0	0	17	15	0	32	0	0	0	0	0	0	19	12	0	31	63
Apprch %	0	0	0	0	0	0	53.1	46.9	0		0	0	0	0	0	0	61.3	38.7	0		
Total %	0	0	0	0	0	0	27	23.8	0	50.8	0	0	0	0	0	0	30.2	19	0	49.2	

Start Time	SR-99 Southbound On Ramp Southbound					Avenue 17 Westbound					SR-99 Southbound On Ramp Northbound					Avenue 17 Eastbound					Int. Total
	Left	Thru	Right	U-Turns	App. Total	Thru	Right	U-Turns	App. Total	Thru	Right	U-Turns	App. Total	Thru	Right	U-Turns	App. Total				
Peak Hour Analysis From 07:15 AM to 08:00 AM - Peak 1 of 1																					
Peak Hour for Entire Intersection Begins at 07:15 AM																					
07:15 AM	0	0	0	0	0	0	3	0	0	3	0	0	0	0	0	0	0	2	0	2	5
07:30 AM	0	0	0	0	0	0	1	2	0	3	0	0	0	0	0	0	2	1	0	3	6
07:45 AM	0	0	0	0	0	0	5	1	0	6	0	0	0	0	0	0	2	0	0	2	8
08:00 AM	0	0	0	0	0	0	1	2	0	3	0	0	0	0	0	0	4	2	0	6	9
Total Volume	0	0	0	0	0	0	10	5	0	15	0	0	0	0	0	0	8	5	0	13	28
% App. Total	0	0	0	0	0	0	66.7	33.3	0		0	0	0	0	0	0	61.5	38.5	0		
PHF	.000	.000	.000	.000	.000	.000	.500	.625	.000	.625	.000	.000	.000	.000	.000	.000	.500	.625	.000	.542	.778

City of Madera
 N/S: SR-99 Southbound On Ramps
 E/W: Avenue 17
 Weather: Clear

File Name : 12A_MDA_99S_Ave 17 AM
 Site Code : 00319628
 Start Date : 9/18/2019
 Page No : 2

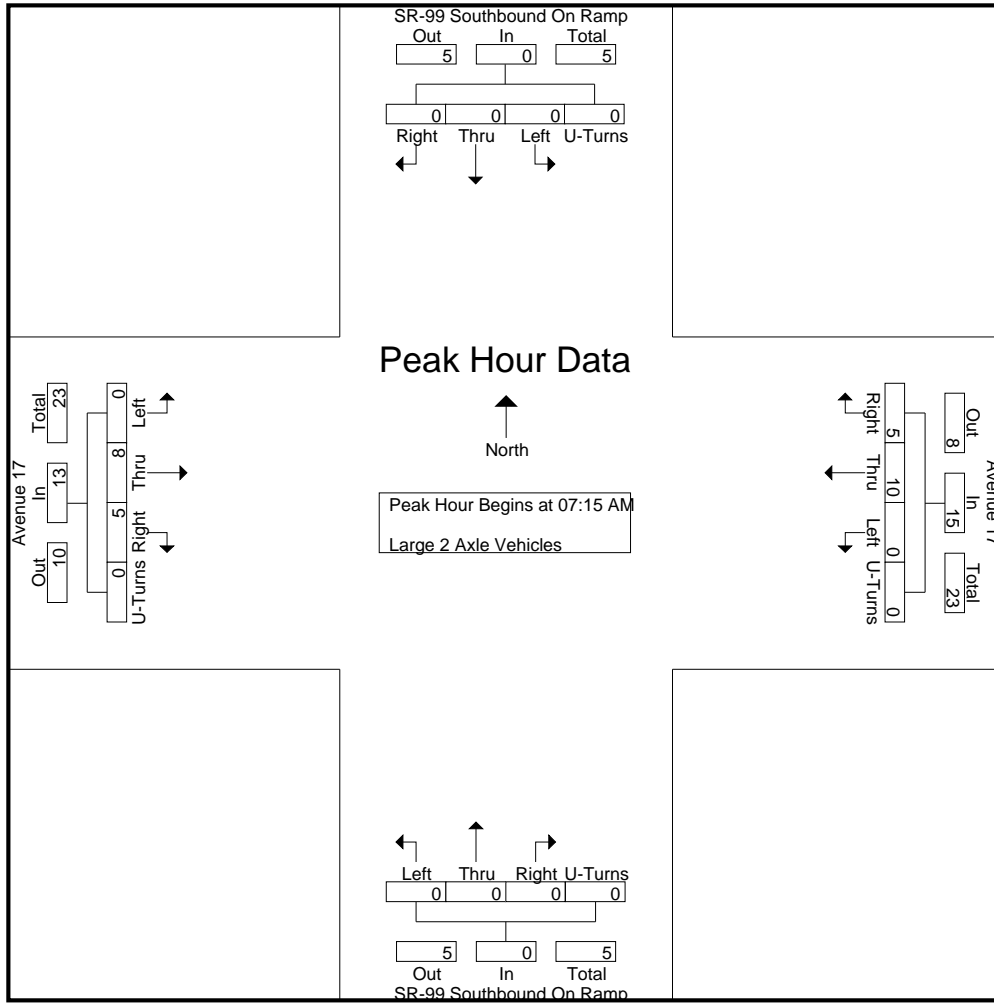

Peak Hour Analysis From 07:15 AM to 08:00 AM - Peak 1 of 1
 Peak Hour for Each Approach Begins at:

	07:15 AM					07:15 AM					07:15 AM									
+0 mins.	0	0	0	0	0	0	3	0	0	3	0	0	0	0	0	0	0	2	0	2
+15 mins.	0	0	0	0	0	0	1	2	0	3	0	0	0	0	0	0	2	1	0	3
+30 mins.	0	0	0	0	0	0	5	1	0	6	0	0	0	0	0	0	2	0	0	2
+45 mins.	0	0	0	0	0	0	1	2	0	3	0	0	0	0	0	0	4	2	0	6
Total Volume	0	0	0	0	0	0	10	5	0	15	0	0	0	0	0	0	8	5	0	13
% App. Total	0	0	0	0	0	0	66.7	33.3	0		0	0	0	0	0	0	61.5	38.5	0	
PHF	.000	.000	.000	.000	.000	.000	.500	.625	.000	.625	.000	.000	.000	.000	.000	.000	.500	.625	.000	.542

City of Madera
 N/S: SR-99 Southbound On Ramps
 E/W: Avenue 17
 Weather: Clear

File Name : 12A_MDA_99S_Ave 17 AM
 Site Code : 00319628
 Start Date : 9/18/2019
 Page No : 1

Groups Printed- 3 Axle Vehicles

Start Time	SR-99 Southbound On Ramp Southbound					Avenue 17 Westbound					SR-99 Southbound On Ramp Northbound					Avenue 17 Eastbound					Int. Total
	Left	Thru	Right	U-Turns	App. Total	Left	Thru	Right	U-Turns	App. Total	Left	Thru	Right	U-Turns	App. Total	Left	Thru	Right	U-Turns	App. Total	
07:00 AM	0	0	0	0	0	0	0	0	0	0	0	0	0	0	0	0	2	0	0	2	2
07:15 AM	0	0	0	0	0	0	0	0	0	0	0	0	0	0	0	0	0	1	0	1	1
07:30 AM	0	0	0	0	0	0	0	0	0	0	0	0	0	0	0	0	0	1	0	1	1
07:45 AM	0	0	0	0	0	0	0	0	0	0	0	0	0	0	0	0	0	0	0	0	0
Total	0	0	0	0	0	0	0	0	0	0	0	0	0	0	0	0	2	2	0	4	4
08:00 AM	0	0	0	0	0	0	0	0	0	0	0	0	0	0	0	0	2	0	0	2	2
08:15 AM	0	0	0	0	0	0	0	0	0	0	0	0	0	0	0	0	0	0	0	0	0
08:30 AM	0	0	0	0	0	0	0	0	0	0	0	0	0	0	0	0	0	1	0	1	1
08:45 AM	0	0	0	0	0	0	0	0	0	0	0	0	0	0	0	0	0	1	0	1	1
Total	0	0	0	0	0	0	0	0	0	0	0	0	0	0	0	0	2	2	0	4	4
Grand Total	0	0	0	0	0	0	0	0	0	0	0	0	0	0	0	0	4	4	0	8	8
Apprch %	0	0	0	0		0	0	0	0		0	0	0	0		0	50	50	0		
Total %	0	0	0	0		0	0	0	0		0	0	0	0		0	50	50	0	100	

Start Time	SR-99 Southbound On Ramp Southbound					Avenue 17 Westbound					SR-99 Southbound On Ramp Northbound					Avenue 17 Eastbound					Int. Total
	Left	Thru	Right	U-Turns	App. Total	Left	Thru	Right	U-Turns	App. Total	Left	Thru	Right	U-Turns	App. Total	Left	Thru	Right	U-Turns	App. Total	
Peak Hour Analysis From 07:15 AM to 08:00 AM - Peak 1 of 1																					
Peak Hour for Entire Intersection Begins at 07:15 AM																					
07:15 AM	0	0	0	0	0	0	0	0	0	0	0	0	0	0	0	0	0	1	0	1	1
07:30 AM	0	0	0	0	0	0	0	0	0	0	0	0	0	0	0	0	0	1	0	1	1
07:45 AM	0	0	0	0	0	0	0	0	0	0	0	0	0	0	0	0	0	0	0	0	0
08:00 AM	0	0	0	0	0	0	0	0	0	0	0	0	0	0	0	0	2	0	0	2	2
Total Volume	0	0	0	0	0	0	0	0	0	0	0	0	0	0	0	0	2	2	0	4	4
% App. Total	0	0	0	0		0	0	0	0		0	0	0	0		0	50	50	0		
PHF	.000	.000	.000	.000	.000	.000	.000	.000	.000	.000	.000	.000	.000	.000	.000	.000	.250	.500	.000	.500	.500

City of Madera
 N/S: SR-99 Southbound On Ramps
 E/W: Avenue 17
 Weather: Clear

File Name : 12A_MDA_99S_Ave 17 AM
 Site Code : 00319628
 Start Date : 9/18/2019
 Page No : 2

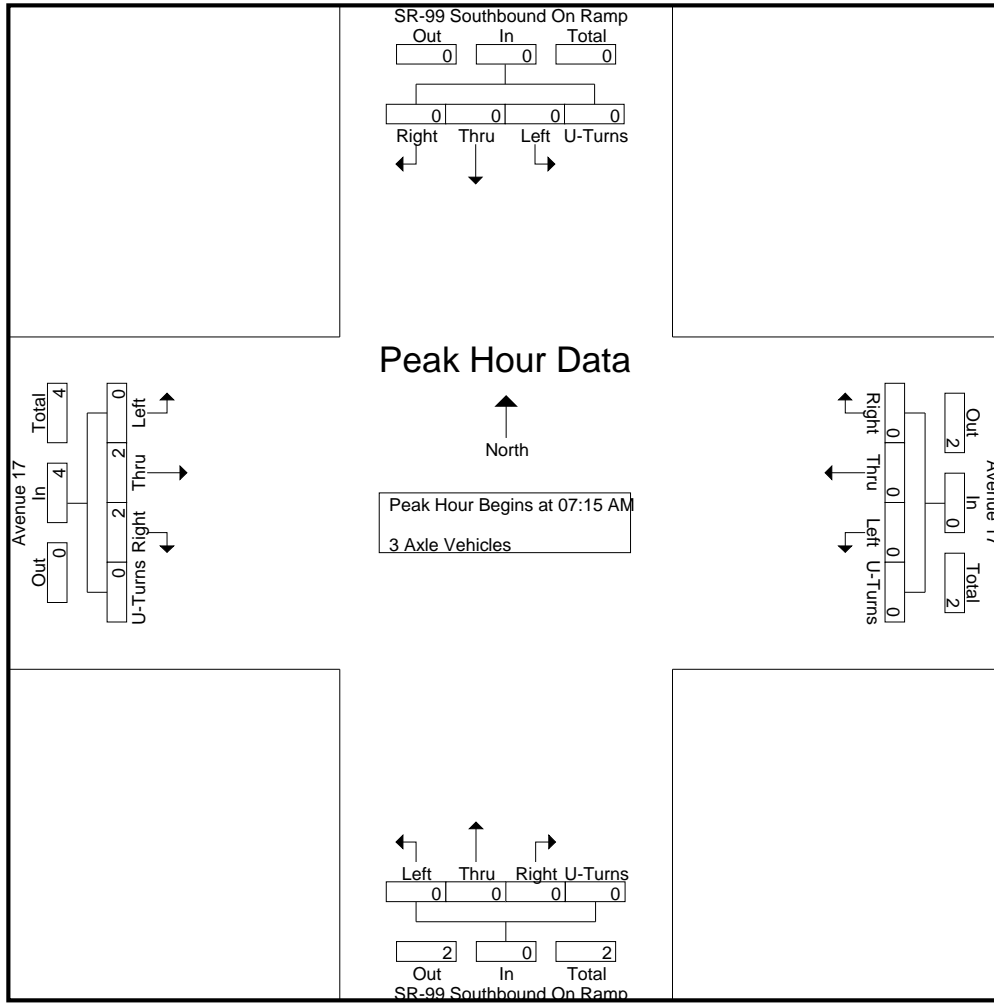

Peak Hour Analysis From 07:15 AM to 08:00 AM - Peak 1 of 1
 Peak Hour for Each Approach Begins at:

	07:15 AM					07:15 AM					07:15 AM									
+0 mins.	0	0	0	0	0	0	0	0	0	0	0	0	0	0	0	0	0	1	0	1
+15 mins.	0	0	0	0	0	0	0	0	0	0	0	0	0	0	0	0	0	1	0	1
+30 mins.	0	0	0	0	0	0	0	0	0	0	0	0	0	0	0	0	0	0	0	0
+45 mins.	0	0	0	0	0	0	0	0	0	0	0	0	0	0	0	0	2	0	0	2
Total Volume	0	0	0	0	0	0	0	0	0	0	0	0	0	0	0	0	2	2	0	4
% App. Total	0	0	0	0	0	0	0	0	0	0	0	0	0	0	0	0	50	50	0	0
PHF	.000	.000	.000	.000	.000	.000	.000	.000	.000	.000	.000	.000	.000	.000	.000	.000	.250	.500	.000	.500

City of Madera
 N/S: SR-99 Southbound On Ramps
 E/W: Avenue 17
 Weather: Clear

File Name : 12A_MDA_99S_Ave 17 AM
 Site Code : 00319628
 Start Date : 9/18/2019
 Page No : 1

Groups Printed- 4+ Axle Trucks

Start Time	SR-99 Southbound On Ramp Southbound					Avenue 17 Westbound					SR-99 Southbound On Ramp Northbound					Avenue 17 Eastbound					Int. Total
	Left	Thru	Right	U-Turns	App. Total	Left	Thru	Right	U-Turns	App. Total	Left	Thru	Right	U-Turns	App. Total	Left	Thru	Right	U-Turns	App. Total	
07:00 AM	0	0	0	0	0	0	2	0	0	2	0	0	0	0	0	0	4	1	0	5	7
07:15 AM	0	0	0	0	0	0	2	6	0	8	0	0	0	0	0	0	3	0	0	3	11
07:30 AM	0	0	0	0	0	0	1	2	0	3	0	0	0	0	0	0	2	2	0	4	7
07:45 AM	0	0	0	0	0	0	2	1	0	3	0	0	0	0	0	0	2	0	0	2	5
Total	0	0	0	0	0	0	7	9	0	16	0	0	0	0	0	0	11	3	0	14	30
08:00 AM	0	0	0	0	0	0	1	6	0	7	0	0	0	0	0	0	3	2	0	5	12
08:15 AM	0	0	0	0	0	0	1	1	0	2	0	0	0	0	0	0	5	0	0	5	7
08:30 AM	0	0	0	0	0	0	0	3	0	3	0	0	0	0	0	0	6	0	0	6	9
08:45 AM	0	0	0	0	0	0	1	0	0	1	0	0	0	0	0	0	2	0	0	2	3
Total	0	0	0	0	0	0	3	10	0	13	0	0	0	0	0	0	16	2	0	18	31
Grand Total	0	0	0	0	0	0	10	19	0	29	0	0	0	0	0	0	27	5	0	32	61
Apprch %	0	0	0	0	0	0	34.5	65.5	0		0	0	0	0	0	0	84.4	15.6	0		
Total %	0	0	0	0	0	0	16.4	31.1	0	47.5	0	0	0	0	0	0	44.3	8.2	0	52.5	

Start Time	SR-99 Southbound On Ramp Southbound					Avenue 17 Westbound					SR-99 Southbound On Ramp Northbound					Avenue 17 Eastbound					Int. Total
	Left	Thru	Right	U-Turns	App. Total	Thru	Right	U-Turns	App. Total	Thru	Right	U-Turns	App. Total	Thru	Right	U-Turns	App. Total				
Peak Hour Analysis From 07:15 AM to 08:00 AM - Peak 1 of 1																					
Peak Hour for Entire Intersection Begins at 07:15 AM																					
07:15 AM	0	0	0	0	0	0	2	6	0	8	0	0	0	0	0	0	3	0	0	3	11
07:30 AM	0	0	0	0	0	0	1	2	0	3	0	0	0	0	0	0	2	2	0	4	7
07:45 AM	0	0	0	0	0	0	2	1	0	3	0	0	0	0	0	0	2	0	0	2	5
08:00 AM	0	0	0	0	0	0	1	6	0	7	0	0	0	0	0	0	3	2	0	5	12
Total Volume	0	0	0	0	0	0	6	15	0	21	0	0	0	0	0	0	10	4	0	14	35
% App. Total	0	0	0	0	0	0	28.6	71.4	0		0	0	0	0	0	0	71.4	28.6	0		
PHF	.000	.000	.000	.000	.000	.000	.750	.625	.000	.656	.000	.000	.000	.000	.000	.000	.833	.500	.000	.700	.729

City of Madera
 N/S: SR-99 Southbound On Ramps
 E/W: Avenue 17
 Weather: Clear

File Name : 12A_MDA_99S_Ave 17 AM
 Site Code : 00319628
 Start Date : 9/18/2019
 Page No : 2

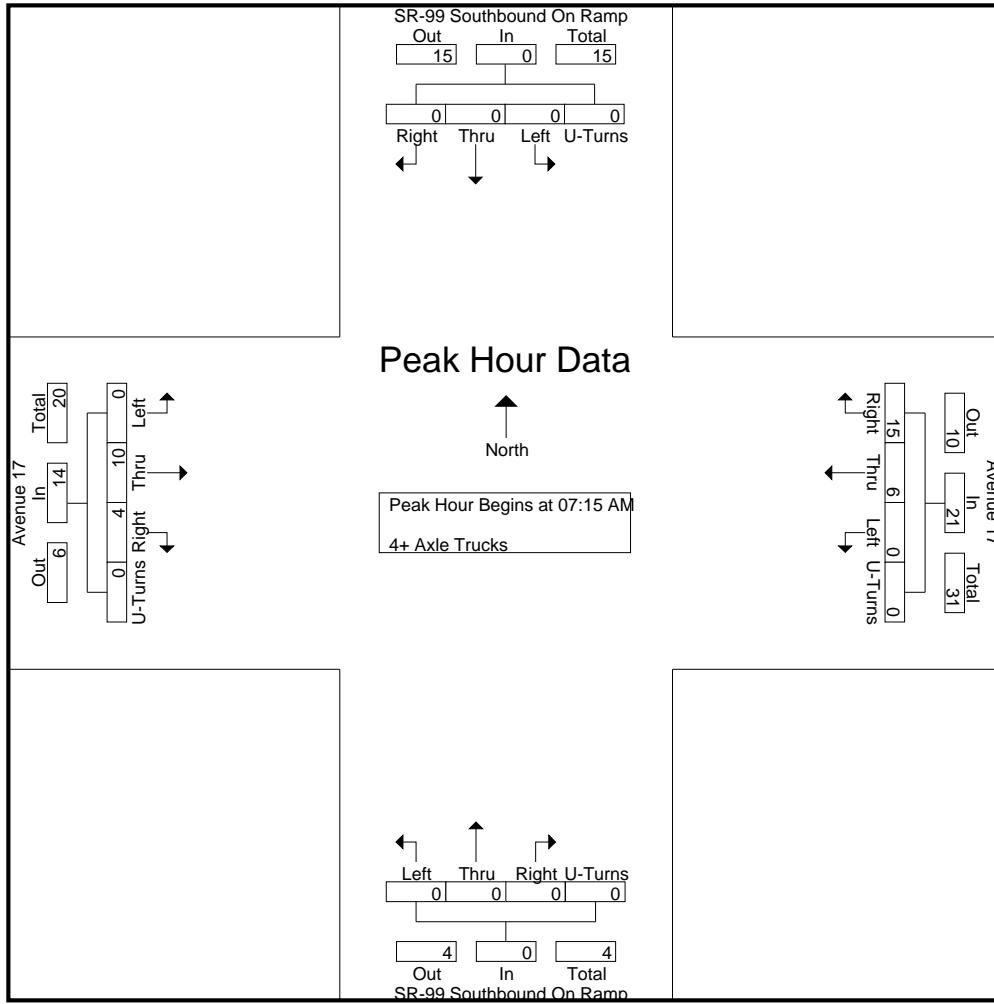

Peak Hour Analysis From 07:15 AM to 08:00 AM - Peak 1 of 1
 Peak Hour for Each Approach Begins at:

	07:15 AM					07:15 AM					07:15 AM									
+0 mins.	0	0	0	0	0	0	2	6	0	8	0	0	0	0	0	0	3	0	0	3
+15 mins.	0	0	0	0	0	0	1	2	0	3	0	0	0	0	0	0	2	2	0	4
+30 mins.	0	0	0	0	0	0	2	1	0	3	0	0	0	0	0	0	2	0	0	2
+45 mins.	0	0	0	0	0	0	1	6	0	7	0	0	0	0	0	0	3	2	0	5
Total Volume	0	0	0	0	0	0	6	15	0	21	0	0	0	0	0	0	10	4	0	14
% App. Total	0	0	0	0	0	0	28.6	71.4	0	0	0	0	0	0	0	0	71.4	28.6	0	0
PHF	.000	.000	.000	.000	.000	.000	.750	.625	.000	.656	.000	.000	.000	.000	.000	.000	.833	.500	.000	.700

City of Madera
 N/S: SR-99 Southbound On Ramps
 E/W: Avenue 17
 Weather: Clear

File Name : 12A_MDA_99S_Ave 17 PM
 Site Code : 00319628
 Start Date : 9/18/2019
 Page No : 1

Groups Printed- Passenger Vehicles - Large 2 Axle Vehicles - 3 Axle Vehicles - 4+ Axle Trucks

Start Time	SR-99 Southbound On Ramp Southbound					Avenue 17 Westbound					SR-99 Southbound On Ramp Northbound					Avenue 17 Eastbound					Int. Total
	Left	Thru	Right	U-Turns	App. Total	Left	Thru	Right	U-Turns	App. Total	Left	Thru	Right	U-Turns	App. Total	Left	Thru	Right	U-Turns	App. Total	
04:00 PM	0	0	0	0	0	0	44	53	0	97	0	0	0	0	0	0	109	50	0	159	256
04:15 PM	0	0	0	0	0	0	44	46	0	90	0	0	0	0	0	0	112	33	0	145	235
04:30 PM	0	0	0	0	0	0	33	36	0	69	0	0	0	0	0	0	118	39	0	157	226
04:45 PM	0	0	0	0	0	0	36	38	0	74	0	0	0	0	0	0	122	25	0	147	221
Total	0	0	0	0	0	0	157	173	0	330	0	0	0	0	0	0	461	147	0	608	938
05:00 PM	0	0	0	0	0	0	54	57	0	111	0	0	0	0	0	0	95	36	0	131	242
05:15 PM	0	0	0	0	0	0	47	46	0	93	0	0	0	0	0	0	87	15	0	102	195
05:30 PM	0	0	0	0	0	0	43	56	0	99	0	0	0	0	0	0	68	13	0	81	180
05:45 PM	0	0	0	0	0	0	46	48	0	94	0	0	0	0	0	0	47	29	0	76	170
Total	0	0	0	0	0	0	190	207	0	397	0	0	0	0	0	0	297	93	0	390	787
Grand Total	0	0	0	0	0	0	347	380	0	727	0	0	0	0	0	0	758	240	0	998	1725
Apprch %	0	0	0	0	0	0	47.7	52.3	0	0	0	0	0	0	0	0	76	24	0	0	0
Total %	0	0	0	0	0	0	20.1	22	0	42.1	0	0	0	0	0	0	43.9	13.9	0	57.9	0
Passenger Vehicles	0	0	0	0	0	0	95.1	96.1	0	95.6	0	0	0	0	0	0	95.1	97.5	0	95.7	95.7
Large 2 Axle Vehicles	0	0	0	0	0	0	1.7	2.9	0	2.3	0	0	0	0	0	0	1.6	0.4	0	1.3	1.7
3 Axle Vehicles	0	0	0	0	0	0	3	1	0	4	0	0	0	0	0	0	6	0	0	6	10
% 3 Axle Vehicles	0	0	0	0	0	0	0.9	0.3	0	0.6	0	0	0	0	0	0	0.8	0	0	0.6	0.6
4+ Axle Trucks	0	0	0	0	0	0	8	3	0	11	0	0	0	0	0	0	19	5	0	24	35
% 4+ Axle Trucks																					

Start Time	SR-99 Southbound On Ramp Southbound					Avenue 17 Westbound					SR-99 Southbound On Ramp Northbound					Avenue 17 Eastbound					Int. Total
	Left	Thru	Right	U-Turns	App. Total	Left	Thru	Right	U-Turns	App. Total	Left	Thru	Right	U-Turns	App. Total	Left	Thru	Right	U-Turns	App. Total	
Peak Hour Analysis From 04:00 PM to 05:45 PM - Peak 1 of 1																					
Peak Hour for Entire Intersection Begins at 04:00 PM																					
04:00 PM	0	0	0	0	0	0	44	53	0	97	0	0	0	0	0	0	109	50	0	159	256
04:15 PM	0	0	0	0	0	0	44	46	0	90	0	0	0	0	0	0	112	33	0	145	235
04:30 PM	0	0	0	0	0	0	33	36	0	69	0	0	0	0	0	0	118	39	0	157	226
04:45 PM	0	0	0	0	0	0	36	38	0	74	0	0	0	0	0	0	122	25	0	147	221
Total Volume	0	0	0	0	0	0	157	173	0	330	0	0	0	0	0	0	461	147	0	608	938
% App. Total	0	0	0	0	0	0	47.6	52.4	0	0	0	0	0	0	0	0	75.8	24.2	0	0	0
PHF	.000	.000	.000	.000	.000	.000	.892	.816	.000	.851	.000	.000	.000	.000	.000	.000	.945	.735	.000	.956	.916

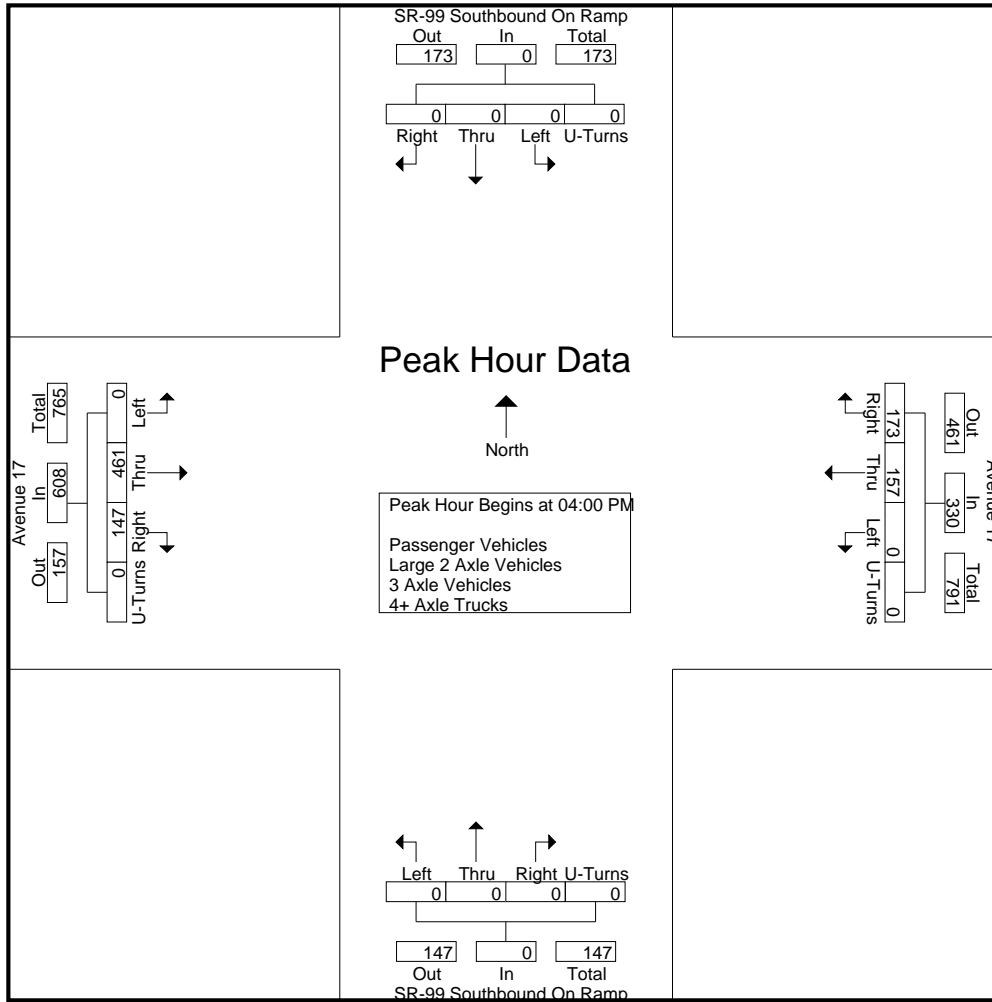

Peak Hour Analysis From 04:00 PM to 05:45 PM - Peak 1 of 1
 Peak Hour for Each Approach Begins at:

	04:00 PM					05:00 PM					04:00 PM					04:00 PM				
+0 mins.	0	0	0	0	0	0	54	57	0	111	0	0	0	0	0	0	109	50	0	159
+15 mins.	0	0	0	0	0	0	47	46	0	93	0	0	0	0	0	0	112	33	0	145
+30 mins.	0	0	0	0	0	0	43	56	0	99	0	0	0	0	0	0	118	39	0	157
+45 mins.	0	0	0	0	0	0	46	48	0	94	0	0	0	0	0	0	122	25	0	147
Total Volume	0	0	0	0	0	0	190	207	0	397	0	0	0	0	0	0	461	147	0	608
% App. Total	0	0	0	0	0	0	47.9	52.1	0	0	0	0	0	0	0	0	75.8	24.2	0	0
PHF	.000	.000	.000	.000	.000	.000	.880	.908	.000	.894	.000	.000	.000	.000	.000	.000	.945	.735	.000	.956

City of Madera
 N/S: SR-99 Southbound On Ramps
 E/W: Avenue 17
 Weather: Clear

File Name : 12A_MDA_99S_Ave 17 PM
 Site Code : 00319628
 Start Date : 9/18/2019
 Page No : 1

Groups Printed- Passenger Vehicles

Start Time	SR-99 Southbound On Ramp Southbound					Avenue 17 Westbound					SR-99 Southbound On Ramp Northbound					Avenue 17 Eastbound					Int. Total
	Left	Thru	Right	U-Turns	App. Total	Left	Thru	Right	U-Turns	App. Total	Left	Thru	Right	U-Turns	App. Total	Left	Thru	Right	U-Turns	App. Total	
04:00 PM	0	0	0	0	0	0	42	46	0	88	0	0	0	0	0	0	109	49	0	158	246
04:15 PM	0	0	0	0	0	0	41	45	0	86	0	0	0	0	0	0	108	31	0	139	225
04:30 PM	0	0	0	0	0	0	31	33	0	64	0	0	0	0	0	0	112	38	0	150	214
04:45 PM	0	0	0	0	0	0	34	38	0	72	0	0	0	0	0	0	120	24	0	144	216
Total	0	0	0	0	0	0	148	162	0	310	0	0	0	0	0	0	449	142	0	591	901
05:00 PM	0	0	0	0	0	0	51	56	0	107	0	0	0	0	0	0	92	36	0	128	235
05:15 PM	0	0	0	0	0	0	45	44	0	89	0	0	0	0	0	0	78	14	0	92	181
05:30 PM	0	0	0	0	0	0	42	55	0	97	0	0	0	0	0	0	61	13	0	74	171
05:45 PM	0	0	0	0	0	0	44	48	0	92	0	0	0	0	0	0	41	29	0	70	162
Total	0	0	0	0	0	0	182	203	0	385	0	0	0	0	0	0	272	92	0	364	749
Grand Total	0	0	0	0	0	0	330	365	0	695	0	0	0	0	0	0	721	234	0	955	1650
Apprch %	0	0	0	0	0	0	47.5	52.5	0		0	0	0	0	0	0	75.5	24.5	0		
Total %	0	0	0	0	0	0	20	22.1	0	42.1	0	0	0	0	0	0	43.7	14.2	0	57.9	

Start Time	SR-99 Southbound On Ramp Southbound					Avenue 17 Westbound					SR-99 Southbound On Ramp Northbound					Avenue 17 Eastbound					Int. Total
	Left	Thru	Right	U-Turns	App. Total	Thru	Right	U-Turns	App. Total	Thru	Right	U-Turns	App. Total	Thru	Right	U-Turns	App. Total				
Peak Hour Analysis From 04:00 PM to 04:45 PM - Peak 1 of 1																					
Peak Hour for Entire Intersection Begins at 04:00 PM																					
04:00 PM	0	0	0	0	0	0	42	46	0	88	0	0	0	0	0	0	109	49	0	158	246
04:15 PM	0	0	0	0	0	0	41	45	0	86	0	0	0	0	0	0	108	31	0	139	225
04:30 PM	0	0	0	0	0	0	31	33	0	64	0	0	0	0	0	0	112	38	0	150	214
04:45 PM	0	0	0	0	0	0	34	38	0	72	0	0	0	0	0	0	120	24	0	144	216
Total Volume	0	0	0	0	0	0	148	162	0	310	0	0	0	0	0	0	449	142	0	591	901
% App. Total	0	0	0	0	0	0	47.7	52.3	0		0	0	0	0	0	0	76	24	0		
PHF	.000	.000	.000	.000	.000	.000	.881	.880	.000	.881	.000	.000	.000	.000	.000	.000	.935	.724	.000	.935	.916

City of Madera
 N/S: SR-99 Southbound On Ramps
 E/W: Avenue 17
 Weather: Clear

File Name : 12A_MDA_99S_Ave 17 PM
 Site Code : 00319628
 Start Date : 9/18/2019
 Page No : 2

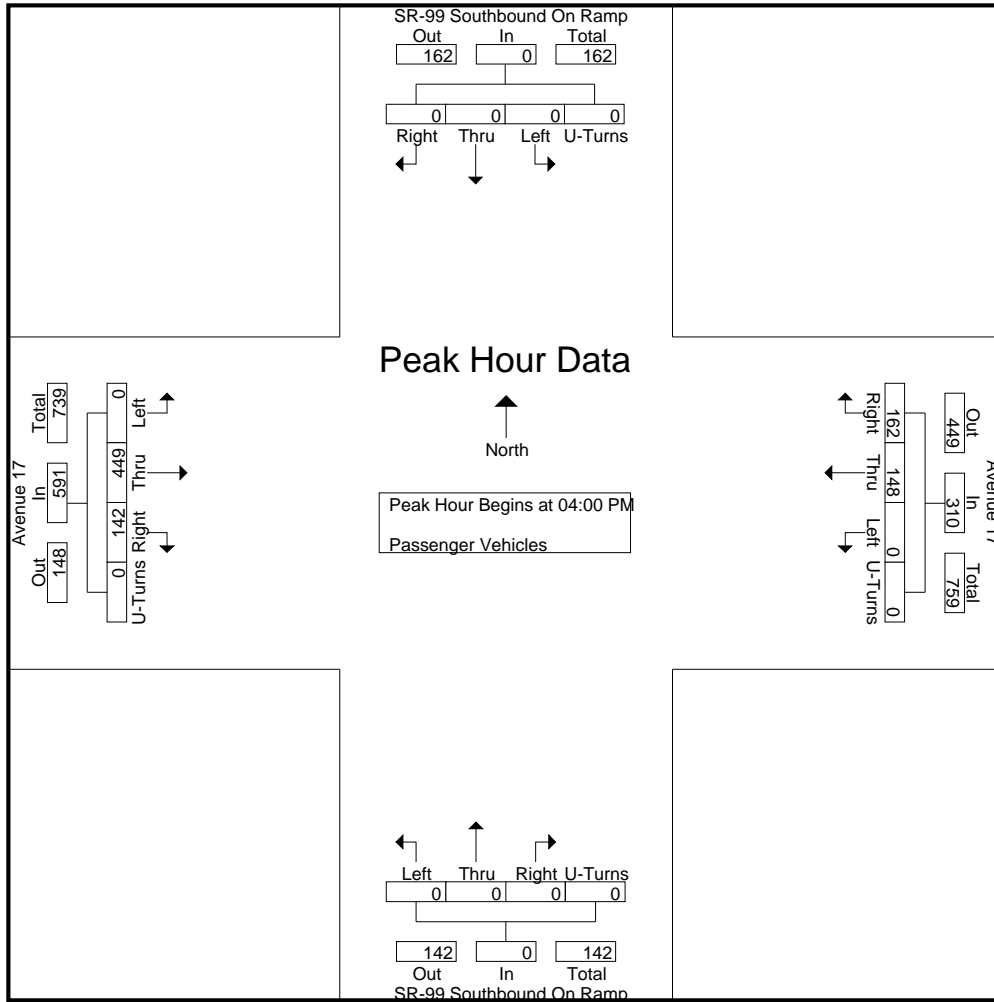

Peak Hour Analysis From 04:00 PM to 04:45 PM - Peak 1 of 1
 Peak Hour for Each Approach Begins at:

	04:00 PM					04:00 PM					04:00 PM									
+0 mins.	0	0	0	0	0	0	42	46	0	88	0	0	0	0	0	0	109	49	0	158
+15 mins.	0	0	0	0	0	0	41	45	0	86	0	0	0	0	0	0	108	31	0	139
+30 mins.	0	0	0	0	0	0	31	33	0	64	0	0	0	0	0	0	112	38	0	150
+45 mins.	0	0	0	0	0	0	34	38	0	72	0	0	0	0	0	0	120	24	0	144
Total Volume	0	0	0	0	0	0	148	162	0	310	0	0	0	0	0	0	449	142	0	591
% App. Total	0	0	0	0	0	0	47.7	52.3	0		0	0	0	0	0	0	76	24	0	
PHF	.000	.000	.000	.000	.000	.000	.881	.880	.000	.881	.000	.000	.000	.000	.000	.000	.935	.724	.000	.935

City of Madera
 N/S: SR-99 Southbound On Ramps
 E/W: Avenue 17
 Weather: Clear

File Name : 12A_MDA_99S_Ave 17 PM
 Site Code : 00319628
 Start Date : 9/18/2019
 Page No : 1

Groups Printed- Large 2 Axle Vehicles

Start Time	SR-99 Southbound On Ramp Southbound					Avenue 17 Westbound					SR-99 Southbound On Ramp Northbound					Avenue 17 Eastbound					Int. Total
	Left	Thru	Right	U-Turns	App. Total	Left	Thru	Right	U-Turns	App. Total	Left	Thru	Right	U-Turns	App. Total	Left	Thru	Right	U-Turns	App. Total	
04:00 PM	0	0	0	0	0	0	0	6	0	6	0	0	0	0	0	0	0	0	0	0	6
04:15 PM	0	0	0	0	0	0	2	1	0	3	0	0	0	0	0	0	1	0	0	0	4
04:30 PM	0	0	0	0	0	0	1	3	0	4	0	0	0	0	0	0	2	1	0	3	7
04:45 PM	0	0	0	0	0	0	1	0	0	1	0	0	0	0	0	0	0	0	0	0	1
Total	0	0	0	0	0	0	4	10	0	14	0	0	0	0	0	0	3	1	0	4	18
05:00 PM	0	0	0	0	0	0	1	0	0	1	0	0	0	0	0	0	2	0	0	2	3
05:15 PM	0	0	0	0	0	0	0	0	0	0	0	0	0	0	0	0	4	0	0	4	4
05:30 PM	0	0	0	0	0	0	0	1	0	1	0	0	0	0	0	0	2	0	0	2	3
05:45 PM	0	0	0	0	0	0	1	0	0	1	0	0	0	0	0	0	1	0	0	1	2
Total	0	0	0	0	0	0	2	1	0	3	0	0	0	0	0	0	9	0	0	9	12
Grand Total	0	0	0	0	0	0	6	11	0	17	0	0	0	0	0	0	12	1	0	13	30
Apprch %	0	0	0	0		0	35.3	64.7	0		0	0	0	0		0	92.3	7.7	0		
Total %	0	0	0	0		0	20	36.7	0	56.7	0	0	0	0		0	40	3.3	0	43.3	

Start Time	SR-99 Southbound On Ramp Southbound					Avenue 17 Westbound					SR-99 Southbound On Ramp Northbound					Avenue 17 Eastbound					Int. Total
	Left	Thru	Right	U-Turns	App. Total	Thru	Right	U-Turns	App. Total	Thru	Right	U-Turns	App. Total	Thru	Right	U-Turns	App. Total				
Peak Hour Analysis From 04:00 PM to 04:45 PM - Peak 1 of 1																					
Peak Hour for Entire Intersection Begins at 04:00 PM																					
04:00 PM	0	0	0	0	0	0	0	6	0	6	0	0	0	0	0	0	0	0	0	0	6
04:15 PM	0	0	0	0	0	0	2	1	0	3	0	0	0	0	0	0	1	0	0	1	4
04:30 PM	0	0	0	0	0	0	1	3	0	4	0	0	0	0	0	0	2	1	0	3	7
04:45 PM	0	0	0	0	0	0	1	0	0	1	0	0	0	0	0	0	0	0	0	0	1
Total Volume	0	0	0	0	0	0	4	10	0	14	0	0	0	0	0	0	3	1	0	4	18
% App. Total	0	0	0	0		0	28.6	71.4	0		0	0	0	0		0	75	25	0		
PHF	.000	.000	.000	.000	.000	.000	.500	.417	.000	.583	.000	.000	.000	.000	.000	.000	.375	.250	.000	.333	.643

City of Madera
 N/S: SR-99 Southbound On Ramps
 E/W: Avenue 17
 Weather: Clear

File Name : 12A_MDA_99S_Ave 17 PM
 Site Code : 00319628
 Start Date : 9/18/2019
 Page No : 2

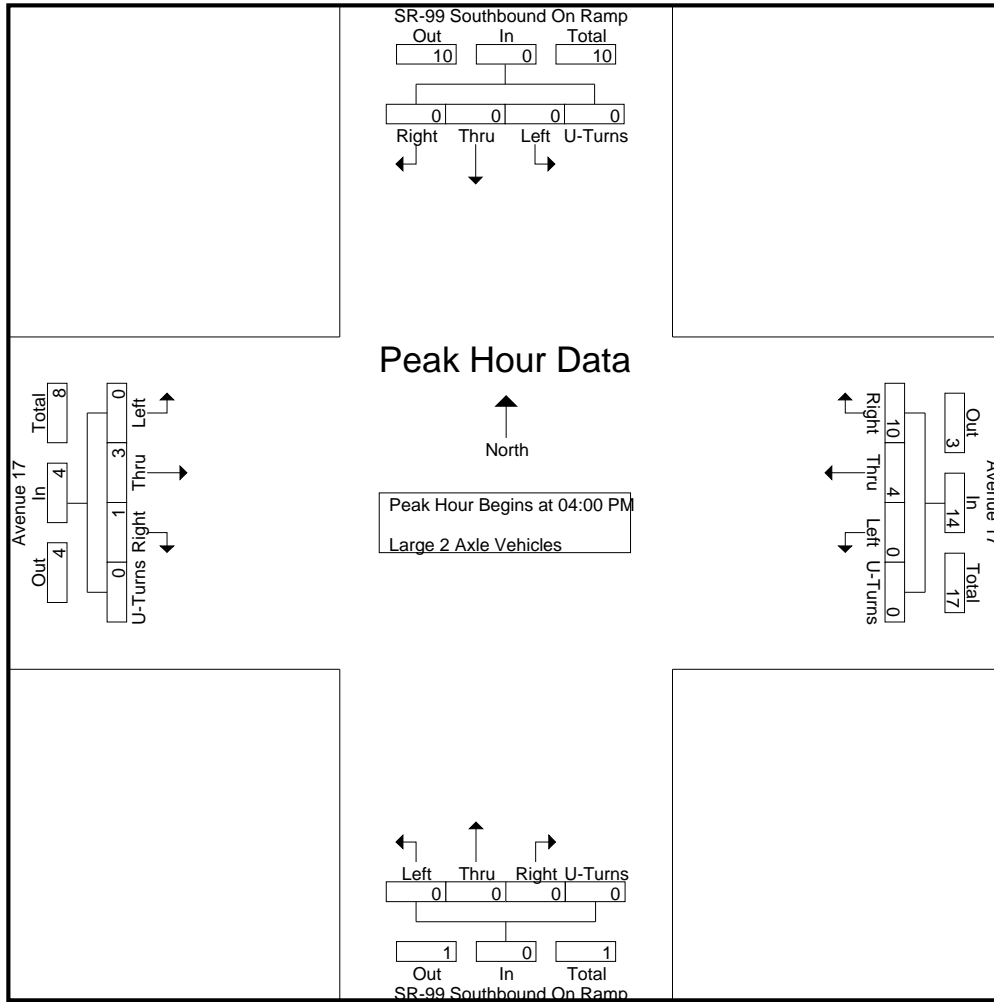

Peak Hour Analysis From 04:00 PM to 04:45 PM - Peak 1 of 1
 Peak Hour for Each Approach Begins at:

	04:00 PM					04:00 PM					04:00 PM					04:00 PM				
+0 mins.	0	0	0	0	0	0	0	6	0	6	0	0	0	0	0	0	0	0	0	0
+15 mins.	0	0	0	0	0	0	2	1	0	3	0	0	0	0	0	0	1	0	0	1
+30 mins.	0	0	0	0	0	0	1	3	0	4	0	0	0	0	0	0	2	1	0	3
+45 mins.	0	0	0	0	0	0	1	0	0	1	0	0	0	0	0	0	0	0	0	0
Total Volume	0	0	0	0	0	0	4	10	0	14	0	0	0	0	0	0	3	1	0	4
% App. Total	0	0	0	0	0	0	28.6	71.4	0	0	0	0	0	0	0	0	75	25	0	0
PHF	.000	.000	.000	.000	.000	.000	.500	.417	.000	.583	.000	.000	.000	.000	.000	.000	.375	.250	.000	.333

City of Madera
 N/S: SR-99 Southbound On Ramps
 E/W: Avenue 17
 Weather: Clear

File Name : 12A_MDA_99S_Ave 17 PM
 Site Code : 00319628
 Start Date : 9/18/2019
 Page No : 1

Groups Printed- 3 Axle Vehicles

Start Time	SR-99 Southbound On Ramp Southbound					Avenue 17 Westbound					SR-99 Southbound On Ramp Northbound					Avenue 17 Eastbound					Int. Total
	Left	Thru	Right	U-Turns	App. Total	Left	Thru	Right	U-Turns	App. Total	Left	Thru	Right	U-Turns	App. Total	Left	Thru	Right	U-Turns	App. Total	
04:00 PM	0	0	0	0	0	0	1	0	0	1	0	0	0	0	0	0	0	0	0	0	1
04:15 PM	0	0	0	0	0	0	0	0	0	0	0	0	0	0	0	0	2	0	0	0	2
04:30 PM	0	0	0	0	0	0	0	0	0	0	0	0	0	0	0	0	0	0	0	0	0
04:45 PM	0	0	0	0	0	0	0	0	0	0	0	0	0	0	0	0	0	0	0	0	0
Total	0	0	0	0	0	0	1	0	0	1	0	0	0	0	0	0	2	0	0	0	3
05:00 PM	0	0	0	0	0	0	1	1	0	2	0	0	0	0	0	0	0	0	0	0	2
05:15 PM	0	0	0	0	0	0	0	0	0	0	0	0	0	0	0	0	2	0	0	0	2
05:30 PM	0	0	0	0	0	0	0	0	0	0	0	0	0	0	0	0	0	0	0	0	0
05:45 PM	0	0	0	0	0	0	1	0	0	1	0	0	0	0	0	0	2	0	0	0	3
Total	0	0	0	0	0	0	2	1	0	3	0	0	0	0	0	0	4	0	0	0	7
Grand Total	0	0	0	0	0	0	3	1	0	4	0	0	0	0	0	0	6	0	0	0	10
Apprch %	0	0	0	0	0	0	75	25	0	0	0	0	0	0	0	0	100	0	0	0	
Total %	0	0	0	0	0	0	30	10	0	40	0	0	0	0	0	0	60	0	0	60	

Start Time	SR-99 Southbound On Ramp Southbound					Avenue 17 Westbound					SR-99 Southbound On Ramp Northbound					Avenue 17 Eastbound					Int. Total
	Left	Thru	Right	U-Turns	App. Total	Left	Thru	Right	U-Turns	App. Total	Left	Thru	Right	U-Turns	App. Total	Left	Thru	Right	U-Turns	App. Total	
Peak Hour Analysis From 04:00 PM to 04:45 PM - Peak 1 of 1																					
Peak Hour for Entire Intersection Begins at 04:00 PM																					
04:00 PM	0	0	0	0	0	0	1	0	0	1	0	0	0	0	0	0	0	0	0	0	1
04:15 PM	0	0	0	0	0	0	0	0	0	0	0	0	0	0	0	0	2	0	0	0	2
04:30 PM	0	0	0	0	0	0	0	0	0	0	0	0	0	0	0	0	0	0	0	0	0
04:45 PM	0	0	0	0	0	0	0	0	0	0	0	0	0	0	0	0	0	0	0	0	0
Total Volume	0	0	0	0	0	0	1	0	0	1	0	0	0	0	0	0	2	0	0	0	3
% App. Total	0	0	0	0	0	0	100	0	0	0	0	0	0	0	0	0	100	0	0	0	
PHF	.000	.000	.000	.000	.000	.000	.250	.000	.000	.250	.000	.000	.000	.000	.000	.000	.250	.000	.000	.250	.375

City of Madera
 N/S: SR-99 Southbound On Ramps
 E/W: Avenue 17
 Weather: Clear

File Name : 12A_MDA_99S_Ave 17 PM
 Site Code : 00319628
 Start Date : 9/18/2019
 Page No : 2

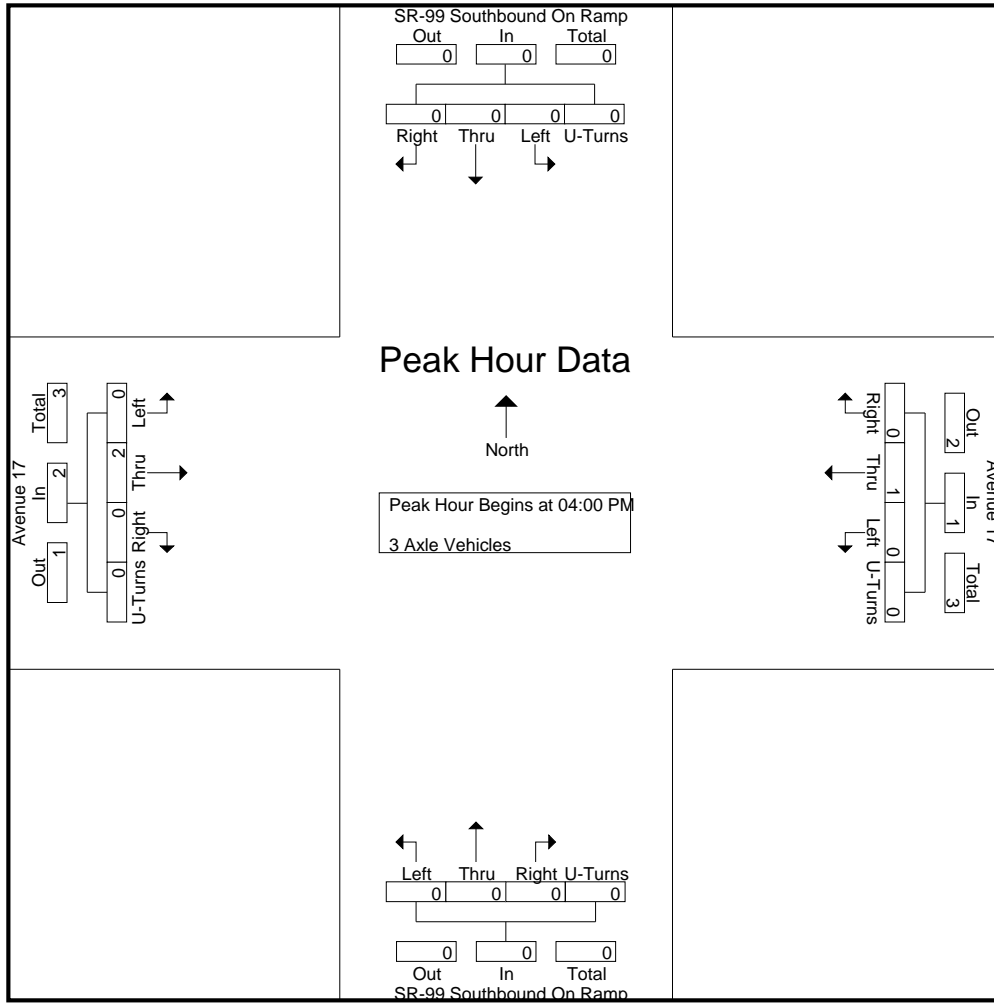

Peak Hour Analysis From 04:00 PM to 04:45 PM - Peak 1 of 1
 Peak Hour for Each Approach Begins at:

	04:00 PM					04:00 PM					04:00 PM					04:00 PM				
+0 mins.	0	0	0	0	0	0	1	0	0	1	0	0	0	0	0	0	0	0	0	0
+15 mins.	0	0	0	0	0	0	0	0	0	0	0	0	0	0	0	0	2	0	0	2
+30 mins.	0	0	0	0	0	0	0	0	0	0	0	0	0	0	0	0	0	0	0	0
+45 mins.	0	0	0	0	0	0	0	0	0	0	0	0	0	0	0	0	0	0	0	0
Total Volume	0	0	0	0	0	0	1	0	0	1	0	0	0	0	0	0	2	0	0	2
% App. Total	0	0	0	0	0	0	100	0	0	0	0	0	0	0	0	0	100	0	0	0
PHF	.000	.000	.000	.000	.000	.000	.250	.000	.000	.250	.000	.000	.000	.000	.000	.000	.250	.000	.000	.250

City of Madera
 N/S: SR-99 Southbound On Ramps
 E/W: Avenue 17
 Weather: Clear

File Name : 12A_MDA_99S_Ave 17 PM
 Site Code : 00319628
 Start Date : 9/18/2019
 Page No : 1

Groups Printed- 4+ Axle Trucks

Start Time	SR-99 Southbound On Ramp Southbound					Avenue 17 Westbound					SR-99 Southbound On Ramp Northbound					Avenue 17 Eastbound					Int. Total
	Left	Thru	Right	U-Turns	App. Total	Left	Thru	Right	U-Turns	App. Total	Left	Thru	Right	U-Turns	App. Total	Left	Thru	Right	U-Turns	App. Total	
04:00 PM	0	0	0	0	0	0	1	1	0	2	0	0	0	0	0	0	0	1	0	1	3
04:15 PM	0	0	0	0	0	0	1	0	0	1	0	0	0	0	0	0	1	2	0	3	4
04:30 PM	0	0	0	0	0	0	1	0	0	1	0	0	0	0	0	0	4	0	0	4	5
04:45 PM	0	0	0	0	0	0	1	0	0	1	0	0	0	0	0	0	2	1	0	3	4
Total	0	0	0	0	0	0	4	1	0	5	0	0	0	0	0	0	7	4	0	11	16
05:00 PM	0	0	0	0	0	0	1	0	0	1	0	0	0	0	0	0	1	0	0	1	2
05:15 PM	0	0	0	0	0	0	2	2	0	4	0	0	0	0	0	0	3	1	0	4	8
05:30 PM	0	0	0	0	0	0	1	0	0	1	0	0	0	0	0	0	5	0	0	5	6
05:45 PM	0	0	0	0	0	0	0	0	0	0	0	0	0	0	0	0	3	0	0	3	3
Total	0	0	0	0	0	0	4	2	0	6	0	0	0	0	0	0	12	1	0	13	19
Grand Total	0	0	0	0	0	0	8	3	0	11	0	0	0	0	0	0	19	5	0	24	35
Apprch %	0	0	0	0		0	72.7	27.3	0		0	0	0	0		0	79.2	20.8	0		
Total %	0	0	0	0		0	22.9	8.6	0	31.4	0	0	0	0		0	54.3	14.3	0	68.6	

Start Time	SR-99 Southbound On Ramp Southbound					Avenue 17 Westbound					SR-99 Southbound On Ramp Northbound					Avenue 17 Eastbound					Int. Total
	Left	Thru	Right	U-Turns	App. Total	Thru	Right	U-Turns	App. Total	Thru	Right	U-Turns	App. Total	Thru	Right	U-Turns	App. Total				
Peak Hour Analysis From 04:00 PM to 04:45 PM - Peak 1 of 1																					
Peak Hour for Entire Intersection Begins at 04:00 PM																					
04:00 PM	0	0	0	0	0	0	1	1	0	2	0	0	0	0	0	0	0	1	0	1	3
04:15 PM	0	0	0	0	0	0	1	0	0	1	0	0	0	0	0	0	1	2	0	3	4
04:30 PM	0	0	0	0	0	0	1	0	0	1	0	0	0	0	0	0	4	0	0	4	5
04:45 PM	0	0	0	0	0	0	1	0	0	1	0	0	0	0	0	0	2	1	0	3	4
Total Volume	0	0	0	0	0	0	4	1	0	5	0	0	0	0	0	0	7	4	0	11	16
% App. Total	0	0	0	0		0	80	20	0		0	0	0	0		0	63.6	36.4	0		
PHF	.000	.000	.000	.000	.000	.000	1.00	.250	.000	.625	.000	.000	.000	.000	.000	.000	.438	.500	.000	.688	.800

City of Madera
 N/S: SR-99 Southbound On Ramps
 E/W: Avenue 17
 Weather: Clear

File Name : 12A_MDA_99S_Ave 17 PM
 Site Code : 00319628
 Start Date : 9/18/2019
 Page No : 2

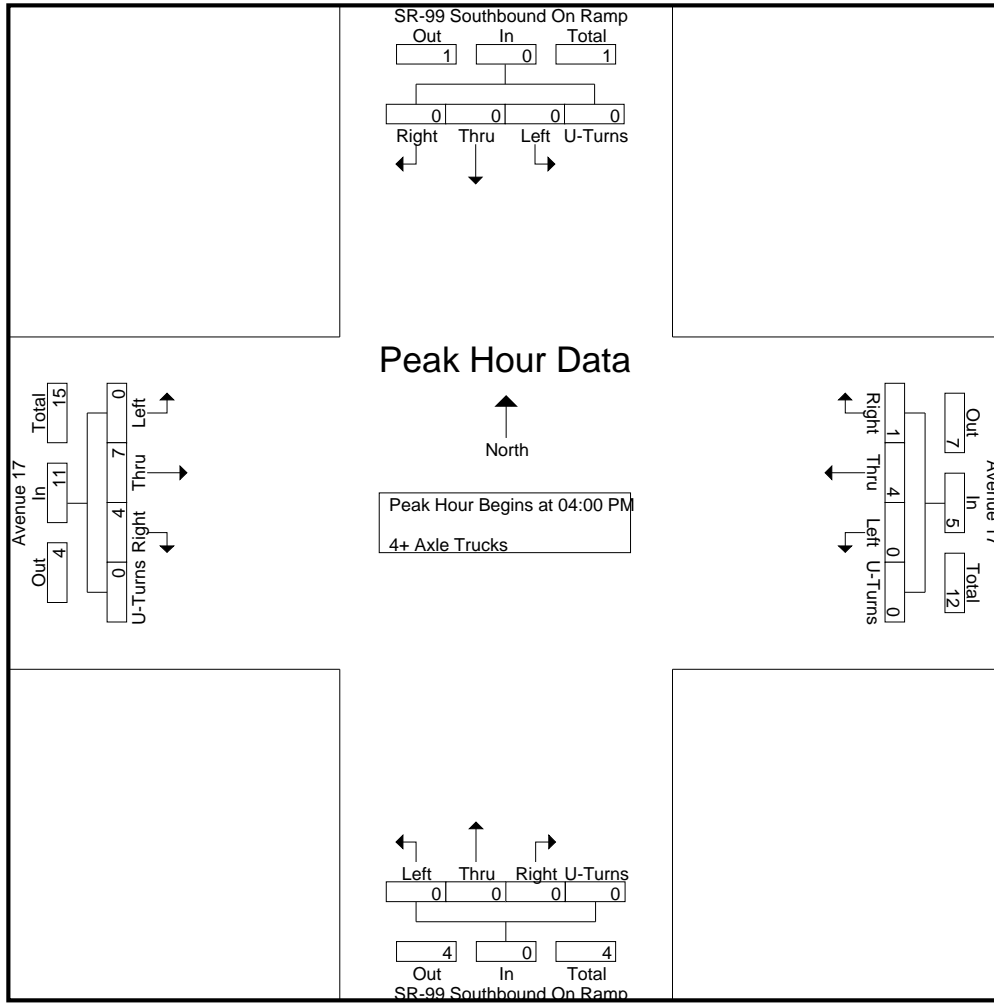

Peak Hour Analysis From 04:00 PM to 04:45 PM - Peak 1 of 1
 Peak Hour for Each Approach Begins at:

	04:00 PM					04:00 PM					04:00 PM									
+0 mins.	0	0	0	0	0	0	1	1	0	2	0	0	0	0	0	0	0	1	0	1
+15 mins.	0	0	0	0	0	0	1	0	0	1	0	0	0	0	0	0	1	2	0	3
+30 mins.	0	0	0	0	0	0	1	0	0	1	0	0	0	0	0	0	4	0	0	4
+45 mins.	0	0	0	0	0	0	1	0	0	1	0	0	0	0	0	0	2	1	0	3
Total Volume	0	0	0	0	0	0	4	1	0	5	0	0	0	0	0	0	7	4	0	11
% App. Total	0	0	0	0	0	0	80	20	0	0	0	0	0	0	0	0	63.6	36.4	0	0
PHF	.000	.000	.000	.000	.000	.000	1.000	.250	.000	.625	.000	.000	.000	.000	.000	.000	.438	.500	.000	.688

Location: Madera
 N/S: SR-99 SB On Ramps
 E/W: Avenue 17



Date: 9/18/2019
 Day: Wednesday

PEDESTRIANS

	North Leg SR-99 SB On Ramps	East Leg Avenue 17	South Leg SR-99 SB On Ramps	West Leg Avenue 17	
	Pedestrians	Pedestrians	Pedestrians	Pedestrians	
7:00 AM	0	0	0	0	0
7:15 AM	0	0	0	0	0
7:30 AM	0	0	0	0	0
7:45 AM	0	0	0	0	0
8:00 AM	0	0	0	0	0
8:15 AM	0	0	0	0	0
8:30 AM	0	0	0	0	0
8:45 AM	0	0	0	0	0
TOTAL VOLUMES:	0	0	0	0	0

	North Leg SR-99 SB On Ramps	East Leg Avenue 17	South Leg SR-99 SB On Ramps	West Leg Avenue 17	
	Pedestrians	Pedestrians	Pedestrians	Pedestrians	
4:00 PM	0	0	0	0	0
4:15 PM	0	0	0	0	0
4:30 PM	0	0	0	0	0
4:45 PM	0	0	0	0	0
5:00 PM	0	0	0	0	0
5:15 PM	0	0	0	0	0
5:30 PM	0	0	0	0	0
5:45 PM	0	0	0	0	0
TOTAL VOLUMES:	0	0	0	0	0

Location: Madera
 N/S: SR-99 SB On Ramps
 E/W: Avenue 17



Date: 9/18/2019
 Day: Wednesday

BICYCLES

	Southbound SR-99 SB On Ramps			Westbound Avenue 17			Northbound SR-99 SB On Ramps			Eastbound Avenue 17			
	Left	Thru	Right	Left	Thru	Right	Left	Thru	Right	Left	Thru	Right	
7:00 AM	0	0	0	0	0	0	0	0	0	0	0	0	0
7:15 AM	0	0	0	0	0	0	0	0	0	0	0	0	0
7:30 AM	0	0	0	0	0	0	0	0	0	0	0	0	0
7:45 AM	0	0	0	0	0	0	0	0	0	0	0	0	0
8:00 AM	0	0	0	0	0	0	0	0	0	0	0	0	0
8:15 AM	0	0	0	0	0	0	0	0	0	0	0	0	0
8:30 AM	0	0	0	0	0	0	0	0	0	0	0	0	0
8:45 AM	0	0	0	0	0	0	0	0	0	0	0	0	0
TOTAL VOLUMES:	0	0	0	0	0	0	0	0	0	0	0	0	0

	Southbound SR-99 SB On Ramps			Westbound Avenue 17			Northbound SR-99 SB On Ramps			Eastbound Avenue 17			
	Left	Thru	Right	Left	Thru	Right	Left	Thru	Right	Left	Thru	Right	
4:00 PM	0	0	0	0	0	0	0	0	0	0	0	0	0
4:15 PM	0	0	0	0	0	0	0	0	0	0	0	0	0
4:30 PM	0	0	0	0	0	0	0	0	0	0	0	0	0
4:45 PM	0	0	0	0	0	0	0	0	0	0	0	0	0
5:00 PM	0	0	0	0	0	0	0	0	0	0	0	0	0
5:15 PM	0	0	0	0	0	0	0	0	0	0	0	0	0
5:30 PM	0	0	0	0	0	0	0	0	0	0	0	0	0
5:45 PM	0	0	0	0	0	0	0	0	0	0	0	0	0
TOTAL VOLUMES:	0	0	0	0	0	0	0	0	0	0	0	0	0

Counts Unlimited, Inc.

City of Madera
 Road 23
 B/ Avenue 17 - Avenue 16
 24 Hour Directional Volume Count

PO Box 1178
 Corona, CA 92878
 Phone: (951) 268-6268
 email: counts@countsunlimited.com

MDA001
 Site Code: 003-19628

Start Time	18-Sep-19 Wed	Northbound		Hour Totals		Southbound		Hour Totals		Combined Totals	
		Morning	Afternoon	Morning	Afternoon	Morning	Afternoon	Morning	Afternoon	Morning	Afternoon
12:00		4	27			4	30				
12:15		4	21			4	26				
12:30		11	29			6	23				
12:45		4	27	23	104	6	28	20	107	43	211
01:00		6	31			6	33				
01:15		1	29			3	24				
01:30		5	31			3	25				
01:45		1	21	13	112	2	38	14	120	27	232
02:00		7	23			4	36				
02:15		6	42			3	32				
02:30		4	32			3	37				
02:45		6	41	23	138	2	49	12	154	35	292
03:00		5	41			3	33				
03:15		11	33			1	52				
03:30		8	38			5	55				
03:45		7	46	31	158	3	51	12	191	43	349
04:00		4	39			6	48				
04:15		12	28			5	75				
04:30		13	42			11	64				
04:45		20	34	49	143	11	57	33	244	82	387
05:00		19	36			10	58				
05:15		22	32			9	60				
05:30		20	28			32	46				
05:45		33	36	94	132	35	40	86	204	180	336
06:00		31	34			35	40				
06:15		30	22			38	26				
06:30		28	19			24	37				
06:45		39	24	128	99	44	14	141	117	269	216
07:00		38	27			26	17				
07:15		20	25			29	20				
07:30		48	20			29	15				
07:45		70	17	176	89	50	16	134	68	310	157
08:00		59	16			49	17				
08:15		41	17			41	13				
08:30		43	16			33	13				
08:45		31	12	174	61	31	16	154	59	328	120
09:00		27	14			24	18				
09:15		26	20			19	12				
09:30		22	7			24	12				
09:45		25	18	100	59	29	9	96	51	196	110
10:00		22	8			34	9				
10:15		24	10			18	24				
10:30		27	7			22	7				
10:45		22	6	95	31	18	8	92	48	187	79
11:00		29	7			16	12				
11:15		37	6			32	12				
11:30		26	5			17	7				
11:45		25	7	117	25	22	9	87	40	204	65
Total		1023	1151	1023	1151	881	1403	881	1403	1904	2554
Combined Total		2174		2174		2284		2284		4458	
AM Peak	-	07:30	-	-	-	07:45	-	-	-	-	-
Vol.	-	218	-	-	-	173	-	-	-	-	-
P.H.F.		0.779				0.865					
PM Peak	-	-	03:00	-	-	-	04:15	-	-	-	-
Vol.	-	-	158	-	-	-	254	-	-	-	-
P.H.F.			0.859				0.847				
Percentage		47.1%	52.9%			38.6%	61.4%				
ADT/AADT		ADT 4,458		AADT 4,458							

Counts Unlimited, Inc.

City of Madera
 Road 23
 B/ Avenue 16 - Cleveland Avenue
 24 Hour Directional Volume Count

PO Box 1178
 Corona, CA 92878
 Phone: (951) 268-6268
 email: counts@countsunlimited.com

MDA001A
 Site Code: 003-19628

Start Time	18-Sep-19 Wed	Northbound		Hour Totals		Southbound		Hour Totals		Combined Totals	
		Morning	Afternoon	Morning	Afternoon	Morning	Afternoon	Morning	Afternoon	Morning	Afternoon
12:00		6	34			6	29				
12:15		9	27			3	33				
12:30		5	28			7	15				
12:45		5	33	25	122	6	23	22	100	47	222
01:00		5	28			7	36				
01:15		3	36			1	25				
01:30		3	23			3	28				
01:45		2	26	13	113	6	36	17	125	30	238
02:00		10	30			4	41				
02:15		3	40			3	32				
02:30		7	36			2	39				
02:45		4	45	24	151	3	44	12	156	36	307
03:00		8	38			2	33				
03:15		12	43			2	52				
03:30		4	37			5	49				
03:45		7	45	31	163	7	55	16	189	47	352
04:00		9	38			1	55				
04:15		10	38			5	71				
04:30		13	34			10	82				
04:45		23	42	55	152	11	69	27	277	82	429
05:00		19	34			9	61				
05:15		23	39			13	55				
05:30		23	24			29	52				
05:45		42	40	107	137	37	43	88	211	195	348
06:00		37	33			30	37				
06:15		38	17			33	35				
06:30		37	22			24	30				
06:45		36	30	148	102	48	20	135	122	283	224
07:00		34	24			23	22				
07:15		28	24			24	18				
07:30		57	20			45	19				
07:45		78	18	197	86	37	13	129	72	326	158
08:00		59	17			41	18				
08:15		40	11			45	12				
08:30		37	19			31	15				
08:45		42	17	178	64	33	17	150	62	328	126
09:00		34	17			25	18				
09:15		23	16			21	10				
09:30		28	10			23	12				
09:45		24	15	109	58	31	10	100	50	209	108
10:00		27	5			37	11				
10:15		28	10			18	22				
10:30		32	7			27	7				
10:45		24	8	111	30	12	11	94	51	205	81
11:00		34	5			21	11				
11:15		35	10			31	14				
11:30		28	4			20	6				
11:45		20	7	117	26	23	8	95	39	212	65
Total		1115	1204	1115	1204	885	1454	885	1454	2000	2658
Combined Total		2319		2319		2339		2339		4658	
AM Peak	-	07:30	-	-	-	07:30	-	-	-	-	-
Vol.	-	234	-	-	-	168	-	-	-	-	-
P.H.F.	-	0.750	-	-	-	0.933	-	-	-	-	-
PM Peak	-	-	02:45	-	-	-	04:15	-	-	-	-
Vol.	-	-	163	-	-	-	283	-	-	-	-
P.H.F.	-	-	0.906	-	-	-	0.863	-	-	-	-
Percentage		48.1%	51.9%			37.8%	62.2%				
ADT/AADT		ADT 4,658		AADT 4,658							

Counts Unlimited, Inc.

City of Madera
 Road 23
 B/ Avenue 14-1/2 - Avenue 14
 24 Hour Directional Volume Count

PO Box 1178
 Corona, CA 92878
 Phone: (951) 268-6268
 email: counts@countsunlimited.com

MDA001C
 Site Code: 003-19628

Start Time	18-Sep-19 Wed	Northbound		Hour Totals		Southbound		Hour Totals		Combined Totals	
		Morning	Afternoon	Morning	Afternoon	Morning	Afternoon	Morning	Afternoon	Morning	Afternoon
12:00		5	33			3	28				
12:15		9	34			4	33				
12:30		5	30			4	27				
12:45		6	43	25	140	5	29	16	117	41	257
01:00		3	34			5	38				
01:15		5	41			2	34				
01:30		3	19			4	32				
01:45		2	28	13	122	2	45	13	149	26	271
02:00		10	35			4	40				
02:15		2	39			2	28				
02:30		8	28			3	42				
02:45		2	55	22	157	2	46	11	156	33	313
03:00		7	43			1	38				
03:15		10	49			1	39				
03:30		3	48			4	45				
03:45		4	58	24	198	13	49	19	171	43	369
04:00		10	60			7	55				
04:15		10	43			20	57				
04:30		13	39			17	59				
04:45		22	62	55	204	26	59	70	230	125	434
05:00		19	44			18	43				
05:15		14	52			30	46				
05:30		27	50			54	53				
05:45		33	43	93	189	70	27	172	169	265	358
06:00		26	40			66	36				
06:15		32	34			68	30				
06:30		29	26			42	35				
06:45		38	42	125	142	51	30	227	131	352	273
07:00		23	31			28	28				
07:15		27	23			31	21				
07:30		35	15			48	20				
07:45		67	17	152	86	54	17	161	86	313	172
08:00		50	23			48	21				
08:15		42	10			41	12				
08:30		37	19			34	10				
08:45		44	13	173	65	40	15	163	58	336	123
09:00		37	18			26	14				
09:15		27	14			25	11				
09:30		28	8			29	16				
09:45		24	18	116	58	35	14	115	55	231	113
10:00		34	6			39	10				
10:15		27	6			24	22				
10:30		26	8			26	11				
10:45		40	4	127	24	16	8	105	51	232	75
11:00		30	4			24	7				
11:15		27	9			40	15				
11:30		19	5			32	8				
11:45		27	2	103	20	43	5	139	35	242	55
Total		1028	1405	1028	1405	1211	1408	1211	1408	2239	2813
Combined Total		2433		2433		2619		2619		5052	
AM Peak	-	07:45	-	-	-	05:30	-	-	-	-	-
Vol.	-	196	-	-	-	258	-	-	-	-	-
P.H.F.	-	0.731	-	-	-	0.921	-	-	-	-	-
PM Peak	-	-	03:15	-	-	-	04:00	-	-	-	-
Vol.	-	-	215	-	-	-	230	-	-	-	-
P.H.F.	-	-	0.896	-	-	-	0.975	-	-	-	-
Percentage		42.3%	57.7%			46.2%	53.8%				
ADT/AADT		ADT 5,052		AADT 5,052							

Counts Unlimited, Inc.

City of Madera
 Westberry Boulevard
 B/ Sunset Avenue - Howard Road
 24 Hour Directional Volume Count

PO Box 1178
 Corona, CA 92878
 Phone: (951) 268-6268
 email: counts@countsunlimited.com

MDA002
 Site Code: 003-19628

Start Time	19-Sep-19 Thu	Northbound		Hour Totals		Southbound		Hour Totals		Combined Totals	
		Morning	Afternoon	Morning	Afternoon	Morning	Afternoon	Morning	Afternoon	Morning	Afternoon
12:00		3	26			2	28				
12:15		6	23			2	30				
12:30		3	28			4	20				
12:45		2	21	14	98	1	17	9	95	23	193
01:00		2	34			1	17				
01:15		0	33			3	23				
01:30		0	37			1	23				
01:45		0	29	2	133	1	69	6	132	8	265
02:00		0	30			1	26				
02:15		1	29			0	24				
02:30		1	29			0	37				
02:45		3	28	5	116	3	25	4	112	9	228
03:00		2	39			0	25				
03:15		2	28			3	36				
03:30		2	40			2	32				
03:45		2	40	8	147	1	31	6	124	14	271
04:00		1	24			2	25				
04:15		3	44			4	38				
04:30		1	39			4	40				
04:45		1	48	6	155	5	39	15	142	21	297
05:00		6	39			7	36				
05:15		6	56			3	37				
05:30		3	43			5	42				
05:45		14	49	29	187	16	38	31	153	60	340
06:00		8	50			14	32				
06:15		9	34			13	57				
06:30		14	30			19	36				
06:45		16	37	47	151	18	30	64	155	111	306
07:00		27	36			23	28				
07:15		24	43			32	24				
07:30		48	24			45	35				
07:45		55	29	154	132	41	27	141	114	295	246
08:00		53	29			52	22				
08:15		31	32			46	21				
08:30		32	23			32	22				
08:45		28	24	144	108	20	21	150	86	294	194
09:00		29	24			18	16				
09:15		29	17			11	16				
09:30		16	14			13	8				
09:45		25	15	99	70	11	14	53	54	152	124
10:00		21	8			13	13				
10:15		11	14			17	11				
10:30		13	11			20	14				
10:45		20	15	65	48	24	12	74	50	139	98
11:00		26	6			15	8				
11:15		26	6			25	5				
11:30		15	4			13	8				
11:45		21	4	88	20	14	4	67	25	155	45
Total		661	1365	661	1365	620	1242	620	1242	1281	2607
Combined Total		2026		2026		1862		1862		3888	
AM Peak	-	07:30	-	-	-	07:30	-	-	-	-	-
Vol.	-	187	-	-	-	184	-	-	-	-	-
P.H.F.	-	0.850	-	-	-	0.885	-	-	-	-	-
PM Peak	-	-	05:15	-	-	-	05:30	-	-	-	-
Vol.	-	-	198	-	-	-	169	-	-	-	-
P.H.F.	-	-	0.884	-	-	-	0.741	-	-	-	-
Percentage		32.6%	67.4%			33.3%	66.7%				
ADT/AADT		ADT 3,888		AADT 3,888							

Counts Unlimited, Inc.

City of Madera
 Granada Drive
 B/ Cleveland Avenue - Fresno River
 24 Hour Directional Volume Count

PO Box 1178
 Corona, CA 92878
 Phone: (951) 268-6268
 email: counts@countsunlimited.com

MDA003
 Site Code: 003-19628

Start Time	19-Sep-19 Thu	Northbound		Hour Totals		Southbound		Hour Totals		Combined Totals	
		Morning	Afternoon	Morning	Afternoon	Morning	Afternoon	Morning	Afternoon	Morning	Afternoon
12:00		9	72			16	83				
12:15		13	63			11	77				
12:30		9	53			7	61				
12:45		4	66	35	254	13	75	47	296	82	550
01:00		4	64			3	63				
01:15		1	65			6	77				
01:30		5	66			7	109				
01:45		4	102	14	297	5	75	21	324	35	621
02:00		3	90			2	58				
02:15		5	68			2	73				
02:30		4	86			4	100				
02:45		3	88	15	332	6	82	14	313	29	645
03:00		8	82			1	98				
03:15		7	90			4	93				
03:30		5	105			5	80				
03:45		10	101	30	378	2	110	12	381	42	759
04:00		9	92			5	94				
04:15		6	95			5	110				
04:30		8	87			8	97				
04:45		14	102	37	376	10	113	28	414	65	790
05:00		28	89			18	110				
05:15		18	81			15	158				
05:30		26	124			16	122				
05:45		36	106	108	400	25	102	74	492	182	892
06:00		35	102			24	134				
06:15		29	87			29	110				
06:30		45	72			28	101				
06:45		53	71	162	332	34	84	115	429	277	761
07:00		71	74			41	65				
07:15		88	77			56	69				
07:30		119	80			64	94				
07:45		131	94	409	325	103	101	264	329	673	654
08:00		167	76			131	72				
08:15		112	47			107	76				
08:30		93	66			93	63				
08:45		89	49	461	238	45	52	376	263	837	501
09:00		78	53			56	61				
09:15		57	31			44	56				
09:30		66	25			46	57				
09:45		43	33	244	142	45	47	191	221	435	363
10:00		63	23			49	32				
10:15		43	31			48	39				
10:30		58	29			51	29				
10:45		54	22	218	105	58	30	206	130	424	235
11:00		57	24			45	36				
11:15		65	9			60	21				
11:30		42	12			60	14				
11:45		70	6	234	51	57	9	222	80	456	131
Total		1967	3230	1967	3230	1570	3672	1570	3672	3537	6902
Combined Total		5197		5197		5242		5242		10439	
AM Peak	-	07:30	-	-	-	07:45	-	-	-	-	-
Vol.	-	529	-	-	-	434	-	-	-	-	-
P.H.F.	-	0.792	-	-	-	0.828	-	-	-	-	-
PM Peak	-	-	05:30	-	-	-	05:15	-	-	-	-
Vol.	-	-	419	-	-	-	516	-	-	-	-
P.H.F.	-	-	0.845	-	-	-	0.816	-	-	-	-
Percentage		37.8%	62.2%			30.0%	70.0%				
ADT/AADT		ADT 10,439		AADT 10,439							

Counts Unlimited, Inc.

City of Madera
 Granada Drive
 B/ Sunset Avenue - Avenue 14
 24 Hour Directional Volume Count

PO Box 1178
 Corona, CA 92878
 Phone: (951) 268-6268
 email: counts@countsunlimited.com

MDA004
 Site Code: 003-19628

Start Time	19-Sep-19 Thu	Northbound		Hour Totals		Southbound		Hour Totals		Combined Totals	
		Morning	Afternoon	Morning	Afternoon	Morning	Afternoon	Morning	Afternoon	Morning	Afternoon
12:00		12	55			7	42				
12:15		9	52			3	54				
12:30		6	39			5	54				
12:45		6	45	33	191	5	47	20	197	53	388
01:00		6	54			2	42				
01:15		4	51			2	59				
01:30		3	34			3	54				
01:45		1	53	14	192	2	41	9	196	23	388
02:00		5	55			2	59				
02:15		0	52			2	64				
02:30		3	60			1	43				
02:45		0	58	8	225	0	63	5	229	13	454
03:00		3	48			2	66				
03:15		1	83			3	60				
03:30		0	108			4	50				
03:45		7	97	11	336	7	79	16	255	27	591
04:00		4	86			5	58				
04:15		4	74			6	73				
04:30		5	89			10	76				
04:45		5	92	18	341	16	83	37	290	55	631
05:00		10	89			30	95				
05:15		6	86			13	101				
05:30		10	86			29	85				
05:45		8	86	34	347	45	96	117	377	151	724
06:00		19	70			46	89				
06:15		21	63			35	72				
06:30		21	54			40	75				
06:45		19	69	80	256	45	66	166	302	246	558
07:00		27	70			75	53				
07:15		51	74			64	51				
07:30		36	73			74	54				
07:45		54	80	168	297	90	44	303	202	471	499
08:00		58	66			89	32				
08:15		55	61			86	23				
08:30		58	77			101	43				
08:45		65	53	236	257	58	33	334	131	570	388
09:00		53	53			47	35				
09:15		31	38			34	30				
09:30		42	23			39	26				
09:45		35	26	161	140	42	26	162	117	323	257
10:00		27	23			48	29				
10:15		31	35			43	18				
10:30		26	24			33	20				
10:45		36	18	120	100	40	12	164	79	284	179
11:00		43	11			31	20				
11:15		42	15			42	14				
11:30		33	7			43	9				
11:45		59	10	177	43	48	7	164	50	341	93
Total		1060	2725	1060	2725	1497	2425	1497	2425	2557	5150
Combined Total		3785		3785		3922		3922		7707	
AM Peak	-	08:00	-	-	-	07:45	-	-	-	-	-
Vol.	-	236	-	-	-	366	-	-	-	-	-
P.H.F.	-	0.908	-	-	-	0.906	-	-	-	-	-
PM Peak	-	-	03:15	-	-	-	05:00	-	-	-	-
Vol.	-	-	374	-	-	-	377	-	-	-	-
P.H.F.	-	-	0.866	-	-	-	0.933	-	-	-	-
Percentage		28.0%	72.0%			38.2%	61.8%				
ADT/AADT		ADT 7,707		AADT 7,707							

Counts Unlimited, Inc.

City of Madera
 Avenue 17
 B/ Golden State Boulevard - State Route 99
 24 Hour Directional Volume Count

PO Box 1178
 Corona, CA 92878
 Phone: (951) 268-6268
 email: counts@countsunlimited.com

MDA005B
 Site Code: 003-19628

Start Time	19-Sep-19 Thu	Eastbound		Hour Totals		Westbound		Hour Totals		Combined Totals	
		Morning	Afternoon	Morning	Afternoon	Morning	Afternoon	Morning	Afternoon	Morning	Afternoon
12:00		5	54			9	60				
12:15		14	67			12	91				
12:30		16	57			8	83				
12:45		7	67	42	245	8	80	37	314	79	559
01:00		9	47			4	88				
01:15		3	54			3	66				
01:30		6	55			1	91				
01:45		10	55	28	211	5	65	13	310	41	521
02:00		2	67			3	82				
02:15		7	69			8	77				
02:30		6	78			5	79				
02:45		4	93	19	307	5	90	21	328	40	635
03:00		11	60			13	96				
03:15		10	80			11	75				
03:30		11	78			15	78				
03:45		10	97	42	315	16	102	55	351	97	666
04:00		8	86			23	76				
04:15		17	144			14	107				
04:30		13	117			27	84				
04:45		29	121	67	468	42	96	106	363	173	831
05:00		20	104			32	94				
05:15		19	101			42	95				
05:30		28	71			65	73				
05:45		34	55	101	331	100	73	239	335	340	666
06:00		42	59			102	71				
06:15		41	49			63	75				
06:30		39	62			83	62				
06:45		56	33	178	203	61	49	309	257	487	460
07:00		54	50			83	55				
07:15		59	47			72	64				
07:30		68	52			86	47				
07:45		54	51	235	200	62	67	303	233	538	433
08:00		52	57			111	52				
08:15		80	54			88	55				
08:30		60	30			69	44				
08:45		68	51	260	192	60	54	328	205	588	397
09:00		50	27			62	46				
09:15		50	26			56	43				
09:30		43	34			51	34				
09:45		45	30	188	117	49	51	218	174	406	291
10:00		58	31			81	34				
10:15		69	36			77	28				
10:30		43	21			65	23				
10:45		55	34	225	122	60	28	283	113	508	235
11:00		51	13			60	17				
11:15		64	14			82	13				
11:30		59	9			66	15				
11:45		84	8	258	44	66	14	274	59	532	103
Total		1643	2755	1643	2755	2186	3042	2186	3042	3829	5797
Combined Total		4398		4398		5228		5228		9626	
AM Peak	-	08:00	-	-	-	05:45	-	-	-	-	-
Vol.	-	260	-	-	-	348	-	-	-	-	-
P.H.F.	-	0.813	-	-	-	0.853	-	-	-	-	-
PM Peak	-	-	04:15	-	-	-	04:15	-	-	-	-
Vol.	-	-	486	-	-	-	381	-	-	-	-
P.H.F.	-	-	0.844	-	-	-	0.890	-	-	-	-
Percentage		37.4%	62.6%			41.8%	58.2%				
ADT/AADT		ADT 9,626		AADT 9,626							

Counts Unlimited, Inc.

City of Madera
 Avenue 16
 B/ Road 22 - Road 23
 24 Hour Directional Volume Count

PO Box 1178
 Corona, CA 92878
 Phone: (951) 268-6268
 email: counts@countsunlimited.com

MDA012
 Site Code: 003-19628

Start Time	19-Sep-19 Thu	Eastbound		Hour Totals		Westbound		Hour Totals		Combined Totals	
		Morning	Afternoon	Morning	Afternoon	Morning	Afternoon	Morning	Afternoon	Morning	Afternoon
12:00		0	6			0	5				
12:15		0	5			0	3				
12:30		1	5			0	2				
12:45		0	3	1	19	0	3	0	13	1	32
01:00		1	4			0	5				
01:15		0	2			0	3				
01:30		0	4			0	1				
01:45		0	2	1	12	0	5	0	14	1	26
02:00		0	3			0	3				
02:15		0	1			0	2				
02:30		0	5			0	3				
02:45		0	10	0	19	1	6	1	14	1	33
03:00		1	4			0	4				
03:15		0	4			0	7				
03:30		0	5			0	3				
03:45		0	3	1	16	0	4	0	18	1	34
04:00		0	7			0	3				
04:15		0	11			0	2				
04:30		0	21			0	4				
04:45		0	10	0	49	0	2	0	11	0	60
05:00		1	6			0	6				
05:15		0	8			1	0				
05:30		0	4			2	2				
05:45		0	4	1	22	1	2	4	10	5	32
06:00		1	3			4	5				
06:15		0	4			6	0				
06:30		0	3			8	2				
06:45		0	2	1	12	4	0	22	7	23	19
07:00		1	2			6	1				
07:15		2	2			19	2				
07:30		2	0			8	1				
07:45		3	2	8	6	8	7	41	11	49	17
08:00		6	0			12	0				
08:15		1	5			2	3				
08:30		4	0			3	1				
08:45		1	0	12	5	4	0	21	4	33	9
09:00		4	2			5	0				
09:15		2	0			3	0				
09:30		2	2			1	0				
09:45		1	0	9	4	2	1	11	1	20	5
10:00		4	1			1	1				
10:15		1	2			1	0				
10:30		3	1			1	0				
10:45		2	0	10	4	2	0	5	1	15	5
11:00		5	0			5	0				
11:15		4	0			2	0				
11:30		3	0			7	1				
11:45		1	0	13	0	4	0	18	1	31	1
Total		57	168	57	168	123	105	123	105	180	273
Combined Total		225		225		228		228		453	
AM Peak	-	07:45	-	-	-	07:15	-	-	-	-	-
Vol.	-	14	-	-	-	47	-	-	-	-	-
P.H.F.	-	0.583	-	-	-	0.618	-	-	-	-	-
PM Peak	-	-	04:00	-	-	-	02:30	-	-	-	-
Vol.	-	-	49	-	-	-	20	-	-	-	-
P.H.F.	-	-	0.583	-	-	-	0.714	-	-	-	-
Percentage		25.3%	74.7%			53.9%	46.1%				
ADT/AADT		ADT 453		AADT 453							

Counts Unlimited, Inc.

City of Madera
 Avenue 15-1/2
 B/ Road 22-1/2 - Road 23
 24 Hour Directional Volume Count

PO Box 1178
 Corona, CA 92878
 Phone: (951) 268-6268
 email: counts@countsunlimited.com

MDA013RD
 Site Code: 003-19628

Start Time	19-Sep-19 Thu	Eastbound		Hour Totals		Westbound		Hour Totals		Combined Totals	
		Morning	Afternoon	Morning	Afternoon	Morning	Afternoon	Morning	Afternoon	Morning	Afternoon
12:00		0	0			0	0				
12:15		0	0			0	0				
12:30		0	0			0	0				
12:45		0	0	0	0	0	1	0	1	0	1
01:00		0	2			0	1				
01:15		0	0			0	2				
01:30		0	1			2	2				
01:45		0	0	0	3	1	0	3	5	3	8
02:00		0	0			3	0				
02:15		0	0			0	0				
02:30		0	0			0	1				
02:45		0	0	0	0	0	1	3	2	3	2
03:00		0	0			0	0				
03:15		0	2			0	2				
03:30		0	2			0	0				
03:45		0	0	0	4	0	0	0	2	0	6
04:00		0	0			0	0				
04:15		0	1			0	0				
04:30		0	0			0	0				
04:45		0	1	0	2	0	0	0	0	0	2
05:00		0	0			0	0				
05:15		0	0			0	0				
05:30		0	0			0	0				
05:45		0	0	0	0	0	0	0	0	0	0
06:00		0	0			0	0				
06:15		0	0			0	0				
06:30		0	0			0	1				
06:45		0	0	0	0	0	0	0	1	0	1
07:00		0	0			0	0				
07:15		0	0			0	0				
07:30		0	1			0	0				
07:45		0	0	0	1	0	0	0	0	0	1
08:00		0	0			0	0				
08:15		0	0			0	0				
08:30		0	0			0	0				
08:45		0	0	0	0	0	0	0	0	0	0
09:00		2	0			0	0				
09:15		0	0			0	0				
09:30		0	0			0	0				
09:45		0	0	2	0	2	0	2	0	4	0
10:00		0	0			1	0				
10:15		1	0			0	0				
10:30		1	0			0	0				
10:45		0	0	2	0	1	0	2	0	4	0
11:00		1	0			0	0				
11:15		0	0			0	0				
11:30		0	0			0	0				
11:45		0	0	1	0	0	0	0	0	1	0
Total		5	10	5	10	10	11	10	11	15	21
Combined Total		15		15		21		21		36	
AM Peak	-	10:15	-	-	-	01:15	-	-	-	-	-
Vol.	-	3	-	-	-	6	-	-	-	-	-
P.H.F.		0.375				0.500					
PM Peak	-	-	02:45	-	-	-	00:45	-	-	-	-
Vol.	-	-	4	-	-	-	6	-	-	-	-
P.H.F.			0.500				0.750				
Percentage		33.3%	66.7%			47.6%	52.4%				
ADT/AADT		ADT 36		AADT 36							

Counts Unlimited, Inc.

City of Madera
 Cleveland Avenue
 B/ Road 23 - Westberry Boulevard
 24 Hour Directional Volume Count

PO Box 1178
 Corona, CA 92878
 Phone: (951) 268-6268
 email: counts@countsunlimited.com

MDA006A
 Site Code: 003-19628

Start Time	19-Sep-19 Thu	Eastbound		Hour Totals		Westbound		Hour Totals		Combined Totals	
		Morning	Afternoon	Morning	Afternoon	Morning	Afternoon	Morning	Afternoon	Morning	Afternoon
12:00		2	18			3	16				
12:15		2	19			1	7				
12:30		2	19			0	13				
12:45		0	12	6	68	4	14	8	50	14	118
01:00		0	29			2	19				
01:15		0	24			1	15				
01:30		0	10			0	18				
01:45		0	26	0	89	2	15	5	67	5	156
02:00		0	22			2	18				
02:15		2	15			1	15				
02:30		0	12			1	15				
02:45		1	23	3	72	0	20	4	68	7	140
03:00		0	14			2	15				
03:15		2	19			1	20				
03:30		0	14			2	15				
03:45		0	39	2	86	2	12	7	62	9	148
04:00		2	49			3	15				
04:15		0	47			11	13				
04:30		0	49			8	22				
04:45		2	49	4	194	17	22	39	72	43	266
05:00		4	36			10	19				
05:15		2	30			12	20				
05:30		9	26			27	12				
05:45		1	29	16	121	47	31	96	82	112	203
06:00		5	17			47	19				
06:15		4	18			44	14				
06:30		6	28			45	23				
06:45		7	17	22	80	42	15	178	71	200	151
07:00		10	30			34	9				
07:15		10	21			16	15				
07:30		11	11			16	17				
07:45		20	15	51	77	24	9	90	50	141	127
08:00		14	6			15	13				
08:15		19	5			17	10				
08:30		5	5			7	4				
08:45		16	4	54	20	15	6	54	33	108	53
09:00		9	7			6	7				
09:15		7	5			8	7				
09:30		9	5			8	8				
09:45		8	1	33	18	6	6	28	28	61	46
10:00		17	5			11	7				
10:15		12	3			15	7				
10:30		11	4			16	6				
10:45		11	4	51	16	10	4	52	24	103	40
11:00		9	3			14	1				
11:15		15	0			10	1				
11:30		5	2			17	4				
11:45		7	0	36	5	9	1	50	7	86	12
Total		278	846	278	846	611	614	611	614	889	1460
Combined Total		1124		1124		1225		1225		2349	
AM Peak	-	07:30	-	-	-	05:45	-	-	-	-	-
Vol.	-	64	-	-	-	183	-	-	-	-	-
P.H.F.	-	0.800				0.973					
PM Peak	-	-	04:00	-	-	-	05:45	-	-	-	-
Vol.	-	-	194	-	-	-	87	-	-	-	-
P.H.F.	-	-	0.990				0.702				
Percentage		24.7%	75.3%			49.9%	50.1%				
ADT/AADT		ADT 2,349		AADT 2,349							

Counts Unlimited, Inc.

City of Madera
 Avenue 15-1/2
 B/ Westberry Boulevard - Granada Drive
 24 Hour Directional Volume Count

PO Box 1178
 Corona, CA 92878
 Phone: (951) 268-6268
 email: counts@countsunlimited.com

MDA006B
 Site Code: 003-19628

Start Time	18-Sep-19 Wed	Eastbound		Hour Totals		Westbound		Hour Totals		Combined Totals	
		Morning	Afternoon	Morning	Afternoon	Morning	Afternoon	Morning	Afternoon	Morning	Afternoon
12:00		4	39			8	32				
12:15		5	31			1	30				
12:30		2	24			3	29				
12:45		1	33	12	127	4	42	16	133	28	260
01:00		2	42			1	33				
01:15		0	35			1	25				
01:30		2	22			2	25				
01:45		0	18	4	117	2	21	6	104	10	221
02:00		0	33			3	25				
02:15		0	27			3	21				
02:30		2	31			1	42				
02:45		1	33	3	124	0	25	7	113	10	237
03:00		0	36			1	18				
03:15		0	51			1	41				
03:30		0	33			2	33				
03:45		1	40	1	160	6	31	10	123	11	283
04:00		3	56			6	32				
04:15		3	43			10	37				
04:30		1	58			10	35				
04:45		2	43	9	200	10	38	36	142	45	342
05:00		10	37			8	24				
05:15		3	45			21	38				
05:30		12	35			28	36				
05:45		7	49	32	166	37	33	94	131	126	297
06:00		12	40			47	33				
06:15		16	42			36	29				
06:30		18	22			36	43				
06:45		17	26	63	130	35	28	154	133	217	263
07:00		14	23			22	23				
07:15		18	18			14	30				
07:30		44	23			14	25				
07:45		41	23	117	87	28	24	78	102	195	189
08:00		42	16			37	18				
08:15		35	17			18	21				
08:30		35	9			20	17				
08:45		30	11	142	53	24	17	99	73	241	126
09:00		29	16			15	15				
09:15		29	13			14	15				
09:30		23	6			18	14				
09:45		21	14	102	49	20	13	67	57	169	106
10:00		34	5			16	12				
10:15		21	8			21	10				
10:30		23	5			23	10				
10:45		25	9	103	27	26	8	86	40	189	67
11:00		26	2			23	4				
11:15		21	4			32	5				
11:30		19	2			41	6				
11:45		30	2	96	10	25	5	121	20	217	30
Total		684	1250	684	1250	774	1171	774	1171	1458	2421
Combined Total		1934		1934		1945		1945		3879	
AM Peak	-	07:30	-	-	-	05:45	-	-	-	-	-
Vol.	-	162	-	-	-	156	-	-	-	-	-
P.H.F.	-	0.920				0.830					
PM Peak	-	-	04:00	-	-	-	04:00	-	-	-	-
Vol.	-	-	200	-	-	-	142	-	-	-	-
P.H.F.	-	-	0.862				0.934				
Percentage		35.4%	64.6%			39.8%	60.2%				
ADT/AADT		ADT 3,879		AADT 3,879							

Counts Unlimited, Inc.

City of Madera
 Cleveland Avenue
 B/ Granada Drive - Schnoor Street
 24 Hour Directional Volume Count

PO Box 1178
 Corona, CA 92878
 Phone: (951) 268-6268
 email: counts@countsunlimited.com

MDA006
 Site Code: 003-19628

Start Time	19-Sep-19 Thu	Eastbound		Hour Totals		Westbound		Hour Totals		Combined Totals	
		Morning	Afternoon	Morning	Afternoon	Morning	Afternoon	Morning	Afternoon	Morning	Afternoon
12:00		10	54			16	76				
12:15		6	76			9	77				
12:30		5	68			9	83				
12:45		0	54	21	252	10	77	44	313	65	565
01:00		2	75			3	67				
01:15		2	66			4	82				
01:30		5	55			6	85				
01:45		1	106	10	302	4	70	17	304	27	606
02:00		1	79			6	60				
02:15		4	58			4	88				
02:30		1	68			5	86				
02:45		3	75	9	280	3	69	18	303	27	583
03:00		4	68			0	84				
03:15		4	85			3	76				
03:30		3	81			3	77				
03:45		3	86	14	320	5	87	11	324	25	644
04:00		5	104			8	92				
04:15		6	98			13	102				
04:30		9	108			12	95				
04:45		15	103	35	413	15	102	48	391	83	804
05:00		22	84			10	91				
05:15		14	84			20	104				
05:30		21	106			37	116				
05:45		26	74	83	348	49	108	116	419	199	767
06:00		31	98			45	105				
06:15		21	76			47	110				
06:30		35	76			47	88				
06:45		46	61	133	311	47	86	186	389	319	700
07:00		52	70			40	71				
07:15		83	71			40	74				
07:30		81	64			45	79				
07:45		107	70	323	275	62	84	187	308	510	583
08:00		100	55			50	75				
08:15		84	40			63	70				
08:30		87	30			49	67				
08:45		63	33	334	158	37	58	199	270	533	428
09:00		62	33			51	62				
09:15		65	27			40	50				
09:30		52	22			37	53				
09:45		41	25	220	107	44	49	172	214	392	321
10:00		53	15			58	35				
10:15		47	24			56	40				
10:30		62	24			53	20				
10:45		62	16	224	79	69	23	236	118	460	197
11:00		72	13			47	29				
11:15		69	9			65	33				
11:30		61	12			63	14				
11:45		61	13	263	47	55	19	230	95	493	142
Total		1669	2892	1669	2892	1464	3448	1464	3448	3133	6340
Combined Total		4561		4561		4912		4912		9473	
AM Peak	-	07:45	-	-	-	10:45	-	-	-	-	-
Vol.	-	378	-	-	-	244	-	-	-	-	-
P.H.F.		0.883				0.884					
PM Peak	-	-	04:00	-	-	-	05:30	-	-	-	-
Vol.	-	-	413	-	-	-	439	-	-	-	-
P.H.F.			0.956				0.946				
Percentage		36.6%	63.4%			29.8%	70.2%				
ADT/AADT		ADT 9,473		AADT 9,473							

Counts Unlimited, Inc.

City of Madera
 Sunset Avenue
 B/ Granada Drive - Schnoor Street
 24 Hour Directional Volume Count

PO Box 1178
 Corona, CA 92878
 Phone: (951) 268-6268
 email: counts@countsunlimited.com

MDA008
 Site Code: 003-19628

Start Time	19-Sep-19 Thu	Eastbound		Hour Totals		Westbound		Hour Totals		Combined Totals	
		Morning	Afternoon	Morning	Afternoon	Morning	Afternoon	Morning	Afternoon	Morning	Afternoon
12:00		3	44			4	49				
12:15		1	46			2	52				
12:30		5	40			4	36				
12:45		5	49	14	179	2	35	12	172	26	351
01:00		3	56			5	39				
01:15		0	49			2	0				
01:30		2	71			1	0				
01:45		1	80	6	256	0	19	8	58	14	314
02:00		0	63			0	44				
02:15		1	41			3	50				
02:30		3	41			0	34				
02:45		5	38	9	183	4	34	7	162	16	345
03:00		4	64			2	31				
03:15		3	58			4	44				
03:30		6	55			4	82				
03:45		3	63	16	240	1	61	11	218	27	458
04:00		4	48			1	64				
04:15		7	62			3	50				
04:30		4	49			4	49				
04:45		10	66	25	225	6	61	14	224	39	449
05:00		8	64			3	65				
05:15		13	51			7	84				
05:30		16	62			6	86				
05:45		22	58	59	235	10	87	26	322	85	557
06:00		23	58			9	59				
06:15		24	52			13	70				
06:30		25	45			15	57				
06:45		52	49	124	204	22	41	59	227	183	431
07:00		41	32			26	37				
07:15		57	41			22	46				
07:30		87	28			31	31				
07:45		114	46	299	147	47	55	126	169	425	316
08:00		127	35			57	41				
08:15		85	25			49	31				
08:30		103	29			41	24				
08:45		72	20	387	109	64	26	211	122	598	231
09:00		58	17			31	33				
09:15		42	15			37	24				
09:30		41	15			28	25				
09:45		32	17	173	64	33	27	129	109	302	173
10:00		41	10			17	26				
10:15		32	18			26	36				
10:30		44	12			30	23				
10:45		26	11	143	51	24	11	97	96	240	147
11:00		42	16			32	17				
11:15		37	11			39	9				
11:30		45	4			38	8				
11:45		38	6	162	37	44	10	153	44	315	81
Total		1417	1930	1417	1930	853	1923	853	1923	2270	3853
Combined Total		3347		3347		2776		2776		6123	
AM Peak	-	07:45	-	-	-	08:00	-	-	-	-	-
Vol.	-	429	-	-	-	211	-	-	-	-	-
P.H.F.		0.844				0.824					
PM Peak	-	-	01:15	-	-	-	05:00	-	-	-	-
Vol.	-	-	263	-	-	-	322	-	-	-	-
P.H.F.			0.822				0.925				
Percentage		42.3%	57.7%			30.7%	69.3%				
ADT/AADT		ADT 6,123		AADT 6,123							

Counts Unlimited, Inc.

City of Madera
 Howard Road
 B/ Granada Drive - Schnoor Street
 24 Hour Directional Volume Count

PO Box 1178
 Corona, CA 92878
 Phone: (951) 268-6268
 email: counts@countsunlimited.com

MDA009
 Site Code: 003-19628

Start Time	19-Sep-19 Thu	Eastbound		Hour Totals		Westbound		Hour Totals		Combined Totals	
		Morning	Afternoon	Morning	Afternoon	Morning	Afternoon	Morning	Afternoon	Morning	Afternoon
12:00		6	61			8	62				
12:15		8	74			8	70				
12:30		12	71			7	77				
12:45		1	60	27	266	5	71	28	280	55	546
01:00		7	84			3	72				
01:15		3	58			7	74				
01:30		6	70			3	89				
01:45		2	112	18	324	4	99	17	334	35	658
02:00		3	81			3	72				
02:15		3	87			4	67				
02:30		1	72			2	68				
02:45		3	80	10	320	2	59	11	266	21	586
03:00		4	99			1	49				
03:15		2	96			3	96				
03:30		5	105			2	150				
03:45		7	106	18	406	6	99	12	394	30	800
04:00		4	85			10	93				
04:15		6	105			10	88				
04:30		6	121			18	113				
04:45		13	126	29	437	14	107	52	401	81	838
05:00		24	121			13	113				
05:15		18	112			23	153				
05:30		32	132			21	105				
05:45		25	109	99	474	58	115	115	486	214	960
06:00		49	88			53	89				
06:15		45	83			49	95				
06:30		46	87			34	105				
06:45		66	80	206	338	47	76	183	365	389	703
07:00		80	96			38	85				
07:15		99	78			63	74				
07:30		118	81			59	78				
07:45		156	69	453	324	80	85	240	322	693	646
08:00		171	54			86	80				
08:15		161	32			79	88				
08:30		139	41			100	56				
08:45		71	37	542	164	108	64	373	288	915	452
09:00		68	36			60	54				
09:15		54	28			53	59				
09:30		70	24			50	40				
09:45		73	23	265	111	53	51	216	204	481	315
10:00		71	28			50	53				
10:15		66	23			45	56				
10:30		66	24			57	28				
10:45		59	10	262	85	62	33	214	170	476	255
11:00		70	14			51	23				
11:15		51	11			44	20				
11:30		68	8			60	10				
11:45		77	10	266	43	71	14	226	67	492	110
Total		2195	3292	2195	3292	1687	3577	1687	3577	3882	6869
Combined Total		5487		5487		5264		5264		10751	
AM Peak	-	07:45	-	-	-	08:00	-	-	-	-	-
Vol.	-	627	-	-	-	373	-	-	-	-	-
P.H.F.	-	0.917	-	-	-	0.863	-	-	-	-	-
PM Peak	-	-	04:45	-	-	-	04:30	-	-	-	-
Vol.	-	-	491	-	-	-	486	-	-	-	-
P.H.F.	-	-	0.930	-	-	-	0.794	-	-	-	-
Percentage		40.0%	60.0%			32.0%	68.0%				
ADT/AADT		ADT 10,751		AADT 10,751							

Counts Unlimited, Inc.

City of Madera
 Howard Road
 B/ Schnoor Street - Pine Street
 24 Hour Directional Volume Count

PO Box 1178
 Corona, CA 92878
 Phone: (951) 268-6268
 email: counts@countsunlimited.com

MDA010
 Site Code: 003-19628

Start Time	19-Sep-19 Thu	Eastbound		Hour Totals		Westbound		Hour Totals		Combined Totals	
		Morning	Afternoon	Morning	Afternoon	Morning	Afternoon	Morning	Afternoon	Morning	Afternoon
12:00		9	127			13	131				
12:15		8	133			11	135				
12:30		12	126			8	147				
12:45		9	119	38	505	7	130	39	543	77	1048
01:00		11	126			8	115				
01:15		5	126			9	136				
01:30		3	115			4	137				
01:45		11	145	30	512	6	140	27	528	57	1040
02:00		2	126			2	157				
02:15		3	132			4	128				
02:30		2	130			5	116				
02:45		2	140	9	528	3	112	14	513	23	1041
03:00		3	155			3	91				
03:15		3	153			6	173				
03:30		4	130			1	221				
03:45		12	172	22	610	7	154	17	639	39	1249
04:00		8	136			11	129				
04:15		4	134			14	147				
04:30		7	148			25	178				
04:45		11	169	30	587	30	178	80	632	110	1219
05:00		30	178			20	197				
05:15		24	156			42	198				
05:30		26	158			31	165				
05:45		30	159	110	651	74	172	167	732	277	1383
06:00		44	153			78	154				
06:15		51	130			61	141				
06:30		58	114			47	142				
06:45		61	135	214	532	66	124	252	561	466	1093
07:00		104	119			80	137				
07:15		116	129			82	117				
07:30		138	128			95	113				
07:45		180	108	538	484	131	116	388	483	926	967
08:00		218	95			124	121				
08:15		200	73			131	125				
08:30		203	79			156	73				
08:45		138	55	759	302	164	89	575	408	1334	710
09:00		114	49			113	74				
09:15		98	58			92	77				
09:30		94	35			81	53				
09:45		104	37	410	179	102	72	388	276	798	455
10:00		112	38			87	57				
10:15		99	41			105	79				
10:30		100	34			104	44				
10:45		89	24	400	137	129	42	425	222	825	359
11:00		120	17			111	29				
11:15		120	17			110	24				
11:30		107	13			114	19				
11:45		129	19	476	66	133	19	468	91	944	157
Total		3036	5093	3036	5093	2840	5628	2840	5628	5876	10721
Combined Total		8129		8129		8468		8468		16597	
AM Peak	-	07:45	-	-	-	08:00	-	-	-	-	-
Vol.	-	801	-	-	-	575	-	-	-	-	-
P.H.F.	-	0.919	-	-	-	0.877	-	-	-	-	-
PM Peak	-	-	04:45	-	-	-	04:30	-	-	-	-
Vol.	-	-	661	-	-	-	751	-	-	-	-
P.H.F.	-	-	0.928	-	-	-	0.948	-	-	-	-
Percentage		37.3%	62.7%			33.5%	66.5%				
ADT/AADT		ADT 16,597		AADT 16,597							

APPENDIX C:

VOLUME DEVELOPMENT WORKSHEETS

Table C-1 - Existing Balanced (2019) Peak Hour Volume Summary

	AM Peak Hour					PM Peak Hour				
	Existing	External Project Trips	Internal Project Trips	Pass-By Trips	Existing with Project	Existing	External Project Trips	Internal Project Trips	Pass-By Trips	Existing with Project
1 Road 22/Avenue 17										
NBL	1	29	0	0	30	1	9	0	0	10
NBT	0	0	0	0	0	0	0	0	0	0
NBR	2	0	8	0	10	0	0	8	0	8
SBL	0	0	0	0	0	0	0	0	0	0
SBT	0	0	0	0	0	0	0	0	0	0
SBR	0	0	0	0	0	0	0	0	0	0
EBL	0	0	0	0	0	0	0	0	0	0
EBT	29	30	0	0	59	60	81	0	0	141
EBR	0	9	0	0	9	0	23	0	0	23
WBL	2	0	8	0	10	0	0	8	0	8
WBT	25	90	0	0	115	25	39	0	0	64
WBR	0	0	0	0	0	0	0	0	0	0
North Leg										
Approach	0	0	0	0	0	0	0	0	0	0
Departure	0	0	0	0	0	0	0	0	0	0
Total	0	0	0	0	0	0	0	0	0	0
South Leg										
Approach	3	29	8	0	40	1	9	8	0	18
Departure	2	9	8	0	19	0	23	8	0	31
Total	5	38	16	0	59	1	32	16	0	49
East Leg										
Approach	27	90	8	0	125	25	39	8	0	72
Departure	31	30	8	0	69	60	81	8	0	149
Total	58	120	16	0	194	85	120	16	0	221
West Leg										
Approach	29	39	0	0	68	60	104	0	0	164
Departure	26	119	0	0	145	26	48	0	0	74
Total	55	158	0	0	213	86	152	0	0	238
Total Approaches										
Approach	59	158	16	0	233	86	152	16	0	254
Departure	59	158	16	0	233	86	152	16	0	254
Total	118	316	32	0	466	172	304	32	0	508



Table C-1 - Existing Balanced (2019) Peak Hour Volume Summary

	AM Peak Hour					PM Peak Hour				
	Existing	External Project Trips	Internal Project Trips	Pass-By Trips	Existing with Project	Existing	External Project Trips	Internal Project Trips	Pass-By Trips	Existing with Project
2 Road 22/Avenue 16										
NBL	0	0	0	0	0	0	0	0	0	0
NBT	0	13	8	0	21	0	3	8	0	11
NBR	0	0	0	0	0	1	0	0	0	1
SBL	2	3	0	0	5	0	15	0	0	15
SBT	0	6	8	0	14	0	8	8	0	16
SBR	1	0	0	0	1	0	0	0	0	0
EBL	2	0	0	0	2	0	0	0	0	0
EBT	12	0	0	0	12	48	0	0	0	48
EBR	0	0	0	0	0	0	0	0	0	0
WBL	0	0	0	0	0	0	0	0	0	0
WBT	29	0	0	0	29	14	0	0	0	14
WBR	4	16	0	0	20	0	6	0	0	6
North Leg										
Approach	3	9	8	0	20	0	23	8	0	31
Departure	6	29	8	0	43	0	9	8	0	17
Total	9	38	16	0	63	0	32	16	0	48
South Leg										
Approach	0	13	8	0	21	1	3	8	0	12
Departure	0	6	8	0	14	0	8	8	0	16
Total	0	19	16	0	35	1	11	16	0	28
East Leg										
Approach	33	16	0	0	49	14	6	0	0	20
Departure	14	3	0	0	17	49	15	0	0	64
Total	47	19	0	0	66	63	21	0	0	84
West Leg										
Approach	14	0	0	0	14	48	0	0	0	48
Departure	30	0	0	0	30	14	0	0	0	14
Total	44	0	0	0	44	62	0	0	0	62
Total Approaches										
Approach	50	38	16	0	104	63	32	16	0	111
Departure	50	38	16	0	104	63	32	16	0	111
Total	100	76	32	0	208	126	64	32	0	222



Table C-1 - Existing Balanced (2019) Peak Hour Volume Summary

	AM Peak Hour					PM Peak Hour				
	Existing	External Project Trips	Internal Project Trips	Pass-By Trips	Existing with Project	Existing	External Project Trips	Internal Project Trips	Pass-By Trips	Existing with Project
3 Golden State Boulevard/Avenue 18 ½										
NBL	0	0	0	0	0	0	0	0	0	0
NBT	0	0	0	0	0	0	0	0	0	0
NBR	0	0	0	0	0	0	0	0	0	0
SBL	92	0	0	0	92	252	0	0	0	252
SBT	0	0	0	0	0	0	0	0	0	0
SBR	4	0	0	0	4	8	0	0	0	8
EBL	2	0	0	0	2	7	0	0	0	7
EBT	98	28	0	0	126	117	91	0	0	208
EBR	0	0	0	0	0	0	0	0	0	0
WBL	0	0	0	0	0	0	0	0	0	0
WBT	96	74	0	0	170	60	58	0	0	118
WBR	106	0	0	0	106	96	0	0	0	96
North Leg										
Approach	96	0	0	0	96	260	0	0	0	260
Departure	108	0	0	0	108	103	0	0	0	103
Total	204	0	0	0	204	363	0	0	0	363
South Leg										
Approach	0	0	0	0	0	0	0	0	0	0
Departure	0	0	0	0	0	0	0	0	0	0
Total	0	0	0	0	0	0	0	0	0	0
East Leg										
Approach	202	74	0	0	276	156	58	0	0	214
Departure	190	28	0	0	218	369	91	0	0	460
Total	392	102	0	0	494	525	149	0	0	674
West Leg										
Approach	100	28	0	0	128	124	91	0	0	215
Departure	100	74	0	0	174	68	58	0	0	126
Total	200	102	0	0	302	192	149	0	0	341
Total Approaches										
Approach	398	102	0	0	500	540	149	0	0	689
Departure	398	102	0	0	500	540	149	0	0	689
Total	796	204	0	0	1,000	1,080	298	0	0	1,378



Table C-1 - Existing Balanced (2019) Peak Hour Volume Summary

	AM Peak Hour				PM Peak Hour					
	Existing	External Project Trips	Internal Project Trips	Pass-By Trips	Existing with Project	Existing	External Project Trips	Internal Project Trips	Pass-By Trips	Existing with Project
4 Pistachio Drive/Avenue 18 ½										
NBL	0	0	0	0	0	2	0	0	0	2
NBT	0	0	0	0	0	0	0	0	0	0
NBR	1	0	0	0	1	5	0	0	0	5
SBL	104	0	0	0	104	154	0	0	0	154
SBT	0	0	0	0	0	0	0	0	0	0
SBR	9	0	0	0	9	12	0	0	0	12
EBL	8	0	0	0	8	12	0	0	0	12
EBT	250	28	0	0	278	425	91	0	0	516
EBR	1	0	0	0	1	1	0	0	0	1
WBL	3	0	0	0	3	6	0	0	0	6
WBT	212	74	0	0	286	148	58	0	0	206
WBR	201	0	0	0	201	187	0	0	0	187
North Leg										
Approach	113	0	0	0	113	166	0	0	0	166
Departure	209	0	0	0	209	199	0	0	0	199
Total	322	0	0	0	322	365	0	0	0	365
South Leg										
Approach	1	0	0	0	1	7	0	0	0	7
Departure	4	0	0	0	4	7	0	0	0	7
Total	5	0	0	0	5	14	0	0	0	14
East Leg										
Approach	416	74	0	0	490	341	58	0	0	399
Departure	355	28	0	0	383	584	91	0	0	675
Total	771	102	0	0	873	925	149	0	0	1,074
West Leg										
Approach	259	28	0	0	287	438	91	0	0	529
Departure	221	74	0	0	295	162	58	0	0	220
Total	480	102	0	0	582	600	149	0	0	749
Total Approaches										
Approach	789	102	0	0	891	952	149	0	0	1,101
Departure	789	102	0	0	891	952	149	0	0	1,101
Total	1,578	204	0	0	1,782	1,904	298	0	0	2,202



Table C-1 - Existing Balanced (2019) Peak Hour Volume Summary

	AM Peak Hour				PM Peak Hour					
	Existing	External Project Trips	Internal Project Trips	Pass-By Trips	Existing with Project	Existing	External Project Trips	Internal Project Trips	Pass-By Trips	Existing with Project
5 SR-99 Southbound Ramps – Road 23/Avenue 18 ½										
NBL	60	74	0	0	134	31	58	0	0	89
NBT	0	0	0	0	0	0	0	0	0	0
NBR	143	579	0	0	722	75	307	0	0	382
SBL	10	0	0	0	10	19	0	0	0	19
SBT	47	208	0	0	255	93	559	0	0	652
SBR	85	0	0	0	85	120	0	0	0	120
EBL	0	0	0	0	0	0	0	0	0	0
EBT	305	0	0	0	305	380	0	0	0	380
EBR	50	28	0	0	78	204	91	0	0	295
WBL	40	0	0	0	40	39	0	0	0	39
WBT	271	0	0	0	271	191	0	0	0	191
WBR	0	0	0	0	0	0	0	0	0	0
North Leg										
Approach	142	208	0	0	350	232	559	0	0	791
Departure	0	0	0	0	0	0	0	0	0	0
Total	142	208	0	0	350	232	559	0	0	791
South Leg										
Approach	203	653	0	0	856	106	365	0	0	471
Departure	137	236	0	0	373	336	650	0	0	986
Total	340	889	0	0	1,229	442	1,015	0	0	1,457
East Leg										
Approach	311	0	0	0	311	230	0	0	0	230
Departure	458	579	0	0	1,037	474	307	0	0	781
Total	769	579	0	0	1,348	704	307	0	0	1,011
West Leg										
Approach	355	28	0	0	383	584	91	0	0	675
Departure	416	74	0	0	490	342	58	0	0	400
Total	771	102	0	0	873	926	149	0	0	1,075
Total Approaches										
Approach	1,011	889	0	0	1,900	1,152	1,015	0	0	2,167
Departure	1,011	889	0	0	1,900	1,152	1,015	0	0	2,167
Total	2,022	1,778	0	0	3,800	2,304	2,030	0	0	4,334



Table C-1 - Existing Balanced (2019) Peak Hour Volume Summary

	AM Peak Hour				PM Peak Hour					
	Existing	External Project Trips	Internal Project Trips	Pass-By Trips	Existing with Project	Existing	External Project Trips	Internal Project Trips	Pass-By Trips	Existing with Project
6 SR-99 Northbound Ramps/Avenue 18 ½										
NBL	213	0	0	0	213	179	0	0	0	179
NBT	1	0	0	0	1	2	0	0	0	2
NBR	18	0	0	0	18	0	0	0	0	0
SBL	0	0	0	0	0	0	0	0	0	0
SBT	0	0	0	0	0	0	0	0	0	0
SBR	0	0	0	0	0	0	0	0	0	0
EBL	216	579	0	0	795	171	307	0	0	478
EBT	54	0	0	0	54	81	0	0	0	81
EBR	0	0	0	0	0	0	0	0	0	0
WBL	0	0	0	0	0	0	0	0	0	0
WBT	134	0	0	0	134	78	0	0	0	78
WBR	22	0	0	0	22	13	0	0	0	13
North Leg										
Approach	0	0	0	0	0	0	0	0	0	0
Departure	239	579	0	0	818	186	307	0	0	493
Total	239	579	0	0	818	186	307	0	0	493
South Leg										
Approach	232	0	0	0	232	181	0	0	0	181
Departure	0	0	0	0	0	0	0	0	0	0
Total	232	0	0	0	232	181	0	0	0	181
East Leg										
Approach	156	0	0	0	156	91	0	0	0	91
Departure	72	0	0	0	72	81	0	0	0	81
Total	228	0	0	0	228	172	0	0	0	172
West Leg										
Approach	270	579	0	0	849	252	307	0	0	559
Departure	347	0	0	0	347	257	0	0	0	257
Total	617	579	0	0	1,196	509	307	0	0	816
Total Approaches										
Approach	658	579	0	0	1,237	524	307	0	0	831
Departure	658	579	0	0	1,237	524	307	0	0	831
Total	1,316	1,158	0	0	2,474	1,048	614	0	0	1,662



Table C-1 - Existing Balanced (2019) Peak Hour Volume Summary

	AM Peak Hour				PM Peak Hour					
	Existing	External Project Trips	Internal Project Trips	Pass-By Trips	Existing with Project	Existing	External Project Trips	Internal Project Trips	Pass-By Trips	Existing with Project
7 Road 23/Avenue 17										
NBL	8	34	9	0	51	5	13	17	0	35
NBT	158	751	0	0	909	77	459	0	0	536
NBR	47	927	0	0	974	60	581	0	0	641
SBL	15	0	0	0	15	61	0	0	0	61
SBT	103	297	0	0	400	219	771	0	0	990
SBR	0	42	0	0	42	2	163	0	0	165
EBL	1	159	0	0	160	1	82	0	0	83
EBT	22	455	0	0	477	48	210	0	0	258
EBR	8	12	10	0	30	11	30	17	0	58
WBL	53	421	0	0	474	29	938	0	0	967
WBT	19	109	0	0	128	19	448	0	0	467
WBR	3	0	0	0	3	9	0	0	0	9
North Leg										
Approach	118	339	0	0	457	282	934	0	0	1,216
Departure	162	910	0	0	1,072	87	541	0	0	628
Total	280	1,249	0	0	1,529	369	1,475	0	0	1,844
South Leg										
Approach	213	1,712	9	0	1,934	142	1,053	17	0	1,212
Departure	164	730	10	0	904	259	1,739	17	0	2,015
Total	377	2,442	19	0	2,838	401	2,792	34	0	3,227
East Leg										
Approach	75	530	0	0	605	57	1,386	0	0	1,443
Departure	84	1,382	0	0	1,466	169	791	0	0	960
Total	159	1,912	0	0	2,071	226	2,177	0	0	2,403
West Leg										
Approach	31	626	10	0	667	60	322	17	0	399
Departure	27	185	9	0	221	26	624	17	0	667
Total	58	811	19	0	888	86	946	34	0	1,066
Total Approaches										
Approach	437	3,207	19	0	3,663	541	3,695	34	0	4,270
Departure	437	3,207	19	0	3,663	541	3,695	34	0	4,270
Total	874	6,414	38	0	7,326	1,082	7,390	68	0	8,540

Table C-1 - Existing Balanced (2019) Peak Hour Volume Summary

	AM Peak Hour				PM Peak Hour					
	Existing	External Project Trips	Internal Project Trips	Pass-By Trips	Existing with Project	Existing	External Project Trips	Internal Project Trips	Pass-By Trips	Existing with Project
8 Road 23/Avenue 16										
NBL	20	106	24	0	150	7	338	41	0	386
NBT	210	627	181	0	1,018	136	574	358	4	1,072
NBR	0	23	26	0	49	1	126	44	0	171
SBL	0	33	25	0	58	2	182	37	1	222
SBT	152	334	177	0	663	253	769	357	6	1,385
SBR	9	27	28	0	64	6	125	51	1	183
EBL	6	105	29	0	140	9	74	51	0	134
EBT	1	0	34	0	35	0	0	25	0	25
EBR	7	357	24	0	388	41	168	41	0	250
WBL	0	137	25	0	162	0	49	44	0	93
WBT	4	0	33	0	37	1	0	25	0	26
WBR	0	198	24	0	222	1	71	37	0	109
North Leg										
Approach	161	394	230	0	785	261	1,076	445	8	1,790
Departure	216	930	234	0	1,380	146	719	446	4	1,315
Total	377	1,324	464	0	2,165	407	1,795	891	12	3,105
South Leg										
Approach	230	756	231	0	1,217	144	1,038	443	4	1,629
Departure	159	828	226	0	1,213	294	986	442	6	1,728
Total	389	1,584	457	0	2,430	438	2,024	885	10	3,357
East Leg										
Approach	4	335	82	0	421	2	120	106	0	228
Departure	1	56	85	0	142	3	308	106	1	418
Total	5	391	167	0	563	5	428	212	1	646
West Leg										
Approach	14	462	87	0	563	50	242	117	0	409
Departure	33	133	85	0	251	14	463	117	1	595
Total	47	595	172	0	814	64	705	234	1	1,004
Total Approaches										
Approach	409	1,947	630	0	2,986	457	2,476	1,111	12	4,056
Departure	409	1,947	630	0	2,986	457	2,476	1,111	12	4,056
Total	818	3,894	1,260	0	5,972	914	4,952	2,222	24	8,112



Table C-1 - Existing Balanced (2019) Peak Hour Volume Summary

	AM Peak Hour				PM Peak Hour					
	Existing	External Project Trips	Internal Project Trips	Pass-By Trips	Existing with Project	Existing	External Project Trips	Internal Project Trips	Pass-By Trips	Existing with Project
9 Road 23/Cleveland Avenue										
NBL	0	210	142	0	352	0	596	353	19	968
NBT	199	235	149	0	583	113	400	350	59	922
NBR	50	239	7	0	296	89	204	8	-15	286
SBL	13	306	35	0	354	59	199	57	-15	300
SBT	148	365	153	0	666	224	310	346	41	921
SBR	0	157	56	0	213	1	476	113	18	608
EBL	0	349	58	0	407	1	349	112	15	477
EBT	0	114	116	0	230	0	359	137	6	502
EBR	0	473	149	0	622	1	423	352	12	788
WBL	52	244	7	0	303	51	201	8	-10	250
WBT	0	126	110	0	236	0	351	137	6	494
WBR	32	169	33	0	234	25	289	57	-13	358
North Leg										
Approach	161	828	244	0	1,233	284	985	516	44	1,829
Departure	231	753	240	0	1,224	139	1,038	519	61	1,757
Total	392	1,581	484	0	2,457	423	2,023	1,035	105	3,586
South Leg										
Approach	249	684	298	0	1,231	202	1,200	711	63	2,176
Departure	200	1,082	309	0	1,591	276	934	706	43	1,959
Total	449	1,766	607	0	2,822	478	2,134	1,417	106	4,135
East Leg										
Approach	84	539	150	0	773	76	841	202	-17	1,102
Departure	63	659	158	0	880	148	762	202	-24	1,088
Total	147	1,198	308	0	1,653	224	1,603	404	-41	2,190
West Leg										
Approach	0	936	323	0	1,259	2	1,131	601	33	1,767
Departure	0	493	308	0	801	1	1,423	603	43	2,070
Total	0	1,429	631	0	2,060	3	2,554	1,204	76	3,837
Total Approaches										
Approach	494	2,987	1,015	0	4,496	564	4,157	2,030	123	6,874
Departure	494	2,987	1,015	0	4,496	564	4,157	2,030	123	6,874
Total	988	5,974	2,030	0	8,992	1,128	8,314	4,060	246	13,748



Table C-1 - Existing Balanced (2019) Peak Hour Volume Summary

	AM Peak Hour				PM Peak Hour					
	Existing	External Project Trips	Internal Project Trips	Pass-By Trips	Existing with Project	Existing	External Project Trips	Internal Project Trips	Pass-By Trips	Existing with Project
10 Road 23/Avenue 14 ½										
NBL	3	0	0	0	3	2	0	0	0	2
NBT	177	407	0	0	584	179	1,077	0	0	1,256
NBR	4	0	0	0	4	2	0	0	0	2
SBL	28	188	0	0	216	60	242	0	0	302
SBT	166	955	0	0	1,121	215	708	0	0	923
SBR	0	0	0	0	0	0	0	0	0	0
EBL	0	0	0	0	0	1	0	0	0	1
EBT	5	0	0	0	5	2	0	0	0	2
EBR	0	0	0	0	0	3	0	0	0	3
WBL	16	0	0	0	16	4	0	0	0	4
WBT	3	0	0	0	3	3	0	0	0	3
WBR	67	115	0	0	182	8	292	0	0	300
North Leg										
Approach	194	1,143	0	0	1,337	275	950	0	0	1,225
Departure	244	522	0	0	766	188	1,369	0	0	1,557
Total	438	1,665	0	0	2,103	463	2,319	0	0	2,782
South Leg										
Approach	184	407	0	0	591	183	1,077	0	0	1,260
Departure	182	955	0	0	1,137	222	708	0	0	930
Total	366	1,362	0	0	1,728	405	1,785	0	0	2,190
East Leg										
Approach	86	115	0	0	201	15	292	0	0	307
Departure	37	188	0	0	225	64	242	0	0	306
Total	123	303	0	0	426	79	534	0	0	613
West Leg										
Approach	5	0	0	0	5	6	0	0	0	6
Departure	6	0	0	0	6	5	0	0	0	5
Total	11	0	0	0	11	11	0	0	0	11
Total Approaches										
Approach	469	1,665	0	0	2,134	479	2,319	0	0	2,798
Departure	469	1,665	0	0	2,134	479	2,319	0	0	2,798
Total	938	3,330	0	0	4,268	958	4,638	0	0	5,596



Table C-1 - Existing Balanced (2019) Peak Hour Volume Summary

	AM Peak Hour				PM Peak Hour					
	Existing	External Project Trips	Internal Project Trips	Pass-By Trips	Existing with Project	Existing	External Project Trips	Internal Project Trips	Pass-By Trips	Existing with Project
11 Road 23/Avenue 14										
NBL	24	0	0	0	24	14	0	0	0	14
NBT	82	95	0	0	177	91	250	0	0	341
NBR	8	0	0	0	8	21	0	0	0	21
SBL	34	654	0	0	688	70	478	0	0	548
SBT	93	212	0	0	305	121	170	0	0	291
SBR	56	88	0	0	144	29	57	0	0	86
EBL	49	35	0	0	84	44	97	0	0	141
EBT	145	0	0	0	145	89	0	0	0	89
EBR	18	0	0	0	18	34	0	0	0	34
WBL	19	0	0	0	19	11	0	0	0	11
WBT	176	0	0	0	176	36	0	0	0	36
WBR	53	279	0	0	332	49	730	0	0	779
North Leg										
Approach	183	954	0	0	1,137	220	705	0	0	925
Departure	184	409	0	0	593	184	1,077	0	0	1,261
Total	367	1,363	0	0	1,730	404	1,782	0	0	2,186
South Leg										
Approach	114	95	0	0	209	126	250	0	0	376
Departure	130	212	0	0	342	166	170	0	0	336
Total	244	307	0	0	551	292	420	0	0	712
East Leg										
Approach	248	279	0	0	527	96	730	0	0	826
Departure	187	654	0	0	841	180	478	0	0	658
Total	435	933	0	0	1,368	276	1,208	0	0	1,484
West Leg										
Approach	212	35	0	0	247	167	97	0	0	264
Departure	256	88	0	0	344	79	57	0	0	136
Total	468	123	0	0	591	246	154	0	0	400
Total Approaches										
Approach	757	1,363	0	0	2,120	609	1,782	0	0	2,391
Departure	757	1,363	0	0	2,120	609	1,782	0	0	2,391
Total	1,514	2,726	0	0	4,240	1,218	3,564	0	0	4,782



Table C-1 - Existing Balanced (2019) Peak Hour Volume Summary

	AM Peak Hour				PM Peak Hour					
	Existing	External Project Trips	Internal Project Trips	Pass-By Trips	Existing with Project	Existing	External Project Trips	Internal Project Trips	Pass-By Trips	Existing with Project
12 Road 23/Avenue 12										
NBL	8	0	0	0	8	4	0	0	0	4
NBT	32	26	0	0	58	40	68	0	0	108
NBR	16	0	0	0	16	38	0	0	0	38
SBL	32	74	0	0	106	55	51	0	0	106
SBT	47	57	0	0	104	45	46	0	0	91
SBR	28	74	0	0	102	33	51	0	0	84
EBL	18	32	0	0	50	56	83	0	0	139
EBT	82	0	0	0	82	116	0	0	0	116
EBR	4	0	0	0	4	8	0	0	0	8
WBL	11	0	0	0	11	14	0	0	0	14
WBT	73	0	0	0	73	66	0	0	0	66
WBR	37	32	0	0	69	23	83	0	0	106
North Leg										
Approach	107	205	0	0	312	133	148	0	0	281
Departure	87	90	0	0	177	119	234	0	0	353
Total	194	295	0	0	489	252	382	0	0	634
South Leg										
Approach	56	26	0	0	82	82	68	0	0	150
Departure	62	57	0	0	119	67	46	0	0	113
Total	118	83	0	0	201	149	114	0	0	263
East Leg										
Approach	121	32	0	0	153	103	83	0	0	186
Departure	130	74	0	0	204	209	51	0	0	260
Total	251	106	0	0	357	312	134	0	0	446
West Leg										
Approach	104	32	0	0	136	180	83	0	0	263
Departure	109	74	0	0	183	103	51	0	0	154
Total	213	106	0	0	319	283	134	0	0	417
Total Approaches										
Approach	388	295	0	0	683	498	382	0	0	880
Departure	388	295	0	0	683	498	382	0	0	880
Total	776	590	0	0	1,366	996	764	0	0	1,760



Table C-1 - Existing Balanced (2019) Peak Hour Volume Summary

	AM Peak Hour				PM Peak Hour					
	Existing	External Project Trips	Internal Project Trips	Pass-By Trips	Existing with Project	Existing	External Project Trips	Internal Project Trips	Pass-By Trips	Existing with Project
13 Golden State Boulevard – Airport Drive/Avenue 17										
NBL	17	83	0	0	100	20	224	0	0	244
NBT	25	0	0	0	25	27	0	0	0	27
NBR	64	0	0	0	64	152	0	0	0	152
SBL	88	0	0	0	88	120	0	0	0	120
SBT	19	0	0	0	19	25	0	0	0	25
SBR	4	0	0	0	4	7	0	0	0	7
EBL	4	0	0	0	4	7	0	0	0	7
EBT	54	1,092	0	0	1,146	180	633	0	0	813
EBR	19	221	0	0	240	25	128	0	0	153
WBL	127	0	0	0	127	81	0	0	0	81
WBT	55	423	0	0	478	37	1,101	0	0	1,138
WBR	85	0	0	0	85	85	0	0	0	85
North Leg										
Approach	111	0	0	0	111	152	0	0	0	152
Departure	114	0	0	0	114	119	0	0	0	119
Total	225	0	0	0	225	271	0	0	0	271
South Leg										
Approach	106	83	0	0	189	199	224	0	0	423
Departure	165	221	0	0	386	131	128	0	0	259
Total	271	304	0	0	575	330	352	0	0	682
East Leg										
Approach	267	423	0	0	690	203	1,101	0	0	1,304
Departure	206	1,092	0	0	1,298	452	633	0	0	1,085
Total	473	1,515	0	0	1,988	655	1,734	0	0	2,389
West Leg										
Approach	77	1,313	0	0	1,390	212	761	0	0	973
Departure	76	506	0	0	582	64	1,325	0	0	1,389
Total	153	1,819	0	0	1,972	276	2,086	0	0	2,362
Total Approaches										
Approach	561	1,819	0	0	2,380	766	2,086	0	0	2,852
Departure	561	1,819	0	0	2,380	766	2,086	0	0	2,852
Total	1,122	3,638	0	0	4,760	1,532	4,172	0	0	5,704



Table C-1 - Existing Balanced (2019) Peak Hour Volume Summary

	AM Peak Hour					PM Peak Hour				
	Existing	External	Internal	Pass-By	Existing	Existing	External	Internal	Pass-By	Existing
		Project	Project				Project	Project		
		Trips	Trips	Trips	with			Trips	Trips	with
					Project					Project
14 SR-99 Southbound Ramps/Avenue 17										
NBL	0	0	0	0	0	0	0	0	0	0
NBT	0	0	0	0	0	0	0	0	0	0
NBR	0	0	0	0	0	0	0	0	0	0
SBL	59	0	0	0	59	153	0	0	0	153
SBT	0	0	0	0	0	0	0	0	0	0
SBR	42	0	0	0	42	43	0	0	0	43
EBL	0	0	0	0	0	0	0	0	0	0
EBT	209	1,092	0	0	1,301	459	633	0	0	1,092
EBR	0	0	0	0	0	0	0	0	0	0
WBL	0	0	0	0	0	0	0	0	0	0
WBT	230	423	0	0	653	157	1,101	0	0	1,258
WBR	0	0	0	0	0	0	0	0	0	0
North Leg										
Approach	101	0	0	0	101	196	0	0	0	196
Departure	0	0	0	0	0	0	0	0	0	0
Total	101	0	0	0	101	196	0	0	0	196
South Leg										
Approach	0	0	0	0	0	0	0	0	0	0
Departure	0	0	0	0	0	0	0	0	0	0
Total	0	0	0	0	0	0	0	0	0	0
East Leg										
Approach	230	423	0	0	653	157	1,101	0	0	1,258
Departure	268	1,092	0	0	1,360	612	633	0	0	1,245
Total	498	1,515	0	0	2,013	769	1,734	0	0	2,503
West Leg										
Approach	209	1,092	0	0	1,301	459	633	0	0	1,092
Departure	272	423	0	0	695	200	1,101	0	0	1,301
Total	481	1,515	0	0	1,996	659	1,734	0	0	2,393
Total Approaches										
Approach	540	1,515	0	0	2,055	812	1,734	0	0	2,546
Departure	540	1,515	0	0	2,055	812	1,734	0	0	2,546
Total	1,080	3,030	0	0	4,110	1,624	3,468	0	0	5,092



Table C-1 - Existing Balanced (2019) Peak Hour Volume Summary

	AM Peak Hour				PM Peak Hour					
	Existing	External Project Trips	Internal Project Trips	Pass-By Trips	Existing with Project	Existing	External Project Trips	Internal Project Trips	Pass-By Trips	Existing with Project
15 SR-99 Northbound Ramps/Avenue 17										
NBL	86	247	0	0	333	66	610	0	0	676
NBT	1	0	0	0	1	1	0	0	0	1
NBR	0	0	0	0	0	0	0	0	0	0
SBL	0	0	0	0	0	0	0	0	0	0
SBT	0	0	0	0	0	0	0	0	0	0
SBR	0	0	0	0	0	0	0	0	0	0
EBL	52	0	0	0	52	64	0	0	0	64
EBT	135	422	0	0	557	389	321	0	0	710
EBR	0	0	0	0	0	0	0	0	0	0
WBL	0	0	0	0	0	0	0	0	0	0
WBT	642	176	0	0	818	270	491	0	0	761
WBR	100	0	0	0	100	66	0	0	0	66
North Leg										
Approach	0	0	0	0	0	0	0	0	0	0
Departure	153	0	0	0	153	131	0	0	0	131
Total	153	0	0	0	153	131	0	0	0	131
South Leg										
Approach	87	247	0	0	334	67	610	0	0	677
Departure	0	0	0	0	0	0	0	0	0	0
Total	87	247	0	0	334	67	610	0	0	677
East Leg										
Approach	742	176	0	0	918	336	491	0	0	827
Departure	135	422	0	0	557	389	321	0	0	710
Total	877	598	0	0	1,475	725	812	0	0	1,537
West Leg										
Approach	187	422	0	0	609	453	321	0	0	774
Departure	728	423	0	0	1,151	336	1,101	0	0	1,437
Total	915	845	0	0	1,760	789	1,422	0	0	2,211
Total Approaches										
Approach	1,016	845	0	0	1,861	856	1,422	0	0	2,278
Departure	1,016	845	0	0	1,861	856	1,422	0	0	2,278
Total	2,032	1,690	0	0	3,722	1,712	2,844	0	0	4,556

Table C-1 - Existing Balanced (2019) Peak Hour Volume Summary

	AM Peak Hour					PM Peak Hour				
	Existing	External	Internal	Pass-By	Existing with Project	Existing	External	Internal	Pass-By	Existing with Project
		Project Trips	Project Trips				Project Trips			
16 Love's Truck Stop Driveway/Avenue 17										
NBL	0	0	0	0	0	0	0	0	0	0
NBT	0	0	0	0	0	0	0	0	0	0
NBR	0	0	0	0	0	0	0	0	0	0
SBL	0	0	0	0	0	0	0	0	0	0
SBT	0	0	0	0	0	0	0	0	0	0
SBR	0	0	0	0	0	0	0	0	0	0
EBL	0	0	0	0	0	0	0	0	0	0
EBT	135	422	0	0	557	389	321	0	0	710
EBR	0	0	0	0	0	0	0	0	0	0
WBL	0	0	0	0	0	0	0	0	0	0
WBT	742	176	0	0	918	336	491	0	0	827
WBR	0	0	0	0	0	0	0	0	0	0
North Leg										
Approach	0	0	0	0	0	0	0	0	0	0
Departure	0	0	0	0	0	0	0	0	0	0
Total	0	0	0	0	0	0	0	0	0	0
South Leg										
Approach	0	0	0	0	0	0	0	0	0	0
Departure	0	0	0	0	0	0	0	0	0	0
Total	0	0	0	0	0	0	0	0	0	0
East Leg										
Approach	742	176	0	0	918	336	491	0	0	827
Departure	135	422	0	0	557	389	321	0	0	710
Total	877	598	0	0	1,475	725	812	0	0	1,537
West Leg										
Approach	135	422	0	0	557	389	321	0	0	710
Departure	742	176	0	0	918	336	491	0	0	827
Total	877	598	0	0	1,475	725	812	0	0	1,537
Total Approaches										
Approach	877	598	0	0	1,475	725	812	0	0	1,537
Departure	877	598	0	0	1,475	725	812	0	0	1,537
Total	1,754	1,196	0	0	2,950	1,450	1,624	0	0	3,074



Table C-1 - Existing Balanced (2019) Peak Hour Volume Summary

	AM Peak Hour					PM Peak Hour				
	Existing	External	Internal	Pass-By	Existing	Existing	External	Internal	Pass-By	Existing
		Project	Project				Project	Project		
		Trips	Trips	Trips	with			Trips	Trips	with
					Project					Project
17 Westberry Boulevard/Cleveland Avenue										
NBL	13	13	0	0	26	4	42	0	0	46
NBT	34	1	0	0	35	6	2	0	0	8
NBR	57	0	0	0	57	34	0	0	0	34
SBL	14	0	0	0	14	13	0	0	0	13
SBT	19	0	0	0	19	20	2	0	0	22
SBR	21	119	0	0	140	8	361	0	0	369
EBL	12	365	0	0	377	23	197	0	0	220
EBT	45	854	0	0	899	122	621	0	0	743
EBR	6	49	0	0	55	9	17	0	0	26
WBL	20	0	0	0	20	27	0	0	0	27
WBT	50	344	0	0	394	62	965	0	0	1,027
WBR	12	0	0	0	12	11	0	0	0	11
North Leg										
Approach	54	119	0	0	173	41	363	0	0	404
Departure	58	366	0	0	424	40	199	0	0	239
Total	112	485	0	0	597	81	562	0	0	643
South Leg										
Approach	104	14	0	0	118	44	44	0	0	88
Departure	45	49	0	0	94	56	19	0	0	75
Total	149	63	0	0	212	100	63	0	0	163
East Leg										
Approach	82	344	0	0	426	100	965	0	0	1,065
Departure	116	854	0	0	970	169	621	0	0	790
Total	198	1,198	0	0	1,396	269	1,586	0	0	1,855
West Leg										
Approach	63	1,268	0	0	1,331	154	835	0	0	989
Departure	84	476	0	0	560	74	1,368	0	0	1,442
Total	147	1,744	0	0	1,891	228	2,203	0	0	2,431
Total Approaches										
Approach	303	1,745	0	0	2,048	339	2,207	0	0	2,546
Departure	303	1,745	0	0	2,048	339	2,207	0	0	2,546
Total	606	3,490	0	0	4,096	678	4,414	0	0	5,092



Table C-1 - Existing Balanced (2019) Peak Hour Volume Summary

	AM Peak Hour				PM Peak Hour					
	Existing	External Project Trips	Internal Project Trips	Pass-By Trips	Existing with Project	Existing	External Project Trips	Internal Project Trips	Pass-By Trips	Existing with Project
18 Westberry Boulevard/Sunset Avenue										
NBL	114	8	0	0	122	43	24	0	0	67
NBT	102	0	0	0	102	108	0	0	0	108
NBR	101	0	0	0	101	55	0	0	0	55
SBL	110	0	0	0	110	16	0	0	0	16
SBT	81	0	0	0	81	95	0	0	0	95
SBR	30	11	0	0	41	13	39	0	0	52
EBL	46	17	0	0	63	6	34	0	0	40
EBT	213	69	0	0	282	55	95	0	0	150
EBR	84	1	0	0	85	23	28	0	0	51
WBL	47	0	0	0	47	64	0	0	0	64
WBT	159	44	0	0	203	74	114	0	0	188
WBR	22	0	0	0	22	16	0	0	0	16
North Leg										
Approach	221	11	0	0	232	124	39	0	0	163
Departure	170	17	0	0	187	130	34	0	0	164
Total	391	28	0	0	419	254	73	0	0	327
South Leg										
Approach	317	8	0	0	325	206	24	0	0	230
Departure	212	1	0	0	213	182	28	0	0	210
Total	529	9	0	0	538	388	52	0	0	440
East Leg										
Approach	228	44	0	0	272	154	114	0	0	268
Departure	424	69	0	0	493	126	95	0	0	221
Total	652	113	0	0	765	280	209	0	0	489
West Leg										
Approach	343	87	0	0	430	84	157	0	0	241
Departure	303	63	0	0	366	130	177	0	0	307
Total	646	150	0	0	796	214	334	0	0	548
Total Approaches										
Approach	1,109	150	0	0	1,259	568	334	0	0	902
Departure	1,109	150	0	0	1,259	568	334	0	0	902
Total	2,218	300	0	0	2,518	1,136	668	0	0	1,804



Table C-1 - Existing Balanced (2019) Peak Hour Volume Summary

	AM Peak Hour				PM Peak Hour					
	Existing	External Project Trips	Internal Project Trips	Pass-By Trips	Existing with Project	Existing	External Project Trips	Internal Project Trips	Pass-By Trips	Existing with Project
19 Westberry Boulevard/Avenue 14										
NBL	71	11	0	0	82	14	39	0	0	53
NBT	36	0	0	0	36	41	0	0	0	41
NBR	24	0	0	0	24	16	0	0	0	16
SBL	162	0	0	0	162	88	0	0	0	88
SBT	55	0	0	0	55	42	0	0	0	42
SBR	53	23	0	0	76	37	43	0	0	80
EBL	43	58	0	0	101	49	19	0	0	68
EBT	200	531	0	0	731	251	396	0	0	647
EBR	37	17	0	0	54	33	34	0	0	67
WBL	11	0	0	0	11	22	0	0	0	22
WBT	163	227	0	0	390	116	598	0	0	714
WBR	95	0	0	0	95	130	0	0	0	130
North Leg										
Approach	270	23	0	0	293	167	43	0	0	210
Departure	174	58	0	0	232	220	19	0	0	239
Total	444	81	0	0	525	387	62	0	0	449
South Leg										
Approach	131	11	0	0	142	71	39	0	0	110
Departure	103	17	0	0	120	97	34	0	0	131
Total	234	28	0	0	262	168	73	0	0	241
East Leg										
Approach	269	227	0	0	496	268	598	0	0	866
Departure	386	531	0	0	917	355	396	0	0	751
Total	655	758	0	0	1,413	623	994	0	0	1,617
West Leg										
Approach	280	606	0	0	886	333	449	0	0	782
Departure	287	261	0	0	548	167	680	0	0	847
Total	567	867	0	0	1,434	500	1,129	0	0	1,629
Total Approaches										
Approach	950	867	0	0	1,817	839	1,129	0	0	1,968
Departure	950	867	0	0	1,817	839	1,129	0	0	1,968
Total	1,900	1,734	0	0	3,634	1,678	2,258	0	0	3,936



Table C-1 - Existing Balanced (2019) Peak Hour Volume Summary

	AM Peak Hour				PM Peak Hour					
	Existing	External Project Trips	Internal Project Trips	Pass-By Trips	Existing with Project	Existing	External Project Trips	Internal Project Trips	Pass-By Trips	Existing with Project
20 Westberry Boulevard/Avenue 16										
NBL	0	0	0	0	0	0	0	0	0	0
NBT	20	123	0	0	143	7	82	0	0	89
NBR	45	230	0	0	275	34	108	0	0	142
SBL	58	0	0	0	58	140	2	0	0	142
SBT	11	46	0	0	57	14	133	0	0	147
SBR	0	0	0	0	0	0	0	0	0	0
EBL	0	0	0	0	0	0	0	0	0	0
EBT	0	0	0	0	0	0	0	0	0	0
EBR	0	0	0	0	0	0	0	0	0	0
WBL	27	65	0	0	92	24	218	0	0	242
WBT	0	0	0	0	0	0	0	0	0	0
WBR	119	1	0	0	120	64	2	0	0	66
North Leg										
Approach	69	46	0	0	115	154	135	0	0	289
Departure	139	124	0	0	263	71	84	0	0	155
Total	208	170	0	0	378	225	219	0	0	444
South Leg										
Approach	65	353	0	0	418	41	190	0	0	231
Departure	38	111	0	0	149	38	351	0	0	389
Total	103	464	0	0	567	79	541	0	0	620
East Leg										
Approach	146	66	0	0	212	88	220	0	0	308
Departure	103	230	0	0	333	174	110	0	0	284
Total	249	296	0	0	545	262	330	0	0	592
West Leg										
Approach	0	0	0	0	0	0	0	0	0	0
Departure	0	0	0	0	0	0	0	0	0	0
Total	0	0	0	0	0	0	0	0	0	0
Total Approaches										
Approach	280	465	0	0	745	283	545	0	0	828
Departure	280	465	0	0	745	283	545	0	0	828
Total	560	930	0	0	1,490	566	1,090	0	0	1,656



Table C-1 - Existing Balanced (2019) Peak Hour Volume Summary

	AM Peak Hour				PM Peak Hour					
	Existing	External Project Trips	Internal Project Trips	Pass-By Trips	Existing with Project	Existing	External Project Trips	Internal Project Trips	Pass-By Trips	Existing with Project
21 Granada Drive/Cleveland Avenue										
NBL	17	8	0	0	25	14	14	0	0	28
NBT	285	1	0	0	286	189	2	0	0	191
NBR	268	0	0	0	268	229	0	0	0	229
SBL	4	0	0	0	4	19	0	0	0	19
SBT	215	0	0	0	215	231	2	0	0	233
SBR	5	0	0	0	5	21	0	0	0	21
EBL	16	0	0	0	16	13	0	0	0	13
EBT	115	794	0	0	909	108	567	0	0	675
EBR	9	19	0	0	28	19	6	0	0	25
WBL	185	0	0	0	185	320	0	0	0	320
WBT	55	320	0	0	375	113	887	0	0	1,000
WBR	10	0	0	0	10	20	0	0	0	20
North Leg										
Approach	224	0	0	0	224	271	2	0	0	273
Departure	311	1	0	0	312	222	2	0	0	224
Total	535	1	0	0	536	493	4	0	0	497
South Leg										
Approach	570	9	0	0	579	432	16	0	0	448
Departure	409	19	0	0	428	570	8	0	0	578
Total	979	28	0	0	1,007	1,002	24	0	0	1,026
East Leg										
Approach	250	320	0	0	570	453	887	0	0	1,340
Departure	387	794	0	0	1,181	356	567	0	0	923
Total	637	1,114	0	0	1,751	809	1,454	0	0	2,263
West Leg										
Approach	140	813	0	0	953	140	573	0	0	713
Departure	77	328	0	0	405	148	901	0	0	1,049
Total	217	1,141	0	0	1,358	288	1,474	0	0	1,762
Total Approaches										
Approach	1,184	1,142	0	0	2,326	1,296	1,478	0	0	2,774
Departure	1,184	1,142	0	0	2,326	1,296	1,478	0	0	2,774
Total	2,368	2,284	0	0	4,652	2,592	2,956	0	0	5,548



Table C-1 - Existing Balanced (2019) Peak Hour Volume Summary

	AM Peak Hour				PM Peak Hour					
	Existing	External Project Trips	Internal Project Trips	Pass-By Trips	Existing with Project	Existing	External Project Trips	Internal Project Trips	Pass-By Trips	Existing with Project
22 Granada Drive/Sunset Avenue										
NBL	47	0	0	0	47	46	0	0	0	46
NBT	207	0	0	0	207	262	0	0	0	262
NBR	24	0	0	0	24	42	0	0	0	42
SBL	127	0	0	0	127	76	0	0	0	76
SBT	270	0	0	0	270	293	0	0	0	293
SBR	48	0	0	0	48	32	0	0	0	32
EBL	59	0	0	0	59	28	0	0	0	28
EBT	259	42	0	0	301	115	52	0	0	167
EBR	69	0	0	0	69	34	0	0	0	34
WBL	25	0	0	0	25	54	0	0	0	54
WBT	101	25	0	0	126	153	63	0	0	216
WBR	65	0	0	0	65	108	0	0	0	108
North Leg										
Approach	445	0	0	0	445	401	0	0	0	401
Departure	331	0	0	0	331	398	0	0	0	398
Total	776	0	0	0	776	799	0	0	0	799
South Leg										
Approach	278	0	0	0	278	350	0	0	0	350
Departure	364	0	0	0	364	381	0	0	0	381
Total	642	0	0	0	642	731	0	0	0	731
East Leg										
Approach	191	25	0	0	216	315	63	0	0	378
Departure	410	42	0	0	452	233	52	0	0	285
Total	601	67	0	0	668	548	115	0	0	663
West Leg										
Approach	387	42	0	0	429	177	52	0	0	229
Departure	196	25	0	0	221	231	63	0	0	294
Total	583	67	0	0	650	408	115	0	0	523
Total Approaches										
Approach	1,301	67	0	0	1,368	1,243	115	0	0	1,358
Departure	1,301	67	0	0	1,368	1,243	115	0	0	1,358
Total	2,602	134	0	0	2,736	2,486	230	0	0	2,716



Table C-1 - Existing Balanced (2019) Peak Hour Volume Summary

	AM Peak Hour					PM Peak Hour				
	Existing	External	Internal	Pass-By	Existing	Existing	External	Internal	Pass-By	Existing
		Project	Project				Project	Project		
		Trips	Trips	Trips	with			Trips	Trips	with
					Project					Project
23 Avenue 16 – Ellis Street/Kennedy Street										
NBL	0	0	0	0	0	0	0	0	0	0
NBT	191	118	0	0	309	150	67	0	0	217
NBR	111	113	0	0	224	127	43	0	0	170
SBL	244	0	0	0	244	181	0	0	0	181
SBT	194	47	0	0	241	174	116	0	0	290
SBR	0	0	0	0	0	0	0	0	0	0
EBL	0	0	0	0	0	0	0	0	0	0
EBT	0	0	0	0	0	0	0	0	0	0
EBR	0	0	0	0	0	0	0	0	0	0
WBL	101	18	0	0	119	96	104	0	0	200
WBT	0	0	0	0	0	0	0	0	0	0
WBR	106	0	0	0	106	211	0	0	0	211
North Leg										
Approach	438	47	0	0	485	355	116	0	0	471
Departure	297	118	0	0	415	361	67	0	0	428
Total	735	165	0	0	900	716	183	0	0	899
South Leg										
Approach	302	231	0	0	533	277	110	0	0	387
Departure	295	65	0	0	360	270	220	0	0	490
Total	597	296	0	0	893	547	330	0	0	877
East Leg										
Approach	207	18	0	0	225	307	104	0	0	411
Departure	355	113	0	0	468	308	43	0	0	351
Total	562	131	0	0	693	615	147	0	0	762
West Leg										
Approach	0	0	0	0	0	0	0	0	0	0
Departure	0	0	0	0	0	0	0	0	0	0
Total	0	0	0	0	0	0	0	0	0	0
Total Approaches										
Approach	947	296	0	0	1,243	939	330	0	0	1,269
Departure	947	296	0	0	1,243	939	330	0	0	1,269
Total	1,894	592	0	0	2,486	1,878	660	0	0	2,538



Table C-1 - Existing Balanced (2019) Peak Hour Volume Summary

	AM Peak Hour				PM Peak Hour					
	Existing	External Project Trips	Internal Project Trips	Pass-By Trips	Existing with Project	Existing	External Project Trips	Internal Project Trips	Pass-By Trips	Existing with Project
24 Schnoor Avenue/Kennedy Street										
NBL	96	0	0	0	96	192	0	0	0	192
NBT	5	0	0	0	5	13	0	0	0	13
NBR	205	16	0	0	221	207	40	0	0	247
SBL	15	0	0	0	15	23	0	0	0	23
SBT	6	0	0	0	6	14	0	0	0	14
SBR	4	0	0	0	4	8	0	0	0	8
EBL	15	0	0	0	15	9	0	0	0	9
EBT	174	113	0	0	287	113	43	0	0	156
EBR	162	0	0	0	162	163	0	0	0	163
WBL	110	42	0	0	152	179	23	0	0	202
WBT	121	18	0	0	139	132	104	0	0	236
WBR	14	0	0	0	14	17	0	0	0	17
North Leg										
Approach	25	0	0	0	25	45	0	0	0	45
Departure	34	0	0	0	34	39	0	0	0	39
Total	59	0	0	0	59	84	0	0	0	84
South Leg										
Approach	306	16	0	0	322	412	40	0	0	452
Departure	278	42	0	0	320	356	23	0	0	379
Total	584	58	0	0	642	768	63	0	0	831
East Leg										
Approach	245	60	0	0	305	328	127	0	0	455
Departure	394	129	0	0	523	343	83	0	0	426
Total	639	189	0	0	828	671	210	0	0	881
West Leg										
Approach	351	113	0	0	464	285	43	0	0	328
Departure	221	18	0	0	239	332	104	0	0	436
Total	572	131	0	0	703	617	147	0	0	764
Total Approaches										
Approach	927	189	0	0	1,116	1,070	210	0	0	1,280
Departure	927	189	0	0	1,116	1,070	210	0	0	1,280
Total	1,854	378	0	0	2,232	2,140	420	0	0	2,560



Table C-1 - Existing Balanced (2019) Peak Hour Volume Summary

	AM Peak Hour					PM Peak Hour				
	Existing	External Project Trips	Internal Project Trips	Pass-By Trips	Existing with Project	Existing	External Project Trips	Internal Project Trips	Pass-By Trips	Existing with Project
25 SR-99 Southbound Ramps/Kennedy Street - Gateway Drive										
NBL	0	0	0	0	0	0	0	0	0	0
NBT	0	0	0	0	0	0	0	0	0	0
NBR	0	0	0	0	0	0	0	0	0	0
SBL	64	0	0	0	64	128	0	0	0	128
SBT	0	0	0	0	0	0	0	0	0	0
SBR	103	42	0	0	145	158	26	0	0	184
EBL	187	112	0	0	299	102	41	0	0	143
EBT	227	16	0	0	243	313	40	0	0	353
EBR	0	0	0	0	0	0	0	0	0	0
WBL	0	0	0	0	0	0	0	0	0	0
WBT	172	23	0	0	195	252	123	0	0	375
WBR	1	0	0	0	1	1	0	0	0	1
North Leg										
Approach	167	42	0	0	209	286	26	0	0	312
Departure	188	112	0	0	300	103	41	0	0	144
Total	355	154	0	0	509	389	67	0	0	456
South Leg										
Approach	0	0	0	0	0	0	0	0	0	0
Departure	0	0	0	0	0	0	0	0	0	0
Total	0	0	0	0	0	0	0	0	0	0
East Leg										
Approach	173	23	0	0	196	253	123	0	0	376
Departure	291	16	0	0	307	441	40	0	0	481
Total	464	39	0	0	503	694	163	0	0	857
West Leg										
Approach	414	128	0	0	542	415	81	0	0	496
Departure	275	65	0	0	340	410	149	0	0	559
Total	689	193	0	0	882	825	230	0	0	1,055
Total Approaches										
Approach	754	193	0	0	947	954	230	0	0	1,184
Departure	754	193	0	0	947	954	230	0	0	1,184
Total	1,508	386	0	0	1,894	1,908	460	0	0	2,368



Table C-1 - Existing Balanced (2019) Peak Hour Volume Summary

	AM Peak Hour					PM Peak Hour				
	Existing	External Project Trips	Internal Project Trips	Pass-By Trips	Existing with Project	Existing	External Project Trips	Internal Project Trips	Pass-By Trips	Existing with Project
26 SR-99 Northbound Off-Ramp/Gateway Drive										
NBL	0	0	0	0	0	0	0	0	0	0
NBT	0	0	0	0	0	0	0	0	0	0
NBR	0	0	0	0	0	0	0	0	0	0
SBL	0	0	0	0	0	0	0	0	0	0
SBT	0	0	0	0	0	0	0	0	0	0
SBR	106	23	0	0	129	135	123	0	0	258
EBL	159	16	0	0	175	153	40	0	0	193
EBT	132	0	0	0	132	288	0	0	0	288
EBR	0	0	0	0	0	0	0	0	0	0
WBL	0	0	0	0	0	0	0	0	0	0
WBT	67	0	0	0	67	118	0	0	0	118
WBR	0	0	0	0	0	0	0	0	0	0
North Leg										
Approach	106	23	0	0	129	135	123	0	0	258
Departure	159	16	0	0	175	153	40	0	0	193
Total	265	39	0	0	304	288	163	0	0	451
South Leg										
Approach	0	0	0	0	0	0	0	0	0	0
Departure	0	0	0	0	0	0	0	0	0	0
Total	0	0	0	0	0	0	0	0	0	0
East Leg										
Approach	67	0	0	0	67	118	0	0	0	118
Departure	132	0	0	0	132	288	0	0	0	288
Total	199	0	0	0	199	406	0	0	0	406
West Leg										
Approach	291	16	0	0	307	441	40	0	0	481
Departure	173	23	0	0	196	253	123	0	0	376
Total	464	39	0	0	503	694	163	0	0	857
Total Approaches										
Approach	464	39	0	0	503	694	163	0	0	857
Departure	464	39	0	0	503	694	163	0	0	857
Total	928	78	0	0	1,006	1,388	326	0	0	1,714



Table C-1 - Existing Balanced (2019) Peak Hour Volume Summary

	AM Peak Hour					PM Peak Hour				
	Existing	External	Internal	Pass-By	Existing with Project	Existing	External	Internal	Pass-By	Existing with Project
		Project	Project				Project	Project		
27 SR-99 Northbound Off-Ramps										
NBL	0	0	0	0	0	0	0	0	0	0
NBT	42	0	0	0	42	78	0	0	0	78
NBR	0	0	0	0	0	0	0	0	0	0
SBL	0	0	0	0	0	0	0	0	0	0
SBT	3	0	0	0	3	3	0	0	0	3
SBR	104	23	0	0	127	135	123	0	0	258
EBL	160	11	0	0	171	153	19	0	0	172
EBT	0	0	0	0	0	0	0	0	0	0
EBR	0	0	0	0	0	0	0	0	0	0
WBL	0	0	0	0	0	0	0	0	0	0
WBT	0	0	0	0	0	0	0	0	0	0
WBR	0	0	0	0	0	0	0	0	0	0
North Leg										
Approach	107	23	0	0	130	138	123	0	0	261
Departure	202	11	0	0	213	231	19	0	0	250
Total	309	34	0	0	343	369	142	0	0	511
South Leg										
Approach	42	0	0	0	42	78	0	0	0	78
Departure	3	0	0	0	3	3	0	0	0	3
Total	45	0	0	0	45	81	0	0	0	81
East Leg										
Approach	0	0	0	0	0	0	0	0	0	0
Departure	0	0	0	0	0	0	0	0	0	0
Total	0	0	0	0	0	0	0	0	0	0
West Leg										
Approach	160	11	0	0	171	153	19	0	0	172
Departure	104	23	0	0	127	135	123	0	0	258
Total	264	34	0	0	298	288	142	0	0	430
Total Approaches										
Approach	309	34	0	0	343	369	142	0	0	511
Departure	309	34	0	0	343	369	142	0	0	511
Total	618	68	0	0	686	738	284	0	0	1,022



Table C-1 - Existing Balanced (2019) Peak Hour Volume Summary

	AM Peak Hour					PM Peak Hour				
	Existing	External	Internal	Pass-By	Existing with Project	Existing	External	Internal	Pass-By	Existing with Project
		Project	Project				Project	Project		
28 SR-99 Northbound Off-Ramp/Gateway Drive										
NBL	0	0	0	0	0	0	0	0	0	0
NBT	0	0	0	0	0	0	0	0	0	0
NBR	0	0	0	0	0	0	0	0	0	0
SBL	0	0	0	0	0	3	0	0	0	3
SBT	0	0	0	0	0	0	0	0	0	0
SBR	0	0	0	0	0	0	0	0	0	0
EBL	0	0	0	0	0	0	0	0	0	0
EBT	129	0	0	0	129	288	0	0	0	288
EBR	0	0	0	0	0	0	0	0	0	0
WBL	0	0	0	0	0	0	0	0	0	0
WBT	72	0	0	0	72	118	0	0	0	118
WBR	50	0	0	0	50	73	0	0	0	73
North Leg										
Approach	0	0	0	0	0	3	0	0	0	3
Departure	50	0	0	0	50	73	0	0	0	73
Total	50	0	0	0	50	76	0	0	0	76
South Leg										
Approach	0	0	0	0	0	0	0	0	0	0
Departure	0	0	0	0	0	0	0	0	0	0
Total	0	0	0	0	0	0	0	0	0	0
East Leg										
Approach	122	0	0	0	122	191	0	0	0	191
Departure	129	0	0	0	129	291	0	0	0	291
Total	251	0	0	0	251	482	0	0	0	482
West Leg										
Approach	129	0	0	0	129	288	0	0	0	288
Departure	72	0	0	0	72	118	0	0	0	118
Total	201	0	0	0	201	406	0	0	0	406
Total Approaches										
Approach	251	0	0	0	251	482	0	0	0	482
Departure	251	0	0	0	251	482	0	0	0	482
Total	502	0	0	0	502	964	0	0	0	964



Table C-1 - Existing Balanced (2019) Peak Hour Volume Summary

	AM Peak Hour				PM Peak Hour					
	Existing	External Project Trips	Internal Project Trips	Pass-By Trips	Existing with Project	Existing	External Project Trips	Internal Project Trips	Pass-By Trips	Existing with Project
29 Schnoor Avenue/Cleveland Avenue										
NBL	50	11	0	0	61	52	28	0	0	80
NBT	212	4	0	0	216	200	16	0	0	216
NBR	155	0	0	0	155	148	0	0	0	148
SBL	79	0	0	0	79	110	0	0	0	110
SBT	156	14	0	0	170	195	8	0	0	203
SBR	59	31	0	0	90	74	83	0	0	157
EBL	71	64	0	0	135	108	57	0	0	165
EBT	321	678	0	0	999	383	481	0	0	864
EBR	32	34	0	0	66	41	11	0	0	52
WBL	161	0	0	0	161	264	0	0	0	264
WBT	210	277	0	0	487	420	754	0	0	1,174
WBR	43	0	0	0	43	103	0	0	0	103
North Leg										
Approach	294	45	0	0	339	379	91	0	0	470
Departure	326	68	0	0	394	411	73	0	0	484
Total	620	113	0	0	733	790	164	0	0	954
South Leg										
Approach	417	15	0	0	432	400	44	0	0	444
Departure	349	48	0	0	397	500	19	0	0	519
Total	766	63	0	0	829	900	63	0	0	963
East Leg										
Approach	414	277	0	0	691	787	754	0	0	1,541
Departure	555	678	0	0	1,233	641	481	0	0	1,122
Total	969	955	0	0	1,924	1,428	1,235	0	0	2,663
West Leg										
Approach	424	776	0	0	1,200	532	549	0	0	1,081
Departure	319	319	0	0	638	546	865	0	0	1,411
Total	743	1,095	0	0	1,838	1,078	1,414	0	0	2,492
Total Approaches										
Approach	1,549	1,113	0	0	2,662	2,098	1,438	0	0	3,536
Departure	1,549	1,113	0	0	2,662	2,098	1,438	0	0	3,536
Total	3,098	2,226	0	0	5,324	4,196	2,876	0	0	7,072



Table C-1 - Existing Balanced (2019) Peak Hour Volume Summary

	AM Peak Hour				PM Peak Hour					
	Existing	External Project Trips	Internal Project Trips	Pass-By Trips	Existing with Project	Existing	External Project Trips	Internal Project Trips	Pass-By Trips	Existing with Project
30 Fairgrounds/Cleveland Avenue										
NBL	13	0	0	0	13	95	0	0	0	95
NBT	6	0	0	0	6	41	0	0	0	41
NBR	23	0	0	0	23	105	0	0	0	105
SBL	95	12	0	0	107	231	31	0	0	262
SBT	5	0	0	0	5	34	0	0	0	34
SBR	38	0	0	0	38	98	0	0	0	98
EBL	80	0	0	0	80	89	0	0	0	89
EBT	506	665	0	0	1,171	478	478	0	0	956
EBR	29	0	0	0	29	91	0	0	0	91
WBL	32	0	0	0	32	155	0	0	0	155
WBT	362	271	0	0	633	503	745	0	0	1,248
WBR	65	34	0	0	99	123	15	0	0	138
North Leg										
Approach	138	12	0	0	150	363	31	0	0	394
Departure	151	34	0	0	185	253	15	0	0	268
Total	289	46	0	0	335	616	46	0	0	662
South Leg										
Approach	42	0	0	0	42	241	0	0	0	241
Departure	66	0	0	0	66	280	0	0	0	280
Total	108	0	0	0	108	521	0	0	0	521
East Leg										
Approach	459	305	0	0	764	781	760	0	0	1,541
Departure	624	677	0	0	1,301	814	509	0	0	1,323
Total	1,083	982	0	0	2,065	1,595	1,269	0	0	2,864
West Leg										
Approach	615	665	0	0	1,280	658	478	0	0	1,136
Departure	413	271	0	0	684	696	745	0	0	1,441
Total	1,028	936	0	0	1,964	1,354	1,223	0	0	2,577
Total Approaches										
Approach	1,254	982	0	0	2,236	2,043	1,269	0	0	3,312
Departure	1,254	982	0	0	2,236	2,043	1,269	0	0	3,312
Total	2,508	1,964	0	0	4,472	4,086	2,538	0	0	6,624



Table C-1 - Existing Balanced (2019) Peak Hour Volume Summary

	AM Peak Hour				PM Peak Hour					
	Existing	External Project Trips	Internal Project Trips	Pass-By Trips	Existing with Project	Existing	External Project Trips	Internal Project Trips	Pass-By Trips	Existing with Project
31 SR-99 Southbound Ramps/Cleveland Avenue										
NBL	0	0	0	0	0	0	0	0	0	0
NBT	0	0	0	0	0	0	0	0	0	0
NBR	0	0	0	0	0	0	0	0	0	0
SBL	57	182	0	0	239	125	87	0	0	212
SBT	0	0	0	0	0	0	0	0	0	0
SBR	46	34	0	0	80	77	15	0	0	92
EBL	0	0	0	0	0	0	0	0	0	0
EBT	413	248	0	0	661	682	264	0	0	946
EBR	306	418	0	0	724	327	241	0	0	568
WBL	313	0	0	0	313	193	0	0	0	193
WBT	651	266	0	0	917	1,050	737	0	0	1,787
WBR	0	0	0	0	0	0	0	0	0	0
North Leg										
Approach	103	216	0	0	319	202	102	0	0	304
Departure	0	0	0	0	0	0	0	0	0	0
Total	103	216	0	0	319	202	102	0	0	304
South Leg										
Approach	0	0	0	0	0	0	0	0	0	0
Departure	619	418	0	0	1,037	520	241	0	0	761
Total	619	418	0	0	1,037	520	241	0	0	761
East Leg										
Approach	964	266	0	0	1,230	1,243	737	0	0	1,980
Departure	470	430	0	0	900	807	351	0	0	1,158
Total	1,434	696	0	0	2,130	2,050	1,088	0	0	3,138
West Leg										
Approach	719	666	0	0	1,385	1,009	505	0	0	1,514
Departure	697	300	0	0	997	1,127	752	0	0	1,879
Total	1,416	966	0	0	2,382	2,136	1,257	0	0	3,393
Total Approaches										
Approach	1,786	1,148	0	0	2,934	2,454	1,344	0	0	3,798
Departure	1,786	1,148	0	0	2,934	2,454	1,344	0	0	3,798
Total	3,572	2,296	0	0	5,868	4,908	2,688	0	0	7,596



Table C-1 - Existing Balanced (2019) Peak Hour Volume Summary

	AM Peak Hour				PM Peak Hour					
	Existing	External Project Trips	Internal Project Trips	Pass-By Trips	Existing with Project	Existing	External Project Trips	Internal Project Trips	Pass-By Trips	Existing with Project
32 SR-99 Northbound Ramps/Cleveland Avenue										
NBL	234	149	0	0	383	417	423	0	0	840
NBT	0	0	0	0	0	5	0	0	0	5
NBR	243	0	0	0	243	265	0	0	0	265
SBL	0	0	0	0	0	0	0	0	0	0
SBT	0	0	0	0	0	0	0	0	0	0
SBR	0	0	0	0	0	0	0	0	0	0
EBL	43	12	0	0	55	71	31	0	0	102
EBT	427	418	0	0	845	736	320	0	0	1,056
EBR	0	0	0	0	0	0	0	0	0	0
WBL	0	0	0	0	0	0	0	0	0	0
WBT	730	117	0	0	847	826	314	0	0	1,140
WBR	59	59	0	0	118	65	172	0	0	237
North Leg										
Approach	0	0	0	0	0	0	0	0	0	0
Departure	102	71	0	0	173	141	203	0	0	344
Total	102	71	0	0	173	141	203	0	0	344
South Leg										
Approach	477	149	0	0	626	687	423	0	0	1,110
Departure	0	0	0	0	0	0	0	0	0	0
Total	477	149	0	0	626	687	423	0	0	1,110
East Leg										
Approach	789	176	0	0	965	891	486	0	0	1,377
Departure	670	418	0	0	1,088	1,001	320	0	0	1,321
Total	1,459	594	0	0	2,053	1,892	806	0	0	2,698
West Leg										
Approach	470	430	0	0	900	807	351	0	0	1,158
Departure	964	266	0	0	1,230	1,243	737	0	0	1,980
Total	1,434	696	0	0	2,130	2,050	1,088	0	0	3,138
Total Approaches										
Approach	1,736	755	0	0	2,491	2,385	1,260	0	0	3,645
Departure	1,736	755	0	0	2,491	2,385	1,260	0	0	3,645
Total	3,472	1,510	0	0	4,982	4,770	2,520	0	0	7,290



Table C-1 - Existing Balanced (2019) Peak Hour Volume Summary

	AM Peak Hour				PM Peak Hour					
	Existing	External Project Trips	Internal Project Trips	Pass-By Trips	Existing with Project	Existing	External Project Trips	Internal Project Trips	Pass-By Trips	Existing with Project
33 Gateway Drive/Cleveland Avenue										
NBL	130	48	0	0	178	218	124	0	0	342
NBT	47	0	0	0	47	112	0	0	0	112
NBR	113	0	0	0	113	210	0	0	0	210
SBL	51	0	0	0	51	155	0	0	0	155
SBT	85	0	0	0	85	124	0	0	0	124
SBR	4	0	0	0	4	22	0	0	0	22
EBL	4	0	0	0	4	14	0	0	0	14
EBT	520	285	0	0	805	734	254	0	0	988
EBR	140	133	0	0	273	231	66	0	0	297
WBL	154	0	0	0	154	144	0	0	0	144
WBT	652	127	0	0	779	654	362	0	0	1,016
WBR	62	0	0	0	62	104	0	0	0	104
North Leg										
Approach	140	0	0	0	140	301	0	0	0	301
Departure	113	0	0	0	113	230	0	0	0	230
Total	253	0	0	0	253	531	0	0	0	531
South Leg										
Approach	290	48	0	0	338	540	124	0	0	664
Departure	379	133	0	0	512	499	66	0	0	565
Total	669	181	0	0	850	1,039	190	0	0	1,229
East Leg										
Approach	868	127	0	0	995	902	362	0	0	1,264
Departure	684	285	0	0	969	1,099	254	0	0	1,353
Total	1,552	412	0	0	1,964	2,001	616	0	0	2,617
West Leg										
Approach	664	418	0	0	1,082	979	320	0	0	1,299
Departure	786	175	0	0	961	894	486	0	0	1,380
Total	1,450	593	0	0	2,043	1,873	806	0	0	2,679
Total Approaches										
Approach	1,962	593	0	0	2,555	2,722	806	0	0	3,528
Departure	1,962	593	0	0	2,555	2,722	806	0	0	3,528
Total	3,924	1,186	0	0	5,110	5,444	1,612	0	0	7,056

Table C-1 - Existing Balanced (2019) Peak Hour Volume Summary

	AM Peak Hour					PM Peak Hour				
	Existing	External	Internal	Pass-By	Existing with Project	Existing	External	Internal	Pass-By	Existing with Project
		Project	Project				Project	Project		
34 Cleveland Avenue – Country Club Drive/W Cleveland Avenue										
NBL	0	0	0	0	0	0	0	0	0	0
NBT	488	70	0	0	558	709	54	0	0	763
NBR	196	214	0	0	410	390	199	0	0	589
SBL	76	0	0	0	76	75	0	0	0	75
SBT	593	31	0	0	624	575	83	0	0	658
SBR	0	0	0	0	0	0	0	0	0	0
EBL	0	0	0	0	0	0	0	0	0	0
EBT	0	0	0	0	0	0	0	0	0	0
EBR	0	0	0	0	0	0	0	0	0	0
WBL	275	96	0	0	371	327	281	0	0	608
WBT	0	0	0	0	0	0	0	0	0	0
WBR	19	0	0	0	19	26	0	0	0	26
North Leg										
Approach	669	31	0	0	700	650	83	0	0	733
Departure	507	70	0	0	577	735	54	0	0	789
Total	1,176	101	0	0	1,277	1,385	137	0	0	1,522
South Leg										
Approach	684	284	0	0	968	1,099	253	0	0	1,352
Departure	868	127	0	0	995	902	364	0	0	1,266
Total	1,552	411	0	0	1,963	2,001	617	0	0	2,618
East Leg										
Approach	294	96	0	0	390	353	281	0	0	634
Departure	272	214	0	0	486	465	199	0	0	664
Total	566	310	0	0	876	818	480	0	0	1,298
West Leg										
Approach	0	0	0	0	0	0	0	0	0	0
Departure	0	0	0	0	0	0	0	0	0	0
Total	0	0	0	0	0	0	0	0	0	0
Total Approaches										
Approach	1,647	411	0	0	2,058	2,102	617	0	0	2,719
Departure	1,647	411	0	0	2,058	2,102	617	0	0	2,719
Total	3,294	822	0	0	4,116	4,204	1,234	0	0	5,438



Table C-1 - Existing Balanced (2019) Peak Hour Volume Summary

	AM Peak Hour				PM Peak Hour					
	Existing	External Project Trips	Internal Project Trips	Pass-By Trips	Existing with Project	Existing	External Project Trips	Internal Project Trips	Pass-By Trips	Existing with Project
35 Country Club Drive/Sharon Boulevard										
NBL	1	0	0	0	1	5	0	0	0	5
NBT	498	34	0	0	532	707	24	0	0	731
NBR	0	0	0	0	0	0	0	0	0	0
SBL	0	0	0	0	0	0	0	0	0	0
SBT	634	15	0	0	649	592	39	0	0	631
SBR	1	0	0	0	1	1	0	0	0	1
EBL	2	0	0	0	2	2	0	0	0	2
EBT	0	0	0	0	0	0	0	0	0	0
EBR	12	0	0	0	12	16	0	0	0	16
WBL	0	0	0	0	0	0	0	0	0	0
WBT	0	0	0	0	0	0	0	0	0	0
WBR	0	0	0	0	0	0	0	0	0	0
North Leg										
Approach	635	15	0	0	650	593	39	0	0	632
Departure	500	34	0	0	534	709	24	0	0	733
Total	1,135	49	0	0	1,184	1,302	63	0	0	1,365
South Leg										
Approach	499	34	0	0	533	712	24	0	0	736
Departure	646	15	0	0	661	608	39	0	0	647
Total	1,145	49	0	0	1,194	1,320	63	0	0	1,383
East Leg										
Approach	0	0	0	0	0	0	0	0	0	0
Departure	0	0	0	0	0	0	0	0	0	0
Total	0	0	0	0	0	0	0	0	0	0
West Leg										
Approach	14	0	0	0	14	18	0	0	0	18
Departure	2	0	0	0	2	6	0	0	0	6
Total	16	0	0	0	16	24	0	0	0	24
Total Approaches										
Approach	1,148	49	0	0	1,197	1,323	63	0	0	1,386
Departure	1,148	49	0	0	1,197	1,323	63	0	0	1,386
Total	2,296	98	0	0	2,394	2,646	126	0	0	2,772



Table C-1 - Existing Balanced (2019) Peak Hour Volume Summary

	AM Peak Hour				PM Peak Hour					
	Existing	External Project Trips	Internal Project Trips	Pass-By Trips	Existing with Project	Existing	External Project Trips	Internal Project Trips	Pass-By Trips	Existing with Project
36 Pine Street/Howard Road										
NBL	115	38	0	0	153	142	90	0	0	232
NBT	151	3	0	0	154	155	14	0	0	169
NBR	222	0	0	0	222	138	0	0	0	138
SBL	16	0	0	0	16	15	0	0	0	15
SBT	239	14	0	0	253	131	6	0	0	137
SBR	97	0	0	0	97	119	0	0	0	119
EBL	33	0	0	0	33	85	0	0	0	85
EBT	667	331	0	0	998	528	232	0	0	760
EBR	72	103	0	0	175	96	44	0	0	140
WBL	126	0	0	0	126	86	0	0	0	86
WBT	433	142	0	0	575	486	358	0	0	844
WBR	6	0	0	0	6	3	0	0	0	3
North Leg										
Approach	352	14	0	0	366	265	6	0	0	271
Departure	190	3	0	0	193	243	14	0	0	257
Total	542	17	0	0	559	508	20	0	0	528
South Leg										
Approach	488	41	0	0	529	435	104	0	0	539
Departure	437	117	0	0	554	313	50	0	0	363
Total	925	158	0	0	1,083	748	154	0	0	902
East Leg										
Approach	565	142	0	0	707	575	358	0	0	933
Departure	905	331	0	0	1,236	681	232	0	0	913
Total	1,470	473	0	0	1,943	1,256	590	0	0	1,846
West Leg										
Approach	772	434	0	0	1,206	709	276	0	0	985
Departure	645	180	0	0	825	747	448	0	0	1,195
Total	1,417	614	0	0	2,031	1,456	724	0	0	2,180
Total Approaches										
Approach	2,177	631	0	0	2,808	1,984	744	0	0	2,728
Departure	2,177	631	0	0	2,808	1,984	744	0	0	2,728
Total	4,354	1,262	0	0	5,616	3,968	1,488	0	0	5,456



Table C-1 - Existing Balanced (2019) Peak Hour Volume Summary

	AM Peak Hour				PM Peak Hour					
	Existing	External Project Trips	Internal Project Trips	Pass-By Trips	Existing with Project	Existing	External Project Trips	Internal Project Trips	Pass-By Trips	Existing with Project
37 Q Street - Olive Avenue/Yosemite Avenue - Howard Road										
NBL	292	125	0	0	417	278	318	0	0	596
NBT	88	0	0	0	88	74	0	0	0	74
NBR	20	0	0	0	20	12	0	0	0	12
SBL	99	0	0	0	99	16	0	0	0	16
SBT	147	0	0	0	147	55	0	0	0	55
SBR	12	0	0	0	12	2	0	0	0	2
EBL	6	0	0	0	6	7	0	0	0	7
EBT	541	41	0	0	582	442	23	0	0	465
EBR	308	289	0	0	597	211	209	0	0	420
WBL	26	0	0	0	26	12	0	0	0	12
WBT	332	17	0	0	349	357	40	0	0	397
WBR	19	0	0	0	19	14	0	0	0	14
North Leg										
Approach	258	0	0	0	258	73	0	0	0	73
Departure	113	0	0	0	113	95	0	0	0	95
Total	371	0	0	0	371	168	0	0	0	168
South Leg										
Approach	400	125	0	0	525	364	318	0	0	682
Departure	481	289	0	0	770	278	209	0	0	487
Total	881	414	0	0	1,295	642	527	0	0	1,169
East Leg										
Approach	377	17	0	0	394	383	40	0	0	423
Departure	660	41	0	0	701	470	23	0	0	493
Total	1,037	58	0	0	1,095	853	63	0	0	916
West Leg										
Approach	855	330	0	0	1,185	660	232	0	0	892
Departure	636	142	0	0	778	637	358	0	0	995
Total	1,491	472	0	0	1,963	1,297	590	0	0	1,887
Total Approaches										
Approach	1,890	472	0	0	2,362	1,480	590	0	0	2,070
Departure	1,890	472	0	0	2,362	1,480	590	0	0	2,070
Total	3,780	944	0	0	4,724	2,960	1,180	0	0	4,140



Table C-1 - Existing Balanced (2019) Peak Hour Volume Summary

	AM Peak Hour				PM Peak Hour					
	Existing	External Project Trips	Internal Project Trips	Pass-By Trips	Existing with Project	Existing	External Project Trips	Internal Project Trips	Pass-By Trips	Existing with Project
38 I Street/SR-99 Southbound Off-Ramp - 2nd Street										
NBL	15	0	0	0	15	42	0	0	0	42
NBT	82	0	0	0	82	141	0	0	0	141
NBR	0	0	0	0	0	0	0	0	0	0
SBL	0	0	0	0	0	0	0	0	0	0
SBT	132	0	0	0	132	112	0	0	0	112
SBR	2	0	0	0	2	0	0	0	0	0
EBL	2	0	0	0	2	0	0	0	0	0
EBT	0	0	0	0	0	0	0	0	0	0
EBR	53	0	0	0	53	32	0	0	0	32
WBL	363	119	0	0	482	236	51	0	0	287
WBT	17	0	0	0	17	10	0	0	0	10
WBR	11	0	0	0	11	4	0	0	0	4
North Leg										
Approach	134	0	0	0	134	112	0	0	0	112
Departure	95	0	0	0	95	145	0	0	0	145
Total	229	0	0	0	229	257	0	0	0	257
South Leg										
Approach	97	0	0	0	97	183	0	0	0	183
Departure	548	119	0	0	667	380	51	0	0	431
Total	645	119	0	0	764	563	51	0	0	614
East Leg										
Approach	391	119	0	0	510	250	51	0	0	301
Departure	0	0	0	0	0	0	0	0	0	0
Total	391	119	0	0	510	250	51	0	0	301
West Leg										
Approach	55	0	0	0	55	32	0	0	0	32
Departure	34	0	0	0	34	52	0	0	0	52
Total	89	0	0	0	89	84	0	0	0	84
Total Approaches										
Approach	677	119	0	0	796	577	51	0	0	628
Departure	677	119	0	0	796	577	51	0	0	628
Total	1,354	238	0	0	1,592	1,154	102	0	0	1,256



Table C-1 - Existing Balanced (2019) Peak Hour Volume Summary

	AM Peak Hour				PM Peak Hour					
	Existing	External Project Trips	Internal Project Trips	Pass-By Trips	Existing with Project	Existing	External Project Trips	Internal Project Trips	Pass-By Trips	Existing with Project
39 4th Street/Sunset Avenue										
NBL	31	0	0	0	31	13	0	0	0	13
NBT	291	20	0	0	311	278	53	0	0	331
NBR	0	0	0	0	0	0	0	0	0	0
SBL	0	0	0	0	0	0	0	0	0	0
SBT	400	60	0	0	460	319	27	0	0	346
SBR	267	9	0	0	276	360	17	0	0	377
EBL	381	13	0	0	394	224	13	0	0	237
EBT	0	0	0	0	0	0	0	0	0	0
EBR	22	0	0	0	22	12	0	0	0	12
WBL	0	0	0	0	0	0	0	0	0	0
WBT	0	0	0	0	0	0	0	0	0	0
WBR	0	0	0	0	0	0	0	0	0	0
North Leg										
Approach	667	69	0	0	736	679	44	0	0	723
Departure	672	33	0	0	705	502	66	0	0	568
Total	1,339	102	0	0	1,441	1,181	110	0	0	1,291
South Leg										
Approach	322	20	0	0	342	291	53	0	0	344
Departure	422	60	0	0	482	331	27	0	0	358
Total	744	80	0	0	824	622	80	0	0	702
East Leg										
Approach	0	0	0	0	0	0	0	0	0	0
Departure	0	0	0	0	0	0	0	0	0	0
Total	0	0	0	0	0	0	0	0	0	0
West Leg										
Approach	403	13	0	0	416	236	13	0	0	249
Departure	298	9	0	0	307	373	17	0	0	390
Total	701	22	0	0	723	609	30	0	0	639
Total Approaches										
Approach	1,392	102	0	0	1,494	1,206	110	0	0	1,316
Departure	1,392	102	0	0	1,494	1,206	110	0	0	1,316
Total	2,784	204	0	0	2,988	2,412	220	0	0	2,632



Table C-1 - Existing Balanced (2019) Peak Hour Volume Summary

	AM Peak Hour				PM Peak Hour					
	Existing	External Project Trips	Internal Project Trips	Pass-By Trips	Existing with Project	Existing	External Project Trips	Internal Project Trips	Pass-By Trips	Existing with Project
40 H Street/SR-99 Northbound On-Ramp - 2nd Street										
NBL	253	39	0	0	292	262	106	0	0	368
NBT	24	0	0	0	24	27	0	0	0	27
NBR	9	0	0	0	9	12	0	0	0	12
SBL	0	0	0	0	0	2	0	0	0	2
SBT	34	0	0	0	34	24	0	0	0	24
SBR	0	0	0	0	0	0	0	0	0	0
EBL	0	0	0	0	0	0	0	0	0	0
EBT	0	0	0	0	0	0	0	0	0	0
EBR	0	0	0	0	0	0	0	0	0	0
WBL	13	0	0	0	13	11	0	0	0	11
WBT	21	0	0	0	21	52	0	0	0	52
WBR	2	0	0	0	2	4	0	0	0	4
North Leg										
Approach	34	0	0	0	34	26	0	0	0	26
Departure	26	0	0	0	26	31	0	0	0	31
Total	60	0	0	0	60	57	0	0	0	57
South Leg										
Approach	286	39	0	0	325	301	106	0	0	407
Departure	47	0	0	0	47	35	0	0	0	35
Total	333	39	0	0	372	336	106	0	0	442
East Leg										
Approach	36	0	0	0	36	67	0	0	0	67
Departure	9	0	0	0	9	14	0	0	0	14
Total	45	0	0	0	45	81	0	0	0	81
West Leg										
Approach	0	0	0	0	0	0	0	0	0	0
Departure	274	39	0	0	313	314	106	0	0	420
Total	274	39	0	0	313	314	106	0	0	420
Total Approaches										
Approach	356	39	0	0	395	394	106	0	0	500
Departure	356	39	0	0	395	394	106	0	0	500
Total	712	78	0	0	790	788	212	0	0	1,000



Table C-1 - Existing Balanced (2019) Peak Hour Volume Summary

	AM Peak Hour				PM Peak Hour					
	Existing	External Project Trips	Internal Project Trips	Pass-By Trips	Existing with Project	Existing	External Project Trips	Internal Project Trips	Pass-By Trips	Existing with Project
41 I Street/4th Street										
NBL	51	0	0	0	51	96	0	0	0	96
NBT	55	0	0	0	55	68	0	0	0	68
NBR	160	0	0	0	160	244	0	0	0	244
SBL	209	59	0	0	268	159	24	0	0	183
SBT	277	0	0	0	277	163	0	0	0	163
SBR	121	60	0	0	181	93	27	0	0	120
EBL	25	0	0	0	25	31	0	0	0	31
EBT	621	33	0	0	654	471	66	0	0	537
EBR	67	0	0	0	67	61	0	0	0	61
WBL	85	0	0	0	85	59	0	0	0	59
WBT	459	9	0	0	468	490	17	0	0	507
WBR	61	0	0	0	61	106	0	0	0	106
North Leg										
Approach	607	119	0	0	726	415	51	0	0	466
Departure	141	0	0	0	141	205	0	0	0	205
Total	748	119	0	0	867	620	51	0	0	671
South Leg										
Approach	266	0	0	0	266	408	0	0	0	408
Departure	429	0	0	0	429	283	0	0	0	283
Total	695	0	0	0	695	691	0	0	0	691
East Leg										
Approach	605	9	0	0	614	655	17	0	0	672
Departure	990	92	0	0	1,082	874	90	0	0	964
Total	1,595	101	0	0	1,696	1,529	107	0	0	1,636
West Leg										
Approach	713	33	0	0	746	563	66	0	0	629
Departure	631	69	0	0	700	679	44	0	0	723
Total	1,344	102	0	0	1,446	1,242	110	0	0	1,352
Total Approaches										
Approach	2,191	161	0	0	2,352	2,041	134	0	0	2,175
Departure	2,191	161	0	0	2,352	2,041	134	0	0	2,175
Total	4,382	322	0	0	4,704	4,082	268	0	0	4,350



Table C-1 - Existing Balanced (2019) Peak Hour Volume Summary

	AM Peak Hour				PM Peak Hour					
	Existing	External Project Trips	Internal Project Trips	Pass-By Trips	Existing with Project	Existing	External Project Trips	Internal Project Trips	Pass-By Trips	Existing with Project
42 SR-99 Southbound On-Ramp/4th Street										
NBL	0	0	0	0	0	0	0	0	0	0
NBT	0	0	0	0	0	0	0	0	0	0
NBR	0	0	0	0	0	0	0	0	0	0
SBL	0	0	0	0	0	0	0	0	0	0
SBT	0	0	0	0	0	0	0	0	0	0
SBR	0	0	0	0	0	0	0	0	0	0
EBL	0	0	0	0	0	0	0	0	0	0
EBT	667	92	0	0	759	599	90	0	0	689
EBR	323	0	0	0	323	275	0	0	0	275
WBL	152	0	0	0	152	151	0	0	0	151
WBT	605	9	0	0	614	655	17	0	0	672
WBR	0	0	0	0	0	0	0	0	0	0
North Leg										
Approach	0	0	0	0	0	0	0	0	0	0
Departure	0	0	0	0	0	0	0	0	0	0
Total	0	0	0	0	0	0	0	0	0	0
South Leg										
Approach	0	0	0	0	0	0	0	0	0	0
Departure	475	0	0	0	475	426	0	0	0	426
Total	475	0	0	0	475	426	0	0	0	426
East Leg										
Approach	757	9	0	0	766	806	17	0	0	823
Departure	667	92	0	0	759	599	90	0	0	689
Total	1,424	101	0	0	1,525	1,405	107	0	0	1,512
West Leg										
Approach	990	92	0	0	1,082	874	90	0	0	964
Departure	605	9	0	0	614	655	17	0	0	672
Total	1,595	101	0	0	1,696	1,529	107	0	0	1,636
Total Approaches										
Approach	1,747	101	0	0	1,848	1,680	107	0	0	1,787
Departure	1,747	101	0	0	1,848	1,680	107	0	0	1,787
Total	3,494	202	0	0	3,696	3,360	214	0	0	3,574



Table C-1 - Existing Balanced (2019) Peak Hour Volume Summary

	AM Peak Hour					PM Peak Hour				
	Existing	External	Internal	Pass-By	Existing with Project	Existing	External	Internal	Pass-By	Existing with Project
		Project	Project				Project			
43 H Street – SR-99 Northbound Off-Ramp/4th Street										
NBL	239	0	0	0	239	239	0	0	0	239
NBT	24	0	0	0	24	19	0	0	0	19
NBR	195	0	0	0	195	144	0	0	0	144
SBL	5	0	0	0	5	20	0	0	0	20
SBT	0	0	0	0	0	0	0	0	0	0
SBR	57	0	0	0	57	66	0	0	0	66
EBL	213	20	0	0	233	200	53	0	0	253
EBT	454	72	0	0	526	399	37	0	0	436
EBR	0	0	0	0	0	0	0	0	0	0
WBL	0	0	0	0	0	0	0	0	0	0
WBT	461	9	0	0	470	501	17	0	0	518
WBR	52	19	0	0	71	87	54	0	0	141
North Leg										
Approach	62	0	0	0	62	86	0	0	0	86
Departure	289	39	0	0	328	306	107	0	0	413
Total	351	39	0	0	390	392	107	0	0	499
South Leg										
Approach	458	0	0	0	458	402	0	0	0	402
Departure	0	0	0	0	0	0	0	0	0	0
Total	458	0	0	0	458	402	0	0	0	402
East Leg										
Approach	513	28	0	0	541	588	71	0	0	659
Departure	654	72	0	0	726	563	37	0	0	600
Total	1,167	100	0	0	1,267	1,151	108	0	0	1,259
West Leg										
Approach	667	92	0	0	759	599	90	0	0	689
Departure	757	9	0	0	766	806	17	0	0	823
Total	1,424	101	0	0	1,525	1,405	107	0	0	1,512
Total Approaches										
Approach	1,700	120	0	0	1,820	1,675	161	0	0	1,836
Departure	1,700	120	0	0	1,820	1,675	161	0	0	1,836
Total	3,400	240	0	0	3,640	3,350	322	0	0	3,672



Table C-1 - Existing Balanced (2019) Peak Hour Volume Summary

	AM Peak Hour				PM Peak Hour					
	Existing	External Project Trips	Internal Project Trips	Pass-By Trips	Existing with Project	Existing	External Project Trips	Internal Project Trips	Pass-By Trips	Existing with Project
44 I Street/Olive Avenue										
NBL	0	0	0	0	0	0	0	0	0	0
NBT	0	0	0	0	0	0	0	0	0	0
NBR	0	0	0	0	0	0	0	0	0	0
SBL	59	0	0	0	59	152	0	0	0	152
SBT	0	0	0	0	0	0	0	0	0	0
SBR	99	0	0	0	99	106	0	0	0	106
EBL	128	0	0	0	128	86	0	0	0	86
EBT	445	247	0	0	692	376	152	0	0	528
EBR	0	0	0	0	0	0	0	0	0	0
WBL	0	0	0	0	0	0	0	0	0	0
WBT	410	99	0	0	509	357	250	0	0	607
WBR	76	0	0	0	76	103	0	0	0	103
North Leg										
Approach	158	0	0	0	158	258	0	0	0	258
Departure	204	0	0	0	204	189	0	0	0	189
Total	362	0	0	0	362	447	0	0	0	447
South Leg										
Approach	0	0	0	0	0	0	0	0	0	0
Departure	0	0	0	0	0	0	0	0	0	0
Total	0	0	0	0	0	0	0	0	0	0
East Leg										
Approach	486	99	0	0	585	460	250	0	0	710
Departure	504	247	0	0	751	528	152	0	0	680
Total	990	346	0	0	1,336	988	402	0	0	1,390
West Leg										
Approach	573	247	0	0	820	462	152	0	0	614
Departure	509	99	0	0	608	463	250	0	0	713
Total	1,082	346	0	0	1,428	925	402	0	0	1,327
Total Approaches										
Approach	1,217	346	0	0	1,563	1,180	402	0	0	1,582
Departure	1,217	346	0	0	1,563	1,180	402	0	0	1,582
Total	2,434	692	0	0	3,126	2,360	804	0	0	3,164



Table C-1 - Existing Balanced (2019) Peak Hour Volume Summary

	AM Peak Hour					PM Peak Hour				
	Existing	External	Internal	Pass-By	Existing	Existing	External	Internal	Pass-By	Existing
		Project	Project				Project	Project		
	Trips	Trips	Trips	with	with	Trips	Trips	Trips	with	
				Project	Project				Project	Project
45 SR-99 Southbound Off-Ramp/Olive Avenue										
NBL	0	0	0	0	0	0	0	0	0	0
NBT	0	0	0	0	0	0	0	0	0	0
NBR	0	0	0	0	0	0	0	0	0	0
SBL	303	202	0	0	505	229	102	0	0	331
SBT	0	0	0	0	0	0	0	0	0	0
SBR	99	0	0	0	99	65	0	0	0	65
EBL	0	0	0	0	0	0	0	0	0	0
EBT	504	247	0	0	751	528	152	0	0	680
EBR	0	0	0	0	0	0	0	0	0	0
WBL	0	0	0	0	0	0	0	0	0	0
WBT	389	99	0	0	488	395	250	0	0	645
WBR	0	0	0	0	0	0	0	0	0	0
North Leg										
Approach	402	202	0	0	604	294	102	0	0	396
Departure	0	0	0	0	0	0	0	0	0	0
Total	402	202	0	0	604	294	102	0	0	396
South Leg										
Approach	0	0	0	0	0	0	0	0	0	0
Departure	0	0	0	0	0	0	0	0	0	0
Total	0	0	0	0	0	0	0	0	0	0
East Leg										
Approach	389	99	0	0	488	395	250	0	0	645
Departure	807	449	0	0	1,256	757	254	0	0	1,011
Total	1,196	548	0	0	1,744	1,152	504	0	0	1,656
West Leg										
Approach	504	247	0	0	751	528	152	0	0	680
Departure	488	99	0	0	587	460	250	0	0	710
Total	992	346	0	0	1,338	988	402	0	0	1,390
Total Approaches										
Approach	1,295	548	0	0	1,843	1,217	504	0	0	1,721
Departure	1,295	548	0	0	1,843	1,217	504	0	0	1,721
Total	2,590	1,096	0	0	3,686	2,434	1,008	0	0	3,442



Table C-1 - Existing Balanced (2019) Peak Hour Volume Summary

	AM Peak Hour				PM Peak Hour					
	Existing	External Project Trips	Internal Project Trips	Pass-By Trips	Existing with Project	Existing	External Project Trips	Internal Project Trips	Pass-By Trips	Existing with Project
46 Madera Avenue/SR-99 Northbound Ramps										
NBL	355	46	0	0	401	377	127	0	0	504
NBT	397	97	0	0	494	520	66	0	0	586
NBR	0	0	0	0	0	0	0	0	0	0
SBL	0	0	0	0	0	0	0	0	0	0
SBT	553	15	0	0	568	581	40	0	0	621
SBR	148	25	0	0	173	171	68	0	0	239
EBL	0	0	0	0	0	0	0	0	0	0
EBT	0	0	0	0	0	0	0	0	0	0
EBR	0	0	0	0	0	0	0	0	0	0
WBL	139	66	0	0	205	171	165	0	0	336
WBT	1	0	0	0	1	1	0	0	0	1
WBR	75	0	0	0	75	32	0	0	0	32
North Leg										
Approach	701	40	0	0	741	752	108	0	0	860
Departure	472	97	0	0	569	552	66	0	0	618
Total	1,173	137	0	0	1,310	1,304	174	0	0	1,478
South Leg										
Approach	752	143	0	0	895	897	193	0	0	1,090
Departure	692	81	0	0	773	752	205	0	0	957
Total	1,444	224	0	0	1,668	1,649	398	0	0	2,047
East Leg										
Approach	215	66	0	0	281	204	165	0	0	369
Departure	0	0	0	0	0	0	0	0	0	0
Total	215	66	0	0	281	204	165	0	0	369
West Leg										
Approach	0	0	0	0	0	0	0	0	0	0
Departure	504	71	0	0	575	549	195	0	0	744
Total	504	71	0	0	575	549	195	0	0	744
Total Approaches										
Approach	1,668	249	0	0	1,917	1,853	466	0	0	2,319
Departure	1,668	249	0	0	1,917	1,853	466	0	0	2,319
Total	3,336	498	0	0	3,834	3,706	932	0	0	4,638



Table C-1 - Existing Balanced (2019) Peak Hour Volume Summary

	AM Peak Hour					PM Peak Hour				
	Existing	External Project Trips	Internal Project Trips	Pass-By Trips	Existing with Project	Existing	External Project Trips	Internal Project Trips	Pass-By Trips	Existing with Project
47 Madera Avenue/Olive Avenue – SR-99 Southbound On-Ramp										
NBL	107	20	0	0	127	104	48	0	0	152
NBT	452	46	0	0	498	573	127	0	0	700
NBR	38	0	0	0	38	29	0	0	0	29
SBL	84	0	0	0	84	130	0	0	0	130
SBT	326	0	0	0	326	331	0	0	0	331
SBR	282	81	0	0	363	291	204	0	0	495
EBL	300	97	0	0	397	324	66	0	0	390
EBT	192	175	0	0	367	135	91	0	0	226
EBR	315	176	0	0	491	298	97	0	0	395
WBL	0	0	0	0	0	0	0	0	0	0
WBT	0	0	0	0	0	0	0	0	0	0
WBR	0	0	0	0	0	0	0	0	0	0
North Leg										
Approach	692	81	0	0	773	752	204	0	0	956
Departure	752	143	0	0	895	897	193	0	0	1,090
Total	1,444	224	0	0	1,668	1,649	397	0	0	2,046
South Leg										
Approach	597	66	0	0	663	706	175	0	0	881
Departure	641	176	0	0	817	629	97	0	0	726
Total	1,238	242	0	0	1,480	1,335	272	0	0	1,607
East Leg										
Approach	0	0	0	0	0	0	0	0	0	0
Departure	314	175	0	0	489	294	91	0	0	385
Total	314	175	0	0	489	294	91	0	0	385
West Leg										
Approach	807	448	0	0	1,255	757	254	0	0	1,011
Departure	389	101	0	0	490	395	252	0	0	647
Total	1,196	549	0	0	1,745	1,152	506	0	0	1,658
Total Approaches										
Approach	2,096	595	0	0	2,691	2,215	633	0	0	2,848
Departure	2,096	595	0	0	2,691	2,215	633	0	0	2,848
Total	4,192	1,190	0	0	5,382	4,430	1,266	0	0	5,696



Table C-1 - Existing Balanced (2019) Peak Hour Volume Summary

	AM Peak Hour					PM Peak Hour				
	Existing	External	Internal	Pass-By	Existing	Existing	External	Internal	Pass-By	Existing
		Project	Project				Project	Project		
	Trips	Trips	Trips	with	with	Trips	Trips	Trips	with	
				Project	Project				Project	Project
48 Madera Avenue (SR-145) /Lewis Street										
NBL	0	0	0	0	0	0	0	0	0	0
NBT	619	65	0	0	684	739	174	0	0	913
NBR	8	0	0	0	8	6	0	0	0	6
SBL	31	0	0	0	31	31	0	0	0	31
SBT	764	176	0	0	940	690	97	0	0	787
SBR	0	0	0	0	0	0	0	0	0	0
EBL	0	0	0	0	0	0	0	0	0	0
EBT	0	0	0	0	0	0	0	0	0	0
EBR	0	0	0	0	0	0	0	0	0	0
WBL	9	0	0	0	9	7	0	0	0	7
WBT	0	0	0	0	0	0	0	0	0	0
WBR	8	0	0	0	8	9	0	0	0	9
North Leg										
Approach	795	176	0	0	971	721	97	0	0	818
Departure	627	65	0	0	692	748	174	0	0	922
Total	1,422	241	0	0	1,663	1,469	271	0	0	1,740
South Leg										
Approach	627	65	0	0	692	745	174	0	0	919
Departure	773	176	0	0	949	697	97	0	0	794
Total	1,400	241	0	0	1,641	1,442	271	0	0	1,713
East Leg										
Approach	17	0	0	0	17	16	0	0	0	16
Departure	39	0	0	0	39	37	0	0	0	37
Total	56	0	0	0	56	53	0	0	0	53
West Leg										
Approach	0	0	0	0	0	0	0	0	0	0
Departure	0	0	0	0	0	0	0	0	0	0
Total	0	0	0	0	0	0	0	0	0	0
Total Approaches										
Approach	1,439	241	0	0	1,680	1,482	271	0	0	1,753
Departure	1,439	241	0	0	1,680	1,482	271	0	0	1,753
Total	2,878	482	0	0	3,360	2,964	542	0	0	3,506



Table C-1 - Existing Balanced (2019) Peak Hour Volume Summary

	AM Peak Hour				PM Peak Hour					
	Existing	External Project Trips	Internal Project Trips	Pass-By Trips	Existing with Project	Existing	External Project Trips	Internal Project Trips	Pass-By Trips	Existing with Project
49 Yosemite Avenue/Cleveland Avenue - Tozer Street										
NBL	131	0	0	0	131	305	0	0	0	305
NBT	105	0	0	0	105	283	0	0	0	283
NBR	74	0	0	0	74	95	0	0	0	95
SBL	60	0	0	0	60	67	0	0	0	67
SBT	229	0	0	0	229	167	0	0	0	167
SBR	168	46	0	0	214	209	121	0	0	330
EBL	164	119	0	0	283	187	70	0	0	257
EBT	514	26	0	0	540	408	11	0	0	419
EBR	248	0	0	0	248	195	0	0	0	195
WBL	110	0	0	0	110	48	0	0	0	48
WBT	289	8	0	0	297	447	25	0	0	472
WBR	41	0	0	0	41	35	0	0	0	35
North Leg										
Approach	457	46	0	0	503	443	121	0	0	564
Departure	310	119	0	0	429	505	70	0	0	575
Total	767	165	0	0	932	948	191	0	0	1,139
South Leg										
Approach	310	0	0	0	310	683	0	0	0	683
Departure	587	0	0	0	587	410	0	0	0	410
Total	897	0	0	0	897	1,093	0	0	0	1,093
East Leg										
Approach	440	8	0	0	448	530	25	0	0	555
Departure	648	26	0	0	674	570	11	0	0	581
Total	1,088	34	0	0	1,122	1,100	36	0	0	1,136
West Leg										
Approach	926	145	0	0	1,071	790	81	0	0	871
Departure	588	54	0	0	642	961	146	0	0	1,107
Total	1,514	199	0	0	1,713	1,751	227	0	0	1,978
Total Approaches										
Approach	2,133	199	0	0	2,332	2,446	227	0	0	2,673
Departure	2,133	199	0	0	2,332	2,446	227	0	0	2,673
Total	4,266	398	0	0	4,664	4,892	454	0	0	5,346



Table C-1 - Existing Balanced (2019) Peak Hour Volume Summary

	AM Peak Hour				PM Peak Hour					
	Existing	External Project Trips	Internal Project Trips	Pass-By Trips	Existing with Project	Existing	External Project Trips	Internal Project Trips	Pass-By Trips	Existing with Project
50 Road 22/Cleveland Avenue										
NBL	0	0	0	0	0	0	0	0	0	0
NBT	0	0	3	0	3	0	0	2	0	2
NBR	0	0	0	0	0	0	0	0	0	0
SBL	0	6	5	0	11	0	8	6	0	14
SBT	0	0	2	0	2	0	0	2	0	2
SBR	0	0	0	0	0	0	0	0	0	0
EBL	0	0	0	0	0	0	0	0	0	0
EBT	0	0	0	0	0	0	0	0	0	0
EBR	0	0	0	0	0	0	0	0	0	0
WBL	0	0	0	0	0	0	0	0	0	0
WBT	0	0	0	0	0	0	0	0	0	0
WBR	0	13	6	0	19	0	3	6	0	9
North Leg										
Approach	0	6	7	0	13	0	8	8	0	16
Departure	0	13	9	0	22	0	3	8	0	11
Total	0	19	16	0	35	0	11	16	0	27
South Leg										
Approach	0	0	3	0	3	0	0	2	0	2
Departure	0	0	2	0	2	0	0	2	0	2
Total	0	0	5	0	5	0	0	4	0	4
East Leg										
Approach	0	13	6	0	19	0	3	6	0	9
Departure	0	6	5	0	11	0	8	6	0	14
Total	0	19	11	0	30	0	11	12	0	23
West Leg										
Approach	0	0	0	0	0	0	0	0	0	0
Departure	0	0	0	0	0	0	0	0	0	0
Total	0	0	0	0	0	0	0	0	0	0
Total Approaches										
Approach	0	19	16	0	35	0	11	16	0	27
Departure	0	19	16	0	35	0	11	16	0	27
Total	0	38	32	0	70	0	22	32	0	54



Table C-1 - Existing Balanced (2019) Peak Hour Volume Summary

	AM Peak Hour				PM Peak Hour					
	Existing	External Project Trips	Internal Project Trips	Pass-By Trips	Existing with Project	Existing	External Project Trips	Internal Project Trips	Pass-By Trips	Existing with Project
51 Project Driveway 1/Avenue 17										
NBL	0	56	0	0	56	0	23	0	0	23
NBT	0	0	0	0	0	0	0	0	0	0
NBR	0	614	15	0	629	0	270	32	0	302
SBL	0	0	0	0	0	0	0	0	0	0
SBT	0	0	0	0	0	0	0	0	0	0
SBR	0	0	0	0	0	0	0	0	0	0
EBL	0	0	0	0	0	0	0	0	0	0
EBT	31	14	4	0	49	60	31	8	0	99
EBR	0	16	0	0	16	0	50	0	0	50
WBL	0	140	15	0	155	0	595	32	0	627
WBT	27	34	5	0	66	25	16	8	0	49
WBR	0	0	0	0	0	0	0	0	0	0
North Leg										
Approach	0	0	0	0	0	0	0	0	0	0
Departure	0	0	0	0	0	0	0	0	0	0
Total	0	0	0	0	0	0	0	0	0	0
South Leg										
Approach	0	670	15	0	685	0	293	32	0	325
Departure	0	156	15	0	171	0	645	32	0	677
Total	0	826	30	0	856	0	938	64	0	1,002
East Leg										
Approach	27	174	20	0	221	25	611	40	0	676
Departure	31	628	19	0	678	60	301	40	0	401
Total	58	802	39	0	899	85	912	80	0	1,077
West Leg										
Approach	31	30	4	0	65	60	81	8	0	149
Departure	27	90	5	0	122	25	39	8	0	72
Total	58	120	9	0	187	85	120	16	0	221
Total Approaches										
Approach	58	874	39	0	971	85	985	80	0	1,150
Departure	58	874	39	0	971	85	985	80	0	1,150
Total	116	1,748	78	0	1,942	170	1,970	160	0	2,300

Table C-1 - Existing Balanced (2019) Peak Hour Volume Summary

	AM Peak Hour					PM Peak Hour				
	Existing	External Project Trips	Internal Project Trips	Pass-By Trips	Existing with Project	Existing	External Project Trips	Internal Project Trips	Pass-By Trips	Existing with Project
52 Road 22 ½ - Project Driveway 2/Avenue 16										
NBL	0	16	0	0	16	0	6	0	0	6
NBT	0	0	131	0	131	0	0	178	0	178
NBR	1	271	45	0	317	0	100	48	0	148
SBL	1	188	44	0	233	1	70	68	0	139
SBT	0	0	126	0	126	0	0	179	0	179
SBR	0	0	0	0	0	0	0	0	0	0
EBL	0	0	0	0	0	0	0	0	0	0
EBT	12	0	0	0	12	49	0	0	0	49
EBR	2	3	0	0	5	0	15	0	0	15
WBL	0	45	43	0	88	0	248	48	0	296
WBT	33	0	0	0	33	14	0	0	0	14
WBR	0	68	43	0	111	0	155	70	0	225
North Leg										
Approach	1	188	170	0	359	1	70	247	0	318
Departure	0	68	174	0	242	0	155	248	0	403
Total	1	256	344	0	601	1	225	495	0	721
South Leg										
Approach	1	287	176	0	464	0	106	226	0	332
Departure	2	48	169	0	219	0	263	227	0	490
Total	3	335	345	0	683	0	369	453	0	822
East Leg										
Approach	33	113	86	0	232	14	403	118	0	535
Departure	14	459	89	0	562	50	170	116	0	336
Total	47	572	175	0	794	64	573	234	0	871
West Leg										
Approach	14	3	0	0	17	49	15	0	0	64
Departure	33	16	0	0	49	14	6	0	0	20
Total	47	19	0	0	66	63	21	0	0	84
Total Approaches										
Approach	49	591	432	0	1,072	64	594	591	0	1,249
Departure	49	591	432	0	1,072	64	594	591	0	1,249
Total	98	1,182	864	0	2,144	128	1,188	1,182	0	2,498



Table C-1 - Existing Balanced (2019) Peak Hour Volume Summary

	AM Peak Hour				PM Peak Hour					
	Existing	External Project Trips	Internal Project Trips	Pass-By Trips	Existing with Project	Existing	External Project Trips	Internal Project Trips	Pass-By Trips	Existing with Project
53 Road 22 ½/Cleveland Avenue										
NBL	1	6	7	0	14	0	2	12	0	14
NBT	0	0	25	0	25	0	0	25	4	29
NBR	2	134	27	0	163	0	35	31	-4	62
SBL	1	258	74	0	333	1	185	106	38	330
SBT	0	0	25	0	25	0	0	25	5	30
SBR	0	0	10	0	10	0	0	8	0	8
EBL	0	0	12	0	12	0	0	8	0	8
EBT	0	265	130	0	395	0	173	244	0	417
EBR	0	3	8	0	11	0	4	12	0	16
WBL	1	59	28	0	88	0	86	31	-4	113
WBT	0	105	127	0	232	0	279	245	0	524
WBR	1	67	76	0	144	0	310	107	32	449
North Leg										
Approach	1	258	109	0	368	1	185	139	43	368
Departure	1	67	113	0	181	0	310	140	36	486
Total	2	325	222	0	549	1	495	279	79	854
South Leg										
Approach	3	140	59	0	202	0	37	68	0	105
Departure	1	62	61	0	124	0	90	68	1	159
Total	4	202	120	0	326	0	127	136	1	264
East Leg										
Approach	2	231	231	0	464	0	675	383	28	1,086
Departure	3	657	231	0	891	1	393	381	34	809
Total	5	888	462	0	1,355	1	1,068	764	62	1,895
West Leg										
Approach	0	268	150	0	418	0	177	264	0	441
Departure	1	111	144	0	256	0	281	265	0	546
Total	1	379	294	0	674	0	458	529	0	987
Total Approaches										
Approach	6	897	549	0	1,452	1	1,074	854	71	2,000
Departure	6	897	549	0	1,452	1	1,074	854	71	2,000
Total	12	1,794	1,098	0	2,904	2	2,148	1,708	142	4,000



Table C-1 - Existing Balanced (2019) Peak Hour Volume Summary

	AM Peak Hour					PM Peak Hour				
	Existing	External Project Trips	Internal Project Trips	Pass-By Trips	Existing with Project	Existing	External Project Trips	Internal Project Trips	Pass-By Trips	Existing with Project
54 Road 22 ½/Project Driveway 5										
NBL	0	0	0	0	0	0	0	0	0	0
NBT	0	0	0	0	0	0	0	0	0	0
NBR	0	0	0	0	0	0	0	0	0	0
SBL	0	70	4	0	74	0	19	7	0	26
SBT	0	0	0	0	0	0	0	0	0	0
SBR	0	0	0	0	0	0	0	0	0	0
EBL	0	0	0	0	0	0	0	0	0	0
EBT	0	76	13	0	89	0	20	17	0	37
EBR	0	0	0	0	0	0	0	0	0	0
WBL	0	0	0	0	0	0	0	0	0	0
WBT	0	34	11	0	45	0	49	17	0	66
WBR	0	31	4	0	35	0	45	7	0	52
North Leg										
Approach	0	70	4	0	74	0	19	7	0	26
Departure	0	31	4	0	35	0	45	7	0	52
Total	0	101	8	0	109	0	64	14	0	78
South Leg										
Approach	0	0	0	0	0	0	0	0	0	0
Departure	0	0	0	0	0	0	0	0	0	0
Total	0	0	0	0	0	0	0	0	0	0
East Leg										
Approach	0	65	15	0	80	0	94	24	0	118
Departure	0	146	17	0	163	0	39	24	0	63
Total	0	211	32	0	243	0	133	48	0	181
West Leg										
Approach	0	76	13	0	89	0	20	17	0	37
Departure	0	34	11	0	45	0	49	17	0	66
Total	0	110	24	0	134	0	69	34	0	103
Total Approaches										
Approach	0	211	32	0	243	0	133	48	0	181
Departure	0	211	32	0	243	0	133	48	0	181
Total	0	422	64	0	486	0	266	96	0	362



Table C-1 - Existing Balanced (2019) Peak Hour Volume Summary

	AM Peak Hour				PM Peak Hour					
	Existing	External Project Trips	Internal Project Trips	Pass-By Trips	Existing with Project	Existing	External Project Trips	Internal Project Trips	Pass-By Trips	Existing with Project
55 Road 23/Project Driveway 3										
NBL	0	13	80	0	93	0	36	192	0	228
NBT	232	917	91	0	1,240	152	742	207	0	1,101
NBR	0	0	0	0	0	0	0	0	0	0
SBL	0	0	0	0	0	0	0	0	0	0
SBT	160	383	90	0	633	242	1,098	204	0	1,544
SBR	0	327	6	0	333	0	620	11	0	631
EBL	0	800	6	0	806	0	283	11	0	294
EBT	0	0	0	0	0	0	0	0	0	0
EBR	0	42	80	0	122	2	17	192	0	211
WBL	0	0	0	0	0	0	0	0	0	0
WBT	0	0	0	0	0	0	0	0	0	0
WBR	0	0	0	0	0	0	0	0	0	0
North Leg										
Approach	160	710	96	0	966	242	1,718	215	0	2,175
Departure	232	1,717	97	0	2,046	152	1,025	218	0	1,395
Total	392	2,427	193	0	3,012	394	2,743	433	0	3,570
South Leg										
Approach	232	930	171	0	1,333	152	778	399	0	1,329
Departure	160	425	170	0	755	244	1,115	396	0	1,755
Total	392	1,355	341	0	2,088	396	1,893	795	0	3,084
East Leg										
Approach	0	0	0	0	0	0	0	0	0	0
Departure	0	0	0	0	0	0	0	0	0	0
Total	0	0	0	0	0	0	0	0	0	0
West Leg										
Approach	0	842	86	0	928	2	300	203	0	505
Departure	0	340	86	0	426	0	656	203	0	859
Total	0	1,182	172	0	1,354	2	956	406	0	1,364
Total Approaches										
Approach	392	2,482	353	0	3,227	396	2,796	817	0	4,009
Departure	392	2,482	353	0	3,227	396	2,796	817	0	4,009
Total	784	4,964	706	0	6,454	792	5,592	1,634	0	8,018



Table C-1 - Existing Balanced (2019) Peak Hour Volume Summary

	AM Peak Hour					PM Peak Hour				
	Existing	External Project Trips	Internal Project Trips	Pass-By Trips	Existing with Project	Existing	External Project Trips	Internal Project Trips	Pass-By Trips	Existing with Project
56 Road 23/Project Driveway 4										
NBL	0	0	0	0	0	0	0	0	0	0
NBT	266	422	8	0	696	241	1,010	9	-19	1,241
NBR	0	110	27	0	137	0	282	40	19	341
SBL	0	132	288	0	420	0	278	675	24	977
SBT	209	951	7	0	1,167	331	655	9	-22	973
SBR	0	0	0	0	0	0	0	0	0	0
EBL	0	0	0	0	0	0	0	0	0	0
EBT	0	0	0	0	0	0	0	0	0	0
EBR	0	0	0	0	0	0	0	0	0	0
WBL	0	80	26	0	106	0	303	40	27	370
WBT	0	0	0	0	0	0	0	0	0	0
WBR	0	263	274	0	537	0	190	677	23	890
North Leg										
Approach	209	1,083	295	0	1,587	331	933	684	2	1,950
Departure	266	685	282	0	1,233	241	1,200	686	4	2,131
Total	475	1,768	577	0	2,820	572	2,133	1,370	6	4,081
South Leg										
Approach	266	532	35	0	833	241	1,292	49	0	1,582
Departure	209	1,031	33	0	1,273	331	958	49	5	1,343
Total	475	1,563	68	0	2,106	572	2,250	98	5	2,925
East Leg										
Approach	0	343	300	0	643	0	493	717	50	1,260
Departure	0	242	315	0	557	0	560	715	43	1,318
Total	0	585	615	0	1,200	0	1,053	1,432	93	2,578
West Leg										
Approach	0	0	0	0	0	0	0	0	0	0
Departure	0	0	0	0	0	0	0	0	0	0
Total	0	0	0	0	0	0	0	0	0	0
Total Approaches										
Approach	475	1,958	630	0	3,063	572	2,718	1,450	52	4,792
Departure	475	1,958	630	0	3,063	572	2,718	1,450	52	4,792
Total	950	3,916	1,260	0	6,126	1,144	5,436	2,900	104	9,584



Table C-1 - Existing Balanced (2019) Peak Hour Volume Summary

	AM Peak Hour				PM Peak Hour					
	Existing	External Project Trips	Internal Project Trips	Pass-By Trips	Existing with Project	Existing	External Project Trips	Internal Project Trips	Pass-By Trips	Existing with Project
57 Road 23/Project Driveway 5										
NBL	1	65	0	0	66	0	94	0	0	94
NBT	266	456	0	0	722	240	1,272	0	0	1,512
NBR	0	0	0	0	0	0	0	0	0	0
SBL	0	0	0	0	0	0	0	0	0	0
SBT	209	996	0	0	1,205	330	909	0	0	1,239
SBR	0	34	39	0	73	1	49	51	0	101
EBL	0	76	41	0	117	1	20	51	0	72
EBT	0	0	0	0	0	0	0	0	0	0
EBR	1	146	0	0	147	2	39	0	0	41
WBL	0	0	0	0	0	0	0	0	0	0
WBT	0	0	0	0	0	0	0	0	0	0
WBR	0	0	0	0	0	0	0	0	0	0
North Leg										
Approach	209	1,030	39	0	1,278	331	958	51	0	1,340
Departure	266	532	41	0	839	241	1,292	51	0	1,584
Total	475	1,562	80	0	2,117	572	2,250	102	0	2,924
South Leg										
Approach	267	521	0	0	788	240	1,366	0	0	1,606
Departure	210	1,142	0	0	1,352	332	948	0	0	1,280
Total	477	1,663	0	0	2,140	572	2,314	0	0	2,886
East Leg										
Approach	0	0	0	0	0	0	0	0	0	0
Departure	0	0	0	0	0	0	0	0	0	0
Total	0	0	0	0	0	0	0	0	0	0
West Leg										
Approach	1	222	41	0	264	3	59	51	0	113
Departure	1	99	39	0	139	1	143	51	0	195
Total	2	321	80	0	403	4	202	102	0	308
Total Approaches										
Approach	477	1,773	80	0	2,330	574	2,383	102	0	3,059
Departure	477	1,773	80	0	2,330	574	2,383	102	0	3,059
Total	954	3,546	160	0	4,660	1,148	4,766	204	0	6,118



Table C-1 - Existing Balanced (2019) Peak Hour Volume Summary

	AM Peak Hour				PM Peak Hour					
	Existing	External Project Trips	Internal Project Trips	Pass-By Trips	Existing with Project	Existing	External Project Trips	Internal Project Trips	Pass-By Trips	Existing with Project
58 Project Driveway 6/Cleveland Avenue										
NBL	0	194	1	0	195	0	63	2	0	65
NBT	0	0	0	0	0	0	0	0	0	0
NBR	0	292	0	0	292	0	236	0	7	243
SBL	0	0	0	0	0	0	0	0	0	0
SBT	0	0	0	0	0	0	0	0	0	0
SBR	0	0	0	0	0	0	0	0	0	0
EBL	0	0	0	0	0	0	0	0	0	0
EBT	63	1,047	13	0	1,123	148	702	18	-7	861
EBR	0	75	2	0	77	0	143	2	0	145
WBL	0	154	0	0	154	0	329	0	3	332
WBT	84	367	12	0	463	76	1,160	18	-3	1,251
WBR	0	0	0	0	0	0	0	0	0	0
North Leg										
Approach	0	0	0	0	0	0	0	0	0	0
Departure	0	0	0	0	0	0	0	0	0	0
Total	0	0	0	0	0	0	0	0	0	0
South Leg										
Approach	0	486	1	0	487	0	299	2	7	308
Departure	0	229	2	0	231	0	472	2	3	477
Total	0	715	3	0	718	0	771	4	10	785
East Leg										
Approach	84	521	12	0	617	76	1,489	18	0	1,583
Departure	63	1,339	13	0	1,415	148	938	18	0	1,104
Total	147	1,860	25	0	2,032	224	2,427	36	0	2,687
West Leg										
Approach	63	1,122	15	0	1,200	148	845	20	-7	1,006
Departure	84	561	13	0	658	76	1,223	20	-3	1,316
Total	147	1,683	28	0	1,858	224	2,068	40	-10	2,322
Total Approaches										
Approach	147	2,129	28	0	2,304	224	2,633	40	0	2,897
Departure	147	2,129	28	0	2,304	224	2,633	40	0	2,897
Total	294	4,258	56	0	4,608	448	5,266	80	0	5,794

Table C-2 - Phase III Project Completion Year (2049) [Project Build-out] Peak Hour Volume Summary

	AM Peak Hour							PM Peak Hour						
	Ph III 2049		Ph III 2049 without Project	External Project Trips	Internal Project Trips	Pass-By Trips	Ph III 2049 with Project	Ph III 2049		Ph III 2049 without Project	External Project Trips	Internal Project Trips	Pass-By Trips	Ph III 2049 with Project
	w/o Proj	Cumulative Project						w/o Proj	Cumulative Project					
1 Road 22/Avenue 17														
NBL	3	0	3	29	0	0	32	1	0	1	9	0	0	10
NBT	0	0	0	0	0	0	0	0	0	0	0	0	0	0
NBR	6	0	6	0	8	0	14	0	0	0	0	8	0	8
SBL	0	0	0	0	0	0	0	0	0	0	0	0	0	0
SBT	0	0	0	0	0	0	0	0	0	0	0	0	0	0
SBR	0	0	0	0	0	0	0	0	0	0	0	0	0	0
EBL	0	0	0	0	0	0	0	0	0	0	0	0	0	0
EBT	38	0	38	30	0	0	68	66	0	66	81	0	0	147
EBR	0	0	0	9	0	0	9	0	0	0	23	0	0	23
WBL	2	0	2	0	8	0	10	0	0	0	0	8	0	8
WBT	30	0	30	90	0	0	120	38	0	38	39	0	0	77
WBR	0	0	0	0	0	0	0	0	0	0	0	0	0	0
North Leg														
Approach	0	0	0	0	0	0	0	0	0	0	0	0	0	0
Departure	0	0	0	0	0	0	0	0	0	0	0	0	0	0
Total	0	0	0	0	0	0	0	0	0	0	0	0	0	0
South Leg														
Approach	9	0	9	29	8	0	46	1	0	1	9	8	0	18
Departure	2	0	2	9	8	0	19	0	0	0	23	8	0	31
Total	11	0	11	38	16	0	65	1	0	1	32	16	0	49
East Leg														
Approach	32	0	32	90	8	0	130	38	0	38	39	8	0	85
Departure	44	0	44	30	8	0	82	66	0	66	81	8	0	155
Total	76	0	76	120	16	0	212	104	0	104	120	16	0	240
West Leg														
Approach	38	0	38	39	0	0	77	66	0	66	104	0	0	170
Departure	33	0	33	119	0	0	152	39	0	39	48	0	0	87
Total	71	0	71	158	0	0	229	105	0	105	152	0	0	257
Total Approaches														
Approach	79	0	79	158	16	0	253	105	0	105	152	16	0	273
Departure	79	0	79	158	16	0	253	105	0	105	152	16	0	273
Total	158	0	158	316	32	0	506	210	0	210	304	32	0	546

Table C-2 - Phase III Project Completion Year (2049) [Project Build-out] Peak Hour Volume Summary

	AM Peak Hour							PM Peak Hour						
	Ph III 2049		Ph III 2049	External	Internal	Pass-By	Ph III 2049	Ph III 2049		Ph III 2049	External	Internal	Pass-By	Ph III 2049
	w/o Proj	Cumul Project	without Project	Project Trips	Project Trips	Trips	with Project	w/o Proj	Cumul Project	without Project	Project Trips	Project Trips	Trips	with Project
2 Road 22/Avenue 16														
NBL	0	0	0	0	0	0	0	0	0	0	0	0	0	0
NBT	0	0	0	13	8	0	21	0	0	0	3	8	0	11
NBR	0	0	0	0	0	0	0	1	0	1	0	0	0	1
SBL	2	0	2	3	0	0	5	0	0	0	15	0	0	15
SBT	0	0	0	6	8	0	14	0	0	0	8	8	0	16
SBR	1	0	1	0	0	0	1	0	0	0	0	0	0	0
EBL	2	0	2	0	0	0	2	0	0	0	0	0	0	0
EBT	13	0	13	0	0	0	13	50	0	50	0	0	0	50
EBR	0	0	0	0	0	0	0	0	0	0	0	0	0	0
WBL	0	0	0	0	0	0	0	0	0	0	0	0	0	0
WBT	30	0	30	0	0	0	30	15	0	15	0	0	0	15
WBR	5	0	5	16	0	0	21	0	0	0	6	0	0	6
North Leg														
Approach	3	0	3	9	8	0	20	0	0	0	23	8	0	31
Departure	7	0	7	29	8	0	44	0	0	0	9	8	0	17
Total	10	0	10	38	16	0	64	0	0	0	32	16	0	48
South Leg														
Approach	0	0	0	13	8	0	21	1	0	1	3	8	0	12
Departure	0	0	0	6	8	0	14	0	0	0	8	8	0	16
Total	0	0	0	19	16	0	35	1	0	1	11	16	0	28
East Leg														
Approach	35	0	35	16	0	0	51	15	0	15	6	0	0	21
Departure	15	0	15	3	0	0	18	51	0	51	15	0	0	66
Total	50	0	50	19	0	0	69	66	0	66	21	0	0	87
West Leg														
Approach	15	0	15	0	0	0	15	50	0	50	0	0	0	50
Departure	32	0	32	0	0	0	32	15	0	15	0	0	0	15
Total	46	0	46	0	0	0	46	65	0	65	0	0	0	65
Total Approaches														
Approach	53	0	53	38	16	0	107	66	0	66	32	16	0	114
Departure	53	0	53	38	16	0	107	66	0	66	32	16	0	114
Total	107	0	107	76	32	0	215	133	0	133	64	32	0	229

Table C-2 - Phase III Project Completion Year (2049) [Project Build-out] Peak Hour Volume Summary

	AM Peak Hour							PM Peak Hour						
	Ph III 2049		Ph III 2049	External	Internal	Pass-By	Ph III 2049	Ph III 2049		Ph III 2049	External	Internal	Pass-By	Ph III 2049
	w/o Proj	Cumul Project	without Project	Project Trips	Project Trips	Trips	with Project	w/o Proj	Cumul Project	without Project	Project Trips	Project Trips	Trips	with Project
3 Golden State Boulevard/Avenue 18 ½														
NBL	0	0	0	0	0	0	0	0	0	0	0	0	0	0
NBT	0	0	0	0	0	0	0	0	0	0	0	0	0	0
NBR	0	0	0	0	0	0	0	0	0	0	0	0	0	0
SBL	98	0	98	0	0	0	98	270	0	270	0	0	0	270
SBT	0	0	0	0	0	0	0	0	0	0	0	0	0	0
SBR	4	0	4	0	0	0	4	8	0	8	0	0	0	8
EBL	2	0	2	0	0	0	2	7	0	7	0	0	0	7
EBT	114	0	114	28	0	0	142	137	0	137	91	0	0	228
EBR	0	0	0	0	0	0	0	0	0	0	0	0	0	0
WBL	0	0	0	0	0	0	0	0	0	0	0	0	0	0
WBT	105	0	105	74	0	0	179	80	0	80	58	0	0	138
WBR	111	0	111	0	0	0	111	115	0	115	0	0	0	115
North Leg														
Approach	102	0	102	0	0	0	102	278	0	278	0	0	0	278
Departure	113	0	113	0	0	0	113	122	0	122	0	0	0	122
Total	215	0	215	0	0	0	215	401	0	401	0	0	0	401
South Leg														
Approach	0	0	0	0	0	0	0	0	0	0	0	0	0	0
Departure	0	0	0	0	0	0	0	0	0	0	0	0	0	0
Total	0	0	0	0	0	0	0	0	0	0	0	0	0	0
East Leg														
Approach	216	0	216	74	0	0	290	195	0	195	58	0	0	253
Departure	212	0	212	28	0	0	240	407	0	407	91	0	0	498
Total	428	0	428	102	0	0	530	602	0	602	149	0	0	751
West Leg														
Approach	116	0	116	28	0	0	144	144	0	144	91	0	0	235
Departure	109	0	109	74	0	0	183	88	0	88	58	0	0	146
Total	225	0	225	102	0	0	327	233	0	233	149	0	0	382
Total Approaches														
Approach	434	0	434	102	0	0	536	618	0	618	149	0	0	767
Departure	434	0	434	102	0	0	536	618	0	618	149	0	0	767
Total	869	0	869	204	0	0	1,073	1,236	0	1,236	298	0	0	1,534

Table C-2 - Phase III Project Completion Year (2049) [Project Build-out] Peak Hour Volume Summary

	AM Peak Hour							PM Peak Hour						
	Ph III 2049		Ph III 2049 without Project	External Project Trips	Internal Project Trips	Pass-By Trips	Ph III 2049 with Project	Ph III 2049		Ph III 2049 without Project	External Project Trips	Internal Project Trips	Pass-By Trips	Ph III 2049 with Project
	w/o Proj	Cumulative Project						w/o Proj	Cumulative Project					
4 Pistachio Drive/Avenue 18 ½														
NBL	0	0	0	0	0	0	0	2	0	2	0	0	0	2
NBT	0	0	0	0	0	0	0	0	0	0	0	0	0	0
NBR	1	0	1	0	0	0	1	5	0	5	0	0	0	5
SBL	110	0	110	0	0	0	110	170	0	170	0	0	0	170
SBT	0	0	0	0	0	0	0	0	0	0	0	0	0	0
SBR	9	0	9	0	0	0	9	13	0	13	0	0	0	13
EBL	8	0	8	0	0	0	8	13	0	13	0	0	0	13
EBT	267	0	267	28	0	0	295	446	0	446	91	0	0	537
EBR	1	0	1	0	0	0	1	1	0	1	0	0	0	1
WBL	3	0	3	0	0	0	3	6	0	6	0	0	0	6
WBT	221	0	221	74	0	0	295	167	0	167	58	0	0	225
WBR	206	0	206	0	0	0	206	206	0	206	0	0	0	206
North Leg														
Approach	119	0	119	0	0	0	119	183	0	183	0	0	0	183
Departure	214	0	214	0	0	0	214	219	0	219	0	0	0	219
Total	334	0	334	0	0	0	334	402	0	402	0	0	0	402
South Leg														
Approach	1	0	1	0	0	0	1	7	0	7	0	0	0	7
Departure	4	0	4	0	0	0	4	7	0	7	0	0	0	7
Total	5	0	5	0	0	0	5	15	0	15	0	0	0	15
East Leg														
Approach	430	0	430	74	0	0	504	379	0	379	58	0	0	437
Departure	378	0	378	28	0	0	406	621	0	621	91	0	0	712
Total	808	0	808	102	0	0	910	1,001	0	1,001	149	0	0	1,150
West Leg														
Approach	276	0	276	28	0	0	304	460	0	460	91	0	0	551
Departure	230	0	230	74	0	0	304	182	0	182	58	0	0	240
Total	507	0	507	102	0	0	609	642	0	642	149	0	0	791
Total Approaches														
Approach	827	0	827	102	0	0	929	1,029	0	1,029	149	0	0	1,178
Departure	827	0	827	102	0	0	929	1,029	0	1,029	149	0	0	1,178
Total	1,654	0	1,654	204	0	0	1,858	2,059	0	2,059	298	0	0	2,357

Table C-2 - Phase III Project Completion Year (2049) [Project Build-out] Peak Hour Volume Summary

	AM Peak Hour							PM Peak Hour						
	Ph III 2049		Ph III 2049	External	Internal	Pass-By	Ph III 2049	Ph III 2049		Ph III 2049	External	Internal	Pass-By	Ph III 2049
	w/o Proj	Cumul Project	without Project	Project Trips	Project Trips	Trips	with Project	w/o Proj	Cumul Project	without Project	Project Trips	Project Trips	Trips	with Project
5 SR-99 Southbound Ramps – Road 23/Avenue 18 ½														
NBL	63	0	63	74	0	0	137	48	0	48	58	0	0	106
NBT	0	0	0	0	0	0	0	0	0	0	0	0	0	0
NBR	159	0	159	579	0	0	738	162	0	162	307	0	0	469
SBL	12	0	12	0	0	0	12	28	0	28	0	0	0	28
SBT	57	0	57	208	0	0	265	136	0	136	559	0	0	695
SBR	86	0	86	0	0	0	86	127	0	127	0	0	0	127
EBL	0	0	0	0	0	0	0	0	0	0	0	0	0	0
EBT	323	0	323	0	0	0	323	405	0	405	0	0	0	405
EBR	55	0	55	28	0	0	83	216	0	216	91	0	0	307
WBL	50	0	50	0	0	0	50	58	0	58	0	0	0	58
WBT	286	0	286	0	0	0	286	206	0	206	0	0	0	206
WBR	0	0	0	0	0	0	0	0	0	0	0	0	0	0
North Leg														
Approach	155	0	155	208	0	0	363	291	0	291	559	0	0	850
Departure	0	0	0	0	0	0	0	0	0	0	0	0	0	0
Total	155	0	155	208	0	0	363	291	0	291	559	0	0	850
South Leg														
Approach	222	0	222	653	0	0	875	210	0	210	365	0	0	575
Departure	162	0	162	236	0	0	398	410	0	410	650	0	0	1,060
Total	384	0	384	889	0	0	1,273	620	0	620	1,015	0	0	1,635
East Leg														
Approach	336	0	336	0	0	0	336	264	0	264	0	0	0	264
Departure	494	0	494	579	0	0	1,073	595	0	595	307	0	0	902
Total	830	0	830	579	0	0	1,409	859	0	859	307	0	0	1,166
West Leg														
Approach	378	0	378	28	0	0	406	621	0	621	91	0	0	712
Departure	435	0	435	74	0	0	509	381	0	381	58	0	0	439
Total	813	0	813	102	0	0	915	1,002	0	1,002	149	0	0	1,151
Total Approaches														
Approach	1,091	0	1,091	889	0	0	1,980	1,386	0	1,386	1,015	0	0	2,401
Departure	1,091	0	1,091	889	0	0	1,980	1,386	0	1,386	1,015	0	0	2,401
Total	2,182	0	2,182	1,778	0	0	3,960	2,772	0	2,772	2,030	0	0	4,802

Table C-2 - Phase III Project Completion Year (2049) [Project Build-out] Peak Hour Volume Summary

	AM Peak Hour							PM Peak Hour						
	Ph III 2049		Ph III 2049	External	Internal	Pass-By	Ph III 2049	Ph III 2049		Ph III 2049	External	Internal	Pass-By	Ph III 2049
	w/o Proj	Cumul Project	without Project	Project Trips	Project Trips	Trips	with Project	w/o Proj	Cumul Project	without Project	Project Trips	Project Trips	Trips	with Project
6 SR-99 Northbound Ramps/Avenue 18 ½														
NBL	216	0	216	0	0	0	216	196	0	196	0	0	0	196
NBT	1	0	1	0	0	0	1	3	0	3	0	0	0	3
NBR	28	0	28	0	0	0	28	0	0	0	0	0	0	0
SBL	0	0	0	0	0	0	0	0	0	0	0	0	0	0
SBT	0	0	0	0	0	0	0	0	0	0	0	0	0	0
SBR	0	0	0	0	0	0	0	0	0	0	0	0	0	0
EBL	227	0	227	579	0	0	806	235	0	235	307	0	0	542
EBT	64	0	64	0	0	0	64	124	0	124	0	0	0	124
EBR	0	0	0	0	0	0	0	0	0	0	0	0	0	0
WBL	0	0	0	0	0	0	0	0	0	0	0	0	0	0
WBT	158	0	158	0	0	0	158	99	0	99	0	0	0	99
WBR	36	0	36	0	0	0	36	22	0	22	0	0	0	22
North Leg														
Approach	0	0	0	0	0	0	0	0	0	0	0	0	0	0
Departure	264	0	264	579	0	0	843	260	0	260	307	0	0	567
Total	264	0	264	579	0	0	843	260	0	260	307	0	0	567
South Leg														
Approach	245	0	245	0	0	0	245	199	0	199	0	0	0	199
Departure	0	0	0	0	0	0	0	0	0	0	0	0	0	0
Total	245	0	245	0	0	0	245	199	0	199	0	0	0	199
East Leg														
Approach	194	0	194	0	0	0	194	121	0	121	0	0	0	121
Departure	92	0	92	0	0	0	92	124	0	124	0	0	0	124
Total	286	0	286	0	0	0	286	245	0	245	0	0	0	245
West Leg														
Approach	291	0	291	579	0	0	870	359	0	359	307	0	0	666
Departure	374	0	374	0	0	0	374	295	0	295	0	0	0	295
Total	665	0	665	579	0	0	1,244	654	0	654	307	0	0	961
Total Approaches														
Approach	730	0	730	579	0	0	1,309	679	0	679	307	0	0	986
Departure	730	0	730	579	0	0	1,309	679	0	679	307	0	0	986
Total	1,460	0	1,460	1,158	0	0	2,618	1,358	0	1,358	614	0	0	1,972

Table C-2 - Phase III Project Completion Year (2049) [Project Build-out] Peak Hour Volume Summary

	AM Peak Hour							PM Peak Hour						
	Ph III 2049		Ph III 2049 without Project	External Project Trips	Internal Project Trips	Pass-By Trips	Ph III 2049 with Project	Ph III 2049		Ph III 2049 without Project	External Project Trips	Internal Project Trips	Pass-By Trips	Ph III 2049 with Project
	w/o Proj	Cumul Project						w/o Proj	Cumul Project					
7 Road 23/Avenue 17														
NBL	9	0	9	34	9	0	52	8	0	8	13	17	0	38
NBT	166	0	166	751	0	0	917	85	0	85	459	0	0	544
NBR	49	0	49	927	0	0	976	65	0	65	581	0	0	646
SBL	16	0	16	0	0	0	16	64	0	64	0	0	0	64
SBT	108	0	108	297	0	0	405	221	0	221	771	0	0	992
SBR	0	0	0	42	0	0	42	3	0	3	163	0	0	166
EBL	3	0	3	159	0	0	162	1	0	1	82	0	0	83
EBT	36	0	36	455	0	0	491	53	0	53	210	0	0	263
EBR	8	0	8	12	10	0	30	12	0	12	30	17	0	59
WBL	56	0	56	421	0	0	477	30	0	30	938	0	0	968
WBT	23	0	23	109	0	0	132	29	0	29	448	0	0	477
WBR	3	0	3	0	0	0	3	10	0	10	0	0	0	10
North Leg														
Approach	124	0	124	339	0	0	463	288	0	288	934	0	0	1,222
Departure	172	0	172	910	0	0	1,082	96	0	96	541	0	0	637
Total	296	0	296	1,249	0	0	1,545	384	0	384	1,475	0	0	1,859
South Leg														
Approach	224	0	224	1,712	9	0	1,945	158	0	158	1,053	17	0	1,228
Departure	172	0	172	730	10	0	912	263	0	263	1,739	17	0	2,019
Total	396	0	396	2,442	19	0	2,857	421	0	421	2,792	34	0	3,247
East Leg														
Approach	82	0	82	530	0	0	612	69	0	69	1,386	0	0	1,455
Departure	101	0	101	1,382	0	0	1,483	182	0	182	791	0	0	973
Total	183	0	183	1,912	0	0	2,095	251	0	251	2,177	0	0	2,428
West Leg														
Approach	47	0	47	626	10	0	683	66	0	66	322	17	0	405
Departure	32	0	32	185	9	0	226	40	0	40	624	17	0	681
Total	79	0	79	811	19	0	909	106	0	106	946	34	0	1,086
Total Approaches														
Approach	477	0	477	3,207	19	0	3,703	581	0	581	3,695	34	0	4,310
Departure	477	0	477	3,207	19	0	3,703	581	0	581	3,695	34	0	4,310
Total	955	0	955	6,414	38	0	7,407	1,162	0	1,162	7,390	68	0	8,620

Table C-2 - Phase III Project Completion Year (2049) [Project Build-out] Peak Hour Volume Summary

	AM Peak Hour							PM Peak Hour						
	Ph III 2049		Ph III 2049	External	Internal	Pass-By	Ph III 2049	Ph III 2049		Ph III 2049	External	Internal	Pass-By	Ph III 2049
	w/o Proj	Cumul Project	without Project	Project Trips	Project Trips	Trips	with Project	w/o Proj	Cumul Project	without Project	Project Trips	Project Trips	Trips	with Project
8 Road 23/Avenue 16														
NBL	37	0	37	106	24	0	167	14	0	14	338	41	0	393
NBT	288	0	288	627	181	0	1,096	274	0	274	574	358	4	1,210
NBR	0	0	0	23	26	0	49	1	0	1	126	44	0	171
SBL	0	0	0	33	25	0	58	2	0	2	182	37	1	222
SBT	325	0	325	334	177	0	836	310	0	310	769	357	6	1,442
SBR	11	0	11	27	28	0	66	51	0	51	125	51	1	228
EBL	12	0	12	105	29	0	146	31	0	31	74	51	0	156
EBT	30	0	30	0	34	0	64	0	0	0	0	25	0	25
EBR	32	0	32	357	24	0	413	43	0	43	168	41	0	252
WBL	0	0	0	137	25	0	162	0	0	0	49	44	0	93
WBT	4	0	4	0	33	0	37	1	0	1	0	25	0	26
WBR	0	0	0	198	24	0	222	1	0	1	71	37	0	109
North Leg														
Approach	336	0	336	394	230	0	960	363	0	363	1,076	445	8	1,892
Departure	300	0	300	930	234	0	1,464	306	0	306	719	446	4	1,475
Total	636	0	636	1,324	464	0	2,424	669	0	669	1,795	891	12	3,367
South Leg														
Approach	325	0	325	756	231	0	1,312	289	0	289	1,038	443	4	1,774
Departure	357	0	357	828	226	0	1,411	353	0	353	986	442	6	1,787
Total	682	0	682	1,584	457	0	2,723	642	0	642	2,024	885	10	3,561
East Leg														
Approach	4	0	4	335	82	0	421	2	0	2	120	106	0	228
Departure	30	0	30	56	85	0	171	3	0	3	308	106	1	418
Total	34	0	34	391	167	0	592	5	0	5	428	212	1	646
West Leg														
Approach	74	0	74	462	87	0	623	74	0	74	242	117	0	433
Departure	52	0	52	133	85	0	270	66	0	66	463	117	1	647
Total	126	0	126	595	172	0	893	140	0	140	705	234	1	1,080
Total Approaches														
Approach	739	0	739	1,947	630	0	3,316	728	0	728	2,476	1,111	12	4,327
Departure	739	0	739	1,947	630	0	3,316	728	0	728	2,476	1,111	12	4,327
Total	1,478	0	1,478	3,894	1,260	0	6,632	1,457	0	1,457	4,952	2,222	24	8,655

Table C-2 - Phase III Project Completion Year (2049) [Project Build-out] Peak Hour Volume Summary

	AM Peak Hour							PM Peak Hour						
	Ph III 2049		Ph III 2049 without Project	External Project Trips	Internal Project Trips	Pass-By Trips	Ph III 2049 with Project	Ph III 2049		Ph III 2049 without Project	External Project Trips	Internal Project Trips	Pass-By Trips	Ph III 2049 with Project
	w/o Proj	Cumulative Project						w/o Proj	Cumulative Project					
9 Road 23/Cleveland Avenue														
NBL	0	0	0	210	142	0	352	0	0	0	596	353	19	968
NBT	297	0	297	235	149	0	681	174	0	174	400	350	59	983
NBR	68	0	68	239	7	0	314	120	0	120	204	8	-15	317
SBL	86	0	86	306	35	0	427	93	0	93	199	57	-15	334
SBT	253	0	253	365	153	0	771	235	0	235	310	346	41	932
SBR	0	0	0	157	56	0	213	1	0	1	476	113	18	608
EBL	0	0	0	349	58	0	407	1	0	1	349	112	15	477
EBT	0	0	0	114	116	0	230	0	0	0	359	137	6	502
EBR	0	0	0	473	149	0	622	1	0	1	423	352	12	788
WBL	74	0	74	244	7	0	325	62	0	62	201	8	-10	261
WBT	0	0	0	126	110	0	236	0	0	0	351	137	6	494
WBR	192	0	192	169	33	0	394	55	0	55	289	57	-13	388
North Leg														
Approach	339	0	339	828	244	0	1,411	329	0	329	985	516	44	1,874
Departure	489	0	489	753	240	0	1,482	230	0	230	1,038	519	61	1,848
Total	828	0	828	1,581	484	0	2,893	559	0	559	2,023	1,035	105	3,722
South Leg														
Approach	365	0	365	684	298	0	1,347	294	0	294	1,200	711	63	2,268
Departure	327	0	327	1,082	309	0	1,718	298	0	298	934	706	43	1,981
Total	692	0	692	1,766	607	0	3,065	592	0	592	2,134	1,417	106	4,249
East Leg														
Approach	266	0	266	539	150	0	955	117	0	117	841	202	-17	1,143
Departure	154	0	154	659	158	0	971	213	0	213	762	202	-24	1,153
Total	420	0	420	1,198	308	0	1,926	330	0	330	1,603	404	-41	2,296
West Leg														
Approach	0	0	0	936	323	0	1,259	2	0	2	1,131	601	33	1,767
Departure	0	0	0	493	308	0	801	1	0	1	1,423	603	43	2,070
Total	0	0	0	1,429	631	0	2,060	3	0	3	2,554	1,204	76	3,837
Total Approaches														
Approach	970	0	970	2,987	1,015	0	4,972	742	0	742	4,157	2,030	123	7,052
Departure	970	0	970	2,987	1,015	0	4,972	742	0	742	4,157	2,030	123	7,052
Total	1,940	0	1,940	5,974	2,030	0	9,944	1,485	0	1,485	8,314	4,060	246	14,105

Table C-2 - Phase III Project Completion Year (2049) [Project Build-out] Peak Hour Volume Summary

	AM Peak Hour							PM Peak Hour						
	Ph III 2049		Ph III 2049 without Project	External Project Trips	Internal Project Trips	Pass-By Trips	Ph III 2049 with Project	Ph III 2049		Ph III 2049 without Project	External Project Trips	Internal Project Trips	Pass-By Trips	Ph III 2049 with Project
	w/o Proj	Cumul Project						w/o Proj	Cumul Project					
10 Road 23/Avenue 14 ½														
NBL	4	0	4	0	0	0	4	2	0	2	0	0	0	2
NBT	265	0	265	407	0	0	672	277	0	277	1,077	0	0	1,354
NBR	4	0	4	0	0	0	4	2	0	2	0	0	0	2
SBL	47	0	47	188	0	0	235	67	0	67	242	0	0	309
SBT	280	0	280	955	0	0	1,235	231	0	231	708	0	0	939
SBR	0	0	0	0	0	0	0	0	0	0	0	0	0	0
EBL	0	0	0	0	0	0	0	1	0	1	0	0	0	1
EBT	5	0	5	0	0	0	5	2	0	2	0	0	0	2
EBR	0	0	0	0	0	0	0	3	0	3	0	0	0	3
WBL	18	0	18	0	0	0	18	6	0	6	0	0	0	6
WBT	3	0	3	0	0	0	3	3	0	3	0	0	0	3
WBR	100	0	100	115	0	0	215	16	0	16	292	0	0	308
North Leg														
Approach	328	0	328	1,143	0	0	1,471	298	0	298	950	0	0	1,248
Departure	365	0	365	522	0	0	887	294	0	294	1,369	0	0	1,663
Total	693	0	693	1,665	0	0	2,358	592	0	592	2,319	0	0	2,911
South Leg														
Approach	273	0	273	407	0	0	680	281	0	281	1,077	0	0	1,358
Departure	298	0	298	955	0	0	1,253	240	0	240	708	0	0	948
Total	571	0	571	1,362	0	0	1,933	521	0	521	1,785	0	0	2,306
East Leg														
Approach	122	0	122	115	0	0	237	25	0	25	292	0	0	317
Departure	57	0	57	188	0	0	245	71	0	71	242	0	0	313
Total	178	0	178	303	0	0	481	96	0	96	534	0	0	630
West Leg														
Approach	5	0	5	0	0	0	5	6	0	6	0	0	0	6
Departure	7	0	7	0	0	0	7	5	0	5	0	0	0	5
Total	12	0	12	0	0	0	12	12	0	12	0	0	0	12
Total Approaches														
Approach	728	0	728	1,665	0	0	2,393	611	0	611	2,319	0	0	2,930
Departure	728	0	728	1,665	0	0	2,393	611	0	611	2,319	0	0	2,930
Total	1,455	0	1,455	3,330	0	0	4,785	1,221	0	1,221	4,638	0	0	5,859

Table C-2 - Phase III Project Completion Year (2049) [Project Build-out] Peak Hour Volume Summary

	AM Peak Hour							PM Peak Hour						
	Ph III 2049		Ph III 2049	External	Internal	Pass-By	Ph III 2049	Ph III 2049		Ph III 2049	External	Internal	Pass-By	Ph III 2049
	w/o Proj	Cumul Project	without Project	Project Trips	Project Trips	Trips	with Project	w/o Proj	Cumul Project	without Project	Project Trips	Project Trips	Trips	with Project
11 Road 23/Avenue 14														
NBL	54	0	54	0	0	0	54	15	0	15	0	0	0	15
NBT	122	0	122	95	0	0	217	124	0	124	250	0	0	374
NBR	8	0	8	0	0	0	8	22	0	22	0	0	0	22
SBL	56	0	56	654	0	0	710	72	0	72	478	0	0	550
SBT	152	0	152	212	0	0	364	124	0	124	170	0	0	294
SBR	91	0	91	88	0	0	179	45	0	45	57	0	0	102
EBL	72	0	72	35	0	0	107	91	0	91	97	0	0	188
EBT	152	0	152	0	0	0	152	93	0	93	0	0	0	93
EBR	60	0	60	0	0	0	60	36	0	36	0	0	0	36
WBL	20	0	20	0	0	0	20	12	0	12	0	0	0	12
WBT	185	0	185	0	0	0	185	38	0	38	0	0	0	38
WBR	79	0	79	279	0	0	358	66	0	66	730	0	0	796
North Leg														
Approach	298	0	298	954	0	0	1,252	241	0	241	705	0	0	946
Departure	273	0	273	409	0	0	682	281	0	281	1,077	0	0	1,358
Total	571	0	571	1,363	0	0	1,934	522	0	522	1,782	0	0	2,304
South Leg														
Approach	185	0	185	95	0	0	280	160	0	160	250	0	0	410
Departure	232	0	232	212	0	0	444	171	0	171	170	0	0	341
Total	416	0	416	307	0	0	723	332	0	332	420	0	0	752
East Leg														
Approach	283	0	283	279	0	0	562	116	0	116	730	0	0	846
Departure	216	0	216	654	0	0	870	187	0	187	478	0	0	665
Total	500	0	500	933	0	0	1,433	303	0	303	1,208	0	0	1,511
West Leg														
Approach	285	0	285	35	0	0	320	220	0	220	97	0	0	317
Departure	330	0	330	88	0	0	418	98	0	98	57	0	0	155
Total	614	0	614	123	0	0	737	318	0	318	154	0	0	472
Total Approaches														
Approach	1,051	0	1,051	1,363	0	0	2,414	737	0	737	1,782	0	0	2,519
Departure	1,051	0	1,051	1,363	0	0	2,414	737	0	737	1,782	0	0	2,519
Total	2,102	0	2,102	2,726	0	0	4,828	1,474	0	1,474	3,564	0	0	5,038

Table C-2 - Phase III Project Completion Year (2049) [Project Build-out] Peak Hour Volume Summary

	AM Peak Hour							PM Peak Hour						
	Ph III 2049		Ph III 2049 without Project	External Project Trips	Internal Project Trips	Pass-By Trips	Ph III 2049 with Project	Ph III 2049		Ph III 2049 without Project	External Project Trips	Internal Project Trips	Pass-By Trips	Ph III 2049 with Project
	w/o Proj	Cumulative Project						w/o Proj	Cumulative Project					
12 Road 23/Avenue 12														
NBL	8	0	8	0	0	0	8	4	0	4	0	0	0	4
NBT	34	0	34	26	0	0	60	42	0	42	68	0	0	110
NBR	17	0	17	0	0	0	17	48	0	48	0	0	0	48
SBL	34	0	34	74	0	0	108	58	0	58	51	0	0	109
SBT	49	0	49	57	0	0	106	47	0	47	46	0	0	93
SBR	45	0	45	74	0	0	119	35	0	35	51	0	0	86
EBL	19	0	19	32	0	0	51	59	0	59	83	0	0	142
EBT	85	0	85	0	0	0	85	178	0	178	0	0	0	178
EBR	4	0	4	0	0	0	4	9	0	9	0	0	0	9
WBL	12	0	12	0	0	0	12	23	0	23	0	0	0	23
WBT	113	0	113	0	0	0	113	96	0	96	0	0	0	96
WBR	39	0	39	32	0	0	71	29	0	29	83	0	0	112
North Leg														
Approach	128	0	128	205	0	0	333	140	0	140	148	0	0	288
Departure	91	0	91	90	0	0	181	130	0	130	234	0	0	364
Total	219	0	219	295	0	0	514	269	0	269	382	0	0	651
South Leg														
Approach	59	0	59	26	0	0	85	94	0	94	68	0	0	162
Departure	65	0	65	57	0	0	122	79	0	79	46	0	0	125
Total	124	0	124	83	0	0	207	173	0	173	114	0	0	287
East Leg														
Approach	163	0	163	32	0	0	195	148	0	148	83	0	0	231
Departure	135	0	135	74	0	0	209	284	0	284	51	0	0	335
Total	299	0	299	106	0	0	405	432	0	432	134	0	0	566
West Leg														
Approach	108	0	108	32	0	0	140	246	0	246	83	0	0	329
Departure	166	0	166	74	0	0	240	135	0	135	51	0	0	186
Total	275	0	275	106	0	0	381	381	0	381	134	0	0	515
Total Approaches														
Approach	458	0	458	295	0	0	753	628	0	628	382	0	0	1,010
Departure	458	0	458	295	0	0	753	628	0	628	382	0	0	1,010
Total	917	0	917	590	0	0	1,507	1,255	0	1,255	764	0	0	2,019

Table C-2 - Phase III Project Completion Year (2049) [Project Build-out] Peak Hour Volume Summary

	AM Peak Hour							PM Peak Hour						
	Ph III 2049		Ph III 2049	External	Internal	Pass-By	Ph III 2049	Ph III 2049		Ph III 2049	External	Internal	Pass-By	Ph III 2049
	w/o Proj	Cumul Project	without Project	Project Trips	Project Trips	Trips	with Project	w/o Proj	Cumul Project	without Project	Project Trips	Project Trips	Trips	with Project
13 Golden State Boulevard – Airport Drive/Avenue 17														
NBL	18	0	18	83	0	0	101	24	0	24	224	0	0	248
NBT	114	0	114	0	0	0	114	105	0	105	0	0	0	105
NBR	173	7	180	0	0	0	180	343	26	369	0	0	0	369
SBL	211	5	216	0	0	0	216	405	17	422	0	0	0	422
SBT	54	0	54	0	0	0	54	105	0	105	0	0	0	105
SBR	4	0	4	0	0	0	4	12	0	12	0	0	0	12
EBL	5	0	5	0	0	0	5	12	0	12	0	0	0	12
EBT	57	28	85	1,092	0	0	1,177	182	62	244	633	0	0	877
EBR	20	0	20	221	0	0	241	32	0	32	128	0	0	160
WBL	298	4	302	0	0	0	302	192	24	216	0	0	0	216
WBT	58	22	80	423	0	0	503	39	57	96	1,101	0	0	1,197
WBR	283	3	286	0	0	0	286	278	16	294	0	0	0	294
North Leg														
Approach	269	5	274	0	0	0	274	522	17	539	0	0	0	539
Departure	402	3	405	0	0	0	405	395	16	411	0	0	0	411
Total	671	8	679	0	0	0	679	917	33	950	0	0	0	950
South Leg														
Approach	305	7	312	83	0	0	395	472	26	498	224	0	0	722
Departure	372	4	376	221	0	0	597	329	24	353	128	0	0	481
Total	677	11	688	304	0	0	992	801	50	851	352	0	0	1,203
East Leg														
Approach	639	29	668	423	0	0	1,091	509	97	606	1,101	0	0	1,707
Departure	441	40	481	1,092	0	0	1,573	930	105	1,035	633	0	0	1,668
Total	1,079	69	1,148	1,515	0	0	2,663	1,439	202	1,641	1,734	0	0	3,375
West Leg														
Approach	82	28	110	1,313	0	0	1,423	226	62	288	761	0	0	1,049
Departure	80	22	102	506	0	0	608	75	57	132	1,325	0	0	1,457
Total	161	50	211	1,819	0	0	2,030	301	119	420	2,086	0	0	2,506
Total Approaches														
Approach	1,294	69	1,363	1,819	0	0	3,182	1,729	202	1,931	2,086	0	0	4,017
Departure	1,294	69	1,363	1,819	0	0	3,182	1,729	202	1,931	2,086	0	0	4,017
Total	2,589	138	2,727	3,638	0	0	6,365	3,458	404	3,862	4,172	0	0	8,034

Table C-2 - Phase III Project Completion Year (2049) [Project Build-out] Peak Hour Volume Summary

	AM Peak Hour							PM Peak Hour						
	Ph III 2049		Ph III 2049 without Project	External Project Trips	Internal Project Trips	Pass-By Trips	Ph III 2049 with Project	Ph III 2049		Ph III 2049 without Project	External Project Trips	Internal Project Trips	Pass-By Trips	Ph III 2049 with Project
	w/o Proj	Cumulative Project						w/o Proj	Cumulative Project					
14 SR-99 Southbound Ramps/Avenue 17														
NBL	0	0	0	0	0	0	0	0	0	0	0	0	0	0
NBT	0	0	0	0	0	0	0	0	0	0	0	0	0	0
NBR	0	0	0	0	0	0	0	0	0	0	0	0	0	0
SBL	129	169	298	0	0	0	298	204	248	452	0	0	0	452
SBT	0	0	0	0	0	0	0	0	0	0	0	0	0	0
SBR	141	0	141	0	0	0	141	92	0	92	0	0	0	92
EBL	0	0	0	0	0	0	0	0	0	0	0	0	0	0
EBT	441	41	482	1,092	0	0	1,574	930	105	1,035	633	0	0	1,668
EBR	0	0	0	0	0	0	0	0	0	0	0	0	0	0
WBL	0	0	0	0	0	0	0	0	0	0	0	0	0	0
WBT	497	29	526	423	0	0	949	417	97	514	1,101	0	0	1,615
WBR	0	0	0	0	0	0	0	0	0	0	0	0	0	0
North Leg														
Approach	270	169	439	0	0	0	439	296	248	544	0	0	0	544
Departure	0	0	0	0	0	0	0	0	0	0	0	0	0	0
Total	270	169	439	0	0	0	439	296	248	544	0	0	0	544
South Leg														
Approach	0	0	0	0	0	0	0	0	0	0	0	0	0	0
Departure	0	0	0	0	0	0	0	0	0	0	0	0	0	0
Total	0	0	0	0	0	0	0	0	0	0	0	0	0	0
East Leg														
Approach	497	29	526	423	0	0	949	417	97	514	1,101	0	0	1,615
Departure	570	210	780	1,092	0	0	1,872	1,134	353	1,487	633	0	0	2,120
Total	1,067	239	1,306	1,515	0	0	2,821	1,551	450	2,001	1,734	0	0	3,735
West Leg														
Approach	441	41	482	1,092	0	0	1,574	930	105	1,035	633	0	0	1,668
Departure	638	29	667	423	0	0	1,090	509	97	606	1,101	0	0	1,707
Total	1,079	70	1,149	1,515	0	0	2,664	1,439	202	1,641	1,734	0	0	3,375
Total Approaches														
Approach	1,208	239	1,447	1,515	0	0	2,962	1,643	450	2,093	1,734	0	0	3,827
Departure	1,208	239	1,447	1,515	0	0	2,962	1,643	450	2,093	1,734	0	0	3,827
Total	2,416	478	2,894	3,030	0	0	5,924	3,286	900	4,186	3,468	0	0	7,654

Table C-2 - Phase III Project Completion Year (2049) [Project Build-out] Peak Hour Volume Summary

	AM Peak Hour							PM Peak Hour						
	Ph III 2049		Ph III 2049 without Project	External Project Trips	Internal Project Trips	Pass-By Trips	Ph III 2049 with Project	Ph III 2049		Ph III 2049 without Project	External Project Trips	Internal Project Trips	Pass-By Trips	Ph III 2049 with Project
	w/o Proj	Cumulative Project						w/o Proj	Cumulative Project					
15 SR-99 Northbound Ramps/Avenue 17														
NBL	299	0	299	247	0	0	546	211	0	211	610	0	0	821
NBT	4	0	4	0	0	0	4	4	0	4	0	0	0	4
NBR	0	240	240	0	0	0	240	0	529	529	0	0	0	529
SBL	0	0	0	0	0	0	0	0	0	0	0	0	0	0
SBT	0	0	0	0	0	0	0	0	0	0	0	0	0	0
SBR	0	0	0	0	0	0	0	0	0	0	0	0	0	0
EBL	145	0	145	0	0	0	145	180	0	180	0	0	0	180
EBT	253	210	463	422	0	0	885	557	352	909	321	0	0	1,230
EBR	0	0	0	0	0	0	0	0	0	0	0	0	0	0
WBL	0	0	0	0	0	0	0	0	0	0	0	0	0	0
WBT	716	219	935	176	0	0	1,111	387	616	1,003	491	0	0	1,494
WBR	125	128	253	0	0	0	253	129	222	351	0	0	0	351
North Leg														
Approach	0	0	0	0	0	0	0	0	0	0	0	0	0	0
Departure	274	128	402	0	0	0	402	313	222	535	0	0	0	535
Total	274	128	402	0	0	0	402	313	222	535	0	0	0	535
South Leg														
Approach	303	240	543	247	0	0	790	215	529	744	610	0	0	1,354
Departure	0	0	0	0	0	0	0	0	0	0	0	0	0	0
Total	303	240	543	247	0	0	790	215	529	744	610	0	0	1,354
East Leg														
Approach	841	347	1,188	176	0	0	1,364	516	838	1,354	491	0	0	1,845
Departure	253	450	703	422	0	0	1,125	557	881	1,438	321	0	0	1,759
Total	1,094	797	1,891	598	0	0	2,489	1,073	1,719	2,792	812	0	0	3,604
West Leg														
Approach	398	210	608	422	0	0	1,030	737	352	1,089	321	0	0	1,410
Departure	1,015	219	1,234	423	0	0	1,657	598	616	1,214	1,101	0	0	2,315
Total	1,413	429	1,842	845	0	0	2,687	1,335	968	2,303	1,422	0	0	3,725
Total Approaches														
Approach	1,542	797	2,339	845	0	0	3,184	1,468	1,719	3,187	1,422	0	0	4,609
Departure	1,542	797	2,339	845	0	0	3,184	1,468	1,719	3,187	1,422	0	0	4,609
Total	3,084	1,594	4,678	1,690	0	0	6,368	2,936	3,438	6,374	2,844	0	0	9,218

Table C-2 - Phase III Project Completion Year (2049) [Project Build-out] Peak Hour Volume Summary

	AM Peak Hour							PM Peak Hour						
	Ph III 2049		Ph III 2049	External	Internal	Pass-By	Ph III 2049	Ph III 2049		Ph III 2049	External	Internal	Pass-By	Ph III 2049
	w/o Proj	Cumul Cumulative Project	without Project	Project Trips	Project Trips	Trips	with Project	w/o Proj	Cumul Cumulative Project	without Project	Project Trips	Project Trips	Trips	with Project
16 Love's Truck Stop Driveway/Avenue 17														
NBL	0	136	136	0	0	0	136	0	160	160	0	0	0	160
NBT	0	0	0	0	0	0	0	0	0	0	0	0	0	0
NBR	0	22	22	0	0	0	22	0	31	31	0	0	0	31
SBL	0	48	48	0	0	0	48	0	279	279	0	0	0	279
SBT	0	0	0	0	0	0	0	0	0	0	0	0	0	0
SBR	0	90	90	0	0	0	90	0	519	519	0	0	0	519
EBL	0	162	162	0	0	0	162	0	556	556	0	0	0	556
EBT	241	156	397	422	0	0	819	543	184	727	321	0	0	1,048
EBR	0	132	132	0	0	0	132	0	141	141	0	0	0	141
WBL	0	45	45	0	0	0	45	0	32	32	0	0	0	32
WBT	805	73	878	176	0	0	1,054	500	158	658	491	0	0	1,149
WBR	0	56	56	0	0	0	56	0	189	189	0	0	0	189
North Leg														
Approach	0	138	138	0	0	0	138	0	798	798	0	0	0	798
Departure	0	218	218	0	0	0	218	0	745	745	0	0	0	745
Total	0	356	356	0	0	0	356	0	1,543	1,543	0	0	0	1,543
South Leg														
Approach	0	158	158	0	0	0	158	0	191	191	0	0	0	191
Departure	0	177	177	0	0	0	177	0	173	173	0	0	0	173
Total	0	335	335	0	0	0	335	0	364	364	0	0	0	364
East Leg														
Approach	805	174	979	176	0	0	1,155	500	379	879	491	0	0	1,370
Departure	241	226	467	422	0	0	889	543	494	1,037	321	0	0	1,358
Total	1,046	400	1,446	598	0	0	2,044	1,043	873	1,916	812	0	0	2,728
West Leg														
Approach	241	450	691	422	0	0	1,113	543	881	1,424	321	0	0	1,745
Departure	805	299	1,104	176	0	0	1,280	500	837	1,337	491	0	0	1,828
Total	1,046	749	1,795	598	0	0	2,393	1,043	1,718	2,761	812	0	0	3,573
Total Approaches														
Approach	1,046	920	1,966	598	0	0	2,564	1,043	2,249	3,292	812	0	0	4,104
Departure	1,046	920	1,966	598	0	0	2,564	1,043	2,249	3,292	812	0	0	4,104
Total	2,092	1,840	3,932	1,196	0	0	5,128	2,086	4,498	6,584	1,624	0	0	8,208

Table C-2 - Phase III Project Completion Year (2049) [Project Build-out] Peak Hour Volume Summary

	AM Peak Hour							PM Peak Hour						
	Ph III 2049		Ph III 2049	External	Internal	Pass-By	Ph III 2049	Ph III 2049		Ph III 2049	External	Internal	Pass-By	Ph III 2049
	w/o Proj	Cumul Project	without Project	Project Trips	Project Trips	Trips	with Project	w/o Proj	Cumul Project	without Project	Project Trips	Project Trips	Trips	with Project
17 Westberry Boulevard/Cleveland Avenue														
NBL	50	0	50	13	0	0	63	20	0	20	42	0	0	62
NBT	239	0	239	1	0	0	240	59	0	59	2	0	0	61
NBR	181	0	181	0	0	0	181	121	0	121	0	0	0	121
SBL	15	0	15	0	0	0	15	27	0	27	0	0	0	27
SBT	80	0	80	0	0	0	80	198	0	198	2	0	0	200
SBR	22	0	22	119	0	0	141	23	0	23	361	0	0	384
EBL	21	0	21	365	0	0	386	53	0	53	197	0	0	250
EBT	47	0	47	854	0	0	901	128	0	128	621	0	0	749
EBR	33	0	33	49	0	0	82	36	0	36	17	0	0	53
WBL	41	0	41	0	0	0	41	141	0	141	0	0	0	141
WBT	53	0	53	344	0	0	397	95	0	95	965	0	0	1,060
WBR	13	0	13	0	0	0	13	34	0	34	0	0	0	34
North Leg														
Approach	117	0	117	119	0	0	236	248	0	248	363	0	0	611
Departure	273	0	273	366	0	0	639	146	0	146	199	0	0	345
Total	389	0	389	485	0	0	874	394	0	394	562	0	0	956
South Leg														
Approach	470	0	470	14	0	0	484	200	0	200	44	0	0	244
Departure	154	0	154	49	0	0	203	375	0	375	19	0	0	394
Total	624	0	624	63	0	0	687	575	0	575	63	0	0	638
East Leg														
Approach	106	0	106	344	0	0	450	270	0	270	965	0	0	1,235
Departure	243	0	243	854	0	0	1,097	276	0	276	621	0	0	897
Total	349	0	349	1,198	0	0	1,547	546	0	546	1,586	0	0	2,132
West Leg														
Approach	101	0	101	1,268	0	0	1,369	217	0	217	835	0	0	1,052
Departure	125	0	125	476	0	0	601	138	0	138	1,368	0	0	1,506
Total	226	0	226	1,744	0	0	1,970	355	0	355	2,203	0	0	2,558
Total Approaches														
Approach	794	0	794	1,745	0	0	2,539	935	0	935	2,207	0	0	3,142
Departure	794	0	794	1,745	0	0	2,539	935	0	935	2,207	0	0	3,142
Total	1,588	0	1,588	3,490	0	0	5,078	1,870	0	1,870	4,414	0	0	6,284

Table C-2 - Phase III Project Completion Year (2049) [Project Build-out] Peak Hour Volume Summary

	AM Peak Hour							PM Peak Hour						
	Ph III 2049		Ph III 2049 without Project	External Project Trips	Internal Project Trips	Pass-By Trips	Ph III 2049 with Project	Ph III 2049		Ph III 2049 without Project	External Project Trips	Internal Project Trips	Pass-By Trips	Ph III 2049 with Project
	w/o Proj	Cumul Project						w/o Proj	Cumul Project					
18 Westberry Boulevard/Sunset Avenue														
NBL	119	0	119	8	0	0	127	48	0	48	24	0	0	72
NBT	211	0	211	0	0	0	211	194	0	194	0	0	0	194
NBR	124	0	124	0	0	0	124	61	0	61	0	0	0	61
SBL	132	0	132	0	0	0	132	24	0	24	0	0	0	24
SBT	147	0	147	0	0	0	147	211	0	211	0	0	0	211
SBR	31	0	31	11	0	0	42	20	0	20	39	0	0	59
EBL	59	0	59	17	0	0	76	8	0	8	34	0	0	42
EBT	224	0	224	69	0	0	293	58	0	58	95	0	0	153
EBR	97	0	97	1	0	0	98	27	0	27	28	0	0	55
WBL	60	0	60	0	0	0	60	77	0	77	0	0	0	77
WBT	167	0	167	44	0	0	211	78	0	78	114	0	0	192
WBR	31	0	31	0	0	0	31	21	0	21	0	0	0	21
North Leg														
Approach	310	0	310	11	0	0	321	255	0	255	39	0	0	294
Departure	301	0	301	17	0	0	318	223	0	223	34	0	0	257
Total	611	0	611	28	0	0	639	478	0	478	73	0	0	551
South Leg														
Approach	454	0	454	8	0	0	462	303	0	303	24	0	0	327
Departure	304	0	304	1	0	0	305	315	0	315	28	0	0	343
Total	758	0	758	9	0	0	767	618	0	618	52	0	0	670
East Leg														
Approach	258	0	258	44	0	0	302	176	0	176	114	0	0	290
Departure	480	0	480	69	0	0	549	143	0	143	95	0	0	238
Total	738	0	738	113	0	0	851	318	0	318	209	0	0	527
West Leg														
Approach	380	0	380	87	0	0	467	93	0	93	157	0	0	250
Departure	317	0	317	63	0	0	380	146	0	146	177	0	0	323
Total	697	0	697	150	0	0	847	238	0	238	334	0	0	572
Total Approaches														
Approach	1,402	0	1,402	150	0	0	1,552	826	0	826	334	0	0	1,160
Departure	1,402	0	1,402	150	0	0	1,552	826	0	826	334	0	0	1,160
Total	2,803	0	2,803	300	0	0	3,103	1,653	0	1,653	668	0	0	2,321

Table C-2 - Phase III Project Completion Year (2049) [Project Build-out] Peak Hour Volume Summary

	AM Peak Hour							PM Peak Hour						
	Ph III 2049		Ph III 2049 without Project	External Project Trips	Internal Project Trips	Pass-By Trips	Ph III 2049 with Project	Ph III 2049		Ph III 2049 without Project	External Project Trips	Internal Project Trips	Pass-By Trips	Ph III 2049 with Project
	w/o Proj	Cumulative Project						w/o Proj	Cumulative Project					
19 Westberry Boulevard/Avenue 14														
NBL	75	0	75	11	0	0	86	15	0	15	39	0	0	54
NBT	53	0	53	0	0	0	53	53	0	53	0	0	0	53
NBR	25	0	25	0	0	0	25	17	0	17	0	0	0	17
SBL	309	0	309	0	0	0	309	151	0	151	0	0	0	151
SBT	73	0	73	0	0	0	73	57	0	57	0	0	0	57
SBR	78	0	78	23	0	0	101	45	0	45	43	0	0	88
EBL	55	0	55	58	0	0	113	69	0	69	19	0	0	88
EBT	210	0	210	531	0	0	741	264	0	264	396	0	0	660
EBR	39	0	39	17	0	0	56	35	0	35	34	0	0	69
WBL	12	0	12	0	0	0	12	23	0	23	0	0	0	23
WBT	171	0	171	227	0	0	398	122	0	122	598	0	0	720
WBR	133	0	133	0	0	0	133	240	0	240	0	0	0	240
North Leg														
Approach	460	0	460	23	0	0	483	253	0	253	43	0	0	296
Departure	241	0	241	58	0	0	299	362	0	362	19	0	0	381
Total	701	0	701	81	0	0	782	615	0	615	62	0	0	677
South Leg														
Approach	153	0	153	11	0	0	164	85	0	85	39	0	0	124
Departure	123	0	123	17	0	0	140	115	0	115	34	0	0	149
Total	276	0	276	28	0	0	304	199	0	199	73	0	0	272
East Leg														
Approach	316	0	316	227	0	0	543	385	0	385	598	0	0	983
Departure	544	0	544	531	0	0	1,075	431	0	431	396	0	0	827
Total	860	0	860	758	0	0	1,618	816	0	816	994	0	0	1,810
West Leg														
Approach	304	0	304	606	0	0	910	367	0	367	449	0	0	816
Departure	324	0	324	261	0	0	585	182	0	182	680	0	0	862
Total	628	0	628	867	0	0	1,495	549	0	549	1,129	0	0	1,678
Total Approaches														
Approach	1,232	0	1,232	867	0	0	2,099	1,090	0	1,090	1,129	0	0	2,219
Departure	1,232	0	1,232	867	0	0	2,099	1,090	0	1,090	1,129	0	0	2,219
Total	2,465	0	2,465	1,734	0	0	4,199	2,179	0	2,179	2,258	0	0	4,437

Table C-2 - Phase III Project Completion Year (2049) [Project Build-out] Peak Hour Volume Summary

	AM Peak Hour							PM Peak Hour						
	Ph III 2049		Ph III 2049 without Project	External Project Trips	Internal Project Trips	Pass-By Trips	Ph III 2049 with Project	Ph III 2049		Ph III 2049 without Project	External Project Trips	Internal Project Trips	Pass-By Trips	Ph III 2049 with Project
	w/o Proj	Cumulative Project						w/o Proj	Cumulative Project					
20 Westberry Boulevard/Avenue 16														
NBL	0	0	0	0	0	0	0	0	0	0	0	0	0	0
NBT	88	0	88	123	0	0	211	15	0	15	82	0	0	97
NBR	315	0	315	230	0	0	545	160	0	160	108	0	0	268
SBL	100	0	100	0	0	0	100	229	0	229	2	0	0	231
SBT	18	0	18	46	0	0	64	50	0	50	133	0	0	183
SBR	0	0	0	0	0	0	0	0	0	0	0	0	0	0
EBL	0	0	0	0	0	0	0	0	0	0	0	0	0	0
EBT	0	0	0	0	0	0	0	0	0	0	0	0	0	0
EBR	0	0	0	0	0	0	0	0	0	0	0	0	0	0
WBL	79	0	79	65	0	0	144	238	0	238	218	0	0	456
WBT	0	0	0	0	0	0	0	0	0	0	0	0	0	0
WBR	234	0	234	1	0	0	235	135	0	135	2	0	0	137
North Leg														
Approach	118	0	118	46	0	0	164	279	0	279	135	0	0	414
Departure	322	0	322	124	0	0	446	150	0	150	84	0	0	234
Total	440	0	440	170	0	0	610	429	0	429	219	0	0	648
South Leg														
Approach	403	0	403	353	0	0	756	175	0	175	190	0	0	365
Departure	97	0	97	111	0	0	208	288	0	288	351	0	0	639
Total	500	0	500	464	0	0	964	463	0	463	541	0	0	1,004
East Leg														
Approach	313	0	313	66	0	0	379	373	0	373	220	0	0	593
Departure	415	0	415	230	0	0	645	389	0	389	110	0	0	499
Total	728	0	728	296	0	0	1,024	762	0	762	330	0	0	1,092
West Leg														
Approach	0	0	0	0	0	0	0	0	0	0	0	0	0	0
Departure	0	0	0	0	0	0	0	0	0	0	0	0	0	0
Total	0	0	0	0	0	0	0	0	0	0	0	0	0	0
Total Approaches														
Approach	834	0	834	465	0	0	1,299	827	0	827	545	0	0	1,372
Departure	834	0	834	465	0	0	1,299	827	0	827	545	0	0	1,372
Total	1,668	0	1,668	930	0	0	2,598	1,654	0	1,654	1,090	0	0	2,744

Table C-2 - Phase III Project Completion Year (2049) [Project Build-out] Peak Hour Volume Summary

	AM Peak Hour							PM Peak Hour						
	Ph III 2049		Ph III 2049	External	Internal	Pass-By	Ph III 2049	Ph III 2049		Ph III 2049	External	Internal	Pass-By	Ph III 2049
	w/o Proj	Cumul Project	without Project	Project Trips	Project Trips	Trips	with Project	w/o Proj	Cumul Project	without Project	Project Trips	Project Trips	Trips	with Project
21 Granada Drive/Cleveland Avenue														
NBL	18	0	18	8	0	0	26	15	0	15	14	0	0	29
NBT	443	0	443	1	0	0	444	273	0	273	2	0	0	275
NBR	350	0	350	0	0	0	350	236	0	236	0	0	0	236
SBL	14	0	14	0	0	0	14	64	0	64	0	0	0	64
SBT	284	0	284	0	0	0	284	360	0	360	2	0	0	362
SBR	5	0	5	0	0	0	5	58	0	58	0	0	0	58
EBL	35	0	35	0	0	0	35	29	0	29	0	0	0	29
EBT	214	0	214	794	0	0	1,008	173	0	173	567	0	0	740
EBR	9	0	9	19	0	0	28	20	0	20	6	0	0	26
WBL	194	0	194	0	0	0	194	379	0	379	0	0	0	379
WBT	58	0	58	320	0	0	378	239	0	239	887	0	0	1,126
WBR	32	0	32	0	0	0	32	72	0	72	0	0	0	72
North Leg														
Approach	303	0	303	0	0	0	303	482	0	482	2	0	0	484
Departure	510	0	510	1	0	0	511	374	0	374	2	0	0	376
Total	813	0	813	1	0	0	814	856	0	856	4	0	0	860
South Leg														
Approach	811	0	811	9	0	0	820	524	0	524	16	0	0	540
Departure	488	0	488	19	0	0	507	759	0	759	8	0	0	767
Total	1,299	0	1,299	28	0	0	1,327	1,283	0	1,283	24	0	0	1,307
East Leg														
Approach	284	0	284	320	0	0	604	690	0	690	887	0	0	1,577
Departure	578	0	578	794	0	0	1,372	473	0	473	567	0	0	1,040
Total	862	0	862	1,114	0	0	1,976	1,163	0	1,163	1,454	0	0	2,617
West Leg														
Approach	258	0	258	813	0	0	1,071	222	0	222	573	0	0	795
Departure	81	0	81	328	0	0	409	312	0	312	901	0	0	1,213
Total	339	0	339	1,141	0	0	1,480	534	0	534	1,474	0	0	2,008
Total Approaches														
Approach	1,657	0	1,657	1,142	0	0	2,799	1,918	0	1,918	1,478	0	0	3,396
Departure	1,657	0	1,657	1,142	0	0	2,799	1,918	0	1,918	1,478	0	0	3,396
Total	3,313	0	3,313	2,284	0	0	5,597	3,835	0	3,835	2,956	0	0	6,791

Table C-2 - Phase III Project Completion Year (2049) [Project Build-out] Peak Hour Volume Summary

	AM Peak Hour							PM Peak Hour						
	Ph III 2049		Ph III 2049 without Project	External Project Trips	Internal Project Trips	Pass-By Trips	Ph III 2049 with Project	Ph III 2049		Ph III 2049 without Project	External Project Trips	Internal Project Trips	Pass-By Trips	Ph III 2049 with Project
	w/o Proj	Cumulative Project						w/o Proj	Cumulative Project					
22 Granada Drive/Sunset Avenue														
NBL	49	0	49	0	0	0	49	53	0	53	0	0	0	53
NBT	260	0	260	0	0	0	260	289	0	289	0	0	0	289
NBR	26	0	26	0	0	0	26	44	0	44	0	0	0	44
SBL	133	0	133	0	0	0	133	84	0	84	0	0	0	84
SBT	292	0	292	0	0	0	292	358	0	358	0	0	0	358
SBR	50	0	50	0	0	0	50	41	0	41	0	0	0	41
EBL	68	0	68	0	0	0	68	32	0	32	0	0	0	32
EBT	272	0	272	42	0	0	314	120	0	120	52	0	0	172
EBR	74	0	74	0	0	0	74	39	0	39	0	0	0	39
WBL	26	0	26	0	0	0	26	57	0	57	0	0	0	57
WBT	106	0	106	25	0	0	131	157	0	157	63	0	0	220
WBR	67	0	67	0	0	0	67	113	0	113	0	0	0	113
North Leg														
Approach	476	0	476	0	0	0	476	483	0	483	0	0	0	483
Departure	395	0	395	0	0	0	395	434	0	434	0	0	0	434
Total	871	0	871	0	0	0	871	917	0	917	0	0	0	917
South Leg														
Approach	335	0	335	0	0	0	335	386	0	386	0	0	0	386
Departure	392	0	392	0	0	0	392	454	0	454	0	0	0	454
Total	727	0	727	0	0	0	727	840	0	840	0	0	0	840
East Leg														
Approach	199	0	199	25	0	0	224	327	0	327	63	0	0	390
Departure	431	0	431	42	0	0	473	248	0	248	52	0	0	300
Total	631	0	631	67	0	0	698	575	0	575	115	0	0	690
West Leg														
Approach	414	0	414	42	0	0	456	191	0	191	52	0	0	243
Departure	205	0	205	25	0	0	230	251	0	251	63	0	0	314
Total	619	0	619	67	0	0	686	442	0	442	115	0	0	557
Total Approaches														
Approach	1,424	0	1,424	67	0	0	1,491	1,387	0	1,387	115	0	0	1,502
Departure	1,424	0	1,424	67	0	0	1,491	1,387	0	1,387	115	0	0	1,502
Total	2,848	0	2,848	134	0	0	2,982	2,774	0	2,774	230	0	0	3,004

Table C-2 - Phase III Project Completion Year (2049) [Project Build-out] Peak Hour Volume Summary

	AM Peak Hour							PM Peak Hour						
	Ph III 2049		Ph III 2049 without Project	External Project Trips	Internal Project Trips	Pass-By Trips	Ph III 2049 with Project	Ph III 2049		Ph III 2049 without Project	External Project Trips	Internal Project Trips	Pass-By Trips	Ph III 2049 with Project
	w/o Proj	Cumulative Project						w/o Proj	Cumulative Project					
23 Avenue 16 – Ellis Street/Kennedy Street														
NBL	0	0	0	0	0	0	0	0	0	0	0	0	0	0
NBT	407	0	407	118	0	0	525	425	0	425	67	0	0	492
NBR	209	0	209	113	0	0	322	385	0	385	43	0	0	428
SBL	272	0	272	0	0	0	272	270	0	270	0	0	0	270
SBT	370	0	370	47	0	0	417	408	0	408	116	0	0	524
SBR	0	0	0	0	0	0	0	0	0	0	0	0	0	0
EBL	0	0	0	0	0	0	0	0	0	0	0	0	0	0
EBT	0	0	0	0	0	0	0	0	0	0	0	0	0	0
EBR	0	0	0	0	0	0	0	0	0	0	0	0	0	0
WBL	242	0	242	18	0	0	260	177	0	177	104	0	0	281
WBT	0	0	0	0	0	0	0	0	0	0	0	0	0	0
WBR	168	0	168	0	0	0	168	231	0	231	0	0	0	231
North Leg														
Approach	642	0	642	47	0	0	689	678	0	678	116	0	0	794
Departure	575	0	575	118	0	0	693	656	0	656	67	0	0	723
Total	1,217	0	1,217	165	0	0	1,382	1,334	0	1,334	183	0	0	1,517
South Leg														
Approach	616	0	616	231	0	0	847	810	0	810	110	0	0	920
Departure	612	0	612	65	0	0	677	585	0	585	220	0	0	805
Total	1,228	0	1,228	296	0	0	1,524	1,395	0	1,395	330	0	0	1,725
East Leg														
Approach	410	0	410	18	0	0	428	408	0	408	104	0	0	512
Departure	481	0	481	113	0	0	594	655	0	655	43	0	0	698
Total	891	0	891	131	0	0	1,022	1,063	0	1,063	147	0	0	1,210
West Leg														
Approach	0	0	0	0	0	0	0	0	0	0	0	0	0	0
Departure	0	0	0	0	0	0	0	0	0	0	0	0	0	0
Total	0	0	0	0	0	0	0	0	0	0	0	0	0	0
Total Approaches														
Approach	1,668	0	1,668	296	0	0	1,964	1,896	0	1,896	330	0	0	2,226
Departure	1,668	0	1,668	296	0	0	1,964	1,896	0	1,896	330	0	0	2,226
Total	3,336	0	3,336	592	0	0	3,928	3,792	0	3,792	660	0	0	4,452

Table C-2 - Phase III Project Completion Year (2049) [Project Build-out] Peak Hour Volume Summary

	AM Peak Hour							PM Peak Hour						
	Ph III 2049		Ph III 2049 without Project	External Project Trips	Internal Project Trips	Pass-By Trips	Ph III 2049 with Project	Ph III 2049		Ph III 2049 without Project	External Project Trips	Internal Project Trips	Pass-By Trips	Ph III 2049 with Project
	w/o Proj	Cumulative Project						w/o Proj	Cumulative Project					
24 Schnoor Avenue/Kennedy Street														
NBL	125	0	125	0	0	0	125	202	0	202	0	0	0	202
NBT	46	0	46	0	0	0	46	89	0	89	0	0	0	89
NBR	291	0	291	16	0	0	307	327	0	327	40	0	0	367
SBL	138	0	138	0	0	0	138	203	0	203	0	0	0	203
SBT	43	0	43	0	0	0	43	69	0	69	0	0	0	69
SBR	34	0	34	0	0	0	34	43	0	43	0	0	0	43
EBL	116	0	116	0	0	0	116	101	0	101	0	0	0	101
EBT	210	0	210	113	0	0	323	295	0	295	43	0	0	338
EBR	170	0	170	0	0	0	170	237	0	237	0	0	0	237
WBL	202	0	202	42	0	0	244	249	0	249	23	0	0	272
WBT	263	0	263	18	0	0	281	203	0	203	104	0	0	307
WBR	214	0	214	0	0	0	214	183	0	183	0	0	0	183
North Leg														
Approach	215	0	215	0	0	0	215	315	0	315	0	0	0	315
Departure	376	0	376	0	0	0	376	373	0	373	0	0	0	373
Total	591	0	591	0	0	0	591	688	0	688	0	0	0	688
South Leg														
Approach	462	0	462	16	0	0	478	618	0	618	40	0	0	658
Departure	415	0	415	42	0	0	457	555	0	555	23	0	0	578
Total	877	0	877	58	0	0	935	1,173	0	1,173	63	0	0	1,236
East Leg														
Approach	679	0	679	60	0	0	739	635	0	635	127	0	0	762
Departure	639	0	639	129	0	0	768	825	0	825	83	0	0	908
Total	1,318	0	1,318	189	0	0	1,507	1,460	0	1,460	210	0	0	1,670
West Leg														
Approach	496	0	496	113	0	0	609	633	0	633	43	0	0	676
Departure	422	0	422	18	0	0	440	448	0	448	104	0	0	552
Total	918	0	918	131	0	0	1,049	1,081	0	1,081	147	0	0	1,228
Total Approaches														
Approach	1,852	0	1,852	189	0	0	2,041	2,201	0	2,201	210	0	0	2,411
Departure	1,852	0	1,852	189	0	0	2,041	2,201	0	2,201	210	0	0	2,411
Total	3,704	0	3,704	378	0	0	4,082	4,401	0	4,401	420	0	0	4,821

Table C-2 - Phase III Project Completion Year (2049) [Project Build-out] Peak Hour Volume Summary

	AM Peak Hour							PM Peak Hour						
	Ph III 2049		Ph III 2049	External	Internal	Pass-By	Ph III 2049	Ph III 2049		Ph III 2049	External	Internal	Pass-By	Ph III 2049
	w/o Proj	Cumulative Project	without Project	Project Trips	Project Trips	Trips	with Project	w/o Proj	Cumulative Project	without Project	Project Trips	Project Trips	Trips	with Project
25 SR-99 Southbound Ramps/Kennedy Street - Gateway Drive														
NBL	0	0	0	0	0	0	0	0	0	0	0	0	0	0
NBT	0	0	0	0	0	0	0	0	0	0	0	0	0	0
NBR	0	0	0	0	0	0	0	0	0	0	0	0	0	0
SBL	67	0	67	0	0	0	67	138	0	138	0	0	0	138
SBT	0	0	0	0	0	0	0	0	0	0	0	0	0	0
SBR	126	0	126	42	0	0	168	223	0	223	26	0	0	249
EBL	380	0	380	112	0	0	492	346	0	346	41	0	0	387
EBT	251	0	251	16	0	0	267	460	0	460	40	0	0	500
EBR	0	0	0	0	0	0	0	0	0	0	0	0	0	0
WBL	0	0	0	0	0	0	0	0	0	0	0	0	0	0
WBT	507	0	507	23	0	0	530	430	0	430	123	0	0	553
WBR	4	0	4	0	0	0	4	3	0	3	0	0	0	3
North Leg														
Approach	193	0	193	42	0	0	235	361	0	361	26	0	0	387
Departure	384	0	384	112	0	0	496	349	0	349	41	0	0	390
Total	577	0	577	154	0	0	731	710	0	710	67	0	0	777
South Leg														
Approach	0	0	0	0	0	0	0	0	0	0	0	0	0	0
Departure	0	0	0	0	0	0	0	0	0	0	0	0	0	0
Total	0	0	0	0	0	0	0	0	0	0	0	0	0	0
East Leg														
Approach	511	0	511	23	0	0	534	433	0	433	123	0	0	556
Departure	318	0	318	16	0	0	334	598	0	598	40	0	0	638
Total	829	0	829	39	0	0	868	1,031	0	1,031	163	0	0	1,194
West Leg														
Approach	631	0	631	128	0	0	759	806	0	806	81	0	0	887
Departure	633	0	633	65	0	0	698	653	0	653	149	0	0	802
Total	1,264	0	1,264	193	0	0	1,457	1,459	0	1,459	230	0	0	1,689
Total Approaches														
Approach	1,335	0	1,335	193	0	0	1,528	1,600	0	1,600	230	0	0	1,830
Departure	1,335	0	1,335	193	0	0	1,528	1,600	0	1,600	230	0	0	1,830
Total	2,670	0	2,670	386	0	0	3,056	3,201	0	3,201	460	0	0	3,661

Table C-2 - Phase III Project Completion Year (2049) [Project Build-out] Peak Hour Volume Summary

	AM Peak Hour							PM Peak Hour						
	Ph III 2049		Ph III 2049	External	Internal	Pass-By	Ph III 2049	Ph III 2049		Ph III 2049	External	Internal	Pass-By	Ph III 2049
	w/o Proj	Cumul Project	without Project	Project Trips	Project Trips	Trips	with Project	w/o Proj	Cumul Project	without Project	Project Trips	Project Trips	Trips	with Project
26 SR-99 Northbound Off-Ramp/Gateway Drive														
NBL	0	0	0	0	0	0	0	0	0	0	0	0	0	0
NBT	0	0	0	0	0	0	0	0	0	0	0	0	0	0
NBR	0	0	0	0	0	0	0	0	0	0	0	0	0	0
SBL	0	0	0	0	0	0	0	0	0	0	0	0	0	0
SBT	0	0	0	0	0	0	0	0	0	0	0	0	0	0
SBR	410	0	410	23	0	0	433	186	0	186	123	0	0	309
EBL	167	0	167	16	0	0	183	161	0	161	40	0	0	201
EBT	151	0	151	0	0	0	151	438	0	438	0	0	0	438
EBR	0	0	0	0	0	0	0	0	0	0	0	0	0	0
WBL	0	0	0	0	0	0	0	0	0	0	0	0	0	0
WBT	101	0	101	0	0	0	101	247	0	247	0	0	0	247
WBR	0	0	0	0	0	0	0	0	0	0	0	0	0	0
North Leg														
Approach	410	0	410	23	0	0	433	186	0	186	123	0	0	309
Departure	167	0	167	16	0	0	183	161	0	161	40	0	0	201
Total	577	0	577	39	0	0	616	347	0	347	163	0	0	510
South Leg														
Approach	0	0	0	0	0	0	0	0	0	0	0	0	0	0
Departure	0	0	0	0	0	0	0	0	0	0	0	0	0	0
Total	0	0	0	0	0	0	0	0	0	0	0	0	0	0
East Leg														
Approach	101	0	101	0	0	0	101	247	0	247	0	0	0	247
Departure	151	0	151	0	0	0	151	438	0	438	0	0	0	438
Total	252	0	252	0	0	0	252	685	0	685	0	0	0	685
West Leg														
Approach	318	0	318	16	0	0	334	599	0	599	40	0	0	639
Departure	511	0	511	23	0	0	534	433	0	433	123	0	0	556
Total	829	0	829	39	0	0	868	1,032	0	1,032	163	0	0	1,195
Total Approaches														
Approach	829	0	829	39	0	0	868	1,032	0	1,032	163	0	0	1,195
Departure	829	0	829	39	0	0	868	1,032	0	1,032	163	0	0	1,195
Total	1,658	0	1,658	78	0	0	1,736	2,063	0	2,063	326	0	0	2,389

Table C-2 - Phase III Project Completion Year (2049) [Project Build-out] Peak Hour Volume Summary

	AM Peak Hour							PM Peak Hour						
	Ph III 2049		Ph III 2049 without Project	External Project Trips	Internal Project Trips	Pass-By Trips	Ph III 2049 with Project	Ph III 2049		Ph III 2049 without Project	External Project Trips	Internal Project Trips	Pass-By Trips	Ph III 2049 with Project
	w/o Proj	Cumul Project						w/o Proj	Cumul Project					
27 SR-99 Northbound Off-Ramps														
NBL	0	0	0	0	0	0	0	0	0	0	0	0	0	0
NBT	44	0	44	0	0	0	44	82	0	82	0	0	0	82
NBR	0	0	0	0	0	0	0	0	0	0	0	0	0	0
SBL	0	0	0	0	0	0	0	0	0	0	0	0	0	0
SBT	3	0	3	0	0	0	3	3	0	3	0	0	0	3
SBR	409	0	409	23	0	0	432	185	0	185	123	0	0	308
EBL	163	0	163	11	0	0	174	161	0	161	19	0	0	180
EBT	0	0	0	0	0	0	0	0	0	0	0	0	0	0
EBR	0	0	0	0	0	0	0	0	0	0	0	0	0	0
WBL	0	0	0	0	0	0	0	0	0	0	0	0	0	0
WBT	0	0	0	0	0	0	0	0	0	0	0	0	0	0
WBR	0	0	0	0	0	0	0	0	0	0	0	0	0	0
North Leg														
Approach	412	0	412	23	0	0	435	188	0	188	123	0	0	311
Departure	207	0	207	11	0	0	218	243	0	243	19	0	0	262
Total	619	0	619	34	0	0	653	431	0	431	142	0	0	573
South Leg														
Approach	44	0	44	0	0	0	44	82	0	82	0	0	0	82
Departure	3	0	3	0	0	0	3	3	0	3	0	0	0	3
Total	47	0	47	0	0	0	47	85	0	85	0	0	0	85
East Leg														
Approach	0	0	0	0	0	0	0	0	0	0	0	0	0	0
Departure	0	0	0	0	0	0	0	0	0	0	0	0	0	0
Total	0	0	0	0	0	0	0	0	0	0	0	0	0	0
West Leg														
Approach	163	0	163	11	0	0	174	161	0	161	19	0	0	180
Departure	409	0	409	23	0	0	432	185	0	185	123	0	0	308
Total	572	0	572	34	0	0	606	346	0	346	142	0	0	488
Total Approaches														
Approach	619	0	619	34	0	0	653	431	0	431	142	0	0	573
Departure	619	0	619	34	0	0	653	431	0	431	142	0	0	573
Total	1,239	0	1,239	68	0	0	1,307	861	0	861	284	0	0	1,145

Table C-2 - Phase III Project Completion Year (2049) [Project Build-out] Peak Hour Volume Summary

	AM Peak Hour							PM Peak Hour						
	Ph III 2049		Ph III 2049	External	Internal	Pass-By	Ph III 2049	Ph III 2049		Ph III 2049	External	Internal	Pass-By	Ph III 2049
	w/o Proj	Cumul Project	without Project	Project Trips	Project Trips	Trips	with Project	w/o Proj	Cumul Project	without Project	Project Trips	Project Trips	Trips	with Project
28 SR-99 Northbound Off-Ramp/Gateway Drive														
NBL	0	0	0	0	0	0	0	0	0	0	0	0	0	0
NBT	0	0	0	0	0	0	0	0	0	0	0	0	0	0
NBR	0	0	0	0	0	0	0	0	0	0	0	0	0	0
SBL	0	0	0	0	0	0	0	3	0	3	0	0	0	3
SBT	0	0	0	0	0	0	0	0	0	0	0	0	0	0
SBR	0	0	0	0	0	0	0	0	0	0	0	0	0	0
EBL	0	0	0	0	0	0	0	0	0	0	0	0	0	0
EBT	144	0	144	0	0	0	144	438	0	438	0	0	0	438
EBR	0	0	0	0	0	0	0	0	0	0	0	0	0	0
WBL	0	0	0	0	0	0	0	0	0	0	0	0	0	0
WBT	106	0	106	0	0	0	106	247	0	247	0	0	0	247
WBR	53	0	53	0	0	0	53	77	0	77	0	0	0	77
North Leg														
Approach	0	0	0	0	0	0	0	3	0	3	0	0	0	3
Departure	53	0	53	0	0	0	53	77	0	77	0	0	0	77
Total	53	0	53	0	0	0	53	80	0	80	0	0	0	80
South Leg														
Approach	0	0	0	0	0	0	0	0	0	0	0	0	0	0
Departure	0	0	0	0	0	0	0	0	0	0	0	0	0	0
Total	0	0	0	0	0	0	0	0	0	0	0	0	0	0
East Leg														
Approach	159	0	159	0	0	0	159	324	0	324	0	0	0	324
Departure	144	0	144	0	0	0	144	441	0	441	0	0	0	441
Total	303	0	303	0	0	0	303	765	0	765	0	0	0	765
West Leg														
Approach	144	0	144	0	0	0	144	438	0	438	0	0	0	438
Departure	106	0	106	0	0	0	106	247	0	247	0	0	0	247
Total	250	0	250	0	0	0	250	685	0	685	0	0	0	685
Total Approaches														
Approach	303	0	303	0	0	0	303	765	0	765	0	0	0	765
Departure	303	0	303	0	0	0	303	765	0	765	0	0	0	765
Total	605	0	605	0	0	0	605	1,530	0	1,530	0	0	0	1,530

Table C-2 - Phase III Project Completion Year (2049) [Project Build-out] Peak Hour Volume Summary

	AM Peak Hour							PM Peak Hour						
	Ph III 2049		Ph III 2049	External	Internal	Pass-By	Ph III 2049	Ph III 2049		Ph III 2049	External	Internal	Pass-By	Ph III 2049
	w/o Proj	Cumul Project	without Project	Project Trips	Project Trips	Trips	with Project	w/o Proj	Cumul Project	without Project	Project Trips	Project Trips	Trips	with Project
29 Schnoor Avenue/Cleveland Avenue														
NBL	51	0	51	11	0	0	62	73	0	73	28	0	0	101
NBT	270	0	270	4	0	0	274	245	0	245	16	0	0	261
NBR	179	0	179	0	0	0	179	159	0	159	0	0	0	159
SBL	94	0	94	0	0	0	94	134	0	134	0	0	0	134
SBT	191	0	191	14	0	0	205	248	0	248	8	0	0	256
SBR	61	0	61	31	0	0	92	119	0	119	83	0	0	202
EBL	113	0	113	64	0	0	177	144	0	144	57	0	0	201
EBT	461	0	461	678	0	0	1,139	447	0	447	481	0	0	928
EBR	48	0	48	34	0	0	82	50	0	50	11	0	0	61
WBL	168	0	168	0	0	0	168	297	0	297	0	0	0	297
WBT	221	0	221	277	0	0	498	598	0	598	754	0	0	1,352
WBR	48	0	48	0	0	0	48	127	0	127	0	0	0	127
North Leg														
Approach	346	0	346	45	0	0	391	501	0	501	91	0	0	592
Departure	431	0	431	68	0	0	499	516	0	516	73	0	0	589
Total	777	0	777	113	0	0	890	1,017	0	1,017	164	0	0	1,181
South Leg														
Approach	500	0	500	15	0	0	515	477	0	477	44	0	0	521
Departure	407	0	407	48	0	0	455	595	0	595	19	0	0	614
Total	907	0	907	63	0	0	970	1,072	0	1,072	63	0	0	1,135
East Leg														
Approach	437	0	437	277	0	0	714	1,022	0	1,022	754	0	0	1,776
Departure	734	0	734	678	0	0	1,412	740	0	740	481	0	0	1,221
Total	1,171	0	1,171	955	0	0	2,126	1,762	0	1,762	1,235	0	0	2,997
West Leg														
Approach	622	0	622	776	0	0	1,398	641	0	641	549	0	0	1,190
Departure	333	0	333	319	0	0	652	790	0	790	865	0	0	1,655
Total	955	0	955	1,095	0	0	2,050	1,431	0	1,431	1,414	0	0	2,845
Total Approaches														
Approach	1,905	0	1,905	1,113	0	0	3,018	2,641	0	2,641	1,438	0	0	4,079
Departure	1,905	0	1,905	1,113	0	0	3,018	2,641	0	2,641	1,438	0	0	4,079
Total	3,809	0	3,809	2,226	0	0	6,035	5,282	0	5,282	2,876	0	0	8,158

Table C-2 - Phase III Project Completion Year (2049) [Project Build-out] Peak Hour Volume Summary

	AM Peak Hour							PM Peak Hour						
	Ph III 2049		Ph III 2049 without Project	External Project Trips	Internal Project Trips	Pass-By Trips	Ph III 2049 with Project	Ph III 2049		Ph III 2049 without Project	External Project Trips	Internal Project Trips	Pass-By Trips	Ph III 2049 with Project
	w/o Proj	Cumulative Project						w/o Proj	Cumulative Project					
30 Fairgrounds/Cleveland Avenue														
NBL	14	0	14	0	0	0	14	100	0	100	0	0	0	100
NBT	8	0	8	0	0	0	8	44	0	44	0	0	0	44
NBR	29	0	29	0	0	0	29	116	0	116	0	0	0	116
SBL	157	0	157	12	0	0	169	334	0	334	31	0	0	365
SBT	5	0	5	0	0	0	5	36	0	36	0	0	0	36
SBR	40	0	40	0	0	0	40	126	0	126	0	0	0	126
EBL	109	0	109	0	0	0	109	105	0	105	0	0	0	105
EBT	664	0	664	665	0	0	1,329	574	0	574	478	0	0	1,052
EBR	30	0	30	0	0	0	30	96	0	96	0	0	0	96
WBL	39	0	39	0	0	0	39	179	0	179	0	0	0	179
WBT	380	0	380	271	0	0	651	711	0	711	745	0	0	1,456
WBR	127	0	127	34	0	0	161	192	0	192	15	0	0	207
North Leg														
Approach	202	0	202	12	0	0	214	496	0	496	31	0	0	527
Departure	244	0	244	34	0	0	278	341	0	341	15	0	0	356
Total	446	0	446	46	0	0	492	837	0	837	46	0	0	883
South Leg														
Approach	51	0	51	0	0	0	51	260	0	260	0	0	0	260
Departure	75	0	75	0	0	0	75	311	0	311	0	0	0	311
Total	125	0	125	0	0	0	125	570	0	570	0	0	0	570
East Leg														
Approach	546	0	546	305	0	0	851	1,082	0	1,082	760	0	0	1,842
Departure	850	0	850	677	0	0	1,527	1,024	0	1,024	509	0	0	1,533
Total	1,396	0	1,396	982	0	0	2,378	2,106	0	2,106	1,269	0	0	3,375
West Leg														
Approach	803	0	803	665	0	0	1,468	775	0	775	478	0	0	1,253
Departure	434	0	434	271	0	0	705	937	0	937	745	0	0	1,682
Total	1,237	0	1,237	936	0	0	2,173	1,711	0	1,711	1,223	0	0	2,934
Total Approaches														
Approach	1,602	0	1,602	982	0	0	2,584	2,612	0	2,612	1,269	0	0	3,881
Departure	1,602	0	1,602	982	0	0	2,584	2,612	0	2,612	1,269	0	0	3,881
Total	3,205	0	3,205	1,964	0	0	5,169	5,225	0	5,225	2,538	0	0	7,763

Table C-2 - Phase III Project Completion Year (2049) [Project Build-out] Peak Hour Volume Summary

	AM Peak Hour							PM Peak Hour						
	Ph III 2049		Ph III 2049	External	Internal	Pass-By	Ph III 2049	Ph III 2049		Ph III 2049	External	Internal	Pass-By	Ph III 2049
	w/o Proj	Cumulative Project	without Project	Project Trips	Project Trips	Trips	with Project	w/o Proj	Cumulative Project	without Project	Project Trips	Project Trips	Trips	with Project
31 SR-99 Southbound Ramps/Cleveland Avenue														
NBL	0	0	0	0	0	0	0	0	0	0	0	0	0	0
NBT	0	0	0	0	0	0	0	0	0	0	0	0	0	0
NBR	0	0	0	0	0	0	0	0	0	0	0	0	0	0
SBL	82	0	82	182	0	0	264	203	0	203	87	0	0	290
SBT	0	0	0	0	0	0	0	0	0	0	0	0	0	0
SBR	70	0	70	34	0	0	104	85	0	85	15	0	0	100
EBL	0	0	0	0	0	0	0	0	0	0	0	0	0	0
EBT	497	0	497	248	0	0	745	817	0	817	264	0	0	1,081
EBR	449	0	449	418	0	0	867	408	0	408	241	0	0	649
WBL	390	0	390	0	0	0	390	381	0	381	0	0	0	381
WBT	699	0	699	266	0	0	965	1,344	0	1,344	737	0	0	2,081
WBR	0	0	0	0	0	0	0	0	0	0	0	0	0	0
North Leg														
Approach	152	0	152	216	0	0	368	288	0	288	102	0	0	390
Departure	0	0	0	0	0	0	0	0	0	0	0	0	0	0
Total	152	0	152	216	0	0	368	288	0	288	102	0	0	390
South Leg														
Approach	0	0	0	0	0	0	0	0	0	0	0	0	0	0
Departure	839	0	839	418	0	0	1,257	789	0	789	241	0	0	1,030
Total	839	0	839	418	0	0	1,257	789	0	789	241	0	0	1,030
East Leg														
Approach	1,089	0	1,089	266	0	0	1,355	1,725	0	1,725	737	0	0	2,462
Departure	579	0	579	430	0	0	1,009	1,020	0	1,020	351	0	0	1,371
Total	1,668	0	1,668	696	0	0	2,364	2,745	0	2,745	1,088	0	0	3,833
West Leg														
Approach	946	0	946	666	0	0	1,612	1,225	0	1,225	505	0	0	1,730
Departure	769	0	769	300	0	0	1,069	1,429	0	1,429	752	0	0	2,181
Total	1,715	0	1,715	966	0	0	2,681	2,654	0	2,654	1,257	0	0	3,911
Total Approaches														
Approach	2,187	0	2,187	1,148	0	0	3,335	3,238	0	3,238	1,344	0	0	4,582
Departure	2,187	0	2,187	1,148	0	0	3,335	3,238	0	3,238	1,344	0	0	4,582
Total	4,374	0	4,374	2,296	0	0	6,670	6,476	0	6,476	2,688	0	0	9,164

Table C-2 - Phase III Project Completion Year (2049) [Project Build-out] Peak Hour Volume Summary

	AM Peak Hour							PM Peak Hour						
	Ph III 2049		Ph III 2049	External	Internal	Pass-By	Ph III 2049	Ph III 2049		Ph III 2049	External	Internal	Pass-By	Ph III 2049
	w/o Proj	Cumulative Project	without Project	Project Trips	Project Trips	Trips	with Project	w/o Proj	Cumulative Project	without Project	Project Trips	Project Trips	Trips	with Project
32 SR-99 Northbound Ramps/Cleveland Avenue														
NBL	289	0	289	149	0	0	438	667	0	667	423	0	0	1,090
NBT	0	0	0	0	0	0	0	6	0	6	0	0	0	6
NBR	389	0	389	0	0	0	389	349	0	349	0	0	0	349
SBL	0	0	0	0	0	0	0	0	0	0	0	0	0	0
SBT	0	0	0	0	0	0	0	0	0	0	0	0	0	0
SBR	0	0	0	0	0	0	0	0	0	0	0	0	0	0
EBL	71	0	71	12	0	0	83	79	0	79	31	0	0	110
EBT	510	0	510	418	0	0	928	939	0	939	320	0	0	1,259
EBR	0	0	0	0	0	0	0	0	0	0	0	0	0	0
WBL	0	0	0	0	0	0	0	0	0	0	0	0	0	0
WBT	808	0	808	117	0	0	925	1,065	0	1,065	314	0	0	1,379
WBR	116	0	116	59	0	0	175	68	0	68	172	0	0	240
North Leg														
Approach	0	0	0	0	0	0	0	0	0	0	0	0	0	0
Departure	187	0	187	71	0	0	258	153	0	153	203	0	0	356
Total	187	0	187	71	0	0	258	153	0	153	203	0	0	356
South Leg														
Approach	678	0	678	149	0	0	827	1,022	0	1,022	423	0	0	1,445
Departure	0	0	0	0	0	0	0	0	0	0	0	0	0	0
Total	678	0	678	149	0	0	827	1,022	0	1,022	423	0	0	1,445
East Leg														
Approach	924	0	924	176	0	0	1,100	1,133	0	1,133	486	0	0	1,619
Departure	899	0	899	418	0	0	1,317	1,288	0	1,288	320	0	0	1,608
Total	1,823	0	1,823	594	0	0	2,417	2,421	0	2,421	806	0	0	3,227
West Leg														
Approach	581	0	581	430	0	0	1,011	1,018	0	1,018	351	0	0	1,369
Departure	1,097	0	1,097	266	0	0	1,363	1,732	0	1,732	737	0	0	2,469
Total	1,678	0	1,678	696	0	0	2,374	2,750	0	2,750	1,088	0	0	3,838
Total Approaches														
Approach	2,183	0	2,183	755	0	0	2,938	3,173	0	3,173	1,260	0	0	4,433
Departure	2,183	0	2,183	755	0	0	2,938	3,173	0	3,173	1,260	0	0	4,433
Total	4,366	0	4,366	1,510	0	0	5,876	6,347	0	6,347	2,520	0	0	8,867

Table C-2 - Phase III Project Completion Year (2049) [Project Build-out] Peak Hour Volume Summary

	AM Peak Hour							PM Peak Hour						
	Ph III 2049		Ph III 2049	External	Internal	Pass-By	Ph III 2049	Ph III 2049		Ph III 2049	External	Internal	Pass-By	Ph III 2049
	w/o Proj	Cumul Project	without Project	Project Trips	Project Trips	Trips	with Project	w/o Proj	Cumul Project	without Project	Project Trips	Project Trips	Trips	with Project
33 Gateway Drive/Cleveland Avenue														
NBL	137	0	137	48	0	0	185	237	0	237	124	0	0	361
NBT	50	0	50	0	0	0	50	154	0	154	0	0	0	154
NBR	196	0	196	0	0	0	196	309	0	309	0	0	0	309
SBL	67	0	67	0	0	0	67	233	0	233	0	0	0	233
SBT	89	0	89	0	0	0	89	179	0	179	0	0	0	179
SBR	4	0	4	0	0	0	4	24	0	24	0	0	0	24
EBL	4	0	4	0	0	0	4	17	0	17	0	0	0	17
EBT	749	0	749	285	0	0	1,034	977	0	977	254	0	0	1,231
EBR	145	0	145	133	0	0	278	294	0	294	66	0	0	360
WBL	237	0	237	0	0	0	237	248	0	248	0	0	0	248
WBT	784	0	784	127	0	0	911	872	0	872	362	0	0	1,234
WBR	82	0	82	0	0	0	82	175	0	175	0	0	0	175
North Leg														
Approach	160	0	160	0	0	0	160	436	0	436	0	0	0	436
Departure	136	0	136	0	0	0	136	346	0	346	0	0	0	346
Total	297	0	297	0	0	0	297	782	0	782	0	0	0	782
South Leg														
Approach	383	0	383	48	0	0	431	700	0	700	124	0	0	824
Departure	471	0	471	133	0	0	604	721	0	721	66	0	0	787
Total	854	0	854	181	0	0	1,035	1,421	0	1,421	190	0	0	1,611
East Leg														
Approach	1,103	0	1,103	127	0	0	1,230	1,295	0	1,295	362	0	0	1,657
Departure	1,012	0	1,012	285	0	0	1,297	1,519	0	1,519	254	0	0	1,773
Total	2,115	0	2,115	412	0	0	2,527	2,814	0	2,814	616	0	0	3,430
West Leg														
Approach	898	0	898	418	0	0	1,316	1,288	0	1,288	320	0	0	1,608
Departure	925	0	925	175	0	0	1,100	1,133	0	1,133	486	0	0	1,619
Total	1,823	0	1,823	593	0	0	2,416	2,421	0	2,421	806	0	0	3,227
Total Approaches														
Approach	2,544	0	2,544	593	0	0	3,137	3,719	0	3,719	806	0	0	4,525
Departure	2,544	0	2,544	593	0	0	3,137	3,719	0	3,719	806	0	0	4,525
Total	5,088	0	5,088	1,186	0	0	6,274	7,438	0	7,438	1,612	0	0	9,050

Table C-2 - Phase III Project Completion Year (2049) [Project Build-out] Peak Hour Volume Summary

	AM Peak Hour							PM Peak Hour						
	Ph III 2049		Ph III 2049		External	Internal	Ph III 2049	Ph III 2049		Ph III 2049		External	Internal	Ph III 2049
	w/o Proj	Cumulative Project	without Project	Project Trips	Project Trips	Pass-By Trips	with Project	w/o Proj	Cumulative Project	without Project	Project Trips	Project Trips	Pass-By Trips	with Project
34 Cleveland Avenue – Country Club Drive/W Cleveland Avenue														
NBL	0	0	0	0	0	0	0	0	0	0	0	0	0	0
NBT	782	0	782	70	0	0	852	953	0	953	54	0	0	1,007
NBR	230	0	230	214	0	0	444	566	0	566	199	0	0	765
SBL	104	0	104	0	0	0	104	147	0	147	0	0	0	147
SBT	673	0	673	31	0	0	704	871	0	871	83	0	0	954
SBR	0	0	0	0	0	0	0	0	0	0	0	0	0	0
EBL	0	0	0	0	0	0	0	0	0	0	0	0	0	0
EBT	0	0	0	0	0	0	0	0	0	0	0	0	0	0
EBR	0	0	0	0	0	0	0	0	0	0	0	0	0	0
WBL	430	0	430	96	0	0	526	424	0	424	281	0	0	705
WBT	0	0	0	0	0	0	0	0	0	0	0	0	0	0
WBR	49	0	49	0	0	0	49	40	0	40	0	0	0	40
North Leg														
Approach	777	0	777	31	0	0	808	1,018	0	1,018	83	0	0	1,101
Departure	831	0	831	70	0	0	901	993	0	993	54	0	0	1,047
Total	1,608	0	1,608	101	0	0	1,709	2,011	0	2,011	137	0	0	2,148
South Leg														
Approach	1,012	0	1,012	284	0	0	1,296	1,519	0	1,519	253	0	0	1,772
Departure	1,103	0	1,103	127	0	0	1,230	1,295	0	1,295	364	0	0	1,659
Total	2,115	0	2,115	411	0	0	2,526	2,814	0	2,814	617	0	0	3,431
East Leg														
Approach	479	0	479	96	0	0	575	464	0	464	281	0	0	745
Departure	334	0	334	214	0	0	548	713	0	713	199	0	0	912
Total	813	0	813	310	0	0	1,123	1,177	0	1,177	480	0	0	1,657
West Leg														
Approach	0	0	0	0	0	0	0	0	0	0	0	0	0	0
Departure	0	0	0	0	0	0	0	0	0	0	0	0	0	0
Total	0	0	0	0	0	0	0	0	0	0	0	0	0	0
Total Approaches														
Approach	2,268	0	2,268	411	0	0	2,679	3,001	0	3,001	617	0	0	3,618
Departure	2,268	0	2,268	411	0	0	2,679	3,001	0	3,001	617	0	0	3,618
Total	4,536	0	4,536	822	0	0	5,358	6,002	0	6,002	1,234	0	0	7,236

Table C-2 - Phase III Project Completion Year (2049) [Project Build-out] Peak Hour Volume Summary

	AM Peak Hour							PM Peak Hour						
	Ph III 2049		Ph III 2049 without Project	External Project Trips	Internal Project Trips	Pass-By Trips	Ph III 2049 with Project	Ph III 2049		Ph III 2049 without Project	External Project Trips	Internal Project Trips	Pass-By Trips	Ph III 2049 with Project
	w/o Proj	Cumulative Project						w/o Proj	Cumulative Project					
35 Country Club Drive/Sharon Boulevard														
NBL	1	0	1	0	0	0	1	5	0	5	0	0	0	5
NBT	834	0	834	34	0	0	868	962	0	962	24	0	0	986
NBR	0	0	0	0	0	0	0	0	0	0	0	0	0	0
SBL	0	0	0	0	0	0	0	0	0	0	0	0	0	0
SBT	755	0	755	15	0	0	770	963	0	963	39	0	0	1,002
SBR	1	0	1	0	0	0	1	1	0	1	0	0	0	1
EBL	2	0	2	0	0	0	2	2	0	2	0	0	0	2
EBT	0	0	0	0	0	0	0	0	0	0	0	0	0	0
EBR	13	0	13	0	0	0	13	17	0	17	0	0	0	17
WBL	0	0	0	0	0	0	0	0	0	0	0	0	0	0
WBT	0	0	0	0	0	0	0	0	0	0	0	0	0	0
WBR	0	0	0	0	0	0	0	0	0	0	0	0	0	0
North Leg														
Approach	756	0	756	15	0	0	771	964	0	964	39	0	0	1,003
Departure	836	0	836	34	0	0	870	964	0	964	24	0	0	988
Total	1,592	0	1,592	49	0	0	1,641	1,928	0	1,928	63	0	0	1,991
South Leg														
Approach	835	0	835	34	0	0	869	967	0	967	24	0	0	991
Departure	768	0	768	15	0	0	783	980	0	980	39	0	0	1,019
Total	1,603	0	1,603	49	0	0	1,652	1,947	0	1,947	63	0	0	2,010
East Leg														
Approach	0	0	0	0	0	0	0	0	0	0	0	0	0	0
Departure	0	0	0	0	0	0	0	0	0	0	0	0	0	0
Total	0	0	0	0	0	0	0	0	0	0	0	0	0	0
West Leg														
Approach	15	0	15	0	0	0	15	19	0	19	0	0	0	19
Departure	2	0	2	0	0	0	2	6	0	6	0	0	0	6
Total	17	0	17	0	0	0	17	25	0	25	0	0	0	25
Total Approaches														
Approach	1,606	0	1,606	49	0	0	1,655	1,950	0	1,950	63	0	0	2,013
Departure	1,606	0	1,606	49	0	0	1,655	1,950	0	1,950	63	0	0	2,013
Total	3,212	0	3,212	98	0	0	3,310	3,900	0	3,900	126	0	0	4,026

Table C-2 - Phase III Project Completion Year (2049) [Project Build-out] Peak Hour Volume Summary

	AM Peak Hour							PM Peak Hour						
	Ph III 2049		Ph III 2049	External	Internal	Pass-By	Ph III 2049	Ph III 2049		Ph III 2049	External	Internal	Pass-By	Ph III 2049
	w/o Proj	Cumulative Project	without Project	Project Trips	Project Trips	Trips	with Project	w/o Proj	Cumulative Project	without Project	Project Trips	Project Trips	Trips	with Project
36 Pine Street/Howard Road														
NBL	121	0	121	38	0	0	159	144	0	144	90	0	0	234
NBT	171	0	171	3	0	0	174	183	0	183	14	0	0	197
NBR	253	0	253	0	0	0	253	171	0	171	0	0	0	171
SBL	17	0	17	0	0	0	17	18	0	18	0	0	0	18
SBT	281	0	281	14	0	0	295	161	0	161	6	0	0	167
SBR	102	0	102	0	0	0	102	120	0	120	0	0	0	120
EBL	35	0	35	0	0	0	35	89	0	89	0	0	0	89
EBT	700	0	700	331	0	0	1,031	559	0	559	232	0	0	791
EBR	84	0	84	103	0	0	187	102	0	102	44	0	0	146
WBL	163	0	163	0	0	0	163	111	0	111	0	0	0	111
WBT	439	0	439	142	0	0	581	515	0	515	358	0	0	873
WBR	7	0	7	0	0	0	7	4	0	4	0	0	0	4
North Leg														
Approach	400	0	400	14	0	0	414	299	0	299	6	0	0	305
Departure	213	0	213	3	0	0	216	276	0	276	14	0	0	290
Total	612	0	612	17	0	0	629	575	0	575	20	0	0	595
South Leg														
Approach	545	0	545	41	0	0	586	498	0	498	104	0	0	602
Departure	528	0	528	117	0	0	645	374	0	374	50	0	0	424
Total	1,073	0	1,073	158	0	0	1,231	872	0	872	154	0	0	1,026
East Leg														
Approach	609	0	609	142	0	0	751	630	0	630	358	0	0	988
Departure	970	0	970	331	0	0	1,301	748	0	748	232	0	0	980
Total	1,579	0	1,579	473	0	0	2,052	1,378	0	1,378	590	0	0	1,968
West Leg														
Approach	819	0	819	434	0	0	1,253	750	0	750	276	0	0	1,026
Departure	662	0	662	180	0	0	842	779	0	779	448	0	0	1,227
Total	1,481	0	1,481	614	0	0	2,095	1,529	0	1,529	724	0	0	2,253
Total Approaches														
Approach	2,373	0	2,373	631	0	0	3,004	2,177	0	2,177	744	0	0	2,921
Departure	2,373	0	2,373	631	0	0	3,004	2,177	0	2,177	744	0	0	2,921
Total	4,745	0	4,745	1,262	0	0	6,007	4,355	0	4,355	1,488	0	0	5,843

Table C-2 - Phase III Project Completion Year (2049) [Project Build-out] Peak Hour Volume Summary

	AM Peak Hour							PM Peak Hour						
	Ph III 2049		Ph III 2049	External	Internal	Pass-By	Ph III 2049	Ph III 2049		Ph III 2049	External	Internal	Pass-By	Ph III 2049
	w/o Proj	Cumul Project	without Project	Project Trips	Project Trips	Trips	with Project	w/o Proj	Cumul Project	without Project	Project Trips	Project Trips	Trips	with Project
37 Q Street - Olive Avenue/Yosemite Avenue - Howard Road														
NBL	320	0	320	125	0	0	445	330	0	330	318	0	0	648
NBT	89	0	89	0	0	0	89	76	0	76	0	0	0	76
NBR	21	0	21	0	0	0	21	13	0	13	0	0	0	13
SBL	104	0	104	0	0	0	104	17	0	17	0	0	0	17
SBT	152	0	152	0	0	0	152	58	0	58	0	0	0	58
SBR	13	0	13	0	0	0	13	2	0	2	0	0	0	2
EBL	6	0	6	0	0	0	6	7	0	7	0	0	0	7
EBT	568	0	568	41	0	0	609	452	0	452	23	0	0	475
EBR	336	0	336	289	0	0	625	269	0	269	209	0	0	478
WBL	28	0	28	0	0	0	28	14	0	14	0	0	0	14
WBT	348	0	348	17	0	0	365	361	0	361	40	0	0	401
WBR	20	0	20	0	0	0	20	15	0	15	0	0	0	15
North Leg														
Approach	269	0	269	0	0	0	269	77	0	77	0	0	0	77
Departure	115	0	115	0	0	0	115	98	0	98	0	0	0	98
Total	384	0	384	0	0	0	384	175	0	175	0	0	0	175
South Leg														
Approach	430	0	430	125	0	0	555	419	0	419	318	0	0	737
Departure	516	0	516	289	0	0	805	341	0	341	209	0	0	550
Total	946	0	946	414	0	0	1,360	760	0	760	527	0	0	1,287
East Leg														
Approach	396	0	396	17	0	0	413	390	0	390	40	0	0	430
Departure	693	0	693	41	0	0	734	482	0	482	23	0	0	505
Total	1,089	0	1,089	58	0	0	1,147	872	0	872	63	0	0	935
West Leg														
Approach	910	0	910	330	0	0	1,240	728	0	728	232	0	0	960
Departure	681	0	681	142	0	0	823	693	0	693	358	0	0	1,051
Total	1,591	0	1,591	472	0	0	2,063	1,421	0	1,421	590	0	0	2,011
Total Approaches														
Approach	2,005	0	2,005	472	0	0	2,477	1,614	0	1,614	590	0	0	2,204
Departure	2,005	0	2,005	472	0	0	2,477	1,614	0	1,614	590	0	0	2,204
Total	4,010	0	4,010	944	0	0	4,954	3,228	0	3,228	1,180	0	0	4,408

Table C-2 - Phase III Project Completion Year (2049) [Project Build-out] Peak Hour Volume Summary

	AM Peak Hour							PM Peak Hour						
	Ph III 2049		Ph III 2049 without Project	External Project Trips	Internal Project Trips	Pass-By Trips	Ph III 2049 with Project	Ph III 2049		Ph III 2049 without Project	External Project Trips	Internal Project Trips	Pass-By Trips	Ph III 2049 with Project
	w/o Proj	Cumul Cumulative Project						w/o Proj	Cumul Cumulative Project					
38 I Street/SR-99 Southbound Off-Ramp - 2nd Street														
NBL	24	0	24	0	0	0	24	54	0	54	0	0	0	54
NBT	89	0	89	0	0	0	89	160	0	160	0	0	0	160
NBR	0	0	0	0	0	0	0	0	0	0	0	0	0	0
SBL	0	0	0	0	0	0	0	0	0	0	0	0	0	0
SBT	156	0	156	0	0	0	156	122	0	122	0	0	0	122
SBR	3	0	3	0	0	0	3	0	0	0	0	0	0	0
EBL	2	0	2	0	0	0	2	0	0	0	0	0	0	0
EBT	0	0	0	0	0	0	0	0	0	0	0	0	0	0
EBR	68	0	68	0	0	0	68	44	0	44	0	0	0	44
WBL	404	0	404	119	0	0	523	296	0	296	51	0	0	347
WBT	22	0	22	0	0	0	22	15	0	15	0	0	0	15
WBR	12	0	12	0	0	0	12	5	0	5	0	0	0	5
North Leg														
Approach	159	0	159	0	0	0	159	122	0	122	0	0	0	122
Departure	103	0	103	0	0	0	103	165	0	165	0	0	0	165
Total	262	0	262	0	0	0	262	287	0	287	0	0	0	287
South Leg														
Approach	113	0	113	0	0	0	113	214	0	214	0	0	0	214
Departure	628	0	628	119	0	0	747	462	0	462	51	0	0	513
Total	741	0	741	119	0	0	860	676	0	676	51	0	0	727
East Leg														
Approach	438	0	438	119	0	0	557	316	0	316	51	0	0	367
Departure	0	0	0	0	0	0	0	0	0	0	0	0	0	0
Total	438	0	438	119	0	0	557	316	0	316	51	0	0	367
West Leg														
Approach	70	0	70	0	0	0	70	44	0	44	0	0	0	44
Departure	49	0	49	0	0	0	49	69	0	69	0	0	0	69
Total	119	0	119	0	0	0	119	113	0	113	0	0	0	113
Total Approaches														
Approach	780	0	780	119	0	0	899	696	0	696	51	0	0	747
Departure	780	0	780	119	0	0	899	696	0	696	51	0	0	747
Total	1,559	0	1,559	238	0	0	1,797	1,392	0	1,392	102	0	0	1,494

Table C-2 - Phase III Project Completion Year (2049) [Project Build-out] Peak Hour Volume Summary

	AM Peak Hour							PM Peak Hour						
	Ph III 2049		Ph III 2049 without Project	External Project Trips	Internal Project Trips	Pass-By Trips	Ph III 2049 with Project	Ph III 2049		Ph III 2049 without Project	External Project Trips	Internal Project Trips	Pass-By Trips	Ph III 2049 with Project
	w/o Proj	Cumulative Project						w/o Proj	Cumulative Project					
39 4th Street/Sunset Avenue														
NBL	35	0	35	0	0	0	35	14	0	14	0	0	0	14
NBT	351	0	351	20	0	0	371	350	0	350	53	0	0	403
NBR	0	0	0	0	0	0	0	0	0	0	0	0	0	0
SBL	0	0	0	0	0	0	0	0	0	0	0	0	0	0
SBT	462	0	462	60	0	0	522	409	0	409	27	0	0	436
SBR	287	0	287	9	0	0	296	378	0	378	17	0	0	395
EBL	400	0	400	13	0	0	413	238	0	238	13	0	0	251
EBT	0	0	0	0	0	0	0	0	0	0	0	0	0	0
EBR	23	0	23	0	0	0	23	14	0	14	0	0	0	14
WBL	0	0	0	0	0	0	0	0	0	0	0	0	0	0
WBT	0	0	0	0	0	0	0	0	0	0	0	0	0	0
WBR	0	0	0	0	0	0	0	0	0	0	0	0	0	0
North Leg														
Approach	749	0	749	69	0	0	818	787	0	787	44	0	0	831
Departure	751	0	751	33	0	0	784	588	0	588	66	0	0	654
Total	1,500	0	1,500	102	0	0	1,602	1,375	0	1,375	110	0	0	1,485
South Leg														
Approach	386	0	386	20	0	0	406	364	0	364	53	0	0	417
Departure	485	0	485	60	0	0	545	423	0	423	27	0	0	450
Total	871	0	871	80	0	0	951	787	0	787	80	0	0	867
East Leg														
Approach	0	0	0	0	0	0	0	0	0	0	0	0	0	0
Departure	0	0	0	0	0	0	0	0	0	0	0	0	0	0
Total	0	0	0	0	0	0	0	0	0	0	0	0	0	0
West Leg														
Approach	423	0	423	13	0	0	436	252	0	252	13	0	0	265
Departure	322	0	322	9	0	0	331	392	0	392	17	0	0	409
Total	745	0	745	22	0	0	767	644	0	644	30	0	0	674
Total Approaches														
Approach	1,558	0	1,558	102	0	0	1,660	1,403	0	1,403	110	0	0	1,513
Departure	1,558	0	1,558	102	0	0	1,660	1,403	0	1,403	110	0	0	1,513
Total	3,116	0	3,116	204	0	0	3,320	2,806	0	2,806	220	0	0	3,026

Table C-2 - Phase III Project Completion Year (2049) [Project Build-out] Peak Hour Volume Summary

	AM Peak Hour							PM Peak Hour						
	Ph III 2049		Ph III 2049	External	Internal	Pass-By	Ph III 2049	Ph III 2049		Ph III 2049	External	Internal	Pass-By	Ph III 2049
	w/o Proj	Cumul Project	without Project	Project Trips	Project Trips	Trips	with Project	w/o Proj	Cumul Project	without Project	Project Trips	Project Trips	Trips	with Project
40 H Street/SR-99 Northbound On-Ramp - 2nd Street														
NBL	316	0	316	39	0	0	355	401	0	401	106	0	0	507
NBT	25	0	25	0	0	0	25	28	0	28	0	0	0	28
NBR	35	0	35	0	0	0	35	54	0	54	0	0	0	54
SBL	0	0	0	0	0	0	0	2	0	2	0	0	0	2
SBT	36	0	36	0	0	0	36	25	0	25	0	0	0	25
SBR	0	0	0	0	0	0	0	0	0	0	0	0	0	0
EBL	0	0	0	0	0	0	0	0	0	0	0	0	0	0
EBT	0	0	0	0	0	0	0	0	0	0	0	0	0	0
EBR	0	0	0	0	0	0	0	0	0	0	0	0	0	0
WBL	43	0	43	0	0	0	43	49	0	49	0	0	0	49
WBT	41	0	41	0	0	0	41	58	0	58	0	0	0	58
WBR	3	0	3	0	0	0	3	4	0	4	0	0	0	4
North Leg														
Approach	36	0	36	0	0	0	36	27	0	27	0	0	0	27
Departure	28	0	28	0	0	0	28	32	0	32	0	0	0	32
Total	64	0	64	0	0	0	64	59	0	59	0	0	0	59
South Leg														
Approach	376	0	376	39	0	0	415	483	0	483	106	0	0	589
Departure	79	0	79	0	0	0	79	74	0	74	0	0	0	74
Total	455	0	455	39	0	0	494	557	0	557	106	0	0	663
East Leg														
Approach	87	0	87	0	0	0	87	111	0	111	0	0	0	111
Departure	35	0	35	0	0	0	35	56	0	56	0	0	0	56
Total	122	0	122	0	0	0	122	167	0	167	0	0	0	167
West Leg														
Approach	0	0	0	0	0	0	0	0	0	0	0	0	0	0
Departure	357	0	357	39	0	0	396	459	0	459	106	0	0	565
Total	357	0	357	39	0	0	396	459	0	459	106	0	0	565
Total Approaches														
Approach	499	0	499	39	0	0	538	621	0	621	106	0	0	727
Departure	499	0	499	39	0	0	538	621	0	621	106	0	0	727
Total	998	0	998	78	0	0	1,076	1,243	0	1,243	212	0	0	1,455

Table C-2 - Phase III Project Completion Year (2049) [Project Build-out] Peak Hour Volume Summary

	AM Peak Hour							PM Peak Hour						
	Ph III 2049		Ph III 2049 without Project	External Project Trips	Internal Project Trips	Pass-By Trips	Ph III 2049 with Project	Ph III 2049		Ph III 2049 without Project	External Project Trips	Internal Project Trips	Pass-By Trips	Ph III 2049 with Project
	w/o Proj	Cumul Project						w/o Proj	Cumul Project					
41 I Street/4th Street														
NBL	54	0	54	0	0	0	54	105	0	105	0	0	0	105
NBT	58	0	58	0	0	0	58	75	0	75	0	0	0	75
NBR	168	0	168	0	0	0	168	256	0	256	0	0	0	256
SBL	252	0	252	59	0	0	311	193	0	193	24	0	0	217
SBT	287	0	287	0	0	0	287	173	0	173	0	0	0	173
SBR	149	0	149	60	0	0	209	132	0	132	27	0	0	159
EBL	29	0	29	0	0	0	29	42	0	42	0	0	0	42
EBT	666	0	666	33	0	0	699	545	0	545	66	0	0	611
EBR	70	0	70	0	0	0	70	62	0	62	0	0	0	62
WBL	89	0	89	0	0	0	89	62	0	62	0	0	0	62
WBT	516	0	516	9	0	0	525	534	0	534	17	0	0	551
WBR	72	0	72	0	0	0	72	117	0	117	0	0	0	117
North Leg														
Approach	688	0	688	119	0	0	807	498	0	498	51	0	0	549
Departure	159	0	159	0	0	0	159	234	0	234	0	0	0	234
Total	847	0	847	119	0	0	966	732	0	732	51	0	0	783
South Leg														
Approach	280	0	280	0	0	0	280	436	0	436	0	0	0	436
Departure	447	0	447	0	0	0	447	297	0	297	0	0	0	297
Total	726	0	726	0	0	0	726	733	0	733	0	0	0	733
East Leg														
Approach	677	0	677	9	0	0	686	713	0	713	17	0	0	730
Departure	1,086	0	1,086	92	0	0	1,178	994	0	994	90	0	0	1,084
Total	1,763	0	1,763	101	0	0	1,864	1,707	0	1,707	107	0	0	1,814
West Leg														
Approach	765	0	765	33	0	0	798	649	0	649	66	0	0	715
Departure	719	0	719	69	0	0	788	771	0	771	44	0	0	815
Total	1,484	0	1,484	102	0	0	1,586	1,420	0	1,420	110	0	0	1,530
Total Approaches														
Approach	2,410	0	2,410	161	0	0	2,571	2,296	0	2,296	134	0	0	2,430
Departure	2,410	0	2,410	161	0	0	2,571	2,296	0	2,296	134	0	0	2,430
Total	4,820	0	4,820	322	0	0	5,142	4,592	0	4,592	268	0	0	4,860

Table C-2 - Phase III Project Completion Year (2049) [Project Build-out] Peak Hour Volume Summary

	AM Peak Hour							PM Peak Hour						
	Ph III 2049		Ph III 2049	External	Internal	Pass-By	Ph III 2049	Ph III 2049		Ph III 2049	External	Internal	Pass-By	Ph III 2049
	w/o Proj	Cumulative Project	without Project	Project Trips	Project Trips	Trips	with Project	w/o Proj	Cumulative Project	without Project	Project Trips	Project Trips	Trips	with Project
42 SR-99 Southbound On-Ramp/4th Street														
NBL	0	0	0	0	0	0	0	0	0	0	0	0	0	0
NBT	0	0	0	0	0	0	0	0	0	0	0	0	0	0
NBR	0	0	0	0	0	0	0	0	0	0	0	0	0	0
SBL	0	0	0	0	0	0	0	0	0	0	0	0	0	0
SBT	0	0	0	0	0	0	0	0	0	0	0	0	0	0
SBR	0	0	0	0	0	0	0	0	0	0	0	0	0	0
EBL	0	0	0	0	0	0	0	0	0	0	0	0	0	0
EBT	735	0	735	92	0	0	827	678	0	678	90	0	0	768
EBR	351	0	351	0	0	0	351	316	0	316	0	0	0	316
WBL	248	0	248	0	0	0	248	226	0	226	0	0	0	226
WBT	677	0	677	9	0	0	686	713	0	713	17	0	0	730
WBR	0	0	0	0	0	0	0	0	0	0	0	0	0	0
North Leg														
Approach	0	0	0	0	0	0	0	0	0	0	0	0	0	0
Departure	0	0	0	0	0	0	0	0	0	0	0	0	0	0
Total	0	0	0	0	0	0	0	0	0	0	0	0	0	0
South Leg														
Approach	0	0	0	0	0	0	0	0	0	0	0	0	0	0
Departure	599	0	599	0	0	0	599	542	0	542	0	0	0	542
Total	599	0	599	0	0	0	599	542	0	542	0	0	0	542
East Leg														
Approach	925	0	925	9	0	0	934	939	0	939	17	0	0	956
Departure	735	0	735	92	0	0	827	678	0	678	90	0	0	768
Total	1,660	0	1,660	101	0	0	1,761	1,617	0	1,617	107	0	0	1,724
West Leg														
Approach	1,086	0	1,086	92	0	0	1,178	994	0	994	90	0	0	1,084
Departure	677	0	677	9	0	0	686	713	0	713	17	0	0	730
Total	1,763	0	1,763	101	0	0	1,864	1,707	0	1,707	107	0	0	1,814
Total Approaches														
Approach	2,011	0	2,011	101	0	0	2,112	1,933	0	1,933	107	0	0	2,040
Departure	2,011	0	2,011	101	0	0	2,112	1,933	0	1,933	107	0	0	2,040
Total	4,022	0	4,022	202	0	0	4,224	3,866	0	3,866	214	0	0	4,080

Table C-2 - Phase III Project Completion Year (2049) [Project Build-out] Peak Hour Volume Summary

	AM Peak Hour							PM Peak Hour						
	Ph III 2049		Ph III 2049 without Project	External Project Trips	Internal Project Trips	Pass-By Trips	Ph III 2049 with Project	Ph III 2049		Ph III 2049 without Project	External Project Trips	Internal Project Trips	Pass-By Trips	Ph III 2049 with Project
	w/o Proj	Cumul Project						w/o Proj	Cumul Project					
43 H Street – SR-99 Northbound Off-Ramp/4th Street														
NBL	281	0	281	0	0	0	281	285	0	285	0	0	0	285
NBT	35	0	35	0	0	0	35	40	0	40	0	0	0	40
NBR	240	0	240	0	0	0	240	208	0	208	0	0	0	208
SBL	8	0	8	0	0	0	8	34	0	34	0	0	0	34
SBT	0	0	0	0	0	0	0	0	0	0	0	0	0	0
SBR	84	0	84	0	0	0	84	92	0	92	0	0	0	92
EBL	265	0	265	20	0	0	285	271	0	271	53	0	0	324
EBT	470	0	470	72	0	0	542	407	0	407	37	0	0	444
EBR	0	0	0	0	0	0	0	0	0	0	0	0	0	0
WBL	0	0	0	0	0	0	0	0	0	0	0	0	0	0
WBT	559	0	559	9	0	0	568	562	0	562	17	0	0	579
WBR	79	0	79	19	0	0	98	171	0	171	54	0	0	225
North Leg														
Approach	92	0	92	0	0	0	92	126	0	126	0	0	0	126
Departure	379	0	379	39	0	0	418	482	0	482	107	0	0	589
Total	471	0	471	39	0	0	510	608	0	608	107	0	0	715
South Leg														
Approach	556	0	556	0	0	0	556	533	0	533	0	0	0	533
Departure	0	0	0	0	0	0	0	0	0	0	0	0	0	0
Total	556	0	556	0	0	0	556	533	0	533	0	0	0	533
East Leg														
Approach	638	0	638	28	0	0	666	733	0	733	71	0	0	804
Departure	718	0	718	72	0	0	790	649	0	649	37	0	0	686
Total	1,356	0	1,356	100	0	0	1,456	1,382	0	1,382	108	0	0	1,490
West Leg														
Approach	735	0	735	92	0	0	827	678	0	678	90	0	0	768
Departure	924	0	924	9	0	0	933	939	0	939	17	0	0	956
Total	1,659	0	1,659	101	0	0	1,760	1,617	0	1,617	107	0	0	1,724
Total Approaches														
Approach	2,021	0	2,021	120	0	0	2,141	2,070	0	2,070	161	0	0	2,231
Departure	2,021	0	2,021	120	0	0	2,141	2,070	0	2,070	161	0	0	2,231
Total	4,042	0	4,042	240	0	0	4,282	4,140	0	4,140	322	0	0	4,462

Table C-2 - Phase III Project Completion Year (2049) [Project Build-out] Peak Hour Volume Summary

	AM Peak Hour							PM Peak Hour						
	Ph III 2049		Ph III 2049 without Project	External Project Trips	Internal Project Trips	Pass-By Trips	Ph III 2049 with Project	Ph III 2049		Ph III 2049 without Project	External Project Trips	Internal Project Trips	Pass-By Trips	Ph III 2049 with Project
	w/o Proj	Cumulative Project						w/o Proj	Cumulative Project					
44 I Street/Olive Avenue														
NBL	0	0	0	0	0	0	0	0	0	0	0	0	0	0
NBT	0	0	0	0	0	0	0	0	0	0	0	0	0	0
NBR	0	0	0	0	0	0	0	0	0	0	0	0	0	0
SBL	62	0	62	0	0	0	62	160	0	160	0	0	0	160
SBT	0	0	0	0	0	0	0	0	0	0	0	0	0	0
SBR	102	0	102	0	0	0	102	111	0	111	0	0	0	111
EBL	134	0	134	0	0	0	134	90	0	90	0	0	0	90
EBT	513	0	513	247	0	0	760	502	0	502	152	0	0	654
EBR	0	0	0	0	0	0	0	0	0	0	0	0	0	0
WBL	0	0	0	0	0	0	0	0	0	0	0	0	0	0
WBT	585	0	585	99	0	0	684	492	0	492	250	0	0	742
WBR	82	0	82	0	0	0	82	113	0	113	0	0	0	113
North Leg														
Approach	164	0	164	0	0	0	164	271	0	271	0	0	0	271
Departure	216	0	216	0	0	0	216	203	0	203	0	0	0	203
Total	380	0	380	0	0	0	380	474	0	474	0	0	0	474
South Leg														
Approach	0	0	0	0	0	0	0	0	0	0	0	0	0	0
Departure	0	0	0	0	0	0	0	0	0	0	0	0	0	0
Total	0	0	0	0	0	0	0	0	0	0	0	0	0	0
East Leg														
Approach	667	0	667	99	0	0	766	605	0	605	250	0	0	855
Departure	575	0	575	247	0	0	822	662	0	662	152	0	0	814
Total	1,242	0	1,242	346	0	0	1,588	1,267	0	1,267	402	0	0	1,669
West Leg														
Approach	647	0	647	247	0	0	894	592	0	592	152	0	0	744
Departure	687	0	687	99	0	0	786	603	0	603	250	0	0	853
Total	1,334	0	1,334	346	0	0	1,680	1,196	0	1,196	402	0	0	1,598
Total Approaches														
Approach	1,478	0	1,478	346	0	0	1,824	1,468	0	1,468	402	0	0	1,870
Departure	1,478	0	1,478	346	0	0	1,824	1,468	0	1,468	402	0	0	1,870
Total	2,957	0	2,957	692	0	0	3,649	2,937	0	2,937	804	0	0	3,741

Table C-2 - Phase III Project Completion Year (2049) [Project Build-out] Peak Hour Volume Summary

	AM Peak Hour							PM Peak Hour						
	Ph III 2049		Ph III 2049	External	Internal	Pass-By	Ph III 2049	Ph III 2049		Ph III 2049	External	Internal	Pass-By	Ph III 2049
	w/o Proj	Cumul Project	without Project	Project Trips	Project Trips	Trips	with Project	w/o Proj	Cumul Project	without Project	Project Trips	Project Trips	Trips	with Project
45 SR-99 Southbound Off-Ramp/Olive Avenue														
NBL	0	0	0	0	0	0	0	0	0	0	0	0	0	0
NBT	0	0	0	0	0	0	0	0	0	0	0	0	0	0
NBR	0	0	0	0	0	0	0	0	0	0	0	0	0	0
SBL	712	0	712	202	0	0	914	674	0	674	102	0	0	776
SBT	0	0	0	0	0	0	0	0	0	0	0	0	0	0
SBR	120	0	120	0	0	0	120	102	0	102	0	0	0	102
EBL	0	0	0	0	0	0	0	0	0	0	0	0	0	0
EBT	575	0	575	247	0	0	822	661	0	661	152	0	0	813
EBR	0	0	0	0	0	0	0	0	0	0	0	0	0	0
WBL	0	0	0	0	0	0	0	0	0	0	0	0	0	0
WBT	547	0	547	99	0	0	646	503	0	503	250	0	0	753
WBR	0	0	0	0	0	0	0	0	0	0	0	0	0	0
North Leg														
Approach	832	0	832	202	0	0	1,034	776	0	776	102	0	0	878
Departure	0	0	0	0	0	0	0	0	0	0	0	0	0	0
Total	832	0	832	202	0	0	1,034	776	0	776	102	0	0	878
South Leg														
Approach	0	0	0	0	0	0	0	0	0	0	0	0	0	0
Departure	0	0	0	0	0	0	0	0	0	0	0	0	0	0
Total	0	0	0	0	0	0	0	0	0	0	0	0	0	0
East Leg														
Approach	547	0	547	99	0	0	646	503	0	503	250	0	0	753
Departure	1,287	0	1,287	449	0	0	1,736	1,335	0	1,335	254	0	0	1,589
Total	1,834	0	1,834	548	0	0	2,382	1,838	0	1,838	504	0	0	2,342
West Leg														
Approach	575	0	575	247	0	0	822	661	0	661	152	0	0	813
Departure	667	0	667	99	0	0	766	605	0	605	250	0	0	855
Total	1,242	0	1,242	346	0	0	1,588	1,266	0	1,266	402	0	0	1,668
Total Approaches														
Approach	1,954	0	1,954	548	0	0	2,502	1,940	0	1,940	504	0	0	2,444
Departure	1,954	0	1,954	548	0	0	2,502	1,940	0	1,940	504	0	0	2,444
Total	3,908	0	3,908	1,096	0	0	5,004	3,880	0	3,880	1,008	0	0	4,888

Table C-2 - Phase III Project Completion Year (2049) [Project Build-out] Peak Hour Volume Summary

	AM Peak Hour							PM Peak Hour						
	Ph III 2049		Ph III 2049 without Project	External Project Trips	Internal Project Trips	Pass-By Trips	Ph III 2049 with Project	Ph III 2049		Ph III 2049 without Project	External Project Trips	Internal Project Trips	Pass-By Trips	Ph III 2049 with Project
	w/o Proj	Cumulative Project						w/o Proj	Cumulative Project					
46 Madera Avenue/SR-99 Northbound Ramps														
NBL	663	0	663	46	0	0	709	820	0	820	127	0	0	947
NBT	447	0	447	97	0	0	544	753	0	753	66	0	0	819
NBR	0	0	0	0	0	0	0	0	0	0	0	0	0	0
SBL	0	0	0	0	0	0	0	0	0	0	0	0	0	0
SBT	701	0	701	15	0	0	716	691	0	691	40	0	0	731
SBR	277	0	277	25	0	0	302	178	0	178	68	0	0	246
EBL	0	0	0	0	0	0	0	0	0	0	0	0	0	0
EBT	0	0	0	0	0	0	0	0	0	0	0	0	0	0
EBR	0	0	0	0	0	0	0	0	0	0	0	0	0	0
WBL	223	0	223	66	0	0	289	209	0	209	165	0	0	374
WBT	2	0	2	0	0	0	2	1	0	1	0	0	0	1
WBR	107	0	107	0	0	0	107	34	0	34	0	0	0	34
North Leg														
Approach	978	0	978	40	0	0	1,018	869	0	869	108	0	0	977
Departure	554	0	554	97	0	0	651	787	0	787	66	0	0	853
Total	1,532	0	1,532	137	0	0	1,669	1,656	0	1,656	174	0	0	1,830
South Leg														
Approach	1,110	0	1,110	143	0	0	1,253	1,573	0	1,573	193	0	0	1,766
Departure	924	0	924	81	0	0	1,005	900	0	900	205	0	0	1,105
Total	2,034	0	2,034	224	0	0	2,258	2,473	0	2,473	398	0	0	2,871
East Leg														
Approach	332	0	332	66	0	0	398	244	0	244	165	0	0	409
Departure	0	0	0	0	0	0	0	0	0	0	0	0	0	0
Total	332	0	332	66	0	0	398	244	0	244	165	0	0	409
West Leg														
Approach	0	0	0	0	0	0	0	0	0	0	0	0	0	0
Departure	942	0	942	71	0	0	1,013	999	0	999	195	0	0	1,194
Total	942	0	942	71	0	0	1,013	999	0	999	195	0	0	1,194
Total Approaches														
Approach	2,420	0	2,420	249	0	0	2,669	2,686	0	2,686	466	0	0	3,152
Departure	2,420	0	2,420	249	0	0	2,669	2,686	0	2,686	466	0	0	3,152
Total	4,840	0	4,840	498	0	0	5,338	5,371	0	5,371	932	0	0	6,303

Table C-2 - Phase III Project Completion Year (2049) [Project Build-out] Peak Hour Volume Summary

	AM Peak Hour							PM Peak Hour						
	Ph III 2049		Ph III 2049	External	Internal	Pass-By	Ph III 2049	Ph III 2049		Ph III 2049	External	Internal	Pass-By	Ph III 2049
	w/o Proj	Cumul Project	without Project	Project Trips	Project Trips	Trips	with Project	w/o Proj	Cumul Project	without Project	Project Trips	Project Trips	Trips	with Project
47 Madera Avenue/Olive Avenue – SR-99 Southbound On-Ramp														
NBL	202	0	202	20	0	0	222	197	0	197	48	0	0	245
NBT	692	0	692	46	0	0	738	1,081	0	1,081	127	0	0	1,208
NBR	44	0	44	0	0	0	44	52	0	52	0	0	0	52
SBL	88	0	88	0	0	0	88	137	0	137	0	0	0	137
SBT	491	0	491	0	0	0	491	458	0	458	0	0	0	458
SBR	345	0	345	81	0	0	426	306	0	306	204	0	0	510
EBL	418	0	418	97	0	0	515	492	0	492	66	0	0	558
EBT	202	0	202	175	0	0	377	196	0	196	91	0	0	287
EBR	667	0	667	176	0	0	843	647	0	647	97	0	0	744
WBL	0	0	0	0	0	0	0	0	0	0	0	0	0	0
WBT	0	0	0	0	0	0	0	0	0	0	0	0	0	0
WBR	0	0	0	0	0	0	0	0	0	0	0	0	0	0
North Leg														
Approach	924	0	924	81	0	0	1,005	900	0	900	204	0	0	1,104
Departure	1,110	0	1,110	143	0	0	1,253	1,573	0	1,573	193	0	0	1,766
Total	2,034	0	2,034	224	0	0	2,258	2,473	0	2,473	397	0	0	2,870
South Leg														
Approach	938	0	938	66	0	0	1,004	1,330	0	1,330	175	0	0	1,505
Departure	1,158	0	1,158	176	0	0	1,334	1,105	0	1,105	97	0	0	1,202
Total	2,096	0	2,096	242	0	0	2,338	2,435	0	2,435	272	0	0	2,707
East Leg														
Approach	0	0	0	0	0	0	0	0	0	0	0	0	0	0
Departure	334	0	334	175	0	0	509	385	0	385	91	0	0	476
Total	334	0	334	175	0	0	509	385	0	385	91	0	0	476
West Leg														
Approach	1,287	0	1,287	448	0	0	1,735	1,335	0	1,335	254	0	0	1,589
Departure	547	0	547	101	0	0	648	503	0	503	252	0	0	755
Total	1,834	0	1,834	549	0	0	2,383	1,838	0	1,838	506	0	0	2,344
Total Approaches														
Approach	3,149	0	3,149	595	0	0	3,744	3,565	0	3,565	633	0	0	4,198
Departure	3,149	0	3,149	595	0	0	3,744	3,565	0	3,565	633	0	0	4,198
Total	6,298	0	6,298	1,190	0	0	7,488	7,130	0	7,130	1,266	0	0	8,396

Table C-2 - Phase III Project Completion Year (2049) [Project Build-out] Peak Hour Volume Summary

	AM Peak Hour							PM Peak Hour						
	Ph III 2049		Ph III 2049	External	Internal	Pass-By	Ph III 2049	Ph III 2049		Ph III 2049	External	Internal	Pass-By	Ph III 2049
	w/o Proj	Cumul Project	without Project	Project Trips	Project Trips	Trips	with Project	w/o Proj	Cumul Project	without Project	Project Trips	Project Trips	Trips	with Project
48 Madera Avenue (SR-145) /Lewis Street														
NBL	0	0	0	0	0	0	0	0	0	0	0	0	0	0
NBT	962	0	962	65	0	0	1,027	1,364	0	1,364	174	0	0	1,538
NBR	8	0	8	0	0	0	8	7	0	7	0	0	0	7
SBL	33	0	33	0	0	0	33	33	0	33	0	0	0	33
SBT	1,281	0	1,281	176	0	0	1,457	1,166	0	1,166	97	0	0	1,263
SBR	0	0	0	0	0	0	0	0	0	0	0	0	0	0
EBL	0	0	0	0	0	0	0	0	0	0	0	0	0	0
EBT	0	0	0	0	0	0	0	0	0	0	0	0	0	0
EBR	0	0	0	0	0	0	0	0	0	0	0	0	0	0
WBL	9	0	9	0	0	0	9	7	0	7	0	0	0	7
WBT	0	0	0	0	0	0	0	0	0	0	0	0	0	0
WBR	8	0	8	0	0	0	8	9	0	9	0	0	0	9
North Leg														
Approach	1,314	0	1,314	176	0	0	1,490	1,199	0	1,199	97	0	0	1,296
Departure	970	0	970	65	0	0	1,035	1,373	0	1,373	174	0	0	1,547
Total	2,284	0	2,284	241	0	0	2,525	2,572	0	2,572	271	0	0	2,843
South Leg														
Approach	970	0	970	65	0	0	1,035	1,371	0	1,371	174	0	0	1,545
Departure	1,290	0	1,290	176	0	0	1,466	1,173	0	1,173	97	0	0	1,270
Total	2,261	0	2,261	241	0	0	2,502	2,544	0	2,544	271	0	0	2,815
East Leg														
Approach	18	0	18	0	0	0	18	17	0	17	0	0	0	17
Departure	41	0	41	0	0	0	41	40	0	40	0	0	0	40
Total	59	0	59	0	0	0	59	56	0	56	0	0	0	56
West Leg														
Approach	0	0	0	0	0	0	0	0	0	0	0	0	0	0
Departure	0	0	0	0	0	0	0	0	0	0	0	0	0	0
Total	0	0	0	0	0	0	0	0	0	0	0	0	0	0
Total Approaches														
Approach	2,302	0	2,302	241	0	0	2,543	2,586	0	2,586	271	0	0	2,857
Departure	2,302	0	2,302	241	0	0	2,543	2,586	0	2,586	271	0	0	2,857
Total	4,604	0	4,604	482	0	0	5,086	5,173	0	5,173	542	0	0	5,715

Table C-2 - Phase III Project Completion Year (2049) [Project Build-out] Peak Hour Volume Summary

	AM Peak Hour							PM Peak Hour								
	Ph III 2049		Ph III 2049		External Project Trips	Internal Project Trips	Pass-By Trips	Ph III 2049		Ph III 2049		External Project Trips	Internal Project Trips	Pass-By Trips	Ph III 2049	
	w/o Proj	Cumulative Project	w/o Proj	Cumulative Project				w/o Proj	Cumulative Project	w/o Proj	Cumulative Project				w/o Proj	Cumulative Project
49 Yosemite Avenue/Cleveland Avenue - Tozer Street																
NBL	141	0	141	0	0	0	141	320	0	320	0	0	0	0	320	
NBT	137	0	137	0	0	0	137	329	0	329	0	0	0	0	329	
NBR	78	0	78	0	0	0	78	100	0	100	0	0	0	0	100	
SBL	79	0	79	0	0	0	79	83	0	83	0	0	0	0	83	
SBT	270	0	270	0	0	0	270	188	0	188	0	0	0	0	188	
SBR	226	0	226	46	0	0	272	240	0	240	121	0	0	0	361	
EBL	210	0	210	119	0	0	329	250	0	250	70	0	0	0	320	
EBT	531	0	531	26	0	0	557	467	0	467	11	0	0	0	478	
EBR	260	0	260	0	0	0	260	203	0	203	0	0	0	0	203	
WBL	116	0	116	0	0	0	116	52	0	52	0	0	0	0	52	
WBT	349	0	349	8	0	0	357	499	0	499	25	0	0	0	524	
WBR	60	0	60	0	0	0	60	49	0	49	0	0	0	0	49	
North Leg																
Approach	575	0	575	46	0	0	621	511	0	511	121	0	0	0	632	
Departure	407	0	407	119	0	0	526	628	0	628	70	0	0	0	698	
Total	982	0	982	165	0	0	1,147	1,139	0	1,139	191	0	0	0	1,330	
South Leg																
Approach	356	0	356	0	0	0	356	749	0	749	0	0	0	0	749	
Departure	646	0	646	0	0	0	646	443	0	443	0	0	0	0	443	
Total	1,002	0	1,002	0	0	0	1,002	1,192	0	1,192	0	0	0	0	1,192	
East Leg																
Approach	525	0	525	8	0	0	533	600	0	600	25	0	0	0	625	
Departure	688	0	688	26	0	0	714	650	0	650	11	0	0	0	661	
Total	1,213	0	1,213	34	0	0	1,247	1,250	0	1,250	36	0	0	0	1,286	
West Leg																
Approach	1,001	0	1,001	145	0	0	1,146	920	0	920	81	0	0	0	1,001	
Departure	716	0	716	54	0	0	770	1,059	0	1,059	146	0	0	0	1,205	
Total	1,717	0	1,717	199	0	0	1,916	1,979	0	1,979	227	0	0	0	2,206	
Total Approaches																
Approach	2,457	0	2,457	199	0	0	2,656	2,780	0	2,780	227	0	0	0	3,007	
Departure	2,457	0	2,457	199	0	0	2,656	2,780	0	2,780	227	0	0	0	3,007	
Total	4,915	0	4,915	398	0	0	5,313	5,560	0	5,560	454	0	0	0	6,014	

Table C-2 - Phase III Project Completion Year (2049) [Project Build-out] Peak Hour Volume Summary

	AM Peak Hour							PM Peak Hour						
	Ph III 2049		Ph III 2049 without Project	External Project Trips	Internal Project Trips	Pass-By Trips	Ph III 2049 with Project	Ph III 2049		Ph III 2049 without Project	External Project Trips	Internal Project Trips	Pass-By Trips	Ph III 2049 with Project
	w/o Proj	Cumulative Project						w/o Proj	Cumulative Project					
50 Road 22/Cleveland Avenue														
NBL	0	0	0	0	0	0	0	0	0	0	0	0	0	0
NBT	0	0	0	0	3	0	3	0	0	0	0	2	0	2
NBR	0	0	0	0	0	0	0	0	0	0	0	0	0	0
SBL	0	0	0	6	5	0	11	0	0	0	8	6	0	14
SBT	0	0	0	0	2	0	2	0	0	0	0	2	0	2
SBR	0	0	0	0	0	0	0	0	0	0	0	0	0	0
EBL	0	0	0	0	0	0	0	0	0	0	0	0	0	0
EBT	0	0	0	0	0	0	0	0	0	0	0	0	0	0
EBR	0	0	0	0	0	0	0	0	0	0	0	0	0	0
WBL	0	0	0	0	0	0	0	0	0	0	0	0	0	0
WBT	0	0	0	0	0	0	0	0	0	0	0	0	0	0
WBR	0	0	0	13	6	0	19	0	0	0	3	6	0	9
North Leg														
Approach	0	0	0	6	7	0	13	0	0	0	8	8	0	16
Departure	0	0	0	13	9	0	22	0	0	0	3	8	0	11
Total	0	0	0	19	16	0	35	0	0	0	11	16	0	27
South Leg														
Approach	0	0	0	0	3	0	3	0	0	0	0	2	0	2
Departure	0	0	0	0	2	0	2	0	0	0	0	2	0	2
Total	0	0	0	0	5	0	5	0	0	0	0	4	0	4
East Leg														
Approach	0	0	0	13	6	0	19	0	0	0	3	6	0	9
Departure	0	0	0	6	5	0	11	0	0	0	8	6	0	14
Total	0	0	0	19	11	0	30	0	0	0	11	12	0	23
West Leg														
Approach	0	0	0	0	0	0	0	0	0	0	0	0	0	0
Departure	0	0	0	0	0	0	0	0	0	0	0	0	0	0
Total	0	0	0	0	0	0	0	0	0	0	0	0	0	0
Total Approaches														
Approach	0	0	0	19	16	0	35	0	0	0	11	16	0	27
Departure	0	0	0	19	16	0	35	0	0	0	11	16	0	27
Total	0	0	0	38	32	0	70	0	0	0	22	32	0	54

Table C-2 - Phase III Project Completion Year (2049) [Project Build-out] Peak Hour Volume Summary

	AM Peak Hour							PM Peak Hour						
	Ph III 2049		Ph III 2049 without Project	External Project Trips	Internal Project Trips	Pass-By Trips	Ph III 2049 with Project	Ph III 2049		Ph III 2049 without Project	External Project Trips	Internal Project Trips	Pass-By Trips	Ph III 2049 with Project
	w/o Proj	Cumul Project						w/o Proj	Cumul Project					
51 Project Driveway 1/Avenue 17														
NBL	0	0	0	56	0	0	56	0	0	0	23	0	0	23
NBT	0	0	0	0	0	0	0	0	0	0	0	0	0	0
NBR	0	0	0	614	15	0	629	0	0	0	270	32	0	302
SBL	0	0	0	0	0	0	0	0	0	0	0	0	0	0
SBT	0	0	0	0	0	0	0	0	0	0	0	0	0	0
SBR	0	0	0	0	0	0	0	0	0	0	0	0	0	0
EBL	0	0	0	0	0	0	0	0	0	0	0	0	0	0
EBT	50	0	50	14	4	0	68	73	0	73	31	8	0	112
EBR	0	0	0	16	0	0	16	0	0	0	50	0	0	50
WBL	0	0	0	140	15	0	155	0	0	0	595	32	0	627
WBT	32	0	32	34	5	0	71	39	0	39	16	8	0	63
WBR	0	0	0	0	0	0	0	0	0	0	0	0	0	0
North Leg														
Approach	0	0	0	0	0	0	0	0	0	0	0	0	0	0
Departure	0	0	0	0	0	0	0	0	0	0	0	0	0	0
Total	0	0	0	0	0	0	0	0	0	0	0	0	0	0
South Leg														
Approach	0	0	0	670	15	0	685	0	0	0	293	32	0	325
Departure	0	0	0	156	15	0	171	0	0	0	645	32	0	677
Total	0	0	0	826	30	0	856	0	0	0	938	64	0	1,002
East Leg														
Approach	32	0	32	174	20	0	226	39	0	39	611	40	0	690
Departure	50	0	50	628	19	0	697	73	0	73	301	40	0	414
Total	82	0	82	802	39	0	923	112	0	112	912	80	0	1,104
West Leg														
Approach	50	0	50	30	4	0	84	73	0	73	81	8	0	162
Departure	32	0	32	90	5	0	127	39	0	39	39	8	0	86
Total	82	0	82	120	9	0	211	112	0	112	120	16	0	248
Total Approaches														
Approach	82	0	82	874	39	0	995	112	0	112	985	80	0	1,177
Departure	82	0	82	874	39	0	995	112	0	112	985	80	0	1,177
Total	164	0	164	1,748	78	0	1,990	224	0	224	1,970	160	0	2,354

Table C-2 - Phase III Project Completion Year (2049) [Project Build-out] Peak Hour Volume Summary

	AM Peak Hour							PM Peak Hour						
	Ph III 2049		Ph III 2049 without Project	External Project Trips	Internal Project Trips	Pass-By Trips	Ph III 2049 with Project	Ph III 2049		Ph III 2049 without Project	External Project Trips	Internal Project Trips	Pass-By Trips	Ph III 2049 with Project
	w/o Proj	Cumulative Project						w/o Proj	Cumulative Project					
52 Road 22 ½ - Project Driveway 2/Avenue 16														
NBL	0	0	0	16	0	0	16	0	0	0	6	0	0	6
NBT	0	0	0	0	131	0	131	0	0	0	0	178	0	178
NBR	4	0	4	271	45	0	320	0	0	0	100	48	0	148
SBL	4	0	4	188	44	0	236	4	0	4	70	68	0	142
SBT	0	0	0	0	126	0	126	0	0	0	0	179	0	179
SBR	0	0	0	0	0	0	0	0	0	0	0	0	0	0
EBL	0	0	0	0	0	0	0	0	0	0	0	0	0	0
EBT	65	0	65	0	0	0	65	202	0	202	0	0	0	202
EBR	2	0	2	3	0	0	5	0	0	0	15	0	0	15
WBL	0	0	0	45	43	0	88	0	0	0	248	48	0	296
WBT	35	0	35	0	0	0	35	15	0	15	0	0	0	15
WBR	0	0	0	68	43	0	111	0	0	0	155	70	0	225
North Leg														
Approach	4	0	4	188	170	0	362	4	0	4	70	247	0	321
Departure	0	0	0	68	174	0	242	0	0	0	155	248	0	403
Total	4	0	4	256	344	0	604	4	0	4	225	495	0	724
South Leg														
Approach	4	0	4	287	176	0	467	0	0	0	106	226	0	332
Departure	2	0	2	48	169	0	219	0	0	0	263	227	0	490
Total	6	0	6	335	345	0	686	0	0	0	369	453	0	822
East Leg														
Approach	35	0	35	113	86	0	234	15	0	15	403	118	0	536
Departure	73	0	73	459	89	0	621	206	0	206	170	116	0	492
Total	108	0	108	572	175	0	855	221	0	221	573	234	0	1,028
West Leg														
Approach	67	0	67	3	0	0	70	202	0	202	15	0	0	217
Departure	35	0	35	16	0	0	51	15	0	15	6	0	0	21
Total	102	0	102	19	0	0	121	217	0	217	21	0	0	238
Total Approaches														
Approach	110	0	110	591	432	0	1,133	221	0	221	594	591	0	1,406
Departure	110	0	110	591	432	0	1,133	221	0	221	594	591	0	1,406
Total	220	0	220	1,182	864	0	2,266	442	0	442	1,188	1,182	0	2,812

Table C-2 - Phase III Project Completion Year (2049) [Project Build-out] Peak Hour Volume Summary

	AM Peak Hour							PM Peak Hour						
	Ph III 2049		Ph III 2049 without Project	External Project Trips	Internal Project Trips	Pass-By Trips	Ph III 2049 with Project	Ph III 2049		Ph III 2049 without Project	External Project Trips	Internal Project Trips	Pass-By Trips	Ph III 2049 with Project
	w/o Proj	Cumul Project						w/o Proj	Cumul Project					
53 Road 22 1/2/Cleveland Avenue														
NBL	1	0	1	6	7	0	14	0	0	0	2	12	0	14
NBT	0	0	0	0	25	0	25	0	0	0	0	25	4	29
NBR	2	0	2	134	27	0	163	0	0	0	35	31	-4	62
SBL	1	0	1	258	74	0	333	1	0	1	185	106	38	330
SBT	0	0	0	0	25	0	25	0	0	0	0	25	5	30
SBR	0	0	0	0	10	0	10	0	0	0	0	8	0	8
EBL	0	0	0	0	12	0	12	0	0	0	0	8	0	8
EBT	0	0	0	265	130	0	395	0	0	0	173	244	0	417
EBR	0	0	0	3	8	0	11	0	0	0	4	12	0	16
WBL	1	0	1	59	28	0	88	0	0	0	86	31	-4	113
WBT	0	0	0	105	127	0	232	0	0	0	279	245	0	524
WBR	1	0	1	67	76	0	144	0	0	0	310	107	32	449
North Leg														
Approach	1	0	1	258	109	0	368	1	0	1	185	139	43	368
Departure	1	0	1	67	113	0	181	0	0	0	310	140	36	486
Total	2	0	2	325	222	0	549	1	0	1	495	279	79	854
South Leg														
Approach	3	0	3	140	59	0	202	0	0	0	37	68	0	105
Departure	1	0	1	62	61	0	124	0	0	0	90	68	1	159
Total	4	0	4	202	120	0	326	0	0	0	127	136	1	264
East Leg														
Approach	2	0	2	231	231	0	464	0	0	0	675	383	28	1,086
Departure	3	0	3	657	231	0	891	1	0	1	393	381	34	809
Total	5	0	5	888	462	0	1,355	1	0	1	1,068	764	62	1,895
West Leg														
Approach	0	0	0	268	150	0	418	0	0	0	177	264	0	441
Departure	1	0	1	111	144	0	256	0	0	0	281	265	0	546
Total	1	0	1	379	294	0	674	0	0	0	458	529	0	987
Total Approaches														
Approach	6	0	6	897	549	0	1,452	1	0	1	1,074	854	71	2,000
Departure	6	0	6	897	549	0	1,452	1	0	1	1,074	854	71	2,000
Total	13	0	13	1,794	1,098	0	2,905	2	0	2	2,148	1,708	142	4,000

Table C-2 - Phase III Project Completion Year (2049) [Project Build-out] Peak Hour Volume Summary

	AM Peak Hour							PM Peak Hour						
	Ph III 2049		Ph III 2049 without Project	External Project Trips	Internal Project Trips	Pass-By Trips	Ph III 2049 with Project	Ph III 2049		Ph III 2049 without Project	External Project Trips	Internal Project Trips	Pass-By Trips	Ph III 2049 with Project
	w/o Proj	Cumulative Project						w/o Proj	Cumulative Project					
54 Road 22 1/2/Project Driveway 5														
NBL	0	0	0	0	0	0	0	0	0	0	0	0	0	0
NBT	0	0	0	0	0	0	0	0	0	0	0	0	0	0
NBR	0	0	0	0	0	0	0	0	0	0	0	0	0	0
SBL	0	0	0	70	4	0	74	0	0	0	19	7	0	26
SBT	0	0	0	0	0	0	0	0	0	0	0	0	0	0
SBR	0	0	0	0	0	0	0	0	0	0	0	0	0	0
EBL	0	0	0	0	0	0	0	0	0	0	0	0	0	0
EBT	0	0	0	76	13	0	89	0	0	0	20	17	0	37
EBR	0	0	0	0	0	0	0	0	0	0	0	0	0	0
WBL	0	0	0	0	0	0	0	0	0	0	0	0	0	0
WBT	0	0	0	34	11	0	45	0	0	0	49	17	0	66
WBR	0	0	0	31	4	0	35	0	0	0	45	7	0	52
North Leg														
Approach	0	0	0	70	4	0	74	0	0	0	19	7	0	26
Departure	0	0	0	31	4	0	35	0	0	0	45	7	0	52
Total	0	0	0	101	8	0	109	0	0	0	64	14	0	78
South Leg														
Approach	0	0	0	0	0	0	0	0	0	0	0	0	0	0
Departure	0	0	0	0	0	0	0	0	0	0	0	0	0	0
Total	0	0	0	0	0	0	0	0	0	0	0	0	0	0
East Leg														
Approach	0	0	0	65	15	0	80	0	0	0	94	24	0	118
Departure	0	0	0	146	17	0	163	0	0	0	39	24	0	63
Total	0	0	0	211	32	0	243	0	0	0	133	48	0	181
West Leg														
Approach	0	0	0	76	13	0	89	0	0	0	20	17	0	37
Departure	0	0	0	34	11	0	45	0	0	0	49	17	0	66
Total	0	0	0	110	24	0	134	0	0	0	69	34	0	103
Total Approaches														
Approach	0	0	0	211	32	0	243	0	0	0	133	48	0	181
Departure	0	0	0	211	32	0	243	0	0	0	133	48	0	181
Total	0	0	0	422	64	0	486	0	0	0	266	96	0	362

Table C-2 - Phase III Project Completion Year (2049) [Project Build-out] Peak Hour Volume Summary

	AM Peak Hour							PM Peak Hour						
	Ph III 2049		Ph III 2049 without Project	External Project Trips	Internal Project Trips	Pass-By Trips	Ph III 2049 with Project	Ph III 2049		Ph III 2049 without Project	External Project Trips	Internal Project Trips	Pass-By Trips	Ph III 2049 with Project
	w/o Proj	Cumul Project						w/o Proj	Cumul Project					
55 Road 23/Project Driveway 3														
NBL	0	0	0	13	80	0	93	0	0	0	36	192	0	228
NBT	300	0	300	917	91	0	1,308	306	0	306	742	207	0	1,255
NBR	0	0	0	0	0	0	0	0	0	0	0	0	0	0
SBL	0	0	0	0	0	0	0	0	0	0	0	0	0	0
SBT	325	0	325	383	90	0	798	385	0	385	1,098	204	0	1,687
SBR	0	0	0	327	6	0	333	0	0	0	620	11	0	631
EBL	0	0	0	800	6	0	806	0	0	0	283	11	0	294
EBT	0	0	0	0	0	0	0	0	0	0	0	0	0	0
EBR	0	0	0	42	80	0	122	2	0	2	17	192	0	211
WBL	0	0	0	0	0	0	0	0	0	0	0	0	0	0
WBT	0	0	0	0	0	0	0	0	0	0	0	0	0	0
WBR	0	0	0	0	0	0	0	0	0	0	0	0	0	0
North Leg														
Approach	325	0	325	710	96	0	1,131	385	0	385	1,718	215	0	2,318
Departure	300	0	300	1,717	97	0	2,114	306	0	306	1,025	218	0	1,549
Total	625	0	625	2,427	193	0	3,245	691	0	691	2,743	433	0	3,867
South Leg														
Approach	300	0	300	930	171	0	1,401	306	0	306	778	399	0	1,483
Departure	325	0	325	425	170	0	920	387	0	387	1,115	396	0	1,898
Total	625	0	625	1,355	341	0	2,321	693	0	693	1,893	795	0	3,381
East Leg														
Approach	0	0	0	0	0	0	0	0	0	0	0	0	0	0
Departure	0	0	0	0	0	0	0	0	0	0	0	0	0	0
Total	0	0	0	0	0	0	0	0	0	0	0	0	0	0
West Leg														
Approach	0	0	0	842	86	0	928	2	0	2	300	203	0	505
Departure	0	0	0	340	86	0	426	0	0	0	656	203	0	859
Total	0	0	0	1,182	172	0	1,354	2	0	2	956	406	0	1,364
Total Approaches														
Approach	625	0	625	2,482	353	0	3,460	693	0	693	2,796	817	0	4,306
Departure	625	0	625	2,482	353	0	3,460	693	0	693	2,796	817	0	4,306
Total	1,250	0	1,250	4,964	706	0	6,920	1,386	0	1,386	5,592	1,634	0	8,612

Table C-2 - Phase III Project Completion Year (2049) [Project Build-out] Peak Hour Volume Summary

	AM Peak Hour							PM Peak Hour						
	Ph III 2049		Ph III 2049 without Project	External Project Trips	Internal Project Trips	Pass-By Trips	Ph III 2049 with Project	Ph III 2049		Ph III 2049 without Project	External Project Trips	Internal Project Trips	Pass-By Trips	Ph III 2049 with Project
	w/o Proj	Cumul Project						w/o Proj	Cumul Project					
56 Road 23/Project Driveway 4														
NBL	0	0	0	0	0	0	0	0	0	0	0	0	0	0
NBT	279	0	279	422	8	0	709	332	0	332	1,010	9	-19	1,332
NBR	0	0	0	110	27	0	137	0	0	0	282	40	19	341
SBL	0	0	0	132	288	0	420	0	0	0	278	675	24	977
SBT	219	0	219	951	7	0	1,177	372	0	372	655	9	-22	1,014
SBR	0	0	0	0	0	0	0	0	0	0	0	0	0	0
EBL	0	0	0	0	0	0	0	0	0	0	0	0	0	0
EBT	0	0	0	0	0	0	0	0	0	0	0	0	0	0
EBR	0	0	0	0	0	0	0	0	0	0	0	0	0	0
WBL	0	0	0	80	26	0	106	0	0	0	303	40	27	370
WBT	0	0	0	0	0	0	0	0	0	0	0	0	0	0
WBR	0	0	0	263	274	0	537	0	0	0	190	677	23	890
North Leg														
Approach	219	0	219	1,083	295	0	1,597	372	0	372	933	684	2	1,991
Departure	279	0	279	685	282	0	1,246	332	0	332	1,200	686	4	2,222
Total	499	0	499	1,768	577	0	2,844	704	0	704	2,133	1,370	6	4,213
South Leg														
Approach	279	0	279	532	35	0	846	332	0	332	1,292	49	0	1,673
Departure	219	0	219	1,031	33	0	1,283	372	0	372	958	49	5	1,384
Total	499	0	499	1,563	68	0	2,130	704	0	704	2,250	98	5	3,057
East Leg														
Approach	0	0	0	343	300	0	643	0	0	0	493	717	50	1,260
Departure	0	0	0	242	315	0	557	0	0	0	560	715	43	1,318
Total	0	0	0	585	615	0	1,200	0	0	0	1,053	1,432	93	2,578
West Leg														
Approach	0	0	0	0	0	0	0	0	0	0	0	0	0	0
Departure	0	0	0	0	0	0	0	0	0	0	0	0	0	0
Total	0	0	0	0	0	0	0	0	0	0	0	0	0	0
Total Approaches														
Approach	499	0	499	1,958	630	0	3,087	704	0	704	2,718	1,450	52	4,924
Departure	499	0	499	1,958	630	0	3,087	704	0	704	2,718	1,450	52	4,924
Total	998	0	998	3,916	1,260	0	6,174	1,408	0	1,408	5,436	2,900	104	9,848

Table C-2 - Phase III Project Completion Year (2049) [Project Build-out] Peak Hour Volume Summary

	AM Peak Hour							PM Peak Hour						
	Ph III 2049		Ph III 2049 without Project	External Project Trips	Internal Project Trips	Pass-By Trips	Ph III 2049 with Project	Ph III 2049		Ph III 2049 without Project	External Project Trips	Internal Project Trips	Pass-By Trips	Ph III 2049 with Project
	w/o Proj	Cumulative Project						w/o Proj	Cumulative Project					
57 Road 23/Project Driveway 5														
NBL	1	0	1	65	0	0	66	0	0	0	94	0	0	94
NBT	279	0	279	456	0	0	735	279	0	279	1,272	0	0	1,551
NBR	0	0	0	0	0	0	0	0	0	0	0	0	0	0
SBL	0	0	0	0	0	0	0	0	0	0	0	0	0	0
SBT	979	0	979	996	0	0	1,975	347	0	347	909	0	0	1,256
SBR	0	0	0	34	39	0	73	36	0	36	49	51	0	136
EBL	0	0	0	76	41	0	117	60	0	60	20	51	0	131
EBT	0	0	0	0	0	0	0	0	0	0	0	0	0	0
EBR	1	0	1	146	0	0	147	23	0	23	39	0	0	62
WBL	0	0	0	0	0	0	0	0	0	0	0	0	0	0
WBT	0	0	0	0	0	0	0	0	0	0	0	0	0	0
WBR	0	0	0	0	0	0	0	0	0	0	0	0	0	0
North Leg														
Approach	979	0	979	1,030	39	0	2,048	383	0	383	958	51	0	1,392
Departure	279	0	279	532	41	0	852	339	0	339	1,292	51	0	1,682
Total	1,258	0	1,258	1,562	80	0	2,900	722	0	722	2,250	102	0	3,074
South Leg														
Approach	280	0	280	521	0	0	801	279	0	279	1,366	0	0	1,645
Departure	980	0	980	1,142	0	0	2,122	370	0	370	948	0	0	1,318
Total	1,260	0	1,260	1,663	0	0	2,923	649	0	649	2,314	0	0	2,963
East Leg														
Approach	0	0	0	0	0	0	0	0	0	0	0	0	0	0
Departure	0	0	0	0	0	0	0	0	0	0	0	0	0	0
Total	0	0	0	0	0	0	0	0	0	0	0	0	0	0
West Leg														
Approach	1	0	1	222	41	0	264	83	0	83	59	51	0	193
Departure	1	0	1	99	39	0	139	36	0	36	143	51	0	230
Total	2	0	2	321	80	0	403	119	0	119	202	102	0	423
Total Approaches														
Approach	1,260	0	1,260	1,773	80	0	3,113	745	0	745	2,383	102	0	3,230
Departure	1,260	0	1,260	1,773	80	0	3,113	745	0	745	2,383	102	0	3,230
Total	2,521	0	2,521	3,546	160	0	6,227	1,489	0	1,489	4,766	204	0	6,459

Table C-2 - Phase III Project Completion Year (2049) [Project Build-out] Peak Hour Volume Summary

	AM Peak Hour							PM Peak Hour						
	Ph III 2049		Ph III 2049	External	Internal	Pass-By	Ph III 2049	Ph III 2049		Ph III 2049	External	Internal	Pass-By	Ph III 2049
	w/o Proj	Cumul Project	without Project	Project Trips	Project Trips	Trips	with Project	w/o Proj	Cumul Project	without Project	Project Trips	Project Trips	Trips	with Project
58 Project Driveway 6/Cleveland Avenue														
NBL	0	0	0	194	1	0	195	0	0	0	63	2	0	65
NBT	0	0	0	0	0	0	0	0	0	0	0	0	0	0
NBR	0	0	0	292	0	0	292	0	0	0	236	0	7	243
SBL	0	0	0	0	0	0	0	0	0	0	0	0	0	0
SBT	0	0	0	0	0	0	0	0	0	0	0	0	0	0
SBR	0	0	0	0	0	0	0	0	0	0	0	0	0	0
EBL	0	0	0	0	0	0	0	0	0	0	0	0	0	0
EBT	66	0	66	1,047	13	0	1,126	157	0	157	702	18	-7	870
EBR	0	0	0	75	2	0	77	0	0	0	143	2	0	145
WBL	0	0	0	154	0	0	154	0	0	0	329	0	3	332
WBT	88	0	88	367	12	0	467	79	0	79	1,160	18	-3	1,254
WBR	0	0	0	0	0	0	0	0	0	0	0	0	0	0
North Leg														
Approach	0	0	0	0	0	0	0	0	0	0	0	0	0	0
Departure	0	0	0	0	0	0	0	0	0	0	0	0	0	0
Total	0	0	0	0	0	0	0	0	0	0	0	0	0	0
South Leg														
Approach	0	0	0	486	1	0	487	0	0	0	299	2	7	308
Departure	0	0	0	229	2	0	231	0	0	0	472	2	3	477
Total	0	0	0	715	3	0	718	0	0	0	771	4	10	785
East Leg														
Approach	88	0	88	521	12	0	621	79	0	79	1,489	18	0	1,586
Departure	66	0	66	1,339	13	0	1,418	157	0	157	938	18	0	1,113
Total	154	0	154	1,860	25	0	2,039	236	0	236	2,427	36	0	2,699
West Leg														
Approach	66	0	66	1,122	15	0	1,203	157	0	157	845	20	-7	1,015
Departure	88	0	88	561	13	0	662	79	0	79	1,223	20	-3	1,319
Total	154	0	154	1,683	28	0	1,865	236	0	236	2,068	40	-10	2,334
Total Approaches														
Approach	154	0	154	2,129	28	0	2,311	236	0	236	2,633	40	0	2,909
Departure	154	0	154	2,129	28	0	2,311	236	0	236	2,633	40	0	2,909
Total	309	0	309	4,258	56	0	4,623	472	0	472	5,266	80	0	5,818

Table C-3 - Phase I Project Completion Year (2029) Volume Summary

	AM Peak Hour										
	Existing	Ph III 2049 without Project	Total Growth (2019-2049)	Adjusted Growth	Cumulative Projects	Year 2029 without Project	External Project Trips	Internal Project Trips	Pass-by Trips	Phase I Project Trips	Year 2029 with Project
1 Road 22/Avenue 17											
NBL	1	3	2	1	0	2	0	0	0	0	2
NBT	0	0	0	0	0	0	0	0	0	0	0
NBR	2	6	4	1	0	3	0	0	0	0	3
SBL	0	0	0	0	0	0	0	0	0	0	0
SBT	0	0	0	0	0	0	0	0	0	0	0
SBR	0	0	0	0	0	0	0	0	0	0	0
EBL	0	0	0	0	0	0	0	0	0	0	0
EBT	29	38	9	3	0	32	11	0	0	11	43
EBR	0	0	0	0	0	0	0	0	0	0	0
WBL	2	2	0	0	0	2	0	0	0	0	2
WBT	25	30	5	2	0	27	34	0	0	34	61
WBR	0	0	0	0	0	0	0	0	0	0	0
North Leg											
Approach	0	0	0	0	0	0	0	0	0	0	0
Departure	0	0	0	0	0	0	0	0	0	0	0
Total	0	0	0	0	0	0	0	0	0	0	0
South Leg											
Approach	3	9	6	2	0	5	0	0	0	0	5
Departure	2	2	0	0	0	2	0	0	0	0	2
Total	5	11	6	2	0	7	0	0	0	0	7
East Leg											
Approach	27	32	5	2	0	29	34	0	0	34	63
Departure	31	44	13	4	0	35	11	0	0	11	46
Total	58	76	18	6	0	64	45	0	0	45	109
West Leg											
Approach	29	38	9	3	0	32	11	0	0	11	43
Departure	26	33	7	2	0	28	34	0	0	34	62
Total	55	71	16	5	0	60	45	0	0	45	105
Total Approaches											
Approach	59	79	20	7	0	66	45	0	0	45	111
Departure	59	79	20	7	0	66	45	0	0	45	111
Total	118	158	40	13	0	131	90	0	0	90	221

Table C-3 - Phase I Project Completion Year (2029) Volume Summary

	AM Peak Hour										
	Existing	Ph III 2049 without Project	Total Growth (2019-2049)	Adjusted Growth	Cumulative Projects	Year 2029 without Project	External Project Trips	Internal Project Trips	Pass-by Trips	Phase I Project Trips	Year 2029 with Project
2 Road 22/Avenue 16											
NBL	0	0	0	0	0	0	0	0	0	0	0
NBT	0	0	0	0	0	0	0	0	0	0	0
NBR	0	0	0	0	0	0	0	0	0	0	0
SBL	2	2	0	0	0	2	0	0	0	0	2
SBT	0	0	0	0	0	0	0	0	0	0	0
SBR	1	1	0	0	0	1	0	0	0	0	1
EBL	2	2	0	0	0	2	0	0	0	0	2
EBT	12	13	1	0	0	12	0	0	0	0	12
EBR	0	0	0	0	0	0	0	0	0	0	0
WBL	0	0	0	0	0	0	0	0	0	0	0
WBT	29	30	1	0	0	29	0	0	0	0	29
WBR	4	5	1	0	0	4	0	0	0	0	4
North Leg											
Approach	3	3	0	0	0	3	0	0	0	0	3
Departure	6	7	1	0	0	6	0	0	0	0	6
Total	9	10	1	0	0	9	0	0	0	0	9
South Leg											
Approach	0	0	0	0	0	0	0	0	0	0	0
Departure	0	0	0	0	0	0	0	0	0	0	0
Total	0	0	0	0	0	0	0	0	0	0	0
East Leg											
Approach	33	35	2	1	0	34	0	0	0	0	34
Departure	14	15	1	0	0	14	0	0	0	0	14
Total	47	50	3	1	0	48	0	0	0	0	48
West Leg											
Approach	14	15	1	0	0	14	0	0	0	0	14
Departure	30	32	2	1	0	31	0	0	0	0	31
Total	44	46	2	1	0	45	0	0	0	0	45
Total Approaches											
Approach	50	53	3	1	0	51	0	0	0	0	51
Departure	50	53	3	1	0	51	0	0	0	0	51
Total	100	107	7	2	0	102	0	0	0	0	102

Table C-3 - Phase I Project Completion Year (2029) Volume Summary

	AM Peak Hour										
	Existing	Ph III 2049 without Project	Total Growth (2019-2049)	Adjusted Growth	Cumulative Projects	Year 2029 without Project	External Project Trips	Internal Project Trips	Pass-by Trips	Phase I Project Trips	Year 2029 with Project
3 Golden State Boulevard/Avenue 18 ½											
NBL	0	0	0	0	0	0	0	0	0	0	0
NBT	0	0	0	0	0	0	0	0	0	0	0
NBR	0	0	0	0	0	0	0	0	0	0	0
SBL	92	98	6	2	0	94	0	0	0	0	94
SBT	0	0	0	0	0	0	0	0	0	0	0
SBR	4	4	0	0	0	4	0	0	0	0	4
EBL	2	2	0	0	0	2	0	0	0	0	2
EBT	98	114	16	5	0	103	6	0	0	6	109
EBR	0	0	0	0	0	0	0	0	0	0	0
WBL	0	0	0	0	0	0	0	0	0	0	0
WBT	96	105	9	3	0	99	15	0	0	15	114
WBR	106	111	5	2	0	108	0	0	0	0	108
North Leg											
Approach	96	102	6	2	0	98	0	0	0	0	98
Departure	108	113	5	2	0	110	0	0	0	0	110
Total	204	215	11	4	0	208	0	0	0	0	208
South Leg											
Approach	0	0	0	0	0	0	0	0	0	0	0
Departure	0	0	0	0	0	0	0	0	0	0	0
Total	0	0	0	0	0	0	0	0	0	0	0
East Leg											
Approach	202	216	14	5	0	207	15	0	0	15	222
Departure	190	212	22	7	0	197	6	0	0	6	203
Total	392	428	36	12	0	404	21	0	0	21	425
West Leg											
Approach	100	116	16	5	0	105	6	0	0	6	111
Departure	100	109	9	3	0	103	15	0	0	15	118
Total	200	225	25	8	0	208	21	0	0	21	229
Total Approaches											
Approach	398	434	36	12	0	410	21	0	0	21	431
Departure	398	434	36	12	0	410	21	0	0	21	431
Total	796	869	73	24	0	820	42	0	0	42	862

Table C-3 - Phase I Project Completion Year (2029) Volume Summary

	AM Peak Hour										
	Existing	Ph III 2049 without Project	Total Growth (2019-2049)	Adjusted Growth	Cumulative Projects	Year 2029 without Project	External Project Trips	Internal Project Trips	Pass-by Trips	Phase I Project Trips	Year 2029 with Project
4 Pistachio Drive/Avenue 18 ½											
NBL	0	0	0	0	0	0	0	0	0	0	0
NBT	0	0	0	0	0	0	0	0	0	0	0
NBR	1	1	0	0	0	1	0	0	0	0	1
SBL	104	110	6	2	0	106	0	0	0	0	106
SBT	0	0	0	0	0	0	0	0	0	0	0
SBR	9	9	0	0	0	9	0	0	0	0	9
EBL	8	8	0	0	0	8	0	0	0	0	8
EBT	250	267	17	6	0	256	6	0	0	6	262
EBR	1	1	0	0	0	1	0	0	0	0	1
WBL	3	3	0	0	0	3	0	0	0	0	3
WBT	212	221	9	3	0	215	15	0	0	15	230
WBR	201	206	5	2	0	203	0	0	0	0	203
North Leg											
Approach	113	119	6	2	0	115	0	0	0	0	115
Departure	209	214	5	2	0	211	0	0	0	0	211
Total	322	334	12	4	0	326	0	0	0	0	326
South Leg											
Approach	1	1	0	0	0	1	0	0	0	0	1
Departure	4	4	0	0	0	4	0	0	0	0	4
Total	5	5	0	0	0	5	0	0	0	0	5
East Leg											
Approach	416	430	14	5	0	421	15	0	0	15	436
Departure	355	378	23	8	0	363	6	0	0	6	369
Total	771	808	37	12	0	783	21	0	0	21	804
West Leg											
Approach	259	276	17	6	0	265	6	0	0	6	271
Departure	221	230	9	3	0	224	15	0	0	15	239
Total	480	507	27	9	0	489	21	0	0	21	510
Total Approaches											
Approach	789	827	38	13	0	802	21	0	0	21	823
Departure	789	827	38	13	0	802	21	0	0	21	823
Total	1,578	1,654	76	25	0	1,603	42	0	0	42	1,645

Table C-3 - Phase I Project Completion Year (2029) Volume Summary

	AM Peak Hour										
	Existing	Ph III 2049 without Project	Total Growth (2019-2049)	Adjusted Growth	Cumulative Projects	Year 2029 without Project	External Project Trips	Internal Project Trips	Pass-by Trips	Phase I Project Trips	Year 2029 with Project
5 SR-99 Southbound Ramps – Road 23/Avenue 18 ½											
NBL	60	63	3	1	0	61	15	0	0	15	76
NBT	0	0	0	0	0	0	0	0	0	0	0
NBR	143	159	16	5	0	148	191	0	0	191	339
SBL	10	12	2	1	0	11	0	0	0	0	11
SBT	47	57	10	3	0	50	66	0	0	66	116
SBR	85	86	1	0	0	85	0	0	0	0	85
EBL	0	0	0	0	0	0	0	0	0	0	0
EBT	305	323	18	6	0	311	0	0	0	0	311
EBR	50	55	5	2	0	52	6	0	0	6	58
WBL	40	50	10	3	0	43	0	0	0	0	43
WBT	271	286	15	5	0	276	0	0	0	0	276
WBR	0	0	0	0	0	0	0	0	0	0	0
North Leg											
Approach	142	155	13	4	0	146	66	0	0	66	212
Departure	0	0	0	0	0	0	0	0	0	0	0
Total	142	155	13	4	0	146	66	0	0	66	212
South Leg											
Approach	203	222	19	6	0	209	206	0	0	206	415
Departure	137	162	25	8	0	145	72	0	0	72	217
Total	340	384	44	15	0	355	278	0	0	278	633
East Leg											
Approach	311	336	25	8	0	319	0	0	0	0	319
Departure	458	494	36	12	0	470	191	0	0	191	661
Total	769	830	61	20	0	789	191	0	0	191	980
West Leg											
Approach	355	378	23	8	0	363	6	0	0	6	369
Departure	416	435	19	6	0	422	15	0	0	15	437
Total	771	813	42	14	0	785	21	0	0	21	806
Total Approaches											
Approach	1,011	1,091	80	27	0	1,038	278	0	0	278	1,316
Departure	1,011	1,091	80	27	0	1,038	278	0	0	278	1,316
Total	2,022	2,182	160	53	0	2,075	556	0	0	556	2,631

Table C-3 - Phase I Project Completion Year (2029) Volume Summary

		AM Peak Hour										
		Ph III 2049	Total Growth	Adjusted	Cumulative	Year 2029	External	Internal	Pass-by	Phase I	Year 2029	
		Existing	without Project	Growth (2019-2049)	Growth	Projects	without Project	Project Trips	Project Trips	Trips	Project Trips	with Project
6 SR-99 Northbound Ramps/Avenue 18 ½												
NBL	213	216	3	1	0	214	0	0	0	0	214	
NBT	1	1	0	0	0	1	0	0	0	0	1	
NBR	18	28	10	3	0	21	0	0	0	0	21	
SBL	0	0	0	0	0	0	0	0	0	0	0	
SBT	0	0	0	0	0	0	0	0	0	0	0	
SBR	0	0	0	0	0	0	0	0	0	0	0	
EBL	216	227	11	4	0	220	191	0	0	191	411	
EBT	54	64	10	3	0	57	0	0	0	0	57	
EBR	0	0	0	0	0	0	0	0	0	0	0	
WBL	0	0	0	0	0	0	0	0	0	0	0	
WBT	134	158	24	8	0	142	0	0	0	0	142	
WBR	22	36	14	5	0	27	0	0	0	0	27	
North Leg												
Approach	0	0	0	0	0	0	0	0	0	0	0	
Departure	239	264	25	8	0	247	191	0	0	191	438	
Total	239	264	25	8	0	247	191	0	0	191	438	
South Leg												
Approach	232	245	13	4	0	236	0	0	0	0	236	
Departure	0	0	0	0	0	0	0	0	0	0	0	
Total	232	245	13	4	0	236	0	0	0	0	236	
East Leg												
Approach	156	194	38	13	0	169	0	0	0	0	169	
Departure	72	92	20	7	0	79	0	0	0	0	79	
Total	228	286	58	19	0	247	0	0	0	0	247	
West Leg												
Approach	270	291	21	7	0	277	191	0	0	191	468	
Departure	347	374	27	9	0	356	0	0	0	0	356	
Total	617	665	48	16	0	633	191	0	0	191	824	
Total Approaches												
Approach	658	730	72	24	0	682	191	0	0	191	873	
Departure	658	730	72	24	0	682	191	0	0	191	873	
Total	1,316	1,460	144	48	0	1,364	382	0	0	382	1,746	

Table C-3 - Phase I Project Completion Year (2029) Volume Summary

		AM Peak Hour									
Existing	Ph III 2049 without Project	Total Growth (2019-2049)	Adjusted Growth	Cumulative Projects	Year 2029 without Project	External Project Trips	Internal Project Trips	Pass-by Trips	Phase I Project Trips	Year 2029 with Project	
7 Road 23/Avenue 17											
NBL	8	9	1	0	0	8	34	0	0	34	42
NBT	158	166	8	3	0	161	274	0	0	274	435
NBR	47	49	2	1	0	48	72	0	0	72	120
SBL	15	16	1	0	0	15	0	0	0	0	15
SBT	103	108	5	2	0	105	95	0	0	95	200
SBR	0	0	0	0	0	0	0	0	0	0	0
EBL	1	3	2	1	0	2	0	0	0	0	2
EBT	22	36	14	5	0	27	0	0	0	0	27
EBR	8	8	0	0	0	8	11	0	0	11	19
WBL	53	56	3	1	0	54	31	0	0	31	85
WBT	19	23	4	1	0	20	0	0	0	0	20
WBR	3	3	0	0	0	3	0	0	0	0	3
North Leg											
Approach	118	124	6	2	0	120	95	0	0	95	215
Departure	162	172	10	3	0	165	274	0	0	274	439
Total	280	296	16	5	0	285	369	0	0	369	654
South Leg											
Approach	213	224	11	4	0	217	380	0	0	380	597
Departure	164	172	8	3	0	167	137	0	0	137	304
Total	377	396	19	6	0	383	517	0	0	517	900
East Leg											
Approach	75	82	7	2	0	77	31	0	0	31	108
Departure	84	101	17	6	0	90	72	0	0	72	162
Total	159	183	24	8	0	167	103	0	0	103	270
West Leg											
Approach	31	47	16	5	0	36	11	0	0	11	47
Departure	27	32	5	2	0	29	34	0	0	34	63
Total	58	79	21	7	0	65	45	0	0	45	110
Total Approaches											
Approach	437	477	40	13	0	450	517	0	0	517	967
Departure	437	477	40	13	0	450	517	0	0	517	967
Total	874	955	81	27	0	901	1,034	0	0	1,034	1,935

Table C-3 - Phase I Project Completion Year (2029) Volume Summary

		AM Peak Hour									
Existing	Ph III 2049 without Project	Total Growth (2019-2049)	Adjusted Growth	Cumulative Projects	Year 2029 without Project	External Project Trips	Internal Project Trips	Pass-by Trips	Phase I Project Trips	Year 2029 with Project	
8 Road 23/Avenue 16											
NBL	20	37	17	6	0	26	0	0	0	26	
NBT	210	288	78	26	0	236	185	0	0	421	
NBR	0	0	0	0	0	0	23	0	0	23	
SBL	0	0	0	0	0	0	33	0	0	33	
SBT	152	325	173	58	0	210	101	0	0	311	
SBR	9	11	2	1	0	10	0	0	0	10	
EBL	6	12	6	2	0	8	0	0	0	8	
EBT	1	30	29	10	0	11	0	0	0	11	
EBR	7	32	25	8	0	15	0	0	0	15	
WBL	0	0	0	0	0	0	137	0	0	137	
WBT	4	4	0	0	0	4	0	0	0	4	
WBR	0	0	0	0	0	0	198	0	0	198	
North Leg											
Approach	161	336	175	58	0	219	134	0	0	353	
Departure	216	300	84	28	0	244	383	0	0	627	
Total	377	636	259	86	0	463	517	0	0	980	
South Leg											
Approach	230	325	95	32	0	262	208	0	0	470	
Departure	159	357	198	66	0	225	238	0	0	463	
Total	389	682	293	98	0	487	446	0	0	933	
East Leg											
Approach	4	4	0	0	0	4	335	0	0	339	
Departure	1	30	29	10	0	11	56	0	0	67	
Total	5	34	29	10	0	15	391	0	0	406	
West Leg											
Approach	14	74	60	20	0	34	0	0	0	34	
Departure	33	52	19	6	0	39	0	0	0	39	
Total	47	126	79	26	0	73	0	0	0	73	
Total Approaches											
Approach	409	739	330	110	0	519	677	0	0	1,196	
Departure	409	739	330	110	0	519	677	0	0	1,196	
Total	818	1,478	660	220	0	1,038	1,354	0	0	2,392	

Table C-3 - Phase I Project Completion Year (2029) Volume Summary

		AM Peak Hour									
		Ph III 2049	Total Growth	Adjusted	Cumulative	Year 2029	External	Internal	Pass-by	Phase I	Year 2029
Existing		without	(2019-2049)	Growth	Projects	without	Project	Project	Trips	Project	with
		Project				Project	Trips	Trips	Trips	Trips	Project
9 Road 23/Cleveland Avenue											
NBL	0	0	0	0	0	0	0	0	0	0	0
NBT	199	297	98	33	0	232	73	0	0	73	305
NBR	50	68	18	6	0	56	239	0	0	239	295
SBL	13	86	73	24	0	37	159	0	0	159	196
SBT	148	253	105	35	0	183	79	0	0	79	262
SBR	0	0	0	0	0	0	0	0	0	0	0
EBL	0	0	0	0	0	0	0	0	0	0	0
EBT	0	0	0	0	0	0	0	0	0	0	0
EBR	0	0	0	0	0	0	0	0	0	0	0
WBL	52	74	22	7	0	59	244	0	0	244	303
WBT	0	0	0	0	0	0	0	0	0	0	0
WBR	32	192	160	53	0	85	135	0	0	135	220
North Leg											
Approach	161	339	178	59	0	220	238	0	0	238	458
Departure	231	489	258	86	0	317	208	0	0	208	525
Total	392	828	436	145	0	537	446	0	0	446	983
South Leg											
Approach	249	365	116	39	0	288	312	0	0	312	600
Departure	200	327	127	42	0	242	323	0	0	323	565
Total	449	692	243	81	0	530	635	0	0	635	1,165
East Leg											
Approach	84	266	182	61	0	145	379	0	0	379	524
Departure	63	154	91	30	0	93	398	0	0	398	491
Total	147	420	273	91	0	238	777	0	0	777	1,015
West Leg											
Approach	0	0	0	0	0	0	0	0	0	0	0
Departure	0	0	0	0	0	0	0	0	0	0	0
Total	0	0	0	0	0	0	0	0	0	0	0
Total Approaches											
Approach	494	970	476	159	0	653	929	0	0	929	1,582
Departure	494	970	476	159	0	653	929	0	0	929	1,582
Total	988	1,940	952	317	0	1,305	1,858	0	0	1,858	3,163

Table C-3 - Phase I Project Completion Year (2029) Volume Summary

		AM Peak Hour									
		Ph III 2049	Total Growth	Adjusted	Cumulative	Year 2029	External	Internal	Pass-by	Phase I	Year 2029
		Existing	without Project	Growth (2019-2049)	Growth	Projects	Project Trips	Project Trips	Trips	Project Trips	with Project
10 Road 23/Avenue 14 ½											
NBL	3	4	1	0	0	3	0	0	0	0	3
NBT	177	265	88	29	0	206	128	0	0	128	334
NBR	4	4	0	0	0	4	0	0	0	0	4
SBL	28	47	19	6	0	34	28	0	0	28	62
SBT	166	280	114	38	0	204	244	0	0	244	448
SBR	0	0	0	0	0	0	0	0	0	0	0
EBL	0	0	0	0	0	0	0	0	0	0	0
EBT	5	5	0	0	0	5	0	0	0	0	5
EBR	0	0	0	0	0	0	0	0	0	0	0
WBL	16	18	2	1	0	17	0	0	0	0	17
WBT	3	3	0	0	0	3	0	0	0	0	3
WBR	67	100	33	11	0	78	32	0	0	32	110
North Leg											
Approach	194	328	134	45	0	239	272	0	0	272	511
Departure	244	365	121	40	0	284	160	0	0	160	444
Total	438	693	255	85	0	523	432	0	0	432	955
South Leg											
Approach	184	273	89	30	0	214	128	0	0	128	342
Departure	182	298	116	39	0	221	244	0	0	244	465
Total	366	571	205	68	0	434	372	0	0	372	806
East Leg											
Approach	86	122	36	12	0	98	32	0	0	32	130
Departure	37	57	20	7	0	44	28	0	0	28	72
Total	123	178	55	18	0	141	60	0	0	60	201
West Leg											
Approach	5	5	0	0	0	5	0	0	0	0	5
Departure	6	7	1	0	0	6	0	0	0	0	6
Total	11	12	1	0	0	11	0	0	0	0	11
Total Approaches											
Approach	469	728	259	86	0	555	432	0	0	432	987
Departure	469	728	259	86	0	555	432	0	0	432	987
Total	938	1,455	517	172	0	1,110	864	0	0	864	1,974

Table C-3 - Phase I Project Completion Year (2029) Volume Summary

		AM Peak Hour								
Existing	Ph III 2049 without Project	Total Growth (2019-2049)	Adjusted Growth	Cumulative Projects	Year 2029 without Project	External Project Trips	Internal Project Trips	Pass-by Trips	Phase I Project Trips	Year 2029 with Project
11 Road 23/Avenue 14										
NBL	24	54	30	10	0	34	0	0	0	34
NBT	82	122	40	13	0	95	37	0	37	132
NBR	8	8	0	0	0	8	0	0	0	8
SBL	34	56	22	7	0	41	122	0	122	163
SBT	93	152	59	20	0	113	86	0	86	199
SBR	56	91	35	12	0	68	34	0	34	102
EBL	49	72	23	8	0	57	14	0	14	71
EBT	145	152	7	2	0	147	0	0	0	147
EBR	18	60	42	14	0	32	0	0	0	32
WBL	19	20	1	0	0	19	0	0	0	19
WBT	176	185	9	3	0	179	0	0	0	179
WBR	53	79	26	9	0	62	77	0	77	139
North Leg										
Approach	183	298	115	38	0	221	242	0	242	463
Departure	184	273	89	30	0	214	128	0	128	342
Total	367	571	204	68	0	435	370	0	370	805
South Leg										
Approach	114	185	71	24	0	138	37	0	37	175
Departure	130	232	102	34	0	164	86	0	86	250
Total	244	416	172	57	0	301	123	0	123	424
East Leg										
Approach	248	283	35	12	0	260	77	0	77	337
Departure	187	216	29	10	0	197	122	0	122	319
Total	435	500	65	22	0	457	199	0	199	656
West Leg										
Approach	212	285	73	24	0	236	14	0	14	250
Departure	256	330	74	25	0	281	34	0	34	315
Total	468	614	146	49	0	517	48	0	48	565
Total Approaches										
Approach	757	1,051	294	98	0	855	370	0	370	1,225
Departure	757	1,051	294	98	0	855	370	0	370	1,225
Total	1,514	2,102	588	196	0	1,710	740	0	740	2,450

Table C-3 - Phase I Project Completion Year (2029) Volume Summary

	AM Peak Hour										
	Existing	Ph III 2049 without Project	Total Growth (2019-2049)	Adjusted Growth	Cumulative Projects	Year 2029 without Project	External Project Trips	Internal Project Trips	Pass-by Trips	Phase I Project Trips	Year 2029 with Project
12 Road 23/Avenue 12											
NBL	8	8	0	0	0	8	0	0	0	0	8
NBT	32	34	2	1	0	33	8	0	0	8	41
NBR	16	17	1	0	0	16	0	0	0	0	16
SBL	32	34	2	1	0	33	34	0	0	34	67
SBT	47	49	2	1	0	48	18	0	0	18	66
SBR	28	45	17	6	0	34	34	0	0	34	68
EBL	18	19	1	0	0	18	14	0	0	14	32
EBT	82	85	3	1	0	83	0	0	0	0	83
EBR	4	4	0	0	0	4	0	0	0	0	4
WBL	11	12	1	0	0	11	0	0	0	0	11
WBT	73	113	40	13	0	86	0	0	0	0	86
WBR	37	39	2	1	0	38	14	0	0	14	52
North Leg											
Approach	107	128	21	7	0	114	86	0	0	86	200
Departure	87	91	4	1	0	88	36	0	0	36	124
Total	194	219	25	8	0	202	122	0	0	122	324
South Leg											
Approach	56	59	3	1	0	57	8	0	0	8	65
Departure	62	65	3	1	0	63	18	0	0	18	81
Total	118	124	6	2	0	120	26	0	0	26	146
East Leg											
Approach	121	163	42	14	0	135	14	0	0	14	149
Departure	130	135	5	2	0	132	34	0	0	34	166
Total	251	299	48	16	0	267	48	0	0	48	315
West Leg											
Approach	104	108	4	1	0	105	14	0	0	14	119
Departure	109	166	57	19	0	128	34	0	0	34	162
Total	213	275	62	21	0	234	48	0	0	48	282
Total Approaches											
Approach	388	458	70	23	0	411	122	0	0	122	533
Departure	388	458	70	23	0	411	122	0	0	122	533
Total	776	917	141	47	0	823	244	0	0	244	1,067

Table C-3 - Phase I Project Completion Year (2029) Volume Summary

		AM Peak Hour								
Existing	Ph III 2049 without Project	Total Growth (2019-2049)	Adjusted Growth	Cumulative Projects	Year 2029 without Project	External Project Trips	Internal Project Trips	Pass-by Trips	Phase I Project Trips	Year 2029 with Project
13 Golden State Boulevard – Airport Drive/Avenue 17										
NBL	17	18	1	0	0	17	0	0	0	17
NBT	25	114	89	30	0	55	0	0	0	55
NBR	64	173	109	36	7	107	0	0	0	107
SBL	88	211	123	41	5	134	0	0	0	134
SBT	19	54	35	12	0	31	0	0	0	31
SBR	4	4	0	0	0	4	0	0	0	4
EBL	4	5	1	0	0	4	0	0	0	4
EBT	54	57	3	1	28	83	46	0	46	129
EBR	19	20	1	0	0	19	0	0	0	19
WBL	127	298	171	57	4	188	0	0	0	188
WBT	55	58	3	1	22	78	22	0	22	100
WBR	85	283	198	66	3	154	0	0	0	154
North Leg										
Approach	111	269	158	53	5	169	0	0	0	169
Departure	114	402	288	96	3	213	0	0	0	213
Total	225	671	446	149	8	382	0	0	0	382
South Leg										
Approach	106	305	199	66	7	179	0	0	0	179
Departure	165	372	207	69	4	238	0	0	0	238
Total	271	677	406	135	11	417	0	0	0	417
East Leg										
Approach	267	639	372	124	29	420	22	0	22	442
Departure	206	441	235	78	40	324	46	0	46	370
Total	473	1,079	606	202	69	744	68	0	68	812
West Leg										
Approach	77	82	5	2	28	107	46	0	46	153
Departure	76	80	4	1	22	99	22	0	22	121
Total	153	161	8	3	50	206	68	0	68	274
Total Approaches										
Approach	561	1,294	733	244	69	874	68	0	68	942
Departure	561	1,294	733	244	69	874	68	0	68	942
Total	1,122	2,589	1,467	489	138	1,749	136	0	136	1,885

Table C-3 - Phase I Project Completion Year (2029) Volume Summary

	AM Peak Hour										
	Existing	Ph III 2049 without Project	Total Growth (2019-2049)	Adjusted Growth	Cumulative Projects	Year 2029 without Project	External Project Trips	Internal Project Trips	Pass-by Trips	Phase I Project Trips	Year 2029 with Project
14 SR-99 Southbound Ramps/Avenue 17											
NBL	0	0	0	0	0	0	0	0	0	0	0
NBT	0	0	0	0	0	0	0	0	0	0	0
NBR	0	0	0	0	0	0	0	0	0	0	0
SBL	59	129	70	23	169	251	0	0	0	0	251
SBT	0	0	0	0	0	0	0	0	0	0	0
SBR	42	141	99	33	0	75	0	0	0	0	75
EBL	0	0	0	0	0	0	0	0	0	0	0
EBT	209	441	232	77	41	327	46	0	0	46	373
EBR	0	0	0	0	0	0	0	0	0	0	0
WBL	0	0	0	0	0	0	0	0	0	0	0
WBT	230	497	267	89	29	348	22	0	0	22	370
WBR	0	0	0	0	0	0	0	0	0	0	0
North Leg											
Approach	101	270	169	56	169	326	0	0	0	0	326
Departure	0	0	0	0	0	0	0	0	0	0	0
Total	101	270	169	56	169	326	0	0	0	0	326
South Leg											
Approach	0	0	0	0	0	0	0	0	0	0	0
Departure	0	0	0	0	0	0	0	0	0	0	0
Total	0	0	0	0	0	0	0	0	0	0	0
East Leg											
Approach	230	497	267	89	29	348	22	0	0	22	370
Departure	268	570	302	101	210	579	46	0	0	46	625
Total	498	1,067	569	190	239	927	68	0	0	68	995
West Leg											
Approach	209	441	232	77	41	327	46	0	0	46	373
Departure	272	638	366	122	29	423	22	0	0	22	445
Total	481	1,079	598	199	70	750	68	0	0	68	818
Total Approaches											
Approach	540	1,208	668	223	239	1,002	68	0	0	68	1,070
Departure	540	1,208	668	223	239	1,002	68	0	0	68	1,070
Total	1,080	2,416	1,336	445	478	2,003	136	0	0	136	2,139

Table C-3 - Phase I Project Completion Year (2029) Volume Summary

		AM Peak Hour								
Existing	Ph III 2049 without Project	Total Growth (2019-2049)	Adjusted Growth	Cumulative Projects	Year 2029 without Project	External Project Trips	Internal Project Trips	Pass-by Trips	Phase I Project Trips	Year 2029 with Project
15 SR-99 Northbound Ramps/Avenue 17										
NBL	86	299	213	71	0	157	0	0	0	157
NBT	1	4	3	1	0	2	0	0	0	2
NBR	0	0	0	0	240	240	0	0	0	240
SBL	0	0	0	0	0	0	0	0	0	0
SBT	0	0	0	0	0	0	0	0	0	0
SBR	0	0	0	0	0	0	0	0	0	0
EBL	52	145	93	31	0	83	0	0	0	83
EBT	135	253	118	39	210	384	46	0	46	430
EBR	0	0	0	0	0	0	0	0	0	0
WBL	0	0	0	0	0	0	0	0	0	0
WBT	642	716	74	25	219	886	22	0	22	908
WBR	100	125	25	8	128	236	0	0	0	236
North Leg										
Approach	0	0	0	0	0	0	0	0	0	0
Departure	153	274	121	40	128	321	0	0	0	321
Total	153	274	121	40	128	321	0	0	0	321
South Leg										
Approach	87	303	216	72	240	399	0	0	0	399
Departure	0	0	0	0	0	0	0	0	0	0
Total	87	303	216	72	240	399	0	0	0	399
East Leg										
Approach	742	841	99	33	347	1,122	22	0	22	1,144
Departure	135	253	118	39	450	624	46	0	46	670
Total	877	1,094	217	72	797	1,746	68	0	68	1,814
West Leg										
Approach	187	398	211	70	210	467	46	0	46	513
Departure	728	1,015	287	96	219	1,043	22	0	22	1,065
Total	915	1,413	498	166	429	1,510	68	0	68	1,578
Total Approaches										
Approach	1,016	1,542	526	175	797	1,988	68	0	68	2,056
Departure	1,016	1,542	526	175	797	1,988	68	0	68	2,056
Total	2,032	3,084	1,052	351	1,594	3,977	136	0	136	4,113

Table C-3 - Phase I Project Completion Year (2029) Volume Summary

		AM Peak Hour									
	Existing	Ph III 2049 without Project	Total Growth (2019-2049)	Adjusted Growth	Cumulative Projects	Year 2029 without Project	External Project Trips	Internal Project Trips	Pass-by Trips	Phase I Project Trips	Year 2029 with Project
16 Love's Truck Stop Driveway/Avenue 17											
NBL	0	0	0	0	136	136	0	0	0	0	136
NBT	0	0	0	0	0	0	0	0	0	0	0
NBR	0	0	0	0	22	22	0	0	0	0	22
SBL	0	0	0	0	48	48	0	0	0	0	48
SBT	0	0	0	0	0	0	0	0	0	0	0
SBR	0	0	0	0	90	90	0	0	0	0	90
EBL	0	0	0	0	162	162	0	0	0	0	162
EBT	135	241	106	35	156	326	46	0	0	46	372
EBR	0	0	0	0	132	132	0	0	0	0	132
WBL	0	0	0	0	45	45	0	0	0	0	45
WBT	742	805	63	21	73	836	22	0	0	22	858
WBR	0	0	0	0	56	56	0	0	0	0	56
North Leg											
Approach	0	0	0	0	138	138	0	0	0	0	138
Departure	0	0	0	0	218	218	0	0	0	0	218
Total	0	0	0	0	356	356	0	0	0	0	356
South Leg											
Approach	0	0	0	0	158	158	0	0	0	0	158
Departure	0	0	0	0	177	177	0	0	0	0	177
Total	0	0	0	0	335	335	0	0	0	0	335
East Leg											
Approach	742	805	63	21	174	937	22	0	0	22	959
Departure	135	241	106	35	226	396	46	0	0	46	442
Total	877	1,046	169	56	400	1,333	68	0	0	68	1,401
West Leg											
Approach	135	241	106	35	450	620	46	0	0	46	666
Departure	742	805	63	21	299	1,062	22	0	0	22	1,084
Total	877	1,046	169	56	749	1,682	68	0	0	68	1,750
Total Approaches											
Approach	877	1,046	169	56	920	1,853	68	0	0	68	1,921
Departure	877	1,046	169	56	920	1,853	68	0	0	68	1,921
Total	1,754	2,092	338	113	1,840	3,707	136	0	0	136	3,843

Table C-3 - Phase I Project Completion Year (2029) Volume Summary

		AM Peak Hour									
Existing	Ph III 2049 without Project	Total Growth (2019-2049)	Adjusted Growth	Cumulative Projects	Year 2029 without Project	External Project Trips	Internal Project Trips	Pass-by Trips	Phase I Project Trips	Year 2029 with Project	
17 Westberry Boulevard/Cleveland Avenue											
NBL	13	50	37	12	0	25	13	0	0	13	38
NBT	34	239	205	68	0	102	0	0	0	0	102
NBR	57	181	124	41	0	98	0	0	0	0	98
SBL	14	15	1	0	0	14	0	0	0	0	14
SBT	19	80	61	20	0	39	0	0	0	0	39
SBR	21	22	1	0	0	21	85	0	0	85	106
EBL	12	21	9	3	0	15	239	0	0	239	254
EBT	45	47	2	1	0	46	755	0	0	755	801
EBR	6	33	27	9	0	15	49	0	0	49	64
WBL	20	41	21	7	0	27	0	0	0	0	27
WBT	50	53	3	1	0	51	245	0	0	245	296
WBR	12	13	1	0	0	12	0	0	0	0	12
North Leg											
Approach	54	117	63	21	0	75	85	0	0	85	160
Departure	58	273	215	72	0	130	239	0	0	239	369
Total	112	389	277	92	0	204	324	0	0	324	528
South Leg											
Approach	104	470	366	122	0	226	13	0	0	13	239
Departure	45	154	109	36	0	81	49	0	0	49	130
Total	149	624	475	158	0	307	62	0	0	62	369
East Leg											
Approach	82	106	24	8	0	90	245	0	0	245	335
Departure	116	243	127	42	0	158	755	0	0	755	913
Total	198	349	151	50	0	248	1,000	0	0	1,000	1,248
West Leg											
Approach	63	101	38	13	0	76	1,043	0	0	1,043	1,119
Departure	84	125	41	14	0	98	343	0	0	343	441
Total	147	226	79	26	0	173	1,386	0	0	1,386	1,559
Total Approaches											
Approach	303	794	491	164	0	467	1,386	0	0	1,386	1,853
Departure	303	794	491	164	0	467	1,386	0	0	1,386	1,853
Total	606	1,588	982	327	0	933	2,772	0	0	2,772	3,705

Table C-3 - Phase I Project Completion Year (2029) Volume Summary

		AM Peak Hour									
Existing	Ph III 2049 without Project	Total Growth (2019-2049)	Adjusted Growth	Cumulative Projects	Year 2029 without Project	External Project Trips	Internal Project Trips	Pass-by Trips	Phase I Project Trips	Year 2029 with Project	
18 Westberry Boulevard/Sunset Avenue											
NBL	114	119	5	2	0	116	3	0	0	3	119
NBT	102	211	109	36	0	138	0	0	0	0	138
NBR	101	124	23	8	0	109	0	0	0	0	109
SBL	110	132	22	7	0	117	0	0	0	0	117
SBT	81	147	66	22	0	103	0	0	0	0	103
SBR	30	31	1	0	0	30	3	0	0	3	33
EBL	46	59	13	4	0	50	0	0	0	0	50
EBT	213	224	11	4	0	217	0	0	0	0	217
EBR	84	97	13	4	0	88	0	0	0	0	88
WBL	47	60	13	4	0	51	0	0	0	0	51
WBT	159	167	8	3	0	162	11	0	0	11	173
WBR	22	31	9	3	0	25	0	0	0	0	25
North Leg											
Approach	221	310	89	30	0	251	3	0	0	3	254
Departure	170	301	131	44	0	214	0	0	0	0	214
Total	391	611	220	73	0	464	3	0	0	3	467
South Leg											
Approach	317	454	137	46	0	363	3	0	0	3	366
Departure	212	304	92	31	0	243	0	0	0	0	243
Total	529	758	229	76	0	605	3	0	0	3	608
East Leg											
Approach	228	258	30	10	0	238	11	0	0	11	249
Departure	424	480	56	19	0	443	0	0	0	0	443
Total	652	738	86	29	0	681	11	0	0	11	692
West Leg											
Approach	343	380	37	12	0	355	0	0	0	0	355
Departure	303	317	14	5	0	308	17	0	0	17	325
Total	646	697	51	17	0	663	17	0	0	17	680
Total Approaches											
Approach	1,109	1,402	293	98	0	1,207	17	0	0	17	1,224
Departure	1,109	1,402	293	98	0	1,207	17	0	0	17	1,224
Total	2,218	2,803	585	195	0	2,413	34	0	0	34	2,447

Table C-3 - Phase I Project Completion Year (2029) Volume Summary

		AM Peak Hour									
Existing	Ph III 2049 without Project	Total Growth (2019-2049)	Adjusted Growth	Cumulative Projects	Year 2029 without Project	External Project Trips	Internal Project Trips	Pass-by Trips	Phase I Project Trips	Year 2029 with Project	
19 Westberry Boulevard/Avenue 14											
NBL	71	75	4	1	0	72	3	0	0	3	75
NBT	36	53	17	6	0	42	0	0	0	0	42
NBR	24	25	1	0	0	24	0	0	0	0	24
SBL	162	309	147	49	0	211	0	0	0	0	211
SBT	55	73	18	6	0	61	0	0	0	0	61
SBR	53	78	25	8	0	61	23	0	0	23	84
EBL	43	55	12	4	0	47	58	0	0	58	105
EBT	200	210	10	3	0	203	47	0	0	47	250
EBR	37	39	2	1	0	38	0	0	0	0	38
WBL	11	12	1	0	0	11	0	0	0	0	11
WBT	163	171	8	3	0	166	44	0	0	44	210
WBR	95	133	38	13	0	108	0	0	0	0	108
North Leg											
Approach	270	460	190	63	0	333	23	0	0	23	356
Departure	174	241	67	22	0	196	58	0	0	58	254
Total	444	701	257	86	0	530	81	0	0	81	611
South Leg											
Approach	131	153	22	7	0	138	3	0	0	3	141
Departure	103	123	20	7	0	110	0	0	0	0	110
Total	234	276	42	14	0	248	3	0	0	3	251
East Leg											
Approach	269	316	47	16	0	285	44	0	0	44	329
Departure	386	544	158	53	0	439	47	0	0	47	486
Total	655	860	205	68	0	723	91	0	0	91	814
West Leg											
Approach	280	304	24	8	0	288	105	0	0	105	393
Departure	287	324	37	12	0	299	70	0	0	70	369
Total	567	628	61	20	0	587	175	0	0	175	762
Total Approaches											
Approach	950	1,232	282	94	0	1,044	175	0	0	175	1,219
Departure	950	1,232	282	94	0	1,044	175	0	0	175	1,219
Total	1,900	2,465	565	188	0	2,088	350	0	0	350	2,438

Table C-3 - Phase I Project Completion Year (2029) Volume Summary

	AM Peak Hour										
	Existing	Ph III 2049 without Project	Total Growth (2019-2049)	Adjusted Growth	Cumulative Projects	Year 2029 without Project	External Project Trips	Internal Project Trips	Pass-by Trips	Phase I Project Trips	Year 2029 with Project
20 Westberry Boulevard/Avenue 16											
NBL	0	0	0	0	0	0	0	0	0	0	0
NBT	20	88	68	23	0	43	121	0	0	121	164
NBR	45	315	270	90	0	135	117	0	0	117	252
SBL	58	100	42	14	0	72	0	0	0	0	72
SBT	11	18	7	2	0	13	41	0	0	41	54
SBR	0	0	0	0	0	0	0	0	0	0	0
EBL	0	0	0	0	0	0	0	0	0	0	0
EBT	0	0	0	0	0	0	0	0	0	0	0
EBR	0	0	0	0	0	0	0	0	0	0	0
WBL	27	79	52	17	0	44	42	0	0	42	86
WBT	0	0	0	0	0	0	0	0	0	0	0
WBR	119	234	115	38	0	157	0	0	0	0	157
North Leg											
Approach	69	118	49	16	0	85	41	0	0	41	126
Departure	139	322	183	61	0	200	121	0	0	121	321
Total	208	440	232	77	0	285	162	0	0	162	447
South Leg											
Approach	65	403	338	113	0	178	238	0	0	238	416
Departure	38	97	59	20	0	58	83	0	0	83	141
Total	103	500	397	132	0	235	321	0	0	321	556
East Leg											
Approach	146	313	167	56	0	202	42	0	0	42	244
Departure	103	415	312	104	0	207	117	0	0	117	324
Total	249	728	479	160	0	409	159	0	0	159	568
West Leg											
Approach	0	0	0	0	0	0	0	0	0	0	0
Departure	0	0	0	0	0	0	0	0	0	0	0
Total	0	0	0	0	0	0	0	0	0	0	0
Total Approaches											
Approach	280	834	554	185	0	465	321	0	0	321	786
Departure	280	834	554	185	0	465	321	0	0	321	786
Total	560	1,668	1,108	369	0	929	642	0	0	642	1,571

Table C-3 - Phase I Project Completion Year (2029) Volume Summary

		AM Peak Hour								
Existing	Ph III 2049 without Project	Total Growth (2019-2049)	Adjusted Growth	Cumulative Projects	Year 2029 without Project	External Project Trips	Internal Project Trips	Pass-by Trips	Phase I Project Trips	Year 2029 with Project
21 Granada Drive/Cleveland Avenue										
NBL	17	18	1	0	0	17	8	0	0	25
NBT	285	443	158	53	0	338	0	0	0	338
NBR	268	350	82	27	0	295	0	0	0	295
SBL	4	14	10	3	0	7	0	0	0	7
SBT	215	284	69	23	0	238	0	0	0	238
SBR	5	5	0	0	0	5	0	0	0	5
EBL	16	35	19	6	0	22	0	0	0	22
EBT	115	214	99	33	0	148	720	0	0	868
EBR	9	9	0	0	0	9	19	0	19	28
WBL	185	194	9	3	0	188	0	0	0	188
WBT	55	58	3	1	0	56	230	0	230	286
WBR	10	32	22	7	0	17	0	0	0	17
North Leg										
Approach	224	303	79	26	0	250	0	0	0	250
Departure	311	510	199	66	0	377	0	0	0	377
Total	535	813	278	93	0	628	0	0	0	628
South Leg										
Approach	570	811	241	80	0	650	8	0	8	658
Departure	409	488	79	26	0	435	19	0	19	454
Total	979	1,299	320	107	0	1,086	27	0	27	1,113
East Leg										
Approach	250	284	34	11	0	261	230	0	230	491
Departure	387	578	191	64	0	451	720	0	720	1,171
Total	637	862	225	75	0	712	950	0	950	1,662
West Leg										
Approach	140	258	118	39	0	179	739	0	739	918
Departure	77	81	4	1	0	78	238	0	238	316
Total	217	339	122	41	0	258	977	0	977	1,235
Total Approaches										
Approach	1,184	1,657	473	158	0	1,342	977	0	977	2,319
Departure	1,184	1,657	473	158	0	1,342	977	0	977	2,319
Total	2,368	3,313	945	315	0	2,683	1,954	0	1,954	4,637

Table C-3 - Phase I Project Completion Year (2029) Volume Summary

		AM Peak Hour									
	Existing	Ph III 2049 without Project	Total Growth (2019-2049)	Adjusted Growth	Cumulative Projects	Year 2029 without Project	External Project Trips	Internal Project Trips	Pass-by Trips	Phase I Project Trips	Year 2029 with Project
22 Granada Drive/Sunset Avenue											
NBL	47	49	2	1	0	48	0	0	0	0	48
NBT	207	260	53	18	0	225	0	0	0	0	225
NBR	24	26	2	1	0	25	0	0	0	0	25
SBL	127	133	6	2	0	129	0	0	0	0	129
SBT	270	292	22	7	0	277	0	0	0	0	277
SBR	48	50	2	1	0	49	0	0	0	0	49
EBL	59	68	9	3	0	62	0	0	0	0	62
EBT	259	272	13	4	0	263	0	0	0	0	263
EBR	69	74	5	2	0	71	0	0	0	0	71
WBL	25	26	1	0	0	25	0	0	0	0	25
WBT	101	106	5	2	0	103	6	0	0	6	109
WBR	65	67	2	1	0	66	0	0	0	0	66
North Leg											
Approach	445	476	31	10	0	455	0	0	0	0	455
Departure	331	395	64	21	0	352	0	0	0	0	352
Total	776	871	95	32	0	808	0	0	0	0	808
South Leg											
Approach	278	335	57	19	0	297	0	0	0	0	297
Departure	364	392	28	9	0	373	0	0	0	0	373
Total	642	727	85	28	0	670	0	0	0	0	670
East Leg											
Approach	191	199	8	3	0	194	6	0	0	6	200
Departure	410	431	21	7	0	417	0	0	0	0	417
Total	601	631	30	10	0	611	6	0	0	6	617
West Leg											
Approach	387	414	27	9	0	396	0	0	0	0	396
Departure	196	205	9	3	0	199	6	0	0	6	205
Total	583	619	36	12	0	595	6	0	0	6	601
Total Approaches											
Approach	1,301	1,424	123	41	0	1,342	6	0	0	6	1,348
Departure	1,301	1,424	123	41	0	1,342	6	0	0	6	1,348
Total	2,602	2,848	246	82	0	2,684	12	0	0	12	2,696

Table C-3 - Phase I Project Completion Year (2029) Volume Summary

		AM Peak Hour								
Existing	Ph III 2049 without Project	Total Growth (2019-2049)	Adjusted Growth	Cumulative Projects	Year 2029 without Project	External Project Trips	Internal Project Trips	Pass-by Trips	Phase I Project Trips	Year 2029 with Project
23 Avenue 16 – Ellis Street/Kennedy Street										
NBL	0	0	0	0	0	0	0	0	0	0
NBT	191	407	216	72	0	263	117	0	117	380
NBR	111	209	98	33	0	144	0	0	0	144
SBL	244	272	28	9	0	253	0	0	0	253
SBT	194	370	176	59	0	253	42	0	42	295
SBR	0	0	0	0	0	0	0	0	0	0
EBL	0	0	0	0	0	0	0	0	0	0
EBT	0	0	0	0	0	0	0	0	0	0
EBR	0	0	0	0	0	0	0	0	0	0
WBL	101	242	141	47	0	148	0	0	0	148
WBT	0	0	0	0	0	0	0	0	0	0
WBR	106	168	62	21	0	127	0	0	0	127
North Leg										
Approach	438	642	204	68	0	506	42	0	42	548
Departure	297	575	278	93	0	390	117	0	117	507
Total	735	1,217	482	161	0	896	159	0	159	1,055
South Leg										
Approach	302	616	314	105	0	407	117	0	117	524
Departure	295	612	317	106	0	401	42	0	42	443
Total	597	1,228	631	210	0	807	159	0	159	966
East Leg										
Approach	207	410	203	68	0	275	0	0	0	275
Departure	355	481	126	42	0	397	0	0	0	397
Total	562	891	329	110	0	672	0	0	0	672
West Leg										
Approach	0	0	0	0	0	0	0	0	0	0
Departure	0	0	0	0	0	0	0	0	0	0
Total	0	0	0	0	0	0	0	0	0	0
Total Approaches										
Approach	947	1,668	721	240	0	1,187	159	0	159	1,346
Departure	947	1,668	721	240	0	1,187	159	0	159	1,346
Total	1,894	3,336	1,442	481	0	2,375	318	0	318	2,693

Table C-3 - Phase I Project Completion Year (2029) Volume Summary

		AM Peak Hour								
Existing	Ph III 2049 without Project	Total Growth (2019-2049)	Adjusted Growth	Cumulative Projects	Year 2029 without Project	External Project Trips	Internal Project Trips	Pass-by Trips	Phase I Project Trips	Year 2029 with Project
24 Schnoor Avenue/Kennedy Street										
NBL	96	125	29	10	0	106	0	0	0	106
NBT	5	46	41	14	0	19	0	0	0	19
NBR	205	291	86	29	0	234	0	0	0	234
SBL	15	138	123	41	0	56	0	0	0	56
SBT	6	43	37	12	0	18	0	0	0	18
SBR	4	34	30	10	0	14	0	0	0	14
EBL	15	116	101	34	0	49	0	0	0	49
EBT	174	210	36	12	0	186	0	0	0	186
EBR	162	170	8	3	0	165	0	0	0	165
WBL	110	202	92	31	0	141	0	0	0	141
WBT	121	263	142	47	0	168	0	0	0	168
WBR	14	214	200	67	0	81	0	0	0	81
North Leg										
Approach	25	215	190	63	0	88	0	0	0	88
Departure	34	376	342	114	0	148	0	0	0	148
Total	59	591	532	177	0	236	0	0	0	236
South Leg										
Approach	306	462	156	52	0	358	0	0	0	358
Departure	278	415	137	46	0	324	0	0	0	324
Total	584	877	293	98	0	682	0	0	0	682
East Leg										
Approach	245	679	434	145	0	390	0	0	0	390
Departure	394	639	245	82	0	476	0	0	0	476
Total	639	1,318	679	226	0	865	0	0	0	865
West Leg										
Approach	351	496	145	48	0	399	0	0	0	399
Departure	221	422	201	67	0	288	0	0	0	288
Total	572	918	346	115	0	687	0	0	0	687
Total Approaches										
Approach	927	1,852	925	308	0	1,235	0	0	0	1,235
Departure	927	1,852	925	308	0	1,235	0	0	0	1,235
Total	1,854	3,704	1,850	617	0	2,471	0	0	0	2,471

Table C-3 - Phase I Project Completion Year (2029) Volume Summary

	AM Peak Hour										
	Existing	Ph III 2049 without Project	Total Growth (2019-2049)	Adjusted Growth	Cumulative Projects	Year 2029 without Project	External Project Trips	Internal Project Trips	Pass-by Trips	Phase I Project Trips	Year 2029 with Project
25 SR-99 Southbound Ramps/Kennedy Street - Gateway Drive											
NBL	0	0	0	0	0	0	0	0	0	0	0
NBT	0	0	0	0	0	0	0	0	0	0	0
NBR	0	0	0	0	0	0	0	0	0	0	0
SBL	64	67	3	1	0	65	0	0	0	0	65
SBT	0	0	0	0	0	0	0	0	0	0	0
SBR	103	126	23	8	0	111	0	0	0	0	111
EBL	187	380	193	64	0	251	0	0	0	0	251
EBT	227	251	24	8	0	235	0	0	0	0	235
EBR	0	0	0	0	0	0	0	0	0	0	0
WBL	0	0	0	0	0	0	0	0	0	0	0
WBT	172	507	335	112	0	284	0	0	0	0	284
WBR	1	4	3	1	0	2	0	0	0	0	2
North Leg											
Approach	167	193	26	9	0	176	0	0	0	0	176
Departure	188	384	196	65	0	253	0	0	0	0	253
Total	355	577	222	74	0	429	0	0	0	0	429
South Leg											
Approach	0	0	0	0	0	0	0	0	0	0	0
Departure	0	0	0	0	0	0	0	0	0	0	0
Total	0	0	0	0	0	0	0	0	0	0	0
East Leg											
Approach	173	511	338	113	0	286	0	0	0	0	286
Departure	291	318	27	9	0	300	0	0	0	0	300
Total	464	829	365	122	0	586	0	0	0	0	586
West Leg											
Approach	414	631	217	72	0	486	0	0	0	0	486
Departure	275	633	358	119	0	394	0	0	0	0	394
Total	689	1,264	575	192	0	881	0	0	0	0	881
Total Approaches											
Approach	754	1,335	581	194	0	948	0	0	0	0	948
Departure	754	1,335	581	194	0	948	0	0	0	0	948
Total	1,508	2,670	1,162	387	0	1,895	0	0	0	0	1,895

Table C-3 - Phase I Project Completion Year (2029) Volume Summary

	AM Peak Hour										
	Existing	Ph III 2049 without Project	Total Growth (2019-2049)	Adjusted Growth	Cumulative Projects	Year 2029 without Project	External Project Trips	Internal Project Trips	Pass-by Trips	Phase I Project Trips	Year 2029 with Project
26 SR-99 Northbound Off-Ramp/Gateway Drive											
NBL	0	0	0	0	0	0	0	0	0	0	0
NBT	0	0	0	0	0	0	0	0	0	0	0
NBR	0	0	0	0	0	0	0	0	0	0	0
SBL	0	0	0	0	0	0	0	0	0	0	0
SBT	0	0	0	0	0	0	0	0	0	0	0
SBR	106	410	304	101	0	207	0	0	0	0	207
EBL	159	167	8	3	0	162	0	0	0	0	162
EBT	132	151	19	6	0	138	0	0	0	0	138
EBR	0	0	0	0	0	0	0	0	0	0	0
WBL	0	0	0	0	0	0	0	0	0	0	0
WBT	67	101	34	11	0	78	0	0	0	0	78
WBR	0	0	0	0	0	0	0	0	0	0	0
North Leg											
Approach	106	410	304	101	0	207	0	0	0	0	207
Departure	159	167	8	3	0	162	0	0	0	0	162
Total	265	577	312	104	0	369	0	0	0	0	369
South Leg											
Approach	0	0	0	0	0	0	0	0	0	0	0
Departure	0	0	0	0	0	0	0	0	0	0	0
Total	0	0	0	0	0	0	0	0	0	0	0
East Leg											
Approach	67	101	34	11	0	78	0	0	0	0	78
Departure	132	151	19	6	0	138	0	0	0	0	138
Total	199	252	53	18	0	217	0	0	0	0	217
West Leg											
Approach	291	318	27	9	0	300	0	0	0	0	300
Departure	173	511	338	113	0	286	0	0	0	0	286
Total	464	829	365	122	0	586	0	0	0	0	586
Total Approaches											
Approach	464	829	365	122	0	586	0	0	0	0	586
Departure	464	829	365	122	0	586	0	0	0	0	586
Total	928	1,658	730	243	0	1,171	0	0	0	0	1,171

Table C-3 - Phase I Project Completion Year (2029) Volume Summary

	AM Peak Hour										
	Existing	Ph III 2049 without Project	Total Growth (2019-2049)	Adjusted Growth	Cumulative Projects	Year 2029 without Project	External Project Trips	Internal Project Trips	Pass-by Trips	Phase I Project Trips	Year 2029 with Project
27 SR-99 Northbound Off-Ramps											
NBL	0	0	0	0	0	0	0	0	0	0	0
NBT	42	44	2	1	0	43	0	0	0	0	43
NBR	0	0	0	0	0	0	0	0	0	0	0
SBL	0	0	0	0	0	0	0	0	0	0	0
SBT	3	3	0	0	0	3	0	0	0	0	3
SBR	104	409	305	102	0	206	0	0	0	0	206
EBL	160	163	3	1	0	161	0	0	0	0	161
EBT	0	0	0	0	0	0	0	0	0	0	0
EBR	0	0	0	0	0	0	0	0	0	0	0
WBL	0	0	0	0	0	0	0	0	0	0	0
WBT	0	0	0	0	0	0	0	0	0	0	0
WBR	0	0	0	0	0	0	0	0	0	0	0
North Leg											
Approach	107	412	305	102	0	209	0	0	0	0	209
Departure	202	207	5	2	0	204	0	0	0	0	204
Total	309	619	310	103	0	412	0	0	0	0	412
South Leg											
Approach	42	44	2	1	0	43	0	0	0	0	43
Departure	3	3	0	0	0	3	0	0	0	0	3
Total	45	47	2	1	0	46	0	0	0	0	46
East Leg											
Approach	0	0	0	0	0	0	0	0	0	0	0
Departure	0	0	0	0	0	0	0	0	0	0	0
Total	0	0	0	0	0	0	0	0	0	0	0
West Leg											
Approach	160	163	3	1	0	161	0	0	0	0	161
Departure	104	409	305	102	0	206	0	0	0	0	206
Total	264	572	308	103	0	367	0	0	0	0	367
Total Approaches											
Approach	309	619	310	103	0	412	0	0	0	0	412
Departure	309	619	310	103	0	412	0	0	0	0	412
Total	618	1,239	621	207	0	825	0	0	0	0	825

Table C-3 - Phase I Project Completion Year (2029) Volume Summary

	AM Peak Hour										
	Existing	Ph III 2049 without Project	Total Growth (2019-2049)	Adjusted Growth	Cumulative Projects	Year 2029 without Project	External Project Trips	Internal Project Trips	Pass-by Trips	Phase I Project Trips	Year 2029 with Project
28 SR-99 Northbound Off-Ramp/Gateway Drive											
NBL	0	0	0	0	0	0	0	0	0	0	0
NBT	0	0	0	0	0	0	0	0	0	0	0
NBR	0	0	0	0	0	0	0	0	0	0	0
SBL	0	0	0	0	0	0	0	0	0	0	0
SBT	0	0	0	0	0	0	0	0	0	0	0
SBR	0	0	0	0	0	0	0	0	0	0	0
EBL	0	0	0	0	0	0	0	0	0	0	0
EBT	129	144	15	5	0	134	0	0	0	0	134
EBR	0	0	0	0	0	0	0	0	0	0	0
WBL	0	0	0	0	0	0	0	0	0	0	0
WBT	72	106	34	11	0	83	0	0	0	0	83
WBR	50	53	3	1	0	51	0	0	0	0	51
North Leg											
Approach	0	0	0	0	0	0	0	0	0	0	0
Departure	50	53	3	1	0	51	0	0	0	0	51
Total	50	53	3	1	0	51	0	0	0	0	51
South Leg											
Approach	0	0	0	0	0	0	0	0	0	0	0
Departure	0	0	0	0	0	0	0	0	0	0	0
Total	0	0	0	0	0	0	0	0	0	0	0
East Leg											
Approach	122	159	37	12	0	134	0	0	0	0	134
Departure	129	144	15	5	0	134	0	0	0	0	134
Total	251	303	52	17	0	268	0	0	0	0	268
West Leg											
Approach	129	144	15	5	0	134	0	0	0	0	134
Departure	72	106	34	11	0	83	0	0	0	0	83
Total	201	250	49	16	0	217	0	0	0	0	217
Total Approaches											
Approach	251	303	52	17	0	268	0	0	0	0	268
Departure	251	303	52	17	0	268	0	0	0	0	268
Total	502	605	103	34	0	536	0	0	0	0	536

Table C-3 - Phase I Project Completion Year (2029) Volume Summary

		AM Peak Hour									
	Existing	Ph III 2049 without Project	Total Growth (2019-2049)	Adjusted Growth	Cumulative Projects	Year 2029 without Project	External Project Trips	Internal Project Trips	Pass-by Trips	Phase I Project Trips	Year 2029 with Project
29 Schnoor Avenue/Cleveland Avenue											
NBL	50	51	1	0	0	50	11	0	0	11	61
NBT	212	270	58	19	0	231	0	0	0	0	231
NBR	155	179	24	8	0	163	0	0	0	0	163
SBL	79	94	15	5	0	84	0	0	0	0	84
SBT	156	191	35	12	0	168	0	0	0	0	168
SBR	59	61	2	1	0	60	14	0	0	14	74
EBL	71	113	42	14	0	85	34	0	0	34	119
EBT	321	461	140	47	0	368	634	0	0	634	1002
EBR	32	48	16	5	0	37	34	0	0	34	71
WBL	161	168	7	2	0	163	0	0	0	0	163
WBT	210	221	11	4	0	214	202	0	0	202	416
WBR	43	48	5	2	0	45	0	0	0	0	45
North Leg											
Approach	294	346	52	17	0	311	14	0	0	14	325
Departure	326	431	105	35	0	361	34	0	0	34	395
Total	620	777	157	52	0	672	48	0	0	48	720
South Leg											
Approach	417	500	83	28	0	445	11	0	0	11	456
Departure	349	407	58	19	0	368	34	0	0	34	402
Total	766	907	141	47	0	813	45	0	0	45	858
East Leg											
Approach	414	437	23	8	0	422	202	0	0	202	624
Departure	555	734	179	60	0	615	634	0	0	634	1,249
Total	969	1,171	202	67	0	1,036	836	0	0	836	1,872
West Leg											
Approach	424	622	198	66	0	490	702	0	0	702	1,192
Departure	319	333	14	5	0	324	227	0	0	227	551
Total	743	955	212	71	0	814	929	0	0	929	1,743
Total Approaches											
Approach	1,549	1,905	356	119	0	1,668	929	0	0	929	2,597
Departure	1,549	1,905	356	119	0	1,668	929	0	0	929	2,597
Total	3,098	3,809	711	237	0	3,335	1,858	0	0	1,858	5,193

Table C-3 - Phase I Project Completion Year (2029) Volume Summary

		AM Peak Hour								
Existing	Ph III 2049 without Project	Total Growth (2019-2049)	Adjusted Growth	Cumulative Projects	Year 2029 without Project	External Project Trips	Internal Project Trips	Pass-by Trips	Phase I Project Trips	Year 2029 with Project
30 Fairgrounds/Cleveland Avenue										
NBL	13	14	1	0	0	13	0	0	0	13
NBT	6	8	2	1	0	7	0	0	0	7
NBR	23	29	6	2	0	25	0	0	0	25
SBL	95	157	62	21	0	116	0	0	0	116
SBT	5	5	0	0	0	5	0	0	0	5
SBR	38	40	2	1	0	39	0	0	0	39
EBL	80	109	29	10	0	90	0	0	0	90
EBT	506	664	158	53	0	559	634	0	634	1193
EBR	29	30	1	0	0	29	0	0	0	29
WBL	32	39	7	2	0	34	0	0	0	34
WBT	362	380	18	6	0	368	202	0	202	570
WBR	65	127	62	21	0	86	0	0	0	86
North Leg										
Approach	138	202	64	21	0	159	0	0	0	159
Departure	151	244	93	31	0	182	0	0	0	182
Total	289	446	157	52	0	341	0	0	0	341
South Leg										
Approach	42	51	9	3	0	45	0	0	0	45
Departure	66	75	9	3	0	69	0	0	0	69
Total	108	125	17	6	0	114	0	0	0	114
East Leg										
Approach	459	546	87	29	0	488	202	0	202	690
Departure	624	850	226	75	0	699	634	0	634	1,333
Total	1,083	1,396	313	104	0	1,187	836	0	836	2,023
West Leg										
Approach	615	803	188	63	0	678	634	0	634	1,312
Departure	413	434	21	7	0	420	202	0	202	622
Total	1,028	1,237	209	70	0	1,098	836	0	836	1,934
Total Approaches										
Approach	1,254	1,602	348	116	0	1,370	836	0	836	2,206
Departure	1,254	1,602	348	116	0	1,370	836	0	836	2,206
Total	2,508	3,205	697	232	0	2,740	1,672	0	1,672	4,412

Table C-3 - Phase I Project Completion Year (2029) Volume Summary

	AM Peak Hour										
	Existing	Ph III 2049 without Project	Total Growth (2019-2049)	Adjusted Growth	Cumulative Projects	Year 2029 without Project	External Project Trips	Internal Project Trips	Pass-by Trips	Phase I Project Trips	Year 2029 with Project
31 SR-99 Southbound Ramps/Cleveland Avenue											
NBL	0	0	0	0	0	0	0	0	0	0	0
NBT	0	0	0	0	0	0	0	0	0	0	0
NBR	0	0	0	0	0	0	0	0	0	0	0
SBL	57	82	25	8	0	65	0	0	0	0	65
SBT	0	0	0	0	0	0	0	0	0	0	0
SBR	46	70	24	8	0	54	0	0	0	0	54
EBL	0	0	0	0	0	0	0	0	0	0	0
EBT	413	497	84	28	0	441	220	0	0	220	661
EBR	306	449	143	48	0	354	415	0	0	415	769
WBL	313	390	77	26	0	339	0	0	0	0	339
WBT	651	699	48	16	0	667	202	0	0	202	869
WBR	0	0	0	0	0	0	0	0	0	0	0
North Leg											
Approach	103	152	49	16	0	119	0	0	0	0	119
Departure	0	0	0	0	0	0	0	0	0	0	0
Total	103	152	49	16	0	119	0	0	0	0	119
South Leg											
Approach	0	0	0	0	0	0	0	0	0	0	0
Departure	619	839	220	73	0	692	415	0	0	415	1,107
Total	619	839	220	73	0	692	415	0	0	415	1,107
East Leg											
Approach	964	1,089	125	42	0	1,006	202	0	0	202	1,208
Departure	470	579	109	36	0	506	220	0	0	220	726
Total	1,434	1,668	234	78	0	1,512	422	0	0	422	1,934
West Leg											
Approach	719	946	227	76	0	795	635	0	0	635	1,430
Departure	697	769	72	24	0	721	202	0	0	202	923
Total	1,416	1,715	299	100	0	1,516	837	0	0	837	2,353
Total Approaches											
Approach	1,786	2,187	401	134	0	1,920	837	0	0	837	2,757
Departure	1,786	2,187	401	134	0	1,920	837	0	0	837	2,757
Total	3,572	4,374	802	267	0	3,839	1,674	0	0	1,674	5,513

Table C-3 - Phase I Project Completion Year (2029) Volume Summary

	AM Peak Hour										
	Existing	Ph III 2049 without Project	Total Growth (2019-2049)	Adjusted Growth	Cumulative Projects	Year 2029 without Project	External Project Trips	Internal Project Trips	Pass-by Trips	Phase I Project Trips	Year 2029 with Project
32 SR-99 Northbound Ramps/Cleveland Avenue											
NBL	234	289	55	18	0	252	121	0	0	121	373
NBT	0	0	0	0	0	0	0	0	0	0	0
NBR	243	389	146	49	0	292	0	0	0	0	292
SBL	0	0	0	0	0	0	0	0	0	0	0
SBT	0	0	0	0	0	0	0	0	0	0	0
SBR	0	0	0	0	0	0	0	0	0	0	0
EBL	43	71	28	9	0	52	0	0	0	0	52
EBT	427	510	83	28	0	455	220	0	0	220	675
EBR	0	0	0	0	0	0	0	0	0	0	0
WBL	0	0	0	0	0	0	0	0	0	0	0
WBT	730	808	78	26	0	756	81	0	0	81	837
WBR	59	116	57	19	0	78	0	0	0	0	78
North Leg											
Approach	0	0	0	0	0	0	0	0	0	0	0
Departure	102	187	85	28	0	130	0	0	0	0	130
Total	102	187	85	28	0	130	0	0	0	0	130
South Leg											
Approach	477	678	201	67	0	544	121	0	0	121	665
Departure	0	0	0	0	0	0	0	0	0	0	0
Total	477	678	201	67	0	544	121	0	0	121	665
East Leg											
Approach	789	924	135	45	0	834	81	0	0	81	915
Departure	670	899	229	76	0	746	220	0	0	220	966
Total	1,459	1,823	364	121	0	1,580	301	0	0	301	1,881
West Leg											
Approach	470	581	111	37	0	507	220	0	0	220	727
Departure	964	1,097	133	44	0	1,008	202	0	0	202	1,210
Total	1,434	1,678	244	81	0	1,515	422	0	0	422	1,937
Total Approaches											
Approach	1,736	2,183	447	149	0	1,885	422	0	0	422	2,307
Departure	1,736	2,183	447	149	0	1,885	422	0	0	422	2,307
Total	3,472	4,366	894	298	0	3,770	844	0	0	844	4,614

Table C-3 - Phase I Project Completion Year (2029) Volume Summary

		AM Peak Hour								
Existing	Ph III 2049 without Project	Total Growth (2019-2049)	Adjusted Growth	Cumulative Projects	Year 2029 without Project	External Project Trips	Internal Project Trips	Pass-by Trips	Phase I Project Trips	Year 2029 with Project
33 Gateway Drive/Cleveland Avenue										
NBL	130	137	7	2	0	132	31	0	0	163
NBT	47	50	3	1	0	48	0	0	0	48
NBR	113	196	83	28	0	141	0	0	0	141
SBL	51	67	16	5	0	56	0	0	0	56
SBT	85	89	4	1	0	86	0	0	0	86
SBR	4	4	0	0	0	4	0	0	0	4
EBL	4	4	0	0	0	4	0	0	0	4
EBT	520	749	229	76	0	596	121	0	0	717
EBR	140	145	5	2	0	142	98	0	0	240
WBL	154	237	83	28	0	182	0	0	0	182
WBT	652	784	132	44	0	696	49	0	0	745
WBR	62	82	20	7	0	69	0	0	0	69
North Leg										
Approach	140	160	20	7	0	147	0	0	0	147
Departure	113	136	23	8	0	121	0	0	0	121
Total	253	297	44	15	0	268	0	0	0	268
South Leg										
Approach	290	383	93	31	0	321	31	0	0	352
Departure	379	471	92	31	0	410	98	0	0	508
Total	669	854	185	62	0	731	129	0	0	860
East Leg										
Approach	868	1,103	235	78	0	946	49	0	0	995
Departure	684	1,012	328	109	0	793	121	0	0	914
Total	1,552	2,115	563	188	0	1,740	170	0	0	1,910
West Leg										
Approach	664	898	234	78	0	742	219	0	0	961
Departure	786	925	139	46	0	832	80	0	0	912
Total	1,450	1,823	373	124	0	1,574	299	0	0	1,873
Total Approaches										
Approach	1,962	2,544	582	194	0	2,156	299	0	0	2,455
Departure	1,962	2,544	582	194	0	2,156	299	0	0	2,455
Total	3,924	5,088	1,164	388	0	4,312	598	0	0	4,910

Table C-3 - Phase I Project Completion Year (2029) Volume Summary

	AM Peak Hour										
	Existing	Ph III 2049 without Project	Total Growth (2019-2049)	Adjusted Growth	Cumulative Projects	Year 2029 without Project	External Project Trips	Internal Project Trips	Pass-by Trips	Phase I Project Trips	Year 2029 with Project
34 Cleveland Avenue – Country Club Drive/W Cleveland Avenue											
NBL	0	0	0	0	0	0	0	0	0	0	0
NBT	488	782	294	98	0	586	34	0	0	34	620
NBR	196	230	34	11	0	207	86	0	0	86	293
SBL	76	104	28	9	0	85	0	0	0	0	85
SBT	593	673	80	27	0	620	14	0	0	14	634
SBR	0	0	0	0	0	0	0	0	0	0	0
EBL	0	0	0	0	0	0	0	0	0	0	0
EBT	0	0	0	0	0	0	0	0	0	0	0
EBR	0	0	0	0	0	0	0	0	0	0	0
WBL	275	430	155	52	0	327	36	0	0	36	363
WBT	0	0	0	0	0	0	0	0	0	0	0
WBR	19	49	30	10	0	29	0	0	0	0	29
North Leg											
Approach	669	777	108	36	0	705	14	0	0	14	719
Departure	507	831	324	108	0	615	34	0	0	34	649
Total	1,176	1,608	432	144	0	1,320	48	0	0	48	1,368
South Leg											
Approach	684	1,012	328	109	0	793	120	0	0	120	913
Departure	868	1,103	235	78	0	946	50	0	0	50	996
Total	1,552	2,115	563	188	0	1,740	170	0	0	170	1,910
East Leg											
Approach	294	479	185	62	0	356	36	0	0	36	392
Departure	272	334	62	21	0	293	86	0	0	86	379
Total	566	813	247	82	0	648	122	0	0	122	770
West Leg											
Approach	0	0	0	0	0	0	0	0	0	0	0
Departure	0	0	0	0	0	0	0	0	0	0	0
Total	0	0	0	0	0	0	0	0	0	0	0
Total Approaches											
Approach	1,647	2,268	621	207	0	1,854	170	0	0	170	2,024
Departure	1,647	2,268	621	207	0	1,854	170	0	0	170	2,024
Total	3,294	4,536	1,242	414	0	3,708	340	0	0	340	4,048

Table C-3 - Phase I Project Completion Year (2029) Volume Summary

AM Peak Hour											
	Existing	Ph III 2049 without Project	Total Growth (2019-2049)	Adjusted Growth	Cumulative Projects	Year 2029 without Project	External Project Trips	Internal Project Trips	Pass-by Trips	Phase I Project Trips	Year 2029 with Project
35 Country Club Drive/Sharon Boulevard											
NBL	1	1	0	0	0	1	0	0	0	0	1
NBT	498	834	336	112	0	610	19	0	0	19	629
NBR	0	0	0	0	0	0	0	0	0	0	0
SBL	0	0	0	0	0	0	0	0	0	0	0
SBT	634	755	121	40	0	674	11	0	0	11	685
SBR	1	1	0	0	0	1	0	0	0	0	1
EBL	2	2	0	0	0	2	0	0	0	0	2
EBT	0	0	0	0	0	0	0	0	0	0	0
EBR	12	13	1	0	0	12	0	0	0	0	12
WBL	0	0	0	0	0	0	0	0	0	0	0
WBT	0	0	0	0	0	0	0	0	0	0	0
WBR	0	0	0	0	0	0	0	0	0	0	0
North Leg											
Approach	635	756	121	40	0	675	11	0	0	11	686
Departure	500	836	336	112	0	612	19	0	0	19	631
Total	1,135	1,592	457	152	0	1,287	30	0	0	30	1,317
South Leg											
Approach	499	835	336	112	0	611	19	0	0	19	630
Departure	646	768	122	41	0	687	11	0	0	11	698
Total	1,145	1,603	458	153	0	1,298	30	0	0	30	1,328
East Leg											
Approach	0	0	0	0	0	0	0	0	0	0	0
Departure	0	0	0	0	0	0	0	0	0	0	0
Total	0	0	0	0	0	0	0	0	0	0	0
West Leg											
Approach	14	15	1	0	0	14	0	0	0	0	14
Departure	2	2	0	0	0	2	0	0	0	0	2
Total	16	17	1	0	0	16	0	0	0	0	16
Total Approaches											
Approach	1,148	1,606	458	153	0	1,301	30	0	0	30	1,331
Departure	1,148	1,606	458	153	0	1,301	30	0	0	30	1,331
Total	2,296	3,212	916	305	0	2,601	60	0	0	60	2,661

Table C-3 - Phase I Project Completion Year (2029) Volume Summary

		AM Peak Hour									
		Ph III 2049	Total Growth	Adjusted	Cumulative	Year 2029	External	Internal	Pass-by	Phase I	Year 2029
Existing		without	(2019-2049)	Growth	Projects	without	Project	Project	Trips	Project	with
		Project				Project	Trips	Trips	Trips	Trips	Project
36 Pine Street/Howard Road											
NBL	115	121	6	2	0	117	21	0	0	21	138
NBT	151	171	20	7	0	158	0	0	0	0	158
NBR	222	253	31	10	0	232	0	0	0	0	232
SBL	16	17	1	0	0	16	0	0	0	0	16
SBT	239	281	42	14	0	253	0	0	0	0	253
SBR	97	102	5	2	0	99	0	0	0	0	99
EBL	33	35	2	1	0	34	0	0	0	0	34
EBT	667	700	33	11	0	678	1	0	0	1	679
EBR	72	84	12	4	0	76	54	0	0	54	130
WBL	126	163	37	12	0	138	0	0	0	0	138
WBT	433	439	6	2	0	435	27	0	0	27	462
WBR	6	7	1	0	0	6	0	0	0	0	6
North Leg											
Approach	352	400	48	16	0	368	0	0	0	0	368
Departure	190	213	23	8	0	198	0	0	0	0	198
Total	542	612	70	23	0	565	0	0	0	0	565
South Leg											
Approach	488	545	57	19	0	507	21	0	0	21	528
Departure	437	528	91	30	0	467	54	0	0	54	521
Total	925	1,073	148	49	0	974	75	0	0	75	1,049
East Leg											
Approach	565	609	44	15	0	580	27	0	0	27	607
Departure	905	970	65	22	0	927	1	0	0	1	928
Total	1,470	1,579	109	36	0	1,506	28	0	0	28	1,534
West Leg											
Approach	772	819	47	16	0	788	55	0	0	55	843
Departure	645	662	17	6	0	651	48	0	0	48	699
Total	1,417	1,481	64	21	0	1,438	103	0	0	103	1,541
Total Approaches											
Approach	2,177	2,373	196	65	0	2,242	103	0	0	103	2,345
Departure	2,177	2,373	196	65	0	2,242	103	0	0	103	2,345
Total	4,354	4,745	391	130	0	4,484	206	0	0	206	4,690

Table C-3 - Phase I Project Completion Year (2029) Volume Summary

	AM Peak Hour										
	Existing	Ph III 2049 without Project	Total Growth (2019-2049)	Adjusted Growth	Cumulative Projects	Year 2029 without Project	External Project Trips	Internal Project Trips	Pass-by Trips	Phase I Project Trips	Year 2029 with Project
37 Q Street - Olive Avenue/Yosemite Avenue - Howard Road											
NBL	292	320	28	9	0	301	24	0	0	24	325
NBT	88	89	1	0	0	88	0	0	0	0	88
NBR	20	21	1	0	0	20	0	0	0	0	20
SBL	99	104	5	2	0	101	0	0	0	0	101
SBT	147	152	5	2	0	149	0	0	0	0	149
SBR	12	13	1	0	0	12	0	0	0	0	12
EBL	6	6	0	0	0	6	0	0	0	0	6
EBT	541	568	27	9	0	550	0	0	0	0	550
EBR	308	336	28	9	0	317	1	0	0	1	318
WBL	26	28	2	1	0	27	0	0	0	0	27
WBT	332	348	16	5	0	337	3	0	0	3	340
WBR	19	20	1	0	0	19	0	0	0	0	19
North Leg											
Approach	258	269	11	4	0	262	0	0	0	0	262
Departure	113	115	2	1	0	114	0	0	0	0	114
Total	371	384	13	4	0	375	0	0	0	0	375
South Leg											
Approach	400	430	30	10	0	410	24	0	0	24	434
Departure	481	516	35	12	0	493	1	0	0	1	494
Total	881	946	65	22	0	903	25	0	0	25	928
East Leg											
Approach	377	396	19	6	0	383	3	0	0	3	386
Departure	660	693	33	11	0	671	0	0	0	0	671
Total	1,037	1,089	52	17	0	1,054	3	0	0	3	1,057
West Leg											
Approach	855	910	55	18	0	873	1	0	0	1	874
Departure	636	681	45	15	0	651	27	0	0	27	678
Total	1,491	1,591	100	33	0	1,524	28	0	0	28	1,552
Total Approaches											
Approach	1,890	2,005	115	38	0	1,928	28	0	0	28	1,956
Departure	1,890	2,005	115	38	0	1,928	28	0	0	28	1,956
Total	3,780	4,010	230	77	0	3,857	56	0	0	56	3,913

Table C-3 - Phase I Project Completion Year (2029) Volume Summary

	AM Peak Hour										
	Existing	Ph III 2049 without Project	Total Growth (2019-2049)	Adjusted Growth	Cumulative Projects	Year 2029 without Project	External Project Trips	Internal Project Trips	Pass-by Trips	Phase I Project Trips	Year 2029 with Project
38 I Street/SR-99 Southbound Off-Ramp - 2nd Street											
NBL	15	24	9	3	0	18	0	0	0	0	18
NBT	82	89	7	2	0	84	0	0	0	0	84
NBR	0	0	0	0	0	0	0	0	0	0	0
SBL	0	0	0	0	0	0	0	0	0	0	0
SBT	132	156	24	8	0	140	0	0	0	0	140
SBR	2	3	1	0	0	2	0	0	0	0	2
EBL	2	2	0	0	0	2	0	0	0	0	2
EBT	0	0	0	0	0	0	0	0	0	0	0
EBR	53	68	15	5	0	58	0	0	0	0	58
WBL	363	404	41	14	0	377	18	0	0	18	395
WBT	17	22	5	2	0	19	0	0	0	0	19
WBR	11	12	1	0	0	11	0	0	0	0	11
North Leg											
Approach	134	159	25	8	0	142	0	0	0	0	142
Departure	95	103	8	3	0	98	0	0	0	0	98
Total	229	262	33	11	0	240	0	0	0	0	240
South Leg											
Approach	97	113	16	5	0	102	0	0	0	0	102
Departure	548	628	80	27	0	575	18	0	0	18	593
Total	645	741	96	32	0	677	18	0	0	18	695
East Leg											
Approach	391	438	47	16	0	407	18	0	0	18	425
Departure	0	0	0	0	0	0	0	0	0	0	0
Total	391	438	47	16	0	407	18	0	0	18	425
West Leg											
Approach	55	70	15	5	0	60	0	0	0	0	60
Departure	34	49	15	5	0	39	0	0	0	0	39
Total	89	119	30	10	0	99	0	0	0	0	99
Total Approaches											
Approach	677	780	103	34	0	711	18	0	0	18	729
Departure	677	780	103	34	0	711	18	0	0	18	729
Total	1,354	1,559	205	68	0	1,422	36	0	0	36	1,458

Table C-3 - Phase I Project Completion Year (2029) Volume Summary

		AM Peak Hour									
		Ph III 2049	Total Growth	Adjusted	Cumulative	Year 2029	External	Internal	Pass-by	Phase I	Year 2029
Existing		without	(2019-2049)	Growth	Projects	without	Project	Project	Trips	Project	with
		Project				Project	Trips	Trips	Trips	Trips	Project
39 4th Street/Sunset Avenue											
NBL	31	35	4	1	0	32	0	0	0	0	32
NBT	291	351	60	20	0	311	5	0	0	5	316
NBR	0	0	0	0	0	0	0	0	0	0	0
SBL	0	0	0	0	0	0	0	0	0	0	0
SBT	400	462	62	21	0	421	18	0	0	18	439
SBR	267	287	20	7	0	274	3	0	0	3	277
EBL	381	400	19	6	0	387	0	0	0	0	387
EBT	0	0	0	0	0	0	0	0	0	0	0
EBR	22	23	1	0	0	22	0	0	0	0	22
WBL	0	0	0	0	0	0	0	0	0	0	0
WBT	0	0	0	0	0	0	0	0	0	0	0
WBR	0	0	0	0	0	0	0	0	0	0	0
North Leg											
Approach	667	749	82	27	0	694	21	0	0	21	715
Departure	672	751	79	26	0	698	5	0	0	5	703
Total	1,339	1,500	161	54	0	1,393	26	0	0	26	1,419
South Leg											
Approach	322	386	64	21	0	343	5	0	0	5	348
Departure	422	485	63	21	0	443	18	0	0	18	461
Total	744	871	127	42	0	786	23	0	0	23	809
East Leg											
Approach	0	0	0	0	0	0	0	0	0	0	0
Departure	0	0	0	0	0	0	0	0	0	0	0
Total	0	0	0	0	0	0	0	0	0	0	0
West Leg											
Approach	403	423	20	7	0	410	0	0	0	0	410
Departure	298	322	24	8	0	306	3	0	0	3	309
Total	701	745	44	15	0	716	3	0	0	3	719
Total Approaches											
Approach	1,392	1,558	166	55	0	1,447	26	0	0	26	1,473
Departure	1,392	1,558	166	55	0	1,447	26	0	0	26	1,473
Total	2,784	3,116	332	111	0	2,895	52	0	0	52	2,947

Table C-3 - Phase I Project Completion Year (2029) Volume Summary

		AM Peak Hour									
Existing	Ph III 2049 without Project	Total Growth (2019-2049)	Adjusted Growth	Cumulative Projects	Year 2029 without Project	External Project Trips	Internal Project Trips	Pass-by Trips	Phase I Project Trips	Year 2029 with Project	
40 H Street/SR-99 Northbound On-Ramp - 2nd Street											
NBL	253	316	63	21	0	274	5	0	0	5	279
NBT	24	25	1	0	0	24	0	0	0	0	24
NBR	9	35	26	9	0	18	0	0	0	0	18
SBL	0	0	0	0	0	0	0	0	0	0	0
SBT	34	36	2	1	0	35	0	0	0	0	35
SBR	0	0	0	0	0	0	0	0	0	0	0
EBL	0	0	0	0	0	0	0	0	0	0	0
EBT	0	0	0	0	0	0	0	0	0	0	0
EBR	0	0	0	0	0	0	0	0	0	0	0
WBL	13	43	30	10	0	23	0	0	0	0	23
WBT	21	41	20	7	0	28	0	0	0	0	28
WBR	2	3	1	0	0	2	0	0	0	0	2
North Leg											
Approach	34	36	2	1	0	35	0	0	0	0	35
Departure	26	28	2	1	0	27	0	0	0	0	27
Total	60	64	4	1	0	61	0	0	0	0	61
South Leg											
Approach	286	376	90	30	0	316	5	0	0	5	321
Departure	47	79	32	11	0	58	0	0	0	0	58
Total	333	455	122	41	0	374	5	0	0	5	379
East Leg											
Approach	36	87	51	17	0	53	0	0	0	0	53
Departure	9	35	26	9	0	18	0	0	0	0	18
Total	45	122	77	26	0	71	0	0	0	0	71
West Leg											
Approach	0	0	0	0	0	0	0	0	0	0	0
Departure	274	357	83	28	0	302	5	0	0	5	307
Total	274	357	83	28	0	302	5	0	0	5	307
Total Approaches											
Approach	356	499	143	48	0	404	5	0	0	5	409
Departure	356	499	143	48	0	404	5	0	0	5	409
Total	712	998	286	95	0	807	10	0	0	10	817

Table C-3 - Phase I Project Completion Year (2029) Volume Summary

		AM Peak Hour									
	Existing	Ph III 2049 without Project	Total Growth (2019-2049)	Adjusted Growth	Cumulative Projects	Year 2029 without Project	External Project Trips	Internal Project Trips	Pass-by Trips	Phase I Project Trips	Year 2029 with Project
41 I Street/4th Street											
NBL	51	54	3	1	0	52	0	0	0	0	52
NBT	55	58	3	1	0	56	0	0	0	0	56
NBR	160	168	8	3	0	163	0	0	0	0	163
SBL	209	252	43	14	0	223	0	0	0	0	223
SBT	277	287	10	3	0	280	0	0	0	0	280
SBR	121	149	28	9	0	130	18	0	0	18	148
EBL	25	29	4	1	0	26	0	0	0	0	26
EBT	621	666	45	15	0	636	5	0	0	5	641
EBR	67	70	3	1	0	68	0	0	0	0	68
WBL	85	89	4	1	0	86	0	0	0	0	86
WBT	459	516	57	19	0	478	3	0	0	3	481
WBR	61	72	11	4	0	65	0	0	0	0	65
North Leg											
Approach	607	688	81	27	0	634	18	0	0	18	652
Departure	141	159	18	6	0	147	0	0	0	0	147
Total	748	847	99	33	0	781	18	0	0	18	799
South Leg											
Approach	266	280	14	5	0	271	0	0	0	0	271
Departure	429	447	18	6	0	435	0	0	0	0	435
Total	695	726	31	10	0	705	0	0	0	0	705
East Leg											
Approach	605	677	72	24	0	629	3	0	0	3	632
Departure	990	1,086	96	32	0	1,022	5	0	0	5	1,027
Total	1,595	1,763	168	56	0	1,651	8	0	0	8	1,659
West Leg											
Approach	713	765	52	17	0	730	5	0	0	5	735
Departure	631	719	88	29	0	660	21	0	0	21	681
Total	1,344	1,484	140	47	0	1,391	26	0	0	26	1,417
Total Approaches											
Approach	2,191	2,410	219	73	0	2,264	26	0	0	26	2,290
Departure	2,191	2,410	219	73	0	2,264	26	0	0	26	2,290
Total	4,382	4,820	438	146	0	4,528	52	0	0	52	4,580

Table C-3 - Phase I Project Completion Year (2029) Volume Summary

	AM Peak Hour										
	Existing	Ph III 2049 without Project	Total Growth (2019-2049)	Adjusted Growth	Cumulative Projects	Year 2029 without Project	External Project Trips	Internal Project Trips	Pass-by Trips	Phase I Project Trips	Year 2029 with Project
42 SR-99 Southbound On-Ramp/4th Street											
NBL	0	0	0	0	0	0	0	0	0	0	0
NBT	0	0	0	0	0	0	0	0	0	0	0
NBR	0	0	0	0	0	0	0	0	0	0	0
SBL	0	0	0	0	0	0	0	0	0	0	0
SBT	0	0	0	0	0	0	0	0	0	0	0
SBR	0	0	0	0	0	0	0	0	0	0	0
EBL	0	0	0	0	0	0	0	0	0	0	0
EBT	667	735	68	23	0	690	5	0	0	5	695
EBR	323	351	28	9	0	332	0	0	0	0	332
WBL	152	248	96	32	0	184	0	0	0	0	184
WBT	605	677	72	24	0	629	3	0	0	3	632
WBR	0	0	0	0	0	0	0	0	0	0	0
North Leg											
Approach	0	0	0	0	0	0	0	0	0	0	0
Departure	0	0	0	0	0	0	0	0	0	0	0
Total	0	0	0	0	0	0	0	0	0	0	0
South Leg											
Approach	0	0	0	0	0	0	0	0	0	0	0
Departure	475	599	124	41	0	516	0	0	0	0	516
Total	475	599	124	41	0	516	0	0	0	0	516
East Leg											
Approach	757	925	168	56	0	813	3	0	0	3	816
Departure	667	735	68	23	0	690	5	0	0	5	695
Total	1,424	1,660	236	79	0	1,503	8	0	0	8	1,511
West Leg											
Approach	990	1,086	96	32	0	1,022	5	0	0	5	1,027
Departure	605	677	72	24	0	629	3	0	0	3	632
Total	1,595	1,763	168	56	0	1,651	8	0	0	8	1,659
Total Approaches											
Approach	1,747	2,011	264	88	0	1,835	8	0	0	8	1,843
Departure	1,747	2,011	264	88	0	1,835	8	0	0	8	1,843
Total	3,494	4,022	528	176	0	3,670	16	0	0	16	3,686

Table C-3 - Phase I Project Completion Year (2029) Volume Summary

		AM Peak Hour								
Existing	Ph III 2049 without Project	Total Growth (2019-2049)	Adjusted Growth	Cumulative Projects	Year 2029 without Project	External Project Trips	Internal Project Trips	Pass-by Trips	Phase I Project Trips	Year 2029 with Project
43 H Street – SR-99 Northbound Off-Ramp/4th Street										
NBL	239	281	42	14	0	253	0	0	0	253
NBT	24	35	11	4	0	28	0	0	0	28
NBR	195	240	45	15	0	210	0	0	0	210
SBL	5	8	3	1	0	6	0	0	0	6
SBT	0	0	0	0	0	0	0	0	0	0
SBR	57	84	27	9	0	66	0	0	0	66
EBL	213	265	52	17	0	230	5	0	5	235
EBT	454	470	16	5	0	459	0	0	0	459
EBR	0	0	0	0	0	0	0	0	0	0
WBL	0	0	0	0	0	0	0	0	0	0
WBT	461	559	98	33	0	494	3	0	3	497
WBR	52	79	27	9	0	61	0	0	0	61
North Leg										
Approach	62	92	30	10	0	72	0	0	0	72
Departure	289	379	90	30	0	319	5	0	5	324
Total	351	471	120	40	0	391	5	0	5	396
South Leg										
Approach	458	556	98	33	0	491	0	0	0	491
Departure	0	0	0	0	0	0	0	0	0	0
Total	458	556	98	33	0	491	0	0	0	491
East Leg										
Approach	513	638	125	42	0	555	3	0	3	558
Departure	654	718	64	21	0	675	0	0	0	675
Total	1,167	1,356	189	63	0	1,230	3	0	3	1,233
West Leg										
Approach	667	735	68	23	0	690	5	0	5	695
Departure	757	924	167	56	0	813	3	0	3	816
Total	1,424	1,659	235	78	0	1,502	8	0	8	1,510
Total Approaches										
Approach	1,700	2,021	321	107	0	1,807	8	0	8	1,815
Departure	1,700	2,021	321	107	0	1,807	8	0	8	1,815
Total	3,400	4,042	642	214	0	3,614	16	0	16	3,630

Table C-3 - Phase I Project Completion Year (2029) Volume Summary

AM Peak Hour											
	Existing	Ph III 2049 without Project	Total Growth (2019-2049)	Adjusted Growth	Cumulative Projects	Year 2029 without Project	External Project Trips	Internal Project Trips	Pass-by Trips	Phase I Project Trips	Year 2029 with Project
44 I Street/Olive Avenue											
NBL	0	0	0	0	0	0	0	0	0	0	0
NBT	0	0	0	0	0	0	0	0	0	0	0
NBR	0	0	0	0	0	0	0	0	0	0	0
SBL	59	62	3	1	0	60	0	0	0	0	60
SBT	0	0	0	0	0	0	0	0	0	0	0
SBR	99	102	3	1	0	100	0	0	0	0	100
EBL	128	134	6	2	0	130	0	0	0	0	130
EBT	445	513	68	23	0	468	0	0	0	0	468
EBR	0	0	0	0	0	0	0	0	0	0	0
WBL	0	0	0	0	0	0	0	0	0	0	0
WBT	410	585	175	58	0	468	17	0	0	17	485
WBR	76	82	6	2	0	78	0	0	0	0	78
North Leg											
Approach	158	164	6	2	0	160	0	0	0	0	160
Departure	204	216	12	4	0	208	0	0	0	0	208
Total	362	380	18	6	0	368	0	0	0	0	368
South Leg											
Approach	0	0	0	0	0	0	0	0	0	0	0
Departure	0	0	0	0	0	0	0	0	0	0	0
Total	0	0	0	0	0	0	0	0	0	0	0
East Leg											
Approach	486	667	181	60	0	546	17	0	0	17	563
Departure	504	575	71	24	0	528	0	0	0	0	528
Total	990	1,242	252	84	0	1,074	17	0	0	17	1,091
West Leg											
Approach	573	647	74	25	0	598	0	0	0	0	598
Departure	509	687	178	59	0	568	17	0	0	17	585
Total	1,082	1,334	252	84	0	1,166	17	0	0	17	1,183
Total Approaches											
Approach	1,217	1,478	261	87	0	1,304	17	0	0	17	1,321
Departure	1,217	1,478	261	87	0	1,304	17	0	0	17	1,321
Total	2,434	2,957	523	174	0	2,608	34	0	0	34	2,642

Table C-3 - Phase I Project Completion Year (2029) Volume Summary

	AM Peak Hour										
	Existing	Ph III 2049 without Project	Total Growth (2019-2049)	Adjusted Growth	Cumulative Projects	Year 2029 without Project	External Project Trips	Internal Project Trips	Pass-by Trips	Phase I Project Trips	Year 2029 with Project
45 SR-99 Southbound Off-Ramp/Olive Avenue											
NBL	0	0	0	0	0	0	0	0	0	0	0
NBT	0	0	0	0	0	0	0	0	0	0	0
NBR	0	0	0	0	0	0	0	0	0	0	0
SBL	303	712	409	136	0	439	94	0	0	94	533
SBT	0	0	0	0	0	0	0	0	0	0	0
SBR	99	120	21	7	0	106	0	0	0	0	106
EBL	0	0	0	0	0	0	0	0	0	0	0
EBT	504	575	71	24	0	528	0	0	0	0	528
EBR	0	0	0	0	0	0	0	0	0	0	0
WBL	0	0	0	0	0	0	0	0	0	0	0
WBT	389	547	158	53	0	442	17	0	0	17	459
WBR	0	0	0	0	0	0	0	0	0	0	0
North Leg											
Approach	402	832	430	143	0	545	94	0	0	94	639
Departure	0	0	0	0	0	0	0	0	0	0	0
Total	402	832	430	143	0	545	94	0	0	94	639
South Leg											
Approach	0	0	0	0	0	0	0	0	0	0	0
Departure	0	0	0	0	0	0	0	0	0	0	0
Total	0	0	0	0	0	0	0	0	0	0	0
East Leg											
Approach	389	547	158	53	0	442	17	0	0	17	459
Departure	807	1,287	480	160	0	967	94	0	0	94	1,061
Total	1,196	1,834	638	213	0	1,409	111	0	0	111	1,520
West Leg											
Approach	504	575	71	24	0	528	0	0	0	0	528
Departure	488	667	179	60	0	548	17	0	0	17	565
Total	992	1,242	250	83	0	1,075	17	0	0	17	1,092
Total Approaches											
Approach	1,295	1,954	659	220	0	1,515	111	0	0	111	1,626
Departure	1,295	1,954	659	220	0	1,515	111	0	0	111	1,626
Total	2,590	3,908	1,318	439	0	3,029	222	0	0	222	3,251

Table C-3 - Phase I Project Completion Year (2029) Volume Summary

AM Peak Hour											
	Existing	Ph III 2049 without Project	Total Growth (2019-2049)	Adjusted Growth	Cumulative Projects	Year 2029 without Project	External Project Trips	Internal Project Trips	Pass-by Trips	Phase I Project Trips	Year 2029 with Project
46 Madera Avenue/SR-99 Northbound Ramps											
NBL	355	663	308	103	0	458	20	0	0	20	478
NBT	397	447	50	17	0	414	25	0	0	25	439
NBR	0	0	0	0	0	0	0	0	0	0	0
SBL	0	0	0	0	0	0	0	0	0	0	0
SBT	553	701	148	49	0	602	3	0	0	3	605
SBR	148	277	129	43	0	191	7	0	0	7	198
EBL	0	0	0	0	0	0	0	0	0	0	0
EBT	0	0	0	0	0	0	0	0	0	0	0
EBR	0	0	0	0	0	0	0	0	0	0	0
WBL	139	223	84	28	0	167	11	0	0	11	178
WBT	1	2	1	0	0	1	0	0	0	0	1
WBR	75	107	32	11	0	86	0	0	0	0	86
North Leg											
Approach	701	978	277	92	0	793	10	0	0	10	803
Departure	472	554	82	27	0	499	25	0	0	25	524
Total	1,173	1,532	359	120	0	1,293	35	0	0	35	1,328
South Leg											
Approach	752	1,110	358	119	0	871	45	0	0	45	916
Departure	692	924	232	77	0	769	14	0	0	14	783
Total	1,444	2,034	590	197	0	1,641	59	0	0	59	1,700
East Leg											
Approach	215	332	117	39	0	254	11	0	0	11	265
Departure	0	0	0	0	0	0	0	0	0	0	0
Total	215	332	117	39	0	254	11	0	0	11	265
West Leg											
Approach	0	0	0	0	0	0	0	0	0	0	0
Departure	504	942	438	146	0	650	27	0	0	27	677
Total	504	942	438	146	0	650	27	0	0	27	677
Total Approaches											
Approach	1,668	2,420	752	251	0	1,919	66	0	0	66	1,985
Departure	1,668	2,420	752	251	0	1,919	66	0	0	66	1,985
Total	3,336	4,840	1,504	501	0	3,837	132	0	0	132	3,969

Table C-3 - Phase I Project Completion Year (2029) Volume Summary

	AM Peak Hour										
	Existing	Ph III 2049 without Project	Total Growth (2019-2049)	Adjusted Growth	Cumulative Projects	Year 2029 without Project	External Project Trips	Internal Project Trips	Pass-by Trips	Phase I Project Trips	Year 2029 with Project
47 Madera Avenue/Olive Avenue – SR-99 Southbound On-Ramp											
NBL	107	202	95	32	0	139	3	0	0	3	142
NBT	452	692	240	80	0	532	20	0	0	20	552
NBR	38	44	6	2	0	40	0	0	0	0	40
SBL	84	88	4	1	0	85	0	0	0	0	85
SBT	326	491	165	55	0	381	0	0	0	0	381
SBR	282	345	63	21	0	303	14	0	0	14	317
EBL	300	418	118	39	0	339	25	0	0	25	364
EBT	192	202	10	3	0	195	0	0	0	0	195
EBR	315	667	352	117	0	432	69	0	0	69	501
WBL	0	0	0	0	0	0	0	0	0	0	0
WBT	0	0	0	0	0	0	0	0	0	0	0
WBR	0	0	0	0	0	0	0	0	0	0	0
North Leg											
Approach	692	924	232	77	0	769	14	0	0	14	783
Departure	752	1,110	358	119	0	871	45	0	0	45	916
Total	1,444	2,034	590	197	0	1,641	59	0	0	59	1,700
South Leg											
Approach	597	938	341	114	0	711	23	0	0	23	734
Departure	641	1,158	517	172	0	813	69	0	0	69	882
Total	1,238	2,096	858	286	0	1,524	92	0	0	92	1,616
East Leg											
Approach	0	0	0	0	0	0	0	0	0	0	0
Departure	314	334	20	7	0	321	0	0	0	0	321
Total	314	334	20	7	0	321	0	0	0	0	321
West Leg											
Approach	807	1,287	480	160	0	967	94	0	0	94	1,061
Departure	389	547	158	53	0	442	17	0	0	17	459
Total	1,196	1,834	638	213	0	1,409	111	0	0	111	1,520
Total Approaches											
Approach	2,096	3,149	1,053	351	0	2,447	131	0	0	131	2,578
Departure	2,096	3,149	1,053	351	0	2,447	131	0	0	131	2,578
Total	4,192	6,298	2,106	702	0	4,894	262	0	0	262	5,156

Table C-3 - Phase I Project Completion Year (2029) Volume Summary

	AM Peak Hour										
	Existing	Ph III 2049 without Project	Total Growth (2019-2049)	Adjusted Growth	Cumulative Projects	Year 2029 without Project	External Project Trips	Internal Project Trips	Pass-by Trips	Phase I Project Trips	Year 2029 with Project
48 Madera Avenue (SR-145) /Lewis Street											
NBL	0	0	0	0	0	0	0	0	0	0	0
NBT	619	962	343	114	0	733	23	0	0	23	756
NBR	8	8	0	0	0	8	0	0	0	0	8
SBL	31	33	2	1	0	32	0	0	0	0	32
SBT	764	1,281	517	172	0	936	69	0	0	69	1005
SBR	0	0	0	0	0	0	0	0	0	0	0
EBL	0	0	0	0	0	0	0	0	0	0	0
EBT	0	0	0	0	0	0	0	0	0	0	0
EBR	0	0	0	0	0	0	0	0	0	0	0
WBL	9	9	0	0	0	9	0	0	0	0	9
WBT	0	0	0	0	0	0	0	0	0	0	0
WBR	8	8	0	0	0	8	0	0	0	0	8
North Leg											
Approach	795	1,314	519	173	0	968	69	0	0	69	1,037
Departure	627	970	343	114	0	741	23	0	0	23	764
Total	1,422	2,284	862	287	0	1,709	92	0	0	92	1,801
South Leg											
Approach	627	970	343	114	0	741	23	0	0	23	764
Departure	773	1,290	517	172	0	945	69	0	0	69	1,014
Total	1,400	2,261	861	287	0	1,687	92	0	0	92	1,779
East Leg											
Approach	17	18	1	0	0	17	0	0	0	0	17
Departure	39	41	2	1	0	40	0	0	0	0	40
Total	56	59	3	1	0	57	0	0	0	0	57
West Leg											
Approach	0	0	0	0	0	0	0	0	0	0	0
Departure	0	0	0	0	0	0	0	0	0	0	0
Total	0	0	0	0	0	0	0	0	0	0	0
Total Approaches											
Approach	1,439	2,302	863	288	0	1,727	92	0	0	92	1,819
Departure	1,439	2,302	863	288	0	1,727	92	0	0	92	1,819
Total	2,878	4,604	1,726	575	0	3,453	184	0	0	184	3,637

Table C-3 - Phase I Project Completion Year (2029) Volume Summary

	AM Peak Hour										
	Existing	Ph III 2049 without Project	Total Growth (2019-2049)	Adjusted Growth	Cumulative Projects	Year 2029 without Project	External Project Trips	Internal Project Trips	Pass-by Trips	Phase I Project Trips	Year 2029 with Project
49 Yosemite Avenue/Cleveland Avenue - Tozer Street											
NBL	131	141	10	3	0	134	0	0	0	0	134
NBT	105	137	32	11	0	116	0	0	0	0	116
NBR	74	78	4	1	0	75	0	0	0	0	75
SBL	60	79	19	6	0	66	0	0	0	0	66
SBT	229	270	41	14	0	243	0	0	0	0	243
SBR	168	226	58	19	0	187	23	0	0	23	210
EBL	164	210	46	15	0	179	69	0	0	69	248
EBT	514	531	17	6	0	520	0	0	0	0	520
EBR	248	260	12	4	0	252	0	0	0	0	252
WBL	110	116	6	2	0	112	0	0	0	0	112
WBT	289	349	60	20	0	309	0	0	0	0	309
WBR	41	60	19	6	0	47	0	0	0	0	47
North Leg											
Approach	457	575	118	39	0	496	23	0	0	23	519
Departure	310	407	97	32	0	342	69	0	0	69	411
Total	767	982	215	72	0	839	92	0	0	92	931
South Leg											
Approach	310	356	46	15	0	325	0	0	0	0	325
Departure	587	646	59	20	0	607	0	0	0	0	607
Total	897	1,002	105	35	0	932	0	0	0	0	932
East Leg											
Approach	440	525	85	28	0	468	0	0	0	0	468
Departure	648	688	40	13	0	661	0	0	0	0	661
Total	1,088	1,213	125	42	0	1,130	0	0	0	0	1,130
West Leg											
Approach	926	1,001	75	25	0	951	69	0	0	69	1,020
Departure	588	716	128	43	0	631	23	0	0	23	654
Total	1,514	1,717	203	68	0	1,582	92	0	0	92	1,674
Total Approaches											
Approach	2,133	2,457	324	108	0	2,241	92	0	0	92	2,333
Departure	2,133	2,457	324	108	0	2,241	92	0	0	92	2,333
Total	4,266	4,915	649	216	0	4,482	184	0	0	184	4,666

Table C-3 - Phase I Project Completion Year (2029) Volume Summary

	AM Peak Hour										
	Existing	Ph III 2049 without Project	Total Growth (2019-2049)	Adjusted Growth	Cumulative Projects	Year 2029 without Project	External Project Trips	Internal Project Trips	Pass-by Trips	Phase I Project Trips	Year 2029 with Project
50 Road 22/Cleveland Avenue											
NBL	0	0	0	0	0	0	0	0	0	0	0
NBT	0	0	0	0	0	0	0	0	0	0	0
NBR	0	0	0	0	0	0	0	0	0	0	0
SBL	0	0	0	0	0	0	0	0	0	0	0
SBT	0	0	0	0	0	0	0	0	0	0	0
SBR	0	0	0	0	0	0	0	0	0	0	0
EBL	0	0	0	0	0	0	0	0	0	0	0
EBT	0	0	0	0	0	0	0	0	0	0	0
EBR	0	0	0	0	0	0	0	0	0	0	0
WBL	0	0	0	0	0	0	0	0	0	0	0
WBT	0	0	0	0	0	0	0	0	0	0	0
WBR	0	0	0	0	0	0	0	0	0	0	0
North Leg											
Approach	0	0	0	0	0	0	0	0	0	0	0
Departure	0	0	0	0	0	0	0	0	0	0	0
Total	0	0	0	0	0	0	0	0	0	0	0
South Leg											
Approach	0	0	0	0	0	0	0	0	0	0	0
Departure	0	0	0	0	0	0	0	0	0	0	0
Total	0	0	0	0	0	0	0	0	0	0	0
East Leg											
Approach	0	0	0	0	0	0	0	0	0	0	0
Departure	0	0	0	0	0	0	0	0	0	0	0
Total	0	0	0	0	0	0	0	0	0	0	0
West Leg											
Approach	0	0	0	0	0	0	0	0	0	0	0
Departure	0	0	0	0	0	0	0	0	0	0	0
Total	0	0	0	0	0	0	0	0	0	0	0
Total Approaches											
Approach	0	0	0	0	0	0	0	0	0	0	0
Departure	0	0	0	0	0	0	0	0	0	0	0
Total	0	0	0	0	0	0	0	0	0	0	0

Table C-3 - Phase I Project Completion Year (2029) Volume Summary

		AM Peak Hour									
		Ph III 2049	Total Growth	Adjusted	Cumulative	Year 2029	External	Internal	Pass-by	Phase I	Year 2029
		Existing	without Project	Growth (2019-2049)	Growth	Projects	Project Trips	Project Trips	Trips	Project Trips	with Project
51 Project Driveway 1/Avenue 17											
NBL	0	0	0	0	0	0	0	0	0	0	0
NBT	0	0	0	0	0	0	0	0	0	0	0
NBR	0	0	0	0	0	0	0	0	0	0	0
SBL	0	0	0	0	0	0	0	0	0	0	0
SBT	0	0	0	0	0	0	0	0	0	0	0
SBR	0	0	0	0	0	0	0	0	0	0	0
EBL	0	0	0	0	0	0	0	0	0	0	0
EBT	31	50	19	6	0	37	11	0	0	11	48
EBR	0	0	0	0	0	0	0	0	0	0	0
WBL	0	0	0	0	0	0	0	0	0	0	0
WBT	27	32	5	2	0	29	34	0	0	34	63
WBR	0	0	0	0	0	0	0	0	0	0	0
North Leg											
Approach	0	0	0	0	0	0	0	0	0	0	0
Departure	0	0	0	0	0	0	0	0	0	0	0
Total	0	0	0	0	0	0	0	0	0	0	0
South Leg											
Approach	0	0	0	0	0	0	0	0	0	0	0
Departure	0	0	0	0	0	0	0	0	0	0	0
Total	0	0	0	0	0	0	0	0	0	0	0
East Leg											
Approach	27	32	5	2	0	29	34	0	0	34	63
Departure	31	50	19	6	0	37	11	0	0	11	48
Total	58	82	24	8	0	66	45	0	0	45	111
West Leg											
Approach	31	50	19	6	0	37	11	0	0	11	48
Departure	27	32	5	2	0	29	34	0	0	34	63
Total	58	82	24	8	0	66	45	0	0	45	111
Total Approaches											
Approach	58	82	24	8	0	66	45	0	0	45	111
Departure	58	82	24	8	0	66	45	0	0	45	111
Total	116	164	48	16	0	132	90	0	0	90	222

Table C-3 - Phase I Project Completion Year (2029) Volume Summary

	AM Peak Hour										
	Existing	Ph III 2049 without Project	Total Growth (2019-2049)	Adjusted Growth	Cumulative Projects	Year 2029 without Project	External Project Trips	Internal Project Trips	Pass-by Trips	Phase I Project Trips	Year 2029 with Project
52 Road 22 ½ - Project Driveway 2/Avenue 16											
NBL	0	0	0	0	0	0	0	0	0	0	0
NBT	0	0	0	0	0	0	0	0	0	0	0
NBR	1	4	3	1	0	2	0	0	0	0	2
SBL	1	4	3	1	0	2	0	0	0	0	2
SBT	0	0	0	0	0	0	0	0	0	0	0
SBR	0	0	0	0	0	0	0	0	0	0	0
EBL	0	0	0	0	0	0	0	0	0	0	0
EBT	12	65	53	18	0	30	0	0	0	0	30
EBR	2	2	0	0	0	2	0	0	0	0	2
WBL	0	0	0	0	0	0	0	0	0	0	0
WBT	33	35	2	1	0	34	0	0	0	0	34
WBR	0	0	0	0	0	0	0	0	0	0	0
North Leg											
Approach	1	4	3	1	0	2	0	0	0	0	2
Departure	0	0	0	0	0	0	0	0	0	0	0
Total	1	4	3	1	0	2	0	0	0	0	2
South Leg											
Approach	1	4	3	1	0	2	0	0	0	0	2
Departure	2	2	0	0	0	2	0	0	0	0	2
Total	3	6	3	1	0	4	0	0	0	0	4
East Leg											
Approach	33	35	2	1	0	34	0	0	0	0	34
Departure	14	73	59	20	0	34	0	0	0	0	34
Total	47	108	61	20	0	67	0	0	0	0	67
West Leg											
Approach	14	67	53	18	0	32	0	0	0	0	32
Departure	33	35	2	1	0	34	0	0	0	0	34
Total	47	102	55	18	0	65	0	0	0	0	65
Total Approaches											
Approach	49	110	61	20	0	69	0	0	0	0	69
Departure	49	110	61	20	0	69	0	0	0	0	69
Total	98	220	122	41	0	139	0	0	0	0	139

Table C-3 - Phase I Project Completion Year (2029) Volume Summary

	AM Peak Hour										
	Existing	Ph III 2049 without Project	Total Growth (2019-2049)	Adjusted Growth	Cumulative Projects	Year 2029 without Project	External Project Trips	Internal Project Trips	Pass-by Trips	Phase I Project Trips	Year 2029 with Project
53 Road 22 1/2/Cleveland Avenue											
NBL	1	1	0	0	0	1	0	0	0	0	1
NBT	0	0	0	0	0	0	0	0	0	0	0
NBR	2	2	0	0	0	2	0	0	0	0	2
SBL	1	1	0	0	0	1	0	0	0	0	1
SBT	0	0	0	0	0	0	0	0	0	0	0
SBR	0	0	0	0	0	0	0	0	0	0	0
EBL	0	0	0	0	0	0	0	0	0	0	0
EBT	0	0	0	0	0	0	0	0	0	0	0
EBR	0	0	0	0	0	0	0	0	0	0	0
WBL	1	1	0	0	0	1	0	0	0	0	1
WBT	0	0	0	0	0	0	0	0	0	0	0
WBR	1	1	0	0	0	1	0	0	0	0	1
North Leg											
Approach	1	1	0	0	0	1	0	0	0	0	1
Departure	1	1	0	0	0	1	0	0	0	0	1
Total	2	2	0	0	0	2	0	0	0	0	2
South Leg											
Approach	3	3	0	0	0	3	0	0	0	0	3
Departure	1	1	0	0	0	1	0	0	0	0	1
Total	4	4	0	0	0	4	0	0	0	0	4
East Leg											
Approach	2	2	0	0	0	2	0	0	0	0	2
Departure	3	3	0	0	0	3	0	0	0	0	3
Total	5	5	0	0	0	5	0	0	0	0	5
West Leg											
Approach	0	0	0	0	0	0	0	0	0	0	0
Departure	1	1	0	0	0	1	0	0	0	0	1
Total	1	1	0	0	0	1	0	0	0	0	1
Total Approaches											
Approach	6	6	0	0	0	6	0	0	0	0	6
Departure	6	6	0	0	0	6	0	0	0	0	6
Total	12	13	1	0	0	12	0	0	0	0	12

Table C-3 - Phase I Project Completion Year (2029) Volume Summary

		AM Peak Hour									
		Ph III 2049	Total Growth	Adjusted	Cumulative	Year 2029	External	Internal	Pass-by	Phase I	Year 2029
		Existing	without Project	Growth (2019-2049)	Growth	Projects	Project Trips	Project Trips	Trips	Project Trips	with Project
54 Road 22 1/2/Project Driveway 5											
NBL	0	0	0	0	0	0	0	0	0	0	0
NBT	0	0	0	0	0	0	0	0	0	0	0
NBR	0	0	0	0	0	0	0	0	0	0	0
SBL	0	0	0	0	0	0	0	0	0	0	0
SBT	0	0	0	0	0	0	0	0	0	0	0
SBR	0	0	0	0	0	0	0	0	0	0	0
EBL	0	0	0	0	0	0	0	0	0	0	0
EBT	0	0	0	0	0	0	0	0	0	0	0
EBR	0	0	0	0	0	0	0	0	0	0	0
WBL	0	0	0	0	0	0	0	0	0	0	0
WBT	0	0	0	0	0	0	0	0	0	0	0
WBR	0	0	0	0	0	0	0	0	0	0	0
North Leg											
Approach	0	0	0	0	0	0	0	0	0	0	0
Departure	0	0	0	0	0	0	0	0	0	0	0
Total	0	0	0	0	0	0	0	0	0	0	0
South Leg											
Approach	0	0	0	0	0	0	0	0	0	0	0
Departure	0	0	0	0	0	0	0	0	0	0	0
Total	0	0	0	0	0	0	0	0	0	0	0
East Leg											
Approach	0	0	0	0	0	0	0	0	0	0	0
Departure	0	0	0	0	0	0	0	0	0	0	0
Total	0	0	0	0	0	0	0	0	0	0	0
West Leg											
Approach	0	0	0	0	0	0	0	0	0	0	0
Departure	0	0	0	0	0	0	0	0	0	0	0
Total	0	0	0	0	0	0	0	0	0	0	0
Total Approaches											
Approach	0	0	0	0	0	0	0	0	0	0	0
Departure	0	0	0	0	0	0	0	0	0	0	0
Total	0	0	0	0	0	0	0	0	0	0	0

Table C-3 - Phase I Project Completion Year (2029) Volume Summary

		AM Peak Hour									
		Ph III 2049	Total Growth	Adjusted	Cumulative	Year 2029	External	Internal	Pass-by	Phase I	Year 2029
Existing		without Project	(2019-2049)	Growth	Projects	without Project	Project Trips	Project Trips	Trips	Project Trips	with Project
55 Road 23/Project Driveway 3											
NBL	0	0	0	0	0	0	0	0	0	0	0
NBT	232	300	68	23	0	255	383	0	0	383	638
NBR	0	0	0	0	0	0	0	0	0	0	0
SBL	0	0	0	0	0	0	0	0	0	0	0
SBT	160	325	165	55	0	215	134	0	0	134	349
SBR	0	0	0	0	0	0	0	0	0	0	0
EBL	0	0	0	0	0	0	0	0	0	0	0
EBT	0	0	0	0	0	0	0	0	0	0	0
EBR	0	0	0	0	0	0	0	0	0	0	0
WBL	0	0	0	0	0	0	0	0	0	0	0
WBT	0	0	0	0	0	0	0	0	0	0	0
WBR	0	0	0	0	0	0	0	0	0	0	0
North Leg											
Approach	160	325	165	55	0	215	134	0	0	134	349
Departure	232	300	68	23	0	255	383	0	0	383	638
Total	392	625	233	78	0	470	517	0	0	517	987
South Leg											
Approach	232	300	68	23	0	255	383	0	0	383	638
Departure	160	325	165	55	0	215	134	0	0	134	349
Total	392	625	233	78	0	470	517	0	0	517	987
East Leg											
Approach	0	0	0	0	0	0	0	0	0	0	0
Departure	0	0	0	0	0	0	0	0	0	0	0
Total	0	0	0	0	0	0	0	0	0	0	0
West Leg											
Approach	0	0	0	0	0	0	0	0	0	0	0
Departure	0	0	0	0	0	0	0	0	0	0	0
Total	0	0	0	0	0	0	0	0	0	0	0
Total Approaches											
Approach	392	625	233	78	0	470	517	0	0	517	987
Departure	392	625	233	78	0	470	517	0	0	517	987
Total	784	1,250	466	155	0	939	1,034	0	0	1,034	1,973

Table C-3 - Phase I Project Completion Year (2029) Volume Summary

		AM Peak Hour								
Existing	Ph III 2049 without Project	Total Growth (2019-2049)	Adjusted Growth	Cumulative Projects	Year 2029 without Project	External Project Trips	Internal Project Trips	Pass-by Trips	Phase I Project Trips	Year 2029 with Project
56 Road 23/Project Driveway 4										
NBL	0	0	0	0	0	0	0	0	0	0
NBT	266	279	13	4	0	270	49	0	49	319
NBR	0	0	0	0	0	0	110	0	110	110
SBL	0	0	0	0	0	0	132	0	132	132
SBT	209	219	10	3	0	212	192	0	192	404
SBR	0	0	0	0	0	0	0	0	0	0
EBL	0	0	0	0	0	0	0	0	0	0
EBT	0	0	0	0	0	0	0	0	0	0
EBR	0	0	0	0	0	0	0	0	0	0
WBL	0	0	0	0	0	0	80	0	80	80
WBT	0	0	0	0	0	0	0	0	0	0
WBR	0	0	0	0	0	0	263	0	263	263
North Leg										
Approach	209	219	10	3	0	212	324	0	324	536
Departure	266	279	13	4	0	270	312	0	312	582
Total	475	499	24	8	0	483	636	0	636	1,119
South Leg										
Approach	266	279	13	4	0	270	159	0	159	429
Departure	209	219	10	3	0	212	272	0	272	484
Total	475	499	24	8	0	483	431	0	431	914
East Leg										
Approach	0	0	0	0	0	0	343	0	343	343
Departure	0	0	0	0	0	0	242	0	242	242
Total	0	0	0	0	0	0	585	0	585	585
West Leg										
Approach	0	0	0	0	0	0	0	0	0	0
Departure	0	0	0	0	0	0	0	0	0	0
Total	0	0	0	0	0	0	0	0	0	0
Total Approaches										
Approach	475	499	24	8	0	483	826	0	826	1,309
Departure	475	499	24	8	0	483	826	0	826	1,309
Total	950	998	48	16	0	966	1,652	0	1,652	2,618

Table C-3 - Phase I Project Completion Year (2029) Volume Summary

	AM Peak Hour										
	Existing	Ph III 2049 without Project	Total Growth (2019-2049)	Adjusted Growth	Cumulative Projects	Year 2029 without Project	External Project Trips	Internal Project Trips	Pass-by Trips	Phase I Project Trips	Year 2029 with Project
57 Road 23/Project Driveway 5											
NBL	1	1	0	0	0	1	0	0	0	0	1
NBT	266	279	13	4	0	270	159	0	0	159	429
NBR	0	0	0	0	0	0	0	0	0	0	0
SBL	0	0	0	0	0	0	0	0	0	0	0
SBT	209	979	770	257	0	466	271	0	0	271	737
SBR	0	0	0	0	0	0	0	0	0	0	0
EBL	0	0	0	0	0	0	0	0	0	0	0
EBT	0	0	0	0	0	0	0	0	0	0	0
EBR	1	1	0	0	0	1	0	0	0	0	1
WBL	0	0	0	0	0	0	0	0	0	0	0
WBT	0	0	0	0	0	0	0	0	0	0	0
WBR	0	0	0	0	0	0	0	0	0	0	0
North Leg											
Approach	209	979	770	257	0	466	271	0	0	271	737
Departure	266	279	13	4	0	270	159	0	0	159	429
Total	475	1,258	783	261	0	736	430	0	0	430	1,166
South Leg											
Approach	267	280	13	4	0	271	159	0	0	159	430
Departure	210	980	770	257	0	467	271	0	0	271	738
Total	477	1,260	783	261	0	738	430	0	0	430	1,168
East Leg											
Approach	0	0	0	0	0	0	0	0	0	0	0
Departure	0	0	0	0	0	0	0	0	0	0	0
Total	0	0	0	0	0	0	0	0	0	0	0
West Leg											
Approach	1	1	0	0	0	1	0	0	0	0	1
Departure	1	1	0	0	0	1	0	0	0	0	1
Total	2	2	0	0	0	2	0	0	0	0	2
Total Approaches											
Approach	477	1,260	783	261	0	738	430	0	0	430	1,168
Departure	477	1,260	783	261	0	738	430	0	0	430	1,168
Total	954	2,521	1,567	522	0	1,476	860	0	0	860	2,336

Table C-3 - Phase I Project Completion Year (2029) Volume Summary

		AM Peak Hour									
	Existing	Ph III 2049 without Project	Total Growth (2019-2049)	Adjusted Growth	Cumulative Projects	Year 2029 without Project	External Project Trips	Internal Project Trips	Pass-by Trips	Phase I Project Trips	Year 2029 with Project
58 Project Driveway 6/Cleveland Avenue											
NBL	0	0	0	0	0	0	194	13	0	207	207
NBT	0	0	0	0	0	0	0	0	0	0	0
NBR	0	0	0	0	0	0	292	0	0	292	292
SBL	0	0	0	0	0	0	0	0	0	0	0
SBT	0	0	0	0	0	0	0	0	0	0	0
SBR	0	0	0	0	0	0	0	0	0	0	0
EBL	0	0	0	0	0	0	0	0	0	0	0
EBT	63	66	3	1	0	64	787	36	0	823	887
EBR	0	0	0	0	0	0	75	13	0	88	88
WBL	0	0	0	0	0	0	154	0	0	154	154
WBT	84	88	4	1	0	85	207	35	0	242	327
WBR	0	0	0	0	0	0	0	0	0	0	0
North Leg											
Approach	0	0	0	0	0	0	0	0	0	0	0
Departure	0	0	0	0	0	0	0	0	0	0	0
Total	0	0	0	0	0	0	0	0	0	0	0
South Leg											
Approach	0	0	0	0	0	0	486	13	0	499	499
Departure	0	0	0	0	0	0	229	13	0	242	242
Total	0	0	0	0	0	0	715	26	0	741	741
East Leg											
Approach	84	88	4	1	0	85	361	35	0	396	481
Departure	63	66	3	1	0	64	1,079	36	0	1,115	1,179
Total	147	154	7	2	0	149	1,440	71	0	1,511	1,660
West Leg											
Approach	63	66	3	1	0	64	862	49	0	911	975
Departure	84	88	4	1	0	85	401	48	0	449	534
Total	147	154	7	2	0	149	1,263	97	0	1,360	1,509
Total Approaches											
Approach	147	154	7	2	0	149	1,709	97	0	1,806	1,955
Departure	147	154	7	2	0	149	1,709	97	0	1,806	1,955
Total	294	309	15	5	0	299	3,418	194	0	3,612	3,911

Table C-3 - Phase I Project Completion Year (2029) Volume Summary

	PM Peak Hour										
	Existing	Ph III 2049 without Project	Total Growth (2019-2049)	Adjusted Growth	Cumulative Projects	Year 2029 without Project	External Project Trips	Internal Project Trips	Pass-by Trips	Phase I Project Trips	Year 2029 with Project
1 Road 22/Avenue 17											
NBL	1	1	0	0	0	1	0	0	0	0	1
NBT	0	0	0	0	0	0	0	0	0	0	0
NBR	0	0	0	0	0	0	0	0	0	0	0
SBL	0	0	0	0	0	0	0	0	0	0	0
SBT	0	0	0	0	0	0	0	0	0	0	0
SBR	0	0	0	0	0	0	0	0	0	0	0
EBL	0	0	0	0	0	0	0	0	0	0	0
EBT	60	66	6	2	0	62	28	0	0	28	90
EBR	0	0	0	0	0	0	0	0	0	0	0
WBL	0	0	0	0	0	0	0	0	0	0	0
WBT	25	38	13	4	0	29	11	0	0	11	40
WBR	0	0	0	0	0	0	0	0	0	0	0
North Leg											
Approach	0	0	0	0	0	0	0	0	0	0	0
Departure	0	0	0	0	0	0	0	0	0	0	0
Total	0	0	0	0	0	0	0	0	0	0	0
South Leg											
Approach	1	1	0	0	0	1	0	0	0	0	1
Departure	0	0	0	0	0	0	0	0	0	0	0
Total	1	1	0	0	0	1	0	0	0	0	1
East Leg											
Approach	25	38	13	4	0	29	11	0	0	11	40
Departure	60	66	6	2	0	62	28	0	0	28	90
Total	85	104	19	6	0	91	39	0	0	39	130
West Leg											
Approach	60	66	6	2	0	62	28	0	0	28	90
Departure	26	39	13	4	0	30	11	0	0	11	41
Total	86	105	19	6	0	92	39	0	0	39	131
Total Approaches											
Approach	86	105	19	6	0	92	39	0	0	39	131
Departure	86	105	19	6	0	92	39	0	0	39	131
Total	172	210	38	13	0	185	78	0	0	78	263

Table C-3 - Phase I Project Completion Year (2029) Volume Summary

	PM Peak Hour										
	Existing	Ph III 2049 without Project	Total Growth (2019-2049)	Adjusted Growth	Cumulative Projects	Year 2029 without Project	External Project Trips	Internal Project Trips	Pass-by Trips	Phase I Project Trips	Year 2029 with Project
2 Road 22/Avenue 16											
NBL	0	0	0	0	0	0	0	0	0	0	0
NBT	0	0	0	0	0	0	0	0	0	0	0
NBR	1	1	0	0	0	1	0	0	0	0	1
SBL	0	0	0	0	0	0	0	0	0	0	0
SBT	0	0	0	0	0	0	0	0	0	0	0
SBR	0	0	0	0	0	0	0	0	0	0	0
EBL	0	0	0	0	0	0	0	0	0	0	0
EBT	48	50	2	1	0	49	0	0	0	0	49
EBR	0	0	0	0	0	0	0	0	0	0	0
WBL	0	0	0	0	0	0	0	0	0	0	0
WBT	14	15	1	0	0	14	0	0	0	0	14
WBR	0	0	0	0	0	0	0	0	0	0	0
North Leg											
Approach	0	0	0	0	0	0	0	0	0	0	0
Departure	0	0	0	0	0	0	0	0	0	0	0
Total	0	0	0	0	0	0	0	0	0	0	0
South Leg											
Approach	1	1	0	0	0	1	0	0	0	0	1
Departure	0	0	0	0	0	0	0	0	0	0	0
Total	1	1	0	0	0	1	0	0	0	0	1
East Leg											
Approach	14	15	1	0	0	14	0	0	0	0	14
Departure	49	51	2	1	0	50	0	0	0	0	50
Total	63	66	3	1	0	64	0	0	0	0	64
West Leg											
Approach	48	50	2	1	0	49	0	0	0	0	49
Departure	14	15	1	0	0	14	0	0	0	0	14
Total	62	65	3	1	0	63	0	0	0	0	63
Total Approaches											
Approach	63	66	3	1	0	64	0	0	0	0	64
Departure	63	66	3	1	0	64	0	0	0	0	64
Total	126	133	7	2	0	128	0	0	0	0	128

Table C-3 - Phase I Project Completion Year (2029) Volume Summary

	PM Peak Hour										
	Existing	Ph III 2049 without Project	Total Growth (2019-2049)	Adjusted Growth	Cumulative Projects	Year 2029 without Project	External Project Trips	Internal Project Trips	Pass-by Trips	Phase I Project Trips	Year 2029 with Project
3 Golden State Boulevard/Avenue 18 ½											
NBL	0	0	0	0	0	0	0	0	0	0	0
NBT	0	0	0	0	0	0	0	0	0	0	0
NBR	0	0	0	0	0	0	0	0	0	0	0
SBL	252	270	18	6	0	258	0	0	0	0	258
SBT	0	0	0	0	0	0	0	0	0	0	0
SBR	8	8	0	0	0	8	0	0	0	0	8
EBL	7	7	0	0	0	7	0	0	0	0	7
EBT	117	137	20	7	0	124	23	0	0	23	147
EBR	0	0	0	0	0	0	0	0	0	0	0
WBL	0	0	0	0	0	0	0	0	0	0	0
WBT	60	80	20	7	0	67	15	0	0	15	82
WBR	96	115	19	6	0	102	0	0	0	0	102
North Leg											
Approach	260	278	18	6	0	266	0	0	0	0	266
Departure	103	122	19	6	0	109	0	0	0	0	109
Total	363	401	38	13	0	376	0	0	0	0	376
South Leg											
Approach	0	0	0	0	0	0	0	0	0	0	0
Departure	0	0	0	0	0	0	0	0	0	0	0
Total	0	0	0	0	0	0	0	0	0	0	0
East Leg											
Approach	156	195	39	13	0	169	15	0	0	15	184
Departure	369	407	38	13	0	382	23	0	0	23	405
Total	525	602	77	26	0	551	38	0	0	38	589
West Leg											
Approach	124	144	20	7	0	131	23	0	0	23	154
Departure	68	88	20	7	0	75	15	0	0	15	90
Total	192	233	41	14	0	206	38	0	0	38	244
Total Approaches											
Approach	540	618	78	26	0	566	38	0	0	38	604
Departure	540	618	78	26	0	566	38	0	0	38	604
Total	1,080	1,236	156	52	0	1,132	76	0	0	76	1,208

Table C-3 - Phase I Project Completion Year (2029) Volume Summary

	PM Peak Hour										
	Ph III 2049 Existing	Ph III 2049 without Project	Total Growth (2019-2049)	Adjusted Growth	Cumulative Projects	Year 2029 without Project	External Project Trips	Internal Project Trips	Pass-by Trips	Phase I Project Trips	Year 2029 with Project
4 Pistachio Drive/Avenue 18 ½											
NBL	2	2	0	0	0	2	0	0	0	0	2
NBT	0	0	0	0	0	0	0	0	0	0	0
NBR	5	5	0	0	0	5	0	0	0	0	5
SBL	154	170	16	5	0	159	0	0	0	0	159
SBT	0	0	0	0	0	0	0	0	0	0	0
SBR	12	13	1	0	0	12	0	0	0	0	12
EBL	12	13	1	0	0	12	0	0	0	0	12
EBT	425	446	21	7	0	432	23	0	0	23	455
EBR	1	1	0	0	0	1	0	0	0	0	1
WBL	6	6	0	0	0	6	0	0	0	0	6
WBT	148	167	19	6	0	154	15	0	0	15	169
WBR	187	206	19	6	0	193	0	0	0	0	193
North Leg											
Approach	166	183	17	6	0	172	0	0	0	0	172
Departure	199	219	20	7	0	206	0	0	0	0	206
Total	365	402	37	12	0	377	0	0	0	0	377
South Leg											
Approach	7	7	0	0	0	7	0	0	0	0	7
Departure	7	7	0	0	0	7	0	0	0	0	7
Total	14	15	1	0	0	14	0	0	0	0	14
East Leg											
Approach	341	379	38	13	0	354	15	0	0	15	369
Departure	584	621	37	12	0	596	23	0	0	23	619
Total	925	1,001	76	25	0	950	38	0	0	38	988
West Leg											
Approach	438	460	22	7	0	445	23	0	0	23	468
Departure	162	182	20	7	0	169	15	0	0	15	184
Total	600	642	42	14	0	614	38	0	0	38	652
Total Approaches											
Approach	952	1,029	77	26	0	978	38	0	0	38	1,016
Departure	952	1,029	77	26	0	978	38	0	0	38	1,016
Total	1,904	2,059	155	52	0	1,956	76	0	0	76	2,032

Table C-3 - Phase I Project Completion Year (2029) Volume Summary

	PM Peak Hour										
	Ph III 2049 Existing	Ph III 2049 without Project	Total Growth (2019-2049)	Adjusted Growth	Cumulative Projects	Year 2029 without Project	External Project Trips	Internal Project Trips	Pass-by Trips	Phase I Project Trips	Year 2029 with Project
5 SR-99 Southbound Ramps – Road 23/Avenue 18 ½											
NBL	31	48	17	6	0	37	15	0	0	15	52
NBT	0	0	0	0	0	0	0	0	0	0	0
NBR	75	162	87	29	0	104	102	0	0	102	206
SBL	19	28	9	3	0	22	0	0	0	0	22
SBT	93	136	43	14	0	107	186	0	0	186	293
SBR	120	127	7	2	0	122	0	0	0	0	122
EBL	0	0	0	0	0	0	0	0	0	0	0
EBT	380	405	25	8	0	388	0	0	0	0	388
EBR	204	216	12	4	0	208	23	0	0	23	231
WBL	39	58	19	6	0	45	0	0	0	0	45
WBT	191	206	15	5	0	196	0	0	0	0	196
WBR	0	0	0	0	0	0	0	0	0	0	0
North Leg											
Approach	232	291	59	20	0	252	186	0	0	186	438
Departure	0	0	0	0	0	0	0	0	0	0	0
Total	232	291	59	20	0	252	186	0	0	186	438
South Leg											
Approach	106	210	104	35	0	141	117	0	0	117	258
Departure	336	410	74	25	0	361	209	0	0	209	570
Total	442	620	178	59	0	501	326	0	0	326	827
East Leg											
Approach	230	264	34	11	0	241	0	0	0	0	241
Departure	474	595	121	40	0	514	102	0	0	102	616
Total	704	859	155	52	0	756	102	0	0	102	858
West Leg											
Approach	584	621	37	12	0	596	23	0	0	23	619
Departure	342	381	39	13	0	355	15	0	0	15	370
Total	926	1,002	76	25	0	951	38	0	0	38	989
Total Approaches											
Approach	1,152	1,386	234	78	0	1,230	326	0	0	326	1,556
Departure	1,152	1,386	234	78	0	1,230	326	0	0	326	1,556
Total	2,304	2,772	468	156	0	2,460	652	0	0	652	3,112

Table C-3 - Phase I Project Completion Year (2029) Volume Summary

		PM Peak Hour										
		Ph III 2049	Total Growth	Adjusted	Cumulative	Year 2029	External	Internal	Pass-by	Phase I	Year 2029	
		Existing	without Project	Growth (2019-2049)	Growth	Projects	without Project	Project Trips	Project Trips	Trips	Project Trips	with Project
6 SR-99 Northbound Ramps/Avenue 18 ½												
NBL	179	196	17	6	0	185	0	0	0	0	185	
NBT	2	3	1	0	0	2	0	0	0	0	2	
NBR	0	0	0	0	0	0	0	0	0	0	0	
SBL	0	0	0	0	0	0	0	0	0	0	0	
SBT	0	0	0	0	0	0	0	0	0	0	0	
SBR	0	0	0	0	0	0	0	0	0	0	0	
EBL	171	235	64	21	0	192	102	0	0	102	294	
EBT	81	124	43	14	0	95	0	0	0	0	95	
EBR	0	0	0	0	0	0	0	0	0	0	0	
WBL	0	0	0	0	0	0	0	0	0	0	0	
WBT	78	99	21	7	0	85	0	0	0	0	85	
WBR	13	22	9	3	0	16	0	0	0	0	16	
North Leg												
Approach	0	0	0	0	0	0	0	0	0	0	0	
Departure	186	260	74	25	0	211	102	0	0	102	313	
Total	186	260	74	25	0	211	102	0	0	102	313	
South Leg												
Approach	181	199	18	6	0	187	0	0	0	0	187	
Departure	0	0	0	0	0	0	0	0	0	0	0	
Total	181	199	18	6	0	187	0	0	0	0	187	
East Leg												
Approach	91	121	30	10	0	101	0	0	0	0	101	
Departure	81	124	43	14	0	95	0	0	0	0	95	
Total	172	245	73	24	0	196	0	0	0	0	196	
West Leg												
Approach	252	359	107	36	0	288	102	0	0	102	390	
Departure	257	295	38	13	0	270	0	0	0	0	270	
Total	509	654	145	48	0	557	102	0	0	102	659	
Total Approaches												
Approach	524	679	155	52	0	576	102	0	0	102	678	
Departure	524	679	155	52	0	576	102	0	0	102	678	
Total	1,048	1,358	310	103	0	1,151	204	0	0	204	1,355	

Table C-3 - Phase I Project Completion Year (2029) Volume Summary

		PM Peak Hour										
		Ph III 2049	Total Growth	Adjusted	Cumulative	Year 2029	External	Internal	Pass-by	Phase I	Year 2029	
		Existing	without Project	(2019-2049)	Growth	Projects	without Project	Project Trips	Project Trips	Trips	Project Trips	with Project
7 Road 23/Avenue 17												
NBL	5	8	3	1	0	6	11	0	0	11	17	
NBT	77	85	8	3	0	80	151	0	0	151	231	
NBR	60	65	5	2	0	62	72	0	0	72	134	
SBL	61	64	3	1	0	62	0	0	0	0	62	
SBT	219	221	2	1	0	220	273	0	0	273	493	
SBR	2	3	1	0	0	2	0	0	0	0	2	
EBL	1	1	0	0	0	1	0	0	0	0	1	
EBT	48	53	5	2	0	50	0	0	0	0	50	
EBR	11	12	1	0	0	11	28	0	0	28	39	
WBL	29	30	1	0	0	29	101	0	0	101	130	
WBT	19	29	10	3	0	22	0	0	0	0	22	
WBR	9	10	1	0	0	9	0	0	0	0	9	
North Leg												
Approach	282	288	6	2	0	284	273	0	0	273	557	
Departure	87	96	9	3	0	90	151	0	0	151	241	
Total	369	384	15	5	0	374	424	0	0	424	798	
South Leg												
Approach	142	158	16	5	0	147	234	0	0	234	381	
Departure	259	263	4	1	0	260	402	0	0	402	662	
Total	401	421	20	7	0	408	636	0	0	636	1,044	
East Leg												
Approach	57	69	12	4	0	61	101	0	0	101	162	
Departure	169	182	13	4	0	173	72	0	0	72	245	
Total	226	251	25	8	0	234	173	0	0	173	407	
West Leg												
Approach	60	66	6	2	0	62	28	0	0	28	90	
Departure	26	40	14	5	0	31	11	0	0	11	42	
Total	86	106	20	7	0	93	39	0	0	39	132	
Total Approaches												
Approach	541	581	40	13	0	554	636	0	0	636	1,190	
Departure	541	581	40	13	0	554	636	0	0	636	1,190	
Total	1,082	1,162	80	27	0	1,109	1,272	0	0	1,272	2,381	

Table C-3 - Phase I Project Completion Year (2029) Volume Summary

	PM Peak Hour										
	Existing	Ph III 2049 without Project	Total Growth (2019-2049)	Adjusted Growth	Cumulative Projects	Year 2029 without Project	External Project Trips	Internal Project Trips	Pass-by Trips	Phase I Project Trips	Year 2029 with Project
8 Road 23/Avenue 16											
NBL	7	14	7	2	0	9	0	0	0	0	9
NBT	136	274	138	46	0	182	165	0	0	165	347
NBR	1	1	0	0	0	1	126	0	0	126	127
SBL	2	2	0	0	0	2	182	0	0	182	184
SBT	253	310	57	19	0	272	221	0	0	221	493
SBR	6	51	45	15	0	21	0	0	0	0	21
EBL	9	31	22	7	0	16	0	0	0	0	16
EBT	0	0	0	0	0	0	0	0	0	0	0
EBR	41	43	2	1	0	42	0	0	0	0	42
WBL	0	0	0	0	0	0	49	0	0	49	49
WBT	1	1	0	0	0	1	0	0	0	0	1
WBR	1	1	0	0	0	1	71	0	0	71	72
North Leg											
Approach	261	363	102	34	0	295	403	0	0	403	698
Departure	146	306	160	53	0	199	236	0	0	236	435
Total	407	669	262	87	0	494	639	0	0	639	1,133
South Leg											
Approach	144	289	145	48	0	192	291	0	0	291	483
Departure	294	353	59	20	0	314	270	0	0	270	584
Total	438	642	204	68	0	506	561	0	0	561	1,067
East Leg											
Approach	2	2	0	0	0	2	120	0	0	120	122
Departure	3	3	0	0	0	3	308	0	0	308	311
Total	5	5	0	0	0	5	428	0	0	428	433
West Leg											
Approach	50	74	24	8	0	58	0	0	0	0	58
Departure	14	66	52	17	0	31	0	0	0	0	31
Total	64	140	76	25	0	89	0	0	0	0	89
Total Approaches											
Approach	457	728	271	90	0	547	814	0	0	814	1,361
Departure	457	728	271	90	0	547	814	0	0	814	1,361
Total	914	1,457	543	181	0	1,095	1,628	0	0	1,628	2,723

Table C-3 - Phase I Project Completion Year (2029) Volume Summary

	PM Peak Hour										
	Existing	Ph III 2049 without Project	Total Growth (2019-2049)	Adjusted Growth	Cumulative Projects	Year 2029 without Project	External Project Trips	Internal Project Trips	Pass-by Trips	Phase I Project Trips	Year 2029 with Project
9 Road 23/Cleveland Avenue											
NBL	0	0	0	0	0	0	0	0	0	0	0
NBT	113	174	61	20	0	133	148	0	14	162	295
NBR	89	120	31	10	0	99	204	0	-15	189	288
SBL	59	93	34	11	0	70	127	0	-13	114	184
SBT	224	235	11	4	0	228	143	0	13	156	384
SBR	1	1	0	0	0	1	0	0	0	0	1
EBL	1	1	0	0	0	1	0	0	0	0	1
EBT	0	0	0	0	0	0	0	0	0	0	0
EBR	1	1	0	0	0	1	0	0	0	0	1
WBL	51	62	11	4	0	55	201	0	-11	190	245
WBT	0	0	0	0	0	0	0	0	0	0	0
WBR	25	55	30	10	0	35	143	0	-12	131	166
North Leg											
Approach	284	329	45	15	0	299	270	0	0	270	569
Departure	139	230	91	30	0	169	291	0	2	293	462
Total	423	559	136	45	0	468	561	0	2	563	1,031
South Leg											
Approach	202	294	92	31	0	233	352	0	-1	351	584
Departure	276	298	22	7	0	283	344	0	2	346	629
Total	478	592	114	38	0	516	696	0	1	697	1,213
East Leg											
Approach	76	117	41	14	0	90	344	0	-23	321	411
Departure	148	213	65	22	0	170	331	0	-28	303	473
Total	224	330	106	35	0	259	675	0	-51	624	883
West Leg											
Approach	2	2	0	0	0	2	0	0	0	0	2
Departure	1	1	0	0	0	1	0	0	0	0	1
Total	3	3	0	0	0	3	0	0	0	0	3
Total Approaches											
Approach	564	742	178	59	0	623	966	0	-24	942	1,565
Departure	564	742	178	59	0	623	966	0	-24	942	1,565
Total	1,128	1,485	357	119	0	1,247	1,932	0	-48	1,884	3,131

Table C-3 - Phase I Project Completion Year (2029) Volume Summary

	PM Peak Hour										
	Existing	Ph III 2049 without Project	Total Growth (2019-2049)	Adjusted Growth	Cumulative Projects	Year 2029 without Project	External Project Trips	Internal Project Trips	Pass-by Trips	Phase I Project Trips	Year 2029 with Project
10 Road 23/Avenue 14 ½											
NBL	2	2	0	0	0	2	0	0	0	0	2
NBT	179	277	98	33	0	212	360	0	0	360	572
NBR	2	2	0	0	0	2	0	0	0	0	2
SBL	60	67	7	2	0	62	88	0	0	88	150
SBT	215	231	16	5	0	220	281	0	0	281	501
SBR	0	0	0	0	0	0	0	0	0	0	0
EBL	1	1	0	0	0	1	0	0	0	0	1
EBT	2	2	0	0	0	2	0	0	0	0	2
EBR	3	3	0	0	0	3	0	0	0	0	3
WBL	4	6	2	1	0	5	0	0	0	0	5
WBT	3	3	0	0	0	3	0	0	0	0	3
WBR	8	16	8	3	0	11	85	0	0	85	96
North Leg											
Approach	275	298	23	8	0	283	369	0	0	369	652
Departure	188	294	106	35	0	223	445	0	0	445	668
Total	463	592	129	43	0	506	814	0	0	814	1,320
South Leg											
Approach	183	281	98	33	0	216	360	0	0	360	576
Departure	222	240	18	6	0	228	281	0	0	281	509
Total	405	521	116	39	0	444	641	0	0	641	1,085
East Leg											
Approach	15	25	10	3	0	18	85	0	0	85	103
Departure	64	71	7	2	0	66	88	0	0	88	154
Total	79	96	17	6	0	85	173	0	0	173	258
West Leg											
Approach	6	6	0	0	0	6	0	0	0	0	6
Departure	5	5	0	0	0	5	0	0	0	0	5
Total	11	12	1	0	0	11	0	0	0	0	11
Total Approaches											
Approach	479	611	132	44	0	523	814	0	0	814	1,337
Departure	479	611	132	44	0	523	814	0	0	814	1,337
Total	958	1,221	263	88	0	1,046	1,628	0	0	1,628	2,674

Table C-3 - Phase I Project Completion Year (2029) Volume Summary

		PM Peak Hour									
		Ph III 2049 without Project	Total Growth (2019-2049)	Adjusted Growth	Cumulative Projects	Year 2029 without Project	External Project Trips	Internal Project Trips	Pass-by Trips	Phase I Project Trips	Year 2029 with Project
Existing											
11 Road 23/Avenue 14											
NBL	14	15	1	0	0	14	0	0	0	0	14
NBT	91	124	33	11	0	102	105	0	0	105	207
NBR	21	22	1	0	0	21	0	0	0	0	21
SBL	70	72	2	1	0	71	188	0	0	188	259
SBT	121	124	3	1	0	122	72	0	0	72	194
SBR	29	45	16	5	0	34	21	0	0	21	55
EBL	44	91	47	16	0	60	37	0	0	37	97
EBT	89	93	4	1	0	90	0	0	0	0	90
EBR	34	36	2	1	0	35	0	0	0	0	35
WBL	11	12	1	0	0	11	0	0	0	0	11
WBT	36	38	2	1	0	37	0	0	0	0	37
WBR	49	66	17	6	0	55	218	0	0	218	273
North Leg											
Approach	220	241	21	7	0	227	281	0	0	281	508
Departure	184	281	97	32	0	216	360	0	0	360	576
Total	404	522	118	39	0	443	641	0	0	641	1,084
South Leg											
Approach	126	160	34	11	0	137	105	0	0	105	242
Departure	166	171	5	2	0	168	72	0	0	72	240
Total	292	332	40	13	0	305	177	0	0	177	482
East Leg											
Approach	96	116	20	7	0	103	218	0	0	218	321
Departure	180	187	7	2	0	182	188	0	0	188	370
Total	276	303	27	9	0	285	406	0	0	406	691
West Leg											
Approach	167	220	53	18	0	185	37	0	0	37	222
Departure	79	98	19	6	0	85	21	0	0	21	106
Total	246	318	72	24	0	270	58	0	0	58	328
Total Approaches											
Approach	609	737	128	43	0	652	641	0	0	641	1,293
Departure	609	737	128	43	0	652	641	0	0	641	1,293
Total	1,218	1,474	256	85	0	1,303	1,282	0	0	1,282	2,585

Table C-3 - Phase I Project Completion Year (2029) Volume Summary

		PM Peak Hour									
		Ph III 2049 without Project	Total Growth (2019-2049)	Adjusted Growth	Cumulative Projects	Year 2029 without Project	External Project Trips	Internal Project Trips	Pass-by Trips	Phase I Project Trips	Year 2029 with Project
12 Road 23/Avenue 12											
NBL	4	4	0	0	0	4	0	0	0	0	4
NBT	40	42	2	1	0	41	23	0	0	23	64
NBR	38	48	10	3	0	41	0	0	0	0	41
SBL	55	58	3	1	0	56	21	0	0	21	77
SBT	45	47	2	1	0	46	16	0	0	16	62
SBR	33	35	2	1	0	34	21	0	0	21	55
EBL	56	59	3	1	0	57	37	0	0	37	94
EBT	116	178	62	21	0	137	0	0	0	0	137
EBR	8	9	1	0	0	8	0	0	0	0	8
WBL	14	23	9	3	0	17	0	0	0	0	17
WBT	66	96	30	10	0	76	0	0	0	0	76
WBR	23	29	6	2	0	25	37	0	0	37	62
North Leg											
Approach	133	140	7	2	0	135	58	0	0	58	193
Departure	119	130	11	4	0	123	97	0	0	97	220
Total	252	269	17	6	0	258	155	0	0	155	413
South Leg											
Approach	82	94	12	4	0	86	23	0	0	23	109
Departure	67	79	12	4	0	71	16	0	0	16	87
Total	149	173	24	8	0	157	39	0	0	39	196
East Leg											
Approach	103	148	45	15	0	118	37	0	0	37	155
Departure	209	284	75	25	0	234	21	0	0	21	255
Total	312	432	120	40	0	352	58	0	0	58	410
West Leg											
Approach	180	246	66	22	0	202	37	0	0	37	239
Departure	103	135	32	11	0	114	21	0	0	21	135
Total	283	381	98	33	0	316	58	0	0	58	374
Total Approaches											
Approach	498	628	130	43	0	541	155	0	0	155	696
Departure	498	628	130	43	0	541	155	0	0	155	696
Total	996	1,255	259	86	0	1,082	310	0	0	310	1,392

Table C-3 - Phase I Project Completion Year (2029) Volume Summary

		PM Peak Hour									
	Ph III 2049 Existing	without Project	Total Growth (2019-2049)	Adjusted Growth	Cumulative Projects	Year 2029 without Project	External Project Trips	Internal Project Trips	Pass-by Trips	Phase I Project Trips	Year 2029 with Project
13 Golden State Boulevard – Airport Drive/Avenue 17											
NBL	20	24	4	1	0	21	0	0	0	0	21
NBT	27	105	78	26	0	53	0	0	0	0	53
NBR	152	343	191	64	26	242	0	0	0	0	242
SBL	120	405	285	95	17	232	0	0	0	0	232
SBT	25	105	80	27	0	52	0	0	0	0	52
SBR	7	12	5	2	0	9	0	0	0	0	9
EBL	7	12	5	2	0	9	0	0	0	0	9
EBT	180	182	2	1	62	243	63	0	0	63	306
EBR	25	32	7	2	0	27	0	0	0	0	27
WBL	81	192	111	37	24	142	0	0	0	0	142
WBT	37	39	2	1	57	95	80	0	0	80	175
WBR	85	278	193	64	16	165	0	0	0	0	165
North Leg											
Approach	152	522	370	123	17	292	0	0	0	0	292
Departure	119	395	276	92	16	227	0	0	0	0	227
Total	271	917	646	215	33	519	0	0	0	0	519
South Leg											
Approach	199	472	273	91	26	316	0	0	0	0	316
Departure	131	329	198	66	24	221	0	0	0	0	221
Total	330	801	471	157	50	537	0	0	0	0	537
East Leg											
Approach	203	509	306	102	97	402	80	0	0	80	482
Departure	452	930	478	159	105	716	63	0	0	63	779
Total	655	1,439	784	261	202	1,118	143	0	0	143	1,261
West Leg											
Approach	212	226	14	5	62	279	63	0	0	63	342
Departure	64	75	11	4	57	125	80	0	0	80	205
Total	276	301	25	8	119	403	143	0	0	143	546
Total Approaches											
Approach	766	1,729	963	321	202	1,289	143	0	0	143	1,432
Departure	766	1,729	963	321	202	1,289	143	0	0	143	1,432
Total	1,532	3,458	1,926	642	404	2,578	286	0	0	286	2,864

Table C-3 - Phase I Project Completion Year (2029) Volume Summary

	PM Peak Hour										
	Existing	Ph III 2049 without Project	Total Growth (2019-2049)	Adjusted Growth	Cumulative Projects	Year 2029 without Project	External Project Trips	Internal Project Trips	Pass-by Trips	Phase I Project Trips	Year 2029 with Project
14 SR-99 Southbound Ramps/Avenue 17											
NBL	0	0	0	0	0	0	0	0	0	0	0
NBT	0	0	0	0	0	0	0	0	0	0	0
NBR	0	0	0	0	0	0	0	0	0	0	0
SBL	153	204	51	17	248	418	0	0	0	0	418
SBT	0	0	0	0	0	0	0	0	0	0	0
SBR	43	92	49	16	0	59	0	0	0	0	59
EBL	0	0	0	0	0	0	0	0	0	0	0
EBT	459	930	471	157	105	721	63	0	0	63	784
EBR	0	0	0	0	0	0	0	0	0	0	0
WBL	0	0	0	0	0	0	0	0	0	0	0
WBT	157	417	260	87	97	341	80	0	0	80	421
WBR	0	0	0	0	0	0	0	0	0	0	0
North Leg											
Approach	196	296	100	33	248	477	0	0	0	0	477
Departure	0	0	0	0	0	0	0	0	0	0	0
Total	196	296	100	33	248	477	0	0	0	0	477
South Leg											
Approach	0	0	0	0	0	0	0	0	0	0	0
Departure	0	0	0	0	0	0	0	0	0	0	0
Total	0	0	0	0	0	0	0	0	0	0	0
East Leg											
Approach	157	417	260	87	97	341	80	0	0	80	421
Departure	612	1,134	522	174	353	1,139	63	0	0	63	1,202
Total	769	1,551	782	261	450	1,480	143	0	0	143	1,623
West Leg											
Approach	459	930	471	157	105	721	63	0	0	63	784
Departure	200	509	309	103	97	400	80	0	0	80	480
Total	659	1,439	780	260	202	1,121	143	0	0	143	1,264
Total Approaches											
Approach	812	1,643	831	277	450	1,539	143	0	0	143	1,682
Departure	812	1,643	831	277	450	1,539	143	0	0	143	1,682
Total	1,624	3,286	1,662	554	900	3,078	286	0	0	286	3,364

Table C-3 - Phase I Project Completion Year (2029) Volume Summary

		PM Peak Hour									
		Ph III 2049 without Project	Total Growth (2019-2049)	Adjusted Growth	Cumulative Projects	Year 2029 without Project	External Project Trips	Internal Project Trips	Pass-by Trips	Phase I Project Trips	Year 2029 with Project
		Existing									
15 SR-99 Northbound Ramps/Avenue 17											
NBL	66	211	145	48	0	114	0	0	0	0	114
NBT	1	4	3	1	0	2	0	0	0	0	2
NBR	0	0	0	0	529	529	0	0	0	0	529
SBL	0	0	0	0	0	0	0	0	0	0	0
SBT	0	0	0	0	0	0	0	0	0	0	0
SBR	0	0	0	0	0	0	0	0	0	0	0
EBL	64	180	116	39	0	103	0	0	0	0	103
EBT	389	557	168	56	352	797	63	0	0	63	860
EBR	0	0	0	0	0	0	0	0	0	0	0
WBL	0	0	0	0	0	0	0	0	0	0	0
WBT	270	387	117	39	616	925	80	0	0	80	1,005
WBR	66	129	63	21	222	309	0	0	0	0	309
North Leg											
Approach	0	0	0	0	0	0	0	0	0	0	0
Departure	131	313	182	61	222	414	0	0	0	0	414
Total	131	313	182	61	222	414	0	0	0	0	414
South Leg											
Approach	67	215	148	49	529	645	0	0	0	0	645
Departure	0	0	0	0	0	0	0	0	0	0	0
Total	67	215	148	49	529	645	0	0	0	0	645
East Leg											
Approach	336	516	180	60	838	1,234	80	0	0	80	1,314
Departure	389	557	168	56	881	1,326	63	0	0	63	1,389
Total	725	1,073	348	116	1,719	2,560	143	0	0	143	2,703
West Leg											
Approach	453	737	284	95	352	900	63	0	0	63	963
Departure	336	598	262	87	616	1,039	80	0	0	80	1,119
Total	789	1,335	546	182	968	1,939	143	0	0	143	2,082
Total Approaches											
Approach	856	1,468	612	204	1,719	2,779	143	0	0	143	2,922
Departure	856	1,468	612	204	1,719	2,779	143	0	0	143	2,922
Total	1,712	2,936	1,224	408	3,438	5,558	286	0	0	286	5,844

Table C-3 - Phase I Project Completion Year (2029) Volume Summary

	PM Peak Hour										
	Existing	Ph III 2049 without Project	Total Growth (2019-2049)	Adjusted Growth	Cumulative Projects	Year 2029 without Project	External Project Trips	Internal Project Trips	Pass-by Trips	Phase I Project Trips	Year 2029 with Project
16 Love's Truck Stop Driveway/Avenue 17											
NBL	0	0	0	0	160	160	0	0	0	0	160
NBT	0	0	0	0	0	0	0	0	0	0	0
NBR	0	0	0	0	31	31	0	0	0	0	31
SBL	0	0	0	0	279	279	0	0	0	0	279
SBT	0	0	0	0	0	0	0	0	0	0	0
SBR	0	0	0	0	519	519	0	0	0	0	519
EBL	0	0	0	0	556	556	0	0	0	0	556
EBT	389	543	154	51	184	624	63	0	0	63	687
EBR	0	0	0	0	141	141	0	0	0	0	141
WBL	0	0	0	0	32	32	0	0	0	0	32
WBT	336	500	164	55	158	549	80	0	0	80	629
WBR	0	0	0	0	189	189	0	0	0	0	189
North Leg											
Approach	0	0	0	0	798	798	0	0	0	0	798
Departure	0	0	0	0	745	745	0	0	0	0	745
Total	0	0	0	0	1,543	1,543	0	0	0	0	1,543
South Leg											
Approach	0	0	0	0	191	191	0	0	0	0	191
Departure	0	0	0	0	173	173	0	0	0	0	173
Total	0	0	0	0	364	364	0	0	0	0	364
East Leg											
Approach	336	500	164	55	379	770	80	0	0	80	850
Departure	389	543	154	51	494	934	63	0	0	63	997
Total	725	1,043	318	106	873	1,704	143	0	0	143	1,847
West Leg											
Approach	389	543	154	51	881	1,321	63	0	0	63	1,384
Departure	336	500	164	55	837	1,228	80	0	0	80	1,308
Total	725	1,043	318	106	1,718	2,549	143	0	0	143	2,692
Total Approaches											
Approach	725	1,043	318	106	2,249	3,080	143	0	0	143	3,223
Departure	725	1,043	318	106	2,249	3,080	143	0	0	143	3,223
Total	1,450	2,086	636	212	4,498	6,160	286	0	0	286	6,446

Table C-3 - Phase I Project Completion Year (2029) Volume Summary

		PM Peak Hour									
		Ph III 2049 without Project	Total Growth (2019-2049)	Adjusted Growth	Cumulative Projects	Year 2029 without Project	External Project Trips	Internal Project Trips	Pass-by Trips	Phase I Project Trips	Year 2029 with Project
Existing											
17 Westberry Boulevard/Cleveland Avenue											
NBL	4	20	16	5	0	9	42	0	0	42	51
NBT	6	59	53	18	0	24	0	0	0	0	24
NBR	34	121	87	29	0	63	0	0	0	0	63
SBL	13	27	14	5	0	18	0	0	0	0	18
SBT	20	198	178	59	0	79	0	0	0	0	79
SBR	8	23	15	5	0	13	221	0	0	221	234
EBL	23	53	30	10	0	33	117	0	0	117	150
EBT	122	128	6	2	0	124	339	0	0	339	463
EBR	9	36	27	9	0	18	17	0	0	17	35
WBL	27	141	114	38	0	65	0	0	0	0	65
WBT	62	95	33	11	0	73	683	0	0	683	756
WBR	11	34	23	8	0	19	0	0	0	0	19
North Leg											
Approach	41	248	207	69	0	110	221	0	0	221	331
Departure	40	146	106	35	0	75	117	0	0	117	192
Total	81	394	313	104	0	185	338	0	0	338	523
South Leg											
Approach	44	200	156	52	0	96	42	0	0	42	138
Departure	56	375	319	106	0	162	17	0	0	17	179
Total	100	575	475	158	0	258	59	0	0	59	317
East Leg											
Approach	100	270	170	57	0	157	683	0	0	683	840
Departure	169	276	107	36	0	205	339	0	0	339	544
Total	269	546	277	92	0	361	1,022	0	0	1,022	1,383
West Leg											
Approach	154	217	63	21	0	175	473	0	0	473	648
Departure	74	138	64	21	0	95	946	0	0	946	1,041
Total	228	355	127	42	0	270	1,419	0	0	1,419	1,689
Total Approaches											
Approach	339	935	596	199	0	538	1,419	0	0	1,419	1,957
Departure	339	935	596	199	0	538	1,419	0	0	1,419	1,957
Total	678	1,870	1,192	397	0	1,075	2,838	0	0	2,838	3,913

Table C-3 - Phase I Project Completion Year (2029) Volume Summary

		PM Peak Hour									
		Ph III 2049 without Project	Total Growth (2019-2049)	Adjusted Growth	Cumulative Projects	Year 2029 without Project	External Project Trips	Internal Project Trips	Pass-by Trips	Phase I Project Trips	Year 2029 with Project
Existing											
18 Westberry Boulevard/Sunset Avenue											
NBL	43	48	5	2	0	45	9	0	0	9	54
NBT	108	194	86	29	0	137	0	0	0	0	137
NBR	55	61	6	2	0	57	0	0	0	0	57
SBL	16	24	8	3	0	19	0	0	0	0	19
SBT	95	211	116	39	0	134	0	0	0	0	134
SBR	13	20	7	2	0	15	9	0	0	9	24
EBL	6	8	2	1	0	7	10	0	0	10	17
EBT	55	58	3	1	0	56	37	0	0	37	93
EBR	23	27	4	1	0	24	10	0	0	10	34
WBL	64	77	13	4	0	68	0	0	0	0	68
WBT	74	78	4	1	0	75	30	0	0	30	105
WBR	16	21	5	2	0	18	0	0	0	0	18
North Leg											
Approach	124	255	131	44	0	168	9	0	0	9	177
Departure	130	223	93	31	0	161	10	0	0	10	171
Total	254	478	224	75	0	329	19	0	0	19	348
South Leg											
Approach	206	303	97	32	0	238	9	0	0	9	247
Departure	182	315	133	44	0	226	10	0	0	10	236
Total	388	618	230	77	0	465	19	0	0	19	484
East Leg											
Approach	154	176	22	7	0	161	30	0	0	30	191
Departure	126	143	17	6	0	132	37	0	0	37	169
Total	280	318	38	13	0	293	67	0	0	67	360
West Leg											
Approach	84	93	9	3	0	87	57	0	0	57	144
Departure	130	146	16	5	0	135	48	0	0	48	183
Total	214	238	24	8	0	222	105	0	0	105	327
Total Approaches											
Approach	568	826	258	86	0	654	105	0	0	105	759
Departure	568	826	258	86	0	654	105	0	0	105	759
Total	1,136	1,653	517	172	0	1,308	210	0	0	210	1,518

Table C-3 - Phase I Project Completion Year (2029) Volume Summary

		PM Peak Hour									
		Ph III 2049 without Project	Total Growth (2019-2049)	Adjusted Growth	Cumulative Projects	Year 2029 without Project	External Project Trips	Internal Project Trips	Pass-by Trips	Phase I Project Trips	Year 2029 with Project
19 Westberry Boulevard/Avenue 14											
NBL	14	15	1	0	0	14	9	0	0	9	23
NBT	41	53	12	4	0	45	0	0	0	0	45
NBR	16	17	1	0	0	16	0	0	0	0	16
SBL	88	151	63	21	0	109	0	0	0	0	109
SBT	42	57	15	5	0	47	0	0	0	0	47
SBR	37	45	8	3	0	40	43	0	0	43	83
EBL	49	69	20	7	0	56	19	0	0	19	75
EBT	251	264	13	4	0	255	142	0	0	142	397
EBR	33	35	2	1	0	34	10	0	0	10	44
WBL	22	23	1	0	0	22	0	0	0	0	22
WBT	116	122	6	2	0	118	144	0	0	144	262
WBR	130	240	110	37	0	167	0	0	0	0	167
North Leg											
Approach	167	253	86	29	0	196	43	0	0	43	239
Departure	220	362	142	47	0	267	19	0	0	19	286
Total	387	615	228	76	0	463	62	0	0	62	525
South Leg											
Approach	71	85	14	5	0	76	9	0	0	9	85
Departure	97	115	18	6	0	103	10	0	0	10	113
Total	168	199	31	10	0	178	19	0	0	19	197
East Leg											
Approach	268	385	117	39	0	307	144	0	0	144	451
Departure	355	431	76	25	0	380	142	0	0	142	522
Total	623	816	193	64	0	687	286	0	0	286	973
West Leg											
Approach	333	367	34	11	0	344	171	0	0	171	515
Departure	167	182	15	5	0	172	196	0	0	196	368
Total	500	549	49	16	0	516	367	0	0	367	883
Total Approaches											
Approach	839	1,090	251	84	0	923	367	0	0	367	1,290
Departure	839	1,090	251	84	0	923	367	0	0	367	1,290
Total	1,678	2,179	501	167	0	1,845	734	0	0	734	2,579

Table C-3 - Phase I Project Completion Year (2029) Volume Summary

		PM Peak Hour									
		Ph III 2049 without Project	Total Growth (2019-2049)	Adjusted Growth	Cumulative Projects	Year 2029 without Project	External Project Trips	Internal Project Trips	Pass-by Trips	Phase I Project Trips	Year 2029 with Project
		Existing									
20	Westberry Boulevard/Avenue 16										
NBL		0	0	0	0	0	0	0	0	0	0
NBT		7	15	8	3	10	62	0	0	62	72
NBR		34	160	126	42	76	49	0	0	49	125
SBL		140	229	89	30	170	0	0	0	0	170
SBT		14	50	36	12	26	116	0	0	116	142
SBR		0	0	0	0	0	0	0	0	0	0
EBL		0	0	0	0	0	0	0	0	0	0
EBT		0	0	0	0	0	0	0	0	0	0
EBR		0	0	0	0	0	0	0	0	0	0
WBL		24	238	214	71	95	101	0	0	101	196
WBT		0	0	0	0	0	0	0	0	0	0
WBR		64	135	71	24	88	0	0	0	0	88
North Leg											
Approach		154	279	125	42	196	116	0	0	116	312
Departure		71	150	79	26	97	62	0	0	62	159
Total		225	429	204	68	293	178	0	0	178	471
South Leg											
Approach		41	175	134	45	86	111	0	0	111	197
Departure		38	288	250	83	121	217	0	0	217	338
Total		79	463	384	128	207	328	0	0	328	535
East Leg											
Approach		88	373	285	95	183	101	0	0	101	284
Departure		174	389	215	72	246	49	0	0	49	295
Total		262	762	500	167	429	150	0	0	150	579
West Leg											
Approach		0	0	0	0	0	0	0	0	0	0
Departure		0	0	0	0	0	0	0	0	0	0
Total		0	0	0	0	0	0	0	0	0	0
Total Approaches											
Approach		283	827	544	181	464	328	0	0	328	792
Departure		283	827	544	181	464	328	0	0	328	792
Total		566	1,654	1,088	363	929	656	0	0	656	1,585

Table C-3 - Phase I Project Completion Year (2029) Volume Summary

	PM Peak Hour										
	Existing	Ph III 2049 without Project	Total Growth (2019-2049)	Adjusted Growth	Cumulative Projects	Year 2029 without Project	External Project Trips	Internal Project Trips	Pass-by Trips	Phase I Project Trips	Year 2029 with Project
21 Granada Drive/Cleveland Avenue											
NBL	14	15	1	0	0	14	14	0	0	14	28
NBT	189	273	84	28	0	217	0	0	0	0	217
NBR	229	236	7	2	0	231	0	0	0	0	231
SBL	19	64	45	15	0	34	0	0	0	0	34
SBT	231	360	129	43	0	274	0	0	0	0	274
SBR	21	58	37	12	0	33	0	0	0	0	33
EBL	13	29	16	5	0	18	0	0	0	0	18
EBT	108	173	65	22	0	130	312	0	0	312	442
EBR	19	20	1	0	0	19	6	0	0	6	25
WBL	320	379	59	20	0	340	0	0	0	0	340
WBT	113	239	126	42	0	155	642	0	0	642	797
WBR	20	72	52	17	0	37	0	0	0	0	37
North Leg											
Approach	271	482	211	70	0	341	0	0	0	0	341
Departure	222	374	152	51	0	273	0	0	0	0	273
Total	493	856	363	121	0	614	0	0	0	0	614
South Leg											
Approach	432	524	92	31	0	463	14	0	0	14	477
Departure	570	759	189	63	0	633	6	0	0	6	639
Total	1,002	1,283	281	94	0	1,096	20	0	0	20	1,116
East Leg											
Approach	453	690	237	79	0	532	642	0	0	642	1,174
Departure	356	473	117	39	0	395	312	0	0	312	707
Total	809	1,163	354	118	0	927	954	0	0	954	1,881
West Leg											
Approach	140	222	82	27	0	167	318	0	0	318	485
Departure	148	312	164	55	0	203	656	0	0	656	859
Total	288	534	246	82	0	370	974	0	0	974	1,344
Total Approaches											
Approach	1,296	1,918	622	207	0	1,503	974	0	0	974	2,477
Departure	1,296	1,918	622	207	0	1,503	974	0	0	974	2,477
Total	2,592	3,835	1,243	414	0	3,006	1,948	0	0	1,948	4,954

Table C-3 - Phase I Project Completion Year (2029) Volume Summary

	PM Peak Hour										
	Existing	Ph III 2049 without Project	Total Growth (2019-2049)	Adjusted Growth	Cumulative Projects	Year 2029 without Project	External Project Trips	Internal Project Trips	Pass-by Trips	Phase I Project Trips	Year 2029 with Project
22 Granada Drive/Sunset Avenue											
NBL	46	53	7	2	0	48	0	0	0	0	48
NBT	262	289	27	9	0	271	0	0	0	0	271
NBR	42	44	2	1	0	43	0	0	0	0	43
SBL	76	84	8	3	0	79	0	0	0	0	79
SBT	293	358	65	22	0	315	0	0	0	0	315
SBR	32	41	9	3	0	35	0	0	0	0	35
EBL	28	32	4	1	0	29	0	0	0	0	29
EBT	115	120	5	2	0	117	21	0	0	21	138
EBR	34	39	5	2	0	36	0	0	0	0	36
WBL	54	57	3	1	0	55	0	0	0	0	55
WBT	153	157	4	1	0	154	17	0	0	17	171
WBR	108	113	5	2	0	110	0	0	0	0	110
North Leg											
Approach	401	483	82	27	0	428	0	0	0	0	428
Departure	398	434	36	12	0	410	0	0	0	0	410
Total	799	917	118	39	0	838	0	0	0	0	838
South Leg											
Approach	350	386	36	12	0	362	0	0	0	0	362
Departure	381	454	73	24	0	405	0	0	0	0	405
Total	731	840	109	36	0	767	0	0	0	0	767
East Leg											
Approach	315	327	12	4	0	319	17	0	0	17	336
Departure	233	248	15	5	0	238	21	0	0	21	259
Total	548	575	27	9	0	557	38	0	0	38	595
West Leg											
Approach	177	191	14	5	0	182	21	0	0	21	203
Departure	231	251	20	7	0	238	17	0	0	17	255
Total	408	442	34	11	0	419	38	0	0	38	457
Total Approaches											
Approach	1,243	1,387	144	48	0	1,291	38	0	0	38	1,329
Departure	1,243	1,387	144	48	0	1,291	38	0	0	38	1,329
Total	2,486	2,774	288	96	0	2,582	76	0	0	76	2,658

Table C-3 - Phase I Project Completion Year (2029) Volume Summary

	PM Peak Hour										
	Ph III 2049 Existing	without Project	Total Growth (2019-2049)	Adjusted Growth	Cumulative Projects	Year 2029 without Project	External Project Trips	Internal Project Trips	Pass-by Trips	Phase I Project Trips	Year 2029 with Project
23 Avenue 16 – Ellis Street/Kennedy Street											
NBL	0	0	0	0	0	0	0	0	0	0	0
NBT	150	425	275	92	0	242	49	0	0	49	291
NBR	127	385	258	86	0	213	0	0	0	0	213
SBL	181	270	89	30	0	211	0	0	0	0	211
SBT	174	408	234	78	0	252	101	0	0	101	353
SBR	0	0	0	0	0	0	0	0	0	0	0
EBL	0	0	0	0	0	0	0	0	0	0	0
EBT	0	0	0	0	0	0	0	0	0	0	0
EBR	0	0	0	0	0	0	0	0	0	0	0
WBL	96	177	81	27	0	123	0	0	0	0	123
WBT	0	0	0	0	0	0	0	0	0	0	0
WBR	211	231	20	7	0	218	0	0	0	0	218
North Leg											
Approach	355	678	323	108	0	463	101	0	0	101	564
Departure	361	656	295	98	0	459	49	0	0	49	508
Total	716	1,334	618	206	0	922	150	0	0	150	1,072
South Leg											
Approach	277	810	533	178	0	455	49	0	0	49	504
Departure	270	585	315	105	0	375	101	0	0	101	476
Total	547	1,395	848	283	0	830	150	0	0	150	980
East Leg											
Approach	307	408	101	34	0	341	0	0	0	0	341
Departure	308	655	347	116	0	424	0	0	0	0	424
Total	615	1,063	448	149	0	764	0	0	0	0	764
West Leg											
Approach	0	0	0	0	0	0	0	0	0	0	0
Departure	0	0	0	0	0	0	0	0	0	0	0
Total	0	0	0	0	0	0	0	0	0	0	0
Total Approaches											
Approach	939	1,896	957	319	0	1,258	150	0	0	150	1,408
Departure	939	1,896	957	319	0	1,258	150	0	0	150	1,408
Total	1,878	3,792	1,914	638	0	2,516	300	0	0	300	2,816

Table C-3 - Phase I Project Completion Year (2029) Volume Summary

		PM Peak Hour									
		Ph III 2049 without Project	Total Growth (2019-2049)	Adjusted Growth	Cumulative Projects	Year 2029 without Project	External Project Trips	Internal Project Trips	Pass-by Trips	Phase I Project Trips	Year 2029 with Project
24 Schnoor Avenue/Kennedy Street											
NBL	192	202	10	3	0	195	0	0	0	0	195
NBT	13	89	76	25	0	38	0	0	0	0	38
NBR	207	327	120	40	0	247	0	0	0	0	247
SBL	23	203	180	60	0	83	0	0	0	0	83
SBT	14	69	55	18	0	32	0	0	0	0	32
SBR	8	43	35	12	0	20	0	0	0	0	20
EBL	9	101	92	31	0	40	0	0	0	0	40
EBT	113	295	182	61	0	174	0	0	0	0	174
EBR	163	237	74	25	0	188	0	0	0	0	188
WBL	179	249	70	23	0	202	0	0	0	0	202
WBT	132	203	71	24	0	156	0	0	0	0	156
WBR	17	183	166	55	0	72	0	0	0	0	72
North Leg											
Approach	45	315	270	90	0	135	0	0	0	0	135
Departure	39	373	334	111	0	150	0	0	0	0	150
Total	84	688	604	201	0	285	0	0	0	0	285
South Leg											
Approach	412	618	206	69	0	481	0	0	0	0	481
Departure	356	555	199	66	0	422	0	0	0	0	422
Total	768	1,173	405	135	0	903	0	0	0	0	903
East Leg											
Approach	328	635	307	102	0	430	0	0	0	0	430
Departure	343	825	482	161	0	504	0	0	0	0	504
Total	671	1,460	789	263	0	934	0	0	0	0	934
West Leg											
Approach	285	633	348	116	0	401	0	0	0	0	401
Departure	332	448	116	39	0	371	0	0	0	0	371
Total	617	1,081	464	155	0	772	0	0	0	0	772
Total Approaches											
Approach	1,070	2,201	1,131	377	0	1,447	0	0	0	0	1,447
Departure	1,070	2,201	1,131	377	0	1,447	0	0	0	0	1,447
Total	2,140	4,401	2,261	754	0	2,894	0	0	0	0	2,894

Table C-3 - Phase I Project Completion Year (2029) Volume Summary

	PM Peak Hour										
	Existing	Ph III 2049 without Project	Total Growth (2019-2049)	Adjusted Growth	Cumulative Projects	Year 2029 without Project	External Project Trips	Internal Project Trips	Pass-by Trips	Phase I Project Trips	Year 2029 with Project
25 SR-99 Southbound Ramps/Kennedy Street - Gateway Drive											
NBL	0	0	0	0	0	0	0	0	0	0	0
NBT	0	0	0	0	0	0	0	0	0	0	0
NBR	0	0	0	0	0	0	0	0	0	0	0
SBL	128	138	10	3	0	131	0	0	0	0	131
SBT	0	0	0	0	0	0	0	0	0	0	0
SBR	158	223	65	22	0	180	0	0	0	0	180
EBL	102	346	244	81	0	183	0	0	0	0	183
EBT	313	460	147	49	0	362	0	0	0	0	362
EBR	0	0	0	0	0	0	0	0	0	0	0
WBL	0	0	0	0	0	0	0	0	0	0	0
WBT	252	430	178	59	0	311	0	0	0	0	311
WBR	1	3	2	1	0	2	0	0	0	0	2
North Leg											
Approach	286	361	75	25	0	311	0	0	0	0	311
Departure	103	349	246	82	0	185	0	0	0	0	185
Total	389	710	321	107	0	496	0	0	0	0	496
South Leg											
Approach	0	0	0	0	0	0	0	0	0	0	0
Departure	0	0	0	0	0	0	0	0	0	0	0
Total	0	0	0	0	0	0	0	0	0	0	0
East Leg											
Approach	253	433	180	60	0	313	0	0	0	0	313
Departure	441	598	157	52	0	493	0	0	0	0	493
Total	694	1,031	337	112	0	806	0	0	0	0	806
West Leg											
Approach	415	806	391	130	0	545	0	0	0	0	545
Departure	410	653	243	81	0	491	0	0	0	0	491
Total	825	1,459	634	211	0	1,036	0	0	0	0	1,036
Total Approaches											
Approach	954	1,600	646	215	0	1,169	0	0	0	0	1,169
Departure	954	1,600	646	215	0	1,169	0	0	0	0	1,169
Total	1,908	3,201	1,293	431	0	2,339	0	0	0	0	2,339

Table C-3 - Phase I Project Completion Year (2029) Volume Summary

	PM Peak Hour										
	Ph III 2049 Existing	Ph III 2049 without Project	Total Growth (2019-2049)	Adjusted Growth	Cumulative Projects	Year 2029 without Project	External Project Trips	Internal Project Trips	Pass-by Trips	Phase I Project Trips	Year 2029 with Project
26 SR-99 Northbound Off-Ramp/Gateway Drive											
NBL	0	0	0	0	0	0	0	0	0	0	0
NBT	0	0	0	0	0	0	0	0	0	0	0
NBR	0	0	0	0	0	0	0	0	0	0	0
SBL	0	0	0	0	0	0	0	0	0	0	0
SBT	0	0	0	0	0	0	0	0	0	0	0
SBR	135	186	51	17	0	152	0	0	0	0	152
EBL	153	161	8	3	0	156	0	0	0	0	156
EBT	288	438	150	50	0	338	0	0	0	0	338
EBR	0	0	0	0	0	0	0	0	0	0	0
WBL	0	0	0	0	0	0	0	0	0	0	0
WBT	118	247	129	43	0	161	0	0	0	0	161
WBR	0	0	0	0	0	0	0	0	0	0	0
North Leg											
Approach	135	186	51	17	0	152	0	0	0	0	152
Departure	153	161	8	3	0	156	0	0	0	0	156
Total	288	347	59	20	0	308	0	0	0	0	308
South Leg											
Approach	0	0	0	0	0	0	0	0	0	0	0
Departure	0	0	0	0	0	0	0	0	0	0	0
Total	0	0	0	0	0	0	0	0	0	0	0
East Leg											
Approach	118	247	129	43	0	161	0	0	0	0	161
Departure	288	438	150	50	0	338	0	0	0	0	338
Total	406	685	279	93	0	499	0	0	0	0	499
West Leg											
Approach	441	599	158	53	0	494	0	0	0	0	494
Departure	253	433	180	60	0	313	0	0	0	0	313
Total	694	1,032	338	113	0	807	0	0	0	0	807
Total Approaches											
Approach	694	1,032	338	113	0	807	0	0	0	0	807
Departure	694	1,032	338	113	0	807	0	0	0	0	807
Total	1,388	2,063	675	225	0	1,613	0	0	0	0	1,613

Table C-3 - Phase I Project Completion Year (2029) Volume Summary

	PM Peak Hour										
	Existing	Ph III 2049 without Project	Total Growth (2019-2049)	Adjusted Growth	Cumulative Projects	Year 2029 without Project	External Project Trips	Internal Project Trips	Pass-by Trips	Phase I Project Trips	Year 2029 with Project
27 SR-99 Northbound Off-Ramps											
NBL	0	0	0	0	0	0	0	0	0	0	0
NBT	78	82	4	1	0	79	0	0	0	0	79
NBR	0	0	0	0	0	0	0	0	0	0	0
SBL	0	0	0	0	0	0	0	0	0	0	0
SBT	3	3	0	0	0	3	0	0	0	0	3
SBR	135	185	50	17	0	152	0	0	0	0	152
EBL	153	161	8	3	0	156	0	0	0	0	156
EBT	0	0	0	0	0	0	0	0	0	0	0
EBR	0	0	0	0	0	0	0	0	0	0	0
WBL	0	0	0	0	0	0	0	0	0	0	0
WBT	0	0	0	0	0	0	0	0	0	0	0
WBR	0	0	0	0	0	0	0	0	0	0	0
North Leg											
Approach	138	188	50	17	0	155	0	0	0	0	155
Departure	231	243	12	4	0	235	0	0	0	0	235
Total	369	431	62	21	0	390	0	0	0	0	390
South Leg											
Approach	78	82	4	1	0	79	0	0	0	0	79
Departure	3	3	0	0	0	3	0	0	0	0	3
Total	81	85	4	1	0	82	0	0	0	0	82
East Leg											
Approach	0	0	0	0	0	0	0	0	0	0	0
Departure	0	0	0	0	0	0	0	0	0	0	0
Total	0	0	0	0	0	0	0	0	0	0	0
West Leg											
Approach	153	161	8	3	0	156	0	0	0	0	156
Departure	135	185	50	17	0	152	0	0	0	0	152
Total	288	346	58	19	0	307	0	0	0	0	307
Total Approaches											
Approach	369	431	62	21	0	390	0	0	0	0	390
Departure	369	431	62	21	0	390	0	0	0	0	390
Total	738	861	123	41	0	779	0	0	0	0	779

Table C-3 - Phase I Project Completion Year (2029) Volume Summary

	PM Peak Hour										
	Existing	Ph III 2049 without Project	Total Growth (2019-2049)	Adjusted Growth	Cumulative Projects	Year 2029 without Project	External Project Trips	Internal Project Trips	Pass-by Trips	Phase I Project Trips	Year 2029 with Project
28 SR-99 Northbound Off-Ramp/Gateway Drive											
NBL	0	0	0	0	0	0	0	0	0	0	0
NBT	0	0	0	0	0	0	0	0	0	0	0
NBR	0	0	0	0	0	0	0	0	0	0	0
SBL	3	3	0	0	0	3	0	0	0	0	3
SBT	0	0	0	0	0	0	0	0	0	0	0
SBR	0	0	0	0	0	0	0	0	0	0	0
EBL	0	0	0	0	0	0	0	0	0	0	0
EBT	288	438	150	50	0	338	0	0	0	0	338
EBR	0	0	0	0	0	0	0	0	0	0	0
WBL	0	0	0	0	0	0	0	0	0	0	0
WBT	118	247	129	43	0	161	0	0	0	0	161
WBR	73	77	4	1	0	74	0	0	0	0	74
North Leg											
Approach	3	3	0	0	0	3	0	0	0	0	3
Departure	73	77	4	1	0	74	0	0	0	0	74
Total	76	80	4	1	0	77	0	0	0	0	77
South Leg											
Approach	0	0	0	0	0	0	0	0	0	0	0
Departure	0	0	0	0	0	0	0	0	0	0	0
Total	0	0	0	0	0	0	0	0	0	0	0
East Leg											
Approach	191	324	133	44	0	235	0	0	0	0	235
Departure	291	441	150	50	0	341	0	0	0	0	341
Total	482	765	283	94	0	576	0	0	0	0	576
West Leg											
Approach	288	438	150	50	0	338	0	0	0	0	338
Departure	118	247	129	43	0	161	0	0	0	0	161
Total	406	685	279	93	0	499	0	0	0	0	499
Total Approaches											
Approach	482	765	283	94	0	576	0	0	0	0	576
Departure	482	765	283	94	0	576	0	0	0	0	576
Total	964	1,530	566	189	0	1,153	0	0	0	0	1,153

Table C-3 - Phase I Project Completion Year (2029) Volume Summary

	PM Peak Hour										
	Existing	Ph III 2049 without Project	Total Growth (2019-2049)	Adjusted Growth	Cumulative Projects	Year 2029 without Project	External Project Trips	Internal Project Trips	Pass-by Trips	Phase I Project Trips	Year 2029 with Project
29 Schnoor Avenue/Cleveland Avenue											
NBL	52	73	21	7	0	59	28	0	0	28	87
NBT	200	245	45	15	0	215	0	0	0	0	215
NBR	148	159	11	4	0	152	0	0	0	0	152
SBL	110	134	24	8	0	118	0	0	0	0	118
SBT	195	248	53	18	0	213	0	0	0	0	213
SBR	74	119	45	15	0	89	37	0	0	37	126
EBL	108	144	36	12	0	120	21	0	0	21	141
EBT	383	447	64	21	0	404	262	0	0	262	666
EBR	41	50	9	3	0	44	11	0	0	11	55
WBL	264	297	33	11	0	275	0	0	0	0	275
WBT	420	598	178	59	0	479	555	0	0	555	1,034
WBR	103	127	24	8	0	111	0	0	0	0	111
North Leg											
Approach	379	501	122	41	0	420	37	0	0	37	457
Departure	411	516	105	35	0	446	21	0	0	21	467
Total	790	1,017	227	76	0	866	58	0	0	58	924
South Leg											
Approach	400	477	77	26	0	426	28	0	0	28	454
Departure	500	595	95	32	0	532	11	0	0	11	543
Total	900	1,072	172	57	0	957	39	0	0	39	996
East Leg											
Approach	787	1,022	235	78	0	865	555	0	0	555	1,420
Departure	641	740	99	33	0	674	262	0	0	262	936
Total	1,428	1,762	334	111	0	1,539	817	0	0	817	2,356
West Leg											
Approach	532	641	109	36	0	568	294	0	0	294	862
Departure	546	790	244	81	0	627	620	0	0	620	1,247
Total	1,078	1,431	353	118	0	1,196	914	0	0	914	2,110
Total Approaches											
Approach	2,098	2,641	543	181	0	2,279	914	0	0	914	3,193
Departure	2,098	2,641	543	181	0	2,279	914	0	0	914	3,193
Total	4,196	5,282	1,086	362	0	4,558	1,828	0	0	1,828	6,386

Table C-3 - Phase I Project Completion Year (2029) Volume Summary

		PM Peak Hour									
		Ph III 2049 without Project	Total Growth (2019-2049)	Adjusted Growth	Cumulative Projects	Year 2029 without Project	External Project Trips	Internal Project Trips	Pass-by Trips	Phase I Project Trips	Year 2029 with Project
30 Fairgrounds/Cleveland Avenue											
NBL	95	100	5	2	0	97	0	0	0	0	97
NBT	41	44	3	1	0	42	0	0	0	0	42
NBR	105	116	11	4	0	109	0	0	0	0	109
SBL	231	334	103	34	0	265	0	0	0	0	265
SBT	34	36	2	1	0	35	0	0	0	0	35
SBR	98	126	28	9	0	107	0	0	0	0	107
EBL	89	105	16	5	0	94	0	0	0	0	94
EBT	478	574	96	32	0	510	262	0	0	262	772
EBR	91	96	5	2	0	93	0	0	0	0	93
WBL	155	179	24	8	0	163	0	0	0	0	163
WBT	503	711	208	69	0	572	555	0	0	555	1,127
WBR	123	192	69	23	0	146	0	0	0	0	146
North Leg											
Approach	363	496	133	44	0	407	0	0	0	0	407
Departure	253	341	88	29	0	282	0	0	0	0	282
Total	616	837	221	74	0	690	0	0	0	0	690
South Leg											
Approach	241	260	19	6	0	247	0	0	0	0	247
Departure	280	311	31	10	0	290	0	0	0	0	290
Total	521	570	49	16	0	537	0	0	0	0	537
East Leg											
Approach	781	1,082	301	100	0	881	555	0	0	555	1,436
Departure	814	1,024	210	70	0	884	262	0	0	262	1,146
Total	1,595	2,106	511	170	0	1,765	817	0	0	817	2,582
West Leg											
Approach	658	775	117	39	0	697	262	0	0	262	959
Departure	696	937	241	80	0	776	555	0	0	555	1,331
Total	1,354	1,711	357	119	0	1,473	817	0	0	817	2,290
Total Approaches											
Approach	2,043	2,612	569	190	0	2,233	817	0	0	817	3,050
Departure	2,043	2,612	569	190	0	2,233	817	0	0	817	3,050
Total	4,086	5,225	1,139	380	0	4,466	1,634	0	0	1,634	6,100

Table C-3 - Phase I Project Completion Year (2029) Volume Summary

	PM Peak Hour										
	Existing	Ph III 2049 without Project	Total Growth (2019-2049)	Adjusted Growth	Cumulative Projects	Year 2029 without Project	External Project Trips	Internal Project Trips	Pass-by Trips	Phase I Project Trips	Year 2029 with Project
31 SR-99 Southbound Ramps/Cleveland Avenue											
NBL	0	0	0	0	0	0	0	0	0	0	0
NBT	0	0	0	0	0	0	0	0	0	0	0
NBR	0	0	0	0	0	0	0	0	0	0	0
SBL	125	203	78	26	0	151	0	0	0	0	151
SBT	0	0	0	0	0	0	0	0	0	0	0
SBR	77	85	8	3	0	80	0	0	0	0	80
EBL	0	0	0	0	0	0	0	0	0	0	0
EBT	682	817	135	45	0	727	121	0	0	121	848
EBR	327	408	81	27	0	354	141	0	0	141	495
WBL	193	381	188	63	0	256	0	0	0	0	256
WBT	1,050	1,344	294	98	0	1,148	555	0	0	555	1,703
WBR	0	0	0	0	0	0	0	0	0	0	0
North Leg											
Approach	202	288	86	29	0	231	0	0	0	0	231
Departure	0	0	0	0	0	0	0	0	0	0	0
Total	202	288	86	29	0	231	0	0	0	0	231
South Leg											
Approach	0	0	0	0	0	0	0	0	0	0	0
Departure	520	789	269	90	0	610	141	0	0	141	751
Total	520	789	269	90	0	610	141	0	0	141	751
East Leg											
Approach	1,243	1,725	482	161	0	1,404	555	0	0	555	1,959
Departure	807	1,020	213	71	0	878	121	0	0	121	999
Total	2,050	2,745	695	232	0	2,282	676	0	0	676	2,958
West Leg											
Approach	1,009	1,225	216	72	0	1,081	262	0	0	262	1,343
Departure	1,127	1,429	302	101	0	1,228	555	0	0	555	1,783
Total	2,136	2,654	518	173	0	2,309	817	0	0	817	3,126
Total Approaches											
Approach	2,454	3,238	784	261	0	2,715	817	0	0	817	3,532
Departure	2,454	3,238	784	261	0	2,715	817	0	0	817	3,532
Total	4,908	6,476	1,568	523	0	5,431	1,634	0	0	1,634	7,065

Table C-3 - Phase I Project Completion Year (2029) Volume Summary

		PM Peak Hour										
		Ph III 2049	Total Growth	Adjusted	Cumulative	Year 2029	External	Internal	Pass-by	Phase I	Year 2029	
		Existing	without Project (2019-2049)	Growth	Projects	without Project	Project Trips	Project Trips	Trips	Project Trips	with Project	
32	SR-99 Northbound Ramps/Cleveland Avenue											
NBL		417	667	250	83	0	500	340	0	0	340	840
NBT		5	6	1	0	0	5	0	0	0	0	5
NBR		265	349	84	28	0	293	0	0	0	0	293
SBL		0	0	0	0	0	0	0	0	0	0	0
SBT		0	0	0	0	0	0	0	0	0	0	0
SBR		0	0	0	0	0	0	0	0	0	0	0
EBL		71	79	8	3	0	74	0	0	0	0	74
EBT		736	939	203	68	0	804	121	0	0	121	925
EBR		0	0	0	0	0	0	0	0	0	0	0
WBL		0	0	0	0	0	0	0	0	0	0	0
WBT		826	1,065	239	80	0	906	215	0	0	215	1,121
WBR		65	68	3	1	0	66	0	0	0	0	66
North Leg												
Approach		0	0	0	0	0	0	0	0	0	0	0
Departure		141	153	12	4	0	145	0	0	0	0	145
Total		141	153	12	4	0	145	0	0	0	0	145
South Leg												
Approach		687	1,022	335	112	0	799	340	0	0	340	1,139
Departure		0	0	0	0	0	0	0	0	0	0	0
Total		687	1,022	335	112	0	799	340	0	0	340	1,139
East Leg												
Approach		891	1,133	242	81	0	972	215	0	0	215	1,187
Departure		1,001	1,288	287	96	0	1,097	121	0	0	121	1,218
Total		1,892	2,421	529	176	0	2,068	336	0	0	336	2,404
West Leg												
Approach		807	1,018	211	70	0	877	121	0	0	121	998
Departure		1,243	1,732	489	163	0	1,406	555	0	0	555	1,961
Total		2,050	2,750	700	233	0	2,283	676	0	0	676	2,959
Total Approaches												
Approach		2,385	3,173	788	263	0	2,648	676	0	0	676	3,324
Departure		2,385	3,173	788	263	0	2,648	676	0	0	676	3,324
Total		4,770	6,347	1,577	526	0	5,296	1,352	0	0	1,352	6,648

Table C-3 - Phase I Project Completion Year (2029) Volume Summary

	PM Peak Hour										
	Existing	Ph III 2049 without Project	Total Growth (2019-2049)	Adjusted Growth	Cumulative Projects	Year 2029 without Project	External Project Trips	Internal Project Trips	Pass-by Trips	Phase I Project Trips	Year 2029 with Project
33 Gateway Drive/Cleveland Avenue											
NBL	218	237	19	6	0	224	78	0	0	78	302
NBT	112	154	42	14	0	126	0	0	0	0	126
NBR	210	309	99	33	0	243	0	0	0	0	243
SBL	155	233	78	26	0	181	0	0	0	0	181
SBT	124	179	55	18	0	142	0	0	0	0	142
SBR	22	24	2	1	0	23	0	0	0	0	23
EBL	14	17	3	1	0	15	0	0	0	0	15
EBT	734	977	243	81	0	815	88	0	0	88	903
EBR	231	294	63	21	0	252	33	0	0	33	285
WBL	144	248	104	35	0	179	0	0	0	0	179
WBT	654	872	218	73	0	727	137	0	0	137	864
WBR	104	175	71	24	0	128	0	0	0	0	128
North Leg											
Approach	301	436	135	45	0	346	0	0	0	0	346
Departure	230	346	116	39	0	269	0	0	0	0	269
Total	531	782	251	84	0	615	0	0	0	0	615
South Leg											
Approach	540	700	160	53	0	593	78	0	0	78	671
Departure	499	721	222	74	0	573	33	0	0	33	606
Total	1,039	1,421	382	127	0	1,166	111	0	0	111	1,277
East Leg											
Approach	902	1,295	393	131	0	1,033	137	0	0	137	1,170
Departure	1,099	1,519	420	140	0	1,239	88	0	0	88	1,327
Total	2,001	2,814	813	271	0	2,272	225	0	0	225	2,497
West Leg											
Approach	979	1,288	309	103	0	1,082	121	0	0	121	1,203
Departure	894	1,133	239	80	0	974	215	0	0	215	1,189
Total	1,873	2,421	548	183	0	2,056	336	0	0	336	2,392
Total Approaches											
Approach	2,722	3,719	997	332	0	3,054	336	0	0	336	3,390
Departure	2,722	3,719	997	332	0	3,054	336	0	0	336	3,390
Total	5,444	7,438	1,994	665	0	6,109	672	0	0	672	6,781

Table C-3 - Phase I Project Completion Year (2029) Volume Summary

	PM Peak Hour										
	Existing	Ph III 2049 without Project	Total Growth (2019-2049)	Adjusted Growth	Cumulative Projects	Year 2029 without Project	External Project Trips	Internal Project Trips	Pass-by Trips	Phase I Project Trips	Year 2029 with Project
34 Cleveland Avenue – Country Club Drive/W Cleveland Avenue											
NBL	0	0	0	0	0	0	0	0	0	0	0
NBT	709	953	244	81	0	790	21	0	0	21	811
NBR	390	566	176	59	0	449	67	0	0	67	516
SBL	75	147	72	24	0	99	0	0	0	0	99
SBT	575	871	296	99	0	674	37	0	0	37	711
SBR	0	0	0	0	0	0	0	0	0	0	0
EBL	0	0	0	0	0	0	0	0	0	0	0
EBT	0	0	0	0	0	0	0	0	0	0	0
EBR	0	0	0	0	0	0	0	0	0	0	0
WBL	327	424	97	32	0	359	101	0	0	101	460
WBT	0	0	0	0	0	0	0	0	0	0	0
WBR	26	40	14	5	0	31	0	0	0	0	31
North Leg											
Approach	650	1,018	368	123	0	773	37	0	0	37	810
Departure	735	993	258	86	0	821	21	0	0	21	842
Total	1,385	2,011	626	209	0	1,594	58	0	0	58	1,652
South Leg											
Approach	1,099	1,519	420	140	0	1,239	88	0	0	88	1,327
Departure	902	1,295	393	131	0	1,033	138	0	0	138	1,171
Total	2,001	2,814	813	271	0	2,272	226	0	0	226	2,498
East Leg											
Approach	353	464	111	37	0	390	101	0	0	101	491
Departure	465	713	248	83	0	548	67	0	0	67	615
Total	818	1,177	359	120	0	938	168	0	0	168	1,106
West Leg											
Approach	0	0	0	0	0	0	0	0	0	0	0
Departure	0	0	0	0	0	0	0	0	0	0	0
Total	0	0	0	0	0	0	0	0	0	0	0
Total Approaches											
Approach	2,102	3,001	899	300	0	2,402	226	0	0	226	2,628
Departure	2,102	3,001	899	300	0	2,402	226	0	0	226	2,628
Total	4,204	6,002	1,798	599	0	4,803	452	0	0	452	5,255

Table C-3 - Phase I Project Completion Year (2029) Volume Summary

	PM Peak Hour										
	Ph III 2049 Existing	Ph III 2049 without Project	Total Growth (2019-2049)	Adjusted Growth	Cumulative Projects	Year 2029 without Project	External Project Trips	Internal Project Trips	Pass-by Trips	Phase I Project Trips	Year 2029 with Project
35 Country Club Drive/Sharon Boulevard											
NBL	5	5	0	0	0	5	0	0	0	0	5
NBT	707	962	255	85	0	792	16	0	0	16	808
NBR	0	0	0	0	0	0	0	0	0	0	0
SBL	0	0	0	0	0	0	0	0	0	0	0
SBT	592	963	371	124	0	716	23	0	0	23	739
SBR	1	1	0	0	0	1	0	0	0	0	1
EBL	2	2	0	0	0	2	0	0	0	0	2
EBT	0	0	0	0	0	0	0	0	0	0	0
EBR	16	17	1	0	0	16	0	0	0	0	16
WBL	0	0	0	0	0	0	0	0	0	0	0
WBT	0	0	0	0	0	0	0	0	0	0	0
WBR	0	0	0	0	0	0	0	0	0	0	0
North Leg											
Approach	593	964	371	124	0	717	23	0	0	23	740
Departure	709	964	255	85	0	794	16	0	0	16	810
Total	1,302	1,928	626	209	0	1,511	39	0	0	39	1,550
South Leg											
Approach	712	967	255	85	0	797	16	0	0	16	813
Departure	608	980	372	124	0	732	23	0	0	23	755
Total	1,320	1,947	627	209	0	1,529	39	0	0	39	1,568
East Leg											
Approach	0	0	0	0	0	0	0	0	0	0	0
Departure	0	0	0	0	0	0	0	0	0	0	0
Total	0	0	0	0	0	0	0	0	0	0	0
West Leg											
Approach	18	19	1	0	0	18	0	0	0	0	18
Departure	6	6	0	0	0	6	0	0	0	0	6
Total	24	25	1	0	0	24	0	0	0	0	24
Total Approaches											
Approach	1,323	1,950	627	209	0	1,532	39	0	0	39	1,571
Departure	1,323	1,950	627	209	0	1,532	39	0	0	39	1,571
Total	2,646	3,900	1,254	418	0	3,064	78	0	0	78	3,142

Table C-3 - Phase I Project Completion Year (2029) Volume Summary

	PM Peak Hour										
	Existing	Ph III 2049 without Project	Total Growth (2019-2049)	Adjusted Growth	Cumulative Projects	Year 2029 without Project	External Project Trips	Internal Project Trips	Pass-by Trips	Phase I Project Trips	Year 2029 with Project
36 Pine Street/Howard Road											
NBL	142	144	2	1	0	143	52	0	0	52	195
NBT	155	183	28	9	0	164	0	0	0	0	164
NBR	138	171	33	11	0	149	0	0	0	0	149
SBL	15	18	3	1	0	16	0	0	0	0	16
SBT	131	161	30	10	0	141	0	0	0	0	141
SBR	119	120	1	0	0	119	0	0	0	0	119
EBL	85	89	4	1	0	86	0	0	0	0	86
EBT	528	559	31	10	0	538	94	0	0	94	632
EBR	96	102	6	2	0	98	28	0	0	28	126
WBL	86	111	25	8	0	94	0	0	0	0	94
WBT	486	515	29	10	0	496	77	0	0	77	573
WBR	3	4	1	0	0	3	0	0	0	0	3
North Leg											
Approach	265	299	34	11	0	276	0	0	0	0	276
Departure	243	276	33	11	0	254	0	0	0	0	254
Total	508	575	67	22	0	530	0	0	0	0	530
South Leg											
Approach	435	498	63	21	0	456	52	0	0	52	508
Departure	313	374	61	20	0	333	28	0	0	28	361
Total	748	872	124	41	0	789	80	0	0	80	869
East Leg											
Approach	575	630	55	18	0	593	77	0	0	77	670
Departure	681	748	67	22	0	703	94	0	0	94	797
Total	1,256	1,378	122	41	0	1,297	171	0	0	171	1,468
West Leg											
Approach	709	750	41	14	0	723	122	0	0	122	845
Departure	747	779	32	11	0	758	129	0	0	129	887
Total	1,456	1,529	73	24	0	1,480	251	0	0	251	1,731
Total Approaches											
Approach	1,984	2,177	193	64	0	2,048	251	0	0	251	2,299
Departure	1,984	2,177	193	64	0	2,048	251	0	0	251	2,299
Total	3,968	4,355	387	129	0	4,097	502	0	0	502	4,599

Table C-3 - Phase I Project Completion Year (2029) Volume Summary

	PM Peak Hour										
	Existing	Ph III 2049 without Project	Total Growth (2019-2049)	Adjusted Growth	Cumulative Projects	Year 2029 without Project	External Project Trips	Internal Project Trips	Pass-by Trips	Phase I Project Trips	Year 2029 with Project
37 Q Street - Olive Avenue/Yosemite Avenue - Howard Road											
NBL	278	330	52	17	0	295	68	0	0	68	363
NBT	74	76	2	1	0	75	0	0	0	0	75
NBR	12	13	1	0	0	12	0	0	0	0	12
SBL	16	17	1	0	0	16	0	0	0	0	16
SBT	55	58	3	1	0	56	0	0	0	0	56
SBR	2	2	0	0	0	2	0	0	0	0	2
EBL	7	7	0	0	0	7	0	0	0	0	7
EBT	442	452	10	3	0	445	10	0	0	10	455
EBR	211	269	58	19	0	230	84	0	0	84	314
WBL	12	14	2	1	0	13	0	0	0	0	13
WBT	357	361	4	1	0	358	9	0	0	9	367
WBR	14	15	1	0	0	14	0	0	0	0	14
North Leg											
Approach	73	77	4	1	0	74	0	0	0	0	74
Departure	95	98	3	1	0	96	0	0	0	0	96
Total	168	175	7	2	0	170	0	0	0	0	170
South Leg											
Approach	364	419	55	18	0	382	68	0	0	68	450
Departure	278	341	63	21	0	299	84	0	0	84	383
Total	642	760	118	39	0	681	152	0	0	152	833
East Leg											
Approach	383	390	7	2	0	385	9	0	0	9	394
Departure	470	482	12	4	0	474	10	0	0	10	484
Total	853	872	19	6	0	859	19	0	0	19	878
West Leg											
Approach	660	728	68	23	0	683	94	0	0	94	777
Departure	637	693	56	19	0	656	77	0	0	77	733
Total	1,297	1,421	124	41	0	1,338	171	0	0	171	1,509
Total Approaches											
Approach	1,480	1,614	134	45	0	1,525	171	0	0	171	1,696
Departure	1,480	1,614	134	45	0	1,525	171	0	0	171	1,696
Total	2,960	3,228	268	89	0	3,049	342	0	0	342	3,391

Table C-3 - Phase I Project Completion Year (2029) Volume Summary

	PM Peak Hour										
	Existing	Ph III 2049 without Project	Total Growth (2019-2049)	Adjusted Growth	Cumulative Projects	Year 2029 without Project	External Project Trips	Internal Project Trips	Pass-by Trips	Phase I Project Trips	Year 2029 with Project
38 I Street/SR-99 Southbound Off-Ramp - 2nd Street											
NBL	42	54	12	4	0	46	0	0	0	0	46
NBT	141	160	19	6	0	147	0	0	0	0	147
NBR	0	0	0	0	0	0	0	0	0	0	0
SBL	0	0	0	0	0	0	0	0	0	0	0
SBT	112	122	10	3	0	115	0	0	0	0	115
SBR	0	0	0	0	0	0	0	0	0	0	0
EBL	0	0	0	0	0	0	0	0	0	0	0
EBT	0	0	0	0	0	0	0	0	0	0	0
EBR	32	44	12	4	0	36	0	0	0	0	36
WBL	236	296	60	20	0	256	6	0	0	6	262
WBT	10	15	5	2	0	12	0	0	0	0	12
WBR	4	5	1	0	0	4	0	0	0	0	4
North Leg											
Approach	112	122	10	3	0	115	0	0	0	0	115
Departure	145	165	20	7	0	152	0	0	0	0	152
Total	257	287	30	10	0	267	0	0	0	0	267
South Leg											
Approach	183	214	31	10	0	193	0	0	0	0	193
Departure	380	462	82	27	0	407	6	0	0	6	413
Total	563	676	113	38	0	601	6	0	0	6	607
East Leg											
Approach	250	316	66	22	0	272	6	0	0	6	278
Departure	0	0	0	0	0	0	0	0	0	0	0
Total	250	316	66	22	0	272	6	0	0	6	278
West Leg											
Approach	32	44	12	4	0	36	0	0	0	0	36
Departure	52	69	17	6	0	58	0	0	0	0	58
Total	84	113	29	10	0	94	0	0	0	0	94
Total Approaches											
Approach	577	696	119	40	0	617	6	0	0	6	623
Departure	577	696	119	40	0	617	6	0	0	6	623
Total	1,154	1,392	238	79	0	1,233	12	0	0	12	1,245

Table C-3 - Phase I Project Completion Year (2029) Volume Summary

		PM Peak Hour									
		Ph III 2049	Total Growth	Adjusted	Cumulative	Year 2029	External	Internal	Pass-by	Phase I	Year 2029
		Existing	without Project	Growth (2019-2049)	Growth	Projects	Project Trips	Project Trips	Trips	Project Trips	with Project
39	4th Street/Sunset Avenue										
NBL		13	14	1	0	0	13	0	0	0	13
NBT		278	350	72	24	0	302	14	0	14	316
NBR		0	0	0	0	0	0	0	0	0	0
SBL		0	0	0	0	0	0	0	0	0	0
SBT		319	409	90	30	0	349	6	0	6	355
SBR		360	378	18	6	0	366	9	0	9	375
EBL		224	238	14	5	0	229	10	0	10	239
EBT		0	0	0	0	0	0	0	0	0	0
EBR		12	14	2	1	0	13	0	0	0	13
WBL		0	0	0	0	0	0	0	0	0	0
WBT		0	0	0	0	0	0	0	0	0	0
WBR		0	0	0	0	0	0	0	0	0	0
North Leg											
Approach		679	787	108	36	0	715	15	0	15	730
Departure		502	588	86	29	0	531	24	0	24	555
Total		1,181	1,375	194	65	0	1,246	39	0	39	1,285
South Leg											
Approach		291	364	73	24	0	315	14	0	14	329
Departure		331	423	92	31	0	362	6	0	6	368
Total		622	787	165	55	0	677	20	0	20	697
East Leg											
Approach		0	0	0	0	0	0	0	0	0	0
Departure		0	0	0	0	0	0	0	0	0	0
Total		0	0	0	0	0	0	0	0	0	0
West Leg											
Approach		236	252	16	5	0	241	10	0	10	251
Departure		373	392	19	6	0	379	9	0	9	388
Total		609	644	35	12	0	621	19	0	19	640
Total Approaches											
Approach		1,206	1,403	197	66	0	1,272	39	0	39	1,311
Departure		1,206	1,403	197	66	0	1,272	39	0	39	1,311
Total		2,412	2,806	394	131	0	2,543	78	0	78	2,621

Table C-3 - Phase I Project Completion Year (2029) Volume Summary

	PM Peak Hour										
	Ph III 2049 Existing	Ph III 2049 without Project	Total Growth (2019-2049)	Adjusted Growth	Cumulative Projects	Year 2029 without Project	External Project Trips	Internal Project Trips	Pass-by Trips	Phase I Project Trips	Year 2029 with Project
40 H Street/SR-99 Northbound On-Ramp - 2nd Street											
NBL	262	401	139	46	0	308	14	0	0	14	322
NBT	27	28	1	0	0	27	0	0	0	0	27
NBR	12	54	42	14	0	26	0	0	0	0	26
SBL	2	2	0	0	0	2	0	0	0	0	2
SBT	24	25	1	0	0	24	0	0	0	0	24
SBR	0	0	0	0	0	0	0	0	0	0	0
EBL	0	0	0	0	0	0	0	0	0	0	0
EBT	0	0	0	0	0	0	0	0	0	0	0
EBR	0	0	0	0	0	0	0	0	0	0	0
WBL	11	49	38	13	0	24	0	0	0	0	24
WBT	52	58	6	2	0	54	0	0	0	0	54
WBR	4	4	0	0	0	4	0	0	0	0	4
North Leg											
Approach	26	27	1	0	0	26	0	0	0	0	26
Departure	31	32	1	0	0	31	0	0	0	0	31
Total	57	59	2	1	0	58	0	0	0	0	58
South Leg											
Approach	301	483	182	61	0	362	14	0	0	14	376
Departure	35	74	39	13	0	48	0	0	0	0	48
Total	336	557	221	74	0	410	14	0	0	14	424
East Leg											
Approach	67	111	44	15	0	82	0	0	0	0	82
Departure	14	56	42	14	0	28	0	0	0	0	28
Total	81	167	86	29	0	110	0	0	0	0	110
West Leg											
Approach	0	0	0	0	0	0	0	0	0	0	0
Departure	314	459	145	48	0	362	14	0	0	14	376
Total	314	459	145	48	0	362	14	0	0	14	376
Total Approaches											
Approach	394	621	227	76	0	470	14	0	0	14	484
Departure	394	621	227	76	0	470	14	0	0	14	484
Total	788	1,243	455	152	0	940	28	0	0	28	968

Table C-3 - Phase I Project Completion Year (2029) Volume Summary

		PM Peak Hour									
		Ph III 2049	Total Growth	Adjusted	Cumulative	Year 2029	External	Internal	Pass-by	Phase I	Year 2029
		Existing	without Project (2019-2049)	Growth	Projects	without Project	Project Trips	Project Trips	Trips	Project Trips	with Project
41 I Street/4th Street											
NBL	96	105	9	3	0	99	0	0	0	0	99
NBT	68	75	7	2	0	70	0	0	0	0	70
NBR	244	256	12	4	0	248	0	0	0	0	248
SBL	159	193	34	11	0	170	0	0	0	0	170
SBT	163	173	10	3	0	166	0	0	0	0	166
SBR	93	132	39	13	0	106	6	0	0	6	112
EBL	31	42	11	4	0	35	0	0	0	0	35
EBT	471	545	74	25	0	496	24	0	0	24	520
EBR	61	62	1	0	0	61	0	0	0	0	61
WBL	59	62	3	1	0	60	0	0	0	0	60
WBT	490	534	44	15	0	505	9	0	0	9	514
WBR	106	117	11	4	0	110	0	0	0	0	110
North Leg											
Approach	415	498	83	28	0	443	6	0	0	6	449
Departure	205	234	29	10	0	215	0	0	0	0	215
Total	620	732	112	37	0	657	6	0	0	6	663
South Leg											
Approach	408	436	28	9	0	417	0	0	0	0	417
Departure	283	297	14	5	0	288	0	0	0	0	288
Total	691	733	42	14	0	705	0	0	0	0	705
East Leg											
Approach	655	713	58	19	0	674	9	0	0	9	683
Departure	874	994	120	40	0	914	24	0	0	24	938
Total	1,529	1,707	178	59	0	1,588	33	0	0	33	1,621
West Leg											
Approach	563	649	86	29	0	592	24	0	0	24	616
Departure	679	771	92	31	0	710	15	0	0	15	725
Total	1,242	1,420	178	59	0	1,301	39	0	0	39	1,340
Total Approaches											
Approach	2,041	2,296	255	85	0	2,126	39	0	0	39	2,165
Departure	2,041	2,296	255	85	0	2,126	39	0	0	39	2,165
Total	4,082	4,592	510	170	0	4,252	78	0	0	78	4,330

Table C-3 - Phase I Project Completion Year (2029) Volume Summary

		PM Peak Hour									
		Ph III 2049 without Project	Total Growth (2019-2049)	Adjusted Growth	Cumulative Projects	Year 2029 without Project	External Project Trips	Internal Project Trips	Pass-by Trips	Phase I Project Trips	Year 2029 with Project
		Existing									
42	SR-99 Southbound On-Ramp/4th Street										
NBL		0	0	0	0	0	0	0	0	0	0
NBT		0	0	0	0	0	0	0	0	0	0
NBR		0	0	0	0	0	0	0	0	0	0
SBL		0	0	0	0	0	0	0	0	0	0
SBT		0	0	0	0	0	0	0	0	0	0
SBR		0	0	0	0	0	0	0	0	0	0
EBL		0	0	0	0	0	0	0	0	0	0
EBT		599	678	79	26	0	625	24	0	24	649
EBR		275	316	41	14	0	289	0	0	0	289
WBL		151	226	75	25	0	176	0	0	0	176
WBT		655	713	58	19	0	674	9	0	9	683
WBR		0	0	0	0	0	0	0	0	0	0
North Leg											
Approach		0	0	0	0	0	0	0	0	0	0
Departure		0	0	0	0	0	0	0	0	0	0
Total		0	0	0	0	0	0	0	0	0	0
South Leg											
Approach		0	0	0	0	0	0	0	0	0	0
Departure		426	542	116	39	0	465	0	0	0	465
Total		426	542	116	39	0	465	0	0	0	465
East Leg											
Approach		806	939	133	44	0	850	9	0	9	859
Departure		599	678	79	26	0	625	24	0	24	649
Total		1,405	1,617	212	71	0	1,476	33	0	33	1,509
West Leg											
Approach		874	994	120	40	0	914	24	0	24	938
Departure		655	713	58	19	0	674	9	0	9	683
Total		1,529	1,707	178	59	0	1,588	33	0	33	1,621
Total Approaches											
Approach		1,680	1,933	253	84	0	1,764	33	0	33	1,797
Departure		1,680	1,933	253	84	0	1,764	33	0	33	1,797
Total		3,360	3,866	506	169	0	3,529	66	0	66	3,595

Table C-3 - Phase I Project Completion Year (2029) Volume Summary

		PM Peak Hour									
		Ph III 2049 without Project	Total Growth (2019-2049)	Adjusted Growth	Cumulative Projects	Year 2029 without Project	External Project Trips	Internal Project Trips	Pass-by Trips	Phase I Project Trips	Year 2029 with Project
43 H Street – SR-99 Northbound Off-Ramp/4th Street											
NBL	239	285	46	15	0	254	0	0	0	0	254
NBT	19	40	21	7	0	26	0	0	0	0	26
NBR	144	208	64	21	0	165	0	0	0	0	165
SBL	20	34	14	5	0	25	0	0	0	0	25
SBT	0	0	0	0	0	0	0	0	0	0	0
SBR	66	92	26	9	0	75	0	0	0	0	75
EBL	200	271	71	24	0	224	14	0	0	14	238
EBT	399	407	8	3	0	402	10	0	0	10	412
EBR	0	0	0	0	0	0	0	0	0	0	0
WBL	0	0	0	0	0	0	0	0	0	0	0
WBT	501	562	61	20	0	521	9	0	0	9	530
WBR	87	171	84	28	0	115	0	0	0	0	115
North Leg											
Approach	86	126	40	13	0	99	0	0	0	0	99
Departure	306	482	176	59	0	365	14	0	0	14	379
Total	392	608	216	72	0	464	14	0	0	14	478
South Leg											
Approach	402	533	131	44	0	446	0	0	0	0	446
Departure	0	0	0	0	0	0	0	0	0	0	0
Total	402	533	131	44	0	446	0	0	0	0	446
East Leg											
Approach	588	733	145	48	0	636	9	0	0	9	645
Departure	563	649	86	29	0	592	10	0	0	10	602
Total	1,151	1,382	231	77	0	1,228	19	0	0	19	1,247
West Leg											
Approach	599	678	79	26	0	625	24	0	0	24	649
Departure	806	939	133	44	0	850	9	0	0	9	859
Total	1,405	1,617	212	71	0	1,476	33	0	0	33	1,509
Total Approaches											
Approach	1,675	2,070	395	132	0	1,807	33	0	0	33	1,840
Departure	1,675	2,070	395	132	0	1,807	33	0	0	33	1,840
Total	3,350	4,140	790	263	0	3,613	66	0	0	66	3,679

Table C-3 - Phase I Project Completion Year (2029) Volume Summary

		PM Peak Hour									
		Ph III 2049	Total Growth	Adjusted	Cumulative	Year 2029	External	Internal	Pass-by	Phase I	Year 2029
		Existing	without Project	Growth (2019-2049)	Growth	Projects	Project Trips	Project Trips	Trips	Project Trips	with Project
44 I Street/Olive Avenue											
NBL	0	0	0	0	0	0	0	0	0	0	0
NBT	0	0	0	0	0	0	0	0	0	0	0
NBR	0	0	0	0	0	0	0	0	0	0	0
SBL	152	160	8	3	0	155	0	0	0	0	155
SBT	0	0	0	0	0	0	0	0	0	0	0
SBR	106	111	5	2	0	108	0	0	0	0	108
EBL	86	90	4	1	0	87	0	0	0	0	87
EBT	376	502	126	42	0	418	58	0	0	58	476
EBR	0	0	0	0	0	0	0	0	0	0	0
WBL	0	0	0	0	0	0	0	0	0	0	0
WBT	357	492	135	45	0	402	47	0	0	47	449
WBR	103	113	10	3	0	106	0	0	0	0	106
North Leg											
Approach	258	271	13	4	0	262	0	0	0	0	262
Departure	189	203	14	5	0	194	0	0	0	0	194
Total	447	474	27	9	0	456	0	0	0	0	456
South Leg											
Approach	0	0	0	0	0	0	0	0	0	0	0
Departure	0	0	0	0	0	0	0	0	0	0	0
Total	0	0	0	0	0	0	0	0	0	0	0
East Leg											
Approach	460	605	145	48	0	508	47	0	0	47	555
Departure	528	662	134	45	0	573	58	0	0	58	631
Total	988	1,267	279	93	0	1,081	105	0	0	105	1,186
West Leg											
Approach	462	592	130	43	0	505	58	0	0	58	563
Departure	463	603	140	47	0	510	47	0	0	47	557
Total	925	1,196	271	90	0	1,015	105	0	0	105	1,120
Total Approaches											
Approach	1,180	1,468	288	96	0	1,276	105	0	0	105	1,381
Departure	1,180	1,468	288	96	0	1,276	105	0	0	105	1,381
Total	2,360	2,937	577	192	0	2,552	210	0	0	210	2,762

Table C-3 - Phase I Project Completion Year (2029) Volume Summary

	PM Peak Hour										
	Existing	Ph III 2049 without Project	Total Growth (2019-2049)	Adjusted Growth	Cumulative Projects	Year 2029 without Project	External Project Trips	Internal Project Trips	Pass-by Trips	Phase I Project Trips	Year 2029 with Project
45 SR-99 Southbound Off-Ramp/Olive Avenue											
NBL	0	0	0	0	0	0	0	0	0	0	0
NBT	0	0	0	0	0	0	0	0	0	0	0
NBR	0	0	0	0	0	0	0	0	0	0	0
SBL	229	674	445	148	0	377	32	0	0	32	409
SBT	0	0	0	0	0	0	0	0	0	0	0
SBR	65	102	37	12	0	77	0	0	0	0	77
EBL	0	0	0	0	0	0	0	0	0	0	0
EBT	528	661	133	44	0	572	58	0	0	58	630
EBR	0	0	0	0	0	0	0	0	0	0	0
WBL	0	0	0	0	0	0	0	0	0	0	0
WBT	395	503	108	36	0	431	47	0	0	47	478
WBR	0	0	0	0	0	0	0	0	0	0	0
North Leg											
Approach	294	776	482	161	0	455	32	0	0	32	487
Departure	0	0	0	0	0	0	0	0	0	0	0
Total	294	776	482	161	0	455	32	0	0	32	487
South Leg											
Approach	0	0	0	0	0	0	0	0	0	0	0
Departure	0	0	0	0	0	0	0	0	0	0	0
Total	0	0	0	0	0	0	0	0	0	0	0
East Leg											
Approach	395	503	108	36	0	431	47	0	0	47	478
Departure	757	1,335	578	193	0	950	90	0	0	90	1,040
Total	1,152	1,838	686	229	0	1,381	137	0	0	137	1,518
West Leg											
Approach	528	661	133	44	0	572	58	0	0	58	630
Departure	460	605	145	48	0	508	47	0	0	47	555
Total	988	1,266	278	93	0	1,081	105	0	0	105	1,186
Total Approaches											
Approach	1,217	1,940	723	241	0	1,458	137	0	0	137	1,595
Departure	1,217	1,940	723	241	0	1,458	137	0	0	137	1,595
Total	2,434	3,880	1,446	482	0	2,916	274	0	0	274	3,190

Table C-3 - Phase I Project Completion Year (2029) Volume Summary

	PM Peak Hour										
	Existing	Ph III 2049 without Project	Total Growth (2019-2049)	Adjusted Growth	Cumulative Projects	Year 2029 without Project	External Project Trips	Internal Project Trips	Pass-by Trips	Phase I Project Trips	Year 2029 with Project
46 Madera Avenue/SR-99 Northbound Ramps											
NBL	377	820	443	148	0	525	57	0	0	57	582
NBT	520	753	233	78	0	598	18	0	0	18	616
NBR	0	0	0	0	0	0	0	0	0	0	0
SBL	0	0	0	0	0	0	0	0	0	0	0
SBT	581	691	110	37	0	618	9	0	0	9	627
SBR	171	178	7	2	0	173	21	0	0	21	194
EBL	0	0	0	0	0	0	0	0	0	0	0
EBT	0	0	0	0	0	0	0	0	0	0	0
EBR	0	0	0	0	0	0	0	0	0	0	0
WBL	171	209	38	13	0	184	30	0	0	30	214
WBT	1	1	0	0	0	1	0	0	0	0	1
WBR	32	34	2	1	0	33	0	0	0	0	33
North Leg											
Approach	752	869	117	39	0	791	30	0	0	30	821
Departure	552	787	235	78	0	630	18	0	0	18	648
Total	1,304	1,656	352	117	0	1,421	48	0	0	48	1,469
South Leg											
Approach	897	1,573	676	225	0	1,122	75	0	0	75	1,197
Departure	752	900	148	49	0	801	39	0	0	39	840
Total	1,649	2,473	824	275	0	1,924	114	0	0	114	2,038
East Leg											
Approach	204	244	40	13	0	217	30	0	0	30	247
Departure	0	0	0	0	0	0	0	0	0	0	0
Total	204	244	40	13	0	217	30	0	0	30	247
West Leg											
Approach	0	0	0	0	0	0	0	0	0	0	0
Departure	549	999	450	150	0	699	78	0	0	78	777
Total	549	999	450	150	0	699	78	0	0	78	777
Total Approaches											
Approach	1,853	2,686	833	278	0	2,131	135	0	0	135	2,266
Departure	1,853	2,686	833	278	0	2,131	135	0	0	135	2,266
Total	3,706	5,371	1,665	555	0	4,261	270	0	0	270	4,531

Table C-3 - Phase I Project Completion Year (2029) Volume Summary

	PM Peak Hour										
	Existing	Ph III 2049 without Project	Total Growth (2019-2049)	Adjusted Growth	Cumulative Projects	Year 2029 without Project	External Project Trips	Internal Project Trips	Pass-by Trips	Phase I Project Trips	Year 2029 with Project
47 Madera Avenue/Olive Avenue – SR-99 Southbound On-Ramp											
NBL	104	197	93	31	0	135	9	0	0	9	144
NBT	573	1,081	508	169	0	742	57	0	0	57	799
NBR	29	52	23	8	0	37	0	0	0	0	37
SBL	130	137	7	2	0	132	0	0	0	0	132
SBT	331	458	127	42	0	373	0	0	0	0	373
SBR	291	306	15	5	0	296	38	0	0	38	334
EBL	324	492	168	56	0	380	18	0	0	18	398
EBT	135	196	61	20	0	155	37	0	0	37	192
EBR	298	647	349	116	0	414	34	0	0	34	448
WBL	0	0	0	0	0	0	0	0	0	0	0
WBT	0	0	0	0	0	0	0	0	0	0	0
WBR	0	0	0	0	0	0	0	0	0	0	0
North Leg											
Approach	752	900	148	49	0	801	38	0	0	38	839
Departure	897	1,573	676	225	0	1,122	75	0	0	75	1,197
Total	1,649	2,473	824	275	0	1,924	113	0	0	113	2,037
South Leg											
Approach	706	1,330	624	208	0	914	66	0	0	66	980
Departure	629	1,105	476	159	0	788	34	0	0	34	822
Total	1,335	2,435	1,100	367	0	1,702	100	0	0	100	1,802
East Leg											
Approach	0	0	0	0	0	0	0	0	0	0	0
Departure	294	385	91	30	0	324	37	0	0	37	361
Total	294	385	91	30	0	324	37	0	0	37	361
West Leg											
Approach	757	1,335	578	193	0	950	89	0	0	89	1,039
Departure	395	503	108	36	0	431	47	0	0	47	478
Total	1,152	1,838	686	229	0	1,381	136	0	0	136	1,517
Total Approaches											
Approach	2,215	3,565	1,350	450	0	2,665	193	0	0	193	2,858
Departure	2,215	3,565	1,350	450	0	2,665	193	0	0	193	2,858
Total	4,430	7,130	2,700	900	0	5,330	386	0	0	386	5,716

Table C-3 - Phase I Project Completion Year (2029) Volume Summary

		PM Peak Hour									
		Ph III 2049	Total Growth	Adjusted	Cumulative	Year 2029	External	Internal	Pass-by	Phase I	Year 2029
		Existing	without Project (2019-2049)	Growth	Projects	without Project	Project Trips	Project Trips	Trips	Project Trips	with Project
48 Madera Avenue (SR-145) /Lewis Street											
NBL	0	0	0	0	0	0	0	0	0	0	0
NBT	739	1,364	625	208	0	947	66	0	0	66	1,013
NBR	6	7	1	0	0	6	0	0	0	0	6
SBL	31	33	2	1	0	32	0	0	0	0	32
SBT	690	1,166	476	159	0	849	34	0	0	34	883
SBR	0	0	0	0	0	0	0	0	0	0	0
EBL	0	0	0	0	0	0	0	0	0	0	0
EBT	0	0	0	0	0	0	0	0	0	0	0
EBR	0	0	0	0	0	0	0	0	0	0	0
WBL	7	7	0	0	0	7	0	0	0	0	7
WBT	0	0	0	0	0	0	0	0	0	0	0
WBR	9	9	0	0	0	9	0	0	0	0	9
North Leg											
Approach	721	1,199	478	159	0	880	34	0	0	34	914
Departure	748	1,373	625	208	0	956	66	0	0	66	1,022
Total	1,469	2,572	1,103	368	0	1,837	100	0	0	100	1,937
South Leg											
Approach	745	1,371	626	209	0	954	66	0	0	66	1,020
Departure	697	1,173	476	159	0	856	34	0	0	34	890
Total	1,442	2,544	1,102	367	0	1,809	100	0	0	100	1,909
East Leg											
Approach	16	17	1	0	0	16	0	0	0	0	16
Departure	37	40	3	1	0	38	0	0	0	0	38
Total	53	56	3	1	0	54	0	0	0	0	54
West Leg											
Approach	0	0	0	0	0	0	0	0	0	0	0
Departure	0	0	0	0	0	0	0	0	0	0	0
Total	0	0	0	0	0	0	0	0	0	0	0
Total Approaches											
Approach	1,482	2,586	1,104	368	0	1,850	100	0	0	100	1,950
Departure	1,482	2,586	1,104	368	0	1,850	100	0	0	100	1,950
Total	2,964	5,173	2,209	736	0	3,700	200	0	0	200	3,900

Table C-3 - Phase I Project Completion Year (2029) Volume Summary

	PM Peak Hour										
	Existing	Ph III 2049 without Project	Total Growth (2019-2049)	Adjusted Growth	Cumulative Projects	Year 2029 without Project	External Project Trips	Internal Project Trips	Pass-by Trips	Phase I Project Trips	Year 2029 with Project
49 Yosemite Avenue/Cleveland Avenue - Tozer Street											
NBL	305	320	15	5	0	310	0	0	0	0	310
NBT	283	329	46	15	0	298	0	0	0	0	298
NBR	95	100	5	2	0	97	0	0	0	0	97
SBL	67	83	16	5	0	72	0	0	0	0	72
SBT	167	188	21	7	0	174	0	0	0	0	174
SBR	209	240	31	10	0	219	66	0	0	66	285
EBL	187	250	63	21	0	208	34	0	0	34	242
EBT	408	467	59	20	0	428	0	0	0	0	428
EBR	195	203	8	3	0	198	0	0	0	0	198
WBL	48	52	4	1	0	49	0	0	0	0	49
WBT	447	499	52	17	0	464	0	0	0	0	464
WBR	35	49	14	5	0	40	0	0	0	0	40
North Leg											
Approach	443	511	68	23	0	466	66	0	0	66	532
Departure	505	628	123	41	0	546	34	0	0	34	580
Total	948	1,139	191	64	0	1,012	100	0	0	100	1,112
South Leg											
Approach	683	749	66	22	0	705	0	0	0	0	705
Departure	410	443	33	11	0	421	0	0	0	0	421
Total	1,093	1,192	99	33	0	1,126	0	0	0	0	1,126
East Leg											
Approach	530	600	70	23	0	553	0	0	0	0	553
Departure	570	650	80	27	0	597	0	0	0	0	597
Total	1,100	1,250	150	50	0	1,150	0	0	0	0	1,150
West Leg											
Approach	790	920	130	43	0	833	34	0	0	34	867
Departure	961	1,059	98	33	0	994	66	0	0	66	1,060
Total	1,751	1,979	228	76	0	1,827	100	0	0	100	1,927
Total Approaches											
Approach	2,446	2,780	334	111	0	2,557	100	0	0	100	2,657
Departure	2,446	2,780	334	111	0	2,557	100	0	0	100	2,657
Total	4,892	5,560	668	223	0	5,115	200	0	0	200	5,315

Table C-3 - Phase I Project Completion Year (2029) Volume Summary

		PM Peak Hour									
		Ph III 2049	Total Growth	Adjusted	Cumulative	Year 2029	External	Internal	Pass-by	Phase I	Year 2029
		Existing	without Project (2019-2049)	Growth	Projects	without Project	Project Trips	Project Trips	Trips	Project Trips	with Project
50	Road 22/Cleveland Avenue										
NBL		0	0	0	0	0	0	0	0	0	0
NBT		0	0	0	0	0	0	0	0	0	0
NBR		0	0	0	0	0	0	0	0	0	0
SBL		0	0	0	0	0	0	0	0	0	0
SBT		0	0	0	0	0	0	0	0	0	0
SBR		0	0	0	0	0	0	0	0	0	0
EBL		0	0	0	0	0	0	0	0	0	0
EBT		0	0	0	0	0	0	0	0	0	0
EBR		0	0	0	0	0	0	0	0	0	0
WBL		0	0	0	0	0	0	0	0	0	0
WBT		0	0	0	0	0	0	0	0	0	0
WBR		0	0	0	0	0	0	0	0	0	0
North Leg											
Approach		0	0	0	0	0	0	0	0	0	0
Departure		0	0	0	0	0	0	0	0	0	0
Total		0	0	0	0	0	0	0	0	0	0
South Leg											
Approach		0	0	0	0	0	0	0	0	0	0
Departure		0	0	0	0	0	0	0	0	0	0
Total		0	0	0	0	0	0	0	0	0	0
East Leg											
Approach		0	0	0	0	0	0	0	0	0	0
Departure		0	0	0	0	0	0	0	0	0	0
Total		0	0	0	0	0	0	0	0	0	0
West Leg											
Approach		0	0	0	0	0	0	0	0	0	0
Departure		0	0	0	0	0	0	0	0	0	0
Total		0	0	0	0	0	0	0	0	0	0
Total Approaches											
Approach		0	0	0	0	0	0	0	0	0	0
Departure		0	0	0	0	0	0	0	0	0	0
Total		0	0	0	0	0	0	0	0	0	0

Table C-3 - Phase I Project Completion Year (2029) Volume Summary

		PM Peak Hour									
		Ph III 2049 without Project	Total Growth (2019-2049)	Adjusted Growth	Cumulative Projects	Year 2029 without Project	External Project Trips	Internal Project Trips	Pass-by Trips	Phase I Project Trips	Year 2029 with Project
51 Project Driveway 1/Avenue 17											
NBL	0	0	0	0	0	0	0	0	0	0	0
NBT	0	0	0	0	0	0	0	0	0	0	0
NBR	0	0	0	0	0	0	0	0	0	0	0
SBL	0	0	0	0	0	0	0	0	0	0	0
SBT	0	0	0	0	0	0	0	0	0	0	0
SBR	0	0	0	0	0	0	0	0	0	0	0
EBL	0	0	0	0	0	0	0	0	0	0	0
EBT	60	73	13	4	0	64	28	0	0	28	92
EBR	0	0	0	0	0	0	0	0	0	0	0
WBL	0	0	0	0	0	0	0	0	0	0	0
WBT	25	39	14	5	0	30	11	0	0	11	41
WBR	0	0	0	0	0	0	0	0	0	0	0
North Leg											
Approach	0	0	0	0	0	0	0	0	0	0	0
Departure	0	0	0	0	0	0	0	0	0	0	0
Total	0	0	0	0	0	0	0	0	0	0	0
South Leg											
Approach	0	0	0	0	0	0	0	0	0	0	0
Departure	0	0	0	0	0	0	0	0	0	0	0
Total	0	0	0	0	0	0	0	0	0	0	0
East Leg											
Approach	25	39	14	5	0	30	11	0	0	11	41
Departure	60	73	13	4	0	64	28	0	0	28	92
Total	85	112	27	9	0	94	39	0	0	39	133
West Leg											
Approach	60	73	13	4	0	64	28	0	0	28	92
Departure	25	39	14	5	0	30	11	0	0	11	41
Total	85	112	27	9	0	94	39	0	0	39	133
Total Approaches											
Approach	85	112	27	9	0	94	39	0	0	39	133
Departure	85	112	27	9	0	94	39	0	0	39	133
Total	170	224	54	18	0	188	78	0	0	78	266

Table C-3 - Phase I Project Completion Year (2029) Volume Summary

	PM Peak Hour										
	Existing	Ph III 2049 without Project	Total Growth (2019-2049)	Adjusted Growth	Cumulative Projects	Year 2029 without Project	External Project Trips	Internal Project Trips	Pass-by Trips	Phase I Project Trips	Year 2029 with Project
52 Road 22 ½ - Project Driveway 2/Avenue 16											
NBL	0	0	0	0	0	0	0	0	0	0	0
NBT	0	0	0	0	0	0	0	0	0	0	0
NBR	0	0	0	0	0	0	0	0	0	0	0
SBL	1	4	3	1	0	2	0	0	0	0	2
SBT	0	0	0	0	0	0	0	0	0	0	0
SBR	0	0	0	0	0	0	0	0	0	0	0
EBL	0	0	0	0	0	0	0	0	0	0	0
EBT	49	202	153	51	0	100	0	0	0	0	100
EBR	0	0	0	0	0	0	0	0	0	0	0
WBL	0	0	0	0	0	0	0	0	0	0	0
WBT	14	15	1	0	0	14	0	0	0	0	14
WBR	0	0	0	0	0	0	0	0	0	0	0
North Leg											
Approach	1	4	3	1	0	2	0	0	0	0	2
Departure	0	0	0	0	0	0	0	0	0	0	0
Total	1	4	3	1	0	2	0	0	0	0	2
South Leg											
Approach	0	0	0	0	0	0	0	0	0	0	0
Departure	0	0	0	0	0	0	0	0	0	0	0
Total	0	0	0	0	0	0	0	0	0	0	0
East Leg											
Approach	14	15	1	0	0	14	0	0	0	0	14
Departure	50	206	156	52	0	102	0	0	0	0	102
Total	64	221	157	52	0	116	0	0	0	0	116
West Leg											
Approach	49	202	153	51	0	100	0	0	0	0	100
Departure	14	15	1	0	0	14	0	0	0	0	14
Total	63	217	154	51	0	114	0	0	0	0	114
Total Approaches											
Approach	64	221	157	52	0	116	0	0	0	0	116
Departure	64	221	157	52	0	116	0	0	0	0	116
Total	128	442	314	105	0	233	0	0	0	0	233

Table C-3 - Phase I Project Completion Year (2029) Volume Summary

	PM Peak Hour										
	Existing	Ph III 2049 without Project	Total Growth (2019-2049)	Adjusted Growth	Cumulative Projects	Year 2029 without Project	External Project Trips	Internal Project Trips	Pass-by Trips	Phase I Project Trips	Year 2029 with Project
53 Road 22 1/2/Cleveland Avenue											
NBL	0	0	0	0	0	0	0	0	0	0	0
NBT	0	0	0	0	0	0	0	0	0	0	0
NBR	0	0	0	0	0	0	0	0	0	0	0
SBL	1	1	0	0	0	1	0	0	0	0	1
SBT	0	0	0	0	0	0	0	0	0	0	0
SBR	0	0	0	0	0	0	0	0	0	0	0
EBL	0	0	0	0	0	0	0	0	0	0	0
EBT	0	0	0	0	0	0	0	0	0	0	0
EBR	0	0	0	0	0	0	0	0	0	0	0
WBL	0	0	0	0	0	0	0	0	0	0	0
WBT	0	0	0	0	0	0	0	0	0	0	0
WBR	0	0	0	0	0	0	0	0	0	0	0
North Leg											
Approach	1	1	0	0	0	1	0	0	0	0	1
Departure	0	0	0	0	0	0	0	0	0	0	0
Total	1	1	0	0	0	1	0	0	0	0	1
South Leg											
Approach	0	0	0	0	0	0	0	0	0	0	0
Departure	0	0	0	0	0	0	0	0	0	0	0
Total	0	0	0	0	0	0	0	0	0	0	0
East Leg											
Approach	0	0	0	0	0	0	0	0	0	0	0
Departure	1	1	0	0	0	1	0	0	0	0	1
Total	1	1	0	0	0	1	0	0	0	0	1
West Leg											
Approach	0	0	0	0	0	0	0	0	0	0	0
Departure	0	0	0	0	0	0	0	0	0	0	0
Total	0	0	0	0	0	0	0	0	0	0	0
Total Approaches											
Approach	1	1	0	0	0	1	0	0	0	0	1
Departure	1	1	0	0	0	1	0	0	0	0	1
Total	2	2	0	0	0	2	0	0	0	0	2

Table C-3 - Phase I Project Completion Year (2029) Volume Summary

	PM Peak Hour										
	Existing	Ph III 2049 without Project	Total Growth (2019-2049)	Adjusted Growth	Cumulative Projects	Year 2029 without Project	External Project Trips	Internal Project Trips	Pass-by Trips	Phase I Project Trips	Year 2029 with Project
54 Road 22 1/2/Project Driveway 5											
NBL	0	0	0	0	0	0	0	0	0	0	0
NBT	0	0	0	0	0	0	0	0	0	0	0
NBR	0	0	0	0	0	0	0	0	0	0	0
SBL	0	0	0	0	0	0	0	0	0	0	0
SBT	0	0	0	0	0	0	0	0	0	0	0
SBR	0	0	0	0	0	0	0	0	0	0	0
EBL	0	0	0	0	0	0	0	0	0	0	0
EBT	0	0	0	0	0	0	0	0	0	0	0
EBR	0	0	0	0	0	0	0	0	0	0	0
WBL	0	0	0	0	0	0	0	0	0	0	0
WBT	0	0	0	0	0	0	0	0	0	0	0
WBR	0	0	0	0	0	0	0	0	0	0	0
North Leg											
Approach	0	0	0	0	0	0	0	0	0	0	0
Departure	0	0	0	0	0	0	0	0	0	0	0
Total	0	0	0	0	0	0	0	0	0	0	0
South Leg											
Approach	0	0	0	0	0	0	0	0	0	0	0
Departure	0	0	0	0	0	0	0	0	0	0	0
Total	0	0	0	0	0	0	0	0	0	0	0
East Leg											
Approach	0	0	0	0	0	0	0	0	0	0	0
Departure	0	0	0	0	0	0	0	0	0	0	0
Total	0	0	0	0	0	0	0	0	0	0	0
West Leg											
Approach	0	0	0	0	0	0	0	0	0	0	0
Departure	0	0	0	0	0	0	0	0	0	0	0
Total	0	0	0	0	0	0	0	0	0	0	0
Total Approaches											
Approach	0	0	0	0	0	0	0	0	0	0	0
Departure	0	0	0	0	0	0	0	0	0	0	0
Total	0	0	0	0	0	0	0	0	0	0	0

Table C-3 - Phase I Project Completion Year (2029) Volume Summary

	PM Peak Hour										
	Existing	Ph III 2049 without Project	Total Growth (2019-2049)	Adjusted Growth	Cumulative Projects	Year 2029 without Project	External Project Trips	Internal Project Trips	Pass-by Trips	Phase I Project Trips	Year 2029 with Project
55 Road 23/Project Driveway 3											
NBL	0	0	0	0	0	0	0	0	0	0	0
NBT	152	306	154	51	0	203	236	0	0	236	439
NBR	0	0	0	0	0	0	0	0	0	0	0
SBL	0	0	0	0	0	0	0	0	0	0	0
SBT	242	385	143	48	0	290	403	0	0	403	693
SBR	0	0	0	0	0	0	0	0	0	0	0
EBL	0	0	0	0	0	0	0	0	0	0	0
EBT	0	0	0	0	0	0	0	0	0	0	0
EBR	2	2	0	0	0	2	0	0	0	0	2
WBL	0	0	0	0	0	0	0	0	0	0	0
WBT	0	0	0	0	0	0	0	0	0	0	0
WBR	0	0	0	0	0	0	0	0	0	0	0
North Leg											
Approach	242	385	143	48	0	290	403	0	0	403	693
Departure	152	306	154	51	0	203	236	0	0	236	439
Total	394	691	297	99	0	493	639	0	0	639	1,132
South Leg											
Approach	152	306	154	51	0	203	236	0	0	236	439
Departure	244	387	143	48	0	292	403	0	0	403	695
Total	396	693	297	99	0	495	639	0	0	639	1,134
East Leg											
Approach	0	0	0	0	0	0	0	0	0	0	0
Departure	0	0	0	0	0	0	0	0	0	0	0
Total	0	0	0	0	0	0	0	0	0	0	0
West Leg											
Approach	2	2	0	0	0	2	0	0	0	0	2
Departure	0	0	0	0	0	0	0	0	0	0	0
Total	2	2	0	0	0	2	0	0	0	0	2
Total Approaches											
Approach	396	693	297	99	0	495	639	0	0	639	1,134
Departure	396	693	297	99	0	495	639	0	0	639	1,134
Total	792	1,386	594	198	0	990	1,278	0	0	1,278	2,268

Table C-3 - Phase I Project Completion Year (2029) Volume Summary

	PM Peak Hour										
	Existing	Ph III 2049 without Project	Total Growth (2019-2049)	Adjusted Growth	Cumulative Projects	Year 2029 without Project	External Project Trips	Internal Project Trips	Pass-by Trips	Phase I Project Trips	Year 2029 with Project
56 Road 23/Project Driveway 4											
NBL	0	0	0	0	0	0	0	0	0	0	0
NBT	241	332	91	30	0	271	162	0	-19	143	414
NBR	0	0	0	0	0	0	282	0	19	301	301
SBL	0	0	0	0	0	0	278	0	24	302	302
SBT	331	372	41	14	0	345	66	0	-22	44	389
SBR	0	0	0	0	0	0	0	0	0	0	0
EBL	0	0	0	0	0	0	0	0	0	0	0
EBT	0	0	0	0	0	0	0	0	0	0	0
EBR	0	0	0	0	0	0	0	0	0	0	0
WBL	0	0	0	0	0	0	303	0	27	330	330
WBT	0	0	0	0	0	0	0	0	0	0	0
WBR	0	0	0	0	0	0	190	0	23	213	213
North Leg											
Approach	331	372	41	14	0	345	344	0	2	346	691
Departure	241	332	91	30	0	271	352	0	4	356	627
Total	572	704	132	44	0	616	696	0	6	702	1,318
South Leg											
Approach	241	332	91	30	0	271	444	0	0	444	715
Departure	331	372	41	14	0	345	369	0	5	374	719
Total	572	704	132	44	0	616	813	0	5	818	1,434
East Leg											
Approach	0	0	0	0	0	0	493	0	50	543	543
Departure	0	0	0	0	0	0	560	0	43	603	603
Total	0	0	0	0	0	0	1,053	0	93	1,146	1,146
West Leg											
Approach	0	0	0	0	0	0	0	0	0	0	0
Departure	0	0	0	0	0	0	0	0	0	0	0
Total	0	0	0	0	0	0	0	0	0	0	0
Total Approaches											
Approach	572	704	132	44	0	616	1,281	0	52	1,333	1,949
Departure	572	704	132	44	0	616	1,281	0	52	1,333	1,949
Total	1,144	1,408	264	88	0	1,232	2,562	0	104	2,666	3,898

Table C-3 - Phase I Project Completion Year (2029) Volume Summary

	PM Peak Hour										
	Existing	Ph III 2049 without Project	Total Growth (2019-2049)	Adjusted Growth	Cumulative Projects	Year 2029 without Project	External Project Trips	Internal Project Trips	Pass-by Trips	Phase I Project Trips	Year 2029 with Project
57 Road 23/Project Driveway 5											
NBL	0	0	0	0	0	0	0	0	0	0	0
NBT	240	279	39	13	0	253	444	0	0	444	697
NBR	0	0	0	0	0	0	0	0	0	0	0
SBL	0	0	0	0	0	0	0	0	0	0	0
SBT	330	347	17	6	0	336	369	0	0	369	705
SBR	1	36	35	12	0	13	0	0	0	0	13
EBL	1	60	59	20	0	21	0	0	0	0	21
EBT	0	0	0	0	0	0	0	0	0	0	0
EBR	2	23	21	7	0	9	0	0	0	0	9
WBL	0	0	0	0	0	0	0	0	0	0	0
WBT	0	0	0	0	0	0	0	0	0	0	0
WBR	0	0	0	0	0	0	0	0	0	0	0
North Leg											
Approach	331	383	52	17	0	348	369	0	0	369	717
Departure	241	339	98	33	0	274	444	0	0	444	718
Total	572	722	150	50	0	622	813	0	0	813	1,435
South Leg											
Approach	240	279	39	13	0	253	444	0	0	444	697
Departure	332	370	38	13	0	345	369	0	0	369	714
Total	572	649	77	26	0	598	813	0	0	813	1,411
East Leg											
Approach	0	0	0	0	0	0	0	0	0	0	0
Departure	0	0	0	0	0	0	0	0	0	0	0
Total	0	0	0	0	0	0	0	0	0	0	0
West Leg											
Approach	3	83	80	27	0	30	0	0	0	0	30
Departure	1	36	35	12	0	13	0	0	0	0	13
Total	4	119	115	38	0	42	0	0	0	0	42
Total Approaches											
Approach	574	745	171	57	0	631	813	0	0	813	1,444
Departure	574	745	171	57	0	631	813	0	0	813	1,444
Total	1,148	1,489	341	114	0	1,262	1,626	0	0	1,626	2,888

Table C-3 - Phase I Project Completion Year (2029) Volume Summary

	PM Peak Hour										
	Ph III 2049 Existing	Ph III 2049 without Project	Total Growth (2019-2049)	Adjusted Growth	Cumulative Projects	Year 2029 without Project	External Project Trips	Internal Project Trips	Pass-by Trips	Phase I Project Trips	Year 2029 with Project
58 Project Driveway 6/Cleveland Avenue											
NBL	0	0	0	0	0	0	63	15	0	78	78
NBT	0	0	0	0	0	0	0	0	0	0	0
NBR	0	0	0	0	0	0	236	0	7	243	243
SBL	0	0	0	0	0	0	0	0	0	0	0
SBT	0	0	0	0	0	0	0	0	0	0	0
SBR	0	0	0	0	0	0	0	0	0	0	0
EBL	0	0	0	0	0	0	0	0	0	0	0
EBT	148	157	9	3	0	151	271	59	-7	323	474
EBR	0	0	0	0	0	0	143	15	0	158	158
WBL	0	0	0	0	0	0	329	0	3	332	332
WBT	76	79	3	1	0	77	663	59	-3	719	796
WBR	0	0	0	0	0	0	0	0	0	0	0
North Leg											
Approach	0	0	0	0	0	0	0	0	0	0	0
Departure	0	0	0	0	0	0	0	0	0	0	0
Total	0	0	0	0	0	0	0	0	0	0	0
South Leg											
Approach	0	0	0	0	0	0	299	15	7	321	321
Departure	0	0	0	0	0	0	472	15	3	490	490
Total	0	0	0	0	0	0	771	30	10	811	811
East Leg											
Approach	76	79	3	1	0	77	992	59	0	1,051	1,128
Departure	148	157	9	3	0	151	507	59	0	566	717
Total	224	236	12	4	0	228	1,499	118	0	1,617	1,845
West Leg											
Approach	148	157	9	3	0	151	414	74	-7	481	632
Departure	76	79	3	1	0	77	726	74	-3	797	874
Total	224	236	12	4	0	228	1,140	148	-10	1,278	1,506
Total Approaches											
Approach	224	236	12	4	0	228	1,705	148	0	1,853	2,081
Departure	224	236	12	4	0	228	1,705	148	0	1,853	2,081
Total	448	472	24	8	0	456	3,410	296	0	3,706	4,162

Table C-4 - Phase II Project Completion Year (2039) Volume Summary

	AM Peak Hour										
	Existing	Ph III 2049 without Project	Total Growth (2019-2049)	Adjusted Growth	Cumulative Projects	Year 2039 without Project	External Project Trips	Internal Project Trips	Pass-by Trips	Phases I + II Project Trips	Year 2039 with Project
1 Road 22/Avenue 17											
NBL	1	3	2	1	0	2	0	0	0	0	2
NBT	0	0	0	0	0	0	0	0	0	0	0
NBR	2	6	4	3	0	5	0	0	0	0	5
SBL	0	0	0	0	0	0	0	0	0	0	0
SBT	0	0	0	0	0	0	0	0	0	0	0
SBR	0	0	0	0	0	0	0	0	0	0	0
EBL	0	0	0	0	0	0	0	0	0	0	0
EBT	29	38	9	6	0	35	30	0	0	30	65
EBR	0	0	0	0	0	0	0	0	0	0	0
WBL	2	2	0	0	0	2	0	0	0	0	2
WBT	25	30	5	3	0	28	90	0	0	90	118
WBR	0	0	0	0	0	0	0	0	0	0	0
North Leg											
Approach	0	0	0	0	0	0	0	0	0	0	0
Departure	0	0	0	0	0	0	0	0	0	0	0
Total	0	0	0	0	0	0	0	0	0	0	0
South Leg											
Approach	3	9	6	4	0	7	0	0	0	0	7
Departure	2	2	0	0	0	2	0	0	0	0	2
Total	5	11	6	4	0	9	0	0	0	0	9
East Leg											
Approach	27	32	5	3	0	30	90	0	0	90	120
Departure	31	44	13	9	0	40	30	0	0	30	70
Total	58	76	18	12	0	70	120	0	0	120	190
West Leg											
Approach	29	38	9	6	0	35	30	0	0	30	65
Departure	26	33	7	5	0	31	90	0	0	90	121
Total	55	71	16	11	0	66	120	0	0	120	186
Total Approaches											
Approach	59	79	20	13	0	72	120	0	0	120	192
Departure	59	79	20	13	0	72	120	0	0	120	192
Total	118	158	40	27	0	145	240	0	0	240	385

Table C-4 - Phase II Project Completion Year (2039) Volume Summary

	AM Peak Hour										
	Existing	Ph III 2049 without Project	Total Growth (2019-2049)	Adjusted Growth	Cumulative Projects	Year 2039 without Project	External Project Trips	Internal Project Trips	Pass-by Trips	Phases I + II Project Trips	Year 2039 with Project
2 Road 22/Avenue 16											
NBL	0	0	0	0	0	0	0	0	0	0	0
NBT	0	0	0	0	0	0	0	0	0	0	0
NBR	0	0	0	0	0	0	0	0	0	0	0
SBL	2	2	0	0	0	2	0	0	0	0	2
SBT	0	0	0	0	0	0	0	0	0	0	0
SBR	1	1	0	0	0	1	0	0	0	0	1
EBL	2	2	0	0	0	2	0	0	0	0	2
EBT	12	13	1	0	0	12	0	0	0	0	12
EBR	0	0	0	0	0	0	0	0	0	0	0
WBL	0	0	0	0	0	0	0	0	0	0	0
WBT	29	30	1	1	0	30	0	0	0	0	30
WBR	4	5	1	1	0	5	0	0	0	0	5
North Leg											
Approach	3	3	0	0	0	3	0	0	0	0	3
Departure	6	7	1	1	0	7	0	0	0	0	7
Total	9	10	1	1	0	10	0	0	0	0	10
South Leg											
Approach	0	0	0	0	0	0	0	0	0	0	0
Departure	0	0	0	0	0	0	0	0	0	0	0
Total	0	0	0	0	0	0	0	0	0	0	0
East Leg											
Approach	33	35	2	2	0	35	0	0	0	0	35
Departure	14	15	1	0	0	14	0	0	0	0	14
Total	47	50	3	2	0	49	0	0	0	0	49
West Leg											
Approach	14	15	1	0	0	14	0	0	0	0	14
Departure	30	32	2	1	0	31	0	0	0	0	31
Total	44	46	2	1	0	45	0	0	0	0	45
Total Approaches											
Approach	50	53	3	2	0	52	0	0	0	0	52
Departure	50	53	3	2	0	52	0	0	0	0	52
Total	100	107	7	4	0	104	0	0	0	0	104

Table C-4 - Phase II Project Completion Year (2039) Volume Summary

	AM Peak Hour										
	Existing	Ph III 2049 without Project	Total Growth (2019-2049)	Adjusted Growth	Cumulative Projects	Year 2039 without Project	External Project Trips	Internal Project Trips	Pass-by Trips	Phases I + II Project Trips	Year 2039 with Project
3 Golden State Boulevard/Avenue 18 ½											
NBL	0	0	0	0	0	0	0	0	0	0	0
NBT	0	0	0	0	0	0	0	0	0	0	0
NBR	0	0	0	0	0	0	0	0	0	0	0
SBL	92	98	6	4	0	96	0	0	0	0	96
SBT	0	0	0	0	0	0	0	0	0	0	0
SBR	4	4	0	0	0	4	0	0	0	0	4
EBL	2	2	0	0	0	2	0	0	0	0	2
EBT	98	114	16	11	0	109	20	0	0	20	129
EBR	0	0	0	0	0	0	0	0	0	0	0
WBL	0	0	0	0	0	0	0	0	0	0	0
WBT	96	105	9	6	0	102	57	0	0	57	159
WBR	106	111	5	3	0	109	0	0	0	0	109
North Leg											
Approach	96	102	6	4	0	100	0	0	0	0	100
Departure	108	113	5	3	0	111	0	0	0	0	111
Total	204	215	11	8	0	212	0	0	0	0	212
South Leg											
Approach	0	0	0	0	0	0	0	0	0	0	0
Departure	0	0	0	0	0	0	0	0	0	0	0
Total	0	0	0	0	0	0	0	0	0	0	0
East Leg											
Approach	202	216	14	9	0	211	57	0	0	57	268
Departure	190	212	22	15	0	205	20	0	0	20	225
Total	392	428	36	24	0	416	77	0	0	77	493
West Leg											
Approach	100	116	16	11	0	111	20	0	0	20	131
Departure	100	109	9	6	0	106	57	0	0	57	163
Total	200	225	25	17	0	217	77	0	0	77	294
Total Approaches											
Approach	398	434	36	24	0	422	77	0	0	77	499
Departure	398	434	36	24	0	422	77	0	0	77	499
Total	796	869	73	48	0	844	154	0	0	154	998

Table C-4 - Phase II Project Completion Year (2039) Volume Summary

	AM Peak Hour										
	Existing	Ph III 2049 without Project	Total Growth (2019-2049)	Adjusted Growth	Cumulative Projects	Year 2039 without Project	External Project Trips	Internal Project Trips	Pass-by Trips	Phases I + II Project Trips	Year 2039 with Project
4 Pistachio Drive/Avenue 18 ½											
NBL	0	0	0	0	0	0	0	0	0	0	0
NBT	0	0	0	0	0	0	0	0	0	0	0
NBR	1	1	0	0	0	1	0	0	0	0	1
SBL	104	110	6	4	0	108	0	0	0	0	108
SBT	0	0	0	0	0	0	0	0	0	0	0
SBR	9	9	0	0	0	9	0	0	0	0	9
EBL	8	8	0	0	0	8	0	0	0	0	8
EBT	250	267	17	11	0	261	20	0	0	20	281
EBR	1	1	0	0	0	1	0	0	0	0	1
WBL	3	3	0	0	0	3	0	0	0	0	3
WBT	212	221	9	6	0	218	57	0	0	57	275
WBR	201	206	5	3	0	204	0	0	0	0	204
North Leg											
Approach	113	119	6	4	0	117	0	0	0	0	117
Departure	209	214	5	4	0	213	0	0	0	0	213
Total	322	334	12	8	0	330	0	0	0	0	330
South Leg											
Approach	1	1	0	0	0	1	0	0	0	0	1
Departure	4	4	0	0	0	4	0	0	0	0	4
Total	5	5	0	0	0	5	0	0	0	0	5
East Leg											
Approach	416	430	14	9	0	425	57	0	0	57	482
Departure	355	378	23	15	0	370	20	0	0	20	390
Total	771	808	37	25	0	796	77	0	0	77	873
West Leg											
Approach	259	276	17	12	0	271	20	0	0	20	291
Departure	221	230	9	6	0	227	57	0	0	57	284
Total	480	507	27	18	0	498	77	0	0	77	575
Total Approaches											
Approach	789	827	38	25	0	814	77	0	0	77	891
Departure	789	827	38	25	0	814	77	0	0	77	891
Total	1,578	1,654	76	51	0	1,629	154	0	0	154	1,783

Table C-4 - Phase II Project Completion Year (2039) Volume Summary

		AM Peak Hour									
		Ph III 2049	Total Growth	Adjusted	Cumulative	Year 2039	External	Internal	Pass-by	Phases I + II	Year 2039
Existing		without	(2019-2049)	Growth	Projects	without	Project	Project	Trips	Project	with
		Project				Project	Trips	Trips	Trips	Trips	Project
5	SR-99 Southbound Ramps – Road 23/Avenue 18 ½										
NBL	60	63	3	2	0	62	57	0	0	57	119
NBT	0	0	0	0	0	0	0	0	0	0	0
NBR	143	159	16	11	0	154	397	0	0	397	551
SBL	10	12	2	1	0	11	0	0	0	0	11
SBT	47	57	10	7	0	54	142	0	0	142	196
SBR	85	86	1	1	0	86	0	0	0	0	86
EBL	0	0	0	0	0	0	0	0	0	0	0
EBT	305	323	18	12	0	317	0	0	0	0	317
EBR	50	55	5	3	0	53	20	0	0	20	73
WBL	40	50	10	7	0	47	0	0	0	0	47
WBT	271	286	15	10	0	281	0	0	0	0	281
WBR	0	0	0	0	0	0	0	0	0	0	0
North Leg											
Approach	142	155	13	9	0	151	142	0	0	142	293
Departure	0	0	0	0	0	0	0	0	0	0	0
Total	142	155	13	9	0	151	142	0	0	142	293
South Leg											
Approach	203	222	19	13	0	216	454	0	0	454	670
Departure	137	162	25	17	0	154	162	0	0	162	316
Total	340	384	44	29	0	369	616	0	0	616	985
East Leg											
Approach	311	336	25	17	0	328	0	0	0	0	328
Departure	458	494	36	24	0	482	397	0	0	397	879
Total	769	830	61	41	0	810	397	0	0	397	1,207
West Leg											
Approach	355	378	23	15	0	370	20	0	0	20	390
Departure	416	435	19	13	0	429	57	0	0	57	486
Total	771	813	42	28	0	799	77	0	0	77	876
Total Approaches											
Approach	1,011	1,091	80	53	0	1,064	616	0	0	616	1,680
Departure	1,011	1,091	80	53	0	1,064	616	0	0	616	1,680
Total	2,022	2,182	160	107	0	2,129	1,232	0	0	1,232	3,361

Table C-4 - Phase II Project Completion Year (2039) Volume Summary

	AM Peak Hour										
	Existing	Ph III 2049 without Project	Total Growth (2019-2049)	Adjusted Growth	Cumulative Projects	Year 2039 without Project	External Project Trips	Internal Project Trips	Pass-by Trips	Phases I + II Project Trips	Year 2039 with Project
6 SR-99 Northbound Ramps/Avenue 18 ½											
NBL	213	216	3	2	0	215	0	0	0	0	215
NBT	1	1	0	0	0	1	0	0	0	0	1
NBR	18	28	10	7	0	25	0	0	0	0	25
SBL	0	0	0	0	0	0	0	0	0	0	0
SBT	0	0	0	0	0	0	0	0	0	0	0
SBR	0	0	0	0	0	0	0	0	0	0	0
EBL	216	227	11	7	0	223	397	0	0	397	620
EBT	54	64	10	7	0	61	0	0	0	0	61
EBR	0	0	0	0	0	0	0	0	0	0	0
WBL	0	0	0	0	0	0	0	0	0	0	0
WBT	134	158	24	16	0	150	0	0	0	0	150
WBR	22	36	14	9	0	31	0	0	0	0	31
North Leg											
Approach	0	0	0	0	0	0	0	0	0	0	0
Departure	239	264	25	17	0	256	397	0	0	397	653
Total	239	264	25	17	0	256	397	0	0	397	653
South Leg											
Approach	232	245	13	9	0	241	0	0	0	0	241
Departure	0	0	0	0	0	0	0	0	0	0	0
Total	232	245	13	9	0	241	0	0	0	0	241
East Leg											
Approach	156	194	38	25	0	181	0	0	0	0	181
Departure	72	92	20	13	0	85	0	0	0	0	85
Total	228	286	58	39	0	267	0	0	0	0	267
West Leg											
Approach	270	291	21	14	0	284	397	0	0	397	681
Departure	347	374	27	18	0	365	0	0	0	0	365
Total	617	665	48	32	0	649	397	0	0	397	1,046
Total Approaches											
Approach	658	730	72	48	0	706	397	0	0	397	1,103
Departure	658	730	72	48	0	706	397	0	0	397	1,103
Total	1,316	1,460	144	96	0	1,412	794	0	0	794	2,206

Table C-4 - Phase II Project Completion Year (2039) Volume Summary

		AM Peak Hour									
		Ph III 2049	Total Growth	Adjusted	Cumulative	Year 2039	External	Internal	Pass-by	Phases I + II	Year 2039
Existing		without	(2019-2049)	Growth	Projects	without	Project	Project	Trips	Project	with
		Project				Project	Trips	Trips	Trips	Trips	Project
7 Road 23/Avenue 17											
NBL	8	9	1	1	0	9	34	31	0	65	74
NBT	158	166	8	5	0	163	479	0	0	479	642
NBR	47	49	2	2	0	49	668	0	0	668	717
SBL	15	16	1	1	0	16	0	0	0	0	16
SBT	103	108	5	3	0	106	185	0	0	185	291
SBR	0	0	0	0	0	0	42	0	0	42	42
EBL	1	3	2	1	0	2	159	0	0	159	161
EBT	22	36	14	9	0	31	455	0	0	455	486
EBR	8	8	0	0	0	8	12	33	0	45	53
WBL	53	56	3	2	0	55	315	0	0	315	370
WBT	19	23	4	3	0	22	109	0	0	109	131
WBR	3	3	0	0	0	3	0	0	0	0	3
North Leg											
Approach	118	124	6	4	0	122	227	0	0	227	349
Departure	162	172	10	7	0	169	638	0	0	638	807
Total	280	296	16	11	0	291	865	0	0	865	1,156
South Leg											
Approach	213	224	11	8	0	221	1,181	31	0	1,212	1,433
Departure	164	172	8	5	0	169	512	33	0	545	714
Total	377	396	19	13	0	390	1,693	64	0	1,757	2,147
East Leg											
Approach	75	82	7	5	0	80	424	0	0	424	504
Departure	84	101	17	11	0	95	1,123	0	0	1,123	1,218
Total	159	183	24	16	0	175	1,547	0	0	1,547	1,722
West Leg											
Approach	31	47	16	11	0	42	626	33	0	659	701
Departure	27	32	5	3	0	30	185	31	0	216	246
Total	58	79	21	14	0	72	811	64	0	875	947
Total Approaches											
Approach	437	477	40	27	0	464	2,458	64	0	2,522	2,986
Departure	437	477	40	27	0	464	2,458	64	0	2,522	2,986
Total	874	955	81	54	0	928	4,916	128	0	5,044	5,972

Table C-4 - Phase II Project Completion Year (2039) Volume Summary

		AM Peak Hour									
		Ph III 2049	Total Growth	Adjusted	Cumulative	Year 2039	External	Internal	Pass-by	Phases I + II	Year 2039
Existing		without	(2019-2049)	Growth	Projects	without	Project	Project	Trips	Project	with
		Project				Project	Trips	Trips	Trips	Trips	Project
8	Road 23/Avenue 16										
NBL	20	37	17	11	0	31	68	59	0	127	158
NBT	210	288	78	52	0	262	201	268	0	469	731
NBR	0	0	0	0	0	0	23	0	0	23	23
SBL	0	0	0	0	0	0	33	84	0	117	117
SBT	152	325	173	115	0	267	143	282	0	425	692
SBR	9	11	2	1	0	10	0	42	0	42	52
EBL	6	12	6	4	0	10	0	40	0	40	50
EBT	1	30	29	19	0	20	0	46	0	46	66
EBR	7	32	25	17	0	24	188	63	0	251	275
WBL	0	0	0	0	0	0	137	0	0	137	137
WBT	4	4	0	0	0	4	0	43	0	43	47
WBR	0	0	0	0	0	0	198	79	0	277	277
North Leg											
Approach	161	336	175	117	0	278	176	408	0	584	862
Departure	216	300	84	56	0	272	399	387	0	786	1,058
Total	377	636	259	173	0	550	575	795	0	1,370	1,920
South Leg											
Approach	230	325	95	63	0	293	292	327	0	619	912
Departure	159	357	198	132	0	291	468	345	0	813	1,104
Total	389	682	293	195	0	584	760	672	0	1,432	2,016
East Leg											
Approach	4	4	0	0	0	4	335	122	0	457	461
Departure	1	30	29	19	0	20	56	130	0	186	206
Total	5	34	29	19	0	24	391	252	0	643	667
West Leg											
Approach	14	74	60	40	0	54	188	149	0	337	391
Departure	33	52	19	13	0	46	68	144	0	212	258
Total	47	126	79	53	0	100	256	293	0	549	649
Total Approaches											
Approach	409	739	330	220	0	629	991	1,006	0	1,997	2,626
Departure	409	739	330	220	0	629	991	1,006	0	1,997	2,626
Total	818	1,478	660	440	0	1,258	1,982	2,012	0	3,994	5,252

Table C-4 - Phase II Project Completion Year (2039) Volume Summary

	AM Peak Hour										
	Existing	Ph III 2049 without Project	Total Growth (2019-2049)	Adjusted Growth	Cumulative Projects	Year 2039 without Project	External Project Trips	Internal Project Trips	Pass-by Trips	Phases I + II Project Trips	Year 2039 with Project
9 Road 23/Cleveland Avenue											
NBL	0	0	0	0	0	0	0	9	0	9	9
NBT	199	297	98	65	0	264	145	272	0	417	681
NBR	50	68	18	12	0	62	239	0	0	239	301
SBL	13	86	73	49	0	62	193	44	0	237	299
SBT	148	253	105	70	0	218	274	285	0	559	777
SBR	0	0	0	0	0	0	0	0	0	0	0
EBL	0	0	0	0	0	0	0	0	0	0	0
EBT	0	0	0	0	0	0	0	19	0	19	19
EBR	0	0	0	0	0	0	0	9	0	9	9
WBL	52	74	22	15	0	67	244	0	0	244	311
WBT	0	0	0	0	0	0	0	19	0	19	19
WBR	32	192	160	107	0	139	146	42	0	188	327
North Leg											
Approach	161	339	178	119	0	280	467	329	0	796	1,076
Departure	231	489	258	172	0	403	291	314	0	605	1,008
Total	392	828	436	291	0	683	758	643	0	1,401	2,084
South Leg											
Approach	249	365	116	77	0	326	384	281	0	665	991
Departure	200	327	127	85	0	285	518	294	0	812	1,097
Total	449	692	243	162	0	611	902	575	0	1,477	2,088
East Leg											
Approach	84	266	182	121	0	205	390	61	0	451	656
Departure	63	154	91	61	0	124	432	63	0	495	619
Total	147	420	273	182	0	329	822	124	0	946	1,275
West Leg											
Approach	0	0	0	0	0	0	0	28	0	28	28
Departure	0	0	0	0	0	0	0	28	0	28	28
Total	0	0	0	0	0	0	0	56	0	56	56
Total Approaches											
Approach	494	970	476	317	0	811	1,241	699	0	1,940	2,751
Departure	494	970	476	317	0	811	1,241	699	0	1,940	2,751
Total	988	1,940	952	635	0	1,623	2,482	1,398	0	3,880	5,503

Table C-4 - Phase II Project Completion Year (2039) Volume Summary

	AM Peak Hour										
	Existing	Ph III 2049 without Project	Total Growth (2019-2049)	Adjusted Growth	Cumulative Projects	Year 2039 without Project	External Project Trips	Internal Project Trips	Pass-by Trips	Phases I + II Project Trips	Year 2039 with Project
10 Road 23/Avenue 14 ½											
NBL	3	4	1	1	0	4	0	0	0	0	4
NBT	177	265	88	59	0	236	180	0	0	180	416
NBR	4	4	0	0	0	4	0	0	0	0	4
SBL	28	47	19	13	0	41	81	0	0	81	122
SBT	166	280	114	76	0	242	385	0	0	385	627
SBR	0	0	0	0	0	0	0	0	0	0	0
EBL	0	0	0	0	0	0	0	0	0	0	0
EBT	5	5	0	0	0	5	0	0	0	0	5
EBR	0	0	0	0	0	0	0	0	0	0	0
WBL	16	18	2	1	0	17	0	0	0	0	17
WBT	3	3	0	0	0	3	0	0	0	0	3
WBR	67	100	33	22	0	89	52	0	0	52	141
North Leg											
Approach	194	328	134	89	0	283	466	0	0	466	749
Departure	244	365	121	81	0	325	232	0	0	232	557
Total	438	693	255	170	0	608	698	0	0	698	1,306
South Leg											
Approach	184	273	89	59	0	243	180	0	0	180	423
Departure	182	298	116	78	0	260	385	0	0	385	645
Total	366	571	205	137	0	503	565	0	0	565	1,068
East Leg											
Approach	86	122	36	24	0	110	52	0	0	52	162
Departure	37	57	20	13	0	50	81	0	0	81	131
Total	123	178	55	37	0	160	133	0	0	133	293
West Leg											
Approach	5	5	0	0	0	5	0	0	0	0	5
Departure	6	7	1	1	0	7	0	0	0	0	7
Total	11	12	1	1	0	12	0	0	0	0	12
Total Approaches											
Approach	469	728	259	172	0	641	698	0	0	698	1,339
Departure	469	728	259	172	0	641	698	0	0	698	1,339
Total	938	1,455	517	345	0	1,283	1,396	0	0	1,396	2,679

Table C-4 - Phase II Project Completion Year (2039) Volume Summary

		AM Peak Hour									
		Ph III 2049	Total Growth	Adjusted	Cumulative	Year 2039	External	Internal	Pass-by	Phases I + II	Year 2039
Existing		without	(2019-2049)	Growth	Projects	without	Project	Project	Trips	Project	with
		Project				Project	Trips	Trips	Trips	Trips	Project
11 Road 23/Avenue 14											
NBL	24	54	30	20	0	44	0	0	0	0	44
NBT	82	122	40	27	0	109	56	0	0	56	165
NBR	8	8	0	0	0	8	0	0	0	0	8
SBL	34	56	22	14	0	48	193	0	0	193	241
SBT	93	152	59	39	0	132	132	0	0	132	264
SBR	56	91	35	23	0	79	58	0	0	58	137
EBL	49	72	23	16	0	65	21	0	0	21	86
EBT	145	152	7	5	0	150	0	0	0	0	150
EBR	18	60	42	28	0	46	0	0	0	0	46
WBL	19	20	1	1	0	20	0	0	0	0	20
WBT	176	185	9	6	0	182	0	0	0	0	182
WBR	53	79	26	17	0	70	103	0	0	103	173
North Leg											
Approach	183	298	115	77	0	260	383	0	0	383	643
Departure	184	273	89	59	0	243	180	0	0	180	423
Total	367	571	204	136	0	503	563	0	0	563	1,066
South Leg											
Approach	114	185	71	47	0	161	56	0	0	56	217
Departure	130	232	102	68	0	198	132	0	0	132	330
Total	244	416	172	115	0	359	188	0	0	188	547
East Leg											
Approach	248	283	35	24	0	272	103	0	0	103	375
Departure	187	216	29	20	0	207	193	0	0	193	400
Total	435	500	65	43	0	478	296	0	0	296	774
West Leg											
Approach	212	285	73	48	0	260	21	0	0	21	281
Departure	256	330	74	49	0	305	58	0	0	58	363
Total	468	614	146	98	0	566	79	0	0	79	645
Total Approaches											
Approach	757	1,051	294	196	0	953	563	0	0	563	1,516
Departure	757	1,051	294	196	0	953	563	0	0	563	1,516
Total	1,514	2,102	588	392	0	1,906	1,126	0	0	1,126	3,032

Table C-4 - Phase II Project Completion Year (2039) Volume Summary

	AM Peak Hour										
	Existing	Ph III 2049 without Project	Total Growth (2019-2049)	Adjusted Growth	Cumulative Projects	Year 2039 without Project	External Project Trips	Internal Project Trips	Pass-by Trips	Phases I + II Project Trips	Year 2039 with Project
12 Road 23/Avenue 12											
NBL	8	8	0	0	0	8	0	0	0	0	8
NBT	32	34	2	1	0	33	14	0	0	14	47
NBR	16	17	1	1	0	17	0	0	0	0	17
SBL	32	34	2	1	0	33	44	0	0	44	77
SBT	47	49	2	2	0	49	35	0	0	35	84
SBR	28	45	17	11	0	39	44	0	0	44	83
EBL	18	19	1	1	0	19	18	0	0	18	37
EBT	82	85	3	2	0	84	0	0	0	0	84
EBR	4	4	0	0	0	4	0	0	0	0	4
WBL	11	12	1	0	0	11	0	0	0	0	11
WBT	73	113	40	27	0	100	0	0	0	0	100
WBR	37	39	2	1	0	38	18	0	0	18	56
North Leg											
Approach	107	128	21	14	0	121	123	0	0	123	244
Departure	87	91	4	3	0	90	50	0	0	50	140
Total	194	219	25	17	0	211	173	0	0	173	384
South Leg											
Approach	56	59	3	2	0	58	14	0	0	14	72
Departure	62	65	3	2	0	64	35	0	0	35	99
Total	118	124	6	4	0	122	49	0	0	49	171
East Leg											
Approach	121	163	42	28	0	149	18	0	0	18	167
Departure	130	135	5	4	0	134	44	0	0	44	178
Total	251	299	48	32	0	283	62	0	0	62	345
West Leg											
Approach	104	108	4	3	0	107	18	0	0	18	125
Departure	109	166	57	38	0	147	44	0	0	44	191
Total	213	275	62	41	0	254	62	0	0	62	316
Total Approaches											
Approach	388	458	70	47	0	435	173	0	0	173	608
Departure	388	458	70	47	0	435	173	0	0	173	608
Total	776	917	141	94	0	870	346	0	0	346	1,216

Table C-4 - Phase II Project Completion Year (2039) Volume Summary

	AM Peak Hour										
	Existing	Ph III 2049 without Project	Total Growth (2019-2049)	Adjusted Growth	Cumulative Projects	Year 2039 without Project	External Project Trips	Internal Project Trips	Pass-by Trips	Phases I + II Project Trips	Year 2039 with Project
13 Golden State Boulevard – Airport Drive/Avenue 17											
NBL	17	18	1	1	0	18	47	0	0	47	65
NBT	25	114	89	59	0	84	0	0	0	0	84
NBR	64	173	109	73	7	144	0	0	0	0	144
SBL	88	211	123	82	5	175	0	0	0	0	175
SBT	19	54	35	23	0	42	0	0	0	0	42
SBR	4	4	0	0	0	4	0	0	0	0	4
EBL	4	5	1	1	0	5	0	0	0	0	5
EBT	54	57	3	2	28	84	944	0	0	944	1028
EBR	19	20	1	1	0	20	126	0	0	126	146
WBL	127	298	171	114	4	245	0	0	0	0	245
WBT	55	58	3	2	22	79	355	0	0	355	434
WBR	85	283	198	132	3	220	0	0	0	0	220
North Leg											
Approach	111	269	158	105	5	221	0	0	0	0	221
Departure	114	402	288	192	3	309	0	0	0	0	309
Total	225	671	446	297	8	530	0	0	0	0	530
South Leg											
Approach	106	305	199	133	7	246	47	0	0	47	293
Departure	165	372	207	138	4	307	126	0	0	126	433
Total	271	677	406	271	11	553	173	0	0	173	726
East Leg											
Approach	267	639	372	248	29	544	355	0	0	355	899
Departure	206	441	235	156	40	402	944	0	0	944	1,346
Total	473	1,079	606	404	69	946	1,299	0	0	1,299	2,245
West Leg											
Approach	77	82	5	3	28	108	1,070	0	0	1,070	1,178
Departure	76	80	4	3	22	101	402	0	0	402	503
Total	153	161	8	6	50	209	1,472	0	0	1,472	1,681
Total Approaches											
Approach	561	1,294	733	489	69	1,119	1,472	0	0	1,472	2,591
Departure	561	1,294	733	489	69	1,119	1,472	0	0	1,472	2,591
Total	1,122	2,589	1,467	978	138	2,238	2,944	0	0	2,944	5,182

Table C-4 - Phase II Project Completion Year (2039) Volume Summary

	AM Peak Hour										
	Existing	Ph III 2049 without Project	Total Growth (2019-2049)	Adjusted Growth	Cumulative Projects	Year 2039 without Project	External Project Trips	Internal Project Trips	Pass-by Trips	Phases I + II Project Trips	Year 2039 with Project
14 SR-99 Southbound Ramps/Avenue 17											
NBL	0	0	0	0	0	0	0	0	0	0	0
NBT	0	0	0	0	0	0	0	0	0	0	0
NBR	0	0	0	0	0	0	0	0	0	0	0
SBL	59	129	70	47	169	275	0	0	0	0	275
SBT	0	0	0	0	0	0	0	0	0	0	0
SBR	42	141	99	66	0	108	0	0	0	0	108
EBL	0	0	0	0	0	0	0	0	0	0	0
EBT	209	441	232	155	41	405	944	0	0	944	1349
EBR	0	0	0	0	0	0	0	0	0	0	0
WBL	0	0	0	0	0	0	0	0	0	0	0
WBT	230	497	267	178	29	437	355	0	0	355	792
WBR	0	0	0	0	0	0	0	0	0	0	0
North Leg											
Approach	101	270	169	113	169	383	0	0	0	0	383
Departure	0	0	0	0	0	0	0	0	0	0	0
Total	101	270	169	113	169	383	0	0	0	0	383
South Leg											
Approach	0	0	0	0	0	0	0	0	0	0	0
Departure	0	0	0	0	0	0	0	0	0	0	0
Total	0	0	0	0	0	0	0	0	0	0	0
East Leg											
Approach	230	497	267	178	29	437	355	0	0	355	792
Departure	268	570	302	201	210	679	944	0	0	944	1,623
Total	498	1,067	569	379	239	1,116	1,299	0	0	1,299	2,415
West Leg											
Approach	209	441	232	155	41	405	944	0	0	944	1,349
Departure	272	638	366	244	29	545	355	0	0	355	900
Total	481	1,079	598	399	70	950	1,299	0	0	1,299	2,249
Total Approaches											
Approach	540	1,208	668	445	239	1,224	1,299	0	0	1,299	2,523
Departure	540	1,208	668	445	239	1,224	1,299	0	0	1,299	2,523
Total	1,080	2,416	1,336	891	478	2,449	2,598	0	0	2,598	5,047

Table C-4 - Phase II Project Completion Year (2039) Volume Summary

	AM Peak Hour										
	Existing	Ph III 2049 without Project	Total Growth (2019-2049)	Adjusted Growth	Cumulative Projects	Year 2039 without Project	External Project Trips	Internal Project Trips	Pass-by Trips	Phases I + II Project Trips	Year 2039 with Project
15 SR-99 Northbound Ramps/Avenue 17											
NBL	86	299	213	142	0	228	247	0	0	247	475
NBT	1	4	3	2	0	3	0	0	0	0	3
NBR	0	0	0	0	240	240	0	0	0	0	240
SBL	0	0	0	0	0	0	0	0	0	0	0
SBT	0	0	0	0	0	0	0	0	0	0	0
SBR	0	0	0	0	0	0	0	0	0	0	0
EBL	52	145	93	62	0	114	0	0	0	0	114
EBT	135	253	118	79	210	424	274	0	0	274	698
EBR	0	0	0	0	0	0	0	0	0	0	0
WBL	0	0	0	0	0	0	0	0	0	0	0
WBT	642	716	74	49	219	910	108	0	0	108	1018
WBR	100	125	25	17	128	245	0	0	0	0	245
North Leg											
Approach	0	0	0	0	0	0	0	0	0	0	0
Departure	153	274	121	81	128	362	0	0	0	0	362
Total	153	274	121	81	128	362	0	0	0	0	362
South Leg											
Approach	87	303	216	144	240	471	247	0	0	247	718
Departure	0	0	0	0	0	0	0	0	0	0	0
Total	87	303	216	144	240	471	247	0	0	247	718
East Leg											
Approach	742	841	99	66	347	1,155	108	0	0	108	1,263
Departure	135	253	118	79	450	664	274	0	0	274	938
Total	877	1,094	217	145	797	1,819	382	0	0	382	2,201
West Leg											
Approach	187	398	211	141	210	538	274	0	0	274	812
Departure	728	1,015	287	191	219	1,138	355	0	0	355	1,493
Total	915	1,413	498	332	429	1,676	629	0	0	629	2,305
Total Approaches											
Approach	1,016	1,542	526	351	797	2,164	629	0	0	629	2,793
Departure	1,016	1,542	526	351	797	2,164	629	0	0	629	2,793
Total	2,032	3,084	1,052	701	1,594	4,327	1,258	0	0	1,258	5,585

Table C-4 - Phase II Project Completion Year (2039) Volume Summary

	AM Peak Hour										
	Existing	Ph III 2049 without Project	Total Growth (2019-2049)	Adjusted Growth	Cumulative Projects	Year 2039 without Project	External Project Trips	Internal Project Trips	Pass-by Trips	Phases I + II Project Trips	Year 2039 with Project
16 Love's Truck Stop Driveway/Avenue 17											
NBL	0	0	0	0	136	136	0	0	0	0	136
NBT	0	0	0	0	0	0	0	0	0	0	0
NBR	0	0	0	0	22	22	0	0	0	0	22
SBL	0	0	0	0	48	48	0	0	0	0	48
SBT	0	0	0	0	0	0	0	0	0	0	0
SBR	0	0	0	0	90	90	0	0	0	0	90
EBL	0	0	0	0	162	162	0	0	0	0	162
EBT	135	241	106	71	156	362	274	0	0	274	636
EBR	0	0	0	0	132	132	0	0	0	0	132
WBL	0	0	0	0	45	45	0	0	0	0	45
WBT	742	805	63	42	73	857	108	0	0	108	965
WBR	0	0	0	0	56	56	0	0	0	0	56
North Leg											
Approach	0	0	0	0	138	138	0	0	0	0	138
Departure	0	0	0	0	218	218	0	0	0	0	218
Total	0	0	0	0	356	356	0	0	0	0	356
South Leg											
Approach	0	0	0	0	158	158	0	0	0	0	158
Departure	0	0	0	0	177	177	0	0	0	0	177
Total	0	0	0	0	335	335	0	0	0	0	335
East Leg											
Approach	742	805	63	42	174	958	108	0	0	108	1,066
Departure	135	241	106	71	226	432	274	0	0	274	706
Total	877	1,046	169	113	400	1,390	382	0	0	382	1,772
West Leg											
Approach	135	241	106	71	450	656	274	0	0	274	930
Departure	742	805	63	42	299	1,083	108	0	0	108	1,191
Total	877	1,046	169	113	749	1,739	382	0	0	382	2,121
Total Approaches											
Approach	877	1,046	169	113	920	1,910	382	0	0	382	2,292
Departure	877	1,046	169	113	920	1,910	382	0	0	382	2,292
Total	1,754	2,092	338	225	1,840	3,819	764	0	0	764	4,583

Table C-4 - Phase II Project Completion Year (2039) Volume Summary

		AM Peak Hour									
Existing	Ph III 2049 without Project	Total Growth (2019-2049)	Adjusted Growth	Cumulative Projects	Year 2039 without Project	External Project Trips	Internal Project Trips	Pass-by Trips	Phases I + II Project Trips	Year 2039 with Project	
17 Westberry Boulevard/Cleveland Avenue											
NBL	13	50	37	25	0	38	13	0	0	13	51
NBT	34	239	205	137	0	171	1	0	0	1	172
NBR	57	181	124	83	0	140	0	0	0	0	140
SBL	14	15	1	0	0	14	0	0	0	0	14
SBT	19	80	61	41	0	60	0	0	0	0	60
SBR	21	22	1	1	0	22	85	0	0	85	107
EBL	12	21	9	6	0	18	239	0	0	239	257
EBT	45	47	2	2	0	47	755	0	0	755	802
EBR	6	33	27	18	0	24	49	0	0	49	73
WBL	20	41	21	14	0	34	0	0	0	0	34
WBT	50	53	3	2	0	52	245	0	0	245	297
WBR	12	13	1	0	0	12	0	0	0	0	12
North Leg											
Approach	54	117	63	42	0	96	85	0	0	85	181
Departure	58	273	215	143	0	201	240	0	0	240	441
Total	112	389	277	185	0	297	325	0	0	325	622
South Leg											
Approach	104	470	366	244	0	348	14	0	0	14	362
Departure	45	154	109	73	0	118	49	0	0	49	167
Total	149	624	475	317	0	466	63	0	0	63	529
East Leg											
Approach	82	106	24	16	0	98	245	0	0	245	343
Departure	116	243	127	85	0	201	755	0	0	755	956
Total	198	349	151	101	0	299	1,000	0	0	1,000	1,299
West Leg											
Approach	63	101	38	26	0	89	1,043	0	0	1,043	1,132
Departure	84	125	41	27	0	111	343	0	0	343	454
Total	147	226	79	53	0	200	1,386	0	0	1,386	1,586
Total Approaches											
Approach	303	794	491	327	0	630	1,387	0	0	1,387	2,017
Departure	303	794	491	327	0	630	1,387	0	0	1,387	2,017
Total	606	1,588	982	655	0	1,261	2,774	0	0	2,774	4,035

Table C-4 - Phase II Project Completion Year (2039) Volume Summary

		AM Peak Hour									
Existing	Ph III 2049 without Project	Total Growth (2019-2049)	Adjusted Growth	Cumulative Projects	Year 2039 without Project	External Project Trips	Internal Project Trips	Pass-by Trips	Phases I + II Project Trips	Year 2039 with Project	
18 Westberry Boulevard/Sunset Avenue											
NBL	114	119	5	3	0	117	3	0	0	3	120
NBT	102	211	109	73	0	175	0	0	0	0	175
NBR	101	124	23	15	0	116	0	0	0	0	116
SBL	110	132	22	15	0	125	0	0	0	0	125
SBT	81	147	66	44	0	125	0	0	0	0	125
SBR	30	31	1	1	0	31	3	0	0	3	34
EBL	46	59	13	9	0	55	0	0	0	0	55
EBT	213	224	11	7	0	220	14	0	0	14	234
EBR	84	97	13	9	0	93	0	0	0	0	93
WBL	47	60	13	9	0	56	0	0	0	0	56
WBT	159	167	8	5	0	164	14	0	0	14	178
WBR	22	31	9	6	0	28	0	0	0	0	28
North Leg											
Approach	221	310	89	59	0	280	3	0	0	3	283
Departure	170	301	131	87	0	257	0	0	0	0	257
Total	391	611	220	147	0	538	3	0	0	3	541
South Leg											
Approach	317	454	137	91	0	408	3	0	0	3	411
Departure	212	304	92	61	0	273	0	0	0	0	273
Total	529	758	229	153	0	682	3	0	0	3	685
East Leg											
Approach	228	258	30	20	0	248	14	0	0	14	262
Departure	424	480	56	37	0	461	14	0	0	14	475
Total	652	738	86	57	0	709	28	0	0	28	737
West Leg											
Approach	343	380	37	24	0	367	14	0	0	14	381
Departure	303	317	14	9	0	312	20	0	0	20	332
Total	646	697	51	34	0	680	34	0	0	34	714
Total Approaches											
Approach	1,109	1,402	293	195	0	1,304	34	0	0	34	1,338
Departure	1,109	1,402	293	195	0	1,304	34	0	0	34	1,338
Total	2,218	2,803	585	390	0	2,608	68	0	0	68	2,676

Table C-4 - Phase II Project Completion Year (2039) Volume Summary

	AM Peak Hour										
	Existing	Ph III 2049 without Project	Total Growth (2019-2049)	Adjusted Growth	Cumulative Projects	Year 2039 without Project	External Project Trips	Internal Project Trips	Pass-by Trips	Phases I + II Project Trips	Year 2039 with Project
19 Westberry Boulevard/Avenue 14											
NBL	71	75	4	2	0	73	3	0	0	3	76
NBT	36	53	17	11	0	47	0	0	0	0	47
NBR	24	25	1	1	0	25	0	0	0	0	25
SBL	162	309	147	98	0	260	0	0	0	0	260
SBT	55	73	18	12	0	67	0	0	0	0	67
SBR	53	78	25	17	0	70	23	0	0	23	93
EBL	43	55	12	8	0	51	58	0	0	58	109
EBT	200	210	10	7	0	207	108	0	0	108	315
EBR	37	39	2	1	0	38	0	0	0	0	38
WBL	11	12	1	0	0	11	0	0	0	0	11
WBT	163	171	8	5	0	168	65	0	0	65	233
WBR	95	133	38	25	0	120	0	0	0	0	120
North Leg											
Approach	270	460	190	127	0	397	23	0	0	23	420
Departure	174	241	67	45	0	219	58	0	0	58	277
Total	444	701	257	171	0	615	81	0	0	81	696
South Leg											
Approach	131	153	22	15	0	146	3	0	0	3	149
Departure	103	123	20	14	0	117	0	0	0	0	117
Total	234	276	42	28	0	262	3	0	0	3	265
East Leg											
Approach	269	316	47	31	0	300	65	0	0	65	365
Departure	386	544	158	105	0	491	108	0	0	108	599
Total	655	860	205	137	0	792	173	0	0	173	965
West Leg											
Approach	280	304	24	16	0	296	166	0	0	166	462
Departure	287	324	37	24	0	311	91	0	0	91	402
Total	567	628	61	40	0	607	257	0	0	257	864
Total Approaches											
Approach	950	1,232	282	188	0	1,138	257	0	0	257	1,395
Departure	950	1,232	282	188	0	1,138	257	0	0	257	1,395
Total	1,900	2,465	565	376	0	2,276	514	0	0	514	2,790

Table C-4 - Phase II Project Completion Year (2039) Volume Summary

	AM Peak Hour										
	Existing	Ph III 2049 without Project	Total Growth (2019-2049)	Adjusted Growth	Cumulative Projects	Year 2039 without Project	External Project Trips	Internal Project Trips	Pass-by Trips	Phases I + II Project Trips	Year 2039 with Project
20 Westberry Boulevard/Avenue 16											
NBL	0	0	0	0	0	0	0	0	0	0	0
NBT	20	88	68	45	0	65	122	0	0	122	187
NBR	45	315	270	180	0	225	117	0	0	117	342
SBL	58	100	42	28	0	86	0	0	0	0	86
SBT	11	18	7	5	0	16	41	0	0	41	57
SBR	0	0	0	0	0	0	0	0	0	0	0
EBL	0	0	0	0	0	0	0	0	0	0	0
EBT	0	0	0	0	0	0	0	0	0	0	0
EBR	0	0	0	0	0	0	0	0	0	0	0
WBL	27	79	52	35	0	62	42	0	0	42	104
WBT	0	0	0	0	0	0	0	0	0	0	0
WBR	119	234	115	77	0	196	1	0	0	1	197
North Leg											
Approach	69	118	49	33	0	102	41	0	0	41	143
Departure	139	322	183	122	0	261	123	0	0	123	384
Total	208	440	232	155	0	363	164	0	0	164	527
South Leg											
Approach	65	403	338	225	0	290	239	0	0	239	529
Departure	38	97	59	39	0	77	83	0	0	83	160
Total	103	500	397	265	0	368	322	0	0	322	690
East Leg											
Approach	146	313	167	111	0	257	43	0	0	43	300
Departure	103	415	312	208	0	311	117	0	0	117	428
Total	249	728	479	319	0	568	160	0	0	160	728
West Leg											
Approach	0	0	0	0	0	0	0	0	0	0	0
Departure	0	0	0	0	0	0	0	0	0	0	0
Total	0	0	0	0	0	0	0	0	0	0	0
Total Approaches											
Approach	280	834	554	369	0	649	323	0	0	323	972
Departure	280	834	554	369	0	649	323	0	0	323	972
Total	560	1,668	1,108	739	0	1,299	646	0	0	646	1,945

Table C-4 - Phase II Project Completion Year (2039) Volume Summary

		AM Peak Hour									
Existing	Ph III 2049 without Project	Total Growth (2019-2049)	Adjusted Growth	Cumulative Projects	Year 2039 without Project	External Project Trips	Internal Project Trips	Pass-by Trips	Phases I + II Project Trips	Year 2039 with Project	
21 Granada Drive/Cleveland Avenue											
NBL	17	18	1	1	0	18	8	0	0	8	26
NBT	285	443	158	105	0	390	1	0	0	1	391
NBR	268	350	82	55	0	323	0	0	0	0	323
SBL	4	14	10	7	0	11	0	0	0	0	11
SBT	215	284	69	46	0	261	0	0	0	0	261
SBR	5	5	0	0	0	5	0	0	0	0	5
EBL	16	35	19	13	0	29	0	0	0	0	29
EBT	115	214	99	66	0	181	720	0	0	720	901
EBR	9	9	0	0	0	9	19	0	0	19	28
WBL	185	194	9	6	0	191	0	0	0	0	191
WBT	55	58	3	2	0	57	230	0	0	230	287
WBR	10	32	22	15	0	25	0	0	0	0	25
North Leg											
Approach	224	303	79	53	0	277	0	0	0	0	277
Departure	311	510	199	133	0	444	1	0	0	1	445
Total	535	813	278	186	0	721	1	0	0	1	722
South Leg											
Approach	570	811	241	161	0	731	9	0	0	9	740
Departure	409	488	79	52	0	461	19	0	0	19	480
Total	979	1,299	320	213	0	1,192	28	0	0	28	1,220
East Leg											
Approach	250	284	34	23	0	273	230	0	0	230	503
Departure	387	578	191	127	0	514	720	0	0	720	1,234
Total	637	862	225	150	0	787	950	0	0	950	1,737
West Leg											
Approach	140	258	118	79	0	219	739	0	0	739	958
Departure	77	81	4	3	0	80	238	0	0	238	318
Total	217	339	122	82	0	299	977	0	0	977	1,276
Total Approaches											
Approach	1,184	1,657	473	315	0	1,499	978	0	0	978	2,477
Departure	1,184	1,657	473	315	0	1,499	978	0	0	978	2,477
Total	2,368	3,313	945	630	0	2,998	1,956	0	0	1,956	4,954

Table C-4 - Phase II Project Completion Year (2039) Volume Summary

		AM Peak Hour								
Existing	Ph III 2049 without Project	Total Growth (2019-2049)	Adjusted Growth	Cumulative Projects	Year 2039 without Project	External Project Trips	Internal Project Trips	Pass-by Trips	Phases I + II Project Trips	Year 2039 with Project
22 Granada Drive/Sunset Avenue										
NBL	47	49	2	1	0	48	0	0	0	48
NBT	207	260	53	35	0	242	0	0	0	242
NBR	24	26	2	1	0	25	0	0	0	25
SBL	127	133	6	4	0	131	0	0	0	131
SBT	270	292	22	15	0	285	0	0	0	285
SBR	48	50	2	2	0	50	0	0	0	50
EBL	59	68	9	6	0	65	0	0	0	65
EBT	259	272	13	9	0	268	0	0	0	268
EBR	69	74	5	3	0	72	0	0	0	72
WBL	25	26	1	1	0	26	0	0	0	26
WBT	101	106	5	3	0	104	6	0	6	110
WBR	65	67	2	1	0	66	0	0	0	66
North Leg										
Approach	445	476	31	21	0	466	0	0	0	466
Departure	331	395	64	43	0	374	0	0	0	374
Total	776	871	95	63	0	839	0	0	0	839
South Leg										
Approach	278	335	57	38	0	316	0	0	0	316
Departure	364	392	28	19	0	383	0	0	0	383
Total	642	727	85	57	0	699	0	0	0	699
East Leg										
Approach	191	199	8	6	0	197	6	0	6	203
Departure	410	431	21	14	0	424	0	0	0	424
Total	601	631	30	20	0	621	6	0	6	627
West Leg										
Approach	387	414	27	18	0	405	0	0	0	405
Departure	196	205	9	6	0	202	6	0	6	208
Total	583	619	36	24	0	607	6	0	6	613
Total Approaches										
Approach	1,301	1,424	123	82	0	1,383	6	0	6	1,389
Departure	1,301	1,424	123	82	0	1,383	6	0	6	1,389
Total	2,602	2,848	246	164	0	2,766	12	0	12	2,778

Table C-4 - Phase II Project Completion Year (2039) Volume Summary

	AM Peak Hour										
	Existing	Ph III 2049 without Project	Total Growth (2019-2049)	Adjusted Growth	Cumulative Projects	Year 2039 without Project	External Project Trips	Internal Project Trips	Pass-by Trips	Phases I + II Project Trips	Year 2039 with Project
23 Avenue 16 – Ellis Street/Kennedy Street											
NBL	0	0	0	0	0	0	0	0	0	0	0
NBT	191	407	216	144	0	335	117	0	0	117	452
NBR	111	209	98	65	0	176	1	0	0	1	177
SBL	244	272	28	19	0	263	0	0	0	0	263
SBT	194	370	176	117	0	311	42	0	0	42	353
SBR	0	0	0	0	0	0	0	0	0	0	0
EBL	0	0	0	0	0	0	0	0	0	0	0
EBT	0	0	0	0	0	0	0	0	0	0	0
EBR	0	0	0	0	0	0	0	0	0	0	0
WBL	101	242	141	94	0	195	0	0	0	0	195
WBT	0	0	0	0	0	0	0	0	0	0	0
WBR	106	168	62	41	0	147	0	0	0	0	147
North Leg											
Approach	438	642	204	136	0	574	42	0	0	42	616
Departure	297	575	278	185	0	482	117	0	0	117	599
Total	735	1,217	482	321	0	1,056	159	0	0	159	1,215
South Leg											
Approach	302	616	314	209	0	511	118	0	0	118	629
Departure	295	612	317	211	0	506	42	0	0	42	548
Total	597	1,228	631	421	0	1,018	160	0	0	160	1,178
East Leg											
Approach	207	410	203	135	0	342	0	0	0	0	342
Departure	355	481	126	84	0	439	1	0	0	1	440
Total	562	891	329	219	0	781	1	0	0	1	782
West Leg											
Approach	0	0	0	0	0	0	0	0	0	0	0
Departure	0	0	0	0	0	0	0	0	0	0	0
Total	0	0	0	0	0	0	0	0	0	0	0
Total Approaches											
Approach	947	1,668	721	481	0	1,428	160	0	0	160	1,588
Departure	947	1,668	721	481	0	1,428	160	0	0	160	1,588
Total	1,894	3,336	1,442	961	0	2,855	320	0	0	320	3,175

Table C-4 - Phase II Project Completion Year (2039) Volume Summary

	AM Peak Hour										
	Existing	Ph III 2049 without Project	Total Growth (2019-2049)	Adjusted Growth	Cumulative Projects	Year 2039 without Project	External Project Trips	Internal Project Trips	Pass-by Trips	Phases I + II Project Trips	Year 2039 with Project
24 Schnoor Avenue/Kennedy Street											
NBL	96	125	29	19	0	115	0	0	0	0	115
NBT	5	46	41	27	0	32	0	0	0	0	32
NBR	205	291	86	57	0	262	16	0	0	16	278
SBL	15	138	123	82	0	97	0	0	0	0	97
SBT	6	43	37	25	0	31	0	0	0	0	31
SBR	4	34	30	20	0	24	0	0	0	0	24
EBL	15	116	101	67	0	82	0	0	0	0	82
EBT	174	210	36	24	0	198	1	0	0	1	199
EBR	162	170	8	5	0	167	0	0	0	0	167
WBL	110	202	92	61	0	171	42	0	0	42	213
WBT	121	263	142	95	0	216	0	0	0	0	216
WBR	14	214	200	133	0	147	0	0	0	0	147
North Leg											
Approach	25	215	190	127	0	152	0	0	0	0	152
Departure	34	376	342	228	0	262	0	0	0	0	262
Total	59	591	532	355	0	414	0	0	0	0	414
South Leg											
Approach	306	462	156	104	0	410	16	0	0	16	426
Departure	278	415	137	91	0	369	42	0	0	42	411
Total	584	877	293	195	0	779	58	0	0	58	837
East Leg											
Approach	245	679	434	289	0	534	42	0	0	42	576
Departure	394	639	245	163	0	557	17	0	0	17	574
Total	639	1,318	679	453	0	1,092	59	0	0	59	1,151
West Leg											
Approach	351	496	145	97	0	448	1	0	0	1	449
Departure	221	422	201	134	0	355	0	0	0	0	355
Total	572	918	346	231	0	803	1	0	0	1	804
Total Approaches											
Approach	927	1,852	925	617	0	1,544	59	0	0	59	1,603
Departure	927	1,852	925	617	0	1,544	59	0	0	59	1,603
Total	1,854	3,704	1,850	1,233	0	3,087	118	0	0	118	3,205

Table C-4 - Phase II Project Completion Year (2039) Volume Summary

	AM Peak Hour										
	Existing	Ph III 2049 without Project	Total Growth (2019-2049)	Adjusted Growth	Cumulative Projects	Year 2039 without Project	External Project Trips	Internal Project Trips	Pass-by Trips	Phases I + II Project Trips	Year 2039 with Project
25 SR-99 Southbound Ramps/Kennedy Street - Gateway Drive											
NBL	0	0	0	0	0	0	0	0	0	0	0
NBT	0	0	0	0	0	0	0	0	0	0	0
NBR	0	0	0	0	0	0	0	0	0	0	0
SBL	64	67	3	2	0	66	0	0	0	0	66
SBT	0	0	0	0	0	0	0	0	0	0	0
SBR	103	126	23	15	0	118	42	0	0	42	160
EBL	187	380	193	129	0	316	0	0	0	0	316
EBT	227	251	24	16	0	243	16	0	0	16	259
EBR	0	0	0	0	0	0	0	0	0	0	0
WBL	0	0	0	0	0	0	0	0	0	0	0
WBT	172	507	335	223	0	395	5	0	0	5	400
WBR	1	4	3	2	0	3	0	0	0	0	3
North Leg											
Approach	167	193	26	17	0	184	42	0	0	42	226
Departure	188	384	196	131	0	319	0	0	0	0	319
Total	355	577	222	148	0	503	42	0	0	42	545
South Leg											
Approach	0	0	0	0	0	0	0	0	0	0	0
Departure	0	0	0	0	0	0	0	0	0	0	0
Total	0	0	0	0	0	0	0	0	0	0	0
East Leg											
Approach	173	511	338	225	0	398	5	0	0	5	403
Departure	291	318	27	18	0	309	16	0	0	16	325
Total	464	829	365	243	0	707	21	0	0	21	728
West Leg											
Approach	414	631	217	145	0	559	16	0	0	16	575
Departure	275	633	358	239	0	514	47	0	0	47	561
Total	689	1,264	575	383	0	1,072	63	0	0	63	1,135
Total Approaches											
Approach	754	1,335	581	387	0	1,141	63	0	0	63	1,204
Departure	754	1,335	581	387	0	1,141	63	0	0	63	1,204
Total	1,508	2,670	1,162	775	0	2,283	126	0	0	126	2,409

Table C-4 - Phase II Project Completion Year (2039) Volume Summary

	AM Peak Hour										
	Existing	Ph III 2049 without Project	Total Growth (2019-2049)	Adjusted Growth	Cumulative Projects	Year 2039 without Project	External Project Trips	Internal Project Trips	Pass-by Trips	Phases I + II Project Trips	Year 2039 with Project
26 SR-99 Northbound Off-Ramp/Gateway Drive											
NBL	0	0	0	0	0	0	0	0	0	0	0
NBT	0	0	0	0	0	0	0	0	0	0	0
NBR	0	0	0	0	0	0	0	0	0	0	0
SBL	0	0	0	0	0	0	0	0	0	0	0
SBT	0	0	0	0	0	0	0	0	0	0	0
SBR	106	410	304	203	0	309	5	0	0	5	314
EBL	159	167	8	5	0	164	16	0	0	16	180
EBT	132	151	19	13	0	145	0	0	0	0	145
EBR	0	0	0	0	0	0	0	0	0	0	0
WBL	0	0	0	0	0	0	0	0	0	0	0
WBT	67	101	34	23	0	90	0	0	0	0	90
WBR	0	0	0	0	0	0	0	0	0	0	0
North Leg											
Approach	106	410	304	203	0	309	5	0	0	5	314
Departure	159	167	8	5	0	164	16	0	0	16	180
Total	265	577	312	208	0	473	21	0	0	21	494
South Leg											
Approach	0	0	0	0	0	0	0	0	0	0	0
Departure	0	0	0	0	0	0	0	0	0	0	0
Total	0	0	0	0	0	0	0	0	0	0	0
East Leg											
Approach	67	101	34	23	0	90	0	0	0	0	90
Departure	132	151	19	13	0	145	0	0	0	0	145
Total	199	252	53	35	0	234	0	0	0	0	234
West Leg											
Approach	291	318	27	18	0	309	16	0	0	16	325
Departure	173	511	338	225	0	398	5	0	0	5	403
Total	464	829	365	243	0	707	21	0	0	21	728
Total Approaches											
Approach	464	829	365	243	0	707	21	0	0	21	728
Departure	464	829	365	243	0	707	21	0	0	21	728
Total	928	1,658	730	487	0	1,415	42	0	0	42	1,457

Table C-4 - Phase II Project Completion Year (2039) Volume Summary

	AM Peak Hour										
	Existing	Ph III 2049 without Project	Total Growth (2019-2049)	Adjusted Growth	Cumulative Projects	Year 2039 without Project	External Project Trips	Internal Project Trips	Pass-by Trips	Phases I + II Project Trips	Year 2039 with Project
27 SR-99 Northbound Off-Ramps											
NBL	0	0	0	0	0	0	0	0	0	0	0
NBT	42	44	2	1	0	43	0	0	0	0	43
NBR	0	0	0	0	0	0	0	0	0	0	0
SBL	0	0	0	0	0	0	0	0	0	0	0
SBT	3	3	0	0	0	3	0	0	0	0	3
SBR	104	409	305	203	0	307	5	0	0	5	312
EBL	160	163	3	2	0	162	11	0	0	11	173
EBT	0	0	0	0	0	0	0	0	0	0	0
EBR	0	0	0	0	0	0	0	0	0	0	0
WBL	0	0	0	0	0	0	0	0	0	0	0
WBT	0	0	0	0	0	0	0	0	0	0	0
WBR	0	0	0	0	0	0	0	0	0	0	0
North Leg											
Approach	107	412	305	203	0	310	5	0	0	5	315
Departure	202	207	5	3	0	205	11	0	0	11	216
Total	309	619	310	207	0	516	16	0	0	16	532
South Leg											
Approach	42	44	2	1	0	43	0	0	0	0	43
Departure	3	3	0	0	0	3	0	0	0	0	3
Total	45	47	2	2	0	47	0	0	0	0	47
East Leg											
Approach	0	0	0	0	0	0	0	0	0	0	0
Departure	0	0	0	0	0	0	0	0	0	0	0
Total	0	0	0	0	0	0	0	0	0	0	0
West Leg											
Approach	160	163	3	2	0	162	11	0	0	11	173
Departure	104	409	305	203	0	307	5	0	0	5	312
Total	264	572	308	205	0	469	16	0	0	16	485
Total Approaches											
Approach	309	619	310	207	0	516	16	0	0	16	532
Departure	309	619	310	207	0	516	16	0	0	16	532
Total	618	1,239	621	414	0	1,032	32	0	0	32	1,064

Table C-4 - Phase II Project Completion Year (2039) Volume Summary

	AM Peak Hour										
	Existing	Ph III 2049 without Project	Total Growth (2019-2049)	Adjusted Growth	Cumulative Projects	Year 2039 without Project	External Project Trips	Internal Project Trips	Pass-by Trips	Phases I + II Project Trips	Year 2039 with Project
28 SR-99 Northbound Off-Ramp/Gateway Drive											
NBL	0	0	0	0	0	0	0	0	0	0	0
NBT	0	0	0	0	0	0	0	0	0	0	0
NBR	0	0	0	0	0	0	0	0	0	0	0
SBL	0	0	0	0	0	0	0	0	0	0	0
SBT	0	0	0	0	0	0	0	0	0	0	0
SBR	0	0	0	0	0	0	0	0	0	0	0
EBL	0	0	0	0	0	0	0	0	0	0	0
EBT	129	144	15	10	0	139	0	0	0	0	139
EBR	0	0	0	0	0	0	0	0	0	0	0
WBL	0	0	0	0	0	0	0	0	0	0	0
WBT	72	106	34	23	0	95	0	0	0	0	95
WBR	50	53	3	2	0	52	0	0	0	0	52
North Leg											
Approach	0	0	0	0	0	0	0	0	0	0	0
Departure	50	53	3	2	0	52	0	0	0	0	52
Total	50	53	3	2	0	52	0	0	0	0	52
South Leg											
Approach	0	0	0	0	0	0	0	0	0	0	0
Departure	0	0	0	0	0	0	0	0	0	0	0
Total	0	0	0	0	0	0	0	0	0	0	0
East Leg											
Approach	122	159	37	24	0	146	0	0	0	0	146
Departure	129	144	15	10	0	139	0	0	0	0	139
Total	251	303	52	34	0	285	0	0	0	0	285
West Leg											
Approach	129	144	15	10	0	139	0	0	0	0	139
Departure	72	106	34	23	0	95	0	0	0	0	95
Total	201	250	49	33	0	234	0	0	0	0	234
Total Approaches											
Approach	251	303	52	34	0	285	0	0	0	0	285
Departure	251	303	52	34	0	285	0	0	0	0	285
Total	502	605	103	69	0	571	0	0	0	0	571

Table C-4 - Phase II Project Completion Year (2039) Volume Summary

	AM Peak Hour										
	Existing	Ph III 2049 without Project	Total Growth (2019-2049)	Adjusted Growth	Cumulative Projects	Year 2039 without Project	External Project Trips	Internal Project Trips	Pass-by Trips	Phases I + II Project Trips	Year 2039 with Project
29 Schnoor Avenue/Cleveland Avenue											
NBL	50	51	1	1	0	51	11	0	0	11	62
NBT	212	270	58	39	0	251	4	0	0	4	255
NBR	155	179	24	16	0	171	0	0	0	0	171
SBL	79	94	15	10	0	89	0	0	0	0	89
SBT	156	191	35	23	0	179	14	0	0	14	193
SBR	59	61	2	1	0	60	14	0	0	14	74
EBL	71	113	42	28	0	99	34	0	0	34	133
EBT	321	461	140	93	0	414	634	0	0	634	1048
EBR	32	48	16	11	0	43	34	0	0	34	77
WBL	161	168	7	5	0	166	0	0	0	0	166
WBT	210	221	11	7	0	217	202	0	0	202	419
WBR	43	48	5	3	0	46	0	0	0	0	46
North Leg											
Approach	294	346	52	35	0	329	28	0	0	28	357
Departure	326	431	105	70	0	396	38	0	0	38	434
Total	620	777	157	105	0	725	66	0	0	66	791
South Leg											
Approach	417	500	83	55	0	472	15	0	0	15	487
Departure	349	407	58	39	0	388	48	0	0	48	436
Total	766	907	141	94	0	860	63	0	0	63	923
East Leg											
Approach	414	437	23	15	0	429	202	0	0	202	631
Departure	555	734	179	119	0	674	634	0	0	634	1,308
Total	969	1,171	202	134	0	1,103	836	0	0	836	1,939
West Leg											
Approach	424	622	198	132	0	556	702	0	0	702	1,258
Departure	319	333	14	9	0	328	227	0	0	227	555
Total	743	955	212	141	0	884	929	0	0	929	1,813
Total Approaches											
Approach	1,549	1,905	356	237	0	1,786	947	0	0	947	2,733
Departure	1,549	1,905	356	237	0	1,786	947	0	0	947	2,733
Total	3,098	3,809	711	474	0	3,572	1,894	0	0	1,894	5,466

Table C-4 - Phase II Project Completion Year (2039) Volume Summary

	AM Peak Hour										
	Existing	Ph III 2049 without Project	Total Growth (2019-2049)	Adjusted Growth	Cumulative Projects	Year 2039 without Project	External Project Trips	Internal Project Trips	Pass-by Trips	Phases I + II Project Trips	Year 2039 with Project
30 Fairgrounds/Cleveland Avenue											
NBL	13	14	1	0	0	13	0	0	0	0	13
NBT	6	8	2	1	0	7	0	0	0	0	7
NBR	23	29	6	4	0	27	0	0	0	0	27
SBL	95	157	62	41	0	136	12	0	0	12	148
SBT	5	5	0	0	0	5	0	0	0	0	5
SBR	38	40	2	1	0	39	0	0	0	0	39
EBL	80	109	29	19	0	99	0	0	0	0	99
EBT	506	664	158	105	0	611	634	0	0	634	1245
EBR	29	30	1	1	0	30	0	0	0	0	30
WBL	32	39	7	5	0	37	0	0	0	0	37
WBT	362	380	18	12	0	374	202	0	0	202	576
WBR	65	127	62	41	0	106	34	0	0	34	140
North Leg											
Approach	138	202	64	43	0	181	12	0	0	12	193
Departure	151	244	93	62	0	213	34	0	0	34	247
Total	289	446	157	105	0	394	46	0	0	46	440
South Leg											
Approach	42	51	9	6	0	48	0	0	0	0	48
Departure	66	75	9	6	0	72	0	0	0	0	72
Total	108	125	17	12	0	120	0	0	0	0	120
East Leg											
Approach	459	546	87	58	0	517	236	0	0	236	753
Departure	624	850	226	151	0	775	646	0	0	646	1,421
Total	1,083	1,396	313	209	0	1,292	882	0	0	882	2,174
West Leg											
Approach	615	803	188	126	0	741	634	0	0	634	1,375
Departure	413	434	21	14	0	427	202	0	0	202	629
Total	1,028	1,237	209	139	0	1,167	836	0	0	836	2,003
Total Approaches											
Approach	1,254	1,602	348	232	0	1,486	882	0	0	882	2,368
Departure	1,254	1,602	348	232	0	1,486	882	0	0	882	2,368
Total	2,508	3,205	697	464	0	2,972	1,764	0	0	1,764	4,736

Table C-4 - Phase II Project Completion Year (2039) Volume Summary

	AM Peak Hour										
	Existing	Ph III 2049 without Project	Total Growth (2019-2049)	Adjusted Growth	Cumulative Projects	Year 2039 without Project	External Project Trips	Internal Project Trips	Pass-by Trips	Phases I + II Project Trips	Year 2039 with Project
31 SR-99 Southbound Ramps/Cleveland Avenue											
NBL	0	0	0	0	0	0	0	0	0	0	0
NBT	0	0	0	0	0	0	0	0	0	0	0
NBR	0	0	0	0	0	0	0	0	0	0	0
SBL	57	82	25	17	0	74	126	0	0	126	200
SBT	0	0	0	0	0	0	0	0	0	0	0
SBR	46	70	24	16	0	62	34	0	0	34	96
EBL	0	0	0	0	0	0	0	0	0	0	0
EBT	413	497	84	56	0	469	232	0	0	232	701
EBR	306	449	143	95	0	401	415	0	0	415	816
WBL	313	390	77	51	0	364	0	0	0	0	364
WBT	651	699	48	32	0	683	202	0	0	202	885
WBR	0	0	0	0	0	0	0	0	0	0	0
North Leg											
Approach	103	152	49	33	0	136	160	0	0	160	296
Departure	0	0	0	0	0	0	0	0	0	0	0
Total	103	152	49	33	0	136	160	0	0	160	296
South Leg											
Approach	0	0	0	0	0	0	0	0	0	0	0
Departure	619	839	220	147	0	766	415	0	0	415	1,181
Total	619	839	220	147	0	766	415	0	0	415	1,181
East Leg											
Approach	964	1,089	125	83	0	1,047	202	0	0	202	1,249
Departure	470	579	109	73	0	543	358	0	0	358	901
Total	1,434	1,668	234	156	0	1,590	560	0	0	560	2,150
West Leg											
Approach	719	946	227	151	0	870	647	0	0	647	1,517
Departure	697	769	72	48	0	745	236	0	0	236	981
Total	1,416	1,715	299	199	0	1,615	883	0	0	883	2,498
Total Approaches											
Approach	1,786	2,187	401	267	0	2,053	1,009	0	0	1,009	3,062
Departure	1,786	2,187	401	267	0	2,053	1,009	0	0	1,009	3,062
Total	3,572	4,374	802	535	0	4,107	2,018	0	0	2,018	6,125

Table C-4 - Phase II Project Completion Year (2039) Volume Summary

	AM Peak Hour										
	Existing	Ph III 2049 without Project	Total Growth (2019-2049)	Adjusted Growth	Cumulative Projects	Year 2039 without Project	External Project Trips	Internal Project Trips	Pass-by Trips	Phases I + II Project Trips	Year 2039 with Project
32 SR-99 Northbound Ramps/Cleveland Avenue											
NBL	234	289	55	37	0	271	121	0	0	121	392
NBT	0	0	0	0	0	0	0	0	0	0	0
NBR	243	389	146	97	0	340	0	0	0	0	340
SBL	0	0	0	0	0	0	0	0	0	0	0
SBT	0	0	0	0	0	0	0	0	0	0	0
SBR	0	0	0	0	0	0	0	0	0	0	0
EBL	43	71	28	19	0	62	12	0	0	12	74
EBT	427	510	83	55	0	482	346	0	0	346	828
EBR	0	0	0	0	0	0	0	0	0	0	0
WBL	0	0	0	0	0	0	0	0	0	0	0
WBT	730	808	78	52	0	782	81	0	0	81	863
WBR	59	116	57	38	0	97	50	0	0	50	147
North Leg											
Approach	0	0	0	0	0	0	0	0	0	0	0
Departure	102	187	85	57	0	159	62	0	0	62	221
Total	102	187	85	57	0	159	62	0	0	62	221
South Leg											
Approach	477	678	201	134	0	611	121	0	0	121	732
Departure	0	0	0	0	0	0	0	0	0	0	0
Total	477	678	201	134	0	611	121	0	0	121	732
East Leg											
Approach	789	924	135	90	0	879	131	0	0	131	1,010
Departure	670	899	229	153	0	823	346	0	0	346	1,169
Total	1,459	1,823	364	243	0	1,702	477	0	0	477	2,179
West Leg											
Approach	470	581	111	74	0	544	358	0	0	358	902
Departure	964	1,097	133	89	0	1,053	202	0	0	202	1,255
Total	1,434	1,678	244	163	0	1,597	560	0	0	560	2,157
Total Approaches											
Approach	1,736	2,183	447	298	0	2,034	610	0	0	610	2,644
Departure	1,736	2,183	447	298	0	2,034	610	0	0	610	2,644
Total	3,472	4,366	894	596	0	4,068	1,220	0	0	1,220	5,288

Table C-4 - Phase II Project Completion Year (2039) Volume Summary

	AM Peak Hour										
	Existing	Ph III 2049 without Project	Total Growth (2019-2049)	Adjusted Growth	Cumulative Projects	Year 2039 without Project	External Project Trips	Internal Project Trips	Pass-by Trips	Phases I + II Project Trips	Year 2039 with Project
33 Gateway Drive/Cleveland Avenue											
NBL	130	137	7	4	0	134	43	0	0	43	177
NBT	47	50	3	2	0	49	0	0	0	0	49
NBR	113	196	83	55	0	168	0	0	0	0	168
SBL	51	67	16	11	0	62	0	0	0	0	62
SBT	85	89	4	3	0	88	0	0	0	0	88
SBR	4	4	0	0	0	4	0	0	0	0	4
EBL	4	4	0	0	0	4	0	0	0	0	4
EBT	520	749	229	153	0	673	213	0	0	213	886
EBR	140	145	5	3	0	143	132	0	0	132	275
WBL	154	237	83	55	0	209	0	0	0	0	209
WBT	652	784	132	88	0	740	87	0	0	87	827
WBR	62	82	20	13	0	75	0	0	0	0	75
North Leg											
Approach	140	160	20	14	0	154	0	0	0	0	154
Departure	113	136	23	15	0	128	0	0	0	0	128
Total	253	297	44	29	0	282	0	0	0	0	282
South Leg											
Approach	290	383	93	62	0	352	43	0	0	43	395
Departure	379	471	92	62	0	441	132	0	0	132	573
Total	669	854	185	123	0	792	175	0	0	175	967
East Leg											
Approach	868	1,103	235	157	0	1,025	87	0	0	87	1,112
Departure	684	1,012	328	219	0	903	213	0	0	213	1,116
Total	1,552	2,115	563	375	0	1,927	300	0	0	300	2,227
West Leg											
Approach	664	898	234	156	0	820	345	0	0	345	1,165
Departure	786	925	139	92	0	878	130	0	0	130	1,008
Total	1,450	1,823	373	249	0	1,699	475	0	0	475	2,174
Total Approaches											
Approach	1,962	2,544	582	388	0	2,350	475	0	0	475	2,825
Departure	1,962	2,544	582	388	0	2,350	475	0	0	475	2,825
Total	3,924	5,088	1,164	776	0	4,700	950	0	0	950	5,650

Table C-4 - Phase II Project Completion Year (2039) Volume Summary

	AM Peak Hour										
	Existing	Ph III 2049 without Project	Total Growth (2019-2049)	Adjusted Growth	Cumulative Projects	Year 2039 without Project	External Project Trips	Internal Project Trips	Pass-by Trips	Phases I + II Project Trips	Year 2039 with Project
34 Cleveland Avenue – Country Club Drive/W Cleveland Avenue											
NBL	0	0	0	0	0	0	0	0	0	0	0
NBT	488	782	294	196	0	684	61	0	0	61	745
NBR	196	230	34	23	0	219	151	0	0	151	370
SBL	76	104	28	19	0	95	0	0	0	0	95
SBT	593	673	80	53	0	646	25	0	0	25	671
SBR	0	0	0	0	0	0	0	0	0	0	0
EBL	0	0	0	0	0	0	0	0	0	0	0
EBT	0	0	0	0	0	0	0	0	0	0	0
EBR	0	0	0	0	0	0	0	0	0	0	0
WBL	275	430	155	103	0	378	62	0	0	62	440
WBT	0	0	0	0	0	0	0	0	0	0	0
WBR	19	49	30	20	0	39	0	0	0	0	39
North Leg											
Approach	669	777	108	72	0	741	25	0	0	25	766
Departure	507	831	324	216	0	723	61	0	0	61	784
Total	1,176	1,608	432	288	0	1,464	86	0	0	86	1,550
South Leg											
Approach	684	1,012	328	219	0	903	212	0	0	212	1,115
Departure	868	1,103	235	157	0	1,025	87	0	0	87	1,112
Total	1,552	2,115	563	375	0	1,927	299	0	0	299	2,226
East Leg											
Approach	294	479	185	123	0	417	62	0	0	62	479
Departure	272	334	62	41	0	313	151	0	0	151	464
Total	566	813	247	165	0	731	213	0	0	213	944
West Leg											
Approach	0	0	0	0	0	0	0	0	0	0	0
Departure	0	0	0	0	0	0	0	0	0	0	0
Total	0	0	0	0	0	0	0	0	0	0	0
Total Approaches											
Approach	1,647	2,268	621	414	0	2,061	299	0	0	299	2,360
Departure	1,647	2,268	621	414	0	2,061	299	0	0	299	2,360
Total	3,294	4,536	1,242	828	0	4,122	598	0	0	598	4,720

Table C-4 - Phase II Project Completion Year (2039) Volume Summary

	AM Peak Hour										
	Existing	Ph III 2049 without Project	Total Growth (2019-2049)	Adjusted Growth	Cumulative Projects	Year 2039 without Project	External Project Trips	Internal Project Trips	Pass-by Trips	Phases I + II Project Trips	Year 2039 with Project
35 Country Club Drive/Sharon Boulevard											
NBL	1	1	0	0	0	1	0	0	0	0	1
NBT	498	834	336	224	0	722	26	0	0	26	748
NBR	0	0	0	0	0	0	0	0	0	0	0
SBL	0	0	0	0	0	0	0	0	0	0	0
SBT	634	755	121	81	0	715	14	0	0	14	729
SBR	1	1	0	0	0	1	0	0	0	0	1
EBL	2	2	0	0	0	2	0	0	0	0	2
EBT	0	0	0	0	0	0	0	0	0	0	0
EBR	12	13	1	0	0	12	0	0	0	0	12
WBL	0	0	0	0	0	0	0	0	0	0	0
WBT	0	0	0	0	0	0	0	0	0	0	0
WBR	0	0	0	0	0	0	0	0	0	0	0
North Leg											
Approach	635	756	121	81	0	716	14	0	0	14	730
Departure	500	836	336	224	0	724	26	0	0	26	750
Total	1,135	1,592	457	305	0	1,440	40	0	0	40	1,480
South Leg											
Approach	499	835	336	224	0	723	26	0	0	26	749
Departure	646	768	122	81	0	727	14	0	0	14	741
Total	1,145	1,603	458	305	0	1,450	40	0	0	40	1,490
East Leg											
Approach	0	0	0	0	0	0	0	0	0	0	0
Departure	0	0	0	0	0	0	0	0	0	0	0
Total	0	0	0	0	0	0	0	0	0	0	0
West Leg											
Approach	14	15	1	0	0	14	0	0	0	0	14
Departure	2	2	0	0	0	2	0	0	0	0	2
Total	16	17	1	1	0	17	0	0	0	0	17
Total Approaches											
Approach	1,148	1,606	458	305	0	1,453	40	0	0	40	1,493
Departure	1,148	1,606	458	305	0	1,453	40	0	0	40	1,493
Total	2,296	3,212	916	610	0	2,906	80	0	0	80	2,986

Table C-4 - Phase II Project Completion Year (2039) Volume Summary

	AM Peak Hour										
	Existing	Ph III 2049 without Project	Total Growth (2019-2049)	Adjusted Growth	Cumulative Projects	Year 2039 without Project	External Project Trips	Internal Project Trips	Pass-by Trips	Phases I + II Project Trips	Year 2039 with Project
36 Pine Street/Howard Road											
NBL	115	121	6	4	0	119	29	0	0	29	148
NBT	151	171	20	13	0	164	3	0	0	3	167
NBR	222	253	31	21	0	243	0	0	0	0	243
SBL	16	17	1	1	0	17	0	0	0	0	17
SBT	239	281	42	28	0	267	14	0	0	14	281
SBR	97	102	5	3	0	100	0	0	0	0	100
EBL	33	35	2	1	0	34	0	0	0	0	34
EBT	667	700	33	22	0	689	1	0	0	1	690
EBR	72	84	12	8	0	80	74	0	0	74	154
WBL	126	163	37	25	0	151	0	0	0	0	151
WBT	433	439	6	4	0	437	27	0	0	27	464
WBR	6	7	1	1	0	7	0	0	0	0	7
North Leg											
Approach	352	400	48	32	0	384	14	0	0	14	398
Departure	190	213	23	15	0	205	3	0	0	3	208
Total	542	612	70	47	0	589	17	0	0	17	606
South Leg											
Approach	488	545	57	38	0	526	32	0	0	32	558
Departure	437	528	91	61	0	498	88	0	0	88	586
Total	925	1,073	148	99	0	1,024	120	0	0	120	1,144
East Leg											
Approach	565	609	44	29	0	594	27	0	0	27	621
Departure	905	970	65	43	0	948	1	0	0	1	949
Total	1,470	1,579	109	73	0	1,543	28	0	0	28	1,571
West Leg											
Approach	772	819	47	31	0	803	75	0	0	75	878
Departure	645	662	17	11	0	656	56	0	0	56	712
Total	1,417	1,481	64	43	0	1,460	131	0	0	131	1,591
Total Approaches											
Approach	2,177	2,373	196	130	0	2,307	148	0	0	148	2,455
Departure	2,177	2,373	196	130	0	2,307	148	0	0	148	2,455
Total	4,354	4,745	391	261	0	4,615	296	0	0	296	4,911

Table C-4 - Phase II Project Completion Year (2039) Volume Summary

	AM Peak Hour										
	Existing	Ph III 2049 without Project	Total Growth (2019-2049)	Adjusted Growth	Cumulative Projects	Year 2039 without Project	External Project Trips	Internal Project Trips	Pass-by Trips	Phases I + II Project Trips	Year 2039 with Project
37 Q Street - Olive Avenue/Yosemite Avenue - Howard Road											
NBL	292	320	28	19	0	311	24	0	0	24	335
NBT	88	89	1	1	0	89	0	0	0	0	89
NBR	20	21	1	1	0	21	0	0	0	0	21
SBL	99	104	5	3	0	102	0	0	0	0	102
SBT	147	152	5	3	0	150	0	0	0	0	150
SBR	12	13	1	0	0	12	0	0	0	0	12
EBL	6	6	0	0	0	6	0	0	0	0	6
EBT	541	568	27	18	0	559	0	0	0	0	559
EBR	308	336	28	19	0	327	1	0	0	1	328
WBL	26	28	2	1	0	27	0	0	0	0	27
WBT	332	348	16	11	0	343	3	0	0	3	346
WBR	19	20	1	1	0	20	0	0	0	0	20
North Leg											
Approach	258	269	11	7	0	265	0	0	0	0	265
Departure	113	115	2	2	0	115	0	0	0	0	115
Total	371	384	13	9	0	380	0	0	0	0	380
South Leg											
Approach	400	430	30	20	0	420	24	0	0	24	444
Departure	481	516	35	23	0	504	1	0	0	1	505
Total	881	946	65	43	0	924	25	0	0	25	949
East Leg											
Approach	377	396	19	13	0	390	3	0	0	3	393
Departure	660	693	33	22	0	682	0	0	0	0	682
Total	1,037	1,089	52	35	0	1,072	3	0	0	3	1,075
West Leg											
Approach	855	910	55	37	0	892	1	0	0	1	893
Departure	636	681	45	30	0	666	27	0	0	27	693
Total	1,491	1,591	100	67	0	1,558	28	0	0	28	1,586
Total Approaches											
Approach	1,890	2,005	115	77	0	1,967	28	0	0	28	1,995
Departure	1,890	2,005	115	77	0	1,967	28	0	0	28	1,995
Total	3,780	4,010	230	153	0	3,933	56	0	0	56	3,989

Table C-4 - Phase II Project Completion Year (2039) Volume Summary

	AM Peak Hour										
	Existing	Ph III 2049 without Project	Total Growth (2019-2049)	Adjusted Growth	Cumulative Projects	Year 2039 without Project	External Project Trips	Internal Project Trips	Pass-by Trips	Phases I + II Project Trips	Year 2039 with Project
38 I Street/SR-99 Southbound Off-Ramp - 2nd Street											
NBL	15	24	9	6	0	21	0	0	0	0	21
NBT	82	89	7	5	0	87	0	0	0	0	87
NBR	0	0	0	0	0	0	0	0	0	0	0
SBL	0	0	0	0	0	0	0	0	0	0	0
SBT	132	156	24	16	0	148	0	0	0	0	148
SBR	2	3	1	1	0	3	0	0	0	0	3
EBL	2	2	0	0	0	2	0	0	0	0	2
EBT	0	0	0	0	0	0	0	0	0	0	0
EBR	53	68	15	10	0	63	0	0	0	0	63
WBL	363	404	41	27	0	390	103	0	0	103	493
WBT	17	22	5	3	0	20	0	0	0	0	20
WBR	11	12	1	0	0	11	0	0	0	0	11
North Leg											
Approach	134	159	25	17	0	151	0	0	0	0	151
Departure	95	103	8	5	0	100	0	0	0	0	100
Total	229	262	33	22	0	251	0	0	0	0	251
South Leg											
Approach	97	113	16	11	0	108	0	0	0	0	108
Departure	548	628	80	53	0	601	103	0	0	103	704
Total	645	741	96	64	0	709	103	0	0	103	812
East Leg											
Approach	391	438	47	31	0	422	103	0	0	103	525
Departure	0	0	0	0	0	0	0	0	0	0	0
Total	391	438	47	31	0	422	103	0	0	103	525
West Leg											
Approach	55	70	15	10	0	65	0	0	0	0	65
Departure	34	49	15	10	0	44	0	0	0	0	44
Total	89	119	30	20	0	109	0	0	0	0	109
Total Approaches											
Approach	677	780	103	68	0	745	103	0	0	103	848
Departure	677	780	103	68	0	745	103	0	0	103	848
Total	1,354	1,559	205	137	0	1,491	206	0	0	206	1,697

Table C-4 - Phase II Project Completion Year (2039) Volume Summary

	AM Peak Hour										
	Existing	Ph III 2049 without Project	Total Growth (2019-2049)	Adjusted Growth	Cumulative Projects	Year 2039 without Project	External Project Trips	Internal Project Trips	Pass-by Trips	Phases I + II Project Trips	Year 2039 with Project
39 4th Street/Sunset Avenue											
NBL	31	35	4	3	0	34	0	0	0	0	34
NBT	291	351	60	40	0	331	20	0	0	20	351
NBR	0	0	0	0	0	0	0	0	0	0	0
SBL	0	0	0	0	0	0	0	0	0	0	0
SBT	400	462	62	41	0	441	60	0	0	60	501
SBR	267	287	20	13	0	280	3	0	0	3	283
EBL	381	400	19	13	0	394	0	0	0	0	394
EBT	0	0	0	0	0	0	0	0	0	0	0
EBR	22	23	1	1	0	23	0	0	0	0	23
WBL	0	0	0	0	0	0	0	0	0	0	0
WBT	0	0	0	0	0	0	0	0	0	0	0
WBR	0	0	0	0	0	0	0	0	0	0	0
North Leg											
Approach	667	749	82	55	0	722	63	0	0	63	785
Departure	672	751	79	53	0	725	20	0	0	20	745
Total	1,339	1,500	161	107	0	1,446	83	0	0	83	1,529
South Leg											
Approach	322	386	64	43	0	365	20	0	0	20	385
Departure	422	485	63	42	0	464	60	0	0	60	524
Total	744	871	127	85	0	829	80	0	0	80	909
East Leg											
Approach	0	0	0	0	0	0	0	0	0	0	0
Departure	0	0	0	0	0	0	0	0	0	0	0
Total	0	0	0	0	0	0	0	0	0	0	0
West Leg											
Approach	403	423	20	13	0	416	0	0	0	0	416
Departure	298	322	24	16	0	314	3	0	0	3	317
Total	701	745	44	29	0	730	3	0	0	3	733
Total Approaches											
Approach	1,392	1,558	166	111	0	1,503	83	0	0	83	1,586
Departure	1,392	1,558	166	111	0	1,503	83	0	0	83	1,586
Total	2,784	3,116	332	222	0	3,006	166	0	0	166	3,172

Table C-4 - Phase II Project Completion Year (2039) Volume Summary

	AM Peak Hour										
	Existing	Ph III 2049 without Project	Total Growth (2019-2049)	Adjusted Growth	Cumulative Projects	Year 2039 without Project	External Project Trips	Internal Project Trips	Pass-by Trips	Phases I + II Project Trips	Year 2039 with Project
40 H Street/SR-99 Northbound On-Ramp - 2nd Street											
NBL	253	316	63	42	0	295	36	0	0	36	331
NBT	24	25	1	1	0	25	0	0	0	0	25
NBR	9	35	26	17	0	26	0	0	0	0	26
SBL	0	0	0	0	0	0	0	0	0	0	0
SBT	34	36	2	1	0	35	0	0	0	0	35
SBR	0	0	0	0	0	0	0	0	0	0	0
EBL	0	0	0	0	0	0	0	0	0	0	0
EBT	0	0	0	0	0	0	0	0	0	0	0
EBR	0	0	0	0	0	0	0	0	0	0	0
WBL	13	43	30	20	0	33	0	0	0	0	33
WBT	21	41	20	13	0	34	0	0	0	0	34
WBR	2	3	1	1	0	3	0	0	0	0	3
North Leg											
Approach	34	36	2	1	0	35	0	0	0	0	35
Departure	26	28	2	1	0	27	0	0	0	0	27
Total	60	64	4	3	0	63	0	0	0	0	63
South Leg											
Approach	286	376	90	60	0	346	36	0	0	36	382
Departure	47	79	32	21	0	68	0	0	0	0	68
Total	333	455	122	81	0	414	36	0	0	36	450
East Leg											
Approach	36	87	51	34	0	70	0	0	0	0	70
Departure	9	35	26	17	0	26	0	0	0	0	26
Total	45	122	77	51	0	96	0	0	0	0	96
West Leg											
Approach	0	0	0	0	0	0	0	0	0	0	0
Departure	274	357	83	55	0	329	36	0	0	36	365
Total	274	357	83	55	0	329	36	0	0	36	365
Total Approaches											
Approach	356	499	143	95	0	451	36	0	0	36	487
Departure	356	499	143	95	0	451	36	0	0	36	487
Total	712	998	286	191	0	903	72	0	0	72	975

Table C-4 - Phase II Project Completion Year (2039) Volume Summary

	AM Peak Hour										
	Existing	Ph III 2049 without Project	Total Growth (2019-2049)	Adjusted Growth	Cumulative Projects	Year 2039 without Project	External Project Trips	Internal Project Trips	Pass-by Trips	Phases I + II Project Trips	Year 2039 with Project
41 I Street/4th Street											
NBL	51	54	3	2	0	53	0	0	0	0	53
NBT	55	58	3	2	0	57	0	0	0	0	57
NBR	160	168	8	5	0	165	0	0	0	0	165
SBL	209	252	43	29	0	238	43	0	0	43	281
SBT	277	287	10	7	0	284	0	0	0	0	284
SBR	121	149	28	19	0	140	60	0	0	60	200
EBL	25	29	4	3	0	28	0	0	0	0	28
EBT	621	666	45	30	0	651	20	0	0	20	671
EBR	67	70	3	2	0	69	0	0	0	0	69
WBL	85	89	4	3	0	88	0	0	0	0	88
WBT	459	516	57	38	0	497	3	0	0	3	500
WBR	61	72	11	7	0	68	0	0	0	0	68
North Leg											
Approach	607	688	81	54	0	661	103	0	0	103	764
Departure	141	159	18	12	0	153	0	0	0	0	153
Total	748	847	99	66	0	814	103	0	0	103	917
South Leg											
Approach	266	280	14	9	0	275	0	0	0	0	275
Departure	429	447	18	12	0	441	0	0	0	0	441
Total	695	726	31	21	0	716	0	0	0	0	716
East Leg											
Approach	605	677	72	48	0	653	3	0	0	3	656
Departure	990	1,086	96	64	0	1,054	63	0	0	63	1,117
Total	1,595	1,763	168	112	0	1,707	66	0	0	66	1,773
West Leg											
Approach	713	765	52	35	0	748	20	0	0	20	768
Departure	631	719	88	58	0	689	63	0	0	63	752
Total	1,344	1,484	140	93	0	1,437	83	0	0	83	1,520
Total Approaches											
Approach	2,191	2,410	219	146	0	2,337	126	0	0	126	2,463
Departure	2,191	2,410	219	146	0	2,337	126	0	0	126	2,463
Total	4,382	4,820	438	292	0	4,674	252	0	0	252	4,926

Table C-4 - Phase II Project Completion Year (2039) Volume Summary

	AM Peak Hour										
	Existing	Ph III 2049 without Project	Total Growth (2019-2049)	Adjusted Growth	Cumulative Projects	Year 2039 without Project	External Project Trips	Internal Project Trips	Pass-by Trips	Phases I + II Project Trips	Year 2039 with Project
42 SR-99 Southbound On-Ramp/4th Street											
NBL	0	0	0	0	0	0	0	0	0	0	0
NBT	0	0	0	0	0	0	0	0	0	0	0
NBR	0	0	0	0	0	0	0	0	0	0	0
SBL	0	0	0	0	0	0	0	0	0	0	0
SBT	0	0	0	0	0	0	0	0	0	0	0
SBR	0	0	0	0	0	0	0	0	0	0	0
EBL	0	0	0	0	0	0	0	0	0	0	0
EBT	667	735	68	45	0	712	63	0	0	63	775
EBR	323	351	28	19	0	342	0	0	0	0	342
WBL	152	248	96	64	0	216	0	0	0	0	216
WBT	605	677	72	48	0	653	3	0	0	3	656
WBR	0	0	0	0	0	0	0	0	0	0	0
North Leg											
Approach	0	0	0	0	0	0	0	0	0	0	0
Departure	0	0	0	0	0	0	0	0	0	0	0
Total	0	0	0	0	0	0	0	0	0	0	0
South Leg											
Approach	0	0	0	0	0	0	0	0	0	0	0
Departure	475	599	124	83	0	558	0	0	0	0	558
Total	475	599	124	83	0	558	0	0	0	0	558
East Leg											
Approach	757	925	168	112	0	869	3	0	0	3	872
Departure	667	735	68	45	0	712	63	0	0	63	775
Total	1,424	1,660	236	157	0	1,581	66	0	0	66	1,647
West Leg											
Approach	990	1,086	96	64	0	1,054	63	0	0	63	1,117
Departure	605	677	72	48	0	653	3	0	0	3	656
Total	1,595	1,763	168	112	0	1,707	66	0	0	66	1,773
Total Approaches											
Approach	1,747	2,011	264	176	0	1,923	66	0	0	66	1,989
Departure	1,747	2,011	264	176	0	1,923	66	0	0	66	1,989
Total	3,494	4,022	528	352	0	3,846	132	0	0	132	3,978

Table C-4 - Phase II Project Completion Year (2039) Volume Summary

	AM Peak Hour										
	Existing	Ph III 2049 without Project	Total Growth (2019-2049)	Adjusted Growth	Cumulative Projects	Year 2039 without Project	External Project Trips	Internal Project Trips	Pass-by Trips	Phases I + II Project Trips	Year 2039 with Project
43 H Street – SR-99 Northbound Off-Ramp/4th Street											
NBL	239	281	42	28	0	267	0	0	0	0	267
NBT	24	35	11	7	0	31	0	0	0	0	31
NBR	195	240	45	30	0	225	0	0	0	0	225
SBL	5	8	3	2	0	7	0	0	0	0	7
SBT	0	0	0	0	0	0	0	0	0	0	0
SBR	57	84	27	18	0	75	0	0	0	0	75
EBL	213	265	52	35	0	248	20	0	0	20	268
EBT	454	470	16	11	0	465	43	0	0	43	508
EBR	0	0	0	0	0	0	0	0	0	0	0
WBL	0	0	0	0	0	0	0	0	0	0	0
WBT	461	559	98	65	0	526	3	0	0	3	529
WBR	52	79	27	18	0	70	16	0	0	16	86
North Leg											
Approach	62	92	30	20	0	82	0	0	0	0	82
Departure	289	379	90	60	0	349	36	0	0	36	385
Total	351	471	120	80	0	431	36	0	0	36	467
South Leg											
Approach	458	556	98	65	0	523	0	0	0	0	523
Departure	0	0	0	0	0	0	0	0	0	0	0
Total	458	556	98	65	0	523	0	0	0	0	523
East Leg											
Approach	513	638	125	83	0	596	19	0	0	19	615
Departure	654	718	64	43	0	697	43	0	0	43	740
Total	1,167	1,356	189	126	0	1,293	62	0	0	62	1,355
West Leg											
Approach	667	735	68	45	0	712	63	0	0	63	775
Departure	757	924	167	111	0	868	3	0	0	3	871
Total	1,424	1,659	235	157	0	1,581	66	0	0	66	1,647
Total Approaches											
Approach	1,700	2,021	321	214	0	1,914	82	0	0	82	1,996
Departure	1,700	2,021	321	214	0	1,914	82	0	0	82	1,996
Total	3,400	4,042	642	428	0	3,828	164	0	0	164	3,992

Table C-4 - Phase II Project Completion Year (2039) Volume Summary

	AM Peak Hour										
	Existing	Ph III 2049 without Project	Total Growth (2019-2049)	Adjusted Growth	Cumulative Projects	Year 2039 without Project	External Project Trips	Internal Project Trips	Pass-by Trips	Phases I + II Project Trips	Year 2039 with Project
44 I Street/Olive Avenue											
NBL	0	0	0	0	0	0	0	0	0	0	0
NBT	0	0	0	0	0	0	0	0	0	0	0
NBR	0	0	0	0	0	0	0	0	0	0	0
SBL	59	62	3	2	0	61	0	0	0	0	61
SBT	0	0	0	0	0	0	0	0	0	0	0
SBR	99	102	3	2	0	101	0	0	0	0	101
EBL	128	134	6	4	0	132	0	0	0	0	132
EBT	445	513	68	45	0	490	0	0	0	0	490
EBR	0	0	0	0	0	0	0	0	0	0	0
WBL	0	0	0	0	0	0	0	0	0	0	0
WBT	410	585	175	117	0	527	17	0	0	17	544
WBR	76	82	6	4	0	80	0	0	0	0	80
North Leg											
Approach	158	164	6	4	0	162	0	0	0	0	162
Departure	204	216	12	8	0	212	0	0	0	0	212
Total	362	380	18	12	0	374	0	0	0	0	374
South Leg											
Approach	0	0	0	0	0	0	0	0	0	0	0
Departure	0	0	0	0	0	0	0	0	0	0	0
Total	0	0	0	0	0	0	0	0	0	0	0
East Leg											
Approach	486	667	181	121	0	607	17	0	0	17	624
Departure	504	575	71	47	0	551	0	0	0	0	551
Total	990	1,242	252	168	0	1,158	17	0	0	17	1,175
West Leg											
Approach	573	647	74	50	0	623	0	0	0	0	623
Departure	509	687	178	119	0	628	17	0	0	17	645
Total	1,082	1,334	252	168	0	1,250	17	0	0	17	1,267
Total Approaches											
Approach	1,217	1,478	261	174	0	1,391	17	0	0	17	1,408
Departure	1,217	1,478	261	174	0	1,391	17	0	0	17	1,408
Total	2,434	2,957	523	348	0	2,782	34	0	0	34	2,816

Table C-4 - Phase II Project Completion Year (2039) Volume Summary

	AM Peak Hour										
	Existing	Ph III 2049 without Project	Total Growth (2019-2049)	Adjusted Growth	Cumulative Projects	Year 2039 without Project	External Project Trips	Internal Project Trips	Pass-by Trips	Phases I + II Project Trips	Year 2039 with Project
45 SR-99 Southbound Off-Ramp/Olive Avenue											
NBL	0	0	0	0	0	0	0	0	0	0	0
NBT	0	0	0	0	0	0	0	0	0	0	0
NBR	0	0	0	0	0	0	0	0	0	0	0
SBL	303	712	409	273	0	576	201	0	0	201	777
SBT	0	0	0	0	0	0	0	0	0	0	0
SBR	99	120	21	14	0	113	0	0	0	0	113
EBL	0	0	0	0	0	0	0	0	0	0	0
EBT	504	575	71	47	0	551	0	0	0	0	551
EBR	0	0	0	0	0	0	0	0	0	0	0
WBL	0	0	0	0	0	0	0	0	0	0	0
WBT	389	547	158	105	0	494	17	0	0	17	511
WBR	0	0	0	0	0	0	0	0	0	0	0
North Leg											
Approach	402	832	430	287	0	689	201	0	0	201	890
Departure	0	0	0	0	0	0	0	0	0	0	0
Total	402	832	430	287	0	689	201	0	0	201	890
South Leg											
Approach	0	0	0	0	0	0	0	0	0	0	0
Departure	0	0	0	0	0	0	0	0	0	0	0
Total	0	0	0	0	0	0	0	0	0	0	0
East Leg											
Approach	389	547	158	105	0	494	17	0	0	17	511
Departure	807	1,287	480	320	0	1,127	201	0	0	201	1,328
Total	1,196	1,834	638	425	0	1,621	218	0	0	218	1,839
West Leg											
Approach	504	575	71	47	0	551	0	0	0	0	551
Departure	488	667	179	119	0	607	17	0	0	17	624
Total	992	1,242	250	167	0	1,159	17	0	0	17	1,176
Total Approaches											
Approach	1,295	1,954	659	439	0	1,734	218	0	0	218	1,952
Departure	1,295	1,954	659	439	0	1,734	218	0	0	218	1,952
Total	2,590	3,908	1,318	879	0	3,469	436	0	0	436	3,905

Table C-4 - Phase II Project Completion Year (2039) Volume Summary

	AM Peak Hour										
	Existing	Ph III 2049 without Project	Total Growth (2019-2049)	Adjusted Growth	Cumulative Projects	Year 2039 without Project	External Project Trips	Internal Project Trips	Pass-by Trips	Phases I + II Project Trips	Year 2039 with Project
46 Madera Avenue/SR-99 Northbound Ramps											
NBL	355	663	308	205	0	560	43	0	0	43	603
NBT	397	447	50	33	0	430	67	0	0	67	497
NBR	0	0	0	0	0	0	0	0	0	0	0
SBL	0	0	0	0	0	0	0	0	0	0	0
SBT	553	701	148	99	0	652	3	0	0	3	655
SBR	148	277	129	86	0	234	22	0	0	22	256
EBL	0	0	0	0	0	0	0	0	0	0	0
EBT	0	0	0	0	0	0	0	0	0	0	0
EBR	0	0	0	0	0	0	0	0	0	0	0
WBL	139	223	84	56	0	195	11	0	0	11	206
WBT	1	2	1	1	0	2	0	0	0	0	2
WBR	75	107	32	21	0	96	0	0	0	0	96
North Leg											
Approach	701	978	277	185	0	886	25	0	0	25	911
Departure	472	554	82	55	0	527	67	0	0	67	594
Total	1,173	1,532	359	239	0	1,412	92	0	0	92	1,504
South Leg											
Approach	752	1,110	358	239	0	991	110	0	0	110	1,101
Departure	692	924	232	155	0	847	14	0	0	14	861
Total	1,444	2,034	590	393	0	1,837	124	0	0	124	1,961
East Leg											
Approach	215	332	117	78	0	293	11	0	0	11	304
Departure	0	0	0	0	0	0	0	0	0	0	0
Total	215	332	117	78	0	293	11	0	0	11	304
West Leg											
Approach	0	0	0	0	0	0	0	0	0	0	0
Departure	504	942	438	292	0	796	65	0	0	65	861
Total	504	942	438	292	0	796	65	0	0	65	861
Total Approaches											
Approach	1,668	2,420	752	501	0	2,169	146	0	0	146	2,315
Departure	1,668	2,420	752	501	0	2,169	146	0	0	146	2,315
Total	3,336	4,840	1,504	1,003	0	4,339	292	0	0	292	4,631

Table C-4 - Phase II Project Completion Year (2039) Volume Summary

	AM Peak Hour										
	Existing	Ph III 2049 without Project	Total Growth (2019-2049)	Adjusted Growth	Cumulative Projects	Year 2039 without Project	External Project Trips	Internal Project Trips	Pass-by Trips	Phases I + II Project Trips	Year 2039 with Project
47 Madera Avenue/Olive Avenue – SR-99 Southbound On-Ramp											
NBL	107	202	95	63	0	170	3	0	0	3	173
NBT	452	692	240	160	0	612	43	0	0	43	655
NBR	38	44	6	4	0	42	0	0	0	0	42
SBL	84	88	4	3	0	87	0	0	0	0	87
SBT	326	491	165	110	0	436	0	0	0	0	436
SBR	282	345	63	42	0	324	14	0	0	14	338
EBL	300	418	118	79	0	379	67	0	0	67	446
EBT	192	202	10	7	0	199	0	0	0	0	199
EBR	315	667	352	235	0	550	134	0	0	134	684
WBL	0	0	0	0	0	0	0	0	0	0	0
WBT	0	0	0	0	0	0	0	0	0	0	0
WBR	0	0	0	0	0	0	0	0	0	0	0
North Leg											
Approach	692	924	232	155	0	847	14	0	0	14	861
Departure	752	1,110	358	239	0	991	110	0	0	110	1,101
Total	1,444	2,034	590	393	0	1,837	124	0	0	124	1,961
South Leg											
Approach	597	938	341	227	0	824	46	0	0	46	870
Departure	641	1,158	517	345	0	986	134	0	0	134	1,120
Total	1,238	2,096	858	572	0	1,810	180	0	0	180	1,990
East Leg											
Approach	0	0	0	0	0	0	0	0	0	0	0
Departure	314	334	20	13	0	327	0	0	0	0	327
Total	314	334	20	13	0	327	0	0	0	0	327
West Leg											
Approach	807	1,287	480	320	0	1,127	201	0	0	201	1,328
Departure	389	547	158	105	0	494	17	0	0	17	511
Total	1,196	1,834	638	425	0	1,621	218	0	0	218	1,839
Total Approaches											
Approach	2,096	3,149	1,053	702	0	2,798	261	0	0	261	3,059
Departure	2,096	3,149	1,053	702	0	2,798	261	0	0	261	3,059
Total	4,192	6,298	2,106	1,404	0	5,596	522	0	0	522	6,118

Table C-4 - Phase II Project Completion Year (2039) Volume Summary

	AM Peak Hour										
	Existing	Ph III 2049 without Project	Total Growth (2019-2049)	Adjusted Growth	Cumulative Projects	Year 2039 without Project	External Project Trips	Internal Project Trips	Pass-by Trips	Phases I + II Project Trips	Year 2039 with Project
48 Madera Avenue (SR-145) /Lewis Street											
NBL	0	0	0	0	0	0	0	0	0	0	0
NBT	619	962	343	229	0	848	46	0	0	46	894
NBR	8	8	0	0	0	8	0	0	0	0	8
SBL	31	33	2	1	0	32	0	0	0	0	32
SBT	764	1,281	517	345	0	1,109	134	0	0	134	1243
SBR	0	0	0	0	0	0	0	0	0	0	0
EBL	0	0	0	0	0	0	0	0	0	0	0
EBT	0	0	0	0	0	0	0	0	0	0	0
EBR	0	0	0	0	0	0	0	0	0	0	0
WBL	9	9	0	0	0	9	0	0	0	0	9
WBT	0	0	0	0	0	0	0	0	0	0	0
WBR	8	8	0	0	0	8	0	0	0	0	8
North Leg											
Approach	795	1,314	519	346	0	1,141	134	0	0	134	1,275
Departure	627	970	343	229	0	856	46	0	0	46	902
Total	1,422	2,284	862	575	0	1,997	180	0	0	180	2,177
South Leg											
Approach	627	970	343	229	0	856	46	0	0	46	902
Departure	773	1,290	517	345	0	1,118	134	0	0	134	1,252
Total	1,400	2,261	861	574	0	1,974	180	0	0	180	2,154
East Leg											
Approach	17	18	1	1	0	18	0	0	0	0	18
Departure	39	41	2	1	0	40	0	0	0	0	40
Total	56	59	3	2	0	58	0	0	0	0	58
West Leg											
Approach	0	0	0	0	0	0	0	0	0	0	0
Departure	0	0	0	0	0	0	0	0	0	0	0
Total	0	0	0	0	0	0	0	0	0	0	0
Total Approaches											
Approach	1,439	2,302	863	575	0	2,014	180	0	0	180	2,194
Departure	1,439	2,302	863	575	0	2,014	180	0	0	180	2,194
Total	2,878	4,604	1,726	1,150	0	4,028	360	0	0	360	4,388

Table C-4 - Phase II Project Completion Year (2039) Volume Summary

	AM Peak Hour										
	Existing	Ph III 2049 without Project	Total Growth (2019-2049)	Adjusted Growth	Cumulative Projects	Year 2039 without Project	External Project Trips	Internal Project Trips	Pass-by Trips	Phases I + II Project Trips	Year 2039 with Project
49 Yosemite Avenue/Cleveland Avenue - Tozer Street											
NBL	131	141	10	7	0	138	0	0	0	0	138
NBT	105	137	32	21	0	126	0	0	0	0	126
NBR	74	78	4	3	0	77	0	0	0	0	77
SBL	60	79	19	13	0	73	0	0	0	0	73
SBT	229	270	41	27	0	256	0	0	0	0	256
SBR	168	226	58	39	0	207	32	0	0	32	239
EBL	164	210	46	31	0	195	89	0	0	89	284
EBT	514	531	17	11	0	525	10	0	0	10	535
EBR	248	260	12	8	0	256	0	0	0	0	256
WBL	110	116	6	4	0	114	0	0	0	0	114
WBT	289	349	60	40	0	329	5	0	0	5	334
WBR	41	60	19	13	0	54	0	0	0	0	54
North Leg											
Approach	457	575	118	79	0	536	32	0	0	32	568
Departure	310	407	97	65	0	375	89	0	0	89	464
Total	767	982	215	143	0	910	121	0	0	121	1,031
South Leg											
Approach	310	356	46	31	0	341	0	0	0	0	341
Departure	587	646	59	40	0	627	0	0	0	0	627
Total	897	1,002	105	70	0	967	0	0	0	0	967
East Leg											
Approach	440	525	85	57	0	497	5	0	0	5	502
Departure	648	688	40	27	0	675	10	0	0	10	685
Total	1,088	1,213	125	83	0	1,171	15	0	0	15	1,186
West Leg											
Approach	926	1,001	75	50	0	976	99	0	0	99	1,075
Departure	588	716	128	85	0	673	37	0	0	37	710
Total	1,514	1,717	203	136	0	1,650	136	0	0	136	1,786
Total Approaches											
Approach	2,133	2,457	324	216	0	2,349	136	0	0	136	2,485
Departure	2,133	2,457	324	216	0	2,349	136	0	0	136	2,485
Total	4,266	4,915	649	433	0	4,699	272	0	0	272	4,971

Table C-4 - Phase II Project Completion Year (2039) Volume Summary

	AM Peak Hour										
	Existing	Ph III 2049 without Project	Total Growth (2019-2049)	Adjusted Growth	Cumulative Projects	Year 2039 without Project	External Project Trips	Internal Project Trips	Pass-by Trips	Phases I + II Project Trips	Year 2039 with Project
50 Road 22/Cleveland Avenue											
NBL	0	0	0	0	0	0	0	0	0	0	0
NBT	0	0	0	0	0	0	0	0	0	0	0
NBR	0	0	0	0	0	0	0	0	0	0	0
SBL	0	0	0	0	0	0	0	0	0	0	0
SBT	0	0	0	0	0	0	0	0	0	0	0
SBR	0	0	0	0	0	0	0	0	0	0	0
EBL	0	0	0	0	0	0	0	0	0	0	0
EBT	0	0	0	0	0	0	0	0	0	0	0
EBR	0	0	0	0	0	0	0	0	0	0	0
WBL	0	0	0	0	0	0	0	0	0	0	0
WBT	0	0	0	0	0	0	0	0	0	0	0
WBR	0	0	0	0	0	0	0	0	0	0	0
North Leg											
Approach	0	0	0	0	0	0	0	0	0	0	0
Departure	0	0	0	0	0	0	0	0	0	0	0
Total	0	0	0	0	0	0	0	0	0	0	0
South Leg											
Approach	0	0	0	0	0	0	0	0	0	0	0
Departure	0	0	0	0	0	0	0	0	0	0	0
Total	0	0	0	0	0	0	0	0	0	0	0
East Leg											
Approach	0	0	0	0	0	0	0	0	0	0	0
Departure	0	0	0	0	0	0	0	0	0	0	0
Total	0	0	0	0	0	0	0	0	0	0	0
West Leg											
Approach	0	0	0	0	0	0	0	0	0	0	0
Departure	0	0	0	0	0	0	0	0	0	0	0
Total	0	0	0	0	0	0	0	0	0	0	0
Total Approaches											
Approach	0	0	0	0	0	0	0	0	0	0	0
Departure	0	0	0	0	0	0	0	0	0	0	0
Total	0	0	0	0	0	0	0	0	0	0	0

Table C-4 - Phase II Project Completion Year (2039) Volume Summary

	AM Peak Hour										
	Existing	Ph III 2049 without Project	Total Growth (2019-2049)	Adjusted Growth	Cumulative Projects	Year 2039 without Project	External Project Trips	Internal Project Trips	Pass-by Trips	Phases I + II Project Trips	Year 2039 with Project
51 Project Driveway 1/Avenue 17											
NBL	0	0	0	0	0	0	56	0	0	56	56
NBT	0	0	0	0	0	0	0	0	0	0	0
NBR	0	0	0	0	0	0	614	32	0	646	646
SBL	0	0	0	0	0	0	0	0	0	0	0
SBT	0	0	0	0	0	0	0	0	0	0	0
SBR	0	0	0	0	0	0	0	0	0	0	0
EBL	0	0	0	0	0	0	0	0	0	0	0
EBT	31	50	19	13	0	44	14	8	0	22	66
EBR	0	0	0	0	0	0	16	0	0	16	16
WBL	0	0	0	0	0	0	140	34	0	174	174
WBT	27	32	5	3	0	30	34	8	0	42	72
WBR	0	0	0	0	0	0	0	0	0	0	0
North Leg											
Approach	0	0	0	0	0	0	0	0	0	0	0
Departure	0	0	0	0	0	0	0	0	0	0	0
Total	0	0	0	0	0	0	0	0	0	0	0
South Leg											
Approach	0	0	0	0	0	0	670	32	0	702	702
Departure	0	0	0	0	0	0	156	34	0	190	190
Total	0	0	0	0	0	0	826	66	0	892	892
East Leg											
Approach	27	32	5	3	0	30	174	42	0	216	246
Departure	31	50	19	13	0	44	628	40	0	668	712
Total	58	82	24	16	0	74	802	82	0	884	958
West Leg											
Approach	31	50	19	13	0	44	30	8	0	38	82
Departure	27	32	5	3	0	30	90	8	0	98	128
Total	58	82	24	16	0	74	120	16	0	136	210
Total Approaches											
Approach	58	82	24	16	0	74	874	82	0	956	1,030
Departure	58	82	24	16	0	74	874	82	0	956	1,030
Total	116	164	48	32	0	148	1,748	164	0	1,912	2,060

Table C-4 - Phase II Project Completion Year (2039) Volume Summary

	AM Peak Hour										
	Existing	Ph III 2049 without Project	Total Growth (2019-2049)	Adjusted Growth	Cumulative Projects	Year 2039 without Project	External Project Trips	Internal Project Trips	Pass-by Trips	Phases I + II Project Trips	Year 2039 with Project
52 Road 22 ½ - Project Driveway 2/Avenue 16											
NBL	0	0	0	0	0	0	0	0	0	0	0
NBT	0	0	0	0	0	0	0	28	0	28	28
NBR	1	4	3	2	0	3	0	0	0	0	3
SBL	1	4	3	2	0	3	188	148	0	336	339
SBT	0	0	0	0	0	0	0	29	0	29	29
SBR	0	0	0	0	0	0	0	0	0	0	0
EBL	0	0	0	0	0	0	0	0	0	0	0
EBT	12	65	53	35	0	47	0	0	0	0	47
EBR	2	2	0	0	0	2	0	0	0	0	2
WBL	0	0	0	0	0	0	0	0	0	0	0
WBT	33	35	2	1	0	34	0	0	0	0	34
WBR	0	0	0	0	0	0	68	145	0	213	213
North Leg											
Approach	1	4	3	2	0	3	188	177	0	365	368
Departure	0	0	0	0	0	0	68	173	0	241	241
Total	1	4	3	2	0	3	256	350	0	606	609
South Leg											
Approach	1	4	3	2	0	3	0	28	0	28	31
Departure	2	2	0	0	0	2	0	29	0	29	31
Total	3	6	3	2	0	5	0	57	0	57	62
East Leg											
Approach	33	35	2	1	0	34	68	145	0	213	247
Departure	14	73	59	39	0	53	188	148	0	336	389
Total	47	108	61	40	0	87	256	293	0	549	636
West Leg											
Approach	14	67	53	35	0	49	0	0	0	0	49
Departure	33	35	2	1	0	34	0	0	0	0	34
Total	47	102	55	37	0	84	0	0	0	0	84
Total Approaches											
Approach	49	110	61	41	0	90	256	350	0	606	696
Departure	49	110	61	41	0	90	256	350	0	606	696
Total	98	220	122	81	0	179	512	700	0	1,212	1,391

Table C-4 - Phase II Project Completion Year (2039) Volume Summary

	AM Peak Hour										
	Existing	Ph III 2049 without Project	Total Growth (2019-2049)	Adjusted Growth	Cumulative Projects	Year 2039 without Project	External Project Trips	Internal Project Trips	Pass-by Trips	Phases I + II Project Trips	Year 2039 with Project
53 Road 22 1/2/Cleveland Avenue											
NBL	1	1	0	0	0	1	0	0	0	0	1
NBT	0	0	0	0	0	0	0	0	0	0	0
NBR	2	2	0	0	0	2	0	0	0	0	2
SBL	1	1	0	0	0	1	0	29	0	29	30
SBT	0	0	0	0	0	0	0	0	0	0	0
SBR	0	0	0	0	0	0	0	0	0	0	0
EBL	0	0	0	0	0	0	0	0	0	0	0
EBT	0	0	0	0	0	0	0	0	0	0	0
EBR	0	0	0	0	0	0	0	0	0	0	0
WBL	1	1	0	0	0	1	0	0	0	0	1
WBT	0	0	0	0	0	0	0	0	0	0	0
WBR	1	1	0	0	0	1	0	28	0	28	29
North Leg											
Approach	1	1	0	0	0	1	0	29	0	29	30
Departure	1	1	0	0	0	1	0	28	0	28	29
Total	2	2	0	0	0	2	0	57	0	57	59
South Leg											
Approach	3	3	0	0	0	3	0	0	0	0	3
Departure	1	1	0	0	0	1	0	0	0	0	1
Total	4	4	0	0	0	4	0	0	0	0	4
East Leg											
Approach	2	2	0	0	0	2	0	28	0	28	30
Departure	3	3	0	0	0	3	0	29	0	29	32
Total	5	5	0	0	0	5	0	57	0	57	62
West Leg											
Approach	0	0	0	0	0	0	0	0	0	0	0
Departure	1	1	0	0	0	1	0	0	0	0	1
Total	1	1	0	0	0	1	0	0	0	0	1
Total Approaches											
Approach	6	6	0	0	0	6	0	57	0	57	63
Departure	6	6	0	0	0	6	0	57	0	57	63
Total	12	13	1	0	0	12	0	114	0	114	126

Table C-4 - Phase II Project Completion Year (2039) Volume Summary

	AM Peak Hour										
	Existing	Ph III 2049 without Project	Total Growth (2019-2049)	Adjusted Growth	Cumulative Projects	Year 2039 without Project	External Project Trips	Internal Project Trips	Pass-by Trips	Phases I + II Project Trips	Year 2039 with Project
54 Road 22 1/2/Project Driveway 5											
NBL	0	0	0	0	0	0	0	0	0	0	0
NBT	0	0	0	0	0	0	0	0	0	0	0
NBR	0	0	0	0	0	0	0	0	0	0	0
SBL	0	0	0	0	0	0	0	0	0	0	0
SBT	0	0	0	0	0	0	0	0	0	0	0
SBR	0	0	0	0	0	0	0	0	0	0	0
EBL	0	0	0	0	0	0	0	0	0	0	0
EBT	0	0	0	0	0	0	0	0	0	0	0
EBR	0	0	0	0	0	0	0	0	0	0	0
WBL	0	0	0	0	0	0	0	0	0	0	0
WBT	0	0	0	0	0	0	0	0	0	0	0
WBR	0	0	0	0	0	0	0	0	0	0	0
North Leg											
Approach	0	0	0	0	0	0	0	0	0	0	0
Departure	0	0	0	0	0	0	0	0	0	0	0
Total	0	0	0	0	0	0	0	0	0	0	0
South Leg											
Approach	0	0	0	0	0	0	0	0	0	0	0
Departure	0	0	0	0	0	0	0	0	0	0	0
Total	0	0	0	0	0	0	0	0	0	0	0
East Leg											
Approach	0	0	0	0	0	0	0	0	0	0	0
Departure	0	0	0	0	0	0	0	0	0	0	0
Total	0	0	0	0	0	0	0	0	0	0	0
West Leg											
Approach	0	0	0	0	0	0	0	0	0	0	0
Departure	0	0	0	0	0	0	0	0	0	0	0
Total	0	0	0	0	0	0	0	0	0	0	0
Total Approaches											
Approach	0	0	0	0	0	0	0	0	0	0	0
Departure	0	0	0	0	0	0	0	0	0	0	0
Total	0	0	0	0	0	0	0	0	0	0	0

Table C-4 - Phase II Project Completion Year (2039) Volume Summary

	AM Peak Hour										
	Existing	Ph III 2049 without Project	Total Growth (2019-2049)	Adjusted Growth	Cumulative Projects	Year 2039 without Project	External Project Trips	Internal Project Trips	Pass-by Trips	Phases I + II Project Trips	Year 2039 with Project
55 Road 23/Project Driveway 3											
NBL	0	0	0	0	0	0	13	216	0	229	229
NBT	232	300	68	45	0	277	386	126	0	512	789
NBR	0	0	0	0	0	0	0	0	0	0	0
SBL	0	0	0	0	0	0	0	0	0	0	0
SBT	160	325	165	110	0	270	165	131	0	296	566
SBR	0	0	0	0	0	0	327	21	0	348	348
EBL	0	0	0	0	0	0	800	20	0	820	820
EBT	0	0	0	0	0	0	0	0	0	0	0
EBR	0	0	0	0	0	0	42	220	0	262	262
WBL	0	0	0	0	0	0	0	0	0	0	0
WBT	0	0	0	0	0	0	0	0	0	0	0
WBR	0	0	0	0	0	0	0	0	0	0	0
North Leg											
Approach	160	325	165	110	0	270	492	152	0	644	914
Departure	232	300	68	45	0	277	1,186	146	0	1,332	1,609
Total	392	625	233	155	0	547	1,678	298	0	1,976	2,523
South Leg											
Approach	232	300	68	45	0	277	399	342	0	741	1,018
Departure	160	325	165	110	0	270	207	351	0	558	828
Total	392	625	233	155	0	547	606	693	0	1,299	1,846
East Leg											
Approach	0	0	0	0	0	0	0	0	0	0	0
Departure	0	0	0	0	0	0	0	0	0	0	0
Total	0	0	0	0	0	0	0	0	0	0	0
West Leg											
Approach	0	0	0	0	0	0	842	240	0	1,082	1,082
Departure	0	0	0	0	0	0	340	237	0	577	577
Total	0	0	0	0	0	0	1,182	477	0	1,659	1,659
Total Approaches											
Approach	392	625	233	155	0	547	1,733	734	0	2,467	3,014
Departure	392	625	233	155	0	547	1,733	734	0	2,467	3,014
Total	784	1,250	466	311	0	1,095	3,466	1,468	0	4,934	6,029

Table C-4 - Phase II Project Completion Year (2039) Volume Summary

	AM Peak Hour										
	Existing	Ph III 2049 without Project	Total Growth (2019-2049)	Adjusted Growth	Cumulative Projects	Year 2039 without Project	External Project Trips	Internal Project Trips	Pass-by Trips	Phases I + II Project Trips	Year 2039 with Project
56 Road 23/Project Driveway 4											
NBL	0	0	0	0	0	0	0	0	0	0	0
NBT	266	279	13	9	0	275	121	0	0	121	396
NBR	0	0	0	0	0	0	110	0	0	110	110
SBL	0	0	0	0	0	0	132	296	0	428	428
SBT	209	219	10	7	0	216	387	0	0	387	603
SBR	0	0	0	0	0	0	0	0	0	0	0
EBL	0	0	0	0	0	0	0	0	0	0	0
EBT	0	0	0	0	0	0	0	0	0	0	0
EBR	0	0	0	0	0	0	0	0	0	0	0
WBL	0	0	0	0	0	0	80	0	0	80	80
WBT	0	0	0	0	0	0	0	0	0	0	0
WBR	0	0	0	0	0	0	263	282	0	545	545
North Leg											
Approach	209	219	10	7	0	216	519	296	0	815	1,031
Departure	266	279	13	9	0	275	384	282	0	666	941
Total	475	499	24	16	0	491	903	578	0	1,481	1,972
South Leg											
Approach	266	279	13	9	0	275	231	0	0	231	506
Departure	209	219	10	7	0	216	467	0	0	467	683
Total	475	499	24	16	0	491	698	0	0	698	1,189
East Leg											
Approach	0	0	0	0	0	0	343	282	0	625	625
Departure	0	0	0	0	0	0	242	296	0	538	538
Total	0	0	0	0	0	0	585	578	0	1,163	1,163
West Leg											
Approach	0	0	0	0	0	0	0	0	0	0	0
Departure	0	0	0	0	0	0	0	0	0	0	0
Total	0	0	0	0	0	0	0	0	0	0	0
Total Approaches											
Approach	475	499	24	16	0	491	1,093	578	0	1,671	2,162
Departure	475	499	24	16	0	491	1,093	578	0	1,671	2,162
Total	950	998	48	32	0	982	2,186	1,156	0	3,342	4,324

Table C-4 - Phase II Project Completion Year (2039) Volume Summary

	AM Peak Hour										
	Existing	Ph III 2049 without Project	Total Growth (2019-2049)	Adjusted Growth	Cumulative Projects	Year 2039 without Project	External Project Trips	Internal Project Trips	Pass-by Trips	Phases I + II Project Trips	Year 2039 with Project
57 Road 23/Project Driveway 5											
NBL	1	1	0	0	0	1	0	0	0	0	1
NBT	266	279	13	9	0	275	231	0	0	231	506
NBR	0	0	0	0	0	0	0	0	0	0	0
SBL	0	0	0	0	0	0	0	0	0	0	0
SBT	209	979	770	513	0	722	466	0	0	466	1188
SBR	0	0	0	0	0	0	0	0	0	0	0
EBL	0	0	0	0	0	0	0	0	0	0	0
EBT	0	0	0	0	0	0	0	0	0	0	0
EBR	1	1	0	0	0	1	0	0	0	0	1
WBL	0	0	0	0	0	0	0	0	0	0	0
WBT	0	0	0	0	0	0	0	0	0	0	0
WBR	0	0	0	0	0	0	0	0	0	0	0
North Leg											
Approach	209	979	770	513	0	722	466	0	0	466	1,188
Departure	266	279	13	9	0	275	231	0	0	231	506
Total	475	1,258	783	522	0	997	697	0	0	697	1,694
South Leg											
Approach	267	280	13	9	0	276	231	0	0	231	507
Departure	210	980	770	513	0	723	466	0	0	466	1,189
Total	477	1,260	783	522	0	999	697	0	0	697	1,696
East Leg											
Approach	0	0	0	0	0	0	0	0	0	0	0
Departure	0	0	0	0	0	0	0	0	0	0	0
Total	0	0	0	0	0	0	0	0	0	0	0
West Leg											
Approach	1	1	0	0	0	1	0	0	0	0	1
Departure	1	1	0	0	0	1	0	0	0	0	1
Total	2	2	0	0	0	2	0	0	0	0	2
Total Approaches											
Approach	477	1,260	783	522	0	999	697	0	0	697	1,696
Departure	477	1,260	783	522	0	999	697	0	0	697	1,696
Total	954	2,521	1,567	1,045	0	1,999	1,394	0	0	1,394	3,393

Table C-4 - Phase II Project Completion Year (2039) Volume Summary

	AM Peak Hour										
	Existing	Ph III 2049 without Project	Total Growth (2019-2049)	Adjusted Growth	Cumulative Projects	Year 2039 without Project	External Project Trips	Internal Project Trips	Pass-by Trips	Phases I + II Project Trips	Year 2039 with Project
58 Project Driveway 6/Cleveland Avenue											
NBL	0	0	0	0	0	0	194	5	0	199	199
NBT	0	0	0	0	0	0	0	0	0	0	0
NBR	0	0	0	0	0	0	292	0	0	292	292
SBL	0	0	0	0	0	0	0	0	0	0	0
SBT	0	0	0	0	0	0	0	0	0	0	0
SBR	0	0	0	0	0	0	0	0	0	0	0
EBL	0	0	0	0	0	0	0	0	0	0	0
EBT	63	66	3	2	0	65	821	19	0	840	905
EBR	0	0	0	0	0	0	75	5	0	80	80
WBL	0	0	0	0	0	0	154	0	0	154	154
WBT	84	88	4	3	0	87	218	18	0	236	323
WBR	0	0	0	0	0	0	0	0	0	0	0
North Leg											
Approach	0	0	0	0	0	0	0	0	0	0	0
Departure	0	0	0	0	0	0	0	0	0	0	0
Total	0	0	0	0	0	0	0	0	0	0	0
South Leg											
Approach	0	0	0	0	0	0	486	5	0	491	491
Departure	0	0	0	0	0	0	229	5	0	234	234
Total	0	0	0	0	0	0	715	10	0	725	725
East Leg											
Approach	84	88	4	3	0	87	372	18	0	390	477
Departure	63	66	3	2	0	65	1,113	19	0	1,132	1,197
Total	147	154	7	5	0	152	1,485	37	0	1,522	1,674
West Leg											
Approach	63	66	3	2	0	65	896	24	0	920	985
Departure	84	88	4	3	0	87	412	23	0	435	522
Total	147	154	7	5	0	152	1,308	47	0	1,355	1,507
Total Approaches											
Approach	147	154	7	5	0	152	1,754	47	0	1,801	1,953
Departure	147	154	7	5	0	152	1,754	47	0	1,801	1,953
Total	294	309	15	10	0	304	3,508	94	0	3,602	3,906

Table C-4 - Phase II Project Completion Year (2039) Volume Summary

	PM Peak Hour										
	Existing	Ph III 2049 without Project	Total Growth (2019-2049)	Adjusted Growth	Cumulative Projects	Year 2039 without Project	External Project Trips	Internal Project Trips	Pass-by Trips	Phases I + II Project Trips	Year 2039 with Project
1 Road 22/Avenue 17											
NBL	1	1	0	0	0	1	0	0	0	0	1
NBT	0	0	0	0	0	0	0	0	0	0	0
NBR	0	0	0	0	0	0	0	0	0	0	0
SBL	0	0	0	0	0	0	0	0	0	0	0
SBT	0	0	0	0	0	0	0	0	0	0	0
SBR	0	0	0	0	0	0	0	0	0	0	0
EBL	0	0	0	0	0	0	0	0	0	0	0
EBT	60	66	6	4	0	64	81	0	0	81	145
EBR	0	0	0	0	0	0	0	0	0	0	0
WBL	0	0	0	0	0	0	0	0	0	0	0
WBT	25	38	13	9	0	34	39	0	0	39	73
WBR	0	0	0	0	0	0	0	0	0	0	0
North Leg											
Approach	0	0	0	0	0	0	0	0	0	0	0
Departure	0	0	0	0	0	0	0	0	0	0	0
Total	0	0	0	0	0	0	0	0	0	0	0
South Leg											
Approach	1	1	0	0	0	1	0	0	0	0	1
Departure	0	0	0	0	0	0	0	0	0	0	0
Total	1	1	0	0	0	1	0	0	0	0	1
East Leg											
Approach	25	38	13	9	0	34	39	0	0	39	73
Departure	60	66	6	4	0	64	81	0	0	81	145
Total	85	104	19	13	0	98	120	0	0	120	218
West Leg											
Approach	60	66	6	4	0	64	81	0	0	81	145
Departure	26	39	13	9	0	35	39	0	0	39	74
Total	86	105	19	13	0	99	120	0	0	120	219
Total Approaches											
Approach	86	105	19	13	0	99	120	0	0	120	219
Departure	86	105	19	13	0	99	120	0	0	120	219
Total	172	210	38	25	0	197	240	0	0	240	437

Table C-4 - Phase II Project Completion Year (2039) Volume Summary

	PM Peak Hour										
	Existing	Ph III 2049 without Project	Total Growth (2019-2049)	Adjusted Growth	Cumulative Projects	Year 2039 without Project	External Project Trips	Internal Project Trips	Pass-by Trips	Phases I + II Project Trips	Year 2039 with Project
2 Road 22/Avenue 16											
NBL	0	0	0	0	0	0	0	0	0	0	0
NBT	0	0	0	0	0	0	0	0	0	0	0
NBR	1	1	0	0	0	1	0	0	0	0	1
SBL	0	0	0	0	0	0	0	0	0	0	0
SBT	0	0	0	0	0	0	0	0	0	0	0
SBR	0	0	0	0	0	0	0	0	0	0	0
EBL	0	0	0	0	0	0	0	0	0	0	0
EBT	48	50	2	2	0	50	0	0	0	0	50
EBR	0	0	0	0	0	0	0	0	0	0	0
WBL	0	0	0	0	0	0	0	0	0	0	0
WBT	14	15	1	1	0	15	0	0	0	0	15
WBR	0	0	0	0	0	0	0	0	0	0	0
North Leg											
Approach	0	0	0	0	0	0	0	0	0	0	0
Departure	0	0	0	0	0	0	0	0	0	0	0
Total	0	0	0	0	0	0	0	0	0	0	0
South Leg											
Approach	1	1	0	0	0	1	0	0	0	0	1
Departure	0	0	0	0	0	0	0	0	0	0	0
Total	1	1	0	0	0	1	0	0	0	0	1
East Leg											
Approach	14	15	1	1	0	15	0	0	0	0	15
Departure	49	51	2	2	0	51	0	0	0	0	51
Total	63	66	3	2	0	65	0	0	0	0	65
West Leg											
Approach	48	50	2	2	0	50	0	0	0	0	50
Departure	14	15	1	1	0	15	0	0	0	0	15
Total	62	65	3	2	0	64	0	0	0	0	64
Total Approaches											
Approach	63	66	3	2	0	65	0	0	0	0	65
Departure	63	66	3	2	0	65	0	0	0	0	65
Total	126	133	7	5	0	131	0	0	0	0	131

Table C-4 - Phase II Project Completion Year (2039) Volume Summary

	PM Peak Hour										
	Existing	Ph III 2049 without Project	Total Growth (2019-2049)	Adjusted Growth	Cumulative Projects	Year 2039 without Project	External Project Trips	Internal Project Trips	Pass-by Trips	Phases I + II Project Trips	Year 2039 with Project
3 Golden State Boulevard/Avenue 18 ½											
NBL	0	0	0	0	0	0	0	0	0	0	0
NBT	0	0	0	0	0	0	0	0	0	0	0
NBR	0	0	0	0	0	0	0	0	0	0	0
SBL	252	270	18	12	0	264	0	0	0	0	264
SBT	0	0	0	0	0	0	0	0	0	0	0
SBR	8	8	0	0	0	8	0	0	0	0	8
EBL	7	7	0	0	0	7	0	0	0	0	7
EBT	117	137	20	13	0	130	61	0	0	61	191
EBR	0	0	0	0	0	0	0	0	0	0	0
WBL	0	0	0	0	0	0	0	0	0	0	0
WBT	60	80	20	13	0	73	34	0	0	34	107
WBR	96	115	19	13	0	109	0	0	0	0	109
North Leg											
Approach	260	278	18	12	0	272	0	0	0	0	272
Departure	103	122	19	13	0	116	0	0	0	0	116
Total	363	401	38	25	0	388	0	0	0	0	388
South Leg											
Approach	0	0	0	0	0	0	0	0	0	0	0
Departure	0	0	0	0	0	0	0	0	0	0	0
Total	0	0	0	0	0	0	0	0	0	0	0
East Leg											
Approach	156	195	39	26	0	182	34	0	0	34	216
Departure	369	407	38	25	0	394	61	0	0	61	455
Total	525	602	77	51	0	576	95	0	0	95	671
West Leg											
Approach	124	144	20	14	0	138	61	0	0	61	199
Departure	68	88	20	14	0	82	34	0	0	34	116
Total	192	233	41	27	0	219	95	0	0	95	314
Total Approaches											
Approach	540	618	78	52	0	592	95	0	0	95	687
Departure	540	618	78	52	0	592	95	0	0	95	687
Total	1,080	1,236	156	104	0	1,184	190	0	0	190	1,374

Table C-4 - Phase II Project Completion Year (2039) Volume Summary

	PM Peak Hour										
	Existing	Ph III 2049 without Project	Total Growth (2019-2049)	Adjusted Growth	Cumulative Projects	Year 2039 without Project	External Project Trips	Internal Project Trips	Pass-by Trips	Phases I + II Project Trips	Year 2039 with Project
4 Pistachio Drive/Avenue 18 ½											
NBL	2	2	0	0	0	2	0	0	0	0	2
NBT	0	0	0	0	0	0	0	0	0	0	0
NBR	5	5	0	0	0	5	0	0	0	0	5
SBL	154	170	16	11	0	165	0	0	0	0	165
SBT	0	0	0	0	0	0	0	0	0	0	0
SBR	12	13	1	1	0	13	0	0	0	0	13
EBL	12	13	1	0	0	12	0	0	0	0	12
EBT	425	446	21	14	0	439	61	0	0	61	500
EBR	1	1	0	0	0	1	0	0	0	0	1
WBL	6	6	0	0	0	6	0	0	0	0	6
WBT	148	167	19	13	0	161	34	0	0	34	195
WBR	187	206	19	13	0	200	0	0	0	0	200
North Leg											
Approach	166	183	17	11	0	177	0	0	0	0	177
Departure	199	219	20	13	0	212	0	0	0	0	212
Total	365	402	37	24	0	389	0	0	0	0	389
South Leg											
Approach	7	7	0	0	0	7	0	0	0	0	7
Departure	7	7	0	0	0	7	0	0	0	0	7
Total	14	15	1	0	0	14	0	0	0	0	14
East Leg											
Approach	341	379	38	26	0	367	34	0	0	34	401
Departure	584	621	37	25	0	609	61	0	0	61	670
Total	925	1,001	76	50	0	975	95	0	0	95	1,070
West Leg											
Approach	438	460	22	14	0	452	61	0	0	61	513
Departure	162	182	20	13	0	175	34	0	0	34	209
Total	600	642	42	28	0	628	95	0	0	95	723
Total Approaches											
Approach	952	1,029	77	52	0	1,004	95	0	0	95	1,099
Departure	952	1,029	77	52	0	1,004	95	0	0	95	1,099
Total	1,904	2,059	155	103	0	2,007	190	0	0	190	2,197

Table C-4 - Phase II Project Completion Year (2039) Volume Summary

	PM Peak Hour										
	Existing	Ph III 2049 without Project	Total Growth (2019-2049)	Adjusted Growth	Cumulative Projects	Year 2039 without Project	External Project Trips	Internal Project Trips	Pass-by Trips	Phases I + II Project Trips	Year 2039 with Project
5 SR-99 Southbound Ramps – Road 23/Avenue 18 ½											
NBL	31	48	17	11	0	42	34	0	0	34	76
NBT	0	0	0	0	0	0	0	0	0	0	0
NBR	75	162	87	58	0	133	194	0	0	194	327
SBL	19	28	9	6	0	25	0	0	0	0	25
SBT	93	136	43	29	0	122	370	0	0	370	492
SBR	120	127	7	5	0	125	0	0	0	0	125
EBL	0	0	0	0	0	0	0	0	0	0	0
EBT	380	405	25	17	0	397	0	0	0	0	397
EBR	204	216	12	8	0	212	61	0	0	61	273
WBL	39	58	19	13	0	52	0	0	0	0	52
WBT	191	206	15	10	0	201	0	0	0	0	201
WBR	0	0	0	0	0	0	0	0	0	0	0
North Leg											
Approach	232	291	59	39	0	271	370	0	0	370	641
Departure	0	0	0	0	0	0	0	0	0	0	0
Total	232	291	59	39	0	271	370	0	0	370	641
South Leg											
Approach	106	210	104	69	0	175	228	0	0	228	403
Departure	336	410	74	49	0	385	431	0	0	431	816
Total	442	620	178	119	0	561	659	0	0	659	1,220
East Leg											
Approach	230	264	34	23	0	253	0	0	0	0	253
Departure	474	595	121	81	0	555	194	0	0	194	749
Total	704	859	155	103	0	807	194	0	0	194	1,001
West Leg											
Approach	584	621	37	25	0	609	61	0	0	61	670
Departure	342	381	39	26	0	368	34	0	0	34	402
Total	926	1,002	76	51	0	977	95	0	0	95	1,072
Total Approaches											
Approach	1,152	1,386	234	156	0	1,308	659	0	0	659	1,967
Departure	1,152	1,386	234	156	0	1,308	659	0	0	659	1,967
Total	2,304	2,772	468	312	0	2,616	1,318	0	0	1,318	3,934

Table C-4 - Phase II Project Completion Year (2039) Volume Summary

	PM Peak Hour										
	Existing	Ph III 2049 without Project	Total Growth (2019-2049)	Adjusted Growth	Cumulative Projects	Year 2039 without Project	External Project Trips	Internal Project Trips	Pass-by Trips	Phases I + II Project Trips	Year 2039 with Project
6 SR-99 Northbound Ramps/Avenue 18 ½											
NBL	179	196	17	11	0	190	0	0	0	0	190
NBT	2	3	1	1	0	3	0	0	0	0	3
NBR	0	0	0	0	0	0	0	0	0	0	0
SBL	0	0	0	0	0	0	0	0	0	0	0
SBT	0	0	0	0	0	0	0	0	0	0	0
SBR	0	0	0	0	0	0	0	0	0	0	0
EBL	171	235	64	43	0	214	194	0	0	194	408
EBT	81	124	43	29	0	110	0	0	0	0	110
EBR	0	0	0	0	0	0	0	0	0	0	0
WBL	0	0	0	0	0	0	0	0	0	0	0
WBT	78	99	21	14	0	92	0	0	0	0	92
WBR	13	22	9	6	0	19	0	0	0	0	19
North Leg											
Approach	0	0	0	0	0	0	0	0	0	0	0
Departure	186	260	74	49	0	235	194	0	0	194	429
Total	186	260	74	49	0	235	194	0	0	194	429
South Leg											
Approach	181	199	18	12	0	193	0	0	0	0	193
Departure	0	0	0	0	0	0	0	0	0	0	0
Total	181	199	18	12	0	193	0	0	0	0	193
East Leg											
Approach	91	121	30	20	0	111	0	0	0	0	111
Departure	81	124	43	29	0	110	0	0	0	0	110
Total	172	245	73	49	0	221	0	0	0	0	221
West Leg											
Approach	252	359	107	71	0	323	194	0	0	194	517
Departure	257	295	38	25	0	282	0	0	0	0	282
Total	509	654	145	97	0	606	194	0	0	194	800
Total Approaches											
Approach	524	679	155	103	0	627	194	0	0	194	821
Departure	524	679	155	103	0	627	194	0	0	194	821
Total	1,048	1,358	310	207	0	1,255	388	0	0	388	1,643

Table C-4 - Phase II Project Completion Year (2039) Volume Summary

	PM Peak Hour										
	Existing	Ph III 2049 without Project	Total Growth (2019-2049)	Adjusted Growth	Cumulative Projects	Year 2039 without Project	External Project Trips	Internal Project Trips	Pass-by Trips	Phases I + II Project Trips	Year 2039 with Project
7 Road 23/Avenue 17											
NBL	5	8	3	2	0	7	13	65	0	78	85
NBT	77	85	8	5	0	82	235	0	0	235	317
NBR	60	65	5	3	0	63	361	0	0	361	424
SBL	61	64	3	2	0	63	0	0	0	0	63
SBT	219	221	2	1	0	220	441	0	0	441	661
SBR	2	3	1	1	0	3	163	0	0	163	166
EBL	1	1	0	0	0	1	82	0	0	82	83
EBT	48	53	5	3	0	51	210	0	0	210	261
EBR	11	12	1	1	0	12	30	65	0	95	107
WBL	29	30	1	1	0	30	616	0	0	616	646
WBT	19	29	10	7	0	26	448	0	0	448	474
WBR	9	10	1	1	0	10	0	0	0	0	10
North Leg											
Approach	282	288	6	4	0	286	604	0	0	604	890
Departure	87	96	9	6	0	93	317	0	0	317	410
Total	369	384	15	10	0	379	921	0	0	921	1,300
South Leg											
Approach	142	158	16	11	0	153	609	65	0	674	827
Departure	259	263	4	3	0	262	1,087	65	0	1,152	1,414
Total	401	421	20	13	0	414	1,696	130	0	1,826	2,240
East Leg											
Approach	57	69	12	8	0	65	1,064	0	0	1,064	1,129
Departure	169	182	13	9	0	178	571	0	0	571	749
Total	226	251	25	17	0	243	1,635	0	0	1,635	1,878
West Leg											
Approach	60	66	6	4	0	64	322	65	0	387	451
Departure	26	40	14	9	0	35	624	65	0	689	724
Total	86	106	20	13	0	99	946	130	0	1,076	1,175
Total Approaches											
Approach	541	581	40	27	0	568	2,599	130	0	2,729	3,297
Departure	541	581	40	27	0	568	2,599	130	0	2,729	3,297
Total	1,082	1,162	80	53	0	1,135	5,198	260	0	5,458	6,593

Table C-4 - Phase II Project Completion Year (2039) Volume Summary

	PM Peak Hour										
	Existing	Ph III 2049 without Project	Total Growth (2019-2049)	Adjusted Growth	Cumulative Projects	Year 2039 without Project	External Project Trips	Internal Project Trips	Pass-by Trips	Phases I + II Project Trips	Year 2039 with Project
8 Road 23/Avenue 16											
NBL	7	14	7	5	0	12	155	117	-1	271	283
NBT	136	274	138	92	0	228	205	538	2	745	973
NBR	1	1	0	0	0	1	126	0	-1	125	126
SBL	2	2	0	0	0	2	182	131	2	315	317
SBT	253	310	57	38	0	291	244	535	4	783	1,074
SBR	6	51	45	30	0	36	0	79	2	81	117
EBL	9	31	22	15	0	24	0	79	1	80	104
EBT	0	0	0	0	0	0	0	52	0	52	52
EBR	41	43	2	1	0	42	70	116	-1	185	227
WBL	0	0	0	0	0	0	49	0	-1	48	48
WBT	1	1	0	0	0	1	0	52	0	52	53
WBR	1	1	0	0	0	1	71	131	1	203	204
North Leg											
Approach	261	363	102	68	0	329	426	745	8	1,179	1,508
Departure	146	306	160	107	0	253	276	748	4	1,028	1,281
Total	407	669	262	175	0	582	702	1,493	12	2,207	2,789
South Leg											
Approach	144	289	145	97	0	241	486	655	0	1,141	1,382
Departure	294	353	59	39	0	333	363	651	2	1,016	1,349
Total	438	642	204	136	0	574	849	1,306	2	2,157	2,731
East Leg											
Approach	2	2	0	0	0	2	120	183	0	303	305
Departure	3	3	0	0	0	3	308	183	1	492	495
Total	5	5	0	0	0	5	428	366	1	795	800
West Leg											
Approach	50	74	24	16	0	66	70	247	0	317	383
Departure	14	66	52	35	0	49	155	248	1	404	453
Total	64	140	76	51	0	115	225	495	1	721	836
Total Approaches											
Approach	457	728	271	181	0	638	1,102	1,830	8	2,940	3,578
Departure	457	728	271	181	0	638	1,102	1,830	8	2,940	3,578
Total	914	1,457	543	362	0	1,276	2,204	3,660	16	5,880	7,156

Table C-4 - Phase II Project Completion Year (2039) Volume Summary

	PM Peak Hour										
	Existing	Ph III 2049 without Project	Total Growth (2019-2049)	Adjusted Growth	Cumulative Projects	Year 2039 without Project	External Project Trips	Internal Project Trips	Pass-by Trips	Phases I + II Project Trips	Year 2039 with Project
9 Road 23/Cleveland Avenue											
NBL	0	0	0	0	0	0	0	13	0	13	13
NBT	113	174	61	41	0	154	314	564	14	892	1,046
NBR	89	120	31	21	0	110	204	0	-15	189	299
SBL	59	93	34	23	0	82	140	70	-13	197	279
SBT	224	235	11	7	0	231	222	561	13	796	1,027
SBR	1	1	0	0	0	1	0	0	0	0	1
EBL	1	1	0	0	0	1	0	0	0	0	1
EBT	0	0	0	0	0	0	0	25	0	25	25
EBR	1	1	0	0	0	1	0	13	0	13	14
WBL	51	62	11	7	0	58	201	0	-11	190	248
WBT	0	0	0	0	0	0	0	25	0	25	25
WBR	25	55	30	20	0	45	172	70	-12	230	275
North Leg											
Approach	284	329	45	30	0	314	362	631	0	993	1,307
Departure	139	230	91	61	0	200	486	634	2	1,122	1,322
Total	423	559	136	91	0	514	848	1,265	2	2,115	2,629
South Leg											
Approach	202	294	92	61	0	263	518	577	-1	1,094	1,357
Departure	276	298	22	15	0	291	423	574	2	999	1,290
Total	478	592	114	76	0	554	941	1,151	1	2,093	2,647
East Leg											
Approach	76	117	41	27	0	103	373	95	-23	445	548
Departure	148	213	65	43	0	191	344	95	-28	411	602
Total	224	330	106	71	0	295	717	190	-51	856	1,151
West Leg											
Approach	2	2	0	0	0	2	0	38	0	38	40
Departure	1	1	0	0	0	1	0	38	0	38	39
Total	3	3	0	0	0	3	0	76	0	76	79
Total Approaches											
Approach	564	742	178	119	0	683	1,253	1,341	-24	2,570	3,253
Departure	564	742	178	119	0	683	1,253	1,341	-24	2,570	3,253
Total	1,128	1,485	357	238	0	1,366	2,506	2,682	-48	5,140	6,506

Table C-4 - Phase II Project Completion Year (2039) Volume Summary

	PM Peak Hour										
	Existing	Ph III 2049 without Project	Total Growth (2019-2049)	Adjusted Growth	Cumulative Projects	Year 2039 without Project	External Project Trips	Internal Project Trips	Pass-by Trips	Phases I + II Project Trips	Year 2039 with Project
10 Road 23/Avenue 14 ½											
NBL	2	2	0	0	0	2	0	0	0	0	2
NBT	179	277	98	65	0	244	481	0	0	481	725
NBR	2	2	0	0	0	2	0	0	0	0	2
SBL	60	67	7	5	0	65	110	0	0	110	175
SBT	215	231	16	11	0	226	339	0	0	339	565
SBR	0	0	0	0	0	0	0	0	0	0	0
EBL	1	1	0	0	0	1	0	0	0	0	1
EBT	2	2	0	0	0	2	0	0	0	0	2
EBR	3	3	0	0	0	3	0	0	0	0	3
WBL	4	6	2	1	0	5	0	0	0	0	5
WBT	3	3	0	0	0	3	0	0	0	0	3
WBR	8	16	8	5	0	13	131	0	0	131	144
North Leg											
Approach	275	298	23	15	0	290	449	0	0	449	739
Departure	188	294	106	71	0	259	612	0	0	612	871
Total	463	592	129	86	0	549	1,061	0	0	1,061	1,610
South Leg											
Approach	183	281	98	65	0	248	481	0	0	481	729
Departure	222	240	18	12	0	234	339	0	0	339	573
Total	405	521	116	78	0	483	820	0	0	820	1,303
East Leg											
Approach	15	25	10	7	0	22	131	0	0	131	153
Departure	64	71	7	5	0	69	110	0	0	110	179
Total	79	96	17	12	0	91	241	0	0	241	332
West Leg											
Approach	6	6	0	0	0	6	0	0	0	0	6
Departure	5	5	0	0	0	5	0	0	0	0	5
Total	11	12	1	0	0	11	0	0	0	0	11
Total Approaches											
Approach	479	611	132	88	0	567	1,061	0	0	1,061	1,628
Departure	479	611	132	88	0	567	1,061	0	0	1,061	1,628
Total	958	1,221	263	176	0	1,134	2,122	0	0	2,122	3,256

Table C-4 - Phase II Project Completion Year (2039) Volume Summary

	PM Peak Hour										
	Existing	Ph III 2049 without Project	Total Growth (2019-2049)	Adjusted Growth	Cumulative Projects	Year 2039 without Project	External Project Trips	Internal Project Trips	Pass-by Trips	Phases I + II Project Trips	Year 2039 with Project
11 Road 23/Avenue 14											
NBL	14	15	1	0	0	14	0	0	0	0	14
NBT	91	124	33	22	0	113	143	0	0	143	256
NBR	21	22	1	1	0	22	0	0	0	0	22
SBL	70	72	2	1	0	71	217	0	0	217	288
SBT	121	124	3	2	0	123	90	0	0	90	213
SBR	29	45	16	11	0	40	30	0	0	30	70
EBL	44	91	47	31	0	75	59	0	0	59	134
EBT	89	93	4	3	0	92	0	0	0	0	92
EBR	34	36	2	1	0	35	0	0	0	0	35
WBL	11	12	1	0	0	11	0	0	0	0	11
WBT	36	38	2	1	0	37	0	0	0	0	37
WBR	49	66	17	12	0	61	279	0	0	279	340
North Leg											
Approach	220	241	21	14	0	234	337	0	0	337	571
Departure	184	281	97	65	0	249	481	0	0	481	730
Total	404	522	118	78	0	482	818	0	0	818	1,300
South Leg											
Approach	126	160	34	23	0	149	143	0	0	143	292
Departure	166	171	5	4	0	170	90	0	0	90	260
Total	292	332	40	26	0	318	233	0	0	233	551
East Leg											
Approach	96	116	20	13	0	109	279	0	0	279	388
Departure	180	187	7	5	0	185	217	0	0	217	402
Total	276	303	27	18	0	294	496	0	0	496	790
West Leg											
Approach	167	220	53	35	0	202	59	0	0	59	261
Departure	79	98	19	12	0	91	30	0	0	30	121
Total	246	318	72	48	0	294	89	0	0	89	383
Total Approaches											
Approach	609	737	128	85	0	694	818	0	0	818	1,512
Departure	609	737	128	85	0	694	818	0	0	818	1,512
Total	1,218	1,474	256	170	0	1,388	1,636	0	0	1,636	3,024

Table C-4 - Phase II Project Completion Year (2039) Volume Summary

	PM Peak Hour										
	Existing	Ph III 2049 without Project	Total Growth (2019-2049)	Adjusted Growth	Cumulative Projects	Year 2039 without Project	External Project Trips	Internal Project Trips	Pass-by Trips	Phases I + II Project Trips	Year 2039 with Project
12 Road 23/Avenue 12											
NBL	4	4	0	0	0	4	0	0	0	0	4
NBT	40	42	2	1	0	41	38	0	0	38	79
NBR	38	48	10	7	0	45	0	0	0	0	45
SBL	55	58	3	2	0	57	24	0	0	24	81
SBT	45	47	2	2	0	47	22	0	0	22	69
SBR	33	35	2	1	0	34	24	0	0	24	58
EBL	56	59	3	2	0	58	45	0	0	45	103
EBT	116	178	62	41	0	157	0	0	0	0	157
EBR	8	9	1	1	0	9	0	0	0	0	9
WBL	14	23	9	6	0	20	0	0	0	0	20
WBT	66	96	30	20	0	86	0	0	0	0	86
WBR	23	29	6	4	0	27	45	0	0	45	72
North Leg											
Approach	133	140	7	4	0	137	70	0	0	70	207
Departure	119	130	11	7	0	126	128	0	0	128	254
Total	252	269	17	12	0	264	198	0	0	198	462
South Leg											
Approach	82	94	12	8	0	90	38	0	0	38	128
Departure	67	79	12	8	0	75	22	0	0	22	97
Total	149	173	24	16	0	165	60	0	0	60	225
East Leg											
Approach	103	148	45	30	0	133	45	0	0	45	178
Departure	209	284	75	50	0	259	24	0	0	24	283
Total	312	432	120	80	0	392	69	0	0	69	461
West Leg											
Approach	180	246	66	44	0	224	45	0	0	45	269
Departure	103	135	32	21	0	124	24	0	0	24	148
Total	283	381	98	65	0	348	69	0	0	69	417
Total Approaches											
Approach	498	628	130	86	0	584	198	0	0	198	782
Departure	498	628	130	86	0	584	198	0	0	198	782
Total	996	1,255	259	173	0	1,169	396	0	0	396	1,565

Table C-4 - Phase II Project Completion Year (2039) Volume Summary

	PM Peak Hour										
	Existing	Ph III 2049 without Project	Total Growth (2019-2049)	Adjusted Growth	Cumulative Projects	Year 2039 without Project	External Project Trips	Internal Project Trips	Pass-by Trips	Phases I + II Project Trips	Year 2039 with Project
13 Golden State Boulevard – Airport Drive/Avenue 17											
NBL	20	24	4	3	0	23	118	0	0	118	141
NBT	27	105	78	52	0	79	0	0	0	0	79
NBR	152	343	191	127	26	305	0	0	0	0	305
SBL	120	405	285	190	17	327	0	0	0	0	327
SBT	25	105	80	53	0	78	0	0	0	0	78
SBR	7	12	5	3	0	10	0	0	0	0	10
EBL	7	12	5	3	0	10	0	0	0	0	10
EBT	180	182	2	1	62	243	486	0	0	486	729
EBR	25	32	7	5	0	30	61	0	0	61	91
WBL	81	192	111	74	24	179	0	0	0	0	179
WBT	37	39	2	1	57	95	901	0	0	901	996
WBR	85	278	193	129	16	230	0	0	0	0	230
North Leg											
Approach	152	522	370	247	17	416	0	0	0	0	416
Departure	119	395	276	184	16	319	0	0	0	0	319
Total	271	917	646	431	33	735	0	0	0	0	735
South Leg											
Approach	199	472	273	182	26	407	118	0	0	118	525
Departure	131	329	198	132	24	287	61	0	0	61	348
Total	330	801	471	314	50	694	179	0	0	179	873
East Leg											
Approach	203	509	306	204	97	504	901	0	0	901	1,405
Departure	452	930	478	319	105	876	486	0	0	486	1,362
Total	655	1,439	784	523	202	1,380	1,387	0	0	1,387	2,767
West Leg											
Approach	212	226	14	9	62	283	547	0	0	547	830
Departure	64	75	11	7	57	128	1,019	0	0	1,019	1,147
Total	276	301	25	17	119	412	1,566	0	0	1,566	1,978
Total Approaches											
Approach	766	1,729	963	642	202	1,610	1,566	0	0	1,566	3,176
Departure	766	1,729	963	642	202	1,610	1,566	0	0	1,566	3,176
Total	1,532	3,458	1,926	1,284	404	3,220	3,132	0	0	3,132	6,352

Table C-4 - Phase II Project Completion Year (2039) Volume Summary

	PM Peak Hour										
	Existing	Ph III 2049 without Project	Total Growth (2019-2049)	Adjusted Growth	Cumulative Projects	Year 2039 without Project	External Project Trips	Internal Project Trips	Pass-by Trips	Phases I + II Project Trips	Year 2039 with Project
14 SR-99 Southbound Ramps/Avenue 17											
NBL	0	0	0	0	0	0	0	0	0	0	0
NBT	0	0	0	0	0	0	0	0	0	0	0
NBR	0	0	0	0	0	0	0	0	0	0	0
SBL	153	204	51	34	248	435	0	0	0	0	435
SBT	0	0	0	0	0	0	0	0	0	0	0
SBR	43	92	49	33	0	76	0	0	0	0	76
EBL	0	0	0	0	0	0	0	0	0	0	0
EBT	459	930	471	314	105	878	486	0	0	486	1,364
EBR	0	0	0	0	0	0	0	0	0	0	0
WBL	0	0	0	0	0	0	0	0	0	0	0
WBT	157	417	260	173	97	427	901	0	0	901	1,328
WBR	0	0	0	0	0	0	0	0	0	0	0
North Leg											
Approach	196	296	100	67	248	511	0	0	0	0	511
Departure	0	0	0	0	0	0	0	0	0	0	0
Total	196	296	100	67	248	511	0	0	0	0	511
South Leg											
Approach	0	0	0	0	0	0	0	0	0	0	0
Departure	0	0	0	0	0	0	0	0	0	0	0
Total	0	0	0	0	0	0	0	0	0	0	0
East Leg											
Approach	157	417	260	173	97	427	901	0	0	901	1,328
Departure	612	1,134	522	348	353	1,313	486	0	0	486	1,799
Total	769	1,551	782	521	450	1,740	1,387	0	0	1,387	3,127
West Leg											
Approach	459	930	471	314	105	878	486	0	0	486	1,364
Departure	200	509	309	206	97	503	901	0	0	901	1,404
Total	659	1,439	780	520	202	1,381	1,387	0	0	1,387	2,768
Total Approaches											
Approach	812	1,643	831	554	450	1,816	1,387	0	0	1,387	3,203
Departure	812	1,643	831	554	450	1,816	1,387	0	0	1,387	3,203
Total	1,624	3,286	1,662	1,108	900	3,632	2,774	0	0	2,774	6,406

Table C-4 - Phase II Project Completion Year (2039) Volume Summary

	PM Peak Hour										
	Existing	Ph III 2049 without Project	Total Growth (2019-2049)	Adjusted Growth	Cumulative Projects	Year 2039 without Project	External Project Trips	Internal Project Trips	Pass-by Trips	Phases I + II Project Trips	Year 2039 with Project
15 SR-99 Northbound Ramps/Avenue 17											
NBL	66	211	145	97	0	163	610	0	0	610	773
NBT	1	4	3	2	0	3	0	0	0	0	3
NBR	0	0	0	0	529	529	0	0	0	0	529
SBL	0	0	0	0	0	0	0	0	0	0	0
SBT	0	0	0	0	0	0	0	0	0	0	0
SBR	0	0	0	0	0	0	0	0	0	0	0
EBL	64	180	116	77	0	141	0	0	0	0	141
EBT	389	557	168	112	352	853	174	0	0	174	1,027
EBR	0	0	0	0	0	0	0	0	0	0	0
WBL	0	0	0	0	0	0	0	0	0	0	0
WBT	270	387	117	78	616	964	291	0	0	291	1,255
WBR	66	129	63	42	222	330	0	0	0	0	330
North Leg											
Approach	0	0	0	0	0	0	0	0	0	0	0
Departure	131	313	182	121	222	474	0	0	0	0	474
Total	131	313	182	121	222	474	0	0	0	0	474
South Leg											
Approach	67	215	148	99	529	695	610	0	0	610	1,305
Departure	0	0	0	0	0	0	0	0	0	0	0
Total	67	215	148	99	529	695	610	0	0	610	1,305
East Leg											
Approach	336	516	180	120	838	1,294	291	0	0	291	1,585
Departure	389	557	168	112	881	1,382	174	0	0	174	1,556
Total	725	1,073	348	232	1,719	2,676	465	0	0	465	3,141
West Leg											
Approach	453	737	284	189	352	994	174	0	0	174	1,168
Departure	336	598	262	175	616	1,127	901	0	0	901	2,028
Total	789	1,335	546	364	968	2,121	1,075	0	0	1,075	3,196
Total Approaches											
Approach	856	1,468	612	408	1,719	2,983	1,075	0	0	1,075	4,058
Departure	856	1,468	612	408	1,719	2,983	1,075	0	0	1,075	4,058
Total	1,712	2,936	1,224	816	3,438	5,966	2,150	0	0	2,150	8,116

Table C-4 - Phase II Project Completion Year (2039) Volume Summary

	PM Peak Hour										
	Existing	Ph III 2049 without Project	Total Growth (2019-2049)	Adjusted Growth	Cumulative Projects	Year 2039 without Project	External Project Trips	Internal Project Trips	Pass-by Trips	Phases I + II Project Trips	Year 2039 with Project
16 Love's Truck Stop Driveway/Avenue 17											
NBL	0	0	0	0	160	160	0	0	0	0	160
NBT	0	0	0	0	0	0	0	0	0	0	0
NBR	0	0	0	0	31	31	0	0	0	0	31
SBL	0	0	0	0	279	279	0	0	0	0	279
SBT	0	0	0	0	0	0	0	0	0	0	0
SBR	0	0	0	0	519	519	0	0	0	0	519
EBL	0	0	0	0	556	556	0	0	0	0	556
EBT	389	543	154	103	184	676	174	0	0	174	850
EBR	0	0	0	0	141	141	0	0	0	0	141
WBL	0	0	0	0	32	32	0	0	0	0	32
WBT	336	500	164	109	158	603	291	0	0	291	894
WBR	0	0	0	0	189	189	0	0	0	0	189
North Leg											
Approach	0	0	0	0	798	798	0	0	0	0	798
Departure	0	0	0	0	745	745	0	0	0	0	745
Total	0	0	0	0	1,543	1,543	0	0	0	0	1,543
South Leg											
Approach	0	0	0	0	191	191	0	0	0	0	191
Departure	0	0	0	0	173	173	0	0	0	0	173
Total	0	0	0	0	364	364	0	0	0	0	364
East Leg											
Approach	336	500	164	109	379	824	291	0	0	291	1,115
Departure	389	543	154	103	494	986	174	0	0	174	1,160
Total	725	1,043	318	212	873	1,810	465	0	0	465	2,275
West Leg											
Approach	389	543	154	103	881	1,373	174	0	0	174	1,547
Departure	336	500	164	109	837	1,282	291	0	0	291	1,573
Total	725	1,043	318	212	1,718	2,655	465	0	0	465	3,120
Total Approaches											
Approach	725	1,043	318	212	2,249	3,186	465	0	0	465	3,651
Departure	725	1,043	318	212	2,249	3,186	465	0	0	465	3,651
Total	1,450	2,086	636	424	4,498	6,372	930	0	0	930	7,302

Table C-4 - Phase II Project Completion Year (2039) Volume Summary

	PM Peak Hour										
	Existing	Ph III 2049 without Project	Total Growth (2019-2049)	Adjusted Growth	Cumulative Projects	Year 2039 without Project	External Project Trips	Internal Project Trips	Pass-by Trips	Phases I + II Project Trips	Year 2039 with Project
17 Westberry Boulevard/Cleveland Avenue											
NBL	4	20	16	11	0	15	42	0	0	42	57
NBT	6	59	53	35	0	41	2	0	0	2	43
NBR	34	121	87	58	0	92	0	0	0	0	92
SBL	13	27	14	9	0	22	0	0	0	0	22
SBT	20	198	178	119	0	139	2	0	0	2	141
SBR	8	23	15	10	0	18	221	0	0	221	239
EBL	23	53	30	20	0	43	117	0	0	117	160
EBT	122	128	6	4	0	126	339	0	0	339	465
EBR	9	36	27	18	0	27	17	0	0	17	44
WBL	27	141	114	76	0	103	0	0	0	0	103
WBT	62	95	33	22	0	84	683	0	0	683	767
WBR	11	34	23	15	0	26	0	0	0	0	26
North Leg											
Approach	41	248	207	138	0	179	223	0	0	223	402
Departure	40	146	106	71	0	111	119	0	0	119	230
Total	81	394	313	209	0	290	342	0	0	342	632
South Leg											
Approach	44	200	156	104	0	148	44	0	0	44	192
Departure	56	375	319	213	0	269	19	0	0	19	288
Total	100	575	475	317	0	417	63	0	0	63	480
East Leg											
Approach	100	270	170	113	0	213	683	0	0	683	896
Departure	169	276	107	71	0	240	339	0	0	339	579
Total	269	546	277	185	0	454	1,022	0	0	1,022	1,476
West Leg											
Approach	154	217	63	42	0	196	473	0	0	473	669
Departure	74	138	64	43	0	117	946	0	0	946	1,063
Total	228	355	127	85	0	313	1,419	0	0	1,419	1,732
Total Approaches											
Approach	339	935	596	397	0	736	1,423	0	0	1,423	2,159
Departure	339	935	596	397	0	736	1,423	0	0	1,423	2,159
Total	678	1,870	1,192	795	0	1,473	2,846	0	0	2,846	4,319

Table C-4 - Phase II Project Completion Year (2039) Volume Summary

	PM Peak Hour										
	Existing	Ph III 2049 without Project	Total Growth (2019-2049)	Adjusted Growth	Cumulative Projects	Year 2039 without Project	External Project Trips	Internal Project Trips	Pass-by Trips	Phases I + II Project Trips	Year 2039 with Project
18 Westberry Boulevard/Sunset Avenue											
NBL	43	48	5	3	0	46	9	0	0	9	55
NBT	108	194	86	57	0	165	0	0	0	0	165
NBR	55	61	6	4	0	59	0	0	0	0	59
SBL	16	24	8	5	0	21	0	0	0	0	21
SBT	95	211	116	77	0	172	0	0	0	0	172
SBR	13	20	7	5	0	18	9	0	0	9	27
EBL	6	8	2	1	0	7	10	0	0	10	17
EBT	55	58	3	2	0	57	43	0	0	43	100
EBR	23	27	4	3	0	26	10	0	0	10	36
WBL	64	77	13	9	0	73	0	0	0	0	73
WBT	74	78	4	2	0	76	44	0	0	44	120
WBR	16	21	5	3	0	19	0	0	0	0	19
North Leg											
Approach	124	255	131	87	0	211	9	0	0	9	220
Departure	130	223	93	62	0	192	10	0	0	10	202
Total	254	478	224	149	0	403	19	0	0	19	422
South Leg											
Approach	206	303	97	65	0	271	9	0	0	9	280
Departure	182	315	133	89	0	271	10	0	0	10	281
Total	388	618	230	153	0	541	19	0	0	19	560
East Leg											
Approach	154	176	22	14	0	168	44	0	0	44	212
Departure	126	143	17	11	0	137	43	0	0	43	180
Total	280	318	38	26	0	306	87	0	0	87	393
West Leg											
Approach	84	93	9	6	0	90	63	0	0	63	153
Departure	130	146	16	10	0	140	62	0	0	62	202
Total	214	238	24	16	0	230	125	0	0	125	355
Total Approaches											
Approach	568	826	258	172	0	740	125	0	0	125	865
Departure	568	826	258	172	0	740	125	0	0	125	865
Total	1,136	1,653	517	345	0	1,481	250	0	0	250	1,731

Table C-4 - Phase II Project Completion Year (2039) Volume Summary

	PM Peak Hour										
	Existing	Ph III 2049 without Project	Total Growth (2019-2049)	Adjusted Growth	Cumulative Projects	Year 2039 without Project	External Project Trips	Internal Project Trips	Pass-by Trips	Phases I + II Project Trips	Year 2039 with Project
19 Westberry Boulevard/Avenue 14											
NBL	14	15	1	0	0	14	9	0	0	9	23
NBT	41	53	12	8	0	49	0	0	0	0	49
NBR	16	17	1	1	0	17	0	0	0	0	17
SBL	88	151	63	42	0	130	0	0	0	0	130
SBT	42	57	15	10	0	52	0	0	0	0	52
SBR	37	45	8	5	0	42	43	0	0	43	85
EBL	49	69	20	13	0	62	19	0	0	19	81
EBT	251	264	13	8	0	259	166	0	0	166	425
EBR	33	35	2	1	0	34	10	0	0	10	44
WBL	22	23	1	1	0	23	0	0	0	0	23
WBT	116	122	6	4	0	120	195	0	0	195	315
WBR	130	240	110	73	0	203	0	0	0	0	203
North Leg											
Approach	167	253	86	57	0	224	43	0	0	43	267
Departure	220	362	142	95	0	315	19	0	0	19	334
Total	387	615	228	152	0	539	62	0	0	62	601
South Leg											
Approach	71	85	14	9	0	80	9	0	0	9	89
Departure	97	115	18	12	0	109	10	0	0	10	119
Total	168	199	31	21	0	189	19	0	0	19	208
East Leg											
Approach	268	385	117	78	0	346	195	0	0	195	541
Departure	355	431	76	51	0	406	166	0	0	166	572
Total	623	816	193	129	0	752	361	0	0	361	1,113
West Leg											
Approach	333	367	34	23	0	356	195	0	0	195	551
Departure	167	182	15	10	0	177	247	0	0	247	424
Total	500	549	49	32	0	532	442	0	0	442	974
Total Approaches											
Approach	839	1,090	251	167	0	1,006	442	0	0	442	1,448
Departure	839	1,090	251	167	0	1,006	442	0	0	442	1,448
Total	1,678	2,179	501	334	0	2,012	884	0	0	884	2,896

Table C-4 - Phase II Project Completion Year (2039) Volume Summary

	PM Peak Hour										
	Existing	Ph III 2049 without Project	Total Growth (2019-2049)	Adjusted Growth	Cumulative Projects	Year 2039 without Project	External Project Trips	Internal Project Trips	Pass-by Trips	Phases I + II Project Trips	Year 2039 with Project
20 Westberry Boulevard/Avenue 16											
NBL	0	0	0	0	0	0	0	0	0	0	0
NBT	7	15	8	5	0	12	64	0	0	64	76
NBR	34	160	126	84	0	118	49	0	0	49	167
SBL	140	229	89	59	0	199	2	0	0	2	201
SBT	14	50	36	24	0	38	118	0	0	118	156
SBR	0	0	0	0	0	0	0	0	0	0	0
EBL	0	0	0	0	0	0	0	0	0	0	0
EBT	0	0	0	0	0	0	0	0	0	0	0
EBR	0	0	0	0	0	0	0	0	0	0	0
WBL	24	238	214	143	0	167	101	0	0	101	268
WBT	0	0	0	0	0	0	0	0	0	0	0
WBR	64	135	71	47	0	111	2	0	0	2	113
North Leg											
Approach	154	279	125	83	0	237	120	0	0	120	357
Departure	71	150	79	53	0	124	66	0	0	66	190
Total	225	429	204	136	0	361	186	0	0	186	547
South Leg											
Approach	41	175	134	89	0	130	113	0	0	113	243
Departure	38	288	250	167	0	205	219	0	0	219	424
Total	79	463	384	256	0	335	332	0	0	332	667
East Leg											
Approach	88	373	285	190	0	278	103	0	0	103	381
Departure	174	389	215	143	0	317	51	0	0	51	368
Total	262	762	500	333	0	595	154	0	0	154	749
West Leg											
Approach	0	0	0	0	0	0	0	0	0	0	0
Departure	0	0	0	0	0	0	0	0	0	0	0
Total	0	0	0	0	0	0	0	0	0	0	0
Total Approaches											
Approach	283	827	544	363	0	646	336	0	0	336	982
Departure	283	827	544	363	0	646	336	0	0	336	982
Total	566	1,654	1,088	725	0	1,291	672	0	0	672	1,963

Table C-4 - Phase II Project Completion Year (2039) Volume Summary

	PM Peak Hour										
	Existing	Ph III 2049 without Project	Total Growth (2019-2049)	Adjusted Growth	Cumulative Projects	Year 2039 without Project	External Project Trips	Internal Project Trips	Pass-by Trips	Phases I + II Project Trips	Year 2039 with Project
21 Granada Drive/Cleveland Avenue											
NBL	14	15	1	0	0	14	14	0	0	14	28
NBT	189	273	84	56	0	245	2	0	0	2	247
NBR	229	236	7	5	0	234	0	0	0	0	234
SBL	19	64	45	30	0	49	0	0	0	0	49
SBT	231	360	129	86	0	317	2	0	0	2	319
SBR	21	58	37	25	0	46	0	0	0	0	46
EBL	13	29	16	11	0	24	0	0	0	0	24
EBT	108	173	65	43	0	151	312	0	0	312	463
EBR	19	20	1	1	0	20	6	0	0	6	26
WBL	320	379	59	39	0	359	0	0	0	0	359
WBT	113	239	126	84	0	197	642	0	0	642	839
WBR	20	72	52	35	0	55	0	0	0	0	55
North Leg											
Approach	271	482	211	141	0	412	2	0	0	2	414
Departure	222	374	152	101	0	323	2	0	0	2	325
Total	493	856	363	242	0	735	4	0	0	4	739
South Leg											
Approach	432	524	92	61	0	493	16	0	0	16	509
Departure	570	759	189	126	0	696	8	0	0	8	704
Total	1,002	1,283	281	187	0	1,189	24	0	0	24	1,213
East Leg											
Approach	453	690	237	158	0	611	642	0	0	642	1,253
Departure	356	473	117	78	0	434	312	0	0	312	746
Total	809	1,163	354	236	0	1,045	954	0	0	954	1,999
West Leg											
Approach	140	222	82	55	0	195	318	0	0	318	513
Departure	148	312	164	109	0	257	656	0	0	656	913
Total	288	534	246	164	0	452	974	0	0	974	1,426
Total Approaches											
Approach	1,296	1,918	622	414	0	1,710	978	0	0	978	2,688
Departure	1,296	1,918	622	414	0	1,710	978	0	0	978	2,688
Total	2,592	3,835	1,243	829	0	3,421	1,956	0	0	1,956	5,377

Table C-4 - Phase II Project Completion Year (2039) Volume Summary

	PM Peak Hour										
	Existing	Ph III 2049 without Project	Total Growth (2019-2049)	Adjusted Growth	Cumulative Projects	Year 2039 without Project	External Project Trips	Internal Project Trips	Pass-by Trips	Phases I + II Project Trips	Year 2039 with Project
22 Granada Drive/Sunset Avenue											
NBL	46	53	7	5	0	51	0	0	0	0	51
NBT	262	289	27	18	0	280	0	0	0	0	280
NBR	42	44	2	1	0	43	0	0	0	0	43
SBL	76	84	8	5	0	81	0	0	0	0	81
SBT	293	358	65	43	0	336	0	0	0	0	336
SBR	32	41	9	6	0	38	0	0	0	0	38
EBL	28	32	4	3	0	31	0	0	0	0	31
EBT	115	120	5	3	0	118	21	0	0	21	139
EBR	34	39	5	3	0	37	0	0	0	0	37
WBL	54	57	3	2	0	56	0	0	0	0	56
WBT	153	157	4	3	0	156	17	0	0	17	173
WBR	108	113	5	4	0	112	0	0	0	0	112
North Leg											
Approach	401	483	82	55	0	456	0	0	0	0	456
Departure	398	434	36	24	0	422	0	0	0	0	422
Total	799	917	118	79	0	878	0	0	0	0	878
South Leg											
Approach	350	386	36	24	0	374	0	0	0	0	374
Departure	381	454	73	48	0	429	0	0	0	0	429
Total	731	840	109	73	0	804	0	0	0	0	804
East Leg											
Approach	315	327	12	8	0	323	17	0	0	17	340
Departure	233	248	15	10	0	243	21	0	0	21	264
Total	548	575	27	18	0	566	38	0	0	38	604
West Leg											
Approach	177	191	14	9	0	186	21	0	0	21	207
Departure	231	251	20	13	0	244	17	0	0	17	261
Total	408	442	34	23	0	431	38	0	0	38	469
Total Approaches											
Approach	1,243	1,387	144	96	0	1,339	38	0	0	38	1,377
Departure	1,243	1,387	144	96	0	1,339	38	0	0	38	1,377
Total	2,486	2,774	288	192	0	2,678	76	0	0	76	2,754

Table C-4 - Phase II Project Completion Year (2039) Volume Summary

	PM Peak Hour										
	Existing	Ph III 2049 without Project	Total Growth (2019-2049)	Adjusted Growth	Cumulative Projects	Year 2039 without Project	External Project Trips	Internal Project Trips	Pass-by Trips	Phases I + II Project Trips	Year 2039 with Project
23 Avenue 16 – Ellis Street/Kennedy Street											
NBL	0	0	0	0	0	0	0	0	0	0	0
NBT	150	425	275	183	0	333	49	0	0	49	382
NBR	127	385	258	172	0	299	2	0	0	2	301
SBL	181	270	89	59	0	240	0	0	0	0	240
SBT	174	408	234	156	0	330	101	0	0	101	431
SBR	0	0	0	0	0	0	0	0	0	0	0
EBL	0	0	0	0	0	0	0	0	0	0	0
EBT	0	0	0	0	0	0	0	0	0	0	0
EBR	0	0	0	0	0	0	0	0	0	0	0
WBL	96	177	81	54	0	150	2	0	0	2	152
WBT	0	0	0	0	0	0	0	0	0	0	0
WBR	211	231	20	13	0	224	0	0	0	0	224
North Leg											
Approach	355	678	323	215	0	570	101	0	0	101	671
Departure	361	656	295	197	0	558	49	0	0	49	607
Total	716	1,334	618	412	0	1,128	150	0	0	150	1,278
South Leg											
Approach	277	810	533	355	0	632	51	0	0	51	683
Departure	270	585	315	210	0	480	103	0	0	103	583
Total	547	1,395	848	565	0	1,112	154	0	0	154	1,266
East Leg											
Approach	307	408	101	67	0	374	2	0	0	2	376
Departure	308	655	347	231	0	539	2	0	0	2	541
Total	615	1,063	448	299	0	914	4	0	0	4	918
West Leg											
Approach	0	0	0	0	0	0	0	0	0	0	0
Departure	0	0	0	0	0	0	0	0	0	0	0
Total	0	0	0	0	0	0	0	0	0	0	0
Total Approaches											
Approach	939	1,896	957	638	0	1,577	154	0	0	154	1,731
Departure	939	1,896	957	638	0	1,577	154	0	0	154	1,731
Total	1,878	3,792	1,914	1,276	0	3,154	308	0	0	308	3,462

Table C-4 - Phase II Project Completion Year (2039) Volume Summary

	PM Peak Hour										
	Existing	Ph III 2049 without Project	Total Growth (2019-2049)	Adjusted Growth	Cumulative Projects	Year 2039 without Project	External Project Trips	Internal Project Trips	Pass-by Trips	Phases I + II Project Trips	Year 2039 with Project
24 Schnoor Avenue/Kennedy Street											
NBL	192	202	10	6	0	198	0	0	0	0	198
NBT	13	89	76	51	0	64	0	0	0	0	64
NBR	207	327	120	80	0	287	40	0	0	40	327
SBL	23	203	180	120	0	143	0	0	0	0	143
SBT	14	69	55	37	0	51	0	0	0	0	51
SBR	8	43	35	23	0	31	0	0	0	0	31
EBL	9	101	92	61	0	70	0	0	0	0	70
EBT	113	295	182	121	0	234	2	0	0	2	236
EBR	163	237	74	49	0	212	0	0	0	0	212
WBL	179	249	70	47	0	226	23	0	0	23	249
WBT	132	203	71	47	0	179	2	0	0	2	181
WBR	17	183	166	111	0	128	0	0	0	0	128
North Leg											
Approach	45	315	270	180	0	225	0	0	0	0	225
Departure	39	373	334	223	0	262	0	0	0	0	262
Total	84	688	604	403	0	487	0	0	0	0	487
South Leg											
Approach	412	618	206	137	0	549	40	0	0	40	589
Departure	356	555	199	133	0	489	23	0	0	23	512
Total	768	1,173	405	270	0	1,038	63	0	0	63	1,101
East Leg											
Approach	328	635	307	205	0	533	25	0	0	25	558
Departure	343	825	482	321	0	664	42	0	0	42	706
Total	671	1,460	789	526	0	1,197	67	0	0	67	1,264
West Leg											
Approach	285	633	348	232	0	517	2	0	0	2	519
Departure	332	448	116	77	0	409	2	0	0	2	411
Total	617	1,081	464	309	0	926	4	0	0	4	930
Total Approaches											
Approach	1,070	2,201	1,131	754	0	1,824	67	0	0	67	1,891
Departure	1,070	2,201	1,131	754	0	1,824	67	0	0	67	1,891
Total	2,140	4,401	2,261	1,507	0	3,647	134	0	0	134	3,781

Table C-4 - Phase II Project Completion Year (2039) Volume Summary

	PM Peak Hour										
	Existing	Ph III 2049 without Project	Total Growth (2019-2049)	Adjusted Growth	Cumulative Projects	Year 2039 without Project	External Project Trips	Internal Project Trips	Pass-by Trips	Phases I + II Project Trips	Year 2039 with Project
25 SR-99 Southbound Ramps/Kennedy Street - Gateway Drive											
NBL	0	0	0	0	0	0	0	0	0	0	0
NBT	0	0	0	0	0	0	0	0	0	0	0
NBR	0	0	0	0	0	0	0	0	0	0	0
SBL	128	138	10	7	0	135	0	0	0	0	135
SBT	0	0	0	0	0	0	0	0	0	0	0
SBR	158	223	65	43	0	201	26	0	0	26	227
EBL	102	346	244	163	0	265	0	0	0	0	265
EBT	313	460	147	98	0	411	40	0	0	40	451
EBR	0	0	0	0	0	0	0	0	0	0	0
WBL	0	0	0	0	0	0	0	0	0	0	0
WBT	252	430	178	119	0	371	21	0	0	21	392
WBR	1	3	2	1	0	2	0	0	0	0	2
North Leg											
Approach	286	361	75	50	0	336	26	0	0	26	362
Departure	103	349	246	164	0	267	0	0	0	0	267
Total	389	710	321	214	0	603	26	0	0	26	629
South Leg											
Approach	0	0	0	0	0	0	0	0	0	0	0
Departure	0	0	0	0	0	0	0	0	0	0	0
Total	0	0	0	0	0	0	0	0	0	0	0
East Leg											
Approach	253	433	180	120	0	373	21	0	0	21	394
Departure	441	598	157	105	0	546	40	0	0	40	586
Total	694	1,031	337	225	0	919	61	0	0	61	980
West Leg											
Approach	415	806	391	261	0	676	40	0	0	40	716
Departure	410	653	243	162	0	572	47	0	0	47	619
Total	825	1,459	634	423	0	1,248	87	0	0	87	1,335
Total Approaches											
Approach	954	1,600	646	431	0	1,385	87	0	0	87	1,472
Departure	954	1,600	646	431	0	1,385	87	0	0	87	1,472
Total	1,908	3,201	1,293	862	0	2,770	174	0	0	174	2,944

Table C-4 - Phase II Project Completion Year (2039) Volume Summary

	PM Peak Hour										
	Existing	Ph III 2049 without Project	Total Growth (2019-2049)	Adjusted Growth	Cumulative Projects	Year 2039 without Project	External Project Trips	Internal Project Trips	Pass-by Trips	Phases I + II Project Trips	Year 2039 with Project
26 SR-99 Northbound Off-Ramp/Gateway Drive											
NBL	0	0	0	0	0	0	0	0	0	0	0
NBT	0	0	0	0	0	0	0	0	0	0	0
NBR	0	0	0	0	0	0	0	0	0	0	0
SBL	0	0	0	0	0	0	0	0	0	0	0
SBT	0	0	0	0	0	0	0	0	0	0	0
SBR	135	186	51	34	0	169	21	0	0	21	190
EBL	153	161	8	5	0	158	40	0	0	40	198
EBT	288	438	150	100	0	388	0	0	0	0	388
EBR	0	0	0	0	0	0	0	0	0	0	0
WBL	0	0	0	0	0	0	0	0	0	0	0
WBT	118	247	129	86	0	204	0	0	0	0	204
WBR	0	0	0	0	0	0	0	0	0	0	0
North Leg											
Approach	135	186	51	34	0	169	21	0	0	21	190
Departure	153	161	8	5	0	158	40	0	0	40	198
Total	288	347	59	39	0	327	61	0	0	61	388
South Leg											
Approach	0	0	0	0	0	0	0	0	0	0	0
Departure	0	0	0	0	0	0	0	0	0	0	0
Total	0	0	0	0	0	0	0	0	0	0	0
East Leg											
Approach	118	247	129	86	0	204	0	0	0	0	204
Departure	288	438	150	100	0	388	0	0	0	0	388
Total	406	685	279	186	0	592	0	0	0	0	592
West Leg											
Approach	441	599	158	105	0	546	40	0	0	40	586
Departure	253	433	180	120	0	373	21	0	0	21	394
Total	694	1,032	338	225	0	919	61	0	0	61	980
Total Approaches											
Approach	694	1,032	338	225	0	919	61	0	0	61	980
Departure	694	1,032	338	225	0	919	61	0	0	61	980
Total	1,388	2,063	675	450	0	1,838	122	0	0	122	1,960

Table C-4 - Phase II Project Completion Year (2039) Volume Summary

	PM Peak Hour										
	Existing	Ph III 2049 without Project	Total Growth (2019-2049)	Adjusted Growth	Cumulative Projects	Year 2039 without Project	External Project Trips	Internal Project Trips	Pass-by Trips	Phases I + II Project Trips	Year 2039 with Project
27 SR-99 Northbound Off-Ramps											
NBL	0	0	0	0	0	0	0	0	0	0	0
NBT	78	82	4	3	0	81	0	0	0	0	81
NBR	0	0	0	0	0	0	0	0	0	0	0
SBL	0	0	0	0	0	0	0	0	0	0	0
SBT	3	3	0	0	0	3	0	0	0	0	3
SBR	135	185	50	33	0	168	21	0	0	21	189
EBL	153	161	8	5	0	158	19	0	0	19	177
EBT	0	0	0	0	0	0	0	0	0	0	0
EBR	0	0	0	0	0	0	0	0	0	0	0
WBL	0	0	0	0	0	0	0	0	0	0	0
WBT	0	0	0	0	0	0	0	0	0	0	0
WBR	0	0	0	0	0	0	0	0	0	0	0
North Leg											
Approach	138	188	50	33	0	171	21	0	0	21	192
Departure	231	243	12	8	0	239	19	0	0	19	258
Total	369	431	62	41	0	410	40	0	0	40	450
South Leg											
Approach	78	82	4	3	0	81	0	0	0	0	81
Departure	3	3	0	0	0	3	0	0	0	0	3
Total	81	85	4	3	0	84	0	0	0	0	84
East Leg											
Approach	0	0	0	0	0	0	0	0	0	0	0
Departure	0	0	0	0	0	0	0	0	0	0	0
Total	0	0	0	0	0	0	0	0	0	0	0
West Leg											
Approach	153	161	8	5	0	158	19	0	0	19	177
Departure	135	185	50	33	0	168	21	0	0	21	189
Total	288	346	58	38	0	326	40	0	0	40	366
Total Approaches											
Approach	369	431	62	41	0	410	40	0	0	40	450
Departure	369	431	62	41	0	410	40	0	0	40	450
Total	738	861	123	82	0	820	80	0	0	80	900

Table C-4 - Phase II Project Completion Year (2039) Volume Summary

	PM Peak Hour										
	Existing	Ph III 2049 without Project	Total Growth (2019-2049)	Adjusted Growth	Cumulative Projects	Year 2039 without Project	External Project Trips	Internal Project Trips	Pass-by Trips	Phases I + II Project Trips	Year 2039 with Project
28 SR-99 Northbound Off-Ramp/Gateway Drive											
NBL	0	0	0	0	0	0	0	0	0	0	0
NBT	0	0	0	0	0	0	0	0	0	0	0
NBR	0	0	0	0	0	0	0	0	0	0	0
SBL	3	3	0	0	0	3	0	0	0	0	3
SBT	0	0	0	0	0	0	0	0	0	0	0
SBR	0	0	0	0	0	0	0	0	0	0	0
EBL	0	0	0	0	0	0	0	0	0	0	0
EBT	288	438	150	100	0	388	0	0	0	0	388
EBR	0	0	0	0	0	0	0	0	0	0	0
WBL	0	0	0	0	0	0	0	0	0	0	0
WBT	118	247	129	86	0	204	0	0	0	0	204
WBR	73	77	4	2	0	75	0	0	0	0	75
North Leg											
Approach	3	3	0	0	0	3	0	0	0	0	3
Departure	73	77	4	2	0	75	0	0	0	0	75
Total	76	80	4	3	0	79	0	0	0	0	79
South Leg											
Approach	0	0	0	0	0	0	0	0	0	0	0
Departure	0	0	0	0	0	0	0	0	0	0	0
Total	0	0	0	0	0	0	0	0	0	0	0
East Leg											
Approach	191	324	133	88	0	279	0	0	0	0	279
Departure	291	441	150	100	0	391	0	0	0	0	391
Total	482	765	283	189	0	671	0	0	0	0	671
West Leg											
Approach	288	438	150	100	0	388	0	0	0	0	388
Departure	118	247	129	86	0	204	0	0	0	0	204
Total	406	685	279	186	0	592	0	0	0	0	592
Total Approaches											
Approach	482	765	283	189	0	671	0	0	0	0	671
Departure	482	765	283	189	0	671	0	0	0	0	671
Total	964	1,530	566	377	0	1,341	0	0	0	0	1,341

Table C-4 - Phase II Project Completion Year (2039) Volume Summary

	PM Peak Hour										
	Existing	Ph III 2049 without Project	Total Growth (2019-2049)	Adjusted Growth	Cumulative Projects	Year 2039 without Project	External Project Trips	Internal Project Trips	Pass-by Trips	Phases I + II Project Trips	Year 2039 with Project
29 Schnoor Avenue/Cleveland Avenue											
NBL	52	73	21	14	0	66	28	0	0	28	94
NBT	200	245	45	30	0	230	16	0	0	16	246
NBR	148	159	11	7	0	155	0	0	0	0	155
SBL	110	134	24	16	0	126	0	0	0	0	126
SBT	195	248	53	35	0	230	8	0	0	8	238
SBR	74	119	45	30	0	104	37	0	0	37	141
EBL	108	144	36	24	0	132	21	0	0	21	153
EBT	383	447	64	43	0	426	262	0	0	262	688
EBR	41	50	9	6	0	47	11	0	0	11	58
WBL	264	297	33	22	0	286	0	0	0	0	286
WBT	420	598	178	119	0	539	555	0	0	555	1,094
WBR	103	127	24	16	0	119	0	0	0	0	119
North Leg											
Approach	379	501	122	81	0	460	45	0	0	45	505
Departure	411	516	105	70	0	481	37	0	0	37	518
Total	790	1,017	227	151	0	941	82	0	0	82	1,023
South Leg											
Approach	400	477	77	51	0	451	44	0	0	44	495
Departure	500	595	95	63	0	563	19	0	0	19	582
Total	900	1,072	172	115	0	1,015	63	0	0	63	1,078
East Leg											
Approach	787	1,022	235	157	0	944	555	0	0	555	1,499
Departure	641	740	99	66	0	707	262	0	0	262	969
Total	1,428	1,762	334	223	0	1,651	817	0	0	817	2,468
West Leg											
Approach	532	641	109	73	0	605	294	0	0	294	899
Departure	546	790	244	163	0	709	620	0	0	620	1,329
Total	1,078	1,431	353	235	0	1,313	914	0	0	914	2,227
Total Approaches											
Approach	2,098	2,641	543	362	0	2,460	938	0	0	938	3,398
Departure	2,098	2,641	543	362	0	2,460	938	0	0	938	3,398
Total	4,196	5,282	1,086	724	0	4,920	1,876	0	0	1,876	6,796

Table C-4 - Phase II Project Completion Year (2039) Volume Summary

	PM Peak Hour										
	Existing	Ph III 2049 without Project	Total Growth (2019-2049)	Adjusted Growth	Cumulative Projects	Year 2039 without Project	External Project Trips	Internal Project Trips	Pass-by Trips	Phases I + II Project Trips	Year 2039 with Project
30 Fairgrounds/Cleveland Avenue											
NBL	95	100	5	3	0	98	0	0	0	0	98
NBT	41	44	3	2	0	43	0	0	0	0	43
NBR	105	116	11	7	0	112	0	0	0	0	112
SBL	231	334	103	69	0	300	31	0	0	31	331
SBT	34	36	2	1	0	35	0	0	0	0	35
SBR	98	126	28	19	0	117	0	0	0	0	117
EBL	89	105	16	11	0	100	0	0	0	0	100
EBT	478	574	96	64	0	542	262	0	0	262	804
EBR	91	96	5	3	0	94	0	0	0	0	94
WBL	155	179	24	16	0	171	0	0	0	0	171
WBT	503	711	208	139	0	642	555	0	0	555	1,197
WBR	123	192	69	46	0	169	15	0	0	15	184
North Leg											
Approach	363	496	133	89	0	452	31	0	0	31	483
Departure	253	341	88	59	0	312	15	0	0	15	327
Total	616	837	221	147	0	763	46	0	0	46	809
South Leg											
Approach	241	260	19	13	0	254	0	0	0	0	254
Departure	280	311	31	20	0	300	0	0	0	0	300
Total	521	570	49	33	0	554	0	0	0	0	554
East Leg											
Approach	781	1,082	301	201	0	982	570	0	0	570	1,552
Departure	814	1,024	210	140	0	954	293	0	0	293	1,247
Total	1,595	2,106	511	341	0	1,936	863	0	0	863	2,799
West Leg											
Approach	658	775	117	78	0	736	262	0	0	262	998
Departure	696	937	241	161	0	857	555	0	0	555	1,412
Total	1,354	1,711	357	238	0	1,592	817	0	0	817	2,409
Total Approaches											
Approach	2,043	2,612	569	380	0	2,423	863	0	0	863	3,286
Departure	2,043	2,612	569	380	0	2,423	863	0	0	863	3,286
Total	4,086	5,225	1,139	759	0	4,845	1,726	0	0	1,726	6,571

Table C-4 - Phase II Project Completion Year (2039) Volume Summary

	PM Peak Hour										
	Existing	Ph III 2049 without Project	Total Growth (2019-2049)	Adjusted Growth	Cumulative Projects	Year 2039 without Project	External Project Trips	Internal Project Trips	Pass-by Trips	Phases I + II Project Trips	Year 2039 with Project
31 SR-99 Southbound Ramps/Cleveland Avenue											
NBL	0	0	0	0	0	0	0	0	0	0	0
NBT	0	0	0	0	0	0	0	0	0	0	0
NBR	0	0	0	0	0	0	0	0	0	0	0
SBL	125	203	78	52	0	177	66	0	0	66	243
SBT	0	0	0	0	0	0	0	0	0	0	0
SBR	77	85	8	5	0	82	15	0	0	15	97
EBL	0	0	0	0	0	0	0	0	0	0	0
EBT	682	817	135	90	0	772	152	0	0	152	924
EBR	327	408	81	54	0	381	141	0	0	141	522
WBL	193	381	188	125	0	318	0	0	0	0	318
WBT	1,050	1,344	294	196	0	1,246	555	0	0	555	1,801
WBR	0	0	0	0	0	0	0	0	0	0	0
North Leg											
Approach	202	288	86	57	0	259	81	0	0	81	340
Departure	0	0	0	0	0	0	0	0	0	0	0
Total	202	288	86	57	0	259	81	0	0	81	340
South Leg											
Approach	0	0	0	0	0	0	0	0	0	0	0
Departure	520	789	269	179	0	699	141	0	0	141	840
Total	520	789	269	179	0	699	141	0	0	141	840
East Leg											
Approach	1,243	1,725	482	321	0	1,564	555	0	0	555	2,119
Departure	807	1,020	213	142	0	949	218	0	0	218	1,167
Total	2,050	2,745	695	463	0	2,513	773	0	0	773	3,286
West Leg											
Approach	1,009	1,225	216	144	0	1,153	293	0	0	293	1,446
Departure	1,127	1,429	302	201	0	1,328	570	0	0	570	1,898
Total	2,136	2,654	518	345	0	2,481	863	0	0	863	3,344
Total Approaches											
Approach	2,454	3,238	784	523	0	2,977	929	0	0	929	3,906
Departure	2,454	3,238	784	523	0	2,977	929	0	0	929	3,906
Total	4,908	6,476	1,568	1,045	0	5,953	1,858	0	0	1,858	7,811

Table C-4 - Phase II Project Completion Year (2039) Volume Summary

	PM Peak Hour										
	Existing	Ph III 2049 without Project	Total Growth (2019-2049)	Adjusted Growth	Cumulative Projects	Year 2039 without Project	External Project Trips	Internal Project Trips	Pass-by Trips	Phases I + II Project Trips	Year 2039 with Project
32 SR-99 Northbound Ramps/Cleveland Avenue											
NBL	417	667	250	167	0	584	340	0	0	340	924
NBT	5	6	1	1	0	6	0	0	0	0	6
NBR	265	349	84	56	0	321	0	0	0	0	321
SBL	0	0	0	0	0	0	0	0	0	0	0
SBT	0	0	0	0	0	0	0	0	0	0	0
SBR	0	0	0	0	0	0	0	0	0	0	0
EBL	71	79	8	5	0	76	31	0	0	31	107
EBT	736	939	203	135	0	871	187	0	0	187	1,058
EBR	0	0	0	0	0	0	0	0	0	0	0
WBL	0	0	0	0	0	0	0	0	0	0	0
WBT	826	1,065	239	159	0	985	215	0	0	215	1,200
WBR	65	68	3	2	0	67	121	0	0	121	188
North Leg											
Approach	0	0	0	0	0	0	0	0	0	0	0
Departure	141	153	12	8	0	149	152	0	0	152	301
Total	141	153	12	8	0	149	152	0	0	152	301
South Leg											
Approach	687	1,022	335	223	0	910	340	0	0	340	1,250
Departure	0	0	0	0	0	0	0	0	0	0	0
Total	687	1,022	335	223	0	910	340	0	0	340	1,250
East Leg											
Approach	891	1,133	242	162	0	1,053	336	0	0	336	1,389
Departure	1,001	1,288	287	191	0	1,192	187	0	0	187	1,379
Total	1,892	2,421	529	353	0	2,245	523	0	0	523	2,768
West Leg											
Approach	807	1,018	211	141	0	948	218	0	0	218	1,166
Departure	1,243	1,732	489	326	0	1,569	555	0	0	555	2,124
Total	2,050	2,750	700	467	0	2,517	773	0	0	773	3,290
Total Approaches											
Approach	2,385	3,173	788	526	0	2,911	894	0	0	894	3,805
Departure	2,385	3,173	788	526	0	2,911	894	0	0	894	3,805
Total	4,770	6,347	1,577	1,051	0	5,821	1,788	0	0	1,788	7,609

Table C-4 - Phase II Project Completion Year (2039) Volume Summary

	PM Peak Hour										
	Existing	Ph III 2049 without Project	Total Growth (2019-2049)	Adjusted Growth	Cumulative Projects	Year 2039 without Project	External Project Trips	Internal Project Trips	Pass-by Trips	Phases I + II Project Trips	Year 2039 with Project
33 Gateway Drive/Cleveland Avenue											
NBL	218	237	19	13	0	231	109	0	0	109	340
NBT	112	154	42	28	0	140	0	0	0	0	140
NBR	210	309	99	66	0	276	0	0	0	0	276
SBL	155	233	78	52	0	207	0	0	0	0	207
SBT	124	179	55	37	0	161	0	0	0	0	161
SBR	22	24	2	1	0	23	0	0	0	0	23
EBL	14	17	3	2	0	16	0	0	0	0	16
EBT	734	977	243	162	0	896	139	0	0	139	1,035
EBR	231	294	63	42	0	273	48	0	0	48	321
WBL	144	248	104	69	0	213	0	0	0	0	213
WBT	654	872	218	145	0	799	227	0	0	227	1,026
WBR	104	175	71	47	0	151	0	0	0	0	151
North Leg											
Approach	301	436	135	90	0	391	0	0	0	0	391
Departure	230	346	116	77	0	307	0	0	0	0	307
Total	531	782	251	167	0	698	0	0	0	0	698
South Leg											
Approach	540	700	160	107	0	647	109	0	0	109	756
Departure	499	721	222	148	0	647	48	0	0	48	695
Total	1,039	1,421	382	255	0	1,294	157	0	0	157	1,451
East Leg											
Approach	902	1,295	393	262	0	1,164	227	0	0	227	1,391
Departure	1,099	1,519	420	280	0	1,379	139	0	0	139	1,518
Total	2,001	2,814	813	542	0	2,543	366	0	0	366	2,909
West Leg											
Approach	979	1,288	309	206	0	1,185	187	0	0	187	1,372
Departure	894	1,133	239	159	0	1,053	336	0	0	336	1,389
Total	1,873	2,421	548	365	0	2,238	523	0	0	523	2,761
Total Approaches											
Approach	2,722	3,719	997	665	0	3,387	523	0	0	523	3,910
Departure	2,722	3,719	997	665	0	3,387	523	0	0	523	3,910
Total	5,444	7,438	1,994	1,329	0	6,773	1,046	0	0	1,046	7,819

Table C-4 - Phase II Project Completion Year (2039) Volume Summary

	PM Peak Hour										
	Existing	Ph III 2049 without Project	Total Growth (2019-2049)	Adjusted Growth	Cumulative Projects	Year 2039 without Project	External Project Trips	Internal Project Trips	Pass-by Trips	Phases I + II Project Trips	Year 2039 with Project
34 Cleveland Avenue – Country Club Drive/W Cleveland Avenue											
NBL	0	0	0	0	0	0	0	0	0	0	0
NBT	709	953	244	163	0	872	33	0	0	33	905
NBR	390	566	176	117	0	507	105	0	0	105	612
SBL	75	147	72	48	0	123	0	0	0	0	123
SBT	575	871	296	197	0	772	61	0	0	61	833
SBR	0	0	0	0	0	0	0	0	0	0	0
EBL	0	0	0	0	0	0	0	0	0	0	0
EBT	0	0	0	0	0	0	0	0	0	0	0
EBR	0	0	0	0	0	0	0	0	0	0	0
WBL	327	424	97	65	0	392	168	0	0	168	560
WBT	0	0	0	0	0	0	0	0	0	0	0
WBR	26	40	14	9	0	35	0	0	0	0	35
North Leg											
Approach	650	1,018	368	245	0	895	61	0	0	61	956
Departure	735	993	258	172	0	907	33	0	0	33	940
Total	1,385	2,011	626	417	0	1,802	94	0	0	94	1,896
South Leg											
Approach	1,099	1,519	420	280	0	1,379	138	0	0	138	1,517
Departure	902	1,295	393	262	0	1,164	229	0	0	229	1,393
Total	2,001	2,814	813	542	0	2,543	367	0	0	367	2,910
East Leg											
Approach	353	464	111	74	0	427	168	0	0	168	595
Departure	465	713	248	165	0	630	105	0	0	105	735
Total	818	1,177	359	239	0	1,057	273	0	0	273	1,330
West Leg											
Approach	0	0	0	0	0	0	0	0	0	0	0
Departure	0	0	0	0	0	0	0	0	0	0	0
Total	0	0	0	0	0	0	0	0	0	0	0
Total Approaches											
Approach	2,102	3,001	899	599	0	2,701	367	0	0	367	3,068
Departure	2,102	3,001	899	599	0	2,701	367	0	0	367	3,068
Total	4,204	6,002	1,798	1,199	0	5,403	734	0	0	734	6,137

Table C-4 - Phase II Project Completion Year (2039) Volume Summary

	PM Peak Hour										
	Existing	Ph III 2049 without Project	Total Growth (2019-2049)	Adjusted Growth	Cumulative Projects	Year 2039 without Project	External Project Trips	Internal Project Trips	Pass-by Trips	Phases I + II Project Trips	Year 2039 with Project
35 Country Club Drive/Sharon Boulevard											
NBL	5	5	0	0	0	5	0	0	0	0	5
NBT	707	962	255	170	0	877	21	0	0	21	898
NBR	0	0	0	0	0	0	0	0	0	0	0
SBL	0	0	0	0	0	0	0	0	0	0	0
SBT	592	963	371	247	0	839	32	0	0	32	871
SBR	1	1	0	0	0	1	0	0	0	0	1
EBL	2	2	0	0	0	2	0	0	0	0	2
EBT	0	0	0	0	0	0	0	0	0	0	0
EBR	16	17	1	1	0	17	0	0	0	0	17
WBL	0	0	0	0	0	0	0	0	0	0	0
WBT	0	0	0	0	0	0	0	0	0	0	0
WBR	0	0	0	0	0	0	0	0	0	0	0
North Leg											
Approach	593	964	371	247	0	840	32	0	0	32	872
Departure	709	964	255	170	0	879	21	0	0	21	900
Total	1,302	1,928	626	417	0	1,719	53	0	0	53	1,772
South Leg											
Approach	712	967	255	170	0	882	21	0	0	21	903
Departure	608	980	372	248	0	856	32	0	0	32	888
Total	1,320	1,947	627	418	0	1,738	53	0	0	53	1,791
East Leg											
Approach	0	0	0	0	0	0	0	0	0	0	0
Departure	0	0	0	0	0	0	0	0	0	0	0
Total	0	0	0	0	0	0	0	0	0	0	0
West Leg											
Approach	18	19	1	1	0	19	0	0	0	0	19
Departure	6	6	0	0	0	6	0	0	0	0	6
Total	24	25	1	1	0	25	0	0	0	0	25
Total Approaches											
Approach	1,323	1,950	627	418	0	1,741	53	0	0	53	1,794
Departure	1,323	1,950	627	418	0	1,741	53	0	0	53	1,794
Total	2,646	3,900	1,254	836	0	3,482	106	0	0	106	3,588

Table C-4 - Phase II Project Completion Year (2039) Volume Summary

	PM Peak Hour										
	Existing	Ph III 2049 without Project	Total Growth (2019-2049)	Adjusted Growth	Cumulative Projects	Year 2039 without Project	External Project Trips	Internal Project Trips	Pass-by Trips	Phases I + II Project Trips	Year 2039 with Project
36 Pine Street/Howard Road											
NBL	142	144	2	1	0	143	67	0	0	67	210
NBT	155	183	28	19	0	174	14	0	0	14	188
NBR	138	171	33	22	0	160	0	0	0	0	160
SBL	15	18	3	2	0	17	0	0	0	0	17
SBT	131	161	30	20	0	151	6	0	0	6	157
SBR	119	120	1	1	0	120	0	0	0	0	120
EBL	85	89	4	3	0	88	0	0	0	0	88
EBT	528	559	31	21	0	549	94	0	0	94	643
EBR	96	102	6	4	0	100	35	0	0	35	135
WBL	86	111	25	17	0	103	0	0	0	0	103
WBT	486	515	29	19	0	505	77	0	0	77	582
WBR	3	4	1	1	0	4	0	0	0	0	4
North Leg											
Approach	265	299	34	23	0	288	6	0	0	6	294
Departure	243	276	33	22	0	265	14	0	0	14	279
Total	508	575	67	45	0	553	20	0	0	20	573
South Leg											
Approach	435	498	63	42	0	477	81	0	0	81	558
Departure	313	374	61	41	0	354	41	0	0	41	395
Total	748	872	124	83	0	831	122	0	0	122	953
East Leg											
Approach	575	630	55	37	0	612	77	0	0	77	689
Departure	681	748	67	45	0	726	94	0	0	94	820
Total	1,256	1,378	122	81	0	1,337	171	0	0	171	1,508
West Leg											
Approach	709	750	41	28	0	737	129	0	0	129	866
Departure	747	779	32	21	0	768	144	0	0	144	912
Total	1,456	1,529	73	49	0	1,505	273	0	0	273	1,778
Total Approaches											
Approach	1,984	2,177	193	129	0	2,113	293	0	0	293	2,406
Departure	1,984	2,177	193	129	0	2,113	293	0	0	293	2,406
Total	3,968	4,355	387	258	0	4,226	586	0	0	586	4,812

Table C-4 - Phase II Project Completion Year (2039) Volume Summary

	PM Peak Hour										
	Existing	Ph III 2049 without Project	Total Growth (2019-2049)	Adjusted Growth	Cumulative Projects	Year 2039 without Project	External Project Trips	Internal Project Trips	Pass-by Trips	Phases I + II Project Trips	Year 2039 with Project
37 Q Street - Olive Avenue/Yosemite Avenue - Howard Road											
NBL	278	330	52	35	0	313	68	0	0	68	381
NBT	74	76	2	1	0	75	0	0	0	0	75
NBR	12	13	1	1	0	13	0	0	0	0	13
SBL	16	17	1	1	0	17	0	0	0	0	17
SBT	55	58	3	2	0	57	0	0	0	0	57
SBR	2	2	0	0	0	2	0	0	0	0	2
EBL	7	7	0	0	0	7	0	0	0	0	7
EBT	442	452	10	7	0	449	10	0	0	10	459
EBR	211	269	58	39	0	250	84	0	0	84	334
WBL	12	14	2	1	0	13	0	0	0	0	13
WBT	357	361	4	3	0	360	9	0	0	9	369
WBR	14	15	1	0	0	14	0	0	0	0	14
North Leg											
Approach	73	77	4	3	0	76	0	0	0	0	76
Departure	95	98	3	2	0	97	0	0	0	0	97
Total	168	175	7	5	0	173	0	0	0	0	173
South Leg											
Approach	364	419	55	37	0	401	68	0	0	68	469
Departure	278	341	63	42	0	320	84	0	0	84	404
Total	642	760	118	79	0	721	152	0	0	152	873
East Leg											
Approach	383	390	7	4	0	387	9	0	0	9	396
Departure	470	482	12	8	0	478	10	0	0	10	488
Total	853	872	19	12	0	865	19	0	0	19	884
West Leg											
Approach	660	728	68	46	0	706	94	0	0	94	800
Departure	637	693	56	37	0	674	77	0	0	77	751
Total	1,297	1,421	124	83	0	1,380	171	0	0	171	1,551
Total Approaches											
Approach	1,480	1,614	134	89	0	1,569	171	0	0	171	1,740
Departure	1,480	1,614	134	89	0	1,569	171	0	0	171	1,740
Total	2,960	3,228	268	179	0	3,139	342	0	0	342	3,481

Table C-4 - Phase II Project Completion Year (2039) Volume Summary

	PM Peak Hour										
	Existing	Ph III 2049 without Project	Total Growth (2019-2049)	Adjusted Growth	Cumulative Projects	Year 2039 without Project	External Project Trips	Internal Project Trips	Pass-by Trips	Phases I + II Project Trips	Year 2039 with Project
38 I Street/SR-99 Southbound Off-Ramp - 2nd Street											
NBL	42	54	12	8	0	50	0	0	0	0	50
NBT	141	160	19	13	0	154	0	0	0	0	154
NBR	0	0	0	0	0	0	0	0	0	0	0
SBL	0	0	0	0	0	0	0	0	0	0	0
SBT	112	122	10	7	0	119	0	0	0	0	119
SBR	0	0	0	0	0	0	0	0	0	0	0
EBL	0	0	0	0	0	0	0	0	0	0	0
EBT	0	0	0	0	0	0	0	0	0	0	0
EBR	32	44	12	8	0	40	0	0	0	0	40
WBL	236	296	60	40	0	276	45	0	0	45	321
WBT	10	15	5	3	0	13	0	0	0	0	13
WBR	4	5	1	1	0	5	0	0	0	0	5
North Leg											
Approach	112	122	10	7	0	119	0	0	0	0	119
Departure	145	165	20	13	0	158	0	0	0	0	158
Total	257	287	30	20	0	277	0	0	0	0	277
South Leg											
Approach	183	214	31	21	0	204	0	0	0	0	204
Departure	380	462	82	55	0	435	45	0	0	45	480
Total	563	676	113	75	0	638	45	0	0	45	683
East Leg											
Approach	250	316	66	44	0	294	45	0	0	45	339
Departure	0	0	0	0	0	0	0	0	0	0	0
Total	250	316	66	44	0	294	45	0	0	45	339
West Leg											
Approach	32	44	12	8	0	40	0	0	0	0	40
Departure	52	69	17	11	0	63	0	0	0	0	63
Total	84	113	29	19	0	103	0	0	0	0	103
Total Approaches											
Approach	577	696	119	79	0	656	45	0	0	45	701
Departure	577	696	119	79	0	656	45	0	0	45	701
Total	1,154	1,392	238	159	0	1,313	90	0	0	90	1,403

Table C-4 - Phase II Project Completion Year (2039) Volume Summary

	PM Peak Hour										
	Existing	Ph III 2049 without Project	Total Growth (2019-2049)	Adjusted Growth	Cumulative Projects	Year 2039 without Project	External Project Trips	Internal Project Trips	Pass-by Trips	Phases I + II Project Trips	Year 2039 with Project
39 4th Street/Sunset Avenue											
NBL	13	14	1	1	0	14	0	0	0	0	14
NBT	278	350	72	48	0	326	53	0	0	53	379
NBR	0	0	0	0	0	0	0	0	0	0	0
SBL	0	0	0	0	0	0	0	0	0	0	0
SBT	319	409	90	60	0	379	27	0	0	27	406
SBR	360	378	18	12	0	372	9	0	0	9	381
EBL	224	238	14	9	0	233	10	0	0	10	243
EBT	0	0	0	0	0	0	0	0	0	0	0
EBR	12	14	2	1	0	13	0	0	0	0	13
WBL	0	0	0	0	0	0	0	0	0	0	0
WBT	0	0	0	0	0	0	0	0	0	0	0
WBR	0	0	0	0	0	0	0	0	0	0	0
North Leg											
Approach	679	787	108	72	0	751	36	0	0	36	787
Departure	502	588	86	57	0	559	63	0	0	63	622
Total	1,181	1,375	194	129	0	1,310	99	0	0	99	1,409
South Leg											
Approach	291	364	73	49	0	340	53	0	0	53	393
Departure	331	423	92	61	0	392	27	0	0	27	419
Total	622	787	165	110	0	732	80	0	0	80	812
East Leg											
Approach	0	0	0	0	0	0	0	0	0	0	0
Departure	0	0	0	0	0	0	0	0	0	0	0
Total	0	0	0	0	0	0	0	0	0	0	0
West Leg											
Approach	236	252	16	11	0	247	10	0	0	10	257
Departure	373	392	19	13	0	386	9	0	0	9	395
Total	609	644	35	23	0	632	19	0	0	19	651
Total Approaches											
Approach	1,206	1,403	197	131	0	1,337	99	0	0	99	1,436
Departure	1,206	1,403	197	131	0	1,337	99	0	0	99	1,436
Total	2,412	2,806	394	263	0	2,675	198	0	0	198	2,873

Table C-4 - Phase II Project Completion Year (2039) Volume Summary

	PM Peak Hour										
	Existing	Ph III 2049 without Project	Total Growth (2019-2049)	Adjusted Growth	Cumulative Projects	Year 2039 without Project	External Project Trips	Internal Project Trips	Pass-by Trips	Phases I + II Project Trips	Year 2039 with Project
40 H Street/SR-99 Northbound On-Ramp - 2nd Street											
NBL	262	401	139	93	0	355	91	0	0	91	446
NBT	27	28	1	1	0	28	0	0	0	0	28
NBR	12	54	42	28	0	40	0	0	0	0	40
SBL	2	2	0	0	0	2	0	0	0	0	2
SBT	24	25	1	1	0	25	0	0	0	0	25
SBR	0	0	0	0	0	0	0	0	0	0	0
EBL	0	0	0	0	0	0	0	0	0	0	0
EBT	0	0	0	0	0	0	0	0	0	0	0
EBR	0	0	0	0	0	0	0	0	0	0	0
WBL	11	49	38	25	0	36	0	0	0	0	36
WBT	52	58	6	4	0	56	0	0	0	0	56
WBR	4	4	0	0	0	4	0	0	0	0	4
North Leg											
Approach	26	27	1	1	0	27	0	0	0	0	27
Departure	31	32	1	1	0	32	0	0	0	0	32
Total	57	59	2	2	0	59	0	0	0	0	59
South Leg											
Approach	301	483	182	121	0	422	91	0	0	91	513
Departure	35	74	39	26	0	61	0	0	0	0	61
Total	336	557	221	147	0	483	91	0	0	91	574
East Leg											
Approach	67	111	44	29	0	96	0	0	0	0	96
Departure	14	56	42	28	0	42	0	0	0	0	42
Total	81	167	86	58	0	139	0	0	0	0	139
West Leg											
Approach	0	0	0	0	0	0	0	0	0	0	0
Departure	314	459	145	97	0	411	91	0	0	91	502
Total	314	459	145	97	0	411	91	0	0	91	502
Total Approaches											
Approach	394	621	227	152	0	546	91	0	0	91	637
Departure	394	621	227	152	0	546	91	0	0	91	637
Total	788	1,243	455	303	0	1,091	182	0	0	182	1,273

Table C-4 - Phase II Project Completion Year (2039) Volume Summary

	PM Peak Hour										
	Existing	Ph III 2049 without Project	Total Growth (2019-2049)	Adjusted Growth	Cumulative Projects	Year 2039 without Project	External Project Trips	Internal Project Trips	Pass-by Trips	Phases I + II Project Trips	Year 2039 with Project
41 I Street/4th Street											
NBL	96	105	9	6	0	102	0	0	0	0	102
NBT	68	75	7	5	0	73	0	0	0	0	73
NBR	244	256	12	8	0	252	0	0	0	0	252
SBL	159	193	34	23	0	182	18	0	0	18	200
SBT	163	173	10	7	0	170	0	0	0	0	170
SBR	93	132	39	26	0	119	27	0	0	27	146
EBL	31	42	11	7	0	38	0	0	0	0	38
EBT	471	545	74	49	0	520	63	0	0	63	583
EBR	61	62	1	1	0	62	0	0	0	0	62
WBL	59	62	3	2	0	61	0	0	0	0	61
WBT	490	534	44	29	0	519	9	0	0	9	528
WBR	106	117	11	7	0	113	0	0	0	0	113
North Leg											
Approach	415	498	83	55	0	470	45	0	0	45	515
Departure	205	234	29	19	0	224	0	0	0	0	224
Total	620	732	112	75	0	695	45	0	0	45	740
South Leg											
Approach	408	436	28	19	0	427	0	0	0	0	427
Departure	283	297	14	9	0	292	0	0	0	0	292
Total	691	733	42	28	0	719	0	0	0	0	719
East Leg											
Approach	655	713	58	39	0	694	9	0	0	9	703
Departure	874	994	120	80	0	954	81	0	0	81	1,035
Total	1,529	1,707	178	119	0	1,648	90	0	0	90	1,738
West Leg											
Approach	563	649	86	57	0	620	63	0	0	63	683
Departure	679	771	92	61	0	740	36	0	0	36	776
Total	1,242	1,420	178	119	0	1,361	99	0	0	99	1,460
Total Approaches											
Approach	2,041	2,296	255	170	0	2,211	117	0	0	117	2,328
Departure	2,041	2,296	255	170	0	2,211	117	0	0	117	2,328
Total	4,082	4,592	510	340	0	4,422	234	0	0	234	4,656

Table C-4 - Phase II Project Completion Year (2039) Volume Summary

	PM Peak Hour										
	Existing	Ph III 2049 without Project	Total Growth (2019-2049)	Adjusted Growth	Cumulative Projects	Year 2039 without Project	External Project Trips	Internal Project Trips	Pass-by Trips	Phases I + II Project Trips	Year 2039 with Project
42 SR-99 Southbound On-Ramp/4th Street											
NBL	0	0	0	0	0	0	0	0	0	0	0
NBT	0	0	0	0	0	0	0	0	0	0	0
NBR	0	0	0	0	0	0	0	0	0	0	0
SBL	0	0	0	0	0	0	0	0	0	0	0
SBT	0	0	0	0	0	0	0	0	0	0	0
SBR	0	0	0	0	0	0	0	0	0	0	0
EBL	0	0	0	0	0	0	0	0	0	0	0
EBT	599	678	79	53	0	652	81	0	0	81	733
EBR	275	316	41	27	0	302	0	0	0	0	302
WBL	151	226	75	50	0	201	0	0	0	0	201
WBT	655	713	58	39	0	694	9	0	0	9	703
WBR	0	0	0	0	0	0	0	0	0	0	0
North Leg											
Approach	0	0	0	0	0	0	0	0	0	0	0
Departure	0	0	0	0	0	0	0	0	0	0	0
Total	0	0	0	0	0	0	0	0	0	0	0
South Leg											
Approach	0	0	0	0	0	0	0	0	0	0	0
Departure	426	542	116	77	0	503	0	0	0	0	503
Total	426	542	116	77	0	503	0	0	0	0	503
East Leg											
Approach	806	939	133	89	0	895	9	0	0	9	904
Departure	599	678	79	53	0	652	81	0	0	81	733
Total	1,405	1,617	212	141	0	1,546	90	0	0	90	1,636
West Leg											
Approach	874	994	120	80	0	954	81	0	0	81	1,035
Departure	655	713	58	39	0	694	9	0	0	9	703
Total	1,529	1,707	178	119	0	1,648	90	0	0	90	1,738
Total Approaches											
Approach	1,680	1,933	253	169	0	1,849	90	0	0	90	1,939
Departure	1,680	1,933	253	169	0	1,849	90	0	0	90	1,939
Total	3,360	3,866	506	337	0	3,697	180	0	0	180	3,877

Table C-4 - Phase II Project Completion Year (2039) Volume Summary

	PM Peak Hour										
	Existing	Ph III 2049 without Project	Total Growth (2019-2049)	Adjusted Growth	Cumulative Projects	Year 2039 without Project	External Project Trips	Internal Project Trips	Pass-by Trips	Phases I + II Project Trips	Year 2039 with Project
43 H Street – SR-99 Northbound Off-Ramp/4th Street											
NBL	239	285	46	31	0	270	0	0	0	0	270
NBT	19	40	21	14	0	33	0	0	0	0	33
NBR	144	208	64	43	0	187	0	0	0	0	187
SBL	20	34	14	9	0	29	0	0	0	0	29
SBT	0	0	0	0	0	0	0	0	0	0	0
SBR	66	92	26	17	0	83	0	0	0	0	83
EBL	200	271	71	47	0	247	53	0	0	53	300
EBT	399	407	8	5	0	404	28	0	0	28	432
EBR	0	0	0	0	0	0	0	0	0	0	0
WBL	0	0	0	0	0	0	0	0	0	0	0
WBT	501	562	61	41	0	542	9	0	0	9	551
WBR	87	171	84	56	0	143	39	0	0	39	182
North Leg											
Approach	86	126	40	27	0	113	0	0	0	0	113
Departure	306	482	176	117	0	423	92	0	0	92	515
Total	392	608	216	144	0	536	92	0	0	92	628
South Leg											
Approach	402	533	131	87	0	489	0	0	0	0	489
Departure	0	0	0	0	0	0	0	0	0	0	0
Total	402	533	131	87	0	489	0	0	0	0	489
East Leg											
Approach	588	733	145	97	0	685	48	0	0	48	733
Departure	563	649	86	57	0	620	28	0	0	28	648
Total	1,151	1,382	231	154	0	1,305	76	0	0	76	1,381
West Leg											
Approach	599	678	79	53	0	652	81	0	0	81	733
Departure	806	939	133	89	0	895	9	0	0	9	904
Total	1,405	1,617	212	141	0	1,546	90	0	0	90	1,636
Total Approaches											
Approach	1,675	2,070	395	263	0	1,938	129	0	0	129	2,067
Departure	1,675	2,070	395	263	0	1,938	129	0	0	129	2,067
Total	3,350	4,140	790	527	0	3,877	258	0	0	258	4,135

Table C-4 - Phase II Project Completion Year (2039) Volume Summary

	PM Peak Hour										
	Existing	Ph III 2049 without Project	Total Growth (2019-2049)	Adjusted Growth	Cumulative Projects	Year 2039 without Project	External Project Trips	Internal Project Trips	Pass-by Trips	Phases I + II Project Trips	Year 2039 with Project
44 I Street/Olive Avenue											
NBL	0	0	0	0	0	0	0	0	0	0	0
NBT	0	0	0	0	0	0	0	0	0	0	0
NBR	0	0	0	0	0	0	0	0	0	0	0
SBL	152	160	8	5	0	157	0	0	0	0	157
SBT	0	0	0	0	0	0	0	0	0	0	0
SBR	106	111	5	4	0	110	0	0	0	0	110
EBL	86	90	4	3	0	89	0	0	0	0	89
EBT	376	502	126	84	0	460	58	0	0	58	518
EBR	0	0	0	0	0	0	0	0	0	0	0
WBL	0	0	0	0	0	0	0	0	0	0	0
WBT	357	492	135	90	0	447	47	0	0	47	494
WBR	103	113	10	7	0	110	0	0	0	0	110
North Leg											
Approach	258	271	13	9	0	267	0	0	0	0	267
Departure	189	203	14	10	0	199	0	0	0	0	199
Total	447	474	27	18	0	465	0	0	0	0	465
South Leg											
Approach	0	0	0	0	0	0	0	0	0	0	0
Departure	0	0	0	0	0	0	0	0	0	0	0
Total	0	0	0	0	0	0	0	0	0	0	0
East Leg											
Approach	460	605	145	97	0	557	47	0	0	47	604
Departure	528	662	134	89	0	617	58	0	0	58	675
Total	988	1,267	279	186	0	1,174	105	0	0	105	1,279
West Leg											
Approach	462	592	130	87	0	549	58	0	0	58	607
Departure	463	603	140	94	0	557	47	0	0	47	604
Total	925	1,196	271	180	0	1,105	105	0	0	105	1,210
Total Approaches											
Approach	1,180	1,468	288	192	0	1,372	105	0	0	105	1,477
Departure	1,180	1,468	288	192	0	1,372	105	0	0	105	1,477
Total	2,360	2,937	577	384	0	2,744	210	0	0	210	2,954

Table C-4 - Phase II Project Completion Year (2039) Volume Summary

	PM Peak Hour										
	Existing	Ph III 2049 without Project	Total Growth (2019-2049)	Adjusted Growth	Cumulative Projects	Year 2039 without Project	External Project Trips	Internal Project Trips	Pass-by Trips	Phases I + II Project Trips	Year 2039 with Project
45 SR-99 Southbound Off-Ramp/Olive Avenue											
NBL	0	0	0	0	0	0	0	0	0	0	0
NBT	0	0	0	0	0	0	0	0	0	0	0
NBR	0	0	0	0	0	0	0	0	0	0	0
SBL	229	674	445	297	0	526	84	0	0	84	610
SBT	0	0	0	0	0	0	0	0	0	0	0
SBR	65	102	37	25	0	90	0	0	0	0	90
EBL	0	0	0	0	0	0	0	0	0	0	0
EBT	528	661	133	89	0	617	58	0	0	58	675
EBR	0	0	0	0	0	0	0	0	0	0	0
WBL	0	0	0	0	0	0	0	0	0	0	0
WBT	395	503	108	72	0	467	47	0	0	47	514
WBR	0	0	0	0	0	0	0	0	0	0	0
North Leg											
Approach	294	776	482	321	0	615	84	0	0	84	699
Departure	0	0	0	0	0	0	0	0	0	0	0
Total	294	776	482	321	0	615	84	0	0	84	699
South Leg											
Approach	0	0	0	0	0	0	0	0	0	0	0
Departure	0	0	0	0	0	0	0	0	0	0	0
Total	0	0	0	0	0	0	0	0	0	0	0
East Leg											
Approach	395	503	108	72	0	467	47	0	0	47	514
Departure	757	1,335	578	385	0	1,142	142	0	0	142	1,284
Total	1,152	1,838	686	457	0	1,609	189	0	0	189	1,798
West Leg											
Approach	528	661	133	89	0	617	58	0	0	58	675
Departure	460	605	145	97	0	557	47	0	0	47	604
Total	988	1,266	278	185	0	1,173	105	0	0	105	1,278
Total Approaches											
Approach	1,217	1,940	723	482	0	1,699	189	0	0	189	1,888
Departure	1,217	1,940	723	482	0	1,699	189	0	0	189	1,888
Total	2,434	3,880	1,446	964	0	3,398	378	0	0	378	3,776

Table C-4 - Phase II Project Completion Year (2039) Volume Summary

	PM Peak Hour										
	Existing	Ph III 2049 without Project	Total Growth (2019-2049)	Adjusted Growth	Cumulative Projects	Year 2039 without Project	External Project Trips	Internal Project Trips	Pass-by Trips	Phases I + II Project Trips	Year 2039 with Project
46 Madera Avenue/SR-99 Northbound Ramps											
NBL	377	820	443	295	0	672	119	0	0	119	791
NBT	520	753	233	155	0	675	39	0	0	39	714
NBR	0	0	0	0	0	0	0	0	0	0	0
SBL	0	0	0	0	0	0	0	0	0	0	0
SBT	581	691	110	73	0	654	9	0	0	9	663
SBR	171	178	7	5	0	176	60	0	0	60	236
EBL	0	0	0	0	0	0	0	0	0	0	0
EBT	0	0	0	0	0	0	0	0	0	0	0
EBR	0	0	0	0	0	0	0	0	0	0	0
WBL	171	209	38	25	0	196	30	0	0	30	226
WBT	1	1	0	0	0	1	0	0	0	0	1
WBR	32	34	2	1	0	33	0	0	0	0	33
North Leg											
Approach	752	869	117	78	0	830	69	0	0	69	899
Departure	552	787	235	156	0	708	39	0	0	39	747
Total	1,304	1,656	352	234	0	1,538	108	0	0	108	1,646
South Leg											
Approach	897	1,573	676	451	0	1,348	158	0	0	158	1,506
Departure	752	900	148	99	0	851	39	0	0	39	890
Total	1,649	2,473	824	549	0	2,198	197	0	0	197	2,395
East Leg											
Approach	204	244	40	26	0	230	30	0	0	30	260
Departure	0	0	0	0	0	0	0	0	0	0	0
Total	204	244	40	26	0	230	30	0	0	30	260
West Leg											
Approach	0	0	0	0	0	0	0	0	0	0	0
Departure	549	999	450	300	0	849	179	0	0	179	1,028
Total	549	999	450	300	0	849	179	0	0	179	1,028
Total Approaches											
Approach	1,853	2,686	833	555	0	2,408	257	0	0	257	2,665
Departure	1,853	2,686	833	555	0	2,408	257	0	0	257	2,665
Total	3,706	5,371	1,665	1,110	0	4,816	514	0	0	514	5,330

Table C-4 - Phase II Project Completion Year (2039) Volume Summary

	PM Peak Hour										
	Existing	Ph III 2049 without Project	Total Growth (2019-2049)	Adjusted Growth	Cumulative Projects	Year 2039 without Project	External Project Trips	Internal Project Trips	Pass-by Trips	Phases I + II Project Trips	Year 2039 with Project
47 Madera Avenue/Olive Avenue – SR-99 Southbound On-Ramp											
NBL	104	197	93	62	0	166	9	0	0	9	175
NBT	573	1,081	508	339	0	912	119	0	0	119	1,031
NBR	29	52	23	15	0	44	0	0	0	0	44
SBL	130	137	7	4	0	134	0	0	0	0	134
SBT	331	458	127	85	0	416	0	0	0	0	416
SBR	291	306	15	10	0	301	38	0	0	38	339
EBL	324	492	168	112	0	436	39	0	0	39	475
EBT	135	196	61	41	0	176	37	0	0	37	213
EBR	298	647	349	233	0	531	66	0	0	66	597
WBL	0	0	0	0	0	0	0	0	0	0	0
WBT	0	0	0	0	0	0	0	0	0	0	0
WBR	0	0	0	0	0	0	0	0	0	0	0
North Leg											
Approach	752	900	148	99	0	851	38	0	0	38	889
Departure	897	1,573	676	451	0	1,348	158	0	0	158	1,506
Total	1,649	2,473	824	549	0	2,198	196	0	0	196	2,394
South Leg											
Approach	706	1,330	624	416	0	1,122	128	0	0	128	1,250
Departure	629	1,105	476	317	0	946	66	0	0	66	1,012
Total	1,335	2,435	1,100	733	0	2,068	194	0	0	194	2,262
East Leg											
Approach	0	0	0	0	0	0	0	0	0	0	0
Departure	294	385	91	60	0	354	37	0	0	37	391
Total	294	385	91	60	0	354	37	0	0	37	391
West Leg											
Approach	757	1,335	578	385	0	1,142	142	0	0	142	1,284
Departure	395	503	108	72	0	467	47	0	0	47	514
Total	1,152	1,838	686	457	0	1,609	189	0	0	189	1,798
Total Approaches											
Approach	2,215	3,565	1,350	900	0	3,115	308	0	0	308	3,423
Departure	2,215	3,565	1,350	900	0	3,115	308	0	0	308	3,423
Total	4,430	7,130	2,700	1,800	0	6,230	616	0	0	616	6,846

Table C-4 - Phase II Project Completion Year (2039) Volume Summary

	PM Peak Hour										
	Existing	Ph III 2049 without Project	Total Growth (2019-2049)	Adjusted Growth	Cumulative Projects	Year 2039 without Project	External Project Trips	Internal Project Trips	Pass-by Trips	Phases I + II Project Trips	Year 2039 with Project
48 Madera Avenue (SR-145) /Lewis Street											
NBL	0	0	0	0	0	0	0	0	0	0	0
NBT	739	1,364	625	417	0	1,156	128	0	0	128	1,284
NBR	6	7	1	1	0	7	0	0	0	0	7
SBL	31	33	2	1	0	32	0	0	0	0	32
SBT	690	1,166	476	317	0	1,007	66	0	0	66	1,073
SBR	0	0	0	0	0	0	0	0	0	0	0
EBL	0	0	0	0	0	0	0	0	0	0	0
EBT	0	0	0	0	0	0	0	0	0	0	0
EBR	0	0	0	0	0	0	0	0	0	0	0
WBL	7	7	0	0	0	7	0	0	0	0	7
WBT	0	0	0	0	0	0	0	0	0	0	0
WBR	9	9	0	0	0	9	0	0	0	0	9
North Leg											
Approach	721	1,199	478	318	0	1,039	66	0	0	66	1,105
Departure	748	1,373	625	417	0	1,165	128	0	0	128	1,293
Total	1,469	2,572	1,103	735	0	2,204	194	0	0	194	2,398
South Leg											
Approach	745	1,371	626	417	0	1,162	128	0	0	128	1,290
Departure	697	1,173	476	318	0	1,015	66	0	0	66	1,081
Total	1,442	2,544	1,102	735	0	2,177	194	0	0	194	2,371
East Leg											
Approach	16	17	1	1	0	17	0	0	0	0	17
Departure	37	40	3	2	0	39	0	0	0	0	39
Total	53	56	3	2	0	55	0	0	0	0	55
West Leg											
Approach	0	0	0	0	0	0	0	0	0	0	0
Departure	0	0	0	0	0	0	0	0	0	0	0
Total	0	0	0	0	0	0	0	0	0	0	0
Total Approaches											
Approach	1,482	2,586	1,104	736	0	2,218	194	0	0	194	2,412
Departure	1,482	2,586	1,104	736	0	2,218	194	0	0	194	2,412
Total	2,964	5,173	2,209	1,472	0	4,436	388	0	0	388	4,824

Table C-4 - Phase II Project Completion Year (2039) Volume Summary

	PM Peak Hour										
	Existing	Ph III 2049 without Project	Total Growth (2019-2049)	Adjusted Growth	Cumulative Projects	Year 2039 without Project	External Project Trips	Internal Project Trips	Pass-by Trips	Phases I + II Project Trips	Year 2039 with Project
49 Yosemite Avenue/Cleveland Avenue - Tozer Street											
NBL	305	320	15	10	0	315	0	0	0	0	315
NBT	283	329	46	31	0	314	0	0	0	0	314
NBR	95	100	5	3	0	98	0	0	0	0	98
SBL	67	83	16	11	0	78	0	0	0	0	78
SBT	167	188	21	14	0	181	0	0	0	0	181
SBR	209	240	31	21	0	230	83	0	0	83	313
EBL	187	250	63	42	0	229	43	0	0	43	272
EBT	408	467	59	39	0	447	5	0	0	5	452
EBR	195	203	8	5	0	200	0	0	0	0	200
WBL	48	52	4	3	0	51	0	0	0	0	51
WBT	447	499	52	35	0	482	10	0	0	10	492
WBR	35	49	14	9	0	44	0	0	0	0	44
North Leg											
Approach	443	511	68	45	0	488	83	0	0	83	571
Departure	505	628	123	82	0	587	43	0	0	43	630
Total	948	1,139	191	127	0	1,075	126	0	0	126	1,201
South Leg											
Approach	683	749	66	44	0	727	0	0	0	0	727
Departure	410	443	33	22	0	432	0	0	0	0	432
Total	1,093	1,192	99	66	0	1,159	0	0	0	0	1,159
East Leg											
Approach	530	600	70	47	0	577	10	0	0	10	587
Departure	570	650	80	53	0	623	5	0	0	5	628
Total	1,100	1,250	150	100	0	1,200	15	0	0	15	1,215
West Leg											
Approach	790	920	130	87	0	877	48	0	0	48	925
Departure	961	1,059	98	66	0	1,027	93	0	0	93	1,120
Total	1,751	1,979	228	152	0	1,903	141	0	0	141	2,044
Total Approaches											
Approach	2,446	2,780	334	223	0	2,669	141	0	0	141	2,810
Departure	2,446	2,780	334	223	0	2,669	141	0	0	141	2,810
Total	4,892	5,560	668	445	0	5,337	282	0	0	282	5,619

Table C-4 - Phase II Project Completion Year (2039) Volume Summary

	PM Peak Hour										
	Existing	Ph III 2049 without Project	Total Growth (2019-2049)	Adjusted Growth	Cumulative Projects	Year 2039 without Project	External Project Trips	Internal Project Trips	Pass-by Trips	Phases I + II Project Trips	Year 2039 with Project
50 Road 22/Cleveland Avenue											
NBL	0	0	0	0	0	0	0	0	0	0	0
NBT	0	0	0	0	0	0	0	0	0	0	0
NBR	0	0	0	0	0	0	0	0	0	0	0
SBL	0	0	0	0	0	0	0	0	0	0	0
SBT	0	0	0	0	0	0	0	0	0	0	0
SBR	0	0	0	0	0	0	0	0	0	0	0
EBL	0	0	0	0	0	0	0	0	0	0	0
EBT	0	0	0	0	0	0	0	0	0	0	0
EBR	0	0	0	0	0	0	0	0	0	0	0
WBL	0	0	0	0	0	0	0	0	0	0	0
WBT	0	0	0	0	0	0	0	0	0	0	0
WBR	0	0	0	0	0	0	0	0	0	0	0
North Leg											
Approach	0	0	0	0	0	0	0	0	0	0	0
Departure	0	0	0	0	0	0	0	0	0	0	0
Total	0	0	0	0	0	0	0	0	0	0	0
South Leg											
Approach	0	0	0	0	0	0	0	0	0	0	0
Departure	0	0	0	0	0	0	0	0	0	0	0
Total	0	0	0	0	0	0	0	0	0	0	0
East Leg											
Approach	0	0	0	0	0	0	0	0	0	0	0
Departure	0	0	0	0	0	0	0	0	0	0	0
Total	0	0	0	0	0	0	0	0	0	0	0
West Leg											
Approach	0	0	0	0	0	0	0	0	0	0	0
Departure	0	0	0	0	0	0	0	0	0	0	0
Total	0	0	0	0	0	0	0	0	0	0	0
Total Approaches											
Approach	0	0	0	0	0	0	0	0	0	0	0
Departure	0	0	0	0	0	0	0	0	0	0	0
Total	0	0	0	0	0	0	0	0	0	0	0

Table C-4 - Phase II Project Completion Year (2039) Volume Summary

	PM Peak Hour										
	Existing	Ph III 2049 without Project	Total Growth (2019-2049)	Adjusted Growth	Cumulative Projects	Year 2039 without Project	External Project Trips	Internal Project Trips	Pass-by Trips	Phases I + II Project Trips	Year 2039 with Project
51 Project Driveway 1/Avenue 17											
NBL	0	0	0	0	0	0	23	0	0	23	23
NBT	0	0	0	0	0	0	0	0	0	0	0
NBR	0	0	0	0	0	0	270	64	0	334	334
SBL	0	0	0	0	0	0	0	0	0	0	0
SBT	0	0	0	0	0	0	0	0	0	0	0
SBR	0	0	0	0	0	0	0	0	0	0	0
EBL	0	0	0	0	0	0	0	0	0	0	0
EBT	60	73	13	9	0	69	31	16	0	47	116
EBR	0	0	0	0	0	0	50	0	0	50	50
WBL	0	0	0	0	0	0	595	64	0	659	659
WBT	25	39	14	9	0	34	16	16	0	32	66
WBR	0	0	0	0	0	0	0	0	0	0	0
North Leg											
Approach	0	0	0	0	0	0	0	0	0	0	0
Departure	0	0	0	0	0	0	0	0	0	0	0
Total	0	0	0	0	0	0	0	0	0	0	0
South Leg											
Approach	0	0	0	0	0	0	293	64	0	357	357
Departure	0	0	0	0	0	0	645	64	0	709	709
Total	0	0	0	0	0	0	938	128	0	1,066	1,066
East Leg											
Approach	25	39	14	9	0	34	611	80	0	691	725
Departure	60	73	13	9	0	69	301	80	0	381	450
Total	85	112	27	18	0	103	912	160	0	1,072	1,175
West Leg											
Approach	60	73	13	9	0	69	81	16	0	97	166
Departure	25	39	14	9	0	34	39	16	0	55	89
Total	85	112	27	18	0	103	120	32	0	152	255
Total Approaches											
Approach	85	112	27	18	0	103	985	160	0	1,145	1,248
Departure	85	112	27	18	0	103	985	160	0	1,145	1,248
Total	170	224	54	36	0	206	1,970	320	0	2,290	2,496

Table C-4 - Phase II Project Completion Year (2039) Volume Summary

	PM Peak Hour										
	Existing	Ph III 2049 without Project	Total Growth (2019-2049)	Adjusted Growth	Cumulative Projects	Year 2039 without Project	External Project Trips	Internal Project Trips	Pass-by Trips	Phases I + II Project Trips	Year 2039 with Project
52 Road 22 ½ - Project Driveway 2/Avenue 16											
NBL	0	0	0	0	0	0	0	0	0	0	0
NBT	0	0	0	0	0	0	0	38	0	38	38
NBR	0	0	0	0	0	0	0	0	0	0	0
SBL	1	4	3	2	0	3	70	246	0	316	319
SBT	0	0	0	0	0	0	0	38	0	38	38
SBR	0	0	0	0	0	0	0	0	0	0	0
EBL	0	0	0	0	0	0	0	0	0	0	0
EBT	49	202	153	102	0	151	0	0	0	0	151
EBR	0	0	0	0	0	0	0	0	0	0	0
WBL	0	0	0	0	0	0	0	0	0	0	0
WBT	14	15	1	1	0	15	0	0	0	0	15
WBR	0	0	0	0	0	0	155	248	0	403	403
North Leg											
Approach	1	4	3	2	0	3	70	284	0	354	357
Departure	0	0	0	0	0	0	155	286	0	441	441
Total	1	4	3	2	0	3	225	570	0	795	798
South Leg											
Approach	0	0	0	0	0	0	0	38	0	38	38
Departure	0	0	0	0	0	0	0	38	0	38	38
Total	0	0	0	0	0	0	0	76	0	76	76
East Leg											
Approach	14	15	1	1	0	15	155	248	0	403	418
Departure	50	206	156	104	0	154	70	246	0	316	470
Total	64	221	157	105	0	169	225	494	0	719	888
West Leg											
Approach	49	202	153	102	0	151	0	0	0	0	151
Departure	14	15	1	1	0	15	0	0	0	0	15
Total	63	217	154	103	0	166	0	0	0	0	166
Total Approaches											
Approach	64	221	157	105	0	169	225	570	0	795	964
Departure	64	221	157	105	0	169	225	570	0	795	964
Total	128	442	314	209	0	337	450	1,140	0	1,590	1,927

Table C-4 - Phase II Project Completion Year (2039) Volume Summary

	PM Peak Hour										
	Existing	Ph III 2049 without Project	Total Growth (2019-2049)	Adjusted Growth	Cumulative Projects	Year 2039 without Project	External Project Trips	Internal Project Trips	Pass-by Trips	Phases I + II Project Trips	Year 2039 with Project
53 Road 22 1/2/Cleveland Avenue											
NBL	0	0	0	0	0	0	0	0	0	0	0
NBT	0	0	0	0	0	0	0	0	0	0	0
NBR	0	0	0	0	0	0	0	0	0	0	0
SBL	1	1	0	0	0	1	0	38	0	38	39
SBT	0	0	0	0	0	0	0	0	0	0	0
SBR	0	0	0	0	0	0	0	0	0	0	0
EBL	0	0	0	0	0	0	0	0	0	0	0
EBT	0	0	0	0	0	0	0	0	0	0	0
EBR	0	0	0	0	0	0	0	0	0	0	0
WBL	0	0	0	0	0	0	0	0	0	0	0
WBT	0	0	0	0	0	0	0	0	0	0	0
WBR	0	0	0	0	0	0	0	38	0	38	38
North Leg											
Approach	1	1	0	0	0	1	0	38	0	38	39
Departure	0	0	0	0	0	0	0	38	0	38	38
Total	1	1	0	0	0	1	0	76	0	76	77
South Leg											
Approach	0	0	0	0	0	0	0	0	0	0	0
Departure	0	0	0	0	0	0	0	0	0	0	0
Total	0	0	0	0	0	0	0	0	0	0	0
East Leg											
Approach	0	0	0	0	0	0	0	38	0	38	38
Departure	1	1	0	0	0	1	0	38	0	38	39
Total	1	1	0	0	0	1	0	76	0	76	77
West Leg											
Approach	0	0	0	0	0	0	0	0	0	0	0
Departure	0	0	0	0	0	0	0	0	0	0	0
Total	0	0	0	0	0	0	0	0	0	0	0
Total Approaches											
Approach	1	1	0	0	0	1	0	76	0	76	77
Departure	1	1	0	0	0	1	0	76	0	76	77
Total	2	2	0	0	0	2	0	152	0	152	154

Table C-4 - Phase II Project Completion Year (2039) Volume Summary

	PM Peak Hour										
	Existing	Ph III 2049 without Project	Total Growth (2019-2049)	Adjusted Growth	Cumulative Projects	Year 2039 without Project	External Project Trips	Internal Project Trips	Pass-by Trips	Phases I + II Project Trips	Year 2039 with Project
54 Road 22 1/2/Project Driveway 5											
NBL	0	0	0	0	0	0	0	0	0	0	0
NBT	0	0	0	0	0	0	0	0	0	0	0
NBR	0	0	0	0	0	0	0	0	0	0	0
SBL	0	0	0	0	0	0	0	0	0	0	0
SBT	0	0	0	0	0	0	0	0	0	0	0
SBR	0	0	0	0	0	0	0	0	0	0	0
EBL	0	0	0	0	0	0	0	0	0	0	0
EBT	0	0	0	0	0	0	0	0	0	0	0
EBR	0	0	0	0	0	0	0	0	0	0	0
WBL	0	0	0	0	0	0	0	0	0	0	0
WBT	0	0	0	0	0	0	0	0	0	0	0
WBR	0	0	0	0	0	0	0	0	0	0	0
North Leg											
Approach	0	0	0	0	0	0	0	0	0	0	0
Departure	0	0	0	0	0	0	0	0	0	0	0
Total	0	0	0	0	0	0	0	0	0	0	0
South Leg											
Approach	0	0	0	0	0	0	0	0	0	0	0
Departure	0	0	0	0	0	0	0	0	0	0	0
Total	0	0	0	0	0	0	0	0	0	0	0
East Leg											
Approach	0	0	0	0	0	0	0	0	0	0	0
Departure	0	0	0	0	0	0	0	0	0	0	0
Total	0	0	0	0	0	0	0	0	0	0	0
West Leg											
Approach	0	0	0	0	0	0	0	0	0	0	0
Departure	0	0	0	0	0	0	0	0	0	0	0
Total	0	0	0	0	0	0	0	0	0	0	0
Total Approaches											
Approach	0	0	0	0	0	0	0	0	0	0	0
Departure	0	0	0	0	0	0	0	0	0	0	0
Total	0	0	0	0	0	0	0	0	0	0	0

Table C-4 - Phase II Project Completion Year (2039) Volume Summary

	PM Peak Hour										
	Existing	Ph III 2049 without Project	Total Growth (2019-2049)	Adjusted Growth	Cumulative Projects	Year 2039 without Project	External Project Trips	Internal Project Trips	Pass-by Trips	Phases I + II Project Trips	Year 2039 with Project
55 Road 23/Project Driveway 3											
NBL	0	0	0	0	0	0	36	395	0	431	431
NBT	152	306	154	103	0	255	298	265	0	563	818
NBR	0	0	0	0	0	0	0	0	0	0	0
SBL	0	0	0	0	0	0	0	0	0	0	0
SBT	242	385	143	95	0	337	448	263	0	711	1,048
SBR	0	0	0	0	0	0	620	40	0	660	660
EBL	0	0	0	0	0	0	283	40	0	323	323
EBT	0	0	0	0	0	0	0	0	0	0	0
EBR	2	2	0	0	0	2	17	394	0	411	413
WBL	0	0	0	0	0	0	0	0	0	0	0
WBT	0	0	0	0	0	0	0	0	0	0	0
WBR	0	0	0	0	0	0	0	0	0	0	0
North Leg											
Approach	242	385	143	95	0	337	1,068	303	0	1,371	1,708
Departure	152	306	154	103	0	255	581	305	0	886	1,141
Total	394	691	297	198	0	592	1,649	608	0	2,257	2,849
South Leg											
Approach	152	306	154	103	0	255	334	660	0	994	1,249
Departure	244	387	143	95	0	339	465	657	0	1,122	1,461
Total	396	693	297	198	0	594	799	1,317	0	2,116	2,710
East Leg											
Approach	0	0	0	0	0	0	0	0	0	0	0
Departure	0	0	0	0	0	0	0	0	0	0	0
Total	0	0	0	0	0	0	0	0	0	0	0
West Leg											
Approach	2	2	0	0	0	2	300	434	0	734	736
Departure	0	0	0	0	0	0	656	435	0	1,091	1,091
Total	2	2	0	0	0	2	956	869	0	1,825	1,827
Total Approaches											
Approach	396	693	297	198	0	594	1,702	1,397	0	3,099	3,693
Departure	396	693	297	198	0	594	1,702	1,397	0	3,099	3,693
Total	792	1,386	594	396	0	1,188	3,404	2,794	0	6,198	7,386

Table C-4 - Phase II Project Completion Year (2039) Volume Summary

	PM Peak Hour										
	Existing	Ph III 2049 without Project	Total Growth (2019-2049)	Adjusted Growth	Cumulative Projects	Year 2039 without Project	External Project Trips	Internal Project Trips	Pass-by Trips	Phases I + II Project Trips	Year 2039 with Project
56 Road 23/Project Driveway 4											
NBL	0	0	0	0	0	0	0	0	0	0	0
NBT	241	332	91	61	0	302	328	0	-19	309	611
NBR	0	0	0	0	0	0	282	0	19	301	301
SBL	0	0	0	0	0	0	278	573	24	875	875
SBT	331	372	41	27	0	358	145	0	-22	123	481
SBR	0	0	0	0	0	0	0	0	0	0	0
EBL	0	0	0	0	0	0	0	0	0	0	0
EBT	0	0	0	0	0	0	0	0	0	0	0
EBR	0	0	0	0	0	0	0	0	0	0	0
WBL	0	0	0	0	0	0	303	0	27	330	330
WBT	0	0	0	0	0	0	0	0	0	0	0
WBR	0	0	0	0	0	0	190	576	23	789	789
North Leg											
Approach	331	372	41	27	0	358	423	573	2	998	1,356
Departure	241	332	91	61	0	302	518	576	4	1,098	1,400
Total	572	704	132	88	0	660	941	1,149	6	2,096	2,756
South Leg											
Approach	241	332	91	61	0	302	610	0	0	610	912
Departure	331	372	41	27	0	358	448	0	5	453	811
Total	572	704	132	88	0	660	1,058	0	5	1,063	1,723
East Leg											
Approach	0	0	0	0	0	0	493	576	50	1,119	1,119
Departure	0	0	0	0	0	0	560	573	43	1,176	1,176
Total	0	0	0	0	0	0	1,053	1,149	93	2,295	2,295
West Leg											
Approach	0	0	0	0	0	0	0	0	0	0	0
Departure	0	0	0	0	0	0	0	0	0	0	0
Total	0	0	0	0	0	0	0	0	0	0	0
Total Approaches											
Approach	572	704	132	88	0	660	1,526	1,149	52	2,727	3,387
Departure	572	704	132	88	0	660	1,526	1,149	52	2,727	3,387
Total	1,144	1,408	264	176	0	1,320	3,052	2,298	104	5,454	6,774

Table C-4 - Phase II Project Completion Year (2039) Volume Summary

	PM Peak Hour										
	Existing	Ph III 2049 without Project	Total Growth (2019-2049)	Adjusted Growth	Cumulative Projects	Year 2039 without Project	External Project Trips	Internal Project Trips	Pass-by Trips	Phases I + II Project Trips	Year 2039 with Project
57 Road 23/Project Driveway 5											
NBL	0	0	0	0	0	0	0	0	0	0	0
NBT	240	279	39	26	0	266	610	0	0	610	876
NBR	0	0	0	0	0	0	0	0	0	0	0
SBL	0	0	0	0	0	0	0	0	0	0	0
SBT	330	347	17	11	0	341	448	0	0	448	789
SBR	1	36	35	23	0	24	0	0	0	0	24
EBL	1	60	59	39	0	40	0	0	0	0	40
EBT	0	0	0	0	0	0	0	0	0	0	0
EBR	2	23	21	14	0	16	0	0	0	0	16
WBL	0	0	0	0	0	0	0	0	0	0	0
WBT	0	0	0	0	0	0	0	0	0	0	0
WBR	0	0	0	0	0	0	0	0	0	0	0
North Leg											
Approach	331	383	52	34	0	365	448	0	0	448	813
Departure	241	339	98	65	0	306	610	0	0	610	916
Total	572	722	150	100	0	672	1,058	0	0	1,058	1,730
South Leg											
Approach	240	279	39	26	0	266	610	0	0	610	876
Departure	332	370	38	25	0	357	448	0	0	448	805
Total	572	649	77	51	0	623	1,058	0	0	1,058	1,681
East Leg											
Approach	0	0	0	0	0	0	0	0	0	0	0
Departure	0	0	0	0	0	0	0	0	0	0	0
Total	0	0	0	0	0	0	0	0	0	0	0
West Leg											
Approach	3	83	80	53	0	56	0	0	0	0	56
Departure	1	36	35	23	0	24	0	0	0	0	24
Total	4	119	115	77	0	81	0	0	0	0	81
Total Approaches											
Approach	574	745	171	114	0	688	1,058	0	0	1,058	1,746
Departure	574	745	171	114	0	688	1,058	0	0	1,058	1,746
Total	1,148	1,489	341	227	0	1,375	2,116	0	0	2,116	3,491

Table C-4 - Phase II Project Completion Year (2039) Volume Summary

	PM Peak Hour										
	Existing	Ph III 2049 without Project	Total Growth (2019-2049)	Adjusted Growth	Cumulative Projects	Year 2039 without Project	External Project Trips	Internal Project Trips	Pass-by Trips	Phases I + II Project Trips	Year 2039 with Project
58 Project Driveway 6/Cleveland Avenue											
NBL	0	0	0	0	0	0	63	6	0	69	69
NBT	0	0	0	0	0	0	0	0	0	0	0
NBR	0	0	0	0	0	0	236	0	7	243	243
SBL	0	0	0	0	0	0	0	0	0	0	0
SBT	0	0	0	0	0	0	0	0	0	0	0
SBR	0	0	0	0	0	0	0	0	0	0	0
EBL	0	0	0	0	0	0	0	0	0	0	0
EBT	148	157	9	6	0	154	284	29	-7	306	460
EBR	0	0	0	0	0	0	143	5	0	148	148
WBL	0	0	0	0	0	0	329	0	3	332	332
WBT	76	79	3	2	0	78	692	30	-3	719	797
WBR	0	0	0	0	0	0	0	0	0	0	0
North Leg											
Approach	0	0	0	0	0	0	0	0	0	0	0
Departure	0	0	0	0	0	0	0	0	0	0	0
Total	0	0	0	0	0	0	0	0	0	0	0
South Leg											
Approach	0	0	0	0	0	0	299	6	7	312	312
Departure	0	0	0	0	0	0	472	5	3	480	480
Total	0	0	0	0	0	0	771	11	10	792	792
East Leg											
Approach	76	79	3	2	0	78	1,021	30	0	1,051	1,129
Departure	148	157	9	6	0	154	520	29	0	549	703
Total	224	236	12	8	0	232	1,541	59	0	1,600	1,832
West Leg											
Approach	148	157	9	6	0	154	427	34	-7	454	608
Departure	76	79	3	2	0	78	755	36	-3	788	866
Total	224	236	12	8	0	232	1,182	70	-10	1,242	1,474
Total Approaches											
Approach	224	236	12	8	0	232	1,747	70	0	1,817	2,049
Departure	224	236	12	8	0	232	1,747	70	0	1,817	2,049
Total	448	472	24	16	0	464	3,494	140	0	3,634	4,098

APPENDIX D:

INTERSECTION LEVEL OF SERVICE WORKSHEETS

Intersection						
Int Delay, s/veh	0.7					
Movement	EBT	EBR	WBL	WBT	NBL	NBR
Lane Configurations						
Traffic Vol, veh/h	29	0	2	25	1	2
Future Vol, veh/h	29	0	2	25	1	2
Conflicting Peds, #/hr	0	0	0	0	0	0
Sign Control	Free	Free	Free	Free	Stop	Stop
RT Channelized	-	None	-	None	-	None
Storage Length	-	-	-	-	-	-
Veh in Median Storage, #	0	-	-	0	0	-
Grade, %	0	-	-	0	0	-
Peak Hour Factor	76	76	76	76	76	76
Heavy Vehicles, %	15	15	15	15	0	0
Mvmt Flow	38	0	3	33	1	3

Major/Minor	Major1	Major2	Minor1		
Conflicting Flow All	0	0	38	0	77 38
Stage 1	-	-	-	-	38 -
Stage 2	-	-	-	-	39 -
Critical Hdwy	-	-	4.25	-	6.4 6.2
Critical Hdwy Stg 1	-	-	-	-	5.4 -
Critical Hdwy Stg 2	-	-	-	-	5.4 -
Follow-up Hdwy	-	-	2.335	-	3.5 3.3
Pot Cap-1 Maneuver	-	-	1492	-	931 1040
Stage 1	-	-	-	-	990 -
Stage 2	-	-	-	-	989 -
Platoon blocked, %	-	-	-	-	-
Mov Cap-1 Maneuver	-	-	1492	-	929 1040
Mov Cap-2 Maneuver	-	-	-	-	929 -
Stage 1	-	-	-	-	990 -
Stage 2	-	-	-	-	987 -

Approach	EB	WB	NB
HCM Control Delay, s	0	0.5	8.6
HCM LOS			A

Minor Lane/Major Mvmt	NBLn1	EBT	EBR	WBL	WBT
Capacity (veh/h)	1000	-	-	1492	-
HCM Lane V/C Ratio	0.004	-	-	0.002	-
HCM Control Delay (s)	8.6	-	-	7.4	0
HCM Lane LOS	A	-	-	A	A
HCM 95th %tile Q(veh)	0	-	-	0	-

Intersection												
Int Delay, s/veh	0.8											
Movement	EBL	EBT	EBR	WBL	WBT	WBR	NBL	NBT	NBR	SBL	SBT	SBR
Lane Configurations		↕			↕			↕			↕	
Traffic Vol, veh/h	2	12	0	0	29	4	0	0	0	2	0	1
Future Vol, veh/h	2	12	0	0	29	4	0	0	0	2	0	1
Conflicting Peds, #/hr	1	0	0	0	0	1	0	0	0	0	0	0
Sign Control	Free	Free	Free	Free	Free	Free	Stop	Stop	Stop	Stop	Stop	Stop
RT Channelized	-	-	None	-	-	None	-	-	None	-	-	None
Storage Length	-	-	-	-	-	-	-	-	-	-	-	-
Veh in Median Storage, #	-	0	-	-	0	-	-	0	-	-	0	-
Grade, %	-	0	-	-	0	-	-	0	-	-	0	-
Peak Hour Factor	83	83	83	83	83	83	83	83	83	83	83	83
Heavy Vehicles, %	11	11	11	11	11	11	0	0	0	0	0	0
Mvmt Flow	2	14	0	0	35	5	0	0	0	2	0	1

Major/Minor	Major1			Major2			Minor1			Minor2		
Conflicting Flow All	41	0	0	14	0	0	56	59	14	57	57	39
Stage 1	-	-	-	-	-	-	18	18	-	39	39	-
Stage 2	-	-	-	-	-	-	38	41	-	18	18	-
Critical Hdwy	4.21	-	-	4.21	-	-	7.1	6.5	6.2	7.1	6.5	6.2
Critical Hdwy Stg 1	-	-	-	-	-	-	6.1	5.5	-	6.1	5.5	-
Critical Hdwy Stg 2	-	-	-	-	-	-	6.1	5.5	-	6.1	5.5	-
Follow-up Hdwy	2.299	-	-	2.299	-	-	3.5	4	3.3	3.5	4	3.3
Pot Cap-1 Maneuver	1512	-	-	1547	-	-	946	836	1072	945	838	1038
Stage 1	-	-	-	-	-	-	1006	884	-	981	866	-
Stage 2	-	-	-	-	-	-	982	865	-	1006	884	-
Platoon blocked, %		-	-		-	-						
Mov Cap-1 Maneuver	1511	-	-	1547	-	-	944	834	1072	943	836	1037
Mov Cap-2 Maneuver	-	-	-	-	-	-	944	834	-	943	836	-
Stage 1	-	-	-	-	-	-	1005	883	-	979	865	-
Stage 2	-	-	-	-	-	-	981	864	-	1005	883	-

Approach	EB	WB	NB	SB
HCM Control Delay, s	1.1	0	0	8.7
HCM LOS			A	A

Minor Lane/Major Mvmt	NBLn1	EBL	EBT	EBR	WBL	WBT	WBR	SBLn1
Capacity (veh/h)	-	1511	-	-	1547	-	-	972
HCM Lane V/C Ratio	-	0.002	-	-	-	-	-	0.004
HCM Control Delay (s)		0	7.4	0	-	0	-	8.7
HCM Lane LOS		A	A	A	-	A	-	A
HCM 95th %tile Q(veh)		-	0	-	-	0	-	0

Intersection						
Int Delay, s/veh	2.9					
Movement	EBL	EBT	WBT	WBR	SBL	SBR
Lane Configurations		↕	↑	↗	↘	
Traffic Vol, veh/h	2	98	96	106	92	4
Future Vol, veh/h	2	98	96	106	92	4
Conflicting Peds, #/hr	0	0	0	0	0	0
Sign Control	Free	Free	Free	Free	Stop	Stop
RT Channelized	-	None	-	None	-	None
Storage Length	-	-	-	0	0	-
Veh in Median Storage, #	-	0	0	-	0	-
Grade, %	-	0	0	-	0	-
Peak Hour Factor	92	92	92	92	92	92
Heavy Vehicles, %	16	16	50	50	81	81
Mvmt Flow	2	107	104	115	100	4

Major/Minor	Major1	Major2	Minor2		
Conflicting Flow All	219	0	-	0	215 104
Stage 1	-	-	-	-	104 -
Stage 2	-	-	-	-	111 -
Critical Hdwy	4.26	-	-	-	7.21 7.01
Critical Hdwy Stg 1	-	-	-	-	6.21 -
Critical Hdwy Stg 2	-	-	-	-	6.21 -
Follow-up Hdwy	2.344	-	-	-	4.229 4.029
Pot Cap-1 Maneuver	1272	-	-	-	626 773
Stage 1	-	-	-	-	756 -
Stage 2	-	-	-	-	750 -
Platoon blocked, %		-	-	-	
Mov Cap-1 Maneuver	1272	-	-	-	625 773
Mov Cap-2 Maneuver	-	-	-	-	625 -
Stage 1	-	-	-	-	754 -
Stage 2	-	-	-	-	750 -

Approach	EB	WB	SB
HCM Control Delay, s	0.2	0	11.8
HCM LOS			B

Minor Lane/Major Mvmt	EBL	EBT	WBT	WBR	SBLn1
Capacity (veh/h)	1272	-	-	-	630
HCM Lane V/C Ratio	0.002	-	-	-	0.166
HCM Control Delay (s)	7.8	0	-	-	11.8
HCM Lane LOS	A	A	-	-	B
HCM 95th %tile Q(veh)	0	-	-	-	0.6

HCM 6th TWSC
 4: Truck Parking Lot/Pistachio Drive & Avenue 18 1/2

Intersection												
Int Delay, s/veh	2.4											
Movement	EBL	EBT	EBR	WBL	WBT	WBR	NBL	NBT	NBR	SBL	SBT	SBR
Lane Configurations		↕			↕	↕		↕			↕	
Traffic Vol, veh/h	8	250	1	3	212	201	0	0	1	104	0	9
Future Vol, veh/h	8	250	1	3	212	201	0	0	1	104	0	9
Conflicting Peds, #/hr	0	0	0	0	0	0	0	0	0	0	0	0
Sign Control	Free	Free	Free	Free	Free	Free	Stop	Stop	Stop	Stop	Stop	Stop
RT Channelized	-	-	None	-	-	None	-	-	None	-	-	None
Storage Length	-	-	-	-	-	50	-	-	-	-	-	-
Veh in Median Storage, #	-	0	-	-	0	-	-	0	-	-	0	-
Grade, %	-	0	-	-	0	-	-	0	-	-	0	-
Peak Hour Factor	93	93	93	93	93	93	93	93	93	93	93	93
Heavy Vehicles, %	34	34	34	26	26	26	100	100	100	12	12	12
Mvmt Flow	9	269	1	3	228	216	0	0	1	112	0	10

Major/Minor	Major1			Major2			Minor1			Minor2		
Conflicting Flow All	444	0	0	270	0	0	635	738	270	522	522	228
Stage 1	-	-	-	-	-	-	288	288	-	234	234	-
Stage 2	-	-	-	-	-	-	347	450	-	288	288	-
Critical Hdwy	4.44	-	-	4.36	-	-	8.1	7.5	7.2	7.22	6.62	6.32
Critical Hdwy Stg 1	-	-	-	-	-	-	7.1	6.5	-	6.22	5.62	-
Critical Hdwy Stg 2	-	-	-	-	-	-	7.1	6.5	-	6.22	5.62	-
Follow-up Hdwy	2.506	-	-	2.434	-	-	4.4	4.9	4.2	3.608	4.108	3.408
Pot Cap-1 Maneuver	966	-	-	1167	-	-	282	250	582	450	445	787
Stage 1	-	-	-	-	-	-	550	528	-	747	693	-
Stage 2	-	-	-	-	-	-	506	436	-	698	656	-
Platoon blocked, %		-	-		-	-						
Mov Cap-1 Maneuver	966	-	-	1167	-	-	275	246	582	444	438	787
Mov Cap-2 Maneuver	-	-	-	-	-	-	275	246	-	444	438	-
Stage 1	-	-	-	-	-	-	544	522	-	739	690	-
Stage 2	-	-	-	-	-	-	498	434	-	689	649	-

Approach	EB			WB			NB			SB		
HCM Control Delay, s	0.3			0.1			11.2			15.6		
HCM LOS							B			C		

Minor Lane/Major Mvmt	NBLn1	EBL	EBT	EBR	WBL	WBT	WBR	SBLn1	
Capacity (veh/h)	582	966	-	-	1167	-	-	460	
HCM Lane V/C Ratio	0.002	0.009	-	-	0.003	-	-	0.264	
HCM Control Delay (s)	11.2	8.8	0	-	8.1	0	-	15.6	
HCM Lane LOS		B	A	A	-	A	A	-	C
HCM 95th %tile Q(veh)		0	0	-	-	0	-	-	1.1

Intersection												
Int Delay, s/veh	7											
Movement	EBL	EBT	EBR	WBL	WBT	WBR	NBL	NBT	NBR	SBL	SBT	SBR
Lane Configurations		↑	↑		↑		↑		↑		↕	
Traffic Vol, veh/h	0	305	50	40	271	0	60	0	143	10	47	85
Future Vol, veh/h	0	305	50	40	271	0	60	0	143	10	47	85
Conflicting Peds, #/hr	0	0	0	0	0	0	0	0	1	1	0	0
Sign Control	Free	Free	Free	Free	Free	Free	Stop	Stop	Stop	Stop	Stop	Stop
RT Channelized	-	-	None	-	-	None	-	-	None	-	-	None
Storage Length	-	-	50	-	-	-	0	-	25	-	-	-
Veh in Median Storage, #	-	0	-	-	0	-	-	0	-	-	0	-
Grade, %	-	0	-	-	0	-	-	0	-	-	0	-
Peak Hour Factor	88	88	88	88	88	88	88	88	88	88	88	88
Heavy Vehicles, %	33	33	33	26	26	26	21	21	21	35	35	35
Mvmt Flow	0	347	57	45	308	0	68	0	163	11	53	97

Major/Minor	Major1			Major2			Minor1			Minor2		
Conflicting Flow All	-	0	0	404	0	0	820	-	348	856	802	308
Stage 1	-	-	-	-	-	-	347	-	-	398	398	-
Stage 2	-	-	-	-	-	-	473	-	-	458	404	-
Critical Hdwy	-	-	-	4.36	-	-	7.31	-	6.41	7.45	6.85	6.55
Critical Hdwy Stg 1	-	-	-	-	-	-	6.31	-	-	6.45	5.85	-
Critical Hdwy Stg 2	-	-	-	-	-	-	6.31	-	-	6.45	5.85	-
Follow-up Hdwy	-	-	-	2.434	-	-	3.689	-	3.489	3.815	4.315	3.615
Pot Cap-1 Maneuver	0	-	-	1036	-	0	273	0	654	244	282	661
Stage 1	0	-	-	-	-	0	631	0	-	567	549	-
Stage 2	0	-	-	-	-	0	537	0	-	524	546	-
Platoon blocked, %	-	-	-	-	-	-	-	-	-	-	-	-
Mov Cap-1 Maneuver	-	-	-	1036	-	-	190	-	653	176	267	661
Mov Cap-2 Maneuver	-	-	-	-	-	-	190	-	-	176	267	-
Stage 1	-	-	-	-	-	-	631	-	-	567	520	-
Stage 2	-	-	-	-	-	-	390	-	-	393	546	-

Approach	EB	WB	NB	SB
HCM Control Delay, s	0	1.1	18.8	20.4
HCM LOS			C	C

Minor Lane/Major Mvmt	NBLn1	NBLn2	EBT	EBR	WBL	WBT	SBLn1
Capacity (veh/h)	190	653	-	-	1036	-	393
HCM Lane V/C Ratio	0.359	0.249	-	-	0.044	-	0.411
HCM Control Delay (s)	34.2	12.3	-	-	8.6	0	20.4
HCM Lane LOS	D	B	-	-	A	A	C
HCM 95th %tile Q(veh)	1.5	1	-	-	0.1	-	2

HCM 6th TWSC
6: SR-99 Northbound Ramps & Avenue 18 1/2

Village D Specific Plan
Existing NP - AM Peak Hour

Intersection												
Int Delay, s/veh	35.1											
Movement	EBL	EBT	EBR	WBL	WBT	WBR	NBL	NBT	NBR	SBL	SBT	SBR
Lane Configurations	↙	↑			↘			↕				
Traffic Vol, veh/h	216	54	0	0	134	22	213	1	18	0	0	0
Future Vol, veh/h	216	54	0	0	134	22	213	1	18	0	0	0
Conflicting Peds, #/hr	1	0	0	0	0	1	0	0	0	0	0	0
Sign Control	Free	Free	Free	Free	Free	Free	Stop	Stop	Stop	Free	Free	Free
RT Channelized	-	-	None	-	-	None	-	-	None	-	-	None
Storage Length	145	-	-	-	-	-	-	-	-	-	-	-
Veh in Median Storage, #	-	0	-	-	0	-	-	0	-	-	16965	-
Grade, %	-	0	-	-	0	-	-	0	-	-	0	-
Peak Hour Factor	83	83	83	83	83	83	83	83	83	83	83	83
Heavy Vehicles, %	31	31	31	18	18	18	29	29	29	0	0	0
Mvmt Flow	260	65	0	0	161	27	257	1	22	0	0	0

Major/Minor	Major1	Major2	Minor1
Conflicting Flow All	189	0	0
Stage 1	-	-	585
Stage 2	-	-	175
Critical Hdwy	4.41	-	6.69
Critical Hdwy Stg 1	-	-	5.69
Critical Hdwy Stg 2	-	-	5.69
Follow-up Hdwy	2.479	-	3.761
Pot Cap-1 Maneuver	1229	0	338
Stage 1	-	0	507
Stage 2	-	0	794
Platoon blocked, %	-	-	-
Mov Cap-1 Maneuver	1229	-	266
Mov Cap-2 Maneuver	-	-	266
Stage 1	-	-	400
Stage 2	-	-	794

Approach	EB	WB	NB
HCM Control Delay, s	7	0	91.3
HCM LOS			F

Minor Lane/Major Mvmt	NBLn1	EBL	EBT	WBT	WBR
Capacity (veh/h)	282	1229	-	-	-
HCM Lane V/C Ratio	0.991	0.212	-	-	-
HCM Control Delay (s)	91.3	8.7	-	-	-
HCM Lane LOS	F	A	-	-	-
HCM 95th %tile Q(veh)	10.1	0.8	-	-	-

Intersection												
Int Delay, s/veh	3.6											
Movement	EBL	EBT	EBR	WBL	WBT	WBR	NBL	NBT	NBR	SBL	SBT	SBR
Lane Configurations		↕			↕			↕			↕	
Traffic Vol, veh/h	1	22	8	53	19	3	8	158	47	15	103	0
Future Vol, veh/h	1	22	8	53	19	3	8	158	47	15	103	0
Conflicting Peds, #/hr	0	0	0	0	0	0	0	0	0	0	0	0
Sign Control	Stop	Stop	Stop	Stop	Stop	Stop	Free	Free	Free	Free	Free	Free
RT Channelized	-	-	None	-	-	None	-	-	None	-	-	None
Storage Length	-	-	-	-	-	-	-	-	-	-	-	-
Veh in Median Storage, #	-	0	-	-	0	-	-	0	-	-	0	-
Grade, %	-	0	-	-	0	-	-	0	-	-	0	-
Peak Hour Factor	86	86	86	86	86	86	86	86	86	86	86	86
Heavy Vehicles, %	6	6	6	19	19	19	18	18	18	24	24	24
Mvmt Flow	1	26	9	62	22	3	9	184	55	17	120	0

Major/Minor	Minor2		Minor1		Major1		Major2					
Conflicting Flow All	396	411	120	402	384	212	120	0	0	239	0	0
Stage 1	154	154	-	230	230	-	-	-	-	-	-	-
Stage 2	242	257	-	172	154	-	-	-	-	-	-	-
Critical Hdwy	7.16	6.56	6.26	7.29	6.69	6.39	4.28	-	-	4.34	-	-
Critical Hdwy Stg 1	6.16	5.56	-	6.29	5.69	-	-	-	-	-	-	-
Critical Hdwy Stg 2	6.16	5.56	-	6.29	5.69	-	-	-	-	-	-	-
Follow-up Hdwy	3.554	4.054	3.354	3.671	4.171	3.471	2.362	-	-	2.416	-	-
Pot Cap-1 Maneuver	557	525	921	530	524	787	1374	-	-	1209	-	-
Stage 1	839	762	-	736	684	-	-	-	-	-	-	-
Stage 2	753	688	-	792	739	-	-	-	-	-	-	-
Platoon blocked, %								-	-	-	-	-
Mov Cap-1 Maneuver	527	513	921	496	512	787	1374	-	-	1209	-	-
Mov Cap-2 Maneuver	527	513	-	496	512	-	-	-	-	-	-	-
Stage 1	832	751	-	730	679	-	-	-	-	-	-	-
Stage 2	719	682	-	746	728	-	-	-	-	-	-	-

Approach	EB		WB		NB		SB	
HCM Control Delay, s	11.6		13.6		0.3		1	
HCM LOS	B		B					

Minor Lane/Major Mvmt	NBL	NBT	NBR	EBLn1	WBLn1	SBL	SBT	SBR
Capacity (veh/h)	1374	-	-	580	508	1209	-	-
HCM Lane V/C Ratio	0.007	-	-	0.062	0.172	0.014	-	-
HCM Control Delay (s)	7.6	0	-	11.6	13.6	8	0	-
HCM Lane LOS	A	A	-	B	B	A	A	-
HCM 95th %tile Q(veh)	0	-	-	0.2	0.6	0	-	-

Intersection												
Int Delay, s/veh	0.9											
Movement	EBL	EBT	EBR	WBL	WBT	WBR	NBL	NBT	NBR	SBL	SBT	SBR
Lane Configurations		↕			↕			↕			↕	
Traffic Vol, veh/h	6	1	7	0	4	0	20	210	0	0	152	9
Future Vol, veh/h	6	1	7	0	4	0	20	210	0	0	152	9
Conflicting Peds, #/hr	0	0	0	0	0	0	0	0	0	0	0	0
Sign Control	Stop	Stop	Stop	Stop	Stop	Stop	Free	Free	Free	Free	Free	Free
RT Channelized	-	-	None	-	-	None	-	-	None	-	-	None
Storage Length	-	-	-	-	-	-	-	-	-	-	-	-
Veh in Median Storage, #	-	0	-	-	0	-	-	0	-	-	0	-
Grade, %	-	0	-	-	0	-	-	0	-	-	0	-
Peak Hour Factor	82	82	82	82	82	82	82	82	82	82	82	82
Heavy Vehicles, %	25	25	25	25	25	25	14	14	14	18	18	18
Mvmt Flow	7	1	9	0	5	0	24	256	0	0	185	11

Major/Minor	Minor2		Minor1		Major1		Major2					
Conflicting Flow All	498	495	191	500	500	256	196	0	0	256	0	0
Stage 1	191	191	-	304	304	-	-	-	-	-	-	-
Stage 2	307	304	-	196	196	-	-	-	-	-	-	-
Critical Hdwy	7.35	6.75	6.45	7.35	6.75	6.45	4.24	-	-	4.28	-	-
Critical Hdwy Stg 1	6.35	5.75	-	6.35	5.75	-	-	-	-	-	-	-
Critical Hdwy Stg 2	6.35	5.75	-	6.35	5.75	-	-	-	-	-	-	-
Follow-up Hdwy	3.725	4.225	3.525	3.725	4.225	3.525	2.326	-	-	2.362	-	-
Pot Cap-1 Maneuver	447	444	795	446	441	730	1308	-	-	1221	-	-
Stage 1	760	701	-	659	623	-	-	-	-	-	-	-
Stage 2	656	623	-	756	697	-	-	-	-	-	-	-
Platoon blocked, %								-	-	-	-	-
Mov Cap-1 Maneuver	436	435	795	433	432	730	1308	-	-	1221	-	-
Mov Cap-2 Maneuver	436	435	-	433	432	-	-	-	-	-	-	-
Stage 1	744	701	-	645	610	-	-	-	-	-	-	-
Stage 2	637	610	-	747	697	-	-	-	-	-	-	-

Approach	EB		WB		NB		SB	
HCM Control Delay, s	11.6		13.4		0.7		0	
HCM LOS	B		B					

Minor Lane/Major Mvmt	NBL	NBT	NBR	EBLn1WBLn1	SBL	SBT	SBR
Capacity (veh/h)	1308	-	-	563	432	1221	-
HCM Lane V/C Ratio	0.019	-	-	0.03	0.011	-	-
HCM Control Delay (s)	7.8	0	-	11.6	13.4	0	-
HCM Lane LOS	A	A	-	B	B	A	-
HCM 95th %tile Q(veh)	0.1	-	-	0.1	0	0	-

Intersection												
Int Delay, s/veh	2.4											
Movement	EBL	EBT	EBR	WBL	WBT	WBR	NBL	NBT	NBR	SBL	SBT	SBR
Lane Configurations		↕			↕			↕			↕	
Traffic Vol, veh/h	0	0	0	52	0	32	0	199	50	13	148	0
Future Vol, veh/h	0	0	0	52	0	32	0	199	50	13	148	0
Conflicting Peds, #/hr	0	0	0	0	0	0	0	0	0	0	0	0
Sign Control	Stop	Stop	Stop	Stop	Stop	Stop	Free	Free	Free	Free	Free	Free
RT Channelized	-	-	None	-	-	None	-	-	None	-	-	None
Storage Length	-	-	-	-	-	-	-	-	-	-	-	-
Veh in Median Storage, #	-	0	-	-	0	-	-	0	-	-	0	-
Grade, %	-	0	-	-	0	-	-	0	-	-	0	-
Peak Hour Factor	82	82	82	82	82	82	82	82	82	82	82	82
Heavy Vehicles, %	0	0	0	7	7	7	15	15	15	23	23	23
Mvmt Flow	0	0	0	63	0	39	0	243	61	16	180	0

Major/Minor	Minor2		Minor1		Major1		Major2					
Conflicting Flow All	505	516	180	486	486	274	180	0	0	304	0	0
Stage 1	212	212	-	274	274	-	-	-	-	-	-	-
Stage 2	293	304	-	212	212	-	-	-	-	-	-	-
Critical Hdwy	7.1	6.5	6.2	7.17	6.57	6.27	4.25	-	-	4.33	-	-
Critical Hdwy Stg 1	6.1	5.5	-	6.17	5.57	-	-	-	-	-	-	-
Critical Hdwy Stg 2	6.1	5.5	-	6.17	5.57	-	-	-	-	-	-	-
Follow-up Hdwy	3.5	4	3.3	3.563	4.063	3.363	2.335	-	-	2.407	-	-
Pot Cap-1 Maneuver	481	466	868	483	474	753	1321	-	-	1147	-	-
Stage 1	795	731	-	721	674	-	-	-	-	-	-	-
Stage 2	719	667	-	779	718	-	-	-	-	-	-	-
Platoon blocked, %								-	-	-	-	-
Mov Cap-1 Maneuver	451	459	868	477	466	753	1321	-	-	1147	-	-
Mov Cap-2 Maneuver	451	459	-	477	466	-	-	-	-	-	-	-
Stage 1	795	719	-	721	674	-	-	-	-	-	-	-
Stage 2	682	667	-	767	707	-	-	-	-	-	-	-

Approach	EB	WB	NB	SB
HCM Control Delay, s	0	13	0	0.7
HCM LOS	A	B		

Minor Lane/Major Mvmt	NBL	NBT	NBR	EBLn1WBLn1	SBL	SBT	SBR
Capacity (veh/h)	1321	-	-	-	554	1147	-
HCM Lane V/C Ratio	-	-	-	-	0.185	0.014	-
HCM Control Delay (s)	0	-	-	0	13	8.2	0
HCM Lane LOS	A	-	-	A	B	A	A
HCM 95th %tile Q(veh)	0	-	-	-	0.7	0	-

Intersection												
Int Delay, s/veh	2.6											
Movement	EBL	EBT	EBR	WBL	WBT	WBR	NBL	NBT	NBR	SBL	SBT	SBR
Lane Configurations		↕			↕			↕			↕	
Traffic Vol, veh/h	0	5	0	16	3	67	3	177	4	28	166	0
Future Vol, veh/h	0	5	0	16	3	67	3	177	4	28	166	0
Conflicting Peds, #/hr	0	0	0	0	0	0	0	0	0	0	0	0
Sign Control	Stop	Stop	Stop	Stop	Stop	Stop	Free	Free	Free	Free	Free	Free
RT Channelized	-	-	None	-	-	None	-	-	None	-	-	None
Storage Length	-	-	-	-	-	-	-	-	-	-	-	-
Veh in Median Storage, #	-	0	-	-	0	-	-	0	-	-	0	-
Grade, %	-	0	-	-	0	-	-	0	-	-	0	-
Peak Hour Factor	85	85	85	85	85	85	85	85	85	85	85	85
Heavy Vehicles, %	0	0	0	0	0	0	18	18	18	18	18	18
Mvmt Flow	0	6	0	19	4	79	4	208	5	33	195	0

Major/Minor	Minor2		Minor1		Major1		Major2					
Conflicting Flow All	521	482	195	483	480	211	195	0	0	213	0	0
Stage 1	261	261	-	219	219	-	-	-	-	-	-	-
Stage 2	260	221	-	264	261	-	-	-	-	-	-	-
Critical Hdwy	7.1	6.5	6.2	7.1	6.5	6.2	4.28	-	-	4.28	-	-
Critical Hdwy Stg 1	6.1	5.5	-	6.1	5.5	-	-	-	-	-	-	-
Critical Hdwy Stg 2	6.1	5.5	-	6.1	5.5	-	-	-	-	-	-	-
Follow-up Hdwy	3.5	4	3.3	3.5	4	3.3	2.362	-	-	2.362	-	-
Pot Cap-1 Maneuver	469	487	851	497	488	834	1288	-	-	1268	-	-
Stage 1	748	696	-	788	726	-	-	-	-	-	-	-
Stage 2	749	724	-	746	696	-	-	-	-	-	-	-
Platoon blocked, %								-	-	-	-	-
Mov Cap-1 Maneuver	412	471	851	480	472	834	1288	-	-	1268	-	-
Mov Cap-2 Maneuver	412	471	-	480	472	-	-	-	-	-	-	-
Stage 1	745	676	-	785	723	-	-	-	-	-	-	-
Stage 2	672	721	-	718	676	-	-	-	-	-	-	-

Approach	EB		WB		NB		SB	
HCM Control Delay, s	12.7		10.8		0.1		1.1	
HCM LOS	B		B					

Minor Lane/Major Mvmt	NBL	NBT	NBR	EBLn1WBLn1	SBL	SBT	SBR
Capacity (veh/h)	1288	-	-	471	717	1268	-
HCM Lane V/C Ratio	0.003	-	-	0.012	0.141	0.026	-
HCM Control Delay (s)	7.8	0	-	12.7	10.8	7.9	0
HCM Lane LOS	A	A	-	B	B	A	A
HCM 95th %tile Q(veh)	0	-	-	0	0.5	0.1	-

Intersection	
Intersection Delay, s/veh	13.7
Intersection LOS	B

Movement	EBL	EBT	EBR	WBL	WBT	WBR	NBL	NBT	NBR	SBL	SBT	SBR
Lane Configurations		↕			↕			↕			↕	
Traffic Vol, veh/h	49	145	18	19	176	53	24	82	8	34	93	56
Future Vol, veh/h	49	145	18	19	176	53	24	82	8	34	93	56
Peak Hour Factor	0.76	0.76	0.76	0.76	0.76	0.76	0.76	0.76	0.76	0.76	0.76	0.76
Heavy Vehicles, %	6	6	6	8	8	8	29	29	29	17	17	17
Mvmt Flow	64	191	24	25	232	70	32	108	11	45	122	74
Number of Lanes	0	1	0	0	1	0	0	1	0	0	1	0

Approach	EB	WB	NB	SB
Opposing Approach	WB	EB	SB	NB
Opposing Lanes	1	1	1	1
Conflicting Approach Left	SB	NB	EB	WB
Conflicting Lanes Left	1	1	1	1
Conflicting Approach Right	NB	SB	WB	EB
Conflicting Lanes Right	1	1	1	1
HCM Control Delay	13.7	14.7	12.3	13.4
HCM LOS	B	B	B	B

Lane	NBLn1	EBLn1	WBLn1	SBLn1
Vol Left, %	21%	23%	8%	19%
Vol Thru, %	72%	68%	71%	51%
Vol Right, %	7%	8%	21%	31%
Sign Control	Stop	Stop	Stop	Stop
Traffic Vol by Lane	114	212	248	183
LT Vol	24	49	19	34
Through Vol	82	145	176	93
RT Vol	8	18	53	56
Lane Flow Rate	150	279	326	241
Geometry Grp	1	1	1	1
Degree of Util (X)	0.277	0.451	0.514	0.408
Departure Headway (Hd)	6.642	5.818	5.669	6.1
Convergence, Y/N	Yes	Yes	Yes	Yes
Cap	537	614	630	585
Service Time	4.737	3.901	3.747	4.186
HCM Lane V/C Ratio	0.279	0.454	0.517	0.412
HCM Control Delay	12.3	13.7	14.7	13.4
HCM Lane LOS	B	B	B	B
HCM 95th-tile Q	1.1	2.3	2.9	2

Intersection												
Intersection Delay, s/veh	9.2											
Intersection LOS	A											

Movement	EBL	EBT	EBR	WBL	WBT	WBR	NBL	NBT	NBR	SBL	SBT	SBR
Lane Configurations												
Traffic Vol, veh/h	18	82	4	11	73	37	8	32	16	32	47	28
Future Vol, veh/h	18	82	4	11	73	37	8	32	16	32	47	28
Peak Hour Factor	0.78	0.78	0.78	0.78	0.78	0.78	0.78	0.78	0.78	0.78	0.78	0.78
Heavy Vehicles, %	11	11	11	31	31	31	11	11	11	21	21	21
Mvmt Flow	23	105	5	14	94	47	10	41	21	41	60	36
Number of Lanes	1	1	0	1	1	0	0	1	0	0	1	0

Approach	EB	WB	NB	SB
Opposing Approach	WB	EB	SB	NB
Opposing Lanes	2	2	1	1
Conflicting Approach Left	SB	NB	EB	WB
Conflicting Lanes Left	1	1	2	2
Conflicting Approach Right	NB	SB	WB	EB
Conflicting Lanes Right	1	1	2	2
HCM Control Delay	9.1	9.6	8.5	9.2
HCM LOS	A	A	A	A

Lane	NBLn1	EBLn1	EBLn2	WBLn1	WBLn2	SBLn1
Vol Left, %	14%	100%	0%	100%	0%	30%
Vol Thru, %	57%	0%	95%	0%	66%	44%
Vol Right, %	29%	0%	5%	0%	34%	26%
Sign Control	Stop	Stop	Stop	Stop	Stop	Stop
Traffic Vol by Lane	56	18	86	11	110	107
LT Vol	8	18	0	11	0	32
Through Vol	32	0	82	0	73	47
RT Vol	16	0	4	0	37	28
Lane Flow Rate	72	23	110	14	141	137
Geometry Grp	2	7	7	7	7	2
Degree of Util (X)	0.098	0.038	0.164	0.024	0.214	0.191
Departure Headway (Hd)	4.894	5.882	5.346	6.199	5.458	5.016
Convergence, Y/N	Yes	Yes	Yes	Yes	Yes	Yes
Cap	729	607	669	577	656	713
Service Time	2.941	3.631	3.095	3.947	3.206	3.058
HCM Lane V/C Ratio	0.099	0.038	0.164	0.024	0.215	0.192
HCM Control Delay	8.5	8.9	9.2	9.1	9.7	9.2
HCM Lane LOS	A	A	A	A	A	A
HCM 95th-tile Q	0.3	0.1	0.6	0.1	0.8	0.7

HCM 6th TWSC
 13: Airport Drive/Golden State Boulevard & Avenue 17

Village D Specific Plan
 Existing NP - AM Peak Hour

Intersection												
Int Delay, s/veh	7.3											
Movement	EBL	EBT	EBR	WBL	WBT	WBR	NBL	NBT	NBR	SBL	SBT	SBR
Lane Configurations	↖	↗	↖	↖	↗	↖	↖	↗	↖		↕	
Traffic Vol, veh/h	4	54	19	127	55	85	17	25	64	88	19	4
Future Vol, veh/h	4	54	19	127	55	85	17	25	64	88	19	4
Conflicting Peds, #/hr	0	0	0	0	0	0	1	0	0	0	0	1
Sign Control	Free	Free	Free	Free	Free	Free	Stop	Stop	Stop	Stop	Stop	Stop
RT Channelized	-	-	None	-	-	None	-	-	None	-	-	None
Storage Length	85	-	0	70	-	105	60	-	50	-	-	-
Veh in Median Storage, #	-	0	-	-	0	-	-	0	-	-	0	-
Grade, %	-	0	-	-	0	-	-	0	-	-	0	-
Peak Hour Factor	91	91	91	91	91	91	91	91	91	91	91	91
Heavy Vehicles, %	12	12	12	9	9	9	13	13	13	9	9	9
Mvmt Flow	4	59	21	140	60	93	19	27	70	97	21	4

Major/Minor	Major1			Major2			Minor1			Minor2		
Conflicting Flow All	153	0	0	80	0	0	467	500	59	466	428	61
Stage 1	-	-	-	-	-	-	67	67	-	340	340	-
Stage 2	-	-	-	-	-	-	400	433	-	126	88	-
Critical Hdwy	4.22	-	-	4.19	-	-	7.23	6.63	6.33	7.19	6.59	6.29
Critical Hdwy Stg 1	-	-	-	-	-	-	6.23	5.63	-	6.19	5.59	-
Critical Hdwy Stg 2	-	-	-	-	-	-	6.23	5.63	-	6.19	5.59	-
Follow-up Hdwy	2.308	-	-	2.281	-	-	3.617	4.117	3.417	3.581	4.081	3.381
Pot Cap-1 Maneuver	1369	-	-	1475	-	-	488	457	977	495	509	985
Stage 1	-	-	-	-	-	-	917	818	-	660	627	-
Stage 2	-	-	-	-	-	-	605	563	-	861	808	-
Platoon blocked, %	-	-	-	-	-	-	-	-	-	-	-	-
Mov Cap-1 Maneuver	1369	-	-	1475	-	-	434	412	977	404	459	984
Mov Cap-2 Maneuver	-	-	-	-	-	-	434	412	-	404	459	-
Stage 1	-	-	-	-	-	-	914	816	-	658	567	-
Stage 2	-	-	-	-	-	-	525	510	-	770	806	-

Approach	EB			WB			NB			SB		
HCM Control Delay, s	0.4			3.7			11			17		
HCM LOS							B			C		

Minor Lane/Major Mvmt	NBLn1	NBLn2	NBLn3	EBL	EBT	EBR	WBL	WBT	WBR	SBLn1
Capacity (veh/h)	434	412	977	1369	-	-	1475	-	-	422
HCM Lane V/C Ratio	0.043	0.067	0.072	0.003	-	-	0.095	-	-	0.289
HCM Control Delay (s)	13.7	14.4	9	7.6	-	-	7.7	-	-	17
HCM Lane LOS	B	B	A	A	-	-	A	-	-	C
HCM 95th %tile Q(veh)	0.1	0.2	0.2	0	-	-	0.3	-	-	1.2

Intersection						
Int Delay, s/veh	2.2					
Movement	EBL	EBT	WBT	WBR	SBL	SBR
Lane Configurations		↑	↑		↓	↓
Traffic Vol, veh/h	0	209	230	0	59	42
Future Vol, veh/h	0	209	230	0	59	42
Conflicting Peds, #/hr	0	0	0	0	0	0
Sign Control	Free	Free	Free	Free	Stop	Stop
RT Channelized	-	None	-	None	-	None
Storage Length	-	-	-	-	0	610
Veh in Median Storage, #	-	0	0	-	0	-
Grade, %	-	0	0	-	0	-
Peak Hour Factor	89	89	89	89	89	89
Heavy Vehicles, %	13	13	10	10	19	19
Mvmt Flow	0	235	258	0	66	47

Major/Minor	Major1	Major2	Minor2		
Conflicting Flow All	-	0	-	0	493 258
Stage 1	-	-	-	-	258 -
Stage 2	-	-	-	-	235 -
Critical Hdwy	-	-	-	-	6.59 6.39
Critical Hdwy Stg 1	-	-	-	-	5.59 -
Critical Hdwy Stg 2	-	-	-	-	5.59 -
Follow-up Hdwy	-	-	-	-	3.671 3.471
Pot Cap-1 Maneuver	0	-	-	0	506 741
Stage 1	0	-	-	0	747 -
Stage 2	0	-	-	0	766 -
Platoon blocked, %	-	-	-	-	-
Mov Cap-1 Maneuver	-	-	-	-	506 741
Mov Cap-2 Maneuver	-	-	-	-	506 -
Stage 1	-	-	-	-	747 -
Stage 2	-	-	-	-	766 -

Approach	EB	WB	SB
HCM Control Delay, s	0	0	12
HCM LOS			B

Minor Lane/Major Mvmt	EBT	WBT	SBLn1	SBLn2
Capacity (veh/h)	-	-	506	741
HCM Lane V/C Ratio	-	-	0.131	0.064
HCM Control Delay (s)	-	-	13.2	10.2
HCM Lane LOS	-	-	B	B
HCM 95th %tile Q(veh)	-	-	0.4	0.2

HCM 6th TWSC
15: SR-99 Northbound Ramps & Avenue 17

Village D Specific Plan
Existing NP - AM Peak Hour

Intersection												
Int Delay, s/veh	3.1											
Movement	EBL	EBT	EBR	WBL	WBT	WBR	NBL	NBT	NBR	SBL	SBT	SBR
Lane Configurations												
Traffic Vol, veh/h	52	135	0	0	642	100	86	1	0	0	0	0
Future Vol, veh/h	52	135	0	0	642	100	86	1	0	0	0	0
Conflicting Peds, #/hr	0	0	0	0	0	0	0	0	0	0	0	0
Sign Control	Free	Free	Free	Free	Free	Free	Stop	Stop	Stop	Free	Free	Free
RT Channelized	-	-	None	-	-	None	-	-	None	-	-	None
Storage Length	125	-	-	-	-	-	-	-	50	-	-	-
Veh in Median Storage, #	-	0	-	-	0	-	-	0	-	-	16965	-
Grade, %	-	0	-	-	0	-	-	0	-	-	0	-
Peak Hour Factor	92	92	92	92	92	92	92	92	92	92	92	92
Heavy Vehicles, %	11	11	11	3	3	3	14	14	14	0	0	0
Mvmt Flow	57	147	0	0	698	109	93	1	0	0	0	0

Major/Minor	Major1	Major2	Minor1
Conflicting Flow All	807	0	0
Stage 1	-	-	261
Stage 2	-	-	753
Critical Hdwy	4.21	-	6.54
Critical Hdwy Stg 1	-	-	5.54
Critical Hdwy Stg 2	-	-	5.54
Follow-up Hdwy	2.299	-	3.626
Pot Cap-1 Maneuver	780	0	251
Stage 1	-	0	756
Stage 2	-	0	445
Platoon blocked, %	-	-	-
Mov Cap-1 Maneuver	780	-	233
Mov Cap-2 Maneuver	-	-	233
Stage 1	-	-	701
Stage 2	-	-	445

Approach	EB	WB	NB
HCM Control Delay, s	2.8	0	30.6
HCM LOS			D

Minor Lane/Major Mvmt	NBLn1	NBLn2	EBL	EBT	WBT	WBR
Capacity (veh/h)	233	-	780	-	-	-
HCM Lane V/C Ratio	0.406	-	0.072	-	-	-
HCM Control Delay (s)	30.6	0	10	-	-	-
HCM Lane LOS	D	A	A	-	-	-
HCM 95th %tile Q(veh)	1.9	-	0.2	-	-	-

Intersection												
Int Delay, s/veh	5.9											
Movement	EBL	EBT	EBR	WBL	WBT	WBR	NBL	NBT	NBR	SBL	SBT	SBR
Lane Configurations	↖	↗		↖	↗		↖	↑	↗	↖	↑	↗
Traffic Vol, veh/h	12	45	6	20	50	12	13	34	57	14	19	21
Future Vol, veh/h	12	45	6	20	50	12	13	34	57	14	19	21
Conflicting Peds, #/hr	1	0	2	2	0	1	1	0	1	1	0	1
Sign Control	Free	Free	Free	Free	Free	Free	Stop	Stop	Stop	Stop	Stop	Stop
RT Channelized	-	-	None	-	-	None	-	-	None	-	-	None
Storage Length	110	-	-	165	-	-	65	-	50	100	-	50
Veh in Median Storage, #	-	0	-	-	0	-	-	0	-	-	0	-
Grade, %	-	0	-	-	0	-	-	0	-	-	0	-
Peak Hour Factor	83	83	83	83	83	83	83	83	83	83	83	83
Heavy Vehicles, %	4	4	4	4	4	4	0	0	0	0	0	0
Mvmt Flow	14	54	7	24	60	14	16	41	69	17	23	25

Major/Minor	Major1			Major2			Minor1			Minor2		
Conflicting Flow All	75	0	0	63	0	0	228	211	61	258	207	69
Stage 1	-	-	-	-	-	-	88	88	-	116	116	-
Stage 2	-	-	-	-	-	-	140	123	-	142	91	-
Critical Hdwy	4.14	-	-	4.14	-	-	7.1	6.5	6.2	7.1	6.5	6.2
Critical Hdwy Stg 1	-	-	-	-	-	-	6.1	5.5	-	6.1	5.5	-
Critical Hdwy Stg 2	-	-	-	-	-	-	6.1	5.5	-	6.1	5.5	-
Follow-up Hdwy	2.236	-	-	2.236	-	-	3.5	4	3.3	3.5	4	3.3
Pot Cap-1 Maneuver	1512	-	-	1527	-	-	731	690	1010	699	693	1000
Stage 1	-	-	-	-	-	-	925	826	-	894	803	-
Stage 2	-	-	-	-	-	-	868	798	-	866	823	-
Platoon blocked, %	-	-	-	-	-	-	-	-	-	-	-	-
Mov Cap-1 Maneuver	1511	-	-	1524	-	-	679	671	1007	608	674	998
Mov Cap-2 Maneuver	-	-	-	-	-	-	679	671	-	608	674	-
Stage 1	-	-	-	-	-	-	915	817	-	885	789	-
Stage 2	-	-	-	-	-	-	808	784	-	759	814	-

Approach	EB			WB			NB			SB		
HCM Control Delay, s	1.4			1.8			9.6			10		
HCM LOS							A			B		

Minor Lane/Major Mvmt	NBLn1	NBLn2	NBLn3	EBL	EBT	EBR	WBL	WBT	WBR	SBLn1	SBLn2	SBLn3
Capacity (veh/h)	679	671	1007	1511	-	-	1524	-	-	608	674	998
HCM Lane V/C Ratio	0.023	0.061	0.068	0.01	-	-	0.016	-	-	0.028	0.034	0.025
HCM Control Delay (s)	10.4	10.7	8.8	7.4	-	-	7.4	-	-	11.1	10.5	8.7
HCM Lane LOS	B	B	A	A	-	-	A	-	-	B	B	A
HCM 95th %tile Q(veh)	0.1	0.2	0.2	0	-	-	0	-	-	0.1	0.1	0.1

Intersection	
Intersection Delay, s/veh	40.5
Intersection LOS	E

Movement	EBL	EBT	EBR	WBL	WBT	WBR	NBL	NBT	NBR	SBL	SBT	SBR
Lane Configurations	↶	↷		↶	↷		↶	↷	↶	↶	↷	↶
Traffic Vol, veh/h	46	213	84	47	159	22	114	102	101	110	81	30
Future Vol, veh/h	46	213	84	47	159	22	114	102	101	110	81	30
Peak Hour Factor	0.69	0.69	0.69	0.69	0.69	0.69	0.69	0.69	0.69	0.69	0.69	0.69
Heavy Vehicles, %	3	3	3	3	3	3	0	0	0	0	0	0
Mvmt Flow	67	309	122	68	230	32	165	148	146	159	117	43
Number of Lanes	1	1	0	1	1	0	1	1	1	1	1	1

Approach	EB	WB	NB	SB
Opposing Approach	WB	EB	SB	NB
Opposing Lanes	2	2	3	3
Conflicting Approach Left	SB	NB	EB	WB
Conflicting Lanes Left	3	3	2	2
Conflicting Approach Right	NB	SB	WB	EB
Conflicting Lanes Right	3	3	2	2
HCM Control Delay	83.1	27.6	18.6	18.9
HCM LOS	F	D	C	C

Lane	NBLn1	NBLn2	NBLn3	EBLn1	EBLn2	WBLn1	WBLn2	SBLn1	SBLn2	SBLn3
Vol Left, %	100%	0%	0%	100%	0%	100%	0%	100%	0%	0%
Vol Thru, %	0%	100%	0%	0%	72%	0%	88%	0%	100%	0%
Vol Right, %	0%	0%	100%	0%	28%	0%	12%	0%	0%	100%
Sign Control	Stop	Stop	Stop	Stop	Stop	Stop	Stop	Stop	Stop	Stop
Traffic Vol by Lane	114	102	101	46	297	47	181	110	81	30
LT Vol	114	0	0	46	0	47	0	110	0	0
Through Vol	0	102	0	0	213	0	159	0	81	0
RT Vol	0	0	101	0	84	0	22	0	0	30
Lane Flow Rate	165	148	146	67	430	68	262	159	117	43
Geometry Grp	8	8	8	8	8	8	8	8	8	8
Degree of Util (X)	0.449	0.381	0.349	0.178	1.067	0.189	0.685	0.45	0.315	0.108
Departure Headway (Hd)	10.174	9.649	8.915	9.637	8.926	10.217	9.617	10.571	10.045	9.309
Convergence, Y/N	Yes	Yes	Yes	Yes	Yes	Yes	Yes	Yes	Yes	Yes
Cap	357	375	405	376	413	354	378	343	360	387
Service Time	7.874	7.349	6.615	7.299	6.588	7.917	7.317	8.271	7.745	7.009
HCM Lane V/C Ratio	0.462	0.395	0.36	0.178	1.041	0.192	0.693	0.464	0.325	0.111
HCM Control Delay	20.9	18.2	16.3	14.4	93.7	15.3	30.8	21.6	17.3	13.1
HCM Lane LOS	C	C	C	B	F	C	D	C	C	B
HCM 95th-tile Q	2.2	1.7	1.5	0.6	14.5	0.7	4.9	2.2	1.3	0.4

Intersection												
Intersection Delay, s/veh	15.6											
Intersection LOS	C											

Movement	EBL	EBT	EBR	WBL	WBT	WBR	NBL	NBT	NBR	SBL	SBT	SBR
Lane Configurations		↕			↕			↕			↕	
Traffic Vol, veh/h	43	200	37	11	163	95	71	36	24	162	55	53
Future Vol, veh/h	43	200	37	11	163	95	71	36	24	162	55	53
Peak Hour Factor	0.86	0.86	0.86	0.86	0.86	0.86	0.86	0.86	0.86	0.86	0.86	0.86
Heavy Vehicles, %	6	6	6	6	6	6	0	0	0	0	0	0
Mvmt Flow	50	233	43	13	190	110	83	42	28	188	64	62
Number of Lanes	0	1	0	0	1	0	0	1	0	0	1	0

Approach	EB	WB	NB	SB
Opposing Approach	WB	EB	SB	NB
Opposing Lanes	1	1	1	1
Conflicting Approach Left	SB	NB	EB	WB
Conflicting Lanes Left	1	1	1	1
Conflicting Approach Right	NB	SB	WB	EB
Conflicting Lanes Right	1	1	1	1
HCM Control Delay	16.5	15.4	12.2	16.4
HCM LOS	C	C	B	C

Lane	NBLn1	EBLn1	WBLn1	SBLn1
Vol Left, %	54%	15%	4%	60%
Vol Thru, %	27%	71%	61%	20%
Vol Right, %	18%	13%	35%	20%
Sign Control	Stop	Stop	Stop	Stop
Traffic Vol by Lane	131	280	269	270
LT Vol	71	43	11	162
Through Vol	36	200	163	55
RT Vol	24	37	95	53
Lane Flow Rate	152	326	313	314
Geometry Grp	1	1	1	1
Degree of Util (X)	0.279	0.552	0.52	0.541
Departure Headway (Hd)	6.596	6.105	5.989	6.198
Convergence, Y/N	Yes	Yes	Yes	Yes
Cap	544	589	601	581
Service Time	4.654	4.152	4.036	4.245
HCM Lane V/C Ratio	0.279	0.553	0.521	0.54
HCM Control Delay	12.2	16.5	15.4	16.4
HCM Lane LOS	B	C	C	C
HCM 95th-tile Q	1.1	3.4	3	3.2

Intersection

Intersection Delay, s/veh 8.1

Intersection LOS A

Movement	EBL	EBT	EBR	WBL	WBT	WBR	NBL	NBT	NBR	SBL	SBT	SBR
Lane Configurations		↕			↕	↕		↕	↕		↕	↕
Traffic Vol, veh/h	0	0	0	27	0	119	0	20	45	58	11	0
Future Vol, veh/h	0	0	0	27	0	119	0	20	45	58	11	0
Peak Hour Factor	0.81	0.81	0.81	0.81	0.81	0.81	0.81	0.81	0.81	0.81	0.81	0.81
Heavy Vehicles, %	0	0	0	3	3	3	0	0	0	0	0	0
Mvmt Flow	0	0	0	33	0	147	0	25	56	72	14	0
Number of Lanes	0	1	0	0	1	1	0	1	1	0	1	1

Approach	EB	WB	NB	SB
Opposing Approach	WB	EB	SB	NB
Opposing Lanes	2	1	2	2
Conflicting Approach Left	SB	NB	EB	WB
Conflicting Lanes Left	2	2	1	2
Conflicting Approach Right	NB	SB	WB	EB
Conflicting Lanes Right	2	2	2	1
HCM Control Delay	0	8	7.5	8.9
HCM LOS	-	A	A	A

Lane	NBLn1	NBLn2	EBLn1	WBLn1	WBLn2	SBLn1	SBLn2
Vol Left, %	0%	0%	0%	100%	0%	84%	0%
Vol Thru, %	100%	0%	100%	0%	0%	16%	100%
Vol Right, %	0%	100%	0%	0%	100%	0%	0%
Sign Control	Stop	Stop	Stop	Stop	Stop	Stop	Stop
Traffic Vol by Lane	20	45	0	27	119	69	0
LT Vol	0	0	0	27	0	58	0
Through Vol	20	0	0	0	0	11	0
RT Vol	0	45	0	0	119	0	0
Lane Flow Rate	25	56	0	33	147	85	0
Geometry Grp	7	7	6	7	7	7	7
Degree of Util (X)	0.034	0.066	0	0.051	0.174	0.128	0
Departure Headway (Hd)	5.003	4.3	5.119	5.472	4.269	5.409	4.986
Convergence, Y/N	Yes	Yes	Yes	Yes	Yes	Yes	Yes
Cap	718	835	0	657	843	665	0
Service Time	2.719	2.015	3.137	3.183	1.98	3.124	2.702
HCM Lane V/C Ratio	0.035	0.067	0	0.05	0.174	0.128	0
HCM Control Delay	7.9	7.3	8.1	8.5	7.9	8.9	7.7
HCM Lane LOS	A	A	N	A	A	A	N
HCM 95th-tile Q	0.1	0.2	0	0.2	0.6	0.4	0

Intersection	
Intersection Delay, s/veh	18.7
Intersection LOS	C

Movement	EBL	EBT	EBR	WBL	WBT	WBR	NBL	NBT	NBR	SBL	SBT	SBR
Lane Configurations	↵	↕↔		↵	↕↔		↵	↕	↵	↵	↕	↕
Traffic Vol, veh/h	16	115	9	185	55	10	17	285	268	4	215	5
Future Vol, veh/h	16	115	9	185	55	10	17	285	268	4	215	5
Peak Hour Factor	0.84	0.84	0.84	0.84	0.84	0.84	0.84	0.84	0.84	0.84	0.84	0.84
Heavy Vehicles, %	4	4	4	4	4	4	0	0	0	0	0	0
Mvmt Flow	19	137	11	220	65	12	20	339	319	5	256	6
Number of Lanes	1	2	0	1	2	0	1	1	1	1	1	1

Approach	EB	WB	NB	SB
Opposing Approach	WB	EB	SB	NB
Opposing Lanes	3	3	3	3
Conflicting Approach Left	SB	NB	EB	WB
Conflicting Lanes Left	3	3	3	3
Conflicting Approach Right	NB	SB	WB	EB
Conflicting Lanes Right	3	3	3	3
HCM Control Delay	12.8	17.7	20.2	19.8
HCM LOS	B	C	C	C

Lane	NBLn1	NBLn2	NBLn3	EBLn1	EBLn2	EBLn3	WBLn1	WBLn2	WBLn3	SBLn1	SBLn2
Vol Left, %	100%	0%	0%	100%	0%	0%	100%	0%	0%	100%	0%
Vol Thru, %	0%	100%	0%	0%	100%	81%	0%	100%	65%	0%	100%
Vol Right, %	0%	0%	100%	0%	0%	19%	0%	0%	35%	0%	0%
Sign Control	Stop	Stop	Stop	Stop	Stop	Stop	Stop	Stop	Stop	Stop	Stop
Traffic Vol by Lane	17	285	268	16	77	47	185	37	28	4	215
LT Vol	17	0	0	16	0	0	185	0	0	4	0
Through Vol	0	285	0	0	77	38	0	37	18	0	215
RT Vol	0	0	268	0	0	9	0	0	10	0	0
Lane Flow Rate	20	339	319	19	91	56	220	44	34	5	256
Geometry Grp	8	8	8	8	8	8	8	8	8	8	8
Degree of Util (X)	0.043	0.673	0.571	0.047	0.212	0.129	0.516	0.096	0.072	0.011	0.559
Departure Headway (Hd)	7.639	7.139	6.439	8.853	8.353	8.22	8.439	7.939	7.692	8.36	7.86
Convergence, Y/N	Yes	Yes	Yes	Yes	Yes	Yes	Yes	Yes	Yes	Yes	Yes
Cap	469	506	558	404	429	436	427	451	465	428	458
Service Time	5.386	4.886	4.186	6.615	6.115	5.982	6.196	5.696	5.449	6.119	5.619
HCM Lane V/C Ratio	0.043	0.67	0.572	0.047	0.212	0.128	0.515	0.098	0.073	0.012	0.559
HCM Control Delay	10.7	23.4	17.5	12.1	13.4	12.2	19.9	11.5	11	11.2	20.2
HCM Lane LOS	B	C	C	B	B	B	C	B	B	B	C
HCM 95th-tile Q	0.1	5	3.6	0.1	0.8	0.4	2.9	0.3	0.2	0	3.4

Intersection

Intersection Delay, s/veh 49.8

Intersection LOS E

Movement	EBL	EBT	EBR	WBL	WBT	WBR	NBL	NBT	NBR	SBL	SBT	SBR
Lane Configurations	↶	↷		↶	↷	↶	↶	↷		↶	↷	
Traffic Vol, veh/h	59	259	69	25	101	65	47	207	24	127	270	48
Future Vol, veh/h	59	259	69	25	101	65	47	207	24	127	270	48
Peak Hour Factor	0.82	0.82	0.82	0.82	0.82	0.82	0.82	0.82	0.82	0.82	0.82	0.82
Heavy Vehicles, %	2	2	2	6	6	6	2	2	2	2	2	2
Mvmt Flow	72	316	84	30	123	79	57	252	29	155	329	59
Number of Lanes	1	1	0	1	1	1	1	1	0	1	1	0

Approach	EB	WB	NB	SB
Opposing Approach	WB	EB	SB	NB
Opposing Lanes	3	2	2	2
Conflicting Approach Left SB		NB	EB	WB
Conflicting Lanes Left	2	2	2	3
Conflicting Approach Right NB		SB	WB	EB
Conflicting Lanes Right	2	2	3	2
HCM Control Delay	74	17.1	32.7	53.4
HCM LOS	F	C	D	F

Lane	NBLn1	NBLn2	EBLn1	EBLn2	WBLn1	WBLn2	WBLn3	SBLn1	SBLn2
Vol Left, %	100%	0%	100%	0%	100%	0%	0%	100%	0%
Vol Thru, %	0%	90%	0%	79%	0%	100%	0%	0%	85%
Vol Right, %	0%	10%	0%	21%	0%	0%	100%	0%	15%
Sign Control	Stop	Stop	Stop	Stop	Stop	Stop	Stop	Stop	Stop
Traffic Vol by Lane	47	231	59	328	25	101	65	127	318
LT Vol	47	0	59	0	25	0	0	127	0
Through Vol	0	207	0	259	0	101	0	0	270
RT Vol	0	24	0	69	0	0	65	0	48
Lane Flow Rate	57	282	72	400	30	123	79	155	388
Geometry Grp	8	8	8	8	8	8	8	8	8
Degree of Util (X)	0.161	0.746	0.199	1.03	0.091	0.351	0.21	0.411	0.962
Departure Headway (Hd)	10.397	9.802	9.942	9.266	11.099	10.574	9.839	9.817	9.19
Convergence, Y/N	Yes	Yes	Yes	Yes	Yes	Yes	Yes	Yes	Yes
Cap	347	372	363	396	325	342	367	369	399
Service Time	8.097	7.502	7.642	6.966	8.799	8.274	7.539	7.517	6.89
HCM Lane V/C Ratio	0.164	0.758	0.198	1.01	0.092	0.36	0.215	0.42	0.972
HCM Control Delay	15.1	36.3	15.1	84.6	14.9	18.9	15.1	19.2	67
HCM Lane LOS	C	E	C	F	B	C	C	C	F
HCM 95th-tile Q	0.6	5.9	0.7	13	0.3	1.5	0.8	2	11

HCM 6th Signalized Intersection Summary
 23: Avenue 16/Ellis Street & Kennedy Street

Village D Specific Plan
 Existing NP - AM Peak Hour



Movement	WBL	WBR	NBT	NBR	SBL	SBT
Lane Configurations						
Traffic Volume (veh/h)	101	106	191	111	244	194
Future Volume (veh/h)	101	106	191	111	244	194
Initial Q (Qb), veh	0	0	0	0	0	0
Ped-Bike Adj(A_pbT)	1.00	1.00		0.98	1.00	
Parking Bus, Adj	1.00	1.00	1.00	1.00	1.00	1.00
Work Zone On Approach	No		No		No	
Adj Sat Flow, veh/h/ln	1841	1841	1841	1841	1870	1870
Adj Flow Rate, veh/h	117	123	222	129	284	226
Peak Hour Factor	0.86	0.86	0.86	0.86	0.86	0.86
Percent Heavy Veh, %	4	4	4	4	2	2
Cap, veh/h	170	266	631	350	785	2810
Arrive On Green	0.10	0.10	0.29	0.29	0.44	0.79
Sat Flow, veh/h	1753	2745	2241	1193	1781	3647
Grp Volume(v), veh/h	117	123	179	172	284	226
Grp Sat Flow(s),veh/h/ln	1753	1373	1749	1593	1781	1777
Q Serve(g_s), s	5.2	3.4	6.4	6.9	8.5	1.1
Cycle Q Clear(g_c), s	5.2	3.4	6.4	6.9	8.5	1.1
Prop In Lane	1.00	1.00		0.75	1.00	
Lane Grp Cap(c), veh/h	170	266	514	468	785	2810
V/C Ratio(X)	0.69	0.46	0.35	0.37	0.36	0.08
Avail Cap(c_a), veh/h	427	669	514	468	785	2810
HCM Platoon Ratio	1.00	1.00	1.00	1.00	1.00	1.00
Upstream Filter(I)	0.95	0.95	1.00	1.00	1.00	1.00
Uniform Delay (d), s/veh	35.0	34.2	22.2	22.4	14.9	1.9
Incr Delay (d2), s/veh	4.7	1.2	1.9	2.2	0.3	0.1
Initial Q Delay(d3),s/veh	0.0	0.0	0.0	0.0	0.0	0.0
%ile BackOfQ(50%),veh/ln	2.4	1.1	2.8	2.8	3.3	0.2
Unsig. Movement Delay, s/veh						
LnGrp Delay(d),s/veh	39.6	35.4	24.1	24.6	15.2	1.9
LnGrp LOS	D	D	C	C	B	A
Approach Vol, veh/h	240		351			510
Approach Delay, s/veh	37.4		24.3			9.3
Approach LOS	D		C			A
Timer - Assigned Phs	1	2			6	8
Phs Duration (G+Y+Rc), s	39.8	28.0			67.8	12.2
Change Period (Y+Rc), s	4.5	4.5			4.5	4.5
Max Green Setting (Gmax), s	23.5	23.5			51.5	19.5
Max Q Clear Time (g_c+10), s	11.0	8.9			3.1	7.2
Green Ext Time (p_c), s	0.7	1.8			1.6	0.6
Intersection Summary						
HCM 6th Ctrl Delay			20.2			
HCM 6th LOS			C			

HCM 6th Signalized Intersection Summary
 24: Schnoor Avenue & Kennedy Street

Village D Specific Plan
 Existing NP - AM Peak Hour



Movement	EBL	EBT	EBR	WBL	WBT	WBR	NBL	NBT	NBR	SBL	SBT	SBR
Lane Configurations												
Traffic Volume (veh/h)	15	174	162	110	121	14	96	5	205	15	6	4
Future Volume (veh/h)	15	174	162	110	121	14	96	5	205	15	6	4
Initial Q (Qb), veh	0	0	0	0	0	0	0	0	0	0	0	0
Ped-Bike Adj(A_pbT)	1.00		1.00	1.00		1.00	1.00		1.00	1.00		1.00
Parking Bus, Adj	1.00	1.00	1.00	1.00	1.00	1.00	1.00	1.00	1.00	1.00	1.00	1.00
Work Zone On Approach		No		No		No		No		No		No
Adj Sat Flow, veh/h/ln	1841	1841	1841	1826	1826	1826	1900	1900	1900	1366	1366	1366
Adj Flow Rate, veh/h	16	191	178	121	133	15	105	5	225	16	7	4
Peak Hour Factor	0.91	0.91	0.91	0.91	0.91	0.91	0.91	0.91	0.91	0.91	0.91	0.91
Percent Heavy Veh, %	4	4	4	5	5	5	0	0	0	36	36	36
Cap, veh/h	33	270	237	155	360	41	944	9	423	344	360	304
Arrive On Green	0.02	0.15	0.15	0.09	0.22	0.22	0.27	0.27	0.27	0.26	0.26	0.26
Sat Flow, veh/h	1753	1762	1546	1739	1611	182	3510	35	1573	1301	1366	1153
Grp Volume(v), veh/h	16	189	180	121	0	148	105	0	230	16	7	4
Grp Sat Flow(s),veh/h/ln	1753	1749	1559	1739	0	1793	1755	0	1608	1301	1366	1153
Q Serve(g_s), s	0.7	8.2	8.8	5.5	0.0	5.6	1.8	0.0	9.8	0.7	0.3	0.2
Cycle Q Clear(g_c), s	0.7	8.2	8.8	5.5	0.0	5.6	1.8	0.0	9.8	0.7	0.3	0.2
Prop In Lane	1.00		0.99	1.00		0.10	1.00		0.98	1.00		1.00
Lane Grp Cap(c), veh/h	33	268	239	155	0	401	944	0	432	344	360	304
V/C Ratio(X)	0.49	0.71	0.75	0.78	0.00	0.37	0.11	0.00	0.53	0.05	0.02	0.01
Avail Cap(c_a), veh/h	121	404	360	359	0	661	944	0	432	344	360	304
HCM Platoon Ratio	1.00	1.00	1.00	1.00	1.00	1.00	1.00	1.00	1.00	1.00	1.00	1.00
Upstream Filter(I)	0.82	0.82	0.82	1.00	0.00	1.00	1.00	0.00	1.00	1.00	1.00	1.00
Uniform Delay (d), s/veh	38.9	32.2	32.4	35.7	0.0	26.3	22.0	0.0	25.0	21.9	21.8	14.7
Incr Delay (d2), s/veh	8.9	2.8	3.9	8.4	0.0	0.6	0.1	0.0	4.6	0.1	0.1	0.1
Initial Q Delay(d3),s/veh	0.0	0.0	0.0	0.0	0.0	0.0	0.0	0.0	0.0	0.0	0.0	0.0
%ile BackOfQ(50%),veh/ln	0.4	3.6	3.5	2.6	0.0	2.4	0.7	0.0	4.1	0.2	0.1	0.1
Unsig. Movement Delay, s/veh												
LnGrp Delay(d),s/veh	47.8	35.0	36.3	44.0	0.0	26.9	22.1	0.0	29.6	22.0	21.9	14.8
LnGrp LOS	D	C	D	D	A	C	C	A	C	C	C	B
Approach Vol, veh/h		385		269		335		27				
Approach Delay, s/veh		36.1		34.6		27.2		20.9				
Approach LOS		D		C		C		C				
Timer - Assigned Phs	1	2	3	4	5	6	7	8				
Phs Duration (G+Y+Rc), s	25.6	26.0	11.6	16.8	26.0	25.6	6.0	22.4				
Change Period (Y+Rc), s	4.5	4.5	4.5	4.5	4.5	4.5	4.5	4.5				
Max Green Setting (Gmax), s	5.5	21.5	16.5	18.5	5.9	21.1	5.5	29.5				
Max Q Clear Time (g_c+1), s	12.5	11.8	7.5	10.8	3.8	2.3	2.7	7.6				
Green Ext Time (p_c), s	0.0	0.9	0.2	1.3	0.0	0.0	0.0	0.7				
Intersection Summary												
HCM 6th Ctrl Delay				32.4								
HCM 6th LOS				C								

Intersection						
Int Delay, s/veh	5.5					
Movement	EBL	EBT	WBT	WBR	SBL	SBR
Lane Configurations	↘	↑	↗		↘	↗
Traffic Vol, veh/h	187	227	172	1	64	103
Future Vol, veh/h	187	227	172	1	64	103
Conflicting Peds, #/hr	0	0	0	0	0	0
Sign Control	Free	Free	Free	Free	Stop	Stop
RT Channelized	-	None	-	Free	-	None
Storage Length	140	-	-	-	0	335
Veh in Median Storage, #	-	0	0	-	0	-
Grade, %	-	0	0	-	0	-
Peak Hour Factor	86	86	86	86	86	86
Heavy Vehicles, %	2	2	6	6	4	4
Mvmt Flow	217	264	200	1	74	120

Major/Minor	Major1	Major2	Minor2		
Conflicting Flow All	200	0	-	0	898 200
Stage 1	-	-	-	-	200 -
Stage 2	-	-	-	-	698 -
Critical Hdwy	4.12	-	-	-	6.44 6.24
Critical Hdwy Stg 1	-	-	-	-	5.44 -
Critical Hdwy Stg 2	-	-	-	-	5.44 -
Follow-up Hdwy	2.218	-	-	-	3.536 3.336
Pot Cap-1 Maneuver	1372	-	-	0	307 836
Stage 1	-	-	-	0	829 -
Stage 2	-	-	-	0	490 -
Platoon blocked, %		-	-		
Mov Cap-1 Maneuver	1372	-	-	-	258 836
Mov Cap-2 Maneuver	-	-	-	-	258 -
Stage 1	-	-	-	-	698 -
Stage 2	-	-	-	-	490 -

Approach	EB	WB	SB
HCM Control Delay, s	3.7	0	15.6
HCM LOS			C

Minor Lane/Major Mvmt	EBL	EBT	WBT	SBLn1	SBLn2
Capacity (veh/h)	1372	-	-	258	836
HCM Lane V/C Ratio	0.158	-	-	0.288	0.143
HCM Control Delay (s)	8.1	-	-	24.5	10
HCM Lane LOS	A	-	-	C	B
HCM 95th %tile Q(veh)	0.6	-	-	1.2	0.5

Intersection						
Int Delay, s/veh	4.8					
Movement	EBL	EBT	WBT	WBR	SBL	SBR
Lane Configurations		↶	↷		↶	↷
Traffic Vol, veh/h	159	132	67	0	0	106
Future Vol, veh/h	159	132	67	0	0	106
Conflicting Peds, #/hr	0	0	0	0	0	0
Sign Control	Free	Free	Free	Free	Stop	Stop
RT Channelized	-	None	-	None	-	None
Storage Length	-	-	-	-	0	-
Veh in Median Storage, #	-	0	0	-	0	-
Grade, %	-	0	0	-	0	-
Peak Hour Factor	81	81	81	81	81	81
Heavy Vehicles, %	3	3	6	6	7	7
Mvmt Flow	196	163	83	0	0	131

Major/Minor	Major1	Major2	Minor2		
Conflicting Flow All	83	0	-	0	638
Stage 1	-	-	-	-	83
Stage 2	-	-	-	-	555
Critical Hdwy	4.13	-	-	-	6.47
Critical Hdwy Stg 1	-	-	-	-	5.47
Critical Hdwy Stg 2	-	-	-	-	5.47
Follow-up Hdwy	2.227	-	-	-	3.563
Pot Cap-1 Maneuver	1508	-	-	-	433
Stage 1	-	-	-	-	928
Stage 2	-	-	-	-	565
Platoon blocked, %		-	-	-	
Mov Cap-1 Maneuver	1508	-	-	-	371
Mov Cap-2 Maneuver	-	-	-	-	371
Stage 1	-	-	-	-	795
Stage 2	-	-	-	-	565

Approach	EB	WB	SB
HCM Control Delay, s	4.2	0	9.3
HCM LOS			A

Minor Lane/Major Mvmt	EBL	EBT	WBT	WBR	SBLn1
Capacity (veh/h)	1508	-	-	-	963
HCM Lane V/C Ratio	0.13	-	-	-	0.136
HCM Control Delay (s)	7.7	0	-	-	9.3
HCM Lane LOS	A	A	-	-	A
HCM 95th %tile Q(veh)	0.4	-	-	-	0.5

Intersection						
Int Delay, s/veh	5.4					
Movement	EBL	EBR	NBL	NBT	SBT	SBR
Lane Configurations	↵			↑	↵	
Traffic Vol, veh/h	160	0	0	42	3	104
Future Vol, veh/h	160	0	0	42	3	104
Conflicting Peds, #/hr	0	0	0	0	0	0
Sign Control	Stop	Stop	Free	Free	Free	Free
RT Channelized	-	None	-	None	-	None
Storage Length	0	-	-	-	-	-
Veh in Median Storage, #	0	-	-	0	0	-
Grade, %	0	-	-	0	0	-
Peak Hour Factor	76	76	76	76	76	76
Heavy Vehicles, %	3	3	10	10	6	6
Mvmt Flow	211	0	0	55	4	137

Major/Minor	Minor2	Major1		Major2	
Conflicting Flow All	128	-	-	0	0
Stage 1	73	-	-	-	-
Stage 2	55	-	-	-	-
Critical Hdwy	6.43	-	-	-	-
Critical Hdwy Stg 1	5.43	-	-	-	-
Critical Hdwy Stg 2	5.43	-	-	-	-
Follow-up Hdwy	3.527	-	-	-	-
Pot Cap-1 Maneuver	864	0	0	-	-
Stage 1	947	0	0	-	-
Stage 2	965	0	0	-	-
Platoon blocked, %				-	-
Mov Cap-1 Maneuver	864	-	-	-	-
Mov Cap-2 Maneuver	864	-	-	-	-
Stage 1	947	-	-	-	-
Stage 2	965	-	-	-	-

Approach	EB	NB	SB
HCM Control Delay, s	10.5	0	0
HCM LOS	B		

Minor Lane/Major Mvmt	NBT	EBLn1	SBT	SBR
Capacity (veh/h)	-	864	-	-
HCM Lane V/C Ratio	-	0.244	-	-
HCM Control Delay (s)	-	10.5	-	-
HCM Lane LOS	-	B	-	-
HCM 95th %tile Q(veh)	-	1	-	-

Intersection						
Int Delay, s/veh	0					
Movement	EBL	EBT	WBT	WBR	SBL	SBR
Lane Configurations		↶	↷		↶	
Traffic Vol, veh/h	0	129	72	50	0	0
Future Vol, veh/h	0	129	72	50	0	0
Conflicting Peds, #/hr	0	0	0	0	0	0
Sign Control	Free	Free	Free	Free	Stop	Stop
RT Channelized	-	None	-	None	-	None
Storage Length	-	-	-	-	0	-
Veh in Median Storage, #	-	0	0	-	0	-
Grade, %	-	0	0	-	0	-
Peak Hour Factor	78	78	78	78	78	78
Heavy Vehicles, %	2	2	13	13	0	0
Mvmt Flow	0	165	92	64	0	0

Major/Minor	Major1	Major2	Minor2		
Conflicting Flow All	156	0	-	0	289
Stage 1	-	-	-	-	124
Stage 2	-	-	-	-	165
Critical Hdwy	4.12	-	-	-	6.4
Critical Hdwy Stg 1	-	-	-	-	5.4
Critical Hdwy Stg 2	-	-	-	-	5.4
Follow-up Hdwy	2.218	-	-	-	3.5
Pot Cap-1 Maneuver	1424	-	-	-	706
Stage 1	-	-	-	-	907
Stage 2	-	-	-	-	869
Platoon blocked, %		-	-	-	
Mov Cap-1 Maneuver	1424	-	-	-	706
Mov Cap-2 Maneuver	-	-	-	-	706
Stage 1	-	-	-	-	907
Stage 2	-	-	-	-	869

Approach	EB	WB	SB
HCM Control Delay, s	0	0	0
HCM LOS			A

Minor Lane/Major Mvmt	EBL	EBT	WBT	WBR	SBLn1
Capacity (veh/h)	1424	-	-	-	-
HCM Lane V/C Ratio	-	-	-	-	-
HCM Control Delay (s)	0	-	-	-	0
HCM Lane LOS	A	-	-	-	A
HCM 95th %tile Q(veh)	0	-	-	-	-

HCM 6th Signalized Intersection Summary
29: Schnoor Avenue & Cleveland Avenue

Village D Specific Plan
Existing NP - AM Peak Hour



Movement	EBL	EBT	EBR	WBL	WBT	WBR	NBL	NBT	NBR	SBL	SBT	SBR
Lane Configurations	↘	↑↑	↗	↘↗	↑↑	↗	↘	↑↑	↗	↘	↑↑	↗
Traffic Volume (veh/h)	71	321	32	161	210	43	50	212	155	79	156	59
Future Volume (veh/h)	71	321	32	161	210	43	50	212	155	79	156	59
Initial Q (Qb), veh	0	0	0	0	0	0	0	0	0	0	0	0
Ped-Bike Adj(A_pbT)	1.00		0.97	1.00		0.97	1.00		0.99	1.00		0.98
Parking Bus, Adj	1.00	1.00	1.00	1.00	1.00	1.00	1.00	1.00	1.00	1.00	1.00	1.00
Work Zone On Approach		No			No			No			No	
Adj Sat Flow, veh/h/ln	1856	1856	1856	1826	1826	1826	1885	1885	1885	1856	1856	1856
Adj Flow Rate, veh/h	78	353	35	177	231	47	55	233	170	87	171	65
Peak Hour Factor	0.91	0.91	0.91	0.91	0.91	0.91	0.91	0.91	0.91	0.91	0.91	0.91
Percent Heavy Veh, %	3	3	3	5	5	5	1	1	1	3	3	3
Cap, veh/h	101	565	245	253	618	268	79	869	503	525	1747	766
Arrive On Green	0.06	0.16	0.16	0.08	0.18	0.18	0.04	0.24	0.24	0.30	0.50	0.50
Sat Flow, veh/h	1767	3526	1528	3374	3469	1506	1795	3582	1582	1767	3526	1545
Grp Volume(v), veh/h	78	353	35	177	231	47	55	233	170	87	171	65
Grp Sat Flow(s),veh/h/ln	1767	1763	1528	1687	1735	1506	1795	1791	1582	1767	1763	1545
Q Serve(g_s), s	3.5	7.5	1.3	4.1	4.7	1.1	2.4	4.2	0.5	2.9	2.1	1.8
Cycle Q Clear(g_c), s	3.5	7.5	1.3	4.1	4.7	1.1	2.4	4.2	0.5	2.9	2.1	1.8
Prop In Lane	1.00		1.00	1.00		1.00	1.00		1.00	1.00		1.00
Lane Grp Cap(c), veh/h	101	565	245	253	618	268	79	869	503	525	1747	766
V/C Ratio(X)	0.77	0.62	0.14	0.70	0.37	0.18	0.69	0.27	0.34	0.17	0.10	0.08
Avail Cap(c_a), veh/h	296	1300	564	274	980	426	117	869	503	525	1747	766
HCM Platoon Ratio	1.00	1.00	1.00	1.00	1.00	1.00	1.00	1.00	1.00	1.00	1.00	1.00
Upstream Filter(I)	1.00	1.00	1.00	0.79	0.79	0.79	1.00	1.00	1.00	1.00	1.00	1.00
Uniform Delay (d), s/veh	37.2	31.3	19.1	36.1	29.0	7.0	37.7	24.5	20.9	20.8	10.7	10.6
Incr Delay (d2), s/veh	11.6	1.1	0.3	5.6	0.3	0.2	10.4	0.8	1.8	0.1	0.1	0.2
Initial Q Delay(d3),s/veh	0.0	0.0	0.0	0.0	0.0	0.0	0.0	0.0	0.0	0.0	0.0	0.0
%ile BackOfQ(50%),veh/ln	1.8	3.2	0.6	1.8	1.9	0.7	1.3	1.8	2.6	1.2	0.8	0.6
Unsig. Movement Delay, s/veh												
LnGrp Delay(d),s/veh	48.8	32.5	19.4	41.7	29.2	7.3	48.1	25.3	22.7	20.9	10.8	10.8
LnGrp LOS	D	C	B	D	C	A	D	C	C	C	B	B
Approach Vol, veh/h		466			455			458			323	
Approach Delay, s/veh		34.2			31.8			27.1			13.5	
Approach LOS		C			C			C			B	
Timer - Assigned Phs	1	2	3	4	5	6	7	8				
Phs Duration (G+Y+Rc), s	28.3	23.9	10.5	17.3	8.0	44.1	9.1	18.7				
Change Period (Y+Rc), s	4.5	4.5	4.5	4.5	4.5	4.5	4.5	4.5				
Max Green Setting (Gmax), s	6.6	19.4	6.5	29.5	5.2	20.8	13.4	22.6				
Max Q Clear Time (g_c+I1), s	4.9	6.2	6.1	9.5	4.4	4.1	5.5	6.7				
Green Ext Time (p_c), s	0.0	1.7	0.0	2.3	0.0	1.1	0.1	1.4				

Intersection Summary

HCM 6th Ctrl Delay	27.7
HCM 6th LOS	C

HCM 6th Signalized Intersection Summary
30: Fairgrounds & Cleveland Avenue

Village D Specific Plan
Existing NP - AM Peak Hour



Movement	EBL	EBT	EBR	WBL	WBT	WBR	NBL	NBT	NBR	SBL	SBT	SBR
Lane Configurations	↑↑↑			↑↑		↑	↑↑	↑	↑	↑	↑	↑
Traffic Volume (veh/h)	80	506	29	32	362	65	13	6	23	95	5	38
Future Volume (veh/h)	80	506	29	32	362	65	13	6	23	95	5	38
Initial Q (Qb), veh	0	0	0	0	0	0	0	0	0	0	0	0
Ped-Bike Adj(A_pbT)	1.00		1.00	1.00		1.00	1.00		1.00	1.00		0.99
Parking Bus, Adj	1.00	1.00	1.00	1.00	1.00	1.00	1.00	1.00	1.00	1.00	1.00	1.00
Work Zone On Approach	No			No			No			No		
Adj Sat Flow, veh/h/ln	1841	1841	1841	1841	1841	1841	1900	1900	1900	1900	1900	1900
Adj Flow Rate, veh/h	85	538	31	34	385	69	14	20	15	101	5	40
Peak Hour Factor	0.94	0.94	0.94	0.94	0.94	0.94	0.94	0.94	0.94	0.94	0.94	0.94
Percent Heavy Veh, %	4	4	4	4	4	4	0	0	0	0	0	0
Cap, veh/h	109	906	52	58	550	245	879	463	392	564	56	449
Arrive On Green	0.06	0.19	0.19	0.03	0.16	0.16	0.24	0.24	0.24	0.31	0.31	0.31
Sat Flow, veh/h	1753	4863	278	1753	3497	1560	3619	1900	1608	1810	180	1437
Grp Volume(v), veh/h	85	369	200	34	385	69	14	20	15	101	0	45
Grp Sat Flow(s),veh/h/ln	1753	1675	1791	1753	1749	1560	1810	1900	1608	1810	0	1617
Q Serve(g_s), s	3.8	8.1	8.2	1.5	8.3	3.1	0.2	0.6	0.5	3.3	0.0	1.6
Cycle Q Clear(g_c), s	3.8	8.1	8.2	1.5	8.3	3.1	0.2	0.6	0.5	3.3	0.0	1.6
Prop In Lane	1.00		0.16	1.00		1.00	1.00		1.00	1.00		0.89
Lane Grp Cap(c), veh/h	109	624	334	58	550	245	879	463	392	564	0	505
V/C Ratio(X)	0.78	0.59	0.60	0.59	0.70	0.28	0.02	0.04	0.04	0.18	0.00	0.09
Avail Cap(c_a), veh/h	186	1110	593	121	1027	458	879	463	392	564	0	505
HCM Platoon Ratio	1.00	1.00	1.00	1.00	1.00	1.00	1.00	1.00	1.00	1.00	1.00	1.00
Upstream Filter(I)	0.87	0.87	0.87	0.93	0.93	0.93	1.00	1.00	1.00	1.00	0.00	1.00
Uniform Delay (d), s/veh	37.0	29.8	29.8	38.1	31.9	29.7	23.0	23.1	15.1	20.1	0.0	19.4
Incr Delay (d2), s/veh	10.0	0.8	1.5	8.4	1.5	0.6	0.0	0.2	0.2	0.2	0.0	0.3
Initial Q Delay(d3),s/veh	0.0	0.0	0.0	0.0	0.0	0.0	0.0	0.0	0.0	0.0	0.0	0.0
%ile BackOfQ(50%),veh/ln	9	3.2	3.5	0.8	3.5	1.2	0.1	0.3	0.2	1.4	0.0	0.6
Unsig. Movement Delay, s/veh												
LnGrp Delay(d),s/veh	47.0	30.5	31.3	46.5	33.4	30.3	23.0	23.3	15.2	20.2	0.0	19.8
LnGrp LOS	D	C	C	D	C	C	C	C	B	C	A	B
Approach Vol, veh/h	654		488				49		146			
Approach Delay, s/veh	32.9		33.9				20.7		20.1			
Approach LOS	C		C				C		C			
Timer - Assigned Phs	1	2	3	4	5	6	7	8				
Phs Duration (G+Y+Rc), s	29.4	24.0	7.2	19.4	23.9	29.5	9.5	17.1				
Change Period (Y+Rc), s	4.5	4.5	4.5	4.5	4.5	4.5	4.5	4.5				
Max Green Setting (Gmax), s	10.5	19.5	5.5	26.5	5.0	25.0	8.5	23.5				
Max Q Clear Time (g_c+1), s	11.3	2.6	3.5	10.2	2.2	3.6	5.8	10.3				
Green Ext Time (p_c), s	0.1	0.1	0.0	3.3	0.0	0.2	0.0	2.2				

Intersection Summary

HCM 6th Ctrl Delay	31.4
HCM 6th LOS	C

Notes

User approved volume balancing among the lanes for turning movement.

HCM 6th Signalized Intersection Summary
 31: SR-99 Southbound Ramps & Cleveland Avenue

Village D Specific Plan
 Existing NP - AM Peak Hour



Movement	EBL	EBT	EBR	WBL	WBT	WBR	NBL	NBT	NBR	SBL	SBT	SBR
Lane Configurations		↑↑	↗	↘	↑↑					↖		↗
Traffic Volume (veh/h)	0	413	306	313	651	0	0	0	0	57	0	46
Future Volume (veh/h)	0	413	306	313	651	0	0	0	0	57	0	46
Initial Q (Qb), veh	0	0	0	0	0	0				0	0	0
Ped-Bike Adj(A_pbT)	1.00		1.00	1.00		1.00				1.00		1.00
Parking Bus, Adj	1.00	1.00	1.00	1.00	1.00	1.00				1.00	1.00	1.00
Work Zone On Approach		No			No						No	
Adj Sat Flow, veh/h/ln	0	1841	1841	1856	1856	0				1678	0	1678
Adj Flow Rate, veh/h	0	475	352	360	748	0				66	0	53
Peak Hour Factor	0.87	0.87	0.87	0.87	0.87	0.87				0.87	0.87	0.87
Percent Heavy Veh, %	0	4	4	3	3	0				15	0	15
Cap, veh/h	0	860	384	394	1830	0				609	0	542
Arrive On Green	0.00	0.25	0.25	0.45	1.00	0.00				0.38	0.00	0.38
Sat Flow, veh/h	0	3589	1560	1767	3618	0				1598	0	1422
Grp Volume(v), veh/h	0	475	352	360	748	0				66	0	53
Grp Sat Flow(s),veh/h/ln	0	1749	1560	1767	1763	0				1598	0	1422
Q Serve(g_s), s	0.0	10.7	19.8	17.1	0.0	0.0				2.4	0.0	2.2
Cycle Q Clear(g_c), s	0.0	10.7	19.8	17.1	0.0	0.0				2.4	0.0	2.2
Prop In Lane	0.00		1.00	1.00		0.00				1.00		1.00
Lane Grp Cap(c), veh/h	0	860	384	394	1830	0				609	0	542
V/C Ratio(X)	0.00	0.55	0.92	0.91	0.41	0.00				0.11	0.00	0.10
Avail Cap(c_a), veh/h	0	874	390	638	2331	0				609	0	542
HCM Platoon Ratio	1.00	1.00	1.00	2.00	2.00	1.00				1.00	1.00	1.00
Upstream Filter(I)	0.00	0.89	0.89	0.70	0.70	0.00				1.00	0.00	1.00
Uniform Delay (d), s/veh	0.0	29.6	33.0	24.1	0.0	0.0				18.0	0.0	17.9
Incr Delay (d2), s/veh	0.0	0.6	23.9	8.7	0.1	0.0				0.1	0.0	0.1
Initial Q Delay(d3),s/veh	0.0	0.0	0.0	0.0	0.0	0.0				0.0	0.0	0.0
%ile BackOfQ(50%),veh/ln	0.0	4.5	9.8	5.9	0.0	0.0				0.9	0.0	0.7
Unsig. Movement Delay, s/veh												
LnGrp Delay(d),s/veh	0.0	30.3	57.0	32.8	0.1	0.0				18.1	0.0	18.0
LnGrp LOS	A	C	E	C	A	A				B	A	B
Approach Vol, veh/h		827		1108						119		
Approach Delay, s/veh		41.6		10.7						18.0		
Approach LOS		D		B						B		
Timer - Assigned Phs			3	4		6			8			
Phs Duration (G+Y+Rc), s			24.6	26.6		38.8			51.2			
Change Period (Y+Rc), s			4.5	4.5		4.5			4.5			
Max Green Setting (Gmax), s			32.5	22.5		5.0			59.5			
Max Q Clear Time (g_c+I1), s			19.1	21.8		4.4			2.0			
Green Ext Time (p_c), s			0.9	0.4		0.0			6.3			
Intersection Summary												
HCM 6th Ctrl Delay		23.6										
HCM 6th LOS		C										

HCM 6th Signalized Intersection Summary
32: SR-99 Northbound Ramps & Cleveland Avenue

Village D Specific Plan
Existing NP - AM Peak Hour



Movement	EBL	EBT	EBR	WBL	WBT	WBR	NBL	NBT	NBR	SBL	SBT	SBR
Lane Configurations	↘	↑↑			↑↑	↗	↘	↖	↗			
Traffic Volume (veh/h)	43	427	0	0	730	59	234	0	243	0	0	0
Future Volume (veh/h)	43	427	0	0	730	59	234	0	243	0	0	0
Initial Q (Qb), veh	0	0	0	0	0	0	0	0	0			
Ped-Bike Adj(A_pbT)	1.00		1.00	1.00		1.00	1.00		1.00			
Parking Bus, Adj	1.00	1.00	1.00	1.00	1.00	1.00	1.00	1.00	1.00			
Work Zone On Approach	No				No				No			
Adj Sat Flow, veh/h/ln	1826	1826	0	0	1856	1856	1826	1826	1826			
Adj Flow Rate, veh/h	53	527	0	0	901	73	289	0	300			
Peak Hour Factor	0.81	0.81	0.81	0.81	0.81	0.81	0.81	0.81	0.81			
Percent Heavy Veh, %	5	5	0	0	3	3	5	5	5			
Cap, veh/h	71	1430	0	0	1133	506	1696	0	755			
Arrive On Green	0.04	0.41	0.00	0.00	0.32	0.32	0.49	0.00	0.49			
Sat Flow, veh/h	1739	3561	0	0	3618	1572	3478	0	1547			
Grp Volume(v), veh/h	53	527	0	0	901	73	289	0	300			
Grp Sat Flow(s),veh/h/ln	1739	1735	0	0	1763	1572	1739	0	1547			
Q Serve(g_s), s	2.7	9.5	0.0	0.0	21.0	3.0	4.2	0.0	11.1			
Cycle Q Clear(g_c), s	2.7	9.5	0.0	0.0	21.0	3.0	4.2	0.0	11.1			
Prop In Lane	1.00		0.00	0.00		1.00	1.00		1.00			
Lane Grp Cap(c), veh/h	71	1430	0	0	1133	506	1696	0	755			
V/C Ratio(X)	0.75	0.37	0.00	0.00	0.79	0.14	0.17	0.00	0.40			
Avail Cap(c_a), veh/h	184	2024	0	0	1508	673	1696	0	755			
HCM Platoon Ratio	1.00	1.00	1.00	1.00	1.00	1.00	1.00	1.00	1.00			
Upstream Filter(I)	0.80	0.80	0.00	0.00	0.71	0.71	1.00	0.00	1.00			
Uniform Delay (d), s/veh	42.7	18.3	0.0	0.0	27.8	21.7	12.9	0.0	14.7			
Incr Delay (d2), s/veh	11.8	0.1	0.0	0.0	1.6	0.1	0.2	0.0	1.6			
Initial Q Delay(d3),s/veh	0.0	0.0	0.0	0.0	0.0	0.0	0.0	0.0	0.0			
%ile BackOfQ(50%),veh/ln	4	3.7	0.0	0.0	8.8	1.1	1.6	0.0	4.0			
Unsig. Movement Delay, s/veh												
LnGrp Delay(d),s/veh	54.5	18.5	0.0	0.0	29.4	21.8	13.1	0.0	16.2			
LnGrp LOS	D	B	A	A	C	C	B	A	B			
Approach Vol, veh/h	580				974		589					
Approach Delay, s/veh	21.7				28.8		14.7					
Approach LOS	C				C		B					
Timer - Assigned Phs	2		4		7		8					
Phs Duration (G+Y+Rc), s	48.4		41.6		8.2		33.4					
Change Period (Y+Rc), s	4.5		4.5		4.5		4.5					
Max Green Setting (Gmax), s	28.5		52.5		9.5		38.5					
Max Q Clear Time (g_c+I1), s	13.1		11.5		4.7		23.0					
Green Ext Time (p_c), s	1.9		4.0		0.0		6.0					

Intersection Summary

HCM 6th Ctrl Delay	23.0
HCM 6th LOS	C

Notes

User approved volume balancing among the lanes for turning movement.

HCM 6th Signalized Intersection Summary
 33: Gateway Drive & Cleveland Avenue

Village D Specific Plan
 Existing NP - AM Peak Hour



Movement	EBL	EBT	EBR	WBL	WBT	WBR	NBL	NBT	NBR	SBL	SBT	SBR
Lane Configurations	↖	↑↑↑	↗	↖↗	↑↑		↖↗	↑	↗	↖	↑↗	
Traffic Volume (veh/h)	4	520	140	154	652	62	130	47	113	51	85	4
Future Volume (veh/h)	4	520	140	154	652	62	130	47	113	51	85	4
Initial Q (Qb), veh	0	0	0	0	0	0	0	0	0	0	0	0
Ped-Bike Adj(A_pbT)	1.00		1.00	1.00		1.00	1.00		0.98	1.00		0.98
Parking Bus, Adj	1.00	1.00	1.00	1.00	1.00	1.00	1.00	1.00	1.00	1.00	1.00	1.00
Work Zone On Approach		No			No			No			No	
Adj Sat Flow, veh/h/ln	1841	1841	1841	1870	1870	1870	1796	1796	1796	1841	1841	1841
Adj Flow Rate, veh/h	5	642	0	190	805	77	160	58	140	63	105	5
Peak Hour Factor	0.81	0.81	0.81	0.81	0.81	0.81	0.81	0.81	0.81	0.81	0.81	0.81
Percent Heavy Veh, %	4	4	4	2	2	2	7	7	7	4	4	4
Cap, veh/h	91	976		397	991	95	914	799	667	81	732	35
Arrive On Green	0.00	0.06	0.00	0.11	0.30	0.30	0.28	0.44	0.44	0.05	0.22	0.22
Sat Flow, veh/h	1753	5025	1560	3456	3276	313	3319	1796	1499	1753	3397	161
Grp Volume(v), veh/h	5	642	0	190	437	445	160	58	140	63	54	56
Grp Sat Flow(s),veh/h/ln	1753	1675	1560	1728	1777	1812	1659	1796	1499	1753	1749	1809
Q Serve(g_s), s	0.2	11.2	0.0	4.6	20.4	20.5	3.3	1.7	3.2	3.2	2.2	2.3
Cycle Q Clear(g_c), s	0.2	11.2	0.0	4.6	20.4	20.5	3.3	1.7	3.2	3.2	2.2	2.3
Prop In Lane	1.00		1.00	1.00		0.17	1.00		1.00	1.00		0.09
Lane Grp Cap(c), veh/h	91	976		397	538	548	914	799	667	81	377	390
V/C Ratio(X)	0.05	0.66		0.48	0.81	0.81	0.18	0.07	0.21	0.78	0.14	0.14
Avail Cap(c_a), veh/h	177	1736		397	709	723	914	799	667	179	377	390
HCM Platoon Ratio	0.33	0.33	0.33	1.00	1.00	1.00	1.00	1.00	1.00	1.00	1.00	1.00
Upstream Filter(I)	0.95	0.95	0.00	0.95	0.95	0.95	1.00	1.00	1.00	1.00	1.00	1.00
Uniform Delay (d), s/veh	32.6	39.2	0.0	37.3	29.0	29.0	24.8	14.3	5.8	42.5	28.6	28.6
Incr Delay (d2), s/veh	0.2	0.7	0.0	0.9	5.2	5.1	0.1	0.2	0.7	14.8	0.8	0.8
Initial Q Delay(d3),s/veh	0.0	0.0	0.0	0.0	0.0	0.0	0.0	0.0	0.0	0.0	0.0	0.0
%ile BackOfQ(50%),veh/ln	0.1	5.1	0.0	2.0	9.2	9.4	1.3	0.7	1.7	1.7	1.0	1.1
Unsig. Movement Delay, s/veh												
LnGrp Delay(d),s/veh	32.9	39.9	0.0	38.2	34.2	34.1	24.9	14.5	6.5	57.3	29.4	29.4
LnGrp LOS	C	D		D	C	C	C	B	A	E	C	C
Approach Vol, veh/h		647	A		1072			358			173	
Approach Delay, s/veh		39.9			34.8			16.0			39.5	
Approach LOS		D			C			B			D	
Timer - Assigned Phs	1	2	3	4	5	6	7	8				
Phs Duration (G+Y+Rc), s	29.3	23.9	5.1	31.7	8.7	44.5	14.8	22.0				
Change Period (Y+Rc), s	4.5	4.5	4.5	4.5	4.5	4.5	4.5	4.5				
Max Green Setting (Gmax), s	19.4	19.4	5.0	35.9	9.2	21.9	9.8	31.1				
Max Q Clear Time (g_c+1), s	4.3	4.3	2.2	22.5	5.2	5.2	6.6	13.2				
Green Ext Time (p_c), s	0.2	0.4	0.0	4.8	0.0	0.7	0.2	4.2				

Intersection Summary

HCM 6th Ctrl Delay	33.7
HCM 6th LOS	C

Notes

Unsignalized Delay for [EBR] is excluded from calculations of the approach delay and intersection delay.

HCM 6th Signalized Intersection Summary
34: Cleveland Avenue & County Club Drive

Village D Specific Plan
Existing NP - AM Peak Hour



Movement	WBL	WBR	NBT	NBR	SBL	SBT
Lane Configurations	↔↔		↑↑	↗	↖	↑↑↑
Traffic Volume (veh/h)	275	19	488	196	76	593
Future Volume (veh/h)	275	19	488	196	76	593
Initial Q (Qb), veh	0	0	0	0	0	0
Ped-Bike Adj(A_pbT)	1.00	1.00		1.00	1.00	
Parking Bus, Adj	1.00	1.00	1.00	1.00	1.00	1.00
Work Zone On Approach	No		No		No	
Adj Sat Flow, veh/h/ln	1900	1900	1856	1856	1856	1856
Adj Flow Rate, veh/h	352	0	588	0	92	714
Peak Hour Factor	0.83	0.83	0.83	0.83	0.83	0.83
Percent Heavy Veh, %	0	0	3	3	3	3
Cap, veh/h	468	208	2717		675	3903
Arrive On Green	0.13	0.00	0.77	0.00	0.77	0.77
Sat Flow, veh/h	3619	1610	3618	1572	821	5233
Grp Volume(v), veh/h	352	0	588	0	92	714
Grp Sat Flow(s),veh/h/ln	1810	1610	1763	1572	821	1689
Q Serve(g_s), s	8.4	0.0	4.1	0.0	3.1	3.4
Cycle Q Clear(g_c), s	8.4	0.0	4.1	0.0	7.3	3.4
Prop In Lane	1.00	1.00		1.00	1.00	
Lane Grp Cap(c), veh/h	468	208	2717		675	3903
V/C Ratio(X)	0.75	0.00	0.22		0.14	0.18
Avail Cap(c_a), veh/h	1307	581	2717		675	3903
HCM Platoon Ratio	1.00	1.00	1.00	1.00	1.00	1.00
Upstream Filter(I)	1.00	0.00	0.82	0.00	1.00	1.00
Uniform Delay (d), s/veh	37.8	0.0	2.8	0.0	3.8	2.8
Incr Delay (d2), s/veh	2.5	0.0	0.2	0.0	0.4	0.1
Initial Q Delay(d3),s/veh	0.0	0.0	0.0	0.0	0.0	0.0
%ile BackOfQ(50%),veh/ln	3.8	0.0	1.1	0.0	0.5	0.8
Unsig. Movement Delay, s/veh						
LnGrp Delay(d),s/veh	40.2	0.0	3.0	0.0	4.3	2.9
LnGrp LOS	D	A	A		A	A
Approach Vol, veh/h	352		588	A		806
Approach Delay, s/veh	40.2		3.0			3.0
Approach LOS	D		A			A
Timer - Assigned Phs		2			6	8
Phs Duration (G+Y+Rc), s		73.9			73.9	16.1
Change Period (Y+Rc), s		4.5			4.5	4.5
Max Green Setting (Gmax), s		48.5			48.5	32.5
Max Q Clear Time (g_c+I1), s		6.1			9.3	10.4
Green Ext Time (p_c), s		4.6			6.6	1.2

Intersection Summary

HCM 6th Ctrl Delay	10.5
HCM 6th LOS	B

Notes

User approved volume balancing among the lanes for turning movement.
Unsignalized Delay for [NBR] is excluded from calculations of the approach delay and intersection delay.

Intersection						
Int Delay, s/veh	0.1					
Movement	EBL	EBR	NBL	NBT	SBT	SBR
Lane Configurations	T			T		
Traffic Vol, veh/h	2	12	1	498	634	1
Future Vol, veh/h	2	12	1	498	634	1
Conflicting Peds, #/hr	0	0	2	0	0	2
Sign Control	Stop	Stop	Free	Free	Free	Free
RT Channelized	-	None	-	None	-	None
Storage Length	0	-	-	-	-	-
Veh in Median Storage, #	0	-	-	0	0	-
Grade, %	0	-	-	0	0	-
Peak Hour Factor	84	84	84	84	84	84
Heavy Vehicles, %	7	7	5	5	4	4
Mvmt Flow	2	14	1	593	755	1

Major/Minor	Minor2	Major1	Major2			
Conflicting Flow All	1057	380	758	0	-	0
Stage 1	758	-	-	-	-	-
Stage 2	299	-	-	-	-	-
Critical Hdwy	6.94	7.04	4.2	-	-	-
Critical Hdwy Stg 1	5.94	-	-	-	-	-
Critical Hdwy Stg 2	5.94	-	-	-	-	-
Follow-up Hdwy	3.57	3.37	2.25	-	-	-
Pot Cap-1 Maneuver	*320	604	830	-	-	-
Stage 1	*411	-	-	-	-	-
Stage 2	*836	-	-	-	-	-
Platoon blocked, %	1			-	-	-
Mov Cap-1 Maneuver	*318	603	828	-	-	-
Mov Cap-2 Maneuver	*361	-	-	-	-	-
Stage 1	*409	-	-	-	-	-
Stage 2	*835	-	-	-	-	-

Approach	EB	NB	SB
HCM Control Delay, s	11.8	0	0
HCM LOS	B		

Minor Lane/Major Mvmt	NBL	NBT	EBLn1	SBT	SBR
Capacity (veh/h)	828	-	550	-	-
HCM Lane V/C Ratio	0.001	-	0.03	-	-
HCM Control Delay (s)	9.4	0	11.8	-	-
HCM Lane LOS	A	A	B	-	-
HCM 95th %tile Q(veh)	0	-	0.1	-	-

Notes
 -: Volume exceeds capacity \$: Delay exceeds 300s +: Computation Not Defined *: All major volume in platoon

HCM 6th Signalized Intersection Summary
 36: Pine Street & Howard Road

Village D Specific Plan
 Existing NP - AM Peak Hour



Movement	EBL	EBT	EBR	WBL	WBT	WBR	NBL	NBT	NBR	SBL	SBT	SBR
Lane Configurations												
Traffic Volume (veh/h)	33	667	72	126	433	6	115	151	222	16	239	97
Future Volume (veh/h)	33	667	72	126	433	6	115	151	222	16	239	97
Initial Q (Qb), veh	0	0	0	0	0	0	0	0	0	0	0	0
Ped-Bike Adj(A_pbT)	1.00		0.97	1.00		0.98	1.00		1.00	1.00		0.98
Parking Bus, Adj	1.00	1.00	1.00	1.00	1.00	1.00	1.00	1.00	1.00	1.00	1.00	1.00
Work Zone On Approach		No			No			No			No	
Adj Sat Flow, veh/h/ln	1870	1870	1870	1856	1856	1856	1811	1811	1811	1841	1841	1841
Adj Flow Rate, veh/h	39	785	85	148	509	7	135	178	261	19	281	114
Peak Hour Factor	0.85	0.85	0.85	0.85	0.85	0.85	0.85	0.85	0.85	0.85	0.85	0.85
Percent Heavy Veh, %	2	2	2	3	3	3	6	6	6	4	4	4
Cap, veh/h	54	937	101	169	1268	17	489	514	434	21	309	274
Arrive On Green	0.03	0.29	0.29	0.10	0.36	0.36	0.28	0.28	0.28	0.18	0.18	0.18
Sat Flow, veh/h	1781	3224	349	1767	3559	49	1725	1811	1530	116	1719	1522
Grp Volume(v), veh/h	39	432	438	148	252	264	135	178	261	300	0	114
Grp Sat Flow(s),veh/h/ln	1781	1777	1797	1767	1763	1845	1725	1811	1530	1835	0	1522
Q Serve(g_s), s	2.6	27.4	27.4	9.9	12.9	12.9	7.3	9.4	17.7	19.2	0.0	8.0
Cycle Q Clear(g_c), s	2.6	27.4	27.4	9.9	12.9	12.9	7.3	9.4	17.7	19.2	0.0	8.0
Prop In Lane	1.00		0.19	1.00		0.03	1.00		1.00	0.06		1.00
Lane Grp Cap(c), veh/h	54	517	522	169	628	657	489	514	434	330	0	274
V/C Ratio(X)	0.72	0.84	0.84	0.87	0.40	0.40	0.28	0.35	0.60	0.91	0.00	0.42
Avail Cap(c_a), veh/h	102	709	717	169	771	807	489	514	434	347	0	288
HCM Platoon Ratio	1.00	1.00	1.00	1.00	1.00	1.00	1.00	1.00	1.00	1.00	1.00	1.00
Upstream Filter(I)	1.00	1.00	1.00	0.93	0.93	0.93	1.00	1.00	1.00	1.00	0.00	1.00
Uniform Delay (d), s/veh	57.7	39.9	39.9	53.5	29.0	29.0	33.4	34.1	37.1	48.3	0.0	43.6
Incr Delay (d2), s/veh	16.5	6.4	6.4	34.3	0.4	0.4	1.4	1.8	6.1	26.2	0.0	1.0
Initial Q Delay(d3),s/veh	0.0	0.0	0.0	0.0	0.0	0.0	0.0	0.0	0.0	0.0	0.0	0.0
%ile BackOfQ(50%),veh/ln	1.4	12.8	12.9	6.0	5.5	5.8	3.3	4.4	7.3	11.2	0.0	3.1
Unsig. Movement Delay, s/veh												
LnGrp Delay(d),s/veh	74.2	46.3	46.3	87.8	29.4	29.4	34.8	36.0	43.2	74.5	0.0	44.6
LnGrp LOS	E	D	D	F	C	C	C	D	D	E	A	D
Approach Vol, veh/h		909			664			574			414	
Approach Delay, s/veh		47.5			42.4			39.0			66.3	
Approach LOS		D			D			D			E	
Timer - Assigned Phs		2	3	4		6	7	8				
Phs Duration (G+Y+Rc), s		38.5	16.0	39.4		26.1	8.1	47.3				
Change Period (Y+Rc), s		4.5	4.5	4.5		4.5	4.5	4.5				
Max Green Setting (Gmax), s		19.9	11.5	47.9		22.7	6.9	52.5				
Max Q Clear Time (g_c+I1), s		19.7	11.9	29.4		21.2	4.6	14.9				
Green Ext Time (p_c), s		0.1	0.0	5.5		0.3	0.0	3.4				
Intersection Summary												
HCM 6th Ctrl Delay			47.3									
HCM 6th LOS			D									

HCM 6th Signalized Intersection Summary
 37: Olive Avenue/Q Street & Howard Road/Yosemite Avenue

Village D Specific Plan
 Existing NP - AM Peak Hour



Movement	EBL	EBT	EBR	WBL	WBT	WBR	NBL	NBT	NBR	SBL	SBT	SBR
Lane Configurations	↘	↑↑	↗	↘	↑↑		↘	↖	↗	↘	↑	↗
Traffic Volume (veh/h)	6	541	308	26	332	19	292	88	20	99	147	12
Future Volume (veh/h)	6	541	308	26	332	19	292	88	20	99	147	12
Initial Q (Qb), veh	0	0	0	0	0	0	0	0	0	0	0	0
Ped-Bike Adj(A_pbT)	1.00		1.00	1.00		0.98	1.00		0.99	1.00		0.97
Parking Bus, Adj	1.00	1.00	1.00	1.00	1.00	1.00	1.00	1.00	1.00	1.00	1.00	1.00
Work Zone On Approach		No			No			No			No	
Adj Sat Flow, veh/h/ln	1856	1856	1856	1870	1870	1870	1826	1826	1826	1870	1870	1870
Adj Flow Rate, veh/h	8	721	0	35	443	25	253	307	27	132	196	16
Peak Hour Factor	0.75	0.75	0.75	0.75	0.75	0.75	0.75	0.75	0.75	0.75	0.75	0.75
Percent Heavy Veh, %	3	3	3	2	2	2	5	5	5	2	2	2
Cap, veh/h	17	817		74	901	51	778	817	685	230	242	198
Arrive On Green	0.02	0.46	0.00	0.04	0.26	0.26	0.45	0.45	0.45	0.13	0.13	0.13
Sat Flow, veh/h	1767	3526	1572	1781	3416	192	1739	1826	1532	1781	1870	1530
Grp Volume(v), veh/h	8	721	0	35	230	238	253	307	27	132	196	16
Grp Sat Flow(s),veh/h/ln	1767	1763	1572	1781	1777	1831	1739	1826	1532	1781	1870	1530
Q Serve(g_s), s	0.5	22.3	0.0	2.3	13.1	13.2	11.3	13.4	1.2	8.4	12.2	1.1
Cycle Q Clear(g_c), s	0.5	22.3	0.0	2.3	13.1	13.2	11.3	13.4	1.2	8.4	12.2	1.1
Prop In Lane	1.00		1.00	1.00		0.10	1.00		1.00	1.00		1.00
Lane Grp Cap(c), veh/h	17	817		74	469	483	778	817	685	230	242	198
V/C Ratio(X)	0.46	0.88		0.47	0.49	0.49	0.33	0.38	0.04	0.57	0.81	0.08
Avail Cap(c_a), veh/h	74	1014		267	703	725	778	817	685	267	281	229
HCM Platoon Ratio	2.00	2.00	2.00	1.00	1.00	1.00	1.00	1.00	1.00	1.00	1.00	1.00
Upstream Filter(I)	0.63	0.63	0.00	1.00	1.00	1.00	1.00	1.00	1.00	1.00	1.00	1.00
Uniform Delay (d), s/veh	58.5	30.7	0.0	56.2	37.4	37.4	21.5	22.0	18.7	49.1	50.8	46.0
Incr Delay (d2), s/veh	11.7	5.2	0.0	4.6	0.8	0.8	1.1	1.3	0.1	2.2	14.4	0.2
Initial Q Delay(d3),s/veh	0.0	0.0	0.0	0.0	0.0	0.0	0.0	0.0	0.0	0.0	0.0	0.0
%ile BackOfQ(50%),veh/ln	0.3	8.0	0.0	1.1	5.8	6.0	4.8	6.0	0.4	3.9	6.7	0.4
Unsig. Movement Delay, s/veh												
LnGrp Delay(d),s/veh	70.3	35.9	0.0	60.8	38.1	38.2	22.6	23.4	18.8	51.4	65.2	46.1
LnGrp LOS	E	D		E	D	D	C	C	B	D	E	D
Approach Vol, veh/h		729	A		503			587			344	
Approach Delay, s/veh		36.2			39.7			22.8			59.0	
Approach LOS		D			D			C			E	
Timer - Assigned Phs		2	3	4		6	7	8				
Phs Duration (G+Y+Rc), s		58.2	9.5	32.3		20.0	5.7	36.2				
Change Period (Y+Rc), s		4.5	4.5	4.5		4.5	4.5	4.5				
Max Green Setting (Gmax), s		31.5	18.0	34.5		18.0	5.0	47.5				
Max Q Clear Time (g_c+1), s		15.4	4.3	24.3		14.2	2.5	15.2				
Green Ext Time (p_c), s		2.5	0.0	3.6		0.5	0.0	3.0				

Intersection Summary

HCM 6th Ctrl Delay	37.0
HCM 6th LOS	D

Notes

User approved volume balancing among the lanes for turning movement.
 Unsignalized Delay for [EBR] is excluded from calculations of the approach delay and intersection delay.

HCM 6th TWSC
 38: I Street & 2nd Street/SR-99 Southbound Off-Ramp

Village D Specific Plan
 Existing NP - AM Peak Hour

Intersection												
Int Delay, s/veh	13.9											
Movement	EBL	EBT	EBR	WBL	WBT	WBR	NBL	NBT	NBR	SBL	SBT	SBR
Lane Configurations		↔			↔	↔	↔	↔			↔	
Traffic Vol, veh/h	2	0	53	363	17	11	15	82	0	0	132	2
Future Vol, veh/h	2	0	53	363	17	11	15	82	0	0	132	2
Conflicting Peds, #/hr	0	0	1	1	0	0	0	0	0	0	0	0
Sign Control	Stop	Stop	Stop	Stop	Stop	Stop	Free	Free	Free	Free	Free	Free
RT Channelized	-	-	None	-	-	Stop	-	-	None	-	-	None
Storage Length	-	-	-	-	-	50	75	-	-	-	-	-
Veh in Median Storage, #	-	0	-	-	0	-	-	0	-	-	0	-
Grade, %	-	0	-	-	0	-	-	0	-	-	0	-
Peak Hour Factor	89	89	89	89	89	89	89	89	89	89	89	89
Heavy Vehicles, %	0	0	0	3	3	3	4	4	4	1	1	1
Mvmt Flow	2	0	60	408	19	12	17	92	0	0	148	2

Major/Minor	Minor2		Minor1		Major1		Major2					
Conflicting Flow All	285	275	150	306	276	92	150	0	-	-	-	0
Stage 1	149	149	-	126	126	-	-	-	-	-	-	-
Stage 2	136	126	-	180	150	-	-	-	-	-	-	-
Critical Hdwy	7.1	6.5	6.2	7.13	6.53	6.23	4.14	-	-	-	-	-
Critical Hdwy Stg 1	6.1	5.5	-	6.13	5.53	-	-	-	-	-	-	-
Critical Hdwy Stg 2	6.1	5.5	-	6.13	5.53	-	-	-	-	-	-	-
Follow-up Hdwy	3.5	4	3.3	3.527	4.027	3.327	2.236	-	-	-	-	-
Pot Cap-1 Maneuver	696	652	902	668	646	997	1419	-	0	0	-	-
Stage 1	858	778	-	902	802	-	-	-	0	0	-	-
Stage 2	898	808	-	819	771	-	-	-	0	0	-	-
Platoon blocked, %	1	1		1	1	1		-			-	-
Mov Cap-1 Maneuver	665	644	901	617	638	997	1419	-	-	-	-	-
Mov Cap-2 Maneuver	665	644	-	617	638	-	-	-	-	-	-	-
Stage 1	848	778	-	891	793	-	-	-	-	-	-	-
Stage 2	855	798	-	764	771	-	-	-	-	-	-	-

Approach	EB		WB		NB		SB			
HCM Control Delay, s	9.3		22.4		1.2		0			
HCM LOS	A		C							

Minor Lane/Major Mvmt	NBL	NBT	EBLn1	WBLn1	WBLn2	SBT	SBR
Capacity (veh/h)	1419	-	890	618	997	-	-
HCM Lane V/C Ratio	0.012	-	0.069	0.691	0.012	-	-
HCM Control Delay (s)	7.6	-	9.3	22.8	8.7	-	-
HCM Lane LOS	A	-	A	C	A	-	-
HCM 95th %tile Q(veh)	0	-	0.2	5.5	0	-	-

HCM 6th Signalized Intersection Summary
39: 4th Street & Sunset Avenue

Village D Specific Plan
Existing NP - AM Peak Hour



Movement	EBL	EBR	NBL	NBT	SBT	SBR
Lane Configurations						
Traffic Volume (veh/h)	381	22	31	291	400	267
Future Volume (veh/h)	381	22	31	291	400	267
Initial Q (Qb), veh	0	0	0	0	0	0
Ped-Bike Adj(A_pbT)	1.00	1.00	1.00			1.00
Parking Bus, Adj	1.00	1.00	1.00	1.00	1.00	1.00
Work Zone On Approach	No			No	No	
Adj Sat Flow, veh/h/ln	1900	1900	1870	1870	1870	1870
Adj Flow Rate, veh/h	436	0	34	316	435	290
Peak Hour Factor	0.92	0.92	0.92	0.92	0.92	0.92
Percent Heavy Veh, %	0	0	2	2	2	2
Cap, veh/h	548	244	57	2660	1247	1295
Arrive On Green	0.15	0.00	0.03	0.75	1.00	1.00
Sat Flow, veh/h	3619	1610	1781	3647	1870	1583
Grp Volume(v), veh/h	436	0	34	316	435	290
Grp Sat Flow(s),veh/h/ln	1810	1610	1781	1777	1870	1583
Q Serve(g_s), s	10.5	0.0	1.7	2.2	0.0	0.0
Cycle Q Clear(g_c), s	10.5	0.0	1.7	2.2	0.0	0.0
Prop In Lane	1.00	1.00	1.00			1.00
Lane Grp Cap(c), veh/h	548	244	57	2660	1247	1295
V/C Ratio(X)	0.80	0.00	0.60	0.12	0.35	0.22
Avail Cap(c_a), veh/h	905	403	148	2660	1247	1295
HCM Platoon Ratio	1.00	1.00	1.00	1.00	2.00	2.00
Upstream Filter(I)	1.00	0.00	1.00	1.00	0.88	0.88
Uniform Delay (d), s/veh	36.8	0.0	43.0	3.1	0.0	0.0
Incr Delay (d2), s/veh	2.7	0.0	9.8	0.1	0.7	0.4
Initial Q Delay(d3),s/veh	0.0	0.0	0.0	0.0	0.0	0.0
%ile BackOfQ(50%),veh/ln	4.7	0.0	0.9	0.6	0.2	0.1
Unsig. Movement Delay, s/veh						
LnGrp Delay(d),s/veh	39.5	0.0	52.8	3.2	0.7	0.4
LnGrp LOS	D	A	D	A	A	A
Approach Vol, veh/h	436			350	725	
Approach Delay, s/veh	39.5			8.0	0.5	
Approach LOS	D			A	A	
Timer - Assigned Phs		2		4	5	6
Phs Duration (G+Y+Rc), s		71.9		18.1	7.4	64.5
Change Period (Y+Rc), s		4.5		4.5	4.5	4.5
Max Green Setting (Gmax), s		58.5		22.5	7.5	46.5
Max Q Clear Time (g_c+I1), s		4.2		12.5	3.7	2.0
Green Ext Time (p_c), s		2.3		1.2	0.0	4.2

Intersection Summary

HCM 6th Ctrl Delay	13.5
HCM 6th LOS	B

Notes

User approved volume balancing among the lanes for turning movement.

40: H Street & SR-99 Southbound On-Ramp/2nd Street Performance by movement

Movement	WBL	WBT	WBR	NBL	NBT	NBR	SBT	All
Denied Delay (hr)	0.0	0.0	0.0	0.0	0.0	0.0	0.0	0.0
Denied Del/Veh (s)	0.1	0.1	0.1	0.0	0.0	0.0	0.1	0.0
Total Delay (hr)	0.0	0.1	0.0	0.1	0.0	0.0	0.1	0.3
Total Del/Veh (s)	8.6	12.5	3.8	2.4	4.6	2.2	9.5	4.3
Stop Delay (hr)	0.0	0.0	0.0	0.0	0.0	0.0	0.0	0.1
Stop Del/Veh (s)	6.9	9.7	2.4	0.2	0.1	0.1	6.6	1.8

HCM 6th Signalized Intersection Summary
41: I Street & 4th Street

Village D Specific Plan
Existing NP - AM Peak Hour



Movement	EBL	EBT	EBR	WBL	WBT	WBR	NBL	NBT	NBR	SBL	SBT	SBR
Lane Configurations												
Traffic Volume (veh/h)	25	621	67	85	459	61	51	55	160	209	277	121
Future Volume (veh/h)	25	621	67	85	459	61	51	55	160	209	277	121
Initial Q (Qb), veh	0	0	0	0	0	0	0	0	0	0	0	0
Ped-Bike Adj(A_pbT)	1.00		0.96	1.00		0.96	1.00		0.97	1.00		0.98
Parking Bus, Adj	1.00	1.00	1.00	1.00	1.00	1.00	1.00	1.00	1.00	1.00	1.00	1.00
Work Zone On Approach		No		No		No		No		No		No
Adj Sat Flow, veh/h/ln	1870	1870	1870	1856	1856	1856	1856	1856	1856	1856	1856	1856
Adj Flow Rate, veh/h	29	722	78	99	534	71	59	64	186	243	322	141
Peak Hour Factor	0.86	0.86	0.86	0.86	0.86	0.86	0.86	0.86	0.86	0.86	0.86	0.86
Percent Heavy Veh, %	2	2	2	3	3	3	3	3	3	3	3	3
Cap, veh/h	51	824	89	126	929	123	210	379	310	475	658	544
Arrive On Green	0.03	0.26	0.26	0.07	0.30	0.30	0.12	0.20	0.20	0.27	0.35	0.35
Sat Flow, veh/h	1781	3220	348	1767	3114	412	1767	1856	1519	1767	1856	1533
Grp Volume(v), veh/h	29	398	402	99	301	304	59	64	186	243	322	141
Grp Sat Flow(s),veh/h/ln	1781	1777	1790	1767	1763	1764	1767	1856	1519	1767	1856	1533
Q Serve(g_s), s	1.4	19.3	19.4	5.0	13.0	13.1	2.7	2.6	10.0	10.5	12.2	4.7
Cycle Q Clear(g_c), s	1.4	19.3	19.4	5.0	13.0	13.1	2.7	2.6	10.0	10.5	12.2	4.7
Prop In Lane	1.00		0.19	1.00		0.23	1.00		1.00	1.00		1.00
Lane Grp Cap(c), veh/h	51	455	458	126	526	526	210	379	310	475	658	544
V/C Ratio(X)	0.57	0.88	0.88	0.79	0.57	0.58	0.28	0.17	0.60	0.51	0.49	0.26
Avail Cap(c_a), veh/h	113	492	495	155	531	531	210	379	310	475	658	544
HCM Platoon Ratio	1.00	1.00	1.00	1.00	1.00	1.00	1.00	1.00	1.00	1.00	1.00	1.00
Upstream Filter(I)	0.90	0.90	0.90	1.00	1.00	1.00	1.00	1.00	1.00	1.00	1.00	1.00
Uniform Delay (d), s/veh	43.2	32.1	32.1	41.1	26.7	26.8	36.2	29.5	32.5	27.9	22.7	13.2
Incr Delay (d2), s/veh	8.6	14.1	14.1	19.3	1.5	1.5	0.7	1.0	8.3	0.9	2.6	1.2
Initial Q Delay(d3),s/veh	0.0	0.0	0.0	0.0	0.0	0.0	0.0	0.0	0.0	0.0	0.0	0.0
%ile BackOfQ(50%),veh/ln	0.8	9.8	9.9	2.8	5.5	5.6	1.2	1.2	4.3	4.5	5.6	2.2
Unsig. Movement Delay, s/veh												
LnGrp Delay(d),s/veh	51.8	46.2	46.3	60.4	28.2	28.3	36.9	30.5	40.7	28.8	25.3	14.4
LnGrp LOS	D	D	D	E	C	C	D	C	D	C	C	B
Approach Vol, veh/h		829		704		309		706				
Approach Delay, s/veh		46.4		32.8		37.9		24.3				
Approach LOS		D		C		D		C				
Timer - Assigned Phs	1	2	3	4	5	6	7	8				
Phs Duration (G+Y+Rc), s	28.7	22.9	10.9	27.5	15.2	36.4	7.1	31.3				
Change Period (Y+Rc), s	4.5	4.5	4.5	4.5	4.5	4.5	4.5	4.5				
Max Green Setting (Gmax), s	20.8	18.4	7.9	24.9	7.3	31.9	5.7	27.1				
Max Q Clear Time (g_c+1/2), s	12.5	12.0	7.0	21.4	4.7	14.2	3.4	15.1				
Green Ext Time (p_c), s	0.4	0.5	0.0	1.7	0.0	2.3	0.0	3.0				
Intersection Summary												
HCM 6th Ctrl Delay			35.5									
HCM 6th LOS			D									

HCM 6th Signalized Intersection Summary
 43: SR-99 Northbound Off-Ramp/H Street & 4th Street

Village D Specific Plan
 Existing NP - AM Peak Hour



Movement	EBL	EBT	EBR	WBL	WBT	WBR	NBL	NBT	NBR	SBL	SBT	SBR
Lane Configurations	↖	↗			↖	↗	↖	↗			↕	
Traffic Volume (veh/h)	213	454	0	0	461	52	239	24	195	5	0	57
Future Volume (veh/h)	213	454	0	0	461	52	239	24	195	5	0	57
Initial Q (Qb), veh	0	0	0	0	0	0	0	0	0	0	0	0
Ped-Bike Adj(A_pbT)	1.00		1.00	1.00		0.94	1.00		1.00	1.00		0.99
Parking Bus, Adj	1.00	1.00	1.00	1.00	1.00	1.00	1.00	1.00	1.00	1.00	1.00	1.00
Work Zone On Approach		No			No			No			No	
Adj Sat Flow, veh/h/ln	1870	1870	0	0	1841	1841	1870	1870	1870	1900	1900	1900
Adj Flow Rate, veh/h	248	528	0	0	536	60	278	28	227	6	0	66
Peak Hour Factor	0.86	0.86	0.86	0.86	0.86	0.86	0.86	0.86	0.86	0.86	0.86	0.86
Percent Heavy Veh, %	2	2	0	0	4	4	2	2	2	0	0	0
Cap, veh/h	284	1445	0	0	620	69	434	43	349	27	0	294
Arrive On Green	0.16	0.41	0.00	0.00	0.20	0.20	0.24	0.24	0.24	0.20	0.00	0.20
Sat Flow, veh/h	1781	3647	0	0	3241	351	1781	177	1435	134	0	1472
Grp Volume(v), veh/h	248	528	0	0	297	299	278	0	255	72	0	0
Grp Sat Flow(s),veh/h/ln	1781	1777	0	0	1749	1752	1781	0	1612	1605	0	0
Q Serve(g_s), s	12.2	9.3	0.0	0.0	14.8	14.9	12.6	0.0	12.8	3.4	0.0	0.0
Cycle Q Clear(g_c), s	12.2	9.3	0.0	0.0	14.8	14.9	12.6	0.0	12.8	3.4	0.0	0.0
Prop In Lane	1.00		0.00	0.00		0.20	1.00		0.89	0.08		0.92
Lane Grp Cap(c), veh/h	284	1445	0	0	344	345	434	0	392	321	0	0
V/C Ratio(X)	0.87	0.37	0.00	0.00	0.86	0.87	0.64	0.00	0.65	0.22	0.00	0.00
Avail Cap(c_a), veh/h	327	1560	0	0	359	360	434	0	392	321	0	0
HCM Platoon Ratio	1.00	1.00	1.00	1.00	1.00	1.00	1.00	1.00	1.00	1.00	1.00	1.00
Upstream Filter(I)	1.00	1.00	0.00	0.00	1.00	1.00	1.00	0.00	1.00	1.00	0.00	0.00
Uniform Delay (d), s/veh	36.9	18.6	0.0	0.0	34.9	35.0	30.5	0.0	30.6	30.2	0.0	0.0
Incr Delay (d2), s/veh	19.9	0.2	0.0	0.0	18.2	19.1	7.1	0.0	8.1	1.6	0.0	0.0
Initial Q Delay(d3),s/veh	0.0	0.0	0.0	0.0	0.0	0.0	0.0	0.0	0.0	0.0	0.0	0.0
%ile BackOfQ(50%),veh/ln	6.8	3.7	0.0	0.0	7.9	8.0	6.1	0.0	5.7	1.4	0.0	0.0
Unsig. Movement Delay, s/veh												
LnGrp Delay(d),s/veh	56.9	18.8	0.0	0.0	53.2	54.1	37.6	0.0	38.7	31.8	0.0	0.0
LnGrp LOS	E	B	A	A	D	D	D	A	D	C	A	A
Approach Vol, veh/h		776			596			533				72
Approach Delay, s/veh		30.9			53.6			38.1				31.8
Approach LOS		C			D			D				C
Timer - Assigned Phs		2		4		6	7	8				
Phs Duration (G+Y+Rc), s		26.4		41.1		22.5	18.9	22.2				
Change Period (Y+Rc), s		4.5		4.5		4.5	4.5	4.5				
Max Green Setting (Gmax), s		19.0		39.5		18.0	16.5	18.5				
Max Q Clear Time (g_c+I1), s		14.8		11.3		5.4	14.2	16.9				
Green Ext Time (p_c), s		1.0		3.8		0.2	0.2	0.6				
Intersection Summary												
HCM 6th Ctrl Delay												39.8
HCM 6th LOS												D

Intersection						
Int Delay, s/veh	2.5					
Movement	EBL	EBT	WBT	WBR	SBL	SBR
Lane Configurations	↘	↑↑	↑↑		↘	↗
Traffic Vol, veh/h	128	445	410	76	59	99
Future Vol, veh/h	128	445	410	76	59	99
Conflicting Peds, #/hr	16	0	0	16	0	0
Sign Control	Free	Free	Free	Free	Stop	Stop
RT Channelized	-	None	-	None	-	None
Storage Length	145	-	-	-	65	0
Veh in Median Storage, #	-	0	0	-	0	-
Grade, %	-	0	0	-	0	-
Peak Hour Factor	98	98	98	98	98	98
Heavy Vehicles, %	5	5	4	4	5	5
Mvmt Flow	131	454	418	78	60	101

Major/Minor	Major1	Major2	Minor2		
Conflicting Flow All	512	0	-	0	962
Stage 1	-	-	-	-	473
Stage 2	-	-	-	-	489
Critical Hdwy	4.2	-	-	-	6.9
Critical Hdwy Stg 1	-	-	-	-	5.9
Critical Hdwy Stg 2	-	-	-	-	5.9
Follow-up Hdwy	2.25	-	-	-	3.55
Pot Cap-1 Maneuver	1289	-	-	-	365
Stage 1	-	-	-	-	847
Stage 2	-	-	-	-	574
Platoon blocked, %	1	-	-	-	1
Mov Cap-1 Maneuver	1269	-	-	-	318
Mov Cap-2 Maneuver	-	-	-	-	318
Stage 1	-	-	-	-	749
Stage 2	-	-	-	-	565

Approach	EB	WB	SB
HCM Control Delay, s	1.8	0	13
HCM LOS			B

Minor Lane/Major Mvmt	EBL	EBT	WBT	WBR	SBLn1	SBLn2
Capacity (veh/h)	1269	-	-	-	318	893
HCM Lane V/C Ratio	0.103	-	-	-	0.189	0.113
HCM Control Delay (s)	8.2	-	-	-	18.9	9.5
HCM Lane LOS	A	-	-	-	C	A
HCM 95th %tile Q(veh)	0.3	-	-	-	0.7	0.4

Notes			
-:	Volume exceeds capacity	Ⓢ:	Delay exceeds 300s
+	Computation Not Defined	*	All major volume in platoon

HCM 6th Signalized Intersection Summary
 45: Olive Avenue & SR-99 Southbound Off-Ramp

Village D Specific Plan
 Existing NP - AM Peak Hour



Movement	EBL	EBT	WBT	WBR	SBL	SBR
Lane Configurations		↑↑↑	↑↑		↵	↵
Traffic Volume (veh/h)	0	504	389	0	303	99
Future Volume (veh/h)	0	504	389	0	303	99
Initial Q (Qb), veh	0	0	0	0	0	0
Ped-Bike Adj(A_pbT)	1.00			1.00	1.00	1.00
Parking Bus, Adj	1.00	1.00	1.00	1.00	1.00	1.00
Work Zone On Approach		No	No		No	
Adj Sat Flow, veh/h/ln	0	1826	1826	0	1752	1752
Adj Flow Rate, veh/h	0	536	414	0	322	105
Peak Hour Factor	0.94	0.94	0.94	0.94	0.94	0.94
Percent Heavy Veh, %	0	5	5	0	10	10
Cap, veh/h	0	817	569	0	1207	1074
Arrive On Green	0.00	0.16	0.16	0.00	0.72	0.72
Sat Flow, veh/h	0	5313	3652	0	1668	1485
Grp Volume(v), veh/h	0	536	414	0	322	105
Grp Sat Flow(s),veh/h/ln	0	1662	1735	0	1668	1485
Q Serve(g_s), s	0.0	8.1	9.1	0.0	5.3	1.7
Cycle Q Clear(g_c), s	0.0	8.1	9.1	0.0	5.3	1.7
Prop In Lane	0.00			0.00	1.00	1.00
Lane Grp Cap(c), veh/h	0	817	569	0	1207	1074
V/C Ratio(X)	0.00	0.66	0.73	0.00	0.27	0.10
Avail Cap(c_a), veh/h	0	1402	976	0	1207	1074
HCM Platoon Ratio	1.00	1.00	1.00	1.00	1.00	1.00
Upstream Filter(I)	0.00	1.00	0.95	0.00	1.00	1.00
Uniform Delay (d), s/veh	0.0	31.3	31.7	0.0	3.8	3.3
Incr Delay (d2), s/veh	0.0	0.9	1.7	0.0	0.5	0.2
Initial Q Delay(d3),s/veh	0.0	0.0	0.0	0.0	0.0	0.0
%ile BackOfQ(50%),veh/ln	0.0	3.2	3.8	0.0	1.5	0.4
Unsig. Movement Delay, s/veh						
LnGrp Delay(d),s/veh	0.0	32.2	33.5	0.0	4.3	3.5
LnGrp LOS	A	C	C	A	A	A
Approach Vol, veh/h		536	414		427	
Approach Delay, s/veh		32.2	33.5		4.1	
Approach LOS		C	C		A	
Timer - Assigned Phs				4	6	8
Phs Duration (G+Y+Rc), s				17.6	62.4	17.6
Change Period (Y+Rc), s				4.5	4.5	4.5
Max Green Setting (Gmax), s				22.5	48.5	22.5
Max Q Clear Time (g_c+I1), s				10.1	7.3	11.1
Green Ext Time (p_c), s				2.9	1.4	2.1
Intersection Summary						
HCM 6th Ctrl Delay			23.9			
HCM 6th LOS			C			

HCM 6th Signalized Intersection Summary

46: Madera Avenue & SR-99 Northbound Ramps

Village D Specific Plan
Existing NP - AM Peak Hour



Movement	EBL	EBT	EBR	WBL	WBT	WBR	NBL	NBT	NBR	SBL	SBT	SBR
Lane Configurations				↶	↷	↶	↶↷	↶↷			↶↷	
Traffic Volume (veh/h)	0	0	0	139	1	75	355	397	0	0	553	148
Future Volume (veh/h)	0	0	0	139	1	75	355	397	0	0	553	148
Initial Q (Qb), veh				0	0	0	0	0	0	0	0	0
Ped-Bike Adj(A_pbT)				1.00		0.98	1.00		1.00	1.00		0.97
Parking Bus, Adj				1.00	1.00	1.00	1.00	1.00	1.00	1.00	1.00	1.00
Work Zone On Approach				No			No			No		
Adj Sat Flow, veh/h/ln				1826	1826	1826	1796	1796	0	0	1841	1841
Adj Flow Rate, veh/h				152	0	82	386	432	0	0	601	161
Peak Hour Factor				0.92	0.92	0.92	0.92	0.92	0.92	0.92	0.92	0.92
Percent Heavy Veh, %				5	5	5	7	7	0	0	4	4
Cap, veh/h				293	0	128	1213	2741	0	0	1032	276
Arrive On Green				0.08	0.00	0.08	0.73	1.00	0.00	0.00	0.38	0.38
Sat Flow, veh/h				3478	0	1517	3319	3503	0	0	2799	723
Grp Volume(v), veh/h				152	0	82	386	432	0	0	388	374
Grp Sat Flow(s),veh/h/ln				1739	0	1517	1659	1706	0	0	1749	1681
Q Serve(g_s), s				3.3	0.0	4.2	3.3	0.0	0.0	0.0	14.1	14.2
Cycle Q Clear(g_c), s				3.3	0.0	4.2	3.3	0.0	0.0	0.0	14.1	14.2
Prop In Lane				1.00		1.00	1.00		0.00	0.00		0.43
Lane Grp Cap(c), veh/h				293	0	128	1213	2741	0	0	667	641
V/C Ratio(X)				0.52	0.00	0.64	0.32	0.16	0.00	0.00	0.58	0.58
Avail Cap(c_a), veh/h				804	0	351	1213	2741	0	0	667	641
HCM Platoon Ratio				1.00	1.00	1.00	2.00	2.00	1.00	1.00	1.00	1.00
Upstream Filter(I)				1.00	0.00	1.00	0.91	0.91	0.00	0.00	1.00	1.00
Uniform Delay (d), s/veh				35.1	0.0	35.5	7.3	0.0	0.0	0.0	19.7	19.7
Incr Delay (d2), s/veh				1.4	0.0	5.3	0.1	0.1	0.0	0.0	3.7	3.9
Initial Q Delay(d3),s/veh				0.0	0.0	0.0	0.0	0.0	0.0	0.0	0.0	0.0
%ile BackOfQ(50%),veh/ln				1.4	0.0	1.7	1.0	0.0	0.0	0.0	6.1	5.9
Unsig. Movement Delay, s/veh												
LnGrp Delay(d),s/veh				36.5	0.0	40.7	7.4	0.1	0.0	0.0	23.4	23.6
LnGrp LOS				D	A	D	A	A	A	A	C	C
Approach Vol, veh/h					234			818			762	
Approach Delay, s/veh					38.0			3.5			23.5	
Approach LOS					D			A			C	
Timer - Assigned Phs		2			5	6		8				
Phs Duration (G+Y+Rc), s		68.7			33.7	35.0		11.3				
Change Period (Y+Rc), s		4.5			4.5	4.5		4.5				
Max Green Setting (Gmax), s		52.5			17.5	30.5		18.5				
Max Q Clear Time (g_c+I1), s		2.0			5.3	16.2		6.2				
Green Ext Time (p_c), s		3.3			1.1	4.3		0.6				

Intersection Summary

HCM 6th Ctrl Delay	16.4
HCM 6th LOS	B

Notes

User approved volume balancing among the lanes for turning movement.

HCM 6th Signalized Intersection Summary
 47: Madera Avenue & Olive Avenue/SR-99 Southbound On-Ramp

Village D Specific Plan
 Existing NP - AM Peak Hour



Movement	EBL	EBT	EBR	WBL	WBT	WBR	NBL	NBT	NBR	SBL	SBT	SBR
Lane Configurations												
Traffic Volume (veh/h)	300	192	315	0	0	0	107	452	38	84	326	282
Future Volume (veh/h)	300	192	315	0	0	0	107	452	38	84	326	282
Initial Q (Qb), veh	0	0	0				0	0	0	0	0	0
Ped-Bike Adj(A_pbT)	1.00		1.00				1.00		0.99	1.00		0.99
Parking Bus, Adj	1.00	1.00	1.00				1.00	1.00	1.00	1.00	1.00	1.00
Work Zone On Approach		No					No			No		
Adj Sat Flow, veh/h/ln	1811	1811	1811				1781	1781	1781	1841	1841	1841
Adj Flow Rate, veh/h	259	282	332				113	476	40	88	343	297
Peak Hour Factor	0.95	0.95	0.95				0.95	0.95	0.95	0.95	0.95	0.95
Percent Heavy Veh, %	6	6	6				8	8	8	4	4	4
Cap, veh/h	442	465	482				189	1610	135	114	922	784
Arrive On Green	0.08	0.08	0.08				0.06	0.51	0.51	0.02	0.17	0.17
Sat Flow, veh/h	1725	1811	1535				3291	3159	265	1753	1783	1516
Grp Volume(v), veh/h	259	282	332				113	254	262	88	336	304
Grp Sat Flow(s),veh/h/ln	1725	1811	1535				1646	1692	1731	1753	1749	1550
Q Serve(g_s), s	11.6	12.0	15.7				2.7	6.9	7.0	4.0	13.6	13.9
Cycle Q Clear(g_c), s	11.6	12.0	15.7				2.7	6.9	7.0	4.0	13.6	13.9
Prop In Lane	1.00		1.00				1.00		0.15	1.00		0.98
Lane Grp Cap(c), veh/h	442	465	482				189	863	882	114	905	802
V/C Ratio(X)	0.59	0.61	0.69				0.60	0.29	0.30	0.77	0.37	0.38
Avail Cap(c_a), veh/h	593	623	616				638	863	882	217	905	802
HCM Platoon Ratio	0.33	0.33	0.33				1.00	1.00	1.00	0.33	0.33	0.33
Upstream Filter(I)	0.88	0.88	0.88				1.00	1.00	1.00	0.90	0.90	0.90
Uniform Delay (d), s/veh	32.5	32.7	29.8				36.8	11.3	11.3	38.6	21.7	21.8
Incr Delay (d2), s/veh	1.1	1.1	2.0				3.0	0.9	0.9	9.6	1.1	1.2
Initial Q Delay(d3),s/veh	0.0	0.0	0.0				0.0	0.0	0.0	0.0	0.0	0.0
%ile BackOfQ(50%),veh/ln	5.4	5.9	13.9				1.1	2.6	2.7	2.0	6.6	6.0
Unsig. Movement Delay, s/veh												
LnGrp Delay(d),s/veh	33.6	33.9	31.8				39.8	12.2	12.2	48.1	22.7	23.0
LnGrp LOS	C	C	C				D	B	B	D	C	C
Approach Vol, veh/h		873						629			728	
Approach Delay, s/veh		33.0						17.1			25.9	
Approach LOS		C						B			C	
Timer - Assigned Phs	1	2		4	5	6						
Phs Duration (G+Y+Rc), s	9.7	45.3		25.0	9.1	45.9						
Change Period (Y+Rc), s	4.5	4.5		4.5	4.5	4.5						
Max Green Setting (Gmax), s	29.1			27.5	15.5	23.5						
Max Q Clear Time (g_c+1), s	9.0			17.7	4.7	15.9						
Green Ext Time (p_c), s	0.1	3.1		2.8	0.2	2.5						

Intersection Summary

HCM 6th Ctrl Delay	26.2
HCM 6th LOS	C

Notes

User approved volume balancing among the lanes for turning movement.

Intersection						
Int Delay, s/veh	0.4					
Movement	WBL	WBR	NBT	NBR	SBL	SBT
Lane Configurations	↔		↕		↔	↕
Traffic Vol, veh/h	9	8	619	8	31	764
Future Vol, veh/h	9	8	619	8	31	764
Conflicting Peds, #/hr	0	0	0	8	8	0
Sign Control	Stop	Stop	Free	Free	Free	Free
RT Channelized	-	None	-	None	-	None
Storage Length	0	-	-	-	100	-
Veh in Median Storage, #	0	-	0	-	-	0
Grade, %	0	-	0	-	-	0
Peak Hour Factor	97	97	97	97	97	97
Heavy Vehicles, %	12	12	6	6	6	6
Mvmt Flow	9	8	638	8	32	788

Major/Minor	Minor1	Major1	Major2		
Conflicting Flow All	1108	331	0	0	654
Stage 1	650	-	-	-	-
Stage 2	458	-	-	-	-
Critical Hdwy	7.04	7.14	-	-	4.22
Critical Hdwy Stg 1	6.04	-	-	-	-
Critical Hdwy Stg 2	6.04	-	-	-	-
Follow-up Hdwy	3.62	3.42	-	-	2.26
Pot Cap-1 Maneuver	*388	636	-	-	902
Stage 1	*455	-	-	-	-
Stage 2	*732	-	-	-	-
Platoon blocked, %	1	-	-	-	-
Mov Cap-1 Maneuver	*371	631	-	-	895
Mov Cap-2 Maneuver	*398	-	-	-	-
Stage 1	*451	-	-	-	-
Stage 2	*705	-	-	-	-

Approach	WB	NB	SB
HCM Control Delay, s	12.8	0	0.4
HCM LOS	B		

Minor Lane/Major Mvmt	NBT	NBRWBLn1	SBL	SBT
Capacity (veh/h)	-	-	482	895
HCM Lane V/C Ratio	-	-	0.036	0.036
HCM Control Delay (s)	-	-	12.8	9.2
HCM Lane LOS	-	-	B	A
HCM 95th %tile Q(veh)	-	-	0.1	0.1

Notes
 -: Volume exceeds capacity \$: Delay exceeds 300s +: Computation Not Defined *: All major volume in platoon

HCM 6th Signalized Intersection Summary
 49: Yosemite Avenue & Cleveland Avenue/Tozer Street

Village D Specific Plan
 Existing NP - AM Peak Hour



Movement	EBL	EBT	EBR	WBL	WBT	WBR	NBL	NBT	NBR	SBL	SBT	SBR
Lane Configurations												
Traffic Volume (veh/h)	164	514	248	110	289	41	131	105	74	60	229	168
Future Volume (veh/h)	164	514	248	110	289	41	131	105	74	60	229	168
Initial Q (Qb), veh	0	0	0	0	0	0	0	0	0	0	0	0
Ped-Bike Adj(A_pbT)	1.00		0.92	1.00		0.93	1.00		1.00	1.00		1.00
Parking Bus, Adj	1.00	1.00	1.00	1.00	1.00	1.00	1.00	1.00	1.00	1.00	1.00	1.00
Work Zone On Approach		No			No			No			No	
Adj Sat Flow, veh/h/ln	1856	1856	1856	1841	1841	1841	1856	1856	1856	1870	1870	1870
Adj Flow Rate, veh/h	195	612	295	131	344	49	156	125	88	71	273	200
Peak Hour Factor	0.84	0.84	0.84	0.84	0.84	0.84	0.84	0.84	0.84	0.84	0.84	0.84
Percent Heavy Veh, %	3	3	3	4	4	4	3	3	3	2	2	2
Cap, veh/h	233	738	355	158	1007	418	171	610	515	92	284	208
Arrive On Green	0.13	0.33	0.33	0.09	0.29	0.29	0.10	0.33	0.33	0.05	0.28	0.28
Sat Flow, veh/h	1767	2236	1077	1753	3497	1452	1767	1856	1568	1781	1002	734
Grp Volume(v), veh/h	195	482	425	131	344	49	156	125	88	71	0	473
Grp Sat Flow(s),veh/h/ln	1767	1763	1550	1753	1749	1452	1767	1856	1568	1781	0	1736
Q Serve(g_s), s	9.7	22.7	22.7	6.6	7.0	2.2	7.9	4.4	3.6	3.5	0.0	24.2
Cycle Q Clear(g_c), s	9.7	22.7	22.7	6.6	7.0	2.2	7.9	4.4	3.6	3.5	0.0	24.2
Prop In Lane	1.00		0.69	1.00		1.00	1.00		1.00	1.00		0.42
Lane Grp Cap(c), veh/h	233	582	512	158	1007	418	171	610	515	92	0	492
V/C Ratio(X)	0.84	0.83	0.83	0.83	0.34	0.12	0.91	0.21	0.17	0.77	0.00	0.96
Avail Cap(c_a), veh/h	355	582	512	158	1007	418	171	610	515	184	0	492
HCM Platoon Ratio	1.00	1.00	1.00	1.00	1.00	1.00	1.00	1.00	1.00	1.00	1.00	1.00
Upstream Filter(I)	1.00	1.00	1.00	1.00	1.00	1.00	1.00	1.00	1.00	1.00	0.00	1.00
Uniform Delay (d), s/veh	38.1	27.8	27.8	40.3	25.3	23.6	40.3	21.8	21.5	42.2	0.0	31.8
Incr Delay (d2), s/veh	10.1	12.9	14.4	29.5	0.9	0.6	44.7	0.2	0.2	12.9	0.0	31.0
Initial Q Delay(d3),s/veh	0.0	0.0	0.0	0.0	0.0	0.0	0.0	0.0	0.0	0.0	0.0	0.0
%ile BackOfQ(50%),veh/ln	4.8	11.3	10.2	4.1	3.0	0.8	5.5	1.9	1.3	1.9	0.0	14.0
Unsig. Movement Delay, s/veh												
LnGrp Delay(d),s/veh	48.3	40.7	42.3	69.8	26.2	24.2	85.0	21.9	21.7	55.0	0.0	62.7
LnGrp LOS	D	D	D	E	C	C	F	C	C	E	A	E
Approach Vol, veh/h		1102			524			369				544
Approach Delay, s/veh		42.6			36.9			48.5				61.7
Approach LOS		D			D			D				E
Timer - Assigned Phs	1	2	3	4	5	6	7	8				
Phs Duration (G+Y+Rc), s	16.4	30.4	9.1	34.1	12.6	34.2	13.2	30.0				
Change Period (Y+Rc), s	4.5	4.5	4.5	4.5	4.5	4.5	4.5	4.5				
Max Green Setting (Gmax), s	18.1	19.7	9.3	24.9	8.1	29.7	8.7	25.5				
Max Q Clear Time (g_c+I1), s	11.7	9.0	5.5	6.4	8.6	24.7	9.9	26.2				
Green Ext Time (p_c), s	0.3	1.7	0.0	0.9	0.0	2.6	0.0	0.0				
Intersection Summary												
HCM 6th Ctrl Delay			46.4									
HCM 6th LOS			D									

Intersection						
Int Delay, s/veh	0					
Movement	EBT	EBR	WBL	WBT	NBL	NBR
Lane Configurations						
Traffic Vol, veh/h	31	0	0	27	0	0
Future Vol, veh/h	31	0	0	27	0	0
Conflicting Peds, #/hr	0	0	0	0	0	0
Sign Control	Free	Free	Free	Free	Stop	Stop
RT Channelized	-	None	-	None	-	None
Storage Length	-	-	-	-	-	-
Veh in Median Storage, #	0	-	-	0	0	-
Grade, %	0	-	-	0	0	-
Peak Hour Factor	76	76	76	76	76	76
Heavy Vehicles, %	15	15	15	15	0	0
Mvmt Flow	41	0	0	36	0	0

Major/Minor	Major1	Major2	Minor1		
Conflicting Flow All	0	0	41	0	77
Stage 1	-	-	-	-	41
Stage 2	-	-	-	-	36
Critical Hdwy	-	-	4.25	-	6.4
Critical Hdwy Stg 1	-	-	-	-	5.4
Critical Hdwy Stg 2	-	-	-	-	5.4
Follow-up Hdwy	-	-	2.335	-	3.5
Pot Cap-1 Maneuver	-	-	1489	-	931
Stage 1	-	-	-	-	987
Stage 2	-	-	-	-	992
Platoon blocked, %	-	-	-	-	-
Mov Cap-1 Maneuver	-	-	1489	-	931
Mov Cap-2 Maneuver	-	-	-	-	931
Stage 1	-	-	-	-	987
Stage 2	-	-	-	-	992

Approach	EB	WB	NB
HCM Control Delay, s	0	0	0
HCM LOS			A

Minor Lane/Major Mvmt	NBLn1	EBT	EBR	WBL	WBT
Capacity (veh/h)	-	-	-	1489	-
HCM Lane V/C Ratio	-	-	-	-	-
HCM Control Delay (s)	0	-	-	0	-
HCM Lane LOS	A	-	-	A	-
HCM 95th %tile Q(veh)	-	-	-	0	-

Intersection												
Int Delay, s/veh	0.4											
Movement	EBL	EBT	EBR	WBL	WBT	WBR	NBL	NBT	NBR	SBL	SBT	SBR
Lane Configurations		↕			↕			↕			↕	
Traffic Vol, veh/h	0	12	2	0	33	0	0	0	1	1	0	0
Future Vol, veh/h	0	12	2	0	33	0	0	0	1	1	0	0
Conflicting Peds, #/hr	0	0	0	0	0	0	0	0	0	0	0	0
Sign Control	Free	Free	Free	Free	Free	Free	Stop	Stop	Stop	Stop	Stop	Stop
RT Channelized	-	-	None	-	-	None	-	-	None	-	-	None
Storage Length	-	-	-	-	-	-	-	-	-	-	-	-
Veh in Median Storage, #	-	0	-	-	0	-	-	0	-	-	0	-
Grade, %	-	0	-	-	0	-	-	0	-	-	0	-
Peak Hour Factor	65	65	65	65	65	65	65	65	65	65	65	65
Heavy Vehicles, %	11	11	11	11	11	11	0	0	0	0	0	0
Mvmt Flow	0	18	3	0	51	0	0	0	2	2	0	0

Major/Minor	Major1			Major2			Minor1			Minor2		
Conflicting Flow All	51	0	0	21	0	0	71	71	20	72	72	51
Stage 1	-	-	-	-	-	-	20	20	-	51	51	-
Stage 2	-	-	-	-	-	-	51	51	-	21	21	-
Critical Hdwy	4.21	-	-	4.21	-	-	7.1	6.5	6.2	7.1	6.5	6.2
Critical Hdwy Stg 1	-	-	-	-	-	-	6.1	5.5	-	6.1	5.5	-
Critical Hdwy Stg 2	-	-	-	-	-	-	6.1	5.5	-	6.1	5.5	-
Follow-up Hdwy	2.299	-	-	2.299	-	-	3.5	4	3.3	3.5	4	3.3
Pot Cap-1 Maneuver	1499	-	-	1538	-	-	925	823	1064	924	822	1023
Stage 1	-	-	-	-	-	-	1004	883	-	967	856	-
Stage 2	-	-	-	-	-	-	967	856	-	1003	882	-
Platoon blocked, %	-	-	-	-	-	-	-	-	-	-	-	-
Mov Cap-1 Maneuver	1499	-	-	1538	-	-	925	823	1064	923	822	1023
Mov Cap-2 Maneuver	-	-	-	-	-	-	925	823	-	923	822	-
Stage 1	-	-	-	-	-	-	1004	883	-	967	856	-
Stage 2	-	-	-	-	-	-	967	856	-	1002	882	-

Approach	EB			WB			NB			SB		
HCM Control Delay, s	0			0			8.4			8.9		
HCM LOS							A			A		

Minor Lane/Major Mvmt	NBLn1	EBL	EBT	EBR	WBL	WBT	WBR	SBLn1
Capacity (veh/h)	1064	1499	-	-	1538	-	-	923
HCM Lane V/C Ratio	0.001	-	-	-	-	-	-	0.002
HCM Control Delay (s)	8.4	0	-	-	0	-	-	8.9
HCM Lane LOS	A	A	-	-	A	-	-	A
HCM 95th %tile Q(veh)	0	0	-	-	0	-	-	0

Intersection						
Int Delay, s/veh	4.8					
Movement	WBL	WBR	NBT	NBR	SBL	SBT
Lane Configurations						
Traffic Vol, veh/h	1	1	0	2	1	0
Future Vol, veh/h	1	1	0	2	1	0
Conflicting Peds, #/hr	0	0	0	0	0	0
Sign Control	Stop	Stop	Free	Free	Free	Free
RT Channelized	-	None	-	None	-	None
Storage Length	-	-	-	-	-	-
Veh in Median Storage, #	0	-	0	-	-	0
Grade, %	0	-	0	-	-	0
Peak Hour Factor	50	50	50	50	50	50
Heavy Vehicles, %	0	0	0	0	0	0
Mvmt Flow	2	2	0	4	2	0

Major/Minor	Minor1	Major1	Major2			
Conflicting Flow All	6	2	0	0	4	0
Stage 1	2	-	-	-	-	-
Stage 2	4	-	-	-	-	-
Critical Hdwy	6.4	6.2	-	-	4.1	-
Critical Hdwy Stg 1	5.4	-	-	-	-	-
Critical Hdwy Stg 2	5.4	-	-	-	-	-
Follow-up Hdwy	3.5	3.3	-	-	2.2	-
Pot Cap-1 Maneuver	1021	1088	-	-	1631	-
Stage 1	1026	-	-	-	-	-
Stage 2	1024	-	-	-	-	-
Platoon blocked, %			-	-	-	-
Mov Cap-1 Maneuver	1020	1088	-	-	1631	-
Mov Cap-2 Maneuver	1020	-	-	-	-	-
Stage 1	1026	-	-	-	-	-
Stage 2	1023	-	-	-	-	-

Approach	WB	NB	SB
HCM Control Delay, s	8.4	0	7.2
HCM LOS	A		

Minor Lane/Major Mvmt	NBT	NBRWBLn1	SBL	SBT
Capacity (veh/h)	-	-	1053	1631
HCM Lane V/C Ratio	-	-	0.004	0.001
HCM Control Delay (s)	-	-	8.4	7.2
HCM Lane LOS	-	-	A	A
HCM 95th %tile Q(veh)	-	-	0	0

Intersection						
Int Delay, s/veh	0					
Movement	EBL	EBR	NBL	NBT	SBT	SBR
Lane Configurations						
Traffic Vol, veh/h	0	0	0	232	160	0
Future Vol, veh/h	0	0	0	232	160	0
Conflicting Peds, #/hr	0	0	0	0	0	0
Sign Control	Stop	Stop	Free	Free	Free	Free
RT Channelized	-	None	-	None	-	None
Storage Length	-	-	-	-	-	-
Veh in Median Storage, #	0	-	-	0	0	-
Grade, %	0	-	-	0	0	-
Peak Hour Factor	82	82	82	82	82	82
Heavy Vehicles, %	0	0	19	19	19	19
Mvmt Flow	0	0	0	283	195	0

Major/Minor	Minor2	Major1		Major2	
Conflicting Flow All	478	195	195	0	0
Stage 1	195	-	-	-	-
Stage 2	283	-	-	-	-
Critical Hdwy	6.4	6.2	4.29	-	-
Critical Hdwy Stg 1	5.4	-	-	-	-
Critical Hdwy Stg 2	5.4	-	-	-	-
Follow-up Hdwy	3.5	3.3	2.371	-	-
Pot Cap-1 Maneuver	550	851	1282	-	-
Stage 1	843	-	-	-	-
Stage 2	770	-	-	-	-
Platoon blocked, %				-	-
Mov Cap-1 Maneuver	550	851	1282	-	-
Mov Cap-2 Maneuver	550	-	-	-	-
Stage 1	843	-	-	-	-
Stage 2	770	-	-	-	-

Approach	EB	NB	SB
HCM Control Delay, s	0	0	0
HCM LOS	A		

Minor Lane/Major Mvmt	NBL	NBT	EBLn1	SBT	SBR
Capacity (veh/h)	1282	-	-	-	-
HCM Lane V/C Ratio	-	-	-	-	-
HCM Control Delay (s)	0	-	0	-	-
HCM Lane LOS	A	-	A	-	-
HCM 95th %tile Q(veh)	0	-	-	-	-

Intersection						
Int Delay, s/veh	0					
Movement	EBL	EBR	NBL	NBT	SBT	SBR
Lane Configurations	FF			FF	FF	
Traffic Vol, veh/h	0	1	1	266	209	0
Future Vol, veh/h	0	1	1	266	209	0
Conflicting Peds, #/hr	0	0	0	0	0	0
Sign Control	Stop	Stop	Free	Free	Free	Free
RT Channelized	-	None	-	None	-	None
Storage Length	0	-	-	-	-	-
Veh in Median Storage, #	0	-	-	0	0	-
Grade, %	0	-	-	0	0	-
Peak Hour Factor	88	88	88	88	88	88
Heavy Vehicles, %	0	0	17	17	17	17
Mvmt Flow	0	1	1	302	238	0

Major/Minor	Minor2	Major1		Major2	
Conflicting Flow All	542	238	238	0	0
Stage 1	238	-	-	-	-
Stage 2	304	-	-	-	-
Critical Hdwy	6.4	6.2	4.27	-	-
Critical Hdwy Stg 1	5.4	-	-	-	-
Critical Hdwy Stg 2	5.4	-	-	-	-
Follow-up Hdwy	3.5	3.3	2.353	-	-
Pot Cap-1 Maneuver	505	806	1246	-	-
Stage 1	806	-	-	-	-
Stage 2	753	-	-	-	-
Platoon blocked, %				-	-
Mov Cap-1 Maneuver	504	806	1246	-	-
Mov Cap-2 Maneuver	504	-	-	-	-
Stage 1	805	-	-	-	-
Stage 2	753	-	-	-	-

Approach	EB	NB	SB
HCM Control Delay, s	9.5	0	0
HCM LOS	A		

Minor Lane/Major Mvmt	NBL	NBT	EBLn1	SBT	SBR
Capacity (veh/h)	1246	-	806	-	-
HCM Lane V/C Ratio	0.001	-	0.001	-	-
HCM Control Delay (s)	7.9	0	9.5	-	-
HCM Lane LOS	A	A	A	-	-
HCM 95th %tile Q(veh)	0	-	0	-	-

Intersection						
Int Delay, s/veh	0.1					
Movement	EBT	EBR	WBL	WBT	NBL	NBR
Lane Configurations						
Traffic Vol, veh/h	60	0	0	25	1	0
Future Vol, veh/h	60	0	0	25	1	0
Conflicting Peds, #/hr	0	0	0	0	0	0
Sign Control	Free	Free	Free	Free	Stop	Stop
RT Channelized	-	None	-	None	-	None
Storage Length	-	-	-	-	-	-
Veh in Median Storage, #	0	-	-	0	0	-
Grade, %	0	-	-	0	0	-
Peak Hour Factor	67	67	67	67	67	67
Heavy Vehicles, %	4	4	4	4	0	0
Mvmt Flow	90	0	0	37	1	0

Major/Minor	Major1	Major2	Minor1		
Conflicting Flow All	0	0	90	0	127
Stage 1	-	-	-	-	90
Stage 2	-	-	-	-	37
Critical Hdwy	-	-	4.14	-	6.4
Critical Hdwy Stg 1	-	-	-	-	5.4
Critical Hdwy Stg 2	-	-	-	-	5.4
Follow-up Hdwy	-	-	2.236	-	3.5
Pot Cap-1 Maneuver	-	-	1493	-	872
Stage 1	-	-	-	-	939
Stage 2	-	-	-	-	991
Platoon blocked, %	-	-	-	-	-
Mov Cap-1 Maneuver	-	-	1493	-	872
Mov Cap-2 Maneuver	-	-	-	-	872
Stage 1	-	-	-	-	939
Stage 2	-	-	-	-	991

Approach	EB	WB	NB
HCM Control Delay, s	0	0	9.1
HCM LOS			A

Minor Lane/Major Mvmt	NBLn1	EBT	EBR	WBL	WBT
Capacity (veh/h)	872	-	-	1493	-
HCM Lane V/C Ratio	0.002	-	-	-	-
HCM Control Delay (s)	9.1	-	-	0	-
HCM Lane LOS	A	-	-	A	-
HCM 95th %tile Q(veh)	0	-	-	0	-

Intersection												
Int Delay, s/veh	0.1											
Movement	EBL	EBT	EBR	WBL	WBT	WBR	NBL	NBT	NBR	SBL	SBT	SBR
Lane Configurations		↕			↕			↕			↕	
Traffic Vol, veh/h	0	48	0	0	14	0	0	0	1	0	0	0
Future Vol, veh/h	0	48	0	0	14	0	0	0	1	0	0	0
Conflicting Peds, #/hr	0	0	0	0	0	0	0	0	0	0	0	0
Sign Control	Free	Free	Free	Free	Free	Free	Stop	Stop	Stop	Stop	Stop	Stop
RT Channelized	-	-	None	-	-	None	-	-	None	-	-	None
Storage Length	-	-	-	-	-	-	-	-	-	-	-	-
Veh in Median Storage, #	-	0	-	-	0	-	-	0	-	-	0	-
Grade, %	-	0	-	-	0	-	-	0	-	-	0	-
Peak Hour Factor	54	54	54	54	54	54	54	54	54	54	54	54
Heavy Vehicles, %	13	13	13	13	13	13	0	0	0	0	0	0
Mvmt Flow	0	89	0	0	26	0	0	0	2	0	0	0

Major/Minor	Major1		Major2		Minor1		Minor2					
Conflicting Flow All	26	0	0	89	0	0	115	115	89	116	115	26
Stage 1	-	-	-	-	-	-	89	89	-	26	26	-
Stage 2	-	-	-	-	-	-	26	26	-	90	89	-
Critical Hdwy	4.23	-	-	4.23	-	-	7.1	6.5	6.2	7.1	6.5	6.2
Critical Hdwy Stg 1	-	-	-	-	-	-	6.1	5.5	-	6.1	5.5	-
Critical Hdwy Stg 2	-	-	-	-	-	-	6.1	5.5	-	6.1	5.5	-
Follow-up Hdwy	2.317	-	-	2.317	-	-	3.5	4	3.3	3.5	4	3.3
Pot Cap-1 Maneuver	1520	-	-	1440	-	-	867	779	975	865	779	1056
Stage 1	-	-	-	-	-	-	923	825	-	997	878	-
Stage 2	-	-	-	-	-	-	997	878	-	922	825	-
Platoon blocked, %		-	-		-	-						
Mov Cap-1 Maneuver	1520	-	-	1440	-	-	867	779	975	863	779	1056
Mov Cap-2 Maneuver	-	-	-	-	-	-	867	779	-	863	779	-
Stage 1	-	-	-	-	-	-	923	825	-	997	878	-
Stage 2	-	-	-	-	-	-	997	878	-	920	825	-

Approach	EB	WB	NB	SB
HCM Control Delay, s	0	0	8.7	0
HCM LOS			A	A

Minor Lane/Major Mvmt	NBLn1	EBL	EBT	EBR	WBL	WBT	WBR	SBLn1
Capacity (veh/h)	975	1520	-	-	1440	-	-	-
HCM Lane V/C Ratio	0.002	-	-	-	-	-	-	-
HCM Control Delay (s)	8.7	0	-	-	0	-	-	0
HCM Lane LOS	A	A	-	-	A	-	-	A
HCM 95th %tile Q(veh)	0	0	-	-	0	-	-	-

Intersection						
Int Delay, s/veh	6.9					
Movement	EBL	EBT	WBT	WBR	SBL	SBR
Lane Configurations		↕	↑	↗	↘	
Traffic Vol, veh/h	7	117	60	96	252	8
Future Vol, veh/h	7	117	60	96	252	8
Conflicting Peds, #/hr	0	0	0	0	0	0
Sign Control	Free	Free	Free	Free	Stop	Stop
RT Channelized	-	None	-	None	-	None
Storage Length	-	-	-	0	0	-
Veh in Median Storage, #	-	0	0	-	0	-
Grade, %	-	0	0	-	0	-
Peak Hour Factor	83	83	83	83	83	83
Heavy Vehicles, %	12	12	58	58	30	30
Mvmt Flow	8	141	72	116	304	10

Major/Minor	Major1	Major2	Minor2		
Conflicting Flow All	188	0	-	0	229 72
Stage 1	-	-	-	-	72 -
Stage 2	-	-	-	-	157 -
Critical Hdwy	4.22	-	-	-	6.7 6.5
Critical Hdwy Stg 1	-	-	-	-	5.7 -
Critical Hdwy Stg 2	-	-	-	-	5.7 -
Follow-up Hdwy	2.308	-	-	-	3.77 3.57
Pot Cap-1 Maneuver	1328	-	-	-	701 917
Stage 1	-	-	-	-	885 -
Stage 2	-	-	-	-	808 -
Platoon blocked, %		-	-	-	
Mov Cap-1 Maneuver	1328	-	-	-	696 917
Mov Cap-2 Maneuver	-	-	-	-	696 -
Stage 1	-	-	-	-	879 -
Stage 2	-	-	-	-	808 -

Approach	EB	WB	SB
HCM Control Delay, s	0.4	0	14.2
HCM LOS			B

Minor Lane/Major Mvmt	EBL	EBT	WBT	WBR	SBLn1
Capacity (veh/h)	1328	-	-	-	701
HCM Lane V/C Ratio	0.006	-	-	-	0.447
HCM Control Delay (s)	7.7	0	-	-	14.2
HCM Lane LOS	A	A	-	-	B
HCM 95th %tile Q(veh)	0	-	-	-	2.3

HCM 6th TWSC
 4: Truck Parking Lot/Pistachio Drive & Avenue 18 1/2

Village D Specific Plan
 Existing NP - PM Peak Hour

Intersection												
Int Delay, s/veh	4.2											
Movement	EBL	EBT	EBR	WBL	WBT	WBR	NBL	NBT	NBR	SBL	SBT	SBR
Lane Configurations		↕			↕	↕		↕			↕	
Traffic Vol, veh/h	12	425	1	6	148	187	2	0	5	154	0	12
Future Vol, veh/h	12	425	1	6	148	187	2	0	5	154	0	12
Conflicting Peds, #/hr	0	0	0	0	0	0	0	0	1	1	0	0
Sign Control	Free	Free	Free	Free	Free	Free	Stop	Stop	Stop	Stop	Stop	Stop
RT Channelized	-	-	None	-	-	None	-	-	None	-	-	None
Storage Length	-	-	-	-	-	50	-	-	-	-	-	-
Veh in Median Storage, #	-	0	-	-	0	-	-	0	-	-	0	-
Grade, %	-	0	-	-	0	-	-	0	-	-	0	-
Peak Hour Factor	93	93	93	93	93	93	93	93	93	93	93	93
Heavy Vehicles, %	23	23	23	26	26	26	71	71	71	5	5	5
Mvmt Flow	13	457	1	6	159	201	2	0	5	166	0	13

Major/Minor	Major1		Major2		Minor1		Minor2					
Conflicting Flow All	360	0	0	458	0	0	762	856	459	658	655	159
Stage 1	-	-	-	-	-	-	484	484	-	171	171	-
Stage 2	-	-	-	-	-	-	278	372	-	487	484	-
Critical Hdwy	4.33	-	-	4.36	-	-	7.81	7.21	6.91	7.15	6.55	6.25
Critical Hdwy Stg 1	-	-	-	-	-	-	6.81	6.21	-	6.15	5.55	-
Critical Hdwy Stg 2	-	-	-	-	-	-	6.81	6.21	-	6.15	5.55	-
Follow-up Hdwy	2.407	-	-	2.434	-	-	4.139	4.639	3.939	3.545	4.045	3.345
Pot Cap-1 Maneuver	1091	-	-	988	-	-	250	231	482	373	382	878
Stage 1	-	-	-	-	-	-	454	453	-	824	752	-
Stage 2	-	-	-	-	-	-	601	514	-	556	547	-
Platoon blocked, %		-	-	-	-	-						
Mov Cap-1 Maneuver	1091	-	-	988	-	-	242	225	482	362	373	878
Mov Cap-2 Maneuver	-	-	-	-	-	-	242	225	-	362	373	-
Stage 1	-	-	-	-	-	-	447	446	-	811	746	-
Stage 2	-	-	-	-	-	-	587	510	-	540	538	-

Approach	EB		WB		NB		SB	
HCM Control Delay, s	0.2		0.2		14.8		22.8	
HCM LOS					B		C	

Minor Lane/Major Mvmt	NBLn1	EBL	EBT	EBR	WBL	WBT	WBR	SBLn1
Capacity (veh/h)	376	1091	-	-	988	-	-	378
HCM Lane V/C Ratio	0.02	0.012	-	-	0.007	-	-	0.472
HCM Control Delay (s)	14.8	8.3	0	-	8.7	0	-	22.8
HCM Lane LOS	B	A	A	-	A	A	-	C
HCM 95th %tile Q(veh)	0.1	0	-	-	0	-	-	2.4

Intersection

Int Delay, s/veh 8.6

Movement	EBL	EBT	EBR	WBL	WBT	WBR	NBL	NBT	NBR	SBL	SBT	SBR
Lane Configurations		↑	↗		↖		↖		↗		↕	
Traffic Vol, veh/h	0	380	204	39	191	0	31	0	75	19	93	120
Future Vol, veh/h	0	380	204	39	191	0	31	0	75	19	93	120
Conflicting Peds, #/hr	0	0	0	0	0	0	0	0	0	0	0	0
Sign Control	Free	Free	Free	Free	Free	Free	Stop	Stop	Stop	Stop	Stop	Stop
RT Channelized	-	-	None	-	-	None	-	-	None	-	-	None
Storage Length	-	-	50	-	-	-	0	-	25	-	-	-
Veh in Median Storage, #	-	0	-	-	0	-	-	0	-	-	0	-
Grade, %	-	0	-	-	0	-	-	0	-	-	0	-
Peak Hour Factor	94	94	94	94	94	94	94	94	94	94	94	94
Heavy Vehicles, %	20	20	20	30	30	30	16	16	16	26	26	26
Mvmt Flow	0	404	217	41	203	0	33	0	80	20	99	128

Major/Minor	Major1			Major2			Minor1			Minor2		
Conflicting Flow All	-	0	0	621	0	0	803	-	404	838	906	203
Stage 1	-	-	-	-	-	-	404	-	-	285	285	-
Stage 2	-	-	-	-	-	-	399	-	-	553	621	-
Critical Hdwy	-	-	-	4.4	-	-	7.26	-	6.36	7.36	6.76	6.46
Critical Hdwy Stg 1	-	-	-	-	-	-	6.26	-	-	6.36	5.76	-
Critical Hdwy Stg 2	-	-	-	-	-	-	6.26	-	-	6.36	5.76	-
Follow-up Hdwy	-	-	-	2.47	-	-	3.644	-	3.444	3.734	4.234	3.534
Pot Cap-1 Maneuver	0	-	-	838	-	0	286	0	617	260	252	781
Stage 1	0	-	-	-	-	0	596	0	-	673	634	-
Stage 2	0	-	-	-	-	0	600	0	-	477	444	-
Platoon blocked, %		-	-	-	-	-	-		-	-	-	-
Mov Cap-1 Maneuver	-	-	-	838	-	-	155	-	617	217	238	781
Mov Cap-2 Maneuver	-	-	-	-	-	-	155	-	-	217	238	-
Stage 1	-	-	-	-	-	-	596	-	-	673	599	-
Stage 2	-	-	-	-	-	-	396	-	-	415	444	-

Approach	EB			WB			NB			SB		
HCM Control Delay, s	0			1.6			18.3			32.8		
HCM LOS							C			D		

Minor Lane/Major Mvmt	NBLn1	NBLn2	EBT	EBR	WBL	WBT	SBLn1
Capacity (veh/h)	155	617	-	-	838	-	367
HCM Lane V/C Ratio	0.213	0.129	-	-	0.05	-	0.673
HCM Control Delay (s)	34.4	11.7	-	-	9.5	0	32.8
HCM Lane LOS	D	B	-	-	A	A	D
HCM 95th %tile Q(veh)	0.8	0.4	-	-	0.2	-	4.7

Intersection												
Int Delay, s/veh	10.4											
Movement	EBL	EBT	EBR	WBL	WBT	WBR	NBL	NBT	NBR	SBL	SBT	SBR
Lane Configurations	↖	↑			↗			↔				
Traffic Vol, veh/h	171	81	0	0	78	13	179	2	0	0	0	0
Future Vol, veh/h	171	81	0	0	78	13	179	2	0	0	0	0
Conflicting Peds, #/hr	0	0	0	0	0	0	0	0	0	0	0	0
Sign Control	Free	Free	Free	Free	Free	Free	Stop	Stop	Stop	Free	Free	Free
RT Channelized	-	-	None	-	-	None	-	-	None	-	-	None
Storage Length	145	-	-	-	-	-	-	-	-	-	-	-
Veh in Median Storage, #	-	0	-	-	0	-	-	0	-	-	16965	-
Grade, %	-	0	-	-	0	-	-	0	-	-	0	-
Peak Hour Factor	92	92	92	92	92	92	92	92	92	92	92	92
Heavy Vehicles, %	20	20	20	12	12	12	24	24	24	0	0	0
Mvmt Flow	186	88	0	0	85	14	195	2	0	0	0	0

Major/Minor	Major1	Major2	Minor1
Conflicting Flow All	99	0	0
Stage 1	-	-	460
Stage 2	-	-	92
Critical Hdwy	4.3	-	6.64
Critical Hdwy Stg 1	-	-	5.64
Critical Hdwy Stg 2	-	-	5.64
Follow-up Hdwy	2.38	-	3.716
Pot Cap-1 Maneuver	1388	0	459
Stage 1	-	0	592
Stage 2	-	0	879
Platoon blocked, %	-	-	-
Mov Cap-1 Maneuver	1388	-	397
Mov Cap-2 Maneuver	-	-	397
Stage 1	-	-	513
Stage 2	-	-	879

Approach	EB	WB	NB
HCM Control Delay, s	5.4	0	22.7
HCM LOS			C

Minor Lane/Major Mvmt	NBLn1	EBL	EBT	WBT	WBR
Capacity (veh/h)	397	1388	-	-	-
HCM Lane V/C Ratio	0.496	0.134	-	-	-
HCM Control Delay (s)	22.7	8	-	-	-
HCM Lane LOS	C	A	-	-	-
HCM 95th %tile Q(veh)	2.7	0.5	-	-	-

Intersection												
Int Delay, s/veh	4.1											
Movement	EBL	EBT	EBR	WBL	WBT	WBR	NBL	NBT	NBR	SBL	SBT	SBR
Lane Configurations		↕			↕			↕			↕	
Traffic Vol, veh/h	1	48	11	29	19	9	5	77	60	61	219	2
Future Vol, veh/h	1	48	11	29	19	9	5	77	60	61	219	2
Conflicting Peds, #/hr	0	0	0	0	0	0	0	0	0	0	0	0
Sign Control	Stop	Stop	Stop	Stop	Stop	Stop	Free	Free	Free	Free	Free	Free
RT Channelized	-	-	None	-	-	None	-	-	None	-	-	None
Storage Length	-	-	-	-	-	-	-	-	-	-	-	-
Veh in Median Storage, #	-	0	-	-	0	-	-	0	-	-	0	-
Grade, %	-	0	-	-	0	-	-	0	-	-	0	-
Peak Hour Factor	91	91	91	91	91	91	91	91	91	91	91	91
Heavy Vehicles, %	3	3	3	5	5	5	8	8	8	8	8	8
Mvmt Flow	1	53	12	32	21	10	5	85	66	67	241	2

Major/Minor	Minor2		Minor1		Major1		Major2					
Conflicting Flow All	520	537	242	537	505	118	243	0	0	151	0	0
Stage 1	376	376	-	128	128	-	-	-	-	-	-	-
Stage 2	144	161	-	409	377	-	-	-	-	-	-	-
Critical Hdwy	7.13	6.53	6.23	7.15	6.55	6.25	4.18	-	-	4.18	-	-
Critical Hdwy Stg 1	6.13	5.53	-	6.15	5.55	-	-	-	-	-	-	-
Critical Hdwy Stg 2	6.13	5.53	-	6.15	5.55	-	-	-	-	-	-	-
Follow-up Hdwy	3.527	4.027	3.327	3.545	4.045	3.345	2.272	-	-	2.272	-	-
Pot Cap-1 Maneuver	465	449	794	450	465	926	1289	-	-	1394	-	-
Stage 1	643	615	-	869	784	-	-	-	-	-	-	-
Stage 2	856	763	-	613	611	-	-	-	-	-	-	-
Platoon blocked, %								-	-	-	-	-
Mov Cap-1 Maneuver	423	422	794	383	437	926	1289	-	-	1394	-	-
Mov Cap-2 Maneuver	423	422	-	383	437	-	-	-	-	-	-	-
Stage 1	640	581	-	866	781	-	-	-	-	-	-	-
Stage 2	821	760	-	518	577	-	-	-	-	-	-	-

Approach	EB		WB		NB		SB	
HCM Control Delay, s	14.1		14.5		0.3		1.7	
HCM LOS	B		B					

Minor Lane/Major Mvmt	NBL	NBT	NBR	EBLn1WBLn1	SBL	SBT	SBR
Capacity (veh/h)	1289	-	-	462	442	1394	-
HCM Lane V/C Ratio	0.004	-	-	0.143	0.142	0.048	-
HCM Control Delay (s)	7.8	0	-	14.1	14.5	7.7	0
HCM Lane LOS	A	A	-	B	B	A	A
HCM 95th %tile Q(veh)	0	-	-	0.5	0.5	0.2	-

Intersection												
Int Delay, s/veh	1.4											
Movement	EBL	EBT	EBR	WBL	WBT	WBR	NBL	NBT	NBR	SBL	SBT	SBR
Lane Configurations		↕			↕			↕			↕	
Traffic Vol, veh/h	9	0	41	0	1	1	7	136	1	2	253	6
Future Vol, veh/h	9	0	41	0	1	1	7	136	1	2	253	6
Conflicting Peds, #/hr	0	0	0	0	0	0	0	0	0	0	0	0
Sign Control	Stop	Stop	Stop	Stop	Stop	Stop	Free	Free	Free	Free	Free	Free
RT Channelized	-	-	None	-	-	None	-	-	None	-	-	None
Storage Length	-	-	-	-	-	-	-	-	-	-	-	-
Veh in Median Storage, #	-	0	-	-	0	-	-	0	-	-	0	-
Grade, %	-	0	-	-	0	-	-	0	-	-	0	-
Peak Hour Factor	95	95	95	95	95	95	95	95	95	95	95	95
Heavy Vehicles, %	6	6	6	50	50	50	8	8	8	9	9	9
Mvmt Flow	9	0	43	0	1	1	7	143	1	2	266	6

Major/Minor	Minor2		Minor1		Major1		Major2					
Conflicting Flow All	432	431	269	453	434	144	272	0	0	144	0	0
Stage 1	273	273	-	158	158	-	-	-	-	-	-	-
Stage 2	159	158	-	295	276	-	-	-	-	-	-	-
Critical Hdwy	7.16	6.56	6.26	7.6	7	6.7	4.18	-	-	4.19	-	-
Critical Hdwy Stg 1	6.16	5.56	-	6.6	6	-	-	-	-	-	-	-
Critical Hdwy Stg 2	6.16	5.56	-	6.6	6	-	-	-	-	-	-	-
Follow-up Hdwy	3.554	4.054	3.354	3.95	4.45	3.75	2.272	-	-	2.281	-	-
Pot Cap-1 Maneuver	527	511	760	444	450	791	1257	-	-	1397	-	-
Stage 1	724	677	-	743	684	-	-	-	-	-	-	-
Stage 2	834	759	-	621	603	-	-	-	-	-	-	-
Platoon blocked, %								-	-	-	-	-
Mov Cap-1 Maneuver	522	507	760	416	446	791	1257	-	-	1397	-	-
Mov Cap-2 Maneuver	522	507	-	416	446	-	-	-	-	-	-	-
Stage 1	720	676	-	739	680	-	-	-	-	-	-	-
Stage 2	827	754	-	585	602	-	-	-	-	-	-	-

Approach	EB		WB		NB		SB	
HCM Control Delay, s	10.5		11.3		0.4		0.1	
HCM LOS	B		B					

Minor Lane/Major Mvmt	NBL	NBT	NBR	EBLn1	WBLn1	SBL	SBT	SBR
Capacity (veh/h)	1257	-	-	702	570	1397	-	-
HCM Lane V/C Ratio	0.006	-	-	0.075	0.004	0.002	-	-
HCM Control Delay (s)	7.9	0	-	10.5	11.3	7.6	0	-
HCM Lane LOS	A	A	-	B	B	A	A	-
HCM 95th %tile Q(veh)	0	-	-	0.2	0	0	-	-

Intersection												
Int Delay, s/veh	2.6											
Movement	EBL	EBT	EBR	WBL	WBT	WBR	NBL	NBT	NBR	SBL	SBT	SBR
Lane Configurations		↕			↕			↕			↕	
Traffic Vol, veh/h	1	0	1	51	0	25	0	113	89	59	224	1
Future Vol, veh/h	1	0	1	51	0	25	0	113	89	59	224	1
Conflicting Peds, #/hr	0	0	0	0	0	0	0	0	0	0	0	0
Sign Control	Stop	Stop	Stop	Stop	Stop	Stop	Free	Free	Free	Free	Free	Free
RT Channelized	-	-	None	-	-	None	-	-	None	-	-	None
Storage Length	-	-	-	-	-	-	-	-	-	-	-	-
Veh in Median Storage, #	-	0	-	-	0	-	-	0	-	-	0	-
Grade, %	-	0	-	-	0	-	-	0	-	-	0	-
Peak Hour Factor	93	93	93	93	93	93	93	93	93	93	93	93
Heavy Vehicles, %	0	0	0	4	4	4	7	7	7	9	9	9
Mvmt Flow	1	0	1	55	0	27	0	122	96	63	241	1

Major/Minor	Minor2		Minor1		Major1		Major2					
Conflicting Flow All	552	586	242	538	538	170	242	0	0	218	0	0
Stage 1	368	368	-	170	170	-	-	-	-	-	-	-
Stage 2	184	218	-	368	368	-	-	-	-	-	-	-
Critical Hdwy	7.1	6.5	6.2	7.14	6.54	6.24	4.17	-	-	4.19	-	-
Critical Hdwy Stg 1	6.1	5.5	-	6.14	5.54	-	-	-	-	-	-	-
Critical Hdwy Stg 2	6.1	5.5	-	6.14	5.54	-	-	-	-	-	-	-
Follow-up Hdwy	3.5	4	3.3	3.536	4.036	3.336	2.263	-	-	2.281	-	-
Pot Cap-1 Maneuver	447	425	802	451	447	869	1296	-	-	1311	-	-
Stage 1	656	625	-	827	754	-	-	-	-	-	-	-
Stage 2	822	726	-	648	618	-	-	-	-	-	-	-
Platoon blocked, %								-	-	-	-	-
Mov Cap-1 Maneuver	415	401	802	431	422	869	1296	-	-	1311	-	-
Mov Cap-2 Maneuver	415	401	-	431	422	-	-	-	-	-	-	-
Stage 1	656	590	-	827	754	-	-	-	-	-	-	-
Stage 2	797	726	-	611	583	-	-	-	-	-	-	-

Approach	EB	WB	NB	SB
HCM Control Delay, s	11.6	13.3	0	1.6
HCM LOS	B	B		

Minor Lane/Major Mvmt	NBL	NBT	NBR	EBLn1WBLn1	SBL	SBT	SBR
Capacity (veh/h)	1296	-	-	547	517	1311	-
HCM Lane V/C Ratio	-	-	-	0.004	0.158	0.048	-
HCM Control Delay (s)	0	-	-	11.6	13.3	7.9	0
HCM Lane LOS	A	-	-	B	B	A	A
HCM 95th %tile Q(veh)	0	-	-	0	0.6	0.2	-

Intersection												
Int Delay, s/veh	1.5											
Movement	EBL	EBT	EBR	WBL	WBT	WBR	NBL	NBT	NBR	SBL	SBT	SBR
Lane Configurations		↕			↕			↕			↕	
Traffic Vol, veh/h	1	2	3	4	3	8	2	179	2	60	215	0
Future Vol, veh/h	1	2	3	4	3	8	2	179	2	60	215	0
Conflicting Peds, #/hr	0	0	0	0	0	0	0	0	0	0	0	0
Sign Control	Stop	Stop	Stop	Stop	Stop	Stop	Free	Free	Free	Free	Free	Free
RT Channelized	-	-	None	-	-	None	-	-	None	-	-	None
Storage Length	-	-	-	-	-	-	-	-	-	-	-	-
Veh in Median Storage, #	-	0	-	-	0	-	-	0	-	-	0	-
Grade, %	-	0	-	-	0	-	-	0	-	-	0	-
Peak Hour Factor	88	88	88	88	88	88	88	88	88	88	88	88
Heavy Vehicles, %	0	0	0	0	0	0	9	9	9	9	9	9
Mvmt Flow	1	2	3	5	3	9	2	203	2	68	244	0

Major/Minor	Minor2		Minor1		Major1		Major2					
Conflicting Flow All	594	589	244	591	588	204	244	0	0	205	0	0
Stage 1	380	380	-	208	208	-	-	-	-	-	-	-
Stage 2	214	209	-	383	380	-	-	-	-	-	-	-
Critical Hdwy	7.1	6.5	6.2	7.1	6.5	6.2	4.19	-	-	4.19	-	-
Critical Hdwy Stg 1	6.1	5.5	-	6.1	5.5	-	-	-	-	-	-	-
Critical Hdwy Stg 2	6.1	5.5	-	6.1	5.5	-	-	-	-	-	-	-
Follow-up Hdwy	3.5	4	3.3	3.5	4	3.3	2.281	-	-	2.281	-	-
Pot Cap-1 Maneuver	420	423	800	422	424	842	1282	-	-	1326	-	-
Stage 1	646	617	-	799	734	-	-	-	-	-	-	-
Stage 2	793	733	-	644	617	-	-	-	-	-	-	-
Platoon blocked, %								-	-	-	-	-
Mov Cap-1 Maneuver	394	397	800	399	398	842	1282	-	-	1326	-	-
Mov Cap-2 Maneuver	394	397	-	399	398	-	-	-	-	-	-	-
Stage 1	645	581	-	797	733	-	-	-	-	-	-	-
Stage 2	779	732	-	601	581	-	-	-	-	-	-	-

Approach	EB		WB		NB		SB	
HCM Control Delay, s	11.9		11.7		0.1		1.7	
HCM LOS	B		B					

Minor Lane/Major Mvmt	NBL	NBT	NBR	EBLn1	WBLn1	SBL	SBT	SBR
Capacity (veh/h)	1282	-	-	530	554	1326	-	-
HCM Lane V/C Ratio	0.002	-	-	0.013	0.031	0.051	-	-
HCM Control Delay (s)	7.8	0	-	11.9	11.7	7.9	0	-
HCM Lane LOS	A	A	-	B	B	A	A	-
HCM 95th %tile Q(veh)	0	-	-	0	0.1	0.2	-	-

Intersection	
Intersection Delay, s/veh	9.6
Intersection LOS	A

Movement	EBL	EBT	EBR	WBL	WBT	WBR	NBL	NBT	NBR	SBL	SBT	SBR
Lane Configurations		↕			↕			↕			↕	
Traffic Vol, veh/h	44	89	34	11	36	49	14	91	21	70	121	29
Future Vol, veh/h	44	89	34	11	36	49	14	91	21	70	121	29
Peak Hour Factor	0.95	0.95	0.95	0.95	0.95	0.95	0.95	0.95	0.95	0.95	0.95	0.95
Heavy Vehicles, %	8	8	8	4	4	4	10	10	10	10	10	10
Mvmt Flow	46	94	36	12	38	52	15	96	22	74	127	31
Number of Lanes	0	1	0	0	1	0	0	1	0	0	1	0

Approach	EB	WB	NB	SB
Opposing Approach	WB	EB	SB	NB
Opposing Lanes	1	1	1	1
Conflicting Approach Left	SB	NB	EB	WB
Conflicting Lanes Left	1	1	1	1
Conflicting Approach Right	NB	SB	WB	EB
Conflicting Lanes Right	1	1	1	1
HCM Control Delay	9.7	8.6	9.2	10.2
HCM LOS	A	A	A	B

Lane	NBLn1	EBLn1	WBLn1	SBLn1
Vol Left, %	11%	26%	11%	32%
Vol Thru, %	72%	53%	38%	55%
Vol Right, %	17%	20%	51%	13%
Sign Control	Stop	Stop	Stop	Stop
Traffic Vol by Lane	126	167	96	220
LT Vol	14	44	11	70
Through Vol	91	89	36	121
RT Vol	21	34	49	29
Lane Flow Rate	133	176	101	232
Geometry Grp	1	1	1	1
Degree of Util (X)	0.183	0.244	0.135	0.315
Departure Headway (Hd)	4.967	4.989	4.816	4.902
Convergence, Y/N	Yes	Yes	Yes	Yes
Cap	716	715	738	729
Service Time	3.038	3.053	2.888	2.964
HCM Lane V/C Ratio	0.186	0.246	0.137	0.318
HCM Control Delay	9.2	9.7	8.6	10.2
HCM Lane LOS	A	A	A	B
HCM 95th-tile Q	0.7	1	0.5	1.4

Intersection												
Intersection Delay, s/veh	9.2											
Intersection LOS	A											

Movement	EBL	EBT	EBR	WBL	WBT	WBR	NBL	NBT	NBR	SBL	SBT	SBR
Lane Configurations												
Traffic Vol, veh/h	56	116	8	14	66	23	4	40	38	55	45	33
Future Vol, veh/h	56	116	8	14	66	23	4	40	38	55	45	33
Peak Hour Factor	0.92	0.92	0.92	0.92	0.92	0.92	0.92	0.92	0.92	0.92	0.92	0.92
Heavy Vehicles, %	14	14	14	21	21	21	8	8	8	13	13	13
Mvmt Flow	61	126	9	15	72	25	4	43	41	60	49	36
Number of Lanes	1	1	0	1	1	0	0	1	0	0	1	0

Approach	EB	WB	NB	SB
Opposing Approach	WB	EB	SB	NB
Opposing Lanes	2	2	1	1
Conflicting Approach Left	SB	NB	EB	WB
Conflicting Lanes Left	1	1	2	2
Conflicting Approach Right	NB	SB	WB	EB
Conflicting Lanes Right	1	1	2	2
HCM Control Delay	9.5	9.2	8.5	9.3
HCM LOS	A	A	A	A

Lane	NBLn1	EBLn1	EBLn2	WBLn1	WBLn2	SBLn1
Vol Left, %	5%	100%	0%	100%	0%	41%
Vol Thru, %	49%	0%	94%	0%	74%	34%
Vol Right, %	46%	0%	6%	0%	26%	25%
Sign Control	Stop	Stop	Stop	Stop	Stop	Stop
Traffic Vol by Lane	82	56	124	14	89	133
LT Vol	4	56	0	14	0	55
Through Vol	40	0	116	0	66	45
RT Vol	38	0	8	0	23	33
Lane Flow Rate	89	61	135	15	97	145
Geometry Grp	2	7	7	7	7	2
Degree of Util (X)	0.118	0.1	0.202	0.026	0.147	0.2
Departure Headway (Hd)	4.767	5.939	5.39	6.156	5.47	4.973
Convergence, Y/N	Yes	Yes	Yes	Yes	Yes	Yes
Cap	749	602	663	580	653	720
Service Time	2.817	3.692	3.142	3.914	3.227	3.017
HCM Lane V/C Ratio	0.119	0.101	0.204	0.026	0.149	0.201
HCM Control Delay	8.5	9.4	9.5	9.1	9.2	9.3
HCM Lane LOS	A	A	A	A	A	A
HCM 95th-tile Q	0.4	0.3	0.8	0.1	0.5	0.7

Intersection												
Int Delay, s/veh	9											
Movement	EBL	EBT	EBR	WBL	WBT	WBR	NBL	NBT	NBR	SBL	SBT	SBR
Lane Configurations	↖	↗	↖	↖	↗	↖	↖	↗	↖		↔	
Traffic Vol, veh/h	7	180	25	81	37	85	20	27	152	120	25	7
Future Vol, veh/h	7	180	25	81	37	85	20	27	152	120	25	7
Conflicting Peds, #/hr	0	0	0	0	0	0	0	0	0	0	0	0
Sign Control	Free	Free	Free	Free	Free	Free	Stop	Stop	Stop	Stop	Stop	Stop
RT Channelized	-	-	None	-	-	None	-	-	None	-	-	None
Storage Length	85	-	0	70	-	105	60	-	50	-	-	-
Veh in Median Storage, #	-	0	-	-	0	-	-	0	-	-	0	-
Grade, %	-	0	-	-	0	-	-	0	-	-	0	-
Peak Hour Factor	89	89	89	89	89	89	89	89	89	89	89	89
Heavy Vehicles, %	2	2	2	5	5	5	5	5	5	3	3	3
Mvmt Flow	8	202	28	91	42	96	22	30	171	135	28	8

Major/Minor	Major1			Major2			Minor1			Minor2		
Conflicting Flow All	138	0	0	230	0	0	508	538	202	557	470	42
Stage 1	-	-	-	-	-	-	218	218	-	224	224	-
Stage 2	-	-	-	-	-	-	290	320	-	333	246	-
Critical Hdwy	4.12	-	-	4.15	-	-	7.15	6.55	6.25	7.13	6.53	6.23
Critical Hdwy Stg 1	-	-	-	-	-	-	6.15	5.55	-	6.13	5.53	-
Critical Hdwy Stg 2	-	-	-	-	-	-	6.15	5.55	-	6.13	5.53	-
Follow-up Hdwy	2.218	-	-	2.245	-	-	3.545	4.045	3.345	3.527	4.027	3.327
Pot Cap-1 Maneuver	1446	-	-	1320	-	-	471	446	831	439	490	1026
Stage 1	-	-	-	-	-	-	778	717	-	776	716	-
Stage 2	-	-	-	-	-	-	711	647	-	679	701	-
Platoon blocked, %	-	-	-	-	-	-	-	-	-	-	-	-
Mov Cap-1 Maneuver	1446	-	-	1320	-	-	420	413	831	311	453	1026
Mov Cap-2 Maneuver	-	-	-	-	-	-	420	413	-	311	453	-
Stage 1	-	-	-	-	-	-	773	713	-	771	667	-
Stage 2	-	-	-	-	-	-	629	602	-	514	697	-

Approach	EB			WB			NB			SB		
HCM Control Delay, s	0.2			3.2			11.3			25.9		
HCM LOS							B			D		

Minor Lane/Major Mvmt	NBLn1	NBLn2	NBLn3	EBL	EBT	EBR	WBL	WBT	WBR	SBLn1
Capacity (veh/h)	420	413	831	1446	-	-	1320	-	-	339
HCM Lane V/C Ratio	0.054	0.073	0.206	0.005	-	-	0.069	-	-	0.504
HCM Control Delay (s)	14.1	14.4	10.4	7.5	-	-	7.9	-	-	25.9
HCM Lane LOS	B	B	B	A	-	-	A	-	-	D
HCM 95th %tile Q(veh)	0.2	0.2	0.8	0	-	-	0.2	-	-	2.7

Intersection						
Int Delay, s/veh	4.1					
Movement	EBL	EBT	WBT	WBR	SBL	SBR
Lane Configurations		↑	↑		↑	↑
Traffic Vol, veh/h	0	459	157	0	153	43
Future Vol, veh/h	0	459	157	0	153	43
Conflicting Peds, #/hr	0	0	0	0	0	0
Sign Control	Free	Free	Free	Free	Stop	Stop
RT Channelized	-	None	-	None	-	None
Storage Length	-	-	-	-	0	610
Veh in Median Storage, #	-	0	0	-	0	-
Grade, %	-	0	0	-	0	-
Peak Hour Factor	92	92	92	92	92	92
Heavy Vehicles, %	4	4	8	8	5	5
Mvmt Flow	0	499	171	0	166	47
Major/Minor	Major1	Major2	Minor2			
Conflicting Flow All	-	0	-	0	670	171
Stage 1	-	-	-	-	171	-
Stage 2	-	-	-	-	499	-
Critical Hdwy	-	-	-	-	6.45	6.25
Critical Hdwy Stg 1	-	-	-	-	5.45	-
Critical Hdwy Stg 2	-	-	-	-	5.45	-
Follow-up Hdwy	-	-	-	-	3.545	3.345
Pot Cap-1 Maneuver	0	-	-	0	418	865
Stage 1	0	-	-	0	852	-
Stage 2	0	-	-	0	604	-
Platoon blocked, %	-	-	-	-	-	-
Mov Cap-1 Maneuver	-	-	-	-	418	865
Mov Cap-2 Maneuver	-	-	-	-	418	-
Stage 1	-	-	-	-	852	-
Stage 2	-	-	-	-	604	-
Approach	EB	WB	SB			
HCM Control Delay, s	0	0	17			
HCM LOS						C
Minor Lane/Major Mvmt	EBT	WBT	SBLn1	SBLn2		
Capacity (veh/h)	-	-	418	865		
HCM Lane V/C Ratio	-	-	0.398	0.054		
HCM Control Delay (s)	-	-	19.2	9.4		
HCM Lane LOS	-	-	C	A		
HCM 95th %tile Q(veh)	-	-	1.9	0.2		

HCM 6th TWSC
15: SR-99 Northbound Ramps & Avenue 17

Village D Specific Plan
Existing NP - PM Peak Hour

Intersection												
Int Delay, s/veh	2.3											
Movement	EBL	EBT	EBR	WBL	WBT	WBR	NBL	NBT	NBR	SBL	SBT	SBR
Lane Configurations	↖	↑			↗			↖	↗			
Traffic Vol, veh/h	64	389	0	0	270	66	66	1	0	0	0	0
Future Vol, veh/h	64	389	0	0	270	66	66	1	0	0	0	0
Conflicting Peds, #/hr	0	0	0	0	0	0	0	0	0	0	0	0
Sign Control	Free	Free	Free	Free	Free	Free	Stop	Stop	Stop	Free	Free	Free
RT Channelized	-	-	None	-	-	None	-	-	None	-	-	None
Storage Length	125	-	-	-	-	-	-	-	50	-	-	-
Veh in Median Storage, #	-	0	-	-	0	-	-	0	-	-	16965	-
Grade, %	-	0	-	-	0	-	-	0	-	-	0	-
Peak Hour Factor	95	95	95	95	95	95	95	95	95	95	95	95
Heavy Vehicles, %	4	4	4	4	4	4	10	10	10	0	0	0
Mvmt Flow	67	409	0	0	284	69	69	1	0	0	0	0

Major/Minor	Major1	Major2	Minor1
Conflicting Flow All	353	0	0
Stage 1	-	-	543
Stage 2	-	-	319
Critical Hdwy	4.14	-	6.5
Critical Hdwy Stg 1	-	-	5.5
Critical Hdwy Stg 2	-	-	5.5
Follow-up Hdwy	2.236	-	3.59
Pot Cap-1 Maneuver	1195	0	315
Stage 1	-	0	567
Stage 2	-	0	719
Platoon blocked, %	-	-	-
Mov Cap-1 Maneuver	1195	-	297
Mov Cap-2 Maneuver	-	-	297
Stage 1	-	-	535
Stage 2	-	-	719

Approach	EB	WB	NB
HCM Control Delay, s	1.2	0	20.9
HCM LOS			C

Minor Lane/Major Mvmt	NBLn1	NBLn2	EBL	EBT	WBT	WBR
Capacity (veh/h)	297	-	1195	-	-	-
HCM Lane V/C Ratio	0.237	-	0.056	-	-	-
HCM Control Delay (s)	20.9	0	8.2	-	-	-
HCM Lane LOS	C	A	A	-	-	-
HCM 95th %tile Q(veh)	0.9	-	0.2	-	-	-

Intersection												
Int Delay, s/veh	3.7											
Movement	EBL	EBT	EBR	WBL	WBT	WBR	NBL	NBT	NBR	SBL	SBT	SBR
Lane Configurations	↖	↗		↖	↗		↖	↑	↗	↖	↑	↗
Traffic Vol, veh/h	23	122	9	27	62	11	4	6	34	13	20	8
Future Vol, veh/h	23	122	9	27	62	11	4	6	34	13	20	8
Conflicting Peds, #/hr	0	0	3	3	0	0	0	0	0	0	0	0
Sign Control	Free	Free	Free	Free	Free	Free	Stop	Stop	Stop	Stop	Stop	Stop
RT Channelized	-	-	None	-	-	None	-	-	None	-	-	None
Storage Length	110	-	-	165	-	-	65	-	50	100	-	50
Veh in Median Storage, #	-	0	-	-	0	-	-	0	-	-	0	-
Grade, %	-	0	-	-	0	-	-	0	-	-	0	-
Peak Hour Factor	84	84	84	84	84	84	84	84	84	84	84	84
Heavy Vehicles, %	1	1	1	1	1	1	0	0	0	0	0	0
Mvmt Flow	27	145	11	32	74	13	5	7	40	15	24	10

Major/Minor	Major1			Major2			Minor1			Minor2		
Conflicting Flow All	87	0	0	159	0	0	370	359	154	373	358	81
Stage 1	-	-	-	-	-	-	208	208	-	145	145	-
Stage 2	-	-	-	-	-	-	162	151	-	228	213	-
Critical Hdwy	4.11	-	-	4.11	-	-	7.1	6.5	6.2	7.1	6.5	6.2
Critical Hdwy Stg 1	-	-	-	-	-	-	6.1	5.5	-	6.1	5.5	-
Critical Hdwy Stg 2	-	-	-	-	-	-	6.1	5.5	-	6.1	5.5	-
Follow-up Hdwy	2.209	-	-	2.209	-	-	3.5	4	3.3	3.5	4	3.3
Pot Cap-1 Maneuver	1515	-	-	1427	-	-	590	571	897	588	572	985
Stage 1	-	-	-	-	-	-	799	734	-	863	781	-
Stage 2	-	-	-	-	-	-	845	776	-	779	730	-
Platoon blocked, %	-	-	-	-	-	-	-	-	-	-	-	-
Mov Cap-1 Maneuver	1515	-	-	1423	-	-	546	547	894	539	548	985
Mov Cap-2 Maneuver	-	-	-	-	-	-	546	547	-	539	548	-
Stage 1	-	-	-	-	-	-	782	719	-	847	764	-
Stage 2	-	-	-	-	-	-	793	759	-	723	715	-

Approach	EB			WB			NB			SB		
HCM Control Delay, s	1.1			2			9.8			11.3		
HCM LOS							A			B		

Minor Lane/Major Mvmt	NBLn1	NBLn2	NBLn3	EBL	EBT	EBR	WBL	WBT	WBR	SBLn1	SBLn2	SBLn3
Capacity (veh/h)	546	547	894	1515	-	-	1423	-	-	539	548	985
HCM Lane V/C Ratio	0.009	0.013	0.045	0.018	-	-	0.023	-	-	0.029	0.043	0.01
HCM Control Delay (s)	11.7	11.7	9.2	7.4	-	-	7.6	-	-	11.9	11.9	8.7
HCM Lane LOS	B	B	A	A	-	-	A	-	-	B	B	A
HCM 95th %tile Q(veh)	0	0	0.1	0.1	-	-	0.1	-	-	0.1	0.1	0

Intersection	
Intersection Delay, s/veh	9.2
Intersection LOS	A

Movement	EBL	EBT	EBR	WBL	WBT	WBR	NBL	NBT	NBR	SBL	SBT	SBR
Lane Configurations	↙	↘		↙	↘		↙	↘	↘	↙	↘	↘
Traffic Vol, veh/h	6	55	23	64	74	16	43	108	55	16	95	13
Future Vol, veh/h	6	55	23	64	74	16	43	108	55	16	95	13
Peak Hour Factor	0.96	0.96	0.96	0.96	0.96	0.96	0.96	0.96	0.96	0.96	0.96	0.96
Heavy Vehicles, %	0	0	0	0	0	0	0	0	0	0	0	0
Mvmt Flow	6	57	24	67	77	17	45	113	57	17	99	14
Number of Lanes	1	1	0	1	1	0	1	1	1	1	1	1

Approach	EB	WB	NB	SB
Opposing Approach	WB	EB	SB	NB
Opposing Lanes	2	2	3	3
Conflicting Approach Left	SB	NB	EB	WB
Conflicting Lanes Left	3	3	2	2
Conflicting Approach Right	NB	SB	WB	EB
Conflicting Lanes Right	3	3	2	2
HCM Control Delay	9.2	9.4	9.1	9.3
HCM LOS	A	A	A	A

Lane	NBLn1	NBLn2	NBLn3	EBLn1	EBLn2	WBLn1	WBLn2	SBLn1	SBLn2	SBLn3
Vol Left, %	100%	0%	0%	100%	0%	100%	0%	100%	0%	0%
Vol Thru, %	0%	100%	0%	0%	71%	0%	82%	0%	100%	0%
Vol Right, %	0%	0%	100%	0%	29%	0%	18%	0%	0%	100%
Sign Control	Stop	Stop	Stop	Stop	Stop	Stop	Stop	Stop	Stop	Stop
Traffic Vol by Lane	43	108	55	6	78	64	90	16	95	13
LT Vol	43	0	0	6	0	64	0	16	0	0
Through Vol	0	108	0	0	55	0	74	0	95	0
RT Vol	0	0	55	0	23	0	16	0	0	13
Lane Flow Rate	45	112	57	6	81	67	94	17	99	14
Geometry Grp	8	8	8	8	8	8	8	8	8	8
Degree of Util (X)	0.075	0.173	0.077	0.011	0.125	0.113	0.143	0.029	0.156	0.019
Departure Headway (Hd)	6.03	5.527	4.822	6.267	5.56	6.103	5.479	6.186	5.682	4.977
Convergence, Y/N	Yes	Yes	Yes	Yes	Yes	Yes	Yes	Yes	Yes	Yes
Cap	590	644	735	566	638	583	649	574	625	711
Service Time	3.811	3.307	2.602	4.063	3.356	3.889	3.265	3.977	3.473	2.767
HCM Lane V/C Ratio	0.076	0.174	0.078	0.011	0.127	0.115	0.145	0.03	0.158	0.02
HCM Control Delay	9.3	9.5	8	9.1	9.2	9.7	9.2	9.2	9.5	7.9
HCM Lane LOS	A	A	A	A	A	A	A	A	A	A
HCM 95th-tile Q	0.2	0.6	0.2	0	0.4	0.4	0.5	0.1	0.5	0.1

Intersection												
Intersection Delay, s/veh	12.5											
Intersection LOS	B											

Movement	EBL	EBT	EBR	WBL	WBT	WBR	NBL	NBT	NBR	SBL	SBT	SBR
Lane Configurations		↕			↕			↕			↕	
Traffic Vol, veh/h	49	251	33	22	116	130	14	41	16	88	42	37
Future Vol, veh/h	49	251	33	22	116	130	14	41	16	88	42	37
Peak Hour Factor	0.89	0.89	0.89	0.89	0.89	0.89	0.89	0.89	0.89	0.89	0.89	0.89
Heavy Vehicles, %	6	6	6	6	6	6	0	0	0	0	0	0
Mvmt Flow	55	282	37	25	130	146	16	46	18	99	47	42
Number of Lanes	0	1	0	0	1	0	0	1	0	0	1	0

Approach	EB	WB	NB	SB
Opposing Approach	WB	EB	SB	NB
Opposing Lanes	1	1	1	1
Conflicting Approach Left	SB	NB	EB	WB
Conflicting Lanes Left	1	1	1	1
Conflicting Approach Right	NB	SB	WB	EB
Conflicting Lanes Right	1	1	1	1
HCM Control Delay	14.2	11.8	9.9	11.3
HCM LOS	B	B	A	B

Lane	NBLn1	EBLn1	WBLn1	SBLn1
Vol Left, %	20%	15%	8%	53%
Vol Thru, %	58%	75%	43%	25%
Vol Right, %	23%	10%	49%	22%
Sign Control	Stop	Stop	Stop	Stop
Traffic Vol by Lane	71	333	268	167
LT Vol	14	49	22	88
Through Vol	41	251	116	42
RT Vol	16	33	130	37
Lane Flow Rate	80	374	301	188
Geometry Grp	1	1	1	1
Degree of Util (X)	0.131	0.541	0.425	0.3
Departure Headway (Hd)	5.92	5.203	5.076	5.75
Convergence, Y/N	Yes	Yes	Yes	Yes
Cap	603	692	708	623
Service Time	3.979	3.24	3.115	3.8
HCM Lane V/C Ratio	0.133	0.54	0.425	0.302
HCM Control Delay	9.9	14.2	11.8	11.3
HCM Lane LOS	A	B	B	B
HCM 95th-tile Q	0.4	3.3	2.1	1.3

Intersection												
Intersection Delay, s/veh	8.8											
Intersection LOS	A											

Movement	EBL	EBT	EBR	WBL	WBT	WBR	NBL	NBT	NBR	SBL	SBT	SBR
Lane Configurations		↕			↕	↕		↕	↕		↕	↕
Traffic Vol, veh/h	0	0	0	24	0	64	0	7	34	140	14	0
Future Vol, veh/h	0	0	0	24	0	64	0	7	34	140	14	0
Peak Hour Factor	0.85	0.85	0.85	0.85	0.85	0.85	0.85	0.85	0.85	0.85	0.85	0.85
Heavy Vehicles, %	0	0	0	2	2	2	0	0	0	0	0	0
Mvmt Flow	0	0	0	28	0	75	0	8	40	165	16	0
Number of Lanes	0	1	0	0	1	1	0	1	1	0	1	1

Approach	EB	WB	NB	SB
Opposing Approach	WB	EB	SB	NB
Opposing Lanes	2	1	2	2
Conflicting Approach Left	SB	NB	EB	WB
Conflicting Lanes Left	2	2	1	2
Conflicting Approach Right	NB	SB	WB	EB
Conflicting Lanes Right	2	2	2	1
HCM Control Delay	0	7.9	7.2	9.8
HCM LOS	-	A	A	A

Lane	NBLn1	NBLn2	EBLn1	WBLn1	WBLn2	SBLn1	SBLn2
Vol Left, %	0%	0%	0%	100%	0%	91%	0%
Vol Thru, %	100%	0%	100%	0%	0%	9%	100%
Vol Right, %	0%	100%	0%	0%	100%	0%	0%
Sign Control	Stop	Stop	Stop	Stop	Stop	Stop	Stop
Traffic Vol by Lane	7	34	0	24	64	154	0
LT Vol	0	0	0	24	0	140	0
Through Vol	7	0	0	0	0	14	0
RT Vol	0	34	0	0	64	0	0
Lane Flow Rate	8	40	0	28	75	181	0
Geometry Grp	7	7	6	7	7	7	7
Degree of Util (X)	0.011	0.047	0	0.044	0.093	0.26	0
Departure Headway (Hd)	4.916	4.213	5.233	5.637	4.433	5.16	4.705
Convergence, Y/N	Yes	Yes	Yes	Yes	Yes	Yes	Yes
Cap	730	853	0	639	812	687	0
Service Time	2.629	1.925	3.243	3.341	2.136	2.957	2.501
HCM Lane V/C Ratio	0.011	0.047	0	0.044	0.092	0.263	0
HCM Control Delay	7.7	7.1	8.2	8.6	7.6	9.8	7.5
HCM Lane LOS	A	A	N	A	A	A	N
HCM 95th-tile Q	0	0.1	0	0.1	0.3	1	0

Intersection	
Intersection Delay, s/veh	19.3
Intersection LOS	C

Movement	EBL	EBT	EBR	WBL	WBT	WBR	NBL	NBT	NBR	SBL	SBT	SBR
Lane Configurations	↙	↕↔		↙	↕↔		↙	↕	↙	↙	↕	↙
Traffic Vol, veh/h	13	108	19	320	113	20	14	189	229	19	231	21
Future Vol, veh/h	13	108	19	320	113	20	14	189	229	19	231	21
Peak Hour Factor	0.94	0.94	0.94	0.94	0.94	0.94	0.94	0.94	0.94	0.94	0.94	0.94
Heavy Vehicles, %	1	1	1	1	1	1	0	0	0	0	0	0
Mvmt Flow	14	115	20	340	120	21	15	201	244	20	246	22
Number of Lanes	1	2	0	1	2	0	1	1	1	1	1	1

Approach	EB	WB	NB	SB
Opposing Approach	WB	EB	SB	NB
Opposing Lanes	3	3	3	3
Conflicting Approach Left	SB	NB	EB	WB
Conflicting Lanes Left	3	3	3	3
Conflicting Approach Right	NB	SB	WB	EB
Conflicting Lanes Right	3	3	3	3
HCM Control Delay	12.5	25.5	15.6	18.4
HCM LOS	B	D	C	C

Lane	NBLn1	NBLn2	NBLn3	EBLn1	EBLn2	EBLn3	WBLn1	WBLn2	WBLn3	SBLn1	SBLn2
Vol Left, %	100%	0%	0%	100%	0%	0%	100%	0%	0%	100%	0%
Vol Thru, %	0%	100%	0%	0%	100%	65%	0%	100%	65%	0%	100%
Vol Right, %	0%	0%	100%	0%	0%	35%	0%	0%	35%	0%	0%
Sign Control	Stop	Stop	Stop	Stop	Stop	Stop	Stop	Stop	Stop	Stop	Stop
Traffic Vol by Lane	14	189	229	13	72	55	320	75	58	19	231
LT Vol	14	0	0	13	0	0	320	0	0	19	0
Through Vol	0	189	0	0	72	36	0	75	38	0	231
RT Vol	0	0	229	0	0	19	0	0	20	0	0
Lane Flow Rate	15	201	244	14	77	59	340	80	61	20	246
Geometry Grp	8	8	8	8	8	8	8	8	8	8	8
Degree of Util (X)	0.034	0.425	0.468	0.034	0.178	0.132	0.754	0.166	0.123	0.047	0.541
Departure Headway (Hd)	8.116	7.616	6.916	8.864	8.364	8.122	7.969	7.469	7.226	8.42	7.92
Convergence, Y/N	Yes	Yes	Yes	Yes	Yes	Yes	Yes	Yes	Yes	Yes	Yes
Cap	441	472	519	403	428	441	453	480	495	425	455
Service Time	5.872	5.372	4.672	6.634	6.134	5.892	5.723	5.223	4.981	6.18	5.68
HCM Lane V/C Ratio	0.034	0.426	0.47	0.035	0.18	0.134	0.751	0.167	0.123	0.047	0.541
HCM Control Delay	11.2	15.9	15.7	11.9	13	12.1	31.4	11.7	11	11.6	19.7
HCM Lane LOS	B	C	C	B	B	B	D	B	B	B	C
HCM 95th-tile Q	0.1	2.1	2.5	0.1	0.6	0.5	6.3	0.6	0.4	0.1	3.2

Intersection												
Intersection Delay, s/veh	23.4											
Intersection LOS	C											

Movement	EBL	EBT	EBR	WBL	WBT	WBR	NBL	NBT	NBR	SBL	SBT	SBR
Lane Configurations	↔	↔		↔	↔	↔	↔	↔		↔	↔	
Traffic Vol, veh/h	28	115	34	54	153	108	46	262	42	76	293	32
Future Vol, veh/h	28	115	34	54	153	108	46	262	42	76	293	32
Peak Hour Factor	0.93	0.93	0.93	0.93	0.93	0.93	0.93	0.93	0.93	0.93	0.93	0.93
Heavy Vehicles, %	1	1	1	0	0	0	1	1	1	1	1	1
Mvmt Flow	30	124	37	58	165	116	49	282	45	82	315	34
Number of Lanes	1	1	0	1	1	1	1	1	0	1	1	0

Approach	EB	WB	NB	SB
Opposing Approach	WB	EB	SB	NB
Opposing Lanes	3	2	2	2
Conflicting Approach Left	SB	NB	EB	WB
Conflicting Lanes Left	2	2	2	3
Conflicting Approach Right	NB	SB	WB	EB
Conflicting Lanes Right	2	2	3	2
HCM Control Delay	16.6	14.8	27.7	29.3
HCM LOS	C	B	D	D

Lane	NBLn1	NBLn2	EBLn1	EBLn2	WBLn1	WBLn2	WBLn3	SBLn1	SBLn2
Vol Left, %	100%	0%	100%	0%	100%	0%	0%	100%	0%
Vol Thru, %	0%	86%	0%	77%	0%	100%	0%	0%	90%
Vol Right, %	0%	14%	0%	23%	0%	0%	100%	0%	10%
Sign Control	Stop	Stop	Stop	Stop	Stop	Stop	Stop	Stop	Stop
Traffic Vol by Lane	46	304	28	149	54	153	108	76	325
LT Vol	46	0	28	0	54	0	0	76	0
Through Vol	0	262	0	115	0	153	0	0	293
RT Vol	0	42	0	34	0	0	108	0	32
Lane Flow Rate	49	327	30	160	58	165	116	82	349
Geometry Grp	8	8	8	8	8	8	8	8	8
Degree of Util (X)	0.119	0.733	0.079	0.392	0.146	0.389	0.251	0.194	0.773
Departure Headway (Hd)	8.683	8.072	9.495	8.808	9.028	8.512	7.789	8.544	7.962
Convergence, Y/N	Yes	Yes	Yes	Yes	Yes	Yes	Yes	Yes	Yes
Cap	413	448	378	409	397	423	461	420	454
Service Time	6.429	5.818	7.249	6.562	6.778	6.262	5.538	6.29	5.708
HCM Lane V/C Ratio	0.119	0.73	0.079	0.391	0.146	0.39	0.252	0.195	0.769
HCM Control Delay	12.6	30	13.1	17.2	13.3	16.6	13.1	13.3	33.1
HCM Lane LOS	B	D	B	C	B	C	B	B	D
HCM 95th-tile Q	0.4	5.9	0.3	1.8	0.5	1.8	1	0.7	6.7

HCM 6th Signalized Intersection Summary
 23: Avenue 16/Ellis Street & Kennedy Street

Village D Specific Plan
 Existing NP - PM Peak Hour



Movement	WBL	WBR	NBT	NBR	SBL	SBT
Lane Configurations						
Traffic Volume (veh/h)	96	211	150	127	181	174
Future Volume (veh/h)	96	211	150	127	181	174
Initial Q (Qb), veh	0	0	0	0	0	0
Ped-Bike Adj(A_pbT)	1.00	1.00		1.00	1.00	
Parking Bus, Adj	1.00	1.00	1.00	1.00	1.00	1.00
Work Zone On Approach	No		No		No	
Adj Sat Flow, veh/h/ln	1870	1870	1885	1885	1885	1885
Adj Flow Rate, veh/h	107	234	167	141	201	193
Peak Hour Factor	0.90	0.90	0.90	0.90	0.90	0.90
Percent Heavy Veh, %	2	2	1	1	1	1
Cap, veh/h	211	331	1095	866	246	2754
Arrive On Green	0.12	0.12	0.58	0.58	0.14	0.77
Sat Flow, veh/h	1781	2790	1996	1504	1795	3676
Grp Volume(v), veh/h	107	234	157	151	201	193
Grp Sat Flow(s),veh/h/ln	1781	1395	1791	1614	1795	1791
Q Serve(g_s), s	4.5	6.5	3.3	3.5	8.7	1.1
Cycle Q Clear(g_c), s	4.5	6.5	3.3	3.5	8.7	1.1
Prop In Lane	1.00	1.00		0.93	1.00	
Lane Grp Cap(c), veh/h	211	331	1031	929	246	2754
V/C Ratio(X)	0.51	0.71	0.15	0.16	0.82	0.07
Avail Cap(c_a), veh/h	501	785	1031	929	460	2754
HCM Platoon Ratio	1.00	1.00	1.00	1.00	1.00	1.00
Upstream Filter(I)	0.90	0.90	1.00	1.00	1.00	1.00
Uniform Delay (d), s/veh	33.1	33.9	7.9	7.9	33.6	2.3
Incr Delay (d2), s/veh	1.7	2.5	0.3	0.4	6.6	0.0
Initial Q Delay(d3),s/veh	0.0	0.0	0.0	0.0	0.0	0.0
%ile BackOfQ(50%),veh/ln	2.0	2.2	1.2	1.2	4.1	0.2
Unsig. Movement Delay, s/veh						
LnGrp Delay(d),s/veh	34.7	36.4	8.2	8.3	40.1	2.3
LnGrp LOS	C	D	A	A	D	A
Approach Vol, veh/h	341		308			394
Approach Delay, s/veh	35.9		8.3			21.6
Approach LOS	D		A			C
Timer - Assigned Phs	1	2			6	8
Phs Duration (G+Y+Rc), s	15.5	50.6			66.0	14.0
Change Period (Y+Rc), s	4.5	4.5			4.5	4.5
Max Green Setting (Gmax), s	20.5	23.5			48.5	22.5
Max Q Clear Time (g_c+10), s	11.0	5.5			3.1	8.5
Green Ext Time (p_c), s	0.4	1.7			1.3	1.0
Intersection Summary						
HCM 6th Ctrl Delay			22.3			
HCM 6th LOS			C			

HCM 6th Signalized Intersection Summary
 24: Schnoor Avenue & Kennedy Street

Village D Specific Plan
 Existing NP - PM Peak Hour



Movement	EBL	EBT	EBR	WBL	WBT	WBR	NBL	NBT	NBR	SBL	SBT	SBR
Lane Configurations	↖	↗		↖	↗		↖	↗		↖	↗	↖
Traffic Volume (veh/h)	9	113	163	179	132	17	192	13	207	23	14	8
Future Volume (veh/h)	9	113	163	179	132	17	192	13	207	23	14	8
Initial Q (Qb), veh	0	0	0	0	0	0	0	0	0	0	0	0
Ped-Bike Adj(A_pbT)	1.00		0.99	1.00		0.98	1.00		1.00	1.00		1.00
Parking Bus, Adj	1.00	1.00	1.00	1.00	1.00	1.00	1.00	1.00	1.00	1.00	1.00	1.00
Work Zone On Approach		No		No		No		No		No		No
Adj Sat Flow, veh/h/ln	1870	1870	1870	1856	1856	1856	1885	1885	1885	1633	1633	1633
Adj Flow Rate, veh/h	10	120	173	190	140	18	204	14	220	24	15	9
Peak Hour Factor	0.94	0.94	0.94	0.94	0.94	0.94	0.94	0.94	0.94	0.94	0.94	0.94
Percent Heavy Veh, %	2	2	2	3	3	3	1	1	1	18	18	18
Cap, veh/h	273	269	238	231	208	27	888	26	405	350	388	328
Arrive On Green	0.15	0.15	0.15	0.13	0.13	0.13	0.26	0.27	0.27	0.23	0.24	0.24
Sat Flow, veh/h	1781	1777	1569	1767	1607	207	3483	96	1514	1555	1633	1382
Grp Volume(v), veh/h	10	120	173	190	0	158	204	0	234	24	15	9
Grp Sat Flow(s),veh/h/ln	1781	1777	1569	1767	0	1814	1742	0	1611	1555	1633	1382
Q Serve(g_s), s	0.4	4.9	8.4	8.4	0.0	6.6	3.7	0.0	10.0	1.0	0.6	0.4
Cycle Q Clear(g_c), s	0.4	4.9	8.4	8.4	0.0	6.6	3.7	0.0	10.0	1.0	0.6	0.4
Prop In Lane	1.00		1.00	1.00		0.11	1.00		0.94	1.00		1.00
Lane Grp Cap(c), veh/h	273	269	238	231	0	235	888	0	431	350	388	328
V/C Ratio(X)	0.04	0.45	0.73	0.82	0.00	0.67	0.23	0.00	0.54	0.07	0.04	0.03
Avail Cap(c_a), veh/h	273	400	353	364	0	669	888	0	431	350	388	328
HCM Platoon Ratio	1.00	1.00	1.00	1.00	1.00	1.00	1.00	1.00	1.00	1.00	1.00	1.00
Upstream Filter(I)	0.73	0.73	0.73	1.00	0.00	1.00	1.00	0.00	1.00	1.00	1.00	1.00
Uniform Delay (d), s/veh	28.9	30.9	32.4	33.8	0.0	33.2	23.6	0.0	25.1	24.4	23.5	23.4
Incr Delay (d2), s/veh	0.0	0.8	3.1	8.1	0.0	3.3	0.1	0.0	4.9	0.1	0.2	0.2
Initial Q Delay(d3),s/veh	0.0	0.0	0.0	0.0	0.0	0.0	0.0	0.0	0.0	0.0	0.0	0.0
%ile BackOfQ(50%),veh/ln	0.2	2.1	3.3	4.0	0.0	3.1	1.5	0.0	4.2	0.4	0.2	0.1
Unsig. Movement Delay, s/veh												
LnGrp Delay(d),s/veh	28.9	31.7	35.5	41.9	0.0	36.5	23.7	0.0	30.0	24.5	23.7	23.6
LnGrp LOS	C	C	D	D	A	D	C	A	C	C	C	C
Approach Vol, veh/h		303			348			438			48	
Approach Delay, s/veh		33.8			39.5			27.1			24.1	
Approach LOS		C			D			C			C	
Timer - Assigned Phs	1	2	3	4	5	6	7	8				
Phs Duration (G+Y+Rc), s	22.5	25.9	15.0	16.6	24.9	23.5	16.7	14.9				
Change Period (Y+Rc), s	4.5	4.5	4.5	4.5	4.5	4.5	4.5	4.5				
Max Green Setting (Gmax), s	15	21.4	16.5	18.0	8.5	19.0	5.0	29.5				
Max Q Clear Time (g_c+1), s	13	12.0	10.4	10.4	5.7	2.6	2.4	8.6				
Green Ext Time (p_c), s	0	0.0	0.9	0.3	1.0	0.2	0.0	0.8				
Intersection Summary												
HCM 6th Ctrl Delay				32.5								
HCM 6th LOS				C								

Intersection						
Int Delay, s/veh	7.2					
Movement	EBL	EBT	WBT	WBR	SBL	SBR
Lane Configurations	↘	↑	↗		↘	↗
Traffic Vol, veh/h	102	313	252	1	128	158
Future Vol, veh/h	102	313	252	1	128	158
Conflicting Peds, #/hr	0	0	0	0	0	0
Sign Control	Free	Free	Free	Free	Stop	Stop
RT Channelized	-	None	-	Free	-	None
Storage Length	140	-	-	-	0	335
Veh in Median Storage, #	-	0	0	-	0	-
Grade, %	-	0	0	-	0	-
Peak Hour Factor	85	85	85	85	85	85
Heavy Vehicles, %	3	3	3	3	4	4
Mvmt Flow	120	368	296	1	151	186

Major/Minor	Major1	Major2	Minor2		
Conflicting Flow All	296	0	-	0	904
Stage 1	-	-	-	-	296
Stage 2	-	-	-	-	608
Critical Hdwy	4.13	-	-	-	6.44
Critical Hdwy Stg 1	-	-	-	-	5.44
Critical Hdwy Stg 2	-	-	-	-	5.44
Follow-up Hdwy	2.227	-	-	-	3.536
Pot Cap-1 Maneuver	1260	-	-	0	305
Stage 1	-	-	-	0	750
Stage 2	-	-	-	0	540
Platoon blocked, %		-	-		
Mov Cap-1 Maneuver	1260	-	-	-	276
Mov Cap-2 Maneuver	-	-	-	-	276
Stage 1	-	-	-	-	679
Stage 2	-	-	-	-	540

Approach	EB	WB	SB
HCM Control Delay, s	2	0	21
HCM LOS			C

Minor Lane/Major Mvmt	EBL	EBT	WBT	SBLn1	SBLn2
Capacity (veh/h)	1260	-	-	276	739
HCM Lane V/C Ratio	0.095	-	-	0.546	0.252
HCM Control Delay (s)	8.2	-	-	32.7	11.5
HCM Lane LOS	A	-	-	D	B
HCM 95th %tile Q(veh)	0.3	-	-	3	1

Intersection						
Int Delay, s/veh	3.6					
Movement	EBL	EBT	WBT	WBR	SBL	SBR
Lane Configurations		↕	↕		↕	
Traffic Vol, veh/h	153	288	118	0	0	135
Future Vol, veh/h	153	288	118	0	0	135
Conflicting Peds, #/hr	0	0	0	0	0	0
Sign Control	Free	Free	Free	Free	Stop	Stop
RT Channelized	-	None	-	None	-	None
Storage Length	-	-	-	-	0	-
Veh in Median Storage, #	-	0	0	-	0	-
Grade, %	-	0	0	-	0	-
Peak Hour Factor	82	82	82	82	82	82
Heavy Vehicles, %	3	3	2	2	4	4
Mvmt Flow	187	351	144	0	0	165

Major/Minor	Major1	Major2	Minor2		
Conflicting Flow All	144	0	-	0	869 144
Stage 1	-	-	-	-	144 -
Stage 2	-	-	-	-	725 -
Critical Hdwy	4.13	-	-	-	6.44 6.24
Critical Hdwy Stg 1	-	-	-	-	5.44 -
Critical Hdwy Stg 2	-	-	-	-	5.44 -
Follow-up Hdwy	2.227	-	-	-	3.536 3.336
Pot Cap-1 Maneuver	1432	-	-	-	320 898
Stage 1	-	-	-	-	878 -
Stage 2	-	-	-	-	476 -
Platoon blocked, %		-	-	-	
Mov Cap-1 Maneuver	1432	-	-	-	268 898
Mov Cap-2 Maneuver	-	-	-	-	268 -
Stage 1	-	-	-	-	736 -
Stage 2	-	-	-	-	476 -

Approach	EB	WB	SB
HCM Control Delay, s	2.7	0	9.9
HCM LOS			A

Minor Lane/Major Mvmt	EBL	EBT	WBT	WBR	SBLn1
Capacity (veh/h)	1432	-	-	-	898
HCM Lane V/C Ratio	0.13	-	-	-	0.183
HCM Control Delay (s)	7.9	0	-	-	9.9
HCM Lane LOS	A	A	-	-	A
HCM 95th %tile Q(veh)	0.4	-	-	-	0.7

Intersection						
Int Delay, s/veh	4.7					
Movement	EBL	EBR	NBL	NBT	SBT	SBR
Lane Configurations	↔			↑	↔	
Traffic Vol, veh/h	153	0	0	78	3	135
Future Vol, veh/h	153	0	0	78	3	135
Conflicting Peds, #/hr	0	0	0	0	0	0
Sign Control	Stop	Stop	Free	Free	Free	Free
RT Channelized	-	None	-	None	-	None
Storage Length	0	-	-	-	-	-
Veh in Median Storage, #	0	-	-	0	0	-
Grade, %	0	-	-	0	0	-
Peak Hour Factor	71	71	71	71	71	71
Heavy Vehicles, %	2	2	9	9	4	4
Mvmt Flow	215	0	0	110	4	190

Major/Minor	Minor2	Major1		Major2	
Conflicting Flow All	209	-	-	0	-
Stage 1	99	-	-	-	-
Stage 2	110	-	-	-	-
Critical Hdwy	6.42	-	-	-	-
Critical Hdwy Stg 1	5.42	-	-	-	-
Critical Hdwy Stg 2	5.42	-	-	-	-
Follow-up Hdwy	3.518	-	-	-	-
Pot Cap-1 Maneuver	779	0	0	-	-
Stage 1	925	0	0	-	-
Stage 2	915	0	0	-	-
Platoon blocked, %				-	-
Mov Cap-1 Maneuver	779	-	-	-	-
Mov Cap-2 Maneuver	779	-	-	-	-
Stage 1	925	-	-	-	-
Stage 2	915	-	-	-	-

Approach	EB	NB	SB
HCM Control Delay, s	11.4	0	0
HCM LOS	B		

Minor Lane/Major Mvmt	NBT EBLn1	SBT	SBR
Capacity (veh/h)	- 779	-	-
HCM Lane V/C Ratio	- 0.277	-	-
HCM Control Delay (s)	- 11.4	-	-
HCM Lane LOS	- B	-	-
HCM 95th %tile Q(veh)	- 1.1	-	-

Intersection						
Int Delay, s/veh	0.1					
Movement	EBL	EBT	WBT	WBR	SBL	SBR
Lane Configurations		↶	↷		↶	
Traffic Vol, veh/h	0	288	118	73	3	0
Future Vol, veh/h	0	288	118	73	3	0
Conflicting Peds, #/hr	0	0	0	0	0	0
Sign Control	Free	Free	Free	Free	Stop	Stop
RT Channelized	-	None	-	None	-	None
Storage Length	-	-	-	-	0	-
Veh in Median Storage, #	-	0	0	-	0	-
Grade, %	-	0	0	-	0	-
Peak Hour Factor	84	84	84	84	84	84
Heavy Vehicles, %	4	4	3	3	0	0
Mvmt Flow	0	343	140	87	4	0

Major/Minor	Major1	Major2	Minor2		
Conflicting Flow All	227	0	-	0	527 184
Stage 1	-	-	-	-	184 -
Stage 2	-	-	-	-	343 -
Critical Hdwy	4.14	-	-	-	6.4 6.2
Critical Hdwy Stg 1	-	-	-	-	5.4 -
Critical Hdwy Stg 2	-	-	-	-	5.4 -
Follow-up Hdwy	2.236	-	-	-	3.5 3.3
Pot Cap-1 Maneuver	1330	-	-	-	515 864
Stage 1	-	-	-	-	852 -
Stage 2	-	-	-	-	723 -
Platoon blocked, %		-	-	-	
Mov Cap-1 Maneuver	1330	-	-	-	515 864
Mov Cap-2 Maneuver	-	-	-	-	515 -
Stage 1	-	-	-	-	852 -
Stage 2	-	-	-	-	723 -

Approach	EB	WB	SB
HCM Control Delay, s	0	0	12
HCM LOS			B

Minor Lane/Major Mvmt	EBL	EBT	WBT	WBR	SBLn1
Capacity (veh/h)	1330	-	-	-	515
HCM Lane V/C Ratio	-	-	-	-	0.007
HCM Control Delay (s)	0	-	-	-	12
HCM Lane LOS	A	-	-	-	B
HCM 95th %tile Q(veh)	0	-	-	-	0

HCM 6th Signalized Intersection Summary
29: Schnoor Avenue & Cleveland Avenue

Village D Specific Plan
Existing NP - PM Peak Hour



Movement	EBL	EBT	EBR	WBL	WBT	WBR	NBL	NBT	NBR	SBL	SBT	SBR
Lane Configurations												
Traffic Volume (veh/h)	108	383	41	264	420	103	52	200	148	110	195	74
Future Volume (veh/h)	108	383	41	264	420	103	52	200	148	110	195	74
Initial Q (Qb), veh	0	0	0	0	0	0	0	0	0	0	0	0
Ped-Bike Adj(A_pbT)	1.00		0.97	1.00		0.97	1.00		0.98	1.00		1.00
Parking Bus, Adj	1.00	1.00	1.00	1.00	1.00	1.00	1.00	1.00	1.00	1.00	1.00	1.00
Work Zone On Approach		No			No			No			No	
Adj Sat Flow, veh/h/ln	1885	1885	1885	1885	1885	1885	1885	1885	1885	1885	1885	1885
Adj Flow Rate, veh/h	111	395	42	272	433	106	54	206	153	113	201	76
Peak Hour Factor	0.97	0.97	0.97	0.97	0.97	0.97	0.97	0.97	0.97	0.97	0.97	0.97
Percent Heavy Veh, %	1	1	1	1	1	1	1	1	1	1	1	1
Cap, veh/h	141	587	254	354	670	291	74	776	500	570	1766	784
Arrive On Green	0.08	0.16	0.16	0.10	0.19	0.19	0.04	0.22	0.22	0.32	0.49	0.49
Sat Flow, veh/h	1795	3582	1551	3483	3582	1555	1795	3582	1559	1795	3582	1590
Grp Volume(v), veh/h	111	395	42	272	433	106	54	206	153	113	201	76
Grp Sat Flow(s),veh/h/ln	1795	1791	1551	1742	1791	1555	1795	1791	1559	1795	1791	1590
Q Serve(g_s), s	5.5	9.3	1.7	6.8	10.1	2.6	2.7	4.3	0.0	4.1	2.7	2.3
Cycle Q Clear(g_c), s	5.5	9.3	1.7	6.8	10.1	2.6	2.7	4.3	0.0	4.1	2.7	2.3
Prop In Lane	1.00		1.00	1.00		1.00	1.00		1.00	1.00		1.00
Lane Grp Cap(c), veh/h	141	587	254	354	670	291	74	776	500	570	1766	784
V/C Ratio(X)	0.79	0.67	0.17	0.77	0.65	0.36	0.73	0.27	0.31	0.20	0.11	0.10
Avail Cap(c_a), veh/h	229	1297	562	480	1333	579	136	776	500	570	1766	784
HCM Platoon Ratio	1.00	1.00	1.00	1.00	1.00	1.00	1.00	1.00	1.00	1.00	1.00	1.00
Upstream Filter(I)	1.00	1.00	1.00	0.75	0.75	0.75	1.00	1.00	1.00	1.00	1.00	1.00
Uniform Delay (d), s/veh	40.7	35.4	22.3	39.4	33.8	7.5	42.7	29.3	23.1	22.4	12.2	12.1
Incr Delay (d2), s/veh	9.2	1.3	0.3	3.9	0.8	0.6	12.9	0.8	1.6	0.2	0.1	0.2
Initial Q Delay(d3),s/veh	0.0	0.0	0.0	0.0	0.0	0.0	0.0	0.0	0.0	0.0	0.0	0.0
%ile BackOfQ(50%),veh/ln	2.7	4.1	0.8	3.1	4.4	1.9	1.4	1.9	2.6	1.7	1.1	0.8
Unsig. Movement Delay, s/veh												
LnGrp Delay(d),s/veh	50.0	36.7	22.6	43.3	34.6	8.1	55.6	30.1	24.7	22.5	12.4	12.4
LnGrp LOS	D	D	C	D	C	A	E	C	C	C	B	B
Approach Vol, veh/h		548			811			413			390	
Approach Delay, s/veh		38.3			34.1			31.4			15.3	
Approach LOS		D			C			C			B	
Timer - Assigned Phs	1	2	3	4	5	6	7	8				
Phs Duration (G+Y+Rc), s	33.1	24.0	13.7	19.3	8.2	48.9	11.6	21.3				
Change Period (Y+Rc), s	4.5	4.5	4.5	4.5	4.5	4.5	4.5	4.5				
Max Green Setting (Gmax), s	7.5	19.5	12.4	32.6	6.8	20.2	11.5	33.5				
Max Q Clear Time (g_c+I1), s	6.1	6.3	8.8	11.3	4.7	4.7	7.5	12.1				
Green Ext Time (p_c), s	0.0	1.5	0.3	2.7	0.0	1.3	0.1	3.2				
Intersection Summary												
HCM 6th Ctrl Delay				31.3								
HCM 6th LOS				C								

HCM 6th Signalized Intersection Summary
30: Fairgrounds & Cleveland Avenue

Village D Specific Plan
Existing NP - PM Peak Hour



Movement	EBL	EBT	EBR	WBL	WBT	WBR	NBL	NBT	NBR	SBL	SBT	SBR
Lane Configurations	↑↑↑			↑↑		↑	↑↑		↑	↑	↑	↑
Traffic Volume (veh/h)	89	478	91	155	503	123	95	41	105	231	34	98
Future Volume (veh/h)	89	478	91	155	503	123	95	41	105	231	34	98
Initial Q (Qb), veh	0	0	0	0	0	0	0	0	0	0	0	0
Ped-Bike Adj(A_pbT)	1.00		0.98	1.00		0.98	1.00		0.98	1.00		1.00
Parking Bus, Adj	1.00	1.00	1.00	1.00	1.00	1.00	1.00	1.00	1.00	1.00	1.00	1.00
Work Zone On Approach	No			No			No			No		
Adj Sat Flow, veh/h/ln	1885	1885	1885	1885	1885	1885	1900	1900	1900	1900	1900	1900
Adj Flow Rate, veh/h	94	503	96	163	529	129	100	94	77	243	36	103
Peak Hour Factor	0.95	0.95	0.95	0.95	0.95	0.95	0.95	0.95	0.95	0.95	0.95	0.95
Percent Heavy Veh, %	1	1	1	1	1	1	0	0	0	0	0	0
Cap, veh/h	122	721	134	200	750	327	823	391	325	574	128	366
Arrive On Green	0.14	0.33	0.33	0.04	0.07	0.07	0.23	0.21	0.21	0.32	0.30	0.30
Sat Flow, veh/h	1795	4344	809	1795	3582	1559	3619	1900	1582	1810	433	1239
Grp Volume(v), veh/h	94	395	204	163	529	129	100	94	77	243	0	139
Grp Sat Flow(s),veh/h/ln	1795	1716	1722	1795	1791	1559	1810	1900	1582	1810	0	1672
Q Serve(g_s), s	4.6	9.0	9.4	8.1	13.0	7.1	2.0	3.7	2.7	9.5	0.0	5.7
Cycle Q Clear(g_c), s	4.6	9.0	9.4	8.1	13.0	7.1	2.0	3.7	2.7	9.5	0.0	5.7
Prop In Lane	1.00		0.47	1.00		1.00	1.00		1.00	1.00		0.74
Lane Grp Cap(c), veh/h	122	569	286	200	750	327	823	391	325	574	0	494
V/C Ratio(X)	0.77	0.69	0.71	0.82	0.71	0.40	0.12	0.24	0.24	0.42	0.00	0.28
Avail Cap(c_a), veh/h	122	1033	519	237	1333	580	823	391	325	574	0	494
HCM Platoon Ratio	2.00	2.00	2.00	0.33	0.33	0.33	1.00	1.00	1.00	1.00	1.00	1.00
Upstream Filter(I)	0.82	0.82	0.82	0.81	0.81	0.81	1.00	1.00	1.00	1.00	0.00	1.00
Uniform Delay (d), s/veh	38.2	28.1	28.2	42.4	39.2	36.4	27.6	29.9	16.1	24.2	0.0	24.4
Incr Delay (d2), s/veh	22.0	1.3	2.7	14.1	1.0	0.6	0.1	1.5	1.7	0.5	0.0	1.4
Initial Q Delay(d3),s/veh	0.0	0.0	0.0	0.0	0.0	0.0	0.0	0.0	0.0	0.0	0.0	0.0
%ile BackOfQ(50%),veh/ln	2.6	3.2	3.5	4.6	6.3	2.9	0.9	1.8	1.5	4.1	0.0	2.4
Unsig. Movement Delay, s/veh												
LnGrp Delay(d),s/veh	60.2	29.3	30.9	56.5	40.2	37.1	27.7	31.3	17.8	24.7	0.0	25.8
LnGrp LOS	E	C	C	E	D	D	C	C	B	C	A	C
Approach Vol, veh/h	693			821			271			382		
Approach Delay, s/veh	34.0			42.9			26.1			25.1		
Approach LOS	C			D			C			C		
Timer - Assigned Phs	1	2	3	4	5	6	7	8				
Phs Duration (G+Y+Rc), s	33.1	23.0	14.5	19.4	25.0	31.1	10.6	23.3				
Change Period (Y+Rc), s	4.5	4.5	4.5	4.5	4.5	4.5	4.5	4.5				
Max Green Setting (Gmax), s	14.5	18.5	11.9	27.1	6.4	26.6	5.5	33.5				
Max Q Clear Time (g_c+M), s	11.5	5.7	10.1	11.4	4.0	7.7	6.6	15.0				
Green Ext Time (p_c), s	0.2	0.5	0.1	3.5	0.1	0.7	0.0	3.8				

Intersection Summary

HCM 6th Ctrl Delay	34.8
HCM 6th LOS	C

Notes

User approved volume balancing among the lanes for turning movement.

HCM 6th Signalized Intersection Summary
 31: SR-99 Southbound Ramps & Cleveland Avenue

Village D Specific Plan
 Existing NP - PM Peak Hour



Movement	EBL	EBT	EBR	WBL	WBT	WBR	NBL	NBT	NBR	SBL	SBT	SBR
Lane Configurations		↑↑	↑	↑	↑↑					↑		↑
Traffic Volume (veh/h)	0	682	327	193	1050	0	0	0	0	125	0	77
Future Volume (veh/h)	0	682	327	193	1050	0	0	0	0	125	0	77
Initial Q (Qb), veh	0	0	0	0	0	0				0	0	0
Ped-Bike Adj(A_pbT)	1.00		0.99	1.00		1.00				1.00		1.00
Parking Bus, Adj	1.00	1.00	1.00	1.00	1.00	1.00				1.00	1.00	1.00
Work Zone On Approach		No			No						No	
Adj Sat Flow, veh/h/ln	0	1885	1885	1885	1885	0				1841	0	1841
Adj Flow Rate, veh/h	0	703	337	199	1082	0				129	0	79
Peak Hour Factor	0.97	0.97	0.97	0.97	0.97	0.97				0.97	0.97	0.97
Percent Heavy Veh, %	0	1	1	1	1	0				4	0	4
Cap, veh/h	0	943	418	233	1588	0				800	0	712
Arrive On Green	0.00	0.53	0.53	0.26	0.89	0.00				0.46	0.00	0.46
Sat Flow, veh/h	0	3676	1589	1795	3676	0				1753	0	1560
Grp Volume(v), veh/h	0	703	337	199	1082	0				129	0	79
Grp Sat Flow(s),veh/h/ln	0	1791	1589	1795	1791	0				1753	0	1560
Q Serve(g_s), s	0.0	13.8	15.7	9.5	7.8	0.0				3.9	0.0	2.6
Cycle Q Clear(g_c), s	0.0	13.8	15.7	9.5	7.8	0.0				3.9	0.0	2.6
Prop In Lane	0.00		1.00	1.00		0.00				1.00		1.00
Lane Grp Cap(c), veh/h	0	943	418	233	1588	0				800	0	712
V/C Ratio(X)	0.00	0.75	0.81	0.85	0.68	0.00				0.16	0.00	0.11
Avail Cap(c_a), veh/h	0	1453	644	369	2368	0				800	0	712
HCM Platoon Ratio	1.00	2.00	2.00	2.00	2.00	1.00				1.00	1.00	1.00
Upstream Filter(I)	0.00	0.78	0.78	0.72	0.72	0.00				1.00	0.00	1.00
Uniform Delay (d), s/veh	0.0	18.9	19.4	32.5	3.3	0.0				14.3	0.0	14.0
Incr Delay (d2), s/veh	0.0	0.9	3.4	7.9	0.4	0.0				0.1	0.0	0.1
Initial Q Delay(d3),s/veh	0.0	0.0	0.0	0.0	0.0	0.0				0.0	0.0	0.0
%ile BackOfQ(50%),veh/ln	0.0	4.1	4.3	4.0	1.4	0.0				1.5	0.0	0.9
Unsig. Movement Delay, s/veh												
LnGrp Delay(d),s/veh	0.0	19.9	22.8	40.4	3.7	0.0				14.4	0.0	14.1
LnGrp LOS		A	B	C	D	A	A			B	A	B
Approach Vol, veh/h		1040		1281						208		
Approach Delay, s/veh		20.8		9.4						14.3		
Approach LOS		C		A						B		
Timer - Assigned Phs			3	4		6		8				
Phs Duration (G+Y+Rc), s			16.2	28.2		45.6		44.4				
Change Period (Y+Rc), s			4.5	4.5		4.5		4.5				
Max Green Setting (Gmax), s			18.5	36.5		21.5		59.5				
Max Q Clear Time (g_c+I1), s			11.5	17.7		5.9		9.8				
Green Ext Time (p_c), s			0.3	6.0		0.5		10.5				
Intersection Summary												
HCM 6th Ctrl Delay		14.5										
HCM 6th LOS		B										

HCM 6th Signalized Intersection Summary
 32: SR-99 Northbound Ramps & Cleveland Avenue

Village D Specific Plan
 Existing NP - PM Peak Hour



Movement	EBL	EBT	EBR	WBL	WBT	WBR	NBL	NBT	NBR	SBL	SBT	SBR
Lane Configurations												
Traffic Volume (veh/h)	71	736	0	0	826	65	417	5	265	0	0	0
Future Volume (veh/h)	71	736	0	0	826	65	417	5	265	0	0	0
Initial Q (Qb), veh	0	0	0	0	0	0	0	0	0			
Ped-Bike Adj(A_pbT)	1.00		1.00	1.00		0.99	1.00		0.99			
Parking Bus, Adj	1.00	1.00	1.00	1.00	1.00	1.00	1.00	1.00	1.00			
Work Zone On Approach	No			No			No					
Adj Sat Flow, veh/h/ln	1885	1885	0	0	1885	1885	1885	1885	1885			
Adj Flow Rate, veh/h	75	775	0	0	869	68	443	0	279			
Peak Hour Factor	0.95	0.95	0.95	0.95	0.95	0.95	0.95	0.95	0.95			
Percent Heavy Veh, %	1	1	0	0	1	1	1	1	1			
Cap, veh/h	97	1461	0	0	1089	481	1767	0	775			
Arrive On Green	0.05	0.41	0.00	0.00	0.30	0.30	0.49	0.00	0.49			
Sat Flow, veh/h	1795	3676	0	0	3676	1582	3591	0	1576			
Grp Volume(v), veh/h	75	775	0	0	869	68	443	0	279			
Grp Sat Flow(s),veh/h/ln	1795	1791	0	0	1791	1582	1795	0	1576			
Q Serve(g_s), s	3.7	14.7	0.0	0.0	20.1	2.8	6.4	0.0	9.8			
Cycle Q Clear(g_c), s	3.7	14.7	0.0	0.0	20.1	2.8	6.4	0.0	9.8			
Prop In Lane	1.00		0.00	0.00		1.00	1.00		1.00			
Lane Grp Cap(c), veh/h	97	1461	0	0	1089	481	1767	0	775			
V/C Ratio(X)	0.77	0.53	0.00	0.00	0.80	0.14	0.25	0.00	0.36			
Avail Cap(c_a), veh/h	170	1930	0	0	1413	624	1767	0	775			
HCM Platoon Ratio	1.00	1.00	1.00	1.00	1.00	1.00	1.00	1.00	1.00			
Upstream Filter(I)	0.79	0.79	0.00	0.00	0.77	0.77	1.00	0.00	1.00			
Uniform Delay (d), s/veh	42.0	20.1	0.0	0.0	28.8	22.8	13.2	0.0	14.1			
Incr Delay (d2), s/veh	9.8	0.2	0.0	0.0	2.0	0.1	0.3	0.0	1.3			
Initial Q Delay(d3),s/veh	0.0	0.0	0.0	0.0	0.0	0.0	0.0	0.0	0.0			
%ile BackOfQ(50%),veh/ln	1.9	5.9	0.0	0.0	8.6	1.0	2.6	0.0	3.6			
Unsig. Movement Delay, s/veh												
LnGrp Delay(d),s/veh	51.9	20.4	0.0	0.0	30.7	22.9	13.6	0.0	15.4			
LnGrp LOS	D	C	A	A	C	C	B	A	B			
Approach Vol, veh/h	850				937		722					
Approach Delay, s/veh	23.1				30.2		14.3					
Approach LOS	C				C		B					
Timer - Assigned Phs	2		4		7		8					
Phs Duration (G+Y+Rc), s	48.8		41.2		9.4		31.9					
Change Period (Y+Rc), s	4.5		4.5		4.5		4.5					
Max Green Setting (Gmax), s	32.5		48.5		8.5		35.5					
Max Q Clear Time (g_c+I1), s	11.8		16.7		5.7		22.1					
Green Ext Time (p_c), s	2.6		6.2		0.0		5.3					

Intersection Summary

HCM 6th Ctrl Delay	23.2
HCM 6th LOS	C

Notes

User approved volume balancing among the lanes for turning movement.

HCM 6th Signalized Intersection Summary
 33: Gateway Drive & Cleveland Avenue

Village D Specific Plan
 Existing NP - PM Peak Hour



Movement	EBL	EBT	EBR	WBL	WBT	WBR	NBL	NBT	NBR	SBL	SBT	SBR
Lane Configurations	↖	↑↑↑	↗	↖↗	↑↑		↖↗	↑	↗	↖	↑↗	
Traffic Volume (veh/h)	14	734	231	144	654	104	218	112	210	155	124	22
Future Volume (veh/h)	14	734	231	144	654	104	218	112	210	155	124	22
Initial Q (Qb), veh	0	0	0	0	0	0	0	0	0	0	0	0
Ped-Bike Adj(A_pbT)	1.00		1.00	1.00		0.99	1.00		0.98	1.00		0.98
Parking Bus, Adj	1.00	1.00	1.00	1.00	1.00	1.00	1.00	1.00	1.00	1.00	1.00	1.00
Work Zone On Approach		No			No			No			No	
Adj Sat Flow, veh/h/ln	1870	1870	1870	1870	1870	1870	1885	1885	1885	1856	1856	1856
Adj Flow Rate, veh/h	15	781	0	153	696	111	232	119	223	165	132	23
Peak Hour Factor	0.94	0.94	0.94	0.94	0.94	0.94	0.94	0.94	0.94	0.94	0.94	0.94
Percent Heavy Veh, %	2	2	2	2	2	2	1	1	1	3	3	3
Cap, veh/h	111	1063		315	865	138	981	423	351	488	657	112
Arrive On Green	0.03	0.42	0.00	0.09	0.28	0.28	0.28	0.22	0.22	0.28	0.22	0.22
Sat Flow, veh/h	1781	5106	1585	3456	3066	489	3483	1885	1565	1767	3003	511
Grp Volume(v), veh/h	15	781	0	153	403	404	232	119	223	165	76	79
Grp Sat Flow(s),veh/h/ln	1781	1702	1585	1728	1777	1778	1742	1885	1565	1767	1763	1751
Q Serve(g_s), s	0.0	11.6	0.0	3.8	19.0	19.0	4.6	4.7	11.6	6.7	3.2	3.3
Cycle Q Clear(g_c), s	0.0	11.6	0.0	3.8	19.0	19.0	4.6	4.7	11.6	6.7	3.2	3.3
Prop In Lane	1.00		1.00	1.00		0.27	1.00		1.00	1.00		0.29
Lane Grp Cap(c), veh/h	111	1063		315	501	502	981	423	351	488	386	383
V/C Ratio(X)	0.14	0.73		0.49	0.80	0.81	0.24	0.28	0.63	0.34	0.20	0.21
Avail Cap(c_a), veh/h	179	1770		326	685	686	981	423	351	488	386	383
HCM Platoon Ratio	2.00	2.00	2.00	1.00	1.00	1.00	1.00	1.00	1.00	1.00	1.00	1.00
Upstream Filter(I)	0.89	0.89	0.00	0.95	0.95	0.95	1.00	1.00	1.00	1.00	1.00	1.00
Uniform Delay (d), s/veh	42.7	24.2	0.0	38.9	30.0	30.0	24.9	28.9	31.6	26.0	28.7	28.8
Incr Delay (d2), s/veh	0.5	0.9	0.0	1.1	4.7	4.8	0.1	1.7	8.5	0.4	1.1	1.2
Initial Q Delay(d3),s/veh	0.0	0.0	0.0	0.0	0.0	0.0	0.0	0.0	0.0	0.0	0.0	0.0
%ile BackOfQ(50%),veh/ln	0.3	3.7	0.0	1.6	8.5	8.5	1.9	2.3	5.1	2.8	1.4	1.5
Unsig. Movement Delay, s/veh												
LnGrp Delay(d),s/veh	43.2	25.1	0.0	40.0	34.7	34.8	25.0	30.5	40.0	26.4	29.8	30.0
LnGrp LOS	D	C		D	C	C	C	C	D	C	C	C
Approach Vol, veh/h		796	A		960			574			320	
Approach Delay, s/veh		25.4			35.6			32.0			28.1	
Approach LOS		C			D			C			C	
Timer - Assigned Phs	1	2	3	4	5	6	7	8				
Phs Duration (G+Y+Rc), s	29.9	24.2	6.1	29.9	29.4	24.7	12.7	23.2				
Change Period (Y+Rc), s	4.5	4.5	4.5	4.5	4.5	4.5	4.5	4.5				
Max Green Setting (Gmax), s	12.6	19.7	5.0	34.7	12.1	20.2	8.5	31.2				
Max Q Clear Time (g_c+1), s	10.6	5.3	2.0	21.0	8.7	13.6	5.8	13.6				
Green Ext Time (p_c), s	0.4	0.6	0.0	4.4	0.1	0.8	0.1	5.2				

Intersection Summary

HCM 6th Ctrl Delay	30.8
HCM 6th LOS	C

Notes

Unsignalized Delay for [EBR] is excluded from calculations of the approach delay and intersection delay.

HCM 6th Signalized Intersection Summary
34: Cleveland Avenue & County Club Drive

Village D Specific Plan
Existing NP - PM Peak Hour



Movement	WBL	WBR	NBT	NBR	SBL	SBT
Lane Configurations	YY		↑↑	↑	Y	↑↑↑
Traffic Volume (veh/h)	327	26	709	390	75	575
Future Volume (veh/h)	327	26	709	390	75	575
Initial Q (Qb), veh	0	0	0	0	0	0
Ped-Bike Adj(A_pbT)	1.00	1.00		1.00	1.00	
Parking Bus, Adj	1.00	1.00	1.00	1.00	1.00	1.00
Work Zone On Approach	No		No		No	
Adj Sat Flow, veh/h/ln	1900	1900	1870	1870	1870	1870
Adj Flow Rate, veh/h	369	0	746	0	79	605
Peak Hour Factor	0.95	0.95	0.95	0.95	0.95	0.95
Percent Heavy Veh, %	0	0	2	2	2	2
Cap, veh/h	488	217	2719		582	3907
Arrive On Green	0.13	0.00	0.77	0.00	0.77	0.77
Sat Flow, veh/h	3619	1610	3647	1585	715	5274
Grp Volume(v), veh/h	369	0	746	0	79	605
Grp Sat Flow(s),veh/h/ln	1810	1610	1777	1585	715	1702
Q Serve(g_s), s	8.8	0.0	5.6	0.0	3.3	2.8
Cycle Q Clear(g_c), s	8.8	0.0	5.6	0.0	8.9	2.8
Prop In Lane	1.00	1.00		1.00	1.00	
Lane Grp Cap(c), veh/h	488	217	2719		582	3907
V/C Ratio(X)	0.76	0.00	0.27		0.14	0.15
Avail Cap(c_a), veh/h	1428	635	2719		582	3907
HCM Platoon Ratio	1.00	1.00	1.00	1.00	1.00	1.00
Upstream Filter(I)	1.00	0.00	0.77	0.00	1.00	1.00
Uniform Delay (d), s/veh	37.5	0.0	3.1	0.0	4.5	2.8
Incr Delay (d2), s/veh	2.4	0.0	0.2	0.0	0.5	0.1
Initial Q Delay(d3),s/veh	0.0	0.0	0.0	0.0	0.0	0.0
%ile BackOfQ(50%),veh/ln	0.0	0.0	1.5	0.0	0.5	0.7
Unsig. Movement Delay, s/veh						
LnGrp Delay(d),s/veh	39.9	0.0	3.3	0.0	5.0	2.9
LnGrp LOS	D	A	A		A	A
Approach Vol, veh/h	369		746	A		684
Approach Delay, s/veh	39.9		3.3			3.1
Approach LOS	D		A			A
Timer - Assigned Phs		2			6	8
Phs Duration (G+Y+Rc), s		73.4			73.4	16.6
Change Period (Y+Rc), s		4.5			4.5	4.5
Max Green Setting (Gmax), s		45.5			45.5	35.5
Max Q Clear Time (g_c+I1), s		7.6			10.9	10.8
Green Ext Time (p_c), s		6.1			5.5	1.3

Intersection Summary

HCM 6th Ctrl Delay	10.8
HCM 6th LOS	B

Notes

User approved volume balancing among the lanes for turning movement.
Unsignalized Delay for [NBR] is excluded from calculations of the approach delay and intersection delay.

Intersection						
Int Delay, s/veh	0.2					
Movement	EBL	EBR	NBL	NBT	SBT	SBR
Lane Configurations	T			T		
Traffic Vol, veh/h	2	16	5	707	592	1
Future Vol, veh/h	2	16	5	707	592	1
Conflicting Peds, #/hr	0	0	0	0	0	0
Sign Control	Stop	Stop	Free	Free	Free	Free
RT Channelized	-	None	-	None	-	None
Storage Length	0	-	-	-	-	-
Veh in Median Storage, #	0	-	-	0	0	-
Grade, %	0	-	-	0	0	-
Peak Hour Factor	94	94	94	94	94	94
Heavy Vehicles, %	0	0	1	1	1	1
Mvmt Flow	2	17	5	752	630	1

Major/Minor	Minor2	Major1		Major2	
Conflicting Flow All	1017	316	631	0	0
Stage 1	631	-	-	-	-
Stage 2	386	-	-	-	-
Critical Hdwy	6.8	6.9	4.12	-	-
Critical Hdwy Stg 1	5.8	-	-	-	-
Critical Hdwy Stg 2	5.8	-	-	-	-
Follow-up Hdwy	3.5	3.3	2.21	-	-
Pot Cap-1 Maneuver	*495	686	954	-	-
Stage 1	*498	-	-	-	-
Stage 2	*754	-	-	-	-
Platoon blocked, %	1	-	-	-	-
Mov Cap-1 Maneuver	*490	686	954	-	-
Mov Cap-2 Maneuver	*451	-	-	-	-
Stage 1	*494	-	-	-	-
Stage 2	*754	-	-	-	-





















Approach	EB	NB	SB
HCM Control Delay, s	10.7	0.1	0
HCM LOS	B		

Minor Lane/Major Mvmt	NBL	NBT	EBLn1	SBT	SBR
Capacity (veh/h)	954	-	648	-	-
HCM Lane V/C Ratio	0.006	-	0.03	-	-
HCM Control Delay (s)	8.8	0	10.7	-	-
HCM Lane LOS	A	A	B	-	-
HCM 95th %tile Q(veh)	0	-	0.1	-	-

Notes
 -: Volume exceeds capacity \$: Delay exceeds 300s +: Computation Not Defined *: All major volume in platoon

HCM 6th Signalized Intersection Summary
36: Pine Street & Howard Road

Village D Specific Plan
Existing NP - PM Peak Hour

												
Movement	EBL	EBT	EBR	WBL	WBT	WBR	NBL	NBT	NBR	SBL	SBT	SBR
Lane Configurations												
Traffic Volume (veh/h)	85	528	96	86	486	3	142	155	138	15	131	119
Future Volume (veh/h)	85	528	96	86	486	3	142	155	138	15	131	119
Initial Q (Qb), veh	0	0	0	0	0	0	0	0	0	0	0	0
Ped-Bike Adj(A_pbT)	1.00		0.94	1.00		0.93	1.00		0.99	1.00		1.00
Parking Bus, Adj	1.00	1.00	1.00	1.00	1.00	1.00	1.00	1.00	1.00	1.00	1.00	1.00
Work Zone On Approach		No			No			No			No	
Adj Sat Flow, veh/h/ln	1870	1870	1870	1885	1885	1885	1870	1870	1870	1870	1870	1870
Adj Flow Rate, veh/h	91	568	103	92	523	3	153	167	148	16	141	128
Peak Hour Factor	0.93	0.93	0.93	0.93	0.93	0.93	0.93	0.93	0.93	0.93	0.93	0.93
Percent Heavy Veh, %	2	2	2	1	1	1	2	2	2	2	2	2
Cap, veh/h	192	700	126	117	706	4	688	722	604	21	189	179
Arrive On Green	0.11	0.24	0.24	0.07	0.19	0.19	0.39	0.39	0.39	0.11	0.11	0.11
Sat Flow, veh/h	1781	2972	537	1795	3649	21	1781	1870	1565	190	1671	1585
Grp Volume(v), veh/h	91	339	332	92	257	269	153	167	148	157	0	128
Grp Sat Flow(s),veh/h/ln	1781	1777	1732	1795	1791	1879	1781	1870	1565	1861	0	1585
Q Serve(g_s), s	4.3	16.2	16.3	4.5	12.1	12.1	5.2	5.4	5.8	7.4	0.0	7.0
Cycle Q Clear(g_c), s	4.3	16.2	16.3	4.5	12.1	12.1	5.2	5.4	5.8	7.4	0.0	7.0
Prop In Lane	1.00		0.31	1.00		0.01	1.00		1.00	0.10		1.00
Lane Grp Cap(c), veh/h	192	419	408	117	346	364	688	722	604	210	0	179
V/C Ratio(X)	0.48	0.81	0.81	0.78	0.74	0.74	0.22	0.23	0.24	0.75	0.00	0.72
Avail Cap(c_a), veh/h	192	543	529	130	547	574	688	722	604	372	0	317
HCM Platoon Ratio	1.00	1.00	1.00	1.00	1.00	1.00	1.00	1.00	1.00	1.00	1.00	1.00
Upstream Filter(I)	1.00	1.00	1.00	0.90	0.90	0.90	1.00	1.00	1.00	1.00	0.00	1.00
Uniform Delay (d), s/veh	37.8	32.5	32.5	41.4	34.2	34.2	18.6	18.6	18.7	38.7	0.0	38.5
Incr Delay (d2), s/veh	1.8	6.9	7.4	22.1	2.8	2.7	0.7	0.7	1.0	5.2	0.0	5.2
Initial Q Delay(d3),s/veh	0.0	0.0	0.0	0.0	0.0	0.0	0.0	0.0	0.0	0.0	0.0	0.0
%ile BackOfQ(50%),veh/ln	2.0	7.6	7.5	2.7	5.4	5.7	2.2	2.4	2.2	3.6	0.0	2.9
Unsig. Movement Delay, s/veh												
LnGrp Delay(d),s/veh	39.6	39.4	40.0	63.6	37.0	36.9	19.3	19.4	19.7	43.9	0.0	43.8
LnGrp LOS	D	D	D	E	D	D	B	B	B	D	A	D
Approach Vol, veh/h		762			618			468			285	
Approach Delay, s/veh		39.7			40.9			19.4			43.8	
Approach LOS		D			D			B			D	
Timer - Assigned Phs		2	3	4		6	7	8				
Phs Duration (G+Y+Rc), s		39.3	10.4	25.7		14.7	14.2	21.9				
Change Period (Y+Rc), s		4.5	4.5	4.5		4.5	4.5	4.5				
Max Green Setting (Gmax), s		20.0	6.5	27.5		18.0	6.5	27.5				
Max Q Clear Time (g_c+I1), s		7.8	6.5	18.3		9.4	6.3	14.1				
Green Ext Time (p_c), s		1.5	0.0	2.9		0.8	0.0	2.6				
Intersection Summary												
HCM 6th Ctrl Delay			36.1									
HCM 6th LOS			D									

HCM 6th Signalized Intersection Summary
 37: Olive Avenue/Q Street & Howard Road/Yosemite Avenue

Village D Specific Plan
 Existing NP - PM Peak Hour



Movement	EBL	EBT	EBR	WBL	WBT	WBR	NBL	NBT	NBR	SBL	SBT	SBR
Lane Configurations												
Traffic Volume (veh/h)	7	442	211	12	357	14	278	74	12	16	55	2
Future Volume (veh/h)	7	442	211	12	357	14	278	74	12	16	55	2
Initial Q (Qb), veh	0	0	0	0	0	0	0	0	0	0	0	0
Ped-Bike Adj(A_pbT)	1.00		1.00	1.00		1.00	1.00		0.99	1.00		0.99
Parking Bus, Adj	1.00	1.00	1.00	1.00	1.00	1.00	1.00	1.00	1.00	1.00	1.00	1.00
Work Zone On Approach		No			No			No			No	
Adj Sat Flow, veh/h/ln	1870	1870	1870	1885	1885	1885	1885	1885	1885	1885	1885	1885
Adj Flow Rate, veh/h	8	502	0	14	406	16	200	246	14	18	62	2
Peak Hour Factor	0.88	0.88	0.88	0.88	0.88	0.88	0.88	0.88	0.88	0.88	0.88	0.88
Percent Heavy Veh, %	2	2	2	1	1	1	1	1	1	1	1	1
Cap, veh/h	18	613		100	766	30	931	978	817	96	100	84
Arrive On Green	0.01	0.17	0.00	0.06	0.22	0.22	0.52	0.52	0.52	0.05	0.05	0.05
Sat Flow, veh/h	1781	3554	1585	1795	3512	138	1795	1885	1576	1795	1885	1580
Grp Volume(v), veh/h	8	502	0	14	207	215	200	246	14	18	62	2
Grp Sat Flow(s),veh/h/ln	1781	1777	1585	1795	1791	1860	1795	1885	1576	1795	1885	1580
Q Serve(g_s), s	0.4	12.3	0.0	0.7	9.2	9.2	5.4	6.5	0.4	0.9	2.9	0.1
Cycle Q Clear(g_c), s	0.4	12.3	0.0	0.7	9.2	9.2	5.4	6.5	0.4	0.9	2.9	0.1
Prop In Lane	1.00		1.00	1.00		0.07	1.00		1.00	1.00		1.00
Lane Grp Cap(c), veh/h	18	613		100	390	405	931	978	817	96	100	84
V/C Ratio(X)	0.45	0.82		0.14	0.53	0.53	0.21	0.25	0.02	0.19	0.62	0.02
Avail Cap(c_a), veh/h	99	711		359	617	641	931	978	817	359	377	316
HCM Platoon Ratio	1.00	1.00	1.00	1.00	1.00	1.00	1.00	1.00	1.00	1.00	1.00	1.00
Upstream Filter(l)	0.70	0.70	0.00	1.00	1.00	1.00	1.00	1.00	1.00	1.00	1.00	1.00
Uniform Delay (d), s/veh	44.3	35.9	0.0	40.5	31.1	31.1	11.7	12.0	10.5	40.7	41.7	40.4
Incr Delay (d2), s/veh	11.7	4.7	0.0	0.6	1.1	1.1	0.5	0.6	0.0	0.9	6.0	0.1
Initial Q Delay(d3),s/veh	0.0	0.0	0.0	0.0	0.0	0.0	0.0	0.0	0.0	0.0	0.0	0.0
%ile BackOfQ(50%),veh/ln	0.2	5.6	0.0	0.3	4.0	4.2	2.2	2.8	0.1	0.4	1.5	0.0
Unsig. Movement Delay, s/veh												
LnGrp Delay(d),s/veh	56.0	40.6	0.0	41.1	32.2	32.2	12.3	12.6	10.6	41.7	47.7	40.5
LnGrp LOS	E	D		D	C	C	B	B	B	D	D	D
Approach Vol, veh/h		510	A		436			460			82	
Approach Delay, s/veh		40.9			32.5			12.4			46.2	
Approach LOS		D			C			B			D	
Timer - Assigned Phs		2	3	4		6	7	8				
Phs Duration (G+Y+Rc), s		51.2	9.5	20.0		9.3	5.4	24.1				
Change Period (Y+Rc), s		4.5	4.5	4.5		4.5	4.5	4.5				
Max Green Setting (Gmax), s		18.0	18.0	18.0		18.0	5.0	31.0				
Max Q Clear Time (g_c+1), s		8.5	2.7	14.3		4.9	2.4	11.2				
Green Ext Time (p_c), s		1.5	0.0	1.1		0.2	0.0	2.4				

Intersection Summary

HCM 6th Ctrl Delay	29.9
HCM 6th LOS	C

Notes

User approved volume balancing among the lanes for turning movement.
 Unsignalized Delay for [EBR] is excluded from calculations of the approach delay and intersection delay.

HCM 6th TWSC
 38: I Street & 2nd Street/SR-99 Southbound Off-Ramp

Village D Specific Plan
 Existing NP - PM Peak Hour

Intersection												
Int Delay, s/veh	7.5											
Movement	EBL	EBT	EBR	WBL	WBT	WBR	NBL	NBT	NBR	SBL	SBT	SBR
Lane Configurations		↕↔			↕	↕	↕	↕			↕	
Traffic Vol, veh/h	0	0	32	236	10	4	42	141	0	0	112	0
Future Vol, veh/h	0	0	32	236	10	4	42	141	0	0	112	0
Conflicting Peds, #/hr	0	0	0	0	0	0	1	0	1	1	0	1
Sign Control	Stop	Stop	Stop	Stop	Stop	Stop	Free	Free	Free	Free	Free	Free
RT Channelized	-	-	None	-	-	Stop	-	-	None	-	-	None
Storage Length	-	-	-	-	-	50	75	-	-	-	-	-
Veh in Median Storage, #	-	0	-	-	0	-	-	0	-	-	0	-
Grade, %	-	0	-	-	0	-	-	0	-	-	0	-
Peak Hour Factor	98	98	98	98	98	98	98	98	98	98	98	98
Heavy Vehicles, %	0	0	0	3	3	3	0	0	0	0	0	0
Mvmt Flow	0	0	33	241	10	4	43	144	0	0	114	0

Major/Minor	Minor2		Minor1		Major1		Major2					
Conflicting Flow All	350	345	115	361	345	144	115	0	-	-	-	0
Stage 1	115	115	-	230	230	-	-	-	-	-	-	-
Stage 2	235	230	-	131	115	-	-	-	-	-	-	-
Critical Hdwy	7.1	6.5	6.2	7.13	6.53	6.23	4.1	-	-	-	-	-
Critical Hdwy Stg 1	6.1	5.5	-	6.13	5.53	-	-	-	-	-	-	-
Critical Hdwy Stg 2	6.1	5.5	-	6.13	5.53	-	-	-	-	-	-	-
Follow-up Hdwy	3.5	4	3.3	3.527	4.027	3.327	2.2	-	-	-	-	-
Pot Cap-1 Maneuver	661	615	943	643	609	977	1487	-	0	0	-	-
Stage 1	895	804	-	821	736	-	-	-	0	0	-	-
Stage 2	823	741	-	870	798	-	-	-	0	0	-	-
Platoon blocked, %	1	1		1	1	1		-			-	-
Mov Cap-1 Maneuver	634	596	942	607	591	977	1486	-	-	-	-	-
Mov Cap-2 Maneuver	634	596	-	607	591	-	-	-	-	-	-	-
Stage 1	868	803	-	797	714	-	-	-	-	-	-	-
Stage 2	784	720	-	840	797	-	-	-	-	-	-	-

Approach	EB		WB		NB		SB			
HCM Control Delay, s	9		15		1.7		0			
HCM LOS	A		C							

Minor Lane/Major Mvmt	NBL	NBT	EBLn1	WBLn1	WBLn2	SBT	SBR
Capacity (veh/h)	1486	-	942	606	977	-	-
HCM Lane V/C Ratio	0.029	-	0.035	0.414	0.004	-	-
HCM Control Delay (s)	7.5	-	9	15.1	8.7	-	-
HCM Lane LOS	A	-	A	C	A	-	-
HCM 95th %tile Q(veh)	0.1	-	0.1	2	0	-	-

HCM 6th Signalized Intersection Summary
39: 4th Street & Sunset Avenue

Village D Specific Plan
Existing NP - PM Peak Hour



Movement	EBL	EBR	NBL	NBT	SBT	SBR
Lane Configurations						
Traffic Volume (veh/h)	224	12	13	278	319	360
Future Volume (veh/h)	224	12	13	278	319	360
Initial Q (Qb), veh	0	0	0	0	0	0
Ped-Bike Adj(A_pbT)	1.00	1.00	1.00			1.00
Parking Bus, Adj	1.00	1.00	1.00	1.00	1.00	1.00
Work Zone On Approach	No			No	No	
Adj Sat Flow, veh/h/ln	1900	1900	1856	1856	1856	1856
Adj Flow Rate, veh/h	264	0	15	312	358	404
Peak Hour Factor	0.89	0.89	0.89	0.89	0.89	0.89
Percent Heavy Veh, %	0	0	3	3	3	3
Cap, veh/h	359	160	443	2859	956	965
Arrive On Green	0.10	0.00	0.25	0.81	0.86	0.86
Sat Flow, veh/h	3619	1610	1767	3618	1856	1571
Grp Volume(v), veh/h	264	0	15	312	358	404
Grp Sat Flow(s),veh/h/ln	1810	1610	1767	1763	1856	1571
Q Serve(g_s), s	7.1	0.0	0.6	1.8	4.0	5.0
Cycle Q Clear(g_c), s	7.1	0.0	0.6	1.8	4.0	5.0
Prop In Lane	1.00	1.00	1.00			1.00
Lane Grp Cap(c), veh/h	359	160	443	2859	956	965
V/C Ratio(X)	0.74	0.00	0.03	0.11	0.37	0.42
Avail Cap(c_a), veh/h	995	443	443	2859	956	965
HCM Platoon Ratio	1.00	1.00	1.00	1.00	1.67	1.67
Upstream Filter(I)	1.00	0.00	1.00	1.00	0.75	0.75
Uniform Delay (d), s/veh	43.8	0.0	28.3	2.0	3.7	2.4
Incr Delay (d2), s/veh	2.9	0.0	0.0	0.1	0.8	1.0
Initial Q Delay(d3),s/veh	0.0	0.0	0.0	0.0	0.0	0.0
%ile BackOfQ(50%),veh/ln	3.3	0.0	0.3	0.4	1.4	1.6
Unsig. Movement Delay, s/veh						
LnGrp Delay(d),s/veh	46.7	0.0	28.3	2.0	4.5	3.4
LnGrp LOS	D	A	C	A	A	A
Approach Vol, veh/h				327	762	
Approach Delay, s/veh				3.2	3.9	
Approach LOS				A	A	
Timer - Assigned Phs		2		4	5	6
Phs Duration (G+Y+Rc), s		85.6		14.4	29.6	56.0
Change Period (Y+Rc), s		4.5		4.5	4.5	4.5
Max Green Setting (Gmax), s		63.5		27.5	7.5	51.5
Max Q Clear Time (g_c+I1), s		3.8		9.1	2.6	7.0
Green Ext Time (p_c), s		2.3		0.8	0.0	4.1

Intersection Summary

HCM 6th Ctrl Delay	12.1
HCM 6th LOS	B

Notes

User approved volume balancing among the lanes for turning movement.

40: H Street & SR-99 Southbound On-Ramp/2nd Street Performance by movement

Movement	WBL	WBT	WBR	NBL	NBT	NBR	SBL	SBT	All
Denied Delay (hr)	0.0	0.0	0.0	0.0	0.0	0.0	0.0	0.0	0.0
Denied Del/Veh (s)	0.1	0.2	0.1	0.0	0.3	0.0	0.1	0.1	0.1
Total Delay (hr)	0.0	0.1	0.0	0.1	0.0	0.0	0.0	0.0	0.3
Total Del/Veh (s)	8.3	10.0	4.9	2.5	2.9	2.0	3.9	8.4	3.9
Stop Delay (hr)	0.0	0.1	0.0	0.0	0.0	0.0	0.0	0.0	0.1
Stop Del/Veh (s)	6.3	6.4	4.4	0.1	0.1	0.2	2.5	5.4	1.5

HCM 6th Signalized Intersection Summary

41: I Street & 4th Street

Village D Specific Plan
Existing NP - PM Peak Hour



Movement	EBL	EBT	EBR	WBL	WBT	WBR	NBL	NBT	NBR	SBL	SBT	SBR
Lane Configurations												
Traffic Volume (veh/h)	31	471	61	59	490	106	96	68	244	159	163	93
Future Volume (veh/h)	31	471	61	59	490	106	96	68	244	159	163	93
Initial Q (Qb), veh	0	0	0	0	0	0	0	0	0	0	0	0
Ped-Bike Adj(A_pbT)	1.00		0.99	1.00		0.99	1.00		1.00	1.00		0.99
Parking Bus, Adj	1.00	1.00	1.00	1.00	1.00	1.00	1.00	1.00	1.00	1.00	1.00	1.00
Work Zone On Approach		No			No			No			No	
Adj Sat Flow, veh/h/ln	1856	1856	1856	1885	1885	1885	1885	1885	1885	1870	1870	1870
Adj Flow Rate, veh/h	35	529	69	66	551	119	108	76	274	179	183	104
Peak Hour Factor	0.89	0.89	0.89	0.89	0.89	0.89	0.89	0.89	0.89	0.89	0.89	0.89
Percent Heavy Veh, %	3	3	3	1	1	1	1	1	1	2	2	2
Cap, veh/h	55	649	84	98	674	145	423	443	375	576	604	505
Arrive On Green	0.03	0.21	0.21	0.05	0.23	0.23	0.24	0.23	0.23	0.32	0.32	0.32
Sat Flow, veh/h	1767	3133	407	1795	2927	630	1795	1885	1598	1781	1870	1564
Grp Volume(v), veh/h	35	297	301	66	336	334	108	76	274	179	183	104
Grp Sat Flow(s),veh/h/ln	1767	1763	1778	1795	1791	1765	1795	1885	1598	1781	1870	1564
Q Serve(g_s), s	2.0	16.1	16.2	3.6	17.8	17.9	4.9	3.2	15.8	7.6	7.3	4.8
Cycle Q Clear(g_c), s	2.0	16.1	16.2	3.6	17.8	17.9	4.9	3.2	15.8	7.6	7.3	4.8
Prop In Lane	1.00		0.23	1.00		0.36	1.00		1.00	1.00		1.00
Lane Grp Cap(c), veh/h	55	365	368	98	413	407	423	443	375	576	604	505
V/C Ratio(X)	0.64	0.81	0.82	0.68	0.82	0.82	0.26	0.17	0.73	0.31	0.30	0.21
Avail Cap(c_a), veh/h	115	485	489	171	546	538	423	443	375	576	604	505
HCM Platoon Ratio	1.00	1.00	1.00	1.00	1.00	1.00	1.00	1.00	1.00	1.00	1.00	1.00
Upstream Filter(l)	0.96	0.96	0.96	1.00	1.00	1.00	1.00	1.00	1.00	1.00	1.00	1.00
Uniform Delay (d), s/veh	47.9	37.8	37.9	46.4	36.5	36.5	31.1	30.5	35.3	25.4	25.4	24.5
Incr Delay (d2), s/veh	11.2	7.4	7.7	7.8	7.1	7.5	0.3	0.8	11.8	0.3	1.3	0.9
Initial Q Delay(d3),s/veh	0.0	0.0	0.0	0.0	0.0	0.0	0.0	0.0	0.0	0.0	0.0	0.0
%ile BackOfQ(50%),veh/ln	0	7.6	7.7	1.8	8.5	8.5	2.1	1.6	7.3	3.2	3.4	1.9
Unsig. Movement Delay, s/veh												
LnGrp Delay(d),s/veh	59.1	45.2	45.6	54.3	43.5	44.0	31.4	31.3	47.1	25.7	26.7	25.5
LnGrp LOS	E	D	D	D	D	D	C	C	D	C	C	C
Approach Vol, veh/h		633			736			458			466	
Approach Delay, s/veh		46.2			44.7			40.8			26.1	
Approach LOS		D			D			D			C	
Timer - Assigned Phs	1	2	3	4	5	6	7	8				
Phs Duration (G+Y+Rc), s	36.9	28.0	9.9	25.2	28.1	36.8	7.6	27.5				
Change Period (Y+Rc), s	4.5	4.5	4.5	4.5	4.5	4.5	4.5	4.5				
Max Green Setting (Gmax), s	21.5	23.5	9.5	27.5	12.7	32.3	6.5	30.5				
Max Q Clear Time (g_c+1), s	19.6	17.8	5.6	18.2	6.9	9.3	4.0	19.9				
Green Ext Time (p_c), s	0.4	0.7	0.0	2.5	0.1	1.3	0.0	3.1				

Intersection Summary

HCM 6th Ctrl Delay	40.5
HCM 6th LOS	D

HCM 6th Signalized Intersection Summary
 43: SR-99 Northbound Off-Ramp/H Street & 4th Street

Village D Specific Plan
 Existing NP - PM Peak Hour



Movement	EBL	EBT	EBR	WBL	WBT	WBR	NBL	NBT	NBR	SBL	SBT	SBR
Lane Configurations												
Traffic Volume (veh/h)	200	399	0	0	501	87	239	19	144	20	0	66
Future Volume (veh/h)	200	399	0	0	501	87	239	19	144	20	0	66
Initial Q (Qb), veh	0	0	0	0	0	0	0	0	0	0	0	0
Ped-Bike Adj(A_pbT)	1.00		1.00	1.00		0.99	1.00		0.99	1.00		0.99
Parking Bus, Adj	1.00	1.00	1.00	1.00	1.00	1.00	1.00	1.00	1.00	1.00	1.00	1.00
Work Zone On Approach		No			No			No			No	
Adj Sat Flow, veh/h/ln	1885	1885	0	0	1885	1885	1885	1885	1885	1900	1900	1900
Adj Flow Rate, veh/h	213	424	0	0	533	93	254	20	153	21	0	70
Peak Hour Factor	0.94	0.94	0.94	0.94	0.94	0.94	0.94	0.94	0.94	0.94	0.94	0.94
Percent Heavy Veh, %	1	1	0	0	1	1	1	1	1	0	0	0
Cap, veh/h	249	1393	0	0	625	109	532	55	420	68	0	226
Arrive On Green	0.14	0.39	0.00	0.00	0.21	0.21	0.30	0.30	0.30	0.18	0.00	0.18
Sat Flow, veh/h	1795	3676	0	0	3138	529	1795	186	1420	377	0	1258
Grp Volume(v), veh/h	213	424	0	0	313	313	254	0	173	91	0	0
Grp Sat Flow(s),veh/h/ln	1795	1791	0	0	1791	1782	1795	0	1605	1635	0	0
Q Serve(g_s), s	11.6	8.2	0.0	0.0	16.8	16.9	11.6	0.0	8.5	4.8	0.0	0.0
Cycle Q Clear(g_c), s	11.6	8.2	0.0	0.0	16.8	16.9	11.6	0.0	8.5	4.8	0.0	0.0
Prop In Lane	1.00		0.00	0.00		0.30	1.00		0.88	0.23		0.77
Lane Grp Cap(c), veh/h	249	1393	0	0	368	366	532	0	475	294	0	0
V/C Ratio(X)	0.86	0.30	0.00	0.00	0.85	0.86	0.48	0.00	0.36	0.31	0.00	0.00
Avail Cap(c_a), veh/h	350	1701	0	0	421	419	532	0	475	294	0	0
HCM Platoon Ratio	1.00	1.00	1.00	1.00	1.00	1.00	1.00	1.00	1.00	1.00	1.00	1.00
Upstream Filter(l)	1.00	1.00	0.00	0.00	1.00	1.00	1.00	0.00	1.00	1.00	0.00	0.00
Uniform Delay (d), s/veh	42.1	21.2	0.0	0.0	38.2	38.3	28.9	0.0	27.8	35.6	0.0	0.0
Incr Delay (d2), s/veh	13.7	0.1	0.0	0.0	13.7	14.5	3.1	0.0	2.2	2.7	0.0	0.0
Initial Q Delay(d3),s/veh	0.0	0.0	0.0	0.0	0.0	0.0	0.0	0.0	0.0	0.0	0.0	0.0
%ile BackOfQ(50%),veh/ln	0.0	3.4	0.0	0.0	8.7	8.8	5.4	0.0	3.5	2.1	0.0	0.0
Unsig. Movement Delay, s/veh												
LnGrp Delay(d),s/veh	55.9	21.3	0.0	0.0	52.0	52.8	31.9	0.0	29.9	38.3	0.0	0.0
LnGrp LOS	E	C	A	A	D	D	C	A	C	D	A	A
Approach Vol, veh/h		637			626			427				91
Approach Delay, s/veh		32.9			52.4			31.1				38.3
Approach LOS		C			D			C				D
Timer - Assigned Phs		2		4		6	7	8				
Phs Duration (G+Y+Rc), s		34.1		43.4		22.5	18.4	25.0				
Change Period (Y+Rc), s		4.5		4.5		4.5	4.5	4.5				
Max Green Setting (Gmax), s		21.0		47.5		18.0	19.5	23.5				
Max Q Clear Time (g_c+I1), s		13.6		10.2		6.8	13.6	18.9				
Green Ext Time (p_c), s		1.1		3.1		0.3	0.3	1.6				
Intersection Summary												
HCM 6th Ctrl Delay												39.6
HCM 6th LOS												D

Intersection						
Int Delay, s/veh	4.1					
Movement	EBL	EBT	WBT	WBR	SBL	SBR
Lane Configurations	↖	↗	↗		↖	↖
Traffic Vol, veh/h	86	376	357	103	152	106
Future Vol, veh/h	86	376	357	103	152	106
Conflicting Peds, #/hr	0	0	0	0	0	0
Sign Control	Free	Free	Free	Free	Stop	Stop
RT Channelized	-	None	-	None	-	None
Storage Length	145	-	-	-	65	0
Veh in Median Storage, #	-	0	0	-	0	-
Grade, %	-	0	0	-	0	-
Peak Hour Factor	95	95	95	95	95	95
Heavy Vehicles, %	2	2	1	1	1	1
Mvmt Flow	91	396	376	108	160	112

Major/Minor	Major1	Major2	Minor2		
Conflicting Flow All	484	0	-	0	810 242
Stage 1	-	-	-	-	430 -
Stage 2	-	-	-	-	380 -
Critical Hdwy	4.14	-	-	-	6.82 6.92
Critical Hdwy Stg 1	-	-	-	-	5.82 -
Critical Hdwy Stg 2	-	-	-	-	5.82 -
Follow-up Hdwy	2.22	-	-	-	3.51 3.31
Pot Cap-1 Maneuver	1238	-	-	-	417 *971
Stage 1	-	-	-	-	794 -
Stage 2	-	-	-	-	664 -
Platoon blocked, %	1	-	-	-	1 1
Mov Cap-1 Maneuver	1238	-	-	-	386 *971
Mov Cap-2 Maneuver	-	-	-	-	386 -
Stage 1	-	-	-	-	736 -
Stage 2	-	-	-	-	664 -

Approach	EB	WB	SB
HCM Control Delay, s	1.5	0	16
HCM LOS			C

Minor Lane/Major Mvmt	EBL	EBT	WBT	WBR	SBLn1	SBLn2
Capacity (veh/h)	1238	-	-	-	386	971
HCM Lane V/C Ratio	0.073	-	-	-	0.415	0.115
HCM Control Delay (s)	8.1	-	-	-	20.8	9.2
HCM Lane LOS	A	-	-	-	C	A
HCM 95th %tile Q(veh)	0.2	-	-	-	2	0.4

Notes
 -: Volume exceeds capacity \$: Delay exceeds 300s +: Computation Not Defined *: All major volume in platoon

HCM 6th Signalized Intersection Summary
 45: Olive Avenue & SR-99 Southbound Off-Ramp

Village D Specific Plan
 Existing NP - PM Peak Hour



Movement	EBL	EBT	WBT	WBR	SBL	SBR
Lane Configurations		↑↑↑	↑↑		↙	↗
Traffic Volume (veh/h)	0	528	395	0	229	65
Future Volume (veh/h)	0	528	395	0	229	65
Initial Q (Qb), veh	0	0	0	0	0	0
Ped-Bike Adj(A_pbT)	1.00			1.00	1.00	1.00
Parking Bus, Adj	1.00	1.00	1.00	1.00	1.00	1.00
Work Zone On Approach		No	No		No	
Adj Sat Flow, veh/h/ln	0	1870	1885	0	1826	1826
Adj Flow Rate, veh/h	0	556	416	0	241	68
Peak Hour Factor	0.95	0.95	0.95	0.95	0.95	0.95
Percent Heavy Veh, %	0	2	1	0	5	5
Cap, veh/h	0	860	603	0	1272	1132
Arrive On Green	0.00	0.17	0.17	0.00	0.73	0.73
Sat Flow, veh/h	0	5443	3770	0	1739	1547
Grp Volume(v), veh/h	0	556	416	0	241	68
Grp Sat Flow(s),veh/h/ln	0	1702	1791	0	1739	1547
Q Serve(g_s), s	0.0	9.1	9.8	0.0	3.9	1.1
Cycle Q Clear(g_c), s	0.0	9.1	9.8	0.0	3.9	1.1
Prop In Lane	0.00			0.00	1.00	1.00
Lane Grp Cap(c), veh/h	0	860	603	0	1272	1132
V/C Ratio(X)	0.00	0.65	0.69	0.00	0.19	0.06
Avail Cap(c_a), veh/h	0	2071	1453	0	1272	1132
HCM Platoon Ratio	1.00	1.00	1.00	1.00	1.00	1.00
Upstream Filter(I)	0.00	1.00	0.95	0.00	1.00	1.00
Uniform Delay (d), s/veh	0.0	34.9	35.2	0.0	3.8	3.4
Incr Delay (d2), s/veh	0.0	0.8	1.3	0.0	0.3	0.1
Initial Q Delay(d3),s/veh	0.0	0.0	0.0	0.0	0.0	0.0
%ile BackOfQ(50%),veh/ln	0.0	3.8	4.3	0.0	1.2	0.3
Unsig. Movement Delay, s/veh						
LnGrp Delay(d),s/veh	0.0	35.7	36.6	0.0	4.1	3.5
LnGrp LOS	A	D	D	A	A	A
Approach Vol, veh/h		556	416		309	
Approach Delay, s/veh		35.7	36.6		4.0	
Approach LOS		D	D		A	
Timer - Assigned Phs				4	6	8
Phs Duration (G+Y+Rc), s				19.7	70.3	19.7
Change Period (Y+Rc), s				4.5	4.5	4.5
Max Green Setting (Gmax), s				36.5	44.5	36.5
Max Q Clear Time (g_c+I1), s				11.1	5.9	11.8
Green Ext Time (p_c), s				4.0	1.0	2.8
Intersection Summary						
HCM 6th Ctrl Delay			28.3			
HCM 6th LOS			C			

HCM 6th Signalized Intersection Summary

46: Madera Avenue & SR-99 Northbound Ramps

Village D Specific Plan
Existing NP - PM Peak Hour



Movement	EBL	EBT	EBR	WBL	WBT	WBR	NBL	NBT	NBR	SBL	SBT	SBR
Lane Configurations				↶	↷	↶	↶↷	↶↷			↶↷	
Traffic Volume (veh/h)	0	0	0	171	1	32	377	520	0	0	581	171
Future Volume (veh/h)	0	0	0	171	1	32	377	520	0	0	581	171
Initial Q (Qb), veh				0	0	0	0	0	0	0	0	0
Ped-Bike Adj(A_pbT)				1.00		0.99	1.00		1.00	1.00		1.00
Parking Bus, Adj				1.00	1.00	1.00	1.00	1.00	1.00	1.00	1.00	1.00
Work Zone On Approach				No			No			No		
Adj Sat Flow, veh/h/ln				1885	1885	1885	1870	1870	0	0	1870	1870
Adj Flow Rate, veh/h				189	0	35	414	571	0	0	638	188
Peak Hour Factor				0.91	0.91	0.91	0.91	0.91	0.91	0.91	0.91	0.91
Percent Heavy Veh, %				1	1	1	2	2	0	0	2	2
Cap, veh/h				285	0	125	1304	2916	0	0	1064	313
Arrive On Green				0.08	0.00	0.08	0.75	1.00	0.00	0.00	0.39	0.39
Sat Flow, veh/h				3591	0	1574	3456	3647	0	0	2798	796
Grp Volume(v), veh/h				189	0	35	414	571	0	0	419	407
Grp Sat Flow(s),veh/h/ln				1795	0	1574	1728	1777	0	0	1777	1724
Q Serve(g_s), s				4.6	0.0	1.9	3.5	0.0	0.0	0.0	16.8	16.9
Cycle Q Clear(g_c), s				4.6	0.0	1.9	3.5	0.0	0.0	0.0	16.8	16.9
Prop In Lane				1.00		1.00	1.00		0.00	0.00		0.46
Lane Grp Cap(c), veh/h				285	0	125	1304	2916	0	0	699	678
V/C Ratio(X)				0.66	0.00	0.28	0.32	0.20	0.00	0.00	0.60	0.60
Avail Cap(c_a), veh/h				742	0	325	1304	2916	0	0	699	678
HCM Platoon Ratio				1.00	1.00	1.00	2.00	2.00	1.00	1.00	1.00	1.00
Upstream Filter(I)				1.00	0.00	1.00	0.90	0.90	0.00	0.00	1.00	1.00
Uniform Delay (d), s/veh				40.3	0.0	39.0	7.3	0.0	0.0	0.0	21.7	21.7
Incr Delay (d2), s/veh				2.6	0.0	1.2	0.1	0.1	0.0	0.0	3.8	3.9
Initial Q Delay(d3),s/veh				0.0	0.0	0.0	0.0	0.0	0.0	0.0	0.0	0.0
%ile BackOfQ(50%),veh/ln				2.1	0.0	0.8	1.1	0.1	0.0	0.0	7.5	7.3
Unsig. Movement Delay, s/veh												
LnGrp Delay(d),s/veh				42.9	0.0	40.2	7.4	0.1	0.0	0.0	25.4	25.6
LnGrp LOS				D	A	D	A	A	A	A	C	C
Approach Vol, veh/h								985			826	
Approach Delay, s/veh								3.2			25.5	
Approach LOS								A			C	
Timer - Assigned Phs		2			5	6		8				
Phs Duration (G+Y+Rc), s		78.4			38.5	39.9		11.6				
Change Period (Y+Rc), s		4.5			4.5	4.5		4.5				
Max Green Setting (Gmax), s		62.4			22.5	35.4		18.6				
Max Q Clear Time (g_c+I1), s		2.0			5.5	18.9		6.6				
Green Ext Time (p_c), s		4.5			1.4	5.0		0.6				

Intersection Summary

HCM 6th Ctrl Delay	16.6
HCM 6th LOS	B

Notes

User approved volume balancing among the lanes for turning movement.

HCM 6th Signalized Intersection Summary
 47: Madera Avenue & Olive Avenue/SR-99 Southbound On-Ramp

Village D Specific Plan
 Existing NP - PM Peak Hour



Movement	EBL	EBT	EBR	WBL	WBT	WBR	NBL	NBT	NBR	SBL	SBT	SBR
Lane Configurations												
Traffic Volume (veh/h)	324	135	298	0	0	0	104	573	29	130	331	291
Future Volume (veh/h)	324	135	298	0	0	0	104	573	29	130	331	291
Initial Q (Qb), veh	0	0	0				0	0	0	0	0	0
Ped-Bike Adj(A_pbT)	1.00		1.00				1.00		1.00	1.00		1.00
Parking Bus, Adj	1.00	1.00	1.00				1.00	1.00	1.00	1.00	1.00	1.00
Work Zone On Approach	No						No			No		
Adj Sat Flow, veh/h/ln	1856	1856	1856				1870	1870	1870	1885	1885	1885
Adj Flow Rate, veh/h	236	275	307				107	591	30	134	341	300
Peak Hour Factor	0.97	0.97	0.97				0.97	0.97	0.97	0.97	0.97	0.97
Percent Heavy Veh, %	3	3	3				2	2	2	1	1	1
Cap, veh/h	417	438	452				179	1787	91	169	1023	884
Arrive On Green	0.08	0.08	0.08				0.05	0.52	0.52	0.03	0.19	0.19
Sat Flow, veh/h	1767	1856	1570				3456	3441	174	1795	1820	1573
Grp Volume(v), veh/h	236	275	307				107	305	316	134	336	305
Grp Sat Flow(s),veh/h/ln	1767	1856	1570				1728	1777	1839	1795	1791	1602
Q Serve(g_s), s	11.6	12.9	16.2				2.7	9.0	9.0	6.7	14.6	14.9
Cycle Q Clear(g_c), s	11.6	12.9	16.2				2.7	9.0	9.0	6.7	14.6	14.9
Prop In Lane	1.00		1.00				1.00		0.09	1.00		0.98
Lane Grp Cap(c), veh/h	417	438	452				179	923	955	169	1007	900
V/C Ratio(X)	0.57	0.63	0.68				0.60	0.33	0.33	0.79	0.33	0.34
Avail Cap(c_a), veh/h	638	670	648				576	923	955	269	1007	900
HCM Platoon Ratio	0.33	0.33	0.33				1.00	1.00	1.00	0.33	0.33	0.33
Upstream Filter(I)	0.88	0.88	0.88				1.00	1.00	1.00	0.86	0.86	0.86
Uniform Delay (d), s/veh	37.0	37.7	34.5				41.8	12.5	12.6	42.7	22.0	22.1
Incr Delay (d2), s/veh	1.1	1.3	1.6				3.2	1.0	0.9	7.0	0.8	0.9
Initial Q Delay(d3),s/veh	0.0	0.0	0.0				0.0	0.0	0.0	0.0	0.0	0.0
%ile BackOfQ(50%),veh/ln	5.6	6.6	14.5				1.2	3.6	3.7	3.4	7.2	6.6
Unsig. Movement Delay, s/veh												
LnGrp Delay(d),s/veh	38.1	39.0	36.1				44.9	13.5	13.5	49.7	22.8	23.0
LnGrp LOS	D	D	D				D	B	B	D	C	C
Approach Vol, veh/h	818						728			775		
Approach Delay, s/veh	37.6						18.1			27.5		
Approach LOS	D						B			C		
Timer - Assigned Phs	1	2		4	5	6						
Phs Duration (G+Y+Rc), s	33.0	51.2		25.8	9.2	55.1						
Change Period (Y+Rc), s	4.5	4.5		4.5	4.5	4.5						
Max Green Setting (Gmax), s	13.5	30.5		32.5	15.0	29.0						
Max Q Clear Time (g_c+I), s	10.7	11.0		18.2	4.7	16.9						
Green Ext Time (p_c), s	0.1	3.7		3.1	0.2	3.3						

Intersection Summary

HCM 6th Ctrl Delay	28.1
HCM 6th LOS	C

Notes

User approved volume balancing among the lanes for turning movement.

Intersection						
Int Delay, s/veh	0.3					
Movement	WBL	WBR	NBT	NBR	SBL	SBT
Lane Configurations	Y		↑↓		Y	↑↑
Traffic Vol, veh/h	7	9	739	6	31	690
Future Vol, veh/h	7	9	739	6	31	690
Conflicting Peds, #/hr	0	0	0	2	2	0
Sign Control	Stop	Stop	Free	Free	Free	Free
RT Channelized	-	None	-	None	-	None
Storage Length	0	-	-	-	100	-
Veh in Median Storage, #	0	-	0	-	-	0
Grade, %	0	-	0	-	-	0
Peak Hour Factor	95	95	95	95	95	95
Heavy Vehicles, %	6	6	2	2	2	2
Mvmt Flow	7	9	778	6	33	726

Major/Minor	Minor1	Major1	Major2		
Conflicting Flow All	1212	394	0	0	786
Stage 1	783	-	-	-	-
Stage 2	429	-	-	-	-
Critical Hdwy	6.92	7.02	-	-	4.14
Critical Hdwy Stg 1	5.92	-	-	-	-
Critical Hdwy Stg 2	5.92	-	-	-	-
Follow-up Hdwy	3.56	3.36	-	-	2.22
Pot Cap-1 Maneuver	*327	594	-	-	829
Stage 1	*401	-	-	-	-
Stage 2	*741	-	-	-	-
Platoon blocked, %	1	-	-	-	-
Mov Cap-1 Maneuver	*314	593	-	-	827
Mov Cap-2 Maneuver	*351	-	-	-	-
Stage 1	*400	-	-	-	-
Stage 2	*712	-	-	-	-

Approach	WB	NB	SB
HCM Control Delay, s	13.2	0	0.4
HCM LOS	B		

Minor Lane/Major Mvmt	NBT	NBRWBLn1	SBL	SBT
Capacity (veh/h)	-	-	456	827
HCM Lane V/C Ratio	-	-	0.037	0.039
HCM Control Delay (s)	-	-	13.2	9.5
HCM Lane LOS	-	-	B	A
HCM 95th %tile Q(veh)	-	-	0.1	0.1

Notes
 -: Volume exceeds capacity \$: Delay exceeds 300s +: Computation Not Defined *: All major volume in platoon

HCM 6th Signalized Intersection Summary
 49: Yosemite Avenue & Cleveland Avenue/Tozer Street

Village D Specific Plan
 Existing NP - PM Peak Hour



Movement	EBL	EBT	EBR	WBL	WBT	WBR	NBL	NBT	NBR	SBL	SBT	SBR
Lane Configurations	↖	↗		↖	↗	↗	↖	↗	↗	↖	↗	↗
Traffic Volume (veh/h)	187	408	195	48	447	35	305	283	95	67	167	209
Future Volume (veh/h)	187	408	195	48	447	35	305	283	95	67	167	209
Initial Q (Qb), veh	0	0	0	0	0	0	0	0	0	0	0	0
Ped-Bike Adj(A_pbT)	1.00		0.99	1.00		0.96	1.00		1.00	1.00		0.98
Parking Bus, Adj	1.00	1.00	1.00	1.00	1.00	1.00	1.00	1.00	1.00	1.00	1.00	1.00
Work Zone On Approach		No			No			No			No	
Adj Sat Flow, veh/h/ln	1870	1870	1870	1900	1900	1900	1870	1870	1870	1870	1870	1870
Adj Flow Rate, veh/h	203	443	212	52	486	38	332	308	103	73	182	227
Peak Hour Factor	0.92	0.92	0.92	0.92	0.92	0.92	0.92	0.92	0.92	0.92	0.92	0.92
Percent Heavy Veh, %	2	2	2	0	0	0	2	2	2	2	2	2
Cap, veh/h	236	765	363	69	846	363	340	749	633	94	196	244
Arrive On Green	0.13	0.33	0.33	0.04	0.23	0.23	0.19	0.40	0.40	0.05	0.26	0.26
Sat Flow, veh/h	1781	2329	1104	1810	3610	1549	1781	1870	1580	1781	748	933
Grp Volume(v), veh/h	203	337	318	52	486	38	332	308	103	73	0	409
Grp Sat Flow(s),veh/h/ln	1781	1777	1656	1810	1805	1549	1781	1870	1580	1781	0	1680
Q Serve(g_s), s	11.2	15.7	16.0	2.8	11.9	1.9	18.5	11.8	4.2	4.0	0.0	23.7
Cycle Q Clear(g_c), s	11.2	15.7	16.0	2.8	11.9	1.9	18.5	11.8	4.2	4.0	0.0	23.7
Prop In Lane	1.00		0.67	1.00		1.00	1.00		1.00	1.00		0.56
Lane Grp Cap(c), veh/h	236	584	544	69	846	363	340	749	633	94	0	440
V/C Ratio(X)	0.86	0.58	0.58	0.75	0.57	0.10	0.98	0.41	0.16	0.78	0.00	0.93
Avail Cap(c_a), veh/h	287	584	544	103	846	363	340	749	633	173	0	462
HCM Platoon Ratio	1.00	1.00	1.00	1.00	1.00	1.00	1.00	1.00	1.00	1.00	1.00	1.00
Upstream Filter(I)	1.00	1.00	1.00	1.00	1.00	1.00	1.00	1.00	1.00	1.00	0.00	1.00
Uniform Delay (d), s/veh	42.5	27.8	27.9	47.6	33.9	30.1	40.2	21.5	19.2	46.8	0.0	36.0
Incr Delay (d2), s/veh	19.3	4.1	4.5	15.4	2.8	0.6	42.1	0.4	0.1	12.7	0.0	24.7
Initial Q Delay(d3),s/veh	0.0	0.0	0.0	0.0	0.0	0.0	0.0	0.0	0.0	0.0	0.0	0.0
%ile BackOfQ(50%),veh/ln	6.1	7.2	6.9	1.6	5.5	0.8	12.0	5.1	1.5	2.1	0.0	12.5
Unsig. Movement Delay, s/veh												
LnGrp Delay(d),s/veh	61.7	31.9	32.4	63.1	36.7	30.6	82.4	21.9	19.4	59.4	0.0	60.6
LnGrp LOS	E	C	C	E	D	C	F	C	B	E	A	E
Approach Vol, veh/h		858			576			743				482
Approach Delay, s/veh		39.2			38.7			48.6				60.5
Approach LOS		D			D			D				E
Timer - Assigned Phs	1	2	3	4	5	6	7	8				
Phs Duration (G+Y+Rc), s	17.8	27.9	9.8	44.5	8.3	37.4	23.6	30.7				
Change Period (Y+Rc), s	4.5	4.5	4.5	4.5	4.5	4.5	4.5	4.5				
Max Green Setting (Gmax), s	16.1	19.3	9.7	36.9	5.7	29.7	19.1	27.5				
Max Q Clear Time (g_c+I1), s	13.2	13.9	6.0	13.8	4.8	18.0	20.5	25.7				
Green Ext Time (p_c), s	0.2	1.6	0.0	2.2	0.0	3.3	0.0	0.5				

Intersection Summary

HCM 6th Ctrl Delay	45.6
HCM 6th LOS	D

Intersection						
Int Delay, s/veh	0					
Movement	EBT	EBR	WBL	WBT	NBL	NBR
Lane Configurations						
Traffic Vol, veh/h	60	0	0	25	0	0
Future Vol, veh/h	60	0	0	25	0	0
Conflicting Peds, #/hr	0	0	0	0	0	0
Sign Control	Free	Free	Free	Free	Stop	Stop
RT Channelized	-	None	-	None	-	None
Storage Length	-	-	-	-	-	-
Veh in Median Storage, #	0	-	-	0	0	-
Grade, %	0	-	-	0	0	-
Peak Hour Factor	71	71	71	71	71	71
Heavy Vehicles, %	4	4	4	4	0	0
Mvmt Flow	85	0	0	35	0	0

Major/Minor	Major1	Major2	Minor1	Minor2	Minor3
Conflicting Flow All	0	0	85	0	120
Stage 1	-	-	-	-	85
Stage 2	-	-	-	-	35
Critical Hdwy	-	-	4.14	-	6.4
Critical Hdwy Stg 1	-	-	-	-	5.4
Critical Hdwy Stg 2	-	-	-	-	5.4
Follow-up Hdwy	-	-	2.236	-	3.5
Pot Cap-1 Maneuver	-	-	1499	-	880
Stage 1	-	-	-	-	943
Stage 2	-	-	-	-	993
Platoon blocked, %	-	-	-	-	-
Mov Cap-1 Maneuver	-	-	1499	-	880
Mov Cap-2 Maneuver	-	-	-	-	880
Stage 1	-	-	-	-	943
Stage 2	-	-	-	-	993

Approach	EB	WB	NB
HCM Control Delay, s	0	0	0
HCM LOS			A

Minor Lane/Major Mvmt	NBLn1	EBT	EBR	WBL	WBT
Capacity (veh/h)	-	-	-	1499	-
HCM Lane V/C Ratio	-	-	-	-	-
HCM Control Delay (s)	0	-	-	0	-
HCM Lane LOS	A	-	-	A	-
HCM 95th %tile Q(veh)	-	-	-	0	-

Intersection												
Int Delay, s/veh	0.1											
Movement	EBL	EBT	EBR	WBL	WBT	WBR	NBL	NBT	NBR	SBL	SBT	SBR
Lane Configurations		↕			↕			↕			↕	
Traffic Vol, veh/h	0	49	0	0	14	0	0	0	0	1	0	0
Future Vol, veh/h	0	49	0	0	14	0	0	0	0	1	0	0
Conflicting Peds, #/hr	0	0	0	0	0	0	0	0	0	0	0	0
Sign Control	Free	Free	Free	Free	Free	Free	Stop	Stop	Stop	Stop	Stop	Stop
RT Channelized	-	-	None	-	-	None	-	-	None	-	-	None
Storage Length	-	-	-	-	-	-	-	-	-	-	-	-
Veh in Median Storage, #	-	0	-	-	0	-	-	0	-	-	0	-
Grade, %	-	0	-	-	0	-	-	0	-	-	0	-
Peak Hour Factor	52	52	52	52	52	52	52	52	52	52	52	52
Heavy Vehicles, %	13	13	13	13	13	13	0	0	0	0	0	0
Mvmt Flow	0	94	0	0	27	0	0	0	0	2	0	0

Major/Minor	Major1			Major2			Minor1			Minor2		
Conflicting Flow All	27	0	0	94	0	0	121	121	94	121	121	27
Stage 1	-	-	-	-	-	-	94	94	-	27	27	-
Stage 2	-	-	-	-	-	-	27	27	-	94	94	-
Critical Hdwy	4.23	-	-	4.23	-	-	7.1	6.5	6.2	7.1	6.5	6.2
Critical Hdwy Stg 1	-	-	-	-	-	-	6.1	5.5	-	6.1	5.5	-
Critical Hdwy Stg 2	-	-	-	-	-	-	6.1	5.5	-	6.1	5.5	-
Follow-up Hdwy	2.317	-	-	2.317	-	-	3.5	4	3.3	3.5	4	3.3
Pot Cap-1 Maneuver	1518	-	-	1434	-	-	859	773	968	859	773	1054
Stage 1	-	-	-	-	-	-	918	821	-	996	877	-
Stage 2	-	-	-	-	-	-	996	877	-	918	821	-
Platoon blocked, %	-	-	-	-	-	-	-	-	-	-	-	-
Mov Cap-1 Maneuver	1518	-	-	1434	-	-	859	773	968	859	773	1054
Mov Cap-2 Maneuver	-	-	-	-	-	-	859	773	-	859	773	-
Stage 1	-	-	-	-	-	-	918	821	-	996	877	-
Stage 2	-	-	-	-	-	-	996	877	-	918	821	-

Approach	EB			WB			NB			SB		
HCM Control Delay, s	0			0			0			9.2		
HCM LOS							A			A		

Minor Lane/Major Mvmt	NBLn1	EBL	EBT	EBR	WBL	WBT	WBR	SBLn1
Capacity (veh/h)	-	1518	-	-	1434	-	-	859
HCM Lane V/C Ratio	-	-	-	-	-	-	-	0.002
HCM Control Delay (s)	0	0	-	-	0	-	-	9.2
HCM Lane LOS	A	A	-	-	A	-	-	A
HCM 95th %tile Q(veh)	-	0	-	-	0	-	-	0

Intersection						
Int Delay, s/veh	0					
Movement	WBL	WBR	NBT	NBR	SBL	SBT
Lane Configurations						
Traffic Vol, veh/h	0	0	0	0	1	0
Future Vol, veh/h	0	0	0	0	1	0
Conflicting Peds, #/hr	0	0	0	0	0	0
Sign Control	Stop	Stop	Free	Free	Free	Free
RT Channelized	-	None	-	None	-	None
Storage Length	-	-	-	-	-	-
Veh in Median Storage, #	0	-	0	-	-	0
Grade, %	0	-	0	-	-	0
Peak Hour Factor	25	25	25	25	25	25
Heavy Vehicles, %	0	0	0	0	0	0
Mvmt Flow	0	0	0	0	4	0

Major/Minor	Minor1	Major1	Major2			
Conflicting Flow All	8	0	0	0	0	0
Stage 1	0	-	-	-	-	-
Stage 2	8	-	-	-	-	-
Critical Hdwy	6.4	6.2	-	-	4.1	-
Critical Hdwy Stg 1	5.4	-	-	-	-	-
Critical Hdwy Stg 2	5.4	-	-	-	-	-
Follow-up Hdwy	3.5	3.3	-	-	2.2	-
Pot Cap-1 Maneuver	1018	-	-	-	-	-
Stage 1	-	-	-	-	-	-
Stage 2	1020	-	-	-	-	-
Platoon blocked, %						
Mov Cap-1 Maneuver	1018	-	-	-	-	-
Mov Cap-2 Maneuver	1018	-	-	-	-	-
Stage 1	-	-	-	-	-	-
Stage 2	1020	-	-	-	-	-

Approach	WB	NB	SB
HCM Control Delay, s	0	0	
HCM LOS	A		

Minor Lane/Major Mvmt	NBT	NBRWBLn1	SBL	SBT
Capacity (veh/h)	-	-	-	-
HCM Lane V/C Ratio	-	-	-	-
HCM Control Delay (s)	-	-	0	-
HCM Lane LOS	-	-	A	-
HCM 95th %tile Q(veh)	-	-	-	-

Intersection						
Int Delay, s/veh	0					
Movement	EBL	EBR	NBL	NBT	SBT	SBR
Lane Configurations						
Traffic Vol, veh/h	0	2	0	152	242	0
Future Vol, veh/h	0	2	0	152	242	0
Conflicting Peds, #/hr	0	0	0	0	0	0
Sign Control	Stop	Stop	Free	Free	Free	Free
RT Channelized	-	None	-	None	-	None
Storage Length	-	-	-	-	-	-
Veh in Median Storage, #	0	-	-	0	0	-
Grade, %	0	-	-	0	0	-
Peak Hour Factor	90	90	90	90	90	90
Heavy Vehicles, %	0	0	9	9	9	9
Mvmt Flow	0	2	0	169	269	0

Major/Minor	Minor2	Major1		Major2	
Conflicting Flow All	438	269	269	0	0
Stage 1	269	-	-	-	-
Stage 2	169	-	-	-	-
Critical Hdwy	6.4	6.2	4.19	-	-
Critical Hdwy Stg 1	5.4	-	-	-	-
Critical Hdwy Stg 2	5.4	-	-	-	-
Follow-up Hdwy	3.5	3.3	2.281	-	-
Pot Cap-1 Maneuver	580	775	1255	-	-
Stage 1	781	-	-	-	-
Stage 2	866	-	-	-	-
Platoon blocked, %				-	-
Mov Cap-1 Maneuver	580	775	1255	-	-
Mov Cap-2 Maneuver	580	-	-	-	-
Stage 1	781	-	-	-	-
Stage 2	866	-	-	-	-

Approach	EB	NB	SB
HCM Control Delay, s	9.7	0	0
HCM LOS	A		

Minor Lane/Major Mvmt	NBL	NBT	EBLn1	SBT	SBR
Capacity (veh/h)	1255	-	775	-	-
HCM Lane V/C Ratio	-	-	0.003	-	-
HCM Control Delay (s)	0	-	9.7	-	-
HCM Lane LOS	A	-	A	-	-
HCM 95th %tile Q(veh)	0	-	0	-	-

Intersection						
Int Delay, s/veh	0.1					
Movement	EBL	EBR	NBL	NBT	SBT	SBR
Lane Configurations	T			T		T
Traffic Vol, veh/h	1	2	0	240	330	1
Future Vol, veh/h	1	2	0	240	330	1
Conflicting Peds, #/hr	0	0	0	0	0	0
Sign Control	Stop	Stop	Free	Free	Free	Free
RT Channelized	-	None	-	None	-	None
Storage Length	0	-	-	-	-	-
Veh in Median Storage, #	0	-	-	0	0	-
Grade, %	0	-	-	0	0	-
Peak Hour Factor	66	66	66	66	66	66
Heavy Vehicles, %	0	0	9	9	9	9
Mvmt Flow	2	3	0	364	500	2

Major/Minor	Minor2	Major1	Major2			
Conflicting Flow All	865	501	502	0	-	0
Stage 1	501	-	-	-	-	-
Stage 2	364	-	-	-	-	-
Critical Hdwy	6.4	6.2	4.19	-	-	-
Critical Hdwy Stg 1	5.4	-	-	-	-	-
Critical Hdwy Stg 2	5.4	-	-	-	-	-
Follow-up Hdwy	3.5	3.3	2.281	-	-	-
Pot Cap-1 Maneuver	327	574	1027	-	-	-
Stage 1	613	-	-	-	-	-
Stage 2	707	-	-	-	-	-
Platoon blocked, %				-	-	-
Mov Cap-1 Maneuver	327	574	1027	-	-	-
Mov Cap-2 Maneuver	327	-	-	-	-	-
Stage 1	613	-	-	-	-	-
Stage 2	707	-	-	-	-	-

Approach	EB	NB	SB
HCM Control Delay, s	12.9	0	0
HCM LOS	B		

Minor Lane/Major Mvmt	NBL	NBT	EBLn1	SBT	SBR
Capacity (veh/h)	1027	-	459	-	-
HCM Lane V/C Ratio	-	-	0.01	-	-
HCM Control Delay (s)	0	-	12.9	-	-
HCM Lane LOS	A	-	B	-	-
HCM 95th %tile Q(veh)	0	-	0	-	-

Intersection						
Int Delay, s/veh	2					
Movement	EBT	EBR	WBL	WBT	NBL	NBR
Lane Configurations						
Traffic Vol, veh/h	59	9	10	115	30	10
Future Vol, veh/h	59	9	10	115	30	10
Conflicting Peds, #/hr	0	0	0	0	0	0
Sign Control	Free	Free	Free	Free	Stop	Stop
RT Channelized	-	None	-	None	-	None
Storage Length	-	-	50	-	-	-
Veh in Median Storage, #	0	-	-	0	0	-
Grade, %	0	-	-	0	0	-
Peak Hour Factor	92	92	92	92	92	92
Heavy Vehicles, %	6	6	3	3	0	0
Mvmt Flow	64	10	11	125	33	11

Major/Minor	Major1	Major2	Minor1		
Conflicting Flow All	0	0	74	0	216 69
Stage 1	-	-	-	-	69 -
Stage 2	-	-	-	-	147 -
Critical Hdwy	-	-	4.13	-	6.4 6.2
Critical Hdwy Stg 1	-	-	-	-	5.4 -
Critical Hdwy Stg 2	-	-	-	-	5.4 -
Follow-up Hdwy	-	-	2.227	-	3.5 3.3
Pot Cap-1 Maneuver	-	-	1519	-	777 1000
Stage 1	-	-	-	-	959 -
Stage 2	-	-	-	-	885 -
Platoon blocked, %	-	-	-	-	-
Mov Cap-1 Maneuver	-	-	1519	-	772 1000
Mov Cap-2 Maneuver	-	-	-	-	772 -
Stage 1	-	-	-	-	959 -
Stage 2	-	-	-	-	879 -

Approach	EB	WB	NB
HCM Control Delay, s	0	0.6	9.6
HCM LOS			A

Minor Lane/Major Mvmt	NBLn1	EBT	EBR	WBL	WBT
Capacity (veh/h)	819	-	-	1519	-
HCM Lane V/C Ratio	0.053	-	-	0.007	-
HCM Control Delay (s)	9.6	-	-	7.4	-
HCM Lane LOS	A	-	-	A	-
HCM 95th %tile Q(veh)	0.2	-	-	0	-

Intersection	
Intersection Delay, s/veh	7.5
Intersection LOS	A

Movement	EBL	EBT	EBR	WBL	WBT	WBR	NBL	NBT	NBR	SBL	SBT	SBR
Lane Configurations	↵	↶		↵	↶		↵	↶		↵	↶	
Traffic Vol, veh/h	2	12	0	0	29	20	0	21	0	5	14	1
Future Vol, veh/h	2	12	0	0	29	20	0	21	0	5	14	1
Peak Hour Factor	0.92	0.92	0.92	0.92	0.92	0.92	0.92	0.92	0.92	0.92	0.92	0.92
Heavy Vehicles, %	11	11	11	8	8	8	0	0	0	0	0	0
Mvmt Flow	2	13	0	0	32	22	0	23	0	5	15	1
Number of Lanes	1	1	0	1	1	0	1	1	0	1	1	0

Approach	EB	WB	NB	SB
Opposing Approach	WB	EB	SB	NB
Opposing Lanes	2	2	2	2
Conflicting Approach Left	SB	NB	EB	WB
Conflicting Lanes Left	2	2	2	2
Conflicting Approach Right	NB	SB	WB	EB
Conflicting Lanes Right	2	2	2	2
HCM Control Delay	7.7	7.5	7.5	7.5
HCM LOS	A	A	A	A

Lane	NBLn1	NBLn2	EBLn1	EBLn2	WBLn1	WBLn2	SBLn1	SBLn2
Vol Left, %	0%	0%	100%	0%	0%	0%	100%	0%
Vol Thru, %	100%	100%	0%	100%	100%	59%	0%	93%
Vol Right, %	0%	0%	0%	0%	0%	41%	0%	7%
Sign Control	Stop	Stop	Stop	Stop	Stop	Stop	Stop	Stop
Traffic Vol by Lane	0	21	2	12	0	49	5	15
LT Vol	0	0	2	0	0	0	5	0
Through Vol	0	21	0	12	0	29	0	14
RT Vol	0	0	0	0	0	20	0	1
Lane Flow Rate	0	23	2	13	0	53	5	16
Geometry Grp	7	7	7	7	7	7	7	7
Degree of Util (X)	0	0.029	0.003	0.017	0	0.066	0.008	0.021
Departure Headway (Hd)	4.63	4.63	5.29	4.789	4.72	4.434	5.13	4.583
Convergence, Y/N	Yes	Yes	Yes	Yes	Yes	Yes	Yes	Yes
Cap	0	769	674	744	0	805	695	777
Service Time	2.384	2.384	3.038	2.538	2.46	2.174	2.884	2.337
HCM Lane V/C Ratio	0	0.03	0.003	0.017	0	0.066	0.007	0.021
HCM Control Delay	7.4	7.5	8.1	7.6	7.5	7.5	7.9	7.4
HCM Lane LOS	N	A	A	A	N	A	A	A
HCM 95th-tile Q	0	0.1	0	0.1	0	0.2	0	0.1

Intersection						
Int Delay, s/veh	2.6					
Movement	EBL	EBT	WBT	WBR	SBL	SBR
Lane Configurations		↕	↑	↗	↘	
Traffic Vol, veh/h	2	126	170	106	92	4
Future Vol, veh/h	2	126	170	106	92	4
Conflicting Peds, #/hr	0	0	0	0	0	0
Sign Control	Free	Free	Free	Free	Stop	Stop
RT Channelized	-	None	-	None	-	None
Storage Length	-	-	-	0	0	-
Veh in Median Storage, #	-	0	0	-	0	-
Grade, %	-	0	0	-	0	-
Peak Hour Factor	92	92	92	92	92	92
Heavy Vehicles, %	13	13	37	37	81	81
Mvmt Flow	2	137	185	115	100	4

Major/Minor	Major1	Major2	Minor2		
Conflicting Flow All	300	0	-	0	326 185
Stage 1	-	-	-	-	185 -
Stage 2	-	-	-	-	141 -
Critical Hdwy	4.23	-	-	-	7.21 7.01
Critical Hdwy Stg 1	-	-	-	-	6.21 -
Critical Hdwy Stg 2	-	-	-	-	6.21 -
Follow-up Hdwy	2.317	-	-	-	4.229 4.029
Pot Cap-1 Maneuver	1201	-	-	-	533 690
Stage 1	-	-	-	-	688 -
Stage 2	-	-	-	-	724 -
Platoon blocked, %		-	-	-	
Mov Cap-1 Maneuver	1201	-	-	-	532 690
Mov Cap-2 Maneuver	-	-	-	-	532 -
Stage 1	-	-	-	-	687 -
Stage 2	-	-	-	-	724 -

Approach	EB	WB	SB
HCM Control Delay, s	0.1	0	13.3
HCM LOS			B

Minor Lane/Major Mvmt	EBL	EBT	WBT	WBR	SBLn1
Capacity (veh/h)	1201	-	-	-	537
HCM Lane V/C Ratio	0.002	-	-	-	0.194
HCM Control Delay (s)	8	0	-	-	13.3
HCM Lane LOS	A	A	-	-	B
HCM 95th %tile Q(veh)	0	-	-	-	0.7

HCM 6th TWSC
4: Truck Parking Lot/Pistachio Drive & Avenue 18 1/2

Village D Specific Plan
Existing WP - AM Peak Hour

Intersection												
Int Delay, s/veh	2.4											
Movement	EBL	EBT	EBR	WBL	WBT	WBR	NBL	NBT	NBR	SBL	SBT	SBR
Lane Configurations		↕			↕	↕		↕			↕	
Traffic Vol, veh/h	8	278	1	3	286	201	0	0	1	104	0	9
Future Vol, veh/h	8	278	1	3	286	201	0	0	1	104	0	9
Conflicting Peds, #/hr	0	0	0	0	0	0	0	0	0	0	0	0
Sign Control	Free	Free	Free	Free	Free	Free	Stop	Stop	Stop	Stop	Stop	Stop
RT Channelized	-	-	None	-	-	None	-	-	None	-	-	None
Storage Length	-	-	-	-	-	50	-	-	-	-	-	-
Veh in Median Storage, #	-	0	-	-	0	-	-	0	-	-	0	-
Grade, %	-	0	-	-	0	-	-	0	-	-	0	-
Peak Hour Factor	93	93	93	93	93	93	93	93	93	93	93	93
Heavy Vehicles, %	30	30	30	22	22	22	100	100	100	12	12	12
Mvmt Flow	9	299	1	3	308	216	0	0	1	112	0	10

Major/Minor	Major1			Major2			Minor1			Minor2		
Conflicting Flow All	524	0	0	300	0	0	745	848	300	632	632	308
Stage 1	-	-	-	-	-	-	318	318	-	314	314	-
Stage 2	-	-	-	-	-	-	427	530	-	318	318	-
Critical Hdwy	4.4	-	-	4.32	-	-	8.1	7.5	7.2	7.22	6.62	6.32
Critical Hdwy Stg 1	-	-	-	-	-	-	7.1	6.5	-	6.22	5.62	-
Critical Hdwy Stg 2	-	-	-	-	-	-	7.1	6.5	-	6.22	5.62	-
Follow-up Hdwy	2.47	-	-	2.398	-	-	4.4	4.9	4.2	3.608	4.108	3.408
Pot Cap-1 Maneuver	915	-	-	1156	-	-	233	212	558	379	385	709
Stage 1	-	-	-	-	-	-	527	510	-	676	639	-
Stage 2	-	-	-	-	-	-	452	396	-	673	636	-
Platoon blocked, %	-	-	-	-	-	-	-	-	-	-	-	-
Mov Cap-1 Maneuver	915	-	-	1156	-	-	227	209	558	374	379	709
Mov Cap-2 Maneuver	-	-	-	-	-	-	227	209	-	374	379	-
Stage 1	-	-	-	-	-	-	521	504	-	668	636	-
Stage 2	-	-	-	-	-	-	444	394	-	664	628	-

Approach	EB	WB	NB	SB
HCM Control Delay, s	0.3	0	11.5	18.4
HCM LOS			B	C

Minor Lane/Major Mvmt	NBLn1	EBL	EBT	EBR	WBL	WBT	WBR	SBLn1
Capacity (veh/h)	558	915	-	-	1156	-	-	389
HCM Lane V/C Ratio	0.002	0.009	-	-	0.003	-	-	0.312
HCM Control Delay (s)	11.5	9	0	-	8.1	0	-	18.4
HCM Lane LOS	B	A	A	-	A	A	-	C
HCM 95th %tile Q(veh)	0	0	-	-	0	-	-	1.3

Intersection												
Int Delay, s/veh	0.2											
Movement	EBL	EBT	EBR	WBL	WBT	WBR	NBL	NBT	NBR	SBL	SBT	SBR
Lane Configurations		↑	↑		↑		↑		↑		↕	
Traffic Vol, veh/h	0	305	78	40	271	0	134	0	722	10	255	85
Future Vol, veh/h	0	305	78	40	271	0	134	0	722	10	255	85
Conflicting Peds, #/hr	0	0	0	0	0	0	0	0	1	1	0	0
Sign Control	Free	Free	Free	Free	Free	Free	Stop	Stop	Stop	Stop	Stop	Stop
RT Channelized	-	-	None	-	-	None	-	-	None	-	-	None
Storage Length	-	-	50	-	-	-	0	-	25	-	-	-
Veh in Median Storage, #	-	0	-	-	0	-	-	0	-	-	0	-
Grade, %	-	0	-	-	0	-	-	0	-	-	0	-
Peak Hour Factor	88	88	88	88	88	88	88	88	88	88	88	88
Heavy Vehicles, %	29	29	29	24	24	24	5	5	5	14	14	14
Mvmt Flow	0	347	89	45	308	0	152	0	820	11	290	97

Major/Minor	Major1			Major2			Minor1			Minor2		
Conflicting Flow All	-	0	0	436	0	0	939	-	348	1201	834	308
Stage 1	-	-	-	-	-	-	347	-	-	398	398	-
Stage 2	-	-	-	-	-	-	592	-	-	803	436	-
Critical Hdwy	-	-	-	4.34	-	-	7.15	-	6.25	7.24	6.64	6.34
Critical Hdwy Stg 1	-	-	-	-	-	-	6.15	-	-	6.24	5.64	-
Critical Hdwy Stg 2	-	-	-	-	-	-	6.15	-	-	6.24	5.64	-
Follow-up Hdwy	-	-	-	2.416	-	-	3.545	-	3.345	3.626	4.126	3.426
Pot Cap-1 Maneuver	0	-	-	1016	-	0	241	0	~ 688	153	291	705
Stage 1	0	-	-	-	-	0	663	0	-	605	582	-
Stage 2	0	-	-	-	-	0	487	0	-	360	560	-
Platoon blocked, %	-	-	-	-	-	-	-	-	-	-	-	-
Mov Cap-1 Maneuver	-	-	-	1016	-	-	-	-	~ 687	-	~ 276	705
Mov Cap-2 Maneuver	-	-	-	-	-	-	-	-	-	-	~ 276	-
Stage 1	-	-	-	-	-	-	663	-	-	605	551	-
Stage 2	-	-	-	-	-	-	189	-	-	-	560	-

Approach	EB	WB	NB	SB
HCM Control Delay, s	0	1.1		
HCM LOS			-	-

Minor Lane/Major Mvmt	NBLn1	NBLn2	EBT	EBR	WBL	WBT	SBLn1
Capacity (veh/h)	-	687	-	-	1016	-	-
HCM Lane V/C Ratio	-	1.194	-	-	0.045	-	-
HCM Control Delay (s)	-	122.7	-	-	8.7	0	-
HCM Lane LOS	-	F	-	-	A	A	-
HCM 95th %tile Q(veh)	-	27.8	-	-	0.1	-	-

Notes
 -: Volume exceeds capacity \$: Delay exceeds 300s +: Computation Not Defined *: All major volume in platoon

Intersection

Int Delay, s/veh 1708.1

Movement	EBL	EBT	EBR	WBL	WBT	WBR	NBL	NBT	NBR	SBL	SBT	SBR
Lane Configurations	↙	↑			↘			↔				
Traffic Vol, veh/h	795	54	0	0	134	22	213	1	18	0	0	0
Future Vol, veh/h	795	54	0	0	134	22	213	1	18	0	0	0
Conflicting Peds, #/hr	1	0	0	0	0	1	0	0	0	0	0	0
Sign Control	Free	Free	Free	Free	Free	Free	Stop	Stop	Stop	Free	Free	Free
RT Channelized	-	-	None	-	-	None	-	-	None	-	-	None
Storage Length	145	-	-	-	-	-	-	-	-	-	-	-
Veh in Median Storage, #	-	0	-	-	0	-	-	0	-	-	16965	-
Grade, %	-	0	-	-	0	-	-	0	-	-	0	-
Peak Hour Factor	83	83	83	83	83	83	83	83	83	83	83	83
Heavy Vehicles, %	9	9	9	17	17	17	27	27	27	0	0	0
Mvmt Flow	958	65	0	0	161	27	257	1	22	0	0	0

Major/Minor	Major1	Major2	Minor1
Conflicting Flow All	189	0	-
Stage 1	-	-	-
Stage 2	-	-	-
Critical Hdwy	4.19	-	-
Critical Hdwy Stg 1	-	-	-
Critical Hdwy Stg 2	-	-	-
Follow-up Hdwy	2.281	-	-
Pot Cap-1 Maneuver	1344	-	0
Stage 1	-	-	0
Stage 2	-	-	0
Platoon blocked, %	-	-	-
Mov Cap-1 Maneuver	1344	-	-
Mov Cap-2 Maneuver	-	-	-
Stage 1	-	-	-
Stage 2	-	-	-

Approach	EB	WB	NB
HCM Control Delay, s	13.1	0	\$ 9059.3
HCM LOS			F

Minor Lane/Major Mvmt	NBLn1	EBL	EBT	WBT	WBR
Capacity (veh/h)	14	1344	-	-	-
HCM Lane V/C Ratio	19.966	0.713	-	-	-
HCM Control Delay (s)	\$ 9059.3	14	-	-	-
HCM Lane LOS	F	B	-	-	-
HCM 95th %tile Q(veh)	36.1	6.6	-	-	-

Notes
 -: Volume exceeds capacity \$: Delay exceeds 300s +: Computation Not Defined *: All major volume in platoon

Intersection												
Int Delay, s/veh	0.2											
Movement	EBL	EBT	EBR	WBL	WBT	WBR	NBL	NBT	NBR	SBL	SBT	SBR
Lane Configurations		↕			↕			↕			↕	
Traffic Vol, veh/h	160	477	30	474	128	3	51	909	974	15	400	42
Future Vol, veh/h	160	477	30	474	128	3	51	909	974	15	400	42
Conflicting Peds, #/hr	0	0	0	0	0	0	0	0	0	0	0	0
Sign Control	Stop	Stop	Stop	Stop	Stop	Stop	Free	Free	Free	Free	Free	Free
RT Channelized	-	-	None	-	-	None	-	-	None	-	-	None
Storage Length	-	-	-	-	-	-	-	-	-	-	-	-
Veh in Median Storage, #	-	0	-	-	0	-	-	0	-	-	0	-
Grade, %	-	0	-	-	0	-	-	0	-	-	0	-
Peak Hour Factor	92	92	92	92	92	92	92	92	92	92	92	92
Heavy Vehicles, %	0	0	0	2	2	2	2	2	2	6	6	6
Mvmt Flow	174	518	33	515	139	3	55	988	1059	16	435	46

Major/Minor	Minor2		Minor1		Major1			Major2				
Conflicting Flow All	2189	2647	458	2394	2141	1518	481	0	0	2047	0	0
Stage 1	490	490	-	1628	1628	-	-	-	-	-	-	-
Stage 2	1699	2157	-	766	513	-	-	-	-	-	-	-
Critical Hdwy	7.1	6.5	6.2	7.12	6.52	6.22	4.12	-	-	4.16	-	-
Critical Hdwy Stg 1	6.1	5.5	-	6.12	5.52	-	-	-	-	-	-	-
Critical Hdwy Stg 2	6.1	5.5	-	6.12	5.52	-	-	-	-	-	-	-
Follow-up Hdwy	3.5	4	3.3	3.518	4.018	3.318	2.218	-	-	2.254	-	-
Pot Cap-1 Maneuver	~ 33	~ 23	607	~ 23	~ 49	146	1082	-	-	266	-	-
Stage 1	564	552	-	~ 128	160	-	-	-	-	-	-	-
Stage 2	~ 118	~ 88	-	~ 395	536	-	-	-	-	-	-	-
Platoon blocked, %								-	-	-	-	-
Mov Cap-1 Maneuver	-	~ 21	607	-	~ 45	146	1082	-	-	266	-	-
Mov Cap-2 Maneuver	-	~ 21	-	-	~ 45	-	-	-	-	-	-	-
Stage 1	564	~ 506	-	~ 128	160	-	-	-	-	-	-	-
Stage 2	~ 15	~ 88	-	-	492	-	-	-	-	-	-	-

Approach	EB	WB	NB	SB
HCM Control Delay, s			0.2	0.6
HCM LOS	-	-		

Minor Lane/Major Mvmt	NBL	NBT	NBR	EBLn1WBLn1	SBL	SBT	SBR
Capacity (veh/h)	1082	-	-	-	266	-	-
HCM Lane V/C Ratio	0.051	-	-	-	0.061	-	-
HCM Control Delay (s)	8.5	0	-	-	19.4	0	-
HCM Lane LOS	A	A	-	-	C	A	-
HCM 95th %tile Q(veh)	0.2	-	-	-	0.2	-	-

Notes			
-: Volume exceeds capacity	\$: Delay exceeds 300s	+: Computation Not Defined	*: All major volume in platoon

Intersection	
Intersection Delay, s/veh	501.2
Intersection LOS	F

Movement	EBL	EBT	EBR	WBL	WBT	WBR	NBL	NBT	NBR	SBL	SBT	SBR
Lane Configurations	↶	↷		↶	↷		↶	↷		↶	↷	
Traffic Vol, veh/h	140	35	388	162	37	222	150	1018	49	58	663	64
Future Vol, veh/h	140	35	388	162	37	222	150	1018	49	58	663	64
Peak Hour Factor	0.92	0.92	0.92	0.92	0.92	0.92	0.92	0.92	0.92	0.92	0.92	0.92
Heavy Vehicles, %	1	1	1	0	0	0	3	3	3	4	4	4
Mvmt Flow	152	38	422	176	40	241	163	1107	53	63	721	70
Number of Lanes	1	1	0	1	1	0	1	1	0	1	1	0

Approach	EB	WB	NB	SB
Opposing Approach	WB	EB	SB	NB
Opposing Lanes	2	2	2	2
Conflicting Approach Left	SB	NB	EB	WB
Conflicting Lanes Left	2	2	2	2
Conflicting Approach Right	NB	SB	WB	EB
Conflicting Lanes Right	2	2	2	2
HCM Control Delay	105	39.7	845.1	499.7
HCM LOS	F	E	F	F

Lane	NBLn1	NBLn2	EBLn1	EBLn2	WBLn1	WBLn2	SBLn1	SBLn2
Vol Left, %	100%	0%	100%	0%	100%	0%	100%	0%
Vol Thru, %	0%	95%	0%	8%	0%	14%	0%	91%
Vol Right, %	0%	5%	0%	92%	0%	86%	0%	9%
Sign Control	Stop	Stop	Stop	Stop	Stop	Stop	Stop	Stop
Traffic Vol by Lane	150	1067	140	423	162	259	58	727
LT Vol	150	0	140	0	162	0	58	0
Through Vol	0	1018	0	35	0	37	0	663
RT Vol	0	49	0	388	0	222	0	64
Lane Flow Rate	163	1160	152	460	176	282	63	790
Geometry Grp	7	7	7	7	7	7	7	7
Degree of Util (X)	0.455	3.064	0.423	1.134	0.504	0.72	0.178	2.111
Departure Headway (Hd)	12.325	11.753	13.858	12.603	14.779	13.567	13.187	12.58
Convergence, Y/N	Yes	Yes	Yes	Yes	Yes	Yes	Yes	Yes
Cap	295	325	262	294	247	270	274	300
Service Time	10.025	9.453	11.558	10.303	12.479	11.267	10.887	10.28
HCM Lane V/C Ratio	0.553	3.569	0.58	1.565	0.713	1.044	0.23	2.633
HCM Control Delay	24.9	960.4	26.3	131.1	31.6	44.7	18.7	538.1
HCM Lane LOS	C	F	D	F	D	E	C	F
HCM 95th-tile Q	2.3	83.3	2	13.7	2.6	5	0.6	44.8

Intersection												
Intersection Delay, s/veh	41.4											
Intersection LOS	F											

Movement	EBL	EBT	EBR	WBL	WBT	WBR	NBL	NBT	NBR	SBL	SBT	SBR
Lane Configurations	↶	↷		↶	↷		↶	↷		↶	↷	
Traffic Vol, veh/h	407	230	622	303	236	234	352	583	296	354	666	213
Future Vol, veh/h	407	230	622	303	236	234	352	583	296	354	666	213
Peak Hour Factor	0.92	0.92	0.92	0.92	0.92	0.92	0.92	0.92	0.92	0.92	0.92	0.92
Heavy Vehicles, %	0	0	0	1	1	1	3	3	3	3	3	3
Mvmt Flow	442	250	676	329	257	254	383	634	322	385	724	232
Number of Lanes	1	1	0	1	1	0	1	1	0	1	1	0

Approach	EB	WB	NB	SB
Opposing Approach	WB	EB	SB	NB
Opposing Lanes	2	2	2	2
Conflicting Approach Left	SB	NB	EB	WB
Conflicting Lanes Left	2	2	2	2
Conflicting Approach Right	NB	SB	WB	EB
Conflicting Lanes Right	2	2	2	2
HCM Control Delay	752.1	468.7	819.2	823.7
HCM LOS	F	F	F	F

Lane	NBLn1	NBLn2	EBLn1	EBLn2	WBLn1	WBLn2	SBLn1	SBLn2
Vol Left, %	100%	0%	100%	0%	100%	0%	100%	0%
Vol Thru, %	0%	66%	0%	27%	0%	50%	0%	76%
Vol Right, %	0%	34%	0%	73%	0%	50%	0%	24%
Sign Control	Stop	Stop	Stop	Stop	Stop	Stop	Stop	Stop
Traffic Vol by Lane	352	879	407	852	303	470	354	879
LT Vol	352	0	407	0	303	0	354	0
Through Vol	0	583	0	230	0	236	0	666
RT Vol	0	296	0	622	0	234	0	213
Lane Flow Rate	383	955	442	926	329	511	385	955
Geometry Grp	7	7	7	7	7	7	7	7
Degree of Util (X)	1.28	3.002	1.474	2.826	1.099	1.584	1.288	3.02
Departure Headway (Hd)	52.115	51.363	47.546	46.508	50.628	40.766	51.537	50.852
Convergence, Y/N	Yes	Yes	Yes	Yes	Yes	Yes	Yes	Yes
Cap	77	86	84	93	40	41	77	86
Service Time	49.815	49.063	45.246	44.208	50.328	40.466	49.237	48.552
HCM Lane V/C Ratio	4.974	11.105	5.262	9.957	8.225	12.463	5	11.105
HCM Control Delay	302.2	1026.3	364	937.5	358.2	539.9	303.6	1033.1
HCM Lane LOS	F	F	F	F	F	F	F	F
HCM 95th-tile Q	7.1	21.3	9.1	21.5	4	6	7.2	21.6

Intersection												
Int Delay, s/veh	1.1											
Movement	EBL	EBT	EBR	WBL	WBT	WBR	NBL	NBT	NBR	SBL	SBT	SBR
Lane Configurations		↕			↕			↕			↕	
Traffic Vol, veh/h	0	5	0	16	3	182	3	584	4	216	1121	0
Future Vol, veh/h	0	5	0	16	3	182	3	584	4	216	1121	0
Conflicting Peds, #/hr	0	0	0	0	0	0	0	0	0	0	0	0
Sign Control	Stop	Stop	Stop	Stop	Stop	Stop	Free	Free	Free	Free	Free	Free
RT Channelized	-	-	None	-	-	None	-	-	None	-	-	None
Storage Length	-	-	-	-	-	-	-	-	-	-	-	-
Veh in Median Storage, #	-	0	-	-	0	-	-	0	-	-	0	-
Grade, %	-	0	-	-	0	-	-	0	-	-	0	-
Peak Hour Factor	85	85	85	85	85	85	85	85	85	85	85	85
Heavy Vehicles, %	0	0	0	0	0	0	6	6	6	3	3	3
Mvmt Flow	0	6	0	19	4	214	4	687	5	254	1319	0

Major/Minor	Minor2		Minor1		Major1		Major2					
Conflicting Flow All	2634	2527	1319	2528	2525	690	1319	0	0	692	0	0
Stage 1	1827	1827	-	698	698	-	-	-	-	-	-	-
Stage 2	807	700	-	1830	1827	-	-	-	-	-	-	-
Critical Hdwy	7.1	6.5	6.2	7.1	6.5	6.2	4.16	-	-	4.13	-	-
Critical Hdwy Stg 1	6.1	5.5	-	6.1	5.5	-	-	-	-	-	-	-
Critical Hdwy Stg 2	6.1	5.5	-	6.1	5.5	-	-	-	-	-	-	-
Follow-up Hdwy	3.5	4	3.3	3.5	4	3.3	2.254	-	-	2.227	-	-
Pot Cap-1 Maneuver	16	28	194	19	28	449	511	-	-	898	-	-
Stage 1	99	129	-	434	445	-	-	-	-	-	-	-
Stage 2	378	444	-	99	129	-	-	-	-	-	-	-
Platoon blocked, %								-	-	-	-	-
Mov Cap-1 Maneuver	-	0	194	-	0	449	511	-	-	898	-	-
Mov Cap-2 Maneuver	-	0	-	-	0	-	-	-	-	-	-	-
Stage 1	98	0	-	428	439	-	-	-	-	-	-	-
Stage 2	194	438	-	-	0	-	-	-	-	-	-	-

Approach	EB		WB		NB		SB	
HCM Control Delay, s						0.1		1.7
HCM LOS								

Minor Lane/Major Mvmt	NBL	NBT	NBR	EBLn1WBLn1	SBL	SBT	SBR
Capacity (veh/h)	511	-	-	-	898	-	-
HCM Lane V/C Ratio	0.007	-	-	-	0.283	-	-
HCM Control Delay (s)	12.1	0	-	-	10.6	0	-
HCM Lane LOS	B	A	-	-	B	A	-
HCM 95th %tile Q(veh)	0	-	-	-	1.2	-	-

Intersection	
Intersection Delay, s/veh	715.4
Intersection LOS	F

Movement	EBL	EBT	EBR	WBL	WBT	WBR	NBL	NBT	NBR	SBL	SBT	SBR
Lane Configurations		↕			↕			↕			↕	
Traffic Vol, veh/h	84	145	18	19	176	332	24	177	8	688	305	144
Future Vol, veh/h	84	145	18	19	176	332	24	177	8	688	305	144
Peak Hour Factor	0.76	0.76	0.76	0.76	0.76	0.76	0.76	0.76	0.76	0.76	0.76	0.76
Heavy Vehicles, %	5	5	5	4	4	4	16	16	16	3	3	3
Mvmt Flow	111	191	24	25	232	437	32	233	11	905	401	189
Number of Lanes	0	1	0	0	1	0	0	1	0	0	1	0

Approach	EB	WB	NB	SB
Opposing Approach	WB	EB	SB	NB
Opposing Lanes	1	1	1	1
Conflicting Approach Left	SB	NB	EB	WB
Conflicting Lanes Left	1	1	1	1
Conflicting Approach Right	NB	SB	WB	EB
Conflicting Lanes Right	1	1	1	1
HCM Control Delay	70.1	304.5	57.6	1166.9
HCM LOS	F	F	F	F

Lane	NBLn1	EBLn1	WBLn1	SBLn1
Vol Left, %	11%	34%	4%	61%
Vol Thru, %	85%	59%	33%	27%
Vol Right, %	4%	7%	63%	13%
Sign Control	Stop	Stop	Stop	Stop
Traffic Vol by Lane	209	247	527	1137
LT Vol	24	84	19	688
Through Vol	177	145	176	305
RT Vol	8	18	332	144
Lane Flow Rate	275	325	693	1496
Geometry Grp	1	1	1	1
Degree of Util (X)	0.708	0.802	1.561	3.534
Departure Headway (Hd)	18.779	18.529	14.23	9.935
Convergence, Y/N	Yes	Yes	Yes	Yes
Cap	195	198	263	389
Service Time	16.779	16.529	12.23	7.935
HCM Lane V/C Ratio	1.41	1.641	2.635	3.846
HCM Control Delay	57.6	70.1	304.5	1166.9
HCM Lane LOS	F	F	F	F
HCM 95th-tile Q	4.4	5.6	23.9	118.8

Intersection												
Intersection Delay, s/veh	12.9											
Intersection LOS	B											

Movement	EBL	EBT	EBR	WBL	WBT	WBR	NBL	NBT	NBR	SBL	SBT	SBR
Lane Configurations												
Traffic Vol, veh/h	50	82	4	11	73	69	8	58	16	106	104	102
Future Vol, veh/h	50	82	4	11	73	69	8	58	16	106	104	102
Peak Hour Factor	0.78	0.78	0.78	0.78	0.78	0.78	0.78	0.78	0.78	0.78	0.78	0.78
Heavy Vehicles, %	8	8	8	25	25	25	7	7	7	7	7	7
Mvmt Flow	64	105	5	14	94	88	10	74	21	136	133	131
Number of Lanes	1	1	0	1	1	0	0	1	0	0	1	0

Approach	EB	WB	NB	SB
Opposing Approach	WB	EB	SB	NB
Opposing Lanes	2	2	1	1
Conflicting Approach Left	SB	NB	EB	WB
Conflicting Lanes Left	1	1	2	2
Conflicting Approach Right	NB	SB	WB	EB
Conflicting Lanes Right	1	1	2	2
HCM Control Delay	10.6	11.9	9.9	15.2
HCM LOS	B	B	A	C

Lane	NBLn1	EBLn1	EBLn2	WBLn1	WBLn2	SBLn1
Vol Left, %	10%	100%	0%	100%	0%	34%
Vol Thru, %	71%	0%	95%	0%	51%	33%
Vol Right, %	20%	0%	5%	0%	49%	33%
Sign Control	Stop	Stop	Stop	Stop	Stop	Stop
Traffic Vol by Lane	82	50	86	11	142	312
LT Vol	8	50	0	11	0	106
Through Vol	58	0	82	0	73	104
RT Vol	16	0	4	0	69	102
Lane Flow Rate	105	64	110	14	182	400
Geometry Grp	2	7	7	7	7	2
Degree of Util (X)	0.167	0.123	0.194	0.028	0.318	0.578
Departure Headway (Hd)	5.718	6.888	6.346	7.144	6.289	5.201
Convergence, Y/N	Yes	Yes	Yes	Yes	Yes	Yes
Cap	626	520	565	501	572	692
Service Time	3.771	4.636	4.094	4.89	4.034	3.238
HCM Lane V/C Ratio	0.168	0.123	0.195	0.028	0.318	0.578
HCM Control Delay	9.9	10.6	10.6	10.1	12	15.2
HCM Lane LOS	A	B	B	B	B	C
HCM 95th-tile Q	0.6	0.4	0.7	0.1	1.4	3.7

Intersection												
Int Delay, s/veh	883.9											
Movement	EBL	EBT	EBR	WBL	WBT	WBR	NBL	NBT	NBR	SBL	SBT	SBR
Lane Configurations	↖	↑	↗	↖	↑	↗	↖	↑	↗		↕	
Traffic Vol, veh/h	4	1146	240	127	478	85	100	25	64	88	19	4
Future Vol, veh/h	4	1146	240	127	478	85	100	25	64	88	19	4
Conflicting Peds, #/hr	0	0	0	0	0	0	1	0	0	0	0	1
Sign Control	Free	Free	Free	Free	Free	Free	Stop	Stop	Stop	Stop	Stop	Stop
RT Channelized	-	-	None	-	-	None	-	-	None	-	-	None
Storage Length	85	-	0	70	-	105	60	-	50	-	-	-
Veh in Median Storage, #	-	0	-	-	0	-	-	0	-	-	0	-
Grade, %	-	0	-	-	0	-	-	0	-	-	0	-
Peak Hour Factor	91	91	91	91	91	91	91	91	91	91	91	91
Heavy Vehicles, %	1	1	1	4	4	4	7	7	7	9	9	9
Mvmt Flow	4	1259	264	140	525	93	110	27	70	97	21	4

Major/Minor	Major1			Major2			Minor1			Minor2		
Conflicting Flow All	618	0	0	1523	0	0	2132	2165	1259	2253	2336	526
Stage 1	-	-	-	-	-	-	1267	1267	-	805	805	-
Stage 2	-	-	-	-	-	-	865	898	-	1448	1531	-
Critical Hdwy	4.11	-	-	4.14	-	-	7.17	6.57	6.27	7.19	6.59	6.29
Critical Hdwy Stg 1	-	-	-	-	-	-	6.17	5.57	-	6.19	5.59	-
Critical Hdwy Stg 2	-	-	-	-	-	-	6.17	5.57	-	6.19	5.59	-
Follow-up Hdwy	2.209	-	-	2.236	-	-	3.563	4.063	3.363	3.581	4.081	3.381
Pot Cap-1 Maneuver	967	-	-	432	-	-	~ 35	46	203	~ 28	35	538
Stage 1	-	-	-	-	-	-	202	235	-	366	385	-
Stage 2	-	-	-	-	-	-	341	351	-	157	172	-
Platoon blocked, %	-	-	-	-	-	-	-	-	-	-	-	-
Mov Cap-1 Maneuver	967	-	-	432	-	-	~ 7	31	203	~ 4	24	537
Mov Cap-2 Maneuver	-	-	-	-	-	-	~ 7	31	-	~ 4	24	-
Stage 1	-	-	-	-	-	-	201	234	-	365	260	-
Stage 2	-	-	-	-	-	-	210	237	-	~ 90	171	-

Approach	EB	WB	NB	SB
HCM Control Delay, s	0	3.2	\$ 4096.3	\$ 11956.8
HCM LOS			F	F

Minor Lane/Major Mvmt	NBLn1	NBLn2	NBLn3	EBL	EBT	EBR	WBL	WBT	WBR	SBLn1
Capacity (veh/h)	7	31	203	967	-	-	432	-	-	5
HCM Lane V/C Ratio	15.699	0.886	0.346	0.005	-	-	0.323	-	-	24.396
HCM Control Delay (s)	\$ 7643.6	\$ 312.2	31.9	8.7	-	-	17.3	-	-	\$ 11956.8
HCM Lane LOS	F	F	D	A	-	-	C	-	-	F
HCM 95th %tile Q(veh)	15.5	3	1.5	0	-	-	1.4	-	-	17.3

Notes
 -: Volume exceeds capacity \$: Delay exceeds 300s +: Computation Not Defined *: All major volume in platoon

Intersection

Int Delay, s/veh 13.6

Movement	EBL	EBT	WBT	WBR	SBL	SBR
Lane Configurations		↑	↑		↓	↓
Traffic Vol, veh/h	0	1301	653	0	59	42
Future Vol, veh/h	0	1301	653	0	59	42
Conflicting Peds, #/hr	0	0	0	0	0	0
Sign Control	Free	Free	Free	Free	Stop	Stop
RT Channelized	-	None	-	None	-	None
Storage Length	-	-	-	-	0	610
Veh in Median Storage, #	-	0	0	-	0	-
Grade, %	-	0	0	-	0	-
Peak Hour Factor	89	89	89	89	89	89
Heavy Vehicles, %	2	2	4	4	19	19
Mvmt Flow	0	1462	734	0	66	47

Major/Minor

	Major1	Major2	Minor2		
Conflicting Flow All	-	0	-	0	2196 734
Stage 1	-	-	-	-	734 -
Stage 2	-	-	-	-	1462 -
Critical Hdwy	-	-	-	-	6.59 6.39
Critical Hdwy Stg 1	-	-	-	-	5.59 -
Critical Hdwy Stg 2	-	-	-	-	5.59 -
Follow-up Hdwy	-	-	-	-	3.671 3.471
Pot Cap-1 Maneuver	0	-	-	0	~ 44 393
Stage 1	0	-	-	0	446 -
Stage 2	0	-	-	0	195 -
Platoon blocked, %	-	-	-	-	-
Mov Cap-1 Maneuver	-	-	-	-	~ 44 393
Mov Cap-2 Maneuver	-	-	-	-	~ 44 -
Stage 1	-	-	-	-	446 -
Stage 2	-	-	-	-	195 -

Approach

	EB	WB	SB
HCM Control Delay, s	0	0	276.6
HCM LOS			F

Minor Lane/Major Mvmt

	EBT	WBT	SBLn1	SBLn2
Capacity (veh/h)	-	-	44	393
HCM Lane V/C Ratio	-	-	1.507	0.12
HCM Control Delay (s)	-	-	462.5	15.4
HCM Lane LOS	-	-	F	C
HCM 95th %tile Q(veh)	-	-	6.6	0.4

Notes

-: Volume exceeds capacity \$: Delay exceeds 300s +: Computation Not Defined *: All major volume in platoon

HCM 6th TWSC
15: SR-99 Northbound Ramps & Avenue 17

Village D Specific Plan
Existing WP - AM Peak Hour

Intersection												
Int Delay, s/veh	241.4											
Movement	EBL	EBT	EBR	WBL	WBT	WBR	NBL	NBT	NBR	SBL	SBT	SBR
Lane Configurations	↙	↑			↘			↙	↘			
Traffic Vol, veh/h	52	557	0	0	818	100	333	1	0	0	0	0
Future Vol, veh/h	52	557	0	0	818	100	333	1	0	0	0	0
Conflicting Peds, #/hr	0	0	0	0	0	0	0	0	0	0	0	0
Sign Control	Free	Free	Free	Free	Free	Free	Stop	Stop	Stop	Free	Free	Free
RT Channelized	-	-	None	-	-	None	-	-	None	-	-	None
Storage Length	125	-	-	-	-	-	-	-	50	-	-	-
Veh in Median Storage, #	-	0	-	-	0	-	-	0	-	-	16965	-
Grade, %	-	0	-	-	0	-	-	0	-	-	0	-
Peak Hour Factor	92	92	92	92	92	92	92	92	92	92	92	92
Heavy Vehicles, %	3	3	3	3	3	3	4	4	4	0	0	0
Mvmt Flow	57	605	0	0	889	109	362	1	0	0	0	0

Major/Minor	Major1	Major2	Minor1
Conflicting Flow All	998	0	0
Stage 1	-	-	-
Stage 2	-	-	-
Critical Hdwy	4.13	-	-
Critical Hdwy Stg 1	-	-	-
Critical Hdwy Stg 2	-	-	-
Follow-up Hdwy	2.227	-	-
Pot Cap-1 Maneuver	689	0	0
Stage 1	-	0	0
Stage 2	-	0	0
Platoon blocked, %	-	-	-
Mov Cap-1 Maneuver	689	-	-
Mov Cap-2 Maneuver	-	-	-
Stage 1	-	-	-
Stage 2	-	-	-

Approach	EB	WB	NB
HCM Control Delay, s	0.9	0	\$ 1343.3
HCM LOS			F

Minor Lane/Major Mvmt	NBLn1	NBLn2	EBL	EBT	WBT	WBR
Capacity (veh/h)	96	-	689	-	-	-
HCM Lane V/C Ratio	3.782	-	0.082	-	-	-
HCM Control Delay (s)	\$ 1343.3	0	10.7	-	-	-
HCM Lane LOS	F	A	B	-	-	-
HCM 95th %tile Q(veh)	37.1	-	0.3	-	-	-

Notes
 -: Volume exceeds capacity \$: Delay exceeds 300s +: Computation Not Defined *: All major volume in platoon

HCM 6th TWSC
17: Westberry Boulevard & Cleveland Avenue

Village D Specific Plan
Existing WP - AM Peak Hour

Intersection												
Int Delay, s/veh	2.1											
Movement	EBL	EBT	EBR	WBL	WBT	WBR	NBL	NBT	NBR	SBL	SBT	SBR
Lane Configurations	↖	↗		↖	↗		↖	↑	↗	↖	↑	↗
Traffic Vol, veh/h	377	899	55	20	394	12	26	35	57	14	19	140
Future Vol, veh/h	377	899	55	20	394	12	26	35	57	14	19	140
Conflicting Peds, #/hr	1	0	2	2	0	1	1	0	1	1	0	1
Sign Control	Free	Free	Free	Free	Free	Free	Stop	Stop	Stop	Stop	Stop	Stop
RT Channelized	-	-	None	-	-	None	-	-	None	-	-	None
Storage Length	110	-	-	165	-	-	65	-	50	100	-	50
Veh in Median Storage, #	-	0	-	-	0	-	-	0	-	-	0	-
Grade, %	-	0	-	-	0	-	-	0	-	-	0	-
Peak Hour Factor	83	83	83	83	83	83	83	83	83	83	83	83
Heavy Vehicles, %	0	0	0	1	1	1	0	0	0	0	0	0
Mvmt Flow	454	1083	66	24	475	14	31	42	69	17	23	169

Major/Minor	Major1			Major2			Minor1			Minor2		
Conflicting Flow All	490	0	0	1151	0	0	2653	2564	1119	2612	2590	484
Stage 1	-	-	-	-	-	-	2026	2026	-	531	531	-
Stage 2	-	-	-	-	-	-	627	538	-	2081	2059	-
Critical Hdwy	4.1	-	-	4.11	-	-	7.1	6.5	6.2	7.1	6.5	6.2
Critical Hdwy Stg 1	-	-	-	-	-	-	6.1	5.5	-	6.1	5.5	-
Critical Hdwy Stg 2	-	-	-	-	-	-	6.1	5.5	-	6.1	5.5	-
Follow-up Hdwy	2.2	-	-	2.209	-	-	3.5	4	3.3	3.5	4	3.3
Pot Cap-1 Maneuver	1084	-	-	611	-	-	~ 15	~ 27	254	~ 16	26	587
Stage 1	-	-	-	-	-	-	76	102	-	536	529	-
Stage 2	-	-	-	-	-	-	475	526	-	71	99	-
Platoon blocked, %		-	-		-	-						
Mov Cap-1 Maneuver	1083	-	-	610	-	-	~ 15	253	-	~ 14	586	
Mov Cap-2 Maneuver	-	-	-	-	-	-	~ 15	-	-	~ 14	-	
Stage 1	-	-	-	-	-	-	44	59	-	311	508	-
Stage 2	-	-	-	-	-	-	310	505	-	~ 9	57	-

Approach	EB			WB			NB			SB		
HCM Control Delay, s	3			0.5								
HCM LOS							-			-		

Minor Lane/Major Mvmt	NBLn1	NBLn2	NBLn3	EBL	EBT	EBR	WBL	WBT	WBR	SBLn1	SBLn2	SBLn3
Capacity (veh/h)	-	15	253	1083	-	-	610	-	-	-	14	586
HCM Lane V/C Ratio	-	2.811	0.271	0.419	-	-	0.04	-	-	-	1.635	0.288
HCM Control Delay (s)		\$ 1337.9	24.4	10.7	-	-	11.1	-	-	-\$ 862.9	13.6	
HCM Lane LOS		-	F	C	B	-	-	B	-	-	F	B
HCM 95th %tile Q(veh)		-	6	1.1	2.1	-	-	0.1	-	-	3.5	1.2

Notes
 -: Volume exceeds capacity \$: Delay exceeds 300s +: Computation Not Defined *: All major volume in platoon

Intersection	
Intersection Delay, s/veh	83.4
Intersection LOS	F

Movement	EBL	EBT	EBR	WBL	WBT	WBR	NBL	NBT	NBR	SBL	SBT	SBR
Lane Configurations	↖	↗		↖	↗		↖	↗	↖	↗	↖	↗
Traffic Vol, veh/h	63	282	85	47	203	22	122	102	101	110	81	41
Future Vol, veh/h	63	282	85	47	203	22	122	102	101	110	81	41
Peak Hour Factor	0.69	0.69	0.69	0.69	0.69	0.69	0.69	0.69	0.69	0.69	0.69	0.69
Heavy Vehicles, %	2	2	2	2	2	2	0	0	0	0	0	0
Mvmt Flow	91	409	123	68	294	32	177	148	146	159	117	59
Number of Lanes	1	1	0	1	1	0	1	1	1	1	1	1

Approach	EB	WB	NB	SB
Opposing Approach	WB	EB	SB	NB
Opposing Lanes	2	2	3	3
Conflicting Approach Left	SB	NB	EB	WB
Conflicting Lanes Left	3	3	2	2
Conflicting Approach Right	NB	SB	WB	EB
Conflicting Lanes Right	3	3	2	2
HCM Control Delay	187.1	47.2	21.2	20.7
HCM LOS	F	E	C	C

Lane	NBLn1	NBLn2	NBLn3	EBLn1	EBLn2	WBLn1	WBLn2	SBLn1	SBLn2	SBLn3
Vol Left, %	100%	0%	0%	100%	0%	100%	0%	100%	0%	0%
Vol Thru, %	0%	100%	0%	0%	77%	0%	90%	0%	100%	0%
Vol Right, %	0%	0%	100%	0%	23%	0%	10%	0%	0%	100%
Sign Control	Stop	Stop	Stop	Stop	Stop	Stop	Stop	Stop	Stop	Stop
Traffic Vol by Lane	122	102	101	63	367	47	225	110	81	41
LT Vol	122	0	0	63	0	47	0	110	0	0
Through Vol	0	102	0	0	282	0	203	0	81	0
RT Vol	0	0	101	0	85	0	22	0	0	41
Lane Flow Rate	177	148	146	91	532	68	326	159	117	59
Geometry Grp	8	8	8	8	8	8	8	8	8	8
Degree of Util (X)	0.498	0.396	0.364	0.256	1.39	0.192	0.868	0.466	0.327	0.154
Departure Headway (Hd)	11.215	10.685	9.944	10.087	9.41	10.982	10.396	11.65	11.119	10.375
Convergence, Y/N	Yes	Yes	Yes	Yes	Yes	Yes	Yes	Yes	Yes	Yes
Cap	324	339	364	358	388	329	352	311	325	348
Service Time	8.915	8.385	7.644	7.787	7.11	8.682	8.096	9.35	8.819	8.075
HCM Lane V/C Ratio	0.546	0.437	0.401	0.254	1.371	0.207	0.926	0.511	0.36	0.17
HCM Control Delay	24.5	20.2	18.2	16.2	216.4	16.3	53.7	24.1	19.1	15
HCM Lane LOS	C	C	C	C	F	C	F	C	C	B
HCM 95th-tile Q	2.6	1.8	1.6	1	26.2	0.7	8.1	2.4	1.4	0.5

Intersection												
Intersection Delay, s/veh	305.9											
Intersection LOS	F											

Movement	EBL	EBT	EBR	WBL	WBT	WBR	NBL	NBT	NBR	SBL	SBT	SBR
Lane Configurations		↕			↕			↕			↕	
Traffic Vol, veh/h	101	731	54	11	390	95	82	36	24	162	55	76
Future Vol, veh/h	101	731	54	11	390	95	82	36	24	162	55	76
Peak Hour Factor	0.86	0.86	0.86	0.86	0.86	0.86	0.86	0.86	0.86	0.86	0.86	0.86
Heavy Vehicles, %	0	0	0	0	0	0	0	0	0	0	0	0
Mvmt Flow	117	850	63	13	453	110	95	42	28	188	64	88
Number of Lanes	0	1	0	0	1	0	0	1	0	0	1	0

Approach	EB	WB	NB	SB
Opposing Approach	WB	EB	SB	NB
Opposing Lanes	1	1	1	1
Conflicting Approach Left	SB	NB	EB	WB
Conflicting Lanes Left	1	1	1	1
Conflicting Approach Right	NB	SB	WB	EB
Conflicting Lanes Right	1	1	1	1
HCM Control Delay	535.6	133.7	23.4	39.5
HCM LOS	F	F	C	E

Lane	NBLn1	EBLn1	WBLn1	SBLn1
Vol Left, %	58%	11%	2%	55%
Vol Thru, %	25%	83%	79%	19%
Vol Right, %	17%	6%	19%	26%
Sign Control	Stop	Stop	Stop	Stop
Traffic Vol by Lane	142	886	496	293
LT Vol	82	101	11	162
Through Vol	36	731	390	55
RT Vol	24	54	95	76
Lane Flow Rate	165	1030	577	341
Geometry Grp	1	1	1	1
Degree of Util (X)	0.408	2.134	1.179	0.753
Departure Headway (Hd)	12.198	7.875	9.334	10.52
Convergence, Y/N	Yes	Yes	Yes	Yes
Cap	297	474	392	348
Service Time	10.198	5.875	7.334	8.52
HCM Lane V/C Ratio	0.556	2.173	1.472	0.98
HCM Control Delay	23.4	535.6	133.7	39.5
HCM Lane LOS	C	F	F	E
HCM 95th-tile Q	1.9	70	18.1	5.9

Intersection												
Intersection Delay, s/veh10.7												
Intersection LOS B												

Movement	EBL	EBT	EBR	WBL	WBT	WBR	NBL	NBT	NBR	SBL	SBT	SBR
Lane Configurations		↕			↕	↕		↕	↕		↕	↕
Traffic Vol, veh/h	0	0	0	92	0	120	0	143	275	58	57	0
Future Vol, veh/h	0	0	0	92	0	120	0	143	275	58	57	0
Peak Hour Factor	0.81	0.81	0.81	0.81	0.81	0.81	0.81	0.81	0.81	0.81	0.81	0.81
Heavy Vehicles, %	0	0	0	2	2	2	0	0	0	0	0	0
Mvmt Flow	0	0	0	114	0	148	0	177	340	72	70	0
Number of Lanes	0	1	0	0	1	1	0	1	1	0	1	1

Approach	EB	WB	NB	SB
Opposing Approach	WB	EB	SB	NB
Opposing Lanes	2	1	2	2
Conflicting Approach Left	SB	NB	EB	WB
Conflicting Lanes Left	2	2	1	2
Conflicting Approach Right	NB	SB	WB	EB
Conflicting Lanes Right	2	2	2	1
HCM Control Delay	0	10.3	10.8	10.8
HCM LOS	-	B	B	B

Lane	NBLn1	NBLn2	EBLn1	WBLn1	WBLn2	SBLn1	SBLn2
Vol Left, %	0%	0%	0%	100%	0%	50%	0%
Vol Thru, %	100%	0%	100%	0%	0%	50%	100%
Vol Right, %	0%	100%	0%	0%	100%	0%	0%
Sign Control	Stop	Stop	Stop	Stop	Stop	Stop	Stop
Traffic Vol by Lane	143	275	0	92	120	115	0
LT Vol	0	0	0	92	0	58	0
Through Vol	143	0	0	0	0	57	0
RT Vol	0	275	0	0	120	0	0
Lane Flow Rate	177	340	0	114	148	142	0
Geometry Grp	7	7	6	7	7	7	7
Degree of Util (X)	0.264	0.442	0	0.209	0.223	0.241	0
Departure Headway (Hd)	5.393	4.687	6.536	6.627	5.414	6.106	5.851
Convergence, Y/N	Yes	Yes	Yes	Yes	Yes	Yes	Yes
Cap	659	757	0	544	667	591	0
Service Time	3.184	2.478	4.551	4.333	3.12	3.82	3.564
HCM Lane V/C Ratio	0.269	0.449	0	0.21	0.222	0.24	0
HCM Control Delay	10.1	11.2	9.6	11.1	9.7	10.8	8.6
HCM Lane LOS	B	B	N	B	A	B	N
HCM 95th-tile Q	1.1	2.3	0	0.8	0.8	0.9	0

Intersection	
Intersection Delay, s/veh	225.2
Intersection LOS	F

Movement	EBL	EBT	EBR	WBL	WBT	WBR	NBL	NBT	NBR	SBL	SBT	SBR
Lane Configurations	↵	↕↗		↵	↕↗		↵	↕	↗	↵	↕	↗
Traffic Vol, veh/h	16	909	28	185	375	10	25	286	268	4	215	5
Future Vol, veh/h	16	909	28	185	375	10	25	286	268	4	215	5
Peak Hour Factor	0.84	0.84	0.84	0.84	0.84	0.84	0.84	0.84	0.84	0.84	0.84	0.84
Heavy Vehicles, %	1	1	1	2	2	2	0	0	0	0	0	0
Mvmt Flow	19	1082	33	220	446	12	30	340	319	5	256	6
Number of Lanes	1	2	0	1	2	0	1	1	1	1	1	1

Approach	EB	WB	NB	SB
Opposing Approach	WB	EB	SB	NB
Opposing Lanes	3	3	3	3
Conflicting Approach Left	SB	NB	EB	WB
Conflicting Lanes Left	3	3	3	3
Conflicting Approach Right	NB	SB	WB	EB
Conflicting Lanes Right	3	3	3	3
HCM Control Delay	442.8	51.7	97.3	71.1
HCM LOS	F	F	F	F

Lane	NBLn1	NBLn2	NBLn3	EBLn1	EBLn2	EBLn3	WBLn1	WBLn2	WBLn3	SBLn1	SBLn2
Vol Left, %	100%	0%	0%	100%	0%	0%	100%	0%	0%	100%	0%
Vol Thru, %	0%	100%	0%	0%	100%	92%	0%	100%	93%	0%	100%
Vol Right, %	0%	0%	100%	0%	0%	8%	0%	0%	7%	0%	0%
Sign Control	Stop	Stop	Stop	Stop	Stop	Stop	Stop	Stop	Stop	Stop	Stop
Traffic Vol by Lane	25	286	268	16	606	331	185	250	135	4	215
LT Vol	25	0	0	16	0	0	185	0	0	4	0
Through Vol	0	286	0	0	606	303	0	250	125	0	215
RT Vol	0	0	268	0	0	28	0	0	10	0	0
Lane Flow Rate	30	340	319	19	721	394	220	298	161	5	256
Geometry Grp	8	8	8	8	8	8	8	8	8	8	8
Degree of Util (X)	0.1	1.098	0.969	0.063	2.273	1.235	0.728	0.943	0.507	0.018	0.908
Departure Headway (Hd)	13.256	12.756	12.056	12.026	11.526	11.467	12.19	11.69	11.638	14.23	13.73
Convergence, Y/N	Yes	Yes	Yes	Yes	Yes	Yes	Yes	Yes	Yes	Yes	Yes
Cap	272	286	303	300	325	319	300	313	312	253	266
Service Time	10.956	10.456	9.756	9.726	9.226	9.167	9.89	9.39	9.338	11.93	11.43
HCM Lane V/C Ratio	0.11	1.189	1.053	0.063	2.218	1.235	0.733	0.952	0.516	0.02	0.962
HCM Control Delay	17.4	119.9	80.6	15.5	607	162.8	41.7	73.2	25.7	17.2	73.4
HCM Lane LOS	C	F	F	C	F	F	E	F	D	C	F
HCM 95th-tile Q	0.3	12.6	9.9	0.2	54.6	17.5	5.3	9.4	2.7	0.1	8.1

Intersection

Intersection Delay, s/veh 66

Intersection LOS F

Movement	EBL	EBT	EBR	WBL	WBT	WBR	NBL	NBT	NBR	SBL	SBT	SBR
Lane Configurations	↔	↔		↔	↔	↔	↔	↔		↔	↔	
Traffic Vol, veh/h	59	301	69	25	126	65	47	207	24	127	270	48
Future Vol, veh/h	59	301	69	25	126	65	47	207	24	127	270	48
Peak Hour Factor	0.82	0.82	0.82	0.82	0.82	0.82	0.82	0.82	0.82	0.82	0.82	0.82
Heavy Vehicles, %	2	2	2	5	5	5	2	2	2	2	2	2
Mvmt Flow	72	367	84	30	154	79	57	252	29	155	329	59
Number of Lanes	1	1	0	1	1	1	1	1	0	1	1	0

Approach	EB	WB	NB	SB
Opposing Approach	WB	EB	SB	NB
Opposing Lanes	3	2	2	2
Conflicting Approach Left	SB	NB	EB	WB
Conflicting Lanes Left	2	2	2	3
Conflicting Approach Right	NB	SB	WB	EB
Conflicting Lanes Right	2	2	3	2
HCM Control Delay	119.6	19.2	34.6	56.7
HCM LOS	F	C	D	F

Lane	NBLn1	NBLn2	EBLn1	EBLn2	WBLn1	WBLn2	WBLn3	SBLn1	SBLn2
Vol Left, %	100%	0%	100%	0%	100%	0%	0%	100%	0%
Vol Thru, %	0%	90%	0%	81%	0%	100%	0%	0%	85%
Vol Right, %	0%	10%	0%	19%	0%	0%	100%	0%	15%
Sign Control	Stop	Stop	Stop	Stop	Stop	Stop	Stop	Stop	Stop
Traffic Vol by Lane	47	231	59	370	25	126	65	127	318
LT Vol	47	0	59	0	25	0	0	127	0
Through Vol	0	207	0	301	0	126	0	0	270
RT Vol	0	24	0	69	0	0	65	0	48
Lane Flow Rate	57	282	72	451	30	154	79	155	388
Geometry Grp	8	8	8	8	8	8	8	8	8
Degree of Util (X)	0.162	0.752	0.202	1.185	0.092	0.44	0.212	0.414	0.972
Departure Headway (Hd)	10.878	10.28	10.117	9.457	11.4	10.874	10.136	10.269	9.639
Convergence, Y/N	Yes	Yes	Yes	Yes	Yes	Yes	Yes	Yes	Yes
Cap	332	355	356	388	316	333	357	353	380
Service Time	8.578	7.98	7.83	7.17	9.1	8.574	7.836	7.969	7.339
HCM Lane V/C Ratio	0.172	0.794	0.202	1.162	0.095	0.462	0.221	0.439	1.021
HCM Control Delay	15.7	38.4	15.4	136.2	15.3	21.8	15.5	20	71.3
HCM Lane LOS	C	E	C	F	C	C	C	C	F
HCM 95th-tile Q	0.6	5.9	0.7	18.1	0.3	2.2	0.8	2	11

HCM 6th Signalized Intersection Summary
 23: Avenue 16/Ellis Street & Kennedy Street

Village D Specific Plan
 Existing WP - AM Peak Hour



Movement	WBL	WBR	NBT	NBR	SBL	SBT
Lane Configurations						
Traffic Volume (veh/h)	119	106	309	224	244	241
Future Volume (veh/h)	119	106	309	224	244	241
Initial Q (Qb), veh	0	0	0	0	0	0
Ped-Bike Adj(A_pbT)	1.00	1.00		0.98	1.00	
Parking Bus, Adj	1.00	1.00	1.00	1.00	1.00	1.00
Work Zone On Approach	No		No		No	
Adj Sat Flow, veh/h/ln	1841	1841	1870	1870	1885	1885
Adj Flow Rate, veh/h	138	123	359	260	284	280
Peak Hour Factor	0.86	0.86	0.86	0.86	0.86	0.86
Percent Heavy Veh, %	4	4	2	2	1	1
Cap, veh/h	191	299	576	410	770	2789
Arrive On Green	0.11	0.11	0.29	0.29	0.43	0.78
Sat Flow, veh/h	1753	2745	2056	1395	1795	3676
Grp Volume(v), veh/h	138	123	324	295	284	280
Grp Sat Flow(s),veh/h/ln	1753	1373	1777	1581	1795	1791
Q Serve(g_s), s	6.1	3.3	12.6	12.9	8.6	1.5
Cycle Q Clear(g_c), s	6.1	3.3	12.6	12.9	8.6	1.5
Prop In Lane	1.00	1.00		0.88	1.00	
Lane Grp Cap(c), veh/h	191	299	522	464	770	2789
V/C Ratio(X)	0.72	0.41	0.62	0.63	0.37	0.10
Avail Cap(c_a), veh/h	427	669	522	464	770	2789
HCM Platoon Ratio	1.00	1.00	1.00	1.00	1.00	1.00
Upstream Filter(I)	0.96	0.96	1.00	1.00	1.00	1.00
Uniform Delay (d), s/veh	34.5	33.3	24.4	24.5	15.5	2.1
Incr Delay (d2), s/veh	4.9	0.9	5.5	6.5	0.3	0.1
Initial Q Delay(d3),s/veh	0.0	0.0	0.0	0.0	0.0	0.0
%ile BackOfQ(50%),veh/ln	2.8	1.1	5.9	5.5	3.4	0.3
Unsig. Movement Delay, s/veh						
LnGrp Delay(d),s/veh	39.4	34.1	29.9	31.0	15.8	2.2
LnGrp LOS	D	C	C	C	B	A
Approach Vol, veh/h	261		619			564
Approach Delay, s/veh	36.9		30.4			9.1
Approach LOS	D		C			A
Timer - Assigned Phs	1	2			6	8
Phs Duration (G+Y+Rc), s	38.8	28.0			66.8	13.2
Change Period (Y+Rc), s	4.5	4.5			4.5	4.5
Max Green Setting (Gmax), s	23.5	23.5			51.5	19.5
Max Q Clear Time (g_c+10), s	10.6	14.9			3.5	8.1
Green Ext Time (p_c), s	0.7	2.6			2.0	0.6
Intersection Summary						
HCM 6th Ctrl Delay			23.2			
HCM 6th LOS			C			

HCM 6th Signalized Intersection Summary
 24: Schnoor Avenue & Kennedy Street

Village D Specific Plan
 Existing WP - AM Peak Hour



Movement	EBL	EBT	EBR	WBL	WBT	WBR	NBL	NBT	NBR	SBL	SBT	SBR
Lane Configurations												
Traffic Volume (veh/h)	15	287	162	152	139	14	96	5	221	15	6	4
Future Volume (veh/h)	15	287	162	152	139	14	96	5	221	15	6	4
Initial Q (Qb), veh	0	0	0	0	0	0	0	0	0	0	0	0
Ped-Bike Adj(A_pbT)	1.00		1.00	1.00		1.00	1.00		1.00	1.00		1.00
Parking Bus, Adj	1.00	1.00	1.00	1.00	1.00	1.00	1.00	1.00	1.00	1.00	1.00	1.00
Work Zone On Approach	No			No			No			No		
Adj Sat Flow, veh/h/ln	1856	1856	1856	1841	1841	1841	1900	1900	1900	1366	1366	1366
Adj Flow Rate, veh/h	16	315	178	167	153	15	105	5	243	16	7	4
Peak Hour Factor	0.91	0.91	0.91	0.91	0.91	0.91	0.91	0.91	0.91	0.91	0.91	0.91
Percent Heavy Veh, %	3	3	3	4	4	4	0	0	0	36	36	36
Cap, veh/h	33	403	223	207	467	46	734	9	423	266	360	304
Arrive On Green	0.02	0.18	0.18	0.12	0.28	0.28	0.21	0.27	0.27	0.20	0.26	0.26
Sat Flow, veh/h	1767	2190	1209	1753	1650	162	3510	32	1576	1301	1366	1153
Grp Volume(v), veh/h	16	252	241	167	0	168	105	0	248	16	7	4
Grp Sat Flow(s),veh/h/ln	1767	1763	1636	1753	0	1811	1755	0	1608	1301	1366	1153
Q Serve(g_s), s	0.7	10.9	11.3	7.4	0.0	5.9	2.0	0.0	10.7	0.8	0.3	0.2
Cycle Q Clear(g_c), s	0.7	10.9	11.3	7.4	0.0	5.9	2.0	0.0	10.7	0.8	0.3	0.2
Prop In Lane	1.00		0.74	1.00		0.09	1.00		0.98	1.00		1.00
Lane Grp Cap(c), veh/h	33	325	301	207	0	513	734	0	432	266	360	304
V/C Ratio(X)	0.48	0.78	0.80	0.81	0.00	0.33	0.14	0.00	0.57	0.06	0.02	0.01
Avail Cap(c_a), veh/h	121	408	378	362	0	668	734	0	432	266	360	304
HCM Platoon Ratio	1.00	1.00	1.00	1.00	1.00	1.00	1.00	1.00	1.00	1.00	1.00	1.00
Upstream Filter(l)	0.82	0.82	0.82	1.00	0.00	1.00	1.00	0.00	1.00	1.00	1.00	1.00
Uniform Delay (d), s/veh	38.9	31.1	31.2	34.4	0.0	22.6	25.8	0.0	25.3	25.6	21.8	14.7
Incr Delay (d2), s/veh	8.7	6.0	7.8	7.3	0.0	0.4	0.1	0.0	5.5	0.1	0.1	0.1
Initial Q Delay(d3),s/veh	0.0	0.0	0.0	0.0	0.0	0.0	0.0	0.0	0.0	0.0	0.0	0.0
%ile BackOfQ(50%),veh/ln	0.4	5.0	5.0	3.5	0.0	2.5	0.8	0.0	4.6	0.2	0.1	0.1
Unsig. Movement Delay, s/veh												
LnGrp Delay(d),s/veh	47.6	37.1	39.0	41.7	0.0	23.0	25.9	0.0	30.7	25.7	21.9	14.8
LnGrp LOS	D	D	D	D	A	C	C	A	C	C	C	B
Approach Vol, veh/h		509			335			353			27	
Approach Delay, s/veh		38.3			32.3			29.3			23.1	
Approach LOS		D			C			C			C	
Timer - Assigned Phs	1	2	3	4	5	6	7	8				
Phs Duration (G+Y+Rc), s	30.8	26.0	13.9	19.2	21.2	25.6	6.0	27.2				
Change Period (Y+Rc), s	4.5	4.5	4.5	4.5	4.5	4.5	4.5	4.5				
Max Green Setting (Gmax), s	5.5	21.5	16.5	18.5	5.9	21.1	5.5	29.5				
Max Q Clear Time (g_c+1), s	12.8	12.7	9.4	13.3	4.0	2.3	2.7	7.9				
Green Ext Time (p_c), s	0.0	1.0	0.2	1.4	0.0	0.0	0.0	0.9				
Intersection Summary												
HCM 6th Ctrl Delay				33.7								
HCM 6th LOS				C								

HCM 6th TWSC
 25: Kennedy Street/Gateway Drive & SR-99 Southbound Ramps

Village D Specific Plan
 Existing WP - AM Peak Hour

Intersection						
Int Delay, s/veh	7.8					
Movement	EBL	EBT	WBT	WBR	SBL	SBR
Lane Configurations	↙	↑	↘		↙	↘
Traffic Vol, veh/h	299	243	195	1	64	145
Future Vol, veh/h	299	243	195	1	64	145
Conflicting Peds, #/hr	0	0	0	0	0	0
Sign Control	Free	Free	Free	Free	Stop	Stop
RT Channelized	-	None	-	Free	-	None
Storage Length	140	-	-	-	0	335
Veh in Median Storage, #	-	0	0	-	0	-
Grade, %	-	0	0	-	0	-
Peak Hour Factor	86	86	86	86	86	86
Heavy Vehicles, %	2	2	6	6	3	3
Mvmt Flow	348	283	227	1	74	169

Major/Minor	Major1	Major2	Minor2		
Conflicting Flow All	227	0	-	0	1206 227
Stage 1	-	-	-	-	227 -
Stage 2	-	-	-	-	979 -
Critical Hdwy	4.12	-	-	-	6.43 6.23
Critical Hdwy Stg 1	-	-	-	-	5.43 -
Critical Hdwy Stg 2	-	-	-	-	5.43 -
Follow-up Hdwy	2.218	-	-	-	3.527 3.327
Pot Cap-1 Maneuver	1341	-	-	0	202 810
Stage 1	-	-	-	0	808 -
Stage 2	-	-	-	0	363 -
Platoon blocked, %		-	-		
Mov Cap-1 Maneuver	1341	-	-	-	149 810
Mov Cap-2 Maneuver	-	-	-	-	149 -
Stage 1	-	-	-	-	598 -
Stage 2	-	-	-	-	363 -

Approach	EB	WB	SB
HCM Control Delay, s	4.8	0	23
HCM LOS			C

Minor Lane/Major Mvmt	EBL	EBT	WBT	SBLn1	SBLn2
Capacity (veh/h)	1341	-	-	149	810
HCM Lane V/C Ratio	0.259	-	-	0.499	0.208
HCM Control Delay (s)	8.6	-	-	51.1	10.6
HCM Lane LOS	A	-	-	F	B
HCM 95th %tile Q(veh)	1	-	-	2.4	0.8

Intersection						
Int Delay, s/veh	5.1					
Movement	EBL	EBT	WBT	WBR	SBL	SBR
Lane Configurations		↕	↕		↕	
Traffic Vol, veh/h	175	132	67	0	0	129
Future Vol, veh/h	175	132	67	0	0	129
Conflicting Peds, #/hr	0	0	0	0	0	0
Sign Control	Free	Free	Free	Free	Stop	Stop
RT Channelized	-	None	-	None	-	None
Storage Length	-	-	-	-	0	-
Veh in Median Storage, #	-	0	0	-	0	-
Grade, %	-	0	0	-	0	-
Peak Hour Factor	81	81	81	81	81	81
Heavy Vehicles, %	3	3	6	6	5	5
Mvmt Flow	216	163	83	0	0	159

Major/Minor	Major1	Major2	Minor2		
Conflicting Flow All	83	0	-	0	678 83
Stage 1	-	-	-	-	83 -
Stage 2	-	-	-	-	595 -
Critical Hdwy	4.13	-	-	-	6.45 6.25
Critical Hdwy Stg 1	-	-	-	-	5.45 -
Critical Hdwy Stg 2	-	-	-	-	5.45 -
Follow-up Hdwy	2.227	-	-	-	3.545 3.345
Pot Cap-1 Maneuver	1508	-	-	-	413 968
Stage 1	-	-	-	-	933 -
Stage 2	-	-	-	-	545 -
Platoon blocked, %		-	-	-	
Mov Cap-1 Maneuver	1508	-	-	-	348 968
Mov Cap-2 Maneuver	-	-	-	-	348 -
Stage 1	-	-	-	-	787 -
Stage 2	-	-	-	-	545 -

Approach	EB	WB	SB
HCM Control Delay, s	4.4	0	9.5
HCM LOS			A

Minor Lane/Major Mvmt	EBL	EBT	WBT	WBR	SBLn1
Capacity (veh/h)	1508	-	-	-	968
HCM Lane V/C Ratio	0.143	-	-	-	0.165
HCM Control Delay (s)	7.8	0	-	-	9.5
HCM Lane LOS	A	A	-	-	A
HCM 95th %tile Q(veh)	0.5	-	-	-	0.6

Intersection						
Int Delay, s/veh	5.4					
Movement	EBL	EBR	NBL	NBT	SBT	SBR
Lane Configurations	↙			↑	↗	
Traffic Vol, veh/h	171	0	0	42	3	127
Future Vol, veh/h	171	0	0	42	3	127
Conflicting Peds, #/hr	0	0	0	0	0	0
Sign Control	Stop	Stop	Free	Free	Free	Free
RT Channelized	-	None	-	None	-	None
Storage Length	0	-	-	-	-	-
Veh in Median Storage, #	0	-	-	0	0	-
Grade, %	0	-	-	0	0	-
Peak Hour Factor	76	76	76	76	76	76
Heavy Vehicles, %	3	3	10	10	5	5
Mvmt Flow	225	0	0	55	4	167

Major/Minor	Minor2	Major1		Major2	
Conflicting Flow All	143	-	-	0	0
Stage 1	88	-	-	-	-
Stage 2	55	-	-	-	-
Critical Hdwy	6.43	-	-	-	-
Critical Hdwy Stg 1	5.43	-	-	-	-
Critical Hdwy Stg 2	5.43	-	-	-	-
Follow-up Hdwy	3.527	-	-	-	-
Pot Cap-1 Maneuver	847	0	0	-	-
Stage 1	933	0	0	-	-
Stage 2	965	0	0	-	-
Platoon blocked, %				-	-
Mov Cap-1 Maneuver	847	-	-	-	-
Mov Cap-2 Maneuver	847	-	-	-	-
Stage 1	933	-	-	-	-
Stage 2	965	-	-	-	-

Approach	EB	NB	SB
HCM Control Delay, s	10.8	0	0
HCM LOS	B		

Minor Lane/Major Mvmt	NBT	EBLn1	SBT	SBR
Capacity (veh/h)	-	847	-	-
HCM Lane V/C Ratio	-	0.266	-	-
HCM Control Delay (s)	-	10.8	-	-
HCM Lane LOS	-	B	-	-
HCM 95th %tile Q(veh)	-	1.1	-	-

Intersection						
Int Delay, s/veh	0					
Movement	EBL	EBT	WBT	WBR	SBL	SBR
Lane Configurations		↶	↷		↶	
Traffic Vol, veh/h	0	129	72	50	0	0
Future Vol, veh/h	0	129	72	50	0	0
Conflicting Peds, #/hr	0	0	0	0	0	0
Sign Control	Free	Free	Free	Free	Stop	Stop
RT Channelized	-	None	-	None	-	None
Storage Length	-	-	-	-	0	-
Veh in Median Storage, #	-	0	0	-	0	-
Grade, %	-	0	0	-	0	-
Peak Hour Factor	78	78	78	78	78	78
Heavy Vehicles, %	2	2	13	13	0	0
Mvmt Flow	0	165	92	64	0	0

Major/Minor	Major1	Major2	Minor2		
Conflicting Flow All	156	0	-	0	289
Stage 1	-	-	-	-	124
Stage 2	-	-	-	-	165
Critical Hdwy	4.12	-	-	-	6.4
Critical Hdwy Stg 1	-	-	-	-	5.4
Critical Hdwy Stg 2	-	-	-	-	5.4
Follow-up Hdwy	2.218	-	-	-	3.5
Pot Cap-1 Maneuver	1424	-	-	-	706
Stage 1	-	-	-	-	907
Stage 2	-	-	-	-	869
Platoon blocked, %		-	-	-	
Mov Cap-1 Maneuver	1424	-	-	-	706
Mov Cap-2 Maneuver	-	-	-	-	706
Stage 1	-	-	-	-	907
Stage 2	-	-	-	-	869

Approach	EB	WB	SB
HCM Control Delay, s	0	0	0
HCM LOS			A

Minor Lane/Major Mvmt	EBL	EBT	WBT	WBR	SBLn1
Capacity (veh/h)	1424	-	-	-	-
HCM Lane V/C Ratio	-	-	-	-	-
HCM Control Delay (s)	0	-	-	-	0
HCM Lane LOS	A	-	-	-	A
HCM 95th %tile Q(veh)	0	-	-	-	-

HCM 6th Signalized Intersection Summary
29: Schnoor Avenue & Cleveland Avenue

Village D Specific Plan
Existing WP - AM Peak Hour

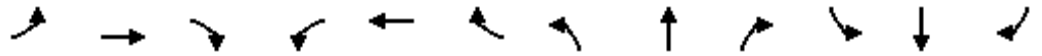

Movement	EBL	EBT	EBR	WBL	WBT	WBR	NBL	NBT	NBR	SBL	SBT	SBR
Lane Configurations	↘	↑↑	↗	↘↗	↑↑	↗	↘	↑↑	↗	↘	↑↑	↗
Traffic Volume (veh/h)	135	999	66	161	487	43	61	216	155	79	170	90
Future Volume (veh/h)	135	999	66	161	487	43	61	216	155	79	170	90
Initial Q (Qb), veh	0	0	0	0	0	0	0	0	0	0	0	0
Ped-Bike Adj(A_pbT)	1.00		0.98	1.00		0.98	1.00		0.99	1.00		0.98
Parking Bus, Adj	1.00	1.00	1.00	1.00	1.00	1.00	1.00	1.00	1.00	1.00	1.00	1.00
Work Zone On Approach		No			No			No			No	
Adj Sat Flow, veh/h/ln	1885	1885	1885	1856	1856	1856	1885	1885	1885	1870	1870	1870
Adj Flow Rate, veh/h	148	1098	73	177	535	47	67	237	170	87	187	99
Peak Hour Factor	0.91	0.91	0.91	0.91	0.91	0.91	0.91	0.91	0.91	0.91	0.91	0.91
Percent Heavy Veh, %	1	1	1	3	3	3	1	1	1	2	2	2
Cap, veh/h	186	1250	547	255	1128	493	87	869	502	195	1078	471
Arrive On Green	0.10	0.35	0.35	0.07	0.32	0.32	0.05	0.24	0.24	0.11	0.30	0.30
Sat Flow, veh/h	1795	3582	1567	3428	3526	1541	1795	3582	1582	1781	3554	1553
Grp Volume(v), veh/h	148	1098	73	177	535	47	67	237	170	87	187	99
Grp Sat Flow(s),veh/h/ln	1795	1791	1567	1714	1763	1541	1795	1791	1582	1781	1777	1553
Q Serve(g_s), s	6.4	23.0	1.9	4.0	9.7	1.2	3.0	4.3	0.6	3.7	3.1	3.8
Cycle Q Clear(g_c), s	6.4	23.0	1.9	4.0	9.7	1.2	3.0	4.3	0.6	3.7	3.1	3.8
Prop In Lane	1.00		1.00	1.00		1.00	1.00		1.00	1.00		1.00
Lane Grp Cap(c), veh/h	186	1250	547	255	1128	493	87	869	502	195	1078	471
V/C Ratio(X)	0.80	0.88	0.13	0.70	0.47	0.10	0.77	0.27	0.34	0.45	0.17	0.21
Avail Cap(c_a), veh/h	301	1321	578	279	1128	493	117	869	502	195	1078	471
HCM Platoon Ratio	1.00	1.00	1.00	1.00	1.00	1.00	1.00	1.00	1.00	1.00	1.00	1.00
Upstream Filter(I)	1.00	1.00	1.00	0.68	0.68	0.68	1.00	1.00	1.00	1.00	1.00	1.00
Uniform Delay (d), s/veh	35.0	24.4	10.1	36.1	21.8	8.7	37.6	24.6	20.9	33.4	20.5	20.7
Incr Delay (d2), s/veh	7.6	6.8	0.1	4.6	0.2	0.1	19.5	0.8	1.8	1.6	0.4	1.0
Initial Q Delay(d3),s/veh	0.0	0.0	0.0	0.0	0.0	0.0	0.0	0.0	0.0	0.0	0.0	0.0
%ile BackOfQ(50%),veh/ln	3.1	10.3	0.9	1.8	3.9	0.6	1.7	1.9	2.6	1.6	1.3	1.5
Unsig. Movement Delay, s/veh												
LnGrp Delay(d),s/veh	42.6	31.2	10.2	40.7	22.0	8.7	57.1	25.4	22.7	35.0	20.8	21.8
LnGrp LOS	D	C	B	D	C	A	E	C	C	C	C	C
Approach Vol, veh/h		1319			759			474			373	
Approach Delay, s/veh		31.4			25.6			28.9			24.4	
Approach LOS		C			C			C			C	
Timer - Assigned Phs	1	2	3	4	5	6	7	8				
Phs Duration (G+Y+Rc), s	13.2	23.9	10.4	32.4	8.4	28.8	12.8	30.1				
Change Period (Y+Rc), s	4.5	4.5	4.5	4.5	4.5	4.5	4.5	4.5				
Max Green Setting (Gmax), s	6.6	19.4	6.5	29.5	5.2	20.8	13.4	22.6				
Max Q Clear Time (g_c+I1), s	5.7	6.3	6.0	25.0	5.0	5.8	8.4	11.7				
Green Ext Time (p_c), s	0.0	1.7	0.0	2.9	0.0	1.3	0.2	2.8				
Intersection Summary												
HCM 6th Ctrl Delay				28.6								
HCM 6th LOS				C								

HCM 6th Signalized Intersection Summary

30: Fairgrounds & Cleveland Avenue

Village D Specific Plan
Existing WP - AM Peak Hour



Movement	EBL	EBT	EBR	WBL	WBT	WBR	NBL	NBT	NBR	SBL	SBT	SBR	
Lane Configurations	↵ ↑↑↑			↵ ↑↑			↵ ↵		↑ ↵		↵ ↵		
Traffic Volume (veh/h)	80	1171	29	32	633	99	13	6	23	107	5	38	
Future Volume (veh/h)	80	1171	29	32	633	99	13	6	23	107	5	38	
Initial Q (Qb), veh	0	0	0	0	0	0	0	0	0	0	0	0	
Ped-Bike Adj(A_pbT)	1.00		1.00	1.00		1.00	1.00		1.00	1.00		0.99	
Parking Bus, Adj	1.00	1.00	1.00	1.00	1.00	1.00	1.00	1.00	1.00	1.00	1.00	1.00	
Work Zone On Approach	No			No			No		No		No		
Adj Sat Flow, veh/h/ln	1870	1870	1870	1870	1870	1870	1900	1900	1900	1900	1900	1900	
Adj Flow Rate, veh/h	85	1246	31	34	673	105	14	20	15	114	5	40	
Peak Hour Factor	0.94	0.94	0.94	0.94	0.94	0.94	0.94	0.94	0.94	0.94	0.94	0.94	
Percent Heavy Veh, %	2	2	2	2	2	2	0	0	0	0	0	0	
Cap, veh/h	109	1332	33	59	824	368	613	463	392	431	56	449	
Arrive On Green	0.12	0.52	0.52	0.03	0.23	0.23	0.17	0.24	0.24	0.24	0.31	0.31	
Sat Flow, veh/h	1781	5124	127	1781	3554	1585	3619	1900	1608	1810	180	1437	
Grp Volume(v), veh/h	85	828	449	34	673	105	14	20	15	114	0	45	
Grp Sat Flow(s),veh/h/ln	1781	1702	1847	1781	1777	1585	1810	1900	1608	1810	0	1617	
Q Serve(g_s), s	3.7	18.2	18.2	1.5	14.4	4.4	0.3	0.6	0.5	4.1	0.0	1.6	
Cycle Q Clear(g_c), s	3.7	18.2	18.2	1.5	14.4	4.4	0.3	0.6	0.5	4.1	0.0	1.6	
Prop In Lane	1.00		0.07	1.00		1.00	1.00		1.00	1.00		0.89	
Lane Grp Cap(c), veh/h	109	885	480	59	824	368	613	463	392	431	0	505	
V/C Ratio(X)	0.78	0.94	0.94	0.58	0.82	0.29	0.02	0.04	0.04	0.26	0.00	0.09	
Avail Cap(c_a), veh/h	234	885	480	256	955	426	613	463	392	431	0	505	
HCM Platoon Ratio	2.00	2.00	2.00	1.00	1.00	1.00	1.00	1.00	1.00	1.00	1.00	1.00	
Upstream Filter(I)	0.56	0.56	0.56	0.89	0.89	0.89	1.00	1.00	1.00	1.00	0.00	1.00	
Uniform Delay (d), s/veh	34.6	18.6	18.6	38.1	29.1	25.3	27.7	23.1	15.1	24.8	0.0	19.4	
Incr Delay (d2), s/veh	6.6	10.8	17.2	7.7	4.4	0.4	0.0	0.2	0.2	0.3	0.0	0.3	
Initial Q Delay(d3),s/veh	0.0	0.0	0.0	0.0	0.0	0.0	0.0	0.0	0.0	0.0	0.0	0.0	
%ile BackOfQ(50%),veh/ln	1.7	5.7	7.0	0.8	6.4	1.6	0.1	0.3	0.2	1.7	0.0	0.6	
Unsig. Movement Delay, s/veh													
LnGrp Delay(d),s/veh	41.2	29.4	35.7	45.8	33.5	25.6	27.7	23.3	15.2	25.1	0.0	19.8	
LnGrp LOS	D	C	D	D	C	C	C	C	C	B	C	A	B
Approach Vol, veh/h	1362			812			49		159				
Approach Delay, s/veh	32.2			33.0			22.1		23.6				
Approach LOS	C			C			C		C				
Timer - Assigned Phs	1	2	3	4	5	6	7	8					
Phs Duration (G+Y+Rc), s	23.5	24.0	7.2	25.3	18.0	29.5	9.4	23.1					
Change Period (Y+Rc), s	4.5	4.5	4.5	4.5	4.5	4.5	4.5	4.5					
Max Green Setting (Gmax), s	10.5	19.5	11.5	20.5	5.0	25.0	10.5	21.5					
Max Q Clear Time (g_c+1), s	10.5	2.6	3.5	20.2	2.3	3.6	5.7	16.4					
Green Ext Time (p_c), s	0.1	0.1	0.0	0.2	0.0	0.2	0.1	2.2					

Intersection Summary

HCM 6th Ctrl Delay	31.7											
HCM 6th LOS	C											

Notes

User approved volume balancing among the lanes for turning movement.

HCM 6th Signalized Intersection Summary
 31: SR-99 Southbound Ramps & Cleveland Avenue

Village D Specific Plan
 Existing WP - AM Peak Hour



Movement	EBL	EBT	EBR	WBL	WBT	WBR	NBL	NBT	NBR	SBL	SBT	SBR
Lane Configurations		↑↑	↑	↑	↑↑					↑		↑
Traffic Volume (veh/h)	0	661	724	313	917	0	0	0	0	239	0	80
Future Volume (veh/h)	0	661	724	313	917	0	0	0	0	239	0	80
Initial Q (Qb), veh	0	0	0	0	0	0				0	0	0
Ped-Bike Adj(A_pbT)	1.00		1.00	1.00		1.00				1.00		1.00
Parking Bus, Adj	1.00	1.00	1.00	1.00	1.00	1.00				1.00	1.00	1.00
Work Zone On Approach		No			No						No	
Adj Sat Flow, veh/h/ln	0	1870	1870	1870	1870	0				1826	0	1826
Adj Flow Rate, veh/h	0	760	832	360	1054	0				275	0	92
Peak Hour Factor	0.87	0.87	0.87	0.87	0.87	0.87				0.87	0.87	0.87
Percent Heavy Veh, %	0	2	2	2	2	0				5	0	5
Cap, veh/h	0	1343	599	389	2296	0				442	0	393
Arrive On Green	0.00	0.38	0.38	0.44	1.00	0.00				0.25	0.00	0.25
Sat Flow, veh/h	0	3647	1585	1781	3647	0				1739	0	1547
Grp Volume(v), veh/h	0	760	832	360	1054	0				275	0	92
Grp Sat Flow(s),veh/h/ln	0	1777	1585	1781	1777	0				1739	0	1547
Q Serve(g_s), s	0.0	15.2	34.0	17.2	0.0	0.0				12.6	0.0	4.2
Cycle Q Clear(g_c), s	0.0	15.2	34.0	17.2	0.0	0.0				12.6	0.0	4.2
Prop In Lane	0.00		1.00	1.00		0.00				1.00		1.00
Lane Grp Cap(c), veh/h	0	1343	599	389	2296	0				442	0	393
V/C Ratio(X)	0.00	0.57	1.39	0.93	0.46	0.00				0.62	0.00	0.23
Avail Cap(c_a), veh/h	0	1343	599	457	2432	0				442	0	393
HCM Platoon Ratio	1.00	1.00	1.00	2.00	2.00	1.00				1.00	1.00	1.00
Upstream Filter(I)	0.00	0.59	0.59	0.65	0.65	0.00				1.00	0.00	1.00
Uniform Delay (d), s/veh	0.0	22.2	28.0	24.7	0.0	0.0				29.8	0.0	26.6
Incr Delay (d2), s/veh	0.0	0.3	181.4	16.7	0.1	0.0				2.7	0.0	0.3
Initial Q Delay(d3),s/veh	0.0	0.0	0.0	0.0	0.0	0.0				0.0	0.0	0.0
%ile BackOfQ(50%),veh/ln	0.0	6.2	42.3	6.9	0.0	0.0				5.5	0.0	1.6
Unsig. Movement Delay, s/veh												
LnGrp Delay(d),s/veh	0.0	22.5	209.4	41.4	0.1	0.0				32.5	0.0	26.9
LnGrp LOS	A	C	F	D	A	A				C	A	C
Approach Vol, veh/h		1592			1414						367	
Approach Delay, s/veh		120.2			10.6						31.1	
Approach LOS		F			B						C	
Timer - Assigned Phs			3	4		6		8				
Phs Duration (G+Y+Rc), s			24.1	38.5		27.4		62.6				
Change Period (Y+Rc), s			4.5	4.5		4.5		4.5				
Max Green Setting (Gmax), s			23.1	34.0		19.4		61.6				
Max Q Clear Time (g_c+I1), s			19.2	36.0		14.6		2.0				
Green Ext Time (p_c), s			0.4	0.0		0.5		10.3				
Intersection Summary												
HCM 6th Ctrl Delay			64.5									
HCM 6th LOS			E									

HCM 6th Signalized Intersection Summary
 32: SR-99 Northbound Ramps & Cleveland Avenue

Village D Specific Plan
 Existing WP - AM Peak Hour



Movement	EBL	EBT	EBR	WBL	WBT	WBR	NBL	NBT	NBR	SBL	SBT	SBR
Lane Configurations												
Traffic Volume (veh/h)	55	845	0	0	847	118	383	0	243	0	0	0
Future Volume (veh/h)	55	845	0	0	847	118	383	0	243	0	0	0
Initial Q (Qb), veh	0	0	0	0	0	0	0	0	0			
Ped-Bike Adj(A_pbT)	1.00		1.00	1.00		1.00	1.00		1.00			
Parking Bus, Adj	1.00	1.00	1.00	1.00	1.00	1.00	1.00	1.00	1.00			
Work Zone On Approach	No				No				No			
Adj Sat Flow, veh/h/ln	1856	1856	0	0	1870	1870	1841	1841	1841			
Adj Flow Rate, veh/h	68	1043	0	0	1046	146	473	0	300			
Peak Hour Factor	0.81	0.81	0.81	0.81	0.81	0.81	0.81	0.81	0.81			
Percent Heavy Veh, %	3	3	0	0	2	2	4	4	4			
Cap, veh/h	89	1485	0	0	1141	509	1679	0	747			
Arrive On Green	0.05	0.42	0.00	0.00	0.32	0.32	0.48	0.00	0.48			
Sat Flow, veh/h	1767	3618	0	0	3647	1585	3506	0	1560			
Grp Volume(v), veh/h	68	1043	0	0	1046	146	473	0	300			
Grp Sat Flow(s),veh/h/ln	1767	1763	0	0	1777	1585	1753	0	1560			
Q Serve(g_s), s	3.4	21.9	0.0	0.0	25.5	6.2	7.3	0.0	11.2			
Cycle Q Clear(g_c), s	3.4	21.9	0.0	0.0	25.5	6.2	7.3	0.0	11.2			
Prop In Lane	1.00		0.00	0.00		1.00	1.00		1.00			
Lane Grp Cap(c), veh/h	89	1485	0	0	1141	509	1679	0	747			
V/C Ratio(X)	0.77	0.70	0.00	0.00	0.92	0.29	0.28	0.00	0.40			
Avail Cap(c_a), veh/h	363	2057	0	0	1165	520	1679	0	747			
HCM Platoon Ratio	1.00	1.00	1.00	1.00	1.00	1.00	1.00	1.00	1.00			
Upstream Filter(I)	0.75	0.75	0.00	0.00	0.67	0.67	1.00	0.00	1.00			
Uniform Delay (d), s/veh	42.2	21.4	0.0	0.0	29.4	22.9	14.1	0.0	15.1			
Incr Delay (d2), s/veh	9.9	0.5	0.0	0.0	8.1	0.2	0.4	0.0	1.6			
Initial Q Delay(d3),s/veh	0.0	0.0	0.0	0.0	0.0	0.0	0.0	0.0	0.0			
%ile BackOfQ(50%),veh/ln	1.7	8.7	0.0	0.0	11.7	2.3	2.9	0.0	4.1			
Unsig. Movement Delay, s/veh												
LnGrp Delay(d),s/veh	52.2	21.9	0.0	0.0	37.5	23.1	14.5	0.0	16.7			
LnGrp LOS	D	C	A	A	D	C	B	A	B			
Approach Vol, veh/h	1111				1192				773			
Approach Delay, s/veh	23.8				35.7				15.4			
Approach LOS	C				D				B			
Timer - Assigned Phs	2		4		7		8					
Phs Duration (G+Y+Rc), s	47.6		42.4		9.0		33.4					
Change Period (Y+Rc), s	4.5		4.5		4.5		4.5					
Max Green Setting (Gmax), s	28.5		52.5		18.5		29.5					
Max Q Clear Time (g_c+I1), s	13.2		23.9		5.4		27.5					
Green Ext Time (p_c), s	2.6		8.9		0.1		1.4					

Intersection Summary

HCM 6th Ctrl Delay	26.3
HCM 6th LOS	C

Notes

User approved volume balancing among the lanes for turning movement.

HCM 6th Signalized Intersection Summary
 33: Gateway Drive & Cleveland Avenue

Village D Specific Plan
 Existing WP - AM Peak Hour



Movement	EBL	EBT	EBR	WBL	WBT	WBR	NBL	NBT	NBR	SBL	SBT	SBR
Lane Configurations	↖	↑↑↑	↗	↖↗	↑↑		↖↗	↑	↗	↖	↑↗	
Traffic Volume (veh/h)	4	805	273	154	779	62	178	47	113	51	85	4
Future Volume (veh/h)	4	805	273	154	779	62	178	47	113	51	85	4
Initial Q (Qb), veh	0	0	0	0	0	0	0	0	0	0	0	0
Ped-Bike Adj(A_pbT)	1.00		1.00	1.00		1.00	1.00		0.98	1.00		0.98
Parking Bus, Adj	1.00	1.00	1.00	1.00	1.00	1.00	1.00	1.00	1.00	1.00	1.00	1.00
Work Zone On Approach		No			No			No			No	
Adj Sat Flow, veh/h/ln	1856	1856	1856	1870	1870	1870	1811	1811	1811	1841	1841	1841
Adj Flow Rate, veh/h	5	994	0	190	962	77	220	58	140	63	105	5
Peak Hour Factor	0.81	0.81	0.81	0.81	0.81	0.81	0.81	0.81	0.81	0.81	0.81	0.81
Percent Heavy Veh, %	3	3	3	2	2	2	6	6	6	4	4	4
Cap, veh/h	92	1264		301	1100	88	829	756	630	81	732	35
Arrive On Green	0.00	0.17	0.00	0.09	0.33	0.33	0.25	0.42	0.42	0.05	0.22	0.22
Sat Flow, veh/h	1767	5066	1572	3456	3331	267	3346	1811	1511	1753	3397	161
Grp Volume(v), veh/h	5	994	0	190	513	526	220	58	140	63	54	56
Grp Sat Flow(s),veh/h/ln	1767	1689	1572	1728	1777	1821	1673	1811	1511	1753	1749	1809
Q Serve(g_s), s	0.2	16.9	0.0	4.8	24.5	24.5	4.8	1.7	3.6	3.2	2.2	2.3
Cycle Q Clear(g_c), s	0.2	16.9	0.0	4.8	24.5	24.5	4.8	1.7	3.6	3.2	2.2	2.3
Prop In Lane	1.00		1.00	1.00		0.15	1.00		1.00	1.00		0.09
Lane Grp Cap(c), veh/h	92	1264		301	587	601	829	756	630	81	377	390
V/C Ratio(X)	0.05	0.79		0.63	0.87	0.87	0.27	0.08	0.22	0.78	0.14	0.14
Avail Cap(c_a), veh/h	247	1435		591	640	656	829	756	630	179	377	390
HCM Platoon Ratio	0.67	0.67	0.67	1.00	1.00	1.00	1.00	1.00	1.00	1.00	1.00	1.00
Upstream Filter(I)	0.81	0.81	0.00	0.93	0.93	0.93	1.00	1.00	1.00	1.00	1.00	1.00
Uniform Delay (d), s/veh	29.5	35.2	0.0	39.7	28.4	28.4	27.3	15.8	7.8	42.5	28.6	28.6
Incr Delay (d2), s/veh	0.2	2.1	0.0	2.0	11.4	11.2	0.2	0.2	0.8	14.8	0.8	0.8
Initial Q Delay(d3),s/veh	0.0	0.0	0.0	0.0	0.0	0.0	0.0	0.0	0.0	0.0	0.0	0.0
%ile BackOfQ(50%),veh/ln	0.1	7.5	0.0	2.1	11.9	12.1	1.9	0.7	1.9	1.7	1.0	1.1
Unsig. Movement Delay, s/veh												
LnGrp Delay(d),s/veh	29.7	37.3	0.0	41.7	39.8	39.6	27.4	16.0	8.6	57.3	29.4	29.4
LnGrp LOS	C	D		D	D	D	C	B	A	E	C	C
Approach Vol, veh/h		999	A		1229			418			173	
Approach Delay, s/veh		37.3			40.0			19.5			39.5	
Approach LOS		D			D			B			D	
Timer - Assigned Phs	1	2	3	4	5	6	7	8				
Phs Duration (G+Y+Rc), s	36.8	23.9	5.1	34.2	8.7	42.0	12.3	27.0				
Change Period (Y+Rc), s	4.5	4.5	4.5	4.5	4.5	4.5	4.5	4.5				
Max Green Setting (Gmax), s	3	19.4	8.5	32.4	9.2	21.9	15.4	25.5				
Max Q Clear Time (g_c+10), s	10.8	4.3	2.2	26.5	5.2	5.6	6.8	18.9				
Green Ext Time (p_c), s	0.3	0.4	0.0	3.2	0.0	0.6	0.4	3.5				

Intersection Summary

HCM 6th Ctrl Delay	36.0
HCM 6th LOS	D

Notes

Unsignalized Delay for [EBR] is excluded from calculations of the approach delay and intersection delay.

HCM 6th Signalized Intersection Summary
34: Cleveland Avenue & County Club Drive

Village D Specific Plan
Existing WP - AM Peak Hour



Movement	WBL	WBR	NBT	NBR	SBL	SBT
Lane Configurations	YY		↑↑	↑	Y	↑↑↑
Traffic Volume (veh/h)	371	19	558	410	76	624
Future Volume (veh/h)	371	19	558	410	76	624
Initial Q (Qb), veh	0	0	0	0	0	0
Ped-Bike Adj(A_pbT)	1.00	1.00		1.00	1.00	
Parking Bus, Adj	1.00	1.00	1.00	1.00	1.00	1.00
Work Zone On Approach	No		No		No	
Adj Sat Flow, veh/h/ln	1900	1900	1900	1900	1900	1900
Adj Flow Rate, veh/h	468	0	672	0	92	752
Peak Hour Factor	0.83	0.83	0.83	0.83	0.83	0.83
Percent Heavy Veh, %	0	0	0	0	0	0
Cap, veh/h	595	265	2656		605	3816
Arrive On Green	0.16	0.00	0.74	0.00	0.74	0.74
Sat Flow, veh/h	3619	1610	3705	1610	778	5358
Grp Volume(v), veh/h	468	0	672	0	92	752
Grp Sat Flow(s),veh/h/ln	1810	1610	1805	1610	778	1729
Q Serve(g_s), s	11.2	0.0	5.4	0.0	3.9	4.0
Cycle Q Clear(g_c), s	11.2	0.0	5.4	0.0	9.4	4.0
Prop In Lane	1.00	1.00		1.00	1.00	
Lane Grp Cap(c), veh/h	595	265	2656		605	3816
V/C Ratio(X)	0.79	0.00	0.25		0.15	0.20
Avail Cap(c_a), veh/h	1307	581	2656		605	3816
HCM Platoon Ratio	1.00	1.00	1.00	1.00	1.00	1.00
Upstream Filter(I)	1.00	0.00	0.70	0.00	1.00	1.00
Uniform Delay (d), s/veh	36.1	0.0	3.9	0.0	5.4	3.7
Incr Delay (d2), s/veh	2.4	0.0	0.2	0.0	0.5	0.1
Initial Q Delay(d3),s/veh	0.0	0.0	0.0	0.0	0.0	0.0
%ile BackOfQ(50%),veh/ln	5.0	0.0	1.6	0.0	0.6	1.1
Unsig. Movement Delay, s/veh						
LnGrp Delay(d),s/veh	38.4	0.0	4.0	0.0	5.9	3.8
LnGrp LOS	D	A	A		A	A
Approach Vol, veh/h	468		672	A		844
Approach Delay, s/veh	38.4		4.0			4.0
Approach LOS	D		A			A
Timer - Assigned Phs		2			6	8
Phs Duration (G+Y+Rc), s		70.7			70.7	19.3
Change Period (Y+Rc), s		4.5			4.5	4.5
Max Green Setting (Gmax), s		48.5			48.5	32.5
Max Q Clear Time (g_c+I1), s		7.4			11.4	13.2
Green Ext Time (p_c), s		5.4			7.0	1.6

Intersection Summary

HCM 6th Ctrl Delay	12.1
HCM 6th LOS	B

Notes

User approved volume balancing among the lanes for turning movement.
Unsignalized Delay for [NBR] is excluded from calculations of the approach delay and intersection delay.

Intersection						
Int Delay, s/veh	0.1					
Movement	EBL	EBR	NBL	NBT	SBT	SBR
Lane Configurations	T			T		
Traffic Vol, veh/h	2	12	1	532	649	1
Future Vol, veh/h	2	12	1	532	649	1
Conflicting Peds, #/hr	0	0	2	0	0	2
Sign Control	Stop	Stop	Free	Free	Free	Free
RT Channelized	-	None	-	None	-	None
Storage Length	0	-	-	-	-	-
Veh in Median Storage, #	0	-	-	0	0	-
Grade, %	0	-	-	0	0	-
Peak Hour Factor	84	84	84	84	84	84
Heavy Vehicles, %	7	7	5	5	4	4
Mvmt Flow	2	14	1	633	773	1

Major/Minor	Minor2	Major1	Major2			
Conflicting Flow All	1095	389	776	0	-	0
Stage 1	776	-	-	-	-	-
Stage 2	319	-	-	-	-	-
Critical Hdwy	6.94	7.04	4.2	-	-	-
Critical Hdwy Stg 1	5.94	-	-	-	-	-
Critical Hdwy Stg 2	5.94	-	-	-	-	-
Follow-up Hdwy	3.57	3.37	2.25	-	-	-
Pot Cap-1 Maneuver	*329	596	817	-	-	-
Stage 1	*402	-	-	-	-	-
Stage 2	*804	-	-	-	-	-
Platoon blocked, %	1			-	-	-
Mov Cap-1 Maneuver	*327	595	815	-	-	-
Mov Cap-2 Maneuver	*356	-	-	-	-	-
Stage 1	*400	-	-	-	-	-
Stage 2	*802	-	-	-	-	-





















Approach	EB	NB	SB
HCM Control Delay, s	11.8	0	0
HCM LOS	B		

Minor Lane/Major Mvmt	NBL	NBT	EBLn1	SBT	SBR
Capacity (veh/h)	815	-	543	-	-
HCM Lane V/C Ratio	0.001	-	0.031	-	-
HCM Control Delay (s)	9.4	0	11.8	-	-
HCM Lane LOS	A	A	B	-	-
HCM 95th %tile Q(veh)	0	-	0.1	-	-

Notes
 -: Volume exceeds capacity \$: Delay exceeds 300s +: Computation Not Defined *: All major volume in platoon

HCM 6th Signalized Intersection Summary
36: Pine Street & Howard Road

Village D Specific Plan
Existing WP - AM Peak Hour

												
Movement	EBL	EBT	EBR	WBL	WBT	WBR	NBL	NBT	NBR	SBL	SBT	SBR
Lane Configurations												
Traffic Volume (veh/h)	33	998	175	126	575	6	153	154	222	16	253	97
Future Volume (veh/h)	33	998	175	126	575	6	153	154	222	16	253	97
Initial Q (Qb), veh	0	0	0	0	0	0	0	0	0	0	0	0
Ped-Bike Adj(A_pbT)	1.00		0.98	1.00		0.98	1.00		0.99	1.00		0.98
Parking Bus, Adj	1.00	1.00	1.00	1.00	1.00	1.00	1.00	1.00	1.00	1.00	1.00	1.00
Work Zone On Approach		No			No			No			No	
Adj Sat Flow, veh/h/ln	1885	1885	1885	1870	1870	1870	1811	1811	1811	1841	1841	1841
Adj Flow Rate, veh/h	39	1174	206	148	676	7	180	181	261	19	298	114
Peak Hour Factor	0.85	0.85	0.85	0.85	0.85	0.85	0.85	0.85	0.85	0.85	0.85	0.85
Percent Heavy Veh, %	1	1	1	2	2	2	6	6	6	4	4	4
Cap, veh/h	54	1213	212	171	1674	17	290	304	256	21	323	285
Arrive On Green	0.03	0.40	0.40	0.10	0.46	0.46	0.17	0.17	0.17	0.19	0.19	0.19
Sat Flow, veh/h	1795	3039	530	1781	3602	37	1725	1811	1527	110	1725	1523
Grp Volume(v), veh/h	39	689	691	148	333	350	180	181	261	317	0	114
Grp Sat Flow(s),veh/h/ln	1795	1791	1778	1781	1777	1863	1725	1811	1527	1835	0	1523
Q Serve(g_s), s	2.6	45.1	45.8	9.8	14.8	14.8	11.6	11.1	20.2	20.4	0.0	7.9
Cycle Q Clear(g_c), s	2.6	45.1	45.8	9.8	14.8	14.8	11.6	11.1	20.2	20.4	0.0	7.9
Prop In Lane	1.00		0.30	1.00		0.02	1.00		1.00	0.06		1.00
Lane Grp Cap(c), veh/h	54	715	709	171	826	866	290	304	256	343	0	285
V/C Ratio(X)	0.72	0.96	0.97	0.87	0.40	0.40	0.62	0.59	1.02	0.92	0.00	0.40
Avail Cap(c_a), veh/h	103	715	710	171	826	866	290	304	256	347	0	288
HCM Platoon Ratio	1.00	1.00	1.00	1.00	1.00	1.00	1.00	1.00	1.00	1.00	1.00	1.00
Upstream Filter(I)	1.00	1.00	1.00	0.90	0.90	0.90	1.00	1.00	1.00	1.00	0.00	1.00
Uniform Delay (d), s/veh	57.7	35.2	35.4	53.5	21.2	21.2	46.4	46.1	49.9	47.9	0.0	42.9
Incr Delay (d2), s/veh	16.1	25.0	27.3	31.9	0.3	0.3	9.6	8.3	60.8	29.4	0.0	0.9
Initial Q Delay(d3),s/veh	0.0	0.0	0.0	0.0	0.0	0.0	0.0	0.0	0.0	0.0	0.0	0.0
%ile BackOfQ(50%),veh/ln	1.4	24.2	24.8	5.9	6.2	6.5	5.8	5.7	12.0	12.1	0.0	3.1
Unsig. Movement Delay, s/veh												
LnGrp Delay(d),s/veh	73.7	60.3	62.7	85.4	21.5	21.4	56.0	54.5	110.8	77.3	0.0	43.8
LnGrp LOS	E	E	E	F	C	C	E	D	F	E	A	D
Approach Vol, veh/h		1419			831			622			431	
Approach Delay, s/veh		61.8			32.8			78.5			68.4	
Approach LOS		E			C			E			E	
Timer - Assigned Phs		2	3	4		6	7	8				
Phs Duration (G+Y+Rc), s		24.7	16.0	52.4		27.0	8.1	60.3				
Change Period (Y+Rc), s		4.5	4.5	4.5		4.5	4.5	4.5				
Max Green Setting (Gmax), s		19.9	11.5	47.9		22.7	6.9	52.5				
Max Q Clear Time (g_c+I1), s		22.2	11.8	47.8		22.4	4.6	16.8				
Green Ext Time (p_c), s		0.0	0.0	0.0		0.1	0.0	4.7				
Intersection Summary												
HCM 6th Ctrl Delay			58.5									
HCM 6th LOS			E									

HCM 6th Signalized Intersection Summary
 37: Olive Avenue/Q Street & Howard Road/Yosemite Avenue

Village D Specific Plan
 Existing WP - AM Peak Hour



Movement	EBL	EBT	EBR	WBL	WBT	WBR	NBL	NBT	NBR	SBL	SBT	SBR
Lane Configurations												
Traffic Volume (veh/h)	6	582	597	26	349	19	417	88	20	99	147	12
Future Volume (veh/h)	6	582	597	26	349	19	417	88	20	99	147	12
Initial Q (Qb), veh	0	0	0	0	0	0	0	0	0	0	0	0
Ped-Bike Adj(A_pbT)	1.00		1.00	1.00		0.98	1.00		0.99	1.00		0.97
Parking Bus, Adj	1.00	1.00	1.00	1.00	1.00	1.00	1.00	1.00	1.00	1.00	1.00	1.00
Work Zone On Approach		No			No			No			No	
Adj Sat Flow, veh/h/ln	1870	1870	1870	1870	1870	1870	1856	1856	1856	1870	1870	1870
Adj Flow Rate, veh/h	8	776	0	35	465	25	640	0	27	132	196	16
Peak Hour Factor	0.75	0.75	0.75	0.75	0.75	0.75	0.75	0.75	0.75	0.75	0.75	0.75
Percent Heavy Veh, %	2	2	2	2	2	2	3	3	3	2	2	2
Cap, veh/h	17	885		74	963	52	1520	0	669	230	242	198
Arrive On Green	0.01	0.33	0.00	0.04	0.28	0.28	0.43	0.00	0.43	0.13	0.13	0.13
Sat Flow, veh/h	1781	3554	1585	1781	3426	184	3534	0	1556	1781	1870	1530
Grp Volume(v), veh/h	8	776	0	35	241	249	640	0	27	132	196	16
Grp Sat Flow(s),veh/h/ln	1781	1777	1585	1781	1777	1833	1767	0	1556	1781	1870	1530
Q Serve(g_s), s	0.5	24.7	0.0	2.3	13.5	13.6	15.1	0.0	1.2	8.4	12.2	1.1
Cycle Q Clear(g_c), s	0.5	24.7	0.0	2.3	13.5	13.6	15.1	0.0	1.2	8.4	12.2	1.1
Prop In Lane	1.00		1.00	1.00		0.10	1.00		1.00	1.00		1.00
Lane Grp Cap(c), veh/h	17	885		74	499	515	1520	0	669	230	242	198
V/C Ratio(X)	0.46	0.88		0.47	0.48	0.48	0.42	0.00	0.04	0.57	0.81	0.08
Avail Cap(c_a), veh/h	74	1022		267	703	726	1520	0	669	267	281	229
HCM Platoon Ratio	1.33	1.33	1.33	1.00	1.00	1.00	1.00	1.00	1.00	1.00	1.00	1.00
Upstream Filter(I)	0.28	0.28	0.00	1.00	1.00	1.00	1.00	0.00	1.00	1.00	1.00	1.00
Uniform Delay (d), s/veh	58.9	38.4	0.0	56.2	35.9	35.9	23.8	0.0	19.8	49.1	50.8	46.0
Incr Delay (d2), s/veh	5.2	2.4	0.0	4.6	0.7	0.7	0.9	0.0	0.1	2.2	14.4	0.2
Initial Q Delay(d3),s/veh	0.0	0.0	0.0	0.0	0.0	0.0	0.0	0.0	0.0	0.0	0.0	0.0
%ile BackOfQ(50%),veh/ln	0.3	10.4	0.0	1.1	6.0	6.2	6.5	0.0	0.5	3.9	6.7	0.4
Unsig. Movement Delay, s/veh												
LnGrp Delay(d),s/veh	64.1	40.8	0.0	60.8	36.6	36.6	24.7	0.0	20.0	51.4	65.2	46.1
LnGrp LOS	E	D		E	D	D	C	A	B	D	E	D
Approach Vol, veh/h		784	A		525		667			344		
Approach Delay, s/veh		41.0			38.2		24.5			59.0		
Approach LOS		D			D		C			E		
Timer - Assigned Phs		2	3	4		6	7	8				
Phs Duration (G+Y+Rc), s		56.1	9.5	34.4		20.0	5.7	38.2				
Change Period (Y+Rc), s		4.5	4.5	4.5		4.5	4.5	4.5				
Max Green Setting (Gmax), s		31.5	18.0	34.5		18.0	5.0	47.5				
Max Q Clear Time (g_c+I1), s		17.1	4.3	26.7		14.2	2.5	15.6				
Green Ext Time (p_c), s		2.2	0.0	3.2		0.5	0.0	3.2				

Intersection Summary

HCM 6th Ctrl Delay	38.3
HCM 6th LOS	D

Notes

User approved volume balancing among the lanes for turning movement.
 Unsignalized Delay for [EBR] is excluded from calculations of the approach delay and intersection delay.

HCM 6th TWSC
 38: I Street & 2nd Street/SR-99 Southbound Off-Ramp

Intersection												
Int Delay, s/veh	27.9											
Movement	EBL	EBT	EBR	WBL	WBT	WBR	NBL	NBT	NBR	SBL	SBT	SBR
Lane Configurations		↔			↔	↔	↔	↔			↔	
Traffic Vol, veh/h	2	0	53	482	17	11	15	82	0	0	132	2
Future Vol, veh/h	2	0	53	482	17	11	15	82	0	0	132	2
Conflicting Peds, #/hr	0	0	1	1	0	0	0	0	0	0	0	0
Sign Control	Stop	Stop	Stop	Stop	Stop	Stop	Free	Free	Free	Free	Free	Free
RT Channelized	-	-	None	-	-	Stop	-	-	None	-	-	None
Storage Length	-	-	-	-	-	50	75	-	-	-	-	-
Veh in Median Storage, #	-	0	-	-	0	-	-	0	-	-	0	-
Grade, %	-	0	-	-	0	-	-	0	-	-	0	-
Peak Hour Factor	89	89	89	89	89	89	89	89	89	89	89	89
Heavy Vehicles, %	0	0	0	3	3	3	4	4	4	1	1	1
Mvmt Flow	2	0	60	542	19	12	17	92	0	0	148	2

Major/Minor	Minor2		Minor1		Major1		Major2					
Conflicting Flow All	285	275	150	306	276	92	150	0	-	-	-	0
Stage 1	149	149	-	126	126	-	-	-	-	-	-	-
Stage 2	136	126	-	180	150	-	-	-	-	-	-	-
Critical Hdwy	7.1	6.5	6.2	7.13	6.53	6.23	4.14	-	-	-	-	-
Critical Hdwy Stg 1	6.1	5.5	-	6.13	5.53	-	-	-	-	-	-	-
Critical Hdwy Stg 2	6.1	5.5	-	6.13	5.53	-	-	-	-	-	-	-
Follow-up Hdwy	3.5	4	3.3	3.527	4.027	3.327	2.236	-	-	-	-	-
Pot Cap-1 Maneuver	696	652	902	668	646	997	1419	-	0	0	-	-
Stage 1	858	778	-	902	802	-	-	-	0	0	-	-
Stage 2	898	808	-	819	771	-	-	-	0	0	-	-
Platoon blocked, %	1	1		1	1	1		-			-	-
Mov Cap-1 Maneuver	665	644	901	617	638	997	1419	-	-	-	-	-
Mov Cap-2 Maneuver	665	644	-	617	638	-	-	-	-	-	-	-
Stage 1	848	778	-	891	793	-	-	-	-	-	-	-
Stage 2	855	798	-	764	771	-	-	-	-	-	-	-

Approach	EB	WB	NB	SB
HCM Control Delay, s	9.3	42.3	1.2	0
HCM LOS	A	E		

Minor Lane/Major Mvmt	NBL	NBT	EBLn1WBLn1WBLn2	SBT	SBR
Capacity (veh/h)	1419	-	890 618 997	-	-
HCM Lane V/C Ratio	0.012	-	0.069 0.907 0.012	-	-
HCM Control Delay (s)	7.6	-	9.3 43 8.7	-	-
HCM Lane LOS	A	-	A E A	-	-
HCM 95th %tile Q(veh)	0	-	0.2 11.4 0	-	-

HCM 6th Signalized Intersection Summary
39: 4th Street & Sunset Avenue

Village D Specific Plan
Existing WP - AM Peak Hour



Movement	EBL	EBR	NBL	NBT	SBT	SBR
Lane Configurations						
Traffic Volume (veh/h)	394	22	31	311	460	276
Future Volume (veh/h)	394	22	31	311	460	276
Initial Q (Qb), veh	0	0	0	0	0	0
Ped-Bike Adj(A_pbT)	1.00	1.00	1.00			1.00
Parking Bus, Adj	1.00	1.00	1.00	1.00	1.00	1.00
Work Zone On Approach	No			No	No	
Adj Sat Flow, veh/h/ln	1900	1900	1870	1870	1870	1870
Adj Flow Rate, veh/h	450	0	34	338	500	300
Peak Hour Factor	0.92	0.92	0.92	0.92	0.92	0.92
Percent Heavy Veh, %	0	0	2	2	2	2
Cap, veh/h	554	247	57	2654	1244	1295
Arrive On Green	0.15	0.00	0.03	0.75	1.00	1.00
Sat Flow, veh/h	3619	1610	1781	3647	1870	1583
Grp Volume(v), veh/h	450	0	34	338	500	300
Grp Sat Flow(s),veh/h/ln	1810	1610	1781	1777	1870	1583
Q Serve(g_s), s	10.8	0.0	1.7	2.4	0.0	0.0
Cycle Q Clear(g_c), s	10.8	0.0	1.7	2.4	0.0	0.0
Prop In Lane	1.00	1.00	1.00			1.00
Lane Grp Cap(c), veh/h	554	247	57	2654	1244	1295
V/C Ratio(X)	0.81	0.00	0.60	0.13	0.40	0.23
Avail Cap(c_a), veh/h	784	349	148	2654	1244	1295
HCM Platoon Ratio	1.00	1.00	1.00	1.00	2.00	2.00
Upstream Filter(I)	1.00	0.00	1.00	1.00	0.88	0.88
Uniform Delay (d), s/veh	36.8	0.0	43.0	3.2	0.0	0.0
Incr Delay (d2), s/veh	4.4	0.0	9.8	0.1	0.9	0.4
Initial Q Delay(d3),s/veh	0.0	0.0	0.0	0.0	0.0	0.0
%ile BackOfQ(50%),veh/ln	5.0	0.0	0.9	0.7	0.3	0.1
Unsig. Movement Delay, s/veh						
LnGrp Delay(d),s/veh	41.3	0.0	52.8	3.3	0.9	0.4
LnGrp LOS	D	A	D	A	A	A
Approach Vol, veh/h	450			372	800	
Approach Delay, s/veh	41.3			7.8	0.7	
Approach LOS	D			A	A	
Timer - Assigned Phs		2		4	5	6
Phs Duration (G+Y+Rc), s		71.7		18.3	7.4	64.3
Change Period (Y+Rc), s		4.5		4.5	4.5	4.5
Max Green Setting (Gmax), s		61.5		19.5	7.5	49.5
Max Q Clear Time (g_c+I1), s		4.4		12.8	3.7	2.0
Green Ext Time (p_c), s		2.5		1.0	0.0	4.9
Intersection Summary						
HCM 6th Ctrl Delay			13.6			
HCM 6th LOS			B			
Notes						
User approved volume balancing among the lanes for turning movement.						

40: H Street & SR-99 Southbound On-Ramp/2nd Street Performance by movement

Movement	WBL	WBT	NBL	NBT	NBR	SBT	All
Denied Delay (hr)	0.0	0.0	0.0	0.0	0.0	0.0	0.0
Denied Del/Veh (s)	0.1	0.2	0.0	0.0	0.0	0.2	0.0
Total Delay (hr)	0.0	0.1	0.2	0.0	0.0	0.1	0.4
Total Del/Veh (s)	11.3	13.2	2.9	3.1	2.7	14.6	4.9
Stop Delay (hr)	0.0	0.1	0.0	0.0	0.0	0.1	0.2
Stop Del/Veh (s)	8.9	9.9	0.2	0.1	0.2	11.7	2.1

HCM 6th Signalized Intersection Summary
41: I Street & 4th Street

Village D Specific Plan
Existing WP - AM Peak Hour



Movement	EBL	EBT	EBR	WBL	WBT	WBR	NBL	NBT	NBR	SBL	SBT	SBR
Lane Configurations	↖	↖↗		↖	↖↗		↖	↑	↖↗	↖	↑	↖↗
Traffic Volume (veh/h)	25	654	67	85	468	61	51	55	160	268	277	181
Future Volume (veh/h)	25	654	67	85	468	61	51	55	160	268	277	181
Initial Q (Qb), veh	0	0	0	0	0	0	0	0	0	0	0	0
Ped-Bike Adj(A_pbT)	1.00		0.96	1.00		0.97	1.00		0.97	1.00		0.98
Parking Bus, Adj	1.00	1.00	1.00	1.00	1.00	1.00	1.00	1.00	1.00	1.00	1.00	1.00
Work Zone On Approach		No		No		No		No		No		No
Adj Sat Flow, veh/h/ln	1870	1870	1870	1856	1856	1856	1856	1856	1856	1870	1870	1870
Adj Flow Rate, veh/h	29	760	78	99	544	71	59	64	186	312	322	210
Peak Hour Factor	0.86	0.86	0.86	0.86	0.86	0.86	0.86	0.86	0.86	0.86	0.86	0.86
Percent Heavy Veh, %	2	2	2	3	3	3	3	3	3	2	2	2
Cap, veh/h	51	851	87	126	953	124	197	379	310	466	663	548
Arrive On Green	0.03	0.26	0.26	0.07	0.31	0.31	0.11	0.20	0.20	0.26	0.35	0.35
Sat Flow, veh/h	1781	3239	332	1767	3122	406	1767	1856	1519	1781	1870	1546
Grp Volume(v), veh/h	29	417	421	99	306	309	59	64	186	312	322	210
Grp Sat Flow(s),veh/h/ln	1781	1777	1794	1767	1763	1765	1767	1856	1519	1781	1870	1546
Q Serve(g_s), s	1.4	20.3	20.4	5.0	13.1	13.3	2.8	2.6	10.0	14.1	12.1	7.3
Cycle Q Clear(g_c), s	1.4	20.3	20.4	5.0	13.1	13.3	2.8	2.6	10.0	14.1	12.1	7.3
Prop In Lane	1.00		0.19	1.00		0.23	1.00		1.00	1.00		1.00
Lane Grp Cap(c), veh/h	51	467	472	126	538	539	197	379	310	466	663	548
V/C Ratio(X)	0.57	0.89	0.89	0.79	0.57	0.57	0.30	0.17	0.60	0.67	0.49	0.38
Avail Cap(c_a), veh/h	113	492	496	155	538	539	197	379	310	466	663	548
HCM Platoon Ratio	1.00	1.00	1.00	1.00	1.00	1.00	1.00	1.00	1.00	1.00	1.00	1.00
Upstream Filter(I)	0.89	0.89	0.89	1.00	1.00	1.00	1.00	1.00	1.00	1.00	1.00	1.00
Uniform Delay (d), s/veh	43.2	31.9	32.0	41.1	26.3	26.3	36.7	29.5	32.5	29.7	22.7	13.9
Incr Delay (d2), s/veh	8.6	16.2	16.2	19.3	1.4	1.5	0.8	1.0	8.3	3.7	2.5	2.0
Initial Q Delay(d3),s/veh	0.0	0.0	0.0	0.0	0.0	0.0	0.0	0.0	0.0	0.0	0.0	0.0
%ile BackOfQ(50%),veh/ln	0.8	10.6	10.7	2.8	5.6	5.6	1.2	1.2	4.3	6.4	5.6	2.7
Unsig. Movement Delay, s/veh												
LnGrp Delay(d),s/veh	51.7	48.2	48.2	60.4	27.7	27.8	37.6	30.5	40.7	33.4	25.2	15.9
LnGrp LOS	D	D	D	E	C	C	D	C	D	C	C	B
Approach Vol, veh/h		867			714			309			844	
Approach Delay, s/veh		48.3			32.3			38.0			25.9	
Approach LOS		D			C			D			C	
Timer - Assigned Phs	1	2	3	4	5	6	7	8				
Phs Duration (G+Y+Rc), s	28.1	22.9	10.9	28.2	14.6	36.4	7.1	32.0				
Change Period (Y+Rc), s	4.5	4.5	4.5	4.5	4.5	4.5	4.5	4.5				
Max Green Setting (Gmax), s	20.8	18.4	7.9	24.9	7.3	31.9	5.7	27.1				
Max Q Clear Time (g_c+10), s	11.0	12.0	7.0	22.4	4.8	14.1	3.4	15.3				
Green Ext Time (p_c), s	0.4	0.5	0.0	1.3	0.0	2.5	0.0	3.0				
Intersection Summary												
HCM 6th Ctrl Delay											36.0	
HCM 6th LOS											D	

HCM 6th Signalized Intersection Summary
 43: SR-99 Northbound Off-Ramp/H Street & 4th Street

Village D Specific Plan
 Existing WP - AM Peak Hour



Movement	EBL	EBT	EBR	WBL	WBT	WBR	NBL	NBT	NBR	SBL	SBT	SBR
Lane Configurations												
Traffic Volume (veh/h)	233	526	0	0	470	71	239	24	195	5	0	57
Future Volume (veh/h)	233	526	0	0	470	71	239	24	195	5	0	57
Initial Q (Qb), veh	0	0	0	0	0	0	0	0	0	0	0	0
Ped-Bike Adj(A_pbT)	1.00		1.00	1.00		0.94	1.00		1.00	1.00		0.99
Parking Bus, Adj	1.00	1.00	1.00	1.00	1.00	1.00	1.00	1.00	1.00	1.00	1.00	1.00
Work Zone On Approach		No			No			No			No	
Adj Sat Flow, veh/h/ln	1885	1885	0	0	1856	1856	1870	1870	1870	1900	1900	1900
Adj Flow Rate, veh/h	271	612	0	0	547	83	278	28	227	6	0	66
Peak Hour Factor	0.86	0.86	0.86	0.86	0.86	0.86	0.86	0.86	0.86	0.86	0.86	0.86
Percent Heavy Veh, %	1	1	0	0	3	3	2	2	2	0	0	0
Cap, veh/h	306	1511	0	0	613	93	406	40	327	27	0	294
Arrive On Green	0.17	0.42	0.00	0.00	0.20	0.20	0.23	0.23	0.23	0.20	0.00	0.20
Sat Flow, veh/h	1795	3676	0	0	3136	460	1781	177	1435	134	0	1472
Grp Volume(v), veh/h	271	612	0	0	316	314	278	0	255	72	0	0
Grp Sat Flow(s),veh/h/ln	1795	1791	0	0	1763	1740	1781	0	1612	1605	0	0
Q Serve(g_s), s	13.3	10.7	0.0	0.0	15.7	15.8	12.8	0.0	13.1	3.4	0.0	0.0
Cycle Q Clear(g_c), s	13.3	10.7	0.0	0.0	15.7	15.8	12.8	0.0	13.1	3.4	0.0	0.0
Prop In Lane	1.00		0.00	0.00		0.26	1.00		0.89	0.08		0.92
Lane Grp Cap(c), veh/h	306	1511	0	0	355	350	406	0	368	321	0	0
V/C Ratio(X)	0.88	0.40	0.00	0.00	0.89	0.90	0.68	0.00	0.69	0.22	0.00	0.00
Avail Cap(c_a), veh/h	329	1572	0	0	362	358	406	0	368	321	0	0
HCM Platoon Ratio	1.00	1.00	1.00	1.00	1.00	1.00	1.00	1.00	1.00	1.00	1.00	1.00
Upstream Filter(I)	1.00	1.00	0.00	0.00	1.00	1.00	1.00	0.00	1.00	1.00	0.00	0.00
Uniform Delay (d), s/veh	36.5	18.1	0.0	0.0	35.0	35.0	31.8	0.0	31.9	30.2	0.0	0.0
Incr Delay (d2), s/veh	22.6	0.2	0.0	0.0	22.5	23.9	9.0	0.0	10.3	1.6	0.0	0.0
Initial Q Delay(d3),s/veh	0.0	0.0	0.0	0.0	0.0	0.0	0.0	0.0	0.0	0.0	0.0	0.0
%ile BackOfQ(50%),veh/ln	7.6	4.3	0.0	0.0	8.8	8.9	6.4	0.0	6.0	1.4	0.0	0.0
Unsig. Movement Delay, s/veh												
LnGrp Delay(d),s/veh	59.1	18.3	0.0	0.0	57.5	58.9	40.8	0.0	42.2	31.8	0.0	0.0
LnGrp LOS	E	B	A	A	E	E	D	A	D	C	A	A
Approach Vol, veh/h		883			630			533				72
Approach Delay, s/veh		30.8			58.2			41.5				31.8
Approach LOS		C			E			D				C
Timer - Assigned Phs		2		4		6	7	8				
Phs Duration (G+Y+Rc), s		25.0		42.5		22.5	19.9	22.6				
Change Period (Y+Rc), s		4.5		4.5		4.5	4.5	4.5				
Max Green Setting (Gmax), s		19.0		39.5		18.0	16.5	18.5				
Max Q Clear Time (g_c+I1), s		15.1		12.7		5.4	15.3	17.8				
Green Ext Time (p_c), s		1.0		4.5		0.2	0.1	0.3				
Intersection Summary												
HCM 6th Ctrl Delay												41.7
HCM 6th LOS												D

Intersection						
Int Delay, s/veh	2.3					
Movement	EBL	EBT	WBT	WBR	SBL	SBR
Lane Configurations	↖	↗↗	↗↖		↖	↖
Traffic Vol, veh/h	128	692	509	76	59	99
Future Vol, veh/h	128	692	509	76	59	99
Conflicting Peds, #/hr	16	0	0	16	0	0
Sign Control	Free	Free	Free	Free	Stop	Stop
RT Channelized	-	None	-	None	-	None
Storage Length	145	-	-	-	65	0
Veh in Median Storage, #	-	0	0	-	0	-
Grade, %	-	0	0	-	0	-
Peak Hour Factor	98	98	98	98	98	98
Heavy Vehicles, %	3	3	4	4	4	4
Mvmt Flow	131	706	519	78	60	101

Major/Minor	Major1	Major2	Minor2		
Conflicting Flow All	613	0	-	0	1189 315
Stage 1	-	-	-	-	574 -
Stage 2	-	-	-	-	615 -
Critical Hdwy	4.16	-	-	-	6.88 6.98
Critical Hdwy Stg 1	-	-	-	-	5.88 -
Critical Hdwy Stg 2	-	-	-	-	5.88 -
Follow-up Hdwy	2.23	-	-	-	3.54 3.34
Pot Cap-1 Maneuver	1252	-	-	-	273 *871
Stage 1	-	-	-	-	821 -
Stage 2	-	-	-	-	496 -
Platoon blocked, %	1	-	-	-	1 1
Mov Cap-1 Maneuver	1233	-	-	-	236 *857
Mov Cap-2 Maneuver	-	-	-	-	236 -
Stage 1	-	-	-	-	724 -
Stage 2	-	-	-	-	489 -

Approach	EB	WB	SB
HCM Control Delay, s	1.3	0	15.6
HCM LOS			C

Minor Lane/Major Mvmt	EBL	EBT	WBT	WBR	SBLn1	SBLn2
Capacity (veh/h)	1233	-	-	-	236	857
HCM Lane V/C Ratio	0.106	-	-	-	0.255	0.118
HCM Control Delay (s)	8.3	-	-	-	25.4	9.8
HCM Lane LOS	A	-	-	-	D	A
HCM 95th %tile Q(veh)	0.4	-	-	-	1	0.4

Notes
 -: Volume exceeds capacity \$: Delay exceeds 300s +: Computation Not Defined *: All major volume in platoon

HCM 6th Signalized Intersection Summary

45: Olive Avenue & SR-99 Southbound Off-Ramp

Village D Specific Plan
Existing WP - AM Peak Hour

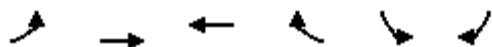

Movement	EBL	EBT	WBT	WBR	SBL	SBR
Lane Configurations		↑↑↑	↑↑		↘	↗
Traffic Volume (veh/h)	0	751	488	0	505	99
Future Volume (veh/h)	0	751	488	0	505	99
Initial Q (Qb), veh	0	0	0	0	0	0
Ped-Bike Adj(A_pbT)	1.00			1.00	1.00	1.00
Parking Bus, Adj	1.00	1.00	1.00	1.00	1.00	1.00
Work Zone On Approach		No	No		No	
Adj Sat Flow, veh/h/ln	0	1856	1841	0	1796	1796
Adj Flow Rate, veh/h	0	799	519	0	537	105
Peak Hour Factor	0.94	0.94	0.94	0.94	0.94	0.94
Percent Heavy Veh, %	0	3	4	0	7	7
Cap, veh/h	0	1042	720	0	1166	1038
Arrive On Green	0.00	0.21	0.21	0.00	0.68	0.68
Sat Flow, veh/h	0	5400	3681	0	1711	1522
Grp Volume(v), veh/h	0	799	519	0	537	105
Grp Sat Flow(s),veh/h/ln	0	1689	1749	0	1711	1522
Q Serve(g_s), s	0.0	11.9	11.1	0.0	11.6	1.9
Cycle Q Clear(g_c), s	0.0	11.9	11.1	0.0	11.6	1.9
Prop In Lane	0.00			0.00	1.00	1.00
Lane Grp Cap(c), veh/h	0	1042	720	0	1166	1038
V/C Ratio(X)	0.00	0.77	0.72	0.00	0.46	0.10
Avail Cap(c_a), veh/h	0	1235	852	0	1166	1038
HCM Platoon Ratio	1.00	1.00	1.00	1.00	1.00	1.00
Upstream Filter(I)	0.00	1.00	0.94	0.00	1.00	1.00
Uniform Delay (d), s/veh	0.0	30.0	29.6	0.0	5.9	4.4
Incr Delay (d2), s/veh	0.0	2.5	2.3	0.0	1.3	0.2
Initial Q Delay(d3),s/veh	0.0	0.0	0.0	0.0	0.0	0.0
%ile BackOfQ(50%),veh/ln	0.0	4.9	4.7	0.0	3.7	0.5
Unsig. Movement Delay, s/veh						
LnGrp Delay(d),s/veh	0.0	32.4	31.9	0.0	7.2	4.5
LnGrp LOS	A	C	C	A	A	A
Approach Vol, veh/h		799	519		642	
Approach Delay, s/veh		32.4	31.9		6.8	
Approach LOS		C	C		A	
Timer - Assigned Phs				4	6	8
Phs Duration (G+Y+Rc), s				21.0	59.0	21.0
Change Period (Y+Rc), s				4.5	4.5	4.5
Max Green Setting (Gmax), s				19.5	51.5	19.5
Max Q Clear Time (g_c+I1), s				13.9	13.6	13.1
Green Ext Time (p_c), s				2.6	2.3	1.8
Intersection Summary						
HCM 6th Ctrl Delay			23.9			
HCM 6th LOS			C			

HCM 6th Signalized Intersection Summary

46: Madera Avenue & SR-99 Northbound Ramps

Village D Specific Plan
Existing WP - AM Peak Hour



Movement	EBL	EBT	EBR	WBL	WBT	WBR	NBL	NBT	NBR	SBL	SBT	SBR
Lane Configurations				↶	↷	↶	↶↷	↶↷			↶↷	
Traffic Volume (veh/h)	0	0	0	205	1	75	401	494	0	0	568	173
Future Volume (veh/h)	0	0	0	205	1	75	401	494	0	0	568	173
Initial Q (Qb), veh				0	0	0	0	0	0	0	0	0
Ped-Bike Adj(A_pbT)				1.00		0.98	1.00		1.00	1.00		0.97
Parking Bus, Adj				1.00	1.00	1.00	1.00	1.00	1.00	1.00	1.00	1.00
Work Zone On Approach				No			No			No		
Adj Sat Flow, veh/h/ln				1841	1841	1841	1826	1826	0	0	1841	1841
Adj Flow Rate, veh/h				224	0	82	436	537	0	0	617	188
Peak Hour Factor				0.92	0.92	0.92	0.92	0.92	0.92	0.92	0.92	0.92
Percent Heavy Veh, %				4	4	4	5	5	0	0	4	4
Cap, veh/h				339	0	148	1192	2744	0	0	998	304
Arrive On Green				0.10	0.00	0.10	0.71	1.00	0.00	0.00	0.38	0.38
Sat Flow, veh/h				3506	0	1530	3374	3561	0	0	2710	796
Grp Volume(v), veh/h				224	0	82	436	537	0	0	412	393
Grp Sat Flow(s),veh/h/ln				1753	0	1530	1687	1735	0	0	1749	1665
Q Serve(g_s), s				4.9	0.0	4.1	4.1	0.0	0.0	0.0	15.2	15.3
Cycle Q Clear(g_c), s				4.9	0.0	4.1	4.1	0.0	0.0	0.0	15.2	15.3
Prop In Lane				1.00		1.00	1.00		0.00	0.00		0.48
Lane Grp Cap(c), veh/h				339	0	148	1192	2744	0	0	667	635
V/C Ratio(X)				0.66	0.00	0.55	0.37	0.20	0.00	0.00	0.62	0.62
Avail Cap(c_a), veh/h				811	0	354	1192	2744	0	0	667	635
HCM Platoon Ratio				1.00	1.00	1.00	2.00	2.00	1.00	1.00	1.00	1.00
Upstream Filter(I)				1.00	0.00	1.00	0.81	0.81	0.00	0.00	1.00	1.00
Uniform Delay (d), s/veh				34.9	0.0	34.5	8.2	0.0	0.0	0.0	20.0	20.0
Incr Delay (d2), s/veh				2.2	0.0	3.2	0.2	0.1	0.0	0.0	4.3	4.5
Initial Q Delay(d3),s/veh				0.0	0.0	0.0	0.0	0.0	0.0	0.0	0.0	0.0
%ile BackOfQ(50%),veh/ln				2.2	0.0	1.6	1.2	0.0	0.0	0.0	6.6	6.4
Unsig. Movement Delay, s/veh												
LnGrp Delay(d),s/veh				37.1	0.0	37.7	8.3	0.1	0.0	0.0	24.3	24.5
LnGrp LOS				D	A	D	A	A	A	A	C	C
Approach Vol, veh/h					306			973			805	
Approach Delay, s/veh					37.2			3.8			24.4	
Approach LOS					D			A			C	
Timer - Assigned Phs		2			5	6		8				
Phs Duration (G+Y+Rc), s		67.8			32.8	35.0		12.2				
Change Period (Y+Rc), s		4.5			4.5	4.5		4.5				
Max Green Setting (Gmax), s		52.5			17.5	30.5		18.5				
Max Q Clear Time (g_c+I1), s		2.0			6.1	17.3		6.9				
Green Ext Time (p_c), s		4.2			1.3	4.4		0.8				

Intersection Summary

HCM 6th Ctrl Delay	16.7
HCM 6th LOS	B

Notes

User approved volume balancing among the lanes for turning movement.

HCM 6th Signalized Intersection Summary

47: Madera Avenue & Olive Avenue/SR-99 Southbound On-Ramp

Village D Specific Plan
Existing WP - AM Peak Hour



Movement	EBL	EBT	EBR	WBL	WBT	WBR	NBL	NBT	NBR	SBL	SBT	SBR
Lane Configurations												
Traffic Volume (veh/h)	397	367	491	0	0	0	127	498	38	84	326	363
Future Volume (veh/h)	397	367	491	0	0	0	127	498	38	84	326	363
Initial Q (Qb), veh	0	0	0				0	0	0	0	0	0
Ped-Bike Adj(A_pbT)	1.00		1.00				1.00		0.99	1.00		0.99
Parking Bus, Adj	1.00	1.00	1.00				1.00	1.00	1.00	1.00	1.00	1.00
Work Zone On Approach		No					No			No		
Adj Sat Flow, veh/h/ln	1841	1841	1841				1796	1796	1796	1841	1841	1841
Adj Flow Rate, veh/h	402	408	517				134	524	40	88	343	382
Peak Hour Factor	0.95	0.95	0.95				0.95	0.95	0.95	0.95	0.95	0.95
Percent Heavy Veh, %	4	4	4				7	7	7	4	4	4
Cap, veh/h	462	485	512				213	1617	123	112	880	777
Arrive On Green	0.44	0.44	0.44				0.06	0.50	0.50	0.11	0.84	0.84
Sat Flow, veh/h	1753	1841	1560				3319	3211	245	1753	1749	1544
Grp Volume(v), veh/h	402	408	517				134	278	286	88	343	382
Grp Sat Flow(s),veh/h/ln	1753	1841	1560				1659	1706	1749	1753	1749	1544
Q Serve(g_s), s	16.6	15.8	21.1				3.1	7.7	7.8	3.9	3.7	5.4
Cycle Q Clear(g_c), s	16.6	15.8	21.1				3.1	7.7	7.8	3.9	3.7	5.4
Prop In Lane	1.00		1.00				1.00		0.14	1.00		1.00
Lane Grp Cap(c), veh/h	462	485	512				213	859	881	112	880	777
V/C Ratio(X)	0.87	0.84	1.01				0.63	0.32	0.32	0.78	0.39	0.49
Avail Cap(c_a), veh/h	462	485	512				643	859	881	217	880	777
HCM Platoon Ratio	1.67	1.67	1.67				1.00	1.00	1.00	1.67	1.67	1.67
Upstream Filter(I)	0.76	0.76	0.76				1.00	1.00	1.00	0.86	0.86	0.86
Uniform Delay (d), s/veh	21.1	20.9	21.0				36.5	11.8	11.8	35.2	3.5	3.6
Incr Delay (d2), s/veh	12.9	9.8	37.3				3.0	1.0	1.0	9.8	1.1	1.9
Initial Q Delay(d3),s/veh	0.0	0.0	0.0				0.0	0.0	0.0	0.0	0.0	0.0
%ile BackOfQ(50%),veh/ln	6.6	6.3	22.5				1.3	2.9	3.0	1.9	1.2	1.5
Unsig. Movement Delay, s/veh												
LnGrp Delay(d),s/veh	34.0	30.7	58.3				39.5	12.8	12.8	45.0	4.6	5.5
LnGrp LOS	C	C	F				D	B	B	D	A	A
Approach Vol, veh/h		1327						698			813	
Approach Delay, s/veh		42.5						17.9			9.4	
Approach LOS		D						B			A	
Timer - Assigned Phs	1	2		4	5	6						
Phs Duration (G+Y+Rc), s	9.6	44.8		25.6	9.6	44.8						
Change Period (Y+Rc), s	4.5	4.5		4.5	4.5	4.5						
Max Green Setting (Gmax), s	35.5			21.1	15.5	29.9						
Max Q Clear Time (g_c+1), s	9.8			23.1	5.1	7.4						
Green Ext Time (p_c), s	0.1	3.6		0.0	0.3	5.0						

Intersection Summary

HCM 6th Ctrl Delay	26.9
HCM 6th LOS	C

Notes

User approved volume balancing among the lanes for turning movement.

Intersection						
Int Delay, s/veh	0.3					
Movement	WBL	WBR	NBT	NBR	SBL	SBT
Lane Configurations	↔		↕		↔	↕
Traffic Vol, veh/h	9	8	684	8	31	940
Future Vol, veh/h	9	8	684	8	31	940
Conflicting Peds, #/hr	0	0	0	8	8	0
Sign Control	Stop	Stop	Free	Free	Free	Free
RT Channelized	-	None	-	None	-	None
Storage Length	0	-	-	-	100	-
Veh in Median Storage, #	0	-	0	-	-	0
Grade, %	0	-	0	-	-	0
Peak Hour Factor	97	97	97	97	97	97
Heavy Vehicles, %	12	12	6	6	5	5
Mvmt Flow	9	8	705	8	32	969

Major/Minor	Minor1	Major1	Major2		
Conflicting Flow All	1266	365	0	0	721
Stage 1	717	-	-	-	-
Stage 2	549	-	-	-	-
Critical Hdwy	7.04	7.14	-	-	4.2
Critical Hdwy Stg 1	6.04	-	-	-	-
Critical Hdwy Stg 2	6.04	-	-	-	-
Follow-up Hdwy	3.62	3.42	-	-	2.25
Pot Cap-1 Maneuver	*372	604	-	-	857
Stage 1	*419	-	-	-	-
Stage 2	*660	-	-	-	-
Platoon blocked, %	1	-	-	-	-
Mov Cap-1 Maneuver	*355	599	-	-	850
Mov Cap-2 Maneuver	*370	-	-	-	-
Stage 1	*416	-	-	-	-
Stage 2	*635	-	-	-	-

Approach	WB	NB	SB
HCM Control Delay, s	13.3	0	0.3
HCM LOS	B		

Minor Lane/Major Mvmt	NBT	NBRWBLn1	SBL	SBT
Capacity (veh/h)	-	-	451	850
HCM Lane V/C Ratio	-	-	0.039	0.038
HCM Control Delay (s)	-	-	13.3	9.4
HCM Lane LOS	-	-	B	A
HCM 95th %tile Q(veh)	-	-	0.1	0.1

Notes
 -: Volume exceeds capacity \$: Delay exceeds 300s +: Computation Not Defined *: All major volume in platoon

HCM 6th Signalized Intersection Summary
 49: Yosemite Avenue & Cleveland Avenue/Tozer Street

Village D Specific Plan
 Existing WP - AM Peak Hour



Movement	EBL	EBT	EBR	WBL	WBT	WBR	NBL	NBT	NBR	SBL	SBT	SBR
Lane Configurations												
Traffic Volume (veh/h)	283	540	248	110	297	41	131	105	74	60	229	214
Future Volume (veh/h)	283	540	248	110	297	41	131	105	74	60	229	214
Initial Q (Qb), veh	0	0	0	0	0	0	0	0	0	0	0	0
Ped-Bike Adj(A_pbT)	1.00		0.92	1.00		0.91	1.00		1.00	1.00		1.00
Parking Bus, Adj	1.00	1.00	1.00	1.00	1.00	1.00	1.00	1.00	1.00	1.00	1.00	1.00
Work Zone On Approach		No			No			No			No	
Adj Sat Flow, veh/h/ln	1856	1856	1856	1841	1841	1841	1856	1856	1856	1870	1870	1870
Adj Flow Rate, veh/h	337	643	295	131	354	49	156	125	88	71	273	255
Peak Hour Factor	0.84	0.84	0.84	0.84	0.84	0.84	0.84	0.84	0.84	0.84	0.84	0.84
Percent Heavy Veh, %	3	3	3	4	4	4	3	3	3	2	2	2
Cap, veh/h	355	752	345	158	766	310	171	610	515	92	252	235
Arrive On Green	0.20	0.33	0.33	0.09	0.22	0.22	0.10	0.33	0.33	0.05	0.28	0.28
Sat Flow, veh/h	1767	2278	1045	1753	3497	1417	1767	1856	1568	1781	888	830
Grp Volume(v), veh/h	337	498	440	131	354	49	156	125	88	71	0	528
Grp Sat Flow(s),veh/h/ln	1767	1763	1560	1753	1749	1417	1767	1856	1568	1781	0	1718
Q Serve(g_s), s	16.9	23.7	23.7	6.6	7.9	2.5	7.9	4.4	3.6	3.5	0.0	25.5
Cycle Q Clear(g_c), s	16.9	23.7	23.7	6.6	7.9	2.5	7.9	4.4	3.6	3.5	0.0	25.5
Prop In Lane	1.00		0.67	1.00		1.00	1.00		1.00	1.00		0.48
Lane Grp Cap(c), veh/h	355	582	515	158	766	310	171	610	515	92	0	487
V/C Ratio(X)	0.95	0.86	0.86	0.83	0.46	0.16	0.91	0.21	0.17	0.77	0.00	1.08
Avail Cap(c_a), veh/h	355	582	515	158	766	310	171	610	515	184	0	487
HCM Platoon Ratio	1.00	1.00	1.00	1.00	1.00	1.00	1.00	1.00	1.00	1.00	1.00	1.00
Upstream Filter(I)	1.00	1.00	1.00	1.00	1.00	1.00	1.00	1.00	1.00	1.00	0.00	1.00
Uniform Delay (d), s/veh	35.5	28.1	28.1	40.3	30.5	28.4	40.3	21.8	21.5	42.2	0.0	32.3
Incr Delay (d2), s/veh	34.4	14.9	16.5	29.5	2.0	1.1	44.7	0.2	0.2	12.9	0.0	65.6
Initial Q Delay(d3),s/veh	0.0	0.0	0.0	0.0	0.0	0.0	0.0	0.0	0.0	0.0	0.0	0.0
%ile BackOfQ(50%),veh/ln	10.5	12.0	10.9	4.1	3.5	0.9	5.5	1.9	1.3	1.9	0.0	19.1
Unsig. Movement Delay, s/veh												
LnGrp Delay(d),s/veh	69.9	43.0	44.7	69.8	32.6	29.5	85.0	21.9	21.7	55.0	0.0	97.9
LnGrp LOS	E	D	D	E	C	C	F	C	C	E	A	F
Approach Vol, veh/h		1275			534			369				599
Approach Delay, s/veh		50.7			41.4			48.5				92.8
Approach LOS		D			D			D				F
Timer - Assigned Phs	1	2	3	4	5	6	7	8				
Phs Duration (G+Y+Rc), s	22.6	24.2	9.1	34.1	12.6	34.2	13.2	30.0				
Change Period (Y+Rc), s	4.5	4.5	4.5	4.5	4.5	4.5	4.5	4.5				
Max Green Setting (Gmax), s	18.1	19.7	9.3	24.9	8.1	29.7	8.7	25.5				
Max Q Clear Time (g_c+I1), s	18.9	9.9	5.5	6.4	8.6	25.7	9.9	27.5				
Green Ext Time (p_c), s	0.0	1.7	0.0	0.9	0.0	2.2	0.0	0.0				

Intersection Summary

HCM 6th Ctrl Delay	57.7
HCM 6th LOS	E

Intersection						
Int Delay, s/veh	6.8					
Movement	WBL	WBR	NBT	NBR	SBL	SBT
Lane Configurations						
Traffic Vol, veh/h	0	19	3	0	11	2
Future Vol, veh/h	0	19	3	0	11	2
Conflicting Peds, #/hr	0	0	0	0	0	0
Sign Control	Stop	Stop	Free	Free	Free	Free
RT Channelized	-	None	-	None	-	None
Storage Length	0	-	-	-	50	-
Veh in Median Storage, #	0	-	0	-	-	0
Grade, %	0	-	0	-	-	0
Peak Hour Factor	92	92	92	92	92	92
Heavy Vehicles, %	0	0	0	0	0	0
Mvmt Flow	0	21	3	0	12	2

Major/Minor	Minor1	Major1	Major2			
Conflicting Flow All	29	3	0	0	3	0
Stage 1	3	-	-	-	-	-
Stage 2	26	-	-	-	-	-
Critical Hdwy	6.4	6.2	-	-	4.1	-
Critical Hdwy Stg 1	5.4	-	-	-	-	-
Critical Hdwy Stg 2	5.4	-	-	-	-	-
Follow-up Hdwy	3.5	3.3	-	-	2.2	-
Pot Cap-1 Maneuver	991	1087	-	-	1632	-
Stage 1	1025	-	-	-	-	-
Stage 2	1002	-	-	-	-	-
Platoon blocked, %			-	-		-
Mov Cap-1 Maneuver	984	1087	-	-	1632	-
Mov Cap-2 Maneuver	984	-	-	-	-	-
Stage 1	1025	-	-	-	-	-
Stage 2	995	-	-	-	-	-

Approach	WB	NB	SB
HCM Control Delay, s	8.4	0	6.1
HCM LOS	A		

Minor Lane/Major Mvmt	NBT	NBRWBLn1	SBL	SBT
Capacity (veh/h)	-	-	1087	1632
HCM Lane V/C Ratio	-	-	0.019	0.007
HCM Control Delay (s)	-	-	8.4	7.2
HCM Lane LOS	-	-	A	A
HCM 95th %tile Q(veh)	-	-	0.1	0

Intersection						
Int Delay, s/veh	12.2					
Movement	EBT	EBR	WBL	WBT	NBL	NBR
Lane Configurations						
Traffic Vol, veh/h	49	16	155	66	56	629
Future Vol, veh/h	49	16	155	66	56	629
Conflicting Peds, #/hr	0	0	0	0	0	0
Sign Control	Free	Free	Free	Free	Stop	Stop
RT Channelized	-	None	-	None	-	None
Storage Length	-	-	50	-	50	0
Veh in Median Storage, #	0	-	-	0	0	-
Grade, %	0	-	-	0	0	-
Peak Hour Factor	92	92	92	92	92	92
Heavy Vehicles, %	7	7	2	2	0	0
Mvmt Flow	53	17	168	72	61	684

Major/Minor	Major1	Major2	Minor1		
Conflicting Flow All	0	0	70	0	470 62
Stage 1	-	-	-	-	62 -
Stage 2	-	-	-	-	408 -
Critical Hdwy	-	-	4.12	-	6.4 6.2
Critical Hdwy Stg 1	-	-	-	-	5.4 -
Critical Hdwy Stg 2	-	-	-	-	5.4 -
Follow-up Hdwy	-	-	2.218	-	3.5 3.3
Pot Cap-1 Maneuver	-	-	1531	-	556 1009
Stage 1	-	-	-	-	966 -
Stage 2	-	-	-	-	676 -
Platoon blocked, %	-	-	-	-	-
Mov Cap-1 Maneuver	-	-	1531	-	495 1009
Mov Cap-2 Maneuver	-	-	-	-	495 -
Stage 1	-	-	-	-	966 -
Stage 2	-	-	-	-	602 -

Approach	EB	WB	NB
HCM Control Delay, s	0	5.4	15.5
HCM LOS			C

Minor Lane/Major Mvmt	NBLn1	NBLn2	EBT	EBR	WBL	WBT
Capacity (veh/h)	495	1009	-	-	1531	-
HCM Lane V/C Ratio	0.123	0.678	-	-	0.11	-
HCM Control Delay (s)	13.3	15.7	-	-	7.6	-
HCM Lane LOS	B	C	-	-	A	-
HCM 95th %tile Q(veh)	0.4	5.5	-	-	0.4	-

Intersection												
Int Delay, s/veh	37.6											
Movement	EBL	EBT	EBR	WBL	WBT	WBR	NBL	NBT	NBR	SBL	SBT	SBR
Lane Configurations	↔	↔		↔	↔		↔	↔		↔	↔	
Traffic Vol, veh/h	0	12	5	88	33	111	16	131	317	233	126	0
Future Vol, veh/h	0	12	5	88	33	111	16	131	317	233	126	0
Conflicting Peds, #/hr	0	0	0	0	0	0	0	0	0	0	0	0
Sign Control	Free	Free	Free	Free	Free	Free	Stop	Stop	Stop	Stop	Stop	Stop
RT Channelized	-	-	None	-	-	None	-	-	None	-	-	None
Storage Length	50	-	-	50	-	-	50	-	-	50	-	-
Veh in Median Storage, #	-	0	-	-	0	-	-	0	-	-	0	-
Grade, %	-	0	-	-	0	-	-	0	-	-	0	-
Peak Hour Factor	92	92	92	92	92	92	92	92	92	92	92	92
Heavy Vehicles, %	9	9	9	2	2	2	0	0	0	0	0	0
Mvmt Flow	0	13	5	96	36	121	17	142	345	253	137	0

Major/Minor	Major1			Major2			Minor1			Minor2		
Conflicting Flow All	157	0	0	18	0	0	373	365	16	548	307	97
Stage 1	-	-	-	-	-	-	16	16	-	289	289	-
Stage 2	-	-	-	-	-	-	357	349	-	259	18	-
Critical Hdwy	4.19	-	-	4.12	-	-	7.1	6.5	6.2	7.1	6.5	6.2
Critical Hdwy Stg 1	-	-	-	-	-	-	6.1	5.5	-	6.1	5.5	-
Critical Hdwy Stg 2	-	-	-	-	-	-	6.1	5.5	-	6.1	5.5	-
Follow-up Hdwy	2.281	-	-	2.218	-	-	3.5	4	3.3	3.5	4	3.3
Pot Cap-1 Maneuver	1381	-	-	1599	-	-	588	566	1069	450	610	965
Stage 1	-	-	-	-	-	-	1009	886	-	723	677	-
Stage 2	-	-	-	-	-	-	665	637	-	750	884	-
Platoon blocked, %	-	-	-	-	-	-	-	-	-	-	-	-
Mov Cap-1 Maneuver	1381	-	-	1599	-	-	459	532	1069	~ 231	573	965
Mov Cap-2 Maneuver	-	-	-	-	-	-	459	532	-	~ 231	573	-
Stage 1	-	-	-	-	-	-	1009	886	-	723	636	-
Stage 2	-	-	-	-	-	-	490	599	-	427	884	-

Approach	EB			WB			NB			SB		
HCM Control Delay, s	0			2.8			15.3			90.7		
HCM LOS							C			F		

Minor Lane/Major Mvmt	NBLn1	NBLn2	EBL	EBT	EBR	WBL	WBT	WBR	SBLn1	SBLn2
Capacity (veh/h)	459	825	1381	-	-	1599	-	-	231	573
HCM Lane V/C Ratio	0.038	0.59	-	-	-	0.06	-	-	1.096	0.239
HCM Control Delay (s)	13.2	15.4	0	-	-	7.4	-	-	132.6	13.2
HCM Lane LOS	B	C	A	-	-	A	-	-	F	B
HCM 95th %tile Q(veh)	0.1	4	0	-	-	0.2	-	-	11.2	0.9

Notes
 -: Volume exceeds capacity \$: Delay exceeds 300s +: Computation Not Defined *: All major volume in platoon

Intersection

Int Delay, s/veh 237.8

Movement	EBL	EBT	EBR	WBL	WBT	WBR	NBL	NBT	NBR	SBL	SBT	SBR
Lane Configurations	↖	↗		↖	↗		↖	↗		↖	↗	
Traffic Vol, veh/h	12	395	11	88	232	144	14	25	163	333	25	10
Future Vol, veh/h	12	395	11	88	232	144	14	25	163	333	25	10
Conflicting Peds, #/hr	0	0	0	0	0	0	0	0	0	0	0	0
Sign Control	Free	Free	Free	Free	Free	Free	Stop	Stop	Stop	Stop	Stop	Stop
RT Channelized	-	-	None	-	-	None	-	-	None	-	-	None
Storage Length	50	-	-	50	-	-	50	-	-	50	-	-
Veh in Median Storage, #	-	0	-	-	0	-	-	0	-	-	0	-
Grade, %	-	0	-	-	0	-	-	0	-	-	0	-
Peak Hour Factor	92	92	92	92	92	92	92	92	92	92	92	92
Heavy Vehicles, %	0	0	0	0	0	0	0	0	0	0	0	0
Mvmt Flow	13	429	12	96	252	157	15	27	177	362	27	11

Major/Minor	Major1			Major2			Minor1			Minor2		
Conflicting Flow All	409	0	0	441	0	0	1003	1062	435	1086	990	331
Stage 1	-	-	-	-	-	-	461	461	-	523	523	-
Stage 2	-	-	-	-	-	-	542	601	-	563	467	-
Critical Hdwy	4.1	-	-	4.1	-	-	7.1	6.5	6.2	7.1	6.5	6.2
Critical Hdwy Stg 1	-	-	-	-	-	-	6.1	5.5	-	6.1	5.5	-
Critical Hdwy Stg 2	-	-	-	-	-	-	6.1	5.5	-	6.1	5.5	-
Follow-up Hdwy	2.2	-	-	2.2	-	-	3.5	4	3.3	3.5	4	3.3
Pot Cap-1 Maneuver	1161	-	-	1130	-	-	223	225	625	~ 196	248	715
Stage 1	-	-	-	-	-	-	584	569	-	541	534	-
Stage 2	-	-	-	-	-	-	528	493	-	514	565	-
Platoon blocked, %		-	-		-	-						
Mov Cap-1 Maneuver	1161	-	-	1130	-	-	185	204	625	~ 117	224	715
Mov Cap-2 Maneuver	-	-	-	-	-	-	185	204	-	~ 117	224	-
Stage 1	-	-	-	-	-	-	578	563	-	535	489	-
Stage 2	-	-	-	-	-	-	449	451	-	~ 347	559	-

Approach	EB			WB			NB			SB		
HCM Control Delay, s	0.2			1.6			18.1			\$ 926.1		
HCM LOS							C			F		

Minor Lane/Major Mvmt	NBLn1	NBLn2	EBL	EBT	EBR	WBL	WBT	WBR	SBLn1	SBLn2
Capacity (veh/h)	185	490	1161	-	-	1130	-	-	117	279
HCM Lane V/C Ratio	0.082	0.417	0.011	-	-	0.085	-	-	3.094	0.136
HCM Control Delay (s)	26.2	17.5	8.1	-	-	8.5	-	-	\$ 1021.4	19.9
HCM Lane LOS	D	C	A	-	-	A	-	-	F	C
HCM 95th %tile Q(veh)	0.3	2	0	-	-	0.3	-	-	34.5	0.5

Notes
 -: Volume exceeds capacity \$: Delay exceeds 300s +: Computation Not Defined *: All major volume in platoon

Intersection						
Int Delay, s/veh	3					
Movement	EBL	EBT	WBT	WBR	SBL	SBR
Lane Configurations						
Traffic Vol, veh/h	0	89	45	35	74	0
Future Vol, veh/h	0	89	45	35	74	0
Conflicting Peds, #/hr	0	0	0	0	0	0
Sign Control	Free	Free	Free	Free	Stop	Stop
RT Channelized	-	None	-	None	-	None
Storage Length	50	-	-	-	50	0
Veh in Median Storage, #	-	0	0	-	0	-
Grade, %	-	0	0	-	0	-
Peak Hour Factor	92	92	92	92	92	92
Heavy Vehicles, %	0	0	0	0	0	0
Mvmt Flow	0	97	49	38	80	0

Major/Minor	Major1	Major2	Minor2		
Conflicting Flow All	87	0	-	0	165 68
Stage 1	-	-	-	-	68 -
Stage 2	-	-	-	-	97 -
Critical Hdwy	4.1	-	-	-	6.4 6.2
Critical Hdwy Stg 1	-	-	-	-	5.4 -
Critical Hdwy Stg 2	-	-	-	-	5.4 -
Follow-up Hdwy	2.2	-	-	-	3.5 3.3
Pot Cap-1 Maneuver	1522	-	-	-	830 1001
Stage 1	-	-	-	-	960 -
Stage 2	-	-	-	-	932 -
Platoon blocked, %		-	-	-	
Mov Cap-1 Maneuver	1522	-	-	-	830 1001
Mov Cap-2 Maneuver	-	-	-	-	830 -
Stage 1	-	-	-	-	960 -
Stage 2	-	-	-	-	932 -

Approach	EB	WB	SB
HCM Control Delay, s	0	0	9.8
HCM LOS			A

Minor Lane/Major Mvmt	EBL	EBT	WBT	WBR	SBLn1	SBLn2
Capacity (veh/h)	1522	-	-	-	830	-
HCM Lane V/C Ratio	-	-	-	-	0.097	-
HCM Control Delay (s)	0	-	-	-	9.8	0
HCM Lane LOS	A	-	-	-	A	A
HCM 95th %tile Q(veh)	0	-	-	-	0.3	-

Intersection						
Int Delay, s/veh	3233					
Movement	EBL	EBR	NBL	NBT	SBT	SBR
Lane Configurations						
Traffic Vol, veh/h	806	122	93	1240	633	333
Future Vol, veh/h	806	122	93	1240	633	333
Conflicting Peds, #/hr	0	0	0	0	0	0
Sign Control	Stop	Stop	Free	Free	Free	Free
RT Channelized	-	None	-	None	-	None
Storage Length	50	0	50	-	-	-
Veh in Median Storage, #	0	-	-	0	0	-
Grade, %	0	-	-	0	0	-
Peak Hour Factor	92	92	92	92	92	92
Heavy Vehicles, %	0	0	3	3	3	3
Mvmt Flow	876	133	101	1348	688	362

Major/Minor	Minor2	Major1	Major2			
Conflicting Flow All	2419	869	1050	0	-	0
Stage 1	869	-	-	-	-	-
Stage 2	1550	-	-	-	-	-
Critical Hdwy	6.4	6.2	4.13	-	-	-
Critical Hdwy Stg 1	5.4	-	-	-	-	-
Critical Hdwy Stg 2	5.4	-	-	-	-	-
Follow-up Hdwy	3.5	3.3	2.227	-	-	-
Pot Cap-1 Maneuver	~ 36	354	659	-	-	-
Stage 1	~ 414	-	-	-	-	-
Stage 2	~ 195	-	-	-	-	-
Platoon blocked, %				-	-	-
Mov Cap-1 Maneuver	~ 30	354	659	-	-	-
Mov Cap-2 Maneuver	~ 30	-	-	-	-	-
Stage 1	~ 351	-	-	-	-	-
Stage 2	~ 195	-	-	-	-	-

Approach	EB	NB	SB
HCM Control Delay \$	1241.1	0.8	0
HCM LOS	F		

Minor Lane/Major Mvmt	NBL	NBT	EBLn1	EBLn2	SBT	SBR
Capacity (veh/h)	659	-	30	354	-	-
HCM Lane V/C Ratio	0.153	-	29.203	0.375	-	-
HCM Control Delay (s)	11.4	\$	12939.4	21.1	-	-
HCM Lane LOS	B	-	F	C	-	-
HCM 95th %tile Q(veh)	0.5	-	108.8	1.7	-	-

Notes
 -: Volume exceeds capacity \$: Delay exceeds 300s +: Computation Not Defined *: All major volume in platoon

Intersection						
Int Delay, s/veh	378.9					
Movement	WBL	WBR	NBT	NBR	SBL	SBT
Lane Configurations	↙	↗	↖		↙	↗
Traffic Vol, veh/h	106	537	696	137	420	1167
Future Vol, veh/h	106	537	696	137	420	1167
Conflicting Peds, #/hr	0	0	0	0	0	0
Sign Control	Stop	Stop	Free	Free	Free	Free
RT Channelized	-	None	-	None	-	None
Storage Length	50	0	-	-	50	-
Veh in Median Storage, #	0	-	0	-	-	0
Grade, %	0	-	0	-	-	0
Peak Hour Factor	92	92	92	92	92	92
Heavy Vehicles, %	0	0	5	5	2	2
Mvmt Flow	115	584	757	149	457	1268

Major/Minor	Minor1	Major1	Major2			
Conflicting Flow All	3014	832	0	0	906	0
Stage 1	832	-	-	-	-	-
Stage 2	2182	-	-	-	-	-
Critical Hdwy	6.4	6.2	-	-	4.12	-
Critical Hdwy Stg 1	5.4	-	-	-	-	-
Critical Hdwy Stg 2	5.4	-	-	-	-	-
Follow-up Hdwy	3.5	3.3	-	-	2.218	-
Pot Cap-1 Maneuver	~ 15	~ 372	-	-	751	-
Stage 1	431	-	-	-	-	-
Stage 2	~ 94	-	-	-	-	-
Platoon blocked, %			-	-	-	-
Mov Cap-1 Maneuver	~ 6	~ 372	-	-	751	-
Mov Cap-2 Maneuver	~ 6	-	-	-	-	-
Stage 1	431	-	-	-	-	-
Stage 2	~ 37	-	-	-	-	-

Approach	WB	NB	SB
HCM Control Delay, \$	1793.9	0	4.5
HCM LOS	F		

Minor Lane/Major Mvmt	NBT	NBR	WBLn1	WBLn2	SBL	SBT
Capacity (veh/h)	-	-	6	372	751	-
HCM Lane V/C Ratio	-	-	19.203	1.569	0.608	-
HCM Control Delay (s)	-	-	\$ 9386.7	295.1	16.9	-
HCM Lane LOS	-	-	F	F	C	-
HCM 95th %tile Q(veh)	-	-	16.3	33.1	4.2	-

Notes
 -: Volume exceeds capacity \$: Delay exceeds 300s +: Computation Not Defined *: All major volume in platoon

Intersection						
Int Delay, s/veh	182					
Movement	EBL	EBR	NBL	NBT	SBT	SBR
Lane Configurations	W		W	↑	↑	
Traffic Vol, veh/h	117	147	66	722	1205	73
Future Vol, veh/h	117	147	66	722	1205	73
Conflicting Peds, #/hr	0	0	0	0	0	0
Sign Control	Stop	Stop	Free	Free	Free	Free
RT Channelized	-	None	-	None	-	None
Storage Length	0	-	50	-	-	-
Veh in Median Storage, #	0	-	-	0	0	-
Grade, %	0	-	-	0	0	-
Peak Hour Factor	92	92	92	92	92	92
Heavy Vehicles, %	0	0	6	6	3	3
Mvmt Flow	127	160	72	785	1310	79

Major/Minor	Minor2	Major1	Major2			
Conflicting Flow All	2279	1350	1389	0	-	0
Stage 1	1350	-	-	-	-	-
Stage 2	929	-	-	-	-	-
Critical Hdwy	6.4	6.2	4.16	-	-	-
Critical Hdwy Stg 1	5.4	-	-	-	-	-
Critical Hdwy Stg 2	5.4	-	-	-	-	-
Follow-up Hdwy	3.5	3.3	2.254	-	-	-
Pot Cap-1 Maneuver	~ 44	186	480	-	-	-
Stage 1	244	-	-	-	-	-
Stage 2	388	-	-	-	-	-
Platoon blocked, %				-	-	-
Mov Cap-1 Maneuver	~ 37	186	480	-	-	-
Mov Cap-2 Maneuver	~ 37	-	-	-	-	-
Stage 1	207	-	-	-	-	-
Stage 2	388	-	-	-	-	-

Approach	EB	NB	SB
HCM Control Delay, \$	1603.1	1.2	0
HCM LOS	F		

Minor Lane/Major Mvmt	NBL	NBT	EBLn1	SBT	SBR
Capacity (veh/h)	480	-	67	-	-
HCM Lane V/C Ratio	0.149	-	4.283	-	-
HCM Control Delay (s)	13.8	\$	1603.1	-	-
HCM Lane LOS	B	-	F	-	-
HCM 95th %tile Q(veh)	0.5	-	31	-	-

Notes
 -: Volume exceeds capacity \$: Delay exceeds 300s +: Computation Not Defined *: All major volume in platoon

Intersection						
Int Delay, s/veh	219.5					
Movement	EBT	EBR	WBL	WBT	NBL	NBR
Lane Configurations	↔		↔	↑	↔	↔
Traffic Vol, veh/h	1123	77	154	463	195	292
Future Vol, veh/h	1123	77	154	463	195	292
Conflicting Peds, #/hr	0	0	0	0	0	0
Sign Control	Free	Free	Free	Free	Stop	Stop
RT Channelized	-	None	-	None	-	None
Storage Length	-	-	50	-	50	0
Veh in Median Storage, #	0	-	-	0	0	-
Grade, %	0	-	-	0	0	-
Peak Hour Factor	92	92	92	92	92	92
Heavy Vehicles, %	1	1	1	1	0	0
Mvmt Flow	1221	84	167	503	212	317

Major/Minor	Major1	Major2	Minor1	Minor2	Minor3
Conflicting Flow All	0	0	1305	0	2100 1263
Stage 1	-	-	-	-	1263 -
Stage 2	-	-	-	-	837 -
Critical Hdwy	-	-	4.11	-	6.4 6.2
Critical Hdwy Stg 1	-	-	-	-	5.4 -
Critical Hdwy Stg 2	-	-	-	-	5.4 -
Follow-up Hdwy	-	-	2.209	-	3.5 3.3
Pot Cap-1 Maneuver	-	-	534	-	~ 58 ~ 209
Stage 1	-	-	-	-	269 -
Stage 2	-	-	-	-	428 -
Platoon blocked, %	-	-	-	-	-
Mov Cap-1 Maneuver	-	-	534	-	~ 40 ~ 209
Mov Cap-2 Maneuver	-	-	-	-	~ 40 -
Stage 1	-	-	-	-	269 -
Stage 2	-	-	-	-	294 -

Approach	EB	WB	NB
HCM Control Delay, s	0	3.7	\$ 1033.6
HCM LOS			F

Minor Lane/Major Mvmt	NBLn1	NBLn2	EBT	EBR	WBL	WBT
Capacity (veh/h)	40	209	-	-	534	-
HCM Lane V/C Ratio	5.299	1.519	-	-	0.313	-
HCM Control Delay (s)	\$ 2134.7	298.2	-	-	14.8	-
HCM Lane LOS	F	F	-	-	B	-
HCM 95th %tile Q(veh)	24.7	19.6	-	-	1.3	-

Notes
 -: Volume exceeds capacity \$: Delay exceeds 300s +: Computation Not Defined *: All major volume in platoon

Intersection						
Int Delay, s/veh	0.9					
Movement	EBT	EBR	WBL	WBT	NBL	NBR
Lane Configurations						
Traffic Vol, veh/h	141	23	8	64	10	8
Future Vol, veh/h	141	23	8	64	10	8
Conflicting Peds, #/hr	0	0	0	0	0	0
Sign Control	Free	Free	Free	Free	Stop	Stop
RT Channelized	-	None	-	None	-	None
Storage Length	-	-	50	-	-	-
Veh in Median Storage, #	0	-	-	0	0	-
Grade, %	0	-	-	0	0	-
Peak Hour Factor	92	92	92	92	92	92
Heavy Vehicles, %	1	1	1	1	0	0
Mvmt Flow	153	25	9	70	11	9

Major/Minor	Major1	Major2	Minor1		
Conflicting Flow All	0	0	178	0	254
Stage 1	-	-	-	-	166
Stage 2	-	-	-	-	88
Critical Hdwy	-	-	4.11	-	6.4
Critical Hdwy Stg 1	-	-	-	-	5.4
Critical Hdwy Stg 2	-	-	-	-	5.4
Follow-up Hdwy	-	-	2.209	-	3.5
Pot Cap-1 Maneuver	-	-	1404	-	739
Stage 1	-	-	-	-	868
Stage 2	-	-	-	-	940
Platoon blocked, %	-	-	-	-	-
Mov Cap-1 Maneuver	-	-	1404	-	735
Mov Cap-2 Maneuver	-	-	-	-	735
Stage 1	-	-	-	-	868
Stage 2	-	-	-	-	934

Approach	EB	WB	NB
HCM Control Delay, s	0	0.8	9.6
HCM LOS			A

Minor Lane/Major Mvmt	NBLn1	EBT	EBR	WBL	WBT
Capacity (veh/h)	795	-	-	1404	-
HCM Lane V/C Ratio	0.025	-	-	0.006	-
HCM Control Delay (s)	9.6	-	-	7.6	-
HCM Lane LOS	A	-	-	A	-
HCM 95th %tile Q(veh)	0.1	-	-	0	-

Intersection	
Intersection Delay, s/veh	7.7
Intersection LOS	A

Movement	EBL	EBT	EBR	WBL	WBT	WBR	NBL	NBT	NBR	SBL	SBT	SBR
Lane Configurations	↵	↶		↵	↶		↵	↶		↵	↶	
Traffic Vol, veh/h	0	48	0	0	14	6	0	11	1	15	16	0
Future Vol, veh/h	0	48	0	0	14	6	0	11	1	15	16	0
Peak Hour Factor	0.92	0.92	0.92	0.92	0.92	0.92	0.92	0.92	0.92	0.92	0.92	0.92
Heavy Vehicles, %	13	13	13	9	9	9	0	0	0	0	0	0
Mvmt Flow	0	52	0	0	15	7	0	12	1	16	17	0
Number of Lanes	1	1	0	1	1	0	1	1	0	1	1	0

Approach	EB	WB	NB	SB
Opposing Approach	WB	EB	SB	NB
Opposing Lanes	2	2	2	2
Conflicting Approach Left	SB	NB	EB	WB
Conflicting Lanes Left	2	2	2	2
Conflicting Approach Right	NB	SB	WB	EB
Conflicting Lanes Right	2	2	2	2
HCM Control Delay	7.9	7.4	7.4	7.7
HCM LOS	A	A	A	A

Lane	NBLn1	NBLn2	EBLn1	EBLn2	WBLn1	WBLn2	SBLn1	SBLn2
Vol Left, %	0%	0%	0%	0%	0%	0%	100%	0%
Vol Thru, %	100%	92%	100%	100%	100%	70%	0%	100%
Vol Right, %	0%	8%	0%	0%	0%	30%	0%	0%
Sign Control	Stop	Stop	Stop	Stop	Stop	Stop	Stop	Stop
Traffic Vol by Lane	0	12	0	48	0	20	15	16
LT Vol	0	0	0	0	0	0	15	0
Through Vol	0	11	0	48	0	14	0	16
RT Vol	0	1	0	0	0	6	0	0
Lane Flow Rate	0	13	0	52	0	22	16	17
Geometry Grp	7	7	7	7	7	7	7	7
Degree of Util (X)	0	0.017	0	0.07	0	0.027	0.023	0.022
Departure Headway (Hd)	4.645	4.587	4.811	4.811	4.758	4.548	5.135	4.634
Convergence, Y/N	Yes	Yes	Yes	Yes	Yes	Yes	Yes	Yes
Cap	0	773	0	742	0	782	692	766
Service Time	2.418	2.36	2.556	2.556	2.513	2.303	2.901	2.4
HCM Lane V/C Ratio	0	0.017	0	0.07	0	0.028	0.023	0.022
HCM Control Delay	7.4	7.4	7.6	7.9	7.5	7.4	8	7.5
HCM Lane LOS	N	A	N	A	N	A	A	A
HCM 95th-tile Q	0	0.1	0	0.2	0	0.1	0.1	0.1

Intersection						
Int Delay, s/veh	7.6					
Movement	EBL	EBT	WBT	WBR	SBL	SBR
Lane Configurations		↕	↑	↗	↘	
Traffic Vol, veh/h	7	208	118	96	252	8
Future Vol, veh/h	7	208	118	96	252	8
Conflicting Peds, #/hr	0	0	0	0	0	0
Sign Control	Free	Free	Free	Free	Stop	Stop
RT Channelized	-	None	-	None	-	None
Storage Length	-	-	-	0	0	-
Veh in Median Storage, #	-	0	0	-	0	-
Grade, %	-	0	0	-	0	-
Peak Hour Factor	83	83	83	83	83	83
Heavy Vehicles, %	7	7	42	42	30	30
Mvmt Flow	8	251	142	116	304	10

Major/Minor	Major1	Major2	Minor2		
Conflicting Flow All	258	0	0	409	142
Stage 1	-	-	-	142	-
Stage 2	-	-	-	267	-
Critical Hdwy	4.17	-	-	6.7	6.5
Critical Hdwy Stg 1	-	-	-	5.7	-
Critical Hdwy Stg 2	-	-	-	5.7	-
Follow-up Hdwy	2.263	-	-	3.77	3.57
Pot Cap-1 Maneuver	1278	-	-	548	837
Stage 1	-	-	-	821	-
Stage 2	-	-	-	717	-
Platoon blocked, %		-	-		
Mov Cap-1 Maneuver	1278	-	-	544	837
Mov Cap-2 Maneuver	-	-	-	544	-
Stage 1	-	-	-	815	-
Stage 2	-	-	-	717	-

Approach	EB	WB	SB
HCM Control Delay, s	0.3	0	19.9
HCM LOS			C

Minor Lane/Major Mvmt	EBL	EBT	WBT	WBR	SBLn1
Capacity (veh/h)	1278	-	-	-	550
HCM Lane V/C Ratio	0.007	-	-	-	0.57
HCM Control Delay (s)	7.8	0	-	-	19.9
HCM Lane LOS	A	A	-	-	C
HCM 95th %tile Q(veh)	0	-	-	-	3.5

HCM 6th TWSC
4: Truck Parking Lot/Pistachio Drive & Avenue 18 1/2

Village D Specific Plan
Existing WP - PM Peak Hour

Intersection												
Int Delay, s/veh	5.4											
Movement	EBL	EBT	EBR	WBL	WBT	WBR	NBL	NBT	NBR	SBL	SBT	SBR
Lane Configurations		↕			↕	↕		↕			↕	
Traffic Vol, veh/h	12	516	1	6	206	187	2	0	5	154	0	12
Future Vol, veh/h	12	516	1	6	206	187	2	0	5	154	0	12
Conflicting Peds, #/hr	0	0	0	0	0	0	0	0	1	1	0	0
Sign Control	Free	Free	Free	Free	Free	Free	Stop	Stop	Stop	Stop	Stop	Stop
RT Channelized	-	-	None	-	-	None	-	-	None	-	-	None
Storage Length	-	-	-	-	-	50	-	-	-	-	-	-
Veh in Median Storage, #	-	0	-	-	0	-	-	0	-	-	0	-
Grade, %	-	0	-	-	0	-	-	0	-	-	0	-
Peak Hour Factor	93	93	93	93	93	93	93	93	93	93	93	93
Heavy Vehicles, %	19	19	19	22	22	22	71	71	71	5	5	5
Mvmt Flow	13	555	1	6	222	201	2	0	5	166	0	13

Major/Minor	Major1			Major2			Minor1			Minor2		
Conflicting Flow All	423	0	0	556	0	0	923	1017	557	819	816	222
Stage 1	-	-	-	-	-	-	582	582	-	234	234	-
Stage 2	-	-	-	-	-	-	341	435	-	585	582	-
Critical Hdwy	4.29	-	-	4.32	-	-	7.81	7.21	6.91	7.15	6.55	6.25
Critical Hdwy Stg 1	-	-	-	-	-	-	6.81	6.21	-	6.15	5.55	-
Critical Hdwy Stg 2	-	-	-	-	-	-	6.81	6.21	-	6.15	5.55	-
Follow-up Hdwy	2.371	-	-	2.398	-	-	4.139	4.639	3.939	3.545	4.045	3.345
Pot Cap-1 Maneuver	1051	-	-	922	-	-	191	182	419	291	308	810
Stage 1	-	-	-	-	-	-	397	404	-	762	706	-
Stage 2	-	-	-	-	-	-	552	479	-	492	494	-
Platoon blocked, %		-	-		-	-						
Mov Cap-1 Maneuver	1051	-	-	922	-	-	184	177	419	281	300	810
Mov Cap-2 Maneuver	-	-	-	-	-	-	184	177	-	281	300	-
Stage 1	-	-	-	-	-	-	390	397	-	748	700	-
Stage 2	-	-	-	-	-	-	538	475	-	476	485	-

Approach	EB			WB			NB			SB		
HCM Control Delay, s	0.2			0.1			17			34.3		
HCM LOS							C			D		

Minor Lane/Major Mvmt	NBLn1	EBL	EBT	EBR	WBL	WBT	WBR	SBLn1
Capacity (veh/h)	307	1051	-	-	922	-	-	295
HCM Lane V/C Ratio	0.025	0.012	-	-	0.007	-	-	0.605
HCM Control Delay (s)	17	8.5	0	-	8.9	0	-	34.3
HCM Lane LOS	C	A	A	-	A	A	-	D
HCM 95th %tile Q(veh)	0.1	0	-	-	0	-	-	3.7

HCM 6th TWSC
5: Road 23/SR-99 Southbound Off-Ramp & Avenue 18 1/2

Village D Specific Plan
Existing WP - PM Peak Hour

Intersection

Int Delay, s/veh 436.6

Movement	EBL	EBT	EBR	WBL	WBT	WBR	NBL	NBT	NBR	SBL	SBT	SBR
Lane Configurations		↑	↑		↑		↑		↑		↕	
Traffic Vol, veh/h	0	380	295	39	191	0	89	0	382	19	652	120
Future Vol, veh/h	0	380	295	39	191	0	89	0	382	19	652	120
Conflicting Peds, #/hr	0	0	0	0	0	0	0	0	0	0	0	0
Sign Control	Free	Free	Free	Free	Free	Free	Stop	Stop	Stop	Stop	Stop	Stop
RT Channelized	-	-	None	-	-	None	-	-	None	-	-	None
Storage Length	-	-	50	-	-	-	0	-	25	-	-	-
Veh in Median Storage, #	-	0	-	-	0	-	-	0	-	-	0	-
Grade, %	-	0	-	-	0	-	-	0	-	-	0	-
Peak Hour Factor	94	94	94	94	94	94	94	94	94	94	94	94
Heavy Vehicles, %	14	14	14	30	30	30	4	4	4	8	8	8
Mvmt Flow	0	404	314	41	203	0	95	0	406	20	694	128

Major/Minor	Major1			Major2			Minor1			Minor2		
Conflicting Flow All	-	0	0	718	0	0	1100	-	404	1049	1003	203
Stage 1	-	-	-	-	-	-	404	-	-	285	285	-
Stage 2	-	-	-	-	-	-	696	-	-	764	718	-
Critical Hdwy	-	-	-	4.4	-	-	7.14	-	6.24	7.18	6.58	6.28
Critical Hdwy Stg 1	-	-	-	-	-	-	6.14	-	-	6.18	5.58	-
Critical Hdwy Stg 2	-	-	-	-	-	-	6.14	-	-	6.18	5.58	-
Follow-up Hdwy	-	-	-	2.47	-	-	3.536	-	3.336	3.572	4.072	3.372
Pot Cap-1 Maneuver	0	-	-	767	-	0	188	0	642	200	~ 236	823
Stage 1	0	-	-	-	-	0	619	0	-	709	~ 665	-
Stage 2	0	-	-	-	-	0	429	0	-	387	~ 424	-
Platoon blocked, %	-	-	-	-	-	-	-	-	-	-	-	-
Mov Cap-1 Maneuver	-	-	-	767	-	-	-	-	642	70	~ 222	823
Mov Cap-2 Maneuver	-	-	-	-	-	-	-	-	-	70	~ 222	-
Stage 1	-	-	-	-	-	-	619	-	-	709	~ 625	-
Stage 2	-	-	-	-	-	-	-	-	-	142	~ 424	-

Approach	EB	WB	NB	SB
HCM Control Delay, s	0	1.7		\$ 1195.6
HCM LOS			-	F

Minor Lane/Major Mvmt	NBLn1	NBLn2	EBT	EBR	WBL	WBT	SBLn1
Capacity (veh/h)	-	642	-	-	767	-	236
HCM Lane V/C Ratio	-	0.633	-	-	0.054	-	3.566
HCM Control Delay (s)	-	19.8	-	-	10		\$ 1195.6
HCM Lane LOS	-	C	-	-	A	A	F
HCM 95th %tile Q(veh)	-	4.5	-	-	0.2	-	79.6

Notes

-: Volume exceeds capacity \$: Delay exceeds 300s +: Computation Not Defined *: All major volume in platoon

HCM 6th TWSC
6: SR-99 Northbound Ramps & Avenue 18 1/2

Village D Specific Plan
Existing WP - PM Peak Hour

Intersection												
Int Delay, s/veh	96.4											
Movement	EBL	EBT	EBR	WBL	WBT	WBR	NBL	NBT	NBR	SBL	SBT	SBR
Lane Configurations	↖	↑			↗			↕				
Traffic Vol, veh/h	478	81	0	0	78	13	179	2	0	0	0	0
Future Vol, veh/h	478	81	0	0	78	13	179	2	0	0	0	0
Conflicting Peds, #/hr	0	0	0	0	0	0	0	0	0	0	0	0
Sign Control	Free	Free	Free	Free	Free	Free	Stop	Stop	Stop	Free	Free	Free
RT Channelized	-	-	None	-	-	None	-	-	None	-	-	None
Storage Length	145	-	-	-	-	-	-	-	-	-	-	-
Veh in Median Storage, #	-	0	-	-	0	-	-	0	-	-	16965	-
Grade, %	-	0	-	-	0	-	-	0	-	-	0	-
Peak Hour Factor	92	92	92	92	92	92	92	92	92	92	92	92
Heavy Vehicles, %	8	8	8	12	12	12	25	25	25	0	0	0
Mvmt Flow	520	88	0	0	85	14	195	2	0	0	0	0

Major/Minor	Major1	Major2	Minor1
Conflicting Flow All	99	0	0
Stage 1	-	-	-
Stage 2	-	-	-
Critical Hdwy	4.18	-	-
Critical Hdwy Stg 1	-	-	-
Critical Hdwy Stg 2	-	-	-
Follow-up Hdwy	2.272	-	-
Pot Cap-1 Maneuver	1457	0	0
Stage 1	-	0	0
Stage 2	-	0	0
Platoon blocked, %	-	-	-
Mov Cap-1 Maneuver	1457	-	-
Mov Cap-2 Maneuver	-	-	-
Stage 1	-	-	-
Stage 2	-	-	-

Approach	EB	WB	NB
HCM Control Delay, s	7.6	0	\$ 419.1
HCM LOS			F

Minor Lane/Major Mvmt	NBLn1	EBL	EBT	WBT	WBR
Capacity (veh/h)	115	1457	-	-	-
HCM Lane V/C Ratio	1.711	0.357	-	-	-
HCM Control Delay (s)	\$ 419.1	8.8	-	-	-
HCM Lane LOS	F	A	-	-	-
HCM 95th %tile Q(veh)	15.1	1.6	-	-	-

Notes
 -: Volume exceeds capacity \$: Delay exceeds 300s +: Computation Not Defined *: All major volume in platoon

Intersection												
Int Delay, s/veh	0.3											
Movement	EBL	EBT	EBR	WBL	WBT	WBR	NBL	NBT	NBR	SBL	SBT	SBR
Lane Configurations		↕			↕			↕			↕	
Traffic Vol, veh/h	83	258	58	967	467	9	35	536	641	61	990	165
Future Vol, veh/h	83	258	58	967	467	9	35	536	641	61	990	165
Conflicting Peds, #/hr	0	0	0	0	0	0	0	0	0	0	0	0
Sign Control	Stop	Stop	Stop	Stop	Stop	Stop	Free	Free	Free	Free	Free	Free
RT Channelized	-	-	None	-	-	None	-	-	None	-	-	None
Storage Length	-	-	-	-	-	-	-	-	-	-	-	-
Veh in Median Storage, #	-	0	-	-	0	-	-	0	-	-	0	-
Grade, %	-	0	-	-	0	-	-	0	-	-	0	-
Peak Hour Factor	92	92	92	92	92	92	92	92	92	92	92	92
Heavy Vehicles, %	1	1	1	0	0	0	1	1	1	2	2	2
Mvmt Flow	90	280	63	1051	508	10	38	583	697	66	1076	179

Major/Minor	Minor2		Minor1		Major1		Major2					
Conflicting Flow All	2565	2654	1166	2477	2395	932	1255	0	0	1280	0	0
Stage 1	1298	1298	-	1008	1008	-	-	-	-	-	-	-
Stage 2	1267	1356	-	1469	1387	-	-	-	-	-	-	-
Critical Hdwy	7.11	6.51	6.21	7.1	6.5	6.2	4.11	-	-	4.12	-	-
Critical Hdwy Stg 1	6.11	5.51	-	6.1	5.5	-	-	-	-	-	-	-
Critical Hdwy Stg 2	6.11	5.51	-	6.1	5.5	-	-	-	-	-	-	-
Follow-up Hdwy	3.509	4.009	3.309	3.5	4	3.3	2.209	-	-	2.218	-	-
Pot Cap-1 Maneuver	~ 18	~ 23	237	~ 21	~ 34	326	558	-	-	542	-	-
Stage 1	200	~ 233	-	~ 292	~ 321	-	-	-	-	-	-	-
Stage 2	208	~ 218	-	~ 160	~ 212	-	-	-	-	-	-	-
Platoon blocked, %								-	-	-	-	-
Mov Cap-1 Maneuver	-	~ 9	237	-	~ 13	326	558	-	-	542	-	-
Mov Cap-2 Maneuver	-	~ 9	-	-	~ 13	-	-	-	-	-	-	-
Stage 1	136	~ 133	-	~ 198	~ 218	-	-	-	-	-	-	-
Stage 2	-	~ 148	-	-	~ 121	-	-	-	-	-	-	-

Approach	EB		WB		NB		SB	
HCM Control Delay, s					0.3		0.6	
HCM LOS	-		-					

Minor Lane/Major Mvmt	NBL	NBT	NBR	EBLn1WBLn1	SBL	SBT	SBR
Capacity (veh/h)	558	-	-	-	542	-	-
HCM Lane V/C Ratio	0.068	-	-	-	0.122	-	-
HCM Control Delay (s)	11.9	0	-	-	12.6	0	-
HCM Lane LOS	B	A	-	-	B	A	-
HCM 95th %tile Q(veh)	0.2	-	-	-	0.4	-	-

Notes
 -: Volume exceeds capacity \$: Delay exceeds 300s +: Computation Not Defined *: All major volume in platoon

Intersection	
Intersection Delay, s/veh	834.5
Intersection LOS	F

Movement	EBL	EBT	EBR	WBL	WBT	WBR	NBL	NBT	NBR	SBL	SBT	SBR
Lane Configurations	↶	↷		↶	↷		↶	↷		↶	↷	
Traffic Vol, veh/h	134	25	250	93	26	109	386	1072	171	222	1385	183
Future Vol, veh/h	134	25	250	93	26	109	386	1072	171	222	1385	183
Peak Hour Factor	0.95	0.95	0.95	0.95	0.95	0.95	0.95	0.95	0.95	0.95	0.95	0.95
Heavy Vehicles, %	1	1	1	0	0	0	1	1	1	1	1	1
Mvmt Flow	141	26	263	98	27	115	406	1128	180	234	1458	193
Number of Lanes	1	1	0	1	1	0	1	1	0	1	1	0

Approach	EB	WB	NB	SB
Opposing Approach	WB	EB	SB	NB
Opposing Lanes	2	2	2	2
Conflicting Approach Left	SB	NB	EB	WB
Conflicting Lanes Left	2	2	2	2
Conflicting Approach Right	NB	SB	WB	EB
Conflicting Lanes Right	2	2	2	2
HCM Control Delay	39.7	25.9	754.8	1191.6
HCM LOS	E	D	F	F

Lane	NBLn1	NBLn2	EBLn1	EBLn2	WBLn1	WBLn2	SBLn1	SBLn2
Vol Left, %	100%	0%	100%	0%	100%	0%	100%	0%
Vol Thru, %	0%	86%	0%	9%	0%	19%	0%	88%
Vol Right, %	0%	14%	0%	91%	0%	81%	0%	12%
Sign Control	Stop	Stop	Stop	Stop	Stop	Stop	Stop	Stop
Traffic Vol by Lane	386	1243	134	275	93	135	222	1568
LT Vol	386	0	134	0	93	0	222	0
Through Vol	0	1072	0	25	0	26	0	1385
RT Vol	0	171	0	250	0	109	0	183
Lane Flow Rate	406	1308	141	289	98	142	234	1651
Geometry Grp	7	7	7	7	7	7	7	7
Degree of Util (X)	1.02	3.067	0.384	0.697	0.28	0.365	0.598	3.958
Departure Headway (Hd)	11.851	11.216	15.842	14.626	16.316	15.169	10.336	9.731
Convergence, Y/N	Yes	Yes	Yes	Yes	Yes	Yes	Yes	Yes
Cap	309	340	230	252	222	240	353	396
Service Time	9.551	8.916	13.542	12.326	14.016	12.869	8.036	7.431
HCM Lane V/C Ratio	1.314	3.847	0.613	1.147	0.441	0.592	0.663	4.169
HCM Control Delay	92.9	960.4	28.1	45.3	25.2	26.3	27.3	1356.4
HCM Lane LOS	F	F	D	E	D	D	D	F
HCM 95th-tile Q	11.2	87.2	1.7	4.6	1.1	1.6	3.7	140.7

Intersection												
Intersection Delay, s/v	39.5											
Intersection LOS	F											

Movement	EBL	EBT	EBR	WBL	WBT	WBR	NBL	NBT	NBR	SBL	SBT	SBR
Lane Configurations	↶	↷		↶	↷		↶	↷		↶	↷	
Traffic Vol, veh/h	477	502	788	250	494	358	968	922	286	300	921	608
Future Vol, veh/h	477	502	788	250	494	358	968	922	286	300	921	608
Peak Hour Factor	0.93	0.93	0.93	0.93	0.93	0.93	0.93	0.93	0.93	0.93	0.93	0.93
Heavy Vehicles, %	0	0	0	0	0	0	1	1	1	1	1	1
Mvmt Flow	513	540	847	269	531	385	1041	991	308	323	990	654
Number of Lanes	1	1	0	1	1	0	1	1	0	1	1	0

Approach	EB	WB	NB	SB
Opposing Approach	WB	EB	SB	NB
Opposing Lanes	2	2	2	2
Conflicting Approach Left	SB	NB	EB	WB
Conflicting Lanes Left	2	2	2	2
Conflicting Approach Right	NB	SB	WB	EB
Conflicting Lanes Right	2	2	2	2
HCM Control Delay	1721.5	2301.1	1542.7	2404.5
HCM LOS	F	F	F	F

Lane	NBLn1	NBLn2	EBLn1	EBLn2	WBLn1	WBLn2	SBLn1	SBLn2
Vol Left, %	100%	0%	100%	0%	100%	0%	100%	0%
Vol Thru, %	0%	76%	0%	39%	0%	58%	0%	60%
Vol Right, %	0%	24%	0%	61%	0%	42%	0%	40%
Sign Control	Stop	Stop	Stop	Stop	Stop	Stop	Stop	Stop
Traffic Vol by Lane	968	1208	477	1290	250	852	300	1529
LT Vol	968	0	477	0	250	0	300	0
Through Vol	0	922	0	502	0	494	0	921
RT Vol	0	286	0	788	0	358	0	608
Lane Flow Rate	1041	1299	513	1387	269	916	323	1644
Geometry Grp	7	7	7	7	7	7	7	7
Degree of Util (X)	3.423	4.032	1.684	4.198	0.896	2.851	1.061	5.052
Departure Headway (Hd)	135.227	34.552	77.392	276.589	36.509	35.774	35.404	34.745
Convergence, Y/N	Yes	Yes	Yes	Yes	Yes	Yes	Yes	Yes
Cap	42	52	21	28	8	18	13	33
Service Time	132.927	32.252	75.092	274.289	34.209	33.474	33.104	32.445
HCM Lane V/C Ratio	24.786	24.981	24.429	49.536	33.625	50.889	24.846	49.818
HCM Control Delay	1394.1	1661.8	917.6	2018.8	1530.7	2527.1	908.2	698.1
HCM Lane LOS	F	F	F	F	F	F	F	F
HCM 95th-tile Q	11.1	13.2	3.5	7.8	1.1	2.5	1.8	6.6

Intersection												
Int Delay, s/veh	3.2											
Movement	EBL	EBT	EBR	WBL	WBT	WBR	NBL	NBT	NBR	SBL	SBT	SBR
Lane Configurations		↕			↕			↕			↕	
Traffic Vol, veh/h	1	2	3	4	3	300	2	1256	2	302	923	0
Future Vol, veh/h	1	2	3	4	3	300	2	1256	2	302	923	0
Conflicting Peds, #/hr	0	0	0	0	0	0	0	0	0	0	0	0
Sign Control	Stop	Stop	Stop	Stop	Stop	Stop	Free	Free	Free	Free	Free	Free
RT Channelized	-	-	None	-	-	None	-	-	None	-	-	None
Storage Length	-	-	-	-	-	-	-	-	-	-	-	-
Veh in Median Storage, #	-	0	-	-	0	-	-	0	-	-	0	-
Grade, %	-	0	-	-	0	-	-	0	-	-	0	-
Peak Hour Factor	88	88	88	88	88	88	88	88	88	88	88	88
Heavy Vehicles, %	0	0	0	0	0	0	1	1	1	2	2	2
Mvmt Flow	1	2	3	5	3	341	2	1427	2	343	1049	0

Major/Minor	Minor2		Minor1		Major1		Major2					
Conflicting Flow All	3339	3168	1049	3170	3167	1428	1049	0	0	1429	0	0
Stage 1	1735	1735	-	1432	1432	-	-	-	-	-	-	-
Stage 2	1604	1433	-	1738	1735	-	-	-	-	-	-	-
Critical Hdwy	7.1	6.5	6.2	7.1	6.5	6.2	4.11	-	-	4.12	-	-
Critical Hdwy Stg 1	6.1	5.5	-	6.1	5.5	-	-	-	-	-	-	-
Critical Hdwy Stg 2	6.1	5.5	-	6.1	5.5	-	-	-	-	-	-	-
Follow-up Hdwy	3.5	4	3.3	3.5	4	3.3	2.209	-	-	2.218	-	-
Pot Cap-1 Maneuver	5	11	279	6	11	~ 167	667	-	-	476	-	-
Stage 1	113	143	-	168	202	-	-	-	-	-	-	-
Stage 2	134	201	-	112	143	-	-	-	-	-	-	-
Platoon blocked, %								-	-	-	-	-
Mov Cap-1 Maneuver	-	0	279	-	0	~ 167	667	-	-	476	-	-
Mov Cap-2 Maneuver	-	0	-	-	0	-	-	-	-	-	-	-
Stage 1	111	0	-	165	199	-	-	-	-	-	-	-
Stage 2	-	198	-	-	0	-	-	-	-	-	-	-

Approach	EB		WB		NB		SB	
HCM Control Delay, s					0		7.3	
HCM LOS	-		-					

Minor Lane/Major Mvmt	NBL	NBT	NBR	EBLn1WBLn1	SBL	SBT	SBR
Capacity (veh/h)	667	-	-	-	476	-	-
HCM Lane V/C Ratio	0.003	-	-	-	0.721	-	-
HCM Control Delay (s)	10.4	0	-	-	29.8	0	-
HCM Lane LOS	B	A	-	-	D	A	-
HCM 95th %tile Q(veh)	0	-	-	-	5.8	-	-

Notes
 -: Volume exceeds capacity \$: Delay exceeds 300s +: Computation Not Defined *: All major volume in platoon

Intersection	
Intersection Delay, s/veh	454
Intersection LOS	F

Movement	EBL	EBT	EBR	WBL	WBT	WBR	NBL	NBT	NBR	SBL	SBT	SBR
Lane Configurations		↕			↕			↕			↕	
Traffic Vol, veh/h	141	89	34	11	36	779	14	341	21	548	291	86
Future Vol, veh/h	141	89	34	11	36	779	14	341	21	548	291	86
Peak Hour Factor	0.95	0.95	0.95	0.95	0.95	0.95	0.95	0.95	0.95	0.95	0.95	0.95
Heavy Vehicles, %	5	5	5	1	1	1	4	4	4	3	3	3
Mvmt Flow	148	94	36	12	38	820	15	359	22	577	306	91
Number of Lanes	0	1	0	0	1	0	0	1	0	0	1	0

Approach	EB	WB	NB	SB
Opposing Approach	WB	EB	SB	NB
Opposing Lanes	1	1	1	1
Conflicting Approach Left	SB	NB	EB	WB
Conflicting Lanes Left	1	1	1	1
Conflicting Approach Right	NB	SB	WB	EB
Conflicting Lanes Right	1	1	1	1
HCM Control Delay	60	491.1	99.8	677.2
HCM LOS	F	F	F	F

Lane	NBLn1	EBLn1	WBLn1	SBLn1
Vol Left, %	4%	53%	1%	59%
Vol Thru, %	91%	34%	4%	31%
Vol Right, %	6%	13%	94%	9%
Sign Control	Stop	Stop	Stop	Stop
Traffic Vol by Lane	376	264	826	925
LT Vol	14	141	11	548
Through Vol	341	89	36	291
RT Vol	21	34	779	86
Lane Flow Rate	396	278	869	974
Geometry Grp	1	1	1	1
Degree of Util (X)	0.975	0.738	2.009	2.429
Departure Headway (Hd)	16.683	18.263	11.737	11.744
Convergence, Y/N	Yes	Yes	Yes	Yes
Cap	222	200	322	321
Service Time	14.683	16.263	9.737	9.744
HCM Lane V/C Ratio	1.784	1.39	2.699	3.034
HCM Control Delay	99.8	60	491.1	677.2
HCM Lane LOS	F	F	F	F
HCM 95th-tile Q	8.6	4.8	43.9	59.5

Intersection

Intersection Delay, s/veh 12.3

Intersection LOS B

Movement	EBL	EBT	EBR	WBL	WBT	WBR	NBL	NBT	NBR	SBL	SBT	SBR
Lane Configurations												
Traffic Vol, veh/h	139	116	8	14	66	106	4	108	38	106	91	84
Future Vol, veh/h	139	116	8	14	66	106	4	108	38	106	91	84
Peak Hour Factor	0.92	0.92	0.92	0.92	0.92	0.92	0.92	0.92	0.92	0.92	0.92	0.92
Heavy Vehicles, %	10	10	10	12	12	12	5	5	5	6	6	6
Mvmt Flow	151	126	9	15	72	115	4	117	41	115	99	91
Number of Lanes	1	1	0	1	1	0	0	1	0	0	1	0

Approach	EB	WB	NB	SB
Opposing Approach	WB	EB	SB	NB
Opposing Lanes	2	2	1	1
Conflicting Approach Left	SB	NB	EB	WB
Conflicting Lanes Left	1	1	2	2
Conflicting Approach Right	NB	SB	WB	EB
Conflicting Lanes Right	1	1	2	2
HCM Control Delay	11.8	11.7	11	13.8
HCM LOS	B	B	B	B

Lane	NBLn1	EBLn1	EBLn2	WBLn1	WBLn2	SBLn1
Vol Left, %		3%	100%	0%	100%	0%
Vol Thru, %		72%	0%	94%	0%	38%
Vol Right, %		25%	0%	6%	0%	62%
Sign Control		Stop	Stop	Stop	Stop	Stop
Traffic Vol by Lane		150	139	124	14	172
LT Vol		4	139	0	14	0
Through Vol		108	0	116	0	66
RT Vol		38	0	8	0	106
Lane Flow Rate		163	151	135	15	187
Geometry Grp		2	7	7	7	7
Degree of Util (X)		0.264	0.289	0.237	0.03	0.318
Departure Headway (Hd)		5.839	6.885	6.33	7.081	6.131
Convergence, Y/N		Yes	Yes	Yes	Yes	Yes
Cap		611	521	566	504	583
Service Time		3.907	4.645	4.089	4.845	3.895
HCM Lane V/C Ratio		0.267	0.29	0.239	0.03	0.321
HCM Control Delay		11	12.4	11.1	10.1	11.8
HCM Lane LOS		B	B	B	B	B
HCM 95th-tile Q		1.1	1.2	0.9	0.1	1.4

HCM 6th TWSC
 13: Airport Drive/Golden State Boulevard & Avenue 17

Village D Specific Plan
 Existing WP - PM Peak Hour

Intersection												
Int Delay, s/veh	0.4											
Movement	EBL	EBT	EBR	WBL	WBT	WBR	NBL	NBT	NBR	SBL	SBT	SBR
Lane Configurations	↘	↑	↗	↘	↑	↗	↘	↑	↗		↕	
Traffic Vol, veh/h	7	813	153	81	1138	85	244	27	152	120	25	7
Future Vol, veh/h	7	813	153	81	1138	85	244	27	152	120	25	7
Conflicting Peds, #/hr	0	0	0	0	0	0	0	0	0	0	0	0
Sign Control	Free	Free	Free	Free	Free	Free	Stop	Stop	Stop	Stop	Stop	Stop
RT Channelized	-	-	None	-	-	None	-	-	None	-	-	None
Storage Length	85	-	0	70	-	105	60	-	50	-	-	-
Veh in Median Storage, #	-	0	-	-	0	-	-	0	-	-	0	-
Grade, %	-	0	-	-	0	-	-	0	-	-	0	-
Peak Hour Factor	89	89	89	89	89	89	89	89	89	89	89	89
Heavy Vehicles, %	1	1	1	1	1	1	2	2	2	3	3	3
Mvmt Flow	8	913	172	91	1279	96	274	30	171	135	28	8

Major/Minor	Major1			Major2			Minor1			Minor2		
Conflicting Flow All	1375	0	0	1085	0	0	2456	2486	913	2577	2562	1279
Stage 1	-	-	-	-	-	-	929	929	-	1461	1461	-
Stage 2	-	-	-	-	-	-	1527	1557	-	1116	1101	-
Critical Hdwy	4.11	-	-	4.11	-	-	7.12	6.52	6.22	7.13	6.53	6.23
Critical Hdwy Stg 1	-	-	-	-	-	-	6.12	5.52	-	6.13	5.53	-
Critical Hdwy Stg 2	-	-	-	-	-	-	6.12	5.52	-	6.13	5.53	-
Follow-up Hdwy	2.209	-	-	2.209	-	-	3.518	4.018	3.318	3.527	4.027	3.327
Pot Cap-1 Maneuver	502	-	-	647	-	-	~ 21	~ 29	331	~ 17	~ 26	202
Stage 1	-	-	-	-	-	-	321	346	-	160	192	-
Stage 2	-	-	-	-	-	-	~ 147	174	-	251	287	-
Platoon blocked, %		-	-		-	-						
Mov Cap-1 Maneuver	502	-	-	647	-	-	~ 25	331	-	~ 22	202	
Mov Cap-2 Maneuver	-	-	-	-	-	-	~ 25	-	-	~ 22	-	
Stage 1	-	-	-	-	-	-	316	340	-	157	165	-
Stage 2	-	-	-	-	-	-	~ 101	149	-	~ 109	282	-

Approach	EB	WB	NB	SB
HCM Control Delay, s	0.1	0.7		
HCM LOS			-	-

Minor Lane/Major Mvmt	NBLn1	NBLn2	NBLn3	EBL	EBT	EBR	WBL	WBT	WBR	SBLn1
Capacity (veh/h)	-	25	331	502	-	-	647	-	-	-
HCM Lane V/C Ratio	-	1.213	0.516	0.016	-	-	0.141	-	-	-
HCM Control Delay (s)	-	\$ 481.5	26.9	12.3	-	-	11.5	-	-	-
HCM Lane LOS	-	F	D	B	-	-	B	-	-	-
HCM 95th %tile Q(veh)	-	3.7	2.8	0	-	-	0.5	-	-	-

Notes
 -: Volume exceeds capacity \$: Delay exceeds 300s +: Computation Not Defined *: All major volume in platoon

Intersection

Int Delay, s/veh 144.8

Movement	EBL	EBT	WBT	WBR	SBL	SBR
Lane Configurations		↑	↑		↑	↑
Traffic Vol, veh/h	0	1092	1258	0	153	43
Future Vol, veh/h	0	1092	1258	0	153	43
Conflicting Peds, #/hr	0	0	0	0	0	0
Sign Control	Free	Free	Free	Free	Stop	Stop
RT Channelized	-	None	-	None	-	None
Storage Length	-	-	-	-	0	610
Veh in Median Storage, #	-	0	0	-	0	-
Grade, %	-	0	0	-	0	-
Peak Hour Factor	92	92	92	92	92	92
Heavy Vehicles, %	2	2	1	1	5	5
Mvmt Flow	0	1187	1367	0	166	47

Major/Minor

	Major1	Major2	Minor2		
Conflicting Flow All	-	0	-	0	2554 1367
Stage 1	-	-	-	-	1367 -
Stage 2	-	-	-	-	1187 -
Critical Hdwy	-	-	-	-	6.45 6.25
Critical Hdwy Stg 1	-	-	-	-	5.45 -
Critical Hdwy Stg 2	-	-	-	-	5.45 -
Follow-up Hdwy	-	-	-	-	3.545 3.345
Pot Cap-1 Maneuver	0	-	-	0	- 29 177
Stage 1	0	-	-	0	233 -
Stage 2	0	-	-	0	286 -
Platoon blocked, %	-	-	-	-	-
Mov Cap-1 Maneuver	-	-	-	-	- 29 177
Mov Cap-2 Maneuver	-	-	-	-	- 29 -
Stage 1	-	-	-	-	233 -
Stage 2	-	-	-	-	286 -

Approach

	EB	WB	SB
HCM Control Delay, s	0	0	\$ 1881.1
HCM LOS			F

Minor Lane/Major Mvmt

	EBT	WBT	SBLn1	SBLn2
Capacity (veh/h)	-	-	29	177
HCM Lane V/C Ratio	-	-	5.735	0.264
HCM Control Delay (s)	-	-	\$ 2400.7	32.5
HCM Lane LOS	-	-	F	D
HCM 95th %tile Q(veh)	-	-	20.2	1

Notes

-: Volume exceeds capacity \$: Delay exceeds 300s +: Computation Not Defined *: All major volume in platoon

HCM 6th TWSC
15: SR-99 Northbound Ramps & Avenue 17

Village D Specific Plan
Existing WP - PM Peak Hour

Intersection												
Int Delay, s/veh	952.3											
Movement	EBL	EBT	EBR	WBL	WBT	WBR	NBL	NBT	NBR	SBL	SBT	SBR
Lane Configurations	↖	↑			↗			↖	↗			
Traffic Vol, veh/h	64	710	0	0	761	66	676	1	0	0	0	0
Future Vol, veh/h	64	710	0	0	761	66	676	1	0	0	0	0
Conflicting Peds, #/hr	0	0	0	0	0	0	0	0	0	0	0	0
Sign Control	Free	Free	Free	Free	Free	Free	Stop	Stop	Stop	Free	Free	Free
RT Channelized	-	-	None	-	-	None	-	-	None	-	-	None
Storage Length	125	-	-	-	-	-	-	-	50	-	-	-
Veh in Median Storage, #	-	0	-	-	0	-	-	0	-	-	16965	-
Grade, %	-	0	-	-	0	-	-	0	-	-	0	-
Peak Hour Factor	95	95	95	95	95	95	95	95	95	95	95	95
Heavy Vehicles, %	2	2	2	2	2	2	1	1	1	0	0	0
Mvmt Flow	67	747	0	0	801	69	712	1	0	0	0	0

Major/Minor	Major1	Major2	Minor1
Conflicting Flow All	870	0	-
Stage 1	-	-	-
Stage 2	-	-	-
Critical Hdwy	4.12	-	-
Critical Hdwy Stg 1	-	-	-
Critical Hdwy Stg 2	-	-	-
Follow-up Hdwy	2.218	-	-
Pot Cap-1 Maneuver	775	-	0
Stage 1	-	-	0
Stage 2	-	-	0
Platoon blocked, %	-	-	-
Mov Cap-1 Maneuver	775	-	-
Mov Cap-2 Maneuver	-	-	-
Stage 1	-	-	-
Stage 2	-	-	-

Approach	EB	WB	NB
HCM Control Delay, s	0.8	0	\$ 3203.3
HCM LOS			F

Minor Lane/Major Mvmt	NBLn1	NBLn2	EBL	EBT	WBT	WBR
Capacity (veh/h)	90	-	775	-	-	-
HCM Lane V/C Ratio	7.918	-	0.087	-	-	-
HCM Control Delay (s)	\$ 3203.3	0	10.1	-	-	-
HCM Lane LOS	F	A	B	-	-	-
HCM 95th %tile Q(veh)	81.1	-	0.3	-	-	-

Notes
 -: Volume exceeds capacity \$: Delay exceeds 300s +: Computation Not Defined *: All major volume in platoon

HCM 6th TWSC
17: Westberry Boulevard & Cleveland Avenue

Village D Specific Plan
Existing WP - PM Peak Hour

Intersection												
Int Delay, s/veh	118											
Movement	EBL	EBT	EBR	WBL	WBT	WBR	NBL	NBT	NBR	SBL	SBT	SBR
Lane Configurations	↖	↗		↖	↗		↖	↑	↗	↖	↑	↗
Traffic Vol, veh/h	220	743	26	27	1027	11	46	8	34	13	22	369
Future Vol, veh/h	220	743	26	27	1027	11	46	8	34	13	22	369
Conflicting Peds, #/hr	0	0	3	3	0	0	0	0	0	0	0	0
Sign Control	Free	Free	Free	Free	Free	Free	Stop	Stop	Stop	Stop	Stop	Stop
RT Channelized	-	-	None	-	-	None	-	-	None	-	-	None
Storage Length	110	-	-	165	-	-	65	-	50	100	-	50
Veh in Median Storage, #	-	0	-	-	0	-	-	0	-	-	0	-
Grade, %	-	0	-	-	0	-	-	0	-	-	0	-
Peak Hour Factor	84	84	84	84	84	84	84	84	84	84	84	84
Heavy Vehicles, %	0	0	0	0	0	0	0	0	0	0	0	0
Mvmt Flow	262	885	31	32	1223	13	55	10	40	15	26	439

Major/Minor	Major1			Major2			Minor1			Minor2		
Conflicting Flow All	1236	0	0	919	0	0	2954	2728	904	2744	2737	1230
Stage 1	-	-	-	-	-	-	1428	1428	-	1294	1294	-
Stage 2	-	-	-	-	-	-	1526	1300	-	1450	1443	-
Critical Hdwy	4.1	-	-	4.1	-	-	7.1	6.5	6.2	7.1	6.5	6.2
Critical Hdwy Stg 1	-	-	-	-	-	-	6.1	5.5	-	6.1	5.5	-
Critical Hdwy Stg 2	-	-	-	-	-	-	6.1	5.5	-	6.1	5.5	-
Follow-up Hdwy	2.2	-	-	2.2	-	-	3.5	4	3.3	3.5	4	3.3
Pot Cap-1 Maneuver	571	-	-	751	-	-	~ 9	21	338	~ 13	~ 21	~ 219
Stage 1	-	-	-	-	-	-	169	203	-	202	235	-
Stage 2	-	-	-	-	-	-	149	233	-	164	199	-
Platoon blocked, %	-	-	-	-	-	-	-	-	-	-	-	-
Mov Cap-1 Maneuver	571	-	-	749	-	-	-	11	337	~ 2	~ 11	~ 219
Mov Cap-2 Maneuver	-	-	-	-	-	-	-	11	-	~ 2	~ 11	-
Stage 1	-	-	-	-	-	-	91	109	-	109	225	-
Stage 2	-	-	-	-	-	-	-	223	-	71	107	-

Approach	EB	WB	NB	SB
HCM Control Delay, s	3.7	0.3		\$ 733.5
HCM LOS			-	F

Minor Lane/Major Mvmt	NBLn1	NBLn2	NBLn3	EBL	EBT	EBR	WBL	WBT	WBR	SBLn1	SBLn2	SBLn3
Capacity (veh/h)	-	11	337	571	-	-	749	-	-	2	11	219
HCM Lane V/C Ratio	-	0.866	0.12	0.459	-	-	0.043	-	-	7.738	2.381	2.006
HCM Control Delay (s)	-	\$ 660.4	17.1	16.5	-	-	10	-	-	\$ 6247.9	\$ 1311.7	\$ 504.8
HCM Lane LOS	-	F	C	C	-	-	B	-	-	F	F	F
HCM 95th %tile Q(veh)	-	1.8	0.4	2.4	-	-	0.1	-	-	3.4	4.2	32.6

Notes
 -: Volume exceeds capacity \$: Delay exceeds 300s +: Computation Not Defined *: All major volume in platoon

Intersection	
Intersection Delay, s/veh	11.8
Intersection LOS	B

Movement	EBL	EBT	EBR	WBL	WBT	WBR	NBL	NBT	NBR	SBL	SBT	SBR
Lane Configurations	↙	↘		↙	↘		↙	↘	↙	↘	↙	↘
Traffic Vol, veh/h	40	150	51	64	188	16	67	108	55	16	95	52
Future Vol, veh/h	40	150	51	64	188	16	67	108	55	16	95	52
Peak Hour Factor	0.96	0.96	0.96	0.96	0.96	0.96	0.96	0.96	0.96	0.96	0.96	0.96
Heavy Vehicles, %	0	0	0	0	0	0	0	0	0	0	0	0
Mvmt Flow	42	156	53	67	196	17	70	113	57	17	99	54
Number of Lanes	1	1	0	1	1	0	1	1	1	1	1	1

Approach	EB	WB	NB	SB
Opposing Approach	WB	EB	SB	NB
Opposing Lanes	2	2	3	3
Conflicting Approach Left	SB	NB	EB	WB
Conflicting Lanes Left	3	3	2	2
Conflicting Approach Right	NB	SB	WB	EB
Conflicting Lanes Right	3	3	2	2
HCM Control Delay	12.5	12.6	10.9	10.8
HCM LOS	B	B	B	B

Lane	NBLn1	NBLn2	NBLn3	EBLn1	EBLn2	WBLn1	WBLn2	SBLn1	SBLn2	SBLn3
Vol Left, %	100%	0%	0%	100%	0%	100%	0%	100%	0%	0%
Vol Thru, %	0%	100%	0%	0%	75%	0%	92%	0%	100%	0%
Vol Right, %	0%	0%	100%	0%	25%	0%	8%	0%	0%	100%
Sign Control	Stop	Stop	Stop	Stop	Stop	Stop	Stop	Stop	Stop	Stop
Traffic Vol by Lane	67	108	55	40	201	64	204	16	95	52
LT Vol	67	0	0	40	0	64	0	16	0	0
Through Vol	0	108	0	0	150	0	188	0	95	0
RT Vol	0	0	55	0	51	0	16	0	0	52
Lane Flow Rate	70	112	57	42	209	67	212	17	99	54
Geometry Grp	8	8	8	8	8	8	8	8	8	8
Degree of Util (X)	0.141	0.211	0.096	0.082	0.37	0.129	0.379	0.034	0.191	0.094
Departure Headway (Hd)	7.267	6.758	6.045	7.05	6.37	6.98	6.423	7.443	6.934	6.22
Convergence, Y/N	Yes	Yes	Yes	Yes	Yes	Yes	Yes	Yes	Yes	Yes
Cap	491	528	589	506	561	511	557	478	515	572
Service Time	5.047	4.538	3.824	4.825	4.145	4.753	4.195	5.229	4.719	4.004
HCM Lane V/C Ratio	0.143	0.212	0.097	0.083	0.373	0.131	0.381	0.036	0.192	0.094
HCM Control Delay	11.2	11.4	9.5	10.5	12.9	10.8	13.1	10.5	11.4	9.7
HCM Lane LOS	B	B	A	B	B	B	B	B	B	A
HCM 95th-tile Q	0.5	0.8	0.3	0.3	1.7	0.4	1.8	0.1	0.7	0.3

Intersection												
Intersection Delay, s/veh	77.5											
Intersection LOS	F											

Movement	EBL	EBT	EBR	WBL	WBT	WBR	NBL	NBT	NBR	SBL	SBT	SBR
Lane Configurations		↕			↕			↕			↕	
Traffic Vol, veh/h	68	647	67	22	714	130	53	41	16	88	42	80
Future Vol, veh/h	68	647	67	22	714	130	53	41	16	88	42	80
Peak Hour Factor	0.89	0.89	0.89	0.89	0.89	0.89	0.89	0.89	0.89	0.89	0.89	0.89
Heavy Vehicles, %	0	0	0	0	0	0	0	0	0	0	0	0
Mvmt Flow	76	727	75	25	802	146	60	46	18	99	47	90
Number of Lanes	0	1	0	0	1	0	0	1	0	0	1	0

Approach	EB	WB	NB	SB
Opposing Approach	WB	EB	SB	NB
Opposing Lanes	1	1	1	1
Conflicting Approach Left	SB	NB	EB	WB
Conflicting Lanes Left	1	1	1	1
Conflicting Approach Right	NB	SB	WB	EB
Conflicting Lanes Right	1	1	1	1
HCM Control Delay	292.1	359.3	18.3	22
HCM LOS	F	F	C	C

Lane	NBLn1	EBLn1	WBLn1	SBLn1
Vol Left, %	48%	9%	3%	42%
Vol Thru, %	37%	83%	82%	20%
Vol Right, %	15%	9%	15%	38%
Sign Control	Stop	Stop	Stop	Stop
Traffic Vol by Lane	110	782	866	210
LT Vol	53	68	22	88
Through Vol	41	647	714	42
RT Vol	16	67	130	80
Lane Flow Rate	124	879	973	236
Geometry Grp	1	1	1	1
Degree of Util (X)	0.284	1.583	1.739	0.498
Departure Headway (Hd)	10.967	7.577	7.32	9.754
Convergence, Y/N	Yes	Yes	Yes	Yes
Cap	330	492	506	373
Service Time	8.967	5.577	5.32	7.754
HCM Lane V/C Ratio	0.376	1.787	1.923	0.633
HCM Control Delay	18.3	292.1	359.3	22
HCM Lane LOS	C	F	F	C
HCM 95th-tile Q	1.1	41.4	51.6	2.7

Intersection

Intersection Delay, s/veh 14.9

Intersection LOS B

Movement	EBL	EBT	EBR	WBL	WBT	WBR	NBL	NBT	NBR	SBL	SBT	SBR
Lane Configurations		↕			↕	↕		↕	↕		↕	↕
Traffic Vol, veh/h	0	0	0	242	0	66	0	89	142	142	147	0
Future Vol, veh/h	0	0	0	242	0	66	0	89	142	142	147	0
Peak Hour Factor	0.85	0.85	0.85	0.85	0.85	0.85	0.85	0.85	0.85	0.85	0.85	0.85
Heavy Vehicles, %	0	0	0	1	1	1	0	0	0	0	0	0
Mvmt Flow	0	0	0	285	0	78	0	105	167	167	173	0
Number of Lanes	0	1	0	0	1	1	0	1	1	0	1	1

Approach	EB	WB	NB	SB
Opposing Approach	WB	EB	SB	NB
Opposing Lanes	2	1	2	2
Conflicting Approach Left	SB	NB	EB	WB
Conflicting Lanes Left	2	2	1	2
Conflicting Approach Right	NB	SB	WB	EB
Conflicting Lanes Right	2	2	2	1
HCM Control Delay	0	15.4	10.3	18
HCM LOS	-	C	B	C

Lane	NBLn1	NBLn2	EBLn1	WBLn1	WBLn2	SBLn1	SBLn2
Vol Left, %	0%	0%	0%	100%	0%	49%	0%
Vol Thru, %	100%	0%	100%	0%	0%	51%	100%
Vol Right, %	0%	100%	0%	0%	100%	0%	0%
Sign Control	Stop	Stop	Stop	Stop	Stop	Stop	Stop
Traffic Vol by Lane	89	142	0	242	66	289	0
LT Vol	0	0	0	242	0	142	0
Through Vol	89	0	0	0	0	147	0
RT Vol	0	142	0	0	66	0	0
Lane Flow Rate	105	167	0	285	78	340	0
Geometry Grp	7	7	6	7	7	7	7
Degree of Util (X)	0.181	0.256	0	0.535	0.12	0.597	0
Departure Headway (Hd)	6.223	5.511	7.094	6.766	5.551	6.318	6.069
Convergence, Y/N	Yes	Yes	Yes	Yes	Yes	Yes	Yes
Cap	576	650	0	532	644	571	0
Service Time	3.973	3.261	5.171	4.509	3.293	4.064	3.814
HCM Lane V/C Ratio	0.182	0.257	0	0.536	0.121	0.595	0
HCM Control Delay	10.4	10.2	10.2	17.1	9.1	18	8.8
HCM Lane LOS	B	B	N	C	A	C	N
HCM 95th-tile Q	0.7	1	0	3.1	0.4	3.9	0

Intersection	
Intersection Delay, s/veh	233.3
Intersection LOS	F

Movement	EBL	EBT	EBR	WBL	WBT	WBR	NBL	NBT	NBR	SBL	SBT	SBR
Lane Configurations	↵	↕↗		↵	↕↗		↵	↕	↗	↵	↕	↗
Traffic Vol, veh/h	13	675	25	320	1000	20	28	191	229	19	233	21
Future Vol, veh/h	13	675	25	320	1000	20	28	191	229	19	233	21
Peak Hour Factor	0.94	0.94	0.94	0.94	0.94	0.94	0.94	0.94	0.94	0.94	0.94	0.94
Heavy Vehicles, %	0	0	0	0	0	0	0	0	0	0	0	0
Mvmt Flow	14	718	27	340	1064	21	30	203	244	20	248	22
Number of Lanes	1	2	0	1	2	0	1	1	1	1	1	1

Approach	EB	WB	NB	SB
Opposing Approach	WB	EB	SB	NB
Opposing Lanes	3	3	3	3
Conflicting Approach Left	SB	NB	EB	WB
Conflicting Lanes Left	3	3	3	3
Conflicting Approach Right	NB	SB	WB	EB
Conflicting Lanes Right	3	3	3	3
HCM Control Delay	238	324.1	58.2	62.7
HCM LOS	F	F	F	F

Lane	NBLn1	NBLn2	NBLn3	EBLn1	EBLn2	EBLn3	WBLn1	WBLn2	WBLn3	SBLn1	SBLn2
Vol Left, %	100%	0%	0%	100%	0%	0%	100%	0%	0%	100%	0%
Vol Thru, %	0%	100%	0%	0%	100%	90%	0%	100%	94%	0%	100%
Vol Right, %	0%	0%	100%	0%	0%	10%	0%	0%	6%	0%	0%
Sign Control	Stop	Stop	Stop	Stop	Stop	Stop	Stop	Stop	Stop	Stop	Stop
Traffic Vol by Lane	28	191	229	13	450	250	320	667	353	19	233
LT Vol	28	0	0	13	0	0	320	0	0	19	0
Through Vol	0	191	0	0	450	225	0	667	333	0	233
RT Vol	0	0	229	0	0	25	0	0	20	0	0
Lane Flow Rate	30	203	244	14	479	266	340	709	376	20	248
Geometry Grp	8	8	8	8	8	8	8	8	8	8	8
Degree of Util (X)	0.111	0.729	0.827	0.049	1.641	0.906	1.062	2.117	1.118	0.076	0.9
Departure Headway (Hd)	17.132	16.632	15.932	14.162	13.662	13.592	11.828	11.328	11.289	13.856	13.356
Convergence, Y/N	Yes	Yes	Yes	Yes	Yes	Yes	Yes	Yes	Yes	Yes	Yes
Cap	211	219	229	254	273	269	310	326	323	260	273
Service Time	14.832	14.332	13.632	11.862	11.362	11.292	9.528	9.028	8.989	11.556	11.056
HCM Lane V/C Ratio	0.142	0.927	1.066	0.055	1.755	0.989	1.097	2.175	1.164	0.077	0.908
HCM Control Delay	22	54.1	66	17.6	336.3	72.5	104.9	537.3	120.4	17.7	70.5
HCM Lane LOS	C	F	F	C	F	F	F	F	F	C	F
HCM 95th-tile Q	0.4	4.9	6.3	0.2	27.1	8.1	12.3	49.5	14.2	0.2	8

Intersection												
Intersection Delay, s/veh	30.3											
Intersection LOS	D											

Movement	EBL	EBT	EBR	WBL	WBT	WBR	NBL	NBT	NBR	SBL	SBT	SBR
Lane Configurations	↔	↔		↔	↔	↔	↔	↔		↔	↔	
Traffic Vol, veh/h	28	167	34	54	216	108	46	262	42	76	293	32
Future Vol, veh/h	28	167	34	54	216	108	46	262	42	76	293	32
Peak Hour Factor	0.93	0.93	0.93	0.93	0.93	0.93	0.93	0.93	0.93	0.93	0.93	0.93
Heavy Vehicles, %	0	0	0	0	0	0	1	1	1	1	1	1
Mvmt Flow	30	180	37	58	232	116	49	282	45	82	315	34
Number of Lanes	1	1	0	1	1	1	1	1	0	1	1	0

Approach	EB	WB	NB	SB
Opposing Approach	WB	EB	SB	NB
Opposing Lanes	3	2	2	2
Conflicting Approach Left	SB	NB	EB	WB
Conflicting Lanes Left	2	2	2	3
Conflicting Approach Right	NB	SB	WB	EB
Conflicting Lanes Right	2	2	3	2
HCM Control Delay	22.8	19.9	36.4	39.2
HCM LOS	C	C	E	E

Lane	NBLn1	NBLn2	EBLn1	EBLn2	WBLn1	WBLn2	WBLn3	SBLn1	SBLn2
Vol Left, %	100%	0%	100%	0%	100%	0%	0%	100%	0%
Vol Thru, %	0%	86%	0%	83%	0%	100%	0%	0%	90%
Vol Right, %	0%	14%	0%	17%	0%	0%	100%	0%	10%
Sign Control	Stop	Stop	Stop	Stop	Stop	Stop	Stop	Stop	Stop
Traffic Vol by Lane	46	304	28	201	54	216	108	76	325
LT Vol	46	0	28	0	54	0	0	76	0
Through Vol	0	262	0	167	0	216	0	0	293
RT Vol	0	42	0	34	0	0	108	0	32
Lane Flow Rate	49	327	30	216	58	232	116	82	349
Geometry Grp	8	8	8	8	8	8	8	8	8
Degree of Util (X)	0.13	0.806	0.084	0.566	0.155	0.587	0.27	0.212	0.85
Departure Headway (Hd)	9.494	8.879	10.083	9.435	9.617	9.098	8.371	9.343	8.757
Convergence, Y/N	Yes	Yes	Yes	Yes	Yes	Yes	Yes	Yes	Yes
Cap	376	405	354	380	372	395	427	383	412
Service Time	7.28	6.664	7.88	7.232	7.404	6.884	6.156	7.126	6.539
HCM Lane V/C Ratio	0.13	0.807	0.085	0.568	0.156	0.587	0.272	0.214	0.847
HCM Control Delay	13.7	39.8	13.8	24	14.2	24.1	14.3	14.6	45
HCM Lane LOS	B	E	B	C	B	C	B	B	E
HCM 95th-tile Q	0.4	7.2	0.3	3.4	0.5	3.6	1.1	0.8	8.2

HCM 6th Signalized Intersection Summary
 23: Avenue 16/Ellis Street & Kennedy Street

Village D Specific Plan
 Existing WP - PM Peak Hour



Movement	WBL	WBR	NBT	NBR	SBL	SBT
Lane Configurations						
Traffic Volume (veh/h)	200	211	217	170	181	290
Future Volume (veh/h)	200	211	217	170	181	290
Initial Q (Qb), veh	0	0	0	0	0	0
Ped-Bike Adj(A_pbT)	1.00	1.00		1.00	1.00	
Parking Bus, Adj	1.00	1.00	1.00	1.00	1.00	1.00
Work Zone On Approach	No		No		No	
Adj Sat Flow, veh/h/ln	1870	1870	1885	1885	1900	1900
Adj Flow Rate, veh/h	222	234	241	189	201	322
Peak Hour Factor	0.90	0.90	0.90	0.90	0.90	0.90
Percent Heavy Veh, %	2	2	1	1	0	0
Cap, veh/h	280	438	1053	793	241	2637
Arrive On Green	0.16	0.16	0.54	0.54	0.13	0.73
Sat Flow, veh/h	1781	2790	2041	1466	1810	3705
Grp Volume(v), veh/h	222	234	221	209	201	322
Grp Sat Flow(s),veh/h/ln	1781	1395	1791	1621	1810	1805
Q Serve(g_s), s	9.6	6.2	5.2	5.4	8.7	2.1
Cycle Q Clear(g_c), s	9.6	6.2	5.2	5.4	8.7	2.1
Prop In Lane	1.00	1.00		0.90	1.00	
Lane Grp Cap(c), veh/h	280	438	969	877	241	2637
V/C Ratio(X)	0.79	0.53	0.23	0.24	0.83	0.12
Avail Cap(c_a), veh/h	412	645	969	877	283	2637
HCM Platoon Ratio	1.00	1.00	1.00	1.00	1.00	1.00
Upstream Filter(I)	0.86	0.86	1.00	1.00	1.00	1.00
Uniform Delay (d), s/veh	32.5	31.0	9.6	9.7	33.8	3.2
Incr Delay (d2), s/veh	5.5	0.9	0.5	0.6	16.8	0.1
Initial Q Delay(d3),s/veh	0.0	0.0	0.0	0.0	0.0	0.0
%ile BackOfQ(50%),veh/ln	4.5	0.1	2.0	1.9	4.8	0.6
Unsig. Movement Delay, s/veh						
LnGrp Delay(d),s/veh	38.0	31.9	10.2	10.3	50.7	3.3
LnGrp LOS	D	C	B	B	D	A
Approach Vol, veh/h	456		430			523
Approach Delay, s/veh	34.9		10.2			21.5
Approach LOS	C		B			C
Timer - Assigned Phs	1	2			6	8
Phs Duration (G+Y+Rc), s	15.1	47.8			62.9	17.1
Change Period (Y+Rc), s	4.5	4.5			4.5	4.5
Max Green Setting (Gmax), s	12.5	35.5			52.5	18.5
Max Q Clear Time (g_c+I), s	11.0	7.4			4.1	11.6
Green Ext Time (p_c), s	0.1	2.8			2.3	1.0
Intersection Summary						
HCM 6th Ctrl Delay			22.4			
HCM 6th LOS			C			

HCM 6th Signalized Intersection Summary
 24: Schnoor Avenue & Kennedy Street

Village D Specific Plan
 Existing WP - PM Peak Hour



Movement	EBL	EBT	EBR	WBL	WBT	WBR	NBL	NBT	NBR	SBL	SBT	SBR
Lane Configurations	↖	↗		↖	↗		↖	↗		↖	↗	↖
Traffic Volume (veh/h)	9	156	163	202	236	17	192	13	247	23	14	8
Future Volume (veh/h)	9	156	163	202	236	17	192	13	247	23	14	8
Initial Q (Qb), veh	0	0	0	0	0	0	0	0	0	0	0	0
Ped-Bike Adj(A_pbT)	1.00		0.99	1.00		0.99	1.00		1.00	1.00		1.00
Parking Bus, Adj	1.00	1.00	1.00	1.00	1.00	1.00	1.00	1.00	1.00	1.00	1.00	1.00
Work Zone On Approach		No		No		No		No		No		No
Adj Sat Flow, veh/h/ln	1870	1870	1870	1870	1870	1870	1885	1885	1885	1633	1633	1633
Adj Flow Rate, veh/h	10	166	173	215	251	18	204	14	263	24	15	9
Peak Hour Factor	0.94	0.94	0.94	0.94	0.94	0.94	0.94	0.94	0.94	0.94	0.94	0.94
Percent Heavy Veh, %	2	2	2	2	2	2	1	1	1	18	18	18
Cap, veh/h	200	273	241	257	320	23	835	22	408	326	388	328
Arrive On Green	0.11	0.15	0.15	0.14	0.19	0.19	0.24	0.27	0.27	0.21	0.24	0.24
Sat Flow, veh/h	1781	1777	1570	1781	1723	124	3483	81	1527	1555	1633	1382
Grp Volume(v), veh/h	10	166	173	215	0	269	204	0	277	24	15	9
Grp Sat Flow(s),veh/h/ln	1781	1777	1570	1781	0	1846	1742	0	1608	1555	1633	1382
Q Serve(g_s), s	0.4	7.0	8.4	9.4	0.0	11.1	3.8	0.0	12.2	1.0	0.6	0.4
Cycle Q Clear(g_c), s	0.4	7.0	8.4	9.4	0.0	11.1	3.8	0.0	12.2	1.0	0.6	0.4
Prop In Lane	1.00		1.00	1.00		0.07	1.00		0.95	1.00		1.00
Lane Grp Cap(c), veh/h	200	273	241	257	0	343	835	0	430	326	388	328
V/C Ratio(X)	0.05	0.61	0.72	0.84	0.00	0.78	0.24	0.00	0.64	0.07	0.04	0.03
Avail Cap(c_a), veh/h	200	400	353	367	0	681	835	0	430	326	388	328
HCM Platoon Ratio	1.00	1.00	1.00	1.00	1.00	1.00	1.00	1.00	1.00	1.00	1.00	1.00
Upstream Filter(I)	0.63	0.63	0.63	1.00	0.00	1.00	1.00	0.00	1.00	1.00	1.00	1.00
Uniform Delay (d), s/veh	31.7	31.6	32.2	33.3	0.0	31.0	24.6	0.0	25.9	25.4	23.5	23.4
Incr Delay (d2), s/veh	0.1	1.4	2.5	10.8	0.0	4.0	0.2	0.0	7.2	0.1	0.2	0.2
Initial Q Delay(d3),s/veh	0.0	0.0	0.0	0.0	0.0	0.0	0.0	0.0	0.0	0.0	0.0	0.0
%ile BackOfQ(50%),veh/ln	0.2	3.0	3.3	4.7	0.0	5.2	1.5	0.0	5.3	0.4	0.2	0.1
Unsig. Movement Delay, s/veh												
LnGrp Delay(d),s/veh	31.8	33.0	34.8	44.1	0.0	35.0	24.7	0.0	33.2	25.5	23.7	23.6
LnGrp LOS	C	C	C	D	A	D	C	A	C	C	C	C
Approach Vol, veh/h		349		484		481		48				
Approach Delay, s/veh		33.9		39.0		29.6		24.5				
Approach LOS		C		D		C		C				
Timer - Assigned Phs	1	2	3	4	5	6	7	8				
Phs Duration (G+Y+Rc), s	21.3	25.9	16.1	16.8	23.7	23.5	13.5	19.4				
Change Period (Y+Rc), s	4.5	4.5	4.5	4.5	4.5	4.5	4.5	4.5				
Max Green Setting (Gmax), s	16.5	21.4	16.5	18.0	8.5	19.0	5.0	29.5				
Max Q Clear Time (g_c+1), s	13.0	14.2	11.4	10.4	5.8	2.6	2.4	13.1				
Green Ext Time (p_c), s	0.0	1.0	0.3	1.2	0.2	0.0	0.0	1.4				
Intersection Summary												
HCM 6th Ctrl Delay				33.9								
HCM 6th LOS				C								

Intersection						
Int Delay, s/veh	12.8					
Movement	EBL	EBT	WBT	WBR	SBL	SBR
Lane Configurations						
Traffic Vol, veh/h	143	353	375	1	128	184
Future Vol, veh/h	143	353	375	1	128	184
Conflicting Peds, #/hr	0	0	0	0	0	0
Sign Control	Free	Free	Free	Free	Stop	Stop
RT Channelized	-	None	-	Free	-	None
Storage Length	140	-	-	-	0	335
Veh in Median Storage, #	-	0	0	-	0	-
Grade, %	-	0	0	-	0	-
Peak Hour Factor	85	85	85	85	85	85
Heavy Vehicles, %	2	2	2	2	3	3
Mvmt Flow	168	415	441	1	151	216

Major/Minor	Major1	Major2	Minor2		
Conflicting Flow All	441	0	-	0	1192 441
Stage 1	-	-	-	-	441 -
Stage 2	-	-	-	-	751 -
Critical Hdwy	4.12	-	-	-	6.43 6.23
Critical Hdwy Stg 1	-	-	-	-	5.43 -
Critical Hdwy Stg 2	-	-	-	-	5.43 -
Follow-up Hdwy	2.218	-	-	-	3.527 3.327
Pot Cap-1 Maneuver	1119	-	-	0	206 614
Stage 1	-	-	-	0	646 -
Stage 2	-	-	-	0	464 -
Platoon blocked, %		-	-		
Mov Cap-1 Maneuver	1119	-	-	-	175 614
Mov Cap-2 Maneuver	-	-	-	-	175 -
Stage 1	-	-	-	-	549 -
Stage 2	-	-	-	-	464 -

Approach	EB	WB	SB
HCM Control Delay, s	2.5	0	44.7
HCM LOS			E

Minor Lane/Major Mvmt	EBL	EBT	WBT	SBLn1	SBLn2
Capacity (veh/h)	1119	-	-	175	614
HCM Lane V/C Ratio	0.15	-	-	0.861	0.353
HCM Control Delay (s)	8.8	-	-	88.8	14
HCM Lane LOS	A	-	-	F	B
HCM 95th %tile Q(veh)	0.5	-	-	6.1	1.6

Intersection						
Int Delay, s/veh	5.1					
Movement	EBL	EBT	WBT	WBR	SBL	SBR
Lane Configurations		↕	↕		↕	
Traffic Vol, veh/h	193	288	118	0	0	258
Future Vol, veh/h	193	288	118	0	0	258
Conflicting Peds, #/hr	0	0	0	0	0	0
Sign Control	Free	Free	Free	Free	Stop	Stop
RT Channelized	-	None	-	None	-	None
Storage Length	-	-	-	-	0	-
Veh in Median Storage, #	-	0	0	-	0	-
Grade, %	-	0	0	-	0	-
Peak Hour Factor	82	82	82	82	82	82
Heavy Vehicles, %	3	3	3	3	2	2
Mvmt Flow	235	351	144	0	0	315

Major/Minor	Major1	Major2	Minor2		
Conflicting Flow All	144	0	-	0	965
Stage 1	-	-	-	-	144
Stage 2	-	-	-	-	821
Critical Hdwy	4.13	-	-	-	6.42
Critical Hdwy Stg 1	-	-	-	-	5.42
Critical Hdwy Stg 2	-	-	-	-	5.42
Follow-up Hdwy	2.227	-	-	-	3.518
Pot Cap-1 Maneuver	1432	-	-	-	283
Stage 1	-	-	-	-	883
Stage 2	-	-	-	-	432
Platoon blocked, %		-	-	-	
Mov Cap-1 Maneuver	1432	-	-	-	225
Mov Cap-2 Maneuver	-	-	-	-	225
Stage 1	-	-	-	-	703
Stage 2	-	-	-	-	432

Approach	EB	WB	SB
HCM Control Delay, s	3.2	0	11.1
HCM LOS			B

Minor Lane/Major Mvmt	EBL	EBT	WBT	WBR	SBLn1
Capacity (veh/h)	1432	-	-	-	903
HCM Lane V/C Ratio	0.164	-	-	-	0.348
HCM Control Delay (s)	8	0	-	-	11.1
HCM Lane LOS	A	A	-	-	B
HCM 95th %tile Q(veh)	0.6	-	-	-	1.6

Intersection						
Int Delay, s/veh	4.3					
Movement	EBL	EBR	NBL	NBT	SBT	SBR
Lane Configurations	↙			↑	↗	
Traffic Vol, veh/h	172	0	0	78	3	258
Future Vol, veh/h	172	0	0	78	3	258
Conflicting Peds, #/hr	0	0	0	0	0	0
Sign Control	Stop	Stop	Free	Free	Free	Free
RT Channelized	-	None	-	None	-	None
Storage Length	0	-	-	-	-	-
Veh in Median Storage, #	0	-	-	0	0	-
Grade, %	0	-	-	0	0	-
Peak Hour Factor	71	71	71	71	71	71
Heavy Vehicles, %	2	2	9	9	2	2
Mvmt Flow	242	0	0	110	4	363

Major/Minor	Minor2	Major1	Major2		
Conflicting Flow All	296	-	-	0	0
Stage 1	186	-	-	-	-
Stage 2	110	-	-	-	-
Critical Hdwy	6.42	-	-	-	-
Critical Hdwy Stg 1	5.42	-	-	-	-
Critical Hdwy Stg 2	5.42	-	-	-	-
Follow-up Hdwy	3.518	-	-	-	-
Pot Cap-1 Maneuver	695	0	0	-	-
Stage 1	846	0	0	-	-
Stage 2	915	0	0	-	-
Platoon blocked, %				-	-
Mov Cap-1 Maneuver	695	-	-	-	-
Mov Cap-2 Maneuver	695	-	-	-	-
Stage 1	846	-	-	-	-
Stage 2	915	-	-	-	-

Approach	EB	NB	SB
HCM Control Delay, s	12.9	0	0
HCM LOS	B		

Minor Lane/Major Mvmt	NBT EBLn1	SBT	SBR
Capacity (veh/h)	- 695	-	-
HCM Lane V/C Ratio	- 0.349	-	-
HCM Control Delay (s)	- 12.9	-	-
HCM Lane LOS	- B	-	-
HCM 95th %tile Q(veh)	- 1.6	-	-

Intersection						
Int Delay, s/veh	0.1					
Movement	EBL	EBT	WBT	WBR	SBL	SBR
Lane Configurations		↶	↷		↶	
Traffic Vol, veh/h	0	288	118	73	3	0
Future Vol, veh/h	0	288	118	73	3	0
Conflicting Peds, #/hr	0	0	0	0	0	0
Sign Control	Free	Free	Free	Free	Stop	Stop
RT Channelized	-	None	-	None	-	None
Storage Length	-	-	-	-	0	-
Veh in Median Storage, #	-	0	0	-	0	-
Grade, %	-	0	0	-	0	-
Peak Hour Factor	84	84	84	84	84	84
Heavy Vehicles, %	4	4	3	3	0	0
Mvmt Flow	0	343	140	87	4	0

Major/Minor	Major1	Major2	Minor2		
Conflicting Flow All	227	0	-	0	527 184
Stage 1	-	-	-	-	184 -
Stage 2	-	-	-	-	343 -
Critical Hdwy	4.14	-	-	-	6.4 6.2
Critical Hdwy Stg 1	-	-	-	-	5.4 -
Critical Hdwy Stg 2	-	-	-	-	5.4 -
Follow-up Hdwy	2.236	-	-	-	3.5 3.3
Pot Cap-1 Maneuver	1330	-	-	-	515 864
Stage 1	-	-	-	-	852 -
Stage 2	-	-	-	-	723 -
Platoon blocked, %		-	-	-	
Mov Cap-1 Maneuver	1330	-	-	-	515 864
Mov Cap-2 Maneuver	-	-	-	-	515 -
Stage 1	-	-	-	-	852 -
Stage 2	-	-	-	-	723 -

Approach	EB	WB	SB
HCM Control Delay, s	0	0	12
HCM LOS			B

Minor Lane/Major Mvmt	EBL	EBT	WBT	WBR	SBLn1
Capacity (veh/h)	1330	-	-	-	515
HCM Lane V/C Ratio	-	-	-	-	0.007
HCM Control Delay (s)	0	-	-	-	12
HCM Lane LOS	A	-	-	-	B
HCM 95th %tile Q(veh)	0	-	-	-	0

HCM 6th Signalized Intersection Summary

29: Schnoor Avenue & Cleveland Avenue

Village D Specific Plan
Existing WP - PM Peak Hour



Movement	EBL	EBT	EBR	WBL	WBT	WBR	NBL	NBT	NBR	SBL	SBT	SBR
Lane Configurations												
Traffic Volume (veh/h)	165	864	52	264	1174	103	80	216	148	110	203	157
Future Volume (veh/h)	165	864	52	264	1174	103	80	216	148	110	203	157
Initial Q (Qb), veh	0	0	0	0	0	0	0	0	0	0	0	0
Ped-Bike Adj(A_pbT)	1.00		0.98	1.00		0.98	1.00		0.98	1.00		0.99
Parking Bus, Adj	1.00	1.00	1.00	1.00	1.00	1.00	1.00	1.00	1.00	1.00	1.00	1.00
Work Zone On Approach		No			No			No			No	
Adj Sat Flow, veh/h/ln	1885	1885	1885	1885	1885	1885	1885	1885	1885	1885	1885	1885
Adj Flow Rate, veh/h	170	891	54	272	1210	106	82	223	153	113	209	162
Peak Hour Factor	0.97	0.97	0.97	0.97	0.97	0.97	0.97	0.97	0.97	0.97	0.97	0.97
Percent Heavy Veh, %	1	1	1	1	1	1	1	1	1	1	1	1
Cap, veh/h	204	1083	473	616	1309	572	105	776	620	187	938	415
Arrive On Green	0.11	0.30	0.30	0.18	0.37	0.37	0.06	0.22	0.22	0.10	0.26	0.26
Sat Flow, veh/h	1795	3582	1564	3483	3582	1566	1795	3582	1559	1795	3582	1583
Grp Volume(v), veh/h	170	891	54	272	1210	106	82	223	153	113	209	162
Grp Sat Flow(s),veh/h/ln	1795	1791	1564	1742	1791	1566	1795	1791	1559	1795	1791	1583
Q Serve(g_s), s	8.3	20.8	1.7	6.3	29.1	2.8	4.1	4.7	0.0	5.4	4.1	7.6
Cycle Q Clear(g_c), s	8.3	20.8	1.7	6.3	29.1	2.8	4.1	4.7	0.0	5.4	4.1	7.6
Prop In Lane	1.00		1.00	1.00		1.00	1.00		1.00	1.00		1.00
Lane Grp Cap(c), veh/h	204	1083	473	616	1309	572	105	776	620	187	938	415
V/C Ratio(X)	0.83	0.82	0.11	0.44	0.92	0.19	0.78	0.29	0.25	0.60	0.22	0.39
Avail Cap(c_a), veh/h	229	1297	566	616	1333	583	136	776	620	187	938	415
HCM Platoon Ratio	1.00	1.00	1.00	1.00	1.00	1.00	1.00	1.00	1.00	1.00	1.00	1.00
Upstream Filter(I)	1.00	1.00	1.00	0.15	0.15	0.15	1.00	1.00	1.00	1.00	1.00	1.00
Uniform Delay (d), s/veh	39.0	29.1	13.5	33.1	27.4	8.9	41.8	29.4	18.3	38.5	26.0	27.3
Incr Delay (d2), s/veh	20.4	3.7	0.1	0.1	2.0	0.0	19.1	0.9	0.9	5.4	0.5	2.8
Initial Q Delay(d3),s/veh	0.0	0.0	0.0	0.0	0.0	0.0	0.0	0.0	0.0	0.0	0.0	0.0
%ile BackOfQ(50%),veh/ln	4.8	9.2	0.8	2.6	12.2	1.4	2.3	2.1	2.2	2.6	1.8	3.1
Unsig. Movement Delay, s/veh												
LnGrp Delay(d),s/veh	59.4	32.9	13.6	33.1	29.4	9.0	60.9	30.4	19.3	44.0	26.6	30.1
LnGrp LOS	E	C	B	C	C	A	E	C	B	D	C	C
Approach Vol, veh/h		1115			1588			458			484	
Approach Delay, s/veh		36.0			28.7			32.1			31.8	
Approach LOS		D			C			C			C	
Timer - Assigned Phs	1	2	3	4	5	6	7	8				
Phs Duration (G+Y+Rc), s	13.9	24.0	20.4	31.7	9.8	28.1	14.7	37.4				
Change Period (Y+Rc), s	4.5	4.5	4.5	4.5	4.5	4.5	4.5	4.5				
Max Green Setting (Gmax), s	7.5	19.5	12.4	32.6	6.8	20.2	11.5	33.5				
Max Q Clear Time (g_c+I1), s	7.4	6.7	8.3	22.8	6.1	9.6	10.3	31.1				
Green Ext Time (p_c), s	0.0	1.6	0.4	4.4	0.0	1.4	0.1	1.8				

Intersection Summary

HCM 6th Ctrl Delay	31.8
HCM 6th LOS	C

HCM 6th Signalized Intersection Summary

30: Fairgrounds & Cleveland Avenue

Village D Specific Plan
Existing WP - PM Peak Hour



Movement	EBL	EBT	EBR	WBL	WBT	WBR	NBL	NBT	NBR	SBL	SBT	SBR
Lane Configurations	↑↑↑			↑↑		↑	↑↑	↑	↑	↑	↑	↑
Traffic Volume (veh/h)	89	956	91	155	1248	138	95	41	105	262	34	98
Future Volume (veh/h)	89	956	91	155	1248	138	95	41	105	262	34	98
Initial Q (Qb), veh	0	0	0	0	0	0	0	0	0	0	0	0
Ped-Bike Adj(A_pbT)	1.00		0.98	1.00		0.98	1.00		0.98	1.00		1.00
Parking Bus, Adj	1.00	1.00	1.00	1.00	1.00	1.00	1.00	1.00	1.00	1.00	1.00	1.00
Work Zone On Approach	No			No			No			No		
Adj Sat Flow, veh/h/ln	1885	1885	1885	1885	1885	1885	1900	1900	1900	1900	1900	1900
Adj Flow Rate, veh/h	94	1006	96	163	1314	145	100	94	77	276	36	103
Peak Hour Factor	0.95	0.95	0.95	0.95	0.95	0.95	0.95	0.95	0.95	0.95	0.95	0.95
Percent Heavy Veh, %	1	1	1	1	1	1	0	0	0	0	0	0
Cap, veh/h	119	1516	144	196	1293	564	280	391	325	303	128	366
Arrive On Green	0.13	0.64	0.64	0.15	0.48	0.48	0.08	0.21	0.21	0.17	0.30	0.30
Sat Flow, veh/h	1795	4772	454	1795	3582	1562	3619	1900	1582	1810	433	1239
Grp Volume(v), veh/h	94	723	379	163	1314	145	100	94	77	276	0	139
Grp Sat Flow(s),veh/h/ln	1795	1716	1795	1795	1791	1562	1810	1900	1582	1810	0	1672
Q Serve(g_s), s	4.6	11.9	12.0	7.9	32.5	5.0	2.4	3.7	2.7	13.5	0.0	5.7
Cycle Q Clear(g_c), s	4.6	11.9	12.0	7.9	32.5	5.0	2.4	3.7	2.7	13.5	0.0	5.7
Prop In Lane	1.00		0.25	1.00		1.00	1.00		1.00	1.00		0.74
Lane Grp Cap(c), veh/h	119	1090	570	196	1293	564	280	391	325	303	0	494
V/C Ratio(X)	0.79	0.66	0.66	0.83	1.02	0.26	0.36	0.24	0.24	0.91	0.00	0.28
Avail Cap(c_a), veh/h	130	1090	570	237	1293	564	280	391	325	303	0	494
HCM Platoon Ratio	2.00	2.00	2.00	1.33	1.33	1.33	1.00	1.00	1.00	1.00	1.00	1.00
Upstream Filter(l)	0.66	0.66	0.66	0.56	0.56	0.56	1.00	1.00	1.00	1.00	0.00	1.00
Uniform Delay (d), s/veh	38.5	13.4	13.4	37.6	23.4	16.2	39.4	29.9	16.2	36.8	0.0	24.4
Incr Delay (d2), s/veh	18.3	1.0	1.9	11.1	22.8	0.1	0.8	1.5	1.7	30.1	0.0	1.4
Initial Q Delay(d3),s/veh	0.0	0.0	0.0	0.0	0.0	0.0	0.0	0.0	0.0	0.0	0.0	0.0
%ile BackOfQ(50%),veh/ln	2.5	3.2	3.5	3.9	15.5	1.7	1.1	1.8	1.5	8.4	0.0	2.4
Unsig. Movement Delay, s/veh												
LnGrp Delay(d),s/veh	56.7	14.4	15.3	48.7	46.2	16.4	40.2	31.3	17.9	66.9	0.0	25.8
LnGrp LOS	E	B	B	D	F	B	D	C	B	E	A	C
Approach Vol, veh/h	1196			1622			271			415		
Approach Delay, s/veh	18.0			43.8			30.8			53.1		
Approach LOS	B			D			C			D		
Timer - Assigned Phs	1	2	3	4	5	6	7	8				
Phs Duration (G+Y+Rc), s	19.6	23.0	14.3	33.1	11.5	31.1	10.4	37.0				
Change Period (Y+Rc), s	4.5	4.5	4.5	4.5	4.5	4.5	4.5	4.5				
Max Green Setting (Gmax), s	14.5	18.5	11.9	27.1	6.4	26.6	6.5	32.5				
Max Q Clear Time (g_c+1.5), s	11.5	5.7	9.9	14.0	4.4	7.7	6.6	34.5				
Green Ext Time (p_c), s	0.0	0.5	0.1	6.1	0.0	0.7	0.0	0.0				

Intersection Summary

HCM 6th Ctrl Delay	35.1
HCM 6th LOS	D

Notes

User approved volume balancing among the lanes for turning movement.

HCM 6th Signalized Intersection Summary
 31: SR-99 Southbound Ramps & Cleveland Avenue

Village D Specific Plan
 Existing WP - PM Peak Hour



Movement	EBL	EBT	EBR	WBL	WBT	WBR	NBL	NBT	NBR	SBL	SBT	SBR
Lane Configurations		↑↑	↑	↑	↑↑					↑		↑
Traffic Volume (veh/h)	0	946	568	193	1787	0	0	0	0	212	0	92
Future Volume (veh/h)	0	946	568	193	1787	0	0	0	0	212	0	92
Initial Q (Qb), veh	0	0	0	0	0	0				0	0	0
Ped-Bike Adj(A_pbT)	1.00		1.00	1.00		1.00				1.00		1.00
Parking Bus, Adj	1.00	1.00	1.00	1.00	1.00	1.00				1.00	1.00	1.00
Work Zone On Approach		No			No						No	
Adj Sat Flow, veh/h/ln	0	1885	1885	1900	1900	0				1856	0	1856
Adj Flow Rate, veh/h	0	975	586	199	1842	0				219	0	95
Peak Hour Factor	0.97	0.97	0.97	0.97	0.97	0.97				0.97	0.97	0.97
Percent Heavy Veh, %	0	1	1	0	0	0				3	0	3
Cap, veh/h	0	1424	633	234	2082	0				571	0	508
Arrive On Green	0.00	0.40	0.40	0.26	1.00	0.00				0.32	0.00	0.32
Sat Flow, veh/h	0	3676	1592	1810	3705	0				1767	0	1572
Grp Volume(v), veh/h	0	975	586	199	1842	0				219	0	95
Grp Sat Flow(s),veh/h/ln	0	1791	1592	1810	1805	0				1767	0	1572
Q Serve(g_s), s	0.0	20.3	31.6	9.4	0.0	0.0				8.6	0.0	3.9
Cycle Q Clear(g_c), s	0.0	20.3	31.6	9.4	0.0	0.0				8.6	0.0	3.9
Prop In Lane	0.00		1.00	1.00		0.00				1.00		1.00
Lane Grp Cap(c), veh/h	0	1424	633	234	2082	0				571	0	508
V/C Ratio(X)	0.00	0.68	0.93	0.85	0.88	0.00				0.38	0.00	0.19
Avail Cap(c_a), veh/h	0	1453	645	372	2387	0				571	0	508
HCM Platoon Ratio	1.00	1.00	1.00	2.00	2.00	1.00				1.00	1.00	1.00
Upstream Filter(I)	0.00	0.62	0.62	0.29	0.29	0.00				1.00	0.00	1.00
Uniform Delay (d), s/veh	0.0	22.4	25.8	32.5	0.0	0.0				23.5	0.0	21.9
Incr Delay (d2), s/veh	0.0	0.8	13.5	3.3	1.2	0.0				1.9	0.0	0.8
Initial Q Delay(d3),s/veh	0.0	0.0	0.0	0.0	0.0	0.0				0.0	0.0	0.0
%ile BackOfQ(50%),veh/ln	0.0	8.3	13.7	3.7	0.3	0.0				3.8	0.0	1.5
Unsig. Movement Delay, s/veh												
LnGrp Delay(d),s/veh	0.0	23.3	39.3	35.8	1.2	0.0				25.5	0.0	22.7
LnGrp LOS	A	C	D	D	A	A				C	A	C
Approach Vol, veh/h		1561		2041						314		
Approach Delay, s/veh		29.3		4.6						24.6		
Approach LOS		C		A						C		
Timer - Assigned Phs			3	4		6			8			
Phs Duration (G+Y+Rc), s			16.1	40.3		33.6			56.4			
Change Period (Y+Rc), s			4.5	4.5		4.5			4.5			
Max Green Setting (Gmax), s			18.5	36.5		21.5			59.5			
Max Q Clear Time (g_c+I1), s			11.4	33.6		10.6			2.0			
Green Ext Time (p_c), s			0.3	2.2		0.7			27.4			
Intersection Summary												
HCM 6th Ctrl Delay		16.0										
HCM 6th LOS		B										

HCM 6th Signalized Intersection Summary
 32: SR-99 Northbound Ramps & Cleveland Avenue

Village D Specific Plan
 Existing WP - PM Peak Hour



Movement	EBL	EBT	EBR	WBL	WBT	WBR	NBL	NBT	NBR	SBL	SBT	SBR
Lane Configurations	↘	↑↑			↑↑	↗	↘	↖	↗			
Traffic Volume (veh/h)	102	1056	0	0	1140	237	840	5	265	0	0	0
Future Volume (veh/h)	102	1056	0	0	1140	237	840	5	265	0	0	0
Initial Q (Qb), veh	0	0	0	0	0	0	0	0	0			
Ped-Bike Adj(A_pbT)	1.00		1.00	1.00		0.99	1.00		0.99			
Parking Bus, Adj	1.00	1.00	1.00	1.00	1.00	1.00	1.00	1.00	1.00			
Work Zone On Approach	No				No				No			
Adj Sat Flow, veh/h/ln	1885	1885	0	0	1885	1885	1885	1885	1885			
Adj Flow Rate, veh/h	107	1112	0	0	1200	249	888	0	279			
Peak Hour Factor	0.95	0.95	0.95	0.95	0.95	0.95	0.95	0.95	0.95			
Percent Heavy Veh, %	1	1	0	0	1	1	1	1	1			
Cap, veh/h	136	1624	0	0	1174	519	1604	0	704			
Arrive On Green	0.15	0.91	0.00	0.00	0.33	0.33	0.45	0.00	0.45			
Sat Flow, veh/h	1795	3676	0	0	3676	1583	3591	0	1575			
Grp Volume(v), veh/h	107	1112	0	0	1200	249	888	0	279			
Grp Sat Flow(s),veh/h/ln	1795	1791	0	0	1791	1583	1795	0	1575			
Q Serve(g_s), s	5.2	6.9	0.0	0.0	29.5	11.3	16.4	0.0	10.7			
Cycle Q Clear(g_c), s	5.2	6.9	0.0	0.0	29.5	11.3	16.4	0.0	10.7			
Prop In Lane	1.00		0.00	0.00		1.00	1.00		1.00			
Lane Grp Cap(c), veh/h	136	1624	0	0	1174	519	1604	0	704			
V/C Ratio(X)	0.79	0.68	0.00	0.00	1.02	0.48	0.55	0.00	0.40			
Avail Cap(c_a), veh/h	289	1930	0	0	1174	519	1604	0	704			
HCM Platoon Ratio	2.00	2.00	1.00	1.00	1.00	1.00	1.00	1.00	1.00			
Upstream Filter(I)	0.69	0.69	0.00	0.00	0.51	0.51	1.00	0.00	1.00			
Uniform Delay (d), s/veh	37.5	2.6	0.0	0.0	30.3	24.1	18.3	0.0	16.7			
Incr Delay (d2), s/veh	6.9	0.6	0.0	0.0	24.6	0.4	1.4	0.0	1.7			
Initial Q Delay(d3),s/veh	0.0	0.0	0.0	0.0	0.0	0.0	0.0	0.0	0.0			
%ile BackOfQ(50%),veh/ln	2.4	1.2	0.0	0.0	16.2	4.2	6.8	0.0	4.0			
Unsig. Movement Delay, s/veh												
LnGrp Delay(d),s/veh	44.4	3.2	0.0	0.0	54.8	24.5	19.7	0.0	18.4			
LnGrp LOS	D	A	A	A	F	C	B	A	B			
Approach Vol, veh/h	1219				1449				1167			
Approach Delay, s/veh	6.8				49.6				19.4			
Approach LOS	A				D				B			
Timer - Assigned Phs	2		4		7		8					
Phs Duration (G+Y+Rc), s	44.7		45.3		11.3		34.0					
Change Period (Y+Rc), s	4.5		4.5		4.5		4.5					
Max Green Setting (Gmax), s	32.5		48.5		14.5		29.5					
Max Q Clear Time (g_c+I1), s	18.4		8.9		7.2		31.5					
Green Ext Time (p_c), s	4.1		10.6		0.1		0.0					

Intersection Summary

HCM 6th Ctrl Delay	26.8
HCM 6th LOS	C

Notes

User approved volume balancing among the lanes for turning movement.

HCM 6th Signalized Intersection Summary

33: Gateway Drive & Cleveland Avenue

Village D Specific Plan
Existing WP - PM Peak Hour



Movement	EBL	EBT	EBR	WBL	WBT	WBR	NBL	NBT	NBR	SBL	SBT	SBR
Lane Configurations	↖	↗	↘	↖	↗	↘	↖	↗	↘	↖	↗	↘
Traffic Volume (veh/h)	14	988	297	144	1016	104	342	112	210	155	124	22
Future Volume (veh/h)	14	988	297	144	1016	104	342	112	210	155	124	22
Initial Q (Qb), veh	0	0	0	0	0	0	0	0	0	0	0	0
Ped-Bike Adj(A_pbT)	1.00		1.00	1.00		0.99	1.00		0.98	1.00		0.98
Parking Bus, Adj	1.00	1.00	1.00	1.00	1.00	1.00	1.00	1.00	1.00	1.00	1.00	1.00
Work Zone On Approach		No			No			No			No	
Adj Sat Flow, veh/h/ln	1885	1885	1885	1870	1870	1870	1885	1885	1885	1856	1856	1856
Adj Flow Rate, veh/h	15	1051	0	153	1081	111	364	119	223	165	132	23
Peak Hour Factor	0.94	0.94	0.94	0.94	0.94	0.94	0.94	0.94	0.94	0.94	0.94	0.94
Percent Heavy Veh, %	1	1	1	2	2	2	1	1	1	3	3	3
Cap, veh/h	111	1333		439	1198	123	680	423	351	335	657	112
Arrive On Green	0.03	0.52	0.00	0.13	0.37	0.37	0.20	0.22	0.22	0.19	0.22	0.22
Sat Flow, veh/h	1795	5147	1598	3456	3251	334	3483	1885	1565	1767	3003	511
Grp Volume(v), veh/h	15	1051	0	153	590	602	364	119	223	165	76	79
Grp Sat Flow(s),veh/h/ln	1795	1716	1598	1728	1777	1808	1742	1885	1565	1767	1763	1751
Q Serve(g_s), s	0.0	15.0	0.0	3.6	28.3	28.3	8.5	4.7	11.6	7.5	3.2	3.3
Cycle Q Clear(g_c), s	0.0	15.0	0.0	3.6	28.3	28.3	8.5	4.7	11.6	7.5	3.2	3.3
Prop In Lane	1.00		1.00	1.00		0.18	1.00		1.00	1.00		0.29
Lane Grp Cap(c), veh/h	111	1333		439	655	666	680	423	351	335	386	383
V/C Ratio(X)	0.13	0.79		0.35	0.90	0.90	0.54	0.28	0.63	0.49	0.20	0.21
Avail Cap(c_a), veh/h	180	1784		439	685	697	680	423	351	335	386	383
HCM Platoon Ratio	2.00	2.00	2.00	1.00	1.00	1.00	1.00	1.00	1.00	1.00	1.00	1.00
Upstream Filter(I)	0.76	0.76	0.00	0.88	0.88	0.88	1.00	1.00	1.00	1.00	1.00	1.00
Uniform Delay (d), s/veh	42.7	19.7	0.0	35.9	26.9	26.9	32.6	28.9	31.6	32.6	28.7	28.8
Incr Delay (d2), s/veh	0.4	1.3	0.0	0.4	13.3	13.3	0.8	1.7	8.5	1.1	1.1	1.2
Initial Q Delay(d3),s/veh	0.0	0.0	0.0	0.0	0.0	0.0	0.0	0.0	0.0	0.0	0.0	0.0
%ile BackOfQ(50%),veh/ln	0.3	4.3	0.0	1.5	13.8	14.1	3.6	2.3	5.1	3.3	1.4	1.5
Unsig. Movement Delay, s/veh												
LnGrp Delay(d),s/veh	43.1	21.0	0.0	36.3	40.2	40.2	33.4	30.5	40.0	33.7	29.8	30.0
LnGrp LOS	D	C		D	D	D	C	C	D	C	C	C
Approach Vol, veh/h		1066	A		1345			706			320	
Approach Delay, s/veh		21.3			39.7			35.0			31.9	
Approach LOS		C			D			D			C	
Timer - Assigned Phs	1	2	3	4	5	6	7	8				
Phs Duration (G+Y+Rc), s	22.1	24.2	6.1	37.7	21.6	24.7	15.9	27.8				
Change Period (Y+Rc), s	4.5	4.5	4.5	4.5	4.5	4.5	4.5	4.5				
Max Green Setting (G_max), s	12.6	19.7	5.0	34.7	12.1	20.2	8.5	31.2				
Max Q Clear Time (g_c+I), s	10.5	5.3	2.0	30.3	9.5	13.6	5.6	17.0				
Green Ext Time (p_c), s	0.3	0.6	0.0	2.8	0.1	0.8	0.1	6.3				

Intersection Summary

HCM 6th Ctrl Delay	32.3
HCM 6th LOS	C

Notes

Unsignalized Delay for [EBR] is excluded from calculations of the approach delay and intersection delay.

HCM 6th Signalized Intersection Summary
34: Cleveland Avenue & County Club Drive

Village D Specific Plan
Existing WP - PM Peak Hour



Movement	WBL	WBR	NBT	NBR	SBL	SBT
Lane Configurations	YY		↑↑	↑	Y	↑↑↑
Traffic Volume (veh/h)	608	26	763	589	75	658
Future Volume (veh/h)	608	26	763	589	75	658
Initial Q (Qb), veh	0	0	0	0	0	0
Ped-Bike Adj(A_pbT)	1.00	1.00		1.00	1.00	
Parking Bus, Adj	1.00	1.00	1.00	1.00	1.00	1.00
Work Zone On Approach	No		No		No	
Adj Sat Flow, veh/h/ln	1900	1900	1900	1900	1900	1900
Adj Flow Rate, veh/h	665	0	803	0	79	693
Peak Hour Factor	0.95	0.95	0.95	0.95	0.95	0.95
Percent Heavy Veh, %	0	0	0	0	0	0
Cap, veh/h	809	360	2442		482	3509
Arrive On Green	0.22	0.00	0.68	0.00	0.68	0.68
Sat Flow, veh/h	3619	1610	3705	1610	688	5358
Grp Volume(v), veh/h	665	0	803	0	79	693
Grp Sat Flow(s),veh/h/ln	1810	1610	1805	1610	688	1729
Q Serve(g_s), s	15.7	0.0	8.3	0.0	4.9	4.5
Cycle Q Clear(g_c), s	15.7	0.0	8.3	0.0	13.2	4.5
Prop In Lane	1.00	1.00		1.00	1.00	
Lane Grp Cap(c), veh/h	809	360	2442		482	3509
V/C Ratio(X)	0.82	0.00	0.33		0.16	0.20
Avail Cap(c_a), veh/h	1428	635	2442		482	3509
HCM Platoon Ratio	1.00	1.00	1.00	1.00	1.00	1.00
Upstream Filter(I)	1.00	0.00	0.72	0.00	1.00	1.00
Uniform Delay (d), s/veh	33.2	0.0	6.1	0.0	8.8	5.4
Incr Delay (d2), s/veh	2.2	0.0	0.3	0.0	0.7	0.1
Initial Q Delay(d3),s/veh	0.0	0.0	0.0	0.0	0.0	0.0
%ile BackOfQ(50%),veh/ln	7.0	0.0	2.8	0.0	0.8	1.4
Unsig. Movement Delay, s/veh						
LnGrp Delay(d),s/veh	35.4	0.0	6.3	0.0	9.5	5.6
LnGrp LOS	D	A	A		A	A
Approach Vol, veh/h	665		803	A		772
Approach Delay, s/veh	35.4		6.3			6.0
Approach LOS	D		A			A
Timer - Assigned Phs		2			6	8
Phs Duration (G+Y+Rc), s		65.4			65.4	24.6
Change Period (Y+Rc), s		4.5			4.5	4.5
Max Green Setting (Gmax), s		45.5			45.5	35.5
Max Q Clear Time (g_c+I1), s		10.3			15.2	17.7
Green Ext Time (p_c), s		6.6			6.2	2.4

Intersection Summary

HCM 6th Ctrl Delay	14.8
HCM 6th LOS	B

Notes

User approved volume balancing among the lanes for turning movement.
Unsignalized Delay for [NBR] is excluded from calculations of the approach delay and intersection delay.

Intersection						
Int Delay, s/veh	0.2					
Movement	EBL	EBR	NBL	NBT	SBT	SBR
Lane Configurations	T			T		
Traffic Vol, veh/h	2	16	5	731	631	1
Future Vol, veh/h	2	16	5	731	631	1
Conflicting Peds, #/hr	0	0	0	0	0	0
Sign Control	Stop	Stop	Free	Free	Free	Free
RT Channelized	-	None	-	None	-	None
Storage Length	0	-	-	-	-	-
Veh in Median Storage, #	0	-	-	0	0	-
Grade, %	0	-	-	0	0	-
Peak Hour Factor	94	94	94	94	94	94
Heavy Vehicles, %	0	0	1	1	1	1
Mvmt Flow	2	17	5	778	671	1

Major/Minor	Minor2	Major1		Major2	
Conflicting Flow All	1071	336	672	0	0
Stage 1	672	-	-	-	-
Stage 2	399	-	-	-	-
Critical Hdwy	6.8	6.9	4.12	-	-
Critical Hdwy Stg 1	5.8	-	-	-	-
Critical Hdwy Stg 2	5.8	-	-	-	-
Follow-up Hdwy	3.5	3.3	2.21	-	-
Pot Cap-1 Maneuver	*446	666	921	-	-
Stage 1	*474	-	-	-	-
Stage 2	*754	-	-	-	-
Platoon blocked, %	1	-	-	-	-
Mov Cap-1 Maneuver	*441	666	921	-	-
Mov Cap-2 Maneuver	*426	-	-	-	-
Stage 1	*469	-	-	-	-
Stage 2	*754	-	-	-	-





















Approach	EB	NB	SB
HCM Control Delay, s	10.9	0.1	0
HCM LOS	B		

Minor Lane/Major Mvmt	NBL	NBT	EBLn1	SBT	SBR
Capacity (veh/h)	921	-	627	-	-
HCM Lane V/C Ratio	0.006	-	0.031	-	-
HCM Control Delay (s)	8.9	0	10.9	-	-
HCM Lane LOS	A	A	B	-	-
HCM 95th %tile Q(veh)	0	-	0.1	-	-

Notes
 -: Volume exceeds capacity \$: Delay exceeds 300s +: Computation Not Defined *: All major volume in platoon

HCM 6th Signalized Intersection Summary
36: Pine Street & Howard Road

Village D Specific Plan
Existing WP - PM Peak Hour

												
Movement	EBL	EBT	EBR	WBL	WBT	WBR	NBL	NBT	NBR	SBL	SBT	SBR
Lane Configurations												
Traffic Volume (veh/h)	85	760	140	86	844	3	232	169	138	15	137	119
Future Volume (veh/h)	85	760	140	86	844	3	232	169	138	15	137	119
Initial Q (Qb), veh	0	0	0	0	0	0	0	0	0	0	0	0
Ped-Bike Adj(A_pbT)	1.00		0.95	1.00		0.95	1.00		0.99	1.00		1.00
Parking Bus, Adj	1.00	1.00	1.00	1.00	1.00	1.00	1.00	1.00	1.00	1.00	1.00	1.00
Work Zone On Approach		No			No			No			No	
Adj Sat Flow, veh/h/ln	1870	1870	1870	1885	1885	1885	1885	1885	1885	1870	1870	1870
Adj Flow Rate, veh/h	91	817	151	92	908	3	249	182	148	16	147	128
Peak Hour Factor	0.93	0.93	0.93	0.93	0.93	0.93	0.93	0.93	0.93	0.93	0.93	0.93
Percent Heavy Veh, %	2	2	2	1	1	1	1	1	1	2	2	2
Cap, veh/h	145	887	164	117	1035	3	574	602	504	21	195	184
Arrive On Green	0.08	0.30	0.30	0.07	0.28	0.28	0.32	0.32	0.32	0.12	0.12	0.12
Sat Flow, veh/h	1781	2967	548	1795	3661	12	1795	1885	1577	183	1679	1585
Grp Volume(v), veh/h	91	489	479	92	444	467	249	182	148	163	0	128
Grp Sat Flow(s),veh/h/ln	1781	1777	1739	1795	1791	1882	1795	1885	1577	1861	0	1585
Q Serve(g_s), s	4.4	24.0	24.0	4.5	21.3	21.3	9.9	6.5	6.3	7.6	0.0	7.0
Cycle Q Clear(g_c), s	4.4	24.0	24.0	4.5	21.3	21.3	9.9	6.5	6.3	7.6	0.0	7.0
Prop In Lane	1.00		0.32	1.00		0.01	1.00		1.00	0.10		1.00
Lane Grp Cap(c), veh/h	145	531	520	117	506	532	574	602	504	216	0	184
V/C Ratio(X)	0.63	0.92	0.92	0.78	0.88	0.88	0.43	0.30	0.29	0.75	0.00	0.70
Avail Cap(c_a), veh/h	145	543	531	130	547	575	574	602	504	372	0	317
HCM Platoon Ratio	1.00	1.00	1.00	1.00	1.00	1.00	1.00	1.00	1.00	1.00	1.00	1.00
Upstream Filter(l)	1.00	1.00	1.00	0.86	0.86	0.86	1.00	1.00	1.00	1.00	0.00	1.00
Uniform Delay (d), s/veh	40.0	30.5	30.5	41.4	30.8	30.8	24.2	23.1	23.0	38.5	0.0	38.2
Incr Delay (d2), s/veh	8.2	21.0	21.3	21.3	12.5	12.0	2.4	1.3	1.5	5.3	0.0	4.7
Initial Q Delay(d3),s/veh	0.0	0.0	0.0	0.0	0.0	0.0	0.0	0.0	0.0	0.0	0.0	0.0
%ile BackOfQ(50%),veh/ln	2.3	13.0	12.7	2.7	10.6	11.1	4.5	3.1	0.2	3.7	0.0	2.9
Unsig. Movement Delay, s/veh												
LnGrp Delay(d),s/veh	48.2	51.5	51.9	62.7	43.3	42.8	26.6	24.4	24.5	43.8	0.0	42.9
LnGrp LOS	D	D	D	E	D	D	C	C	C	D	A	D
Approach Vol, veh/h		1059			1003			579				291
Approach Delay, s/veh		51.4			44.9			25.3				43.4
Approach LOS		D			D			C				D
Timer - Assigned Phs		2	3	4		6	7	8				
Phs Duration (G+Y+Rc), s		33.3	10.4	31.4		15.0	11.8	29.9				
Change Period (Y+Rc), s		4.5	4.5	4.5		4.5	4.5	4.5				
Max Green Setting (Gmax), s		20.0	6.5	27.5		18.0	6.5	27.5				
Max Q Clear Time (g_c+I1), s		11.9	6.5	26.0		9.6	6.4	23.3				
Green Ext Time (p_c), s		1.6	0.0	0.9		0.8	0.0	2.2				
Intersection Summary												
HCM 6th Ctrl Delay			43.2									
HCM 6th LOS			D									

HCM 6th Signalized Intersection Summary

37: Olive Avenue/Q Street & Howard Road/Yosemite Avenue

Village D Specific Plan
Existing WP - PM Peak Hour



Movement	EBL	EBT	EBR	WBL	WBT	WBR	NBL	NBT	NBR	SBL	SBT	SBR
Lane Configurations	↙	↑↑	↗	↙	↑↑		↙	↖	↗	↙	↑	↗
Traffic Volume (veh/h)	7	465	420	12	397	14	596	74	12	16	55	2
Future Volume (veh/h)	7	465	420	12	397	14	596	74	12	16	55	2
Initial Q (Qb), veh	0	0	0	0	0	0	0	0	0	0	0	0
Ped-Bike Adj(A_pbT)	1.00		1.00	1.00		0.99	1.00		0.99	1.00		0.99
Parking Bus, Adj	1.00	1.00	1.00	1.00	1.00	1.00	1.00	1.00	1.00	1.00	1.00	1.00
Work Zone On Approach		No			No			No			No	
Adj Sat Flow, veh/h/ln	1885	1885	1885	1885	1885	1885	1900	1900	1900	1885	1885	1885
Adj Flow Rate, veh/h	8	528	0	14	451	16	737	0	14	18	62	2
Peak Hour Factor	0.88	0.88	0.88	0.88	0.88	0.88	0.88	0.88	0.88	0.88	0.88	0.88
Percent Heavy Veh, %	1	1	1	1	1	1	0	0	0	1	1	1
Cap, veh/h	124	644		100	586	21	1851	0	812	96	100	84
Arrive On Green	0.02	0.06	0.00	0.06	0.17	0.17	0.51	0.00	0.51	0.05	0.05	0.05
Sat Flow, veh/h	1795	3582	1598	1795	3528	125	3619	0	1588	1795	1885	1580
Grp Volume(v), veh/h	8	528	0	14	229	238	737	0	14	18	62	2
Grp Sat Flow(s),veh/h/ln	1795	1791	1598	1795	1791	1862	1810	0	1588	1795	1885	1580
Q Serve(g_s), s	0.4	13.1	0.0	0.7	11.0	11.0	11.2	0.0	0.4	0.9	2.9	0.1
Cycle Q Clear(g_c), s	0.4	13.1	0.0	0.7	11.0	11.0	11.2	0.0	0.4	0.9	2.9	0.1
Prop In Lane	1.00		1.00	1.00		0.07	1.00		1.00	1.00		1.00
Lane Grp Cap(c), veh/h	124	644		100	298	309	1851	0	812	96	100	84
V/C Ratio(X)	0.06	0.82		0.14	0.77	0.77	0.40	0.00	0.02	0.19	0.62	0.02
Avail Cap(c_a), veh/h	289	716		359	428	445	1851	0	812	359	377	316
HCM Platoon Ratio	0.33	0.33	0.33	1.00	1.00	1.00	1.00	1.00	1.00	1.00	1.00	1.00
Upstream Filter(I)	0.48	0.48	0.00	1.00	1.00	1.00	1.00	0.00	1.00	1.00	1.00	1.00
Uniform Delay (d), s/veh	41.1	40.9	0.0	40.5	35.9	35.9	13.5	0.0	10.8	40.7	41.7	40.4
Incr Delay (d2), s/veh	0.1	3.4	0.0	0.6	5.2	5.1	0.6	0.0	0.0	0.9	6.0	0.1
Initial Q Delay(d3),s/veh	0.0	0.0	0.0	0.0	0.0	0.0	0.0	0.0	0.0	0.0	0.0	0.0
%ile BackOfQ(50%),veh/ln	0.2	6.6	0.0	0.3	5.1	5.4	4.5	0.0	0.1	0.4	1.5	0.0
Unsig. Movement Delay, s/veh												
LnGrp Delay(d),s/veh	41.2	44.3	0.0	41.1	41.0	41.0	14.1	0.0	10.9	41.7	47.7	40.5
LnGrp LOS	D	D		D	D	D	B	A	B	D	D	D
Approach Vol, veh/h		536	A		481		751				82	
Approach Delay, s/veh		44.3			41.0		14.1				46.2	
Approach LOS		D			D		B				D	
Timer - Assigned Phs		2	3	4		6	7	8				
Phs Duration (G+Y+Rc), s		50.5	9.5	20.7		9.3	10.7	19.5				
Change Period (Y+Rc), s		4.5	4.5	4.5		4.5	4.5	4.5				
Max Green Setting (Gmax), s		18.0	18.0	18.0		18.0	14.5	21.5				
Max Q Clear Time (g_c+I1), s		13.2	2.7	15.1		4.9	2.4	13.0				
Green Ext Time (p_c), s		1.4	0.0	1.0		0.2	0.0	1.8				

Intersection Summary

HCM 6th Ctrl Delay	31.3
HCM 6th LOS	C

Notes

User approved volume balancing among the lanes for turning movement.
Unsignalized Delay for [EBR] is excluded from calculations of the approach delay and intersection delay.

HCM 6th TWSC
 38: I Street & 2nd Street/SR-99 Southbound Off-Ramp

Village D Specific Plan
 Existing WP - PM Peak Hour

Intersection												
Int Delay, s/veh	8.9											
Movement	EBL	EBT	EBR	WBL	WBT	WBR	NBL	NBT	NBR	SBL	SBT	SBR
Lane Configurations		↕↔			↕	↕	↕	↕			↕	
Traffic Vol, veh/h	0	0	32	287	10	4	42	141	0	0	112	0
Future Vol, veh/h	0	0	32	287	10	4	42	141	0	0	112	0
Conflicting Peds, #/hr	0	0	0	0	0	0	1	0	1	1	0	1
Sign Control	Stop	Stop	Stop	Stop	Stop	Stop	Free	Free	Free	Free	Free	Free
RT Channelized	-	-	None	-	-	Stop	-	-	None	-	-	None
Storage Length	-	-	-	-	-	50	75	-	-	-	-	-
Veh in Median Storage, #	-	0	-	-	0	-	-	0	-	-	0	-
Grade, %	-	0	-	-	0	-	-	0	-	-	0	-
Peak Hour Factor	98	98	98	98	98	98	98	98	98	98	98	98
Heavy Vehicles, %	0	0	0	2	2	2	0	0	0	0	0	0
Mvmt Flow	0	0	33	293	10	4	43	144	0	0	114	0

Major/Minor	Minor2		Minor1		Major1		Major2					
Conflicting Flow All	350	345	115	361	345	144	115	0	-	-	-	0
Stage 1	115	115	-	230	230	-	-	-	-	-	-	-
Stage 2	235	230	-	131	115	-	-	-	-	-	-	-
Critical Hdwy	7.1	6.5	6.2	7.12	6.52	6.22	4.1	-	-	-	-	-
Critical Hdwy Stg 1	6.1	5.5	-	6.12	5.52	-	-	-	-	-	-	-
Critical Hdwy Stg 2	6.1	5.5	-	6.12	5.52	-	-	-	-	-	-	-
Follow-up Hdwy	3.5	4	3.3	3.518	4.018	3.318	2.2	-	-	-	-	-
Pot Cap-1 Maneuver	661	615	943	645	611	980	1487	-	0	0	-	-
Stage 1	895	804	-	824	738	-	-	-	0	0	-	-
Stage 2	823	741	-	873	800	-	-	-	0	0	-	-
Platoon blocked, %	1	1		1	1	1		-			-	-
Mov Cap-1 Maneuver	634	596	942	609	593	980	1486	-	-	-	-	-
Mov Cap-2 Maneuver	634	596	-	609	593	-	-	-	-	-	-	-
Stage 1	868	803	-	800	716	-	-	-	-	-	-	-
Stage 2	784	720	-	843	799	-	-	-	-	-	-	-

Approach	EB		WB		NB		SB	
HCM Control Delay, s	9		16.6		1.7		0	
HCM LOS	A		C					

Minor Lane/Major Mvmt	NBL	NBT	EBLn1	WBLn1	WBLn2	SBT	SBR
Capacity (veh/h)	1486	-	942	608	980	-	-
HCM Lane V/C Ratio	0.029	-	0.035	0.498	0.004	-	-
HCM Control Delay (s)	7.5	-	9	16.7	8.7	-	-
HCM Lane LOS	A	-	A	C	A	-	-
HCM 95th %tile Q(veh)	0.1	-	0.1	2.8	0	-	-

HCM 6th Signalized Intersection Summary
39: 4th Street & Sunset Avenue

Village D Specific Plan
Existing WP - PM Peak Hour



Movement	EBL	EBR	NBL	NBT	SBT	SBR
Lane Configurations						
Traffic Volume (veh/h)	237	12	13	331	346	377
Future Volume (veh/h)	237	12	13	331	346	377
Initial Q (Qb), veh	0	0	0	0	0	0
Ped-Bike Adj(A_pbT)	1.00	1.00	1.00			1.00
Parking Bus, Adj	1.00	1.00	1.00	1.00	1.00	1.00
Work Zone On Approach	No			No	No	
Adj Sat Flow, veh/h/ln	1900	1900	1870	1870	1870	1870
Adj Flow Rate, veh/h	278	0	15	372	389	424
Peak Hour Factor	0.89	0.89	0.89	0.89	0.89	0.89
Percent Heavy Veh, %	0	0	2	2	2	2
Cap, veh/h	374	166	475	2867	926	948
Arrive On Green	0.10	0.00	0.27	0.81	0.83	0.83
Sat Flow, veh/h	3619	1610	1781	3647	1870	1583
Grp Volume(v), veh/h	278	0	15	372	389	424
Grp Sat Flow(s),veh/h/ln	1810	1610	1781	1777	1870	1583
Q Serve(g_s), s	7.5	0.0	0.6	2.3	5.5	6.7
Cycle Q Clear(g_c), s	7.5	0.0	0.6	2.3	5.5	6.7
Prop In Lane	1.00	1.00	1.00			1.00
Lane Grp Cap(c), veh/h	374	166	475	2867	926	948
V/C Ratio(X)	0.74	0.00	0.03	0.13	0.42	0.45
Avail Cap(c_a), veh/h	995	443	475	2867	926	948
HCM Platoon Ratio	1.00	1.00	1.00	1.00	1.67	1.67
Upstream Filter(I)	1.00	0.00	1.00	1.00	0.76	0.76
Uniform Delay (d), s/veh	43.5	0.0	27.1	2.1	4.9	3.2
Incr Delay (d2), s/veh	2.9	0.0	0.0	0.1	1.1	1.2
Initial Q Delay(d3),s/veh	0.0	0.0	0.0	0.0	0.0	0.0
%ile BackOfQ(50%),veh/ln	3.5	0.0	0.3	0.6	1.9	2.1
Unsig. Movement Delay, s/veh						
LnGrp Delay(d),s/veh	46.5	0.0	27.1	2.2	5.9	4.4
LnGrp LOS	D	A	C	A	A	A
Approach Vol, veh/h	278			387	813	
Approach Delay, s/veh	46.5			3.1	5.1	
Approach LOS	D			A	A	
Timer - Assigned Phs		2		4	5	6
Phs Duration (G+Y+Rc), s		85.2		14.8	31.2	54.0
Change Period (Y+Rc), s		4.5		4.5	4.5	4.5
Max Green Setting (Gmax), s		63.5		27.5	9.5	49.5
Max Q Clear Time (g_c+I1), s		4.3		9.5	2.6	8.7
Green Ext Time (p_c), s		2.8		0.9	0.0	4.4

Intersection Summary

HCM 6th Ctrl Delay	12.4
HCM 6th LOS	B

Notes

User approved volume balancing among the lanes for turning movement.

40: H Street & SR-99 Southbound On-Ramp/2nd Street Performance by movement

Movement	WBL	WBT	WBR	NBL	NBT	NBR	SBL	SBT	All
Denied Delay (hr)	0.0	0.0	0.0	0.0	0.0	0.0	0.0	0.0	0.0
Denied Del/Veh (s)	0.1	0.1	0.1	0.0	0.0	0.0	0.1	0.1	0.0
Total Delay (hr)	0.0	0.2	0.0	0.2	0.0	0.0	0.0	0.1	0.5
Total Del/Veh (s)	8.9	13.4	2.3	2.7	3.3	1.3	5.3	13.4	4.9
Stop Delay (hr)	0.0	0.1	0.0	0.0	0.0	0.0	0.0	0.1	0.2
Stop Del/Veh (s)	6.8	9.8	2.2	0.2	0.1	0.0	4.3	10.6	2.2

HCM 6th Signalized Intersection Summary
41: I Street & 4th Street

Village D Specific Plan
Existing WP - PM Peak Hour



Movement	EBL	EBT	EBR	WBL	WBT	WBR	NBL	NBT	NBR	SBL	SBT	SBR
Lane Configurations												
Traffic Volume (veh/h)	31	537	61	59	507	106	96	68	244	183	163	120
Future Volume (veh/h)	31	537	61	59	507	106	96	68	244	183	163	120
Initial Q (Qb), veh	0	0	0	0	0	0	0	0	0	0	0	0
Ped-Bike Adj(A_pbT)	1.00		0.99	1.00		0.99	1.00		1.00	1.00		0.99
Parking Bus, Adj	1.00	1.00	1.00	1.00	1.00	1.00	1.00	1.00	1.00	1.00	1.00	1.00
Work Zone On Approach		No		No		No		No		No		No
Adj Sat Flow, veh/h/ln	1856	1856	1856	1885	1885	1885	1885	1885	1885	1870	1870	1870
Adj Flow Rate, veh/h	35	603	69	66	570	119	108	76	274	206	183	135
Peak Hour Factor	0.89	0.89	0.89	0.89	0.89	0.89	0.89	0.89	0.89	0.89	0.89	0.89
Percent Heavy Veh, %	3	3	3	1	1	1	1	1	1	2	2	2
Cap, veh/h	67	719	82	86	693	144	401	443	375	555	604	505
Arrive On Green	0.04	0.23	0.23	0.05	0.24	0.24	0.22	0.23	0.23	0.31	0.32	0.32
Sat Flow, veh/h	1767	3185	364	1795	2946	613	1795	1885	1598	1781	1870	1564
Grp Volume(v), veh/h	35	333	339	66	346	343	108	76	274	206	183	135
Grp Sat Flow(s),veh/h/ln	1767	1763	1786	1795	1791	1769	1795	1885	1598	1781	1870	1564
Q Serve(g_s), s	1.9	18.0	18.1	3.6	18.3	18.4	5.0	3.2	15.8	9.0	7.3	6.4
Cycle Q Clear(g_c), s	1.9	18.0	18.1	3.6	18.3	18.4	5.0	3.2	15.8	9.0	7.3	6.4
Prop In Lane	1.00		0.20	1.00		0.35	1.00		1.00	1.00		1.00
Lane Grp Cap(c), veh/h	67	398	403	86	421	416	401	443	375	555	604	505
V/C Ratio(X)	0.52	0.84	0.84	0.77	0.82	0.82	0.27	0.17	0.73	0.37	0.30	0.27
Avail Cap(c_a), veh/h	115	485	491	171	546	539	401	443	375	555	604	505
HCM Platoon Ratio	1.00	1.00	1.00	1.00	1.00	1.00	1.00	1.00	1.00	1.00	1.00	1.00
Upstream Filter(I)	0.96	0.96	0.96	1.00	1.00	1.00	1.00	1.00	1.00	1.00	1.00	1.00
Uniform Delay (d), s/veh	47.2	37.0	37.0	47.1	36.2	36.3	32.1	30.5	35.3	26.8	25.4	25.1
Incr Delay (d2), s/veh	5.8	10.0	10.1	13.6	7.6	8.0	0.4	0.8	11.8	0.4	1.3	1.3
Initial Q Delay(d3),s/veh	0.0	0.0	0.0	0.0	0.0	0.0	0.0	0.0	0.0	0.0	0.0	0.0
%ile BackOfQ(50%),veh/ln	0	8.8	8.9	1.9	8.8	8.7	2.2	1.6	7.3	3.8	3.4	2.5
Unsig. Movement Delay, s/veh												
LnGrp Delay(d),s/veh	53.0	47.0	47.1	60.7	43.8	44.2	32.4	31.3	47.1	27.2	26.7	26.4
LnGrp LOS	D	D	D	E	D	D	C	C	D	C	C	C
Approach Vol, veh/h		707			755			458			524	
Approach Delay, s/veh		47.3			45.5			41.0			26.8	
Approach LOS		D			D			D			C	
Timer - Assigned Phs	1	2	3	4	5	6	7	8				
Phs Duration (G+Y+Rc), s	35.7	28.0	9.3	27.1	26.9	36.8	8.3	28.0				
Change Period (Y+Rc), s	4.5	4.5	4.5	4.5	4.5	4.5	4.5	4.5				
Max Green Setting (Gmax), s	21.5	23.5	9.5	27.5	12.7	32.3	6.5	30.5				
Max Q Clear Time (g_c+I), s	11.0	17.8	5.6	20.1	7.0	9.3	3.9	20.4				
Green Ext Time (p_c), s	0.4	0.7	0.0	2.5	0.1	1.5	0.0	3.1				
Intersection Summary												
HCM 6th Ctrl Delay				41.2								
HCM 6th LOS				D								

HCM 6th Signalized Intersection Summary
43: SR-99 Northbound Off-Ramp/H Street & 4th Street

Village D Specific Plan
Existing WP - PM Peak Hour



Movement	EBL	EBT	EBR	WBL	WBT	WBR	NBL	NBT	NBR	SBL	SBT	SBR
Lane Configurations												
Traffic Volume (veh/h)	253	436	0	0	518	141	239	19	144	20	0	66
Future Volume (veh/h)	253	436	0	0	518	141	239	19	144	20	0	66
Initial Q (Qb), veh	0	0	0	0	0	0	0	0	0	0	0	0
Ped-Bike Adj(A_pbT)	1.00		1.00	1.00		0.99	1.00		0.99	1.00		0.99
Parking Bus, Adj	1.00	1.00	1.00	1.00	1.00	1.00	1.00	1.00	1.00	1.00	1.00	1.00
Work Zone On Approach		No			No			No			No	
Adj Sat Flow, veh/h/ln	1885	1885	0	0	1885	1885	1885	1885	1885	1900	1900	1900
Adj Flow Rate, veh/h	269	464	0	0	551	150	254	20	153	21	0	70
Peak Hour Factor	0.94	0.94	0.94	0.94	0.94	0.94	0.94	0.94	0.94	0.94	0.94	0.94
Percent Heavy Veh, %	1	1	0	0	1	1	1	1	1	0	0	0
Cap, veh/h	303	1564	0	0	619	168	446	46	353	68	0	226
Arrive On Green	0.17	0.44	0.00	0.00	0.22	0.22	0.25	0.25	0.25	0.18	0.00	0.18
Sat Flow, veh/h	1795	3676	0	0	2872	753	1795	186	1419	377	0	1258
Grp Volume(v), veh/h	269	464	0	0	355	346	254	0	173	91	0	0
Grp Sat Flow(s),veh/h/ln	1795	1791	0	0	1791	1740	1795	0	1605	1635	0	0
Q Serve(g_s), s	14.7	8.4	0.0	0.0	19.2	19.3	12.4	0.0	9.1	4.8	0.0	0.0
Cycle Q Clear(g_c), s	14.7	8.4	0.0	0.0	19.2	19.3	12.4	0.0	9.1	4.8	0.0	0.0
Prop In Lane	1.00		0.00	0.00		0.43	1.00		0.88	0.23		0.77
Lane Grp Cap(c), veh/h	303	1564	0	0	399	388	446	0	399	294	0	0
V/C Ratio(X)	0.89	0.30	0.00	0.00	0.89	0.89	0.57	0.00	0.43	0.31	0.00	0.00
Avail Cap(c_a), veh/h	350	1701	0	0	421	409	446	0	399	294	0	0
HCM Platoon Ratio	1.00	1.00	1.00	1.00	1.00	1.00	1.00	1.00	1.00	1.00	1.00	1.00
Upstream Filter(l)	1.00	1.00	0.00	0.00	1.00	1.00	1.00	0.00	1.00	1.00	0.00	0.00
Uniform Delay (d), s/veh	40.6	18.2	0.0	0.0	37.7	37.7	32.9	0.0	31.7	35.6	0.0	0.0
Incr Delay (d2), s/veh	21.2	0.1	0.0	0.0	19.5	20.7	5.2	0.0	3.4	2.7	0.0	0.0
Initial Q Delay(d3),s/veh	0.0	0.0	0.0	0.0	0.0	0.0	0.0	0.0	0.0	0.0	0.0	0.0
%ile BackOfQ(50%),veh/ln	8.2	3.4	0.0	0.0	10.4	10.3	6.0	0.0	3.9	2.1	0.0	0.0
Unsig. Movement Delay, s/veh												
LnGrp Delay(d),s/veh	61.8	18.3	0.0	0.0	57.1	58.4	38.1	0.0	35.1	38.3	0.0	0.0
LnGrp LOS	E	B	A	A	E	E	D	A	D	D	A	A
Approach Vol, veh/h		733			701			427			91	
Approach Delay, s/veh		34.3			57.8			36.9			38.3	
Approach LOS		C			E			D			D	
Timer - Assigned Phs		2		4		6	7	8				
Phs Duration (G+Y+Rc), s		29.3		48.2		22.5	21.4	26.8				
Change Period (Y+Rc), s		4.5		4.5		4.5	4.5	4.5				
Max Green Setting (Gmax), s		21.0		47.5		18.0	19.5	23.5				
Max Q Clear Time (g_c+I1), s		14.4		10.4		6.8	16.7	21.3				
Green Ext Time (p_c), s		1.0		3.4		0.3	0.2	1.0				
Intersection Summary												
HCM 6th Ctrl Delay											43.5	
HCM 6th LOS											D	

Intersection						
Int Delay, s/veh	3.8					
Movement	EBL	EBT	WBT	WBR	SBL	SBR
Lane Configurations	↖	↗	↖		↖	↖
Traffic Vol, veh/h	86	528	607	103	152	106
Future Vol, veh/h	86	528	607	103	152	106
Conflicting Peds, #/hr	0	0	0	0	0	0
Sign Control	Free	Free	Free	Free	Stop	Stop
RT Channelized	-	None	-	None	-	None
Storage Length	145	-	-	-	65	0
Veh in Median Storage, #	-	0	0	-	0	-
Grade, %	-	0	0	-	0	-
Peak Hour Factor	95	95	95	95	95	95
Heavy Vehicles, %	1	1	1	1	1	1
Mvmt Flow	91	556	639	108	160	112

Major/Minor	Major1	Major2	Minor2		
Conflicting Flow All	747	0	-	0	1153 374
Stage 1	-	-	-	-	693 -
Stage 2	-	-	-	-	460 -
Critical Hdwy	4.12	-	-	-	6.82 6.92
Critical Hdwy Stg 1	-	-	-	-	5.82 -
Critical Hdwy Stg 2	-	-	-	-	5.82 -
Follow-up Hdwy	2.21	-	-	-	3.51 3.31
Pot Cap-1 Maneuver	1188	-	-	-	*338 *832
Stage 1	-	-	-	-	*785 -
Stage 2	-	-	-	-	*605 -
Platoon blocked, %	1	-	-	-	1 1
Mov Cap-1 Maneuver	1188	-	-	-	*312 *832
Mov Cap-2 Maneuver	-	-	-	-	*312 -
Stage 1	-	-	-	-	*724 -
Stage 2	-	-	-	-	*605 -

Approach	EB	WB	SB
HCM Control Delay, s	1.2	0	20.7
HCM LOS			C

Minor Lane/Major Mvmt	EBL	EBT	WBT	WBR	SBLn1	SBLn2
Capacity (veh/h)	1188	-	-	-	312	832
HCM Lane V/C Ratio	0.076	-	-	-	0.513	0.134
HCM Control Delay (s)	8.3	-	-	-	28.1	10
HCM Lane LOS	A	-	-	-	D	B
HCM 95th %tile Q(veh)	0.2	-	-	-	2.8	0.5

Notes			
-:	Volume exceeds capacity	Ⓢ:	Delay exceeds 300s
+	Computation Not Defined	*	All major volume in platoon

HCM 6th Signalized Intersection Summary
45: Olive Avenue & SR-99 Southbound Off-Ramp

Village D Specific Plan
Existing WP - PM Peak Hour

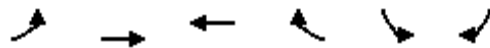

Movement	EBL	EBT	WBT	WBR	SBL	SBR
Lane Configurations		↑↑↑	↑↑		↙	↗
Traffic Volume (veh/h)	0	680	645	0	331	65
Future Volume (veh/h)	0	680	645	0	331	65
Initial Q (Qb), veh	0	0	0	0	0	0
Ped-Bike Adj(A_pbT)	1.00			1.00	1.00	1.00
Parking Bus, Adj	1.00	1.00	1.00	1.00	1.00	1.00
Work Zone On Approach		No	No		No	
Adj Sat Flow, veh/h/ln	0	1885	1885	0	1856	1856
Adj Flow Rate, veh/h	0	716	679	0	348	68
Peak Hour Factor	0.95	0.95	0.95	0.95	0.95	0.95
Percent Heavy Veh, %	0	1	1	0	3	3
Cap, veh/h	0	1148	799	0	1196	1065
Arrive On Green	0.00	0.22	0.22	0.00	0.68	0.68
Sat Flow, veh/h	0	5486	3770	0	1767	1572
Grp Volume(v), veh/h	0	716	679	0	348	68
Grp Sat Flow(s),veh/h/ln	0	1716	1791	0	1767	1572
Q Serve(g_s), s	0.0	11.3	16.4	0.0	7.1	1.3
Cycle Q Clear(g_c), s	0.0	11.3	16.4	0.0	7.1	1.3
Prop In Lane	0.00			0.00	1.00	1.00
Lane Grp Cap(c), veh/h	0	1148	799	0	1196	1065
V/C Ratio(X)	0.00	0.62	0.85	0.00	0.29	0.06
Avail Cap(c_a), veh/h	0	1287	895	0	1196	1065
HCM Platoon Ratio	1.00	1.00	1.00	1.00	1.00	1.00
Upstream Filter(I)	0.00	1.00	0.61	0.00	1.00	1.00
Uniform Delay (d), s/veh	0.0	31.6	33.5	0.0	5.8	4.9
Incr Delay (d2), s/veh	0.0	0.8	4.5	0.0	0.6	0.1
Initial Q Delay(d3),s/veh	0.0	0.0	0.0	0.0	0.0	0.0
%ile BackOfQ(50%),veh/ln	0.0	4.7	7.4	0.0	2.4	0.4
Unsig. Movement Delay, s/veh						
LnGrp Delay(d),s/veh	0.0	32.3	38.1	0.0	6.5	5.0
LnGrp LOS	A	C	D	A	A	A
Approach Vol, veh/h		716	679		416	
Approach Delay, s/veh		32.3	38.1		6.2	
Approach LOS		C	D		A	
Timer - Assigned Phs				4	6	8
Phs Duration (G+Y+Rc), s				24.6	65.4	24.6
Change Period (Y+Rc), s				4.5	4.5	4.5
Max Green Setting (Gmax), s				22.5	58.5	22.5
Max Q Clear Time (g_c+I1), s				13.3	9.1	18.4
Green Ext Time (p_c), s				3.3	1.3	1.7
Intersection Summary						
HCM 6th Ctrl Delay			28.5			
HCM 6th LOS			C			

HCM 6th Signalized Intersection Summary

46: Madera Avenue & SR-99 Northbound Ramps

Village D Specific Plan
Existing WP - PM Peak Hour



Movement	EBL	EBT	EBR	WBL	WBT	WBR	NBL	NBT	NBR	SBL	SBT	SBR
Lane Configurations				↶	↷	↶	↶	↶			↷	↷
Traffic Volume (veh/h)	0	0	0	336	1	32	504	586	0	0	621	239
Future Volume (veh/h)	0	0	0	336	1	32	504	586	0	0	621	239
Initial Q (Qb), veh				0	0	0	0	0	0	0	0	0
Ped-Bike Adj(A_pbT)				1.00		0.99	1.00		1.00	1.00		1.00
Parking Bus, Adj				1.00	1.00	1.00	1.00	1.00	1.00	1.00	1.00	1.00
Work Zone On Approach				No			No			No		
Adj Sat Flow, veh/h/ln				1885	1885	1885	1885	1885	0	0	1870	1870
Adj Flow Rate, veh/h				370	0	35	554	644	0	0	682	263
Peak Hour Factor				0.91	0.91	0.91	0.91	0.91	0.91	0.91	0.91	0.91
Percent Heavy Veh, %				1	1	1	1	1	0	0	2	2
Cap, veh/h				474	0	208	1131	2751	0	0	985	380
Arrive On Green				0.13	0.00	0.13	0.43	1.00	0.00	0.00	0.39	0.39
Sat Flow, veh/h				3591	0	1576	3483	3676	0	0	2598	966
Grp Volume(v), veh/h				370	0	35	554	644	0	0	484	461
Grp Sat Flow(s),veh/h/ln				1795	0	1576	1742	1791	0	0	1777	1693
Q Serve(g_s), s				9.0	0.0	1.8	10.3	0.0	0.0	0.0	20.4	20.4
Cycle Q Clear(g_c), s				9.0	0.0	1.8	10.3	0.0	0.0	0.0	20.4	20.4
Prop In Lane				1.00		1.00	1.00		0.00	0.00		0.57
Lane Grp Cap(c), veh/h				474	0	208	1131	2751	0	0	699	666
V/C Ratio(X)				0.78	0.00	0.17	0.49	0.23	0.00	0.00	0.69	0.69
Avail Cap(c_a), veh/h				742	0	326	1131	2751	0	0	699	666
HCM Platoon Ratio				1.00	1.00	1.00	1.33	1.33	1.00	1.00	1.00	1.00
Upstream Filter(I)				1.00	0.00	1.00	0.81	0.81	0.00	0.00	1.00	1.00
Uniform Delay (d), s/veh				37.8	0.0	34.7	20.2	0.0	0.0	0.0	22.8	22.8
Incr Delay (d2), s/veh				2.8	0.0	0.4	0.3	0.2	0.0	0.0	5.6	5.8
Initial Q Delay(d3),s/veh				0.0	0.0	0.0	0.0	0.0	0.0	0.0	0.0	0.0
%ile BackOfQ(50%),veh/ln				4.1	0.0	0.7	3.8	0.1	0.0	0.0	9.2	8.9
Unsig. Movement Delay, s/veh												
LnGrp Delay(d),s/veh				40.6	0.0	35.0	20.5	0.2	0.0	0.0	28.3	28.6
LnGrp LOS				D	A	D	C	A	A	A	C	C
Approach Vol, veh/h					405			1198			945	
Approach Delay, s/veh					40.1			9.6			28.5	
Approach LOS					D			A			C	
Timer - Assigned Phs		2			5	6		8				
Phs Duration (G+Y+Rc), s		73.6			33.7	39.9		16.4				
Change Period (Y+Rc), s		4.5			4.5	4.5		4.5				
Max Green Setting (Gmax), s		62.4			22.5	35.4		18.6				
Max Q Clear Time (g_c+I1), s		2.0			12.3	22.4		11.0				
Green Ext Time (p_c), s		5.2			1.6	5.2		0.9				

Intersection Summary

HCM 6th Ctrl Delay	21.4
HCM 6th LOS	C

Notes

User approved volume balancing among the lanes for turning movement.

HCM 6th Signalized Intersection Summary

47: Madera Avenue & Olive Avenue/SR-99 Southbound On-Ramp

Village D Specific Plan
Existing WP - PM Peak Hour



Movement	EBL	EBT	EBR	WBL	WBT	WBR	NBL	NBT	NBR	SBL	SBT	SBR
Lane Configurations												
Traffic Volume (veh/h)	390	226	395	0	0	0	152	700	29	130	331	495
Future Volume (veh/h)	390	226	395	0	0	0	152	700	29	130	331	495
Initial Q (Qb), veh	0	0	0				0	0	0	0	0	0
Ped-Bike Adj(A_pbT)	1.00		1.00				1.00		1.00	1.00		1.00
Parking Bus, Adj	1.00	1.00	1.00				1.00	1.00	1.00	1.00	1.00	1.00
Work Zone On Approach		No					No			No		
Adj Sat Flow, veh/h/ln	1856	1856	1856				1870	1870	1870	1885	1885	1885
Adj Flow Rate, veh/h	318	351	407				157	722	30	134	341	510
Peak Hour Factor	0.97	0.97	0.97				0.97	0.97	0.97	0.97	0.97	0.97
Percent Heavy Veh, %	3	3	3				2	2	2	1	1	1
Cap, veh/h	363	381	419				211	1922	80	165	1045	932
Arrive On Green	0.34	0.34	0.34				0.06	0.55	0.55	0.15	0.97	0.97
Sat Flow, veh/h	1767	1856	1570				3456	3477	144	1795	1791	1598
Grp Volume(v), veh/h	318	351	407				157	369	383	134	341	510
Grp Sat Flow(s),veh/h/ln	1767	1856	1570				1728	1777	1844	1795	1791	1598
Q Serve(g_s), s	15.2	16.3	18.5				4.0	10.5	10.6	6.5	0.6	1.6
Cycle Q Clear(g_c), s	15.2	16.3	18.5				4.0	10.5	10.6	6.5	0.6	1.6
Prop In Lane	1.00		1.00				1.00		0.08	1.00		1.00
Lane Grp Cap(c), veh/h	363	381	419				211	982	1019	165	1045	932
V/C Ratio(X)	0.88	0.92	0.97				0.74	0.38	0.38	0.81	0.33	0.55
Avail Cap(c_a), veh/h	363	381	419				211	982	1019	209	1045	932
HCM Platoon Ratio	1.67	1.67	1.67				1.00	1.00	1.00	1.67	1.67	1.67
Upstream Filter(I)	0.86	0.86	0.86				1.00	1.00	1.00	0.74	0.74	0.74
Uniform Delay (d), s/veh	28.5	28.8	27.4				41.6	11.4	11.4	37.4	0.5	0.5
Incr Delay (d2), s/veh	18.2	24.4	33.4				13.2	1.1	1.1	13.3	0.6	1.7
Initial Q Delay(d3),s/veh	0.0	0.0	0.0				0.0	0.0	0.0	0.0	0.0	0.0
%ile BackOfQ(50%),veh/ln	7.1	8.5	20.2				2.1	4.2	4.3	3.3	0.3	0.7
Unsig. Movement Delay, s/veh												
LnGrp Delay(d),s/veh	46.7	53.2	60.9				54.8	12.5	12.4	50.6	1.1	2.2
LnGrp LOS	D	D	E				D	B	B	D	A	A
Approach Vol, veh/h		1076						909			985	
Approach Delay, s/veh		54.2						19.8			8.4	
Approach LOS		D						B			A	
Timer - Assigned Phs	1	2		4	5	6						
Phs Duration (G+Y+Rc), s	12.8	54.2		23.0	10.0	57.0						
Change Period (Y+Rc), s	4.5	4.5		4.5	4.5	4.5						
Max Green Setting (Gmax), s	40.5	47.5		18.5	5.5	52.5						
Max Q Clear Time (g_c+I), s	10.5	12.6		20.5	6.0	3.6						
Green Ext Time (p_c), s	0.1	5.4		0.0	0.0	7.2						

Intersection Summary

HCM 6th Ctrl Delay	28.5
HCM 6th LOS	C

Notes

User approved volume balancing among the lanes for turning movement.

Intersection						
Int Delay, s/veh	0.3					
Movement	WBL	WBR	NBT	NBR	SBL	SBT
Lane Configurations	↔		↕		↔	↕
Traffic Vol, veh/h	7	9	913	6	31	787
Future Vol, veh/h	7	9	913	6	31	787
Conflicting Peds, #/hr	0	0	0	2	2	0
Sign Control	Stop	Stop	Free	Free	Free	Free
RT Channelized	-	None	-	None	-	None
Storage Length	0	-	-	-	100	-
Veh in Median Storage, #	0	-	0	-	-	0
Grade, %	0	-	0	-	-	0
Peak Hour Factor	95	95	95	95	95	95
Heavy Vehicles, %	6	6	2	2	2	2
Mvmt Flow	7	9	961	6	33	828

Major/Minor	Minor1	Major1	Major2		
Conflicting Flow All	1446	486	0	0	969
Stage 1	966	-	-	-	-
Stage 2	480	-	-	-	-
Critical Hdwy	6.92	7.02	-	-	4.14
Critical Hdwy Stg 1	5.92	-	-	-	-
Critical Hdwy Stg 2	5.92	-	-	-	-
Follow-up Hdwy	3.56	3.36	-	-	2.22
Pot Cap-1 Maneuver	*225	517	-	-	707
Stage 1	*321	-	-	-	-
Stage 2	*709	-	-	-	-
Platoon blocked, %	1	-	-	-	-
Mov Cap-1 Maneuver	*214	516	-	-	706
Mov Cap-2 Maneuver	*274	-	-	-	-
Stage 1	*320	-	-	-	-
Stage 2	*676	-	-	-	-

Approach	WB	NB	SB
HCM Control Delay, s	15.1	0	0.4
HCM LOS	C		

Minor Lane/Major Mvmt	NBT	NBRWBLn1	SBL	SBT
Capacity (veh/h)	-	-	372	706
HCM Lane V/C Ratio	-	-	0.045	0.046
HCM Control Delay (s)	-	-	15.1	10.3
HCM Lane LOS	-	-	C	B
HCM 95th %tile Q(veh)	-	-	0.1	0.1

Notes
 -: Volume exceeds capacity \$: Delay exceeds 300s +: Computation Not Defined *: All major volume in platoon

HCM 6th Signalized Intersection Summary
 49: Yosemite Avenue & Cleveland Avenue/Tozer Street

Village D Specific Plan
 Existing WP - PM Peak Hour



Movement	EBL	EBT	EBR	WBL	WBT	WBR	NBL	NBT	NBR	SBL	SBT	SBR
Lane Configurations	↖	↗		↖	↗	↗	↖	↗	↗	↖	↗	↗
Traffic Volume (veh/h)	257	419	195	48	472	35	305	283	95	67	167	330
Future Volume (veh/h)	257	419	195	48	472	35	305	283	95	67	167	330
Initial Q (Qb), veh	0	0	0	0	0	0	0	0	0	0	0	0
Ped-Bike Adj(A_pbT)	1.00		0.99	1.00		0.96	1.00		1.00	1.00		0.98
Parking Bus, Adj	1.00	1.00	1.00	1.00	1.00	1.00	1.00	1.00	1.00	1.00	1.00	1.00
Work Zone On Approach		No			No			No			No	
Adj Sat Flow, veh/h/ln	1870	1870	1870	1900	1900	1900	1870	1870	1870	1870	1870	1870
Adj Flow Rate, veh/h	279	455	212	52	513	38	332	308	103	73	182	359
Peak Hour Factor	0.92	0.92	0.92	0.92	0.92	0.92	0.92	0.92	0.92	0.92	0.92	0.92
Percent Heavy Veh, %	2	2	2	0	0	0	2	2	2	2	2	2
Cap, veh/h	287	742	343	69	697	298	340	773	653	94	152	301
Arrive On Green	0.16	0.32	0.32	0.04	0.19	0.19	0.19	0.41	0.41	0.05	0.28	0.28
Sat Flow, veh/h	1781	2350	1086	1810	3610	1542	1781	1870	1580	1781	554	1094
Grp Volume(v), veh/h	279	343	324	52	513	38	332	308	103	73	0	541
Grp Sat Flow(s),veh/h/ln	1781	1777	1659	1810	1805	1542	1781	1870	1580	1781	0	1648
Q Serve(g_s), s	15.6	16.4	16.6	2.8	13.4	2.0	18.5	11.6	4.1	4.0	0.0	27.5
Cycle Q Clear(g_c), s	15.6	16.4	16.6	2.8	13.4	2.0	18.5	11.6	4.1	4.0	0.0	27.5
Prop In Lane	1.00		0.65	1.00		1.00	1.00		1.00	1.00		0.66
Lane Grp Cap(c), veh/h	287	561	524	69	697	298	340	773	653	94	0	453
V/C Ratio(X)	0.97	0.61	0.62	0.75	0.74	0.13	0.98	0.40	0.16	0.78	0.00	1.19
Avail Cap(c_a), veh/h	287	561	524	103	697	298	340	773	653	173	0	453
HCM Platoon Ratio	1.00	1.00	1.00	1.00	1.00	1.00	1.00	1.00	1.00	1.00	1.00	1.00
Upstream Filter(I)	1.00	1.00	1.00	1.00	1.00	1.00	1.00	1.00	1.00	1.00	0.00	1.00
Uniform Delay (d), s/veh	41.7	29.0	29.1	47.6	38.0	33.4	40.2	20.6	18.4	46.8	0.0	36.3
Incr Delay (d2), s/veh	45.5	4.9	5.4	15.4	6.8	0.9	42.1	0.3	0.1	12.7	0.0	107.1
Initial Q Delay(d3),s/veh	0.0	0.0	0.0	0.0	0.0	0.0	0.0	0.0	0.0	0.0	0.0	0.0
%ile BackOfQ(50%),veh/ln	10.4	7.6	7.3	1.6	6.5	0.8	12.0	5.0	1.5	2.1	0.0	24.3
Unsig. Movement Delay, s/veh												
LnGrp Delay(d),s/veh	87.3	33.9	34.5	63.1	44.8	34.3	82.4	20.9	18.5	59.4	0.0	143.4
LnGrp LOS	F	C	C	E	D	C	F	C	B	E	A	F
Approach Vol, veh/h		946			603			743				614
Approach Delay, s/veh		49.8			45.7			48.1				133.4
Approach LOS		D			D			D				F
Timer - Assigned Phs	1	2	3	4	5	6	7	8				
Phs Duration (G+Y+Rc), s	20.6	23.8	9.8	45.8	8.3	36.1	23.6	32.0				
Change Period (Y+Rc), s	4.5	4.5	4.5	4.5	4.5	4.5	4.5	4.5				
Max Green Setting (Gmax), s	16.1	19.3	9.7	36.9	5.7	29.7	19.1	27.5				
Max Q Clear Time (g_c+I1), s	17.6	15.4	6.0	13.6	4.8	18.6	20.5	29.5				
Green Ext Time (p_c), s	0.0	1.3	0.0	2.2	0.0	3.2	0.0	0.0				
Intersection Summary												
HCM 6th Ctrl Delay			66.2									
HCM 6th LOS			E									

Intersection						
Int Delay, s/veh	6.5					
Movement	WBL	WBR	NBT	NBR	SBL	SBT
Lane Configurations						
Traffic Vol, veh/h	0	9	2	0	14	2
Future Vol, veh/h	0	9	2	0	14	2
Conflicting Peds, #/hr	0	0	0	0	0	0
Sign Control	Stop	Stop	Free	Free	Free	Free
RT Channelized	-	None	-	None	-	None
Storage Length	0	-	-	-	50	-
Veh in Median Storage, #	0	-	0	-	-	0
Grade, %	0	-	0	-	-	0
Peak Hour Factor	92	92	92	92	92	92
Heavy Vehicles, %	0	0	0	0	0	0
Mvmt Flow	0	10	2	0	15	2

Major/Minor	Minor1	Major1	Major2		
Conflicting Flow All	34	2	0	0	2
Stage 1	2	-	-	-	-
Stage 2	32	-	-	-	-
Critical Hdwy	6.4	6.2	-	-	4.1
Critical Hdwy Stg 1	5.4	-	-	-	-
Critical Hdwy Stg 2	5.4	-	-	-	-
Follow-up Hdwy	3.5	3.3	-	-	2.2
Pot Cap-1 Maneuver	984	1088	-	-	1634
Stage 1	1026	-	-	-	-
Stage 2	996	-	-	-	-
Platoon blocked, %			-	-	-
Mov Cap-1 Maneuver	975	1088	-	-	1634
Mov Cap-2 Maneuver	975	-	-	-	-
Stage 1	1026	-	-	-	-
Stage 2	987	-	-	-	-

Approach	WB	NB	SB
HCM Control Delay, s	8.3	0	6.3
HCM LOS	A		

Minor Lane/Major Mvmt	NBT	NBRWBLn1	SBL	SBT
Capacity (veh/h)	-	-	1088	1634
HCM Lane V/C Ratio	-	-	0.009	0.009
HCM Control Delay (s)	-	-	8.3	7.2
HCM Lane LOS	-	-	A	A
HCM 95th %tile Q(veh)	-	-	0	0

Intersection						
Int Delay, s/veh	10.1					
Movement	EBT	EBR	WBL	WBT	NBL	NBR
Lane Configurations						
Traffic Vol, veh/h	99	50	627	49	23	302
Future Vol, veh/h	99	50	627	49	23	302
Conflicting Peds, #/hr	0	0	0	0	0	0
Sign Control	Free	Free	Free	Free	Stop	Stop
RT Channelized	-	None	-	None	-	None
Storage Length	-	-	50	-	50	0
Veh in Median Storage, #	0	-	-	0	0	-
Grade, %	0	-	-	0	0	-
Peak Hour Factor	92	92	92	92	92	92
Heavy Vehicles, %	1	1	0	0	0	0
Mvmt Flow	108	54	682	53	25	328

Major/Minor	Major1	Major2	Minor1		
Conflicting Flow All	0	0	162	0	1552
Stage 1	-	-	-	-	135
Stage 2	-	-	-	-	1417
Critical Hdwy	-	-	4.1	-	6.4
Critical Hdwy Stg 1	-	-	-	-	5.4
Critical Hdwy Stg 2	-	-	-	-	5.4
Follow-up Hdwy	-	-	2.2	-	3.5
Pot Cap-1 Maneuver	-	-	1429	-	126
Stage 1	-	-	-	-	896
Stage 2	-	-	-	-	226
Platoon blocked, %	-	-	-	-	-
Mov Cap-1 Maneuver	-	-	1429	-	66
Mov Cap-2 Maneuver	-	-	-	-	66
Stage 1	-	-	-	-	896
Stage 2	-	-	-	-	118

Approach	EB	WB	NB
HCM Control Delay, s	0	9.1	16.7
HCM LOS			C

Minor Lane/Major Mvmt	NBLn1	NBLn2	EBT	EBR	WBL	WBT
Capacity (veh/h)	66	919	-	-	1429	-
HCM Lane V/C Ratio	0.379	0.357	-	-	0.477	-
HCM Control Delay (s)	89.6	11.1	-	-	9.8	-
HCM Lane LOS	F	B	-	-	A	-
HCM 95th %tile Q(veh)	1.4	1.6	-	-	2.7	-

Intersection

Int Delay, s/veh 329.7

Movement	EBL	EBT	EBR	WBL	WBT	WBR	NBL	NBT	NBR	SBL	SBT	SBR
Lane Configurations	↖	↗		↖	↗		↖	↗		↖	↗	
Traffic Vol, veh/h	0	49	15	296	14	225	6	178	148	139	179	0
Future Vol, veh/h	0	49	15	296	14	225	6	178	148	139	179	0
Conflicting Peds, #/hr	0	0	0	0	0	0	0	0	0	0	0	0
Sign Control	Free	Free	Free	Free	Free	Free	Stop	Stop	Stop	Stop	Stop	Stop
RT Channelized	-	-	None	-	-	None	-	-	None	-	-	None
Storage Length	50	-	-	50	-	-	50	-	-	50	-	-
Veh in Median Storage, #	-	0	-	-	0	-	-	0	-	-	0	-
Grade, %	-	0	-	-	0	-	-	0	-	-	0	-
Peak Hour Factor	92	92	92	92	92	92	92	92	92	92	92	92
Heavy Vehicles, %	10	10	10	0	0	0	0	0	0	0	0	0
Mvmt Flow	0	53	16	322	15	245	7	193	161	151	195	0

Major/Minor	Major1			Major2			Minor1			Minor2		
Conflicting Flow All	260	0	0	69	0	0	940	965	61	1020	851	138
Stage 1	-	-	-	-	-	-	61	61	-	782	782	-
Stage 2	-	-	-	-	-	-	879	904	-	238	69	-
Critical Hdwy	4.2	-	-	4.1	-	-	7.1	6.5	6.2	7.1	6.5	6.2
Critical Hdwy Stg 1	-	-	-	-	-	-	6.1	5.5	-	6.1	5.5	-
Critical Hdwy Stg 2	-	-	-	-	-	-	6.1	5.5	-	6.1	5.5	-
Follow-up Hdwy	2.29	-	-	2.2	-	-	3.5	4	3.3	3.5	4	3.3
Pot Cap-1 Maneuver	1259	-	-	1545	-	-	246	257	1010	217	299	916
Stage 1	-	-	-	-	-	-	955	848	-	390	408	-
Stage 2	-	-	-	-	-	-	345	358	-	770	841	-
Platoon blocked, %		-	-		-	-						
Mov Cap-1 Maneuver	1259	-	-	1545	-	-	67	204	1010	~ 25	237	916
Mov Cap-2 Maneuver	-	-	-	-	-	-	67	204	-	~ 25	237	-
Stage 1	-	-	-	-	-	-	955	848	-	390	323	-
Stage 2	-	-	-	-	-	-	109	284	-	500	841	-

Approach	EB	WB	NB	SB
HCM Control Delay, s	0	4.4	118.1	\$ 1164.2
HCM LOS			F	F

Minor Lane/Major Mvmt	NBLn1	NBLn2	EBL	EBT	EBR	WBL	WBT	WBR	SBLn1	SBLn2
Capacity (veh/h)	67	320	1259	-	-	1545	-	-	25	237
HCM Lane V/C Ratio	0.097	1.107	-	-	-	0.208	-	-	6.043	0.821
HCM Control Delay (s)	64.4	119.1	0	-	-	7.9	-	\$ 2579.7	65	
HCM Lane LOS	F	F	A	-	-	A	-	-	F	F
HCM 95th %tile Q(veh)	0.3	13.9	0	-	-	0.8	-	-	18.8	6.3

Notes
 -: Volume exceeds capacity \$: Delay exceeds 300s +: Computation Not Defined *: All major volume in platoon

Intersection												
Int Delay, s/veh	524.2											
Movement	EBL	EBT	EBR	WBL	WBT	WBR	NBL	NBT	NBR	SBL	SBT	SBR
Lane Configurations	↶	↷		↶	↷		↶	↷		↶	↷	
Traffic Vol, veh/h	8	417	16	113	524	449	14	29	62	330	30	8
Future Vol, veh/h	8	417	16	113	524	449	14	29	62	330	30	8
Conflicting Peds, #/hr	0	0	0	0	0	0	0	0	0	0	0	0
Sign Control	Free	Free	Free	Free	Free	Free	Stop	Stop	Stop	Stop	Stop	Stop
RT Channelized	-	-	None	-	-	None	-	-	None	-	-	None
Storage Length	50	-	-	50	-	-	50	-	-	50	-	-
Veh in Median Storage, #	-	0	-	-	0	-	-	0	-	-	0	-
Grade, %	-	0	-	-	0	-	-	0	-	-	0	-
Peak Hour Factor	92	92	92	92	92	92	92	92	92	92	92	92
Heavy Vehicles, %	0	0	0	0	0	0	0	0	0	0	0	0
Mvmt Flow	9	453	17	123	570	488	15	32	67	359	33	9

Major/Minor	Major1			Major2			Minor1			Minor2		
Conflicting Flow All	1058	0	0	470	0	0	1561	1784	462	1589	1548	814
Stage 1	-	-	-	-	-	-	480	480	-	1060	1060	-
Stage 2	-	-	-	-	-	-	1081	1304	-	529	488	-
Critical Hdwy	4.1	-	-	4.1	-	-	7.1	6.5	6.2	7.1	6.5	6.2
Critical Hdwy Stg 1	-	-	-	-	-	-	6.1	5.5	-	6.1	5.5	-
Critical Hdwy Stg 2	-	-	-	-	-	-	6.1	5.5	-	6.1	5.5	-
Follow-up Hdwy	2.2	-	-	2.2	-	-	3.5	4	3.3	3.5	4	3.3
Pot Cap-1 Maneuver	666	-	-	1102	-	-	92	83	604	~ 88	115	381
Stage 1	-	-	-	-	-	-	571	558	-	~ 273	303	-
Stage 2	-	-	-	-	-	-	266	232	-	537	553	-
Platoon blocked, %		-	-		-	-						
Mov Cap-1 Maneuver	666	-	-	1102	-	-	61	73	604	~ 47	101	381
Mov Cap-2 Maneuver	-	-	-	-	-	-	61	73	-	~ 47	101	-
Stage 1	-	-	-	-	-	-	563	550	-	~ 269	269	-
Stage 2	-	-	-	-	-	-	203	206	-	444	545	-

Approach	EB			WB			NB			SB		
HCM Control Delay, s	0.2			0.9			51			\$ 2831.4		
HCM LOS							F			F		

Minor Lane/Major Mvmt	NBLn1	NBLn2	EBL	EBT	EBR	WBL	WBT	WBR	SBLn1	SBLn2
Capacity (veh/h)	61	182	666	-	-	1102	-	-	47	119
HCM Lane V/C Ratio	0.249	0.543	0.013	-	-	0.111	-	-	7.632	0.347
HCM Control Delay (s)	82.6	46.1	10.5	-	-	8.7	-	-	\$ 3151.6	50.5
HCM Lane LOS	F	E	B	-	-	A	-	-	F	F
HCM 95th %tile Q(veh)	0.9	2.8	0	-	-	0.4	-	-	42.2	1.4

Notes												
-: Volume exceeds capacity \$: Delay exceeds 300s +: Computation Not Defined *: All major volume in platoon												

Intersection						
Int Delay, s/veh	1.3					
Movement	EBL	EBT	WBT	WBR	SBL	SBR
Lane Configurations						
Traffic Vol, veh/h	0	37	66	52	26	0
Future Vol, veh/h	0	37	66	52	26	0
Conflicting Peds, #/hr	0	0	0	0	0	0
Sign Control	Free	Free	Free	Free	Stop	Stop
RT Channelized	-	None	-	None	-	None
Storage Length	50	-	-	-	50	0
Veh in Median Storage, #	-	0	0	-	0	-
Grade, %	-	0	0	-	0	-
Peak Hour Factor	92	92	92	92	92	92
Heavy Vehicles, %	0	0	0	0	0	0
Mvmt Flow	0	40	72	57	28	0

Major/Minor	Major1	Major2	Minor2		
Conflicting Flow All	129	0	-	0	141
Stage 1	-	-	-	-	101
Stage 2	-	-	-	-	40
Critical Hdwy	4.1	-	-	-	6.4
Critical Hdwy Stg 1	-	-	-	-	5.4
Critical Hdwy Stg 2	-	-	-	-	5.4
Follow-up Hdwy	2.2	-	-	-	3.5
Pot Cap-1 Maneuver	1469	-	-	-	857
Stage 1	-	-	-	-	928
Stage 2	-	-	-	-	988
Platoon blocked, %		-	-	-	
Mov Cap-1 Maneuver	1469	-	-	-	857
Mov Cap-2 Maneuver	-	-	-	-	857
Stage 1	-	-	-	-	928
Stage 2	-	-	-	-	988

Approach	EB	WB	SB
HCM Control Delay, s	0	0	9.3
HCM LOS			A

Minor Lane/Major Mvmt	EBL	EBT	WBT	WBR	SBLn1	SBLn2
Capacity (veh/h)	1469	-	-	-	857	-
HCM Lane V/C Ratio	-	-	-	-	0.033	-
HCM Control Delay (s)	0	-	-	-	9.3	0
HCM Lane LOS	A	-	-	-	A	A
HCM 95th %tile Q(veh)	0	-	-	-	0.1	-

Intersection						
Int Delay, s/veh	9.7					
Movement	EBL	EBR	NBL	NBT	SBT	SBR
Lane Configurations						
Traffic Vol, veh/h	294	211	228	1101	1544	631
Future Vol, veh/h	294	211	228	1101	1544	631
Conflicting Peds, #/hr	0	0	0	0	0	0
Sign Control	Stop	Stop	Free	Free	Free	Free
RT Channelized	-	None	-	None	-	None
Storage Length	50	0	50	-	-	-
Veh in Median Storage, #	0	-	-	0	0	-
Grade, %	0	-	-	0	0	-
Peak Hour Factor	92	92	92	92	92	92
Heavy Vehicles, %	0	0	1	1	1	1
Mvmt Flow	320	229	248	1197	1678	686

Major/Minor	Minor2	Major1	Major2			
Conflicting Flow All	3714	2021	2364	0	-	0
Stage 1	2021	-	-	-	-	-
Stage 2	1693	-	-	-	-	-
Critical Hdwy	6.4	6.2	4.11	-	-	-
Critical Hdwy Stg 1	5.4	-	-	-	-	-
Critical Hdwy Stg 2	5.4	-	-	-	-	-
Follow-up Hdwy	3.5	3.3	2.209	-	-	-
Pot Cap-1 Maneuver	~ 5	~ 74	~ 208	-	-	-
Stage 1	~ 113	-	-	-	-	-
Stage 2	~ 166	-	-	-	-	-
Platoon blocked, %				-	-	-
Mov Cap-1 Maneuver	0	~ 74	~ 208	-	-	-
Mov Cap-2 Maneuver	0	-	-	-	-	-
Stage 1	0	-	-	-	-	-
Stage 2	~ 166	-	-	-	-	-

Approach	EB	NB	SB
HCM Control Delay, s		29.3	0
HCM LOS	-		

Minor Lane/Major Mvmt	NBL	NBT	EBLn1	EBLn2	SBT	SBR
Capacity (veh/h)	~ 208	-	-	74	-	-
HCM Lane V/C Ratio	1.191	-	-	3.099	-	-
HCM Control Delay (s)	170.9	-		\$ 1065.4	-	-
HCM Lane LOS	F	-	-	F	-	-
HCM 95th %tile Q(veh)	12.4	-	-	23.1	-	-

Notes
 -: Volume exceeds capacity \$: Delay exceeds 300s +: Computation Not Defined *: All major volume in platoon

Intersection						
Int Delay, s/veh	179					
Movement	WBL	WBR	NBT	NBR	SBL	SBT
Lane Configurations	↖	↗	↖		↖	↗
Traffic Vol, veh/h	370	890	1241	341	977	973
Future Vol, veh/h	370	890	1241	341	977	973
Conflicting Peds, #/hr	0	0	0	0	0	0
Sign Control	Stop	Stop	Free	Free	Free	Free
RT Channelized	-	None	-	None	-	None
Storage Length	50	0	-	-	50	-
Veh in Median Storage, #	0	-	0	-	-	0
Grade, %	0	-	0	-	-	0
Peak Hour Factor	92	92	92	92	92	92
Heavy Vehicles, %	0	0	1	1	2	2
Mvmt Flow	402	967	1349	371	1062	1058

Major/Minor	Minor1	Major1	Major2		
Conflicting Flow All	4717	1535	0	0	1720
Stage 1	1535	-	-	-	-
Stage 2	3182	-	-	-	-
Critical Hdwy	6.4	6.2	-	-	4.12
Critical Hdwy Stg 1	5.4	-	-	-	-
Critical Hdwy Stg 2	5.4	-	-	-	-
Follow-up Hdwy	3.5	3.3	-	-	2.218
Pot Cap-1 Maneuver	~ 1	~ 145	-	-	~ 368
Stage 1	~ 198	-	-	-	-
Stage 2	~ 28	-	-	-	-
Platoon blocked, %			-	-	-
Mov Cap-1 Maneuver	0	~ 145	-	-	~ 368
Mov Cap-2 Maneuver	0	-	-	-	-
Stage 1	~ 198	-	-	-	-
Stage 2	0	-	-	-	-

Approach	WB	NB	SB
HCM Control Delay, s		0	\$ 439.9
HCM LOS	-		

Minor Lane/Major Mvmt	NBT	NBRWBLn1WBLn2	SBL	SBT
Capacity (veh/h)	-	-	145	~ 368
HCM Lane V/C Ratio	-	-	6.672	2.886
HCM Control Delay (s)	-	-	\$ 2611	\$ 878.1
HCM Lane LOS	-	-	F	F
HCM 95th %tile Q(veh)	-	-	106.2	91.1

Notes
 -: Volume exceeds capacity \$: Delay exceeds 300s +: Computation Not Defined *: All major volume in platoon

Intersection						
Int Delay, s/veh	149.3					
Movement	EBL	EBR	NBL	NBT	SBT	SBR
Lane Configurations	↔		↔	↑	↑	
Traffic Vol, veh/h	72	41	94	1512	1239	101
Future Vol, veh/h	72	41	94	1512	1239	101
Conflicting Peds, #/hr	0	0	0	0	0	0
Sign Control	Stop	Stop	Free	Free	Free	Free
RT Channelized	-	None	-	None	-	None
Storage Length	0	-	50	-	-	-
Veh in Median Storage, #	0	-	-	0	0	-
Grade, %	0	-	-	0	0	-
Peak Hour Factor	92	92	92	92	92	92
Heavy Vehicles, %	0	0	1	1	2	2
Mvmt Flow	78	45	102	1643	1347	110

Major/Minor	Minor2	Major1	Major2			
Conflicting Flow All	3249	1402	1457	0	-	0
Stage 1	1402	-	-	-	-	-
Stage 2	1847	-	-	-	-	-
Critical Hdwy	6.4	6.2	4.11	-	-	-
Critical Hdwy Stg 1	5.4	-	-	-	-	-
Critical Hdwy Stg 2	5.4	-	-	-	-	-
Follow-up Hdwy	3.5	3.3	2.209	-	-	-
Pot Cap-1 Maneuver	~ 11	173	467	-	-	-
Stage 1	230	-	-	-	-	-
Stage 2	139	-	-	-	-	-
Platoon blocked, %				-	-	-
Mov Cap-1 Maneuver	~ 9	173	467	-	-	-
Mov Cap-2 Maneuver	~ 9	-	-	-	-	-
Stage 1	180	-	-	-	-	-
Stage 2	139	-	-	-	-	-

Approach	EB	NB	SB
HCM Control Delay, \$	4029.6	0.9	0
HCM LOS	F		

Minor Lane/Major Mvmt	NBL	NBT	EBLn1	SBT	SBR
Capacity (veh/h)	467	-	14	-	-
HCM Lane V/C Ratio	0.219	-	8.773	-	-
HCM Control Delay (s)	14.9	\$	4029.6	-	-
HCM Lane LOS	B	-	F	-	-
HCM 95th %tile Q(veh)	0.8	-	16.4	-	-

Notes
 -: Volume exceeds capacity \$: Delay exceeds 300s +: Computation Not Defined *: All major volume in platoon

Intersection						
Int Delay, s/veh	143.4					
Movement	EBT	EBR	WBL	WBT	NBL	NBR
Lane Configurations	↬		↶	↑	↶	↶
Traffic Vol, veh/h	861	145	332	1251	65	243
Future Vol, veh/h	861	145	332	1251	65	243
Conflicting Peds, #/hr	0	0	0	0	0	0
Sign Control	Free	Free	Free	Free	Stop	Stop
RT Channelized	-	None	-	None	-	None
Storage Length	-	-	50	-	50	0
Veh in Median Storage, #	0	-	-	0	0	-
Grade, %	0	-	-	0	0	-
Peak Hour Factor	92	92	92	92	92	92
Heavy Vehicles, %	1	1	0	0	0	0
Mvmt Flow	936	158	361	1360	71	264

Major/Minor	Major1	Major2	Minor1		
Conflicting Flow All	0	0	1094	0	3097 1015
Stage 1	-	-	-	-	1015 -
Stage 2	-	-	-	-	2082 -
Critical Hdwy	-	-	4.1	-	6.4 6.2
Critical Hdwy Stg 1	-	-	-	-	5.4 -
Critical Hdwy Stg 2	-	-	-	-	5.4 -
Follow-up Hdwy	-	-	2.2	-	3.5 3.3
Pot Cap-1 Maneuver	-	-	645	-	~ 13 292
Stage 1	-	-	-	-	353 -
Stage 2	-	-	-	-	106 -
Platoon blocked, %	-	-	-	-	-
Mov Cap-1 Maneuver	-	-	645	-	~ 6 292
Mov Cap-2 Maneuver	-	-	-	-	~ 6 -
Stage 1	-	-	-	-	353 -
Stage 2	-	-	-	-	~ 47 -

Approach	EB	WB	NB
HCM Control Delay, s	0	3.7	\$ 1329.6
HCM LOS			F

Minor Lane/Major Mvmt	NBLn1	NBLn2	EBT	EBR	WBL	WBT
Capacity (veh/h)	6	292	-	-	645	-
HCM Lane V/C Ratio	11.775	0.905	-	-	0.559	-
HCM Control Delay (s)	\$ 6039	69.9	-	-	17.4	-
HCM Lane LOS	F	F	-	-	C	-
HCM 95th %tile Q(veh)	10.6	8.4	-	-	3.5	-

Notes
 -: Volume exceeds capacity \$: Delay exceeds 300s +: Computation Not Defined *: All major volume in platoon

Intersection						
Int Delay, s/veh	0.9					
Movement	EBT	EBR	WBL	WBT	NBL	NBR
Lane Configurations						
Traffic Vol, veh/h	32	0	2	27	2	3
Future Vol, veh/h	32	0	2	27	2	3
Conflicting Peds, #/hr	0	0	0	0	0	0
Sign Control	Free	Free	Free	Free	Stop	Stop
RT Channelized	-	None	-	None	-	None
Storage Length	-	-	-	-	-	-
Veh in Median Storage, #	0	-	-	0	0	-
Grade, %	0	-	-	0	0	-
Peak Hour Factor	92	92	92	92	92	92
Heavy Vehicles, %	15	15	15	15	0	0
Mvmt Flow	35	0	2	29	2	3

Major/Minor	Major1	Major2	Minor1	Minor2	Minor3
Conflicting Flow All	0	0	35	0	68
Stage 1	-	-	-	-	35
Stage 2	-	-	-	-	33
Critical Hdwy	-	-	4.25	-	6.4
Critical Hdwy Stg 1	-	-	-	-	5.4
Critical Hdwy Stg 2	-	-	-	-	5.4
Follow-up Hdwy	-	-	2.335	-	3.5
Pot Cap-1 Maneuver	-	-	1496	-	942
Stage 1	-	-	-	-	993
Stage 2	-	-	-	-	995
Platoon blocked, %	-	-	-	-	-
Mov Cap-1 Maneuver	-	-	1496	-	941
Mov Cap-2 Maneuver	-	-	-	-	941
Stage 1	-	-	-	-	993
Stage 2	-	-	-	-	994

Approach	EB	WB	NB
HCM Control Delay, s	0	0.5	8.6
HCM LOS			A

Minor Lane/Major Mvmt	NBLn1	EBT	EBR	WBL	WBT
Capacity (veh/h)	1000	-	-	1496	-
HCM Lane V/C Ratio	0.005	-	-	0.001	-
HCM Control Delay (s)	8.6	-	-	7.4	0
HCM Lane LOS	A	-	-	A	A
HCM 95th %tile Q(veh)	0	-	-	0	-

Intersection												
Int Delay, s/veh	0.8											
Movement	EBL	EBT	EBR	WBL	WBT	WBR	NBL	NBT	NBR	SBL	SBT	SBR
Lane Configurations		↕			↕			↕			↕	
Traffic Vol, veh/h	2	12	0	0	29	4	0	0	0	2	0	1
Future Vol, veh/h	2	12	0	0	29	4	0	0	0	2	0	1
Conflicting Peds, #/hr	1	0	0	0	0	1	0	0	0	0	0	0
Sign Control	Free	Free	Free	Free	Free	Free	Stop	Stop	Stop	Stop	Stop	Stop
RT Channelized	-	-	None	-	-	None	-	-	None	-	-	None
Storage Length	-	-	-	-	-	-	-	-	-	-	-	-
Veh in Median Storage, #	-	0	-	-	0	-	-	0	-	-	0	-
Grade, %	-	0	-	-	0	-	-	0	-	-	0	-
Peak Hour Factor	92	92	92	92	92	92	92	92	92	92	92	92
Heavy Vehicles, %	11	11	11	11	11	11	0	0	0	0	0	0
Mvmt Flow	2	13	0	0	32	4	0	0	0	2	0	1

Major/Minor	Major1			Major2			Minor1			Minor2		
Conflicting Flow All	37	0	0	13	0	0	52	54	13	52	52	35
Stage 1	-	-	-	-	-	-	17	17	-	35	35	-
Stage 2	-	-	-	-	-	-	35	37	-	17	17	-
Critical Hdwy	4.21	-	-	4.21	-	-	7.1	6.5	6.2	7.1	6.5	6.2
Critical Hdwy Stg 1	-	-	-	-	-	-	6.1	5.5	-	6.1	5.5	-
Critical Hdwy Stg 2	-	-	-	-	-	-	6.1	5.5	-	6.1	5.5	-
Follow-up Hdwy	2.299	-	-	2.299	-	-	3.5	4	3.3	3.5	4	3.3
Pot Cap-1 Maneuver	1517	-	-	1549	-	-	952	841	1073	952	843	1044
Stage 1	-	-	-	-	-	-	1008	885	-	986	870	-
Stage 2	-	-	-	-	-	-	986	868	-	1008	885	-
Platoon blocked, %	-	-	-	-	-	-	-	-	-	-	-	-
Mov Cap-1 Maneuver	1516	-	-	1549	-	-	950	839	1073	950	841	1043
Mov Cap-2 Maneuver	-	-	-	-	-	-	950	839	-	950	841	-
Stage 1	-	-	-	-	-	-	1007	884	-	984	869	-
Stage 2	-	-	-	-	-	-	985	867	-	1007	884	-

Approach	EB	WB	NB	SB
HCM Control Delay, s	1.1	0	0	8.7
HCM LOS			A	A

Minor Lane/Major Mvmt	NBLn1	EBL	EBT	EBR	WBL	WBT	WBR	SBLn1
Capacity (veh/h)	-	1516	-	-	1549	-	-	979
HCM Lane V/C Ratio	-	0.001	-	-	-	-	-	0.003
HCM Control Delay (s)	0	7.4	0	-	0	-	-	8.7
HCM Lane LOS	A	A	A	-	A	-	-	A
HCM 95th %tile Q(veh)	-	0	-	-	0	-	-	0

Intersection

Int Delay, s/veh 2.9

Movement	EBL	EBT	WBT	WBR	SBL	SBR
Lane Configurations		↕	↑	↗	↘	
Traffic Vol, veh/h	2	103	99	108	94	4
Future Vol, veh/h	2	103	99	108	94	4
Conflicting Peds, #/hr	0	0	0	0	0	0
Sign Control	Free	Free	Free	Free	Stop	Stop
RT Channelized	-	None	-	None	-	None
Storage Length	-	-	-	0	0	-
Veh in Median Storage, #	-	0	0	-	0	-
Grade, %	-	0	0	-	0	-
Peak Hour Factor	92	92	92	92	92	92
Heavy Vehicles, %	16	16	50	50	81	81
Mvmt Flow	2	112	108	117	102	4

Major/Minor	Major1	Major2	Minor2
Conflicting Flow All	225	0	0
Stage 1	-	-	-
Stage 2	-	-	-
Critical Hdwy	4.26	-	-
Critical Hdwy Stg 1	-	-	-
Critical Hdwy Stg 2	-	-	-
Follow-up Hdwy	2.344	-	-
Pot Cap-1 Maneuver	1265	-	-
Stage 1	-	-	-
Stage 2	-	-	-
Platoon blocked, %	-	-	-
Mov Cap-1 Maneuver	1265	-	-
Mov Cap-2 Maneuver	-	-	-
Stage 1	-	-	-
Stage 2	-	-	-

Approach	EB	WB	SB
HCM Control Delay, s	0.1	0	12
HCM LOS			B

Minor Lane/Major Mvmt	EBL	EBT	WBT	WBR	SBLn1
Capacity (veh/h)	1265	-	-	-	622
HCM Lane V/C Ratio	0.002	-	-	-	0.171
HCM Control Delay (s)	7.9	0	-	-	12
HCM Lane LOS	A	A	-	-	B
HCM 95th %tile Q(veh)	0	-	-	-	0.6

Intersection												
Int Delay, s/veh	2.4											
Movement	EBL	EBT	EBR	WBL	WBT	WBR	NBL	NBT	NBR	SBL	SBT	SBR
Lane Configurations		↕			↕	↕		↕			↕	
Traffic Vol, veh/h	8	256	1	3	215	203	0	0	1	106	0	9
Future Vol, veh/h	8	256	1	3	215	203	0	0	1	106	0	9
Conflicting Peds, #/hr	0	0	0	0	0	0	0	0	0	0	0	0
Sign Control	Free	Free	Free	Free	Free	Free	Stop	Stop	Stop	Stop	Stop	Stop
RT Channelized	-	-	None	-	-	None	-	-	None	-	-	None
Storage Length	-	-	-	-	-	50	-	-	-	-	-	-
Veh in Median Storage, #	-	0	-	-	0	-	-	0	-	-	0	-
Grade, %	-	0	-	-	0	-	-	0	-	-	0	-
Peak Hour Factor	93	93	93	93	93	93	93	93	93	93	93	93
Heavy Vehicles, %	34	34	34	26	26	26	100	100	100	12	12	12
Mvmt Flow	9	275	1	3	231	218	0	0	1	114	0	10

Major/Minor	Major1			Major2			Minor1			Minor2		
Conflicting Flow All	449	0	0	276	0	0	645	749	276	531	531	231
Stage 1	-	-	-	-	-	-	294	294	-	237	237	-
Stage 2	-	-	-	-	-	-	351	455	-	294	294	-
Critical Hdwy	4.44	-	-	4.36	-	-	8.1	7.5	7.2	7.22	6.62	6.32
Critical Hdwy Stg 1	-	-	-	-	-	-	7.1	6.5	-	6.22	5.62	-
Critical Hdwy Stg 2	-	-	-	-	-	-	7.1	6.5	-	6.22	5.62	-
Follow-up Hdwy	2.506	-	-	2.434	-	-	4.4	4.9	4.2	3.608	4.108	3.408
Pot Cap-1 Maneuver	961	-	-	1161	-	-	277	246	577	444	440	784
Stage 1	-	-	-	-	-	-	545	524	-	744	691	-
Stage 2	-	-	-	-	-	-	504	433	-	693	652	-
Platoon blocked, %	-	-	-	-	-	-	-	-	-	-	-	-
Mov Cap-1 Maneuver	961	-	-	1161	-	-	270	242	577	438	433	784
Mov Cap-2 Maneuver	-	-	-	-	-	-	270	242	-	438	433	-
Stage 1	-	-	-	-	-	-	539	518	-	736	688	-
Stage 2	-	-	-	-	-	-	496	431	-	684	645	-

Approach	EB			WB			NB			SB		
HCM Control Delay, s	0.3			0.1			11.3			15.9		
HCM LOS							B			C		

Minor Lane/Major Mvmt	NBLn1	EBL	EBT	EBR	WBL	WBT	WBR	SBLn1
Capacity (veh/h)	577	961	-	-	1161	-	-	454
HCM Lane V/C Ratio	0.002	0.009	-	-	0.003	-	-	0.272
HCM Control Delay (s)	11.3	8.8	0	-	8.1	0	-	15.9
HCM Lane LOS	B	A	A	-	A	A	-	C
HCM 95th %tile Q(veh)	0	0	-	-	0	-	-	1.1

Intersection

Int Delay, s/veh 6.9

Movement	EBL	EBT	EBR	WBL	WBT	WBR	NBL	NBT	NBR	SBL	SBT	SBR
Lane Configurations		↑	↑		↑		↑		↑		↕	
Traffic Vol, veh/h	0	311	52	43	276	0	61	0	148	11	50	85
Future Vol, veh/h	0	311	52	43	276	0	61	0	148	11	50	85
Conflicting Peds, #/hr	0	0	0	0	0	0	0	0	1	1	0	0
Sign Control	Free	Free	Free	Free	Free	Free	Stop	Stop	Stop	Stop	Stop	Stop
RT Channelized	-	-	None	-	-	None	-	-	None	-	-	None
Storage Length	-	-	50	-	-	-	0	-	25	-	-	-
Veh in Median Storage, #	-	0	-	-	0	-	-	0	-	-	0	-
Grade, %	-	0	-	-	0	-	-	0	-	-	0	-
Peak Hour Factor	92	92	92	92	92	92	92	92	92	92	92	92
Heavy Vehicles, %	33	33	33	26	26	26	21	21	21	35	35	35
Mvmt Flow	0	338	57	47	300	0	66	0	161	12	54	92

Major/Minor	Major1			Major2			Minor1			Minor2		
Conflicting Flow All	-	0	0	395	0	0	805	-	339	842	789	300
Stage 1	-	-	-	-	-	-	338	-	-	394	394	-
Stage 2	-	-	-	-	-	-	467	-	-	448	395	-
Critical Hdwy	-	-	-	4.36	-	-	7.31	-	6.41	7.45	6.85	6.55
Critical Hdwy Stg 1	-	-	-	-	-	-	6.31	-	-	6.45	5.85	-
Critical Hdwy Stg 2	-	-	-	-	-	-	6.31	-	-	6.45	5.85	-
Follow-up Hdwy	-	-	-	2.434	-	-	3.689	-	3.489	3.815	4.315	3.615
Pot Cap-1 Maneuver	0	-	-	1045	-	0	279	0	662	250	287	668
Stage 1	0	-	-	-	-	0	638	0	-	570	552	-
Stage 2	0	-	-	-	-	0	542	0	-	531	551	-
Platoon blocked, %	-	-	-	-	-	-	-	-	-	-	-	-
Mov Cap-1 Maneuver	-	-	-	1045	-	-	195	-	661	181	272	668
Mov Cap-2 Maneuver	-	-	-	-	-	-	195	-	-	181	272	-
Stage 1	-	-	-	-	-	-	638	-	-	570	522	-
Stage 2	-	-	-	-	-	-	396	-	-	401	551	-

Approach	EB			WB			NB			SB		
HCM Control Delay, s	0			1.2			18.2			20.2		
HCM LOS							C			C		

Minor Lane/Major Mvmt	NBLn1	NBLn2	EBT	EBR	WBL	WBT	SBLn1
Capacity (veh/h)	195	661	-	-	1045	-	393
HCM Lane V/C Ratio	0.34	0.243	-	-	0.045	-	0.404
HCM Control Delay (s)	32.7	12.2	-	-	8.6	0	20.2
HCM Lane LOS	D	B	-	-	A	A	C
HCM 95th %tile Q(veh)	1.4	1	-	-	0.1	-	1.9

Intersection												
Int Delay, s/veh	21.1											
Movement	EBL	EBT	EBR	WBL	WBT	WBR	NBL	NBT	NBR	SBL	SBT	SBR
Lane Configurations	↙	↑			↘			↕				
Traffic Vol, veh/h	220	57	0	0	142	27	214	1	21	0	0	0
Future Vol, veh/h	220	57	0	0	142	27	214	1	21	0	0	0
Conflicting Peds, #/hr	1	0	0	0	0	1	0	0	0	0	0	0
Sign Control	Free	Free	Free	Free	Free	Free	Stop	Stop	Stop	Free	Free	Free
RT Channelized	-	-	None	-	-	None	-	-	None	-	-	None
Storage Length	145	-	-	-	-	-	-	-	-	-	-	-
Veh in Median Storage, #	-	0	-	-	0	-	-	0	-	-	16965	-
Grade, %	-	0	-	-	0	-	-	0	-	-	0	-
Peak Hour Factor	92	92	92	92	92	92	92	92	92	92	92	92
Heavy Vehicles, %	31	31	31	18	18	18	29	29	29	0	0	0
Mvmt Flow	239	62	0	0	154	29	233	1	23	0	0	0

Major/Minor	Major1	Major2	Minor1
Conflicting Flow All	184	0	0
Stage 1	-	-	540
Stage 2	-	-	169
Critical Hdwy	4.41	-	6.69
Critical Hdwy Stg 1	-	-	5.69
Critical Hdwy Stg 2	-	-	5.69
Follow-up Hdwy	2.479	-	3.761
Pot Cap-1 Maneuver	1234	0	363
Stage 1	-	0	533
Stage 2	-	0	799
Platoon blocked, %	-	-	-
Mov Cap-1 Maneuver	1234	-	293
Mov Cap-2 Maneuver	-	-	293
Stage 1	-	-	430
Stage 2	-	-	799

Approach	EB	WB	NB
HCM Control Delay, s	6.8	0	53.1
HCM LOS			F

Minor Lane/Major Mvmt	NBLn1	EBL	EBT	WBT	WBR
Capacity (veh/h)	312	1234	-	-	-
HCM Lane V/C Ratio	0.822	0.194	-	-	-
HCM Control Delay (s)	53.1	8.6	-	-	-
HCM Lane LOS	F	A	-	-	-
HCM 95th %tile Q(veh)	6.9	0.7	-	-	-

Intersection												
Int Delay, s/veh	3.6											
Movement	EBL	EBT	EBR	WBL	WBT	WBR	NBL	NBT	NBR	SBL	SBT	SBR
Lane Configurations		↕			↕			↕			↕	
Traffic Vol, veh/h	2	27	8	54	20	3	8	161	48	15	105	0
Future Vol, veh/h	2	27	8	54	20	3	8	161	48	15	105	0
Conflicting Peds, #/hr	0	0	0	0	0	0	0	0	0	0	0	0
Sign Control	Stop	Stop	Stop	Stop	Stop	Stop	Free	Free	Free	Free	Free	Free
RT Channelized	-	-	None	-	-	None	-	-	None	-	-	None
Storage Length	-	-	-	-	-	-	-	-	-	-	-	-
Veh in Median Storage, #	-	0	-	-	0	-	-	0	-	-	0	-
Grade, %	-	0	-	-	0	-	-	0	-	-	0	-
Peak Hour Factor	92	92	92	92	92	92	92	92	92	92	92	92
Heavy Vehicles, %	6	6	6	19	19	19	18	18	18	24	24	24
Mvmt Flow	2	29	9	59	22	3	9	175	52	16	114	0

Major/Minor	Minor2		Minor1		Major1		Major2					
Conflicting Flow All	378	391	114	384	365	201	114	0	0	227	0	0
Stage 1	146	146	-	219	219	-	-	-	-	-	-	-
Stage 2	232	245	-	165	146	-	-	-	-	-	-	-
Critical Hdwy	7.16	6.56	6.26	7.29	6.69	6.39	4.28	-	-	4.34	-	-
Critical Hdwy Stg 1	6.16	5.56	-	6.29	5.69	-	-	-	-	-	-	-
Critical Hdwy Stg 2	6.16	5.56	-	6.29	5.69	-	-	-	-	-	-	-
Follow-up Hdwy	3.554	4.054	3.354	3.671	4.171	3.471	2.362	-	-	2.416	-	-
Pot Cap-1 Maneuver	572	538	928	545	537	799	1381	-	-	1222	-	-
Stage 1	847	769	-	746	691	-	-	-	-	-	-	-
Stage 2	762	696	-	799	745	-	-	-	-	-	-	-
Platoon blocked, %								-	-	-	-	-
Mov Cap-1 Maneuver	542	526	928	508	525	799	1381	-	-	1222	-	-
Mov Cap-2 Maneuver	542	526	-	508	525	-	-	-	-	-	-	-
Stage 1	840	758	-	740	685	-	-	-	-	-	-	-
Stage 2	729	690	-	750	735	-	-	-	-	-	-	-

Approach	EB		WB		NB		SB	
HCM Control Delay, s	11.7		13.2		0.3		1	
HCM LOS	B		B					

Minor Lane/Major Mvmt	NBL	NBT	NBR	EBLn1WBLn1	SBL	SBT	SBR
Capacity (veh/h)	1381	-	-	581	520	1222	-
HCM Lane V/C Ratio	0.006	-	-	0.069	0.161	0.013	-
HCM Control Delay (s)	7.6	0	-	11.7	13.2	8	0
HCM Lane LOS	A	A	-	B	B	A	A
HCM 95th %tile Q(veh)	0	-	-	0.2	0.6	0	-

Intersection												
Int Delay, s/veh	1.3											
Movement	EBL	EBT	EBR	WBL	WBT	WBR	NBL	NBT	NBR	SBL	SBT	SBR
Lane Configurations		↕			↕			↕			↕	
Traffic Vol, veh/h	8	11	15	0	4	0	26	236	0	0	210	10
Future Vol, veh/h	8	11	15	0	4	0	26	236	0	0	210	10
Conflicting Peds, #/hr	0	0	0	0	0	0	0	0	0	0	0	0
Sign Control	Stop	Stop	Stop	Stop	Stop	Stop	Free	Free	Free	Free	Free	Free
RT Channelized	-	-	None	-	-	None	-	-	None	-	-	None
Storage Length	-	-	-	-	-	-	-	-	-	-	-	-
Veh in Median Storage, #	-	0	-	-	0	-	-	0	-	-	0	-
Grade, %	-	0	-	-	0	-	-	0	-	-	0	-
Peak Hour Factor	92	92	92	92	92	92	92	92	92	92	92	92
Heavy Vehicles, %	25	25	25	25	25	25	14	14	14	18	18	18
Mvmt Flow	9	12	16	0	4	0	28	257	0	0	228	11

Major/Minor	Minor2		Minor1			Major1			Major2			
Conflicting Flow All	549	547	234	561	552	257	239	0	0	257	0	0
Stage 1	234	234	-	313	313	-	-	-	-	-	-	-
Stage 2	315	313	-	248	239	-	-	-	-	-	-	-
Critical Hdwy	7.35	6.75	6.45	7.35	6.75	6.45	4.24	-	-	4.28	-	-
Critical Hdwy Stg 1	6.35	5.75	-	6.35	5.75	-	-	-	-	-	-	-
Critical Hdwy Stg 2	6.35	5.75	-	6.35	5.75	-	-	-	-	-	-	-
Follow-up Hdwy	3.725	4.225	3.525	3.725	4.225	3.525	2.326	-	-	2.362	-	-
Pot Cap-1 Maneuver	413	414	751	405	411	729	1261	-	-	1220	-	-
Stage 1	720	671	-	651	618	-	-	-	-	-	-	-
Stage 2	650	618	-	708	667	-	-	-	-	-	-	-
Platoon blocked, %								-	-	-	-	-
Mov Cap-1 Maneuver	401	403	751	379	400	729	1261	-	-	1220	-	-
Mov Cap-2 Maneuver	401	403	-	379	400	-	-	-	-	-	-	-
Stage 1	701	671	-	634	602	-	-	-	-	-	-	-
Stage 2	629	602	-	680	667	-	-	-	-	-	-	-

Approach	EB		WB			NB			SB		
HCM Control Delay, s	12.7		14.1			0.8			0		
HCM LOS	B		B								

Minor Lane/Major Mvmt	NBL	NBT	NBR	EBLn1	WBLn1	SBL	SBT	SBR
Capacity (veh/h)	1261	-	-	506	400	1220	-	-
HCM Lane V/C Ratio	0.022	-	-	0.073	0.011	-	-	-
HCM Control Delay (s)	7.9	0	-	12.7	14.1	0	-	-
HCM Lane LOS	A	A	-	B	B	A	-	-
HCM 95th %tile Q(veh)	0.1	-	-	0.2	0	0	-	-

Intersection												
Int Delay, s/veh	3.5											
Movement	EBL	EBT	EBR	WBL	WBT	WBR	NBL	NBT	NBR	SBL	SBT	SBR
Lane Configurations		↕			↕			↕			↕	
Traffic Vol, veh/h	0	0	0	59	0	85	0	232	56	37	183	0
Future Vol, veh/h	0	0	0	59	0	85	0	232	56	37	183	0
Conflicting Peds, #/hr	0	0	0	0	0	0	0	0	0	0	0	0
Sign Control	Stop	Stop	Stop	Stop	Stop	Stop	Free	Free	Free	Free	Free	Free
RT Channelized	-	-	None	-	-	None	-	-	None	-	-	None
Storage Length	-	-	-	-	-	-	-	-	-	-	-	-
Veh in Median Storage, #	-	0	-	-	0	-	-	0	-	-	0	-
Grade, %	-	0	-	-	0	-	-	0	-	-	0	-
Peak Hour Factor	92	92	92	92	92	92	92	92	92	92	92	92
Heavy Vehicles, %	0	0	0	7	7	7	15	15	15	23	23	23
Mvmt Flow	0	0	0	64	0	92	0	252	61	40	199	0

Major/Minor	Minor2		Minor1		Major1		Major2					
Conflicting Flow All	608	592	199	562	562	283	199	0	0	313	0	0
Stage 1	279	279	-	283	283	-	-	-	-	-	-	-
Stage 2	329	313	-	279	279	-	-	-	-	-	-	-
Critical Hdwy	7.1	6.5	6.2	7.17	6.57	6.27	4.25	-	-	4.33	-	-
Critical Hdwy Stg 1	6.1	5.5	-	6.17	5.57	-	-	-	-	-	-	-
Critical Hdwy Stg 2	6.1	5.5	-	6.17	5.57	-	-	-	-	-	-	-
Follow-up Hdwy	3.5	4	3.3	3.563	4.063	3.363	2.335	-	-	2.407	-	-
Pot Cap-1 Maneuver	411	422	847	430	429	744	1299	-	-	1138	-	-
Stage 1	732	683	-	713	668	-	-	-	-	-	-	-
Stage 2	688	661	-	717	671	-	-	-	-	-	-	-
Platoon blocked, %								-	-	-	-	-
Mov Cap-1 Maneuver	349	405	847	417	412	744	1299	-	-	1138	-	-
Mov Cap-2 Maneuver	349	405	-	417	412	-	-	-	-	-	-	-
Stage 1	732	656	-	713	668	-	-	-	-	-	-	-
Stage 2	603	661	-	688	644	-	-	-	-	-	-	-

Approach	EB	WB	NB	SB
HCM Control Delay, s	0	13.8	0	1.4
HCM LOS	A	B		

Minor Lane/Major Mvmt	NBL	NBT	NBR	EBLn1WBLn1	SBL	SBT	SBR
Capacity (veh/h)	1299	-	-	-	563	1138	-
HCM Lane V/C Ratio	-	-	-	-	0.278	0.035	-
HCM Control Delay (s)	0	-	-	0	13.8	8.3	0
HCM Lane LOS	A	-	-	A	B	A	A
HCM 95th %tile Q(veh)	0	-	-	-	1.1	0.1	-

Intersection												
Int Delay, s/veh	2.6											
Movement	EBL	EBT	EBR	WBL	WBT	WBR	NBL	NBT	NBR	SBL	SBT	SBR
Lane Configurations		↕			↕			↕			↕	
Traffic Vol, veh/h	0	5	0	17	3	78	3	206	4	34	204	0
Future Vol, veh/h	0	5	0	17	3	78	3	206	4	34	204	0
Conflicting Peds, #/hr	0	0	0	0	0	0	0	0	0	0	0	0
Sign Control	Stop	Stop	Stop	Stop	Stop	Stop	Free	Free	Free	Free	Free	Free
RT Channelized	-	-	None	-	-	None	-	-	None	-	-	None
Storage Length	-	-	-	-	-	-	-	-	-	-	-	-
Veh in Median Storage, #	-	0	-	-	0	-	-	0	-	-	0	-
Grade, %	-	0	-	-	0	-	-	0	-	-	0	-
Peak Hour Factor	92	92	92	92	92	92	92	92	92	92	92	92
Heavy Vehicles, %	0	0	0	0	0	0	18	18	18	18	18	18
Mvmt Flow	0	5	0	18	3	85	3	224	4	37	222	0

Major/Minor	Minor2		Minor1		Major1			Major2				
Conflicting Flow All	572	530	222	531	528	226	222	0	0	228	0	0
Stage 1	296	296	-	232	232	-	-	-	-	-	-	-
Stage 2	276	234	-	299	296	-	-	-	-	-	-	-
Critical Hdwy	7.1	6.5	6.2	7.1	6.5	6.2	4.28	-	-	4.28	-	-
Critical Hdwy Stg 1	6.1	5.5	-	6.1	5.5	-	-	-	-	-	-	-
Critical Hdwy Stg 2	6.1	5.5	-	6.1	5.5	-	-	-	-	-	-	-
Follow-up Hdwy	3.5	4	3.3	3.5	4	3.3	2.362	-	-	2.362	-	-
Pot Cap-1 Maneuver	434	457	823	462	459	818	1258	-	-	1251	-	-
Stage 1	717	672	-	775	716	-	-	-	-	-	-	-
Stage 2	735	715	-	714	672	-	-	-	-	-	-	-
Platoon blocked, %								-	-	-	-	-
Mov Cap-1 Maneuver	376	440	823	445	442	818	1258	-	-	1251	-	-
Mov Cap-2 Maneuver	376	440	-	445	442	-	-	-	-	-	-	-
Stage 1	715	649	-	773	714	-	-	-	-	-	-	-
Stage 2	654	713	-	684	649	-	-	-	-	-	-	-

Approach	EB		WB		NB		SB	
HCM Control Delay, s	13.3		11.1		0.1		1.1	
HCM LOS	B		B					

Minor Lane/Major Mvmt	NBL	NBT	NBR	EBLn1WBLn1	SBL	SBT	SBR
Capacity (veh/h)	1258	-	-	440	698	1251	-
HCM Lane V/C Ratio	0.003	-	-	0.012	0.153	0.03	-
HCM Control Delay (s)	7.9	0	-	13.3	11.1	8	0
HCM Lane LOS	A	A	-	B	B	A	A
HCM 95th %tile Q(veh)	0	-	-	0	0.5	0.1	-

Intersection	
Intersection Delay, s/veh	12.6
Intersection LOS	B

Movement	EBL	EBT	EBR	WBL	WBT	WBR	NBL	NBT	NBR	SBL	SBT	SBR
Lane Configurations		↕			↕			↕			↕	
Traffic Vol, veh/h	57	147	32	19	179	62	34	95	8	41	113	68
Future Vol, veh/h	57	147	32	19	179	62	34	95	8	41	113	68
Peak Hour Factor	0.92	0.92	0.92	0.92	0.92	0.92	0.92	0.92	0.92	0.92	0.92	0.92
Heavy Vehicles, %	6	6	6	8	8	8	29	29	29	17	17	17
Mvmt Flow	62	160	35	21	195	67	37	103	9	45	123	74
Number of Lanes	0	1	0	0	1	0	0	1	0	0	1	0

Approach	EB	WB	NB	SB
Opposing Approach	WB	EB	SB	NB
Opposing Lanes	1	1	1	1
Conflicting Approach Left	SB	NB	EB	WB
Conflicting Lanes Left	1	1	1	1
Conflicting Approach Right	NB	SB	WB	EB
Conflicting Lanes Right	1	1	1	1
HCM Control Delay	12.5	12.9	11.8	12.7
HCM LOS	B	B	B	B

Lane	NBLn1	EBLn1	WBLn1	SBLn1
Vol Left, %	25%	24%	7%	18%
Vol Thru, %	69%	62%	69%	51%
Vol Right, %	6%	14%	24%	31%
Sign Control	Stop	Stop	Stop	Stop
Traffic Vol by Lane	137	236	260	222
LT Vol	34	57	19	41
Through Vol	95	147	179	113
RT Vol	8	32	62	68
Lane Flow Rate	149	257	283	241
Geometry Grp	1	1	1	1
Degree of Util (X)	0.265	0.403	0.436	0.393
Departure Headway (Hd)	6.406	5.657	5.556	5.867
Convergence, Y/N	Yes	Yes	Yes	Yes
Cap	558	634	644	611
Service Time	4.478	3.72	3.617	3.93
HCM Lane V/C Ratio	0.267	0.405	0.439	0.394
HCM Control Delay	11.8	12.5	12.9	12.7
HCM Lane LOS	B	B	B	B
HCM 95th-tile Q	1.1	1.9	2.2	1.9

Intersection	
Intersection Delay, s/veh	9
Intersection LOS	A

Movement	EBL	EBT	EBR	WBL	WBT	WBR	NBL	NBT	NBR	SBL	SBT	SBR
Lane Configurations												
Traffic Vol, veh/h	18	83	4	11	86	38	8	33	16	33	48	34
Future Vol, veh/h	18	83	4	11	86	38	8	33	16	33	48	34
Peak Hour Factor	0.92	0.92	0.92	0.92	0.92	0.92	0.92	0.92	0.92	0.92	0.92	0.92
Heavy Vehicles, %	11	11	11	31	31	31	11	11	11	21	21	21
Mvmt Flow	20	90	4	12	93	41	9	36	17	36	52	37
Number of Lanes	1	1	0	1	1	0	0	1	0	0	1	0

Approach	EB	WB	NB	SB
Opposing Approach	WB	EB	SB	NB
Opposing Lanes	2	2	1	1
Conflicting Approach Left SB		NB	EB	WB
Conflicting Lanes Left	1	1	2	2
Conflicting Approach Right NB		SB	WB	EB
Conflicting Lanes Right	1	1	2	2
HCM Control Delay	8.9	9.5	8.3	8.9
HCM LOS	A	A	A	A

Lane	NBLn1	EBLn1	EBLn2	WBLn1	WBLn2	SBLn1
Vol Left, %		14%	100%	0%	100%	0%
Vol Thru, %		58%	0%	95%	0%	69%
Vol Right, %		28%	0%	5%	0%	31%
Sign Control		Stop	Stop	Stop	Stop	Stop
Traffic Vol by Lane		57	18	87	11	124
LT Vol		8	18	0	11	0
Through Vol		33	0	83	0	86
RT Vol		16	0	4	0	38
Lane Flow Rate		62	20	95	12	135
Geometry Grp		2	7	7	7	7
Degree of Util (X)		0.083	0.032	0.138	0.02	0.202
Departure Headway (Hd)		4.799	5.806	5.27	6.111	5.392
Convergence, Y/N		Yes	Yes	Yes	Yes	Yes
Cap		745	616	680	586	664
Service Time		2.835	3.544	3.008	3.849	3.13
HCM Lane V/C Ratio		0.083	0.032	0.14	0.02	0.203
HCM Control Delay		8.3	8.7	8.9	9	9.5
HCM Lane LOS		A	A	A	A	A
HCM 95th-tile Q		0.3	0.1	0.5	0.1	0.8

Intersection												
Int Delay, s/veh	14.6											
Movement	EBL	EBT	EBR	WBL	WBT	WBR	NBL	NBT	NBR	SBL	SBT	SBR
Lane Configurations	↖	↑	↗	↖	↑	↗	↖	↑	↗		↕	
Traffic Vol, veh/h	4	83	19	188	78	154	17	55	107	134	31	4
Future Vol, veh/h	4	83	19	188	78	154	17	55	107	134	31	4
Conflicting Peds, #/hr	0	0	0	0	0	0	1	0	0	0	0	1
Sign Control	Free	Free	Free	Free	Free	Free	Stop	Stop	Stop	Stop	Stop	Stop
RT Channelized	-	-	None	-	-	None	-	-	None	-	-	None
Storage Length	85	-	0	70	-	105	60	-	50	-	-	-
Veh in Median Storage, #	-	0	-	-	0	-	-	0	-	-	0	-
Grade, %	-	0	-	-	0	-	-	0	-	-	0	-
Peak Hour Factor	92	92	92	92	92	92	92	92	92	92	92	92
Heavy Vehicles, %	12	12	12	9	9	9	13	13	13	9	9	9
Mvmt Flow	4	90	21	204	85	167	18	60	116	146	34	4

Major/Minor	Major1			Major2			Minor1			Minor2		
Conflicting Flow All	252	0	0	111	0	0	695	758	90	690	612	86
Stage 1	-	-	-	-	-	-	98	98	-	493	493	-
Stage 2	-	-	-	-	-	-	597	660	-	197	119	-
Critical Hdwy	4.22	-	-	4.19	-	-	7.23	6.63	6.33	7.19	6.59	6.29
Critical Hdwy Stg 1	-	-	-	-	-	-	6.23	5.63	-	6.19	5.59	-
Critical Hdwy Stg 2	-	-	-	-	-	-	6.23	5.63	-	6.19	5.59	-
Follow-up Hdwy	2.308	-	-	2.281	-	-	3.617	4.117	3.417	3.581	4.081	3.381
Pot Cap-1 Maneuver	1257	-	-	1436	-	-	342	324	938	350	399	954
Stage 1	-	-	-	-	-	-	882	793	-	545	536	-
Stage 2	-	-	-	-	-	-	471	444	-	789	784	-
Platoon blocked, %	-	-	-	-	-	-	-	-	-	-	-	-
Mov Cap-1 Maneuver	1257	-	-	1436	-	-	280	277	938	228	341	953
Mov Cap-2 Maneuver	-	-	-	-	-	-	280	277	-	228	341	-
Stage 1	-	-	-	-	-	-	879	791	-	543	460	-
Stage 2	-	-	-	-	-	-	372	381	-	637	782	-

Approach	EB			WB			NB			SB		
HCM Control Delay, s	0.3			3.5			14			52		
HCM LOS							B			F		

Minor Lane/Major Mvmt	NBLn1	NBLn2	NBLn3	EBL	EBT	EBR	WBL	WBT	WBR	SBLn1
Capacity (veh/h)	280	277	938	1257	-	-	1436	-	-	248
HCM Lane V/C Ratio	0.066	0.216	0.124	0.003	-	-	0.142	-	-	0.741
HCM Control Delay (s)	18.8	21.5	9.4	7.9	-	-	7.9	-	-	52
HCM Lane LOS	C	C	A	A	-	-	A	-	-	F
HCM 95th %tile Q(veh)	0.2	0.8	0.4	0	-	-	0.5	-	-	5.2

Intersection						
Int Delay, s/veh	10.7					
Movement	EBL	EBT	WBT	WBR	SBL	SBR
Lane Configurations		↑	↑		↑	↑
Traffic Vol, veh/h	0	327	348	0	251	75
Future Vol, veh/h	0	327	348	0	251	75
Conflicting Peds, #/hr	0	0	0	0	0	0
Sign Control	Free	Free	Free	Free	Stop	Stop
RT Channelized	-	None	-	None	-	None
Storage Length	-	-	-	-	0	610
Veh in Median Storage, #	-	0	0	-	0	-
Grade, %	-	0	0	-	0	-
Peak Hour Factor	92	92	92	92	92	92
Heavy Vehicles, %	13	13	10	10	19	19
Mvmt Flow	0	355	378	0	273	82

Major/Minor	Major1	Major2	Minor2		
Conflicting Flow All	-	0	-	0	733 378
Stage 1	-	-	-	-	378 -
Stage 2	-	-	-	-	355 -
Critical Hdwy	-	-	-	-	6.59 6.39
Critical Hdwy Stg 1	-	-	-	-	5.59 -
Critical Hdwy Stg 2	-	-	-	-	5.59 -
Follow-up Hdwy	-	-	-	-	3.671 3.471
Pot Cap-1 Maneuver	0	-	-	0	364 633
Stage 1	0	-	-	0	657 -
Stage 2	0	-	-	0	674 -
Platoon blocked, %	-	-	-	-	-
Mov Cap-1 Maneuver	-	-	-	-	364 633
Mov Cap-2 Maneuver	-	-	-	-	364 -
Stage 1	-	-	-	-	657 -
Stage 2	-	-	-	-	674 -

Approach	EB	WB	SB
HCM Control Delay, s	0	0	32.8
HCM LOS			D

Minor Lane/Major Mvmt	EBT	WBT	SBLn1	SBLn2
Capacity (veh/h)	-	-	364	633
HCM Lane V/C Ratio	-	-	0.75	0.129
HCM Control Delay (s)	-	-	39.2	11.5
HCM Lane LOS	-	-	E	B
HCM 95th %tile Q(veh)	-	-	5.9	0.4

HCM 6th TWSC
15: SR-99 Northbound Ramps & Avenue 17

Village D Specific Plan
Phase I NP - AM Peak Hour

Intersection												
Int Delay, s/veh	54											
Movement	EBL	EBT	EBR	WBL	WBT	WBR	NBL	NBT	NBR	SBL	SBT	SBR
Lane Configurations	↖	↑			↗			↖	↗			
Traffic Vol, veh/h	83	384	0	0	886	236	157	2	240	0	0	0
Future Vol, veh/h	83	384	0	0	886	236	157	2	240	0	0	0
Conflicting Peds, #/hr	0	0	0	0	0	0	0	0	0	0	0	0
Sign Control	Free	Free	Free	Free	Free	Free	Stop	Stop	Stop	Free	Free	Free
RT Channelized	-	-	None	-	-	None	-	-	None	-	-	None
Storage Length	125	-	-	-	-	-	-	-	50	-	-	-
Veh in Median Storage, #	-	0	-	-	0	-	-	0	-	-	16965	-
Grade, %	-	0	-	-	0	-	-	0	-	-	0	-
Peak Hour Factor	92	92	92	92	92	92	92	92	92	92	92	92
Heavy Vehicles, %	11	11	11	3	3	3	14	14	14	0	0	0
Mvmt Flow	90	417	0	0	963	257	171	2	261	0	0	0

Major/Minor	Major1	Major2	Minor1
Conflicting Flow All	1220	0	-
Stage 1	-	-	-
Stage 2	-	-	-
Critical Hdwy	4.21	-	-
Critical Hdwy Stg 1	-	-	-
Critical Hdwy Stg 2	-	-	-
Follow-up Hdwy	2.299	-	-
Pot Cap-1 Maneuver	541	-	0
Stage 1	-	-	0
Stage 2	-	-	0
Platoon blocked, %	-	-	-
Mov Cap-1 Maneuver	541	-	-
Mov Cap-2 Maneuver	-	-	-
Stage 1	-	-	-
Stage 2	-	-	-

Approach	EB	WB	NB
HCM Control Delay, s	2.3	0	266.4
HCM LOS			F

Minor Lane/Major Mvmt	NBLn1	NBLn2	EBL	EBT	WBT	WBR
Capacity (veh/h)	80	611	541	-	-	-
HCM Lane V/C Ratio	2.16	0.427	0.167	-	-	-
HCM Control Delay (s)	\$ 645.6	15.2	13	-	-	-
HCM Lane LOS	F	C	B	-	-	-
HCM 95th %tile Q(veh)	15.7	2.1	0.6	-	-	-

Notes
 -: Volume exceeds capacity \$: Delay exceeds 300s +: Computation Not Defined *: All major volume in platoon

HCM 6th Signalized Intersection Summary
 16: Love's Truck Stop Driveway/Driveway & Avenue 17

Village D Specific Plan
 Phase I NP - AM Peak Hour



Movement	EBL	EBT	EBR	WBL	WBT	WBR	NBL	NBT	NBR	SBL	SBT	SBR
Lane Configurations												
Traffic Volume (veh/h)	162	326	132	45	836	56	136	0	22	48	0	90
Future Volume (veh/h)	162	326	132	45	836	56	136	0	22	48	0	90
Initial Q (Qb), veh	0	0	0	0	0	0	0	0	0	0	0	0
Ped-Bike Adj(A_pbT)	1.00		1.00	1.00		1.00	1.00		1.00	1.00		1.00
Parking Bus, Adj	1.00	1.00	1.00	1.00	1.00	1.00	1.00	1.00	1.00	1.00	1.00	1.00
Work Zone On Approach		No			No			No			No	
Adj Sat Flow, veh/h/ln	1796	1796	1796	1856	1856	1856	1900	1900	1900	1900	1900	1900
Adj Flow Rate, veh/h	176	354	143	49	909	61	148	0	24	52	0	98
Peak Hour Factor	0.92	0.92	0.92	0.92	0.92	0.92	0.92	0.92	0.92	0.92	0.92	0.92
Percent Heavy Veh, %	7	7	7	3	3	3	0	0	0	0	0	0
Cap, veh/h	184	1937	864	63	853	57	158	0	337	68	0	256
Arrive On Green	0.11	0.57	0.57	0.04	0.50	0.50	0.09	0.00	0.21	0.04	0.00	0.16
Sat Flow, veh/h	1711	3413	1522	1767	1719	115	1810	0	1610	1810	0	1610
Grp Volume(v), veh/h	176	354	143	49	0	970	148	0	24	52	0	98
Grp Sat Flow(s),veh/h/ln	1711	1706	1522	1767	0	1835	1810	0	1610	1810	0	1610
Q Serve(g_s), s	12.3	6.0	5.4	3.3	0.0	59.5	9.8	0.0	1.4	3.4	0.0	6.5
Cycle Q Clear(g_c), s	12.3	6.0	5.4	3.3	0.0	59.5	9.8	0.0	1.4	3.4	0.0	6.5
Prop In Lane	1.00		1.00	1.00		0.06	1.00		1.00	1.00		1.00
Lane Grp Cap(c), veh/h	184	1937	864	63	0	910	158	0	337	68	0	256
V/C Ratio(X)	0.96	0.18	0.17	0.78	0.00	1.07	0.93	0.00	0.07	0.77	0.00	0.38
Avail Cap(c_a), veh/h	184	1937	864	131	0	910	158	0	337	134	0	256
HCM Platoon Ratio	1.00	1.00	1.00	1.00	1.00	1.00	1.00	1.00	1.00	1.00	1.00	1.00
Upstream Filter(I)	1.00	1.00	1.00	1.00	0.00	1.00	1.00	0.00	1.00	1.00	0.00	1.00
Uniform Delay (d), s/veh	53.3	12.5	12.4	57.4	0.0	30.3	54.4	0.0	38.1	57.3	0.0	45.2
Incr Delay (d2), s/veh	53.8	0.0	0.1	18.2	0.0	49.1	52.5	0.0	0.4	16.6	0.0	4.3
Initial Q Delay(d3),s/veh	0.0	0.0	0.0	0.0	0.0	0.0	0.0	0.0	0.0	0.0	0.0	0.0
%ile BackOfQ(50%),veh/ln	8.0	2.3	1.8	1.8	0.0	37.5	6.7	0.0	0.6	1.9	0.0	2.9
Unsig. Movement Delay, s/veh												
LnGrp Delay(d),s/veh	107.0	12.6	12.5	75.6	0.0	79.4	106.9	0.0	38.5	73.9	0.0	49.5
LnGrp LOS	F	B	B	E	A	F	F	A	D	E	A	D
Approach Vol, veh/h		673			1019			172				150
Approach Delay, s/veh		37.2			79.2			97.3				57.9
Approach LOS		D			E			F				E
Timer - Assigned Phs	1	2	3	4	5	6	7	8				
Phs Duration (G+Y+Rc), s	9.0	29.6	8.8	72.6	15.0	23.6	17.4	64.0				
Change Period (Y+Rc), s	4.5	4.5	4.5	4.5	4.5	4.5	4.5	4.5				
Max Green Setting (Gmax), s	8.9	20.7	8.9	63.5	10.5	19.1	12.9	59.5				
Max Q Clear Time (g_c+I1), s	5.4	3.4	5.3	8.0	11.8	8.5	14.3	61.5				
Green Ext Time (p_c), s	0.0	0.1	0.0	3.1	0.0	0.3	0.0	0.0				
Intersection Summary												
HCM 6th Ctrl Delay			65.1									
HCM 6th LOS			E									

Intersection												
Int Delay, s/veh	7.4											
Movement	EBL	EBT	EBR	WBL	WBT	WBR	NBL	NBT	NBR	SBL	SBT	SBR
Lane Configurations	↖	↗		↖	↗		↖	↑	↗	↖	↑	↗
Traffic Vol, veh/h	15	46	15	27	51	12	25	102	98	14	39	21
Future Vol, veh/h	15	46	15	27	51	12	25	102	98	14	39	21
Conflicting Peds, #/hr	1	0	2	2	0	1	1	0	1	1	0	1
Sign Control	Free	Free	Free	Free	Free	Free	Stop	Stop	Stop	Stop	Stop	Stop
RT Channelized	-	-	None	-	-	None	-	-	None	-	-	None
Storage Length	110	-	-	165	-	-	65	-	50	100	-	50
Veh in Median Storage, #	-	0	-	-	0	-	-	0	-	-	0	-
Grade, %	-	0	-	-	0	-	-	0	-	-	0	-
Peak Hour Factor	92	92	92	92	92	92	92	92	92	92	92	92
Heavy Vehicles, %	4	4	4	4	4	4	0	0	0	0	0	0
Mvmt Flow	16	50	16	29	55	13	27	111	107	15	42	23

Major/Minor	Major1			Major2			Minor1			Minor2		
Conflicting Flow All	69	0	0	68	0	0	245	219	61	321	221	64
Stage 1	-	-	-	-	-	-	92	92	-	121	121	-
Stage 2	-	-	-	-	-	-	153	127	-	200	100	-
Critical Hdwy	4.14	-	-	4.14	-	-	7.1	6.5	6.2	7.1	6.5	6.2
Critical Hdwy Stg 1	-	-	-	-	-	-	6.1	5.5	-	6.1	5.5	-
Critical Hdwy Stg 2	-	-	-	-	-	-	6.1	5.5	-	6.1	5.5	-
Follow-up Hdwy	2.236	-	-	2.236	-	-	3.5	4	3.3	3.5	4	3.3
Pot Cap-1 Maneuver	1519	-	-	1521	-	-	713	683	1010	636	681	1006
Stage 1	-	-	-	-	-	-	920	823	-	888	800	-
Stage 2	-	-	-	-	-	-	854	795	-	806	816	-
Platoon blocked, %	-	-	-	-	-	-	-	-	-	-	-	-
Mov Cap-1 Maneuver	1518	-	-	1518	-	-	646	660	1007	483	659	1004
Mov Cap-2 Maneuver	-	-	-	-	-	-	646	660	-	483	659	-
Stage 1	-	-	-	-	-	-	909	812	-	878	784	-
Stage 2	-	-	-	-	-	-	774	779	-	615	805	-

Approach	EB			WB			NB			SB		
HCM Control Delay, s	1.5			2.2			10.4			10.6		
HCM LOS							B			B		

Minor Lane/Major Mvmt	NBLn1	NBLn2	NBLn3	EBL	EBT	EBR	WBL	WBT	WBR	SBLn1	SBLn2	SBLn3
Capacity (veh/h)	646	660	1007	1518	-	-	1518	-	-	483	659	1004
HCM Lane V/C Ratio	0.042	0.168	0.106	0.011	-	-	0.019	-	-	0.032	0.064	0.023
HCM Control Delay (s)	10.8	11.6	9	7.4	-	-	7.4	-	-	12.7	10.8	8.7
HCM Lane LOS	B	B	A	A	-	-	A	-	-	B	B	A
HCM 95th %tile Q(veh)	0.1	0.6	0.4	0	-	-	0.1	-	-	0.1	0.2	0.1

Intersection	
Intersection Delay, s/veh	17.8
Intersection LOS	C

Movement	EBL	EBT	EBR	WBL	WBT	WBR	NBL	NBT	NBR	SBL	SBT	SBR
Lane Configurations												
Traffic Vol, veh/h	50	217	88	51	162	25	116	138	109	117	103	30
Future Vol, veh/h	50	217	88	51	162	25	116	138	109	117	103	30
Peak Hour Factor	0.92	0.92	0.92	0.92	0.92	0.92	0.92	0.92	0.92	0.92	0.92	0.92
Heavy Vehicles, %	3	3	3	3	3	3	0	0	0	0	0	0
Mvmt Flow	54	236	96	55	176	27	126	150	118	127	112	33
Number of Lanes	1	1	0	1	1	0	1	1	1	1	1	1

Approach	EB	WB	NB	SB
Opposing Approach	WB	EB	SB	NB
Opposing Lanes	2	2	3	3
Conflicting Approach Left	SB	NB	EB	WB
Conflicting Lanes Left	3	3	2	2
Conflicting Approach Right	NB	SB	WB	EB
Conflicting Lanes Right	3	3	2	2
HCM Control Delay	24.7	16.7	14.2	14.5
HCM LOS	C	C	B	B

Lane	NBLn1	NBLn2	NBLn3	EBLn1	EBLn2	WBLn1	WBLn2	SBLn1	SBLn2	SBLn3
Vol Left, %	100%	0%	0%	100%	0%	100%	0%	100%	0%	0%
Vol Thru, %	0%	100%	0%	0%	71%	0%	87%	0%	100%	0%
Vol Right, %	0%	0%	100%	0%	29%	0%	13%	0%	0%	100%
Sign Control	Stop	Stop	Stop	Stop	Stop	Stop	Stop	Stop	Stop	Stop
Traffic Vol by Lane	116	138	109	50	305	51	187	117	103	30
LT Vol	116	0	0	50	0	51	0	117	0	0
Through Vol	0	138	0	0	217	0	162	0	103	0
RT Vol	0	0	109	0	88	0	25	0	0	30
Lane Flow Rate	126	150	118	54	332	55	203	127	112	33
Geometry Grp	8	8	8	8	8	8	8	8	8	8
Degree of Util (X)	0.3	0.335	0.241	0.126	0.703	0.134	0.458	0.313	0.259	0.069
Departure Headway (Hd)	8.553	8.037	7.316	8.348	7.639	8.721	8.119	8.851	8.334	7.611
Convergence, Y/N	Yes	Yes	Yes	Yes	Yes	Yes	Yes	Yes	Yes	Yes
Cap	419	446	488	428	471	409	441	404	429	468
Service Time	6.343	5.827	5.105	6.132	5.423	6.514	5.912	6.648	6.131	5.407
HCM Lane V/C Ratio	0.301	0.336	0.242	0.126	0.705	0.134	0.46	0.314	0.261	0.071
HCM Control Delay	15	14.9	12.4	12.3	26.7	12.9	17.7	15.7	14.1	11
HCM Lane LOS	B	B	B	B	D	B	C	C	B	B
HCM 95th-tile Q	1.2	1.5	0.9	0.4	5.4	0.5	2.3	1.3	1	0.2

Intersection												
Intersection Delay, s/veh	16.7											
Intersection LOS	C											

Movement	EBL	EBT	EBR	WBL	WBT	WBR	NBL	NBT	NBR	SBL	SBT	SBR
Lane Configurations		↕			↕			↕			↕	
Traffic Vol, veh/h	47	203	38	11	166	108	72	42	24	211	61	61
Future Vol, veh/h	47	203	38	11	166	108	72	42	24	211	61	61
Peak Hour Factor	0.92	0.92	0.92	0.92	0.92	0.92	0.92	0.92	0.92	0.92	0.92	0.92
Heavy Vehicles, %	6	6	6	6	6	6	0	0	0	0	0	0
Mvmt Flow	51	221	41	12	180	117	78	46	26	229	66	66
Number of Lanes	0	1	0	0	1	0	0	1	0	0	1	0

Approach	EB	WB	NB	SB
Opposing Approach	WB	EB	SB	NB
Opposing Lanes	1	1	1	1
Conflicting Approach Left	SB	NB	EB	WB
Conflicting Lanes Left	1	1	1	1
Conflicting Approach Right	NB	SB	WB	EB
Conflicting Lanes Right	1	1	1	1
HCM Control Delay	16.7	15.9	12.4	19.1
HCM LOS	C	C	B	C

Lane	NBLn1	EBLn1	WBLn1	SBLn1
Vol Left, %	52%	16%	4%	63%
Vol Thru, %	30%	70%	58%	18%
Vol Right, %	17%	13%	38%	18%
Sign Control	Stop	Stop	Stop	Stop
Traffic Vol by Lane	138	288	285	333
LT Vol	72	47	11	211
Through Vol	42	203	166	61
RT Vol	24	38	108	61
Lane Flow Rate	150	313	310	362
Geometry Grp	1	1	1	1
Degree of Util (X)	0.28	0.547	0.529	0.625
Departure Headway (Hd)	6.727	6.293	6.142	6.217
Convergence, Y/N	Yes	Yes	Yes	Yes
Cap	533	573	585	579
Service Time	4.796	4.348	4.196	4.269
HCM Lane V/C Ratio	0.281	0.546	0.53	0.625
HCM Control Delay	12.4	16.7	15.9	19.1
HCM Lane LOS	B	C	C	C
HCM 95th-tile Q	1.1	3.3	3.1	4.3

Intersection												
Intersection Delay, s/veh	8.5											
Intersection LOS	A											

Movement	EBL	EBT	EBR	WBL	WBT	WBR	NBL	NBT	NBR	SBL	SBT	SBR
Lane Configurations		↔			↔	↔		↔	↔		↔	↔
Traffic Vol, veh/h	0	0	0	44	0	157	0	43	135	72	13	0
Future Vol, veh/h	0	0	0	44	0	157	0	43	135	72	13	0
Peak Hour Factor	0.92	0.92	0.92	0.92	0.92	0.92	0.92	0.92	0.92	0.92	0.92	0.92
Heavy Vehicles, %	0	0	0	3	3	3	0	0	0	0	0	0
Mvmt Flow	0	0	0	48	0	171	0	47	147	78	14	0
Number of Lanes	0	1	0	0	1	1	0	1	1	0	1	1

Approach	EB	WB	NB	SB
Opposing Approach	WB	EB	SB	NB
Opposing Lanes	2	1	2	2
Conflicting Approach Left	SB	NB	EB	WB
Conflicting Lanes Left	2	2	1	2
Conflicting Approach Right	NB	SB	WB	EB
Conflicting Lanes Right	2	2	2	1
HCM Control Delay	0	8.6	8.1	9.3
HCM LOS	-	A	A	A

Lane	NBLn1	NBLn2	EBLn1	WBLn1	WBLn2	SBLn1	SBLn2
Vol Left, %	0%	0%	0%	100%	0%	85%	0%
Vol Thru, %	100%	0%	100%	0%	0%	15%	100%
Vol Right, %	0%	100%	0%	0%	100%	0%	0%
Sign Control	Stop	Stop	Stop	Stop	Stop	Stop	Stop
Traffic Vol by Lane	43	135	0	44	157	85	0
LT Vol	0	0	0	44	0	72	0
Through Vol	43	0	0	0	0	13	0
RT Vol	0	135	0	0	157	0	0
Lane Flow Rate	47	147	0	48	171	92	0
Geometry Grp	7	7	6	7	7	7	7
Degree of Util (X)	0.067	0.18	0	0.076	0.215	0.144	0
Departure Headway (Hd)	5.127	4.424	5.461	5.746	4.54	5.628	5.202
Convergence, Y/N	Yes	Yes	Yes	Yes	Yes	Yes	Yes
Cap	699	811	0	624	790	637	0
Service Time	2.856	2.152	3.503	3.474	2.268	3.362	2.936
HCM Lane V/C Ratio	0.067	0.181	0	0.077	0.216	0.144	0
HCM Control Delay	8.2	8.1	8.5	8.9	8.5	9.3	7.9
HCM Lane LOS	A	A	N	A	A	A	N
HCM 95th-tile Q	0.2	0.7	0	0.2	0.8	0.5	0

Intersection	
Intersection Delay, s/veh	20.1
Intersection LOS	C

Movement	EBL	EBT	EBR	WBL	WBT	WBR	NBL	NBT	NBR	SBL	SBT	SBR
Lane Configurations	↙	↕↔		↙	↕↔		↙	↕	↙	↙	↕	↙
Traffic Vol, veh/h	22	148	9	188	56	17	17	338	295	7	238	5
Future Vol, veh/h	22	148	9	188	56	17	17	338	295	7	238	5
Peak Hour Factor	0.92	0.92	0.92	0.92	0.92	0.92	0.92	0.92	0.92	0.92	0.92	0.92
Heavy Vehicles, %	4	4	4	4	4	4	0	0	0	0	0	0
Mvmt Flow	24	161	10	204	61	18	18	367	321	8	259	5
Number of Lanes	1	2	0	1	2	0	1	1	1	1	1	1

Approach	EB	WB	NB	SB
Opposing Approach	WB	EB	SB	NB
Opposing Lanes	3	3	3	3
Conflicting Approach Left	SB	NB	EB	WB
Conflicting Lanes Left	3	3	3	3
Conflicting Approach Right	NB	SB	WB	EB
Conflicting Lanes Right	3	3	3	3
HCM Control Delay	13.3	17.3	22.9	20.6
HCM LOS	B	C	C	C

Lane	NBLn1	NBLn2	NBLn3	EBLn1	EBLn2	EBLn3	WBLn1	WBLn2	WBLn3	SBLn1	SBLn2
Vol Left, %	100%	0%	0%	100%	0%	0%	100%	0%	0%	100%	0%
Vol Thru, %	0%	100%	0%	0%	100%	85%	0%	100%	52%	0%	100%
Vol Right, %	0%	0%	100%	0%	0%	15%	0%	0%	48%	0%	0%
Sign Control	Stop	Stop	Stop	Stop	Stop	Stop	Stop	Stop	Stop	Stop	Stop
Traffic Vol by Lane	17	338	295	22	99	58	188	37	36	7	238
LT Vol	17	0	0	22	0	0	188	0	0	7	0
Through Vol	0	338	0	0	99	49	0	37	19	0	238
RT Vol	0	0	295	0	0	9	0	0	17	0	0
Lane Flow Rate	18	367	321	24	107	63	204	41	39	8	259
Geometry Grp	8	8	8	8	8	8	8	8	8	8	8
Degree of Util (X)	0.04	0.738	0.582	0.059	0.251	0.147	0.49	0.092	0.084	0.018	0.575
Departure Headway (Hd)	7.733	7.233	6.533	8.935	8.435	8.327	8.639	8.139	7.806	8.504	8.004
Convergence, Y/N	Yes	Yes	Yes	Yes	Yes	Yes	Yes	Yes	Yes	Yes	Yes
Cap	463	500	552	400	425	430	417	439	458	420	450
Service Time	5.484	4.984	4.284	6.702	6.202	6.094	6.401	5.901	5.568	6.268	5.768
HCM Lane V/C Ratio	0.039	0.734	0.582	0.06	0.252	0.147	0.489	0.093	0.085	0.019	0.576
HCM Control Delay	10.8	27.8	18	12.3	14	12.5	19.5	11.7	11.3	11.4	21.1
HCM Lane LOS	B	D	C	B	B	B	C	B	B	B	C
HCM 95th-tile Q	0.1	6.1	3.7	0.2	1	0.5	2.6	0.3	0.3	0.1	3.5

Intersection	
Intersection Delay, s/veh	33
Intersection LOS	D

Movement	EBL	EBT	EBR	WBL	WBT	WBR	NBL	NBT	NBR	SBL	SBT	SBR
Lane Configurations												
Traffic Vol, veh/h	62	263	71	25	103	66	48	225	25	129	277	49
Future Vol, veh/h	62	263	71	25	103	66	48	225	25	129	277	49
Peak Hour Factor	0.92	0.92	0.92	0.92	0.92	0.92	0.92	0.92	0.92	0.92	0.92	0.92
Heavy Vehicles, %	2	2	2	6	6	6	2	2	2	2	2	2
Mvmt Flow	67	286	77	27	112	72	52	245	27	140	301	53
Number of Lanes	1	1	0	1	1	1	1	1	0	1	1	0

Approach	EB	WB	NB	SB
Opposing Approach	WB	EB	SB	NB
Opposing Lanes	3	2	2	2
Conflicting Approach Left	SB	NB	EB	WB
Conflicting Lanes Left	2	2	2	3
Conflicting Approach Right	NB	SB	WB	EB
Conflicting Lanes Right	2	2	3	2
HCM Control Delay	43.2	15.4	26.8	35.6
HCM LOS	E	C	D	E

Lane	NBLn1	NBLn2	EBLn1	EBLn2	WBLn1	WBLn2	WBLn3	SBLn1	SBLn2
Vol Left, %	100%	0%	100%	0%	100%	0%	0%	100%	0%
Vol Thru, %	0%	90%	0%	79%	0%	100%	0%	0%	85%
Vol Right, %	0%	10%	0%	21%	0%	0%	100%	0%	15%
Sign Control	Stop	Stop	Stop	Stop	Stop	Stop	Stop	Stop	Stop
Traffic Vol by Lane	48	250	62	334	25	103	66	129	326
LT Vol	48	0	62	0	25	0	0	129	0
Through Vol	0	225	0	263	0	103	0	0	277
RT Vol	0	25	0	71	0	0	66	0	49
Lane Flow Rate	52	272	67	363	27	112	72	140	354
Geometry Grp	8	8	8	8	8	8	8	8	8
Degree of Util (X)	0.14	0.683	0.175	0.876	0.078	0.304	0.18	0.357	0.841
Departure Headway (Hd)	9.632	9.043	9.364	8.69	10.307	9.786	9.055	9.166	8.544
Convergence, Y/N	Yes	Yes	Yes	Yes	Yes	Yes	Yes	Yes	Yes
Cap	371	399	383	417	347	366	395	391	422
Service Time	7.407	6.819	7.135	6.461	8.097	7.575	6.844	6.938	6.315
HCM Lane V/C Ratio	0.14	0.682	0.175	0.871	0.078	0.306	0.182	0.358	0.839
HCM Control Delay	14	29.3	14.1	48.6	14	16.8	13.8	17	42.9
HCM Lane LOS	B	D	B	E	B	C	B	C	E
HCM 95th-tile Q	0.5	4.9	0.6	8.9	0.3	1.3	0.6	1.6	8.1

HCM 6th Signalized Intersection Summary
 23: Avenue 16/Ellis Street & Kennedy Street

Village D Specific Plan
 Phase I NP - AM Peak Hour



Movement	WBL	WBR	NBT	NBR	SBL	SBT
Lane Configurations						
Traffic Volume (veh/h)	148	127	263	144	253	253
Future Volume (veh/h)	148	127	263	144	253	253
Initial Q (Qb), veh	0	0	0	0	0	0
Ped-Bike Adj(A_pbT)	1.00	1.00		0.98	1.00	
Parking Bus, Adj	1.00	1.00	1.00	1.00	1.00	1.00
Work Zone On Approach	No		No		No	
Adj Sat Flow, veh/h/ln	1841	1841	1841	1841	1870	1870
Adj Flow Rate, veh/h	161	138	286	157	275	275
Peak Hour Factor	0.92	0.92	0.92	0.92	0.92	0.92
Percent Heavy Veh, %	4	4	4	4	2	2
Cap, veh/h	215	337	642	341	739	2718
Arrive On Green	0.12	0.12	0.29	0.29	0.41	0.76
Sat Flow, veh/h	1753	2745	2278	1162	1781	3647
Grp Volume(v), veh/h	161	138	227	216	275	275
Grp Sat Flow(s),veh/h/ln	1753	1373	1749	1599	1781	1777
Q Serve(g_s), s	7.1	3.7	8.4	8.8	8.5	1.6
Cycle Q Clear(g_c), s	7.1	3.7	8.4	8.8	8.5	1.6
Prop In Lane	1.00	1.00		0.73	1.00	
Lane Grp Cap(c), veh/h	215	337	514	470	739	2718
V/C Ratio(X)	0.75	0.41	0.44	0.46	0.37	0.10
Avail Cap(c_a), veh/h	427	669	514	470	739	2718
HCM Platoon Ratio	1.00	1.00	1.00	1.00	1.00	1.00
Upstream Filter(I)	0.85	0.85	1.00	1.00	1.00	1.00
Uniform Delay (d), s/veh	33.9	32.4	22.9	23.1	16.2	2.4
Incr Delay (d2), s/veh	4.4	0.7	2.7	3.2	0.3	0.1
Initial Q Delay(d3),s/veh	0.0	0.0	0.0	0.0	0.0	0.0
%ile BackOfQ(50%),veh/ln	3.2	1.2	3.7	3.6	3.4	0.4
Unsig. Movement Delay, s/veh						
LnGrp Delay(d),s/veh	38.3	33.1	25.7	26.3	16.5	2.5
LnGrp LOS	D	C	C	C	B	A
Approach Vol, veh/h	299		443			550
Approach Delay, s/veh	35.9		26.0			9.5
Approach LOS	D		C			A
Timer - Assigned Phs	1	2			6	8
Phs Duration (G+Y+Rc), s	37.7	28.0			65.7	14.3
Change Period (Y+Rc), s	4.5	4.5			4.5	4.5
Max Green Setting (Gmax), s	23.5	23.5			51.5	19.5
Max Q Clear Time (g_c+10), s	10.5	10.8			3.6	9.1
Green Ext Time (p_c), s	0.7	2.2			2.0	0.7
Intersection Summary						
HCM 6th Ctrl Delay			21.3			
HCM 6th LOS			C			

HCM 6th Signalized Intersection Summary
 24: Schnoor Avenue & Kennedy Street

Village D Specific Plan
 Phase I NP - AM Peak Hour



Movement	EBL	EBT	EBR	WBL	WBT	WBR	NBL	NBT	NBR	SBL	SBT	SBR
Lane Configurations	↖	↗		↖	↗		↖	↗		↖	↗	↖
Traffic Volume (veh/h)	49	186	165	141	168	81	106	19	234	56	18	14
Future Volume (veh/h)	49	186	165	141	168	81	106	19	234	56	18	14
Initial Q (Qb), veh	0	0	0	0	0	0	0	0	0	0	0	0
Ped-Bike Adj(A_pbT)	1.00		1.00	1.00		1.00	1.00		1.00	1.00		1.00
Parking Bus, Adj	1.00	1.00	1.00	1.00	1.00	1.00	1.00	1.00	1.00	1.00	1.00	1.00
Work Zone On Approach		No			No			No			No	
Adj Sat Flow, veh/h/ln	1841	1841	1841	1826	1826	1826	1900	1900	1900	1366	1366	1366
Adj Flow Rate, veh/h	53	202	179	153	183	88	115	21	254	61	20	15
Peak Hour Factor	0.92	0.92	0.92	0.92	0.92	0.92	0.92	0.92	0.92	0.92	0.92	0.92
Percent Heavy Veh, %	4	4	4	5	5	5	0	0	0	36	36	36
Cap, veh/h	76	282	237	191	260	125	859	33	403	312	360	304
Arrive On Green	0.04	0.16	0.16	0.11	0.22	0.22	0.24	0.27	0.27	0.24	0.26	0.26
Sat Flow, veh/h	1753	1802	1511	1739	1164	560	3510	124	1498	1301	1366	1153
Grp Volume(v), veh/h	53	196	185	153	0	271	115	0	275	61	20	15
Grp Sat Flow(s),veh/h/ln	1753	1749	1565	1739	0	1724	1755	0	1622	1301	1366	1153
Q Serve(g_s), s	2.4	8.5	9.1	6.9	0.0	11.6	2.0	0.0	11.9	3.0	0.9	0.6
Cycle Q Clear(g_c), s	2.4	8.5	9.1	6.9	0.0	11.6	2.0	0.0	11.9	3.0	0.9	0.6
Prop In Lane	1.00		0.97	1.00		0.32	1.00		0.92	1.00		1.00
Lane Grp Cap(c), veh/h	76	274	245	191	0	385	859	0	436	312	360	304
V/C Ratio(X)	0.70	0.71	0.76	0.80	0.00	0.70	0.13	0.00	0.63	0.20	0.06	0.05
Avail Cap(c_a), veh/h	121	404	362	359	0	636	859	0	436	312	360	304
HCM Platoon Ratio	1.00	1.00	1.00	1.00	1.00	1.00	1.00	1.00	1.00	1.00	1.00	1.00
Upstream Filter(I)	0.83	0.83	0.83	1.00	0.00	1.00	1.00	0.00	1.00	1.00	1.00	1.00
Uniform Delay (d), s/veh	37.8	32.0	32.3	34.8	0.0	28.6	23.6	0.0	25.8	24.3	22.0	13.7
Incr Delay (d2), s/veh	9.3	2.9	4.3	7.6	0.0	2.4	0.1	0.0	6.8	0.3	0.3	0.3
Initial Q Delay(d3),s/veh	0.0	0.0	0.0	0.0	0.0	0.0	0.0	0.0	0.0	0.0	0.0	0.0
%ile BackOfQ(50%),veh/ln	1.2	3.7	3.6	3.2	0.0	4.9	0.8	0.0	5.2	0.9	0.3	0.2
Unsig. Movement Delay, s/veh												
LnGrp Delay(d),s/veh	47.0	34.9	36.5	42.3	0.0	31.0	23.7	0.0	32.5	24.6	22.3	14.0
LnGrp LOS	D	C	D	D	A	C	C	A	C	C	C	B
Approach Vol, veh/h		434			424			390			96	
Approach Delay, s/veh		37.1			35.1			29.9			22.4	
Approach LOS		D			D			C			C	
Timer - Assigned Phs	1	2	3	4	5	6	7	8				
Phs Duration (G+Y+Rc), s	33.7	26.0	13.3	17.0	24.1	25.6	8.0	22.4				
Change Period (Y+Rc), s	4.5	4.5	4.5	4.5	4.5	4.5	4.5	4.5				
Max Green Setting (Gmax), s	5.5	21.5	16.5	18.5	5.9	21.1	5.5	29.5				
Max Q Clear Time (g_c+1), s	11.0	13.9	8.9	11.1	4.0	2.9	4.4	13.6				
Green Ext Time (p_c), s	0.0	1.0	0.2	1.3	0.1	0.1	0.0	1.4				
Intersection Summary												
HCM 6th Ctrl Delay											33.3	
HCM 6th LOS											C	

Intersection						
Int Delay, s/veh	6.2					
Movement	EBL	EBT	WBT	WBR	SBL	SBR
Lane Configurations						
Traffic Vol, veh/h	251	235	284	2	65	111
Future Vol, veh/h	251	235	284	2	65	111
Conflicting Peds, #/hr	0	0	0	0	0	0
Sign Control	Free	Free	Free	Free	Stop	Stop
RT Channelized	-	None	-	Free	-	None
Storage Length	140	-	-	-	0	335
Veh in Median Storage, #	-	0	0	-	0	-
Grade, %	-	0	0	-	0	-
Peak Hour Factor	92	92	92	92	92	92
Heavy Vehicles, %	2	2	6	6	4	4
Mvmt Flow	273	255	309	2	71	121

Major/Minor	Major1	Major2	Minor2		
Conflicting Flow All	309	0	-	0	1110 309
Stage 1	-	-	-	-	309 -
Stage 2	-	-	-	-	801 -
Critical Hdwy	4.12	-	-	-	6.44 6.24
Critical Hdwy Stg 1	-	-	-	-	5.44 -
Critical Hdwy Stg 2	-	-	-	-	5.44 -
Follow-up Hdwy	2.218	-	-	-	3.536 3.336
Pot Cap-1 Maneuver	1252	-	-	0	230 726
Stage 1	-	-	-	0	740 -
Stage 2	-	-	-	0	438 -
Platoon blocked, %		-	-		
Mov Cap-1 Maneuver	1252	-	-	-	180 726
Mov Cap-2 Maneuver	-	-	-	-	180 -
Stage 1	-	-	-	-	579 -
Stage 2	-	-	-	-	438 -

Approach	EB	WB	SB
HCM Control Delay, s	4.5	0	20.7
HCM LOS			C

Minor Lane/Major Mvmt	EBL	EBT	WBT	SBLn1	SBLn2
Capacity (veh/h)	1252	-	-	180	726
HCM Lane V/C Ratio	0.218	-	-	0.393	0.166
HCM Control Delay (s)	8.7	-	-	37.4	10.9
HCM Lane LOS	A	-	-	E	B
HCM 95th %tile Q(veh)	0.8	-	-	1.7	0.6

Intersection						
Int Delay, s/veh	5.7					
Movement	EBL	EBT	WBT	WBR	SBL	SBR
Lane Configurations		↶	↷		↶	
Traffic Vol, veh/h	162	138	78	0	0	207
Future Vol, veh/h	162	138	78	0	0	207
Conflicting Peds, #/hr	0	0	0	0	0	0
Sign Control	Free	Free	Free	Free	Stop	Stop
RT Channelized	-	None	-	None	-	None
Storage Length	-	-	-	-	0	-
Veh in Median Storage, #	-	0	0	-	0	-
Grade, %	-	0	0	-	0	-
Peak Hour Factor	92	92	92	92	92	92
Heavy Vehicles, %	3	3	6	6	7	7
Mvmt Flow	176	150	85	0	0	225

Major/Minor	Major1	Major2	Minor2		
Conflicting Flow All	85	0	-	0	587 85
Stage 1	-	-	-	-	85 -
Stage 2	-	-	-	-	502 -
Critical Hdwy	4.13	-	-	-	6.47 6.27
Critical Hdwy Stg 1	-	-	-	-	5.47 -
Critical Hdwy Stg 2	-	-	-	-	5.47 -
Follow-up Hdwy	2.227	-	-	-	3.563 3.363
Pot Cap-1 Maneuver	1505	-	-	-	464 960
Stage 1	-	-	-	-	926 -
Stage 2	-	-	-	-	598 -
Platoon blocked, %		-	-	-	
Mov Cap-1 Maneuver	1505	-	-	-	405 960
Mov Cap-2 Maneuver	-	-	-	-	405 -
Stage 1	-	-	-	-	807 -
Stage 2	-	-	-	-	598 -

Approach	EB	WB	SB
HCM Control Delay, s	4.2	0	9.9
HCM LOS			A

Minor Lane/Major Mvmt	EBL	EBT	WBT	WBR	SBLn1
Capacity (veh/h)	1505	-	-	-	960
HCM Lane V/C Ratio	0.117	-	-	-	0.234
HCM Control Delay (s)	7.7	0	-	-	9.9
HCM Lane LOS	A	A	-	-	A
HCM 95th %tile Q(veh)	0.4	-	-	-	0.9

Intersection						
Int Delay, s/veh	4.1					
Movement	EBL	EBR	NBL	NBT	SBT	SBR
Lane Configurations	↵			↑	↵	
Traffic Vol, veh/h	161	0	0	43	3	206
Future Vol, veh/h	161	0	0	43	3	206
Conflicting Peds, #/hr	0	0	0	0	0	0
Sign Control	Stop	Stop	Free	Free	Free	Free
RT Channelized	-	None	-	None	-	None
Storage Length	0	-	-	-	-	-
Veh in Median Storage, #	0	-	-	0	0	-
Grade, %	0	-	-	0	0	-
Peak Hour Factor	92	92	92	92	92	92
Heavy Vehicles, %	3	3	10	10	6	6
Mvmt Flow	175	0	0	47	3	224

Major/Minor	Minor2	Major1		Major2	
Conflicting Flow All	162	-	-	0	0
Stage 1	115	-	-	-	-
Stage 2	47	-	-	-	-
Critical Hdwy	6.43	-	-	-	-
Critical Hdwy Stg 1	5.43	-	-	-	-
Critical Hdwy Stg 2	5.43	-	-	-	-
Follow-up Hdwy	3.527	-	-	-	-
Pot Cap-1 Maneuver	826	0	0	-	-
Stage 1	907	0	0	-	-
Stage 2	973	0	0	-	-
Platoon blocked, %				-	-
Mov Cap-1 Maneuver	826	-	-	-	-
Mov Cap-2 Maneuver	826	-	-	-	-
Stage 1	907	-	-	-	-
Stage 2	973	-	-	-	-

Approach	EB	NB	SB
HCM Control Delay, s	10.5	0	0
HCM LOS	B		

Minor Lane/Major Mvmt	NBT EBLn1	SBT	SBR
Capacity (veh/h)	- 826	-	-
HCM Lane V/C Ratio	- 0.212	-	-
HCM Control Delay (s)	- 10.5	-	-
HCM Lane LOS	- B	-	-
HCM 95th %tile Q(veh)	- 0.8	-	-

Intersection						
Int Delay, s/veh	0					
Movement	EBL	EBT	WBT	WBR	SBL	SBR
Lane Configurations		↕	↕		↕	
Traffic Vol, veh/h	0	134	83	51	0	0
Future Vol, veh/h	0	134	83	51	0	0
Conflicting Peds, #/hr	0	0	0	0	0	0
Sign Control	Free	Free	Free	Free	Stop	Stop
RT Channelized	-	None	-	None	-	None
Storage Length	-	-	-	-	0	-
Veh in Median Storage, #	-	0	0	-	0	-
Grade, %	-	0	0	-	0	-
Peak Hour Factor	92	92	92	92	92	92
Heavy Vehicles, %	2	2	13	13	0	0
Mvmt Flow	0	146	90	55	0	0

Major/Minor	Major1	Major2	Minor2		
Conflicting Flow All	145	0	-	0	264
Stage 1	-	-	-	-	118
Stage 2	-	-	-	-	146
Critical Hdwy	4.12	-	-	-	6.4
Critical Hdwy Stg 1	-	-	-	-	5.4
Critical Hdwy Stg 2	-	-	-	-	5.4
Follow-up Hdwy	2.218	-	-	-	3.5
Pot Cap-1 Maneuver	1437	-	-	-	729
Stage 1	-	-	-	-	912
Stage 2	-	-	-	-	886
Platoon blocked, %		-	-	-	
Mov Cap-1 Maneuver	1437	-	-	-	729
Mov Cap-2 Maneuver	-	-	-	-	729
Stage 1	-	-	-	-	912
Stage 2	-	-	-	-	886

Approach	EB	WB	SB
HCM Control Delay, s	0	0	0
HCM LOS			A

Minor Lane/Major Mvmt	EBL	EBT	WBT	WBR	SBLn1
Capacity (veh/h)	1437	-	-	-	-
HCM Lane V/C Ratio	-	-	-	-	-
HCM Control Delay (s)	0	-	-	-	0
HCM Lane LOS	A	-	-	-	A
HCM 95th %tile Q(veh)	0	-	-	-	-

HCM 6th Signalized Intersection Summary
29: Schnoor Avenue & Cleveland Avenue

Village D Specific Plan
Phase I NP - AM Peak Hour



Movement	EBL	EBT	EBR	WBL	WBT	WBR	NBL	NBT	NBR	SBL	SBT	SBR
Lane Configurations	↶	↷	↷	↶↷	↷	↷	↶	↷	↷	↶	↷	↷
Traffic Volume (veh/h)	85	368	37	163	214	45	50	231	163	84	168	60
Future Volume (veh/h)	85	368	37	163	214	45	50	231	163	84	168	60
Initial Q (Qb), veh	0	0	0	0	0	0	0	0	0	0	0	0
Ped-Bike Adj(A_pbT)	1.00		0.97	1.00		0.97	1.00		0.99	1.00		0.98
Parking Bus, Adj	1.00	1.00	1.00	1.00	1.00	1.00	1.00	1.00	1.00	1.00	1.00	1.00
Work Zone On Approach		No			No			No			No	
Adj Sat Flow, veh/h/ln	1856	1856	1856	1826	1826	1826	1885	1885	1885	1856	1856	1856
Adj Flow Rate, veh/h	92	400	40	177	233	49	54	251	177	91	183	65
Peak Hour Factor	0.92	0.92	0.92	0.92	0.92	0.92	0.92	0.92	0.92	0.92	0.92	0.92
Percent Heavy Veh, %	3	3	3	5	5	5	1	1	1	3	3	3
Cap, veh/h	118	613	266	253	631	274	78	869	503	501	1701	746
Arrive On Green	0.07	0.17	0.17	0.08	0.18	0.18	0.04	0.24	0.24	0.28	0.48	0.48
Sat Flow, veh/h	1767	3526	1530	3374	3469	1507	1795	3582	1582	1767	3526	1545
Grp Volume(v), veh/h	92	400	40	177	233	49	54	251	177	91	183	65
Grp Sat Flow(s),veh/h/ln	1767	1763	1530	1687	1735	1507	1795	1791	1582	1767	1763	1545
Q Serve(g_s), s	4.1	8.5	1.4	4.1	4.7	1.1	2.4	4.6	0.8	3.1	2.3	1.8
Cycle Q Clear(g_c), s	4.1	8.5	1.4	4.1	4.7	1.1	2.4	4.6	0.8	3.1	2.3	1.8
Prop In Lane	1.00		1.00	1.00		1.00	1.00		1.00	1.00		1.00
Lane Grp Cap(c), veh/h	118	613	266	253	631	274	78	869	503	501	1701	746
V/C Ratio(X)	0.78	0.65	0.15	0.70	0.37	0.18	0.69	0.29	0.35	0.18	0.11	0.09
Avail Cap(c_a), veh/h	188	1300	564	274	1193	518	117	869	503	501	1701	746
HCM Platoon Ratio	1.00	1.00	1.00	1.00	1.00	1.00	1.00	1.00	1.00	1.00	1.00	1.00
Upstream Filter(I)	1.00	1.00	1.00	0.78	0.78	0.78	1.00	1.00	1.00	1.00	1.00	1.00
Uniform Delay (d), s/veh	36.7	30.8	18.4	36.1	28.7	7.4	37.7	24.7	21.0	21.6	11.3	11.2
Incr Delay (d2), s/veh	10.5	1.2	0.3	5.5	0.3	0.2	10.2	0.8	1.9	0.2	0.1	0.2
Initial Q Delay(d3),s/veh	0.0	0.0	0.0	0.0	0.0	0.0	0.0	0.0	0.0	0.0	0.0	0.0
%ile BackOfQ(50%),veh/ln	2.1	3.6	0.6	1.8	1.9	0.8	1.2	2.0	2.7	1.3	0.9	0.6
Unsig. Movement Delay, s/veh												
LnGrp Delay(d),s/veh	47.3	32.0	18.7	41.6	29.0	7.6	47.9	25.5	22.9	21.8	11.4	11.4
LnGrp LOS	D	C	B	D	C	A	D	C	C	C	B	B
Approach Vol, veh/h		532			459			482			339	
Approach Delay, s/veh		33.6			31.6			27.1			14.2	
Approach LOS		C			C			C			B	
Timer - Assigned Phs	1	2	3	4	5	6	7	8				
Phs Duration (G+Y+Rc), s	27.2	23.9	10.5	18.4	8.0	43.1	9.8	19.1				
Change Period (Y+Rc), s	4.5	4.5	4.5	4.5	4.5	4.5	4.5	4.5				
Max Green Setting (Gmax), s	6.6	19.4	6.5	29.5	5.2	20.8	8.5	27.5				
Max Q Clear Time (g_c+I1), s	5.1	6.6	6.1	10.5	4.4	4.3	6.1	6.7				
Green Ext Time (p_c), s	0.0	1.8	0.0	2.6	0.0	1.2	0.0	1.6				

Intersection Summary

HCM 6th Ctrl Delay	27.7
HCM 6th LOS	C

HCM 6th Signalized Intersection Summary
30: Fairgrounds & Cleveland Avenue

Village D Specific Plan
Phase I NP - AM Peak Hour



Movement	EBL	EBT	EBR	WBL	WBT	WBR	NBL	NBT	NBR	SBL	SBT	SBR
Lane Configurations	↑↑↑			↑↑		↑	↑↑	↑	↑	↑	↑	↑
Traffic Volume (veh/h)	90	559	29	34	368	86	13	7	25	116	5	39
Future Volume (veh/h)	90	559	29	34	368	86	13	7	25	116	5	39
Initial Q (Qb), veh	0	0	0	0	0	0	0	0	0	0	0	0
Ped-Bike Adj(A_pbT)	1.00		1.00	1.00		1.00	1.00		1.00	1.00		0.99
Parking Bus, Adj	1.00	1.00	1.00	1.00	1.00	1.00	1.00	1.00	1.00	1.00	1.00	1.00
Work Zone On Approach	No			No			No			No		
Adj Sat Flow, veh/h/ln	1841	1841	1841	1841	1841	1841	1900	1900	1900	1900	1900	1900
Adj Flow Rate, veh/h	96	595	31	36	391	91	14	22	17	123	5	41
Peak Hour Factor	0.94	0.94	0.94	0.94	0.94	0.94	0.94	0.94	0.94	0.94	0.94	0.94
Percent Heavy Veh, %	4	4	4	4	4	4	0	0	0	0	0	0
Cap, veh/h	125	932	48	60	537	240	60	463	392	554	94	769
Arrive On Green	0.02	0.06	0.06	0.03	0.15	0.15	0.02	0.24	0.24	0.31	0.53	0.53
Sat Flow, veh/h	1753	4892	253	1753	3497	1560	3619	1900	1608	1810	176	1442
Grp Volume(v), veh/h	96	406	220	36	391	91	14	22	17	123	0	46
Grp Sat Flow(s),veh/h/ln	1753	1675	1795	1753	1749	1560	1810	1900	1608	1810	0	1617
Q Serve(g_s), s	4.4	9.5	9.6	1.6	8.5	4.2	0.3	0.7	0.5	4.0	0.0	1.1
Cycle Q Clear(g_c), s	4.4	9.5	9.6	1.6	8.5	4.2	0.3	0.7	0.5	4.0	0.0	1.1
Prop In Lane	1.00		0.14	1.00		1.00	1.00		1.00	1.00		0.89
Lane Grp Cap(c), veh/h	125	638	342	60	537	240	60	463	392	554	0	863
V/C Ratio(X)	0.77	0.64	0.64	0.60	0.73	0.38	0.23	0.05	0.04	0.22	0.00	0.05
Avail Cap(c_a), veh/h	296	1110	595	121	809	361	475	463	392	554	0	863
HCM Platoon Ratio	0.33	0.33	0.33	1.00	1.00	1.00	1.00	1.00	1.00	1.00	1.00	1.00
Upstream Filter(I)	0.86	0.86	0.86	0.94	0.94	0.94	1.00	1.00	1.00	1.00	0.00	1.00
Uniform Delay (d), s/veh	38.4	34.8	34.8	38.1	32.3	30.4	38.8	23.1	15.0	20.6	0.0	9.0
Incr Delay (d2), s/veh	8.3	0.9	1.7	8.6	1.8	0.9	1.9	0.2	0.2	0.2	0.0	0.1
Initial Q Delay(d3),s/veh	0.0	0.0	0.0	0.0	0.0	0.0	0.0	0.0	0.0	0.0	0.0	0.0
%ile BackOfQ(50%),veh/ln	2.2	4.2	4.6	0.8	3.6	1.6	0.1	0.3	0.3	1.7	0.0	0.4
Unsig. Movement Delay, s/veh												
LnGrp Delay(d),s/veh	46.7	35.7	36.6	46.6	34.1	31.4	40.8	23.3	15.2	20.8	0.0	9.1
LnGrp LOS	D	D	D	D	C	C	D	C	B	C	A	A
Approach Vol, veh/h	722			518			53			169		
Approach Delay, s/veh	37.4			34.5			25.3			17.6		
Approach LOS	D			C			C			B		
Timer - Assigned Phs	1	2	3	4	5	6	7	8				
Phs Duration (G+Y+Rc), s	29.0	24.0	7.3	19.7	5.8	47.2	10.2	16.8				
Change Period (Y+Rc), s	4.5	4.5	4.5	4.5	4.5	4.5	4.5	4.5				
Max Green Setting (Gmax), s	10.5	19.5	5.5	26.5	10.5	19.5	13.5	18.5				
Max Q Clear Time (g_c+10), s	10.5	2.7	3.6	11.6	2.3	3.1	6.4	10.5				
Green Ext Time (p_c), s	0.1	0.1	0.0	3.5	0.0	0.1	0.1	1.8				

Intersection Summary

HCM 6th Ctrl Delay	33.6
HCM 6th LOS	C

Notes

User approved volume balancing among the lanes for turning movement.

HCM 6th Signalized Intersection Summary
 31: SR-99 Southbound Ramps & Cleveland Avenue

Village D Specific Plan
 Phase I NP - AM Peak Hour



Movement	EBL	EBT	EBR	WBL	WBT	WBR	NBL	NBT	NBR	SBL	SBT	SBR
Lane Configurations		↑↑	↑	↑	↑↑					↑		↑
Traffic Volume (veh/h)	0	441	354	339	667	0	0	0	0	65	0	54
Future Volume (veh/h)	0	441	354	339	667	0	0	0	0	65	0	54
Initial Q (Qb), veh	0	0	0	0	0	0				0	0	0
Ped-Bike Adj(A_pbT)	1.00		1.00	1.00		1.00				1.00		1.00
Parking Bus, Adj	1.00	1.00	1.00	1.00	1.00	1.00				1.00	1.00	1.00
Work Zone On Approach		No			No						No	
Adj Sat Flow, veh/h/ln	0	1841	1841	1856	1856	0				1678	0	1678
Adj Flow Rate, veh/h	0	479	385	368	725	0				71	0	59
Peak Hour Factor	0.92	0.92	0.92	0.92	0.92	0.92				0.92	0.92	0.92
Percent Heavy Veh, %	0	4	4	3	3	0				15	0	15
Cap, veh/h	0	913	407	402	1898	0				578	0	514
Arrive On Green	0.00	0.26	0.26	0.45	1.00	0.00				0.36	0.00	0.36
Sat Flow, veh/h	0	3589	1560	1767	3618	0				1598	0	1422
Grp Volume(v), veh/h	0	479	385	368	725	0				71	0	59
Grp Sat Flow(s),veh/h/ln	0	1749	1560	1767	1763	0				1598	0	1422
Q Serve(g_s), s	0.0	10.6	21.8	17.5	0.0	0.0				2.7	0.0	2.5
Cycle Q Clear(g_c), s	0.0	10.6	21.8	17.5	0.0	0.0				2.7	0.0	2.5
Prop In Lane	0.00		1.00	1.00		0.00				1.00		1.00
Lane Grp Cap(c), veh/h	0	913	407	402	1898	0				578	0	514
V/C Ratio(X)	0.00	0.52	0.95	0.92	0.38	0.00				0.12	0.00	0.11
Avail Cap(c_a), veh/h	0	913	407	638	2370	0				578	0	514
HCM Platoon Ratio	1.00	1.00	1.00	2.00	2.00	1.00				1.00	1.00	1.00
Upstream Filter(I)	0.00	0.87	0.87	0.72	0.72	0.00				1.00	0.00	1.00
Uniform Delay (d), s/veh	0.0	28.5	32.6	23.7	0.0	0.0				19.2	0.0	19.1
Incr Delay (d2), s/veh	0.0	0.5	28.3	9.4	0.1	0.0				0.1	0.0	0.1
Initial Q Delay(d3),s/veh	0.0	0.0	0.0	0.0	0.0	0.0				0.0	0.0	0.0
%ile BackOfQ(50%),veh/ln	0.0	4.4	11.2	6.1	0.0	0.0				1.0	0.0	0.8
Unsig. Movement Delay, s/veh												
LnGrp Delay(d),s/veh	0.0	28.9	60.9	33.2	0.1	0.0				19.3	0.0	19.2
LnGrp LOS	A	C	E	C	A	A				B	A	B
Approach Vol, veh/h		864			1093						130	
Approach Delay, s/veh		43.2			11.2						19.3	
Approach LOS		D			B						B	
Timer - Assigned Phs			3	4		6		8				
Phs Duration (G+Y+Rc), s			25.0	28.0		37.0		53.0				
Change Period (Y+Rc), s			4.5	4.5		4.5		4.5				
Max Green Setting (Gmax), s			32.5	23.5		5.0		60.5				
Max Q Clear Time (g_c+1), s			19.5	23.8		4.7		2.0				
Green Ext Time (p_c), s			1.0	0.0		0.0		6.1				
Intersection Summary												
HCM 6th Ctrl Delay			25.0									
HCM 6th LOS			C									

HCM 6th Signalized Intersection Summary
 32: SR-99 Northbound Ramps & Cleveland Avenue

Village D Specific Plan
 Phase I NP - AM Peak Hour



Movement	EBL	EBT	EBR	WBL	WBT	WBR	NBL	NBT	NBR	SBL	SBT	SBR
Lane Configurations	↘	↑↑			↑↑	↗	↘	↖	↗			
Traffic Volume (veh/h)	52	455	0	0	756	78	252	0	292	0	0	0
Future Volume (veh/h)	52	455	0	0	756	78	252	0	292	0	0	0
Initial Q (Qb), veh	0	0	0	0	0	0	0	0	0			
Ped-Bike Adj(A_pbT)	1.00		1.00	1.00		1.00	1.00		1.00			
Parking Bus, Adj	1.00	1.00	1.00	1.00	1.00	1.00	1.00	1.00	1.00			
Work Zone On Approach	No				No				No			
Adj Sat Flow, veh/h/ln	1826	1826	0	0	1856	1856	1826	1826	1826			
Adj Flow Rate, veh/h	57	495	0	0	822	85	274	0	317			
Peak Hour Factor	0.92	0.92	0.92	0.92	0.92	0.92	0.92	0.92	0.92			
Percent Heavy Veh, %	5	5	0	0	3	3	5	5	5			
Cap, veh/h	73	1342	0	0	1038	463	1785	0	794			
Arrive On Green	0.04	0.39	0.00	0.00	0.29	0.29	0.51	0.00	0.51			
Sat Flow, veh/h	1739	3561	0	0	3618	1572	3478	0	1547			
Grp Volume(v), veh/h	57	495	0	0	822	85	274	0	317			
Grp Sat Flow(s),veh/h/ln	1739	3561	0	0	3618	1572	3478	0	1547			
Q Serve(g_s), s	2.9	9.2	0.0	0.0	19.3	3.6	3.7	0.0	11.3			
Cycle Q Clear(g_c), s	2.9	9.2	0.0	0.0	19.3	3.6	3.7	0.0	11.3			
Prop In Lane	1.00		0.00	0.00		1.00	1.00		1.00			
Lane Grp Cap(c), veh/h	73	1342	0	0	1038	463	1785	0	794			
V/C Ratio(X)	0.78	0.37	0.00	0.00	0.79	0.18	0.15	0.00	0.40			
Avail Cap(c_a), veh/h	242	2024	0	0	1391	620	1785	0	794			
HCM Platoon Ratio	1.00	1.00	1.00	1.00	1.00	1.00	1.00	1.00	1.00			
Upstream Filter(I)	0.81	0.81	0.00	0.00	0.75	0.75	1.00	0.00	1.00			
Uniform Delay (d), s/veh	42.7	19.7	0.0	0.0	29.2	23.7	11.6	0.0	13.4			
Incr Delay (d2), s/veh	13.2	0.1	0.0	0.0	1.7	0.1	0.2	0.0	1.5			
Initial Q Delay(d3),s/veh	0.0	0.0	0.0	0.0	0.0	0.0	0.0	0.0	0.0			
%ile BackOfQ(50%),veh/ln	1.5	3.6	0.0	0.0	8.2	1.3	1.4	0.0	4.0			
Unsig. Movement Delay, s/veh												
LnGrp Delay(d),s/veh	55.9	19.9	0.0	0.0	30.9	23.8	11.8	0.0	14.9			
LnGrp LOS	E	B	A	A	C	C	B	A	B			
Approach Vol, veh/h	552				907				591			
Approach Delay, s/veh	23.6				30.3				13.4			
Approach LOS	C				C				B			
Timer - Assigned Phs	2		4		7		8					
Phs Duration (G+Y+Rc), s	50.7		39.3		8.3		31.0					
Change Period (Y+Rc), s	4.5		4.5		4.5		4.5					
Max Green Setting (Gmax), s	28.5		52.5		12.5		35.5					
Max Q Clear Time (g_c+I1), s	13.3		11.2		4.9		21.3					
Green Ext Time (p_c), s	1.9		3.8		0.1		5.2					

Intersection Summary

HCM 6th Ctrl Delay	23.6
HCM 6th LOS	C

Notes

User approved volume balancing among the lanes for turning movement.

HCM 6th Signalized Intersection Summary
 33: Gateway Drive & Cleveland Avenue

Village D Specific Plan
 Phase I NP - AM Peak Hour



Movement	EBL	EBT	EBR	WBL	WBT	WBR	NBL	NBT	NBR	SBL	SBT	SBR
Lane Configurations	↖	↑↑↑	↗	↖↗	↑↑		↖↗	↑	↗	↖	↑↗	
Traffic Volume (veh/h)	4	596	142	182	696	69	132	48	141	56	86	4
Future Volume (veh/h)	4	596	142	182	696	69	132	48	141	56	86	4
Initial Q (Qb), veh	0	0	0	0	0	0	0	0	0	0	0	0
Ped-Bike Adj(A_pbT)	1.00		1.00	1.00		0.99	1.00		0.98	1.00		0.98
Parking Bus, Adj	1.00	1.00	1.00	1.00	1.00	1.00	1.00	1.00	1.00	1.00	1.00	1.00
Work Zone On Approach		No			No			No			No	
Adj Sat Flow, veh/h/ln	1841	1841	1841	1870	1870	1870	1796	1796	1796	1841	1841	1841
Adj Flow Rate, veh/h	4	648	0	198	757	75	143	52	153	61	93	4
Peak Hour Factor	0.92	0.92	0.92	0.92	0.92	0.92	0.92	0.92	0.92	0.92	0.92	0.92
Percent Heavy Veh, %	4	4	4	2	2	2	7	7	7	4	4	4
Cap, veh/h	89	983		340	943	93	963	828	691	78	736	31
Arrive On Green	0.00	0.06	0.00	0.10	0.29	0.29	0.29	0.46	0.46	0.04	0.22	0.22
Sat Flow, veh/h	1753	5025	1560	3456	3264	323	3319	1796	1499	1753	3414	146
Grp Volume(v), veh/h	4	648	0	198	412	420	143	52	153	61	47	50
Grp Sat Flow(s),veh/h/ln	1753	1675	1560	1728	1777	1810	1659	1796	1499	1753	1749	1812
Q Serve(g_s), s	0.2	11.3	0.0	4.9	19.3	19.3	2.9	1.4	3.5	3.1	2.0	2.0
Cycle Q Clear(g_c), s	0.2	11.3	0.0	4.9	19.3	19.3	2.9	1.4	3.5	3.1	2.0	2.0
Prop In Lane	1.00		1.00	1.00		0.18	1.00		1.00	1.00		0.08
Lane Grp Cap(c), veh/h	89	983		340	513	523	963	828	691	78	377	391
V/C Ratio(X)	0.04	0.66		0.58	0.80	0.80	0.15	0.06	0.22	0.78	0.13	0.13
Avail Cap(c_a), veh/h	177	1736		376	709	722	963	828	691	179	377	391
HCM Platoon Ratio	0.33	0.33	0.33	1.00	1.00	1.00	1.00	1.00	1.00	1.00	1.00	1.00
Upstream Filter(I)	0.95	0.95	0.00	0.94	0.94	0.94	1.00	1.00	1.00	1.00	1.00	1.00
Uniform Delay (d), s/veh	32.5	39.2	0.0	38.8	29.6	29.6	23.7	13.5	5.8	42.6	28.5	28.5
Incr Delay (d2), s/veh	0.2	0.7	0.0	1.8	4.4	4.3	0.1	0.1	0.7	15.3	0.7	0.7
Initial Q Delay(d3),s/veh	0.0	0.0	0.0	0.0	0.0	0.0	0.0	0.0	0.0	0.0	0.0	0.0
%ile BackOfQ(50%),veh/ln	0.1	5.1	0.0	2.1	8.6	8.8	1.1	0.6	1.9	1.7	0.9	0.9
Unsig. Movement Delay, s/veh												
LnGrp Delay(d),s/veh	32.7	39.9	0.0	40.6	34.0	34.0	23.8	13.6	6.5	57.8	29.1	29.1
LnGrp LOS	C	D		D	C	C	C	B	A	E	C	C
Approach Vol, veh/h		652	A		1030			348			158	
Approach Delay, s/veh		39.8			35.3			14.7			40.2	
Approach LOS		D			D			B			D	
Timer - Assigned Phs	1	2	3	4	5	6	7	8				
Phs Duration (G+Y+Rc), s	30.6	23.9	5.0	30.5	8.5	46.0	13.4	22.1				
Change Period (Y+Rc), s	4.5	4.5	4.5	4.5	4.5	4.5	4.5	4.5				
Max Green Setting (Gmax), s	3	19.4	5.0	35.9	9.2	21.9	9.8	31.1				
Max Q Clear Time (g_c+1), s	3	4.0	2.2	21.3	5.1	5.5	6.9	13.3				
Green Ext Time (p_c), s	0.2	0.3	0.0	4.7	0.0	0.7	0.2	4.2				

Intersection Summary

HCM 6th Ctrl Delay	33.7
HCM 6th LOS	C

Notes

Unsignalized Delay for [EBR] is excluded from calculations of the approach delay and intersection delay.

HCM 6th Signalized Intersection Summary
 34: Cleveland Avenue & County Club Drive

Village D Specific Plan
 Phase I NP - AM Peak Hour



Movement	WBL	WBR	NBT	NBR	SBL	SBT
Lane Configurations	←←		↑↑	→	←	↑↑↑
Traffic Volume (veh/h)	327	29	586	207	85	620
Future Volume (veh/h)	327	29	586	207	85	620
Initial Q (Qb), veh	0	0	0	0	0	0
Ped-Bike Adj(A_pbT)	1.00	1.00		1.00	1.00	
Parking Bus, Adj	1.00	1.00	1.00	1.00	1.00	1.00
Work Zone On Approach	No		No		No	
Adj Sat Flow, veh/h/ln	1900	1900	1856	1856	1856	1856
Adj Flow Rate, veh/h	385	0	637	0	92	674
Peak Hour Factor	0.92	0.92	0.92	0.92	0.92	0.92
Percent Heavy Veh, %	0	0	3	3	3	3
Cap, veh/h	505	225	2681		636	3853
Arrive On Green	0.14	0.00	0.76	0.00	0.76	0.76
Sat Flow, veh/h	3619	1610	3618	1572	785	5233
Grp Volume(v), veh/h	385	0	637	0	92	674
Grp Sat Flow(s),veh/h/ln	1810	1610	1763	1572	785	1689
Q Serve(g_s), s	9.2	0.0	4.8	0.0	3.5	3.3
Cycle Q Clear(g_c), s	9.2	0.0	4.8	0.0	8.2	3.3
Prop In Lane	1.00	1.00		1.00	1.00	
Lane Grp Cap(c), veh/h	505	225	2681		636	3853
V/C Ratio(X)	0.76	0.00	0.24		0.14	0.17
Avail Cap(c_a), veh/h	1307	581	2681		636	3853
HCM Platoon Ratio	1.00	1.00	1.00	1.00	1.00	1.00
Upstream Filter(I)	1.00	0.00	0.82	0.00	1.00	1.00
Uniform Delay (d), s/veh	37.3	0.0	3.1	0.0	4.4	3.0
Incr Delay (d2), s/veh	2.4	0.0	0.2	0.0	0.5	0.1
Initial Q Delay(d3),s/veh	0.0	0.0	0.0	0.0	0.0	0.0
%ile BackOfQ(50%),veh/ln	4.2	0.0	1.3	0.0	0.5	0.8
Unsig. Movement Delay, s/veh						
LnGrp Delay(d),s/veh	39.7	0.0	3.3	0.0	4.8	3.1
LnGrp LOS	D	A	A		A	A
Approach Vol, veh/h	385		637	A		766
Approach Delay, s/veh	39.7		3.3			3.3
Approach LOS	D		A			A
Timer - Assigned Phs		2			6	8
Phs Duration (G+Y+Rc), s		73.0			73.0	17.0
Change Period (Y+Rc), s		4.5			4.5	4.5
Max Green Setting (Gmax), s		48.5			48.5	32.5
Max Q Clear Time (g_c+I1), s		6.8			10.2	11.2
Green Ext Time (p_c), s		5.1			6.3	1.3

Intersection Summary

HCM 6th Ctrl Delay	11.1
HCM 6th LOS	B

Notes

User approved volume balancing among the lanes for turning movement.
 Unsignalized Delay for [NBR] is excluded from calculations of the approach delay and intersection delay.

Intersection						
Int Delay, s/veh	0.1					
Movement	EBL	EBR	NBL	NBT	SBT	SBR
Lane Configurations	T			T		
Traffic Vol, veh/h	2	12	1	610	674	1
Future Vol, veh/h	2	12	1	610	674	1
Conflicting Peds, #/hr	0	0	2	0	0	2
Sign Control	Stop	Stop	Free	Free	Free	Free
RT Channelized	-	None	-	None	-	None
Storage Length	0	-	-	-	-	-
Veh in Median Storage, #	0	-	-	0	0	-
Grade, %	0	-	-	0	0	-
Peak Hour Factor	92	92	92	92	92	92
Heavy Vehicles, %	7	7	5	5	4	4
Mvmt Flow	2	13	1	663	733	1

Major/Minor	Minor2	Major1	Major2			
Conflicting Flow All	1070	369	736	0	-	0
Stage 1	736	-	-	-	-	-
Stage 2	334	-	-	-	-	-
Critical Hdwy	6.94	7.04	4.2	-	-	-
Critical Hdwy Stg 1	5.94	-	-	-	-	-
Critical Hdwy Stg 2	5.94	-	-	-	-	-
Follow-up Hdwy	3.57	3.37	2.25	-	-	-
Pot Cap-1 Maneuver	*385	614	846	-	-	-
Stage 1	*422	-	-	-	-	-
Stage 2	*772	-	-	-	-	-
Platoon blocked, %	1			-	-	-
Mov Cap-1 Maneuver	*382	613	844	-	-	-
Mov Cap-2 Maneuver	*380	-	-	-	-	-
Stage 1	*420	-	-	-	-	-
Stage 2	*770	-	-	-	-	-

Approach	EB	NB	SB
HCM Control Delay, s	11.6	0	0
HCM LOS	B		

Minor Lane/Major Mvmt	NBL	NBT	EBLn1	SBT	SBR
Capacity (veh/h)	844	-	564	-	-
HCM Lane V/C Ratio	0.001	-	0.027	-	-
HCM Control Delay (s)	9.3	0	11.6	-	-
HCM Lane LOS	A	A	B	-	-
HCM 95th %tile Q(veh)	0	-	0.1	-	-

Notes
 -: Volume exceeds capacity \$: Delay exceeds 300s +: Computation Not Defined *: All major volume in platoon

HCM 6th Signalized Intersection Summary
 36: Pine Street & Howard Road

Village D Specific Plan
 Phase I NP - AM Peak Hour



Movement	EBL	EBT	EBR	WBL	WBT	WBR	NBL	NBT	NBR	SBL	SBT	SBR
Lane Configurations												
Traffic Volume (veh/h)	34	678	76	138	435	6	117	158	232	16	253	99
Future Volume (veh/h)	34	678	76	138	435	6	117	158	232	16	253	99
Initial Q (Qb), veh	0	0	0	0	0	0	0	0	0	0	0	0
Ped-Bike Adj(A_pbT)	1.00		0.97	1.00		0.98	1.00		1.00	1.00		0.98
Parking Bus, Adj	1.00	1.00	1.00	1.00	1.00	1.00	1.00	1.00	1.00	1.00	1.00	1.00
Work Zone On Approach		No			No			No			No	
Adj Sat Flow, veh/h/ln	1870	1870	1870	1856	1856	1856	1811	1811	1811	1841	1841	1841
Adj Flow Rate, veh/h	37	737	83	150	473	7	127	172	252	17	275	108
Peak Hour Factor	0.92	0.92	0.92	0.92	0.92	0.92	0.92	0.92	0.92	0.92	0.92	0.92
Percent Heavy Veh, %	2	2	2	3	3	3	6	6	6	4	4	4
Cap, veh/h	53	888	100	161	1202	18	528	555	469	19	304	268
Arrive On Green	0.03	0.28	0.28	0.09	0.34	0.34	0.31	0.31	0.31	0.18	0.18	0.18
Sat Flow, veh/h	1781	3209	361	1767	3555	53	1725	1811	1530	107	1729	1522
Grp Volume(v), veh/h	37	408	412	150	234	246	127	172	252	292	0	108
Grp Sat Flow(s),veh/h/ln	1781	1777	1793	1767	1763	1845	1725	1811	1530	1835	0	1522
Q Serve(g_s), s	2.5	25.9	25.9	10.1	12.2	12.2	6.6	8.7	16.4	18.7	0.0	7.6
Cycle Q Clear(g_c), s	2.5	25.9	25.9	10.1	12.2	12.2	6.6	8.7	16.4	18.7	0.0	7.6
Prop In Lane	1.00		0.20	1.00		0.03	1.00		1.00	0.06		1.00
Lane Grp Cap(c), veh/h	53	492	497	161	596	624	528	555	469	323	0	268
V/C Ratio(X)	0.70	0.83	0.83	0.93	0.39	0.39	0.24	0.31	0.54	0.90	0.00	0.40
Avail Cap(c_a), veh/h	102	718	725	161	771	807	528	555	469	347	0	288
HCM Platoon Ratio	1.00	1.00	1.00	1.00	1.00	1.00	1.00	1.00	1.00	1.00	1.00	1.00
Upstream Filter(I)	1.00	1.00	1.00	0.95	0.95	0.95	1.00	1.00	1.00	1.00	0.00	1.00
Uniform Delay (d), s/veh	57.7	40.7	40.7	54.2	30.3	30.3	31.2	31.9	34.6	48.4	0.0	43.8
Incr Delay (d2), s/veh	15.7	5.4	5.4	50.3	0.4	0.4	1.1	1.5	4.4	24.8	0.0	1.0
Initial Q Delay(d3),s/veh	0.0	0.0	0.0	0.0	0.0	0.0	0.0	0.0	0.0	0.0	0.0	0.0
%ile BackOfQ(50%),veh/ln	1.3	12.0	12.1	6.7	5.2	5.5	2.9	4.1	6.7	10.8	0.0	2.9
Unsig. Movement Delay, s/veh												
LnGrp Delay(d),s/veh	73.4	46.1	46.1	104.5	30.7	30.7	32.3	33.4	39.0	73.3	0.0	44.8
LnGrp LOS	E	D	D	F	C	C	C	C	D	E	A	D
Approach Vol, veh/h		857			630			551			400	
Approach Delay, s/veh		47.3			48.3			35.7			65.6	
Approach LOS		D			D			D			E	
Timer - Assigned Phs		2	3	4		6	7	8				
Phs Duration (G+Y+Rc), s		41.2	15.4	37.7		25.6	8.0	45.1				
Change Period (Y+Rc), s		4.5	4.5	4.5		4.5	4.5	4.5				
Max Green Setting (Gmax), s		19.9	10.9	48.5		22.7	6.9	52.5				
Max Q Clear Time (g_c+I1), s		18.4	12.1	27.9		20.7	4.5	14.2				
Green Ext Time (p_c), s		0.4	0.0	5.3		0.4	0.0	3.1				
Intersection Summary												
HCM 6th Ctrl Delay				47.9								
HCM 6th LOS				D								

HCM 6th Signalized Intersection Summary
 37: Olive Avenue/Q Street & Howard Road/Yosemite Avenue

Village D Specific Plan
 Phase I NP - AM Peak Hour



Movement	EBL	EBT	EBR	WBL	WBT	WBR	NBL	NBT	NBR	SBL	SBT	SBR
Lane Configurations												
Traffic Volume (veh/h)	6	550	317	27	337	19	301	88	20	101	149	12
Future Volume (veh/h)	6	550	317	27	337	19	301	88	20	101	149	12
Initial Q (Qb), veh	0	0	0	0	0	0	0	0	0	0	0	0
Ped-Bike Adj(A_pbT)	1.00		1.00	1.00		0.98	1.00		0.99	1.00		0.96
Parking Bus, Adj	1.00	1.00	1.00	1.00	1.00	1.00	1.00	1.00	1.00	1.00	1.00	1.00
Work Zone On Approach		No			No			No			No	
Adj Sat Flow, veh/h/ln	1856	1856	1856	1870	1870	1870	1826	1826	1826	1870	1870	1870
Adj Flow Rate, veh/h	7	598	0	29	366	21	212	258	22	110	162	13
Peak Hour Factor	0.92	0.92	0.92	0.92	0.92	0.92	0.92	0.92	0.92	0.92	0.92	0.92
Percent Heavy Veh, %	3	3	3	2	2	2	5	5	5	2	2	2
Cap, veh/h	15	690		74	780	45	864	908	762	206	216	176
Arrive On Green	0.02	0.39	0.00	0.04	0.23	0.23	0.50	0.50	0.50	0.12	0.12	0.12
Sat Flow, veh/h	1767	3526	1572	1781	3412	195	1739	1826	1533	1781	1870	1523
Grp Volume(v), veh/h	7	598	0	29	190	197	212	258	22	110	162	13
Grp Sat Flow(s),veh/h/ln	1767	1763	1572	1781	1777	1830	1739	1826	1533	1781	1870	1523
Q Serve(g_s), s	0.5	18.8	0.0	1.9	11.1	11.2	8.4	9.9	0.9	7.0	10.1	0.9
Cycle Q Clear(g_c), s	0.5	18.8	0.0	1.9	11.1	11.2	8.4	9.9	0.9	7.0	10.1	0.9
Prop In Lane	1.00		1.00	1.00		0.11	1.00		1.00	1.00		1.00
Lane Grp Cap(c), veh/h	15	690		74	406	418	864	908	762	206	216	176
V/C Ratio(X)	0.46	0.87		0.39	0.47	0.47	0.25	0.28	0.03	0.53	0.75	0.07
Avail Cap(c_a), veh/h	74	881		334	703	724	864	908	762	267	281	229
HCM Platoon Ratio	2.00	2.00	2.00	1.00	1.00	1.00	1.00	1.00	1.00	1.00	1.00	1.00
Upstream Filter(I)	0.64	0.64	0.00	1.00	1.00	1.00	1.00	1.00	1.00	1.00	1.00	1.00
Uniform Delay (d), s/veh	58.7	35.1	0.0	56.0	40.0	40.0	17.3	17.7	15.4	50.0	51.4	47.3
Incr Delay (d2), s/veh	13.0	5.0	0.0	3.3	0.8	0.8	0.7	0.8	0.1	2.1	7.8	0.2
Initial Q Delay(d3),s/veh	0.0	0.0	0.0	0.0	0.0	0.0	0.0	0.0	0.0	0.0	0.0	0.0
%ile BackOfQ(50%),veh/ln	0.3	7.0	0.0	0.9	4.9	5.1	3.5	4.4	0.3	3.2	5.2	0.4
Unsig. Movement Delay, s/veh												
LnGrp Delay(d),s/veh	71.7	40.1	0.0	59.3	40.8	40.8	18.0	18.5	15.5	52.2	59.2	47.5
LnGrp LOS	E	D		E	D	D	B	B	B	D	E	D
Approach Vol, veh/h		605	A		416		492			285		
Approach Delay, s/veh		40.4			42.1		18.1			56.0		
Approach LOS		D			D		B			E		
Timer - Assigned Phs		2	3	4		6	7	8				
Phs Duration (G+Y+Rc), s		64.1	9.5	28.0		18.4	5.5	31.9				
Change Period (Y+Rc), s		4.5	4.5	4.5		4.5	4.5	4.5				
Max Green Setting (Gmax), s		31.5	22.5	30.0		18.0	5.0	47.5				
Max Q Clear Time (g_c+I1), s		11.9	3.9	20.8		12.1	2.5	13.2				
Green Ext Time (p_c), s		2.1	0.0	2.7		0.6	0.0	2.4				

Intersection Summary

HCM 6th Ctrl Delay	37.2
HCM 6th LOS	D

Notes

User approved volume balancing among the lanes for turning movement.
 Unsignalized Delay for [EBR] is excluded from calculations of the approach delay and intersection delay.

HCM 6th TWSC
 38: I Street & 2nd Street/SR-99 Southbound Off-Ramp

Village D Specific Plan
 Phase I NP - AM Peak Hour

Intersection												
Int Delay, s/veh	14.7											
Movement	EBL	EBT	EBR	WBL	WBT	WBR	NBL	NBT	NBR	SBL	SBT	SBR
Lane Configurations		↔			↔	↔	↔	↔			↔	
Traffic Vol, veh/h	2	0	58	377	19	11	18	84	0	0	140	2
Future Vol, veh/h	2	0	58	377	19	11	18	84	0	0	140	2
Conflicting Peds, #/hr	0	0	1	1	0	0	0	0	0	0	0	0
Sign Control	Stop	Stop	Stop	Stop	Stop	Stop	Free	Free	Free	Free	Free	Free
RT Channelized	-	-	None	-	-	Stop	-	-	None	-	-	None
Storage Length	-	-	-	-	-	50	75	-	-	-	-	-
Veh in Median Storage, #	-	0	-	-	0	-	-	0	-	-	0	-
Grade, %	-	0	-	-	0	-	-	0	-	-	0	-
Peak Hour Factor	92	92	92	92	92	92	92	92	92	92	92	92
Heavy Vehicles, %	0	0	0	3	3	3	4	4	4	1	1	1
Mvmt Flow	2	0	63	410	21	12	20	91	0	0	152	2

Major/Minor	Minor2		Minor1		Major1		Major2					
Conflicting Flow All	295	284	154	317	285	91	154	0	-	-	-	0
Stage 1	153	153	-	131	131	-	-	-	-	-	-	-
Stage 2	142	131	-	186	154	-	-	-	-	-	-	-
Critical Hdwy	7.1	6.5	6.2	7.13	6.53	6.23	4.14	-	-	-	-	-
Critical Hdwy Stg 1	6.1	5.5	-	6.13	5.53	-	-	-	-	-	-	-
Critical Hdwy Stg 2	6.1	5.5	-	6.13	5.53	-	-	-	-	-	-	-
Follow-up Hdwy	3.5	4	3.3	3.527	4.027	3.327	2.236	-	-	-	-	-
Pot Cap-1 Maneuver	685	644	897	657	638	998	1414	-	0	0	-	-
Stage 1	854	775	-	896	799	-	-	-	0	0	-	-
Stage 2	892	804	-	813	768	-	-	-	0	0	-	-
Platoon blocked, %	1	1		1	1	1		-			-	-
Mov Cap-1 Maneuver	653	635	896	603	630	998	1414	-	-	-	-	-
Mov Cap-2 Maneuver	653	635	-	603	630	-	-	-	-	-	-	-
Stage 1	842	775	-	884	787	-	-	-	-	-	-	-
Stage 2	846	793	-	755	768	-	-	-	-	-	-	-

Approach	EB	WB	NB	SB
HCM Control Delay, s	9.4	24	1.3	0
HCM LOS	A	C		

Minor Lane/Major Mvmt	NBL	NBT	EBLn1WBLn1WBLn2	SBT	SBR
Capacity (veh/h)	1414	-	885 604 998	-	-
HCM Lane V/C Ratio	0.014	-	0.074 0.713 0.012	-	-
HCM Control Delay (s)	7.6	-	9.4 24.4 8.7	-	-
HCM Lane LOS	A	-	A C A	-	-
HCM 95th %tile Q(veh)	0	-	0.2 5.9 0	-	-

HCM 6th Signalized Intersection Summary
39: 4th Street & Sunset Avenue

Village D Specific Plan
Phase I NP - AM Peak Hour



Movement	EBL	EBR	NBL	NBT	SBT	SBR
Lane Configurations						
Traffic Volume (veh/h)	387	22	32	311	421	274
Future Volume (veh/h)	387	22	32	311	421	274
Initial Q (Qb), veh	0	0	0	0	0	0
Ped-Bike Adj(A_pbT)	1.00	1.00	1.00			1.00
Parking Bus, Adj	1.00	1.00	1.00	1.00	1.00	1.00
Work Zone On Approach	No			No	No	
Adj Sat Flow, veh/h/ln	1900	1900	1870	1870	1870	1870
Adj Flow Rate, veh/h	443	0	35	338	458	298
Peak Hour Factor	0.92	0.92	0.92	0.92	0.92	0.92
Percent Heavy Veh, %	0	0	2	2	2	2
Cap, veh/h	548	244	58	2661	1246	1294
Arrive On Green	0.15	0.00	0.03	0.75	1.00	1.00
Sat Flow, veh/h	3619	1610	1781	3647	1870	1583
Grp Volume(v), veh/h	443	0	35	338	458	298
Grp Sat Flow(s),veh/h/ln	1810	1610	1781	1777	1870	1583
Q Serve(g_s), s	10.7	0.0	1.7	2.4	0.0	0.0
Cycle Q Clear(g_c), s	10.7	0.0	1.7	2.4	0.0	0.0
Prop In Lane	1.00	1.00	1.00			1.00
Lane Grp Cap(c), veh/h	548	244	58	2661	1246	1294
V/C Ratio(X)	0.81	0.00	0.61	0.13	0.37	0.23
Avail Cap(c_a), veh/h	784	349	148	2661	1246	1294
HCM Platoon Ratio	1.00	1.00	1.00	1.00	2.00	2.00
Upstream Filter(I)	1.00	0.00	1.00	1.00	0.89	0.89
Uniform Delay (d), s/veh	36.9	0.0	43.0	3.1	0.0	0.0
Incr Delay (d2), s/veh	4.2	0.0	9.8	0.1	0.7	0.4
Initial Q Delay(d3),s/veh	0.0	0.0	0.0	0.0	0.0	0.0
%ile BackOfQ(50%),veh/ln	4.9	0.0	0.9	0.7	0.3	0.1
Unsig. Movement Delay, s/veh						
LnGrp Delay(d),s/veh	41.2	0.0	52.8	3.2	0.7	0.4
LnGrp LOS	D	A	D	A	A	A
Approach Vol, veh/h	443			373	756	
Approach Delay, s/veh	41.2			7.9	0.6	
Approach LOS	D			A	A	
Timer - Assigned Phs		2		4	5	6
Phs Duration (G+Y+Rc), s		71.9		18.1	7.4	64.5
Change Period (Y+Rc), s		4.5		4.5	4.5	4.5
Max Green Setting (Gmax), s		61.5		19.5	7.5	49.5
Max Q Clear Time (g_c+I1), s		4.4		12.7	3.7	2.0
Green Ext Time (p_c), s		2.5		1.0	0.0	4.5

Intersection Summary

HCM 6th Ctrl Delay	13.8
HCM 6th LOS	B

Notes

User approved volume balancing among the lanes for turning movement.

40: H Street & SR-99 Southbound On-Ramp/2nd Street Performance by movement

Movement	WBL	WBT	WBR	NBL	NBT	NBR	SBT	All
Denied Delay (hr)	0.0	0.0	0.0	0.0	0.0	0.0	0.0	0.0
Denied Del/Veh (s)	0.1	0.1	0.1	0.0	0.0	0.0	0.1	0.0
Total Delay (hr)	0.0	0.1	0.0	0.1	0.0	0.0	0.1	0.3
Total Del/Veh (s)	8.2	9.5	2.3	2.3	3.3	1.2	9.8	3.9
Stop Delay (hr)	0.0	0.0	0.0	0.0	0.0	0.0	0.0	0.1
Stop Del/Veh (s)	6.1	6.2	2.2	0.2	0.2	0.2	7.0	1.6

HCM 6th Signalized Intersection Summary
41: I Street & 4th Street

Village D Specific Plan
Phase I NP - AM Peak Hour



Movement	EBL	EBT	EBR	WBL	WBT	WBR	NBL	NBT	NBR	SBL	SBT	SBR
Lane Configurations	↖	↗		↖	↗		↖	↗	↗	↖	↗	↗
Traffic Volume (veh/h)	26	636	68	86	478	65	52	56	163	223	280	130
Future Volume (veh/h)	26	636	68	86	478	65	52	56	163	223	280	130
Initial Q (Qb), veh	0	0	0	0	0	0	0	0	0	0	0	0
Ped-Bike Adj(A_pbT)	1.00		0.96	1.00		0.96	1.00		0.97	1.00		0.98
Parking Bus, Adj	1.00	1.00	1.00	1.00	1.00	1.00	1.00	1.00	1.00	1.00	1.00	1.00
Work Zone On Approach		No			No			No			No	
Adj Sat Flow, veh/h/ln	1870	1870	1870	1856	1856	1856	1856	1856	1856	1856	1856	1856
Adj Flow Rate, veh/h	28	691	74	93	520	71	57	61	177	242	304	141
Peak Hour Factor	0.92	0.92	0.92	0.92	0.92	0.92	0.92	0.92	0.92	0.92	0.92	0.92
Percent Heavy Veh, %	2	2	2	3	3	3	3	3	3	3	3	3
Cap, veh/h	50	786	84	119	878	119	238	379	310	503	658	544
Arrive On Green	0.03	0.24	0.24	0.07	0.28	0.28	0.13	0.20	0.20	0.28	0.35	0.35
Sat Flow, veh/h	1781	3222	345	1767	3102	422	1767	1856	1519	1767	1856	1533
Grp Volume(v), veh/h	28	381	384	93	295	296	57	61	177	242	304	141
Grp Sat Flow(s),veh/h/ln	1781	1777	1790	1767	1763	1760	1767	1856	1519	1767	1856	1533
Q Serve(g_s), s	1.4	18.6	18.6	4.7	12.9	13.1	2.6	2.4	9.4	10.2	11.4	4.7
Cycle Q Clear(g_c), s	1.4	18.6	18.6	4.7	12.9	13.1	2.6	2.4	9.4	10.2	11.4	4.7
Prop In Lane	1.00		0.19	1.00		0.24	1.00		1.00	1.00		1.00
Lane Grp Cap(c), veh/h	50	433	436	119	499	498	238	379	310	503	658	544
V/C Ratio(X)	0.56	0.88	0.88	0.78	0.59	0.59	0.24	0.16	0.57	0.48	0.46	0.26
Avail Cap(c_a), veh/h	113	464	467	183	531	530	238	379	310	503	658	544
HCM Platoon Ratio	1.00	1.00	1.00	1.00	1.00	1.00	1.00	1.00	1.00	1.00	1.00	1.00
Upstream Filter(l)	0.89	0.89	0.89	1.00	1.00	1.00	1.00	1.00	1.00	1.00	1.00	1.00
Uniform Delay (d), s/veh	43.2	32.8	32.8	41.3	27.8	27.8	34.8	29.4	32.2	26.7	22.4	13.3
Incr Delay (d2), s/veh	8.5	15.1	15.2	11.3	1.6	1.6	0.5	0.9	7.4	0.7	2.3	1.2
Initial Q Delay(d3),s/veh	0.0	0.0	0.0	0.0	0.0	0.0	0.0	0.0	0.0	0.0	0.0	0.0
%ile BackOfQ(50%),veh/ln	0.7	9.6	9.7	2.4	5.5	5.6	1.1	1.2	4.0	4.3	5.2	2.2
Unsig. Movement Delay, s/veh												
LnGrp Delay(d),s/veh	51.7	47.9	48.0	52.6	29.3	29.4	35.3	30.4	39.6	27.4	24.8	14.4
LnGrp LOS	D	D	D	D	C	C	D	C	D	C	C	B
Approach Vol, veh/h		793			684			295			687	
Approach Delay, s/veh		48.1			32.5			36.9			23.6	
Approach LOS		D			C			D			C	
Timer - Assigned Phs	1	2	3	4	5	6	7	8				
Phs Duration (G+Y+Rc), s	30.1	22.9	10.6	26.4	16.6	36.4	7.0	30.0				
Change Period (Y+Rc), s	4.5	4.5	4.5	4.5	4.5	4.5	4.5	4.5				
Max Green Setting (Gmax), s	20.8	18.4	9.3	23.5	7.3	31.9	5.7	27.1				
Max Q Clear Time (g_c+1/2), s	11.2	11.4	6.7	20.6	4.6	13.4	3.4	15.1				
Green Ext Time (p_c), s	0.5	0.5	0.0	1.3	0.0	2.2	0.0	2.9				
Intersection Summary												
HCM 6th Ctrl Delay											35.6	
HCM 6th LOS											D	

HCM 6th Signalized Intersection Summary
 43: SR-99 Northbound Off-Ramp/H Street & 4th Street

Village D Specific Plan
 Phase I NP - AM Peak Hour



Movement	EBL	EBT	EBR	WBL	WBT	WBR	NBL	NBT	NBR	SBL	SBT	SBR
Lane Configurations												
Traffic Volume (veh/h)	230	459	0	0	494	61	253	28	210	6	0	66
Future Volume (veh/h)	230	459	0	0	494	61	253	28	210	6	0	66
Initial Q (Qb), veh	0	0	0	0	0	0	0	0	0	0	0	0
Ped-Bike Adj(A_pbT)	1.00		1.00	1.00		0.94	1.00		1.00	1.00		0.99
Parking Bus, Adj	1.00	1.00	1.00	1.00	1.00	1.00	1.00	1.00	1.00	1.00	1.00	1.00
Work Zone On Approach	No				No				No			
Adj Sat Flow, veh/h/ln	1870	1870	0	0	1841	1841	1870	1870	1870	1900	1900	1900
Adj Flow Rate, veh/h	250	499	0	0	537	66	275	30	228	7	0	72
Peak Hour Factor	0.92	0.92	0.92	0.92	0.92	0.92	0.92	0.92	0.92	0.92	0.92	0.92
Percent Heavy Veh, %	2	2	0	0	4	4	2	2	2	0	0	0
Cap, veh/h	286	1452	0	0	616	75	430	45	344	28	0	293
Arrive On Green	0.16	0.41	0.00	0.00	0.20	0.20	0.24	0.24	0.24	0.20	0.00	0.20
Sat Flow, veh/h	1781	3647	0	0	3204	381	1781	188	1426	142	0	1464
Grp Volume(v), veh/h	250	499	0	0	301	302	275	0	258	79	0	0
Grp Sat Flow(s),veh/h/ln	1781	1777	0	0	1749	1744	1781	0	1614	1606	0	0
Q Serve(g_s), s	12.3	8.7	0.0	0.0	15.0	15.1	12.5	0.0	13.0	3.7	0.0	0.0
Cycle Q Clear(g_c), s	12.3	8.7	0.0	0.0	15.0	15.1	12.5	0.0	13.0	3.7	0.0	0.0
Prop In Lane	1.00		0.00	0.00		0.22	1.00		0.88	0.09		0.91
Lane Grp Cap(c), veh/h	286	1452	0	0	346	345	430	0	389	321	0	0
V/C Ratio(X)	0.87	0.34	0.00	0.00	0.87	0.88	0.64	0.00	0.66	0.25	0.00	0.00
Avail Cap(c_a), veh/h	327	1560	0	0	359	359	430	0	389	321	0	0
HCM Platoon Ratio	1.00	1.00	1.00	1.00	1.00	1.00	1.00	1.00	1.00	1.00	1.00	1.00
Upstream Filter(I)	1.00	1.00	0.00	0.00	1.00	1.00	1.00	0.00	1.00	1.00	0.00	0.00
Uniform Delay (d), s/veh	36.9	18.3	0.0	0.0	35.0	35.0	30.6	0.0	30.8	30.3	0.0	0.0
Incr Delay (d2), s/veh	20.2	0.1	0.0	0.0	19.3	20.3	7.1	0.0	8.6	1.8	0.0	0.0
Initial Q Delay(d3),s/veh	0.0	0.0	0.0	0.0	0.0	0.0	0.0	0.0	0.0	0.0	0.0	0.0
%ile BackOfQ(50%),veh/ln	6.9	3.5	0.0	0.0	8.1	8.2	6.1	0.0	5.9	1.6	0.0	0.0
Unsig. Movement Delay, s/veh												
LnGrp Delay(d),s/veh	57.1	18.4	0.0	0.0	54.3	55.3	37.8	0.0	39.4	32.1	0.0	0.0
LnGrp LOS	E	B	A	A	D	E	D	A	D	C	A	A
Approach Vol, veh/h	749				603				533		79	
Approach Delay, s/veh	31.3				54.8				38.6		32.1	
Approach LOS	C				D				D		C	
Timer - Assigned Phs	2		4		6		7		8			
Phs Duration (G+Y+Rc), s	26.2		41.3		22.5		19.0		22.3			
Change Period (Y+Rc), s	4.5		4.5		4.5		4.5		4.5			
Max Green Setting (Gmax), s	19.0		39.5		18.0		16.5		18.5			
Max Q Clear Time (g_c+I1), s	15.0		10.7		5.7		14.3		17.1			
Green Ext Time (p_c), s	1.0		3.6		0.3		0.2		0.5			
Intersection Summary												
HCM 6th Ctrl Delay			40.5									
HCM 6th LOS			D									

Intersection						
Int Delay, s/veh	2.6					
Movement	EBL	EBT	WBT	WBR	SBL	SBR
Lane Configurations	↖	↗	↗		↖	↖
Traffic Vol, veh/h	130	468	468	78	60	100
Future Vol, veh/h	130	468	468	78	60	100
Conflicting Peds, #/hr	16	0	0	16	0	0
Sign Control	Free	Free	Free	Free	Stop	Stop
RT Channelized	-	None	-	None	-	None
Storage Length	145	-	-	-	65	0
Veh in Median Storage, #	-	0	0	-	0	-
Grade, %	-	0	0	-	0	-
Peak Hour Factor	98	98	98	98	98	98
Heavy Vehicles, %	5	5	4	4	5	5
Mvmt Flow	133	478	478	80	61	102

Major/Minor	Major1	Major2	Minor2		
Conflicting Flow All	574	0	-	0	1039 295
Stage 1	-	-	-	-	534 -
Stage 2	-	-	-	-	505 -
Critical Hdwy	4.2	-	-	-	6.9 7
Critical Hdwy Stg 1	-	-	-	-	5.9 -
Critical Hdwy Stg 2	-	-	-	-	5.9 -
Follow-up Hdwy	2.25	-	-	-	3.55 3.35
Pot Cap-1 Maneuver	1210	-	-	-	320 *907
Stage 1	-	-	-	-	779 -
Stage 2	-	-	-	-	563 -
Platoon blocked, %	1	-	-	-	1 1
Mov Cap-1 Maneuver	1192	-	-	-	275 *893
Mov Cap-2 Maneuver	-	-	-	-	275 -
Stage 1	-	-	-	-	682 -
Stage 2	-	-	-	-	555 -

Approach	EB	WB	SB
HCM Control Delay, s	1.8	0	14.2
HCM LOS			B

Minor Lane/Major Mvmt	EBL	EBT	WBT	WBR	SBLn1	SBLn2
Capacity (veh/h)	1192	-	-	-	275	893
HCM Lane V/C Ratio	0.111	-	-	-	0.223	0.114
HCM Control Delay (s)	8.4	-	-	-	21.8	9.6
HCM Lane LOS	A	-	-	-	C	A
HCM 95th %tile Q(veh)	0.4	-	-	-	0.8	0.4

Notes
 -: Volume exceeds capacity \$: Delay exceeds 300s +: Computation Not Defined *: All major volume in platoon

HCM 6th Signalized Intersection Summary
 45: Olive Avenue & SR-99 Southbound Off-Ramp

Village D Specific Plan
 Phase I NP - AM Peak Hour



Movement	EBL	EBT	WBT	WBR	SBL	SBR
Lane Configurations		↑↑↑	↑↑		↵	↵
Traffic Volume (veh/h)	0	528	442	0	439	106
Future Volume (veh/h)	0	528	442	0	439	106
Initial Q (Qb), veh	0	0	0	0	0	0
Ped-Bike Adj(A_pbT)	1.00			1.00	1.00	1.00
Parking Bus, Adj	1.00	1.00	1.00	1.00	1.00	1.00
Work Zone On Approach		No	No		No	
Adj Sat Flow, veh/h/ln	0	1826	1826	0	1752	1752
Adj Flow Rate, veh/h	0	562	470	0	467	113
Peak Hour Factor	0.94	0.94	0.94	0.94	0.94	0.94
Percent Heavy Veh, %	0	5	5	0	10	10
Cap, veh/h	0	868	604	0	1190	1059
Arrive On Green	0.00	0.17	0.17	0.00	0.71	0.71
Sat Flow, veh/h	0	5313	3652	0	1668	1485
Grp Volume(v), veh/h	0	562	470	0	467	113
Grp Sat Flow(s),veh/h/ln	0	1662	1735	0	1668	1485
Q Serve(g_s), s	0.0	8.4	10.4	0.0	8.9	1.9
Cycle Q Clear(g_c), s	0.0	8.4	10.4	0.0	8.9	1.9
Prop In Lane	0.00			0.00	1.00	1.00
Lane Grp Cap(c), veh/h	0	868	604	0	1190	1059
V/C Ratio(X)	0.00	0.65	0.78	0.00	0.39	0.11
Avail Cap(c_a), veh/h	0	1153	802	0	1190	1059
HCM Platoon Ratio	1.00	1.00	1.00	1.00	1.00	1.00
Upstream Filter(I)	0.00	1.00	0.93	0.00	1.00	1.00
Uniform Delay (d), s/veh	0.0	30.7	31.6	0.0	4.6	3.6
Incr Delay (d2), s/veh	0.0	0.8	3.3	0.0	1.0	0.2
Initial Q Delay(d3),s/veh	0.0	0.0	0.0	0.0	0.0	0.0
%ile BackOfQ(50%),veh/ln	0.0	3.3	4.5	0.0	2.6	0.5
Unsig. Movement Delay, s/veh						
LnGrp Delay(d),s/veh	0.0	31.6	34.9	0.0	5.5	3.8
LnGrp LOS	A	C	C	A	A	A
Approach Vol, veh/h		562	470		580	
Approach Delay, s/veh		31.6	34.9		5.2	
Approach LOS		C	C		A	
Timer - Assigned Phs				4	6	8
Phs Duration (G+Y+Rc), s				18.4	61.6	18.4
Change Period (Y+Rc), s				4.5	4.5	4.5
Max Green Setting (Gmax), s				18.5	52.5	18.5
Max Q Clear Time (g_c+I1), s				10.4	10.9	12.4
Green Ext Time (p_c), s				2.4	2.0	1.6
Intersection Summary						
HCM 6th Ctrl Delay			23.0			
HCM 6th LOS			C			

HCM 6th Signalized Intersection Summary

46: Madera Avenue & SR-99 Northbound Ramps

Village D Specific Plan
Phase I NP - AM Peak Hour



Movement	EBL	EBT	EBR	WBL	WBT	WBR	NBL	NBT	NBR	SBL	SBT	SBR
Lane Configurations				↶	↷	↶	↶↷	↶↷			↶↷	
Traffic Volume (veh/h)	0	0	0	167	1	86	458	414	0	0	602	191
Future Volume (veh/h)	0	0	0	167	1	86	458	414	0	0	602	191
Initial Q (Qb), veh				0	0	0	0	0	0	0	0	0
Ped-Bike Adj(A_pbT)				1.00		0.98	1.00		1.00	1.00		0.97
Parking Bus, Adj				1.00	1.00	1.00	1.00	1.00	1.00	1.00	1.00	1.00
Work Zone On Approach				No			No			No		
Adj Sat Flow, veh/h/ln				1826	1826	1826	1796	1796	0	0	1841	1841
Adj Flow Rate, veh/h				183	0	93	498	450	0	0	654	208
Peak Hour Factor				0.92	0.92	0.92	0.92	0.92	0.92	0.92	0.92	0.92
Percent Heavy Veh, %				5	5	5	7	7	0	0	4	4
Cap, veh/h				323	0	141	1185	2712	0	0	986	313
Arrive On Green				0.09	0.00	0.09	0.60	1.00	0.00	0.00	0.38	0.38
Sat Flow, veh/h				3478	0	1518	3319	3503	0	0	2678	822
Grp Volume(v), veh/h				183	0	93	498	450	0	0	442	420
Grp Sat Flow(s),veh/h/ln				1739	0	1518	1659	1706	0	0	1749	1660
Q Serve(g_s), s				4.0	0.0	4.7	6.5	0.0	0.0	0.0	16.7	16.8
Cycle Q Clear(g_c), s				4.0	0.0	4.7	6.5	0.0	0.0	0.0	16.7	16.8
Prop In Lane				1.00		1.00	1.00		0.00	0.00		0.50
Lane Grp Cap(c), veh/h				323	0	141	1185	2712	0	0	667	633
V/C Ratio(X)				0.57	0.00	0.66	0.42	0.17	0.00	0.00	0.66	0.66
Avail Cap(c_a), veh/h				804	0	351	1185	2712	0	0	667	633
HCM Platoon Ratio				1.00	1.00	1.00	1.67	1.67	1.00	1.00	1.00	1.00
Upstream Filter(I)				1.00	0.00	1.00	0.88	0.88	0.00	0.00	1.00	1.00
Uniform Delay (d), s/veh				34.7	0.0	35.1	11.7	0.0	0.0	0.0	20.5	20.5
Incr Delay (d2), s/veh				1.6	0.0	5.1	0.2	0.1	0.0	0.0	5.1	5.4
Initial Q Delay(d3),s/veh				0.0	0.0	0.0	0.0	0.0	0.0	0.0	0.0	0.0
%ile BackOfQ(50%),veh/ln				1.7	0.0	1.9	2.0	0.0	0.0	0.0	7.4	7.1
Unsig. Movement Delay, s/veh												
LnGrp Delay(d),s/veh				36.3	0.0	40.2	11.9	0.1	0.0	0.0	25.6	25.9
LnGrp LOS				D	A	D	B	A	A	A	C	C
Approach Vol, veh/h								948			862	
Approach Delay, s/veh								6.3			25.8	
Approach LOS								A			C	
Timer - Assigned Phs		2			5	6		8				
Phs Duration (G+Y+Rc), s		68.1			33.1	35.0		11.9				
Change Period (Y+Rc), s		4.5			4.5	4.5		4.5				
Max Green Setting (Gmax), s		52.5			17.5	30.5		18.5				
Max Q Clear Time (g_c+I1), s		2.0			8.5	18.8		6.7				
Green Ext Time (p_c), s		3.4			1.3	4.4		0.7				

Intersection Summary

HCM 6th Ctrl Delay	18.5
HCM 6th LOS	B

Notes

User approved volume balancing among the lanes for turning movement.

HCM 6th Signalized Intersection Summary
 47: Madera Avenue & Olive Avenue/SR-99 Southbound On-Ramp

Village D Specific Plan
 Phase I NP - AM Peak Hour



Movement	EBL	EBT	EBR	WBL	WBT	WBR	NBL	NBT	NBR	SBL	SBT	SBR
Lane Configurations												
Traffic Volume (veh/h)	339	195	432	0	0	0	139	532	40	85	381	303
Future Volume (veh/h)	339	195	432	0	0	0	139	532	40	85	381	303
Initial Q (Qb), veh	0	0	0				0	0	0	0	0	0
Ped-Bike Adj(A_pbT)	1.00		1.00				1.00		0.99	1.00		0.99
Parking Bus, Adj	1.00	1.00	1.00				1.00	1.00	1.00	1.00	1.00	1.00
Work Zone On Approach		No					No			No		
Adj Sat Flow, veh/h/ln	1811	1811	1811				1781	1781	1781	1841	1841	1841
Adj Flow Rate, veh/h	281	311	455				146	560	42	89	401	319
Peak Hour Factor	0.95	0.95	0.95				0.95	0.95	0.95	0.95	0.95	0.95
Percent Heavy Veh, %	6	6	6				8	8	8	4	4	4
Cap, veh/h	542	569	588				227	1440	108	115	829	653
Arrive On Green	0.10	0.10	0.10				0.07	0.45	0.45	0.02	0.15	0.15
Sat Flow, veh/h	1725	1811	1535				3291	3189	239	1753	1850	1457
Grp Volume(v), veh/h	281	311	455				146	297	305	89	379	341
Grp Sat Flow(s),veh/h/ln	1725	1811	1535				1646	1692	1735	1753	1749	1559
Q Serve(g_s), s	12.3	13.1	21.2				3.5	9.3	9.4	4.0	15.9	16.1
Cycle Q Clear(g_c), s	12.3	13.1	21.2				3.5	9.3	9.4	4.0	15.9	16.1
Prop In Lane	1.00		1.00				1.00		0.14	1.00		0.93
Lane Grp Cap(c), veh/h	542	569	588				227	764	784	115	784	699
V/C Ratio(X)	0.52	0.55	0.77				0.64	0.39	0.39	0.77	0.48	0.49
Avail Cap(c_a), veh/h	593	623	634				638	764	784	217	784	699
HCM Platoon Ratio	0.33	0.33	0.33				1.00	1.00	1.00	0.33	0.33	0.33
Upstream Filter(l)	0.86	0.86	0.86				1.00	1.00	1.00	0.86	0.86	0.86
Uniform Delay (d), s/veh	30.1	30.4	28.4				36.3	14.6	14.6	38.5	25.6	25.7
Incr Delay (d2), s/veh	0.7	0.7	4.8				3.0	1.5	1.5	9.1	1.8	2.1
Initial Q Delay(d3),s/veh	0.0	0.0	0.0				0.0	0.0	0.0	0.0	0.0	0.0
%ile BackOfQ(50%),veh/ln	5.7	6.4	19.0				1.5	3.7	3.8	2.1	7.7	7.0
Unsig. Movement Delay, s/veh												
LnGrp Delay(d),s/veh	30.8	31.2	33.2				39.3	16.1	16.1	47.6	27.4	27.8
LnGrp LOS	C	C	C				D	B	B	D	C	C
Approach Vol, veh/h		1047						748			809	
Approach Delay, s/veh		32.0						20.6			29.8	
Approach LOS		C						C			C	
Timer - Assigned Phs	1	2		4	5	6						
Phs Duration (G+Y+Rc), s	9.8	40.6		29.6	10.0	40.3						
Change Period (Y+Rc), s	4.5	4.5		4.5	4.5	4.5						
Max Green Setting (Gmax), s	29.1			27.5	15.5	23.5						
Max Q Clear Time (g_c+1), s	11.4			23.2	5.5	18.1						
Green Ext Time (p_c), s	0.1	3.5		1.9	0.3	2.2						

Intersection Summary

HCM 6th Ctrl Delay	28.0
HCM 6th LOS	C

Notes

User approved volume balancing among the lanes for turning movement.

Intersection						
Int Delay, s/veh	0.3					
Movement	WBL	WBR	NBT	NBR	SBL	SBT
Lane Configurations	↔		↑↓		↔	↑↑
Traffic Vol, veh/h	9	8	733	8	32	936
Future Vol, veh/h	9	8	733	8	32	936
Conflicting Peds, #/hr	0	0	0	8	8	0
Sign Control	Stop	Stop	Free	Free	Free	Free
RT Channelized	-	None	-	None	-	None
Storage Length	0	-	-	-	100	-
Veh in Median Storage, #	0	-	0	-	-	0
Grade, %	0	-	0	-	-	0
Peak Hour Factor	97	97	97	97	97	97
Heavy Vehicles, %	12	12	6	6	6	6
Mvmt Flow	9	8	756	8	33	965

Major/Minor	Minor1	Major1	Major2			
Conflicting Flow All	1317	390	0	0	772	0
Stage 1	768	-	-	-	-	-
Stage 2	549	-	-	-	-	-
Critical Hdwy	7.04	7.14	-	-	4.22	-
Critical Hdwy Stg 1	6.04	-	-	-	-	-
Critical Hdwy Stg 2	6.04	-	-	-	-	-
Follow-up Hdwy	3.62	3.42	-	-	2.26	-
Pot Cap-1 Maneuver	*332	581	-	-	813	-
Stage 1	*394	-	-	-	-	-
Stage 2	*660	-	-	-	-	-
Platoon blocked, %	1	-	-	-	-	-
Mov Cap-1 Maneuver	*315	577	-	-	807	-
Mov Cap-2 Maneuver	*344	-	-	-	-	-
Stage 1	*391	-	-	-	-	-
Stage 2	*633	-	-	-	-	-



























Approach	WB	NB	SB
HCM Control Delay, s	13.8	0	0.3
HCM LOS	B		

Minor Lane/Major Mvmt	NBT	NBRWBLn1	SBL	SBT
Capacity (veh/h)	-	-	425	807
HCM Lane V/C Ratio	-	-	0.041	0.041
HCM Control Delay (s)	-	-	13.8	9.7
HCM Lane LOS	-	-	B	A
HCM 95th %tile Q(veh)	-	-	0.1	0.1

Notes
 -: Volume exceeds capacity \$: Delay exceeds 300s +: Computation Not Defined *: All major volume in platoon

HCM 6th Signalized Intersection Summary
 49: Yosemite Avenue & Cleveland Avenue/Tozer Street

Village D Specific Plan
 Phase I NP - AM Peak Hour

												
Movement	EBL	EBT	EBR	WBL	WBT	WBR	NBL	NBT	NBR	SBL	SBT	SBR
Lane Configurations		 			 					 		
Traffic Volume (veh/h)	179	520	252	112	309	47	134	116	75	66	243	187
Future Volume (veh/h)	179	520	252	112	309	47	134	116	75	66	243	187
Initial Q (Qb), veh	0	0	0	0	0	0	0	0	0	0	0	0
Ped-Bike Adj(A_pbT)	1.00		0.93	1.00		0.94	1.00		1.00	1.00		1.00
Parking Bus, Adj	1.00	1.00	1.00	1.00	1.00	1.00	1.00	1.00	1.00	1.00	1.00	1.00
Work Zone On Approach		No			No			No			No	
Adj Sat Flow, veh/h/ln	1856	1856	1856	1841	1841	1841	1856	1856	1856	1870	1870	1870
Adj Flow Rate, veh/h	195	565	274	122	336	51	146	126	82	72	264	203
Peak Hour Factor	0.92	0.92	0.92	0.92	0.92	0.92	0.92	0.92	0.92	0.92	0.92	0.92
Percent Heavy Veh, %	3	3	3	4	4	4	3	3	3	2	2	2
Cap, veh/h	233	823	398	127	1077	449	135	571	483	93	277	213
Arrive On Green	0.13	0.37	0.37	0.07	0.31	0.31	0.08	0.31	0.31	0.05	0.28	0.28
Sat Flow, veh/h	1767	2238	1083	1753	3497	1459	1767	1856	1568	1781	979	753
Grp Volume(v), veh/h	195	445	394	122	336	51	146	126	82	72	0	467
Grp Sat Flow(s),veh/h/ln	1767	1763	1558	1753	1749	1459	1767	1856	1568	1781	0	1732
Q Serve(g_s), s	9.7	19.2	19.3	6.2	6.6	2.3	6.9	4.5	3.4	3.6	0.0	23.8
Cycle Q Clear(g_c), s	9.7	19.2	19.3	6.2	6.6	2.3	6.9	4.5	3.4	3.6	0.0	23.8
Prop In Lane	1.00		0.69	1.00		1.00	1.00		1.00	1.00		0.43
Lane Grp Cap(c), veh/h	233	648	573	127	1077	449	135	571	483	93	0	491
V/C Ratio(X)	0.84	0.69	0.69	0.96	0.31	0.11	1.08	0.22	0.17	0.78	0.00	0.95
Avail Cap(c_a), veh/h	355	648	573	127	1077	449	135	571	483	148	0	491
HCM Platoon Ratio	1.00	1.00	1.00	1.00	1.00	1.00	1.00	1.00	1.00	1.00	1.00	1.00
Upstream Filter(I)	1.00	1.00	1.00	1.00	1.00	1.00	1.00	1.00	1.00	1.00	0.00	1.00
Uniform Delay (d), s/veh	38.1	24.1	24.1	41.6	23.8	22.3	41.5	23.1	22.7	42.1	0.0	31.6
Incr Delay (d2), s/veh	10.1	5.8	6.6	68.5	0.8	0.5	99.6	0.2	0.2	12.9	0.0	28.7
Initial Q Delay(d3),s/veh	0.0	0.0	0.0	0.0	0.0	0.0	0.0	0.0	0.0	0.0	0.0	0.0
%ile BackOfQ(50%),veh/ln	4.8	8.7	7.9	5.1	2.8	0.8	6.7	2.0	1.3	1.9	0.0	13.5
Unsig. Movement Delay, s/veh												
LnGrp Delay(d),s/veh	48.3	29.9	30.7	110.1	24.6	22.8	141.2	23.3	22.9	55.0	0.0	60.4
LnGrp LOS	D	C	C	F	C	C	F	C	C	E	A	E
Approach Vol, veh/h		1034			509			354			539	
Approach Delay, s/veh		33.7			44.9			71.8			59.7	
Approach LOS		C			D			E			E	
Timer - Assigned Phs	1	2	3	4	5	6	7	8				
Phs Duration (G+Y+Rc), s	16.4	32.2	9.2	32.2	11.0	37.6	11.4	30.0				
Change Period (Y+Rc), s	4.5	4.5	4.5	4.5	4.5	4.5	4.5	4.5				
Max Green Setting (Gmax), s	18.1	21.5	7.5	24.9	6.5	33.1	6.9	25.5				
Max Q Clear Time (g_c+I1), s	11.7	8.6	5.6	6.5	8.2	21.3	8.9	25.8				
Green Ext Time (p_c), s	0.3	1.9	0.0	0.8	0.0	4.4	0.0	0.0				
Intersection Summary												
HCM 6th Ctrl Delay				47.3								
HCM 6th LOS				D								

Intersection						
Int Delay, s/veh	0					
Movement	EBT	EBR	WBL	WBT	NBL	NBR
Lane Configurations						
Traffic Vol, veh/h	37	0	0	29	0	0
Future Vol, veh/h	37	0	0	29	0	0
Conflicting Peds, #/hr	0	0	0	0	0	0
Sign Control	Free	Free	Free	Free	Stop	Stop
RT Channelized	-	None	-	None	-	None
Storage Length	-	-	-	-	-	-
Veh in Median Storage, #	0	-	-	0	0	-
Grade, %	0	-	-	0	0	-
Peak Hour Factor	92	92	92	92	92	92
Heavy Vehicles, %	15	15	15	15	0	0
Mvmt Flow	40	0	0	32	0	0

Major/Minor	Major1	Major2	Minor1	Minor2	Minor3
Conflicting Flow All	0	0	40	0	72
Stage 1	-	-	-	-	40
Stage 2	-	-	-	-	32
Critical Hdwy	-	-	4.25	-	6.4
Critical Hdwy Stg 1	-	-	-	-	5.4
Critical Hdwy Stg 2	-	-	-	-	5.4
Follow-up Hdwy	-	-	2.335	-	3.5
Pot Cap-1 Maneuver	-	-	1490	-	937
Stage 1	-	-	-	-	988
Stage 2	-	-	-	-	996
Platoon blocked, %	-	-	-	-	-
Mov Cap-1 Maneuver	-	-	1490	-	937
Mov Cap-2 Maneuver	-	-	-	-	937
Stage 1	-	-	-	-	988
Stage 2	-	-	-	-	996

Approach	EB	WB	NB
HCM Control Delay, s	0	0	0
HCM LOS			A

Minor Lane/Major Mvmt	NBLn1	EBT	EBR	WBL	WBT
Capacity (veh/h)	-	-	-	1490	-
HCM Lane V/C Ratio	-	-	-	-	-
HCM Control Delay (s)	0	-	-	0	-
HCM Lane LOS	A	-	-	A	-
HCM 95th %tile Q(veh)	-	-	-	0	-

Intersection												
Int Delay, s/veh	0.5											
Movement	EBL	EBT	EBR	WBL	WBT	WBR	NBL	NBT	NBR	SBL	SBT	SBR
Lane Configurations		↕			↕			↕			↕	
Traffic Vol, veh/h	0	30	2	0	34	0	0	0	2	2	0	0
Future Vol, veh/h	0	30	2	0	34	0	0	0	2	2	0	0
Conflicting Peds, #/hr	0	0	0	0	0	0	0	0	0	0	0	0
Sign Control	Free	Free	Free	Free	Free	Free	Stop	Stop	Stop	Stop	Stop	Stop
RT Channelized	-	-	None	-	-	None	-	-	None	-	-	None
Storage Length	-	-	-	-	-	-	-	-	-	-	-	-
Veh in Median Storage, #	-	0	-	-	0	-	-	0	-	-	0	-
Grade, %	-	0	-	-	0	-	-	0	-	-	0	-
Peak Hour Factor	92	92	92	92	92	92	92	92	92	92	92	92
Heavy Vehicles, %	11	11	11	11	11	11	0	0	0	0	0	0
Mvmt Flow	0	33	2	0	37	0	0	0	2	2	0	0

Major/Minor	Major1		Major2		Minor1		Minor2					
Conflicting Flow All	37	0	0	35	0	0	71	71	34	72	72	37
Stage 1	-	-	-	-	-	-	34	34	-	37	37	-
Stage 2	-	-	-	-	-	-	37	37	-	35	35	-
Critical Hdwy	4.21	-	-	4.21	-	-	7.1	6.5	6.2	7.1	6.5	6.2
Critical Hdwy Stg 1	-	-	-	-	-	-	6.1	5.5	-	6.1	5.5	-
Critical Hdwy Stg 2	-	-	-	-	-	-	6.1	5.5	-	6.1	5.5	-
Follow-up Hdwy	2.299	-	-	2.299	-	-	3.5	4	3.3	3.5	4	3.3
Pot Cap-1 Maneuver	1517	-	-	1520	-	-	925	823	1045	924	822	1041
Stage 1	-	-	-	-	-	-	987	871	-	984	868	-
Stage 2	-	-	-	-	-	-	984	868	-	986	870	-
Platoon blocked, %		-	-		-	-						
Mov Cap-1 Maneuver	1517	-	-	1520	-	-	925	823	1045	922	822	1041
Mov Cap-2 Maneuver	-	-	-	-	-	-	925	823	-	922	822	-
Stage 1	-	-	-	-	-	-	987	871	-	984	868	-
Stage 2	-	-	-	-	-	-	984	868	-	984	870	-

Approach	EB	WB	NB	SB
HCM Control Delay, s	0	0	8.5	8.9
HCM LOS			A	A

Minor Lane/Major Mvmt	NBLn1	EBL	EBT	EBR	WBL	WBT	WBR	SBLn1
Capacity (veh/h)	1045	1517	-	-	1520	-	-	922
HCM Lane V/C Ratio	0.002	-	-	-	-	-	-	0.002
HCM Control Delay (s)	8.5	0	-	-	0	-	-	8.9
HCM Lane LOS	A	A	-	-	A	-	-	A
HCM 95th %tile Q(veh)	0	0	-	-	0	-	-	0

Intersection						
Int Delay, s/veh	4.8					
Movement	WBL	WBR	NBT	NBR	SBL	SBT
Lane Configurations						
Traffic Vol, veh/h	1	1	0	2	1	0
Future Vol, veh/h	1	1	0	2	1	0
Conflicting Peds, #/hr	0	0	0	0	0	0
Sign Control	Stop	Stop	Free	Free	Free	Free
RT Channelized	-	None	-	None	-	None
Storage Length	-	-	-	-	-	-
Veh in Median Storage, #	0	-	0	-	-	0
Grade, %	0	-	0	-	-	0
Peak Hour Factor	92	92	92	92	92	92
Heavy Vehicles, %	0	0	0	0	0	0
Mvmt Flow	1	1	0	2	1	0

Major/Minor	Minor1	Major1	Major2		
Conflicting Flow All	3	1	0	0	2
Stage 1	1	-	-	-	-
Stage 2	2	-	-	-	-
Critical Hdwy	6.4	6.2	-	-	4.1
Critical Hdwy Stg 1	5.4	-	-	-	-
Critical Hdwy Stg 2	5.4	-	-	-	-
Follow-up Hdwy	3.5	3.3	-	-	2.2
Pot Cap-1 Maneuver	1025	1090	-	-	1634
Stage 1	1028	-	-	-	-
Stage 2	1026	-	-	-	-
Platoon blocked, %			-	-	-
Mov Cap-1 Maneuver	1024	1090	-	-	1634
Mov Cap-2 Maneuver	1024	-	-	-	-
Stage 1	1028	-	-	-	-
Stage 2	1025	-	-	-	-

Approach	WB	NB	SB
HCM Control Delay, s	8.4	0	7.2
HCM LOS	A		

Minor Lane/Major Mvmt	NBT	NBRWBLn1	SBL	SBT
Capacity (veh/h)	-	-	1056	1634
HCM Lane V/C Ratio	-	-	0.002	0.001
HCM Control Delay (s)	-	-	8.4	7.2
HCM Lane LOS	-	-	A	A
HCM 95th %tile Q(veh)	-	-	0	0

Intersection						
Int Delay, s/veh	0					
Movement	EBL	EBR	NBL	NBT	SBT	SBR
Lane Configurations	T			T		
Traffic Vol, veh/h	0	0	0	255	215	0
Future Vol, veh/h	0	0	0	255	215	0
Conflicting Peds, #/hr	0	0	0	0	0	0
Sign Control	Stop	Stop	Free	Free	Free	Free
RT Channelized	-	None	-	None	-	None
Storage Length	-	-	-	-	-	-
Veh in Median Storage, #	0	-	-	0	0	-
Grade, %	0	-	-	0	0	-
Peak Hour Factor	92	92	92	92	92	92
Heavy Vehicles, %	0	0	19	19	19	19
Mvmt Flow	0	0	0	277	234	0

Major/Minor	Minor2	Major1		Major2	
Conflicting Flow All	511	234	234	0	0
Stage 1	234	-	-	-	-
Stage 2	277	-	-	-	-
Critical Hdwy	6.4	6.2	4.29	-	-
Critical Hdwy Stg 1	5.4	-	-	-	-
Critical Hdwy Stg 2	5.4	-	-	-	-
Follow-up Hdwy	3.5	3.3	2.371	-	-
Pot Cap-1 Maneuver	526	810	1240	-	-
Stage 1	810	-	-	-	-
Stage 2	774	-	-	-	-
Platoon blocked, %				-	-
Mov Cap-1 Maneuver	526	810	1240	-	-
Mov Cap-2 Maneuver	526	-	-	-	-
Stage 1	810	-	-	-	-
Stage 2	774	-	-	-	-

Approach	EB	NB	SB
HCM Control Delay, s	0	0	0
HCM LOS	A		

Minor Lane/Major Mvmt	NBL	NBT	EBLn1	SBT	SBR
Capacity (veh/h)	1240	-	-	-	-
HCM Lane V/C Ratio	-	-	-	-	-
HCM Control Delay (s)	0	-	0	-	-
HCM Lane LOS	A	-	A	-	-
HCM 95th %tile Q(veh)	0	-	-	-	-

Intersection						
Int Delay, s/veh	0					
Movement	EBL	EBR	NBL	NBT	SBT	SBR
Lane Configurations	T			T		
Traffic Vol, veh/h	0	1	1	270	466	0
Future Vol, veh/h	0	1	1	270	466	0
Conflicting Peds, #/hr	0	0	0	0	0	0
Sign Control	Stop	Stop	Free	Free	Free	Free
RT Channelized	-	None	-	None	-	None
Storage Length	0	-	-	-	-	-
Veh in Median Storage, #	0	-	-	0	0	-
Grade, %	0	-	-	0	0	-
Peak Hour Factor	92	92	92	92	92	92
Heavy Vehicles, %	0	0	17	17	17	17
Mvmt Flow	0	1	1	293	507	0

Major/Minor	Minor2	Major1	Major2			
Conflicting Flow All	802	507	507	0	-	0
Stage 1	507	-	-	-	-	-
Stage 2	295	-	-	-	-	-
Critical Hdwy	6.4	6.2	4.27	-	-	-
Critical Hdwy Stg 1	5.4	-	-	-	-	-
Critical Hdwy Stg 2	5.4	-	-	-	-	-
Follow-up Hdwy	3.5	3.3	2.353	-	-	-
Pot Cap-1 Maneuver	356	570	985	-	-	-
Stage 1	609	-	-	-	-	-
Stage 2	760	-	-	-	-	-
Platoon blocked, %				-	-	-
Mov Cap-1 Maneuver	356	570	985	-	-	-
Mov Cap-2 Maneuver	356	-	-	-	-	-
Stage 1	608	-	-	-	-	-
Stage 2	760	-	-	-	-	-

Approach	EB	NB	SB
HCM Control Delay, s	11.3	0	0
HCM LOS	B		

Minor Lane/Major Mvmt	NBL	NBT	EBLn1	SBT	SBR
Capacity (veh/h)	985	-	570	-	-
HCM Lane V/C Ratio	0.001	-	0.002	-	-
HCM Control Delay (s)	8.7	0	11.3	-	-
HCM Lane LOS	A	A	B	-	-
HCM 95th %tile Q(veh)	0	-	0	-	-

Intersection						
Int Delay, s/veh	0.1					
Movement	EBT	EBR	WBL	WBT	NBL	NBR
Lane Configurations						
Traffic Vol, veh/h	62	0	0	29	1	0
Future Vol, veh/h	62	0	0	29	1	0
Conflicting Peds, #/hr	0	0	0	0	0	0
Sign Control	Free	Free	Free	Free	Stop	Stop
RT Channelized	-	None	-	None	-	None
Storage Length	-	-	-	-	-	-
Veh in Median Storage, #	0	-	-	0	0	-
Grade, %	0	-	-	0	0	-
Peak Hour Factor	92	92	92	92	92	92
Heavy Vehicles, %	4	4	4	4	0	0
Mvmt Flow	67	0	0	32	1	0

Major/Minor	Major1	Major2	Minor1		
Conflicting Flow All	0	0	67	0	99
Stage 1	-	-	-	-	67
Stage 2	-	-	-	-	32
Critical Hdwy	-	-	4.14	-	6.4
Critical Hdwy Stg 1	-	-	-	-	5.4
Critical Hdwy Stg 2	-	-	-	-	5.4
Follow-up Hdwy	-	-	2.236	-	3.5
Pot Cap-1 Maneuver	-	-	1522	-	905
Stage 1	-	-	-	-	961
Stage 2	-	-	-	-	996
Platoon blocked, %	-	-	-	-	-
Mov Cap-1 Maneuver	-	-	1522	-	905
Mov Cap-2 Maneuver	-	-	-	-	905
Stage 1	-	-	-	-	961
Stage 2	-	-	-	-	996

Approach	EB	WB	NB
HCM Control Delay, s	0	0	9
HCM LOS			A

Minor Lane/Major Mvmt	NBLn1	EBT	EBR	WBL	WBT
Capacity (veh/h)	905	-	-	1522	-
HCM Lane V/C Ratio	0.001	-	-	-	-
HCM Control Delay (s)	9	-	-	0	-
HCM Lane LOS	A	-	-	A	-
HCM 95th %tile Q(veh)	0	-	-	0	-

Intersection												
Int Delay, s/veh	0.1											
Movement	EBL	EBT	EBR	WBL	WBT	WBR	NBL	NBT	NBR	SBL	SBT	SBR
Lane Configurations		↕			↕			↕			↕	
Traffic Vol, veh/h	0	49	0	0	14	0	0	0	1	0	0	0
Future Vol, veh/h	0	49	0	0	14	0	0	0	1	0	0	0
Conflicting Peds, #/hr	0	0	0	0	0	0	0	0	0	0	0	0
Sign Control	Free	Free	Free	Free	Free	Free	Stop	Stop	Stop	Stop	Stop	Stop
RT Channelized	-	-	None	-	-	None	-	-	None	-	-	None
Storage Length	-	-	-	-	-	-	-	-	-	-	-	-
Veh in Median Storage, #	-	0	-	-	0	-	-	0	-	-	0	-
Grade, %	-	0	-	-	0	-	-	0	-	-	0	-
Peak Hour Factor	92	92	92	92	92	92	92	92	92	92	92	92
Heavy Vehicles, %	13	13	13	13	13	13	0	0	0	0	0	0
Mvmt Flow	0	53	0	0	15	0	0	0	1	0	0	0

Major/Minor	Major1			Major2			Minor1			Minor2		
Conflicting Flow All	15	0	0	53	0	0	68	68	53	69	68	15
Stage 1	-	-	-	-	-	-	53	53	-	15	15	-
Stage 2	-	-	-	-	-	-	15	15	-	54	53	-
Critical Hdwy	4.23	-	-	4.23	-	-	7.1	6.5	6.2	7.1	6.5	6.2
Critical Hdwy Stg 1	-	-	-	-	-	-	6.1	5.5	-	6.1	5.5	-
Critical Hdwy Stg 2	-	-	-	-	-	-	6.1	5.5	-	6.1	5.5	-
Follow-up Hdwy	2.317	-	-	2.317	-	-	3.5	4	3.3	3.5	4	3.3
Pot Cap-1 Maneuver	1534	-	-	1485	-	-	930	826	1020	928	826	1070
Stage 1	-	-	-	-	-	-	965	855	-	1010	887	-
Stage 2	-	-	-	-	-	-	1010	887	-	963	855	-
Platoon blocked, %	-	-	-	-	-	-	-	-	-	-	-	-
Mov Cap-1 Maneuver	1534	-	-	1485	-	-	930	826	1020	927	826	1070
Mov Cap-2 Maneuver	-	-	-	-	-	-	930	826	-	927	826	-
Stage 1	-	-	-	-	-	-	965	855	-	1010	887	-
Stage 2	-	-	-	-	-	-	1010	887	-	962	855	-

Approach	EB			WB			NB			SB		
HCM Control Delay, s	0			0			8.5			0		
HCM LOS							A			A		

Minor Lane/Major Mvmt	NBLn1	EBL	EBT	EBR	WBL	WBT	WBR	SBLn1
Capacity (veh/h)	1020	1534	-	-	1485	-	-	-
HCM Lane V/C Ratio	0.001	-	-	-	-	-	-	-
HCM Control Delay (s)	8.5	0	-	-	0	-	-	0
HCM Lane LOS	A	A	-	-	A	-	-	A
HCM 95th %tile Q(veh)	0	0	-	-	0	-	-	-

Intersection						
Int Delay, s/veh	6.5					
Movement	EBL	EBT	WBT	WBR	SBL	SBR
Lane Configurations		↕	↑	↗	↘	
Traffic Vol, veh/h	7	124	67	102	258	8
Future Vol, veh/h	7	124	67	102	258	8
Conflicting Peds, #/hr	0	0	0	0	0	0
Sign Control	Free	Free	Free	Free	Stop	Stop
RT Channelized	-	None	-	None	-	None
Storage Length	-	-	-	0	0	-
Veh in Median Storage, #	-	0	0	-	0	-
Grade, %	-	0	0	-	0	-
Peak Hour Factor	92	92	92	92	92	92
Heavy Vehicles, %	12	12	58	58	30	30
Mvmt Flow	8	135	73	111	280	9

Major/Minor	Major1	Major2	Minor2		
Conflicting Flow All	184	0	-	0	224
Stage 1	-	-	-	-	73
Stage 2	-	-	-	-	151
Critical Hdwy	4.22	-	-	-	6.7
Critical Hdwy Stg 1	-	-	-	-	5.7
Critical Hdwy Stg 2	-	-	-	-	5.7
Follow-up Hdwy	2.308	-	-	-	3.77
Pot Cap-1 Maneuver	1333	-	-	-	706
Stage 1	-	-	-	-	884
Stage 2	-	-	-	-	813
Platoon blocked, %		-	-	-	
Mov Cap-1 Maneuver	1333	-	-	-	702
Mov Cap-2 Maneuver	-	-	-	-	702
Stage 1	-	-	-	-	879
Stage 2	-	-	-	-	813

Approach	EB	WB	SB
HCM Control Delay, s	0.4	0	13.6
HCM LOS			B

Minor Lane/Major Mvmt	EBL	EBT	WBT	WBR	SBLn1
Capacity (veh/h)	1333	-	-	-	707
HCM Lane V/C Ratio	0.006	-	-	-	0.409
HCM Control Delay (s)	7.7	0	-	-	13.6
HCM Lane LOS	A	A	-	-	B
HCM 95th %tile Q(veh)	0	-	-	-	2

HCM 6th TWSC
 4: Truck Parking Lot/Pistachio Drive & Avenue 18 1/2

Village D Specific Plan
 Phase I NP - PM Peak Hour

Intersection												
Int Delay, s/veh	4.5											
Movement	EBL	EBT	EBR	WBL	WBT	WBR	NBL	NBT	NBR	SBL	SBT	SBR
Lane Configurations		↕			↕	↕		↕			↕	
Traffic Vol, veh/h	12	432	1	6	154	193	2	0	5	159	0	12
Future Vol, veh/h	12	432	1	6	154	193	2	0	5	159	0	12
Conflicting Peds, #/hr	0	0	0	0	0	0	0	0	1	1	0	0
Sign Control	Free	Free	Free	Free	Free	Free	Stop	Stop	Stop	Stop	Stop	Stop
RT Channelized	-	-	None	-	-	None	-	-	None	-	-	None
Storage Length	-	-	-	-	-	50	-	-	-	-	-	-
Veh in Median Storage, #	-	0	-	-	0	-	-	0	-	-	0	-
Grade, %	-	0	-	-	0	-	-	0	-	-	0	-
Peak Hour Factor	93	93	93	93	93	93	93	93	93	93	93	93
Heavy Vehicles, %	23	23	23	26	26	26	71	71	71	5	5	5
Mvmt Flow	13	465	1	6	166	208	2	0	5	171	0	13

Major/Minor	Major1		Major2		Minor1		Minor2					
Conflicting Flow All	374	0	0	466	0	0	781	878	467	673	670	166
Stage 1	-	-	-	-	-	-	492	492	-	178	178	-
Stage 2	-	-	-	-	-	-	289	386	-	495	492	-
Critical Hdwy	4.33	-	-	4.36	-	-	7.81	7.21	6.91	7.15	6.55	6.25
Critical Hdwy Stg 1	-	-	-	-	-	-	6.81	6.21	-	6.15	5.55	-
Critical Hdwy Stg 2	-	-	-	-	-	-	6.81	6.21	-	6.15	5.55	-
Follow-up Hdwy	2.407	-	-	2.434	-	-	4.139	4.639	3.939	3.545	4.045	3.345
Pot Cap-1 Maneuver	1078	-	-	981	-	-	242	223	476	365	374	871
Stage 1	-	-	-	-	-	-	449	448	-	817	746	-
Stage 2	-	-	-	-	-	-	592	506	-	551	543	-
Platoon blocked, %	-	-	-	-	-	-	-	-	-	-	-	-
Mov Cap-1 Maneuver	1078	-	-	981	-	-	234	218	476	354	365	871
Mov Cap-2 Maneuver	-	-	-	-	-	-	234	218	-	354	365	-
Stage 1	-	-	-	-	-	-	442	441	-	804	740	-
Stage 2	-	-	-	-	-	-	579	502	-	536	534	-

Approach	EB		WB		NB		SB	
HCM Control Delay, s	0.2		0.1		15		24.1	
HCM LOS					C		C	

Minor Lane/Major Mvmt	NBLn1	EBL	EBT	EBR	WBL	WBT	WBR	SBLn1
Capacity (veh/h)	367	1078	-	-	981	-	-	369
HCM Lane V/C Ratio	0.021	0.012	-	-	0.007	-	-	0.498
HCM Control Delay (s)	15	8.4	0	-	8.7	0	-	24.1
HCM Lane LOS	C	A	A	-	A	A	-	C
HCM 95th %tile Q(veh)	0.1	0	-	-	0	-	-	2.7

Intersection												
Int Delay, s/veh	12.4											
Movement	EBL	EBT	EBR	WBL	WBT	WBR	NBL	NBT	NBR	SBL	SBT	SBR
Lane Configurations		↑	↑		↑		↑		↑		↕	
Traffic Vol, veh/h	0	388	208	45	196	0	37	0	104	22	107	122
Future Vol, veh/h	0	388	208	45	196	0	37	0	104	22	107	122
Conflicting Peds, #/hr	0	0	0	0	0	0	0	0	0	0	0	0
Sign Control	Free	Free	Free	Free	Free	Free	Stop	Stop	Stop	Stop	Stop	Stop
RT Channelized	-	-	None	-	-	None	-	-	None	-	-	None
Storage Length	-	-	50	-	-	-	0	-	25	-	-	-
Veh in Median Storage, #	-	0	-	-	0	-	-	0	-	-	0	-
Grade, %	-	0	-	-	0	-	-	0	-	-	0	-
Peak Hour Factor	94	94	94	94	94	94	94	94	94	94	94	94
Heavy Vehicles, %	20	20	20	30	30	30	16	16	16	26	26	26
Mvmt Flow	0	413	221	48	209	0	39	0	111	23	114	130

Major/Minor	Major1			Major2			Minor1			Minor2		
Conflicting Flow All	-	0	0	634	0	0	840	-	413	884	939	209
Stage 1	-	-	-	-	-	-	413	-	-	305	305	-
Stage 2	-	-	-	-	-	-	427	-	-	579	634	-
Critical Hdwy	-	-	-	4.4	-	-	7.26	-	6.36	7.36	6.76	6.46
Critical Hdwy Stg 1	-	-	-	-	-	-	6.26	-	-	6.36	5.76	-
Critical Hdwy Stg 2	-	-	-	-	-	-	6.26	-	-	6.36	5.76	-
Follow-up Hdwy	-	-	-	2.47	-	-	3.644	-	3.444	3.734	4.234	3.534
Pot Cap-1 Maneuver	0	-	-	828	-	0	270	0	610	242	241	774
Stage 1	0	-	-	-	-	0	589	0	-	656	621	-
Stage 2	0	-	-	-	-	0	579	0	-	461	437	-
Platoon blocked, %	-	-	-	-	-	-	-	-	-	-	-	-
Mov Cap-1 Maneuver	-	-	-	828	-	-	129	-	610	188	225	774
Mov Cap-2 Maneuver	-	-	-	-	-	-	129	-	-	188	225	-
Stage 1	-	-	-	-	-	-	589	-	-	656	580	-
Stage 2	-	-	-	-	-	-	362	-	-	377	437	-

Approach	EB			WB			NB			SB		
HCM Control Delay, s	0			1.8			20.7			47.2		
HCM LOS							C			E		

Minor Lane/Major Mvmt	NBLn1	NBLn2	EBT	EBR	WBL	WBT	SBLn1
Capacity (veh/h)	129	610	-	-	828	-	335
HCM Lane V/C Ratio	0.305	0.181	-	-	0.058	-	0.797
HCM Control Delay (s)	44.7	12.2	-	-	9.6	0	47.2
HCM Lane LOS	E	B	-	-	A	A	E
HCM 95th %tile Q(veh)	1.2	0.7	-	-	0.2	-	6.6

Intersection												
Int Delay, s/veh	11.8											
Movement	EBL	EBT	EBR	WBL	WBT	WBR	NBL	NBT	NBR	SBL	SBT	SBR
Lane Configurations	↙	↑			↘			↔				
Traffic Vol, veh/h	192	95	0	0	85	16	185	2	0	0	0	0
Future Vol, veh/h	192	95	0	0	85	16	185	2	0	0	0	0
Conflicting Peds, #/hr	0	0	0	0	0	0	0	0	0	0	0	0
Sign Control	Free	Free	Free	Free	Free	Free	Stop	Stop	Stop	Free	Free	Free
RT Channelized	-	-	None	-	-	None	-	-	None	-	-	None
Storage Length	145	-	-	-	-	-	-	-	-	-	-	-
Veh in Median Storage, #	-	0	-	-	0	-	-	0	-	-	16965	-
Grade, %	-	0	-	-	0	-	-	0	-	-	0	-
Peak Hour Factor	92	92	92	92	92	92	92	92	92	92	92	92
Heavy Vehicles, %	20	20	20	12	12	12	24	24	24	0	0	0
Mvmt Flow	209	103	0	0	92	17	201	2	0	0	0	0

Major/Minor	Major1	Major2	Minor1
Conflicting Flow All	109	0	0
Stage 1	-	-	521
Stage 2	-	-	101
Critical Hdwy	4.3	-	6.64
Critical Hdwy Stg 1	-	-	5.64
Critical Hdwy Stg 2	-	-	5.64
Follow-up Hdwy	2.38	-	3.716
Pot Cap-1 Maneuver	1376	0	417
Stage 1	-	0	554
Stage 2	-	0	871
Platoon blocked, %	-	-	-
Mov Cap-1 Maneuver	1376	-	354
Mov Cap-2 Maneuver	-	-	354
Stage 1	-	-	470
Stage 2	-	-	871

Approach	EB	WB	NB
HCM Control Delay, s	5.4	0	28
HCM LOS			D

Minor Lane/Major Mvmt	NBLn1	EBL	EBT	WBT	WBR
Capacity (veh/h)	354	1376	-	-	-
HCM Lane V/C Ratio	0.574	0.152	-	-	-
HCM Control Delay (s)	28	8.1	-	-	-
HCM Lane LOS	D	A	-	-	-
HCM 95th %tile Q(veh)	3.4	0.5	-	-	-

Intersection												
Int Delay, s/veh	4.1											
Movement	EBL	EBT	EBR	WBL	WBT	WBR	NBL	NBT	NBR	SBL	SBT	SBR
Lane Configurations		↕			↕			↕			↕	
Traffic Vol, veh/h	1	50	11	29	22	9	6	80	62	62	220	2
Future Vol, veh/h	1	50	11	29	22	9	6	80	62	62	220	2
Conflicting Peds, #/hr	0	0	0	0	0	0	0	0	0	0	0	0
Sign Control	Stop	Stop	Stop	Stop	Stop	Stop	Free	Free	Free	Free	Free	Free
RT Channelized	-	-	None	-	-	None	-	-	None	-	-	None
Storage Length	-	-	-	-	-	-	-	-	-	-	-	-
Veh in Median Storage, #	-	0	-	-	0	-	-	0	-	-	0	-
Grade, %	-	0	-	-	0	-	-	0	-	-	0	-
Peak Hour Factor	92	92	92	92	92	92	92	92	92	92	92	92
Heavy Vehicles, %	3	3	3	5	5	5	8	8	8	8	8	8
Mvmt Flow	1	54	12	32	24	10	7	87	67	67	239	2

Major/Minor	Minor2		Minor1		Major1		Major2					
Conflicting Flow All	526	542	240	542	510	121	241	0	0	154	0	0
Stage 1	374	374	-	135	135	-	-	-	-	-	-	-
Stage 2	152	168	-	407	375	-	-	-	-	-	-	-
Critical Hdwy	7.13	6.53	6.23	7.15	6.55	6.25	4.18	-	-	4.18	-	-
Critical Hdwy Stg 1	6.13	5.53	-	6.15	5.55	-	-	-	-	-	-	-
Critical Hdwy Stg 2	6.13	5.53	-	6.15	5.55	-	-	-	-	-	-	-
Follow-up Hdwy	3.527	4.027	3.327	3.545	4.045	3.345	2.272	-	-	2.272	-	-
Pot Cap-1 Maneuver	461	446	796	447	462	922	1291	-	-	1391	-	-
Stage 1	645	616	-	861	779	-	-	-	-	-	-	-
Stage 2	848	758	-	615	612	-	-	-	-	-	-	-
Platoon blocked, %								-	-	-	-	-
Mov Cap-1 Maneuver	416	418	796	378	433	922	1291	-	-	1391	-	-
Mov Cap-2 Maneuver	416	418	-	378	433	-	-	-	-	-	-	-
Stage 1	641	582	-	856	774	-	-	-	-	-	-	-
Stage 2	808	753	-	518	578	-	-	-	-	-	-	-

Approach	EB		WB		NB		SB	
HCM Control Delay, s	14.3		14.7		0.3		1.7	
HCM LOS	B		B					

Minor Lane/Major Mvmt	NBL	NBT	NBR	EBLn1WBLn1	SBL	SBT	SBR
Capacity (veh/h)	1291	-	-	456	437	1391	-
HCM Lane V/C Ratio	0.005	-	-	0.148	0.149	0.048	-
HCM Control Delay (s)	7.8	0	-	14.3	14.7	7.7	0
HCM Lane LOS	A	A	-	B	B	A	A
HCM 95th %tile Q(veh)	0	-	-	0.5	0.5	0.2	-

Intersection												
Int Delay, s/veh	1.4											
Movement	EBL	EBT	EBR	WBL	WBT	WBR	NBL	NBT	NBR	SBL	SBT	SBR
Lane Configurations		↕			↕			↕			↕	
Traffic Vol, veh/h	16	0	42	0	1	1	9	182	1	2	272	21
Future Vol, veh/h	16	0	42	0	1	1	9	182	1	2	272	21
Conflicting Peds, #/hr	0	0	0	0	0	0	0	0	0	0	0	0
Sign Control	Stop	Stop	Stop	Stop	Stop	Stop	Free	Free	Free	Free	Free	Free
RT Channelized	-	-	None	-	-	None	-	-	None	-	-	None
Storage Length	-	-	-	-	-	-	-	-	-	-	-	-
Veh in Median Storage, #	-	0	-	-	0	-	-	0	-	-	0	-
Grade, %	-	0	-	-	0	-	-	0	-	-	0	-
Peak Hour Factor	95	95	95	95	95	95	95	95	95	95	95	95
Heavy Vehicles, %	6	6	6	50	50	50	8	8	8	9	9	9
Mvmt Flow	17	0	44	0	1	1	9	192	1	2	286	22

Major/Minor	Minor2		Minor1		Major1		Major2					
Conflicting Flow All	513	512	297	534	523	193	308	0	0	193	0	0
Stage 1	301	301	-	211	211	-	-	-	-	-	-	-
Stage 2	212	211	-	323	312	-	-	-	-	-	-	-
Critical Hdwy	7.16	6.56	6.26	7.6	7	6.7	4.18	-	-	4.19	-	-
Critical Hdwy Stg 1	6.16	5.56	-	6.6	6	-	-	-	-	-	-	-
Critical Hdwy Stg 2	6.16	5.56	-	6.6	6	-	-	-	-	-	-	-
Follow-up Hdwy	3.554	4.054	3.354	3.95	4.45	3.75	2.272	-	-	2.281	-	-
Pot Cap-1 Maneuver	465	460	733	390	397	740	1219	-	-	1339	-	-
Stage 1	700	658	-	693	647	-	-	-	-	-	-	-
Stage 2	781	720	-	599	580	-	-	-	-	-	-	-
Platoon blocked, %								-	-	-	-	-
Mov Cap-1 Maneuver	460	455	733	364	393	740	1219	-	-	1339	-	-
Mov Cap-2 Maneuver	460	455	-	364	393	-	-	-	-	-	-	-
Stage 1	694	657	-	687	642	-	-	-	-	-	-	-
Stage 2	772	714	-	562	579	-	-	-	-	-	-	-

Approach	EB		WB		NB		SB	
HCM Control Delay, s	11.3		12		0.4		0.1	
HCM LOS	B		B					

Minor Lane/Major Mvmt	NBL	NBT	NBR	EBLn1	WBLn1	SBL	SBT	SBR
Capacity (veh/h)	1219	-	-	630	513	1339	-	-
HCM Lane V/C Ratio	0.008	-	-	0.097	0.004	0.002	-	-
HCM Control Delay (s)	8	0	-	11.3	12	7.7	0	-
HCM Lane LOS	A	A	-	B	B	A	A	-
HCM 95th %tile Q(veh)	0	-	-	0.3	0	0	-	-

Intersection												
Int Delay, s/veh	3											
Movement	EBL	EBT	EBR	WBL	WBT	WBR	NBL	NBT	NBR	SBL	SBT	SBR
Lane Configurations		↕			↕			↕			↕	
Traffic Vol, veh/h	1	0	1	55	0	35	0	133	99	70	228	1
Future Vol, veh/h	1	0	1	55	0	35	0	133	99	70	228	1
Conflicting Peds, #/hr	0	0	0	0	0	0	0	0	0	0	0	0
Sign Control	Stop	Stop	Stop	Stop	Stop	Stop	Free	Free	Free	Free	Free	Free
RT Channelized	-	-	None	-	-	None	-	-	None	-	-	None
Storage Length	-	-	-	-	-	-	-	-	-	-	-	-
Veh in Median Storage, #	-	0	-	-	0	-	-	0	-	-	0	-
Grade, %	-	0	-	-	0	-	-	0	-	-	0	-
Peak Hour Factor	93	93	93	93	93	93	93	93	93	93	93	93
Heavy Vehicles, %	0	0	0	4	4	4	7	7	7	9	9	9
Mvmt Flow	1	0	1	59	0	38	0	143	106	75	245	1

Major/Minor	Minor2		Minor1		Major1		Major2					
Conflicting Flow All	611	645	246	592	592	196	246	0	0	249	0	0
Stage 1	396	396	-	196	196	-	-	-	-	-	-	-
Stage 2	215	249	-	396	396	-	-	-	-	-	-	-
Critical Hdwy	7.1	6.5	6.2	7.14	6.54	6.24	4.17	-	-	4.19	-	-
Critical Hdwy Stg 1	6.1	5.5	-	6.14	5.54	-	-	-	-	-	-	-
Critical Hdwy Stg 2	6.1	5.5	-	6.14	5.54	-	-	-	-	-	-	-
Follow-up Hdwy	3.5	4	3.3	3.536	4.036	3.336	2.263	-	-	2.281	-	-
Pot Cap-1 Maneuver	409	393	798	415	416	840	1291	-	-	1277	-	-
Stage 1	633	607	-	801	735	-	-	-	-	-	-	-
Stage 2	792	704	-	625	601	-	-	-	-	-	-	-
Platoon blocked, %								-	-	-	-	-
Mov Cap-1 Maneuver	371	366	798	393	388	840	1291	-	-	1277	-	-
Mov Cap-2 Maneuver	371	366	-	393	388	-	-	-	-	-	-	-
Stage 1	633	566	-	801	735	-	-	-	-	-	-	-
Stage 2	757	704	-	582	560	-	-	-	-	-	-	-

Approach	EB	WB	NB	SB
HCM Control Delay, s	12.1	14	0	1.9
HCM LOS	B	B		

Minor Lane/Major Mvmt	NBL	NBT	NBR	EBLn1	WBLn1	SBL	SBT	SBR
Capacity (veh/h)	1291	-	-	507	496	1277	-	-
HCM Lane V/C Ratio	-	-	-	0.004	0.195	0.059	-	-
HCM Control Delay (s)	0	-	-	12.1	14	8	0	-
HCM Lane LOS	A	-	-	B	B	A	A	-
HCM 95th %tile Q(veh)	0	-	-	0	0.7	0.2	-	-

Intersection												
Int Delay, s/veh	1.5											
Movement	EBL	EBT	EBR	WBL	WBT	WBR	NBL	NBT	NBR	SBL	SBT	SBR
Lane Configurations		↔			↔			↔			↔	
Traffic Vol, veh/h	1	2	3	5	3	11	2	212	2	62	220	0
Future Vol, veh/h	1	2	3	5	3	11	2	212	2	62	220	0
Conflicting Peds, #/hr	0	0	0	0	0	0	0	0	0	0	0	0
Sign Control	Stop	Stop	Stop	Stop	Stop	Stop	Free	Free	Free	Free	Free	Free
RT Channelized	-	-	None	-	-	None	-	-	None	-	-	None
Storage Length	-	-	-	-	-	-	-	-	-	-	-	-
Veh in Median Storage, #	-	0	-	-	0	-	-	0	-	-	0	-
Grade, %	-	0	-	-	0	-	-	0	-	-	0	-
Peak Hour Factor	92	92	92	92	92	92	92	92	92	92	92	92
Heavy Vehicles, %	0	0	0	0	0	0	9	9	9	9	9	9
Mvmt Flow	1	2	3	5	3	12	2	230	2	67	239	0

Major/Minor	Minor2		Minor1		Major1		Major2					
Conflicting Flow All	616	609	239	611	608	231	239	0	0	232	0	0
Stage 1	373	373	-	235	235	-	-	-	-	-	-	-
Stage 2	243	236	-	376	373	-	-	-	-	-	-	-
Critical Hdwy	7.1	6.5	6.2	7.1	6.5	6.2	4.19	-	-	4.19	-	-
Critical Hdwy Stg 1	6.1	5.5	-	6.1	5.5	-	-	-	-	-	-	-
Critical Hdwy Stg 2	6.1	5.5	-	6.1	5.5	-	-	-	-	-	-	-
Follow-up Hdwy	3.5	4	3.3	3.5	4	3.3	2.281	-	-	2.281	-	-
Pot Cap-1 Maneuver	406	412	805	409	413	813	1288	-	-	1295	-	-
Stage 1	652	622	-	773	714	-	-	-	-	-	-	-
Stage 2	765	713	-	649	622	-	-	-	-	-	-	-
Platoon blocked, %								-	-	-	-	-
Mov Cap-1 Maneuver	379	386	805	387	387	813	1288	-	-	1295	-	-
Mov Cap-2 Maneuver	379	386	-	387	387	-	-	-	-	-	-	-
Stage 1	651	585	-	771	713	-	-	-	-	-	-	-
Stage 2	749	712	-	605	585	-	-	-	-	-	-	-

Approach	EB		WB		NB		SB	
HCM Control Delay, s	12		11.7		0.1		1.7	
HCM LOS	B		B					

Minor Lane/Major Mvmt	NBL	NBT	NBR	EBLn1	WBLn1	SBL	SBT	SBR
Capacity (veh/h)	1288	-	-	520	556	1295	-	-
HCM Lane V/C Ratio	0.002	-	-	0.013	0.037	0.052	-	-
HCM Control Delay (s)	7.8	0	-	12	11.7	7.9	0	-
HCM Lane LOS	A	A	-	B	B	A	A	-
HCM 95th %tile Q(veh)	0	-	-	0	0.1	0.2	-	-

Intersection	
Intersection Delay, s/veh	9.9
Intersection LOS	A

Movement	EBL	EBT	EBR	WBL	WBT	WBR	NBL	NBT	NBR	SBL	SBT	SBR
Lane Configurations		↕			↕			↕			↕	
Traffic Vol, veh/h	60	90	35	11	37	55	14	102	21	71	122	34
Future Vol, veh/h	60	90	35	11	37	55	14	102	21	71	122	34
Peak Hour Factor	0.95	0.95	0.95	0.95	0.95	0.95	0.95	0.95	0.95	0.95	0.95	0.95
Heavy Vehicles, %	8	8	8	4	4	4	10	10	10	10	10	10
Mvmt Flow	63	95	37	12	39	58	15	107	22	75	128	36
Number of Lanes	0	1	0	0	1	0	0	1	0	0	1	0

Approach	EB	WB	NB	SB
Opposing Approach	WB	EB	SB	NB
Opposing Lanes	1	1	1	1
Conflicting Approach Left	SB	NB	EB	WB
Conflicting Lanes Left	1	1	1	1
Conflicting Approach Right	NB	SB	WB	EB
Conflicting Lanes Right	1	1	1	1
HCM Control Delay	10.1	8.8	9.5	10.5
HCM LOS	B	A	A	B

Lane	NBLn1	EBLn1	WBLn1	SBLn1
Vol Left, %	10%	32%	11%	31%
Vol Thru, %	74%	49%	36%	54%
Vol Right, %	15%	19%	53%	15%
Sign Control	Stop	Stop	Stop	Stop
Traffic Vol by Lane	137	185	103	227
LT Vol	14	60	11	71
Through Vol	102	90	37	122
RT Vol	21	35	55	34
Lane Flow Rate	144	195	108	239
Geometry Grp	1	1	1	1
Degree of Util (X)	0.203	0.275	0.147	0.331
Departure Headway (Hd)	5.064	5.077	4.889	4.982
Convergence, Y/N	Yes	Yes	Yes	Yes
Cap	701	701	725	714
Service Time	3.148	3.155	2.977	3.058
HCM Lane V/C Ratio	0.205	0.278	0.149	0.335
HCM Control Delay	9.5	10.1	8.8	10.5
HCM Lane LOS	A	B	A	B
HCM 95th-tile Q	0.8	1.1	0.5	1.4

Intersection												
Intersection Delay, s/veh	9.5											
Intersection LOS	A											

Movement	EBL	EBT	EBR	WBL	WBT	WBR	NBL	NBT	NBR	SBL	SBT	SBR
Lane Configurations												
Traffic Vol, veh/h	57	137	8	17	76	25	4	41	41	56	46	34
Future Vol, veh/h	57	137	8	17	76	25	4	41	41	56	46	34
Peak Hour Factor	0.92	0.92	0.92	0.92	0.92	0.92	0.92	0.92	0.92	0.92	0.92	0.92
Heavy Vehicles, %	14	14	14	21	21	21	8	8	8	13	13	13
Mvmt Flow	62	149	9	18	83	27	4	45	45	61	50	37
Number of Lanes	1	1	0	1	1	0	0	1	0	0	1	0

Approach	EB	WB	NB	SB
Opposing Approach	WB	EB	SB	NB
Opposing Lanes	2	2	1	1
Conflicting Approach Left	SB	NB	EB	WB
Conflicting Lanes Left	1	1	2	2
Conflicting Approach Right	NB	SB	WB	EB
Conflicting Lanes Right	1	1	2	2
HCM Control Delay	9.8	9.4	8.7	9.5
HCM LOS	A	A	A	A

Lane	NBLn1	EBLn1	EBLn2	WBLn1	WBLn2	SBLn1
Vol Left, %		5%	100%	0%	100%	0%
Vol Thru, %		48%	0%	94%	0%	75%
Vol Right, %		48%	0%	6%	0%	25%
Sign Control		Stop	Stop	Stop	Stop	Stop
Traffic Vol by Lane		86	57	145	17	101
LT Vol		4	57	0	17	0
Through Vol		41	0	137	0	76
RT Vol		41	0	8	0	25
Lane Flow Rate		93	62	158	18	110
Geometry Grp		2	7	7	7	7
Degree of Util (X)		0.127	0.103	0.238	0.032	0.169
Departure Headway (Hd)		4.873	5.985	5.442	6.212	5.532
Convergence, Y/N		Yes	Yes	Yes	Yes	Yes
Cap		731	596	656	573	644
Service Time		2.935	3.75	3.207	3.983	3.303
HCM Lane V/C Ratio		0.127	0.104	0.241	0.031	0.171
HCM Control Delay		8.7	9.4	9.9	9.2	9.4
HCM Lane LOS		A	A	A	A	A
HCM 95th-tile Q		0.4	0.3	0.9	0.1	0.6

Intersection												
Int Delay, s/veh	134											
Movement	EBL	EBT	EBR	WBL	WBT	WBR	NBL	NBT	NBR	SBL	SBT	SBR
Lane Configurations	↘	↑	↗	↘	↑	↗	↘	↑	↗		↕	
Traffic Vol, veh/h	9	243	27	142	95	165	21	53	242	232	52	9
Future Vol, veh/h	9	243	27	142	95	165	21	53	242	232	52	9
Conflicting Peds, #/hr	0	0	0	0	0	0	0	0	0	0	0	0
Sign Control	Free	Free	Free	Free	Free	Free	Stop	Stop	Stop	Stop	Stop	Stop
RT Channelized	-	-	None	-	-	None	-	-	None	-	-	None
Storage Length	85	-	0	70	-	105	60	-	50	-	-	-
Veh in Median Storage, #	-	0	-	-	0	-	-	0	-	-	0	-
Grade, %	-	0	-	-	0	-	-	0	-	-	0	-
Peak Hour Factor	92	92	92	92	92	92	92	92	92	92	92	92
Heavy Vehicles, %	2	2	2	5	5	5	5	5	5	3	3	3
Mvmt Flow	10	264	29	154	103	179	23	58	263	252	57	10

Major/Minor	Major1			Major2			Minor1			Minor2		
Conflicting Flow All	282	0	0	293	0	0	818	874	264	870	724	103
Stage 1	-	-	-	-	-	-	284	284	-	411	411	-
Stage 2	-	-	-	-	-	-	534	590	-	459	313	-
Critical Hdwy	4.12	-	-	4.15	-	-	7.15	6.55	6.25	7.13	6.53	6.23
Critical Hdwy Stg 1	-	-	-	-	-	-	6.15	5.55	-	6.13	5.53	-
Critical Hdwy Stg 2	-	-	-	-	-	-	6.15	5.55	-	6.13	5.53	-
Follow-up Hdwy	2.218	-	-	2.245	-	-	3.545	4.045	3.345	3.527	4.027	3.327
Pot Cap-1 Maneuver	1280	-	-	1252	-	-	291	285	767	271	351	949
Stage 1	-	-	-	-	-	-	717	671	-	616	593	-
Stage 2	-	-	-	-	-	-	524	490	-	580	655	-
Platoon blocked, %		-	-		-	-						
Mov Cap-1 Maneuver	1280	-	-	1252	-	-	223	248	767	~ 132	305	949
Mov Cap-2 Maneuver	-	-	-	-	-	-	223	248	-	~ 132	305	-
Stage 1	-	-	-	-	-	-	711	666	-	611	520	-
Stage 2	-	-	-	-	-	-	405	430	-	345	650	-

Approach	EB			WB			NB			SB		
HCM Control Delay, s	0.3			2.9			14.8			\$ 569.8		
HCM LOS							B			F		

Minor Lane/Major Mvmt	NBLn1	NBLn2	NBLn3	EBL	EBT	EBR	WBL	WBT	WBR	SBLn1
Capacity (veh/h)	223	248	767	1280	-	-	1252	-	-	151
HCM Lane V/C Ratio	0.102	0.232	0.343	0.008	-	-	0.123	-	-	2.109
HCM Control Delay (s)	23	23.9	12.1	7.8	-	-	8.3	-	-	\$ 569.8
HCM Lane LOS	C	C	B	A	-	-	A	-	-	F
HCM 95th %tile Q(veh)	0.3	0.9	1.5	0	-	-	0.4	-	-	25.6

Notes
 -: Volume exceeds capacity \$: Delay exceeds 300s +: Computation Not Defined *: All major volume in platoon

HCM 6th TWSC
 14: Avenue 17 & SR-99 Southbound Off-Ramp

Village D Specific Plan
 Phase I NP - PM Peak Hour

Intersection						
Int Delay, s/veh	150.5					
Movement	EBL	EBT	WBT	WBR	SBL	SBR
Lane Configurations		↑	↑		↑	↑
Traffic Vol, veh/h	0	721	341	0	418	59
Future Vol, veh/h	0	721	341	0	418	59
Conflicting Peds, #/hr	0	0	0	0	0	0
Sign Control	Free	Free	Free	Free	Stop	Stop
RT Channelized	-	None	-	None	-	None
Storage Length	-	-	-	-	0	610
Veh in Median Storage, #	-	0	0	-	0	-
Grade, %	-	0	0	-	0	-
Peak Hour Factor	92	92	92	92	92	92
Heavy Vehicles, %	4	4	8	8	5	5
Mvmt Flow	0	784	371	0	454	64

Major/Minor	Major1	Major2	Minor2
Conflicting Flow All	-	0	0 1155 371
Stage 1	-	-	- 371 -
Stage 2	-	-	- 784 -
Critical Hdwy	-	-	- 6.45 6.25
Critical Hdwy Stg 1	-	-	- 5.45 -
Critical Hdwy Stg 2	-	-	- 5.45 -
Follow-up Hdwy	-	-	- 3.545 3.345
Pot Cap-1 Maneuver	0	-	0 ~ 215 668
Stage 1	0	-	0 691 -
Stage 2	0	-	0 ~ 445 -
Platoon blocked, %	-	-	
Mov Cap-1 Maneuver	-	-	- ~ 215 668
Mov Cap-2 Maneuver	-	-	- ~ 215 -
Stage 1	-	-	- 691 -
Stage 2	-	-	- ~ 445 -

Approach	EB	WB	SB
HCM Control Delay, s	0	0	\$ 485.7
HCM LOS			F

Minor Lane/Major Mvmt	EBT	WBT	SBLn1	SBLn2
Capacity (veh/h)	-	-	215	668
HCM Lane V/C Ratio	-	-	2.113	0.096
HCM Control Delay (s)	-	-	\$ 552.7	11
HCM Lane LOS	-	-	F	B
HCM 95th %tile Q(veh)	-	-	34.8	0.3

Notes
 -: Volume exceeds capacity \$: Delay exceeds 300s +: Computation Not Defined *: All major volume in platoon

HCM 6th TWSC
15: SR-99 Northbound Ramps & Avenue 17

Village D Specific Plan
Phase I NP - PM Peak Hour

Intersection												
Int Delay, s/veh	110											
Movement	EBL	EBT	EBR	WBL	WBT	WBR	NBL	NBT	NBR	SBL	SBT	SBR
Lane Configurations	↖	↑			↗			↖	↗			
Traffic Vol, veh/h	103	797	0	0	925	309	114	2	529	0	0	0
Future Vol, veh/h	103	797	0	0	925	309	114	2	529	0	0	0
Conflicting Peds, #/hr	0	0	0	0	0	0	0	0	0	0	0	0
Sign Control	Free	Free	Free	Free	Free	Free	Stop	Stop	Stop	Free	Free	Free
RT Channelized	-	-	None	-	-	None	-	-	None	-	-	None
Storage Length	125	-	-	-	-	-	-	-	50	-	-	-
Veh in Median Storage, #	-	0	-	-	0	-	-	0	-	-	16965	-
Grade, %	-	0	-	-	0	-	-	0	-	-	0	-
Peak Hour Factor	95	95	95	95	95	95	95	95	95	95	95	95
Heavy Vehicles, %	4	4	4	4	4	4	10	10	10	0	0	0
Mvmt Flow	108	839	0	0	974	325	120	2	557	0	0	0

Major/Minor	Major1	Major2	Minor1
Conflicting Flow All	1299	0	- - - 0 2192 2354 839
Stage 1	-	-	- - - 1055 1055 -
Stage 2	-	-	- - - 1137 1299 -
Critical Hdwy	4.14	-	- - - 6.5 6.6 6.3
Critical Hdwy Stg 1	-	-	- - - 5.5 5.6 -
Critical Hdwy Stg 2	-	-	- - - 5.5 5.6 -
Follow-up Hdwy	2.236	-	- - - 3.59 4.09 3.39
Pot Cap-1 Maneuver	527	- 0 0	- - - ~ 47 34 ~ 354
Stage 1	-	- 0 0	- - - 323 293 -
Stage 2	-	- 0 0	- - - 295 223 -
Platoon blocked, %	-	-	- -
Mov Cap-1 Maneuver	527	- - -	- - - ~ 37 0 ~ 354
Mov Cap-2 Maneuver	-	- - -	- - - ~ 37 0 -
Stage 1	-	- - -	- - - 257 0 -
Stage 2	-	- - -	- - - 295 0 -

Approach	EB	WB	NB
HCM Control Delay, s	1.6	0	\$ 471.7
HCM LOS			F

Minor Lane/Major Mvmt	NBLn1	NBLn2	EBL	EBT	WBT	WBR
Capacity (veh/h)	37	354	527	-	-	-
HCM Lane V/C Ratio	3.3	1.573	0.206	-	-	-
HCM Control Delay (s)	\$ 1262	298.4	13.6	-	-	-
HCM Lane LOS	F	F	B	-	-	-
HCM 95th %tile Q(veh)	13.9	31.9	0.8	-	-	-

Notes
 -: Volume exceeds capacity \$: Delay exceeds 300s +: Computation Not Defined *: All major volume in platoon

HCM 6th Signalized Intersection Summary
 16: Love's Truck Stop Driveway/Driveway & Avenue 17

Village D Specific Plan
 Phase I NP - PM Peak Hour



Movement	EBL	EBT	EBR	WBL	WBT	WBR	NBL	NBT	NBR	SBL	SBT	SBR
Lane Configurations	↖	↗	↘	↖	↗	↘	↖	↗	↘	↖	↗	↘
Traffic Volume (veh/h)	556	624	141	32	549	189	160	0	31	279	0	519
Future Volume (veh/h)	556	624	141	32	549	189	160	0	31	279	0	519
Initial Q (Qb), veh	0	0	0	0	0	0	0	0	0	0	0	0
Ped-Bike Adj(A_pbT)	1.00		1.00	1.00		1.00	1.00		1.00	1.00		1.00
Parking Bus, Adj	1.00	1.00	1.00	1.00	1.00	1.00	1.00	1.00	1.00	1.00	1.00	1.00
Work Zone On Approach		No			No			No			No	
Adj Sat Flow, veh/h/ln	1870	1870	1870	1841	1841	1841	1900	1900	1900	1900	1900	1900
Adj Flow Rate, veh/h	604	678	153	35	597	205	174	0	34	303	0	564
Peak Hour Factor	0.92	0.92	0.92	0.92	0.92	0.92	0.92	0.92	0.92	0.92	0.92	0.92
Percent Heavy Veh, %	2	2	2	4	4	4	0	0	0	0	0	0
Cap, veh/h	423	1912	853	50	431	148	173	0	262	219	0	302
Arrive On Green	0.24	0.54	0.54	0.03	0.33	0.33	0.10	0.00	0.16	0.12	0.00	0.19
Sat Flow, veh/h	1781	3554	1585	1753	1310	450	1810	0	1610	1810	0	1610
Grp Volume(v), veh/h	604	678	153	35	0	802	174	0	34	303	0	564
Grp Sat Flow(s),veh/h/ln	1781	1777	1585	1753	0	1760	1810	0	1610	1810	0	1610
Q Serve(g_s), s	28.5	13.1	5.9	2.4	0.0	39.5	11.5	0.0	2.2	14.5	0.0	22.5
Cycle Q Clear(g_c), s	28.5	13.1	5.9	2.4	0.0	39.5	11.5	0.0	2.2	14.5	0.0	22.5
Prop In Lane	1.00		1.00	1.00		0.26	1.00		1.00	1.00		1.00
Lane Grp Cap(c), veh/h	423	1912	853	50	0	579	173	0	262	219	0	302
V/C Ratio(X)	1.43	0.35	0.18	0.70	0.00	1.38	1.00	0.00	0.13	1.39	0.00	1.87
Avail Cap(c_a), veh/h	423	1912	853	98	0	579	173	0	262	219	0	302
HCM Platoon Ratio	1.00	1.00	1.00	1.00	1.00	1.00	1.00	1.00	1.00	1.00	1.00	1.00
Upstream Filter(I)	1.00	1.00	1.00	1.00	0.00	1.00	1.00	0.00	1.00	1.00	0.00	1.00
Uniform Delay (d), s/veh	45.8	15.8	14.2	57.8	0.0	40.3	54.3	0.0	43.0	52.8	0.0	48.8
Incr Delay (d2), s/veh	205.8	0.1	0.1	15.9	0.0	183.6	69.2	0.0	1.0	199.3	0.0	403.1
Initial Q Delay(d3),s/veh	0.0	0.0	0.0	0.0	0.0	0.0	0.0	0.0	0.0	0.0	0.0	0.0
%ile BackOfQ(50%),veh/ln	36.7	5.3	2.1	1.3	0.0	46.3	8.6	0.0	0.9	18.7	0.0	42.8
Unsig. Movement Delay, s/veh												
LnGrp Delay(d),s/veh	251.5	15.9	14.3	73.6	0.0	223.8	123.5	0.0	44.0	252.1	0.0	451.8
LnGrp LOS	F	B	B	E	A	F	F	A	D	F	A	F
Approach Vol, veh/h		1435			837			208				867
Approach Delay, s/veh		114.9			217.6			110.5				382.0
Approach LOS		F			F			F				F
Timer - Assigned Phs	1	2	3	4	5	6	7	8				
Phs Duration (G+Y+Rc), s	19.0	24.0	7.9	69.1	16.0	27.0	33.0	44.0				
Change Period (Y+Rc), s	4.5	4.5	4.5	4.5	4.5	4.5	4.5	4.5				
Max Green Setting (Gmax), s	14.5	19.5	6.7	61.3	11.5	22.5	28.5	39.5				
Max Q Clear Time (g_c+I1), s	16.5	4.2	4.4	15.1	13.5	24.5	30.5	41.5				
Green Ext Time (p_c), s	0.0	0.1	0.0	6.1	0.0	0.0	0.0	0.0				

Intersection Summary

HCM 6th Ctrl Delay	209.5
HCM 6th LOS	F

Intersection												
Int Delay, s/veh	6.2											
Movement	EBL	EBT	EBR	WBL	WBT	WBR	NBL	NBT	NBR	SBL	SBT	SBR
Lane Configurations	↖	↗		↖	↗		↖	↑	↗	↖	↑	↗
Traffic Vol, veh/h	33	124	18	65	73	19	9	24	63	18	79	13
Future Vol, veh/h	33	124	18	65	73	19	9	24	63	18	79	13
Conflicting Peds, #/hr	0	0	3	3	0	0	0	0	0	0	0	0
Sign Control	Free	Free	Free	Free	Free	Free	Stop	Stop	Stop	Stop	Stop	Stop
RT Channelized	-	-	None	-	-	None	-	-	None	-	-	None
Storage Length	110	-	-	165	-	-	65	-	50	100	-	50
Veh in Median Storage, #	-	0	-	-	0	-	-	0	-	-	0	-
Grade, %	-	0	-	-	0	-	-	0	-	-	0	-
Peak Hour Factor	92	92	92	92	92	92	92	92	92	92	92	92
Heavy Vehicles, %	1	1	1	1	1	1	0	0	0	0	0	0
Mvmt Flow	36	135	20	71	79	21	10	26	68	20	86	14

Major/Minor	Major1			Major2			Minor1			Minor2		
Conflicting Flow All	100	0	0	158	0	0	502	462	148	496	462	90
Stage 1	-	-	-	-	-	-	220	220	-	232	232	-
Stage 2	-	-	-	-	-	-	282	242	-	264	230	-
Critical Hdwy	4.11	-	-	4.11	-	-	7.1	6.5	6.2	7.1	6.5	6.2
Critical Hdwy Stg 1	-	-	-	-	-	-	6.1	5.5	-	6.1	5.5	-
Critical Hdwy Stg 2	-	-	-	-	-	-	6.1	5.5	-	6.1	5.5	-
Follow-up Hdwy	2.209	-	-	2.209	-	-	3.5	4	3.3	3.5	4	3.3
Pot Cap-1 Maneuver	1499	-	-	1428	-	-	483	500	904	487	500	973
Stage 1	-	-	-	-	-	-	787	725	-	775	716	-
Stage 2	-	-	-	-	-	-	729	709	-	746	718	-
Platoon blocked, %	-	-	-	-	-	-	-	-	-	-	-	-
Mov Cap-1 Maneuver	1499	-	-	1424	-	-	385	462	901	407	462	973
Mov Cap-2 Maneuver	-	-	-	-	-	-	385	462	-	407	462	-
Stage 1	-	-	-	-	-	-	766	705	-	756	680	-
Stage 2	-	-	-	-	-	-	596	674	-	648	699	-

Approach	EB			WB			NB			SB		
HCM Control Delay, s	1.4			3.2			10.8			13.9		
HCM LOS							B			B		

Minor Lane/Major Mvmt	NBLn1	NBLn2	NBLn3	EBL	EBT	EBR	WBL	WBT	WBR	SBLn1	SBLn2	SBLn3
Capacity (veh/h)	385	462	901	1499	-	-	1424	-	-	407	462	973
HCM Lane V/C Ratio	0.025	0.056	0.076	0.024	-	-	0.05	-	-	0.048	0.186	0.015
HCM Control Delay (s)	14.6	13.3	9.3	7.5	-	-	7.7	-	-	14.3	14.6	8.8
HCM Lane LOS	B	B	A	A	-	-	A	-	-	B	B	A
HCM 95th %tile Q(veh)	0.1	0.2	0.2	0.1	-	-	0.2	-	-	0.2	0.7	0

Intersection	
Intersection Delay, s/veh	9.8
Intersection LOS	A

Movement	EBL	EBT	EBR	WBL	WBT	WBR	NBL	NBT	NBR	SBL	SBT	SBR
Lane Configurations	↶	↷		↶	↷		↶	↷	↷	↶	↷	↶
Traffic Vol, veh/h	7	56	24	68	75	18	45	137	57	19	134	15
Future Vol, veh/h	7	56	24	68	75	18	45	137	57	19	134	15
Peak Hour Factor	0.96	0.96	0.96	0.96	0.96	0.96	0.96	0.96	0.96	0.96	0.96	0.96
Heavy Vehicles, %	0	0	0	0	0	0	0	0	0	0	0	0
Mvmt Flow	7	58	25	71	78	19	47	143	59	20	140	16
Number of Lanes	1	1	0	1	1	0	1	1	1	1	1	1

Approach	EB	WB	NB	SB
Opposing Approach	WB	EB	SB	NB
Opposing Lanes	2	2	3	3
Conflicting Approach Left	SB	NB	EB	WB
Conflicting Lanes Left	3	3	2	2
Conflicting Approach Right	NB	SB	WB	EB
Conflicting Lanes Right	3	3	2	2
HCM Control Delay	9.6	9.8	9.6	10.1
HCM LOS	A	A	A	B

Lane	NBLn1	NBLn2	NBLn3	EBLn1	EBLn2	WBLn1	WBLn2	SBLn1	SBLn2	SBLn3
Vol Left, %	100%	0%	0%	100%	0%	100%	0%	100%	0%	0%
Vol Thru, %	0%	100%	0%	0%	70%	0%	81%	0%	100%	0%
Vol Right, %	0%	0%	100%	0%	30%	0%	19%	0%	0%	100%
Sign Control	Stop	Stop	Stop	Stop	Stop	Stop	Stop	Stop	Stop	Stop
Traffic Vol by Lane	45	137	57	7	80	68	93	19	134	15
LT Vol	45	0	0	7	0	68	0	19	0	0
Through Vol	0	137	0	0	56	0	75	0	134	0
RT Vol	0	0	57	0	24	0	18	0	0	15
Lane Flow Rate	47	143	59	7	83	71	97	20	140	16
Geometry Grp	8	8	8	8	8	8	8	8	8	8
Degree of Util (X)	0.082	0.229	0.084	0.013	0.137	0.127	0.156	0.035	0.23	0.023
Departure Headway (Hd)	6.29	5.786	5.08	6.641	5.93	6.45	5.815	6.428	5.924	5.217
Convergence, Y/N	Yes	Yes	Yes	Yes	Yes	Yes	Yes	Yes	Yes	Yes
Cap	571	622	706	540	605	557	617	558	607	687
Service Time	4.014	3.51	2.804	4.372	3.661	4.179	3.543	4.155	3.65	2.944
HCM Lane V/C Ratio	0.082	0.23	0.084	0.013	0.137	0.127	0.157	0.036	0.231	0.023
HCM Control Delay	9.6	10.2	8.3	9.5	9.6	10.1	9.6	9.4	10.4	8.1
HCM Lane LOS	A	B	A	A	A	B	A	A	B	A
HCM 95th-tile Q	0.3	0.9	0.3	0	0.5	0.4	0.5	0.1	0.9	0.1

Intersection

Intersection Delay, s/veh 13.3

Intersection LOS B

Movement	EBL	EBT	EBR	WBL	WBT	WBR	NBL	NBT	NBR	SBL	SBT	SBR
Lane Configurations		↕			↕			↕			↕	
Traffic Vol, veh/h	56	255	34	22	118	167	14	45	16	109	47	40
Future Vol, veh/h	56	255	34	22	118	167	14	45	16	109	47	40
Peak Hour Factor	0.92	0.92	0.92	0.92	0.92	0.92	0.92	0.92	0.92	0.92	0.92	0.92
Heavy Vehicles, %	6	6	6	6	6	6	0	0	0	0	0	0
Mvmt Flow	61	277	37	24	128	182	15	49	17	118	51	43
Number of Lanes	0	1	0	0	1	0	0	1	0	0	1	0

Approach	EB	WB	NB	SB
Opposing Approach	WB	EB	SB	NB
Opposing Lanes	1	1	1	1
Conflicting Approach Left	SB	NB	EB	WB
Conflicting Lanes Left	1	1	1	1
Conflicting Approach Right	NB	SB	WB	EB
Conflicting Lanes Right	1	1	1	1
HCM Control Delay	15.1	12.9	10.2	12.1
HCM LOS	C	B	B	B

Lane	NBLn1	EBLn1	WBLn1	SBLn1
Vol Left, %	19%	16%	7%	56%
Vol Thru, %	60%	74%	38%	24%
Vol Right, %	21%	10%	54%	20%
Sign Control	Stop	Stop	Stop	Stop
Traffic Vol by Lane	75	345	307	196
LT Vol	14	56	22	109
Through Vol	45	255	118	47
RT Vol	16	34	167	40
Lane Flow Rate	82	375	334	213
Geometry Grp	1	1	1	1
Degree of Util (X)	0.139	0.559	0.479	0.349
Departure Headway (Hd)	6.121	5.37	5.167	5.891
Convergence, Y/N	Yes	Yes	Yes	Yes
Cap	582	671	694	607
Service Time	4.195	3.423	3.22	3.953
HCM Lane V/C Ratio	0.141	0.559	0.481	0.351
HCM Control Delay	10.2	15.1	12.9	12.1
HCM Lane LOS	B	C	B	B
HCM 95th-tile Q	0.5	3.5	2.6	1.6

Intersection												
Intersection Delay, s/veh	9.6											
Intersection LOS	A											

Movement	EBL	EBT	EBR	WBL	WBT	WBR	NBL	NBT	NBR	SBL	SBT	SBR
Lane Configurations		↕			↕	↕		↕	↕		↕	↕
Traffic Vol, veh/h	0	0	0	95	0	88	0	10	76	170	26	0
Future Vol, veh/h	0	0	0	95	0	88	0	10	76	170	26	0
Peak Hour Factor	0.92	0.92	0.92	0.92	0.92	0.92	0.92	0.92	0.92	0.92	0.92	0.92
Heavy Vehicles, %	0	0	0	2	2	2	0	0	0	0	0	0
Mvmt Flow	0	0	0	103	0	96	0	11	83	185	28	0
Number of Lanes	0	1	0	0	1	1	0	1	1	0	1	1

Approach	EB	WB	NB	SB
Opposing Approach	WB	EB	SB	NB
Opposing Lanes	2	1	2	2
Conflicting Approach Left	SB	NB	EB	WB
Conflicting Lanes Left	2	2	1	2
Conflicting Approach Right	NB	SB	WB	EB
Conflicting Lanes Right	2	2	2	1
HCM Control Delay	0	8.9	7.8	11
HCM LOS	-	A	A	B

Lane	NBLn1	NBLn2	EBLn1	WBLn1	WBLn2	SBLn1	SBLn2
Vol Left, %	0%	0%	0%	100%	0%	87%	0%
Vol Thru, %	100%	0%	100%	0%	0%	13%	100%
Vol Right, %	0%	100%	0%	0%	100%	0%	0%
Sign Control	Stop	Stop	Stop	Stop	Stop	Stop	Stop
Traffic Vol by Lane	10	76	0	95	88	196	0
LT Vol	0	0	0	95	0	170	0
Through Vol	10	0	0	0	0	26	0
RT Vol	0	76	0	0	88	0	0
Lane Flow Rate	11	83	0	103	96	213	0
Geometry Grp	7	7	6	7	7	7	7
Degree of Util (X)	0.016	0.104	0	0.168	0.123	0.328	0
Departure Headway (Hd)	5.244	4.539	5.583	5.84	4.634	5.537	5.101
Convergence, Y/N	Yes	Yes	Yes	Yes	Yes	Yes	Yes
Cap	681	787	0	614	772	650	0
Service Time	2.985	2.279	3.637	3.577	2.37	3.272	2.836
HCM Lane V/C Ratio	0.016	0.105	0	0.168	0.124	0.328	0
HCM Control Delay	8.1	7.8	8.6	9.8	8	11	7.8
HCM Lane LOS	A	A	N	A	A	B	N
HCM 95th-tile Q	0	0.3	0	0.6	0.4	1.4	0

Intersection	
Intersection Delay, s/veh	25.4
Intersection LOS	D

Movement	EBL	EBT	EBR	WBL	WBT	WBR	NBL	NBT	NBR	SBL	SBT	SBR
Lane Configurations	↙	↕↔		↙	↕↔		↙	↕	↙	↙	↕	↙
Traffic Vol, veh/h	18	130	19	340	155	37	14	217	231	34	274	33
Future Vol, veh/h	18	130	19	340	155	37	14	217	231	34	274	33
Peak Hour Factor	0.94	0.94	0.94	0.94	0.94	0.94	0.94	0.94	0.94	0.94	0.94	0.94
Heavy Vehicles, %	1	1	1	1	1	1	0	0	0	0	0	0
Mvmt Flow	19	138	20	362	165	39	15	231	246	36	291	35
Number of Lanes	1	2	0	1	2	0	1	1	1	1	1	1

Approach	EB	WB	NB	SB
Opposing Approach	WB	EB	SB	NB
Opposing Lanes	3	3	3	3
Conflicting Approach Left	SB	NB	EB	WB
Conflicting Lanes Left	3	3	3	3
Conflicting Approach Right	NB	SB	WB	EB
Conflicting Lanes Right	3	3	3	3
HCM Control Delay	14.2	34.1	19.1	25.8
HCM LOS	B	D	C	D

Lane	NBLn1	NBLn2	NBLn3	EBLn1	EBLn2	EBLn3	WBLn1	WBLn2	WBLn3	SBLn1	SBLn2
Vol Left, %	100%	0%	0%	100%	0%	0%	100%	0%	0%	100%	0%
Vol Thru, %	0%	100%	0%	0%	100%	70%	0%	100%	58%	0%	100%
Vol Right, %	0%	0%	100%	0%	0%	30%	0%	0%	42%	0%	0%
Sign Control	Stop	Stop	Stop	Stop	Stop	Stop	Stop	Stop	Stop	Stop	Stop
Traffic Vol by Lane	14	217	231	18	87	62	340	103	89	34	274
LT Vol	14	0	0	18	0	0	340	0	0	34	0
Through Vol	0	217	0	0	87	43	0	103	52	0	274
RT Vol	0	0	231	0	0	19	0	0	37	0	0
Lane Flow Rate	15	231	246	19	92	66	362	110	94	36	291
Geometry Grp	8	8	8	8	8	8	8	8	8	8	8
Degree of Util (X)	0.036	0.533	0.52	0.052	0.237	0.167	0.861	0.246	0.204	0.092	0.699
Departure Headway (Hd)	8.93	8.43	7.73	9.754	9.254	9.04	8.681	8.181	7.889	9.137	8.637
Convergence, Y/N	Yes	Yes	Yes	Yes	Yes	Yes	Yes	Yes	Yes	Yes	Yes
Cap	403	429	469	369	390	399	420	442	457	395	420
Service Time	6.63	6.13	5.43	7.469	6.969	6.755	6.381	5.881	5.589	6.837	6.337
HCM Lane V/C Ratio	0.037	0.538	0.525	0.051	0.236	0.165	0.862	0.249	0.206	0.091	0.693
HCM Control Delay	12	20.3	18.5	13	14.8	13.6	46	13.5	12.6	12.8	29.1
HCM Lane LOS	B	C	C	B	B	B	E	B	B	B	D
HCM 95th-tile Q	0.1	3.1	2.9	0.2	0.9	0.6	8.5	1	0.8	0.3	5.2

Intersection												
Intersection Delay, s/veh	27.6											
Intersection LOS	D											

Movement	EBL	EBT	EBR	WBL	WBT	WBR	NBL	NBT	NBR	SBL	SBT	SBR
Lane Configurations	↖	↗		↖	↗	↖	↖	↗		↖	↗	
Traffic Vol, veh/h	29	117	36	55	154	110	48	271	43	79	315	35
Future Vol, veh/h	29	117	36	55	154	110	48	271	43	79	315	35
Peak Hour Factor	0.93	0.93	0.93	0.93	0.93	0.93	0.93	0.93	0.93	0.93	0.93	0.93
Heavy Vehicles, %	1	1	1	0	0	0	1	1	1	1	1	1
Mvmt Flow	31	126	39	59	166	118	52	291	46	85	339	38
Number of Lanes	1	1	0	1	1	1	1	1	0	1	1	0

Approach	EB	WB	NB	SB
Opposing Approach	WB	EB	SB	NB
Opposing Lanes	3	2	2	2
Conflicting Approach Left SB		NB	EB	WB
Conflicting Lanes Left	2	2	2	3
Conflicting Approach Right NB		SB	WB	EB
Conflicting Lanes Right	2	2	3	2
HCM Control Delay	17.5	15.5	31.8	37.4
HCM LOS	C	C	D	E

Lane	NBLn1	NBLn2	EBLn1	EBLn2	WBLn1	WBLn2	WBLn3	SBLn1	SBLn2
Vol Left, %	100%	0%	100%	0%	100%	0%	0%	100%	0%
Vol Thru, %	0%	86%	0%	76%	0%	100%	0%	0%	90%
Vol Right, %	0%	14%	0%	24%	0%	0%	100%	0%	10%
Sign Control	Stop	Stop	Stop	Stop	Stop	Stop	Stop	Stop	Stop
Traffic Vol by Lane	48	314	29	153	55	154	110	79	350
LT Vol	48	0	29	0	55	0	0	79	0
Through Vol	0	271	0	117	0	154	0	0	315
RT Vol	0	43	0	36	0	0	110	0	35
Lane Flow Rate	52	338	31	165	59	166	118	85	376
Geometry Grp	8	8	8	8	8	8	8	8	8
Degree of Util (X)	0.128	0.778	0.085	0.415	0.153	0.404	0.265	0.206	0.851
Departure Headway (Hd)	8.911	8.299	9.776	9.082	9.299	8.781	8.056	8.724	8.14
Convergence, Y/N	Yes	Yes	Yes	Yes	Yes	Yes	Yes	Yes	Yes
Cap	402	436	366	396	386	409	445	411	444
Service Time	6.67	6.059	7.544	6.849	7.061	6.543	5.818	6.48	5.896
HCM Lane V/C Ratio	0.129	0.775	0.085	0.417	0.153	0.406	0.265	0.207	0.847
HCM Control Delay	13	34.7	13.5	18.2	13.7	17.4	13.7	13.7	42.7
HCM Lane LOS	B	D	B	C	B	C	B	B	E
HCM 95th-tile Q	0.4	6.7	0.3	2	0.5	1.9	1.1	0.8	8.4

HCM 6th Signalized Intersection Summary
 23: Avenue 16/Ellis Street & Kennedy Street

Village D Specific Plan
 Phase I NP - PM Peak Hour



Movement	WBL	WBR	NBT	NBR	SBL	SBT
Lane Configurations						
Traffic Volume (veh/h)	123	218	242	213	211	252
Future Volume (veh/h)	123	218	242	213	211	252
Initial Q (Qb), veh	0	0	0	0	0	0
Ped-Bike Adj(A_pbT)	1.00	1.00		1.00	1.00	
Parking Bus, Adj	1.00	1.00	1.00	1.00	1.00	1.00
Work Zone On Approach	No		No		No	
Adj Sat Flow, veh/h/ln	1870	1870	1885	1885	1885	1885
Adj Flow Rate, veh/h	134	237	263	232	229	274
Peak Hour Factor	0.92	0.92	0.92	0.92	0.92	0.92
Percent Heavy Veh, %	2	2	1	1	1	1
Cap, veh/h	215	337	1029	876	269	2747
Arrive On Green	0.12	0.12	0.56	0.56	0.15	0.77
Sat Flow, veh/h	1781	2790	1928	1561	1795	3676
Grp Volume(v), veh/h	134	237	257	238	229	274
Grp Sat Flow(s),veh/h/ln	1781	1395	1791	1604	1795	1791
Q Serve(g_s), s	5.7	6.5	5.9	6.1	9.9	1.5
Cycle Q Clear(g_c), s	5.7	6.5	5.9	6.1	9.9	1.5
Prop In Lane	1.00	1.00		0.97	1.00	
Lane Grp Cap(c), veh/h	215	337	1004	900	269	2747
V/C Ratio(X)	0.62	0.70	0.26	0.26	0.85	0.10
Avail Cap(c_a), veh/h	501	785	1004	900	303	2747
HCM Platoon Ratio	1.00	1.00	1.00	1.00	1.00	1.00
Upstream Filter(l)	0.84	0.84	1.00	1.00	1.00	1.00
Uniform Delay (d), s/veh	33.4	33.8	9.0	9.1	33.1	2.4
Incr Delay (d2), s/veh	2.5	2.3	0.6	0.7	18.6	0.1
Initial Q Delay(d3),s/veh	0.0	0.0	0.0	0.0	0.0	0.0
%ile BackOfQ(50%),veh/ln	2.6	2.3	2.2	2.1	5.6	0.4
Unsig. Movement Delay, s/veh						
LnGrp Delay(d),s/veh	35.9	36.1	9.6	9.8	51.7	2.4
LnGrp LOS	D	D	A	A	D	A
Approach Vol, veh/h	371		495			503
Approach Delay, s/veh	36.0		9.7			24.9
Approach LOS	D		A			C
Timer - Assigned Phs	1	2			6	8
Phs Duration (G+Y+Rc), s	65.5	49.4			65.8	14.2
Change Period (Y+Rc), s	4.5	4.5			4.5	4.5
Max Green Setting (Gmax), s	30.5	30.5			48.5	22.5
Max Q Clear Time (g_c+M), s	8.1	8.1			3.5	8.5
Green Ext Time (p_c), s	0.1	3.1			1.9	1.1
Intersection Summary						
HCM 6th Ctrl Delay			22.4			
HCM 6th LOS			C			

HCM 6th Signalized Intersection Summary
 24: Schnoor Avenue & Kennedy Street

Village D Specific Plan
 Phase I NP - PM Peak Hour



Movement	EBL	EBT	EBR	WBL	WBT	WBR	NBL	NBT	NBR	SBL	SBT	SBR
Lane Configurations	↖	↗		↖	↗		↖	↗		↖	↗	↖
Traffic Volume (veh/h)	40	174	188	202	156	72	195	38	247	83	32	20
Future Volume (veh/h)	40	174	188	202	156	72	195	38	247	83	32	20
Initial Q (Qb), veh	0	0	0	0	0	0	0	0	0	0	0	0
Ped-Bike Adj(A_pbT)	1.00		0.99	1.00		0.99	1.00		1.00	1.00		1.00
Parking Bus, Adj	1.00	1.00	1.00	1.00	1.00	1.00	1.00	1.00	1.00	1.00	1.00	1.00
Work Zone On Approach		No		No		No		No		No		No
Adj Sat Flow, veh/h/ln	1870	1870	1870	1856	1856	1856	1885	1885	1885	1633	1633	1633
Adj Flow Rate, veh/h	43	185	200	215	166	77	207	40	263	88	34	21
Peak Hour Factor	0.94	0.94	0.94	0.94	0.94	0.94	0.94	0.94	0.94	0.94	0.94	0.94
Percent Heavy Veh, %	2	2	2	3	3	3	1	1	1	18	18	18
Cap, veh/h	240	299	264	257	214	99	779	58	378	301	388	328
Arrive On Green	0.13	0.17	0.17	0.15	0.18	0.18	0.22	0.27	0.27	0.19	0.24	0.24
Sat Flow, veh/h	1781	1777	1571	1767	1193	553	3483	215	1414	1555	1633	1382
Grp Volume(v), veh/h	43	185	200	215	0	243	207	0	303	88	34	21
Grp Sat Flow(s),veh/h/ln	1781	1777	1571	1767	0	1747	1742	0	1629	1555	1633	1382
Q Serve(g_s), s	1.7	7.7	9.7	9.5	0.0	10.6	3.9	0.0	13.4	3.9	1.3	0.9
Cycle Q Clear(g_c), s	1.7	7.7	9.7	9.5	0.0	10.6	3.9	0.0	13.4	3.9	1.3	0.9
Prop In Lane	1.00		1.00	1.00		0.32	1.00		0.87	1.00		1.00
Lane Grp Cap(c), veh/h	240	299	264	257	0	313	779	0	436	301	388	328
V/C Ratio(X)	0.18	0.62	0.76	0.84	0.00	0.78	0.27	0.00	0.70	0.29	0.09	0.06
Avail Cap(c_a), veh/h	240	400	353	364	0	644	779	0	436	301	388	328
HCM Platoon Ratio	1.00	1.00	1.00	1.00	1.00	1.00	1.00	1.00	1.00	1.00	1.00	1.00
Upstream Filter(I)	0.71	0.71	0.71	1.00	0.00	1.00	1.00	0.00	1.00	1.00	1.00	1.00
Uniform Delay (d), s/veh	30.7	30.9	31.7	33.3	0.0	31.3	25.6	0.0	26.4	27.6	23.8	23.6
Incr Delay (d2), s/veh	0.3	1.5	4.6	11.1	0.0	4.2	0.2	0.0	8.9	0.5	0.4	0.4
Initial Q Delay(d3),s/veh	0.0	0.0	0.0	0.0	0.0	0.0	0.0	0.0	0.0	0.0	0.0	0.0
%ile BackOfQ(50%),veh/ln	0.7	3.3	3.9	4.7	0.0	4.7	1.6	0.0	6.1	1.4	0.5	0.3
Unsig. Movement Delay, s/veh												
LnGrp Delay(d),s/veh	30.9	32.4	36.3	44.4	0.0	35.5	25.8	0.0	35.2	28.1	24.2	24.0
LnGrp LOS	C	C	D	D	A	D	C	A	D	C	C	C
Approach Vol, veh/h		428			458			510			143	
Approach Delay, s/veh		34.1			39.7			31.4			26.6	
Approach LOS		C			D			C			C	
Timer - Assigned Phs	1	2	3	4	5	6	7	8				
Phs Duration (G+Y+Rc), s	30.0	25.9	16.1	18.0	22.4	23.5	15.3	18.8				
Change Period (Y+Rc), s	4.5	4.5	4.5	4.5	4.5	4.5	4.5	4.5				
Max Green Setting (Gmax), s	15.0	21.4	16.5	18.0	8.5	19.0	5.0	29.5				
Max Q Clear Time (g_c+1), s	15.0	15.4	11.5	11.7	5.9	3.3	3.7	12.6				
Green Ext Time (p_c), s	0.0	0.9	0.3	1.2	0.2	0.1	0.0	1.3				
Intersection Summary												
HCM 6th Ctrl Delay				34.1								
HCM 6th LOS				C								

Intersection						
Int Delay, s/veh	10.8					
Movement	EBL	EBT	WBT	WBR	SBL	SBR
Lane Configurations	↖	↑	↗		↖	↗
Traffic Vol, veh/h	183	362	311	2	131	180
Future Vol, veh/h	183	362	311	2	131	180
Conflicting Peds, #/hr	0	0	0	0	0	0
Sign Control	Free	Free	Free	Free	Stop	Stop
RT Channelized	-	None	-	Free	-	None
Storage Length	140	-	-	-	0	335
Veh in Median Storage, #	-	0	0	-	0	-
Grade, %	-	0	0	-	0	-
Peak Hour Factor	92	92	92	92	92	92
Heavy Vehicles, %	3	3	3	3	4	4
Mvmt Flow	199	393	338	2	142	196

Major/Minor	Major1	Major2	Minor2		
Conflicting Flow All	338	0	-	0	1129 338
Stage 1	-	-	-	-	338 -
Stage 2	-	-	-	-	791 -
Critical Hdwy	4.13	-	-	-	6.44 6.24
Critical Hdwy Stg 1	-	-	-	-	5.44 -
Critical Hdwy Stg 2	-	-	-	-	5.44 -
Follow-up Hdwy	2.227	-	-	-	3.536 3.336
Pot Cap-1 Maneuver	1216	-	-	0	224 700
Stage 1	-	-	-	0	718 -
Stage 2	-	-	-	0	443 -
Platoon blocked, %		-	-		
Mov Cap-1 Maneuver	1216	-	-	-	187 700
Mov Cap-2 Maneuver	-	-	-	-	187 -
Stage 1	-	-	-	-	600 -
Stage 2	-	-	-	-	443 -

Approach	EB	WB	SB
HCM Control Delay, s	2.9	0	35.6
HCM LOS			E

Minor Lane/Major Mvmt	EBL	EBT	WBT	SBLn1	SBLn2
Capacity (veh/h)	1216	-	-	187	700
HCM Lane V/C Ratio	0.164	-	-	0.761	0.28
HCM Control Delay (s)	8.5	-	-	67.9	12.1
HCM Lane LOS	A	-	-	F	B
HCM 95th %tile Q(veh)	0.6	-	-	5	1.1

Intersection						
Int Delay, s/veh	3.5					
Movement	EBL	EBT	WBT	WBR	SBL	SBR
Lane Configurations		↕	↕		↕	
Traffic Vol, veh/h	156	338	161	0	0	152
Future Vol, veh/h	156	338	161	0	0	152
Conflicting Peds, #/hr	0	0	0	0	0	0
Sign Control	Free	Free	Free	Free	Stop	Stop
RT Channelized	-	None	-	None	-	None
Storage Length	-	-	-	-	0	-
Veh in Median Storage, #	-	0	0	-	0	-
Grade, %	-	0	0	-	0	-
Peak Hour Factor	92	92	92	92	92	92
Heavy Vehicles, %	3	3	2	2	4	4
Mvmt Flow	170	367	175	0	0	165

Major/Minor	Major1	Major2	Minor2		
Conflicting Flow All	175	0	0	882	175
Stage 1	-	-	-	175	-
Stage 2	-	-	-	707	-
Critical Hdwy	4.13	-	-	6.44	6.24
Critical Hdwy Stg 1	-	-	-	5.44	-
Critical Hdwy Stg 2	-	-	-	5.44	-
Follow-up Hdwy	2.227	-	-	3.536	3.336
Pot Cap-1 Maneuver	1395	-	-	314	863
Stage 1	-	-	-	851	-
Stage 2	-	-	-	485	-
Platoon blocked, %	-	-	-	-	-
Mov Cap-1 Maneuver	1395	-	-	266	863
Mov Cap-2 Maneuver	-	-	-	266	-
Stage 1	-	-	-	721	-
Stage 2	-	-	-	485	-

Approach	EB	WB	SB
HCM Control Delay, s	2.5	0	10.2
HCM LOS			B

Minor Lane/Major Mvmt	EBL	EBT	WBT	WBR	SBLn1
Capacity (veh/h)	1395	-	-	-	863
HCM Lane V/C Ratio	0.122	-	-	-	0.191
HCM Control Delay (s)	7.9	0	-	-	10.2
HCM Lane LOS	A	A	-	-	B
HCM 95th %tile Q(veh)	0.4	-	-	-	0.7

Intersection						
Int Delay, s/veh	4.2					
Movement	EBL	EBR	NBL	NBT	SBT	SBR
Lane Configurations	↵			↑	↵	
Traffic Vol, veh/h	156	0	0	79	3	152
Future Vol, veh/h	156	0	0	79	3	152
Conflicting Peds, #/hr	0	0	0	0	0	0
Sign Control	Stop	Stop	Free	Free	Free	Free
RT Channelized	-	None	-	None	-	None
Storage Length	0	-	-	-	-	-
Veh in Median Storage, #	0	-	-	0	0	-
Grade, %	0	-	-	0	0	-
Peak Hour Factor	92	92	92	92	92	92
Heavy Vehicles, %	2	2	9	9	4	4
Mvmt Flow	170	0	0	86	3	165

Major/Minor	Minor2	Major1		Major2	
Conflicting Flow All	172	-	-	0	0
Stage 1	86	-	-	-	-
Stage 2	86	-	-	-	-
Critical Hdwy	6.42	-	-	-	-
Critical Hdwy Stg 1	5.42	-	-	-	-
Critical Hdwy Stg 2	5.42	-	-	-	-
Follow-up Hdwy	3.518	-	-	-	-
Pot Cap-1 Maneuver	818	0	0	-	-
Stage 1	937	0	0	-	-
Stage 2	937	0	0	-	-
Platoon blocked, %				-	-
Mov Cap-1 Maneuver	818	-	-	-	-
Mov Cap-2 Maneuver	818	-	-	-	-
Stage 1	937	-	-	-	-
Stage 2	937	-	-	-	-

Approach	EB	NB	SB
HCM Control Delay, s	10.5	0	0
HCM LOS	B		

Minor Lane/Major Mvmt	NBT	EBLn1	SBT	SBR
Capacity (veh/h)	-	818	-	-
HCM Lane V/C Ratio	-	0.207	-	-
HCM Control Delay (s)	-	10.5	-	-
HCM Lane LOS	-	B	-	-
HCM 95th %tile Q(veh)	-	0.8	-	-

Intersection						
Int Delay, s/veh	0.1					
Movement	EBL	EBT	WBT	WBR	SBL	SBR
Lane Configurations		↶	↷		↶	
Traffic Vol, veh/h	0	338	161	74	3	0
Future Vol, veh/h	0	338	161	74	3	0
Conflicting Peds, #/hr	0	0	0	0	0	0
Sign Control	Free	Free	Free	Free	Stop	Stop
RT Channelized	-	None	-	None	-	None
Storage Length	-	-	-	-	0	-
Veh in Median Storage, #	-	0	0	-	0	-
Grade, %	-	0	0	-	0	-
Peak Hour Factor	92	92	92	92	92	92
Heavy Vehicles, %	4	4	3	3	0	0
Mvmt Flow	0	367	175	80	3	0

Major/Minor	Major1	Major2	Minor2		
Conflicting Flow All	255	0	-	0	582 215
Stage 1	-	-	-	-	215 -
Stage 2	-	-	-	-	367 -
Critical Hdwy	4.14	-	-	-	6.4 6.2
Critical Hdwy Stg 1	-	-	-	-	5.4 -
Critical Hdwy Stg 2	-	-	-	-	5.4 -
Follow-up Hdwy	2.236	-	-	-	3.5 3.3
Pot Cap-1 Maneuver	1298	-	-	-	479 830
Stage 1	-	-	-	-	826 -
Stage 2	-	-	-	-	705 -
Platoon blocked, %		-	-	-	
Mov Cap-1 Maneuver	1298	-	-	-	479 830
Mov Cap-2 Maneuver	-	-	-	-	479 -
Stage 1	-	-	-	-	826 -
Stage 2	-	-	-	-	705 -

Approach	EB	WB	SB
HCM Control Delay, s	0	0	12.6
HCM LOS			B

Minor Lane/Major Mvmt	EBL	EBT	WBT	WBR	SBLn1
Capacity (veh/h)	1298	-	-	-	479
HCM Lane V/C Ratio	-	-	-	-	0.007
HCM Control Delay (s)	0	-	-	-	12.6
HCM Lane LOS	A	-	-	-	B
HCM 95th %tile Q(veh)	0	-	-	-	0

HCM 6th Signalized Intersection Summary
29: Schnoor Avenue & Cleveland Avenue

Village D Specific Plan
Phase I NP - PM Peak Hour



Movement	EBL	EBT	EBR	WBL	WBT	WBR	NBL	NBT	NBR	SBL	SBT	SBR
Lane Configurations												
Traffic Volume (veh/h)	120	404	44	275	479	111	59	215	152	118	213	89
Future Volume (veh/h)	120	404	44	275	479	111	59	215	152	118	213	89
Initial Q (Qb), veh	0	0	0	0	0	0	0	0	0	0	0	0
Ped-Bike Adj(A_pbT)	1.00		0.97	1.00		0.97	1.00		0.98	1.00		0.99
Parking Bus, Adj	1.00	1.00	1.00	1.00	1.00	1.00	1.00	1.00	1.00	1.00	1.00	1.00
Work Zone On Approach		No			No			No			No	
Adj Sat Flow, veh/h/ln	1885	1885	1885	1885	1885	1885	1885	1885	1885	1885	1885	1885
Adj Flow Rate, veh/h	124	416	45	284	494	114	61	222	157	122	220	92
Peak Hour Factor	0.97	0.97	0.97	0.97	0.97	0.97	0.97	0.97	0.97	0.97	0.97	0.97
Percent Heavy Veh, %	1	1	1	1	1	1	1	1	1	1	1	1
Cap, veh/h	156	608	263	384	692	300	79	776	514	545	1706	757
Arrive On Green	0.09	0.17	0.17	0.11	0.19	0.19	0.04	0.22	0.22	0.30	0.48	0.48
Sat Flow, veh/h	1795	3582	1552	3483	3582	1555	1795	3582	1559	1795	3582	1590
Grp Volume(v), veh/h	124	416	45	284	494	114	61	222	157	122	220	92
Grp Sat Flow(s),veh/h/ln	1795	1791	1552	1742	1791	1555	1795	1791	1559	1795	1791	1590
Q Serve(g_s), s	6.1	9.8	1.8	7.1	11.6	2.9	3.0	4.7	0.0	4.6	3.1	2.9
Cycle Q Clear(g_c), s	6.1	9.8	1.8	7.1	11.6	2.9	3.0	4.7	0.0	4.6	3.1	2.9
Prop In Lane	1.00		1.00	1.00		1.00	1.00		1.00	1.00		1.00
Lane Grp Cap(c), veh/h	156	608	263	384	692	300	79	776	514	545	1706	757
V/C Ratio(X)	0.80	0.68	0.17	0.74	0.71	0.38	0.78	0.29	0.31	0.22	0.13	0.12
Avail Cap(c_a), veh/h	229	1297	562	480	1333	579	136	776	514	545	1706	757
HCM Platoon Ratio	1.00	1.00	1.00	1.00	1.00	1.00	1.00	1.00	1.00	1.00	1.00	1.00
Upstream Filter(I)	1.00	1.00	1.00	0.73	0.73	0.73	1.00	1.00	1.00	1.00	1.00	1.00
Uniform Delay (d), s/veh	40.3	35.1	21.8	38.8	34.0	7.9	42.6	29.4	22.6	23.4	13.2	13.1
Incr Delay (d2), s/veh	11.2	1.4	0.3	3.4	1.0	0.6	14.9	0.9	1.5	0.2	0.2	0.3
Initial Q Delay(d3),s/veh	0.0	0.0	0.0	0.0	0.0	0.0	0.0	0.0	0.0	0.0	0.0	0.0
%ile BackOfQ(50%),veh/ln	3.1	4.3	0.8	3.2	5.1	2.1	1.7	2.1	2.6	1.9	1.2	1.1
Unsig. Movement Delay, s/veh												
LnGrp Delay(d),s/veh	51.5	36.5	22.1	42.2	35.0	8.5	57.5	30.4	24.1	23.6	13.3	13.4
LnGrp LOS	D	D	C	D	D	A	E	C	C	C	B	B
Approach Vol, veh/h		585			892			440			434	
Approach Delay, s/veh		38.6			33.9			31.9			16.2	
Approach LOS		D			C			C			B	
Timer - Assigned Phs	1	2	3	4	5	6	7	8				
Phs Duration (G+Y+Rc), s	31.8	24.0	14.4	19.8	8.4	47.4	12.3	21.9				
Change Period (Y+Rc), s	4.5	4.5	4.5	4.5	4.5	4.5	4.5	4.5				
Max Green Setting (Gmax), s	7.5	19.5	12.4	32.6	6.8	20.2	11.5	33.5				
Max Q Clear Time (g_c+I1), s	6.6	6.7	9.1	11.8	5.0	5.1	8.1	13.6				
Green Ext Time (p_c), s	0.0	1.6	0.3	2.8	0.0	1.4	0.1	3.6				

Intersection Summary

HCM 6th Ctrl Delay			31.4									
HCM 6th LOS			C									

HCM 6th Signalized Intersection Summary

30: Fairgrounds & Cleveland Avenue

Village D Specific Plan
Phase I NP - PM Peak Hour



Movement	EBL	EBT	EBR	WBL	WBT	WBR	NBL	NBT	NBR	SBL	SBT	SBR
Lane Configurations	↑↑↑			↑↑		↑	↑↑		↑	↑	↑	↑
Traffic Volume (veh/h)	94	510	93	163	572	146	97	42	109	265	35	107
Future Volume (veh/h)	94	510	93	163	572	146	97	42	109	265	35	107
Initial Q (Qb), veh	0	0	0	0	0	0	0	0	0	0	0	0
Ped-Bike Adj(A_pbT)	1.00		0.98	1.00		0.98	1.00		0.98	1.00		1.00
Parking Bus, Adj	1.00	1.00	1.00	1.00	1.00	1.00	1.00	1.00	1.00	1.00	1.00	1.00
Work Zone On Approach	No			No			No			No		
Adj Sat Flow, veh/h/ln	1885	1885	1885	1885	1885	1885	1900	1900	1900	1900	1900	1900
Adj Flow Rate, veh/h	99	537	98	172	602	154	102	97	80	279	37	113
Peak Hour Factor	0.95	0.95	0.95	0.95	0.95	0.95	0.95	0.95	0.95	0.95	0.95	0.95
Percent Heavy Veh, %	1	1	1	1	1	1	0	0	0	0	0	0
Cap, veh/h	110	783	140	209	839	365	757	391	325	541	122	372
Arrive On Green	0.12	0.36	0.36	0.04	0.08	0.08	0.21	0.21	0.21	0.30	0.30	0.30
Sat Flow, veh/h	1795	4377	782	1795	3582	1560	3619	1900	1582	1810	412	1257
Grp Volume(v), veh/h	99	418	217	172	602	154	102	97	80	279	0	150
Grp Sat Flow(s),veh/h/ln	1795	1716	1728	1795	1791	1560	1810	1900	1582	1810	0	1669
Q Serve(g_s), s	4.9	9.3	9.7	8.6	14.8	8.5	2.1	3.8	2.8	11.5	0.0	6.3
Cycle Q Clear(g_c), s	4.9	9.3	9.7	8.6	14.8	8.5	2.1	3.8	2.8	11.5	0.0	6.3
Prop In Lane	1.00		0.45	1.00		1.00	1.00		1.00	1.00		0.75
Lane Grp Cap(c), veh/h	110	614	309	209	839	365	757	391	325	541	0	493
V/C Ratio(X)	0.90	0.68	0.70	0.82	0.72	0.42	0.13	0.25	0.25	0.52	0.00	0.30
Avail Cap(c_a), veh/h	110	1033	520	237	1333	581	757	391	325	541	0	493
HCM Platoon Ratio	2.00	2.00	2.00	0.33	0.33	0.33	1.00	1.00	1.00	1.00	1.00	1.00
Upstream Filter(I)	0.80	0.80	0.80	0.81	0.81	0.81	1.00	1.00	1.00	1.00	0.00	1.00
Uniform Delay (d), s/veh	39.2	26.7	26.8	42.4	38.6	35.7	29.0	29.9	15.8	26.1	0.0	24.5
Incr Delay (d2), s/veh	48.7	1.1	2.3	15.4	0.9	0.6	0.1	1.5	1.8	0.8	0.0	1.6
Initial Q Delay(d3),s/veh	0.0	0.0	0.0	0.0	0.0	0.0	0.0	0.0	0.0	0.0	0.0	0.0
%ile BackOfQ(50%),veh/ln	3.5	3.3	3.5	4.9	7.2	3.5	0.9	1.9	1.6	5.0	0.0	2.6
Unsig. Movement Delay, s/veh												
LnGrp Delay(d),s/veh	87.9	27.8	29.1	57.8	39.6	36.3	29.0	31.4	17.6	27.0	0.0	26.1
LnGrp LOS	F	C	C	E	D	D	C	C	B	C	A	C
Approach Vol, veh/h	734			928			279			429		
Approach Delay, s/veh	36.3			42.4			26.6			26.7		
Approach LOS	D			D			C			C		
Timer - Assigned Phs	1	2	3	4	5	6	7	8				
Phs Duration (G+Y+Rc), s	31.4	23.0	15.0	20.6	23.3	31.1	10.0	25.6				
Change Period (Y+Rc), s	4.5	4.5	4.5	4.5	4.5	4.5	4.5	4.5				
Max Green Setting (Gmax), s	17.5	18.5	11.9	27.1	6.4	26.6	5.5	33.5				
Max Q Clear Time (g_c+1/3), s	11.5	5.8	10.6	11.7	4.1	8.3	6.9	16.8				
Green Ext Time (p_c), s	0.1	0.6	0.1	3.7	0.1	0.8	0.0	4.3				

Intersection Summary

HCM 6th Ctrl Delay	35.8
HCM 6th LOS	D

Notes

User approved volume balancing among the lanes for turning movement.

HCM 6th Signalized Intersection Summary
 31: SR-99 Southbound Ramps & Cleveland Avenue

Village D Specific Plan
 Phase I NP - PM Peak Hour



Movement	EBL	EBT	EBR	WBL	WBT	WBR	NBL	NBT	NBR	SBL	SBT	SBR
Lane Configurations		↑↑	↑	↑	↑↑					↑		↑
Traffic Volume (veh/h)	0	727	354	256	1148	0	0	0	0	151	0	80
Future Volume (veh/h)	0	727	354	256	1148	0	0	0	0	151	0	80
Initial Q (Qb), veh	0	0	0	0	0	0				0	0	0
Ped-Bike Adj(A_pbT)	1.00		0.99	1.00		1.00				1.00		1.00
Parking Bus, Adj	1.00	1.00	1.00	1.00	1.00	1.00				1.00	1.00	1.00
Work Zone On Approach		No			No						No	
Adj Sat Flow, veh/h/ln	0	1885	1885	1885	1885	0				1841	0	1841
Adj Flow Rate, veh/h	0	749	365	264	1184	0				156	0	82
Peak Hour Factor	0.97	0.97	0.97	0.97	0.97	0.97				0.97	0.97	0.97
Percent Heavy Veh, %	0	1	1	1	1	0				4	0	4
Cap, veh/h	0	1005	446	289	1761	0				716	0	637
Arrive On Green	0.00	0.56	0.56	0.32	0.98	0.00				0.41	0.00	0.41
Sat Flow, veh/h	0	3676	1589	1795	3676	0				1753	0	1560
Grp Volume(v), veh/h	0	749	365	264	1184	0				156	0	82
Grp Sat Flow(s),veh/h/ln	0	1791	1589	1795	1791	0				1753	0	1560
Q Serve(g_s), s	0.0	14.2	16.8	12.7	1.5	0.0				5.2	0.0	3.0
Cycle Q Clear(g_c), s	0.0	14.2	16.8	12.7	1.5	0.0				5.2	0.0	3.0
Prop In Lane	0.00		1.00	1.00		0.00				1.00		1.00
Lane Grp Cap(c), veh/h	0	1005	446	289	1761	0				716	0	637
V/C Ratio(X)	0.00	0.75	0.82	0.91	0.67	0.00				0.22	0.00	0.13
Avail Cap(c_a), veh/h	0	1492	662	289	2249	0				716	0	637
HCM Platoon Ratio	1.00	2.00	2.00	2.00	2.00	1.00				1.00	1.00	1.00
Upstream Filter(I)	0.00	0.76	0.76	0.68	0.68	0.00				1.00	0.00	1.00
Uniform Delay (d), s/veh	0.0	17.3	17.9	29.9	0.4	0.0				17.3	0.0	16.6
Incr Delay (d2), s/veh	0.0	0.9	3.9	23.8	0.4	0.0				0.2	0.0	0.1
Initial Q Delay(d3),s/veh	0.0	0.0	0.0	0.0	0.0	0.0				0.0	0.0	0.0
%ile BackOfQ(50%),veh/ln	0.0	4.1	4.4	6.3	0.3	0.0				2.1	0.0	1.0
Unsig. Movement Delay, s/veh												
LnGrp Delay(d),s/veh	0.0	18.2	21.8	53.7	0.8	0.0				17.4	0.0	16.7
LnGrp LOS		A	B	C	D	A	A			B	A	B
Approach Vol, veh/h		1114			1448					238		
Approach Delay, s/veh		19.4			10.4					17.2		
Approach LOS		B			B					B		
Timer - Assigned Phs			3	4		6		8				
Phs Duration (G+Y+Rc), s			19.0	29.8		41.2		48.8				
Change Period (Y+Rc), s			4.5	4.5		4.5		4.5				
Max Green Setting (Gmax), s			14.5	37.5		24.5		56.5				
Max Q Clear Time (g_c+1), s			14.7	18.8		7.2		3.5				
Green Ext Time (p_c), s			0.0	6.5		0.6		12.3				
Intersection Summary												
HCM 6th Ctrl Delay		14.5										
HCM 6th LOS		B										

HCM 6th Signalized Intersection Summary
 32: SR-99 Northbound Ramps & Cleveland Avenue

Village D Specific Plan
 Phase I NP - PM Peak Hour



Movement	EBL	EBT	EBR	WBL	WBT	WBR	NBL	NBT	NBR	SBL	SBT	SBR
Lane Configurations	↘	↑↑			↑↑	↗	↘	↖	↗			
Traffic Volume (veh/h)	74	804	0	0	906	66	500	5	293	0	0	0
Future Volume (veh/h)	74	804	0	0	906	66	500	5	293	0	0	0
Initial Q (Qb), veh	0	0	0	0	0	0	0	0	0			
Ped-Bike Adj(A_pbT)	1.00		1.00	1.00		0.99	1.00		0.99			
Parking Bus, Adj	1.00	1.00	1.00	1.00	1.00	1.00	1.00	1.00	1.00			
Work Zone On Approach		No			No			No				
Adj Sat Flow, veh/h/ln	1885	1885	0	0	1885	1885	1885	1885	1885			
Adj Flow Rate, veh/h	78	846	0	0	954	69	530	0	308			
Peak Hour Factor	0.95	0.95	0.95	0.95	0.95	0.95	0.95	0.95	0.95			
Percent Heavy Veh, %	1	1	0	0	1	1	1	1	1			
Cap, veh/h	101	1547	0	0	1167	516	1681	0	738			
Arrive On Green	0.06	0.43	0.00	0.00	0.33	0.33	0.47	0.00	0.47			
Sat Flow, veh/h	1795	3676	0	0	3676	1583	3591	0	1575			
Grp Volume(v), veh/h	78	846	0	0	954	69	530	0	308			
Grp Sat Flow(s),veh/h/ln	1795	1791	0	0	1791	1583	1795	0	1575			
Q Serve(g_s), s	3.9	15.8	0.0	0.0	22.0	2.8	8.3	0.0	11.6			
Cycle Q Clear(g_c), s	3.9	15.8	0.0	0.0	22.0	2.8	8.3	0.0	11.6			
Prop In Lane	1.00		0.00	0.00		1.00	1.00		1.00			
Lane Grp Cap(c), veh/h	101	1547	0	0	1167	516	1681	0	738			
V/C Ratio(X)	0.77	0.55	0.00	0.00	0.82	0.13	0.32	0.00	0.42			
Avail Cap(c_a), veh/h	170	1930	0	0	1413	624	1681	0	738			
HCM Platoon Ratio	1.00	1.00	1.00	1.00	1.00	1.00	1.00	1.00	1.00			
Upstream Filter(I)	0.78	0.78	0.00	0.00	0.74	0.74	1.00	0.00	1.00			
Uniform Delay (d), s/veh	41.9	19.0	0.0	0.0	27.9	21.4	14.9	0.0	15.8			
Incr Delay (d2), s/veh	9.4	0.2	0.0	0.0	2.4	0.1	0.5	0.0	1.7			
Initial Q Delay(d3),s/veh	0.0	0.0	0.0	0.0	0.0	0.0	0.0	0.0	0.0			
%ile BackOfQ(50%),veh/ln	2.0	6.3	0.0	0.0	9.5	1.0	3.3	0.0	4.3			
Unsig. Movement Delay, s/veh												
LnGrp Delay(d),s/veh	51.3	19.3	0.0	0.0	30.3	21.5	15.4	0.0	17.6			
LnGrp LOS	D	B	A	A	C	C	B	A	B			
Approach Vol, veh/h		924			1023			838				
Approach Delay, s/veh		22.0			29.7			16.2				
Approach LOS		C			C			B				
Timer - Assigned Phs		2		4			7	8				
Phs Duration (G+Y+Rc), s		46.6		43.4			9.6	33.8				
Change Period (Y+Rc), s		4.5		4.5			4.5	4.5				
Max Green Setting (Gmax), s		32.5		48.5			8.5	35.5				
Max Q Clear Time (g_c+I1), s		13.6		17.8			5.9	24.0				
Green Ext Time (p_c), s		3.0		6.9			0.0	5.3				

Intersection Summary

HCM 6th Ctrl Delay	23.1
HCM 6th LOS	C

Notes

User approved volume balancing among the lanes for turning movement.

HCM 6th Signalized Intersection Summary
 33: Gateway Drive & Cleveland Avenue

Village D Specific Plan
 Phase I NP - PM Peak Hour



Movement	EBL	EBT	EBR	WBL	WBT	WBR	NBL	NBT	NBR	SBL	SBT	SBR
Lane Configurations	↖	↑↑↑	↗	↖↗	↑↑		↖↗	↑	↗	↖	↑↘	
Traffic Volume (veh/h)	15	815	252	179	727	128	224	126	243	181	142	23
Future Volume (veh/h)	15	815	252	179	727	128	224	126	243	181	142	23
Initial Q (Qb), veh	0	0	0	0	0	0	0	0	0	0	0	0
Ped-Bike Adj(A_pbT)	1.00		1.00	1.00		0.99	1.00		0.98	1.00		0.98
Parking Bus, Adj	1.00	1.00	1.00	1.00	1.00	1.00	1.00	1.00	1.00	1.00	1.00	1.00
Work Zone On Approach		No			No			No			No	
Adj Sat Flow, veh/h/ln	1870	1870	1870	1870	1870	1870	1885	1885	1885	1856	1856	1856
Adj Flow Rate, veh/h	16	867	0	190	773	136	238	134	259	193	151	24
Peak Hour Factor	0.94	0.94	0.94	0.94	0.94	0.94	0.94	0.94	0.94	0.94	0.94	0.94
Percent Heavy Veh, %	2	2	2	2	2	2	1	1	1	3	3	3
Cap, veh/h	113	1152		355	935	165	880	423	351	437	667	104
Arrive On Green	0.04	0.45	0.00	0.10	0.31	0.31	0.25	0.22	0.22	0.25	0.22	0.22
Sat Flow, veh/h	1781	5106	1585	3456	3017	531	3483	1885	1565	1767	3047	474
Grp Volume(v), veh/h	16	867	0	190	455	454	238	134	259	193	86	89
Grp Sat Flow(s),veh/h/ln	1781	1702	1585	1728	1777	1771	1742	1885	1565	1767	1763	1758
Q Serve(g_s), s	0.0	12.7	0.0	4.7	21.4	21.4	4.9	5.3	13.8	8.3	3.6	3.7
Cycle Q Clear(g_c), s	0.0	12.7	0.0	4.7	21.4	21.4	4.9	5.3	13.8	8.3	3.6	3.7
Prop In Lane	1.00		1.00	1.00		0.30	1.00		1.00	1.00		0.27
Lane Grp Cap(c), veh/h	113	1152		355	551	549	880	423	351	437	386	385
V/C Ratio(X)	0.14	0.75		0.54	0.83	0.83	0.27	0.32	0.74	0.44	0.22	0.23
Avail Cap(c_a), veh/h	179	1770		355	685	683	880	423	351	437	386	385
HCM Platoon Ratio	2.00	2.00	2.00	1.00	1.00	1.00	1.00	1.00	1.00	1.00	1.00	1.00
Upstream Filter(I)	0.87	0.87	0.00	0.94	0.94	0.94	1.00	1.00	1.00	1.00	1.00	1.00
Uniform Delay (d), s/veh	42.6	22.6	0.0	38.3	28.8	28.8	27.0	29.1	32.4	28.6	28.9	28.9
Incr Delay (d2), s/veh	0.5	0.9	0.0	1.5	6.4	6.4	0.2	2.0	13.0	0.7	1.3	1.4
Initial Q Delay(d3),s/veh	0.0	0.0	0.0	0.0	0.0	0.0	0.0	0.0	0.0	0.0	0.0	0.0
%ile BackOfQ(50%),veh/ln	0.4	3.9	0.0	2.0	9.8	9.7	2.0	2.6	6.4	3.5	1.6	1.7
Unsig. Movement Delay, s/veh												
LnGrp Delay(d),s/veh	43.1	23.5	0.0	39.8	35.2	35.2	27.1	31.1	45.4	29.3	30.2	30.3
LnGrp LOS	D	C		D	D	D	C	C	D	C	C	C
Approach Vol, veh/h		883	A		1099			631			368	
Approach Delay, s/veh		23.8			36.0			35.5			29.8	
Approach LOS		C			D			D			C	
Timer - Assigned Phs	1	2	3	4	5	6	7	8				
Phs Duration (G+Y+Rc), s	27.3	24.2	6.1	32.4	26.8	24.7	13.7	24.8				
Change Period (Y+Rc), s	4.5	4.5	4.5	4.5	4.5	4.5	4.5	4.5				
Max Green Setting (Gmax), s	12.6	19.7	5.0	34.7	12.1	20.2	8.5	31.2				
Max Q Clear Time (g_c+10), s	10.9	5.7	2.0	23.4	10.3	15.8	6.7	14.7				
Green Ext Time (p_c), s	0.4	0.7	0.0	4.5	0.1	0.7	0.1	5.6				

Intersection Summary

HCM 6th Ctrl Delay	31.5
HCM 6th LOS	C

Notes

Unsignalized Delay for [EBR] is excluded from calculations of the approach delay and intersection delay.

HCM 6th Signalized Intersection Summary
 34: Cleveland Avenue & County Club Drive

Village D Specific Plan
 Phase I NP - PM Peak Hour



Movement	WBL	WBR	NBT	NBR	SBL	SBT
Lane Configurations	↔↔		↑↑	↗	↘	↑↑↑
Traffic Volume (veh/h)	359	31	790	449	99	674
Future Volume (veh/h)	359	31	790	449	99	674
Initial Q (Qb), veh	0	0	0	0	0	0
Ped-Bike Adj(A_pbT)	1.00	1.00		1.00	1.00	
Parking Bus, Adj	1.00	1.00	1.00	1.00	1.00	1.00
Work Zone On Approach	No		No		No	
Adj Sat Flow, veh/h/ln	1900	1900	1870	1870	1870	1870
Adj Flow Rate, veh/h	409	0	832	0	104	709
Peak Hour Factor	0.95	0.95	0.95	0.95	0.95	0.95
Percent Heavy Veh, %	0	0	2	2	2	2
Cap, veh/h	532	237	2676		527	3845
Arrive On Green	0.15	0.00	0.75	0.00	0.75	0.75
Sat Flow, veh/h	3619	1610	3647	1585	659	5274
Grp Volume(v), veh/h	409	0	832	0	104	709
Grp Sat Flow(s),veh/h/ln	1810	1610	1777	1585	659	1702
Q Serve(g_s), s	9.8	0.0	6.8	0.0	5.4	3.6
Cycle Q Clear(g_c), s	9.8	0.0	6.8	0.0	12.2	3.6
Prop In Lane	1.00	1.00		1.00	1.00	
Lane Grp Cap(c), veh/h	532	237	2676		527	3845
V/C Ratio(X)	0.77	0.00	0.31		0.20	0.18
Avail Cap(c_a), veh/h	1428	635	2676		527	3845
HCM Platoon Ratio	1.00	1.00	1.00	1.00	1.00	1.00
Upstream Filter(I)	1.00	0.00	0.72	0.00	1.00	1.00
Uniform Delay (d), s/veh	36.9	0.0	3.6	0.0	5.6	3.2
Incr Delay (d2), s/veh	2.4	0.0	0.2	0.0	0.8	0.1
Initial Q Delay(d3),s/veh	0.0	0.0	0.0	0.0	0.0	0.0
%ile BackOfQ(50%),veh/ln	4	0.0	1.9	0.0	0.8	0.9
Unsig. Movement Delay, s/veh						
LnGrp Delay(d),s/veh	39.3	0.0	3.8	0.0	6.4	3.3
LnGrp LOS	D	A	A		A	A
Approach Vol, veh/h	409		832	A		813
Approach Delay, s/veh	39.3		3.8			3.7
Approach LOS	D		A			A
Timer - Assigned Phs		2			6	8
Phs Duration (G+Y+Rc), s		72.3			72.3	17.7
Change Period (Y+Rc), s		4.5			4.5	4.5
Max Green Setting (Gmax), s		45.5			45.5	35.5
Max Q Clear Time (g_c+I1), s		8.8			14.2	11.8
Green Ext Time (p_c), s		7.0			6.8	1.5

Intersection Summary

HCM 6th Ctrl Delay	10.8
HCM 6th LOS	B

Notes

User approved volume balancing among the lanes for turning movement.
 Unsignalized Delay for [NBR] is excluded from calculations of the approach delay and intersection delay.

Intersection						
Int Delay, s/veh	0.2					
Movement	EBL	EBR	NBL	NBT	SBT	SBR
Lane Configurations	T			T		
Traffic Vol, veh/h	2	16	5	792	716	1
Future Vol, veh/h	2	16	5	792	716	1
Conflicting Peds, #/hr	0	0	0	0	0	0
Sign Control	Stop	Stop	Free	Free	Free	Free
RT Channelized	-	None	-	None	-	None
Storage Length	0	-	-	-	-	-
Veh in Median Storage, #	0	-	-	0	0	-
Grade, %	0	-	-	0	0	-
Peak Hour Factor	94	94	94	94	94	94
Heavy Vehicles, %	0	0	1	1	1	1
Mvmt Flow	2	17	5	843	762	1

Major/Minor	Minor2	Major1	Major2			
Conflicting Flow All	1195	382	763	0	-	0
Stage 1	763	-	-	-	-	-
Stage 2	432	-	-	-	-	-
Critical Hdwy	6.8	6.9	4.12	-	-	-
Critical Hdwy Stg 1	5.8	-	-	-	-	-
Critical Hdwy Stg 2	5.8	-	-	-	-	-
Follow-up Hdwy	3.5	3.3	2.21	-	-	-
Pot Cap-1 Maneuver	*392	622	852	-	-	-
Stage 1	*426	-	-	-	-	-
Stage 2	*721	-	-	-	-	-
Platoon blocked, %	1			-	-	-
Mov Cap-1 Maneuver	*388	622	852	-	-	-
Mov Cap-2 Maneuver	*382	-	-	-	-	-
Stage 1	*421	-	-	-	-	-
Stage 2	*721	-	-	-	-	-























Approach	EB	NB	SB
HCM Control Delay, s	11.4	0.2	0
HCM LOS	B		

Minor Lane/Major Mvmt	NBL	NBT	EBLn1	SBT	SBR
Capacity (veh/h)	852	-	581	-	-
HCM Lane V/C Ratio	0.006	-	0.033	-	-
HCM Control Delay (s)	9.3	0.1	11.4	-	-
HCM Lane LOS	A	A	B	-	-
HCM 95th %tile Q(veh)	0	-	0.1	-	-

Notes
 -: Volume exceeds capacity \$: Delay exceeds 300s +: Computation Not Defined *: All major volume in platoon

HCM 6th Signalized Intersection Summary
 36: Pine Street & Howard Road

Village D Specific Plan
 Phase I NP - PM Peak Hour

												
Movement	EBL	EBT	EBR	WBL	WBT	WBR	NBL	NBT	NBR	SBL	SBT	SBR
Lane Configurations		 			 							
Traffic Volume (veh/h)	86	538	98	94	496	3	143	164	149	16	141	119
Future Volume (veh/h)	86	538	98	94	496	3	143	164	149	16	141	119
Initial Q (Qb), veh	0	0	0	0	0	0	0	0	0	0	0	0
Ped-Bike Adj(A_pbT)	1.00		0.94	1.00		0.93	1.00		0.99	1.00		1.00
Parking Bus, Adj	1.00	1.00	1.00	1.00	1.00	1.00	1.00	1.00	1.00	1.00	1.00	1.00
Work Zone On Approach		No			No			No			No	
Adj Sat Flow, veh/h/ln	1870	1870	1870	1885	1885	1885	1870	1870	1870	1870	1870	1870
Adj Flow Rate, veh/h	92	578	105	101	533	3	154	176	160	17	152	128
Peak Hour Factor	0.93	0.93	0.93	0.93	0.93	0.93	0.93	0.93	0.93	0.93	0.93	0.93
Percent Heavy Veh, %	2	2	2	1	1	1	2	2	2	2	2	2
Cap, veh/h	205	709	128	128	711	4	660	693	580	22	200	189
Arrive On Green	0.12	0.24	0.24	0.07	0.19	0.19	0.37	0.37	0.37	0.12	0.12	0.12
Sat Flow, veh/h	1781	2972	538	1795	3650	21	1781	1870	1565	187	1674	1585
Grp Volume(v), veh/h	92	345	338	101	261	275	154	176	160	169	0	128
Grp Sat Flow(s),veh/h/ln	1781	1777	1733	1795	1791	1880	1781	1870	1565	1861	0	1585
Q Serve(g_s), s	4.3	16.5	16.6	5.0	12.4	12.4	5.4	5.9	6.5	7.9	0.0	7.0
Cycle Q Clear(g_c), s	4.3	16.5	16.6	5.0	12.4	12.4	5.4	5.9	6.5	7.9	0.0	7.0
Prop In Lane	1.00		0.31	1.00		0.01	1.00		1.00	0.10		1.00
Lane Grp Cap(c), veh/h	205	424	414	128	349	366	660	693	580	222	0	189
V/C Ratio(X)	0.45	0.81	0.82	0.79	0.75	0.75	0.23	0.25	0.28	0.76	0.00	0.68
Avail Cap(c_a), veh/h	205	543	529	130	547	574	660	693	580	372	0	317
HCM Platoon Ratio	1.00	1.00	1.00	1.00	1.00	1.00	1.00	1.00	1.00	1.00	1.00	1.00
Upstream Filter(I)	1.00	1.00	1.00	0.91	0.91	0.91	1.00	1.00	1.00	1.00	0.00	1.00
Uniform Delay (d), s/veh	37.2	32.4	32.4	41.1	34.2	34.2	19.5	19.7	19.9	38.4	0.0	38.0
Incr Delay (d2), s/veh	1.5	7.2	7.8	24.7	2.9	2.8	0.8	0.9	1.2	5.3	0.0	4.2
Initial Q Delay(d3),s/veh	0.0	0.0	0.0	0.0	0.0	0.0	0.0	0.0	0.0	0.0	0.0	0.0
%ile BackOfQ(50%),veh/ln	2.0	7.8	7.7	3.1	5.6	5.8	2.3	2.7	0.2	3.9	0.0	2.9
Unsig. Movement Delay, s/veh												
LnGrp Delay(d),s/veh	38.7	39.6	40.2	65.8	37.1	37.0	20.3	20.6	21.0	43.7	0.0	42.1
LnGrp LOS	D	D	D	E	D	D	C	C	C	D	A	D
Approach Vol, veh/h		775			637			490			297	
Approach Delay, s/veh		39.7			41.6			20.6			43.0	
Approach LOS		D			D			C			D	
Timer - Assigned Phs		2	3	4		6	7	8				
Phs Duration (G+Y+Rc), s		37.9	10.9	26.0		15.2	14.9	22.0				
Change Period (Y+Rc), s		4.5	4.5	4.5		4.5	4.5	4.5				
Max Green Setting (Gmax), s		20.0	6.5	27.5		18.0	6.5	27.5				
Max Q Clear Time (g_c+I1), s		8.5	7.0	18.6		9.9	6.3	14.4				
Green Ext Time (p_c), s		1.6	0.0	2.9		0.8	0.0	2.6				
Intersection Summary												
HCM 6th Ctrl Delay				36.5								
HCM 6th LOS				D								

HCM 6th Signalized Intersection Summary
 37: Olive Avenue/Q Street & Howard Road/Yosemite Avenue

Village D Specific Plan
 Phase I NP - PM Peak Hour



Movement	EBL	EBT	EBR	WBL	WBT	WBR	NBL	NBT	NBR	SBL	SBT	SBR
Lane Configurations												
Traffic Volume (veh/h)	7	445	230	13	358	14	295	75	12	16	56	2
Future Volume (veh/h)	7	445	230	13	358	14	295	75	12	16	56	2
Initial Q (Qb), veh	0	0	0	0	0	0	0	0	0	0	0	0
Ped-Bike Adj(A_pbT)	1.00		1.00	1.00		1.00	1.00		0.99	1.00		0.99
Parking Bus, Adj	1.00	1.00	1.00	1.00	1.00	1.00	1.00	1.00	1.00	1.00	1.00	1.00
Work Zone On Approach		No			No			No			No	
Adj Sat Flow, veh/h/ln	1870	1870	1870	1885	1885	1885	1885	1885	1885	1885	1885	1885
Adj Flow Rate, veh/h	8	484	0	14	389	15	202	249	13	17	61	2
Peak Hour Factor	0.92	0.92	0.92	0.92	0.92	0.92	0.92	0.92	0.92	0.92	0.92	0.92
Percent Heavy Veh, %	2	2	2	1	1	1	1	1	1	1	1	1
Cap, veh/h	18	598		100	752	29	940	987	825	94	99	83
Arrive On Green	0.01	0.17	0.00	0.06	0.21	0.21	0.52	0.52	0.52	0.05	0.05	0.05
Sat Flow, veh/h	1781	3554	1585	1795	3516	135	1795	1885	1576	1795	1885	1580
Grp Volume(v), veh/h	8	484	0	14	198	206	202	249	13	17	61	2
Grp Sat Flow(s),veh/h/ln	1781	1777	1585	1795	1791	1860	1795	1885	1576	1795	1885	1580
Q Serve(g_s), s	0.4	11.8	0.0	0.7	8.8	8.8	5.4	6.5	0.4	0.8	2.9	0.1
Cycle Q Clear(g_c), s	0.4	11.8	0.0	0.7	8.8	8.8	5.4	6.5	0.4	0.8	2.9	0.1
Prop In Lane	1.00		1.00	1.00		0.07	1.00		1.00	1.00		1.00
Lane Grp Cap(c), veh/h	18	598		100	383	398	940	987	825	94	99	83
V/C Ratio(X)	0.45	0.81		0.14	0.52	0.52	0.21	0.25	0.02	0.18	0.62	0.02
Avail Cap(c_a), veh/h	99	711		359	617	641	940	987	825	359	377	316
HCM Platoon Ratio	1.00	1.00	1.00	1.00	1.00	1.00	1.00	1.00	1.00	1.00	1.00	1.00
Upstream Filter(I)	0.70	0.70	0.00	1.00	1.00	1.00	1.00	1.00	1.00	1.00	1.00	1.00
Uniform Delay (d), s/veh	44.3	36.0	0.0	40.5	31.3	31.3	11.5	11.8	10.3	40.8	41.8	40.5
Incr Delay (d2), s/veh	11.7	4.2	0.0	0.6	1.1	1.0	0.5	0.6	0.0	0.9	6.1	0.1
Initial Q Delay(d3),s/veh	0.0	0.0	0.0	0.0	0.0	0.0	0.0	0.0	0.0	0.0	0.0	0.0
%ile BackOfQ(50%),veh/ln	0.2	5.4	0.0	0.3	3.8	4.0	2.2	2.8	0.1	0.4	1.5	0.0
Unsig. Movement Delay, s/veh												
LnGrp Delay(d),s/veh	56.0	40.3	0.0	41.1	32.3	32.3	12.0	12.4	10.3	41.7	47.9	40.6
LnGrp LOS	E	D		D	C	C	B	B	B	D	D	D
Approach Vol, veh/h		492	A		418			464			80	
Approach Delay, s/veh		40.5			32.6			12.2			46.4	
Approach LOS		D			C			B			D	
Timer - Assigned Phs		2	3	4		6	7	8				
Phs Duration (G+Y+Rc), s		51.6	9.5	19.7		9.2	5.4	23.7				
Change Period (Y+Rc), s		4.5	4.5	4.5		4.5	4.5	4.5				
Max Green Setting (Gmax), s		18.0	18.0	18.0		18.0	5.0	31.0				
Max Q Clear Time (g_c+I1), s		8.5	2.7	13.8		4.9	2.4	10.8				
Green Ext Time (p_c), s		1.5	0.0	1.2		0.2	0.0	2.3				

Intersection Summary

HCM 6th Ctrl Delay	29.5
HCM 6th LOS	C

Notes

User approved volume balancing among the lanes for turning movement.
 Unsignalized Delay for [EBR] is excluded from calculations of the approach delay and intersection delay.

HCM 6th TWSC
 38: I Street & 2nd Street/SR-99 Southbound Off-Ramp

Village D Specific Plan
 Phase I NP - PM Peak Hour

Intersection												
Int Delay, s/veh	8.3											
Movement	EBL	EBT	EBR	WBL	WBT	WBR	NBL	NBT	NBR	SBL	SBT	SBR
Lane Configurations		↕↔			↕↑	↕↑	↕↑	↑			↕	
Traffic Vol, veh/h	0	0	36	256	12	4	46	147	0	0	115	0
Future Vol, veh/h	0	0	36	256	12	4	46	147	0	0	115	0
Conflicting Peds, #/hr	0	0	0	0	0	0	1	0	1	1	0	1
Sign Control	Stop	Stop	Stop	Stop	Stop	Stop	Free	Free	Free	Free	Free	Free
RT Channelized	-	-	None	-	-	Stop	-	-	None	-	-	None
Storage Length	-	-	-	-	-	50	75	-	-	-	-	-
Veh in Median Storage, #	-	0	-	-	0	-	-	0	-	-	0	-
Grade, %	-	0	-	-	0	-	-	0	-	-	0	-
Peak Hour Factor	98	98	98	98	98	98	98	98	98	98	98	98
Heavy Vehicles, %	0	0	0	3	3	3	0	0	0	0	0	0
Mvmt Flow	0	0	37	261	12	4	47	150	0	0	117	0

Major/Minor	Minor2		Minor1		Major1		Major2					
Conflicting Flow All	368	362	118	380	362	150	118	0	-	-	-	0
Stage 1	118	118	-	244	244	-	-	-	-	-	-	-
Stage 2	250	244	-	136	118	-	-	-	-	-	-	-
Critical Hdwy	7.1	6.5	6.2	7.13	6.53	6.23	4.1	-	-	-	-	-
Critical Hdwy Stg 1	6.1	5.5	-	6.13	5.53	-	-	-	-	-	-	-
Critical Hdwy Stg 2	6.1	5.5	-	6.13	5.53	-	-	-	-	-	-	-
Follow-up Hdwy	3.5	4	3.3	3.527	4.027	3.327	2.2	-	-	-	-	-
Pot Cap-1 Maneuver	641	600	939	623	595	969	1483	-	0	0	-	-
Stage 1	891	802	-	806	725	-	-	-	0	0	-	-
Stage 2	806	729	-	865	796	-	-	-	0	0	-	-
Platoon blocked, %	1	1		1	1	1		-			-	-
Mov Cap-1 Maneuver	612	580	938	584	575	969	1482	-	-	-	-	-
Mov Cap-2 Maneuver	612	580	-	584	575	-	-	-	-	-	-	-
Stage 1	862	801	-	780	702	-	-	-	-	-	-	-
Stage 2	763	706	-	831	795	-	-	-	-	-	-	-

Approach	EB		WB		NB		SB			
HCM Control Delay, s	9		16.4		1.8		0			
HCM LOS	A		C							

Minor Lane/Major Mvmt	NBL	NBT	EBLn1WBLn1WBLn2	SBT	SBR
Capacity (veh/h)	1482	-	938 584 969	-	-
HCM Lane V/C Ratio	0.032	-	0.039 0.468 0.004	-	-
HCM Control Delay (s)	7.5	-	9 16.5 8.7	-	-
HCM Lane LOS	A	-	A C A	-	-
HCM 95th %tile Q(veh)	0.1	-	0.1 2.5 0	-	-

HCM 6th Signalized Intersection Summary
39: 4th Street & Sunset Avenue

Village D Specific Plan
Phase I NP - PM Peak Hour



Movement	EBL	EBR	NBL	NBT	SBT	SBR
Lane Configurations						
Traffic Volume (veh/h)	229	13	13	302	349	366
Future Volume (veh/h)	229	13	13	302	349	366
Initial Q (Qb), veh	0	0	0	0	0	0
Ped-Bike Adj(A_pbT)	1.00	1.00	1.00			1.00
Parking Bus, Adj	1.00	1.00	1.00	1.00	1.00	1.00
Work Zone On Approach	No			No	No	
Adj Sat Flow, veh/h/ln	1900	1900	1856	1856	1856	1856
Adj Flow Rate, veh/h	262	0	14	328	379	398
Peak Hour Factor	0.92	0.92	0.92	0.92	0.92	0.92
Percent Heavy Veh, %	0	0	3	3	3	3
Cap, veh/h	357	159	462	2861	937	948
Arrive On Green	0.10	0.00	0.26	0.81	0.84	0.84
Sat Flow, veh/h	3619	1610	1767	3618	1856	1571
Grp Volume(v), veh/h	262	0	14	328	379	398
Grp Sat Flow(s),veh/h/ln	1810	1610	1767	1763	1856	1571
Q Serve(g_s), s	7.0	0.0	0.6	1.9	4.9	5.5
Cycle Q Clear(g_c), s	7.0	0.0	0.6	1.9	4.9	5.5
Prop In Lane	1.00	1.00	1.00			1.00
Lane Grp Cap(c), veh/h	357	159	462	2861	937	948
V/C Ratio(X)	0.73	0.00	0.03	0.11	0.40	0.42
Avail Cap(c_a), veh/h	995	443	462	2861	937	948
HCM Platoon Ratio	1.00	1.00	1.00	1.00	1.67	1.67
Upstream Filter(I)	1.00	0.00	1.00	1.00	0.76	0.76
Uniform Delay (d), s/veh	43.8	0.0	27.5	2.0	4.3	2.8
Incr Delay (d2), s/veh	3.0	0.0	0.0	0.1	1.0	1.0
Initial Q Delay(d3),s/veh	0.0	0.0	0.0	0.0	0.0	0.0
%ile BackOfQ(50%),veh/ln	3.3	0.0	0.3	0.5	1.6	1.8
Unsig. Movement Delay, s/veh						
LnGrp Delay(d),s/veh	46.8	0.0	27.5	2.0	5.2	3.9
LnGrp LOS	D	A	C	A	A	A
Approach Vol, veh/h				342	777	
Approach Delay, s/veh				3.1	4.5	
Approach LOS				A	A	
Timer - Assigned Phs		2		4	5	6
Phs Duration (G+Y+Rc), s		85.6		14.4	30.6	55.0
Change Period (Y+Rc), s		4.5		4.5	4.5	4.5
Max Green Setting (Gmax), s		63.5		27.5	8.5	50.5
Max Q Clear Time (g_c+I1), s		3.9		9.0	2.6	7.5
Green Ext Time (p_c), s		2.4		0.8	0.0	4.2

Intersection Summary

HCM 6th Ctrl Delay	12.2
HCM 6th LOS	B

Notes

User approved volume balancing among the lanes for turning movement.

40: H Street & SR-99 Southbound On-Ramp/2nd Street Performance by movement

Movement	WBL	WBT	WBR	NBL	NBT	NBR	SBL	SBT	All
Denied Delay (hr)	0.0	0.0	0.0	0.0	0.0	0.0	0.0	0.0	0.0
Denied Del/Veh (s)	0.1	0.1	0.1	0.0	0.6	0.0	0.1	0.1	0.1
Total Delay (hr)	0.1	0.2	0.0	0.2	0.0	0.0	0.0	0.0	0.6
Total Del/Veh (s)	15.8	16.3	2.9	2.9	2.8	2.0	27.2	16.2	5.4
Stop Delay (hr)	0.1	0.1	0.0	0.0	0.0	0.0	0.0	0.0	0.3
Stop Del/Veh (s)	13.4	12.6	2.3	0.1	0.2	0.1	26.5	13.2	2.6

HCM 6th Signalized Intersection Summary

41: I Street & 4th Street

Village D Specific Plan
Phase I NP - PM Peak Hour



Movement	EBL	EBT	EBR	WBL	WBT	WBR	NBL	NBT	NBR	SBL	SBT	SBR
Lane Configurations	↖	↗		↖	↗		↖	↑	↗	↖	↑	↗
Traffic Volume (veh/h)	35	496	61	60	505	110	99	70	248	170	166	106
Future Volume (veh/h)	35	496	61	60	505	110	99	70	248	170	166	106
Initial Q (Qb), veh	0	0	0	0	0	0	0	0	0	0	0	0
Ped-Bike Adj(A_pbT)	1.00		0.99	1.00		0.99	1.00		1.00	1.00		0.99
Parking Bus, Adj	1.00	1.00	1.00	1.00	1.00	1.00	1.00	1.00	1.00	1.00	1.00	1.00
Work Zone On Approach		No			No			No			No	
Adj Sat Flow, veh/h/ln	1856	1856	1856	1885	1885	1885	1885	1885	1885	1870	1870	1870
Adj Flow Rate, veh/h	38	539	66	65	549	120	108	76	270	185	180	115
Peak Hour Factor	0.92	0.92	0.92	0.92	0.92	0.92	0.92	0.92	0.92	0.92	0.92	0.92
Percent Heavy Veh, %	3	3	3	1	1	1	1	1	1	2	2	2
Cap, veh/h	58	659	80	97	672	146	421	443	375	574	604	505
Arrive On Green	0.03	0.21	0.21	0.05	0.23	0.23	0.23	0.23	0.23	0.32	0.32	0.32
Sat Flow, veh/h	1767	3159	386	1795	2919	636	1795	1885	1598	1781	1870	1564
Grp Volume(v), veh/h	38	300	305	65	336	333	108	76	270	185	180	115
Grp Sat Flow(s),veh/h/ln	1767	1763	1782	1795	1791	1764	1795	1885	1598	1781	1870	1564
Q Serve(g_s), s	2.1	16.2	16.3	3.6	17.8	17.9	4.9	3.2	15.6	7.9	7.2	5.4
Cycle Q Clear(g_c), s	2.1	16.2	16.3	3.6	17.8	17.9	4.9	3.2	15.6	7.9	7.2	5.4
Prop In Lane	1.00		0.22	1.00		0.36	1.00		1.00	1.00		1.00
Lane Grp Cap(c), veh/h	58	368	372	97	412	406	421	443	375	574	604	505
V/C Ratio(X)	0.66	0.82	0.82	0.67	0.82	0.82	0.26	0.17	0.72	0.32	0.30	0.23
Avail Cap(c_a), veh/h	115	485	490	171	546	538	421	443	375	574	604	505
HCM Platoon Ratio	1.00	1.00	1.00	1.00	1.00	1.00	1.00	1.00	1.00	1.00	1.00	1.00
Upstream Filter(I)	0.96	0.96	0.96	1.00	1.00	1.00	1.00	1.00	1.00	1.00	1.00	1.00
Uniform Delay (d), s/veh	47.8	37.7	37.8	46.4	36.5	36.5	31.2	30.5	35.2	25.6	25.4	24.7
Incr Delay (d2), s/veh	11.7	7.7	7.9	7.7	7.0	7.5	0.3	0.8	11.3	0.3	1.3	1.0
Initial Q Delay(d3),s/veh	0.0	0.0	0.0	0.0	0.0	0.0	0.0	0.0	0.0	0.0	0.0	0.0
%ile BackOfQ(50%),veh/ln	1.1	7.7	7.8	1.8	8.4	8.4	2.1	1.6	7.1	3.3	3.4	2.1
Unsig. Movement Delay, s/veh												
LnGrp Delay(d),s/veh	59.5	45.4	45.7	54.1	43.5	44.0	31.5	31.3	46.5	25.9	26.6	25.8
LnGrp LOS	E	D	D	D	D	D	C	C	D	C	C	C
Approach Vol, veh/h		643			734			454			480	
Approach Delay, s/veh		46.4			44.7			40.4			26.2	
Approach LOS		D			D			D			C	
Timer - Assigned Phs	1	2	3	4	5	6	7	8				
Phs Duration (G+Y+Rc), s	36.7	28.0	9.9	25.4	27.9	36.8	7.8	27.5				
Change Period (Y+Rc), s	4.5	4.5	4.5	4.5	4.5	4.5	4.5	4.5				
Max Green Setting (Gmax), s	21.5	23.5	9.5	27.5	12.7	32.3	6.5	30.5				
Max Q Clear Time (g_c+19.5), s	19.5	17.6	5.6	18.3	6.9	9.2	4.1	19.9				
Green Ext Time (p_c), s	0.4	0.7	0.0	2.5	0.1	1.4	0.0	3.1				
Intersection Summary												
HCM 6th Ctrl Delay				40.5								
HCM 6th LOS				D								

HCM 6th Signalized Intersection Summary
 43: SR-99 Northbound Off-Ramp/H Street & 4th Street

Village D Specific Plan
 Phase I NP - PM Peak Hour



Movement	EBL	EBT	EBR	WBL	WBT	WBR	NBL	NBT	NBR	SBL	SBT	SBR
Lane Configurations												
Traffic Volume (veh/h)	224	402	0	0	521	115	254	26	165	25	0	75
Future Volume (veh/h)	224	402	0	0	521	115	254	26	165	25	0	75
Initial Q (Qb), veh	0	0	0	0	0	0	0	0	0	0	0	0
Ped-Bike Adj(A_pbT)	1.00		1.00	1.00		0.99	1.00		0.99	1.00		0.99
Parking Bus, Adj	1.00	1.00	1.00	1.00	1.00	1.00	1.00	1.00	1.00	1.00	1.00	1.00
Work Zone On Approach	No				No				No			
Adj Sat Flow, veh/h/ln	1885	1885	0	0	1885	1885	1885	1885	1885	1900	1900	1900
Adj Flow Rate, veh/h	238	428	0	0	554	122	270	28	176	27	0	80
Peak Hour Factor	0.94	0.94	0.94	0.94	0.94	0.94	0.94	0.94	0.94	0.94	0.94	0.94
Percent Heavy Veh, %	1	1	0	0	1	1	1	1	1	0	0	0
Cap, veh/h	273	1484	0	0	632	139	486	60	376	74	0	221
Arrive On Green	0.15	0.41	0.00	0.00	0.22	0.22	0.27	0.27	0.27	0.18	0.00	0.18
Sat Flow, veh/h	1795	3676	0	0	3007	639	1795	221	1390	414	0	1226
Grp Volume(v), veh/h	238	428	0	0	340	336	270	0	204	107	0	0
Grp Sat Flow(s),veh/h/ln	1795	1791	0	0	1791	1761	1795	0	1611	1639	0	0
Q Serve(g_s), s	13.0	7.9	0.0	0.0	18.3	18.5	12.9	0.0	10.6	5.7	0.0	0.0
Cycle Q Clear(g_c), s	13.0	7.9	0.0	0.0	18.3	18.5	12.9	0.0	10.6	5.7	0.0	0.0
Prop In Lane	1.00		0.00	0.00		0.36	1.00		0.86	0.25		0.75
Lane Grp Cap(c), veh/h	273	1484	0	0	389	382	486	0	436	295	0	0
V/C Ratio(X)	0.87	0.29	0.00	0.00	0.87	0.88	0.56	0.00	0.47	0.36	0.00	0.00
Avail Cap(c_a), veh/h	350	1701	0	0	421	414	486	0	436	295	0	0
HCM Platoon Ratio	1.00	1.00	1.00	1.00	1.00	1.00	1.00	1.00	1.00	1.00	1.00	1.00
Upstream Filter(I)	1.00	1.00	0.00	0.00	1.00	1.00	1.00	0.00	1.00	1.00	0.00	0.00
Uniform Delay (d), s/veh	41.4	19.5	0.0	0.0	37.8	37.9	31.3	0.0	30.4	36.0	0.0	0.0
Incr Delay (d2), s/veh	17.1	0.1	0.0	0.0	17.2	18.2	4.5	0.0	3.6	3.4	0.0	0.0
Initial Q Delay(d3),s/veh	0.0	0.0	0.0	0.0	0.0	0.0	0.0	0.0	0.0	0.0	0.0	0.0
%ile BackOfQ(50%),veh/ln	7.0	3.3	0.0	0.0	9.8	9.8	6.1	0.0	4.5	2.6	0.0	0.0
Unsig. Movement Delay, s/veh												
LnGrp Delay(d),s/veh	58.6	19.6	0.0	0.0	55.0	56.0	35.8	0.0	34.0	39.4	0.0	0.0
LnGrp LOS	E	B	A	A	E	E	D	A	C	D	A	A
Approach Vol, veh/h	666				676				474		107	
Approach Delay, s/veh	33.5				55.5				35.0		39.4	
Approach LOS	C				E				D		D	
Timer - Assigned Phs	2		4		6		7		8			
Phs Duration (G+Y+Rc), s	31.6		45.9		22.5		19.7		26.2			
Change Period (Y+Rc), s	4.5		4.5		4.5		4.5		4.5			
Max Green Setting (Gmax), s	21.0		47.5		18.0		19.5		23.5			
Max Q Clear Time (g_c+I1), s	14.9		9.9		7.7		15.0		20.5			
Green Ext Time (p_c), s	1.1		3.1		0.3		0.3		1.2			
Intersection Summary												
HCM 6th Ctrl Delay			42.0									
HCM 6th LOS			D									

Intersection						
Int Delay, s/veh	4					
Movement	EBL	EBT	WBT	WBR	SBL	SBR
Lane Configurations	↘	↑↑	↑↑		↘	↘
Traffic Vol, veh/h	87	418	402	106	155	108
Future Vol, veh/h	87	418	402	106	155	108
Conflicting Peds, #/hr	0	0	0	0	0	0
Sign Control	Free	Free	Free	Free	Stop	Stop
RT Channelized	-	None	-	None	-	None
Storage Length	145	-	-	-	65	0
Veh in Median Storage, #	-	0	0	-	0	-
Grade, %	-	0	0	-	0	-
Peak Hour Factor	95	95	95	95	95	95
Heavy Vehicles, %	2	2	1	1	1	1
Mvmt Flow	92	440	423	112	163	114

Major/Minor	Major1	Major2	Minor2		
Conflicting Flow All	535	0	-	0	883
Stage 1	-	-	-	-	479
Stage 2	-	-	-	-	404
Critical Hdwy	4.14	-	-	-	6.82
Critical Hdwy Stg 1	-	-	-	-	5.82
Critical Hdwy Stg 2	-	-	-	-	5.82
Follow-up Hdwy	2.22	-	-	-	3.51
Pot Cap-1 Maneuver	1241	-	-	-	406
Stage 1	-	-	-	-	811
Stage 2	-	-	-	-	646
Platoon blocked, %	1	-	-	-	1
Mov Cap-1 Maneuver	1241	-	-	-	376
Mov Cap-2 Maneuver	-	-	-	-	376
Stage 1	-	-	-	-	751
Stage 2	-	-	-	-	646

Approach	EB	WB	SB
HCM Control Delay, s	1.4	0	16.6
HCM LOS			C

Minor Lane/Major Mvmt	EBL	EBT	WBT	WBR	SBLn1	SBLn2
Capacity (veh/h)	1241	-	-	-	376	937
HCM Lane V/C Ratio	0.074	-	-	-	0.434	0.121
HCM Control Delay (s)	8.1	-	-	-	21.7	9.4
HCM Lane LOS	A	-	-	-	C	A
HCM 95th %tile Q(veh)	0.2	-	-	-	2.1	0.4

Notes
 -: Volume exceeds capacity \$: Delay exceeds 300s +: Computation Not Defined *: All major volume in platoon

HCM 6th Signalized Intersection Summary
45: Olive Avenue & SR-99 Southbound Off-Ramp

Village D Specific Plan
Phase I NP - PM Peak Hour



Movement	EBL	EBT	WBT	WBR	SBL	SBR
Lane Configurations		↑↑↑	↑↑		↙	↗
Traffic Volume (veh/h)	0	572	431	0	377	77
Future Volume (veh/h)	0	572	431	0	377	77
Initial Q (Qb), veh	0	0	0	0	0	0
Ped-Bike Adj(A_pbT)	1.00			1.00	1.00	1.00
Parking Bus, Adj	1.00	1.00	1.00	1.00	1.00	1.00
Work Zone On Approach		No	No		No	
Adj Sat Flow, veh/h/ln	0	1870	1885	0	1826	1826
Adj Flow Rate, veh/h	0	602	454	0	397	81
Peak Hour Factor	0.95	0.95	0.95	0.95	0.95	0.95
Percent Heavy Veh, %	0	2	1	0	5	5
Cap, veh/h	0	815	572	0	1287	1146
Arrive On Green	0.00	0.16	0.16	0.00	0.74	0.74
Sat Flow, veh/h	0	5443	3770	0	1739	1547
Grp Volume(v), veh/h	0	602	454	0	397	81
Grp Sat Flow(s),veh/h/ln	0	1702	1791	0	1739	1547
Q Serve(g_s), s	0.0	10.1	11.0	0.0	6.9	1.3
Cycle Q Clear(g_c), s	0.0	10.1	11.0	0.0	6.9	1.3
Prop In Lane	0.00			0.00	1.00	1.00
Lane Grp Cap(c), veh/h	0	815	572	0	1287	1146
V/C Ratio(X)	0.00	0.74	0.79	0.00	0.31	0.07
Avail Cap(c_a), veh/h	0	1050	736	0	1287	1146
HCM Platoon Ratio	1.00	1.00	1.00	1.00	1.00	1.00
Upstream Filter(I)	0.00	1.00	0.92	0.00	1.00	1.00
Uniform Delay (d), s/veh	0.0	36.0	36.4	0.0	3.9	3.2
Incr Delay (d2), s/veh	0.0	2.0	4.3	0.0	0.6	0.1
Initial Q Delay(d3),s/veh	0.0	0.0	0.0	0.0	0.0	0.0
%ile BackOfQ(50%),veh/ln	0.0	4.3	5.0	0.0	2.1	0.3
Unsig. Movement Delay, s/veh						
LnGrp Delay(d),s/veh	0.0	38.1	40.6	0.0	4.6	3.3
LnGrp LOS	A	D	D	A	A	A
Approach Vol, veh/h		602	454		478	
Approach Delay, s/veh		38.1	40.6		4.3	
Approach LOS		D	D		A	
Timer - Assigned Phs				4	6	8
Phs Duration (G+Y+Rc), s				18.9	71.1	18.9
Change Period (Y+Rc), s				4.5	4.5	4.5
Max Green Setting (Gmax), s				18.5	62.5	18.5
Max Q Clear Time (g_c+I1), s				12.1	8.9	13.0
Green Ext Time (p_c), s				2.1	1.6	1.4
Intersection Summary						
HCM 6th Ctrl Delay			28.3			
HCM 6th LOS			C			

HCM 6th Signalized Intersection Summary

46: Madera Avenue & SR-99 Northbound Ramps

Village D Specific Plan
Phase I NP - PM Peak Hour



Movement	EBL	EBT	EBR	WBL	WBT	WBR	NBL	NBT	NBR	SBL	SBT	SBR
Lane Configurations				↶	↷	↶	↶↷	↶↷			↶↷	
Traffic Volume (veh/h)	0	0	0	184	1	33	525	598	0	0	618	173
Future Volume (veh/h)	0	0	0	184	1	33	525	598	0	0	618	173
Initial Q (Qb), veh				0	0	0	0	0	0	0	0	0
Ped-Bike Adj(A_pbT)				1.00		0.99	1.00		1.00	1.00		1.00
Parking Bus, Adj				1.00	1.00	1.00	1.00	1.00	1.00	1.00	1.00	1.00
Work Zone On Approach				No			No			No		
Adj Sat Flow, veh/h/ln				1885	1885	1885	1870	1870	0	0	1870	1870
Adj Flow Rate, veh/h				203	0	36	577	657	0	0	679	190
Peak Hour Factor				0.91	0.91	0.91	0.91	0.91	0.91	0.91	0.91	0.91
Percent Heavy Veh, %				1	1	1	2	2	0	0	2	2
Cap, veh/h				300	0	132	1362	2901	0	0	1020	285
Arrive On Green				0.08	0.00	0.08	0.79	1.00	0.00	0.00	0.37	0.37
Sat Flow, veh/h				3591	0	1574	3456	3647	0	0	2834	766
Grp Volume(v), veh/h				203	0	36	577	657	0	0	440	429
Grp Sat Flow(s),veh/h/ln				1795	0	1574	1728	1777	0	0	1777	1730
Q Serve(g_s), s				4.9	0.0	1.9	4.8	0.0	0.0	0.0	18.6	18.6
Cycle Q Clear(g_c), s				4.9	0.0	1.9	4.8	0.0	0.0	0.0	18.6	18.6
Prop In Lane				1.00		1.00	1.00		0.00	0.00		0.44
Lane Grp Cap(c), veh/h				300	0	132	1362	2901	0	0	661	644
V/C Ratio(X)				0.68	0.00	0.27	0.42	0.23	0.00	0.00	0.67	0.67
Avail Cap(c_a), veh/h				742	0	325	1362	2901	0	0	661	644
HCM Platoon Ratio				1.00	1.00	1.00	2.00	2.00	1.00	1.00	1.00	1.00
Upstream Filter(I)				1.00	0.00	1.00	0.84	0.84	0.00	0.00	1.00	1.00
Uniform Delay (d), s/veh				40.1	0.0	38.7	6.3	0.0	0.0	0.0	23.6	23.6
Incr Delay (d2), s/veh				2.7	0.0	1.1	0.2	0.2	0.0	0.0	5.2	5.4
Initial Q Delay(d3),s/veh				0.0	0.0	0.0	0.0	0.0	0.0	0.0	0.0	0.0
%ile BackOfQ(50%),veh/ln				2.3	0.0	0.8	1.3	0.1	0.0	0.0	8.4	8.3
Unsig. Movement Delay, s/veh												
LnGrp Delay(d),s/veh				42.7	0.0	39.8	6.5	0.2	0.0	0.0	28.8	29.0
LnGrp LOS				D	A	D	A	A	A	A	C	C
Approach Vol, veh/h								1234			869	
Approach Delay, s/veh								3.1			28.9	
Approach LOS								A			C	
Timer - Assigned Phs		2			5	6		8				
Phs Duration (G+Y+Rc), s		78.0			40.0	38.0		12.0				
Change Period (Y+Rc), s		4.5			4.5	4.5		4.5				
Max Green Setting (Gmax), s		62.4			24.4	33.5		18.6				
Max Q Clear Time (g_c+I1), s		2.0			6.8	20.6		6.9				
Green Ext Time (p_c), s		5.4			2.0	4.7		0.6				

Intersection Summary

HCM 6th Ctrl Delay	16.7
HCM 6th LOS	B

Notes

User approved volume balancing among the lanes for turning movement.

HCM 6th Signalized Intersection Summary
 47: Madera Avenue & Olive Avenue/SR-99 Southbound On-Ramp

Village D Specific Plan
 Phase I NP - PM Peak Hour



Movement	EBL	EBT	EBR	WBL	WBT	WBR	NBL	NBT	NBR	SBL	SBT	SBR
Lane Configurations												
Traffic Volume (veh/h)	380	155	414	0	0	0	135	742	37	132	373	296
Future Volume (veh/h)	380	155	414	0	0	0	135	742	37	132	373	296
Initial Q (Qb), veh	0	0	0				0	0	0	0	0	0
Ped-Bike Adj(A_pbT)	1.00		1.00				1.00		1.00	1.00		1.00
Parking Bus, Adj	1.00	1.00	1.00				1.00	1.00	1.00	1.00	1.00	1.00
Work Zone On Approach		No					No		No			
Adj Sat Flow, veh/h/ln	1856	1856	1856				1870	1870	1870	1885	1885	1885
Adj Flow Rate, veh/h	276	322	427				139	765	38	136	385	305
Peak Hour Factor	0.97	0.97	0.97				0.97	0.97	0.97	0.97	0.97	0.97
Percent Heavy Veh, %	3	3	3				2	2	2	1	1	1
Cap, veh/h	532	558	571				216	1562	78	172	930	728
Arrive On Green	0.10	0.10	0.10				0.06	0.45	0.45	0.03	0.16	0.16
Sat Flow, veh/h	1767	1856	1571				3456	3445	171	1795	1910	1496
Grp Volume(v), veh/h	276	322	427				139	394	409	136	361	329
Grp Sat Flow(s),veh/h/ln	1767	1856	1571				1728	1777	1840	1795	1791	1616
Q Serve(g_s), s	13.3	14.9	22.0				3.5	14.0	14.0	6.8	16.3	16.5
Cycle Q Clear(g_c), s	13.3	14.9	22.0				3.5	14.0	14.0	6.8	16.3	16.5
Prop In Lane	1.00		1.00				1.00		0.09	1.00		0.93
Lane Grp Cap(c), veh/h	532	558	571				216	806	834	172	871	786
V/C Ratio(X)	0.52	0.58	0.75				0.64	0.49	0.49	0.79	0.41	0.42
Avail Cap(c_a), veh/h	638	670	665				576	806	834	269	871	786
HCM Platoon Ratio	0.33	0.33	0.33				1.00	1.00	1.00	0.33	0.33	0.33
Upstream Filter(I)	0.84	0.84	0.84				1.00	1.00	1.00	0.82	0.82	0.82
Uniform Delay (d), s/veh	34.3	35.1	32.5				41.2	17.3	17.3	42.7	26.2	26.3
Incr Delay (d2), s/veh	0.7	0.8	3.3				3.2	2.1	2.1	6.8	1.2	1.3
Initial Q Delay(d3),s/veh	0.0	0.0	0.0				0.0	0.0	0.0	0.0	0.0	0.0
%ile BackOfQ(50%),veh/ln	6.4	7.5	19.9				1.6	5.9	6.1	3.4	8.0	7.4
Unsig. Movement Delay, s/veh												
LnGrp Delay(d),s/veh	35.0	35.8	35.9				44.4	19.4	19.3	49.5	27.4	27.7
LnGrp LOS	D	D	D				D	B	B	D	C	C
Approach Vol, veh/h		1025						942			826	
Approach Delay, s/veh		35.6						23.1			31.2	
Approach LOS		D						C			C	
Timer - Assigned Phs	1	2		4	5	6						
Phs Duration (G+Y+Rc), s	33.1	45.3		31.6	10.1	48.3						
Change Period (Y+Rc), s	4.5	4.5		4.5	4.5	4.5						
Max Green Setting (Gmax), s	13.5	30.5		32.5	15.0	29.0						
Max Q Clear Time (g_c+1), s	10.8	16.0		24.0	5.5	18.5						
Green Ext Time (p_c), s	0.1	4.4		3.0	0.3	3.3						

Intersection Summary

HCM 6th Ctrl Delay	30.1
HCM 6th LOS	C

Notes

User approved volume balancing among the lanes for turning movement.

Intersection						
Int Delay, s/veh	0.3					
Movement	WBL	WBR	NBT	NBR	SBL	SBT
Lane Configurations	↔		↕		↔	↕
Traffic Vol, veh/h	7	9	947	6	32	849
Future Vol, veh/h	7	9	947	6	32	849
Conflicting Peds, #/hr	0	0	0	2	2	0
Sign Control	Stop	Stop	Free	Free	Free	Free
RT Channelized	-	None	-	None	-	None
Storage Length	0	-	-	-	100	-
Veh in Median Storage, #	0	-	0	-	-	0
Grade, %	0	-	0	-	-	0
Peak Hour Factor	95	95	95	95	95	95
Heavy Vehicles, %	6	6	2	2	2	2
Mvmt Flow	7	9	997	6	34	894

Major/Minor	Minor1	Major1	Major2		
Conflicting Flow All	1517	504	0	0	1005
Stage 1	1002	-	-	-	-
Stage 2	515	-	-	-	-
Critical Hdwy	6.92	7.02	-	-	4.14
Critical Hdwy Stg 1	5.92	-	-	-	-
Critical Hdwy Stg 2	5.92	-	-	-	-
Follow-up Hdwy	3.56	3.36	-	-	2.22
Pot Cap-1 Maneuver	*215	503	-	-	685
Stage 1	*307	-	-	-	-
Stage 2	*677	-	-	-	-
Platoon blocked, %	1	-	-	-	-
Mov Cap-1 Maneuver	*204	502	-	-	684
Mov Cap-2 Maneuver	*262	-	-	-	-
Stage 1	*306	-	-	-	-
Stage 2	*643	-	-	-	-

Approach	WB	NB	SB
HCM Control Delay, s	15.6	0	0.4
HCM LOS	C		

Minor Lane/Major Mvmt	NBT	NBRWBLn1	SBL	SBT
Capacity (veh/h)	-	-	358	684
HCM Lane V/C Ratio	-	-	0.047	0.049
HCM Control Delay (s)	-	-	15.6	10.5
HCM Lane LOS	-	-	C	B
HCM 95th %tile Q(veh)	-	-	0.1	0.2

Notes
 -: Volume exceeds capacity \$: Delay exceeds 300s +: Computation Not Defined *: All major volume in platoon

HCM 6th Signalized Intersection Summary
49: Yosemite Avenue & Cleveland Avenue/Tozer Street

Village D Specific Plan
Phase I NP - PM Peak Hour



Movement	EBL	EBT	EBR	WBL	WBT	WBR	NBL	NBT	NBR	SBL	SBT	SBR
Lane Configurations	↖	↗		↖	↗	↗	↖	↗	↗	↖	↗	↗
Traffic Volume (veh/h)	208	428	198	49	464	40	310	298	97	72	174	219
Future Volume (veh/h)	208	428	198	49	464	40	310	298	97	72	174	219
Initial Q (Qb), veh	0	0	0	0	0	0	0	0	0	0	0	0
Ped-Bike Adj(A_pbT)	1.00		0.99	1.00		0.96	1.00		1.00	1.00		0.98
Parking Bus, Adj	1.00	1.00	1.00	1.00	1.00	1.00	1.00	1.00	1.00	1.00	1.00	1.00
Work Zone On Approach		No			No			No			No	
Adj Sat Flow, veh/h/ln	1870	1870	1870	1900	1900	1900	1870	1870	1870	1870	1870	1870
Adj Flow Rate, veh/h	226	465	215	53	504	43	337	324	105	78	189	238
Peak Hour Factor	0.92	0.92	0.92	0.92	0.92	0.92	0.92	0.92	0.92	0.92	0.92	0.92
Percent Heavy Veh, %	2	2	2	0	0	0	2	2	2	2	2	2
Cap, veh/h	258	754	346	70	770	330	340	758	640	100	201	253
Arrive On Green	0.15	0.32	0.32	0.04	0.21	0.21	0.19	0.41	0.41	0.06	0.27	0.27
Sat Flow, veh/h	1781	2356	1081	1810	3610	1546	1781	1870	1580	1781	743	936
Grp Volume(v), veh/h	226	350	330	53	504	43	337	324	105	78	0	427
Grp Sat Flow(s),veh/h/ln	1781	1777	1660	1810	1805	1546	1781	1870	1580	1781	0	1680
Q Serve(g_s), s	12.4	16.7	16.9	2.9	12.8	2.3	18.9	12.5	4.2	4.3	0.0	24.9
Cycle Q Clear(g_c), s	12.4	16.7	16.9	2.9	12.8	2.3	18.9	12.5	4.2	4.3	0.0	24.9
Prop In Lane	1.00		0.65	1.00		1.00	1.00		1.00	1.00		0.56
Lane Grp Cap(c), veh/h	258	568	531	70	770	330	340	758	640	100	0	454
V/C Ratio(X)	0.87	0.62	0.62	0.76	0.65	0.13	0.99	0.43	0.16	0.78	0.00	0.94
Avail Cap(c_a), veh/h	287	568	531	103	770	330	340	758	640	173	0	462
HCM Platoon Ratio	1.00	1.00	1.00	1.00	1.00	1.00	1.00	1.00	1.00	1.00	1.00	1.00
Upstream Filter(I)	1.00	1.00	1.00	1.00	1.00	1.00	1.00	1.00	1.00	1.00	0.00	1.00
Uniform Delay (d), s/veh	41.9	28.8	28.9	47.6	36.0	31.8	40.4	21.4	18.9	46.6	0.0	35.7
Incr Delay (d2), s/veh	23.0	4.9	5.4	16.8	4.3	0.8	46.1	0.4	0.1	12.1	0.0	27.2
Initial Q Delay(d3),s/veh	0.0	0.0	0.0	0.0	0.0	0.0	0.0	0.0	0.0	0.0	0.0	0.0
%ile BackOfQ(50%),veh/ln	7.1	7.8	7.4	1.6	6.0	0.9	12.5	5.4	1.5	2.2	0.0	13.4
Unsig. Movement Delay, s/veh												
LnGrp Delay(d),s/veh	64.9	33.7	34.3	64.4	40.3	32.6	86.5	21.8	19.1	58.6	0.0	62.8
LnGrp LOS	E	C	C	E	D	C	F	C	B	E	A	E
Approach Vol, veh/h		906			600			766				505
Approach Delay, s/veh		41.7			41.9			49.9				62.2
Approach LOS		D			D			D				E
Timer - Assigned Phs	1	2	3	4	5	6	7	8				
Phs Duration (G+Y+Rc), s	19.0	25.8	10.1	45.0	8.4	36.5	23.6	31.6				
Change Period (Y+Rc), s	4.5	4.5	4.5	4.5	4.5	4.5	4.5	4.5				
Max Green Setting (Gmax), s	16.1	19.3	9.7	36.9	5.7	29.7	19.1	27.5				
Max Q Clear Time (g_c+I1), s	14.4	14.8	6.3	14.5	4.9	18.9	20.9	26.9				
Green Ext Time (p_c), s	0.1	1.4	0.0	2.3	0.0	3.3	0.0	0.2				

Intersection Summary

HCM 6th Ctrl Delay	47.7
HCM 6th LOS	D

Intersection						
Int Delay, s/veh	0					
Movement	EBT	EBR	WBL	WBT	NBL	NBR
Lane Configurations						
Traffic Vol, veh/h	64	0	0	30	0	0
Future Vol, veh/h	64	0	0	30	0	0
Conflicting Peds, #/hr	0	0	0	0	0	0
Sign Control	Free	Free	Free	Free	Stop	Stop
RT Channelized	-	None	-	None	-	None
Storage Length	-	-	-	-	-	-
Veh in Median Storage, #	0	-	-	0	0	-
Grade, %	0	-	-	0	0	-
Peak Hour Factor	92	92	92	92	92	92
Heavy Vehicles, %	4	4	4	4	0	0
Mvmt Flow	70	0	0	33	0	0

Major/Minor	Major1	Major2	Minor1		
Conflicting Flow All	0	0	70	0	103
Stage 1	-	-	-	-	70
Stage 2	-	-	-	-	33
Critical Hdwy	-	-	4.14	-	6.4
Critical Hdwy Stg 1	-	-	-	-	5.4
Critical Hdwy Stg 2	-	-	-	-	5.4
Follow-up Hdwy	-	-	2.236	-	3.5
Pot Cap-1 Maneuver	-	-	1518	-	900
Stage 1	-	-	-	-	958
Stage 2	-	-	-	-	995
Platoon blocked, %	-	-	-	-	-
Mov Cap-1 Maneuver	-	-	1518	-	900
Mov Cap-2 Maneuver	-	-	-	-	900
Stage 1	-	-	-	-	958
Stage 2	-	-	-	-	995

Approach	EB	WB	NB
HCM Control Delay, s	0	0	0
HCM LOS			A

Minor Lane/Major Mvmt	NBLn1	EBT	EBR	WBL	WBT
Capacity (veh/h)	-	-	-	1518	-
HCM Lane V/C Ratio	-	-	-	-	-
HCM Control Delay (s)	0	-	-	0	-
HCM Lane LOS	A	-	-	A	-
HCM 95th %tile Q(veh)	-	-	-	0	-

Intersection												
Int Delay, s/veh	0.2											
Movement	EBL	EBT	EBR	WBL	WBT	WBR	NBL	NBT	NBR	SBL	SBT	SBR
Lane Configurations		↕			↕			↕			↕	
Traffic Vol, veh/h	0	100	0	0	14	0	0	0	0	2	0	0
Future Vol, veh/h	0	100	0	0	14	0	0	0	0	2	0	0
Conflicting Peds, #/hr	0	0	0	0	0	0	0	0	0	0	0	0
Sign Control	Free	Free	Free	Free	Free	Free	Stop	Stop	Stop	Stop	Stop	Stop
RT Channelized	-	-	None	-	-	None	-	-	None	-	-	None
Storage Length	-	-	-	-	-	-	-	-	-	-	-	-
Veh in Median Storage, #	-	0	-	-	0	-	-	0	-	-	0	-
Grade, %	-	0	-	-	0	-	-	0	-	-	0	-
Peak Hour Factor	92	92	92	92	92	92	92	92	92	92	92	92
Heavy Vehicles, %	13	13	13	13	13	13	0	0	0	0	0	0
Mvmt Flow	0	109	0	0	15	0	0	0	0	2	0	0

Major/Minor	Major1			Major2			Minor1			Minor2		
Conflicting Flow All	15	0	0	109	0	0	124	124	109	124	124	15
Stage 1	-	-	-	-	-	-	109	109	-	15	15	-
Stage 2	-	-	-	-	-	-	15	15	-	109	109	-
Critical Hdwy	4.23	-	-	4.23	-	-	7.1	6.5	6.2	7.1	6.5	6.2
Critical Hdwy Stg 1	-	-	-	-	-	-	6.1	5.5	-	6.1	5.5	-
Critical Hdwy Stg 2	-	-	-	-	-	-	6.1	5.5	-	6.1	5.5	-
Follow-up Hdwy	2.317	-	-	2.317	-	-	3.5	4	3.3	3.5	4	3.3
Pot Cap-1 Maneuver	1534	-	-	1415	-	-	855	770	950	855	770	1070
Stage 1	-	-	-	-	-	-	901	809	-	1010	887	-
Stage 2	-	-	-	-	-	-	1010	887	-	901	809	-
Platoon blocked, %	-	-	-	-	-	-	-	-	-	-	-	-
Mov Cap-1 Maneuver	1534	-	-	1415	-	-	855	770	950	855	770	1070
Mov Cap-2 Maneuver	-	-	-	-	-	-	855	770	-	855	770	-
Stage 1	-	-	-	-	-	-	901	809	-	1010	887	-
Stage 2	-	-	-	-	-	-	1010	887	-	901	809	-

Approach	EB			WB			NB			SB		
HCM Control Delay, s	0			0			0			9.2		
HCM LOS							A			A		

Minor Lane/Major Mvmt	NBLn1	EBL	EBT	EBR	WBL	WBT	WBR	SBLn1
Capacity (veh/h)	-	1534	-	-	1415	-	-	855
HCM Lane V/C Ratio	-	-	-	-	-	-	-	0.003
HCM Control Delay (s)	0	0	-	-	0	-	-	9.2
HCM Lane LOS	A	A	-	-	A	-	-	A
HCM 95th %tile Q(veh)	-	0	-	-	0	-	-	0

Intersection						
Int Delay, s/veh	0					
Movement	WBL	WBR	NBT	NBR	SBL	SBT
Lane Configurations						
Traffic Vol, veh/h	0	0	0	0	1	0
Future Vol, veh/h	0	0	0	0	1	0
Conflicting Peds, #/hr	0	0	0	0	0	0
Sign Control	Stop	Stop	Free	Free	Free	Free
RT Channelized	-	None	-	None	-	None
Storage Length	-	-	-	-	-	-
Veh in Median Storage, #	0	-	0	-	-	0
Grade, %	0	-	0	-	-	0
Peak Hour Factor	92	92	92	92	92	92
Heavy Vehicles, %	0	0	0	0	0	0
Mvmt Flow	0	0	0	0	1	0

Major/Minor	Minor1	Major1	Major2			
Conflicting Flow All	2	0	0	0	0	0
Stage 1	0	-	-	-	-	-
Stage 2	2	-	-	-	-	-
Critical Hdwy	6.4	6.2	-	-	4.1	-
Critical Hdwy Stg 1	5.4	-	-	-	-	-
Critical Hdwy Stg 2	5.4	-	-	-	-	-
Follow-up Hdwy	3.5	3.3	-	-	2.2	-
Pot Cap-1 Maneuver	1026	-	-	-	-	-
Stage 1	-	-	-	-	-	-
Stage 2	1026	-	-	-	-	-
Platoon blocked, %						
Mov Cap-1 Maneuver	1026	-	-	-	-	-
Mov Cap-2 Maneuver	1026	-	-	-	-	-
Stage 1	-	-	-	-	-	-
Stage 2	1026	-	-	-	-	-

Approach	WB	NB	SB
HCM Control Delay, s	0	0	
HCM LOS	A		

Minor Lane/Major Mvmt	NBT	NBRWBLn1	SBL	SBT
Capacity (veh/h)	-	-	-	-
HCM Lane V/C Ratio	-	-	-	-
HCM Control Delay (s)	-	-	0	-
HCM Lane LOS	-	-	A	-
HCM 95th %tile Q(veh)	-	-	-	-

Intersection						
Int Delay, s/veh	0					
Movement	EBL	EBR	NBL	NBT	SBT	SBR
Lane Configurations	T			T		
Traffic Vol, veh/h	0	2	0	203	290	0
Future Vol, veh/h	0	2	0	203	290	0
Conflicting Peds, #/hr	0	0	0	0	0	0
Sign Control	Stop	Stop	Free	Free	Free	Free
RT Channelized	-	None	-	None	-	None
Storage Length	-	-	-	-	-	-
Veh in Median Storage, #	0	-	-	0	0	-
Grade, %	0	-	-	0	0	-
Peak Hour Factor	92	92	92	92	92	92
Heavy Vehicles, %	0	0	9	9	9	9
Mvmt Flow	0	2	0	221	315	0

Major/Minor	Minor2	Major1	Major2			
Conflicting Flow All	536	315	315	0	-	0
Stage 1	315	-	-	-	-	-
Stage 2	221	-	-	-	-	-
Critical Hdwy	6.4	6.2	4.19	-	-	-
Critical Hdwy Stg 1	5.4	-	-	-	-	-
Critical Hdwy Stg 2	5.4	-	-	-	-	-
Follow-up Hdwy	3.5	3.3	2.281	-	-	-
Pot Cap-1 Maneuver	509	730	1207	-	-	-
Stage 1	744	-	-	-	-	-
Stage 2	821	-	-	-	-	-
Platoon blocked, %				-	-	-
Mov Cap-1 Maneuver	509	730	1207	-	-	-
Mov Cap-2 Maneuver	509	-	-	-	-	-
Stage 1	744	-	-	-	-	-
Stage 2	821	-	-	-	-	-

Approach	EB	NB	SB
HCM Control Delay, s	9.9	0	0
HCM LOS	A		

Minor Lane/Major Mvmt	NBL	NBT	EBLn1	SBT	SBR
Capacity (veh/h)	1207	-	730	-	-
HCM Lane V/C Ratio	-	-	0.003	-	-
HCM Control Delay (s)	0	-	9.9	-	-
HCM Lane LOS	A	-	A	-	-
HCM 95th %tile Q(veh)	0	-	0	-	-

Intersection						
Int Delay, s/veh	0.6					
Movement	EBL	EBR	NBL	NBT	SBT	SBR
Lane Configurations	T			T		
Traffic Vol, veh/h	21	9	0	253	336	13
Future Vol, veh/h	21	9	0	253	336	13
Conflicting Peds, #/hr	0	0	0	0	0	0
Sign Control	Stop	Stop	Free	Free	Free	Free
RT Channelized	-	None	-	None	-	None
Storage Length	0	-	-	-	-	-
Veh in Median Storage, #	0	-	-	0	0	-
Grade, %	0	-	-	0	0	-
Peak Hour Factor	92	92	92	92	92	92
Heavy Vehicles, %	0	0	9	9	9	9
Mvmt Flow	23	10	0	275	365	14

Major/Minor	Minor2	Major1	Major2			
Conflicting Flow All	647	372	379	0	-	0
Stage 1	372	-	-	-	-	-
Stage 2	275	-	-	-	-	-
Critical Hdwy	6.4	6.2	4.19	-	-	-
Critical Hdwy Stg 1	5.4	-	-	-	-	-
Critical Hdwy Stg 2	5.4	-	-	-	-	-
Follow-up Hdwy	3.5	3.3	2.281	-	-	-
Pot Cap-1 Maneuver	439	678	1142	-	-	-
Stage 1	702	-	-	-	-	-
Stage 2	776	-	-	-	-	-
Platoon blocked, %				-	-	-
Mov Cap-1 Maneuver	439	678	1142	-	-	-
Mov Cap-2 Maneuver	439	-	-	-	-	-
Stage 1	702	-	-	-	-	-
Stage 2	776	-	-	-	-	-

Approach	EB	NB	SB
HCM Control Delay, s	12.9	0	0
HCM LOS	B		

Minor Lane/Major Mvmt	NBL	NBT	EBLn1	SBT	SBR
Capacity (veh/h)	1142	-	491	-	-
HCM Lane V/C Ratio	-	-	0.066	-	-
HCM Control Delay (s)	0	-	12.9	-	-
HCM Lane LOS	A	-	B	-	-
HCM 95th %tile Q(veh)	0	-	0.2	-	-

Intersection						
Int Delay, s/veh	0.5					
Movement	EBT	EBR	WBL	WBT	NBL	NBR
Lane Configurations						
Traffic Vol, veh/h	43	0	2	61	2	3
Future Vol, veh/h	43	0	2	61	2	3
Conflicting Peds, #/hr	0	0	0	0	0	0
Sign Control	Free	Free	Free	Free	Stop	Stop
RT Channelized	-	None	-	None	-	None
Storage Length	-	-	50	-	-	-
Veh in Median Storage, #	0	-	-	0	0	-
Grade, %	0	-	-	0	0	-
Peak Hour Factor	92	92	92	92	92	92
Heavy Vehicles, %	11	11	7	7	0	0
Mvmt Flow	47	0	2	66	2	3

Major/Minor	Major1	Major2	Minor1		
Conflicting Flow All	0	0	47	0	117
Stage 1	-	-	-	-	47
Stage 2	-	-	-	-	70
Critical Hdwy	-	-	4.17	-	6.4
Critical Hdwy Stg 1	-	-	-	-	5.4
Critical Hdwy Stg 2	-	-	-	-	5.4
Follow-up Hdwy	-	-	2.263	-	3.5
Pot Cap-1 Maneuver	-	-	1529	-	884
Stage 1	-	-	-	-	981
Stage 2	-	-	-	-	958
Platoon blocked, %	-	-	-	-	-
Mov Cap-1 Maneuver	-	-	1529	-	883
Mov Cap-2 Maneuver	-	-	-	-	883
Stage 1	-	-	-	-	981
Stage 2	-	-	-	-	957

Approach	EB	WB	NB
HCM Control Delay, s	0	0.2	8.8
HCM LOS			A

Minor Lane/Major Mvmt	NBLn1	EBT	EBR	WBL	WBT
Capacity (veh/h)	965	-	-	1529	-
HCM Lane V/C Ratio	0.006	-	-	0.001	-
HCM Control Delay (s)	8.8	-	-	7.4	-
HCM Lane LOS	A	-	-	A	-
HCM 95th %tile Q(veh)	0	-	-	0	-

Intersection	
Intersection Delay, s/veh	7.5
Intersection LOS	A

Movement	EBL	EBT	EBR	WBL	WBT	WBR	NBL	NBT	NBR	SBL	SBT	SBR
Lane Configurations	↵	↶		↵	↶		↵	↶		↵	↶	
Traffic Vol, veh/h	2	12	0	0	29	4	0	0	0	2	0	1
Future Vol, veh/h	2	12	0	0	29	4	0	0	0	2	0	1
Peak Hour Factor	0.92	0.92	0.92	0.92	0.92	0.92	0.92	0.92	0.92	0.92	0.92	0.92
Heavy Vehicles, %	11	11	11	11	11	11	0	0	0	0	0	0
Mvmt Flow	2	13	0	0	32	4	0	0	0	2	0	1
Number of Lanes	1	1	0	1	1	0	1	1	0	1	1	0

Approach	EB	WB	NB	SB
Opposing Approach	WB	EB	SB	NB
Opposing Lanes	2	2	2	2
Conflicting Approach Left	SB	NB	EB	WB
Conflicting Lanes Left	2	2	2	2
Conflicting Approach Right	NB	SB	WB	EB
Conflicting Lanes Right	2	2	2	2
HCM Control Delay	7.6	7.5	0	7.4
HCM LOS	A	A	-	A

Lane	NBLn1	NBLn2	EBLn1	EBLn2	WBLn1	WBLn2	SBLn1	SBLn2
Vol Left, %	0%	0%	100%	0%	0%	0%	100%	0%
Vol Thru, %	100%	100%	0%	100%	100%	88%	0%	0%
Vol Right, %	0%	0%	0%	0%	0%	12%	0%	100%
Sign Control	Stop	Stop	Stop	Stop	Stop	Stop	Stop	Stop
Traffic Vol by Lane	0	0	2	12	0	33	2	1
LT Vol	0	0	2	0	0	0	2	0
Through Vol	0	0	0	12	0	29	0	0
RT Vol	0	0	0	0	0	4	0	1
Lane Flow Rate	0	0	2	13	0	36	2	1
Geometry Grp	7	7	7	7	7	7	7	7
Degree of Util (X)	0	0	0.003	0.017	0	0.046	0.003	0.001
Departure Headway (Hd)	4.591	4.591	5.21	4.71	4.7	4.615	5.089	3.888
Convergence, Y/N	Yes	Yes	Yes	Yes	Yes	Yes	Yes	Yes
Cap	0	0	690	763	0	779	702	917
Service Time	2.331	2.331	2.92	2.42	2.405	2.321	2.827	1.626
HCM Lane V/C Ratio	0	0	0.003	0.017	0	0.046	0.003	0.001
HCM Control Delay	7.3	7.3	7.9	7.5	7.4	7.5	7.8	6.6
HCM Lane LOS	N	N	A	A	N	A	A	A
HCM 95th-tile Q	0	0	0	0.1	0	0.1	0	0

Intersection						
Int Delay, s/veh	2.8					
Movement	EBL	EBT	WBT	WBR	SBL	SBR
Lane Configurations		↕	↑	↗	↘	
Traffic Vol, veh/h	2	109	114	108	94	4
Future Vol, veh/h	2	109	114	108	94	4
Conflicting Peds, #/hr	0	0	0	0	0	0
Sign Control	Free	Free	Free	Free	Stop	Stop
RT Channelized	-	None	-	None	-	None
Storage Length	-	-	-	0	0	-
Veh in Median Storage, #	-	0	0	-	0	-
Grade, %	-	0	0	-	0	-
Peak Hour Factor	92	92	92	92	92	92
Heavy Vehicles, %	15	15	47	47	81	81
Mvmt Flow	2	118	124	117	102	4

Major/Minor	Major1	Major2	Minor2		
Conflicting Flow All	241	0	-	0	246 124
Stage 1	-	-	-	-	124 -
Stage 2	-	-	-	-	122 -
Critical Hdwy	4.25	-	-	-	7.21 7.01
Critical Hdwy Stg 1	-	-	-	-	6.21 -
Critical Hdwy Stg 2	-	-	-	-	6.21 -
Follow-up Hdwy	2.335	-	-	-	4.229 4.029
Pot Cap-1 Maneuver	1253	-	-	-	599 752
Stage 1	-	-	-	-	739 -
Stage 2	-	-	-	-	740 -
Platoon blocked, %		-	-	-	
Mov Cap-1 Maneuver	1253	-	-	-	598 752
Mov Cap-2 Maneuver	-	-	-	-	598 -
Stage 1	-	-	-	-	738 -
Stage 2	-	-	-	-	740 -

Approach	EB	WB	SB
HCM Control Delay, s	0.1	0	12.2
HCM LOS			B

Minor Lane/Major Mvmt	EBL	EBT	WBT	WBR	SBLn1
Capacity (veh/h)	1253	-	-	-	603
HCM Lane V/C Ratio	0.002	-	-	-	0.177
HCM Control Delay (s)	7.9	0	-	-	12.2
HCM Lane LOS	A	A	-	-	B
HCM 95th %tile Q(veh)	0	-	-	-	0.6

HCM 6th TWSC
 4: Truck Parking Lot/Pistachio Drive & Avenue 18 1/2

Village D Specific Plan
 Phase I WP - AM Peak Hour

Intersection												
Int Delay, s/veh	2.5											
Movement	EBL	EBT	EBR	WBL	WBT	WBR	NBL	NBT	NBR	SBL	SBT	SBR
Lane Configurations		↕			↕	↕		↕			↕	
Traffic Vol, veh/h	8	262	1	3	230	203	0	0	1	106	0	9
Future Vol, veh/h	8	262	1	3	230	203	0	0	1	106	0	9
Conflicting Peds, #/hr	0	0	0	0	0	0	0	0	0	0	0	0
Sign Control	Free	Free	Free	Free	Free	Free	Stop	Stop	Stop	Stop	Stop	Stop
RT Channelized	-	-	None	-	-	None	-	-	None	-	-	None
Storage Length	-	-	-	-	-	50	-	-	-	-	-	-
Veh in Median Storage, #	-	0	-	-	0	-	-	0	-	-	0	-
Grade, %	-	0	-	-	0	-	-	0	-	-	0	-
Peak Hour Factor	93	93	93	93	93	93	93	93	93	93	93	93
Heavy Vehicles, %	33	33	33	25	25	25	100	100	100	12	12	12
Mvmt Flow	9	282	1	3	247	218	0	0	1	114	0	10

Major/Minor	Major1			Major2			Minor1			Minor2		
Conflicting Flow All	465	0	0	283	0	0	668	772	283	554	554	247
Stage 1	-	-	-	-	-	-	301	301	-	253	253	-
Stage 2	-	-	-	-	-	-	367	471	-	301	301	-
Critical Hdwy	4.43	-	-	4.35	-	-	8.1	7.5	7.2	7.22	6.62	6.32
Critical Hdwy Stg 1	-	-	-	-	-	-	7.1	6.5	-	6.22	5.62	-
Critical Hdwy Stg 2	-	-	-	-	-	-	7.1	6.5	-	6.22	5.62	-
Follow-up Hdwy	2.497	-	-	2.425	-	-	4.4	4.9	4.2	3.608	4.108	3.408
Pot Cap-1 Maneuver	952	-	-	1158	-	-	266	238	571	428	427	768
Stage 1	-	-	-	-	-	-	540	520	-	730	680	-
Stage 2	-	-	-	-	-	-	492	425	-	687	647	-
Platoon blocked, %		-	-		-	-						
Mov Cap-1 Maneuver	952	-	-	1158	-	-	260	234	571	422	421	768
Mov Cap-2 Maneuver	-	-	-	-	-	-	260	234	-	422	421	-
Stage 1	-	-	-	-	-	-	534	514	-	722	677	-
Stage 2	-	-	-	-	-	-	484	423	-	678	640	-

Approach	EB			WB			NB			SB		
HCM Control Delay, s	0.3			0.1			11.3			16.5		
HCM LOS							B			C		

Minor Lane/Major Mvmt	NBLn1	EBL	EBT	EBR	WBL	WBT	WBR	SBLn1
Capacity (veh/h)	571	952	-	-	1158	-	-	437
HCM Lane V/C Ratio	0.002	0.009	-	-	0.003	-	-	0.283
HCM Control Delay (s)	11.3	8.8	0	-	8.1	0	-	16.5
HCM Lane LOS	B	A	A	-	A	A	-	C
HCM 95th %tile Q(veh)	0	0	-	-	0	-	-	1.1

Intersection

Int Delay, s/veh 13.9

Movement	EBL	EBT	EBR	WBL	WBT	WBR	NBL	NBT	NBR	SBL	SBT	SBR
Lane Configurations		↑	↑		↑		↑		↑		↔	
Traffic Vol, veh/h	0	311	58	43	276	0	76	0	339	11	116	85
Future Vol, veh/h	0	311	58	43	276	0	76	0	339	11	116	85
Conflicting Peds, #/hr	0	0	0	0	0	0	0	0	1	1	0	0
Sign Control	Free	Free	Free	Free	Free	Free	Stop	Stop	Stop	Stop	Stop	Stop
RT Channelized	-	-	None	-	-	None	-	-	None	-	-	None
Storage Length	-	-	50	-	-	-	0	-	25	-	-	-
Veh in Median Storage, #	-	0	-	-	0	-	-	0	-	-	0	-
Grade, %	-	0	-	-	0	-	-	0	-	-	0	-
Peak Hour Factor	92	92	92	92	92	92	92	92	92	92	92	92
Heavy Vehicles, %	32	32	32	26	26	26	10	10	10	24	24	24
Mvmt Flow	0	338	63	47	300	0	83	0	368	12	126	92

Major/Minor	Major1			Major2			Minor1			Minor2		
Conflicting Flow All	-	0	0	401	0	0	841	-	339	949	795	300
Stage 1	-	-	-	-	-	-	338	-	-	394	394	-
Stage 2	-	-	-	-	-	-	503	-	-	555	401	-
Critical Hdwy	-	-	-	4.36	-	-	7.2	-	6.3	7.34	6.74	6.44
Critical Hdwy Stg 1	-	-	-	-	-	-	6.2	-	-	6.34	5.74	-
Critical Hdwy Stg 2	-	-	-	-	-	-	6.2	-	-	6.34	5.74	-
Follow-up Hdwy	-	-	-	2.434	-	-	3.59	-	3.39	3.716	4.216	3.516
Pot Cap-1 Maneuver	0	-	-	1039	-	0	276	0	685	219	296	691
Stage 1	0	-	-	-	-	0	660	0	-	589	569	-
Stage 2	0	-	-	-	-	0	536	0	-	479	565	-
Platoon blocked, %	-	-	-	-	-	-	-	-	-	-	-	-
Mov Cap-1 Maneuver	-	-	-	1039	-	-	149	-	684	97	280	691
Mov Cap-2 Maneuver	-	-	-	-	-	-	149	-	-	97	280	-
Stage 1	-	-	-	-	-	-	660	-	-	589	538	-
Stage 2	-	-	-	-	-	-	336	-	-	221	565	-

Approach	EB			WB			NB			SB		
HCM Control Delay, s	0			1.2			23.4			38.8		
HCM LOS							C			E		

Minor Lane/Major Mvmt	NBLn1	NBLn2	EBT	EBR	WBL	WBT	SBLn1
Capacity (veh/h)	149	684	-	-	1039	-	326
HCM Lane V/C Ratio	0.554	0.539	-	-	0.045	-	0.707
HCM Control Delay (s)	55.7	16.2	-	-	8.6	0	38.8
HCM Lane LOS	F	C	-	-	A	A	E
HCM 95th %tile Q(veh)	2.8	3.2	-	-	0.1	-	5.1

HCM 6th TWSC
6: SR-99 Northbound Ramps & Avenue 18 1/2

Village D Specific Plan
Phase I WP - AM Peak Hour

Intersection												
Int Delay, s/veh	122.6											
Movement	EBL	EBT	EBR	WBL	WBT	WBR	NBL	NBT	NBR	SBL	SBT	SBR
Lane Configurations	↖	↑			↗			↔				
Traffic Vol, veh/h	411	57	0	0	142	27	214	1	21	0	0	0
Future Vol, veh/h	411	57	0	0	142	27	214	1	21	0	0	0
Conflicting Peds, #/hr	1	0	0	0	0	1	0	0	0	0	0	0
Sign Control	Free	Free	Free	Free	Free	Free	Stop	Stop	Stop	Free	Free	Free
RT Channelized	-	-	None	-	-	None	-	-	None	-	-	None
Storage Length	145	-	-	-	-	-	-	-	-	-	-	-
Veh in Median Storage, #	-	0	-	-	0	-	-	0	-	-	16965	-
Grade, %	-	0	-	-	0	-	-	0	-	-	0	-
Peak Hour Factor	92	92	92	92	92	92	92	92	92	92	92	92
Heavy Vehicles, %	18	18	18	18	18	18	29	29	29	0	0	0
Mvmt Flow	447	62	0	0	154	29	233	1	23	0	0	0

Major/Minor	Major1	Major2	Minor1
Conflicting Flow All	184	0	-
Stage 1	-	-	-
Stage 2	-	-	-
Critical Hdwy	4.28	-	-
Critical Hdwy Stg 1	-	-	-
Critical Hdwy Stg 2	-	-	-
Follow-up Hdwy	2.362	-	-
Pot Cap-1 Maneuver	1300	-	0
Stage 1	-	-	0
Stage 2	-	-	0
Platoon blocked, %	-	-	-
Mov Cap-1 Maneuver	1300	-	-
Mov Cap-2 Maneuver	-	-	-
Stage 1	-	-	-
Stage 2	-	-	-

Approach	EB	WB	NB
HCM Control Delay, s	8.1	0	\$ 437.3
HCM LOS			F

Minor Lane/Major Mvmt	NBLn1	EBL	EBT	WBT	WBR
Capacity (veh/h)	143	1300	-	-	-
HCM Lane V/C Ratio	1.794	0.344	-	-	-
HCM Control Delay (s)	\$ 437.3	9.2	-	-	-
HCM Lane LOS	F	A	-	-	-
HCM 95th %tile Q(veh)	19.2	1.5	-	-	-

Notes
 -: Volume exceeds capacity \$: Delay exceeds 300s +: Computation Not Defined *: All major volume in platoon

Intersection												
Int Delay, s/veh	5.7											
Movement	EBL	EBT	EBR	WBL	WBT	WBR	NBL	NBT	NBR	SBL	SBT	SBR
Lane Configurations		↕			↕			↕			↕	
Traffic Vol, veh/h	2	27	19	85	20	3	42	435	120	15	200	0
Future Vol, veh/h	2	27	19	85	20	3	42	435	120	15	200	0
Conflicting Peds, #/hr	0	0	0	0	0	0	0	0	0	0	0	0
Sign Control	Stop	Stop	Stop	Stop	Stop	Stop	Free	Free	Free	Free	Free	Free
RT Channelized	-	-	None	-	-	None	-	-	None	-	-	None
Storage Length	-	-	-	-	-	-	-	-	-	-	-	-
Veh in Median Storage, #	-	0	-	-	0	-	-	0	-	-	0	-
Grade, %	-	0	-	-	0	-	-	0	-	-	0	-
Peak Hour Factor	92	92	92	92	92	92	92	92	92	92	92	92
Heavy Vehicles, %	5	5	5	14	14	14	6	6	6	13	13	13
Mvmt Flow	2	29	21	92	22	3	46	473	130	16	217	0

Major/Minor	Minor2		Minor1		Major1		Major2					
Conflicting Flow All	892	944	217	904	879	538	217	0	0	603	0	0
Stage 1	249	249	-	630	630	-	-	-	-	-	-	-
Stage 2	643	695	-	274	249	-	-	-	-	-	-	-
Critical Hdwy	7.15	6.55	6.25	7.24	6.64	6.34	4.16	-	-	4.23	-	-
Critical Hdwy Stg 1	6.15	5.55	-	6.24	5.64	-	-	-	-	-	-	-
Critical Hdwy Stg 2	6.15	5.55	-	6.24	5.64	-	-	-	-	-	-	-
Follow-up Hdwy	3.545	4.045	3.345	3.626	4.126	3.426	2.254	-	-	2.317	-	-
Pot Cap-1 Maneuver	260	259	815	246	274	521	1329	-	-	923	-	-
Stage 1	748	695	-	450	457	-	-	-	-	-	-	-
Stage 2	457	439	-	707	679	-	-	-	-	-	-	-
Platoon blocked, %								-	-	-	-	-
Mov Cap-1 Maneuver	228	240	815	206	254	521	1329	-	-	923	-	-
Mov Cap-2 Maneuver	228	240	-	206	254	-	-	-	-	-	-	-
Stage 1	708	681	-	426	433	-	-	-	-	-	-	-
Stage 2	408	416	-	646	665	-	-	-	-	-	-	-

Approach	EB		WB		NB		SB	
HCM Control Delay, s	17.9		39.6		0.5		0.6	
HCM LOS	C		E					

Minor Lane/Major Mvmt	NBL	NBT	NBR	EBLn1WBLn1	SBL	SBT	SBR
Capacity (veh/h)	1329	-	-	332	217	923	-
HCM Lane V/C Ratio	0.034	-	-	0.157	0.541	0.018	-
HCM Control Delay (s)	7.8	0	-	17.9	39.6	9	0
HCM Lane LOS	A	A	-	C	E	A	A
HCM 95th %tile Q(veh)	0.1	-	-	0.6	2.9	0.1	-

Intersection	
Intersection Delay, s/veh	27.1
Intersection LOS	D

Movement	EBL	EBT	EBR	WBL	WBT	WBR	NBL	NBT	NBR	SBL	SBT	SBR
Lane Configurations	↶	↷		↶	↷		↶	↷		↶	↷	
Traffic Vol, veh/h	8	11	15	137	4	198	26	421	23	33	311	10
Future Vol, veh/h	8	11	15	137	4	198	26	421	23	33	311	10
Peak Hour Factor	0.92	0.92	0.92	0.92	0.92	0.92	0.92	0.92	0.92	0.92	0.92	0.92
Heavy Vehicles, %	25	25	25	0	0	0	8	8	8	11	11	11
Mvmt Flow	9	12	16	149	4	215	28	458	25	36	338	11
Number of Lanes	1	1	0	1	1	0	1	1	0	1	1	0

Approach	EB	WB	NB	SB
Opposing Approach	WB	EB	SB	NB
Opposing Lanes	2	2	2	2
Conflicting Approach Left	SB	NB	EB	WB
Conflicting Lanes Left	2	2	2	2
Conflicting Approach Right	NB	SB	WB	EB
Conflicting Lanes Right	2	2	2	2
HCM Control Delay	11.7	14	41.7	21.8
HCM LOS	B	B	E	C

Lane	NBLn1	NBLn2	EBLn1	EBLn2	WBLn1	WBLn2	SBLn1	SBLn2
Vol Left, %	100%	0%	100%	0%	100%	0%	100%	0%
Vol Thru, %	0%	95%	0%	42%	0%	2%	0%	97%
Vol Right, %	0%	5%	0%	58%	0%	98%	0%	3%
Sign Control	Stop	Stop	Stop	Stop	Stop	Stop	Stop	Stop
Traffic Vol by Lane	26	444	8	26	137	202	33	321
LT Vol	26	0	8	0	137	0	33	0
Through Vol	0	421	0	11	0	4	0	311
RT Vol	0	23	0	15	0	198	0	10
Lane Flow Rate	28	483	9	28	149	220	36	349
Geometry Grp	7	7	7	7	7	7	7	7
Degree of Util (X)	0.057	0.899	0.022	0.065	0.325	0.405	0.074	0.673
Departure Headway (Hd)	7.253	6.707	9.231	8.294	7.852	6.636	7.472	6.939
Convergence, Y/N	Yes	Yes	Yes	Yes	Yes	Yes	Yes	Yes
Cap	497	545	387	431	459	542	480	520
Service Time	4.953	4.407	6.996	6.059	5.594	4.377	5.213	4.679
HCM Lane V/C Ratio	0.056	0.886	0.023	0.065	0.325	0.406	0.075	0.671
HCM Control Delay	10.4	43.5	12.2	11.6	14.3	13.8	10.8	22.9
HCM Lane LOS	B	E	B	B	B	B	B	C
HCM 95th-tile Q	0.2	10.5	0.1	0.2	1.4	1.9	0.2	5

Intersection

Intersection Delay, s/veh 76.4

Intersection LOS F

Movement	EBL	EBT	EBR	WBL	WBT	WBR	NBL	NBT	NBR	SBL	SBT	SBR
Lane Configurations	↶	↷		↶	↷		↶	↷		↶	↷	
Traffic Vol, veh/h	0	0	0	303	0	220	0	305	295	196	262	0
Future Vol, veh/h	0	0	0	303	0	220	0	305	295	196	262	0
Peak Hour Factor	0.92	0.92	0.92	0.92	0.92	0.92	0.92	0.92	0.92	0.92	0.92	0.92
Heavy Vehicles, %	0	0	0	2	2	2	7	7	7	11	11	11
Mvmt Flow	0	0	0	329	0	239	0	332	321	213	285	0
Number of Lanes	1	1	0	1	1	0	1	1	0	1	1	0

Approach	EB	WB	NB	SB
Opposing Approach	WB	EB	SB	NB
Opposing Lanes	2	2	2	2
Conflicting Approach Left SB		NB	EB	WB
Conflicting Lanes Left	2	2	2	2
Conflicting Approach Right NB		SB	WB	EB
Conflicting Lanes Right	2	2	2	2
HCM Control Delay	0	24	165.2	20
HCM LOS	-	C	F	C

Lane	NBLn1	NBLn2	EBLn1	EBLn2	WBLn1	WBLn2	SBLn1	SBLn2
Vol Left, %	0%	0%	0%	0%	100%	0%	100%	0%
Vol Thru, %	100%	51%	100%	100%	0%	0%	0%	100%
Vol Right, %	0%	49%	0%	0%	0%	100%	0%	0%
Sign Control	Stop	Stop	Stop	Stop	Stop	Stop	Stop	Stop
Traffic Vol by Lane	0	600	0	0	303	220	196	262
LT Vol	0	0	0	0	303	0	196	0
Through Vol	0	305	0	0	0	0	0	262
RT Vol	0	295	0	0	0	220	0	0
Lane Flow Rate	0	652	0	0	329	239	213	285
Geometry Grp	7	7	7	7	7	7	7	7
Degree of Util (X)	0	1.286	0	0	0.723	0.445	0.469	0.588
Departure Headway (Hd)	7.453	7.099	9.778	9.778	8.431	7.192	8.395	7.878
Convergence, Y/N	Yes	Yes	Yes	Yes	Yes	Yes	Yes	Yes
Cap	0	515	0	0	431	505	432	461
Service Time	5.202	4.848	7.478	7.478	6.131	4.892	6.095	5.578
HCM Lane V/C Ratio	0	1.266	0	0	0.763	0.473	0.493	0.618
HCM Control Delay	10.2	165.2	12.5	12.5	30.2	15.5	18.3	21.2
HCM Lane LOS	N	F	N	N	D	C	C	C
HCM 95th-tile Q	0	27	0	0	5.7	2.3	2.4	3.7

Intersection												
Int Delay, s/veh	2.6											
Movement	EBL	EBT	EBR	WBL	WBT	WBR	NBL	NBT	NBR	SBL	SBT	SBR
Lane Configurations		↕			↕			↕			↕	
Traffic Vol, veh/h	0	5	0	17	3	110	3	334	4	62	448	0
Future Vol, veh/h	0	5	0	17	3	110	3	334	4	62	448	0
Conflicting Peds, #/hr	0	0	0	0	0	0	0	0	0	0	0	0
Sign Control	Stop	Stop	Stop	Stop	Stop	Stop	Free	Free	Free	Free	Free	Free
RT Channelized	-	-	None	-	-	None	-	-	None	-	-	None
Storage Length	-	-	-	-	-	-	-	-	-	-	-	-
Veh in Median Storage, #	-	0	-	-	0	-	-	0	-	-	0	-
Grade, %	-	0	-	-	0	-	-	0	-	-	0	-
Peak Hour Factor	92	92	92	92	92	92	92	92	92	92	92	92
Heavy Vehicles, %	0	0	0	0	0	0	11	11	11	8	8	8
Mvmt Flow	0	5	0	18	3	120	3	363	4	67	487	0

Major/Minor	Minor2			Minor1			Major1			Major2		
Conflicting Flow All	1054	994	487	995	992	365	487	0	0	367	0	0
Stage 1	621	621	-	371	371	-	-	-	-	-	-	-
Stage 2	433	373	-	624	621	-	-	-	-	-	-	-
Critical Hdwy	7.1	6.5	6.2	7.1	6.5	6.2	4.21	-	-	4.18	-	-
Critical Hdwy Stg 1	6.1	5.5	-	6.1	5.5	-	-	-	-	-	-	-
Critical Hdwy Stg 2	6.1	5.5	-	6.1	5.5	-	-	-	-	-	-	-
Follow-up Hdwy	3.5	4	3.3	3.5	4	3.3	2.299	-	-	2.272	-	-
Pot Cap-1 Maneuver	206	247	585	226	248	685	1031	-	-	1159	-	-
Stage 1	478	482	-	653	623	-	-	-	-	-	-	-
Stage 2	605	622	-	477	482	-	-	-	-	-	-	-
Platoon blocked, %								-	-	-	-	-
Mov Cap-1 Maneuver	158	226	585	208	227	685	1031	-	-	1159	-	-
Mov Cap-2 Maneuver	158	226	-	208	227	-	-	-	-	-	-	-
Stage 1	476	444	-	650	621	-	-	-	-	-	-	-
Stage 2	495	620	-	434	444	-	-	-	-	-	-	-

Approach	EB			WB			NB			SB		
HCM Control Delay, s	21.3			14.8			0.1			1		
HCM LOS	C			B								

Minor Lane/Major Mvmt	NBL	NBT	NBR	EBLn1WBLn1	SBL	SBT	SBR
Capacity (veh/h)	1031	-	-	226	509	1159	-
HCM Lane V/C Ratio	0.003	-	-	0.024	0.278	0.058	-
HCM Control Delay (s)	8.5	0	-	21.3	14.8	8.3	0
HCM Lane LOS	A	A	-	C	B	A	A
HCM 95th %tile Q(veh)	0	-	-	0.1	1.1	0.2	-

Intersection	
Intersection Delay, s/veh	38.2
Intersection LOS	E

Movement	EBL	EBT	EBR	WBL	WBT	WBR	NBL	NBT	NBR	SBL	SBT	SBR
Lane Configurations		↕			↕			↕			↕	
Traffic Vol, veh/h	71	147	32	19	179	139	34	132	8	163	199	102
Future Vol, veh/h	71	147	32	19	179	139	34	132	8	163	199	102
Peak Hour Factor	0.92	0.92	0.92	0.92	0.92	0.92	0.92	0.92	0.92	0.92	0.92	0.92
Heavy Vehicles, %	6	6	6	6	6	6	23	23	23	8	8	8
Mvmt Flow	77	160	35	21	195	151	37	143	9	177	216	111
Number of Lanes	0	1	0	0	1	0	0	1	0	0	1	0

Approach	EB	WB	NB	SB
Opposing Approach	WB	EB	SB	NB
Opposing Lanes	1	1	1	1
Conflicting Approach Left	SB	NB	EB	WB
Conflicting Lanes Left	1	1	1	1
Conflicting Approach Right	NB	SB	WB	EB
Conflicting Lanes Right	1	1	1	1
HCM Control Delay	21.6	28.9	17.9	61.5
HCM LOS	C	D	C	F

Lane	NBLn1	EBLn1	WBLn1	SBLn1
Vol Left, %	20%	28%	6%	35%
Vol Thru, %	76%	59%	53%	43%
Vol Right, %	5%	13%	41%	22%
Sign Control	Stop	Stop	Stop	Stop
Traffic Vol by Lane	174	250	337	464
LT Vol	34	71	19	163
Through Vol	132	147	179	199
RT Vol	8	32	139	102
Lane Flow Rate	189	272	366	504
Geometry Grp	1	1	1	1
Degree of Util (X)	0.441	0.592	0.746	0.979
Departure Headway (Hd)	8.389	7.843	7.336	7.105
Convergence, Y/N	Yes	Yes	Yes	Yes
Cap	429	462	495	514
Service Time	6.435	5.862	5.351	5.105
HCM Lane V/C Ratio	0.441	0.589	0.739	0.981
HCM Control Delay	17.9	21.6	28.9	61.5
HCM Lane LOS	C	C	D	F
HCM 95th-tile Q	2.2	3.8	6.3	13

Intersection

Intersection Delay, s/veh 9.6

Intersection LOS A

Movement	EBL	EBT	EBR	WBL	WBT	WBR	NBL	NBT	NBR	SBL	SBT	SBR
Lane Configurations												
Traffic Vol, veh/h	32	83	4	11	86	52	8	41	16	67	66	68
Future Vol, veh/h	32	83	4	11	86	52	8	41	16	67	66	68
Peak Hour Factor	0.92	0.92	0.92	0.92	0.92	0.92	0.92	0.92	0.92	0.92	0.92	0.92
Heavy Vehicles, %	9	9	9	29	29	29	9	9	9	12	12	12
Mvmt Flow	35	90	4	12	93	57	9	45	17	73	72	74
Number of Lanes	1	1	0	1	1	0	0	1	0	0	1	0

Approach	EB	WB	NB	SB
Opposing Approach	WB	EB	SB	NB
Opposing Lanes	2	2	1	1
Conflicting Approach Left	SB	NB	EB	WB
Conflicting Lanes Left	1	1	2	2
Conflicting Approach Right	NB	SB	WB	EB
Conflicting Lanes Right	1	1	2	2
HCM Control Delay	9.2	10	8.6	9.9
HCM LOS	A	A	A	A

Lane	NBLn1	EBLn1	EBLn2	WBLn1	WBLn2	SBLn1
Vol Left, %	12%	100%	0%	100%	0%	33%
Vol Thru, %	63%	0%	95%	0%	62%	33%
Vol Right, %	25%	0%	5%	0%	38%	34%
Sign Control	Stop	Stop	Stop	Stop	Stop	Stop
Traffic Vol by Lane	65	32	87	11	138	201
LT Vol	8	32	0	11	0	67
Through Vol	41	0	83	0	86	66
RT Vol	16	0	4	0	52	68
Lane Flow Rate	71	35	95	12	150	218
Geometry Grp	2	7	7	7	7	2
Degree of Util (X)	0.098	0.059	0.145	0.021	0.233	0.294
Departure Headway (Hd)	5.004	6.057	5.52	6.361	5.59	4.846
Convergence, Y/N	Yes	Yes	Yes	Yes	Yes	Yes
Cap	711	588	646	560	639	738
Service Time	3.069	3.827	3.29	4.129	3.358	2.894
HCM Lane V/C Ratio	0.1	0.06	0.147	0.021	0.235	0.295
HCM Control Delay	8.6	9.2	9.2	9.3	10.1	9.9
HCM Lane LOS	A	A	A	A	B	A
HCM 95th-tile Q	0.3	0.2	0.5	0.1	0.9	1.2

Intersection												
Int Delay, s/veh	18.2											
Movement	EBL	EBT	EBR	WBL	WBT	WBR	NBL	NBT	NBR	SBL	SBT	SBR
Lane Configurations	↖	↗	↖	↖	↗	↖	↖	↗	↖		↔	
Traffic Vol, veh/h	4	129	19	188	100	154	17	55	107	134	31	4
Future Vol, veh/h	4	129	19	188	100	154	17	55	107	134	31	4
Conflicting Peds, #/hr	0	0	0	0	0	0	1	0	0	0	0	1
Sign Control	Free	Free	Free	Free	Free	Free	Stop	Stop	Stop	Stop	Stop	Stop
RT Channelized	-	-	None	-	-	None	-	-	None	-	-	None
Storage Length	85	-	0	70	-	105	60	-	50	-	-	-
Veh in Median Storage, #	-	0	-	-	0	-	-	0	-	-	0	-
Grade, %	-	0	-	-	0	-	-	0	-	-	0	-
Peak Hour Factor	92	92	92	92	92	92	92	92	92	92	92	92
Heavy Vehicles, %	6	6	6	8	8	8	13	13	13	9	9	9
Mvmt Flow	4	140	21	204	109	167	18	60	116	146	34	4

Major/Minor	Major1			Major2			Minor1			Minor2		
Conflicting Flow All	276	0	0	161	0	0	769	832	140	764	686	110
Stage 1	-	-	-	-	-	-	148	148	-	517	517	-
Stage 2	-	-	-	-	-	-	621	684	-	247	169	-
Critical Hdwy	4.16	-	-	4.18	-	-	7.23	6.63	6.33	7.19	6.59	6.29
Critical Hdwy Stg 1	-	-	-	-	-	-	6.23	5.63	-	6.19	5.59	-
Critical Hdwy Stg 2	-	-	-	-	-	-	6.23	5.63	-	6.19	5.59	-
Follow-up Hdwy	2.254	-	-	2.272	-	-	3.617	4.117	3.417	3.581	4.081	3.381
Pot Cap-1 Maneuver	1264	-	-	1382	-	-	305	293	880	312	362	925
Stage 1	-	-	-	-	-	-	829	754	-	529	522	-
Stage 2	-	-	-	-	-	-	457	433	-	742	746	-
Platoon blocked, %	-	-	-	-	-	-	-	-	-	-	-	-
Mov Cap-1 Maneuver	1264	-	-	1382	-	-	246	249	880	196	307	924
Mov Cap-2 Maneuver	-	-	-	-	-	-	246	249	-	196	307	-
Stage 1	-	-	-	-	-	-	827	752	-	527	445	-
Stage 2	-	-	-	-	-	-	358	369	-	591	744	-

Approach	EB			WB			NB			SB		
HCM Control Delay, s	0.2			3.4			15.1			76.6		
HCM LOS							C			F		

Minor Lane/Major Mvmt	NBLn1	NBLn2	NBLn3	EBL	EBT	EBR	WBL	WBT	WBR	SBLn1
Capacity (veh/h)	246	249	880	1264	-	-	1382	-	-	214
HCM Lane V/C Ratio	0.075	0.24	0.132	0.003	-	-	0.148	-	-	0.858
HCM Control Delay (s)	20.8	24	9.7	7.9	-	-	8.1	-	-	76.6
HCM Lane LOS	C	C	A	A	-	-	A	-	-	F
HCM 95th %tile Q(veh)	0.2	0.9	0.5	0	-	-	0.5	-	-	6.6

Intersection						
Int Delay, s/veh	11.8					
Movement	EBL	EBT	WBT	WBR	SBL	SBR
Lane Configurations		↑	↑		↑	↑
Traffic Vol, veh/h	0	373	370	0	251	75
Future Vol, veh/h	0	373	370	0	251	75
Conflicting Peds, #/hr	0	0	0	0	0	0
Sign Control	Free	Free	Free	Free	Stop	Stop
RT Channelized	-	None	-	None	-	None
Storage Length	-	-	-	-	0	610
Veh in Median Storage, #	-	0	0	-	0	-
Grade, %	-	0	0	-	0	-
Peak Hour Factor	92	92	92	92	92	92
Heavy Vehicles, %	10	10	9	9	9	9
Mvmt Flow	0	405	402	0	273	82

Major/Minor	Major1	Major2	Minor2		
Conflicting Flow All	-	0	-	0	807
Stage 1	-	-	-	-	402
Stage 2	-	-	-	-	405
Critical Hdwy	-	-	-	-	6.49
Critical Hdwy Stg 1	-	-	-	-	5.49
Critical Hdwy Stg 2	-	-	-	-	5.49
Follow-up Hdwy	-	-	-	-	3.581
Pot Cap-1 Maneuver	0	-	-	0	341
Stage 1	0	-	-	0	661
Stage 2	0	-	-	0	659
Platoon blocked, %	-	-	-	-	-
Mov Cap-1 Maneuver	-	-	-	-	341
Mov Cap-2 Maneuver	-	-	-	-	341
Stage 1	-	-	-	-	661
Stage 2	-	-	-	-	659

Approach	EB	WB	SB
HCM Control Delay, s	0	0	38.8
HCM LOS			E

Minor Lane/Major Mvmt	EBT	WBT	SBLn1	SBLn2
Capacity (veh/h)	-	-	341	633
HCM Lane V/C Ratio	-	-	0.8	0.129
HCM Control Delay (s)	-	-	46.9	11.5
HCM Lane LOS	-	-	E	B
HCM 95th %tile Q(veh)	-	-	6.7	0.4

HCM 6th TWSC
15: SR-99 Northbound Ramps & Avenue 17

Village D Specific Plan
Phase I WP - AM Peak Hour

Intersection												
Int Delay, s/veh	57.7											
Movement	EBL	EBT	EBR	WBL	WBT	WBR	NBL	NBT	NBR	SBL	SBT	SBR
Lane Configurations	↖	↑			↗			↖	↗			
Traffic Vol, veh/h	83	430	0	0	908	236	157	2	240	0	0	0
Future Vol, veh/h	83	430	0	0	908	236	157	2	240	0	0	0
Conflicting Peds, #/hr	0	0	0	0	0	0	0	0	0	0	0	0
Sign Control	Free	Free	Free	Free	Free	Free	Stop	Stop	Stop	Free	Free	Free
RT Channelized	-	-	None	-	-	None	-	-	None	-	-	None
Storage Length	125	-	-	-	-	-	-	-	50	-	-	-
Veh in Median Storage, #	-	0	-	-	0	-	-	0	-	-	16965	-
Grade, %	-	0	-	-	0	-	-	0	-	-	0	-
Peak Hour Factor	92	92	92	92	92	92	92	92	92	92	92	92
Heavy Vehicles, %	5	5	5	2	2	2	6	6	6	0	0	0
Mvmt Flow	90	467	0	0	987	257	171	2	261	0	0	0

Major/Minor	Major1	Major2	Minor1
Conflicting Flow All	1244	0	0
Stage 1	-	-	647
Stage 2	-	-	1116
Critical Hdwy	4.15	-	6.46
Critical Hdwy Stg 1	-	-	5.46
Critical Hdwy Stg 2	-	-	5.46
Follow-up Hdwy	2.245	-	3.554
Pot Cap-1 Maneuver	549	0	90
Stage 1	-	0	514
Stage 2	-	0	308
Platoon blocked, %	-	-	-
Mov Cap-1 Maneuver	549	-	75
Mov Cap-2 Maneuver	-	-	75
Stage 1	-	-	430
Stage 2	-	-	308

Approach	EB	WB	NB
HCM Control Delay, s	2.1	0	294.5
HCM LOS			F

Minor Lane/Major Mvmt	NBLn1	NBLn2	EBL	EBT	WBT	WBR
Capacity (veh/h)	75	588	549	-	-	-
HCM Lane V/C Ratio	2.304	0.444	0.164	-	-	-
HCM Control Delay (s)	\$ 715.1	15.9	12.8	-	-	-
HCM Lane LOS	F	C	B	-	-	-
HCM 95th %tile Q(veh)	16.2	2.3	0.6	-	-	-

Notes
 -: Volume exceeds capacity \$: Delay exceeds 300s +: Computation Not Defined *: All major volume in platoon

HCM 6th Signalized Intersection Summary
 16: Love's Truck Stop Driveway/Driveway & Avenue 17

Village D Specific Plan
 Phase I WP - AM Peak Hour



Movement	EBL	EBT	EBR	WBL	WBT	WBR	NBL	NBT	NBR	SBL	SBT	SBR
Lane Configurations												
Traffic Volume (veh/h)	162	372	132	45	858	56	136	0	22	48	0	90
Future Volume (veh/h)	162	372	132	45	858	56	136	0	22	48	0	90
Initial Q (Qb), veh	0	0	0	0	0	0	0	0	0	0	0	0
Ped-Bike Adj(A_pbT)	1.00		1.00	1.00		1.00	1.00		1.00	1.00		1.00
Parking Bus, Adj	1.00	1.00	1.00	1.00	1.00	1.00	1.00	1.00	1.00	1.00	1.00	1.00
Work Zone On Approach		No			No			No			No	
Adj Sat Flow, veh/h/ln	1870	1870	1870	1856	1856	1856	1900	1900	1900	1900	1900	1900
Adj Flow Rate, veh/h	176	404	143	49	933	61	148	0	24	52	0	98
Peak Hour Factor	0.92	0.92	0.92	0.92	0.92	0.92	0.92	0.92	0.92	0.92	0.92	0.92
Percent Heavy Veh, %	2	2	2	3	3	3	0	0	0	0	0	0
Cap, veh/h	89	1947	868	66	922	60	90	0	317	69	0	298
Arrive On Green	0.05	0.55	0.55	0.04	0.54	0.54	0.05	0.00	0.20	0.04	0.00	0.19
Sat Flow, veh/h	1781	3554	1585	1767	1723	113	1810	0	1610	1810	0	1610
Grp Volume(v), veh/h	176	404	143	49	0	994	148	0	24	52	0	98
Grp Sat Flow(s),veh/h/ln	1781	1777	1585	1767	0	1835	1810	0	1610	1810	0	1610
Q Serve(g_s), s	5.0	5.8	4.5	2.7	0.0	53.5	5.0	0.0	1.2	2.8	0.0	5.3
Cycle Q Clear(g_c), s	5.0	5.8	4.5	2.7	0.0	53.5	5.0	0.0	1.2	2.8	0.0	5.3
Prop In Lane	1.00		1.00	1.00		0.06	1.00		1.00	1.00		1.00
Lane Grp Cap(c), veh/h	89	1947	868	66	0	982	90	0	317	69	0	298
V/C Ratio(X)	1.98	0.21	0.16	0.75	0.00	1.01	1.64	0.00	0.08	0.75	0.00	0.33
Avail Cap(c_a), veh/h	89	1947	868	88	0	982	90	0	317	90	0	298
HCM Platoon Ratio	1.00	1.00	1.00	1.00	1.00	1.00	1.00	1.00	1.00	1.00	1.00	1.00
Upstream Filter(I)	1.00	1.00	1.00	1.00	0.00	1.00	1.00	0.00	1.00	1.00	0.00	1.00
Uniform Delay (d), s/veh	47.5	11.5	11.2	47.7	0.0	23.3	47.5	0.0	32.7	47.6	0.0	35.4
Incr Delay (d2), s/veh	476.9	0.1	0.1	20.5	0.0	31.8	330.4	0.0	0.5	22.0	0.0	2.9
Initial Q Delay(d3),s/veh	0.0	0.0	0.0	0.0	0.0	0.0	0.0	0.0	0.0	0.0	0.0	0.0
%ile BackOfQ(50%),veh/ln	14.0	2.2	1.5	1.6	0.0	29.8	10.5	0.0	0.5	1.7	0.0	2.3
Unsig. Movement Delay, s/veh												
LnGrp Delay(d),s/veh	524.4	11.6	11.3	68.2	0.0	55.1	377.9	0.0	33.2	69.6	0.0	38.3
LnGrp LOS	F	B	B	E	A	F	F	A	C	E	A	D
Approach Vol, veh/h		723			1043			172				150
Approach Delay, s/veh		136.4			55.7			329.8				49.2
Approach LOS		F			E			F				D
Timer - Assigned Phs	1	2	3	4	5	6	7	8				
Phs Duration (G+Y+Rc), s	8.3	24.2	8.2	59.3	9.5	23.0	9.5	58.0				
Change Period (Y+Rc), s	4.5	4.5	4.5	4.5	4.5	4.5	4.5	4.5				
Max Green Setting (Gmax), s	5.0	18.5	5.0	53.5	5.0	18.5	5.0	53.5				
Max Q Clear Time (g_c+I1), s	4.8	3.2	4.7	7.8	7.0	7.3	7.0	55.5				
Green Ext Time (p_c), s	0.0	0.0	0.0	3.5	0.0	0.3	0.0	0.0				

Intersection Summary

HCM 6th Ctrl Delay	105.7
HCM 6th LOS	F

Intersection												
Int Delay, s/veh	71.9											
Movement	EBL	EBT	EBR	WBL	WBT	WBR	NBL	NBT	NBR	SBL	SBT	SBR
Lane Configurations	↖	↗		↖	↗		↖	↑	↗	↖	↑	↗
Traffic Vol, veh/h	254	801	64	27	296	12	38	102	98	14	39	106
Future Vol, veh/h	254	801	64	27	296	12	38	102	98	14	39	106
Conflicting Peds, #/hr	1	0	2	2	0	1	1	0	1	1	0	1
Sign Control	Free	Free	Free	Free	Free	Free	Stop	Stop	Stop	Stop	Stop	Stop
RT Channelized	-	-	None	-	-	None	-	-	None	-	-	None
Storage Length	110	-	-	165	-	-	65	-	50	100	-	50
Veh in Median Storage, #	-	0	-	-	0	-	-	0	-	-	0	-
Grade, %	-	0	-	-	0	-	-	0	-	-	0	-
Peak Hour Factor	92	92	92	92	92	92	92	92	92	92	92	92
Heavy Vehicles, %	0	0	0	1	1	1	0	0	0	0	0	0
Mvmt Flow	276	871	70	29	322	13	41	111	107	15	42	115

Major/Minor	Major1			Major2			Minor1			Minor2		
Conflicting Flow All	336	0	0	943	0	0	1926	1854	909	1956	1883	331
Stage 1	-	-	-	-	-	-	1460	1460	-	388	388	-
Stage 2	-	-	-	-	-	-	466	394	-	1568	1495	-
Critical Hdwy	4.1	-	-	4.11	-	-	7.1	6.5	6.2	7.1	6.5	6.2
Critical Hdwy Stg 1	-	-	-	-	-	-	6.1	5.5	-	6.1	5.5	-
Critical Hdwy Stg 2	-	-	-	-	-	-	6.1	5.5	-	6.1	5.5	-
Follow-up Hdwy	2.2	-	-	2.209	-	-	3.5	4	3.3	3.5	4	3.3
Pot Cap-1 Maneuver	1235	-	-	731	-	-	51	~ 75	336	49	72	715
Stage 1	-	-	-	-	-	-	162	196	-	640	612	-
Stage 2	-	-	-	-	-	-	581	609	-	141	188	-
Platoon blocked, %	-	-	-	-	-	-	-	-	-	-	-	-
Mov Cap-1 Maneuver	1234	-	-	730	-	-	~ 12	~ 56	335	-	53	714
Mov Cap-2 Maneuver	-	-	-	-	-	-	~ 12	~ 56	-	-	53	-
Stage 1	-	-	-	-	-	-	126	152	-	497	587	-
Stage 2	-	-	-	-	-	-	434	584	-	20	146	-

Approach	EB			WB			NB			SB		
HCM Control Delay, s	2			0.8			\$ 548.4					
HCM LOS							F			-		

Minor Lane/Major Mvmt	NBLn1	NBLn2	NBLn3	EBL	EBT	EBR	WBL	WBT	WBR	SBLn1	SBLn2	SBLn3
Capacity (veh/h)	12	56	335	1234	-	-	730	-	-	-	53	714
HCM Lane V/C Ratio	3.442	1.98	0.318	0.224	-	-	0.04	-	-	-	0.8	0.161
HCM Control Delay (s)	\$ 1730	\$ 615.1	20.7	8.8	-	-	10.1	-	-	-	190.6	11
HCM Lane LOS	F	F	C	A	-	-	B	-	-	-	F	B
HCM 95th %tile Q(veh)	6.2	10.7	1.3	0.9	-	-	0.1	-	-	-	3.4	0.6

Notes												
-: Volume exceeds capacity	\$: Delay exceeds 300s			+: Computation Not Defined			*: All major volume in platoon					

Intersection	
Intersection Delay, s/veh	18.6
Intersection LOS	C

Movement	EBL	EBT	EBR	WBL	WBT	WBR	NBL	NBT	NBR	SBL	SBT	SBR
Lane Configurations	↘	↘		↘	↘		↘	↗	↘	↘	↗	↘
Traffic Vol, veh/h	50	217	88	51	173	25	119	138	109	117	103	33
Future Vol, veh/h	50	217	88	51	173	25	119	138	109	117	103	33
Peak Hour Factor	0.92	0.92	0.92	0.92	0.92	0.92	0.92	0.92	0.92	0.92	0.92	0.92
Heavy Vehicles, %	3	3	3	3	3	3	0	0	0	0	0	0
Mvmt Flow	54	236	96	55	188	27	129	150	118	127	112	36
Number of Lanes	1	1	0	1	1	0	1	1	1	1	1	1

Approach	EB	WB	NB	SB
Opposing Approach	WB	EB	SB	NB
Opposing Lanes	2	2	3	3
Conflicting Approach Left	SB	NB	EB	WB
Conflicting Lanes Left	3	3	2	2
Conflicting Approach Right	NB	SB	WB	EB
Conflicting Lanes Right	3	3	2	2
HCM Control Delay	26.1	17.7	14.5	14.7
HCM LOS	D	C	B	B

Lane	NBLn1	NBLn2	NBLn3	EBLn1	EBLn2	WBLn1	WBLn2	SBLn1	SBLn2	SBLn3
Vol Left, %	100%	0%	0%	100%	0%	100%	0%	100%	0%	0%
Vol Thru, %	0%	100%	0%	0%	71%	0%	87%	0%	100%	0%
Vol Right, %	0%	0%	100%	0%	29%	0%	13%	0%	0%	100%
Sign Control	Stop	Stop	Stop	Stop	Stop	Stop	Stop	Stop	Stop	Stop
Traffic Vol by Lane	119	138	109	50	305	51	198	117	103	33
LT Vol	119	0	0	50	0	51	0	117	0	0
Through Vol	0	138	0	0	217	0	173	0	103	0
RT Vol	0	0	109	0	88	0	25	0	0	33
Lane Flow Rate	129	150	118	54	332	55	215	127	112	36
Geometry Grp	8	8	8	8	8	8	8	8	8	8
Degree of Util (X)	0.314	0.343	0.247	0.129	0.721	0.137	0.495	0.319	0.265	0.078
Departure Headway (Hd)	8.736	8.229	7.506	8.539	7.829	8.885	8.288	9.043	8.526	7.801
Convergence, Y/N	Yes	Yes	Yes	Yes	Yes	Yes	Yes	Yes	Yes	Yes
Cap	411	438	479	421	464	405	437	398	421	459
Service Time	6.48	5.963	5.24	6.263	5.553	6.616	6.018	6.795	6.277	5.552
HCM Lane V/C Ratio	0.314	0.342	0.246	0.128	0.716	0.136	0.492	0.319	0.266	0.078
HCM Control Delay	15.4	15.2	12.7	12.5	28.3	13	18.9	16	14.3	11.2
HCM Lane LOS	C	C	B	B	D	B	C	C	B	B
HCM 95th-tile Q	1.3	1.5	1	0.4	5.7	0.5	2.7	1.4	1.1	0.3

Intersection												
Intersection Delay, s/veh	28.6											
Intersection LOS	D											

Movement	EBL	EBT	EBR	WBL	WBT	WBR	NBL	NBT	NBR	SBL	SBT	SBR
Lane Configurations		↕			↕			↕			↕	
Traffic Vol, veh/h	105	250	38	11	210	108	75	42	24	211	61	84
Future Vol, veh/h	105	250	38	11	210	108	75	42	24	211	61	84
Peak Hour Factor	0.92	0.92	0.92	0.92	0.92	0.92	0.92	0.92	0.92	0.92	0.92	0.92
Heavy Vehicles, %	5	5	5	6	6	6	0	0	0	0	0	0
Mvmt Flow	114	272	41	12	228	117	82	46	26	229	66	91
Number of Lanes	0	1	0	0	1	0	0	1	0	0	1	0

Approach	EB	WB	NB	SB
Opposing Approach	WB	EB	SB	NB
Opposing Lanes	1	1	1	1
Conflicting Approach Left	SB	NB	EB	WB
Conflicting Lanes Left	1	1	1	1
Conflicting Approach Right	NB	SB	WB	EB
Conflicting Lanes Right	1	1	1	1
HCM Control Delay	35.7	24.7	15.1	29.7
HCM LOS	E	C	C	D

Lane	NBLn1	EBLn1	WBLn1	SBLn1
Vol Left, %	53%	27%	3%	59%
Vol Thru, %	30%	64%	64%	17%
Vol Right, %	17%	10%	33%	24%
Sign Control	Stop	Stop	Stop	Stop
Traffic Vol by Lane	141	393	329	356
LT Vol	75	105	11	211
Through Vol	42	250	210	61
RT Vol	24	38	108	84
Lane Flow Rate	153	427	358	387
Geometry Grp	1	1	1	1
Degree of Util (X)	0.339	0.829	0.696	0.763
Departure Headway (Hd)	7.964	6.983	7.01	7.095
Convergence, Y/N	Yes	Yes	Yes	Yes
Cap	449	517	515	507
Service Time	6.06	5.051	5.085	5.162
HCM Lane V/C Ratio	0.341	0.826	0.695	0.763
HCM Control Delay	15.1	35.7	24.7	29.7
HCM Lane LOS	C	E	C	D
HCM 95th-tile Q	1.5	8.3	5.4	6.7

Intersection

Intersection Delay, s/veh10.1

Intersection LOS B

Movement	EBL	EBT	EBR	WBL	WBT	WBR	NBL	NBT	NBR	SBL	SBT	SBR
Lane Configurations		↔			↔	↔		↔	↔		↔	↔
Traffic Vol, veh/h	0	0	0	86	0	157	0	164	252	72	54	0
Future Vol, veh/h	0	0	0	86	0	157	0	164	252	72	54	0
Peak Hour Factor	0.92	0.92	0.92	0.92	0.92	0.92	0.92	0.92	0.92	0.92	0.92	0.92
Heavy Vehicles, %	0	0	0	3	3	3	0	0	0	0	0	0
Mvmt Flow	0	0	0	93	0	171	0	178	274	78	59	0
Number of Lanes	0	1	0	0	1	1	0	1	1	0	1	1

Approach	EB	WB	NB	SB
Opposing Approach	WB	EB	SB	NB
Opposing Lanes	2	1	2	2
Conflicting Approach Left	SB	NB	EB	WB
Conflicting Lanes Left	2	2	1	2
Conflicting Approach Right	NB	SB	WB	EB
Conflicting Lanes Right	2	2	2	1
HCM Control Delay	0	10	10	10.5
HCM LOS	-	A	A	B

Lane	NBLn1	NBLn2	EBLn1	WBLn1	WBLn2	SBLn1	SBLn2
Vol Left, %	0%	0%	0%	100%	0%	57%	0%
Vol Thru, %	100%	0%	100%	0%	0%	43%	100%
Vol Right, %	0%	100%	0%	0%	100%	0%	0%
Sign Control	Stop	Stop	Stop	Stop	Stop	Stop	Stop
Traffic Vol by Lane	164	252	0	86	157	126	0
LT Vol	0	0	0	86	0	72	0
Through Vol	164	0	0	0	0	54	0
RT Vol	0	252	0	0	157	0	0
Lane Flow Rate	178	274	0	93	171	137	0
Geometry Grp	7	7	6	7	7	7	7
Degree of Util (X)	0.266	0.355	0	0.166	0.247	0.227	0
Departure Headway (Hd)	5.372	4.666	6.376	6.411	5.201	5.957	5.668
Convergence, Y/N	Yes	Yes	Yes	Yes	Yes	Yes	Yes
Cap	665	764	0	555	683	597	0
Service Time	3.141	2.435	4.376	4.202	2.99	3.751	3.461
HCM Lane V/C Ratio	0.268	0.359	0	0.168	0.25	0.229	0
HCM Control Delay	10.1	10	9.4	10.5	9.7	10.5	8.5
HCM Lane LOS	B	A	N	B	A	B	N
HCM 95th-tile Q	1.1	1.6	0	0.6	1	0.9	0

Intersection	
Intersection Delay, s/veh	159.7
Intersection LOS	F

Movement	EBL	EBT	EBR	WBL	WBT	WBR	NBL	NBT	NBR	SBL	SBT	SBR
Lane Configurations	↵	↕↗		↵	↕↗		↵	↕	↗	↵	↕	↗
Traffic Vol, veh/h	22	868	28	188	286	17	25	338	295	7	238	5
Future Vol, veh/h	22	868	28	188	286	17	25	338	295	7	238	5
Peak Hour Factor	0.92	0.92	0.92	0.92	0.92	0.92	0.92	0.92	0.92	0.92	0.92	0.92
Heavy Vehicles, %	1	1	1	2	2	2	0	0	0	0	0	0
Mvmt Flow	24	943	30	204	311	18	27	367	321	8	259	5
Number of Lanes	1	2	0	1	2	0	1	1	1	1	1	1

Approach	EB	WB	NB	SB
Opposing Approach	WB	EB	SB	NB
Opposing Lanes	3	3	3	3
Conflicting Approach Left	SB	NB	EB	WB
Conflicting Lanes Left	3	3	3	3
Conflicting Approach Right	NB	SB	WB	EB
Conflicting Lanes Right	3	3	3	3
HCM Control Delay	302.6	31.9	92.6	62.3
HCM LOS	F	D	F	F

Lane	NBLn1	NBLn2	NBLn3	EBLn1	EBLn2	EBLn3	WBLn1	WBLn2	WBLn3	SBLn1	SBLn2
Vol Left, %	100%	0%	0%	100%	0%	0%	100%	0%	0%	100%	0%
Vol Thru, %	0%	100%	0%	0%	100%	91%	0%	100%	85%	0%	100%
Vol Right, %	0%	0%	100%	0%	0%	9%	0%	0%	15%	0%	0%
Sign Control	Stop	Stop	Stop	Stop	Stop	Stop	Stop	Stop	Stop	Stop	Stop
Traffic Vol by Lane	25	338	295	22	579	317	188	191	112	7	238
LT Vol	25	0	0	22	0	0	188	0	0	7	0
Through Vol	0	338	0	0	579	289	0	191	95	0	238
RT Vol	0	0	295	0	0	28	0	0	17	0	0
Lane Flow Rate	27	367	321	24	629	345	204	207	122	8	259
Geometry Grp	8	8	8	8	8	8	8	8	8	8	8
Degree of Util (X)	0.087	1.121	0.917	0.075	1.877	1.024	0.67	0.651	0.38	0.027	0.878
Departure Headway (Hd)	12.101	11.601	10.901	11.385	10.885	10.823	12.149	11.649	11.543	13.393	12.893
Convergence, Y/N	Yes	Yes	Yes	Yes	Yes	Yes	Yes	Yes	Yes	Yes	Yes
Cap	298	316	333	317	340	338	300	313	314	269	282
Service Time	9.801	9.301	8.601	9.085	8.585	8.523	9.849	9.349	9.243	11.093	10.593
HCM Lane V/C Ratio	0.091	1.161	0.964	0.076	1.85	1.021	0.68	0.661	0.389	0.03	0.918
HCM Control Delay	16	122.7	64.5	15	430.3	89.7	36.4	33.7	21.1	16.5	64.6
HCM Lane LOS	C	F	F	B	F	F	E	D	C	C	F
HCM 95th-tile Q	0.3	14	9.1	0.2	41.8	11.8	4.5	4.3	1.7	0.1	7.7

Intersection

Intersection Delay, s/veh 33.5

Intersection LOS D

Movement	EBL	EBT	EBR	WBL	WBT	WBR	NBL	NBT	NBR	SBL	SBT	SBR
Lane Configurations	↖	↗		↖	↗	↖	↖	↗		↖	↗	
Traffic Vol, veh/h	62	263	71	25	109	66	48	225	25	129	277	49
Future Vol, veh/h	62	263	71	25	109	66	48	225	25	129	277	49
Peak Hour Factor	0.92	0.92	0.92	0.92	0.92	0.92	0.92	0.92	0.92	0.92	0.92	0.92
Heavy Vehicles, %	2	2	2	6	6	6	2	2	2	2	2	2
Mvmt Flow	67	286	77	27	118	72	52	245	27	140	301	53
Number of Lanes	1	1	0	1	1	1	1	1	0	1	1	0

Approach	EB	WB	NB	SB
Opposing Approach	WB	EB	SB	NB
Opposing Lanes	3	2	2	2
Conflicting Approach Left SB		NB	EB	WB
Conflicting Lanes Left	2	2	2	3
Conflicting Approach Right NB		SB	WB	EB
Conflicting Lanes Right	2	2	3	2
HCM Control Delay	44.1	15.8	27.2	36.2
HCM LOS	E	C	D	E

Lane	NBLn1	NBLn2	EBLn1	EBLn2	WBLn1	WBLn2	WBLn3	SBLn1	SBLn2
Vol Left, %	100%	0%	100%	0%	100%	0%	0%	100%	0%
Vol Thru, %	0%	90%	0%	79%	0%	100%	0%	0%	85%
Vol Right, %	0%	10%	0%	21%	0%	0%	100%	0%	15%
Sign Control	Stop	Stop	Stop	Stop	Stop	Stop	Stop	Stop	Stop
Traffic Vol by Lane	48	250	62	334	25	109	66	129	326
LT Vol	48	0	62	0	25	0	0	129	0
Through Vol	0	225	0	263	0	109	0	0	277
RT Vol	0	25	0	71	0	0	66	0	49
Lane Flow Rate	52	272	67	363	27	118	72	140	354
Geometry Grp	8	8	8	8	8	8	8	8	8
Degree of Util (X)	0.14	0.687	0.176	0.881	0.078	0.323	0.181	0.359	0.846
Departure Headway (Hd)	9.684	9.095	9.412	8.738	10.335	9.813	9.083	9.217	8.594
Convergence, Y/N	Yes	Yes	Yes	Yes	Yes	Yes	Yes	Yes	Yes
Cap	369	397	381	414	346	365	394	390	422
Service Time	7.463	6.874	7.185	6.511	8.125	7.603	6.872	6.989	6.366
HCM Lane V/C Ratio	0.141	0.685	0.176	0.877	0.078	0.323	0.183	0.359	0.839
HCM Control Delay	14	29.7	14.2	49.6	14	17.3	13.9	17.1	43.8
HCM Lane LOS	B	D	B	E	B	C	B	C	E
HCM 95th-tile Q	0.5	5	0.6	9	0.3	1.4	0.7	1.6	8.2

HCM 6th Signalized Intersection Summary
 23: Avenue 16/Ellis Street & Kennedy Street

Village D Specific Plan
 Phase I WP - AM Peak Hour



Movement	WBL	WBR	NBT	NBR	SBL	SBT
Lane Configurations						
Traffic Volume (veh/h)	148	127	380	144	253	295
Future Volume (veh/h)	148	127	380	144	253	295
Initial Q (Qb), veh	0	0	0	0	0	0
Ped-Bike Adj(A_pbT)	1.00	1.00		0.98	1.00	
Parking Bus, Adj	1.00	1.00	1.00	1.00	1.00	1.00
Work Zone On Approach	No		No		No	
Adj Sat Flow, veh/h/ln	1841	1841	1856	1856	1870	1870
Adj Flow Rate, veh/h	161	138	413	157	275	321
Peak Hour Factor	0.92	0.92	0.92	0.92	0.92	0.92
Percent Heavy Veh, %	4	4	3	3	2	2
Cap, veh/h	215	337	731	274	739	2718
Arrive On Green	0.12	0.12	0.29	0.29	0.41	0.76
Sat Flow, veh/h	1753	2745	2583	934	1781	3647
Grp Volume(v), veh/h	161	138	291	279	275	321
Grp Sat Flow(s),veh/h/ln	1753	1373	1763	1661	1781	1777
Q Serve(g_s), s	7.1	3.7	11.2	11.4	8.5	1.9
Cycle Q Clear(g_c), s	7.1	3.7	11.2	11.4	8.5	1.9
Prop In Lane	1.00	1.00		0.56	1.00	
Lane Grp Cap(c), veh/h	215	337	518	488	739	2718
V/C Ratio(X)	0.75	0.41	0.56	0.57	0.37	0.12
Avail Cap(c_a), veh/h	427	669	518	488	739	2718
HCM Platoon Ratio	1.00	1.00	1.00	1.00	1.00	1.00
Upstream Filter(I)	0.85	0.85	1.00	1.00	1.00	1.00
Uniform Delay (d), s/veh	33.9	32.4	23.9	24.0	16.2	2.4
Incr Delay (d2), s/veh	4.4	0.7	4.4	4.8	0.3	0.1
Initial Q Delay(d3),s/veh	0.0	0.0	0.0	0.0	0.0	0.0
%ile BackOfQ(50%),veh/ln	3.2	1.2	5.1	4.9	3.4	0.4
Unsig. Movement Delay, s/veh						
LnGrp Delay(d),s/veh	38.3	33.1	28.3	28.8	16.5	2.5
LnGrp LOS	D	C	C	C	B	A
Approach Vol, veh/h	299		570			596
Approach Delay, s/veh	35.9		28.5			9.0
Approach LOS	D		C			A
Timer - Assigned Phs	1	2			6	8
Phs Duration (G+Y+Rc), s	37.7	28.0			65.7	14.3
Change Period (Y+Rc), s	4.5	4.5			4.5	4.5
Max Green Setting (Gmax), s	23.5	23.5			51.5	19.5
Max Q Clear Time (g_c+10), s	11.5	13.4			3.9	9.1
Green Ext Time (p_c), s	0.7	2.6			2.3	0.7
Intersection Summary						
HCM 6th Ctrl Delay			22.1			
HCM 6th LOS			C			

HCM 6th Signalized Intersection Summary
 24: Schnoor Avenue & Kennedy Street

Village D Specific Plan
 Phase I WP - AM Peak Hour



Movement	EBL	EBT	EBR	WBL	WBT	WBR	NBL	NBT	NBR	SBL	SBT	SBR
Lane Configurations	↖	↗		↖	↗		↖	↗		↖	↗	↖
Traffic Volume (veh/h)	49	186	165	141	168	81	106	19	234	56	18	14
Future Volume (veh/h)	49	186	165	141	168	81	106	19	234	56	18	14
Initial Q (Qb), veh	0	0	0	0	0	0	0	0	0	0	0	0
Ped-Bike Adj(A_pbT)	1.00		1.00	1.00		1.00	1.00		1.00	1.00		1.00
Parking Bus, Adj	1.00	1.00	1.00	1.00	1.00	1.00	1.00	1.00	1.00	1.00	1.00	1.00
Work Zone On Approach		No			No			No			No	
Adj Sat Flow, veh/h/ln	1841	1841	1841	1826	1826	1826	1900	1900	1900	1366	1366	1366
Adj Flow Rate, veh/h	53	202	179	153	183	88	115	21	254	61	20	15
Peak Hour Factor	0.92	0.92	0.92	0.92	0.92	0.92	0.92	0.92	0.92	0.92	0.92	0.92
Percent Heavy Veh, %	4	4	4	5	5	5	0	0	0	36	36	36
Cap, veh/h	76	282	237	191	260	125	859	33	403	312	360	304
Arrive On Green	0.04	0.16	0.16	0.11	0.22	0.22	0.24	0.27	0.27	0.24	0.26	0.26
Sat Flow, veh/h	1753	1802	1511	1739	1164	560	3510	124	1498	1301	1366	1153
Grp Volume(v), veh/h	53	196	185	153	0	271	115	0	275	61	20	15
Grp Sat Flow(s),veh/h/ln	1753	1749	1565	1739	0	1724	1755	0	1622	1301	1366	1153
Q Serve(g_s), s	2.4	8.5	9.1	6.9	0.0	11.6	2.0	0.0	11.9	3.0	0.9	0.6
Cycle Q Clear(g_c), s	2.4	8.5	9.1	6.9	0.0	11.6	2.0	0.0	11.9	3.0	0.9	0.6
Prop In Lane	1.00		0.97	1.00		0.32	1.00		0.92	1.00		1.00
Lane Grp Cap(c), veh/h	76	274	245	191	0	385	859	0	436	312	360	304
V/C Ratio(X)	0.70	0.71	0.76	0.80	0.00	0.70	0.13	0.00	0.63	0.20	0.06	0.05
Avail Cap(c_a), veh/h	121	404	362	359	0	636	859	0	436	312	360	304
HCM Platoon Ratio	1.00	1.00	1.00	1.00	1.00	1.00	1.00	1.00	1.00	1.00	1.00	1.00
Upstream Filter(I)	0.83	0.83	0.83	1.00	0.00	1.00	1.00	0.00	1.00	1.00	1.00	1.00
Uniform Delay (d), s/veh	37.8	32.0	32.3	34.8	0.0	28.6	23.6	0.0	25.8	24.3	22.0	13.7
Incr Delay (d2), s/veh	9.3	2.9	4.3	7.6	0.0	2.4	0.1	0.0	6.8	0.3	0.3	0.3
Initial Q Delay(d3),s/veh	0.0	0.0	0.0	0.0	0.0	0.0	0.0	0.0	0.0	0.0	0.0	0.0
%ile BackOfQ(50%),veh/ln	1.2	3.7	3.6	3.2	0.0	4.9	0.8	0.0	5.2	0.9	0.3	0.2
Unsig. Movement Delay, s/veh												
LnGrp Delay(d),s/veh	47.0	34.9	36.5	42.3	0.0	31.0	23.7	0.0	32.5	24.6	22.3	14.0
LnGrp LOS	D	C	D	D	A	C	C	A	C	C	C	B
Approach Vol, veh/h		434			424			390			96	
Approach Delay, s/veh		37.1			35.1			29.9			22.4	
Approach LOS		D			D			C			C	
Timer - Assigned Phs	1	2	3	4	5	6	7	8				
Phs Duration (G+Y+Rc), s	33.7	26.0	13.3	17.0	24.1	25.6	8.0	22.4				
Change Period (Y+Rc), s	4.5	4.5	4.5	4.5	4.5	4.5	4.5	4.5				
Max Green Setting (Gmax), s	5.5	21.5	16.5	18.5	5.9	21.1	5.5	29.5				
Max Q Clear Time (g_c+1/3), s	11.0	13.9	8.9	11.1	4.0	2.9	4.4	13.6				
Green Ext Time (p_c), s	0.0	1.0	0.2	1.3	0.1	0.1	0.0	1.4				
Intersection Summary												
HCM 6th Ctrl Delay											33.3	
HCM 6th LOS											C	

Intersection						
Int Delay, s/veh	6.2					
Movement	EBL	EBT	WBT	WBR	SBL	SBR
Lane Configurations						
Traffic Vol, veh/h	251	235	284	2	65	111
Future Vol, veh/h	251	235	284	2	65	111
Conflicting Peds, #/hr	0	0	0	0	0	0
Sign Control	Free	Free	Free	Free	Stop	Stop
RT Channelized	-	None	-	Free	-	None
Storage Length	140	-	-	-	0	335
Veh in Median Storage, #	-	0	0	-	0	-
Grade, %	-	0	0	-	0	-
Peak Hour Factor	92	92	92	92	92	92
Heavy Vehicles, %	2	2	6	6	4	4
Mvmt Flow	273	255	309	2	71	121

Major/Minor	Major1	Major2	Minor2		
Conflicting Flow All	309	0	-	0	1110 309
Stage 1	-	-	-	-	309 -
Stage 2	-	-	-	-	801 -
Critical Hdwy	4.12	-	-	-	6.44 6.24
Critical Hdwy Stg 1	-	-	-	-	5.44 -
Critical Hdwy Stg 2	-	-	-	-	5.44 -
Follow-up Hdwy	2.218	-	-	-	3.536 3.336
Pot Cap-1 Maneuver	1252	-	-	0	230 726
Stage 1	-	-	-	0	740 -
Stage 2	-	-	-	0	438 -
Platoon blocked, %		-	-		
Mov Cap-1 Maneuver	1252	-	-	-	180 726
Mov Cap-2 Maneuver	-	-	-	-	180 -
Stage 1	-	-	-	-	579 -
Stage 2	-	-	-	-	438 -

Approach	EB	WB	SB
HCM Control Delay, s	4.5	0	20.7
HCM LOS			C

Minor Lane/Major Mvmt	EBL	EBT	WBT	SBLn1	SBLn2
Capacity (veh/h)	1252	-	-	180	726
HCM Lane V/C Ratio	0.218	-	-	0.393	0.166
HCM Control Delay (s)	8.7	-	-	37.4	10.9
HCM Lane LOS	A	-	-	E	B
HCM 95th %tile Q(veh)	0.8	-	-	1.7	0.6

Intersection						
Int Delay, s/veh	5.7					
Movement	EBL	EBT	WBT	WBR	SBL	SBR
Lane Configurations		↕	↕		↕	
Traffic Vol, veh/h	162	138	78	0	0	207
Future Vol, veh/h	162	138	78	0	0	207
Conflicting Peds, #/hr	0	0	0	0	0	0
Sign Control	Free	Free	Free	Free	Stop	Stop
RT Channelized	-	None	-	None	-	None
Storage Length	-	-	-	-	0	-
Veh in Median Storage, #	-	0	0	-	0	-
Grade, %	-	0	0	-	0	-
Peak Hour Factor	92	92	92	92	92	92
Heavy Vehicles, %	3	3	6	6	7	7
Mvmt Flow	176	150	85	0	0	225

Major/Minor	Major1	Major2	Minor2		
Conflicting Flow All	85	0	-	0	587 85
Stage 1	-	-	-	-	85 -
Stage 2	-	-	-	-	502 -
Critical Hdwy	4.13	-	-	-	6.47 6.27
Critical Hdwy Stg 1	-	-	-	-	5.47 -
Critical Hdwy Stg 2	-	-	-	-	5.47 -
Follow-up Hdwy	2.227	-	-	-	3.563 3.363
Pot Cap-1 Maneuver	1505	-	-	-	464 960
Stage 1	-	-	-	-	926 -
Stage 2	-	-	-	-	598 -
Platoon blocked, %		-	-	-	
Mov Cap-1 Maneuver	1505	-	-	-	405 960
Mov Cap-2 Maneuver	-	-	-	-	405 -
Stage 1	-	-	-	-	807 -
Stage 2	-	-	-	-	598 -

Approach	EB	WB	SB
HCM Control Delay, s	4.2	0	9.9
HCM LOS			A

Minor Lane/Major Mvmt	EBL	EBT	WBT	WBR	SBLn1
Capacity (veh/h)	1505	-	-	-	960
HCM Lane V/C Ratio	0.117	-	-	-	0.234
HCM Control Delay (s)	7.7	0	-	-	9.9
HCM Lane LOS	A	A	-	-	A
HCM 95th %tile Q(veh)	0.4	-	-	-	0.9

Intersection						
Int Delay, s/veh	4.1					
Movement	EBL	EBR	NBL	NBT	SBT	SBR
Lane Configurations	↙			↑	↗	
Traffic Vol, veh/h	161	0	0	43	3	206
Future Vol, veh/h	161	0	0	43	3	206
Conflicting Peds, #/hr	0	0	0	0	0	0
Sign Control	Stop	Stop	Free	Free	Free	Free
RT Channelized	-	None	-	None	-	None
Storage Length	0	-	-	-	-	-
Veh in Median Storage, #	0	-	-	0	0	-
Grade, %	0	-	-	0	0	-
Peak Hour Factor	92	92	92	92	92	92
Heavy Vehicles, %	3	3	10	10	7	7
Mvmt Flow	175	0	0	47	3	224

Major/Minor	Minor2	Major1		Major2	
Conflicting Flow All	162	-	-	0	0
Stage 1	115	-	-	-	-
Stage 2	47	-	-	-	-
Critical Hdwy	6.43	-	-	-	-
Critical Hdwy Stg 1	5.43	-	-	-	-
Critical Hdwy Stg 2	5.43	-	-	-	-
Follow-up Hdwy	3.527	-	-	-	-
Pot Cap-1 Maneuver	826	0	0	-	-
Stage 1	907	0	0	-	-
Stage 2	973	0	0	-	-
Platoon blocked, %				-	-
Mov Cap-1 Maneuver	826	-	-	-	-
Mov Cap-2 Maneuver	826	-	-	-	-
Stage 1	907	-	-	-	-
Stage 2	973	-	-	-	-

Approach	EB	NB	SB
HCM Control Delay, s	10.5	0	0
HCM LOS	B		

Minor Lane/Major Mvmt	NBT EBLn1	SBT	SBR
Capacity (veh/h)	- 826	-	-
HCM Lane V/C Ratio	- 0.212	-	-
HCM Control Delay (s)	- 10.5	-	-
HCM Lane LOS	- B	-	-
HCM 95th %tile Q(veh)	- 0.8	-	-

Intersection						
Int Delay, s/veh	0					
Movement	EBL	EBT	WBT	WBR	SBL	SBR
Lane Configurations		↕	↕		↕	
Traffic Vol, veh/h	0	134	83	51	0	0
Future Vol, veh/h	0	134	83	51	0	0
Conflicting Peds, #/hr	0	0	0	0	0	0
Sign Control	Free	Free	Free	Free	Stop	Stop
RT Channelized	-	None	-	None	-	None
Storage Length	-	-	-	-	0	-
Veh in Median Storage, #	-	0	0	-	0	-
Grade, %	-	0	0	-	0	-
Peak Hour Factor	92	92	92	92	92	92
Heavy Vehicles, %	2	2	13	13	0	0
Mvmt Flow	0	146	90	55	0	0

Major/Minor	Major1	Major2	Minor2		
Conflicting Flow All	145	0	-	0	264
Stage 1	-	-	-	-	118
Stage 2	-	-	-	-	146
Critical Hdwy	4.12	-	-	-	6.4
Critical Hdwy Stg 1	-	-	-	-	5.4
Critical Hdwy Stg 2	-	-	-	-	5.4
Follow-up Hdwy	2.218	-	-	-	3.5
Pot Cap-1 Maneuver	1437	-	-	-	729
Stage 1	-	-	-	-	912
Stage 2	-	-	-	-	886
Platoon blocked, %		-	-	-	
Mov Cap-1 Maneuver	1437	-	-	-	729
Mov Cap-2 Maneuver	-	-	-	-	729
Stage 1	-	-	-	-	912
Stage 2	-	-	-	-	886

Approach	EB	WB	SB
HCM Control Delay, s	0	0	0
HCM LOS			A

Minor Lane/Major Mvmt	EBL	EBT	WBT	WBR	SBLn1
Capacity (veh/h)	1437	-	-	-	-
HCM Lane V/C Ratio	-	-	-	-	-
HCM Control Delay (s)	0	-	-	-	0
HCM Lane LOS	A	-	-	-	A
HCM 95th %tile Q(veh)	0	-	-	-	-

HCM 6th Signalized Intersection Summary
29: Schnoor Avenue & Cleveland Avenue

Village D Specific Plan
Phase I WP - AM Peak Hour



Movement	EBL	EBT	EBR	WBL	WBT	WBR	NBL	NBT	NBR	SBL	SBT	SBR
Lane Configurations												
Traffic Volume (veh/h)	119	1002	71	163	416	45	61	231	163	84	168	74
Future Volume (veh/h)	119	1002	71	163	416	45	61	231	163	84	168	74
Initial Q (Qb), veh	0	0	0	0	0	0	0	0	0	0	0	0
Ped-Bike Adj(A_pbT)	1.00		0.98	1.00		0.98	1.00		0.99	1.00		0.98
Parking Bus, Adj	1.00	1.00	1.00	1.00	1.00	1.00	1.00	1.00	1.00	1.00	1.00	1.00
Work Zone On Approach		No			No			No			No	
Adj Sat Flow, veh/h/ln	1885	1885	1885	1856	1856	1856	1885	1885	1885	1856	1856	1856
Adj Flow Rate, veh/h	129	1089	77	177	452	49	66	251	177	91	183	80
Peak Hour Factor	0.92	0.92	0.92	0.92	0.92	0.92	0.92	0.92	0.92	0.92	0.92	0.92
Percent Heavy Veh, %	1	1	1	3	3	3	1	1	1	3	3	3
Cap, veh/h	164	1245	545	255	1165	509	86	869	502	196	1075	470
Arrive On Green	0.09	0.35	0.35	0.07	0.33	0.33	0.05	0.24	0.24	0.11	0.31	0.31
Sat Flow, veh/h	1795	3582	1567	3428	3526	1541	1795	3582	1582	1767	3526	1540
Grp Volume(v), veh/h	129	1089	77	177	452	49	66	251	177	91	183	80
Grp Sat Flow(s),veh/h/ln	1795	1791	1567	1714	1763	1541	1795	1791	1582	1767	1763	1540
Q Serve(g_s), s	5.6	22.8	2.0	4.0	7.9	1.2	2.9	4.6	0.9	3.9	3.0	3.0
Cycle Q Clear(g_c), s	5.6	22.8	2.0	4.0	7.9	1.2	2.9	4.6	0.9	3.9	3.0	3.0
Prop In Lane	1.00		1.00	1.00		1.00	1.00		1.00	1.00		1.00
Lane Grp Cap(c), veh/h	164	1245	545	255	1165	509	86	869	502	196	1075	470
V/C Ratio(X)	0.78	0.87	0.14	0.70	0.39	0.10	0.76	0.29	0.35	0.47	0.17	0.17
Avail Cap(c_a), veh/h	301	1321	578	279	1165	509	117	869	502	196	1075	470
HCM Platoon Ratio	1.00	1.00	1.00	1.00	1.00	1.00	1.00	1.00	1.00	1.00	1.00	1.00
Upstream Filter(I)	1.00	1.00	1.00	0.75	0.75	0.75	1.00	1.00	1.00	1.00	1.00	1.00
Uniform Delay (d), s/veh	35.6	24.5	10.2	36.1	20.6	8.2	37.6	24.7	21.0	33.4	20.4	20.4
Incr Delay (d2), s/veh	8.0	6.5	0.1	5.0	0.2	0.1	18.4	0.8	1.9	1.7	0.3	0.8
Initial Q Delay(d3),s/veh	0.0	0.0	0.0	0.0	0.0	0.0	0.0	0.0	0.0	0.0	0.0	0.0
%ile BackOfQ(50%),veh/ln	2.8	10.2	0.9	1.8	3.1	0.6	1.7	2.0	2.7	1.7	1.3	1.2
Unsig. Movement Delay, s/veh												
LnGrp Delay(d),s/veh	43.5	31.0	10.3	41.2	20.7	8.3	56.0	25.5	22.9	35.1	20.7	21.2
LnGrp LOS	D	C	B	D	C	A	E	C	C	D	C	C
Approach Vol, veh/h		1295			678			494			354	
Approach Delay, s/veh		31.0			25.2			28.7			24.5	
Approach LOS		C			C			C			C	
Timer - Assigned Phs	1	2	3	4	5	6	7	8				
Phs Duration (G+Y+Rc), s	13.4	23.9	10.4	32.3	8.3	28.9	11.8	30.9				
Change Period (Y+Rc), s	4.5	4.5	4.5	4.5	4.5	4.5	4.5	4.5				
Max Green Setting (Gmax), s	6.6	19.4	6.5	29.5	5.2	20.8	13.4	22.6				
Max Q Clear Time (g_c+I1), s	5.9	6.6	6.0	24.8	4.9	5.0	7.6	9.9				
Green Ext Time (p_c), s	0.0	1.8	0.0	3.0	0.0	1.2	0.1	2.6				
Intersection Summary												
HCM 6th Ctrl Delay				28.4								
HCM 6th LOS				C								

HCM 6th Signalized Intersection Summary
30: Fairgrounds & Cleveland Avenue

Village D Specific Plan
Phase I WP - AM Peak Hour



Movement	EBL	EBT	EBR	WBL	WBT	WBR	NBL	NBT	NBR	SBL	SBT	SBR
Lane Configurations	↖ ↑↑ ↗			↖ ↑↑ ↗		↖ ↗	↖ ↗	↖ ↗	↖ ↗	↖ ↗	↖ ↗	↖ ↗
Traffic Volume (veh/h)	90	1193	29	34	570	86	13	7	25	116	5	39
Future Volume (veh/h)	90	1193	29	34	570	86	13	7	25	116	5	39
Initial Q (Qb), veh	0	0	0	0	0	0	0	0	0	0	0	0
Ped-Bike Adj(A_pbT)	1.00		1.00	1.00		1.00	1.00		1.00	1.00		0.99
Parking Bus, Adj	1.00	1.00	1.00	1.00	1.00	1.00	1.00	1.00	1.00	1.00	1.00	1.00
Work Zone On Approach	No			No			No			No		
Adj Sat Flow, veh/h/ln	1870	1870	1870	1856	1856	1856	1900	1900	1900	1900	1900	1900
Adj Flow Rate, veh/h	96	1269	31	36	606	91	14	22	17	123	5	41
Peak Hour Factor	0.94	0.94	0.94	0.94	0.94	0.94	0.94	0.94	0.94	0.94	0.94	0.94
Percent Heavy Veh, %	2	2	2	3	3	3	0	0	0	0	0	0
Cap, veh/h	131	1314	32	61	765	341	622	463	392	435	55	450
Arrive On Green	0.15	0.51	0.51	0.03	0.22	0.22	0.17	0.24	0.24	0.24	0.31	0.31
Sat Flow, veh/h	1781	5127	125	1767	3526	1572	3619	1900	1608	1810	176	1440
Grp Volume(v), veh/h	96	843	457	36	606	91	14	22	17	123	0	46
Grp Sat Flow(s),veh/h/ln	1781	1702	1848	1767	1763	1572	1810	1900	1608	1810	0	1616
Q Serve(g_s), s	4.1	19.1	19.1	1.6	13.0	3.8	0.3	0.7	0.5	4.4	0.0	1.6
Cycle Q Clear(g_c), s	4.1	19.1	19.1	1.6	13.0	3.8	0.3	0.7	0.5	4.4	0.0	1.6
Prop In Lane	1.00		0.07	1.00		1.00	1.00		1.00	1.00		0.89
Lane Grp Cap(c), veh/h	131	872	474	61	765	341	622	463	392	435	0	505
V/C Ratio(X)	0.73	0.97	0.97	0.59	0.79	0.27	0.02	0.05	0.04	0.28	0.00	0.09
Avail Cap(c_a), veh/h	234	872	474	254	947	423	622	463	392	435	0	505
HCM Platoon Ratio	2.00	2.00	2.00	1.00	1.00	1.00	1.00	1.00	1.00	1.00	1.00	1.00
Upstream Filter(I)	0.57	0.57	0.57	0.92	0.92	0.92	1.00	1.00	1.00	1.00	0.00	1.00
Uniform Delay (d), s/veh	33.4	19.2	19.2	38.1	29.6	26.0	27.5	23.1	15.0	24.8	0.0	19.5
Incr Delay (d2), s/veh	4.4	15.6	23.2	8.2	3.5	0.4	0.0	0.2	0.2	0.4	0.0	0.4
Initial Q Delay(d3),s/veh	0.0	0.0	0.0	0.0	0.0	0.0	0.0	0.0	0.0	0.0	0.0	0.0
%ile BackOfQ(50%),veh/ln	1.8	6.4	7.9	0.8	5.7	1.4	0.1	0.3	0.3	1.9	0.0	0.6
Unsig. Movement Delay, s/veh												
LnGrp Delay(d),s/veh	37.8	34.8	42.4	46.2	33.1	26.4	27.6	23.3	15.2	25.1	0.0	19.8
LnGrp LOS	D	C	D	D	C	C	C	C	B	C	A	B
Approach Vol, veh/h	1396			733			53			169		
Approach Delay, s/veh	37.5			32.9			21.8			23.7		
Approach LOS	D			C			C			C		
Timer - Assigned Phs	1	2	3	4	5	6	7	8				
Phs Duration (G+Y+Rc), s	23.7	24.0	7.3	25.0	18.2	29.5	10.4	21.9				
Change Period (Y+Rc), s	4.5	4.5	4.5	4.5	4.5	4.5	4.5	4.5				
Max Green Setting (Gmax), s	10.5	19.5	11.5	20.5	5.0	25.0	10.5	21.5				
Max Q Clear Time (g_c+10), s	10.5	2.7	3.6	21.1	2.3	3.6	6.1	15.0				
Green Ext Time (p_c), s	0.1	0.1	0.0	0.0	0.0	0.2	0.1	2.4				

Intersection Summary

HCM 6th Ctrl Delay	34.7
HCM 6th LOS	C

Notes

User approved volume balancing among the lanes for turning movement.

HCM 6th Signalized Intersection Summary
 31: SR-99 Southbound Ramps & Cleveland Avenue

Village D Specific Plan
 Phase I WP - AM Peak Hour



Movement	EBL	EBT	EBR	WBL	WBT	WBR	NBL	NBT	NBR	SBL	SBT	SBR
Lane Configurations		↑↑	↑	↑	↑↑					↑		↑
Traffic Volume (veh/h)	0	661	769	339	869	0	0	0	0	65	0	54
Future Volume (veh/h)	0	661	769	339	869	0	0	0	0	65	0	54
Initial Q (Qb), veh	0	0	0	0	0	0				0	0	0
Ped-Bike Adj(A_pbT)	1.00		1.00	1.00		1.00				1.00		1.00
Parking Bus, Adj	1.00	1.00	1.00	1.00	1.00	1.00				1.00	1.00	1.00
Work Zone On Approach		No			No						No	
Adj Sat Flow, veh/h/ln	0	1870	1870	1856	1856	0				1678	0	1678
Adj Flow Rate, veh/h	0	718	836	368	945	0				71	0	59
Peak Hour Factor	0.92	0.92	0.92	0.92	0.92	0.92				0.92	0.92	0.92
Percent Heavy Veh, %	0	2	2	3	3	0				15	0	15
Cap, veh/h	0	1323	590	396	2279	0				405	0	361
Arrive On Green	0.00	0.37	0.37	0.45	1.00	0.00				0.25	0.00	0.25
Sat Flow, veh/h	0	3647	1585	1767	3618	0				1598	0	1422
Grp Volume(v), veh/h	0	718	836	368	945	0				71	0	59
Grp Sat Flow(s),veh/h/ln	0	1777	1585	1767	1763	0				1598	0	1422
Q Serve(g_s), s	0.0	14.3	33.5	17.7	0.0	0.0				3.1	0.0	2.9
Cycle Q Clear(g_c), s	0.0	14.3	33.5	17.7	0.0	0.0				3.1	0.0	2.9
Prop In Lane	0.00		1.00	1.00		0.00				1.00		1.00
Lane Grp Cap(c), veh/h	0	1323	590	396	2279	0				405	0	361
V/C Ratio(X)	0.00	0.54	1.42	0.93	0.41	0.00				0.18	0.00	0.16
Avail Cap(c_a), veh/h	0	1323	590	461	2409	0				405	0	361
HCM Platoon Ratio	1.00	1.00	1.00	2.00	2.00	1.00				1.00	1.00	1.00
Upstream Filter(I)	0.00	0.57	0.57	0.68	0.68	0.00				1.00	0.00	1.00
Uniform Delay (d), s/veh	0.0	22.2	28.3	24.2	0.0	0.0				26.2	0.0	26.2
Incr Delay (d2), s/veh	0.0	0.3	193.4	17.8	0.1	0.0				0.2	0.0	0.2
Initial Q Delay(d3),s/veh	0.0	0.0	0.0	0.0	0.0	0.0				0.0	0.0	0.0
%ile BackOfQ(50%),veh/ln	0.0	5.8	43.7	7.0	0.0	0.0				1.2	0.0	1.0
Unsig. Movement Delay, s/veh												
LnGrp Delay(d),s/veh	0.0	22.5	221.6	41.9	0.1	0.0				26.4	0.0	26.4
LnGrp LOS	A	C	F	D	A	A				C	A	C
Approach Vol, veh/h		1554			1313						130	
Approach Delay, s/veh		129.6			11.8						26.4	
Approach LOS		F			B						C	
Timer - Assigned Phs			3	4		6		8				
Phs Duration (G+Y+Rc), s			24.7	38.0		27.3		62.7				
Change Period (Y+Rc), s			4.5	4.5		4.5		4.5				
Max Green Setting (Gmax), s			23.5	33.5		19.5		61.5				
Max Q Clear Time (g_c+I1), s			19.7	35.5		5.1		2.0				
Green Ext Time (p_c), s			0.4	0.0		0.3		8.8				
Intersection Summary												
HCM 6th Ctrl Delay			73.5									
HCM 6th LOS			E									

HCM 6th Signalized Intersection Summary
32: SR-99 Northbound Ramps & Cleveland Avenue

Village D Specific Plan
Phase I WP - AM Peak Hour



Movement	EBL	EBT	EBR	WBL	WBT	WBR	NBL	NBT	NBR	SBL	SBT	SBR
Lane Configurations	↘	↑↑			↑↑	↗	↘	↖	↗			
Traffic Volume (veh/h)	52	675	0	0	837	78	373	0	292	0	0	0
Future Volume (veh/h)	52	675	0	0	837	78	373	0	292	0	0	0
Initial Q (Qb), veh	0	0	0	0	0	0	0	0	0			
Ped-Bike Adj(A_pbT)	1.00		1.00	1.00		1.00	1.00		1.00			
Parking Bus, Adj	1.00	1.00	1.00	1.00	1.00	1.00	1.00	1.00	1.00			
Work Zone On Approach	No				No				No			
Adj Sat Flow, veh/h/ln	1841	1841	0	0	1856	1856	1841	1841	1841			
Adj Flow Rate, veh/h	57	734	0	0	910	85	405	0	317			
Peak Hour Factor	0.92	0.92	0.92	0.92	0.92	0.92	0.92	0.92	0.92			
Percent Heavy Veh, %	4	4	0	0	3	3	4	4	4			
Cap, veh/h	74	1370	0	0	1056	471	1782	0	793			
Arrive On Green	0.04	0.39	0.00	0.00	0.30	0.30	0.51	0.00	0.51			
Sat Flow, veh/h	1753	3589	0	0	3618	1572	3506	0	1560			
Grp Volume(v), veh/h	57	734	0	0	910	85	405	0	317			
Grp Sat Flow(s),veh/h/ln	1753	1749	0	0	1763	1572	1753	0	1560			
Q Serve(g_s), s	2.9	14.5	0.0	0.0	21.9	3.6	5.8	0.0	11.3			
Cycle Q Clear(g_c), s	2.9	14.5	0.0	0.0	21.9	3.6	5.8	0.0	11.3			
Prop In Lane	1.00		0.00	0.00		1.00	1.00		1.00			
Lane Grp Cap(c), veh/h	74	1370	0	0	1056	471	1782	0	793			
V/C Ratio(X)	0.77	0.54	0.00	0.00	0.86	0.18	0.23	0.00	0.40			
Avail Cap(c_a), veh/h	360	2040	0	0	1156	515	1782	0	793			
HCM Platoon Ratio	1.00	1.00	1.00	1.00	1.00	1.00	1.00	1.00	1.00			
Upstream Filter(I)	0.81	0.81	0.00	0.00	0.75	0.75	1.00	0.00	1.00			
Uniform Delay (d), s/veh	42.7	21.1	0.0	0.0	29.8	23.3	12.3	0.0	13.7			
Incr Delay (d2), s/veh	12.7	0.3	0.0	0.0	4.9	0.1	0.3	0.0	1.5			
Initial Q Delay(d3),s/veh	0.0	0.0	0.0	0.0	0.0	0.0	0.0	0.0	0.0			
%ile BackOfQ(50%),veh/ln	1.5	5.8	0.0	0.0	9.7	1.3	2.2	0.0	4.1			
Unsig. Movement Delay, s/veh												
LnGrp Delay(d),s/veh	55.4	21.3	0.0	0.0	34.7	23.5	12.6	0.0	15.2			
LnGrp LOS	E	C	A	A	C	C	B	A	B			
Approach Vol, veh/h	791				995		722					
Approach Delay, s/veh	23.8				33.7		13.7					
Approach LOS	C				C		B					
Timer - Assigned Phs	2		4		7		8					
Phs Duration (G+Y+Rc), s	50.3		39.7		8.3		31.4					
Change Period (Y+Rc), s	4.5		4.5		4.5		4.5					
Max Green Setting (Gmax), s	28.5		52.5		18.5		29.5					
Max Q Clear Time (g_c+I1), s	13.3		16.5		4.9		23.9					
Green Ext Time (p_c), s	2.4		5.9		0.1		3.0					

Intersection Summary

HCM 6th Ctrl Delay	24.8
HCM 6th LOS	C

Notes

User approved volume balancing among the lanes for turning movement.

HCM 6th Signalized Intersection Summary
 33: Gateway Drive & Cleveland Avenue

Village D Specific Plan
 Phase I WP - AM Peak Hour



Movement	EBL	EBT	EBR	WBL	WBT	WBR	NBL	NBT	NBR	SBL	SBT	SBR
Lane Configurations	↖	↑↑↑	↗	↖↗	↑↑		↖↗	↑	↗	↖	↑↗	
Traffic Volume (veh/h)	4	717	240	182	745	69	163	48	141	56	86	4
Future Volume (veh/h)	4	717	240	182	745	69	163	48	141	56	86	4
Initial Q (Qb), veh	0	0	0	0	0	0	0	0	0	0	0	0
Ped-Bike Adj(A_pbT)	1.00		1.00	1.00		0.99	1.00		0.98	1.00		0.98
Parking Bus, Adj	1.00	1.00	1.00	1.00	1.00	1.00	1.00	1.00	1.00	1.00	1.00	1.00
Work Zone On Approach		No			No			No			No	
Adj Sat Flow, veh/h/ln	1856	1856	1856	1870	1870	1870	1796	1796	1796	1841	1841	1841
Adj Flow Rate, veh/h	4	779	0	198	810	75	177	52	153	61	93	4
Peak Hour Factor	0.92	0.92	0.92	0.92	0.92	0.92	0.92	0.92	0.92	0.92	0.92	0.92
Percent Heavy Veh, %	3	3	3	2	2	2	7	7	7	4	4	4
Cap, veh/h	89	1088		300	974	90	939	815	680	78	736	31
Arrive On Green	0.00	0.07	0.00	0.09	0.30	0.30	0.28	0.45	0.45	0.04	0.22	0.22
Sat Flow, veh/h	1767	5066	1572	3456	3286	304	3319	1796	1499	1753	3414	146
Grp Volume(v), veh/h	4	779	0	198	438	447	177	52	153	61	47	50
Grp Sat Flow(s),veh/h/ln	1767	1689	1572	1728	1777	1814	1659	1796	1499	1753	1749	1812
Q Serve(g_s), s	0.2	13.5	0.0	5.0	20.7	20.7	3.6	1.5	3.7	3.1	2.0	2.0
Cycle Q Clear(g_c), s	0.2	13.5	0.0	5.0	20.7	20.7	3.6	1.5	3.7	3.1	2.0	2.0
Prop In Lane	1.00		1.00	1.00		0.17	1.00		1.00	1.00		0.08
Lane Grp Cap(c), veh/h	89	1088		300	526	537	939	815	680	78	377	391
V/C Ratio(X)	0.04	0.72		0.66	0.83	0.83	0.19	0.06	0.22	0.78	0.13	0.13
Avail Cap(c_a), veh/h	247	1435		591	640	653	939	815	680	179	377	391
HCM Platoon Ratio	0.33	0.33	0.33	1.00	1.00	1.00	1.00	1.00	1.00	1.00	1.00	1.00
Upstream Filter(I)	0.90	0.90	0.00	0.93	0.93	0.93	1.00	1.00	1.00	1.00	1.00	1.00
Uniform Delay (d), s/veh	31.4	39.1	0.0	39.8	29.6	29.6	24.4	13.8	6.5	42.6	28.5	28.5
Incr Delay (d2), s/veh	0.2	1.1	0.0	2.3	7.3	7.1	0.1	0.2	0.8	15.3	0.7	0.7
Initial Q Delay(d3),s/veh	0.0	0.0	0.0	0.0	0.0	0.0	0.0	0.0	0.0	0.0	0.0	0.0
%ile BackOfQ(50%),veh/ln	0.1	6.2	0.0	2.2	9.6	9.8	1.4	0.6	1.9	1.7	0.9	0.9
Unsig. Movement Delay, s/veh												
LnGrp Delay(d),s/veh	31.6	40.2	0.0	42.1	36.8	36.7	24.5	14.0	7.2	57.8	29.1	29.1
LnGrp LOS	C	D		D	D	D	C	B	A	E	C	C
Approach Vol, veh/h		783	A		1083			382			158	
Approach Delay, s/veh		40.1			37.7			16.2			40.2	
Approach LOS		D			D			B			D	
Timer - Assigned Phs	1	2	3	4	5	6	7	8				
Phs Duration (G+Y+Rc), s	30.0	23.9	5.0	31.2	8.5	45.3	12.3	23.8				
Change Period (Y+Rc), s	4.5	4.5	4.5	4.5	4.5	4.5	4.5	4.5				
Max Green Setting (Gmax), s	3	19.4	8.5	32.4	9.2	21.9	15.4	25.5				
Max Q Clear Time (g_c+1), s	1.6	4.0	2.2	22.7	5.1	5.7	7.0	15.5				
Green Ext Time (p_c), s	0.3	0.3	0.0	3.9	0.0	0.7	0.4	3.8				

Intersection Summary

HCM 6th Ctrl Delay	35.3
HCM 6th LOS	D

Notes

Unsignalized Delay for [EBR] is excluded from calculations of the approach delay and intersection delay.

HCM 6th Signalized Intersection Summary
 34: Cleveland Avenue & County Club Drive



Movement	WBL	WBR	NBT	NBR	SBL	SBT
Lane Configurations	←←←		↑↑	←	←	↑↑↑
Traffic Volume (veh/h)	363	29	620	293	85	634
Future Volume (veh/h)	363	29	620	293	85	634
Initial Q (Qb), veh	0	0	0	0	0	0
Ped-Bike Adj(A_pbT)	1.00	1.00		1.00	1.00	
Parking Bus, Adj	1.00	1.00	1.00	1.00	1.00	1.00
Work Zone On Approach	No		No		No	
Adj Sat Flow, veh/h/ln	1900	1900	1856	1856	1856	1856
Adj Flow Rate, veh/h	425	0	674	0	92	689
Peak Hour Factor	0.92	0.92	0.92	0.92	0.92	0.92
Percent Heavy Veh, %	0	0	3	3	3	3
Cap, veh/h	548	244	2639		603	3792
Arrive On Green	0.15	0.00	0.75	0.00	0.75	0.75
Sat Flow, veh/h	3619	1610	3618	1572	758	5233
Grp Volume(v), veh/h	425	0	674	0	92	689
Grp Sat Flow(s),veh/h/ln	1810	1610	1763	1572	758	1689
Q Serve(g_s), s	10.2	0.0	5.3	0.0	3.9	3.6
Cycle Q Clear(g_c), s	10.2	0.0	5.3	0.0	9.2	3.6
Prop In Lane	1.00	1.00		1.00	1.00	
Lane Grp Cap(c), veh/h	548	244	2639		603	3792
V/C Ratio(X)	0.78	0.00	0.26		0.15	0.18
Avail Cap(c_a), veh/h	1307	581	2639		603	3792
HCM Platoon Ratio	1.00	1.00	1.00	1.00	1.00	1.00
Upstream Filter(I)	1.00	0.00	0.79	0.00	1.00	1.00
Uniform Delay (d), s/veh	36.7	0.0	3.5	0.0	5.0	3.3
Incr Delay (d2), s/veh	2.4	0.0	0.2	0.0	0.5	0.1
Initial Q Delay(d3),s/veh	0.0	0.0	0.0	0.0	0.0	0.0
%ile BackOfQ(50%),veh/ln	4.6	0.0	1.5	0.0	0.6	0.9
Unsig. Movement Delay, s/veh						
LnGrp Delay(d),s/veh	39.1	0.0	3.7	0.0	5.5	3.4
LnGrp LOS	D	A	A		A	A
Approach Vol, veh/h	425		674	A		781
Approach Delay, s/veh	39.1		3.7			3.6
Approach LOS	D		A			A
Timer - Assigned Phs		2			6	8
Phs Duration (G+Y+Rc), s		71.9			71.9	18.1
Change Period (Y+Rc), s		4.5			4.5	4.5
Max Green Setting (Gmax), s		48.5			48.5	32.5
Max Q Clear Time (g_c+1), s		7.3			11.2	12.2
Green Ext Time (p_c), s		5.4			6.4	1.5

Intersection Summary

HCM 6th Ctrl Delay	11.7
HCM 6th LOS	B

Notes

User approved volume balancing among the lanes for turning movement.
 Unsignalized Delay for [NBR] is excluded from calculations of the approach delay and intersection delay.

Intersection						
Int Delay, s/veh	0.1					
Movement	EBL	EBR	NBL	NBT	SBT	SBR
Lane Configurations	T			T		
Traffic Vol, veh/h	2	12	1	629	685	1
Future Vol, veh/h	2	12	1	629	685	1
Conflicting Peds, #/hr	0	0	2	0	0	2
Sign Control	Stop	Stop	Free	Free	Free	Free
RT Channelized	-	None	-	None	-	None
Storage Length	0	-	-	-	-	-
Veh in Median Storage, #	0	-	-	0	0	-
Grade, %	0	-	-	0	0	-
Peak Hour Factor	92	92	92	92	92	92
Heavy Vehicles, %	7	7	5	5	4	4
Mvmt Flow	2	13	1	684	745	1

Major/Minor	Minor2	Major1	Major2			
Conflicting Flow All	1092	375	748	0	-	0
Stage 1	748	-	-	-	-	-
Stage 2	344	-	-	-	-	-
Critical Hdwy	6.94	7.04	4.2	-	-	-
Critical Hdwy Stg 1	5.94	-	-	-	-	-
Critical Hdwy Stg 2	5.94	-	-	-	-	-
Follow-up Hdwy	3.57	3.37	2.25	-	-	-
Pot Cap-1 Maneuver	*369	608	837	-	-	-
Stage 1	*416	-	-	-	-	-
Stage 2	*772	-	-	-	-	-
Platoon blocked, %	1			-	-	-
Mov Cap-1 Maneuver	*366	607	835	-	-	-
Mov Cap-2 Maneuver	*373	-	-	-	-	-
Stage 1	*414	-	-	-	-	-
Stage 2	*770	-	-	-	-	-

Approach	EB	NB	SB
HCM Control Delay, s	11.6	0	0
HCM LOS	B		

Minor Lane/Major Mvmt	NBL	NBT	EBLn1	SBT	SBR
Capacity (veh/h)	835	-	557	-	-
HCM Lane V/C Ratio	0.001	-	0.027	-	-
HCM Control Delay (s)	9.3	0	11.6	-	-
HCM Lane LOS	A	A	B	-	-
HCM 95th %tile Q(veh)	0	-	0.1	-	-

Notes
 -: Volume exceeds capacity \$: Delay exceeds 300s +: Computation Not Defined *: All major volume in platoon

HCM 6th Signalized Intersection Summary
36: Pine Street & Howard Road

Village D Specific Plan
Phase I WP - AM Peak Hour



Movement	EBL	EBT	EBR	WBL	WBT	WBR	NBL	NBT	NBR	SBL	SBT	SBR
Lane Configurations												
Traffic Volume (veh/h)	34	679	130	138	462	6	138	158	232	16	253	99
Future Volume (veh/h)	34	679	130	138	462	6	138	158	232	16	253	99
Initial Q (Qb), veh	0	0	0	0	0	0	0	0	0	0	0	0
Ped-Bike Adj(A_pbT)	1.00		0.97	1.00		0.98	1.00		1.00	1.00		0.98
Parking Bus, Adj	1.00	1.00	1.00	1.00	1.00	1.00	1.00	1.00	1.00	1.00	1.00	1.00
Work Zone On Approach		No			No			No			No	
Adj Sat Flow, veh/h/ln	1870	1870	1870	1856	1856	1856	1811	1811	1811	1841	1841	1841
Adj Flow Rate, veh/h	37	738	141	150	502	7	150	172	252	17	275	108
Peak Hour Factor	0.92	0.92	0.92	0.92	0.92	0.92	0.92	0.92	0.92	0.92	0.92	0.92
Percent Heavy Veh, %	2	2	2	3	3	3	6	6	6	4	4	4
Cap, veh/h	53	880	168	161	1275	18	494	519	438	19	304	268
Arrive On Green	0.03	0.30	0.30	0.09	0.36	0.36	0.29	0.29	0.29	0.18	0.18	0.18
Sat Flow, veh/h	1781	2962	566	1767	3559	50	1725	1811	1530	107	1729	1522
Grp Volume(v), veh/h	37	443	436	150	249	260	150	172	252	292	0	108
Grp Sat Flow(s),veh/h/ln	1781	1777	1751	1767	1763	1845	1725	1811	1530	1835	0	1522
Q Serve(g_s), s	2.5	28.0	28.0	10.1	12.6	12.7	8.2	9.0	16.9	18.7	0.0	7.6
Cycle Q Clear(g_c), s	2.5	28.0	28.0	10.1	12.6	12.7	8.2	9.0	16.9	18.7	0.0	7.6
Prop In Lane	1.00		0.32	1.00		0.03	1.00		1.00	0.06		1.00
Lane Grp Cap(c), veh/h	53	528	520	161	632	661	494	519	438	323	0	268
V/C Ratio(X)	0.70	0.84	0.84	0.93	0.39	0.39	0.30	0.33	0.58	0.90	0.00	0.40
Avail Cap(c_a), veh/h	105	721	711	161	771	807	494	519	438	344	0	285
HCM Platoon Ratio	1.00	1.00	1.00	1.00	1.00	1.00	1.00	1.00	1.00	1.00	1.00	1.00
Upstream Filter(I)	1.00	1.00	1.00	0.95	0.95	0.95	1.00	1.00	1.00	1.00	0.00	1.00
Uniform Delay (d), s/veh	57.7	39.5	39.5	54.2	28.8	28.8	33.5	33.8	36.6	48.5	0.0	43.9
Incr Delay (d2), s/veh	15.7	6.4	6.5	50.3	0.4	0.4	1.6	1.7	5.4	25.4	0.0	1.0
Initial Q Delay(d3),s/veh	0.0	0.0	0.0	0.0	0.0	0.0	0.0	0.0	0.0	0.0	0.0	0.0
%ile BackOfQ(50%),veh/ln	1.3	13.1	12.9	6.7	5.4	5.7	3.7	4.2	7.0	10.8	0.0	2.9
Unsig. Movement Delay, s/veh												
LnGrp Delay(d),s/veh	73.4	45.9	46.0	104.5	29.1	29.1	35.1	35.5	42.0	73.8	0.0	44.8
LnGrp LOS	E	D	D	F	C	C	D	D	D	E	A	D
Approach Vol, veh/h		916			659			574			400	
Approach Delay, s/veh		47.1			46.3			38.2			66.0	
Approach LOS		D			D			D			E	
Timer - Assigned Phs		2	3	4		6	7	8				
Phs Duration (G+Y+Rc), s		38.9	15.4	40.1		25.6	8.0	47.5				
Change Period (Y+Rc), s		4.5	4.5	4.5		4.5	4.5	4.5				
Max Green Setting (Gmax), s		19.9	10.9	48.7		22.5	7.1	52.5				
Max Q Clear Time (g_c+I1), s		18.9	12.1	30.0		20.7	4.5	14.7				
Green Ext Time (p_c), s		0.3	0.0	5.6		0.4	0.0	3.4				
Intersection Summary												
HCM 6th Ctrl Delay				47.9								
HCM 6th LOS				D								

HCM 6th Signalized Intersection Summary
 37: Olive Avenue/Q Street & Howard Road/Yosemite Avenue

Village D Specific Plan
 Phase I WP - AM Peak Hour



Movement	EBL	EBT	EBR	WBL	WBT	WBR	NBL	NBT	NBR	SBL	SBT	SBR
Lane Configurations												
Traffic Volume (veh/h)	6	550	318	27	340	19	325	88	20	101	149	12
Future Volume (veh/h)	6	550	318	27	340	19	325	88	20	101	149	12
Initial Q (Qb), veh	0	0	0	0	0	0	0	0	0	0	0	0
Ped-Bike Adj(A_pbT)	1.00		1.00	1.00		0.98	1.00		0.99	1.00		0.96
Parking Bus, Adj	1.00	1.00	1.00	1.00	1.00	1.00	1.00	1.00	1.00	1.00	1.00	1.00
Work Zone On Approach		No			No			No			No	
Adj Sat Flow, veh/h/ln	1856	1856	1856	1870	1870	1870	1841	1841	1841	1870	1870	1870
Adj Flow Rate, veh/h	7	598	0	29	370	21	224	276	22	110	162	13
Peak Hour Factor	0.92	0.92	0.92	0.92	0.92	0.92	0.92	0.92	0.92	0.92	0.92	0.92
Percent Heavy Veh, %	3	3	3	2	2	2	4	4	4	2	2	2
Cap, veh/h	15	728		74	818	46	852	895	751	206	216	176
Arrive On Green	0.01	0.21	0.00	0.04	0.24	0.24	0.49	0.49	0.49	0.12	0.12	0.12
Sat Flow, veh/h	1767	3526	1572	1781	3414	193	1753	1841	1545	1781	1870	1523
Grp Volume(v), veh/h	7	598	0	29	192	199	224	276	22	110	162	13
Grp Sat Flow(s),veh/h/ln	1767	1763	1572	1781	1777	1830	1753	1841	1545	1781	1870	1523
Q Serve(g_s), s	0.5	19.4	0.0	1.9	11.0	11.1	9.0	10.9	0.9	7.0	10.1	0.9
Cycle Q Clear(g_c), s	0.5	19.4	0.0	1.9	11.0	11.1	9.0	10.9	0.9	7.0	10.1	0.9
Prop In Lane	1.00		1.00	1.00		0.11	1.00		1.00	1.00		1.00
Lane Grp Cap(c), veh/h	15	728		74	426	438	852	895	751	206	216	176
V/C Ratio(X)	0.46	0.82		0.39	0.45	0.45	0.26	0.31	0.03	0.53	0.75	0.07
Avail Cap(c_a), veh/h	74	1014		267	703	724	852	895	751	267	281	229
HCM Platoon Ratio	1.00	1.00	1.00	1.00	1.00	1.00	1.00	1.00	1.00	1.00	1.00	1.00
Upstream Filter(I)	0.62	0.62	0.00	1.00	1.00	1.00	1.00	1.00	1.00	1.00	1.00	1.00
Uniform Delay (d), s/veh	59.2	45.5	0.0	56.0	38.9	38.9	18.2	18.6	16.1	50.0	51.4	47.3
Incr Delay (d2), s/veh	12.6	2.4	0.0	3.3	0.7	0.7	0.8	0.9	0.1	2.1	7.8	0.2
Initial Q Delay(d3),s/veh	0.0	0.0	0.0	0.0	0.0	0.0	0.0	0.0	0.0	0.0	0.0	0.0
%ile BackOfQ(50%),veh/ln	0.3	8.7	0.0	0.9	4.9	5.1	3.8	4.8	0.3	3.2	5.2	0.4
Unsig. Movement Delay, s/veh												
LnGrp Delay(d),s/veh	71.8	47.9	0.0	59.3	39.6	39.7	18.9	19.5	16.1	52.2	59.2	47.5
LnGrp LOS	E	D		E	D	D	B	B	B	D	E	D
Approach Vol, veh/h		605	A		420			522			285	
Approach Delay, s/veh		48.2			41.0			19.1			56.0	
Approach LOS		D			D			B			E	
Timer - Assigned Phs		2	3	4		6	7	8				
Phs Duration (G+Y+Rc), s		62.8	9.5	29.3		18.4	5.5	33.2				
Change Period (Y+Rc), s		4.5	4.5	4.5		4.5	4.5	4.5				
Max Green Setting (Gmax), s		31.5	18.0	34.5		18.0	5.0	47.5				
Max Q Clear Time (g_c+I1), s		12.9	3.9	21.4		12.1	2.5	13.1				
Green Ext Time (p_c), s		2.3	0.0	3.3		0.6	0.0	2.5				

Intersection Summary

HCM 6th Ctrl Delay	39.5
HCM 6th LOS	D

Notes

User approved volume balancing among the lanes for turning movement.
 Unsignalized Delay for [EBR] is excluded from calculations of the approach delay and intersection delay.

HCM 6th TWSC
 38: I Street & 2nd Street/SR-99 Southbound Off-Ramp

Village D Specific Plan
 Phase I WP - AM Peak Hour

Intersection												
Int Delay, s/veh	16											
Movement	EBL	EBT	EBR	WBL	WBT	WBR	NBL	NBT	NBR	SBL	SBT	SBR
Lane Configurations		↕			↕	↕	↕	↕			↕	
Traffic Vol, veh/h	2	0	58	395	19	11	18	84	0	0	140	2
Future Vol, veh/h	2	0	58	395	19	11	18	84	0	0	140	2
Conflicting Peds, #/hr	0	0	1	1	0	0	0	0	0	0	0	0
Sign Control	Stop	Stop	Stop	Stop	Stop	Stop	Free	Free	Free	Free	Free	Free
RT Channelized	-	-	None	-	-	Stop	-	-	None	-	-	None
Storage Length	-	-	-	-	-	50	75	-	-	-	-	-
Veh in Median Storage, #	-	0	-	-	0	-	-	0	-	-	0	-
Grade, %	-	0	-	-	0	-	-	0	-	-	0	-
Peak Hour Factor	92	92	92	92	92	92	92	92	92	92	92	92
Heavy Vehicles, %	0	0	0	3	3	3	4	4	4	1	1	1
Mvmt Flow	2	0	63	429	21	12	20	91	0	0	152	2

Major/Minor	Minor2		Minor1		Major1		Major2					
Conflicting Flow All	295	284	154	317	285	91	154	0	-	-	-	0
Stage 1	153	153	-	131	131	-	-	-	-	-	-	-
Stage 2	142	131	-	186	154	-	-	-	-	-	-	-
Critical Hdwy	7.1	6.5	6.2	7.13	6.53	6.23	4.14	-	-	-	-	-
Critical Hdwy Stg 1	6.1	5.5	-	6.13	5.53	-	-	-	-	-	-	-
Critical Hdwy Stg 2	6.1	5.5	-	6.13	5.53	-	-	-	-	-	-	-
Follow-up Hdwy	3.5	4	3.3	3.527	4.027	3.327	2.236	-	-	-	-	-
Pot Cap-1 Maneuver	685	644	897	657	638	998	1414	-	0	0	-	-
Stage 1	854	775	-	896	799	-	-	-	0	0	-	-
Stage 2	892	804	-	813	768	-	-	-	0	0	-	-
Platoon blocked, %	1	1		1	1	1		-			-	-
Mov Cap-1 Maneuver	653	635	896	603	630	998	1414	-	-	-	-	-
Mov Cap-2 Maneuver	653	635	-	603	630	-	-	-	-	-	-	-
Stage 1	842	775	-	884	787	-	-	-	-	-	-	-
Stage 2	846	793	-	755	768	-	-	-	-	-	-	-

Approach	EB	WB	NB	SB
HCM Control Delay, s	9.4	25.8	1.3	0
HCM LOS	A	D		

Minor Lane/Major Mvmt	NBL	NBT	EBLn1WBLn1WBLn2	SBT	SBR
Capacity (veh/h)	1414	-	885 604 998	-	-
HCM Lane V/C Ratio	0.014	-	0.074 0.745 0.012	-	-
HCM Control Delay (s)	7.6	-	9.4 26.3 8.7	-	-
HCM Lane LOS	A	-	A D A	-	-
HCM 95th %tile Q(veh)	0	-	0.2 6.5 0	-	-

HCM 6th Signalized Intersection Summary
39: 4th Street & Sunset Avenue

Village D Specific Plan
Phase I WP - AM Peak Hour



Movement	EBL	EBR	NBL	NBT	SBT	SBR
Lane Configurations	🔴🔴		🔴	🔴🔴	🔴	🔴
Traffic Volume (veh/h)	387	22	32	316	439	277
Future Volume (veh/h)	387	22	32	316	439	277
Initial Q (Qb), veh	0	0	0	0	0	0
Ped-Bike Adj(A_pbT)	1.00	1.00	1.00			1.00
Parking Bus, Adj	1.00	1.00	1.00	1.00	1.00	1.00
Work Zone On Approach	No			No	No	
Adj Sat Flow, veh/h/ln	1900	1900	1870	1870	1870	1870
Adj Flow Rate, veh/h	443	0	35	343	477	301
Peak Hour Factor	0.92	0.92	0.92	0.92	0.92	0.92
Percent Heavy Veh, %	0	0	2	2	2	2
Cap, veh/h	544	242	58	2664	1248	1294
Arrive On Green	0.15	0.00	0.03	0.75	1.00	1.00
Sat Flow, veh/h	3619	1610	1781	3647	1870	1583
Grp Volume(v), veh/h	443	0	35	343	477	301
Grp Sat Flow(s),veh/h/ln	1810	1610	1781	1777	1870	1583
Q Serve(g_s), s	10.7	0.0	1.7	2.4	0.0	0.0
Cycle Q Clear(g_c), s	10.7	0.0	1.7	2.4	0.0	0.0
Prop In Lane	1.00	1.00	1.00			1.00
Lane Grp Cap(c), veh/h	544	242	58	2664	1248	1294
V/C Ratio(X)	0.81	0.00	0.61	0.13	0.38	0.23
Avail Cap(c_a), veh/h	744	331	148	2664	1248	1294
HCM Platoon Ratio	1.00	1.00	1.00	1.00	2.00	2.00
Upstream Filter(I)	1.00	0.00	1.00	1.00	0.89	0.89
Uniform Delay (d), s/veh	37.0	0.0	43.0	3.1	0.0	0.0
Incr Delay (d2), s/veh	5.0	0.0	9.8	0.1	0.8	0.4
Initial Q Delay(d3),s/veh	0.0	0.0	0.0	0.0	0.0	0.0
%ile BackOfQ(50%),veh/ln	5.0	0.0	0.9	0.7	0.3	0.1
Unsig. Movement Delay, s/veh						
LnGrp Delay(d),s/veh	42.0	0.0	52.8	3.2	0.8	0.4
LnGrp LOS	D	A	D	A	A	A
Approach Vol, veh/h	443			378	778	
Approach Delay, s/veh	42.0			7.8	0.6	
Approach LOS	D			A	A	
Timer - Assigned Phs		2		4	5	6
Phs Duration (G+Y+Rc), s		72.0		18.0	7.4	64.6
Change Period (Y+Rc), s		4.5		4.5	4.5	4.5
Max Green Setting (Gmax), s		62.5		18.5	7.5	50.5
Max Q Clear Time (g_c+I1), s		4.4		12.7	3.7	2.0
Green Ext Time (p_c), s		2.5		0.9	0.0	4.7

Intersection Summary

HCM 6th Ctrl Delay	13.8
HCM 6th LOS	B

Notes

User approved volume balancing among the lanes for turning movement.

40: H Street & SR-99 Southbound On-Ramp/2nd Street Performance by movement

Movement	WBL	WBT	WBR	NBL	NBT	NBR	SBT	All
Denied Delay (hr)	0.0	0.0	0.0	0.0	0.0	0.0	0.0	0.0
Denied Del/Veh (s)	0.1	0.2	0.1	0.0	0.0	0.0	0.1	0.0
Total Delay (hr)	0.0	0.1	0.0	0.2	0.0	0.0	0.2	0.5
Total Del/Veh (s)	7.9	12.1	3.8	3.0	3.5	2.8	14.5	5.3
Stop Delay (hr)	0.0	0.1	0.0	0.0	0.0	0.0	0.1	0.2
Stop Del/Veh (s)	5.7	8.3	3.8	0.2	0.1	0.1	11.4	2.5

HCM 6th Signalized Intersection Summary
 41: I Street & 4th Street

Village D Specific Plan
 Phase I WP - AM Peak Hour



Movement	EBL	EBT	EBR	WBL	WBT	WBR	NBL	NBT	NBR	SBL	SBT	SBR
Lane Configurations												
Traffic Volume (veh/h)	26	641	68	86	481	65	52	56	163	223	280	148
Future Volume (veh/h)	26	641	68	86	481	65	52	56	163	223	280	148
Initial Q (Qb), veh	0	0	0	0	0	0	0	0	0	0	0	0
Ped-Bike Adj(A_pbT)	1.00		0.96	1.00		0.96	1.00		0.97	1.00		0.98
Parking Bus, Adj	1.00	1.00	1.00	1.00	1.00	1.00	1.00	1.00	1.00	1.00	1.00	1.00
Work Zone On Approach	No			No			No			No		
Adj Sat Flow, veh/h/ln	1870	1870	1870	1856	1856	1856	1856	1856	1856	1856	1856	1856
Adj Flow Rate, veh/h	28	697	74	93	523	71	57	61	177	242	304	161
Peak Hour Factor	0.92	0.92	0.92	0.92	0.92	0.92	0.92	0.92	0.92	0.92	0.92	0.92
Percent Heavy Veh, %	2	2	2	3	3	3	3	3	3	3	3	3
Cap, veh/h	50	790	84	119	882	119	236	379	310	501	658	544
Arrive On Green	0.03	0.24	0.24	0.07	0.28	0.28	0.13	0.20	0.20	0.28	0.35	0.35
Sat Flow, veh/h	1781	3225	342	1767	3104	420	1767	1856	1519	1767	1856	1533
Grp Volume(v), veh/h	28	384	387	93	296	298	57	61	177	242	304	161
Grp Sat Flow(s),veh/h/ln	1781	1777	1791	1767	1763	1761	1767	1856	1519	1767	1856	1533
Q Serve(g_s), s	1.4	18.7	18.8	4.7	13.0	13.1	2.6	2.4	9.4	10.2	11.4	5.5
Cycle Q Clear(g_c), s	1.4	18.7	18.8	4.7	13.0	13.1	2.6	2.4	9.4	10.2	11.4	5.5
Prop In Lane	1.00		0.19	1.00		0.24	1.00		1.00	1.00		1.00
Lane Grp Cap(c), veh/h	50	435	439	119	501	500	236	379	310	501	658	544
V/C Ratio(X)	0.56	0.88	0.88	0.78	0.59	0.60	0.24	0.16	0.57	0.48	0.46	0.30
Avail Cap(c_a), veh/h	109	464	468	179	531	530	236	379	310	501	658	544
HCM Platoon Ratio	1.00	1.00	1.00	1.00	1.00	1.00	1.00	1.00	1.00	1.00	1.00	1.00
Upstream Filter(l)	0.89	0.89	0.89	1.00	1.00	1.00	1.00	1.00	1.00	1.00	1.00	1.00
Uniform Delay (d), s/veh	43.2	32.7	32.7	41.3	27.7	27.8	34.9	29.4	32.2	26.8	22.4	13.5
Incr Delay (d2), s/veh	8.5	15.5	15.6	12.1	1.6	1.6	0.5	0.9	7.4	0.7	2.3	1.4
Initial Q Delay(d3),s/veh	0.0	0.0	0.0	0.0	0.0	0.0	0.0	0.0	0.0	0.0	0.0	0.0
%ile BackOfQ(50%),veh/ln	0.7	9.7	9.8	2.4	5.6	5.6	1.1	1.2	4.0	4.3	5.2	2.5
Unsig. Movement Delay, s/veh												
LnGrp Delay(d),s/veh	51.7	48.2	48.3	53.4	29.3	29.4	35.4	30.4	39.6	27.5	24.8	14.9
LnGrp LOS	D	D	D	D	C	C	D	C	D	C	C	B
Approach Vol, veh/h	799			687			295			707		
Approach Delay, s/veh	48.4			32.6			36.9			23.4		
Approach LOS	D			C			D			C		
Timer - Assigned Phs	1	2	3	4	5	6	7	8				
Phs Duration (G+Y+Rc), s	30.0	22.9	10.5	26.5	16.5	36.4	7.0	30.1				
Change Period (Y+Rc), s	4.5	4.5	4.5	4.5	4.5	4.5	4.5	4.5				
Max Green Setting (Gmax), s	18.4	18.4	9.1	23.5	7.5	31.9	5.5	27.1				
Max Q Clear Time (g_c+1/2), s	11.4	11.4	6.7	20.8	4.6	13.4	3.4	15.1				
Green Ext Time (p_c), s	0.5	0.5	0.0	1.3	0.0	2.2	0.0	2.9				

Intersection Summary

HCM 6th Ctrl Delay	35.6
HCM 6th LOS	D

HCM 6th Signalized Intersection Summary
 43: SR-99 Northbound Off-Ramp/H Street & 4th Street

Village D Specific Plan
 Phase I WP - AM Peak Hour



Movement	EBL	EBT	EBR	WBL	WBT	WBR	NBL	NBT	NBR	SBL	SBT	SBR
Lane Configurations	↖	↑↑			↑↑		↖	↑			↕	
Traffic Volume (veh/h)	235	459	0	0	497	61	253	28	210	6	0	66
Future Volume (veh/h)	235	459	0	0	497	61	253	28	210	6	0	66
Initial Q (Qb), veh	0	0	0	0	0	0	0	0	0	0	0	0
Ped-Bike Adj(A_pbT)	1.00		1.00	1.00		0.94	1.00		1.00	1.00		0.99
Parking Bus, Adj	1.00	1.00	1.00	1.00	1.00	1.00	1.00	1.00	1.00	1.00	1.00	1.00
Work Zone On Approach		No			No			No			No	
Adj Sat Flow, veh/h/ln	1870	1870	0	0	1841	1841	1870	1870	1870	1900	1900	1900
Adj Flow Rate, veh/h	255	499	0	0	540	66	275	30	228	7	0	72
Peak Hour Factor	0.92	0.92	0.92	0.92	0.92	0.92	0.92	0.92	0.92	0.92	0.92	0.92
Percent Heavy Veh, %	2	2	0	0	4	4	2	2	2	0	0	0
Cap, veh/h	291	1463	0	0	617	75	425	45	340	28	0	293
Arrive On Green	0.16	0.41	0.00	0.00	0.20	0.20	0.24	0.24	0.24	0.20	0.00	0.20
Sat Flow, veh/h	1781	3647	0	0	3207	379	1781	188	1426	142	0	1464
Grp Volume(v), veh/h	255	499	0	0	302	304	275	0	258	79	0	0
Grp Sat Flow(s),veh/h/ln	1781	1777	0	0	1749	1745	1781	0	1614	1606	0	0
Q Serve(g_s), s	12.6	8.7	0.0	0.0	15.1	15.2	12.5	0.0	13.0	3.7	0.0	0.0
Cycle Q Clear(g_c), s	12.6	8.7	0.0	0.0	15.1	15.2	12.5	0.0	13.0	3.7	0.0	0.0
Prop In Lane	1.00		0.00	0.00		0.22	1.00		0.88	0.09		0.91
Lane Grp Cap(c), veh/h	291	1463	0	0	347	346	425	0	385	321	0	0
V/C Ratio(X)	0.88	0.34	0.00	0.00	0.87	0.88	0.65	0.00	0.67	0.25	0.00	0.00
Avail Cap(c_a), veh/h	327	1560	0	0	359	359	425	0	385	321	0	0
HCM Platoon Ratio	1.00	1.00	1.00	1.00	1.00	1.00	1.00	1.00	1.00	1.00	1.00	1.00
Upstream Filter(I)	1.00	1.00	0.00	0.00	1.00	1.00	1.00	0.00	1.00	1.00	0.00	0.00
Uniform Delay (d), s/veh	36.8	18.1	0.0	0.0	35.0	35.0	30.9	0.0	31.1	30.3	0.0	0.0
Incr Delay (d2), s/veh	20.9	0.1	0.0	0.0	19.7	20.7	7.4	0.0	9.0	1.8	0.0	0.0
Initial Q Delay(d3),s/veh	0.0	0.0	0.0	0.0	0.0	0.0	0.0	0.0	0.0	0.0	0.0	0.0
%ile BackOfQ(50%),veh/ln	7.1	3.5	0.0	0.0	8.2	8.3	6.1	0.0	5.9	1.6	0.0	0.0
Unsig. Movement Delay, s/veh												
LnGrp Delay(d),s/veh	57.6	18.3	0.0	0.0	54.7	55.7	38.3	0.0	40.1	32.1	0.0	0.0
LnGrp LOS	E	B	A	A	D	E	D	A	D	C	A	A
Approach Vol, veh/h		754			606			533				79
Approach Delay, s/veh		31.6			55.2			39.2				32.1
Approach LOS		C			E			D				C
Timer - Assigned Phs		2		4		6	7	8				
Phs Duration (G+Y+Rc), s		26.0		41.5		22.5	19.2	22.3				
Change Period (Y+Rc), s		4.5		4.5		4.5	4.5	4.5				
Max Green Setting (Gmax), s		19.0		39.5		18.0	16.5	18.5				
Max Q Clear Time (g_c+I1), s		15.0		10.7		5.7	14.6	17.2				
Green Ext Time (p_c), s		1.0		3.6		0.3	0.2	0.5				
Intersection Summary												
HCM 6th Ctrl Delay					40.9							
HCM 6th LOS					D							

Intersection						
Int Delay, s/veh	2.6					
Movement	EBL	EBT	WBT	WBR	SBL	SBR
Lane Configurations	↖	↗	↗		↖	↖
Traffic Vol, veh/h	130	468	485	78	60	100
Future Vol, veh/h	130	468	485	78	60	100
Conflicting Peds, #/hr	16	0	0	16	0	0
Sign Control	Free	Free	Free	Free	Stop	Stop
RT Channelized	-	None	-	None	-	None
Storage Length	145	-	-	-	65	0
Veh in Median Storage, #	-	0	0	-	0	-
Grade, %	-	0	0	-	0	-
Peak Hour Factor	98	98	98	98	98	98
Heavy Vehicles, %	5	5	4	4	5	5
Mvmt Flow	133	478	495	80	61	102

Major/Minor	Major1	Major2	Minor2		
Conflicting Flow All	591	0	-	0	1056 304
Stage 1	-	-	-	-	551 -
Stage 2	-	-	-	-	505 -
Critical Hdwy	4.2	-	-	-	6.9 7
Critical Hdwy Stg 1	-	-	-	-	5.9 -
Critical Hdwy Stg 2	-	-	-	-	5.9 -
Follow-up Hdwy	2.25	-	-	-	3.55 3.35
Pot Cap-1 Maneuver	1189	-	-	-	310 *907
Stage 1	-	-	-	-	762 -
Stage 2	-	-	-	-	563 -
Platoon blocked, %	1	-	-	-	1 1
Mov Cap-1 Maneuver	1171	-	-	-	267 *893
Mov Cap-2 Maneuver	-	-	-	-	267 -
Stage 1	-	-	-	-	665 -
Stage 2	-	-	-	-	555 -

Approach	EB	WB	SB
HCM Control Delay, s	1.8	0	14.4
HCM LOS			B

Minor Lane/Major Mvmt	EBL	EBT	WBT	WBR	SBLn1	SBLn2
Capacity (veh/h)	1171	-	-	-	267	893
HCM Lane V/C Ratio	0.113	-	-	-	0.229	0.114
HCM Control Delay (s)	8.5	-	-	-	22.4	9.6
HCM Lane LOS	A	-	-	-	C	A
HCM 95th %tile Q(veh)	0.4	-	-	-	0.9	0.4

Notes
 -: Volume exceeds capacity \$: Delay exceeds 300s +: Computation Not Defined *: All major volume in platoon

HCM 6th Signalized Intersection Summary

45: Olive Avenue & SR-99 Southbound Off-Ramp

Village D Specific Plan
Phase I WP - AM Peak Hour



Movement	EBL	EBT	WBT	WBR	SBL	SBR
Lane Configurations		↑↑↑	↑↑		↙	↗
Traffic Volume (veh/h)	0	528	459	0	533	106
Future Volume (veh/h)	0	528	459	0	533	106
Initial Q (Qb), veh	0	0	0	0	0	0
Ped-Bike Adj(A_pbT)	1.00			1.00	1.00	1.00
Parking Bus, Adj	1.00	1.00	1.00	1.00	1.00	1.00
Work Zone On Approach		No	No		No	
Adj Sat Flow, veh/h/ln	0	1826	1826	0	1781	1781
Adj Flow Rate, veh/h	0	562	488	0	567	113
Peak Hour Factor	0.94	0.94	0.94	0.94	0.94	0.94
Percent Heavy Veh, %	0	5	5	0	8	8
Cap, veh/h	0	913	635	0	1195	1063
Arrive On Green	0.00	0.18	0.18	0.00	0.70	0.70
Sat Flow, veh/h	0	5313	3652	0	1697	1510
Grp Volume(v), veh/h	0	562	488	0	567	113
Grp Sat Flow(s),veh/h/ln	0	1662	1735	0	1697	1510
Q Serve(g_s), s	0.0	8.3	10.7	0.0	11.9	1.9
Cycle Q Clear(g_c), s	0.0	8.3	10.7	0.0	11.9	1.9
Prop In Lane	0.00			0.00	1.00	1.00
Lane Grp Cap(c), veh/h	0	913	635	0	1195	1063
V/C Ratio(X)	0.00	0.62	0.77	0.00	0.47	0.11
Avail Cap(c_a), veh/h	0	1277	889	0	1195	1063
HCM Platoon Ratio	1.00	1.00	1.00	1.00	1.00	1.00
Upstream Filter(I)	0.00	1.00	0.93	0.00	1.00	1.00
Uniform Delay (d), s/veh	0.0	30.1	31.1	0.0	5.2	3.8
Incr Delay (d2), s/veh	0.0	0.7	2.5	0.0	1.4	0.2
Initial Q Delay(d3),s/veh	0.0	0.0	0.0	0.0	0.0	0.0
%ile BackOfQ(50%),veh/ln	0.0	3.3	4.6	0.0	3.6	0.5
Unsig. Movement Delay, s/veh						
LnGrp Delay(d),s/veh	0.0	30.8	33.6	0.0	6.6	4.0
LnGrp LOS	A	C	C	A	A	A
Approach Vol, veh/h		562	488		680	
Approach Delay, s/veh		30.8	33.6		6.2	
Approach LOS		C	C		A	
Timer - Assigned Phs				4	6	8
Phs Duration (G+Y+Rc), s				19.1	60.9	19.1
Change Period (Y+Rc), s				4.5	4.5	4.5
Max Green Setting (Gmax), s				20.5	50.5	20.5
Max Q Clear Time (g_c+I1), s				10.3	13.9	12.7
Green Ext Time (p_c), s				2.7	2.4	2.0
Intersection Summary						
HCM 6th Ctrl Delay			21.9			
HCM 6th LOS			C			

HCM 6th Signalized Intersection Summary

46: Madera Avenue & SR-99 Northbound Ramps

Village D Specific Plan
Phase I WP - AM Peak Hour



Movement	EBL	EBT	EBR	WBL	WBT	WBR	NBL	NBT	NBR	SBL	SBT	SBR
Lane Configurations				↶	↷	↶	↶	↶			↷	↷
Traffic Volume (veh/h)	0	0	0	178	1	86	478	439	0	0	605	198
Future Volume (veh/h)	0	0	0	178	1	86	478	439	0	0	605	198
Initial Q (Qb), veh				0	0	0	0	0	0	0	0	0
Ped-Bike Adj(A_pbT)				1.00		0.98	1.00		1.00	1.00		0.97
Parking Bus, Adj				1.00	1.00	1.00	1.00	1.00	1.00	1.00	1.00	1.00
Work Zone On Approach				No			No			No		
Adj Sat Flow, veh/h/ln				1826	1826	1826	1811	1811	0	0	1841	1841
Adj Flow Rate, veh/h				194	0	93	520	477	0	0	658	215
Peak Hour Factor				0.92	0.92	0.92	0.92	0.92	0.92	0.92	0.92	0.92
Percent Heavy Veh, %				5	5	5	6	6	0	0	4	4
Cap, veh/h				325	0	142	1193	2732	0	0	979	320
Arrive On Green				0.09	0.00	0.09	0.60	1.00	0.00	0.00	0.38	0.38
Sat Flow, veh/h				3478	0	1518	3346	3532	0	0	2659	838
Grp Volume(v), veh/h				194	0	93	520	477	0	0	448	425
Grp Sat Flow(s),veh/h/ln				1739	0	1518	1673	1721	0	0	1749	1656
Q Serve(g_s), s				4.3	0.0	4.7	6.8	0.0	0.0	0.0	17.1	17.1
Cycle Q Clear(g_c), s				4.3	0.0	4.7	6.8	0.0	0.0	0.0	17.1	17.1
Prop In Lane				1.00		1.00	1.00		0.00	0.00		0.51
Lane Grp Cap(c), veh/h				325	0	142	1193	2732	0	0	667	631
V/C Ratio(X)				0.60	0.00	0.66	0.44	0.17	0.00	0.00	0.67	0.67
Avail Cap(c_a), veh/h				804	0	351	1193	2732	0	0	667	631
HCM Platoon Ratio				1.00	1.00	1.00	1.67	1.67	1.00	1.00	1.00	1.00
Upstream Filter(I)				1.00	0.00	1.00	0.86	0.86	0.00	0.00	1.00	1.00
Uniform Delay (d), s/veh				34.8	0.0	35.0	11.8	0.0	0.0	0.0	20.6	20.6
Incr Delay (d2), s/veh				1.8	0.0	5.1	0.2	0.1	0.0	0.0	5.3	5.6
Initial Q Delay(d3),s/veh				0.0	0.0	0.0	0.0	0.0	0.0	0.0	0.0	0.0
%ile BackOfQ(50%),veh/ln				1.9	0.0	1.9	2.1	0.0	0.0	0.0	7.5	7.2
Unsig. Movement Delay, s/veh												
LnGrp Delay(d),s/veh				36.6	0.0	40.1	12.0	0.1	0.0	0.0	25.9	26.2
LnGrp LOS				D	A	D	B	A	A	A	C	C
Approach Vol, veh/h					287			997			873	
Approach Delay, s/veh					37.7			6.3			26.1	
Approach LOS					D			A			C	
Timer - Assigned Phs		2			5	6		8				
Phs Duration (G+Y+Rc), s		68.0			33.0	35.0		12.0				
Change Period (Y+Rc), s		4.5			4.5	4.5		4.5				
Max Green Setting (Gmax), s		52.5			17.5	30.5		18.5				
Max Q Clear Time (g_c+I1), s		2.0			8.8	19.1		6.7				
Green Ext Time (p_c), s		3.7			1.4	4.4		0.8				

Intersection Summary

HCM 6th Ctrl Delay	18.5
HCM 6th LOS	B

Notes

User approved volume balancing among the lanes for turning movement.

HCM 6th Signalized Intersection Summary
 47: Madera Avenue & Olive Avenue/SR-99 Southbound On-Ramp

Village D Specific Plan
 Phase I WP - AM Peak Hour



Movement	EBL	EBT	EBR	WBL	WBT	WBR	NBL	NBT	NBR	SBL	SBT	SBR
Lane Configurations												
Traffic Volume (veh/h)	364	195	501	0	0	0	142	552	40	85	381	317
Future Volume (veh/h)	364	195	501	0	0	0	142	552	40	85	381	317
Initial Q (Qb), veh	0	0	0				0	0	0	0	0	0
Ped-Bike Adj(A_pbT)	1.00		1.00				1.00		0.99	1.00		0.99
Parking Bus, Adj	1.00	1.00	1.00				1.00	1.00	1.00	1.00	1.00	1.00
Work Zone On Approach		No					No			No		
Adj Sat Flow, veh/h/ln	1811	1811	1811				1781	1781	1781	1841	1841	1841
Adj Flow Rate, veh/h	294	330	527				149	581	42	89	401	334
Peak Hour Factor	0.95	0.95	0.95				0.95	0.95	0.95	0.95	0.95	0.95
Percent Heavy Veh, %	6	6	6				8	8	8	4	4	4
Cap, veh/h	433	455	493				231	1648	119	114	922	761
Arrive On Green	0.42	0.42	0.42				0.07	0.52	0.52	0.11	0.85	0.85
Sat Flow, veh/h	1725	1811	1535				3291	3199	231	1753	1809	1494
Grp Volume(v), veh/h	294	330	527				149	307	316	89	387	348
Grp Sat Flow(s),veh/h/ln	1725	1811	1535				1646	1692	1737	1753	1749	1554
Q Serve(g_s), s	11.1	12.2	20.1				3.5	8.6	8.6	4.0	4.2	4.2
Cycle Q Clear(g_c), s	11.1	12.2	20.1				3.5	8.6	8.6	4.0	4.2	4.2
Prop In Lane	1.00		1.00				1.00		0.13	1.00		0.96
Lane Grp Cap(c), veh/h	433	455	493				231	872	895	114	891	792
V/C Ratio(X)	0.68	0.73	1.07				0.64	0.35	0.35	0.78	0.43	0.44
Avail Cap(c_a), veh/h	433	455	493				638	872	895	217	891	792
HCM Platoon Ratio	1.67	1.67	1.67				1.00	1.00	1.00	1.67	1.67	1.67
Upstream Filter(I)	0.84	0.84	0.84				1.00	1.00	1.00	0.83	0.83	0.83
Uniform Delay (d), s/veh	20.6	20.9	21.7				36.2	11.5	11.5	35.1	3.2	3.2
Incr Delay (d2), s/veh	3.6	4.8	56.7				3.0	1.1	1.1	9.4	1.3	1.5
Initial Q Delay(d3),s/veh	0.0	0.0	0.0				0.0	0.0	0.0	0.0	0.0	0.0
%ile BackOfQ(50%),veh/ln	0.0	4.7	24.5				1.5	3.2	3.3	1.9	1.3	1.2
Unsig. Movement Delay, s/veh												
LnGrp Delay(d),s/veh	24.2	25.7	78.3				39.2	12.6	12.6	44.5	4.5	4.7
LnGrp LOS	C	C	F				D	B	B	D	A	A
Approach Vol, veh/h		1151						772			824	
Approach Delay, s/veh		49.4						17.7			8.9	
Approach LOS		D						B			A	
Timer - Assigned Phs	1	2		4	5	6						
Phs Duration (G+Y+Rc), s	9.7	45.7		24.6	10.1	45.3						
Change Period (Y+Rc), s	4.5	4.5		4.5	4.5	4.5						
Max Green Setting (Gmax), s	36.5			20.1	15.5	30.9						
Max Q Clear Time (g_c+1), s	10.6			22.1	5.5	6.2						
Green Ext Time (p_c), s	0.1	4.1		0.0	0.3	5.2						

Intersection Summary

HCM 6th Ctrl Delay	28.4
HCM 6th LOS	C

Notes

User approved volume balancing among the lanes for turning movement.

Intersection						
Int Delay, s/veh	0.3					
Movement	WBL	WBR	NBT	NBR	SBL	SBT
Lane Configurations	↘↗		↑↓		↘	↑↑
Traffic Vol, veh/h	9	8	756	8	32	1005
Future Vol, veh/h	9	8	756	8	32	1005
Conflicting Peds, #/hr	0	0	0	8	8	0
Sign Control	Stop	Stop	Free	Free	Free	Free
RT Channelized	-	None	-	None	-	None
Storage Length	0	-	-	-	100	-
Veh in Median Storage, #	0	-	0	-	-	0
Grade, %	0	-	0	-	-	0
Peak Hour Factor	97	97	97	97	97	97
Heavy Vehicles, %	12	12	6	6	6	6
Mvmt Flow	9	8	779	8	33	1036

Major/Minor	Minor1	Major1	Major2		
Conflicting Flow All	1375	402	0	0	795
Stage 1	791	-	-	-	-
Stage 2	584	-	-	-	-
Critical Hdwy	7.04	7.14	-	-	4.22
Critical Hdwy Stg 1	6.04	-	-	-	-
Critical Hdwy Stg 2	6.04	-	-	-	-
Follow-up Hdwy	3.62	3.42	-	-	2.26
Pot Cap-1 Maneuver	*340	571	-	-	797
Stage 1	*382	-	-	-	-
Stage 2	*624	-	-	-	-
Platoon blocked, %	1	-	-	-	-
Mov Cap-1 Maneuver	*323	567	-	-	791
Mov Cap-2 Maneuver	*337	-	-	-	-
Stage 1	*379	-	-	-	-
Stage 2	*598	-	-	-	-

Approach	WB	NB	SB
HCM Control Delay, s	14	0	0.3
HCM LOS	B		

Minor Lane/Major Mvmt	NBT	NBRWBLn1	SBL	SBT
Capacity (veh/h)	-	-	417	791
HCM Lane V/C Ratio	-	-	0.042	0.042
HCM Control Delay (s)	-	-	14	9.7
HCM Lane LOS	-	-	B	A
HCM 95th %tile Q(veh)	-	-	0.1	0.1

Notes
 -: Volume exceeds capacity \$: Delay exceeds 300s +: Computation Not Defined *: All major volume in platoon

HCM 6th Signalized Intersection Summary
 49: Yosemite Avenue & Cleveland Avenue/Tozer Street

Village D Specific Plan
 Phase I WP - AM Peak Hour



Movement	EBL	EBT	EBR	WBL	WBT	WBR	NBL	NBT	NBR	SBL	SBT	SBR
Lane Configurations	↖	↗		↖	↗	↗	↖	↗	↗	↖	↗	↗
Traffic Volume (veh/h)	248	520	252	112	309	47	134	116	75	66	243	210
Future Volume (veh/h)	248	520	252	112	309	47	134	116	75	66	243	210
Initial Q (Qb), veh	0	0	0	0	0	0	0	0	0	0	0	0
Ped-Bike Adj(A_pbT)	1.00		0.92	1.00		0.92	1.00		1.00	1.00		1.00
Parking Bus, Adj	1.00	1.00	1.00	1.00	1.00	1.00	1.00	1.00	1.00	1.00	1.00	1.00
Work Zone On Approach		No			No			No			No	
Adj Sat Flow, veh/h/ln	1856	1856	1856	1841	1841	1841	1856	1856	1856	1870	1870	1870
Adj Flow Rate, veh/h	270	565	274	122	336	51	146	126	82	72	264	228
Peak Hour Factor	0.92	0.92	0.92	0.92	0.92	0.92	0.92	0.92	0.92	0.92	0.92	0.92
Percent Heavy Veh, %	3	3	3	4	4	4	3	3	3	2	2	2
Cap, veh/h	307	740	358	151	853	349	172	611	516	93	263	227
Arrive On Green	0.17	0.33	0.33	0.09	0.24	0.24	0.10	0.33	0.33	0.05	0.28	0.28
Sat Flow, veh/h	1767	2233	1080	1753	3497	1432	1767	1856	1568	1781	925	799
Grp Volume(v), veh/h	270	446	393	122	336	51	146	126	82	72	0	492
Grp Sat Flow(s),veh/h/ln	1767	1763	1550	1753	1749	1432	1767	1856	1568	1781	0	1724
Q Serve(g_s), s	13.4	20.3	20.4	6.1	7.2	2.5	7.3	4.4	3.3	3.6	0.0	25.5
Cycle Q Clear(g_c), s	13.4	20.3	20.4	6.1	7.2	2.5	7.3	4.4	3.3	3.6	0.0	25.5
Prop In Lane	1.00		0.70	1.00		1.00	1.00		1.00	1.00		0.46
Lane Grp Cap(c), veh/h	307	584	514	151	853	349	172	611	516	93	0	490
V/C Ratio(X)	0.88	0.76	0.77	0.81	0.39	0.15	0.85	0.21	0.16	0.77	0.00	1.00
Avail Cap(c_a), veh/h	357	584	514	158	853	349	172	611	516	185	0	490
HCM Platoon Ratio	1.00	1.00	1.00	1.00	1.00	1.00	1.00	1.00	1.00	1.00	1.00	1.00
Upstream Filter(I)	1.00	1.00	1.00	1.00	1.00	1.00	1.00	1.00	1.00	1.00	0.00	1.00
Uniform Delay (d), s/veh	36.1	26.8	26.9	40.2	28.3	26.6	39.8	21.6	21.3	42.0	0.0	32.1
Incr Delay (d2), s/veh	19.5	9.1	10.4	24.7	1.4	0.9	31.4	0.2	0.1	12.7	0.0	41.5
Initial Q Delay(d3),s/veh	0.0	0.0	0.0	0.0	0.0	0.0	0.0	0.0	0.0	0.0	0.0	0.0
%ile BackOfQ(50%),veh/ln	7.3	9.7	8.7	3.6	3.1	0.9	4.6	1.9	1.2	1.9	0.0	15.9
Unsig. Movement Delay, s/veh												
LnGrp Delay(d),s/veh	55.7	36.0	37.3	64.9	29.7	27.4	71.2	21.8	21.4	54.7	0.0	73.6
LnGrp LOS	E	D	D	E	C	C	E	C	C	D	A	F
Approach Vol, veh/h		1109			509			354			564	
Approach Delay, s/veh		41.2			37.9			42.1			71.1	
Approach LOS		D			D			D			E	
Timer - Assigned Phs	1	2	3	4	5	6	7	8				
Phs Duration (G+Y+Rc), s	20.1	26.4	9.2	34.0	12.2	34.2	13.2	30.0				
Change Period (Y+Rc), s	4.5	4.5	4.5	4.5	4.5	4.5	4.5	4.5				
Max Green Setting (Gmax), s	18.1	19.7	9.3	24.9	8.1	29.7	8.7	25.5				
Max Q Clear Time (g_c+I1), s	15.4	9.2	5.6	6.4	8.1	22.4	9.3	27.5				
Green Ext Time (p_c), s	0.2	1.7	0.0	0.8	0.0	3.2	0.0	0.0				

Intersection Summary

HCM 6th Ctrl Delay	47.3
HCM 6th LOS	D

Intersection						
Int Delay, s/veh	0					
Movement	WBL	WBR	NBT	NBR	SBL	SBT
Lane Configurations						
Traffic Vol, veh/h	0	0	0	0	0	0
Future Vol, veh/h	0	0	0	0	0	0
Conflicting Peds, #/hr	0	0	0	0	0	0
Sign Control	Stop	Stop	Free	Free	Free	Free
RT Channelized	-	None	-	None	-	None
Storage Length	0	-	-	-	50	-
Veh in Median Storage, #	0	-	0	-	-	0
Grade, %	0	-	0	-	-	0
Peak Hour Factor	92	92	92	92	92	92
Heavy Vehicles, %	0	0	0	0	0	0
Mvmt Flow	0	0	0	0	0	0

Major/Minor	Minor1	Major1	Major2			
Conflicting Flow All	1	0	0	0	0	0
Stage 1	0	-	-	-	-	-
Stage 2	1	-	-	-	-	-
Critical Hdwy	6.4	6.2	-	-	4.1	-
Critical Hdwy Stg 1	5.4	-	-	-	-	-
Critical Hdwy Stg 2	5.4	-	-	-	-	-
Follow-up Hdwy	3.5	3.3	-	-	2.2	-
Pot Cap-1 Maneuver	1027	-	-	-	-	-
Stage 1	-	-	-	-	-	-
Stage 2	1028	-	-	-	-	-
Platoon blocked, %						
Mov Cap-1 Maneuver	1027	-	-	-	-	-
Mov Cap-2 Maneuver	1027	-	-	-	-	-
Stage 1	-	-	-	-	-	-
Stage 2	1028	-	-	-	-	-

Approach	WB	NB	SB
HCM Control Delay, s	0	0	0
HCM LOS	A		

Minor Lane/Major Mvmt	NBT	NBRWBLn1	SBL	SBT
Capacity (veh/h)	-	-	-	-
HCM Lane V/C Ratio	-	-	-	-
HCM Control Delay (s)	-	-	0	0
HCM Lane LOS	-	-	A	A
HCM 95th %tile Q(veh)	-	-	-	-

Intersection						
Int Delay, s/veh	0					
Movement	EBT	EBR	WBL	WBT	NBL	NBR
Lane Configurations	↔		↔	↑	↔	↔
Traffic Vol, veh/h	48	0	0	63	0	0
Future Vol, veh/h	48	0	0	63	0	0
Conflicting Peds, #/hr	0	0	0	0	0	0
Sign Control	Free	Free	Free	Free	Stop	Stop
RT Channelized	-	None	-	None	-	None
Storage Length	-	-	50	-	50	0
Veh in Median Storage, #	0	-	-	0	0	-
Grade, %	0	-	-	0	0	-
Peak Hour Factor	92	92	92	92	92	92
Heavy Vehicles, %	11	11	7	7	0	0
Mvmt Flow	52	0	0	68	0	0

Major/Minor	Major1	Major2	Minor1		
Conflicting Flow All	0	0	52	0	120
Stage 1	-	-	-	-	52
Stage 2	-	-	-	-	68
Critical Hdwy	-	-	4.17	-	6.4
Critical Hdwy Stg 1	-	-	-	-	5.4
Critical Hdwy Stg 2	-	-	-	-	5.4
Follow-up Hdwy	-	-	2.263	-	3.5
Pot Cap-1 Maneuver	-	-	1522	-	880
Stage 1	-	-	-	-	976
Stage 2	-	-	-	-	960
Platoon blocked, %	-	-	-	-	-
Mov Cap-1 Maneuver	-	-	1522	-	880
Mov Cap-2 Maneuver	-	-	-	-	880
Stage 1	-	-	-	-	976
Stage 2	-	-	-	-	960

Approach	EB	WB	NB
HCM Control Delay, s	0	0	0
HCM LOS			A

Minor Lane/Major Mvmt	NBLn1	NBLn2	EBT	EBR	WBL	WBT
Capacity (veh/h)	-	-	-	-	1522	-
HCM Lane V/C Ratio	-	-	-	-	-	-
HCM Control Delay (s)	0	0	-	-	0	-
HCM Lane LOS	A	A	-	-	A	-
HCM 95th %tile Q(veh)	-	-	-	-	0	-

Intersection												
Int Delay, s/veh	0.5											
Movement	EBL	EBT	EBR	WBL	WBT	WBR	NBL	NBT	NBR	SBL	SBT	SBR
Lane Configurations	↶	↷		↶	↷		↶	↷		↶	↷	
Traffic Vol, veh/h	0	30	2	0	34	0	0	0	2	2	0	0
Future Vol, veh/h	0	30	2	0	34	0	0	0	2	2	0	0
Conflicting Peds, #/hr	0	0	0	0	0	0	0	0	0	0	0	0
Sign Control	Free	Free	Free	Free	Free	Free	Stop	Stop	Stop	Stop	Stop	Stop
RT Channelized	-	-	None	-	-	None	-	-	None	-	-	None
Storage Length	50	-	-	50	-	-	50	-	-	50	-	-
Veh in Median Storage, #	-	0	-	-	0	-	-	0	-	-	0	-
Grade, %	-	0	-	-	0	-	-	0	-	-	0	-
Peak Hour Factor	92	92	92	92	92	92	92	92	92	92	92	92
Heavy Vehicles, %	11	11	11	11	11	11	0	0	0	0	0	0
Mvmt Flow	0	33	2	0	37	0	0	0	2	2	0	0

Major/Minor	Major1		Major2		Minor1		Minor2					
Conflicting Flow All	37	0	0	35	0	0	71	71	34	72	72	37
Stage 1	-	-	-	-	-	-	34	34	-	37	37	-
Stage 2	-	-	-	-	-	-	37	37	-	35	35	-
Critical Hdwy	4.21	-	-	4.21	-	-	7.1	6.5	6.2	7.1	6.5	6.2
Critical Hdwy Stg 1	-	-	-	-	-	-	6.1	5.5	-	6.1	5.5	-
Critical Hdwy Stg 2	-	-	-	-	-	-	6.1	5.5	-	6.1	5.5	-
Follow-up Hdwy	2.299	-	-	2.299	-	-	3.5	4	3.3	3.5	4	3.3
Pot Cap-1 Maneuver	1517	-	-	1520	-	-	925	823	1045	924	822	1041
Stage 1	-	-	-	-	-	-	987	871	-	984	868	-
Stage 2	-	-	-	-	-	-	984	868	-	986	870	-
Platoon blocked, %	-	-	-	-	-	-	-	-	-	-	-	-
Mov Cap-1 Maneuver	1517	-	-	1520	-	-	925	823	1045	922	822	1041
Mov Cap-2 Maneuver	-	-	-	-	-	-	925	823	-	922	822	-
Stage 1	-	-	-	-	-	-	987	871	-	984	868	-
Stage 2	-	-	-	-	-	-	984	868	-	984	870	-

Approach	EB	WB	NB	SB
HCM Control Delay, s	0	0	8.5	8.9
HCM LOS			A	A

Minor Lane/Major Mvmt	NBLn1	NBLn2	EBL	EBT	EBR	WBL	WBT	WBR	SBLn1	SBLn2
Capacity (veh/h)	-	1045	1517	-	-	1520	-	-	922	-
HCM Lane V/C Ratio	-	0.002	-	-	-	-	-	-	0.002	-
HCM Control Delay (s)	0	8.5	0	-	-	0	-	-	8.9	0
HCM Lane LOS	A	A	A	-	-	A	-	-	A	A
HCM 95th %tile Q(veh)	-	0	0	-	-	0	-	-	0	-

Intersection												
Int Delay, s/veh	5.8											
Movement	EBL	EBT	EBR	WBL	WBT	WBR	NBL	NBT	NBR	SBL	SBT	SBR
Lane Configurations	↶	↷		↶	↷		↶	↷		↶	↷	
Traffic Vol, veh/h	0	0	0	1	0	1	1	0	2	1	0	0
Future Vol, veh/h	0	0	0	1	0	1	1	0	2	1	0	0
Conflicting Peds, #/hr	0	0	0	0	0	0	0	0	0	0	0	0
Sign Control	Free	Free	Free	Free	Free	Free	Stop	Stop	Stop	Stop	Stop	Stop
RT Channelized	-	-	None	-	-	None	-	-	None	-	-	None
Storage Length	50	-	-	50	-	-	50	-	-	50	-	-
Veh in Median Storage, #	-	0	-	-	0	-	-	0	-	-	0	-
Grade, %	-	0	-	-	0	-	-	0	-	-	0	-
Peak Hour Factor	92	92	92	92	92	92	92	92	92	92	92	92
Heavy Vehicles, %	0	0	0	0	0	0	0	0	0	0	0	0
Mvmt Flow	0	0	0	1	0	1	1	0	2	1	0	0

Major/Minor	Major1			Major2			Minor1			Minor2		
Conflicting Flow All	1	0	0	1	0	0	4	4	1	5	4	1
Stage 1	-	-	-	-	-	-	1	1	-	3	3	-
Stage 2	-	-	-	-	-	-	3	3	-	2	1	-
Critical Hdwy	4.1	-	-	4.1	-	-	7.1	6.5	6.2	7.1	6.5	6.2
Critical Hdwy Stg 1	-	-	-	-	-	-	6.1	5.5	-	6.1	5.5	-
Critical Hdwy Stg 2	-	-	-	-	-	-	6.1	5.5	-	6.1	5.5	-
Follow-up Hdwy	2.2	-	-	2.2	-	-	3.5	4	3.3	3.5	4	3.3
Pot Cap-1 Maneuver	1635	-	-	1635	-	-	1022	896	1090	1021	896	1090
Stage 1	-	-	-	-	-	-	1027	899	-	1025	897	-
Stage 2	-	-	-	-	-	-	1025	897	-	1026	899	-
Platoon blocked, %	-	-	-	-	-	-	-	-	-	-	-	-
Mov Cap-1 Maneuver	1635	-	-	1635	-	-	1022	895	1090	1019	895	1090
Mov Cap-2 Maneuver	-	-	-	-	-	-	1022	895	-	1019	895	-
Stage 1	-	-	-	-	-	-	1027	899	-	1025	896	-
Stage 2	-	-	-	-	-	-	1024	896	-	1024	899	-

Approach	EB			WB			NB			SB		
HCM Control Delay, s	0			3.6			8.4			8.5		
HCM LOS							A			A		

Minor Lane/Major Mvmt	NBLn1	NBLn2	EBL	EBT	EBR	WBL	WBT	WBR	SBLn1	SBLn2
Capacity (veh/h)	1022	1090	1635	-	-	1635	-	-	1019	-
HCM Lane V/C Ratio	0.001	0.002	-	-	-	0.001	-	-	0.001	-
HCM Control Delay (s)	8.5	8.3	0	-	-	7.2	-	-	8.5	0
HCM Lane LOS	A	A	A	-	-	A	-	-	A	A
HCM 95th %tile Q(veh)	0	0	0	-	-	0	-	-	0	-

Intersection						
Int Delay, s/veh	0					
Movement	EBL	EBT	WBT	WBR	SBL	SBR
Lane Configurations	↙	↑	↘		↙	↘
Traffic Vol, veh/h	0	0	0	0	0	0
Future Vol, veh/h	0	0	0	0	0	0
Conflicting Peds, #/hr	0	0	0	0	0	0
Sign Control	Free	Free	Free	Free	Stop	Stop
RT Channelized	-	None	-	None	-	None
Storage Length	50	-	-	-	50	0
Veh in Median Storage, #	-	0	0	-	0	-
Grade, %	-	0	0	-	0	-
Peak Hour Factor	92	92	92	92	92	92
Heavy Vehicles, %	0	0	0	0	0	0
Mvmt Flow	0	0	0	0	0	0

Major/Minor	Major1	Major2	Minor2		
Conflicting Flow All	1	0	-	0	1 1
Stage 1	-	-	-	-	1 -
Stage 2	-	-	-	-	0 -
Critical Hdwy	4.1	-	-	-	6.4 6.2
Critical Hdwy Stg 1	-	-	-	-	5.4 -
Critical Hdwy Stg 2	-	-	-	-	5.4 -
Follow-up Hdwy	2.2	-	-	-	3.5 3.3
Pot Cap-1 Maneuver	1635	-	-	-	1027 1090
Stage 1	-	-	-	-	1028 -
Stage 2	-	-	-	-	- -
Platoon blocked, %		-	-	-	
Mov Cap-1 Maneuver	1635	-	-	-	1027 1090
Mov Cap-2 Maneuver	-	-	-	-	1027 -
Stage 1	-	-	-	-	1028 -
Stage 2	-	-	-	-	- -

Approach	EB	WB	SB
HCM Control Delay, s	0	0	0
HCM LOS			A

Minor Lane/Major Mvmt	EBL	EBT	WBT	WBR	SBLn1	SBLn2
Capacity (veh/h)	1635	-	-	-	-	-
HCM Lane V/C Ratio	-	-	-	-	-	-
HCM Control Delay (s)	0	-	-	-	0	0
HCM Lane LOS	A	-	-	-	A	A
HCM 95th %tile Q(veh)	0	-	-	-	-	-

Intersection						
Int Delay, s/veh	0					
Movement	EBL	EBR	NBL	NBT	SBT	SBR
Lane Configurations						
Traffic Vol, veh/h	0	0	0	638	349	0
Future Vol, veh/h	0	0	0	638	349	0
Conflicting Peds, #/hr	0	0	0	0	0	0
Sign Control	Stop	Stop	Free	Free	Free	Free
RT Channelized	-	None	-	None	-	None
Storage Length	50	0	50	-	-	-
Veh in Median Storage, #	0	-	-	0	0	-
Grade, %	0	-	-	0	0	-
Peak Hour Factor	92	92	92	92	92	92
Heavy Vehicles, %	0	0	8	8	12	12
Mvmt Flow	0	0	0	693	379	0

Major/Minor	Minor2	Major1	Major2			
Conflicting Flow All	1072	379	379	0	-	0
Stage 1	379	-	-	-	-	-
Stage 2	693	-	-	-	-	-
Critical Hdwy	6.4	6.2	4.18	-	-	-
Critical Hdwy Stg 1	5.4	-	-	-	-	-
Critical Hdwy Stg 2	5.4	-	-	-	-	-
Follow-up Hdwy	3.5	3.3	2.272	-	-	-
Pot Cap-1 Maneuver	246	672	1147	-	-	-
Stage 1	696	-	-	-	-	-
Stage 2	500	-	-	-	-	-
Platoon blocked, %				-	-	-
Mov Cap-1 Maneuver	246	672	1147	-	-	-
Mov Cap-2 Maneuver	246	-	-	-	-	-
Stage 1	696	-	-	-	-	-
Stage 2	500	-	-	-	-	-

Approach	EB	NB	SB
HCM Control Delay, s	0	0	0
HCM LOS	A		

Minor Lane/Major Mvmt	NBL	NBT	EBLn1	EBLn2	SBT	SBR
Capacity (veh/h)	1147	-	-	-	-	-
HCM Lane V/C Ratio	-	-	-	-	-	-
HCM Control Delay (s)	0	-	0	0	-	-
HCM Lane LOS	A	-	A	A	-	-
HCM 95th %tile Q(veh)	0	-	-	-	-	-

Intersection						
Int Delay, s/veh	6.2					
Movement	WBL	WBR	NBT	NBR	SBL	SBT
Lane Configurations	↙	↗	↖		↙	↗
Traffic Vol, veh/h	80	263	319	110	132	404
Future Vol, veh/h	80	263	319	110	132	404
Conflicting Peds, #/hr	0	0	0	0	0	0
Sign Control	Stop	Stop	Free	Free	Free	Free
RT Channelized	-	None	-	None	-	None
Storage Length	50	0	-	-	50	-
Veh in Median Storage, #	0	-	0	-	-	0
Grade, %	0	-	0	-	-	0
Peak Hour Factor	92	92	92	92	92	92
Heavy Vehicles, %	0	0	11	11	7	7
Mvmt Flow	87	286	347	120	143	439

Major/Minor	Minor1	Major1	Major2			
Conflicting Flow All	1132	407	0	0	467	0
Stage 1	407	-	-	-	-	-
Stage 2	725	-	-	-	-	-
Critical Hdwy	6.4	6.2	-	-	4.17	-
Critical Hdwy Stg 1	5.4	-	-	-	-	-
Critical Hdwy Stg 2	5.4	-	-	-	-	-
Follow-up Hdwy	3.5	3.3	-	-	2.263	-
Pot Cap-1 Maneuver	227	648	-	-	1069	-
Stage 1	676	-	-	-	-	-
Stage 2	483	-	-	-	-	-
Platoon blocked, %			-	-	-	-
Mov Cap-1 Maneuver	197	648	-	-	1069	-
Mov Cap-2 Maneuver	197	-	-	-	-	-
Stage 1	676	-	-	-	-	-
Stage 2	418	-	-	-	-	-

Approach	WB	NB	SB
HCM Control Delay, s	20.1	0	2.2
HCM LOS	C		

Minor Lane/Major Mvmt	NBT	NBR	WBLn1	WBLn2	SBL	SBT
Capacity (veh/h)	-	-	197	648	1069	-
HCM Lane V/C Ratio	-	-	0.441	0.441	0.134	-
HCM Control Delay (s)	-	-	37	14.9	8.9	-
HCM Lane LOS	-	-	E	B	A	-
HCM 95th %tile Q(veh)	-	-	2.1	2.3	0.5	-

Intersection						
Int Delay, s/veh	0					
Movement	EBL	EBR	NBL	NBT	SBT	SBR
Lane Configurations						
Traffic Vol, veh/h	0	1	1	429	737	0
Future Vol, veh/h	0	1	1	429	737	0
Conflicting Peds, #/hr	0	0	0	0	0	0
Sign Control	Stop	Stop	Free	Free	Free	Free
RT Channelized	-	None	-	None	-	None
Storage Length	0	-	50	-	-	-
Veh in Median Storage, #	0	-	-	0	0	-
Grade, %	0	-	-	0	0	-
Peak Hour Factor	92	92	92	92	92	92
Heavy Vehicles, %	0	0	11	11	11	11
Mvmt Flow	0	1	1	466	801	0

Major/Minor	Minor2	Major1		Major2	
Conflicting Flow All	1269	801	801	0	0
Stage 1	801	-	-	-	-
Stage 2	468	-	-	-	-
Critical Hdwy	6.4	6.2	4.21	-	-
Critical Hdwy Stg 1	5.4	-	-	-	-
Critical Hdwy Stg 2	5.4	-	-	-	-
Follow-up Hdwy	3.5	3.3	2.299	-	-
Pot Cap-1 Maneuver	188	388	784	-	-
Stage 1	445	-	-	-	-
Stage 2	634	-	-	-	-
Platoon blocked, %				-	-
Mov Cap-1 Maneuver	188	388	784	-	-
Mov Cap-2 Maneuver	188	-	-	-	-
Stage 1	445	-	-	-	-
Stage 2	634	-	-	-	-

Approach	EB	NB	SB
HCM Control Delay, s	14.3	0	0
HCM LOS	B		

Minor Lane/Major Mvmt	NBL	NBT	EBLn1	SBT	SBR
Capacity (veh/h)	784	-	388	-	-
HCM Lane V/C Ratio	0.001	-	0.003	-	-
HCM Control Delay (s)	9.6	-	14.3	-	-
HCM Lane LOS	A	-	B	-	-
HCM 95th %tile Q(veh)	0	-	0	-	-

Intersection						
Int Delay, s/veh	124.2					
Movement	EBT	EBR	WBL	WBT	NBL	NBR
Lane Configurations	↔		↔	↑	↔	↔
Traffic Vol, veh/h	887	88	154	327	207	292
Future Vol, veh/h	887	88	154	327	207	292
Conflicting Peds, #/hr	0	0	0	0	0	0
Sign Control	Free	Free	Free	Free	Stop	Stop
RT Channelized	-	None	-	None	-	None
Storage Length	-	-	50	-	50	0
Veh in Median Storage, #	0	-	-	0	0	-
Grade, %	0	-	-	0	0	-
Peak Hour Factor	92	92	92	92	92	92
Heavy Vehicles, %	1	1	1	1	0	0
Mvmt Flow	964	96	167	355	225	317
Major/Minor	Major1	Major2	Minor1			
Conflicting Flow All	0	0	1060	0	1701	1012
Stage 1	-	-	-	-	1012	-
Stage 2	-	-	-	-	689	-
Critical Hdwy	-	-	4.11	-	6.4	6.2
Critical Hdwy Stg 1	-	-	-	-	5.4	-
Critical Hdwy Stg 2	-	-	-	-	5.4	-
Follow-up Hdwy	-	-	2.209	-	3.5	3.3
Pot Cap-1 Maneuver	-	-	661	-	~ 102	~ 293
Stage 1	-	-	-	-	354	-
Stage 2	-	-	-	-	502	-
Platoon blocked, %	-	-	-	-	-	-
Mov Cap-1 Maneuver	-	-	661	-	~ 76	~ 293
Mov Cap-2 Maneuver	-	-	-	-	~ 76	-
Stage 1	-	-	-	-	354	-
Stage 2	-	-	-	-	375	-
Approach	EB	WB	NB			
HCM Control Delay, s	0	3.9	\$ 482.9			
HCM LOS			F			
Minor Lane/Major Mvmt	NBLn1	NBLn2	EBT	EBR	WBL	WBT
Capacity (veh/h)	76	293	-	-	661	-
HCM Lane V/C Ratio	2.961	1.083	-	-	0.253	-
HCM Control Delay (s)	\$ 1001.1	115.6	-	-	12.3	-
HCM Lane LOS	F	F	-	-	B	-
HCM 95th %tile Q(veh)	22.4	12.5	-	-	1	-
Notes						
-: Volume exceeds capacity \$: Delay exceeds 300s +: Computation Not Defined *: All major volume in platoon						

Intersection						
Int Delay, s/veh	0.1					
Movement	EBT	EBR	WBL	WBT	NBL	NBR
Lane Configurations						
Traffic Vol, veh/h	90	0	0	40	1	0
Future Vol, veh/h	90	0	0	40	1	0
Conflicting Peds, #/hr	0	0	0	0	0	0
Sign Control	Free	Free	Free	Free	Stop	Stop
RT Channelized	-	None	-	None	-	None
Storage Length	-	-	50	-	-	-
Veh in Median Storage, #	0	-	-	0	0	-
Grade, %	0	-	-	0	0	-
Peak Hour Factor	92	92	92	92	92	92
Heavy Vehicles, %	2	2	3	3	0	0
Mvmt Flow	98	0	0	43	1	0

Major/Minor	Major1	Major2	Minor1		
Conflicting Flow All	0	0	98	0	141
Stage 1	-	-	-	-	98
Stage 2	-	-	-	-	43
Critical Hdwy	-	-	4.13	-	6.4
Critical Hdwy Stg 1	-	-	-	-	5.4
Critical Hdwy Stg 2	-	-	-	-	5.4
Follow-up Hdwy	-	-	2.227	-	3.5
Pot Cap-1 Maneuver	-	-	1489	-	857
Stage 1	-	-	-	-	931
Stage 2	-	-	-	-	985
Platoon blocked, %	-	-	-	-	-
Mov Cap-1 Maneuver	-	-	1489	-	857
Mov Cap-2 Maneuver	-	-	-	-	857
Stage 1	-	-	-	-	931
Stage 2	-	-	-	-	985

Approach	EB	WB	NB
HCM Control Delay, s	0	0	9.2
HCM LOS			A

Minor Lane/Major Mvmt	NBLn1	EBT	EBR	WBL	WBT
Capacity (veh/h)	857	-	-	1489	-
HCM Lane V/C Ratio	0.001	-	-	-	-
HCM Control Delay (s)	9.2	-	-	0	-
HCM Lane LOS	A	-	-	A	-
HCM 95th %tile Q(veh)	0	-	-	0	-

Intersection	
Intersection Delay, s/veh	7.7
Intersection LOS	A

Movement	EBL	EBT	EBR	WBL	WBT	WBR	NBL	NBT	NBR	SBL	SBT	SBR
Lane Configurations	↶	↷		↶	↷		↶	↷		↶	↷	
Traffic Vol, veh/h	0	49	0	0	14	0	0	0	1	0	0	0
Future Vol, veh/h	0	49	0	0	14	0	0	0	1	0	0	0
Peak Hour Factor	0.92	0.92	0.92	0.92	0.92	0.92	0.92	0.92	0.92	0.92	0.92	0.92
Heavy Vehicles, %	13	13	13	13	13	13	0	0	0	0	0	0
Mvmt Flow	0	53	0	0	15	0	0	0	1	0	0	0
Number of Lanes	1	1	0	1	1	0	1	1	0	1	1	0

Approach	EB	WB	NB	SB
Opposing Approach	WB	EB	SB	NB
Opposing Lanes	2	2	2	2
Conflicting Approach Left	SB	NB	EB	WB
Conflicting Lanes Left	2	2	2	2
Conflicting Approach Right	NB	SB	WB	EB
Conflicting Lanes Right	2	2	2	2
HCM Control Delay	7.8	7.6	6.7	0
HCM LOS	A	A	A	-

Lane	NBLn1	NBLn2	EBLn1	EBLn2	WBLn1	WBLn2	SBLn1	SBLn2
Vol Left, %	0%	0%	0%	0%	0%	0%	0%	0%
Vol Thru, %	100%	0%	100%	100%	100%	100%	100%	100%
Vol Right, %	0%	100%	0%	0%	0%	0%	0%	0%
Sign Control	Stop	Stop	Stop	Stop	Stop	Stop	Stop	Stop
Traffic Vol by Lane	0	1	0	49	0	14	0	0
LT Vol	0	0	0	0	0	0	0	0
Through Vol	0	0	0	49	0	14	0	0
RT Vol	0	1	0	0	0	0	0	0
Lane Flow Rate	0	1	0	53	0	15	0	0
Geometry Grp	7	7	7	7	7	7	7	7
Degree of Util (X)	0	0.001	0	0.07	0	0.02	0	0
Departure Headway (Hd)	4.619	3.919	4.731	4.731	4.748	4.748	4.62	4.62
Convergence, Y/N	Yes	Yes	Yes	Yes	Yes	Yes	Yes	Yes
Cap	0	906	0	761	0	756	0	0
Service Time	2.376	1.675	2.434	2.434	2.461	2.461	2.377	2.377
HCM Lane V/C Ratio	0	0.001	0	0.07	0	0.02	0	0
HCM Control Delay	7.4	6.7	7.4	7.8	7.5	7.6	7.4	7.4
HCM Lane LOS	N	A	N	A	N	A	N	N
HCM 95th-tile Q	0	0	0	0.2	0	0.1	0	0

Intersection

Int Delay, s/veh 6.4

Movement	EBL	EBT	WBT	WBR	SBL	SBR
Lane Configurations		↕	↑	↗	↘	
Traffic Vol, veh/h	7	147	82	102	258	8
Future Vol, veh/h	7	147	82	102	258	8
Conflicting Peds, #/hr	0	0	0	0	0	0
Sign Control	Free	Free	Free	Free	Stop	Stop
RT Channelized	-	None	-	None	-	None
Storage Length	-	-	-	0	0	-
Veh in Median Storage, #	-	0	0	-	0	-
Grade, %	-	0	0	-	0	-
Peak Hour Factor	92	92	92	92	92	92
Heavy Vehicles, %	10	10	53	53	30	30
Mvmt Flow	8	160	89	111	280	9

Major/Minor	Major1	Major2	Minor2		
Conflicting Flow All	200	0	-	0	265 89
Stage 1	-	-	-	-	89 -
Stage 2	-	-	-	-	176 -
Critical Hdwy	4.2	-	-	-	6.7 6.5
Critical Hdwy Stg 1	-	-	-	-	5.7 -
Critical Hdwy Stg 2	-	-	-	-	5.7 -
Follow-up Hdwy	2.29	-	-	-	3.77 3.57
Pot Cap-1 Maneuver	1326	-	-	-	668 897
Stage 1	-	-	-	-	869 -
Stage 2	-	-	-	-	791 -
Platoon blocked, %		-	-	-	
Mov Cap-1 Maneuver	1326	-	-	-	663 897
Mov Cap-2 Maneuver	-	-	-	-	663 -
Stage 1	-	-	-	-	863 -
Stage 2	-	-	-	-	791 -

Approach	EB	WB	SB
HCM Control Delay, s	0.4	0	14.4
HCM LOS			B

Minor Lane/Major Mvmt	EBL	EBT	WBT	WBR	SBLn1
Capacity (veh/h)	1326	-	-	-	668
HCM Lane V/C Ratio	0.006	-	-	-	0.433
HCM Control Delay (s)	7.7	0	-	-	14.4
HCM Lane LOS	A	A	-	-	B
HCM 95th %tile Q(veh)	0	-	-	-	2.2

HCM 6th TWSC
4: Truck Parking Lot/Pistachio Drive & Avenue 18 1/2

Village D Specific Plan
Phase I WP - PM Peak Hour

Intersection												
Int Delay, s/veh	4.7											
Movement	EBL	EBT	EBR	WBL	WBT	WBR	NBL	NBT	NBR	SBL	SBT	SBR
Lane Configurations		↕			↕	↕		↕			↕	
Traffic Vol, veh/h	12	455	1	6	169	193	2	0	5	159	0	12
Future Vol, veh/h	12	455	1	6	169	193	2	0	5	159	0	12
Conflicting Peds, #/hr	0	0	0	0	0	0	0	0	1	1	0	0
Sign Control	Free	Free	Free	Free	Free	Free	Stop	Stop	Stop	Stop	Stop	Stop
RT Channelized	-	-	None	-	-	None	-	-	None	-	-	None
Storage Length	-	-	-	-	-	50	-	-	-	-	-	-
Veh in Median Storage, #	-	0	-	-	0	-	-	0	-	-	0	-
Grade, %	-	0	-	-	0	-	-	0	-	-	0	-
Peak Hour Factor	93	93	93	93	93	93	93	93	93	93	93	93
Heavy Vehicles, %	22	22	22	25	25	25	71	71	71	5	5	5
Mvmt Flow	13	489	1	6	182	208	2	0	5	171	0	13

Major/Minor	Major1			Major2			Minor1			Minor2		
Conflicting Flow All	390	0	0	490	0	0	821	918	491	713	710	182
Stage 1	-	-	-	-	-	-	516	516	-	194	194	-
Stage 2	-	-	-	-	-	-	305	402	-	519	516	-
Critical Hdwy	4.32	-	-	4.35	-	-	7.81	7.21	6.91	7.15	6.55	6.25
Critical Hdwy Stg 1	-	-	-	-	-	-	6.81	6.21	-	6.15	5.55	-
Critical Hdwy Stg 2	-	-	-	-	-	-	6.81	6.21	-	6.15	5.55	-
Follow-up Hdwy	2.398	-	-	2.425	-	-	4.139	4.639	3.939	3.545	4.045	3.345
Pot Cap-1 Maneuver	1068	-	-	964	-	-	226	210	460	343	355	853
Stage 1	-	-	-	-	-	-	434	436	-	801	734	-
Stage 2	-	-	-	-	-	-	579	497	-	534	529	-
Platoon blocked, %	-	-	-	-	-	-	-	-	-	-	-	-
Mov Cap-1 Maneuver	1068	-	-	964	-	-	218	205	460	332	346	853
Mov Cap-2 Maneuver	-	-	-	-	-	-	218	205	-	332	346	-
Stage 1	-	-	-	-	-	-	427	429	-	787	728	-
Stage 2	-	-	-	-	-	-	566	493	-	518	520	-

Approach	EB			WB			NB			SB		
HCM Control Delay, s	0.2			0.1			15.5			26.5		
HCM LOS							C			D		

Minor Lane/Major Mvmt	NBLn1	EBL	EBT	EBR	WBL	WBT	WBR	SBLn1
Capacity (veh/h)	349	1068	-	-	964	-	-	347
HCM Lane V/C Ratio	0.022	0.012	-	-	0.007	-	-	0.53
HCM Control Delay (s)	15.5	8.4	0	-	8.8	0	-	26.5
HCM Lane LOS	C	A	A	-	A	A	-	D
HCM 95th %tile Q(veh)	0.1	0	-	-	0	-	-	3

Intersection

Int Delay, s/veh 102.5

Movement	EBL	EBT	EBR	WBL	WBT	WBR	NBL	NBT	NBR	SBL	SBT	SBR
Lane Configurations		↑	↑		↑		↑		↑		↕	
Traffic Vol, veh/h	0	388	231	45	196	0	52	0	206	22	293	122
Future Vol, veh/h	0	388	231	45	196	0	52	0	206	22	293	122
Conflicting Peds, #/hr	0	0	0	0	0	0	0	0	0	0	0	0
Sign Control	Free	Free	Free	Free	Free	Free	Stop	Stop	Stop	Stop	Stop	Stop
RT Channelized	-	-	None	-	-	None	-	-	None	-	-	None
Storage Length	-	-	50	-	-	-	0	-	25	-	-	-
Veh in Median Storage, #	-	0	-	-	0	-	-	0	-	-	0	-
Grade, %	-	0	-	-	0	-	-	0	-	-	0	-
Peak Hour Factor	94	94	94	94	94	94	94	94	94	94	94	94
Heavy Vehicles, %	19	19	19	30	30	30	9	9	9	15	15	15
Mvmt Flow	0	413	246	48	209	0	55	0	219	23	312	130

Major/Minor	Major1			Major2			Minor1			Minor2		
Conflicting Flow All	-	0	0	659	0	0	939	-	413	951	964	209
Stage 1	-	-	-	-	-	-	413	-	-	305	305	-
Stage 2	-	-	-	-	-	-	526	-	-	646	659	-
Critical Hdwy	-	-	-	4.4	-	-	7.19	-	6.29	7.25	6.65	6.35
Critical Hdwy Stg 1	-	-	-	-	-	-	6.19	-	-	6.25	5.65	-
Critical Hdwy Stg 2	-	-	-	-	-	-	6.19	-	-	6.25	5.65	-
Follow-up Hdwy	-	-	-	2.47	-	-	3.581	-	3.381	3.635	4.135	3.435
Pot Cap-1 Maneuver	0	-	-	810	-	0	237	0	624	227	~ 243	800
Stage 1	0	-	-	-	-	0	603	0	-	678	639	-
Stage 2	0	-	-	-	-	0	523	0	-	439	441	-
Platoon blocked, %	-	-	-	-	-	-	-	-	-	-	-	-
Mov Cap-1 Maneuver	-	-	-	810	-	-	-	-	624	140	~ 227	800
Mov Cap-2 Maneuver	-	-	-	-	-	-	-	-	-	140	~ 227	-
Stage 1	-	-	-	-	-	-	603	-	-	678	596	-
Stage 2	-	-	-	-	-	-	195	-	-	285	441	-

Approach	EB	WB	NB	SB
HCM Control Delay, s	0	1.8		\$ 363.7
HCM LOS			-	F

Minor Lane/Major Mvmt	NBLn1	NBLn2	EBT	EBR	WBL	WBT	SBLn1
Capacity (veh/h)	-	624	-	-	810	-	273
HCM Lane V/C Ratio	-	0.351	-	-	0.059	-	1.703
HCM Control Delay (s)	-	13.9	-	-	9.7	-	\$ 363.7
HCM Lane LOS	-	B	-	-	A	A	F
HCM 95th %tile Q(veh)	-	1.6	-	-	0.2	-	29.8

Notes
 -: Volume exceeds capacity \$: Delay exceeds 300s +: Computation Not Defined *: All major volume in platoon

Intersection												
Int Delay, s/veh	23.5											
Movement	EBL	EBT	EBR	WBL	WBT	WBR	NBL	NBT	NBR	SBL	SBT	SBR
Lane Configurations	↖	↑			↗			↕				
Traffic Vol, veh/h	294	95	0	0	85	16	185	2	0	0	0	0
Future Vol, veh/h	294	95	0	0	85	16	185	2	0	0	0	0
Conflicting Peds, #/hr	0	0	0	0	0	0	0	0	0	0	0	0
Sign Control	Free	Free	Free	Free	Free	Free	Stop	Stop	Stop	Free	Free	Free
RT Channelized	-	-	None	-	-	None	-	-	None	-	-	None
Storage Length	145	-	-	-	-	-	-	-	-	-	-	-
Veh in Median Storage, #	-	0	-	-	0	-	-	0	-	-	16965	-
Grade, %	-	0	-	-	0	-	-	0	-	-	0	-
Peak Hour Factor	92	92	92	92	92	92	92	92	92	92	92	92
Heavy Vehicles, %	15	15	15	12	12	12	24	24	24	0	0	0
Mvmt Flow	320	103	0	0	92	17	201	2	0	0	0	0

Major/Minor	Major1	Major2	Minor1
Conflicting Flow All	109	0	-
Stage 1	-	-	-
Stage 2	-	-	-
Critical Hdwy	4.25	-	-
Critical Hdwy Stg 1	-	-	-
Critical Hdwy Stg 2	-	-	-
Follow-up Hdwy	2.335	-	-
Pot Cap-1 Maneuver	1404	0	0
Stage 1	-	0	0
Stage 2	-	0	0
Platoon blocked, %	-	-	-
Mov Cap-1 Maneuver	1404	-	-
Mov Cap-2 Maneuver	-	-	-
Stage 1	-	-	-
Stage 2	-	-	-

Approach	EB	WB	NB
HCM Control Delay, s	6.3	0	72
HCM LOS			F

Minor Lane/Major Mvmt	NBLn1	EBL	EBT	WBT	WBR
Capacity (veh/h)	236	1404	-	-	-
HCM Lane V/C Ratio	0.861	0.228	-	-	-
HCM Control Delay (s)	72	8.3	-	-	-
HCM Lane LOS	F	A	-	-	-
HCM 95th %tile Q(veh)	6.9	0.9	-	-	-

Intersection												
Int Delay, s/veh	30.3											
Movement	EBL	EBT	EBR	WBL	WBT	WBR	NBL	NBT	NBR	SBL	SBT	SBR
Lane Configurations		↕			↕			↕			↕	
Traffic Vol, veh/h	1	50	39	130	22	9	17	231	134	62	493	2
Future Vol, veh/h	1	50	39	130	22	9	17	231	134	62	493	2
Conflicting Peds, #/hr	0	0	0	0	0	0	0	0	0	0	0	0
Sign Control	Stop	Stop	Stop	Stop	Stop	Stop	Free	Free	Free	Free	Free	Free
RT Channelized	-	-	None	-	-	None	-	-	None	-	-	None
Storage Length	-	-	-	-	-	-	-	-	-	-	-	-
Veh in Median Storage, #	-	0	-	-	0	-	-	0	-	-	0	-
Grade, %	-	0	-	-	0	-	-	0	-	-	0	-
Peak Hour Factor	92	92	92	92	92	92	92	92	92	92	92	92
Heavy Vehicles, %	2	2	2	2	2	2	3	3	3	4	4	4
Mvmt Flow	1	54	42	141	24	10	18	251	146	67	536	2

Major/Minor	Minor2		Minor1		Major1			Major2				
Conflicting Flow All	1048	1104	537	1079	1032	324	538	0	0	397	0	0
Stage 1	671	671	-	360	360	-	-	-	-	-	-	-
Stage 2	377	433	-	719	672	-	-	-	-	-	-	-
Critical Hdwy	7.12	6.52	6.22	7.12	6.52	6.22	4.13	-	-	4.14	-	-
Critical Hdwy Stg 1	6.12	5.52	-	6.12	5.52	-	-	-	-	-	-	-
Critical Hdwy Stg 2	6.12	5.52	-	6.12	5.52	-	-	-	-	-	-	-
Follow-up Hdwy	3.518	4.018	3.318	3.518	4.018	3.318	2.227	-	-	2.236	-	-
Pot Cap-1 Maneuver	206	211	544	196	233	717	1025	-	-	1151	-	-
Stage 1	446	455	-	658	626	-	-	-	-	-	-	-
Stage 2	644	582	-	420	454	-	-	-	-	-	-	-
Platoon blocked, %								-	-	-	-	-
Mov Cap-1 Maneuver	171	189	544	~ 130	209	717	1025	-	-	1151	-	-
Mov Cap-2 Maneuver	171	189	-	~ 130	209	-	-	-	-	-	-	-
Stage 1	436	417	-	643	612	-	-	-	-	-	-	-
Stage 2	596	569	-	309	416	-	-	-	-	-	-	-

Approach	EB		WB		NB		SB	
HCM Control Delay, s	26.6		205		0.4		0.9	
HCM LOS	D		F					

Minor Lane/Major Mvmt	NBL	NBT	NBR	EBLn1WBLn1	SBL	SBT	SBR
Capacity (veh/h)	1025	-	-	263	144	1151	-
HCM Lane V/C Ratio	0.018	-	-	0.372	1.215	0.059	-
HCM Control Delay (s)	8.6	0	-	26.6	205	8.3	0
HCM Lane LOS	A	A	-	D	F	A	A
HCM 95th %tile Q(veh)	0.1	-	-	1.6	10.3	0.2	-

Notes
 -: Volume exceeds capacity \$: Delay exceeds 300s +: Computation Not Defined *: All major volume in platoon

Intersection	
Intersection Delay, s/veh	28.8
Intersection LOS	D

Movement	EBL	EBT	EBR	WBL	WBT	WBR	NBL	NBT	NBR	SBL	SBT	SBR
Lane Configurations	↶	↷		↶	↷		↶	↷		↶	↷	
Traffic Vol, veh/h	16	0	42	49	1	72	9	347	127	184	493	21
Future Vol, veh/h	16	0	42	49	1	72	9	347	127	184	493	21
Peak Hour Factor	0.95	0.95	0.95	0.95	0.95	0.95	0.95	0.95	0.95	0.95	0.95	0.95
Heavy Vehicles, %	6	6	6	1	1	1	3	3	3	4	4	4
Mvmt Flow	17	0	44	52	1	76	9	365	134	194	519	22
Number of Lanes	1	1	0	1	1	0	1	1	0	1	1	0

Approach	EB	WB	NB	SB
Opposing Approach	WB	EB	SB	NB
Opposing Lanes	2	2	2	2
Conflicting Approach Left	SB	NB	EB	WB
Conflicting Lanes Left	2	2	2	2
Conflicting Approach Right	NB	SB	WB	EB
Conflicting Lanes Right	2	2	2	2
HCM Control Delay	11	11.4	31.8	31.2
HCM LOS	B	B	D	D

Lane	NBLn1	NBLn2	EBLn1	EBLn2	WBLn1	WBLn2	SBLn1	SBLn2
Vol Left, %	100%	0%	100%	0%	100%	0%	100%	0%
Vol Thru, %	0%	73%	0%	0%	0%	1%	0%	96%
Vol Right, %	0%	27%	0%	100%	0%	99%	0%	4%
Sign Control	Stop	Stop	Stop	Stop	Stop	Stop	Stop	Stop
Traffic Vol by Lane	9	474	16	42	49	73	184	514
LT Vol	9	0	16	0	49	0	184	0
Through Vol	0	347	0	0	0	1	0	493
RT Vol	0	127	0	42	0	72	0	21
Lane Flow Rate	9	499	17	44	52	77	194	541
Geometry Grp	7	7	7	7	7	7	7	7
Degree of Util (X)	0.018	0.835	0.04	0.089	0.117	0.149	0.346	0.885
Departure Headway (Hd)	6.722	6.024	8.512	7.274	8.196	6.971	6.423	5.888
Convergence, Y/N	Yes	Yes	Yes	Yes	Yes	Yes	Yes	Yes
Cap	531	599	418	489	435	512	558	611
Service Time	4.486	3.788	6.309	5.069	5.981	4.755	4.179	3.643
HCM Lane V/C Ratio	0.017	0.833	0.041	0.09	0.12	0.15	0.348	0.885
HCM Control Delay	9.6	32.2	11.7	10.8	12.1	11	12.6	37.9
HCM Lane LOS	A	D	B	B	B	B	B	E
HCM 95th-tile Q	0.1	8.8	0.1	0.3	0.4	0.5	1.5	10.5

Intersection												
Intersection Delay, s/veh	61.6											
Intersection LOS	F											

Movement	EBL	EBT	EBR	WBL	WBT	WBR	NBL	NBT	NBR	SBL	SBT	SBR
Lane Configurations	↔	↔		↔	↔		↔	↔		↔	↔	
Traffic Vol, veh/h	1	0	1	245	0	166	0	295	288	184	384	1
Future Vol, veh/h	1	0	1	245	0	166	0	295	288	184	384	1
Peak Hour Factor	0.93	0.93	0.93	0.93	0.93	0.93	0.93	0.93	0.93	0.93	0.93	0.93
Heavy Vehicles, %	0	0	0	1	1	1	3	3	3	5	5	5
Mvmt Flow	1	0	1	263	0	178	0	317	310	198	413	1
Number of Lanes	1	1	0	1	1	0	1	1	0	1	1	0

Approach	EB	WB	NB	SB
Opposing Approach	WB	EB	SB	NB
Opposing Lanes	2	2	2	2
Conflicting Approach Left	SB	NB	EB	WB
Conflicting Lanes Left	2	2	2	2
Conflicting Approach Right	NB	SB	WB	EB
Conflicting Lanes Right	2	2	2	2
HCM Control Delay	12.2	18.7	124.9	27.9
HCM LOS	B	C	F	D

Lane	NBLn1	NBLn2	EBLn1	EBLn2	WBLn1	WBLn2	SBLn1	SBLn2
Vol Left, %	0%	0%	100%	0%	100%	0%	100%	0%
Vol Thru, %	100%	51%	0%	0%	0%	0%	0%	100%
Vol Right, %	0%	49%	0%	100%	0%	100%	0%	0%
Sign Control	Stop	Stop	Stop	Stop	Stop	Stop	Stop	Stop
Traffic Vol by Lane	0	583	1	1	245	166	184	385
LT Vol	0	0	1	0	245	0	184	0
Through Vol	0	295	0	0	0	0	0	384
RT Vol	0	288	0	1	0	166	0	1
Lane Flow Rate	0	627	1	1	263	178	198	414
Geometry Grp	7	7	7	7	7	7	7	7
Degree of Util (X)	0	1.186	0.003	0.002	0.582	0.339	0.412	0.805
Departure Headway (Hd)	7.162	6.808	10.039	8.776	8.436	7.192	7.823	7.307
Convergence, Y/N	Yes	Yes	Yes	Yes	Yes	Yes	Yes	Yes
Cap	0	533	359	410	429	503	463	501
Service Time	4.892	4.538	7.739	6.476	6.136	4.892	5.523	5.007
HCM Lane V/C Ratio	0	1.176	0.003	0.002	0.613	0.354	0.428	0.826
HCM Control Delay	9.9	124.9	12.8	11.5	22.2	13.5	15.9	33.7
HCM Lane LOS	N	F	B	B	C	B	C	D
HCM 95th-tile Q	0	22.6	0	0	3.6	1.5	2	7.6

Intersection												
Int Delay, s/veh	2.7											
Movement	EBL	EBT	EBR	WBL	WBT	WBR	NBL	NBT	NBR	SBL	SBT	SBR
Lane Configurations		↕			↕			↕			↕	
Traffic Vol, veh/h	1	2	3	5	3	96	2	572	2	150	501	0
Future Vol, veh/h	1	2	3	5	3	96	2	572	2	150	501	0
Conflicting Peds, #/hr	0	0	0	0	0	0	0	0	0	0	0	0
Sign Control	Stop	Stop	Stop	Stop	Stop	Stop	Free	Free	Free	Free	Free	Free
RT Channelized	-	-	None	-	-	None	-	-	None	-	-	None
Storage Length	-	-	-	-	-	-	-	-	-	-	-	-
Veh in Median Storage, #	-	0	-	-	0	-	-	0	-	-	0	-
Grade, %	-	0	-	-	0	-	-	0	-	-	0	-
Peak Hour Factor	92	92	92	92	92	92	92	92	92	92	92	92
Heavy Vehicles, %	0	0	0	0	0	0	3	3	3	4	4	4
Mvmt Flow	1	2	3	5	3	104	2	622	2	163	545	0

Major/Minor	Minor2		Minor1		Major1		Major2					
Conflicting Flow All	1552	1499	545	1501	1498	623	545	0	0	624	0	0
Stage 1	871	871	-	627	627	-	-	-	-	-	-	-
Stage 2	681	628	-	874	871	-	-	-	-	-	-	-
Critical Hdwy	7.1	6.5	6.2	7.1	6.5	6.2	4.13	-	-	4.14	-	-
Critical Hdwy Stg 1	6.1	5.5	-	6.1	5.5	-	-	-	-	-	-	-
Critical Hdwy Stg 2	6.1	5.5	-	6.1	5.5	-	-	-	-	-	-	-
Follow-up Hdwy	3.5	4	3.3	3.5	4	3.3	2.227	-	-	2.236	-	-
Pot Cap-1 Maneuver	93	123	542	101	124	490	1019	-	-	948	-	-
Stage 1	349	371	-	475	479	-	-	-	-	-	-	-
Stage 2	444	479	-	347	371	-	-	-	-	-	-	-
Platoon blocked, %								-	-	-	-	-
Mov Cap-1 Maneuver	58	92	542	80	93	490	1019	-	-	948	-	-
Mov Cap-2 Maneuver	58	92	-	80	93	-	-	-	-	-	-	-
Stage 1	348	279	-	474	478	-	-	-	-	-	-	-
Stage 2	346	478	-	258	279	-	-	-	-	-	-	-

Approach	EB		WB		NB		SB	
HCM Control Delay, s	33		19.6		0		2.2	
HCM LOS	D		C					

Minor Lane/Major Mvmt	NBL	NBT	NBR	EBLn1WBLn1	SBL	SBT	SBR
Capacity (veh/h)	1019	-	-	135	358	948	-
HCM Lane V/C Ratio	0.002	-	-	0.048	0.316	0.172	-
HCM Control Delay (s)	8.5	0	-	33	19.6	9.6	0
HCM Lane LOS	A	A	-	D	C	A	A
HCM 95th %tile Q(veh)	0	-	-	0.2	1.3	0.6	-

Intersection	
Intersection Delay, s/veh	41.2
Intersection LOS	E

Movement	EBL	EBT	EBR	WBL	WBT	WBR	NBL	NBT	NBR	SBL	SBT	SBR
Lane Configurations		↕			↕			↕			↕	
Traffic Vol, veh/h	97	90	35	11	37	273	14	207	21	259	194	55
Future Vol, veh/h	97	90	35	11	37	273	14	207	21	259	194	55
Peak Hour Factor	0.95	0.95	0.95	0.95	0.95	0.95	0.95	0.95	0.95	0.95	0.95	0.95
Heavy Vehicles, %	7	7	7	1	1	1	6	6	6	5	5	5
Mvmt Flow	102	95	37	12	39	287	15	218	22	273	204	58
Number of Lanes	0	1	0	0	1	0	0	1	0	0	1	0

Approach	EB	WB	NB	SB
Opposing Approach	WB	EB	SB	NB
Opposing Lanes	1	1	1	1
Conflicting Approach Left	SB	NB	EB	WB
Conflicting Lanes Left	1	1	1	1
Conflicting Approach Right	NB	SB	WB	EB
Conflicting Lanes Right	1	1	1	1
HCM Control Delay	18.9	22.2	19	73.5
HCM LOS	C	C	C	F

Lane	NBLn1	EBLn1	WBLn1	SBLn1
Vol Left, %	6%	44%	3%	51%
Vol Thru, %	86%	41%	12%	38%
Vol Right, %	9%	16%	85%	11%
Sign Control	Stop	Stop	Stop	Stop
Traffic Vol by Lane	242	222	321	508
LT Vol	14	97	11	259
Through Vol	207	90	37	194
RT Vol	21	35	273	55
Lane Flow Rate	255	234	338	535
Geometry Grp	1	1	1	1
Degree of Util (X)	0.529	0.505	0.647	1.029
Departure Headway (Hd)	7.692	8.009	7.102	6.93
Convergence, Y/N	Yes	Yes	Yes	Yes
Cap	471	453	514	529
Service Time	5.692	6.009	5.102	4.93
HCM Lane V/C Ratio	0.541	0.517	0.658	1.011
HCM Control Delay	19	18.9	22.2	73.5
HCM Lane LOS	C	C	C	F
HCM 95th-tile Q	3	2.8	4.6	15.1

Intersection

Intersection Delay, s/veh 10.4
Intersection LOS B

Movement	EBL	EBT	EBR	WBL	WBT	WBR	NBL	NBT	NBR	SBL	SBT	SBR
Lane Configurations												
Traffic Vol, veh/h	94	137	8	17	76	62	4	64	41	77	62	55
Future Vol, veh/h	94	137	8	17	76	62	4	64	41	77	62	55
Peak Hour Factor	0.92	0.92	0.92	0.92	0.92	0.92	0.92	0.92	0.92	0.92	0.92	0.92
Heavy Vehicles, %	12	12	12	16	16	16	7	7	7	9	9	9
Mvmt Flow	102	149	9	18	83	67	4	70	45	84	67	60
Number of Lanes	1	1	0	1	1	0	0	1	0	0	1	0

Approach	EB	WB	NB	SB
Opposing Approach	WB	EB	SB	NB
Opposing Lanes	2	2	1	1
Conflicting Approach Left SB		NB	EB	WB
Conflicting Lanes Left	1	1	2	2
Conflicting Approach Right NB		SB	WB	EB
Conflicting Lanes Right	1	1	2	2
HCM Control Delay	10.5	10.2	9.5	10.8
HCM LOS	B	B	A	B

Lane	NBLn1	EBLn1	EBLn2	WBLn1	WBLn2	SBLn1
Vol Left, %		4%	100%	0%	100%	0%
Vol Thru, %		59%	0%	94%	0%	55%
Vol Right, %		38%	0%	6%	0%	45%
Sign Control		Stop	Stop	Stop	Stop	Stop
Traffic Vol by Lane		109	94	145	17	138
LT Vol		4	94	0	17	0
Through Vol		64	0	137	0	76
RT Vol		41	0	8	0	62
Lane Flow Rate		118	102	158	18	150
Geometry Grp		2	7	7	7	7
Degree of Util (X)		0.176	0.181	0.255	0.034	0.239
Departure Headway (Hd)		5.342	6.364	5.819	6.573	5.747
Convergence, Y/N		Yes	Yes	Yes	Yes	Yes
Cap		672	565	618	545	626
Service Time		3.375	4.092	3.547	4.304	3.478
HCM Lane V/C Ratio		0.176	0.181	0.256	0.033	0.24
HCM Control Delay		9.5	10.5	10.5	9.5	10.3
HCM Lane LOS		A	B	B	A	B
HCM 95th-tile Q		0.6	0.7	1	0.1	0.9

Intersection

Int Delay, s/veh 201.6

Movement	EBL	EBT	EBR	WBL	WBT	WBR	NBL	NBT	NBR	SBL	SBT	SBR
Lane Configurations	↘	↑	↗	↘	↑	↗	↘	↑	↗		↕	
Traffic Vol, veh/h	9	306	27	142	175	165	21	53	242	232	52	9
Future Vol, veh/h	9	306	27	142	175	165	21	53	242	232	52	9
Conflicting Peds, #/hr	0	0	0	0	0	0	0	0	0	0	0	0
Sign Control	Free	Free	Free	Free	Free	Free	Stop	Stop	Stop	Stop	Stop	Stop
RT Channelized	-	-	None	-	-	None	-	-	None	-	-	None
Storage Length	85	-	0	70	-	105	60	-	50	-	-	-
Veh in Median Storage, #	-	0	-	-	0	-	-	0	-	-	0	-
Grade, %	-	0	-	-	0	-	-	0	-	-	0	-
Peak Hour Factor	92	92	92	92	92	92	92	92	92	92	92	92
Heavy Vehicles, %	2	2	2	3	3	3	5	5	5	3	3	3
Mvmt Flow	10	333	29	154	190	179	23	58	263	252	57	10

Major/Minor	Major1	Major2	Minor1	Minor2
Conflicting Flow All	369	0	0	362
Stage 1	-	-	-	-
Stage 2	-	-	-	-
Critical Hdwy	4.12	-	-	4.13
Critical Hdwy Stg 1	-	-	-	-
Critical Hdwy Stg 2	-	-	-	-
Follow-up Hdwy	2.218	-	-	2.227
Pot Cap-1 Maneuver	1190	-	-	1191
Stage 1	-	-	-	-
Stage 2	-	-	-	-
Platoon blocked, %				
Mov Cap-1 Maneuver	1190	-	-	1191
Mov Cap-2 Maneuver	-	-	-	-
Stage 1	-	-	-	-
Stage 2	-	-	-	-

Approach	EB	WB	NB	SB
HCM Control Delay, s	0.2	2.5	17.1	\$ 963.2
HCM LOS			C	F

Minor Lane/Major Mvmt	NBLn1	NBLn2	NBLn3	EBL	EBT	EBR	WBL	WBT	WBR	SBLn1
Capacity (veh/h)	167	200	702	1190	-	-	1191	-	-	108
HCM Lane V/C Ratio	0.137	0.288	0.375	0.008	-	-	0.13	-	-	2.949
HCM Control Delay (s)	29.9	30.1	13.2	8.1	-	-	8.5	-	-	\$ 963.2
HCM Lane LOS	D	D	B	A	-	-	A	-	-	F
HCM 95th %tile Q(veh)	0.5	1.1	1.7	0	-	-	0.4	-	-	30.3

Notes
 -: Volume exceeds capacity \$: Delay exceeds 300s +: Computation Not Defined *: All major volume in platoon

Intersection

Int Delay, s/veh 193.2

Movement	EBL	EBT	WBT	WBR	SBL	SBR
Lane Configurations		↑	↑		↑	↑
Traffic Vol, veh/h	0	784	421	0	418	59
Future Vol, veh/h	0	784	421	0	418	59
Conflicting Peds, #/hr	0	0	0	0	0	0
Sign Control	Free	Free	Free	Free	Stop	Stop
RT Channelized	-	None	-	None	-	None
Storage Length	-	-	-	-	0	610
Veh in Median Storage, #	-	0	0	-	0	-
Grade, %	-	0	0	-	0	-
Peak Hour Factor	92	92	92	92	92	92
Heavy Vehicles, %	3	3	5	5	2	2
Mvmt Flow	0	852	458	0	454	64

Major/Minor	Major1	Major2	Minor2
Conflicting Flow All	-	0	0 1310 458
Stage 1	-	-	- 458 -
Stage 2	-	-	- 852 -
Critical Hdwy	-	-	- 6.42 6.22
Critical Hdwy Stg 1	-	-	- 5.42 -
Critical Hdwy Stg 2	-	-	- 5.42 -
Follow-up Hdwy	-	-	- 3.518 3.318
Pot Cap-1 Maneuver	0	-	0 ~ 175 603
Stage 1	0	-	0 637 -
Stage 2	0	-	0 ~ 418 -
Platoon blocked, %	-	-	
Mov Cap-1 Maneuver	-	-	- ~ 175 603
Mov Cap-2 Maneuver	-	-	- ~ 175 -
Stage 1	-	-	- 637 -
Stage 2	-	-	- ~ 418 -

Approach	EB	WB	SB
HCM Control Delay, s	0	0	\$ 681.4
HCM LOS			F

Minor Lane/Major Mvmt	EBT	WBT	SBLn1	SBLn2
Capacity (veh/h)	-	-	175	603
HCM Lane V/C Ratio	-	-	2.596	0.106
HCM Control Delay (s)	-	-	\$ 775.9	11.7
HCM Lane LOS	-	-	F	B
HCM 95th %tile Q(veh)	-	-	39.3	0.4

Notes

-: Volume exceeds capacity \$: Delay exceeds 300s +: Computation Not Defined *: All major volume in platoon

Intersection												
Int Delay, s/veh	124.7											
Movement	EBL	EBT	EBR	WBL	WBT	WBR	NBL	NBT	NBR	SBL	SBT	SBR
Lane Configurations	↖	↑			↗			↖	↗			
Traffic Vol, veh/h	103	860	0	0	1005	309	114	2	529	0	0	0
Future Vol, veh/h	103	860	0	0	1005	309	114	2	529	0	0	0
Conflicting Peds, #/hr	0	0	0	0	0	0	0	0	0	0	0	0
Sign Control	Free	Free	Free	Free	Free	Free	Stop	Stop	Stop	Free	Free	Free
RT Channelized	-	-	None	-	-	None	-	-	None	-	-	None
Storage Length	125	-	-	-	-	-	-	-	50	-	-	-
Veh in Median Storage, #	-	0	-	-	0	-	-	0	-	-	16965	-
Grade, %	-	0	-	-	0	-	-	0	-	-	0	-
Peak Hour Factor	95	95	95	95	95	95	95	95	95	95	95	95
Heavy Vehicles, %	2	2	2	1	1	1	2	2	2	0	0	0
Mvmt Flow	108	905	0	0	1058	325	120	2	557	0	0	0

Major/Minor	Major1	Major2	Minor1
Conflicting Flow All	1383	0	0
Stage 1	-	-	-
Stage 2	-	-	-
Critical Hdwy	4.12	-	-
Critical Hdwy Stg 1	-	-	-
Critical Hdwy Stg 2	-	-	-
Follow-up Hdwy	2.218	-	-
Pot Cap-1 Maneuver	495	0	0
Stage 1	-	0	0
Stage 2	-	0	0
Platoon blocked, %	-	-	-
Mov Cap-1 Maneuver	495	-	-
Mov Cap-2 Maneuver	-	-	-
Stage 1	-	-	-
Stage 2	-	-	-

Approach	EB	WB	NB
HCM Control Delay, s	1.5	0	\$ 562.6
HCM LOS			F

Minor Lane/Major Mvmt	NBLn1	NBLn2	EBL	EBT	WBT	WBR
Capacity (veh/h)	31	335	495	-	-	-
HCM Lane V/C Ratio	3.939	1.662	0.219	-	-	-
HCM Control Delay (s)	\$ 1584.3	\$ 338.6	14.3	-	-	-
HCM Lane LOS	F	F	B	-	-	-
HCM 95th %tile Q(veh)	14.5	33.9	0.8	-	-	-

Notes
 -: Volume exceeds capacity \$: Delay exceeds 300s +: Computation Not Defined *: All major volume in platoon

HCM 6th Signalized Intersection Summary
 16: Love's Truck Stop Driveway/Driveway & Avenue 17

Village D Specific Plan
 Phase I WP - PM Peak Hour



Movement	EBL	EBT	EBR	WBL	WBT	WBR	NBL	NBT	NBR	SBL	SBT	SBR
Lane Configurations	↖	↗	↘	↖	↗	↘	↖	↗	↘	↖	↗	↘
Traffic Volume (veh/h)	556	687	141	32	629	189	160	0	31	279	0	519
Future Volume (veh/h)	556	687	141	32	629	189	160	0	31	279	0	519
Initial Q (Qb), veh	0	0	0	0	0	0	0	0	0	0	0	0
Ped-Bike Adj(A_pbT)	1.00		1.00	1.00		1.00	1.00		1.00	1.00		1.00
Parking Bus, Adj	1.00	1.00	1.00	1.00	1.00	1.00	1.00	1.00	1.00	1.00	1.00	1.00
Work Zone On Approach		No			No			No			No	
Adj Sat Flow, veh/h/ln	1885	1885	1885	1870	1870	1870	1900	1900	1900	1900	1900	1900
Adj Flow Rate, veh/h	604	747	153	35	684	205	174	0	34	303	0	564
Peak Hour Factor	0.92	0.92	0.92	0.92	0.92	0.92	0.92	0.92	0.92	0.92	0.92	0.92
Percent Heavy Veh, %	1	1	1	2	2	2	0	0	0	0	0	0
Cap, veh/h	140	1158	516	64	389	116	141	0	453	141	0	453
Arrive On Green	0.08	0.32	0.32	0.04	0.28	0.28	0.08	0.00	0.28	0.08	0.00	0.28
Sat Flow, veh/h	1795	3582	1598	1781	1382	414	1810	0	1610	1810	0	1610
Grp Volume(v), veh/h	604	747	153	35	0	889	174	0	34	303	0	564
Grp Sat Flow(s),veh/h/ln	1795	1791	1598	1781	0	1796	1810	0	1610	1810	0	1610
Q Serve(g_s), s	5.0	11.4	4.6	1.2	0.0	18.0	5.0	0.0	1.0	5.0	0.0	18.0
Cycle Q Clear(g_c), s	5.0	11.4	4.6	1.2	0.0	18.0	5.0	0.0	1.0	5.0	0.0	18.0
Prop In Lane	1.00		1.00	1.00		0.23	1.00		1.00	1.00		1.00
Lane Grp Cap(c), veh/h	140	1158	516	64	0	505	141	0	453	141	0	453
V/C Ratio(X)	4.31	0.65	0.30	0.54	0.00	1.76	1.23	0.00	0.08	2.14	0.00	1.25
Avail Cap(c_a), veh/h	140	1158	516	139	0	505	141	0	453	141	0	453
HCM Platoon Ratio	1.00	1.00	1.00	1.00	1.00	1.00	1.00	1.00	1.00	1.00	1.00	1.00
Upstream Filter(I)	1.00	1.00	1.00	1.00	0.00	1.00	1.00	0.00	1.00	1.00	0.00	1.00
Uniform Delay (d), s/veh	29.5	18.5	16.2	30.3	0.0	23.0	29.5	0.0	16.9	29.5	0.0	23.0
Incr Delay (d2), s/veh	1504.3	1.2	0.3	6.9	0.0	350.1	150.7	0.0	0.3	537.4	0.0	127.9
Initial Q Delay(d3),s/veh	0.0	0.0	0.0	0.0	0.0	0.0	0.0	0.0	0.0	0.0	0.0	0.0
%ile BackOfQ(50%),veh/ln	60.7	4.5	1.6	0.6	0.0	56.1	8.0	0.0	0.4	23.2	0.0	22.3
Unsig. Movement Delay, s/veh												
LnGrp Delay(d),s/veh	1533.8	19.8	16.5	37.3	0.0	373.1	180.2	0.0	17.2	566.9	0.0	150.9
LnGrp LOS	F	B	B	D	A	F	F	A	B	F	A	F
Approach Vol, veh/h		1504			924			208				867
Approach Delay, s/veh		627.5			360.4			153.5				296.2
Approach LOS		F			F			F				F
Timer - Assigned Phs	1	2	3	4	5	6	7	8				
Phs Duration (G+Y+Rc), s	9.5	22.5	6.8	25.2	9.5	22.5	9.5	22.5				
Change Period (Y+Rc), s	4.5	4.5	4.5	4.5	4.5	4.5	4.5	4.5				
Max Green Setting (Gmax), s	5.0	18.0	5.0	18.0	5.0	18.0	5.0	18.0				
Max Q Clear Time (g_c+I1), s	7.0	3.0	3.2	13.4	7.0	20.0	7.0	20.0				
Green Ext Time (p_c), s	0.0	0.1	0.0	2.3	0.0	0.0	0.0	0.0				

Intersection Summary

HCM 6th Ctrl Delay	446.9
HCM 6th LOS	F

Intersection												
Int Delay, s/veh	25.4											
Movement	EBL	EBT	EBR	WBL	WBT	WBR	NBL	NBT	NBR	SBL	SBT	SBR
Lane Configurations	↖	↗		↖	↗		↖	↑	↗	↖	↑	↗
Traffic Vol, veh/h	150	463	35	65	756	19	51	24	63	18	79	234
Future Vol, veh/h	150	463	35	65	756	19	51	24	63	18	79	234
Conflicting Peds, #/hr	0	0	3	3	0	0	0	0	0	0	0	0
Sign Control	Free	Free	Free	Free	Free	Free	Stop	Stop	Stop	Stop	Stop	Stop
RT Channelized	-	-	None	-	-	None	-	-	None	-	-	None
Storage Length	110	-	-	165	-	-	65	-	50	100	-	50
Veh in Median Storage, #	-	0	-	-	0	-	-	0	-	-	0	-
Grade, %	-	0	-	-	0	-	-	0	-	-	0	-
Peak Hour Factor	92	92	92	92	92	92	92	92	92	92	92	92
Heavy Vehicles, %	0	0	0	0	0	0	0	0	0	0	0	0
Mvmt Flow	163	503	38	71	822	21	55	26	68	20	86	254

Major/Minor	Major1			Major2			Minor1			Minor2		
Conflicting Flow All	843	0	0	544	0	0	1996	1836	525	1870	1845	833
Stage 1	-	-	-	-	-	-	851	851	-	975	975	-
Stage 2	-	-	-	-	-	-	1145	985	-	895	870	-
Critical Hdwy	4.1	-	-	4.1	-	-	7.1	6.5	6.2	7.1	6.5	6.2
Critical Hdwy Stg 1	-	-	-	-	-	-	6.1	5.5	-	6.1	5.5	-
Critical Hdwy Stg 2	-	-	-	-	-	-	6.1	5.5	-	6.1	5.5	-
Follow-up Hdwy	2.2	-	-	2.2	-	-	3.5	4	3.3	3.5	4	3.3
Pot Cap-1 Maneuver	802	-	-	1035	-	-	~ 45	77	556	56	~ 76	372
Stage 1	-	-	-	-	-	-	358	379	-	305	332	-
Stage 2	-	-	-	-	-	-	245	329	-	338	372	-
Platoon blocked, %		-	-		-	-						
Mov Cap-1 Maneuver	802	-	-	1032	-	-	57	554	26	~ 56	372	
Mov Cap-2 Maneuver	-	-	-	-	-	-	57	-	26	~ 56	-	
Stage 1	-	-	-	-	-	-	284	301	-	243	309	-
Stage 2	-	-	-	-	-	-	~ 52	306	-	216	296	-

Approach	EB	WB	NB	SB
HCM Control Delay, s	2.5	0.7		143.4
HCM LOS			-	F

Minor Lane/Major Mvmt	NBLn1	NBLn2	NBLn3	EBL	EBT	EBR	WBL	WBT	WBR	SBLn1	SBLn2	SBLn3
Capacity (veh/h)	-	57	554	802	-	-	1032	-	-	26	56	372
HCM Lane V/C Ratio	-	0.458	0.124	0.203	-	-	0.068	-	-	0.753	1.533	0.684
HCM Control Delay (s)	-	113.2	12.4	10.6	-	-	8.7	-	-	\$ 311.4\$	431.7	33.2
HCM Lane LOS	-	F	B	B	-	-	A	-	-	F	F	D
HCM 95th %tile Q(veh)	-	1.7	0.4	0.8	-	-	0.2	-	-	2.3	7.8	4.9

Notes
 -: Volume exceeds capacity \$: Delay exceeds 300s +: Computation Not Defined *: All major volume in platoon

Intersection	
Intersection Delay, s/veh	10.5
Intersection LOS	B

Movement	EBL	EBT	EBR	WBL	WBT	WBR	NBL	NBT	NBR	SBL	SBT	SBR
Lane Configurations	↶	↷		↶	↷		↶	↷	↶	↶	↷	↷
Traffic Vol, veh/h	17	93	34	68	105	18	54	137	57	19	134	24
Future Vol, veh/h	17	93	34	68	105	18	54	137	57	19	134	24
Peak Hour Factor	0.96	0.96	0.96	0.96	0.96	0.96	0.96	0.96	0.96	0.96	0.96	0.96
Heavy Vehicles, %	0	0	0	0	0	0	0	0	0	0	0	0
Mvmt Flow	18	97	35	71	109	19	56	143	59	20	140	25
Number of Lanes	1	1	0	1	1	0	1	1	1	1	1	1

Approach	EB	WB	NB	SB
Opposing Approach	WB	EB	SB	NB
Opposing Lanes	2	2	3	3
Conflicting Approach Left	SB	NB	EB	WB
Conflicting Lanes Left	3	3	2	2
Conflicting Approach Right	NB	SB	WB	EB
Conflicting Lanes Right	3	3	2	2
HCM Control Delay	10.6	10.6	10.2	10.6
HCM LOS	B	B	B	B

Lane	NBLn1	NBLn2	NBLn3	EBLn1	EBLn2	WBLn1	WBLn2	SBLn1	SBLn2	SBLn3
Vol Left, %	100%	0%	0%	100%	0%	100%	0%	100%	0%	0%
Vol Thru, %	0%	100%	0%	0%	73%	0%	85%	0%	100%	0%
Vol Right, %	0%	0%	100%	0%	27%	0%	15%	0%	0%	100%
Sign Control	Stop	Stop	Stop	Stop	Stop	Stop	Stop	Stop	Stop	Stop
Traffic Vol by Lane	54	137	57	17	127	68	123	19	134	24
LT Vol	54	0	0	17	0	68	0	19	0	0
Through Vol	0	137	0	0	93	0	105	0	134	0
RT Vol	0	0	57	0	34	0	18	0	0	24
Lane Flow Rate	56	143	59	18	132	71	128	20	140	25
Geometry Grp	8	8	8	8	8	8	8	8	8	8
Degree of Util (X)	0.104	0.244	0.09	0.034	0.226	0.132	0.218	0.037	0.245	0.039
Departure Headway (Hd)	6.663	6.157	5.448	6.847	6.158	6.725	6.122	6.815	6.308	5.599
Convergence, Y/N	Yes	Yes	Yes	Yes	Yes	Yes	Yes	Yes	Yes	Yes
Cap	538	582	657	522	582	533	586	525	568	638
Service Time	4.406	3.9	3.191	4.594	3.904	4.469	3.866	4.56	4.054	3.344
HCM Lane V/C Ratio	0.104	0.246	0.09	0.034	0.227	0.133	0.218	0.038	0.246	0.039
HCM Control Delay	10.2	10.9	8.7	9.8	10.7	10.5	10.6	9.8	11.1	8.6
HCM Lane LOS	B	B	A	A	B	B	B	A	B	A
HCM 95th-tile Q	0.3	1	0.3	0.1	0.9	0.5	0.8	0.1	1	0.1

Intersection

Intersection Delay, s/veh 39.2
 Intersection LOS E

Movement	EBL	EBT	EBR	WBL	WBT	WBR	NBL	NBT	NBR	SBL	SBT	SBR
Lane Configurations		↕			↕			↕			↕	
Traffic Vol, veh/h	75	397	44	22	262	167	23	45	16	109	47	83
Future Vol, veh/h	75	397	44	22	262	167	23	45	16	109	47	83
Peak Hour Factor	0.92	0.92	0.92	0.92	0.92	0.92	0.92	0.92	0.92	0.92	0.92	0.92
Heavy Vehicles, %	4	4	4	4	4	4	0	0	0	0	0	0
Mvmt Flow	82	432	48	24	285	182	25	49	17	118	51	90
Number of Lanes	0	1	0	0	1	0	0	1	0	0	1	0

Approach	EB	WB	NB	SB
Opposing Approach	WB	EB	SB	NB
Opposing Lanes	1	1	1	1
Conflicting Approach Left	SB	NB	EB	WB
Conflicting Lanes Left	1	1	1	1
Conflicting Approach Right	NB	SB	WB	EB
Conflicting Lanes Right	1	1	1	1
HCM Control Delay	56.9	34.9	13.2	18
HCM LOS	F	D	B	C

Lane	NBLn1	EBLn1	WBLn1	SBLn1
Vol Left, %	27%	15%	5%	46%
Vol Thru, %	54%	77%	58%	20%
Vol Right, %	19%	9%	37%	35%
Sign Control	Stop	Stop	Stop	Stop
Traffic Vol by Lane	84	516	451	239
LT Vol	23	75	22	109
Through Vol	45	397	262	47
RT Vol	16	44	167	83
Lane Flow Rate	91	561	490	260
Geometry Grp	1	1	1	1
Degree of Util (X)	0.205	0.975	0.847	0.525
Departure Headway (Hd)	8.089	6.366	6.332	7.276
Convergence, Y/N	Yes	Yes	Yes	Yes
Cap	446	572	574	499
Service Time	6.109	4.366	4.332	5.276
HCM Lane V/C Ratio	0.204	0.981	0.854	0.521
HCM Control Delay	13.2	56.9	34.9	18
HCM Lane LOS	B	F	D	C
HCM 95th-tile Q	0.8	13.5	9.1	3

Intersection												
Intersection Delay, s/veh	13											
Intersection LOS	B											

Movement	EBL	EBT	EBR	WBL	WBT	WBR	NBL	NBT	NBR	SBL	SBT	SBR
Lane Configurations		↕			↕	↕		↕	↕		↕	↕
Traffic Vol, veh/h	0	0	0	196	0	88	0	72	125	170	142	0
Future Vol, veh/h	0	0	0	196	0	88	0	72	125	170	142	0
Peak Hour Factor	0.92	0.92	0.92	0.92	0.92	0.92	0.92	0.92	0.92	0.92	0.92	0.92
Heavy Vehicles, %	0	0	0	1	1	1	0	0	0	0	0	0
Mvmt Flow	0	0	0	213	0	96	0	78	136	185	154	0
Number of Lanes	0	1	0	0	1	1	0	1	1	0	1	1

Approach	EB	WB	NB	SB
Opposing Approach	WB	EB	SB	NB
Opposing Lanes	2	1	2	2
Conflicting Approach Left	SB	NB	EB	WB
Conflicting Lanes Left	2	2	1	2
Conflicting Approach Right	NB	SB	WB	EB
Conflicting Lanes Right	2	2	2	1
HCM Control Delay	0	12	9.3	16.3
HCM LOS	-	B	A	C

Lane	NBLn1	NBLn2	EBLn1	WBLn1	WBLn2	SBLn1	SBLn2
Vol Left, %	0%	0%	0%	100%	0%	54%	0%
Vol Thru, %	100%	0%	100%	0%	0%	46%	100%
Vol Right, %	0%	100%	0%	0%	100%	0%	0%
Sign Control	Stop	Stop	Stop	Stop	Stop	Stop	Stop
Traffic Vol by Lane	72	125	0	196	88	312	0
LT Vol	0	0	0	196	0	170	0
Through Vol	72	0	0	0	0	142	0
RT Vol	0	125	0	0	88	0	0
Lane Flow Rate	78	136	0	213	96	339	0
Geometry Grp	7	7	6	7	7	7	7
Degree of Util (X)	0.129	0.197	0	0.389	0.142	0.566	0
Departure Headway (Hd)	5.936	5.226	6.702	6.577	5.363	6.01	5.735
Convergence, Y/N	Yes	Yes	Yes	Yes	Yes	Yes	Yes
Cap	605	687	0	548	670	600	0
Service Time	3.665	2.955	4.746	4.304	3.091	3.735	3.459
HCM Lane V/C Ratio	0.129	0.198	0	0.389	0.143	0.565	0
HCM Control Delay	9.5	9.2	9.7	13.4	9	16.3	8.5
HCM Lane LOS	A	A	N	B	A	C	N
HCM 95th-tile Q	0.4	0.7	0	1.8	0.5	3.5	0

Intersection	
Intersection Delay, s/veh	144.5
Intersection LOS	F

Movement	EBL	EBT	EBR	WBL	WBT	WBR	NBL	NBT	NBR	SBL	SBT	SBR
Lane Configurations	↙	↕↗		↙	↕↗		↙	↕	↗	↙	↕	↗
Traffic Vol, veh/h	18	442	25	340	797	37	28	217	231	34	274	33
Future Vol, veh/h	18	442	25	340	797	37	28	217	231	34	274	33
Peak Hour Factor	0.94	0.94	0.94	0.94	0.94	0.94	0.94	0.94	0.94	0.94	0.94	0.94
Heavy Vehicles, %	0	0	0	0	0	0	0	0	0	0	0	0
Mvmt Flow	19	470	27	362	848	39	30	231	246	36	291	35
Number of Lanes	1	2	0	1	2	0	1	1	1	1	1	1

Approach	EB	WB	NB	SB
Opposing Approach	WB	EB	SB	NB
Opposing Lanes	3	3	3	3
Conflicting Approach Left	SB	NB	EB	WB
Conflicting Lanes Left	3	3	3	3
Conflicting Approach Right	NB	SB	WB	EB
Conflicting Lanes Right	3	3	3	3
HCM Control Delay	86.6	223.3	51.6	85.1
HCM LOS	F	F	F	F

Lane	NBLn1	NBLn2	NBLn3	EBLn1	EBLn2	EBLn3	WBLn1	WBLn2	WBLn3	SBLn1	SBLn2
Vol Left, %	100%	0%	0%	100%	0%	0%	100%	0%	0%	100%	0%
Vol Thru, %	0%	100%	0%	0%	100%	85%	0%	100%	88%	0%	100%
Vol Right, %	0%	0%	100%	0%	0%	15%	0%	0%	12%	0%	0%
Sign Control	Stop	Stop	Stop	Stop	Stop	Stop	Stop	Stop	Stop	Stop	Stop
Traffic Vol by Lane	28	217	231	18	295	172	340	531	303	34	274
LT Vol	28	0	0	18	0	0	340	0	0	34	0
Through Vol	0	217	0	0	295	147	0	531	266	0	274
RT Vol	0	0	231	0	0	25	0	0	37	0	0
Lane Flow Rate	30	231	246	19	313	183	362	565	322	36	291
Geometry Grp	8	8	8	8	8	8	8	8	8	8	8
Degree of Util (X)	0.108	0.806	0.811	0.069	1.094	0.635	1.152	1.724	0.975	0.133	1.032
Departure Headway (Hd)	13.847	13.347	12.647	13.709	13.209	13.107	11.466	10.982	10.899	13.669	13.169
Convergence, Y/N	Yes	Yes	Yes	Yes	Yes	Yes	Yes	Yes	Yes	Yes	Yes
Cap	260	272	288	263	276	277	318	333	335	264	277
Service Time	11.547	11.047	10.347	11.409	10.909	10.807	9.241	8.741	8.655	11.369	10.869
HCM Lane V/C Ratio	0.115	0.849	0.854	0.072	1.134	0.661	1.138	1.697	0.961	0.136	1.051
HCM Control Delay	18.2	54.5	53	17.4	120.4	36.1	133	364	77.6	18.5	101.6
HCM Lane LOS	C	F	F	C	F	E	F	F	F	C	F
HCM 95th-tile Q	0.4	6.3	6.5	0.2	12.3	4	14.9	35.5	10.5	0.5	10.8

Intersection												
Intersection Delay, s/veh	30.3											
Intersection LOS	D											

Movement	EBL	EBT	EBR	WBL	WBT	WBR	NBL	NBT	NBR	SBL	SBT	SBR
Lane Configurations	↖	↗		↖	↗	↖	↖	↗		↖	↗	
Traffic Vol, veh/h	29	138	36	55	171	110	48	271	43	79	315	35
Future Vol, veh/h	29	138	36	55	171	110	48	271	43	79	315	35
Peak Hour Factor	0.93	0.93	0.93	0.93	0.93	0.93	0.93	0.93	0.93	0.93	0.93	0.93
Heavy Vehicles, %	1	1	1	0	0	0	1	1	1	1	1	1
Mvmt Flow	31	148	39	59	184	118	52	291	46	85	339	38
Number of Lanes	1	1	0	1	1	1	1	1	0	1	1	0

Approach	EB	WB	NB	SB
Opposing Approach	WB	EB	SB	NB
Opposing Lanes	3	2	2	2
Conflicting Approach Left	SB	NB	EB	WB
Conflicting Lanes Left	2	2	2	3
Conflicting Approach Right	NB	SB	WB	EB
Conflicting Lanes Right	2	2	3	2
HCM Control Delay	19.5	16.7	35.3	41.9
HCM LOS	C	C	E	E

Lane	NBLn1	NBLn2	EBLn1	EBLn2	WBLn1	WBLn2	WBLn3	SBLn1	SBLn2
Vol Left, %	100%	0%	100%	0%	100%	0%	0%	100%	0%
Vol Thru, %	0%	86%	0%	79%	0%	100%	0%	0%	90%
Vol Right, %	0%	14%	0%	21%	0%	0%	100%	0%	10%
Sign Control	Stop	Stop	Stop	Stop	Stop	Stop	Stop	Stop	Stop
Traffic Vol by Lane	48	314	29	174	55	171	110	79	350
LT Vol	48	0	29	0	55	0	0	79	0
Through Vol	0	271	0	138	0	171	0	0	315
RT Vol	0	43	0	36	0	0	110	0	35
Lane Flow Rate	52	338	31	187	59	184	118	85	376
Geometry Grp	8	8	8	8	8	8	8	8	8
Degree of Util (X)	0.132	0.805	0.086	0.483	0.156	0.46	0.272	0.212	0.88
Departure Headway (Hd)	9.193	8.58	9.975	9.3	9.523	9.004	8.278	9	8.415
Convergence, Y/N	Yes	Yes	Yes	Yes	Yes	Yes	Yes	Yes	Yes
Cap	389	422	359	387	376	399	433	398	429
Service Time	6.963	6.35	7.756	7.081	7.298	6.779	6.052	6.767	6.181
HCM Lane V/C Ratio	0.134	0.801	0.086	0.483	0.157	0.461	0.273	0.214	0.876
HCM Control Delay	13.4	38.6	13.7	20.5	14.1	19.3	14.1	14.2	48.1
HCM Lane LOS	B	E	B	C	B	C	B	B	E
HCM 95th-tile Q	0.5	7.2	0.3	2.5	0.5	2.3	1.1	0.8	9.1

HCM 6th Signalized Intersection Summary
 23: Avenue 16/Ellis Street & Kennedy Street

Village D Specific Plan
 Phase I WP - PM Peak Hour



Movement	WBL	WBR	NBT	NBR	SBL	SBT
Lane Configurations						
Traffic Volume (veh/h)	123	218	291	213	211	353
Future Volume (veh/h)	123	218	291	213	211	353
Initial Q (Qb), veh	0	0	0	0	0	0
Ped-Bike Adj(A_pbT)	1.00	1.00		1.00	1.00	
Parking Bus, Adj	1.00	1.00	1.00	1.00	1.00	1.00
Work Zone On Approach	No		No		No	
Adj Sat Flow, veh/h/ln	1870	1870	1885	1885	1885	1885
Adj Flow Rate, veh/h	134	237	316	232	229	384
Peak Hour Factor	0.92	0.92	0.92	0.92	0.92	0.92
Percent Heavy Veh, %	2	2	1	1	1	1
Cap, veh/h	212	332	1157	830	236	2753
Arrive On Green	0.12	0.12	0.58	0.58	0.13	0.77
Sat Flow, veh/h	1781	2790	2086	1428	1795	3676
Grp Volume(v), veh/h	134	237	283	265	229	384
Grp Sat Flow(s),veh/h/ln	1781	1395	1791	1628	1795	1791
Q Serve(g_s), s	5.7	6.5	6.3	6.5	10.2	2.2
Cycle Q Clear(g_c), s	5.7	6.5	6.3	6.5	10.2	2.2
Prop In Lane	1.00	1.00		0.88	1.00	
Lane Grp Cap(c), veh/h	212	332	1041	946	236	2753
V/C Ratio(X)	0.63	0.71	0.27	0.28	0.97	0.14
Avail Cap(c_a), veh/h	412	645	1041	946	236	2753
HCM Platoon Ratio	1.00	1.00	1.00	1.00	1.00	1.00
Upstream Filter(I)	0.84	0.84	1.00	1.00	1.00	1.00
Uniform Delay (d), s/veh	33.6	33.9	8.3	8.4	34.6	2.4
Incr Delay (d2), s/veh	2.6	2.4	0.6	0.7	50.5	0.1
Initial Q Delay(d3),s/veh	0.0	0.0	0.0	0.0	0.0	0.0
%ile BackOfQ(50%),veh/ln	2.6	2.3	2.4	2.2	7.6	0.5
Unsig. Movement Delay, s/veh						
LnGrp Delay(d),s/veh	36.2	36.4	9.0	9.1	85.1	2.5
LnGrp LOS	D	D	A	A	F	A
Approach Vol, veh/h	371		548			613
Approach Delay, s/veh	36.3		9.0			33.4
Approach LOS	D		A			C
Timer - Assigned Phs	1	2			6	8
Phs Duration (G+Y+Rc), s	5.0	51.0			66.0	14.0
Change Period (Y+Rc), s	4.5	4.5			4.5	4.5
Max Green Setting (Gmax), s	10.5	37.5			52.5	18.5
Max Q Clear Time (g_c+I), s	12.2	8.5			4.2	8.5
Green Ext Time (p_c), s	0.0	3.7			2.8	1.0
Intersection Summary						
HCM 6th Ctrl Delay			25.4			
HCM 6th LOS			C			

HCM 6th Signalized Intersection Summary

24: Schnoor Avenue & Kennedy Street

Village D Specific Plan
Phase I WP - PM Peak Hour



Movement	EBL	EBT	EBR	WBL	WBT	WBR	NBL	NBT	NBR	SBL	SBT	SBR
Lane Configurations												
Traffic Volume (veh/h)	40	174	188	202	156	72	195	38	247	83	32	20
Future Volume (veh/h)	40	174	188	202	156	72	195	38	247	83	32	20
Initial Q (Qb), veh	0	0	0	0	0	0	0	0	0	0	0	0
Ped-Bike Adj(A_pbT)	1.00		0.99	1.00		0.99	1.00		1.00	1.00		1.00
Parking Bus, Adj	1.00	1.00	1.00	1.00	1.00	1.00	1.00	1.00	1.00	1.00	1.00	1.00
Work Zone On Approach		No			No			No			No	
Adj Sat Flow, veh/h/ln	1870	1870	1870	1856	1856	1856	1885	1885	1885	1633	1633	1633
Adj Flow Rate, veh/h	43	185	200	215	166	77	207	40	263	88	34	21
Peak Hour Factor	0.94	0.94	0.94	0.94	0.94	0.94	0.94	0.94	0.94	0.94	0.94	0.94
Percent Heavy Veh, %	2	2	2	3	3	3	1	1	1	18	18	18
Cap, veh/h	240	299	264	257	214	99	779	58	378	301	388	328
Arrive On Green	0.13	0.17	0.17	0.15	0.18	0.18	0.22	0.27	0.27	0.19	0.24	0.24
Sat Flow, veh/h	1781	1777	1571	1767	1193	553	3483	215	1414	1555	1633	1382
Grp Volume(v), veh/h	43	185	200	215	0	243	207	0	303	88	34	21
Grp Sat Flow(s),veh/h/ln	1781	1777	1571	1767	0	1747	1742	0	1629	1555	1633	1382
Q Serve(g_s), s	1.7	7.7	9.7	9.5	0.0	10.6	3.9	0.0	13.4	3.9	1.3	0.9
Cycle Q Clear(g_c), s	1.7	7.7	9.7	9.5	0.0	10.6	3.9	0.0	13.4	3.9	1.3	0.9
Prop In Lane	1.00		1.00	1.00		0.32	1.00		0.87	1.00		1.00
Lane Grp Cap(c), veh/h	240	299	264	257	0	313	779	0	436	301	388	328
V/C Ratio(X)	0.18	0.62	0.76	0.84	0.00	0.78	0.27	0.00	0.70	0.29	0.09	0.06
Avail Cap(c_a), veh/h	240	400	353	364	0	644	779	0	436	301	388	328
HCM Platoon Ratio	1.00	1.00	1.00	1.00	1.00	1.00	1.00	1.00	1.00	1.00	1.00	1.00
Upstream Filter(I)	0.71	0.71	0.71	1.00	0.00	1.00	1.00	0.00	1.00	1.00	1.00	1.00
Uniform Delay (d), s/veh	30.7	30.9	31.7	33.3	0.0	31.3	25.6	0.0	26.4	27.6	23.8	23.6
Incr Delay (d2), s/veh	0.3	1.5	4.6	11.1	0.0	4.2	0.2	0.0	8.9	0.5	0.4	0.4
Initial Q Delay(d3),s/veh	0.0	0.0	0.0	0.0	0.0	0.0	0.0	0.0	0.0	0.0	0.0	0.0
%ile BackOfQ(50%),veh/ln	0.7	3.3	3.9	4.7	0.0	4.7	1.6	0.0	6.1	1.4	0.5	0.3
Unsig. Movement Delay, s/veh												
LnGrp Delay(d),s/veh	30.9	32.4	36.3	44.4	0.0	35.5	25.8	0.0	35.2	28.1	24.2	24.0
LnGrp LOS	C	C	D	D	A	D	C	A	D	C	C	C
Approach Vol, veh/h		428			458			510			143	
Approach Delay, s/veh		34.1			39.7			31.4			26.6	
Approach LOS		C			D			C			C	
Timer - Assigned Phs	1	2	3	4	5	6	7	8				
Phs Duration (G+Y+Rc), s	30.0	25.9	16.1	18.0	22.4	23.5	15.3	18.8				
Change Period (Y+Rc), s	4.5	4.5	4.5	4.5	4.5	4.5	4.5	4.5				
Max Green Setting (Gmax), s	15.0	21.4	16.5	18.0	8.5	19.0	5.0	29.5				
Max Q Clear Time (g_c+1), s	15.0	15.4	11.5	11.7	5.9	3.3	3.7	12.6				
Green Ext Time (p_c), s	0.0	0.9	0.3	1.2	0.2	0.1	0.0	1.3				
Intersection Summary												
HCM 6th Ctrl Delay											34.1	
HCM 6th LOS											C	

Intersection						
Int Delay, s/veh	10.8					
Movement	EBL	EBT	WBT	WBR	SBL	SBR
Lane Configurations						
Traffic Vol, veh/h	183	362	311	2	131	180
Future Vol, veh/h	183	362	311	2	131	180
Conflicting Peds, #/hr	0	0	0	0	0	0
Sign Control	Free	Free	Free	Free	Stop	Stop
RT Channelized	-	None	-	Free	-	None
Storage Length	140	-	-	-	0	335
Veh in Median Storage, #	-	0	0	-	0	-
Grade, %	-	0	0	-	0	-
Peak Hour Factor	92	92	92	92	92	92
Heavy Vehicles, %	3	3	3	3	4	4
Mvmt Flow	199	393	338	2	142	196

Major/Minor	Major1	Major2	Minor2		
Conflicting Flow All	338	0	-	0	1129 338
Stage 1	-	-	-	-	338 -
Stage 2	-	-	-	-	791 -
Critical Hdwy	4.13	-	-	-	6.44 6.24
Critical Hdwy Stg 1	-	-	-	-	5.44 -
Critical Hdwy Stg 2	-	-	-	-	5.44 -
Follow-up Hdwy	2.227	-	-	-	3.536 3.336
Pot Cap-1 Maneuver	1216	-	-	0	224 700
Stage 1	-	-	-	0	718 -
Stage 2	-	-	-	0	443 -
Platoon blocked, %		-	-		
Mov Cap-1 Maneuver	1216	-	-	-	187 700
Mov Cap-2 Maneuver	-	-	-	-	187 -
Stage 1	-	-	-	-	600 -
Stage 2	-	-	-	-	443 -

Approach	EB	WB	SB
HCM Control Delay, s	2.9	0	35.6
HCM LOS			E

Minor Lane/Major Mvmt	EBL	EBT	WBT	SBLn1	SBLn2
Capacity (veh/h)	1216	-	-	187	700
HCM Lane V/C Ratio	0.164	-	-	0.761	0.28
HCM Control Delay (s)	8.5	-	-	67.9	12.1
HCM Lane LOS	A	-	-	F	B
HCM 95th %tile Q(veh)	0.6	-	-	5	1.1

Intersection						
Int Delay, s/veh	3.5					
Movement	EBL	EBT	WBT	WBR	SBL	SBR
Lane Configurations		↕	↕		↕	
Traffic Vol, veh/h	156	338	161	0	0	152
Future Vol, veh/h	156	338	161	0	0	152
Conflicting Peds, #/hr	0	0	0	0	0	0
Sign Control	Free	Free	Free	Free	Stop	Stop
RT Channelized	-	None	-	None	-	None
Storage Length	-	-	-	-	0	-
Veh in Median Storage, #	-	0	0	-	0	-
Grade, %	-	0	0	-	0	-
Peak Hour Factor	92	92	92	92	92	92
Heavy Vehicles, %	3	3	3	3	4	4
Mvmt Flow	170	367	175	0	0	165

Major/Minor	Major1	Major2	Minor2		
Conflicting Flow All	175	0	-	0	882 175
Stage 1	-	-	-	-	175 -
Stage 2	-	-	-	-	707 -
Critical Hdwy	4.13	-	-	-	6.44 6.24
Critical Hdwy Stg 1	-	-	-	-	5.44 -
Critical Hdwy Stg 2	-	-	-	-	5.44 -
Follow-up Hdwy	2.227	-	-	-	3.536 3.336
Pot Cap-1 Maneuver	1395	-	-	-	314 863
Stage 1	-	-	-	-	851 -
Stage 2	-	-	-	-	485 -
Platoon blocked, %		-	-	-	
Mov Cap-1 Maneuver	1395	-	-	-	266 863
Mov Cap-2 Maneuver	-	-	-	-	266 -
Stage 1	-	-	-	-	721 -
Stage 2	-	-	-	-	485 -

Approach	EB	WB	SB
HCM Control Delay, s	2.5	0	10.2
HCM LOS			B

Minor Lane/Major Mvmt	EBL	EBT	WBT	WBR	SBLn1
Capacity (veh/h)	1395	-	-	-	863
HCM Lane V/C Ratio	0.122	-	-	-	0.191
HCM Control Delay (s)	7.9	0	-	-	10.2
HCM Lane LOS	A	A	-	-	B
HCM 95th %tile Q(veh)	0.4	-	-	-	0.7

Intersection						
Int Delay, s/veh	4.2					
Movement	EBL	EBR	NBL	NBT	SBT	SBR
Lane Configurations	↵			↑	↵	
Traffic Vol, veh/h	156	0	0	79	3	152
Future Vol, veh/h	156	0	0	79	3	152
Conflicting Peds, #/hr	0	0	0	0	0	0
Sign Control	Stop	Stop	Free	Free	Free	Free
RT Channelized	-	None	-	None	-	None
Storage Length	0	-	-	-	-	-
Veh in Median Storage, #	0	-	-	0	0	-
Grade, %	0	-	-	0	0	-
Peak Hour Factor	92	92	92	92	92	92
Heavy Vehicles, %	2	2	9	9	4	4
Mvmt Flow	170	0	0	86	3	165

Major/Minor	Minor2	Major1		Major2	
Conflicting Flow All	172	-	-	0	-
Stage 1	86	-	-	-	-
Stage 2	86	-	-	-	-
Critical Hdwy	6.42	-	-	-	-
Critical Hdwy Stg 1	5.42	-	-	-	-
Critical Hdwy Stg 2	5.42	-	-	-	-
Follow-up Hdwy	3.518	-	-	-	-
Pot Cap-1 Maneuver	818	0	0	-	-
Stage 1	937	0	0	-	-
Stage 2	937	0	0	-	-
Platoon blocked, %				-	-
Mov Cap-1 Maneuver	818	-	-	-	-
Mov Cap-2 Maneuver	818	-	-	-	-
Stage 1	937	-	-	-	-
Stage 2	937	-	-	-	-

Approach	EB	NB	SB
HCM Control Delay, s	10.5	0	0
HCM LOS	B		

Minor Lane/Major Mvmt	NBT	EBLn1	SBT	SBR
Capacity (veh/h)	-	818	-	-
HCM Lane V/C Ratio	-	0.207	-	-
HCM Control Delay (s)	-	10.5	-	-
HCM Lane LOS	-	B	-	-
HCM 95th %tile Q(veh)	-	0.8	-	-

Intersection						
Int Delay, s/veh	0.1					
Movement	EBL	EBT	WBT	WBR	SBL	SBR
Lane Configurations		↶	↷		↶	
Traffic Vol, veh/h	0	338	161	74	3	0
Future Vol, veh/h	0	338	161	74	3	0
Conflicting Peds, #/hr	0	0	0	0	0	0
Sign Control	Free	Free	Free	Free	Stop	Stop
RT Channelized	-	None	-	None	-	None
Storage Length	-	-	-	-	0	-
Veh in Median Storage, #	-	0	0	-	0	-
Grade, %	-	0	0	-	0	-
Peak Hour Factor	92	92	92	92	92	92
Heavy Vehicles, %	4	4	3	3	0	0
Mvmt Flow	0	367	175	80	3	0

Major/Minor	Major1	Major2	Minor2		
Conflicting Flow All	255	0	-	0	582 215
Stage 1	-	-	-	-	215 -
Stage 2	-	-	-	-	367 -
Critical Hdwy	4.14	-	-	-	6.4 6.2
Critical Hdwy Stg 1	-	-	-	-	5.4 -
Critical Hdwy Stg 2	-	-	-	-	5.4 -
Follow-up Hdwy	2.236	-	-	-	3.5 3.3
Pot Cap-1 Maneuver	1298	-	-	-	479 830
Stage 1	-	-	-	-	826 -
Stage 2	-	-	-	-	705 -
Platoon blocked, %		-	-	-	
Mov Cap-1 Maneuver	1298	-	-	-	479 830
Mov Cap-2 Maneuver	-	-	-	-	479 -
Stage 1	-	-	-	-	826 -
Stage 2	-	-	-	-	705 -

Approach	EB	WB	SB
HCM Control Delay, s	0	0	12.6
HCM LOS			B

Minor Lane/Major Mvmt	EBL	EBT	WBT	WBR	SBLn1
Capacity (veh/h)	1298	-	-	-	479
HCM Lane V/C Ratio	-	-	-	-	0.007
HCM Control Delay (s)	0	-	-	-	12.6
HCM Lane LOS	A	-	-	-	B
HCM 95th %tile Q(veh)	0	-	-	-	0

HCM 6th Signalized Intersection Summary
29: Schnoor Avenue & Cleveland Avenue

Village D Specific Plan
Phase I WP - PM Peak Hour



Movement	EBL	EBT	EBR	WBL	WBT	WBR	NBL	NBT	NBR	SBL	SBT	SBR
Lane Configurations												
Traffic Volume (veh/h)	141	666	55	275	1034	111	87	215	152	118	213	126
Future Volume (veh/h)	141	666	55	275	1034	111	87	215	152	118	213	126
Initial Q (Qb), veh	0	0	0	0	0	0	0	0	0	0	0	0
Ped-Bike Adj(A_pbT)	1.00		0.98	1.00		0.98	1.00		0.98	1.00		0.99
Parking Bus, Adj	1.00	1.00	1.00	1.00	1.00	1.00	1.00	1.00	1.00	1.00	1.00	1.00
Work Zone On Approach		No			No			No			No	
Adj Sat Flow, veh/h/ln	1885	1885	1885	1885	1885	1885	1885	1885	1885	1885	1885	1885
Adj Flow Rate, veh/h	145	687	57	284	1066	114	90	222	157	122	220	130
Peak Hour Factor	0.97	0.97	0.97	0.97	0.97	0.97	0.97	0.97	0.97	0.97	0.97	0.97
Percent Heavy Veh, %	1	1	1	1	1	1	1	1	1	1	1	1
Cap, veh/h	179	889	387	680	1231	538	110	776	650	251	1059	468
Arrive On Green	0.10	0.25	0.25	0.20	0.34	0.34	0.06	0.22	0.22	0.14	0.30	0.30
Sat Flow, veh/h	1795	3582	1560	3483	3582	1565	1795	3582	1559	1795	3582	1585
Grp Volume(v), veh/h	145	687	57	284	1066	114	90	222	157	122	220	130
Grp Sat Flow(s),veh/h/ln	1795	1791	1560	1742	1791	1565	1795	1791	1559	1795	1791	1585
Q Serve(g_s), s	7.1	16.1	2.0	6.4	25.0	2.9	4.5	4.7	0.0	5.6	4.1	5.7
Cycle Q Clear(g_c), s	7.1	16.1	2.0	6.4	25.0	2.9	4.5	4.7	0.0	5.6	4.1	5.7
Prop In Lane	1.00		1.00	1.00		1.00	1.00		1.00	1.00		1.00
Lane Grp Cap(c), veh/h	179	889	387	680	1231	538	110	776	650	251	1059	468
V/C Ratio(X)	0.81	0.77	0.15	0.42	0.87	0.21	0.82	0.29	0.24	0.49	0.21	0.28
Avail Cap(c_a), veh/h	229	1297	565	680	1333	583	110	776	650	251	1059	468
HCM Platoon Ratio	1.00	1.00	1.00	1.00	1.00	1.00	1.00	1.00	1.00	1.00	1.00	1.00
Upstream Filter(I)	1.00	1.00	1.00	0.35	0.35	0.35	1.00	1.00	1.00	1.00	1.00	1.00
Uniform Delay (d), s/veh	39.7	31.5	16.3	31.7	27.6	8.4	41.8	29.4	17.3	35.7	23.8	24.3
Incr Delay (d2), s/veh	15.5	1.8	0.2	0.1	2.2	0.1	36.9	0.9	0.9	1.4	0.4	1.5
Initial Q Delay(d3),s/veh	0.0	0.0	0.0	0.0	0.0	0.0	0.0	0.0	0.0	0.0	0.0	0.0
%ile BackOfQ(50%),veh/ln	3.9	7.0	0.9	2.7	10.6	1.6	3.1	2.1	2.2	2.5	1.8	2.3
Unsig. Movement Delay, s/veh												
LnGrp Delay(d),s/veh	55.2	33.2	16.5	31.9	29.8	8.5	78.7	30.4	18.1	37.2	24.2	25.8
LnGrp LOS	E	C	B	C	C	A	E	C	B	D	C	C
Approach Vol, veh/h		889			1464			469			472	
Approach Delay, s/veh		35.8			28.5			35.5			28.0	
Approach LOS		D			C			D			C	
Timer - Assigned Phs	1	2	3	4	5	6	7	8				
Phs Duration (G+Y+Rc), s	17.1	24.0	22.1	26.8	10.0	31.1	13.5	35.4				
Change Period (Y+Rc), s	4.5	4.5	4.5	4.5	4.5	4.5	4.5	4.5				
Max Green Setting (Gmax), s	7.5	19.5	12.4	32.6	5.5	21.5	11.5	33.5				
Max Q Clear Time (g_c+I1), s	7.6	6.7	8.4	18.1	6.5	7.7	9.1	27.0				
Green Ext Time (p_c), s	0.0	1.6	0.4	4.3	0.0	1.5	0.1	3.9				

Intersection Summary

HCM 6th Ctrl Delay			31.4									
HCM 6th LOS			C									

HCM 6th Signalized Intersection Summary
30: Fairgrounds & Cleveland Avenue

Village D Specific Plan
Phase I WP - PM Peak Hour



Movement	EBL	EBT	EBR	WBL	WBT	WBR	NBL	NBT	NBR	SBL	SBT	SBR
Lane Configurations	↖ ↑↑ ↗			↖ ↑↑ ↗			↖ ↗		↖ ↗		↖ ↗	
Traffic Volume (veh/h)	94	772	93	163	1127	146	97	42	109	265	35	107
Future Volume (veh/h)	94	772	93	163	1127	146	97	42	109	265	35	107
Initial Q (Qb), veh	0	0	0	0	0	0	0	0	0	0	0	0
Ped-Bike Adj(A_pbT)	1.00		0.98	1.00		0.98	1.00		0.98	1.00		1.00
Parking Bus, Adj	1.00	1.00	1.00	1.00	1.00	1.00	1.00	1.00	1.00	1.00	1.00	1.00
Work Zone On Approach	No			No			No		No		No	
Adj Sat Flow, veh/h/ln	1885	1885	1885	1885	1885	1885	1900	1900	1900	1900	1900	1900
Adj Flow Rate, veh/h	99	813	98	172	1186	154	102	97	80	279	37	113
Peak Hour Factor	0.95	0.95	0.95	0.95	0.95	0.95	0.95	0.95	0.95	0.95	0.95	0.95
Percent Heavy Veh, %	1	1	1	1	1	1	0	0	0	0	0	0
Cap, veh/h	124	1437	172	206	1269	554	292	454	378	249	122	372
Arrive On Green	0.14	0.62	0.62	0.15	0.47	0.47	0.08	0.24	0.24	0.14	0.30	0.30
Sat Flow, veh/h	1795	4649	557	1795	3582	1562	3619	1900	1583	1810	412	1257
Grp Volume(v), veh/h	99	599	312	172	1186	154	102	97	80	279	0	150
Grp Sat Flow(s),veh/h/ln	1795	1716	1775	1795	1791	1562	1810	1900	1583	1810	0	1669
Q Serve(g_s), s	4.8	9.2	9.3	8.4	28.1	5.4	2.4	3.7	2.6	12.4	0.0	6.3
Cycle Q Clear(g_c), s	4.8	9.2	9.3	8.4	28.1	5.4	2.4	3.7	2.6	12.4	0.0	6.3
Prop In Lane	1.00		0.31	1.00		1.00	1.00		1.00	1.00		0.75
Lane Grp Cap(c), veh/h	124	1061	549	206	1269	554	292	454	378	249	0	493
V/C Ratio(X)	0.80	0.56	0.57	0.84	0.93	0.28	0.35	0.21	0.21	1.12	0.00	0.30
Avail Cap(c_a), veh/h	130	1061	549	237	1293	564	292	454	378	249	0	493
HCM Platoon Ratio	2.00	2.00	2.00	1.33	1.33	1.33	1.00	1.00	1.00	1.00	1.00	1.00
Upstream Filter(l)	0.72	0.72	0.72	0.59	0.59	0.59	1.00	1.00	1.00	1.00	0.00	1.00
Uniform Delay (d), s/veh	38.2	13.6	13.6	37.3	22.8	16.8	39.1	27.5	14.2	38.8	0.0	24.5
Incr Delay (d2), s/veh	20.9	0.5	1.0	12.8	8.1	0.2	0.7	1.1	1.3	93.8	0.0	1.6
Initial Q Delay(d3),s/veh	0.0	0.0	0.0	0.0	0.0	0.0	0.0	0.0	0.0	0.0	0.0	0.0
%ile BackOfQ(50%),veh/ln	2.7	2.7	2.9	4.2	11.4	1.8	1.1	1.8	1.5	11.9	0.0	2.6
Unsig. Movement Delay, s/veh												
LnGrp Delay(d),s/veh	59.0	14.1	14.6	50.2	30.9	16.9	39.8	28.5	15.4	132.6	0.0	26.1
LnGrp LOS	E	B	B	D	C	B	D	C	B	F	A	C
Approach Vol, veh/h	1010			1512			279		429			
Approach Delay, s/veh	18.7			31.7			28.9		95.4			
Approach LOS	B			C			C		F			
Timer - Assigned Phs	1	2	3	4	5	6	7	8				
Phs Duration (G+Y+Rc), s	16.9	26.0	14.8	32.3	11.8	31.1	10.7	36.4				
Change Period (Y+Rc), s	4.5	4.5	4.5	4.5	4.5	4.5	4.5	4.5				
Max Green Setting (Gmax), s	5	21.5	11.9	27.1	6.4	26.6	6.5	32.5				
Max Q Clear Time (g_c+M), s	4	5.7	10.4	11.3	4.4	8.3	6.8	30.1				
Green Ext Time (p_c), s	0.0	0.6	0.1	5.5	0.0	0.8	0.0	1.7				

Intersection Summary

HCM 6th Ctrl Delay	35.8
HCM 6th LOS	D

Notes

User approved volume balancing among the lanes for turning movement.

HCM 6th Signalized Intersection Summary
 31: SR-99 Southbound Ramps & Cleveland Avenue

Village D Specific Plan
 Phase I WP - PM Peak Hour



Movement	EBL	EBT	EBR	WBL	WBT	WBR	NBL	NBT	NBR	SBL	SBT	SBR
Lane Configurations		↑↑	↑	↑	↑↑					↑		↑
Traffic Volume (veh/h)	0	848	495	256	1703	0	0	0	0	151	0	80
Future Volume (veh/h)	0	848	495	256	1703	0	0	0	0	151	0	80
Initial Q (Qb), veh	0	0	0	0	0	0				0	0	0
Ped-Bike Adj(A_pbT)	1.00		1.00	1.00		1.00				1.00		1.00
Parking Bus, Adj	1.00	1.00	1.00	1.00	1.00	1.00				1.00	1.00	1.00
Work Zone On Approach		No			No						No	
Adj Sat Flow, veh/h/ln	0	1885	1885	1900	1900	0				1841	0	1841
Adj Flow Rate, veh/h	0	874	510	264	1756	0				156	0	82
Peak Hour Factor	0.97	0.97	0.97	0.97	0.97	0.97				0.97	0.97	0.97
Percent Heavy Veh, %	0	1	1	0	0	0				4	0	4
Cap, veh/h	0	1328	590	296	2110	0				553	0	492
Arrive On Green	0.00	0.37	0.37	0.33	1.00	0.00				0.32	0.00	0.32
Sat Flow, veh/h	0	3676	1591	1810	3705	0				1753	0	1560
Grp Volume(v), veh/h	0	874	510	264	1756	0				156	0	82
Grp Sat Flow(s),veh/h/ln	0	1791	1591	1810	1805	0				1753	0	1560
Q Serve(g_s), s	0.0	18.3	26.7	12.5	0.0	0.0				6.0	0.0	3.4
Cycle Q Clear(g_c), s	0.0	18.3	26.7	12.5	0.0	0.0				6.0	0.0	3.4
Prop In Lane	0.00		1.00	1.00		0.00				1.00		1.00
Lane Grp Cap(c), veh/h	0	1328	590	296	2110	0				553	0	492
V/C Ratio(X)	0.00	0.66	0.86	0.89	0.83	0.00				0.28	0.00	0.17
Avail Cap(c_a), veh/h	0	1453	645	372	2387	0				553	0	492
HCM Platoon Ratio	1.00	1.00	1.00	2.00	2.00	1.00				1.00	1.00	1.00
Upstream Filter(I)	0.00	0.66	0.66	0.33	0.33	0.00				1.00	0.00	1.00
Uniform Delay (d), s/veh	0.0	23.6	26.2	29.5	0.0	0.0				23.1	0.0	22.3
Incr Delay (d2), s/veh	0.0	0.6	7.7	7.7	0.8	0.0				1.3	0.0	0.7
Initial Q Delay(d3),s/veh	0.0	0.0	0.0	0.0	0.0	0.0				0.0	0.0	0.0
%ile BackOfQ(50%),veh/ln	0.0	7.5	10.9	5.0	0.2	0.0				2.6	0.0	1.3
Unsig. Movement Delay, s/veh												
LnGrp Delay(d),s/veh	0.0	24.2	33.9	37.2	0.8	0.0				24.4	0.0	23.0
LnGrp LOS	A	C	C	D	A	A				C	A	C
Approach Vol, veh/h		1384			2020						238	
Approach Delay, s/veh		27.8			5.6						23.9	
Approach LOS		C			A						C	
Timer - Assigned Phs			3	4		6		8				
Phs Duration (G+Y+Rc), s			19.2	37.9		32.9		57.1				
Change Period (Y+Rc), s			4.5	4.5		4.5		4.5				
Max Green Setting (Gmax), s			18.5	36.5		21.5		59.5				
Max Q Clear Time (g_c+1), s			14.5	28.7		8.0		2.0				
Green Ext Time (p_c), s			0.3	4.6		0.6		25.1				
Intersection Summary												
HCM 6th Ctrl Delay			15.2									
HCM 6th LOS			B									

HCM 6th Signalized Intersection Summary
32: SR-99 Northbound Ramps & Cleveland Avenue

Village D Specific Plan
Phase I WP - PM Peak Hour



Movement	EBL	EBT	EBR	WBL	WBT	WBR	NBL	NBT	NBR	SBL	SBT	SBR
Lane Configurations												
Traffic Volume (veh/h)	74	925	0	0	1121	66	840	5	293	0	0	0
Future Volume (veh/h)	74	925	0	0	1121	66	840	5	293	0	0	0
Initial Q (Qb), veh	0	0	0	0	0	0	0	0	0			
Ped-Bike Adj(A_pbT)	1.00		1.00	1.00		0.99	1.00		0.99			
Parking Bus, Adj	1.00	1.00	1.00	1.00	1.00	1.00	1.00	1.00	1.00			
Work Zone On Approach	No				No				No			
Adj Sat Flow, veh/h/ln	1885	1885	0	0	1885	1885	1885	1885	1885			
Adj Flow Rate, veh/h	78	974	0	0	1180	69	888	0	308			
Peak Hour Factor	0.95	0.95	0.95	0.95	0.95	0.95	0.95	0.95	0.95			
Percent Heavy Veh, %	1	1	0	0	1	1	1	1	1			
Cap, veh/h	101	1554	0	0	1174	519	1674	0	734			
Arrive On Green	0.11	0.87	0.00	0.00	0.33	0.33	0.47	0.00	0.47			
Sat Flow, veh/h	1795	3676	0	0	3676	1583	3591	0	1575			
Grp Volume(v), veh/h	78	974	0	0	1180	69	888	0	308			
Grp Sat Flow(s),veh/h/ln	1795	1791	0	0	1791	1583	1795	0	1575			
Q Serve(g_s), s	3.8	7.1	0.0	0.0	29.5	2.8	15.8	0.0	11.7			
Cycle Q Clear(g_c), s	3.8	7.1	0.0	0.0	29.5	2.8	15.8	0.0	11.7			
Prop In Lane	1.00		0.00	0.00		1.00	1.00		1.00			
Lane Grp Cap(c), veh/h	101	1554	0	0	1174	519	1674	0	734			
V/C Ratio(X)	0.77	0.63	0.00	0.00	1.01	0.13	0.53	0.00	0.42			
Avail Cap(c_a), veh/h	289	1930	0	0	1174	519	1674	0	734			
HCM Platoon Ratio	2.00	2.00	1.00	1.00	1.00	1.00	1.00	1.00	1.00			
Upstream Filter(l)	0.74	0.74	0.00	0.00	0.63	0.63	1.00	0.00	1.00			
Uniform Delay (d), s/veh	39.4	3.8	0.0	0.0	30.3	21.3	17.0	0.0	15.9			
Incr Delay (d2), s/veh	9.0	0.3	0.0	0.0	22.1	0.1	1.2	0.0	1.8			
Initial Q Delay(d3),s/veh	0.0	0.0	0.0	0.0	0.0	0.0	0.0	0.0	0.0			
%ile BackOfQ(50%),veh/ln	1.8	1.4	0.0	0.0	15.7	1.0	6.4	0.0	4.4			
Unsig. Movement Delay, s/veh												
LnGrp Delay(d),s/veh	48.4	4.2	0.0	0.0	52.3	21.3	18.3	0.0	17.7			
LnGrp LOS	D	A	A	A	F	C	B	A	B			
Approach Vol, veh/h	1052				1249				1196			
Approach Delay, s/veh	7.4				50.6				18.1			
Approach LOS	A				D				B			
Timer - Assigned Phs	2		4		7		8					
Phs Duration (G+Y+Rc), s	46.4		43.6		9.6		34.0					
Change Period (Y+Rc), s	4.5		4.5		4.5		4.5					
Max Green Setting (Gmax), s	32.5		48.5		14.5		29.5					
Max Q Clear Time (g_c+1), s	17.8		9.1		5.8		31.5					
Green Ext Time (p_c), s	4.3		8.7		0.1		0.0					

Intersection Summary

HCM 6th Ctrl Delay	26.5
HCM 6th LOS	C

Notes

User approved volume balancing among the lanes for turning movement.

HCM 6th Signalized Intersection Summary
 33: Gateway Drive & Cleveland Avenue

Village D Specific Plan
 Phase I WP - PM Peak Hour



Movement	EBL	EBT	EBR	WBL	WBT	WBR	NBL	NBT	NBR	SBL	SBT	SBR
Lane Configurations	↖	↑↑↑	↗	↖↗	↑↑		↖↗	↑	↗	↖	↑↘	
Traffic Volume (veh/h)	15	903	285	179	864	128	302	126	243	181	142	23
Future Volume (veh/h)	15	903	285	179	864	128	302	126	243	181	142	23
Initial Q (Qb), veh	0	0	0	0	0	0	0	0	0	0	0	0
Ped-Bike Adj(A_pbT)	1.00		1.00	1.00		0.99	1.00		0.98	1.00		0.98
Parking Bus, Adj	1.00	1.00	1.00	1.00	1.00	1.00	1.00	1.00	1.00	1.00	1.00	1.00
Work Zone On Approach		No			No			No			No	
Adj Sat Flow, veh/h/ln	1870	1870	1870	1870	1870	1870	1885	1885	1885	1856	1856	1856
Adj Flow Rate, veh/h	16	961	0	190	919	136	321	134	259	193	151	24
Peak Hour Factor	0.94	0.94	0.94	0.94	0.94	0.94	0.94	0.94	0.94	0.94	0.94	0.94
Percent Heavy Veh, %	2	2	2	2	2	2	1	1	1	3	3	3
Cap, veh/h	113	1245		409	1067	158	762	423	351	377	667	104
Arrive On Green	0.04	0.49	0.00	0.12	0.34	0.34	0.22	0.22	0.22	0.21	0.22	0.22
Sat Flow, veh/h	1781	5106	1585	3456	3102	459	3483	1885	1565	1767	3047	474
Grp Volume(v), veh/h	16	961	0	190	526	529	321	134	259	193	86	89
Grp Sat Flow(s),veh/h/ln	1781	1702	1585	1728	1777	1785	1742	1885	1565	1767	1763	1758
Q Serve(g_s), s	0.0	13.9	0.0	4.6	24.8	24.9	7.1	5.3	13.8	8.7	3.6	3.7
Cycle Q Clear(g_c), s	0.0	13.9	0.0	4.6	24.8	24.9	7.1	5.3	13.8	8.7	3.6	3.7
Prop In Lane	1.00		1.00	1.00		0.26	1.00		1.00	1.00		0.27
Lane Grp Cap(c), veh/h	113	1245		409	611	614	762	423	351	377	386	385
V/C Ratio(X)	0.14	0.77		0.46	0.86	0.86	0.42	0.32	0.74	0.51	0.22	0.23
Avail Cap(c_a), veh/h	179	1770		409	685	688	762	423	351	377	386	385
HCM Platoon Ratio	2.00	2.00	2.00	1.00	1.00	1.00	1.00	1.00	1.00	1.00	1.00	1.00
Upstream Filter(I)	0.82	0.82	0.00	0.91	0.91	0.91	1.00	1.00	1.00	1.00	1.00	1.00
Uniform Delay (d), s/veh	42.6	21.0	0.0	37.0	27.5	27.5	30.2	29.1	32.4	31.3	28.9	28.9
Incr Delay (d2), s/veh	0.5	1.1	0.0	0.7	9.2	9.2	0.4	2.0	13.0	1.2	1.3	1.4
Initial Q Delay(d3),s/veh	0.0	0.0	0.0	0.0	0.0	0.0	0.0	0.0	0.0	0.0	0.0	0.0
%ile BackOfQ(50%),veh/ln	0.4	4.1	0.0	2.0	11.7	11.7	3.0	2.6	6.4	3.8	1.6	1.7
Unsig. Movement Delay, s/veh												
LnGrp Delay(d),s/veh	43.0	22.1	0.0	37.8	36.7	36.7	30.6	31.1	45.4	32.4	30.2	30.3
LnGrp LOS	D	C		D	D	D	C	C	D	C	C	C
Approach Vol, veh/h		977	A		1245			714			368	
Approach Delay, s/veh		22.5			36.9			36.1			31.4	
Approach LOS		C			D			D			C	
Timer - Assigned Phs	1	2	3	4	5	6	7	8				
Phs Duration (G+Y+Rc), s	24.2	24.2	6.1	35.5	23.7	24.7	15.2	26.4				
Change Period (Y+Rc), s	4.5	4.5	4.5	4.5	4.5	4.5	4.5	4.5				
Max Green Setting (Gmax), s	12.6	19.7	5.0	34.7	12.1	20.2	8.5	31.2				
Max Q Clear Time (g_c+1), s	19.1	5.7	2.0	26.9	10.7	15.8	6.6	15.9				
Green Ext Time (p_c), s	0.4	0.7	0.0	4.1	0.1	0.7	0.1	6.0				

Intersection Summary

HCM 6th Ctrl Delay	31.8
HCM 6th LOS	C

Notes

Unsignalized Delay for [EBR] is excluded from calculations of the approach delay and intersection delay.

HCM 6th Signalized Intersection Summary
 34: Cleveland Avenue & County Club Drive

Village D Specific Plan
 Phase I WP - PM Peak Hour



Movement	WBL	WBR	NBT	NBR	SBL	SBT
Lane Configurations	←←←		↑↑	↗	←	↑↑↑
Traffic Volume (veh/h)	460	31	811	516	99	711
Future Volume (veh/h)	460	31	811	516	99	711
Initial Q (Qb), veh	0	0	0	0	0	0
Ped-Bike Adj(A_pbT)	1.00	1.00		1.00	1.00	
Parking Bus, Adj	1.00	1.00	1.00	1.00	1.00	1.00
Work Zone On Approach	No		No		No	
Adj Sat Flow, veh/h/ln	1900	1900	1870	1870	1870	1870
Adj Flow Rate, veh/h	515	0	854	0	104	748
Peak Hour Factor	0.95	0.95	0.95	0.95	0.95	0.95
Percent Heavy Veh, %	0	0	2	2	2	2
Cap, veh/h	648	288	2562		489	3681
Arrive On Green	0.18	0.00	0.72	0.00	0.72	0.72
Sat Flow, veh/h	3619	1610	3647	1585	646	5274
Grp Volume(v), veh/h	515	0	854	0	104	748
Grp Sat Flow(s),veh/h/ln	1810	1610	1777	1585	646	1702
Q Serve(g_s), s	12.3	0.0	7.9	0.0	6.3	4.3
Cycle Q Clear(g_c), s	12.3	0.0	7.9	0.0	14.3	4.3
Prop In Lane	1.00	1.00		1.00	1.00	
Lane Grp Cap(c), veh/h	648	288	2562		489	3681
V/C Ratio(X)	0.79	0.00	0.33		0.21	0.20
Avail Cap(c_a), veh/h	1428	635	2562		489	3681
HCM Platoon Ratio	1.00	1.00	1.00	1.00	1.00	1.00
Upstream Filter(I)	1.00	0.00	0.71	0.00	1.00	1.00
Uniform Delay (d), s/veh	35.4	0.0	4.6	0.0	7.2	4.1
Incr Delay (d2), s/veh	2.3	0.0	0.2	0.0	1.0	0.1
Initial Q Delay(d3),s/veh	0.0	0.0	0.0	0.0	0.0	0.0
%ile BackOfQ(50%),veh/ln	5.5	0.0	2.4	0.0	0.9	1.2
Unsig. Movement Delay, s/veh						
LnGrp Delay(d),s/veh	37.6	0.0	4.9	0.0	8.2	4.2
LnGrp LOS	D	A	A		A	A
Approach Vol, veh/h	515		854	A		852
Approach Delay, s/veh	37.6		4.9			4.7
Approach LOS	D		A			A
Timer - Assigned Phs		2			6	8
Phs Duration (G+Y+Rc), s		69.4			69.4	20.6
Change Period (Y+Rc), s		4.5			4.5	4.5
Max Green Setting (Gmax), s		45.5			45.5	35.5
Max Q Clear Time (g_c+I1), s		9.9			16.3	14.3
Green Ext Time (p_c), s		7.2			7.0	1.9

Intersection Summary

HCM 6th Ctrl Delay	12.4
HCM 6th LOS	B

Notes

User approved volume balancing among the lanes for turning movement.
 Unsignalized Delay for [NBR] is excluded from calculations of the approach delay and intersection delay.

Intersection						
Int Delay, s/veh	0.2					
Movement	EBL	EBR	NBL	NBT	SBT	SBR
Lane Configurations	T			T		
Traffic Vol, veh/h	2	16	5	808	739	1
Future Vol, veh/h	2	16	5	808	739	1
Conflicting Peds, #/hr	0	0	0	0	0	0
Sign Control	Stop	Stop	Free	Free	Free	Free
RT Channelized	-	None	-	None	-	None
Storage Length	0	-	-	-	-	-
Veh in Median Storage, #	0	-	-	0	0	-
Grade, %	0	-	-	0	0	-
Peak Hour Factor	94	94	94	94	94	94
Heavy Vehicles, %	0	0	1	1	1	1
Mvmt Flow	2	17	5	860	786	1

Major/Minor	Minor2	Major1	Major2			
Conflicting Flow All	1227	394	787	0	-	0
Stage 1	787	-	-	-	-	-
Stage 2	440	-	-	-	-	-
Critical Hdwy	6.8	6.9	4.12	-	-	-
Critical Hdwy Stg 1	5.8	-	-	-	-	-
Critical Hdwy Stg 2	5.8	-	-	-	-	-
Follow-up Hdwy	3.5	3.3	2.21	-	-	-
Pot Cap-1 Maneuver	*368	611	835	-	-	-
Stage 1	*414	-	-	-	-	-
Stage 2	*721	-	-	-	-	-
Platoon blocked, %	1			-	-	-
Mov Cap-1 Maneuver	*364	611	835	-	-	-
Mov Cap-2 Maneuver	*369	-	-	-	-	-
Stage 1	*409	-	-	-	-	-
Stage 2	*721	-	-	-	-	-

Approach	EB	NB	SB
HCM Control Delay, s	11.5	0.2	0
HCM LOS	B		

Minor Lane/Major Mvmt	NBL	NBT	EBLn1	SBT	SBR
Capacity (veh/h)	835	-	570	-	-
HCM Lane V/C Ratio	0.006	-	0.034	-	-
HCM Control Delay (s)	9.3	0.1	11.5	-	-
HCM Lane LOS	A	A	B	-	-
HCM 95th %tile Q(veh)	0	-	0.1	-	-

Notes
 -: Volume exceeds capacity \$: Delay exceeds 300s +: Computation Not Defined *: All major volume in platoon

HCM 6th Signalized Intersection Summary

36: Pine Street & Howard Road

Village D Specific Plan
Phase I WP - PM Peak Hour



Movement	EBL	EBT	EBR	WBL	WBT	WBR	NBL	NBT	NBR	SBL	SBT	SBR
Lane Configurations	↖	↗		↖	↗		↖	↗	↗		↗	↗
Traffic Volume (veh/h)	86	632	126	94	573	3	195	164	149	16	141	119
Future Volume (veh/h)	86	632	126	94	573	3	195	164	149	16	141	119
Initial Q (Qb), veh	0	0	0	0	0	0	0	0	0	0	0	0
Ped-Bike Adj(A_pbT)	1.00		0.95	1.00		0.93	1.00		0.99	1.00		1.00
Parking Bus, Adj	1.00	1.00	1.00	1.00	1.00	1.00	1.00	1.00	1.00	1.00	1.00	1.00
Work Zone On Approach		No			No			No			No	
Adj Sat Flow, veh/h/ln	1870	1870	1870	1885	1885	1885	1885	1885	1885	1870	1870	1870
Adj Flow Rate, veh/h	92	680	135	101	616	3	210	176	160	17	152	128
Peak Hour Factor	0.93	0.93	0.93	0.93	0.93	0.93	0.93	0.93	0.93	0.93	0.93	0.93
Percent Heavy Veh, %	2	2	2	1	1	1	1	1	1	2	2	2
Cap, veh/h	229	792	157	128	780	4	607	638	534	22	200	189
Arrive On Green	0.13	0.27	0.27	0.07	0.21	0.21	0.34	0.34	0.34	0.12	0.12	0.12
Sat Flow, veh/h	1781	2924	580	1795	3654	18	1795	1885	1577	187	1674	1585
Grp Volume(v), veh/h	92	413	402	101	302	317	210	176	160	169	0	128
Grp Sat Flow(s),veh/h/ln	1781	1777	1727	1795	1791	1880	1795	1885	1577	1861	0	1585
Q Serve(g_s), s	4.3	19.9	19.9	5.0	14.4	14.4	7.9	6.1	6.7	7.9	0.0	7.0
Cycle Q Clear(g_c), s	4.3	19.9	19.9	5.0	14.4	14.4	7.9	6.1	6.7	7.9	0.0	7.0
Prop In Lane	1.00		0.34	1.00		0.01	1.00		1.00	0.10		1.00
Lane Grp Cap(c), veh/h	229	481	468	128	383	402	607	638	534	222	0	189
V/C Ratio(X)	0.40	0.86	0.86	0.79	0.79	0.79	0.35	0.28	0.30	0.76	0.00	0.68
Avail Cap(c_a), veh/h	229	543	528	130	547	575	607	638	534	372	0	317
HCM Platoon Ratio	1.00	1.00	1.00	1.00	1.00	1.00	1.00	1.00	1.00	1.00	1.00	1.00
Upstream Filter(I)	1.00	1.00	1.00	0.91	0.91	0.91	1.00	1.00	1.00	1.00	0.00	1.00
Uniform Delay (d), s/veh	36.0	31.2	31.2	41.1	33.5	33.5	22.3	21.7	21.9	38.4	0.0	38.0
Incr Delay (d2), s/veh	1.1	11.9	12.3	24.7	4.5	4.3	1.6	1.1	1.4	5.3	0.0	4.2
Initial Q Delay(d3),s/veh	0.0	0.0	0.0	0.0	0.0	0.0	0.0	0.0	0.0	0.0	0.0	0.0
%ile BackOfQ(50%),veh/ln	1.9	9.8	9.6	3.1	6.6	6.9	3.5	2.8	2.6	3.9	0.0	2.9
Unsig. Movement Delay, s/veh												
LnGrp Delay(d),s/veh	37.1	43.0	43.5	65.8	38.0	37.8	23.9	22.8	23.4	43.7	0.0	42.1
LnGrp LOS	D	D	D	E	D	D	C	C	C	D	A	D
Approach Vol, veh/h		907			720			546			297	
Approach Delay, s/veh		42.6			41.8			23.4			43.0	
Approach LOS		D			D			C			D	
Timer - Assigned Phs		2	3	4		6	7	8				
Phs Duration (G+Y+Rc), s		34.9	10.9	28.9		15.2	16.1	23.7				
Change Period (Y+Rc), s		4.5	4.5	4.5		4.5	4.5	4.5				
Max Green Setting (Gmax), s		20.0	6.5	27.5		18.0	6.5	27.5				
Max Q Clear Time (g_c+I1), s		9.9	7.0	21.9		9.9	6.3	16.4				
Green Ext Time (p_c), s		1.6	0.0	2.5		0.8	0.0	2.9				
Intersection Summary												
HCM 6th Ctrl Delay				38.2								
HCM 6th LOS				D								

HCM 6th Signalized Intersection Summary
 37: Olive Avenue/Q Street & Howard Road/Yosemite Avenue

Village D Specific Plan
 Phase I WP - PM Peak Hour



Movement	EBL	EBT	EBR	WBL	WBT	WBR	NBL	NBT	NBR	SBL	SBT	SBR
Lane Configurations	↖	↑↑	↗	↖	↑↑		↖	↖	↗	↖	↑	↗
Traffic Volume (veh/h)	7	455	314	13	367	14	363	75	12	16	56	2
Future Volume (veh/h)	7	455	314	13	367	14	363	75	12	16	56	2
Initial Q (Qb), veh	0	0	0	0	0	0	0	0	0	0	0	0
Ped-Bike Adj(A_pbT)	1.00		1.00	1.00		1.00	1.00		0.99	1.00		0.99
Parking Bus, Adj	1.00	1.00	1.00	1.00	1.00	1.00	1.00	1.00	1.00	1.00	1.00	1.00
Work Zone On Approach		No			No			No			No	
Adj Sat Flow, veh/h/ln	1870	1870	1870	1885	1885	1885	1885	1885	1885	1885	1885	1885
Adj Flow Rate, veh/h	8	495	0	14	399	15	454	0	13	17	61	2
Peak Hour Factor	0.92	0.92	0.92	0.92	0.92	0.92	0.92	0.92	0.92	0.92	0.92	0.92
Percent Heavy Veh, %	2	2	2	1	1	1	1	1	1	1	1	1
Cap, veh/h	18	616		100	770	29	1862	0	817	94	99	83
Arrive On Green	0.00	0.06	0.00	0.06	0.22	0.22	0.52	0.00	0.52	0.05	0.05	0.05
Sat Flow, veh/h	1781	3554	1585	1795	3520	132	3591	0	1576	1795	1885	1580
Grp Volume(v), veh/h	8	495	0	14	203	211	454	0	13	17	61	2
Grp Sat Flow(s),veh/h/ln	1781	1777	1585	1795	1791	1861	1795	0	1576	1795	1885	1580
Q Serve(g_s), s	0.4	12.4	0.0	0.7	9.0	9.0	6.3	0.0	0.4	0.8	2.9	0.1
Cycle Q Clear(g_c), s	0.4	12.4	0.0	0.7	9.0	9.0	6.3	0.0	0.4	0.8	2.9	0.1
Prop In Lane	1.00		1.00	1.00		0.07	1.00		1.00	1.00		1.00
Lane Grp Cap(c), veh/h	18	616		100	392	407	1862	0	817	94	99	83
V/C Ratio(X)	0.45	0.80		0.14	0.52	0.52	0.24	0.00	0.02	0.18	0.62	0.02
Avail Cap(c_a), veh/h	99	711		359	617	641	1862	0	817	359	377	316
HCM Platoon Ratio	0.33	0.33	0.33	1.00	1.00	1.00	1.00	1.00	1.00	1.00	1.00	1.00
Upstream Filter(I)	0.60	0.60	0.00	1.00	1.00	1.00	1.00	0.00	1.00	1.00	1.00	1.00
Uniform Delay (d), s/veh	44.6	40.9	0.0	40.5	31.0	31.0	11.9	0.0	10.5	40.8	41.8	40.5
Incr Delay (d2), s/veh	10.1	3.6	0.0	0.6	1.1	1.0	0.3	0.0	0.0	0.9	6.1	0.1
Initial Q Delay(d3),s/veh	0.0	0.0	0.0	0.0	0.0	0.0	0.0	0.0	0.0	0.0	0.0	0.0
%ile BackOfQ(50%),veh/ln	0.2	6.2	0.0	0.3	3.9	4.1	2.5	0.0	0.1	0.4	1.5	0.0
Unsig. Movement Delay, s/veh												
LnGrp Delay(d),s/veh	54.7	44.5	0.0	41.1	32.0	32.0	12.2	0.0	10.6	41.7	47.9	40.6
LnGrp LOS	D	D		D	C	C	B	A	B	D	D	D
Approach Vol, veh/h		503	A		428		467				80	
Approach Delay, s/veh		44.7			32.3		12.2				46.4	
Approach LOS		D			C		B				D	
Timer - Assigned Phs		2	3	4		6	7	8				
Phs Duration (G+Y+Rc), s		51.2	9.5	20.1		9.2	5.4	24.2				
Change Period (Y+Rc), s		4.5	4.5	4.5		4.5	4.5	4.5				
Max Green Setting (Gmax), s		18.0	18.0	18.0		18.0	5.0	31.0				
Max Q Clear Time (g_c+I1), s		8.3	2.7	14.4		4.9	2.4	11.0				
Green Ext Time (p_c), s		1.3	0.0	1.1		0.2	0.0	2.3				

Intersection Summary

HCM 6th Ctrl Delay	30.9
HCM 6th LOS	C

Notes

User approved volume balancing among the lanes for turning movement.
 Unsignalized Delay for [EBR] is excluded from calculations of the approach delay and intersection delay.

HCM 6th TWSC
 38: I Street & 2nd Street/SR-99 Southbound Off-Ramp

Village D Specific Plan
 Phase I WP - PM Peak Hour

Intersection												
Int Delay, s/veh	8.5											
Movement	EBL	EBT	EBR	WBL	WBT	WBR	NBL	NBT	NBR	SBL	SBT	SBR
Lane Configurations		↕			↕	↕	↕	↕			↕	
Traffic Vol, veh/h	0	0	36	262	12	4	46	147	0	0	115	0
Future Vol, veh/h	0	0	36	262	12	4	46	147	0	0	115	0
Conflicting Peds, #/hr	0	0	0	0	0	0	1	0	1	1	0	1
Sign Control	Stop	Stop	Stop	Stop	Stop	Stop	Free	Free	Free	Free	Free	Free
RT Channelized	-	-	None	-	-	Stop	-	-	None	-	-	None
Storage Length	-	-	-	-	-	50	75	-	-	-	-	-
Veh in Median Storage, #	-	0	-	-	0	-	-	0	-	-	0	-
Grade, %	-	0	-	-	0	-	-	0	-	-	0	-
Peak Hour Factor	98	98	98	98	98	98	98	98	98	98	98	98
Heavy Vehicles, %	0	0	0	3	3	3	0	0	0	0	0	0
Mvmt Flow	0	0	37	267	12	4	47	150	0	0	117	0

Major/Minor	Minor2		Minor1		Major1		Major2					
Conflicting Flow All	368	362	118	380	362	150	118	0	-	-	-	0
Stage 1	118	118	-	244	244	-	-	-	-	-	-	-
Stage 2	250	244	-	136	118	-	-	-	-	-	-	-
Critical Hdwy	7.1	6.5	6.2	7.13	6.53	6.23	4.1	-	-	-	-	-
Critical Hdwy Stg 1	6.1	5.5	-	6.13	5.53	-	-	-	-	-	-	-
Critical Hdwy Stg 2	6.1	5.5	-	6.13	5.53	-	-	-	-	-	-	-
Follow-up Hdwy	3.5	4	3.3	3.527	4.027	3.327	2.2	-	-	-	-	-
Pot Cap-1 Maneuver	641	600	939	623	595	969	1483	-	0	0	-	-
Stage 1	891	802	-	806	725	-	-	-	0	0	-	-
Stage 2	806	729	-	865	796	-	-	-	0	0	-	-
Platoon blocked, %	1	1		1	1	1		-			-	-
Mov Cap-1 Maneuver	612	580	938	584	575	969	1482	-	-	-	-	-
Mov Cap-2 Maneuver	612	580	-	584	575	-	-	-	-	-	-	-
Stage 1	862	801	-	780	702	-	-	-	-	-	-	-
Stage 2	763	706	-	831	795	-	-	-	-	-	-	-

Approach	EB		WB		NB		SB			
HCM Control Delay, s	9		16.6		1.8		0			
HCM LOS	A		C							

Minor Lane/Major Mvmt	NBL	NBT	EBLn1	WBLn1	WBLn2	SBT	SBR
Capacity (veh/h)	1482	-	938	584	969	-	-
HCM Lane V/C Ratio	0.032	-	0.039	0.479	0.004	-	-
HCM Control Delay (s)	7.5	-	9	16.7	8.7	-	-
HCM Lane LOS	A	-	A	C	A	-	-
HCM 95th %tile Q(veh)	0.1	-	0.1	2.6	0	-	-

HCM 6th Signalized Intersection Summary
39: 4th Street & Sunset Avenue

Village D Specific Plan
Phase I WP - PM Peak Hour



Movement	EBL	EBR	NBL	NBT	SBT	SBR
Lane Configurations						
Traffic Volume (veh/h)	239	13	13	316	355	375
Future Volume (veh/h)	239	13	13	316	355	375
Initial Q (Qb), veh	0	0	0	0	0	0
Ped-Bike Adj(A_pbT)	1.00	1.00	1.00			1.00
Parking Bus, Adj	1.00	1.00	1.00	1.00	1.00	1.00
Work Zone On Approach	No			No	No	
Adj Sat Flow, veh/h/ln	1900	1900	1856	1856	1856	1856
Adj Flow Rate, veh/h	273	0	14	343	386	408
Peak Hour Factor	0.92	0.92	0.92	0.92	0.92	0.92
Percent Heavy Veh, %	0	0	3	3	3	3
Cap, veh/h	368	164	474	2849	918	938
Arrive On Green	0.10	0.00	0.27	0.81	0.83	0.83
Sat Flow, veh/h	3619	1610	1767	3618	1856	1571
Grp Volume(v), veh/h	273	0	14	343	386	408
Grp Sat Flow(s),veh/h/ln	1810	1610	1767	1763	1856	1571
Q Serve(g_s), s	7.3	0.0	0.6	2.1	5.5	6.3
Cycle Q Clear(g_c), s	7.3	0.0	0.6	2.1	5.5	6.3
Prop In Lane	1.00	1.00	1.00			1.00
Lane Grp Cap(c), veh/h	368	164	474	2849	918	938
V/C Ratio(X)	0.74	0.00	0.03	0.12	0.42	0.44
Avail Cap(c_a), veh/h	995	443	474	2849	918	938
HCM Platoon Ratio	1.00	1.00	1.00	1.00	1.67	1.67
Upstream Filter(I)	1.00	0.00	1.00	1.00	0.75	0.75
Uniform Delay (d), s/veh	43.6	0.0	27.0	2.0	4.9	3.2
Incr Delay (d2), s/veh	2.9	0.0	0.0	0.1	1.1	1.1
Initial Q Delay(d3),s/veh	0.0	0.0	0.0	0.0	0.0	0.0
%ile BackOfQ(50%),veh/ln	3.4	0.0	0.2	0.5	1.9	2.0
Unsig. Movement Delay, s/veh						
LnGrp Delay(d),s/veh	46.6	0.0	27.0	2.1	5.9	4.3
LnGrp LOS	D	A	C	A	A	A
Approach Vol, veh/h	273			357	794	
Approach Delay, s/veh	46.6			3.1	5.1	
Approach LOS	D			A	A	
Timer - Assigned Phs		2		4	5	6
Phs Duration (G+Y+Rc), s		85.3		14.7	31.3	54.0
Change Period (Y+Rc), s		4.5		4.5	4.5	4.5
Max Green Setting (Gmax), s		63.5		27.5	9.5	49.5
Max Q Clear Time (g_c+I1), s		4.1		9.3	2.6	8.3
Green Ext Time (p_c), s		2.5		0.9	0.0	4.3

Intersection Summary

HCM 6th Ctrl Delay	12.6
HCM 6th LOS	B

Notes

User approved volume balancing among the lanes for turning movement.

40: H Street & SR-99 Southbound On-Ramp/2nd Street Performance by movement

Movement	WBL	WBT	WBR	NBL	NBT	NBR	SBT	All
Denied Delay (hr)	0.0	0.0	0.0	0.0	0.0	0.0	0.0	0.0
Denied Del/Veh (s)	0.2	0.2	0.1	0.0	0.0	0.0	0.2	0.0
Total Delay (hr)	0.1	0.1	0.0	0.1	0.0	0.0	0.1	0.4
Total Del/Veh (s)	11.7	11.9	3.4	2.5	3.0	1.4	13.3	4.5
Stop Delay (hr)	0.0	0.1	0.0	0.0	0.0	0.0	0.1	0.2
Stop Del/Veh (s)	9.3	8.5	2.3	0.1	0.2	0.1	10.5	2.0

HCM 6th Signalized Intersection Summary

41: I Street & 4th Street

Village D Specific Plan
Phase I WP - PM Peak Hour



Movement	EBL	EBT	EBR	WBL	WBT	WBR	NBL	NBT	NBR	SBL	SBT	SBR
Lane Configurations												
Traffic Volume (veh/h)	35	520	61	60	514	110	99	70	248	170	166	112
Future Volume (veh/h)	35	520	61	60	514	110	99	70	248	170	166	112
Initial Q (Qb), veh	0	0	0	0	0	0	0	0	0	0	0	0
Ped-Bike Adj(A_pbT)	1.00		0.99	1.00		0.99	1.00		1.00	1.00		0.99
Parking Bus, Adj	1.00	1.00	1.00	1.00	1.00	1.00	1.00	1.00	1.00	1.00	1.00	1.00
Work Zone On Approach		No			No			No			No	
Adj Sat Flow, veh/h/ln	1856	1856	1856	1885	1885	1885	1885	1885	1885	1870	1870	1870
Adj Flow Rate, veh/h	38	565	66	65	559	120	108	76	270	185	180	122
Peak Hour Factor	0.92	0.92	0.92	0.92	0.92	0.92	0.92	0.92	0.92	0.92	0.92	0.92
Percent Heavy Veh, %	3	3	3	1	1	1	1	1	1	2	2	2
Cap, veh/h	58	684	80	90	682	146	416	443	375	569	604	505
Arrive On Green	0.03	0.22	0.22	0.05	0.23	0.23	0.23	0.23	0.23	0.32	0.32	0.32
Sat Flow, veh/h	1767	3177	370	1795	2930	627	1795	1885	1598	1781	1870	1564
Grp Volume(v), veh/h	38	313	318	65	341	338	108	76	270	185	180	122
Grp Sat Flow(s),veh/h/ln	1767	1763	1785	1795	1791	1766	1795	1885	1598	1781	1870	1564
Q Serve(g_s), s	2.1	16.9	17.0	3.6	18.0	18.2	4.9	3.2	15.6	7.9	7.2	5.7
Cycle Q Clear(g_c), s	2.1	16.9	17.0	3.6	18.0	18.2	4.9	3.2	15.6	7.9	7.2	5.7
Prop In Lane	1.00		0.21	1.00		0.35	1.00		1.00	1.00		1.00
Lane Grp Cap(c), veh/h	58	380	384	90	417	411	416	443	375	569	604	505
V/C Ratio(X)	0.66	0.82	0.83	0.73	0.82	0.82	0.26	0.17	0.72	0.32	0.30	0.24
Avail Cap(c_a), veh/h	115	485	491	171	546	539	416	443	375	569	604	505
HCM Platoon Ratio	1.00	1.00	1.00	1.00	1.00	1.00	1.00	1.00	1.00	1.00	1.00	1.00
Upstream Filter(l)	0.95	0.95	0.95	1.00	1.00	1.00	1.00	1.00	1.00	1.00	1.00	1.00
Uniform Delay (d), s/veh	47.8	37.4	37.5	46.8	36.4	36.4	31.4	30.5	35.2	25.8	25.4	24.9
Incr Delay (d2), s/veh	11.6	8.4	8.6	10.6	7.3	7.7	0.3	0.8	11.3	0.3	1.3	1.1
Initial Q Delay(d3),s/veh	0.0	0.0	0.0	0.0	0.0	0.0	0.0	0.0	0.0	0.0	0.0	0.0
%ile BackOfQ(50%),veh/ln	1.1	8.1	8.2	1.8	8.6	8.6	2.2	1.6	7.1	3.4	3.4	2.3
Unsig. Movement Delay, s/veh												
LnGrp Delay(d),s/veh	59.4	45.9	46.1	57.4	43.7	44.1	31.7	31.3	46.5	26.2	26.6	26.0
LnGrp LOS	E	D	D	E	D	D	C	C	D	C	C	C
Approach Vol, veh/h		669			744			454			487	
Approach Delay, s/veh		46.7			45.1			40.4			26.3	
Approach LOS		D			D			D			C	
Timer - Assigned Phs	1	2	3	4	5	6	7	8				
Phs Duration (G+Y+Rc), s	36.5	28.0	9.5	26.0	27.7	36.8	7.8	27.8				
Change Period (Y+Rc), s	4.5	4.5	4.5	4.5	4.5	4.5	4.5	4.5				
Max Green Setting (Gmax), s	21.5	23.5	9.5	27.5	12.7	32.3	6.5	30.5				
Max Q Clear Time (g_c+19.5), s	19.5	17.6	5.6	19.0	6.9	9.2	4.1	20.2				
Green Ext Time (p_c), s	0.4	0.7	0.0	2.5	0.1	1.4	0.0	3.1				
Intersection Summary												
HCM 6th Ctrl Delay												40.8
HCM 6th LOS												D

HCM 6th Signalized Intersection Summary
 43: SR-99 Northbound Off-Ramp/H Street & 4th Street

Village D Specific Plan
 Phase I WP - PM Peak Hour



Movement	EBL	EBT	EBR	WBL	WBT	WBR	NBL	NBT	NBR	SBL	SBT	SBR
Lane Configurations	↖	↗			↖	↗	↖	↗			↕	
Traffic Volume (veh/h)	238	412	0	0	530	115	254	26	165	25	0	75
Future Volume (veh/h)	238	412	0	0	530	115	254	26	165	25	0	75
Initial Q (Qb), veh	0	0	0	0	0	0	0	0	0	0	0	0
Ped-Bike Adj(A_pbT)	1.00		1.00	1.00		0.99	1.00		0.99	1.00		0.99
Parking Bus, Adj	1.00	1.00	1.00	1.00	1.00	1.00	1.00	1.00	1.00	1.00	1.00	1.00
Work Zone On Approach		No			No			No			No	
Adj Sat Flow, veh/h/ln	1885	1885	0	0	1885	1885	1885	1885	1885	1900	1900	1900
Adj Flow Rate, veh/h	253	438	0	0	564	122	270	28	176	27	0	80
Peak Hour Factor	0.94	0.94	0.94	0.94	0.94	0.94	0.94	0.94	0.94	0.94	0.94	0.94
Percent Heavy Veh, %	1	1	0	0	1	1	1	1	1	0	0	0
Cap, veh/h	288	1519	0	0	640	138	468	58	362	74	0	221
Arrive On Green	0.16	0.42	0.00	0.00	0.22	0.22	0.26	0.26	0.26	0.18	0.00	0.18
Sat Flow, veh/h	1795	3676	0	0	3018	630	1795	221	1390	414	0	1226
Grp Volume(v), veh/h	253	438	0	0	345	341	270	0	204	107	0	0
Grp Sat Flow(s),veh/h/ln	1795	1791	0	0	1791	1763	1795	0	1611	1639	0	0
Q Serve(g_s), s	13.8	8.0	0.0	0.0	18.6	18.7	13.1	0.0	10.7	5.7	0.0	0.0
Cycle Q Clear(g_c), s	13.8	8.0	0.0	0.0	18.6	18.7	13.1	0.0	10.7	5.7	0.0	0.0
Prop In Lane	1.00		0.00	0.00		0.36	1.00		0.86	0.25		0.75
Lane Grp Cap(c), veh/h	288	1519	0	0	392	386	468	0	420	295	0	0
V/C Ratio(X)	0.88	0.29	0.00	0.00	0.88	0.88	0.58	0.00	0.49	0.36	0.00	0.00
Avail Cap(c_a), veh/h	350	1701	0	0	421	414	468	0	420	295	0	0
HCM Platoon Ratio	1.00	1.00	1.00	1.00	1.00	1.00	1.00	1.00	1.00	1.00	1.00	1.00
Upstream Filter(I)	1.00	1.00	0.00	0.00	1.00	1.00	1.00	0.00	1.00	1.00	0.00	0.00
Uniform Delay (d), s/veh	41.0	18.9	0.0	0.0	37.8	37.8	32.2	0.0	31.3	36.0	0.0	0.0
Incr Delay (d2), s/veh	19.1	0.1	0.0	0.0	18.0	18.9	5.1	0.0	4.0	3.4	0.0	0.0
Initial Q Delay(d3),s/veh	0.0	0.0	0.0	0.0	0.0	0.0	0.0	0.0	0.0	0.0	0.0	0.0
%ile BackOfQ(50%),veh/ln	7.5	3.3	0.0	0.0	10.0	10.0	6.3	0.0	4.6	2.6	0.0	0.0
Unsig. Movement Delay, s/veh												
LnGrp Delay(d),s/veh	60.1	19.0	0.0	0.0	55.7	56.7	37.3	0.0	35.3	39.4	0.0	0.0
LnGrp LOS	E	B	A	A	E	E	D	A	D	D	A	A
Approach Vol, veh/h		691			686			474			107	
Approach Delay, s/veh		34.1			56.2			36.4			39.4	
Approach LOS		C			E			D			D	
Timer - Assigned Phs		2		4		6	7	8				
Phs Duration (G+Y+Rc), s		30.6		46.9		22.5	20.5	26.4				
Change Period (Y+Rc), s		4.5		4.5		4.5	4.5	4.5				
Max Green Setting (Gmax), s		21.0		47.5		18.0	19.5	23.5				
Max Q Clear Time (g_c+I1), s		15.1		10.0		7.7	15.8	20.7				
Green Ext Time (p_c), s		1.1		3.2		0.3	0.3	1.2				
Intersection Summary												
HCM 6th Ctrl Delay											42.7	
HCM 6th LOS											D	

Intersection						
Int Delay, s/veh	3.8					
Movement	EBL	EBT	WBT	WBR	SBL	SBR
Lane Configurations	↔	↑↑	↑↑		↔	↔
Traffic Vol, veh/h	87	476	449	106	155	108
Future Vol, veh/h	87	476	449	106	155	108
Conflicting Peds, #/hr	0	0	0	0	0	0
Sign Control	Free	Free	Free	Free	Stop	Stop
RT Channelized	-	None	-	None	-	None
Storage Length	145	-	-	-	65	0
Veh in Median Storage, #	-	0	0	-	0	-
Grade, %	-	0	0	-	0	-
Peak Hour Factor	95	95	95	95	95	95
Heavy Vehicles, %	2	2	1	1	1	1
Mvmt Flow	92	501	473	112	163	114

Major/Minor	Major1	Major2	Minor2		
Conflicting Flow All	585	0	-	0	964 293
Stage 1	-	-	-	-	529 -
Stage 2	-	-	-	-	435 -
Critical Hdwy	4.14	-	-	-	6.82 6.92
Critical Hdwy Stg 1	-	-	-	-	5.82 -
Critical Hdwy Stg 2	-	-	-	-	5.82 -
Follow-up Hdwy	2.22	-	-	-	3.51 3.31
Pot Cap-1 Maneuver	1246	-	-	-	389 *902
Stage 1	-	-	-	-	829 -
Stage 2	-	-	-	-	623 -
Platoon blocked, %	1	-	-	-	1 1
Mov Cap-1 Maneuver	1246	-	-	-	361 *902
Mov Cap-2 Maneuver	-	-	-	-	361 -
Stage 1	-	-	-	-	767 -
Stage 2	-	-	-	-	623 -

Approach	EB	WB	SB
HCM Control Delay, s	1.3	0	17.4
HCM LOS			C

Minor Lane/Major Mvmt	EBL	EBT	WBT	WBR	SBLn1	SBLn2
Capacity (veh/h)	1246	-	-	-	361	902
HCM Lane V/C Ratio	0.073	-	-	-	0.452	0.126
HCM Control Delay (s)	8.1	-	-	-	22.9	9.6
HCM Lane LOS	A	-	-	-	C	A
HCM 95th %tile Q(veh)	0.2	-	-	-	2.3	0.4

Notes
 -: Volume exceeds capacity \$: Delay exceeds 300s +: Computation Not Defined *: All major volume in platoon

HCM 6th Signalized Intersection Summary
45: Olive Avenue & SR-99 Southbound Off-Ramp

Village D Specific Plan
Phase I WP - PM Peak Hour



Movement	EBL	EBT	WBT	WBR	SBL	SBR
Lane Configurations		↑↑↑	↑↑		↵	↵
Traffic Volume (veh/h)	0	630	478	0	409	77
Future Volume (veh/h)	0	630	478	0	409	77
Initial Q (Qb), veh	0	0	0	0	0	0
Ped-Bike Adj(A_pbT)	1.00			1.00	1.00	1.00
Parking Bus, Adj	1.00	1.00	1.00	1.00	1.00	1.00
Work Zone On Approach		No	No		No	
Adj Sat Flow, veh/h/ln	0	1885	1885	0	1841	1841
Adj Flow Rate, veh/h	0	663	503	0	431	81
Peak Hour Factor	0.95	0.95	0.95	0.95	0.95	0.95
Percent Heavy Veh, %	0	1	1	0	4	4
Cap, veh/h	0	916	638	0	1266	1126
Arrive On Green	0.00	0.18	0.18	0.00	0.72	0.72
Sat Flow, veh/h	0	5486	3770	0	1753	1560
Grp Volume(v), veh/h	0	663	503	0	431	81
Grp Sat Flow(s),veh/h/ln	0	1716	1791	0	1753	1560
Q Serve(g_s), s	0.0	10.9	12.1	0.0	8.2	1.4
Cycle Q Clear(g_c), s	0.0	10.9	12.1	0.0	8.2	1.4
Prop In Lane	0.00			0.00	1.00	1.00
Lane Grp Cap(c), veh/h	0	916	638	0	1266	1126
V/C Ratio(X)	0.00	0.72	0.79	0.00	0.34	0.07
Avail Cap(c_a), veh/h	0	1229	856	0	1266	1126
HCM Platoon Ratio	1.00	1.00	1.00	1.00	1.00	1.00
Upstream Filter(I)	0.00	1.00	0.90	0.00	1.00	1.00
Uniform Delay (d), s/veh	0.0	34.9	35.4	0.0	4.6	3.7
Incr Delay (d2), s/veh	0.0	1.4	3.2	0.0	0.7	0.1
Initial Q Delay(d3),s/veh	0.0	0.0	0.0	0.0	0.0	0.0
%ile BackOfQ(50%),veh/ln	0.0	4.6	5.5	0.0	2.6	0.4
Unsig. Movement Delay, s/veh						
LnGrp Delay(d),s/veh	0.0	36.3	38.6	0.0	5.3	3.8
LnGrp LOS	A	D	D	A	A	A
Approach Vol, veh/h		663	503		512	
Approach Delay, s/veh		36.3	38.6		5.1	
Approach LOS		D	D		A	
Timer - Assigned Phs				4	6	8
Phs Duration (G+Y+Rc), s				20.5	69.5	20.5
Change Period (Y+Rc), s				4.5	4.5	4.5
Max Green Setting (Gmax), s				21.5	59.5	21.5
Max Q Clear Time (g_c+I1), s				12.9	10.2	14.1
Green Ext Time (p_c), s				2.9	1.7	1.9
Intersection Summary						
HCM 6th Ctrl Delay			27.5			
HCM 6th LOS			C			

HCM 6th Signalized Intersection Summary

46: Madera Avenue & SR-99 Northbound Ramps

Village D Specific Plan
Phase I WP - PM Peak Hour



Movement	EBL	EBT	EBR	WBL	WBT	WBR	NBL	NBT	NBR	SBL	SBT	SBR
Lane Configurations				↖	↖	↖	↖↖	↖↖			↖↖	
Traffic Volume (veh/h)	0	0	0	214	1	33	582	616	0	0	627	194
Future Volume (veh/h)	0	0	0	214	1	33	582	616	0	0	627	194
Initial Q (Qb), veh				0	0	0	0	0	0	0	0	0
Ped-Bike Adj(A_pbT)				1.00		0.99	1.00		1.00	1.00		1.00
Parking Bus, Adj				1.00	1.00	1.00	1.00	1.00	1.00	1.00	1.00	1.00
Work Zone On Approach				No			No			No		
Adj Sat Flow, veh/h/ln				1885	1885	1885	1870	1870	0	0	1870	1870
Adj Flow Rate, veh/h				234	0	36	633	670	0	0	682	211
Peak Hour Factor				0.92	0.92	0.92	0.92	0.92	0.92	0.92	0.92	0.92
Percent Heavy Veh, %				1	1	1	2	2	0	0	2	2
Cap, veh/h				333	0	146	1257	2868	0	0	1050	325
Arrive On Green				0.09	0.00	0.09	0.73	1.00	0.00	0.00	0.39	0.39
Sat Flow, veh/h				3591	0	1575	3456	3647	0	0	2763	826
Grp Volume(v), veh/h				234	0	36	633	670	0	0	454	439
Grp Sat Flow(s),veh/h/ln				1795	0	1575	1728	1777	0	0	1777	1719
Q Serve(g_s), s				5.7	0.0	1.9	7.1	0.0	0.0	0.0	18.7	18.7
Cycle Q Clear(g_c), s				5.7	0.0	1.9	7.1	0.0	0.0	0.0	18.7	18.7
Prop In Lane				1.00		1.00	1.00		0.00	0.00		0.48
Lane Grp Cap(c), veh/h				333	0	146	1257	2868	0	0	699	676
V/C Ratio(X)				0.70	0.00	0.25	0.50	0.23	0.00	0.00	0.65	0.65
Avail Cap(c_a), veh/h				742	0	325	1257	2868	0	0	699	676
HCM Platoon Ratio				1.00	1.00	1.00	2.00	2.00	1.00	1.00	1.00	1.00
Upstream Filter(I)				1.00	0.00	1.00	0.80	0.80	0.00	0.00	1.00	1.00
Uniform Delay (d), s/veh				39.6	0.0	37.9	8.8	0.0	0.0	0.0	22.2	22.2
Incr Delay (d2), s/veh				2.7	0.0	0.9	0.3	0.2	0.0	0.0	4.6	4.8
Initial Q Delay(d3),s/veh				0.0	0.0	0.0	0.0	0.0	0.0	0.0	0.0	0.0
%ile BackOfQ(50%),veh/ln				2.6	0.0	0.8	2.0	0.1	0.0	0.0	8.4	8.1
Unsig. Movement Delay, s/veh												
LnGrp Delay(d),s/veh				42.3	0.0	38.8	9.0	0.2	0.0	0.0	26.9	27.0
LnGrp LOS				D	A	D	A	A	A	A	C	C
Approach Vol, veh/h								1303				893
Approach Delay, s/veh								4.5				27.0
Approach LOS								A				C
Timer - Assigned Phs		2			5	6		8				
Phs Duration (G+Y+Rc), s		77.1			37.2	39.9		12.9				
Change Period (Y+Rc), s		4.5			4.5	4.5		4.5				
Max Green Setting (Gmax), s		62.4			22.5	35.4		18.6				
Max Q Clear Time (g_c+I1), s		2.0			9.1	20.7		7.7				
Green Ext Time (p_c), s		5.5			2.1	5.2		0.7				

Intersection Summary

HCM 6th Ctrl Delay	16.7
HCM 6th LOS	B

Notes

User approved volume balancing among the lanes for turning movement.

HCM 6th Signalized Intersection Summary

47: Madera Avenue & Olive Avenue/SR-99 Southbound On-Ramp

Village D Specific Plan
Phase I WP - PM Peak Hour



Movement	EBL	EBT	EBR	WBL	WBT	WBR	NBL	NBT	NBR	SBL	SBT	SBR
Lane Configurations												
Traffic Volume (veh/h)	398	192	448	0	0	0	144	799	37	132	373	334
Future Volume (veh/h)	398	192	448	0	0	0	144	799	37	132	373	334
Initial Q (Qb), veh	0	0	0				0	0	0	0	0	0
Ped-Bike Adj(A_pbT)	1.00		1.00				1.00		1.00	1.00		1.00
Parking Bus, Adj	1.00	1.00	1.00				1.00	1.00	1.00	1.00	1.00	1.00
Work Zone On Approach	No						No			No		
Adj Sat Flow, veh/h/ln	1856	1856	1856				1870	1870	1870	1885	1885	1885
Adj Flow Rate, veh/h	304	346	462				148	824	38	136	385	344
Peak Hour Factor	0.97	0.97	0.97				0.97	0.97	0.97	0.97	0.97	0.97
Percent Heavy Veh, %	3	3	3				2	2	2	1	1	1
Cap, veh/h	363	381	424				222	1908	88	167	1043	923
Arrive On Green	0.34	0.34	0.34				0.06	0.55	0.55	0.16	0.97	0.97
Sat Flow, veh/h	1767	1856	1570				3456	3459	160	1795	1798	1591
Grp Volume(v), veh/h	304	346	462				148	423	439	136	383	346
Grp Sat Flow(s),veh/h/ln	1767	1856	1570				1728	1777	1842	1795	1791	1599
Q Serve(g_s), s	14.3	16.0	18.5				3.8	12.6	12.6	6.6	0.9	1.0
Cycle Q Clear(g_c), s	14.3	16.0	18.5				3.8	12.6	12.6	6.6	0.9	1.0
Prop In Lane	1.00		1.00				1.00		0.09	1.00		1.00
Lane Grp Cap(c), veh/h	363	381	424				222	980	1016	167	1039	927
V/C Ratio(X)	0.84	0.91	1.09				0.67	0.43	0.43	0.82	0.37	0.37
Avail Cap(c_a), veh/h	363	381	424				403	980	1016	209	1039	927
HCM Platoon Ratio	1.67	1.67	1.67				1.00	1.00	1.00	1.67	1.67	1.67
Upstream Filter(I)	0.83	0.83	0.83				1.00	1.00	1.00	0.82	0.82	0.82
Uniform Delay (d), s/veh	28.2	28.7	27.7				41.2	11.9	11.9	37.3	0.6	0.6
Incr Delay (d2), s/veh	13.3	21.6	66.4				3.4	1.4	1.3	14.9	0.8	0.9
Initial Q Delay(d3),s/veh	0.0	0.0	0.0				0.0	0.0	0.0	0.0	0.0	0.0
%ile BackOfQ(50%),veh/ln	6.3	8.1	24.8				1.7	5.0	5.2	3.4	0.5	0.4
Unsig. Movement Delay, s/veh												
LnGrp Delay(d),s/veh	41.5	50.3	94.1				44.6	13.3	13.2	52.2	1.4	1.5
LnGrp LOS	D	D	F				D	B	B	D	A	A
Approach Vol, veh/h	1112						1010			865		
Approach Delay, s/veh	66.1						17.8			9.5		
Approach LOS	E						B			A		
Timer - Assigned Phs	1	2		4	5	6						
Phs Duration (G+Y+Rc), s	32.9	54.1		23.0	10.3	56.7						
Change Period (Y+Rc), s	4.5	4.5		4.5	4.5	4.5						
Max Green Setting (Gmax), s	40.5	47.5		18.5	10.5	47.5						
Max Q Clear Time (g_c+1), s	19.6	14.6		20.5	5.8	3.0						
Green Ext Time (p_c), s	0.1	6.4		0.0	0.2	5.6						

Intersection Summary

HCM 6th Ctrl Delay	33.4
HCM 6th LOS	C

Notes

User approved volume balancing among the lanes for turning movement.

Intersection						
Int Delay, s/veh	0.3					
Movement	WBL	WBR	NBT	NBR	SBL	SBT
Lane Configurations	↘↗		↑↓		↘	↑↑
Traffic Vol, veh/h	7	9	1013	6	32	883
Future Vol, veh/h	7	9	1013	6	32	883
Conflicting Peds, #/hr	0	0	0	2	2	0
Sign Control	Stop	Stop	Free	Free	Free	Free
RT Channelized	-	None	-	None	-	None
Storage Length	0	-	-	-	100	-
Veh in Median Storage, #	0	-	0	-	-	0
Grade, %	0	-	0	-	-	0
Peak Hour Factor	95	95	95	95	95	95
Heavy Vehicles, %	6	6	2	2	2	2
Mvmt Flow	7	9	1066	6	34	929

Major/Minor	Minor1	Major1	Major2		
Conflicting Flow All	1604	538	0	0	1074
Stage 1	1071	-	-	-	-
Stage 2	533	-	-	-	-
Critical Hdwy	6.92	7.02	-	-	4.14
Critical Hdwy Stg 1	5.92	-	-	-	-
Critical Hdwy Stg 2	5.92	-	-	-	-
Follow-up Hdwy	3.56	3.36	-	-	2.22
Pot Cap-1 Maneuver	*177	477	-	-	645
Stage 1	*282	-	-	-	-
Stage 2	*677	-	-	-	-
Platoon blocked, %	1	-	-	-	-
Mov Cap-1 Maneuver	*167	476	-	-	644
Mov Cap-2 Maneuver	*236	-	-	-	-
Stage 1	*281	-	-	-	-
Stage 2	*641	-	-	-	-

Approach	WB	NB	SB
HCM Control Delay, s	16.5	0	0.4
HCM LOS	C		

Minor Lane/Major Mvmt	NBT	NBRWBLn1	SBL	SBT
Capacity (veh/h)	-	-	329	644
HCM Lane V/C Ratio	-	-	0.051	0.052
HCM Control Delay (s)	-	-	16.5	10.9
HCM Lane LOS	-	-	C	B
HCM 95th %tile Q(veh)	-	-	0.2	0.2

Notes
 -: Volume exceeds capacity \$: Delay exceeds 300s +: Computation Not Defined *: All major volume in platoon

HCM 6th Signalized Intersection Summary
 49: Yosemite Avenue & Cleveland Avenue/Tozer Street

Village D Specific Plan
 Phase I WP - PM Peak Hour



Movement	EBL	EBT	EBR	WBL	WBT	WBR	NBL	NBT	NBR	SBL	SBT	SBR
Lane Configurations												
Traffic Volume (veh/h)	242	428	198	49	464	40	310	298	97	72	174	285
Future Volume (veh/h)	242	428	198	49	464	40	310	298	97	72	174	285
Initial Q (Qb), veh	0	0	0	0	0	0	0	0	0	0	0	0
Ped-Bike Adj(A_pbT)	1.00		0.99	1.00		0.96	1.00		1.00	1.00		0.98
Parking Bus, Adj	1.00	1.00	1.00	1.00	1.00	1.00	1.00	1.00	1.00	1.00	1.00	1.00
Work Zone On Approach		No			No			No			No	
Adj Sat Flow, veh/h/ln	1870	1870	1870	1900	1900	1900	1870	1870	1870	1870	1870	1870
Adj Flow Rate, veh/h	263	465	215	53	504	43	337	324	105	78	189	310
Peak Hour Factor	0.92	0.92	0.92	0.92	0.92	0.92	0.92	0.92	0.92	0.92	0.92	0.92
Percent Heavy Veh, %	2	2	2	0	0	0	2	2	2	2	2	2
Cap, veh/h	287	743	341	70	697	298	340	766	647	100	173	284
Arrive On Green	0.16	0.32	0.32	0.04	0.19	0.19	0.19	0.41	0.41	0.06	0.28	0.28
Sat Flow, veh/h	1781	2356	1081	1810	3610	1542	1781	1870	1580	1781	629	1032
Grp Volume(v), veh/h	263	350	330	53	504	43	337	324	105	78	0	499
Grp Sat Flow(s),veh/h/ln	1781	1777	1659	1810	1805	1542	1781	1870	1580	1781	0	1660
Q Serve(g_s), s	14.5	16.8	17.0	2.9	13.1	2.3	18.9	12.4	4.2	4.3	0.0	27.5
Cycle Q Clear(g_c), s	14.5	16.8	17.0	2.9	13.1	2.3	18.9	12.4	4.2	4.3	0.0	27.5
Prop In Lane	1.00		0.65	1.00		1.00	1.00		1.00	1.00		0.62
Lane Grp Cap(c), veh/h	287	561	524	70	697	298	340	766	647	100	0	457
V/C Ratio(X)	0.92	0.62	0.63	0.76	0.72	0.14	0.99	0.42	0.16	0.78	0.00	1.09
Avail Cap(c_a), veh/h	287	561	524	103	697	298	340	766	647	173	0	457
HCM Platoon Ratio	1.00	1.00	1.00	1.00	1.00	1.00	1.00	1.00	1.00	1.00	1.00	1.00
Upstream Filter(I)	1.00	1.00	1.00	1.00	1.00	1.00	1.00	1.00	1.00	1.00	0.00	1.00
Uniform Delay (d), s/veh	41.3	29.2	29.2	47.6	37.8	33.5	40.4	21.1	18.7	46.6	0.0	36.3
Incr Delay (d2), s/veh	32.3	5.2	5.7	16.8	6.4	1.0	46.1	0.4	0.1	12.1	0.0	69.6
Initial Q Delay(d3),s/veh	0.0	0.0	0.0	0.0	0.0	0.0	0.0	0.0	0.0	0.0	0.0	0.0
%ile BackOfQ(50%),veh/ln	8.9	7.8	7.5	1.6	6.3	0.9	12.5	5.4	1.5	2.2	0.0	19.7
Unsig. Movement Delay, s/veh												
LnGrp Delay(d),s/veh	73.6	34.3	34.9	64.4	44.3	34.5	86.5	21.4	18.8	58.6	0.0	105.9
LnGrp LOS	E	C	C	E	D	C	F	C	B	E	A	F
Approach Vol, veh/h		943			600			766				577
Approach Delay, s/veh		45.5			45.4			49.7				99.5
Approach LOS		D			D			D				F
Timer - Assigned Phs	1	2	3	4	5	6	7	8				
Phs Duration (G+Y+Rc), s	20.6	23.8	10.1	45.5	8.4	36.0	23.6	32.0				
Change Period (Y+Rc), s	4.5	4.5	4.5	4.5	4.5	4.5	4.5	4.5				
Max Green Setting (Gmax), s	16.1	19.3	9.7	36.9	5.7	29.7	19.1	27.5				
Max Q Clear Time (g_c+I1), s	16.5	15.1	6.3	14.4	4.9	19.0	20.9	29.5				
Green Ext Time (p_c), s	0.0	1.3	0.0	2.3	0.0	3.2	0.0	0.0				

Intersection Summary

HCM 6th Ctrl Delay	57.4
HCM 6th LOS	E

Intersection						
Int Delay, s/veh	0					
Movement	WBL	WBR	NBT	NBR	SBL	SBT
Lane Configurations						
Traffic Vol, veh/h	0	0	0	0	0	0
Future Vol, veh/h	0	0	0	0	0	0
Conflicting Peds, #/hr	0	0	0	0	0	0
Sign Control	Stop	Stop	Free	Free	Free	Free
RT Channelized	-	None	-	None	-	None
Storage Length	0	-	-	-	50	-
Veh in Median Storage, #	0	-	0	-	-	0
Grade, %	0	-	0	-	-	0
Peak Hour Factor	92	92	92	92	92	92
Heavy Vehicles, %	0	0	0	0	0	0
Mvmt Flow	0	0	0	0	0	0

Major/Minor	Minor1	Major1	Major2			
Conflicting Flow All	1	0	0	0	0	0
Stage 1	0	-	-	-	-	-
Stage 2	1	-	-	-	-	-
Critical Hdwy	6.4	6.2	-	-	4.1	-
Critical Hdwy Stg 1	5.4	-	-	-	-	-
Critical Hdwy Stg 2	5.4	-	-	-	-	-
Follow-up Hdwy	3.5	3.3	-	-	2.2	-
Pot Cap-1 Maneuver	1027	-	-	-	-	-
Stage 1	-	-	-	-	-	-
Stage 2	1028	-	-	-	-	-
Platoon blocked, %						
Mov Cap-1 Maneuver	1027	-	-	-	-	-
Mov Cap-2 Maneuver	1027	-	-	-	-	-
Stage 1	-	-	-	-	-	-
Stage 2	1028	-	-	-	-	-

Approach	WB	NB	SB
HCM Control Delay, s	0	0	0
HCM LOS	A		

Minor Lane/Major Mvmt	NBT	NBRWBLn1	SBL	SBT
Capacity (veh/h)	-	-	-	-
HCM Lane V/C Ratio	-	-	-	-
HCM Control Delay (s)	-	-	0	0
HCM Lane LOS	-	-	A	A
HCM 95th %tile Q(veh)	-	-	-	-

Intersection						
Int Delay, s/veh	0					
Movement	EBT	EBR	WBL	WBT	NBL	NBR
Lane Configurations						
Traffic Vol, veh/h	92	0	0	41	0	0
Future Vol, veh/h	92	0	0	41	0	0
Conflicting Peds, #/hr	0	0	0	0	0	0
Sign Control	Free	Free	Free	Free	Stop	Stop
RT Channelized	-	None	-	None	-	None
Storage Length	-	-	50	-	50	0
Veh in Median Storage, #	0	-	-	0	0	-
Grade, %	0	-	-	0	0	-
Peak Hour Factor	92	92	92	92	92	92
Heavy Vehicles, %	2	2	3	3	0	0
Mvmt Flow	100	0	0	45	0	0

Major/Minor	Major1	Major2	Minor1		
Conflicting Flow All	0	0	100	0	145
Stage 1	-	-	-	-	100
Stage 2	-	-	-	-	45
Critical Hdwy	-	-	4.13	-	6.4
Critical Hdwy Stg 1	-	-	-	-	5.4
Critical Hdwy Stg 2	-	-	-	-	5.4
Follow-up Hdwy	-	-	2.227	-	3.5
Pot Cap-1 Maneuver	-	-	1486	-	852
Stage 1	-	-	-	-	929
Stage 2	-	-	-	-	983
Platoon blocked, %	-	-	-	-	-
Mov Cap-1 Maneuver	-	-	1486	-	852
Mov Cap-2 Maneuver	-	-	-	-	852
Stage 1	-	-	-	-	929
Stage 2	-	-	-	-	983

Approach	EB	WB	NB
HCM Control Delay, s	0	0	0
HCM LOS			A

Minor Lane/Major Mvmt	NBLn1	NBLn2	EBT	EBR	WBL	WBT
Capacity (veh/h)	-	-	-	-	1486	-
HCM Lane V/C Ratio	-	-	-	-	-	-
HCM Control Delay (s)	0	0	-	-	0	-
HCM Lane LOS	A	A	-	-	A	-
HCM 95th %tile Q(veh)	-	-	-	-	0	-

Intersection												
Int Delay, s/veh	0.2											
Movement	EBL	EBT	EBR	WBL	WBT	WBR	NBL	NBT	NBR	SBL	SBT	SBR
Lane Configurations	↶	↷		↶	↷		↶	↷		↶	↷	
Traffic Vol, veh/h	0	100	0	0	14	0	0	0	0	2	0	0
Future Vol, veh/h	0	100	0	0	14	0	0	0	0	2	0	0
Conflicting Peds, #/hr	0	0	0	0	0	0	0	0	0	0	0	0
Sign Control	Free	Free	Free	Free	Free	Free	Stop	Stop	Stop	Stop	Stop	Stop
RT Channelized	-	-	None	-	-	None	-	-	None	-	-	None
Storage Length	50	-	-	50	-	-	50	-	-	50	-	-
Veh in Median Storage, #	-	0	-	-	0	-	-	0	-	-	0	-
Grade, %	-	0	-	-	0	-	-	0	-	-	0	-
Peak Hour Factor	92	92	92	92	92	92	92	92	92	92	92	92
Heavy Vehicles, %	13	13	13	13	13	13	0	0	0	0	0	0
Mvmt Flow	0	109	0	0	15	0	0	0	0	2	0	0

Major/Minor	Major1			Major2			Minor1			Minor2		
Conflicting Flow All	15	0	0	109	0	0	124	124	109	124	124	15
Stage 1	-	-	-	-	-	-	109	109	-	15	15	-
Stage 2	-	-	-	-	-	-	15	15	-	109	109	-
Critical Hdwy	4.23	-	-	4.23	-	-	7.1	6.5	6.2	7.1	6.5	6.2
Critical Hdwy Stg 1	-	-	-	-	-	-	6.1	5.5	-	6.1	5.5	-
Critical Hdwy Stg 2	-	-	-	-	-	-	6.1	5.5	-	6.1	5.5	-
Follow-up Hdwy	2.317	-	-	2.317	-	-	3.5	4	3.3	3.5	4	3.3
Pot Cap-1 Maneuver	1534	-	-	1415	-	-	855	770	950	855	770	1070
Stage 1	-	-	-	-	-	-	901	809	-	1010	887	-
Stage 2	-	-	-	-	-	-	1010	887	-	901	809	-
Platoon blocked, %	-	-	-	-	-	-	-	-	-	-	-	-
Mov Cap-1 Maneuver	1534	-	-	1415	-	-	855	770	950	855	770	1070
Mov Cap-2 Maneuver	-	-	-	-	-	-	855	770	-	855	770	-
Stage 1	-	-	-	-	-	-	901	809	-	1010	887	-
Stage 2	-	-	-	-	-	-	1010	887	-	901	809	-

Approach	EB	WB	NB	SB
HCM Control Delay, s	0	0	0	9.2
HCM LOS			A	A

Minor Lane/Major Mvmt	NBLn1	NBLn2	EBL	EBT	EBR	WBL	WBT	WBR	SBLn1	SBLn2
Capacity (veh/h)	-	-	1534	-	-	1415	-	-	855	-
HCM Lane V/C Ratio	-	-	-	-	-	-	-	-	0.003	-
HCM Control Delay (s)	0	0	0	-	-	0	-	-	9.2	0
HCM Lane LOS	A	A	A	-	-	A	-	-	A	A
HCM 95th %tile Q(veh)	-	-	0	-	-	0	-	-	0	-

Intersection												
Int Delay, s/veh	2.8											
Movement	EBL	EBT	EBR	WBL	WBT	WBR	NBL	NBT	NBR	SBL	SBT	SBR
Lane Configurations	↶	↷		↶	↷		↶	↷		↶	↷	
Traffic Vol, veh/h	0	0	0	0	0	0	0	0	0	1	0	0
Future Vol, veh/h	0	0	0	0	0	0	0	0	0	1	0	0
Conflicting Peds, #/hr	0	0	0	0	0	0	0	0	0	0	0	0
Sign Control	Free	Free	Free	Free	Free	Free	Stop	Stop	Stop	Stop	Stop	Stop
RT Channelized	-	-	None	-	-	None	-	-	None	-	-	None
Storage Length	50	-	-	50	-	-	50	-	-	50	-	-
Veh in Median Storage, #	-	0	-	-	0	-	-	0	-	-	0	-
Grade, %	-	0	-	-	0	-	-	0	-	-	0	-
Peak Hour Factor	92	92	92	92	92	92	92	92	92	92	92	92
Heavy Vehicles, %	0	0	0	0	0	0	0	0	0	0	0	0
Mvmt Flow	0	0	0	0	0	0	0	0	0	1	0	0

Major/Minor	Major1		Major2		Minor1		Minor2					
Conflicting Flow All	1	0	0	1	0	0	2	2	1	2	2	1
Stage 1	-	-	-	-	-	-	1	1	-	1	1	-
Stage 2	-	-	-	-	-	-	1	1	-	1	1	-
Critical Hdwy	4.1	-	-	4.1	-	-	7.1	6.5	6.2	7.1	6.5	6.2
Critical Hdwy Stg 1	-	-	-	-	-	-	6.1	5.5	-	6.1	5.5	-
Critical Hdwy Stg 2	-	-	-	-	-	-	6.1	5.5	-	6.1	5.5	-
Follow-up Hdwy	2.2	-	-	2.2	-	-	3.5	4	3.3	3.5	4	3.3
Pot Cap-1 Maneuver	1635	-	-	1635	-	-	1026	898	1090	1026	898	1090
Stage 1	-	-	-	-	-	-	1027	899	-	1027	899	-
Stage 2	-	-	-	-	-	-	1027	899	-	1027	899	-
Platoon blocked, %	-	-	-	-	-	-	-	-	-	-	-	-
Mov Cap-1 Maneuver	1635	-	-	1635	-	-	1026	898	1090	1026	898	1090
Mov Cap-2 Maneuver	-	-	-	-	-	-	1026	898	-	1026	898	-
Stage 1	-	-	-	-	-	-	1027	899	-	1027	899	-
Stage 2	-	-	-	-	-	-	1027	899	-	1027	899	-

Approach	EB	WB	NB	SB
HCM Control Delay, s	0	0	0	8.5
HCM LOS			A	A

Minor Lane/Major Mvmt	NBLn1	NBLn2	EBL	EBT	EBR	WBL	WBT	WBR	SBLn1	SBLn2
Capacity (veh/h)	-	-	1635	-	-	1635	-	-	1026	-
HCM Lane V/C Ratio	-	-	-	-	-	-	-	-	0.001	-
HCM Control Delay (s)	0	0	0	-	-	0	-	-	8.5	0
HCM Lane LOS	A	A	A	-	-	A	-	-	A	A
HCM 95th %tile Q(veh)	-	-	0	-	-	0	-	-	0	-

Intersection						
Int Delay, s/veh	0					
Movement	EBL	EBT	WBT	WBR	SBL	SBR
Lane Configurations	↙	↑	↘		↙	↘
Traffic Vol, veh/h	0	0	0	0	0	0
Future Vol, veh/h	0	0	0	0	0	0
Conflicting Peds, #/hr	0	0	0	0	0	0
Sign Control	Free	Free	Free	Free	Stop	Stop
RT Channelized	-	None	-	None	-	None
Storage Length	50	-	-	-	50	0
Veh in Median Storage, #	-	0	0	-	0	-
Grade, %	-	0	0	-	0	-
Peak Hour Factor	92	92	92	92	92	92
Heavy Vehicles, %	0	0	0	0	0	0
Mvmt Flow	0	0	0	0	0	0

Major/Minor	Major1	Major2	Minor2
Conflicting Flow All	1	0	0
Stage 1	-	-	1
Stage 2	-	-	0
Critical Hdwy	4.1	-	6.4
Critical Hdwy Stg 1	-	-	5.4
Critical Hdwy Stg 2	-	-	5.4
Follow-up Hdwy	2.2	-	3.5
Pot Cap-1 Maneuver	1635	-	1027
Stage 1	-	-	1028
Stage 2	-	-	-
Platoon blocked, %	-	-	-
Mov Cap-1 Maneuver	1635	-	1027
Mov Cap-2 Maneuver	-	-	1027
Stage 1	-	-	1028
Stage 2	-	-	-

Approach	EB	WB	SB
HCM Control Delay, s	0	0	0
HCM LOS			A

Minor Lane/Major Mvmt	EBL	EBT	WBT	WBR	SBLn1	SBLn2
Capacity (veh/h)	1635	-	-	-	-	-
HCM Lane V/C Ratio	-	-	-	-	-	-
HCM Control Delay (s)	0	-	-	-	0	0
HCM Lane LOS	A	-	-	-	A	A
HCM 95th %tile Q(veh)	0	-	-	-	-	-

Intersection						
Int Delay, s/veh	0					
Movement	EBL	EBR	NBL	NBT	SBT	SBR
Lane Configurations						
Traffic Vol, veh/h	0	2	0	439	693	0
Future Vol, veh/h	0	2	0	439	693	0
Conflicting Peds, #/hr	0	0	0	0	0	0
Sign Control	Stop	Stop	Free	Free	Free	Free
RT Channelized	-	None	-	None	-	None
Storage Length	50	0	50	-	-	-
Veh in Median Storage, #	0	-	-	0	0	-
Grade, %	0	-	-	0	0	-
Peak Hour Factor	92	92	92	92	92	92
Heavy Vehicles, %	0	0	4	4	4	4
Mvmt Flow	0	2	0	477	753	0

Major/Minor	Minor2	Major1	Major2			
Conflicting Flow All	1230	753	753	0	-	0
Stage 1	753	-	-	-	-	-
Stage 2	477	-	-	-	-	-
Critical Hdwy	6.4	6.2	4.14	-	-	-
Critical Hdwy Stg 1	5.4	-	-	-	-	-
Critical Hdwy Stg 2	5.4	-	-	-	-	-
Follow-up Hdwy	3.5	3.3	2.236	-	-	-
Pot Cap-1 Maneuver	198	413	848	-	-	-
Stage 1	469	-	-	-	-	-
Stage 2	629	-	-	-	-	-
Platoon blocked, %				-	-	-
Mov Cap-1 Maneuver	198	413	848	-	-	-
Mov Cap-2 Maneuver	198	-	-	-	-	-
Stage 1	469	-	-	-	-	-
Stage 2	629	-	-	-	-	-

Approach	EB	NB	SB
HCM Control Delay, s	13.8	0	0
HCM LOS	B		

Minor Lane/Major Mvmt	NBL	NBT	EBLn1	EBLn2	SBT	SBR
Capacity (veh/h)	848	-	-	413	-	-
HCM Lane V/C Ratio	-	-	-	0.005	-	-
HCM Control Delay (s)	0	-	0	13.8	-	-
HCM Lane LOS	A	-	A	B	-	-
HCM 95th %tile Q(veh)	0	-	-	0	-	-

Intersection

Int Delay, s/veh 390.7

Movement	WBL	WBR	NBT	NBR	SBL	SBT
Lane Configurations	↙	↗	↖		↙	↗
Traffic Vol, veh/h	330	213	414	301	302	389
Future Vol, veh/h	330	213	414	301	302	389
Conflicting Peds, #/hr	0	0	0	0	0	0
Sign Control	Stop	Stop	Free	Free	Free	Free
RT Channelized	-	None	-	None	-	None
Storage Length	50	0	-	-	50	-
Veh in Median Storage, #	0	-	0	-	-	0
Grade, %	0	-	0	-	-	0
Peak Hour Factor	92	92	92	92	92	92
Heavy Vehicles, %	0	0	3	3	4	4
Mvmt Flow	359	232	450	327	328	423

Major/Minor	Minor1	Major1	Major2			
Conflicting Flow All	1693	614	0	0	777	0
Stage 1	614	-	-	-	-	-
Stage 2	1079	-	-	-	-	-
Critical Hdwy	6.4	6.2	-	-	4.14	-
Critical Hdwy Stg 1	5.4	-	-	-	-	-
Critical Hdwy Stg 2	5.4	-	-	-	-	-
Follow-up Hdwy	3.5	3.3	-	-	2.236	-
Pot Cap-1 Maneuver	~ 103	496	-	-	831	-
Stage 1	544	-	-	-	-	-
Stage 2	~ 329	-	-	-	-	-
Platoon blocked, %			-	-		
Mov Cap-1 Maneuver	~ 62	496	-	-	831	-
Mov Cap-2 Maneuver	~ 62	-	-	-	-	-
Stage 1	544	-	-	-	-	-
Stage 2	~ 199	-	-	-	-	-

Approach	WB	NB	SB
HCM Control Delay, \$	1395.6	0	5.3
HCM LOS	F		

Minor Lane/Major Mvmt	NBT	NBR	WBLn1	WBLn2	SBL	SBT
Capacity (veh/h)	-	-	62	496	831	-
HCM Lane V/C Ratio	-	-	5.785	0.467	0.395	-
HCM Control Delay (s)	-	\$	2284.5	18.5	12.1	-
HCM Lane LOS	-	-	F	C	B	-
HCM 95th %tile Q(veh)	-	-	40.4	2.4	1.9	-

Notes

-: Volume exceeds capacity \$: Delay exceeds 300s +: Computation Not Defined *: All major volume in platoon

Intersection						
Int Delay, s/veh	0.7					
Movement	EBL	EBR	NBL	NBT	SBT	SBR
Lane Configurations						
Traffic Vol, veh/h	21	9	0	697	705	13
Future Vol, veh/h	21	9	0	697	705	13
Conflicting Peds, #/hr	0	0	0	0	0	0
Sign Control	Stop	Stop	Free	Free	Free	Free
RT Channelized	-	None	-	None	-	None
Storage Length	0	-	50	-	-	-
Veh in Median Storage, #	0	-	-	0	0	-
Grade, %	0	-	-	0	0	-
Peak Hour Factor	92	92	92	92	92	92
Heavy Vehicles, %	0	0	3	3	4	4
Mvmt Flow	23	10	0	758	766	14

Major/Minor	Minor2	Major1		Major2	
Conflicting Flow All	1531	773	780	0	0
Stage 1	773	-	-	-	-
Stage 2	758	-	-	-	-
Critical Hdwy	6.4	6.2	4.13	-	-
Critical Hdwy Stg 1	5.4	-	-	-	-
Critical Hdwy Stg 2	5.4	-	-	-	-
Follow-up Hdwy	3.5	3.3	2.227	-	-
Pot Cap-1 Maneuver	130	402	833	-	-
Stage 1	459	-	-	-	-
Stage 2	466	-	-	-	-
Platoon blocked, %				-	-
Mov Cap-1 Maneuver	130	402	833	-	-
Mov Cap-2 Maneuver	130	-	-	-	-
Stage 1	459	-	-	-	-
Stage 2	466	-	-	-	-

Approach	EB	NB	SB
HCM Control Delay, s	32.5	0	0
HCM LOS	D		

Minor Lane/Major Mvmt	NBL	NBT	EBLn1	SBT	SBR
Capacity (veh/h)	833	-	163	-	-
HCM Lane V/C Ratio	-	-	0.2	-	-
HCM Control Delay (s)	0	-	32.5	-	-
HCM Lane LOS	A	-	D	-	-
HCM 95th %tile Q(veh)	0	-	0.7	-	-

Intersection						
Int Delay, s/veh	43.7					
Movement	EBT	EBR	WBL	WBT	NBL	NBR
Lane Configurations	↔		↔	↑	↔	↔
Traffic Vol, veh/h	474	158	332	796	78	243
Future Vol, veh/h	474	158	332	796	78	243
Conflicting Peds, #/hr	0	0	0	0	0	0
Sign Control	Free	Free	Free	Free	Stop	Stop
RT Channelized	-	None	-	None	-	None
Storage Length	-	-	50	-	50	0
Veh in Median Storage, #	0	-	-	0	0	-
Grade, %	0	-	-	0	0	-
Peak Hour Factor	92	92	92	92	92	92
Heavy Vehicles, %	1	1	0	0	0	0
Mvmt Flow	515	172	361	865	85	264

Major/Minor	Major1	Major2	Minor1		
Conflicting Flow All	0	0	687	0	2188 601
Stage 1	-	-	-	-	601 -
Stage 2	-	-	-	-	1587 -
Critical Hdwy	-	-	4.1	-	6.4 6.2
Critical Hdwy Stg 1	-	-	-	-	5.4 -
Critical Hdwy Stg 2	-	-	-	-	5.4 -
Follow-up Hdwy	-	-	2.2	-	3.5 3.3
Pot Cap-1 Maneuver	-	-	916	-	~ 51 504
Stage 1	-	-	-	-	551 -
Stage 2	-	-	-	-	187 -
Platoon blocked, %	-	-	-	-	-
Mov Cap-1 Maneuver	-	-	916	-	~ 31 504
Mov Cap-2 Maneuver	-	-	-	-	~ 31 -
Stage 1	-	-	-	-	551 -
Stage 2	-	-	-	-	113 -

Approach	EB	WB	NB
HCM Control Delay, s	0	3.4	271.2
HCM LOS			F

Minor Lane/Major Mvmt	NBLn1	NBLn2	EBT	EBR	WBL	WBT
Capacity (veh/h)	31	504	-	-	916	-
HCM Lane V/C Ratio	2.735	0.524	-	-	0.394	-
HCM Control Delay (s)	\$ 1054.9	19.7	-	-	11.5	-
HCM Lane LOS	F	C	-	-	B	-
HCM 95th %tile Q(veh)	9.9	3	-	-	1.9	-

Notes
 -: Volume exceeds capacity \$: Delay exceeds 300s +: Computation Not Defined *: All major volume in platoon

Intersection						
Int Delay, s/veh	1					
Movement	EBT	EBR	WBL	WBT	NBL	NBR
Lane Configurations						
Traffic Vol, veh/h	35	0	2	28	2	5
Future Vol, veh/h	35	0	2	28	2	5
Conflicting Peds, #/hr	0	0	0	0	0	0
Sign Control	Free	Free	Free	Free	Stop	Stop
RT Channelized	-	None	-	None	-	None
Storage Length	-	-	-	-	-	-
Veh in Median Storage, #	0	-	-	0	0	-
Grade, %	0	-	-	0	0	-
Peak Hour Factor	92	92	92	92	92	92
Heavy Vehicles, %	15	15	15	15	0	0
Mvmt Flow	38	0	2	30	2	5

Major/Minor	Major1	Major2	Minor1	Minor2	Minor3
Conflicting Flow All	0	0	38	0	72
Stage 1	-	-	-	-	38
Stage 2	-	-	-	-	34
Critical Hdwy	-	-	4.25	-	6.4
Critical Hdwy Stg 1	-	-	-	-	5.4
Critical Hdwy Stg 2	-	-	-	-	5.4
Follow-up Hdwy	-	-	2.335	-	3.5
Pot Cap-1 Maneuver	-	-	1492	-	937
Stage 1	-	-	-	-	990
Stage 2	-	-	-	-	994
Platoon blocked, %	-	-	-	-	-
Mov Cap-1 Maneuver	-	-	1492	-	936
Mov Cap-2 Maneuver	-	-	-	-	936
Stage 1	-	-	-	-	990
Stage 2	-	-	-	-	993

Approach	EB	WB	NB
HCM Control Delay, s	0	0.5	8.6
HCM LOS			A

Minor Lane/Major Mvmt	NBLn1	EBT	EBR	WBL	WBT
Capacity (veh/h)	1008	-	-	1492	-
HCM Lane V/C Ratio	0.008	-	-	0.001	-
HCM Control Delay (s)	8.6	-	-	7.4	0
HCM Lane LOS	A	-	-	A	A
HCM 95th %tile Q(veh)	0	-	-	0	-

Intersection												
Int Delay, s/veh	0.8											
Movement	EBL	EBT	EBR	WBL	WBT	WBR	NBL	NBT	NBR	SBL	SBT	SBR
Lane Configurations		↕			↕			↕			↕	
Traffic Vol, veh/h	2	12	0	0	30	5	0	0	0	2	0	1
Future Vol, veh/h	2	12	0	0	30	5	0	0	0	2	0	1
Conflicting Peds, #/hr	1	0	0	0	0	1	0	0	0	0	0	0
Sign Control	Free	Free	Free	Free	Free	Free	Stop	Stop	Stop	Stop	Stop	Stop
RT Channelized	-	-	None	-	-	None	-	-	None	-	-	None
Storage Length	-	-	-	-	-	-	-	-	-	-	-	-
Veh in Median Storage, #	-	0	-	-	0	-	-	0	-	-	0	-
Grade, %	-	0	-	-	0	-	-	0	-	-	0	-
Peak Hour Factor	92	92	92	92	92	92	92	92	92	92	92	92
Heavy Vehicles, %	11	11	11	11	11	11	0	0	0	0	0	0
Mvmt Flow	2	13	0	0	33	5	0	0	0	2	0	1

Major/Minor	Major1			Major2			Minor1			Minor2		
Conflicting Flow All	39	0	0	13	0	0	53	56	13	54	54	37
Stage 1	-	-	-	-	-	-	17	17	-	37	37	-
Stage 2	-	-	-	-	-	-	36	39	-	17	17	-
Critical Hdwy	4.21	-	-	4.21	-	-	7.1	6.5	6.2	7.1	6.5	6.2
Critical Hdwy Stg 1	-	-	-	-	-	-	6.1	5.5	-	6.1	5.5	-
Critical Hdwy Stg 2	-	-	-	-	-	-	6.1	5.5	-	6.1	5.5	-
Follow-up Hdwy	2.299	-	-	2.299	-	-	3.5	4	3.3	3.5	4	3.3
Pot Cap-1 Maneuver	1515	-	-	1549	-	-	951	839	1073	949	841	1041
Stage 1	-	-	-	-	-	-	1008	885	-	984	868	-
Stage 2	-	-	-	-	-	-	985	866	-	1008	885	-
Platoon blocked, %		-	-		-	-						
Mov Cap-1 Maneuver	1514	-	-	1549	-	-	949	837	1073	947	839	1040
Mov Cap-2 Maneuver	-	-	-	-	-	-	949	837	-	947	839	-
Stage 1	-	-	-	-	-	-	1007	884	-	982	867	-
Stage 2	-	-	-	-	-	-	984	865	-	1007	884	-

Approach	EB	WB	NB	SB
HCM Control Delay, s	1.1	0	0	8.7
HCM LOS			A	A

Minor Lane/Major Mvmt	NBLn1	EBL	EBT	EBR	WBL	WBT	WBR	SBLn1
Capacity (veh/h)	-	1514	-	-	1549	-	-	976
HCM Lane V/C Ratio	-	0.001	-	-	-	-	-	0.003
HCM Control Delay (s)	0	7.4	0	-	0	-	-	8.7
HCM Lane LOS	A	A	A	-	A	-	-	A
HCM 95th %tile Q(veh)	-	0	-	-	0	-	-	0

Intersection						
Int Delay, s/veh	2.9					
Movement	EBL	EBT	WBT	WBR	SBL	SBR
Lane Configurations		↕	↑	↗	↘	
Traffic Vol, veh/h	2	109	102	109	96	4
Future Vol, veh/h	2	109	102	109	96	4
Conflicting Peds, #/hr	0	0	0	0	0	0
Sign Control	Free	Free	Free	Free	Stop	Stop
RT Channelized	-	None	-	None	-	None
Storage Length	-	-	-	0	0	-
Veh in Median Storage, #	-	0	0	-	0	-
Grade, %	-	0	0	-	0	-
Peak Hour Factor	92	92	92	92	92	92
Heavy Vehicles, %	16	16	50	50	81	81
Mvmt Flow	2	118	111	118	104	4

Major/Minor	Major1	Major2	Minor2		
Conflicting Flow All	229	0	-	0	233 111
Stage 1	-	-	-	-	111 -
Stage 2	-	-	-	-	122 -
Critical Hdwy	4.26	-	-	-	7.21 7.01
Critical Hdwy Stg 1	-	-	-	-	6.21 -
Critical Hdwy Stg 2	-	-	-	-	6.21 -
Follow-up Hdwy	2.344	-	-	-	4.229 4.029
Pot Cap-1 Maneuver	1261	-	-	-	610 765
Stage 1	-	-	-	-	750 -
Stage 2	-	-	-	-	740 -
Platoon blocked, %		-	-	-	
Mov Cap-1 Maneuver	1261	-	-	-	609 765
Mov Cap-2 Maneuver	-	-	-	-	609 -
Stage 1	-	-	-	-	749 -
Stage 2	-	-	-	-	740 -

Approach	EB	WB	SB
HCM Control Delay, s	0.1	0	12.1
HCM LOS			B

Minor Lane/Major Mvmt	EBL	EBT	WBT	WBR	SBLn1
Capacity (veh/h)	1261	-	-	-	614
HCM Lane V/C Ratio	0.002	-	-	-	0.177
HCM Control Delay (s)	7.9	0	-	-	12.1
HCM Lane LOS	A	A	-	-	B
HCM 95th %tile Q(veh)	0	-	-	-	0.6

HCM 6th TWSC
4: Truck Parking Lot/Pistachio Drive & Avenue 18 1/2

Village D Specific Plan
Phase II NP - AM Peak Hour

Intersection												
Int Delay, s/veh	2.5											
Movement	EBL	EBT	EBR	WBL	WBT	WBR	NBL	NBT	NBR	SBL	SBT	SBR
Lane Configurations		↕			↕	↕		↕			↕	
Traffic Vol, veh/h	8	261	1	3	218	204	0	0	1	108	0	9
Future Vol, veh/h	8	261	1	3	218	204	0	0	1	108	0	9
Conflicting Peds, #/hr	0	0	0	0	0	0	0	0	0	0	0	0
Sign Control	Free	Free	Free	Free	Free	Free	Stop	Stop	Stop	Stop	Stop	Stop
RT Channelized	-	-	None	-	-	None	-	-	None	-	-	None
Storage Length	-	-	-	-	-	50	-	-	-	-	-	-
Veh in Median Storage, #	-	0	-	-	0	-	-	0	-	-	0	-
Grade, %	-	0	-	-	0	-	-	0	-	-	0	-
Peak Hour Factor	93	93	93	93	93	93	93	93	93	93	93	93
Heavy Vehicles, %	34	34	34	26	26	26	100	100	100	12	12	12
Mvmt Flow	9	281	1	3	234	219	0	0	1	116	0	10

Major/Minor	Major1			Major2			Minor1			Minor2		
Conflicting Flow All	453	0	0	282	0	0	655	759	282	540	540	234
Stage 1	-	-	-	-	-	-	300	300	-	240	240	-
Stage 2	-	-	-	-	-	-	355	459	-	300	300	-
Critical Hdwy	4.44	-	-	4.36	-	-	8.1	7.5	7.2	7.22	6.62	6.32
Critical Hdwy Stg 1	-	-	-	-	-	-	7.1	6.5	-	6.22	5.62	-
Critical Hdwy Stg 2	-	-	-	-	-	-	7.1	6.5	-	6.22	5.62	-
Follow-up Hdwy	2.506	-	-	2.434	-	-	4.4	4.9	4.2	3.608	4.108	3.408
Pot Cap-1 Maneuver	958	-	-	1155	-	-	272	242	572	437	435	781
Stage 1	-	-	-	-	-	-	541	521	-	742	689	-
Stage 2	-	-	-	-	-	-	501	431	-	688	648	-
Platoon blocked, %		-	-		-	-						
Mov Cap-1 Maneuver	958	-	-	1155	-	-	265	238	572	431	428	781
Mov Cap-2 Maneuver	-	-	-	-	-	-	265	238	-	431	428	-
Stage 1	-	-	-	-	-	-	535	515	-	734	686	-
Stage 2	-	-	-	-	-	-	493	429	-	679	641	-

Approach	EB			WB			NB			SB		
HCM Control Delay, s	0.3			0.1			11.3			16.2		
HCM LOS							B			C		

Minor Lane/Major Mvmt	NBLn1	EBL	EBT	EBR	WBL	WBT	WBR	SBLn1	
Capacity (veh/h)	572	958	-	-	1155	-	-	446	
HCM Lane V/C Ratio	0.002	0.009	-	-	0.003	-	-	0.282	
HCM Control Delay (s)	11.3	8.8	0	-	8.1	0	-	16.2	
HCM Lane LOS		B	A	A	-	A	A	-	C
HCM 95th %tile Q(veh)		0	0	-	-	0	-	-	1.1

Intersection												
Int Delay, s/veh	7.3											
Movement	EBL	EBT	EBR	WBL	WBT	WBR	NBL	NBT	NBR	SBL	SBT	SBR
Lane Configurations		↑	↑		↑		↑		↑		↕	
Traffic Vol, veh/h	0	317	53	47	281	0	62	0	154	11	54	86
Future Vol, veh/h	0	317	53	47	281	0	62	0	154	11	54	86
Conflicting Peds, #/hr	0	0	0	0	0	0	0	0	1	1	0	0
Sign Control	Free	Free	Free	Free	Free	Free	Stop	Stop	Stop	Stop	Stop	Stop
RT Channelized	-	-	None	-	-	None	-	-	None	-	-	None
Storage Length	-	-	50	-	-	-	0	-	25	-	-	-
Veh in Median Storage, #	-	0	-	-	0	-	-	0	-	-	0	-
Grade, %	-	0	-	-	0	-	-	0	-	-	0	-
Peak Hour Factor	92	92	92	92	92	92	92	92	92	92	92	92
Heavy Vehicles, %	33	33	33	26	26	26	21	21	21	35	35	35
Mvmt Flow	0	345	58	51	305	0	67	0	167	12	59	93

Major/Minor	Major1			Major2			Minor1			Minor2		
Conflicting Flow All	-	0	0	403	0	0	828	-	346	866	810	305
Stage 1	-	-	-	-	-	-	345	-	-	407	407	-
Stage 2	-	-	-	-	-	-	483	-	-	459	403	-
Critical Hdwy	-	-	-	4.36	-	-	7.31	-	6.41	7.45	6.85	6.55
Critical Hdwy Stg 1	-	-	-	-	-	-	6.31	-	-	6.45	5.85	-
Critical Hdwy Stg 2	-	-	-	-	-	-	6.31	-	-	6.45	5.85	-
Follow-up Hdwy	-	-	-	2.434	-	-	3.689	-	3.489	3.815	4.315	3.615
Pot Cap-1 Maneuver	0	-	-	1037	-	0	269	0	656	240	279	664
Stage 1	0	-	-	-	-	0	633	0	-	560	544	-
Stage 2	0	-	-	-	-	0	531	0	-	524	546	-
Platoon blocked, %	-	-	-	-	-	-	-	-	-	-	-	-
Mov Cap-1 Maneuver	-	-	-	1037	-	-	183	-	655	170	263	664
Mov Cap-2 Maneuver	-	-	-	-	-	-	183	-	-	170	263	-
Stage 1	-	-	-	-	-	-	633	-	-	560	512	-
Stage 2	-	-	-	-	-	-	380	-	-	390	546	-

Approach	EB			WB			NB			SB		
HCM Control Delay, s	0			1.2			19.1			21.6		
HCM LOS							C			C		

Minor Lane/Major Mvmt	NBLn1	NBLn2	EBT	EBR	WBL	WBT	SBLn1
Capacity (veh/h)	183	655	-	-	1037	-	378
HCM Lane V/C Ratio	0.368	0.256	-	-	0.049	-	0.434
HCM Control Delay (s)	35.7	12.4	-	-	8.7	0	21.6
HCM Lane LOS	E	B	-	-	A	A	C
HCM 95th %tile Q(veh)	1.6	1	-	-	0.2	-	2.1

Intersection												
Int Delay, s/veh	23.3											
Movement	EBL	EBT	EBR	WBL	WBT	WBR	NBL	NBT	NBR	SBL	SBT	SBR
Lane Configurations	↙	↑			↘			↕				
Traffic Vol, veh/h	223	61	0	0	150	31	215	1	25	0	0	0
Future Vol, veh/h	223	61	0	0	150	31	215	1	25	0	0	0
Conflicting Peds, #/hr	1	0	0	0	0	1	0	0	0	0	0	0
Sign Control	Free	Free	Free	Free	Free	Free	Stop	Stop	Stop	Free	Free	Free
RT Channelized	-	-	None	-	-	None	-	-	None	-	-	None
Storage Length	145	-	-	-	-	-	-	-	-	-	-	-
Veh in Median Storage, #	-	0	-	-	0	-	-	0	-	-	16965	-
Grade, %	-	0	-	-	0	-	-	0	-	-	0	-
Peak Hour Factor	92	92	92	92	92	92	92	92	92	92	92	92
Heavy Vehicles, %	31	31	31	18	18	18	29	29	29	0	0	0
Mvmt Flow	242	66	0	0	163	34	234	1	27	0	0	0

Major/Minor	Major1	Major2	Minor1
Conflicting Flow All	198	0	0
Stage 1	-	-	550
Stage 2	-	-	180
Critical Hdwy	4.41	-	6.69
Critical Hdwy Stg 1	-	-	5.69
Critical Hdwy Stg 2	-	-	5.69
Follow-up Hdwy	2.479	-	3.761
Pot Cap-1 Maneuver	1219	0	352
Stage 1	-	0	528
Stage 2	-	0	790
Platoon blocked, %	-	-	-
Mov Cap-1 Maneuver	1219	-	282
Mov Cap-2 Maneuver	-	-	282
Stage 1	-	-	423
Stage 2	-	-	790

Approach	EB	WB	NB
HCM Control Delay, s	6.8	0	60.3
HCM LOS			F

Minor Lane/Major Mvmt	NBLn1	EBL	EBT	WBT	WBR
Capacity (veh/h)	304	1219	-	-	-
HCM Lane V/C Ratio	0.862	0.199	-	-	-
HCM Control Delay (s)	60.3	8.7	-	-	-
HCM Lane LOS	F	A	-	-	-
HCM 95th %tile Q(veh)	7.6	0.7	-	-	-

Intersection												
Int Delay, s/veh	3.8											
Movement	EBL	EBT	EBR	WBL	WBT	WBR	NBL	NBT	NBR	SBL	SBT	SBR
Lane Configurations		↕			↕			↕			↕	
Traffic Vol, veh/h	2	31	8	55	22	3	9	163	49	16	106	0
Future Vol, veh/h	2	31	8	55	22	3	9	163	49	16	106	0
Conflicting Peds, #/hr	0	0	0	0	0	0	0	0	0	0	0	0
Sign Control	Stop	Stop	Stop	Stop	Stop	Stop	Free	Free	Free	Free	Free	Free
RT Channelized	-	-	None	-	-	None	-	-	None	-	-	None
Storage Length	-	-	-	-	-	-	-	-	-	-	-	-
Veh in Median Storage, #	-	0	-	-	0	-	-	0	-	-	0	-
Grade, %	-	0	-	-	0	-	-	0	-	-	0	-
Peak Hour Factor	92	92	92	92	92	92	92	92	92	92	92	92
Heavy Vehicles, %	6	6	6	19	19	19	18	18	18	24	24	24
Mvmt Flow	2	34	9	60	24	3	10	177	53	17	115	0

Major/Minor	Minor2		Minor1		Major1		Major2					
Conflicting Flow All	386	399	115	395	373	204	115	0	0	230	0	0
Stage 1	149	149	-	224	224	-	-	-	-	-	-	-
Stage 2	237	250	-	171	149	-	-	-	-	-	-	-
Critical Hdwy	7.16	6.56	6.26	7.29	6.69	6.39	4.28	-	-	4.34	-	-
Critical Hdwy Stg 1	6.16	5.56	-	6.29	5.69	-	-	-	-	-	-	-
Critical Hdwy Stg 2	6.16	5.56	-	6.29	5.69	-	-	-	-	-	-	-
Follow-up Hdwy	3.554	4.054	3.354	3.671	4.171	3.471	2.362	-	-	2.416	-	-
Pot Cap-1 Maneuver	565	533	927	535	531	795	1380	-	-	1219	-	-
Stage 1	844	766	-	742	688	-	-	-	-	-	-	-
Stage 2	757	693	-	793	743	-	-	-	-	-	-	-
Platoon blocked, %								-	-	-	-	-
Mov Cap-1 Maneuver	533	521	927	495	519	795	1380	-	-	1219	-	-
Mov Cap-2 Maneuver	533	521	-	495	519	-	-	-	-	-	-	-
Stage 1	837	755	-	736	682	-	-	-	-	-	-	-
Stage 2	722	687	-	739	732	-	-	-	-	-	-	-

Approach	EB		WB		NB		SB	
HCM Control Delay, s	11.9		13.5		0.3		1	
HCM LOS	B		B					

Minor Lane/Major Mvmt	NBL	NBT	NBR	EBLn1WBLn1	SBL	SBT	SBR
Capacity (veh/h)	1380	-	-	570	509	1219	-
HCM Lane V/C Ratio	0.007	-	-	0.078	0.171	0.014	-
HCM Control Delay (s)	7.6	0	-	11.9	13.5	8	0
HCM Lane LOS	A	A	-	B	B	A	A
HCM 95th %tile Q(veh)	0	-	-	0.3	0.6	0	-

Intersection												
Int Delay, s/veh	1.7											
Movement	EBL	EBT	EBR	WBL	WBT	WBR	NBL	NBT	NBR	SBL	SBT	SBR
Lane Configurations		↕			↕			↕			↕	
Traffic Vol, veh/h	10	20	24	0	4	0	31	262	0	0	267	10
Future Vol, veh/h	10	20	24	0	4	0	31	262	0	0	267	10
Conflicting Peds, #/hr	0	0	0	0	0	0	0	0	0	0	0	0
Sign Control	Stop	Stop	Stop	Stop	Stop	Stop	Free	Free	Free	Free	Free	Free
RT Channelized	-	-	None	-	-	None	-	-	None	-	-	None
Storage Length	-	-	-	-	-	-	-	-	-	-	-	-
Veh in Median Storage, #	-	0	-	-	0	-	-	0	-	-	0	-
Grade, %	-	0	-	-	0	-	-	0	-	-	0	-
Peak Hour Factor	92	92	92	92	92	92	92	92	92	92	92	92
Heavy Vehicles, %	25	25	25	25	25	25	14	14	14	18	18	18
Mvmt Flow	11	22	26	0	4	0	34	285	0	0	290	11

Major/Minor	Minor2		Minor1		Major1			Major2				
Conflicting Flow All	651	649	296	673	654	285	301	0	0	285	0	0
Stage 1	296	296	-	353	353	-	-	-	-	-	-	-
Stage 2	355	353	-	320	301	-	-	-	-	-	-	-
Critical Hdwy	7.35	6.75	6.45	7.35	6.75	6.45	4.24	-	-	4.28	-	-
Critical Hdwy Stg 1	6.35	5.75	-	6.35	5.75	-	-	-	-	-	-	-
Critical Hdwy Stg 2	6.35	5.75	-	6.35	5.75	-	-	-	-	-	-	-
Follow-up Hdwy	3.725	4.225	3.525	3.725	4.225	3.525	2.326	-	-	2.362	-	-
Pot Cap-1 Maneuver	352	361	692	340	358	702	1195	-	-	1191	-	-
Stage 1	666	629	-	619	592	-	-	-	-	-	-	-
Stage 2	617	592	-	646	625	-	-	-	-	-	-	-
Platoon blocked, %								-	-	-	-	-
Mov Cap-1 Maneuver	340	349	692	304	346	702	1195	-	-	1191	-	-
Mov Cap-2 Maneuver	340	349	-	304	346	-	-	-	-	-	-	-
Stage 1	643	629	-	598	572	-	-	-	-	-	-	-
Stage 2	591	572	-	600	625	-	-	-	-	-	-	-

Approach	EB		WB		NB		SB	
HCM Control Delay, s	14.3		15.5		0.9		0	
HCM LOS	B		C					

Minor Lane/Major Mvmt	NBL	NBT	NBR	EBLn1WBLn1	SBL	SBT	SBR
Capacity (veh/h)	1195	-	-	445	346	1191	-
HCM Lane V/C Ratio	0.028	-	-	0.132	0.013	-	-
HCM Control Delay (s)	8.1	0	-	14.3	15.5	0	-
HCM Lane LOS	A	A	-	B	C	A	-
HCM 95th %tile Q(veh)	0.1	-	-	0.5	0	0	-

Intersection												
Int Delay, s/veh	5											
Movement	EBL	EBT	EBR	WBL	WBT	WBR	NBL	NBT	NBR	SBL	SBT	SBR
Lane Configurations		↕			↕			↕			↕	
Traffic Vol, veh/h	0	0	0	67	0	139	0	264	62	62	218	0
Future Vol, veh/h	0	0	0	67	0	139	0	264	62	62	218	0
Conflicting Peds, #/hr	0	0	0	0	0	0	0	0	0	0	0	0
Sign Control	Stop	Stop	Stop	Stop	Stop	Stop	Free	Free	Free	Free	Free	Free
RT Channelized	-	-	None	-	-	None	-	-	None	-	-	None
Storage Length	-	-	-	-	-	-	-	-	-	-	-	-
Veh in Median Storage, #	-	0	-	-	0	-	-	0	-	-	0	-
Grade, %	-	0	-	-	0	-	-	0	-	-	0	-
Peak Hour Factor	92	92	92	92	92	92	92	92	92	92	92	92
Heavy Vehicles, %	0	0	0	7	7	7	15	15	15	23	23	23
Mvmt Flow	0	0	0	73	0	151	0	287	67	67	237	0

Major/Minor	Minor2		Minor1		Major1		Major2					
Conflicting Flow All	767	725	237	692	692	321	237	0	0	354	0	0
Stage 1	371	371	-	321	321	-	-	-	-	-	-	-
Stage 2	396	354	-	371	371	-	-	-	-	-	-	-
Critical Hdwy	7.1	6.5	6.2	7.17	6.57	6.27	4.25	-	-	4.33	-	-
Critical Hdwy Stg 1	6.1	5.5	-	6.17	5.57	-	-	-	-	-	-	-
Critical Hdwy Stg 2	6.1	5.5	-	6.17	5.57	-	-	-	-	-	-	-
Follow-up Hdwy	3.5	4	3.3	3.563	4.063	3.363	2.335	-	-	2.407	-	-
Pot Cap-1 Maneuver	322	354	807	352	361	708	1257	-	-	1097	-	-
Stage 1	653	623	-	680	643	-	-	-	-	-	-	-
Stage 2	633	634	-	639	611	-	-	-	-	-	-	-
Platoon blocked, %								-	-	-	-	-
Mov Cap-1 Maneuver	240	329	807	333	336	708	1257	-	-	1097	-	-
Mov Cap-2 Maneuver	240	329	-	333	336	-	-	-	-	-	-	-
Stage 1	653	579	-	680	643	-	-	-	-	-	-	-
Stage 2	498	634	-	594	568	-	-	-	-	-	-	-

Approach	EB	WB	NB	SB
HCM Control Delay, s	0	17.1	0	1.9
HCM LOS	A	C		

Minor Lane/Major Mvmt	NBL	NBT	NBR	EBLn1WBLn1	SBL	SBT	SBR
Capacity (veh/h)	1257	-	-	-	518	1097	-
HCM Lane V/C Ratio	-	-	-	-	0.432	0.061	-
HCM Control Delay (s)	0	-	-	0	17.1	8.5	0
HCM Lane LOS	A	-	-	A	C	A	A
HCM 95th %tile Q(veh)	0	-	-	-	2.2	0.2	-

Intersection												
Int Delay, s/veh	2.7											
Movement	EBL	EBT	EBR	WBL	WBT	WBR	NBL	NBT	NBR	SBL	SBT	SBR
Lane Configurations		↕			↕			↕			↕	
Traffic Vol, veh/h	0	5	0	17	3	89	4	236	4	41	242	0
Future Vol, veh/h	0	5	0	17	3	89	4	236	4	41	242	0
Conflicting Peds, #/hr	0	0	0	0	0	0	0	0	0	0	0	0
Sign Control	Stop	Stop	Stop	Stop	Stop	Stop	Free	Free	Free	Free	Free	Free
RT Channelized	-	-	None	-	-	None	-	-	None	-	-	None
Storage Length	-	-	-	-	-	-	-	-	-	-	-	-
Veh in Median Storage, #	-	0	-	-	0	-	-	0	-	-	0	-
Grade, %	-	0	-	-	0	-	-	0	-	-	0	-
Peak Hour Factor	92	92	92	92	92	92	92	92	92	92	92	92
Heavy Vehicles, %	0	0	0	0	0	0	18	18	18	18	18	18
Mvmt Flow	0	5	0	18	3	97	4	257	4	45	263	0

Major/Minor	Minor2		Minor1		Major1		Major2					
Conflicting Flow All	670	622	263	623	620	259	263	0	0	261	0	0
Stage 1	353	353	-	267	267	-	-	-	-	-	-	-
Stage 2	317	269	-	356	353	-	-	-	-	-	-	-
Critical Hdwy	7.1	6.5	6.2	7.1	6.5	6.2	4.28	-	-	4.28	-	-
Critical Hdwy Stg 1	6.1	5.5	-	6.1	5.5	-	-	-	-	-	-	-
Critical Hdwy Stg 2	6.1	5.5	-	6.1	5.5	-	-	-	-	-	-	-
Follow-up Hdwy	3.5	4	3.3	3.5	4	3.3	2.362	-	-	2.362	-	-
Pot Cap-1 Maneuver	373	405	781	401	407	785	1214	-	-	1216	-	-
Stage 1	668	634	-	743	692	-	-	-	-	-	-	-
Stage 2	698	690	-	666	634	-	-	-	-	-	-	-
Platoon blocked, %								-	-	-	-	-
Mov Cap-1 Maneuver	313	386	781	383	388	785	1214	-	-	1216	-	-
Mov Cap-2 Maneuver	313	386	-	383	388	-	-	-	-	-	-	-
Stage 1	665	607	-	740	689	-	-	-	-	-	-	-
Stage 2	607	687	-	632	607	-	-	-	-	-	-	-

Approach	EB		WB		NB		SB	
HCM Control Delay, s	14.5		11.7		0.1		1.2	
HCM LOS	B		B					

Minor Lane/Major Mvmt	NBL	NBT	NBR	EBLn1WBLn1	SBL	SBT	SBR
Capacity (veh/h)	1214	-	-	386	659	1216	-
HCM Lane V/C Ratio	0.004	-	-	0.014	0.18	0.037	-
HCM Control Delay (s)	8	0	-	14.5	11.7	8.1	0
HCM Lane LOS	A	A	-	B	B	A	A
HCM 95th %tile Q(veh)	0	-	-	0	0.7	0.1	-

Intersection	
Intersection Delay, s/veh	14.6
Intersection LOS	B

Movement	EBL	EBT	EBR	WBL	WBT	WBR	NBL	NBT	NBR	SBL	SBT	SBR
Lane Configurations		↕			↕			↕			↕	
Traffic Vol, veh/h	65	150	46	20	182	70	44	109	8	48	132	79
Future Vol, veh/h	65	150	46	20	182	70	44	109	8	48	132	79
Peak Hour Factor	0.92	0.92	0.92	0.92	0.92	0.92	0.92	0.92	0.92	0.92	0.92	0.92
Heavy Vehicles, %	6	6	6	8	8	8	29	29	29	17	17	17
Mvmt Flow	71	163	50	22	198	76	48	118	9	52	143	86
Number of Lanes	0	1	0	0	1	0	0	1	0	0	1	0

Approach	EB	WB	NB	SB
Opposing Approach	WB	EB	SB	NB
Opposing Lanes	1	1	1	1
Conflicting Approach Left	SB	NB	EB	WB
Conflicting Lanes Left	1	1	1	1
Conflicting Approach Right	NB	SB	WB	EB
Conflicting Lanes Right	1	1	1	1
HCM Control Delay	14.6	14.8	13.3	15.1
HCM LOS	B	B	B	C

Lane	NBLn1	EBLn1	WBLn1	SBLn1
Vol Left, %	27%	25%	7%	19%
Vol Thru, %	68%	57%	67%	51%
Vol Right, %	5%	18%	26%	31%
Sign Control	Stop	Stop	Stop	Stop
Traffic Vol by Lane	161	261	272	259
LT Vol	44	65	20	48
Through Vol	109	150	182	132
RT Vol	8	46	70	79
Lane Flow Rate	175	284	296	282
Geometry Grp	1	1	1	1
Degree of Util (X)	0.333	0.478	0.493	0.488
Departure Headway (Hd)	6.846	6.067	5.997	6.239
Convergence, Y/N	Yes	Yes	Yes	Yes
Cap	525	593	600	577
Service Time	4.894	4.108	4.037	4.28
HCM Lane V/C Ratio	0.333	0.479	0.493	0.489
HCM Control Delay	13.3	14.6	14.8	15.1
HCM Lane LOS	B	B	B	C
HCM 95th-tile Q	1.4	2.6	2.7	2.7

Intersection												
Intersection Delay, s/veh	9.1											
Intersection LOS	A											

Movement	EBL	EBT	EBR	WBL	WBT	WBR	NBL	NBT	NBR	SBL	SBT	SBR
Lane Configurations												
Traffic Vol, veh/h	19	84	4	11	100	38	8	33	17	33	49	39
Future Vol, veh/h	19	84	4	11	100	38	8	33	17	33	49	39
Peak Hour Factor	0.92	0.92	0.92	0.92	0.92	0.92	0.92	0.92	0.92	0.92	0.92	0.92
Heavy Vehicles, %	11	11	11	31	31	31	11	11	11	21	21	21
Mvmt Flow	21	91	4	12	109	41	9	36	18	36	53	42
Number of Lanes	1	1	0	1	1	0	0	1	0	0	1	0

Approach	EB	WB	NB	SB
Opposing Approach	WB	EB	SB	NB
Opposing Lanes	2	2	1	1
Conflicting Approach Left	SB	NB	EB	WB
Conflicting Lanes Left	1	1	2	2
Conflicting Approach Right	NB	SB	WB	EB
Conflicting Lanes Right	1	1	2	2
HCM Control Delay	8.9	9.7	8.3	9.1
HCM LOS	A	A	A	A

Lane	NBLn1	EBLn1	EBLn2	WBLn1	WBLn2	SBLn1
Vol Left, %	14%	100%	0%	100%	0%	27%
Vol Thru, %	57%	0%	95%	0%	72%	40%
Vol Right, %	29%	0%	5%	0%	28%	32%
Sign Control	Stop	Stop	Stop	Stop	Stop	Stop
Traffic Vol by Lane	58	19	88	11	138	121
LT Vol	8	19	0	11	0	33
Through Vol	33	0	84	0	100	49
RT Vol	17	0	4	0	38	39
Lane Flow Rate	63	21	96	12	150	132
Geometry Grp	2	7	7	7	7	2
Degree of Util (X)	0.085	0.034	0.141	0.02	0.227	0.18
Departure Headway (Hd)	4.851	5.845	5.31	6.137	5.44	4.936
Convergence, Y/N	Yes	Yes	Yes	Yes	Yes	Yes
Cap	736	612	674	583	659	726
Service Time	2.894	3.588	3.052	3.877	3.18	2.973
HCM Lane V/C Ratio	0.086	0.034	0.142	0.021	0.228	0.182
HCM Control Delay	8.3	8.8	8.9	9	9.8	9.1
HCM Lane LOS	A	A	A	A	A	A
HCM 95th-tile Q	0.3	0.1	0.5	0.1	0.9	0.7

Intersection												
Int Delay, s/veh	83											
Movement	EBL	EBT	EBR	WBL	WBT	WBR	NBL	NBT	NBR	SBL	SBT	SBR
Lane Configurations	↙	↑	↗	↙	↑	↗	↙	↑	↗		↕	
Traffic Vol, veh/h	5	84	20	245	79	220	18	84	144	175	42	4
Future Vol, veh/h	5	84	20	245	79	220	18	84	144	175	42	4
Conflicting Peds, #/hr	0	0	0	0	0	0	1	0	0	0	0	1
Sign Control	Free	Free	Free	Free	Free	Free	Stop	Stop	Stop	Stop	Stop	Stop
RT Channelized	-	-	None	-	-	None	-	-	None	-	-	None
Storage Length	85	-	0	70	-	105	60	-	50	-	-	-
Veh in Median Storage, #	-	0	-	-	0	-	-	0	-	-	0	-
Grade, %	-	0	-	-	0	-	-	0	-	-	0	-
Peak Hour Factor	92	92	92	92	92	92	92	92	92	92	92	92
Heavy Vehicles, %	12	12	12	9	9	9	13	13	13	9	9	9
Mvmt Flow	5	91	22	266	86	239	20	91	157	190	46	4

Major/Minor	Major1			Major2			Minor1			Minor2		
Conflicting Flow All	325	0	0	113	0	0	865	958	91	854	741	87
Stage 1	-	-	-	-	-	-	101	101	-	618	618	-
Stage 2	-	-	-	-	-	-	764	857	-	236	123	-
Critical Hdwy	4.22	-	-	4.19	-	-	7.23	6.63	6.33	7.19	6.59	6.29
Critical Hdwy Stg 1	-	-	-	-	-	-	6.23	5.63	-	6.19	5.59	-
Critical Hdwy Stg 2	-	-	-	-	-	-	6.23	5.63	-	6.19	5.59	-
Follow-up Hdwy	2.308	-	-	2.281	-	-	3.617	4.117	3.417	3.581	4.081	3.381
Pot Cap-1 Maneuver	1181	-	-	1434	-	-	262	247	937	271	336	952
Stage 1	-	-	-	-	-	-	879	791	-	465	470	-
Stage 2	-	-	-	-	-	-	380	359	-	752	781	-
Platoon blocked, %		-	-		-	-						
Mov Cap-1 Maneuver	1181	-	-	1434	-	-	195	201	937	~ 126	273	951
Mov Cap-2 Maneuver	-	-	-	-	-	-	195	201	-	~ 126	273	-
Stage 1	-	-	-	-	-	-	875	788	-	463	383	-
Stage 2	-	-	-	-	-	-	271	293	-	551	778	-

Approach	EB			WB			NB			SB		
HCM Control Delay, s	0.4			3.6			20.1			\$ 389.1		
HCM LOS							C			F		

Minor Lane/Major Mvmt	NBLn1	NBLn2	NBLn3	EBL	EBT	EBR	WBL	WBT	WBR	SBLn1
Capacity (veh/h)	195	201	937	1181	-	-	1434	-	-	143
HCM Lane V/C Ratio	0.1	0.454	0.167	0.005	-	-	0.186	-	-	1.68
HCM Control Delay (s)	25.5	37	9.6	8.1	-	-	8.1	-	-	\$ 389.1
HCM Lane LOS	D	E	A	A	-	-	A	-	-	F
HCM 95th %tile Q(veh)	0.3	2.2	0.6	0	-	-	0.7	-	-	17.3

Notes
 -: Volume exceeds capacity \$: Delay exceeds 300s +: Computation Not Defined *: All major volume in platoon

Intersection						
Int Delay, s/veh	25.7					
Movement	EBL	EBT	WBT	WBR	SBL	SBR
Lane Configurations		↑	↑		↑	↑
Traffic Vol, veh/h	0	405	437	0	275	108
Future Vol, veh/h	0	405	437	0	275	108
Conflicting Peds, #/hr	0	0	0	0	0	0
Sign Control	Free	Free	Free	Free	Stop	Stop
RT Channelized	-	None	-	None	-	None
Storage Length	-	-	-	-	0	610
Veh in Median Storage, #	-	0	0	-	0	-
Grade, %	-	0	0	-	0	-
Peak Hour Factor	92	92	92	92	92	92
Heavy Vehicles, %	13	13	10	10	19	19
Mvmt Flow	0	440	475	0	299	117
Major/Minor	Major1	Major2	Minor2			
Conflicting Flow All	-	0	-	0	915	475
Stage 1	-	-	-	-	475	-
Stage 2	-	-	-	-	440	-
Critical Hdwy	-	-	-	-	6.59	6.39
Critical Hdwy Stg 1	-	-	-	-	5.59	-
Critical Hdwy Stg 2	-	-	-	-	5.59	-
Follow-up Hdwy	-	-	-	-	3.671	3.471
Pot Cap-1 Maneuver	0	-	-	0	~ 283	556
Stage 1	0	-	-	0	592	-
Stage 2	0	-	-	0	615	-
Platoon blocked, %	-	-	-	-	-	-
Mov Cap-1 Maneuver	-	-	-	-	~ 283	556
Mov Cap-2 Maneuver	-	-	-	-	~ 283	-
Stage 1	-	-	-	-	592	-
Stage 2	-	-	-	-	615	-
Approach	EB	WB	SB			
HCM Control Delay, s	0	0	82.1			
HCM LOS						F
Minor Lane/Major Mvmt	EBT	WBT	SBLn1	SBLn2		
Capacity (veh/h)	-	-	283	556		
HCM Lane V/C Ratio	-	-	1.056	0.211		
HCM Control Delay (s)	-	-	109.2	13.2		
HCM Lane LOS	-	-	F	B		
HCM 95th %tile Q(veh)	-	-	11.6	0.8		
Notes						
-: Volume exceeds capacity \$: Delay exceeds 300s +: Computation Not Defined *: All major volume in platoon						

HCM 6th TWSC
15: SR-99 Northbound Ramps & Avenue 17

Village D Specific Plan
Phase II NP - AM Peak Hour

Intersection												
Int Delay, s/veh	170.5											
Movement	EBL	EBT	EBR	WBL	WBT	WBR	NBL	NBT	NBR	SBL	SBT	SBR
Lane Configurations	↖	↗			↘			↙	↕			
Traffic Vol, veh/h	114	424	0	0	910	245	228	3	240	0	0	0
Future Vol, veh/h	114	424	0	0	910	245	228	3	240	0	0	0
Conflicting Peds, #/hr	0	0	0	0	0	0	0	0	0	0	0	0
Sign Control	Free	Free	Free	Free	Free	Free	Stop	Stop	Stop	Free	Free	Free
RT Channelized	-	-	None	-	-	None	-	-	None	-	-	None
Storage Length	125	-	-	-	-	-	-	-	50	-	-	-
Veh in Median Storage, #	-	0	-	-	0	-	-	0	-	-	16965	-
Grade, %	-	0	-	-	0	-	-	0	-	-	0	-
Peak Hour Factor	92	92	92	92	92	92	92	92	92	92	92	92
Heavy Vehicles, %	11	11	11	3	3	3	14	14	14	0	0	0
Mvmt Flow	124	461	0	0	989	266	248	3	261	0	0	0

Major/Minor	Major1	Major2	Minor1
Conflicting Flow All	1255	0	0
Stage 1	-	-	709
Stage 2	-	-	1122
Critical Hdwy	4.21	-	6.54
Critical Hdwy Stg 1	-	-	5.54
Critical Hdwy Stg 2	-	-	5.54
Follow-up Hdwy	2.299	-	3.626
Pot Cap-1 Maneuver	525	0	~ 78
Stage 1	-	0	467
Stage 2	-	0	295
Platoon blocked, %	-	-	-
Mov Cap-1 Maneuver	525	-	~ 60
Mov Cap-2 Maneuver	-	-	~ 60
Stage 1	-	-	357
Stage 2	-	-	295

Approach	EB	WB	NB
HCM Control Delay, s	3	0	\$ 779.8
HCM LOS			F

Minor Lane/Major Mvmt	NBLn1	NBLn2	EBL	EBT	WBT	WBR
Capacity (veh/h)	60	576	525	-	-	-
HCM Lane V/C Ratio	4.185	0.453	0.236	-	-	-
HCM Control Delay (s)	\$ 1573.1	16.3	14	-	-	-
HCM Lane LOS	F	C	B	-	-	-
HCM 95th %tile Q(veh)	27.3	2.3	0.9	-	-	-

Notes
 -: Volume exceeds capacity \$: Delay exceeds 300s +: Computation Not Defined *: All major volume in platoon

HCM 6th Signalized Intersection Summary
 16: Love's Truck Stop Driveway/Driveway & Avenue 17

Village D Specific Plan
 Phase II NP - AM Peak Hour



Movement	EBL	EBT	EBR	WBL	WBT	WBR	NBL	NBT	NBR	SBL	SBT	SBR
Lane Configurations	↗	↑↑	↘	↗	↘		↗	↘		↗	↘	
Traffic Volume (veh/h)	162	362	132	45	857	56	136	0	22	48	0	90
Future Volume (veh/h)	162	362	132	45	857	56	136	0	22	48	0	90
Initial Q (Qb), veh	0	0	0	0	0	0	0	0	0	0	0	0
Ped-Bike Adj(A_pbT)	1.00		1.00	1.00		1.00	1.00		1.00	1.00		1.00
Parking Bus, Adj	1.00	1.00	1.00	1.00	1.00	1.00	1.00	1.00	1.00	1.00	1.00	1.00
Work Zone On Approach		No			No			No			No	
Adj Sat Flow, veh/h/ln	1796	1796	1796	1856	1856	1856	1900	1900	1900	1900	1900	1900
Adj Flow Rate, veh/h	176	393	143	49	932	61	148	0	24	52	0	98
Peak Hour Factor	0.92	0.92	0.92	0.92	0.92	0.92	0.92	0.92	0.92	0.92	0.92	0.92
Percent Heavy Veh, %	7	7	7	3	3	3	0	0	0	0	0	0
Cap, veh/h	184	1937	864	63	854	56	155	0	337	68	0	259
Arrive On Green	0.11	0.57	0.57	0.04	0.50	0.50	0.09	0.00	0.21	0.04	0.00	0.16
Sat Flow, veh/h	1711	3413	1522	1767	1723	113	1810	0	1610	1810	0	1610
Grp Volume(v), veh/h	176	393	143	49	0	993	148	0	24	52	0	98
Grp Sat Flow(s),veh/h/ln	1711	1706	1522	1767	0	1835	1810	0	1610	1810	0	1610
Q Serve(g_s), s	12.3	6.8	5.4	3.3	0.0	59.5	9.8	0.0	1.4	3.4	0.0	6.5
Cycle Q Clear(g_c), s	12.3	6.8	5.4	3.3	0.0	59.5	9.8	0.0	1.4	3.4	0.0	6.5
Prop In Lane	1.00		1.00	1.00		0.06	1.00		1.00	1.00		1.00
Lane Grp Cap(c), veh/h	184	1937	864	63	0	910	155	0	337	68	0	259
V/C Ratio(X)	0.96	0.20	0.17	0.78	0.00	1.09	0.95	0.00	0.07	0.77	0.00	0.38
Avail Cap(c_a), veh/h	184	1937	864	131	0	910	155	0	337	134	0	259
HCM Platoon Ratio	1.00	1.00	1.00	1.00	1.00	1.00	1.00	1.00	1.00	1.00	1.00	1.00
Upstream Filter(I)	1.00	1.00	1.00	1.00	0.00	1.00	1.00	0.00	1.00	1.00	0.00	1.00
Uniform Delay (d), s/veh	53.3	12.7	12.4	57.4	0.0	30.3	54.6	0.0	38.1	57.3	0.0	45.0
Incr Delay (d2), s/veh	53.8	0.1	0.1	18.2	0.0	57.8	58.1	0.0	0.4	16.6	0.0	4.2
Initial Q Delay(d3),s/veh	0.0	0.0	0.0	0.0	0.0	0.0	0.0	0.0	0.0	0.0	0.0	0.0
%ile BackOfQ(50%),veh/ln	8.0	2.6	1.8	1.8	0.0	39.7	6.9	0.0	0.6	1.9	0.0	2.9
Unsig. Movement Delay, s/veh												
LnGrp Delay(d),s/veh	107.0	12.7	12.5	75.6	0.0	88.1	112.7	0.0	38.5	73.9	0.0	49.2
LnGrp LOS	F	B	B	E	A	F	F	A	D	E	A	D
Approach Vol, veh/h		712			1042			172				150
Approach Delay, s/veh		36.0			87.5			102.3				57.7
Approach LOS		D			F			F				E
Timer - Assigned Phs	1	2	3	4	5	6	7	8				
Phs Duration (G+Y+Rc), s	9.0	29.6	8.8	72.6	14.8	23.8	17.4	64.0				
Change Period (Y+Rc), s	4.5	4.5	4.5	4.5	4.5	4.5	4.5	4.5				
Max Green Setting (Gmax), s	8.9	20.7	8.9	63.5	10.3	19.3	12.9	59.5				
Max Q Clear Time (g_c+I1), s	5.4	3.4	5.3	8.8	11.8	8.5	14.3	61.5				
Green Ext Time (p_c), s	0.0	0.1	0.0	3.4	0.0	0.3	0.0	0.0				

Intersection Summary

HCM 6th Ctrl Delay	68.9
HCM 6th LOS	E

Intersection												
Int Delay, s/veh	8.7											
Movement	EBL	EBT	EBR	WBL	WBT	WBR	NBL	NBT	NBR	SBL	SBT	SBR
Lane Configurations	↖	↗		↖	↗		↖	↑	↗	↖	↑	↗
Traffic Vol, veh/h	18	47	24	34	52	12	38	171	140	14	60	22
Future Vol, veh/h	18	47	24	34	52	12	38	171	140	14	60	22
Conflicting Peds, #/hr	1	0	2	2	0	1	1	0	1	1	0	1
Sign Control	Free	Free	Free	Free	Free	Free	Stop	Stop	Stop	Stop	Stop	Stop
RT Channelized	-	-	None	-	-	None	-	-	None	-	-	None
Storage Length	110	-	-	165	-	-	65	-	50	100	-	50
Veh in Median Storage, #	-	0	-	-	0	-	-	0	-	-	0	-
Grade, %	-	0	-	-	0	-	-	0	-	-	0	-
Peak Hour Factor	92	92	92	92	92	92	92	92	92	92	92	92
Heavy Vehicles, %	4	4	4	4	4	4	0	0	0	0	0	0
Mvmt Flow	20	51	26	37	57	13	41	186	152	15	65	24

Major/Minor	Major1			Major2			Minor1			Minor2		
Conflicting Flow All	71	0	0	79	0	0	289	251	67	413	258	66
Stage 1	-	-	-	-	-	-	106	106	-	139	139	-
Stage 2	-	-	-	-	-	-	183	145	-	274	119	-
Critical Hdwy	4.14	-	-	4.14	-	-	7.1	6.5	6.2	7.1	6.5	6.2
Critical Hdwy Stg 1	-	-	-	-	-	-	6.1	5.5	-	6.1	5.5	-
Critical Hdwy Stg 2	-	-	-	-	-	-	6.1	5.5	-	6.1	5.5	-
Follow-up Hdwy	2.236	-	-	2.236	-	-	3.5	4	3.3	3.5	4	3.3
Pot Cap-1 Maneuver	1517	-	-	1507	-	-	667	656	1002	553	650	1003
Stage 1	-	-	-	-	-	-	905	811	-	869	785	-
Stage 2	-	-	-	-	-	-	823	781	-	736	801	-
Platoon blocked, %	-	-	-	-	-	-	-	-	-	-	-	-
Mov Cap-1 Maneuver	1516	-	-	1504	-	-	580	629	999	351	623	1001
Mov Cap-2 Maneuver	-	-	-	-	-	-	580	629	-	351	623	-
Stage 1	-	-	-	-	-	-	891	799	-	857	765	-
Stage 2	-	-	-	-	-	-	716	761	-	472	789	-

Approach	EB			WB			NB			SB		
HCM Control Delay, s	1.5			2.6			11.4			11.5		
HCM LOS							B			B		

Minor Lane/Major Mvmt	NBLn1	NBLn2	NBLn3	EBL	EBT	EBR	WBL	WBT	WBR	SBLn1	SBLn2	SBLn3
Capacity (veh/h)	580	629	999	1516	-	-	1504	-	-	351	623	1001
HCM Lane V/C Ratio	0.071	0.296	0.152	0.013	-	-	0.025	-	-	0.043	0.105	0.024
HCM Control Delay (s)	11.7	13.1	9.3	7.4	-	-	7.5	-	-	15.7	11.5	8.7
HCM Lane LOS	B	B	A	A	-	-	A	-	-	C	B	A
HCM 95th %tile Q(veh)	0.2	1.2	0.5	0	-	-	0.1	-	-	0.1	0.3	0.1

Intersection	
Intersection Delay, s/veh	20.7
Intersection LOS	C

Movement	EBL	EBT	EBR	WBL	WBT	WBR	NBL	NBT	NBR	SBL	SBT	SBR
Lane Configurations	↖	↗		↖	↗		↖	↗	↗	↖	↗	↖
Traffic Vol, veh/h	55	220	93	56	164	28	117	175	116	125	125	31
Future Vol, veh/h	55	220	93	56	164	28	117	175	116	125	125	31
Peak Hour Factor	0.92	0.92	0.92	0.92	0.92	0.92	0.92	0.92	0.92	0.92	0.92	0.92
Heavy Vehicles, %	3	3	3	3	3	3	0	0	0	0	0	0
Mvmt Flow	60	239	101	61	178	30	127	190	126	136	136	34
Number of Lanes	1	1	0	1	1	0	1	1	1	1	1	1

Approach	EB	WB	NB	SB
Opposing Approach	WB	EB	SB	NB
Opposing Lanes	2	2	3	3
Conflicting Approach Left	SB	NB	EB	WB
Conflicting Lanes Left	3	3	2	2
Conflicting Approach Right	NB	SB	WB	EB
Conflicting Lanes Right	3	3	2	2
HCM Control Delay	30.6	18.6	16.2	16
HCM LOS	D	C	C	C

Lane	NBLn1	NBLn2	NBLn3	EBLn1	EBLn2	WBLn1	WBLn2	SBLn1	SBLn2	SBLn3
Vol Left, %	100%	0%	0%	100%	0%	100%	0%	100%	0%	0%
Vol Thru, %	0%	100%	0%	0%	70%	0%	85%	0%	100%	0%
Vol Right, %	0%	0%	100%	0%	30%	0%	15%	0%	0%	100%
Sign Control	Stop	Stop	Stop	Stop	Stop	Stop	Stop	Stop	Stop	Stop
Traffic Vol by Lane	117	175	116	55	313	56	192	125	125	31
LT Vol	117	0	0	55	0	56	0	125	0	0
Through Vol	0	175	0	0	220	0	164	0	125	0
RT Vol	0	0	116	0	93	0	28	0	0	31
Lane Flow Rate	127	190	126	60	340	61	209	136	136	34
Geometry Grp	8	8	8	8	8	8	8	8	8	8
Degree of Util (X)	0.319	0.45	0.273	0.148	0.772	0.157	0.504	0.354	0.335	0.076
Departure Headway (Hd)	9.033	8.516	7.79	8.889	8.171	9.31	8.697	9.382	8.863	8.136
Convergence, Y/N	Yes	Yes	Yes	Yes	Yes	Yes	Yes	Yes	Yes	Yes
Cap	398	422	461	404	442	385	415	383	406	440
Service Time	6.786	6.268	5.543	6.639	5.922	7.066	6.453	7.138	6.618	5.891
HCM Lane V/C Ratio	0.319	0.45	0.273	0.149	0.769	0.158	0.504	0.355	0.335	0.077
HCM Control Delay	16	18.1	13.5	13.2	33.7	13.8	20	17.2	16	11.6
HCM Lane LOS	C	C	B	B	D	B	C	C	C	B
HCM 95th-tile Q	1.4	2.3	1.1	0.5	6.6	0.6	2.8	1.6	1.4	0.2

Intersection												
Intersection Delay, s/veh	22.1											
Intersection LOS	C											

Movement	EBL	EBT	EBR	WBL	WBT	WBR	NBL	NBT	NBR	SBL	SBT	SBR
Lane Configurations		↕			↕			↕			↕	
Traffic Vol, veh/h	51	207	38	11	168	120	73	47	25	260	67	70
Future Vol, veh/h	51	207	38	11	168	120	73	47	25	260	67	70
Peak Hour Factor	0.92	0.92	0.92	0.92	0.92	0.92	0.92	0.92	0.92	0.92	0.92	0.92
Heavy Vehicles, %	6	6	6	6	6	6	0	0	0	0	0	0
Mvmt Flow	55	225	41	12	183	130	79	51	27	283	73	76
Number of Lanes	0	1	0	0	1	0	0	1	0	0	1	0

Approach	EB	WB	NB	SB
Opposing Approach	WB	EB	SB	NB
Opposing Lanes	1	1	1	1
Conflicting Approach Left	SB	NB	EB	WB
Conflicting Lanes Left	1	1	1	1
Conflicting Approach Right	NB	SB	WB	EB
Conflicting Lanes Right	1	1	1	1
HCM Control Delay	20.2	19.3	13.8	28.8
HCM LOS	C	C	B	D

Lane	NBLn1	EBLn1	WBLn1	SBLn1
Vol Left, %	50%	17%	4%	65%
Vol Thru, %	32%	70%	56%	17%
Vol Right, %	17%	13%	40%	18%
Sign Control	Stop	Stop	Stop	Stop
Traffic Vol by Lane	145	296	299	397
LT Vol	73	51	11	260
Through Vol	47	207	168	67
RT Vol	25	38	120	70
Lane Flow Rate	158	322	325	432
Geometry Grp	1	1	1	1
Degree of Util (X)	0.32	0.613	0.603	0.776
Departure Headway (Hd)	7.314	6.856	6.677	6.604
Convergence, Y/N	Yes	Yes	Yes	Yes
Cap	492	528	543	552
Service Time	5.358	4.872	4.691	4.604
HCM Lane V/C Ratio	0.321	0.61	0.599	0.783
HCM Control Delay	13.8	20.2	19.3	28.8
HCM Lane LOS	B	C	C	D
HCM 95th-tile Q	1.4	4.1	4	7.1

Intersection												
Intersection Delay, s/veh	9.5											
Intersection LOS	A											

Movement	EBL	EBT	EBR	WBL	WBT	WBR	NBL	NBT	NBR	SBL	SBT	SBR
Lane Configurations		↕			↕	↕		↕	↕		↕	↕
Traffic Vol, veh/h	0	0	0	62	0	196	0	65	225	86	16	0
Future Vol, veh/h	0	0	0	62	0	196	0	65	225	86	16	0
Peak Hour Factor	0.92	0.92	0.92	0.92	0.92	0.92	0.92	0.92	0.92	0.92	0.92	0.92
Heavy Vehicles, %	0	0	0	3	3	3	0	0	0	0	0	0
Mvmt Flow	0	0	0	67	0	213	0	71	245	93	17	0
Number of Lanes	0	1	0	0	1	1	0	1	1	0	1	1

Approach	EB	WB	NB	SB
Opposing Approach	WB	EB	SB	NB
Opposing Lanes	2	1	2	2
Conflicting Approach Left	SB	NB	EB	WB
Conflicting Lanes Left	2	2	1	2
Conflicting Approach Right	NB	SB	WB	EB
Conflicting Lanes Right	2	2	2	1
HCM Control Delay	0	9.6	9.3	10.1
HCM LOS	-	A	A	B

Lane	NBLn1	NBLn2	EBLn1	WBLn1	WBLn2	SBLn1	SBLn2
Vol Left, %	0%	0%	0%	100%	0%	84%	0%
Vol Thru, %	100%	0%	100%	0%	0%	16%	100%
Vol Right, %	0%	100%	0%	0%	100%	0%	0%
Sign Control	Stop	Stop	Stop	Stop	Stop	Stop	Stop
Traffic Vol by Lane	65	225	0	62	196	102	0
LT Vol	0	0	0	62	0	86	0
Through Vol	65	0	0	0	0	16	0
RT Vol	0	225	0	0	196	0	0
Lane Flow Rate	71	245	0	67	213	111	0
Geometry Grp	7	7	6	7	7	7	7
Degree of Util (X)	0.105	0.315	0	0.114	0.288	0.183	0
Departure Headway (Hd)	5.338	4.633	5.904	6.074	4.866	5.943	5.517
Convergence, Y/N	Yes	Yes	Yes	Yes	Yes	Yes	Yes
Cap	668	770	0	588	733	601	0
Service Time	3.094	2.389	3.996	3.836	2.627	3.713	3.287
HCM Lane V/C Ratio	0.106	0.318	0	0.114	0.291	0.185	0
HCM Control Delay	8.7	9.5	9	9.6	9.6	10.1	8.3
HCM Lane LOS	A	A	N	A	A	B	N
HCM 95th-tile Q	0.4	1.4	0	0.4	1.2	0.7	0

Intersection	
Intersection Delay, s/veh	28.4
Intersection LOS	D

Movement	EBL	EBT	EBR	WBL	WBT	WBR	NBL	NBT	NBR	SBL	SBT	SBR
Lane Configurations	↘	↕↗		↘	↕↗		↘	↕	↗	↘	↕	↗
Traffic Vol, veh/h	29	181	9	191	57	25	18	390	323	11	261	5
Future Vol, veh/h	29	181	9	191	57	25	18	390	323	11	261	5
Peak Hour Factor	0.92	0.92	0.92	0.92	0.92	0.92	0.92	0.92	0.92	0.92	0.92	0.92
Heavy Vehicles, %	4	4	4	4	4	4	0	0	0	0	0	0
Mvmt Flow	32	197	10	208	62	27	20	424	351	12	284	5
Number of Lanes	1	2	0	1	2	0	1	1	1	1	1	1

Approach	EB	WB	NB	SB
Opposing Approach	WB	EB	SB	NB
Opposing Lanes	3	3	3	3
Conflicting Approach Left	SB	NB	EB	WB
Conflicting Lanes Left	3	3	3	3
Conflicting Approach Right	NB	SB	WB	EB
Conflicting Lanes Right	3	3	3	3
HCM Control Delay	14.9	19.2	36.5	26.5
HCM LOS	B	C	E	D

Lane	NBLn1	NBLn2	NBLn3	EBLn1	EBLn2	EBLn3	WBLn1	WBLn2	WBLn3	SBLn1	SBLn2
Vol Left, %	100%	0%	0%	100%	0%	0%	100%	0%	0%	100%	0%
Vol Thru, %	0%	100%	0%	0%	100%	87%	0%	100%	43%	0%	100%
Vol Right, %	0%	0%	100%	0%	0%	13%	0%	0%	57%	0%	0%
Sign Control	Stop	Stop	Stop	Stop	Stop	Stop	Stop	Stop	Stop	Stop	Stop
Traffic Vol by Lane	18	390	323	29	121	69	191	38	44	11	261
LT Vol	18	0	0	29	0	0	191	0	0	11	0
Through Vol	0	390	0	0	121	60	0	38	19	0	261
RT Vol	0	0	323	0	0	9	0	0	25	0	0
Lane Flow Rate	20	424	351	32	131	75	208	41	48	12	284
Geometry Grp	8	8	8	8	8	8	8	8	8	8	8
Degree of Util (X)	0.044	0.902	0.679	0.083	0.326	0.185	0.532	0.1	0.111	0.03	0.674
Departure Headway (Hd)	8.162	7.662	6.962	9.446	8.946	8.855	9.223	8.723	8.326	9.048	8.548
Convergence, Y/N	Yes	Yes	Yes	Yes	Yes	Yes	Yes	Yes	Yes	Yes	Yes
Cap	437	471	516	378	400	403	390	409	429	394	420
Service Time	5.941	5.441	4.741	7.246	6.746	6.655	7.017	6.517	6.119	6.84	6.34
HCM Lane V/C Ratio	0.046	0.9	0.68	0.085	0.328	0.186	0.533	0.1	0.112	0.03	0.676
HCM Control Delay	11.3	48.6	23.4	13.1	16.1	13.7	22.1	12.5	12.2	12.1	27.4
HCM Lane LOS	B	E	C	B	C	B	C	B	B	B	D
HCM 95th-tile Q	0.1	10	5.1	0.3	1.4	0.7	3	0.3	0.4	0.1	4.8

Intersection

Intersection Delay, s/veh 37.9

Intersection LOS E

Movement	EBL	EBT	EBR	WBL	WBT	WBR	NBL	NBT	NBR	SBL	SBT	SBR
Lane Configurations	↔	↔		↔	↔	↔	↔	↔		↔	↔	
Traffic Vol, veh/h	65	268	72	26	104	66	48	242	25	131	285	50
Future Vol, veh/h	65	268	72	26	104	66	48	242	25	131	285	50
Peak Hour Factor	0.92	0.92	0.92	0.92	0.92	0.92	0.92	0.92	0.92	0.92	0.92	0.92
Heavy Vehicles, %	2	2	2	6	6	6	2	2	2	2	2	2
Mvmt Flow	71	291	78	28	113	72	52	263	27	142	310	54
Number of Lanes	1	1	0	1	1	1	1	1	0	1	1	0

Approach	EB	WB	NB	SB
Opposing Approach	WB	EB	SB	NB
Opposing Lanes	3	2	2	2
Conflicting Approach Left SB		NB	EB	WB
Conflicting Lanes Left	2	2	2	3
Conflicting Approach Right NB		SB	WB	EB
Conflicting Lanes Right	2	2	3	2
HCM Control Delay	49.4	16	31.7	41.3
HCM LOS	E	C	D	E

Lane	NBLn1	NBLn2	EBLn1	EBLn2	WBLn1	WBLn2	WBLn3	SBLn1	SBLn2
Vol Left, %	100%	0%	100%	0%	100%	0%	0%	100%	0%
Vol Thru, %	0%	91%	0%	79%	0%	100%	0%	0%	85%
Vol Right, %	0%	9%	0%	21%	0%	0%	100%	0%	15%
Sign Control	Stop	Stop	Stop	Stop	Stop	Stop	Stop	Stop	Stop
Traffic Vol by Lane	48	267	65	340	26	104	66	131	335
LT Vol	48	0	65	0	26	0	0	131	0
Through Vol	0	242	0	268	0	104	0	0	285
RT Vol	0	25	0	72	0	0	66	0	50
Lane Flow Rate	52	290	71	370	28	113	72	142	364
Geometry Grp	8	8	8	8	8	8	8	8	8
Degree of Util (X)	0.142	0.745	0.188	0.914	0.084	0.316	0.186	0.371	0.886
Departure Headway (Hd)	9.82	9.236	9.581	8.907	10.692	10.068	9.336	9.381	8.758
Convergence, Y/N	Yes	Yes	Yes	Yes	Yes	Yes	Yes	Yes	Yes
Cap	364	392	374	407	337	356	382	383	411
Service Time	7.61	7.025	7.364	6.689	8.392	7.868	7.135	7.166	6.542
HCM Lane V/C Ratio	0.143	0.74	0.19	0.909	0.083	0.317	0.188	0.371	0.886
HCM Control Delay	14.2	34.8	14.6	56.1	14.4	17.5	14.3	17.6	50.6
HCM Lane LOS	B	D	B	F	B	C	B	C	F
HCM 95th-tile Q	0.5	5.9	0.7	9.8	0.3	1.3	0.7	1.7	9.1

HCM 6th Signalized Intersection Summary
 23: Avenue 16/Ellis Street & Kennedy Street

Village D Specific Plan
 Phase II NP - AM Peak Hour



Movement	WBL	WBR	NBT	NBR	SBL	SBT
Lane Configurations						
Traffic Volume (veh/h)	195	147	335	176	263	311
Future Volume (veh/h)	195	147	335	176	263	311
Initial Q (Qb), veh	0	0	0	0	0	0
Ped-Bike Adj(A_pbT)	1.00	1.00		0.98	1.00	
Parking Bus, Adj	1.00	1.00	1.00	1.00	1.00	1.00
Work Zone On Approach	No		No		No	
Adj Sat Flow, veh/h/ln	1841	1841	1841	1841	1870	1870
Adj Flow Rate, veh/h	212	160	364	191	286	338
Peak Hour Factor	0.92	0.92	0.92	0.92	0.92	0.92
Percent Heavy Veh, %	4	4	4	4	2	2
Cap, veh/h	266	417	650	335	687	2614
Arrive On Green	0.15	0.15	0.29	0.29	0.39	0.74
Sat Flow, veh/h	1753	2745	2305	1140	1781	3647
Grp Volume(v), veh/h	212	160	286	269	286	338
Grp Sat Flow(s),veh/h/ln	1753	1373	1749	1604	1781	1777
Q Serve(g_s), s	9.3	4.2	11.1	11.4	9.4	2.2
Cycle Q Clear(g_c), s	9.3	4.2	11.1	11.4	9.4	2.2
Prop In Lane	1.00	1.00		0.71	1.00	
Lane Grp Cap(c), veh/h	266	417	514	471	687	2614
V/C Ratio(X)	0.80	0.38	0.56	0.57	0.42	0.13
Avail Cap(c_a), veh/h	427	669	514	471	687	2614
HCM Platoon Ratio	1.00	1.00	1.00	1.00	1.00	1.00
Upstream Filter(I)	0.70	0.70	1.00	1.00	1.00	1.00
Uniform Delay (d), s/veh	32.7	30.5	23.9	24.0	18.0	3.1
Incr Delay (d2), s/veh	3.8	0.4	4.3	4.9	0.4	0.1
Initial Q Delay(d3),s/veh	0.0	0.0	0.0	0.0	0.0	0.0
%ile BackOfQ(50%),veh/ln	4.1	1.4	5.0	4.8	3.7	0.6
Unsig. Movement Delay, s/veh						
LnGrp Delay(d),s/veh	36.5	31.0	28.2	28.9	18.4	3.2
LnGrp LOS	D	C	C	C	B	A
Approach Vol, veh/h	372		555			624
Approach Delay, s/veh	34.1		28.5			10.2
Approach LOS	C		C			B
Timer - Assigned Phs	1	2			6	8
Phs Duration (G+Y+Rc), s	35.3	28.0			63.3	16.7
Change Period (Y+Rc), s	4.5	4.5			4.5	4.5
Max Green Setting (Gmax), s	23.5	23.5			51.5	19.5
Max Q Clear Time (g_c+I), s	11.4	13.4			4.2	11.3
Green Ext Time (p_c), s	0.7	2.5			2.5	0.8
Intersection Summary						
HCM 6th Ctrl Delay			22.5			
HCM 6th LOS			C			

HCM 6th Signalized Intersection Summary
 24: Schnoor Avenue & Kennedy Street

Village D Specific Plan
 Phase II NP - AM Peak Hour



Movement	EBL	EBT	EBR	WBL	WBT	WBR	NBL	NBT	NBR	SBL	SBT	SBR
Lane Configurations	↖	↗		↖	↗		↖	↗		↖	↗	↖
Traffic Volume (veh/h)	82	198	167	171	216	147	115	32	262	97	31	24
Future Volume (veh/h)	82	198	167	171	216	147	115	32	262	97	31	24
Initial Q (Qb), veh	0	0	0	0	0	0	0	0	0	0	0	0
Ped-Bike Adj(A_pbT)	1.00		1.00	1.00		1.00	1.00		1.00	1.00		1.00
Parking Bus, Adj	1.00	1.00	1.00	1.00	1.00	1.00	1.00	1.00	1.00	1.00	1.00	1.00
Work Zone On Approach		No			No			No			No	
Adj Sat Flow, veh/h/ln	1841	1841	1841	1826	1826	1826	1900	1900	1900	1366	1366	1366
Adj Flow Rate, veh/h	89	215	182	186	235	160	125	35	285	105	34	26
Peak Hour Factor	0.92	0.92	0.92	0.92	0.92	0.92	0.92	0.92	0.92	0.92	0.92	0.92
Percent Heavy Veh, %	4	4	4	5	5	5	0	0	0	36	36	36
Cap, veh/h	113	373	300	226	272	185	626	48	390	225	360	304
Arrive On Green	0.06	0.20	0.20	0.13	0.27	0.27	0.18	0.27	0.27	0.17	0.26	0.26
Sat Flow, veh/h	1753	1839	1481	1739	1012	689	3510	178	1452	1301	1366	1153
Grp Volume(v), veh/h	89	204	193	186	0	395	125	0	320	105	34	26
Grp Sat Flow(s),veh/h/ln	1753	1749	1572	1739	0	1700	1755	0	1631	1301	1366	1153
Q Serve(g_s), s	4.0	8.4	8.9	8.3	0.0	17.7	2.4	0.0	14.3	5.8	1.5	1.0
Cycle Q Clear(g_c), s	4.0	8.4	8.9	8.3	0.0	17.7	2.4	0.0	14.3	5.8	1.5	1.0
Prop In Lane	1.00		0.94	1.00		0.41	1.00		0.89	1.00		1.00
Lane Grp Cap(c), veh/h	113	355	319	226	0	456	626	0	438	225	360	304
V/C Ratio(X)	0.79	0.57	0.61	0.82	0.00	0.87	0.20	0.00	0.73	0.47	0.09	0.09
Avail Cap(c_a), veh/h	121	404	363	359	0	627	626	0	438	225	360	304
HCM Platoon Ratio	1.00	1.00	1.00	1.00	1.00	1.00	1.00	1.00	1.00	1.00	1.00	1.00
Upstream Filter(I)	0.82	0.82	0.82	1.00	0.00	1.00	1.00	0.00	1.00	1.00	1.00	1.00
Uniform Delay (d), s/veh	36.9	28.8	29.0	33.9	0.0	27.9	28.0	0.0	26.6	29.7	22.2	12.8
Incr Delay (d2), s/veh	22.8	1.2	1.9	8.1	0.0	9.2	0.2	0.0	10.2	1.5	0.5	0.6
Initial Q Delay(d3),s/veh	0.0	0.0	0.0	0.0	0.0	0.0	0.0	0.0	0.0	0.0	0.0	0.0
%ile BackOfQ(50%),veh/ln	2.4	3.5	3.4	3.9	0.0	8.1	1.0	0.0	6.6	1.9	0.5	0.4
Unsig. Movement Delay, s/veh												
LnGrp Delay(d),s/veh	59.6	30.0	30.8	42.0	0.0	37.1	28.2	0.0	36.9	31.2	22.8	13.3
LnGrp LOS	E	C	C	D	A	D	C	A	D	C	C	B
Approach Vol, veh/h		486			581			445			165	
Approach Delay, s/veh		35.8			38.7			34.4			26.7	
Approach LOS		D			D			C			C	
Timer - Assigned Phs	1	2	3	4	5	6	7	8				
Phs Duration (G+Y+Rc), s	18.4	26.0	14.9	20.7	18.8	25.6	9.7	26.0				
Change Period (Y+Rc), s	4.5	4.5	4.5	4.5	4.5	4.5	4.5	4.5				
Max Green Setting (Gmax), s	5.5	21.5	16.5	18.5	5.9	21.1	5.5	29.5				
Max Q Clear Time (g_c+1T), s	17.8	16.3	10.3	10.9	4.4	3.5	6.0	19.7				
Green Ext Time (p_c), s	0.0	0.9	0.3	1.4	0.0	0.2	0.0	1.8				

Intersection Summary

HCM 6th Ctrl Delay				35.5								
HCM 6th LOS				D								

Intersection						
Int Delay, s/veh	8.8					
Movement	EBL	EBT	WBT	WBR	SBL	SBR
Lane Configurations	↖	↑	↗		↖	↗
Traffic Vol, veh/h	316	243	395	3	66	118
Future Vol, veh/h	316	243	395	3	66	118
Conflicting Peds, #/hr	0	0	0	0	0	0
Sign Control	Free	Free	Free	Free	Stop	Stop
RT Channelized	-	None	-	Free	-	None
Storage Length	140	-	-	-	0	335
Veh in Median Storage, #	-	0	0	-	0	-
Grade, %	-	0	0	-	0	-
Peak Hour Factor	92	92	92	92	92	92
Heavy Vehicles, %	2	2	6	6	4	4
Mvmt Flow	343	264	429	3	72	128

Major/Minor	Major1	Major2	Minor2		
Conflicting Flow All	429	0	-	0	1379 429
Stage 1	-	-	-	-	429 -
Stage 2	-	-	-	-	950 -
Critical Hdwy	4.12	-	-	-	6.44 6.24
Critical Hdwy Stg 1	-	-	-	-	5.44 -
Critical Hdwy Stg 2	-	-	-	-	5.44 -
Follow-up Hdwy	2.218	-	-	-	3.536 3.336
Pot Cap-1 Maneuver	1130	-	-	0	158 622
Stage 1	-	-	-	0	652 -
Stage 2	-	-	-	0	373 -
Platoon blocked, %		-	-		
Mov Cap-1 Maneuver	1130	-	-	-	110 622
Mov Cap-2 Maneuver	-	-	-	-	110 -
Stage 1	-	-	-	-	454 -
Stage 2	-	-	-	-	373 -

Approach	EB	WB	SB
HCM Control Delay, s	5.4	0	38.3
HCM LOS			E

Minor Lane/Major Mvmt	EBL	EBT	WBT	SBLn1	SBLn2
Capacity (veh/h)	1130	-	-	110	622
HCM Lane V/C Ratio	0.304	-	-	0.652	0.206
HCM Control Delay (s)	9.6	-	-	84.9	12.3
HCM Lane LOS	A	-	-	F	B
HCM 95th %tile Q(veh)	1.3	-	-	3.3	0.8

Intersection						
Int Delay, s/veh	6.5					
Movement	EBL	EBT	WBT	WBR	SBL	SBR
Lane Configurations		↕	↕		↕	
Traffic Vol, veh/h	164	145	90	0	0	309
Future Vol, veh/h	164	145	90	0	0	309
Conflicting Peds, #/hr	0	0	0	0	0	0
Sign Control	Free	Free	Free	Free	Stop	Stop
RT Channelized	-	None	-	None	-	None
Storage Length	-	-	-	-	0	-
Veh in Median Storage, #	-	0	0	-	0	-
Grade, %	-	0	0	-	0	-
Peak Hour Factor	92	92	92	92	92	92
Heavy Vehicles, %	3	3	6	6	7	7
Mvmt Flow	178	158	98	0	0	336

Major/Minor	Major1	Major2	Minor2		
Conflicting Flow All	98	0	-	0	612 98
Stage 1	-	-	-	-	98 -
Stage 2	-	-	-	-	514 -
Critical Hdwy	4.13	-	-	-	6.47 6.27
Critical Hdwy Stg 1	-	-	-	-	5.47 -
Critical Hdwy Stg 2	-	-	-	-	5.47 -
Follow-up Hdwy	2.227	-	-	-	3.563 3.363
Pot Cap-1 Maneuver	1489	-	-	-	448 944
Stage 1	-	-	-	-	914 -
Stage 2	-	-	-	-	590 -
Platoon blocked, %		-	-	-	
Mov Cap-1 Maneuver	1489	-	-	-	389 944
Mov Cap-2 Maneuver	-	-	-	-	389 -
Stage 1	-	-	-	-	794 -
Stage 2	-	-	-	-	590 -

Approach	EB	WB	SB
HCM Control Delay, s	4.1	0	10.9
HCM LOS			B

Minor Lane/Major Mvmt	EBL	EBT	WBT	WBR	SBLn1
Capacity (veh/h)	1489	-	-	-	944
HCM Lane V/C Ratio	0.12	-	-	-	0.356
HCM Control Delay (s)	7.7	0	-	-	10.9
HCM Lane LOS	A	A	-	-	B
HCM 95th %tile Q(veh)	0.4	-	-	-	1.6

Intersection						
Int Delay, s/veh	3.5					
Movement	EBL	EBR	NBL	NBT	SBT	SBR
Lane Configurations	↙			↑	↗	
Traffic Vol, veh/h	162	0	0	43	3	307
Future Vol, veh/h	162	0	0	43	3	307
Conflicting Peds, #/hr	0	0	0	0	0	0
Sign Control	Stop	Stop	Free	Free	Free	Free
RT Channelized	-	None	-	None	-	None
Storage Length	0	-	-	-	-	-
Veh in Median Storage, #	0	-	-	0	0	-
Grade, %	0	-	-	0	0	-
Peak Hour Factor	92	92	92	92	92	92
Heavy Vehicles, %	3	3	10	10	6	6
Mvmt Flow	176	0	0	47	3	334

Major/Minor	Minor2	Major1	Major2		
Conflicting Flow All	217	-	-	0	0
Stage 1	170	-	-	-	-
Stage 2	47	-	-	-	-
Critical Hdwy	6.43	-	-	-	-
Critical Hdwy Stg 1	5.43	-	-	-	-
Critical Hdwy Stg 2	5.43	-	-	-	-
Follow-up Hdwy	3.527	-	-	-	-
Pot Cap-1 Maneuver	769	0	0	-	-
Stage 1	857	0	0	-	-
Stage 2	973	0	0	-	-
Platoon blocked, %				-	-
Mov Cap-1 Maneuver	769	-	-	-	-
Mov Cap-2 Maneuver	769	-	-	-	-
Stage 1	857	-	-	-	-
Stage 2	973	-	-	-	-

Approach	EB	NB	SB
HCM Control Delay, s	11.1	0	0
HCM LOS	B		

Minor Lane/Major Mvmt	NBT EBLn1	SBT	SBR
Capacity (veh/h)	- 769	-	-
HCM Lane V/C Ratio	- 0.229	-	-
HCM Control Delay (s)	- 11.1	-	-
HCM Lane LOS	- B	-	-
HCM 95th %tile Q(veh)	- 0.9	-	-

Intersection						
Int Delay, s/veh	0					
Movement	EBL	EBT	WBT	WBR	SBL	SBR
Lane Configurations		↶	↷		↶	
Traffic Vol, veh/h	0	139	95	52	0	0
Future Vol, veh/h	0	139	95	52	0	0
Conflicting Peds, #/hr	0	0	0	0	0	0
Sign Control	Free	Free	Free	Free	Stop	Stop
RT Channelized	-	None	-	None	-	None
Storage Length	-	-	-	-	0	-
Veh in Median Storage, #	-	0	0	-	0	-
Grade, %	-	0	0	-	0	-
Peak Hour Factor	92	92	92	92	92	92
Heavy Vehicles, %	2	2	13	13	0	0
Mvmt Flow	0	151	103	57	0	0

Major/Minor	Major1	Major2	Minor2		
Conflicting Flow All	160	0	-	0	283
Stage 1	-	-	-	-	132
Stage 2	-	-	-	-	151
Critical Hdwy	4.12	-	-	-	6.4
Critical Hdwy Stg 1	-	-	-	-	5.4
Critical Hdwy Stg 2	-	-	-	-	5.4
Follow-up Hdwy	2.218	-	-	-	3.5
Pot Cap-1 Maneuver	1419	-	-	-	711
Stage 1	-	-	-	-	899
Stage 2	-	-	-	-	882
Platoon blocked, %		-	-	-	
Mov Cap-1 Maneuver	1419	-	-	-	711
Mov Cap-2 Maneuver	-	-	-	-	711
Stage 1	-	-	-	-	899
Stage 2	-	-	-	-	882

Approach	EB	WB	SB
HCM Control Delay, s	0	0	0
HCM LOS			A

Minor Lane/Major Mvmt	EBL	EBT	WBT	WBR	SBLn1
Capacity (veh/h)	1419	-	-	-	-
HCM Lane V/C Ratio	-	-	-	-	-
HCM Control Delay (s)	0	-	-	-	0
HCM Lane LOS	A	-	-	-	A
HCM 95th %tile Q(veh)	0	-	-	-	-

HCM 6th Signalized Intersection Summary
29: Schnoor Avenue & Cleveland Avenue

Village D Specific Plan
Phase II NP - AM Peak Hour



Movement	EBL	EBT	EBR	WBL	WBT	WBR	NBL	NBT	NBR	SBL	SBT	SBR
Lane Configurations												
Traffic Volume (veh/h)	99	414	43	166	217	46	51	251	171	89	179	60
Future Volume (veh/h)	99	414	43	166	217	46	51	251	171	89	179	60
Initial Q (Qb), veh	0	0	0	0	0	0	0	0	0	0	0	0
Ped-Bike Adj(A_pbT)	1.00		0.97	1.00		0.97	1.00		0.99	1.00		0.98
Parking Bus, Adj	1.00	1.00	1.00	1.00	1.00	1.00	1.00	1.00	1.00	1.00	1.00	1.00
Work Zone On Approach		No			No			No			No	
Adj Sat Flow, veh/h/ln	1856	1856	1856	1826	1826	1826	1885	1885	1885	1856	1856	1856
Adj Flow Rate, veh/h	108	450	47	180	236	50	55	273	186	97	195	65
Peak Hour Factor	0.92	0.92	0.92	0.92	0.92	0.92	0.92	0.92	0.92	0.92	0.92	0.92
Percent Heavy Veh, %	3	3	3	5	5	5	1	1	1	3	3	3
Cap, veh/h	137	663	288	256	647	281	79	1579	822	124	1646	721
Arrive On Green	0.08	0.19	0.19	0.08	0.19	0.19	0.04	0.44	0.44	0.07	0.47	0.47
Sat Flow, veh/h	1767	3526	1532	3374	3469	1507	1795	3582	1589	1767	3526	1545
Grp Volume(v), veh/h	108	450	47	180	236	50	55	273	186	97	195	65
Grp Sat Flow(s),veh/h/ln	1767	1763	1532	1687	1735	1507	1795	1791	1589	1767	1763	1545
Q Serve(g_s), s	4.8	9.5	2.1	4.2	4.8	2.2	2.4	3.7	5.1	4.3	2.5	1.9
Cycle Q Clear(g_c), s	4.8	9.5	2.1	4.2	4.8	2.2	2.4	3.7	5.1	4.3	2.5	1.9
Prop In Lane	1.00		1.00	1.00		1.00	1.00		1.00	1.00		1.00
Lane Grp Cap(c), veh/h	137	663	288	256	647	281	79	1579	822	124	1646	721
V/C Ratio(X)	0.79	0.68	0.16	0.70	0.36	0.18	0.69	0.17	0.23	0.78	0.12	0.09
Avail Cap(c_a), veh/h	166	1300	565	274	1236	537	117	1579	822	166	1646	721
HCM Platoon Ratio	1.00	1.00	1.00	1.00	1.00	1.00	1.00	1.00	1.00	1.00	1.00	1.00
Upstream Filter(I)	1.00	1.00	1.00	0.80	0.80	0.80	1.00	1.00	1.00	1.00	1.00	1.00
Uniform Delay (d), s/veh	36.3	30.2	27.2	36.1	28.4	27.4	37.7	13.5	10.6	36.6	12.0	11.9
Incr Delay (d2), s/veh	18.6	1.2	0.3	5.9	0.3	0.2	10.4	0.2	0.6	15.8	0.1	0.2
Initial Q Delay(d3),s/veh	0.0	0.0	0.0	0.0	0.0	0.0	0.0	0.0	0.0	0.0	0.0	0.0
%ile BackOfQ(50%),veh/ln	2.7	4.0	0.8	1.9	1.9	0.8	1.3	1.5	1.8	2.4	1.0	0.7
Unsig. Movement Delay, s/veh												
LnGrp Delay(d),s/veh	54.9	31.5	27.5	42.0	28.7	27.6	48.1	13.8	11.2	52.4	12.2	12.1
LnGrp LOS	D	C	C	D	C	C	D	B	B	D	B	B
Approach Vol, veh/h		605			466			514			357	
Approach Delay, s/veh		35.3			33.7			16.5			23.1	
Approach LOS		D			C			B			C	
Timer - Assigned Phs	1	2	3	4	5	6	7	8				
Phs Duration (G+Y+Rc), s	10.1	39.8	10.6	19.5	8.0	41.9	10.7	19.4				
Change Period (Y+Rc), s	4.5	4.5	4.5	4.5	4.5	4.5	4.5	4.5				
Max Green Setting (Gmax), s	7.5	18.5	6.5	29.5	5.2	20.8	7.5	28.5				
Max Q Clear Time (g_c+I1), s	6.3	7.1	6.2	11.5	4.4	4.5	6.8	6.8				
Green Ext Time (p_c), s	0.0	1.8	0.0	3.0	0.0	1.2	0.0	1.6				

Intersection Summary

HCM 6th Ctrl Delay	27.7
HCM 6th LOS	C

HCM 6th Signalized Intersection Summary
30: Fairgrounds & Cleveland Avenue

Village D Specific Plan
Phase II NP - AM Peak Hour



Movement	EBL	EBT	EBR	WBL	WBT	WBR	NBL	NBT	NBR	SBL	SBT	SBR
Lane Configurations	↑↑↑			↑↑		↑	↑↑		↑	↑	↑	↑
Traffic Volume (veh/h)	99	611	30	37	374	106	13	7	27	136	5	39
Future Volume (veh/h)	99	611	30	37	374	106	13	7	27	136	5	39
Initial Q (Qb), veh	0	0	0	0	0	0	0	0	0	0	0	0
Ped-Bike Adj(A_pbT)	1.00		1.00	1.00		1.00	1.00		1.00	1.00		0.99
Parking Bus, Adj	1.00	1.00	1.00	1.00	1.00	1.00	1.00	1.00	1.00	1.00	1.00	1.00
Work Zone On Approach	No			No			No			No		
Adj Sat Flow, veh/h/ln	1841	1841	1841	1841	1841	1841	1900	1900	1900	1900	1900	1900
Adj Flow Rate, veh/h	105	650	32	39	398	113	14	24	18	145	5	41
Peak Hour Factor	0.94	0.94	0.94	0.94	0.94	0.94	0.94	0.94	0.94	0.94	0.94	0.94
Percent Heavy Veh, %	4	4	4	4	4	4	0	0	0	0	0	0
Cap, veh/h	135	999	49	64	570	254	806	827	700	181	55	450
Arrive On Green	0.03	0.07	0.07	0.04	0.16	0.16	0.22	0.44	0.44	0.10	0.31	0.31
Sat Flow, veh/h	1753	4907	240	1753	3497	1560	3619	1900	1609	1810	176	1440
Grp Volume(v), veh/h	105	443	239	39	398	113	14	24	18	145	0	46
Grp Sat Flow(s),veh/h/ln	1753	1675	1797	1753	1749	1560	1810	1900	1609	1810	0	1616
Q Serve(g_s), s	4.8	10.3	10.4	1.8	8.6	3.9	0.2	0.6	0.5	6.3	0.0	1.6
Cycle Q Clear(g_c), s	4.8	10.3	10.4	1.8	8.6	3.9	0.2	0.6	0.5	6.3	0.0	1.6
Prop In Lane	1.00		0.13	1.00		1.00	1.00		1.00	1.00		0.89
Lane Grp Cap(c), veh/h	135	682	366	64	570	254	806	827	700	181	0	505
V/C Ratio(X)	0.78	0.65	0.65	0.61	0.70	0.44	0.02	0.03	0.03	0.80	0.00	0.09
Avail Cap(c_a), veh/h	186	1110	595	121	1027	458	806	827	700	238	0	505
HCM Platoon Ratio	0.33	0.33	0.33	1.00	1.00	1.00	1.00	1.00	1.00	1.00	1.00	1.00
Upstream Filter(I)	0.86	0.86	0.86	0.94	0.94	0.94	1.00	1.00	1.00	1.00	0.00	1.00
Uniform Delay (d), s/veh	38.3	34.5	34.6	38.0	31.6	16.8	24.3	12.9	12.9	35.2	0.0	19.5
Incr Delay (d2), s/veh	11.6	0.9	1.7	8.7	1.5	1.1	0.0	0.1	0.1	13.5	0.0	0.4
Initial Q Delay(d3),s/veh	0.0	0.0	0.0	0.0	0.0	0.0	0.0	0.0	0.0	0.0	0.0	0.0
%ile BackOfQ(50%),veh/ln	2.5	4.6	5.1	0.9	3.6	1.9	0.1	0.2	0.2	3.4	0.0	0.6
Unsig. Movement Delay, s/veh												
LnGrp Delay(d),s/veh	49.9	35.4	36.3	46.7	33.1	17.9	24.3	13.0	13.0	48.7	0.0	19.8
LnGrp LOS	D	D	D	D	C	B	C	B	B	D	A	B
Approach Vol, veh/h	787			550			56			191		
Approach Delay, s/veh	37.6			30.9			15.8			41.7		
Approach LOS	D			C			B			D		
Timer - Assigned Phs	1	2	3	4	5	6	7	8				
Phs Duration (G+Y+Rc), s	12.5	39.3	7.4	20.8	22.3	29.5	10.6	17.5				
Change Period (Y+Rc), s	4.5	4.5	4.5	4.5	4.5	4.5	4.5	4.5				
Max Green Setting (Gmax), s	10.5	19.5	5.5	26.5	5.0	25.0	8.5	23.5				
Max Q Clear Time (g_c+1), s	10.3	2.6	3.8	12.4	2.2	3.6	6.8	10.6				
Green Ext Time (p_c), s	0.1	0.1	0.0	3.8	0.0	0.2	0.0	2.4				

Intersection Summary

HCM 6th Ctrl Delay	35.0
HCM 6th LOS	D

Notes

User approved volume balancing among the lanes for turning movement.

HCM 6th Signalized Intersection Summary
 31: SR-99 Southbound Ramps & Cleveland Avenue

Village D Specific Plan
 Phase II NP - AM Peak Hour



Movement	EBL	EBT	EBR	WBL	WBT	WBR	NBL	NBT	NBR	SBL	SBT	SBR
Lane Configurations		↑↑	↑	↑	↑↑					↑		↑
Traffic Volume (veh/h)	0	469	401	364	683	0	0	0	0	74	0	62
Future Volume (veh/h)	0	469	401	364	683	0	0	0	0	74	0	62
Initial Q (Qb), veh	0	0	0	0	0	0				0	0	0
Ped-Bike Adj(A_pbT)	1.00		1.00	1.00		1.00				1.00		1.00
Parking Bus, Adj	1.00	1.00	1.00	1.00	1.00	1.00				1.00	1.00	1.00
Work Zone On Approach		No			No						No	
Adj Sat Flow, veh/h/ln	0	1841	1841	1856	1856	0				1678	0	1678
Adj Flow Rate, veh/h	0	510	436	396	742	0				80	0	67
Peak Hour Factor	0.92	0.92	0.92	0.92	0.92	0.92				0.92	0.92	0.92
Percent Heavy Veh, %	0	4	4	3	3	0				15	0	15
Cap, veh/h	0	960	428	429	1999	0				532	0	473
Arrive On Green	0.00	0.27	0.27	0.49	1.00	0.00				0.33	0.00	0.33
Sat Flow, veh/h	0	3589	1560	1767	3618	0				1598	0	1422
Grp Volume(v), veh/h	0	510	436	396	742	0				80	0	67
Grp Sat Flow(s),veh/h/ln	0	1749	1560	1767	1763	0				1598	0	1422
Q Serve(g_s), s	0.0	11.1	24.7	18.8	0.0	0.0				3.2	0.0	3.0
Cycle Q Clear(g_c), s	0.0	11.1	24.7	18.8	0.0	0.0				3.2	0.0	3.0
Prop In Lane	0.00		1.00	1.00		0.00				1.00		1.00
Lane Grp Cap(c), veh/h	0	960	428	429	1999	0				532	0	473
V/C Ratio(X)	0.00	0.53	1.02	0.92	0.37	0.00				0.15	0.00	0.14
Avail Cap(c_a), veh/h	0	960	428	650	2440	0				532	0	473
HCM Platoon Ratio	1.00	1.00	1.00	2.00	2.00	1.00				1.00	1.00	1.00
Upstream Filter(I)	0.00	0.85	0.85	0.71	0.71	0.00				1.00	0.00	1.00
Uniform Delay (d), s/veh	0.0	27.7	32.6	22.4	0.0	0.0				21.1	0.0	21.0
Incr Delay (d2), s/veh	0.0	0.5	44.8	10.7	0.1	0.0				0.6	0.0	0.6
Initial Q Delay(d3),s/veh	0.0	0.0	0.0	0.0	0.0	0.0				0.0	0.0	0.0
%ile BackOfQ(50%),veh/ln	0.0	4.6	14.3	6.4	0.0	0.0				1.3	0.0	1.1
Unsig. Movement Delay, s/veh												
LnGrp Delay(d),s/veh	0.0	28.2	77.5	33.0	0.1	0.0				21.7	0.0	21.6
LnGrp LOS	A	C	F	C	A	A				C	A	C
Approach Vol, veh/h		946			1138						147	
Approach Delay, s/veh		50.9			11.6						21.7	
Approach LOS		D			B						C	
Timer - Assigned Phs			3	4		6		8				
Phs Duration (G+Y+Rc), s			26.3	29.2		34.5		55.5				
Change Period (Y+Rc), s			4.5	4.5		4.5		4.5				
Max Green Setting (Gmax), s			33.1	24.7		18.7		62.3				
Max Q Clear Time (g_c+1), s			20.8	26.7		5.2		2.0				
Green Ext Time (p_c), s			1.0	0.0		0.3		6.3				
Intersection Summary												
HCM 6th Ctrl Delay			28.9									
HCM 6th LOS			C									

HCM 6th Signalized Intersection Summary
32: SR-99 Northbound Ramps & Cleveland Avenue

Village D Specific Plan
Phase II NP - AM Peak Hour



Movement	EBL	EBT	EBR	WBL	WBT	WBR	NBL	NBT	NBR	SBL	SBT	SBR
Lane Configurations	↘	↑↑			↑↑	↗	↘	↖	↗			
Traffic Volume (veh/h)	62	482	0	0	782	97	271	0	340	0	0	0
Future Volume (veh/h)	62	482	0	0	782	97	271	0	340	0	0	0
Initial Q (Qb), veh	0	0	0	0	0	0	0	0	0			
Ped-Bike Adj(A_pbT)	1.00		1.00	1.00		1.00	1.00		1.00			
Parking Bus, Adj	1.00	1.00	1.00	1.00	1.00	1.00	1.00	1.00	1.00			
Work Zone On Approach	No				No				No			
Adj Sat Flow, veh/h/ln	1826	1826	0	0	1856	1856	1826	1826	1826			
Adj Flow Rate, veh/h	67	524	0	0	850	105	295	0	370			
Peak Hour Factor	0.92	0.92	0.92	0.92	0.92	0.92	0.92	0.92	0.92			
Percent Heavy Veh, %	5	5	0	0	3	3	5	5	5			
Cap, veh/h	86	1267	0	0	936	418	1860	0	827			
Arrive On Green	0.10	0.73	0.00	0.00	0.27	0.27	0.53	0.00	0.53			
Sat Flow, veh/h	1739	3561	0	0	3618	1572	3478	0	1547			
Grp Volume(v), veh/h	67	524	0	0	850	105	295	0	370			
Grp Sat Flow(s),veh/h/ln	1739	1735	0	0	1763	1572	1739	0	1547			
Q Serve(g_s), s	3.4	5.2	0.0	0.0	21.0	4.7	3.9	0.0	13.2			
Cycle Q Clear(g_c), s	3.4	5.2	0.0	0.0	21.0	4.7	3.9	0.0	13.2			
Prop In Lane	1.00		0.00	0.00		1.00	1.00		1.00			
Lane Grp Cap(c), veh/h	86	1267	0	0	936	418	1860	0	827			
V/C Ratio(X)	0.78	0.41	0.00	0.00	0.91	0.25	0.16	0.00	0.45			
Avail Cap(c_a), veh/h	454	2024	0	0	960	428	1860	0	827			
HCM Platoon Ratio	2.00	2.00	1.00	1.00	1.00	1.00	1.00	1.00	1.00			
Upstream Filter(I)	0.80	0.80	0.00	0.00	0.75	0.75	1.00	0.00	1.00			
Uniform Delay (d), s/veh	40.0	8.4	0.0	0.0	32.0	26.0	10.6	0.0	12.8			
Incr Delay (d2), s/veh	11.2	0.2	0.0	0.0	9.5	0.2	0.2	0.0	1.7			
Initial Q Delay(d3),s/veh	0.0	0.0	0.0	0.0	0.0	0.0	0.0	0.0	0.0			
%ile BackOfQ(50%),veh/ln	1.6	1.6	0.0	0.0	9.9	1.8	1.5	0.0	4.6			
Unsig. Movement Delay, s/veh												
LnGrp Delay(d),s/veh	51.2	8.6	0.0	0.0	41.5	26.2	10.8	0.0	14.6			
LnGrp LOS	D	A	A	A	D	C	B	A	B			
Approach Vol, veh/h	591				955				665			
Approach Delay, s/veh	13.4				39.8				12.9			
Approach LOS	B				D				B			
Timer - Assigned Phs	2		4		7		8					
Phs Duration (G+Y+Rc), s	52.6		37.4		9.0		28.4					
Change Period (Y+Rc), s	4.5		4.5		4.5		4.5					
Max Green Setting (Gmax), s	28.5		52.5		23.5		24.5					
Max Q Clear Time (g_c+I1), s	15.2		7.2		5.4		23.0					
Green Ext Time (p_c), s	2.1		4.1		0.1		0.9					

Intersection Summary

HCM 6th Ctrl Delay	24.7
HCM 6th LOS	C

Notes

User approved volume balancing among the lanes for turning movement.

HCM 6th Signalized Intersection Summary
 33: Gateway Drive & Cleveland Avenue

Village D Specific Plan
 Phase II NP - AM Peak Hour



Movement	EBL	EBT	EBR	WBL	WBT	WBR	NBL	NBT	NBR	SBL	SBT	SBR
Lane Configurations	↖	↑↑↑	↗	↖↗	↑↑		↖↗	↑	↗	↖	↑↗	
Traffic Volume (veh/h)	4	673	143	209	740	75	134	49	168	62	88	4
Future Volume (veh/h)	4	673	143	209	740	75	134	49	168	62	88	4
Initial Q (Qb), veh	0	0	0	0	0	0	0	0	0	0	0	0
Ped-Bike Adj(A_pbT)	1.00		1.00	1.00		1.00	1.00		0.98	1.00		0.98
Parking Bus, Adj	1.00	1.00	1.00	1.00	1.00	1.00	1.00	1.00	1.00	1.00	1.00	1.00
Work Zone On Approach		No			No			No			No	
Adj Sat Flow, veh/h/ln	1841	1841	1841	1870	1870	1870	1796	1796	1796	1841	1841	1841
Adj Flow Rate, veh/h	4	732	0	227	804	82	146	53	183	67	96	4
Peak Hour Factor	0.92	0.92	0.92	0.92	0.92	0.92	0.92	0.92	0.92	0.92	0.92	0.92
Percent Heavy Veh, %	4	4	4	2	2	2	7	7	7	4	4	4
Cap, veh/h	89	1086		321	989	101	914	793	662	86	737	31
Arrive On Green	0.00	0.07	0.00	0.09	0.30	0.30	0.28	0.44	0.44	0.05	0.22	0.22
Sat Flow, veh/h	1753	5025	1560	3456	3254	332	3319	1796	1499	1753	3420	142
Grp Volume(v), veh/h	4	732	0	227	439	447	146	53	183	67	49	51
Grp Sat Flow(s),veh/h/ln	1753	1675	1560	1728	1777	1809	1659	1796	1499	1753	1749	1813
Q Serve(g_s), s	0.2	12.8	0.0	5.7	20.6	20.6	3.0	1.5	4.6	3.4	2.0	2.1
Cycle Q Clear(g_c), s	0.2	12.8	0.0	5.7	20.6	20.6	3.0	1.5	4.6	3.4	2.0	2.1
Prop In Lane	1.00		1.00	1.00		0.18	1.00		1.00	1.00		0.08
Lane Grp Cap(c), veh/h	89	1086		321	540	550	914	793	662	86	377	391
V/C Ratio(X)	0.04	0.67		0.71	0.81	0.81	0.16	0.07	0.28	0.78	0.13	0.13
Avail Cap(c_a), veh/h	177	1736		376	709	721	914	793	662	179	377	391
HCM Platoon Ratio	0.33	0.33	0.33	1.00	1.00	1.00	1.00	1.00	1.00	1.00	1.00	1.00
Upstream Filter(I)	0.94	0.94	0.00	0.93	0.93	0.93	1.00	1.00	1.00	1.00	1.00	1.00
Uniform Delay (d), s/veh	31.3	38.7	0.0	39.6	29.0	29.0	24.7	14.5	6.8	42.3	28.5	28.5
Incr Delay (d2), s/veh	0.2	0.7	0.0	4.6	5.1	5.0	0.1	0.2	1.0	13.9	0.7	0.7
Initial Q Delay(d3),s/veh	0.0	0.0	0.0	0.0	0.0	0.0	0.0	0.0	0.0	0.0	0.0	0.0
%ile BackOfQ(50%),veh/ln	0.1	5.8	0.0	2.6	9.2	9.4	1.2	0.6	2.4	1.8	0.9	1.0
Unsig. Movement Delay, s/veh												
LnGrp Delay(d),s/veh	31.5	39.4	0.0	44.2	34.1	34.0	24.8	14.6	7.9	56.2	29.2	29.2
LnGrp LOS	C	D		D	C	C	C	B	A	E	C	C
Approach Vol, veh/h		736	A		1113			382			167	
Approach Delay, s/veh		39.3			36.1			15.3			40.0	
Approach LOS		D			D			B			D	
Timer - Assigned Phs	1	2	3	4	5	6	7	8				
Phs Duration (G+Y+Rc), s	29.3	23.9	5.0	31.8	8.9	44.3	12.9	24.0				
Change Period (Y+Rc), s	4.5	4.5	4.5	4.5	4.5	4.5	4.5	4.5				
Max Green Setting (Gmax), s	19.4	19.4	5.0	35.9	9.2	21.9	9.8	31.1				
Max Q Clear Time (g_c+1), s	4.1	4.1	2.2	22.6	5.4	6.6	7.7	14.8				
Green Ext Time (p_c), s	0.2	0.4	0.0	4.8	0.0	0.8	0.2	4.7				

Intersection Summary

HCM 6th Ctrl Delay	34.1
HCM 6th LOS	C

Notes

Unsignalized Delay for [EBR] is excluded from calculations of the approach delay and intersection delay.

HCM 6th Signalized Intersection Summary
 34: Cleveland Avenue & County Club Drive

Village D Specific Plan
 Phase II NP - AM Peak Hour



Movement	WBL	WBR	NBT	NBR	SBL	SBT
Lane Configurations	←←←		↑↑	↘	←	↑↑↑
Traffic Volume (veh/h)	378	39	684	219	95	646
Future Volume (veh/h)	378	39	684	219	95	646
Initial Q (Qb), veh	0	0	0	0	0	0
Ped-Bike Adj(A_pbT)	1.00	1.00		1.00	1.00	
Parking Bus, Adj	1.00	1.00	1.00	1.00	1.00	1.00
Work Zone On Approach	No		No		No	
Adj Sat Flow, veh/h/ln	1900	1900	1856	1856	1856	1856
Adj Flow Rate, veh/h	450	0	743	0	103	702
Peak Hour Factor	0.92	0.92	0.92	0.92	0.92	0.92
Percent Heavy Veh, %	0	0	3	3	3	3
Cap, veh/h	575	256	2612		558	3754
Arrive On Green	0.16	0.00	0.74	0.00	0.74	0.74
Sat Flow, veh/h	3619	1610	3618	1572	711	5233
Grp Volume(v), veh/h	450	0	743	0	103	702
Grp Sat Flow(s),veh/h/ln	1810	1610	1763	1572	711	1689
Q Serve(g_s), s	10.7	0.0	6.2	0.0	5.0	3.8
Cycle Q Clear(g_c), s	10.7	0.0	6.2	0.0	11.2	3.8
Prop In Lane	1.00	1.00		1.00	1.00	
Lane Grp Cap(c), veh/h	575	256	2612		558	3754
V/C Ratio(X)	0.78	0.00	0.28		0.18	0.19
Avail Cap(c_a), veh/h	1307	581	2612		558	3754
HCM Platoon Ratio	1.00	1.00	1.00	1.00	1.00	1.00
Upstream Filter(I)	1.00	0.00	0.81	0.00	1.00	1.00
Uniform Delay (d), s/veh	36.3	0.0	3.8	0.0	5.7	3.5
Incr Delay (d2), s/veh	2.4	0.0	0.2	0.0	0.7	0.1
Initial Q Delay(d3),s/veh	0.0	0.0	0.0	0.0	0.0	0.0
%ile BackOfQ(50%),veh/ln	4.8	0.0	1.8	0.0	0.8	1.0
Unsig. Movement Delay, s/veh						
LnGrp Delay(d),s/veh	38.7	0.0	4.0	0.0	6.4	3.6
LnGrp LOS	D	A	A		A	A
Approach Vol, veh/h	450		743	A		805
Approach Delay, s/veh	38.7		4.0			4.0
Approach LOS	D		A			A
Timer - Assigned Phs		2			6	8
Phs Duration (G+Y+Rc), s		71.2			71.2	18.8
Change Period (Y+Rc), s		4.5			4.5	4.5
Max Green Setting (Gmax), s		48.5			48.5	32.5
Max Q Clear Time (g_c+I1), s		8.2			13.2	12.7
Green Ext Time (p_c), s		6.1			6.7	1.6

Intersection Summary

HCM 6th Ctrl Delay	11.8
HCM 6th LOS	B

Notes

User approved volume balancing among the lanes for turning movement.
 Unsignalized Delay for [NBR] is excluded from calculations of the approach delay and intersection delay.

Intersection						
Int Delay, s/veh	0.1					
Movement	EBL	EBR	NBL	NBT	SBT	SBR
Lane Configurations	T			T		
Traffic Vol, veh/h	2	12	1	722	715	1
Future Vol, veh/h	2	12	1	722	715	1
Conflicting Peds, #/hr	0	0	2	0	0	2
Sign Control	Stop	Stop	Free	Free	Free	Free
RT Channelized	-	None	-	None	-	None
Storage Length	0	-	-	-	-	-
Veh in Median Storage, #	0	-	-	0	0	-
Grade, %	0	-	-	0	0	-
Peak Hour Factor	92	92	92	92	92	92
Heavy Vehicles, %	7	7	5	5	4	4
Mvmt Flow	2	13	1	785	777	1

Major/Minor	Minor2	Major1	Major2			
Conflicting Flow All	1175	391	780	0	-	0
Stage 1	780	-	-	-	-	-
Stage 2	395	-	-	-	-	-
Critical Hdwy	6.94	7.04	4.2	-	-	-
Critical Hdwy Stg 1	5.94	-	-	-	-	-
Critical Hdwy Stg 2	5.94	-	-	-	-	-
Follow-up Hdwy	3.57	3.37	2.25	-	-	-
Pot Cap-1 Maneuver	*351	594	814	-	-	-
Stage 1	*400	-	-	-	-	-
Stage 2	*739	-	-	-	-	-
Platoon blocked, %	1			-	-	-
Mov Cap-1 Maneuver	*349	593	812	-	-	-
Mov Cap-2 Maneuver	*358	-	-	-	-	-
Stage 1	*398	-	-	-	-	-
Stage 2	*738	-	-	-	-	-

Approach	EB	NB	SB
HCM Control Delay, s	11.8	0	0
HCM LOS	B		

Minor Lane/Major Mvmt	NBL	NBT	EBLn1	SBT	SBR
Capacity (veh/h)	812	-	542	-	-
HCM Lane V/C Ratio	0.001	-	0.028	-	-
HCM Control Delay (s)	9.4	0	11.8	-	-
HCM Lane LOS	A	A	B	-	-
HCM 95th %tile Q(veh)	0	-	0.1	-	-

Notes
 -: Volume exceeds capacity \$: Delay exceeds 300s +: Computation Not Defined *: All major volume in platoon

HCM 6th Signalized Intersection Summary
36: Pine Street & Howard Road

Village D Specific Plan
Phase II NP - AM Peak Hour



Movement	EBL	EBT	EBR	WBL	WBT	WBR	NBL	NBT	NBR	SBL	SBT	SBR
Lane Configurations												
Traffic Volume (veh/h)	34	689	80	151	437	7	119	164	243	17	267	100
Future Volume (veh/h)	34	689	80	151	437	7	119	164	243	17	267	100
Initial Q (Qb), veh	0	0	0	0	0	0	0	0	0	0	0	0
Ped-Bike Adj(A_pbT)	1.00		0.97	1.00		0.98	1.00		1.00	1.00		0.98
Parking Bus, Adj	1.00	1.00	1.00	1.00	1.00	1.00	1.00	1.00	1.00	1.00	1.00	1.00
Work Zone On Approach		No			No			No			No	
Adj Sat Flow, veh/h/ln	1870	1870	1870	1856	1856	1856	1811	1811	1811	1841	1841	1841
Adj Flow Rate, veh/h	37	749	87	164	475	8	129	178	264	18	290	109
Peak Hour Factor	0.92	0.92	0.92	0.92	0.92	0.92	0.92	0.92	0.92	0.92	0.92	0.92
Percent Heavy Veh, %	2	2	2	3	3	3	6	6	6	4	4	4
Cap, veh/h	53	899	104	169	1233	21	500	525	443	20	317	279
Arrive On Green	0.03	0.28	0.28	0.10	0.35	0.35	0.29	0.29	0.29	0.18	0.18	0.18
Sat Flow, veh/h	1781	3197	371	1767	3546	60	1725	1811	1530	107	1728	1522
Grp Volume(v), veh/h	37	416	420	164	236	247	129	178	264	308	0	109
Grp Sat Flow(s),veh/h/ln	1781	1777	1792	1767	1763	1843	1725	1811	1530	1835	0	1522
Q Serve(g_s), s	2.5	26.4	26.4	11.1	12.1	12.1	6.9	9.3	17.8	19.8	0.0	7.6
Cycle Q Clear(g_c), s	2.5	26.4	26.4	11.1	12.1	12.1	6.9	9.3	17.8	19.8	0.0	7.6
Prop In Lane	1.00		0.21	1.00		0.03	1.00		1.00	0.06		1.00
Lane Grp Cap(c), veh/h	53	500	504	169	613	641	500	525	443	336	0	279
V/C Ratio(X)	0.70	0.83	0.83	0.97	0.39	0.39	0.26	0.34	0.60	0.92	0.00	0.39
Avail Cap(c_a), veh/h	102	709	715	169	771	806	500	525	443	347	0	288
HCM Platoon Ratio	1.00	1.00	1.00	1.00	1.00	1.00	1.00	1.00	1.00	1.00	1.00	1.00
Upstream Filter(I)	1.00	1.00	1.00	0.95	0.95	0.95	1.00	1.00	1.00	1.00	0.00	1.00
Uniform Delay (d), s/veh	57.7	40.5	40.5	54.1	29.5	29.5	32.7	33.6	36.6	48.1	0.0	43.1
Incr Delay (d2), s/veh	15.7	5.9	5.8	57.9	0.4	0.4	1.2	1.8	5.8	27.7	0.0	0.9
Initial Q Delay(d3),s/veh	0.0	0.0	0.0	0.0	0.0	0.0	0.0	0.0	0.0	0.0	0.0	0.0
%ile BackOfQ(50%),veh/ln	1.3	12.3	12.4	7.7	5.2	5.4	3.1	4.4	7.3	11.6	0.0	2.9
Unsig. Movement Delay, s/veh												
LnGrp Delay(d),s/veh	73.4	46.3	46.3	112.0	29.9	29.9	34.0	35.3	42.4	75.8	0.0	44.0
LnGrp LOS	E	D	D	F	C	C	C	D	D	E	A	D
Approach Vol, veh/h		873			647			571				417
Approach Delay, s/veh		47.5			50.7			38.3				67.5
Approach LOS		D			D			D				E
Timer - Assigned Phs		2	3	4		6	7	8				
Phs Duration (G+Y+Rc), s		39.3	16.0	38.3		26.5	8.0	46.2				
Change Period (Y+Rc), s		4.5	4.5	4.5		4.5	4.5	4.5				
Max Green Setting (Gmax), s		19.9	11.5	47.9		22.7	6.9	52.5				
Max Q Clear Time (g_c+I1), s		19.8	13.1	28.4		21.8	4.5	14.1				
Green Ext Time (p_c), s		0.0	0.0	5.3		0.2	0.0	3.2				
Intersection Summary												
HCM 6th Ctrl Delay				49.5								
HCM 6th LOS				D								

HCM 6th Signalized Intersection Summary
 37: Olive Avenue/Q Street & Howard Road/Yosemite Avenue

Village D Specific Plan
 Phase II NP - AM Peak Hour



Movement	EBL	EBT	EBR	WBL	WBT	WBR	NBL	NBT	NBR	SBL	SBT	SBR
Lane Configurations	↘	↑↑	↗	↘	↑↑		↘	↗	↗	↘	↑	↗
Traffic Volume (veh/h)	6	559	327	27	343	20	311	89	21	102	150	12
Future Volume (veh/h)	6	559	327	27	343	20	311	89	21	102	150	12
Initial Q (Qb), veh	0	0	0	0	0	0	0	0	0	0	0	0
Ped-Bike Adj(A_pbT)	1.00		1.00	1.00		0.98	1.00		0.99	1.00		0.96
Parking Bus, Adj	1.00	1.00	1.00	1.00	1.00	1.00	1.00	1.00	1.00	1.00	1.00	1.00
Work Zone On Approach		No			No			No			No	
Adj Sat Flow, veh/h/ln	1856	1856	1856	1870	1870	1870	1826	1826	1826	1870	1870	1870
Adj Flow Rate, veh/h	7	608	0	29	373	22	218	266	23	111	163	13
Peak Hour Factor	0.92	0.92	0.92	0.92	0.92	0.92	0.92	0.92	0.92	0.92	0.92	0.92
Percent Heavy Veh, %	3	3	3	2	2	2	5	5	5	2	2	2
Cap, veh/h	15	712		74	800	47	853	895	752	207	217	177
Arrive On Green	0.02	0.40	0.00	0.04	0.23	0.23	0.49	0.49	0.49	0.12	0.12	0.12
Sat Flow, veh/h	1767	3526	1572	1781	3406	200	1739	1826	1533	1781	1870	1524
Grp Volume(v), veh/h	7	608	0	29	194	201	218	266	23	111	163	13
Grp Sat Flow(s),veh/h/ln	1767	1763	1572	1781	1777	1829	1739	1826	1533	1781	1870	1524
Q Serve(g_s), s	0.5	18.8	0.0	1.9	11.2	11.3	8.8	10.4	0.9	7.0	10.1	0.9
Cycle Q Clear(g_c), s	0.5	18.8	0.0	1.9	11.2	11.3	8.8	10.4	0.9	7.0	10.1	0.9
Prop In Lane	1.00		1.00	1.00		0.11	1.00		1.00	1.00		1.00
Lane Grp Cap(c), veh/h	15	712		74	418	430	853	895	752	207	217	177
V/C Ratio(X)	0.46	0.85		0.39	0.46	0.47	0.26	0.30	0.03	0.54	0.75	0.07
Avail Cap(c_a), veh/h	81	999		275	696	716	853	895	752	267	281	229
HCM Platoon Ratio	2.00	2.00	2.00	1.00	1.00	1.00	1.00	1.00	1.00	1.00	1.00	1.00
Upstream Filter(I)	0.63	0.63	0.00	1.00	1.00	1.00	1.00	1.00	1.00	1.00	1.00	1.00
Uniform Delay (d), s/veh	58.7	34.1	0.0	56.0	39.4	39.5	17.8	18.2	15.8	50.0	51.4	47.3
Incr Delay (d2), s/veh	12.8	3.4	0.0	3.3	0.8	0.8	0.7	0.8	0.1	2.2	8.0	0.2
Initial Q Delay(d3),s/veh	0.0	0.0	0.0	0.0	0.0	0.0	0.0	0.0	0.0	0.0	0.0	0.0
%ile BackOfQ(50%),veh/ln	0.3	6.9	0.0	0.9	5.0	5.2	3.7	4.6	0.3	3.3	5.2	0.4
Unsig. Movement Delay, s/veh												
LnGrp Delay(d),s/veh	71.5	37.6	0.0	59.3	40.2	40.2	18.5	19.1	15.9	52.2	59.4	47.5
LnGrp LOS	E	D		E	D	D	B	B	B	D	E	D
Approach Vol, veh/h		615	A		424			507			287	
Approach Delay, s/veh		37.9			41.5			18.7			56.0	
Approach LOS		D			D			B			E	
Timer - Assigned Phs		2	3	4		6	7	8				
Phs Duration (G+Y+Rc), s		63.3	9.5	28.7		18.4	5.5	32.7				
Change Period (Y+Rc), s		4.5	4.5	4.5		4.5	4.5	4.5				
Max Green Setting (Gmax), s		31.5	18.5	34.0		18.0	5.5	47.0				
Max Q Clear Time (g_c+I1), s		12.4	3.9	20.8		12.1	2.5	13.3				
Green Ext Time (p_c), s		2.2	0.0	3.4		0.6	0.0	2.5				

Intersection Summary

HCM 6th Ctrl Delay	36.3
HCM 6th LOS	D

Notes

User approved volume balancing among the lanes for turning movement.
 Unsignalized Delay for [EBR] is excluded from calculations of the approach delay and intersection delay.

Intersection												
Int Delay, s/veh	17.2											
Movement	EBL	EBT	EBR	WBL	WBT	WBR	NBL	NBT	NBR	SBL	SBT	SBR
Lane Configurations		↕			↕	↕	↕	↕			↕	
Traffic Vol, veh/h	2	0	63	390	20	11	21	87	0	0	148	3
Future Vol, veh/h	2	0	63	390	20	11	21	87	0	0	148	3
Conflicting Peds, #/hr	0	0	1	1	0	0	0	0	0	0	0	0
Sign Control	Stop	Stop	Stop	Stop	Stop	Stop	Free	Free	Free	Free	Free	Free
RT Channelized	-	-	None	-	-	Stop	-	-	None	-	-	None
Storage Length	-	-	-	-	-	50	75	-	-	-	-	-
Veh in Median Storage, #	-	0	-	-	0	-	-	0	-	-	0	-
Grade, %	-	0	-	-	0	-	-	0	-	-	0	-
Peak Hour Factor	92	92	92	92	92	92	92	92	92	92	92	92
Heavy Vehicles, %	0	0	0	3	3	3	4	4	4	1	1	1
Mvmt Flow	2	0	68	424	22	12	23	95	0	0	161	3

Major/Minor	Minor2		Minor1		Major1		Major2					
Conflicting Flow All	315	304	164	339	305	95	164	0	-	-	-	0
Stage 1	163	163	-	141	141	-	-	-	-	-	-	-
Stage 2	152	141	-	198	164	-	-	-	-	-	-	-
Critical Hdwy	7.1	6.5	6.2	7.13	6.53	6.23	4.14	-	-	-	-	-
Critical Hdwy Stg 1	6.1	5.5	-	6.13	5.53	-	-	-	-	-	-	-
Critical Hdwy Stg 2	6.1	5.5	-	6.13	5.53	-	-	-	-	-	-	-
Follow-up Hdwy	3.5	4	3.3	3.527	4.027	3.327	2.236	-	-	-	-	-
Pot Cap-1 Maneuver	664	627	886	634	621	993	1402	-	0	0	-	-
Stage 1	844	767	-	885	791	-	-	-	0	0	-	-
Stage 2	880	796	-	802	761	-	-	-	0	0	-	-
Platoon blocked, %	1	1		1	1	1		-			-	-
Mov Cap-1 Maneuver	630	617	885	577	611	993	1402	-	-	-	-	-
Mov Cap-2 Maneuver	630	617	-	577	611	-	-	-	-	-	-	-
Stage 1	830	767	-	871	778	-	-	-	-	-	-	-
Stage 2	831	783	-	739	761	-	-	-	-	-	-	-

Approach	EB	WB	NB	SB
HCM Control Delay, s	9.5	28.5	1.5	0
HCM LOS	A	D		

Minor Lane/Major Mvmt	NBL	NBT	EBLn1WBLn1WBLn2	SBT	SBR
Capacity (veh/h)	1402	-	874 579 993	-	-
HCM Lane V/C Ratio	0.016	-	0.081 0.77 0.012	-	-
HCM Control Delay (s)	7.6	-	9.5 29 8.7	-	-
HCM Lane LOS	A	-	A D A	-	-
HCM 95th %tile Q(veh)	0.1	-	0.3 7 0	-	-

HCM 6th Signalized Intersection Summary
39: 4th Street & Sunset Avenue

Village D Specific Plan
Phase II NP - AM Peak Hour



Movement	EBL	EBR	NBL	NBT	SBT	SBR
Lane Configurations						
Traffic Volume (veh/h)	394	23	34	331	441	280
Future Volume (veh/h)	394	23	34	331	441	280
Initial Q (Qb), veh	0	0	0	0	0	0
Ped-Bike Adj(A_pbT)	1.00	1.00	1.00			1.00
Parking Bus, Adj	1.00	1.00	1.00	1.00	1.00	1.00
Work Zone On Approach	No			No	No	
Adj Sat Flow, veh/h/ln	1900	1900	1870	1870	1870	1870
Adj Flow Rate, veh/h	451	0	37	360	479	304
Peak Hour Factor	0.92	0.92	0.92	0.92	0.92	0.92
Percent Heavy Veh, %	0	0	2	2	2	2
Cap, veh/h	552	246	60	2656	1242	1293
Arrive On Green	0.15	0.00	0.03	0.75	1.00	1.00
Sat Flow, veh/h	3619	1610	1781	3647	1870	1583
Grp Volume(v), veh/h	451	0	37	360	479	304
Grp Sat Flow(s),veh/h/ln	1810	1610	1781	1777	1870	1583
Q Serve(g_s), s	10.9	0.0	1.8	2.6	0.0	0.0
Cycle Q Clear(g_c), s	10.9	0.0	1.8	2.6	0.0	0.0
Prop In Lane	1.00	1.00	1.00			1.00
Lane Grp Cap(c), veh/h	552	246	60	2656	1242	1293
V/C Ratio(X)	0.82	0.00	0.62	0.14	0.39	0.24
Avail Cap(c_a), veh/h	744	331	148	2656	1242	1293
HCM Platoon Ratio	1.00	1.00	1.00	1.00	2.00	2.00
Upstream Filter(I)	1.00	0.00	1.00	1.00	0.86	0.86
Uniform Delay (d), s/veh	36.9	0.0	42.9	3.2	0.0	0.0
Incr Delay (d2), s/veh	5.2	0.0	10.0	0.1	0.8	0.4
Initial Q Delay(d3),s/veh	0.0	0.0	0.0	0.0	0.0	0.0
%ile BackOfQ(50%),veh/ln	5.1	0.0	1.0	0.7	0.3	0.1
Unsig. Movement Delay, s/veh						
LnGrp Delay(d),s/veh	42.2	0.0	52.9	3.3	0.8	0.4
LnGrp LOS	D	A	D	A	A	A
Approach Vol, veh/h	451			397	783	
Approach Delay, s/veh	42.2			7.9	0.6	
Approach LOS	D			A	A	
Timer - Assigned Phs		2		4	5	6
Phs Duration (G+Y+Rc), s		71.8		18.2	7.5	64.3
Change Period (Y+Rc), s		4.5		4.5	4.5	4.5
Max Green Setting (Gmax), s		62.5		18.5	7.5	50.5
Max Q Clear Time (g_c+I1), s		4.6		12.9	3.8	2.0
Green Ext Time (p_c), s		2.7		0.9	0.0	4.7
Intersection Summary						
HCM 6th Ctrl Delay			13.9			
HCM 6th LOS			B			

Notes

User approved volume balancing among the lanes for turning movement.

40: H Street & SR-99 Southbound On-Ramp/2nd Street Performance by movement

Movement	WBL	WBT	WBR	NBL	NBT	NBR	SBT	All
Denied Delay (hr)	0.0	0.0	0.0	0.0	0.0	0.0	0.0	0.0
Denied Del/Veh (s)	0.2	0.1	0.1	0.0	0.0	0.0	0.1	0.1
Total Delay (hr)	0.1	0.1	0.0	0.2	0.0	0.0	0.1	0.4
Total Del/Veh (s)	9.6	10.7	3.6	2.8	4.4	1.9	13.9	4.7
Stop Delay (hr)	0.0	0.0	0.0	0.0	0.0	0.0	0.1	0.2
Stop Del/Veh (s)	7.4	7.5	3.6	0.2	0.3	0.0	10.9	2.0

HCM 6th Signalized Intersection Summary

41: I Street & 4th Street

Village D Specific Plan
Phase II NP - AM Peak Hour



Movement	EBL	EBT	EBR	WBL	WBT	WBR	NBL	NBT	NBR	SBL	SBT	SBR
Lane Configurations												
Traffic Volume (veh/h)	28	651	69	88	497	68	53	57	165	238	284	140
Future Volume (veh/h)	28	651	69	88	497	68	53	57	165	238	284	140
Initial Q (Qb), veh	0	0	0	0	0	0	0	0	0	0	0	0
Ped-Bike Adj(A_pbT)	1.00		0.96	1.00		0.96	1.00		0.97	1.00		0.98
Parking Bus, Adj	1.00	1.00	1.00	1.00	1.00	1.00	1.00	1.00	1.00	1.00	1.00	1.00
Work Zone On Approach		No			No			No			No	
Adj Sat Flow, veh/h/ln	1870	1870	1870	1856	1856	1856	1856	1856	1856	1856	1856	1856
Adj Flow Rate, veh/h	30	708	75	96	540	74	58	62	179	259	309	152
Peak Hour Factor	0.92	0.92	0.92	0.92	0.92	0.92	0.92	0.92	0.92	0.92	0.92	0.92
Percent Heavy Veh, %	2	2	2	3	3	3	3	3	3	3	3	3
Cap, veh/h	52	815	86	122	906	124	219	379	310	484	658	544
Arrive On Green	0.03	0.25	0.25	0.07	0.29	0.29	0.12	0.20	0.20	0.27	0.35	0.35
Sat Flow, veh/h	1781	3227	342	1767	3100	423	1767	1856	1519	1767	1856	1533
Grp Volume(v), veh/h	30	390	393	96	306	308	58	62	179	259	309	152
Grp Sat Flow(s),veh/h/ln	1781	1777	1791	1767	1763	1761	1767	1856	1519	1767	1856	1533
Q Serve(g_s), s	1.5	18.9	18.9	4.8	13.4	13.5	2.7	2.5	9.6	11.2	11.6	5.1
Cycle Q Clear(g_c), s	1.5	18.9	18.9	4.8	13.4	13.5	2.7	2.5	9.6	11.2	11.6	5.1
Prop In Lane	1.00		0.19	1.00		0.24	1.00		1.00	1.00		1.00
Lane Grp Cap(c), veh/h	52	449	452	122	515	514	219	379	310	484	658	544
V/C Ratio(X)	0.57	0.87	0.87	0.79	0.59	0.60	0.26	0.16	0.58	0.53	0.47	0.28
Avail Cap(c_a), veh/h	113	492	496	155	531	530	219	379	310	484	658	544
HCM Platoon Ratio	1.00	1.00	1.00	1.00	1.00	1.00	1.00	1.00	1.00	1.00	1.00	1.00
Upstream Filter(I)	0.89	0.89	0.89	1.00	1.00	1.00	1.00	1.00	1.00	1.00	1.00	1.00
Uniform Delay (d), s/veh	43.1	32.2	32.2	41.2	27.3	27.3	35.7	29.5	32.3	27.8	22.5	13.3
Incr Delay (d2), s/veh	8.6	13.0	13.1	18.4	1.7	1.8	0.6	0.9	7.6	1.1	2.4	1.3
Initial Q Delay(d3),s/veh	0.0	0.0	0.0	0.0	0.0	0.0	0.0	0.0	0.0	0.0	0.0	0.0
%ile BackOfQ(50%),veh/ln	0.8	9.5	9.6	2.7	5.7	5.8	1.2	1.2	4.1	4.8	5.3	2.4
Unsig. Movement Delay, s/veh												
LnGrp Delay(d),s/veh	51.7	45.2	45.3	59.6	29.0	29.1	36.3	30.4	39.9	28.9	24.9	14.6
LnGrp LOS	D	D	D	E	C	C	D	C	D	C	C	B
Approach Vol, veh/h		813			710			299			720	
Approach Delay, s/veh		45.5			33.2			37.2			24.2	
Approach LOS		D			C			D			C	
Timer - Assigned Phs	1	2	3	4	5	6	7	8				
Phs Duration (G+Y+Rc), s	29.2	22.9	10.7	27.2	15.7	36.4	7.1	30.8				
Change Period (Y+Rc), s	4.5	4.5	4.5	4.5	4.5	4.5	4.5	4.5				
Max Green Setting (Gmax), s	20.8	18.4	7.9	24.9	7.3	31.9	5.7	27.1				
Max Q Clear Time (g_c+I), s	11.2	11.6	6.8	20.9	4.7	13.6	3.5	15.5				
Green Ext Time (p_c), s	0.5	0.5	0.0	1.8	0.0	2.2	0.0	3.0				

Intersection Summary

HCM 6th Ctrl Delay	35.7
HCM 6th LOS	D

HCM 6th Signalized Intersection Summary
 43: SR-99 Northbound Off-Ramp/H Street & 4th Street

Village D Specific Plan
 Phase II NP - AM Peak Hour



Movement	EBL	EBT	EBR	WBL	WBT	WBR	NBL	NBT	NBR	SBL	SBT	SBR
Lane Configurations	↖	↗			↖	↗	↖	↗			↕	
Traffic Volume (veh/h)	248	465	0	0	526	70	267	31	225	7	0	75
Future Volume (veh/h)	248	465	0	0	526	70	267	31	225	7	0	75
Initial Q (Qb), veh	0	0	0	0	0	0	0	0	0	0	0	0
Ped-Bike Adj(A_pbT)	1.00		1.00	1.00		0.94	1.00		1.00	1.00		0.99
Parking Bus, Adj	1.00	1.00	1.00	1.00	1.00	1.00	1.00	1.00	1.00	1.00	1.00	1.00
Work Zone On Approach		No			No			No			No	
Adj Sat Flow, veh/h/ln	1870	1870	0	0	1841	1841	1870	1870	1870	1900	1900	1900
Adj Flow Rate, veh/h	270	505	0	0	572	76	290	34	245	8	0	82
Peak Hour Factor	0.92	0.92	0.92	0.92	0.92	0.92	0.92	0.92	0.92	0.92	0.92	0.92
Percent Heavy Veh, %	2	2	0	0	4	4	2	2	2	0	0	0
Cap, veh/h	305	1514	0	0	631	84	399	44	317	29	0	293
Arrive On Green	0.17	0.43	0.00	0.00	0.20	0.20	0.22	0.22	0.22	0.20	0.00	0.20
Sat Flow, veh/h	1781	3647	0	0	3172	408	1781	197	1418	143	0	1464
Grp Volume(v), veh/h	270	505	0	0	324	324	290	0	279	90	0	0
Grp Sat Flow(s),veh/h/ln	1781	1777	0	0	1749	1739	1781	0	1615	1606	0	0
Q Serve(g_s), s	13.3	8.6	0.0	0.0	16.3	16.4	13.6	0.0	14.6	4.3	0.0	0.0
Cycle Q Clear(g_c), s	13.3	8.6	0.0	0.0	16.3	16.4	13.6	0.0	14.6	4.3	0.0	0.0
Prop In Lane	1.00		0.00	0.00		0.23	1.00		0.88	0.09		0.91
Lane Grp Cap(c), veh/h	305	1514	0	0	358	356	399	0	362	321	0	0
V/C Ratio(X)	0.89	0.33	0.00	0.00	0.90	0.91	0.73	0.00	0.77	0.28	0.00	0.00
Avail Cap(c_a), veh/h	327	1560	0	0	359	357	399	0	362	321	0	0
HCM Platoon Ratio	1.00	1.00	1.00	1.00	1.00	1.00	1.00	1.00	1.00	1.00	1.00	1.00
Upstream Filter(I)	1.00	1.00	0.00	0.00	1.00	1.00	1.00	0.00	1.00	1.00	0.00	0.00
Uniform Delay (d), s/veh	36.4	17.3	0.0	0.0	34.9	35.0	32.4	0.0	32.8	30.5	0.0	0.0
Incr Delay (d2), s/veh	22.9	0.1	0.0	0.0	25.2	26.4	11.0	0.0	14.7	2.2	0.0	0.0
Initial Q Delay(d3),s/veh	0.0	0.0	0.0	0.0	0.0	0.0	0.0	0.0	0.0	0.0	0.0	0.0
%ile BackOfQ(50%),veh/ln	7.6	3.4	0.0	0.0	9.3	9.4	6.9	0.0	7.1	1.8	0.0	0.0
Unsig. Movement Delay, s/veh												
LnGrp Delay(d),s/veh	59.4	17.4	0.0	0.0	60.2	61.3	43.4	0.0	47.5	32.7	0.0	0.0
LnGrp LOS	E	B	A	A	E	E	D	A	D	C	A	A
Approach Vol, veh/h		775			648			569				90
Approach Delay, s/veh		32.0			60.7			45.4				32.7
Approach LOS		C			E			D				C
Timer - Assigned Phs		2		4		6	7	8				
Phs Duration (G+Y+Rc), s		24.6		42.9		22.5	19.9	22.9				
Change Period (Y+Rc), s		4.5		4.5		4.5	4.5	4.5				
Max Green Setting (Gmax), s		19.0		39.5		18.0	16.5	18.5				
Max Q Clear Time (g_c+I1), s		16.6		10.6		6.3	15.3	18.4				
Green Ext Time (p_c), s		0.7		3.7		0.3	0.1	0.0				
Intersection Summary												
HCM 6th Ctrl Delay					44.6							
HCM 6th LOS					D							

Intersection						
Int Delay, s/veh	2.5					
Movement	EBL	EBT	WBT	WBR	SBL	SBR
Lane Configurations	↖	↗↗	↗↖		↖	↖
Traffic Vol, veh/h	132	490	525	80	61	101
Future Vol, veh/h	132	490	525	80	61	101
Conflicting Peds, #/hr	16	0	0	16	0	0
Sign Control	Free	Free	Free	Free	Stop	Stop
RT Channelized	-	None	-	None	-	None
Storage Length	145	-	-	-	65	0
Veh in Median Storage, #	-	0	0	-	0	-
Grade, %	-	0	0	-	0	-
Peak Hour Factor	98	98	98	98	98	98
Heavy Vehicles, %	5	5	4	4	5	5
Mvmt Flow	135	500	536	82	62	103

Major/Minor	Major1	Major2	Minor2		
Conflicting Flow All	634	0	-	0	1113 325
Stage 1	-	-	-	-	593 -
Stage 2	-	-	-	-	520 -
Critical Hdwy	4.2	-	-	-	6.9 7
Critical Hdwy Stg 1	-	-	-	-	5.9 -
Critical Hdwy Stg 2	-	-	-	-	5.9 -
Follow-up Hdwy	2.25	-	-	-	3.55 3.35
Pot Cap-1 Maneuver	1213	-	-	-	312 *868
Stage 1	-	-	-	-	797 -
Stage 2	-	-	-	-	553 -
Platoon blocked, %	1	-	-	-	1 1
Mov Cap-1 Maneuver	1194	-	-	-	268 *855
Mov Cap-2 Maneuver	-	-	-	-	268 -
Stage 1	-	-	-	-	697 -
Stage 2	-	-	-	-	545 -

Approach	EB	WB	SB
HCM Control Delay, s	1.8	0	14.6
HCM LOS			B

Minor Lane/Major Mvmt	EBL	EBT	WBT	WBR	SBLn1	SBLn2
Capacity (veh/h)	1194	-	-	-	268	855
HCM Lane V/C Ratio	0.113	-	-	-	0.232	0.121
HCM Control Delay (s)	8.4	-	-	-	22.5	9.8
HCM Lane LOS	A	-	-	-	C	A
HCM 95th %tile Q(veh)	0.4	-	-	-	0.9	0.4

Notes
 -: Volume exceeds capacity \$: Delay exceeds 300s +: Computation Not Defined *: All major volume in platoon

HCM 6th Signalized Intersection Summary
45: Olive Avenue & SR-99 Southbound Off-Ramp

Village D Specific Plan
Phase II NP - AM Peak Hour



Movement	EBL	EBT	WBT	WBR	SBL	SBR
Lane Configurations		↑↑↑	↑↑		↵	↵
Traffic Volume (veh/h)	0	551	494	0	576	113
Future Volume (veh/h)	0	551	494	0	576	113
Initial Q (Qb), veh	0	0	0	0	0	0
Ped-Bike Adj(A_pbT)	1.00			1.00	1.00	1.00
Parking Bus, Adj	1.00	1.00	1.00	1.00	1.00	1.00
Work Zone On Approach		No	No		No	
Adj Sat Flow, veh/h/ln	0	1826	1826	0	1752	1752
Adj Flow Rate, veh/h	0	586	526	0	613	120
Peak Hour Factor	0.94	0.94	0.94	0.94	0.94	0.94
Percent Heavy Veh, %	0	5	5	0	10	10
Cap, veh/h	0	985	686	0	1151	1024
Arrive On Green	0.00	0.20	0.20	0.00	0.69	0.69
Sat Flow, veh/h	0	5313	3652	0	1668	1485
Grp Volume(v), veh/h	0	586	526	0	613	120
Grp Sat Flow(s),veh/h/ln	0	1662	1735	0	1668	1485
Q Serve(g_s), s	0.0	8.6	11.5	0.0	14.4	2.2
Cycle Q Clear(g_c), s	0.0	8.6	11.5	0.0	14.4	2.2
Prop In Lane	0.00			0.00	1.00	1.00
Lane Grp Cap(c), veh/h	0	985	686	0	1151	1024
V/C Ratio(X)	0.00	0.59	0.77	0.00	0.53	0.12
Avail Cap(c_a), veh/h	0	1402	976	0	1151	1024
HCM Platoon Ratio	1.00	1.00	1.00	1.00	1.00	1.00
Upstream Filter(I)	0.00	1.00	0.92	0.00	1.00	1.00
Uniform Delay (d), s/veh	0.0	29.2	30.4	0.0	6.1	4.2
Incr Delay (d2), s/veh	0.0	0.6	2.2	0.0	1.8	0.2
Initial Q Delay(d3),s/veh	0.0	0.0	0.0	0.0	0.0	0.0
%ile BackOfQ(50%),veh/ln	0.0	3.4	4.8	0.0	4.5	0.6
Unsig. Movement Delay, s/veh						
LnGrp Delay(d),s/veh	0.0	29.8	32.5	0.0	7.8	4.4
LnGrp LOS	A	C	C	A	A	A
Approach Vol, veh/h		586	526		733	
Approach Delay, s/veh		29.8	32.5		7.3	
Approach LOS		C	C		A	
Timer - Assigned Phs				4	6	8
Phs Duration (G+Y+Rc), s				20.3	59.7	20.3
Change Period (Y+Rc), s				4.5	4.5	4.5
Max Green Setting (Gmax), s				22.5	48.5	22.5
Max Q Clear Time (g_c+I1), s				10.6	16.4	13.5
Green Ext Time (p_c), s				3.1	2.7	2.3
Intersection Summary						
HCM 6th Ctrl Delay			21.6			
HCM 6th LOS			C			

HCM 6th Signalized Intersection Summary

46: Madera Avenue & SR-99 Northbound Ramps

Village D Specific Plan
Phase II NP - AM Peak Hour



Movement	EBL	EBT	EBR	WBL	WBT	WBR	NBL	NBT	NBR	SBL	SBT	SBR
Lane Configurations				↶ ↷	↶ ↷	↶ ↷	↶ ↷	↶ ↷			↶ ↷	
Traffic Volume (veh/h)	0	0	0	195	2	96	560	430	0	0	652	234
Future Volume (veh/h)	0	0	0	195	2	96	560	430	0	0	652	234
Initial Q (Qb), veh				0	0	0	0	0	0	0	0	0
Ped-Bike Adj(A_pbT)				1.00		0.98	1.00		1.00	1.00		0.97
Parking Bus, Adj				1.00	1.00	1.00	1.00	1.00	1.00	1.00	1.00	1.00
Work Zone On Approach				No			No			No		
Adj Sat Flow, veh/h/ln				1826	1826	1826	1796	1796	0	0	1841	1841
Adj Flow Rate, veh/h				213	0	104	609	467	0	0	709	254
Peak Hour Factor				0.92	0.92	0.92	0.92	0.92	0.92	0.92	0.92	0.92
Percent Heavy Veh, %				5	5	5	7	7	0	0	4	4
Cap, veh/h				353	0	154	1157	2683	0	0	952	341
Arrive On Green				0.10	0.00	0.10	0.58	1.00	0.00	0.00	0.38	0.38
Sat Flow, veh/h				3478	0	1519	3319	3503	0	0	2590	895
Grp Volume(v), veh/h				213	0	104	609	467	0	0	496	467
Grp Sat Flow(s),veh/h/ln				1739	0	1519	1659	1706	0	0	1749	1644
Q Serve(g_s), s				4.7	0.0	5.3	8.8	0.0	0.0	0.0	19.6	19.6
Cycle Q Clear(g_c), s				4.7	0.0	5.3	8.8	0.0	0.0	0.0	19.6	19.6
Prop In Lane				1.00		1.00	1.00		0.00	0.00		0.54
Lane Grp Cap(c), veh/h				353	0	154	1157	2683	0	0	667	627
V/C Ratio(X)				0.60	0.00	0.68	0.53	0.17	0.00	0.00	0.74	0.74
Avail Cap(c_a), veh/h				804	0	351	1157	2683	0	0	667	627
HCM Platoon Ratio				1.00	1.00	1.00	1.67	1.67	1.00	1.00	1.00	1.00
Upstream Filter(I)				1.00	0.00	1.00	0.85	0.85	0.00	0.00	1.00	1.00
Uniform Delay (d), s/veh				34.4	0.0	34.7	12.7	0.0	0.0	0.0	21.4	21.4
Incr Delay (d2), s/veh				1.7	0.0	5.1	0.4	0.1	0.0	0.0	7.4	7.8
Initial Q Delay(d3),s/veh				0.0	0.0	0.0	0.0	0.0	0.0	0.0	0.0	0.0
%ile BackOfQ(50%),veh/ln				2.0	0.0	2.1	2.6	0.0	0.0	0.0	8.9	8.4
Unsig. Movement Delay, s/veh												
LnGrp Delay(d),s/veh				36.1	0.0	39.8	13.1	0.1	0.0	0.0	28.8	29.2
LnGrp LOS				D	A	D	B	A	A	A	C	C
Approach Vol, veh/h					317			1076			963	
Approach Delay, s/veh					37.3			7.5			29.0	
Approach LOS					D			A			C	
Timer - Assigned Phs		2			5	6		8				
Phs Duration (G+Y+Rc), s		67.4			32.4	35.0		12.6				
Change Period (Y+Rc), s		4.5			4.5	4.5		4.5				
Max Green Setting (Gmax), s		52.5			17.5	30.5		18.5				
Max Q Clear Time (g_c+I1), s		2.0			10.8	21.6		7.3				
Green Ext Time (p_c), s		3.6			1.4	4.2		0.8				

Intersection Summary

HCM 6th Ctrl Delay	20.3
HCM 6th LOS	C

Notes

User approved volume balancing among the lanes for turning movement.

HCM 6th Signalized Intersection Summary

47: Madera Avenue & Olive Avenue/SR-99 Southbound On-Ramp

Village D Specific Plan
Phase II NP - AM Peak Hour



Movement	EBL	EBT	EBR	WBL	WBT	WBR	NBL	NBT	NBR	SBL	SBT	SBR
Lane Configurations												
Traffic Volume (veh/h)	379	199	550	0	0	0	170	612	42	87	436	324
Future Volume (veh/h)	379	199	550	0	0	0	170	612	42	87	436	324
Initial Q (Qb), veh	0	0	0				0	0	0	0	0	0
Ped-Bike Adj(A_pbT)	1.00		1.00				1.00		0.99	1.00		0.99
Parking Bus, Adj	1.00	1.00	1.00				1.00	1.00	1.00	1.00	1.00	1.00
Work Zone On Approach		No					No			No		
Adj Sat Flow, veh/h/ln	1811	1811	1811				1781	1781	1781	1841	1841	1841
Adj Flow Rate, veh/h	304	342	579				179	644	44	92	459	341
Peak Hour Factor	0.95	0.95	0.95				0.95	0.95	0.95	0.95	0.95	0.95
Percent Heavy Veh, %	6	6	6				8	8	8	4	4	4
Cap, veh/h	593	623	652				266	1348	92	119	775	573
Arrive On Green	0.11	0.11	0.11				0.08	0.42	0.42	0.02	0.13	0.13
Sat Flow, veh/h	1725	1811	1535				3291	3212	219	1753	1905	1410
Grp Volume(v), veh/h	304	342	579				179	339	349	92	421	379
Grp Sat Flow(s),veh/h/ln	1725	1811	1535				1646	1692	1739	1753	1749	1566
Q Serve(g_s), s	13.3	14.3	26.8				4.2	11.6	11.7	4.2	18.1	18.2
Cycle Q Clear(g_c), s	13.3	14.3	26.8				4.2	11.6	11.7	4.2	18.1	18.2
Prop In Lane	1.00		1.00				1.00		0.13	1.00		0.90
Lane Grp Cap(c), veh/h	593	623	652				266	710	730	119	711	637
V/C Ratio(X)	0.51	0.55	0.89				0.67	0.48	0.48	0.77	0.59	0.60
Avail Cap(c_a), veh/h	593	623	652				638	710	730	217	711	637
HCM Platoon Ratio	0.33	0.33	0.33				1.00	1.00	1.00	0.33	0.33	0.33
Upstream Filter(I)	0.82	0.82	0.82				1.00	1.00	1.00	0.78	0.78	0.78
Uniform Delay (d), s/veh	29.2	29.6	28.3				35.7	16.8	16.9	38.5	28.4	28.4
Incr Delay (d2), s/veh	0.6	0.8	12.0				2.9	2.3	2.2	8.1	2.8	3.2
Initial Q Delay(d3),s/veh	0.0	0.0	0.0				0.0	0.0	0.0	0.0	0.0	0.0
%ile BackOfQ(50%),veh/ln	6.2	7.0	25.0				1.8	4.7	4.8	2.1	8.9	8.1
Unsig. Movement Delay, s/veh												
LnGrp Delay(d),s/veh	29.8	30.4	40.3				38.7	19.1	19.1	46.6	31.2	31.6
LnGrp LOS	C	C	D				D	B	B	D	C	C
Approach Vol, veh/h		1225						867			892	
Approach Delay, s/veh		34.9						23.2			33.0	
Approach LOS		C						C			C	
Timer - Assigned Phs	1	2		4	5	6						
Phs Duration (G+Y+Rc), s	9.9	38.1		32.0	11.0	37.0						
Change Period (Y+Rc), s	4.5	4.5		4.5	4.5	4.5						
Max Green Setting (Gmax), s	29.1			27.5	15.5	23.5						
Max Q Clear Time (g_c+1), s	13.7			28.8	6.2	20.2						
Green Ext Time (p_c), s	0.1	3.9		0.0	0.4	1.6						

Intersection Summary

HCM 6th Ctrl Delay	30.9
HCM 6th LOS	C

Notes

User approved volume balancing among the lanes for turning movement.

Intersection						
Int Delay, s/veh	0.3					
Movement	WBL	WBR	NBT	NBR	SBL	SBT
Lane Configurations	↔		↑↓		↔	↑↑
Traffic Vol, veh/h	9	8	848	8	32	1109
Future Vol, veh/h	9	8	848	8	32	1109
Conflicting Peds, #/hr	0	0	0	8	8	0
Sign Control	Stop	Stop	Free	Free	Free	Free
RT Channelized	-	None	-	None	-	None
Storage Length	0	-	-	-	100	-
Veh in Median Storage, #	0	-	0	-	-	0
Grade, %	0	-	0	-	-	0
Peak Hour Factor	97	97	97	97	97	97
Heavy Vehicles, %	12	12	6	6	6	6
Mvmt Flow	9	8	874	8	33	1143

Major/Minor	Minor1	Major1	Major2			
Conflicting Flow All	1524	449	0	0	890	0
Stage 1	886	-	-	-	-	-
Stage 2	638	-	-	-	-	-
Critical Hdwy	7.04	7.14	-	-	4.22	-
Critical Hdwy Stg 1	6.04	-	-	-	-	-
Critical Hdwy Stg 2	6.04	-	-	-	-	-
Follow-up Hdwy	3.62	3.42	-	-	2.26	-
Pot Cap-1 Maneuver	*278	531	-	-	732	-
Stage 1	*340	-	-	-	-	-
Stage 2	*589	-	-	-	-	-
Platoon blocked, %	1	-	-	-	-	-
Mov Cap-1 Maneuver	*263	527	-	-	726	-
Mov Cap-2 Maneuver	*294	-	-	-	-	-
Stage 1	*337	-	-	-	-	-
Stage 2	*562	-	-	-	-	-

Approach	WB	NB	SB
HCM Control Delay, s	15.2	0	0.3
HCM LOS	C		

Minor Lane/Major Mvmt	NBT	NBRWBLn1	SBL	SBT
Capacity (veh/h)	-	-	371	726
HCM Lane V/C Ratio	-	-	0.047	0.045
HCM Control Delay (s)	-	-	15.2	10.2
HCM Lane LOS	-	-	C	B
HCM 95th %tile Q(veh)	-	-	0.1	0.1

Notes
 -: Volume exceeds capacity \$: Delay exceeds 300s +: Computation Not Defined *: All major volume in platoon

HCM 6th Signalized Intersection Summary
 49: Yosemite Avenue & Cleveland Avenue/Tozer Street

Village D Specific Plan
 Phase II NP - AM Peak Hour



Movement	EBL	EBT	EBR	WBL	WBT	WBR	NBL	NBT	NBR	SBL	SBT	SBR
Lane Configurations	↖	↗		↖	↗	↗	↖	↗	↗	↖	↗	↗
Traffic Volume (veh/h)	195	525	256	114	329	54	138	126	77	73	256	207
Future Volume (veh/h)	195	525	256	114	329	54	138	126	77	73	256	207
Initial Q (Qb), veh	0	0	0	0	0	0	0	0	0	0	0	0
Ped-Bike Adj(A_pbT)	1.00		0.92	1.00		0.93	1.00		1.00	1.00		1.00
Parking Bus, Adj	1.00	1.00	1.00	1.00	1.00	1.00	1.00	1.00	1.00	1.00	1.00	1.00
Work Zone On Approach		No			No			No			No	
Adj Sat Flow, veh/h/ln	1856	1856	1856	1841	1841	1841	1856	1856	1856	1870	1870	1870
Adj Flow Rate, veh/h	212	571	278	124	358	59	150	137	84	79	278	225
Peak Hour Factor	0.92	0.92	0.92	0.92	0.92	0.92	0.92	0.92	0.92	0.92	0.92	0.92
Percent Heavy Veh, %	3	3	3	4	4	4	3	3	3	2	2	2
Cap, veh/h	250	741	360	153	974	403	171	599	506	102	271	219
Arrive On Green	0.14	0.33	0.33	0.09	0.28	0.28	0.10	0.32	0.32	0.06	0.28	0.28
Sat Flow, veh/h	1767	2229	1083	1753	3497	1448	1767	1856	1568	1781	955	773
Grp Volume(v), veh/h	212	451	398	124	358	59	150	137	84	79	0	503
Grp Sat Flow(s),veh/h/ln	1767	1763	1549	1753	1749	1448	1767	1856	1568	1781	0	1728
Q Serve(g_s), s	10.5	20.7	20.7	6.3	7.4	2.8	7.5	4.9	3.4	3.9	0.0	25.5
Cycle Q Clear(g_c), s	10.5	20.7	20.7	6.3	7.4	2.8	7.5	4.9	3.4	3.9	0.0	25.5
Prop In Lane	1.00		0.70	1.00		1.00	1.00		1.00	1.00		0.45
Lane Grp Cap(c), veh/h	250	586	515	153	974	403	171	599	506	102	0	490
V/C Ratio(X)	0.85	0.77	0.77	0.81	0.37	0.15	0.88	0.23	0.17	0.78	0.00	1.03
Avail Cap(c_a), veh/h	355	586	515	158	974	403	171	599	506	184	0	490
HCM Platoon Ratio	1.00	1.00	1.00	1.00	1.00	1.00	1.00	1.00	1.00	1.00	1.00	1.00
Upstream Filter(I)	1.00	1.00	1.00	1.00	1.00	1.00	1.00	1.00	1.00	1.00	0.00	1.00
Uniform Delay (d), s/veh	37.7	27.0	27.0	40.3	26.1	24.4	40.1	22.3	21.8	41.9	0.0	32.3
Incr Delay (d2), s/veh	12.4	9.4	10.7	25.3	1.1	0.8	36.8	0.2	0.2	11.8	0.0	47.8
Initial Q Delay(d3),s/veh	0.0	0.0	0.0	0.0	0.0	0.0	0.0	0.0	0.0	0.0	0.0	0.0
%ile BackOfQ(50%),veh/ln	5.3	9.9	8.9	3.7	3.2	1.0	5.0	2.1	1.3	2.0	0.0	16.8
Unsig. Movement Delay, s/veh												
LnGrp Delay(d),s/veh	50.1	36.4	37.7	65.7	27.2	25.2	76.9	22.5	22.0	53.6	0.0	80.0
LnGrp LOS	D	D	D	E	C	C	E	C	C	D	A	F
Approach Vol, veh/h		1061			541			371			582	
Approach Delay, s/veh		39.6			35.8			44.4			76.5	
Approach LOS		D			D			D			E	
Timer - Assigned Phs	1	2	3	4	5	6	7	8				
Phs Duration (G+Y+Rc), s	17.2	29.6	9.6	33.6	12.4	34.4	13.2	30.0				
Change Period (Y+Rc), s	4.5	4.5	4.5	4.5	4.5	4.5	4.5	4.5				
Max Green Setting (Gmax), s	18.1	19.7	9.3	24.9	8.1	29.7	8.7	25.5				
Max Q Clear Time (g_c+I1), s	12.5	9.4	5.9	6.9	8.3	22.7	9.5	27.5				
Green Ext Time (p_c), s	0.3	1.8	0.0	0.9	0.0	3.1	0.0	0.0				

Intersection Summary

HCM 6th Ctrl Delay	47.9
HCM 6th LOS	D

Intersection						
Int Delay, s/veh	0					
Movement	EBT	EBR	WBL	WBT	NBL	NBR
Lane Configurations						
Traffic Vol, veh/h	44	0	0	30	0	0
Future Vol, veh/h	44	0	0	30	0	0
Conflicting Peds, #/hr	0	0	0	0	0	0
Sign Control	Free	Free	Free	Free	Stop	Stop
RT Channelized	-	None	-	None	-	None
Storage Length	-	-	-	-	-	-
Veh in Median Storage, #	0	-	-	0	0	-
Grade, %	0	-	-	0	0	-
Peak Hour Factor	92	92	92	92	92	92
Heavy Vehicles, %	15	15	15	15	0	0
Mvmt Flow	48	0	0	33	0	0

Major/Minor	Major1	Major2	Minor1		
Conflicting Flow All	0	0	48	0	81
Stage 1	-	-	-	-	48
Stage 2	-	-	-	-	33
Critical Hdwy	-	-	4.25	-	6.4
Critical Hdwy Stg 1	-	-	-	-	5.4
Critical Hdwy Stg 2	-	-	-	-	5.4
Follow-up Hdwy	-	-	2.335	-	3.5
Pot Cap-1 Maneuver	-	-	1480	-	926
Stage 1	-	-	-	-	980
Stage 2	-	-	-	-	995
Platoon blocked, %	-	-	-	-	-
Mov Cap-1 Maneuver	-	-	1480	-	926
Mov Cap-2 Maneuver	-	-	-	-	926
Stage 1	-	-	-	-	980
Stage 2	-	-	-	-	995

Approach	EB	WB	NB
HCM Control Delay, s	0	0	0
HCM LOS			A

Minor Lane/Major Mvmt	NBLn1	EBT	EBR	WBL	WBT
Capacity (veh/h)	-	-	-	1480	-
HCM Lane V/C Ratio	-	-	-	-	-
HCM Control Delay (s)	0	-	-	0	-
HCM Lane LOS	A	-	-	A	-
HCM 95th %tile Q(veh)	-	-	-	0	-

Intersection												
Int Delay, s/veh	0.6											
Movement	EBL	EBT	EBR	WBL	WBT	WBR	NBL	NBT	NBR	SBL	SBT	SBR
Lane Configurations		↕			↕			↕			↕	
Traffic Vol, veh/h	0	47	2	0	34	0	0	0	3	3	0	0
Future Vol, veh/h	0	47	2	0	34	0	0	0	3	3	0	0
Conflicting Peds, #/hr	0	0	0	0	0	0	0	0	0	0	0	0
Sign Control	Free	Free	Free	Free	Free	Free	Stop	Stop	Stop	Stop	Stop	Stop
RT Channelized	-	-	None	-	-	None	-	-	None	-	-	None
Storage Length	-	-	-	-	-	-	-	-	-	-	-	-
Veh in Median Storage, #	-	0	-	-	0	-	-	0	-	-	0	-
Grade, %	-	0	-	-	0	-	-	0	-	-	0	-
Peak Hour Factor	92	92	92	92	92	92	92	92	92	92	92	92
Heavy Vehicles, %	11	11	11	11	11	11	0	0	0	0	0	0
Mvmt Flow	0	51	2	0	37	0	0	0	3	3	0	0

Major/Minor	Major1		Major2		Minor1		Minor2					
Conflicting Flow All	37	0	0	53	0	0	89	89	52	91	90	37
Stage 1	-	-	-	-	-	-	52	52	-	37	37	-
Stage 2	-	-	-	-	-	-	37	37	-	54	53	-
Critical Hdwy	4.21	-	-	4.21	-	-	7.1	6.5	6.2	7.1	6.5	6.2
Critical Hdwy Stg 1	-	-	-	-	-	-	6.1	5.5	-	6.1	5.5	-
Critical Hdwy Stg 2	-	-	-	-	-	-	6.1	5.5	-	6.1	5.5	-
Follow-up Hdwy	2.299	-	-	2.299	-	-	3.5	4	3.3	3.5	4	3.3
Pot Cap-1 Maneuver	1517	-	-	1497	-	-	901	805	1021	898	804	1041
Stage 1	-	-	-	-	-	-	966	856	-	984	868	-
Stage 2	-	-	-	-	-	-	984	868	-	963	855	-
Platoon blocked, %		-	-	-	-	-						
Mov Cap-1 Maneuver	1517	-	-	1497	-	-	901	805	1021	895	804	1041
Mov Cap-2 Maneuver	-	-	-	-	-	-	901	805	-	895	804	-
Stage 1	-	-	-	-	-	-	966	856	-	984	868	-
Stage 2	-	-	-	-	-	-	984	868	-	960	855	-

Approach	EB	WB	NB	SB
HCM Control Delay, s	0	0	8.5	9
HCM LOS			A	A

Minor Lane/Major Mvmt	NBLn1	EBL	EBT	EBR	WBL	WBT	WBR	SBLn1
Capacity (veh/h)	1021	1517	-	-	1497	-	-	895
HCM Lane V/C Ratio	0.003	-	-	-	-	-	-	0.004
HCM Control Delay (s)	8.5	0	-	-	0	-	-	9
HCM Lane LOS	A	A	-	-	A	-	-	A
HCM 95th %tile Q(veh)	0	0	-	-	0	-	-	0

Intersection						
Int Delay, s/veh	4.8					
Movement	WBL	WBR	NBT	NBR	SBL	SBT
Lane Configurations						
Traffic Vol, veh/h	1	1	0	2	1	0
Future Vol, veh/h	1	1	0	2	1	0
Conflicting Peds, #/hr	0	0	0	0	0	0
Sign Control	Stop	Stop	Free	Free	Free	Free
RT Channelized	-	None	-	None	-	None
Storage Length	-	-	-	-	-	-
Veh in Median Storage, #	0	-	0	-	-	0
Grade, %	0	-	0	-	-	0
Peak Hour Factor	92	92	92	92	92	92
Heavy Vehicles, %	0	0	0	0	0	0
Mvmt Flow	1	1	0	2	1	0

Major/Minor	Minor1	Major1	Major2			
Conflicting Flow All	3	1	0	0	2	0
Stage 1	1	-	-	-	-	-
Stage 2	2	-	-	-	-	-
Critical Hdwy	6.4	6.2	-	-	4.1	-
Critical Hdwy Stg 1	5.4	-	-	-	-	-
Critical Hdwy Stg 2	5.4	-	-	-	-	-
Follow-up Hdwy	3.5	3.3	-	-	2.2	-
Pot Cap-1 Maneuver	1025	1090	-	-	1634	-
Stage 1	1028	-	-	-	-	-
Stage 2	1026	-	-	-	-	-
Platoon blocked, %			-	-		-
Mov Cap-1 Maneuver	1024	1090	-	-	1634	-
Mov Cap-2 Maneuver	1024	-	-	-	-	-
Stage 1	1028	-	-	-	-	-
Stage 2	1025	-	-	-	-	-

Approach	WB	NB	SB
HCM Control Delay, s	8.4	0	7.2
HCM LOS	A		

Minor Lane/Major Mvmt	NBT	NBRWBLn1	SBL	SBT
Capacity (veh/h)	-	-	1056	1634
HCM Lane V/C Ratio	-	-	0.002	0.001
HCM Control Delay (s)	-	-	8.4	7.2
HCM Lane LOS	-	-	A	A
HCM 95th %tile Q(veh)	-	-	0	0

Intersection						
Int Delay, s/veh	0					
Movement	EBL	EBR	NBL	NBT	SBT	SBR
Lane Configurations	T			T		
Traffic Vol, veh/h	0	0	0	277	270	0
Future Vol, veh/h	0	0	0	277	270	0
Conflicting Peds, #/hr	0	0	0	0	0	0
Sign Control	Stop	Stop	Free	Free	Free	Free
RT Channelized	-	None	-	None	-	None
Storage Length	-	-	-	-	-	-
Veh in Median Storage, #	0	-	-	0	0	-
Grade, %	0	-	-	0	0	-
Peak Hour Factor	92	92	92	92	92	92
Heavy Vehicles, %	0	0	19	19	19	19
Mvmt Flow	0	0	0	301	293	0

Major/Minor	Minor2	Major1		Major2	
Conflicting Flow All	594	293	293	0	0
Stage 1	293	-	-	-	-
Stage 2	301	-	-	-	-
Critical Hdwy	6.4	6.2	4.29	-	-
Critical Hdwy Stg 1	5.4	-	-	-	-
Critical Hdwy Stg 2	5.4	-	-	-	-
Follow-up Hdwy	3.5	3.3	2.371	-	-
Pot Cap-1 Maneuver	471	751	1178	-	-
Stage 1	762	-	-	-	-
Stage 2	755	-	-	-	-
Platoon blocked, %				-	-
Mov Cap-1 Maneuver	471	751	1178	-	-
Mov Cap-2 Maneuver	471	-	-	-	-
Stage 1	762	-	-	-	-
Stage 2	755	-	-	-	-

Approach	EB	NB	SB
HCM Control Delay, s	0	0	0
HCM LOS	A		

Minor Lane/Major Mvmt	NBL	NBT	EBLn1	SBT	SBR
Capacity (veh/h)	1178	-	-	-	-
HCM Lane V/C Ratio	-	-	-	-	-
HCM Control Delay (s)	0	-	0	-	-
HCM Lane LOS	A	-	A	-	-
HCM 95th %tile Q(veh)	0	-	-	-	-

Intersection						
Int Delay, s/veh	0					
Movement	EBL	EBR	NBL	NBT	SBT	SBR
Lane Configurations	T			T		
Traffic Vol, veh/h	0	1	1	275	722	0
Future Vol, veh/h	0	1	1	275	722	0
Conflicting Peds, #/hr	0	0	0	0	0	0
Sign Control	Stop	Stop	Free	Free	Free	Free
RT Channelized	-	None	-	None	-	None
Storage Length	0	-	-	-	-	-
Veh in Median Storage, #	0	-	-	0	0	-
Grade, %	0	-	-	0	0	-
Peak Hour Factor	92	92	92	92	92	92
Heavy Vehicles, %	0	0	17	17	17	17
Mvmt Flow	0	1	1	299	785	0

Major/Minor	Minor2	Major1	Major2			
Conflicting Flow All	1086	785	785	0	-	0
Stage 1	785	-	-	-	-	-
Stage 2	301	-	-	-	-	-
Critical Hdwy	6.4	6.2	4.27	-	-	-
Critical Hdwy Stg 1	5.4	-	-	-	-	-
Critical Hdwy Stg 2	5.4	-	-	-	-	-
Follow-up Hdwy	3.5	3.3	2.353	-	-	-
Pot Cap-1 Maneuver	242	396	771	-	-	-
Stage 1	453	-	-	-	-	-
Stage 2	755	-	-	-	-	-
Platoon blocked, %				-	-	-
Mov Cap-1 Maneuver	242	396	771	-	-	-
Mov Cap-2 Maneuver	242	-	-	-	-	-
Stage 1	452	-	-	-	-	-
Stage 2	755	-	-	-	-	-

Approach	EB	NB	SB
HCM Control Delay, s	14.1	0	0
HCM LOS	B		

Minor Lane/Major Mvmt	NBL	NBT	EBLn1	SBT	SBR
Capacity (veh/h)	771	-	396	-	-
HCM Lane V/C Ratio	0.001	-	0.003	-	-
HCM Control Delay (s)	9.7	0	14.1	-	-
HCM Lane LOS	A	A	B	-	-
HCM 95th %tile Q(veh)	0	-	0	-	-

Intersection						
Int Delay, s/veh	0.1					
Movement	EBT	EBR	WBL	WBT	NBL	NBR
Lane Configurations						
Traffic Vol, veh/h	64	0	0	34	1	0
Future Vol, veh/h	64	0	0	34	1	0
Conflicting Peds, #/hr	0	0	0	0	0	0
Sign Control	Free	Free	Free	Free	Stop	Stop
RT Channelized	-	None	-	None	-	None
Storage Length	-	-	-	-	-	-
Veh in Median Storage, #	0	-	-	0	0	-
Grade, %	0	-	-	0	0	-
Peak Hour Factor	92	92	92	92	92	92
Heavy Vehicles, %	4	4	4	4	0	0
Mvmt Flow	70	0	0	37	1	0

Major/Minor	Major1	Major2	Minor1	Minor2
Conflicting Flow All	0	0	70	107
Stage 1	-	-	-	70
Stage 2	-	-	-	37
Critical Hdwy	-	4.14	-	6.2
Critical Hdwy Stg 1	-	-	-	5.4
Critical Hdwy Stg 2	-	-	-	5.4
Follow-up Hdwy	-	2.236	-	3.3
Pot Cap-1 Maneuver	-	1518	-	998
Stage 1	-	-	-	958
Stage 2	-	-	-	991
Platoon blocked, %	-	-	-	-
Mov Cap-1 Maneuver	-	1518	-	998
Mov Cap-2 Maneuver	-	-	-	895
Stage 1	-	-	-	958
Stage 2	-	-	-	991

Approach	EB	WB	NB
HCM Control Delay, s	0	0	9
HCM LOS			A

Minor Lane/Major Mvmt	NBLn1	EBT	EBR	WBL	WBT
Capacity (veh/h)	895	-	-	1518	-
HCM Lane V/C Ratio	0.001	-	-	-	-
HCM Control Delay (s)	9	-	-	0	-
HCM Lane LOS	A	-	-	A	-
HCM 95th %tile Q(veh)	0	-	-	0	-

Intersection												
Int Delay, s/veh	0.1											
Movement	EBL	EBT	EBR	WBL	WBT	WBR	NBL	NBT	NBR	SBL	SBT	SBR
Lane Configurations		↕			↕			↕			↕	
Traffic Vol, veh/h	0	50	0	0	15	0	0	0	1	0	0	0
Future Vol, veh/h	0	50	0	0	15	0	0	0	1	0	0	0
Conflicting Peds, #/hr	0	0	0	0	0	0	0	0	0	0	0	0
Sign Control	Free	Free	Free	Free	Free	Free	Stop	Stop	Stop	Stop	Stop	Stop
RT Channelized	-	-	None	-	-	None	-	-	None	-	-	None
Storage Length	-	-	-	-	-	-	-	-	-	-	-	-
Veh in Median Storage, #	-	0	-	-	0	-	-	0	-	-	0	-
Grade, %	-	0	-	-	0	-	-	0	-	-	0	-
Peak Hour Factor	92	92	92	92	92	92	92	92	92	92	92	92
Heavy Vehicles, %	13	13	13	13	13	13	0	0	0	0	0	0
Mvmt Flow	0	54	0	0	16	0	0	0	1	0	0	0

Major/Minor	Major1			Major2			Minor1			Minor2		
Conflicting Flow All	16	0	0	54	0	0	70	70	54	71	70	16
Stage 1	-	-	-	-	-	-	54	54	-	16	16	-
Stage 2	-	-	-	-	-	-	16	16	-	55	54	-
Critical Hdwy	4.23	-	-	4.23	-	-	7.1	6.5	6.2	7.1	6.5	6.2
Critical Hdwy Stg 1	-	-	-	-	-	-	6.1	5.5	-	6.1	5.5	-
Critical Hdwy Stg 2	-	-	-	-	-	-	6.1	5.5	-	6.1	5.5	-
Follow-up Hdwy	2.317	-	-	2.317	-	-	3.5	4	3.3	3.5	4	3.3
Pot Cap-1 Maneuver	1533	-	-	1484	-	-	927	824	1019	925	824	1069
Stage 1	-	-	-	-	-	-	963	854	-	1009	886	-
Stage 2	-	-	-	-	-	-	1009	886	-	962	854	-
Platoon blocked, %		-	-		-	-						
Mov Cap-1 Maneuver	1533	-	-	1484	-	-	927	824	1019	924	824	1069
Mov Cap-2 Maneuver	-	-	-	-	-	-	927	824	-	924	824	-
Stage 1	-	-	-	-	-	-	963	854	-	1009	886	-
Stage 2	-	-	-	-	-	-	1009	886	-	961	854	-

Approach	EB			WB			NB			SB		
HCM Control Delay, s	0			0			8.5			0		
HCM LOS							A			A		

Minor Lane/Major Mvmt	NBLn1	EBL	EBT	EBR	WBL	WBT	WBR	SBLn1
Capacity (veh/h)	1019	1533	-	-	1484	-	-	-
HCM Lane V/C Ratio	0.001	-	-	-	-	-	-	-
HCM Control Delay (s)	8.5	0	-	-	0	-	-	0
HCM Lane LOS	A	A	-	-	A	-	-	A
HCM 95th %tile Q(veh)	0	0	-	-	0	-	-	-

Intersection						
Int Delay, s/veh	6.5					
Movement	EBL	EBT	WBT	WBR	SBL	SBR
Lane Configurations		↕	↑	↗	↘	
Traffic Vol, veh/h	7	130	73	109	264	8
Future Vol, veh/h	7	130	73	109	264	8
Conflicting Peds, #/hr	0	0	0	0	0	0
Sign Control	Free	Free	Free	Free	Stop	Stop
RT Channelized	-	None	-	None	-	None
Storage Length	-	-	-	0	0	-
Veh in Median Storage, #	-	0	0	-	0	-
Grade, %	-	0	0	-	0	-
Peak Hour Factor	92	92	92	92	92	92
Heavy Vehicles, %	12	12	58	58	30	30
Mvmt Flow	8	141	79	118	287	9

Major/Minor	Major1	Major2	Minor2		
Conflicting Flow All	197	0	-	0	236 79
Stage 1	-	-	-	-	79 -
Stage 2	-	-	-	-	157 -
Critical Hdwy	4.22	-	-	-	6.7 6.5
Critical Hdwy Stg 1	-	-	-	-	5.7 -
Critical Hdwy Stg 2	-	-	-	-	5.7 -
Follow-up Hdwy	2.308	-	-	-	3.77 3.57
Pot Cap-1 Maneuver	1318	-	-	-	695 909
Stage 1	-	-	-	-	878 -
Stage 2	-	-	-	-	808 -
Platoon blocked, %		-	-	-	
Mov Cap-1 Maneuver	1318	-	-	-	690 909
Mov Cap-2 Maneuver	-	-	-	-	690 -
Stage 1	-	-	-	-	872 -
Stage 2	-	-	-	-	808 -

Approach	EB	WB	SB
HCM Control Delay, s	0.4	0	14
HCM LOS			B

Minor Lane/Major Mvmt	EBL	EBT	WBT	WBR	SBLn1
Capacity (veh/h)	1318	-	-	-	695
HCM Lane V/C Ratio	0.006	-	-	-	0.425
HCM Control Delay (s)	7.7	0	-	-	14
HCM Lane LOS	A	A	-	-	B
HCM 95th %tile Q(veh)	0	-	-	-	2.1

HCM 6th TWSC
 4: Truck Parking Lot/Pistachio Drive & Avenue 18 1/2

Village D Specific Plan
 Phase II NP - PM Peak Hour

Intersection												
Int Delay, s/veh	4.8											
Movement	EBL	EBT	EBR	WBL	WBT	WBR	NBL	NBT	NBR	SBL	SBT	SBR
Lane Configurations		↕			↕	↕		↕			↕	
Traffic Vol, veh/h	12	439	1	6	161	200	2	0	5	165	0	13
Future Vol, veh/h	12	439	1	6	161	200	2	0	5	165	0	13
Conflicting Peds, #/hr	0	0	0	0	0	0	0	0	1	1	0	0
Sign Control	Free	Free	Free	Free	Free	Free	Stop	Stop	Stop	Stop	Stop	Stop
RT Channelized	-	-	None	-	-	None	-	-	None	-	-	None
Storage Length	-	-	-	-	-	50	-	-	-	-	-	-
Veh in Median Storage, #	-	0	-	-	0	-	-	0	-	-	0	-
Grade, %	-	0	-	-	0	-	-	0	-	-	0	-
Peak Hour Factor	93	93	93	93	93	93	93	93	93	93	93	93
Heavy Vehicles, %	23	23	23	26	26	26	71	71	71	5	5	5
Mvmt Flow	13	472	1	6	173	215	2	0	5	177	0	14

Major/Minor	Major1			Major2			Minor1			Minor2		
Conflicting Flow All	388	0	0	473	0	0	799	899	474	687	684	173
Stage 1	-	-	-	-	-	-	499	499	-	185	185	-
Stage 2	-	-	-	-	-	-	300	400	-	502	499	-
Critical Hdwy	4.33	-	-	4.36	-	-	7.81	7.21	6.91	7.15	6.55	6.25
Critical Hdwy Stg 1	-	-	-	-	-	-	6.81	6.21	-	6.15	5.55	-
Critical Hdwy Stg 2	-	-	-	-	-	-	6.81	6.21	-	6.15	5.55	-
Follow-up Hdwy	2.407	-	-	2.434	-	-	4.139	4.639	3.939	3.545	4.045	3.345
Pot Cap-1 Maneuver	1065	-	-	975	-	-	235	217	472	357	367	863
Stage 1	-	-	-	-	-	-	445	445	-	810	741	-
Stage 2	-	-	-	-	-	-	583	498	-	546	539	-
Platoon blocked, %		-	-		-	-						
Mov Cap-1 Maneuver	1065	-	-	975	-	-	227	212	472	346	358	863
Mov Cap-2 Maneuver	-	-	-	-	-	-	227	212	-	346	358	-
Stage 1	-	-	-	-	-	-	437	437	-	796	735	-
Stage 2	-	-	-	-	-	-	569	494	-	530	530	-

Approach	EB	WB	NB	SB
HCM Control Delay, s	0.2	0.1	15.2	25.6
HCM LOS			C	D

Minor Lane/Major Mvmt	NBLn1	EBL	EBT	EBR	WBL	WBT	WBR	SBLn1
Capacity (veh/h)	361	1065	-	-	975	-	-	362
HCM Lane V/C Ratio	0.021	0.012	-	-	0.007	-	-	0.529
HCM Control Delay (s)	15.2	8.4	0	-	8.7	0	-	25.6
HCM Lane LOS	C	A	A	-	A	A	-	D
HCM 95th %tile Q(veh)	0.1	0	-	-	0	-	-	3

Intersection

Int Delay, s/veh 19.6

Movement	EBL	EBT	EBR	WBL	WBT	WBR	NBL	NBT	NBR	SBL	SBT	SBR
Lane Configurations		↑	↑		↑		↑		↑		↕	
Traffic Vol, veh/h	0	397	212	52	201	0	42	0	133	25	122	125
Future Vol, veh/h	0	397	212	52	201	0	42	0	133	25	122	125
Conflicting Peds, #/hr	0	0	0	0	0	0	0	0	0	0	0	0
Sign Control	Free	Free	Free	Free	Free	Free	Stop	Stop	Stop	Stop	Stop	Stop
RT Channelized	-	-	None	-	-	None	-	-	None	-	-	None
Storage Length	-	-	50	-	-	-	0	-	25	-	-	-
Veh in Median Storage, #	-	0	-	-	0	-	-	0	-	-	0	-
Grade, %	-	0	-	-	0	-	-	0	-	-	0	-
Peak Hour Factor	94	94	94	94	94	94	94	94	94	94	94	94
Heavy Vehicles, %	20	20	20	30	30	30	16	16	16	26	26	26
Mvmt Flow	0	422	226	55	214	0	45	0	141	27	130	133

Major/Minor	Major1			Major2			Minor1			Minor2		
Conflicting Flow All	-	0	0	648	0	0	878	-	422	930	972	214
Stage 1	-	-	-	-	-	-	422	-	-	324	324	-
Stage 2	-	-	-	-	-	-	456	-	-	606	648	-
Critical Hdwy	-	-	-	4.4	-	-	7.26	-	6.36	7.36	6.76	6.46
Critical Hdwy Stg 1	-	-	-	-	-	-	6.26	-	-	6.36	5.76	-
Critical Hdwy Stg 2	-	-	-	-	-	-	6.26	-	-	6.36	5.76	-
Follow-up Hdwy	-	-	-	2.47	-	-	3.644	-	3.444	3.734	4.234	3.534
Pot Cap-1 Maneuver	0	-	-	818	-	0	254	0	603	224	230	769
Stage 1	0	-	-	-	-	0	583	0	-	640	609	-
Stage 2	0	-	-	-	-	0	558	0	-	445	431	-
Platoon blocked, %	-	-	-	-	-	-	-	-	-	-	-	-
Mov Cap-1 Maneuver	-	-	-	818	-	-	102	-	603	162	213	769
Mov Cap-2 Maneuver	-	-	-	-	-	-	102	-	-	162	213	-
Stage 1	-	-	-	-	-	-	583	-	-	640	563	-
Stage 2	-	-	-	-	-	-	328	-	-	341	431	-

Approach	EB			WB			NB			SB		
HCM Control Delay, s	0			2			25.4			76.3		
HCM LOS							D			F		

Minor Lane/Major Mvmt	NBLn1	NBLn2	EBT	EBR	WBL	WBT	SBLn1
Capacity (veh/h)	102	603	-	-	818	-	306
HCM Lane V/C Ratio	0.438	0.235	-	-	0.068	-	0.946
HCM Control Delay (s)	65.3	12.8	-	-	9.7	0	76.3
HCM Lane LOS	F	B	-	-	A	A	F
HCM 95th %tile Q(veh)	1.9	0.9	-	-	0.2	-	9.4

Intersection												
Int Delay, s/veh	14.2											
Movement	EBL	EBT	EBR	WBL	WBT	WBR	NBL	NBT	NBR	SBL	SBT	SBR
Lane Configurations	↙	↑			↘			↔				
Traffic Vol, veh/h	214	110	0	0	92	19	190	3	0	0	0	0
Future Vol, veh/h	214	110	0	0	92	19	190	3	0	0	0	0
Conflicting Peds, #/hr	0	0	0	0	0	0	0	0	0	0	0	0
Sign Control	Free	Free	Free	Free	Free	Free	Stop	Stop	Stop	Free	Free	Free
RT Channelized	-	-	None	-	-	None	-	-	None	-	-	None
Storage Length	145	-	-	-	-	-	-	-	-	-	-	-
Veh in Median Storage, #	-	0	-	-	0	-	-	0	-	-	16965	-
Grade, %	-	0	-	-	0	-	-	0	-	-	0	-
Peak Hour Factor	92	92	92	92	92	92	92	92	92	92	92	92
Heavy Vehicles, %	20	20	20	12	12	12	24	24	24	0	0	0
Mvmt Flow	233	120	0	0	100	21	207	3	0	0	0	0

Major/Minor	Major1	Major2	Minor1
Conflicting Flow All	121	0	-
Stage 1	-	-	-
Stage 2	-	-	-
Critical Hdwy	4.3	-	-
Critical Hdwy Stg 1	-	-	-
Critical Hdwy Stg 2	-	-	-
Follow-up Hdwy	2.38	-	-
Pot Cap-1 Maneuver	1362	0	0
Stage 1	-	0	0
Stage 2	-	0	0
Platoon blocked, %	-	-	-
Mov Cap-1 Maneuver	1362	-	-
Mov Cap-2 Maneuver	-	-	-
Stage 1	-	-	-
Stage 2	-	-	-

Approach	EB	WB	NB
HCM Control Delay, s	5.4	0	37.3
HCM LOS			E

Minor Lane/Major Mvmt	NBLn1	EBL	EBT	WBT	WBR
Capacity (veh/h)	312	1362	-	-	-
HCM Lane V/C Ratio	0.672	0.171	-	-	-
HCM Control Delay (s)	37.3	8.2	-	-	-
HCM Lane LOS	E	A	-	-	-
HCM 95th %tile Q(veh)	4.5	0.6	-	-	-

Intersection												
Int Delay, s/veh	4.3											
Movement	EBL	EBT	EBR	WBL	WBT	WBR	NBL	NBT	NBR	SBL	SBT	SBR
Lane Configurations		↕			↕			↕			↕	
Traffic Vol, veh/h	1	51	12	30	26	10	7	82	63	63	220	3
Future Vol, veh/h	1	51	12	30	26	10	7	82	63	63	220	3
Conflicting Peds, #/hr	0	0	0	0	0	0	0	0	0	0	0	0
Sign Control	Stop	Stop	Stop	Stop	Stop	Stop	Free	Free	Free	Free	Free	Free
RT Channelized	-	-	None	-	-	None	-	-	None	-	-	None
Storage Length	-	-	-	-	-	-	-	-	-	-	-	-
Veh in Median Storage, #	-	0	-	-	0	-	-	0	-	-	0	-
Grade, %	-	0	-	-	0	-	-	0	-	-	0	-
Peak Hour Factor	92	92	92	92	92	92	92	92	92	92	92	92
Heavy Vehicles, %	3	3	3	5	5	5	8	8	8	8	8	8
Mvmt Flow	1	55	13	33	28	11	8	89	68	68	239	3

Major/Minor	Minor2		Minor1		Major1		Major2					
Conflicting Flow All	536	550	241	550	517	123	242	0	0	157	0	0
Stage 1	377	377	-	139	139	-	-	-	-	-	-	-
Stage 2	159	173	-	411	378	-	-	-	-	-	-	-
Critical Hdwy	7.13	6.53	6.23	7.15	6.55	6.25	4.18	-	-	4.18	-	-
Critical Hdwy Stg 1	6.13	5.53	-	6.15	5.55	-	-	-	-	-	-	-
Critical Hdwy Stg 2	6.13	5.53	-	6.15	5.55	-	-	-	-	-	-	-
Follow-up Hdwy	3.527	4.027	3.327	3.545	4.045	3.345	2.272	-	-	2.272	-	-
Pot Cap-1 Maneuver	454	441	795	441	458	920	1290	-	-	1387	-	-
Stage 1	642	614	-	857	776	-	-	-	-	-	-	-
Stage 2	841	754	-	612	610	-	-	-	-	-	-	-
Platoon blocked, %								-	-	-	-	-
Mov Cap-1 Maneuver	405	413	795	370	429	920	1290	-	-	1387	-	-
Mov Cap-2 Maneuver	405	413	-	370	429	-	-	-	-	-	-	-
Stage 1	638	579	-	851	771	-	-	-	-	-	-	-
Stage 2	795	749	-	513	575	-	-	-	-	-	-	-

Approach	EB		WB		NB		SB	
HCM Control Delay, s	14.4		15		0.4		1.7	
HCM LOS	B		C					

Minor Lane/Major Mvmt	NBL	NBT	NBR	EBLn1WBLn1	SBL	SBT	SBR
Capacity (veh/h)	1290	-	-	454	433	1387	-
HCM Lane V/C Ratio	0.006	-	-	0.153	0.166	0.049	-
HCM Control Delay (s)	7.8	0	-	14.4	15	7.7	0
HCM Lane LOS	A	A	-	B	C	A	A
HCM 95th %tile Q(veh)	0	-	-	0.5	0.6	0.2	-

Intersection												
Int Delay, s/veh	1.5											
Movement	EBL	EBT	EBR	WBL	WBT	WBR	NBL	NBT	NBR	SBL	SBT	SBR
Lane Configurations		↕			↕			↕			↕	
Traffic Vol, veh/h	24	0	42	0	1	1	12	228	1	2	291	36
Future Vol, veh/h	24	0	42	0	1	1	12	228	1	2	291	36
Conflicting Peds, #/hr	0	0	0	0	0	0	0	0	0	0	0	0
Sign Control	Stop	Stop	Stop	Stop	Stop	Stop	Free	Free	Free	Free	Free	Free
RT Channelized	-	-	None	-	-	None	-	-	None	-	-	None
Storage Length	-	-	-	-	-	-	-	-	-	-	-	-
Veh in Median Storage, #	-	0	-	-	0	-	-	0	-	-	0	-
Grade, %	-	0	-	-	0	-	-	0	-	-	0	-
Peak Hour Factor	95	95	95	95	95	95	95	95	95	95	95	95
Heavy Vehicles, %	6	6	6	50	50	50	8	8	8	9	9	9
Mvmt Flow	25	0	44	0	1	1	13	240	1	2	306	38

Major/Minor	Minor2		Minor1		Major1		Major2					
Conflicting Flow All	597	596	325	618	615	241	344	0	0	241	0	0
Stage 1	329	329	-	267	267	-	-	-	-	-	-	-
Stage 2	268	267	-	351	348	-	-	-	-	-	-	-
Critical Hdwy	7.16	6.56	6.26	7.6	7	6.7	4.18	-	-	4.19	-	-
Critical Hdwy Stg 1	6.16	5.56	-	6.6	6	-	-	-	-	-	-	-
Critical Hdwy Stg 2	6.16	5.56	-	6.6	6	-	-	-	-	-	-	-
Follow-up Hdwy	3.554	4.054	3.354	3.95	4.45	3.75	2.272	-	-	2.281	-	-
Pot Cap-1 Maneuver	409	412	707	340	349	693	1182	-	-	1286	-	-
Stage 1	676	639	-	644	609	-	-	-	-	-	-	-
Stage 2	729	681	-	577	557	-	-	-	-	-	-	-
Platoon blocked, %								-	-	-	-	-
Mov Cap-1 Maneuver	403	406	707	315	344	693	1182	-	-	1286	-	-
Mov Cap-2 Maneuver	403	406	-	315	344	-	-	-	-	-	-	-
Stage 1	667	638	-	636	601	-	-	-	-	-	-	-
Stage 2	717	672	-	540	556	-	-	-	-	-	-	-

Approach	EB	WB	NB	SB
HCM Control Delay, s	12.4	12.9	0.4	0
HCM LOS	B	B		

Minor Lane/Major Mvmt	NBL	NBT	NBR	EBLn1WBLn1	SBL	SBT	SBR
Capacity (veh/h)	1182	-	-	555	460	1286	-
HCM Lane V/C Ratio	0.011	-	-	0.125	0.005	0.002	-
HCM Control Delay (s)	8.1	0	-	12.4	12.9	7.8	0
HCM Lane LOS	A	A	-	B	B	A	A
HCM 95th %tile Q(veh)	0	-	-	0.4	0	0	-

Intersection												
Int Delay, s/veh	3.3											
Movement	EBL	EBT	EBR	WBL	WBT	WBR	NBL	NBT	NBR	SBL	SBT	SBR
Lane Configurations		↕			↕			↕			↕	
Traffic Vol, veh/h	1	0	1	58	0	45	0	154	110	82	231	1
Future Vol, veh/h	1	0	1	58	0	45	0	154	110	82	231	1
Conflicting Peds, #/hr	0	0	0	0	0	0	0	0	0	0	0	0
Sign Control	Stop	Stop	Stop	Stop	Stop	Stop	Free	Free	Free	Free	Free	Free
RT Channelized	-	-	None	-	-	None	-	-	None	-	-	None
Storage Length	-	-	-	-	-	-	-	-	-	-	-	-
Veh in Median Storage, #	-	0	-	-	0	-	-	0	-	-	0	-
Grade, %	-	0	-	-	0	-	-	0	-	-	0	-
Peak Hour Factor	93	93	93	93	93	93	93	93	93	93	93	93
Heavy Vehicles, %	0	0	0	4	4	4	7	7	7	9	9	9
Mvmt Flow	1	0	1	62	0	48	0	166	118	88	248	1

Major/Minor	Minor2		Minor1		Major1		Major2					
Conflicting Flow All	674	709	249	650	650	225	249	0	0	284	0	0
Stage 1	425	425	-	225	225	-	-	-	-	-	-	-
Stage 2	249	284	-	425	425	-	-	-	-	-	-	-
Critical Hdwy	7.1	6.5	6.2	7.14	6.54	6.24	4.17	-	-	4.19	-	-
Critical Hdwy Stg 1	6.1	5.5	-	6.14	5.54	-	-	-	-	-	-	-
Critical Hdwy Stg 2	6.1	5.5	-	6.14	5.54	-	-	-	-	-	-	-
Follow-up Hdwy	3.5	4	3.3	3.536	4.036	3.336	2.263	-	-	2.281	-	-
Pot Cap-1 Maneuver	371	362	795	379	386	809	1288	-	-	1239	-	-
Stage 1	611	590	-	773	714	-	-	-	-	-	-	-
Stage 2	759	680	-	603	583	-	-	-	-	-	-	-
Platoon blocked, %								-	-	-	-	-
Mov Cap-1 Maneuver	327	332	795	355	354	809	1288	-	-	1239	-	-
Mov Cap-2 Maneuver	327	332	-	355	354	-	-	-	-	-	-	-
Stage 1	611	542	-	773	714	-	-	-	-	-	-	-
Stage 2	714	680	-	553	535	-	-	-	-	-	-	-

Approach	EB		WB		NB		SB	
HCM Control Delay, s	12.8		15		0		2.1	
HCM LOS	B		C					

Minor Lane/Major Mvmt	NBL	NBT	NBR	EBLn1	WBLn1	SBL	SBT	SBR
Capacity (veh/h)	1288	-	-	463	470	1239	-	-
HCM Lane V/C Ratio	-	-	-	0.005	0.236	0.071	-	-
HCM Control Delay (s)	0	-	-	12.8	15	8.1	0	-
HCM Lane LOS	A	-	-	B	C	A	A	-
HCM 95th %tile Q(veh)	0	-	-	0	0.9	0.2	-	-

Intersection												
Int Delay, s/veh	1.5											
Movement	EBL	EBT	EBR	WBL	WBT	WBR	NBL	NBT	NBR	SBL	SBT	SBR
Lane Configurations		↕			↕			↕			↕	
Traffic Vol, veh/h	1	2	3	5	3	13	2	244	2	65	226	0
Future Vol, veh/h	1	2	3	5	3	13	2	244	2	65	226	0
Conflicting Peds, #/hr	0	0	0	0	0	0	0	0	0	0	0	0
Sign Control	Stop	Stop	Stop	Stop	Stop	Stop	Free	Free	Free	Free	Free	Free
RT Channelized	-	-	None	-	-	None	-	-	None	-	-	None
Storage Length	-	-	-	-	-	-	-	-	-	-	-	-
Veh in Median Storage, #	-	0	-	-	0	-	-	0	-	-	0	-
Grade, %	-	0	-	-	0	-	-	0	-	-	0	-
Peak Hour Factor	92	92	92	92	92	92	92	92	92	92	92	92
Heavy Vehicles, %	0	0	0	0	0	0	9	9	9	9	9	9
Mvmt Flow	1	2	3	5	3	14	2	265	2	71	246	0

Major/Minor	Minor2		Minor1		Major1		Major2					
Conflicting Flow All	667	659	246	661	658	266	246	0	0	267	0	0
Stage 1	388	388	-	270	270	-	-	-	-	-	-	-
Stage 2	279	271	-	391	388	-	-	-	-	-	-	-
Critical Hdwy	7.1	6.5	6.2	7.1	6.5	6.2	4.19	-	-	4.19	-	-
Critical Hdwy Stg 1	6.1	5.5	-	6.1	5.5	-	-	-	-	-	-	-
Critical Hdwy Stg 2	6.1	5.5	-	6.1	5.5	-	-	-	-	-	-	-
Follow-up Hdwy	3.5	4	3.3	3.5	4	3.3	2.281	-	-	2.281	-	-
Pot Cap-1 Maneuver	375	386	798	379	387	778	1280	-	-	1257	-	-
Stage 1	640	612	-	740	690	-	-	-	-	-	-	-
Stage 2	732	689	-	637	612	-	-	-	-	-	-	-
Platoon blocked, %								-	-	-	-	-
Mov Cap-1 Maneuver	347	360	798	357	361	778	1280	-	-	1257	-	-
Mov Cap-2 Maneuver	347	360	-	357	361	-	-	-	-	-	-	-
Stage 1	639	572	-	739	689	-	-	-	-	-	-	-
Stage 2	714	688	-	591	572	-	-	-	-	-	-	-

Approach	EB		WB		NB		SB	
HCM Control Delay, s	12.4		12		0.1		1.8	
HCM LOS	B		B					

Minor Lane/Major Mvmt	NBL	NBT	NBR	EBLn1	WBLn1	SBL	SBT	SBR
Capacity (veh/h)	1280	-	-	492	538	1257	-	-
HCM Lane V/C Ratio	0.002	-	-	0.013	0.042	0.056	-	-
HCM Control Delay (s)	7.8	0	-	12.4	12	8	0	-
HCM Lane LOS	A	A	-	B	B	A	A	-
HCM 95th %tile Q(veh)	0	-	-	0	0.1	0.2	-	-

Intersection	
Intersection Delay, s/veh	10.3
Intersection LOS	B

Movement	EBL	EBT	EBR	WBL	WBT	WBR	NBL	NBT	NBR	SBL	SBT	SBR
Lane Configurations		↕			↕			↕			↕	
Traffic Vol, veh/h	75	92	35	11	37	61	14	113	22	71	123	40
Future Vol, veh/h	75	92	35	11	37	61	14	113	22	71	123	40
Peak Hour Factor	0.95	0.95	0.95	0.95	0.95	0.95	0.95	0.95	0.95	0.95	0.95	0.95
Heavy Vehicles, %	8	8	8	4	4	4	10	10	10	10	10	10
Mvmt Flow	79	97	37	12	39	64	15	119	23	75	129	42
Number of Lanes	0	1	0	0	1	0	0	1	0	0	1	0

Approach	EB	WB	NB	SB
Opposing Approach	WB	EB	SB	NB
Opposing Lanes	1	1	1	1
Conflicting Approach Left	SB	NB	EB	WB
Conflicting Lanes Left	1	1	1	1
Conflicting Approach Right	NB	SB	WB	EB
Conflicting Lanes Right	1	1	1	1
HCM Control Delay	10.6	9	9.8	10.9
HCM LOS	B	A	A	B

Lane	NBLn1	EBLn1	WBLn1	SBLn1
Vol Left, %	9%	37%	10%	30%
Vol Thru, %	76%	46%	34%	53%
Vol Right, %	15%	17%	56%	17%
Sign Control	Stop	Stop	Stop	Stop
Traffic Vol by Lane	149	202	109	234
LT Vol	14	75	11	71
Through Vol	113	92	37	123
RT Vol	22	35	61	40
Lane Flow Rate	157	213	115	246
Geometry Grp	1	1	1	1
Degree of Util (X)	0.229	0.305	0.161	0.346
Departure Headway (Hd)	5.256	5.267	5.065	5.058
Convergence, Y/N	Yes	Yes	Yes	Yes
Cap	687	687	711	702
Service Time	3.256	3.267	3.075	3.157
HCM Lane V/C Ratio	0.229	0.31	0.162	0.35
HCM Control Delay	9.8	10.6	9	10.9
HCM Lane LOS	A	B	A	B
HCM 95th-tile Q	0.9	1.3	0.6	1.5

Intersection												
Intersection Delay, s/veh	9.7											
Intersection LOS	A											

Movement	EBL	EBT	EBR	WBL	WBT	WBR	NBL	NBT	NBR	SBL	SBT	SBR
Lane Configurations												
Traffic Vol, veh/h	58	157	9	20	86	27	4	41	45	57	47	34
Future Vol, veh/h	58	157	9	20	86	27	4	41	45	57	47	34
Peak Hour Factor	0.92	0.92	0.92	0.92	0.92	0.92	0.92	0.92	0.92	0.92	0.92	0.92
Heavy Vehicles, %	14	14	14	21	21	21	8	8	8	13	13	13
Mvmt Flow	63	171	10	22	93	29	4	45	49	62	51	37
Number of Lanes	1	1	0	1	1	0	0	1	0	0	1	0

Approach	EB	WB	NB	SB
Opposing Approach	WB	EB	SB	NB
Opposing Lanes	2	2	1	1
Conflicting Approach Left	SB	NB	EB	WB
Conflicting Lanes Left	1	1	2	2
Conflicting Approach Right	NB	SB	WB	EB
Conflicting Lanes Right	1	1	2	2
HCM Control Delay	10.2	9.6	8.8	9.7
HCM LOS	B	A	A	A

Lane	NBLn1	EBLn1	EBLn2	WBLn1	WBLn2	SBLn1
Vol Left, %		4%	100%	0%	100%	0%
Vol Thru, %		46%	0%	95%	0%	76%
Vol Right, %		50%	0%	5%	0%	24%
Sign Control		Stop	Stop	Stop	Stop	Stop
Traffic Vol by Lane		90	58	166	20	113
LT Vol		4	58	0	20	0
Through Vol		41	0	157	0	86
RT Vol		45	0	9	0	27
Lane Flow Rate		98	63	180	22	123
Geometry Grp		2	7	7	7	7
Degree of Util (X)		0.135	0.106	0.275	0.038	0.191
Departure Headway (Hd)		4.973	6.032	5.489	6.268	5.595
Convergence, Y/N		Yes	Yes	Yes	Yes	Yes
Cap		715	591	650	567	636
Service Time		3.046	3.805	3.263	4.049	3.375
HCM Lane V/C Ratio		0.137	0.107	0.277	0.039	0.193
HCM Control Delay		8.8	9.5	10.4	9.3	9.7
HCM Lane LOS		A	A	B	A	A
HCM 95th-tile Q		0.5	0.4	1.1	0.1	0.7

HCM 6th TWSC
 13: Airport Drive/Golden State Boulevard & Avenue 17

Village D Specific Plan
 Phase II NP - PM Peak Hour

Intersection												
Int Delay, s/veh	523.6											
Movement	EBL	EBT	EBR	WBL	WBT	WBR	NBL	NBT	NBR	SBL	SBT	SBR
Lane Configurations	↘	↑	↗	↘	↑	↗	↘	↑	↗		↕	
Traffic Vol, veh/h	10	243	30	179	95	230	23	79	305	327	78	10
Future Vol, veh/h	10	243	30	179	95	230	23	79	305	327	78	10
Conflicting Peds, #/hr	0	0	0	0	0	0	0	0	0	0	0	0
Sign Control	Free	Free	Free	Free	Free	Free	Stop	Stop	Stop	Stop	Stop	Stop
RT Channelized	-	-	None	-	-	None	-	-	None	-	-	None
Storage Length	85	-	0	70	-	105	60	-	50	-	-	-
Veh in Median Storage, #	-	0	-	-	0	-	-	0	-	-	0	-
Grade, %	-	0	-	-	0	-	-	0	-	-	0	-
Peak Hour Factor	92	92	92	92	92	92	92	92	92	92	92	92
Heavy Vehicles, %	2	2	2	5	5	5	5	5	5	3	3	3
Mvmt Flow	11	264	33	195	103	250	25	86	332	355	85	11

Major/Minor	Major1			Major2			Minor1			Minor2		
Conflicting Flow All	353	0	0	297	0	0	952	1029	264	1005	812	103
Stage 1	-	-	-	-	-	-	286	286	-	493	493	-
Stage 2	-	-	-	-	-	-	666	743	-	512	319	-
Critical Hdwy	4.12	-	-	4.15	-	-	7.15	6.55	6.25	7.13	6.53	6.23
Critical Hdwy Stg 1	-	-	-	-	-	-	6.15	5.55	-	6.13	5.53	-
Critical Hdwy Stg 2	-	-	-	-	-	-	6.15	5.55	-	6.13	5.53	-
Follow-up Hdwy	2.218	-	-	2.245	-	-	3.545	4.045	3.345	3.527	4.027	3.327
Pot Cap-1 Maneuver	1206	-	-	1247	-	-	236	231	767	~ 219	312	949
Stage 1	-	-	-	-	-	-	715	670	-	556	545	-
Stage 2	-	-	-	-	-	-	444	418	-	543	651	-
Platoon blocked, %		-	-		-	-						
Mov Cap-1 Maneuver	1206	-	-	1247	-	-	154	193	767	~ 72	261	949
Mov Cap-2 Maneuver	-	-	-	-	-	-	154	193	-	~ 72	261	-
Stage 1	-	-	-	-	-	-	709	664	-	551	460	-
Stage 2	-	-	-	-	-	-	302	353	-	~ 266	645	-

Approach	EB	WB	NB	SB
HCM Control Delay, s	0.3	3	19.1	\$ 2007.6
HCM LOS			C	F

Minor Lane/Major Mvmt	NBLn1	NBLn2	NBLn3	EBL	EBT	EBR	WBL	WBT	WBR	SBLn1
Capacity (veh/h)	154	193	767	1206	-	-	1247	-	-	86
HCM Lane V/C Ratio	0.162	0.445	0.432	0.009	-	-	0.156	-	-	5.245
HCM Control Delay (s)	32.9	37.8	13.2	8	-	-	8.4	-	-	\$ 2007.6
HCM Lane LOS	D	E	B	A	-	-	A	-	-	F
HCM 95th %tile Q(veh)	0.6	2.1	2.2	0	-	-	0.6	-	-	49.1

Notes
 -: Volume exceeds capacity \$: Delay exceeds 300s +: Computation Not Defined *: All major volume in platoon

HCM 6th TWSC
 14: Avenue 17 & SR-99 Southbound Off-Ramp

Village D Specific Plan
 Phase II NP - PM Peak Hour

Intersection

Int Delay, s/veh 249.9

Movement	EBL	EBT	WBT	WBR	SBL	SBR
Lane Configurations		↑	↑		↑	↑
Traffic Vol, veh/h	0	878	427	0	435	76
Future Vol, veh/h	0	878	427	0	435	76
Conflicting Peds, #/hr	0	0	0	0	0	0
Sign Control	Free	Free	Free	Free	Stop	Stop
RT Channelized	-	None	-	None	-	None
Storage Length	-	-	-	-	0	610
Veh in Median Storage, #	-	0	0	-	0	-
Grade, %	-	0	0	-	0	-
Peak Hour Factor	92	92	92	92	92	92
Heavy Vehicles, %	4	4	8	8	5	5
Mvmt Flow	0	954	464	0	473	83

Major/Minor	Major1	Major2	Minor2
Conflicting Flow All	-	0	0 1418 464
Stage 1	-	-	- 464 -
Stage 2	-	-	- 954 -
Critical Hdwy	-	-	- 6.45 6.25
Critical Hdwy Stg 1	-	-	- 5.45 -
Critical Hdwy Stg 2	-	-	- 5.45 -
Follow-up Hdwy	-	-	- 3.545 3.345
Pot Cap-1 Maneuver	0	-	0 ~ 149 592
Stage 1	0	-	0 627 -
Stage 2	0	-	0 ~ 369 -
Platoon blocked, %	-	-	
Mov Cap-1 Maneuver	-	-	- ~ 149 592
Mov Cap-2 Maneuver	-	-	- ~ 149 -
Stage 1	-	-	- 627 -
Stage 2	-	-	- ~ 369 -

Approach	EB	WB	SB
HCM Control Delay, s	0	0	\$ 888.1
HCM LOS			F

Minor Lane/Major Mvmt	EBT	WBT	SBLn1	SBLn2
Capacity (veh/h)	-	-	149	592
HCM Lane V/C Ratio	-	-	3.173	0.14
HCM Control Delay (s)	-	-	\$ 1041.2	12.1
HCM Lane LOS	-	-	F	B
HCM 95th %tile Q(veh)	-	-	44.5	0.5

Notes

-: Volume exceeds capacity \$: Delay exceeds 300s +: Computation Not Defined *: All major volume in platoon

HCM 6th TWSC
15: SR-99 Northbound Ramps & Avenue 17

Village D Specific Plan
Phase II NP - PM Peak Hour

Intersection												
Int Delay, s/veh	231.2											
Movement	EBL	EBT	EBR	WBL	WBT	WBR	NBL	NBT	NBR	SBL	SBT	SBR
Lane Configurations	↖	↑			↗			↖	↗			
Traffic Vol, veh/h	141	853	0	0	964	330	163	3	529	0	0	0
Future Vol, veh/h	141	853	0	0	964	330	163	3	529	0	0	0
Conflicting Peds, #/hr	0	0	0	0	0	0	0	0	0	0	0	0
Sign Control	Free	Free	Free	Free	Free	Free	Stop	Stop	Stop	Free	Free	Free
RT Channelized	-	-	None	-	-	None	-	-	None	-	-	None
Storage Length	125	-	-	-	-	-	-	-	50	-	-	-
Veh in Median Storage, #	-	0	-	-	0	-	-	0	-	-	16965	-
Grade, %	-	0	-	-	0	-	-	0	-	-	0	-
Peak Hour Factor	95	95	95	95	95	95	95	95	95	95	95	95
Heavy Vehicles, %	4	4	4	4	4	4	10	10	10	0	0	0
Mvmt Flow	148	898	0	0	1015	347	172	3	557	0	0	0

Major/Minor	Major1	Major2	Minor1
Conflicting Flow All	1362	0	-
Stage 1	-	-	-
Stage 2	-	-	-
Critical Hdwy	4.14	-	-
Critical Hdwy Stg 1	-	-	-
Critical Hdwy Stg 2	-	-	-
Follow-up Hdwy	2.236	-	-
Pot Cap-1 Maneuver	498	-	0
Stage 1	-	-	0
Stage 2	-	-	0
Platoon blocked, %	-	-	-
Mov Cap-1 Maneuver	498	-	-
Mov Cap-2 Maneuver	-	-	-
Stage 1	-	-	-
Stage 2	-	-	-

Approach	EB	WB	NB
HCM Control Delay, s	2.2	0	\$ 989
HCM LOS			F

Minor Lane/Major Mvmt	NBLn1	NBLn2	EBL	EBT	WBT	WBR
Capacity (veh/h)	25	327	498	-	-	-
HCM Lane V/C Ratio	6.989	1.703	0.298	-	-	-
HCM Control Delay (s)	\$ 3003	\$ 357	15.3	-	-	-
HCM Lane LOS	F	F	C	-	-	-
HCM 95th %tile Q(veh)	21.7	34.7	1.2	-	-	-

Notes
 -: Volume exceeds capacity \$: Delay exceeds 300s +: Computation Not Defined *: All major volume in platoon

HCM 6th Signalized Intersection Summary
 16: Love's Truck Stop Driveway/Driveway & Avenue 17

Village D Specific Plan
 Phase II NP - PM Peak Hour



Movement	EBL	EBT	EBR	WBL	WBT	WBR	NBL	NBT	NBR	SBL	SBT	SBR
Lane Configurations	↖	↗↗	↖	↖	↖		↖	↖		↖	↖	
Traffic Volume (veh/h)	556	676	141	32	603	189	160	0	31	279	0	519
Future Volume (veh/h)	556	676	141	32	603	189	160	0	31	279	0	519
Initial Q (Qb), veh	0	0	0	0	0	0	0	0	0	0	0	0
Ped-Bike Adj(A_pbT)	1.00		1.00	1.00		1.00	1.00		1.00	1.00		1.00
Parking Bus, Adj	1.00	1.00	1.00	1.00	1.00	1.00	1.00	1.00	1.00	1.00	1.00	1.00
Work Zone On Approach		No			No			No			No	
Adj Sat Flow, veh/h/ln	1870	1870	1870	1841	1841	1841	1900	1900	1900	1900	1900	1900
Adj Flow Rate, veh/h	604	735	153	35	655	205	174	0	34	303	0	564
Peak Hour Factor	0.92	0.92	0.92	0.92	0.92	0.92	0.92	0.92	0.92	0.92	0.92	0.92
Percent Heavy Veh, %	2	2	2	4	4	4	0	0	0	0	0	0
Cap, veh/h	393	1882	840	50	454	142	143	0	275	219	0	342
Arrive On Green	0.22	0.53	0.53	0.03	0.34	0.34	0.08	0.00	0.17	0.12	0.00	0.21
Sat Flow, veh/h	1781	3554	1585	1753	1344	421	1810	0	1610	1810	0	1610
Grp Volume(v), veh/h	604	735	153	35	0	860	174	0	34	303	0	564
Grp Sat Flow(s),veh/h/ln	1781	1777	1585	1753	0	1765	1810	0	1610	1810	0	1610
Q Serve(g_s), s	26.5	14.7	6.0	2.4	0.0	40.5	9.5	0.0	2.1	14.5	0.0	25.5
Cycle Q Clear(g_c), s	26.5	14.7	6.0	2.4	0.0	40.5	9.5	0.0	2.1	14.5	0.0	25.5
Prop In Lane	1.00		1.00	1.00		0.24	1.00		1.00	1.00		1.00
Lane Grp Cap(c), veh/h	393	1882	840	50	0	596	143	0	275	219	0	342
V/C Ratio(X)	1.54	0.39	0.18	0.70	0.00	1.44	1.21	0.00	0.12	1.39	0.00	1.65
Avail Cap(c_a), veh/h	393	1882	840	98	0	596	143	0	275	219	0	342
HCM Platoon Ratio	1.00	1.00	1.00	1.00	1.00	1.00	1.00	1.00	1.00	1.00	1.00	1.00
Upstream Filter(I)	1.00	1.00	1.00	1.00	0.00	1.00	1.00	0.00	1.00	1.00	0.00	1.00
Uniform Delay (d), s/veh	46.8	16.7	14.7	57.8	0.0	39.8	55.3	0.0	42.1	52.8	0.0	47.3
Incr Delay (d2), s/veh	253.4	0.1	0.1	15.9	0.0	209.1	144.2	0.0	0.9	199.3	0.0	304.6
Initial Q Delay(d3),s/veh	0.0	0.0	0.0	0.0	0.0	0.0	0.0	0.0	0.0	0.0	0.0	0.0
%ile BackOfQ(50%),veh/ln	39.3	6.0	2.2	1.3	0.0	51.9	10.1	0.0	0.9	18.7	0.0	39.1
Unsig. Movement Delay, s/veh												
LnGrp Delay(d),s/veh	300.2	16.9	14.8	73.6	0.0	248.8	199.5	0.0	43.1	252.1	0.0	351.8
LnGrp LOS	F	B	B	E	A	F	F	A	D	F	A	F
Approach Vol, veh/h		1492			895			208				867
Approach Delay, s/veh		131.3			242.0			173.9				317.0
Approach LOS		F			F			F				F
Timer - Assigned Phs	1	2	3	4	5	6	7	8				
Phs Duration (G+Y+Rc), s	19.0	25.0	7.9	68.1	14.0	30.0	31.0	45.0				
Change Period (Y+Rc), s	4.5	4.5	4.5	4.5	4.5	4.5	4.5	4.5				
Max Green Setting (Gmax), s	14.5	20.5	6.7	60.3	9.5	25.5	26.5	40.5				
Max Q Clear Time (g_c+I1), s	16.5	4.1	4.4	16.7	11.5	27.5	28.5	42.5				
Green Ext Time (p_c), s	0.0	0.1	0.0	6.7	0.0	0.0	0.0	0.0				
Intersection Summary												
HCM 6th Ctrl Delay			209.0									
HCM 6th LOS			F									

Intersection												
Int Delay, s/veh	8.8											
Movement	EBL	EBT	EBR	WBL	WBT	WBR	NBL	NBT	NBR	SBL	SBT	SBR
Lane Configurations	↖	↗		↖	↗		↖	↑	↗	↖	↑	↗
Traffic Vol, veh/h	43	126	27	103	84	26	15	41	92	22	139	18
Future Vol, veh/h	43	126	27	103	84	26	15	41	92	22	139	18
Conflicting Peds, #/hr	0	0	3	3	0	0	0	0	0	0	0	0
Sign Control	Free	Free	Free	Free	Free	Free	Stop	Stop	Stop	Stop	Stop	Stop
RT Channelized	-	-	None	-	-	None	-	-	None	-	-	None
Storage Length	110	-	-	165	-	-	65	-	50	100	-	50
Veh in Median Storage, #	-	0	-	-	0	-	-	0	-	-	0	-
Grade, %	-	0	-	-	0	-	-	0	-	-	0	-
Peak Hour Factor	92	92	92	92	92	92	92	92	92	92	92	92
Heavy Vehicles, %	1	1	1	1	1	1	0	0	0	0	0	0
Mvmt Flow	47	137	29	112	91	28	16	45	100	24	151	20

Major/Minor	Major1			Major2			Minor1			Minor2		
Conflicting Flow All	119	0	0	169	0	0	664	592	155	647	592	105
Stage 1	-	-	-	-	-	-	249	249	-	329	329	-
Stage 2	-	-	-	-	-	-	415	343	-	318	263	-
Critical Hdwy	4.11	-	-	4.11	-	-	7.1	6.5	6.2	7.1	6.5	6.2
Critical Hdwy Stg 1	-	-	-	-	-	-	6.1	5.5	-	6.1	5.5	-
Critical Hdwy Stg 2	-	-	-	-	-	-	6.1	5.5	-	6.1	5.5	-
Follow-up Hdwy	2.209	-	-	2.209	-	-	3.5	4	3.3	3.5	4	3.3
Pot Cap-1 Maneuver	1475	-	-	1415	-	-	377	422	896	387	422	955
Stage 1	-	-	-	-	-	-	759	704	-	688	650	-
Stage 2	-	-	-	-	-	-	619	641	-	698	694	-
Platoon blocked, %	-	-	-	-	-	-	-	-	-	-	-	-
Mov Cap-1 Maneuver	1475	-	-	1411	-	-	233	375	893	287	375	955
Mov Cap-2 Maneuver	-	-	-	-	-	-	233	375	-	287	375	-
Stage 1	-	-	-	-	-	-	732	679	-	666	599	-
Stage 2	-	-	-	-	-	-	417	590	-	561	670	-

Approach	EB			WB			NB			SB		
HCM Control Delay, s	1.7			3.8			12.5			19.4		
HCM LOS							B			C		

Minor Lane/Major Mvmt	NBLn1	NBLn2	NBLn3	EBL	EBT	EBR	WBL	WBT	WBR	SBLn1	SBLn2	SBLn3
Capacity (veh/h)	233	375	893	1475	-	-	1411	-	-	287	375	955
HCM Lane V/C Ratio	0.07	0.119	0.112	0.032	-	-	0.079	-	-	0.083	0.403	0.02
HCM Control Delay (s)	21.6	15.9	9.5	7.5	-	-	7.8	-	-	18.7	20.9	8.8
HCM Lane LOS	C	C	A	A	-	-	A	-	-	C	C	A
HCM 95th %tile Q(veh)	0.2	0.4	0.4	0.1	-	-	0.3	-	-	0.3	1.9	0.1

Intersection	
Intersection Delay, s/veh	10.5
Intersection LOS	B

Movement	EBL	EBT	EBR	WBL	WBT	WBR	NBL	NBT	NBR	SBL	SBT	SBR
Lane Configurations	↶	↷		↶	↷		↶	↷	↷	↶	↷	↶
Traffic Vol, veh/h	7	57	26	73	76	19	46	165	59	21	172	18
Future Vol, veh/h	7	57	26	73	76	19	46	165	59	21	172	18
Peak Hour Factor	0.96	0.96	0.96	0.96	0.96	0.96	0.96	0.96	0.96	0.96	0.96	0.96
Heavy Vehicles, %	0	0	0	0	0	0	0	0	0	0	0	0
Mvmt Flow	7	59	27	76	79	20	48	172	61	22	179	19
Number of Lanes	1	1	0	1	1	0	1	1	1	1	1	1

Approach	EB	WB	NB	SB
Opposing Approach	WB	EB	SB	NB
Opposing Lanes	2	2	3	3
Conflicting Approach Left	SB	NB	EB	WB
Conflicting Lanes Left	3	3	2	2
Conflicting Approach Right	NB	SB	WB	EB
Conflicting Lanes Right	3	3	2	2
HCM Control Delay	10	10.3	10.3	11
HCM LOS	A	B	B	B

Lane	NBLn1	NBLn2	NBLn3	EBLn1	EBLn2	WBLn1	WBLn2	SBLn1	SBLn2	SBLn3
Vol Left, %	100%	0%	0%	100%	0%	100%	0%	100%	0%	0%
Vol Thru, %	0%	100%	0%	0%	69%	0%	80%	0%	100%	0%
Vol Right, %	0%	0%	100%	0%	31%	0%	20%	0%	0%	100%
Sign Control	Stop	Stop	Stop	Stop	Stop	Stop	Stop	Stop	Stop	Stop
Traffic Vol by Lane	46	165	59	7	83	73	95	21	172	18
LT Vol	46	0	0	7	0	73	0	21	0	0
Through Vol	0	165	0	0	57	0	76	0	172	0
RT Vol	0	0	59	0	26	0	19	0	0	18
Lane Flow Rate	48	172	61	7	86	76	99	22	179	19
Geometry Grp	8	8	8	8	8	8	8	8	8	8
Degree of Util (X)	0.086	0.285	0.09	0.014	0.149	0.142	0.167	0.04	0.303	0.028
Departure Headway (Hd)	6.476	5.971	5.264	6.92	6.199	6.71	6.07	6.585	6.08	5.372
Convergence, Y/N	Yes	Yes	Yes	Yes	Yes	Yes	Yes	Yes	Yes	Yes
Cap	553	602	680	517	578	535	591	544	591	666
Service Time	4.211	3.706	2.999	4.667	3.945	4.453	3.812	4.322	3.817	3.11
HCM Lane V/C Ratio	0.087	0.286	0.09	0.014	0.149	0.142	0.168	0.04	0.303	0.029
HCM Control Delay	9.8	11.1	8.5	9.8	10	10.6	10	9.6	11.5	8.3
HCM Lane LOS	A	B	A	A	A	B	A	A	B	A
HCM 95th-tile Q	0.3	1.2	0.3	0	0.5	0.5	0.6	0.1	1.3	0.1

Intersection												
Intersection Delay, s/veh	15											
Intersection LOS	B											

Movement	EBL	EBT	EBR	WBL	WBT	WBR	NBL	NBT	NBR	SBL	SBT	SBR
Lane Configurations		↕			↕			↕			↕	
Traffic Vol, veh/h	62	259	34	23	120	203	14	49	17	130	52	42
Future Vol, veh/h	62	259	34	23	120	203	14	49	17	130	52	42
Peak Hour Factor	0.92	0.92	0.92	0.92	0.92	0.92	0.92	0.92	0.92	0.92	0.92	0.92
Heavy Vehicles, %	6	6	6	6	6	6	0	0	0	0	0	0
Mvmt Flow	67	282	37	25	130	221	15	53	18	141	57	46
Number of Lanes	0	1	0	0	1	0	0	1	0	0	1	0

Approach	EB	WB	NB	SB
Opposing Approach	WB	EB	SB	NB
Opposing Lanes	1	1	1	1
Conflicting Approach Left	SB	NB	EB	WB
Conflicting Lanes Left	1	1	1	1
Conflicting Approach Right	NB	SB	WB	EB
Conflicting Lanes Right	1	1	1	1
HCM Control Delay	16.9	15.1	10.8	13.5
HCM LOS	C	C	B	B

Lane	NBLn1	EBLn1	WBLn1	SBLn1
Vol Left, %	17%	17%	7%	58%
Vol Thru, %	61%	73%	35%	23%
Vol Right, %	21%	10%	59%	19%
Sign Control	Stop	Stop	Stop	Stop
Traffic Vol by Lane	80	355	346	224
LT Vol	14	62	23	130
Through Vol	49	259	120	52
RT Vol	17	34	203	42
Lane Flow Rate	87	386	376	243
Geometry Grp	1	1	1	1
Degree of Util (X)	0.158	0.602	0.558	0.414
Departure Headway (Hd)	6.534	5.616	5.343	6.118
Convergence, Y/N	Yes	Yes	Yes	Yes
Cap	552	637	669	584
Service Time	4.534	3.696	3.425	4.208
HCM Lane V/C Ratio	0.158	0.606	0.562	0.416
HCM Control Delay	10.8	16.9	15.1	13.5
HCM Lane LOS	B	C	C	B
HCM 95th-tile Q	0.6	4	3.5	2

Intersection												
Intersection Delay, s/veh	11											
Intersection LOS	B											

Movement	EBL	EBT	EBR	WBL	WBT	WBR	NBL	NBT	NBR	SBL	SBT	SBR
Lane Configurations		↕			↕	↕		↕	↕		↕	↕
Traffic Vol, veh/h	0	0	0	167	0	111	0	12	118	199	38	0
Future Vol, veh/h	0	0	0	167	0	111	0	12	118	199	38	0
Peak Hour Factor	0.92	0.92	0.92	0.92	0.92	0.92	0.92	0.92	0.92	0.92	0.92	0.92
Heavy Vehicles, %	0	0	0	2	2	2	0	0	0	0	0	0
Mvmt Flow	0	0	0	182	0	121	0	13	128	216	41	0
Number of Lanes	0	1	0	0	1	1	0	1	1	0	1	1

Approach	EB	WB	NB	SB
Opposing Approach	WB	EB	SB	NB
Opposing Lanes	2	1	2	2
Conflicting Approach Left	SB	NB	EB	WB
Conflicting Lanes Left	2	2	1	2
Conflicting Approach Right	NB	SB	WB	EB
Conflicting Lanes Right	2	2	2	1
HCM Control Delay	0	10.4	8.8	12.9
HCM LOS	-	B	A	B

Lane	NBLn1	NBLn2	EBLn1	WBLn1	WBLn2	SBLn1	SBLn2
Vol Left, %	0%	0%	0%	100%	0%	84%	0%
Vol Thru, %	100%	0%	100%	0%	0%	16%	100%
Vol Right, %	0%	100%	0%	0%	100%	0%	0%
Sign Control	Stop	Stop	Stop	Stop	Stop	Stop	Stop
Traffic Vol by Lane	12	118	0	167	111	237	0
LT Vol	0	0	0	167	0	199	0
Through Vol	12	0	0	0	0	38	0
RT Vol	0	118	0	0	111	0	0
Lane Flow Rate	13	128	0	182	121	258	0
Geometry Grp	7	7	6	7	7	7	7
Degree of Util (X)	0.02	0.175	0	0.307	0.164	0.421	0
Departure Headway (Hd)	5.629	4.921	6.145	6.098	4.89	5.881	5.457
Convergence, Y/N	Yes	Yes	Yes	Yes	Yes	Yes	Yes
Cap	631	722	0	586	726	608	0
Service Time	3.411	2.703	4.145	3.874	2.665	3.652	3.229
HCM Lane V/C Ratio	0.021	0.177	0	0.311	0.167	0.424	0
HCM Control Delay	8.5	8.8	9.1	11.6	8.6	12.9	8.2
HCM Lane LOS	A	A	N	B	A	B	N
HCM 95th-tile Q	0.1	0.6	0	1.3	0.6	2.1	0

Intersection	
Intersection Delay, s/veh	37.6
Intersection LOS	E

Movement	EBL	EBT	EBR	WBL	WBT	WBR	NBL	NBT	NBR	SBL	SBT	SBR
Lane Configurations	↵	↕↔		↵	↕↔		↵	↕	↵	↵	↕	↕
Traffic Vol, veh/h	24	151	20	359	197	55	14	245	234	49	317	46
Future Vol, veh/h	24	151	20	359	197	55	14	245	234	49	317	46
Peak Hour Factor	0.94	0.94	0.94	0.94	0.94	0.94	0.94	0.94	0.94	0.94	0.94	0.94
Heavy Vehicles, %	1	1	1	1	1	1	0	0	0	0	0	0
Mvmt Flow	26	161	21	382	210	59	15	261	249	52	337	49
Number of Lanes	1	2	0	1	2	0	1	1	1	1	1	1

Approach	EB	WB	NB	SB
Opposing Approach	WB	EB	SB	NB
Opposing Lanes	3	3	3	3
Conflicting Approach Left	SB	NB	EB	WB
Conflicting Lanes Left	3	3	3	3
Conflicting Approach Right	NB	SB	WB	EB
Conflicting Lanes Right	3	3	3	3
HCM Control Delay	16.2	50.9	25.5	42.5
HCM LOS	C	F	D	E

Lane	NBLn1	NBLn2	NBLn3	EBLn1	EBLn2	EBLn3	WBLn1	WBLn2	WBLn3	SBLn1	SBLn2
Vol Left, %	100%	0%	0%	100%	0%	0%	100%	0%	0%	100%	0%
Vol Thru, %	0%	100%	0%	0%	100%	72%	0%	100%	54%	0%	100%
Vol Right, %	0%	0%	100%	0%	0%	28%	0%	0%	46%	0%	0%
Sign Control	Stop	Stop	Stop	Stop	Stop	Stop	Stop	Stop	Stop	Stop	Stop
Traffic Vol by Lane	14	245	234	24	101	70	359	131	121	49	317
LT Vol	14	0	0	24	0	0	359	0	0	49	0
Through Vol	0	245	0	0	101	50	0	131	66	0	317
RT Vol	0	0	234	0	0	20	0	0	55	0	0
Lane Flow Rate	15	261	249	26	107	75	382	140	128	52	337
Geometry Grp	8	8	8	8	8	8	8	8	8	8	8
Degree of Util (X)	0.04	0.668	0.59	0.076	0.302	0.207	0.994	0.344	0.305	0.143	0.876
Departure Headway (Hd)	9.731	9.231	8.531	10.663	10.163	9.964	9.367	8.867	8.548	9.854	9.354
Convergence, Y/N	Yes	Yes	Yes	Yes	Yes	Yes	Yes	Yes	Yes	Yes	Yes
Cap	368	391	423	335	353	360	386	405	420	364	388
Service Time	7.498	6.998	6.298	8.439	7.939	7.74	7.127	6.627	6.308	7.621	7.121
HCM Lane V/C Ratio	0.041	0.668	0.589	0.078	0.303	0.208	0.99	0.346	0.305	0.143	0.869
HCM Control Delay	12.9	28.8	22.9	14.3	17.3	15.3	75.7	16.2	15	14.3	51.2
HCM Lane LOS	B	D	C	B	C	C	F	C	B	B	F
HCM 95th-tile Q	0.1	4.7	3.7	0.2	1.2	0.8	11.8	1.5	1.3	0.5	8.6

Intersection												
Intersection Delay, s/veh 33.4												
Intersection LOS D												

Movement	EBL	EBT	EBR	WBL	WBT	WBR	NBL	NBT	NBR	SBL	SBT	SBR
Lane Configurations												
Traffic Vol, veh/h	31	118	37	56	156	112	51	280	43	81	336	38
Future Vol, veh/h	31	118	37	56	156	112	51	280	43	81	336	38
Peak Hour Factor	0.93	0.93	0.93	0.93	0.93	0.93	0.93	0.93	0.93	0.93	0.93	0.93
Heavy Vehicles, %	1	1	1	0	0	0	1	1	1	1	1	1
Mvmt Flow	33	127	40	60	168	120	55	301	46	87	361	41
Number of Lanes	1	1	0	1	1	1	1	1	0	1	1	0

Approach	EB	WB	NB	SB
Opposing Approach	WB	EB	SB	NB
Opposing Lanes	3	2	2	2
Conflicting Approach Left SB		NB	EB	WB
Conflicting Lanes Left	2	2	2	3
Conflicting Approach Right NB		SB	WB	EB
Conflicting Lanes Right	2	2	3	2
HCM Control Delay	18.3	16.2	36.8	48.9
HCM LOS	C	C	E	E

Lane	NBLn1	NBLn2	EBLn1	EBLn2	WBLn1	WBLn2	WBLn3	SBLn1	SBLn2
Vol Left, %	100%	0%	100%	0%	100%	0%	0%	100%	0%
Vol Thru, %	0%	87%	0%	76%	0%	100%	0%	0%	90%
Vol Right, %	0%	13%	0%	24%	0%	0%	100%	0%	10%
Sign Control	Stop	Stop	Stop	Stop	Stop	Stop	Stop	Stop	Stop
Traffic Vol by Lane	51	323	31	155	56	156	112	81	374
LT Vol	51	0	31	0	56	0	0	81	0
Through Vol	0	280	0	118	0	156	0	0	336
RT Vol	0	43	0	37	0	0	112	0	38
Lane Flow Rate	55	347	33	167	60	168	120	87	402
Geometry Grp	8	8	8	8	8	8	8	8	8
Degree of Util (X)	0.139	0.823	0.093	0.433	0.16	0.421	0.278	0.215	0.929
Departure Headway (Hd)	9.137	8.527	10.058	9.36	9.564	9.045	8.318	8.902	8.316
Convergence, Y/N	Yes	Yes	Yes	Yes	Yes	Yes	Yes	Yes	Yes
Cap	392	424	356	383	375	398	431	402	434
Service Time	6.904	6.293	7.837	7.138	7.335	6.815	6.088	6.667	6.08
HCM Lane V/C Ratio	0.14	0.818	0.093	0.436	0.16	0.422	0.278	0.216	0.926
HCM Control Delay	13.4	40.5	13.9	19.2	14.2	18.3	14.3	14.1	56.4
HCM Lane LOS	B	E	B	C	B	C	B	B	F
HCM 95th-tile Q	0.5	7.6	0.3	2.1	0.6	2	1.1	0.8	10.5

HCM 6th Signalized Intersection Summary
 23: Avenue 16/Ellis Street & Kennedy Street

Village D Specific Plan
 Phase II NP - PM Peak Hour



Movement	WBL	WBR	NBT	NBR	SBL	SBT
Lane Configurations						
Traffic Volume (veh/h)	150	224	333	299	240	330
Future Volume (veh/h)	150	224	333	299	240	330
Initial Q (Qb), veh	0	0	0	0	0	0
Ped-Bike Adj(A_pbT)	1.00	1.00		1.00	1.00	
Parking Bus, Adj	1.00	1.00	1.00	1.00	1.00	1.00
Work Zone On Approach	No		No		No	
Adj Sat Flow, veh/h/ln	1870	1870	1885	1885	1885	1885
Adj Flow Rate, veh/h	163	243	362	325	261	359
Peak Hour Factor	0.92	0.92	0.92	0.92	0.92	0.92
Percent Heavy Veh, %	2	2	1	1	1	1
Cap, veh/h	228	357	957	848	306	2720
Arrive On Green	0.13	0.13	0.53	0.53	0.17	0.76
Sat Flow, veh/h	1781	2790	1891	1592	1795	3676
Grp Volume(v), veh/h	163	243	361	326	261	359
Grp Sat Flow(s),veh/h/ln	1781	1395	1791	1599	1795	1791
Q Serve(g_s), s	7.0	6.7	9.4	9.6	11.3	2.1
Cycle Q Clear(g_c), s	7.0	6.7	9.4	9.6	11.3	2.1
Prop In Lane	1.00	1.00		1.00	1.00	
Lane Grp Cap(c), veh/h	228	357	954	851	306	2720
V/C Ratio(X)	0.71	0.68	0.38	0.38	0.85	0.13
Avail Cap(c_a), veh/h	501	785	954	851	438	2720
HCM Platoon Ratio	1.00	1.00	1.00	1.00	1.00	1.00
Upstream Filter(I)	0.77	0.77	1.00	1.00	1.00	1.00
Uniform Delay (d), s/veh	33.5	33.3	10.9	11.0	32.2	2.6
Incr Delay (d2), s/veh	3.2	1.8	1.1	1.3	10.7	0.1
Initial Q Delay(d3),s/veh	0.0	0.0	0.0	0.0	0.0	0.0
%ile BackOfQ(50%),veh/ln	3.2	2.3	3.7	3.4	5.7	0.5
Unsig. Movement Delay, s/veh						
LnGrp Delay(d),s/veh	36.7	35.1	12.1	12.3	42.9	2.7
LnGrp LOS	D	D	B	B	D	A
Approach Vol, veh/h	406		687		620	
Approach Delay, s/veh	35.7		12.2		19.6	
Approach LOS	D		B		B	
Timer - Assigned Phs	1	2			6	8
Phs Duration (G+Y+Rc), s	48.1	47.1			65.3	14.7
Change Period (Y+Rc), s	4.5	4.5			4.5	4.5
Max Green Setting (Gmax), s	49.5	24.5			48.5	22.5
Max Q Clear Time (g_c+I), s	11.6	11.6			4.1	9.0
Green Ext Time (p_c), s	0.4	3.7			2.6	1.2
Intersection Summary						
HCM 6th Ctrl Delay			20.4			
HCM 6th LOS			C			

HCM 6th Signalized Intersection Summary
 24: Schnoor Avenue & Kennedy Street

Village D Specific Plan
 Phase II NP - PM Peak Hour



Movement	EBL	EBT	EBR	WBL	WBT	WBR	NBL	NBT	NBR	SBL	SBT	SBR
Lane Configurations												
Traffic Volume (veh/h)	70	234	212	226	179	128	198	64	287	143	51	31
Future Volume (veh/h)	70	234	212	226	179	128	198	64	287	143	51	31
Initial Q (Qb), veh	0	0	0	0	0	0	0	0	0	0	0	0
Ped-Bike Adj(A_pbT)	1.00		0.99	1.00		0.99	1.00		1.00	1.00		1.00
Parking Bus, Adj	1.00	1.00	1.00	1.00	1.00	1.00	1.00	1.00	1.00	1.00	1.00	1.00
Work Zone On Approach		No			No			No			No	
Adj Sat Flow, veh/h/ln	1870	1870	1870	1856	1856	1856	1885	1885	1885	1633	1633	1633
Adj Flow Rate, veh/h	74	249	226	240	190	136	211	68	305	152	54	33
Peak Hour Factor	0.94	0.94	0.94	0.94	0.94	0.94	0.94	0.94	0.94	0.94	0.94	0.94
Percent Heavy Veh, %	2	2	2	3	3	3	1	1	1	18	18	18
Cap, veh/h	209	330	287	282	227	162	675	80	359	255	388	328
Arrive On Green	0.12	0.18	0.18	0.16	0.23	0.23	0.19	0.27	0.27	0.16	0.24	0.24
Sat Flow, veh/h	1781	1792	1560	1767	1001	716	3483	299	1342	1555	1633	1382
Grp Volume(v), veh/h	74	247	228	240	0	326	211	0	373	152	54	33
Grp Sat Flow(s),veh/h/ln	1781	1777	1575	1767	0	1717	1742	0	1642	1555	1633	1382
Q Serve(g_s), s	3.1	10.5	11.1	10.6	0.0	14.5	4.2	0.0	17.2	7.2	2.1	1.5
Cycle Q Clear(g_c), s	3.1	10.5	11.1	10.6	0.0	14.5	4.2	0.0	17.2	7.2	2.1	1.5
Prop In Lane	1.00		0.99	1.00		0.42	1.00		0.82	1.00		1.00
Lane Grp Cap(c), veh/h	209	327	290	282	0	389	675	0	439	255	388	328
V/C Ratio(X)	0.35	0.75	0.79	0.85	0.00	0.84	0.31	0.00	0.85	0.60	0.14	0.10
Avail Cap(c_a), veh/h	209	400	354	364	0	633	675	0	439	255	388	328
HCM Platoon Ratio	1.00	1.00	1.00	1.00	1.00	1.00	1.00	1.00	1.00	1.00	1.00	1.00
Upstream Filter(l)	0.65	0.65	0.65	1.00	0.00	1.00	1.00	0.00	1.00	1.00	1.00	1.00
Uniform Delay (d), s/veh	32.5	30.9	31.1	32.7	0.0	29.5	27.7	0.0	27.8	31.0	24.1	23.8
Incr Delay (d2), s/veh	0.7	4.2	6.2	14.1	0.0	5.3	0.3	0.0	18.2	3.8	0.7	0.6
Initial Q Delay(d3),s/veh	0.0	0.0	0.0	0.0	0.0	0.0	0.0	0.0	0.0	0.0	0.0	0.0
%ile BackOfQ(50%),veh/ln	1.3	4.8	4.6	5.5	0.0	6.3	1.7	0.0	8.7	2.9	0.9	0.5
Unsig. Movement Delay, s/veh												
LnGrp Delay(d),s/veh	33.2	35.1	37.3	46.8	0.0	34.9	27.9	0.0	46.0	34.8	24.8	24.4
LnGrp LOS	C	D	D	D	A	C	C	A	D	C	C	C
Approach Vol, veh/h		549			566			584			239	
Approach Delay, s/veh		35.8			39.9			39.5			31.1	
Approach LOS		D			D			D			C	
Timer - Assigned Phs	1	2	3	4	5	6	7	8				
Phs Duration (G+Y+Rc), s	17.6	25.9	17.3	19.2	20.0	23.5	13.9	22.6				
Change Period (Y+Rc), s	4.5	4.5	4.5	4.5	4.5	4.5	4.5	4.5				
Max Green Setting (Gmax), s	19.2	21.4	16.5	18.0	8.5	19.0	5.0	29.5				
Max Q Clear Time (g_c+19.2), s	19.2	19.2	12.6	13.1	6.2	4.1	5.1	16.5				
Green Ext Time (p_c), s	0.0	0.5	0.3	1.3	0.2	0.3	0.0	1.6				
Intersection Summary												
HCM 6th Ctrl Delay												37.5
HCM 6th LOS												D

HCM 6th TWSC
 25: Kennedy Street/Gateway Drive & SR-99 Southbound Ramps

Village D Specific Plan
 Phase II NP - PM Peak Hour

Intersection						
Int Delay, s/veh	29.7					
Movement	EBL	EBT	WBT	WBR	SBL	SBR
Lane Configurations	↘	↑	↗		↘	↗
Traffic Vol, veh/h	265	411	371	2	135	201
Future Vol, veh/h	265	411	371	2	135	201
Conflicting Peds, #/hr	0	0	0	0	0	0
Sign Control	Free	Free	Free	Free	Stop	Stop
RT Channelized	-	None	-	Free	-	None
Storage Length	140	-	-	-	0	335
Veh in Median Storage, #	-	0	0	-	0	-
Grade, %	-	0	0	-	0	-
Peak Hour Factor	92	92	92	92	92	92
Heavy Vehicles, %	3	3	3	3	4	4
Mvmt Flow	288	447	403	2	147	218

Major/Minor	Major1	Major2	Minor2		
Conflicting Flow All	403	0	-	0	1426 403
Stage 1	-	-	-	-	403 -
Stage 2	-	-	-	-	1023 -
Critical Hdwy	4.13	-	-	-	6.44 6.24
Critical Hdwy Stg 1	-	-	-	-	5.44 -
Critical Hdwy Stg 2	-	-	-	-	5.44 -
Follow-up Hdwy	2.227	-	-	-	3.536 3.336
Pot Cap-1 Maneuver	1150	-	-	0	148 643
Stage 1	-	-	-	0	671 -
Stage 2	-	-	-	0	344 -
Platoon blocked, %		-	-		
Mov Cap-1 Maneuver	1150	-	-	-	~ 111 643
Mov Cap-2 Maneuver	-	-	-	-	~ 111 -
Stage 1	-	-	-	-	503 -
Stage 2	-	-	-	-	344 -

Approach	EB	WB	SB
HCM Control Delay, s	3.6	0	115.2
HCM LOS			F

Minor Lane/Major Mvmt	EBL	EBT	WBT	SBLn1	SBLn2
Capacity (veh/h)	1150	-	-	111	643
HCM Lane V/C Ratio	0.25	-	-	1.322	0.34
HCM Control Delay (s)	9.2	-	-	266.5	13.5
HCM Lane LOS	A	-	-	F	B
HCM 95th %tile Q(veh)	1	-	-	10	1.5

Notes
 -: Volume exceeds capacity \$: Delay exceeds 300s +: Computation Not Defined *: All major volume in platoon

Intersection						
Int Delay, s/veh	3.3					
Movement	EBL	EBT	WBT	WBR	SBL	SBR
Lane Configurations		↕	↕		↕	
Traffic Vol, veh/h	158	388	204	0	0	169
Future Vol, veh/h	158	388	204	0	0	169
Conflicting Peds, #/hr	0	0	0	0	0	0
Sign Control	Free	Free	Free	Free	Stop	Stop
RT Channelized	-	None	-	None	-	None
Storage Length	-	-	-	-	0	-
Veh in Median Storage, #	-	0	0	-	0	-
Grade, %	-	0	0	-	0	-
Peak Hour Factor	92	92	92	92	92	92
Heavy Vehicles, %	3	3	2	2	4	4
Mvmt Flow	172	422	222	0	0	184

Major/Minor	Major1	Major2	Minor2		
Conflicting Flow All	222	0	-	0	988 222
Stage 1	-	-	-	-	222 -
Stage 2	-	-	-	-	766 -
Critical Hdwy	4.13	-	-	-	6.44 6.24
Critical Hdwy Stg 1	-	-	-	-	5.44 -
Critical Hdwy Stg 2	-	-	-	-	5.44 -
Follow-up Hdwy	2.227	-	-	-	3.536 3.336
Pot Cap-1 Maneuver	1341	-	-	-	272 813
Stage 1	-	-	-	-	810 -
Stage 2	-	-	-	-	455 -
Platoon blocked, %		-	-	-	
Mov Cap-1 Maneuver	1341	-	-	-	226 813
Mov Cap-2 Maneuver	-	-	-	-	226 -
Stage 1	-	-	-	-	674 -
Stage 2	-	-	-	-	455 -

Approach	EB	WB	SB
HCM Control Delay, s	2.3	0	10.7
HCM LOS			B

Minor Lane/Major Mvmt	EBL	EBT	WBT	WBR	SBLn1
Capacity (veh/h)	1341	-	-	-	813
HCM Lane V/C Ratio	0.128	-	-	-	0.226
HCM Control Delay (s)	8.1	0	-	-	10.7
HCM Lane LOS	A	A	-	-	B
HCM 95th %tile Q(veh)	0.4	-	-	-	0.9

Intersection						
Int Delay, s/veh	4.1					
Movement	EBL	EBR	NBL	NBT	SBT	SBR
Lane Configurations	↙			↑	↗	
Traffic Vol, veh/h	158	0	0	81	3	168
Future Vol, veh/h	158	0	0	81	3	168
Conflicting Peds, #/hr	0	0	0	0	0	0
Sign Control	Stop	Stop	Free	Free	Free	Free
RT Channelized	-	None	-	None	-	None
Storage Length	0	-	-	-	-	-
Veh in Median Storage, #	0	-	-	0	0	-
Grade, %	0	-	-	0	0	-
Peak Hour Factor	92	92	92	92	92	92
Heavy Vehicles, %	2	2	9	9	4	4
Mvmt Flow	172	0	0	88	3	183

Major/Minor	Minor2	Major1		Major2	
Conflicting Flow All	183	-	-	0	0
Stage 1	95	-	-	-	-
Stage 2	88	-	-	-	-
Critical Hdwy	6.42	-	-	-	-
Critical Hdwy Stg 1	5.42	-	-	-	-
Critical Hdwy Stg 2	5.42	-	-	-	-
Follow-up Hdwy	3.518	-	-	-	-
Pot Cap-1 Maneuver	806	0	0	-	-
Stage 1	929	0	0	-	-
Stage 2	935	0	0	-	-
Platoon blocked, %				-	-
Mov Cap-1 Maneuver	806	-	-	-	-
Mov Cap-2 Maneuver	806	-	-	-	-
Stage 1	929	-	-	-	-
Stage 2	935	-	-	-	-

Approach	EB	NB	SB
HCM Control Delay, s	10.7	0	0
HCM LOS	B		

Minor Lane/Major Mvmt	NBT EBLn1	SBT	SBR
Capacity (veh/h)	- 806	-	-
HCM Lane V/C Ratio	- 0.213	-	-
HCM Control Delay (s)	- 10.7	-	-
HCM Lane LOS	- B	-	-
HCM 95th %tile Q(veh)	- 0.8	-	-

Intersection						
Int Delay, s/veh	0.1					
Movement	EBL	EBT	WBT	WBR	SBL	SBR
Lane Configurations		↶	↷		↶	
Traffic Vol, veh/h	0	388	204	75	3	0
Future Vol, veh/h	0	388	204	75	3	0
Conflicting Peds, #/hr	0	0	0	0	0	0
Sign Control	Free	Free	Free	Free	Stop	Stop
RT Channelized	-	None	-	None	-	None
Storage Length	-	-	-	-	0	-
Veh in Median Storage, #	-	0	0	-	0	-
Grade, %	-	0	0	-	0	-
Peak Hour Factor	92	92	92	92	92	92
Heavy Vehicles, %	4	4	3	3	0	0
Mvmt Flow	0	422	222	82	3	0

























Major/Minor	Major1	Major2	Minor2		
Conflicting Flow All	304	0	-	0	685
Stage 1	-	-	-	-	263
Stage 2	-	-	-	-	422
Critical Hdwy	4.14	-	-	-	6.4
Critical Hdwy Stg 1	-	-	-	-	5.4
Critical Hdwy Stg 2	-	-	-	-	5.4
Follow-up Hdwy	2.236	-	-	-	3.5
Pot Cap-1 Maneuver	1246	-	-	-	417
Stage 1	-	-	-	-	786
Stage 2	-	-	-	-	666
Platoon blocked, %		-	-	-	
Mov Cap-1 Maneuver	1246	-	-	-	417
Mov Cap-2 Maneuver	-	-	-	-	417
Stage 1	-	-	-	-	786
Stage 2	-	-	-	-	666

Approach	EB	WB	SB
HCM Control Delay, s	0	0	13.7
HCM LOS			B

Minor Lane/Major Mvmt	EBL	EBT	WBT	WBR	SBLn1
Capacity (veh/h)	1246	-	-	-	417
HCM Lane V/C Ratio	-	-	-	-	0.008
HCM Control Delay (s)	0	-	-	-	13.7
HCM Lane LOS	A	-	-	-	B
HCM 95th %tile Q(veh)	0	-	-	-	0

HCM 6th Signalized Intersection Summary
29: Schnoor Avenue & Cleveland Avenue

Village D Specific Plan
Phase II NP - PM Peak Hour

												
Movement	EBL	EBT	EBR	WBL	WBT	WBR	NBL	NBT	NBR	SBL	SBT	SBR
Lane Configurations												
Traffic Volume (veh/h)	132	426	47	286	539	119	66	230	155	126	230	104
Future Volume (veh/h)	132	426	47	286	539	119	66	230	155	126	230	104
Initial Q (Qb), veh	0	0	0	0	0	0	0	0	0	0	0	0
Ped-Bike Adj(A_pbT)	1.00		0.97	1.00		0.97	1.00		0.98	1.00		0.99
Parking Bus, Adj	1.00	1.00	1.00	1.00	1.00	1.00	1.00	1.00	1.00	1.00	1.00	1.00
Work Zone On Approach		No			No			No			No	
Adj Sat Flow, veh/h/ln	1885	1885	1885	1885	1885	1885	1885	1885	1885	1885	1885	1885
Adj Flow Rate, veh/h	136	439	48	295	556	123	68	237	160	130	237	107
Peak Hour Factor	0.97	0.97	0.97	0.97	0.97	0.97	0.97	0.97	0.97	0.97	0.97	0.97
Percent Heavy Veh, %	1	1	1	1	1	1	1	1	1	1	1	1
Cap, veh/h	169	630	273	452	758	330	88	776	545	498	1595	708
Arrive On Green	0.09	0.18	0.18	0.13	0.21	0.21	0.05	0.22	0.22	0.28	0.45	0.45
Sat Flow, veh/h	1795	3582	1553	3483	3582	1557	1795	3582	1559	1795	3582	1589
Grp Volume(v), veh/h	136	439	48	295	556	123	68	237	160	130	237	107
Grp Sat Flow(s),veh/h/ln	1795	1791	1553	1742	1791	1557	1795	1791	1559	1795	1791	1589
Q Serve(g_s), s	6.7	10.4	1.9	7.2	13.0	3.2	3.4	5.0	0.0	5.1	3.5	3.6
Cycle Q Clear(g_c), s	6.7	10.4	1.9	7.2	13.0	3.2	3.4	5.0	0.0	5.1	3.5	3.6
Prop In Lane	1.00		1.00	1.00		1.00	1.00		1.00	1.00		1.00
Lane Grp Cap(c), veh/h	169	630	273	452	758	330	88	776	545	498	1595	708
V/C Ratio(X)	0.80	0.70	0.18	0.65	0.73	0.37	0.78	0.31	0.29	0.26	0.15	0.15
Avail Cap(c_a), veh/h	229	1297	563	480	1333	580	110	776	545	498	1595	708
HCM Platoon Ratio	1.00	1.00	1.00	1.00	1.00	1.00	1.00	1.00	1.00	1.00	1.00	1.00
Upstream Filter(I)	1.00	1.00	1.00	0.72	0.72	0.72	1.00	1.00	1.00	1.00	1.00	1.00
Uniform Delay (d), s/veh	40.0	34.8	21.2	37.2	33.1	8.2	42.3	29.6	21.4	25.3	14.8	14.8
Incr Delay (d2), s/veh	13.7	1.4	0.3	2.1	1.0	0.5	23.4	1.0	1.4	0.3	0.2	0.5
Initial Q Delay(d3),s/veh	0.0	0.0	0.0	0.0	0.0	0.0	0.0	0.0	0.0	0.0	0.0	0.0
%ile BackOfQ(50%),veh/ln	3.6	4.6	0.9	3.2	5.6	2.2	2.0	2.2	2.6	2.2	1.4	1.3
Unsig. Movement Delay, s/veh												
LnGrp Delay(d),s/veh	53.7	36.2	21.5	39.3	34.1	8.7	65.7	30.6	22.7	25.6	15.0	15.3
LnGrp LOS	D	D	C	D	C	A	E	C	C	C	B	B
Approach Vol, veh/h		623			974			465			474	
Approach Delay, s/veh		38.9			32.5			33.0			18.0	
Approach LOS		D			C			C			B	
Timer - Assigned Phs	1	2	3	4	5	6	7	8				
Phs Duration (G+Y+Rc), s	29.5	24.0	16.2	20.3	8.9	44.6	13.0	23.6				
Change Period (Y+Rc), s	4.5	4.5	4.5	4.5	4.5	4.5	4.5	4.5				
Max Green Setting (Gmax), s	7.5	19.5	12.4	32.6	5.5	21.5	11.5	33.5				
Max Q Clear Time (g_c+I1), s	7.1	7.0	9.2	12.4	5.4	5.6	8.7	15.0				
Green Ext Time (p_c), s	0.0	1.6	0.3	3.0	0.0	1.6	0.1	4.0				
Intersection Summary												
HCM 6th Ctrl Delay				31.4								
HCM 6th LOS				C								

HCM 6th Signalized Intersection Summary
30: Fairgrounds & Cleveland Avenue

Village D Specific Plan
Phase II NP - PM Peak Hour



Movement	EBL	EBT	EBR	WBL	WBT	WBR	NBL	NBT	NBR	SBL	SBT	SBR
Lane Configurations	↑↑↑			↑↑		↑	↑↑		↑	↑	↑	↑
Traffic Volume (veh/h)	100	542	94	171	642	169	98	43	112	300	35	117
Future Volume (veh/h)	100	542	94	171	642	169	98	43	112	300	35	117
Initial Q (Qb), veh	0	0	0	0	0	0	0	0	0	0	0	0
Ped-Bike Adj(A_pbT)	1.00		0.98	1.00		0.98	1.00		0.98	1.00		1.00
Parking Bus, Adj	1.00	1.00	1.00	1.00	1.00	1.00	1.00	1.00	1.00	1.00	1.00	1.00
Work Zone On Approach	No			No			No			No		
Adj Sat Flow, veh/h/ln	1885	1885	1885	1885	1885	1885	1900	1900	1900	1900	1900	1900
Adj Flow Rate, veh/h	105	571	99	180	676	178	103	100	82	316	37	123
Peak Hour Factor	0.95	0.95	0.95	0.95	0.95	0.95	0.95	0.95	0.95	0.95	0.95	0.95
Percent Heavy Veh, %	1	1	1	1	1	1	0	0	0	0	0	0
Cap, veh/h	110	876	149	217	925	403	670	391	325	498	114	378
Arrive On Green	0.12	0.40	0.40	0.04	0.09	0.09	0.19	0.21	0.21	0.28	0.30	0.30
Sat Flow, veh/h	1795	4414	751	1795	3582	1560	3619	1900	1582	1810	385	1280
Grp Volume(v), veh/h	105	441	229	180	676	178	103	100	82	316	0	160
Grp Sat Flow(s),veh/h/ln	1795	1716	1735	1795	1791	1560	1810	1900	1582	1810	0	1665
Q Serve(g_s), s	5.2	9.4	9.7	9.0	16.6	9.8	2.1	4.0	2.8	13.8	0.0	6.7
Cycle Q Clear(g_c), s	5.2	9.4	9.7	9.0	16.6	9.8	2.1	4.0	2.8	13.8	0.0	6.7
Prop In Lane	1.00		0.43	1.00		1.00	1.00		1.00	1.00		0.77
Lane Grp Cap(c), veh/h	110	681	344	217	925	403	670	391	325	498	0	492
V/C Ratio(X)	0.96	0.65	0.66	0.83	0.73	0.44	0.15	0.26	0.25	0.63	0.00	0.33
Avail Cap(c_a), veh/h	110	1033	522	237	1333	581	670	391	325	498	0	492
HCM Platoon Ratio	2.00	2.00	2.00	0.33	0.33	0.33	1.00	1.00	1.00	1.00	1.00	1.00
Upstream Filter(l)	0.78	0.78	0.78	0.80	0.80	0.80	1.00	1.00	1.00	1.00	0.00	1.00
Uniform Delay (d), s/veh	39.4	24.6	24.7	42.3	38.1	35.0	30.8	30.0	15.6	28.7	0.0	24.7
Incr Delay (d2), s/veh	62.7	0.8	1.7	16.5	1.0	0.6	0.1	1.6	1.9	2.6	0.0	1.8
Initial Q Delay(d3),s/veh	0.0	0.0	0.0	0.0	0.0	0.0	0.0	0.0	0.0	0.0	0.0	0.0
%ile BackOfQ(50%),veh/ln	0.0	3.2	3.4	5.2	8.0	4.1	0.9	2.0	1.6	6.2	0.0	2.8
Unsig. Movement Delay, s/veh												
LnGrp Delay(d),s/veh	102.0	25.4	26.4	58.7	39.1	35.6	30.9	31.6	17.5	31.3	0.0	26.5
LnGrp LOS	F	C	C	E	D	D	C	C	B	C	A	C
Approach Vol, veh/h	775		1034				285		476			
Approach Delay, s/veh	36.1		41.9				27.3		29.7			
Approach LOS	D		D				C		C			
Timer - Assigned Phs	1	2	3	4	5	6	7	8				
Phs Duration (G+Y+Rc), s	29.3	23.0	15.4	22.4	21.2	31.1	10.0	27.7				
Change Period (Y+Rc), s	4.5	4.5	4.5	4.5	4.5	4.5	4.5	4.5				
Max Green Setting (Gmax), s	14.5	18.5	11.9	27.1	6.4	26.6	5.5	33.5				
Max Q Clear Time (g_c+1/3), s	11.8	6.0	11.0	11.7	4.1	8.7	7.2	18.6				
Green Ext Time (p_c), s	0.0	0.6	0.0	3.9	0.1	0.8	0.0	4.7				

Intersection Summary

HCM 6th Ctrl Delay	36.3
HCM 6th LOS	D

Notes

User approved volume balancing among the lanes for turning movement.

HCM 6th Signalized Intersection Summary
 31: SR-99 Southbound Ramps & Cleveland Avenue

Village D Specific Plan
 Phase II NP - PM Peak Hour



Movement	EBL	EBT	EBR	WBL	WBT	WBR	NBL	NBT	NBR	SBL	SBT	SBR	
Lane Configurations		↑↑	↑	↑	↑↑					↑		↑	
Traffic Volume (veh/h)	0	772	381	318	1246	0	0	0	0	177	0	82	
Future Volume (veh/h)	0	772	381	318	1246	0	0	0	0	177	0	82	
Initial Q (Qb), veh	0	0	0	0	0	0				0	0	0	
Ped-Bike Adj(A_pbT)	1.00		0.99	1.00		1.00				1.00		1.00	
Parking Bus, Adj	1.00	1.00	1.00	1.00	1.00	1.00				1.00	1.00	1.00	
Work Zone On Approach		No			No						No		
Adj Sat Flow, veh/h/ln	0	1885	1885	1885	1885	0				1841	0	1841	
Adj Flow Rate, veh/h	0	796	393	328	1285	0				182	0	85	
Peak Hour Factor	0.97	0.97	0.97	0.97	0.97	0.97				0.97	0.97	0.97	
Percent Heavy Veh, %	0	1	1	1	1	0				4	0	4	
Cap, veh/h	0	1058	470	355	1944	0				626	0	557	
Arrive On Green	0.00	0.59	0.59	0.39	1.00	0.00				0.36	0.00	0.36	
Sat Flow, veh/h	0	3676	1589	1795	3676	0				1753	0	1560	
Grp Volume(v), veh/h	0	796	393	328	1285	0				182	0	85	
Grp Sat Flow(s),veh/h/ln	0	1791	1589	1795	1791	0				1753	0	1560	
Q Serve(g_s), s	0.0	14.7	18.0	15.7	0.0	0.0				6.7	0.0	3.3	
Cycle Q Clear(g_c), s	0.0	14.7	18.0	15.7	0.0	0.0				6.7	0.0	3.3	
Prop In Lane	0.00		1.00	1.00		0.00				1.00		1.00	
Lane Grp Cap(c), veh/h	0	1058	470	355	1944	0				626	0	557	
V/C Ratio(X)	0.00	0.75	0.84	0.93	0.66	0.00				0.29	0.00	0.15	
Avail Cap(c_a), veh/h	0	1453	645	369	2368	0				626	0	557	
HCM Platoon Ratio	1.00	2.00	2.00	2.00	2.00	1.00				1.00	1.00	1.00	
Upstream Filter(I)	0.00	0.72	0.72	0.62	0.62	0.00				1.00	0.00	1.00	
Uniform Delay (d), s/veh	0.0	16.0	16.7	26.6	0.0	0.0				20.7	0.0	19.7	
Incr Delay (d2), s/veh	0.0	1.1	5.1	20.1	0.3	0.0				0.3	0.0	0.1	
Initial Q Delay(d3),s/veh	0.0	0.0	0.0	0.0	0.0	0.0				0.0	0.0	0.0	
%ile BackOfQ(50%),veh/ln	0.0	4.1	4.6	6.9	0.1	0.0				2.7	0.0	1.2	
Unsig. Movement Delay, s/veh													
LnGrp Delay(d),s/veh	0.0	17.1	21.8	46.7	0.3	0.0				21.0	0.0	19.8	
LnGrp LOS	A	B	C	D	A	A				C	A	B	
Approach Vol, veh/h		1189			1613						267		
Approach Delay, s/veh		18.6			9.8						20.6		
Approach LOS		B			A						C		
Timer - Assigned Phs			3	4		6		8					
Phs Duration (G+Y+Rc), s			22.3	31.1		36.6		53.4					
Change Period (Y+Rc), s			4.5	4.5		4.5		4.5					
Max Green Setting (Gmax), s			18.5	36.5		21.5		59.5					
Max Q Clear Time (g_c+I1), s			17.7	20.0		8.7		2.0					
Green Ext Time (p_c), s			0.1	6.6		0.6		14.2					
Intersection Summary													
HCM 6th Ctrl Delay			14.1										
HCM 6th LOS			B										

HCM 6th Signalized Intersection Summary
 32: SR-99 Northbound Ramps & Cleveland Avenue

Village D Specific Plan
 Phase II NP - PM Peak Hour



Movement	EBL	EBT	EBR	WBL	WBT	WBR	NBL	NBT	NBR	SBL	SBT	SBR
Lane Configurations												
Traffic Volume (veh/h)	76	871	0	0	985	67	584	6	321	0	0	0
Future Volume (veh/h)	76	871	0	0	985	67	584	6	321	0	0	0
Initial Q (Qb), veh	0	0	0	0	0	0	0	0	0			
Ped-Bike Adj(A_pbT)	1.00		1.00	1.00		0.99	1.00		1.00			
Parking Bus, Adj	1.00	1.00	1.00	1.00	1.00	1.00	1.00	1.00	1.00			
Work Zone On Approach	No				No				No			
Adj Sat Flow, veh/h/ln	1885	1885	0	0	1885	1885	1885	1885	1885			
Adj Flow Rate, veh/h	80	917	0	0	1037	71	619	0	0			
Peak Hour Factor	0.95	0.95	0.95	0.95	0.95	0.95	0.95	0.95	0.95			
Percent Heavy Veh, %	1	1	0	0	1	1	1	1	1			
Cap, veh/h	103	1609	0	0	1223	541	1619	0				
Arrive On Green	0.06	0.45	0.00	0.00	0.34	0.34	0.45	0.00	0.00			
Sat Flow, veh/h	1795	3676	0	0	3676	1584	3591	0	1598			
Grp Volume(v), veh/h	80	917	0	0	1037	71	619	0	0			
Grp Sat Flow(s),veh/h/ln	1795	1791	0	0	1791	1584	1795	0	1598			
Q Serve(g_s), s	4.0	17.1	0.0	0.0	24.2	2.8	10.3	0.0	0.0			
Cycle Q Clear(g_c), s	4.0	17.1	0.0	0.0	24.2	2.8	10.3	0.0	0.0			
Prop In Lane	1.00		0.00	0.00		1.00	1.00		1.00			
Lane Grp Cap(c), veh/h	103	1609	0	0	1223	541	1619	0				
V/C Ratio(X)	0.77	0.57	0.00	0.00	0.85	0.13	0.38	0.00				
Avail Cap(c_a), veh/h	190	1930	0	0	1373	607	1619	0				
HCM Platoon Ratio	1.00	1.00	1.00	1.00	1.00	1.00	1.00	1.00	1.00			
Upstream Filter(I)	0.76	0.76	0.00	0.00	0.67	0.67	1.00	0.00	0.00			
Uniform Delay (d), s/veh	41.8	18.4	0.0	0.0	27.5	20.4	16.4	0.0	0.0			
Incr Delay (d2), s/veh	8.9	0.2	0.0	0.0	3.2	0.1	0.7	0.0	0.0			
Initial Q Delay(d3),s/veh	0.0	0.0	0.0	0.0	0.0	0.0	0.0	0.0	0.0			
%ile BackOfQ(50%),veh/ln	2.0	6.8	0.0	0.0	10.5	1.0	4.2	0.0	0.0			
Unsig. Movement Delay, s/veh												
LnGrp Delay(d),s/veh	50.8	18.6	0.0	0.0	30.7	20.5	17.1	0.0	0.0			
LnGrp LOS	D	B	A	A	C	C	B	A				
Approach Vol, veh/h	997				1108		619		A			
Approach Delay, s/veh	21.2				30.0		17.1					
Approach LOS	C				C		B					
Timer - Assigned Phs	2		4		7		8					
Phs Duration (G+Y+Rc), s	45.1		44.9		9.7		35.2					
Change Period (Y+Rc), s	4.5		4.5		4.5		4.5					
Max Green Setting (Gmax), s	32.5		48.5		9.5		34.5					
Max Q Clear Time (g_c+I1), s	12.3		19.1		6.0		26.2					
Green Ext Time (p_c), s	2.3		7.5		0.0		4.6					

Intersection Summary

HCM 6th Ctrl Delay	23.9
HCM 6th LOS	C

Notes

User approved volume balancing among the lanes for turning movement.
 Unsignalized Delay for [NBR] is excluded from calculations of the approach delay and intersection delay.

HCM 6th Signalized Intersection Summary

33: Gateway Drive & Cleveland Avenue

Village D Specific Plan
Phase II NP - PM Peak Hour



Movement	EBL	EBT	EBR	WBL	WBT	WBR	NBL	NBT	NBR	SBL	SBT	SBR
Lane Configurations	↖	↑↑↑	↗	↖↗	↑↑		↖↗	↑	↗	↖	↑↘	
Traffic Volume (veh/h)	16	896	273	213	799	151	231	140	276	207	161	23
Future Volume (veh/h)	16	896	273	213	799	151	231	140	276	207	161	23
Initial Q (Qb), veh	0	0	0	0	0	0	0	0	0	0	0	0
Ped-Bike Adj(A_pbT)	1.00		1.00	1.00		0.99	1.00		0.98	1.00		0.98
Parking Bus, Adj	1.00	1.00	1.00	1.00	1.00	1.00	1.00	1.00	1.00	1.00	1.00	1.00
Work Zone On Approach		No			No			No			No	
Adj Sat Flow, veh/h/ln	1870	1870	1870	1870	1870	1870	1885	1885	1885	1856	1856	1856
Adj Flow Rate, veh/h	17	953	0	227	850	161	246	149	294	220	171	24
Peak Hour Factor	0.94	0.94	0.94	0.94	0.94	0.94	0.94	0.94	0.94	0.94	0.94	0.94
Percent Heavy Veh, %	2	2	2	2	2	2	1	1	1	3	3	3
Cap, veh/h	114	1237		388	998	189	789	423	351	391	679	94
Arrive On Green	0.04	0.48	0.00	0.11	0.34	0.34	0.23	0.22	0.22	0.22	0.22	0.22
Sat Flow, veh/h	1781	5106	1585	3456	2978	564	3483	1885	1565	1767	3103	428
Grp Volume(v), veh/h	17	953	0	227	507	504	246	149	294	220	96	99
Grp Sat Flow(s),veh/h/ln	1781	1702	1585	1728	1777	1765	1742	1885	1565	1767	1763	1768
Q Serve(g_s), s	0.0	13.8	0.0	5.6	23.9	23.9	5.3	6.0	16.1	10.0	4.0	4.2
Cycle Q Clear(g_c), s	0.0	13.8	0.0	5.6	23.9	23.9	5.3	6.0	16.1	10.0	4.0	4.2
Prop In Lane	1.00		1.00	1.00		0.32	1.00		1.00	1.00		0.24
Lane Grp Cap(c), veh/h	114	1237		388	596	592	789	423	351	391	386	387
V/C Ratio(X)	0.15	0.77		0.59	0.85	0.85	0.31	0.35	0.84	0.56	0.25	0.26
Avail Cap(c_a), veh/h	179	1770		388	685	680	789	423	351	391	386	387
HCM Platoon Ratio	2.00	2.00	2.00	1.00	1.00	1.00	1.00	1.00	1.00	1.00	1.00	1.00
Upstream Filter(I)	0.85	0.85	0.00	0.93	0.93	0.93	1.00	1.00	1.00	1.00	1.00	1.00
Uniform Delay (d), s/veh	42.4	21.1	0.0	38.0	27.8	27.8	29.0	29.4	33.3	31.2	29.0	29.1
Incr Delay (d2), s/veh	0.5	1.1	0.0	2.1	8.5	8.5	0.2	2.3	20.6	1.9	1.5	1.6
Initial Q Delay(d3),s/veh	0.0	0.0	0.0	0.0	0.0	0.0	0.0	0.0	0.0	0.0	0.0	0.0
%ile BackOfQ(50%),veh/ln	0.4	4.1	0.0	2.5	11.2	11.1	2.2	2.9	8.0	4.4	1.9	1.9
Unsig. Movement Delay, s/veh												
LnGrp Delay(d),s/veh	42.9	22.3	0.0	40.1	36.3	36.4	29.2	31.7	53.9	33.0	30.6	30.7
LnGrp LOS	D	C		D	D	D	C	C	D	C	C	C
Approach Vol, veh/h		970	A		1238			689			415	
Approach Delay, s/veh		22.6			37.0			40.3			31.9	
Approach LOS		C			D			D			C	
Timer - Assigned Phs	1	2	3	4	5	6	7	8				
Phs Duration (G+Y+Rc), s	24.9	24.2	6.2	34.7	24.4	24.7	14.6	26.3				
Change Period (Y+Rc), s	4.5	4.5	4.5	4.5	4.5	4.5	4.5	4.5				
Max Green Setting (Gmax), s	12.6	19.7	5.0	34.7	12.1	20.2	8.5	31.2				
Max Q Clear Time (g_c+1), s	17.3	6.2	2.0	25.9	12.0	18.1	7.6	15.8				
Green Ext Time (p_c), s	0.4	0.8	0.0	4.3	0.0	0.4	0.1	6.0				

Intersection Summary

HCM 6th Ctrl Delay	32.8
HCM 6th LOS	C

Notes

Unsignalized Delay for [EBR] is excluded from calculations of the approach delay and intersection delay.

HCM 6th Signalized Intersection Summary
34: Cleveland Avenue & County Club Drive

Village D Specific Plan
Phase II NP - PM Peak Hour



Movement	WBL	WBR	NBT	NBR	SBL	SBT
Lane Configurations	←←		↑↑	←	←	↑↑↑
Traffic Volume (veh/h)	392	35	872	507	123	772
Future Volume (veh/h)	392	35	872	507	123	772
Initial Q (Qb), veh	0	0	0	0	0	0
Ped-Bike Adj(A_pbT)	1.00	1.00		1.00	1.00	
Parking Bus, Adj	1.00	1.00	1.00	1.00	1.00	1.00
Work Zone On Approach	No		No		No	
Adj Sat Flow, veh/h/ln	1900	1900	1870	1870	1870	1870
Adj Flow Rate, veh/h	448	0	918	0	129	813
Peak Hour Factor	0.95	0.95	0.95	0.95	0.95	0.95
Percent Heavy Veh, %	0	0	2	2	2	2
Cap, veh/h	575	256	2634		476	3784
Arrive On Green	0.16	0.00	0.74	0.00	0.74	0.74
Sat Flow, veh/h	3619	1610	3647	1585	608	5274
Grp Volume(v), veh/h	448	0	918	0	129	813
Grp Sat Flow(s),veh/h/ln	1810	1610	1777	1585	608	1702
Q Serve(g_s), s	10.7	0.0	8.1	0.0	8.5	4.4
Cycle Q Clear(g_c), s	10.7	0.0	8.1	0.0	16.6	4.4
Prop In Lane	1.00	1.00		1.00	1.00	
Lane Grp Cap(c), veh/h	575	256	2634		476	3784
V/C Ratio(X)	0.78	0.00	0.35		0.27	0.21
Avail Cap(c_a), veh/h	1428	635	2634		476	3784
HCM Platoon Ratio	1.00	1.00	1.00	1.00	1.00	1.00
Upstream Filter(I)	1.00	0.00	0.67	0.00	1.00	1.00
Uniform Delay (d), s/veh	36.3	0.0	4.1	0.0	7.0	3.6
Incr Delay (d2), s/veh	2.3	0.0	0.2	0.0	1.4	0.1
Initial Q Delay(d3),s/veh	0.0	0.0	0.0	0.0	0.0	0.0
%ile BackOfQ(50%),veh/ln	4.8	0.0	2.3	0.0	1.1	1.2
Unsig. Movement Delay, s/veh						
LnGrp Delay(d),s/veh	38.7	0.0	4.3	0.0	8.4	3.7
LnGrp LOS	D	A	A		A	A
Approach Vol, veh/h	448		918	A		942
Approach Delay, s/veh	38.7		4.3			4.4
Approach LOS	D		A			A
Timer - Assigned Phs		2			6	8
Phs Duration (G+Y+Rc), s		71.2			71.2	18.8
Change Period (Y+Rc), s		4.5			4.5	4.5
Max Green Setting (Gmax), s		45.5			45.5	35.5
Max Q Clear Time (g_c+I1), s		10.1			18.6	12.7
Green Ext Time (p_c), s		7.9			7.9	1.6

Intersection Summary

HCM 6th Ctrl Delay	11.0
HCM 6th LOS	B

Notes

User approved volume balancing among the lanes for turning movement.
Unsignalized Delay for [NBR] is excluded from calculations of the approach delay and intersection delay.

Intersection						
Int Delay, s/veh	0.2					
Movement	EBL	EBR	NBL	NBT	SBT	SBR
Lane Configurations	T			T		
Traffic Vol, veh/h	2	17	5	877	839	1
Future Vol, veh/h	2	17	5	877	839	1
Conflicting Peds, #/hr	0	0	0	0	0	0
Sign Control	Stop	Stop	Free	Free	Free	Free
RT Channelized	-	None	-	None	-	None
Storage Length	0	-	-	-	-	-
Veh in Median Storage, #	0	-	-	0	0	-
Grade, %	0	-	-	0	0	-
Peak Hour Factor	94	94	94	94	94	94
Heavy Vehicles, %	0	0	1	1	1	1
Mvmt Flow	2	18	5	933	893	1

Major/Minor	Minor2	Major1		Major2	
Conflicting Flow All	1371	447	894	0	0
Stage 1	894	-	-	-	-
Stage 2	477	-	-	-	-
Critical Hdwy	6.8	6.9	4.12	-	-
Critical Hdwy Stg 1	5.8	-	-	-	-
Critical Hdwy Stg 2	5.8	-	-	-	-
Follow-up Hdwy	3.5	3.3	2.21	-	-
Pot Cap-1 Maneuver	*306	564	761	-	-
Stage 1	*365	-	-	-	-
Stage 2	*688	-	-	-	-
Platoon blocked, %	1	-	-	-	-
Mov Cap-1 Maneuver	*302	564	761	-	-
Mov Cap-2 Maneuver	*322	-	-	-	-
Stage 1	*360	-	-	-	-
Stage 2	*688	-	-	-	-

Approach	EB	NB	SB
HCM Control Delay, s	12.2	0.2	0
HCM LOS	B		

Minor Lane/Major Mvmt	NBL	NBT	EBLn1	SBT	SBR
Capacity (veh/h)	761	-	523	-	-
HCM Lane V/C Ratio	0.007	-	0.039	-	-
HCM Control Delay (s)	9.8	0.1	12.2	-	-
HCM Lane LOS	A	A	B	-	-
HCM 95th %tile Q(veh)	0	-	0.1	-	-

Notes
 -: Volume exceeds capacity \$: Delay exceeds 300s +: Computation Not Defined *: All major volume in platoon

HCM 6th Signalized Intersection Summary

36: Pine Street & Howard Road

Village D Specific Plan
Phase II NP - PM Peak Hour



Movement	EBL	EBT	EBR	WBL	WBT	WBR	NBL	NBT	NBR	SBL	SBT	SBR
Lane Configurations												
Traffic Volume (veh/h)	88	549	100	103	505	4	143	174	160	17	151	120
Future Volume (veh/h)	88	549	100	103	505	4	143	174	160	17	151	120
Initial Q (Qb), veh	0	0	0	0	0	0	0	0	0	0	0	0
Ped-Bike Adj(A_pbT)	1.00		0.94	1.00		0.93	1.00		0.99	1.00		1.00
Parking Bus, Adj	1.00	1.00	1.00	1.00	1.00	1.00	1.00	1.00	1.00	1.00	1.00	1.00
Work Zone On Approach		No			No			No			No	
Adj Sat Flow, veh/h/ln	1870	1870	1870	1885	1885	1885	1870	1870	1870	1870	1870	1870
Adj Flow Rate, veh/h	95	590	108	111	543	4	154	187	172	18	162	129
Peak Hour Factor	0.93	0.93	0.93	0.93	0.93	0.93	0.93	0.93	0.93	0.93	0.93	0.93
Percent Heavy Veh, %	2	2	2	1	1	1	2	2	2	2	2	2
Cap, veh/h	211	720	131	130	716	5	641	673	563	23	210	198
Arrive On Green	0.12	0.24	0.24	0.07	0.20	0.20	0.36	0.36	0.36	0.13	0.13	0.13
Sat Flow, veh/h	1781	2968	541	1795	3642	27	1781	1870	1565	186	1675	1585
Grp Volume(v), veh/h	95	352	346	111	267	280	154	187	172	180	0	129
Grp Sat Flow(s),veh/h/ln	1781	1777	1732	1795	1791	1878	1781	1870	1565	1861	0	1585
Q Serve(g_s), s	4.5	16.9	17.0	5.5	12.7	12.7	5.5	6.4	7.1	8.4	0.0	7.0
Cycle Q Clear(g_c), s	4.5	16.9	17.0	5.5	12.7	12.7	5.5	6.4	7.1	8.4	0.0	7.0
Prop In Lane	1.00		0.31	1.00		0.01	1.00		1.00	0.10		1.00
Lane Grp Cap(c), veh/h	211	431	420	130	352	369	641	673	563	233	0	198
V/C Ratio(X)	0.45	0.82	0.82	0.86	0.76	0.76	0.24	0.28	0.31	0.77	0.00	0.65
Avail Cap(c_a), veh/h	211	543	529	130	547	574	641	673	563	372	0	317
HCM Platoon Ratio	1.00	1.00	1.00	1.00	1.00	1.00	1.00	1.00	1.00	1.00	1.00	1.00
Upstream Filter(I)	1.00	1.00	1.00	0.91	0.91	0.91	1.00	1.00	1.00	1.00	0.00	1.00
Uniform Delay (d), s/veh	37.0	32.2	32.2	41.3	34.1	34.1	20.2	20.5	20.7	38.1	0.0	37.5
Incr Delay (d2), s/veh	1.5	7.7	8.2	37.0	3.1	2.9	0.9	1.0	1.4	5.4	0.0	3.6
Initial Q Delay(d3),s/veh	0.0	0.0	0.0	0.0	0.0	0.0	0.0	0.0	0.0	0.0	0.0	0.0
%ile BackOfQ(50%),veh/ln	2.0	8.0	7.9	3.7	5.7	6.0	2.4	2.9	2.8	4.1	0.0	2.9
Unsig. Movement Delay, s/veh												
LnGrp Delay(d),s/veh	38.5	39.9	40.4	78.3	37.2	37.1	21.1	21.5	22.1	43.5	0.0	41.1
LnGrp LOS	D	D	D	E	D	D	C	C	C	D	A	D
Approach Vol, veh/h		793			658			513			309	
Approach Delay, s/veh		40.0			44.1			21.6			42.5	
Approach LOS		D			D			C			D	
Timer - Assigned Phs		2	3	4		6	7	8				
Phs Duration (G+Y+Rc), s		36.9	11.0	26.3		15.8	15.1	22.2				
Change Period (Y+Rc), s		4.5	4.5	4.5		4.5	4.5	4.5				
Max Green Setting (Gmax), s		20.0	6.5	27.5		18.0	6.5	27.5				
Max Q Clear Time (g_c+I1), s		9.1	7.5	19.0		10.4	6.5	14.7				
Green Ext Time (p_c), s		1.6	0.0	2.8		0.8	0.0	2.7				
Intersection Summary												
HCM 6th Ctrl Delay				37.3								
HCM 6th LOS				D								

HCM 6th Signalized Intersection Summary
 37: Olive Avenue/Q Street & Howard Road/Yosemite Avenue

Village D Specific Plan
 Phase II NP - PM Peak Hour



Movement	EBL	EBT	EBR	WBL	WBT	WBR	NBL	NBT	NBR	SBL	SBT	SBR
Lane Configurations												
Traffic Volume (veh/h)	7	449	250	13	360	14	313	75	13	17	57	2
Future Volume (veh/h)	7	449	250	13	360	14	313	75	13	17	57	2
Initial Q (Qb), veh	0	0	0	0	0	0	0	0	0	0	0	0
Ped-Bike Adj(A_pbT)	1.00		1.00	1.00		1.00	1.00		0.99	1.00		0.99
Parking Bus, Adj	1.00	1.00	1.00	1.00	1.00	1.00	1.00	1.00	1.00	1.00	1.00	1.00
Work Zone On Approach		No			No			No			No	
Adj Sat Flow, veh/h/ln	1870	1870	1870	1885	1885	1885	1885	1885	1885	1885	1885	1885
Adj Flow Rate, veh/h	8	488	0	14	391	15	211	263	14	18	62	2
Peak Hour Factor	0.92	0.92	0.92	0.92	0.92	0.92	0.92	0.92	0.92	0.92	0.92	0.92
Percent Heavy Veh, %	2	2	2	1	1	1	1	1	1	1	1	1
Cap, veh/h	18	602		100	755	29	937	984	822	96	100	84
Arrive On Green	0.01	0.17	0.00	0.06	0.21	0.21	0.52	0.52	0.52	0.05	0.05	0.05
Sat Flow, veh/h	1781	3554	1585	1795	3517	135	1795	1885	1576	1795	1885	1580
Grp Volume(v), veh/h	8	488	0	14	199	207	211	263	14	18	62	2
Grp Sat Flow(s),veh/h/ln	1781	1777	1585	1795	1791	1860	1795	1885	1576	1795	1885	1580
Q Serve(g_s), s	0.4	11.9	0.0	0.7	8.8	8.9	5.7	7.0	0.4	0.9	2.9	0.1
Cycle Q Clear(g_c), s	0.4	11.9	0.0	0.7	8.8	8.9	5.7	7.0	0.4	0.9	2.9	0.1
Prop In Lane	1.00		1.00	1.00		0.07	1.00		1.00	1.00		1.00
Lane Grp Cap(c), veh/h	18	602		100	385	400	937	984	822	96	100	84
V/C Ratio(X)	0.45	0.81		0.14	0.52	0.52	0.23	0.27	0.02	0.19	0.62	0.02
Avail Cap(c_a), veh/h	109	711		359	607	630	937	984	822	359	377	316
HCM Platoon Ratio	1.00	1.00	1.00	1.00	1.00	1.00	1.00	1.00	1.00	1.00	1.00	1.00
Upstream Filter(I)	0.69	0.69	0.00	1.00	1.00	1.00	1.00	1.00	1.00	1.00	1.00	1.00
Uniform Delay (d), s/veh	44.3	36.0	0.0	40.5	31.2	31.2	11.7	12.0	10.4	40.7	41.7	40.4
Incr Delay (d2), s/veh	11.5	4.3	0.0	0.6	1.1	1.0	0.6	0.7	0.0	0.9	6.0	0.1
Initial Q Delay(d3),s/veh	0.0	0.0	0.0	0.0	0.0	0.0	0.0	0.0	0.0	0.0	0.0	0.0
%ile BackOfQ(50%),veh/ln	0.2	5.4	0.0	0.3	3.9	4.0	2.3	3.0	0.1	0.4	1.5	0.0
Unsig. Movement Delay, s/veh												
LnGrp Delay(d),s/veh	55.8	40.3	0.0	41.1	32.3	32.3	12.2	12.6	10.4	41.7	47.7	40.5
LnGrp LOS	E	D		D	C	C	B	B	B	D	D	D
Approach Vol, veh/h		496	A		420			488			82	
Approach Delay, s/veh		40.5			32.6			12.4			46.2	
Approach LOS		D			C			B			D	
Timer - Assigned Phs		2	3	4		6	7	8				
Phs Duration (G+Y+Rc), s		51.5	9.5	19.7		9.3	5.4	23.8				
Change Period (Y+Rc), s		4.5	4.5	4.5		4.5	4.5	4.5				
Max Green Setting (Gmax), s		18.0	18.0	18.0		18.0	5.5	30.5				
Max Q Clear Time (g_c+1), s		9.0	2.7	13.9		4.9	2.4	10.9				
Green Ext Time (p_c), s		1.5	0.0	1.2		0.2	0.0	2.3				

Intersection Summary

HCM 6th Ctrl Delay	29.4
HCM 6th LOS	C

Notes

User approved volume balancing among the lanes for turning movement.
 Unsignalized Delay for [EBR] is excluded from calculations of the approach delay and intersection delay.

HCM 6th TWSC
 38: I Street & 2nd Street/SR-99 Southbound Off-Ramp

Village D Specific Plan
 Phase II NP - PM Peak Hour

Intersection												
Int Delay, s/veh	9.3											
Movement	EBL	EBT	EBR	WBL	WBT	WBR	NBL	NBT	NBR	SBL	SBT	SBR
Lane Configurations		↕			↕	↕	↕	↕			↕	
Traffic Vol, veh/h	0	0	40	276	13	5	50	154	0	0	119	0
Future Vol, veh/h	0	0	40	276	13	5	50	154	0	0	119	0
Conflicting Peds, #/hr	0	0	0	0	0	0	1	0	1	1	0	1
Sign Control	Stop	Stop	Stop	Stop	Stop	Stop	Free	Free	Free	Free	Free	Free
RT Channelized	-	-	None	-	-	Stop	-	-	None	-	-	None
Storage Length	-	-	-	-	-	50	75	-	-	-	-	-
Veh in Median Storage, #	-	0	-	-	0	-	-	0	-	-	0	-
Grade, %	-	0	-	-	0	-	-	0	-	-	0	-
Peak Hour Factor	98	98	98	98	98	98	98	98	98	98	98	98
Heavy Vehicles, %	0	0	0	3	3	3	0	0	0	0	0	0
Mvmt Flow	0	0	41	282	13	5	51	157	0	0	121	0

Major/Minor	Minor2		Minor1		Major1		Major2					
Conflicting Flow All	388	381	122	401	381	157	122	0	-	-	-	0
Stage 1	122	122	-	259	259	-	-	-	-	-	-	-
Stage 2	266	259	-	142	122	-	-	-	-	-	-	-
Critical Hdwy	7.1	6.5	6.2	7.13	6.53	6.23	4.1	-	-	-	-	-
Critical Hdwy Stg 1	6.1	5.5	-	6.13	5.53	-	-	-	-	-	-	-
Critical Hdwy Stg 2	6.1	5.5	-	6.13	5.53	-	-	-	-	-	-	-
Follow-up Hdwy	3.5	4	3.3	3.527	4.027	3.327	2.2	-	-	-	-	-
Pot Cap-1 Maneuver	620	584	935	602	579	959	1478	-	0	0	-	-
Stage 1	887	799	-	789	713	-	-	-	0	0	-	-
Stage 2	788	718	-	859	793	-	-	-	0	0	-	-
Platoon blocked, %	1	1		1	1	1		-			-	-
Mov Cap-1 Maneuver	589	563	934	560	558	959	1477	-	-	-	-	-
Mov Cap-2 Maneuver	589	563	-	560	558	-	-	-	-	-	-	-
Stage 1	856	798	-	762	688	-	-	-	-	-	-	-
Stage 2	742	693	-	821	792	-	-	-	-	-	-	-

Approach	EB		WB		NB		SB			
HCM Control Delay, s	9		18.2		1.8		0			
HCM LOS	A		C							

Minor Lane/Major Mvmt	NBL	NBT	EBLn1	WBLn1	WBLn2	SBT	SBR
Capacity (veh/h)	1477	-	934	560	959	-	-
HCM Lane V/C Ratio	0.035	-	0.044	0.527	0.005	-	-
HCM Control Delay (s)	7.5	-	9	18.4	8.8	-	-
HCM Lane LOS	A	-	A	C	A	-	-
HCM 95th %tile Q(veh)	0.1	-	0.1	3.1	0	-	-

HCM 6th Signalized Intersection Summary
39: 4th Street & Sunset Avenue

Village D Specific Plan
Phase II NP - PM Peak Hour



Movement	EBL	EBR	NBL	NBT	SBT	SBR
Lane Configurations						
Traffic Volume (veh/h)	233	13	14	326	379	372
Future Volume (veh/h)	233	13	14	326	379	372
Initial Q (Qb), veh	0	0	0	0	0	0
Ped-Bike Adj(A_pbT)	1.00	1.00	1.00			1.00
Parking Bus, Adj	1.00	1.00	1.00	1.00	1.00	1.00
Work Zone On Approach	No			No	No	
Adj Sat Flow, veh/h/ln	1900	1900	1856	1856	1856	1856
Adj Flow Rate, veh/h	266	0	15	354	412	404
Peak Hour Factor	0.92	0.92	0.92	0.92	0.92	0.92
Percent Heavy Veh, %	0	0	3	3	3	3
Cap, veh/h	361	161	584	2857	807	840
Arrive On Green	0.10	0.00	0.33	0.81	0.87	0.87
Sat Flow, veh/h	3619	1610	1767	3618	1856	1571
Grp Volume(v), veh/h	266	0	15	354	412	404
Grp Sat Flow(s),veh/h/ln	1810	1610	1767	1763	1856	1571
Q Serve(g_s), s	7.1	0.0	0.6	2.1	5.2	5.7
Cycle Q Clear(g_c), s	7.1	0.0	0.6	2.1	5.2	5.7
Prop In Lane	1.00	1.00	1.00			1.00
Lane Grp Cap(c), veh/h	361	161	584	2857	807	840
V/C Ratio(X)	0.74	0.00	0.03	0.12	0.51	0.48
Avail Cap(c_a), veh/h	995	443	584	2857	807	840
HCM Platoon Ratio	1.00	1.00	1.00	1.00	2.00	2.00
Upstream Filter(I)	1.00	0.00	1.00	1.00	0.75	0.75
Uniform Delay (d), s/veh	43.7	0.0	22.6	2.0	4.0	2.8
Incr Delay (d2), s/veh	2.9	0.0	0.0	0.1	1.7	1.5
Initial Q Delay(d3),s/veh	0.0	0.0	0.0	0.0	0.0	0.0
%ile BackOfQ(50%),veh/ln	3.3	0.0	0.2	0.5	1.7	1.6
Unsig. Movement Delay, s/veh						
LnGrp Delay(d),s/veh	46.7	0.0	22.6	2.1	5.7	4.3
LnGrp LOS	D	A	C	A	A	A
Approach Vol, veh/h				369	816	
Approach Delay, s/veh				2.9	5.0	
Approach LOS				A	A	
Timer - Assigned Phs		2		4	5	6
Phs Duration (G+Y+Rc), s		85.5		14.5	37.5	48.0
Change Period (Y+Rc), s		4.5		4.5	4.5	4.5
Max Green Setting (Gmax), s		63.5		27.5	15.5	43.5
Max Q Clear Time (g_c+I1), s		4.1		9.1	2.6	7.7
Green Ext Time (p_c), s		2.6		0.8	0.0	4.5

Intersection Summary

HCM 6th Ctrl Delay	12.1
HCM 6th LOS	B

Notes

User approved volume balancing among the lanes for turning movement.

40: H Street & SR-99 Southbound On-Ramp/2nd Street Performance by movement

Movement	WBL	WBT	WBR	NBL	NBT	NBR	SBL	SBT	All
Denied Delay (hr)	0.0	0.0	0.0	0.0	0.0	0.0	0.0	0.0	0.0
Denied Del/Veh (s)	0.1	0.2	0.1	0.1	0.0	0.0	0.1	0.2	0.1
Total Delay (hr)	0.1	0.1	0.0	0.2	0.0	0.0	0.0	0.1	0.6
Total Del/Veh (s)	10.9	15.9	18.4	2.9	3.0	2.8	3.2	16.0	5.1
Stop Delay (hr)	0.1	0.1	0.0	0.0	0.0	0.0	0.0	0.1	0.3
Stop Del/Veh (s)	8.8	12.3	16.8	0.2	0.2	0.1	2.5	13.2	2.3

HCM 6th Signalized Intersection Summary
41: I Street & 4th Street

Village D Specific Plan
Phase II NP - PM Peak Hour



Movement	EBL	EBT	EBR	WBL	WBT	WBR	NBL	NBT	NBR	SBL	SBT	SBR
Lane Configurations	↖	↗		↖	↗		↖	↗	↗	↖	↗	↗
Traffic Volume (veh/h)	38	520	62	61	519	113	102	73	252	182	170	119
Future Volume (veh/h)	38	520	62	61	519	113	102	73	252	182	170	119
Initial Q (Qb), veh	0	0	0	0	0	0	0	0	0	0	0	0
Ped-Bike Adj(A_pbT)	1.00		0.99	1.00		0.99	1.00		1.00	1.00		0.99
Parking Bus, Adj	1.00	1.00	1.00	1.00	1.00	1.00	1.00	1.00	1.00	1.00	1.00	1.00
Work Zone On Approach		No			No			No			No	
Adj Sat Flow, veh/h/ln	1856	1856	1856	1885	1885	1885	1885	1885	1885	1870	1870	1870
Adj Flow Rate, veh/h	41	565	67	66	564	123	111	79	274	198	185	129
Peak Hour Factor	0.92	0.92	0.92	0.92	0.92	0.92	0.92	0.92	0.92	0.92	0.92	0.92
Percent Heavy Veh, %	3	3	3	1	1	1	1	1	1	2	2	2
Cap, veh/h	60	684	81	96	686	149	409	443	375	563	604	505
Arrive On Green	0.03	0.22	0.22	0.05	0.23	0.23	0.23	0.23	0.23	0.32	0.32	0.32
Sat Flow, veh/h	1767	3172	375	1795	2921	635	1795	1885	1598	1781	1870	1564
Grp Volume(v), veh/h	41	313	319	66	345	342	111	79	274	198	185	129
Grp Sat Flow(s),veh/h/ln	1767	1763	1784	1795	1791	1764	1795	1885	1598	1781	1870	1564
Q Serve(g_s), s	2.3	17.0	17.1	3.6	18.3	18.4	5.1	3.3	15.8	8.6	7.4	6.1
Cycle Q Clear(g_c), s	2.3	17.0	17.1	3.6	18.3	18.4	5.1	3.3	15.8	8.6	7.4	6.1
Prop In Lane	1.00		0.21	1.00		0.36	1.00		1.00	1.00		1.00
Lane Grp Cap(c), veh/h	60	380	385	96	421	415	409	443	375	563	604	505
V/C Ratio(X)	0.68	0.82	0.83	0.69	0.82	0.82	0.27	0.18	0.73	0.35	0.31	0.26
Avail Cap(c_a), veh/h	115	485	491	171	546	538	409	443	375	563	604	505
HCM Platoon Ratio	1.00	1.00	1.00	1.00	1.00	1.00	1.00	1.00	1.00	1.00	1.00	1.00
Upstream Filter(I)	0.96	0.96	0.96	1.00	1.00	1.00	1.00	1.00	1.00	1.00	1.00	1.00
Uniform Delay (d), s/veh	47.8	37.4	37.4	46.5	36.3	36.3	31.8	30.5	35.3	26.3	25.4	25.0
Incr Delay (d2), s/veh	12.3	8.6	8.8	8.6	7.5	8.0	0.4	0.9	11.8	0.4	1.3	1.2
Initial Q Delay(d3),s/veh	0.0	0.0	0.0	0.0	0.0	0.0	0.0	0.0	0.0	0.0	0.0	0.0
%ile BackOfQ(50%),veh/ln	1.2	8.1	8.3	1.8	8.7	8.7	2.2	1.6	7.3	3.6	3.5	2.4
Unsig. Movement Delay, s/veh												
LnGrp Delay(d),s/veh	60.1	46.0	46.2	55.1	43.8	44.3	32.1	31.4	47.1	26.7	26.7	26.2
LnGrp LOS	E	D	D	E	D	D	C	C	D	C	C	C
Approach Vol, veh/h		673			753			464			512	
Approach Delay, s/veh		46.9			45.0			40.9			26.6	
Approach LOS		D			D			D			C	
Timer - Assigned Phs	1	2	3	4	5	6	7	8				
Phs Duration (G+Y+Rc), s	36.1	28.0	9.8	26.1	27.3	36.8	7.9	28.0				
Change Period (Y+Rc), s	4.5	4.5	4.5	4.5	4.5	4.5	4.5	4.5				
Max Green Setting (Gmax), s	21.5	23.5	9.5	27.5	12.7	32.3	6.5	30.5				
Max Q Clear Time (g_c+10), s	10.6	17.8	5.6	19.1	7.1	9.4	4.3	20.4				
Green Ext Time (p_c), s	0.4	0.7	0.0	2.5	0.1	1.5	0.0	3.1				

Intersection Summary

HCM 6th Ctrl Delay	40.8
HCM 6th LOS	D

HCM 6th Signalized Intersection Summary
 43: SR-99 Northbound Off-Ramp/H Street & 4th Street

Village D Specific Plan
 Phase II NP - PM Peak Hour



Movement	EBL	EBT	EBR	WBL	WBT	WBR	NBL	NBT	NBR	SBL	SBT	SBR
Lane Configurations												
Traffic Volume (veh/h)	247	404	0	0	542	143	270	33	187	29	0	83
Future Volume (veh/h)	247	404	0	0	542	143	270	33	187	29	0	83
Initial Q (Qb), veh	0	0	0	0	0	0	0	0	0	0	0	0
Ped-Bike Adj(A_pbT)	1.00		1.00	1.00		0.99	1.00		0.99	1.00		0.99
Parking Bus, Adj	1.00	1.00	1.00	1.00	1.00	1.00	1.00	1.00	1.00	1.00	1.00	1.00
Work Zone On Approach	No			No			No			No		
Adj Sat Flow, veh/h/ln	1885	1885	0	0	1885	1885	1885	1885	1885	1900	1900	1900
Adj Flow Rate, veh/h	263	430	0	0	577	152	287	35	199	31	0	88
Peak Hour Factor	0.94	0.94	0.94	0.94	0.94	0.94	0.94	0.94	0.94	0.94	0.94	0.94
Percent Heavy Veh, %	1	1	0	0	1	1	1	1	1	0	0	0
Cap, veh/h	297	1570	0	0	638	167	443	60	339	77	0	218
Arrive On Green	0.17	0.44	0.00	0.00	0.23	0.23	0.25	0.25	0.25	0.18	0.00	0.18
Sat Flow, veh/h	1795	3676	0	0	2893	735	1795	241	1373	427	0	1214
Grp Volume(v), veh/h	263	430	0	0	369	360	287	0	234	119	0	0
Grp Sat Flow(s),veh/h/ln	1795	1791	0	0	1791	1743	1795	0	1614	1641	0	0
Q Serve(g_s), s	14.3	7.7	0.0	0.0	20.0	20.1	14.3	0.0	12.8	6.4	0.0	0.0
Cycle Q Clear(g_c), s	14.3	7.7	0.0	0.0	20.0	20.1	14.3	0.0	12.8	6.4	0.0	0.0
Prop In Lane	1.00		0.00	0.00		0.42	1.00		0.85	0.26		0.74
Lane Grp Cap(c), veh/h	297	1570	0	0	408	397	443	0	398	295	0	0
V/C Ratio(X)	0.88	0.27	0.00	0.00	0.90	0.91	0.65	0.00	0.59	0.40	0.00	0.00
Avail Cap(c_a), veh/h	350	1701	0	0	421	410	443	0	398	295	0	0
HCM Platoon Ratio	1.00	1.00	1.00	1.00	1.00	1.00	1.00	1.00	1.00	1.00	1.00	1.00
Upstream Filter(I)	1.00	1.00	0.00	0.00	1.00	1.00	1.00	0.00	1.00	1.00	0.00	0.00
Uniform Delay (d), s/veh	40.8	17.9	0.0	0.0	37.5	37.6	33.8	0.0	33.2	36.2	0.0	0.0
Incr Delay (d2), s/veh	20.4	0.1	0.0	0.0	22.0	23.2	7.2	0.0	6.2	4.1	0.0	0.0
Initial Q Delay(d3),s/veh	0.0	0.0	0.0	0.0	0.0	0.0	0.0	0.0	0.0	0.0	0.0	0.0
%ile BackOfQ(50%),veh/ln	7.9	3.1	0.0	0.0	11.1	11.0	7.0	0.0	5.6	2.9	0.0	0.0
Unsig. Movement Delay, s/veh												
LnGrp Delay(d),s/veh	61.2	18.0	0.0	0.0	59.6	60.8	40.9	0.0	39.4	40.3	0.0	0.0
LnGrp LOS	E	B	A	A	E	E	D	A	D	D	A	A
Approach Vol, veh/h	693			729			521			119		
Approach Delay, s/veh	34.4			60.2			40.3			40.3		
Approach LOS	C			E			D			D		
Timer - Assigned Phs	2		4		6		7		8			
Phs Duration (G+Y+Rc), s	29.2		48.3		22.5		21.1		27.3			
Change Period (Y+Rc), s	4.5		4.5		4.5		4.5		4.5			
Max Green Setting (Gmax), s	21.0		47.5		18.0		19.5		23.5			
Max Q Clear Time (g_c+I1), s	16.3		9.7		8.4		16.3		22.1			
Green Ext Time (p_c), s	1.1		3.2		0.4		0.2		0.6			

Intersection Summary

HCM 6th Ctrl Delay	45.3
HCM 6th LOS	D

Intersection						
Int Delay, s/veh	3.9					
Movement	EBL	EBT	WBT	WBR	SBL	SBR
Lane Configurations	↖	↗	↖		↖	↖
Traffic Vol, veh/h	89	460	447	110	157	110
Future Vol, veh/h	89	460	447	110	157	110
Conflicting Peds, #/hr	0	0	0	0	0	0
Sign Control	Free	Free	Free	Free	Stop	Stop
RT Channelized	-	None	-	None	-	None
Storage Length	145	-	-	-	65	0
Veh in Median Storage, #	-	0	0	-	0	-
Grade, %	-	0	0	-	0	-
Peak Hour Factor	95	95	95	95	95	95
Heavy Vehicles, %	2	2	1	1	1	1
Mvmt Flow	94	484	471	116	165	116

Major/Minor	Major1	Major2	Minor2		
Conflicting Flow All	587	0	-	0	959 294
Stage 1	-	-	-	-	529 -
Stage 2	-	-	-	-	430 -
Critical Hdwy	4.14	-	-	-	6.82 6.92
Critical Hdwy Stg 1	-	-	-	-	5.82 -
Critical Hdwy Stg 2	-	-	-	-	5.82 -
Follow-up Hdwy	2.22	-	-	-	3.51 3.31
Pot Cap-1 Maneuver	1244	-	-	-	393 *902
Stage 1	-	-	-	-	829 -
Stage 2	-	-	-	-	627 -
Platoon blocked, %	1	-	-	-	1 1
Mov Cap-1 Maneuver	1244	-	-	-	363 *902
Mov Cap-2 Maneuver	-	-	-	-	363 -
Stage 1	-	-	-	-	766 -
Stage 2	-	-	-	-	627 -

Approach	EB	WB	SB
HCM Control Delay, s	1.3	0	17.4
HCM LOS			C

Minor Lane/Major Mvmt	EBL	EBT	WBT	WBR	SBLn1	SBLn2
Capacity (veh/h)	1244	-	-	-	363	902
HCM Lane V/C Ratio	0.075	-	-	-	0.455	0.128
HCM Control Delay (s)	8.1	-	-	-	22.9	9.6
HCM Lane LOS	A	-	-	-	C	A
HCM 95th %tile Q(veh)	0.2	-	-	-	2.3	0.4

Notes
 -: Volume exceeds capacity \$: Delay exceeds 300s +: Computation Not Defined *: All major volume in platoon

HCM 6th Signalized Intersection Summary
 45: Olive Avenue & SR-99 Southbound Off-Ramp

Village D Specific Plan
 Phase II NP - PM Peak Hour



Movement	EBL	EBT	WBT	WBR	SBL	SBR
Lane Configurations		↑↑↑	↑↑		↵	↵
Traffic Volume (veh/h)	0	617	467	0	526	90
Future Volume (veh/h)	0	617	467	0	526	90
Initial Q (Qb), veh	0	0	0	0	0	0
Ped-Bike Adj(A_pbT)	1.00			1.00	1.00	1.00
Parking Bus, Adj	1.00	1.00	1.00	1.00	1.00	1.00
Work Zone On Approach		No	No		No	
Adj Sat Flow, veh/h/ln	0	1870	1885	0	1826	1826
Adj Flow Rate, veh/h	0	649	492	0	554	95
Peak Hour Factor	0.95	0.95	0.95	0.95	0.95	0.95
Percent Heavy Veh, %	0	2	1	0	5	5
Cap, veh/h	0	864	606	0	1271	1131
Arrive On Green	0.00	0.17	0.17	0.00	0.73	0.73
Sat Flow, veh/h	0	5443	3770	0	1739	1547
Grp Volume(v), veh/h	0	649	492	0	554	95
Grp Sat Flow(s),veh/h/ln	0	1702	1791	0	1739	1547
Q Serve(g_s), s	0.0	10.9	11.9	0.0	11.3	1.6
Cycle Q Clear(g_c), s	0.0	10.9	11.9	0.0	11.3	1.6
Prop In Lane	0.00			0.00	1.00	1.00
Lane Grp Cap(c), veh/h	0	864	606	0	1271	1131
V/C Ratio(X)	0.00	0.75	0.81	0.00	0.44	0.08
Avail Cap(c_a), veh/h	0	1050	736	0	1271	1131
HCM Platoon Ratio	1.00	1.00	1.00	1.00	1.00	1.00
Upstream Filter(I)	0.00	1.00	0.91	0.00	1.00	1.00
Uniform Delay (d), s/veh	0.0	35.6	36.0	0.0	4.8	3.5
Incr Delay (d2), s/veh	0.0	2.5	5.3	0.0	1.1	0.1
Initial Q Delay(d3),s/veh	0.0	0.0	0.0	0.0	0.0	0.0
%ile BackOfQ(50%),veh/ln	0.0	4.6	5.5	0.0	3.5	0.4
Unsig. Movement Delay, s/veh						
LnGrp Delay(d),s/veh	0.0	38.1	41.3	0.0	5.9	3.6
LnGrp LOS	A	D	D	A	A	A
Approach Vol, veh/h		649	492		649	
Approach Delay, s/veh		38.1	41.3		5.5	
Approach LOS		D	D		A	
Timer - Assigned Phs				4	6	8
Phs Duration (G+Y+Rc), s				19.7	70.3	19.7
Change Period (Y+Rc), s				4.5	4.5	4.5
Max Green Setting (Gmax), s				18.5	62.5	18.5
Max Q Clear Time (g_c+I1), s				12.9	13.3	13.9
Green Ext Time (p_c), s				2.1	2.3	1.3
Intersection Summary						
HCM 6th Ctrl Delay			27.2			
HCM 6th LOS			C			

HCM 6th Signalized Intersection Summary
 46: Madera Avenue & SR-99 Northbound Ramps

Village D Specific Plan
 Phase II NP - PM Peak Hour



Movement	EBL	EBT	EBR	WBL	WBT	WBR	NBL	NBT	NBR	SBL	SBT	SBR
Lane Configurations				↶	↷	↶	↶↷	↶↷			↶↷	
Traffic Volume (veh/h)	0	0	0	196	1	33	672	675	0	0	654	176
Future Volume (veh/h)	0	0	0	196	1	33	672	675	0	0	654	176
Initial Q (Qb), veh				0	0	0	0	0	0	0	0	0
Ped-Bike Adj(A_pbT)				1.00		0.99	1.00		1.00	1.00		1.00
Parking Bus, Adj				1.00	1.00	1.00	1.00	1.00	1.00	1.00	1.00	1.00
Work Zone On Approach				No			No			No		
Adj Sat Flow, veh/h/ln				1885	1885	1885	1870	1870	0	0	1870	1870
Adj Flow Rate, veh/h				214	0	36	730	734	0	0	711	191
Peak Hour Factor				0.92	0.92	0.92	0.92	0.92	0.92	0.92	0.92	0.92
Percent Heavy Veh, %				1	1	1	2	2	0	0	2	2
Cap, veh/h				312	0	137	1312	2890	0	0	1061	285
Arrive On Green				0.09	0.00	0.09	0.76	1.00	0.00	0.00	0.38	0.38
Sat Flow, veh/h				3591	0	1574	3456	3647	0	0	2861	743
Grp Volume(v), veh/h				214	0	36	730	734	0	0	456	446
Grp Sat Flow(s),veh/h/ln				1795	0	1574	1728	1777	0	0	1777	1734
Q Serve(g_s), s				5.2	0.0	1.9	7.9	0.0	0.0	0.0	19.2	19.2
Cycle Q Clear(g_c), s				5.2	0.0	1.9	7.9	0.0	0.0	0.0	19.2	19.2
Prop In Lane				1.00		1.00	1.00		0.00	0.00		0.43
Lane Grp Cap(c), veh/h				312	0	137	1312	2890	0	0	681	665
V/C Ratio(X)				0.69	0.00	0.26	0.56	0.25	0.00	0.00	0.67	0.67
Avail Cap(c_a), veh/h				742	0	325	1312	2890	0	0	681	665
HCM Platoon Ratio				1.00	1.00	1.00	2.00	2.00	1.00	1.00	1.00	1.00
Upstream Filter(I)				1.00	0.00	1.00	0.73	0.73	0.00	0.00	1.00	1.00
Uniform Delay (d), s/veh				39.9	0.0	38.4	7.7	0.0	0.0	0.0	23.0	23.0
Incr Delay (d2), s/veh				2.7	0.0	1.0	0.4	0.2	0.0	0.0	5.2	5.3
Initial Q Delay(d3),s/veh				0.0	0.0	0.0	0.0	0.0	0.0	0.0	0.0	0.0
%ile BackOfQ(50%),veh/ln				2.4	0.0	0.8	2.0	0.1	0.0	0.0	8.7	8.5
Unsig. Movement Delay, s/veh												
LnGrp Delay(d),s/veh				42.6	0.0	39.4	8.0	0.2	0.0	0.0	28.2	28.3
LnGrp LOS				D	A	D	A	A	A	A	C	C
Approach Vol, veh/h								1464			902	
Approach Delay, s/veh								4.1			28.3	
Approach LOS								A			C	
Timer - Assigned Phs		2			5	6		8				
Phs Duration (G+Y+Rc), s		77.7			38.7	39.0		12.3				
Change Period (Y+Rc), s		4.5			4.5	4.5		4.5				
Max Green Setting (Gmax), s		62.4			23.4	34.5		18.6				
Max Q Clear Time (g_c+I1), s		2.0			9.9	21.2		7.2				
Green Ext Time (p_c), s		6.2			2.5	4.9		0.6				

Intersection Summary

HCM 6th Ctrl Delay	16.1
HCM 6th LOS	B

Notes

User approved volume balancing among the lanes for turning movement.

HCM 6th Signalized Intersection Summary
 47: Madera Avenue & Olive Avenue/SR-99 Southbound On-Ramp

Village D Specific Plan
 Phase II NP - PM Peak Hour



Movement	EBL	EBT	EBR	WBL	WBT	WBR	NBL	NBT	NBR	SBL	SBT	SBR
Lane Configurations												
Traffic Volume (veh/h)	436	176	531	0	0	0	166	912	44	134	416	301
Future Volume (veh/h)	436	176	531	0	0	0	166	912	44	134	416	301
Initial Q (Qb), veh	0	0	0				0	0	0	0	0	0
Ped-Bike Adj(A_pbT)	1.00		1.00				1.00		1.00	1.00		1.00
Parking Bus, Adj	1.00	1.00	1.00				1.00	1.00	1.00	1.00	1.00	1.00
Work Zone On Approach		No					No		No			
Adj Sat Flow, veh/h/ln	1856	1856	1856				1870	1870	1870	1885	1885	1885
Adj Flow Rate, veh/h	315	369	547				171	940	45	138	429	310
Peak Hour Factor	0.97	0.97	0.97				0.97	0.97	0.97	0.97	0.97	0.97
Percent Heavy Veh, %	3	3	3				2	2	2	1	1	1
Cap, veh/h	615	646	662				253	1398	67	174	853	612
Arrive On Green	0.11	0.11	0.11				0.07	0.41	0.41	0.03	0.14	0.14
Sat Flow, veh/h	1767	1856	1571				3456	3452	165	1795	1991	1428
Grp Volume(v), veh/h	315	369	547				171	484	501	138	386	353
Grp Sat Flow(s),veh/h/ln	1767	1856	1571				1728	1777	1841	1795	1791	1628
Q Serve(g_s), s	15.1	17.0	27.8				4.3	20.0	20.0	6.9	17.9	18.1
Cycle Q Clear(g_c), s	15.1	17.0	27.8				4.3	20.0	20.0	6.9	17.9	18.1
Prop In Lane	1.00		1.00				1.00		0.09	1.00		0.88
Lane Grp Cap(c), veh/h	615	646	662				253	720	745	174	768	698
V/C Ratio(X)	0.51	0.57	0.83				0.68	0.67	0.67	0.79	0.50	0.51
Avail Cap(c_a), veh/h	638	670	682				576	720	745	269	768	698
HCM Platoon Ratio	0.33	0.33	0.33				1.00	1.00	1.00	0.33	0.33	0.33
Upstream Filter(l)	0.79	0.79	0.79				1.00	1.00	1.00	0.81	0.81	0.81
Uniform Delay (d), s/veh	32.6	33.5	31.4				40.7	21.9	21.9	42.7	29.8	29.8
Incr Delay (d2), s/veh	0.5	0.9	6.5				3.2	5.0	4.8	7.1	1.9	2.1
Initial Q Delay(d3),s/veh	0.0	0.0	0.0				0.0	0.0	0.0	0.0	0.0	0.0
%ile BackOfQ(50%),veh/ln	7.2	8.5	25.6				1.9	9.0	9.2	3.5	8.9	8.2
Unsig. Movement Delay, s/veh												
LnGrp Delay(d),s/veh	33.2	34.3	37.9				43.8	26.9	26.7	49.7	31.7	31.9
LnGrp LOS	C	C	D				D	C	C	D	C	C
Approach Vol, veh/h		1231						1156			877	
Approach Delay, s/veh		35.6						29.3			34.6	
Approach LOS		D						C			C	
Timer - Assigned Phs	1	2		4	5	6						
Phs Duration (G+Y+Rc), s	33.2	41.0		35.8	11.1	43.1						
Change Period (Y+Rc), s	4.5	4.5		4.5	4.5	4.5						
Max Green Setting (Gmax), s	13.5	30.5		32.5	15.0	29.0						
Max Q Clear Time (g_c+10), s	10.9	22.0		29.8	6.3	20.1						
Green Ext Time (p_c), s	0.1	4.0		1.5	0.3	3.2						

Intersection Summary

HCM 6th Ctrl Delay	33.1
HCM 6th LOS	C

Notes

User approved volume balancing among the lanes for turning movement.

Intersection						
Int Delay, s/veh	0.3					
Movement	WBL	WBR	NBT	NBR	SBL	SBT
Lane Configurations	↔		↕		↔	↕
Traffic Vol, veh/h	7	9	1156	7	32	1007
Future Vol, veh/h	7	9	1156	7	32	1007
Conflicting Peds, #/hr	0	0	0	2	2	0
Sign Control	Stop	Stop	Free	Free	Free	Free
RT Channelized	-	None	-	None	-	None
Storage Length	0	-	-	-	100	-
Veh in Median Storage, #	0	-	0	-	-	0
Grade, %	0	-	0	-	-	0
Peak Hour Factor	95	95	95	95	95	95
Heavy Vehicles, %	6	6	2	2	2	2
Mvmt Flow	7	9	1217	7	34	1060

Major/Minor	Minor1	Major1	Major2		
Conflicting Flow All	1821	614	0	0	1226
Stage 1	1223	-	-	-	-
Stage 2	598	-	-	-	-
Critical Hdwy	6.92	7.02	-	-	4.14
Critical Hdwy Stg 1	5.92	-	-	-	-
Critical Hdwy Stg 2	5.92	-	-	-	-
Follow-up Hdwy	3.56	3.36	-	-	2.22
Pot Cap-1 Maneuver	*130	425	-	-	564
Stage 1	*233	-	-	-	-
Stage 2	*612	-	-	-	-
Platoon blocked, %	1	-	-	-	-
Mov Cap-1 Maneuver	*122	424	-	-	563
Mov Cap-2 Maneuver	*193	-	-	-	-
Stage 1	*233	-	-	-	-
Stage 2	*575	-	-	-	-

Approach	WB	NB	SB
HCM Control Delay, s	18.8	0	0.4
HCM LOS	C		

Minor Lane/Major Mvmt	NBT	NBRWBLn1	SBL	SBT
Capacity (veh/h)	-	-	278	563
HCM Lane V/C Ratio	-	-	0.061	0.06
HCM Control Delay (s)	-	-	18.8	11.8
HCM Lane LOS	-	-	C	B
HCM 95th %tile Q(veh)	-	-	0.2	0.2

Notes
 -: Volume exceeds capacity \$: Delay exceeds 300s +: Computation Not Defined *: All major volume in platoon

HCM 6th Signalized Intersection Summary
 49: Yosemite Avenue & Cleveland Avenue/Tozer Street

Village D Specific Plan
 Phase II NP - PM Peak Hour



Movement	EBL	EBT	EBR	WBL	WBT	WBR	NBL	NBT	NBR	SBL	SBT	SBR
Lane Configurations												
Traffic Volume (veh/h)	229	447	200	51	482	44	315	314	98	78	181	230
Future Volume (veh/h)	229	447	200	51	482	44	315	314	98	78	181	230
Initial Q (Qb), veh	0	0	0	0	0	0	0	0	0	0	0	0
Ped-Bike Adj(A_pbT)	1.00		0.99	1.00		0.96	1.00		1.00	1.00		0.98
Parking Bus, Adj	1.00	1.00	1.00	1.00	1.00	1.00	1.00	1.00	1.00	1.00	1.00	1.00
Work Zone On Approach		No			No			No			No	
Adj Sat Flow, veh/h/ln	1870	1870	1870	1900	1900	1900	1870	1870	1870	1870	1870	1870
Adj Flow Rate, veh/h	249	486	217	55	524	48	342	341	107	85	197	250
Peak Hour Factor	0.92	0.92	0.92	0.92	0.92	0.92	0.92	0.92	0.92	0.92	0.92	0.92
Percent Heavy Veh, %	2	2	2	0	0	0	2	2	2	2	2	2
Cap, veh/h	280	750	333	71	711	304	340	757	640	109	204	258
Arrive On Green	0.16	0.31	0.31	0.04	0.20	0.20	0.19	0.40	0.40	0.06	0.28	0.28
Sat Flow, veh/h	1781	2383	1057	1810	3610	1543	1781	1870	1580	1781	740	939
Grp Volume(v), veh/h	249	362	341	55	524	48	342	341	107	85	0	447
Grp Sat Flow(s),veh/h/ln	1781	1777	1664	1810	1805	1543	1781	1870	1580	1781	0	1679
Q Serve(g_s), s	13.7	17.5	17.7	3.0	13.6	2.6	19.1	13.3	4.3	4.7	0.0	26.3
Cycle Q Clear(g_c), s	13.7	17.5	17.7	3.0	13.6	2.6	19.1	13.3	4.3	4.7	0.0	26.3
Prop In Lane	1.00		0.64	1.00		1.00	1.00		1.00	1.00		0.56
Lane Grp Cap(c), veh/h	280	559	524	71	711	304	340	757	640	109	0	462
V/C Ratio(X)	0.89	0.65	0.65	0.77	0.74	0.16	1.01	0.45	0.17	0.78	0.00	0.97
Avail Cap(c_a), veh/h	287	559	524	103	711	304	340	757	640	173	0	462
HCM Platoon Ratio	1.00	1.00	1.00	1.00	1.00	1.00	1.00	1.00	1.00	1.00	1.00	1.00
Upstream Filter(I)	1.00	1.00	1.00	1.00	1.00	1.00	1.00	1.00	1.00	1.00	0.00	1.00
Uniform Delay (d), s/veh	41.3	29.5	29.5	47.6	37.7	33.3	40.4	21.7	19.0	46.3	0.0	35.8
Incr Delay (d2), s/veh	26.7	5.7	6.2	19.5	6.7	1.1	50.1	0.4	0.1	11.4	0.0	33.6
Initial Q Delay(d3),s/veh	0.0	0.0	0.0	0.0	0.0	0.0	0.0	0.0	0.0	0.0	0.0	0.0
%ile BackOfQ(50%),veh/ln	8.0	8.2	7.8	1.7	6.6	1.1	13.0	5.8	1.6	2.4	0.0	14.8
Unsig. Movement Delay, s/veh												
LnGrp Delay(d),s/veh	68.0	35.2	35.7	67.1	44.5	34.4	90.6	22.1	19.1	57.7	0.0	69.4
LnGrp LOS	E	D	D	E	D	C	F	C	B	E	A	E
Approach Vol, veh/h		952			627			790				532
Approach Delay, s/veh		44.0			45.7			51.3				67.5
Approach LOS		D			D			D				E
Timer - Assigned Phs	1	2	3	4	5	6	7	8				
Phs Duration (G+Y+Rc), s	20.2	24.2	10.6	45.0	8.4	36.0	23.6	32.0				
Change Period (Y+Rc), s	4.5	4.5	4.5	4.5	4.5	4.5	4.5	4.5				
Max Green Setting (Gmax), s	16.1	19.3	9.7	36.9	5.7	29.7	19.1	27.5				
Max Q Clear Time (g_c+I1), s	15.7	15.6	6.7	15.3	5.0	19.7	21.1	28.3				
Green Ext Time (p_c), s	0.0	1.2	0.0	2.4	0.0	3.2	0.0	0.0				

Intersection Summary

HCM 6th Ctrl Delay			50.7									
HCM 6th LOS			D									

Intersection						
Int Delay, s/veh	0					
Movement	EBT	EBR	WBL	WBT	NBL	NBR
Lane Configurations						
Traffic Vol, veh/h	69	0	0	34	0	0
Future Vol, veh/h	69	0	0	34	0	0
Conflicting Peds, #/hr	0	0	0	0	0	0
Sign Control	Free	Free	Free	Free	Stop	Stop
RT Channelized	-	None	-	None	-	None
Storage Length	-	-	-	-	-	-
Veh in Median Storage, #	0	-	-	0	0	-
Grade, %	0	-	-	0	0	-
Peak Hour Factor	92	92	92	92	92	92
Heavy Vehicles, %	4	4	4	4	0	0
Mvmt Flow	75	0	0	37	0	0

Major/Minor	Major1	Major2	Minor1	Minor2	Minor3
Conflicting Flow All	0	0	75	0	112
Stage 1	-	-	-	-	75
Stage 2	-	-	-	-	37
Critical Hdwy	-	-	4.14	-	6.4
Critical Hdwy Stg 1	-	-	-	-	5.4
Critical Hdwy Stg 2	-	-	-	-	5.4
Follow-up Hdwy	-	-	2.236	-	3.5
Pot Cap-1 Maneuver	-	-	1512	-	890
Stage 1	-	-	-	-	953
Stage 2	-	-	-	-	991
Platoon blocked, %	-	-	-	-	-
Mov Cap-1 Maneuver	-	-	1512	-	890
Mov Cap-2 Maneuver	-	-	-	-	890
Stage 1	-	-	-	-	953
Stage 2	-	-	-	-	991

Approach	EB	WB	NB
HCM Control Delay, s	0	0	0
HCM LOS			A

Minor Lane/Major Mvmt	NBLn1	EBT	EBR	WBL	WBT
Capacity (veh/h)	-	-	-	1512	-
HCM Lane V/C Ratio	-	-	-	-	-
HCM Control Delay (s)	0	-	-	0	-
HCM Lane LOS	A	-	-	A	-
HCM 95th %tile Q(veh)	-	-	-	0	-

Intersection												
Int Delay, s/veh	0.2											
Movement	EBL	EBT	EBR	WBL	WBT	WBR	NBL	NBT	NBR	SBL	SBT	SBR
Lane Configurations		↕			↕			↕			↕	
Traffic Vol, veh/h	0	151	0	0	15	0	0	0	0	3	0	0
Future Vol, veh/h	0	151	0	0	15	0	0	0	0	3	0	0
Conflicting Peds, #/hr	0	0	0	0	0	0	0	0	0	0	0	0
Sign Control	Free	Free	Free	Free	Free	Free	Stop	Stop	Stop	Stop	Stop	Stop
RT Channelized	-	-	None	-	-	None	-	-	None	-	-	None
Storage Length	-	-	-	-	-	-	-	-	-	-	-	-
Veh in Median Storage, #	-	0	-	-	0	-	-	0	-	-	0	-
Grade, %	-	0	-	-	0	-	-	0	-	-	0	-
Peak Hour Factor	92	92	92	92	92	92	92	92	92	92	92	92
Heavy Vehicles, %	13	13	13	13	13	13	0	0	0	0	0	0
Mvmt Flow	0	164	0	0	16	0	0	0	0	3	0	0

Major/Minor	Major1		Major2		Minor1		Minor2					
Conflicting Flow All	16	0	0	164	0	0	180	180	164	180	180	16
Stage 1	-	-	-	-	-	-	164	164	-	16	16	-
Stage 2	-	-	-	-	-	-	16	16	-	164	164	-
Critical Hdwy	4.23	-	-	4.23	-	-	7.1	6.5	6.2	7.1	6.5	6.2
Critical Hdwy Stg 1	-	-	-	-	-	-	6.1	5.5	-	6.1	5.5	-
Critical Hdwy Stg 2	-	-	-	-	-	-	6.1	5.5	-	6.1	5.5	-
Follow-up Hdwy	2.317	-	-	2.317	-	-	3.5	4	3.3	3.5	4	3.3
Pot Cap-1 Maneuver	1533	-	-	1350	-	-	786	717	886	786	717	1069
Stage 1	-	-	-	-	-	-	843	766	-	1009	886	-
Stage 2	-	-	-	-	-	-	1009	886	-	843	766	-
Platoon blocked, %	-	-	-	-	-	-	-	-	-	-	-	-
Mov Cap-1 Maneuver	1533	-	-	1350	-	-	786	717	886	786	717	1069
Mov Cap-2 Maneuver	-	-	-	-	-	-	786	717	-	786	717	-
Stage 1	-	-	-	-	-	-	843	766	-	1009	886	-
Stage 2	-	-	-	-	-	-	1009	886	-	843	766	-

Approach	EB		WB		NB		SB	
HCM Control Delay, s	0		0		0		9.6	
HCM LOS					A		A	

Minor Lane/Major Mvmt	NBLn1	EBL	EBT	EBR	WBL	WBT	WBR	SBLn1
Capacity (veh/h)	-	1533	-	-	1350	-	-	786
HCM Lane V/C Ratio	-	-	-	-	-	-	-	0.004
HCM Control Delay (s)	0	0	-	-	0	-	-	9.6
HCM Lane LOS	A	A	-	-	A	-	-	A
HCM 95th %tile Q(veh)	-	0	-	-	0	-	-	0

Intersection						
Int Delay, s/veh	0					
Movement	WBL	WBR	NBT	NBR	SBL	SBT
Lane Configurations						
Traffic Vol, veh/h	0	0	0	0	1	0
Future Vol, veh/h	0	0	0	0	1	0
Conflicting Peds, #/hr	0	0	0	0	0	0
Sign Control	Stop	Stop	Free	Free	Free	Free
RT Channelized	-	None	-	None	-	None
Storage Length	-	-	-	-	-	-
Veh in Median Storage, #	0	-	0	-	-	0
Grade, %	0	-	0	-	-	0
Peak Hour Factor	92	92	92	92	92	92
Heavy Vehicles, %	0	0	0	0	0	0
Mvmt Flow	0	0	0	0	1	0

Major/Minor	Minor1	Major1	Major2			
Conflicting Flow All	2	0	0	0	0	0
Stage 1	0	-	-	-	-	-
Stage 2	2	-	-	-	-	-
Critical Hdwy	6.4	6.2	-	-	4.1	-
Critical Hdwy Stg 1	5.4	-	-	-	-	-
Critical Hdwy Stg 2	5.4	-	-	-	-	-
Follow-up Hdwy	3.5	3.3	-	-	2.2	-
Pot Cap-1 Maneuver	1026	-	-	-	-	-
Stage 1	-	-	-	-	-	-
Stage 2	1026	-	-	-	-	-
Platoon blocked, %						
Mov Cap-1 Maneuver	1026	-	-	-	-	-
Mov Cap-2 Maneuver	1026	-	-	-	-	-
Stage 1	-	-	-	-	-	-
Stage 2	1026	-	-	-	-	-

Approach	WB	NB	SB
HCM Control Delay, s	0	0	
HCM LOS	A		

Minor Lane/Major Mvmt	NBT	NBRWBLn1	SBL	SBT
Capacity (veh/h)	-	-	-	-
HCM Lane V/C Ratio	-	-	-	-
HCM Control Delay (s)	-	-	0	-
HCM Lane LOS	-	-	A	-
HCM 95th %tile Q(veh)	-	-	-	-

Intersection						
Int Delay, s/veh	0					
Movement	EBL	EBR	NBL	NBT	SBT	SBR
Lane Configurations	T			T		
Traffic Vol, veh/h	0	2	0	255	337	0
Future Vol, veh/h	0	2	0	255	337	0
Conflicting Peds, #/hr	0	0	0	0	0	0
Sign Control	Stop	Stop	Free	Free	Free	Free
RT Channelized	-	None	-	None	-	None
Storage Length	-	-	-	-	-	-
Veh in Median Storage, #	0	-	-	0	0	-
Grade, %	0	-	-	0	0	-
Peak Hour Factor	92	92	92	92	92	92
Heavy Vehicles, %	0	0	9	9	9	9
Mvmt Flow	0	2	0	277	366	0

Major/Minor	Minor2	Major1		Major2	
Conflicting Flow All	643	366	366	0	0
Stage 1	366	-	-	-	-
Stage 2	277	-	-	-	-
Critical Hdwy	6.4	6.2	4.19	-	-
Critical Hdwy Stg 1	5.4	-	-	-	-
Critical Hdwy Stg 2	5.4	-	-	-	-
Follow-up Hdwy	3.5	3.3	2.281	-	-
Pot Cap-1 Maneuver	441	684	1155	-	-
Stage 1	706	-	-	-	-
Stage 2	774	-	-	-	-
Platoon blocked, %				-	-
Mov Cap-1 Maneuver	441	684	1155	-	-
Mov Cap-2 Maneuver	441	-	-	-	-
Stage 1	706	-	-	-	-
Stage 2	774	-	-	-	-

Approach	EB	NB	SB
HCM Control Delay, s	10.3	0	0
HCM LOS	B		

Minor Lane/Major Mvmt	NBL	NBT	EBLn1	SBT	SBR
Capacity (veh/h)	1155	-	684	-	-
HCM Lane V/C Ratio	-	-	0.003	-	-
HCM Control Delay (s)	0	-	10.3	-	-
HCM Lane LOS	A	-	B	-	-
HCM 95th %tile Q(veh)	0	-	0	-	-

Intersection						
Int Delay, s/veh	1.1					
Movement	EBL	EBR	NBL	NBT	SBT	SBR
Lane Configurations	T			T		T
Traffic Vol, veh/h	40	16	0	266	341	24
Future Vol, veh/h	40	16	0	266	341	24
Conflicting Peds, #/hr	0	0	0	0	0	0
Sign Control	Stop	Stop	Free	Free	Free	Free
RT Channelized	-	None	-	None	-	None
Storage Length	0	-	-	-	-	-
Veh in Median Storage, #	0	-	-	0	0	-
Grade, %	0	-	-	0	0	-
Peak Hour Factor	92	92	92	92	92	92
Heavy Vehicles, %	0	0	9	9	9	9
Mvmt Flow	43	17	0	289	371	26

Major/Minor	Minor2	Major1		Major2	
Conflicting Flow All	673	384	397	0	0
Stage 1	384	-	-	-	-
Stage 2	289	-	-	-	-
Critical Hdwy	6.4	6.2	4.19	-	-
Critical Hdwy Stg 1	5.4	-	-	-	-
Critical Hdwy Stg 2	5.4	-	-	-	-
Follow-up Hdwy	3.5	3.3	2.281	-	-
Pot Cap-1 Maneuver	424	668	1125	-	-
Stage 1	693	-	-	-	-
Stage 2	765	-	-	-	-
Platoon blocked, %				-	-
Mov Cap-1 Maneuver	424	668	1125	-	-
Mov Cap-2 Maneuver	424	-	-	-	-
Stage 1	693	-	-	-	-
Stage 2	765	-	-	-	-

Approach	EB	NB	SB
HCM Control Delay, s	13.7	0	0
HCM LOS	B		

Minor Lane/Major Mvmt	NBL	NBT	EBLn1	SBT	SBR
Capacity (veh/h)	1125	-	473	-	-
HCM Lane V/C Ratio	-	-	0.129	-	-
HCM Control Delay (s)	0	-	13.7	-	-
HCM Lane LOS	A	-	B	-	-
HCM 95th %tile Q(veh)	0	-	0.4	-	-

Intersection						
Int Delay, s/veh	0.4					
Movement	EBT	EBR	WBL	WBT	NBL	NBR
Lane Configurations						
Traffic Vol, veh/h	65	0	2	118	2	5
Future Vol, veh/h	65	0	2	118	2	5
Conflicting Peds, #/hr	0	0	0	0	0	0
Sign Control	Free	Free	Free	Free	Stop	Stop
RT Channelized	-	None	-	None	-	None
Storage Length	-	-	50	-	-	-
Veh in Median Storage, #	0	-	-	0	0	-
Grade, %	0	-	-	0	0	-
Peak Hour Factor	92	92	92	92	92	92
Heavy Vehicles, %	8	8	4	4	0	0
Mvmt Flow	71	0	2	128	2	5

Major/Minor	Major1	Major2	Minor1		
Conflicting Flow All	0	0	71	0	203
Stage 1	-	-	-	-	71
Stage 2	-	-	-	-	132
Critical Hdwy	-	-	4.14	-	6.4
Critical Hdwy Stg 1	-	-	-	-	5.4
Critical Hdwy Stg 2	-	-	-	-	5.4
Follow-up Hdwy	-	-	2.236	-	3.5
Pot Cap-1 Maneuver	-	-	1517	-	790
Stage 1	-	-	-	-	957
Stage 2	-	-	-	-	899
Platoon blocked, %	-	-	-	-	-
Mov Cap-1 Maneuver	-	-	1517	-	789
Mov Cap-2 Maneuver	-	-	-	-	789
Stage 1	-	-	-	-	957
Stage 2	-	-	-	-	898

Approach	EB	WB	NB
HCM Control Delay, s	0	0.1	8.9
HCM LOS			A

Minor Lane/Major Mvmt	NBLn1	EBT	EBR	WBL	WBT
Capacity (veh/h)	927	-	-	1517	-
HCM Lane V/C Ratio	0.008	-	-	0.001	-
HCM Control Delay (s)	8.9	-	-	7.4	-
HCM Lane LOS	A	-	-	A	-
HCM 95th %tile Q(veh)	0	-	-	0	-

Intersection	
Intersection Delay, s/veh	7.5
Intersection LOS	A

Movement	EBL	EBT	EBR	WBL	WBT	WBR	NBL	NBT	NBR	SBL	SBT	SBR
Lane Configurations	↶	↷		↶	↷		↶	↷		↶	↷	
Traffic Vol, veh/h	2	12	0	0	30	5	0	0	0	2	0	1
Future Vol, veh/h	2	12	0	0	30	5	0	0	0	2	0	1
Peak Hour Factor	0.92	0.92	0.92	0.92	0.92	0.92	0.92	0.92	0.92	0.92	0.92	0.92
Heavy Vehicles, %	11	11	11	11	11	11	0	0	0	0	0	0
Mvmt Flow	2	13	0	0	33	5	0	0	0	2	0	1
Number of Lanes	1	1	0	1	1	0	1	1	0	1	1	0

Approach	EB	WB	NB	SB
Opposing Approach	WB	EB	SB	NB
Opposing Lanes	2	2	2	2
Conflicting Approach Left	SB	NB	EB	WB
Conflicting Lanes Left	2	2	2	2
Conflicting Approach Right	NB	SB	WB	EB
Conflicting Lanes Right	2	2	2	2
HCM Control Delay	7.6	7.5	0	7.4
HCM LOS	A	A	-	A

Lane	NBLn1	NBLn2	EBLn1	EBLn2	WBLn1	WBLn2	SBLn1	SBLn2
Vol Left, %	0%	0%	100%	0%	0%	0%	100%	0%
Vol Thru, %	100%	100%	0%	100%	100%	86%	0%	0%
Vol Right, %	0%	0%	0%	0%	0%	14%	0%	100%
Sign Control	Stop	Stop	Stop	Stop	Stop	Stop	Stop	Stop
Traffic Vol by Lane	0	0	2	12	0	35	2	1
LT Vol	0	0	2	0	0	0	2	0
Through Vol	0	0	0	12	0	30	0	0
RT Vol	0	0	0	0	0	5	0	1
Lane Flow Rate	0	0	2	13	0	38	2	1
Geometry Grp	7	7	7	7	7	7	7	7
Degree of Util (X)	0	0	0.003	0.017	0	0.049	0.003	0.001
Departure Headway (Hd)	4.595	4.595	5.211	4.711	4.7	4.6	5.093	3.892
Convergence, Y/N	Yes	Yes	Yes	Yes	Yes	Yes	Yes	Yes
Cap	0	0	689	763	0	782	701	916
Service Time	2.337	2.337	2.922	2.421	2.405	2.305	2.833	1.632
HCM Lane V/C Ratio	0	0	0.003	0.017	0	0.049	0.003	0.001
HCM Control Delay	7.3	7.3	7.9	7.5	7.4	7.5	7.8	6.6
HCM Lane LOS	N	N	A	A	N	A	A	A
HCM 95th-tile Q	0	0	0	0.1	0	0.2	0	0

Intersection						
Int Delay, s/veh	2.7					
Movement	EBL	EBT	WBT	WBR	SBL	SBR
Lane Configurations		↕	↑	↗	↘	
Traffic Vol, veh/h	2	129	159	109	96	4
Future Vol, veh/h	2	129	159	109	96	4
Conflicting Peds, #/hr	0	0	0	0	0	0
Sign Control	Free	Free	Free	Free	Stop	Stop
RT Channelized	-	None	-	None	-	None
Storage Length	-	-	-	0	0	-
Veh in Median Storage, #	-	0	0	-	0	-
Grade, %	-	0	0	-	0	-
Peak Hour Factor	92	92	92	92	92	92
Heavy Vehicles, %	14	14	39	39	81	81
Mvmt Flow	2	140	173	118	104	4

Major/Minor	Major1	Major2	Minor2		
Conflicting Flow All	291	0	0	317	173
Stage 1	-	-	-	173	-
Stage 2	-	-	-	144	-
Critical Hdwy	4.24	-	-	7.21	7.01
Critical Hdwy Stg 1	-	-	-	6.21	-
Critical Hdwy Stg 2	-	-	-	6.21	-
Follow-up Hdwy	2.326	-	-	4.229	4.029
Pot Cap-1 Maneuver	1205	-	-	540	702
Stage 1	-	-	-	698	-
Stage 2	-	-	-	722	-
Platoon blocked, %		-	-		
Mov Cap-1 Maneuver	1205	-	-	539	702
Mov Cap-2 Maneuver	-	-	-	539	-
Stage 1	-	-	-	697	-
Stage 2	-	-	-	722	-

Approach	EB	WB	SB
HCM Control Delay, s	0.1	0	13.3
HCM LOS			B

Minor Lane/Major Mvmt	EBL	EBT	WBT	WBR	SBLn1
Capacity (veh/h)	1205	-	-	-	544
HCM Lane V/C Ratio	0.002	-	-	-	0.2
HCM Control Delay (s)	8	0	-	-	13.3
HCM Lane LOS	A	A	-	-	B
HCM 95th %tile Q(veh)	0	-	-	-	0.7

HCM 6th TWSC
 4: Truck Parking Lot/Pistachio Drive & Avenue 18 1/2

Village D Specific Plan
 Phase II WP - AM Peak Hour

Intersection												
Int Delay, s/veh	2.6											
Movement	EBL	EBT	EBR	WBL	WBT	WBR	NBL	NBT	NBR	SBL	SBT	SBR
Lane Configurations		↕			↕	↕		↕			↕	
Traffic Vol, veh/h	8	281	1	3	275	204	0	0	1	108	0	9
Future Vol, veh/h	8	281	1	3	275	204	0	0	1	108	0	9
Conflicting Peds, #/hr	0	0	0	0	0	0	0	0	0	0	0	0
Sign Control	Free	Free	Free	Free	Free	Free	Stop	Stop	Stop	Stop	Stop	Stop
RT Channelized	-	-	None	-	-	None	-	-	None	-	-	None
Storage Length	-	-	-	-	-	50	-	-	-	-	-	-
Veh in Median Storage, #	-	0	-	-	0	-	-	0	-	-	0	-
Grade, %	-	0	-	-	0	-	-	0	-	-	0	-
Peak Hour Factor	93	93	93	93	93	93	93	93	93	93	93	93
Heavy Vehicles, %	31	31	31	23	23	23	100	100	100	12	12	12
Mvmt Flow	9	302	1	3	296	219	0	0	1	116	0	10

Major/Minor	Major1			Major2			Minor1			Minor2		
Conflicting Flow All	515	0	0	303	0	0	738	842	303	623	623	296
Stage 1	-	-	-	-	-	-	321	321	-	302	302	-
Stage 2	-	-	-	-	-	-	417	521	-	321	321	-
Critical Hdwy	4.41	-	-	4.33	-	-	8.1	7.5	7.2	7.22	6.62	6.32
Critical Hdwy Stg 1	-	-	-	-	-	-	7.1	6.5	-	6.22	5.62	-
Critical Hdwy Stg 2	-	-	-	-	-	-	7.1	6.5	-	6.22	5.62	-
Follow-up Hdwy	2.479	-	-	2.407	-	-	4.4	4.9	4.2	3.608	4.108	3.408
Pot Cap-1 Maneuver	918	-	-	1148	-	-	236	214	555	385	389	720
Stage 1	-	-	-	-	-	-	525	508	-	686	647	-
Stage 2	-	-	-	-	-	-	459	400	-	670	634	-
Platoon blocked, %		-	-		-	-						
Mov Cap-1 Maneuver	918	-	-	1148	-	-	230	211	555	380	383	720
Mov Cap-2 Maneuver	-	-	-	-	-	-	230	211	-	380	383	-
Stage 1	-	-	-	-	-	-	519	502	-	678	644	-
Stage 2	-	-	-	-	-	-	451	398	-	661	626	-

Approach	EB			WB			NB			SB		
HCM Control Delay, s	0.2			0.1			11.5			18.4		
HCM LOS							B			C		

Minor Lane/Major Mvmt	NBLn1	EBL	EBT	EBR	WBL	WBT	WBR	SBLn1	
Capacity (veh/h)	555	918	-	-	1148	-	-	394	
HCM Lane V/C Ratio	0.002	0.009	-	-	0.003	-	-	0.319	
HCM Control Delay (s)	11.5	9	0	-	8.1	0	-	18.4	
HCM Lane LOS		B	A	A	-	A	A	-	C
HCM 95th %tile Q(veh)		0	0	-	-	0	-	-	1.4

HCM 6th TWSC
 5: Road 23/SR-99 Southbound Off-Ramp & Avenue 18 1/2

Village D Specific Plan
 Phase II WP - AM Peak Hour

Intersection												
Int Delay, s/veh	95.4											
Movement	EBL	EBT	EBR	WBL	WBT	WBR	NBL	NBT	NBR	SBL	SBT	SBR
Lane Configurations		↑	↑		↑		↑		↑		↕	
Traffic Vol, veh/h	0	317	73	47	281	0	119	0	551	11	196	86
Future Vol, veh/h	0	317	73	47	281	0	119	0	551	11	196	86
Conflicting Peds, #/hr	0	0	0	0	0	0	0	0	1	1	0	0
Sign Control	Free	Free	Free	Free	Free	Free	Stop	Stop	Stop	Stop	Stop	Stop
RT Channelized	-	-	None	-	-	None	-	-	None	-	-	None
Storage Length	-	-	50	-	-	-	0	-	25	-	-	-
Veh in Median Storage, #	-	0	-	-	0	-	-	0	-	-	0	-
Grade, %	-	0	-	-	0	-	-	0	-	-	0	-
Peak Hour Factor	92	92	92	92	92	92	92	92	92	92	92	92
Heavy Vehicles, %	31	31	31	26	26	26	7	7	7	18	18	18
Mvmt Flow	0	345	79	51	305	0	129	0	599	12	213	93

Major/Minor	Major1			Major2			Minor1			Minor2		
Conflicting Flow All	-	0	0	424	0	0	905	-	346	1092	831	305
Stage 1	-	-	-	-	-	-	345	-	-	407	407	-
Stage 2	-	-	-	-	-	-	560	-	-	685	424	-
Critical Hdwy	-	-	-	4.36	-	-	7.17	-	6.27	7.28	6.68	6.38
Critical Hdwy Stg 1	-	-	-	-	-	-	6.17	-	-	6.28	5.68	-
Critical Hdwy Stg 2	-	-	-	-	-	-	6.17	-	-	6.28	5.68	-
Follow-up Hdwy	-	-	-	2.434	-	-	3.563	-	3.363	3.662	4.162	3.462
Pot Cap-1 Maneuver	0	-	-	1018	-	0	252	0	686	179	288	699
Stage 1	0	-	-	-	-	0	660	0	-	590	571	-
Stage 2	0	-	-	-	-	0	504	0	-	413	560	-
Platoon blocked, %		-	-	-	-	-	-	-	-	-	-	-
Mov Cap-1 Maneuver	-	-	-	1018	-	-	~ 74	-	685	21	271	699
Mov Cap-2 Maneuver	-	-	-	-	-	-	~ 74	-	-	21	271	-
Stage 1	-	-	-	-	-	-	660	-	-	590	537	-
Stage 2	-	-	-	-	-	-	248	-	-	52	560	-

Approach	EB	WB	NB	SB
HCM Control Delay, s	0	1.2	114.4	284.4
HCM LOS			F	F

Minor Lane/Major Mvmt	NBLn1	NBLn2	EBT	EBR	WBL	WBT	SBLn1
Capacity (veh/h)	74	685	-	-	1018	-	214
HCM Lane V/C Ratio	1.748	0.874	-	-	0.05	-	1.488
HCM Control Delay (s)	\$ 480	35.5	-	-	8.7	0	284.4
HCM Lane LOS	F	E	-	-	A	A	F
HCM 95th %tile Q(veh)	11.2	10.5	-	-	0.2	-	19.3

Notes
 -: Volume exceeds capacity \$: Delay exceeds 300s +: Computation Not Defined *: All major volume in platoon

HCM 6th TWSC
6: SR-99 Northbound Ramps & Avenue 18 1/2

Village D Specific Plan
Phase II WP - AM Peak Hour

Intersection												
Int Delay, s/veh	408.7											
Movement	EBL	EBT	EBR	WBL	WBT	WBR	NBL	NBT	NBR	SBL	SBT	SBR
Lane Configurations	↙	↑			↘			↔				
Traffic Vol, veh/h	620	61	0	0	150	31	215	1	25	0	0	0
Future Vol, veh/h	620	61	0	0	150	31	215	1	25	0	0	0
Conflicting Peds, #/hr	1	0	0	0	0	1	0	0	0	0	0	0
Sign Control	Free	Free	Free	Free	Free	Free	Stop	Stop	Stop	Free	Free	Free
RT Channelized	-	-	None	-	-	None	-	-	None	-	-	None
Storage Length	145	-	-	-	-	-	-	-	-	-	-	-
Veh in Median Storage, #	-	0	-	-	0	-	-	0	-	-	16965	-
Grade, %	-	0	-	-	0	-	-	0	-	-	0	-
Peak Hour Factor	92	92	92	92	92	92	92	92	92	92	92	92
Heavy Vehicles, %	13	13	13	18	18	18	29	29	29	0	0	0
Mvmt Flow	674	66	0	0	163	34	234	1	27	0	0	0

Major/Minor	Major1	Major2	Minor1
Conflicting Flow All	198	0	-
Stage 1	-	-	-
Stage 2	-	-	-
Critical Hdwy	4.23	-	-
Critical Hdwy Stg 1	-	-	-
Critical Hdwy Stg 2	-	-	-
Follow-up Hdwy	2.317	-	-
Pot Cap-1 Maneuver	1311	-	0
Stage 1	-	-	0
Stage 2	-	-	0
Platoon blocked, %	-	-	-
Mov Cap-1 Maneuver	1311	-	-
Mov Cap-2 Maneuver	-	-	-
Stage 1	-	-	-
Stage 2	-	-	-

Approach	EB	WB	NB
HCM Control Delay, s	9.7	0	\$ 1842.9
HCM LOS			F

Minor Lane/Major Mvmt	NBLn1	EBL	EBT	WBT	WBR
Capacity (veh/h)	55	1311	-	-	-
HCM Lane V/C Ratio	4.763	0.514	-	-	-
HCM Control Delay (s)	\$ 1842.9	10.6	-	-	-
HCM Lane LOS	F	B	-	-	-
HCM 95th %tile Q(veh)	29.2	3.1	-	-	-

Notes
 -: Volume exceeds capacity \$: Delay exceeds 300s +: Computation Not Defined *: All major volume in platoon

Intersection												
Int Delay, s/veh	0.3											
Movement	EBL	EBT	EBR	WBL	WBT	WBR	NBL	NBT	NBR	SBL	SBT	SBR
Lane Configurations		↕			↕			↕			↕	
Traffic Vol, veh/h	161	486	53	370	131	3	74	642	717	16	291	42
Future Vol, veh/h	161	486	53	370	131	3	74	642	717	16	291	42
Conflicting Peds, #/hr	0	0	0	0	0	0	0	0	0	0	0	0
Sign Control	Stop	Stop	Stop	Stop	Stop	Stop	Free	Free	Free	Free	Free	Free
RT Channelized	-	-	None	-	-	None	-	-	None	-	-	None
Storage Length	-	-	-	-	-	-	-	-	-	-	-	-
Veh in Median Storage, #	-	0	-	-	0	-	-	0	-	-	0	-
Grade, %	-	0	-	-	0	-	-	0	-	-	0	-
Peak Hour Factor	92	92	92	92	92	92	92	92	92	92	92	92
Heavy Vehicles, %	0	0	0	3	3	3	3	3	3	8	8	8
Mvmt Flow	175	528	58	402	142	3	80	698	779	17	316	46

Major/Minor	Minor2		Minor1		Major1		Major2					
Conflicting Flow All	1693	2010	339	1914	1644	1088	362	0	0	1477	0	0
Stage 1	373	373	-	1248	1248	-	-	-	-	-	-	-
Stage 2	1320	1637	-	666	396	-	-	-	-	-	-	-
Critical Hdwy	7.1	6.5	6.2	7.13	6.53	6.23	4.13	-	-	4.18	-	-
Critical Hdwy Stg 1	6.1	5.5	-	6.13	5.53	-	-	-	-	-	-	-
Critical Hdwy Stg 2	6.1	5.5	-	6.13	5.53	-	-	-	-	-	-	-
Follow-up Hdwy	3.5	4	3.3	3.527	4.027	3.327	2.227	-	-	2.272	-	-
Pot Cap-1 Maneuver	~ 74	~ 60	708	~ 51	~ 99	261	1191	-	-	438	-	-
Stage 1	652	622	-	~ 211	244	-	-	-	-	-	-	-
Stage 2	195	~ 160	-	447	602	-	-	-	-	-	-	-
Platoon blocked, %								-	-	-	-	-
Mov Cap-1 Maneuver	-	~ 16	708	-	~ 26	261	1191	-	-	438	-	-
Mov Cap-2 Maneuver	-	~ 16	-	-	~ 26	-	-	-	-	-	-	-
Stage 1	180	592	-	~ 58	~ 67	-	-	-	-	-	-	-
Stage 2	-	~ 44	-	~ 42	573	-	-	-	-	-	-	-

Approach	EB	WB	NB	SB
HCM Control Delay, s			0.4	0.6
HCM LOS	-	-		

Minor Lane/Major Mvmt	NBL	NBT	NBR	EBLn1WBLn1	SBL	SBT	SBR
Capacity (veh/h)	1191	-	-	-	438	-	-
HCM Lane V/C Ratio	0.068	-	-	-	0.04	-	-
HCM Control Delay (s)	8.2	0	-	-	13.6	0	-
HCM Lane LOS	A	A	-	-	B	A	-
HCM 95th %tile Q(veh)	0.2	-	-	-	0.1	-	-

Notes
 -: Volume exceeds capacity \$: Delay exceeds 300s +: Computation Not Defined *: All major volume in platoon

Intersection	
Intersection Delay, s/veh	344.7
Intersection LOS	F

Movement	EBL	EBT	EBR	WBL	WBT	WBR	NBL	NBT	NBR	SBL	SBT	SBR
Lane Configurations	↶	↷		↶	↷		↶	↷		↶	↷	
Traffic Vol, veh/h	50	66	275	137	47	277	158	731	23	117	692	52
Future Vol, veh/h	50	66	275	137	47	277	158	731	23	117	692	52
Peak Hour Factor	0.92	0.92	0.92	0.92	0.92	0.92	0.92	0.92	0.92	0.92	0.92	0.92
Heavy Vehicles, %	4	4	4	0	0	0	5	5	5	6	6	6
Mvmt Flow	54	72	299	149	51	301	172	795	25	127	752	57
Number of Lanes	1	1	0	1	1	0	1	1	0	1	1	0

Approach	EB	WB	NB	SB
Opposing Approach	WB	EB	SB	NB
Opposing Lanes	2	2	2	2
Conflicting Approach Left	SB	NB	EB	WB
Conflicting Lanes Left	2	2	2	2
Conflicting Approach Right	NB	SB	WB	EB
Conflicting Lanes Right	2	2	2	2
HCM Control Delay	68.5	51.4	477.1	486.9
HCM LOS	F	F	F	F

Lane	NBLn1	NBLn2	EBLn1	EBLn2	WBLn1	WBLn2	SBLn1	SBLn2
Vol Left, %	100%	0%	100%	0%	100%	0%	100%	0%
Vol Thru, %	0%	97%	0%	19%	0%	15%	0%	93%
Vol Right, %	0%	3%	0%	81%	0%	85%	0%	7%
Sign Control	Stop	Stop	Stop	Stop	Stop	Stop	Stop	Stop
Traffic Vol by Lane	158	754	50	341	137	324	117	744
LT Vol	158	0	50	0	137	0	117	0
Through Vol	0	731	0	66	0	47	0	692
RT Vol	0	23	0	275	0	277	0	52
Lane Flow Rate	172	820	54	371	149	352	127	809
Geometry Grp	7	7	7	7	7	7	7	7
Degree of Util (X)	0.485	2.194	0.155	0.946	0.419	0.884	0.361	2.169
Departure Headway (Hd)	12	11.442	13.335	12.18	13.216	12.024	11.827	11.241
Convergence, Y/N	Yes	Yes	Yes	Yes	Yes	Yes	Yes	Yes
Cap	302	328	271	300	274	306	306	332
Service Time	9.7	9.142	11.035	9.88	10.916	9.724	9.527	8.941
HCM Lane V/C Ratio	0.57	2.5	0.199	1.237	0.544	1.15	0.415	2.437
HCM Control Delay	25.5	571.7	18.5	75.8	25.1	62.5	21.1	560.1
HCM Lane LOS	D	F	C	F	D	F	C	F
HCM 95th-tile Q	2.5	51.9	0.5	9.3	2	8	1.6	51.8

Intersection												
Intersection Delay, s/veh	67.8											
Intersection LOS	F											

Movement	EBL	EBT	EBR	WBL	WBT	WBR	NBL	NBT	NBR	SBL	SBT	SBR
Lane Configurations	↔	↔		↔	↔		↔	↔		↔	↔	
Traffic Vol, veh/h	0	19	9	311	19	327	9	681	301	299	777	0
Future Vol, veh/h	0	19	9	311	19	327	9	681	301	299	777	0
Peak Hour Factor	0.92	0.92	0.92	0.92	0.92	0.92	0.92	0.92	0.92	0.92	0.92	0.92
Heavy Vehicles, %	0	0	0	2	2	2	5	5	5	6	6	6
Mvmt Flow	0	21	10	338	21	355	10	740	327	325	845	0
Number of Lanes	1	1	0	1	1	0	1	1	0	1	1	0

Approach	EB	WB	NB	SB
Opposing Approach	WB	EB	SB	NB
Opposing Lanes	2	2	2	2
Conflicting Approach Left	SB	NB	EB	WB
Conflicting Lanes Left	2	2	2	2
Conflicting Approach Right	NB	SB	WB	EB
Conflicting Lanes Right	2	2	2	2
HCM Control Delay	15.7	36.9	667.4	303.1
HCM LOS	C	E	F	F

Lane	NBLn1	NBLn2	EBLn1	EBLn2	WBLn1	WBLn2	SBLn1	SBLn2
Vol Left, %	100%	0%	0%	0%	100%	0%	100%	0%
Vol Thru, %	0%	69%	100%	68%	0%	5%	0%	100%
Vol Right, %	0%	31%	0%	32%	0%	95%	0%	0%
Sign Control	Stop	Stop	Stop	Stop	Stop	Stop	Stop	Stop
Traffic Vol by Lane	9	982	0	28	311	346	299	777
LT Vol	9	0	0	0	311	0	299	0
Through Vol	0	681	0	19	0	19	0	777
RT Vol	0	301	0	9	0	327	0	0
Lane Flow Rate	10	1067	0	30	338	376	325	845
Geometry Grp	7	7	7	7	7	7	7	7
Degree of Util (X)	0.024	2.437	0	0.08	0.789	0.757	0.749	1.83
Departure Headway (Hd)	9.807	9.064	12.239	11.994	9.788	8.543	9.977	9.445
Convergence, Y/N	Yes	Yes	Yes	Yes	Yes	Yes	Yes	Yes
Cap	367	416	0	301	372	429	367	397
Service Time	7.507	6.764	9.939	9.694	7.488	6.243	7.677	7.145
HCM Lane V/C Ratio	0.027	2.565	0	0.1	0.909	0.876	0.886	2.128
HCM Control Delay	12.7	673.4	14.9	15.7	40.7	33.4	37.1	405.4
HCM Lane LOS	B	F	N	C	E	D	E	F
HCM 95th-tile Q	0.1	76.1	0	0.3	6.7	6.3	5.9	45.3

Intersection												
Int Delay, s/veh	3.8											
Movement	EBL	EBT	EBR	WBL	WBT	WBR	NBL	NBT	NBR	SBL	SBT	SBR
Lane Configurations		↕			↕			↕			↕	
Traffic Vol, veh/h	0	5	0	17	3	141	4	416	4	122	627	0
Future Vol, veh/h	0	5	0	17	3	141	4	416	4	122	627	0
Conflicting Peds, #/hr	0	0	0	0	0	0	0	0	0	0	0	0
Sign Control	Stop	Stop	Stop	Stop	Stop	Stop	Free	Free	Free	Free	Free	Free
RT Channelized	-	-	None	-	-	None	-	-	None	-	-	None
Storage Length	-	-	-	-	-	-	-	-	-	-	-	-
Veh in Median Storage, #	-	0	-	-	0	-	-	0	-	-	0	-
Grade, %	-	0	-	-	0	-	-	0	-	-	0	-
Peak Hour Factor	92	92	92	92	92	92	92	92	92	92	92	92
Heavy Vehicles, %	0	0	0	0	0	0	10	10	10	7	7	7
Mvmt Flow	0	5	0	18	3	153	4	452	4	133	682	0

Major/Minor	Minor2		Minor1		Major1		Major2					
Conflicting Flow All	1488	1412	682	1413	1410	454	682	0	0	456	0	0
Stage 1	948	948	-	462	462	-	-	-	-	-	-	-
Stage 2	540	464	-	951	948	-	-	-	-	-	-	-
Critical Hdwy	7.1	6.5	6.2	7.1	6.5	6.2	4.2	-	-	4.17	-	-
Critical Hdwy Stg 1	6.1	5.5	-	6.1	5.5	-	-	-	-	-	-	-
Critical Hdwy Stg 2	6.1	5.5	-	6.1	5.5	-	-	-	-	-	-	-
Follow-up Hdwy	3.5	4	3.3	3.5	4	3.3	2.29	-	-	2.263	-	-
Pot Cap-1 Maneuver	103	139	453	117	140	610	874	-	-	1079	-	-
Stage 1	316	342	-	584	568	-	-	-	-	-	-	-
Stage 2	530	567	-	315	342	-	-	-	-	-	-	-
Platoon blocked, %								-	-	-	-	-
Mov Cap-1 Maneuver	64	111	453	95	112	610	874	-	-	1079	-	-
Mov Cap-2 Maneuver	64	111	-	95	112	-	-	-	-	-	-	-
Stage 1	314	274	-	580	565	-	-	-	-	-	-	-
Stage 2	392	564	-	248	274	-	-	-	-	-	-	-

Approach	EB		WB		NB		SB	
HCM Control Delay, s	39.1		23.3		0.1		1.4	
HCM LOS	E		C					

Minor Lane/Major Mvmt	NBL	NBT	NBR	EBLn1WBLn1	SBL	SBT	SBR
Capacity (veh/h)	874	-	-	111	369	1079	-
HCM Lane V/C Ratio	0.005	-	-	0.049	0.474	0.123	-
HCM Control Delay (s)	9.1	0	-	39.1	23.3	8.8	0
HCM Lane LOS	A	A	-	E	C	A	A
HCM 95th %tile Q(veh)	0	-	-	0.2	2.5	0.4	-

Intersection	
Intersection Delay, s/veh	134
Intersection LOS	F

Movement	EBL	EBT	EBR	WBL	WBT	WBR	NBL	NBT	NBR	SBL	SBT	SBR
Lane Configurations		↕			↕			↕			↕	
Traffic Vol, veh/h	86	150	46	20	182	173	44	165	8	241	264	137
Future Vol, veh/h	86	150	46	20	182	173	44	165	8	241	264	137
Peak Hour Factor	0.92	0.92	0.92	0.92	0.92	0.92	0.92	0.92	0.92	0.92	0.92	0.92
Heavy Vehicles, %	6	6	6	6	6	6	22	22	22	7	7	7
Mvmt Flow	93	163	50	22	198	188	48	179	9	262	287	149
Number of Lanes	0	1	0	0	1	0	0	1	0	0	1	0

Approach	EB	WB	NB	SB
Opposing Approach	WB	EB	SB	NB
Opposing Lanes	1	1	1	1
Conflicting Approach Left	SB	NB	EB	WB
Conflicting Lanes Left	1	1	1	1
Conflicting Approach Right	NB	SB	WB	EB
Conflicting Lanes Right	1	1	1	1
HCM Control Delay	32.5	48.6	26.1	265
HCM LOS	D	E	D	F

Lane	NBLn1	EBLn1	WBLn1	SBLn1
Vol Left, %	20%	30%	5%	38%
Vol Thru, %	76%	53%	49%	41%
Vol Right, %	4%	16%	46%	21%
Sign Control	Stop	Stop	Stop	Stop
Traffic Vol by Lane	217	282	375	642
LT Vol	44	86	20	241
Through Vol	165	150	182	264
RT Vol	8	46	173	137
Lane Flow Rate	236	307	408	698
Geometry Grp	1	1	1	1
Degree of Util (X)	0.576	0.7	0.867	1.518
Departure Headway (Hd)	10.147	9.708	9.037	7.829
Convergence, Y/N	Yes	Yes	Yes	Yes
Cap	359	374	404	468
Service Time	8.147	7.708	7.037	5.829
HCM Lane V/C Ratio	0.657	0.821	1.01	1.491
HCM Control Delay	26.1	32.5	48.6	265
HCM Lane LOS	D	D	E	F
HCM 95th-tile Q	3.4	5.1	8.5	36.9

Intersection

Intersection Delay, s/veh10.2

Intersection LOS B

Movement	EBL	EBT	EBR	WBL	WBT	WBR	NBL	NBT	NBR	SBL	SBT	SBR
Lane Configurations												
Traffic Vol, veh/h	37	84	4	11	100	56	8	47	17	77	84	83
Future Vol, veh/h	37	84	4	11	100	56	8	47	17	77	84	83
Peak Hour Factor	0.92	0.92	0.92	0.92	0.92	0.92	0.92	0.92	0.92	0.92	0.92	0.92
Heavy Vehicles, %	9	9	9	28	28	28	9	9	9	10	10	10
Mvmt Flow	40	91	4	12	109	61	9	51	18	84	91	90
Number of Lanes	1	1	0	1	1	0	0	1	0	0	1	0

Approach	EB	WB	NB	SB
Opposing Approach	WB	EB	SB	NB
Opposing Lanes	2	2	1	1
Conflicting Approach Left SB		NB	EB	WB
Conflicting Lanes Left	1	1	2	2
Conflicting Approach Right NB		SB	WB	EB
Conflicting Lanes Right	1	1	2	2
HCM Control Delay	9.5	10.6	8.9	10.7
HCM LOS	A	B	A	B

Lane	NBLn1	EBLn1	EBLn2	WBLn1	WBLn2	SBLn1
Vol Left, %	11%	100%	0%	100%	0%	32%
Vol Thru, %	65%	0%	95%	0%	64%	34%
Vol Right, %	24%	0%	5%	0%	36%	34%
Sign Control	Stop	Stop	Stop	Stop	Stop	Stop
Traffic Vol by Lane	72	37	88	11	156	244
LT Vol	8	37	0	11	0	77
Through Vol	47	0	84	0	100	84
RT Vol	17	0	4	0	56	83
Lane Flow Rate	78	40	96	12	170	265
Geometry Grp	2	7	7	7	7	2
Degree of Util (X)	0.112	0.07	0.151	0.022	0.271	0.361
Departure Headway (Hd)	5.163	6.236	5.698	6.504	5.745	4.904
Convergence, Y/N	Yes	Yes	Yes	Yes	Yes	Yes
Cap	686	569	623	546	619	729
Service Time	3.252	4.031	3.493	4.293	3.533	2.968
HCM Lane V/C Ratio	0.114	0.07	0.154	0.022	0.275	0.364
HCM Control Delay	8.9	9.5	9.5	9.4	10.7	10.7
HCM Lane LOS	A	A	A	A	B	B
HCM 95th-tile Q	0.4	0.2	0.5	0.1	1.1	1.6

Intersection												
Int Delay, s/veh	1.7											
Movement	EBL	EBT	EBR	WBL	WBT	WBR	NBL	NBT	NBR	SBL	SBT	SBR
Lane Configurations	↙	↑	↗	↙	↑	↗	↙	↑	↗		↕	
Traffic Vol, veh/h	5	1028	146	245	434	220	65	84	144	175	42	4
Future Vol, veh/h	5	1028	146	245	434	220	65	84	144	175	42	4
Conflicting Peds, #/hr	0	0	0	0	0	0	1	0	0	0	0	1
Sign Control	Free	Free	Free	Free	Free	Free	Stop	Stop	Stop	Stop	Stop	Stop
RT Channelized	-	-	None	-	-	None	-	-	None	-	-	None
Storage Length	85	-	0	70	-	105	60	-	50	-	-	-
Veh in Median Storage, #	-	0	-	-	0	-	-	0	-	-	0	-
Grade, %	-	0	-	-	0	-	-	0	-	-	0	-
Peak Hour Factor	92	92	92	92	92	92	92	92	92	92	92	92
Heavy Vehicles, %	1	1	1	5	5	5	11	11	11	9	9	9
Mvmt Flow	5	1117	159	266	472	239	71	91	157	190	46	4

Major/Minor	Major1			Major2			Minor1			Minor2		
Conflicting Flow All	711	0	0	1276	0	0	2277	2370	1117	2335	2290	473
Stage 1	-	-	-	-	-	-	1127	1127	-	1004	1004	-
Stage 2	-	-	-	-	-	-	1150	1243	-	1331	1286	-
Critical Hdwy	4.11	-	-	4.15	-	-	7.21	6.61	6.31	7.19	6.59	6.29
Critical Hdwy Stg 1	-	-	-	-	-	-	6.21	5.61	-	6.19	5.59	-
Critical Hdwy Stg 2	-	-	-	-	-	-	6.21	5.61	-	6.19	5.59	-
Follow-up Hdwy	2.209	-	-	2.245	-	-	3.599	4.099	3.399	3.581	4.081	3.381
Pot Cap-1 Maneuver	893	-	-	534	-	-	~ 27	~ 33	242	~ 24	~ 37	577
Stage 1	-	-	-	-	-	-	239	269	-	283	311	-
Stage 2	-	-	-	-	-	-	232	237	-	~ 184	228	-
Platoon blocked, %		-	-	-	-	-						
Mov Cap-1 Maneuver	893	-	-	534	-	-	~ 16	242	-	~ 18	576	
Mov Cap-2 Maneuver	-	-	-	-	-	-	~ 16	-	-	~ 18	-	
Stage 1	-	-	-	-	-	-	238	267	-	281	156	-
Stage 2	-	-	-	-	-	-	82	119	-	~ 43	227	-

Approach	EB	WB	NB	SB
HCM Control Delay, s	0	5		
HCM LOS			-	-

Minor Lane/Major Mvmt	NBLn1	NBLn2	NBLn3	EBL	EBT	EBR	WBL	WBT	WBR	SBLn1
Capacity (veh/h)	-	16	242	893	-	-	534	-	-	-
HCM Lane V/C Ratio	-	5.707	0.647	0.006	-	-	0.499	-	-	-
HCM Control Delay (s)		\$ 2592.5	43.6	9.1	-	-	18.3	-	-	-
HCM Lane LOS		-	F	E	A	-	-	C	-	-
HCM 95th %tile Q(veh)		-	12.2	4	0	-	-	2.8	-	-

Notes
 -: Volume exceeds capacity \$: Delay exceeds 300s +: Computation Not Defined *: All major volume in platoon

HCM 6th TWSC
 14: Avenue 17 & SR-99 Southbound Off-Ramp

Village D Specific Plan
 Phase II WP - AM Peak Hour

Intersection

Int Delay, s/veh 359.8

Movement	EBL	EBT	WBT	WBR	SBL	SBR
Lane Configurations		↑	↑		↑	↑
Traffic Vol, veh/h	0	1349	792	0	275	108
Future Vol, veh/h	0	1349	792	0	275	108
Conflicting Peds, #/hr	0	0	0	0	0	0
Sign Control	Free	Free	Free	Free	Stop	Stop
RT Channelized	-	None	-	None	-	None
Storage Length	-	-	-	-	0	610
Veh in Median Storage, #	-	0	0	-	0	-
Grade, %	-	0	0	-	0	-
Peak Hour Factor	92	92	92	92	92	92
Heavy Vehicles, %	4	4	5	5	11	11
Mvmt Flow	0	1466	861	0	299	117

Major/Minor	Major1	Major2	Minor2
Conflicting Flow All	-	0	0 2327 861
Stage 1	-	-	- 861 -
Stage 2	-	-	- 1466 -
Critical Hdwy	-	-	- 6.51 6.31
Critical Hdwy Stg 1	-	-	- 5.51 -
Critical Hdwy Stg 2	-	-	- 5.51 -
Follow-up Hdwy	-	-	- 3.599 3.399
Pot Cap-1 Maneuver	0	-	0 ~ 38 342
Stage 1	0	-	0 399 -
Stage 2	0	-	0 ~ 202 -
Platoon blocked, %	-	-	
Mov Cap-1 Maneuver	-	-	- ~ 38 342
Mov Cap-2 Maneuver	-	-	- ~ 38 -
Stage 1	-	-	- 399 -
Stage 2	-	-	- ~ 202 -

Approach	EB	WB	SB
HCM Control Delay, s	0	0	\$ 2371.4
HCM LOS			F

Minor Lane/Major Mvmt	EBT	WBT	SBLn1	SBLn2
Capacity (veh/h)	-	-	38	342
HCM Lane V/C Ratio	-	-	7.866	0.343
HCM Control Delay (s)	-	-	\$ 3294.5	20.9
HCM Lane LOS	-	-	F	C
HCM 95th %tile Q(veh)	-	-	35.8	1.5

Notes

~: Volume exceeds capacity \$: Delay exceeds 300s +: Computation Not Defined *: All major volume in platoon

HCM 6th TWSC
15: SR-99 Northbound Ramps & Avenue 17

Village D Specific Plan
Phase II WP - AM Peak Hour

Intersection												
Int Delay, s/veh	1141											
Movement	EBL	EBT	EBR	WBL	WBT	WBR	NBL	NBT	NBR	SBL	SBT	SBR
Lane Configurations	↖	↗			↘			↙	↕			
Traffic Vol, veh/h	114	698	0	0	1018	245	475	3	240	0	0	0
Future Vol, veh/h	114	698	0	0	1018	245	475	3	240	0	0	0
Conflicting Peds, #/hr	0	0	0	0	0	0	0	0	0	0	0	0
Sign Control	Free	Free	Free	Free	Free	Free	Stop	Stop	Stop	Free	Free	Free
RT Channelized	-	-	None	-	-	None	-	-	None	-	-	None
Storage Length	125	-	-	-	-	-	-	-	50	-	-	-
Veh in Median Storage, #	-	0	-	-	0	-	-	0	-	-	16965	-
Grade, %	-	0	-	-	0	-	-	0	-	-	0	-
Peak Hour Factor	92	92	92	92	92	92	92	92	92	92	92	92
Heavy Vehicles, %	4	4	4	2	2	2	4	4	4	0	0	0
Mvmt Flow	124	759	0	0	1107	266	516	3	261	0	0	0

Major/Minor	Major1	Major2	Minor1
Conflicting Flow All	1373	0	-
Stage 1	-	-	-
Stage 2	-	-	-
Critical Hdwy	4.14	-	-
Critical Hdwy Stg 1	-	-	-
Critical Hdwy Stg 2	-	-	-
Follow-up Hdwy	2.236	-	-
Pot Cap-1 Maneuver	493	0	0
Stage 1	-	0	0
Stage 2	-	0	0
Platoon blocked, %	-	-	-
Mov Cap-1 Maneuver	493	-	-
Mov Cap-2 Maneuver	-	-	-
Stage 1	-	-	-
Stage 2	-	-	-

Approach	EB	WB	NB
HCM Control Delay, s	2.1	0	\$ 4436
HCM LOS			F

Minor Lane/Major Mvmt	NBLn1	NBLn2	EBL	EBT	WBT	WBR
Capacity (veh/h)	34	403	493	-	-	-
HCM Lane V/C Ratio	15.281	0.647	0.251	-	-	-
HCM Control Delay (s)	\$ 6648.8	28.9	14.7	-	-	-
HCM Lane LOS	F	D	B	-	-	-
HCM 95th %tile Q(veh)	63.8	4.4	1	-	-	-

Notes
 -: Volume exceeds capacity \$: Delay exceeds 300s +: Computation Not Defined *: All major volume in platoon

HCM 6th Signalized Intersection Summary
 16: Love's Truck Stop Driveway/Driveway & Avenue 17

Village D Specific Plan
 Phase II WP - AM Peak Hour



Movement	EBL	EBT	EBR	WBL	WBT	WBR	NBL	NBT	NBR	SBL	SBT	SBR
Lane Configurations	↖	↑↑	↗	↖	↗		↖	↗		↖	↗	
Traffic Volume (veh/h)	162	636	132	45	965	56	136	0	22	48	0	90
Future Volume (veh/h)	162	636	132	45	965	56	136	0	22	48	0	90
Initial Q (Qb), veh	0	0	0	0	0	0	0	0	0	0	0	0
Ped-Bike Adj(A_pbT)	1.00		1.00	1.00		1.00	1.00		1.00	1.00		1.00
Parking Bus, Adj	1.00	1.00	1.00	1.00	1.00	1.00	1.00	1.00	1.00	1.00	1.00	1.00
Work Zone On Approach		No			No			No			No	
Adj Sat Flow, veh/h/ln	1870	1870	1870	1870	1870	1870	1900	1900	1900	1900	1900	1900
Adj Flow Rate, veh/h	176	691	143	49	1049	61	148	0	24	52	0	98
Peak Hour Factor	0.92	0.92	0.92	0.92	0.92	0.92	0.92	0.92	0.92	0.92	0.92	0.92
Percent Heavy Veh, %	2	2	2	2	2	2	0	0	0	0	0	0
Cap, veh/h	89	1947	868	66	936	54	90	0	317	69	0	298
Arrive On Green	0.05	0.55	0.55	0.04	0.54	0.54	0.05	0.00	0.20	0.04	0.00	0.19
Sat Flow, veh/h	1781	3554	1585	1781	1750	102	1810	0	1610	1810	0	1610
Grp Volume(v), veh/h	176	691	143	49	0	1110	148	0	24	52	0	98
Grp Sat Flow(s),veh/h/ln	1781	1777	1585	1781	0	1852	1810	0	1610	1810	0	1610
Q Serve(g_s), s	5.0	10.9	4.5	2.7	0.0	53.5	5.0	0.0	1.2	2.8	0.0	5.3
Cycle Q Clear(g_c), s	5.0	10.9	4.5	2.7	0.0	53.5	5.0	0.0	1.2	2.8	0.0	5.3
Prop In Lane	1.00		1.00	1.00		0.05	1.00		1.00	1.00		1.00
Lane Grp Cap(c), veh/h	89	1947	868	66	0	991	90	0	317	69	0	298
V/C Ratio(X)	1.98	0.35	0.16	0.74	0.00	1.12	1.64	0.00	0.08	0.75	0.00	0.33
Avail Cap(c_a), veh/h	89	1947	868	89	0	991	90	0	317	90	0	298
HCM Platoon Ratio	1.00	1.00	1.00	1.00	1.00	1.00	1.00	1.00	1.00	1.00	1.00	1.00
Upstream Filter(I)	1.00	1.00	1.00	1.00	0.00	1.00	1.00	0.00	1.00	1.00	0.00	1.00
Uniform Delay (d), s/veh	47.5	12.7	11.2	47.7	0.0	23.3	47.5	0.0	32.7	47.6	0.0	35.4
Incr Delay (d2), s/veh	476.9	0.1	0.1	19.5	0.0	67.7	330.4	0.0	0.5	22.0	0.0	2.9
Initial Q Delay(d3),s/veh	0.0	0.0	0.0	0.0	0.0	0.0	0.0	0.0	0.0	0.0	0.0	0.0
%ile BackOfQ(50%),veh/ln	14.0	4.2	1.5	1.6	0.0	40.0	10.5	0.0	0.5	1.7	0.0	2.3
Unsig. Movement Delay, s/veh												
LnGrp Delay(d),s/veh	524.4	12.8	11.3	67.2	0.0	90.9	377.9	0.0	33.2	69.6	0.0	38.3
LnGrp LOS	F	B	B	E	A	F	F	A	C	E	A	D
Approach Vol, veh/h		1010			1159			172				150
Approach Delay, s/veh		101.7			89.9			329.8				49.2
Approach LOS		F			F			F				D
Timer - Assigned Phs	1	2	3	4	5	6	7	8				
Phs Duration (G+Y+Rc), s	8.3	24.2	8.2	59.3	9.5	23.0	9.5	58.0				
Change Period (Y+Rc), s	4.5	4.5	4.5	4.5	4.5	4.5	4.5	4.5				
Max Green Setting (Gmax), s	5.0	18.5	5.0	53.5	5.0	18.5	5.0	53.5				
Max Q Clear Time (g_c+I1), s	4.8	3.2	4.7	12.9	7.0	7.3	7.0	55.5				
Green Ext Time (p_c), s	0.0	0.0	0.0	6.2	0.0	0.3	0.0	0.0				

Intersection Summary

HCM 6th Ctrl Delay	108.8
HCM 6th LOS	F

HCM 6th TWSC
17: Westberry Boulevard & Cleveland Avenue

Village D Specific Plan
Phase II WP - AM Peak Hour

Intersection												
Int Delay, s/veh	1.3											
Movement	EBL	EBT	EBR	WBL	WBT	WBR	NBL	NBT	NBR	SBL	SBT	SBR
Lane Configurations	↖	↗		↖	↗		↖	↑	↗	↖	↑	↗
Traffic Vol, veh/h	257	802	73	34	297	12	51	172	140	14	60	107
Future Vol, veh/h	257	802	73	34	297	12	51	172	140	14	60	107
Conflicting Peds, #/hr	1	0	2	2	0	1	1	0	1	1	0	1
Sign Control	Free	Free	Free	Free	Free	Free	Stop	Stop	Stop	Stop	Stop	Stop
RT Channelized	-	-	None	-	-	None	-	-	None	-	-	None
Storage Length	110	-	-	165	-	-	65	-	50	100	-	50
Veh in Median Storage, #	-	0	-	-	0	-	-	0	-	-	0	-
Grade, %	-	0	-	-	0	-	-	0	-	-	0	-
Peak Hour Factor	92	92	92	92	92	92	92	92	92	92	92	92
Heavy Vehicles, %	0	0	0	1	1	1	0	0	0	0	0	0
Mvmt Flow	279	872	79	37	323	13	55	187	152	15	65	116

Major/Minor	Major1			Major2			Minor1			Minor2		
Conflicting Flow All	337	0	0	953	0	0	1967	1883	915	2045	1916	332
Stage 1	-	-	-	-	-	-	1472	1472	-	405	405	-
Stage 2	-	-	-	-	-	-	495	411	-	1640	1511	-
Critical Hdwy	4.1	-	-	4.11	-	-	7.1	6.5	6.2	7.1	6.5	6.2
Critical Hdwy Stg 1	-	-	-	-	-	-	6.1	5.5	-	6.1	5.5	-
Critical Hdwy Stg 2	-	-	-	-	-	-	6.1	5.5	-	6.1	5.5	-
Follow-up Hdwy	2.2	-	-	2.209	-	-	3.5	4	3.3	3.5	4	3.3
Pot Cap-1 Maneuver	1234	-	-	725	-	-	~ 48	~ 72	333	42	68	714
Stage 1	-	-	-	-	-	-	160	193	-	626	602	-
Stage 2	-	-	-	-	-	-	560	598	-	128	185	-
Platoon blocked, %	-	-	-	-	-	-	-	-	-	-	-	-
Mov Cap-1 Maneuver	1233	-	-	724	-	-	~ 53	332	-	~ 50	713	-
Mov Cap-2 Maneuver	-	-	-	-	-	-	~ 53	-	-	~ 50	-	-
Stage 1	-	-	-	-	-	-	124	~ 149	-	484	571	-
Stage 2	-	-	-	-	-	-	394	567	-	-	143	-

Approach	EB	WB	NB	SB
HCM Control Delay, s	2	1		
HCM LOS			-	-

Minor Lane/Major Mvmt	NBLn1	NBLn2	NBLn3	EBL	EBT	EBR	WBL	WBT	WBR	SBLn1	SBLn2	SBLn3	
Capacity (veh/h)	-	53	332	1233	-	-	724	-	-	-	50	713	
HCM Lane V/C Ratio	-	3.527	0.458	0.227	-	-	0.051	-	-	-	1.304	0.163	
HCM Control Delay (s)		\$ 1298.3	24.7	8.8	-	-	10.2	-	-	-	\$ 362.2	11	
HCM Lane LOS		-	F	C	A	-	-	B	-	-	-	F	B
HCM 95th %tile Q(veh)		-	20.2	2.3	0.9	-	-	0.2	-	-	-	6	0.6

Notes
 -: Volume exceeds capacity \$: Delay exceeds 300s +: Computation Not Defined *: All major volume in platoon

Intersection	
Intersection Delay, s/veh	22.9
Intersection LOS	C

Movement	EBL	EBT	EBR	WBL	WBT	WBR	NBL	NBT	NBR	SBL	SBT	SBR
Lane Configurations												
Traffic Vol, veh/h	55	234	93	56	178	28	120	175	116	125	125	34
Future Vol, veh/h	55	234	93	56	178	28	120	175	116	125	125	34
Peak Hour Factor	0.92	0.92	0.92	0.92	0.92	0.92	0.92	0.92	0.92	0.92	0.92	0.92
Heavy Vehicles, %	3	3	3	3	3	3	0	0	0	0	0	0
Mvmt Flow	60	254	101	61	193	30	130	190	126	136	136	37
Number of Lanes	1	1	0	1	1	0	1	1	1	1	1	1

Approach	EB	WB	NB	SB
Opposing Approach	WB	EB	SB	NB
Opposing Lanes	2	2	3	3
Conflicting Approach Left	SB	NB	EB	WB
Conflicting Lanes Left	3	3	2	2
Conflicting Approach Right	NB	SB	WB	EB
Conflicting Lanes Right	3	3	2	2
HCM Control Delay	36	20.3	16.8	16.6
HCM LOS	E	C	C	C

Lane	NBLn1	NBLn2	NBLn3	EBLn1	EBLn2	WBLn1	WBLn2	SBLn1	SBLn2	SBLn3
Vol Left, %	100%	0%	0%	100%	0%	100%	0%	100%	0%	0%
Vol Thru, %	0%	100%	0%	0%	72%	0%	86%	0%	100%	0%
Vol Right, %	0%	0%	100%	0%	28%	0%	14%	0%	0%	100%
Sign Control	Stop	Stop	Stop	Stop	Stop	Stop	Stop	Stop	Stop	Stop
Traffic Vol by Lane	120	175	116	55	327	56	206	125	125	34
LT Vol	120	0	0	55	0	56	0	125	0	0
Through Vol	0	175	0	0	234	0	178	0	125	0
RT Vol	0	0	116	0	93	0	28	0	0	34
Lane Flow Rate	130	190	126	60	355	61	224	136	136	37
Geometry Grp	8	8	8	8	8	8	8	8	8	8
Degree of Util (X)	0.335	0.461	0.28	0.15	0.823	0.16	0.551	0.362	0.343	0.086
Departure Headway (Hd)	9.244	8.725	7.998	9.042	8.332	9.469	8.862	9.604	9.084	8.355
Convergence, Y/N	Yes	Yes	Yes	Yes	Yes	Yes	Yes	Yes	Yes	Yes
Cap	389	413	449	396	434	379	408	374	395	428
Service Time	7.007	6.488	5.76	6.799	6.09	7.234	6.627	7.372	6.851	6.122
HCM Lane V/C Ratio	0.334	0.46	0.281	0.152	0.818	0.161	0.549	0.364	0.344	0.086
HCM Control Delay	16.6	18.8	13.9	13.4	39.8	14	22	17.8	16.6	11.9
HCM Lane LOS	C	C	B	B	E	B	C	C	C	B
HCM 95th-tile Q	1.4	2.4	1.1	0.5	7.7	0.6	3.2	1.6	1.5	0.3

Intersection												
Intersection Delay, s/veh	68.2											
Intersection LOS	F											

Movement	EBL	EBT	EBR	WBL	WBT	WBR	NBL	NBT	NBR	SBL	SBT	SBR
Lane Configurations		↔			↔			↔			↔	
Traffic Vol, veh/h	109	315	38	11	233	120	76	47	25	260	67	93
Future Vol, veh/h	109	315	38	11	233	120	76	47	25	260	67	93
Peak Hour Factor	0.92	0.92	0.92	0.92	0.92	0.92	0.92	0.92	0.92	0.92	0.92	0.92
Heavy Vehicles, %	4	4	4	5	5	5	0	0	0	0	0	0
Mvmt Flow	118	342	41	12	253	130	83	51	27	283	73	101
Number of Lanes	0	1	0	0	1	0	0	1	0	0	1	0

Approach	EB	WB	NB	SB
Opposing Approach	WB	EB	SB	NB
Opposing Lanes	1	1	1	1
Conflicting Approach Left	SB	NB	EB	WB
Conflicting Lanes Left	1	1	1	1
Conflicting Approach Right	NB	SB	WB	EB
Conflicting Lanes Right	1	1	1	1
HCM Control Delay	102	45.4	19.2	68
HCM LOS	F	E	C	F

Lane	NBLn1	EBLn1	WBLn1	SBLn1
Vol Left, %	51%	24%	3%	62%
Vol Thru, %	32%	68%	64%	16%
Vol Right, %	17%	8%	33%	22%
Sign Control	Stop	Stop	Stop	Stop
Traffic Vol by Lane	148	462	364	420
LT Vol	76	109	11	260
Through Vol	47	315	233	67
RT Vol	25	38	120	93
Lane Flow Rate	161	502	396	457
Geometry Grp	1	1	1	1
Degree of Util (X)	0.409	1.105	0.866	0.985
Departure Headway (Hd)	9.673	7.924	8.262	8.16
Convergence, Y/N	Yes	Yes	Yes	Yes
Cap	375	457	443	447
Service Time	7.673	6.004	6.262	6.16
HCM Lane V/C Ratio	0.429	1.098	0.894	1.022
HCM Control Delay	19.2	102	45.4	68
HCM Lane LOS	C	F	E	F
HCM 95th-tile Q	1.9	16.9	8.8	12.4

Intersection

Intersection Delay, s/veh 11.9

Intersection LOS B

Movement	EBL	EBT	EBR	WBL	WBT	WBR	NBL	NBT	NBR	SBL	SBT	SBR
Lane Configurations		↕			↕	↕		↕	↕		↕	↕
Traffic Vol, veh/h	0	0	0	104	0	197	0	187	342	86	57	0
Future Vol, veh/h	0	0	0	104	0	197	0	187	342	86	57	0
Peak Hour Factor	0.92	0.92	0.92	0.92	0.92	0.92	0.92	0.92	0.92	0.92	0.92	0.92
Heavy Vehicles, %	0	0	0	3	3	3	0	0	0	0	0	0
Mvmt Flow	0	0	0	113	0	214	0	203	372	93	62	0
Number of Lanes	0	1	0	0	1	1	0	1	1	0	1	1

Approach	EB	WB	NB	SB
Opposing Approach	WB	EB	SB	NB
Opposing Lanes	2	1	2	2
Conflicting Approach Left	SB	NB	EB	WB
Conflicting Lanes Left	2	2	1	2
Conflicting Approach Right	NB	SB	WB	EB
Conflicting Lanes Right	2	2	2	1
HCM Control Delay	0	11.3	12.3	11.7
HCM LOS	-	B	B	B

Lane	NBLn1	NBLn2	EBLn1	WBLn1	WBLn2	SBLn1	SBLn2
Vol Left, %	0%	0%	0%	100%	0%	60%	0%
Vol Thru, %	100%	0%	100%	0%	0%	40%	100%
Vol Right, %	0%	100%	0%	0%	100%	0%	0%
Sign Control	Stop	Stop	Stop	Stop	Stop	Stop	Stop
Traffic Vol by Lane	187	342	0	104	197	143	0
LT Vol	0	0	0	104	0	86	0
Through Vol	187	0	0	0	0	57	0
RT Vol	0	342	0	0	197	0	0
Lane Flow Rate	203	372	0	113	214	155	0
Geometry Grp	7	7	6	7	7	7	7
Degree of Util (X)	0.322	0.516	0	0.215	0.335	0.279	0
Departure Headway (Hd)	5.707	4.999	6.884	6.854	5.639	6.473	6.167
Convergence, Y/N	Yes	Yes	Yes	Yes	Yes	Yes	Yes
Cap	632	721	0	525	638	555	0
Service Time	3.431	2.724	4.93	4.585	3.37	4.207	3.902
HCM Lane V/C Ratio	0.321	0.516	0	0.215	0.335	0.279	0
HCM Control Delay	11.1	13	9.9	11.5	11.2	11.7	8.9
HCM Lane LOS	B	B	N	B	B	B	N
HCM 95th-tile Q	1.4	3	0	0.8	1.5	1.1	0

Intersection	
Intersection Delay, s/veh	201.4
Intersection LOS	F

Movement	EBL	EBT	EBR	WBL	WBT	WBR	NBL	NBT	NBR	SBL	SBT	SBR
Lane Configurations	↵	↕↗		↵	↕↗		↵	↕	↗	↵	↕	↗
Traffic Vol, veh/h	29	901	28	191	287	25	26	391	323	11	261	5
Future Vol, veh/h	29	901	28	191	287	25	26	391	323	11	261	5
Peak Hour Factor	0.92	0.92	0.92	0.92	0.92	0.92	0.92	0.92	0.92	0.92	0.92	0.92
Heavy Vehicles, %	1	1	1	2	2	2	0	0	0	0	0	0
Mvmt Flow	32	979	30	208	312	27	28	425	351	12	284	5
Number of Lanes	1	2	0	1	2	0	1	1	1	1	1	1

Approach	EB	WB	NB	SB
Opposing Approach	WB	EB	SB	NB
Opposing Lanes	3	3	3	3
Conflicting Approach Left	SB	NB	EB	WB
Conflicting Lanes Left	3	3	3	3
Conflicting Approach Right	NB	SB	WB	EB
Conflicting Lanes Right	3	3	3	3
HCM Control Delay	361.5	34.6	150.3	86.9
HCM LOS	F	D	F	F

Lane	NBLn1	NBLn2	NBLn3	EBLn1	EBLn2	EBLn3	WBLn1	WBLn2	WBLn3	SBLn1	SBLn2
Vol Left, %	100%	0%	0%	100%	0%	0%	100%	0%	0%	100%	0%
Vol Thru, %	0%	100%	0%	0%	100%	91%	0%	100%	79%	0%	100%
Vol Right, %	0%	0%	100%	0%	0%	9%	0%	0%	21%	0%	0%
Sign Control	Stop	Stop	Stop	Stop	Stop	Stop	Stop	Stop	Stop	Stop	Stop
Traffic Vol by Lane	26	391	323	29	601	328	191	191	121	11	261
LT Vol	26	0	0	29	0	0	191	0	0	11	0
Through Vol	0	391	0	0	601	300	0	191	96	0	261
RT Vol	0	0	323	0	0	28	0	0	25	0	0
Lane Flow Rate	28	425	351	32	653	357	208	208	131	12	284
Geometry Grp	8	8	8	8	8	8	8	8	8	8	8
Degree of Util (X)	0.093	1.336	1.037	0.103	2.054	1.117	0.705	0.677	0.422	0.043	0.988
Departure Headway (Hd)	12.581	12.081	11.381	11.962	11.462	11.402	12.458	11.958	11.813	14.051	13.551
Convergence, Y/N	Yes	Yes	Yes	Yes	Yes	Yes	Yes	Yes	Yes	Yes	Yes
Cap	287	306	323	301	326	321	293	304	307	256	270
Service Time	10.281	9.781	9.081	9.662	9.162	9.102	10.158	9.658	9.513	11.751	11.251
HCM Lane V/C Ratio	0.098	1.389	1.087	0.106	2.003	1.112	0.71	0.684	0.427	0.047	1.052
HCM Control Delay	16.6	204.3	95.8	16	509.8	120.6	40.2	36.5	22.9	17.4	91.2
HCM Lane LOS	C	F	F	C	F	F	E	E	C	C	F
HCM 95th-tile Q	0.3	20	11.8	0.3	46.6	14	4.9	4.6	2	0.1	9.7

Intersection												
Intersection Delay, s/veh	38.7											
Intersection LOS	E											

Movement	EBL	EBT	EBR	WBL	WBT	WBR	NBL	NBT	NBR	SBL	SBT	SBR
Lane Configurations	↖	↗		↖	↗	↖	↖	↗		↖	↗	
Traffic Vol, veh/h	65	268	72	26	110	66	48	242	25	131	285	50
Future Vol, veh/h	65	268	72	26	110	66	48	242	25	131	285	50
Peak Hour Factor	0.92	0.92	0.92	0.92	0.92	0.92	0.92	0.92	0.92	0.92	0.92	0.92
Heavy Vehicles, %	2	2	2	6	6	6	2	2	2	2	2	2
Mvmt Flow	71	291	78	28	120	72	52	263	27	142	310	54
Number of Lanes	1	1	0	1	1	1	1	1	0	1	1	0

Approach	EB	WB	NB	SB
Opposing Approach	WB	EB	SB	NB
Opposing Lanes	3	2	2	2
Conflicting Approach Left SB		NB	EB	WB
Conflicting Lanes Left	2	2	2	3
Conflicting Approach Right NB		SB	WB	EB
Conflicting Lanes Right	2	2	3	2
HCM Control Delay	50.5	16.4	32.8	42.2
HCM LOS	F	C	D	E

Lane	NBLn1	NBLn2	EBLn1	EBLn2	WBLn1	WBLn2	WBLn3	SBLn1	SBLn2
Vol Left, %	100%	0%	100%	0%	100%	0%	0%	100%	0%
Vol Thru, %	0%	91%	0%	79%	0%	100%	0%	0%	85%
Vol Right, %	0%	9%	0%	21%	0%	0%	100%	0%	15%
Sign Control	Stop	Stop	Stop	Stop	Stop	Stop	Stop	Stop	Stop
Traffic Vol by Lane	48	267	65	340	26	110	66	131	335
LT Vol	48	0	65	0	26	0	0	131	0
Through Vol	0	242	0	268	0	110	0	0	285
RT Vol	0	25	0	72	0	0	66	0	50
Lane Flow Rate	52	290	71	370	28	120	72	142	364
Geometry Grp	8	8	8	8	8	8	8	8	8
Degree of Util (X)	0.145	0.757	0.189	0.919	0.084	0.339	0.189	0.373	0.891
Departure Headway (Hd)	9.977	9.391	9.742	9.067	10.721	10.198	9.464	9.544	8.92
Convergence, Y/N	Yes	Yes	Yes	Yes	Yes	Yes	Yes	Yes	Yes
Cap	362	389	371	403	336	354	381	379	408
Service Time	7.677	7.091	7.442	6.767	8.439	7.916	7.183	7.244	6.62
HCM Lane V/C Ratio	0.144	0.746	0.191	0.918	0.083	0.339	0.189	0.375	0.892
HCM Control Delay	14.4	36.1	14.7	57.4	14.4	18.1	14.4	17.8	51.7
HCM Lane LOS	B	E	B	F	B	C	B	C	F
HCM 95th-tile Q	0.5	6.1	0.7	9.9	0.3	1.5	0.7	1.7	9.2

HCM 6th Signalized Intersection Summary
 23: Avenue 16/Ellis Street & Kennedy Street

Village D Specific Plan
 Phase II WP - AM Peak Hour



Movement	WBL	WBR	NBT	NBR	SBL	SBT
Lane Configurations						
Traffic Volume (veh/h)	195	147	452	177	263	353
Future Volume (veh/h)	195	147	452	177	263	353
Initial Q (Qb), veh	0	0	0	0	0	0
Ped-Bike Adj(A_pbT)	1.00	1.00		0.98	1.00	
Parking Bus, Adj	1.00	1.00	1.00	1.00	1.00	1.00
Work Zone On Approach	No		No		No	
Adj Sat Flow, veh/h/ln	1841	1841	1856	1856	1870	1870
Adj Flow Rate, veh/h	212	160	491	192	286	384
Peak Hour Factor	0.92	0.92	0.92	0.92	0.92	0.92
Percent Heavy Veh, %	4	4	3	3	2	2
Cap, veh/h	266	417	724	281	687	2614
Arrive On Green	0.15	0.15	0.29	0.29	0.39	0.74
Sat Flow, veh/h	1753	2745	2556	957	1781	3647
Grp Volume(v), veh/h	212	160	350	333	286	384
Grp Sat Flow(s),veh/h/ln	1753	1373	1763	1657	1781	1777
Q Serve(g_s), s	9.3	4.2	14.0	14.2	9.4	2.6
Cycle Q Clear(g_c), s	9.3	4.2	14.0	14.2	9.4	2.6
Prop In Lane	1.00	1.00		0.58	1.00	
Lane Grp Cap(c), veh/h	266	417	518	487	687	2614
V/C Ratio(X)	0.80	0.38	0.68	0.68	0.42	0.15
Avail Cap(c_a), veh/h	427	669	518	487	687	2614
HCM Platoon Ratio	1.00	1.00	1.00	1.00	1.00	1.00
Upstream Filter(I)	0.71	0.71	1.00	1.00	1.00	1.00
Uniform Delay (d), s/veh	32.7	30.5	24.9	25.0	18.0	3.1
Incr Delay (d2), s/veh	3.9	0.4	6.9	7.6	0.4	0.1
Initial Q Delay(d3),s/veh	0.0	0.0	0.0	0.0	0.0	0.0
%ile BackOfQ(50%),veh/ln	4.1	1.4	6.6	6.3	3.7	0.7
Unsig. Movement Delay, s/veh						
LnGrp Delay(d),s/veh	36.6	31.0	31.8	32.5	18.4	3.3
LnGrp LOS	D	C	C	C	B	A
Approach Vol, veh/h	372		683			670
Approach Delay, s/veh	34.2		32.2			9.7
Approach LOS	C		C			A
Timer - Assigned Phs	1	2			6	8
Phs Duration (G+Y+Rc), s	35.3	28.0			63.3	16.7
Change Period (Y+Rc), s	4.5	4.5			4.5	4.5
Max Green Setting (Gmax), s	23.5	23.5			51.5	19.5
Max Q Clear Time (g_c+M), s	11.4	16.2			4.6	11.3
Green Ext Time (p_c), s	0.7	2.5			2.8	0.8
Intersection Summary						
HCM 6th Ctrl Delay			23.9			
HCM 6th LOS			C			

HCM 6th Signalized Intersection Summary

24: Schnoor Avenue & Kennedy Street

Village D Specific Plan
Phase II WP - AM Peak Hour



Movement	EBL	EBT	EBR	WBL	WBT	WBR	NBL	NBT	NBR	SBL	SBT	SBR
Lane Configurations	↖	↗		↖	↗		↖	↗		↖	↗	↖
Traffic Volume (veh/h)	82	199	167	213	216	147	115	32	278	97	31	24
Future Volume (veh/h)	82	199	167	213	216	147	115	32	278	97	31	24
Initial Q (Qb), veh	0	0	0	0	0	0	0	0	0	0	0	0
Ped-Bike Adj(A_pbT)	1.00		1.00	1.00		1.00	1.00		1.00	1.00		1.00
Parking Bus, Adj	1.00	1.00	1.00	1.00	1.00	1.00	1.00	1.00	1.00	1.00	1.00	1.00
Work Zone On Approach		No			No			No			No	
Adj Sat Flow, veh/h/ln	1841	1841	1841	1826	1826	1826	1900	1900	1900	1366	1366	1366
Adj Flow Rate, veh/h	89	216	182	232	235	160	125	35	302	105	34	26
Peak Hour Factor	0.92	0.92	0.92	0.92	0.92	0.92	0.92	0.92	0.92	0.92	0.92	0.92
Percent Heavy Veh, %	4	4	4	5	5	5	0	0	0	36	36	36
Cap, veh/h	113	324	260	273	272	185	626	45	392	225	360	304
Arrive On Green	0.06	0.18	0.18	0.16	0.27	0.27	0.18	0.27	0.27	0.17	0.26	0.26
Sat Flow, veh/h	1753	1843	1478	1739	1012	689	3510	169	1460	1301	1366	1153
Grp Volume(v), veh/h	89	204	194	232	0	395	125	0	337	105	34	26
Grp Sat Flow(s),veh/h/ln	1753	1749	1572	1739	0	1700	1755	0	1629	1301	1366	1153
Q Serve(g_s), s	4.0	8.7	9.3	10.4	0.0	17.7	2.4	0.0	15.3	5.8	1.5	1.0
Cycle Q Clear(g_c), s	4.0	8.7	9.3	10.4	0.0	17.7	2.4	0.0	15.3	5.8	1.5	1.0
Prop In Lane	1.00		0.94	1.00		0.41	1.00		0.90	1.00		1.00
Lane Grp Cap(c), veh/h	113	308	277	273	0	456	626	0	438	225	360	304
V/C Ratio(X)	0.79	0.66	0.70	0.85	0.00	0.87	0.20	0.00	0.77	0.47	0.09	0.09
Avail Cap(c_a), veh/h	121	404	363	359	0	627	626	0	438	225	360	304
HCM Platoon Ratio	1.00	1.00	1.00	1.00	1.00	1.00	1.00	1.00	1.00	1.00	1.00	1.00
Upstream Filter(I)	0.82	0.82	0.82	1.00	0.00	1.00	1.00	0.00	1.00	1.00	1.00	1.00
Uniform Delay (d), s/veh	36.9	30.8	31.0	32.8	0.0	27.9	28.0	0.0	27.0	29.7	22.2	12.8
Incr Delay (d2), s/veh	22.8	2.1	3.2	13.8	0.0	9.2	0.2	0.0	12.3	1.5	0.5	0.6
Initial Q Delay(d3),s/veh	0.0	0.0	0.0	0.0	0.0	0.0	0.0	0.0	0.0	0.0	0.0	0.0
%ile BackOfQ(50%),veh/ln	2.4	3.8	3.7	5.3	0.0	8.1	1.0	0.0	7.2	1.9	0.5	0.4
Unsig. Movement Delay, s/veh												
LnGrp Delay(d),s/veh	59.6	32.9	34.2	46.6	0.0	37.1	28.2	0.0	39.2	31.2	22.8	13.3
LnGrp LOS	E	C	C	D	A	D	C	A	D	C	C	B
Approach Vol, veh/h		487			627			462			165	
Approach Delay, s/veh		38.3			40.6			36.2			26.7	
Approach LOS		D			D			D			C	
Timer - Assigned Phs	1	2	3	4	5	6	7	8				
Phs Duration (G+Y+Rc), s	18.4	26.0	17.1	18.6	18.8	25.6	9.7	26.0				
Change Period (Y+Rc), s	4.5	4.5	4.5	4.5	4.5	4.5	4.5	4.5				
Max Green Setting (Gmax), s	5.5	21.5	16.5	18.5	5.9	21.1	5.5	29.5				
Max Q Clear Time (g_c+1T), s	17.8	17.3	12.4	11.3	4.4	3.5	6.0	19.7				
Green Ext Time (p_c), s	0.0	0.8	0.3	1.4	0.0	0.2	0.0	1.8				
Intersection Summary												
HCM 6th Ctrl Delay												37.5
HCM 6th LOS												D

Intersection						
Int Delay, s/veh	9.3					
Movement	EBL	EBT	WBT	WBR	SBL	SBR
Lane Configurations	↖	↑	↗		↖	↗
Traffic Vol, veh/h	316	259	400	3	66	160
Future Vol, veh/h	316	259	400	3	66	160
Conflicting Peds, #/hr	0	0	0	0	0	0
Sign Control	Free	Free	Free	Free	Stop	Stop
RT Channelized	-	None	-	Free	-	None
Storage Length	140	-	-	-	0	335
Veh in Median Storage, #	-	0	0	-	0	-
Grade, %	-	0	0	-	0	-
Peak Hour Factor	92	92	92	92	92	92
Heavy Vehicles, %	2	2	6	6	3	3
Mvmt Flow	343	282	435	3	72	174

Major/Minor	Major1	Major2	Minor2		
Conflicting Flow All	435	0	-	0	1403 435
Stage 1	-	-	-	-	435 -
Stage 2	-	-	-	-	968 -
Critical Hdwy	4.12	-	-	-	6.43 6.23
Critical Hdwy Stg 1	-	-	-	-	5.43 -
Critical Hdwy Stg 2	-	-	-	-	5.43 -
Follow-up Hdwy	2.218	-	-	-	3.527 3.327
Pot Cap-1 Maneuver	1125	-	-	0	153 619
Stage 1	-	-	-	0	650 -
Stage 2	-	-	-	0	367 -
Platoon blocked, %		-	-		
Mov Cap-1 Maneuver	1125	-	-	-	106 619
Mov Cap-2 Maneuver	-	-	-	-	106 -
Stage 1	-	-	-	-	452 -
Stage 2	-	-	-	-	367 -

Approach	EB	WB	SB
HCM Control Delay, s	5.3	0	35.9
HCM LOS			E

Minor Lane/Major Mvmt	EBL	EBT	WBT	SBLn1	SBLn2
Capacity (veh/h)	1125	-	-	106	619
HCM Lane V/C Ratio	0.305	-	-	0.677	0.281
HCM Control Delay (s)	9.6	-	-	91.3	13.1
HCM Lane LOS	A	-	-	F	B
HCM 95th %tile Q(veh)	1.3	-	-	3.5	1.1

Intersection						
Int Delay, s/veh	6.7					
Movement	EBL	EBT	WBT	WBR	SBL	SBR
Lane Configurations		↶	↷		↶	
Traffic Vol, veh/h	180	145	90	0	0	314
Future Vol, veh/h	180	145	90	0	0	314
Conflicting Peds, #/hr	0	0	0	0	0	0
Sign Control	Free	Free	Free	Free	Stop	Stop
RT Channelized	-	None	-	None	-	None
Storage Length	-	-	-	-	0	-
Veh in Median Storage, #	-	0	0	-	0	-
Grade, %	-	0	0	-	0	-
Peak Hour Factor	92	92	92	92	92	92
Heavy Vehicles, %	3	3	6	6	7	7
Mvmt Flow	196	158	98	0	0	341

Major/Minor	Major1	Major2	Minor2		
Conflicting Flow All	98	0	-	0	648 98
Stage 1	-	-	-	-	98 -
Stage 2	-	-	-	-	550 -
Critical Hdwy	4.13	-	-	-	6.47 6.27
Critical Hdwy Stg 1	-	-	-	-	5.47 -
Critical Hdwy Stg 2	-	-	-	-	5.47 -
Follow-up Hdwy	2.227	-	-	-	3.563 3.363
Pot Cap-1 Maneuver	1489	-	-	-	427 944
Stage 1	-	-	-	-	914 -
Stage 2	-	-	-	-	568 -
Platoon blocked, %		-	-	-	
Mov Cap-1 Maneuver	1489	-	-	-	366 944
Mov Cap-2 Maneuver	-	-	-	-	366 -
Stage 1	-	-	-	-	782 -
Stage 2	-	-	-	-	568 -

Approach	EB	WB	SB
HCM Control Delay, s	4.3	0	11
HCM LOS			B

Minor Lane/Major Mvmt	EBL	EBT	WBT	WBR	SBLn1
Capacity (veh/h)	1489	-	-	-	944
HCM Lane V/C Ratio	0.131	-	-	-	0.362
HCM Control Delay (s)	7.8	0	-	-	11
HCM Lane LOS	A	A	-	-	B
HCM 95th %tile Q(veh)	0.5	-	-	-	1.7

Intersection						
Int Delay, s/veh	3.6					
Movement	EBL	EBR	NBL	NBT	SBT	SBR
Lane Configurations	↵			↑	↵	
Traffic Vol, veh/h	173	0	0	43	3	312
Future Vol, veh/h	173	0	0	43	3	312
Conflicting Peds, #/hr	0	0	0	0	0	0
Sign Control	Stop	Stop	Free	Free	Free	Free
RT Channelized	-	None	-	None	-	None
Storage Length	0	-	-	-	-	-
Veh in Median Storage, #	0	-	-	0	0	-
Grade, %	0	-	-	0	0	-
Peak Hour Factor	92	92	92	92	92	92
Heavy Vehicles, %	3	3	10	10	6	6
Mvmt Flow	188	0	0	47	3	339

Major/Minor	Minor2	Major1		Major2	
Conflicting Flow All	220	-	-	0	0
Stage 1	173	-	-	-	-
Stage 2	47	-	-	-	-
Critical Hdwy	6.43	-	-	-	-
Critical Hdwy Stg 1	5.43	-	-	-	-
Critical Hdwy Stg 2	5.43	-	-	-	-
Follow-up Hdwy	3.527	-	-	-	-
Pot Cap-1 Maneuver	766	0	0	-	-
Stage 1	855	0	0	-	-
Stage 2	973	0	0	-	-
Platoon blocked, %				-	-
Mov Cap-1 Maneuver	766	-	-	-	-
Mov Cap-2 Maneuver	766	-	-	-	-
Stage 1	855	-	-	-	-
Stage 2	973	-	-	-	-

Approach	EB	NB	SB
HCM Control Delay, s	11.2	0	0
HCM LOS	B		

Minor Lane/Major Mvmt	NBT EBLn1	SBT	SBR
Capacity (veh/h)	- 766	-	-
HCM Lane V/C Ratio	- 0.245	-	-
HCM Control Delay (s)	- 11.2	-	-
HCM Lane LOS	- B	-	-
HCM 95th %tile Q(veh)	- 1	-	-

Intersection						
Int Delay, s/veh	0					
Movement	EBL	EBT	WBT	WBR	SBL	SBR
Lane Configurations		↶	↷		↶	
Traffic Vol, veh/h	0	139	95	52	0	0
Future Vol, veh/h	0	139	95	52	0	0
Conflicting Peds, #/hr	0	0	0	0	0	0
Sign Control	Free	Free	Free	Free	Stop	Stop
RT Channelized	-	None	-	None	-	None
Storage Length	-	-	-	-	0	-
Veh in Median Storage, #	-	0	0	-	0	-
Grade, %	-	0	0	-	0	-
Peak Hour Factor	92	92	92	92	92	92
Heavy Vehicles, %	2	2	13	13	0	0
Mvmt Flow	0	151	103	57	0	0

Major/Minor	Major1	Major2	Minor2		
Conflicting Flow All	160	0	-	0	283
Stage 1	-	-	-	-	132
Stage 2	-	-	-	-	151
Critical Hdwy	4.12	-	-	-	6.4
Critical Hdwy Stg 1	-	-	-	-	5.4
Critical Hdwy Stg 2	-	-	-	-	5.4
Follow-up Hdwy	2.218	-	-	-	3.5
Pot Cap-1 Maneuver	1419	-	-	-	711
Stage 1	-	-	-	-	899
Stage 2	-	-	-	-	882
Platoon blocked, %		-	-	-	
Mov Cap-1 Maneuver	1419	-	-	-	711
Mov Cap-2 Maneuver	-	-	-	-	711
Stage 1	-	-	-	-	899
Stage 2	-	-	-	-	882

Approach	EB	WB	SB
HCM Control Delay, s	0	0	0
HCM LOS			A

Minor Lane/Major Mvmt	EBL	EBT	WBT	WBR	SBLn1
Capacity (veh/h)	1419	-	-	-	-
HCM Lane V/C Ratio	-	-	-	-	-
HCM Control Delay (s)	0	-	-	-	0
HCM Lane LOS	A	-	-	-	A
HCM 95th %tile Q(veh)	0	-	-	-	-

HCM 6th Signalized Intersection Summary
29: Schnoor Avenue & Cleveland Avenue

Village D Specific Plan
Phase II WP - AM Peak Hour



Movement	EBL	EBT	EBR	WBL	WBT	WBR	NBL	NBT	NBR	SBL	SBT	SBR
Lane Configurations	↘	↑↑	↗	↘↗	↑↑	↗	↘	↑↑	↗	↘	↑↑	↗
Traffic Volume (veh/h)	133	1048	77	166	419	46	62	255	171	89	193	74
Future Volume (veh/h)	133	1048	77	166	419	46	62	255	171	89	193	74
Initial Q (Qb), veh	0	0	0	0	0	0	0	0	0	0	0	0
Ped-Bike Adj(A_pbT)	1.00		0.98	1.00		0.98	1.00		0.99	1.00		0.98
Parking Bus, Adj	1.00	1.00	1.00	1.00	1.00	1.00	1.00	1.00	1.00	1.00	1.00	1.00
Work Zone On Approach		No			No			No			No	
Adj Sat Flow, veh/h/ln	1885	1885	1885	1856	1856	1856	1885	1885	1885	1856	1856	1856
Adj Flow Rate, veh/h	145	1139	84	180	455	50	67	277	186	97	210	80
Peak Hour Factor	0.92	0.92	0.92	0.92	0.92	0.92	0.92	0.92	0.92	0.92	0.92	0.92
Percent Heavy Veh, %	1	1	1	3	3	3	1	1	1	3	3	3
Cap, veh/h	182	1273	557	258	1159	507	87	869	504	180	1044	456
Arrive On Green	0.10	0.36	0.36	0.08	0.33	0.33	0.05	0.24	0.24	0.10	0.30	0.30
Sat Flow, veh/h	1795	3582	1567	3428	3526	1541	1795	3582	1582	1767	3526	1540
Grp Volume(v), veh/h	145	1139	84	180	455	50	67	277	186	97	210	80
Grp Sat Flow(s),veh/h/ln	1795	1791	1567	1714	1763	1541	1795	1791	1582	1767	1763	1540
Q Serve(g_s), s	6.3	24.0	2.2	4.1	8.0	1.2	3.0	5.1	1.2	4.2	3.6	3.1
Cycle Q Clear(g_c), s	6.3	24.0	2.2	4.1	8.0	1.2	3.0	5.1	1.2	4.2	3.6	3.1
Prop In Lane	1.00		1.00	1.00		1.00	1.00		1.00	1.00		1.00
Lane Grp Cap(c), veh/h	182	1273	557	258	1159	507	87	869	504	180	1044	456
V/C Ratio(X)	0.79	0.90	0.15	0.70	0.39	0.10	0.77	0.32	0.37	0.54	0.20	0.18
Avail Cap(c_a), veh/h	301	1321	578	279	1159	507	117	869	504	180	1044	456
HCM Platoon Ratio	1.00	1.00	1.00	1.00	1.00	1.00	1.00	1.00	1.00	1.00	1.00	1.00
Upstream Filter(I)	1.00	1.00	1.00	0.77	0.77	0.77	1.00	1.00	1.00	1.00	1.00	1.00
Uniform Delay (d), s/veh	35.1	24.4	9.9	36.1	20.7	8.6	37.6	24.9	21.1	34.1	21.1	20.9
Incr Delay (d2), s/veh	7.6	8.1	0.1	5.3	0.2	0.1	19.5	1.0	2.1	3.1	0.4	0.8
Initial Q Delay(d3),s/veh	0.0	0.0	0.0	0.0	0.0	0.0	0.0	0.0	0.0	0.0	0.0	0.0
%ile BackOfQ(50%),veh/ln	3.1	11.0	1.0	1.9	3.2	0.6	1.7	2.2	2.9	1.9	1.5	1.2
Unsig. Movement Delay, s/veh												
LnGrp Delay(d),s/veh	42.8	32.5	10.0	41.5	20.9	8.7	57.1	25.8	23.2	37.3	21.5	21.7
LnGrp LOS	D	C	B	D	C	A	E	C	C	D	C	C
Approach Vol, veh/h		1368			685			530			387	
Approach Delay, s/veh		32.2			25.4			28.9			25.5	
Approach LOS		C			C			C			C	
Timer - Assigned Phs	1	2	3	4	5	6	7	8				
Phs Duration (G+Y+Rc), s	12.7	23.9	10.5	32.9	8.4	28.2	12.6	30.8				
Change Period (Y+Rc), s	4.5	4.5	4.5	4.5	4.5	4.5	4.5	4.5				
Max Green Setting (Gmax), s	6.6	19.4	6.5	29.5	5.2	20.8	13.4	22.6				
Max Q Clear Time (g_c+I1), s	6.2	7.1	6.1	26.0	5.0	5.6	8.3	10.0				
Green Ext Time (p_c), s	0.0	1.9	0.0	2.4	0.0	1.3	0.1	2.6				

Intersection Summary

HCM 6th Ctrl Delay	29.1
HCM 6th LOS	C

HCM 6th Signalized Intersection Summary
30: Fairgrounds & Cleveland Avenue

Village D Specific Plan
Phase II WP - AM Peak Hour



Movement	EBL	EBT	EBR	WBL	WBT	WBR	NBL	NBT	NBR	SBL	SBT	SBR
Lane Configurations	↑↑↑			↑↑		↑	↑↑	↑	↑	↑	↑	↑
Traffic Volume (veh/h)	99	1245	30	37	576	140	13	7	27	148	5	39
Future Volume (veh/h)	99	1245	30	37	576	140	13	7	27	148	5	39
Initial Q (Qb), veh	0	0	0	0	0	0	0	0	0	0	0	0
Ped-Bike Adj(A_pbT)	1.00		1.00	1.00		1.00	1.00		1.00	1.00		0.99
Parking Bus, Adj	1.00	1.00	1.00	1.00	1.00	1.00	1.00	1.00	1.00	1.00	1.00	1.00
Work Zone On Approach	No			No			No			No		
Adj Sat Flow, veh/h/ln	1870	1870	1870	1856	1856	1856	1900	1900	1900	1900	1900	1900
Adj Flow Rate, veh/h	105	1324	32	39	613	149	14	24	18	157	5	41
Peak Hour Factor	0.94	0.94	0.94	0.94	0.94	0.94	0.94	0.94	0.94	0.94	0.94	0.94
Percent Heavy Veh, %	2	2	2	3	3	3	0	0	0	0	0	0
Cap, veh/h	133	1326	32	64	776	346	607	463	392	428	55	450
Arrive On Green	0.15	0.52	0.52	0.04	0.22	0.22	0.17	0.24	0.24	0.24	0.31	0.31
Sat Flow, veh/h	1781	5128	124	1767	3526	1572	3619	1900	1608	1810	176	1440
Grp Volume(v), veh/h	105	879	477	39	613	149	14	24	18	157	0	46
Grp Sat Flow(s),veh/h/ln	1781	1702	1848	1767	1763	1572	1810	1900	1608	1810	0	1616
Q Serve(g_s), s	4.5	20.6	20.6	1.7	13.1	6.5	0.3	0.8	0.6	5.8	0.0	1.6
Cycle Q Clear(g_c), s	4.5	20.6	20.6	1.7	13.1	6.5	0.3	0.8	0.6	5.8	0.0	1.6
Prop In Lane	1.00		0.07	1.00		1.00	1.00		1.00	1.00		0.89
Lane Grp Cap(c), veh/h	133	880	478	64	776	346	607	463	392	428	0	505
V/C Ratio(X)	0.79	1.00	1.00	0.61	0.79	0.43	0.02	0.05	0.05	0.37	0.00	0.09
Avail Cap(c_a), veh/h	234	880	478	254	947	423	607	463	392	428	0	505
HCM Platoon Ratio	2.00	2.00	2.00	1.00	1.00	1.00	1.00	1.00	1.00	1.00	1.00	1.00
Upstream Filter(I)	0.52	0.52	0.52	0.92	0.92	0.92	1.00	1.00	1.00	1.00	0.00	1.00
Uniform Delay (d), s/veh	33.4	19.3	19.3	38.0	29.5	26.9	27.8	23.2	14.9	25.5	0.0	19.5
Incr Delay (d2), s/veh	5.4	21.5	29.4	8.3	3.5	0.8	0.0	0.2	0.2	0.5	0.0	0.4
Initial Q Delay(d3),s/veh	0.0	0.0	0.0	0.0	0.0	0.0	0.0	0.0	0.0	0.0	0.0	0.0
%ile BackOfQ(50%),veh/ln	2.0	7.3	9.0	0.9	5.7	2.5	0.1	0.4	0.3	2.5	0.0	0.6
Unsig. Movement Delay, s/veh												
LnGrp Delay(d),s/veh	38.8	40.8	48.7	46.3	32.9	27.7	27.8	23.4	15.2	26.1	0.0	19.8
LnGrp LOS	D	D	D	D	C	C	C	C	B	C	A	B
Approach Vol, veh/h	1461		801				56			203		
Approach Delay, s/veh	43.2		32.6				21.8			24.6		
Approach LOS	D		C				C			C		
Timer - Assigned Phs	1	2	3	4	5	6	7	8				
Phs Duration (G+Y+Rc), s	23.4	24.0	7.4	25.2	17.9	29.5	10.5	22.1				
Change Period (Y+Rc), s	4.5	4.5	4.5	4.5	4.5	4.5	4.5	4.5				
Max Green Setting (Gmax), s	10.5	19.5	11.5	20.5	5.0	25.0	10.5	21.5				
Max Q Clear Time (g_c+1T), s	10.5	2.8	3.7	22.6	2.3	3.6	6.5	15.1				
Green Ext Time (p_c), s	0.1	0.1	0.0	0.0	0.0	0.2	0.1	2.5				

Intersection Summary

HCM 6th Ctrl Delay	37.9
HCM 6th LOS	D

Notes

User approved volume balancing among the lanes for turning movement.

HCM 6th Signalized Intersection Summary

31: SR-99 Southbound Ramps & Cleveland Avenue

Village D Specific Plan
Phase II WP - AM Peak Hour



Movement	EBL	EBT	EBR	WBL	WBT	WBR	NBL	NBT	NBR	SBL	SBT	SBR
Lane Configurations		↑↑	↑	↑	↑↑					↑		↑
Traffic Volume (veh/h)	0	701	816	364	885	0	0	0	0	200	0	96
Future Volume (veh/h)	0	701	816	364	885	0	0	0	0	200	0	96
Initial Q (Qb), veh	0	0	0	0	0	0				0	0	0
Ped-Bike Adj(A_pbT)	1.00		1.00	1.00		1.00				1.00		1.00
Parking Bus, Adj	1.00	1.00	1.00	1.00	1.00	1.00				1.00	1.00	1.00
Work Zone On Approach		No			No						No	
Adj Sat Flow, veh/h/ln	0	1856	1856	1856	1856	0				1796	0	1796
Adj Flow Rate, veh/h	0	762	887	396	962	0				217	0	104
Peak Hour Factor	0.92	0.92	0.92	0.92	0.92	0.92				0.92	0.92	0.92
Percent Heavy Veh, %	0	3	3	3	3	0				7	0	7
Cap, veh/h	0	1351	603	420	2366	0				392	0	348
Arrive On Green	0.00	0.38	0.38	0.48	1.00	0.00				0.23	0.00	0.23
Sat Flow, veh/h	0	3618	1572	1767	3618	0				1711	0	1522
Grp Volume(v), veh/h	0	762	887	396	962	0				217	0	104
Grp Sat Flow(s),veh/h/ln	0	1763	1572	1767	1763	0				1711	0	1522
Q Serve(g_s), s	0.0	15.3	34.5	19.2	0.0	0.0				10.1	0.0	5.1
Cycle Q Clear(g_c), s	0.0	15.3	34.5	19.2	0.0	0.0				10.1	0.0	5.1
Prop In Lane	0.00		1.00	1.00		0.00				1.00		1.00
Lane Grp Cap(c), veh/h	0	1351	603	420	2366	0				392	0	348
V/C Ratio(X)	0.00	0.56	1.47	0.94	0.41	0.00				0.55	0.00	0.30
Avail Cap(c_a), veh/h	0	1351	603	446	2417	0				392	0	348
HCM Platoon Ratio	1.00	1.00	1.00	2.00	2.00	1.00				1.00	1.00	1.00
Upstream Filter(I)	0.00	0.56	0.56	0.68	0.68	0.00				1.00	0.00	1.00
Uniform Delay (d), s/veh	0.0	21.8	27.7	23.0	0.0	0.0				30.6	0.0	28.7
Incr Delay (d2), s/veh	0.0	0.3	217.3	21.5	0.1	0.0				1.7	0.0	0.5
Initial Q Delay(d3),s/veh	0.0	0.0	0.0	0.0	0.0	0.0				0.0	0.0	0.0
%ile BackOfQ(50%),veh/ln	0.0	6.1	48.6	7.8	0.0	0.0				4.3	0.0	1.9
Unsig. Movement Delay, s/veh												
LnGrp Delay(d),s/veh	0.0	22.1	245.0	44.5	0.1	0.0				32.3	0.0	29.2
LnGrp LOS	A	C	F	D	A	A				C	A	C
Approach Vol, veh/h		1649			1358						321	
Approach Delay, s/veh		142.0			13.0						31.3	
Approach LOS		F			B						C	
Timer - Assigned Phs			3	4		6			8			
Phs Duration (G+Y+Rc), s			25.9	39.0		25.1			64.9			
Change Period (Y+Rc), s			4.5	4.5		4.5			4.5			
Max Green Setting (Gmax), s			22.7	34.5		19.3			61.7			
Max Q Clear Time (g_c+I1), s			21.2	36.5		12.1			2.0			
Green Ext Time (p_c), s			0.2	0.0		0.6			9.0			
Intersection Summary												
HCM 6th Ctrl Delay			78.7									
HCM 6th LOS			E									

HCM 6th Signalized Intersection Summary
32: SR-99 Northbound Ramps & Cleveland Avenue

Village D Specific Plan
Phase II WP - AM Peak Hour



Movement	EBL	EBT	EBR	WBL	WBT	WBR	NBL	NBT	NBR	SBL	SBT	SBR
Lane Configurations												
Traffic Volume (veh/h)	74	828	0	0	863	147	392	0	340	0	0	0
Future Volume (veh/h)	74	828	0	0	863	147	392	0	340	0	0	0
Initial Q (Qb), veh	0	0	0	0	0	0	0	0	0			
Ped-Bike Adj(A_pbT)	1.00		1.00	1.00		1.00	1.00		1.00			
Parking Bus, Adj	1.00	1.00	1.00	1.00	1.00	1.00	1.00	1.00	1.00			
Work Zone On Approach	No			No			No					
Adj Sat Flow, veh/h/ln	1856	1856	0	0	1856	1856	1841	1841	1841			
Adj Flow Rate, veh/h	80	900	0	0	938	160	426	0	370			
Peak Hour Factor	0.92	0.92	0.92	0.92	0.92	0.92	0.92	0.92	0.92			
Percent Heavy Veh, %	3	3	0	0	3	3	4	4	4			
Cap, veh/h	104	1445	0	0	1061	473	1719	0	765			
Arrive On Green	0.06	0.41	0.00	0.00	0.30	0.30	0.49	0.00	0.49			
Sat Flow, veh/h	1767	3618	0	0	3618	1572	3506	0	1560			
Grp Volume(v), veh/h	80	900	0	0	938	160	426	0	370			
Grp Sat Flow(s),veh/h/ln	1767	1763	0	0	1763	1572	1753	0	1560			
Q Serve(g_s), s	4.0	18.2	0.0	0.0	22.8	7.1	6.3	0.0	14.3			
Cycle Q Clear(g_c), s	4.0	18.2	0.0	0.0	22.8	7.1	6.3	0.0	14.3			
Prop In Lane	1.00		0.00	0.00		1.00	1.00		1.00			
Lane Grp Cap(c), veh/h	104	1445	0	0	1061	473	1719	0	765			
V/C Ratio(X)	0.77	0.62	0.00	0.00	0.88	0.34	0.25	0.00	0.48			
Avail Cap(c_a), veh/h	383	2057	0	0	1116	498	1719	0	765			
HCM Platoon Ratio	1.00	1.00	1.00	1.00	1.00	1.00	1.00	1.00	1.00			
Upstream Filter(I)	0.78	0.78	0.00	0.00	0.73	0.73	1.00	0.00	1.00			
Uniform Delay (d), s/veh	41.7	21.0	0.0	0.0	30.0	24.5	13.3	0.0	15.3			
Incr Delay (d2), s/veh	8.8	0.3	0.0	0.0	6.3	0.3	0.3	0.0	2.2			
Initial Q Delay(d3),s/veh	0.0	0.0	0.0	0.0	0.0	0.0	0.0	0.0	0.0			
%ile BackOfQ(50%),veh/ln	2.0	7.2	0.0	0.0	10.3	2.6	2.5	0.0	5.2			
Unsig. Movement Delay, s/veh												
LnGrp Delay(d),s/veh	50.6	21.4	0.0	0.0	36.3	24.8	13.7	0.0	17.5			
LnGrp LOS	D	C	A	A	D	C	B	A	B			
Approach Vol, veh/h	980				1098				796			
Approach Delay, s/veh	23.8				34.6				15.5			
Approach LOS	C				C				B			
Timer - Assigned Phs	2		4		7		8					
Phs Duration (G+Y+Rc), s	48.6		41.4		9.8		31.6					
Change Period (Y+Rc), s	4.5		4.5		4.5		4.5					
Max Green Setting (Gmax), s	28.5		52.5		19.5		28.5					
Max Q Clear Time (g_c+I1), s	16.3		20.2		6.0		24.8					
Green Ext Time (p_c), s	2.5		7.6		0.1		2.3					

Intersection Summary

HCM 6th Ctrl Delay	25.6
HCM 6th LOS	C

Notes

User approved volume balancing among the lanes for turning movement.

HCM 6th Signalized Intersection Summary
 33: Gateway Drive & Cleveland Avenue

Village D Specific Plan
 Phase II WP - AM Peak Hour



Movement	EBL	EBT	EBR	WBL	WBT	WBR	NBL	NBT	NBR	SBL	SBT	SBR
Lane Configurations	↖	↑↑↑	↗	↖↗	↑↑		↖↗	↑	↗	↖	↑↗	
Traffic Volume (veh/h)	4	886	275	209	827	75	177	49	168	62	88	4
Future Volume (veh/h)	4	886	275	209	827	75	177	49	168	62	88	4
Initial Q (Qb), veh	0	0	0	0	0	0	0	0	0	0	0	0
Ped-Bike Adj(A_pbT)	1.00		1.00	1.00		1.00	1.00		0.98	1.00		0.98
Parking Bus, Adj	1.00	1.00	1.00	1.00	1.00	1.00	1.00	1.00	1.00	1.00	1.00	1.00
Work Zone On Approach		No			No			No			No	
Adj Sat Flow, veh/h/ln	1856	1856	1856	1870	1870	1870	1796	1796	1796	1841	1841	1841
Adj Flow Rate, veh/h	4	963	0	227	899	82	192	53	183	67	96	4
Peak Hour Factor	0.92	0.92	0.92	0.92	0.92	0.92	0.92	0.92	0.92	0.92	0.92	0.92
Percent Heavy Veh, %	3	3	3	2	2	2	7	7	7	4	4	4
Cap, veh/h	89	1240		314	1087	99	826	746	622	86	737	31
Arrive On Green	0.00	0.16	0.00	0.09	0.33	0.33	0.25	0.42	0.42	0.05	0.22	0.22
Sat Flow, veh/h	1767	5066	1572	3456	3291	300	3319	1796	1499	1753	3420	142
Grp Volume(v), veh/h	4	963	0	227	485	496	192	53	183	67	49	51
Grp Sat Flow(s),veh/h/ln	1767	1689	1572	1728	1777	1815	1659	1796	1499	1753	1749	1813
Q Serve(g_s), s	0.2	16.4	0.0	5.8	22.6	22.6	4.2	1.6	4.9	3.4	2.0	2.1
Cycle Q Clear(g_c), s	0.2	16.4	0.0	5.8	22.6	22.6	4.2	1.6	4.9	3.4	2.0	2.1
Prop In Lane	1.00		1.00	1.00		0.17	1.00		1.00	1.00		0.08
Lane Grp Cap(c), veh/h	89	1240		314	587	599	826	746	622	86	377	391
V/C Ratio(X)	0.04	0.78		0.72	0.83	0.83	0.23	0.07	0.29	0.78	0.13	0.13
Avail Cap(c_a), veh/h	247	1435		591	640	653	826	746	622	179	377	391
HCM Platoon Ratio	0.67	0.67	0.67	1.00	1.00	1.00	1.00	1.00	1.00	1.00	1.00	1.00
Upstream Filter(I)	0.84	0.84	0.00	0.91	0.91	0.91	1.00	1.00	1.00	1.00	1.00	1.00
Uniform Delay (d), s/veh	29.7	35.3	0.0	39.8	27.8	27.8	27.0	15.9	8.0	42.3	28.5	28.5
Incr Delay (d2), s/veh	0.2	2.0	0.0	2.9	7.6	7.4	0.1	0.2	1.2	13.9	0.7	0.7
Initial Q Delay(d3),s/veh	0.0	0.0	0.0	0.0	0.0	0.0	0.0	0.0	0.0	0.0	0.0	0.0
%ile BackOfQ(50%),veh/ln	0.1	7.2	0.0	2.5	10.5	10.7	1.6	0.7	2.5	1.8	0.9	1.0
Unsig. Movement Delay, s/veh												
LnGrp Delay(d),s/veh	29.9	37.3	0.0	42.7	35.3	35.2	27.1	16.0	9.2	56.2	29.2	29.2
LnGrp LOS	C	D		D	D	D	C	B	A	E	C	C
Approach Vol, veh/h		967	A		1208			428			167	
Approach Delay, s/veh		37.2			36.6			18.1			40.0	
Approach LOS		D			D			B			D	
Timer - Assigned Phs	1	2	3	4	5	6	7	8				
Phs Duration (G+Y+Rc), s	36.9	23.9	5.0	34.2	8.9	41.9	12.7	26.5				
Change Period (Y+Rc), s	4.5	4.5	4.5	4.5	4.5	4.5	4.5	4.5				
Max Green Setting (Gmax), s	3	19.4	8.5	32.4	9.2	21.9	15.4	25.5				
Max Q Clear Time (g_c+10), s	3	4.1	2.2	24.6	5.4	6.9	7.8	18.4				
Green Ext Time (p_c), s	0.3	0.4	0.0	3.8	0.0	0.8	0.4	3.6				

Intersection Summary

HCM 6th Ctrl Delay	34.2
HCM 6th LOS	C

Notes

Unsignalized Delay for [EBR] is excluded from calculations of the approach delay and intersection delay.

HCM 6th Signalized Intersection Summary
 34: Cleveland Avenue & County Club Drive

Village D Specific Plan
 Phase II WP - AM Peak Hour



Movement	WBL	WBR	NBT	NBR	SBL	SBT
Lane Configurations	←←←		↑↑	↗	←	↑↑↑
Traffic Volume (veh/h)	440	39	745	370	95	671
Future Volume (veh/h)	440	39	745	370	95	671
Initial Q (Qb), veh	0	0	0	0	0	0
Ped-Bike Adj(A_pbT)	1.00	1.00		1.00	1.00	
Parking Bus, Adj	1.00	1.00	1.00	1.00	1.00	1.00
Work Zone On Approach	No		No		No	
Adj Sat Flow, veh/h/ln	1900	1900	1856	1856	1856	1856
Adj Flow Rate, veh/h	517	0	810	0	103	729
Peak Hour Factor	0.92	0.92	0.92	0.92	0.92	0.92
Percent Heavy Veh, %	0	0	3	3	3	3
Cap, veh/h	648	288	2542		506	3652
Arrive On Green	0.18	0.00	0.72	0.00	0.72	0.72
Sat Flow, veh/h	3619	1610	3618	1572	668	5233
Grp Volume(v), veh/h	517	0	810	0	103	729
Grp Sat Flow(s),veh/h/ln	1810	1610	1763	1572	668	1689
Q Serve(g_s), s	12.3	0.0	7.5	0.0	5.9	4.2
Cycle Q Clear(g_c), s	12.3	0.0	7.5	0.0	13.4	4.2
Prop In Lane	1.00	1.00		1.00	1.00	
Lane Grp Cap(c), veh/h	648	288	2542		506	3652
V/C Ratio(X)	0.80	0.00	0.32		0.20	0.20
Avail Cap(c_a), veh/h	1307	581	2542		506	3652
HCM Platoon Ratio	1.00	1.00	1.00	1.00	1.00	1.00
Upstream Filter(I)	1.00	0.00	0.72	0.00	1.00	1.00
Uniform Delay (d), s/veh	35.4	0.0	4.5	0.0	7.0	4.1
Incr Delay (d2), s/veh	2.3	0.0	0.2	0.0	0.9	0.1
Initial Q Delay(d3),s/veh	0.0	0.0	0.0	0.0	0.0	0.0
%ile BackOfQ(50%),veh/ln	5.5	0.0	2.2	0.0	0.9	1.2
Unsig. Movement Delay, s/veh						
LnGrp Delay(d),s/veh	37.7	0.0	4.8	0.0	7.9	4.2
LnGrp LOS	D	A	A		A	A
Approach Vol, veh/h	517		810	A		832
Approach Delay, s/veh	37.7		4.8			4.7
Approach LOS	D		A			A
Timer - Assigned Phs		2			6	8
Phs Duration (G+Y+Rc), s		69.4			69.4	20.6
Change Period (Y+Rc), s		4.5			4.5	4.5
Max Green Setting (Gmax), s		48.5			48.5	32.5
Max Q Clear Time (g_c+I1), s		9.5			15.4	14.3
Green Ext Time (p_c), s		6.8			7.0	1.8

Intersection Summary

HCM 6th Ctrl Delay	12.6
HCM 6th LOS	B

Notes

User approved volume balancing among the lanes for turning movement.
 Unsignalized Delay for [NBR] is excluded from calculations of the approach delay and intersection delay.

Intersection						
Int Delay, s/veh	0.1					
Movement	EBL	EBR	NBL	NBT	SBT	SBR
Lane Configurations	T			T		
Traffic Vol, veh/h	2	12	1	748	729	1
Future Vol, veh/h	2	12	1	748	729	1
Conflicting Peds, #/hr	0	0	2	0	0	2
Sign Control	Stop	Stop	Free	Free	Free	Free
RT Channelized	-	None	-	None	-	None
Storage Length	0	-	-	-	-	-
Veh in Median Storage, #	0	-	-	0	0	-
Grade, %	0	-	-	0	0	-
Peak Hour Factor	92	92	92	92	92	92
Heavy Vehicles, %	7	7	5	5	4	4
Mvmt Flow	2	13	1	813	792	1

Major/Minor	Minor2	Major1	Major2			
Conflicting Flow All	1204	399	795	0	-	0
Stage 1	795	-	-	-	-	-
Stage 2	409	-	-	-	-	-
Critical Hdwy	6.94	7.04	4.2	-	-	-
Critical Hdwy Stg 1	5.94	-	-	-	-	-
Critical Hdwy Stg 2	5.94	-	-	-	-	-
Follow-up Hdwy	3.57	3.37	2.25	-	-	-
Pot Cap-1 Maneuver	*331	587	803	-	-	-
Stage 1	*393	-	-	-	-	-
Stage 2	*739	-	-	-	-	-
Platoon blocked, %	1			-	-	-
Mov Cap-1 Maneuver	*329	586	801	-	-	-
Mov Cap-2 Maneuver	*349	-	-	-	-	-
Stage 1	*391	-	-	-	-	-
Stage 2	*738	-	-	-	-	-

Approach	EB	NB	SB
HCM Control Delay, s	11.9	0	0
HCM LOS	B		

Minor Lane/Major Mvmt	NBL	NBT	EBLn1	SBT	SBR
Capacity (veh/h)	801	-	534	-	-
HCM Lane V/C Ratio	0.001	-	0.028	-	-
HCM Control Delay (s)	9.5	0	11.9	-	-
HCM Lane LOS	A	A	B	-	-
HCM 95th %tile Q(veh)	0	-	0.1	-	-

Notes
 -: Volume exceeds capacity \$: Delay exceeds 300s +: Computation Not Defined *: All major volume in platoon

HCM 6th Signalized Intersection Summary

36: Pine Street & Howard Road

Village D Specific Plan
Phase II WP - AM Peak Hour



Movement	EBL	EBT	EBR	WBL	WBT	WBR	NBL	NBT	NBR	SBL	SBT	SBR
Lane Configurations												
Traffic Volume (veh/h)	34	690	154	151	464	7	148	167	243	17	281	100
Future Volume (veh/h)	34	690	154	151	464	7	148	167	243	17	281	100
Initial Q (Qb), veh	0	0	0	0	0	0	0	0	0	0	0	0
Ped-Bike Adj(A_pbT)	1.00		0.98	1.00		0.98	1.00		1.00	1.00		0.98
Parking Bus, Adj	1.00	1.00	1.00	1.00	1.00	1.00	1.00	1.00	1.00	1.00	1.00	1.00
Work Zone On Approach		No			No			No			No	
Adj Sat Flow, veh/h/ln	1870	1870	1870	1856	1856	1856	1811	1811	1811	1841	1841	1841
Adj Flow Rate, veh/h	37	750	167	164	504	8	161	182	264	18	305	109
Peak Hour Factor	0.92	0.92	0.92	0.92	0.92	0.92	0.92	0.92	0.92	0.92	0.92	0.92
Percent Heavy Veh, %	2	2	2	3	3	3	6	6	6	4	4	4
Cap, veh/h	53	885	197	169	1329	21	443	465	393	19	328	288
Arrive On Green	0.03	0.31	0.31	0.10	0.37	0.37	0.26	0.26	0.26	0.19	0.19	0.19
Sat Flow, veh/h	1781	2873	640	1767	3550	56	1725	1811	1529	102	1733	1523
Grp Volume(v), veh/h	37	464	453	164	250	262	161	182	264	323	0	109
Grp Sat Flow(s),veh/h/ln	1781	1777	1736	1767	1763	1844	1725	1811	1529	1836	0	1523
Q Serve(g_s), s	2.5	29.3	29.3	11.1	12.4	12.4	9.2	10.0	18.6	20.8	0.0	7.5
Cycle Q Clear(g_c), s	2.5	29.3	29.3	11.1	12.4	12.4	9.2	10.0	18.6	20.8	0.0	7.5
Prop In Lane	1.00		0.37	1.00		0.03	1.00		1.00	0.06		1.00
Lane Grp Cap(c), veh/h	53	547	535	169	660	690	443	465	393	347	0	288
V/C Ratio(X)	0.70	0.85	0.85	0.97	0.38	0.38	0.36	0.39	0.67	0.93	0.00	0.38
Avail Cap(c_a), veh/h	102	709	693	169	771	807	443	465	393	347	0	288
HCM Platoon Ratio	1.00	1.00	1.00	1.00	1.00	1.00	1.00	1.00	1.00	1.00	1.00	1.00
Upstream Filter(I)	1.00	1.00	1.00	0.95	0.95	0.95	1.00	1.00	1.00	1.00	0.00	1.00
Uniform Delay (d), s/veh	57.7	38.9	38.9	54.1	27.4	27.4	36.5	36.8	40.0	47.9	0.0	42.5
Incr Delay (d2), s/veh	15.7	7.5	7.7	57.9	0.3	0.3	2.3	2.5	8.8	31.0	0.0	0.8
Initial Q Delay(d3),s/veh	0.0	0.0	0.0	0.0	0.0	0.0	0.0	0.0	0.0	0.0	0.0	0.0
%ile BackOfQ(50%),veh/ln	1.3	13.8	13.5	7.7	5.3	5.5	4.2	4.7	7.9	12.4	0.0	2.9
Unsig. Movement Delay, s/veh												
LnGrp Delay(d),s/veh	73.4	46.4	46.6	112.0	27.7	27.7	38.8	39.3	48.9	78.8	0.0	43.3
LnGrp LOS	E	D	D	F	C	C	D	D	D	E	A	D
Approach Vol, veh/h		954			676			607				432
Approach Delay, s/veh		47.5			48.2			43.3				69.9
Approach LOS		D			D			D				E
Timer - Assigned Phs		2	3	4		6	7	8				
Phs Duration (G+Y+Rc), s		35.3	16.0	41.5		27.2	8.0	49.4				
Change Period (Y+Rc), s		4.5	4.5	4.5		4.5	4.5	4.5				
Max Green Setting (Gmax), s		19.9	11.5	47.9		22.7	6.9	52.5				
Max Q Clear Time (g_c+I1), s		20.6	13.1	31.3		22.8	4.5	14.4				
Green Ext Time (p_c), s		0.0	0.0	5.6		0.0	0.0	3.4				
Intersection Summary												
HCM 6th Ctrl Delay				50.4								
HCM 6th LOS				D								

HCM 6th Signalized Intersection Summary
 37: Olive Avenue/Q Street & Howard Road/Yosemite Avenue

Village D Specific Plan
 Phase II WP - AM Peak Hour



Movement	EBL	EBT	EBR	WBL	WBT	WBR	NBL	NBT	NBR	SBL	SBT	SBR
Lane Configurations												
Traffic Volume (veh/h)	6	559	328	27	346	20	335	89	21	102	150	12
Future Volume (veh/h)	6	559	328	27	346	20	335	89	21	102	150	12
Initial Q (Qb), veh	0	0	0	0	0	0	0	0	0	0	0	0
Ped-Bike Adj(A_pbT)	1.00		1.00	1.00		0.98	1.00		0.99	1.00		0.96
Parking Bus, Adj	1.00	1.00	1.00	1.00	1.00	1.00	1.00	1.00	1.00	1.00	1.00	1.00
Work Zone On Approach		No			No			No			No	
Adj Sat Flow, veh/h/ln	1856	1856	1856	1870	1870	1870	1841	1841	1841	1870	1870	1870
Adj Flow Rate, veh/h	7	608	0	29	376	22	230	284	23	111	163	13
Peak Hour Factor	0.92	0.92	0.92	0.92	0.92	0.92	0.92	0.92	0.92	0.92	0.92	0.92
Percent Heavy Veh, %	3	3	3	2	2	2	4	4	4	2	2	2
Cap, veh/h	15	738		74	826	48	847	889	746	207	217	177
Arrive On Green	0.01	0.21	0.00	0.04	0.24	0.24	0.48	0.48	0.48	0.12	0.12	0.12
Sat Flow, veh/h	1767	3526	1572	1781	3407	199	1753	1841	1545	1781	1870	1524
Grp Volume(v), veh/h	7	608	0	29	195	203	230	284	23	111	163	13
Grp Sat Flow(s),veh/h/ln	1767	1763	1572	1781	1777	1829	1753	1841	1545	1781	1870	1524
Q Serve(g_s), s	0.5	19.8	0.0	1.9	11.2	11.3	9.4	11.3	0.9	7.0	10.1	0.9
Cycle Q Clear(g_c), s	0.5	19.8	0.0	1.9	11.2	11.3	9.4	11.3	0.9	7.0	10.1	0.9
Prop In Lane	1.00		1.00	1.00		0.11	1.00		1.00	1.00		1.00
Lane Grp Cap(c), veh/h	15	738		74	431	443	847	889	746	207	217	177
V/C Ratio(X)	0.46	0.82		0.39	0.45	0.46	0.27	0.32	0.03	0.54	0.75	0.07
Avail Cap(c_a), veh/h	74	1014		267	703	724	847	889	746	267	281	229
HCM Platoon Ratio	1.00	1.00	1.00	1.00	1.00	1.00	1.00	1.00	1.00	1.00	1.00	1.00
Upstream Filter(I)	0.60	0.60	0.00	1.00	1.00	1.00	1.00	1.00	1.00	1.00	1.00	1.00
Uniform Delay (d), s/veh	59.2	45.3	0.0	56.0	38.7	38.7	18.5	19.0	16.3	50.0	51.4	47.3
Incr Delay (d2), s/veh	12.2	2.5	0.0	3.3	0.7	0.7	0.8	0.9	0.1	2.2	8.0	0.2
Initial Q Delay(d3),s/veh	0.0	0.0	0.0	0.0	0.0	0.0	0.0	0.0	0.0	0.0	0.0	0.0
%ile BackOfQ(50%),veh/ln	0.3	8.9	0.0	0.9	5.0	5.2	4.0	5.1	0.4	3.3	5.2	0.4
Unsig. Movement Delay, s/veh												
LnGrp Delay(d),s/veh	71.4	47.8	0.0	59.3	39.4	39.5	19.3	19.9	16.4	52.2	59.4	47.5
LnGrp LOS	E	D		E	D	D	B	B	B	D	E	D
Approach Vol, veh/h		615	A		427			537			287	
Approach Delay, s/veh		48.1			40.8			19.5			56.0	
Approach LOS		D			D			B			E	
Timer - Assigned Phs		2	3	4		6	7	8				
Phs Duration (G+Y+Rc), s		62.5	9.5	29.6		18.4	5.5	33.6				
Change Period (Y+Rc), s		4.5	4.5	4.5		4.5	4.5	4.5				
Max Green Setting (Gmax), s		31.5	18.0	34.5		18.0	5.0	47.5				
Max Q Clear Time (g_c+I1), s		13.3	3.9	21.8		12.1	2.5	13.3				
Green Ext Time (p_c), s		2.3	0.0	3.4		0.6	0.0	2.5				

Intersection Summary

HCM 6th Ctrl Delay	39.4
HCM 6th LOS	D

Notes

User approved volume balancing among the lanes for turning movement.
 Unsignalized Delay for [EBR] is excluded from calculations of the approach delay and intersection delay.

Intersection												
Int Delay, s/veh	34.8											
Movement	EBL	EBT	EBR	WBL	WBT	WBR	NBL	NBT	NBR	SBL	SBT	SBR
Lane Configurations		↔			↔	↔	↔	↔			↔	
Traffic Vol, veh/h	2	0	63	493	20	11	21	87	0	0	148	3
Future Vol, veh/h	2	0	63	493	20	11	21	87	0	0	148	3
Conflicting Peds, #/hr	0	0	1	1	0	0	0	0	0	0	0	0
Sign Control	Stop	Stop	Stop	Stop	Stop	Stop	Free	Free	Free	Free	Free	Free
RT Channelized	-	-	None	-	-	Stop	-	-	None	-	-	None
Storage Length	-	-	-	-	-	50	75	-	-	-	-	-
Veh in Median Storage, #	-	0	-	-	0	-	-	0	-	-	0	-
Grade, %	-	0	-	-	0	-	-	0	-	-	0	-
Peak Hour Factor	92	92	92	92	92	92	92	92	92	92	92	92
Heavy Vehicles, %	0	0	0	3	3	3	4	4	4	1	1	1
Mvmt Flow	2	0	68	536	22	12	23	95	0	0	161	3

Major/Minor	Minor2		Minor1		Major1		Major2					
Conflicting Flow All	315	304	164	339	305	95	164	0	-	-	-	0
Stage 1	163	163	-	141	141	-	-	-	-	-	-	-
Stage 2	152	141	-	198	164	-	-	-	-	-	-	-
Critical Hdwy	7.1	6.5	6.2	7.13	6.53	6.23	4.14	-	-	-	-	-
Critical Hdwy Stg 1	6.1	5.5	-	6.13	5.53	-	-	-	-	-	-	-
Critical Hdwy Stg 2	6.1	5.5	-	6.13	5.53	-	-	-	-	-	-	-
Follow-up Hdwy	3.5	4	3.3	3.527	4.027	3.327	2.236	-	-	-	-	-
Pot Cap-1 Maneuver	664	627	886	634	621	993	1402	-	0	0	-	-
Stage 1	844	767	-	885	791	-	-	-	0	0	-	-
Stage 2	880	796	-	802	761	-	-	-	0	0	-	-
Platoon blocked, %	1	1		1	1	1		-			-	-
Mov Cap-1 Maneuver	630	617	885	577	611	993	1402	-	-	-	-	-
Mov Cap-2 Maneuver	630	617	-	577	611	-	-	-	-	-	-	-
Stage 1	830	767	-	871	778	-	-	-	-	-	-	-
Stage 2	831	783	-	739	761	-	-	-	-	-	-	-

Approach	EB	WB	NB	SB
HCM Control Delay, s	9.5	54.9	1.5	0
HCM LOS	A	F		

Minor Lane/Major Mvmt	NBL	NBT	EBLn1WBLn1WBLn2	SBT	SBR
Capacity (veh/h)	1402	-	874 578 993	-	-
HCM Lane V/C Ratio	0.016	-	0.081 0.965 0.012	-	-
HCM Control Delay (s)	7.6	-	9.5 55.9 8.7	-	-
HCM Lane LOS	A	-	A F A	-	-
HCM 95th %tile Q(veh)	0.1	-	0.3 13.2 0	-	-

HCM 6th Signalized Intersection Summary
 39: 4th Street & Sunset Avenue

Village D Specific Plan
 Phase II WP - AM Peak Hour



Movement	EBL	EBR	NBL	NBT	SBT	SBR
Lane Configurations						
Traffic Volume (veh/h)	394	23	34	351	501	283
Future Volume (veh/h)	394	23	34	351	501	283
Initial Q (Qb), veh	0	0	0	0	0	0
Ped-Bike Adj(A_pbT)	1.00	1.00	1.00			1.00
Parking Bus, Adj	1.00	1.00	1.00	1.00	1.00	1.00
Work Zone On Approach	No			No	No	
Adj Sat Flow, veh/h/ln	1900	1900	1870	1870	1870	1870
Adj Flow Rate, veh/h	451	0	37	382	545	308
Peak Hour Factor	0.92	0.92	0.92	0.92	0.92	0.92
Percent Heavy Veh, %	0	0	2	2	2	2
Cap, veh/h	552	246	441	2656	842	953
Arrive On Green	0.15	0.00	0.25	0.75	0.90	0.90
Sat Flow, veh/h	3619	1610	1781	3647	1870	1582
Grp Volume(v), veh/h	451	0	37	382	545	308
Grp Sat Flow(s),veh/h/ln	1810	1610	1781	1777	1870	1582
Q Serve(g_s), s	10.9	0.0	1.4	2.7	6.3	2.1
Cycle Q Clear(g_c), s	10.9	0.0	1.4	2.7	6.3	2.1
Prop In Lane	1.00	1.00	1.00			1.00
Lane Grp Cap(c), veh/h	552	246	441	2656	842	953
V/C Ratio(X)	0.82	0.00	0.08	0.14	0.65	0.32
Avail Cap(c_a), veh/h	744	331	441	2656	842	953
HCM Platoon Ratio	1.00	1.00	1.00	1.00	2.00	2.00
Upstream Filter(I)	1.00	0.00	1.00	1.00	0.86	0.86
Uniform Delay (d), s/veh	36.9	0.0	26.0	3.2	2.8	1.4
Incr Delay (d2), s/veh	5.2	0.0	0.1	0.1	3.3	0.8
Initial Q Delay(d3),s/veh	0.0	0.0	0.0	0.0	0.0	0.0
%ile BackOfQ(50%),veh/ln	5.1	0.0	0.6	0.8	1.9	0.8
Unsig. Movement Delay, s/veh						
LnGrp Delay(d),s/veh	42.2	0.0	26.1	3.3	6.1	2.1
LnGrp LOS	D	A	C	A	A	A
Approach Vol, veh/h	451			419	853	
Approach Delay, s/veh	42.2			5.3	4.7	
Approach LOS	D			A	A	
Timer - Assigned Phs		2		4	5	6
Phs Duration (G+Y+Rc), s		71.8		18.2	26.8	45.0
Change Period (Y+Rc), s		4.5		4.5	4.5	4.5
Max Green Setting (Gmax), s		62.5		18.5	17.5	40.5
Max Q Clear Time (g_c+I1), s		4.7		12.9	3.4	8.3
Green Ext Time (p_c), s		2.8		0.9	0.0	5.2
Intersection Summary						
HCM 6th Ctrl Delay			14.6			
HCM 6th LOS			B			
Notes						
User approved volume balancing among the lanes for turning movement.						

40: H Street & SR-99 Southbound On-Ramp/2nd Street Performance by movement

Movement	WBL	WBT	WBR	NBL	NBT	NBR	SBT	All
Denied Delay (hr)	0.0	0.0	0.0	0.0	0.0	0.0	0.0	0.0
Denied Del/Veh (s)	0.1	0.1	0.1	0.0	0.4	0.0	0.1	0.1
Total Delay (hr)	0.1	0.1	0.0	0.2	0.0	0.0	0.1	0.4
Total Del/Veh (s)	10.4	9.5	2.3	2.8	2.4	2.0	10.9	4.8
Stop Delay (hr)	0.1	0.0	0.0	0.0	0.0	0.0	0.1	0.2
Stop Del/Veh (s)	8.4	6.2	2.3	0.2	0.2	0.1	7.8	2.2

HCM 6th Signalized Intersection Summary

41: I Street & 4th Street

Village D Specific Plan
Phase II WP - AM Peak Hour



Movement	EBL	EBT	EBR	WBL	WBT	WBR	NBL	NBT	NBR	SBL	SBT	SBR
Lane Configurations												
Traffic Volume (veh/h)	28	671	69	88	500	68	53	57	165	281	284	200
Future Volume (veh/h)	28	671	69	88	500	68	53	57	165	281	284	200
Initial Q (Qb), veh	0	0	0	0	0	0	0	0	0	0	0	0
Ped-Bike Adj(A_pbT)	1.00		0.96	1.00		0.96	1.00		0.97	1.00		0.98
Parking Bus, Adj	1.00	1.00	1.00	1.00	1.00	1.00	1.00	1.00	1.00	1.00	1.00	1.00
Work Zone On Approach		No			No			No			No	
Adj Sat Flow, veh/h/ln	1870	1870	1870	1856	1856	1856	1856	1856	1856	1870	1870	1870
Adj Flow Rate, veh/h	30	729	75	96	543	74	58	62	179	305	309	217
Peak Hour Factor	0.92	0.92	0.92	0.92	0.92	0.92	0.92	0.92	0.92	0.92	0.92	0.92
Percent Heavy Veh, %	2	2	2	3	3	3	3	3	3	2	2	2
Cap, veh/h	52	822	84	122	911	124	217	379	310	486	663	548
Arrive On Green	0.03	0.25	0.25	0.07	0.29	0.29	0.12	0.20	0.20	0.27	0.35	0.35
Sat Flow, veh/h	1781	3237	333	1767	3103	421	1767	1856	1519	1781	1870	1546
Grp Volume(v), veh/h	30	400	404	96	308	309	58	62	179	305	309	217
Grp Sat Flow(s),veh/h/ln	1781	1777	1793	1767	1763	1761	1767	1856	1519	1781	1870	1546
Q Serve(g_s), s	1.5	19.5	19.5	4.8	13.4	13.6	2.7	2.5	9.6	13.5	11.5	7.6
Cycle Q Clear(g_c), s	1.5	19.5	19.5	4.8	13.4	13.6	2.7	2.5	9.6	13.5	11.5	7.6
Prop In Lane	1.00		0.19	1.00		0.24	1.00		1.00	1.00		1.00
Lane Grp Cap(c), veh/h	52	451	455	122	517	517	217	379	310	486	663	548
V/C Ratio(X)	0.57	0.89	0.89	0.79	0.59	0.60	0.27	0.16	0.58	0.63	0.47	0.40
Avail Cap(c_a), veh/h	99	478	482	155	531	530	217	379	310	486	663	548
HCM Platoon Ratio	1.00	1.00	1.00	1.00	1.00	1.00	1.00	1.00	1.00	1.00	1.00	1.00
Upstream Filter(l)	0.89	0.89	0.89	1.00	1.00	1.00	1.00	1.00	1.00	1.00	1.00	1.00
Uniform Delay (d), s/veh	43.1	32.3	32.3	41.2	27.2	27.3	35.8	29.5	32.3	28.7	22.5	14.0
Incr Delay (d2), s/veh	8.6	15.8	15.8	18.4	1.7	1.8	0.7	0.9	7.6	2.6	2.3	2.1
Initial Q Delay(d3),s/veh	0.0	0.0	0.0	0.0	0.0	0.0	0.0	0.0	0.0	0.0	0.0	0.0
%ile BackOfQ(50%),veh/ln	0.8	10.1	10.2	2.7	5.7	5.8	1.2	1.2	4.1	6.0	5.3	2.8
Unsig. Movement Delay, s/veh												
LnGrp Delay(d),s/veh	51.7	48.2	48.2	59.6	28.9	29.0	36.5	30.4	39.9	31.3	24.8	16.1
LnGrp LOS	D	D	D	E	C	C	D	C	D	C	C	B
Approach Vol, veh/h		834			713			299			831	
Approach Delay, s/veh		48.3			33.1			37.2			24.9	
Approach LOS		D			C			D			C	
Timer - Assigned Phs	1	2	3	4	5	6	7	8				
Phs Duration (G+Y+Rc), s	29.0	22.9	10.7	27.3	15.5	36.4	7.1	30.9				
Change Period (Y+Rc), s	4.5	4.5	4.5	4.5	4.5	4.5	4.5	4.5				
Max Green Setting (Gmax), s	21.5	18.4	7.9	24.2	8.0	31.9	5.0	27.1				
Max Q Clear Time (g_c+1/5), s	11.5	11.6	6.8	21.5	4.7	13.5	3.5	15.6				
Green Ext Time (p_c), s	0.5	0.5	0.0	1.3	0.0	2.5	0.0	3.0				
Intersection Summary												
HCM 6th Ctrl Delay											35.8	
HCM 6th LOS											D	

HCM 6th Signalized Intersection Summary
 43: SR-99 Northbound Off-Ramp/H Street & 4th Street

Village D Specific Plan
 Phase II WP - AM Peak Hour



Movement	EBL	EBT	EBR	WBL	WBT	WBR	NBL	NBT	NBR	SBL	SBT	SBR
Lane Configurations												
Traffic Volume (veh/h)	268	508	0	0	529	86	267	31	225	7	0	75
Future Volume (veh/h)	268	508	0	0	529	86	267	31	225	7	0	75
Initial Q (Qb), veh	0	0	0	0	0	0	0	0	0	0	0	0
Ped-Bike Adj(A_pbT)	1.00		1.00	1.00		0.94	1.00		1.00	1.00		0.99
Parking Bus, Adj	1.00	1.00	1.00	1.00	1.00	1.00	1.00	1.00	1.00	1.00	1.00	1.00
Work Zone On Approach		No			No			No			No	
Adj Sat Flow, veh/h/ln	1885	1885	0	0	1841	1841	1870	1870	1870	1900	1900	1900
Adj Flow Rate, veh/h	291	552	0	0	575	93	290	34	245	8	0	82
Peak Hour Factor	0.92	0.92	0.92	0.92	0.92	0.92	0.92	0.92	0.92	0.92	0.92	0.92
Percent Heavy Veh, %	1	1	0	0	4	4	2	2	2	0	0	0
Cap, veh/h	325	1563	0	0	614	99	381	42	303	29	0	293
Arrive On Green	0.18	0.44	0.00	0.00	0.21	0.21	0.21	0.21	0.21	0.20	0.00	0.20
Sat Flow, veh/h	1795	3676	0	0	3080	481	1781	197	1418	143	0	1464
Grp Volume(v), veh/h	291	552	0	0	336	332	290	0	279	90	0	0
Grp Sat Flow(s),veh/h/ln	1795	1791	0	0	1749	1720	1781	0	1615	1606	0	0
Q Serve(g_s), s	14.3	9.2	0.0	0.0	17.0	17.1	13.8	0.0	14.8	4.3	0.0	0.0
Cycle Q Clear(g_c), s	14.3	9.2	0.0	0.0	17.0	17.1	13.8	0.0	14.8	4.3	0.0	0.0
Prop In Lane	1.00		0.00	0.00		0.28	1.00		0.88	0.09		0.91
Lane Grp Cap(c), veh/h	325	1563	0	0	359	354	381	0	345	321	0	0
V/C Ratio(X)	0.90	0.35	0.00	0.00	0.93	0.94	0.76	0.00	0.81	0.28	0.00	0.00
Avail Cap(c_a), veh/h	329	1572	0	0	359	354	381	0	345	321	0	0
HCM Platoon Ratio	1.00	1.00	1.00	1.00	1.00	1.00	1.00	1.00	1.00	1.00	1.00	1.00
Upstream Filter(I)	1.00	1.00	0.00	0.00	1.00	1.00	1.00	0.00	1.00	1.00	0.00	0.00
Uniform Delay (d), s/veh	36.0	16.9	0.0	0.0	35.1	35.2	33.2	0.0	33.6	30.5	0.0	0.0
Incr Delay (d2), s/veh	25.4	0.1	0.0	0.0	31.0	32.6	13.5	0.0	18.2	2.2	0.0	0.0
Initial Q Delay(d3),s/veh	0.0	0.0	0.0	0.0	0.0	0.0	0.0	0.0	0.0	0.0	0.0	0.0
%ile BackOfQ(50%),veh/ln	8.4	3.7	0.0	0.0	10.1	10.2	7.2	0.0	7.4	1.8	0.0	0.0
Unsig. Movement Delay, s/veh												
LnGrp Delay(d),s/veh	61.4	17.0	0.0	0.0	66.2	67.8	46.7	0.0	51.8	32.7	0.0	0.0
LnGrp LOS	E	B	A	A	E	E	D	A	D	C	A	A
Approach Vol, veh/h		843			668			569				90
Approach Delay, s/veh		32.4			67.0			49.2				32.7
Approach LOS		C			E			D				C
Timer - Assigned Phs		2		4		6	7	8				
Phs Duration (G+Y+Rc), s		23.7		43.8		22.5	20.8	23.0				
Change Period (Y+Rc), s		4.5		4.5		4.5	4.5	4.5				
Max Green Setting (Gmax), s		19.0		39.5		18.0	16.5	18.5				
Max Q Clear Time (g_c+I1), s		16.8		11.2		6.3	16.3	19.1				
Green Ext Time (p_c), s		0.7		4.0		0.3	0.0	0.0				
Intersection Summary												
HCM 6th Ctrl Delay												47.5
HCM 6th LOS												D

Intersection						
Int Delay, s/veh	2.5					
Movement	EBL	EBT	WBT	WBR	SBL	SBR
Lane Configurations	↖	↗	↗		↖	↖
Traffic Vol, veh/h	132	490	542	80	61	101
Future Vol, veh/h	132	490	542	80	61	101
Conflicting Peds, #/hr	16	0	0	16	0	0
Sign Control	Free	Free	Free	Free	Stop	Stop
RT Channelized	-	None	-	None	-	None
Storage Length	145	-	-	-	65	0
Veh in Median Storage, #	-	0	0	-	0	-
Grade, %	-	0	0	-	0	-
Peak Hour Factor	98	98	98	98	98	98
Heavy Vehicles, %	5	5	4	4	5	5
Mvmt Flow	135	500	553	82	62	103

Major/Minor	Major1	Major2	Minor2		
Conflicting Flow All	651	0	-	0	1130 334
Stage 1	-	-	-	-	610 -
Stage 2	-	-	-	-	520 -
Critical Hdwy	4.2	-	-	-	6.9 7
Critical Hdwy Stg 1	-	-	-	-	5.9 -
Critical Hdwy Stg 2	-	-	-	-	5.9 -
Follow-up Hdwy	2.25	-	-	-	3.55 3.35
Pot Cap-1 Maneuver	1192	-	-	-	302 *868
Stage 1	-	-	-	-	778 -
Stage 2	-	-	-	-	553 -
Platoon blocked, %	1	-	-	-	1 1
Mov Cap-1 Maneuver	1174	-	-	-	259 *855
Mov Cap-2 Maneuver	-	-	-	-	259 -
Stage 1	-	-	-	-	679 -
Stage 2	-	-	-	-	545 -

Approach	EB	WB	SB
HCM Control Delay, s	1.8	0	14.8
HCM LOS			B

Minor Lane/Major Mvmt	EBL	EBT	WBT	WBR	SBLn1	SBLn2
Capacity (veh/h)	1174	-	-	-	259	855
HCM Lane V/C Ratio	0.115	-	-	-	0.24	0.121
HCM Control Delay (s)	8.5	-	-	-	23.2	9.8
HCM Lane LOS	A	-	-	-	C	A
HCM 95th %tile Q(veh)	0.4	-	-	-	0.9	0.4

Notes
 -: Volume exceeds capacity \$: Delay exceeds 300s +: Computation Not Defined *: All major volume in platoon

HCM 6th Signalized Intersection Summary

45: Olive Avenue & SR-99 Southbound Off-Ramp

Village D Specific Plan
Phase II WP - AM Peak Hour



Movement	EBL	EBT	WBT	WBR	SBL	SBR
Lane Configurations		↑↑↑	↑↑		↙	↗
Traffic Volume (veh/h)	0	551	511	0	777	113
Future Volume (veh/h)	0	551	511	0	777	113
Initial Q (Qb), veh	0	0	0	0	0	0
Ped-Bike Adj(A_pbT)	1.00			1.00	1.00	1.00
Parking Bus, Adj	1.00	1.00	1.00	1.00	1.00	1.00
Work Zone On Approach		No	No		No	
Adj Sat Flow, veh/h/ln	0	1826	1826	0	1781	1781
Adj Flow Rate, veh/h	0	586	544	0	827	120
Peak Hour Factor	0.94	0.94	0.94	0.94	0.94	0.94
Percent Heavy Veh, %	0	5	5	0	8	8
Cap, veh/h	0	989	688	0	1169	1040
Arrive On Green	0.00	0.20	0.20	0.00	0.69	0.69
Sat Flow, veh/h	0	5313	3652	0	1697	1510
Grp Volume(v), veh/h	0	586	544	0	827	120
Grp Sat Flow(s),veh/h/ln	0	1662	1735	0	1697	1510
Q Serve(g_s), s	0.0	8.5	11.9	0.0	23.7	2.1
Cycle Q Clear(g_c), s	0.0	8.5	11.9	0.0	23.7	2.1
Prop In Lane	0.00			0.00	1.00	1.00
Lane Grp Cap(c), veh/h	0	989	688	0	1169	1040
V/C Ratio(X)	0.00	0.59	0.79	0.00	0.71	0.12
Avail Cap(c_a), veh/h	0	1277	889	0	1169	1040
HCM Platoon Ratio	1.00	1.00	1.00	1.00	1.00	1.00
Upstream Filter(I)	0.00	1.00	0.97	0.00	1.00	1.00
Uniform Delay (d), s/veh	0.0	29.1	30.5	0.0	7.5	4.2
Incr Delay (d2), s/veh	0.0	0.6	3.6	0.0	3.6	0.2
Initial Q Delay(d3),s/veh	0.0	0.0	0.0	0.0	0.0	0.0
%ile BackOfQ(50%),veh/ln	0.0	3.4	5.2	0.0	7.7	0.6
Unsig. Movement Delay, s/veh						
LnGrp Delay(d),s/veh	0.0	29.7	34.1	0.0	11.2	4.4
LnGrp LOS	A	C	C	A	B	A
Approach Vol, veh/h		586	544		947	
Approach Delay, s/veh		29.7	34.1		10.3	
Approach LOS		C	C		B	
Timer - Assigned Phs				4	6	8
Phs Duration (G+Y+Rc), s				20.4	59.6	20.4
Change Period (Y+Rc), s				4.5	4.5	4.5
Max Green Setting (Gmax), s				20.5	50.5	20.5
Max Q Clear Time (g_c+I1), s				10.5	25.7	13.9
Green Ext Time (p_c), s				2.8	3.8	2.0
Intersection Summary						
HCM 6th Ctrl Delay			22.0			
HCM 6th LOS			C			

HCM 6th Signalized Intersection Summary

46: Madera Avenue & SR-99 Northbound Ramps

Village D Specific Plan
Phase II WP - AM Peak Hour



Movement	EBL	EBT	EBR	WBL	WBT	WBR	NBL	NBT	NBR	SBL	SBT	SBR
Lane Configurations				↶	↷	↶	↶	↶			↶	↶
Traffic Volume (veh/h)	0	0	0	206	2	96	603	497	0	0	655	256
Future Volume (veh/h)	0	0	0	206	2	96	603	497	0	0	655	256
Initial Q (Qb), veh				0	0	0	0	0	0	0	0	0
Ped-Bike Adj(A_pbT)				1.00		0.98	1.00		1.00	1.00		0.97
Parking Bus, Adj				1.00	1.00	1.00	1.00	1.00	1.00	1.00	1.00	1.00
Work Zone On Approach				No			No			No		
Adj Sat Flow, veh/h/ln				1826	1826	1826	1811	1811	0	0	1841	1841
Adj Flow Rate, veh/h				225	0	104	655	540	0	0	712	278
Peak Hour Factor				0.92	0.92	0.92	0.92	0.92	0.92	0.92	0.92	0.92
Percent Heavy Veh, %				5	5	5	6	6	0	0	4	4
Cap, veh/h				354	0	155	1165	2703	0	0	927	362
Arrive On Green				0.10	0.00	0.10	0.58	1.00	0.00	0.00	0.38	0.38
Sat Flow, veh/h				3478	0	1519	3346	3532	0	0	2523	949
Grp Volume(v), veh/h				225	0	104	655	540	0	0	512	478
Grp Sat Flow(s),veh/h/ln				1739	0	1519	1673	1721	0	0	1749	1632
Q Serve(g_s), s				5.0	0.0	5.3	9.7	0.0	0.0	0.0	20.5	20.5
Cycle Q Clear(g_c), s				5.0	0.0	5.3	9.7	0.0	0.0	0.0	20.5	20.5
Prop In Lane				1.00		1.00	1.00		0.00	0.00		0.58
Lane Grp Cap(c), veh/h				354	0	155	1165	2703	0	0	667	622
V/C Ratio(X)				0.64	0.00	0.67	0.56	0.20	0.00	0.00	0.77	0.77
Avail Cap(c_a), veh/h				804	0	351	1165	2703	0	0	667	622
HCM Platoon Ratio				1.00	1.00	1.00	1.67	1.67	1.00	1.00	1.00	1.00
Upstream Filter(I)				1.00	0.00	1.00	0.82	0.82	0.00	0.00	1.00	1.00
Uniform Delay (d), s/veh				34.5	0.0	34.6	13.0	0.0	0.0	0.0	21.7	21.7
Incr Delay (d2), s/veh				1.9	0.0	5.0	0.5	0.1	0.0	0.0	8.3	8.8
Initial Q Delay(d3),s/veh				0.0	0.0	0.0	0.0	0.0	0.0	0.0	0.0	0.0
%ile BackOfQ(50%),veh/ln				2.1	0.0	2.1	2.9	0.1	0.0	0.0	9.4	8.9
Unsig. Movement Delay, s/veh												
LnGrp Delay(d),s/veh				36.4	0.0	39.6	13.5	0.1	0.0	0.0	29.9	30.5
LnGrp LOS				D	A	D	B	A	A	A	C	C
Approach Vol, veh/h						329		1195			990	
Approach Delay, s/veh						37.4		7.4			30.2	
Approach LOS						D		A			C	
Timer - Assigned Phs		2			5	6		8				
Phs Duration (G+Y+Rc), s		67.4			32.4	35.0		12.6				
Change Period (Y+Rc), s		4.5			4.5	4.5		4.5				
Max Green Setting (Gmax), s		52.5			17.5	30.5		18.5				
Max Q Clear Time (g_c+I1), s		2.0			11.7	22.5		7.3				
Green Ext Time (p_c), s		4.2			1.4	4.0		0.9				

Intersection Summary

HCM 6th Ctrl Delay	20.3
HCM 6th LOS	C

Notes

User approved volume balancing among the lanes for turning movement.

HCM 6th Signalized Intersection Summary

47: Madera Avenue & Olive Avenue/SR-99 Southbound On-Ramp

Village D Specific Plan
Phase II WP - AM Peak Hour



Movement	EBL	EBT	EBR	WBL	WBT	WBR	NBL	NBT	NBR	SBL	SBT	SBR
Lane Configurations												
Traffic Volume (veh/h)	446	199	684	0	0	0	173	655	42	87	436	338
Future Volume (veh/h)	446	199	684	0	0	0	173	655	42	87	436	338
Initial Q (Qb), veh	0	0	0				0	0	0	0	0	0
Ped-Bike Adj(A_pbT)	1.00		1.00				1.00		0.99	1.00		0.99
Parking Bus, Adj	1.00	1.00	1.00				1.00	1.00	1.00	1.00	1.00	1.00
Work Zone On Approach		No					No			No		
Adj Sat Flow, veh/h/ln	1826	1826	1826				1796	1796	1796	1841	1841	1841
Adj Flow Rate, veh/h	339	391	720				182	689	44	92	459	356
Peak Hour Factor	0.95	0.95	0.95				0.95	0.95	0.95	0.95	0.95	0.95
Percent Heavy Veh, %	5	5	5				7	7	7	4	4	4
Cap, veh/h	576	605	639				271	1410	90	117	781	604
Arrive On Green	0.55	0.55	0.55				0.08	0.43	0.43	0.13	0.84	0.84
Sat Flow, veh/h	1739	1826	1547				3319	3255	208	1753	1867	1442
Grp Volume(v), veh/h	339	391	720				182	361	372	92	430	385
Grp Sat Flow(s),veh/h/ln	1739	1826	1547				1659	1706	1756	1753	1749	1561
Q Serve(g_s), s	10.3	11.9	26.5				4.3	12.2	12.2	4.1	6.3	6.4
Cycle Q Clear(g_c), s	10.3	11.9	26.5				4.3	12.2	12.2	4.1	6.3	6.4
Prop In Lane	1.00		1.00				1.00		0.12	1.00		0.92
Lane Grp Cap(c), veh/h	576	605	639				271	739	761	117	732	653
V/C Ratio(X)	0.59	0.65	1.13				0.67	0.49	0.49	0.79	0.59	0.59
Avail Cap(c_a), veh/h	576	605	639				643	739	761	217	732	653
HCM Platoon Ratio	1.67	1.67	1.67				1.00	1.00	1.00	2.00	2.00	2.00
Upstream Filter(I)	0.70	0.70	0.70				1.00	1.00	1.00	0.76	0.76	0.76
Uniform Delay (d), s/veh	14.3	14.6	16.8				35.7	16.3	16.3	34.1	4.3	4.3
Incr Delay (d2), s/veh	1.1	1.7	71.3				2.9	2.3	2.2	8.6	2.6	3.0
Initial Q Delay(d3),s/veh	0.0	0.0	0.0				0.0	0.0	0.0	0.0	0.0	0.0
%ile BackOfQ(50%),veh/ln	8.3	3.9	32.4				1.8	4.9	5.1	1.9	1.8	1.7
Unsig. Movement Delay, s/veh												
LnGrp Delay(d),s/veh	15.4	16.3	88.1				38.6	18.6	18.5	42.7	6.9	7.3
LnGrp LOS	B	B	F				D	B	B	D	A	A
Approach Vol, veh/h		1450						915			907	
Approach Delay, s/veh		51.7						22.5			10.7	
Approach LOS		D						C			B	
Timer - Assigned Phs	1	2		4	5	6						
Phs Duration (G+Y+Rc), s	9.8	39.2		31.0	11.0	38.0						
Change Period (Y+Rc), s	4.5	4.5		4.5	4.5	4.5						
Max Green Setting (Gmax), s	30.1			26.5	15.5	24.5						
Max Q Clear Time (g_c+1), s	14.2			28.5	6.3	8.4						
Green Ext Time (p_c), s	0.1	4.2		0.0	0.4	5.0						

Intersection Summary

HCM 6th Ctrl Delay	32.2
HCM 6th LOS	C

Notes

User approved volume balancing among the lanes for turning movement.

Intersection						
Int Delay, s/veh	0.3					
Movement	WBL	WBR	NBT	NBR	SBL	SBT
Lane Configurations	↔		↕		↔	↕
Traffic Vol, veh/h	9	8	894	8	32	1243
Future Vol, veh/h	9	8	894	8	32	1243
Conflicting Peds, #/hr	0	0	0	8	8	0
Sign Control	Stop	Stop	Free	Free	Free	Free
RT Channelized	-	None	-	None	-	None
Storage Length	0	-	-	-	100	-
Veh in Median Storage, #	0	-	0	-	-	0
Grade, %	0	-	0	-	-	0
Peak Hour Factor	97	97	97	97	97	97
Heavy Vehicles, %	12	12	6	6	5	5
Mvmt Flow	9	8	922	8	33	1281

Major/Minor	Minor1	Major1	Major2		
Conflicting Flow All	1641	473	0	0	938
Stage 1	934	-	-	-	-
Stage 2	707	-	-	-	-
Critical Hdwy	7.04	7.14	-	-	4.2
Critical Hdwy Stg 1	6.04	-	-	-	-
Critical Hdwy Stg 2	6.04	-	-	-	-
Follow-up Hdwy	3.62	3.42	-	-	2.25
Pot Cap-1 Maneuver	*293	511	-	-	708
Stage 1	*320	-	-	-	-
Stage 2	*517	-	-	-	-
Platoon blocked, %	1	-	-	-	-
Mov Cap-1 Maneuver	*276	507	-	-	703
Mov Cap-2 Maneuver	*283	-	-	-	-
Stage 1	*317	-	-	-	-
Stage 2	*493	-	-	-	-

Approach	WB	NB	SB
HCM Control Delay, s	15.6	0	0.3
HCM LOS	C		

Minor Lane/Major Mvmt	NBT	NBRWBLn1	SBL	SBT
Capacity (veh/h)	-	-	357	703
HCM Lane V/C Ratio	-	-	0.049	0.047
HCM Control Delay (s)	-	-	15.6	10.4
HCM Lane LOS	-	-	C	B
HCM 95th %tile Q(veh)	-	-	0.2	0.1

Notes			
-: Volume exceeds capacity	\$: Delay exceeds 300s	+: Computation Not Defined	*: All major volume in platoon

HCM 6th Signalized Intersection Summary
 49: Yosemite Avenue & Cleveland Avenue/Tozer Street

Village D Specific Plan
 Phase II WP - AM Peak Hour



Movement	EBL	EBT	EBR	WBL	WBT	WBR	NBL	NBT	NBR	SBL	SBT	SBR
Lane Configurations												
Traffic Volume (veh/h)	284	535	256	114	334	54	138	126	77	73	256	239
Future Volume (veh/h)	284	535	256	114	334	54	138	126	77	73	256	239
Initial Q (Qb), veh	0	0	0	0	0	0	0	0	0	0	0	0
Ped-Bike Adj(A_pbT)	1.00		0.92	1.00		0.91	1.00		1.00	1.00		1.00
Parking Bus, Adj	1.00	1.00	1.00	1.00	1.00	1.00	1.00	1.00	1.00	1.00	1.00	1.00
Work Zone On Approach		No			No			No			No	
Adj Sat Flow, veh/h/ln	1856	1856	1856	1841	1841	1841	1856	1856	1856	1870	1870	1870
Adj Flow Rate, veh/h	309	582	278	124	363	59	150	137	84	79	278	260
Peak Hour Factor	0.92	0.92	0.92	0.92	0.92	0.92	0.92	0.92	0.92	0.92	0.92	0.92
Percent Heavy Veh, %	3	3	3	4	4	4	3	3	3	2	2	2
Cap, veh/h	343	743	354	154	785	319	171	601	508	102	252	236
Arrive On Green	0.19	0.33	0.33	0.09	0.22	0.22	0.10	0.32	0.32	0.06	0.28	0.28
Sat Flow, veh/h	1767	2245	1070	1753	3497	1421	1767	1856	1568	1781	888	830
Grp Volume(v), veh/h	309	457	403	124	363	59	150	137	84	79	0	538
Grp Sat Flow(s),veh/h/ln	1767	1763	1553	1753	1749	1421	1767	1856	1568	1781	0	1718
Q Serve(g_s), s	15.3	21.0	21.1	6.2	8.1	3.0	7.5	4.8	3.4	3.9	0.0	25.5
Cycle Q Clear(g_c), s	15.3	21.0	21.1	6.2	8.1	3.0	7.5	4.8	3.4	3.9	0.0	25.5
Prop In Lane	1.00		0.69	1.00		1.00	1.00		1.00	1.00		0.48
Lane Grp Cap(c), veh/h	343	583	514	154	785	319	171	601	508	102	0	488
V/C Ratio(X)	0.90	0.78	0.78	0.81	0.46	0.18	0.88	0.23	0.17	0.78	0.00	1.10
Avail Cap(c_a), veh/h	356	583	514	158	785	319	171	601	508	185	0	488
HCM Platoon Ratio	1.00	1.00	1.00	1.00	1.00	1.00	1.00	1.00	1.00	1.00	1.00	1.00
Upstream Filter(I)	1.00	1.00	1.00	1.00	1.00	1.00	1.00	1.00	1.00	1.00	0.00	1.00
Uniform Delay (d), s/veh	35.3	27.1	27.1	40.2	30.1	28.2	40.0	22.2	21.7	41.7	0.0	32.1
Incr Delay (d2), s/veh	24.5	10.1	11.4	25.2	2.0	1.3	36.2	0.2	0.2	11.8	0.0	71.6
Initial Q Delay(d3),s/veh	0.0	0.0	0.0	0.0	0.0	0.0	0.0	0.0	0.0	0.0	0.0	0.0
%ile BackOfQ(50%),veh/ln	8.8	10.1	9.1	3.7	3.5	1.1	4.9	2.1	1.3	2.0	0.0	19.9
Unsig. Movement Delay, s/veh												
LnGrp Delay(d),s/veh	59.8	37.2	38.6	65.4	32.1	29.4	76.2	22.3	21.8	53.5	0.0	103.8
LnGrp LOS	E	D	D	E	C	C	E	C	C	D	A	F
Approach Vol, veh/h		1169			546			371			617	
Approach Delay, s/veh		43.7			39.4			44.0			97.3	
Approach LOS		D			D			D			F	
Timer - Assigned Phs	1	2	3	4	5	6	7	8				
Phs Duration (G+Y+Rc), s	21.9	24.7	9.6	33.6	12.4	34.2	13.2	30.0				
Change Period (Y+Rc), s	4.5	4.5	4.5	4.5	4.5	4.5	4.5	4.5				
Max Green Setting (Gmax), s	18.1	19.7	9.3	24.9	8.1	29.7	8.7	25.5				
Max Q Clear Time (g_c+I1), s	17.3	10.1	5.9	6.8	8.2	23.1	9.5	27.5				
Green Ext Time (p_c), s	0.1	1.8	0.0	0.9	0.0	3.1	0.0	0.0				
Intersection Summary												
HCM 6th Ctrl Delay			55.1									
HCM 6th LOS			E									

Intersection						
Int Delay, s/veh	0					
Movement	WBL	WBR	NBT	NBR	SBL	SBT
Lane Configurations						
Traffic Vol, veh/h	0	0	0	0	0	0
Future Vol, veh/h	0	0	0	0	0	0
Conflicting Peds, #/hr	0	0	0	0	0	0
Sign Control	Stop	Stop	Free	Free	Free	Free
RT Channelized	-	None	-	None	-	None
Storage Length	0	-	-	-	50	-
Veh in Median Storage, #	0	-	0	-	-	0
Grade, %	0	-	0	-	-	0
Peak Hour Factor	92	92	92	92	92	92
Heavy Vehicles, %	0	0	0	0	0	0
Mvmt Flow	0	0	0	0	0	0

Major/Minor	Minor1	Major1	Major2			
Conflicting Flow All	1	0	0	0	0	0
Stage 1	0	-	-	-	-	-
Stage 2	1	-	-	-	-	-
Critical Hdwy	6.4	6.2	-	-	4.1	-
Critical Hdwy Stg 1	5.4	-	-	-	-	-
Critical Hdwy Stg 2	5.4	-	-	-	-	-
Follow-up Hdwy	3.5	3.3	-	-	2.2	-
Pot Cap-1 Maneuver	1027	-	-	-	-	-
Stage 1	-	-	-	-	-	-
Stage 2	1028	-	-	-	-	-
Platoon blocked, %						
Mov Cap-1 Maneuver	1027	-	-	-	-	-
Mov Cap-2 Maneuver	1027	-	-	-	-	-
Stage 1	-	-	-	-	-	-
Stage 2	1028	-	-	-	-	-

Approach	WB	NB	SB
HCM Control Delay, s	0	0	0
HCM LOS	A		

Minor Lane/Major Mvmt	NBT	NBRWBLn1	SBL	SBT
Capacity (veh/h)	-	-	-	-
HCM Lane V/C Ratio	-	-	-	-
HCM Control Delay (s)	-	-	0	0
HCM Lane LOS	-	-	A	A
HCM 95th %tile Q(veh)	-	-	-	-

Intersection						
Int Delay, s/veh	12.9					
Movement	EBT	EBR	WBL	WBT	NBL	NBR
Lane Configurations						
Traffic Vol, veh/h	66	16	174	72	56	646
Future Vol, veh/h	66	16	174	72	56	646
Conflicting Peds, #/hr	0	0	0	0	0	0
Sign Control	Free	Free	Free	Free	Stop	Stop
RT Channelized	-	None	-	None	-	None
Storage Length	-	-	50	-	50	0
Veh in Median Storage, #	0	-	-	0	0	-
Grade, %	0	-	-	0	0	-
Peak Hour Factor	92	92	92	92	92	92
Heavy Vehicles, %	8	8	2	2	0	0
Mvmt Flow	72	17	189	78	61	702

Major/Minor	Major1	Major2	Minor1		
Conflicting Flow All	0	0	89	0	537 81
Stage 1	-	-	-	-	81 -
Stage 2	-	-	-	-	456 -
Critical Hdwy	-	-	4.12	-	6.4 6.2
Critical Hdwy Stg 1	-	-	-	-	5.4 -
Critical Hdwy Stg 2	-	-	-	-	5.4 -
Follow-up Hdwy	-	-	2.218	-	3.5 3.3
Pot Cap-1 Maneuver	-	-	1506	-	508 985
Stage 1	-	-	-	-	947 -
Stage 2	-	-	-	-	643 -
Platoon blocked, %	-	-	-	-	-
Mov Cap-1 Maneuver	-	-	1506	-	445 985
Mov Cap-2 Maneuver	-	-	-	-	445 -
Stage 1	-	-	-	-	947 -
Stage 2	-	-	-	-	563 -

Approach	EB	WB	NB
HCM Control Delay, s	0	5.5	17
HCM LOS			C

Minor Lane/Major Mvmt	NBLn1	NBLn2	EBT	EBR	WBL	WBT
Capacity (veh/h)	445	985	-	-	1506	-
HCM Lane V/C Ratio	0.137	0.713	-	-	0.126	-
HCM Control Delay (s)	14.4	17.2	-	-	7.7	-
HCM Lane LOS	B	C	-	-	A	-
HCM 95th %tile Q(veh)	0.5	6.3	-	-	0.4	-

Intersection												
Int Delay, s/veh	8.5											
Movement	EBL	EBT	EBR	WBL	WBT	WBR	NBL	NBT	NBR	SBL	SBT	SBR
Lane Configurations	↔	↔		↔	↔		↔	↔		↔	↔	
Traffic Vol, veh/h	0	47	2	0	34	213	0	28	3	339	29	0
Future Vol, veh/h	0	47	2	0	34	213	0	28	3	339	29	0
Conflicting Peds, #/hr	0	0	0	0	0	0	0	0	0	0	0	0
Sign Control	Free	Free	Free	Free	Free	Free	Stop	Stop	Stop	Stop	Stop	Stop
RT Channelized	-	-	None	-	-	None	-	-	None	-	-	None
Storage Length	50	-	-	50	-	-	50	-	-	50	-	-
Veh in Median Storage, #	-	0	-	-	0	-	-	0	-	-	0	-
Grade, %	-	0	-	-	0	-	-	0	-	-	0	-
Peak Hour Factor	92	92	92	92	92	92	92	92	92	92	92	92
Heavy Vehicles, %	11	11	11	2	2	2	0	0	0	0	0	0
Mvmt Flow	0	51	2	0	37	232	0	30	3	368	32	0

Major/Minor	Major1		Major2		Minor1		Minor2					
Conflicting Flow All	269	0	0	53	0	0	221	321	52	222	206	153
Stage 1	-	-	-	-	-	-	52	52	-	153	153	-
Stage 2	-	-	-	-	-	-	169	269	-	69	53	-
Critical Hdwy	4.21	-	-	4.12	-	-	7.1	6.5	6.2	7.1	6.5	6.2
Critical Hdwy Stg 1	-	-	-	-	-	-	6.1	5.5	-	6.1	5.5	-
Critical Hdwy Stg 2	-	-	-	-	-	-	6.1	5.5	-	6.1	5.5	-
Follow-up Hdwy	2.299	-	-	2.218	-	-	3.5	4	3.3	3.5	4	3.3
Pot Cap-1 Maneuver	1244	-	-	1553	-	-	739	599	1021	738	694	898
Stage 1	-	-	-	-	-	-	966	856	-	854	775	-
Stage 2	-	-	-	-	-	-	838	690	-	946	855	-
Platoon blocked, %	-	-	-	-	-	-	-	-	-	-	-	-
Mov Cap-1 Maneuver	1244	-	-	1553	-	-	713	599	1021	707	694	898
Mov Cap-2 Maneuver	-	-	-	-	-	-	713	599	-	707	694	-
Stage 1	-	-	-	-	-	-	966	856	-	854	775	-
Stage 2	-	-	-	-	-	-	804	690	-	909	855	-

Approach	EB	WB	NB	SB
HCM Control Delay, s	0	0	11.1	15.1
HCM LOS			B	C

Minor Lane/Major Mvmt	NBLn1	NBLn2	EBL	EBT	EBR	WBL	WBT	WBR	SBLn1	SBLn2
Capacity (veh/h)	-	624	1244	-	-	1553	-	-	707	694
HCM Lane V/C Ratio	-	0.054	-	-	-	-	-	-	0.521	0.045
HCM Control Delay (s)	0	11.1	0	-	-	0	-	-	15.5	10.4
HCM Lane LOS	A	B	A	-	-	A	-	-	C	B
HCM 95th %tile Q(veh)	-	0.2	0	-	-	0	-	-	3	0.1

Intersection												
Int Delay, s/veh	4.6											
Movement	EBL	EBT	EBR	WBL	WBT	WBR	NBL	NBT	NBR	SBL	SBT	SBR
Lane Configurations	↶	↷		↶	↷		↶	↷		↶	↷	
Traffic Vol, veh/h	0	0	0	1	0	29	1	0	2	30	0	0
Future Vol, veh/h	0	0	0	1	0	29	1	0	2	30	0	0
Conflicting Peds, #/hr	0	0	0	0	0	0	0	0	0	0	0	0
Sign Control	Free	Free	Free	Free	Free	Free	Stop	Stop	Stop	Stop	Stop	Stop
RT Channelized	-	-	None	-	-	None	-	-	None	-	-	None
Storage Length	50	-	-	50	-	-	50	-	-	50	-	-
Veh in Median Storage, #	-	0	-	-	0	-	-	0	-	-	0	-
Grade, %	-	0	-	-	0	-	-	0	-	-	0	-
Peak Hour Factor	92	92	92	92	92	92	92	92	92	92	92	92
Heavy Vehicles, %	0	0	0	0	0	0	0	0	0	0	0	0
Mvmt Flow	0	0	0	1	0	32	1	0	2	33	0	0

Major/Minor	Major1		Major2			Minor1			Minor2			
Conflicting Flow All	32	0	0	1	0	0	19	35	1	20	19	16
Stage 1	-	-	-	-	-	-	1	1	-	18	18	-
Stage 2	-	-	-	-	-	-	18	34	-	2	1	-
Critical Hdwy	4.1	-	-	4.1	-	-	7.1	6.5	6.2	7.1	6.5	6.2
Critical Hdwy Stg 1	-	-	-	-	-	-	6.1	5.5	-	6.1	5.5	-
Critical Hdwy Stg 2	-	-	-	-	-	-	6.1	5.5	-	6.1	5.5	-
Follow-up Hdwy	2.2	-	-	2.2	-	-	3.5	4	3.3	3.5	4	3.3
Pot Cap-1 Maneuver	1593	-	-	1635	-	-	1000	861	1090	998	879	1069
Stage 1	-	-	-	-	-	-	1027	899	-	1006	884	-
Stage 2	-	-	-	-	-	-	1006	871	-	1026	899	-
Platoon blocked, %	-	-	-	-	-	-	-	-	-	-	-	-
Mov Cap-1 Maneuver	1593	-	-	1635	-	-	1000	860	1090	996	878	1069
Mov Cap-2 Maneuver	-	-	-	-	-	-	1000	860	-	996	878	-
Stage 1	-	-	-	-	-	-	1027	899	-	1006	883	-
Stage 2	-	-	-	-	-	-	1005	870	-	1024	899	-

Approach	EB		WB			NB			SB		
HCM Control Delay, s	0		0.2			8.4			8.7		
HCM LOS						A			A		

Minor Lane/Major Mvmt	NBLn1	NBLn2	EBL	EBT	EBR	WBL	WBT	WBR	SBLn1	SBLn2
Capacity (veh/h)	1000	1090	1593	-	-	1635	-	-	996	-
HCM Lane V/C Ratio	0.001	0.002	-	-	-	0.001	-	-	0.033	-
HCM Control Delay (s)	8.6	8.3	0	-	-	7.2	-	-	8.7	0
HCM Lane LOS	A	A	A	-	-	A	-	-	A	A
HCM 95th %tile Q(veh)	0	0	0	-	-	0	-	-	0.1	-

Intersection						
Int Delay, s/veh	0					
Movement	EBL	EBT	WBT	WBR	SBL	SBR
Lane Configurations	↔	↑	↔		↔	↔
Traffic Vol, veh/h	0	0	0	0	0	0
Future Vol, veh/h	0	0	0	0	0	0
Conflicting Peds, #/hr	0	0	0	0	0	0
Sign Control	Free	Free	Free	Free	Stop	Stop
RT Channelized	-	None	-	None	-	None
Storage Length	50	-	-	-	50	0
Veh in Median Storage, #	-	0	0	-	0	-
Grade, %	-	0	0	-	0	-
Peak Hour Factor	92	92	92	92	92	92
Heavy Vehicles, %	0	0	0	0	0	0
Mvmt Flow	0	0	0	0	0	0

Major/Minor	Major1	Major2	Minor2
Conflicting Flow All	1	0	0
Stage 1	-	-	1
Stage 2	-	-	0
Critical Hdwy	4.1	-	6.4
Critical Hdwy Stg 1	-	-	5.4
Critical Hdwy Stg 2	-	-	5.4
Follow-up Hdwy	2.2	-	3.5
Pot Cap-1 Maneuver	1635	-	1027
Stage 1	-	-	1028
Stage 2	-	-	-
Platoon blocked, %	-	-	-
Mov Cap-1 Maneuver	1635	-	1027
Mov Cap-2 Maneuver	-	-	1027
Stage 1	-	-	1028
Stage 2	-	-	-

Approach	EB	WB	SB
HCM Control Delay, s	0	0	0
HCM LOS			A

Minor Lane/Major Mvmt	EBL	EBT	WBT	WBR	SBLn1	SBLn2
Capacity (veh/h)	1635	-	-	-	-	-
HCM Lane V/C Ratio	-	-	-	-	-	-
HCM Control Delay (s)	0	-	-	-	0	0
HCM Lane LOS	A	-	-	-	A	A
HCM 95th %tile Q(veh)	0	-	-	-	-	-

Intersection						
Int Delay, s/veh	3151					
Movement	EBL	EBR	NBL	NBT	SBT	SBR
Lane Configurations						
Traffic Vol, veh/h	820	262	229	789	566	348
Future Vol, veh/h	820	262	229	789	566	348
Conflicting Peds, #/hr	0	0	0	0	0	0
Sign Control	Stop	Stop	Free	Free	Free	Free
RT Channelized	-	None	-	None	-	None
Storage Length	50	0	50	-	-	-
Veh in Median Storage, #	0	-	-	0	0	-
Grade, %	0	-	-	0	0	-
Peak Hour Factor	92	92	92	92	92	92
Heavy Vehicles, %	0	0	5	5	6	6
Mvmt Flow	891	285	249	858	615	378

Major/Minor	Minor2	Major1	Major2			
Conflicting Flow All	2160	804	993	0	-	0
Stage 1	804	-	-	-	-	-
Stage 2	1356	-	-	-	-	-
Critical Hdwy	6.4	6.2	4.15	-	-	-
Critical Hdwy Stg 1	5.4	-	-	-	-	-
Critical Hdwy Stg 2	5.4	-	-	-	-	-
Follow-up Hdwy	3.5	3.3	2.245	-	-	-
Pot Cap-1 Maneuver	~ 53	386	685	-	-	-
Stage 1	~ 444	-	-	-	-	-
Stage 2	~ 242	-	-	-	-	-
Platoon blocked, %				-	-	-
Mov Cap-1 Maneuver	~ 34	386	685	-	-	-
Mov Cap-2 Maneuver	~ 34	-	-	-	-	-
Stage 1	~ 282	-	-	-	-	-
Stage 2	~ 242	-	-	-	-	-

Approach	EB	NB	SB
HCM Control Delay, \$ 8774.6		3	0
HCM LOS	F		

Minor Lane/Major Mvmt	NBL	NBT	EBLn1	EBLn2	SBT	SBR
Capacity (veh/h)	685	-	34	386	-	-
HCM Lane V/C Ratio	0.363	-	26.215	0.738	-	-
HCM Control Delay (s)	13.2	\$	11566.6	36.4	-	-
HCM Lane LOS	B	-	F	E	-	-
HCM 95th %tile Q(veh)	1.7	-	110.2	5.8	-	-

Notes
 -: Volume exceeds capacity \$: Delay exceeds 300s +: Computation Not Defined *: All major volume in platoon

Intersection						
Int Delay, s/veh	58.1					
Movement	WBL	WBR	NBT	NBR	SBL	SBT
Lane Configurations	↙	↗	↖		↙	↗
Traffic Vol, veh/h	80	545	396	110	428	603
Future Vol, veh/h	80	545	396	110	428	603
Conflicting Peds, #/hr	0	0	0	0	0	0
Sign Control	Stop	Stop	Free	Free	Free	Free
RT Channelized	-	None	-	None	-	None
Storage Length	50	0	-	-	50	-
Veh in Median Storage, #	0	-	0	-	-	0
Grade, %	0	-	0	-	-	0
Peak Hour Factor	92	92	92	92	92	92
Heavy Vehicles, %	0	0	9	9	4	4
Mvmt Flow	87	592	430	120	465	655

Major/Minor	Minor1	Major1	Major2			
Conflicting Flow All	2075	490	0	0	550	0
Stage 1	490	-	-	-	-	-
Stage 2	1585	-	-	-	-	-
Critical Hdwy	6.4	6.2	-	-	4.14	-
Critical Hdwy Stg 1	5.4	-	-	-	-	-
Critical Hdwy Stg 2	5.4	-	-	-	-	-
Follow-up Hdwy	3.5	3.3	-	-	2.236	-
Pot Cap-1 Maneuver	~ 60	~ 582	-	-	1010	-
Stage 1	620	-	-	-	-	-
Stage 2	187	-	-	-	-	-
Platoon blocked, %			-	-	-	-
Mov Cap-1 Maneuver	~ 32	~ 582	-	-	1010	-
Mov Cap-2 Maneuver	~ 32	-	-	-	-	-
Stage 1	620	-	-	-	-	-
Stage 2	101	-	-	-	-	-

Approach	WB	NB	SB
HCM Control Delay, s	192.9	0	4.8
HCM LOS	F		

Minor Lane/Major Mvmt	NBT	NBRWBLn1	WBLn2	SBL	SBT
Capacity (veh/h)	-	-	32	582	1010
HCM Lane V/C Ratio	-	-	2.717	1.018	0.461
HCM Control Delay (s)	-	\$	1039.5	68.6	11.6
HCM Lane LOS	-	-	F	F	B
HCM 95th %tile Q(veh)	-	-	10.1	15.6	2.5

Notes
 -: Volume exceeds capacity \$: Delay exceeds 300s +: Computation Not Defined *: All major volume in platoon

Intersection						
Int Delay, s/veh	0					
Movement	EBL	EBR	NBL	NBT	SBT	SBR
Lane Configurations						
Traffic Vol, veh/h	0	1	1	506	1188	0
Future Vol, veh/h	0	1	1	506	1188	0
Conflicting Peds, #/hr	0	0	0	0	0	0
Sign Control	Stop	Stop	Free	Free	Free	Free
RT Channelized	-	None	-	None	-	None
Storage Length	0	-	50	-	-	-
Veh in Median Storage, #	0	-	-	0	0	-
Grade, %	0	-	-	0	0	-
Peak Hour Factor	92	92	92	92	92	92
Heavy Vehicles, %	0	0	9	9	10	10
Mvmt Flow	0	1	1	550	1291	0

Major/Minor	Minor2	Major1	Major2			
Conflicting Flow All	1843	1291	1291	0	-	0
Stage 1	1291	-	-	-	-	-
Stage 2	552	-	-	-	-	-
Critical Hdwy	6.4	6.2	4.19	-	-	-
Critical Hdwy Stg 1	5.4	-	-	-	-	-
Critical Hdwy Stg 2	5.4	-	-	-	-	-
Follow-up Hdwy	3.5	3.3	2.281	-	-	-
Pot Cap-1 Maneuver	84	201	514	-	-	-
Stage 1	260	-	-	-	-	-
Stage 2	581	-	-	-	-	-
Platoon blocked, %				-	-	-
Mov Cap-1 Maneuver	84	201	514	-	-	-
Mov Cap-2 Maneuver	84	-	-	-	-	-
Stage 1	259	-	-	-	-	-
Stage 2	581	-	-	-	-	-

Approach	EB	NB	SB
HCM Control Delay, s	23	0	0
HCM LOS	C		

Minor Lane/Major Mvmt	NBL	NBT	EBLn1	SBT	SBR
Capacity (veh/h)	514	-	201	-	-
HCM Lane V/C Ratio	0.002	-	0.005	-	-
HCM Control Delay (s)	12	-	23	-	-
HCM Lane LOS	B	-	C	-	-
HCM 95th %tile Q(veh)	0	-	0	-	-

Intersection

Int Delay, s/veh 118.2

Movement	EBT	EBR	WBL	WBT	NBL	NBR
Lane Configurations						
Traffic Vol, veh/h	905	80	154	323	199	292
Future Vol, veh/h	905	80	154	323	199	292
Conflicting Peds, #/hr	0	0	0	0	0	0
Sign Control	Free	Free	Free	Free	Stop	Stop
RT Channelized	-	None	-	None	-	None
Storage Length	-	-	50	-	50	0
Veh in Median Storage, #	0	-	-	0	0	-
Grade, %	0	-	-	0	0	-
Peak Hour Factor	92	92	92	92	92	92
Heavy Vehicles, %	1	1	1	1	0	0
Mvmt Flow	984	87	167	351	216	317

Major/Minor

	Major1	Major2	Minor1		
Conflicting Flow All	0	0	1071	0	1713 1028
Stage 1	-	-	-	-	1028 -
Stage 2	-	-	-	-	685 -
Critical Hdwy	-	-	4.11	-	6.4 6.2
Critical Hdwy Stg 1	-	-	-	-	5.4 -
Critical Hdwy Stg 2	-	-	-	-	5.4 -
Follow-up Hdwy	-	-	2.209	-	3.5 3.3
Pot Cap-1 Maneuver	-	-	655	-	~ 101 ~ 287
Stage 1	-	-	-	-	348 -
Stage 2	-	-	-	-	504 -
Platoon blocked, %	-	-	-	-	-
Mov Cap-1 Maneuver	-	-	655	-	~ 75 ~ 287
Mov Cap-2 Maneuver	-	-	-	-	~ 75 -
Stage 1	-	-	-	-	348 -
Stage 2	-	-	-	-	375 -

Approach

	EB	WB	NB
HCM Control Delay, s	0	4	\$ 466.3
HCM LOS			F

Minor Lane/Major Mvmt

	NBLn1	NBLn2	EBT	EBR	WBL	WBT
Capacity (veh/h)	75	287	-	-	655	-
HCM Lane V/C Ratio	2.884	1.106	-	-	0.256	-
HCM Control Delay (s)	\$ 968.8	123.9	-	-	12.4	-
HCM Lane LOS	F	F	-	-	B	-
HCM 95th %tile Q(veh)	21.4	13	-	-	1	-

Notes

-: Volume exceeds capacity \$: Delay exceeds 300s +: Computation Not Defined *: All major volume in platoon

Intersection						
Int Delay, s/veh	0					
Movement	EBT	EBR	WBL	WBT	NBL	NBR
Lane Configurations						
Traffic Vol, veh/h	145	0	0	73	1	0
Future Vol, veh/h	145	0	0	73	1	0
Conflicting Peds, #/hr	0	0	0	0	0	0
Sign Control	Free	Free	Free	Free	Stop	Stop
RT Channelized	-	None	-	None	-	None
Storage Length	-	-	50	-	-	-
Veh in Median Storage, #	0	-	-	0	0	-
Grade, %	0	-	-	0	0	-
Peak Hour Factor	92	92	92	92	92	92
Heavy Vehicles, %	2	2	2	2	0	0
Mvmt Flow	158	0	0	79	1	0

Major/Minor	Major1	Major2	Minor1		
Conflicting Flow All	0	0	158	0	237
Stage 1	-	-	-	-	158
Stage 2	-	-	-	-	79
Critical Hdwy	-	-	4.12	-	6.4
Critical Hdwy Stg 1	-	-	-	-	5.4
Critical Hdwy Stg 2	-	-	-	-	5.4
Follow-up Hdwy	-	-	2.218	-	3.5
Pot Cap-1 Maneuver	-	-	1422	-	756
Stage 1	-	-	-	-	875
Stage 2	-	-	-	-	949
Platoon blocked, %	-	-	-	-	-
Mov Cap-1 Maneuver	-	-	1422	-	756
Mov Cap-2 Maneuver	-	-	-	-	756
Stage 1	-	-	-	-	875
Stage 2	-	-	-	-	949

Approach	EB	WB	NB
HCM Control Delay, s	0	0	9.8
HCM LOS			A

Minor Lane/Major Mvmt	NBLn1	EBT	EBR	WBL	WBT
Capacity (veh/h)	756	-	-	1422	-
HCM Lane V/C Ratio	0.001	-	-	-	-
HCM Control Delay (s)	9.8	-	-	0	-
HCM Lane LOS	A	-	-	A	-
HCM 95th %tile Q(veh)	0	-	-	0	-

Intersection	
Intersection Delay, s/veh	7.7
Intersection LOS	A

Movement	EBL	EBT	EBR	WBL	WBT	WBR	NBL	NBT	NBR	SBL	SBT	SBR
Lane Configurations	↶	↷		↶	↷		↶	↷		↶	↷	
Traffic Vol, veh/h	0	50	0	0	15	0	0	0	1	0	0	0
Future Vol, veh/h	0	50	0	0	15	0	0	0	1	0	0	0
Peak Hour Factor	0.92	0.92	0.92	0.92	0.92	0.92	0.92	0.92	0.92	0.92	0.92	0.92
Heavy Vehicles, %	13	13	13	13	13	13	0	0	0	0	0	0
Mvmt Flow	0	54	0	0	16	0	0	0	1	0	0	0
Number of Lanes	1	1	0	1	1	0	1	1	0	1	1	0

Approach	EB	WB	NB	SB
Opposing Approach	WB	EB	SB	NB
Opposing Lanes	2	2	2	2
Conflicting Approach Left	SB	NB	EB	WB
Conflicting Lanes Left	2	2	2	2
Conflicting Approach Right	NB	SB	WB	EB
Conflicting Lanes Right	2	2	2	2
HCM Control Delay	7.8	7.6	6.7	0
HCM LOS	A	A	A	-

Lane	NBLn1	NBLn2	EBLn1	EBLn2	WBLn1	WBLn2	SBLn1	SBLn2
Vol Left, %	0%	0%	0%	0%	0%	0%	0%	0%
Vol Thru, %	100%	0%	100%	100%	100%	100%	100%	100%
Vol Right, %	0%	100%	0%	0%	0%	0%	0%	0%
Sign Control	Stop	Stop	Stop	Stop	Stop	Stop	Stop	Stop
Traffic Vol by Lane	0	1	0	50	0	15	0	0
LT Vol	0	0	0	0	0	0	0	0
Through Vol	0	0	0	50	0	15	0	0
RT Vol	0	1	0	0	0	0	0	0
Lane Flow Rate	0	1	0	54	0	16	0	0
Geometry Grp	7	7	7	7	7	7	7	7
Degree of Util (X)	0	0.001	0	0.071	0	0.022	0	0
Departure Headway (Hd)	4.621	3.921	4.731	4.731	4.749	4.749	4.622	4.622
Convergence, Y/N	Yes	Yes	Yes	Yes	Yes	Yes	Yes	Yes
Cap	0	905	0	761	0	756	0	0
Service Time	2.381	1.68	2.435	2.435	2.461	2.461	2.383	2.383
HCM Lane V/C Ratio	0	0.001	0	0.071	0	0.021	0	0
HCM Control Delay	7.4	6.7	7.4	7.8	7.5	7.6	7.4	7.4
HCM Lane LOS	N	A	N	A	N	A	N	N
HCM 95th-tile Q	0	0	0	0.2	0	0.1	0	0

Intersection						
Int Delay, s/veh	6.6					
Movement	EBL	EBT	WBT	WBR	SBL	SBR
Lane Configurations		↕	↑	↗	↘	
Traffic Vol, veh/h	7	191	107	109	264	8
Future Vol, veh/h	7	191	107	109	264	8
Conflicting Peds, #/hr	0	0	0	0	0	0
Sign Control	Free	Free	Free	Free	Stop	Stop
RT Channelized	-	None	-	None	-	None
Storage Length	-	-	-	0	0	-
Veh in Median Storage, #	-	0	0	-	0	-
Grade, %	-	0	0	-	0	-
Peak Hour Factor	92	92	92	92	92	92
Heavy Vehicles, %	8	8	49	49	30	30
Mvmt Flow	8	208	116	118	287	9

Major/Minor	Major1	Major2	Minor2		
Conflicting Flow All	234	0	0	340	116
Stage 1	-	-	-	116	-
Stage 2	-	-	-	224	-
Critical Hdwy	4.18	-	-	6.7	6.5
Critical Hdwy Stg 1	-	-	-	5.7	-
Critical Hdwy Stg 2	-	-	-	5.7	-
Follow-up Hdwy	2.272	-	-	3.77	3.57
Pot Cap-1 Maneuver	1299	-	-	603	866
Stage 1	-	-	-	844	-
Stage 2	-	-	-	751	-
Platoon blocked, %		-	-		
Mov Cap-1 Maneuver	1299	-	-	599	866
Mov Cap-2 Maneuver	-	-	-	599	-
Stage 1	-	-	-	838	-
Stage 2	-	-	-	751	-

Approach	EB	WB	SB
HCM Control Delay, s	0.3	0	16.5
HCM LOS			C

Minor Lane/Major Mvmt	EBL	EBT	WBT	WBR	SBLn1
Capacity (veh/h)	1299	-	-	-	604
HCM Lane V/C Ratio	0.006	-	-	-	0.489
HCM Control Delay (s)	7.8	0	-	-	16.5
HCM Lane LOS	A	A	-	-	C
HCM 95th %tile Q(veh)	0	-	-	-	2.7

HCM 6th TWSC
 4: Truck Parking Lot/Pistachio Drive & Avenue 18 1/2

Village D Specific Plan
 Phase II WP - PM Peak Hour

Intersection												
Int Delay, s/veh	5.8											
Movement	EBL	EBT	EBR	WBL	WBT	WBR	NBL	NBT	NBR	SBL	SBT	SBR
Lane Configurations		↕			↕	↕		↕			↕	
Traffic Vol, veh/h	12	500	1	6	195	200	2	0	5	165	0	13
Future Vol, veh/h	12	500	1	6	195	200	2	0	5	165	0	13
Conflicting Peds, #/hr	0	0	0	0	0	0	0	0	1	1	0	0
Sign Control	Free	Free	Free	Free	Free	Free	Stop	Stop	Stop	Stop	Stop	Stop
RT Channelized	-	-	None	-	-	None	-	-	None	-	-	None
Storage Length	-	-	-	-	-	50	-	-	-	-	-	-
Veh in Median Storage, #	-	0	-	-	0	-	-	0	-	-	0	-
Grade, %	-	0	-	-	0	-	-	0	-	-	0	-
Peak Hour Factor	93	93	93	93	93	93	93	93	93	93	93	93
Heavy Vehicles, %	20	20	20	24	24	24	51	51	51	5	5	5
Mvmt Flow	13	538	1	6	210	215	2	0	5	177	0	14

Major/Minor	Major1			Major2			Minor1			Minor2		
Conflicting Flow All	425	0	0	539	0	0	902	1002	540	790	787	210
Stage 1	-	-	-	-	-	-	565	565	-	222	222	-
Stage 2	-	-	-	-	-	-	337	437	-	568	565	-
Critical Hdwy	4.3	-	-	4.34	-	-	7.61	7.01	6.71	7.15	6.55	6.25
Critical Hdwy Stg 1	-	-	-	-	-	-	6.61	6.01	-	6.15	5.55	-
Critical Hdwy Stg 2	-	-	-	-	-	-	6.61	6.01	-	6.15	5.55	-
Follow-up Hdwy	2.38	-	-	2.416	-	-	3.959	4.459	3.759	3.545	4.045	3.345
Pot Cap-1 Maneuver	1044	-	-	927	-	-	213	200	458	304	320	823
Stage 1	-	-	-	-	-	-	433	437	-	774	714	-
Stage 2	-	-	-	-	-	-	586	504	-	502	503	-
Platoon blocked, %		-	-		-	-						
Mov Cap-1 Maneuver	1044	-	-	927	-	-	205	195	458	294	311	823
Mov Cap-2 Maneuver	-	-	-	-	-	-	205	195	-	294	311	-
Stage 1	-	-	-	-	-	-	425	429	-	760	708	-
Stage 2	-	-	-	-	-	-	571	499	-	487	494	-

Approach	EB			WB			NB			SB		
HCM Control Delay, s	0.2			0.1			15.9			34.1		
HCM LOS							C			D		

Minor Lane/Major Mvmt	NBLn1	EBL	EBT	EBR	WBL	WBT	WBR	SBLn1
Capacity (veh/h)	339	1044	-	-	927	-	-	308
HCM Lane V/C Ratio	0.022	0.012	-	-	0.007	-	-	0.621
HCM Control Delay (s)	15.9	8.5	0	-	8.9	0	-	34.1
HCM Lane LOS	C	A	A	-	A	A	-	D
HCM 95th %tile Q(veh)	0.1	0	-	-	0	-	-	3.9

Intersection

Int Delay, s/veh 315.6

Movement	EBL	EBT	EBR	WBL	WBT	WBR	NBL	NBT	NBR	SBL	SBT	SBR
Lane Configurations		↑	↑		↑		↑		↑		↕	
Traffic Vol, veh/h	0	397	273	52	201	0	76	0	327	25	492	125
Future Vol, veh/h	0	397	273	52	201	0	76	0	327	25	492	125
Conflicting Peds, #/hr	0	0	0	0	0	0	0	0	0	0	0	0
Sign Control	Free	Free	Free	Free	Free	Free	Stop	Stop	Stop	Stop	Stop	Stop
RT Channelized	-	-	None	-	-	None	-	-	None	-	-	None
Storage Length	-	-	50	-	-	-	0	-	25	-	-	-
Veh in Median Storage, #	-	0	-	-	0	-	-	0	-	-	0	-
Grade, %	-	0	-	-	0	-	-	0	-	-	0	-
Peak Hour Factor	94	94	94	94	94	94	94	94	94	94	94	94
Heavy Vehicles, %	18	18	18	30	30	30	5	5	5	11	11	11
Mvmt Flow	0	422	290	55	214	0	81	0	348	27	523	133

Major/Minor	Major1			Major2			Minor1			Minor2		
Conflicting Flow All	-	0	0	712	0	0	1074	-	422	1065	1036	214
Stage 1	-	-	-	-	-	-	422	-	-	324	324	-
Stage 2	-	-	-	-	-	-	652	-	-	741	712	-
Critical Hdwy	-	-	-	4.4	-	-	7.15	-	6.25	7.21	6.61	6.31
Critical Hdwy Stg 1	-	-	-	-	-	-	6.15	-	-	6.21	5.61	-
Critical Hdwy Stg 2	-	-	-	-	-	-	6.15	-	-	6.21	5.61	-
Follow-up Hdwy	-	-	-	2.47	-	-	3.545	-	3.345	3.599	4.099	3.399
Pot Cap-1 Maneuver	0	-	-	772	-	0	195	0	625	193	~ 223	804
Stage 1	0	-	-	-	-	0	604	0	-	670	634	-
Stage 2	0	-	-	-	-	0	452	0	-	394	~ 423	-
Platoon blocked, %	-	-	-	-	-	-	-	-	-	-	-	-
Mov Cap-1 Maneuver	-	-	-	772	-	-	-	-	625	80	~ 205	804
Mov Cap-2 Maneuver	-	-	-	-	-	-	-	-	-	80	~ 205	-
Stage 1	-	-	-	-	-	-	604	-	-	670	583	-
Stage 2	-	-	-	-	-	-	~ 35	-	-	175	~ 423	-

Approach	EB	WB	NB	SB
HCM Control Delay, s	0	2.1		\$ 966.5
HCM LOS			-	F

Minor Lane/Major Mvmt	NBLn1	NBLn2	EBT	EBR	WBL	WBT	SBLn1
Capacity (veh/h)	-	625	-	-	772	-	224
HCM Lane V/C Ratio	-	0.557	-	-	0.072	-	3.049
HCM Control Delay (s)	-	17.7	-	-	10	-	\$ 966.5
HCM Lane LOS	-	C	-	-	B	A	F
HCM 95th %tile Q(veh)	-	3.4	-	-	0.2	-	61.5

Notes
 -: Volume exceeds capacity \$: Delay exceeds 300s +: Computation Not Defined *: All major volume in platoon

Intersection												
Int Delay, s/veh	60.6											
Movement	EBL	EBT	EBR	WBL	WBT	WBR	NBL	NBT	NBR	SBL	SBT	SBR
Lane Configurations	↙	↑			↘			↕				
Traffic Vol, veh/h	408	110	0	0	92	19	190	3	0	0	0	0
Future Vol, veh/h	408	110	0	0	92	19	190	3	0	0	0	0
Conflicting Peds, #/hr	0	0	0	0	0	0	0	0	0	0	0	0
Sign Control	Free	Free	Free	Free	Free	Free	Stop	Stop	Stop	Free	Free	Free
RT Channelized	-	-	None	-	-	None	-	-	None	-	-	None
Storage Length	145	-	-	-	-	-	-	-	-	-	-	-
Veh in Median Storage, #	-	0	-	-	0	-	-	0	-	-	16965	-
Grade, %	-	0	-	-	0	-	-	0	-	-	0	-
Peak Hour Factor	92	92	92	92	92	92	92	92	92	92	92	92
Heavy Vehicles, %	13	13	13	12	12	12	0	0	0	0	0	0
Mvmt Flow	443	120	0	0	100	21	207	3	0	0	0	0

Major/Minor	Major1	Major2	Minor1
Conflicting Flow All	121	0	- - - 0 1117 1127 120
Stage 1	-	-	- - - 1006 1006 -
Stage 2	-	-	- - - 111 121 -
Critical Hdwy	4.23	-	- - - 6.4 6.5 6.2
Critical Hdwy Stg 1	-	-	- - - 5.4 5.5 -
Critical Hdwy Stg 2	-	-	- - - 5.4 5.5 -
Follow-up Hdwy	2.317	-	- - - 3.5 4 3.3
Pot Cap-1 Maneuver	1401	-	0 0 - - 231 206 937
Stage 1	-	-	0 0 - - 357 321 -
Stage 2	-	-	0 0 - - 919 800 -
Platoon blocked, %	-	-	- -
Mov Cap-1 Maneuver	1401	-	- - - ~ 158 0 937
Mov Cap-2 Maneuver	-	-	- - - ~ 158 0 -
Stage 1	-	-	- - - 244 0 -
Stage 2	-	-	- - - 919 0 -

Approach	EB	WB	NB
HCM Control Delay, s	6.9	0	239.6
HCM LOS			F

Minor Lane/Major Mvmt	NBLn1	EBL	EBT	WBT	WBR
Capacity (veh/h)	158	1401	-	-	-
HCM Lane V/C Ratio	1.328	0.317	-	-	-
HCM Control Delay (s)	239.6	8.8	-	-	-
HCM Lane LOS	F	A	-	-	-
HCM 95th %tile Q(veh)	12.7	1.4	-	-	-

Notes
 -: Volume exceeds capacity \$: Delay exceeds 300s +: Computation Not Defined *: All major volume in platoon

Intersection												
Int Delay, s/veh	0.5											
Movement	EBL	EBT	EBR	WBL	WBT	WBR	NBL	NBT	NBR	SBL	SBT	SBR
Lane Configurations		↕			↕			↕			↕	
Traffic Vol, veh/h	83	261	107	646	474	10	85	317	424	63	661	166
Future Vol, veh/h	83	261	107	646	474	10	85	317	424	63	661	166
Conflicting Peds, #/hr	0	0	0	0	0	0	0	0	0	0	0	0
Sign Control	Stop	Stop	Stop	Stop	Stop	Stop	Free	Free	Free	Free	Free	Free
RT Channelized	-	-	None	-	-	None	-	-	None	-	-	None
Storage Length	-	-	-	-	-	-	-	-	-	-	-	-
Veh in Median Storage, #	-	0	-	-	0	-	-	0	-	-	0	-
Grade, %	-	0	-	-	0	-	-	0	-	-	0	-
Peak Hour Factor	92	92	92	92	92	92	92	92	92	92	92	92
Heavy Vehicles, %	1	1	1	0	0	0	2	2	2	3	3	3
Mvmt Flow	90	284	116	702	515	11	92	345	461	68	718	180

Major/Minor	Minor2			Minor1			Major1			Major2		
Conflicting Flow All	1967	1934	808	1904	1794	576	898	0	0	806	0	0
Stage 1	944	944	-	760	760	-	-	-	-	-	-	-
Stage 2	1023	990	-	1144	1034	-	-	-	-	-	-	-
Critical Hdwy	7.11	6.51	6.21	7.1	6.5	6.2	4.12	-	-	4.13	-	-
Critical Hdwy Stg 1	6.11	5.51	-	6.1	5.5	-	-	-	-	-	-	-
Critical Hdwy Stg 2	6.11	5.51	-	6.1	5.5	-	-	-	-	-	-	-
Follow-up Hdwy	3.509	4.009	3.309	3.5	4	3.3	2.218	-	-	2.227	-	-
Pot Cap-1 Maneuver	~ 47	~ 66	382	~ 53	~ 81	521	756	-	-	814	-	-
Stage 1	316	342	-	~ 401	~ 417	-	-	-	-	-	-	-
Stage 2	286	326	-	~ 245	~ 312	-	-	-	-	-	-	-
Platoon blocked, %	-	-	-	-	-	-	-	-	-	-	-	-
Mov Cap-1 Maneuver	-	~ 41	382	-	~ 51	521	756	-	-	814	-	-
Mov Cap-2 Maneuver	-	~ 41	-	-	~ 51	-	-	-	-	-	-	-
Stage 1	239	~ 282	-	~ 304	~ 316	-	-	-	-	-	-	-
Stage 2	-	~ 247	-	-	~ 258	-	-	-	-	-	-	-

Approach	EB			WB			NB			SB		
HCM Control Delay, s							1.1			0.7		
HCM LOS	-			-								

Minor Lane/Major Mvmt	NBL	NBT	NBR	EBLn1WBLn1	SBL	SBT	SBR
Capacity (veh/h)	756	-	-	-	814	-	-
HCM Lane V/C Ratio	0.122	-	-	-	0.084	-	-
HCM Control Delay (s)	10.4	0	-	-	9.8	0	-
HCM Lane LOS	B	A	-	-	A	A	-
HCM 95th %tile Q(veh)	0.4	-	-	-	0.3	-	-

Notes
 -: Volume exceeds capacity \$: Delay exceeds 300s +: Computation Not Defined *: All major volume in platoon

Intersection	
Intersection Delay, s/veh	602.9
Intersection LOS	F

Movement	EBL	EBT	EBR	WBL	WBT	WBR	NBL	NBT	NBR	SBL	SBT	SBR
Lane Configurations	↶	↷		↶	↷		↶	↷		↶	↷	
Traffic Vol, veh/h	104	52	227	48	53	204	283	973	126	317	1074	117
Future Vol, veh/h	104	52	227	48	53	204	283	973	126	317	1074	117
Peak Hour Factor	0.95	0.95	0.95	0.95	0.95	0.95	0.95	0.95	0.95	0.95	0.95	0.95
Heavy Vehicles, %	1	1	1	0	0	0	1	1	1	2	2	2
Mvmt Flow	109	55	239	51	56	215	298	1024	133	334	1131	123
Number of Lanes	1	1	0	1	1	0	1	1	0	1	1	0

Approach	EB	WB	NB	SB
Opposing Approach	WB	EB	SB	NB
Opposing Lanes	2	2	2	2
Conflicting Approach Left	SB	NB	EB	WB
Conflicting Lanes Left	2	2	2	2
Conflicting Approach Right	NB	SB	WB	EB
Conflicting Lanes Right	2	2	2	2
HCM Control Delay	39.6	39.5	693.6	776.7
HCM LOS	E	E	F	F

Lane	NBLn1	NBLn2	EBLn1	EBLn2	WBLn1	WBLn2	SBLn1	SBLn2
Vol Left, %	100%	0%	100%	0%	100%	0%	100%	0%
Vol Thru, %	0%	89%	0%	19%	0%	21%	0%	90%
Vol Right, %	0%	11%	0%	81%	0%	79%	0%	10%
Sign Control	Stop	Stop	Stop	Stop	Stop	Stop	Stop	Stop
Traffic Vol by Lane	283	1099	104	279	48	257	317	1191
LT Vol	283	0	104	0	48	0	317	0
Through Vol	0	973	0	52	0	53	0	1074
RT Vol	0	126	0	227	0	204	0	117
Lane Flow Rate	298	1157	109	294	51	271	334	1254
Geometry Grp	7	7	7	7	7	7	7	7
Degree of Util (X)	0.782	2.851	0.307	0.737	0.145	0.696	0.875	3.09
Departure Headway (Hd)	10.759	10.149	14.405	13.266	14.969	13.844	10.879	10.28
Convergence, Y/N	Yes	Yes	Yes	Yes	Yes	Yes	Yes	Yes
Cap	340	370	252	276	241	265	337	364
Service Time	8.459	7.849	12.105	10.966	12.669	11.544	8.579	7.98
HCM Lane V/C Ratio	0.876	3.127	0.433	1.065	0.212	1.023	0.991	3.445
HCM Control Delay	43.1	861.1	23.4	45.7	20.2	43.1	56.7	968.4
HCM Lane LOS	E	F	C	E	C	E	F	F
HCM 95th-tile Q	6.3	86.5	1.3	5.3	0.5	4.7	8.2	95.7

Intersection												
Intersection Delay, s/veh	17.9											
Intersection LOS	F											

Movement	EBL	EBT	EBR	WBL	WBT	WBR	NBL	NBT	NBR	SBL	SBT	SBR
Lane Configurations	↔	↔		↔	↔		↔	↔		↔	↔	
Traffic Vol, veh/h	1	25	14	248	25	275	13	1046	299	279	1027	1
Future Vol, veh/h	1	25	14	248	25	275	13	1046	299	279	1027	1
Peak Hour Factor	0.93	0.93	0.93	0.93	0.93	0.93	0.93	0.93	0.93	0.93	0.93	0.93
Heavy Vehicles, %	0	0	0	1	1	1	1	1	1	2	2	2
Mvmt Flow	1	27	15	267	27	296	14	1125	322	300	1104	1
Number of Lanes	1	1	0	1	1	0	1	1	0	1	1	0

Approach	EB	WB	NB	SB
Opposing Approach	WB	EB	SB	NB
Opposing Lanes	2	2	2	2
Conflicting Approach Left SB		NB	EB	WB
Conflicting Lanes Left	2	2	2	2
Conflicting Approach Right NB		SB	WB	EB
Conflicting Lanes Right	2	2	2	2
HCM Control Delay	17.1	27.5	989.7	497.6
HCM LOS	C	D	F	F

Lane	NBLn1	NBLn2	EBLn1	EBLn2	WBLn1	WBLn2	SBLn1	SBLn2	
Vol Left, %	100%	0%	100%	0%	100%	0%	100%	0%	
Vol Thru, %	0%	78%	0%	64%	0%	8%	0%	100%	
Vol Right, %	0%	22%	0%	36%	0%	92%	0%	0%	
Sign Control	Stop	Stop	Stop	Stop	Stop	Stop	Stop	Stop	
Traffic Vol by Lane	13	1345	1	39	248	300	279	1028	
LT Vol	13	0	1	0	248	0	279	0	
Through Vol	0	1046	0	25	0	25	0	1027	
RT Vol	0	299	0	14	0	275	0	1	
Lane Flow Rate	14	1446	1	42	267	323	300	1105	
Geometry Grp	7	7	7	7	7	7	7	7	
Degree of Util (X)	0.033	3.165	0.003	0.107	0.625	0.653	0.672	2.32	
Departure Headway (Hd)	9.745	9.064	13.742	12.908	10.111	8.862	10.572	10.036	
Convergence, Y/N	Yes	Yes	Yes	Yes	Yes	Yes	Yes	Yes	
Cap	370	419	262	280	360	410	345	376	
Service Time	7.445	6.764	11.442	10.608	7.811	6.562	8.272	7.736	
HCM Lane V/C Ratio	0.038	3.451	0.004	0.15	0.742	0.788	0.87	2.939	
HCM Control Delay	12.8	999.1	16.5	17.1	28.3	26.8	32.4	623.9	
HCM Lane LOS		B	F	C	C	D	D	D	F
HCM 95th-tile Q		0.1	111.7	0	0.4	4	4.5	4.6	64.1

Intersection												
Int Delay, s/veh	4.5											
Movement	EBL	EBT	EBR	WBL	WBT	WBR	NBL	NBT	NBR	SBL	SBT	SBR
Lane Configurations		↕			↕			↕			↕	
Traffic Vol, veh/h	1	2	3	5	3	144	2	725	2	175	565	0
Future Vol, veh/h	1	2	3	5	3	144	2	725	2	175	565	0
Conflicting Peds, #/hr	0	0	0	0	0	0	0	0	0	0	0	0
Sign Control	Stop	Stop	Stop	Stop	Stop	Stop	Free	Free	Free	Free	Free	Free
RT Channelized	-	-	None	-	-	None	-	-	None	-	-	None
Storage Length	-	-	-	-	-	-	-	-	-	-	-	-
Veh in Median Storage, #	-	0	-	-	0	-	-	0	-	-	0	-
Grade, %	-	0	-	-	0	-	-	0	-	-	0	-
Peak Hour Factor	92	92	92	92	92	92	92	92	92	92	92	92
Heavy Vehicles, %	0	0	0	0	0	0	3	3	3	3	3	3
Mvmt Flow	1	2	3	5	3	157	2	788	2	190	614	0

Major/Minor	Minor2		Minor1		Major1		Major2					
Conflicting Flow All	1867	1788	614	1790	1787	789	614	0	0	790	0	0
Stage 1	994	994	-	793	793	-	-	-	-	-	-	-
Stage 2	873	794	-	997	994	-	-	-	-	-	-	-
Critical Hdwy	7.1	6.5	6.2	7.1	6.5	6.2	4.13	-	-	4.13	-	-
Critical Hdwy Stg 1	6.1	5.5	-	6.1	5.5	-	-	-	-	-	-	-
Critical Hdwy Stg 2	6.1	5.5	-	6.1	5.5	-	-	-	-	-	-	-
Follow-up Hdwy	3.5	4	3.3	3.5	4	3.3	2.227	-	-	2.227	-	-
Pot Cap-1 Maneuver	56	82	496	64	82	394	961	-	-	826	-	-
Stage 1	298	326	-	385	403	-	-	-	-	-	-	-
Stage 2	348	403	-	297	326	-	-	-	-	-	-	-
Platoon blocked, %								-	-	-	-	-
Mov Cap-1 Maneuver	23	53	496	45	53	394	961	-	-	826	-	-
Mov Cap-2 Maneuver	23	53	-	45	53	-	-	-	-	-	-	-
Stage 1	297	212	-	383	401	-	-	-	-	-	-	-
Stage 2	207	401	-	190	212	-	-	-	-	-	-	-

Approach	EB		WB		NB		SB	
HCM Control Delay, s	62.5		33.7		0		2.5	
HCM LOS	F		D					

Minor Lane/Major Mvmt	NBL	NBT	NBR	EBLn1WBLn1	SBL	SBT	SBR
Capacity (veh/h)	961	-	-	69	285	826	-
HCM Lane V/C Ratio	0.002	-	-	0.095	0.58	0.23	-
HCM Control Delay (s)	8.8	0	-	62.5	33.7	10.7	0
HCM Lane LOS	A	A	-	F	D	B	A
HCM 95th %tile Q(veh)	0	-	-	0.3	3.4	0.9	-

Intersection	
Intersection Delay, s/veh	93.8
Intersection LOS	F

Movement	EBL	EBT	EBR	WBL	WBT	WBR	NBL	NBT	NBR	SBL	SBT	SBR
Lane Configurations		↕			↕			↕			↕	
Traffic Vol, veh/h	134	92	35	11	37	340	14	256	22	288	213	70
Future Vol, veh/h	134	92	35	11	37	340	14	256	22	288	213	70
Peak Hour Factor	0.95	0.95	0.95	0.95	0.95	0.95	0.95	0.95	0.95	0.95	0.95	0.95
Heavy Vehicles, %	7	7	7	1	1	1	5	5	5	4	4	4
Mvmt Flow	141	97	37	12	39	358	15	269	23	303	224	74
Number of Lanes	0	1	0	0	1	0	0	1	0	0	1	0

Approach	EB	WB	NB	SB
Opposing Approach	WB	EB	SB	NB
Opposing Lanes	1	1	1	1
Conflicting Approach Left	SB	NB	EB	WB
Conflicting Lanes Left	1	1	1	1
Conflicting Approach Right	NB	SB	WB	EB
Conflicting Lanes Right	1	1	1	1
HCM Control Delay	29.5	45.7	32.3	187.3
HCM LOS	D	E	D	F

Lane	NBLn1	EBLn1	WBLn1	SBLn1
Vol Left, %	5%	51%	3%	50%
Vol Thru, %	88%	35%	10%	37%
Vol Right, %	8%	13%	88%	12%
Sign Control	Stop	Stop	Stop	Stop
Traffic Vol by Lane	292	261	388	571
LT Vol	14	134	11	288
Through Vol	256	92	37	213
RT Vol	22	35	340	70
Lane Flow Rate	307	275	408	601
Geometry Grp	1	1	1	1
Degree of Util (X)	0.715	0.659	0.863	1.331
Departure Headway (Hd)	9.259	9.676	8.465	7.972
Convergence, Y/N	Yes	Yes	Yes	Yes
Cap	393	376	433	457
Service Time	7.259	7.676	6.465	6.049
HCM Lane V/C Ratio	0.781	0.731	0.942	1.315
HCM Control Delay	32.3	29.5	45.7	187.3
HCM Lane LOS	D	D	E	F
HCM 95th-tile Q	5.4	4.5	8.6	26.8

Intersection

Intersection Delay, s/veh 11.1

Intersection LOS B

Movement	EBL	EBT	EBR	WBL	WBT	WBR	NBL	NBT	NBR	SBL	SBT	SBR
Lane Configurations												
Traffic Vol, veh/h	103	157	9	20	86	72	4	79	45	81	69	58
Future Vol, veh/h	103	157	9	20	86	72	4	79	45	81	69	58
Peak Hour Factor	0.92	0.92	0.92	0.92	0.92	0.92	0.92	0.92	0.92	0.92	0.92	0.92
Heavy Vehicles, %	12	12	12	16	16	16	6	6	6	9	9	9
Mvmt Flow	112	171	10	22	93	78	4	86	49	88	75	63
Number of Lanes	1	1	0	1	1	0	0	1	0	0	1	0

Approach	EB	WB	NB	SB
Opposing Approach	WB	EB	SB	NB
Opposing Lanes	2	2	1	1
Conflicting Approach Left SB		NB	EB	WB
Conflicting Lanes Left	1	1	2	2
Conflicting Approach Right NB		SB	WB	EB
Conflicting Lanes Right	1	1	2	2
HCM Control Delay	11.2	11	10.2	11.6
HCM LOS	B	B	B	B

Lane	NBLn1	EBLn1	EBLn2	WBLn1	WBLn2	SBLn1
Vol Left, %		3%	100%	0%	100%	0%
Vol Thru, %		62%	0%	95%	0%	54%
Vol Right, %		35%	0%	5%	0%	46%
Sign Control		Stop	Stop	Stop	Stop	Stop
Traffic Vol by Lane		128	103	166	20	158
LT Vol		4	103	0	20	0
Through Vol		79	0	157	0	86
RT Vol		45	0	9	0	72
Lane Flow Rate		139	112	180	22	172
Geometry Grp		2	7	7	7	7
Degree of Util (X)		0.215	0.204	0.301	0.041	0.284
Departure Headway (Hd)		5.573	6.558	6.012	6.785	5.953
Convergence, Y/N		Yes	Yes	Yes	Yes	Yes
Cap		643	547	597	528	603
Service Time		3.618	4.293	3.747	4.523	3.691
HCM Lane V/C Ratio		0.216	0.205	0.302	0.042	0.285
HCM Control Delay		10.2	11	11.3	9.8	11.1
HCM Lane LOS		B	B	B	A	B
HCM 95th-tile Q		0.8	0.8	1.3	0.1	1.2

HCM 6th TWSC
 13: Airport Drive/Golden State Boulevard & Avenue 17

Village D Specific Plan
 Phase II WP - PM Peak Hour

Intersection												
Int Delay, s/veh	0.6											
Movement	EBL	EBT	EBR	WBL	WBT	WBR	NBL	NBT	NBR	SBL	SBT	SBR
Lane Configurations	↖	↑	↗	↖	↑	↗	↖	↑	↗		↕	
Traffic Vol, veh/h	10	729	91	179	996	230	141	79	305	327	78	10
Future Vol, veh/h	10	729	91	179	996	230	141	79	305	327	78	10
Conflicting Peds, #/hr	0	0	0	0	0	0	0	0	0	0	0	0
Sign Control	Free	Free	Free	Free	Free	Free	Stop	Stop	Stop	Stop	Stop	Stop
RT Channelized	-	-	None	-	-	None	-	-	None	-	-	None
Storage Length	85	-	0	70	-	105	60	-	50	-	-	-
Veh in Median Storage, #	-	0	-	-	0	-	-	0	-	-	0	-
Grade, %	-	0	-	-	0	-	-	0	-	-	0	-
Peak Hour Factor	92	92	92	92	92	92	92	92	92	92	92	92
Heavy Vehicles, %	1	1	1	1	1	1	3	3	3	3	3	3
Mvmt Flow	11	792	99	195	1083	250	153	86	332	355	85	11

Major/Minor	Major1			Major2			Minor1			Minor2		
Conflicting Flow All	1333	0	0	891	0	0	2460	2537	792	2546	2386	1083
Stage 1	-	-	-	-	-	-	814	814	-	1473	1473	-
Stage 2	-	-	-	-	-	-	1646	1723	-	1073	913	-
Critical Hdwy	4.11	-	-	4.11	-	-	7.13	6.53	6.23	7.13	6.53	6.23
Critical Hdwy Stg 1	-	-	-	-	-	-	6.13	5.53	-	6.13	5.53	-
Critical Hdwy Stg 2	-	-	-	-	-	-	6.13	5.53	-	6.13	5.53	-
Follow-up Hdwy	2.209	-	-	2.209	-	-	3.527	4.027	3.327	3.527	4.027	3.327
Pot Cap-1 Maneuver	521	-	-	765	-	-	~ 21	~ 27	388	~ 18	~ 34	263
Stage 1	-	-	-	-	-	-	370	390	-	~ 157	190	-
Stage 2	-	-	-	-	-	-	~ 125	143	-	~ 265	351	-
Platoon blocked, %	-	-	-	-	-	-	-	-	-	-	-	-
Mov Cap-1 Maneuver	521	-	-	765	-	-	~ 20	388	-	~ 25	263	-
Mov Cap-2 Maneuver	-	-	-	-	-	-	~ 20	-	-	~ 25	-	-
Stage 1	-	-	-	-	-	-	362	382	-	~ 154	142	-
Stage 2	-	-	-	-	-	-	~ 36	107	-	~ 29	344	-

Approach	EB	WB	NB	SB
HCM Control Delay, s	0.1	1.4		
HCM LOS			-	-

Minor Lane/Major Mvmt	NBLn1	NBLn2	NBLn3	EBL	EBT	EBR	WBL	WBT	WBR	SBLn1
Capacity (veh/h)	-	20	388	521	-	-	765	-	-	-
HCM Lane V/C Ratio	-	4.293	0.854	0.021	-	-	0.254	-	-	-
HCM Control Delay (s)	\$	1873.1	49.6	12.1	-	-	11.3	-	-	-
HCM Lane LOS	-	F	E	B	-	-	B	-	-	-
HCM 95th %tile Q(veh)	-	11.1	8.2	0.1	-	-	1	-	-	-

Notes
 -: Volume exceeds capacity \$: Delay exceeds 300s +: Computation Not Defined *: All major volume in platoon

HCM 6th TWSC
 14: Avenue 17 & SR-99 Southbound Off-Ramp

Intersection

Int Delay, s/veh 1698.6

Movement	EBL	EBT	WBT	WBR	SBL	SBR
Lane Configurations		↑	↑		↑	↑
Traffic Vol, veh/h	0	1364	1328	0	435	76
Future Vol, veh/h	0	1364	1328	0	435	76
Conflicting Peds, #/hr	0	0	0	0	0	0
Sign Control	Free	Free	Free	Free	Stop	Stop
RT Channelized	-	None	-	None	-	None
Storage Length	-	-	-	-	0	610
Veh in Median Storage, #	-	0	0	-	0	-
Grade, %	-	0	0	-	0	-
Peak Hour Factor	92	92	92	92	92	92
Heavy Vehicles, %	3	3	2	2	2	2
Mvmt Flow	0	1483	1443	0	473	83

Major/Minor	Major1	Major2	Minor2
Conflicting Flow All	-	0	0 2926 1443
Stage 1	-	-	- 1443 -
Stage 2	-	-	- 1483 -
Critical Hdwy	-	-	- 6.42 6.22
Critical Hdwy Stg 1	-	-	- 5.42 -
Critical Hdwy Stg 2	-	-	- 5.42 -
Follow-up Hdwy	-	-	- 3.518 3.318
Pot Cap-1 Maneuver	0	-	0 ~ 17 162
Stage 1	0	-	0 ~ 217 -
Stage 2	0	-	0 ~ 208 -
Platoon blocked, %	-	-	
Mov Cap-1 Maneuver	-	-	- ~ 17 162
Mov Cap-2 Maneuver	-	-	- ~ 17 -
Stage 1	-	-	- ~ 217 -
Stage 2	-	-	- ~ 208 -

Approach	EB	WB	SB
HCM Control Delay, s	0	0	\$ 10646.9
HCM LOS			F

Minor Lane/Major Mvmt	EBT	WBT	SBLn1	SBLn2
Capacity (veh/h)	-	-	17	162
HCM Lane V/C Ratio	-	-	27.813	0.51
HCM Control Delay (s)	-	\$	12498.6	48.3
HCM Lane LOS	-	-	F	E
HCM 95th %tile Q(veh)	-	-	59.9	2.5

Notes

~: Volume exceeds capacity \$: Delay exceeds 300s +: Computation Not Defined *: All major volume in platoon

Intersection												
Int Delay, s/veh	5957.5											
Movement	EBL	EBT	EBR	WBL	WBT	WBR	NBL	NBT	NBR	SBL	SBT	SBR
Lane Configurations	↖	↑			↗			↖	↗			
Traffic Vol, veh/h	141	1027	0	0	1255	330	773	3	529	0	0	0
Future Vol, veh/h	141	1027	0	0	1255	330	773	3	529	0	0	0
Conflicting Peds, #/hr	0	0	0	0	0	0	0	0	0	0	0	0
Sign Control	Free	Free	Free	Free	Free	Free	Stop	Stop	Stop	Free	Free	Free
RT Channelized	-	-	None	-	-	None	-	-	None	-	-	None
Storage Length	125	-	-	-	-	-	-	-	50	-	-	-
Veh in Median Storage, #	-	0	-	-	0	-	-	0	-	-	16965	-
Grade, %	-	0	-	-	0	-	-	0	-	-	0	-
Peak Hour Factor	95	95	95	95	95	95	95	95	95	95	95	95
Heavy Vehicles, %	2	2	2	1	1	1	0	0	0	0	0	0
Mvmt Flow	148	1081	0	0	1321	347	814	3	557	0	0	0

Major/Minor	Major1	Major2	Minor1
Conflicting Flow All	1668	0	- - - 0 2872 3045 1081
Stage 1	-	-	- - - 1377 1377 -
Stage 2	-	-	- - - 1495 1668 -
Critical Hdwy	4.12	-	- - - 6.4 6.5 6.2
Critical Hdwy Stg 1	-	-	- - - 5.4 5.5 -
Critical Hdwy Stg 2	-	-	- - - 5.4 5.5 -
Follow-up Hdwy	2.218	-	- - - 3.5 4 3.3
Pot Cap-1 Maneuver	385	- 0 0	- - ~ 19 13 ~ 267
Stage 1	-	- 0 0	- - ~ 237 214 -
Stage 2	-	- 0 0	- - ~ 207 155 -
Platoon blocked, %	-	-	- -
Mov Cap-1 Maneuver	385	- - -	- - ~ 12 0 ~ 267
Mov Cap-2 Maneuver	-	- - -	- - ~ 12 0 -
Stage 1	-	- - -	- - ~ 146 0 -
Stage 2	-	- - -	- - ~ 207 0 -

Approach	EB	WB	NB
HCM Control Delay, s	2.4	0	\$ 18523.1
HCM LOS			F

Minor Lane/Major Mvmt	NBLn1	NBLn2	EBL	EBT	WBT	WBR
Capacity (veh/h)	12	267	385	-	-	-
HCM Lane V/C Ratio	68.07	2.086	0.386	-	-	-
HCM Control Delay (s)	\$ 30788	531.6	20.1	-	-	-
HCM Lane LOS	F	F	C	-	-	-
HCM 95th %tile Q(veh)	103.6	41.3	1.8	-	-	-

Notes
 -: Volume exceeds capacity \$: Delay exceeds 300s +: Computation Not Defined *: All major volume in platoon

HCM 6th Signalized Intersection Summary
 16: Love's Truck Stop Driveway/Driveway & Avenue 17

Village D Specific Plan
 Phase II WP - PM Peak Hour



Movement	EBL	EBT	EBR	WBL	WBT	WBR	NBL	NBT	NBR	SBL	SBT	SBR
Lane Configurations	↖	↗	↘	↖	↗	↘	↖	↗	↘	↖	↗	↘
Traffic Volume (veh/h)	556	850	141	32	894	189	160	0	31	279	0	519
Future Volume (veh/h)	556	850	141	32	894	189	160	0	31	279	0	519
Initial Q (Qb), veh	0	0	0	0	0	0	0	0	0	0	0	0
Ped-Bike Adj(A_pbT)	1.00		1.00	1.00		1.00	1.00		1.00	1.00		1.00
Parking Bus, Adj	1.00	1.00	1.00	1.00	1.00	1.00	1.00	1.00	1.00	1.00	1.00	1.00
Work Zone On Approach		No			No			No			No	
Adj Sat Flow, veh/h/ln	1885	1885	1885	1870	1870	1870	1900	1900	1900	1900	1900	1900
Adj Flow Rate, veh/h	604	924	153	35	972	205	174	0	34	303	0	564
Peak Hour Factor	0.92	0.92	0.92	0.92	0.92	0.92	0.92	0.92	0.92	0.92	0.92	0.92
Percent Heavy Veh, %	1	1	1	2	2	2	0	0	0	0	0	0
Cap, veh/h	140	1158	516	64	421	89	141	0	453	141	0	453
Arrive On Green	0.08	0.32	0.32	0.04	0.28	0.28	0.08	0.00	0.28	0.08	0.00	0.28
Sat Flow, veh/h	1795	3582	1598	1781	1498	316	1810	0	1610	1810	0	1610
Grp Volume(v), veh/h	604	924	153	35	0	1177	174	0	34	303	0	564
Grp Sat Flow(s),veh/h/ln	1795	1791	1598	1781	0	1814	1810	0	1610	1810	0	1610
Q Serve(g_s), s	5.0	15.1	4.6	1.2	0.0	18.0	5.0	0.0	1.0	5.0	0.0	18.0
Cycle Q Clear(g_c), s	5.0	15.1	4.6	1.2	0.0	18.0	5.0	0.0	1.0	5.0	0.0	18.0
Prop In Lane	1.00		1.00	1.00		0.17	1.00		1.00	1.00		1.00
Lane Grp Cap(c), veh/h	140	1158	516	64	0	510	141	0	453	141	0	453
V/C Ratio(X)	4.31	0.80	0.30	0.54	0.00	2.31	1.23	0.00	0.08	2.14	0.00	1.25
Avail Cap(c_a), veh/h	140	1158	516	139	0	510	141	0	453	141	0	453
HCM Platoon Ratio	1.00	1.00	1.00	1.00	1.00	1.00	1.00	1.00	1.00	1.00	1.00	1.00
Upstream Filter(I)	1.00	1.00	1.00	1.00	0.00	1.00	1.00	0.00	1.00	1.00	0.00	1.00
Uniform Delay (d), s/veh	29.5	19.8	16.2	30.3	0.0	23.0	29.5	0.0	16.9	29.5	0.0	23.0
Incr Delay (d2), s/veh	1504.3	4.0	0.3	6.9	0.0	594.6	150.7	0.0	0.3	537.4	0.0	127.9
Initial Q Delay(d3),s/veh	0.0	0.0	0.0	0.0	0.0	0.0	0.0	0.0	0.0	0.0	0.0	0.0
%ile BackOfQ(50%),veh/ln	60.7	6.3	1.6	0.6	0.0	91.3	8.0	0.0	0.4	23.2	0.0	22.3
Unsig. Movement Delay, s/veh												
LnGrp Delay(d),s/veh	1533.8	23.8	16.5	37.3	0.0	617.6	180.2	0.0	17.2	566.9	0.0	150.9
LnGrp LOS	F	C	B	D	A	F	F	A	B	F	A	F
Approach Vol, veh/h		1681			1212			208				867
Approach Delay, s/veh		565.7			600.8			153.5				296.2
Approach LOS		F			F			F				F
Timer - Assigned Phs	1	2	3	4	5	6	7	8				
Phs Duration (G+Y+Rc), s	9.5	22.5	6.8	25.2	9.5	22.5	9.5	22.5				
Change Period (Y+Rc), s	4.5	4.5	4.5	4.5	4.5	4.5	4.5	4.5				
Max Green Setting (Gmax), s	5.0	18.0	5.0	18.0	5.0	18.0	5.0	18.0				
Max Q Clear Time (g_c+I1), s	7.0	3.0	3.2	17.1	7.0	20.0	7.0	20.0				
Green Ext Time (p_c), s	0.0	0.1	0.0	0.6	0.0	0.0	0.0	0.0				
Intersection Summary												
HCM 6th Ctrl Delay												495.9
HCM 6th LOS												F

Intersection												
Int Delay, s/veh	1.2											
Movement	EBL	EBT	EBR	WBL	WBT	WBR	NBL	NBT	NBR	SBL	SBT	SBR
Lane Configurations	↖	↗		↖	↗		↖	↑	↗	↖	↑	↗
Traffic Vol, veh/h	160	465	44	103	767	26	57	43	92	22	141	239
Future Vol, veh/h	160	465	44	103	767	26	57	43	92	22	141	239
Conflicting Peds, #/hr	0	0	3	3	0	0	0	0	0	0	0	0
Sign Control	Free	Free	Free	Free	Free	Free	Stop	Stop	Stop	Stop	Stop	Stop
RT Channelized	-	-	None	-	-	None	-	-	None	-	-	None
Storage Length	110	-	-	165	-	-	65	-	50	100	-	50
Veh in Median Storage, #	-	0	-	-	0	-	-	0	-	-	0	-
Grade, %	-	0	-	-	0	-	-	0	-	-	0	-
Peak Hour Factor	92	92	92	92	92	92	92	92	92	92	92	92
Heavy Vehicles, %	0	0	0	0	0	0	0	0	0	0	0	0
Mvmt Flow	174	505	48	112	834	28	62	47	100	24	153	260

Major/Minor	Major1			Major2			Minor1			Minor2		
Conflicting Flow All	862	0	0	556	0	0	2159	1966	532	2023	1976	848
Stage 1	-	-	-	-	-	-	880	880	-	1072	1072	-
Stage 2	-	-	-	-	-	-	1279	1086	-	951	904	-
Critical Hdwy	4.1	-	-	4.1	-	-	7.1	6.5	6.2	7.1	6.5	6.2
Critical Hdwy Stg 1	-	-	-	-	-	-	6.1	5.5	-	6.1	5.5	-
Critical Hdwy Stg 2	-	-	-	-	-	-	6.1	5.5	-	6.1	5.5	-
Follow-up Hdwy	2.2	-	-	2.2	-	-	3.5	4	3.3	3.5	4	3.3
Pot Cap-1 Maneuver	789	-	-	1025	-	-	~ 35	64	551	44	~ 63	364
Stage 1	-	-	-	-	-	-	345	368	-	269	299	-
Stage 2	-	-	-	-	-	-	206	295	-	315	358	-
Platoon blocked, %	-	-	-	-	-	-	-	-	-	-	-	-
Mov Cap-1 Maneuver	789	-	-	1022	-	-	~ 44	549	-	~ 44	364	-
Mov Cap-2 Maneuver	-	-	-	-	-	-	~ 44	-	-	~ 44	-	-
Stage 1	-	-	-	-	-	-	268	286	-	210	266	-
Stage 2	-	-	-	-	-	-	~ 22	263	-	168	278	-

Approach	EB	WB	NB	SB
HCM Control Delay, s	2.6	1		
HCM LOS			-	-

Minor Lane/Major Mvmt	NBLn1	NBLn2	NBLn3	EBL	EBT	EBR	WBL	WBT	WBR	SBLn1	SBLn2	SBLn3
Capacity (veh/h)	-	44	549	789	-	-	1022	-	-	-	44	364
HCM Lane V/C Ratio	-	1.062	0.182	0.22	-	-	0.11	-	-	-	3.483	0.714
HCM Control Delay (s)	-	299.1	13	10.8	-	-	9	-	-	-	\$ 1309.2	36.1
HCM Lane LOS	-	F	B	B	-	-	A	-	-	-	F	E
HCM 95th %tile Q(veh)	-	4.4	0.7	0.8	-	-	0.4	-	-	-	17	5.3

Notes
 -: Volume exceeds capacity \$: Delay exceeds 300s +: Computation Not Defined *: All major volume in platoon

Intersection	
Intersection Delay, s/veh	11.4
Intersection LOS	B

Movement	EBL	EBT	EBR	WBL	WBT	WBR	NBL	NBT	NBR	SBL	SBT	SBR
Lane Configurations	↔	↔		↔	↔		↔	↑	↔	↔	↑	↔
Traffic Vol, veh/h	17	100	36	73	120	19	55	165	59	21	172	27
Future Vol, veh/h	17	100	36	73	120	19	55	165	59	21	172	27
Peak Hour Factor	0.96	0.96	0.96	0.96	0.96	0.96	0.96	0.96	0.96	0.96	0.96	0.96
Heavy Vehicles, %	0	0	0	0	0	0	0	0	0	0	0	0
Mvmt Flow	18	104	38	76	125	20	57	172	61	22	179	28
Number of Lanes	1	1	0	1	1	0	1	1	1	1	1	1

Approach	EB	WB	NB	SB
Opposing Approach	WB	EB	SB	NB
Opposing Lanes	2	2	3	3
Conflicting Approach Left	SB	NB	EB	WB
Conflicting Lanes Left	3	3	2	2
Conflicting Approach Right	NB	SB	WB	EB
Conflicting Lanes Right	3	3	2	2
HCM Control Delay	11.4	11.3	11.2	11.8
HCM LOS	B	B	B	B

Lane	NBLn1	NBLn2	NBLn3	EBLn1	EBLn2	WBLn1	WBLn2	SBLn1	SBLn2	SBLn3
Vol Left, %	100%	0%	0%	100%	0%	100%	0%	100%	0%	0%
Vol Thru, %	0%	100%	0%	0%	74%	0%	86%	0%	100%	0%
Vol Right, %	0%	0%	100%	0%	26%	0%	14%	0%	0%	100%
Sign Control	Stop	Stop	Stop	Stop	Stop	Stop	Stop	Stop	Stop	Stop
Traffic Vol by Lane	55	165	59	17	136	73	139	21	172	27
LT Vol	55	0	0	17	0	73	0	21	0	0
Through Vol	0	165	0	0	100	0	120	0	172	0
RT Vol	0	0	59	0	36	0	19	0	0	27
Lane Flow Rate	57	172	61	18	142	76	145	22	179	28
Geometry Grp	8	8	8	8	8	8	8	8	8	8
Degree of Util (X)	0.111	0.307	0.098	0.035	0.256	0.149	0.259	0.043	0.327	0.046
Departure Headway (Hd)	6.948	6.44	5.73	7.196	6.508	7.039	6.441	7.068	6.561	5.85
Convergence, Y/N	Yes	Yes	Yes	Yes	Yes	Yes	Yes	Yes	Yes	Yes
Cap	514	555	622	495	550	508	555	505	546	609
Service Time	4.715	4.207	3.497	4.97	4.282	4.808	4.21	4.838	4.33	3.619
HCM Lane V/C Ratio	0.111	0.31	0.098	0.036	0.258	0.15	0.261	0.044	0.328	0.046
HCM Control Delay	10.6	12.1	9.1	10.2	11.5	11	11.5	10.2	12.5	8.9
HCM Lane LOS	B	B	A	B	B	B	B	B	B	A
HCM 95th-tile Q	0.4	1.3	0.3	0.1	1	0.5	1	0.1	1.4	0.1

Intersection												
Intersection Delay, s/veh	71.1											
Intersection LOS	F											

Movement	EBL	EBT	EBR	WBL	WBT	WBR	NBL	NBT	NBR	SBL	SBT	SBR
Lane Configurations		↕			↕			↕			↕	
Traffic Vol, veh/h	81	425	44	23	315	203	23	49	17	130	52	85
Future Vol, veh/h	81	425	44	23	315	203	23	49	17	130	52	85
Peak Hour Factor	0.92	0.92	0.92	0.92	0.92	0.92	0.92	0.92	0.92	0.92	0.92	0.92
Heavy Vehicles, %	4	4	4	4	4	4	0	0	0	0	0	0
Mvmt Flow	88	462	48	25	342	221	25	53	18	141	57	92
Number of Lanes	0	1	0	0	1	0	0	1	0	0	1	0

Approach	EB	WB	NB	SB
Opposing Approach	WB	EB	SB	NB
Opposing Lanes	1	1	1	1
Conflicting Approach Left	SB	NB	EB	WB
Conflicting Lanes Left	1	1	1	1
Conflicting Approach Right	NB	SB	WB	EB
Conflicting Lanes Right	1	1	1	1
HCM Control Delay	94.2	81.1	14.6	21.9
HCM LOS	F	F	B	C

Lane	NBLn1	EBLn1	WBLn1	SBLn1
Vol Left, %	26%	15%	4%	49%
Vol Thru, %	55%	77%	58%	19%
Vol Right, %	19%	8%	38%	32%
Sign Control	Stop	Stop	Stop	Stop
Traffic Vol by Lane	89	550	541	267
LT Vol	23	81	23	130
Through Vol	49	425	315	52
RT Vol	17	44	203	85
Lane Flow Rate	97	598	588	290
Geometry Grp	1	1	1	1
Degree of Util (X)	0.228	1.098	1.059	0.596
Departure Headway (Hd)	8.979	6.873	6.721	7.886
Convergence, Y/N	Yes	Yes	Yes	Yes
Cap	402	532	547	461
Service Time	6.979	4.873	4.721	5.886
HCM Lane V/C Ratio	0.241	1.124	1.075	0.629
HCM Control Delay	14.6	94.2	81.1	21.9
HCM Lane LOS	B	F	F	C
HCM 95th-tile Q	0.9	18.2	16.7	3.8

Intersection

Intersection Delay, s/veh 17.2

Intersection LOS C

Movement	EBL	EBT	EBR	WBL	WBT	WBR	NBL	NBT	NBR	SBL	SBT	SBR
Lane Configurations		↕			↕	↕		↕	↕		↕	↕
Traffic Vol, veh/h	0	0	0	268	0	113	0	76	167	201	156	0
Future Vol, veh/h	0	0	0	268	0	113	0	76	167	201	156	0
Peak Hour Factor	0.92	0.92	0.92	0.92	0.92	0.92	0.92	0.92	0.92	0.92	0.92	0.92
Heavy Vehicles, %	0	0	0	1	1	1	0	0	0	0	0	0
Mvmt Flow	0	0	0	291	0	123	0	83	182	218	170	0
Number of Lanes	0	1	0	0	1	1	0	1	1	0	1	1

Approach	EB	WB	NB	SB
Opposing Approach	WB	EB	SB	NB
Opposing Lanes	2	1	2	2
Conflicting Approach Left	SB	NB	EB	WB
Conflicting Lanes Left	2	2	1	2
Conflicting Approach Right	NB	SB	WB	EB
Conflicting Lanes Right	2	2	2	1
HCM Control Delay	0	15.7	10.7	23.2
HCM LOS	-	C	B	C

Lane	NBLn1	NBLn2	EBLn1	WBLn1	WBLn2	SBLn1	SBLn2
Vol Left, %	0%	0%	0%	100%	0%	56%	0%
Vol Thru, %	100%	0%	100%	0%	0%	44%	100%
Vol Right, %	0%	100%	0%	0%	100%	0%	0%
Sign Control	Stop	Stop	Stop	Stop	Stop	Stop	Stop
Traffic Vol by Lane	76	167	0	268	113	357	0
LT Vol	0	0	0	268	0	201	0
Through Vol	76	0	0	0	0	156	0
RT Vol	0	167	0	0	113	0	0
Lane Flow Rate	83	182	0	291	123	388	0
Geometry Grp	7	7	6	7	7	7	7
Degree of Util (X)	0.148	0.29	0	0.561	0.195	0.701	0
Departure Headway (Hd)	6.466	5.752	7.403	6.936	5.719	6.502	6.215
Convergence, Y/N	Yes	Yes	Yes	Yes	Yes	Yes	Yes
Cap	553	623	0	519	625	555	0
Service Time	4.228	3.513	5.498	4.688	3.47	4.254	3.968
HCM Lane V/C Ratio	0.15	0.292	0	0.561	0.197	0.699	0
HCM Control Delay	10.4	10.9	10.5	18.2	9.9	23.2	9
HCM Lane LOS	B	B	N	C	A	C	N
HCM 95th-tile Q	0.5	1.2	0	3.4	0.7	5.5	0

Intersection	
Intersection Delay, s/veh	182.9
Intersection LOS	F

Movement	EBL	EBT	EBR	WBL	WBT	WBR	NBL	NBT	NBR	SBL	SBT	SBR
Lane Configurations	↘	↕↘		↘	↕↘		↘	↕	↘	↘	↕	↘
Traffic Vol, veh/h	24	463	26	359	839	55	28	247	234	49	319	46
Future Vol, veh/h	24	463	26	359	839	55	28	247	234	49	319	46
Peak Hour Factor	0.94	0.94	0.94	0.94	0.94	0.94	0.94	0.94	0.94	0.94	0.94	0.94
Heavy Vehicles, %	0	0	0	1	1	1	0	0	0	0	0	0
Mvmt Flow	26	493	28	382	893	59	30	263	249	52	339	49
Number of Lanes	1	2	0	1	2	0	1	1	1	1	1	1

Approach	EB	WB	NB	SB
Opposing Approach	WB	EB	SB	NB
Opposing Lanes	3	3	3	3
Conflicting Approach Left	SB	NB	EB	WB
Conflicting Lanes Left	3	3	3	3
Conflicting Approach Right	NB	SB	WB	EB
Conflicting Lanes Right	3	3	3	3
HCM Control Delay	104.9	278.6	66.8	132.4
HCM LOS	F	F	F	F

Lane	NBLn1	NBLn2	NBLn3	EBLn1	EBLn2	EBLn3	WBLn1	WBLn2	WBLn3	SBLn1	SBLn2
Vol Left, %	100%	0%	0%	100%	0%	0%	100%	0%	0%	100%	0%
Vol Thru, %	0%	100%	0%	0%	100%	86%	0%	100%	84%	0%	100%
Vol Right, %	0%	0%	100%	0%	0%	14%	0%	0%	16%	0%	0%
Sign Control	Stop	Stop	Stop	Stop	Stop	Stop	Stop	Stop	Stop	Stop	Stop
Traffic Vol by Lane	28	247	234	24	309	180	359	559	335	49	319
LT Vol	28	0	0	24	0	0	359	0	0	49	0
Through Vol	0	247	0	0	309	154	0	559	280	0	319
RT Vol	0	0	234	0	0	26	0	0	55	0	0
Lane Flow Rate	30	263	249	26	328	192	382	595	356	52	339
Geometry Grp	8	8	8	8	8	8	8	8	8	8	8
Degree of Util (X)	0.11	0.936	0.839	0.095	1.172	0.68	1.264	1.888	1.119	0.196	1.228
Departure Headway (Hd)	14.323	13.823	13.123	14.3	13.8	13.699	12.249	11.749	11.634	13.524	13.028
Convergence, Y/N	Yes	Yes	Yes	Yes	Yes	Yes	Yes	Yes	Yes	Yes	Yes
Cap	252	265	279	252	266	265	298	315	313	266	282
Service Time	12.023	11.523	10.823	12	11.5	11.399	9.949	9.449	9.334	11.259	10.759
HCM Lane V/C Ratio	0.119	0.992	0.892	0.103	1.233	0.725	1.282	1.889	1.137	0.195	1.202
HCM Control Delay	18.8	79.8	58.8	18.5	148.9	41.2	176.8	437.6	122.2	19.5	166.3
HCM Lane LOS	C	F	F	C	F	E	F	F	F	F	C
HCM 95th-tile Q	0.4	8.6	6.9	0.3	13.9	4.5	17.6	39.5	13.9	0.7	15.9

Intersection	
Intersection Delay, s/veh	37
Intersection LOS	E

Movement	EBL	EBT	EBR	WBL	WBT	WBR	NBL	NBT	NBR	SBL	SBT	SBR
Lane Configurations	↖	↗		↖	↗	↖	↖	↗		↖	↗	
Traffic Vol, veh/h	31	139	37	56	173	112	51	280	43	81	336	38
Future Vol, veh/h	31	139	37	56	173	112	51	280	43	81	336	38
Peak Hour Factor	0.93	0.93	0.93	0.93	0.93	0.93	0.93	0.93	0.93	0.93	0.93	0.93
Heavy Vehicles, %	1	1	1	0	0	0	1	1	1	1	1	1
Mvmt Flow	33	149	40	60	186	120	55	301	46	87	361	41
Number of Lanes	1	1	0	1	1	1	1	1	0	1	1	0

Approach	EB	WB	NB	SB
Opposing Approach	WB	EB	SB	NB
Opposing Lanes	3	2	2	2
Conflicting Approach Left	SB	NB	EB	WB
Conflicting Lanes Left	2	2	2	3
Conflicting Approach Right	NB	SB	WB	EB
Conflicting Lanes Right	2	2	3	2
HCM Control Delay	20.7	17.6	41.1	55.6
HCM LOS	C	C	E	F

Lane	NBLn1	NBLn2	EBLn1	EBLn2	WBLn1	WBLn2	WBLn3	SBLn1	SBLn2
Vol Left, %	100%	0%	100%	0%	100%	0%	0%	100%	0%
Vol Thru, %	0%	87%	0%	79%	0%	100%	0%	0%	90%
Vol Right, %	0%	13%	0%	21%	0%	0%	100%	0%	10%
Sign Control	Stop	Stop	Stop	Stop	Stop	Stop	Stop	Stop	Stop
Traffic Vol by Lane	51	323	31	176	56	173	112	81	374
LT Vol	51	0	31	0	56	0	0	81	0
Through Vol	0	280	0	139	0	173	0	0	336
RT Vol	0	43	0	37	0	0	112	0	38
Lane Flow Rate	55	347	33	189	60	186	120	87	402
Geometry Grp	8	8	8	8	8	8	8	8	8
Degree of Util (X)	0.144	0.851	0.095	0.504	0.164	0.48	0.286	0.222	0.961
Departure Headway (Hd)	9.433	8.821	10.269	9.59	9.801	9.281	8.552	9.191	8.603
Convergence, Y/N	Yes	Yes	Yes	Yes	Yes	Yes	Yes	Yes	Yes
Cap	379	410	348	375	365	387	418	389	422
Service Time	7.218	6.606	8.066	7.387	7.59	7.069	6.34	6.971	6.382
HCM Lane V/C Ratio	0.145	0.846	0.095	0.504	0.164	0.481	0.287	0.224	0.953
HCM Control Delay	13.8	45.4	14.2	21.8	14.5	20.4	14.8	14.6	64.5
HCM Lane LOS	B	E	B	C	B	C	B	B	F
HCM 95th-tile Q	0.5	8.2	0.3	2.7	0.6	2.5	1.2	0.8	11.3

HCM 6th Signalized Intersection Summary
 23: Avenue 16/Ellis Street & Kennedy Street

Village D Specific Plan
 Phase II WP - PM Peak Hour



Movement	WBL	WBR	NBT	NBR	SBL	SBT
Lane Configurations						
Traffic Volume (veh/h)	152	224	382	301	240	431
Future Volume (veh/h)	152	224	382	301	240	431
Initial Q (Qb), veh	0	0	0	0	0	0
Ped-Bike Adj(A_pbT)	1.00	1.00		1.00	1.00	
Parking Bus, Adj	1.00	1.00	1.00	1.00	1.00	1.00
Work Zone On Approach	No		No		No	
Adj Sat Flow, veh/h/ln	1870	1870	1885	1885	1885	1885
Adj Flow Rate, veh/h	165	243	415	327	261	468
Peak Hour Factor	0.92	0.92	0.92	0.92	0.92	0.92
Percent Heavy Veh, %	2	2	1	1	1	1
Cap, veh/h	226	354	1048	819	281	2724
Arrive On Green	0.13	0.13	0.55	0.55	0.16	0.76
Sat Flow, veh/h	1781	2790	2006	1495	1795	3676
Grp Volume(v), veh/h	165	243	389	353	261	468
Grp Sat Flow(s),veh/h/ln	1781	1395	1791	1616	1795	1791
Q Serve(g_s), s	7.1	6.7	10.0	10.1	11.5	2.9
Cycle Q Clear(g_c), s	7.1	6.7	10.0	10.1	11.5	2.9
Prop In Lane	1.00	1.00		0.93	1.00	
Lane Grp Cap(c), veh/h	226	354	981	886	281	2724
V/C Ratio(X)	0.73	0.69	0.40	0.40	0.93	0.17
Avail Cap(c_a), veh/h	412	645	981	886	281	2724
HCM Platoon Ratio	1.00	1.00	1.00	1.00	1.00	1.00
Upstream Filter(I)	0.77	0.77	1.00	1.00	1.00	1.00
Uniform Delay (d), s/veh	33.6	33.4	10.4	10.5	33.3	2.6
Incr Delay (d2), s/veh	3.5	1.8	1.2	1.3	35.7	0.1
Initial Q Delay(d3),s/veh	0.0	0.0	0.0	0.0	0.0	0.0
%ile BackOfQ(50%),veh/ln	3.2	2.3	3.9	3.6	7.6	0.7
Unsig. Movement Delay, s/veh						
LnGrp Delay(d),s/veh	37.1	35.2	11.6	11.8	69.0	2.8
LnGrp LOS	D	D	B	B	E	A
Approach Vol, veh/h	408		742			729
Approach Delay, s/veh	36.0		11.7			26.5
Approach LOS	D		B			C
Timer - Assigned Phs	1	2			6	8
Phs Duration (G+Y+Rc), s	7.0	48.3			65.3	14.7
Change Period (Y+Rc), s	4.5	4.5			4.5	4.5
Max Green Setting (Gmax), s	12.5	35.5			52.5	18.5
Max Q Clear Time (g_c+M), s	12.5	12.1			4.9	9.1
Green Ext Time (p_c), s	0.0	5.1			3.5	1.0
Intersection Summary						
HCM 6th Ctrl Delay			22.7			
HCM 6th LOS			C			

HCM 6th Signalized Intersection Summary
 24: Schnoor Avenue & Kennedy Street

Village D Specific Plan
 Phase II WP - PM Peak Hour



Movement	EBL	EBT	EBR	WBL	WBT	WBR	NBL	NBT	NBR	SBL	SBT	SBR
Lane Configurations												
Traffic Volume (veh/h)	70	236	212	249	181	128	198	64	327	143	51	31
Future Volume (veh/h)	70	236	212	249	181	128	198	64	327	143	51	31
Initial Q (Qb), veh	0	0	0	0	0	0	0	0	0	0	0	0
Ped-Bike Adj(A_pbT)	1.00		0.99	1.00		0.99	1.00		1.00	1.00		1.00
Parking Bus, Adj	1.00	1.00	1.00	1.00	1.00	1.00	1.00	1.00	1.00	1.00	1.00	1.00
Work Zone On Approach		No			No			No			No	
Adj Sat Flow, veh/h/ln	1870	1870	1870	1856	1856	1856	1885	1885	1885	1633	1633	1633
Adj Flow Rate, veh/h	74	251	226	265	193	136	211	68	348	152	54	33
Peak Hour Factor	0.94	0.94	0.94	0.94	0.94	0.94	0.94	0.94	0.94	0.94	0.94	0.94
Percent Heavy Veh, %	2	2	2	3	3	3	1	1	1	18	18	18
Cap, veh/h	231	332	287	306	230	162	626	72	366	233	388	328
Arrive On Green	0.13	0.18	0.18	0.17	0.23	0.23	0.18	0.27	0.27	0.15	0.24	0.24
Sat Flow, veh/h	1781	1799	1554	1767	1008	710	3483	268	1369	1555	1633	1382
Grp Volume(v), veh/h	74	248	229	265	0	329	211	0	416	152	54	33
Grp Sat Flow(s),veh/h/ln	1781	1777	1576	1767	0	1718	1742	0	1637	1555	1633	1382
Q Serve(g_s), s	3.0	10.6	11.1	11.7	0.0	14.6	4.2	0.0	20.0	7.4	2.1	1.5
Cycle Q Clear(g_c), s	3.0	10.6	11.1	11.7	0.0	14.6	4.2	0.0	20.0	7.4	2.1	1.5
Prop In Lane	1.00		0.99	1.00		0.41	1.00		0.84	1.00		1.00
Lane Grp Cap(c), veh/h	231	328	291	306	0	392	626	0	438	233	388	328
V/C Ratio(X)	0.32	0.76	0.79	0.87	0.00	0.84	0.34	0.00	0.95	0.65	0.14	0.10
Avail Cap(c_a), veh/h	231	400	355	364	0	634	626	0	438	233	388	328
HCM Platoon Ratio	1.00	1.00	1.00	1.00	1.00	1.00	1.00	1.00	1.00	1.00	1.00	1.00
Upstream Filter(l)	0.60	0.60	0.60	1.00	0.00	1.00	1.00	0.00	1.00	1.00	1.00	1.00
Uniform Delay (d), s/veh	31.6	30.9	31.1	32.2	0.0	29.5	28.7	0.0	28.8	32.1	24.1	23.8
Incr Delay (d2), s/veh	0.5	4.0	5.8	17.0	0.0	5.5	0.3	0.0	32.2	6.4	0.7	0.6
Initial Q Delay(d3),s/veh	0.0	0.0	0.0	0.0	0.0	0.0	0.0	0.0	0.0	0.0	0.0	0.0
%ile BackOfQ(50%),veh/ln	1.3	4.7	4.6	6.3	0.0	6.4	1.8	0.0	11.4	3.1	0.9	0.5
Unsig. Movement Delay, s/veh												
LnGrp Delay(d),s/veh	32.1	34.9	36.9	49.1	0.0	34.9	29.0	0.0	60.9	38.4	24.8	24.4
LnGrp LOS	C	C	D	D	A	C	C	A	E	D	C	C
Approach Vol, veh/h		551			594			627			239	
Approach Delay, s/veh		35.3			41.3			50.2			33.4	
Approach LOS		D			D			D			C	
Timer - Assigned Phs	1	2	3	4	5	6	7	8				
Phs Duration (G+Y+Rc), s	16.5	25.9	18.4	19.3	18.9	23.5	14.9	22.8				
Change Period (Y+Rc), s	4.5	4.5	4.5	4.5	4.5	4.5	4.5	4.5				
Max Green Setting (Gmax), s	16.5	21.4	16.5	18.0	8.5	19.0	5.0	29.5				
Max Q Clear Time (g_c+1/4), s	19.4	22.0	13.7	13.1	6.2	4.1	5.0	16.6				
Green Ext Time (p_c), s	0.0	0.0	0.2	1.3	0.2	0.3	0.0	1.6				
Intersection Summary												
HCM 6th Ctrl Delay				41.5								
HCM 6th LOS				D								

HCM 6th TWSC
 25: Kennedy Street/Gateway Drive & SR-99 Southbound Ramps

Village D Specific Plan
 Phase II WP - PM Peak Hour

Intersection						
Int Delay, s/veh	33.8					
Movement	EBL	EBT	WBT	WBR	SBL	SBR
Lane Configurations	↘	↑	↗		↘	↗
Traffic Vol, veh/h	265	451	392	2	135	227
Future Vol, veh/h	265	451	392	2	135	227
Conflicting Peds, #/hr	0	0	0	0	0	0
Sign Control	Free	Free	Free	Free	Stop	Stop
RT Channelized	-	None	-	Free	-	None
Storage Length	140	-	-	-	0	335
Veh in Median Storage, #	-	0	0	-	0	-
Grade, %	-	0	0	-	0	-
Peak Hour Factor	92	92	92	92	92	92
Heavy Vehicles, %	2	2	3	3	3	3
Mvmt Flow	288	490	426	2	147	247

Major/Minor	Major1	Major2	Minor2		
Conflicting Flow All	426	0	-	0	1492 426
Stage 1	-	-	-	-	426 -
Stage 2	-	-	-	-	1066 -
Critical Hdwy	4.12	-	-	-	6.43 6.23
Critical Hdwy Stg 1	-	-	-	-	5.43 -
Critical Hdwy Stg 2	-	-	-	-	5.43 -
Follow-up Hdwy	2.218	-	-	-	3.527 3.327
Pot Cap-1 Maneuver	1133	-	-	0 ~ 135	626
Stage 1	-	-	-	0	657 -
Stage 2	-	-	-	0	329 -
Platoon blocked, %		-	-		
Mov Cap-1 Maneuver	1133	-	-	- ~ 101	626
Mov Cap-2 Maneuver	-	-	-	- ~ 101	-
Stage 1	-	-	-	-	490 -
Stage 2	-	-	-	-	329 -

Approach	EB	WB	SB
HCM Control Delay, s	3.4	0	130.6
HCM LOS			F

Minor Lane/Major Mvmt	EBL	EBT	WBT	SBLn1	SBLn2
Capacity (veh/h)	1133	-	-	101	626
HCM Lane V/C Ratio	0.254	-	-	1.453	0.394
HCM Control Delay (s)	9.3	-	-	\$ 326.1	14.4
HCM Lane LOS	A	-	-	F	B
HCM 95th %tile Q(veh)	1	-	-	10.8	1.9

Notes
 -: Volume exceeds capacity \$: Delay exceeds 300s +: Computation Not Defined *: All major volume in platoon

Intersection						
Int Delay, s/veh	3.8					
Movement	EBL	EBT	WBT	WBR	SBL	SBR
Lane Configurations		↕	↕		↕	
Traffic Vol, veh/h	198	388	204	0	0	190
Future Vol, veh/h	198	388	204	0	0	190
Conflicting Peds, #/hr	0	0	0	0	0	0
Sign Control	Free	Free	Free	Free	Stop	Stop
RT Channelized	-	None	-	None	-	None
Storage Length	-	-	-	-	0	-
Veh in Median Storage, #	-	0	0	-	0	-
Grade, %	-	0	0	-	0	-
Peak Hour Factor	92	92	92	92	92	92
Heavy Vehicles, %	3	3	3	3	3	3
Mvmt Flow	215	422	222	0	0	207

Major/Minor	Major1	Major2	Minor2		
Conflicting Flow All	222	0	-	0	1074 222
Stage 1	-	-	-	-	222 -
Stage 2	-	-	-	-	852 -
Critical Hdwy	4.13	-	-	-	6.43 6.23
Critical Hdwy Stg 1	-	-	-	-	5.43 -
Critical Hdwy Stg 2	-	-	-	-	5.43 -
Follow-up Hdwy	2.227	-	-	-	3.527 3.327
Pot Cap-1 Maneuver	1341	-	-	-	242 815
Stage 1	-	-	-	-	813 -
Stage 2	-	-	-	-	416 -
Platoon blocked, %		-	-	-	
Mov Cap-1 Maneuver	1341	-	-	-	191 815
Mov Cap-2 Maneuver	-	-	-	-	191 -
Stage 1	-	-	-	-	643 -
Stage 2	-	-	-	-	416 -

Approach	EB	WB	SB
HCM Control Delay, s	2.8	0	10.9
HCM LOS			B

Minor Lane/Major Mvmt	EBL	EBT	WBT	WBR	SBLn1
Capacity (veh/h)	1341	-	-	-	815
HCM Lane V/C Ratio	0.16	-	-	-	0.253
HCM Control Delay (s)	8.2	0	-	-	10.9
HCM Lane LOS	A	A	-	-	B
HCM 95th %tile Q(veh)	0.6	-	-	-	1

Intersection						
Int Delay, s/veh	4.3					
Movement	EBL	EBR	NBL	NBT	SBT	SBR
Lane Configurations	↙			↑	↗	
Traffic Vol, veh/h	177	0	0	81	3	189
Future Vol, veh/h	177	0	0	81	3	189
Conflicting Peds, #/hr	0	0	0	0	0	0
Sign Control	Stop	Stop	Free	Free	Free	Free
RT Channelized	-	None	-	None	-	None
Storage Length	0	-	-	-	-	-
Veh in Median Storage, #	0	-	-	0	0	-
Grade, %	0	-	-	0	0	-
Peak Hour Factor	92	92	92	92	92	92
Heavy Vehicles, %	2	2	9	9	3	3
Mvmt Flow	192	0	0	88	3	205

Major/Minor	Minor2	Major1		Major2	
Conflicting Flow All	194	-	-	0	0
Stage 1	106	-	-	-	-
Stage 2	88	-	-	-	-
Critical Hdwy	6.42	-	-	-	-
Critical Hdwy Stg 1	5.42	-	-	-	-
Critical Hdwy Stg 2	5.42	-	-	-	-
Follow-up Hdwy	3.518	-	-	-	-
Pot Cap-1 Maneuver	795	0	0	-	-
Stage 1	918	0	0	-	-
Stage 2	935	0	0	-	-
Platoon blocked, %				-	-
Mov Cap-1 Maneuver	795	-	-	-	-
Mov Cap-2 Maneuver	795	-	-	-	-
Stage 1	918	-	-	-	-
Stage 2	935	-	-	-	-

Approach	EB	NB	SB
HCM Control Delay, s	11	0	0
HCM LOS	B		

Minor Lane/Major Mvmt	NBT EBLn1	SBT	SBR
Capacity (veh/h)	- 795	-	-
HCM Lane V/C Ratio	- 0.242	-	-
HCM Control Delay (s)	- 11	-	-
HCM Lane LOS	- B	-	-
HCM 95th %tile Q(veh)	- 0.9	-	-

Intersection						
Int Delay, s/veh	0.1					
Movement	EBL	EBT	WBT	WBR	SBL	SBR
Lane Configurations		↶	↷		↶	
Traffic Vol, veh/h	0	388	204	75	3	0
Future Vol, veh/h	0	388	204	75	3	0
Conflicting Peds, #/hr	0	0	0	0	0	0
Sign Control	Free	Free	Free	Free	Stop	Stop
RT Channelized	-	None	-	None	-	None
Storage Length	-	-	-	-	0	-
Veh in Median Storage, #	-	0	0	-	0	-
Grade, %	-	0	0	-	0	-
Peak Hour Factor	92	92	92	92	92	92
Heavy Vehicles, %	4	4	3	3	0	0
Mvmt Flow	0	422	222	82	3	0

Major/Minor	Major1	Major2	Minor2		
Conflicting Flow All	304	0	-	0	685
Stage 1	-	-	-	-	263
Stage 2	-	-	-	-	422
Critical Hdwy	4.14	-	-	-	6.4
Critical Hdwy Stg 1	-	-	-	-	5.4
Critical Hdwy Stg 2	-	-	-	-	5.4
Follow-up Hdwy	2.236	-	-	-	3.5
Pot Cap-1 Maneuver	1246	-	-	-	417
Stage 1	-	-	-	-	786
Stage 2	-	-	-	-	666
Platoon blocked, %		-	-	-	
Mov Cap-1 Maneuver	1246	-	-	-	417
Mov Cap-2 Maneuver	-	-	-	-	417
Stage 1	-	-	-	-	786
Stage 2	-	-	-	-	666

Approach	EB	WB	SB
HCM Control Delay, s	0	0	13.7
HCM LOS			B

Minor Lane/Major Mvmt	EBL	EBT	WBT	WBR	SBLn1
Capacity (veh/h)	1246	-	-	-	417
HCM Lane V/C Ratio	-	-	-	-	0.008
HCM Control Delay (s)	0	-	-	-	13.7
HCM Lane LOS	A	-	-	-	B
HCM 95th %tile Q(veh)	0	-	-	-	0

HCM 6th Signalized Intersection Summary
29: Schnoor Avenue & Cleveland Avenue

Village D Specific Plan
Phase II WP - PM Peak Hour



Movement	EBL	EBT	EBR	WBL	WBT	WBR	NBL	NBT	NBR	SBL	SBT	SBR
Lane Configurations												
Traffic Volume (veh/h)	153	688	58	286	1094	119	94	246	155	126	238	141
Future Volume (veh/h)	153	688	58	286	1094	119	94	246	155	126	238	141
Initial Q (Qb), veh	0	0	0	0	0	0	0	0	0	0	0	0
Ped-Bike Adj(A_pbT)	1.00		0.98	1.00		0.98	1.00		0.98	1.00		0.99
Parking Bus, Adj	1.00	1.00	1.00	1.00	1.00	1.00	1.00	1.00	1.00	1.00	1.00	1.00
Work Zone On Approach		No			No			No			No	
Adj Sat Flow, veh/h/ln	1885	1885	1885	1885	1885	1885	1900	1900	1900	1885	1885	1885
Adj Flow Rate, veh/h	158	709	60	295	1128	123	97	254	160	130	245	145
Peak Hour Factor	0.97	0.97	0.97	0.97	0.97	0.97	0.97	0.97	0.97	0.97	0.97	0.97
Percent Heavy Veh, %	1	1	1	1	1	1	0	0	0	1	1	1
Cap, veh/h	192	912	397	720	1269	555	111	782	674	219	994	439
Arrive On Green	0.11	0.25	0.25	0.21	0.35	0.35	0.06	0.22	0.22	0.12	0.28	0.28
Sat Flow, veh/h	1795	3582	1561	3483	3582	1566	1810	3610	1572	1795	3582	1584
Grp Volume(v), veh/h	158	709	60	295	1128	123	97	254	160	130	245	145
Grp Sat Flow(s),veh/h/ln	1795	1791	1561	1742	1791	1566	1810	1805	1572	1795	1791	1584
Q Serve(g_s), s	7.8	16.6	2.1	6.6	26.7	3.3	4.8	5.3	0.0	6.2	4.8	6.6
Cycle Q Clear(g_c), s	7.8	16.6	2.1	6.6	26.7	3.3	4.8	5.3	0.0	6.2	4.8	6.6
Prop In Lane	1.00		1.00	1.00		1.00	1.00		1.00	1.00		1.00
Lane Grp Cap(c), veh/h	192	912	397	720	1269	555	111	782	674	219	994	439
V/C Ratio(X)	0.82	0.78	0.15	0.41	0.89	0.22	0.88	0.32	0.24	0.59	0.25	0.33
Avail Cap(c_a), veh/h	229	1297	565	720	1333	583	111	782	674	219	994	439
HCM Platoon Ratio	1.00	1.00	1.00	1.00	1.00	1.00	1.00	1.00	1.00	1.00	1.00	1.00
Upstream Filter(I)	1.00	1.00	1.00	0.24	0.24	0.24	1.00	1.00	1.00	1.00	1.00	1.00
Uniform Delay (d), s/veh	39.3	31.2	16.0	30.9	27.4	8.8	41.9	29.7	16.6	37.4	25.2	25.9
Incr Delay (d2), s/veh	18.1	2.0	0.2	0.1	2.0	0.0	49.5	1.1	0.8	4.3	0.6	2.0
Initial Q Delay(d3),s/veh	0.0	0.0	0.0	0.0	0.0	0.0	0.0	0.0	0.0	0.0	0.0	0.0
%ile BackOfQ(50%),veh/ln	4.3	7.2	1.0	2.7	11.3	1.7	3.6	2.4	2.2	2.9	2.1	2.7
Unsig. Movement Delay, s/veh												
LnGrp Delay(d),s/veh	57.4	33.1	16.1	31.0	29.4	8.8	91.4	30.8	17.4	41.7	25.8	27.9
LnGrp LOS	E	C	B	C	C	A	F	C	B	D	C	C
Approach Vol, veh/h		927			1546			511			520	
Approach Delay, s/veh		36.2			28.0			38.1			30.4	
Approach LOS		D			C			D			C	
Timer - Assigned Phs	1	2	3	4	5	6	7	8				
Phs Duration (G+Y+Rc), s	15.5	24.0	23.1	27.4	10.0	29.5	14.1	36.4				
Change Period (Y+Rc), s	4.5	4.5	4.5	4.5	4.5	4.5	4.5	4.5				
Max Green Setting (Gmax), s	7.5	19.5	12.4	32.6	5.5	21.5	11.5	33.5				
Max Q Clear Time (g_c+I1), s	8.2	7.3	8.6	18.6	6.8	8.6	9.8	28.7				
Green Ext Time (p_c), s	0.0	1.7	0.4	4.4	0.0	1.6	0.1	3.2				

Intersection Summary

HCM 6th Ctrl Delay	32.0
HCM 6th LOS	C

HCM 6th Signalized Intersection Summary
30: Fairgrounds & Cleveland Avenue

Village D Specific Plan
Phase II WP - PM Peak Hour



Movement	EBL	EBT	EBR	WBL	WBT	WBR	NBL	NBT	NBR	SBL	SBT	SBR
Lane Configurations	↑↑↑			↑↑		↑	↑↑	↑	↑	↑	↑	↑
Traffic Volume (veh/h)	100	804	94	171	1197	184	98	43	112	331	35	117
Future Volume (veh/h)	100	804	94	171	1197	184	98	43	112	331	35	117
Initial Q (Qb), veh	0	0	0	0	0	0	0	0	0	0	0	0
Ped-Bike Adj(A_pbT)	1.00		0.98	1.00		0.98	1.00		0.98	1.00		1.00
Parking Bus, Adj	1.00	1.00	1.00	1.00	1.00	1.00	1.00	1.00	1.00	1.00	1.00	1.00
Work Zone On Approach	No			No			No			No		
Adj Sat Flow, veh/h/ln	1885	1885	1885	1885	1885	1885	1900	1900	1900	1900	1900	1900
Adj Flow Rate, veh/h	105	846	99	180	1260	194	103	100	82	348	37	123
Peak Hour Factor	0.95	0.95	0.95	0.95	0.95	0.95	0.95	0.95	0.95	0.95	0.95	0.95
Percent Heavy Veh, %	1	1	1	1	1	1	0	0	0	0	0	0
Cap, veh/h	130	1467	171	213	1293	564	257	391	325	292	114	378
Arrive On Green	0.14	0.63	0.63	0.16	0.48	0.48	0.07	0.21	0.21	0.16	0.30	0.30
Sat Flow, veh/h	1795	4666	543	1795	3582	1562	3619	1900	1582	1810	385	1280
Grp Volume(v), veh/h	105	621	324	180	1260	194	103	100	82	348	0	160
Grp Sat Flow(s),veh/h/ln	1795	1716	1778	1795	1791	1562	1810	1900	1582	1810	0	1665
Q Serve(g_s), s	5.1	9.5	9.6	8.8	30.9	7.0	2.4	4.0	2.8	14.5	0.0	6.7
Cycle Q Clear(g_c), s	5.1	9.5	9.6	8.8	30.9	7.0	2.4	4.0	2.8	14.5	0.0	6.7
Prop In Lane	1.00		0.31	1.00		1.00	1.00		1.00	1.00		0.77
Lane Grp Cap(c), veh/h	130	1079	559	213	1293	564	257	391	325	292	0	492
V/C Ratio(X)	0.81	0.58	0.58	0.84	0.97	0.34	0.40	0.26	0.25	1.19	0.00	0.33
Avail Cap(c_a), veh/h	130	1079	559	237	1293	564	257	391	325	292	0	492
HCM Platoon Ratio	2.00	2.00	2.00	1.33	1.33	1.33	1.00	1.00	1.00	1.00	1.00	1.00
Upstream Filter(I)	0.71	0.71	0.71	0.54	0.54	0.54	1.00	1.00	1.00	1.00	0.00	1.00
Uniform Delay (d), s/veh	37.9	13.2	13.2	37.1	23.0	16.8	40.0	30.0	15.7	37.8	0.0	24.7
Incr Delay (d2), s/veh	23.2	0.5	1.1	12.9	12.9	0.2	1.0	1.6	1.9	115.8	0.0	1.8
Initial Q Delay(d3),s/veh	0.0	0.0	0.0	0.0	0.0	0.0	0.0	0.0	0.0	0.0	0.0	0.0
%ile BackOfQ(50%),veh/ln	2.9	2.7	2.9	4.4	13.1	0.0	1.1	2.0	1.6	15.7	0.0	2.8
Unsig. Movement Delay, s/veh												
LnGrp Delay(d),s/veh	61.1	13.7	14.3	49.9	35.9	16.9	41.0	31.6	17.6	153.5	0.0	26.5
LnGrp LOS	E	B	B	D	D	B	D	C	B	F	A	C
Approach Vol, veh/h	1050			1634			285			508		
Approach Delay, s/veh	18.6			35.2			30.9			113.5		
Approach LOS	B			D			C			F		
Timer - Assigned Phs	1	2	3	4	5	6	7	8				
Phs Duration (G+Y+Rc), s	19.0	23.0	15.2	32.8	10.9	31.1	11.0	37.0				
Change Period (Y+Rc), s	4.5	4.5	4.5	4.5	4.5	4.5	4.5	4.5				
Max Green Setting (Gmax), s	14.5	18.5	11.9	27.1	6.4	26.6	6.5	32.5				
Max Q Clear Time (g_c+10), s	10.5	6.0	10.8	11.6	4.4	8.7	7.1	32.9				
Green Ext Time (p_c), s	0.0	0.6	0.1	5.7	0.0	0.8	0.0	0.0				

Intersection Summary

HCM 6th Ctrl Delay	41.3
HCM 6th LOS	D

Notes

User approved volume balancing among the lanes for turning movement.

HCM 6th Signalized Intersection Summary

31: SR-99 Southbound Ramps & Cleveland Avenue

Village D Specific Plan
Phase II WP - PM Peak Hour



Movement	EBL	EBT	EBR	WBL	WBT	WBR	NBL	NBT	NBR	SBL	SBT	SBR
Lane Configurations		↑↑	↑	↑	↑↑					↑		↑
Traffic Volume (veh/h)	0	924	522	318	1801	0	0	0	0	243	0	97
Future Volume (veh/h)	0	924	522	318	1801	0	0	0	0	243	0	97
Initial Q (Qb), veh	0	0	0	0	0	0				0	0	0
Ped-Bike Adj(A_pbT)	1.00		1.00	1.00		1.00				1.00		1.00
Parking Bus, Adj	1.00	1.00	1.00	1.00	1.00	1.00				1.00	1.00	1.00
Work Zone On Approach		No			No						No	
Adj Sat Flow, veh/h/ln	0	1885	1885	1900	1900	0				1856	0	1856
Adj Flow Rate, veh/h	0	953	538	328	1857	0				251	0	100
Peak Hour Factor	0.97	0.97	0.97	0.97	0.97	0.97				0.97	0.97	0.97
Percent Heavy Veh, %	0	1	1	0	0	0				3	0	3
Cap, veh/h	0	1371	609	355	2271	0				479	0	426
Arrive On Green	0.00	0.38	0.38	0.39	1.00	0.00				0.27	0.00	0.27
Sat Flow, veh/h	0	3676	1591	1810	3705	0				1767	0	1572
Grp Volume(v), veh/h	0	953	538	328	1857	0				251	0	100
Grp Sat Flow(s),veh/h/ln	0	1791	1591	1810	1805	0				1767	0	1572
Q Serve(g_s), s	0.0	20.1	28.4	15.5	0.0	0.0				10.9	0.0	4.5
Cycle Q Clear(g_c), s	0.0	20.1	28.4	15.5	0.0	0.0				10.9	0.0	4.5
Prop In Lane	0.00		1.00	1.00		0.00				1.00		1.00
Lane Grp Cap(c), veh/h	0	1371	609	355	2271	0				479	0	426
V/C Ratio(X)	0.00	0.69	0.88	0.92	0.82	0.00				0.52	0.00	0.23
Avail Cap(c_a), veh/h	0	1453	645	372	2387	0				479	0	426
HCM Platoon Ratio	1.00	1.00	1.00	2.00	2.00	1.00				1.00	1.00	1.00
Upstream Filter(I)	0.00	0.61	0.61	0.18	0.18	0.00				1.00	0.00	1.00
Uniform Delay (d), s/veh	0.0	23.4	25.9	26.7	0.0	0.0				27.9	0.0	25.5
Incr Delay (d2), s/veh	0.0	0.8	8.6	7.4	0.4	0.0				4.1	0.0	1.3
Initial Q Delay(d3),s/veh	0.0	0.0	0.0	0.0	0.0	0.0				0.0	0.0	0.0
%ile BackOfQ(50%),veh/ln	0.0	8.3	11.7	5.7	0.1	0.0				5.0	0.0	1.8
Unsig. Movement Delay, s/veh												
LnGrp Delay(d),s/veh	0.0	24.2	34.5	34.1	0.4	0.0				31.9	0.0	26.8
LnGrp LOS	A	C	C	C	A	A				C	A	C
Approach Vol, veh/h		1491			2185						351	
Approach Delay, s/veh		27.9			5.5						30.5	
Approach LOS		C			A						C	
Timer - Assigned Phs			3	4		6		8				
Phs Duration (G+Y+Rc), s			22.2	39.0		28.9		61.1				
Change Period (Y+Rc), s			4.5	4.5		4.5		4.5				
Max Green Setting (Gmax), s			18.5	36.5		21.5		59.5				
Max Q Clear Time (g_c+1), s			17.5	30.4		12.9		2.0				
Green Ext Time (p_c), s			0.1	4.1		0.7		27.8				
Intersection Summary												
HCM 6th Ctrl Delay			16.0									
HCM 6th LOS			B									

HCM 6th Signalized Intersection Summary
 32: SR-99 Northbound Ramps & Cleveland Avenue

Village D Specific Plan
 Phase II WP - PM Peak Hour



Movement	EBL	EBT	EBR	WBL	WBT	WBR	NBL	NBT	NBR	SBL	SBT	SBR
Lane Configurations	↘	↑↑			↑↑	↗	↘	↖	↗			
Traffic Volume (veh/h)	107	1058	0	0	1200	188	924	6	321	0	0	0
Future Volume (veh/h)	107	1058	0	0	1200	188	924	6	321	0	0	0
Initial Q (Qb), veh	0	0	0	0	0	0	0	0	0			
Ped-Bike Adj(A_pbT)	1.00		1.00	1.00		0.99	1.00		0.99			
Parking Bus, Adj	1.00	1.00	1.00	1.00	1.00	1.00	1.00	1.00	1.00			
Work Zone On Approach	No				No				No			
Adj Sat Flow, veh/h/ln	1885	1885	0	0	1885	1885	1900	1900	1900			
Adj Flow Rate, veh/h	113	1114	0	0	1263	198	977	0	338			
Peak Hour Factor	0.95	0.95	0.95	0.95	0.95	0.95	0.95	0.95	0.95			
Percent Heavy Veh, %	1	1	0	0	1	1	0	0	0			
Cap, veh/h	142	1637	0	0	1174	519	1603	0	703			
Arrive On Green	0.16	0.91	0.00	0.00	0.33	0.33	0.44	0.00	0.44			
Sat Flow, veh/h	1795	3676	0	0	3676	1583	3619	0	1588			
Grp Volume(v), veh/h	113	1114	0	0	1263	198	977	0	338			
Grp Sat Flow(s),veh/h/ln	1795	1791	0	0	1791	1583	1810	0	1588			
Q Serve(g_s), s	5.5	6.4	0.0	0.0	29.5	8.6	18.5	0.0	13.6			
Cycle Q Clear(g_c), s	5.5	6.4	0.0	0.0	29.5	8.6	18.5	0.0	13.6			
Prop In Lane	1.00		0.00	0.00		1.00	1.00		1.00			
Lane Grp Cap(c), veh/h	142	1637	0	0	1174	519	1603	0	703			
V/C Ratio(X)	0.79	0.68	0.00	0.00	1.08	0.38	0.61	0.00	0.48			
Avail Cap(c_a), veh/h	289	1930	0	0	1174	519	1603	0	703			
HCM Platoon Ratio	2.00	2.00	1.00	1.00	1.00	1.00	1.00	1.00	1.00			
Upstream Filter(I)	0.68	0.68	0.00	0.00	0.45	0.45	1.00	0.00	1.00			
Uniform Delay (d), s/veh	37.2	2.4	0.0	0.0	30.3	23.2	19.1	0.0	17.7			
Incr Delay (d2), s/veh	6.7	0.5	0.0	0.0	42.0	0.2	1.7	0.0	2.3			
Initial Q Delay(d3),s/veh	0.0	0.0	0.0	0.0	0.0	0.0	0.0	0.0	0.0			
%ile BackOfQ(50%),veh/ln	2.5	1.1	0.0	0.0	19.0	3.2	7.8	0.0	5.2			
Unsig. Movement Delay, s/veh												
LnGrp Delay(d),s/veh	43.8	2.9	0.0	0.0	72.3	23.4	20.9	0.0	20.1			
LnGrp LOS	D	A	A	A	F	C	C	A	C			
Approach Vol, veh/h	1227				1461				1315			
Approach Delay, s/veh	6.7				65.7				20.7			
Approach LOS	A				E				C			
Timer - Assigned Phs	2		4		7		8					
Phs Duration (G+Y+Rc), s	44.4		45.6		11.6		34.0					
Change Period (Y+Rc), s	4.5		4.5		4.5		4.5					
Max Green Setting (Gmax), s	32.5		48.5		14.5		29.5					
Max Q Clear Time (g_c+I1), s	20.5		8.4		7.5		31.5					
Green Ext Time (p_c), s	4.4		10.6		0.1		0.0					

Intersection Summary

HCM 6th Ctrl Delay	32.8
HCM 6th LOS	C

Notes

User approved volume balancing among the lanes for turning movement.

HCM 6th Signalized Intersection Summary
 33: Gateway Drive & Cleveland Avenue

Village D Specific Plan
 Phase II WP - PM Peak Hour



Movement	EBL	EBT	EBR	WBL	WBT	WBR	NBL	NBT	NBR	SBL	SBT	SBR
Lane Configurations	↖ ↗	↑ ↑ ↑	↖	↖ ↗	↑ ↑		↖ ↗	↑	↖	↖	↑ ↗	
Traffic Volume (veh/h)	16	1035	321	213	1026	151	340	140	276	207	161	23
Future Volume (veh/h)	16	1035	321	213	1026	151	340	140	276	207	161	23
Initial Q (Qb), veh	0	0	0	0	0	0	0	0	0	0	0	0
Ped-Bike Adj(A_pbT)	1.00		1.00	1.00		0.99	1.00		0.98	1.00		0.98
Parking Bus, Adj	1.00	1.00	1.00	1.00	1.00	1.00	1.00	1.00	1.00	1.00	1.00	1.00
Work Zone On Approach		No			No			No			No	
Adj Sat Flow, veh/h/ln	1870	1870	1870	1870	1870	1870	1885	1885	1885	1856	1856	1856
Adj Flow Rate, veh/h	17	1101	0	227	1091	161	362	149	294	220	171	24
Peak Hour Factor	0.94	0.94	0.94	0.94	0.94	0.94	0.94	0.94	0.94	0.94	0.94	0.94
Percent Heavy Veh, %	2	2	2	2	2	2	1	1	1	3	3	3
Cap, veh/h	114	1373		445	1175	173	639	423	351	314	679	94
Arrive On Green	0.04	0.54	0.00	0.13	0.38	0.38	0.18	0.22	0.22	0.18	0.22	0.22
Sat Flow, veh/h	1781	5106	1585	3456	3105	457	3483	1885	1565	1767	3103	428
Grp Volume(v), veh/h	17	1101	0	227	623	629	362	149	294	220	96	99
Grp Sat Flow(s),veh/h/ln	1781	1702	1585	1728	1777	1785	1742	1885	1565	1767	1763	1768
Q Serve(g_s), s	0.0	15.8	0.0	5.5	30.2	30.4	8.5	6.0	16.1	10.5	4.0	4.2
Cycle Q Clear(g_c), s	0.0	15.8	0.0	5.5	30.2	30.4	8.5	6.0	16.1	10.5	4.0	4.2
Prop In Lane	1.00		1.00	1.00		0.26	1.00		1.00	1.00		0.24
Lane Grp Cap(c), veh/h	114	1373		445	672	676	639	423	351	314	386	387
V/C Ratio(X)	0.15	0.80		0.51	0.93	0.93	0.57	0.35	0.84	0.70	0.25	0.26
Avail Cap(c_a), veh/h	179	1770		445	685	688	639	423	351	314	386	387
HCM Platoon Ratio	2.00	2.00	2.00	1.00	1.00	1.00	1.00	1.00	1.00	1.00	1.00	1.00
Upstream Filter(I)	0.75	0.75	0.00	0.89	0.89	0.89	1.00	1.00	1.00	1.00	1.00	1.00
Uniform Delay (d), s/veh	42.4	18.9	0.0	36.6	26.8	26.8	33.5	29.4	33.3	34.7	29.0	29.1
Incr Delay (d2), s/veh	0.4	1.6	0.0	0.9	17.1	17.6	1.2	2.3	20.6	6.7	1.5	1.6
Initial Q Delay(d3),s/veh	0.0	0.0	0.0	0.0	0.0	0.0	0.0	0.0	0.0	0.0	0.0	0.0
%ile BackOfQ(50%),veh/ln	0.4	4.3	0.0	2.3	15.4	15.6	3.6	2.9	8.0	5.0	1.9	1.9
Unsig. Movement Delay, s/veh												
LnGrp Delay(d),s/veh	42.9	20.5	0.0	37.4	43.9	44.4	34.7	31.7	53.9	41.5	30.6	30.7
LnGrp LOS	D	C		D	D	D	C	C	D	D	C	C
Approach Vol, veh/h		1118	A		1479			805			415	
Approach Delay, s/veh		20.8			43.1			41.1			36.4	
Approach LOS		C			D			D			D	
Timer - Assigned Phs	1	2	3	4	5	6	7	8				
Phs Duration (G+Y+Rc), s	31.0	24.2	6.2	38.6	20.5	24.7	16.1	28.7				
Change Period (Y+Rc), s	4.5	4.5	4.5	4.5	4.5	4.5	4.5	4.5				
Max Green Setting (Gmax), s	12.6	19.7	5.0	34.7	12.1	20.2	8.5	31.2				
Max Q Clear Time (g_c+10), s	10.5	6.2	2.0	32.4	12.5	18.1	7.5	17.8				
Green Ext Time (p_c), s	0.3	0.8	0.0	1.6	0.0	0.4	0.1	6.4				

Intersection Summary

HCM 6th Ctrl Delay	35.4
HCM 6th LOS	D

Notes

Unsignalized Delay for [EBR] is excluded from calculations of the approach delay and intersection delay.

HCM 6th Signalized Intersection Summary
34: Cleveland Avenue & County Club Drive

Village D Specific Plan
Phase II WP - PM Peak Hour



Movement	WBL	WBR	NBT	NBR	SBL	SBT
Lane Configurations	←←←		↑↑	↗	↖	↑↑↑
Traffic Volume (veh/h)	560	35	905	612	123	833
Future Volume (veh/h)	560	35	905	612	123	833
Initial Q (Qb), veh	0	0	0	0	0	0
Ped-Bike Adj(A_pbT)	1.00	1.00		1.00	1.00	
Parking Bus, Adj	1.00	1.00	1.00	1.00	1.00	1.00
Work Zone On Approach	No		No		No	
Adj Sat Flow, veh/h/ln	1900	1900	1870	1870	1870	1870
Adj Flow Rate, veh/h	624	0	953	0	129	877
Peak Hour Factor	0.95	0.95	0.95	0.95	0.95	0.95
Percent Heavy Veh, %	0	0	2	2	2	2
Cap, veh/h	765	341	2447		418	3516
Arrive On Green	0.21	0.00	0.69	0.00	0.69	0.69
Sat Flow, veh/h	3619	1610	3647	1585	589	5274
Grp Volume(v), veh/h	624	0	953	0	129	877
Grp Sat Flow(s),veh/h/ln	1810	1610	1777	1585	589	1702
Q Serve(g_s), s	14.8	0.0	10.3	0.0	10.7	5.8
Cycle Q Clear(g_c), s	14.8	0.0	10.3	0.0	21.0	5.8
Prop In Lane	1.00	1.00		1.00	1.00	
Lane Grp Cap(c), veh/h	765	341	2447		418	3516
V/C Ratio(X)	0.82	0.00	0.39		0.31	0.25
Avail Cap(c_a), veh/h	1428	635	2447		418	3516
HCM Platoon Ratio	1.00	1.00	1.00	1.00	1.00	1.00
Upstream Filter(I)	1.00	0.00	0.64	0.00	1.00	1.00
Uniform Delay (d), s/veh	33.8	0.0	6.0	0.0	10.4	5.3
Incr Delay (d2), s/veh	2.2	0.0	0.3	0.0	1.9	0.2
Initial Q Delay(d3),s/veh	0.0	0.0	0.0	0.0	0.0	0.0
%ile BackOfQ(50%),veh/ln	6.6	0.0	3.3	0.0	1.5	1.8
Unsig. Movement Delay, s/veh						
LnGrp Delay(d),s/veh	36.0	0.0	6.3	0.0	12.3	5.4
LnGrp LOS	D	A	A		B	A
Approach Vol, veh/h	624		953	A		1006
Approach Delay, s/veh	36.0		6.3			6.3
Approach LOS	D		A			A
Timer - Assigned Phs		2			6	8
Phs Duration (G+Y+Rc), s		66.5			66.5	23.5
Change Period (Y+Rc), s		4.5			4.5	4.5
Max Green Setting (Gmax), s		45.5			45.5	35.5
Max Q Clear Time (g_c+I1), s		12.3			23.0	16.8
Green Ext Time (p_c), s		8.2			8.0	2.3

Intersection Summary

HCM 6th Ctrl Delay	13.5
HCM 6th LOS	B

Notes

User approved volume balancing among the lanes for turning movement.
Unsignalized Delay for [NBR] is excluded from calculations of the approach delay and intersection delay.

Intersection						
Int Delay, s/veh	0.2					
Movement	EBL	EBR	NBL	NBT	SBT	SBR
Lane Configurations	T			T		
Traffic Vol, veh/h	2	17	5	898	871	1
Future Vol, veh/h	2	17	5	898	871	1
Conflicting Peds, #/hr	0	0	0	0	0	0
Sign Control	Stop	Stop	Free	Free	Free	Free
RT Channelized	-	None	-	None	-	None
Storage Length	0	-	-	-	-	-
Veh in Median Storage, #	0	-	-	0	0	-
Grade, %	0	-	-	0	0	-
Peak Hour Factor	94	94	94	94	94	94
Heavy Vehicles, %	0	0	1	1	1	1
Mvmt Flow	2	18	5	955	927	1

Major/Minor	Minor2	Major1		Major2	
Conflicting Flow All	1416	464	928	0	0
Stage 1	928	-	-	-	-
Stage 2	488	-	-	-	-
Critical Hdwy	6.8	6.9	4.12	-	-
Critical Hdwy Stg 1	5.8	-	-	-	-
Critical Hdwy Stg 2	5.8	-	-	-	-
Follow-up Hdwy	3.5	3.3	2.21	-	-
Pot Cap-1 Maneuver	*278	550	739	-	-
Stage 1	*350	-	-	-	-
Stage 2	*688	-	-	-	-
Platoon blocked, %	1	-	-	-	-
Mov Cap-1 Maneuver	*274	550	739	-	-
Mov Cap-2 Maneuver	*305	-	-	-	-
Stage 1	*345	-	-	-	-
Stage 2	*688	-	-	-	-

Approach	EB	NB	SB
HCM Control Delay, s	12.4	0.2	0
HCM LOS	B		

Minor Lane/Major Mvmt	NBL	NBT	EBLn1	SBT	SBR
Capacity (veh/h)	739	-	507	-	-
HCM Lane V/C Ratio	0.007	-	0.04	-	-
HCM Control Delay (s)	9.9	0.1	12.4	-	-
HCM Lane LOS	A	A	B	-	-
HCM 95th %tile Q(veh)	0	-	0.1	-	-

Notes
 -: Volume exceeds capacity \$: Delay exceeds 300s +: Computation Not Defined *: All major volume in platoon

HCM 6th Signalized Intersection Summary
36: Pine Street & Howard Road

Village D Specific Plan
Phase II WP - PM Peak Hour



Movement	EBL	EBT	EBR	WBL	WBT	WBR	NBL	NBT	NBR	SBL	SBT	SBR
Lane Configurations												
Traffic Volume (veh/h)	88	643	135	103	582	4	210	188	160	17	157	120
Future Volume (veh/h)	88	643	135	103	582	4	210	188	160	17	157	120
Initial Q (Qb), veh	0	0	0	0	0	0	0	0	0	0	0	0
Ped-Bike Adj(A_pbT)	1.00		0.95	1.00		0.93	1.00		0.99	1.00		1.00
Parking Bus, Adj	1.00	1.00	1.00	1.00	1.00	1.00	1.00	1.00	1.00	1.00	1.00	1.00
Work Zone On Approach		No			No			No			No	
Adj Sat Flow, veh/h/ln	1870	1870	1870	1885	1885	1885	1885	1885	1885	1870	1870	1870
Adj Flow Rate, veh/h	95	691	145	111	626	4	226	202	172	18	169	129
Peak Hour Factor	0.93	0.93	0.93	0.93	0.93	0.93	0.93	0.93	0.93	0.93	0.93	0.93
Percent Heavy Veh, %	2	2	2	1	1	1	1	1	1	2	2	2
Cap, veh/h	234	798	167	130	790	5	580	609	510	23	217	204
Arrive On Green	0.13	0.28	0.28	0.07	0.22	0.22	0.32	0.32	0.32	0.13	0.13	0.13
Sat Flow, veh/h	1781	2892	606	1795	3647	23	1795	1885	1577	179	1682	1585
Grp Volume(v), veh/h	95	424	412	111	307	323	226	202	172	187	0	129
Grp Sat Flow(s),veh/h/ln	1781	1777	1722	1795	1791	1879	1795	1885	1577	1861	0	1585
Q Serve(g_s), s	4.4	20.4	20.5	5.5	14.6	14.6	8.8	7.3	7.5	8.8	0.0	6.9
Cycle Q Clear(g_c), s	4.4	20.4	20.5	5.5	14.6	14.6	8.8	7.3	7.5	8.8	0.0	6.9
Prop In Lane	1.00		0.35	1.00		0.01	1.00		1.00	0.10		1.00
Lane Grp Cap(c), veh/h	234	490	475	130	388	407	580	609	510	240	0	204
V/C Ratio(X)	0.41	0.87	0.87	0.86	0.79	0.79	0.39	0.33	0.34	0.78	0.00	0.63
Avail Cap(c_a), veh/h	234	543	526	130	547	574	580	609	510	372	0	317
HCM Platoon Ratio	1.00	1.00	1.00	1.00	1.00	1.00	1.00	1.00	1.00	1.00	1.00	1.00
Upstream Filter(I)	1.00	1.00	1.00	0.91	0.91	0.91	1.00	1.00	1.00	1.00	0.00	1.00
Uniform Delay (d), s/veh	35.9	31.0	31.0	41.3	33.3	33.3	23.6	23.1	23.1	38.0	0.0	37.2
Incr Delay (d2), s/veh	1.1	12.9	13.3	37.0	4.8	4.6	2.0	1.5	1.8	5.5	0.0	3.2
Initial Q Delay(d3),s/veh	0.0	0.0	0.0	0.0	0.0	0.0	0.0	0.0	0.0	0.0	0.0	0.0
%ile BackOfQ(50%),veh/ln	2.0	10.2	10.0	3.7	6.7	7.0	3.9	3.4	3.0	4.3	0.0	2.8
Unsig. Movement Delay, s/veh												
LnGrp Delay(d),s/veh	37.0	43.9	44.4	78.3	38.1	37.9	25.5	24.5	24.9	43.5	0.0	40.4
LnGrp LOS	D	D	D	E	D	D	C	C	C	D	A	D
Approach Vol, veh/h		931			741			600				316
Approach Delay, s/veh		43.4			44.1			25.0				42.2
Approach LOS		D			D			C				D
Timer - Assigned Phs		2	3	4		6	7	8				
Phs Duration (G+Y+Rc), s		33.6	11.0	29.3		16.1	16.3	24.0				
Change Period (Y+Rc), s		4.5	4.5	4.5		4.5	4.5	4.5				
Max Green Setting (Gmax), s		20.0	6.5	27.5		18.0	6.5	27.5				
Max Q Clear Time (g_c+I1), s		10.8	7.5	22.5		10.8	6.4	16.6				
Green Ext Time (p_c), s		1.8	0.0	2.3		0.8	0.0	2.9				
Intersection Summary												
HCM 6th Ctrl Delay				39.2								
HCM 6th LOS				D								

HCM 6th Signalized Intersection Summary
 37: Olive Avenue/Q Street & Howard Road/Yosemite Avenue

Village D Specific Plan
 Phase II WP - PM Peak Hour



Movement	EBL	EBT	EBR	WBL	WBT	WBR	NBL	NBT	NBR	SBL	SBT	SBR
Lane Configurations	↘	↑↑	↗	↘	↑↑		↘	↗	↗	↘	↑	↗
Traffic Volume (veh/h)	7	459	334	13	369	14	381	75	13	17	57	2
Future Volume (veh/h)	7	459	334	13	369	14	381	75	13	17	57	2
Initial Q (Qb), veh	0	0	0	0	0	0	0	0	0	0	0	0
Ped-Bike Adj(A_pbT)	1.00		1.00	1.00		1.00	1.00		0.99	1.00		0.99
Parking Bus, Adj	1.00	1.00	1.00	1.00	1.00	1.00	1.00	1.00	1.00	1.00	1.00	1.00
Work Zone On Approach		No			No			No			No	
Adj Sat Flow, veh/h/ln	1870	1870	1870	1885	1885	1885	1900	1900	1900	1885	1885	1885
Adj Flow Rate, veh/h	8	499	0	14	401	15	473	0	14	18	62	2
Peak Hour Factor	0.92	0.92	0.92	0.92	0.92	0.92	0.92	0.92	0.92	0.92	0.92	0.92
Percent Heavy Veh, %	2	2	2	1	1	1	0	0	0	1	1	1
Cap, veh/h	18	619		100	774	29	1871	0	821	96	100	84
Arrive On Green	0.00	0.06	0.00	0.06	0.22	0.22	0.52	0.00	0.52	0.05	0.05	0.05
Sat Flow, veh/h	1781	3554	1585	1795	3520	131	3619	0	1588	1795	1885	1580
Grp Volume(v), veh/h	8	499	0	14	204	212	473	0	14	18	62	2
Grp Sat Flow(s),veh/h/ln	1781	1777	1585	1795	1791	1861	1810	0	1588	1795	1885	1580
Q Serve(g_s), s	0.4	12.5	0.0	0.7	9.0	9.0	6.5	0.0	0.4	0.9	2.9	0.1
Cycle Q Clear(g_c), s	0.4	12.5	0.0	0.7	9.0	9.0	6.5	0.0	0.4	0.9	2.9	0.1
Prop In Lane	1.00		1.00	1.00		0.07	1.00		1.00	1.00		1.00
Lane Grp Cap(c), veh/h	18	619		100	394	409	1871	0	821	96	100	84
V/C Ratio(X)	0.45	0.81		0.14	0.52	0.52	0.25	0.00	0.02	0.19	0.62	0.02
Avail Cap(c_a), veh/h	99	711		359	617	641	1871	0	821	359	377	316
HCM Platoon Ratio	0.33	0.33	0.33	1.00	1.00	1.00	1.00	1.00	1.00	1.00	1.00	1.00
Upstream Filter(I)	0.58	0.58	0.00	1.00	1.00	1.00	1.00	0.00	1.00	1.00	1.00	1.00
Uniform Delay (d), s/veh	44.6	40.9	0.0	40.5	30.9	30.9	12.1	0.0	10.6	40.7	41.7	40.4
Incr Delay (d2), s/veh	9.7	3.6	0.0	0.6	1.1	1.0	0.3	0.0	0.0	0.9	6.0	0.1
Initial Q Delay(d3),s/veh	0.0	0.0	0.0	0.0	0.0	0.0	0.0	0.0	0.0	0.0	0.0	0.0
%ile BackOfQ(50%),veh/ln	0.2	6.2	0.0	0.3	3.9	4.1	2.6	0.0	0.1	0.4	1.5	0.0
Unsig. Movement Delay, s/veh												
LnGrp Delay(d),s/veh	54.3	44.5	0.0	41.1	32.0	31.9	12.4	0.0	10.6	41.7	47.7	40.5
LnGrp LOS	D	D		D	C	C	B	A	B	D	D	D
Approach Vol, veh/h		507	A		430		487				82	
Approach Delay, s/veh		44.6			32.3		12.4				46.2	
Approach LOS		D			C		B				D	
Timer - Assigned Phs		2	3	4		6	7	8				
Phs Duration (G+Y+Rc), s		51.0	9.5	20.2		9.3	5.4	24.3				
Change Period (Y+Rc), s		4.5	4.5	4.5		4.5	4.5	4.5				
Max Green Setting (Gmax), s		18.0	18.0	18.0		18.0	5.0	31.0				
Max Q Clear Time (g_c+I1), s		8.5	2.7	14.5		4.9	2.4	11.0				
Green Ext Time (p_c), s		1.3	0.0	1.1		0.2	0.0	2.3				

Intersection Summary

HCM 6th Ctrl Delay	30.7
HCM 6th LOS	C

Notes

User approved volume balancing among the lanes for turning movement.
 Unsignalized Delay for [EBR] is excluded from calculations of the approach delay and intersection delay.

HCM 6th TWSC
 38: I Street & 2nd Street/SR-99 Southbound Off-Ramp

Intersection												
Int Delay, s/veh	11											
Movement	EBL	EBT	EBR	WBL	WBT	WBR	NBL	NBT	NBR	SBL	SBT	SBR
Lane Configurations		↕			↕	↕	↕	↕			↕	
Traffic Vol, veh/h	0	0	40	321	13	5	50	154	0	0	119	0
Future Vol, veh/h	0	0	40	321	13	5	50	154	0	0	119	0
Conflicting Peds, #/hr	0	0	0	0	0	0	1	0	1	1	0	1
Sign Control	Stop	Stop	Stop	Stop	Stop	Stop	Free	Free	Free	Free	Free	Free
RT Channelized	-	-	None	-	-	Stop	-	-	None	-	-	None
Storage Length	-	-	-	-	-	50	75	-	-	-	-	-
Veh in Median Storage, #	-	0	-	-	0	-	-	0	-	-	0	-
Grade, %	-	0	-	-	0	-	-	0	-	-	0	-
Peak Hour Factor	98	98	98	98	98	98	98	98	98	98	98	98
Heavy Vehicles, %	0	0	0	2	2	2	0	0	0	0	0	0
Mvmt Flow	0	0	41	328	13	5	51	157	0	0	121	0

Major/Minor	Minor2		Minor1		Major1		Major2					
Conflicting Flow All	388	381	122	401	381	157	122	0	-	-	-	0
Stage 1	122	122	-	259	259	-	-	-	-	-	-	-
Stage 2	266	259	-	142	122	-	-	-	-	-	-	-
Critical Hdwy	7.1	6.5	6.2	7.12	6.52	6.22	4.1	-	-	-	-	-
Critical Hdwy Stg 1	6.1	5.5	-	6.12	5.52	-	-	-	-	-	-	-
Critical Hdwy Stg 2	6.1	5.5	-	6.12	5.52	-	-	-	-	-	-	-
Follow-up Hdwy	3.5	4	3.3	3.518	4.018	3.318	2.2	-	-	-	-	-
Pot Cap-1 Maneuver	620	584	935	604	581	962	1478	-	0	0	-	-
Stage 1	887	799	-	792	714	-	-	-	0	0	-	-
Stage 2	788	718	-	861	795	-	-	-	0	0	-	-
Platoon blocked, %	1	1		1	1	1		-			-	-
Mov Cap-1 Maneuver	589	563	934	562	560	962	1477	-	-	-	-	-
Mov Cap-2 Maneuver	589	563	-	562	560	-	-	-	-	-	-	-
Stage 1	856	798	-	764	689	-	-	-	-	-	-	-
Stage 2	742	693	-	823	794	-	-	-	-	-	-	-

Approach	EB		WB		NB		SB			
HCM Control Delay, s	9		20.6		1.8		0			
HCM LOS	A		C							

Minor Lane/Major Mvmt	NBL	NBT	EBLn1	WBLn1	WBLn2	SBT	SBR
Capacity (veh/h)	1477	-	934	562	962	-	-
HCM Lane V/C Ratio	0.035	-	0.044	0.606	0.005	-	-
HCM Control Delay (s)	7.5	-	9	20.8	8.8	-	-
HCM Lane LOS	A	-	A	C	A	-	-
HCM 95th %tile Q(veh)	0.1	-	0.1	4	0	-	-

HCM 6th Signalized Intersection Summary
39: 4th Street & Sunset Avenue

Village D Specific Plan
Phase II WP - PM Peak Hour



Movement	EBL	EBR	NBL	NBT	SBT	SBR
Lane Configurations						
Traffic Volume (veh/h)	243	13	14	379	406	381
Future Volume (veh/h)	243	13	14	379	406	381
Initial Q (Qb), veh	0	0	0	0	0	0
Ped-Bike Adj(A_pbT)	1.00	1.00	1.00			1.00
Parking Bus, Adj	1.00	1.00	1.00	1.00	1.00	1.00
Work Zone On Approach	No			No	No	
Adj Sat Flow, veh/h/ln	1900	1900	1870	1870	1856	1856
Adj Flow Rate, veh/h	277	0	15	412	441	414
Peak Hour Factor	0.92	0.92	0.92	0.92	0.92	0.92
Percent Heavy Veh, %	0	0	2	2	3	3
Cap, veh/h	373	166	600	2868	789	830
Arrive On Green	0.10	0.00	0.34	0.81	0.85	0.85
Sat Flow, veh/h	3619	1610	1781	3647	1856	1571
Grp Volume(v), veh/h	277	0	15	412	441	414
Grp Sat Flow(s),veh/h/ln	1810	1610	1781	1777	1856	1571
Q Serve(g_s), s	7.4	0.0	0.6	2.5	6.8	6.9
Cycle Q Clear(g_c), s	7.4	0.0	0.6	2.5	6.8	6.9
Prop In Lane	1.00	1.00	1.00			1.00
Lane Grp Cap(c), veh/h	373	166	600	2868	789	830
V/C Ratio(X)	0.74	0.00	0.02	0.14	0.56	0.50
Avail Cap(c_a), veh/h	995	443	600	2868	789	830
HCM Platoon Ratio	1.00	1.00	1.00	1.00	2.00	2.00
Upstream Filter(I)	1.00	0.00	1.00	1.00	0.76	0.76
Uniform Delay (d), s/veh	43.6	0.0	22.2	2.1	4.8	3.3
Incr Delay (d2), s/veh	2.9	0.0	0.0	0.1	2.2	1.6
Initial Q Delay(d3),s/veh	0.0	0.0	0.0	0.0	0.0	0.0
%ile BackOfQ(50%),veh/ln	3.5	0.0	0.2	0.6	2.1	1.9
Unsig. Movement Delay, s/veh						
LnGrp Delay(d),s/veh	46.5	0.0	22.2	2.2	7.0	5.0
LnGrp LOS	D	A	C	A	A	A
Approach Vol, veh/h	277			427	855	
Approach Delay, s/veh	46.5			2.9	6.0	
Approach LOS	D			A	A	
Timer - Assigned Phs		2		4	5	6
Phs Duration (G+Y+Rc), s		85.2		14.8	38.2	47.0
Change Period (Y+Rc), s		4.5		4.5	4.5	4.5
Max Green Setting (Gmax), s		63.5		27.5	16.5	42.5
Max Q Clear Time (g_c+I1), s		4.5		9.4	2.6	8.9
Green Ext Time (p_c), s		3.1		0.9	0.0	4.8

Intersection Summary

HCM 6th Ctrl Delay	12.4
HCM 6th LOS	B

Notes

User approved volume balancing among the lanes for turning movement.

40: H Street & SR-99 Southbound On-Ramp/2nd Street Performance by movement

Movement	WBL	WBT	NBL	NBT	NBR	SBT	All
Denied Delay (hr)	0.0	0.0	0.0	0.0	0.0	0.0	0.0
Denied Del/Veh (s)	0.1	0.1	0.0	0.0	0.0	0.1	0.0
Total Delay (hr)	0.1	0.3	0.3	0.0	0.0	0.2	0.9
Total Del/Veh (s)	16.0	19.5	3.5	4.1	2.7	19.7	7.1
Stop Delay (hr)	0.1	0.2	0.0	0.0	0.0	0.1	0.5
Stop Del/Veh (s)	13.9	15.9	0.1	0.1	0.2	16.7	3.8

HCM 6th Signalized Intersection Summary
41: I Street & 4th Street

Village D Specific Plan
Phase II WP - PM Peak Hour



Movement	EBL	EBT	EBR	WBL	WBT	WBR	NBL	NBT	NBR	SBL	SBT	SBR
Lane Configurations												
Traffic Volume (veh/h)	38	583	62	61	528	113	102	73	252	200	170	146
Future Volume (veh/h)	38	583	62	61	528	113	102	73	252	200	170	146
Initial Q (Qb), veh	0	0	0	0	0	0	0	0	0	0	0	0
Ped-Bike Adj(A_pbT)	1.00		0.99	1.00		0.99	1.00		1.00	1.00		0.99
Parking Bus, Adj	1.00	1.00	1.00	1.00	1.00	1.00	1.00	1.00	1.00	1.00	1.00	1.00
Work Zone On Approach		No			No			No			No	
Adj Sat Flow, veh/h/ln	1856	1856	1856	1885	1885	1885	1885	1885	1885	1870	1870	1870
Adj Flow Rate, veh/h	41	634	67	66	574	123	111	79	274	217	185	159
Peak Hour Factor	0.92	0.92	0.92	0.92	0.92	0.92	0.92	0.92	0.92	0.92	0.92	0.92
Percent Heavy Veh, %	3	3	3	1	1	1	1	1	1	2	2	2
Cap, veh/h	76	748	79	86	696	149	389	443	375	543	604	505
Arrive On Green	0.04	0.23	0.23	0.05	0.24	0.24	0.22	0.23	0.23	0.30	0.32	0.32
Sat Flow, veh/h	1767	3215	339	1795	2931	626	1795	1885	1598	1781	1870	1564
Grp Volume(v), veh/h	41	347	354	66	350	347	111	79	274	217	185	159
Grp Sat Flow(s),veh/h/ln	1767	1763	1791	1795	1791	1766	1795	1885	1598	1781	1870	1564
Q Serve(g_s), s	2.3	18.8	18.9	3.6	18.5	18.6	5.2	3.3	15.8	9.6	7.4	7.7
Cycle Q Clear(g_c), s	2.3	18.8	18.9	3.6	18.5	18.6	5.2	3.3	15.8	9.6	7.4	7.7
Prop In Lane	1.00		0.19	1.00		0.35	1.00		1.00	1.00		1.00
Lane Grp Cap(c), veh/h	76	410	417	86	425	419	389	443	375	543	604	505
V/C Ratio(X)	0.54	0.85	0.85	0.77	0.82	0.83	0.29	0.18	0.73	0.40	0.31	0.31
Avail Cap(c_a), veh/h	115	485	493	171	546	539	389	443	375	543	604	505
HCM Platoon Ratio	1.00	1.00	1.00	1.00	1.00	1.00	1.00	1.00	1.00	1.00	1.00	1.00
Upstream Filter(I)	0.96	0.96	0.96	1.00	1.00	1.00	1.00	1.00	1.00	1.00	1.00	1.00
Uniform Delay (d), s/veh	46.9	36.7	36.7	47.1	36.1	36.2	32.7	30.5	35.3	27.5	25.4	25.5
Incr Delay (d2), s/veh	5.7	11.1	11.2	13.6	7.8	8.2	0.4	0.9	11.8	0.5	1.3	1.6
Initial Q Delay(d3),s/veh	0.0	0.0	0.0	0.0	0.0	0.0	0.0	0.0	0.0	0.0	0.0	0.0
%ile BackOfQ(50%),veh/ln	1.1	9.2	9.4	1.9	8.9	8.9	2.3	1.6	7.3	4.1	3.5	3.0
Unsig. Movement Delay, s/veh												
LnGrp Delay(d),s/veh	52.6	47.8	47.9	60.7	44.0	44.4	33.1	31.4	47.1	28.0	26.7	27.1
LnGrp LOS	D	D	D	E	D	D	C	C	D	C	C	C
Approach Vol, veh/h		742			763			464			561	
Approach Delay, s/veh		48.1			45.6			41.1			27.3	
Approach LOS		D			D			D			C	
Timer - Assigned Phs	1	2	3	4	5	6	7	8				
Phs Duration (G+Y+Rc), s	35.0	28.0	9.3	27.8	26.2	36.8	8.8	28.2				
Change Period (Y+Rc), s	4.5	4.5	4.5	4.5	4.5	4.5	4.5	4.5				
Max Green Setting (Gmax), s	21.5	23.5	9.5	27.5	12.7	32.3	6.5	30.5				
Max Q Clear Time (g_c+I), s	11.6	17.8	5.6	20.9	7.2	9.7	4.3	20.6				
Green Ext Time (p_c), s	0.4	0.7	0.0	2.4	0.1	1.6	0.0	3.1				

Intersection Summary

HCM 6th Ctrl Delay	41.5
HCM 6th LOS	D

HCM 6th Signalized Intersection Summary
 43: SR-99 Northbound Off-Ramp/H Street & 4th Street

Village D Specific Plan
 Phase II WP - PM Peak Hour



Movement	EBL	EBT	EBR	WBL	WBT	WBR	NBL	NBT	NBR	SBL	SBT	SBR
Lane Configurations	↖	↗			↖	↗	↖	↗			↕	
Traffic Volume (veh/h)	300	432	0	0	551	182	270	33	187	29	0	83
Future Volume (veh/h)	300	432	0	0	551	182	270	33	187	29	0	83
Initial Q (Qb), veh	0	0	0	0	0	0	0	0	0	0	0	0
Ped-Bike Adj(A_pbT)	1.00		1.00	1.00		0.99	1.00		0.98	1.00		0.99
Parking Bus, Adj	1.00	1.00	1.00	1.00	1.00	1.00	1.00	1.00	1.00	1.00	1.00	1.00
Work Zone On Approach	No				No				No			
Adj Sat Flow, veh/h/ln	1885	1885	0	0	1885	1885	1885	1885	1885	1900	1900	1900
Adj Flow Rate, veh/h	319	460	0	0	586	194	287	35	199	31	0	88
Peak Hour Factor	0.94	0.94	0.94	0.94	0.94	0.94	0.94	0.94	0.94	0.94	0.94	0.94
Percent Heavy Veh, %	1	1	0	0	1	1	1	1	1	0	0	0
Cap, veh/h	349	1698	0	0	620	205	378	51	289	77	0	218
Arrive On Green	0.19	0.47	0.00	0.00	0.23	0.23	0.21	0.21	0.21	0.18	0.00	0.18
Sat Flow, veh/h	1795	3676	0	0	2732	871	1795	241	1372	427	0	1214
Grp Volume(v), veh/h	319	460	0	0	397	383	287	0	234	119	0	0
Grp Sat Flow(s),veh/h/ln	1795	1791	0	0	1791	1717	1795	0	1613	1641	0	0
Q Serve(g_s), s	17.4	7.7	0.0	0.0	21.8	21.9	15.0	0.0	13.4	6.4	0.0	0.0
Cycle Q Clear(g_c), s	17.4	7.7	0.0	0.0	21.8	21.9	15.0	0.0	13.4	6.4	0.0	0.0
Prop In Lane	1.00		0.00	0.00		0.51	1.00		0.85	0.26		0.74
Lane Grp Cap(c), veh/h	349	1698	0	0	421	404	378	0	340	295	0	0
V/C Ratio(X)	0.91	0.27	0.00	0.00	0.94	0.95	0.76	0.00	0.69	0.40	0.00	0.00
Avail Cap(c_a), veh/h	350	1701	0	0	421	404	378	0	340	295	0	0
HCM Platoon Ratio	1.00	1.00	1.00	1.00	1.00	1.00	1.00	1.00	1.00	1.00	1.00	1.00
Upstream Filter(I)	1.00	1.00	0.00	0.00	1.00	1.00	1.00	0.00	1.00	1.00	0.00	0.00
Uniform Delay (d), s/veh	39.5	15.9	0.0	0.0	37.6	37.6	37.1	0.0	36.4	36.2	0.0	0.0
Incr Delay (d2), s/veh	27.7	0.1	0.0	0.0	30.1	31.7	13.3	0.0	10.8	4.1	0.0	0.0
Initial Q Delay(d3),s/veh	0.0	0.0	0.0	0.0	0.0	0.0	0.0	0.0	0.0	0.0	0.0	0.0
%ile BackOfQ(50%),veh/ln	10.2	3.1	0.0	0.0	12.9	12.6	7.9	0.0	6.2	2.9	0.0	0.0
Unsig. Movement Delay, s/veh												
LnGrp Delay(d),s/veh	67.2	15.9	0.0	0.0	67.7	69.3	50.4	0.0	47.3	40.3	0.0	0.0
LnGrp LOS	E	B	A	A	E	E	D	A	D	D	A	A
Approach Vol, veh/h	779				780				521		119	
Approach Delay, s/veh	36.9				68.5				49.0		40.3	
Approach LOS	D				E				D		D	
Timer - Assigned Phs	2		4		6		7		8			
Phs Duration (G+Y+Rc), s	25.6		51.9		22.5		23.9		28.0			
Change Period (Y+Rc), s	4.5		4.5		4.5		4.5		4.5			
Max Green Setting (Gmax), s	21.0		47.5		18.0		19.5		23.5			
Max Q Clear Time (g_c+I1), s	17.0		9.7		8.4		19.4		23.9			
Green Ext Time (p_c), s	0.9		3.4		0.4		0.0		0.0			
Intersection Summary												
HCM 6th Ctrl Delay			51.2									
HCM 6th LOS			D									

Intersection						
Int Delay, s/veh	4.2					
Movement	EBL	EBT	WBT	WBR	SBL	SBR
Lane Configurations	↖	↗	↖		↖	↗
Traffic Vol, veh/h	89	518	494	110	157	110
Future Vol, veh/h	89	518	494	110	157	110
Conflicting Peds, #/hr	0	0	0	0	0	0
Sign Control	Free	Free	Free	Free	Stop	Stop
RT Channelized	-	None	-	None	-	None
Storage Length	145	-	-	-	65	0
Veh in Median Storage, #	-	0	0	-	0	-
Grade, %	-	0	0	-	0	-
Peak Hour Factor	95	95	95	95	95	95
Heavy Vehicles, %	2	2	1	1	1	1
Mvmt Flow	94	545	520	116	165	116

Major/Minor	Major1	Major2	Minor2		
Conflicting Flow All	636	0	-	0	1039 318
Stage 1	-	-	-	-	578 -
Stage 2	-	-	-	-	461 -
Critical Hdwy	4.14	-	-	-	6.82 6.92
Critical Hdwy Stg 1	-	-	-	-	5.82 -
Critical Hdwy Stg 2	-	-	-	-	5.82 -
Follow-up Hdwy	2.22	-	-	-	3.51 3.31
Pot Cap-1 Maneuver	1183	-	-	-	341 *902
Stage 1	-	-	-	-	775 -
Stage 2	-	-	-	-	604 -
Platoon blocked, %	1	-	-	-	1 1
Mov Cap-1 Maneuver	1183	-	-	-	314 *902
Mov Cap-2 Maneuver	-	-	-	-	314 -
Stage 1	-	-	-	-	714 -
Stage 2	-	-	-	-	604 -

Approach	EB	WB	SB
HCM Control Delay, s	1.2	0	20.7
HCM LOS			C

Minor Lane/Major Mvmt	EBL	EBT	WBT	WBR	SBLn1	SBLn2
Capacity (veh/h)	1183	-	-	-	314	902
HCM Lane V/C Ratio	0.079	-	-	-	0.526	0.128
HCM Control Delay (s)	8.3	-	-	-	28.5	9.6
HCM Lane LOS	A	-	-	-	D	A
HCM 95th %tile Q(veh)	0.3	-	-	-	2.9	0.4

Notes
 -: Volume exceeds capacity \$: Delay exceeds 300s +: Computation Not Defined *: All major volume in platoon

HCM 6th Signalized Intersection Summary
 45: Olive Avenue & SR-99 Southbound Off-Ramp

Village D Specific Plan
 Phase II WP - PM Peak Hour



Movement	EBL	EBT	WBT	WBR	SBL	SBR
Lane Configurations		↑↑↑	↑↑		↵	↵
Traffic Volume (veh/h)	0	675	514	0	610	90
Future Volume (veh/h)	0	675	514	0	610	90
Initial Q (Qb), veh	0	0	0	0	0	0
Ped-Bike Adj(A_pbT)	1.00			1.00	1.00	1.00
Parking Bus, Adj	1.00	1.00	1.00	1.00	1.00	1.00
Work Zone On Approach		No	No		No	
Adj Sat Flow, veh/h/ln	0	1885	1885	0	1841	1841
Adj Flow Rate, veh/h	0	711	541	0	642	95
Peak Hour Factor	0.95	0.95	0.95	0.95	0.95	0.95
Percent Heavy Veh, %	0	1	1	0	4	4
Cap, veh/h	0	930	647	0	1261	1122
Arrive On Green	0.00	0.18	0.18	0.00	0.72	0.72
Sat Flow, veh/h	0	5486	3770	0	1753	1560
Grp Volume(v), veh/h	0	711	541	0	642	95
Grp Sat Flow(s),veh/h/ln	0	1716	1791	0	1753	1560
Q Serve(g_s), s	0.0	11.8	13.1	0.0	14.6	1.6
Cycle Q Clear(g_c), s	0.0	11.8	13.1	0.0	14.6	1.6
Prop In Lane	0.00			0.00	1.00	1.00
Lane Grp Cap(c), veh/h	0	930	647	0	1261	1122
V/C Ratio(X)	0.00	0.76	0.84	0.00	0.51	0.08
Avail Cap(c_a), veh/h	0	1058	736	0	1261	1122
HCM Platoon Ratio	1.00	1.00	1.00	1.00	1.00	1.00
Upstream Filter(I)	0.00	1.00	0.86	0.00	1.00	1.00
Uniform Delay (d), s/veh	0.0	35.1	35.6	0.0	5.6	3.8
Incr Delay (d2), s/veh	0.0	3.0	6.6	0.0	1.5	0.1
Initial Q Delay(d3),s/veh	0.0	0.0	0.0	0.0	0.0	0.0
%ile BackOfQ(50%),veh/ln	0.0	5.1	6.2	0.0	4.7	0.5
Unsig. Movement Delay, s/veh						
LnGrp Delay(d),s/veh	0.0	38.0	42.1	0.0	7.1	3.9
LnGrp LOS	A	D	D	A	A	A
Approach Vol, veh/h		711	541		737	
Approach Delay, s/veh		38.0	42.1		6.7	
Approach LOS		D	D		A	
Timer - Assigned Phs				4	6	8
Phs Duration (G+Y+Rc), s				20.8	69.2	20.8
Change Period (Y+Rc), s				4.5	4.5	4.5
Max Green Setting (Gmax), s				18.5	62.5	18.5
Max Q Clear Time (g_c+I1), s				13.8	16.6	15.1
Green Ext Time (p_c), s				2.0	2.7	1.1
Intersection Summary						
HCM 6th Ctrl Delay			27.5			
HCM 6th LOS			C			

HCM 6th Signalized Intersection Summary

46: Madera Avenue & SR-99 Northbound Ramps

Village D Specific Plan
Phase II WP - PM Peak Hour



Movement	EBL	EBT	EBR	WBL	WBT	WBR	NBL	NBT	NBR	SBL	SBT	SBR
Lane Configurations				↶	↷	↶	↶	↶			↶	↶
Traffic Volume (veh/h)	0	0	0	226	1	33	791	714	0	0	663	236
Future Volume (veh/h)	0	0	0	226	1	33	791	714	0	0	663	236
Initial Q (Qb), veh				0	0	0	0	0	0	0	0	0
Ped-Bike Adj(A_pbT)				1.00		0.99	1.00		1.00	1.00		1.00
Parking Bus, Adj				1.00	1.00	1.00	1.00	1.00	1.00	1.00	1.00	1.00
Work Zone On Approach				No			No			No		
Adj Sat Flow, veh/h/ln				1885	1885	1885	1885	1885	0	0	1870	1870
Adj Flow Rate, veh/h				247	0	36	860	776	0	0	721	257
Peak Hour Factor				0.92	0.92	0.92	0.92	0.92	0.92	0.92	0.92	0.92
Percent Heavy Veh, %				1	1	1	1	1	0	0	2	2
Cap, veh/h				347	0	152	1254	2877	0	0	1009	360
Arrive On Green				0.10	0.00	0.10	0.60	1.00	0.00	0.00	0.39	0.39
Sat Flow, veh/h				3591	0	1575	3483	3676	0	0	2659	914
Grp Volume(v), veh/h				247	0	36	860	776	0	0	499	479
Grp Sat Flow(s),veh/h/ln				1795	0	1575	1742	1791	0	0	1777	1702
Q Serve(g_s), s				6.0	0.0	1.9	15.1	0.0	0.0	0.0	21.3	21.3
Cycle Q Clear(g_c), s				6.0	0.0	1.9	15.1	0.0	0.0	0.0	21.3	21.3
Prop In Lane				1.00		1.00	1.00		0.00	0.00		0.54
Lane Grp Cap(c), veh/h				347	0	152	1254	2877	0	0	699	670
V/C Ratio(X)				0.71	0.00	0.24	0.69	0.27	0.00	0.00	0.71	0.71
Avail Cap(c_a), veh/h				742	0	325	1254	2877	0	0	699	670
HCM Platoon Ratio				1.00	1.00	1.00	1.67	1.67	1.00	1.00	1.00	1.00
Upstream Filter(I)				1.00	0.00	1.00	0.66	0.66	0.00	0.00	1.00	1.00
Uniform Delay (d), s/veh				39.4	0.0	37.6	14.5	0.0	0.0	0.0	23.0	23.0
Incr Delay (d2), s/veh				2.7	0.0	0.8	1.0	0.2	0.0	0.0	6.2	6.4
Initial Q Delay(d3),s/veh				0.0	0.0	0.0	0.0	0.0	0.0	0.0	0.0	0.0
%ile BackOfQ(50%),veh/ln				2.7	0.0	0.8	4.3	0.1	0.0	0.0	9.7	9.4
Unsig. Movement Delay, s/veh												
LnGrp Delay(d),s/veh				42.1	0.0	38.4	15.5	0.2	0.0	0.0	29.2	29.4
LnGrp LOS				D	A	D	B	A	A	A	C	C
Approach Vol, veh/h					283			1636			978	
Approach Delay, s/veh					41.7			8.2			29.3	
Approach LOS					D			A			C	
Timer - Assigned Phs		2			5	6		8				
Phs Duration (G+Y+Rc), s		76.8			36.9	39.9		13.2				
Change Period (Y+Rc), s		4.5			4.5	4.5		4.5				
Max Green Setting (Gmax), s		62.4			22.5	35.4		18.6				
Max Q Clear Time (g_c+I1), s		2.0			17.1	23.3		8.0				
Green Ext Time (p_c), s		6.6			1.8	5.1		0.7				

Intersection Summary

HCM 6th Ctrl Delay	18.6
HCM 6th LOS	B

Notes

User approved volume balancing among the lanes for turning movement.

HCM 6th Signalized Intersection Summary
 47: Madera Avenue & Olive Avenue/SR-99 Southbound On-Ramp

Village D Specific Plan
 Phase II WP - PM Peak Hour



Movement	EBL	EBT	EBR	WBL	WBT	WBR	NBL	NBT	NBR	SBL	SBT	SBR
Lane Configurations												
Traffic Volume (veh/h)	475	213	597	0	0	0	175	1031	44	134	416	339
Future Volume (veh/h)	475	213	597	0	0	0	175	1031	44	134	416	339
Initial Q (Qb), veh	0	0	0				0	0	0	0	0	0
Ped-Bike Adj(A_pbT)	1.00		1.00				1.00		1.00	1.00		1.00
Parking Bus, Adj	1.00	1.00	1.00				1.00	1.00	1.00	1.00	1.00	1.00
Work Zone On Approach		No					No			No		
Adj Sat Flow, veh/h/ln	1856	1856	1856				1870	1870	1870	1885	1885	1885
Adj Flow Rate, veh/h	355	409	615				180	1063	45	138	429	349
Peak Hour Factor	0.97	0.97	0.97				0.97	0.97	0.97	0.97	0.97	0.97
Percent Heavy Veh, %	3	3	3				2	2	2	1	1	1
Cap, veh/h	481	505	545				257	1680	71	169	947	766
Arrive On Green	0.45	0.45	0.45				0.07	0.48	0.48	0.16	0.84	0.84
Sat Flow, veh/h	1767	1856	1571				3456	3474	147	1795	1881	1522
Grp Volume(v), veh/h	355	409	615				180	544	564	138	408	370
Grp Sat Flow(s),veh/h/ln	1767	1856	1571				1728	1777	1844	1795	1791	1611
Q Serve(g_s), s	14.8	17.1	24.5				4.6	20.5	20.5	6.7	5.3	5.3
Cycle Q Clear(g_c), s	14.8	17.1	24.5				4.6	20.5	20.5	6.7	5.3	5.3
Prop In Lane	1.00		1.00				1.00		0.08	1.00		0.94
Lane Grp Cap(c), veh/h	481	505	545				257	859	892	169	902	811
V/C Ratio(X)	0.74	0.81	1.13				0.70	0.63	0.63	0.82	0.45	0.46
Avail Cap(c_a), veh/h	481	505	545				403	859	892	209	902	811
HCM Platoon Ratio	1.67	1.67	1.67				1.00	1.00	1.00	1.67	1.67	1.67
Upstream Filter(I)	0.74	0.74	0.74				1.00	1.00	1.00	0.77	0.77	0.77
Uniform Delay (d), s/veh	21.9	22.5	22.9				40.7	17.3	17.3	37.2	4.0	4.0
Incr Delay (d2), s/veh	4.4	7.3	74.8				3.4	3.5	3.4	14.5	1.3	1.4
Initial Q Delay(d3),s/veh	0.0	0.0	0.0				0.0	0.0	0.0	0.0	0.0	0.0
%ile BackOfQ(50%),veh/ln	5.4	6.7	31.6				2.0	8.7	9.0	3.4	1.7	1.5
Unsig. Movement Delay, s/veh												
LnGrp Delay(d),s/veh	26.3	29.8	97.7				44.1	20.8	20.7	51.7	5.2	5.4
LnGrp LOS	C	C	F				D	C	C	D	A	A
Approach Vol, veh/h		1379						1288			916	
Approach Delay, s/veh		59.2						24.0			12.3	
Approach LOS		E						C			B	
Timer - Assigned Phs	1	2		4	5	6						
Phs Duration (G+Y+Rc), s	33.0	48.0		29.0	11.2	49.8						
Change Period (Y+Rc), s	4.5	4.5		4.5	4.5	4.5						
Max Green Setting (Gmax), s	40.5	41.5		24.5	10.5	41.5						
Max Q Clear Time (g_c+10), s	19.5	22.5		26.5	6.6	7.3						
Green Ext Time (p_c), s	0.1	7.4		0.0	0.2	5.9						

Intersection Summary

HCM 6th Ctrl Delay	34.6
HCM 6th LOS	C

Notes

User approved volume balancing among the lanes for turning movement.

Intersection						
Int Delay, s/veh	0.3					
Movement	WBL	WBR	NBT	NBR	SBL	SBT
Lane Configurations	↘↗		↑↑		↘	↑↑
Traffic Vol, veh/h	7	9	1284	7	32	1073
Future Vol, veh/h	7	9	1284	7	32	1073
Conflicting Peds, #/hr	0	0	0	2	2	0
Sign Control	Stop	Stop	Free	Free	Free	Free
RT Channelized	-	None	-	None	-	None
Storage Length	0	-	-	-	100	-
Veh in Median Storage, #	0	-	0	-	-	0
Grade, %	0	-	0	-	-	0
Peak Hour Factor	95	95	95	95	95	95
Heavy Vehicles, %	6	6	2	2	2	2
Mvmt Flow	7	9	1352	7	34	1129

Major/Minor	Minor1	Major1	Major2		
Conflicting Flow All	1991	682	0	0	1361
Stage 1	1358	-	-	-	-
Stage 2	633	-	-	-	-
Critical Hdwy	6.92	7.02	-	-	4.14
Critical Hdwy Stg 1	5.92	-	-	-	-
Critical Hdwy Stg 2	5.92	-	-	-	-
Follow-up Hdwy	3.56	3.36	-	-	2.22
Pot Cap-1 Maneuver	*85	383	-	-	501
Stage 1	*197	-	-	-	-
Stage 2	*612	-	-	-	-
Platoon blocked, %	1	-	-	-	-
Mov Cap-1 Maneuver	*79	382	-	-	500
Mov Cap-2 Maneuver	*159	-	-	-	-
Stage 1	*197	-	-	-	-
Stage 2	*570	-	-	-	-

Approach	WB	NB	SB
HCM Control Delay, s	21.3	0	0.4
HCM LOS	C		

Minor Lane/Major Mvmt	NBT	NBRWBLn1	SBL	SBT
Capacity (veh/h)	-	-	237	500
HCM Lane V/C Ratio	-	-	0.071	0.067
HCM Control Delay (s)	-	-	21.3	12.7
HCM Lane LOS	-	-	C	B
HCM 95th %tile Q(veh)	-	-	0.2	0.2

Notes
 -: Volume exceeds capacity \$: Delay exceeds 300s +: Computation Not Defined *: All major volume in platoon

HCM 6th Signalized Intersection Summary
 49: Yosemite Avenue & Cleveland Avenue/Tozer Street

Village D Specific Plan
 Phase II WP - PM Peak Hour



Movement	EBL	EBT	EBR	WBL	WBT	WBR	NBL	NBT	NBR	SBL	SBT	SBR
Lane Configurations	↖	↗		↖	↗	↗	↖	↗	↗	↖	↗	↗
Traffic Volume (veh/h)	272	452	200	51	492	44	315	314	98	78	181	313
Future Volume (veh/h)	272	452	200	51	492	44	315	314	98	78	181	313
Initial Q (Qb), veh	0	0	0	0	0	0	0	0	0	0	0	0
Ped-Bike Adj(A_pbT)	1.00		0.99	1.00		0.96	1.00		1.00	1.00		0.98
Parking Bus, Adj	1.00	1.00	1.00	1.00	1.00	1.00	1.00	1.00	1.00	1.00	1.00	1.00
Work Zone On Approach		No			No			No			No	
Adj Sat Flow, veh/h/ln	1870	1870	1870	1900	1900	1900	1885	1885	1885	1870	1870	1870
Adj Flow Rate, veh/h	296	491	217	55	535	48	342	341	107	85	197	340
Peak Hour Factor	0.92	0.92	0.92	0.92	0.92	0.92	0.92	0.92	0.92	0.92	0.92	0.92
Percent Heavy Veh, %	2	2	2	0	0	0	1	1	1	2	2	2
Cap, veh/h	287	753	331	71	697	298	343	763	645	109	167	288
Arrive On Green	0.16	0.31	0.31	0.04	0.19	0.19	0.19	0.40	0.40	0.06	0.28	0.28
Sat Flow, veh/h	1781	2392	1051	1810	3610	1542	1795	1885	1593	1781	608	1049
Grp Volume(v), veh/h	296	364	344	55	535	48	342	341	107	85	0	537
Grp Sat Flow(s),veh/h/ln	1781	1777	1665	1810	1805	1542	1795	1885	1593	1781	0	1657
Q Serve(g_s), s	16.1	17.7	17.8	3.0	14.0	2.6	19.0	13.1	4.3	4.7	0.0	27.5
Cycle Q Clear(g_c), s	16.1	17.7	17.8	3.0	14.0	2.6	19.0	13.1	4.3	4.7	0.0	27.5
Prop In Lane	1.00		0.63	1.00		1.00	1.00		1.00	1.00		0.63
Lane Grp Cap(c), veh/h	287	559	524	71	697	298	343	763	645	109	0	456
V/C Ratio(X)	1.03	0.65	0.66	0.77	0.77	0.16	1.00	0.45	0.17	0.78	0.00	1.18
Avail Cap(c_a), veh/h	287	559	524	103	697	298	343	763	645	173	0	456
HCM Platoon Ratio	1.00	1.00	1.00	1.00	1.00	1.00	1.00	1.00	1.00	1.00	1.00	1.00
Upstream Filter(I)	1.00	1.00	1.00	1.00	1.00	1.00	1.00	1.00	1.00	1.00	0.00	1.00
Uniform Delay (d), s/veh	42.0	29.5	29.6	47.6	38.2	33.6	40.4	21.6	19.0	46.3	0.0	36.3
Incr Delay (d2), s/veh	61.7	5.8	6.3	19.5	7.9	1.2	47.8	0.4	0.1	11.4	0.0	101.1
Initial Q Delay(d3),s/veh	0.0	0.0	0.0	0.0	0.0	0.0	0.0	0.0	0.0	0.0	0.0	0.0
%ile BackOfQ(50%),veh/ln	11.9	8.3	7.9	1.7	6.9	1.1	12.8	5.8	1.6	2.4	0.0	23.6
Unsig. Movement Delay, s/veh												
LnGrp Delay(d),s/veh	103.6	35.3	35.9	67.1	46.2	34.8	88.3	22.0	19.1	57.7	0.0	137.3
LnGrp LOS	F	D	D	E	D	C	F	C	B	E	A	F
Approach Vol, veh/h		1004			638			790			622	
Approach Delay, s/veh		55.7			47.1			50.3			126.4	
Approach LOS		E			D			D			F	
Timer - Assigned Phs	1	2	3	4	5	6	7	8				
Phs Duration (G+Y+Rc), s	20.6	23.8	10.6	45.0	8.4	36.0	23.6	32.0				
Change Period (Y+Rc), s	4.5	4.5	4.5	4.5	4.5	4.5	4.5	4.5				
Max Green Setting (Gmax), s	16.1	19.3	9.7	36.9	5.7	29.7	19.1	27.5				
Max Q Clear Time (g_c+I1), s	18.1	16.0	6.7	15.1	5.0	19.8	21.0	29.5				
Green Ext Time (p_c), s	0.0	1.2	0.0	2.4	0.0	3.2	0.0	0.0				
Intersection Summary												
HCM 6th Ctrl Delay			66.9									
HCM 6th LOS			E									

Intersection						
Int Delay, s/veh	0					
Movement	WBL	WBR	NBT	NBR	SBL	SBT
Lane Configurations						
Traffic Vol, veh/h	0	0	0	0	0	0
Future Vol, veh/h	0	0	0	0	0	0
Conflicting Peds, #/hr	0	0	0	0	0	0
Sign Control	Stop	Stop	Free	Free	Free	Free
RT Channelized	-	None	-	None	-	None
Storage Length	0	-	-	-	50	-
Veh in Median Storage, #	0	-	0	-	-	0
Grade, %	0	-	0	-	-	0
Peak Hour Factor	92	92	92	92	92	92
Heavy Vehicles, %	0	0	0	0	0	0
Mvmt Flow	0	0	0	0	0	0

Major/Minor	Minor1	Major1	Major2			
Conflicting Flow All	1	0	0	0	0	0
Stage 1	0	-	-	-	-	-
Stage 2	1	-	-	-	-	-
Critical Hdwy	6.4	6.2	-	-	4.1	-
Critical Hdwy Stg 1	5.4	-	-	-	-	-
Critical Hdwy Stg 2	5.4	-	-	-	-	-
Follow-up Hdwy	3.5	3.3	-	-	2.2	-
Pot Cap-1 Maneuver	1027	-	-	-	-	-
Stage 1	-	-	-	-	-	-
Stage 2	1028	-	-	-	-	-
Platoon blocked, %						
Mov Cap-1 Maneuver	1027	-	-	-	-	-
Mov Cap-2 Maneuver	1027	-	-	-	-	-
Stage 1	-	-	-	-	-	-
Stage 2	1028	-	-	-	-	-

Approach	WB	NB	SB
HCM Control Delay, s	0	0	0
HCM LOS	A		

Minor Lane/Major Mvmt	NBT	NBRWBLn1	SBL	SBT
Capacity (veh/h)	-	-	-	-
HCM Lane V/C Ratio	-	-	-	-
HCM Control Delay (s)	-	-	0	0
HCM Lane LOS	-	-	A	A
HCM 95th %tile Q(veh)	-	-	-	-

Intersection						
Int Delay, s/veh	10.7					
Movement	EBT	EBR	WBL	WBT	NBL	NBR
Lane Configurations						
Traffic Vol, veh/h	116	50	659	66	23	334
Future Vol, veh/h	116	50	659	66	23	334
Conflicting Peds, #/hr	0	0	0	0	0	0
Sign Control	Free	Free	Free	Free	Stop	Stop
RT Channelized	-	None	-	None	-	None
Storage Length	-	-	50	-	50	0
Veh in Median Storage, #	0	-	-	0	0	-
Grade, %	0	-	-	0	0	-
Peak Hour Factor	92	92	92	92	92	92
Heavy Vehicles, %	1	1	0	0	0	0
Mvmt Flow	126	54	716	72	25	363

Major/Minor	Major1	Major2	Minor1		
Conflicting Flow All	0	0	180	0	1657
Stage 1	-	-	-	-	153
Stage 2	-	-	-	-	1504
Critical Hdwy	-	-	4.1	-	6.4
Critical Hdwy Stg 1	-	-	-	-	5.4
Critical Hdwy Stg 2	-	-	-	-	5.4
Follow-up Hdwy	-	-	2.2	-	3.5
Pot Cap-1 Maneuver	-	-	1408	-	109
Stage 1	-	-	-	-	880
Stage 2	-	-	-	-	205
Platoon blocked, %	-	-	-	-	-
Mov Cap-1 Maneuver	-	-	1408	-	54
Mov Cap-2 Maneuver	-	-	-	-	54
Stage 1	-	-	-	-	880
Stage 2	-	-	-	-	101

Approach	EB	WB	NB
HCM Control Delay, s	0	9.2	18.7
HCM LOS			C

Minor Lane/Major Mvmt	NBLn1	NBLn2	EBT	EBR	WBL	WBT
Capacity (veh/h)	54	898	-	-	1408	-
HCM Lane V/C Ratio	0.463	0.404	-	-	0.509	-
HCM Control Delay (s)	119.6	11.7	-	-	10.2	-
HCM Lane LOS	F	B	-	-	B	-
HCM 95th %tile Q(veh)	1.7	2	-	-	3	-

Intersection												
Int Delay, s/veh	9.8											
Movement	EBL	EBT	EBR	WBL	WBT	WBR	NBL	NBT	NBR	SBL	SBT	SBR
Lane Configurations	↔	↔		↔	↔		↔	↔		↔	↔	
Traffic Vol, veh/h	0	151	0	0	15	403	0	38	0	319	38	0
Future Vol, veh/h	0	151	0	0	15	403	0	38	0	319	38	0
Conflicting Peds, #/hr	0	0	0	0	0	0	0	0	0	0	0	0
Sign Control	Free	Free	Free	Free	Free	Free	Stop	Stop	Stop	Stop	Stop	Stop
RT Channelized	-	-	None	-	-	None	-	-	None	-	-	None
Storage Length	50	-	-	50	-	-	50	-	-	50	-	-
Veh in Median Storage, #	-	0	-	-	0	-	-	0	-	-	0	-
Grade, %	-	0	-	-	0	-	-	0	-	-	0	-
Peak Hour Factor	92	92	92	92	92	92	92	92	92	92	92	92
Heavy Vehicles, %	13	13	13	1	1	1	0	0	0	0	0	0
Mvmt Flow	0	164	0	0	16	438	0	41	0	347	41	0

Major/Minor	Major1			Major2			Minor1			Minor2		
Conflicting Flow All	454	0	0	164	0	0	420	618	164	420	399	235
Stage 1	-	-	-	-	-	-	164	164	-	235	235	-
Stage 2	-	-	-	-	-	-	256	454	-	185	164	-
Critical Hdwy	4.23	-	-	4.11	-	-	7.1	6.5	6.2	7.1	6.5	6.2
Critical Hdwy Stg 1	-	-	-	-	-	-	6.1	5.5	-	6.1	5.5	-
Critical Hdwy Stg 2	-	-	-	-	-	-	6.1	5.5	-	6.1	5.5	-
Follow-up Hdwy	2.317	-	-	2.209	-	-	3.5	4	3.3	3.5	4	3.3
Pot Cap-1 Maneuver	1051	-	-	1421	-	-	547	408	886	547	542	809
Stage 1	-	-	-	-	-	-	843	766	-	773	714	-
Stage 2	-	-	-	-	-	-	753	573	-	821	766	-
Platoon blocked, %	-	-	-	-	-	-	-	-	-	-	-	-
Mov Cap-1 Maneuver	1051	-	-	1421	-	-	515	408	886	504	542	809
Mov Cap-2 Maneuver	-	-	-	-	-	-	515	408	-	504	542	-
Stage 1	-	-	-	-	-	-	843	766	-	773	714	-
Stage 2	-	-	-	-	-	-	709	573	-	777	766	-

Approach	EB			WB			NB			SB		
HCM Control Delay, s	0			0			14.8			24.9		
HCM LOS							B			C		

Minor Lane/Major Mvmt	NBLn1	NBLn2	EBL	EBT	EBR	WBL	WBT	WBR	SBLn1	SBLn2
Capacity (veh/h)	-	408	1051	-	-	1421	-	-	504	542
HCM Lane V/C Ratio	-	0.101	-	-	-	-	-	-	0.688	0.076
HCM Control Delay (s)	-	0	14.8	0	-	-	0	-	26.4	12.2
HCM Lane LOS	-	A	B	A	-	-	A	-	D	B
HCM 95th %tile Q(veh)	-	0.3	0	-	-	0	-	-	5.2	0.2

Intersection												
Int Delay, s/veh	4.4											
Movement	EBL	EBT	EBR	WBL	WBT	WBR	NBL	NBT	NBR	SBL	SBT	SBR
Lane Configurations	↔	↔		↔	↔		↔	↔		↔	↔	
Traffic Vol, veh/h	0	0	0	0	0	38	0	0	0	39	0	0
Future Vol, veh/h	0	0	0	0	0	38	0	0	0	39	0	0
Conflicting Peds, #/hr	0	0	0	0	0	0	0	0	0	0	0	0
Sign Control	Free	Free	Free	Free	Free	Free	Stop	Stop	Stop	Stop	Stop	Stop
RT Channelized	-	-	None	-	-	None	-	-	None	-	-	None
Storage Length	50	-	-	50	-	-	50	-	-	50	-	-
Veh in Median Storage, #	-	0	-	-	0	-	-	0	-	-	0	-
Grade, %	-	0	-	-	0	-	-	0	-	-	0	-
Peak Hour Factor	92	92	92	92	92	92	92	92	92	92	92	92
Heavy Vehicles, %	0	0	0	0	0	0	0	0	0	0	0	0
Mvmt Flow	0	0	0	0	0	41	0	0	0	42	0	0

Major/Minor	Major1			Major2			Minor1			Minor2		
Conflicting Flow All	41	0	0	1	0	0	22	42	1	22	22	21
Stage 1	-	-	-	-	-	-	1	1	-	21	21	-
Stage 2	-	-	-	-	-	-	21	41	-	1	1	-
Critical Hdwy	4.1	-	-	4.1	-	-	7.1	6.5	6.2	7.1	6.5	6.2
Critical Hdwy Stg 1	-	-	-	-	-	-	6.1	5.5	-	6.1	5.5	-
Critical Hdwy Stg 2	-	-	-	-	-	-	6.1	5.5	-	6.1	5.5	-
Follow-up Hdwy	2.2	-	-	2.2	-	-	3.5	4	3.3	3.5	4	3.3
Pot Cap-1 Maneuver	1581	-	-	1635	-	-	995	854	1090	995	876	1062
Stage 1	-	-	-	-	-	-	1027	899	-	1003	882	-
Stage 2	-	-	-	-	-	-	1003	865	-	1027	899	-
Platoon blocked, %	-	-	-	-	-	-	-	-	-	-	-	-
Mov Cap-1 Maneuver	1581	-	-	1635	-	-	995	854	1090	995	876	1062
Mov Cap-2 Maneuver	-	-	-	-	-	-	995	854	-	995	876	-
Stage 1	-	-	-	-	-	-	1027	899	-	1003	882	-
Stage 2	-	-	-	-	-	-	1003	865	-	1027	899	-

Approach	EB	WB	NB	SB
HCM Control Delay, s	0	0	0	8.8
HCM LOS			A	A

Minor Lane/Major Mvmt	NBLn1	NBLn2	EBL	EBT	EBR	WBL	WBT	WBR	SBLn1	SBLn2
Capacity (veh/h)	-	-	1581	-	-	1635	-	-	995	-
HCM Lane V/C Ratio	-	-	-	-	-	-	-	-	0.043	-
HCM Control Delay (s)	0	0	0	-	-	0	-	-	8.8	0
HCM Lane LOS	A	A	A	-	-	A	-	-	A	A
HCM 95th %tile Q(veh)	-	-	0	-	-	0	-	-	0.1	-

Intersection						
Int Delay, s/veh	0					
Movement	EBL	EBT	WBT	WBR	SBL	SBR
Lane Configurations	↙	↑	↘		↙	↘
Traffic Vol, veh/h	0	0	0	0	0	0
Future Vol, veh/h	0	0	0	0	0	0
Conflicting Peds, #/hr	0	0	0	0	0	0
Sign Control	Free	Free	Free	Free	Stop	Stop
RT Channelized	-	None	-	None	-	None
Storage Length	50	-	-	-	50	0
Veh in Median Storage, #	-	0	0	-	0	-
Grade, %	-	0	0	-	0	-
Peak Hour Factor	92	92	92	92	92	92
Heavy Vehicles, %	0	0	0	0	0	0
Mvmt Flow	0	0	0	0	0	0

Major/Minor	Major1	Major2	Minor2
Conflicting Flow All	1	0	0
Stage 1	-	-	1
Stage 2	-	-	0
Critical Hdwy	4.1	-	6.4
Critical Hdwy Stg 1	-	-	5.4
Critical Hdwy Stg 2	-	-	5.4
Follow-up Hdwy	2.2	-	3.5
Pot Cap-1 Maneuver	1635	-	1027
Stage 1	-	-	1028
Stage 2	-	-	-
Platoon blocked, %	-	-	-
Mov Cap-1 Maneuver	1635	-	1027
Mov Cap-2 Maneuver	-	-	1027
Stage 1	-	-	1028
Stage 2	-	-	-

Approach	EB	WB	SB
HCM Control Delay, s	0	0	0
HCM LOS			A

Minor Lane/Major Mvmt	EBL	EBT	WBT	WBR	SBLn1	SBLn2
Capacity (veh/h)	1635	-	-	-	-	-
HCM Lane V/C Ratio	-	-	-	-	-	-
HCM Control Delay (s)	0	-	-	-	0	0
HCM Lane LOS	A	-	-	-	A	A
HCM 95th %tile Q(veh)	0	-	-	-	-	-

Intersection						
Int Delay, s/veh	28.5					
Movement	EBL	EBR	NBL	NBT	SBT	SBR
Lane Configurations	↙	↗	↙	↑	↗	
Traffic Vol, veh/h	323	413	431	818	1048	660
Future Vol, veh/h	323	413	431	818	1048	660
Conflicting Peds, #/hr	0	0	0	0	0	0
Sign Control	Stop	Stop	Free	Free	Free	Free
RT Channelized	-	None	-	None	-	None
Storage Length	50	0	50	-	-	-
Veh in Median Storage, #	0	-	-	0	0	-
Grade, %	0	-	-	0	0	-
Peak Hour Factor	92	92	92	92	92	92
Heavy Vehicles, %	0	0	2	2	2	2
Mvmt Flow	351	449	468	889	1139	717

Major/Minor	Minor2	Major1	Major2			
Conflicting Flow All	3323	1498	1856	0	-	0
Stage 1	1498	-	-	-	-	-
Stage 2	1825	-	-	-	-	-
Critical Hdwy	6.4	6.2	4.12	-	-	-
Critical Hdwy Stg 1	5.4	-	-	-	-	-
Critical Hdwy Stg 2	5.4	-	-	-	-	-
Follow-up Hdwy	3.5	3.3	2.218	-	-	-
Pot Cap-1 Maneuver	~ 9	~ 152	~ 326	-	-	-
Stage 1	~ 206	-	-	-	-	-
Stage 2	~ 142	-	-	-	-	-
Platoon blocked, %				-	-	-
Mov Cap-1 Maneuver	0	~ 152	~ 326	-	-	-
Mov Cap-2 Maneuver	0	-	-	-	-	-
Stage 1	0	-	-	-	-	-
Stage 2	~ 142	-	-	-	-	-

Approach	EB	NB	SB
HCM Control Delay, s		84.2	0
HCM LOS	-		

Minor Lane/Major Mvmt	NBL	NBT	EBLn1	EBLn2	SBT	SBR
Capacity (veh/h)	~ 326	-	-	152	-	-
HCM Lane V/C Ratio	1.437	-	-	2.953	-	-
HCM Control Delay (s)	244	-	-	\$ 942.2	-	-
HCM Lane LOS	F	-	-	F	-	-
HCM 95th %tile Q(veh)	24.9	-	-	41.2	-	-

Notes
 -: Volume exceeds capacity \$: Delay exceeds 300s +: Computation Not Defined *: All major volume in platoon

Intersection						
Int Delay, s/veh	49.3					
Movement	WBL	WBR	NBT	NBR	SBL	SBT
Lane Configurations	↖	↗	↖		↖	↗
Traffic Vol, veh/h	330	789	611	301	875	481
Future Vol, veh/h	330	789	611	301	875	481
Conflicting Peds, #/hr	0	0	0	0	0	0
Sign Control	Stop	Stop	Free	Free	Free	Free
RT Channelized	-	None	-	None	-	None
Storage Length	50	0	-	-	50	-
Veh in Median Storage, #	0	-	0	-	-	0
Grade, %	0	-	0	-	-	0
Peak Hour Factor	92	92	92	92	92	92
Heavy Vehicles, %	0	0	3	3	2	2
Mvmt Flow	359	858	664	327	951	523

Major/Minor	Minor1	Major1	Major2		
Conflicting Flow All	3253	828	0	0	991
Stage 1	828	-	-	-	-
Stage 2	2425	-	-	-	-
Critical Hdwy	6.4	6.2	-	-	4.12
Critical Hdwy Stg 1	5.4	-	-	-	-
Critical Hdwy Stg 2	5.4	-	-	-	-
Follow-up Hdwy	3.5	3.3	-	-	2.218
Pot Cap-1 Maneuver	~ 10	~ 374	-	-	~ 698
Stage 1	432	-	-	-	-
Stage 2	~ 70	-	-	-	-
Platoon blocked, %			-	-	-
Mov Cap-1 Maneuver	0	~ 374	-	-	~ 698
Mov Cap-2 Maneuver	0	-	-	-	-
Stage 1	432	-	-	-	-
Stage 2	0	-	-	-	-

Approach	WB	NB	SB
HCM Control Delay, s		0	123.1
HCM LOS	-		

Minor Lane/Major Mvmt	NBT	NBRWBLn1WBLn2	SBL	SBT
Capacity (veh/h)	-	-	374	~ 698
HCM Lane V/C Ratio	-	-	2.293	1.363
HCM Control Delay (s)	-	-	613.1	190.8
HCM Lane LOS	-	-	F	F
HCM 95th %tile Q(veh)	-	-	65.4	40.5

Notes
 -: Volume exceeds capacity \$: Delay exceeds 300s +: Computation Not Defined *: All major volume in platoon

Intersection						
Int Delay, s/veh	2.3					
Movement	EBL	EBR	NBL	NBT	SBT	SBR
Lane Configurations						
Traffic Vol, veh/h	40	16	0	876	789	24
Future Vol, veh/h	40	16	0	876	789	24
Conflicting Peds, #/hr	0	0	0	0	0	0
Sign Control	Stop	Stop	Free	Free	Free	Free
RT Channelized	-	None	-	None	-	None
Storage Length	0	-	50	-	-	-
Veh in Median Storage, #	0	-	-	0	0	-
Grade, %	0	-	-	0	0	-
Peak Hour Factor	92	92	92	92	92	92
Heavy Vehicles, %	0	0	3	3	4	4
Mvmt Flow	43	17	0	952	858	26

Major/Minor	Minor2	Major1		Major2	
Conflicting Flow All	1823	871	884	0	0
Stage 1	871	-	-	-	-
Stage 2	952	-	-	-	-
Critical Hdwy	6.4	6.2	4.13	-	-
Critical Hdwy Stg 1	5.4	-	-	-	-
Critical Hdwy Stg 2	5.4	-	-	-	-
Follow-up Hdwy	3.5	3.3	2.227	-	-
Pot Cap-1 Maneuver	86	353	761	-	-
Stage 1	413	-	-	-	-
Stage 2	378	-	-	-	-
Platoon blocked, %				-	-
Mov Cap-1 Maneuver	86	353	761	-	-
Mov Cap-2 Maneuver	86	-	-	-	-
Stage 1	413	-	-	-	-
Stage 2	378	-	-	-	-

Approach	EB	NB	SB
HCM Control Delay, s	72.3	0	0
HCM LOS	F		

Minor Lane/Major Mvmt	NBL	NBT	EBLn1	SBT	SBR
Capacity (veh/h)	761	-	110	-	-
HCM Lane V/C Ratio	-	-	0.553	-	-
HCM Control Delay (s)	0	-	72.3	-	-
HCM Lane LOS	A	-	F	-	-
HCM 95th %tile Q(veh)	0	-	2.6	-	-

Intersection						
Int Delay, s/veh	33.6					
Movement	EBT	EBR	WBL	WBT	NBL	NBR
Lane Configurations	↔		↔	↑	↔	↔
Traffic Vol, veh/h	460	148	332	797	69	243
Future Vol, veh/h	460	148	332	797	69	243
Conflicting Peds, #/hr	0	0	0	0	0	0
Sign Control	Free	Free	Free	Free	Stop	Stop
RT Channelized	-	None	-	None	-	None
Storage Length	-	-	50	-	50	0
Veh in Median Storage, #	0	-	-	0	0	-
Grade, %	0	-	-	0	0	-
Peak Hour Factor	92	92	92	92	92	92
Heavy Vehicles, %	1	1	0	0	0	0
Mvmt Flow	500	161	361	866	75	264

Major/Minor	Major1	Major2	Minor1		
Conflicting Flow All	0	0	661	0	2169 581
Stage 1	-	-	-	-	581 -
Stage 2	-	-	-	-	1588 -
Critical Hdwy	-	-	4.1	-	6.4 6.2
Critical Hdwy Stg 1	-	-	-	-	5.4 -
Critical Hdwy Stg 2	-	-	-	-	5.4 -
Follow-up Hdwy	-	-	2.2	-	3.5 3.3
Pot Cap-1 Maneuver	-	-	937	-	~ 52 517
Stage 1	-	-	-	-	563 -
Stage 2	-	-	-	-	187 -
Platoon blocked, %	-	-	-	-	-
Mov Cap-1 Maneuver	-	-	937	-	~ 32 517
Mov Cap-2 Maneuver	-	-	-	-	~ 32 -
Stage 1	-	-	-	-	563 -
Stage 2	-	-	-	-	115 -

Approach	EB	WB	NB
HCM Control Delay, s	0	3.3	209
HCM LOS			F

Minor Lane/Major Mvmt	NBLn1	NBLn2	EBT	EBR	WBL	WBT
Capacity (veh/h)	32	517	-	-	937	-
HCM Lane V/C Ratio	2.344	0.511	-	-	0.385	-
HCM Control Delay (s)	\$ 878.2	19	-	-	11.2	-
HCM Lane LOS	F	C	-	-	B	-
HCM 95th %tile Q(veh)	8.6	2.9	-	-	1.8	-

Notes
 -: Volume exceeds capacity \$: Delay exceeds 300s +: Computation Not Defined *: All major volume in platoon

Intersection						
Int Delay, s/veh	1.2					
Movement	EBT	EBR	WBL	WBT	NBL	NBR
Lane Configurations						
Traffic Vol, veh/h	38	0	2	30	3	6
Future Vol, veh/h	38	0	2	30	3	6
Conflicting Peds, #/hr	0	0	0	0	0	0
Sign Control	Free	Free	Free	Free	Stop	Stop
RT Channelized	-	None	-	None	-	None
Storage Length	-	-	-	-	-	-
Veh in Median Storage, #	0	-	-	0	0	-
Grade, %	0	-	-	0	0	-
Peak Hour Factor	92	92	92	92	92	92
Heavy Vehicles, %	15	15	15	15	0	0
Mvmt Flow	41	0	2	33	3	7

Major/Minor	Major1	Major2	Minor1		
Conflicting Flow All	0	0	41	0	78
Stage 1	-	-	-	-	41
Stage 2	-	-	-	-	37
Critical Hdwy	-	-	4.25	-	6.4
Critical Hdwy Stg 1	-	-	-	-	5.4
Critical Hdwy Stg 2	-	-	-	-	5.4
Follow-up Hdwy	-	-	2.335	-	3.5
Pot Cap-1 Maneuver	-	-	1489	-	930
Stage 1	-	-	-	-	987
Stage 2	-	-	-	-	991
Platoon blocked, %	-	-	-	-	-
Mov Cap-1 Maneuver	-	-	1489	-	929
Mov Cap-2 Maneuver	-	-	-	-	929
Stage 1	-	-	-	-	987
Stage 2	-	-	-	-	990

Approach	EB	WB	NB
HCM Control Delay, s	0	0.5	8.6
HCM LOS			A

Minor Lane/Major Mvmt	NBLn1	EBT	EBR	WBL	WBT
Capacity (veh/h)	998	-	-	1489	-
HCM Lane V/C Ratio	0.01	-	-	0.001	-
HCM Control Delay (s)	8.6	-	-	7.4	0
HCM Lane LOS	A	-	-	A	A
HCM 95th %tile Q(veh)	0	-	-	0	-

Intersection												
Int Delay, s/veh	0.8											
Movement	EBL	EBT	EBR	WBL	WBT	WBR	NBL	NBT	NBR	SBL	SBT	SBR
Lane Configurations		↕			↕			↕			↕	
Traffic Vol, veh/h	2	13	0	0	30	5	0	0	0	2	0	1
Future Vol, veh/h	2	13	0	0	30	5	0	0	0	2	0	1
Conflicting Peds, #/hr	1	0	0	0	0	1	0	0	0	0	0	0
Sign Control	Free	Free	Free	Free	Free	Free	Stop	Stop	Stop	Stop	Stop	Stop
RT Channelized	-	-	None	-	-	None	-	-	None	-	-	None
Storage Length	-	-	-	-	-	-	-	-	-	-	-	-
Veh in Median Storage, #	-	0	-	-	0	-	-	0	-	-	0	-
Grade, %	-	0	-	-	0	-	-	0	-	-	0	-
Peak Hour Factor	92	92	92	92	92	92	92	92	92	92	92	92
Heavy Vehicles, %	11	11	11	11	11	11	0	0	0	0	0	0
Mvmt Flow	2	14	0	0	33	5	0	0	0	2	0	1

Major/Minor	Major1			Major2			Minor1			Minor2		
Conflicting Flow All	39	0	0	14	0	0	54	57	14	55	55	37
Stage 1	-	-	-	-	-	-	18	18	-	37	37	-
Stage 2	-	-	-	-	-	-	36	39	-	18	18	-
Critical Hdwy	4.21	-	-	4.21	-	-	7.1	6.5	6.2	7.1	6.5	6.2
Critical Hdwy Stg 1	-	-	-	-	-	-	6.1	5.5	-	6.1	5.5	-
Critical Hdwy Stg 2	-	-	-	-	-	-	6.1	5.5	-	6.1	5.5	-
Follow-up Hdwy	2.299	-	-	2.299	-	-	3.5	4	3.3	3.5	4	3.3
Pot Cap-1 Maneuver	1515	-	-	1547	-	-	949	838	1072	948	840	1041
Stage 1	-	-	-	-	-	-	1006	884	-	984	868	-
Stage 2	-	-	-	-	-	-	985	866	-	1006	884	-
Platoon blocked, %		-	-		-	-						
Mov Cap-1 Maneuver	1514	-	-	1547	-	-	947	836	1072	946	838	1040
Mov Cap-2 Maneuver	-	-	-	-	-	-	947	836	-	946	838	-
Stage 1	-	-	-	-	-	-	1005	883	-	982	867	-
Stage 2	-	-	-	-	-	-	984	865	-	1005	883	-

Approach	EB			WB			NB			SB		
HCM Control Delay, s	1			0			0			8.7		
HCM LOS							A			A		

Minor Lane/Major Mvmt	NBLn1	EBL	EBT	EBR	WBL	WBT	WBR	SBLn1
Capacity (veh/h)	-	1514	-	-	1547	-	-	975
HCM Lane V/C Ratio	-	0.001	-	-	-	-	-	0.003
HCM Control Delay (s)		0	7.4	0	-	0	-	8.7
HCM Lane LOS		A	A	A	-	A	-	A
HCM 95th %tile Q(veh)		-	0	-	-	0	-	0

Intersection						
Int Delay, s/veh	2.9					
Movement	EBL	EBT	WBT	WBR	SBL	SBR
Lane Configurations		↕	↑	↗	↘	
Traffic Vol, veh/h	2	114	105	111	98	4
Future Vol, veh/h	2	114	105	111	98	4
Conflicting Peds, #/hr	0	0	0	0	0	0
Sign Control	Free	Free	Free	Free	Stop	Stop
RT Channelized	-	None	-	None	-	None
Storage Length	-	-	-	0	0	-
Veh in Median Storage, #	-	0	0	-	0	-
Grade, %	-	0	0	-	0	-
Peak Hour Factor	92	92	92	92	92	92
Heavy Vehicles, %	16	16	50	50	81	81
Mvmt Flow	2	124	114	121	107	4

Major/Minor	Major1	Major2	Minor2		
Conflicting Flow All	235	0	-	0	242 114
Stage 1	-	-	-	-	114 -
Stage 2	-	-	-	-	128 -
Critical Hdwy	4.26	-	-	-	7.21 7.01
Critical Hdwy Stg 1	-	-	-	-	6.21 -
Critical Hdwy Stg 2	-	-	-	-	6.21 -
Follow-up Hdwy	2.344	-	-	-	4.229 4.029
Pot Cap-1 Maneuver	1254	-	-	-	602 762
Stage 1	-	-	-	-	747 -
Stage 2	-	-	-	-	735 -
Platoon blocked, %		-	-	-	
Mov Cap-1 Maneuver	1254	-	-	-	601 762
Mov Cap-2 Maneuver	-	-	-	-	601 -
Stage 1	-	-	-	-	746 -
Stage 2	-	-	-	-	735 -

Approach	EB	WB	SB
HCM Control Delay, s	0.1	0	12.3
HCM LOS			B

Minor Lane/Major Mvmt	EBL	EBT	WBT	WBR	SBLn1
Capacity (veh/h)	1254	-	-	-	606
HCM Lane V/C Ratio	0.002	-	-	-	0.183
HCM Control Delay (s)	7.9	0	-	-	12.3
HCM Lane LOS	A	A	-	-	B
HCM 95th %tile Q(veh)	0	-	-	-	0.7

HCM 6th TWSC
4: Truck Parking Lot/Pistachio Drive & Avenue 18 1/2

Village D Specific Plan
Phase III NP - AM Peak Hour

Intersection												
Int Delay, s/veh	2.5											
Movement	EBL	EBT	EBR	WBL	WBT	WBR	NBL	NBT	NBR	SBL	SBT	SBR
Lane Configurations		↕			↕	↕		↕			↕	
Traffic Vol, veh/h	8	267	1	3	221	206	0	0	1	110	0	9
Future Vol, veh/h	8	267	1	3	221	206	0	0	1	110	0	9
Conflicting Peds, #/hr	0	0	0	0	0	0	0	0	0	0	0	0
Sign Control	Free	Free	Free	Free	Free	Free	Stop	Stop	Stop	Stop	Stop	Stop
RT Channelized	-	-	None	-	-	None	-	-	None	-	-	None
Storage Length	-	-	-	-	-	50	-	-	-	-	-	-
Veh in Median Storage, #	-	0	-	-	0	-	-	0	-	-	0	-
Grade, %	-	0	-	-	0	-	-	0	-	-	0	-
Peak Hour Factor	93	93	93	93	93	93	93	93	93	93	93	93
Heavy Vehicles, %	34	34	34	26	26	26	100	100	100	12	12	12
Mvmt Flow	9	287	1	3	238	222	0	0	1	118	0	10

Major/Minor	Major1			Major2			Minor1			Minor2		
Conflicting Flow All	460	0	0	288	0	0	666	772	288	550	550	238
Stage 1	-	-	-	-	-	-	306	306	-	244	244	-
Stage 2	-	-	-	-	-	-	360	466	-	306	306	-
Critical Hdwy	4.44	-	-	4.36	-	-	8.1	7.5	7.2	7.22	6.62	6.32
Critical Hdwy Stg 1	-	-	-	-	-	-	7.1	6.5	-	6.22	5.62	-
Critical Hdwy Stg 2	-	-	-	-	-	-	7.1	6.5	-	6.22	5.62	-
Follow-up Hdwy	2.506	-	-	2.434	-	-	4.4	4.9	4.2	3.608	4.108	3.408
Pot Cap-1 Maneuver	952	-	-	1148	-	-	267	238	567	431	429	777
Stage 1	-	-	-	-	-	-	536	517	-	738	686	-
Stage 2	-	-	-	-	-	-	497	428	-	683	644	-
Platoon blocked, %		-	-	-	-	-						
Mov Cap-1 Maneuver	952	-	-	1148	-	-	261	234	567	425	423	777
Mov Cap-2 Maneuver	-	-	-	-	-	-	261	234	-	425	423	-
Stage 1	-	-	-	-	-	-	530	511	-	730	683	-
Stage 2	-	-	-	-	-	-	489	426	-	674	637	-

Approach	EB			WB			NB			SB		
HCM Control Delay, s	0.3			0.1			11.4			16.5		
HCM LOS							B			C		

Minor Lane/Major Mvmt	NBLn1	EBL	EBT	EBR	WBL	WBT	WBR	SBLn1
Capacity (veh/h)	567	952	-	-	1148	-	-	440
HCM Lane V/C Ratio	0.002	0.009	-	-	0.003	-	-	0.291
HCM Control Delay (s)	11.4	8.8	0	-	8.1	0	-	16.5
HCM Lane LOS	B	A	A	-	A	A	-	C
HCM 95th %tile Q(veh)	0	0	-	-	0	-	-	1.2

HCM 6th TWSC
 5: Road 23/SR-99 Southbound Off-Ramp & Avenue 18 1/2

Village D Specific Plan
 Phase III NP - AM Peak Hour

Intersection												
Int Delay, s/veh	7.8											
Movement	EBL	EBT	EBR	WBL	WBT	WBR	NBL	NBT	NBR	SBL	SBT	SBR
Lane Configurations		↑	↑		↑		↑		↑		↕	
Traffic Vol, veh/h	0	323	55	50	286	0	63	0	159	12	57	86
Future Vol, veh/h	0	323	55	50	286	0	63	0	159	12	57	86
Conflicting Peds, #/hr	0	0	0	0	0	0	0	0	1	1	0	0
Sign Control	Free	Free	Free	Free	Free	Free	Stop	Stop	Stop	Stop	Stop	Stop
RT Channelized	-	-	None	-	-	None	-	-	None	-	-	None
Storage Length	-	-	50	-	-	-	0	-	25	-	-	-
Veh in Median Storage, #	-	0	-	-	0	-	-	0	-	-	0	-
Grade, %	-	0	-	-	0	-	-	0	-	-	0	-
Peak Hour Factor	92	92	92	92	92	92	92	92	92	92	92	92
Heavy Vehicles, %	33	33	33	26	26	26	21	21	21	35	35	35
Mvmt Flow	0	351	60	54	311	0	68	0	173	13	62	93

Major/Minor	Major1			Major2			Minor1			Minor2		
Conflicting Flow All	-	0	0	411	0	0	848	-	352	888	830	311
Stage 1	-	-	-	-	-	-	351	-	-	419	419	-
Stage 2	-	-	-	-	-	-	497	-	-	469	411	-
Critical Hdwy	-	-	-	4.36	-	-	7.31	-	6.41	7.45	6.85	6.55
Critical Hdwy Stg 1	-	-	-	-	-	-	6.31	-	-	6.45	5.85	-
Critical Hdwy Stg 2	-	-	-	-	-	-	6.31	-	-	6.45	5.85	-
Follow-up Hdwy	-	-	-	2.434	-	-	3.689	-	3.489	3.815	4.315	3.615
Pot Cap-1 Maneuver	0	-	-	1030	-	0	261	0	651	232	271	658
Stage 1	0	-	-	-	-	0	628	0	-	552	537	-
Stage 2	0	-	-	-	-	0	521	0	-	517	542	-
Platoon blocked, %	-	-	-	-	-	-	-	-	-	-	-	-
Mov Cap-1 Maneuver	-	-	-	1030	-	-	173	-	650	162	254	658
Mov Cap-2 Maneuver	-	-	-	-	-	-	173	-	-	162	254	-
Stage 1	-	-	-	-	-	-	628	-	-	552	503	-
Stage 2	-	-	-	-	-	-	367	-	-	379	542	-

Approach	EB			WB			NB			SB		
HCM Control Delay, s	0			1.3			20			23.4		
HCM LOS							C			C		

Minor Lane/Major Mvmt	NBLn1	NBLn2	EBT	EBR	WBL	WBT	SBLn1
Capacity (veh/h)	173	650	-	-	1030	-	361
HCM Lane V/C Ratio	0.396	0.266	-	-	0.053	-	0.467
HCM Control Delay (s)	38.8	12.5	-	-	8.7	0	23.4
HCM Lane LOS	E	B	-	-	A	A	C
HCM 95th %tile Q(veh)	1.7	1.1	-	-	0.2	-	2.4

Intersection												
Int Delay, s/veh	26.1											
Movement	EBL	EBT	EBR	WBL	WBT	WBR	NBL	NBT	NBR	SBL	SBT	SBR
Lane Configurations	↙	↑			↘			↕				
Traffic Vol, veh/h	227	64	0	0	158	36	216	1	28	0	0	0
Future Vol, veh/h	227	64	0	0	158	36	216	1	28	0	0	0
Conflicting Peds, #/hr	1	0	0	0	0	1	0	0	0	0	0	0
Sign Control	Free	Free	Free	Free	Free	Free	Stop	Stop	Stop	Free	Free	Free
RT Channelized	-	-	None	-	-	None	-	-	None	-	-	None
Storage Length	145	-	-	-	-	-	-	-	-	-	-	-
Veh in Median Storage, #	-	0	-	-	0	-	-	0	-	-	16965	-
Grade, %	-	0	-	-	0	-	-	0	-	-	0	-
Peak Hour Factor	92	92	92	92	92	92	92	92	92	92	92	92
Heavy Vehicles, %	31	31	31	18	18	18	29	29	29	0	0	0
Mvmt Flow	247	70	0	0	172	39	235	1	30	0	0	0

Major/Minor	Major1	Major2	Minor1
Conflicting Flow All	212	0	-
Stage 1	-	-	-
Stage 2	-	-	-
Critical Hdwy	4.41	-	-
Critical Hdwy Stg 1	-	-	-
Critical Hdwy Stg 2	-	-	-
Follow-up Hdwy	2.479	-	-
Pot Cap-1 Maneuver	1204	-	0
Stage 1	-	-	0
Stage 2	-	-	0
Platoon blocked, %	-	-	-
Mov Cap-1 Maneuver	1204	-	-
Mov Cap-2 Maneuver	-	-	-
Stage 1	-	-	-
Stage 2	-	-	-

Approach	EB	WB	NB
HCM Control Delay, s	6.8	0	69.8
HCM LOS			F

Minor Lane/Major Mvmt	NBLn1	EBL	EBT	WBT	WBR
Capacity (veh/h)	294	1204	-	-	-
HCM Lane V/C Ratio	0.906	0.205	-	-	-
HCM Control Delay (s)	69.8	8.8	-	-	-
HCM Lane LOS	F	A	-	-	-
HCM 95th %tile Q(veh)	8.4	0.8	-	-	-

Intersection												
Int Delay, s/veh	3.9											
Movement	EBL	EBT	EBR	WBL	WBT	WBR	NBL	NBT	NBR	SBL	SBT	SBR
Lane Configurations		↕			↕			↕			↕	
Traffic Vol, veh/h	3	36	8	56	23	3	9	166	49	16	108	0
Future Vol, veh/h	3	36	8	56	23	3	9	166	49	16	108	0
Conflicting Peds, #/hr	0	0	0	0	0	0	0	0	0	0	0	0
Sign Control	Stop	Stop	Stop	Stop	Stop	Stop	Free	Free	Free	Free	Free	Free
RT Channelized	-	-	None	-	-	None	-	-	None	-	-	None
Storage Length	-	-	-	-	-	-	-	-	-	-	-	-
Veh in Median Storage, #	-	0	-	-	0	-	-	0	-	-	0	-
Grade, %	-	0	-	-	0	-	-	0	-	-	0	-
Peak Hour Factor	92	92	92	92	92	92	92	92	92	92	92	92
Heavy Vehicles, %	6	6	6	19	19	19	18	18	18	24	24	24
Mvmt Flow	3	39	9	61	25	3	10	180	53	17	117	0

Major/Minor	Minor2		Minor1		Major1			Major2				
Conflicting Flow All	392	404	117	402	378	207	117	0	0	233	0	0
Stage 1	151	151	-	227	227	-	-	-	-	-	-	-
Stage 2	241	253	-	175	151	-	-	-	-	-	-	-
Critical Hdwy	7.16	6.56	6.26	7.29	6.69	6.39	4.28	-	-	4.34	-	-
Critical Hdwy Stg 1	6.16	5.56	-	6.29	5.69	-	-	-	-	-	-	-
Critical Hdwy Stg 2	6.16	5.56	-	6.29	5.69	-	-	-	-	-	-	-
Follow-up Hdwy	3.554	4.054	3.354	3.671	4.171	3.471	2.362	-	-	2.416	-	-
Pot Cap-1 Maneuver	560	529	924	530	528	792	1378	-	-	1215	-	-
Stage 1	842	765	-	739	686	-	-	-	-	-	-	-
Stage 2	754	690	-	789	741	-	-	-	-	-	-	-
Platoon blocked, %	-	-	-	-	-	-	-	-	-	-	-	-
Mov Cap-1 Maneuver	528	517	924	486	516	792	1378	-	-	1215	-	-
Mov Cap-2 Maneuver	528	517	-	486	516	-	-	-	-	-	-	-
Stage 1	835	754	-	733	681	-	-	-	-	-	-	-
Stage 2	718	684	-	730	730	-	-	-	-	-	-	-

Approach	EB		WB		NB		SB	
HCM Control Delay, s	12.1		13.7		0.3		1	
HCM LOS	B		B					

Minor Lane/Major Mvmt	NBL	NBT	NBR	EBLn1WBLn1	SBL	SBT	SBR
Capacity (veh/h)	1378	-	-	560	501	1215	-
HCM Lane V/C Ratio	0.007	-	-	0.091	0.178	0.014	-
HCM Control Delay (s)	7.6	0	-	12.1	13.7	8	0
HCM Lane LOS	A	A	-	B	B	A	A
HCM 95th %tile Q(veh)	0	-	-	0.3	0.6	0	-

Intersection												
Int Delay, s/veh	2.2											
Movement	EBL	EBT	EBR	WBL	WBT	WBR	NBL	NBT	NBR	SBL	SBT	SBR
Lane Configurations		↕			↕			↕			↕	
Traffic Vol, veh/h	12	30	32	0	4	0	37	288	0	0	325	11
Future Vol, veh/h	12	30	32	0	4	0	37	288	0	0	325	11
Conflicting Peds, #/hr	0	0	0	0	0	0	0	0	0	0	0	0
Sign Control	Stop	Stop	Stop	Stop	Stop	Stop	Free	Free	Free	Free	Free	Free
RT Channelized	-	-	None	-	-	None	-	-	None	-	-	None
Storage Length	-	-	-	-	-	-	-	-	-	-	-	-
Veh in Median Storage, #	-	0	-	-	0	-	-	0	-	-	0	-
Grade, %	-	0	-	-	0	-	-	0	-	-	0	-
Peak Hour Factor	92	92	92	92	92	92	92	92	92	92	92	92
Heavy Vehicles, %	25	25	25	25	25	25	14	14	14	18	18	18
Mvmt Flow	13	33	35	0	4	0	40	313	0	0	353	12

Major/Minor	Minor2		Minor1			Major1		Major2				
Conflicting Flow All	754	752	359	786	758	313	365	0	0	313	0	0
Stage 1	359	359	-	393	393	-	-	-	-	-	-	-
Stage 2	395	393	-	393	365	-	-	-	-	-	-	-
Critical Hdwy	7.35	6.75	6.45	7.35	6.75	6.45	4.24	-	-	4.28	-	-
Critical Hdwy Stg 1	6.35	5.75	-	6.35	5.75	-	-	-	-	-	-	-
Critical Hdwy Stg 2	6.35	5.75	-	6.35	5.75	-	-	-	-	-	-	-
Follow-up Hdwy	3.725	4.225	3.525	3.725	4.225	3.525	2.326	-	-	2.362	-	-
Pot Cap-1 Maneuver	299	313	637	284	311	677	1130	-	-	1162	-	-
Stage 1	614	588	-	588	568	-	-	-	-	-	-	-
Stage 2	587	568	-	588	585	-	-	-	-	-	-	-
Platoon blocked, %								-	-	-	-	-
Mov Cap-1 Maneuver	286	300	637	238	298	677	1130	-	-	1162	-	-
Mov Cap-2 Maneuver	286	300	-	238	298	-	-	-	-	-	-	-
Stage 1	588	588	-	563	544	-	-	-	-	-	-	-
Stage 2	557	544	-	525	585	-	-	-	-	-	-	-

Approach	EB		WB			NB		SB		
HCM Control Delay, s	16.8		17.3			0.9		0		
HCM LOS	C		C							

Minor Lane/Major Mvmt	NBL	NBT	NBR	EBLn1WBLn1	SBL	SBT	SBR
Capacity (veh/h)	1130	-	-	385	298	1162	-
HCM Lane V/C Ratio	0.036	-	-	0.209	0.015	-	-
HCM Control Delay (s)	8.3	0	-	16.8	17.3	0	-
HCM Lane LOS	A	A	-	C	C	A	-
HCM 95th %tile Q(veh)	0.1	-	-	0.8	0	0	-

Intersection												
Int Delay, s/veh	7.4											
Movement	EBL	EBT	EBR	WBL	WBT	WBR	NBL	NBT	NBR	SBL	SBT	SBR
Lane Configurations		↕			↕			↕			↕	
Traffic Vol, veh/h	0	0	0	74	0	192	0	297	68	86	253	0
Future Vol, veh/h	0	0	0	74	0	192	0	297	68	86	253	0
Conflicting Peds, #/hr	0	0	0	0	0	0	0	0	0	0	0	0
Sign Control	Stop	Stop	Stop	Stop	Stop	Stop	Free	Free	Free	Free	Free	Free
RT Channelized	-	-	None	-	-	None	-	-	None	-	-	None
Storage Length	-	-	-	-	-	-	-	-	-	-	-	-
Veh in Median Storage, #	-	0	-	-	0	-	-	0	-	-	0	-
Grade, %	-	0	-	-	0	-	-	0	-	-	0	-
Peak Hour Factor	92	92	92	92	92	92	92	92	92	92	92	92
Heavy Vehicles, %	0	0	0	7	7	7	15	15	15	23	23	23
Mvmt Flow	0	0	0	80	0	209	0	323	74	93	275	0

Major/Minor	Minor2		Minor1		Major1		Major2					
Conflicting Flow All	926	858	275	821	821	360	275	0	0	397	0	0
Stage 1	461	461	-	360	360	-	-	-	-	-	-	-
Stage 2	465	397	-	461	461	-	-	-	-	-	-	-
Critical Hdwy	7.1	6.5	6.2	7.17	6.57	6.27	4.25	-	-	4.33	-	-
Critical Hdwy Stg 1	6.1	5.5	-	6.17	5.57	-	-	-	-	-	-	-
Critical Hdwy Stg 2	6.1	5.5	-	6.17	5.57	-	-	-	-	-	-	-
Follow-up Hdwy	3.5	4	3.3	3.563	4.063	3.363	2.335	-	-	2.407	-	-
Pot Cap-1 Maneuver	251	297	769	288	304	673	1217	-	-	1056	-	-
Stage 1	584	569	-	648	618	-	-	-	-	-	-	-
Stage 2	581	607	-	571	557	-	-	-	-	-	-	-
Platoon blocked, %								-	-	-	-	-
Mov Cap-1 Maneuver	159	266	769	265	272	673	1217	-	-	1056	-	-
Mov Cap-2 Maneuver	159	266	-	265	272	-	-	-	-	-	-	-
Stage 1	584	510	-	648	618	-	-	-	-	-	-	-
Stage 2	401	607	-	512	499	-	-	-	-	-	-	-

Approach	EB	WB	NB	SB
HCM Control Delay, s	0	24	0	2.2
HCM LOS	A	C		

Minor Lane/Major Mvmt	NBL	NBT	NBR	EBLn1WBLn1	SBL	SBT	SBR
Capacity (veh/h)	1217	-	-	-	471	1056	-
HCM Lane V/C Ratio	-	-	-	-	0.614	0.089	-
HCM Control Delay (s)	0	-	-	0	24	8.7	0
HCM Lane LOS	A	-	-	A	C	A	A
HCM 95th %tile Q(veh)	0	-	-	-	4	0.3	-

Intersection												
Int Delay, s/veh	2.8											
Movement	EBL	EBT	EBR	WBL	WBT	WBR	NBL	NBT	NBR	SBL	SBT	SBR
Lane Configurations		↕			↕			↕			↕	
Traffic Vol, veh/h	0	5	0	18	3	100	4	265	4	47	280	0
Future Vol, veh/h	0	5	0	18	3	100	4	265	4	47	280	0
Conflicting Peds, #/hr	0	0	0	0	0	0	0	0	0	0	0	0
Sign Control	Stop	Stop	Stop	Stop	Stop	Stop	Free	Free	Free	Free	Free	Free
RT Channelized	-	-	None	-	-	None	-	-	None	-	-	None
Storage Length	-	-	-	-	-	-	-	-	-	-	-	-
Veh in Median Storage, #	-	0	-	-	0	-	-	0	-	-	0	-
Grade, %	-	0	-	-	0	-	-	0	-	-	0	-
Peak Hour Factor	92	92	92	92	92	92	92	92	92	92	92	92
Heavy Vehicles, %	0	0	0	0	0	0	18	18	18	18	18	18
Mvmt Flow	0	5	0	20	3	109	4	288	4	51	304	0

Major/Minor	Minor2		Minor1		Major1		Major2					
Conflicting Flow All	760	706	304	707	704	290	304	0	0	292	0	0
Stage 1	406	406	-	298	298	-	-	-	-	-	-	-
Stage 2	354	300	-	409	406	-	-	-	-	-	-	-
Critical Hdwy	7.1	6.5	6.2	7.1	6.5	6.2	4.28	-	-	4.28	-	-
Critical Hdwy Stg 1	6.1	5.5	-	6.1	5.5	-	-	-	-	-	-	-
Critical Hdwy Stg 2	6.1	5.5	-	6.1	5.5	-	-	-	-	-	-	-
Follow-up Hdwy	3.5	4	3.3	3.5	4	3.3	2.362	-	-	2.362	-	-
Pot Cap-1 Maneuver	325	363	740	353	364	754	1171	-	-	1184	-	-
Stage 1	626	601	-	715	671	-	-	-	-	-	-	-
Stage 2	667	669	-	623	601	-	-	-	-	-	-	-
Platoon blocked, %								-	-	-	-	-
Mov Cap-1 Maneuver	264	343	740	334	344	754	1171	-	-	1184	-	-
Mov Cap-2 Maneuver	264	343	-	334	344	-	-	-	-	-	-	-
Stage 1	623	570	-	712	668	-	-	-	-	-	-	-
Stage 2	566	666	-	585	570	-	-	-	-	-	-	-

Approach	EB		WB		NB		SB	
HCM Control Delay, s	15.7		12.4		0.1		1.2	
HCM LOS	C		B					

Minor Lane/Major Mvmt	NBL	NBT	NBR	EBLn1WBLn1	SBL	SBT	SBR
Capacity (veh/h)	1171	-	-	343	620	1184	-
HCM Lane V/C Ratio	0.004	-	-	0.016	0.212	0.043	-
HCM Control Delay (s)	8.1	0	-	15.7	12.4	8.2	0
HCM Lane LOS	A	A	-	C	B	A	A
HCM 95th %tile Q(veh)	0	-	-	0	0.8	0.1	-

Intersection	
Intersection Delay, s/veh	17.4
Intersection LOS	C

Movement	EBL	EBT	EBR	WBL	WBT	WBR	NBL	NBT	NBR	SBL	SBT	SBR
Lane Configurations		↕			↕			↕			↕	
Traffic Vol, veh/h	72	152	60	20	185	79	54	122	8	56	152	91
Future Vol, veh/h	72	152	60	20	185	79	54	122	8	56	152	91
Peak Hour Factor	0.92	0.92	0.92	0.92	0.92	0.92	0.92	0.92	0.92	0.92	0.92	0.92
Heavy Vehicles, %	6	6	6	8	8	8	29	29	29	17	17	17
Mvmt Flow	78	165	65	22	201	86	59	133	9	61	165	99
Number of Lanes	0	1	0	0	1	0	0	1	0	0	1	0

Approach	EB	WB	NB	SB
Opposing Approach	WB	EB	SB	NB
Opposing Lanes	1	1	1	1
Conflicting Approach Left	SB	NB	EB	WB
Conflicting Lanes Left	1	1	1	1
Conflicting Approach Right	NB	SB	WB	EB
Conflicting Lanes Right	1	1	1	1
HCM Control Delay	17.4	17.2	15.2	18.9
HCM LOS	C	C	C	C

Lane	NBLn1	EBLn1	WBLn1	SBLn1
Vol Left, %	29%	25%	7%	19%
Vol Thru, %	66%	54%	65%	51%
Vol Right, %	4%	21%	28%	30%
Sign Control	Stop	Stop	Stop	Stop
Traffic Vol by Lane	184	284	284	299
LT Vol	54	72	20	56
Through Vol	122	152	185	152
RT Vol	8	60	79	91
Lane Flow Rate	200	309	309	325
Geometry Grp	1	1	1	1
Degree of Util (X)	0.404	0.555	0.552	0.594
Departure Headway (Hd)	7.273	6.474	6.435	6.585
Convergence, Y/N	Yes	Yes	Yes	Yes
Cap	492	556	559	546
Service Time	5.354	4.544	4.505	4.656
HCM Lane V/C Ratio	0.407	0.556	0.553	0.595
HCM Control Delay	15.2	17.4	17.2	18.9
HCM Lane LOS	C	C	C	C
HCM 95th-tile Q	1.9	3.4	3.3	3.8

Intersection

Intersection Delay, s/veh	9.3
Intersection LOS	A

Movement	EBL	EBT	EBR	WBL	WBT	WBR	NBL	NBT	NBR	SBL	SBT	SBR
Lane Configurations	↶	↷		↶	↷			↕			↕	
Traffic Vol, veh/h	19	85	4	12	113	39	8	34	17	34	49	45
Future Vol, veh/h	19	85	4	12	113	39	8	34	17	34	49	45
Peak Hour Factor	0.92	0.92	0.92	0.92	0.92	0.92	0.92	0.92	0.92	0.92	0.92	0.92
Heavy Vehicles, %	11	11	11	31	31	31	11	11	11	21	21	21
Mvmt Flow	21	92	4	13	123	42	9	37	18	37	53	49
Number of Lanes	1	1	0	1	1	0	0	1	0	0	1	0

Approach	EB	WB	NB	SB
Opposing Approach	WB	EB	SB	NB
Opposing Lanes	2	2	1	1
Conflicting Approach Left	SB	NB	EB	WB
Conflicting Lanes Left	1	1	2	2
Conflicting Approach Right	NB	SB	WB	EB
Conflicting Lanes Right	1	1	2	2
HCM Control Delay	9	10	8.4	9.2
HCM LOS	A	A	A	A

Lane	NBLn1	EBLn1	EBLn2	WBLn1	WBLn2	SBLn1
Vol Left, %	14%	100%	0%	100%	0%	27%
Vol Thru, %	58%	0%	96%	0%	74%	38%
Vol Right, %	29%	0%	4%	0%	26%	35%
Sign Control	Stop	Stop	Stop	Stop	Stop	Stop
Traffic Vol by Lane	59	19	89	12	152	128
LT Vol	8	19	0	12	0	34
Through Vol	34	0	85	0	113	49
RT Vol	17	0	4	0	39	45
Lane Flow Rate	64	21	97	13	165	139
Geometry Grp	2	7	7	7	7	2
Degree of Util (X)	0.088	0.034	0.144	0.022	0.251	0.192
Departure Headway (Hd)	4.916	5.89	5.355	6.163	5.479	4.97
Convergence, Y/N	Yes	Yes	Yes	Yes	Yes	Yes
Cap	727	607	668	580	654	721
Service Time	2.963	3.639	3.103	3.911	3.226	3.009
HCM Lane V/C Ratio	0.088	0.035	0.145	0.022	0.252	0.193
HCM Control Delay	8.4	8.8	9	9.1	10.1	9.2
HCM Lane LOS	A	A	A	A	B	A
HCM 95th-tile Q	0.3	0.1	0.5	0.1	1	0.7

HCM 6th TWSC
13: Airport Drive/Golden State Boulevard & Avenue 17

Village D Specific Plan
Phase III NP - AM Peak Hour

Intersection												
Int Delay, s/veh	541.7											
Movement	EBL	EBT	EBR	WBL	WBT	WBR	NBL	NBT	NBR	SBL	SBT	SBR
Lane Configurations	↙	↑	↗	↙	↑	↗	↙	↑	↗		↕	
Traffic Vol, veh/h	5	85	20	302	80	286	18	114	180	216	54	4
Future Vol, veh/h	5	85	20	302	80	286	18	114	180	216	54	4
Conflicting Peds, #/hr	0	0	0	0	0	0	1	0	0	0	0	1
Sign Control	Free	Free	Free	Free	Free	Free	Stop	Stop	Stop	Stop	Stop	Stop
RT Channelized	-	-	None	-	-	None	-	-	None	-	-	None
Storage Length	85	-	0	70	-	105	60	-	50	-	-	-
Veh in Median Storage, #	-	0	-	-	0	-	-	0	-	-	0	-
Grade, %	-	0	-	-	0	-	-	0	-	-	0	-
Peak Hour Factor	92	92	92	92	92	92	92	92	92	92	92	92
Heavy Vehicles, %	12	12	12	9	9	9	13	13	13	9	9	9
Mvmt Flow	5	92	22	328	87	311	20	124	196	235	59	4

Major/Minor	Major1			Major2			Minor1			Minor2		
Conflicting Flow All	398	0	0	114	0	0	1033	1156	92	1016	867	88
Stage 1	-	-	-	-	-	-	102	102	-	743	743	-
Stage 2	-	-	-	-	-	-	931	1054	-	273	124	-
Critical Hdwy	4.22	-	-	4.19	-	-	7.23	6.63	6.33	7.19	6.59	6.29
Critical Hdwy Stg 1	-	-	-	-	-	-	6.23	5.63	-	6.19	5.59	-
Critical Hdwy Stg 2	-	-	-	-	-	-	6.23	5.63	-	6.19	5.59	-
Follow-up Hdwy	2.308	-	-	2.281	-	-	3.617	4.117	3.417	3.581	4.081	3.381
Pot Cap-1 Maneuver	1108	-	-	1433	-	-	201	188	936	~ 210	283	951
Stage 1	-	-	-	-	-	-	878	790	-	396	412	-
Stage 2	-	-	-	-	-	-	306	289	-	718	780	-
Platoon blocked, %		-	-	-	-	-						
Mov Cap-1 Maneuver	1108	-	-	1433	-	-	131	144	936	~ 38	217	950
Mov Cap-2 Maneuver	-	-	-	-	-	-	131	144	-	~ 38	217	-
Stage 1	-	-	-	-	-	-	874	786	-	394	318	-
Stage 2	-	-	-	-	-	-	191	223	-	476	776	-

Approach	EB			WB			NB			SB		
HCM Control Delay, s	0.4			3.7			45.1			\$ 2636.1		
HCM LOS							E			F		

Minor Lane/Major Mvmt	NBLn1	NBLn2	NBLn3	EBL	EBT	EBR	WBL	WBT	WBR	SBLn1
Capacity (veh/h)	131	144	936	1108	-	-	1433	-	-	46
HCM Lane V/C Ratio	0.149	0.861	0.209	0.005	-	-	0.229	-	-	6.474
HCM Control Delay (s)	37.2	101.9	9.9	8.3	-	-	8.3	-	-	\$ 2636.1
HCM Lane LOS		E	F	A	A	-	A	-	-	F
HCM 95th %tile Q(veh)	0.5	5.7	0.8	0	-	-	0.9	-	-	34.7

Notes
 -: Volume exceeds capacity \$: Delay exceeds 300s +: Computation Not Defined *: All major volume in platoon

Intersection						
Int Delay, s/veh	59.1					
Movement	EBL	EBT	WBT	WBR	SBL	SBR
Lane Configurations		↑	↑		↑	↑
Traffic Vol, veh/h	0	482	526	0	298	141
Future Vol, veh/h	0	482	526	0	298	141
Conflicting Peds, #/hr	0	0	0	0	0	0
Sign Control	Free	Free	Free	Free	Stop	Stop
RT Channelized	-	None	-	None	-	None
Storage Length	-	-	-	-	0	610
Veh in Median Storage, #	-	0	0	-	0	-
Grade, %	-	0	0	-	0	-
Peak Hour Factor	92	92	92	92	92	92
Heavy Vehicles, %	13	13	10	10	19	19
Mvmt Flow	0	524	572	0	324	153

Major/Minor	Major1	Major2	Minor2		
Conflicting Flow All	-	0	-	0	1096 572
Stage 1	-	-	-	-	572 -
Stage 2	-	-	-	-	524 -
Critical Hdwy	-	-	-	-	6.59 6.39
Critical Hdwy Stg 1	-	-	-	-	5.59 -
Critical Hdwy Stg 2	-	-	-	-	5.59 -
Follow-up Hdwy	-	-	-	-	3.671 3.471
Pot Cap-1 Maneuver	0	-	-	0	~ 219 489
Stage 1	0	-	-	0	532 -
Stage 2	0	-	-	0	561 -
Platoon blocked, %	-	-	-	-	-
Mov Cap-1 Maneuver	-	-	-	-	~ 219 489
Mov Cap-2 Maneuver	-	-	-	-	~ 219 -
Stage 1	-	-	-	-	532 -
Stage 2	-	-	-	-	561 -

Approach	EB	WB	SB
HCM Control Delay, s	0	0	194.7
HCM LOS			F

Minor Lane/Major Mvmt	EBT	WBT	SBLn1	SBLn2
Capacity (veh/h)	-	-	219	489
HCM Lane V/C Ratio	-	-	1.479	0.313
HCM Control Delay (s)	-	-	279.4	15.7
HCM Lane LOS	-	-	F	C
HCM 95th %tile Q(veh)	-	-	19.4	1.3

Notes
 -: Volume exceeds capacity \$: Delay exceeds 300s +: Computation Not Defined *: All major volume in platoon

Intersection												
Int Delay, s/veh	414.5											
Movement	EBL	EBT	EBR	WBL	WBT	WBR	NBL	NBT	NBR	SBL	SBT	SBR
Lane Configurations	↖	↑			↗			↖	↗			
Traffic Vol, veh/h	145	463	0	0	935	253	299	4	240	0	0	0
Future Vol, veh/h	145	463	0	0	935	253	299	4	240	0	0	0
Conflicting Peds, #/hr	0	0	0	0	0	0	0	0	0	0	0	0
Sign Control	Free	Free	Free	Free	Free	Free	Stop	Stop	Stop	Free	Free	Free
RT Channelized	-	-	None	-	-	None	-	-	None	-	-	None
Storage Length	125	-	-	-	-	-	-	-	50	-	-	-
Veh in Median Storage, #	-	0	-	-	0	-	-	0	-	-	16965	-
Grade, %	-	0	-	-	0	-	-	0	-	-	0	-
Peak Hour Factor	92	92	92	92	92	92	92	92	92	92	92	92
Heavy Vehicles, %	11	11	11	3	3	3	14	14	14	0	0	0
Mvmt Flow	158	503	0	0	1016	275	325	4	261	0	0	0

Major/Minor	Major1	Major2	Minor1
Conflicting Flow All	1291	0	0
Stage 1	-	-	819
Stage 2	-	-	1154
Critical Hdwy	4.21	-	6.54
Critical Hdwy Stg 1	-	-	5.54
Critical Hdwy Stg 2	-	-	5.54
Follow-up Hdwy	2.299	-	3.626
Pot Cap-1 Maneuver	508	0	~ 63
Stage 1	-	0	413
Stage 2	-	0	~ 284
Platoon blocked, %	-	-	-
Mov Cap-1 Maneuver	508	-	~ 43
Mov Cap-2 Maneuver	-	-	~ 43
Stage 1	-	-	~ 285
Stage 2	-	-	~ 284

Approach	EB	WB	NB
HCM Control Delay, s	3.6	0	\$ 1781.5
HCM LOS			F

Minor Lane/Major Mvmt	NBLn1	NBLn2	EBL	EBT	WBT	WBR
Capacity (veh/h)	43	545	508	-	-	-
HCM Lane V/C Ratio	7.659	0.479	0.31	-	-	-
HCM Control Delay (s)	\$ 3178.8	17.5	15.2	-	-	-
HCM Lane LOS	F	C	C	-	-	-
HCM 95th %tile Q(veh)	39	2.6	1.3	-	-	-

Notes
 -: Volume exceeds capacity \$: Delay exceeds 300s +: Computation Not Defined *: All major volume in platoon

HCM 6th Signalized Intersection Summary
 16: Love's Truck Stop Driveway/Driveway & Avenue 17

Village D Specific Plan
 Phase III NP - AM Peak Hour



Movement	EBL	EBT	EBR	WBL	WBT	WBR	NBL	NBT	NBR	SBL	SBT	SBR
Lane Configurations												
Traffic Volume (veh/h)	162	397	132	45	878	56	136	0	22	48	0	90
Future Volume (veh/h)	162	397	132	45	878	56	136	0	22	48	0	90
Initial Q (Qb), veh	0	0	0	0	0	0	0	0	0	0	0	0
Ped-Bike Adj(A_pbT)	1.00		1.00	1.00		1.00	1.00		1.00	1.00		1.00
Parking Bus, Adj	1.00	1.00	1.00	1.00	1.00	1.00	1.00	1.00	1.00	1.00	1.00	1.00
Work Zone On Approach		No			No			No			No	
Adj Sat Flow, veh/h/ln	1796	1796	1796	1856	1856	1856	1900	1900	1900	1900	1900	1900
Adj Flow Rate, veh/h	176	432	143	49	954	61	148	0	24	52	0	98
Peak Hour Factor	0.92	0.92	0.92	0.92	0.92	0.92	0.92	0.92	0.92	0.92	0.92	0.92
Percent Heavy Veh, %	7	7	7	3	3	3	0	0	0	0	0	0
Cap, veh/h	182	1952	870	63	864	55	155	0	330	68	0	252
Arrive On Green	0.11	0.57	0.57	0.04	0.50	0.50	0.09	0.00	0.21	0.04	0.00	0.16
Sat Flow, veh/h	1711	3413	1522	1767	1725	110	1810	0	1610	1810	0	1610
Grp Volume(v), veh/h	176	432	143	49	0	1015	148	0	24	52	0	98
Grp Sat Flow(s),veh/h/ln	1711	1706	1522	1767	0	1836	1810	0	1610	1810	0	1610
Q Serve(g_s), s	12.3	7.4	5.3	3.3	0.0	60.1	9.8	0.0	1.4	3.4	0.0	6.6
Cycle Q Clear(g_c), s	12.3	7.4	5.3	3.3	0.0	60.1	9.8	0.0	1.4	3.4	0.0	6.6
Prop In Lane	1.00		1.00	1.00		0.06	1.00		1.00	1.00		1.00
Lane Grp Cap(c), veh/h	182	1952	870	63	0	919	155	0	330	68	0	252
V/C Ratio(X)	0.96	0.22	0.16	0.78	0.00	1.10	0.95	0.00	0.07	0.77	0.00	0.39
Avail Cap(c_a), veh/h	182	1952	870	131	0	919	155	0	330	134	0	252
HCM Platoon Ratio	1.00	1.00	1.00	1.00	1.00	1.00	1.00	1.00	1.00	1.00	1.00	1.00
Upstream Filter(I)	1.00	1.00	1.00	1.00	0.00	1.00	1.00	0.00	1.00	1.00	0.00	1.00
Uniform Delay (d), s/veh	53.4	12.6	12.1	57.4	0.0	30.0	54.6	0.0	38.5	57.3	0.0	45.4
Incr Delay (d2), s/veh	56.1	0.1	0.1	18.2	0.0	62.4	58.1	0.0	0.4	16.6	0.0	4.5
Initial Q Delay(d3),s/veh	0.0	0.0	0.0	0.0	0.0	0.0	0.0	0.0	0.0	0.0	0.0	0.0
%ile BackOfQ(50%),veh/ln	8.1	2.8	1.8	1.8	0.0	41.3	6.9	0.0	0.6	1.9	0.0	2.9
Unsig. Movement Delay, s/veh												
LnGrp Delay(d),s/veh	109.5	12.7	12.2	75.6	0.0	92.3	112.7	0.0	38.9	73.9	0.0	49.9
LnGrp LOS	F	B	B	E	A	F	F	A	D	E	A	D
Approach Vol, veh/h		751			1064			172				150
Approach Delay, s/veh		35.3			91.6			102.4				58.2
Approach LOS		D			F			F				E
Timer - Assigned Phs	1	2	3	4	5	6	7	8				
Phs Duration (G+Y+Rc), s	9.0	29.1	8.8	73.1	14.8	23.3	17.3	64.6				
Change Period (Y+Rc), s	4.5	4.5	4.5	4.5	4.5	4.5	4.5	4.5				
Max Green Setting (Gmax), s	8.9	20.2	8.9	64.0	10.3	18.8	12.8	60.1				
Max Q Clear Time (g_c+I1), s	5.4	3.4	5.3	9.4	11.8	8.6	14.3	62.1				
Green Ext Time (p_c), s	0.0	0.1	0.0	3.8	0.0	0.3	0.0	0.0				
Intersection Summary												
HCM 6th Ctrl Delay				70.3								
HCM 6th LOS				E								

HCM 6th TWSC
 17: Westberry Boulevard & Cleveland Avenue

Village D Specific Plan
 Phase III NP - AM Peak Hour

Intersection												
Int Delay, s/veh	10											
Movement	EBL	EBT	EBR	WBL	WBT	WBR	NBL	NBT	NBR	SBL	SBT	SBR
Lane Configurations	↖	↗		↖	↗		↖	↗	↖	↗	↖	↗
Traffic Vol, veh/h	21	47	33	41	53	13	50	239	181	15	80	22
Future Vol, veh/h	21	47	33	41	53	13	50	239	181	15	80	22
Conflicting Peds, #/hr	1	0	2	2	0	1	1	0	1	1	0	1
Sign Control	Free	Free	Free	Free	Free	Free	Stop	Stop	Stop	Stop	Stop	Stop
RT Channelized	-	-	None	-	-	None	-	-	None	-	-	None
Storage Length	110	-	-	165	-	-	65	-	50	100	-	50
Veh in Median Storage, #	-	0	-	-	0	-	-	0	-	-	0	-
Grade, %	-	0	-	-	0	-	-	0	-	-	0	-
Peak Hour Factor	92	92	92	92	92	92	92	92	92	92	92	92
Heavy Vehicles, %	4	4	4	4	4	4	0	0	0	0	0	0
Mvmt Flow	23	51	36	45	58	14	54	260	197	16	87	24

Major/Minor	Major1			Major2			Minor1			Minor2		
Conflicting Flow All	73	0	0	89	0	0	329	280	72	501	291	67
Stage 1	-	-	-	-	-	-	117	117	-	156	156	-
Stage 2	-	-	-	-	-	-	212	163	-	345	135	-
Critical Hdwy	4.14	-	-	4.14	-	-	7.1	6.5	6.2	7.1	6.5	6.2
Critical Hdwy Stg 1	-	-	-	-	-	-	6.1	5.5	-	6.1	5.5	-
Critical Hdwy Stg 2	-	-	-	-	-	-	6.1	5.5	-	6.1	5.5	-
Follow-up Hdwy	2.236	-	-	2.236	-	-	3.5	4	3.3	3.5	4	3.3
Pot Cap-1 Maneuver	1514	-	-	1494	-	-	628	632	996	484	623	1002
Stage 1	-	-	-	-	-	-	892	803	-	851	772	-
Stage 2	-	-	-	-	-	-	795	767	-	675	789	-
Platoon blocked, %	-	-	-	-	-	-	-	-	-	-	-	-
Mov Cap-1 Maneuver	1513	-	-	1491	-	-	524	602	993	249	594	1000
Mov Cap-2 Maneuver	-	-	-	-	-	-	524	602	-	249	594	-
Stage 1	-	-	-	-	-	-	877	789	-	837	748	-
Stage 2	-	-	-	-	-	-	664	743	-	357	776	-

Approach	EB			WB			NB			SB		
HCM Control Delay, s	1.5			2.9			12.8			12.5		
HCM LOS							B			B		

Minor Lane/Major Mvmt	NBLn1	NBLn2	NBLn3	EBL	EBT	EBR	WBL	WBT	WBR	SBLn1	SBLn2	SBLn3
Capacity (veh/h)	524	602	993	1513	-	-	1491	-	-	249	594	1000
HCM Lane V/C Ratio	0.104	0.432	0.198	0.015	-	-	0.03	-	-	0.065	0.146	0.024
HCM Control Delay (s)	12.7	15.4	9.5	7.4	-	-	7.5	-	-	20.5	12.1	8.7
HCM Lane LOS	B	C	A	A	-	-	A	-	-	C	B	A
HCM 95th %tile Q(veh)	0.3	2.2	0.7	0	-	-	0.1	-	-	0.2	0.5	0.1

Intersection	
Intersection Delay, s/veh	24.4
Intersection LOS	C

Movement	EBL	EBT	EBR	WBL	WBT	WBR	NBL	NBT	NBR	SBL	SBT	SBR
Lane Configurations	↶	↷		↶	↷		↶	↷	↷	↶	↷	↶
Traffic Vol, veh/h	59	224	97	60	167	31	119	211	124	132	147	31
Future Vol, veh/h	59	224	97	60	167	31	119	211	124	132	147	31
Peak Hour Factor	0.92	0.92	0.92	0.92	0.92	0.92	0.92	0.92	0.92	0.92	0.92	0.92
Heavy Vehicles, %	3	3	3	3	3	3	0	0	0	0	0	0
Mvmt Flow	64	243	105	65	182	34	129	229	135	143	160	34
Number of Lanes	1	1	0	1	1	0	1	1	1	1	1	1

Approach	EB	WB	NB	SB
Opposing Approach	WB	EB	SB	NB
Opposing Lanes	2	2	3	3
Conflicting Approach Left	SB	NB	EB	WB
Conflicting Lanes Left	3	3	2	2
Conflicting Approach Right	NB	SB	WB	EB
Conflicting Lanes Right	3	3	2	2
HCM Control Delay	38.4	20.9	19.1	18
HCM LOS	E	C	C	C

Lane	NBLn1	NBLn2	NBLn3	EBLn1	EBLn2	WBLn1	WBLn2	SBLn1	SBLn2	SBLn3
Vol Left, %	100%	0%	0%	100%	0%	100%	0%	100%	0%	0%
Vol Thru, %	0%	100%	0%	0%	70%	0%	84%	0%	100%	0%
Vol Right, %	0%	0%	100%	0%	30%	0%	16%	0%	0%	100%
Sign Control	Stop	Stop	Stop	Stop	Stop	Stop	Stop	Stop	Stop	Stop
Traffic Vol by Lane	119	211	124	59	321	60	198	132	147	31
LT Vol	119	0	0	59	0	60	0	132	0	0
Through Vol	0	211	0	0	224	0	167	0	147	0
RT Vol	0	0	124	0	97	0	31	0	0	31
Lane Flow Rate	129	229	135	64	349	65	215	143	160	34
Geometry Grp	8	8	8	8	8	8	8	8	8	8
Degree of Util (X)	0.339	0.568	0.307	0.167	0.838	0.178	0.55	0.392	0.413	0.08
Departure Headway (Hd)	9.435	8.915	8.187	9.368	8.644	9.826	9.203	9.837	9.315	8.585
Convergence, Y/N	Yes	Yes	Yes	Yes	Yes	Yes	Yes	Yes	Yes	Yes
Cap	380	404	438	382	419	365	392	364	385	416
Service Time	7.208	6.688	5.96	7.136	6.413	7.604	6.981	7.618	7.096	6.366
HCM Lane V/C Ratio	0.339	0.567	0.308	0.168	0.833	0.178	0.548	0.393	0.416	0.082
HCM Control Delay	17	22.9	14.6	14	42.9	14.7	22.8	18.9	18.5	12.1
HCM Lane LOS	C	C	B	B	E	B	C	C	C	B
HCM 95th-tile Q	1.5	3.4	1.3	0.6	8	0.6	3.2	1.8	2	0.3

Intersection												
Intersection Delay, s/veh	35.8											
Intersection LOS	E											

Movement	EBL	EBT	EBR	WBL	WBT	WBR	NBL	NBT	NBR	SBL	SBT	SBR
Lane Configurations		↕			↕			↕			↕	
Traffic Vol, veh/h	55	210	39	12	171	133	75	53	25	309	73	78
Future Vol, veh/h	55	210	39	12	171	133	75	53	25	309	73	78
Peak Hour Factor	0.92	0.92	0.92	0.92	0.92	0.92	0.92	0.92	0.92	0.92	0.92	0.92
Heavy Vehicles, %	6	6	6	6	6	6	0	0	0	0	0	0
Mvmt Flow	60	228	42	13	186	145	82	58	27	336	79	85
Number of Lanes	0	1	0	0	1	0	0	1	0	0	1	0

Approach	EB	WB	NB	SB
Opposing Approach	WB	EB	SB	NB
Opposing Lanes	1	1	1	1
Conflicting Approach Left	SB	NB	EB	WB
Conflicting Lanes Left	1	1	1	1
Conflicting Approach Right	NB	SB	WB	EB
Conflicting Lanes Right	1	1	1	1
HCM Control Delay	25.3	25	15.8	56.9
HCM LOS	D	C	C	F

Lane	NBLn1	EBLn1	WBLn1	SBLn1
Vol Left, %	49%	18%	4%	67%
Vol Thru, %	35%	69%	54%	16%
Vol Right, %	16%	13%	42%	17%
Sign Control	Stop	Stop	Stop	Stop
Traffic Vol by Lane	153	304	316	460
LT Vol	75	55	12	309
Through Vol	53	210	171	73
RT Vol	25	39	133	78
Lane Flow Rate	166	330	343	500
Geometry Grp	1	1	1	1
Degree of Util (X)	0.373	0.683	0.689	0.961
Departure Headway (Hd)	8.073	7.446	7.225	6.921
Convergence, Y/N	Yes	Yes	Yes	Yes
Cap	449	482	498	520
Service Time	6.073	5.542	5.32	5
HCM Lane V/C Ratio	0.37	0.685	0.689	0.962
HCM Control Delay	15.8	25.3	25	56.9
HCM Lane LOS	C	D	C	F
HCM 95th-tile Q	1.7	5.1	5.2	12.4

Intersection

Intersection Delay, s/veh11.2

Intersection LOS B

Movement	EBL	EBT	EBR	WBL	WBT	WBR	NBL	NBT	NBR	SBL	SBT	SBR
Lane Configurations		↕			↕	↕		↕	↕		↕	↕
Traffic Vol, veh/h	0	0	0	79	0	234	0	88	315	100	18	0
Future Vol, veh/h	0	0	0	79	0	234	0	88	315	100	18	0
Peak Hour Factor	0.92	0.92	0.92	0.92	0.92	0.92	0.92	0.92	0.92	0.92	0.92	0.92
Heavy Vehicles, %	0	0	0	3	3	3	0	0	0	0	0	0
Mvmt Flow	0	0	0	86	0	254	0	96	342	109	20	0
Number of Lanes	0	1	0	0	1	1	0	1	1	0	1	1

Approach	EB	WB	NB	SB
Opposing Approach	WB	EB	SB	NB
Opposing Lanes	2	1	2	2
Conflicting Approach Left	SB	NB	EB	WB
Conflicting Lanes Left	2	2	1	2
Conflicting Approach Right	NB	SB	WB	EB
Conflicting Lanes Right	2	2	2	1
HCM Control Delay	0	11	11.4	11
HCM LOS	-	B	B	B

Lane	NBLn1	NBLn2	EBLn1	WBLn1	WBLn2	SBLn1	SBLn2
Vol Left, %	0%	0%	0%	100%	0%	85%	0%
Vol Thru, %	100%	0%	100%	0%	0%	15%	100%
Vol Right, %	0%	100%	0%	0%	100%	0%	0%
Sign Control	Stop	Stop	Stop	Stop	Stop	Stop	Stop
Traffic Vol by Lane	88	315	0	79	234	118	0
LT Vol	0	0	0	79	0	100	0
Through Vol	88	0	0	0	0	18	0
RT Vol	0	315	0	0	234	0	0
Lane Flow Rate	96	342	0	86	254	128	0
Geometry Grp	7	7	6	7	7	7	7
Degree of Util (X)	0.15	0.471	0	0.155	0.374	0.228	0
Departure Headway (Hd)	5.663	4.956	6.519	6.505	5.293	6.401	5.971
Convergence, Y/N	Yes	Yes	Yes	Yes	Yes	Yes	Yes
Cap	637	733	0	553	682	562	0
Service Time	3.363	2.656	4.557	4.23	3.018	4.129	3.699
HCM Lane V/C Ratio	0.151	0.467	0	0.156	0.372	0.228	0
HCM Control Delay	9.4	12	9.6	10.4	11.2	11	8.7
HCM Lane LOS	A	B	N	B	B	B	N
HCM 95th-tile Q	0.5	2.5	0	0.5	1.7	0.9	0

Intersection	
Intersection Delay, s/veh	45.5
Intersection LOS	E

Movement	EBL	EBT	EBR	WBL	WBT	WBR	NBL	NBT	NBR	SBL	SBT	SBR
Lane Configurations	↵	↕↗		↵	↕↗		↵	↕	↗	↵	↕	↗
Traffic Vol, veh/h	35	214	9	194	58	32	18	443	350	14	284	5
Future Vol, veh/h	35	214	9	194	58	32	18	443	350	14	284	5
Peak Hour Factor	0.92	0.92	0.92	0.92	0.92	0.92	0.92	0.92	0.92	0.92	0.92	0.92
Heavy Vehicles, %	4	4	4	4	4	4	0	0	0	0	0	0
Mvmt Flow	38	233	10	211	63	35	20	482	380	15	309	5
Number of Lanes	1	2	0	1	2	0	1	1	1	1	1	1

Approach	EB	WB	NB	SB
Opposing Approach	WB	EB	SB	NB
Opposing Lanes	3	3	3	3
Conflicting Approach Left	SB	NB	EB	WB
Conflicting Lanes Left	3	3	3	3
Conflicting Approach Right	NB	SB	WB	EB
Conflicting Lanes Right	3	3	3	3
HCM Control Delay	16.9	21.3	66.5	36.2
HCM LOS	C	C	F	E

Lane	NBLn1	NBLn2	NBLn3	EBLn1	EBLn2	EBLn3	WBLn1	WBLn2	WBLn3	SBLn1	SBLn2
Vol Left, %	100%	0%	0%	100%	0%	0%	100%	0%	0%	100%	0%
Vol Thru, %	0%	100%	0%	0%	100%	89%	0%	100%	38%	0%	100%
Vol Right, %	0%	0%	100%	0%	0%	11%	0%	0%	62%	0%	0%
Sign Control	Stop	Stop	Stop	Stop	Stop	Stop	Stop	Stop	Stop	Stop	Stop
Traffic Vol by Lane	18	443	350	35	143	80	194	39	51	14	284
LT Vol	18	0	0	35	0	0	194	0	0	14	0
Through Vol	0	443	0	0	143	71	0	39	19	0	284
RT Vol	0	0	350	0	0	9	0	0	32	0	0
Lane Flow Rate	20	482	380	38	155	87	211	42	56	15	309
Geometry Grp	8	8	8	8	8	8	8	8	8	8	8
Degree of Util (X)	0.047	1.084	0.783	0.105	0.405	0.226	0.571	0.108	0.137	0.041	0.78
Departure Headway (Hd)	8.605	8.105	7.405	10.094	9.594	9.515	9.95	9.45	9.013	9.711	9.211
Convergence, Y/N	Yes	Yes	Yes	Yes	Yes	Yes	Yes	Yes	Yes	Yes	Yes
Cap	414	448	487	357	377	380	365	382	400	371	395
Service Time	6.399	5.899	5.199	7.794	7.294	7.215	7.65	7.15	6.713	7.411	6.911
HCM Lane V/C Ratio	0.048	1.076	0.78	0.106	0.411	0.229	0.578	0.11	0.14	0.04	0.782
HCM Control Delay	11.8	95.8	32.3	14	18.7	15	25.1	13.3	13.1	12.8	37.8
HCM Lane LOS	B	F	D	B	C	B	D	B	B	B	E
HCM 95th-tile Q	0.1	15.9	7	0.3	1.9	0.9	3.4	0.4	0.5	0.1	6.6

Intersection												
Intersection Delay, s/veh	46											
Intersection LOS	E											

Movement	EBL	EBT	EBR	WBL	WBT	WBR	NBL	NBT	NBR	SBL	SBT	SBR
Lane Configurations												
Traffic Vol, veh/h	68	272	74	26	106	67	49	260	26	133	292	50
Future Vol, veh/h	68	272	74	26	106	67	49	260	26	133	292	50
Peak Hour Factor	0.92	0.92	0.92	0.92	0.92	0.92	0.92	0.92	0.92	0.92	0.92	0.92
Heavy Vehicles, %	2	2	2	6	6	6	2	2	2	2	2	2
Mvmt Flow	74	296	80	28	115	73	53	283	28	145	317	54
Number of Lanes	1	1	0	1	1	1	1	1	0	1	1	0

Approach	EB	WB	NB	SB
Opposing Approach	WB	EB	SB	NB
Opposing Lanes	3	2	2	2
Conflicting Approach Left	SB	NB	EB	WB
Conflicting Lanes Left	2	2	2	3
Conflicting Approach Right	NB	SB	WB	EB
Conflicting Lanes Right	2	2	3	2
HCM Control Delay	60	16.8	40	50.4
HCM LOS	F	C	E	F

Lane	NBLn1	NBLn2	EBLn1	EBLn2	WBLn1	WBLn2	WBLn3	SBLn1	SBLn2
Vol Left, %	100%	0%	100%	0%	100%	0%	0%	100%	0%
Vol Thru, %	0%	91%	0%	79%	0%	100%	0%	0%	85%
Vol Right, %	0%	9%	0%	21%	0%	0%	100%	0%	15%
Sign Control	Stop	Stop	Stop	Stop	Stop	Stop	Stop	Stop	Stop
Traffic Vol by Lane	49	286	68	346	26	106	67	133	342
LT Vol	49	0	68	0	26	0	0	133	0
Through Vol	0	260	0	272	0	106	0	0	292
RT Vol	0	26	0	74	0	0	67	0	50
Lane Flow Rate	53	311	74	376	28	115	73	145	372
Geometry Grp	8	8	8	8	8	8	8	8	8
Degree of Util (X)	0.15	0.824	0.204	0.968	0.086	0.336	0.197	0.392	0.943
Departure Headway (Hd)	10.124	9.54	9.945	9.266	11.014	10.489	9.754	9.751	9.128
Convergence, Y/N	Yes	Yes	Yes	Yes	Yes	Yes	Yes	Yes	Yes
Cap	354	379	362	395	325	342	368	370	398
Service Time	7.884	7.299	7.668	6.989	8.786	8.261	7.526	7.477	6.853
HCM Lane V/C Ratio	0.15	0.821	0.204	0.952	0.086	0.336	0.198	0.392	0.935
HCM Control Delay	14.7	44.3	15.2	68.8	14.8	18.5	14.9	18.6	62.7
HCM Lane LOS	B	E	C	F	B	C	B	C	F
HCM 95th-tile Q	0.5	7.4	0.8	11.1	0.3	1.4	0.7	1.8	10.5

HCM 6th Signalized Intersection Summary
 23: Avenue 16/Ellis Street & Kennedy Street

Village D Specific Plan
 Phase III NP - AM Peak Hour



Movement	WBL	WBR	NBT	NBR	SBL	SBT
Lane Configurations						
Traffic Volume (veh/h)	242	168	407	209	272	370
Future Volume (veh/h)	242	168	407	209	272	370
Initial Q (Qb), veh	0	0	0	0	0	0
Ped-Bike Adj(A_pbT)	1.00	1.00		0.98	1.00	
Parking Bus, Adj	1.00	1.00	1.00	1.00	1.00	1.00
Work Zone On Approach	No		No		No	
Adj Sat Flow, veh/h/ln	1841	1841	1841	1841	1870	1870
Adj Flow Rate, veh/h	263	183	442	227	296	402
Peak Hour Factor	0.92	0.92	0.92	0.92	0.92	0.92
Percent Heavy Veh, %	4	4	4	4	2	2
Cap, veh/h	316	495	653	332	636	2513
Arrive On Green	0.18	0.18	0.29	0.29	0.36	0.71
Sat Flow, veh/h	1753	2745	2316	1131	1781	3647
Grp Volume(v), veh/h	263	183	347	322	296	402
Grp Sat Flow(s),veh/h/ln	1753	1373	1749	1606	1781	1777
Q Serve(g_s), s	11.6	4.7	14.0	14.2	10.2	3.0
Cycle Q Clear(g_c), s	11.6	4.7	14.0	14.2	10.2	3.0
Prop In Lane	1.00	1.00		0.70	1.00	
Lane Grp Cap(c), veh/h	316	495	514	472	636	2513
V/C Ratio(X)	0.83	0.37	0.67	0.68	0.47	0.16
Avail Cap(c_a), veh/h	427	669	514	472	636	2513
HCM Platoon Ratio	1.00	1.00	1.00	1.00	1.00	1.00
Upstream Filter(I)	0.56	0.56	1.00	1.00	1.00	1.00
Uniform Delay (d), s/veh	31.6	28.8	24.9	25.0	19.8	3.9
Incr Delay (d2), s/veh	5.8	0.3	6.9	7.8	0.5	0.1
Initial Q Delay(d3),s/veh	0.0	0.0	0.0	0.0	0.0	0.0
%ile BackOfQ(50%),veh/ln	5.3	1.5	6.5	6.2	4.1	0.9
Unsig. Movement Delay, s/veh						
LnGrp Delay(d),s/veh	37.5	29.1	31.8	32.8	20.3	4.0
LnGrp LOS	D	C	C	C	C	A
Approach Vol, veh/h	446		669			698
Approach Delay, s/veh	34.0		32.3			10.9
Approach LOS	C		C			B
Timer - Assigned Phs	1	2			6	8
Phs Duration (G+Y+Rc), s	33.1	28.0			61.1	18.9
Change Period (Y+Rc), s	4.5	4.5			4.5	4.5
Max Green Setting (Gmax), s	23.5	23.5			51.5	19.5
Max Q Clear Time (g_c+1/2), s	11.2	16.2			5.0	13.6
Green Ext Time (p_c), s	0.7	2.5			3.0	0.8
Intersection Summary						
HCM 6th Ctrl Delay			24.5			
HCM 6th LOS			C			

HCM 6th Signalized Intersection Summary
24: Schnoor Avenue & Kennedy Street

Village D Specific Plan
Phase III NP - AM Peak Hour



Movement	EBL	EBT	EBR	WBL	WBT	WBR	NBL	NBT	NBR	SBL	SBT	SBR
Lane Configurations												
Traffic Volume (veh/h)	116	210	170	202	263	214	125	46	291	138	43	34
Future Volume (veh/h)	116	210	170	202	263	214	125	46	291	138	43	34
Initial Q (Qb), veh	0	0	0	0	0	0	0	0	0	0	0	0
Ped-Bike Adj(A_pbT)	1.00		1.00	1.00		1.00	1.00		1.00	1.00		1.00
Parking Bus, Adj	1.00	1.00	1.00	1.00	1.00	1.00	1.00	1.00	1.00	1.00	1.00	1.00
Work Zone On Approach		No			No			No			No	
Adj Sat Flow, veh/h/ln	1841	1841	1841	1826	1826	1826	1900	1900	1900	1366	1366	1366
Adj Flow Rate, veh/h	126	228	185	220	286	233	136	50	316	150	47	37
Peak Hour Factor	0.92	0.92	0.92	0.92	0.92	0.92	0.92	0.92	0.92	0.92	0.92	0.92
Percent Heavy Veh, %	4	4	4	5	5	5	0	0	0	36	36	36
Cap, veh/h	121	476	369	261	312	254	375	60	380	133	360	304
Arrive On Green	0.07	0.25	0.25	0.15	0.34	0.34	0.11	0.27	0.27	0.10	0.26	0.26
Sat Flow, veh/h	1753	1873	1453	1739	930	758	3510	224	1414	1301	1366	1153
Grp Volume(v), veh/h	126	212	201	220	0	519	136	0	366	150	47	37
Grp Sat Flow(s),veh/h/ln	1753	1749	1577	1739	0	1688	1755	0	1638	1301	1366	1153
Q Serve(g_s), s	5.5	8.2	8.7	9.8	0.0	23.6	2.9	0.0	16.8	8.1	2.1	1.5
Cycle Q Clear(g_c), s	5.5	8.2	8.7	9.8	0.0	23.6	2.9	0.0	16.8	8.1	2.1	1.5
Prop In Lane	1.00		0.92	1.00		0.45	1.00		0.86	1.00		1.00
Lane Grp Cap(c), veh/h	121	445	401	261	0	567	375	0	440	133	360	304
V/C Ratio(X)	1.05	0.48	0.50	0.84	0.00	0.92	0.36	0.00	0.83	1.13	0.13	0.12
Avail Cap(c_a), veh/h	121	445	401	359	0	623	375	0	440	133	360	304
HCM Platoon Ratio	1.00	1.00	1.00	1.00	1.00	1.00	1.00	1.00	1.00	1.00	1.00	1.00
Upstream Filter(I)	0.80	0.80	0.80	1.00	0.00	1.00	1.00	0.00	1.00	1.00	1.00	1.00
Uniform Delay (d), s/veh	37.3	25.3	25.5	33.1	0.0	25.5	33.2	0.0	27.5	35.9	22.5	12.7
Incr Delay (d2), s/veh	85.9	0.6	0.8	12.4	0.0	17.5	0.6	0.0	16.6	117.9	0.7	0.8
Initial Q Delay(d3),s/veh	0.0	0.0	0.0	0.0	0.0	0.0	0.0	0.0	0.0	0.0	0.0	0.0
%ile BackOfQ(50%),veh/ln	5.2	3.4	3.2	4.9	0.0	11.6	1.2	0.0	8.3	6.9	0.7	0.6
Unsig. Movement Delay, s/veh												
LnGrp Delay(d),s/veh	123.1	26.0	26.3	45.4	0.0	43.0	33.8	0.0	44.1	153.8	23.2	13.5
LnGrp LOS	F	C	C	D	A	D	C	A	D	F	C	B
Approach Vol, veh/h		539			739			502			234	
Approach Delay, s/veh		48.8			43.7			41.3			105.4	
Approach LOS		D			D			D			F	
Timer - Assigned Phs	1	2	3	4	5	6	7	8				
Phs Duration (G+Y+Rc), s	2.6	26.0	16.5	24.8	13.0	25.6	10.0	31.4				
Change Period (Y+Rc), s	4.5	4.5	4.5	4.5	4.5	4.5	4.5	4.5				
Max Green Setting (Gmax), s	5.5	21.5	16.5	18.5	5.9	21.1	5.5	29.5				
Max Q Clear Time (g_c+TQ), s	11.0	18.8	11.8	10.7	4.9	4.1	7.5	25.6				
Green Ext Time (p_c), s	0.0	0.6	0.3	1.5	0.0	0.3	0.0	1.3				
Intersection Summary												
HCM 6th Ctrl Delay				51.6								
HCM 6th LOS				D								

HCM 6th TWSC
 25: Kennedy Street/Gateway Drive & SR-99 Southbound Ramps

Village D Specific Plan
 Phase III NP - AM Peak Hour

Intersection						
Int Delay, s/veh	17.8					
Movement	EBL	EBT	WBT	WBR	SBL	SBR
Lane Configurations	↘	↑	↗		↘	↗
Traffic Vol, veh/h	380	251	507	4	67	126
Future Vol, veh/h	380	251	507	4	67	126
Conflicting Peds, #/hr	0	0	0	0	0	0
Sign Control	Free	Free	Free	Free	Stop	Stop
RT Channelized	-	None	-	Free	-	None
Storage Length	140	-	-	-	0	335
Veh in Median Storage, #	-	0	0	-	0	-
Grade, %	-	0	0	-	0	-
Peak Hour Factor	92	92	92	92	92	92
Heavy Vehicles, %	2	2	6	6	4	4
Mvmt Flow	413	273	551	4	73	137

Major/Minor	Major1	Major2	Minor2		
Conflicting Flow All	551	0	-	0	1650 551
Stage 1	-	-	-	-	551 -
Stage 2	-	-	-	-	1099 -
Critical Hdwy	4.12	-	-	-	6.44 6.24
Critical Hdwy Stg 1	-	-	-	-	5.44 -
Critical Hdwy Stg 2	-	-	-	-	5.44 -
Follow-up Hdwy	2.218	-	-	-	3.536 3.336
Pot Cap-1 Maneuver	1019	-	-	0	107 530
Stage 1	-	-	-	0	573 -
Stage 2	-	-	-	0	316 -
Platoon blocked, %		-	-		
Mov Cap-1 Maneuver	1019	-	-	-	64 530
Mov Cap-2 Maneuver	-	-	-	-	64 -
Stage 1	-	-	-	-	341 -
Stage 2	-	-	-	-	316 -

Approach	EB	WB	SB
HCM Control Delay, s	6.6	0	101.1
HCM LOS			F

Minor Lane/Major Mvmt	EBL	EBT	WBT	SBLn1	SBLn2
Capacity (veh/h)	1019	-	-	64	530
HCM Lane V/C Ratio	0.405	-	-	1.138	0.258
HCM Control Delay (s)	10.9	-	-	264.8	14.1
HCM Lane LOS	B	-	-	F	B
HCM 95th %tile Q(veh)	2	-	-	5.8	1

Notes
 -: Volume exceeds capacity \$: Delay exceeds 300s +: Computation Not Defined *: All major volume in platoon

Intersection						
Int Delay, s/veh	7.7					
Movement	EBL	EBT	WBT	WBR	SBL	SBR
Lane Configurations		↔	↔		↔	
Traffic Vol, veh/h	167	151	101	0	0	410
Future Vol, veh/h	167	151	101	0	0	410
Conflicting Peds, #/hr	0	0	0	0	0	0
Sign Control	Free	Free	Free	Free	Stop	Stop
RT Channelized	-	None	-	None	-	None
Storage Length	-	-	-	-	0	-
Veh in Median Storage, #	-	0	0	-	0	-
Grade, %	-	0	0	-	0	-
Peak Hour Factor	92	92	92	92	92	92
Heavy Vehicles, %	3	3	6	6	7	7
Mvmt Flow	182	164	110	0	0	446

Major/Minor	Major1	Major2	Minor2		
Conflicting Flow All	110	0	-	0	638 110
Stage 1	-	-	-	-	110 -
Stage 2	-	-	-	-	528 -
Critical Hdwy	4.13	-	-	-	6.47 6.27
Critical Hdwy Stg 1	-	-	-	-	5.47 -
Critical Hdwy Stg 2	-	-	-	-	5.47 -
Follow-up Hdwy	2.227	-	-	-	3.563 3.363
Pot Cap-1 Maneuver	1474	-	-	-	433 930
Stage 1	-	-	-	-	902 -
Stage 2	-	-	-	-	582 -
Platoon blocked, %		-	-	-	
Mov Cap-1 Maneuver	1474	-	-	-	374 930
Mov Cap-2 Maneuver	-	-	-	-	374 -
Stage 1	-	-	-	-	779 -
Stage 2	-	-	-	-	582 -

Approach	EB	WB	SB
HCM Control Delay, s	4.1	0	12.4
HCM LOS			B

Minor Lane/Major Mvmt	EBL	EBT	WBT	WBR	SBLn1
Capacity (veh/h)	1474	-	-	-	930
HCM Lane V/C Ratio	0.123	-	-	-	0.479
HCM Control Delay (s)	7.8	0	-	-	12.4
HCM Lane LOS	A	A	-	-	B
HCM 95th %tile Q(veh)	0.4	-	-	-	2.6

Intersection						
Int Delay, s/veh	3.1					
Movement	EBL	EBR	NBL	NBT	SBT	SBR
Lane Configurations	↵			↑	↵	
Traffic Vol, veh/h	163	0	0	44	3	409
Future Vol, veh/h	163	0	0	44	3	409
Conflicting Peds, #/hr	0	0	0	0	0	0
Sign Control	Stop	Stop	Free	Free	Free	Free
RT Channelized	-	None	-	None	-	None
Storage Length	0	-	-	-	-	-
Veh in Median Storage, #	0	-	-	0	0	-
Grade, %	0	-	-	0	0	-
Peak Hour Factor	92	92	92	92	92	92
Heavy Vehicles, %	3	3	10	10	6	6
Mvmt Flow	177	0	0	48	3	445

Major/Minor	Minor2	Major1		Major2	
Conflicting Flow All	274	-	-	0	0
Stage 1	226	-	-	-	-
Stage 2	48	-	-	-	-
Critical Hdwy	6.43	-	-	-	-
Critical Hdwy Stg 1	5.43	-	-	-	-
Critical Hdwy Stg 2	5.43	-	-	-	-
Follow-up Hdwy	3.527	-	-	-	-
Pot Cap-1 Maneuver	713	0	0	-	-
Stage 1	809	0	0	-	-
Stage 2	972	0	0	-	-
Platoon blocked, %				-	-
Mov Cap-1 Maneuver	713	-	-	-	-
Mov Cap-2 Maneuver	713	-	-	-	-
Stage 1	809	-	-	-	-
Stage 2	972	-	-	-	-

Approach	EB	NB	SB
HCM Control Delay, s	11.7	0	0
HCM LOS	B		

Minor Lane/Major Mvmt	NBT EBLn1	SBT	SBR
Capacity (veh/h)	- 713	-	-
HCM Lane V/C Ratio	- 0.248	-	-
HCM Control Delay (s)	- 11.7	-	-
HCM Lane LOS	- B	-	-
HCM 95th %tile Q(veh)	- 1	-	-

Intersection						
Int Delay, s/veh	0					
Movement	EBL	EBT	WBT	WBR	SBL	SBR
Lane Configurations		↶	↷		↶	
Traffic Vol, veh/h	0	144	106	53	0	0
Future Vol, veh/h	0	144	106	53	0	0
Conflicting Peds, #/hr	0	0	0	0	0	0
Sign Control	Free	Free	Free	Free	Stop	Stop
RT Channelized	-	None	-	None	-	None
Storage Length	-	-	-	-	0	-
Veh in Median Storage, #	-	0	0	-	0	-
Grade, %	-	0	0	-	0	-
Peak Hour Factor	92	92	92	92	92	92
Heavy Vehicles, %	2	2	13	13	0	0
Mvmt Flow	0	157	115	58	0	0

Major/Minor	Major1	Major2	Minor2		
Conflicting Flow All	173	0	-	0	301 144
Stage 1	-	-	-	-	144 -
Stage 2	-	-	-	-	157 -
Critical Hdwy	4.12	-	-	-	6.4 6.2
Critical Hdwy Stg 1	-	-	-	-	5.4 -
Critical Hdwy Stg 2	-	-	-	-	5.4 -
Follow-up Hdwy	2.218	-	-	-	3.5 3.3
Pot Cap-1 Maneuver	1404	-	-	-	695 909
Stage 1	-	-	-	-	888 -
Stage 2	-	-	-	-	876 -
Platoon blocked, %		-	-	-	
Mov Cap-1 Maneuver	1404	-	-	-	695 909
Mov Cap-2 Maneuver	-	-	-	-	695 -
Stage 1	-	-	-	-	888 -
Stage 2	-	-	-	-	876 -

Approach	EB	WB	SB
HCM Control Delay, s	0	0	0
HCM LOS			A

Minor Lane/Major Mvmt	EBL	EBT	WBT	WBR	SBLn1
Capacity (veh/h)	1404	-	-	-	-
HCM Lane V/C Ratio	-	-	-	-	-
HCM Control Delay (s)	0	-	-	-	0
HCM Lane LOS	A	-	-	-	A
HCM 95th %tile Q(veh)	0	-	-	-	-

HCM 6th Signalized Intersection Summary
29: Schnoor Avenue & Cleveland Avenue

Village D Specific Plan
Phase III NP - AM Peak Hour



Movement	EBL	EBT	EBR	WBL	WBT	WBR	NBL	NBT	NBR	SBL	SBT	SBR
Lane Configurations	↘	↑↑	↗	↘↗	↑↑	↗	↘	↑↑	↗	↘	↑↑	↗
Traffic Volume (veh/h)	113	461	48	168	221	48	51	270	179	94	191	61
Future Volume (veh/h)	113	461	48	168	221	48	51	270	179	94	191	61
Initial Q (Qb), veh	0	0	0	0	0	0	0	0	0	0	0	0
Ped-Bike Adj(A_pbT)	1.00		0.98	1.00		0.97	1.00		0.99	1.00		0.98
Parking Bus, Adj	1.00	1.00	1.00	1.00	1.00	1.00	1.00	1.00	1.00	1.00	1.00	1.00
Work Zone On Approach		No			No			No			No	
Adj Sat Flow, veh/h/ln	1856	1856	1856	1826	1826	1826	1885	1885	1885	1856	1856	1856
Adj Flow Rate, veh/h	123	501	52	183	240	52	55	293	195	102	208	66
Peak Hour Factor	0.92	0.92	0.92	0.92	0.92	0.92	0.92	0.92	0.92	0.92	0.92	0.92
Percent Heavy Veh, %	3	3	3	5	5	5	1	1	1	3	3	3
Cap, veh/h	157	713	310	259	661	287	79	828	488	468	1593	698
Arrive On Green	0.09	0.20	0.20	0.08	0.19	0.19	0.04	0.23	0.23	0.26	0.45	0.45
Sat Flow, veh/h	1767	3526	1534	3374	3469	1508	1795	3582	1581	1767	3526	1545
Grp Volume(v), veh/h	123	501	52	183	240	52	55	293	195	102	208	66
Grp Sat Flow(s),veh/h/ln	1767	1763	1534	1687	1735	1508	1795	1791	1581	1767	1763	1545
Q Serve(g_s), s	5.5	10.6	1.8	4.2	4.8	1.2	2.4	5.5	1.6	3.6	2.7	2.0
Cycle Q Clear(g_c), s	5.5	10.6	1.8	4.2	4.8	1.2	2.4	5.5	1.6	3.6	2.7	2.0
Prop In Lane	1.00		1.00	1.00		1.00	1.00		1.00	1.00		1.00
Lane Grp Cap(c), veh/h	157	713	310	259	661	287	79	828	488	468	1593	698
V/C Ratio(X)	0.78	0.70	0.17	0.71	0.36	0.18	0.69	0.35	0.40	0.22	0.13	0.09
Avail Cap(c_a), veh/h	296	1300	566	274	980	426	117	828	488	468	1593	698
HCM Platoon Ratio	1.00	1.00	1.00	1.00	1.00	1.00	1.00	1.00	1.00	1.00	1.00	1.00
Upstream Filter(I)	1.00	1.00	1.00	0.81	0.81	0.81	1.00	1.00	1.00	1.00	1.00	1.00
Uniform Delay (d), s/veh	35.7	29.7	17.0	36.0	28.2	7.7	37.7	25.7	21.8	23.0	12.8	12.6
Incr Delay (d2), s/veh	8.3	1.3	0.3	6.2	0.3	0.2	10.4	1.2	2.4	0.2	0.2	0.3
Initial Q Delay(d3),s/veh	0.0	0.0	0.0	0.0	0.0	0.0	0.0	0.0	0.0	0.0	0.0	0.0
%ile BackOfQ(50%),veh/ln	2.7	4.5	0.8	1.9	2.0	0.8	1.3	2.4	3.1	1.5	1.1	0.7
Unsig. Movement Delay, s/veh												
LnGrp Delay(d),s/veh	44.0	30.9	17.3	42.2	28.4	8.0	48.1	26.9	24.2	23.2	12.9	12.8
LnGrp LOS	D	C	B	D	C	A	D	C	C	C	B	B
Approach Vol, veh/h		676			475			543			376	
Approach Delay, s/veh		32.3			31.5			28.1			15.7	
Approach LOS		C			C			C			B	
Timer - Assigned Phs	1	2	3	4	5	6	7	8				
Phs Duration (G+Y+Rc), s	25.7	23.0	10.6	20.7	8.0	40.6	11.6	19.7				
Change Period (Y+Rc), s	4.5	4.5	4.5	4.5	4.5	4.5	4.5	4.5				
Max Green Setting (Gmax), s	7.5	18.5	6.5	29.5	5.2	20.8	13.4	22.6				
Max Q Clear Time (g_c+I1), s	5.6	7.5	6.2	12.6	4.4	4.7	7.5	6.8				
Green Ext Time (p_c), s	0.0	1.9	0.0	3.3	0.0	1.3	0.1	1.5				
Intersection Summary												
HCM 6th Ctrl Delay				28.0								
HCM 6th LOS				C								

HCM 6th Signalized Intersection Summary
30: Fairgrounds & Cleveland Avenue

Village D Specific Plan
Phase III NP - AM Peak Hour



Movement	EBL	EBT	EBR	WBL	WBT	WBR	NBL	NBT	NBR	SBL	SBT	SBR
Lane Configurations	↑↑↑			↑↑		↑	↑↑	↑	↑	↑	↑	↑
Traffic Volume (veh/h)	109	664	30	39	380	127	14	8	29	157	5	40
Future Volume (veh/h)	109	664	30	39	380	127	14	8	29	157	5	40
Initial Q (Qb), veh	0	0	0	0	0	0	0	0	0	0	0	0
Ped-Bike Adj(A_pbT)	1.00		1.00	1.00		1.00	1.00		1.00	1.00		0.99
Parking Bus, Adj	1.00	1.00	1.00	1.00	1.00	1.00	1.00	1.00	1.00	1.00	1.00	1.00
Work Zone On Approach	No			No			No			No		
Adj Sat Flow, veh/h/ln	1841	1841	1841	1841	1841	1841	1900	1900	1900	1900	1900	1900
Adj Flow Rate, veh/h	116	706	32	41	404	135	15	26	20	167	5	43
Peak Hour Factor	0.94	0.94	0.94	0.94	0.94	0.94	0.94	0.94	0.94	0.94	0.94	0.94
Percent Heavy Veh, %	4	4	4	4	4	4	0	0	0	0	0	0
Cap, veh/h	148	1048	47	66	580	259	64	783	663	205	85	734
Arrive On Green	0.03	0.07	0.07	0.04	0.17	0.17	0.02	0.41	0.41	0.11	0.51	0.51
Sat Flow, veh/h	1753	4928	223	1753	3497	1560	3619	1900	1609	1810	168	1448
Grp Volume(v), veh/h	116	479	259	41	404	135	15	26	20	167	0	48
Grp Sat Flow(s),veh/h/ln	1753	1675	1801	1753	1749	1560	1810	1900	1609	1810	0	1616
Q Serve(g_s), s	5.3	11.2	11.2	1.8	8.7	4.6	0.3	0.7	0.6	7.2	0.0	1.2
Cycle Q Clear(g_c), s	5.3	11.2	11.2	1.8	8.7	4.6	0.3	0.7	0.6	7.2	0.0	1.2
Prop In Lane	1.00		0.12	1.00		1.00	1.00		1.00	1.00		0.90
Lane Grp Cap(c), veh/h	148	712	383	66	580	259	64	783	663	205	0	820
V/C Ratio(X)	0.79	0.67	0.68	0.63	0.70	0.52	0.23	0.03	0.03	0.82	0.00	0.06
Avail Cap(c_a), veh/h	186	900	484	230	1027	458	226	783	663	238	0	820
HCM Platoon Ratio	0.33	0.33	0.33	1.00	1.00	1.00	1.00	1.00	1.00	1.00	1.00	1.00
Upstream Filter(I)	0.82	0.82	0.82	0.95	0.95	0.95	1.00	1.00	1.00	1.00	0.00	1.00
Uniform Delay (d), s/veh	38.2	34.5	34.5	38.0	31.5	16.2	38.8	14.0	14.0	34.7	0.0	10.0
Incr Delay (d2), s/veh	13.2	1.1	2.2	9.0	1.4	1.5	1.8	0.1	0.1	17.3	0.0	0.1
Initial Q Delay(d3),s/veh	0.0	0.0	0.0	0.0	0.0	0.0	0.0	0.0	0.0	0.0	0.0	0.0
%ile BackOfQ(50%),veh/ln	2.9	5.1	5.6	0.9	3.7	2.4	0.2	0.3	0.2	4.1	0.0	0.4
Unsig. Movement Delay, s/veh												
LnGrp Delay(d),s/veh	51.3	35.6	36.7	46.9	32.9	17.8	40.6	14.1	14.1	52.0	0.0	10.1
LnGrp LOS	D	D	D	D	C	B	D	B	B	D	A	B
Approach Vol, veh/h	854			580			61			215		
Approach Delay, s/veh	38.1			30.4			20.6			42.6		
Approach LOS	D			C			C			D		
Timer - Assigned Phs	1	2	3	4	5	6	7	8				
Phs Duration (G+Y+Rc), s	33.5	37.5	7.5	21.5	5.9	45.1	11.2	17.8				
Change Period (Y+Rc), s	4.5	4.5	4.5	4.5	4.5	4.5	4.5	4.5				
Max Green Setting (Gmax), s	10.5	19.5	10.5	21.5	5.0	25.0	8.5	23.5				
Max Q Clear Time (g_c+1), s	19.2	2.7	3.8	13.2	2.3	3.2	7.3	10.7				
Green Ext Time (p_c), s	0.1	0.1	0.0	3.0	0.0	0.2	0.0	2.5				

Intersection Summary

HCM 6th Ctrl Delay	35.4
HCM 6th LOS	D

Notes

User approved volume balancing among the lanes for turning movement.

HCM 6th Signalized Intersection Summary
 31: SR-99 Southbound Ramps & Cleveland Avenue

Village D Specific Plan
 Phase III NP - AM Peak Hour



Movement	EBL	EBT	EBR	WBL	WBT	WBR	NBL	NBT	NBR	SBL	SBT	SBR
Lane Configurations		↑↑	↑	↑	↑↑					↑		↑
Traffic Volume (veh/h)	0	497	449	390	699	0	0	0	0	82	0	70
Future Volume (veh/h)	0	497	449	390	699	0	0	0	0	82	0	70
Initial Q (Qb), veh	0	0	0	0	0	0				0	0	0
Ped-Bike Adj(A_pbT)	1.00		1.00	1.00		1.00				1.00		1.00
Parking Bus, Adj	1.00	1.00	1.00	1.00	1.00	1.00				1.00	1.00	1.00
Work Zone On Approach		No			No						No	
Adj Sat Flow, veh/h/ln	0	1841	1841	1856	1856	0				1678	0	1678
Adj Flow Rate, veh/h	0	540	488	424	760	0				89	0	76
Peak Hour Factor	0.92	0.92	0.92	0.92	0.92	0.92				0.92	0.92	0.92
Percent Heavy Veh, %	0	4	4	3	3	0				15	0	15
Cap, veh/h	0	913	407	455	2005	0				529	0	471
Arrive On Green	0.00	0.26	0.26	0.52	1.00	0.00				0.33	0.00	0.33
Sat Flow, veh/h	0	3589	1560	1767	3618	0				1598	0	1422
Grp Volume(v), veh/h	0	540	488	424	760	0				89	0	76
Grp Sat Flow(s),veh/h/ln	0	1749	1560	1767	1763	0				1598	0	1422
Q Serve(g_s), s	0.0	12.1	23.5	20.1	0.0	0.0				3.6	0.0	3.4
Cycle Q Clear(g_c), s	0.0	12.1	23.5	20.1	0.0	0.0				3.6	0.0	3.4
Prop In Lane	0.00		1.00	1.00		0.00				1.00		1.00
Lane Grp Cap(c), veh/h	0	913	407	455	2005	0				529	0	471
V/C Ratio(X)	0.00	0.59	1.20	0.93	0.38	0.00				0.17	0.00	0.16
Avail Cap(c_a), veh/h	0	913	407	658	2409	0				529	0	471
HCM Platoon Ratio	1.00	1.00	1.00	2.00	2.00	1.00				1.00	1.00	1.00
Upstream Filter(I)	0.00	0.79	0.79	0.71	0.71	0.00				1.00	0.00	1.00
Uniform Delay (d), s/veh	0.0	29.1	33.3	21.1	0.0	0.0				21.3	0.0	21.3
Incr Delay (d2), s/veh	0.0	0.8	106.8	12.1	0.1	0.0				0.7	0.0	0.7
Initial Q Delay(d3),s/veh	0.0	0.0	0.0	0.0	0.0	0.0				0.0	0.0	0.0
%ile BackOfQ(50%),veh/ln	0.0	5.1	20.7	6.7	0.0	0.0				1.4	0.0	1.2
Unsig. Movement Delay, s/veh												
LnGrp Delay(d),s/veh	0.0	29.9	140.0	33.1	0.1	0.0				22.0	0.0	22.0
LnGrp LOS	A	C	F	C	A	A				C	A	C
Approach Vol, veh/h		1028			1184						165	
Approach Delay, s/veh		82.2			11.9						22.0	
Approach LOS		F			B						C	
Timer - Assigned Phs			3	4		6			8			
Phs Duration (G+Y+Rc), s			27.7	28.0		34.3			55.7			
Change Period (Y+Rc), s			4.5	4.5		4.5			4.5			
Max Green Setting (Gmax), s			33.5	23.5		19.5			61.5			
Max Q Clear Time (g_c+1), s			22.1	25.5		5.6			2.0			
Green Ext Time (p_c), s			1.1	0.0		0.4			6.5			
Intersection Summary												
HCM 6th Ctrl Delay			43.0									
HCM 6th LOS			D									

HCM 6th Signalized Intersection Summary
 32: SR-99 Northbound Ramps & Cleveland Avenue

Village D Specific Plan
 Phase III NP - AM Peak Hour



Movement	EBL	EBT	EBR	WBL	WBT	WBR	NBL	NBT	NBR	SBL	SBT	SBR
Lane Configurations												
Traffic Volume (veh/h)	71	510	0	0	808	116	289	0	389	0	0	0
Future Volume (veh/h)	71	510	0	0	808	116	289	0	389	0	0	0
Initial Q (Qb), veh	0	0	0	0	0	0	0	0	0			
Ped-Bike Adj(A_pbT)	1.00		1.00	1.00		1.00	1.00		1.00			
Parking Bus, Adj	1.00	1.00	1.00	1.00	1.00	1.00	1.00	1.00	1.00			
Work Zone On Approach	No			No			No					
Adj Sat Flow, veh/h/ln	1826	1826	0	0	1856	1856	1826	1826	1826			
Adj Flow Rate, veh/h	77	554	0	0	878	126	314	0	423			
Peak Hour Factor	0.92	0.92	0.92	0.92	0.92	0.92	0.92	0.92	0.92			
Percent Heavy Veh, %	5	5	0	0	3	3	5	5	5			
Cap, veh/h	100	1307	0	0	950	424	1819	0	810			
Arrive On Green	0.11	0.75	0.00	0.00	0.27	0.27	0.52	0.00	0.52			
Sat Flow, veh/h	1739	3561	0	0	3618	1572	3478	0	1547			
Grp Volume(v), veh/h	77	554	0	0	878	126	314	0	423			
Grp Sat Flow(s),veh/h/ln	1739	3561	0	0	3618	1572	3478	0	1547			
Q Serve(g_s), s	3.9	5.2	0.0	0.0	21.8	5.7	4.3	0.0	16.1			
Cycle Q Clear(g_c), s	3.9	5.2	0.0	0.0	21.8	5.7	4.3	0.0	16.1			
Prop In Lane	1.00		0.00	0.00		1.00	1.00		1.00			
Lane Grp Cap(c), veh/h	100	1307	0	0	950	424	1819	0	810			
V/C Ratio(X)	0.77	0.42	0.00	0.00	0.92	0.30	0.17	0.00	0.52			
Avail Cap(c_a), veh/h	628	2371	0	0	960	428	1819	0	810			
HCM Platoon Ratio	2.00	2.00	1.00	1.00	1.00	1.00	1.00	1.00	1.00			
Upstream Filter(I)	0.79	0.79	0.00	0.00	0.75	0.75	1.00	0.00	1.00			
Uniform Delay (d), s/veh	39.3	7.5	0.0	0.0	32.0	26.1	11.2	0.0	14.1			
Incr Delay (d2), s/veh	9.5	0.2	0.0	0.0	11.3	0.3	0.2	0.0	2.4			
Initial Q Delay(d3),s/veh	0.0	0.0	0.0	0.0	0.0	0.0	0.0	0.0	0.0			
%ile BackOfQ(50%),veh/ln	1.8	1.5	0.0	0.0	10.5	2.1	1.6	0.0	5.8			
Unsig. Movement Delay, s/veh												
LnGrp Delay(d),s/veh	48.8	7.7	0.0	0.0	43.3	26.4	11.5	0.0	16.5			
LnGrp LOS	D	A	A	A	D	C	B	A	B			
Approach Vol, veh/h	631				1004				737			
Approach Delay, s/veh	12.7				41.1				14.3			
Approach LOS	B				D				B			
Timer - Assigned Phs	2		4		7		8					
Phs Duration (G+Y+Rc), s	51.6		38.4		9.7		28.8					
Change Period (Y+Rc), s	4.5		4.5		4.5		4.5					
Max Green Setting (Gmax), s	19.5		61.5		32.5		24.5					
Max Q Clear Time (g_c+I1), s	18.1		7.2		5.9		23.8					
Green Ext Time (p_c), s	0.5		4.4		0.2		0.4					

Intersection Summary

HCM 6th Ctrl Delay	25.3
HCM 6th LOS	C

Notes

User approved volume balancing among the lanes for turning movement.

HCM 6th Signalized Intersection Summary
 33: Gateway Drive & Cleveland Avenue

Village D Specific Plan
 Phase III NP - AM Peak Hour



Movement	EBL	EBT	EBR	WBL	WBT	WBR	NBL	NBT	NBR	SBL	SBT	SBR
Lane Configurations	↖	↑↑↑	↗	↖↗	↑↑		↖↗	↑	↗	↖	↑↗	
Traffic Volume (veh/h)	4	749	145	237	784	82	137	50	196	67	89	4
Future Volume (veh/h)	4	749	145	237	784	82	137	50	196	67	89	4
Initial Q (Qb), veh	0	0	0	0	0	0	0	0	0	0	0	0
Ped-Bike Adj(A_pbT)	1.00		1.00	1.00		1.00	1.00		0.98	1.00		0.98
Parking Bus, Adj	1.00	1.00	1.00	1.00	1.00	1.00	1.00	1.00	1.00	1.00	1.00	1.00
Work Zone On Approach		No		No		No		No		No		No
Adj Sat Flow, veh/h/ln	1841	1841	1841	1870	1870	1870	1796	1796	1796	1841	1841	1841
Adj Flow Rate, veh/h	4	814	0	258	852	89	149	54	213	73	97	4
Peak Hour Factor	0.92	0.92	0.92	0.92	0.92	0.92	0.92	0.92	0.92	0.92	0.92	0.92
Percent Heavy Veh, %	4	4	4	2	2	2	7	7	7	4	4	4
Cap, veh/h	89	1188		331	1061	111	837	744	621	94	737	30
Arrive On Green	0.00	0.08	0.00	0.10	0.33	0.33	0.25	0.41	0.41	0.05	0.22	0.22
Sat Flow, veh/h	1753	5025	1560	3456	3245	339	3319	1796	1499	1753	3421	140
Grp Volume(v), veh/h	4	814	0	258	466	475	149	54	213	73	49	52
Grp Sat Flow(s),veh/h/ln	1753	1675	1560	1728	1777	1807	1659	1796	1499	1753	1749	1813
Q Serve(g_s), s	0.2	14.2	0.0	6.6	21.6	21.6	3.2	1.6	5.8	3.7	2.0	2.1
Cycle Q Clear(g_c), s	0.2	14.2	0.0	6.6	21.6	21.6	3.2	1.6	5.8	3.7	2.0	2.1
Prop In Lane	1.00		1.00	1.00		0.19	1.00		1.00	1.00		0.08
Lane Grp Cap(c), veh/h	89	1188		331	581	591	837	744	621	94	377	391
V/C Ratio(X)	0.04	0.69		0.78	0.80	0.80	0.18	0.07	0.34	0.78	0.13	0.13
Avail Cap(c_a), veh/h	177	1759		361	709	721	837	744	621	179	377	391
HCM Platoon Ratio	0.33	0.33	0.33	1.00	1.00	1.00	1.00	1.00	1.00	1.00	1.00	1.00
Upstream Filter(I)	0.92	0.92	0.00	0.91	0.91	0.91	1.00	1.00	1.00	1.00	1.00	1.00
Uniform Delay (d), s/veh	30.2	38.2	0.0	39.8	27.6	27.6	26.3	15.9	8.0	42.1	28.5	28.5
Incr Delay (d2), s/veh	0.2	0.7	0.0	8.8	5.0	5.0	0.1	0.2	1.5	12.9	0.7	0.7
Initial Q Delay(d3),s/veh	0.0	0.0	0.0	0.0	0.0	0.0	0.0	0.0	0.0	0.0	0.0	0.0
%ile BackOfQ(50%),veh/ln	0.1	6.4	0.0	3.2	9.6	9.8	1.2	0.7	3.0	1.9	0.9	1.0
Unsig. Movement Delay, s/veh												
LnGrp Delay(d),s/veh	30.4	38.9	0.0	48.6	32.7	32.6	26.4	16.1	9.5	55.0	29.2	29.2
LnGrp LOS	C	D		D	C	C	C	B	A	D	C	C
Approach Vol, veh/h		818	A		1199			416			174	
Approach Delay, s/veh		38.8			36.1			16.4			40.0	
Approach LOS		D			D			B			D	
Timer - Assigned Phs	1	2	3	4	5	6	7	8				
Phs Duration (G+Y+Rc), s	37.2	23.9	5.0	33.9	9.3	41.8	13.1	25.8				
Change Period (Y+Rc), s	4.5	4.5	4.5	4.5	4.5	4.5	4.5	4.5				
Max Green Setting (Gmax), s	37.2	19.4	5.0	35.9	9.2	21.9	9.4	31.5				
Max Q Clear Time (g_c+1/2), s	37.2	4.1	2.2	23.6	5.7	7.8	8.6	16.2				
Green Ext Time (p_c), s	0.2	0.4	0.0	4.9	0.0	0.8	0.1	5.1				

Intersection Summary

HCM 6th Ctrl Delay	34.1
HCM 6th LOS	C

Notes

Unsignalized Delay for [EBR] is excluded from calculations of the approach delay and intersection delay.

HCM 6th Signalized Intersection Summary
 34: Cleveland Avenue & County Club Drive

Village D Specific Plan
 Phase III NP - AM Peak Hour



Movement	WBL	WBR	NBT	NBR	SBL	SBT
Lane Configurations	↔↔		↑↑	↗	↖	↑↑↑
Traffic Volume (veh/h)	430	49	782	230	104	673
Future Volume (veh/h)	430	49	782	230	104	673
Initial Q (Qb), veh	0	0	0	0	0	0
Ped-Bike Adj(A_pbT)	1.00	1.00		1.00	1.00	
Parking Bus, Adj	1.00	1.00	1.00	1.00	1.00	1.00
Work Zone On Approach	No		No		No	
Adj Sat Flow, veh/h/ln	1900	1900	1856	1856	1856	1856
Adj Flow Rate, veh/h	516	0	850	0	113	732
Peak Hour Factor	0.92	0.92	0.92	0.92	0.92	0.92
Percent Heavy Veh, %	0	0	3	3	3	3
Cap, veh/h	647	288	2543		487	3654
Arrive On Green	0.18	0.00	0.72	0.00	0.72	0.72
Sat Flow, veh/h	3619	1610	3618	1572	643	5233
Grp Volume(v), veh/h	516	0	850	0	113	732
Grp Sat Flow(s),veh/h/ln	1810	1610	1763	1572	643	1689
Q Serve(g_s), s	12.3	0.0	8.0	0.0	7.0	4.2
Cycle Q Clear(g_c), s	12.3	0.0	8.0	0.0	15.0	4.2
Prop In Lane	1.00	1.00		1.00	1.00	
Lane Grp Cap(c), veh/h	647	288	2543		487	3654
V/C Ratio(X)	0.80	0.00	0.33		0.23	0.20
Avail Cap(c_a), veh/h	1307	581	2543		487	3654
HCM Platoon Ratio	1.00	1.00	1.00	1.00	1.00	1.00
Upstream Filter(I)	1.00	0.00	0.79	0.00	1.00	1.00
Uniform Delay (d), s/veh	35.4	0.0	4.6	0.0	7.4	4.1
Incr Delay (d2), s/veh	2.3	0.0	0.3	0.0	1.1	0.1
Initial Q Delay(d3),s/veh	0.0	0.0	0.0	0.0	0.0	0.0
%ile BackOfQ(50%),veh/ln	5.5	0.0	2.4	0.0	1.0	1.2
Unsig. Movement Delay, s/veh						
LnGrp Delay(d),s/veh	37.7	0.0	4.9	0.0	8.5	4.2
LnGrp LOS	D	A	A		A	A
Approach Vol, veh/h	516		850	A		845
Approach Delay, s/veh	37.7		4.9			4.8
Approach LOS	D		A			A
Timer - Assigned Phs		2			6	8
Phs Duration (G+Y+Rc), s		69.4			69.4	20.6
Change Period (Y+Rc), s		4.5			4.5	4.5
Max Green Setting (Gmax), s		48.5			48.5	32.5
Max Q Clear Time (g_c+I1), s		10.0			17.0	14.3
Green Ext Time (p_c), s		7.3			7.2	1.8

Intersection Summary

HCM 6th Ctrl Delay	12.5
HCM 6th LOS	B

Notes

User approved volume balancing among the lanes for turning movement.
 Unsignalized Delay for [NBR] is excluded from calculations of the approach delay and intersection delay.

Intersection						
Int Delay, s/veh	0.1					
Movement	EBL	EBR	NBL	NBT	SBT	SBR
Lane Configurations	T			T		
Traffic Vol, veh/h	2	13	1	834	755	1
Future Vol, veh/h	2	13	1	834	755	1
Conflicting Peds, #/hr	0	0	2	0	0	2
Sign Control	Stop	Stop	Free	Free	Free	Free
RT Channelized	-	None	-	None	-	None
Storage Length	0	-	-	-	-	-
Veh in Median Storage, #	0	-	-	0	0	-
Grade, %	0	-	-	0	0	-
Peak Hour Factor	92	92	92	92	92	92
Heavy Vehicles, %	7	7	5	5	4	4
Mvmt Flow	2	14	1	907	821	1

Major/Minor	Minor2	Major1	Major2			
Conflicting Flow All	1280	413	824	0	-	0
Stage 1	824	-	-	-	-	-
Stage 2	456	-	-	-	-	-
Critical Hdwy	6.94	7.04	4.2	-	-	-
Critical Hdwy Stg 1	5.94	-	-	-	-	-
Critical Hdwy Stg 2	5.94	-	-	-	-	-
Follow-up Hdwy	3.57	3.37	2.25	-	-	-
Pot Cap-1 Maneuver	*318	574	783	-	-	-
Stage 1	*379	-	-	-	-	-
Stage 2	*707	-	-	-	-	-
Platoon blocked, %	1			-	-	-
Mov Cap-1 Maneuver	*316	573	782	-	-	-
Mov Cap-2 Maneuver	*337	-	-	-	-	-
Stage 1	*377	-	-	-	-	-
Stage 2	*706	-	-	-	-	-

Approach	EB	NB	SB
HCM Control Delay, s	12.1	0	0
HCM LOS	B		

Minor Lane/Major Mvmt	NBL	NBT	EBLn1	SBT	SBR
Capacity (veh/h)	782	-	524	-	-
HCM Lane V/C Ratio	0.001	-	0.031	-	-
HCM Control Delay (s)	9.6	0	12.1	-	-
HCM Lane LOS	A	A	B	-	-
HCM 95th %tile Q(veh)	0	-	0.1	-	-

Notes
 -: Volume exceeds capacity \$: Delay exceeds 300s +: Computation Not Defined *: All major volume in platoon

HCM 6th Signalized Intersection Summary
36: Pine Street & Howard Road

Village D Specific Plan
Phase III NP - AM Peak Hour



Movement	EBL	EBT	EBR	WBL	WBT	WBR	NBL	NBT	NBR	SBL	SBT	SBR
Lane Configurations												
Traffic Volume (veh/h)	35	700	84	163	439	7	121	171	253	17	281	102
Future Volume (veh/h)	35	700	84	163	439	7	121	171	253	17	281	102
Initial Q (Qb), veh	0	0	0	0	0	0	0	0	0	0	0	0
Ped-Bike Adj(A_pbT)	1.00		0.97	1.00		0.98	1.00		1.00	1.00		0.98
Parking Bus, Adj	1.00	1.00	1.00	1.00	1.00	1.00	1.00	1.00	1.00	1.00	1.00	1.00
Work Zone On Approach		No			No			No			No	
Adj Sat Flow, veh/h/ln	1870	1870	1870	1856	1856	1856	1811	1811	1811	1841	1841	1841
Adj Flow Rate, veh/h	38	761	91	177	477	8	132	186	275	18	305	111
Peak Hour Factor	0.92	0.92	0.92	0.92	0.92	0.92	0.92	0.92	0.92	0.92	0.92	0.92
Percent Heavy Veh, %	2	2	2	3	3	3	6	6	6	4	4	4
Cap, veh/h	53	911	109	169	1248	21	481	505	427	19	328	288
Arrive On Green	0.03	0.29	0.29	0.10	0.35	0.35	0.28	0.28	0.28	0.19	0.19	0.19
Sat Flow, veh/h	1781	3186	381	1767	3547	59	1725	1811	1530	102	1733	1523
Grp Volume(v), veh/h	38	424	428	177	237	248	132	186	275	323	0	111
Grp Sat Flow(s),veh/h/ln	1781	1777	1790	1767	1763	1843	1725	1811	1530	1836	0	1523
Q Serve(g_s), s	2.5	26.9	26.9	11.5	12.1	12.1	7.2	9.9	19.0	20.8	0.0	7.6
Cycle Q Clear(g_c), s	2.5	26.9	26.9	11.5	12.1	12.1	7.2	9.9	19.0	20.8	0.0	7.6
Prop In Lane	1.00		0.21	1.00		0.03	1.00		1.00	0.06		1.00
Lane Grp Cap(c), veh/h	53	508	512	169	620	649	481	505	427	347	0	288
V/C Ratio(X)	0.71	0.83	0.84	1.05	0.38	0.38	0.27	0.37	0.64	0.93	0.00	0.39
Avail Cap(c_a), veh/h	102	709	714	169	771	806	481	505	427	347	0	288
HCM Platoon Ratio	1.00	1.00	1.00	1.00	1.00	1.00	1.00	1.00	1.00	1.00	1.00	1.00
Upstream Filter(I)	1.00	1.00	1.00	0.95	0.95	0.95	1.00	1.00	1.00	1.00	0.00	1.00
Uniform Delay (d), s/veh	57.7	40.2	40.2	54.2	29.1	29.1	33.8	34.8	38.0	47.9	0.0	42.5
Incr Delay (d2), s/veh	16.1	6.1	6.1	79.8	0.4	0.4	1.4	2.1	7.3	31.0	0.0	0.8
Initial Q Delay(d3),s/veh	0.0	0.0	0.0	0.0	0.0	0.0	0.0	0.0	0.0	0.0	0.0	0.0
%ile BackOfQ(50%),veh/ln	1.4	12.5	12.6	8.9	5.2	5.4	3.2	4.7	7.9	12.4	0.0	3.0
Unsig. Movement Delay, s/veh												
LnGrp Delay(d),s/veh	73.8	46.3	46.3	134.1	29.5	29.5	35.2	36.8	45.3	78.8	0.0	43.4
LnGrp LOS	E	D	D	F	C	C	D	D	D	E	A	D
Approach Vol, veh/h		890			662			593			434	
Approach Delay, s/veh		47.5			57.4			40.4			69.8	
Approach LOS		D			E			D			E	
Timer - Assigned Phs		2	3	4		6	7	8				
Phs Duration (G+Y+Rc), s		38.0	16.0	38.8		27.2	8.1	46.7				
Change Period (Y+Rc), s		4.5	4.5	4.5		4.5	4.5	4.5				
Max Green Setting (Gmax), s		19.9	11.5	47.9		22.7	6.9	52.5				
Max Q Clear Time (g_c+I1), s		21.0	13.5	28.9		22.8	4.5	14.1				
Green Ext Time (p_c), s		0.0	0.0	5.4		0.0	0.0	3.2				
Intersection Summary												
HCM 6th Ctrl Delay				52.2								
HCM 6th LOS				D								

HCM 6th Signalized Intersection Summary
 37: Olive Avenue/Q Street & Howard Road/Yosemite Avenue

Village D Specific Plan
 Phase III NP - AM Peak Hour



Movement	EBL	EBT	EBR	WBL	WBT	WBR	NBL	NBT	NBR	SBL	SBT	SBR
Lane Configurations												
Traffic Volume (veh/h)	6	568	336	28	348	20	320	89	21	104	152	13
Future Volume (veh/h)	6	568	336	28	348	20	320	89	21	104	152	13
Initial Q (Qb), veh	0	0	0	0	0	0	0	0	0	0	0	0
Ped-Bike Adj(A_pbT)	1.00		1.00	1.00		0.98	1.00		0.99	1.00		0.96
Parking Bus, Adj	1.00	1.00	1.00	1.00	1.00	1.00	1.00	1.00	1.00	1.00	1.00	1.00
Work Zone On Approach		No			No			No			No	
Adj Sat Flow, veh/h/ln	1856	1856	1856	1870	1870	1870	1826	1826	1826	1870	1870	1870
Adj Flow Rate, veh/h	7	617	0	30	378	22	222	273	23	113	165	14
Peak Hour Factor	0.92	0.92	0.92	0.92	0.92	0.92	0.92	0.92	0.92	0.92	0.92	0.92
Percent Heavy Veh, %	3	3	3	2	2	2	5	5	5	2	2	2
Cap, veh/h	15	722		74	811	47	846	889	746	208	219	178
Arrive On Green	0.02	0.41	0.00	0.04	0.24	0.24	0.49	0.49	0.49	0.12	0.12	0.12
Sat Flow, veh/h	1767	3526	1572	1781	3409	198	1739	1826	1533	1781	1870	1524
Grp Volume(v), veh/h	7	617	0	30	196	204	222	273	23	113	165	14
Grp Sat Flow(s),veh/h/ln	1767	1763	1572	1781	1777	1829	1739	1826	1533	1781	1870	1524
Q Serve(g_s), s	0.5	19.1	0.0	2.0	11.4	11.5	9.0	10.8	0.9	7.2	10.3	1.0
Cycle Q Clear(g_c), s	0.5	19.1	0.0	2.0	11.4	11.5	9.0	10.8	0.9	7.2	10.3	1.0
Prop In Lane	1.00		1.00	1.00		0.11	1.00		1.00	1.00		1.00
Lane Grp Cap(c), veh/h	15	722		74	423	435	846	889	746	208	219	178
V/C Ratio(X)	0.46	0.85		0.40	0.46	0.47	0.26	0.31	0.03	0.54	0.75	0.08
Avail Cap(c_a), veh/h	74	1014		267	703	724	846	889	746	267	281	229
HCM Platoon Ratio	2.00	2.00	2.00	1.00	1.00	1.00	1.00	1.00	1.00	1.00	1.00	1.00
Upstream Filter(I)	0.62	0.62	0.00	1.00	1.00	1.00	1.00	1.00	1.00	1.00	1.00	1.00
Uniform Delay (d), s/veh	58.7	33.8	0.0	56.0	39.2	39.2	18.1	18.6	16.1	50.0	51.3	47.2
Incr Delay (d2), s/veh	12.6	3.3	0.0	3.5	0.8	0.8	0.8	0.9	0.1	2.2	8.4	0.2
Initial Q Delay(d3),s/veh	0.0	0.0	0.0	0.0	0.0	0.0	0.0	0.0	0.0	0.0	0.0	0.0
%ile BackOfQ(50%),veh/ln	0.3	6.9	0.0	1.0	5.1	5.3	3.8	4.8	0.3	3.3	5.3	0.4
Unsig. Movement Delay, s/veh												
LnGrp Delay(d),s/veh	71.3	37.1	0.0	59.6	40.0	40.0	18.9	19.5	16.1	52.2	59.7	47.4
LnGrp LOS	E	D		E	D	D	B	B	B	D	E	D
Approach Vol, veh/h		624	A		430			518			292	
Approach Delay, s/veh		37.5			41.4			19.1			56.2	
Approach LOS		D			D			B			E	
Timer - Assigned Phs		2	3	4		6	7	8				
Phs Duration (G+Y+Rc), s		62.9	9.5	29.1		18.5	5.5	33.0				
Change Period (Y+Rc), s		4.5	4.5	4.5		4.5	4.5	4.5				
Max Green Setting (Gmax), s		31.5	18.0	34.5		18.0	5.0	47.5				
Max Q Clear Time (g_c+I1), s		12.8	4.0	21.1		12.3	2.5	13.5				
Green Ext Time (p_c), s		2.2	0.0	3.5		0.6	0.0	2.5				

Intersection Summary

HCM 6th Ctrl Delay	36.2
HCM 6th LOS	D

Notes

User approved volume balancing among the lanes for turning movement.
 Unsignalized Delay for [EBR] is excluded from calculations of the approach delay and intersection delay.

HCM 6th TWSC
 38: I Street & 2nd Street/SR-99 Southbound Off-Ramp

Village D Specific Plan
 Phase III NP - AM Peak Hour

Intersection												
Int Delay, s/veh	20.8											
Movement	EBL	EBT	EBR	WBL	WBT	WBR	NBL	NBT	NBR	SBL	SBT	SBR
Lane Configurations		↔			↔	↔	↔	↔			↔	
Traffic Vol, veh/h	2	0	68	404	22	12	24	89	0	0	156	3
Future Vol, veh/h	2	0	68	404	22	12	24	89	0	0	156	3
Conflicting Peds, #/hr	0	0	1	1	0	0	0	0	0	0	0	0
Sign Control	Stop	Stop	Stop	Stop	Stop	Stop	Free	Free	Free	Free	Free	Free
RT Channelized	-	-	None	-	-	Stop	-	-	None	-	-	None
Storage Length	-	-	-	-	-	50	75	-	-	-	-	-
Veh in Median Storage, #	-	0	-	-	0	-	-	0	-	-	0	-
Grade, %	-	0	-	-	0	-	-	0	-	-	0	-
Peak Hour Factor	92	92	92	92	92	92	92	92	92	92	92	92
Heavy Vehicles, %	0	0	0	3	3	3	4	4	4	1	1	1
Mvmt Flow	2	0	74	439	24	13	26	97	0	0	170	3

Major/Minor	Minor2		Minor1		Major1		Major2					
Conflicting Flow All	333	321	173	359	322	97	173	0	-	-	-	0
Stage 1	172	172	-	149	149	-	-	-	-	-	-	-
Stage 2	161	149	-	210	173	-	-	-	-	-	-	-
Critical Hdwy	7.1	6.5	6.2	7.13	6.53	6.23	4.14	-	-	-	-	-
Critical Hdwy Stg 1	6.1	5.5	-	6.13	5.53	-	-	-	-	-	-	-
Critical Hdwy Stg 2	6.1	5.5	-	6.13	5.53	-	-	-	-	-	-	-
Follow-up Hdwy	3.5	4	3.3	3.527	4.027	3.327	2.236	-	-	-	-	-
Pot Cap-1 Maneuver	646	614	876	615	608	990	1392	-	0	0	-	-
Stage 1	835	760	-	876	784	-	-	-	0	0	-	-
Stage 2	870	790	-	790	754	-	-	-	0	0	-	-
Platoon blocked, %	1	1		1	1	1		-			-	-
Mov Cap-1 Maneuver	609	602	875	554	596	990	1392	-	-	-	-	-
Mov Cap-2 Maneuver	609	602	-	554	596	-	-	-	-	-	-	-
Stage 1	819	760	-	860	769	-	-	-	-	-	-	-
Stage 2	817	775	-	723	754	-	-	-	-	-	-	-

Approach	EB	WB	NB	SB
HCM Control Delay, s	9.6	35.1	1.6	0
HCM LOS	A	E		

Minor Lane/Major Mvmt	NBL	NBT	EBLn1WBLn1WBLn2	SBT	SBR
Capacity (veh/h)	1392	-	864 556 990	-	-
HCM Lane V/C Ratio	0.019	-	0.088 0.833 0.013	-	-
HCM Control Delay (s)	7.6	-	9.6 35.8 8.7	-	-
HCM Lane LOS	A	-	A E A	-	-
HCM 95th %tile Q(veh)	0.1	-	0.3 8.6 0	-	-

HCM 6th Signalized Intersection Summary
 39: 4th Street & Sunset Avenue

Village D Specific Plan
 Phase III NP - AM Peak Hour



Movement	EBL	EBR	NBL	NBT	SBT	SBR
Lane Configurations	←←		←	↑↑	↑	←
Traffic Volume (veh/h)	400	23	35	351	462	287
Future Volume (veh/h)	400	23	35	351	462	287
Initial Q (Qb), veh	0	0	0	0	0	0
Ped-Bike Adj(A_pbT)	1.00	1.00	1.00			1.00
Parking Bus, Adj	1.00	1.00	1.00	1.00	1.00	1.00
Work Zone On Approach	No			No	No	
Adj Sat Flow, veh/h/ln	1900	1900	1870	1870	1870	1870
Adj Flow Rate, veh/h	458	0	38	382	502	312
Peak Hour Factor	0.92	0.92	0.92	0.92	0.92	0.92
Percent Heavy Veh, %	0	0	2	2	2	2
Cap, veh/h	566	252	61	2643	1234	1292
Arrive On Green	0.16	0.00	0.03	0.74	1.00	1.00
Sat Flow, veh/h	3619	1610	1781	3647	1870	1583
Grp Volume(v), veh/h	458	0	38	382	502	312
Grp Sat Flow(s),veh/h/ln	1810	1610	1781	1777	1870	1583
Q Serve(g_s), s	11.0	0.0	1.9	2.8	0.0	0.0
Cycle Q Clear(g_c), s	11.0	0.0	1.9	2.8	0.0	0.0
Prop In Lane	1.00	1.00	1.00			1.00
Lane Grp Cap(c), veh/h	566	252	61	2643	1234	1292
V/C Ratio(X)	0.81	0.00	0.63	0.14	0.41	0.24
Avail Cap(c_a), veh/h	824	367	148	2643	1234	1292
HCM Platoon Ratio	1.00	1.00	1.00	1.00	2.00	2.00
Upstream Filter(I)	1.00	0.00	1.00	1.00	0.85	0.85
Uniform Delay (d), s/veh	36.7	0.0	42.9	3.3	0.0	0.0
Incr Delay (d2), s/veh	3.9	0.0	10.1	0.1	0.8	0.4
Initial Q Delay(d3),s/veh	0.0	0.0	0.0	0.0	0.0	0.0
%ile BackOfQ(50%),veh/ln	5.1	0.0	1.0	0.8	0.3	0.1
Unsig. Movement Delay, s/veh						
LnGrp Delay(d),s/veh	40.6	0.0	53.0	3.4	0.8	0.4
LnGrp LOS	D	A	D	A	A	A
Approach Vol, veh/h	458			420	814	
Approach Delay, s/veh	40.6			7.9	0.7	
Approach LOS	D			A	A	
Timer - Assigned Phs		2		4	5	6
Phs Duration (G+Y+Rc), s		71.4		18.6	7.6	63.9
Change Period (Y+Rc), s		4.5		4.5	4.5	4.5
Max Green Setting (Gmax), s		60.5		20.5	7.5	48.5
Max Q Clear Time (g_c+I1), s		4.8		13.0	3.9	2.0
Green Ext Time (p_c), s		2.8		1.1	0.0	5.0
Intersection Summary						
HCM 6th Ctrl Delay			13.3			
HCM 6th LOS			B			
Notes						
User approved volume balancing among the lanes for turning movement.						

40: H Street & SR-99 Southbound On-Ramp/2nd Street Performance by movement

Movement	WBL	WBT	WBR	NBL	NBT	NBR	SBT	All
Denied Delay (hr)	0.0	0.0	0.0	0.0	0.0	0.0	0.0	0.0
Denied Del/Veh (s)	0.1	0.2	0.7	0.0	0.0	0.0	0.1	0.0
Total Delay (hr)	0.1	0.1	0.0	0.2	0.0	0.0	0.1	0.5
Total Del/Veh (s)	10.2	13.7	3.2	2.8	2.6	2.5	11.4	5.0
Stop Delay (hr)	0.1	0.1	0.0	0.0	0.0	0.0	0.1	0.2
Stop Del/Veh (s)	8.1	10.2	2.4	0.2	0.1	0.2	8.2	2.4

HCM 6th Signalized Intersection Summary
41: I Street & 4th Street

Village D Specific Plan
Phase III NP - AM Peak Hour



Movement	EBL	EBT	EBR	WBL	WBT	WBR	NBL	NBT	NBR	SBL	SBT	SBR
Lane Configurations												
Traffic Volume (veh/h)	29	666	70	89	516	72	54	58	168	252	287	149
Future Volume (veh/h)	29	666	70	89	516	72	54	58	168	252	287	149
Initial Q (Qb), veh	0	0	0	0	0	0	0	0	0	0	0	0
Ped-Bike Adj(A_pbT)	1.00		0.96	1.00		0.96	1.00		0.97	1.00		0.98
Parking Bus, Adj	1.00	1.00	1.00	1.00	1.00	1.00	1.00	1.00	1.00	1.00	1.00	1.00
Work Zone On Approach		No			No			No			No	
Adj Sat Flow, veh/h/ln	1870	1870	1870	1856	1856	1856	1856	1856	1856	1856	1856	1856
Adj Flow Rate, veh/h	32	724	76	97	561	78	59	63	183	274	312	162
Peak Hour Factor	0.92	0.92	0.92	0.92	0.92	0.92	0.92	0.92	0.92	0.92	0.92	0.92
Percent Heavy Veh, %	2	2	2	3	3	3	3	3	3	3	3	3
Cap, veh/h	54	826	87	123	912	126	212	379	310	477	658	544
Arrive On Green	0.03	0.26	0.26	0.07	0.29	0.29	0.12	0.20	0.20	0.27	0.35	0.35
Sat Flow, veh/h	1781	3230	339	1767	3094	429	1767	1856	1519	1767	1856	1533
Grp Volume(v), veh/h	32	398	402	97	319	320	59	63	183	274	312	162
Grp Sat Flow(s),veh/h/ln	1781	1777	1792	1767	1763	1760	1767	1856	1519	1767	1856	1533
Q Serve(g_s), s	1.6	19.3	19.4	4.9	14.0	14.1	2.7	2.5	9.8	12.1	11.7	5.5
Cycle Q Clear(g_c), s	1.6	19.3	19.4	4.9	14.0	14.1	2.7	2.5	9.8	12.1	11.7	5.5
Prop In Lane	1.00		0.19	1.00		0.24	1.00		1.00	1.00		1.00
Lane Grp Cap(c), veh/h	54	455	458	123	520	519	212	379	310	477	658	544
V/C Ratio(X)	0.59	0.88	0.88	0.79	0.61	0.62	0.28	0.17	0.59	0.57	0.47	0.30
Avail Cap(c_a), veh/h	113	492	496	155	531	530	212	379	310	477	658	544
HCM Platoon Ratio	1.00	1.00	1.00	1.00	1.00	1.00	1.00	1.00	1.00	1.00	1.00	1.00
Upstream Filter(I)	0.89	0.89	0.89	1.00	1.00	1.00	1.00	1.00	1.00	1.00	1.00	1.00
Uniform Delay (d), s/veh	43.1	32.1	32.1	41.2	27.3	27.3	36.0	29.5	32.4	28.4	22.5	13.3
Incr Delay (d2), s/veh	8.6	13.9	14.0	18.7	2.0	2.1	0.7	0.9	8.0	1.7	2.4	1.4
Initial Q Delay(d3),s/veh	0.0	0.0	0.0	0.0	0.0	0.0	0.0	0.0	0.0	0.0	0.0	0.0
%ile BackOfQ(50%),veh/ln	0.8	9.8	9.9	2.7	6.0	6.1	1.2	1.2	4.2	5.2	5.4	2.5
Unsig. Movement Delay, s/veh												
LnGrp Delay(d),s/veh	51.7	46.0	46.1	59.9	29.3	29.4	36.8	30.4	40.4	30.1	25.0	14.7
LnGrp LOS	D	D	D	E	C	C	D	C	D	C	C	B
Approach Vol, veh/h		832			736			305			748	
Approach Delay, s/veh		46.3			33.4			37.6			24.6	
Approach LOS		D			C			D			C	
Timer - Assigned Phs	1	2	3	4	5	6	7	8				
Phs Duration (G+Y+Rc), s	28.8	22.9	10.8	27.5	15.3	36.4	7.3	31.0				
Change Period (Y+Rc), s	4.5	4.5	4.5	4.5	4.5	4.5	4.5	4.5				
Max Green Setting (Gmax), s	20.8	18.4	7.9	24.9	7.3	31.9	5.7	27.1				
Max Q Clear Time (g_c+1/4), s	11.8	11.8	6.9	21.4	4.7	13.7	3.6	16.1				
Green Ext Time (p_c), s	0.5	0.5	0.0	1.7	0.0	2.3	0.0	3.0				

Intersection Summary

HCM 6th Ctrl Delay		35.5										
HCM 6th LOS			D									

HCM 6th Signalized Intersection Summary
 43: SR-99 Northbound Off-Ramp/H Street & 4th Street

Village D Specific Plan
 Phase III NP - AM Peak Hour



Movement	EBL	EBT	EBR	WBL	WBT	WBR	NBL	NBT	NBR	SBL	SBT	SBR
Lane Configurations	↖	↗			↖	↗	↖	↗			↕	
Traffic Volume (veh/h)	265	470	0	0	559	79	281	35	240	8	0	84
Future Volume (veh/h)	265	470	0	0	559	79	281	35	240	8	0	84
Initial Q (Qb), veh	0	0	0	0	0	0	0	0	0	0	0	0
Ped-Bike Adj(A_pbT)	1.00		1.00	1.00		0.94	1.00		1.00	1.00		0.99
Parking Bus, Adj	1.00	1.00	1.00	1.00	1.00	1.00	1.00	1.00	1.00	1.00	1.00	1.00
Work Zone On Approach		No			No			No			No	
Adj Sat Flow, veh/h/ln	1870	1870	0	0	1841	1841	1870	1870	1870	1900	1900	1900
Adj Flow Rate, veh/h	288	511	0	0	608	86	305	38	261	9	0	91
Peak Hour Factor	0.92	0.92	0.92	0.92	0.92	0.92	0.92	0.92	0.92	0.92	0.92	0.92
Percent Heavy Veh, %	2	2	0	0	4	4	2	2	2	0	0	0
Cap, veh/h	321	1549	0	0	627	88	381	44	302	29	0	292
Arrive On Green	0.18	0.44	0.00	0.00	0.21	0.21	0.21	0.21	0.21	0.20	0.00	0.20
Sat Flow, veh/h	1781	3647	0	0	3143	430	1781	205	1411	145	0	1462
Grp Volume(v), veh/h	288	511	0	0	348	346	305	0	299	100	0	0
Grp Sat Flow(s),veh/h/ln	1781	1777	0	0	1749	1733	1781	0	1616	1607	0	0
Q Serve(g_s), s	14.2	8.5	0.0	0.0	17.7	17.9	14.6	0.0	16.1	4.8	0.0	0.0
Cycle Q Clear(g_c), s	14.2	8.5	0.0	0.0	17.7	17.9	14.6	0.0	16.1	4.8	0.0	0.0
Prop In Lane	1.00		0.00	0.00		0.25	1.00		0.87	0.09		0.91
Lane Grp Cap(c), veh/h	321	1549	0	0	359	356	381	0	346	321	0	0
V/C Ratio(X)	0.90	0.33	0.00	0.00	0.97	0.97	0.80	0.00	0.86	0.31	0.00	0.00
Avail Cap(c_a), veh/h	327	1560	0	0	359	356	381	0	346	321	0	0
HCM Platoon Ratio	1.00	1.00	1.00	1.00	1.00	1.00	1.00	1.00	1.00	1.00	1.00	1.00
Upstream Filter(I)	1.00	1.00	0.00	0.00	1.00	1.00	1.00	0.00	1.00	1.00	0.00	0.00
Uniform Delay (d), s/veh	36.1	16.7	0.0	0.0	35.5	35.5	33.5	0.0	34.1	30.7	0.0	0.0
Incr Delay (d2), s/veh	25.5	0.1	0.0	0.0	38.7	40.1	16.0	0.0	23.9	2.5	0.0	0.0
Initial Q Delay(d3),s/veh	0.0	0.0	0.0	0.0	0.0	0.0	0.0	0.0	0.0	0.0	0.0	0.0
%ile BackOfQ(50%),veh/ln	8.3	3.4	0.0	0.0	11.2	11.3	7.9	0.0	8.4	2.0	0.0	0.0
Unsig. Movement Delay, s/veh												
LnGrp Delay(d),s/veh	61.5	16.8	0.0	0.0	74.2	75.6	49.6	0.0	58.0	33.2	0.0	0.0
LnGrp LOS	E	B	A	A	E	E	D	A	E	C	A	A
Approach Vol, veh/h		799			694			604			100	
Approach Delay, s/veh		32.9			74.9			53.7			33.2	
Approach LOS		C			E			D			C	
Timer - Assigned Phs		2		4		6	7	8				
Phs Duration (G+Y+Rc), s		23.8		43.7		22.5	20.7	23.0				
Change Period (Y+Rc), s		4.5		4.5		4.5	4.5	4.5				
Max Green Setting (Gmax), s		19.0		39.5		18.0	16.5	18.5				
Max Q Clear Time (g_c+I1), s		18.1		10.5		6.8	16.2	19.9				
Green Ext Time (p_c), s		0.3		3.7		0.3	0.0	0.0				
Intersection Summary												
HCM 6th Ctrl Delay					51.9							
HCM 6th LOS					D							

Intersection						
Int Delay, s/veh	2.6					
Movement	EBL	EBT	WBT	WBR	SBL	SBR
Lane Configurations	↖	↗	↗		↖	↖
Traffic Vol, veh/h	134	513	583	82	62	102
Future Vol, veh/h	134	513	583	82	62	102
Conflicting Peds, #/hr	16	0	0	16	0	0
Sign Control	Free	Free	Free	Free	Stop	Stop
RT Channelized	-	None	-	None	-	None
Storage Length	145	-	-	-	65	0
Veh in Median Storage, #	-	0	0	-	0	-
Grade, %	-	0	0	-	0	-
Peak Hour Factor	98	98	98	98	98	98
Heavy Vehicles, %	5	5	4	4	5	5
Mvmt Flow	137	523	595	84	63	104

Major/Minor	Major1	Major2	Minor2		
Conflicting Flow All	695	0	-	0	1189 356
Stage 1	-	-	-	-	653 -
Stage 2	-	-	-	-	536 -
Critical Hdwy	4.2	-	-	-	6.9 7
Critical Hdwy Stg 1	-	-	-	-	5.9 -
Critical Hdwy Stg 2	-	-	-	-	5.9 -
Follow-up Hdwy	2.25	-	-	-	3.55 3.35
Pot Cap-1 Maneuver	1137	-	-	-	271 *868
Stage 1	-	-	-	-	731 -
Stage 2	-	-	-	-	542 -
Platoon blocked, %	1	-	-	-	1 1
Mov Cap-1 Maneuver	1120	-	-	-	231 *855
Mov Cap-2 Maneuver	-	-	-	-	231 -
Stage 1	-	-	-	-	633 -
Stage 2	-	-	-	-	534 -

Approach	EB	WB	SB
HCM Control Delay, s	1.8	0	16.1
HCM LOS			C

Minor Lane/Major Mvmt	EBL	EBT	WBT	WBR	SBLn1	SBLn2
Capacity (veh/h)	1120	-	-	-	231	855
HCM Lane V/C Ratio	0.122	-	-	-	0.274	0.122
HCM Control Delay (s)	8.7	-	-	-	26.4	9.8
HCM Lane LOS	A	-	-	-	D	A
HCM 95th %tile Q(veh)	0.4	-	-	-	1.1	0.4

Notes
 -: Volume exceeds capacity \$: Delay exceeds 300s +: Computation Not Defined *: All major volume in platoon

HCM 6th Signalized Intersection Summary
 45: Olive Avenue & SR-99 Southbound Off-Ramp

Village D Specific Plan
 Phase III NP - AM Peak Hour



Movement	EBL	EBT	WBT	WBR	SBL	SBR
Lane Configurations		↑↑↑	↑↑		↵	↵
Traffic Volume (veh/h)	0	575	547	0	712	120
Future Volume (veh/h)	0	575	547	0	712	120
Initial Q (Qb), veh	0	0	0	0	0	0
Ped-Bike Adj(A_pbT)	1.00			1.00	1.00	1.00
Parking Bus, Adj	1.00	1.00	1.00	1.00	1.00	1.00
Work Zone On Approach		No	No		No	
Adj Sat Flow, veh/h/ln	0	1826	1826	0	1752	1752
Adj Flow Rate, veh/h	0	612	582	0	757	128
Peak Hour Factor	0.94	0.94	0.94	0.94	0.94	0.94
Percent Heavy Veh, %	0	5	5	0	10	10
Cap, veh/h	0	1063	740	0	1125	1001
Arrive On Green	0.00	0.21	0.21	0.00	0.67	0.67
Sat Flow, veh/h	0	5313	3652	0	1668	1485
Grp Volume(v), veh/h	0	612	582	0	757	128
Grp Sat Flow(s),veh/h/ln	0	1662	1735	0	1668	1485
Q Serve(g_s), s	0.0	8.8	12.7	0.0	21.6	2.5
Cycle Q Clear(g_c), s	0.0	8.8	12.7	0.0	21.6	2.5
Prop In Lane	0.00			0.00	1.00	1.00
Lane Grp Cap(c), veh/h	0	1063	740	0	1125	1001
V/C Ratio(X)	0.00	0.58	0.79	0.00	0.67	0.13
Avail Cap(c_a), veh/h	0	1402	976	0	1125	1001
HCM Platoon Ratio	1.00	1.00	1.00	1.00	1.00	1.00
Upstream Filter(I)	0.00	1.00	0.96	0.00	1.00	1.00
Uniform Delay (d), s/veh	0.0	28.2	29.8	0.0	7.8	4.6
Incr Delay (d2), s/veh	0.0	0.5	3.1	0.0	3.2	0.3
Initial Q Delay(d3),s/veh	0.0	0.0	0.0	0.0	0.0	0.0
%ile BackOfQ(50%),veh/ln	0.0	3.4	5.4	0.0	7.0	0.7
Unsig. Movement Delay, s/veh						
LnGrp Delay(d),s/veh	0.0	28.7	32.8	0.0	11.0	4.9
LnGrp LOS	A	C	C	A	B	A
Approach Vol, veh/h		612	582		885	
Approach Delay, s/veh		28.7	32.8		10.1	
Approach LOS		C	C		B	
Timer - Assigned Phs				4	6	8
Phs Duration (G+Y+Rc), s				21.6	58.4	21.6
Change Period (Y+Rc), s				4.5	4.5	4.5
Max Green Setting (Gmax), s				22.5	48.5	22.5
Max Q Clear Time (g_c+I1), s				10.8	23.6	14.7
Green Ext Time (p_c), s				3.3	3.5	2.4
Intersection Summary						
HCM 6th Ctrl Delay			21.9			
HCM 6th LOS			C			

HCM 6th Signalized Intersection Summary

46: Madera Avenue & SR-99 Northbound Ramps

Village D Specific Plan
Phase III NP - AM Peak Hour



Movement	EBL	EBT	EBR	WBL	WBT	WBR	NBL	NBT	NBR	SBL	SBT	SBR
Lane Configurations				↶	↷	↶	↶↷	↶↷			↶↷	
Traffic Volume (veh/h)	0	0	0	223	2	107	663	447	0	0	701	277
Future Volume (veh/h)	0	0	0	223	2	107	663	447	0	0	701	277
Initial Q (Qb), veh				0	0	0	0	0	0	0	0	0
Ped-Bike Adj(A_pbT)				1.00		0.98	1.00		1.00	1.00		0.97
Parking Bus, Adj				1.00	1.00	1.00	1.00	1.00	1.00	1.00	1.00	1.00
Work Zone On Approach				No			No			No		
Adj Sat Flow, veh/h/ln				1826	1826	1826	1796	1796	0	0	1841	1841
Adj Flow Rate, veh/h				243	0	116	721	486	0	0	762	301
Peak Hour Factor				0.92	0.92	0.92	0.92	0.92	0.92	0.92	0.92	0.92
Percent Heavy Veh, %				5	5	5	7	7	0	0	4	4
Cap, veh/h				384	0	168	1127	2653	0	0	924	365
Arrive On Green				0.11	0.00	0.11	0.57	1.00	0.00	0.00	0.38	0.38
Sat Flow, veh/h				3478	0	1519	3319	3503	0	0	2515	956
Grp Volume(v), veh/h				243	0	116	721	486	0	0	550	513
Grp Sat Flow(s),veh/h/ln				1739	0	1519	1659	1706	0	0	1749	1630
Q Serve(g_s), s				5.3	0.0	5.9	11.8	0.0	0.0	0.0	22.7	22.7
Cycle Q Clear(g_c), s				5.3	0.0	5.9	11.8	0.0	0.0	0.0	22.7	22.7
Prop In Lane				1.00		1.00	1.00		0.00	0.00		0.59
Lane Grp Cap(c), veh/h				384	0	168	1127	2653	0	0	667	621
V/C Ratio(X)				0.63	0.00	0.69	0.64	0.18	0.00	0.00	0.82	0.83
Avail Cap(c_a), veh/h				804	0	351	1127	2653	0	0	667	621
HCM Platoon Ratio				1.00	1.00	1.00	1.67	1.67	1.00	1.00	1.00	1.00
Upstream Filter(I)				1.00	0.00	1.00	0.81	0.81	0.00	0.00	1.00	1.00
Uniform Delay (d), s/veh				34.0	0.0	34.3	14.0	0.0	0.0	0.0	22.3	22.3
Incr Delay (d2), s/veh				1.7	0.0	5.0	1.0	0.1	0.0	0.0	11.1	11.9
Initial Q Delay(d3),s/veh				0.0	0.0	0.0	0.0	0.0	0.0	0.0	0.0	0.0
%ile BackOfQ(50%),veh/ln				2.3	0.0	2.4	3.4	0.0	0.0	0.0	10.8	10.2
Unsig. Movement Delay, s/veh												
LnGrp Delay(d),s/veh				35.8	0.0	39.3	15.0	0.1	0.0	0.0	33.5	34.3
LnGrp LOS				D	A	D	B	A	A	A	C	C
Approach Vol, veh/h					359			1207			1063	
Approach Delay, s/veh					36.9			9.0			33.9	
Approach LOS					D			A			C	
Timer - Assigned Phs		2			5	6		8				
Phs Duration (G+Y+Rc), s		66.7			31.7	35.0		13.3				
Change Period (Y+Rc), s		4.5			4.5	4.5		4.5				
Max Green Setting (Gmax), s		52.5			17.5	30.5		18.5				
Max Q Clear Time (g_c+I1), s		2.0			13.8	24.7		7.9				
Green Ext Time (p_c), s		3.7			1.1	3.3		0.9				

Intersection Summary

HCM 6th Ctrl Delay	22.9
HCM 6th LOS	C

Notes

User approved volume balancing among the lanes for turning movement.

HCM 6th Signalized Intersection Summary

47: Madera Avenue & Olive Avenue/SR-99 Southbound On-Ramp

Village D Specific Plan
Phase III NP - AM Peak Hour



Movement	EBL	EBT	EBR	WBL	WBT	WBR	NBL	NBT	NBR	SBL	SBT	SBR
Lane Configurations												
Traffic Volume (veh/h)	418	202	667	0	0	0	202	692	44	88	491	345
Future Volume (veh/h)	418	202	667	0	0	0	202	692	44	88	491	345
Initial Q (Qb), veh	0	0	0				0	0	0	0	0	0
Ped-Bike Adj(A_pbT)	1.00		1.00				1.00		0.99	1.00		0.99
Parking Bus, Adj	1.00	1.00	1.00				1.00	1.00	1.00	1.00	1.00	1.00
Work Zone On Approach		No					No			No		
Adj Sat Flow, veh/h/ln	1811	1811	1811				1781	1781	1781	1841	1841	1841
Adj Flow Rate, veh/h	326	372	702				213	728	46	93	517	363
Peak Hour Factor	0.95	0.95	0.95				0.95	0.95	0.95	0.95	0.95	0.95
Percent Heavy Veh, %	6	6	6				8	8	8	4	4	4
Cap, veh/h	593	623	670				304	1353	85	120	771	541
Arrive On Green	0.11	0.11	0.11				0.09	0.42	0.42	0.02	0.13	0.13
Sat Flow, veh/h	1725	1811	1535				3291	3230	204	1753	1953	1369
Grp Volume(v), veh/h	326	372	702				213	381	393	93	463	417
Grp Sat Flow(s),veh/h/ln	1725	1811	1535				1646	1692	1742	1753	1749	1574
Q Serve(g_s), s	14.3	15.6	27.5				5.0	13.5	13.5	4.2	20.2	20.2
Cycle Q Clear(g_c), s	14.3	15.6	27.5				5.0	13.5	13.5	4.2	20.2	20.2
Prop In Lane	1.00		1.00				1.00		0.12	1.00		0.87
Lane Grp Cap(c), veh/h	593	623	670				304	709	730	120	691	622
V/C Ratio(X)	0.55	0.60	1.05				0.70	0.54	0.54	0.77	0.67	0.67
Avail Cap(c_a), veh/h	593	623	670				638	709	730	217	691	622
HCM Platoon Ratio	0.33	0.33	0.33				1.00	1.00	1.00	0.33	0.33	0.33
Upstream Filter(I)	0.74	0.74	0.74				1.00	1.00	1.00	0.70	0.70	0.70
Uniform Delay (d), s/veh	29.6	30.2	29.2				35.2	17.4	17.4	38.5	29.8	29.8
Incr Delay (d2), s/veh	0.8	1.2	43.4				2.9	2.9	2.8	7.2	3.6	4.0
Initial Q Delay(d3),s/veh	0.0	0.0	0.0				0.0	0.0	0.0	0.0	0.0	0.0
%ile BackOfQ(50%),veh/ln	6.7	7.7	34.3				2.1	5.5	5.7	2.1	10.0	9.1
Unsig. Movement Delay, s/veh												
LnGrp Delay(d),s/veh	30.4	31.4	72.6				38.1	20.3	20.3	45.7	33.4	33.9
LnGrp LOS	C	C	F				D	C	C	D	C	C
Approach Vol, veh/h		1400						987			973	
Approach Delay, s/veh		51.8						24.2			34.8	
Approach LOS		D						C			C	
Timer - Assigned Phs	1	2		4	5	6						
Phs Duration (G+Y+Rc), s	30.0	38.0		32.0	11.9	36.1						
Change Period (Y+Rc), s	4.5	4.5		4.5	4.5	4.5						
Max Green Setting (Gmax), s	29.1			27.5	15.5	23.5						
Max Q Clear Time (g_c+I), s	15.5			29.5	7.0	22.2						
Green Ext Time (p_c), s	0.1	4.2		0.0	0.4	0.7						

Intersection Summary

HCM 6th Ctrl Delay	38.8
HCM 6th LOS	D

Notes

User approved volume balancing among the lanes for turning movement.

Intersection						
Int Delay, s/veh	0.3					
Movement	WBL	WBR	NBT	NBR	SBL	SBT
Lane Configurations	↘↗		↑↓		↘	↑↑
Traffic Vol, veh/h	9	8	962	8	33	1281
Future Vol, veh/h	9	8	962	8	33	1281
Conflicting Peds, #/hr	0	0	0	8	8	0
Sign Control	Stop	Stop	Free	Free	Free	Free
RT Channelized	-	None	-	None	-	None
Storage Length	0	-	-	-	100	-
Veh in Median Storage, #	0	-	0	-	-	0
Grade, %	0	-	0	-	-	0
Peak Hour Factor	97	97	97	97	97	97
Heavy Vehicles, %	12	12	6	6	6	6
Mvmt Flow	9	8	992	8	34	1321

Major/Minor	Minor1	Major1	Major2		
Conflicting Flow All	1733	508	0	0	1008
Stage 1	1004	-	-	-	-
Stage 2	729	-	-	-	-
Critical Hdwy	7.04	7.14	-	-	4.22
Critical Hdwy Stg 1	6.04	-	-	-	-
Critical Hdwy Stg 2	6.04	-	-	-	-
Follow-up Hdwy	3.62	3.42	-	-	2.26
Pot Cap-1 Maneuver	*224	485	-	-	660
Stage 1	*293	-	-	-	-
Stage 2	*517	-	-	-	-
Platoon blocked, %	1	-	-	-	-
Mov Cap-1 Maneuver	*211	481	-	-	655
Mov Cap-2 Maneuver	*249	-	-	-	-
Stage 1	*291	-	-	-	-
Stage 2	*490	-	-	-	-

Approach	WB	NB	SB
HCM Control Delay, s	16.8	0	0.3
HCM LOS	C		

Minor Lane/Major Mvmt	NBT	NBRWBLn1	SBL	SBT
Capacity (veh/h)	-	-	322	655
HCM Lane V/C Ratio	-	-	0.054	0.052
HCM Control Delay (s)	-	-	16.8	10.8
HCM Lane LOS	-	-	C	B
HCM 95th %tile Q(veh)	-	-	0.2	0.2

Notes
 -: Volume exceeds capacity \$: Delay exceeds 300s +: Computation Not Defined *: All major volume in platoon

HCM 6th Signalized Intersection Summary
 49: Yosemite Avenue & Cleveland Avenue/Tozer Street

Village D Specific Plan
 Phase III NP - AM Peak Hour



Movement	EBL	EBT	EBR	WBL	WBT	WBR	NBL	NBT	NBR	SBL	SBT	SBR
Lane Configurations	↖	↗		↖	↗	↗	↖	↗	↗	↖	↗	↗
Traffic Volume (veh/h)	210	531	260	116	349	60	141	137	78	79	270	226
Future Volume (veh/h)	210	531	260	116	349	60	141	137	78	79	270	226
Initial Q (Qb), veh	0	0	0	0	0	0	0	0	0	0	0	0
Ped-Bike Adj(A_pbT)	1.00		0.92	1.00		0.93	1.00		1.00	1.00		1.00
Parking Bus, Adj	1.00	1.00	1.00	1.00	1.00	1.00	1.00	1.00	1.00	1.00	1.00	1.00
Work Zone On Approach		No			No			No			No	
Adj Sat Flow, veh/h/ln	1856	1856	1856	1841	1841	1841	1856	1856	1856	1870	1870	1870
Adj Flow Rate, veh/h	228	577	283	126	379	65	153	149	85	86	293	246
Peak Hour Factor	0.92	0.92	0.92	0.92	0.92	0.92	0.92	0.92	0.92	0.92	0.92	0.92
Percent Heavy Veh, %	3	3	3	4	4	4	3	3	3	2	2	2
Cap, veh/h	266	736	360	156	942	389	171	590	498	111	266	223
Arrive On Green	0.15	0.33	0.33	0.09	0.27	0.27	0.10	0.32	0.32	0.06	0.28	0.28
Sat Flow, veh/h	1767	2222	1088	1753	3497	1444	1767	1856	1568	1781	938	788
Grp Volume(v), veh/h	228	457	403	126	379	65	153	149	85	86	0	539
Grp Sat Flow(s),veh/h/ln	1767	1763	1548	1753	1749	1444	1767	1856	1568	1781	0	1726
Q Serve(g_s), s	11.3	21.1	21.2	6.4	8.0	3.1	7.7	5.4	3.5	4.3	0.0	25.5
Cycle Q Clear(g_c), s	11.3	21.1	21.2	6.4	8.0	3.1	7.7	5.4	3.5	4.3	0.0	25.5
Prop In Lane	1.00		0.70	1.00		1.00	1.00		1.00	1.00		0.46
Lane Grp Cap(c), veh/h	266	584	513	156	942	389	171	590	498	111	0	489
V/C Ratio(X)	0.86	0.78	0.79	0.81	0.40	0.17	0.90	0.25	0.17	0.78	0.00	1.10
Avail Cap(c_a), veh/h	355	584	513	158	942	389	171	590	498	184	0	489
HCM Platoon Ratio	1.00	1.00	1.00	1.00	1.00	1.00	1.00	1.00	1.00	1.00	1.00	1.00
Upstream Filter(I)	1.00	1.00	1.00	1.00	1.00	1.00	1.00	1.00	1.00	1.00	0.00	1.00
Uniform Delay (d), s/veh	37.3	27.2	27.2	40.3	26.9	25.2	40.2	22.8	22.1	41.6	0.0	32.3
Incr Delay (d2), s/veh	14.5	10.1	11.5	25.8	1.3	0.9	40.6	0.2	0.2	11.1	0.0	71.6
Initial Q Delay(d3),s/veh	0.0	0.0	0.0	0.0	0.0	0.0	0.0	0.0	0.0	0.0	0.0	0.0
%ile BackOfQ(50%),veh/ln	5.9	10.2	9.2	3.8	3.4	1.1	5.2	2.3	1.3	2.2	0.0	20.0
Unsig. Movement Delay, s/veh												
LnGrp Delay(d),s/veh	51.7	37.3	38.7	66.1	28.2	26.1	80.8	23.0	22.3	52.7	0.0	103.8
LnGrp LOS	D	D	D	E	C	C	F	C	C	D	A	F
Approach Vol, veh/h		1088			570			387			625	
Approach Delay, s/veh		40.8			36.3			45.7			96.8	
Approach LOS		D			D			D			F	
Timer - Assigned Phs	1	2	3	4	5	6	7	8				
Phs Duration (G+Y+Rc), s	18.1	28.7	10.1	33.1	12.5	34.3	13.2	30.0				
Change Period (Y+Rc), s	4.5	4.5	4.5	4.5	4.5	4.5	4.5	4.5				
Max Green Setting (Gmax), s	18.1	19.7	9.3	24.9	8.1	29.7	8.7	25.5				
Max Q Clear Time (g_c+I1), s	13.3	10.0	6.3	7.4	8.4	23.2	9.7	27.5				
Green Ext Time (p_c), s	0.3	1.9	0.0	1.0	0.0	3.0	0.0	0.0				

Intersection Summary

HCM 6th Ctrl Delay	53.7
HCM 6th LOS	D

Intersection						
Int Delay, s/veh	0					
Movement	EBT	EBR	WBL	WBT	NBL	NBR
Lane Configurations						
Traffic Vol, veh/h	50	0	0	32	0	0
Future Vol, veh/h	50	0	0	32	0	0
Conflicting Peds, #/hr	0	0	0	0	0	0
Sign Control	Free	Free	Free	Free	Stop	Stop
RT Channelized	-	None	-	None	-	None
Storage Length	-	-	-	-	-	-
Veh in Median Storage, #	0	-	-	0	0	-
Grade, %	0	-	-	0	0	-
Peak Hour Factor	92	92	92	92	92	92
Heavy Vehicles, %	15	15	15	15	0	0
Mvmt Flow	54	0	0	35	0	0

Major/Minor	Major1	Major2	Minor1		
Conflicting Flow All	0	0	54	0	89
Stage 1	-	-	-	-	54
Stage 2	-	-	-	-	35
Critical Hdwy	-	-	4.25	-	6.4
Critical Hdwy Stg 1	-	-	-	-	5.4
Critical Hdwy Stg 2	-	-	-	-	5.4
Follow-up Hdwy	-	-	2.335	-	3.5
Pot Cap-1 Maneuver	-	-	1472	-	917
Stage 1	-	-	-	-	974
Stage 2	-	-	-	-	993
Platoon blocked, %	-	-	-	-	-
Mov Cap-1 Maneuver	-	-	1472	-	917
Mov Cap-2 Maneuver	-	-	-	-	917
Stage 1	-	-	-	-	974
Stage 2	-	-	-	-	993

Approach	EB	WB	NB
HCM Control Delay, s	0	0	0
HCM LOS			A

Minor Lane/Major Mvmt	NBLn1	EBT	EBR	WBL	WBT
Capacity (veh/h)	-	-	-	1472	-
HCM Lane V/C Ratio	-	-	-	-	-
HCM Control Delay (s)	0	-	-	0	-
HCM Lane LOS	A	-	-	A	-
HCM 95th %tile Q(veh)	-	-	-	0	-

Intersection												
Int Delay, s/veh	0.6											
Movement	EBL	EBT	EBR	WBL	WBT	WBR	NBL	NBT	NBR	SBL	SBT	SBR
Lane Configurations		↕			↕			↕			↕	
Traffic Vol, veh/h	0	65	2	0	35	0	0	0	4	4	0	0
Future Vol, veh/h	0	65	2	0	35	0	0	0	4	4	0	0
Conflicting Peds, #/hr	0	0	0	0	0	0	0	0	0	0	0	0
Sign Control	Free	Free	Free	Free	Free	Free	Stop	Stop	Stop	Stop	Stop	Stop
RT Channelized	-	-	None	-	-	None	-	-	None	-	-	None
Storage Length	-	-	-	-	-	-	-	-	-	-	-	-
Veh in Median Storage, #	-	0	-	-	0	-	-	0	-	-	0	-
Grade, %	-	0	-	-	0	-	-	0	-	-	0	-
Peak Hour Factor	92	92	92	92	92	92	92	92	92	92	92	92
Heavy Vehicles, %	11	11	11	11	11	11	0	0	0	0	0	0
Mvmt Flow	0	71	2	0	38	0	0	0	4	4	0	0

Major/Minor	Major1			Major2			Minor1			Minor2		
Conflicting Flow All	38	0	0	73	0	0	110	110	72	112	111	38
Stage 1	-	-	-	-	-	-	72	72	-	38	38	-
Stage 2	-	-	-	-	-	-	38	38	-	74	73	-
Critical Hdwy	4.21	-	-	4.21	-	-	7.1	6.5	6.2	7.1	6.5	6.2
Critical Hdwy Stg 1	-	-	-	-	-	-	6.1	5.5	-	6.1	5.5	-
Critical Hdwy Stg 2	-	-	-	-	-	-	6.1	5.5	-	6.1	5.5	-
Follow-up Hdwy	2.299	-	-	2.299	-	-	3.5	4	3.3	3.5	4	3.3
Pot Cap-1 Maneuver	1516	-	-	1472	-	-	873	784	996	870	783	1040
Stage 1	-	-	-	-	-	-	943	839	-	982	867	-
Stage 2	-	-	-	-	-	-	982	867	-	940	838	-
Platoon blocked, %	-	-	-	-	-	-	-	-	-	-	-	-
Mov Cap-1 Maneuver	1516	-	-	1472	-	-	873	784	996	867	783	1040
Mov Cap-2 Maneuver	-	-	-	-	-	-	873	784	-	867	783	-
Stage 1	-	-	-	-	-	-	943	839	-	982	867	-
Stage 2	-	-	-	-	-	-	982	867	-	936	838	-

Approach	EB			WB			NB			SB		
HCM Control Delay, s	0			0			8.6			9.2		
HCM LOS							A			A		

Minor Lane/Major Mvmt	NBLn1	EBL	EBT	EBR	WBL	WBT	WBR	SBLn1
Capacity (veh/h)	996	1516	-	-	1472	-	-	867
HCM Lane V/C Ratio	0.004	-	-	-	-	-	-	0.005
HCM Control Delay (s)	8.6	0	-	-	0	-	-	9.2
HCM Lane LOS	A	A	-	-	A	-	-	A
HCM 95th %tile Q(veh)	0	0	-	-	0	-	-	0

Intersection						
Int Delay, s/veh	4.8					
Movement	WBL	WBR	NBT	NBR	SBL	SBT
Lane Configurations						
Traffic Vol, veh/h	1	1	0	2	1	0
Future Vol, veh/h	1	1	0	2	1	0
Conflicting Peds, #/hr	0	0	0	0	0	0
Sign Control	Stop	Stop	Free	Free	Free	Free
RT Channelized	-	None	-	None	-	None
Storage Length	-	-	-	-	-	-
Veh in Median Storage, #	0	-	0	-	-	0
Grade, %	0	-	0	-	-	0
Peak Hour Factor	92	92	92	92	92	92
Heavy Vehicles, %	0	0	0	0	0	0
Mvmt Flow	1	1	0	2	1	0

Major/Minor	Minor1	Major1	Major2			
Conflicting Flow All	3	1	0	0	2	0
Stage 1	1	-	-	-	-	-
Stage 2	2	-	-	-	-	-
Critical Hdwy	6.4	6.2	-	-	4.1	-
Critical Hdwy Stg 1	5.4	-	-	-	-	-
Critical Hdwy Stg 2	5.4	-	-	-	-	-
Follow-up Hdwy	3.5	3.3	-	-	2.2	-
Pot Cap-1 Maneuver	1025	1090	-	-	1634	-
Stage 1	1028	-	-	-	-	-
Stage 2	1026	-	-	-	-	-
Platoon blocked, %			-	-	-	-
Mov Cap-1 Maneuver	1024	1090	-	-	1634	-
Mov Cap-2 Maneuver	1024	-	-	-	-	-
Stage 1	1028	-	-	-	-	-
Stage 2	1025	-	-	-	-	-

Approach	WB	NB	SB
HCM Control Delay, s	8.4	0	7.2
HCM LOS	A		

Minor Lane/Major Mvmt	NBT	NBRWBLn1	SBL	SBT
Capacity (veh/h)	-	-	1056	1634
HCM Lane V/C Ratio	-	-	0.002	0.001
HCM Control Delay (s)	-	-	8.4	7.2
HCM Lane LOS	-	-	A	A
HCM 95th %tile Q(veh)	-	-	0	0

Intersection						
Int Delay, s/veh	0					
Movement	EBL	EBR	NBL	NBT	SBT	SBR
Lane Configurations	T			T		
Traffic Vol, veh/h	0	0	0	300	325	0
Future Vol, veh/h	0	0	0	300	325	0
Conflicting Peds, #/hr	0	0	0	0	0	0
Sign Control	Stop	Stop	Free	Free	Free	Free
RT Channelized	-	None	-	None	-	None
Storage Length	-	-	-	-	-	-
Veh in Median Storage, #	0	-	-	0	0	-
Grade, %	0	-	-	0	0	-
Peak Hour Factor	92	92	92	92	92	92
Heavy Vehicles, %	0	0	19	19	19	19
Mvmt Flow	0	0	0	326	353	0

Major/Minor	Minor2	Major1		Major2	
Conflicting Flow All	679	353	353	0	0
Stage 1	353	-	-	-	-
Stage 2	326	-	-	-	-
Critical Hdwy	6.4	6.2	4.29	-	-
Critical Hdwy Stg 1	5.4	-	-	-	-
Critical Hdwy Stg 2	5.4	-	-	-	-
Follow-up Hdwy	3.5	3.3	2.371	-	-
Pot Cap-1 Maneuver	420	695	1117	-	-
Stage 1	716	-	-	-	-
Stage 2	736	-	-	-	-
Platoon blocked, %				-	-
Mov Cap-1 Maneuver	420	695	1117	-	-
Mov Cap-2 Maneuver	420	-	-	-	-
Stage 1	716	-	-	-	-
Stage 2	736	-	-	-	-

Approach	EB	NB	SB
HCM Control Delay, s	0	0	0
HCM LOS	A		

Minor Lane/Major Mvmt	NBL	NBT	EBLn1	SBT	SBR
Capacity (veh/h)	1117	-	-	-	-
HCM Lane V/C Ratio	-	-	-	-	-
HCM Control Delay (s)	0	-	0	-	-
HCM Lane LOS	A	-	A	-	-
HCM 95th %tile Q(veh)	0	-	-	-	-

Intersection						
Int Delay, s/veh	0					
Movement	EBL	EBR	NBL	NBT	SBT	SBR
Lane Configurations	T			T		
Traffic Vol, veh/h	0	1	1	279	979	0
Future Vol, veh/h	0	1	1	279	979	0
Conflicting Peds, #/hr	0	0	0	0	0	0
Sign Control	Stop	Stop	Free	Free	Free	Free
RT Channelized	-	None	-	None	-	None
Storage Length	0	-	-	-	-	-
Veh in Median Storage, #	0	-	-	0	0	-
Grade, %	0	-	-	0	0	-
Peak Hour Factor	92	92	92	92	92	92
Heavy Vehicles, %	0	0	17	17	17	17
Mvmt Flow	0	1	1	303	1064	0

Major/Minor	Minor2	Major1	Major2			
Conflicting Flow All	1369	1064	1064	0	-	0
Stage 1	1064	-	-	-	-	-
Stage 2	305	-	-	-	-	-
Critical Hdwy	6.4	6.2	4.27	-	-	-
Critical Hdwy Stg 1	5.4	-	-	-	-	-
Critical Hdwy Stg 2	5.4	-	-	-	-	-
Follow-up Hdwy	3.5	3.3	2.353	-	-	-
Pot Cap-1 Maneuver	163	273	601	-	-	-
Stage 1	335	-	-	-	-	-
Stage 2	752	-	-	-	-	-
Platoon blocked, %				-	-	-
Mov Cap-1 Maneuver	163	273	601	-	-	-
Mov Cap-2 Maneuver	163	-	-	-	-	-
Stage 1	334	-	-	-	-	-
Stage 2	752	-	-	-	-	-

Approach	EB	NB	SB
HCM Control Delay, s	18.2	0	0
HCM LOS	C		

Minor Lane/Major Mvmt	NBL	NBT	EBLn1	SBT	SBR
Capacity (veh/h)	601	-	273	-	-
HCM Lane V/C Ratio	0.002	-	0.004	-	-
HCM Control Delay (s)	11	0	18.2	-	-
HCM Lane LOS	B	A	C	-	-
HCM 95th %tile Q(veh)	0	-	0	-	-

Intersection						
Int Delay, s/veh	0.1					
Movement	EBT	EBR	WBL	WBT	NBL	NBR
Lane Configurations						
Traffic Vol, veh/h	66	0	0	38	1	0
Future Vol, veh/h	66	0	0	38	1	0
Conflicting Peds, #/hr	0	0	0	0	0	0
Sign Control	Free	Free	Free	Free	Stop	Stop
RT Channelized	-	None	-	None	-	None
Storage Length	-	-	-	-	-	-
Veh in Median Storage, #	0	-	-	0	0	-
Grade, %	0	-	-	0	0	-
Peak Hour Factor	92	92	92	92	92	92
Heavy Vehicles, %	4	4	4	4	0	0
Mvmt Flow	72	0	0	41	1	0

Major/Minor	Major1	Major2	Minor1		
Conflicting Flow All	0	0	72	0	113
Stage 1	-	-	-	-	72
Stage 2	-	-	-	-	41
Critical Hdwy	-	-	4.14	-	6.4
Critical Hdwy Stg 1	-	-	-	-	5.4
Critical Hdwy Stg 2	-	-	-	-	5.4
Follow-up Hdwy	-	-	2.236	-	3.5
Pot Cap-1 Maneuver	-	-	1515	-	888
Stage 1	-	-	-	-	956
Stage 2	-	-	-	-	987
Platoon blocked, %	-	-	-	-	-
Mov Cap-1 Maneuver	-	-	1515	-	888
Mov Cap-2 Maneuver	-	-	-	-	888
Stage 1	-	-	-	-	956
Stage 2	-	-	-	-	987

Approach	EB	WB	NB
HCM Control Delay, s	0	0	9.1
HCM LOS			A

Minor Lane/Major Mvmt	NBLn1	EBT	EBR	WBL	WBT
Capacity (veh/h)	888	-	-	1515	-
HCM Lane V/C Ratio	0.001	-	-	-	-
HCM Control Delay (s)	9.1	-	-	0	-
HCM Lane LOS	A	-	-	A	-
HCM 95th %tile Q(veh)	0	-	-	0	-

Intersection												
Int Delay, s/veh	0.1											
Movement	EBL	EBT	EBR	WBL	WBT	WBR	NBL	NBT	NBR	SBL	SBT	SBR
Lane Configurations		↕			↕			↕			↕	
Traffic Vol, veh/h	0	50	0	0	15	0	0	0	1	0	0	0
Future Vol, veh/h	0	50	0	0	15	0	0	0	1	0	0	0
Conflicting Peds, #/hr	0	0	0	0	0	0	0	0	0	0	0	0
Sign Control	Free	Free	Free	Free	Free	Free	Stop	Stop	Stop	Stop	Stop	Stop
RT Channelized	-	-	None	-	-	None	-	-	None	-	-	None
Storage Length	-	-	-	-	-	-	-	-	-	-	-	-
Veh in Median Storage, #	-	0	-	-	0	-	-	0	-	-	0	-
Grade, %	-	0	-	-	0	-	-	0	-	-	0	-
Peak Hour Factor	92	92	92	92	92	92	92	92	92	92	92	92
Heavy Vehicles, %	13	13	13	13	13	13	0	0	0	0	0	0
Mvmt Flow	0	54	0	0	16	0	0	0	1	0	0	0

Major/Minor	Major1			Major2			Minor1			Minor2		
Conflicting Flow All	16	0	0	54	0	0	70	70	54	71	70	16
Stage 1	-	-	-	-	-	-	54	54	-	16	16	-
Stage 2	-	-	-	-	-	-	16	16	-	55	54	-
Critical Hdwy	4.23	-	-	4.23	-	-	7.1	6.5	6.2	7.1	6.5	6.2
Critical Hdwy Stg 1	-	-	-	-	-	-	6.1	5.5	-	6.1	5.5	-
Critical Hdwy Stg 2	-	-	-	-	-	-	6.1	5.5	-	6.1	5.5	-
Follow-up Hdwy	2.317	-	-	2.317	-	-	3.5	4	3.3	3.5	4	3.3
Pot Cap-1 Maneuver	1533	-	-	1484	-	-	927	824	1019	925	824	1069
Stage 1	-	-	-	-	-	-	963	854	-	1009	886	-
Stage 2	-	-	-	-	-	-	1009	886	-	962	854	-
Platoon blocked, %		-	-		-	-						
Mov Cap-1 Maneuver	1533	-	-	1484	-	-	927	824	1019	924	824	1069
Mov Cap-2 Maneuver	-	-	-	-	-	-	927	824	-	924	824	-
Stage 1	-	-	-	-	-	-	963	854	-	1009	886	-
Stage 2	-	-	-	-	-	-	1009	886	-	961	854	-

Approach	EB			WB			NB			SB		
HCM Control Delay, s	0			0			8.5			0		
HCM LOS							A			A		

Minor Lane/Major Mvmt	NBLn1	EBL	EBT	EBR	WBL	WBT	WBR	SBLn1
Capacity (veh/h)	1019	1533	-	-	1484	-	-	-
HCM Lane V/C Ratio	0.001	-	-	-	-	-	-	-
HCM Control Delay (s)	8.5	0	-	-	0	-	-	0
HCM Lane LOS	A	A	-	-	A	-	-	A
HCM 95th %tile Q(veh)	0	0	-	-	0	-	-	-

Intersection						
Int Delay, s/veh	6.6					
Movement	EBL	EBT	WBT	WBR	SBL	SBR
Lane Configurations		↕	↑	↗	↘	
Traffic Vol, veh/h	7	137	80	115	270	8
Future Vol, veh/h	7	137	80	115	270	8
Conflicting Peds, #/hr	0	0	0	0	0	0
Sign Control	Free	Free	Free	Free	Stop	Stop
RT Channelized	-	None	-	None	-	None
Storage Length	-	-	-	0	0	-
Veh in Median Storage, #	-	0	0	-	0	-
Grade, %	-	0	0	-	0	-
Peak Hour Factor	92	92	92	92	92	92
Heavy Vehicles, %	12	12	58	58	30	30
Mvmt Flow	8	149	87	125	293	9

Major/Minor	Major1	Major2	Minor2		
Conflicting Flow All	212	0	-	0	252
Stage 1	-	-	-	-	87
Stage 2	-	-	-	-	165
Critical Hdwy	4.22	-	-	-	6.7
Critical Hdwy Stg 1	-	-	-	-	5.7
Critical Hdwy Stg 2	-	-	-	-	5.7
Follow-up Hdwy	2.308	-	-	-	3.77
Pot Cap-1 Maneuver	1301	-	-	-	680
Stage 1	-	-	-	-	871
Stage 2	-	-	-	-	801
Platoon blocked, %		-	-	-	
Mov Cap-1 Maneuver	1301	-	-	-	675
Mov Cap-2 Maneuver	-	-	-	-	675
Stage 1	-	-	-	-	865
Stage 2	-	-	-	-	801

Approach	EB	WB	SB
HCM Control Delay, s	0.4	0	14.5
HCM LOS			B

Minor Lane/Major Mvmt	EBL	EBT	WBT	WBR	SBLn1
Capacity (veh/h)	1301	-	-	-	680
HCM Lane V/C Ratio	0.006	-	-	-	0.444
HCM Control Delay (s)	7.8	0	-	-	14.5
HCM Lane LOS	A	A	-	-	B
HCM 95th %tile Q(veh)	0	-	-	-	2.3

HCM 6th TWSC
 4: Truck Parking Lot/Pistachio Drive & Avenue 18 1/2

Village D Specific Plan
 Phase III NP - PM Peak Hour

Intersection												
Int Delay, s/veh	5.1											
Movement	EBL	EBT	EBR	WBL	WBT	WBR	NBL	NBT	NBR	SBL	SBT	SBR
Lane Configurations		↕			↕	↕		↕			↕	
Traffic Vol, veh/h	13	446	1	6	167	206	2	0	5	170	0	13
Future Vol, veh/h	13	446	1	6	167	206	2	0	5	170	0	13
Conflicting Peds, #/hr	0	0	0	0	0	0	0	0	1	1	0	0
Sign Control	Free	Free	Free	Free	Free	Free	Stop	Stop	Stop	Stop	Stop	Stop
RT Channelized	-	-	None	-	-	None	-	-	None	-	-	None
Storage Length	-	-	-	-	-	50	-	-	-	-	-	-
Veh in Median Storage, #	-	0	-	-	0	-	-	0	-	-	0	-
Grade, %	-	0	-	-	0	-	-	0	-	-	0	-
Peak Hour Factor	93	93	93	93	93	93	93	93	93	93	93	93
Heavy Vehicles, %	23	23	23	26	26	26	71	71	71	5	5	5
Mvmt Flow	14	480	1	6	180	222	2	0	5	183	0	14

Major/Minor	Major1			Major2			Minor1			Minor2		
Conflicting Flow All	402	0	0	481	0	0	819	923	482	704	701	180
Stage 1	-	-	-	-	-	-	509	509	-	192	192	-
Stage 2	-	-	-	-	-	-	310	414	-	512	509	-
Critical Hdwy	4.33	-	-	4.36	-	-	7.81	7.21	6.91	7.15	6.55	6.25
Critical Hdwy Stg 1	-	-	-	-	-	-	6.81	6.21	-	6.15	5.55	-
Critical Hdwy Stg 2	-	-	-	-	-	-	6.81	6.21	-	6.15	5.55	-
Follow-up Hdwy	2.407	-	-	2.434	-	-	4.139	4.639	3.939	3.545	4.045	3.345
Pot Cap-1 Maneuver	1052	-	-	968	-	-	227	209	466	348	359	855
Stage 1	-	-	-	-	-	-	439	440	-	803	736	-
Stage 2	-	-	-	-	-	-	575	490	-	539	533	-
Platoon blocked, %		-	-		-	-						
Mov Cap-1 Maneuver	1052	-	-	968	-	-	219	204	466	337	350	855
Mov Cap-2 Maneuver	-	-	-	-	-	-	219	204	-	337	350	-
Stage 1	-	-	-	-	-	-	431	432	-	789	730	-
Stage 2	-	-	-	-	-	-	561	486	-	523	523	-

Approach	EB			WB			NB			SB		
HCM Control Delay, s	0.2			0.1			15.5			27.4		
HCM LOS							C			D		

Minor Lane/Major Mvmt	NBLn1	EBL	EBT	EBR	WBL	WBT	WBR	SBLn1
Capacity (veh/h)	352	1052	-	-	968	-	-	352
HCM Lane V/C Ratio	0.021	0.013	-	-	0.007	-	-	0.559
HCM Control Delay (s)	15.5	8.5	0	-	8.7	0	-	27.4
HCM Lane LOS	C	A	A	-	A	A	-	D
HCM 95th %tile Q(veh)	0.1	0	-	-	0	-	-	3.3

Intersection												
Int Delay, s/veh	32.6											
Movement	EBL	EBT	EBR	WBL	WBT	WBR	NBL	NBT	NBR	SBL	SBT	SBR
Lane Configurations		↑	↗		↖		↖		↗		↕	
Traffic Vol, veh/h	0	405	216	58	206	0	48	0	162	28	136	127
Future Vol, veh/h	0	405	216	58	206	0	48	0	162	28	136	127
Conflicting Peds, #/hr	0	0	0	0	0	0	0	0	0	0	0	0
Sign Control	Free	Free	Free	Free	Free	Free	Stop	Stop	Stop	Stop	Stop	Stop
RT Channelized	-	-	None	-	-	None	-	-	None	-	-	None
Storage Length	-	-	50	-	-	-	0	-	25	-	-	-
Veh in Median Storage, #	-	0	-	-	0	-	-	0	-	-	0	-
Grade, %	-	0	-	-	0	-	-	0	-	-	0	-
Peak Hour Factor	94	94	94	94	94	94	94	94	94	94	94	94
Heavy Vehicles, %	20	20	20	30	30	30	16	16	16	26	26	26
Mvmt Flow	0	431	230	62	219	0	51	0	172	30	145	135

Major/Minor	Major1			Major2			Minor1			Minor2		
Conflicting Flow All	-	0	0	661	0	0	914	-	431	975	1004	219
Stage 1	-	-	-	-	-	-	431	-	-	343	343	-
Stage 2	-	-	-	-	-	-	483	-	-	632	661	-
Critical Hdwy	-	-	-	4.4	-	-	7.26	-	6.36	7.36	6.76	6.46
Critical Hdwy Stg 1	-	-	-	-	-	-	6.26	-	-	6.36	5.76	-
Critical Hdwy Stg 2	-	-	-	-	-	-	6.26	-	-	6.36	5.76	-
Follow-up Hdwy	-	-	-	2.47	-	-	3.644	-	3.444	3.734	4.234	3.534
Pot Cap-1 Maneuver	0	-	-	808	-	0	240	0	596	209	220	764
Stage 1	0	-	-	-	-	0	576	0	-	625	597	-
Stage 2	0	-	-	-	-	0	539	0	-	430	425	-
Platoon blocked, %	-	-	-	-	-	-	-	-	-	-	-	-
Mov Cap-1 Maneuver	-	-	-	808	-	-	77	-	596	139	201	764
Mov Cap-2 Maneuver	-	-	-	-	-	-	77	-	-	139	201	-
Stage 1	-	-	-	-	-	-	576	-	-	625	545	-
Stage 2	-	-	-	-	-	-	298	-	-	306	425	-

Approach	EB			WB			NB			SB		
HCM Control Delay, s	0			2.2			37			126.5		
HCM LOS							E			F		

Minor Lane/Major Mvmt	NBLn1	NBLn2	EBT	EBR	WBL	WBT	SBLn1
Capacity (veh/h)	77	596	-	-	808	-	279
HCM Lane V/C Ratio	0.663	0.289	-	-	0.076	-	1.11
HCM Control Delay (s)	116.3	13.5	-	-	9.8	0	126.5
HCM Lane LOS	F	B	-	-	A	A	F
HCM 95th %tile Q(veh)	3	1.2	-	-	0.2	-	12.9

Intersection												
Int Delay, s/veh	18.2											
Movement	EBL	EBT	EBR	WBL	WBT	WBR	NBL	NBT	NBR	SBL	SBT	SBR
Lane Configurations	↙	↑			↘			↕				
Traffic Vol, veh/h	235	124	0	0	99	22	196	3	0	0	0	0
Future Vol, veh/h	235	124	0	0	99	22	196	3	0	0	0	0
Conflicting Peds, #/hr	0	0	0	0	0	0	0	0	0	0	0	0
Sign Control	Free	Free	Free	Free	Free	Free	Stop	Stop	Stop	Free	Free	Free
RT Channelized	-	-	None	-	-	None	-	-	None	-	-	None
Storage Length	145	-	-	-	-	-	-	-	-	-	-	-
Veh in Median Storage, #	-	0	-	-	0	-	-	0	-	-	16965	-
Grade, %	-	0	-	-	0	-	-	0	-	-	0	-
Peak Hour Factor	92	92	92	92	92	92	92	92	92	92	92	92
Heavy Vehicles, %	20	20	20	12	12	12	24	24	24	0	0	0
Mvmt Flow	255	135	0	0	108	24	213	3	0	0	0	0

Major/Minor	Major1	Major2	Minor1
Conflicting Flow All	132	0	- - - 0 765 777 135
Stage 1	-	-	- - - 645 645 -
Stage 2	-	-	- - - 120 132 -
Critical Hdwy	4.3	-	- - - 6.64 6.74 6.44
Critical Hdwy Stg 1	-	-	- - - 5.64 5.74 -
Critical Hdwy Stg 2	-	-	- - - 5.64 5.74 -
Follow-up Hdwy	2.38	-	- - - 3.716 4.216 3.516
Pot Cap-1 Maneuver	1349	- 0 0	- - - 342 304 858
Stage 1	-	- 0 0	- - - 483 435 -
Stage 2	-	- 0 0	- - - 853 747 -
Platoon blocked, %	-	-	- -
Mov Cap-1 Maneuver	1349	- - -	- - - 277 0 858
Mov Cap-2 Maneuver	-	- - -	- - - 277 0 -
Stage 1	-	- - -	- - - 392 0 -
Stage 2	-	- - -	- - - 853 0 -

Approach	EB	WB	NB
HCM Control Delay, s	5.4	0	52.3
HCM LOS			F

Minor Lane/Major Mvmt	NBLn1	EBL	EBT	WBT	WBR
Capacity (veh/h)	277	1349	-	-	-
HCM Lane V/C Ratio	0.781	0.189	-	-	-
HCM Control Delay (s)	52.3	8.3	-	-	-
HCM Lane LOS	F	A	-	-	-
HCM 95th %tile Q(veh)	6	0.7	-	-	-

Intersection												
Int Delay, s/veh	4.4											
Movement	EBL	EBT	EBR	WBL	WBT	WBR	NBL	NBT	NBR	SBL	SBT	SBR
Lane Configurations		↕			↕			↕			↕	
Traffic Vol, veh/h	1	53	12	30	29	10	8	85	65	64	221	3
Future Vol, veh/h	1	53	12	30	29	10	8	85	65	64	221	3
Conflicting Peds, #/hr	0	0	0	0	0	0	0	0	0	0	0	0
Sign Control	Stop	Stop	Stop	Stop	Stop	Stop	Free	Free	Free	Free	Free	Free
RT Channelized	-	-	None	-	-	None	-	-	None	-	-	None
Storage Length	-	-	-	-	-	-	-	-	-	-	-	-
Veh in Median Storage, #	-	0	-	-	0	-	-	0	-	-	0	-
Grade, %	-	0	-	-	0	-	-	0	-	-	0	-
Peak Hour Factor	92	92	92	92	92	92	92	92	92	92	92	92
Heavy Vehicles, %	3	3	3	5	5	5	8	8	8	8	8	8
Mvmt Flow	1	58	13	33	32	11	9	92	71	70	240	3

Major/Minor	Minor2		Minor1		Major1		Major2					
Conflicting Flow All	549	563	242	563	529	128	243	0	0	163	0	0
Stage 1	382	382	-	146	146	-	-	-	-	-	-	-
Stage 2	167	181	-	417	383	-	-	-	-	-	-	-
Critical Hdwy	7.13	6.53	6.23	7.15	6.55	6.25	4.18	-	-	4.18	-	-
Critical Hdwy Stg 1	6.13	5.53	-	6.15	5.55	-	-	-	-	-	-	-
Critical Hdwy Stg 2	6.13	5.53	-	6.15	5.55	-	-	-	-	-	-	-
Follow-up Hdwy	3.527	4.027	3.327	3.545	4.045	3.345	2.272	-	-	2.272	-	-
Pot Cap-1 Maneuver	445	434	794	432	451	914	1289	-	-	1380	-	-
Stage 1	638	611	-	850	770	-	-	-	-	-	-	-
Stage 2	833	748	-	607	607	-	-	-	-	-	-	-
Platoon blocked, %								-	-	-	-	-
Mov Cap-1 Maneuver	394	405	794	360	421	914	1289	-	-	1380	-	-
Mov Cap-2 Maneuver	394	405	-	360	421	-	-	-	-	-	-	-
Stage 1	633	575	-	843	764	-	-	-	-	-	-	-
Stage 2	783	742	-	506	571	-	-	-	-	-	-	-

Approach	EB		WB		NB		SB	
HCM Control Delay, s	14.7		15.3		0.4		1.7	
HCM LOS	B		C					

Minor Lane/Major Mvmt	NBL	NBT	NBR	EBLn1WBLn1	SBL	SBT	SBR
Capacity (veh/h)	1289	-	-	444	423	1380	-
HCM Lane V/C Ratio	0.007	-	-	0.162	0.177	0.05	-
HCM Control Delay (s)	7.8	0	-	14.7	15.3	7.7	0
HCM Lane LOS	A	A	-	B	C	A	A
HCM 95th %tile Q(veh)	0	-	-	0.6	0.6	0.2	-

Intersection												
Int Delay, s/veh	1.6											
Movement	EBL	EBT	EBR	WBL	WBT	WBR	NBL	NBT	NBR	SBL	SBT	SBR
Lane Configurations		↕			↕			↕			↕	
Traffic Vol, veh/h	31	0	43	0	1	1	14	274	1	2	310	51
Future Vol, veh/h	31	0	43	0	1	1	14	274	1	2	310	51
Conflicting Peds, #/hr	0	0	0	0	0	0	0	0	0	0	0	0
Sign Control	Stop	Stop	Stop	Stop	Stop	Stop	Free	Free	Free	Free	Free	Free
RT Channelized	-	-	None	-	-	None	-	-	None	-	-	None
Storage Length	-	-	-	-	-	-	-	-	-	-	-	-
Veh in Median Storage, #	-	0	-	-	0	-	-	0	-	-	0	-
Grade, %	-	0	-	-	0	-	-	0	-	-	0	-
Peak Hour Factor	95	95	95	95	95	95	95	95	95	95	95	95
Heavy Vehicles, %	6	6	6	50	50	50	8	8	8	9	9	9
Mvmt Flow	33	0	45	0	1	1	15	288	1	2	326	54

Major/Minor	Minor2		Minor1		Major1		Major2					
Conflicting Flow All	677	676	353	699	703	289	380	0	0	289	0	0
Stage 1	357	357	-	319	319	-	-	-	-	-	-	-
Stage 2	320	319	-	380	384	-	-	-	-	-	-	-
Critical Hdwy	7.16	6.56	6.26	7.6	7	6.7	4.18	-	-	4.19	-	-
Critical Hdwy Stg 1	6.16	5.56	-	6.6	6	-	-	-	-	-	-	-
Critical Hdwy Stg 2	6.16	5.56	-	6.6	6	-	-	-	-	-	-	-
Follow-up Hdwy	3.554	4.054	3.354	3.95	4.45	3.75	2.272	-	-	2.281	-	-
Pot Cap-1 Maneuver	361	370	682	298	309	649	1146	-	-	1234	-	-
Stage 1	652	621	-	602	575	-	-	-	-	-	-	-
Stage 2	683	646	-	555	536	-	-	-	-	-	-	-
Platoon blocked, %								-	-	-	-	-
Mov Cap-1 Maneuver	355	363	682	274	303	649	1146	-	-	1234	-	-
Mov Cap-2 Maneuver	355	363	-	274	303	-	-	-	-	-	-	-
Stage 1	642	620	-	592	566	-	-	-	-	-	-	-
Stage 2	670	636	-	517	535	-	-	-	-	-	-	-

Approach	EB		WB		NB		SB	
HCM Control Delay, s	13.7		13.8		0.4		0	
HCM LOS	B		B					

Minor Lane/Major Mvmt	NBL	NBT	NBR	EBLn1WBLn1	SBL	SBT	SBR
Capacity (veh/h)	1146	-	-	492	413	1234	-
HCM Lane V/C Ratio	0.013	-	-	0.158	0.005	0.002	-
HCM Control Delay (s)	8.2	0	-	13.7	13.8	7.9	0
HCM Lane LOS	A	A	-	B	B	A	A
HCM 95th %tile Q(veh)	0	-	-	0.6	0	0	-

Intersection												
Int Delay, s/veh	3.6											
Movement	EBL	EBT	EBR	WBL	WBT	WBR	NBL	NBT	NBR	SBL	SBT	SBR
Lane Configurations		↕			↕			↕			↕	
Traffic Vol, veh/h	1	0	1	62	0	55	0	174	120	93	235	1
Future Vol, veh/h	1	0	1	62	0	55	0	174	120	93	235	1
Conflicting Peds, #/hr	0	0	0	0	0	0	0	0	0	0	0	0
Sign Control	Stop	Stop	Stop	Stop	Stop	Stop	Free	Free	Free	Free	Free	Free
RT Channelized	-	-	None	-	-	None	-	-	None	-	-	None
Storage Length	-	-	-	-	-	-	-	-	-	-	-	-
Veh in Median Storage, #	-	0	-	-	0	-	-	0	-	-	0	-
Grade, %	-	0	-	-	0	-	-	0	-	-	0	-
Peak Hour Factor	93	93	93	93	93	93	93	93	93	93	93	93
Heavy Vehicles, %	0	0	0	4	4	4	7	7	7	9	9	9
Mvmt Flow	1	0	1	67	0	59	0	187	129	100	253	1

Major/Minor	Minor2		Minor1		Major1		Major2					
Conflicting Flow All	735	770	254	706	706	252	254	0	0	316	0	0
Stage 1	454	454	-	252	252	-	-	-	-	-	-	-
Stage 2	281	316	-	454	454	-	-	-	-	-	-	-
Critical Hdwy	7.1	6.5	6.2	7.14	6.54	6.24	4.17	-	-	4.19	-	-
Critical Hdwy Stg 1	6.1	5.5	-	6.14	5.54	-	-	-	-	-	-	-
Critical Hdwy Stg 2	6.1	5.5	-	6.14	5.54	-	-	-	-	-	-	-
Follow-up Hdwy	3.5	4	3.3	3.536	4.036	3.336	2.263	-	-	2.281	-	-
Pot Cap-1 Maneuver	338	333	790	348	358	782	1282	-	-	1206	-	-
Stage 1	589	573	-	748	695	-	-	-	-	-	-	-
Stage 2	730	659	-	582	566	-	-	-	-	-	-	-
Platoon blocked, %								-	-	-	-	-
Mov Cap-1 Maneuver	289	301	790	322	323	782	1282	-	-	1206	-	-
Mov Cap-2 Maneuver	289	301	-	322	323	-	-	-	-	-	-	-
Stage 1	589	517	-	748	695	-	-	-	-	-	-	-
Stage 2	675	659	-	525	511	-	-	-	-	-	-	-

Approach	EB		WB		NB		SB	
HCM Control Delay, s	13.6		16.2		0		2.3	
HCM LOS	B		C					

Minor Lane/Major Mvmt	NBL	NBT	NBR	EBLn1	WBLn1	SBL	SBT	SBR
Capacity (veh/h)	1282	-	-	423	445	1206	-	-
HCM Lane V/C Ratio	-	-	-	0.005	0.283	0.083	-	-
HCM Control Delay (s)	0	-	-	13.6	16.2	8.3	0	-
HCM Lane LOS	A	-	-	B	C	A	A	-
HCM 95th %tile Q(veh)	0	-	-	0	1.1	0.3	-	-

Intersection												
Int Delay, s/veh	1.6											
Movement	EBL	EBT	EBR	WBL	WBT	WBR	NBL	NBT	NBR	SBL	SBT	SBR
Lane Configurations		↕			↕			↕			↕	
Traffic Vol, veh/h	1	2	3	6	3	16	2	277	2	67	231	0
Future Vol, veh/h	1	2	3	6	3	16	2	277	2	67	231	0
Conflicting Peds, #/hr	0	0	0	0	0	0	0	0	0	0	0	0
Sign Control	Stop	Stop	Stop	Stop	Stop	Stop	Free	Free	Free	Free	Free	Free
RT Channelized	-	-	None	-	-	None	-	-	None	-	-	None
Storage Length	-	-	-	-	-	-	-	-	-	-	-	-
Veh in Median Storage, #	-	0	-	-	0	-	-	0	-	-	0	-
Grade, %	-	0	-	-	0	-	-	0	-	-	0	-
Peak Hour Factor	92	92	92	92	92	92	92	92	92	92	92	92
Heavy Vehicles, %	0	0	0	0	0	0	9	9	9	9	9	9
Mvmt Flow	1	2	3	7	3	17	2	301	2	73	251	0

Major/Minor	Minor2		Minor1		Major1			Major2				
Conflicting Flow All	713	704	251	706	703	302	251	0	0	303	0	0
Stage 1	397	397	-	306	306	-	-	-	-	-	-	-
Stage 2	316	307	-	400	397	-	-	-	-	-	-	-
Critical Hdwy	7.1	6.5	6.2	7.1	6.5	6.2	4.19	-	-	4.19	-	-
Critical Hdwy Stg 1	6.1	5.5	-	6.1	5.5	-	-	-	-	-	-	-
Critical Hdwy Stg 2	6.1	5.5	-	6.1	5.5	-	-	-	-	-	-	-
Follow-up Hdwy	3.5	4	3.3	3.5	4	3.3	2.281	-	-	2.281	-	-
Pot Cap-1 Maneuver	349	364	793	353	364	742	1275	-	-	1219	-	-
Stage 1	633	607	-	708	665	-	-	-	-	-	-	-
Stage 2	699	665	-	630	607	-	-	-	-	-	-	-
Platoon blocked, %								-	-	-	-	-
Mov Cap-1 Maneuver	320	338	793	331	338	742	1275	-	-	1219	-	-
Mov Cap-2 Maneuver	320	338	-	331	338	-	-	-	-	-	-	-
Stage 1	632	565	-	707	664	-	-	-	-	-	-	-
Stage 2	678	664	-	581	565	-	-	-	-	-	-	-

Approach	EB		WB		NB		SB	
HCM Control Delay, s	12.8		12.4		0.1		1.8	
HCM LOS	B		B					

Minor Lane/Major Mvmt	NBL	NBT	NBR	EBLn1	WBLn1	SBL	SBT	SBR
Capacity (veh/h)	1275	-	-	468	515	1219	-	-
HCM Lane V/C Ratio	0.002	-	-	0.014	0.053	0.06	-	-
HCM Control Delay (s)	7.8	0	-	12.8	12.4	8.1	0	-
HCM Lane LOS	A	A	-	B	B	A	A	-
HCM 95th %tile Q(veh)	0	-	-	0	0.2	0.2	-	-

Intersection	
Intersection Delay, s/veh	10.7
Intersection LOS	B

Movement	EBL	EBT	EBR	WBL	WBT	WBR	NBL	NBT	NBR	SBL	SBT	SBR
Lane Configurations		↕			↕			↕			↕	
Traffic Vol, veh/h	91	93	36	12	38	66	15	124	22	72	124	45
Future Vol, veh/h	91	93	36	12	38	66	15	124	22	72	124	45
Peak Hour Factor	0.95	0.95	0.95	0.95	0.95	0.95	0.95	0.95	0.95	0.95	0.95	0.95
Heavy Vehicles, %	8	8	8	4	4	4	10	10	10	10	10	10
Mvmt Flow	96	98	38	13	40	69	16	131	23	76	131	47
Number of Lanes	0	1	0	0	1	0	0	1	0	0	1	0

Approach	EB	WB	NB	SB
Opposing Approach	WB	EB	SB	NB
Opposing Lanes	1	1	1	1
Conflicting Approach Left	SB	NB	EB	WB
Conflicting Lanes Left	1	1	1	1
Conflicting Approach Right	NB	SB	WB	EB
Conflicting Lanes Right	1	1	1	1
HCM Control Delay	11.2	9.3	10.2	11.3
HCM LOS	B	A	B	B

Lane	NBLn1	EBLn1	WBLn1	SBLn1
Vol Left, %	9%	41%	10%	30%
Vol Thru, %	77%	42%	33%	51%
Vol Right, %	14%	16%	57%	19%
Sign Control	Stop	Stop	Stop	Stop
Traffic Vol by Lane	161	220	116	241
LT Vol	15	91	12	72
Through Vol	124	93	38	124
RT Vol	22	36	66	45
Lane Flow Rate	169	232	122	254
Geometry Grp	1	1	1	1
Degree of Util (X)	0.253	0.345	0.176	0.37
Departure Headway (Hd)	5.369	5.358	5.178	5.251
Convergence, Y/N	Yes	Yes	Yes	Yes
Cap	669	672	692	685
Service Time	3.401	3.389	3.212	3.281
HCM Lane V/C Ratio	0.253	0.345	0.176	0.371
HCM Control Delay	10.2	11.2	9.3	11.3
HCM Lane LOS	B	B	A	B
HCM 95th-tile Q	1	1.5	0.6	1.7

Intersection												
Intersection Delay, s/veh	10											
Intersection LOS	A											

Movement	EBL	EBT	EBR	WBL	WBT	WBR	NBL	NBT	NBR	SBL	SBT	SBR
Lane Configurations												
Traffic Vol, veh/h	59	178	9	23	96	29	4	42	48	58	47	35
Future Vol, veh/h	59	178	9	23	96	29	4	42	48	58	47	35
Peak Hour Factor	0.92	0.92	0.92	0.92	0.92	0.92	0.92	0.92	0.92	0.92	0.92	0.92
Heavy Vehicles, %	14	14	14	21	21	21	8	8	8	13	13	13
Mvmt Flow	64	193	10	25	104	32	4	46	52	63	51	38
Number of Lanes	1	1	0	1	1	0	0	1	0	0	1	0

Approach	EB	WB	NB	SB
Opposing Approach	WB	EB	SB	NB
Opposing Lanes	2	2	1	1
Conflicting Approach Left	SB	NB	EB	WB
Conflicting Lanes Left	1	1	2	2
Conflicting Approach Right	NB	SB	WB	EB
Conflicting Lanes Right	1	1	2	2
HCM Control Delay	10.6	9.9	9	9.9
HCM LOS	B	A	A	A

Lane	NBLn1	EBLn1	EBLn2	WBLn1	WBLn2	SBLn1
Vol Left, %	4%	100%	0%	100%	0%	41%
Vol Thru, %	45%	0%	95%	0%	77%	34%
Vol Right, %	51%	0%	5%	0%	23%	25%
Sign Control	Stop	Stop	Stop	Stop	Stop	Stop
Traffic Vol by Lane	94	59	187	23	125	140
LT Vol	4	59	0	23	0	58
Through Vol	42	0	178	0	96	47
RT Vol	48	0	9	0	29	35
Lane Flow Rate	102	64	203	25	136	152
Geometry Grp	2	7	7	7	7	2
Degree of Util (X)	0.144	0.108	0.313	0.044	0.213	0.224
Departure Headway (Hd)	5.077	6.076	5.538	6.323	5.654	5.306
Convergence, Y/N	Yes	Yes	Yes	Yes	Yes	Yes
Cap	699	586	644	562	629	671
Service Time	3.164	3.861	3.322	4.116	3.446	3.385
HCM Lane V/C Ratio	0.146	0.109	0.315	0.044	0.216	0.227
HCM Control Delay	9	9.6	10.9	9.4	10	9.9
HCM Lane LOS	A	A	B	A	A	A
HCM 95th-tile Q	0.5	0.4	1.3	0.1	0.8	0.9

Intersection												
Int Delay, s/veh	2177											
Movement	EBL	EBT	EBR	WBL	WBT	WBR	NBL	NBT	NBR	SBL	SBT	SBR
Lane Configurations	↖	↗	↖	↖	↗	↖	↖	↗	↖		↕	
Traffic Vol, veh/h	12	244	32	216	96	294	24	105	369	422	105	12
Future Vol, veh/h	12	244	32	216	96	294	24	105	369	422	105	12
Conflicting Peds, #/hr	0	0	0	0	0	0	0	0	0	0	0	0
Sign Control	Free	Free	Free	Free	Free	Free	Stop	Stop	Stop	Stop	Stop	Stop
RT Channelized	-	-	None	-	-	None	-	-	None	-	-	None
Storage Length	85	-	0	70	-	105	60	-	50	-	-	-
Veh in Median Storage, #	-	0	-	-	0	-	-	0	-	-	0	-
Grade, %	-	0	-	-	0	-	-	0	-	-	0	-
Peak Hour Factor	92	92	92	92	92	92	92	92	92	92	92	92
Heavy Vehicles, %	2	2	2	5	5	5	5	5	5	3	3	3
Mvmt Flow	13	265	35	235	104	320	26	114	401	459	114	13

Major/Minor	Major1			Major2			Minor1			Minor2		
Conflicting Flow All	424	0	0	300	0	0	1089	1185	265	1140	900	104
Stage 1	-	-	-	-	-	-	291	291	-	574	574	-
Stage 2	-	-	-	-	-	-	798	894	-	566	326	-
Critical Hdwy	4.12	-	-	4.15	-	-	7.15	6.55	6.25	7.13	6.53	6.23
Critical Hdwy Stg 1	-	-	-	-	-	-	6.15	5.55	-	6.13	5.53	-
Critical Hdwy Stg 2	-	-	-	-	-	-	6.15	5.55	-	6.13	5.53	-
Follow-up Hdwy	2.218	-	-	2.245	-	-	3.545	4.045	3.345	3.527	4.027	3.327
Pot Cap-1 Maneuver	1135	-	-	1244	-	-	190	186	766	~ 177	277	948
Stage 1	-	-	-	-	-	-	710	666	-	502	502	-
Stage 2	-	-	-	-	-	-	375	355	-	507	647	-
Platoon blocked, %		-	-		-	-						
Mov Cap-1 Maneuver	1135	-	-	1244	-	-	96	149	766	~ 27	222	948
Mov Cap-2 Maneuver	-	-	-	-	-	-	96	149	-	~ 27	222	-
Stage 1	-	-	-	-	-	-	702	659	-	496	407	-
Stage 2	-	-	-	-	-	-	216	288	-	~ 197	640	-

Approach	EB	WB	NB	SB
HCM Control Delay, s	0.3	3.1	30.9	\$ 7767.1
HCM LOS			D	F

Minor Lane/Major Mvmt	NBLn1	NBLn2	NBLn3	EBL	EBT	EBR	WBL	WBT	WBR	SBLn1
Capacity (veh/h)	96	149	766	1135	-	-	1244	-	-	33
HCM Lane V/C Ratio	0.272	0.766	0.524	0.011	-	-	0.189	-	-	17.754
HCM Control Delay (s)	55.9	81.9	14.7	8.2	-	-	8.6	-	-	\$ 7767.1
HCM Lane LOS	F	F	B	A	-	-	A	-	-	F
HCM 95th %tile Q(veh)	1	4.7	3.1	0	-	-	0.7	-	-	72.2

Notes
 -: Volume exceeds capacity \$: Delay exceeds 300s +: Computation Not Defined *: All major volume in platoon

HCM 6th TWSC
 14: Avenue 17 & SR-99 Southbound Off-Ramp

Village D Specific Plan
 Phase III NP - PM Peak Hour

Intersection

Int Delay, s/veh 389.6

Movement	EBL	EBT	WBT	WBR	SBL	SBR
Lane Configurations		↑	↑		↑	↑
Traffic Vol, veh/h	0	1035	514	0	452	92
Future Vol, veh/h	0	1035	514	0	452	92
Conflicting Peds, #/hr	0	0	0	0	0	0
Sign Control	Free	Free	Free	Free	Stop	Stop
RT Channelized	-	None	-	None	-	None
Storage Length	-	-	-	-	0	610
Veh in Median Storage, #	-	0	0	-	0	-
Grade, %	-	0	0	-	0	-
Peak Hour Factor	92	92	92	92	92	92
Heavy Vehicles, %	4	4	8	8	5	5
Mvmt Flow	0	1125	559	0	491	100

Major/Minor

	Major1	Major2	Minor2
Conflicting Flow All	-	0	0 1684 559
Stage 1	-	-	- 559 -
Stage 2	-	-	- 1125 -
Critical Hdwy	-	-	- 6.45 6.25
Critical Hdwy Stg 1	-	-	- 5.45 -
Critical Hdwy Stg 2	-	-	- 5.45 -
Follow-up Hdwy	-	-	- 3.545 3.345
Pot Cap-1 Maneuver	0	-	0 ~ 102 523
Stage 1	0	-	0 567 -
Stage 2	0	-	0 ~ 306 -
Platoon blocked, %	-	-	
Mov Cap-1 Maneuver	-	-	- ~ 102 523
Mov Cap-2 Maneuver	-	-	- ~ 102 -
Stage 1	-	-	- 567 -
Stage 2	-	-	- ~ 306 -

Approach

	EB	WB	SB
HCM Control Delay, s	0	0	\$ 1499
HCM LOS			F

Minor Lane/Major Mvmt

	EBT	WBT	SBLn1	SBLn2
Capacity (veh/h)	-	-	102	523
HCM Lane V/C Ratio	-	-	4.817	0.191
HCM Control Delay (s)	-	-	\$ 1801.3	13.5
HCM Lane LOS	-	-	F	B
HCM 95th %tile Q(veh)	-	-	52.2	0.7

Notes

~: Volume exceeds capacity \$: Delay exceeds 300s +: Computation Not Defined *: All major volume in platoon

HCM 6th TWSC
15: SR-99 Northbound Ramps & Avenue 17

Village D Specific Plan
Phase III NP - PM Peak Hour

Intersection												
Int Delay, s/veh	501.2											
Movement	EBL	EBT	EBR	WBL	WBT	WBR	NBL	NBT	NBR	SBL	SBT	SBR
Lane Configurations	↙	↑			↘			↙	↘			
Traffic Vol, veh/h	180	909	0	0	1003	351	211	4	529	0	0	0
Future Vol, veh/h	180	909	0	0	1003	351	211	4	529	0	0	0
Conflicting Peds, #/hr	0	0	0	0	0	0	0	0	0	0	0	0
Sign Control	Free	Free	Free	Free	Free	Free	Stop	Stop	Stop	Free	Free	Free
RT Channelized	-	-	None	-	-	None	-	-	None	-	-	None
Storage Length	125	-	-	-	-	-	-	-	50	-	-	-
Veh in Median Storage, #	-	0	-	-	0	-	-	0	-	-	16965	-
Grade, %	-	0	-	-	0	-	-	0	-	-	0	-
Peak Hour Factor	95	95	95	95	95	95	95	95	95	95	95	95
Heavy Vehicles, %	4	4	4	4	4	4	10	10	10	0	0	0
Mvmt Flow	189	957	0	0	1056	369	222	4	557	0	0	0

Major/Minor	Major1	Major2	Minor1
Conflicting Flow All	1425	0	- - - 0 2576 2760 957
Stage 1	-	-	- - - 1335 1335 -
Stage 2	-	-	- - - 1241 1425 -
Critical Hdwy	4.14	-	- - - 6.5 6.6 6.3
Critical Hdwy Stg 1	-	-	- - - 5.5 5.6 -
Critical Hdwy Stg 2	-	-	- - - 5.5 5.6 -
Follow-up Hdwy	2.236	-	- - - 3.59 4.09 3.39
Pot Cap-1 Maneuver	471	- 0 0	- - ~ 27 18 ~ 302
Stage 1	-	- 0 0	- - 236 214 -
Stage 2	-	- 0 0	- - 263 194 -
Platoon blocked, %	-	-	- -
Mov Cap-1 Maneuver	471	- - -	- - ~ 16 0 ~ 302
Mov Cap-2 Maneuver	-	- - -	- - ~ 16 0 -
Stage 1	-	- - -	- - ~ 141 0 -
Stage 2	-	- - -	- - 263 0 -

Approach	EB	WB	NB
HCM Control Delay, s	2.9	0	\$ 2142.5
HCM LOS			F

Minor Lane/Major Mvmt	NBLn1	NBLn2	EBL	EBT	WBT	WBR
Capacity (veh/h)	16	302	471	-	-	-
HCM Lane V/C Ratio	14.145	1.844	0.402	-	-	-
HCM Control Delay (s)	\$ 6378.1	\$ 421.1	17.7	-	-	-
HCM Lane LOS	F	F	C	-	-	-
HCM 95th %tile Q(veh)	29.2	37.4	1.9	-	-	-

Notes
 -: Volume exceeds capacity \$: Delay exceeds 300s +: Computation Not Defined *: All major volume in platoon

HCM 6th Signalized Intersection Summary
 16: Love's Truck Stop Driveway/Driveway & Avenue 17

Village D Specific Plan
 Phase III NP - PM Peak Hour



Movement	EBL	EBT	EBR	WBL	WBT	WBR	NBL	NBT	NBR	SBL	SBT	SBR
Lane Configurations	↖	↗	↘	↖	↗		↖	↗		↖	↗	
Traffic Volume (veh/h)	556	727	141	32	658	189	160	0	31	279	0	519
Future Volume (veh/h)	556	727	141	32	658	189	160	0	31	279	0	519
Initial Q (Qb), veh	0	0	0	0	0	0	0	0	0	0	0	0
Ped-Bike Adj(A_pbT)	1.00		1.00	1.00		1.00	1.00		1.00	1.00		1.00
Parking Bus, Adj	1.00	1.00	1.00	1.00	1.00	1.00	1.00	1.00	1.00	1.00	1.00	1.00
Work Zone On Approach		No			No			No			No	
Adj Sat Flow, veh/h/ln	1870	1870	1870	1841	1841	1841	1900	1900	1900	1900	1900	1900
Adj Flow Rate, veh/h	604	790	153	35	715	205	174	0	34	303	0	564
Peak Hour Factor	0.92	0.92	0.92	0.92	0.92	0.92	0.92	0.92	0.92	0.92	0.92	0.92
Percent Heavy Veh, %	2	2	2	4	4	4	0	0	0	0	0	0
Cap, veh/h	393	1912	853	50	476	136	128	0	275	204	0	342
Arrive On Green	0.22	0.54	0.54	0.03	0.35	0.35	0.07	0.00	0.17	0.11	0.00	0.21
Sat Flow, veh/h	1781	3554	1585	1753	1375	394	1810	0	1610	1810	0	1610
Grp Volume(v), veh/h	604	790	153	35	0	920	174	0	34	303	0	564
Grp Sat Flow(s),veh/h/ln	1781	1777	1585	1753	0	1770	1810	0	1610	1810	0	1610
Q Serve(g_s), s	26.5	15.8	5.9	2.4	0.0	41.5	8.5	0.0	2.1	13.5	0.0	25.5
Cycle Q Clear(g_c), s	26.5	15.8	5.9	2.4	0.0	41.5	8.5	0.0	2.1	13.5	0.0	25.5
Prop In Lane	1.00		1.00	1.00		0.22	1.00		1.00	1.00		1.00
Lane Grp Cap(c), veh/h	393	1912	853	50	0	612	128	0	275	204	0	342
V/C Ratio(X)	1.54	0.41	0.18	0.70	0.00	1.50	1.36	0.00	0.12	1.49	0.00	1.65
Avail Cap(c_a), veh/h	393	1912	853	98	0	612	128	0	275	204	0	342
HCM Platoon Ratio	1.00	1.00	1.00	1.00	1.00	1.00	1.00	1.00	1.00	1.00	1.00	1.00
Upstream Filter(I)	1.00	1.00	1.00	1.00	0.00	1.00	1.00	0.00	1.00	1.00	0.00	1.00
Uniform Delay (d), s/veh	46.8	16.5	14.2	57.8	0.0	39.3	55.8	0.0	42.1	53.3	0.0	47.3
Incr Delay (d2), s/veh	253.4	0.1	0.1	15.9	0.0	234.9	203.1	0.0	0.9	244.1	0.0	304.6
Initial Q Delay(d3),s/veh	0.0	0.0	0.0	0.0	0.0	0.0	0.0	0.0	0.0	0.0	0.0	0.0
%ile BackOfQ(50%),veh/ln	39.3	6.4	2.1	1.3	0.0	57.6	11.1	0.0	0.9	19.9	0.0	39.1
Unsig. Movement Delay, s/veh												
LnGrp Delay(d),s/veh	300.2	16.6	14.3	73.6	0.0	274.2	258.9	0.0	43.1	297.3	0.0	351.8
LnGrp LOS	F	B	B	E	A	F	F	A	D	F	A	F
Approach Vol, veh/h		1547			955			208				867
Approach Delay, s/veh		127.1			266.8			223.6				332.8
Approach LOS		F			F			F				F
Timer - Assigned Phs	1	2	3	4	5	6	7	8				
Phs Duration (G+Y+Rc), s	18.0	25.0	7.9	69.1	13.0	30.0	31.0	46.0				
Change Period (Y+Rc), s	4.5	4.5	4.5	4.5	4.5	4.5	4.5	4.5				
Max Green Setting (Gmax), s	13.5	20.5	6.7	61.3	8.5	25.5	26.5	41.5				
Max Q Clear Time (g_c+I1), s	15.5	4.1	4.4	17.8	10.5	27.5	28.5	43.5				
Green Ext Time (p_c), s	0.0	0.1	0.0	7.3	0.0	0.0	0.0	0.0				
Intersection Summary												
HCM 6th Ctrl Delay			219.9									
HCM 6th LOS			F									

HCM 6th TWSC
17: Westberry Boulevard & Cleveland Avenue

Village D Specific Plan
Phase III NP - PM Peak Hour

Intersection												
Int Delay, s/veh	15											
Movement	EBL	EBT	EBR	WBL	WBT	WBR	NBL	NBT	NBR	SBL	SBT	SBR
Lane Configurations	↖	↗		↖	↗		↖	↑	↗	↖	↑	↗
Traffic Vol, veh/h	53	128	36	141	95	34	20	59	121	27	198	23
Future Vol, veh/h	53	128	36	141	95	34	20	59	121	27	198	23
Conflicting Peds, #/hr	0	0	3	3	0	0	0	0	0	0	0	0
Sign Control	Free	Free	Free	Free	Free	Free	Stop	Stop	Stop	Stop	Stop	Stop
RT Channelized	-	-	None	-	-	None	-	-	None	-	-	None
Storage Length	110	-	-	165	-	-	65	-	50	100	-	50
Veh in Median Storage, #	-	0	-	-	0	-	-	0	-	-	0	-
Grade, %	-	0	-	-	0	-	-	0	-	-	0	-
Peak Hour Factor	92	92	92	92	92	92	92	92	92	92	92	92
Heavy Vehicles, %	1	1	1	1	1	1	0	0	0	0	0	0
Mvmt Flow	58	139	39	153	103	37	22	64	132	29	215	25

Major/Minor	Major1			Major2			Minor1			Minor2		
Conflicting Flow All	140	0	0	181	0	0	826	724	162	801	725	122
Stage 1	-	-	-	-	-	-	278	278	-	428	428	-
Stage 2	-	-	-	-	-	-	548	446	-	373	297	-
Critical Hdwy	4.11	-	-	4.11	-	-	7.1	6.5	6.2	7.1	6.5	6.2
Critical Hdwy Stg 1	-	-	-	-	-	-	6.1	5.5	-	6.1	5.5	-
Critical Hdwy Stg 2	-	-	-	-	-	-	6.1	5.5	-	6.1	5.5	-
Follow-up Hdwy	2.209	-	-	2.209	-	-	3.5	4	3.3	3.5	4	3.3
Pot Cap-1 Maneuver	1449	-	-	1400	-	-	293	354	888	305	354	935
Stage 1	-	-	-	-	-	-	733	684	-	609	588	-
Stage 2	-	-	-	-	-	-	524	577	-	652	671	-
Platoon blocked, %	-	-	-	-	-	-	-	-	-	-	-	-
Mov Cap-1 Maneuver	1449	-	-	1396	-	-	108	302	885	194	302	935
Mov Cap-2 Maneuver	-	-	-	-	-	-	108	302	-	194	302	-
Stage 1	-	-	-	-	-	-	701	655	-	585	523	-
Stage 2	-	-	-	-	-	-	267	514	-	481	642	-

Approach	EB			WB			NB			SB		
HCM Control Delay, s	1.9			4.1			16.5			37		
HCM LOS							C			E		

Minor Lane/Major Mvmt	NBLn1	NBLn2	NBLn3	EBL	EBT	EBR	WBL	WBT	WBR	SBLn1	SBLn2	SBLn3
Capacity (veh/h)	108	302	885	1449	-	-	1396	-	-	194	302	935
HCM Lane V/C Ratio	0.201	0.212	0.149	0.04	-	-	0.11	-	-	0.151	0.713	0.027
HCM Control Delay (s)	46.5	20.1	9.8	7.6	-	-	7.9	-	-	26.8	41.7	9
HCM Lane LOS	E	C	A	A	-	-	A	-	-	D	E	A
HCM 95th %tile Q(veh)	0.7	0.8	0.5	0.1	-	-	0.4	-	-	0.5	5.1	0.1

Intersection	
Intersection Delay, s/veh	11.3
Intersection LOS	B

Movement	EBL	EBT	EBR	WBL	WBT	WBR	NBL	NBT	NBR	SBL	SBT	SBR
Lane Configurations	↶	↷		↶	↷		↶	↷	↶	↶	↷	↶
Traffic Vol, veh/h	8	58	27	77	78	21	48	194	61	24	211	20
Future Vol, veh/h	8	58	27	77	78	21	48	194	61	24	211	20
Peak Hour Factor	0.96	0.96	0.96	0.96	0.96	0.96	0.96	0.96	0.96	0.96	0.96	0.96
Heavy Vehicles, %	0	0	0	0	0	0	0	0	0	0	0	0
Mvmt Flow	8	60	28	80	81	22	50	202	64	25	220	21
Number of Lanes	1	1	0	1	1	0	1	1	1	1	1	1

Approach	EB	WB	NB	SB
Opposing Approach	WB	EB	SB	NB
Opposing Lanes	2	2	3	3
Conflicting Approach Left	SB	NB	EB	WB
Conflicting Lanes Left	3	3	2	2
Conflicting Approach Right	NB	SB	WB	EB
Conflicting Lanes Right	3	3	2	2
HCM Control Delay	10.5	10.7	11.2	12.2
HCM LOS	B	B	B	B

Lane	NBLn1	NBLn2	NBLn3	EBLn1	EBLn2	WBLn1	WBLn2	SBLn1	SBLn2	SBLn3
Vol Left, %	100%	0%	0%	100%	0%	100%	0%	100%	0%	0%
Vol Thru, %	0%	100%	0%	0%	68%	0%	79%	0%	100%	0%
Vol Right, %	0%	0%	100%	0%	32%	0%	21%	0%	0%	100%
Sign Control	Stop	Stop	Stop	Stop	Stop	Stop	Stop	Stop	Stop	Stop
Traffic Vol by Lane	48	194	61	8	85	77	99	24	211	20
LT Vol	48	0	0	8	0	77	0	24	0	0
Through Vol	0	194	0	0	58	0	78	0	211	0
RT Vol	0	0	61	0	27	0	21	0	0	20
Lane Flow Rate	50	202	64	8	89	80	103	25	220	21
Geometry Grp	8	8	8	8	8	8	8	8	8	8
Degree of Util (X)	0.093	0.346	0.096	0.017	0.16	0.156	0.182	0.047	0.381	0.032
Departure Headway (Hd)	6.67	6.164	5.457	7.22	6.495	6.987	6.337	6.751	6.245	5.537
Convergence, Y/N	Yes	Yes	Yes	Yes	Yes	Yes	Yes	Yes	Yes	Yes
Cap	536	582	654	494	550	513	564	529	574	644
Service Time	4.424	3.918	3.21	4.983	4.258	4.745	4.095	4.507	4.001	3.293
HCM Lane V/C Ratio	0.093	0.347	0.098	0.016	0.162	0.156	0.183	0.047	0.383	0.033
HCM Control Delay	10.1	12.2	8.8	10.1	10.5	11	10.5	9.8	12.8	8.5
HCM Lane LOS	B	B	A	B	B	B	B	A	B	A
HCM 95th-tile Q	0.3	1.5	0.3	0.1	0.6	0.5	0.7	0.1	1.8	0.1

Intersection												
Intersection Delay, s/veh	18											
Intersection LOS	C											

Movement	EBL	EBT	EBR	WBL	WBT	WBR	NBL	NBT	NBR	SBL	SBT	SBR
Lane Configurations		↕			↕			↕			↕	
Traffic Vol, veh/h	69	264	35	23	122	240	15	53	17	151	57	45
Future Vol, veh/h	69	264	35	23	122	240	15	53	17	151	57	45
Peak Hour Factor	0.92	0.92	0.92	0.92	0.92	0.92	0.92	0.92	0.92	0.92	0.92	0.92
Heavy Vehicles, %	6	6	6	6	6	6	0	0	0	0	0	0
Mvmt Flow	75	287	38	25	133	261	16	58	18	164	62	49
Number of Lanes	0	1	0	0	1	0	0	1	0	0	1	0

Approach	EB	WB	NB	SB
Opposing Approach	WB	EB	SB	NB
Opposing Lanes	1	1	1	1
Conflicting Approach Left	SB	NB	EB	WB
Conflicting Lanes Left	1	1	1	1
Conflicting Approach Right	NB	SB	WB	EB
Conflicting Lanes Right	1	1	1	1
HCM Control Delay	20.2	18.9	11.5	15.8
HCM LOS	C	C	B	C

Lane	NBLn1	EBLn1	WBLn1	SBLn1
Vol Left, %	18%	19%	6%	60%
Vol Thru, %	62%	72%	32%	23%
Vol Right, %	20%	10%	62%	18%
Sign Control	Stop	Stop	Stop	Stop
Traffic Vol by Lane	85	368	385	253
LT Vol	15	69	23	151
Through Vol	53	264	122	57
RT Vol	17	35	240	45
Lane Flow Rate	92	400	418	275
Geometry Grp	1	1	1	1
Degree of Util (X)	0.178	0.666	0.657	0.495
Departure Headway (Hd)	6.944	5.994	5.656	6.482
Convergence, Y/N	Yes	Yes	Yes	Yes
Cap	515	604	636	556
Service Time	5.009	4.038	3.7	4.53
HCM Lane V/C Ratio	0.179	0.662	0.657	0.495
HCM Control Delay	11.5	20.2	18.9	15.8
HCM Lane LOS	B	C	C	C
HCM 95th-tile Q	0.6	5	4.9	2.7

Intersection

Intersection Delay, s/veh 13.5

Intersection LOS B

Movement	EBL	EBT	EBR	WBL	WBT	WBR	NBL	NBT	NBR	SBL	SBT	SBR
Lane Configurations		↕			↕	↕		↕	↕		↕	↕
Traffic Vol, veh/h	0	0	0	238	0	135	0	15	160	229	50	0
Future Vol, veh/h	0	0	0	238	0	135	0	15	160	229	50	0
Peak Hour Factor	0.92	0.92	0.92	0.92	0.92	0.92	0.92	0.92	0.92	0.92	0.92	0.92
Heavy Vehicles, %	0	0	0	2	2	2	0	0	0	0	0	0
Mvmt Flow	0	0	0	259	0	147	0	16	174	249	54	0
Number of Lanes	0	1	0	0	1	1	0	1	1	0	1	1

Approach	EB	WB	NB	SB
Opposing Approach	WB	EB	SB	NB
Opposing Lanes	2	1	2	2
Conflicting Approach Left	SB	NB	EB	WB
Conflicting Lanes Left	2	2	1	2
Conflicting Approach Right	NB	SB	WB	EB
Conflicting Lanes Right	2	2	2	1
HCM Control Delay	0	12.9	10.1	16.3
HCM LOS	-	B	B	C

Lane	NBLn1	NBLn2	EBLn1	WBLn1	WBLn2	SBLn1	SBLn2
Vol Left, %	0%	0%	0%	100%	0%	82%	0%
Vol Thru, %	100%	0%	100%	0%	0%	18%	100%
Vol Right, %	0%	100%	0%	0%	100%	0%	0%
Sign Control	Stop	Stop	Stop	Stop	Stop	Stop	Stop
Traffic Vol by Lane	15	160	0	238	135	279	0
LT Vol	0	0	0	238	0	229	0
Through Vol	15	0	0	0	0	50	0
RT Vol	0	160	0	0	135	0	0
Lane Flow Rate	16	174	0	259	147	303	0
Geometry Grp	7	7	6	7	7	7	7
Degree of Util (X)	0.028	0.264	0	0.467	0.216	0.537	0
Departure Headway (Hd)	6.176	5.465	6.741	6.505	5.292	6.376	5.96
Convergence, Y/N	Yes	Yes	Yes	Yes	Yes	Yes	Yes
Cap	580	657	0	554	678	567	0
Service Time	3.913	3.201	4.796	4.237	3.024	4.109	3.693
HCM Lane V/C Ratio	0.028	0.265	0	0.468	0.217	0.534	0
HCM Control Delay	9.1	10.2	9.8	14.8	9.5	16.3	8.7
HCM Lane LOS	A	B	N	B	A	C	N
HCM 95th-tile Q	0.1	1.1	0	2.5	0.8	3.2	0

Intersection	
Intersection Delay, s/veh	58.7
Intersection LOS	F

Movement	EBL	EBT	EBR	WBL	WBT	WBR	NBL	NBT	NBR	SBL	SBT	SBR
Lane Configurations	↵	↕↔		↵	↕↔		↵	↕	↵	↵	↕	↵
Traffic Vol, veh/h	29	173	20	379	239	72	15	273	236	64	360	58
Future Vol, veh/h	29	173	20	379	239	72	15	273	236	64	360	58
Peak Hour Factor	0.94	0.94	0.94	0.94	0.94	0.94	0.94	0.94	0.94	0.94	0.94	0.94
Heavy Vehicles, %	1	1	1	1	1	1	0	0	0	0	0	0
Mvmt Flow	31	184	21	403	254	77	16	290	251	68	383	62
Number of Lanes	1	2	0	1	2	0	1	1	1	1	1	1

Approach	EB	WB	NB	SB
Opposing Approach	WB	EB	SB	NB
Opposing Lanes	3	3	3	3
Conflicting Approach Left	SB	NB	EB	WB
Conflicting Lanes Left	3	3	3	3
Conflicting Approach Right	NB	SB	WB	EB
Conflicting Lanes Right	3	3	3	3
HCM Control Delay	18.8	73.9	37	78.8
HCM LOS	C	F	E	F

Lane	NBLn1	NBLn2	NBLn3	EBLn1	EBLn2	EBLn3	WBLn1	WBLn2	WBLn3	SBLn1	SBLn2
Vol Left, %	100%	0%	0%	100%	0%	0%	100%	0%	0%	100%	0%
Vol Thru, %	0%	100%	0%	0%	100%	74%	0%	100%	53%	0%	100%
Vol Right, %	0%	0%	100%	0%	0%	26%	0%	0%	47%	0%	0%
Sign Control	Stop	Stop	Stop	Stop	Stop	Stop	Stop	Stop	Stop	Stop	Stop
Traffic Vol by Lane	15	273	236	29	115	78	379	159	152	64	360
LT Vol	15	0	0	29	0	0	379	0	0	64	0
Through Vol	0	273	0	0	115	58	0	159	80	0	360
RT Vol	0	0	236	0	0	20	0	0	72	0	0
Lane Flow Rate	16	290	251	31	123	83	403	170	161	68	383
Geometry Grp	8	8	8	8	8	8	8	8	8	8	8
Degree of Util (X)	0.047	0.816	0.658	0.099	0.379	0.251	1.126	0.451	0.415	0.199	1.069
Departure Headway (Hd)	10.717	10.217	9.43	11.717	11.123	10.948	10.213	9.713	9.381	10.753	10.253
Convergence, Y/N	Yes	Yes	Yes	Yes	Yes	Yes	Yes	Yes	Yes	Yes	Yes
Cap	336	357	382	308	323	327	359	373	386	336	356
Service Time	8.417	7.917	7.217	9.417	8.917	8.737	7.913	7.413	7.081	8.453	7.953
HCM Lane V/C Ratio	0.048	0.812	0.657	0.101	0.381	0.254	1.123	0.456	0.417	0.202	1.076
HCM Control Delay	13.9	45.4	28.8	15.7	20.6	17.4	118.6	20.1	18.6	16.1	100.4
HCM Lane LOS	B	E	D	C	C	C	F	C	C	C	F
HCM 95th-tile Q	0.1	7.1	4.5	0.3	1.7	1	15.3	2.3	2	0.7	13.5

Intersection												
Intersection Delay, s/veh	41.1											
Intersection LOS	E											

Movement	EBL	EBT	EBR	WBL	WBT	WBR	NBL	NBT	NBR	SBL	SBT	SBR
Lane Configurations	↖	↗		↖	↗	↖	↖	↗		↖	↗	
Traffic Vol, veh/h	32	120	39	57	157	113	53	289	44	84	358	41
Future Vol, veh/h	32	120	39	57	157	113	53	289	44	84	358	41
Peak Hour Factor	0.93	0.93	0.93	0.93	0.93	0.93	0.93	0.93	0.93	0.93	0.93	0.93
Heavy Vehicles, %	1	1	1	0	0	0	1	1	1	1	1	1
Mvmt Flow	34	129	42	61	169	122	57	311	47	90	385	44
Number of Lanes	1	1	0	1	1	1	1	1	0	1	1	0

Approach	EB	WB	NB	SB
Opposing Approach	WB	EB	SB	NB
Opposing Lanes	3	2	2	2
Conflicting Approach Left SB		NB	EB	WB
Conflicting Lanes Left	2	2	2	3
Conflicting Approach Right NB		SB	WB	EB
Conflicting Lanes Right	2	2	3	2
HCM Control Delay	19	16.8	41.8	65.7
HCM LOS	C	C	E	F

Lane	NBLn1	NBLn2	EBLn1	EBLn2	WBLn1	WBLn2	WBLn3	SBLn1	SBLn2
Vol Left, %	100%	0%	100%	0%	100%	0%	0%	100%	0%
Vol Thru, %	0%	87%	0%	75%	0%	100%	0%	0%	90%
Vol Right, %	0%	13%	0%	25%	0%	0%	100%	0%	10%
Sign Control	Stop	Stop	Stop	Stop	Stop	Stop	Stop	Stop	Stop
Traffic Vol by Lane	53	333	32	159	57	157	113	84	399
LT Vol	53	0	32	0	57	0	0	84	0
Through Vol	0	289	0	120	0	157	0	0	358
RT Vol	0	44	0	39	0	0	113	0	41
Lane Flow Rate	57	358	34	171	61	169	122	90	429
Geometry Grp	8	8	8	8	8	8	8	8	8
Degree of Util (X)	0.146	0.86	0.097	0.448	0.165	0.431	0.286	0.228	1.013
Departure Headway (Hd)	9.415	8.805	10.403	9.697	9.89	9.37	8.641	9.092	8.504
Convergence, Y/N	Yes	Yes	Yes	Yes	Yes	Yes	Yes	Yes	Yes
Cap	383	415	346	374	365	387	418	397	429
Service Time	7.115	6.505	8.103	7.397	7.59	7.07	6.341	6.803	6.215
HCM Lane V/C Ratio	0.149	0.863	0.098	0.457	0.167	0.437	0.292	0.227	1
HCM Control Delay	13.7	46.3	14.2	20	14.5	19	14.8	14.5	76.5
HCM Lane LOS	B	E	B	C	B	C	B	B	F
HCM 95th-tile Q	0.5	8.4	0.3	2.2	0.6	2.1	1.2	0.9	13

HCM 6th Signalized Intersection Summary
 23: Avenue 16/Ellis Street & Kennedy Street

Village D Specific Plan
 Phase III NP - PM Peak Hour



Movement	WBL	WBR	NBT	NBR	SBL	SBT
Lane Configurations						
Traffic Volume (veh/h)	177	231	425	385	270	408
Future Volume (veh/h)	177	231	425	385	270	408
Initial Q (Qb), veh	0	0	0	0	0	0
Ped-Bike Adj(A_pbT)	1.00	1.00		1.00	1.00	
Parking Bus, Adj	1.00	1.00	1.00	1.00	1.00	1.00
Work Zone On Approach	No		No			No
Adj Sat Flow, veh/h/ln	1870	1870	1885	1885	1885	1885
Adj Flow Rate, veh/h	192	251	462	418	293	443
Peak Hour Factor	0.92	0.92	0.92	0.92	0.92	0.92
Percent Heavy Veh, %	2	2	1	1	1	1
Cap, veh/h	259	406	903	806	325	2657
Arrive On Green	0.15	0.15	0.50	0.50	0.18	0.74
Sat Flow, veh/h	1781	2790	1885	1598	1795	3676
Grp Volume(v), veh/h	192	251	462	418	293	443
Grp Sat Flow(s),veh/h/ln	1781	1395	1791	1598	1795	1791
Q Serve(g_s), s	8.3	6.8	13.8	14.1	12.8	2.9
Cycle Q Clear(g_c), s	8.3	6.8	13.8	14.1	12.8	2.9
Prop In Lane	1.00	1.00		1.00	1.00	
Lane Grp Cap(c), veh/h	259	406	903	806	325	2657
V/C Ratio(X)	0.74	0.62	0.51	0.52	0.90	0.17
Avail Cap(c_a), veh/h	568	889	903	806	325	2657
HCM Platoon Ratio	1.00	1.00	1.00	1.00	1.00	1.00
Upstream Filter(I)	0.68	0.68	1.00	1.00	1.00	1.00
Uniform Delay (d), s/veh	32.7	32.1	13.2	13.3	32.0	3.0
Incr Delay (d2), s/veh	2.8	1.0	2.1	2.4	26.5	0.1
Initial Q Delay(d3),s/veh	0.0	0.0	0.0	0.0	0.0	0.0
%ile BackOfQ(50%),veh/ln	3.7	2.3	5.6	5.1	7.8	0.8
Unsig. Movement Delay, s/veh						
LnGrp Delay(d),s/veh	35.6	33.1	15.3	15.7	58.6	3.2
LnGrp LOS	D	C	B	B	E	A
Approach Vol, veh/h	443		880			736
Approach Delay, s/veh	34.2		15.5			25.2
Approach LOS	C		B			C
Timer - Assigned Phs	1	2			6	8
Phs Duration (G+Y+Rc), s	19.0	44.8			63.8	16.2
Change Period (Y+Rc), s	4.5	4.5			4.5	4.5
Max Green Setting (Gmax), s	14.5	26.5			45.5	25.5
Max Q Clear Time (g_c+I1), s	14.8	16.1			4.9	10.3
Green Ext Time (p_c), s	0.0	4.3			3.3	1.4
Intersection Summary						
HCM 6th Ctrl Delay			23.0			
HCM 6th LOS			C			

HCM 6th Signalized Intersection Summary
24: Schnoor Avenue & Kennedy Street

Village D Specific Plan
Phase III NP - PM Peak Hour



Movement	EBL	EBT	EBR	WBL	WBT	WBR	NBL	NBT	NBR	SBL	SBT	SBR
Lane Configurations												
Traffic Volume (veh/h)	101	295	237	249	203	183	202	89	327	203	69	43
Future Volume (veh/h)	101	295	237	249	203	183	202	89	327	203	69	43
Initial Q (Qb), veh	0	0	0	0	0	0	0	0	0	0	0	0
Ped-Bike Adj(A_pbT)	1.00		0.99	1.00		0.99	1.00		1.00	1.00		1.00
Parking Bus, Adj	1.00	1.00	1.00	1.00	1.00	1.00	1.00	1.00	1.00	1.00	1.00	1.00
Work Zone On Approach		No			No			No			No	
Adj Sat Flow, veh/h/ln	1870	1870	1870	1856	1856	1856	1885	1885	1885	1633	1633	1633
Adj Flow Rate, veh/h	107	314	252	265	216	195	215	95	348	216	73	46
Peak Hour Factor	0.94	0.94	0.94	0.94	0.94	0.94	0.94	0.94	0.94	0.94	0.94	0.94
Percent Heavy Veh, %	2	2	2	3	3	3	1	1	1	18	18	18
Cap, veh/h	177	385	301	306	248	224	559	95	347	203	388	328
Arrive On Green	0.10	0.20	0.20	0.17	0.28	0.28	0.16	0.27	0.27	0.13	0.24	0.24
Sat Flow, veh/h	1781	1889	1479	1767	894	807	3483	354	1296	1555	1633	1382
Grp Volume(v), veh/h	107	295	271	265	0	411	215	0	443	216	73	46
Grp Sat Flow(s),veh/h/ln	1781	1777	1591	1767	0	1702	1742	0	1650	1555	1633	1382
Q Serve(g_s), s	4.6	12.7	13.1	11.7	0.0	18.4	4.4	0.0	21.4	10.4	2.9	2.1
Cycle Q Clear(g_c), s	4.6	12.7	13.1	11.7	0.0	18.4	4.4	0.0	21.4	10.4	2.9	2.1
Prop In Lane	1.00		0.93	1.00		0.47	1.00		0.79	1.00		1.00
Lane Grp Cap(c), veh/h	177	362	324	306	0	472	559	0	441	203	388	328
V/C Ratio(X)	0.60	0.81	0.84	0.87	0.00	0.87	0.38	0.00	1.00	1.06	0.19	0.14
Avail Cap(c_a), veh/h	177	400	358	364	0	627	559	0	441	203	388	328
HCM Platoon Ratio	1.00	1.00	1.00	1.00	1.00	1.00	1.00	1.00	1.00	1.00	1.00	1.00
Upstream Filter(I)	0.61	0.61	0.61	1.00	0.00	1.00	1.00	0.00	1.00	1.00	1.00	1.00
Uniform Delay (d), s/veh	34.5	30.4	30.6	32.2	0.0	27.5	30.0	0.0	29.3	34.8	24.3	24.1
Incr Delay (d2), s/veh	3.5	7.2	9.5	17.0	0.0	10.1	0.4	0.0	43.7	80.9	1.1	0.9
Initial Q Delay(d3),s/veh	0.0	0.0	0.0	0.0	0.0	0.0	0.0	0.0	0.0	0.0	0.0	0.0
%ile BackOfQ(50%),veh/ln	2.1	6.0	5.7	6.3	0.0	8.5	1.8	0.0	13.4	8.4	1.2	0.7
Unsig. Movement Delay, s/veh												
LnGrp Delay(d),s/veh	38.0	37.6	40.1	49.1	0.0	37.6	30.5	0.0	73.0	115.7	25.4	24.9
LnGrp LOS	D	D	D	D	A	D	C	A	F	F	C	C
Approach Vol, veh/h		673			676			658			335	
Approach Delay, s/veh		38.7			42.1			59.1			83.6	
Approach LOS		D			D			E			F	
Timer - Assigned Phs	1	2	3	4	5	6	7	8				
Phs Duration (G+Y+Rc), s	14.9	25.9	18.4	20.8	17.3	23.5	12.5	26.7				
Change Period (Y+Rc), s	4.5	4.5	4.5	4.5	4.5	4.5	4.5	4.5				
Max Green Setting (Gmax), s	11.5	21.4	16.5	18.0	8.5	19.0	5.0	29.5				
Max Q Clear Time (g_c+M2), s	11.5	23.4	13.7	15.1	6.4	4.9	6.6	20.4				
Green Ext Time (p_c), s	0.0	0.0	0.2	1.0	0.1	0.4	0.0	1.8				
Intersection Summary												
HCM 6th Ctrl Delay											51.8	
HCM 6th LOS											D	

HCM 6th TWSC
 25: Kennedy Street/Gateway Drive & SR-99 Southbound Ramps

Village D Specific Plan
 Phase III NP - PM Peak Hour

Intersection						
Int Delay, s/veh	69.3					
Movement	EBL	EBT	WBT	WBR	SBL	SBR
Lane Configurations	↘	↑	↗		↘	↗
Traffic Vol, veh/h	346	460	430	3	138	223
Future Vol, veh/h	346	460	430	3	138	223
Conflicting Peds, #/hr	0	0	0	0	0	0
Sign Control	Free	Free	Free	Free	Stop	Stop
RT Channelized	-	None	-	Free	-	None
Storage Length	140	-	-	-	0	335
Veh in Median Storage, #	-	0	0	-	0	-
Grade, %	-	0	0	-	0	-
Peak Hour Factor	92	92	92	92	92	92
Heavy Vehicles, %	3	3	3	3	4	4
Mvmt Flow	376	500	467	3	150	242

Major/Minor	Major1	Major2	Minor2		
Conflicting Flow All	467	0	-	0	1719 467
Stage 1	-	-	-	-	467 -
Stage 2	-	-	-	-	1252 -
Critical Hdwy	4.13	-	-	-	6.44 6.24
Critical Hdwy Stg 1	-	-	-	-	5.44 -
Critical Hdwy Stg 2	-	-	-	-	5.44 -
Follow-up Hdwy	2.227	-	-	-	3.536 3.336
Pot Cap-1 Maneuver	1089	-	-	0	- 97 592
Stage 1	-	-	-	0	627 -
Stage 2	-	-	-	0	267 -
Platoon blocked, %		-	-		
Mov Cap-1 Maneuver	1089	-	-	-	- 64 592
Mov Cap-2 Maneuver	-	-	-	-	- 64 -
Stage 1	-	-	-	-	411 -
Stage 2	-	-	-	-	267 -

Approach	EB	WB	SB
HCM Control Delay, s	4.3	0	296.8
HCM LOS			F

Minor Lane/Major Mvmt	EBL	EBT	WBT	SBLn1	SBLn2
Capacity (veh/h)	1089	-	-	64	592
HCM Lane V/C Ratio	0.345	-	-	2.344	0.409
HCM Control Delay (s)	10	-	-	751.8	15.2
HCM Lane LOS	B	-	-	F	C
HCM 95th %tile Q(veh)	1.6	-	-	14.6	2

Notes
 -: Volume exceeds capacity \$: Delay exceeds 300s +: Computation Not Defined *: All major volume in platoon

Intersection						
Int Delay, s/veh	3.3					
Movement	EBL	EBT	WBT	WBR	SBL	SBR
Lane Configurations		↕	↕		↕	
Traffic Vol, veh/h	161	438	247	0	0	186
Future Vol, veh/h	161	438	247	0	0	186
Conflicting Peds, #/hr	0	0	0	0	0	0
Sign Control	Free	Free	Free	Free	Stop	Stop
RT Channelized	-	None	-	None	-	None
Storage Length	-	-	-	-	0	-
Veh in Median Storage, #	-	0	0	-	0	-
Grade, %	-	0	0	-	0	-
Peak Hour Factor	92	92	92	92	92	92
Heavy Vehicles, %	3	3	2	2	4	4
Mvmt Flow	175	476	268	0	0	202

Major/Minor	Major1	Major2	Minor2		
Conflicting Flow All	268	0	-	0	1094 268
Stage 1	-	-	-	-	268 -
Stage 2	-	-	-	-	826 -
Critical Hdwy	4.13	-	-	-	6.44 6.24
Critical Hdwy Stg 1	-	-	-	-	5.44 -
Critical Hdwy Stg 2	-	-	-	-	5.44 -
Follow-up Hdwy	2.227	-	-	-	3.536 3.336
Pot Cap-1 Maneuver	1290	-	-	-	235 766
Stage 1	-	-	-	-	772 -
Stage 2	-	-	-	-	427 -
Platoon blocked, %		-	-	-	
Mov Cap-1 Maneuver	1290	-	-	-	192 766
Mov Cap-2 Maneuver	-	-	-	-	192 -
Stage 1	-	-	-	-	630 -
Stage 2	-	-	-	-	427 -

Approach	EB	WB	SB
HCM Control Delay, s	2.2	0	11.4
HCM LOS			B

Minor Lane/Major Mvmt	EBL	EBT	WBT	WBR	SBLn1
Capacity (veh/h)	1290	-	-	-	766
HCM Lane V/C Ratio	0.136	-	-	-	0.264
HCM Control Delay (s)	8.2	0	-	-	11.4
HCM Lane LOS	A	A	-	-	B
HCM 95th %tile Q(veh)	0.5	-	-	-	1.1

Intersection						
Int Delay, s/veh	4					
Movement	EBL	EBR	NBL	NBT	SBT	SBR
Lane Configurations	↵			↑	↵	
Traffic Vol, veh/h	161	0	0	82	3	185
Future Vol, veh/h	161	0	0	82	3	185
Conflicting Peds, #/hr	0	0	0	0	0	0
Sign Control	Stop	Stop	Free	Free	Free	Free
RT Channelized	-	None	-	None	-	None
Storage Length	0	-	-	-	-	-
Veh in Median Storage, #	0	-	-	0	0	-
Grade, %	0	-	-	0	0	-
Peak Hour Factor	92	92	92	92	92	92
Heavy Vehicles, %	2	2	9	9	4	4
Mvmt Flow	175	0	0	89	3	201

Major/Minor	Minor2	Major1		Major2	
Conflicting Flow All	193	-	-	0	0
Stage 1	104	-	-	-	-
Stage 2	89	-	-	-	-
Critical Hdwy	6.42	-	-	-	-
Critical Hdwy Stg 1	5.42	-	-	-	-
Critical Hdwy Stg 2	5.42	-	-	-	-
Follow-up Hdwy	3.518	-	-	-	-
Pot Cap-1 Maneuver	796	0	0	-	-
Stage 1	920	0	0	-	-
Stage 2	934	0	0	-	-
Platoon blocked, %				-	-
Mov Cap-1 Maneuver	796	-	-	-	-
Mov Cap-2 Maneuver	796	-	-	-	-
Stage 1	920	-	-	-	-
Stage 2	934	-	-	-	-

Approach	EB	NB	SB
HCM Control Delay, s	10.8	0	0
HCM LOS	B		

Minor Lane/Major Mvmt	NBT	EBLn1	SBT	SBR
Capacity (veh/h)	-	796	-	-
HCM Lane V/C Ratio	-	0.22	-	-
HCM Control Delay (s)	-	10.8	-	-
HCM Lane LOS	-	B	-	-
HCM 95th %tile Q(veh)	-	0.8	-	-

Intersection						
Int Delay, s/veh	0.1					
Movement	EBL	EBT	WBT	WBR	SBL	SBR
Lane Configurations		↶	↷		↶	
Traffic Vol, veh/h	0	438	247	77	3	0
Future Vol, veh/h	0	438	247	77	3	0
Conflicting Peds, #/hr	0	0	0	0	0	0
Sign Control	Free	Free	Free	Free	Stop	Stop
RT Channelized	-	None	-	None	-	None
Storage Length	-	-	-	-	0	-
Veh in Median Storage, #	-	0	0	-	0	-
Grade, %	-	0	0	-	0	-
Peak Hour Factor	92	92	92	92	92	92
Heavy Vehicles, %	4	4	3	3	0	0
Mvmt Flow	0	476	268	84	3	0

Major/Minor	Major1	Major2	Minor2		
Conflicting Flow All	352	0	-	0	786 310
Stage 1	-	-	-	-	310 -
Stage 2	-	-	-	-	476 -
Critical Hdwy	4.14	-	-	-	6.4 6.2
Critical Hdwy Stg 1	-	-	-	-	5.4 -
Critical Hdwy Stg 2	-	-	-	-	5.4 -
Follow-up Hdwy	2.236	-	-	-	3.5 3.3
Pot Cap-1 Maneuver	1196	-	-	-	364 735
Stage 1	-	-	-	-	748 -
Stage 2	-	-	-	-	629 -
Platoon blocked, %		-	-	-	
Mov Cap-1 Maneuver	1196	-	-	-	364 735
Mov Cap-2 Maneuver	-	-	-	-	364 -
Stage 1	-	-	-	-	748 -
Stage 2	-	-	-	-	629 -

Approach	EB	WB	SB
HCM Control Delay, s	0	0	15
HCM LOS			C

Minor Lane/Major Mvmt	EBL	EBT	WBT	WBR	SBLn1
Capacity (veh/h)	1196	-	-	-	364
HCM Lane V/C Ratio	-	-	-	-	0.009
HCM Control Delay (s)	0	-	-	-	15
HCM Lane LOS	A	-	-	-	C
HCM 95th %tile Q(veh)	0	-	-	-	0

HCM 6th Signalized Intersection Summary
29: Schnoor Avenue & Cleveland Avenue

Village D Specific Plan
Phase III NP - PM Peak Hour



Movement	EBL	EBT	EBR	WBL	WBT	WBR	NBL	NBT	NBR	SBL	SBT	SBR
Lane Configurations												
Traffic Volume (veh/h)	144	447	50	297	598	127	73	245	159	134	248	119
Future Volume (veh/h)	144	447	50	297	598	127	73	245	159	134	248	119
Initial Q (Qb), veh	0	0	0	0	0	0	0	0	0	0	0	0
Ped-Bike Adj(A_pbT)	1.00		0.97	1.00		0.98	1.00		0.98	1.00		0.99
Parking Bus, Adj	1.00	1.00	1.00	1.00	1.00	1.00	1.00	1.00	1.00	1.00	1.00	1.00
Work Zone On Approach		No			No			No			No	
Adj Sat Flow, veh/h/ln	1885	1885	1885	1885	1885	1885	1885	1885	1885	1885	1885	1885
Adj Flow Rate, veh/h	148	461	52	306	616	131	75	253	164	138	256	123
Peak Hour Factor	0.97	0.97	0.97	0.97	0.97	0.97	0.97	0.97	0.97	0.97	0.97	0.97
Percent Heavy Veh, %	1	1	1	1	1	1	1	1	1	1	1	1
Cap, veh/h	181	650	282	524	829	361	97	776	578	451	1484	658
Arrive On Green	0.10	0.18	0.18	0.15	0.23	0.23	0.05	0.22	0.22	0.25	0.41	0.41
Sat Flow, veh/h	1795	3582	1554	3483	3582	1559	1795	3582	1559	1795	3582	1588
Grp Volume(v), veh/h	148	461	52	306	616	131	75	253	164	138	256	123
Grp Sat Flow(s),veh/h/ln	1795	1791	1554	1742	1791	1559	1795	1791	1559	1795	1791	1588
Q Serve(g_s), s	7.3	10.9	2.1	7.4	14.4	3.4	3.7	5.4	0.0	5.6	4.1	4.4
Cycle Q Clear(g_c), s	7.3	10.9	2.1	7.4	14.4	3.4	3.7	5.4	0.0	5.6	4.1	4.4
Prop In Lane	1.00		1.00	1.00		1.00	1.00		1.00	1.00		1.00
Lane Grp Cap(c), veh/h	181	650	282	524	829	361	97	776	578	451	1484	658
V/C Ratio(X)	0.82	0.71	0.18	0.58	0.74	0.36	0.78	0.33	0.28	0.31	0.17	0.19
Avail Cap(c_a), veh/h	190	1258	546	524	1373	598	130	776	578	451	1484	658
HCM Platoon Ratio	1.00	1.00	1.00	1.00	1.00	1.00	1.00	1.00	1.00	1.00	1.00	1.00
Upstream Filter(I)	1.00	1.00	1.00	0.69	0.69	0.69	1.00	1.00	1.00	1.00	1.00	1.00
Uniform Delay (d), s/veh	39.7	34.6	20.6	35.6	32.1	8.6	42.0	29.7	20.1	27.3	16.6	16.7
Incr Delay (d2), s/veh	23.1	1.4	0.3	1.2	0.9	0.4	18.5	1.1	1.2	0.4	0.3	0.6
Initial Q Delay(d3),s/veh	0.0	0.0	0.0	0.0	0.0	0.0	0.0	0.0	0.0	0.0	0.0	0.0
%ile BackOfQ(50%),veh/ln	4.3	4.8	1.0	3.2	6.2	2.3	2.1	2.4	2.6	2.4	1.7	1.7
Unsig. Movement Delay, s/veh												
LnGrp Delay(d),s/veh	62.8	36.0	20.9	36.8	33.0	9.0	60.5	30.8	21.3	27.7	16.9	17.4
LnGrp LOS	E	D	C	D	C	A	E	C	C	C	B	B
Approach Vol, veh/h		661			1053			492			517	
Approach Delay, s/veh		40.8			31.1			32.2			19.9	
Approach LOS		D			C			C			B	
Timer - Assigned Phs	1	2	3	4	5	6	7	8				
Phs Duration (G+Y+Rc), s	27.1	24.0	18.0	20.8	9.3	41.8	13.6	25.3				
Change Period (Y+Rc), s	4.5	4.5	4.5	4.5	4.5	4.5	4.5	4.5				
Max Green Setting (Gmax), s	8.5	19.5	12.4	31.6	6.5	21.5	9.5	34.5				
Max Q Clear Time (g_c+I1), s	7.6	7.4	9.4	12.9	5.7	6.4	9.3	16.4				
Green Ext Time (p_c), s	0.0	1.7	0.3	3.1	0.0	1.8	0.0	4.5				

Intersection Summary												
HCM 6th Ctrl Delay				31.5								
HCM 6th LOS				C								

HCM 6th Signalized Intersection Summary
30: Fairgrounds & Cleveland Avenue

Village D Specific Plan
Phase III NP - PM Peak Hour



Movement	EBL	EBT	EBR	WBL	WBT	WBR	NBL	NBT	NBR	SBL	SBT	SBR
Lane Configurations	↑↑↑			↑↑		↑	↑↑	↑	↑	↑	↑	↑
Traffic Volume (veh/h)	105	574	96	179	711	192	100	44	116	334	36	126
Future Volume (veh/h)	105	574	96	179	711	192	100	44	116	334	36	126
Initial Q (Qb), veh	0	0	0	0	0	0	0	0	0	0	0	0
Ped-Bike Adj(A_pbT)	1.00		0.98	1.00		0.98	1.00		0.98	1.00		1.00
Parking Bus, Adj	1.00	1.00	1.00	1.00	1.00	1.00	1.00	1.00	1.00	1.00	1.00	1.00
Work Zone On Approach	No			No			No			No		
Adj Sat Flow, veh/h/ln	1885	1885	1885	1885	1885	1885	1900	1900	1900	1900	1900	1900
Adj Flow Rate, veh/h	111	604	101	188	748	202	105	103	84	352	38	133
Peak Hour Factor	0.95	0.95	0.95	0.95	0.95	0.95	0.95	0.95	0.95	0.95	0.95	0.95
Percent Heavy Veh, %	1	1	1	1	1	1	0	0	0	0	0	0
Cap, veh/h	110	959	158	225	1004	437	590	391	325	458	109	382
Arrive On Green	0.12	0.43	0.43	0.04	0.09	0.09	0.16	0.21	0.21	0.25	0.30	0.30
Sat Flow, veh/h	1795	4440	731	1795	3582	1561	3619	1900	1582	1810	369	1293
Grp Volume(v), veh/h	111	465	240	188	748	202	105	103	84	352	0	171
Grp Sat Flow(s),veh/h/ln	1795	1716	1739	1795	1791	1561	1810	1900	1582	1810	0	1663
Q Serve(g_s), s	5.5	9.5	9.8	9.4	18.3	11.0	2.3	4.1	2.9	16.2	0.0	7.3
Cycle Q Clear(g_c), s	5.5	9.5	9.8	9.4	18.3	11.0	2.3	4.1	2.9	16.2	0.0	7.3
Prop In Lane	1.00		0.42	1.00		1.00	1.00		1.00	1.00		0.78
Lane Grp Cap(c), veh/h	110	741	376	225	1004	437	590	391	325	458	0	491
V/C Ratio(X)	1.01	0.63	0.64	0.84	0.75	0.46	0.18	0.26	0.26	0.77	0.00	0.35
Avail Cap(c_a), veh/h	110	1033	524	237	1333	581	590	391	325	458	0	491
HCM Platoon Ratio	2.00	2.00	2.00	0.33	0.33	0.33	1.00	1.00	1.00	1.00	1.00	1.00
Upstream Filter(I)	0.76	0.76	0.76	0.78	0.78	0.78	1.00	1.00	1.00	1.00	0.00	1.00
Uniform Delay (d), s/veh	39.5	22.7	22.8	42.2	37.7	34.4	32.5	30.0	15.4	31.2	0.0	24.9
Incr Delay (d2), s/veh	78.0	0.7	1.4	17.3	1.3	0.6	0.1	1.6	1.9	7.8	0.0	1.9
Initial Q Delay(d3),s/veh	0.0	0.0	0.0	0.0	0.0	0.0	0.0	0.0	0.0	0.0	0.0	0.0
%ile BackOfQ(50%),veh/ln	4.6	3.2	3.4	5.5	8.9	4.7	1.0	2.0	1.7	7.9	0.0	3.1
Unsig. Movement Delay, s/veh												
LnGrp Delay(d),s/veh	117.5	23.4	24.2	59.5	39.0	35.0	32.6	31.7	17.3	38.9	0.0	26.8
LnGrp LOS	F	C	C	E	D	C	C	C	B	D	A	C
Approach Vol, veh/h	816		1138				292		523			
Approach Delay, s/veh	36.4		41.7				27.9		35.0			
Approach LOS	D		D				C		C			
Timer - Assigned Phs	1	2	3	4	5	6	7	8				
Phs Duration (G+Y+Rc), s	27.3	23.0	15.8	23.9	19.2	31.1	10.0	29.7				
Change Period (Y+Rc), s	4.5	4.5	4.5	4.5	4.5	4.5	4.5	4.5				
Max Green Setting (Gmax), s	17.5	18.5	11.9	27.1	6.4	26.6	5.5	33.5				
Max Q Clear Time (g_c+10), s	10.2	6.1	11.4	11.8	4.3	9.3	7.5	20.3				
Green Ext Time (p_c), s	0.0	0.6	0.0	4.1	0.1	0.9	0.0	4.9				

Intersection Summary

HCM 6th Ctrl Delay	37.4
HCM 6th LOS	D

Notes

User approved volume balancing among the lanes for turning movement.

HCM 6th Signalized Intersection Summary
 31: SR-99 Southbound Ramps & Cleveland Avenue

Village D Specific Plan
 Phase III NP - PM Peak Hour



Movement	EBL	EBT	EBR	WBL	WBT	WBR	NBL	NBT	NBR	SBL	SBT	SBR
Lane Configurations		↑↑	↑	↑	↑↑					↑		↑
Traffic Volume (veh/h)	0	817	408	381	1344	0	0	0	0	203	0	85
Future Volume (veh/h)	0	817	408	381	1344	0	0	0	0	203	0	85
Initial Q (Qb), veh	0	0	0	0	0	0				0	0	0
Ped-Bike Adj(A_pbT)	1.00		1.00	1.00		1.00				1.00		1.00
Parking Bus, Adj	1.00	1.00	1.00	1.00	1.00	1.00				1.00	1.00	1.00
Work Zone On Approach		No		No						No		
Adj Sat Flow, veh/h/ln	0	1885	1885	1885	1885	0				1841	0	1841
Adj Flow Rate, veh/h	0	842	421	393	1386	0				209	0	88
Peak Hour Factor	0.97	0.97	0.97	0.97	0.97	0.97				0.97	0.97	0.97
Percent Heavy Veh, %	0	1	1	1	1	0				4	0	4
Cap, veh/h	0	1079	479	421	2098	0				551	0	490
Arrive On Green	0.00	0.60	0.60	0.47	1.00	0.00				0.31	0.00	0.31
Sat Flow, veh/h	0	3676	1590	1795	3676	0				1753	0	1560
Grp Volume(v), veh/h	0	842	421	393	1386	0				209	0	88
Grp Sat Flow(s),veh/h/ln	0	1791	1590	1795	1791	0				1753	0	1560
Q Serve(g_s), s	0.0	15.9	20.2	18.6	0.0	0.0				8.4	0.0	3.7
Cycle Q Clear(g_c), s	0.0	15.9	20.2	18.6	0.0	0.0				8.4	0.0	3.7
Prop In Lane	0.00		1.00	1.00		0.00				1.00		1.00
Lane Grp Cap(c), veh/h	0	1079	479	421	2098	0				551	0	490
V/C Ratio(X)	0.00	0.78	0.88	0.93	0.66	0.00				0.38	0.00	0.18
Avail Cap(c_a), veh/h	0	1254	556	489	2408	0				551	0	490
HCM Platoon Ratio	1.00	2.00	2.00	2.00	2.00	1.00				1.00	1.00	1.00
Upstream Filter(I)	0.00	0.66	0.66	0.57	0.57	0.00				1.00	0.00	1.00
Uniform Delay (d), s/veh	0.0	15.7	16.5	23.2	0.0	0.0				24.0	0.0	22.4
Incr Delay (d2), s/veh	0.0	1.9	9.5	15.6	0.3	0.0				0.4	0.0	0.2
Initial Q Delay(d3),s/veh	0.0	0.0	0.0	0.0	0.0	0.0				0.0	0.0	0.0
%ile BackOfQ(50%),veh/ln	0.0	4.3	5.4	7.1	0.1	0.0				3.5	0.0	1.4
Unsig. Movement Delay, s/veh												
LnGrp Delay(d),s/veh	0.0	17.5	26.0	38.8	0.3	0.0				24.5	0.0	22.6
LnGrp LOS	A	B	C	D	A	A				C	A	C
Approach Vol, veh/h		1263			1779						297	
Approach Delay, s/veh		20.4			8.8						23.9	
Approach LOS		C			A						C	
Timer - Assigned Phs			3	4		6		8				
Phs Duration (G+Y+Rc), s			25.6	31.6		32.8		57.2				
Change Period (Y+Rc), s			4.5	4.5		4.5		4.5				
Max Green Setting (Gmax), s			24.5	31.5		20.5		60.5				
Max Q Clear Time (g_c+I1), s			20.6	22.2		10.4		2.0				
Green Ext Time (p_c), s			0.5	5.0		0.7		16.3				
Intersection Summary												
HCM 6th Ctrl Delay			14.5									
HCM 6th LOS			B									

HCM 6th Signalized Intersection Summary
 32: SR-99 Northbound Ramps & Cleveland Avenue

Village D Specific Plan
 Phase III NP - PM Peak Hour



Movement	EBL	EBT	EBR	WBL	WBT	WBR	NBL	NBT	NBR	SBL	SBT	SBR
Lane Configurations	↘	↑↑			↑↑	↗	↘	↖	↗			
Traffic Volume (veh/h)	79	939	0	0	1065	68	667	6	349	0	0	0
Future Volume (veh/h)	79	939	0	0	1065	68	667	6	349	0	0	0
Initial Q (Qb), veh	0	0	0	0	0	0	0	0	0			
Ped-Bike Adj(A_pbT)	1.00		1.00	1.00		0.99	1.00		0.99			
Parking Bus, Adj	1.00	1.00	1.00	1.00	1.00	1.00	1.00	1.00	1.00			
Work Zone On Approach	No				No				No			
Adj Sat Flow, veh/h/ln	1885	1885	0	0	1885	1885	1885	1885	1885			
Adj Flow Rate, veh/h	83	988	0	0	1121	72	706	0	367			
Peak Hour Factor	0.95	0.95	0.95	0.95	0.95	0.95	0.95	0.95	0.95			
Percent Heavy Veh, %	1	1	0	0	1	1	1	1	1			
Cap, veh/h	107	1690	0	0	1297	574	1538	0	675			
Arrive On Green	0.06	0.47	0.00	0.00	0.36	0.36	0.43	0.00	0.43			
Sat Flow, veh/h	1795	3676	0	0	3676	1584	3591	0	1575			
Grp Volume(v), veh/h	83	988	0	0	1121	72	706	0	367			
Grp Sat Flow(s),veh/h/ln	1795	1791	0	0	1791	1584	1795	0	1575			
Q Serve(g_s), s	4.1	18.1	0.0	0.0	26.2	2.7	12.6	0.0	15.6			
Cycle Q Clear(g_c), s	4.1	18.1	0.0	0.0	26.2	2.7	12.6	0.0	15.6			
Prop In Lane	1.00		0.00	0.00		1.00	1.00		1.00			
Lane Grp Cap(c), veh/h	107	1690	0	0	1297	574	1538	0	675			
V/C Ratio(X)	0.78	0.58	0.00	0.00	0.86	0.13	0.46	0.00	0.54			
Avail Cap(c_a), veh/h	170	1930	0	0	1413	625	1538	0	675			
HCM Platoon Ratio	1.00	1.00	1.00	1.00	1.00	1.00	1.00	1.00	1.00			
Upstream Filter(I)	0.69	0.69	0.00	0.00	0.63	0.63	1.00	0.00	1.00			
Uniform Delay (d), s/veh	41.7	17.3	0.0	0.0	26.6	19.2	18.3	0.0	19.2			
Incr Delay (d2), s/veh	8.0	0.2	0.0	0.0	3.6	0.1	1.0	0.0	3.1			
Initial Q Delay(d3),s/veh	0.0	0.0	0.0	0.0	0.0	0.0	0.0	0.0	0.0			
%ile BackOfQ(50%),veh/ln	2.0	7.1	0.0	0.0	11.3	1.0	5.2	0.0	6.0			
Unsig. Movement Delay, s/veh												
LnGrp Delay(d),s/veh	49.8	17.6	0.0	0.0	30.2	19.2	19.3	0.0	22.3			
LnGrp LOS	D	B	A	A	C	B	B	A	C			
Approach Vol, veh/h	1071				1193				1073			
Approach Delay, s/veh	20.1				29.5				20.3			
Approach LOS	C				C				C			
Timer - Assigned Phs	2		4		7		8					
Phs Duration (G+Y+Rc), s	43.0		47.0		9.9		37.1					
Change Period (Y+Rc), s	4.5		4.5		4.5		4.5					
Max Green Setting (Gmax), s	32.5		48.5		8.5		35.5					
Max Q Clear Time (g_c+I1), s	17.6		20.1		6.1		28.2					
Green Ext Time (p_c), s	3.8		8.2		0.0		4.4					

Intersection Summary

HCM 6th Ctrl Delay	23.5
HCM 6th LOS	C

Notes

User approved volume balancing among the lanes for turning movement.

HCM 6th Signalized Intersection Summary
 33: Gateway Drive & Cleveland Avenue

Village D Specific Plan
 Phase III NP - PM Peak Hour



Movement	EBL	EBT	EBR	WBL	WBT	WBR	NBL	NBT	NBR	SBL	SBT	SBR
Lane Configurations	↖	↑↑↑	↗	↖↗	↑↑		↖↗	↑	↗	↖	↑↘	
Traffic Volume (veh/h)	17	977	294	248	872	175	237	154	309	233	179	24
Future Volume (veh/h)	17	977	294	248	872	175	237	154	309	233	179	24
Initial Q (Qb), veh	0	0	0	0	0	0	0	0	0	0	0	0
Ped-Bike Adj(A_pbT)	1.00		1.00	1.00		0.99	1.00		0.98	1.00		0.98
Parking Bus, Adj	1.00	1.00	1.00	1.00	1.00	1.00	1.00	1.00	1.00	1.00	1.00	1.00
Work Zone On Approach		No			No			No			No	
Adj Sat Flow, veh/h/ln	1870	1870	1870	1870	1870	1870	1885	1885	1885	1856	1856	1856
Adj Flow Rate, veh/h	18	1039	0	264	928	186	252	164	329	248	190	26
Peak Hour Factor	0.94	0.94	0.94	0.94	0.94	0.94	0.94	0.94	0.94	0.94	0.94	0.94
Percent Heavy Veh, %	2	2	2	2	2	2	1	1	1	3	3	3
Cap, veh/h	116	1318		413	1053	211	709	423	351	350	681	92
Arrive On Green	0.04	0.52	0.00	0.12	0.36	0.36	0.20	0.22	0.22	0.20	0.22	0.22
Sat Flow, veh/h	1781	5106	1585	3456	2947	590	3483	1885	1565	1767	3113	419
Grp Volume(v), veh/h	18	1039	0	264	559	555	252	164	329	248	106	110
Grp Sat Flow(s),veh/h/ln	1781	1702	1585	1728	1777	1760	1742	1885	1565	1767	1763	1770
Q Serve(g_s), s	0.0	14.9	0.0	6.6	26.6	26.6	5.6	6.7	18.6	11.8	4.5	4.6
Cycle Q Clear(g_c), s	0.0	14.9	0.0	6.6	26.6	26.6	5.6	6.7	18.6	11.8	4.5	4.6
Prop In Lane	1.00		1.00	1.00		0.34	1.00		1.00	1.00		0.24
Lane Grp Cap(c), veh/h	116	1318		413	635	629	709	423	351	350	386	387
V/C Ratio(X)	0.16	0.79		0.64	0.88	0.88	0.36	0.39	0.94	0.71	0.28	0.28
Avail Cap(c_a), veh/h	179	1770		413	685	679	709	423	351	350	386	387
HCM Platoon Ratio	2.00	2.00	2.00	1.00	1.00	1.00	1.00	1.00	1.00	1.00	1.00	1.00
Upstream Filter(l)	0.81	0.81	0.00	0.92	0.92	0.92	1.00	1.00	1.00	1.00	1.00	1.00
Uniform Delay (d), s/veh	42.3	19.8	0.0	37.8	27.1	27.1	30.8	29.6	34.3	33.7	29.2	29.3
Incr Delay (d2), s/veh	0.5	1.4	0.0	3.0	11.3	11.5	0.3	2.7	34.4	6.5	1.8	1.8
Initial Q Delay(d3),s/veh	0.0	0.0	0.0	0.0	0.0	0.0	0.0	0.0	0.0	0.0	0.0	0.0
%ile BackOfQ(50%),veh/ln	0.4	4.3	0.0	2.9	12.8	12.7	2.3	3.3	10.2	5.6	2.1	2.1
Unsig. Movement Delay, s/veh												
LnGrp Delay(d),s/veh	42.8	21.2	0.0	40.8	38.4	38.7	31.1	32.3	68.6	40.1	31.0	31.1
LnGrp LOS	D	C		D	D	D	C	C	E	D	C	C
Approach Vol, veh/h		1057	A		1378			745			464	
Approach Delay, s/veh		21.6			39.0			47.9			35.9	
Approach LOS		C			D			D			D	
Timer - Assigned Phs	1	2	3	4	5	6	7	8				
Phs Duration (G+Y+Rc), s	22.8	24.2	6.3	36.7	22.3	24.7	15.3	27.7				
Change Period (Y+Rc), s	4.5	4.5	4.5	4.5	4.5	4.5	4.5	4.5				
Max Green Setting (Gmax), s	12.6	19.7	5.0	34.7	12.1	20.2	8.5	31.2				
Max Q Clear Time (g_c+1), s	11.6	6.6	2.0	28.6	13.8	20.6	8.6	16.9				
Green Ext Time (p_c), s	0.4	0.9	0.0	3.6	0.0	0.0	0.0	6.3				

Intersection Summary

HCM 6th Ctrl Delay	35.4
HCM 6th LOS	D

Notes

Unsignalized Delay for [EBR] is excluded from calculations of the approach delay and intersection delay.

HCM 6th Signalized Intersection Summary
 34: Cleveland Avenue & County Club Drive

Village D Specific Plan
 Phase III NP - PM Peak Hour



Movement	WBL	WBR	NBT	NBR	SBL	SBT
Lane Configurations	↔↔		↑↑	↗	↖	↑↑↑
Traffic Volume (veh/h)	424	40	953	566	147	871
Future Volume (veh/h)	424	40	953	566	147	871
Initial Q (Qb), veh	0	0	0	0	0	0
Ped-Bike Adj(A_pbT)	1.00	1.00		1.00	1.00	
Parking Bus, Adj	1.00	1.00	1.00	1.00	1.00	1.00
Work Zone On Approach	No		No		No	
Adj Sat Flow, veh/h/ln	1900	1900	1870	1870	1870	1870
Adj Flow Rate, veh/h	485	0	1003	0	155	917
Peak Hour Factor	0.95	0.95	0.95	0.95	0.95	0.95
Percent Heavy Veh, %	0	0	2	2	2	2
Cap, veh/h	615	274	2594		430	3727
Arrive On Green	0.17	0.00	0.73	0.00	0.73	0.73
Sat Flow, veh/h	3619	1610	3647	1585	562	5274
Grp Volume(v), veh/h	485	0	1003	0	155	917
Grp Sat Flow(s),veh/h/ln	1810	1610	1777	1585	562	1702
Q Serve(g_s), s	11.6	0.0	9.6	0.0	12.9	5.3
Cycle Q Clear(g_c), s	11.6	0.0	9.6	0.0	22.5	5.3
Prop In Lane	1.00	1.00		1.00	1.00	
Lane Grp Cap(c), veh/h	615	274	2594		430	3727
V/C Ratio(X)	0.79	0.00	0.39		0.36	0.25
Avail Cap(c_a), veh/h	1428	635	2594		430	3727
HCM Platoon Ratio	1.00	1.00	1.00	1.00	1.00	1.00
Upstream Filter(I)	1.00	0.00	0.61	0.00	1.00	1.00
Uniform Delay (d), s/veh	35.8	0.0	4.6	0.0	8.8	4.0
Incr Delay (d2), s/veh	2.3	0.0	0.3	0.0	2.3	0.2
Initial Q Delay(d3),s/veh	0.0	0.0	0.0	0.0	0.0	0.0
%ile BackOfQ(50%),veh/ln	5.2	0.0	2.8	0.0	1.7	1.5
Unsig. Movement Delay, s/veh						
LnGrp Delay(d),s/veh	38.1	0.0	4.8	0.0	11.1	4.2
LnGrp LOS	D	A	A		B	A
Approach Vol, veh/h	485		1003	A		1072
Approach Delay, s/veh	38.1		4.8			5.2
Approach LOS	D		A			A
Timer - Assigned Phs		2			6	8
Phs Duration (G+Y+Rc), s		70.2			70.2	19.8
Change Period (Y+Rc), s		4.5			4.5	4.5
Max Green Setting (Gmax), s		45.5			45.5	35.5
Max Q Clear Time (g_c+I1), s		11.6			24.5	13.6
Green Ext Time (p_c), s		8.8			8.5	1.7

Intersection Summary

HCM 6th Ctrl Delay	11.3
HCM 6th LOS	B

Notes

User approved volume balancing among the lanes for turning movement.
 Unsignalized Delay for [NBR] is excluded from calculations of the approach delay and intersection delay.

Intersection						
Int Delay, s/veh	0.2					
Movement	EBL	EBR	NBL	NBT	SBT	SBR
Lane Configurations	T			T		
Traffic Vol, veh/h	2	17	5	962	963	1
Future Vol, veh/h	2	17	5	962	963	1
Conflicting Peds, #/hr	0	0	0	0	0	0
Sign Control	Stop	Stop	Free	Free	Free	Free
RT Channelized	-	None	-	None	-	None
Storage Length	0	-	-	-	-	-
Veh in Median Storage, #	0	-	-	0	0	-
Grade, %	0	-	-	0	0	-
Peak Hour Factor	94	94	94	94	94	94
Heavy Vehicles, %	0	0	1	1	1	1
Mvmt Flow	2	18	5	1023	1024	1

Major/Minor	Minor2	Major1	Major2			
Conflicting Flow All	1547	513	1025	0	-	0
Stage 1	1025	-	-	-	-	-
Stage 2	522	-	-	-	-	-
Critical Hdwy	6.8	6.9	4.12	-	-	-
Critical Hdwy Stg 1	5.8	-	-	-	-	-
Critical Hdwy Stg 2	5.8	-	-	-	-	-
Follow-up Hdwy	3.5	3.3	2.21	-	-	-
Pot Cap-1 Maneuver	*233	512	679	-	-	-
Stage 1	*312	-	-	-	-	-
Stage 2	*655	-	-	-	-	-
Platoon blocked, %	1			-	-	-
Mov Cap-1 Maneuver	*230	512	679	-	-	-
Mov Cap-2 Maneuver	*269	-	-	-	-	-
Stage 1	*307	-	-	-	-	-
Stage 2	*655	-	-	-	-	-

Approach	EB	NB	SB
HCM Control Delay, s	13	0.2	0
HCM LOS	B		

Minor Lane/Major Mvmt	NBL	NBT	EBLn1	SBT	SBR
Capacity (veh/h)	679	-	468	-	-
HCM Lane V/C Ratio	0.008	-	0.043	-	-
HCM Control Delay (s)	10.3	0.1	13	-	-
HCM Lane LOS	B	A	B	-	-
HCM 95th %tile Q(veh)	0	-	0.1	-	-

Notes
 -: Volume exceeds capacity \$: Delay exceeds 300s +: Computation Not Defined *: All major volume in platoon

HCM 6th Signalized Intersection Summary
 36: Pine Street & Howard Road

Village D Specific Plan
 Phase III NP - PM Peak Hour



Movement	EBL	EBT	EBR	WBL	WBT	WBR	NBL	NBT	NBR	SBL	SBT	SBR
Lane Configurations												
Traffic Volume (veh/h)	89	559	102	111	515	4	144	183	171	18	161	120
Future Volume (veh/h)	89	559	102	111	515	4	144	183	171	18	161	120
Initial Q (Qb), veh	0	0	0	0	0	0	0	0	0	0	0	0
Ped-Bike Adj(A_pbT)	1.00		0.94	1.00		0.93	1.00		0.99	1.00		1.00
Parking Bus, Adj	1.00	1.00	1.00	1.00	1.00	1.00	1.00	1.00	1.00	1.00	1.00	1.00
Work Zone On Approach		No			No			No			No	
Adj Sat Flow, veh/h/ln	1870	1870	1870	1885	1885	1885	1870	1870	1870	1870	1870	1870
Adj Flow Rate, veh/h	96	601	110	119	554	4	155	197	184	19	173	129
Peak Hour Factor	0.93	0.93	0.93	0.93	0.93	0.93	0.93	0.93	0.93	0.93	0.93	0.93
Percent Heavy Veh, %	2	2	2	1	1	1	2	2	2	2	2	2
Cap, veh/h	214	730	133	130	722	5	624	655	548	24	220	208
Arrive On Green	0.12	0.25	0.25	0.07	0.20	0.20	0.35	0.35	0.35	0.13	0.13	0.13
Sat Flow, veh/h	1781	2968	542	1795	3643	26	1781	1870	1565	184	1677	1585
Grp Volume(v), veh/h	96	359	352	119	272	286	155	197	184	192	0	129
Grp Sat Flow(s),veh/h/ln	1781	1777	1733	1795	1791	1878	1781	1870	1565	1861	0	1585
Q Serve(g_s), s	4.5	17.2	17.3	5.9	12.9	12.9	5.6	6.9	7.8	9.0	0.0	6.9
Cycle Q Clear(g_c), s	4.5	17.2	17.3	5.9	12.9	12.9	5.6	6.9	7.8	9.0	0.0	6.9
Prop In Lane	1.00		0.31	1.00		0.01	1.00		1.00	0.10		1.00
Lane Grp Cap(c), veh/h	214	437	426	130	355	372	624	655	548	245	0	208
V/C Ratio(X)	0.45	0.82	0.83	0.92	0.77	0.77	0.25	0.30	0.34	0.78	0.00	0.62
Avail Cap(c_a), veh/h	214	543	529	130	547	574	624	655	548	372	0	317
HCM Platoon Ratio	1.00	1.00	1.00	1.00	1.00	1.00	1.00	1.00	1.00	1.00	1.00	1.00
Upstream Filter(I)	1.00	1.00	1.00	0.91	0.91	0.91	1.00	1.00	1.00	1.00	0.00	1.00
Uniform Delay (d), s/veh	36.8	32.1	32.1	41.5	34.1	34.1	20.8	21.2	21.5	37.9	0.0	37.0
Incr Delay (d2), s/veh	1.5	8.1	8.6	51.4	3.2	3.1	1.0	1.2	1.6	6.1	0.0	3.0
Initial Q Delay(d3),s/veh	0.0	0.0	0.0	0.0	0.0	0.0	0.0	0.0	0.0	0.0	0.0	0.0
%ile BackOfQ(50%),veh/ln	2.0	8.2	8.1	4.4	5.8	6.1	2.4	3.2	3.0	4.4	0.0	2.8
Unsig. Movement Delay, s/veh												
LnGrp Delay(d),s/veh	38.3	40.1	40.7	92.9	37.3	37.2	21.8	22.4	23.2	43.9	0.0	39.9
LnGrp LOS	D	D	D	F	D	D	C	C	C	D	A	D
Approach Vol, veh/h		807			677			536			321	
Approach Delay, s/veh		40.2			47.0			22.5			42.3	
Approach LOS		D			D			C			D	
Timer - Assigned Phs		2	3	4		6	7	8				
Phs Duration (G+Y+Rc), s		36.0	11.0	26.6		16.3	15.3	22.3				
Change Period (Y+Rc), s		4.5	4.5	4.5		4.5	4.5	4.5				
Max Green Setting (Gmax), s		20.0	6.5	27.5		18.0	6.5	27.5				
Max Q Clear Time (g_c+I1), s		9.8	7.9	19.3		11.0	6.5	14.9				
Green Ext Time (p_c), s		1.7	0.0	2.8		0.8	0.0	2.7				
Intersection Summary												
HCM 6th Ctrl Delay				38.4								
HCM 6th LOS				D								

HCM 6th Signalized Intersection Summary
 37: Olive Avenue/Q Street & Howard Road/Yosemite Avenue

Village D Specific Plan
 Phase III NP - PM Peak Hour



Movement	EBL	EBT	EBR	WBL	WBT	WBR	NBL	NBT	NBR	SBL	SBT	SBR
Lane Configurations												
Traffic Volume (veh/h)	7	452	269	14	361	15	330	76	13	17	58	2
Future Volume (veh/h)	7	452	269	14	361	15	330	76	13	17	58	2
Initial Q (Qb), veh	0	0	0	0	0	0	0	0	0	0	0	0
Ped-Bike Adj(A_pbT)	1.00		1.00	1.00		1.00	1.00		0.99	1.00		0.99
Parking Bus, Adj	1.00	1.00	1.00	1.00	1.00	1.00	1.00	1.00	1.00	1.00	1.00	1.00
Work Zone On Approach		No			No			No			No	
Adj Sat Flow, veh/h/ln	1870	1870	1870	1885	1885	1885	1885	1885	1885	1885	1885	1885
Adj Flow Rate, veh/h	8	491	0	15	392	16	418	0	14	18	63	2
Peak Hour Factor	0.92	0.92	0.92	0.92	0.92	0.92	0.92	0.92	0.92	0.92	0.92	0.92
Percent Heavy Veh, %	2	2	2	1	1	1	1	1	1	1	1	1
Cap, veh/h	18	604		100	756	31	1869	0	820	97	102	85
Arrive On Green	0.01	0.17	0.00	0.06	0.22	0.22	0.52	0.00	0.52	0.05	0.05	0.05
Sat Flow, veh/h	1781	3554	1585	1795	3507	143	3591	0	1576	1795	1885	1580
Grp Volume(v), veh/h	8	491	0	15	200	208	418	0	14	18	63	2
Grp Sat Flow(s),veh/h/ln	1781	1777	1585	1795	1791	1859	1795	0	1576	1795	1885	1580
Q Serve(g_s), s	0.4	12.0	0.0	0.7	8.9	8.9	5.7	0.0	0.4	0.9	2.9	0.1
Cycle Q Clear(g_c), s	0.4	12.0	0.0	0.7	8.9	8.9	5.7	0.0	0.4	0.9	2.9	0.1
Prop In Lane	1.00		1.00	1.00		0.08	1.00		1.00	1.00		1.00
Lane Grp Cap(c), veh/h	18	604		100	386	401	1869	0	820	97	102	85
V/C Ratio(X)	0.45	0.81		0.15	0.52	0.52	0.22	0.00	0.02	0.19	0.62	0.02
Avail Cap(c_a), veh/h	99	711		359	617	640	1869	0	820	359	377	316
HCM Platoon Ratio	1.00	1.00	1.00	1.00	1.00	1.00	1.00	1.00	1.00	1.00	1.00	1.00
Upstream Filter(I)	0.68	0.68	0.00	1.00	1.00	1.00	1.00	0.00	1.00	1.00	1.00	1.00
Uniform Delay (d), s/veh	44.3	36.0	0.0	40.5	31.2	31.2	11.7	0.0	10.4	40.7	41.7	40.3
Incr Delay (d2), s/veh	11.4	4.3	0.0	0.7	1.1	1.0	0.3	0.0	0.0	0.9	6.0	0.1
Initial Q Delay(d3),s/veh	0.0	0.0	0.0	0.0	0.0	0.0	0.0	0.0	0.0	0.0	0.0	0.0
%ile BackOfQ(50%),veh/ln	0.2	5.4	0.0	0.3	3.9	4.0	2.2	0.0	0.1	0.4	1.5	0.0
Unsig. Movement Delay, s/veh												
LnGrp Delay(d),s/veh	55.6	40.3	0.0	41.2	32.2	32.2	12.0	0.0	10.5	41.6	47.7	40.4
LnGrp LOS	E	D		D	C	C	B	A	B	D	D	D
Approach Vol, veh/h		499	A		423		432				83	
Approach Delay, s/veh		40.5			32.6		11.9				46.2	
Approach LOS		D			C		B				D	
Timer - Assigned Phs		2	3	4		6	7	8				
Phs Duration (G+Y+Rc), s		51.3	9.5	19.8		9.4	5.4	23.9				
Change Period (Y+Rc), s		4.5	4.5	4.5		4.5	4.5	4.5				
Max Green Setting (Gmax), s		18.0	18.0	18.0		18.0	5.0	31.0				
Max Q Clear Time (g_c+I1), s		7.7	2.7	14.0		4.9	2.4	10.9				
Green Ext Time (p_c), s		1.2	0.0	1.2		0.2	0.0	2.3				

Intersection Summary

HCM 6th Ctrl Delay	29.9
HCM 6th LOS	C

Notes

User approved volume balancing among the lanes for turning movement.
 Unsignalized Delay for [EBR] is excluded from calculations of the approach delay and intersection delay.

Intersection												
Int Delay, s/veh	10.5											
Movement	EBL	EBT	EBR	WBL	WBT	WBR	NBL	NBT	NBR	SBL	SBT	SBR
Lane Configurations		↔			↔	↔	↔	↔			↔	
Traffic Vol, veh/h	0	0	44	296	15	5	54	160	0	0	122	0
Future Vol, veh/h	0	0	44	296	15	5	54	160	0	0	122	0
Conflicting Peds, #/hr	0	0	0	0	0	0	1	0	1	1	0	1
Sign Control	Stop	Stop	Stop	Stop	Stop	Stop	Free	Free	Free	Free	Free	Free
RT Channelized	-	-	None	-	-	Stop	-	-	None	-	-	None
Storage Length	-	-	-	-	-	50	75	-	-	-	-	-
Veh in Median Storage, #	-	0	-	-	0	-	-	0	-	-	0	-
Grade, %	-	0	-	-	0	-	-	0	-	-	0	-
Peak Hour Factor	98	98	98	98	98	98	98	98	98	98	98	98
Heavy Vehicles, %	0	0	0	3	3	3	0	0	0	0	0	0
Mvmt Flow	0	0	45	302	15	5	55	163	0	0	124	0

Major/Minor	Minor2		Minor1		Major1		Major2					
Conflicting Flow All	406	398	125	420	398	163	125	0	-	-	-	0
Stage 1	125	125	-	273	273	-	-	-	-	-	-	-
Stage 2	281	273	-	147	125	-	-	-	-	-	-	-
Critical Hdwy	7.1	6.5	6.2	7.13	6.53	6.23	4.1	-	-	-	-	-
Critical Hdwy Stg 1	6.1	5.5	-	6.13	5.53	-	-	-	-	-	-	-
Critical Hdwy Stg 2	6.1	5.5	-	6.13	5.53	-	-	-	-	-	-	-
Follow-up Hdwy	3.5	4	3.3	3.527	4.027	3.327	2.2	-	-	-	-	-
Pot Cap-1 Maneuver	602	570	931	583	566	951	1474	-	0	0	-	-
Stage 1	884	796	-	775	702	-	-	-	0	0	-	-
Stage 2	773	707	-	853	791	-	-	-	0	0	-	-
Platoon blocked, %	1	1		1	1	1		-			-	-
Mov Cap-1 Maneuver	569	549	930	539	544	951	1473	-	-	-	-	-
Mov Cap-2 Maneuver	569	549	-	539	544	-	-	-	-	-	-	-
Stage 1	850	795	-	746	676	-	-	-	-	-	-	-
Stage 2	723	681	-	812	790	-	-	-	-	-	-	-

Approach	EB		WB		NB		SB			
HCM Control Delay, s	9.1		20.6		1.9		0			
HCM LOS	A		C							

Minor Lane/Major Mvmt	NBL	NBT	EBLn1	WBLn1	WBLn2	SBT	SBR
Capacity (veh/h)	1473	-	930	539	951	-	-
HCM Lane V/C Ratio	0.037	-	0.048	0.589	0.005	-	-
HCM Control Delay (s)	7.5	-	9.1	20.8	8.8	-	-
HCM Lane LOS	A	-	A	C	A	-	-
HCM 95th %tile Q(veh)	0.1	-	0.2	3.8	0	-	-

HCM 6th Signalized Intersection Summary
 39: 4th Street & Sunset Avenue

Village D Specific Plan
 Phase III NP - PM Peak Hour



Movement	EBL	EBR	NBL	NBT	SBT	SBR
Lane Configurations	LT		LT	TH	TH	LT
Traffic Volume (veh/h)	238	14	14	350	409	378
Future Volume (veh/h)	238	14	14	350	409	378
Initial Q (Qb), veh	0	0	0	0	0	0
Ped-Bike Adj(A_pbT)	1.00	1.00	1.00			1.00
Parking Bus, Adj	1.00	1.00	1.00	1.00	1.00	1.00
Work Zone On Approach	No			No	No	
Adj Sat Flow, veh/h/ln	1900	1900	1856	1856	1856	1856
Adj Flow Rate, veh/h	273	0	15	380	445	411
Peak Hour Factor	0.92	0.92	0.92	0.92	0.92	0.92
Percent Heavy Veh, %	0	0	3	3	3	3
Cap, veh/h	368	164	598	2849	789	828
Arrive On Green	0.10	0.00	0.34	0.81	0.85	0.85
Sat Flow, veh/h	3619	1610	1767	3618	1856	1571
Grp Volume(v), veh/h	273	0	15	380	445	411
Grp Sat Flow(s),veh/h/ln	1810	1610	1767	1763	1856	1571
Q Serve(g_s), s	7.3	0.0	0.6	2.3	6.9	6.8
Cycle Q Clear(g_c), s	7.3	0.0	0.6	2.3	6.9	6.8
Prop In Lane	1.00	1.00	1.00			1.00
Lane Grp Cap(c), veh/h	368	164	598	2849	789	828
V/C Ratio(X)	0.74	0.00	0.03	0.13	0.56	0.50
Avail Cap(c_a), veh/h	995	443	598	2849	789	828
HCM Platoon Ratio	1.00	1.00	1.00	1.00	2.00	2.00
Upstream Filter(I)	1.00	0.00	1.00	1.00	0.75	0.75
Uniform Delay (d), s/veh	43.6	0.0	22.1	2.1	4.8	3.3
Incr Delay (d2), s/veh	2.9	0.0	0.0	0.1	2.2	1.6
Initial Q Delay(d3),s/veh	0.0	0.0	0.0	0.0	0.0	0.0
%ile BackOfQ(50%),veh/ln	3.4	0.0	0.2	0.6	2.1	1.9
Unsig. Movement Delay, s/veh						
LnGrp Delay(d),s/veh	46.6	0.0	22.1	2.2	7.0	4.9
LnGrp LOS	D	A	C	A	A	A
Approach Vol, veh/h	273			395	856	
Approach Delay, s/veh	46.6			2.9	6.0	
Approach LOS	D			A	A	
Timer - Assigned Phs		2		4	5	6
Phs Duration (G+Y+Rc), s		85.3		14.7	38.3	47.0
Change Period (Y+Rc), s		4.5		4.5	4.5	4.5
Max Green Setting (Gmax), s		63.5		27.5	16.5	42.5
Max Q Clear Time (g_c+I1), s		4.3		9.3	2.6	8.9
Green Ext Time (p_c), s		2.8		0.9	0.0	4.8

Intersection Summary

HCM 6th Ctrl Delay	12.5
HCM 6th LOS	B

Notes

User approved volume balancing among the lanes for turning movement.

40: H Street & SR-99 Southbound On-Ramp/2nd Street Performance by movement

Movement	WBL	WBT	WBR	NBL	NBT	NBR	SBL	SBT	All
Denied Delay (hr)	0.0	0.0	0.0	0.0	0.0	0.0	0.0	0.0	0.0
Denied Del/Veh (s)	0.1	0.2	0.3	0.0	0.0	0.1	0.1	0.1	0.0
Total Delay (hr)	0.1	0.2	0.0	0.2	0.0	0.0	0.0	0.1	0.7
Total Del/Veh (s)	15.4	16.6	9.4	3.1	4.1	2.1	3.5	19.7	6.1
Stop Delay (hr)	0.1	0.1	0.0	0.0	0.0	0.0	0.0	0.1	0.4
Stop Del/Veh (s)	13.0	13.0	8.6	0.2	0.1	0.2	2.4	17.0	3.2

HCM 6th Signalized Intersection Summary
41: I Street & 4th Street

Village D Specific Plan
Phase III NP - PM Peak Hour



Movement	EBL	EBT	EBR	WBL	WBT	WBR	NBL	NBT	NBR	SBL	SBT	SBR
Lane Configurations	↖	↗		↖	↗		↖	↑	↗	↖	↑	↗
Traffic Volume (veh/h)	42	545	62	62	534	117	105	75	256	193	173	132
Future Volume (veh/h)	42	545	62	62	534	117	105	75	256	193	173	132
Initial Q (Qb), veh	0	0	0	0	0	0	0	0	0	0	0	0
Ped-Bike Adj(A_pbT)	1.00		0.99	1.00		0.99	1.00		1.00	1.00		0.99
Parking Bus, Adj	1.00	1.00	1.00	1.00	1.00	1.00	1.00	1.00	1.00	1.00	1.00	1.00
Work Zone On Approach		No			No			No			No	
Adj Sat Flow, veh/h/ln	1856	1856	1856	1885	1885	1885	1885	1885	1885	1870	1870	1870
Adj Flow Rate, veh/h	46	592	67	67	580	127	114	82	278	210	188	143
Peak Hour Factor	0.92	0.92	0.92	0.92	0.92	0.92	0.92	0.92	0.92	0.92	0.92	0.92
Percent Heavy Veh, %	3	3	3	1	1	1	1	1	1	2	2	2
Cap, veh/h	64	710	80	97	701	153	396	443	375	550	604	505
Arrive On Green	0.04	0.22	0.22	0.05	0.24	0.24	0.22	0.23	0.23	0.31	0.32	0.32
Sat Flow, veh/h	1767	3189	360	1795	2918	637	1795	1885	1598	1781	1870	1564
Grp Volume(v), veh/h	46	327	332	67	355	352	114	82	278	210	188	143
Grp Sat Flow(s),veh/h/ln	1767	1763	1787	1795	1791	1764	1795	1885	1598	1781	1870	1564
Q Serve(g_s), s	2.6	17.7	17.8	3.7	18.8	18.9	5.3	3.5	16.1	9.2	7.6	6.8
Cycle Q Clear(g_c), s	2.6	17.7	17.8	3.7	18.8	18.9	5.3	3.5	16.1	9.2	7.6	6.8
Prop In Lane	1.00		0.20	1.00		0.36	1.00		1.00	1.00		1.00
Lane Grp Cap(c), veh/h	64	392	398	97	430	424	396	443	375	550	604	505
V/C Ratio(X)	0.72	0.83	0.84	0.69	0.83	0.83	0.29	0.19	0.74	0.38	0.31	0.28
Avail Cap(c_a), veh/h	115	485	491	171	546	538	396	443	375	550	604	505
HCM Platoon Ratio	1.00	1.00	1.00	1.00	1.00	1.00	1.00	1.00	1.00	1.00	1.00	1.00
Upstream Filter(I)	0.96	0.96	0.96	1.00	1.00	1.00	1.00	1.00	1.00	1.00	1.00	1.00
Uniform Delay (d), s/veh	47.7	37.1	37.1	46.5	36.0	36.1	32.4	30.6	35.4	27.1	25.5	25.2
Incr Delay (d2), s/veh	13.7	9.5	9.6	8.6	8.1	8.5	0.4	0.9	12.4	0.4	1.3	1.4
Initial Q Delay(d3),s/veh	0.0	0.0	0.0	0.0	0.0	0.0	0.0	0.0	0.0	0.0	0.0	0.0
%ile BackOfQ(50%),veh/ln	4	8.5	8.7	1.9	9.0	9.0	2.3	1.7	7.5	4.0	3.6	2.7
Unsig. Movement Delay, s/veh												
LnGrp Delay(d),s/veh	61.4	46.6	46.8	55.1	44.1	44.6	32.8	31.5	47.8	27.5	26.8	26.6
LnGrp LOS	E	D	D	E	D	D	C	C	D	C	C	C
Approach Vol, veh/h		705			774			474			541	
Approach Delay, s/veh		47.7			45.3			41.4			27.0	
Approach LOS		D			D			D			C	
Timer - Assigned Phs	1	2	3	4	5	6	7	8				
Phs Duration (G+Y+Rc), s	35.4	28.0	9.9	26.8	26.6	36.8	8.1	28.5				
Change Period (Y+Rc), s	4.5	4.5	4.5	4.5	4.5	4.5	4.5	4.5				
Max Green Setting (Gmax), s	21.5	23.5	9.5	27.5	12.7	32.3	6.5	30.5				
Max Q Clear Time (g_c+I), s	11.2	18.1	5.7	19.8	7.3	9.6	4.6	20.9				
Green Ext Time (p_c), s	0.4	0.7	0.0	2.5	0.1	1.5	0.0	3.1				

Intersection Summary

HCM 6th Ctrl Delay	41.3
HCM 6th LOS	D

HCM 6th Signalized Intersection Summary
 43: SR-99 Northbound Off-Ramp/H Street & 4th Street

Village D Specific Plan
 Phase III NP - PM Peak Hour



Movement	EBL	EBT	EBR	WBL	WBT	WBR	NBL	NBT	NBR	SBL	SBT	SBR
Lane Configurations												
Traffic Volume (veh/h)	271	407	0	0	562	171	285	40	208	34	0	92
Future Volume (veh/h)	271	407	0	0	562	171	285	40	208	34	0	92
Initial Q (Qb), veh	0	0	0	0	0	0	0	0	0	0	0	0
Ped-Bike Adj(A_pbT)	1.00		1.00	1.00		0.99	1.00		0.99	1.00		0.99
Parking Bus, Adj	1.00	1.00	1.00	1.00	1.00	1.00	1.00	1.00	1.00	1.00	1.00	1.00
Work Zone On Approach		No			No			No			No	
Adj Sat Flow, veh/h/ln	1885	1885	0	0	1885	1885	1885	1885	1885	1900	1900	1900
Adj Flow Rate, veh/h	288	433	0	0	598	182	303	43	221	36	0	98
Peak Hour Factor	0.94	0.94	0.94	0.94	0.94	0.94	0.94	0.94	0.94	0.94	0.94	0.94
Percent Heavy Veh, %	1	1	0	0	1	1	1	1	1	0	0	0
Cap, veh/h	321	1643	0	0	634	193	407	60	307	79	0	216
Arrive On Green	0.18	0.46	0.00	0.00	0.23	0.23	0.23	0.23	0.23	0.18	0.00	0.18
Sat Flow, veh/h	1795	3676	0	0	2793	820	1795	263	1354	441	0	1201
Grp Volume(v), veh/h	288	433	0	0	396	384	303	0	264	134	0	0
Grp Sat Flow(s),veh/h/ln	1795	1791	0	0	1791	1727	1795	0	1617	1643	0	0
Q Serve(g_s), s	15.7	7.4	0.0	0.0	21.7	21.8	15.7	0.0	15.1	7.3	0.0	0.0
Cycle Q Clear(g_c), s	15.7	7.4	0.0	0.0	21.7	21.8	15.7	0.0	15.1	7.3	0.0	0.0
Prop In Lane	1.00		0.00	0.00		0.47	1.00		0.84	0.27		0.73
Lane Grp Cap(c), veh/h	321	1643	0	0	421	406	407	0	366	296	0	0
V/C Ratio(X)	0.90	0.26	0.00	0.00	0.94	0.95	0.75	0.00	0.72	0.45	0.00	0.00
Avail Cap(c_a), veh/h	350	1701	0	0	421	406	407	0	366	296	0	0
HCM Platoon Ratio	1.00	1.00	1.00	1.00	1.00	1.00	1.00	1.00	1.00	1.00	1.00	1.00
Upstream Filter(I)	1.00	1.00	0.00	0.00	1.00	1.00	1.00	0.00	1.00	1.00	0.00	0.00
Uniform Delay (d), s/veh	40.2	16.7	0.0	0.0	37.6	37.6	36.0	0.0	35.8	36.6	0.0	0.0
Incr Delay (d2), s/veh	23.6	0.1	0.0	0.0	29.6	30.9	11.8	0.0	11.6	4.9	0.0	0.0
Initial Q Delay(d3),s/veh	0.0	0.0	0.0	0.0	0.0	0.0	0.0	0.0	0.0	0.0	0.0	0.0
%ile BackOfQ(50%),veh/ln	8.9	3.0	0.0	0.0	12.8	12.5	8.1	0.0	7.0	3.3	0.0	0.0
Unsig. Movement Delay, s/veh												
LnGrp Delay(d),s/veh	63.8	16.8	0.0	0.0	67.2	68.6	47.7	0.0	47.4	41.6	0.0	0.0
LnGrp LOS	E	B	A	A	E	E	D	A	D	D	A	A
Approach Vol, veh/h		721			780			567			134	
Approach Delay, s/veh		35.5			67.8			47.6			41.6	
Approach LOS		D			E			D			D	
Timer - Assigned Phs		2		4		6	7	8				
Phs Duration (G+Y+Rc), s		27.1		50.4		22.5	22.4	28.0				
Change Period (Y+Rc), s		4.5		4.5		4.5	4.5	4.5				
Max Green Setting (Gmax), s		21.0		47.5		18.0	19.5	23.5				
Max Q Clear Time (g_c+I1), s		17.7		9.4		9.3	17.7	23.8				
Green Ext Time (p_c), s		0.9		3.2		0.4	0.2	0.0				
Intersection Summary												
HCM 6th Ctrl Delay				50.4								
HCM 6th LOS				D								

Intersection						
Int Delay, s/veh	4.3					
Movement	EBL	EBT	WBT	WBR	SBL	SBR
Lane Configurations	↖	↗	↖		↖	↖
Traffic Vol, veh/h	90	502	492	113	160	111
Future Vol, veh/h	90	502	492	113	160	111
Conflicting Peds, #/hr	0	0	0	0	0	0
Sign Control	Free	Free	Free	Free	Stop	Stop
RT Channelized	-	None	-	None	-	None
Storage Length	145	-	-	-	65	0
Veh in Median Storage, #	-	0	0	-	0	-
Grade, %	-	0	0	-	0	-
Peak Hour Factor	95	95	95	95	95	95
Heavy Vehicles, %	2	2	1	1	1	1
Mvmt Flow	95	528	518	119	168	117

Major/Minor	Major1	Major2	Minor2		
Conflicting Flow All	637	0	-	0	1032 319
Stage 1	-	-	-	-	578 -
Stage 2	-	-	-	-	454 -
Critical Hdwy	4.14	-	-	-	6.82 6.92
Critical Hdwy Stg 1	-	-	-	-	5.82 -
Critical Hdwy Stg 2	-	-	-	-	5.82 -
Follow-up Hdwy	2.22	-	-	-	3.51 3.31
Pot Cap-1 Maneuver	1182	-	-	-	345 *902
Stage 1	-	-	-	-	775 -
Stage 2	-	-	-	-	609 -
Platoon blocked, %	1	-	-	-	1 1
Mov Cap-1 Maneuver	1182	-	-	-	318 *902
Mov Cap-2 Maneuver	-	-	-	-	318 -
Stage 1	-	-	-	-	713 -
Stage 2	-	-	-	-	609 -

Approach	EB	WB	SB
HCM Control Delay, s	1.3	0	20.7
HCM LOS			C

Minor Lane/Major Mvmt	EBL	EBT	WBT	WBR	SBLn1	SBLn2
Capacity (veh/h)	1182	-	-	-	318	902
HCM Lane V/C Ratio	0.08	-	-	-	0.53	0.13
HCM Control Delay (s)	8.3	-	-	-	28.4	9.6
HCM Lane LOS	A	-	-	-	D	A
HCM 95th %tile Q(veh)	0.3	-	-	-	2.9	0.4

Notes
 -: Volume exceeds capacity \$: Delay exceeds 300s +: Computation Not Defined *: All major volume in platoon

HCM 6th Signalized Intersection Summary
 45: Olive Avenue & SR-99 Southbound Off-Ramp

Village D Specific Plan
 Phase III NP - PM Peak Hour



Movement	EBL	EBT	WBT	WBR	SBL	SBR
Lane Configurations		↑↑↑	↑↑		↙	↗
Traffic Volume (veh/h)	0	661	503	0	674	102
Future Volume (veh/h)	0	661	503	0	674	102
Initial Q (Qb), veh	0	0	0	0	0	0
Ped-Bike Adj(A_pbT)	1.00			1.00	1.00	1.00
Parking Bus, Adj	1.00	1.00	1.00	1.00	1.00	1.00
Work Zone On Approach		No	No		No	
Adj Sat Flow, veh/h/ln	0	1870	1885	0	1826	1826
Adj Flow Rate, veh/h	0	696	529	0	709	107
Peak Hour Factor	0.95	0.95	0.95	0.95	0.95	0.95
Percent Heavy Veh, %	0	2	1	0	5	5
Cap, veh/h	0	908	637	0	1256	1117
Arrive On Green	0.00	0.18	0.18	0.00	0.72	0.72
Sat Flow, veh/h	0	5443	3770	0	1739	1547
Grp Volume(v), veh/h	0	696	529	0	709	107
Grp Sat Flow(s),veh/h/ln	0	1702	1791	0	1739	1547
Q Serve(g_s), s	0.0	11.7	12.8	0.0	17.2	1.9
Cycle Q Clear(g_c), s	0.0	11.7	12.8	0.0	17.2	1.9
Prop In Lane	0.00			0.00	1.00	1.00
Lane Grp Cap(c), veh/h	0	908	637	0	1256	1117
V/C Ratio(X)	0.00	0.77	0.83	0.00	0.56	0.10
Avail Cap(c_a), veh/h	0	1050	736	0	1256	1117
HCM Platoon Ratio	1.00	1.00	1.00	1.00	1.00	1.00
Upstream Filter(I)	0.00	1.00	0.90	0.00	1.00	1.00
Uniform Delay (d), s/veh	0.0	35.2	35.7	0.0	5.9	3.7
Incr Delay (d2), s/veh	0.0	3.0	6.4	0.0	1.8	0.2
Initial Q Delay(d3),s/veh	0.0	0.0	0.0	0.0	0.0	0.0
%ile BackOfQ(50%),veh/ln	0.0	5.0	6.0	0.0	5.5	0.5
Unsig. Movement Delay, s/veh						
LnGrp Delay(d),s/veh	0.0	38.2	42.1	0.0	7.7	3.9
LnGrp LOS	A	D	D	A	A	A
Approach Vol, veh/h		696	529		816	
Approach Delay, s/veh		38.2	42.1		7.2	
Approach LOS		D	D		A	
Timer - Assigned Phs				4	6	8
Phs Duration (G+Y+Rc), s				20.5	69.5	20.5
Change Period (Y+Rc), s				4.5	4.5	4.5
Max Green Setting (Gmax), s				18.5	62.5	18.5
Max Q Clear Time (g_c+I1), s				13.7	19.2	14.8
Green Ext Time (p_c), s				2.0	3.2	1.2
Intersection Summary						
HCM 6th Ctrl Delay			26.8			
HCM 6th LOS			C			

HCM 6th Signalized Intersection Summary
 46: Madera Avenue & SR-99 Northbound Ramps

Village D Specific Plan
 Phase III NP - PM Peak Hour



Movement	EBL	EBT	EBR	WBL	WBT	WBR	NBL	NBT	NBR	SBL	SBT	SBR
Lane Configurations				↶	↷	↶	↶↷	↶↷			↶↷	
Traffic Volume (veh/h)	0	0	0	209	1	34	820	753	0	0	691	178
Future Volume (veh/h)	0	0	0	209	1	34	820	753	0	0	691	178
Initial Q (Qb), veh				0	0	0	0	0	0	0	0	0
Ped-Bike Adj(A_pbT)				1.00		0.99	1.00		1.00	1.00		1.00
Parking Bus, Adj				1.00	1.00	1.00	1.00	1.00	1.00	1.00	1.00	1.00
Work Zone On Approach				No			No			No		
Adj Sat Flow, veh/h/ln				1885	1885	1885	1870	1870	0	0	1870	1870
Adj Flow Rate, veh/h				228	0	37	891	818	0	0	751	193
Peak Hour Factor				0.92	0.92	0.92	0.92	0.92	0.92	0.92	0.92	0.92
Percent Heavy Veh, %				1	1	1	2	2	0	0	2	2
Cap, veh/h				327	0	143	1263	2875	0	0	1100	283
Arrive On Green				0.09	0.00	0.09	0.61	1.00	0.00	0.00	0.39	0.39
Sat Flow, veh/h				3591	0	1575	3456	3647	0	0	2890	719
Grp Volume(v), veh/h				228	0	37	891	818	0	0	477	467
Grp Sat Flow(s),veh/h/ln				1795	0	1575	1728	1777	0	0	1777	1738
Q Serve(g_s), s				5.5	0.0	2.0	15.9	0.0	0.0	0.0	20.0	20.0
Cycle Q Clear(g_c), s				5.5	0.0	2.0	15.9	0.0	0.0	0.0	20.0	20.0
Prop In Lane				1.00		1.00	1.00		0.00	0.00		0.41
Lane Grp Cap(c), veh/h				327	0	143	1263	2875	0	0	699	684
V/C Ratio(X)				0.70	0.00	0.26	0.71	0.28	0.00	0.00	0.68	0.68
Avail Cap(c_a), veh/h				742	0	325	1263	2875	0	0	699	684
HCM Platoon Ratio				1.00	1.00	1.00	1.67	1.67	1.00	1.00	1.00	1.00
Upstream Filter(I)				1.00	0.00	1.00	0.58	0.58	0.00	0.00	1.00	1.00
Uniform Delay (d), s/veh				39.7	0.0	38.1	14.2	0.0	0.0	0.0	22.6	22.6
Incr Delay (d2), s/veh				2.7	0.0	0.9	1.1	0.1	0.0	0.0	5.3	5.5
Initial Q Delay(d3),s/veh				0.0	0.0	0.0	0.0	0.0	0.0	0.0	0.0	0.0
%ile BackOfQ(50%),veh/ln				2.5	0.0	0.8	4.4	0.1	0.0	0.0	9.0	8.9
Unsig. Movement Delay, s/veh												
LnGrp Delay(d),s/veh				42.4	0.0	39.0	15.3	0.1	0.0	0.0	28.0	28.1
LnGrp LOS				D	A	D	B	A	A	A	C	C
Approach Vol, veh/h					265			1709			944	
Approach Delay, s/veh					41.9			8.0			28.0	
Approach LOS					D			A			C	
Timer - Assigned Phs		2			5	6		8				
Phs Duration (G+Y+Rc), s		77.3			37.4	39.9		12.7				
Change Period (Y+Rc), s		4.5			4.5	4.5		4.5				
Max Green Setting (Gmax), s		62.4			22.5	35.4		18.6				
Max Q Clear Time (g_c+I1), s		2.0			17.9	22.0		7.5				
Green Ext Time (p_c), s		7.1			1.7	5.2		0.7				

Intersection Summary

HCM 6th Ctrl Delay	17.6
HCM 6th LOS	B

Notes

User approved volume balancing among the lanes for turning movement.

HCM 6th Signalized Intersection Summary
 47: Madera Avenue & Olive Avenue/SR-99 Southbound On-Ramp

Village D Specific Plan
 Phase III NP - PM Peak Hour



Movement	EBL	EBT	EBR	WBL	WBT	WBR	NBL	NBT	NBR	SBL	SBT	SBR
Lane Configurations												
Traffic Volume (veh/h)	492	196	647	0	0	0	197	1081	52	137	458	306
Future Volume (veh/h)	492	196	647	0	0	0	197	1081	52	137	458	306
Initial Q (Qb), veh	0	0	0				0	0	0	0	0	0
Ped-Bike Adj(A_pbT)	1.00		1.00				1.00		1.00	1.00		1.00
Parking Bus, Adj	1.00	1.00	1.00				1.00	1.00	1.00	1.00	1.00	1.00
Work Zone On Approach		No					No			No		
Adj Sat Flow, veh/h/ln	1856	1856	1856				1870	1870	1870	1885	1885	1885
Adj Flow Rate, veh/h	354	415	667				203	1114	54	141	472	315
Peak Hour Factor	0.97	0.97	0.97				0.97	0.97	0.97	0.97	0.97	0.97
Percent Heavy Veh, %	3	3	3				2	2	2	1	1	1
Cap, veh/h	638	670	698				288	1346	65	177	836	555
Arrive On Green	0.36	0.36	0.36				0.08	0.39	0.39	0.03	0.13	0.13
Sat Flow, veh/h	1767	1856	1571				3456	3450	167	1795	2060	1369
Grp Volume(v), veh/h	354	415	667				203	574	594	141	410	377
Grp Sat Flow(s),veh/h/ln	1767	1856	1571				1728	1777	1840	1795	1791	1639
Q Serve(g_s), s	14.4	16.6	32.5				5.1	26.2	26.2	7.0	19.3	19.4
Cycle Q Clear(g_c), s	14.4	16.6	32.5				5.1	26.2	26.2	7.0	19.3	19.4
Prop In Lane	1.00		1.00				1.00		0.09	1.00		0.84
Lane Grp Cap(c), veh/h	638	670	698				288	693	718	177	727	665
V/C Ratio(X)	0.55	0.62	0.96				0.71	0.83	0.83	0.80	0.56	0.57
Avail Cap(c_a), veh/h	638	670	698				576	693	718	269	727	665
HCM Platoon Ratio	1.00	1.00	1.00				1.00	1.00	1.00	0.33	0.33	0.33
Upstream Filter(I)	0.72	0.72	0.72				1.00	1.00	1.00	0.80	0.80	0.80
Uniform Delay (d), s/veh	23.0	23.7	24.1				40.2	24.7	24.7	42.6	31.5	31.6
Incr Delay (d2), s/veh	0.8	1.3	19.0				3.2	10.9	10.6	7.4	2.5	2.8
Initial Q Delay(d3),s/veh	0.0	0.0	0.0				0.0	0.0	0.0	0.0	0.0	0.0
%ile BackOfQ(50%),veh/ln	5.9	7.2	29.6				2.3	12.6	13.0	3.6	9.7	9.0
Unsig. Movement Delay, s/veh												
LnGrp Delay(d),s/veh	23.7	24.9	43.1				43.4	35.6	35.3	50.1	34.1	34.4
LnGrp LOS	C	C	D				D	D	D	D	C	C
Approach Vol, veh/h		1436						1371			928	
Approach Delay, s/veh		33.1						36.6			36.6	
Approach LOS		C						D			D	
Timer - Assigned Phs	1	2		4	5	6						
Phs Duration (G+Y+Rc), s	33.4	39.6		37.0	12.0	41.0						
Change Period (Y+Rc), s	4.5	4.5		4.5	4.5	4.5						
Max Green Setting (Gmax), s	30.5	30.5		32.5	15.0	29.0						
Max Q Clear Time (g_c+I), s	28.2	28.2		34.5	7.1	21.4						
Green Ext Time (p_c), s	0.1	1.6		0.0	0.4	3.0						

Intersection Summary

HCM 6th Ctrl Delay	35.3
HCM 6th LOS	D

Notes

User approved volume balancing among the lanes for turning movement.

Intersection						
Int Delay, s/veh	0.3					
Movement	WBL	WBR	NBT	NBR	SBL	SBT
Lane Configurations	↘↗		↑↓		↘↗	↑↑
Traffic Vol, veh/h	7	9	1364	7	33	1166
Future Vol, veh/h	7	9	1364	7	33	1166
Conflicting Peds, #/hr	0	0	0	2	2	0
Sign Control	Stop	Stop	Free	Free	Free	Free
RT Channelized	-	None	-	None	-	None
Storage Length	0	-	-	-	100	-
Veh in Median Storage, #	0	-	0	-	-	0
Grade, %	0	-	0	-	-	0
Peak Hour Factor	95	95	95	95	95	95
Heavy Vehicles, %	6	6	2	2	2	2
Mvmt Flow	7	9	1436	7	35	1227

Major/Minor	Minor1	Major1	Major2		
Conflicting Flow All	2126	724	0	0	1445
Stage 1	1442	-	-	-	-
Stage 2	684	-	-	-	-
Critical Hdwy	6.92	7.02	-	-	4.14
Critical Hdwy Stg 1	5.92	-	-	-	-
Critical Hdwy Stg 2	5.92	-	-	-	-
Follow-up Hdwy	3.56	3.36	-	-	2.22
Pot Cap-1 Maneuver	*70	359	-	-	465
Stage 1	*177	-	-	-	-
Stage 2	*547	-	-	-	-
Platoon blocked, %	1	-	-	-	-
Mov Cap-1 Maneuver	*64	358	-	-	464
Mov Cap-2 Maneuver	*141	-	-	-	-
Stage 1	*177	-	-	-	-
Stage 2	*506	-	-	-	-

Approach	WB	NB	SB
HCM Control Delay, s	23.3	0	0.4
HCM LOS	C		

Minor Lane/Major Mvmt	NBT	NBRWBLn1	SBL	SBT
Capacity (veh/h)	-	-	214	464
HCM Lane V/C Ratio	-	-	0.079	0.075
HCM Control Delay (s)	-	-	23.3	13.4
HCM Lane LOS	-	-	C	B
HCM 95th %tile Q(veh)	-	-	0.3	0.2

Notes
 -: Volume exceeds capacity \$: Delay exceeds 300s +: Computation Not Defined *: All major volume in platoon

HCM 6th Signalized Intersection Summary
49: Yosemite Avenue & Cleveland Avenue/Tozer Street

Village D Specific Plan
Phase III NP - PM Peak Hour



Movement	EBL	EBT	EBR	WBL	WBT	WBR	NBL	NBT	NBR	SBL	SBT	SBR
Lane Configurations												
Traffic Volume (veh/h)	250	467	203	52	499	49	320	329	100	83	188	240
Future Volume (veh/h)	250	467	203	52	499	49	320	329	100	83	188	240
Initial Q (Qb), veh	0	0	0	0	0	0	0	0	0	0	0	0
Ped-Bike Adj(A_pbT)	1.00		0.99	1.00		0.96	1.00		1.00	1.00		0.98
Parking Bus, Adj	1.00	1.00	1.00	1.00	1.00	1.00	1.00	1.00	1.00	1.00	1.00	1.00
Work Zone On Approach		No			No			No			No	
Adj Sat Flow, veh/h/ln	1870	1870	1870	1900	1900	1900	1870	1870	1870	1870	1870	1870
Adj Flow Rate, veh/h	272	508	221	57	542	53	348	358	109	90	204	261
Peak Hour Factor	0.92	0.92	0.92	0.92	0.92	0.92	0.92	0.92	0.92	0.92	0.92	0.92
Percent Heavy Veh, %	2	2	2	0	0	0	2	2	2	2	2	2
Cap, veh/h	287	753	326	74	697	298	340	751	635	115	203	259
Arrive On Green	0.16	0.31	0.31	0.04	0.19	0.19	0.19	0.40	0.40	0.06	0.28	0.28
Sat Flow, veh/h	1781	2404	1040	1810	3610	1542	1781	1870	1580	1781	736	942
Grp Volume(v), veh/h	272	375	354	57	542	53	348	358	109	90	0	465
Grp Sat Flow(s),veh/h/ln	1781	1777	1667	1810	1805	1542	1781	1870	1580	1781	0	1679
Q Serve(g_s), s	15.1	18.4	18.5	3.1	14.3	2.9	19.1	14.2	4.4	5.0	0.0	27.5
Cycle Q Clear(g_c), s	15.1	18.4	18.5	3.1	14.3	2.9	19.1	14.2	4.4	5.0	0.0	27.5
Prop In Lane	1.00		0.62	1.00		1.00	1.00		1.00	1.00		0.56
Lane Grp Cap(c), veh/h	287	557	522	74	697	298	340	751	635	115	0	462
V/C Ratio(X)	0.95	0.67	0.68	0.77	0.78	0.18	1.02	0.48	0.17	0.78	0.00	1.01
Avail Cap(c_a), veh/h	287	557	522	103	697	298	340	751	635	173	0	462
HCM Platoon Ratio	1.00	1.00	1.00	1.00	1.00	1.00	1.00	1.00	1.00	1.00	1.00	1.00
Upstream Filter(I)	1.00	1.00	1.00	1.00	1.00	1.00	1.00	1.00	1.00	1.00	0.00	1.00
Uniform Delay (d), s/veh	41.5	29.9	29.9	47.5	38.3	33.7	40.4	22.1	19.2	46.1	0.0	36.3
Incr Delay (d2), s/veh	39.4	6.4	6.9	20.7	8.4	1.3	54.8	0.5	0.1	12.5	0.0	43.7
Initial Q Delay(d3),s/veh	0.0	0.0	0.0	0.0	0.0	0.0	0.0	0.0	0.0	0.0	0.0	0.0
%ile BackOfQ(50%),veh/ln	9.7	8.7	8.3	1.8	7.0	1.2	13.4	6.2	1.6	2.6	0.0	16.6
Unsig. Movement Delay, s/veh												
LnGrp Delay(d),s/veh	80.9	36.3	36.9	68.2	46.7	35.0	95.2	22.6	19.4	58.6	0.0	80.0
LnGrp LOS	F	D	D	E	D	D	F	C	B	E	A	F
Approach Vol, veh/h		1001			652			815			555	
Approach Delay, s/veh		48.6			47.6			53.2			76.5	
Approach LOS		D			D			D			E	
Timer - Assigned Phs	1	2	3	4	5	6	7	8				
Phs Duration (G+Y+Rc), s	20.6	23.8	10.9	44.7	8.6	35.8	23.6	32.0				
Change Period (Y+Rc), s	4.5	4.5	4.5	4.5	4.5	4.5	4.5	4.5				
Max Green Setting (Gmax), s	16.1	19.3	9.7	36.9	5.7	29.7	19.1	27.5				
Max Q Clear Time (g_c+I1), s	17.1	16.3	7.0	16.2	5.1	20.5	21.1	29.5				
Green Ext Time (p_c), s	0.0	1.1	0.0	2.5	0.0	3.2	0.0	0.0				

Intersection Summary

HCM 6th Ctrl Delay			54.7									
HCM 6th LOS			D									

Intersection						
Int Delay, s/veh	0					
Movement	EBT	EBR	WBL	WBT	NBL	NBR
Lane Configurations						
Traffic Vol, veh/h	73	0	0	39	0	0
Future Vol, veh/h	73	0	0	39	0	0
Conflicting Peds, #/hr	0	0	0	0	0	0
Sign Control	Free	Free	Free	Free	Stop	Stop
RT Channelized	-	None	-	None	-	None
Storage Length	-	-	-	-	-	-
Veh in Median Storage, #	0	-	-	0	0	-
Grade, %	0	-	-	0	0	-
Peak Hour Factor	92	92	92	92	92	92
Heavy Vehicles, %	4	4	4	4	0	0
Mvmt Flow	79	0	0	42	0	0

Major/Minor	Major1	Major2	Minor1	Minor2
Conflicting Flow All	0	0	79	0
Stage 1	-	-	-	79
Stage 2	-	-	-	42
Critical Hdwy	-	-	4.14	-
Critical Hdwy Stg 1	-	-	-	5.4
Critical Hdwy Stg 2	-	-	-	5.4
Follow-up Hdwy	-	-	2.236	-
Pot Cap-1 Maneuver	-	-	1507	-
Stage 1	-	-	-	949
Stage 2	-	-	-	986
Platoon blocked, %	-	-	-	-
Mov Cap-1 Maneuver	-	-	1507	-
Mov Cap-2 Maneuver	-	-	-	879
Stage 1	-	-	-	949
Stage 2	-	-	-	986

Approach	EB	WB	NB
HCM Control Delay, s	0	0	0
HCM LOS			A

Minor Lane/Major Mvmt	NBLn1	EBT	EBR	WBL	WBT
Capacity (veh/h)	-	-	-	1507	-
HCM Lane V/C Ratio	-	-	-	-	-
HCM Control Delay (s)	0	-	-	0	-
HCM Lane LOS	A	-	-	A	-
HCM 95th %tile Q(veh)	-	-	-	0	-

Intersection												
Int Delay, s/veh	0.2											
Movement	EBL	EBT	EBR	WBL	WBT	WBR	NBL	NBT	NBR	SBL	SBT	SBR
Lane Configurations		↕			↕			↕			↕	
Traffic Vol, veh/h	0	202	0	0	15	0	0	0	0	4	0	0
Future Vol, veh/h	0	202	0	0	15	0	0	0	0	4	0	0
Conflicting Peds, #/hr	0	0	0	0	0	0	0	0	0	0	0	0
Sign Control	Free	Free	Free	Free	Free	Free	Stop	Stop	Stop	Stop	Stop	Stop
RT Channelized	-	-	None	-	-	None	-	-	None	-	-	None
Storage Length	-	-	-	-	-	-	-	-	-	-	-	-
Veh in Median Storage, #	-	0	-	-	0	-	-	0	-	-	0	-
Grade, %	-	0	-	-	0	-	-	0	-	-	0	-
Peak Hour Factor	92	92	92	92	92	92	92	92	92	92	92	92
Heavy Vehicles, %	13	13	13	13	13	13	0	0	0	0	0	0
Mvmt Flow	0	220	0	0	16	0	0	0	0	4	0	0

Major/Minor	Major1			Major2			Minor1			Minor2		
Conflicting Flow All	16	0	0	220	0	0	236	236	220	236	236	16
Stage 1	-	-	-	-	-	-	220	220	-	16	16	-
Stage 2	-	-	-	-	-	-	16	16	-	220	220	-
Critical Hdwy	4.23	-	-	4.23	-	-	7.1	6.5	6.2	7.1	6.5	6.2
Critical Hdwy Stg 1	-	-	-	-	-	-	6.1	5.5	-	6.1	5.5	-
Critical Hdwy Stg 2	-	-	-	-	-	-	6.1	5.5	-	6.1	5.5	-
Follow-up Hdwy	2.317	-	-	2.317	-	-	3.5	4	3.3	3.5	4	3.3
Pot Cap-1 Maneuver	1533	-	-	1287	-	-	723	668	825	723	668	1069
Stage 1	-	-	-	-	-	-	787	725	-	1009	886	-
Stage 2	-	-	-	-	-	-	1009	886	-	787	725	-
Platoon blocked, %	-	-	-	-	-	-	-	-	-	-	-	-
Mov Cap-1 Maneuver	1533	-	-	1287	-	-	723	668	825	723	668	1069
Mov Cap-2 Maneuver	-	-	-	-	-	-	723	668	-	723	668	-
Stage 1	-	-	-	-	-	-	787	725	-	1009	886	-
Stage 2	-	-	-	-	-	-	1009	886	-	787	725	-

Approach	EB			WB			NB			SB		
HCM Control Delay, s	0			0			0			10		
HCM LOS							A			B		

Minor Lane/Major Mvmt	NBLn1	EBL	EBT	EBR	WBL	WBT	WBR	SBLn1
Capacity (veh/h)	-	1533	-	-	1287	-	-	723
HCM Lane V/C Ratio	-	-	-	-	-	-	-	0.006
HCM Control Delay (s)	0	0	-	-	0	-	-	10
HCM Lane LOS	A	A	-	-	A	-	-	B
HCM 95th %tile Q(veh)	-	0	-	-	0	-	-	0

Intersection						
Int Delay, s/veh	0					
Movement	WBL	WBR	NBT	NBR	SBL	SBT
Lane Configurations						
Traffic Vol, veh/h	0	0	0	0	1	0
Future Vol, veh/h	0	0	0	0	1	0
Conflicting Peds, #/hr	0	0	0	0	0	0
Sign Control	Stop	Stop	Free	Free	Free	Free
RT Channelized	-	None	-	None	-	None
Storage Length	-	-	-	-	-	-
Veh in Median Storage, #	0	-	0	-	-	0
Grade, %	0	-	0	-	-	0
Peak Hour Factor	92	92	92	92	92	92
Heavy Vehicles, %	0	0	0	0	0	0
Mvmt Flow	0	0	0	0	1	0

Major/Minor	Minor1	Major1	Major2			
Conflicting Flow All	2	0	0	0	0	0
Stage 1	0	-	-	-	-	-
Stage 2	2	-	-	-	-	-
Critical Hdwy	6.4	6.2	-	-	4.1	-
Critical Hdwy Stg 1	5.4	-	-	-	-	-
Critical Hdwy Stg 2	5.4	-	-	-	-	-
Follow-up Hdwy	3.5	3.3	-	-	2.2	-
Pot Cap-1 Maneuver	1026	-	-	-	-	-
Stage 1	-	-	-	-	-	-
Stage 2	1026	-	-	-	-	-
Platoon blocked, %						
Mov Cap-1 Maneuver	1026	-	-	-	-	-
Mov Cap-2 Maneuver	1026	-	-	-	-	-
Stage 1	-	-	-	-	-	-
Stage 2	1026	-	-	-	-	-

Approach	WB	NB	SB
HCM Control Delay, s	0	0	
HCM LOS	A		

Minor Lane/Major Mvmt	NBT	NBRWBLn1	SBL	SBT
Capacity (veh/h)	-	-	-	-
HCM Lane V/C Ratio	-	-	-	-
HCM Control Delay (s)	-	-	0	-
HCM Lane LOS	-	-	A	-
HCM 95th %tile Q(veh)	-	-	-	-

Intersection						
Int Delay, s/veh	0					
Movement	EBL	EBR	NBL	NBT	SBT	SBR
Lane Configurations	T			T		
Traffic Vol, veh/h	0	2	0	306	385	0
Future Vol, veh/h	0	2	0	306	385	0
Conflicting Peds, #/hr	0	0	0	0	0	0
Sign Control	Stop	Stop	Free	Free	Free	Free
RT Channelized	-	None	-	None	-	None
Storage Length	-	-	-	-	-	-
Veh in Median Storage, #	0	-	-	0	0	-
Grade, %	0	-	-	0	0	-
Peak Hour Factor	92	92	92	92	92	92
Heavy Vehicles, %	0	0	9	9	9	9
Mvmt Flow	0	2	0	333	418	0

Major/Minor	Minor2	Major1		Major2	
Conflicting Flow All	751	418	418	0	0
Stage 1	418	-	-	-	-
Stage 2	333	-	-	-	-
Critical Hdwy	6.4	6.2	4.19	-	-
Critical Hdwy Stg 1	5.4	-	-	-	-
Critical Hdwy Stg 2	5.4	-	-	-	-
Follow-up Hdwy	3.5	3.3	2.281	-	-
Pot Cap-1 Maneuver	381	639	1104	-	-
Stage 1	669	-	-	-	-
Stage 2	731	-	-	-	-
Platoon blocked, %				-	-
Mov Cap-1 Maneuver	381	639	1104	-	-
Mov Cap-2 Maneuver	381	-	-	-	-
Stage 1	669	-	-	-	-
Stage 2	731	-	-	-	-

Approach	EB	NB	SB
HCM Control Delay, s	10.7	0	0
HCM LOS	B		

Minor Lane/Major Mvmt	NBL	NBT	EBLn1	SBT	SBR
Capacity (veh/h)	1104	-	639	-	-
HCM Lane V/C Ratio	-	-	0.003	-	-
HCM Control Delay (s)	0	-	10.7	-	-
HCM Lane LOS	A	-	B	-	-
HCM 95th %tile Q(veh)	0	-	0	-	-

Intersection						
Int Delay, s/veh	1.6					
Movement	EBL	EBR	NBL	NBT	SBT	SBR
Lane Configurations	T			T		T
Traffic Vol, veh/h	60	23	0	279	347	36
Future Vol, veh/h	60	23	0	279	347	36
Conflicting Peds, #/hr	0	0	0	0	0	0
Sign Control	Stop	Stop	Free	Free	Free	Free
RT Channelized	-	None	-	None	-	None
Storage Length	0	-	-	-	-	-
Veh in Median Storage, #	0	-	-	0	0	-
Grade, %	0	-	-	0	0	-
Peak Hour Factor	92	92	92	92	92	92
Heavy Vehicles, %	0	0	9	9	9	9
Mvmt Flow	65	25	0	303	377	39

Major/Minor	Minor2	Major1		Major2	
Conflicting Flow All	700	397	416	0	0
Stage 1	397	-	-	-	-
Stage 2	303	-	-	-	-
Critical Hdwy	6.4	6.2	4.19	-	-
Critical Hdwy Stg 1	5.4	-	-	-	-
Critical Hdwy Stg 2	5.4	-	-	-	-
Follow-up Hdwy	3.5	3.3	2.281	-	-
Pot Cap-1 Maneuver	409	657	1106	-	-
Stage 1	683	-	-	-	-
Stage 2	754	-	-	-	-
Platoon blocked, %				-	-
Mov Cap-1 Maneuver	409	657	1106	-	-
Mov Cap-2 Maneuver	409	-	-	-	-
Stage 1	683	-	-	-	-
Stage 2	754	-	-	-	-

Approach	EB	NB	SB
HCM Control Delay, s	14.8	0	0
HCM LOS	B		

Minor Lane/Major Mvmt	NBL	NBT	EBLn1	SBT	SBR
Capacity (veh/h)	1106	-	457	-	-
HCM Lane V/C Ratio	-	-	0.197	-	-
HCM Control Delay (s)	0	-	14.8	-	-
HCM Lane LOS	A	-	B	-	-
HCM 95th %tile Q(veh)	0	-	0.7	-	-

Intersection						
Int Delay, s/veh	2.1					
Movement	EBT	EBR	WBL	WBT	NBL	NBR
Lane Configurations						
Traffic Vol, veh/h	68	9	10	120	32	14
Future Vol, veh/h	68	9	10	120	32	14
Conflicting Peds, #/hr	0	0	0	0	0	0
Sign Control	Free	Free	Free	Free	Stop	Stop
RT Channelized	-	None	-	None	-	None
Storage Length	-	-	50	-	-	-
Veh in Median Storage, #	0	-	-	0	0	-
Grade, %	0	-	-	0	0	-
Peak Hour Factor	92	92	92	92	92	92
Heavy Vehicles, %	7	7	4	4	0	0
Mvmt Flow	74	10	11	130	35	15

Major/Minor	Major1	Major2	Minor1		
Conflicting Flow All	0	0	84	0	231
Stage 1	-	-	-	-	79
Stage 2	-	-	-	-	152
Critical Hdwy	-	-	4.14	-	6.4
Critical Hdwy Stg 1	-	-	-	-	5.4
Critical Hdwy Stg 2	-	-	-	-	5.4
Follow-up Hdwy	-	-	2.236	-	3.5
Pot Cap-1 Maneuver	-	-	1500	-	762
Stage 1	-	-	-	-	949
Stage 2	-	-	-	-	881
Platoon blocked, %	-	-	-	-	-
Mov Cap-1 Maneuver	-	-	1500	-	757
Mov Cap-2 Maneuver	-	-	-	-	757
Stage 1	-	-	-	-	949
Stage 2	-	-	-	-	875

Approach	EB	WB	NB
HCM Control Delay, s	0	0.6	9.7
HCM LOS			A

Minor Lane/Major Mvmt	NBLn1	EBT	EBR	WBL	WBT
Capacity (veh/h)	815	-	-	1500	-
HCM Lane V/C Ratio	0.061	-	-	0.007	-
HCM Control Delay (s)	9.7	-	-	7.4	-
HCM Lane LOS	A	-	-	A	-
HCM 95th %tile Q(veh)	0.2	-	-	0	-

Intersection	
Intersection Delay, s/veh	7.5
Intersection LOS	A

Movement	EBL	EBT	EBR	WBL	WBT	WBR	NBL	NBT	NBR	SBL	SBT	SBR
Lane Configurations	↶	↷		↶	↷		↶	↷		↶	↷	
Traffic Vol, veh/h	2	13	0	0	30	21	0	21	0	5	14	1
Future Vol, veh/h	2	13	0	0	30	21	0	21	0	5	14	1
Peak Hour Factor	0.92	0.92	0.92	0.92	0.92	0.92	0.92	0.92	0.92	0.92	0.92	0.92
Heavy Vehicles, %	11	11	11	8	8	8	0	0	0	0	0	0
Mvmt Flow	2	14	0	0	33	23	0	23	0	5	15	1
Number of Lanes	1	1	0	1	1	0	1	1	0	1	1	0

Approach	EB	WB	NB	SB
Opposing Approach	WB	EB	SB	NB
Opposing Lanes	2	2	2	2
Conflicting Approach Left	SB	NB	EB	WB
Conflicting Lanes Left	2	2	2	2
Conflicting Approach Right	NB	SB	WB	EB
Conflicting Lanes Right	2	2	2	2
HCM Control Delay	7.7	7.5	7.5	7.5
HCM LOS	A	A	A	A

Lane	NBLn1	NBLn2	EBLn1	EBLn2	WBLn1	WBLn2	SBLn1	SBLn2
Vol Left, %	0%	0%	100%	0%	0%	0%	100%	0%
Vol Thru, %	100%	100%	0%	100%	100%	59%	0%	93%
Vol Right, %	0%	0%	0%	0%	0%	41%	0%	7%
Sign Control	Stop	Stop	Stop	Stop	Stop	Stop	Stop	Stop
Traffic Vol by Lane	0	21	2	13	0	51	5	15
LT Vol	0	0	2	0	0	0	5	0
Through Vol	0	21	0	13	0	30	0	14
RT Vol	0	0	0	0	0	21	0	1
Lane Flow Rate	0	23	2	14	0	55	5	16
Geometry Grp	7	7	7	7	7	7	7	7
Degree of Util (X)	0	0.029	0.003	0.019	0	0.068	0.008	0.021
Departure Headway (Hd)	4.636	4.636	5.291	4.79	4.72	4.432	5.136	4.589
Convergence, Y/N	Yes	Yes	Yes	Yes	Yes	Yes	Yes	Yes
Cap	0	768	674	744	0	805	693	775
Service Time	2.392	2.392	3.039	2.539	2.461	2.173	2.892	2.345
HCM Lane V/C Ratio	0	0.03	0.003	0.019	0	0.068	0.007	0.021
HCM Control Delay	7.4	7.5	8.1	7.6	7.5	7.5	7.9	7.4
HCM Lane LOS	N	A	A	A	N	A	A	A
HCM 95th-tile Q	0	0.1	0	0.1	0	0.2	0	0.1

Intersection						
Int Delay, s/veh	2.7					
Movement	EBL	EBT	WBT	WBR	SBL	SBR
Lane Configurations		↕	↑	↗	↘	
Traffic Vol, veh/h	2	142	179	111	98	4
Future Vol, veh/h	2	142	179	111	98	4
Conflicting Peds, #/hr	0	0	0	0	0	0
Sign Control	Free	Free	Free	Free	Stop	Stop
RT Channelized	-	None	-	None	-	None
Storage Length	-	-	-	0	0	-
Veh in Median Storage, #	-	0	0	-	0	-
Grade, %	-	0	0	-	0	-
Peak Hour Factor	92	92	92	92	92	92
Heavy Vehicles, %	13	13	37	37	81	81
Mvmt Flow	2	154	195	121	107	4

Major/Minor	Major1	Major2	Minor2		
Conflicting Flow All	316	0	-	0	353 195
Stage 1	-	-	-	-	195 -
Stage 2	-	-	-	-	158 -
Critical Hdwy	4.23	-	-	-	7.21 7.01
Critical Hdwy Stg 1	-	-	-	-	6.21 -
Critical Hdwy Stg 2	-	-	-	-	6.21 -
Follow-up Hdwy	2.317	-	-	-	4.229 4.029
Pot Cap-1 Maneuver	1185	-	-	-	513 680
Stage 1	-	-	-	-	680 -
Stage 2	-	-	-	-	710 -
Platoon blocked, %		-	-	-	
Mov Cap-1 Maneuver	1185	-	-	-	512 680
Mov Cap-2 Maneuver	-	-	-	-	512 -
Stage 1	-	-	-	-	679 -
Stage 2	-	-	-	-	710 -

Approach	EB	WB	SB
HCM Control Delay, s	0.1	0	13.9
HCM LOS			B

Minor Lane/Major Mvmt	EBL	EBT	WBT	WBR	SBLn1
Capacity (veh/h)	1185	-	-	-	517
HCM Lane V/C Ratio	0.002	-	-	-	0.214
HCM Control Delay (s)	8	0	-	-	13.9
HCM Lane LOS	A	A	-	-	B
HCM 95th %tile Q(veh)	0	-	-	-	0.8

Intersection												
Int Delay, s/veh	2.6											
Movement	EBL	EBT	EBR	WBL	WBT	WBR	NBL	NBT	NBR	SBL	SBT	SBR
Lane Configurations		↕			↕	↕		↕			↕	
Traffic Vol, veh/h	8	295	1	3	295	206	0	0	1	110	0	9
Future Vol, veh/h	8	295	1	3	295	206	0	0	1	110	0	9
Conflicting Peds, #/hr	0	0	0	0	0	0	0	0	0	0	0	0
Sign Control	Free	Free	Free	Free	Free	Free	Stop	Stop	Stop	Stop	Stop	Stop
RT Channelized	-	-	None	-	-	None	-	-	None	-	-	None
Storage Length	-	-	-	-	-	50	-	-	-	-	-	-
Veh in Median Storage, #	-	0	-	-	0	-	-	0	-	-	0	-
Grade, %	-	0	-	-	0	-	-	0	-	-	0	-
Peak Hour Factor	93	93	93	93	93	93	93	93	93	93	93	93
Heavy Vehicles, %	31	31	31	22	22	22	100	100	100	12	12	12
Mvmt Flow	9	317	1	3	317	222	0	0	1	118	0	10

Major/Minor	Major1			Major2			Minor1			Minor2		
Conflicting Flow All	539	0	0	318	0	0	775	881	318	659	659	317
Stage 1	-	-	-	-	-	-	336	336	-	323	323	-
Stage 2	-	-	-	-	-	-	439	545	-	336	336	-
Critical Hdwy	4.41	-	-	4.32	-	-	8.1	7.5	7.2	7.22	6.62	6.32
Critical Hdwy Stg 1	-	-	-	-	-	-	7.1	6.5	-	6.22	5.62	-
Critical Hdwy Stg 2	-	-	-	-	-	-	7.1	6.5	-	6.22	5.62	-
Follow-up Hdwy	2.479	-	-	2.398	-	-	4.4	4.9	4.2	3.608	4.108	3.408
Pot Cap-1 Maneuver	898	-	-	1137	-	-	221	201	543	364	371	701
Stage 1	-	-	-	-	-	-	514	499	-	668	633	-
Stage 2	-	-	-	-	-	-	445	389	-	658	624	-
Platoon blocked, %		-	-		-	-						
Mov Cap-1 Maneuver	898	-	-	1137	-	-	215	198	543	359	365	701
Mov Cap-2 Maneuver	-	-	-	-	-	-	215	198	-	359	365	-
Stage 1	-	-	-	-	-	-	508	493	-	660	630	-
Stage 2	-	-	-	-	-	-	437	387	-	649	617	-

Approach	EB	WB	NB	SB
HCM Control Delay, s	0.2	0	11.6	19.6
HCM LOS			B	C

Minor Lane/Major Mvmt	NBLn1	EBL	EBT	EBR	WBL	WBT	WBR	SBLn1
Capacity (veh/h)	543	898	-	-	1137	-	-	373
HCM Lane V/C Ratio	0.002	0.01	-	-	0.003	-	-	0.343
HCM Control Delay (s)	11.6	9	0	-	8.2	0	-	19.6
HCM Lane LOS	B	A	A	-	A	A	-	C
HCM 95th %tile Q(veh)	0	0	-	-	0	-	-	1.5

HCM 6th TWSC
5: Road 23/SR-99 Southbound Off-Ramp & Avenue 18 1/2

Village D Specific Plan
Phase III WP - AM Peak Hour

Intersection												
Int Delay, s/veh	0.2											
Movement	EBL	EBT	EBR	WBL	WBT	WBR	NBL	NBT	NBR	SBL	SBT	SBR
Lane Configurations		↑	↑		↑		↑		↑		↕	
Traffic Vol, veh/h	0	323	83	50	286	0	137	0	738	12	265	86
Future Vol, veh/h	0	323	83	50	286	0	137	0	738	12	265	86
Conflicting Peds, #/hr	0	0	0	0	0	0	0	0	1	1	0	0
Sign Control	Free	Free	Free	Free	Free	Free	Stop	Stop	Stop	Stop	Stop	Stop
RT Channelized	-	-	None	-	-	None	-	-	None	-	-	None
Storage Length	-	-	50	-	-	-	0	-	25	-	-	-
Veh in Median Storage, #	-	0	-	-	0	-	-	0	-	-	0	-
Grade, %	-	0	-	-	0	-	-	0	-	-	0	-
Peak Hour Factor	92	92	92	92	92	92	92	92	92	92	92	92
Heavy Vehicles, %	31	31	31	26	26	26	5	5	5	15	15	15
Mvmt Flow	0	351	90	54	311	0	149	0	802	13	288	93

Major/Minor	Major1			Major2			Minor1			Minor2		
Conflicting Flow All	-	0	0	441	0	0	961	-	352	1217	860	311
Stage 1	-	-	-	-	-	-	351	-	-	419	419	-
Stage 2	-	-	-	-	-	-	610	-	-	798	441	-
Critical Hdwy	-	-	-	4.36	-	-	7.15	-	6.25	7.25	6.65	6.35
Critical Hdwy Stg 1	-	-	-	-	-	-	6.15	-	-	6.25	5.65	-
Critical Hdwy Stg 2	-	-	-	-	-	-	6.15	-	-	6.25	5.65	-
Follow-up Hdwy	-	-	-	2.434	-	-	3.545	-	3.345	3.635	4.135	3.435
Pot Cap-1 Maneuver	0	-	-	1003	-	0	233	0	~ 685	148	~ 280	700
Stage 1	0	-	-	-	-	0	659	0	-	587	568	-
Stage 2	0	-	-	-	-	0	476	0	-	361	555	-
Platoon blocked, %	-	-	-	-	-	-	-	-	-	-	-	-
Mov Cap-1 Maneuver	-	-	-	1003	-	-	-	-	~ 684	-	~ 262	700
Mov Cap-2 Maneuver	-	-	-	-	-	-	-	-	-	~ 262	-	-
Stage 1	-	-	-	-	-	-	659	-	-	587	531	-
Stage 2	-	-	-	-	-	-	176	-	-	-	555	-

Approach	EB	WB	NB	SB
HCM Control Delay, s	0	1.3		
HCM LOS			-	-

Minor Lane/Major Mvmt	NBLn1	NBLn2	EBT	EBR	WBL	WBT	SBLn1
Capacity (veh/h)	-	684	-	-	1003	-	-
HCM Lane V/C Ratio	-	1.173	-	-	0.054	-	-
HCM Control Delay (s)	-	114.6	-	-	8.8	0	-
HCM Lane LOS	-	F	-	-	A	A	-
HCM 95th %tile Q(veh)	-	26.2	-	-	0.2	-	-

Notes
 -: Volume exceeds capacity \$: Delay exceeds 300s +: Computation Not Defined *: All major volume in platoon

HCM 6th TWSC
6: SR-99 Northbound Ramps & Avenue 18 1/2

Village D Specific Plan
Phase III WP - AM Peak Hour

Intersection												
Int Delay, s/veh	1115.1											
Movement	EBL	EBT	EBR	WBL	WBT	WBR	NBL	NBT	NBR	SBL	SBT	SBR
Lane Configurations	↙	↑			↘			↔				
Traffic Vol, veh/h	806	64	0	0	158	36	216	1	28	0	0	0
Future Vol, veh/h	806	64	0	0	158	36	216	1	28	0	0	0
Conflicting Peds, #/hr	1	0	0	0	0	1	0	0	0	0	0	0
Sign Control	Free	Free	Free	Free	Free	Free	Stop	Stop	Stop	Free	Free	Free
RT Channelized	-	-	None	-	-	None	-	-	None	-	-	None
Storage Length	145	-	-	-	-	-	-	-	-	-	-	-
Veh in Median Storage, #	-	0	-	-	0	-	-	0	-	-	16965	-
Grade, %	-	0	-	-	0	-	-	0	-	-	0	-
Peak Hour Factor	92	92	92	92	92	92	92	92	92	92	92	92
Heavy Vehicles, %	10	10	10	18	18	18	29	29	29	0	0	0
Mvmt Flow	876	70	0	0	172	39	235	1	30	0	0	0

Major/Minor	Major1	Major2	Minor1
Conflicting Flow All	212	0	- - - 0 2014 2034 70
Stage 1	-	-	- - - 1822 1822 -
Stage 2	-	-	- - - 192 212 -
Critical Hdwy	4.2	-	- - - 6.69 6.79 6.49
Critical Hdwy Stg 1	-	-	- - - 5.69 5.79 -
Critical Hdwy Stg 2	-	-	- - - 5.69 5.79 -
Follow-up Hdwy	2.29	-	- - - 3.761 4.261 3.561
Pot Cap-1 Maneuver	1312	-	0 0 - - ~ 54 48 922
Stage 1	-	-	0 0 - - ~ 120 110 -
Stage 2	-	-	0 0 - - 780 679 -
Platoon blocked, %	-	-	- -
Mov Cap-1 Maneuver	1312	-	- - - ~ 18 0 922
Mov Cap-2 Maneuver	-	-	- - - ~ 18 0 -
Stage 1	-	-	- - - ~ 40 0 -
Stage 2	-	-	- - - 780 0 -

Approach	EB	WB	NB
HCM Control Delay, s	12.1	0	\$ 5915.1
HCM LOS			F

Minor Lane/Major Mvmt	NBLn1	EBL	EBT	WBT	WBR
Capacity (veh/h)	20	1312	-	-	-
HCM Lane V/C Ratio	13.315	0.668	-	-	-
HCM Control Delay (s)	\$ 5915.1	13.1	-	-	-
HCM Lane LOS	F	B	-	-	-
HCM 95th %tile Q(veh)	33.7	5.5	-	-	-

Notes
 -: Volume exceeds capacity \$: Delay exceeds 300s +: Computation Not Defined *: All major volume in platoon

Intersection												
Int Delay, s/veh	0.2											
Movement	EBL	EBT	EBR	WBL	WBT	WBR	NBL	NBT	NBR	SBL	SBT	SBR
Lane Configurations		↕			↕			↕			↕	
Traffic Vol, veh/h	162	491	30	477	132	3	52	917	976	16	405	42
Future Vol, veh/h	162	491	30	477	132	3	52	917	976	16	405	42
Conflicting Peds, #/hr	0	0	0	0	0	0	0	0	0	0	0	0
Sign Control	Stop	Stop	Stop	Stop	Stop	Stop	Free	Free	Free	Free	Free	Free
RT Channelized	-	-	None	-	-	None	-	-	None	-	-	None
Storage Length	-	-	-	-	-	-	-	-	-	-	-	-
Veh in Median Storage, #	-	0	-	-	0	-	-	0	-	-	0	-
Grade, %	-	0	-	-	0	-	-	0	-	-	0	-
Peak Hour Factor	92	92	92	92	92	92	92	92	92	92	92	92
Heavy Vehicles, %	0	0	0	3	3	3	2	2	2	6	6	6
Mvmt Flow	176	534	33	518	143	3	57	997	1061	17	440	46

Major/Minor	Minor2		Minor1		Major1		Major2					
Conflicting Flow All	2212	2669	463	2423	2162	1528	486	0	0	2058	0	0
Stage 1	497	497	-	1642	1642	-	-	-	-	-	-	-
Stage 2	1715	2172	-	781	520	-	-	-	-	-	-	-
Critical Hdwy	7.1	6.5	6.2	7.13	6.53	6.23	4.12	-	-	4.16	-	-
Critical Hdwy Stg 1	6.1	5.5	-	6.13	5.53	-	-	-	-	-	-	-
Critical Hdwy Stg 2	6.1	5.5	-	6.13	5.53	-	-	-	-	-	-	-
Follow-up Hdwy	3.5	4	3.3	3.527	4.027	3.327	2.218	-	-	2.254	-	-
Pot Cap-1 Maneuver	~ 32	~ 23	603	~ 22	~ 47	144	1077	-	-	263	-	-
Stage 1	559	548	-	~ 125	157	-	-	-	-	-	-	-
Stage 2	~ 116	~ 86	-	~ 386	530	-	-	-	-	-	-	-
Platoon blocked, %								-	-	-	-	-
Mov Cap-1 Maneuver	-	~ 21	603	-	~ 43	144	1077	-	-	263	-	-
Mov Cap-2 Maneuver	-	~ 21	-	-	~ 43	-	-	-	-	-	-	-
Stage 1	559	~ 499	-	~ 125	157	-	-	-	-	-	-	-
Stage 2	~ 10	~ 86	-	-	483	-	-	-	-	-	-	-

Approach	EB	WB	NB	SB
HCM Control Delay, s			0.2	0.7
HCM LOS	-	-		

Minor Lane/Major Mvmt	NBL	NBT	NBR	EBLn1WBLn1	SBL	SBT	SBR
Capacity (veh/h)	1077	-	-	-	263	-	-
HCM Lane V/C Ratio	0.052	-	-	-	0.066	-	-
HCM Control Delay (s)	8.5	0	-	-	19.7	0	-
HCM Lane LOS	A	A	-	-	C	A	-
HCM 95th %tile Q(veh)	0.2	-	-	-	0.2	-	-

Notes
 -: Volume exceeds capacity \$: Delay exceeds 300s +: Computation Not Defined *: All major volume in platoon

Intersection	
Intersection Delay, s/veh	616.4
Intersection LOS	F

Movement	EBL	EBT	EBR	WBL	WBT	WBR	NBL	NBT	NBR	SBL	SBT	SBR
Lane Configurations	↖	↗		↖	↗		↖	↗		↖	↗	
Traffic Vol, veh/h	146	64	413	162	37	222	167	1096	49	58	836	66
Future Vol, veh/h	146	64	413	162	37	222	167	1096	49	58	836	66
Peak Hour Factor	0.92	0.92	0.92	0.92	0.92	0.92	0.92	0.92	0.92	0.92	0.92	0.92
Heavy Vehicles, %	3	3	3	0	0	0	4	4	4	6	6	6
Mvmt Flow	159	70	449	176	40	241	182	1191	53	63	909	72
Number of Lanes	1	1	0	1	1	0	1	1	0	1	1	0

Approach	EB	WB	NB	SB
Opposing Approach	WB	EB	SB	NB
Opposing Lanes	2	2	2	2
Conflicting Approach Left	SB	NB	EB	WB
Conflicting Lanes Left	2	2	2	2
Conflicting Approach Right	NB	SB	WB	EB
Conflicting Lanes Right	2	2	2	2
HCM Control Delay	153.1	42	937.3	730.3
HCM LOS	F	E	F	F

Lane	NBLn1	NBLn2	EBLn1	EBLn2	WBLn1	WBLn2	SBLn1	SBLn2
Vol Left, %	100%	0%	100%	0%	100%	0%	100%	0%
Vol Thru, %	0%	96%	0%	13%	0%	14%	0%	93%
Vol Right, %	0%	4%	0%	87%	0%	86%	0%	7%
Sign Control	Stop	Stop	Stop	Stop	Stop	Stop	Stop	Stop
Traffic Vol by Lane	167	1145	146	477	162	259	58	902
LT Vol	167	0	146	0	162	0	58	0
Through Vol	0	1096	0	64	0	37	0	836
RT Vol	0	49	0	413	0	222	0	66
Lane Flow Rate	182	1245	159	518	176	282	63	980
Geometry Grp	7	7	7	7	7	7	7	7
Degree of Util (X)	0.508	3.302	0.444	1.293	0.502	0.718	0.18	2.644
Departure Headway (Hd)	13.465	12.888	14.368	13.143	15.82	14.596	13.642	13.045
Convergence, Y/N	Yes	Yes	Yes	Yes	Yes	Yes	Yes	Yes
Cap	270	299	252	280	231	251	265	294
Service Time	11.165	10.588	12.068	10.843	13.52	12.296	11.342	10.745
HCM Lane V/C Ratio	0.674	4.164	0.631	1.85	0.762	1.124	0.238	3.333
HCM Control Delay	29.3	1069.7	28.1	191.3	33.5	47.3	19.3	776
HCM Lane LOS	D	F	D	F	D	E	C	F
HCM 95th-tile Q	2.7	84.5	2.1	17.6	2.6	4.9	0.6	61.2

Intersection												
Intersection Delay, s/veh	43.7											
Intersection LOS	F											

Movement	EBL	EBT	EBR	WBL	WBT	WBR	NBL	NBT	NBR	SBL	SBT	SBR
Lane Configurations	↶	↷		↶	↷		↶	↷		↶	↷	
Traffic Vol, veh/h	407	230	622	325	236	394	352	681	314	427	771	213
Future Vol, veh/h	407	230	622	325	236	394	352	681	314	427	771	213
Peak Hour Factor	0.92	0.92	0.92	0.92	0.92	0.92	0.92	0.92	0.92	0.92	0.92	0.92
Heavy Vehicles, %	0	0	0	2	2	2	4	4	4	6	6	6
Mvmt Flow	442	250	676	353	257	428	383	740	341	464	838	232
Number of Lanes	1	1	0	1	1	0	1	1	0	1	1	0

Approach	EB	WB	NB	SB
Opposing Approach	WB	EB	SB	NB
Opposing Lanes	2	2	2	2
Conflicting Approach Left	SB	NB	EB	WB
Conflicting Lanes Left	2	2	2	2
Conflicting Approach Right	NB	SB	WB	EB
Conflicting Lanes Right	2	2	2	2
HCM Control Delay	865.8	754.1	1069.1	1021.7
HCM LOS	F	F	F	F

Lane	NBLn1	NBLn2	EBLn1	EBLn2	WBLn1	WBLn2	SBLn1	SBLn2
Vol Left, %	100%	0%	100%	0%	100%	0%	100%	0%
Vol Thru, %	0%	68%	0%	27%	0%	37%	0%	78%
Vol Right, %	0%	32%	0%	73%	0%	63%	0%	22%
Sign Control	Stop	Stop	Stop	Stop	Stop	Stop	Stop	Stop
Traffic Vol by Lane	352	995	407	852	325	630	427	984
LT Vol	352	0	407	0	325	0	427	0
Through Vol	0	681	0	230	0	236	0	771
RT Vol	0	314	0	622	0	394	0	213
Lane Flow Rate	383	1082	442	926	353	685	464	1070
Geometry Grp	7	7	7	7	7	7	7	7
Degree of Util (X)	1.282	3.408	1.474	2.826	1.18	2.11	1.56	3.401
Departure Headway (Hd)	96.311	95.587	97.165	96.149	64.328	63.391	77.781	77.118
Convergence, Y/N	Yes	Yes	Yes	Yes	Yes	Yes	Yes	Yes
Cap	42	54	44	56	28	34	51	64
Service Time	94.011	93.287	94.865	93.849	62.028	61.091	75.481	74.818
HCM Lane V/C Ratio	9.119	20.037	10.045	16.536	12.607	20.147	9.098	16.719
HCM Control Delay	406.6	1303.5	481.9	1049.2	505.7	882.2	472	1260.3
HCM Lane LOS	F	F	F	F	F	F	F	F
HCM 95th-tile Q	4.9	14.6	5.8	11.9	3.4	6	7.1	17.4

Intersection												
Int Delay, s/veh	1.1											
Movement	EBL	EBT	EBR	WBL	WBT	WBR	NBL	NBT	NBR	SBL	SBT	SBR
Lane Configurations		↕			↕			↕			↕	
Traffic Vol, veh/h	0	5	0	18	3	215	4	672	4	235	1235	0
Future Vol, veh/h	0	5	0	18	3	215	4	672	4	235	1235	0
Conflicting Peds, #/hr	0	0	0	0	0	0	0	0	0	0	0	0
Sign Control	Stop	Stop	Stop	Stop	Stop	Stop	Free	Free	Free	Free	Free	Free
RT Channelized	-	-	None	-	-	None	-	-	None	-	-	None
Storage Length	-	-	-	-	-	-	-	-	-	-	-	-
Veh in Median Storage, #	-	0	-	-	0	-	-	0	-	-	0	-
Grade, %	-	0	-	-	0	-	-	0	-	-	0	-
Peak Hour Factor	92	92	92	92	92	92	92	92	92	92	92	92
Heavy Vehicles, %	0	0	0	0	0	0	7	7	7	4	4	4
Mvmt Flow	0	5	0	20	3	234	4	730	4	255	1342	0

Major/Minor	Minor2		Minor1		Major1		Major2					
Conflicting Flow All	2711	2594	1342	2595	2592	732	1342	0	0	734	0	0
Stage 1	1852	1852	-	740	740	-	-	-	-	-	-	-
Stage 2	859	742	-	1855	1852	-	-	-	-	-	-	-
Critical Hdwy	7.1	6.5	6.2	7.1	6.5	6.2	4.17	-	-	4.14	-	-
Critical Hdwy Stg 1	6.1	5.5	-	6.1	5.5	-	-	-	-	-	-	-
Critical Hdwy Stg 2	6.1	5.5	-	6.1	5.5	-	-	-	-	-	-	-
Follow-up Hdwy	3.5	4	3.3	3.5	4	3.3	2.263	-	-	2.236	-	-
Pot Cap-1 Maneuver	14	25	188	~ 17	25	424	498	-	-	862	-	-
Stage 1	96	125	-	412	426	-	-	-	-	-	-	-
Stage 2	354	425	-	96	125	-	-	-	-	-	-	-
Platoon blocked, %								-	-	-	-	-
Mov Cap-1 Maneuver	-	0	188	-	0	424	498	-	-	862	-	-
Mov Cap-2 Maneuver	-	0	-	-	0	-	-	-	-	-	-	-
Stage 1	95	0	-	406	420	-	-	-	-	-	-	-
Stage 2	155	419	-	-	0	-	-	-	-	-	-	-

Approach	EB		WB		NB		SB	
HCM Control Delay, s					0.1		1.7	
HCM LOS	-		-					

Minor Lane/Major Mvmt	NBL	NBT	NBR	EBLn1WBLn1	SBL	SBT	SBR
Capacity (veh/h)	498	-	-	-	862	-	-
HCM Lane V/C Ratio	0.009	-	-	-	0.296	-	-
HCM Control Delay (s)	12.3	0	-	-	10.9	0	-
HCM Lane LOS	B	A	-	-	B	A	-
HCM 95th %tile Q(veh)	0	-	-	-	1.2	-	-

Notes
 -: Volume exceeds capacity \$: Delay exceeds 300s +: Computation Not Defined *: All major volume in platoon

Intersection	
Intersection Delay, s/veh	643.9
Intersection LOS	F

Movement	EBL	EBT	EBR	WBL	WBT	WBR	NBL	NBT	NBR	SBL	SBT	SBR
Lane Configurations		↕			↕			↕			↕	
Traffic Vol, veh/h	107	152	60	20	185	358	54	217	8	710	364	179
Future Vol, veh/h	107	152	60	20	185	358	54	217	8	710	364	179
Peak Hour Factor	0.92	0.92	0.92	0.92	0.92	0.92	0.92	0.92	0.92	0.92	0.92	0.92
Heavy Vehicles, %	6	6	6	4	4	4	19	19	19	4	4	4
Mvmt Flow	116	165	65	22	201	389	59	236	9	772	396	195
Number of Lanes	0	1	0	0	1	0	0	1	0	0	1	0

Approach	EB	WB	NB	SB
Opposing Approach	WB	EB	SB	NB
Opposing Lanes	1	1	1	1
Conflicting Approach Left	SB	NB	EB	WB
Conflicting Lanes Left	1	1	1	1
Conflicting Approach Right	NB	SB	WB	EB
Conflicting Lanes Right	1	1	1	1
HCM Control Delay	82.5	255.4	70.4	1089
HCM LOS	F	F	F	F

Lane	NBLn1	EBLn1	WBLn1	SBLn1
Vol Left, %	19%	34%	4%	57%
Vol Thru, %	78%	48%	33%	29%
Vol Right, %	3%	19%	64%	14%
Sign Control	Stop	Stop	Stop	Stop
Traffic Vol by Lane	279	319	563	1253
LT Vol	54	107	20	710
Through Vol	217	152	185	364
RT Vol	8	60	358	179
Lane Flow Rate	303	347	612	1362
Geometry Grp	1	1	1	1
Degree of Util (X)	0.809	0.882	1.441	3.359
Departure Headway (Hd)	18.232	17.817	14.492	10.153
Convergence, Y/N	Yes	Yes	Yes	Yes
Cap	203	208	257	381
Service Time	16.232	15.817	12.492	8.153
HCM Lane V/C Ratio	1.493	1.668	2.381	3.575
HCM Control Delay	70.4	82.5	255.4	1089
HCM Lane LOS	F	F	F	F
HCM 95th-tile Q	5.7	6.8	20.3	108.7

Intersection

Intersection Delay, s/veh12.1

Intersection LOS B

Movement	EBL	EBT	EBR	WBL	WBT	WBR	NBL	NBT	NBR	SBL	SBT	SBR
Lane Configurations												
Traffic Vol, veh/h	51	85	4	12	113	71	8	60	17	108	106	119
Future Vol, veh/h	51	85	4	12	113	71	8	60	17	108	106	119
Peak Hour Factor	0.92	0.92	0.92	0.92	0.92	0.92	0.92	0.92	0.92	0.92	0.92	0.92
Heavy Vehicles, %	8	8	8	26	26	26	7	7	7	8	8	8
Mvmt Flow	55	92	4	13	123	77	9	65	18	117	115	129
Number of Lanes	1	1	0	1	1	0	0	1	0	0	1	0

Approach	EB	WB	NB	SB
Opposing Approach	WB	EB	SB	NB
Opposing Lanes	2	2	1	1
Conflicting Approach Left SB		NB	EB	WB
Conflicting Lanes Left	1	1	2	2
Conflicting Approach Right NB		SB	WB	EB
Conflicting Lanes Right	1	1	2	2
HCM Control Delay	10.2	12	9.6	13.6
HCM LOS	B	B	A	B

Lane	NBLn1	EBLn1	EBLn2	WBLn1	WBLn2	SBLn1
Vol Left, %	9%	100%	0%	100%	0%	32%
Vol Thru, %	71%	0%	96%	0%	61%	32%
Vol Right, %	20%	0%	4%	0%	39%	36%
Sign Control	Stop	Stop	Stop	Stop	Stop	Stop
Traffic Vol by Lane	85	51	89	12	184	333
LT Vol	8	51	0	12	0	108
Through Vol	60	0	85	0	113	106
RT Vol	17	0	4	0	71	119
Lane Flow Rate	92	55	97	13	200	362
Geometry Grp	2	7	7	7	7	2
Degree of Util (X)	0.144	0.104	0.167	0.025	0.343	0.52
Departure Headway (Hd)	5.613	6.747	6.207	6.954	6.172	5.175
Convergence, Y/N	Yes	Yes	Yes	Yes	Yes	Yes
Cap	637	531	578	515	582	702
Service Time	3.66	4.491	3.951	4.697	3.914	3.175
HCM Lane V/C Ratio	0.144	0.104	0.168	0.025	0.344	0.516
HCM Control Delay	9.6	10.3	10.2	9.9	12.1	13.6
HCM Lane LOS	A	B	B	A	B	B
HCM 95th-tile Q	0.5	0.3	0.6	0.1	1.5	3

Intersection												
Int Delay, s/veh	3.6											
Movement	EBL	EBT	EBR	WBL	WBT	WBR	NBL	NBT	NBR	SBL	SBT	SBR
Lane Configurations	↖	↑	↗	↖	↑	↗	↖	↑	↗		↕	
Traffic Vol, veh/h	5	1177	241	302	503	286	101	114	180	216	54	4
Future Vol, veh/h	5	1177	241	302	503	286	101	114	180	216	54	4
Conflicting Peds, #/hr	0	0	0	0	0	0	1	0	0	0	0	1
Sign Control	Free	Free	Free	Free	Free	Free	Stop	Stop	Stop	Stop	Stop	Stop
RT Channelized	-	-	None	-	-	None	-	-	None	-	-	None
Storage Length	85	-	0	70	-	105	60	-	50	-	-	-
Veh in Median Storage, #	-	0	-	-	0	-	-	0	-	-	0	-
Grade, %	-	0	-	-	0	-	-	0	-	-	0	-
Peak Hour Factor	92	92	92	92	92	92	92	92	92	92	92	92
Heavy Vehicles, %	1	1	1	5	5	5	10	10	10	9	9	9
Mvmt Flow	5	1279	262	328	547	311	110	124	196	235	59	4

Major/Minor	Major1			Major2			Minor1			Minor2		
Conflicting Flow All	858	0	0	1541	0	0	2680	2803	1279	2783	2754	548
Stage 1	-	-	-	-	-	-	1289	1289	-	1203	1203	-
Stage 2	-	-	-	-	-	-	1391	1514	-	1580	1551	-
Critical Hdwy	4.11	-	-	4.15	-	-	7.2	6.6	6.3	7.19	6.59	6.29
Critical Hdwy Stg 1	-	-	-	-	-	-	6.2	5.6	-	6.19	5.59	-
Critical Hdwy Stg 2	-	-	-	-	-	-	6.2	5.6	-	6.19	5.59	-
Follow-up Hdwy	2.209	-	-	2.245	-	-	3.59	4.09	3.39	3.581	4.081	3.381
Pot Cap-1 Maneuver	787	-	-	422	-	-	~ 14	~ 17	~ 195	~ 11	~ 19	523
Stage 1	-	-	-	-	-	-	194	226	-	~ 218	250	-
Stage 2	-	-	-	-	-	-	169	175	-	~ 132	169	-
Platoon blocked, %	-	-	-	-	-	-	-	-	-	-	-	-
Mov Cap-1 Maneuver	787	-	-	422	-	-	~ 4	~ 195	-	~ 4	523	-
Mov Cap-2 Maneuver	-	-	-	-	-	-	~ 4	-	-	~ 4	-	-
Stage 1	-	-	-	-	-	-	193	225	-	~ 217	~ 56	-
Stage 2	-	-	-	-	-	-	~ 39	-	-	168	-	-

Approach	EB	WB	NB	SB
HCM Control Delay, s	0	10.4		
HCM LOS			-	-

Minor Lane/Major Mvmt	NBLn1	NBLn2	NBLn3	EBL	EBT	EBR	WBL	WBT	WBR	SBLn1
Capacity (veh/h)	-	4	195	787	-	-	422	-	-	-
HCM Lane V/C Ratio	-	30.978	1.003	0.007	-	-	0.778	-	-	-
HCM Control Delay (s)	-	\$ 15268.7	115.5	9.6	-	-	37.6	-	-	-
HCM Lane LOS	-	F	F	A	-	-	E	-	-	-
HCM 95th %tile Q(veh)	-	17.6	8.6	0	-	-	6.7	-	-	-

Notes
 -: Volume exceeds capacity \$: Delay exceeds 300s +: Computation Not Defined *: All major volume in platoon

Intersection						
Int Delay, s/veh	727					
Movement	EBL	EBT	WBT	WBR	SBL	SBR
Lane Configurations		↑	↑		↑	↑
Traffic Vol, veh/h	0	1574	949	0	298	141
Future Vol, veh/h	0	1574	949	0	298	141
Conflicting Peds, #/hr	0	0	0	0	0	0
Sign Control	Free	Free	Free	Free	Stop	Stop
RT Channelized	-	None	-	None	-	None
Storage Length	-	-	-	-	0	610
Veh in Median Storage, #	-	0	0	-	0	-
Grade, %	-	0	0	-	0	-
Peak Hour Factor	92	92	92	92	92	92
Heavy Vehicles, %	4	4	5	5	12	12
Mvmt Flow	0	1711	1032	0	324	153

Major/Minor	Major1	Major2	Minor2		
Conflicting Flow All	-	0	-	0	2743 1032
Stage 1	-	-	-	-	1032 -
Stage 2	-	-	-	-	1711 -
Critical Hdwy	-	-	-	-	6.52 6.32
Critical Hdwy Stg 1	-	-	-	-	5.52 -
Critical Hdwy Stg 2	-	-	-	-	5.52 -
Follow-up Hdwy	-	-	-	-	3.608 3.408
Pot Cap-1 Maneuver	0	-	-	0	~ 20 270
Stage 1	0	-	-	0	329 -
Stage 2	0	-	-	0	~ 151 -
Platoon blocked, %	-	-	-	-	-
Mov Cap-1 Maneuver	-	-	-	-	~ 20 270
Mov Cap-2 Maneuver	-	-	-	-	~ 20 -
Stage 1	-	-	-	-	329 -
Stage 2	-	-	-	-	~ 151 -

Approach	EB	WB	SB
HCM Control Delay, s	0	0	\$ 4905.2
HCM LOS			F

Minor Lane/Major Mvmt	EBT	WBT	SBLn1	SBLn2
Capacity (veh/h)	-	-	20	270
HCM Lane V/C Ratio	-	-	16.196	0.568
HCM Control Delay (s)	-	-	\$ 7209.8	34.5
HCM Lane LOS	-	-	F	D
HCM 95th %tile Q(veh)	-	-	41	3.2

Notes
 -: Volume exceeds capacity \$: Delay exceeds 300s +: Computation Not Defined *: All major volume in platoon

HCM 6th TWSC
15: SR-99 Northbound Ramps & Avenue 17

Village D Specific Plan
Phase III WP - AM Peak Hour

Intersection												
Int Delay, s/veh	2735.6											
Movement	EBL	EBT	EBR	WBL	WBT	WBR	NBL	NBT	NBR	SBL	SBT	SBR
Lane Configurations	↖	↗			↘			↙	↕			
Traffic Vol, veh/h	145	885	0	0	1111	253	546	4	240	0	0	0
Future Vol, veh/h	145	885	0	0	1111	253	546	4	240	0	0	0
Conflicting Peds, #/hr	0	0	0	0	0	0	0	0	0	0	0	0
Sign Control	Free	Free	Free	Free	Free	Free	Stop	Stop	Stop	Free	Free	Free
RT Channelized	-	-	None	-	-	None	-	-	None	-	-	None
Storage Length	125	-	-	-	-	-	-	-	50	-	-	-
Veh in Median Storage, #	-	0	-	-	0	-	-	0	-	-	16965	-
Grade, %	-	0	-	-	0	-	-	0	-	-	0	-
Peak Hour Factor	92	92	92	92	92	92	92	92	92	92	92	92
Heavy Vehicles, %	4	4	4	2	2	2	5	5	5	0	0	0
Mvmt Flow	158	962	0	0	1208	275	593	4	261	0	0	0

Major/Minor	Major1	Major2	Minor1
Conflicting Flow All	1483	0	0
Stage 1	-	-	-
Stage 2	-	-	-
Critical Hdwy	4.14	-	-
Critical Hdwy Stg 1	-	-	-
Critical Hdwy Stg 2	-	-	-
Follow-up Hdwy	2.236	-	-
Pot Cap-1 Maneuver	448	0	0
Stage 1	-	0	-
Stage 2	-	0	-
Platoon blocked, %	-	-	-
Mov Cap-1 Maneuver	448	-	-
Mov Cap-2 Maneuver	-	-	-
Stage 1	-	-	-
Stage 2	-	-	-

Approach	EB	WB	NB
HCM Control Delay, s	2.4	0	\$ 11022.3
HCM LOS			F

Minor Lane/Major Mvmt	NBLn1	NBLn2	EBL	EBT	WBT	WBR
Capacity (veh/h)	17	306	448	-	-	-
HCM Lane V/C Ratio	35.166	0.853	0.352	-	-	-
HCM Control Delay (s)	\$ 15806.5	58.5	17.3	-	-	-
HCM Lane LOS	F	F	C	-	-	-
HCM 95th %tile Q(veh)	75.6	7.5	1.6	-	-	-

Notes
 -: Volume exceeds capacity \$: Delay exceeds 300s +: Computation Not Defined *: All major volume in platoon

HCM 6th Signalized Intersection Summary
 16: Love's Truck Stop Driveway/Driveway & Avenue 17

Village D Specific Plan
 Phase III WP - AM Peak Hour



Movement	EBL	EBT	EBR	WBL	WBT	WBR	NBL	NBT	NBR	SBL	SBT	SBR
Lane Configurations	↖	↗↗	↖	↖	↗		↖	↗		↖	↗	
Traffic Volume (veh/h)	162	819	132	45	1054	56	136	0	22	48	0	90
Future Volume (veh/h)	162	819	132	45	1054	56	136	0	22	48	0	90
Initial Q (Qb), veh	0	0	0	0	0	0	0	0	0	0	0	0
Ped-Bike Adj(A_pbT)	1.00		1.00	1.00		1.00	1.00		1.00	1.00		1.00
Parking Bus, Adj	1.00	1.00	1.00	1.00	1.00	1.00	1.00	1.00	1.00	1.00	1.00	1.00
Work Zone On Approach		No			No			No			No	
Adj Sat Flow, veh/h/ln	1870	1870	1870	1870	1870	1870	1900	1900	1900	1900	1900	1900
Adj Flow Rate, veh/h	176	890	143	49	1146	61	148	0	24	52	0	98
Peak Hour Factor	0.92	0.92	0.92	0.92	0.92	0.92	0.92	0.92	0.92	0.92	0.92	0.92
Percent Heavy Veh, %	2	2	2	2	2	2	0	0	0	0	0	0
Cap, veh/h	89	1947	868	66	942	50	90	0	317	69	0	298
Arrive On Green	0.05	0.55	0.55	0.04	0.54	0.54	0.05	0.00	0.20	0.04	0.00	0.19
Sat Flow, veh/h	1781	3554	1585	1781	1760	94	1810	0	1610	1810	0	1610
Grp Volume(v), veh/h	176	890	143	49	0	1207	148	0	24	52	0	98
Grp Sat Flow(s),veh/h/ln	1781	1777	1585	1781	0	1853	1810	0	1610	1810	0	1610
Q Serve(g_s), s	5.0	15.1	4.5	2.7	0.0	53.5	5.0	0.0	1.2	2.8	0.0	5.3
Cycle Q Clear(g_c), s	5.0	15.1	4.5	2.7	0.0	53.5	5.0	0.0	1.2	2.8	0.0	5.3
Prop In Lane	1.00		1.00	1.00		0.05	1.00		1.00	1.00		1.00
Lane Grp Cap(c), veh/h	89	1947	868	66	0	992	90	0	317	69	0	298
V/C Ratio(X)	1.98	0.46	0.16	0.74	0.00	1.22	1.64	0.00	0.08	0.75	0.00	0.33
Avail Cap(c_a), veh/h	89	1947	868	89	0	992	90	0	317	90	0	298
HCM Platoon Ratio	1.00	1.00	1.00	1.00	1.00	1.00	1.00	1.00	1.00	1.00	1.00	1.00
Upstream Filter(I)	1.00	1.00	1.00	1.00	0.00	1.00	1.00	0.00	1.00	1.00	0.00	1.00
Uniform Delay (d), s/veh	47.5	13.6	11.2	47.7	0.0	23.3	47.5	0.0	32.7	47.6	0.0	35.4
Incr Delay (d2), s/veh	476.9	0.2	0.1	19.5	0.0	107.0	330.4	0.0	0.5	22.0	0.0	2.9
Initial Q Delay(d3),s/veh	0.0	0.0	0.0	0.0	0.0	0.0	0.0	0.0	0.0	0.0	0.0	0.0
%ile BackOfQ(50%),veh/ln	14.0	5.8	1.5	1.6	0.0	50.9	10.5	0.0	0.5	1.7	0.0	2.3
Unsig. Movement Delay, s/veh												
LnGrp Delay(d),s/veh	524.4	13.8	11.3	67.2	0.0	130.3	377.9	0.0	33.2	69.6	0.0	38.3
LnGrp LOS	F	B	B	E	A	F	F	A	C	E	A	D
Approach Vol, veh/h		1209			1256			172				150
Approach Delay, s/veh		87.8			127.8			329.8				49.2
Approach LOS		F			F			F				D
Timer - Assigned Phs	1	2	3	4	5	6	7	8				
Phs Duration (G+Y+Rc), s	8.3	24.2	8.2	59.3	9.5	23.0	9.5	58.0				
Change Period (Y+Rc), s	4.5	4.5	4.5	4.5	4.5	4.5	4.5	4.5				
Max Green Setting (Gmax), s	5.0	18.5	5.0	53.5	5.0	18.5	5.0	53.5				
Max Q Clear Time (g_c+I1), s	4.8	3.2	4.7	17.1	7.0	7.3	7.0	55.5				
Green Ext Time (p_c), s	0.0	0.0	0.0	8.3	0.0	0.3	0.0	0.0				

Intersection Summary

HCM 6th Ctrl Delay	118.7
HCM 6th LOS	F

HCM 6th TWSC
17: Westberry Boulevard & Cleveland Avenue

Village D Specific Plan
Phase III WP - AM Peak Hour

Intersection												
Int Delay, s/veh	1.7											
Movement	EBL	EBT	EBR	WBL	WBT	WBR	NBL	NBT	NBR	SBL	SBT	SBR
Lane Configurations	↖	↗		↖	↗		↖	↑	↗	↖	↑	↗
Traffic Vol, veh/h	386	901	82	41	397	13	63	240	181	15	80	141
Future Vol, veh/h	386	901	82	41	397	13	63	240	181	15	80	141
Conflicting Peds, #/hr	1	0	2	2	0	1	1	0	1	1	0	1
Sign Control	Free	Free	Free	Free	Free	Free	Stop	Stop	Stop	Stop	Stop	Stop
RT Channelized	-	-	None	-	-	None	-	-	None	-	-	None
Storage Length	110	-	-	165	-	-	65	-	50	100	-	50
Veh in Median Storage, #	-	0	-	-	0	-	-	0	-	-	0	-
Grade, %	-	0	-	-	0	-	-	0	-	-	0	-
Peak Hour Factor	92	92	92	92	92	92	92	92	92	92	92	92
Heavy Vehicles, %	0	0	0	1	1	1	0	0	0	0	0	0
Mvmt Flow	420	979	89	45	432	14	68	261	197	16	87	153

Major/Minor	Major1			Major2			Minor1			Minor2		
Conflicting Flow All	447	0	0	1070	0	0	2516	2403	1027	2624	2440	441
Stage 1	-	-	-	-	-	-	1866	1866	-	530	530	-
Stage 2	-	-	-	-	-	-	650	537	-	2094	1910	-
Critical Hdwy	4.1	-	-	4.11	-	-	7.1	6.5	6.2	7.1	6.5	6.2
Critical Hdwy Stg 1	-	-	-	-	-	-	6.1	5.5	-	6.1	5.5	-
Critical Hdwy Stg 2	-	-	-	-	-	-	6.1	5.5	-	6.1	5.5	-
Follow-up Hdwy	2.2	-	-	2.209	-	-	3.5	4	3.3	3.5	4	3.3
Pot Cap-1 Maneuver	1124	-	-	655	-	-	~ 19	~ 34	287	~ 16	~ 32	621
Stage 1	-	-	-	-	-	-	94	~ 123	-	536	530	-
Stage 2	-	-	-	-	-	-	461	526	-	69	117	-
Platoon blocked, %	-	-	-	-	-	-	-	-	-	-	-	-
Mov Cap-1 Maneuver	1123	-	-	654	-	-	~ 20	286	-	~ 19	620	-
Mov Cap-2 Maneuver	-	-	-	-	-	-	~ 20	-	-	~ 19	-	-
Stage 1	-	-	-	-	-	-	~ 59	~ 77	-	335	493	-
Stage 2	-	-	-	-	-	-	266	489	-	-	~ 73	-

Approach	EB	WB	NB	SB
HCM Control Delay, s	2.8	1		
HCM LOS			-	-

Minor Lane/Major Mvmt	NBLn1	NBLn2	NBLn3	EBL	EBT	EBR	WBL	WBT	WBR	SBLn1	SBLn2	SBLn3
Capacity (veh/h)	-	20	286	1123	-	-	654	-	-	-	19	620
HCM Lane V/C Ratio	-	13.043	0.688	0.374	-	-	0.068	-	-	-	4.577	0.247
HCM Control Delay (s)	-	\$ 5793	41.3	10.1	-	-	10.9	-	-	-	\$ 2018	12.7
HCM Lane LOS	-	F	E	B	-	-	B	-	-	-	F	B
HCM 95th %tile Q(veh)	-	33.1	4.7	1.8	-	-	0.2	-	-	-	11.4	1

Notes
 -: Volume exceeds capacity \$: Delay exceeds 300s +: Computation Not Defined *: All major volume in platoon

Intersection	
Intersection Delay, s/veh	42.5
Intersection LOS	E

Movement	EBL	EBT	EBR	WBL	WBT	WBR	NBL	NBT	NBR	SBL	SBT	SBR
Lane Configurations	↖	↗		↖	↗		↖	↗	↗	↖	↗	↖
Traffic Vol, veh/h	76	293	98	60	211	31	127	211	124	132	147	42
Future Vol, veh/h	76	293	98	60	211	31	127	211	124	132	147	42
Peak Hour Factor	0.92	0.92	0.92	0.92	0.92	0.92	0.92	0.92	0.92	0.92	0.92	0.92
Heavy Vehicles, %	2	2	2	3	3	3	0	0	0	0	0	0
Mvmt Flow	83	318	107	65	229	34	138	229	135	143	160	46
Number of Lanes	1	1	0	1	1	0	1	1	1	1	1	1

Approach	EB	WB	NB	SB
Opposing Approach	WB	EB	SB	NB
Opposing Lanes	2	2	3	3
Conflicting Approach Left	SB	NB	EB	WB
Conflicting Lanes Left	3	3	2	2
Conflicting Approach Right	NB	SB	WB	EB
Conflicting Lanes Right	3	3	2	2
HCM Control Delay	87.1	29.7	21.5	19.8
HCM LOS	F	D	C	C

Lane	NBLn1	NBLn2	NBLn3	EBLn1	EBLn2	WBLn1	WBLn2	SBLn1	SBLn2	SBLn3
Vol Left, %	100%	0%	0%	100%	0%	100%	0%	100%	0%	0%
Vol Thru, %	0%	100%	0%	0%	75%	0%	87%	0%	100%	0%
Vol Right, %	0%	0%	100%	0%	25%	0%	13%	0%	0%	100%
Sign Control	Stop	Stop	Stop	Stop	Stop	Stop	Stop	Stop	Stop	Stop
Traffic Vol by Lane	127	211	124	76	391	60	242	132	147	42
LT Vol	127	0	0	76	0	60	0	132	0	0
Through Vol	0	211	0	0	293	0	211	0	147	0
RT Vol	0	0	124	0	98	0	31	0	0	42
Lane Flow Rate	138	229	135	83	425	65	263	143	160	46
Geometry Grp	8	8	8	8	8	8	8	8	8	8
Degree of Util (X)	0.378	0.596	0.324	0.227	1.086	0.185	0.704	0.409	0.434	0.115
Departure Headway (Hd)	10.391	9.866	9.131	9.885	9.195	10.575	9.969	10.838	10.311	9.573
Convergence, Y/N	Yes	Yes	Yes	Yes	Yes	Yes	Yes	Yes	Yes	Yes
Cap	348	369	396	365	400	341	366	334	352	377
Service Time	8.091	7.566	6.831	7.585	6.895	8.275	7.669	8.538	8.011	7.273
HCM Lane V/C Ratio	0.397	0.621	0.341	0.227	1.063	0.191	0.719	0.428	0.455	0.122
HCM Control Delay	19.3	26.1	16.1	15.5	101	15.7	33.2	20.8	20.7	13.5
HCM Lane LOS	C	D	C	C	F	C	D	C	C	B
HCM 95th-tile Q	1.7	3.7	1.4	0.9	14.9	0.7	5.2	1.9	2.1	0.4

Intersection												
Intersection Delay, s/veh	48.6											
Intersection LOS	F											

Movement	EBL	EBT	EBR	WBL	WBT	WBR	NBL	NBT	NBR	SBL	SBT	SBR
Lane Configurations		↕			↕			↕			↕	
Traffic Vol, veh/h	113	741	56	12	398	133	86	53	25	309	73	101
Future Vol, veh/h	113	741	56	12	398	133	86	53	25	309	73	101
Peak Hour Factor	0.92	0.92	0.92	0.92	0.92	0.92	0.92	0.92	0.92	0.92	0.92	0.92
Heavy Vehicles, %	2	2	2	4	4	4	0	0	0	0	0	0
Mvmt Flow	123	805	61	13	433	145	93	58	27	336	79	110
Number of Lanes	0	1	0	0	1	0	0	1	0	0	1	0

Approach	EB	WB	NB	SB
Opposing Approach	WB	EB	SB	NB
Opposing Lanes	1	1	1	1
Conflicting Approach Left	SB	NB	EB	WB
Conflicting Lanes Left	1	1	1	1
Conflicting Approach Right	NB	SB	WB	EB
Conflicting Lanes Right	1	1	1	1
HCM Control Delay	598.6	202.4	31.3	149.5
HCM LOS	F	F	D	F

Lane	NBLn1	EBLn1	WBLn1	SBLn1
Vol Left, %	52%	12%	2%	64%
Vol Thru, %	32%	81%	73%	15%
Vol Right, %	15%	6%	24%	21%
Sign Control	Stop	Stop	Stop	Stop
Traffic Vol by Lane	164	910	543	483
LT Vol	86	113	12	309
Through Vol	53	741	398	73
RT Vol	25	56	133	101
Lane Flow Rate	178	989	590	525
Geometry Grp	1	1	1	1
Degree of Util (X)	0.476	2.265	1.336	1.199
Departure Headway (Hd)	15.231	9.631	11.489	11.393
Convergence, Y/N	Yes	Yes	Yes	Yes
Cap	239	386	325	326
Service Time	13.231	7.631	9.489	9.393
HCM Lane V/C Ratio	0.745	2.562	1.815	1.61
HCM Control Delay	31.3	598.6	202.4	149.5
HCM Lane LOS	D	F	F	F
HCM 95th-tile Q	2.4	64.1	20.7	16.5

Intersection

Intersection Delay, s/veh 23.1

Intersection LOS C

Movement	EBL	EBT	EBR	WBL	WBT	WBR	NBL	NBT	NBR	SBL	SBT	SBR
Lane Configurations		↕			↕	↕		↕	↕		↕	↕
Traffic Vol, veh/h	0	0	0	144	0	235	0	211	545	100	64	0
Future Vol, veh/h	0	0	0	144	0	235	0	211	545	100	64	0
Peak Hour Factor	0.92	0.92	0.92	0.92	0.92	0.92	0.92	0.92	0.92	0.92	0.92	0.92
Heavy Vehicles, %	0	0	0	3	3	3	0	0	0	0	0	0
Mvmt Flow	0	0	0	157	0	255	0	229	592	109	70	0
Number of Lanes	0	1	0	0	1	1	0	1	1	0	1	1

Approach	EB	WB	NB	SB
Opposing Approach	WB	EB	SB	NB
Opposing Lanes	2	1	2	2
Conflicting Approach Left	SB	NB	EB	WB
Conflicting Lanes Left	2	2	1	2
Conflicting Approach Right	NB	SB	WB	EB
Conflicting Lanes Right	2	2	2	1
HCM Control Delay	0	14	29.7	13.9
HCM LOS	-	B	D	B

Lane	NBLn1	NBLn2	EBLn1	WBLn1	WBLn2	SBLn1	SBLn2
Vol Left, %	0%	0%	0%	100%	0%	61%	0%
Vol Thru, %	100%	0%	100%	0%	0%	39%	100%
Vol Right, %	0%	100%	0%	0%	100%	0%	0%
Sign Control	Stop	Stop	Stop	Stop	Stop	Stop	Stop
Traffic Vol by Lane	211	545	0	144	235	164	0
LT Vol	0	0	0	144	0	100	0
Through Vol	211	0	0	0	0	64	0
RT Vol	0	545	0	0	235	0	0
Lane Flow Rate	229	592	0	157	255	178	0
Geometry Grp	7	7	6	7	7	7	7
Degree of Util (X)	0.39	0.889	0	0.326	0.445	0.356	0
Departure Headway (Hd)	6.115	5.405	7.797	7.49	6.27	7.193	6.881
Convergence, Y/N	Yes	Yes	Yes	Yes	Yes	Yes	Yes
Cap	587	669	0	479	572	497	0
Service Time	3.87	3.159	5.894	5.248	4.027	4.968	4.656
HCM Lane V/C Ratio	0.39	0.885	0	0.328	0.446	0.358	0
HCM Control Delay	12.8	36.2	10.9	13.9	14	13.9	9.7
HCM Lane LOS	B	E	N	B	B	B	N
HCM 95th-tile Q	1.8	10.9	0	1.4	2.3	1.6	0

Intersection	
Intersection Delay, s/veh	280.3
Intersection LOS	F

Movement	EBL	EBT	EBR	WBL	WBT	WBR	NBL	NBT	NBR	SBL	SBT	SBR
Lane Configurations	↘	↕↘		↘	↕↘		↘	↕	↘	↘	↕	↘
Traffic Vol, veh/h	35	1008	28	194	378	32	26	444	350	14	284	5
Future Vol, veh/h	35	1008	28	194	378	32	26	444	350	14	284	5
Peak Hour Factor	0.92	0.92	0.92	0.92	0.92	0.92	0.92	0.92	0.92	0.92	0.92	0.92
Heavy Vehicles, %	1	1	1	2	2	2	0	0	0	0	0	0
Mvmt Flow	38	1096	30	211	411	35	28	483	380	15	309	5
Number of Lanes	1	2	0	1	2	0	1	1	1	1	1	1

Approach	EB	WB	NB	SB
Opposing Approach	WB	EB	SB	NB
Opposing Lanes	3	3	3	3
Conflicting Approach Left	SB	NB	EB	WB
Conflicting Lanes Left	3	3	3	3
Conflicting Approach Right	NB	SB	WB	EB
Conflicting Lanes Right	3	3	3	3
HCM Control Delay	490.2	47.7	236.2	121
HCM LOS	F	E	F	F

Lane	NBLn1	NBLn2	NBLn3	EBLn1	EBLn2	EBLn3	WBLn1	WBLn2	WBLn3	SBLn1	SBLn2
Vol Left, %	100%	0%	0%	100%	0%	0%	100%	0%	0%	100%	0%
Vol Thru, %	0%	100%	0%	0%	100%	92%	0%	100%	80%	0%	100%
Vol Right, %	0%	0%	100%	0%	0%	8%	0%	0%	20%	0%	0%
Sign Control	Stop	Stop	Stop	Stop	Stop	Stop	Stop	Stop	Stop	Stop	Stop
Traffic Vol by Lane	26	444	350	35	672	364	194	252	158	14	284
LT Vol	26	0	0	35	0	0	194	0	0	14	0
Through Vol	0	444	0	0	672	336	0	252	126	0	284
RT Vol	0	0	350	0	0	28	0	0	32	0	0
Lane Flow Rate	28	483	380	38	730	396	211	274	172	15	309
Geometry Grp	8	8	8	8	8	8	8	8	8	8	8
Degree of Util (X)	0.098	1.601	1.189	0.131	2.422	1.306	0.725	0.904	0.56	0.057	1.105
Departure Headway (Hd)	13.584	13.084	12.384	12.915	12.415	12.361	12.187	11.687	11.545	14.725	14.225
Convergence, Y/N	Yes	Yes	Yes	Yes	Yes	Yes	Yes	Yes	Yes	Yes	Yes
Cap	265	285	297	279	299	297	299	312	314	245	256
Service Time	11.284	10.784	10.084	10.615	10.115	10.061	9.887	9.387	9.245	12.425	11.925
HCM Lane V/C Ratio	0.106	1.695	1.279	0.136	2.441	1.333	0.706	0.878	0.548	0.061	1.207
HCM Control Delay	17.8	317.5	149.4	17.6	675.5	193.5	41.4	65	28	18.3	127.9
HCM Lane LOS	C	F	F	C	F	F	E	F	D	C	F
HCM 95th-tile Q	0.3	26.8	15.3	0.4	56.2	18.7	5.2	8.5	3.2	0.2	12

Intersection

Intersection Delay, s/veh 56.3

Intersection LOS F

Movement	EBL	EBT	EBR	WBL	WBT	WBR	NBL	NBT	NBR	SBL	SBT	SBR
Lane Configurations	↖	↗		↖	↗	↖	↖	↗		↖	↗	
Traffic Vol, veh/h	68	314	74	26	131	67	49	260	26	133	292	50
Future Vol, veh/h	68	314	74	26	131	67	49	260	26	133	292	50
Peak Hour Factor	0.92	0.92	0.92	0.92	0.92	0.92	0.92	0.92	0.92	0.92	0.92	0.92
Heavy Vehicles, %	2	2	2	5	5	5	2	2	2	2	2	2
Mvmt Flow	74	341	80	28	142	73	53	283	28	145	317	54
Number of Lanes	1	1	0	1	1	1	1	1	0	1	1	0

Approach	EB	WB	NB	SB
Opposing Approach	WB	EB	SB	NB
Opposing Lanes	3	2	2	2
Conflicting Approach Left SB		NB	EB	WB
Conflicting Lanes Left	2	2	2	3
Conflicting Approach Right NB		SB	WB	EB
Conflicting Lanes Right	2	2	3	2
HCM Control Delay	92.8	18.3	40.5	50.2
HCM LOS	F	C	E	F

Lane	NBLn1	NBLn2	EBLn1	EBLn2	WBLn1	WBLn2	WBLn3	SBLn1	SBLn2
Vol Left, %	100%	0%	100%	0%	100%	0%	0%	100%	0%
Vol Thru, %	0%	91%	0%	81%	0%	100%	0%	0%	85%
Vol Right, %	0%	9%	0%	19%	0%	0%	100%	0%	15%
Sign Control	Stop	Stop	Stop	Stop	Stop	Stop	Stop	Stop	Stop
Traffic Vol by Lane	49	286	68	388	26	131	67	133	342
LT Vol	49	0	68	0	26	0	0	133	0
Through Vol	0	260	0	314	0	131	0	0	292
RT Vol	0	26	0	74	0	0	67	0	50
Lane Flow Rate	53	311	74	422	28	142	73	145	372
Geometry Grp	8	8	8	8	8	8	8	8	8
Degree of Util (X)	0.148	0.818	0.206	1.1	0.085	0.405	0.195	0.387	0.934
Departure Headway (Hd)	10.538	9.951	10.052	9.389	11.279	10.753	10.016	10.124	9.499
Convergence, Y/N	Yes	Yes	Yes	Yes	Yes	Yes	Yes	Yes	Yes
Cap	342	367	359	388	320	337	360	357	383
Service Time	8.238	7.651	7.756	7.094	8.979	8.453	7.716	7.824	7.199
HCM Lane V/C Ratio	0.155	0.847	0.206	1.088	0.087	0.421	0.203	0.406	0.971
HCM Control Delay	15.1	44.8	15.3	106.4	15	20.6	15.1	19.1	62.3
HCM Lane LOS	C	E	C	F	B	C	C	C	F
HCM 95th-tile Q	0.5	7.2	0.8	15.2	0.3	1.9	0.7	1.8	10.1

HCM 6th Signalized Intersection Summary
 23: Avenue 16/Ellis Street & Kennedy Street

Village D Specific Plan
 Phase III WP - AM Peak Hour



Movement	WBL	WBR	NBT	NBR	SBL	SBT
Lane Configurations						
Traffic Volume (veh/h)	260	168	525	322	272	417
Future Volume (veh/h)	260	168	525	322	272	417
Initial Q (Qb), veh	0	0	0	0	0	0
Ped-Bike Adj(A_pbT)	1.00	1.00		0.98	1.00	
Parking Bus, Adj	1.00	1.00	1.00	1.00	1.00	1.00
Work Zone On Approach	No		No		No	
Adj Sat Flow, veh/h/ln	1841	1841	1856	1856	1870	1870
Adj Flow Rate, veh/h	283	183	571	350	296	453
Peak Hour Factor	0.92	0.92	0.92	0.92	0.92	0.92
Percent Heavy Veh, %	4	4	3	3	2	2
Cap, veh/h	334	524	611	374	618	2476
Arrive On Green	0.19	0.19	0.29	0.29	0.35	0.70
Sat Flow, veh/h	1753	2745	2172	1274	1781	3647
Grp Volume(v), veh/h	283	183	484	437	296	453
Grp Sat Flow(s),veh/h/ln	1753	1373	1763	1591	1781	1777
Q Serve(g_s), s	12.5	4.6	21.4	21.4	10.4	3.5
Cycle Q Clear(g_c), s	12.5	4.6	21.4	21.4	10.4	3.5
Prop In Lane	1.00	1.00		0.80	1.00	
Lane Grp Cap(c), veh/h	334	524	518	467	618	2476
V/C Ratio(X)	0.85	0.35	0.93	0.94	0.48	0.18
Avail Cap(c_a), veh/h	427	669	518	467	618	2476
HCM Platoon Ratio	1.00	1.00	1.00	1.00	1.00	1.00
Upstream Filter(I)	0.54	0.54	1.00	1.00	1.00	1.00
Uniform Delay (d), s/veh	31.2	28.1	27.5	27.5	20.5	4.2
Incr Delay (d2), s/veh	6.9	0.2	26.3	28.2	0.6	0.2
Initial Q Delay(d3),s/veh	0.0	0.0	0.0	0.0	0.0	0.0
%ile BackOfQ(50%),veh/ln	5.7	1.5	12.3	11.4	4.2	1.1
Unsig. Movement Delay, s/veh						
LnGrp Delay(d),s/veh	38.1	28.3	53.8	55.7	21.0	4.4
LnGrp LOS	D	C	D	E	C	A
Approach Vol, veh/h	466		921			749
Approach Delay, s/veh	34.2		54.7			11.0
Approach LOS	C		D			B
Timer - Assigned Phs	1	2			6	8
Phs Duration (G+Y+Rc), s	32.2	28.0			60.2	19.8
Change Period (Y+Rc), s	4.5	4.5			4.5	4.5
Max Green Setting (Gmax), s	23.5	23.5			51.5	19.5
Max Q Clear Time (g_c+1/2), s	12.4	23.4			5.5	14.5
Green Ext Time (p_c), s	0.7	0.1			3.4	0.8
Intersection Summary						
HCM 6th Ctrl Delay			34.9			
HCM 6th LOS			C			

HCM 6th Signalized Intersection Summary

24: Schnoor Avenue & Kennedy Street

Village D Specific Plan
Phase III WP - AM Peak Hour



Movement	EBL	EBT	EBR	WBL	WBT	WBR	NBL	NBT	NBR	SBL	SBT	SBR
Lane Configurations												
Traffic Volume (veh/h)	116	323	170	244	281	214	125	46	307	138	43	34
Future Volume (veh/h)	116	323	170	244	281	214	125	46	307	138	43	34
Initial Q (Qb), veh	0	0	0	0	0	0	0	0	0	0	0	0
Ped-Bike Adj(A_pbT)	1.00		1.00	1.00		1.00	1.00		1.00	1.00		1.00
Parking Bus, Adj	1.00	1.00	1.00	1.00	1.00	1.00	1.00	1.00	1.00	1.00	1.00	1.00
Work Zone On Approach		No			No			No			No	
Adj Sat Flow, veh/h/ln	1856	1856	1856	1826	1826	1826	1900	1900	1900	1366	1366	1366
Adj Flow Rate, veh/h	126	351	185	265	305	233	136	50	334	150	47	37
Peak Hour Factor	0.92	0.92	0.92	0.92	0.92	0.92	0.92	0.92	0.92	0.92	0.92	0.92
Percent Heavy Veh, %	3	3	3	5	5	5	0	0	0	36	36	36
Cap, veh/h	121	533	276	305	330	252	346	57	382	122	360	304
Arrive On Green	0.07	0.24	0.24	0.18	0.34	0.34	0.10	0.27	0.27	0.09	0.26	0.26
Sat Flow, veh/h	1767	2245	1162	1739	960	733	3510	213	1423	1301	1366	1153
Grp Volume(v), veh/h	126	274	262	265	0	538	136	0	384	150	47	37
Grp Sat Flow(s),veh/h/ln	1767	1763	1645	1739	0	1693	1755	0	1636	1301	1366	1153
Q Serve(g_s), s	5.5	11.2	11.6	11.9	0.0	24.5	2.9	0.0	17.9	7.5	2.1	1.5
Cycle Q Clear(g_c), s	5.5	11.2	11.6	11.9	0.0	24.5	2.9	0.0	17.9	7.5	2.1	1.5
Prop In Lane	1.00		0.71	1.00		0.43	1.00		0.87	1.00		1.00
Lane Grp Cap(c), veh/h	121	418	390	305	0	582	346	0	440	122	360	304
V/C Ratio(X)	1.04	0.66	0.67	0.87	0.00	0.92	0.39	0.00	0.87	1.23	0.13	0.12
Avail Cap(c_a), veh/h	121	418	390	359	0	624	346	0	440	122	360	304
HCM Platoon Ratio	1.00	1.00	1.00	1.00	1.00	1.00	1.00	1.00	1.00	1.00	1.00	1.00
Upstream Filter(I)	0.80	0.80	0.80	1.00	0.00	1.00	1.00	0.00	1.00	1.00	1.00	1.00
Uniform Delay (d), s/veh	37.3	27.6	27.7	32.1	0.0	25.2	33.8	0.0	27.9	36.3	22.5	12.7
Incr Delay (d2), s/veh	83.2	3.0	3.6	17.7	0.0	19.0	0.7	0.0	20.7	156.6	0.7	0.8
Initial Q Delay(d3),s/veh	0.0	0.0	0.0	0.0	0.0	0.0	0.0	0.0	0.0	0.0	0.0	0.0
%ile BackOfQ(50%),veh/ln	5.1	4.9	4.8	6.3	0.0	12.3	1.2	0.0	9.2	7.6	0.7	0.6
Unsig. Movement Delay, s/veh												
LnGrp Delay(d),s/veh	120.4	30.5	31.2	49.8	0.0	44.2	34.5	0.0	48.6	192.9	23.2	13.5
LnGrp LOS	F	C	C	D	A	D	C	A	D	F	C	B
Approach Vol, veh/h		662			803			520			234	
Approach Delay, s/veh		47.9			46.1			45.0			130.5	
Approach LOS		D			D			D			F	
Timer - Assigned Phs	1	2	3	4	5	6	7	8				
Phs Duration (G+Y+Rc), s	2.0	26.0	18.5	23.5	12.4	25.6	10.0	32.0				
Change Period (Y+Rc), s	4.5	4.5	4.5	4.5	4.5	4.5	4.5	4.5				
Max Green Setting (Gmax), s	5.5	21.5	16.5	18.5	5.9	21.1	5.5	29.5				
Max Q Clear Time (g_c+I), s	19.5	19.9	13.9	13.6	4.9	4.1	7.5	26.5				
Green Ext Time (p_c), s	0.0	0.4	0.2	1.5	0.0	0.3	0.0	1.1				
Intersection Summary												
HCM 6th Ctrl Delay												55.3
HCM 6th LOS												E

Intersection						
Int Delay, s/veh	41.5					
Movement	EBL	EBT	WBT	WBR	SBL	SBR
Lane Configurations	↘	↑	↗		↘	↗
Traffic Vol, veh/h	492	267	530	4	67	168
Future Vol, veh/h	492	267	530	4	67	168
Conflicting Peds, #/hr	0	0	0	0	0	0
Sign Control	Free	Free	Free	Free	Stop	Stop
RT Channelized	-	None	-	Free	-	None
Storage Length	140	-	-	-	0	335
Veh in Median Storage, #	-	0	0	-	0	-
Grade, %	-	0	0	-	0	-
Peak Hour Factor	92	92	92	92	92	92
Heavy Vehicles, %	2	2	6	6	3	3
Mvmt Flow	535	290	576	4	73	183

Major/Minor	Major1	Major2	Minor2		
Conflicting Flow All	576	0	-	0	1936 576
Stage 1	-	-	-	-	576 -
Stage 2	-	-	-	-	1360 -
Critical Hdwy	4.12	-	-	-	6.43 6.23
Critical Hdwy Stg 1	-	-	-	-	5.43 -
Critical Hdwy Stg 2	-	-	-	-	5.43 -
Follow-up Hdwy	2.218	-	-	-	3.527 3.327
Pot Cap-1 Maneuver	997	-	-	0	~ 72 515
Stage 1	-	-	-	0	560 -
Stage 2	-	-	-	0	238 -
Platoon blocked, %		-	-		
Mov Cap-1 Maneuver	997	-	-	-	~ 33 515
Mov Cap-2 Maneuver	-	-	-	-	~ 33 -
Stage 1	-	-	-	-	259 -
Stage 2	-	-	-	-	238 -

Approach	EB	WB	SB
HCM Control Delay, s	8.2	0	242.9
HCM LOS			F

Minor Lane/Major Mvmt	EBL	EBT	WBT	SBLn1	SBLn2
Capacity (veh/h)	997	-	-	33	515
HCM Lane V/C Ratio	0.536	-	-	2.207	0.355
HCM Control Delay (s)	12.7	-	-	812.3	15.8
HCM Lane LOS	B	-	-	F	C
HCM 95th %tile Q(veh)	3.3	-	-	8.3	1.6

Notes
 -: Volume exceeds capacity \$: Delay exceeds 300s +: Computation Not Defined *: All major volume in platoon

Intersection						
Int Delay, s/veh	8					
Movement	EBL	EBT	WBT	WBR	SBL	SBR
Lane Configurations		↶	↷		↶	
Traffic Vol, veh/h	183	151	101	0	0	433
Future Vol, veh/h	183	151	101	0	0	433
Conflicting Peds, #/hr	0	0	0	0	0	0
Sign Control	Free	Free	Free	Free	Stop	Stop
RT Channelized	-	None	-	None	-	None
Storage Length	-	-	-	-	0	-
Veh in Median Storage, #	-	0	0	-	0	-
Grade, %	-	0	0	-	0	-
Peak Hour Factor	92	92	92	92	92	92
Heavy Vehicles, %	3	3	6	6	6	6
Mvmt Flow	199	164	110	0	0	471

Major/Minor	Major1	Major2	Minor2		
Conflicting Flow All	110	0	-	0	672 110
Stage 1	-	-	-	-	110 -
Stage 2	-	-	-	-	562 -
Critical Hdwy	4.13	-	-	-	6.46 6.26
Critical Hdwy Stg 1	-	-	-	-	5.46 -
Critical Hdwy Stg 2	-	-	-	-	5.46 -
Follow-up Hdwy	2.227	-	-	-	3.554 3.354
Pot Cap-1 Maneuver	1474	-	-	-	415 933
Stage 1	-	-	-	-	905 -
Stage 2	-	-	-	-	563 -
Platoon blocked, %		-	-	-	
Mov Cap-1 Maneuver	1474	-	-	-	353 933
Mov Cap-2 Maneuver	-	-	-	-	353 -
Stage 1	-	-	-	-	770 -
Stage 2	-	-	-	-	563 -

Approach	EB	WB	SB
HCM Control Delay, s	4.3	0	12.7
HCM LOS			B

Minor Lane/Major Mvmt	EBL	EBT	WBT	WBR	SBLn1
Capacity (veh/h)	1474	-	-	-	933
HCM Lane V/C Ratio	0.135	-	-	-	0.504
HCM Control Delay (s)	7.8	0	-	-	12.7
HCM Lane LOS	A	A	-	-	B
HCM 95th %tile Q(veh)	0.5	-	-	-	2.9

Intersection						
Int Delay, s/veh	3.2					
Movement	EBL	EBR	NBL	NBT	SBT	SBR
Lane Configurations	↶			↶	↷	
Traffic Vol, veh/h	174	0	0	44	3	432
Future Vol, veh/h	174	0	0	44	3	432
Conflicting Peds, #/hr	0	0	0	0	0	0
Sign Control	Stop	Stop	Free	Free	Free	Free
RT Channelized	-	None	-	None	-	None
Storage Length	0	-	-	-	-	-
Veh in Median Storage, #	0	-	-	0	0	-
Grade, %	0	-	-	0	0	-
Peak Hour Factor	92	92	92	92	92	92
Heavy Vehicles, %	3	3	10	10	6	6
Mvmt Flow	189	0	0	48	3	470

Major/Minor	Minor2	Major1	Major2		
Conflicting Flow All	286	-	-	0	-
Stage 1	238	-	-	-	-
Stage 2	48	-	-	-	-
Critical Hdwy	6.43	-	-	-	-
Critical Hdwy Stg 1	5.43	-	-	-	-
Critical Hdwy Stg 2	5.43	-	-	-	-
Follow-up Hdwy	3.527	-	-	-	-
Pot Cap-1 Maneuver	702	0	0	-	-
Stage 1	799	0	0	-	-
Stage 2	972	0	0	-	-
Platoon blocked, %				-	-
Mov Cap-1 Maneuver	702	-	-	-	-
Mov Cap-2 Maneuver	702	-	-	-	-
Stage 1	799	-	-	-	-
Stage 2	972	-	-	-	-

Approach	EB	NB	SB
HCM Control Delay, s	12	0	0
HCM LOS	B		

Minor Lane/Major Mvmt	NBT EBLn1	SBT	SBR
Capacity (veh/h)	- 702	-	-
HCM Lane V/C Ratio	- 0.269	-	-
HCM Control Delay (s)	- 12	-	-
HCM Lane LOS	- B	-	-
HCM 95th %tile Q(veh)	- 1.1	-	-

Intersection						
Int Delay, s/veh	0					
Movement	EBL	EBT	WBT	WBR	SBL	SBR
Lane Configurations		↶	↷		↶	
Traffic Vol, veh/h	0	144	106	53	0	0
Future Vol, veh/h	0	144	106	53	0	0
Conflicting Peds, #/hr	0	0	0	0	0	0
Sign Control	Free	Free	Free	Free	Stop	Stop
RT Channelized	-	None	-	None	-	None
Storage Length	-	-	-	-	0	-
Veh in Median Storage, #	-	0	0	-	0	-
Grade, %	-	0	0	-	0	-
Peak Hour Factor	92	92	92	92	92	92
Heavy Vehicles, %	2	2	13	13	0	0
Mvmt Flow	0	157	115	58	0	0

Major/Minor	Major1	Major2	Minor2		
Conflicting Flow All	173	0	-	0	301
Stage 1	-	-	-	-	144
Stage 2	-	-	-	-	157
Critical Hdwy	4.12	-	-	-	6.4
Critical Hdwy Stg 1	-	-	-	-	5.4
Critical Hdwy Stg 2	-	-	-	-	5.4
Follow-up Hdwy	2.218	-	-	-	3.5
Pot Cap-1 Maneuver	1404	-	-	-	695
Stage 1	-	-	-	-	888
Stage 2	-	-	-	-	876
Platoon blocked, %		-	-	-	
Mov Cap-1 Maneuver	1404	-	-	-	695
Mov Cap-2 Maneuver	-	-	-	-	695
Stage 1	-	-	-	-	888
Stage 2	-	-	-	-	876

Approach	EB	WB	SB
HCM Control Delay, s	0	0	0
HCM LOS			A

Minor Lane/Major Mvmt	EBL	EBT	WBT	WBR	SBLn1
Capacity (veh/h)	1404	-	-	-	-
HCM Lane V/C Ratio	-	-	-	-	-
HCM Control Delay (s)	0	-	-	-	0
HCM Lane LOS	A	-	-	-	A
HCM 95th %tile Q(veh)	0	-	-	-	-

HCM 6th Signalized Intersection Summary
29: Schnoor Avenue & Cleveland Avenue

Village D Specific Plan
Phase III WP - AM Peak Hour



Movement	EBL	EBT	EBR	WBL	WBT	WBR	NBL	NBT	NBR	SBL	SBT	SBR
Lane Configurations	↘	↑↑	↗	↘↗	↑↑	↗	↘	↑↑	↗	↘	↑↑	↗
Traffic Volume (veh/h)	177	1139	82	168	498	48	62	274	179	94	205	92
Future Volume (veh/h)	177	1139	82	168	498	48	62	274	179	94	205	92
Initial Q (Qb), veh	0	0	0	0	0	0	0	0	0	0	0	0
Ped-Bike Adj(A_pbT)	1.00		0.98	1.00		0.98	1.00		0.99	1.00		0.98
Parking Bus, Adj	1.00	1.00	1.00	1.00	1.00	1.00	1.00	1.00	1.00	1.00	1.00	1.00
Work Zone On Approach		No			No			No			No	
Adj Sat Flow, veh/h/ln	1885	1885	1885	1856	1856	1856	1885	1885	1885	1870	1870	1870
Adj Flow Rate, veh/h	192	1238	89	183	541	52	67	298	195	102	223	100
Peak Hour Factor	0.92	0.92	0.92	0.92	0.92	0.92	0.92	0.92	0.92	0.92	0.92	0.92
Percent Heavy Veh, %	1	1	1	3	3	3	1	1	1	2	2	2
Cap, veh/h	232	1314	575	261	1105	483	87	869	505	160	1009	440
Arrive On Green	0.13	0.37	0.37	0.08	0.31	0.31	0.05	0.24	0.24	0.09	0.28	0.28
Sat Flow, veh/h	1795	3582	1567	3428	3526	1541	1795	3582	1582	1781	3554	1552
Grp Volume(v), veh/h	192	1238	89	183	541	52	67	298	195	102	223	100
Grp Sat Flow(s),veh/h/ln	1795	1791	1567	1714	1763	1541	1795	1791	1582	1781	1777	1552
Q Serve(g_s), s	8.3	26.8	2.3	4.2	10.0	1.4	3.0	5.5	1.5	4.4	3.8	3.9
Cycle Q Clear(g_c), s	8.3	26.8	2.3	4.2	10.0	1.4	3.0	5.5	1.5	4.4	3.8	3.9
Prop In Lane	1.00		1.00	1.00		1.00	1.00		1.00	1.00		1.00
Lane Grp Cap(c), veh/h	232	1314	575	261	1105	483	87	869	505	160	1009	440
V/C Ratio(X)	0.83	0.94	0.15	0.70	0.49	0.11	0.77	0.34	0.39	0.64	0.22	0.23
Avail Cap(c_a), veh/h	301	1321	578	279	1105	483	117	869	505	160	1009	440
HCM Platoon Ratio	1.00	1.00	1.00	1.00	1.00	1.00	1.00	1.00	1.00	1.00	1.00	1.00
Upstream Filter(I)	1.00	1.00	1.00	0.69	0.69	0.69	1.00	1.00	1.00	1.00	1.00	1.00
Uniform Delay (d), s/veh	34.0	24.5	9.5	36.1	22.3	9.7	37.6	25.0	21.2	35.2	21.9	21.9
Incr Delay (d2), s/veh	13.7	13.4	0.1	5.0	0.2	0.1	19.5	1.1	2.2	8.2	0.5	1.2
Initial Q Delay(d3),s/veh	0.0	0.0	0.0	0.0	0.0	0.0	0.0	0.0	0.0	0.0	0.0	0.0
%ile BackOfQ(50%),veh/ln	4.4	13.0	1.1	1.9	4.0	0.7	1.7	2.4	3.0	2.2	1.6	1.5
Unsig. Movement Delay, s/veh												
LnGrp Delay(d),s/veh	47.6	37.9	9.6	41.1	22.5	9.8	57.1	26.1	23.4	43.3	22.4	23.1
LnGrp LOS	D	D	A	D	C	A	E	C	C	D	C	C
Approach Vol, veh/h		1519			776			560			425	
Approach Delay, s/veh		37.4			26.0			28.9			27.6	
Approach LOS		D			C			C			C	
Timer - Assigned Phs	1	2	3	4	5	6	7	8				
Phs Duration (G+Y+Rc), s	11.7	23.9	10.6	33.8	8.4	27.2	14.8	29.6				
Change Period (Y+Rc), s	4.5	4.5	4.5	4.5	4.5	4.5	4.5	4.5				
Max Green Setting (Gmax), s	6.6	19.4	6.5	29.5	5.2	20.8	13.4	22.6				
Max Q Clear Time (g_c+I1), s	6.4	7.5	6.2	28.8	5.0	5.9	10.3	12.0				
Green Ext Time (p_c), s	0.0	2.0	0.0	0.6	0.0	1.5	0.1	2.8				

Intersection Summary

HCM 6th Ctrl Delay			32.0									
HCM 6th LOS			C									

HCM 6th Signalized Intersection Summary

30: Fairgrounds & Cleveland Avenue

Village D Specific Plan
Phase III WP - AM Peak Hour



Movement	EBL	EBT	EBR	WBL	WBT	WBR	NBL	NBT	NBR	SBL	SBT	SBR
Lane Configurations	↑↑↑			↑↑		↑	↑↑	↑	↑	↑	↑	↑
Traffic Volume (veh/h)	109	1329	30	39	651	161	14	8	29	169	5	40
Future Volume (veh/h)	109	1329	30	39	651	161	14	8	29	169	5	40
Initial Q (Qb), veh	0	0	0	0	0	0	0	0	0	0	0	0
Ped-Bike Adj(A_pbT)	1.00		1.00	1.00		1.00	1.00		1.00	1.00		0.99
Parking Bus, Adj	1.00	1.00	1.00	1.00	1.00	1.00	1.00	1.00	1.00	1.00	1.00	1.00
Work Zone On Approach	No			No			No			No		
Adj Sat Flow, veh/h/ln	1870	1870	1870	1856	1856	1856	1900	1900	1900	1900	1900	1900
Adj Flow Rate, veh/h	116	1414	32	41	693	171	15	26	20	180	5	43
Peak Hour Factor	0.94	0.94	0.94	0.94	0.94	0.94	0.94	0.94	0.94	0.94	0.94	0.94
Percent Heavy Veh, %	2	2	2	3	3	3	0	0	0	0	0	0
Cap, veh/h	146	1408	32	66	808	360	547	463	392	398	53	452
Arrive On Green	0.16	0.55	0.55	0.04	0.23	0.23	0.15	0.24	0.24	0.22	0.31	0.31
Sat Flow, veh/h	1781	5137	116	1767	3526	1572	3619	1900	1608	1810	168	1447
Grp Volume(v), veh/h	116	937	509	41	693	171	15	26	20	180	0	48
Grp Sat Flow(s),veh/h/ln	1781	1702	1849	1767	1763	1572	1810	1900	1608	1810	0	1615
Q Serve(g_s), s	5.0	21.9	21.9	1.8	15.1	7.5	0.3	0.8	0.6	6.9	0.0	1.7
Cycle Q Clear(g_c), s	5.0	21.9	21.9	1.8	15.1	7.5	0.3	0.8	0.6	6.9	0.0	1.7
Prop In Lane	1.00		0.06	1.00		1.00	1.00		1.00	1.00		0.90
Lane Grp Cap(c), veh/h	146	933	507	66	808	360	547	463	392	398	0	505
V/C Ratio(X)	0.79	1.00	1.00	0.62	0.86	0.47	0.03	0.06	0.05	0.45	0.00	0.10
Avail Cap(c_a), veh/h	278	933	507	254	859	383	547	463	392	398	0	505
HCM Platoon Ratio	2.00	2.00	2.00	1.00	1.00	1.00	1.00	1.00	1.00	1.00	1.00	1.00
Upstream Filter(I)	0.42	0.42	0.42	0.91	0.91	0.91	1.00	1.00	1.00	1.00	0.00	1.00
Uniform Delay (d), s/veh	32.8	18.1	18.1	37.9	29.6	26.7	28.9	23.2	14.9	27.0	0.0	19.5
Incr Delay (d2), s/veh	4.1	20.2	27.0	8.4	7.6	0.9	0.0	0.2	0.2	0.8	0.0	0.4
Initial Q Delay(d3),s/veh	0.0	0.0	0.0	0.0	0.0	0.0	0.0	0.0	0.0	0.0	0.0	0.0
%ile BackOfQ(50%),veh/ln	2.1	7.3	8.8	0.9	7.0	2.8	0.1	0.4	0.3	3.0	0.0	0.7
Unsig. Movement Delay, s/veh												
LnGrp Delay(d),s/veh	36.8	38.2	45.1	46.3	37.2	27.6	29.0	23.4	15.1	27.8	0.0	19.9
LnGrp LOS	D	F	F	D	D	C	C	C	B	C	A	B
Approach Vol, veh/h	1562		905				61		228			
Approach Delay, s/veh	40.4		35.8				22.1		26.2			
Approach LOS	D		D				C		C			
Timer - Assigned Phs	1	2	3	4	5	6	7	8				
Phs Duration (G+Y+Rc), s	22.1	24.0	7.5	26.4	16.6	29.5	11.1	22.8				
Change Period (Y+Rc), s	4.5	4.5	4.5	4.5	4.5	4.5	4.5	4.5				
Max Green Setting (Gmax), s	10.5	19.5	11.5	20.5	5.0	25.0	12.5	19.5				
Max Q Clear Time (g_c+10), s	10.5	2.8	3.8	23.9	2.3	3.7	7.0	17.1				
Green Ext Time (p_c), s	0.1	0.1	0.0	0.0	0.0	0.2	0.1	1.2				

Intersection Summary

HCM 6th Ctrl Delay	37.3
HCM 6th LOS	D

Notes

User approved volume balancing among the lanes for turning movement.

HCM 6th Signalized Intersection Summary
 31: SR-99 Southbound Ramps & Cleveland Avenue

Village D Specific Plan
 Phase III WP - AM Peak Hour



Movement	EBL	EBT	EBR	WBL	WBT	WBR	NBL	NBT	NBR	SBL	SBT	SBR
Lane Configurations		↑↑	↑	↑	↑↑					↑		↑
Traffic Volume (veh/h)	0	745	867	390	965	0	0	0	0	264	0	104
Future Volume (veh/h)	0	745	867	390	965	0	0	0	0	264	0	104
Initial Q (Qb), veh	0	0	0	0	0	0				0	0	0
Ped-Bike Adj(A_pbT)	1.00		1.00	1.00		1.00				1.00		1.00
Parking Bus, Adj	1.00	1.00	1.00	1.00	1.00	1.00				1.00	1.00	1.00
Work Zone On Approach		No			No						No	
Adj Sat Flow, veh/h/ln	0	1856	1856	1856	1856	0				1811	0	1811
Adj Flow Rate, veh/h	0	810	942	424	1049	0				287	0	113
Peak Hour Factor	0.92	0.92	0.92	0.92	0.92	0.92				0.92	0.92	0.92
Percent Heavy Veh, %	0	3	3	3	3	0				6	0	6
Cap, veh/h	0	1375	613	445	2440	0				359	0	319
Arrive On Green	0.00	0.39	0.39	0.50	1.00	0.00				0.21	0.00	0.21
Sat Flow, veh/h	0	3618	1572	1767	3618	0				1725	0	1535
Grp Volume(v), veh/h	0	810	942	424	1049	0				287	0	113
Grp Sat Flow(s),veh/h/ln	0	1763	1572	1767	1763	0				1725	0	1535
Q Serve(g_s), s	0.0	16.4	35.1	20.6	0.0	0.0				14.2	0.0	5.7
Cycle Q Clear(g_c), s	0.0	16.4	35.1	20.6	0.0	0.0				14.2	0.0	5.7
Prop In Lane	0.00		1.00	1.00		0.00				1.00		1.00
Lane Grp Cap(c), veh/h	0	1375	613	445	2440	0				359	0	319
V/C Ratio(X)	0.00	0.59	1.54	0.95	0.43	0.00				0.80	0.00	0.35
Avail Cap(c_a), veh/h	0	1375	613	454	2456	0				359	0	319
HCM Platoon Ratio	1.00	1.00	1.00	2.00	2.00	1.00				1.00	1.00	1.00
Upstream Filter(I)	0.00	0.54	0.54	0.65	0.65	0.00				1.00	0.00	1.00
Uniform Delay (d), s/veh	0.0	21.7	27.5	21.8	0.0	0.0				33.9	0.0	30.5
Incr Delay (d2), s/veh	0.0	0.4	245.7	22.8	0.1	0.0				12.1	0.0	0.7
Initial Q Delay(d3),s/veh	0.0	0.0	0.0	0.0	0.0	0.0				0.0	0.0	0.0
%ile BackOfQ(50%),veh/ln	0.0	6.6	54.3	8.2	0.0	0.0				7.0	0.0	2.1
Unsig. Movement Delay, s/veh												
LnGrp Delay(d),s/veh	0.0	22.1	273.1	44.6	0.1	0.0				46.0	0.0	31.1
LnGrp LOS	A	C	F	D	A	A				D	A	C
Approach Vol, veh/h		1752			1473					400		
Approach Delay, s/veh		157.1			12.9					41.8		
Approach LOS		F			B					D		
Timer - Assigned Phs			3	4		6		8				
Phs Duration (G+Y+Rc), s			27.2	39.6		23.2		66.8				
Change Period (Y+Rc), s			4.5	4.5		4.5		4.5				
Max Green Setting (Gmax), s			23.1	35.1		18.3		62.7				
Max Q Clear Time (g_c+I1), s			22.6	37.1		16.2		2.0				
Green Ext Time (p_c), s			0.1	0.0		0.3		10.3				
Intersection Summary												
HCM 6th Ctrl Delay			85.8									
HCM 6th LOS			F									

HCM 6th Signalized Intersection Summary
 32: SR-99 Northbound Ramps & Cleveland Avenue

Village D Specific Plan
 Phase III WP - AM Peak Hour



Movement	EBL	EBT	EBR	WBL	WBT	WBR	NBL	NBT	NBR	SBL	SBT	SBR
Lane Configurations	↘	↑↑			↑↑	↗	↘	↖	↗			
Traffic Volume (veh/h)	83	928	0	0	925	175	438	0	389	0	0	0
Future Volume (veh/h)	83	928	0	0	925	175	438	0	389	0	0	0
Initial Q (Qb), veh	0	0	0	0	0	0	0	0	0			
Ped-Bike Adj(A_pbT)	1.00		1.00	1.00		1.00	1.00		1.00			
Parking Bus, Adj	1.00	1.00	1.00	1.00	1.00	1.00	1.00	1.00	1.00			
Work Zone On Approach	No			No			No					
Adj Sat Flow, veh/h/ln	1856	1856	0	0	1870	1870	1841	1841	1841			
Adj Flow Rate, veh/h	90	1009	0	0	1005	190	476	0	423			
Peak Hour Factor	0.92	0.92	0.92	0.92	0.92	0.92	0.92	0.92	0.92			
Percent Heavy Veh, %	3	3	0	0	2	2	4	4	4			
Cap, veh/h	117	1522	0	0	1122	500	1642	0	730			
Arrive On Green	0.07	0.43	0.00	0.00	0.32	0.32	0.47	0.00	0.47			
Sat Flow, veh/h	1767	3618	0	0	3647	1585	3506	0	1560			
Grp Volume(v), veh/h	90	1009	0	0	1005	190	476	0	423			
Grp Sat Flow(s),veh/h/ln	1767	1763	0	0	1777	1585	1753	0	1560			
Q Serve(g_s), s	4.5	20.5	0.0	0.0	24.3	8.4	7.5	0.0	17.8			
Cycle Q Clear(g_c), s	4.5	20.5	0.0	0.0	24.3	8.4	7.5	0.0	17.8			
Prop In Lane	1.00		0.00	0.00		1.00	1.00		1.00			
Lane Grp Cap(c), veh/h	117	1522	0	0	1122	500	1642	0	730			
V/C Ratio(X)	0.77	0.66	0.00	0.00	0.90	0.38	0.29	0.00	0.58			
Avail Cap(c_a), veh/h	363	2057	0	0	1165	520	1642	0	730			
HCM Platoon Ratio	1.00	1.00	1.00	1.00	1.00	1.00	1.00	1.00	1.00			
Upstream Filter(I)	0.71	0.71	0.00	0.00	0.69	0.69	1.00	0.00	1.00			
Uniform Delay (d), s/veh	41.4	20.4	0.0	0.0	29.4	23.9	14.7	0.0	17.5			
Incr Delay (d2), s/veh	7.4	0.4	0.0	0.0	6.6	0.3	0.4	0.0	3.3			
Initial Q Delay(d3),s/veh	0.0	0.0	0.0	0.0	0.0	0.0	0.0	0.0	0.0			
%ile BackOfQ(50%),veh/ln	2.2	8.1	0.0	0.0	11.0	3.1	3.0	0.0	6.7			
Unsig. Movement Delay, s/veh												
LnGrp Delay(d),s/veh	48.7	20.7	0.0	0.0	35.9	24.3	15.2	0.0	20.8			
LnGrp LOS	D	C	A	A	D	C	B	A	C			
Approach Vol, veh/h	1099				1195		899					
Approach Delay, s/veh	23.0				34.1		17.8					
Approach LOS	C				C		B					
Timer - Assigned Phs	2		4		7		8					
Phs Duration (G+Y+Rc), s	46.6		43.4		10.5		32.9					
Change Period (Y+Rc), s	4.5		4.5		4.5		4.5					
Max Green Setting (Gmax), s	28.5		52.5		18.5		29.5					
Max Q Clear Time (g_c+I1), s	19.8		22.5		6.5		26.3					
Green Ext Time (p_c), s	2.4		8.6		0.1		2.1					

Intersection Summary

HCM 6th Ctrl Delay	25.7
HCM 6th LOS	C

Notes

User approved volume balancing among the lanes for turning movement.

HCM 6th Signalized Intersection Summary
 33: Gateway Drive & Cleveland Avenue

Village D Specific Plan
 Phase III WP - AM Peak Hour



Movement	EBL	EBT	EBR	WBL	WBT	WBR	NBL	NBT	NBR	SBL	SBT	SBR
Lane Configurations	↖	↑↑↑	↗	↖↗	↑↑		↖↗	↑	↗	↖	↑↘	
Traffic Volume (veh/h)	4	1034	278	237	911	82	185	50	196	67	89	4
Future Volume (veh/h)	4	1034	278	237	911	82	185	50	196	67	89	4
Initial Q (Qb), veh	0	0	0	0	0	0	0	0	0	0	0	0
Ped-Bike Adj(A_pbT)	1.00		1.00	1.00		1.00	1.00		0.98	1.00		0.98
Parking Bus, Adj	1.00	1.00	1.00	1.00	1.00	1.00	1.00	1.00	1.00	1.00	1.00	1.00
Work Zone On Approach		No			No			No			No	
Adj Sat Flow, veh/h/ln	1856	1856	1856	1870	1870	1870	1811	1811	1811	1841	1841	1841
Adj Flow Rate, veh/h	4	1124	0	258	990	89	201	54	213	73	97	4
Peak Hour Factor	0.92	0.92	0.92	0.92	0.92	0.92	0.92	0.92	0.92	0.92	0.92	0.92
Percent Heavy Veh, %	3	3	3	2	2	2	6	6	6	4	4	4
Cap, veh/h	89	1349		346	1191	107	729	688	574	94	737	30
Arrive On Green	0.00	0.18	0.00	0.10	0.36	0.36	0.22	0.38	0.38	0.05	0.22	0.22
Sat Flow, veh/h	1767	5066	1572	3456	3296	296	3346	1811	1510	1753	3421	140
Grp Volume(v), veh/h	4	1124	0	258	534	545	201	54	213	73	49	52
Grp Sat Flow(s),veh/h/ln	1767	1689	1572	1728	1777	1816	1673	1811	1510	1753	1749	1813
Q Serve(g_s), s	0.2	19.3	0.0	6.5	24.7	24.7	4.5	1.7	6.2	3.7	2.0	2.1
Cycle Q Clear(g_c), s	0.2	19.3	0.0	6.5	24.7	24.7	4.5	1.7	6.2	3.7	2.0	2.1
Prop In Lane	1.00		1.00	1.00		0.16	1.00		1.00	1.00		0.08
Lane Grp Cap(c), veh/h	89	1349		346	642	656	729	688	574	94	377	391
V/C Ratio(X)	0.04	0.83		0.75	0.83	0.83	0.28	0.08	0.37	0.78	0.13	0.13
Avail Cap(c_a), veh/h	247	1435		591	642	656	729	688	574	205	377	391
HCM Platoon Ratio	0.67	0.67	0.67	1.00	1.00	1.00	1.00	1.00	1.00	1.00	1.00	1.00
Upstream Filter(I)	0.78	0.78	0.00	0.89	0.89	0.89	1.00	1.00	1.00	1.00	1.00	1.00
Uniform Delay (d), s/veh	28.6	35.0	0.0	39.4	26.2	26.2	29.3	17.8	9.2	42.1	28.5	28.5
Incr Delay (d2), s/veh	0.2	3.3	0.0	2.9	8.2	8.0	0.2	0.2	1.8	12.8	0.7	0.7
Initial Q Delay(d3),s/veh	0.0	0.0	0.0	0.0	0.0	0.0	0.0	0.0	0.0	0.0	0.0	0.0
%ile BackOfQ(50%),veh/ln	0.1	8.6	0.0	2.9	11.4	11.7	1.8	0.7	3.2	1.9	0.9	1.0
Unsig. Movement Delay, s/veh												
LnGrp Delay(d),s/veh	28.8	38.3	0.0	42.2	34.4	34.3	29.5	18.1	11.1	54.8	29.2	29.2
LnGrp LOS	C	D		D	C	C	C	B	B	D	C	C
Approach Vol, veh/h		1128	A		1337			468			174	
Approach Delay, s/veh		38.3			35.9			19.8			40.0	
Approach LOS		D			D			B			D	
Timer - Assigned Phs	1	2	3	4	5	6	7	8				
Phs Duration (G+Y+Rc), s	24.1	23.9	5.0	37.0	9.3	38.7	13.5	28.5				
Change Period (Y+Rc), s	4.5	4.5	4.5	4.5	4.5	4.5	4.5	4.5				
Max Green Setting (Gmax), s	19.4	19.4	8.5	32.4	10.5	20.6	15.4	25.5				
Max Q Clear Time (g_c+10), s	4.1	4.1	2.2	26.7	5.7	8.2	8.5	21.3				
Green Ext Time (p_c), s	0.3	0.4	0.0	3.3	0.1	0.8	0.5	2.7				

Intersection Summary

HCM 6th Ctrl Delay	34.6
HCM 6th LOS	C

Notes

Unsignalized Delay for [EBR] is excluded from calculations of the approach delay and intersection delay.

HCM 6th Signalized Intersection Summary
34: Cleveland Avenue & County Club Drive

Village D Specific Plan
Phase III WP - AM Peak Hour



Movement	WBL	WBR	NBT	NBR	SBL	SBT
Lane Configurations	⇐⇐		⇑⇑	⇑	⇑	⇑⇑⇑
Traffic Volume (veh/h)	526	49	852	444	104	704
Future Volume (veh/h)	526	49	852	444	104	704
Initial Q (Qb), veh	0	0	0	0	0	0
Ped-Bike Adj(A_pbT)	1.00	1.00		1.00	1.00	
Parking Bus, Adj	1.00	1.00	1.00	1.00	1.00	1.00
Work Zone On Approach	No		No		No	
Adj Sat Flow, veh/h/ln	1900	1900	1856	1856	1856	1856
Adj Flow Rate, veh/h	621	0	926	0	113	765
Peak Hour Factor	0.92	0.92	0.92	0.92	0.92	0.92
Percent Heavy Veh, %	0	0	3	3	3	3
Cap, veh/h	759	338	2434		428	3497
Arrive On Green	0.21	0.00	0.69	0.00	0.69	0.69
Sat Flow, veh/h	3619	1610	3618	1572	599	5233
Grp Volume(v), veh/h	621	0	926	0	113	765
Grp Sat Flow(s),veh/h/ln	1810	1610	1763	1572	599	1689
Q Serve(g_s), s	14.7	0.0	9.9	0.0	8.8	5.0
Cycle Q Clear(g_c), s	14.7	0.0	9.9	0.0	18.7	5.0
Prop In Lane	1.00	1.00		1.00	1.00	
Lane Grp Cap(c), veh/h	759	338	2434		428	3497
V/C Ratio(X)	0.82	0.00	0.38		0.26	0.22
Avail Cap(c_a), veh/h	1307	581	2434		428	3497
HCM Platoon Ratio	1.00	1.00	1.00	1.00	1.00	1.00
Upstream Filter(I)	1.00	0.00	0.63	0.00	1.00	1.00
Uniform Delay (d), s/veh	33.9	0.0	5.9	0.0	9.8	5.1
Incr Delay (d2), s/veh	2.2	0.0	0.3	0.0	1.5	0.1
Initial Q Delay(d3),s/veh	0.0	0.0	0.0	0.0	0.0	0.0
%ile BackOfQ(50%),veh/ln	6.6	0.0	3.1	0.0	1.2	1.5
Unsig. Movement Delay, s/veh						
LnGrp Delay(d),s/veh	36.2	0.0	6.1	0.0	11.3	5.2
LnGrp LOS	D	A	A		B	A
Approach Vol, veh/h	621		926	A		878
Approach Delay, s/veh	36.2		6.1			6.0
Approach LOS	D		A			A
Timer - Assigned Phs		2			6	8
Phs Duration (G+Y+Rc), s		66.6			66.6	23.4
Change Period (Y+Rc), s		4.5			4.5	4.5
Max Green Setting (Gmax), s		48.5			48.5	32.5
Max Q Clear Time (g_c+I1), s		11.9			20.7	16.7
Green Ext Time (p_c), s		8.1			7.4	2.1

Intersection Summary

HCM 6th Ctrl Delay	13.8
HCM 6th LOS	B

Notes

User approved volume balancing among the lanes for turning movement.
Unsignalized Delay for [NBR] is excluded from calculations of the approach delay and intersection delay.

Intersection						
Int Delay, s/veh	0.1					
Movement	EBL	EBR	NBL	NBT	SBT	SBR
Lane Configurations	T			T		
Traffic Vol, veh/h	2	13	1	868	770	1
Future Vol, veh/h	2	13	1	868	770	1
Conflicting Peds, #/hr	0	0	2	0	0	2
Sign Control	Stop	Stop	Free	Free	Free	Free
RT Channelized	-	None	-	None	-	None
Storage Length	0	-	-	-	-	-
Veh in Median Storage, #	0	-	-	0	0	-
Grade, %	0	-	-	0	0	-
Peak Hour Factor	92	92	92	92	92	92
Heavy Vehicles, %	7	7	5	5	4	4
Mvmt Flow	2	14	1	943	837	1

Major/Minor	Minor2	Major1	Major2			
Conflicting Flow All	1314	421	840	0	-	0
Stage 1	840	-	-	-	-	-
Stage 2	474	-	-	-	-	-
Critical Hdwy	6.94	7.04	4.2	-	-	-
Critical Hdwy Stg 1	5.94	-	-	-	-	-
Critical Hdwy Stg 2	5.94	-	-	-	-	-
Follow-up Hdwy	3.57	3.37	2.25	-	-	-
Pot Cap-1 Maneuver	*335	567	772	-	-	-
Stage 1	*372	-	-	-	-	-
Stage 2	*675	-	-	-	-	-
Platoon blocked, %	1			-	-	-
Mov Cap-1 Maneuver	*333	566	771	-	-	-
Mov Cap-2 Maneuver	*334	-	-	-	-	-
Stage 1	*370	-	-	-	-	-
Stage 2	*673	-	-	-	-	-

Approach	EB	NB	SB
HCM Control Delay, s	12.2	0	0
HCM LOS	B		

Minor Lane/Major Mvmt	NBL	NBT	EBLn1	SBT	SBR
Capacity (veh/h)	771	-	518	-	-
HCM Lane V/C Ratio	0.001	-	0.031	-	-
HCM Control Delay (s)	9.7	0	12.2	-	-
HCM Lane LOS	A	A	B	-	-
HCM 95th %tile Q(veh)	0	-	0.1	-	-

Notes
 -: Volume exceeds capacity \$: Delay exceeds 300s +: Computation Not Defined *: All major volume in platoon

HCM 6th Signalized Intersection Summary
 36: Pine Street & Howard Road

Village D Specific Plan
 Phase III WP - AM Peak Hour



Movement	EBL	EBT	EBR	WBL	WBT	WBR	NBL	NBT	NBR	SBL	SBT	SBR
Lane Configurations												
Traffic Volume (veh/h)	35	1031	187	163	581	7	159	174	253	17	295	102
Future Volume (veh/h)	35	1031	187	163	581	7	159	174	253	17	295	102
Initial Q (Qb), veh	0	0	0	0	0	0	0	0	0	0	0	0
Ped-Bike Adj(A_pbT)	1.00		0.98	1.00		0.98	1.00		0.99	1.00		0.98
Parking Bus, Adj	1.00	1.00	1.00	1.00	1.00	1.00	1.00	1.00	1.00	1.00	1.00	1.00
Work Zone On Approach		No			No			No			No	
Adj Sat Flow, veh/h/ln	1885	1885	1885	1870	1870	1870	1811	1811	1811	1841	1841	1841
Adj Flow Rate, veh/h	38	1121	203	177	632	8	173	189	275	18	321	111
Peak Hour Factor	0.92	0.92	0.92	0.92	0.92	0.92	0.92	0.92	0.92	0.92	0.92	0.92
Percent Heavy Veh, %	1	1	1	2	2	2	6	6	6	4	4	4
Cap, veh/h	54	1189	214	171	1650	21	296	311	262	18	329	288
Arrive On Green	0.03	0.39	0.39	0.10	0.46	0.46	0.17	0.17	0.17	0.19	0.19	0.19
Sat Flow, veh/h	1795	3021	545	1781	3593	45	1725	1811	1527	97	1738	1523
Grp Volume(v), veh/h	38	662	662	177	312	328	173	189	275	339	0	111
Grp Sat Flow(s),veh/h/ln	1795	1791	1775	1781	1777	1861	1725	1811	1527	1836	0	1523
Q Serve(g_s), s	2.5	42.7	43.3	11.5	13.8	13.9	11.1	11.6	20.6	22.0	0.0	7.6
Cycle Q Clear(g_c), s	2.5	42.7	43.3	11.5	13.8	13.9	11.1	11.6	20.6	22.0	0.0	7.6
Prop In Lane	1.00		0.31	1.00		0.02	1.00		1.00	0.05		1.00
Lane Grp Cap(c), veh/h	54	705	698	171	816	855	296	311	262	347	0	288
V/C Ratio(X)	0.71	0.94	0.95	1.04	0.38	0.38	0.58	0.61	1.05	0.98	0.00	0.39
Avail Cap(c_a), veh/h	103	715	708	171	816	855	296	311	262	347	0	288
HCM Platoon Ratio	1.00	1.00	1.00	1.00	1.00	1.00	1.00	1.00	1.00	1.00	1.00	1.00
Upstream Filter(I)	1.00	1.00	1.00	0.93	0.93	0.93	1.00	1.00	1.00	1.00	0.00	1.00
Uniform Delay (d), s/veh	57.7	35.0	35.2	54.3	21.3	21.3	45.8	46.0	49.7	48.4	0.0	42.5
Incr Delay (d2), s/veh	15.6	20.3	21.7	76.4	0.3	0.3	8.2	8.6	69.3	41.8	0.0	0.8
Initial Q Delay(d3),s/veh	0.0	0.0	0.0	0.0	0.0	0.0	0.0	0.0	0.0	0.0	0.0	0.0
%ile BackOfQ(50%),veh/ln	1.4	22.2	22.5	8.8	5.8	6.1	5.4	6.0	12.9	14.1	0.0	3.0
Unsig. Movement Delay, s/veh												
LnGrp Delay(d),s/veh	73.3	55.3	56.9	130.7	21.6	21.5	54.0	54.6	119.0	90.1	0.0	43.4
LnGrp LOS	E	E	E	F	C	C	D	D	F	F	A	D
Approach Vol, veh/h		1362			817			637				450
Approach Delay, s/veh		56.6			45.2			82.2				78.6
Approach LOS		E			D			F				E
Timer - Assigned Phs		2	3	4		6	7	8				
Phs Duration (G+Y+Rc), s		25.1	16.0	51.7		27.2	8.1	59.6				
Change Period (Y+Rc), s		4.5	4.5	4.5		4.5	4.5	4.5				
Max Green Setting (Gmax), s		19.9	11.5	47.9		22.7	6.9	52.5				
Max Q Clear Time (g_c+I1), s		22.6	13.5	45.3		24.0	4.5	15.9				
Green Ext Time (p_c), s		0.0	0.0	2.0		0.0	0.0	4.4				
Intersection Summary												
HCM 6th Ctrl Delay				61.8								
HCM 6th LOS				E								

HCM 6th Signalized Intersection Summary
 37: Olive Avenue/Q Street & Howard Road/Yosemite Avenue

Village D Specific Plan
 Phase III WP - AM Peak Hour



Movement	EBL	EBT	EBR	WBL	WBT	WBR	NBL	NBT	NBR	SBL	SBT	SBR
Lane Configurations												
Traffic Volume (veh/h)	6	609	625	28	365	20	445	89	21	104	152	13
Future Volume (veh/h)	6	609	625	28	365	20	445	89	21	104	152	13
Initial Q (Qb), veh	0	0	0	0	0	0	0	0	0	0	0	0
Ped-Bike Adj(A_pbT)	1.00		1.00	1.00		0.98	1.00		0.99	1.00		0.96
Parking Bus, Adj	1.00	1.00	1.00	1.00	1.00	1.00	1.00	1.00	1.00	1.00	1.00	1.00
Work Zone On Approach		No			No			No			No	
Adj Sat Flow, veh/h/ln	1870	1870	1870	1870	1870	1870	1841	1841	1841	1870	1870	1870
Adj Flow Rate, veh/h	7	662	0	30	397	22	553	0	23	113	165	14
Peak Hour Factor	0.92	0.92	0.92	0.92	0.92	0.92	0.92	0.92	0.92	0.92	0.92	0.92
Percent Heavy Veh, %	2	2	2	2	2	2	4	4	4	2	2	2
Cap, veh/h	15	784		74	867	48	1651	0	727	208	219	178
Arrive On Green	0.01	0.29	0.00	0.04	0.25	0.25	0.47	0.00	0.47	0.12	0.12	0.12
Sat Flow, veh/h	1781	3554	1585	1781	3419	189	3506	0	1545	1781	1870	1524
Grp Volume(v), veh/h	7	662	0	30	206	213	553	0	23	113	165	14
Grp Sat Flow(s),veh/h/ln	1781	1777	1585	1781	1777	1831	1753	0	1545	1781	1870	1524
Q Serve(g_s), s	0.5	21.0	0.0	2.0	11.7	11.8	11.9	0.0	1.0	7.2	10.3	1.0
Cycle Q Clear(g_c), s	0.5	21.0	0.0	2.0	11.7	11.8	11.9	0.0	1.0	7.2	10.3	1.0
Prop In Lane	1.00		1.00	1.00		0.10	1.00		1.00	1.00		1.00
Lane Grp Cap(c), veh/h	15	784		74	451	464	1651	0	727	208	219	178
V/C Ratio(X)	0.45	0.84		0.40	0.46	0.46	0.33	0.00	0.03	0.54	0.75	0.08
Avail Cap(c_a), veh/h	74	1022		267	703	725	1651	0	727	267	281	229
HCM Platoon Ratio	1.33	1.33	1.33	1.00	1.00	1.00	1.00	1.00	1.00	1.00	1.00	1.00
Upstream Filter(I)	0.34	0.34	0.00	1.00	1.00	1.00	1.00	0.00	1.00	1.00	1.00	1.00
Uniform Delay (d), s/veh	59.0	40.5	0.0	56.0	37.8	37.8	19.9	0.0	17.1	50.0	51.3	47.2
Incr Delay (d2), s/veh	6.9	1.8	0.0	3.5	0.7	0.7	0.5	0.0	0.1	2.2	8.4	0.2
Initial Q Delay(d3),s/veh	0.0	0.0	0.0	0.0	0.0	0.0	0.0	0.0	0.0	0.0	0.0	0.0
%ile BackOfQ(50%),veh/ln	0.2	8.9	0.0	1.0	5.2	5.4	5.0	0.0	0.4	3.3	5.3	0.4
Unsig. Movement Delay, s/veh												
LnGrp Delay(d),s/veh	65.9	42.3	0.0	59.6	38.5	38.5	20.5	0.0	17.1	52.2	59.7	47.4
LnGrp LOS	E	D		E	D	D	C	A	B	D	E	D
Approach Vol, veh/h		669	A		449		576		292			
Approach Delay, s/veh		42.6			39.9		20.4		56.2			
Approach LOS		D			D		C		E			
Timer - Assigned Phs		2	3	4		6	7	8				
Phs Duration (G+Y+Rc), s		61.0	9.5	31.0		18.5	5.5	34.9				
Change Period (Y+Rc), s		4.5	4.5	4.5		4.5	4.5	4.5				
Max Green Setting (Gmax), s		31.5	18.0	34.5		18.0	5.0	47.5				
Max Q Clear Time (g_c+I1), s		13.9	4.0	23.0		12.3	2.5	13.8				
Green Ext Time (p_c), s		2.0	0.0	3.5		0.6	0.0	2.7				

Intersection Summary

HCM 6th Ctrl Delay	37.5
HCM 6th LOS	D

Notes

User approved volume balancing among the lanes for turning movement.
 Unsignalized Delay for [EBR] is excluded from calculations of the approach delay and intersection delay.

Intersection												
Int Delay, s/veh	51.9											
Movement	EBL	EBT	EBR	WBL	WBT	WBR	NBL	NBT	NBR	SBL	SBT	SBR
Lane Configurations		↕			↕	↕	↕	↕			↕	
Traffic Vol, veh/h	2	0	68	523	22	12	24	89	0	0	156	3
Future Vol, veh/h	2	0	68	523	22	12	24	89	0	0	156	3
Conflicting Peds, #/hr	0	0	1	1	0	0	0	0	0	0	0	0
Sign Control	Stop	Stop	Stop	Stop	Stop	Stop	Free	Free	Free	Free	Free	Free
RT Channelized	-	-	None	-	-	Stop	-	-	None	-	-	None
Storage Length	-	-	-	-	-	50	75	-	-	-	-	-
Veh in Median Storage, #	-	0	-	-	0	-	-	0	-	-	0	-
Grade, %	-	0	-	-	0	-	-	0	-	-	0	-
Peak Hour Factor	92	92	92	92	92	92	92	92	92	92	92	92
Heavy Vehicles, %	0	0	0	3	3	3	4	4	4	1	1	1
Mvmt Flow	2	0	74	568	24	13	26	97	0	0	170	3

Major/Minor	Minor2		Minor1		Major1		Major2					
Conflicting Flow All	333	321	173	359	322	97	173	0	-	-	-	0
Stage 1	172	172	-	149	149	-	-	-	-	-	-	-
Stage 2	161	149	-	210	173	-	-	-	-	-	-	-
Critical Hdwy	7.1	6.5	6.2	7.13	6.53	6.23	4.14	-	-	-	-	-
Critical Hdwy Stg 1	6.1	5.5	-	6.13	5.53	-	-	-	-	-	-	-
Critical Hdwy Stg 2	6.1	5.5	-	6.13	5.53	-	-	-	-	-	-	-
Follow-up Hdwy	3.5	4	3.3	3.527	4.027	3.327	2.236	-	-	-	-	-
Pot Cap-1 Maneuver	646	614	876	615	608	990	1392	-	0	0	-	-
Stage 1	835	760	-	876	784	-	-	-	0	0	-	-
Stage 2	870	790	-	790	754	-	-	-	0	0	-	-
Platoon blocked, %	1	1		1	1	1		-			-	-
Mov Cap-1 Maneuver	609	602	875	~ 554	596	990	1392	-	-	-	-	-
Mov Cap-2 Maneuver	609	602	-	~ 554	596	-	-	-	-	-	-	-
Stage 1	819	760	-	860	769	-	-	-	-	-	-	-
Stage 2	817	775	-	723	754	-	-	-	-	-	-	-

Approach	EB	WB	NB	SB
HCM Control Delay, s	9.6	82.2	1.6	0
HCM LOS	A	F		

Minor Lane/Major Mvmt	NBL	NBT	EBLn1	WBLn1	WBLn2	SBT	SBR
Capacity (veh/h)	1392	-	864	556	990	-	-
HCM Lane V/C Ratio	0.019	-	0.088	1.065	0.013	-	-
HCM Control Delay (s)	7.6	-	9.6	83.8	8.7	-	-
HCM Lane LOS	A	-	A	F	A	-	-
HCM 95th %tile Q(veh)	0.1	-	0.3	17.4	0	-	-

Notes
 -: Volume exceeds capacity \$: Delay exceeds 300s +: Computation Not Defined *: All major volume in platoon

HCM 6th Signalized Intersection Summary
39: 4th Street & Sunset Avenue

Village D Specific Plan
Phase III WP - AM Peak Hour



Movement	EBL	EBR	NBL	NBT	SBT	SBR
Lane Configurations	↔↔		↔	↑↑	↑	↔
Traffic Volume (veh/h)	413	23	35	371	522	296
Future Volume (veh/h)	413	23	35	371	522	296
Initial Q (Qb), veh	0	0	0	0	0	0
Ped-Bike Adj(A_pbT)	1.00	1.00	1.00			1.00
Parking Bus, Adj	1.00	1.00	1.00	1.00	1.00	1.00
Work Zone On Approach	No			No	No	
Adj Sat Flow, veh/h/ln	1900	1900	1870	1870	1870	1870
Adj Flow Rate, veh/h	472	0	38	403	567	322
Peak Hour Factor	0.92	0.92	0.92	0.92	0.92	0.92
Percent Heavy Veh, %	0	0	2	2	2	2
Cap, veh/h	572	254	451	2637	821	945
Arrive On Green	0.16	0.00	0.25	0.74	0.88	0.88
Sat Flow, veh/h	3619	1610	1781	3647	1870	1581
Grp Volume(v), veh/h	472	0	38	403	567	322
Grp Sat Flow(s),veh/h/ln	1810	1610	1781	1777	1870	1581
Q Serve(g_s), s	11.4	0.0	1.5	3.0	8.5	2.7
Cycle Q Clear(g_c), s	11.4	0.0	1.5	3.0	8.5	2.7
Prop In Lane	1.00	1.00	1.00			1.00
Lane Grp Cap(c), veh/h	572	254	451	2637	821	945
V/C Ratio(X)	0.83	0.00	0.08	0.15	0.69	0.34
Avail Cap(c_a), veh/h	744	331	451	2637	821	945
HCM Platoon Ratio	1.00	1.00	1.00	1.00	2.00	2.00
Upstream Filter(I)	1.00	0.00	1.00	1.00	0.84	0.84
Uniform Delay (d), s/veh	36.7	0.0	25.7	3.4	3.6	1.7
Incr Delay (d2), s/veh	5.9	0.0	0.1	0.1	4.0	0.8
Initial Q Delay(d3),s/veh	0.0	0.0	0.0	0.0	0.0	0.0
%ile BackOfQ(50%),veh/ln	5.4	0.0	0.6	0.9	2.4	1.0
Unsig. Movement Delay, s/veh						
LnGrp Delay(d),s/veh	42.6	0.0	25.7	3.5	7.6	2.5
LnGrp LOS	D	A	C	A	A	A
Approach Vol, veh/h	472			441	889	
Approach Delay, s/veh	42.6			5.4	5.8	
Approach LOS	D			A	A	
Timer - Assigned Phs		2		4	5	6
Phs Duration (G+Y+Rc), s		71.3		18.7	27.3	44.0
Change Period (Y+Rc), s		4.5		4.5	4.5	4.5
Max Green Setting (Gmax), s		62.5		18.5	18.5	39.5
Max Q Clear Time (g_c+I1), s		5.0		13.4	3.5	10.5
Green Ext Time (p_c), s		3.0		0.9	0.0	5.4

Intersection Summary

HCM 6th Ctrl Delay	15.3
HCM 6th LOS	B

Notes

User approved volume balancing among the lanes for turning movement.

40: H Street & SR-99 Southbound On-Ramp/2nd Street Performance by movement

Movement	WBL	WBT	WBR	NBL	NBT	NBR	SBT	All
Denied Delay (hr)	0.0	0.0	0.0	0.0	0.0	0.0	0.0	0.0
Denied Del/Veh (s)	0.1	0.1	0.1	0.0	0.0	0.0	0.1	0.0
Total Delay (hr)	0.1	0.1	0.0	0.2	0.0	0.0	0.1	0.6
Total Del/Veh (s)	13.2	11.2	6.4	2.7	3.2	2.9	17.9	5.4
Stop Delay (hr)	0.1	0.1	0.0	0.0	0.0	0.0	0.1	0.3
Stop Del/Veh (s)	11.2	7.7	5.6	0.1	0.3	0.1	15.0	2.8

HCM 6th Signalized Intersection Summary
41: I Street & 4th Street

Village D Specific Plan
Phase III WP - AM Peak Hour



Movement	EBL	EBT	EBR	WBL	WBT	WBR	NBL	NBT	NBR	SBL	SBT	SBR
Lane Configurations												
Traffic Volume (veh/h)	29	699	70	89	525	72	54	58	168	311	287	209
Future Volume (veh/h)	29	699	70	89	525	72	54	58	168	311	287	209
Initial Q (Qb), veh	0	0	0	0	0	0	0	0	0	0	0	0
Ped-Bike Adj(A_pbT)	1.00		0.96	1.00		0.97	1.00		0.97	1.00		0.98
Parking Bus, Adj	1.00	1.00	1.00	1.00	1.00	1.00	1.00	1.00	1.00	1.00	1.00	1.00
Work Zone On Approach		No			No			No			No	
Adj Sat Flow, veh/h/ln	1870	1870	1870	1856	1856	1856	1856	1856	1856	1870	1870	1870
Adj Flow Rate, veh/h	32	760	76	97	571	78	59	63	183	338	312	227
Peak Hour Factor	0.92	0.92	0.92	0.92	0.92	0.92	0.92	0.92	0.92	0.92	0.92	0.92
Percent Heavy Veh, %	2	2	2	3	3	3	3	3	3	2	2	2
Cap, veh/h	54	852	85	123	935	127	200	379	310	469	663	548
Arrive On Green	0.03	0.26	0.26	0.07	0.30	0.30	0.11	0.20	0.20	0.26	0.35	0.35
Sat Flow, veh/h	1781	3248	325	1767	3102	422	1767	1856	1519	1781	1870	1546
Grp Volume(v), veh/h	32	416	420	97	324	325	59	63	183	338	312	227
Grp Sat Flow(s),veh/h/ln	1781	1777	1796	1767	1763	1762	1767	1856	1519	1781	1870	1546
Q Serve(g_s), s	1.6	20.3	20.3	4.9	14.1	14.2	2.8	2.5	9.8	15.5	11.6	8.0
Cycle Q Clear(g_c), s	1.6	20.3	20.3	4.9	14.1	14.2	2.8	2.5	9.8	15.5	11.6	8.0
Prop In Lane	1.00		0.18	1.00		0.24	1.00		1.00	1.00		1.00
Lane Grp Cap(c), veh/h	54	466	471	123	531	531	200	379	310	469	663	548
V/C Ratio(X)	0.59	0.89	0.89	0.79	0.61	0.61	0.29	0.17	0.59	0.72	0.47	0.41
Avail Cap(c_a), veh/h	113	492	497	155	531	531	200	379	310	469	663	548
HCM Platoon Ratio	1.00	1.00	1.00	1.00	1.00	1.00	1.00	1.00	1.00	1.00	1.00	1.00
Upstream Filter(I)	0.88	0.88	0.88	1.00	1.00	1.00	1.00	1.00	1.00	1.00	1.00	1.00
Uniform Delay (d), s/veh	43.1	32.0	32.0	41.2	26.9	26.9	36.6	29.5	32.4	30.1	22.5	14.0
Incr Delay (d2), s/veh	8.5	15.9	15.9	18.7	2.0	2.1	0.8	0.9	8.0	5.3	2.4	2.3
Initial Q Delay(d3),s/veh	0.0	0.0	0.0	0.0	0.0	0.0	0.0	0.0	0.0	0.0	0.0	0.0
%ile BackOfQ(50%),veh/ln	0.8	10.5	10.6	2.7	6.1	6.1	1.2	1.2	4.2	7.2	5.4	3.0
Unsig. Movement Delay, s/veh												
LnGrp Delay(d),s/veh	51.6	47.9	47.8	59.9	28.9	29.0	37.4	30.4	40.4	35.4	24.9	16.3
LnGrp LOS	D	D	D	E	C	C	D	C	D	D	C	B
Approach Vol, veh/h		868			746			305			877	
Approach Delay, s/veh		48.0			33.0			37.7			26.7	
Approach LOS		D			C			D			C	
Timer - Assigned Phs	1	2	3	4	5	6	7	8				
Phs Duration (G+Y+Rc), s	28.2	22.9	10.8	28.1	14.7	36.4	7.3	31.6				
Change Period (Y+Rc), s	4.5	4.5	4.5	4.5	4.5	4.5	4.5	4.5				
Max Green Setting (Gmax), s	20.8	18.4	7.9	24.9	7.3	31.9	5.7	27.1				
Max Q Clear Time (g_c+1/3), s	11.5	11.8	6.9	22.3	4.8	13.6	3.6	16.2				
Green Ext Time (p_c), s	0.4	0.5	0.0	1.3	0.0	2.5	0.0	3.0				
Intersection Summary												
HCM 6th Ctrl Delay											36.2	
HCM 6th LOS											D	

HCM 6th Signalized Intersection Summary
 43: SR-99 Northbound Off-Ramp/H Street & 4th Street

Village D Specific Plan
 Phase III WP - AM Peak Hour



Movement	EBL	EBT	EBR	WBL	WBT	WBR	NBL	NBT	NBR	SBL	SBT	SBR
Lane Configurations	↖	↗			↖	↗	↖	↗			↕	
Traffic Volume (veh/h)	285	542	0	0	568	98	281	35	240	8	0	84
Future Volume (veh/h)	285	542	0	0	568	98	281	35	240	8	0	84
Initial Q (Qb), veh	0	0	0	0	0	0	0	0	0	0	0	0
Ped-Bike Adj(A_pbT)	1.00		1.00	1.00		0.94	1.00		1.00	1.00		0.99
Parking Bus, Adj	1.00	1.00	1.00	1.00	1.00	1.00	1.00	1.00	1.00	1.00	1.00	1.00
Work Zone On Approach		No			No			No			No	
Adj Sat Flow, veh/h/ln	1885	1885	0	0	1856	1856	1870	1870	1870	1900	1900	1900
Adj Flow Rate, veh/h	310	589	0	0	617	107	305	38	261	9	0	91
Peak Hour Factor	0.92	0.92	0.92	0.92	0.92	0.92	0.92	0.92	0.92	0.92	0.92	0.92
Percent Heavy Veh, %	1	1	0	0	3	3	2	2	2	0	0	0
Cap, veh/h	329	1572	0	0	612	106	376	43	298	29	0	292
Arrive On Green	0.18	0.44	0.00	0.00	0.21	0.21	0.21	0.21	0.21	0.20	0.00	0.20
Sat Flow, veh/h	1795	3676	0	0	3068	515	1781	205	1411	145	0	1462
Grp Volume(v), veh/h	310	589	0	0	365	359	305	0	299	100	0	0
Grp Sat Flow(s),veh/h/ln	1795	1791	0	0	1763	1727	1781	0	1616	1607	0	0
Q Serve(g_s), s	15.3	9.9	0.0	0.0	18.5	18.5	14.7	0.0	16.1	4.8	0.0	0.0
Cycle Q Clear(g_c), s	15.3	9.9	0.0	0.0	18.5	18.5	14.7	0.0	16.1	4.8	0.0	0.0
Prop In Lane	1.00		0.00	0.00		0.30	1.00		0.87	0.09		0.91
Lane Grp Cap(c), veh/h	329	1572	0	0	362	355	376	0	341	321	0	0
V/C Ratio(X)	0.94	0.37	0.00	0.00	1.01	1.01	0.81	0.00	0.88	0.31	0.00	0.00
Avail Cap(c_a), veh/h	329	1572	0	0	362	355	376	0	341	321	0	0
HCM Platoon Ratio	1.00	1.00	1.00	1.00	1.00	1.00	1.00	1.00	1.00	1.00	1.00	1.00
Upstream Filter(I)	1.00	1.00	0.00	0.00	1.00	1.00	1.00	0.00	1.00	1.00	0.00	0.00
Uniform Delay (d), s/veh	36.3	17.0	0.0	0.0	35.8	35.8	33.8	0.0	34.4	30.7	0.0	0.0
Incr Delay (d2), s/veh	34.6	0.1	0.0	0.0	49.1	50.7	17.1	0.0	25.6	2.5	0.0	0.0
Initial Q Delay(d3),s/veh	0.0	0.0	0.0	0.0	0.0	0.0	0.0	0.0	0.0	0.0	0.0	0.0
%ile BackOfQ(50%),veh/ln	9.7	4.0	0.0	0.0	12.7	12.6	8.0	0.0	8.6	2.0	0.0	0.0
Unsig. Movement Delay, s/veh												
LnGrp Delay(d),s/veh	70.9	17.1	0.0	0.0	84.8	86.5	50.9	0.0	59.9	33.2	0.0	0.0
LnGrp LOS	E	B	A	A	F	F	D	A	E	C	A	A
Approach Vol, veh/h		899			724			604			100	
Approach Delay, s/veh		35.7			85.6			55.4			33.2	
Approach LOS		D			F			E			C	
Timer - Assigned Phs		2		4		6	7	8				
Phs Duration (G+Y+Rc), s		23.5		44.0		22.5	21.0	23.0				
Change Period (Y+Rc), s		4.5		4.5		4.5	4.5	4.5				
Max Green Setting (Gmax), s		19.0		39.5		18.0	16.5	18.5				
Max Q Clear Time (g_c+I1), s		18.1		11.9		6.8	17.3	20.5				
Green Ext Time (p_c), s		0.3		4.3		0.3	0.0	0.0				
Intersection Summary												
HCM 6th Ctrl Delay					56.2							
HCM 6th LOS					E							

Intersection						
Int Delay, s/veh	2.4					
Movement	EBL	EBT	WBT	WBR	SBL	SBR
Lane Configurations	↖	↗	↗		↖	↖
Traffic Vol, veh/h	134	760	682	82	62	102
Future Vol, veh/h	134	760	682	82	62	102
Conflicting Peds, #/hr	16	0	0	16	0	0
Sign Control	Free	Free	Free	Free	Stop	Stop
RT Channelized	-	None	-	None	-	None
Storage Length	145	-	-	-	65	0
Veh in Median Storage, #	-	0	0	-	0	-
Grade, %	-	0	0	-	0	-
Peak Hour Factor	98	98	98	98	98	98
Heavy Vehicles, %	3	3	4	4	5	5
Mvmt Flow	137	776	696	84	63	104

Major/Minor	Major1	Major2	Minor2		
Conflicting Flow All	796	0	-	0	1416 406
Stage 1	-	-	-	-	754 -
Stage 2	-	-	-	-	662 -
Critical Hdwy	4.16	-	-	-	6.9 7
Critical Hdwy Stg 1	-	-	-	-	5.9 -
Critical Hdwy Stg 2	-	-	-	-	5.9 -
Follow-up Hdwy	2.23	-	-	-	3.55 3.35
Pot Cap-1 Maneuver	1180	-	-	-	*216 *791
Stage 1	-	-	-	-	*747 -
Stage 2	-	-	-	-	*467 -
Platoon blocked, %	1	-	-	-	1 1
Mov Cap-1 Maneuver	1162	-	-	-	*185 *779
Mov Cap-2 Maneuver	-	-	-	-	*185 -
Stage 1	-	-	-	-	*649 -
Stage 2	-	-	-	-	*460 -

Approach	EB	WB	SB
HCM Control Delay, s	1.3	0	19.3
HCM LOS			C

Minor Lane/Major Mvmt	EBL	EBT	WBT	WBR	SBLn1	SBLn2
Capacity (veh/h)	1162	-	-	-	185	779
HCM Lane V/C Ratio	0.118	-	-	-	0.342	0.134
HCM Control Delay (s)	8.5	-	-	-	34.2	10.3
HCM Lane LOS	A	-	-	-	D	B
HCM 95th %tile Q(veh)	0.4	-	-	-	1.4	0.5

Notes
 -: Volume exceeds capacity \$: Delay exceeds 300s +: Computation Not Defined *: All major volume in platoon

HCM 6th Signalized Intersection Summary
 45: Olive Avenue & SR-99 Southbound Off-Ramp

Village D Specific Plan
 Phase III WP - AM Peak Hour



Movement	EBL	EBT	WBT	WBR	SBL	SBR
Lane Configurations		↑↑↑	↑↑		↙	↗
Traffic Volume (veh/h)	0	822	646	0	914	120
Future Volume (veh/h)	0	822	646	0	914	120
Initial Q (Qb), veh	0	0	0	0	0	0
Ped-Bike Adj(A_pbT)	1.00			1.00	1.00	1.00
Parking Bus, Adj	1.00	1.00	1.00	1.00	1.00	1.00
Work Zone On Approach		No	No		No	
Adj Sat Flow, veh/h/ln	0	1856	1841	0	1781	1781
Adj Flow Rate, veh/h	0	874	687	0	972	128
Peak Hour Factor	0.94	0.94	0.94	0.94	0.94	0.94
Percent Heavy Veh, %	0	3	4	0	8	8
Cap, veh/h	0	1173	810	0	1113	990
Arrive On Green	0.00	0.23	0.23	0.00	0.66	0.66
Sat Flow, veh/h	0	5400	3681	0	1697	1510
Grp Volume(v), veh/h	0	874	687	0	972	128
Grp Sat Flow(s),veh/h/ln	0	1689	1749	0	1697	1510
Q Serve(g_s), s	0.0	12.8	15.0	0.0	36.9	2.5
Cycle Q Clear(g_c), s	0.0	12.8	15.0	0.0	36.9	2.5
Prop In Lane	0.00			0.00	1.00	1.00
Lane Grp Cap(c), veh/h	0	1173	810	0	1113	990
V/C Ratio(X)	0.00	0.75	0.85	0.00	0.87	0.13
Avail Cap(c_a), veh/h	0	1298	896	0	1113	990
HCM Platoon Ratio	1.00	1.00	1.00	1.00	1.00	1.00
Upstream Filter(I)	0.00	1.00	0.94	0.00	1.00	1.00
Uniform Delay (d), s/veh	0.0	28.5	29.4	0.0	11.1	5.2
Incr Delay (d2), s/veh	0.0	2.1	6.7	0.0	9.6	0.3
Initial Q Delay(d3),s/veh	0.0	0.0	0.0	0.0	0.0	0.0
%ile BackOfQ(50%),veh/ln	0.0	5.2	6.8	0.0	13.8	0.7
Unsig. Movement Delay, s/veh						
LnGrp Delay(d),s/veh	0.0	30.7	36.1	0.0	20.6	5.4
LnGrp LOS	A	C	D	A	C	A
Approach Vol, veh/h		874	687		1100	
Approach Delay, s/veh		30.7	36.1		18.9	
Approach LOS		C	D		B	
Timer - Assigned Phs				4	6	8
Phs Duration (G+Y+Rc), s				23.0	57.0	23.0
Change Period (Y+Rc), s				4.5	4.5	4.5
Max Green Setting (Gmax), s				20.5	50.5	20.5
Max Q Clear Time (g_c+I1), s				14.8	38.9	17.0
Green Ext Time (p_c), s				2.8	3.8	1.5
Intersection Summary						
HCM 6th Ctrl Delay			27.2			
HCM 6th LOS			C			

HCM 6th Signalized Intersection Summary
 46: Madera Avenue & SR-99 Northbound Ramps

Village D Specific Plan
 Phase III WP - AM Peak Hour



Movement	EBL	EBT	EBR	WBL	WBT	WBR	NBL	NBT	NBR	SBL	SBT	SBR
Lane Configurations				↶	↷	↶	↶↷	↶↷			↶↷	
Traffic Volume (veh/h)	0	0	0	289	2	107	709	544	0	0	716	302
Future Volume (veh/h)	0	0	0	289	2	107	709	544	0	0	716	302
Initial Q (Qb), veh				0	0	0	0	0	0	0	0	0
Ped-Bike Adj(A_pbT)				1.00		0.98	1.00		1.00	1.00		0.97
Parking Bus, Adj				1.00	1.00	1.00	1.00	1.00	1.00	1.00	1.00	1.00
Work Zone On Approach				No			No			No		
Adj Sat Flow, veh/h/ln				1841	1841	1841	1811	1811	0	0	1841	1841
Adj Flow Rate, veh/h				315	0	116	771	591	0	0	778	328
Peak Hour Factor				0.92	0.92	0.92	0.92	0.92	0.92	0.92	0.92	0.92
Percent Heavy Veh, %				4	4	4	6	6	0	0	4	4
Cap, veh/h				439	0	192	1087	2623	0	0	904	381
Arrive On Green				0.13	0.00	0.13	0.54	1.00	0.00	0.00	0.38	0.38
Sat Flow, veh/h				3506	0	1533	3346	3532	0	0	2463	998
Grp Volume(v), veh/h				315	0	116	771	591	0	0	573	533
Grp Sat Flow(s),veh/h/ln				1753	0	1533	1673	1721	0	0	1749	1621
Q Serve(g_s), s				6.9	0.0	5.7	13.7	0.0	0.0	0.0	24.1	24.2
Cycle Q Clear(g_c), s				6.9	0.0	5.7	13.7	0.0	0.0	0.0	24.1	24.2
Prop In Lane				1.00		1.00	1.00		0.00	0.00		0.62
Lane Grp Cap(c), veh/h				439	0	192	1087	2623	0	0	667	618
V/C Ratio(X)				0.72	0.00	0.60	0.71	0.23	0.00	0.00	0.86	0.86
Avail Cap(c_a), veh/h				811	0	354	1087	2623	0	0	667	618
HCM Platoon Ratio				1.00	1.00	1.00	1.67	1.67	1.00	1.00	1.00	1.00
Upstream Filter(I)				1.00	0.00	1.00	0.64	0.64	0.00	0.00	1.00	1.00
Uniform Delay (d), s/veh				33.6	0.0	33.1	15.5	0.0	0.0	0.0	22.8	22.8
Incr Delay (d2), s/veh				2.2	0.0	3.0	1.4	0.1	0.0	0.0	13.6	14.7
Initial Q Delay(d3),s/veh				0.0	0.0	0.0	0.0	0.0	0.0	0.0	0.0	0.0
%ile BackOfQ(50%),veh/ln				3.0	0.0	2.2	4.0	0.0	0.0	0.0	11.8	11.1
Unsig. Movement Delay, s/veh												
LnGrp Delay(d),s/veh				35.8	0.0	36.2	16.9	0.1	0.0	0.0	36.4	37.5
LnGrp LOS				D	A	D	B	A	A	A	D	D
Approach Vol, veh/h					431			1362			1106	
Approach Delay, s/veh					35.9			9.6			36.9	
Approach LOS					D			A			D	
Timer - Assigned Phs		2			5	6		8				
Phs Duration (G+Y+Rc), s		65.5			30.5	35.0		14.5				
Change Period (Y+Rc), s		4.5			4.5	4.5		4.5				
Max Green Setting (Gmax), s		52.5			17.5	30.5		18.5				
Max Q Clear Time (g_c+I1), s		2.0			15.7	26.2		8.9				
Green Ext Time (p_c), s		4.7			0.7	2.7		1.1				

Intersection Summary

HCM 6th Ctrl Delay	24.0
HCM 6th LOS	C

Notes

User approved volume balancing among the lanes for turning movement.

HCM 6th Signalized Intersection Summary
 47: Madera Avenue & Olive Avenue/SR-99 Southbound On-Ramp

Village D Specific Plan
 Phase III WP - AM Peak Hour



Movement	EBL	EBT	EBR	WBL	WBT	WBR	NBL	NBT	NBR	SBL	SBT	SBR
Lane Configurations	↖	↖	↖				↖↗	↖↗		↖	↖↗	
Traffic Volume (veh/h)	515	377	843	0	0	0	222	738	44	88	491	426
Future Volume (veh/h)	515	377	843	0	0	0	222	738	44	88	491	426
Initial Q (Qb), veh	0	0	0				0	0	0	0	0	0
Ped-Bike Adj(A_pbT)	1.00		1.00				1.00		0.99	1.00		0.99
Parking Bus, Adj	1.00	1.00	1.00				1.00	1.00	1.00	1.00	1.00	1.00
Work Zone On Approach		No						No			No	
Adj Sat Flow, veh/h/ln	1826	1826	1826				1796	1796	1796	1841	1841	1841
Adj Flow Rate, veh/h	470	498	887				234	777	46	93	517	448
Peak Hour Factor	0.95	0.95	0.95				0.95	0.95	0.95	0.95	0.95	0.95
Percent Heavy Veh, %	5	5	5				7	7	7	4	4	4
Cap, veh/h	663	696	743				328	1251	74	118	619	536
Arrive On Green	0.64	0.64	0.64				0.10	0.38	0.38	0.11	0.59	0.59
Sat Flow, veh/h	1739	1826	1547				3319	3271	194	1753	1762	1527
Grp Volume(v), veh/h	470	498	887				234	405	418	93	513	452
Grp Sat Flow(s),veh/h/ln	1739	1826	1547				1659	1706	1758	1753	1749	1540
Q Serve(g_s), s	14.3	14.6	30.5				5.5	15.4	15.4	4.1	19.0	19.0
Cycle Q Clear(g_c), s	14.3	14.6	30.5				5.5	15.4	15.4	4.1	19.0	19.0
Prop In Lane	1.00		1.00				1.00		0.11	1.00		0.99
Lane Grp Cap(c), veh/h	663	696	743				328	653	672	118	614	541
V/C Ratio(X)	0.71	0.72	1.19				0.71	0.62	0.62	0.78	0.84	0.84
Avail Cap(c_a), veh/h	663	696	743				643	653	672	217	614	541
HCM Platoon Ratio	1.67	1.67	1.67				1.00	1.00	1.00	1.67	1.67	1.67
Upstream Filter(I)	0.48	0.48	0.48				1.00	1.00	1.00	0.63	0.63	0.63
Uniform Delay (d), s/veh	11.6	11.6	13.8				34.9	20.0	20.0	34.9	14.7	14.7
Incr Delay (d2), s/veh	1.7	1.7	94.0				2.9	4.4	4.3	7.0	8.4	9.4
Initial Q Delay(d3),s/veh	0.0	0.0	0.0				0.0	0.0	0.0	0.0	0.0	0.0
%ile BackOfQ(50%),veh/ln	3.9	4.1	40.9				2.3	6.6	6.7	1.9	6.1	5.5
Unsig. Movement Delay, s/veh												
LnGrp Delay(d),s/veh	13.3	13.3	107.8				37.8	24.4	24.3	42.0	23.1	24.1
LnGrp LOS	B	B	F				D	C	C	D	C	C
Approach Vol, veh/h		1855						1057			1058	
Approach Delay, s/veh		58.5						27.3			25.2	
Approach LOS		E						C			C	
Timer - Assigned Phs	1	2		4	5	6						
Phs Duration (G+Y+Rc), s	9.9	35.1		35.0	12.4	32.6						
Change Period (Y+Rc), s	4.5	4.5		4.5	4.5	4.5						
Max Green Setting (Gmax), s	9.9	26.1		30.5	15.5	20.5						
Max Q Clear Time (g_c+I1), s	6.1	17.4		32.5	7.5	21.0						
Green Ext Time (p_c), s	0.1	3.4		0.0	0.5	0.0						

Intersection Summary

HCM 6th Ctrl Delay	41.3
HCM 6th LOS	D

Notes

User approved volume balancing among the lanes for turning movement.

Intersection						
Int Delay, s/veh	0.2					
Movement	WBL	WBR	NBT	NBR	SBL	SBT
Lane Configurations	↔		↕		↔	↕
Traffic Vol, veh/h	9	8	1027	8	33	1457
Future Vol, veh/h	9	8	1027	8	33	1457
Conflicting Peds, #/hr	0	0	0	8	8	0
Sign Control	Stop	Stop	Free	Free	Free	Free
RT Channelized	-	None	-	None	-	None
Storage Length	0	-	-	-	100	-
Veh in Median Storage, #	0	-	0	-	-	0
Grade, %	0	-	0	-	-	0
Peak Hour Factor	97	97	97	97	97	97
Heavy Vehicles, %	12	12	6	6	5	5
Mvmt Flow	9	8	1059	8	34	1502

Major/Minor	Minor1	Major1	Major2		
Conflicting Flow All	1890	542	0	0	1075
Stage 1	1071	-	-	-	-
Stage 2	819	-	-	-	-
Critical Hdwy	7.04	7.14	-	-	4.2
Critical Hdwy Stg 1	6.04	-	-	-	-
Critical Hdwy Stg 2	6.04	-	-	-	-
Follow-up Hdwy	3.62	3.42	-	-	2.25
Pot Cap-1 Maneuver	*206	460	-	-	627
Stage 1	*269	-	-	-	-
Stage 2	*445	-	-	-	-
Platoon blocked, %	1	-	-	-	-
Mov Cap-1 Maneuver	*193	456	-	-	622
Mov Cap-2 Maneuver	*227	-	-	-	-
Stage 1	*267	-	-	-	-
Stage 2	*421	-	-	-	-

Approach	WB	NB	SB
HCM Control Delay, s	17.9	0	0.2
HCM LOS	C		

Minor Lane/Major Mvmt	NBT	NBRWBLn1	SBL	SBT
Capacity (veh/h)	-	-	297	622
HCM Lane V/C Ratio	-	-	0.059	0.055
HCM Control Delay (s)	-	-	17.9	11.1
HCM Lane LOS	-	-	C	B
HCM 95th %tile Q(veh)	-	-	0.2	0.2

Notes
 -: Volume exceeds capacity \$: Delay exceeds 300s +: Computation Not Defined *: All major volume in platoon

HCM 6th Signalized Intersection Summary
 49: Yosemite Avenue & Cleveland Avenue/Tozer Street

Village D Specific Plan
 Phase III WP - AM Peak Hour



Movement	EBL	EBT	EBR	WBL	WBT	WBR	NBL	NBT	NBR	SBL	SBT	SBR
Lane Configurations	↖	↗		↖	↗	↗	↖	↗	↗	↖	↗	↗
Traffic Volume (veh/h)	329	557	260	116	357	60	141	137	78	79	270	272
Future Volume (veh/h)	329	557	260	116	357	60	141	137	78	79	270	272
Initial Q (Qb), veh	0	0	0	0	0	0	0	0	0	0	0	0
Ped-Bike Adj(A_pbT)	1.00		0.92	1.00		0.91	1.00		1.00	1.00		1.00
Parking Bus, Adj	1.00	1.00	1.00	1.00	1.00	1.00	1.00	1.00	1.00	1.00	1.00	1.00
Work Zone On Approach		No			No			No			No	
Adj Sat Flow, veh/h/ln	1856	1856	1856	1841	1841	1841	1856	1856	1856	1870	1870	1870
Adj Flow Rate, veh/h	358	605	283	126	388	65	153	149	85	86	293	296
Peak Hour Factor	0.92	0.92	0.92	0.92	0.92	0.92	0.92	0.92	0.92	0.92	0.92	0.92
Percent Heavy Veh, %	3	3	3	4	4	4	3	3	3	2	2	2
Cap, veh/h	355	749	350	156	766	310	171	590	498	111	241	244
Arrive On Green	0.20	0.33	0.33	0.09	0.22	0.22	0.10	0.32	0.32	0.06	0.28	0.28
Sat Flow, veh/h	1767	2262	1057	1753	3497	1417	1767	1856	1568	1781	852	860
Grp Volume(v), veh/h	358	471	417	126	388	65	153	149	85	86	0	589
Grp Sat Flow(s),veh/h/ln	1767	1763	1556	1753	1749	1417	1767	1856	1568	1781	0	1712
Q Serve(g_s), s	18.1	22.0	22.0	6.4	8.8	3.4	7.7	5.4	3.5	4.3	0.0	25.5
Cycle Q Clear(g_c), s	18.1	22.0	22.0	6.4	8.8	3.4	7.7	5.4	3.5	4.3	0.0	25.5
Prop In Lane	1.00		0.68	1.00		1.00	1.00		1.00	1.00		0.50
Lane Grp Cap(c), veh/h	355	584	515	156	766	310	171	590	498	111	0	485
V/C Ratio(X)	1.01	0.81	0.81	0.81	0.51	0.21	0.90	0.25	0.17	0.78	0.00	1.21
Avail Cap(c_a), veh/h	355	584	515	158	766	310	171	590	498	184	0	485
HCM Platoon Ratio	1.00	1.00	1.00	1.00	1.00	1.00	1.00	1.00	1.00	1.00	1.00	1.00
Upstream Filter(I)	1.00	1.00	1.00	1.00	1.00	1.00	1.00	1.00	1.00	1.00	0.00	1.00
Uniform Delay (d), s/veh	36.0	27.5	27.5	40.3	30.9	28.8	40.2	22.8	22.1	41.6	0.0	32.3
Incr Delay (d2), s/veh	49.6	11.4	12.8	25.8	2.4	1.5	40.6	0.2	0.2	11.1	0.0	114.1
Initial Q Delay(d3),s/veh	0.0	0.0	0.0	0.0	0.0	0.0	0.0	0.0	0.0	0.0	0.0	0.0
%ile BackOfQ(50%),veh/ln	12.5	10.7	9.7	3.8	3.9	1.3	5.2	2.3	1.3	2.2	0.0	25.5
Unsig. Movement Delay, s/veh												
LnGrp Delay(d),s/veh	85.5	38.9	40.3	66.1	33.3	30.3	80.8	23.0	22.3	52.7	0.0	146.4
LnGrp LOS	F	D	D	E	C	C	F	C	C	D	A	F
Approach Vol, veh/h		1246			579			387			675	
Approach Delay, s/veh		52.8			40.1			45.7			134.4	
Approach LOS		D			D			D			F	
Timer - Assigned Phs	1	2	3	4	5	6	7	8				
Phs Duration (G+Y+Rc), s	22.6	24.2	10.1	33.1	12.5	34.3	13.2	30.0				
Change Period (Y+Rc), s	4.5	4.5	4.5	4.5	4.5	4.5	4.5	4.5				
Max Green Setting (Gmax), s	18.1	19.7	9.3	24.9	8.1	29.7	8.7	25.5				
Max Q Clear Time (g_c+I1), s	20.1	10.8	6.3	7.4	8.4	24.0	9.7	27.5				
Green Ext Time (p_c), s	0.0	1.8	0.0	1.0	0.0	2.8	0.0	0.0				

Intersection Summary

HCM 6th Ctrl Delay	68.4
HCM 6th LOS	E

Intersection						
Int Delay, s/veh	6.8					
Movement	WBL	WBR	NBT	NBR	SBL	SBT
Lane Configurations						
Traffic Vol, veh/h	0	19	3	0	11	2
Future Vol, veh/h	0	19	3	0	11	2
Conflicting Peds, #/hr	0	0	0	0	0	0
Sign Control	Stop	Stop	Free	Free	Free	Free
RT Channelized	-	None	-	None	-	None
Storage Length	0	-	-	-	50	-
Veh in Median Storage, #	0	-	0	-	-	0
Grade, %	0	-	0	-	-	0
Peak Hour Factor	92	92	92	92	92	92
Heavy Vehicles, %	0	0	0	0	0	0
Mvmt Flow	0	21	3	0	12	2

Major/Minor	Minor1	Major1	Major2			
Conflicting Flow All	29	3	0	0	3	0
Stage 1	3	-	-	-	-	-
Stage 2	26	-	-	-	-	-
Critical Hdwy	6.4	6.2	-	-	4.1	-
Critical Hdwy Stg 1	5.4	-	-	-	-	-
Critical Hdwy Stg 2	5.4	-	-	-	-	-
Follow-up Hdwy	3.5	3.3	-	-	2.2	-
Pot Cap-1 Maneuver	991	1087	-	-	1632	-
Stage 1	1025	-	-	-	-	-
Stage 2	1002	-	-	-	-	-
Platoon blocked, %			-	-		
Mov Cap-1 Maneuver	984	1087	-	-	1632	-
Mov Cap-2 Maneuver	984	-	-	-	-	-
Stage 1	1025	-	-	-	-	-
Stage 2	995	-	-	-	-	-

Approach	WB	NB	SB
HCM Control Delay, s	8.4	0	6.1
HCM LOS	A		

Minor Lane/Major Mvmt	NBT	NBRWBLn1	SBL	SBT
Capacity (veh/h)	-	-	1087	1632
HCM Lane V/C Ratio	-	-	0.019	0.007
HCM Control Delay (s)	-	-	8.4	7.2
HCM Lane LOS	-	-	A	A
HCM 95th %tile Q(veh)	-	-	0.1	0

Intersection						
Int Delay, s/veh	12.5					
Movement	EBT	EBR	WBL	WBT	NBL	NBR
Lane Configurations						
Traffic Vol, veh/h	68	16	155	71	56	629
Future Vol, veh/h	68	16	155	71	56	629
Conflicting Peds, #/hr	0	0	0	0	0	0
Sign Control	Free	Free	Free	Free	Stop	Stop
RT Channelized	-	None	-	None	-	None
Storage Length	-	-	50	-	50	0
Veh in Median Storage, #	0	-	-	0	0	-
Grade, %	0	-	-	0	0	-
Peak Hour Factor	92	92	92	92	92	92
Heavy Vehicles, %	9	9	2	2	0	0
Mvmt Flow	74	17	168	77	61	684

Major/Minor	Major1	Major2	Minor1		
Conflicting Flow All	0	0	91	0	496 83
Stage 1	-	-	-	-	83 -
Stage 2	-	-	-	-	413 -
Critical Hdwy	-	-	4.12	-	6.4 6.2
Critical Hdwy Stg 1	-	-	-	-	5.4 -
Critical Hdwy Stg 2	-	-	-	-	5.4 -
Follow-up Hdwy	-	-	2.218	-	3.5 3.3
Pot Cap-1 Maneuver	-	-	1504	-	537 982
Stage 1	-	-	-	-	945 -
Stage 2	-	-	-	-	672 -
Platoon blocked, %	-	-	-	-	-
Mov Cap-1 Maneuver	-	-	1504	-	477 982
Mov Cap-2 Maneuver	-	-	-	-	477 -
Stage 1	-	-	-	-	945 -
Stage 2	-	-	-	-	597 -

Approach	EB	WB	NB
HCM Control Delay, s	0	5.3	16.4
HCM LOS			C

Minor Lane/Major Mvmt	NBLn1	NBLn2	EBT	EBR	WBL	WBT
Capacity (veh/h)	477	982	-	-	1504	-
HCM Lane V/C Ratio	0.128	0.696	-	-	0.112	-
HCM Control Delay (s)	13.6	16.6	-	-	7.7	-
HCM Lane LOS	B	C	-	-	A	-
HCM 95th %tile Q(veh)	0.4	5.9	-	-	0.4	-

Intersection												
Int Delay, s/veh	54.2											
Movement	EBL	EBT	EBR	WBL	WBT	WBR	NBL	NBT	NBR	SBL	SBT	SBR
Lane Configurations	↖	↗		↖	↗		↖	↗		↖	↗	
Traffic Vol, veh/h	0	65	5	88	35	111	16	131	320	236	126	0
Future Vol, veh/h	0	65	5	88	35	111	16	131	320	236	126	0
Conflicting Peds, #/hr	0	0	0	0	0	0	0	0	0	0	0	0
Sign Control	Free	Free	Free	Free	Free	Free	Stop	Stop	Stop	Stop	Stop	Stop
RT Channelized	-	-	None	-	-	None	-	-	None	-	-	None
Storage Length	50	-	-	50	-	-	50	-	-	50	-	-
Veh in Median Storage, #	-	0	-	-	0	-	-	0	-	-	0	-
Grade, %	-	0	-	-	0	-	-	0	-	-	0	-
Peak Hour Factor	92	92	92	92	92	92	92	92	92	92	92	92
Heavy Vehicles, %	11	11	11	2	2	2	0	0	0	0	0	0
Mvmt Flow	0	71	5	96	38	121	17	142	348	257	137	0

Major/Minor	Major1			Major2			Minor1			Minor2		
Conflicting Flow All	159	0	0	76	0	0	433	425	74	610	367	99
Stage 1	-	-	-	-	-	-	74	74	-	291	291	-
Stage 2	-	-	-	-	-	-	359	351	-	319	76	-
Critical Hdwy	4.21	-	-	4.12	-	-	7.1	6.5	6.2	7.1	6.5	6.2
Critical Hdwy Stg 1	-	-	-	-	-	-	6.1	5.5	-	6.1	5.5	-
Critical Hdwy Stg 2	-	-	-	-	-	-	6.1	5.5	-	6.1	5.5	-
Follow-up Hdwy	2.299	-	-	2.218	-	-	3.5	4	3.3	3.5	4	3.3
Pot Cap-1 Maneuver	1367	-	-	1523	-	-	537	524	993	409	565	962
Stage 1	-	-	-	-	-	-	940	837	-	721	675	-
Stage 2	-	-	-	-	-	-	663	636	-	697	836	-
Platoon blocked, %	-	-	-	-	-	-	-	-	-	-	-	-
Mov Cap-1 Maneuver	1367	-	-	1523	-	-	410	491	993	~ 197	529	962
Mov Cap-2 Maneuver	-	-	-	-	-	-	410	491	-	~ 197	529	-
Stage 1	-	-	-	-	-	-	940	837	-	721	632	-
Stage 2	-	-	-	-	-	-	487	596	-	376	836	-

Approach	EB	WB	NB	SB
HCM Control Delay, s	0	2.8	17.6	145.2
HCM LOS			C	F

Minor Lane/Major Mvmt	NBLn1	NBLn2	EBL	EBT	EBR	WBL	WBT	WBR	SBLn1	SBLn2
Capacity (veh/h)	410	766	1367	-	-	1523	-	-	197	529
HCM Lane V/C Ratio	0.042	0.64	-	-	-	0.063	-	-	1.302	0.259
HCM Control Delay (s)	14.2	17.7	0	-	-	7.5	-	-	215.1	14.2
HCM Lane LOS	B	C	A	-	-	A	-	-	F	B
HCM 95th %tile Q(veh)	0.1	4.7	0	-	-	0.2	-	-	14.2	1

Notes			
-: Volume exceeds capacity	\$: Delay exceeds 300s	+: Computation Not Defined	*: All major volume in platoon

Intersection

Int Delay, s/veh 237.8

Movement	EBL	EBT	EBR	WBL	WBT	WBR	NBL	NBT	NBR	SBL	SBT	SBR
Lane Configurations	↖	↗		↖	↗		↖	↗		↖	↗	
Traffic Vol, veh/h	12	395	11	88	232	144	14	25	163	333	25	10
Future Vol, veh/h	12	395	11	88	232	144	14	25	163	333	25	10
Conflicting Peds, #/hr	0	0	0	0	0	0	0	0	0	0	0	0
Sign Control	Free	Free	Free	Free	Free	Free	Stop	Stop	Stop	Stop	Stop	Stop
RT Channelized	-	-	None	-	-	None	-	-	None	-	-	None
Storage Length	50	-	-	50	-	-	50	-	-	50	-	-
Veh in Median Storage, #	-	0	-	-	0	-	-	0	-	-	0	-
Grade, %	-	0	-	-	0	-	-	0	-	-	0	-
Peak Hour Factor	92	92	92	92	92	92	92	92	92	92	92	92
Heavy Vehicles, %	0	0	0	0	0	0	0	0	0	0	0	0
Mvmt Flow	13	429	12	96	252	157	15	27	177	362	27	11

Major/Minor	Major1			Major2			Minor1			Minor2		
Conflicting Flow All	409	0	0	441	0	0	1003	1062	435	1086	990	331
Stage 1	-	-	-	-	-	-	461	461	-	523	523	-
Stage 2	-	-	-	-	-	-	542	601	-	563	467	-
Critical Hdwy	4.1	-	-	4.1	-	-	7.1	6.5	6.2	7.1	6.5	6.2
Critical Hdwy Stg 1	-	-	-	-	-	-	6.1	5.5	-	6.1	5.5	-
Critical Hdwy Stg 2	-	-	-	-	-	-	6.1	5.5	-	6.1	5.5	-
Follow-up Hdwy	2.2	-	-	2.2	-	-	3.5	4	3.3	3.5	4	3.3
Pot Cap-1 Maneuver	1161	-	-	1130	-	-	223	225	625	~ 196	248	715
Stage 1	-	-	-	-	-	-	584	569	-	541	534	-
Stage 2	-	-	-	-	-	-	528	493	-	514	565	-
Platoon blocked, %		-	-		-	-						
Mov Cap-1 Maneuver	1161	-	-	1130	-	-	185	204	625	~ 117	224	715
Mov Cap-2 Maneuver	-	-	-	-	-	-	185	204	-	~ 117	224	-
Stage 1	-	-	-	-	-	-	578	563	-	535	489	-
Stage 2	-	-	-	-	-	-	449	451	-	~ 347	559	-

Approach	EB			WB			NB			SB		
HCM Control Delay, s	0.2			1.6			18.1			\$ 926.1		
HCM LOS							C			F		

Minor Lane/Major Mvmt	NBLn1	NBLn2	EBL	EBT	EBR	WBL	WBT	WBR	SBLn1	SBLn2
Capacity (veh/h)	185	490	1161	-	-	1130	-	-	117	279
HCM Lane V/C Ratio	0.082	0.417	0.011	-	-	0.085	-	-	3.094	0.136
HCM Control Delay (s)	26.2	17.5	8.1	-	-	8.5	-	-	\$ 1021.4	19.9
HCM Lane LOS	D	C	A	-	-	A	-	-	F	C
HCM 95th %tile Q(veh)	0.3	2	0	-	-	0.3	-	-	34.5	0.5

Notes
 -: Volume exceeds capacity \$: Delay exceeds 300s +: Computation Not Defined *: All major volume in platoon

Intersection						
Int Delay, s/veh	3					
Movement	EBL	EBT	WBT	WBR	SBL	SBR
Lane Configurations						
Traffic Vol, veh/h	0	89	45	35	74	0
Future Vol, veh/h	0	89	45	35	74	0
Conflicting Peds, #/hr	0	0	0	0	0	0
Sign Control	Free	Free	Free	Free	Stop	Stop
RT Channelized	-	None	-	None	-	None
Storage Length	50	-	-	-	50	0
Veh in Median Storage, #	-	0	0	-	0	-
Grade, %	-	0	0	-	0	-
Peak Hour Factor	92	92	92	92	92	92
Heavy Vehicles, %	0	0	0	0	0	0
Mvmt Flow	0	97	49	38	80	0

Major/Minor	Major1	Major2	Minor2		
Conflicting Flow All	87	0	-	0	165 68
Stage 1	-	-	-	-	68 -
Stage 2	-	-	-	-	97 -
Critical Hdwy	4.1	-	-	-	6.4 6.2
Critical Hdwy Stg 1	-	-	-	-	5.4 -
Critical Hdwy Stg 2	-	-	-	-	5.4 -
Follow-up Hdwy	2.2	-	-	-	3.5 3.3
Pot Cap-1 Maneuver	1522	-	-	-	830 1001
Stage 1	-	-	-	-	960 -
Stage 2	-	-	-	-	932 -
Platoon blocked, %		-	-	-	
Mov Cap-1 Maneuver	1522	-	-	-	830 1001
Mov Cap-2 Maneuver	-	-	-	-	830 -
Stage 1	-	-	-	-	960 -
Stage 2	-	-	-	-	932 -

Approach	EB	WB	SB
HCM Control Delay, s	0	0	9.8
HCM LOS			A

Minor Lane/Major Mvmt	EBL	EBT	WBT	WBR	SBLn1	SBLn2
Capacity (veh/h)	1522	-	-	-	830	-
HCM Lane V/C Ratio	-	-	-	-	0.097	-
HCM Control Delay (s)	0	-	-	-	9.8	0
HCM Lane LOS	A	-	-	-	A	A
HCM 95th %tile Q(veh)	0	-	-	-	0.3	-

Intersection						
Int Delay, s/veh	4351.4					
Movement	EBL	EBR	NBL	NBT	SBT	SBR
Lane Configurations						
Traffic Vol, veh/h	806	122	93	1308	798	333
Future Vol, veh/h	806	122	93	1308	798	333
Conflicting Peds, #/hr	0	0	0	0	0	0
Sign Control	Stop	Stop	Free	Free	Free	Free
RT Channelized	-	None	-	None	-	None
Storage Length	50	0	50	-	-	-
Veh in Median Storage, #	0	-	-	0	0	-
Grade, %	0	-	-	0	0	-
Peak Hour Factor	92	92	92	92	92	92
Heavy Vehicles, %	0	0	4	4	6	6
Mvmt Flow	876	133	101	1422	867	362

Major/Minor	Minor2	Major1	Major2			
Conflicting Flow All	2672	1048	1229	0	-	0
Stage 1	1048	-	-	-	-	-
Stage 2	1624	-	-	-	-	-
Critical Hdwy	6.4	6.2	4.14	-	-	-
Critical Hdwy Stg 1	5.4	-	-	-	-	-
Critical Hdwy Stg 2	5.4	-	-	-	-	-
Follow-up Hdwy	3.5	3.3	2.236	-	-	-
Pot Cap-1 Maneuver	~ 25	279	560	-	-	-
Stage 1	~ 341	-	-	-	-	-
Stage 2	~ 179	-	-	-	-	-
Platoon blocked, %				-	-	-
Mov Cap-1 Maneuver	~ 21	279	560	-	-	-
Mov Cap-2 Maneuver	~ 21	-	-	-	-	-
Stage 1	~ 280	-	-	-	-	-
Stage 2	~ 179	-	-	-	-	-

Approach	EB	NB	SB
HCM Control Delay \$	6222.6	0.9	0
HCM LOS	F		

Minor Lane/Major Mvmt	NBL	NBT	EBLn1	EBLn2	SBT	SBR
Capacity (veh/h)	560	-	21	279	-	-
HCM Lane V/C Ratio	0.181	-	41.718	0.475	-	-
HCM Control Delay (s)	12.8	\$	18673.7	29.1	-	-
HCM Lane LOS	B	-	F	D	-	-
HCM 95th %tile Q(veh)	0.7	-	109.9	2.4	-	-

Notes
 -: Volume exceeds capacity \$: Delay exceeds 300s +: Computation Not Defined *: All major volume in platoon

Intersection						
Int Delay, s/veh	445.8					
Movement	WBL	WBR	NBT	NBR	SBL	SBT
Lane Configurations	↵	↵	↵		↵	↵
Traffic Vol, veh/h	106	537	709	137	420	1177
Future Vol, veh/h	106	537	709	137	420	1177
Conflicting Peds, #/hr	0	0	0	0	0	0
Sign Control	Stop	Stop	Free	Free	Free	Free
RT Channelized	-	None	-	None	-	None
Storage Length	50	0	-	-	50	-
Veh in Median Storage, #	0	-	0	-	-	0
Grade, %	0	-	0	-	-	0
Peak Hour Factor	92	92	92	92	92	92
Heavy Vehicles, %	0	0	6	6	2	2
Mvmt Flow	115	584	771	149	457	1279

Major/Minor	Minor1	Major1	Major2			
Conflicting Flow All	3039	846	0	0	920	0
Stage 1	846	-	-	-	-	-
Stage 2	2193	-	-	-	-	-
Critical Hdwy	6.4	6.2	-	-	4.12	-
Critical Hdwy Stg 1	5.4	-	-	-	-	-
Critical Hdwy Stg 2	5.4	-	-	-	-	-
Follow-up Hdwy	3.5	3.3	-	-	2.218	-
Pot Cap-1 Maneuver	~ 14	~ 365	-	-	742	-
Stage 1	424	-	-	-	-	-
Stage 2	~ 93	-	-	-	-	-
Platoon blocked, %			-	-	-	-
Mov Cap-1 Maneuver	~ 5	~ 365	-	-	742	-
Mov Cap-2 Maneuver	~ 5	-	-	-	-	-
Stage 1	424	-	-	-	-	-
Stage 2	~ 36	-	-	-	-	-

Approach	WB	NB	SB
HCM Control Delay, \$ 2128.4		0	4.5
HCM LOS	F		

Minor Lane/Major Mvmt	NBT	NBR	WBLn1	WBLn2	SBL	SBT
Capacity (veh/h)	-	-	5	365	742	-
HCM Lane V/C Ratio	-	-	23.043	1.599	0.615	-
HCM Control Delay (s)	-	-	\$ 11347.4	\$ 308.6	17.3	-
HCM Lane LOS	-	-	F	F	C	-
HCM 95th %tile Q(veh)	-	-	16.4	33.8	4.3	-

Notes
 -: Volume exceeds capacity \$: Delay exceeds 300s +: Computation Not Defined *: All major volume in platoon

Intersection						
Int Delay, s/veh	643.5					
Movement	EBL	EBR	NBL	NBT	SBT	SBR
Lane Configurations	W		W	U	U	
Traffic Vol, veh/h	117	147	66	735	1975	73
Future Vol, veh/h	117	147	66	735	1975	73
Conflicting Peds, #/hr	0	0	0	0	0	0
Sign Control	Stop	Stop	Free	Free	Free	Free
RT Channelized	-	None	-	None	-	None
Storage Length	0	-	50	-	-	-
Veh in Median Storage, #	0	-	-	0	0	-
Grade, %	0	-	-	0	0	-
Peak Hour Factor	92	92	92	92	92	92
Heavy Vehicles, %	0	0	6	6	8	8
Mvmt Flow	127	160	72	799	2147	79
Major/Minor	Minor2	Major1		Major2		
Conflicting Flow All	3130	2187	2226	0	0	
Stage 1	2187	-	-	-	-	
Stage 2	943	-	-	-	-	
Critical Hdwy	6.4	6.2	4.16	-	-	
Critical Hdwy Stg 1	5.4	-	-	-	-	
Critical Hdwy Stg 2	5.4	-	-	-	-	
Follow-up Hdwy	3.5	3.3	2.254	-	-	
Pot Cap-1 Maneuver	~ 13	~ 58	226	-	-	
Stage 1	~ 93	-	-	-	-	
Stage 2	382	-	-	-	-	
Platoon blocked, %				-	-	
Mov Cap-1 Maneuver	~ 9	~ 58	226	-	-	
Mov Cap-2 Maneuver	~ 9	-	-	-	-	
Stage 1	~ 63	-	-	-	-	
Stage 2	382	-	-	-	-	
Approach	EB	NB	SB			
HCM Control Delay, \$	7581.1	2.3	0			
HCM LOS	F					
Minor Lane/Major Mvmt	NBL	NBT	EBLn1	SBT	SBR	
Capacity (veh/h)	226	-	17	-	-	
HCM Lane V/C Ratio	0.317	-	16.88	-	-	
HCM Control Delay (s)	28.2	\$	7581.1	-	-	
HCM Lane LOS	D	-	F	-	-	
HCM 95th %tile Q(veh)	1.3	-	36.7	-	-	
Notes						
-: Volume exceeds capacity \$: Delay exceeds 300s +: Computation Not Defined *: All major volume in platoon						

Intersection

Int Delay, s/veh 224.7

Movement	EBT	EBR	WBL	WBT	NBL	NBR
Lane Configurations	↔		↔	↑	↔	↔
Traffic Vol, veh/h	1126	77	154	467	195	292
Future Vol, veh/h	1126	77	154	467	195	292
Conflicting Peds, #/hr	0	0	0	0	0	0
Sign Control	Free	Free	Free	Free	Stop	Stop
RT Channelized	-	None	-	None	-	None
Storage Length	-	-	50	-	50	0
Veh in Median Storage, #	0	-	-	0	0	-
Grade, %	0	-	-	0	0	-
Peak Hour Factor	92	92	92	92	92	92
Heavy Vehicles, %	1	1	1	1	0	0
Mvmt Flow	1224	84	167	508	212	317

Major/Minor	Major1	Major2	Minor1
Conflicting Flow All	0	0	1308
Stage 1	-	-	-
Stage 2	-	-	-
Critical Hdwy	-	-	4.11
Critical Hdwy Stg 1	-	-	-
Critical Hdwy Stg 2	-	-	-
Follow-up Hdwy	-	-	2.209
Pot Cap-1 Maneuver	-	-	532
Stage 1	-	-	-
Stage 2	-	-	-
Platoon blocked, %	-	-	-
Mov Cap-1 Maneuver	-	-	532
Mov Cap-2 Maneuver	-	-	-
Stage 1	-	-	-
Stage 2	-	-	-

Approach	EB	WB	NB
HCM Control Delay, s	0	3.7	\$ 1061.8
HCM LOS			F

Minor Lane/Major Mvmt	NBLn1	NBLn2	EBT	EBR	WBL	WBT
Capacity (veh/h)	39	208	-	-	532	-
HCM Lane V/C Ratio	5.435	1.526	-	-	0.315	-
HCM Control Delay (s)	\$ 2200.3	\$ 301.5	-	-	14.8	-
HCM Lane LOS	F	F	-	-	B	-
HCM 95th %tile Q(veh)	24.8	19.7	-	-	1.3	-

Notes

-: Volume exceeds capacity \$: Delay exceeds 300s +: Computation Not Defined *: All major volume in platoon

Intersection						
Int Delay, s/veh	0.9					
Movement	EBT	EBR	WBL	WBT	NBL	NBR
Lane Configurations						
Traffic Vol, veh/h	147	23	8	77	10	8
Future Vol, veh/h	147	23	8	77	10	8
Conflicting Peds, #/hr	0	0	0	0	0	0
Sign Control	Free	Free	Free	Free	Stop	Stop
RT Channelized	-	None	-	None	-	None
Storage Length	-	-	50	-	-	-
Veh in Median Storage, #	0	-	-	0	0	-
Grade, %	0	-	-	0	0	-
Peak Hour Factor	92	92	92	92	92	92
Heavy Vehicles, %	1	1	2	2	0	0
Mvmt Flow	160	25	9	84	11	9

Major/Minor	Major1	Major2	Minor1		
Conflicting Flow All	0	0	185	0	275
Stage 1	-	-	-	-	173
Stage 2	-	-	-	-	102
Critical Hdwy	-	-	4.12	-	6.4
Critical Hdwy Stg 1	-	-	-	-	5.4
Critical Hdwy Stg 2	-	-	-	-	5.4
Follow-up Hdwy	-	-	2.218	-	3.5
Pot Cap-1 Maneuver	-	-	1390	-	719
Stage 1	-	-	-	-	862
Stage 2	-	-	-	-	927
Platoon blocked, %	-	-	-	-	-
Mov Cap-1 Maneuver	-	-	1390	-	715
Mov Cap-2 Maneuver	-	-	-	-	715
Stage 1	-	-	-	-	862
Stage 2	-	-	-	-	921

Approach	EB	WB	NB
HCM Control Delay, s	0	0.7	9.7
HCM LOS			A

Minor Lane/Major Mvmt	NBLn1	EBT	EBR	WBL	WBT
Capacity (veh/h)	779	-	-	1390	-
HCM Lane V/C Ratio	0.025	-	-	0.006	-
HCM Control Delay (s)	9.7	-	-	7.6	-
HCM Lane LOS	A	-	-	A	-
HCM 95th %tile Q(veh)	0.1	-	-	0	-

Intersection	
Intersection Delay, s/veh	7.7
Intersection LOS	A

Movement	EBL	EBT	EBR	WBL	WBT	WBR	NBL	NBT	NBR	SBL	SBT	SBR
Lane Configurations	↵	↶		↵	↶		↵	↶		↵	↶	
Traffic Vol, veh/h	0	50	0	0	15	6	0	11	1	15	16	0
Future Vol, veh/h	0	50	0	0	15	6	0	11	1	15	16	0
Peak Hour Factor	0.92	0.92	0.92	0.92	0.92	0.92	0.92	0.92	0.92	0.92	0.92	0.92
Heavy Vehicles, %	13	13	13	9	9	9	0	0	0	0	0	0
Mvmt Flow	0	54	0	0	16	7	0	12	1	16	17	0
Number of Lanes	1	1	0	1	1	0	1	1	0	1	1	0

Approach	EB	WB	NB	SB
Opposing Approach	WB	EB	SB	NB
Opposing Lanes	2	2	2	2
Conflicting Approach Left	SB	NB	EB	WB
Conflicting Lanes Left	2	2	2	2
Conflicting Approach Right	NB	SB	WB	EB
Conflicting Lanes Right	2	2	2	2
HCM Control Delay	7.9	7.5	7.5	7.7
HCM LOS	A	A	A	A

Lane	NBLn1	NBLn2	EBLn1	EBLn2	WBLn1	WBLn2	SBLn1	SBLn2
Vol Left, %	0%	0%	0%	0%	0%	0%	100%	0%
Vol Thru, %	100%	92%	100%	100%	100%	71%	0%	100%
Vol Right, %	0%	8%	0%	0%	0%	29%	0%	0%
Sign Control	Stop	Stop	Stop	Stop	Stop	Stop	Stop	Stop
Traffic Vol by Lane	0	12	0	50	0	21	15	16
LT Vol	0	0	0	0	0	0	15	0
Through Vol	0	11	0	50	0	15	0	16
RT Vol	0	1	0	0	0	6	0	0
Lane Flow Rate	0	13	0	54	0	23	16	17
Geometry Grp	7	7	7	7	7	7	7	7
Degree of Util (X)	0	0.017	0	0.073	0	0.029	0.023	0.022
Departure Headway (Hd)	4.651	4.593	4.812	4.812	4.76	4.559	5.141	4.64
Convergence, Y/N	Yes	Yes	Yes	Yes	Yes	Yes	Yes	Yes
Cap	0	771	0	742	0	780	691	765
Service Time	2.428	2.37	2.557	2.557	2.515	2.315	2.911	2.41
HCM Lane V/C Ratio	0	0.017	0	0.073	0	0.029	0.023	0.022
HCM Control Delay	7.4	7.5	7.6	7.9	7.5	7.5	8	7.5
HCM Lane LOS	N	A	N	A	N	A	A	A
HCM 95th-tile Q	0	0.1	0	0.2	0	0.1	0.1	0.1

Intersection						
Int Delay, s/veh	7.1					
Movement	EBL	EBT	WBT	WBR	SBL	SBR
Lane Configurations		↕	↑	↗	↘	
Traffic Vol, veh/h	7	228	138	115	270	8
Future Vol, veh/h	7	228	138	115	270	8
Conflicting Peds, #/hr	0	0	0	0	0	0
Sign Control	Free	Free	Free	Free	Stop	Stop
RT Channelized	-	None	-	None	-	None
Storage Length	-	-	-	0	0	-
Veh in Median Storage, #	-	0	0	-	0	-
Grade, %	-	0	0	-	0	-
Peak Hour Factor	92	92	92	92	92	92
Heavy Vehicles, %	7	7	45	45	30	30
Mvmt Flow	8	248	150	125	293	9

Major/Minor	Major1	Major2	Minor2		
Conflicting Flow All	275	0	-	0	414
Stage 1	-	-	-	-	150
Stage 2	-	-	-	-	264
Critical Hdwy	4.17	-	-	-	6.7
Critical Hdwy Stg 1	-	-	-	-	5.7
Critical Hdwy Stg 2	-	-	-	-	5.7
Follow-up Hdwy	2.263	-	-	-	3.77
Pot Cap-1 Maneuver	1260	-	-	-	545
Stage 1	-	-	-	-	814
Stage 2	-	-	-	-	720
Platoon blocked, %		-	-	-	
Mov Cap-1 Maneuver	1260	-	-	-	541
Mov Cap-2 Maneuver	-	-	-	-	541
Stage 1	-	-	-	-	808
Stage 2	-	-	-	-	720

Approach	EB	WB	SB
HCM Control Delay, s	0.2	0	19.5
HCM LOS			C

Minor Lane/Major Mvmt	EBL	EBT	WBT	WBR	SBLn1
Capacity (veh/h)	1260	-	-	-	546
HCM Lane V/C Ratio	0.006	-	-	-	0.553
HCM Control Delay (s)	7.9	0	-	-	19.5
HCM Lane LOS	A	A	-	-	C
HCM 95th %tile Q(veh)	0	-	-	-	3.4

Intersection												
Int Delay, s/veh	7.3											
Movement	EBL	EBT	EBR	WBL	WBT	WBR	NBL	NBT	NBR	SBL	SBT	SBR
Lane Configurations		↕			↕	↕		↕			↕	
Traffic Vol, veh/h	13	537	1	6	225	206	2	0	5	170	0	13
Future Vol, veh/h	13	537	1	6	225	206	2	0	5	170	0	13
Conflicting Peds, #/hr	0	0	0	0	0	0	0	0	1	1	0	0
Sign Control	Free	Free	Free	Free	Free	Free	Stop	Stop	Stop	Stop	Stop	Stop
RT Channelized	-	-	None	-	-	None	-	-	None	-	-	None
Storage Length	-	-	-	-	-	50	-	-	-	-	-	-
Veh in Median Storage, #	-	0	-	-	0	-	-	0	-	-	0	-
Grade, %	-	0	-	-	0	-	-	0	-	-	0	-
Peak Hour Factor	93	93	93	93	93	93	93	93	93	93	93	93
Heavy Vehicles, %	19	19	19	22	22	22	71	71	71	5	5	5
Mvmt Flow	14	577	1	6	242	222	2	0	5	183	0	14

Major/Minor	Major1			Major2			Minor1			Minor2		
Conflicting Flow All	464	0	0	578	0	0	978	1082	579	863	860	242
Stage 1	-	-	-	-	-	-	606	606	-	254	254	-
Stage 2	-	-	-	-	-	-	372	476	-	609	606	-
Critical Hdwy	4.29	-	-	4.32	-	-	7.81	7.21	6.91	7.15	6.55	6.25
Critical Hdwy Stg 1	-	-	-	-	-	-	6.81	6.21	-	6.15	5.55	-
Critical Hdwy Stg 2	-	-	-	-	-	-	6.81	6.21	-	6.15	5.55	-
Follow-up Hdwy	2.371	-	-	2.398	-	-	4.139	4.639	3.939	3.545	4.045	3.345
Pot Cap-1 Maneuver	1014	-	-	904	-	-	174	165	406	272	290	790
Stage 1	-	-	-	-	-	-	384	393	-	744	692	-
Stage 2	-	-	-	-	-	-	529	457	-	477	482	-
Platoon blocked, %		-	-	-	-	-						
Mov Cap-1 Maneuver	1014	-	-	904	-	-	167	160	406	262	282	790
Mov Cap-2 Maneuver	-	-	-	-	-	-	167	160	-	262	282	-
Stage 1	-	-	-	-	-	-	376	385	-	729	686	-
Stage 2	-	-	-	-	-	-	515	453	-	461	472	-

Approach	EB			WB			NB			SB		
HCM Control Delay, s	0.2			0.1			17.8			45.3		
HCM LOS							C			E		

Minor Lane/Major Mvmt	NBLn1	EBL	EBT	EBR	WBL	WBT	WBR	SBLn1
Capacity (veh/h)	288	1014	-	-	904	-	-	275
HCM Lane V/C Ratio	0.026	0.014	-	-	0.007	-	-	0.716
HCM Control Delay (s)	17.8	8.6	0	-	9	0	-	45.3
HCM Lane LOS	C	A	A	-	A	A	-	E
HCM 95th %tile Q(veh)	0.1	0	-	-	0	-	-	5

HCM 6th TWSC
5: Road 23/SR-99 Southbound Off-Ramp & Avenue 18 1/2

Village D Specific Plan
Phase III WP - PM Peak Hour

Intersection												
Int Delay, s/veh	686.9											
Movement	EBL	EBT	EBR	WBL	WBT	WBR	NBL	NBT	NBR	SBL	SBT	SBR
Lane Configurations		↑	↑		↑		↑		↑		↕	
Traffic Vol, veh/h	0	405	307	58	206	0	106	0	469	28	695	127
Future Vol, veh/h	0	405	307	58	206	0	106	0	469	28	695	127
Conflicting Peds, #/hr	0	0	0	0	0	0	0	0	0	0	0	0
Sign Control	Free	Free	Free	Free	Free	Free	Stop	Stop	Stop	Stop	Stop	Stop
RT Channelized	-	-	None	-	-	None	-	-	None	-	-	None
Storage Length	-	-	50	-	-	-	0	-	25	-	-	-
Veh in Median Storage, #	-	0	-	-	0	-	-	0	-	-	0	-
Grade, %	-	0	-	-	0	-	-	0	-	-	0	-
Peak Hour Factor	94	94	94	94	94	94	94	94	94	94	94	94
Heavy Vehicles, %	18	18	18	30	30	30	6	6	6	9	9	9
Mvmt Flow	0	431	327	62	219	0	113	0	499	30	739	135

Major/Minor	Major1			Major2			Minor1			Minor2		
Conflicting Flow All	-	0	0	758	0	0	1211	-	431	1187	1101	219
Stage 1	-	-	-	-	-	-	431	-	-	343	343	-
Stage 2	-	-	-	-	-	-	780	-	-	844	758	-
Critical Hdwy	-	-	-	4.4	-	-	7.16	-	6.26	7.19	6.59	6.29
Critical Hdwy Stg 1	-	-	-	-	-	-	6.16	-	-	6.19	5.59	-
Critical Hdwy Stg 2	-	-	-	-	-	-	6.16	-	-	6.19	5.59	-
Follow-up Hdwy	-	-	-	2.47	-	-	3.554	-	3.354	3.581	4.081	3.381
Pot Cap-1 Maneuver	0	-	-	740	-	0	156	0	616	160	~ 206	803
Stage 1	0	-	-	-	-	0	595	0	-	658	~ 625	-
Stage 2	0	-	-	-	-	0	382	0	-	348	~ 405	-
Platoon blocked, %	-	-	-	-	-	-	-	-	-	-	-	-
Mov Cap-1 Maneuver	-	-	-	740	-	-	-	-	616	~ 28	~ 186	803
Mov Cap-2 Maneuver	-	-	-	-	-	-	-	-	-	~ 28	~ 186	-
Stage 1	-	-	-	-	-	-	595	-	-	658	~ 566	-
Stage 2	-	-	-	-	-	-	-	-	-	66	~ 405	-

Approach	EB	WB	NB	SB
HCM Control Delay, s	0	2.3		\$ 1939.6
HCM LOS			-	F

Minor Lane/Major Mvmt	NBLn1	NBLn2	EBT	EBR	WBL	WBT	SBLn1
Capacity (veh/h)	-	616	-	-	740	-	174
HCM Lane V/C Ratio	-	0.81	-	-	0.083	-	5.197
HCM Control Delay (s)	-	31	-	-	10.3	-	\$ 1939.6
HCM Lane LOS	-	D	-	-	B	A	F
HCM 95th %tile Q(veh)	-	8.2	-	-	0.3	-	94.9

Notes
 -: Volume exceeds capacity \$: Delay exceeds 300s +: Computation Not Defined *: All major volume in platoon

HCM 6th TWSC
6: SR-99 Northbound Ramps & Avenue 18 1/2

Village D Specific Plan
Phase III WP - PM Peak Hour

Intersection												
Int Delay, s/veh	197.1											
Movement	EBL	EBT	EBR	WBL	WBT	WBR	NBL	NBT	NBR	SBL	SBT	SBR
Lane Configurations	↙	↑			↘			↔				
Traffic Vol, veh/h	542	124	0	0	99	22	196	3	0	0	0	0
Future Vol, veh/h	542	124	0	0	99	22	196	3	0	0	0	0
Conflicting Peds, #/hr	0	0	0	0	0	0	0	0	0	0	0	0
Sign Control	Free	Free	Free	Free	Free	Free	Stop	Stop	Stop	Free	Free	Free
RT Channelized	-	-	None	-	-	None	-	-	None	-	-	None
Storage Length	145	-	-	-	-	-	-	-	-	-	-	-
Veh in Median Storage, #	-	0	-	-	0	-	-	0	-	-	16965	-
Grade, %	-	0	-	-	0	-	-	0	-	-	0	-
Peak Hour Factor	92	92	92	92	92	92	92	92	92	92	92	92
Heavy Vehicles, %	11	11	11	12	12	12	24	24	24	0	0	0
Mvmt Flow	589	135	0	0	108	24	213	3	0	0	0	0

Major/Minor	Major1	Major2	Minor1
Conflicting Flow All	132	0	- - - 0 1433 1445 135
Stage 1	-	-	- - - 1313 1313 -
Stage 2	-	-	- - - 120 132 -
Critical Hdwy	4.21	-	- - - 6.64 6.74 6.44
Critical Hdwy Stg 1	-	-	- - - 5.64 5.74 -
Critical Hdwy Stg 2	-	-	- - - 5.64 5.74 -
Follow-up Hdwy	2.299	-	- - - 3.716 4.216 3.516
Pot Cap-1 Maneuver	1399	-	0 0 - - ~ 132 118 858
Stage 1	-	-	0 0 - - 226 206 -
Stage 2	-	-	0 0 - - 853 747 -
Platoon blocked, %	-	-	- -
Mov Cap-1 Maneuver	1399	-	- - - ~ 76 0 858
Mov Cap-2 Maneuver	-	-	- - - ~ 76 0 -
Stage 1	-	-	- - - ~ 131 0 -
Stage 2	-	-	- - - 853 0 -

Approach	EB	WB	NB
HCM Control Delay, s	7.7	0	\$ 950.7
HCM LOS			F

Minor Lane/Major Mvmt	NBLn1	EBL	EBT	WBT	WBR
Capacity (veh/h)	76	1399	-	-	-
HCM Lane V/C Ratio	2.846	0.421	-	-	-
HCM Control Delay (s)	\$ 950.7	9.4	-	-	-
HCM Lane LOS	F	A	-	-	-
HCM 95th %tile Q(veh)	21.3	2.1	-	-	-

Notes
 -: Volume exceeds capacity \$: Delay exceeds 300s +: Computation Not Defined *: All major volume in platoon

Intersection												
Int Delay, s/veh	0.3											
Movement	EBL	EBT	EBR	WBL	WBT	WBR	NBL	NBT	NBR	SBL	SBT	SBR
Lane Configurations		↕			↕			↕			↕	
Traffic Vol, veh/h	83	263	59	968	477	10	38	544	646	64	992	166
Future Vol, veh/h	83	263	59	968	477	10	38	544	646	64	992	166
Conflicting Peds, #/hr	0	0	0	0	0	0	0	0	0	0	0	0
Sign Control	Stop	Stop	Stop	Stop	Stop	Stop	Free	Free	Free	Free	Free	Free
RT Channelized	-	-	None	-	-	None	-	-	None	-	-	None
Storage Length	-	-	-	-	-	-	-	-	-	-	-	-
Veh in Median Storage, #	-	0	-	-	0	-	-	0	-	-	0	-
Grade, %	-	0	-	-	0	-	-	0	-	-	0	-
Peak Hour Factor	92	92	92	92	92	92	92	92	92	92	92	92
Heavy Vehicles, %	1	1	1	0	0	0	1	1	1	2	2	2
Mvmt Flow	90	286	64	1052	518	11	41	591	702	70	1078	180

Major/Minor	Minor2		Minor1		Major1		Major2					
Conflicting Flow All	2597	2683	1168	2507	2422	942	1258	0	0	1293	0	0
Stage 1	1308	1308	-	1024	1024	-	-	-	-	-	-	-
Stage 2	1289	1375	-	1483	1398	-	-	-	-	-	-	-
Critical Hdwy	7.11	6.51	6.21	7.1	6.5	6.2	4.11	-	-	4.12	-	-
Critical Hdwy Stg 1	6.11	5.51	-	6.1	5.5	-	-	-	-	-	-	-
Critical Hdwy Stg 2	6.11	5.51	-	6.1	5.5	-	-	-	-	-	-	-
Follow-up Hdwy	3.509	4.009	3.309	3.5	4	3.3	2.209	-	-	2.218	-	-
Pot Cap-1 Maneuver	~ 17	~ 22	237	~ 20	~ 33	322	556	-	-	536	-	-
Stage 1	197	~ 230	-	~ 286	~ 315	-	-	-	-	-	-	-
Stage 2	202	~ 214	-	~ 157	~ 209	-	-	-	-	-	-	-
Platoon blocked, %								-	-	-	-	-
Mov Cap-1 Maneuver	-	~ 8	237	-	~ 11	322	556	-	-	536	-	-
Mov Cap-2 Maneuver	-	~ 8	-	-	~ 11	-	-	-	-	-	-	-
Stage 1	125	~ 123	-	~ 182	~ 201	-	-	-	-	-	-	-
Stage 2	-	~ 136	-	-	~ 112	-	-	-	-	-	-	-

Approach	EB		WB		NB		SB	
HCM Control Delay, s					0.4		0.7	
HCM LOS	-		-					

Minor Lane/Major Mvmt	NBL	NBT	NBR	EBLn1WBLn1	SBL	SBT	SBR
Capacity (veh/h)	556	-	-	-	536	-	-
HCM Lane V/C Ratio	0.074	-	-	-	0.13	-	-
HCM Control Delay (s)	12	0	-	-	12.7	0	-
HCM Lane LOS	B	A	-	-	B	A	-
HCM 95th %tile Q(veh)	0.2	-	-	-	0.4	-	-

Notes
 -: Volume exceeds capacity \$: Delay exceeds 300s +: Computation Not Defined *: All major volume in platoon

Intersection	
Intersection Delay, s/veh	954
Intersection LOS	F

Movement	EBL	EBT	EBR	WBL	WBT	WBR	NBL	NBT	NBR	SBL	SBT	SBR
Lane Configurations	↶	↷		↶	↷		↶	↷		↶	↷	
Traffic Vol, veh/h	156	25	252	93	26	109	393	1210	171	222	1442	228
Future Vol, veh/h	156	25	252	93	26	109	393	1210	171	222	1442	228
Peak Hour Factor	0.95	0.95	0.95	0.95	0.95	0.95	0.95	0.95	0.95	0.95	0.95	0.95
Heavy Vehicles, %	1	1	1	1	1	1	1	1	1	2	2	2
Mvmt Flow	164	26	265	98	27	115	414	1274	180	234	1518	240
Number of Lanes	1	1	0	1	1	0	1	1	0	1	1	0

Approach	EB	WB	NB	SB
Opposing Approach	WB	EB	SB	NB
Opposing Lanes	2	2	2	2
Conflicting Approach Left	SB	NB	EB	WB
Conflicting Lanes Left	2	2	2	2
Conflicting Approach Right	NB	SB	WB	EB
Conflicting Lanes Right	2	2	2	2
HCM Control Delay	43.4	28.1	902.9	1321.9
HCM LOS	E	D	F	F

Lane	NBLn1	NBLn2	EBLn1	EBLn2	WBLn1	WBLn2	SBLn1	SBLn2
Vol Left, %	100%	0%	100%	0%	100%	0%	100%	0%
Vol Thru, %	0%	88%	0%	9%	0%	19%	0%	86%
Vol Right, %	0%	12%	0%	91%	0%	81%	0%	14%
Sign Control	Stop	Stop	Stop	Stop	Stop	Stop	Stop	Stop
Traffic Vol by Lane	393	1381	156	277	93	135	222	1670
LT Vol	393	0	156	0	93	0	222	0
Through Vol	0	1210	0	25	0	26	0	1442
RT Vol	0	171	0	252	0	109	0	228
Lane Flow Rate	414	1454	164	292	98	142	234	1758
Geometry Grp	7	7	7	7	7	7	7	7
Degree of Util (X)	1.048	3.445	0.449	0.705	0.284	0.37	0.605	4.263
Departure Headway (Hd)	12.223	11.597	17.046	15.83	17.707	16.558	10.591	9.972
Convergence, Y/N	Yes	Yes	Yes	Yes	Yes	Yes	Yes	Yes
Cap	302	334	213	230	205	219	344	387
Service Time	9.923	9.297	14.746	13.53	15.407	14.258	8.291	7.672
HCM Lane V/C Ratio	1.371	4.353	0.77	1.27	0.478	0.648	0.68	4.543
HCM Control Delay	102.4	1130.7	32.9	49.3	27.3	28.7	28.3	1493.9
HCM Lane LOS	F	F	D	E	D	D	D	F
HCM 95th-tile Q	11.7	98.9	2.1	4.6	1.1	1.6	3.8	151.1

Intersection												
Intersection Delay, s/v	183.7											
Intersection LOS	F											

Movement	EBL	EBT	EBR	WBL	WBT	WBR	NBL	NBT	NBR	SBL	SBT	SBR
Lane Configurations	↔	↔		↔	↔		↔	↔		↔	↔	
Traffic Vol, veh/h	477	502	788	261	494	388	968	983	317	334	932	608
Future Vol, veh/h	477	502	788	261	494	388	968	983	317	334	932	608
Peak Hour Factor	0.93	0.93	0.93	0.93	0.93	0.93	0.93	0.93	0.93	0.93	0.93	0.93
Heavy Vehicles, %	0	0	0	0	0	0	1	1	1	2	2	2
Mvmt Flow	513	540	847	281	531	417	1041	1057	341	359	1002	654
Number of Lanes	1	1	0	1	1	0	1	1	0	1	1	0

Approach	EB	WB	NB	SB
Opposing Approach	WB	EB	SB	NB
Opposing Lanes	2	2	2	2
Conflicting Approach Left	SB	NB	EB	WB
Conflicting Lanes Left	2	2	2	2
Conflicting Approach Right	NB	SB	WB	EB
Conflicting Lanes Right	2	2	2	2
HCM Control Delay	1955.1	2796.5	1722.4	2583.6
HCM LOS	F	F	F	F

Lane	NBLn1	NBLn2	EBLn1	EBLn2	WBLn1	WBLn2	SBLn1	SBLn2
Vol Left, %	100%	0%	100%	0%	100%	0%	100%	0%
Vol Thru, %	0%	76%	0%	39%	0%	56%	0%	61%
Vol Right, %	0%	24%	0%	61%	0%	44%	0%	39%
Sign Control	Stop	Stop	Stop	Stop	Stop	Stop	Stop	Stop
Traffic Vol by Lane	968	1300	477	1290	261	882	334	1540
LT Vol	968	0	477	0	261	0	334	0
Through Vol	0	983	0	502	0	494	0	932
RT Vol	0	317	0	788	0	388	0	608
Lane Flow Rate	1041	1398	513	1387	281	948	359	1656
Geometry Grp	7	7	7	7	7	7	7	7
Degree of Util (X)	3.444	4.366	1.695	4.226	0.935	2.948	1.19	5.131
Departure Headway (Hd)	177.164	76.499	98.859	98.102	46.276	45.465	28.735	28.086
Convergence, Y/N	Yes	Yes	Yes	Yes	Yes	Yes	Yes	Yes
Cap	31	42	15	28	8	19	11	33
Service Time	174.864	74.199	96.559	95.802	43.976	43.165	26.435	25.786
HCM Lane V/C Ratio	33.581	33.286	34.249	53.635	12.549	8.953	2.636	50.182
HCM Control Delay	1489.3	1895.9	1131.2	2259.8	1958.6	3044.5	1108	2903.6
HCM Lane LOS	F	F	F	F	F	F	F	F
HCM 95th-tile Q	9.1	11.5	2.8	6	1	2.2	1.8	5.8

Intersection												
Int Delay, s/veh	3.4											
Movement	EBL	EBT	EBR	WBL	WBT	WBR	NBL	NBT	NBR	SBL	SBT	SBR
Lane Configurations		↕			↕			↕			↕	
Traffic Vol, veh/h	1	2	3	6	3	308	2	1354	2	309	939	0
Future Vol, veh/h	1	2	3	6	3	308	2	1354	2	309	939	0
Conflicting Peds, #/hr	0	0	0	0	0	0	0	0	0	0	0	0
Sign Control	Stop	Stop	Stop	Stop	Stop	Stop	Free	Free	Free	Free	Free	Free
RT Channelized	-	-	None	-	-	None	-	-	None	-	-	None
Storage Length	-	-	-	-	-	-	-	-	-	-	-	-
Veh in Median Storage, #	-	0	-	-	0	-	-	0	-	-	0	-
Grade, %	-	0	-	-	0	-	-	0	-	-	0	-
Peak Hour Factor	92	92	92	92	92	92	92	92	92	92	92	92
Heavy Vehicles, %	0	0	0	0	0	0	2	2	2	2	2	2
Mvmt Flow	1	2	3	7	3	335	2	1472	2	336	1021	0

Major/Minor	Minor2		Minor1		Major1		Major2					
Conflicting Flow All	3339	3171	1021	3173	3170	1473	1021	0	0	1474	0	0
Stage 1	1693	1693	-	1477	1477	-	-	-	-	-	-	-
Stage 2	1646	1478	-	1696	1693	-	-	-	-	-	-	-
Critical Hdwy	7.1	6.5	6.2	7.1	6.5	6.2	4.12	-	-	4.12	-	-
Critical Hdwy Stg 1	6.1	5.5	-	6.1	5.5	-	-	-	-	-	-	-
Critical Hdwy Stg 2	6.1	5.5	-	6.1	5.5	-	-	-	-	-	-	-
Follow-up Hdwy	3.5	4	3.3	3.5	4	3.3	2.218	-	-	2.218	-	-
Pot Cap-1 Maneuver	5	11	289	~ 6	11	~ 157	680	-	-	457	-	-
Stage 1	119	150	-	159	192	-	-	-	-	-	-	-
Stage 2	127	192	-	119	150	-	-	-	-	-	-	-
Platoon blocked, %								-	-	-	-	-
Mov Cap-1 Maneuver	-	0	289	-	0	~ 157	680	-	-	457	-	-
Mov Cap-2 Maneuver	-	0	-	-	0	-	-	-	-	-	-	-
Stage 1	117	0	-	156	189	-	-	-	-	-	-	-
Stage 2	-	189	-	-	0	-	-	-	-	-	-	-

Approach	EB	WB	NB	SB
HCM Control Delay, s			0	7.9
HCM LOS	-	-		

Minor Lane/Major Mvmt	NBL	NBT	NBR	EBLn1WBLn1	SBL	SBT	SBR
Capacity (veh/h)	680	-	-	-	457	-	-
HCM Lane V/C Ratio	0.003	-	-	-	0.735	-	-
HCM Control Delay (s)	10.3	0	-	-	31.7	0	-
HCM Lane LOS	B	A	-	-	D	A	-
HCM 95th %tile Q(veh)	0	-	-	-	6	-	-

Notes
 -: Volume exceeds capacity \$: Delay exceeds 300s +: Computation Not Defined *: All major volume in platoon

Intersection	
Intersection Delay, s/veh	507.8
Intersection LOS	F

Movement	EBL	EBT	EBR	WBL	WBT	WBR	NBL	NBT	NBR	SBL	SBT	SBR
Lane Configurations		↕			↕			↕			↕	
Traffic Vol, veh/h	188	93	36	12	38	796	15	374	22	550	294	102
Future Vol, veh/h	188	93	36	12	38	796	15	374	22	550	294	102
Peak Hour Factor	0.95	0.95	0.95	0.95	0.95	0.95	0.95	0.95	0.95	0.95	0.95	0.95
Heavy Vehicles, %	6	6	6	1	1	1	4	4	4	3	3	3
Mvmt Flow	198	98	38	13	40	838	16	394	23	579	309	107
Number of Lanes	0	1	0	0	1	0	0	1	0	0	1	0

Approach	EB	WB	NB	SB
Opposing Approach	WB	EB	SB	NB
Opposing Lanes	1	1	1	1
Conflicting Approach Left	SB	NB	EB	WB
Conflicting Lanes Left	1	1	1	1
Conflicting Approach Right	NB	SB	WB	EB
Conflicting Lanes Right	1	1	1	1
HCM Control Delay	96.1	561.1	150.4	753.4
HCM LOS	F	F	F	F

Lane	NBLn1	EBLn1	WBLn1	SBLn1
Vol Left, %	4%	59%	1%	58%
Vol Thru, %	91%	29%	4%	31%
Vol Right, %	5%	11%	94%	11%
Sign Control	Stop	Stop	Stop	Stop
Traffic Vol by Lane	411	317	846	946
LT Vol	15	188	12	550
Through Vol	374	93	38	294
RT Vol	22	36	796	102
Lane Flow Rate	433	334	891	996
Geometry Grp	1	1	1	1
Degree of Util (X)	1.119	0.904	2.158	2.592
Departure Headway (Hd)	19.055	20.606	13.311	13.177
Convergence, Y/N	Yes	Yes	Yes	Yes
Cap	195	180	285	289
Service Time	17.055	18.606	11.311	11.177
HCM Lane V/C Ratio	2.221	1.856	3.126	3.446
HCM Control Delay	150.4	96.1	561.1	753.4
HCM Lane LOS	F	F	F	F
HCM 95th-tile Q	10.4	6.7	44.1	58.9

Intersection

Intersection Delay, s/veh 14.1

Intersection LOS B

Movement	EBL	EBT	EBR	WBL	WBT	WBR	NBL	NBT	NBR	SBL	SBT	SBR
Lane Configurations	↶	↷		↶	↷			↕			↕	
Traffic Vol, veh/h	142	178	9	23	96	112	4	110	48	109	93	86
Future Vol, veh/h	142	178	9	23	96	112	4	110	48	109	93	86
Peak Hour Factor	0.92	0.92	0.92	0.92	0.92	0.92	0.92	0.92	0.92	0.92	0.92	0.92
Heavy Vehicles, %	11	11	11	14	14	14	5	5	5	6	6	6
Mvmt Flow	154	193	10	25	104	122	4	120	52	118	101	93
Number of Lanes	1	1	0	1	1	0	0	1	0	0	1	0

Approach	EB	WB	NB	SB
Opposing Approach	WB	EB	SB	NB
Opposing Lanes	2	2	1	1
Conflicting Approach Left	SB	NB	EB	WB
Conflicting Lanes Left	1	1	2	2
Conflicting Approach Right	NB	SB	WB	EB
Conflicting Lanes Right	1	1	2	2
HCM Control Delay	13.5	13.8	12.3	16.1
HCM LOS	B	B	B	C

Lane	NBLn1	EBLn1	EBLn2	WBLn1	WBLn2	SBLn1
Vol Left, %	2%	100%	0%	100%	0%	38%
Vol Thru, %	68%	0%	95%	0%	46%	32%
Vol Right, %	30%	0%	5%	0%	54%	30%
Sign Control	Stop	Stop	Stop	Stop	Stop	Stop
Traffic Vol by Lane	162	142	187	23	208	288
LT Vol	4	142	0	23	0	109
Through Vol	110	0	178	0	96	93
RT Vol	48	0	9	0	112	86
Lane Flow Rate	176	154	203	25	226	313
Geometry Grp	2	7	7	7	7	2
Degree of Util (X)	0.313	0.312	0.381	0.052	0.417	0.535
Departure Headway (Hd)	6.391	7.285	6.74	7.522	6.637	6.152
Convergence, Y/N	Yes	Yes	Yes	Yes	Yes	Yes
Cap	562	494	535	476	543	589
Service Time	4.434	5.013	4.467	5.264	4.366	4.178
HCM Lane V/C Ratio	0.313	0.312	0.379	0.053	0.416	0.531
HCM Control Delay	12.3	13.3	13.6	10.7	14.1	16.1
HCM Lane LOS	B	B	B	B	B	C
HCM 95th-tile Q	1.3	1.3	1.8	0.2	2	3.2

HCM 6th TWSC
 13: Airport Drive/Golden State Boulevard & Avenue 17

Village D Specific Plan
 Phase III WP - PM Peak Hour

Intersection												
Int Delay, s/veh	0.8											
Movement	EBL	EBT	EBR	WBL	WBT	WBR	NBL	NBT	NBR	SBL	SBT	SBR
Lane Configurations	↖	↗	↖	↖	↗	↖	↖	↗	↖		↕	
Traffic Vol, veh/h	12	877	160	216	1197	294	248	105	369	422	105	12
Future Vol, veh/h	12	877	160	216	1197	294	248	105	369	422	105	12
Conflicting Peds, #/hr	0	0	0	0	0	0	0	0	0	0	0	0
Sign Control	Free	Free	Free	Free	Free	Free	Stop	Stop	Stop	Stop	Stop	Stop
RT Channelized	-	-	None	-	-	None	-	-	None	-	-	None
Storage Length	85	-	0	70	-	105	60	-	50	-	-	-
Veh in Median Storage, #	-	0	-	-	0	-	-	0	-	-	0	-
Grade, %	-	0	-	-	0	-	-	0	-	-	0	-
Peak Hour Factor	92	92	92	92	92	92	92	92	92	92	92	92
Heavy Vehicles, %	1	1	1	2	2	2	3	3	3	3	3	3
Mvmt Flow	13	953	174	235	1301	320	270	114	401	459	114	13

Major/Minor	Major1			Major2			Minor1			Minor2		
Conflicting Flow All	1621	0	0	1127	0	0	2974	3070	953	3095	2924	1301
Stage 1	-	-	-	-	-	-	979	979	-	1771	1771	-
Stage 2	-	-	-	-	-	-	1995	2091	-	1324	1153	-
Critical Hdwy	4.11	-	-	4.12	-	-	7.13	6.53	6.23	7.13	6.53	6.23
Critical Hdwy Stg 1	-	-	-	-	-	-	6.13	5.53	-	6.13	5.53	-
Critical Hdwy Stg 2	-	-	-	-	-	-	6.13	5.53	-	6.13	5.53	-
Follow-up Hdwy	2.209	-	-	2.218	-	-	3.527	4.027	3.327	3.527	4.027	3.327
Pot Cap-1 Maneuver	404	-	-	620	-	-	~ 9	~ 12	~ 313	~ 7	~ 15	196
Stage 1	-	-	-	-	-	-	300	327	-	~ 105	135	-
Stage 2	-	-	-	-	-	-	~ 78	~ 93	-	~ 191	271	-
Platoon blocked, %		-	-		-	-						
Mov Cap-1 Maneuver	404	-	-	620	-	-	~ 7	~ 313	-	~ 9	196	
Mov Cap-2 Maneuver	-	-	-	-	-	-	~ 7	-	-	~ 9	-	
Stage 1	-	-	-	-	-	-	290	317	-	~ 102	~ 84	-
Stage 2	-	-	-	-	-	-	~ 58	-	-	262	-	

Approach	EB	WB	NB	SB
HCM Control Delay, s	0.2	1.8		
HCM LOS			-	-

Minor Lane/Major Mvmt	NBLn1	NBLn2	NBLn3	EBL	EBT	EBR	WBL	WBT	WBR	SBLn1
Capacity (veh/h)	-	7	313	404	-	-	620	-	-	-
HCM Lane V/C Ratio	-	16.304	1.281	0.032	-	-	0.379	-	-	-
HCM Control Delay (s)		\$ 7916.3	183	14.2	-	-	14.3	-	-	-
HCM Lane LOS		-	F	F	B	-	B	-	-	-
HCM 95th %tile Q(veh)		-	16.1	18.9	0.1	-	1.8	-	-	-

Notes
 -: Volume exceeds capacity \$: Delay exceeds 300s +: Computation Not Defined *: All major volume in platoon

Intersection

Int Delay, s/veh 4444.5

Movement	EBL	EBT	WBT	WBR	SBL	SBR
Lane Configurations		↑	↑		↑	↑
Traffic Vol, veh/h	0	1668	1615	0	452	92
Future Vol, veh/h	0	1668	1615	0	452	92
Conflicting Peds, #/hr	0	0	0	0	0	0
Sign Control	Free	Free	Free	Free	Stop	Stop
RT Channelized	-	None	-	None	-	None
Storage Length	-	-	-	-	0	610
Veh in Median Storage, #	-	0	0	-	0	-
Grade, %	-	0	0	-	0	-
Peak Hour Factor	92	92	92	92	92	92
Heavy Vehicles, %	2	2	2	2	3	3
Mvmt Flow	0	1813	1755	0	491	100

Major/Minor

	Major1	Major2	Minor2
Conflicting Flow All	-	0	0 3568 1755
Stage 1	-	-	- 1755 -
Stage 2	-	-	- 1813 -
Critical Hdwy	-	-	- 6.43 6.23
Critical Hdwy Stg 1	-	-	- 5.43 -
Critical Hdwy Stg 2	-	-	- 5.43 -
Follow-up Hdwy	-	-	- 3.527 3.327
Pot Cap-1 Maneuver	0	-	0 ~ 6 105
Stage 1	0	-	0 ~ 151 -
Stage 2	0	-	0 ~ 142 -
Platoon blocked, %	-	-	
Mov Cap-1 Maneuver	-	-	- ~ 6 105
Mov Cap-2 Maneuver	-	-	- ~ 6 -
Stage 1	-	-	- ~ 151 -
Stage 2	-	-	- ~ 142 -

Approach

	EB	WB	SB
HCM Control Delay, s	0	0	\$ 31266.9
HCM LOS			F

Minor Lane/Major Mvmt

	EBT	WBT	SBLn1	SBLn2
Capacity (veh/h)	-	-	6	105
HCM Lane V/C Ratio	-	-	81.884	0.952
HCM Control Delay (s)	-	\$	37600.4	150.3
HCM Lane LOS	-	-	F	F
HCM 95th %tile Q(veh)	-	-	63.6	5.8

Notes

-: Volume exceeds capacity \$: Delay exceeds 300s +: Computation Not Defined *: All major volume in platoon

HCM 6th TWSC
15: SR-99 Northbound Ramps & Avenue 17

Village D Specific Plan
Phase III WP - PM Peak Hour

Intersection

Int Delay, s/veh 23766.3

Movement	EBL	EBT	EBR	WBL	WBT	WBR	NBL	NBT	NBR	SBL	SBT	SBR
Lane Configurations	↙	↑			↘			↙	↘			
Traffic Vol, veh/h	180	1230	0	0	1494	351	821	4	529	0	0	0
Future Vol, veh/h	180	1230	0	0	1494	351	821	4	529	0	0	0
Conflicting Peds, #/hr	0	0	0	0	0	0	0	0	0	0	0	0
Sign Control	Free	Free	Free	Free	Free	Free	Stop	Stop	Stop	Free	Free	Free
RT Channelized	-	-	None	-	-	None	-	-	None	-	-	None
Storage Length	125	-	-	-	-	-	-	-	50	-	-	-
Veh in Median Storage, #	-	0	-	-	0	-	-	0	-	-	16965	-
Grade, %	-	0	-	-	0	-	-	0	-	-	0	-
Peak Hour Factor	95	95	95	95	95	95	95	95	95	95	95	95
Heavy Vehicles, %	2	2	2	1	1	1	2	2	2	0	0	0
Mvmt Flow	189	1295	0	0	1573	369	864	4	557	0	0	0

Major/Minor	Major1	Major2	Minor1
Conflicting Flow All	1942	0	- - - 0 3431 3615 1295
Stage 1	-	-	- - - 1673 1673 -
Stage 2	-	-	- - - 1758 1942 -
Critical Hdwy	4.12	-	- - - 6.42 6.52 6.22
Critical Hdwy Stg 1	-	-	- - - 5.42 5.52 -
Critical Hdwy Stg 2	-	-	- - - 5.42 5.52 -
Follow-up Hdwy	2.218	-	- - - 3.518 4.018 3.318
Pot Cap-1 Maneuver	302	- 0 0	- - ~ 8 5 ~ 198
Stage 1	-	- 0 0	- - ~ 167 152 -
Stage 2	-	- 0 0	- - ~ 152 112 -
Platoon blocked, %	-	-	- -
Mov Cap-1 Maneuver	302	- - -	- - ~ 3 0 ~ 198
Mov Cap-2 Maneuver	-	- - -	- - ~ 3 0 -
Stage 1	-	- - -	- - ~ 62 0 -
Stage 2	-	- - -	- - ~ 152 0 -

Approach	EB	WB	NB
HCM Control Delay, s	4.5	0	\$ 80895.5
HCM LOS			F

Minor Lane/Major Mvmt	NBLn1	NBLn2	EBL	EBT	WBT	WBR
Capacity (veh/h)	3	198	302	-	-	-
HCM Lane V/C Ratio	289.474	2.812	0.627	-	-	-
HCM Control Delay (s)	\$ 132211.4	\$ 866	35	-	-	-
HCM Lane LOS	F	F	E	-	-	-
HCM 95th %tile Q(veh)	111.1	49.1	3.9	-	-	-

Notes
 -: Volume exceeds capacity \$: Delay exceeds 300s +: Computation Not Defined *: All major volume in platoon

HCM 6th Signalized Intersection Summary
 16: Love's Truck Stop Driveway/Driveway & Avenue 17

Village D Specific Plan
 Phase III WP - PM Peak Hour



Movement	EBL	EBT	EBR	WBL	WBT	WBR	NBL	NBT	NBR	SBL	SBT	SBR
Lane Configurations	↖	↗	↘	↖	↗	↘	↖	↗	↘	↖	↗	↘
Traffic Volume (veh/h)	556	1048	141	32	1149	189	160	0	31	279	0	519
Future Volume (veh/h)	556	1048	141	32	1149	189	160	0	31	279	0	519
Initial Q (Qb), veh	0	0	0	0	0	0	0	0	0	0	0	0
Ped-Bike Adj(A_pbT)	1.00		1.00	1.00		1.00	1.00		1.00	1.00		1.00
Parking Bus, Adj	1.00	1.00	1.00	1.00	1.00	1.00	1.00	1.00	1.00	1.00	1.00	1.00
Work Zone On Approach		No			No			No			No	
Adj Sat Flow, veh/h/ln	1885	1885	1885	1885	1885	1885	1900	1900	1900	1900	1900	1900
Adj Flow Rate, veh/h	604	1139	153	35	1249	205	174	0	34	303	0	564
Peak Hour Factor	0.92	0.92	0.92	0.92	0.92	0.92	0.92	0.92	0.92	0.92	0.92	0.92
Percent Heavy Veh, %	1	1	1	1	1	1	0	0	0	0	0	0
Cap, veh/h	140	1158	516	65	444	73	141	0	453	141	0	453
Arrive On Green	0.08	0.32	0.32	0.04	0.28	0.28	0.08	0.00	0.28	0.08	0.00	0.28
Sat Flow, veh/h	1795	3582	1598	1795	1579	259	1810	0	1610	1810	0	1610
Grp Volume(v), veh/h	604	1139	153	35	0	1454	174	0	34	303	0	564
Grp Sat Flow(s),veh/h/ln	1795	1791	1598	1795	0	1839	1810	0	1610	1810	0	1610
Q Serve(g_s), s	5.0	20.2	4.6	1.2	0.0	18.0	5.0	0.0	1.0	5.0	0.0	18.0
Cycle Q Clear(g_c), s	5.0	20.2	4.6	1.2	0.0	18.0	5.0	0.0	1.0	5.0	0.0	18.0
Prop In Lane	1.00		1.00	1.00		0.14	1.00		1.00	1.00		1.00
Lane Grp Cap(c), veh/h	140	1158	516	65	0	517	141	0	453	141	0	453
V/C Ratio(X)	4.31	0.98	0.30	0.54	0.00	2.81	1.23	0.00	0.08	2.14	0.00	1.25
Avail Cap(c_a), veh/h	140	1158	516	140	0	517	141	0	453	141	0	453
HCM Platoon Ratio	1.00	1.00	1.00	1.00	1.00	1.00	1.00	1.00	1.00	1.00	1.00	1.00
Upstream Filter(I)	1.00	1.00	1.00	1.00	0.00	1.00	1.00	0.00	1.00	1.00	0.00	1.00
Uniform Delay (d), s/veh	29.5	21.5	16.2	30.3	0.0	23.0	29.5	0.0	16.9	29.5	0.0	23.0
Incr Delay (d2), s/veh	1504.3	22.5	0.3	6.8	0.0	820.7	150.7	0.0	0.3	537.4	0.0	127.9
Initial Q Delay(d3),s/veh	0.0	0.0	0.0	0.0	0.0	0.0	0.0	0.0	0.0	0.0	0.0	0.0
%ile BackOfQ(50%),veh/ln	60.7	11.3	1.6	0.6	0.0	125.0	8.0	0.0	0.4	23.2	0.0	22.3
Unsig. Movement Delay, s/veh												
LnGrp Delay(d),s/veh	1533.8	44.0	16.5	37.1	0.0	843.7	180.2	0.0	17.2	566.9	0.0	150.9
LnGrp LOS	F	D	B	D	A	F	F	A	B	F	A	F
Approach Vol, veh/h		1896			1489			208				867
Approach Delay, s/veh		516.4			824.8			153.5				296.2
Approach LOS		F			F			F				F
Timer - Assigned Phs	1	2	3	4	5	6	7	8				
Phs Duration (G+Y+Rc), s	9.5	22.5	6.8	25.2	9.5	22.5	9.5	22.5				
Change Period (Y+Rc), s	4.5	4.5	4.5	4.5	4.5	4.5	4.5	4.5				
Max Green Setting (Gmax), s	5.0	18.0	5.0	18.0	5.0	18.0	5.0	18.0				
Max Q Clear Time (g_c+I1), s	7.0	3.0	3.2	22.2	7.0	20.0	7.0	20.0				
Green Ext Time (p_c), s	0.0	0.1	0.0	0.0	0.0	0.0	0.0	0.0				

Intersection Summary

HCM 6th Ctrl Delay	559.6
HCM 6th LOS	F

HCM 6th TWSC
 17: Westberry Boulevard & Cleveland Avenue

Village D Specific Plan
 Phase III WP - PM Peak Hour

Intersection												
Int Delay, s/veh	1.7											
Movement	EBL	EBT	EBR	WBL	WBT	WBR	NBL	NBT	NBR	SBL	SBT	SBR
Lane Configurations	↖	↗		↖	↗		↖	↗	↖	↗	↖	↗
Traffic Vol, veh/h	250	749	53	141	1060	34	62	61	121	27	200	384
Future Vol, veh/h	250	749	53	141	1060	34	62	61	121	27	200	384
Conflicting Peds, #/hr	0	0	3	3	0	0	0	0	0	0	0	0
Sign Control	Free	Free	Free	Free	Free	Free	Stop	Stop	Stop	Stop	Stop	Stop
RT Channelized	-	-	None	-	-	None	-	-	None	-	-	None
Storage Length	110	-	-	165	-	-	65	-	50	100	-	50
Veh in Median Storage, #	-	0	-	-	0	-	-	0	-	-	0	-
Grade, %	-	0	-	-	0	-	-	0	-	-	0	-
Peak Hour Factor	92	92	92	92	92	92	92	92	92	92	92	92
Heavy Vehicles, %	0	0	0	0	0	0	0	0	0	0	0	0
Mvmt Flow	272	814	58	153	1152	37	67	66	132	29	217	417

Major/Minor	Major1			Major2			Minor1			Minor2		
Conflicting Flow All	1189	0	0	875	0	0	3184	2885	846	2963	2896	1171
Stage 1	-	-	-	-	-	-	1390	1390	-	1477	1477	-
Stage 2	-	-	-	-	-	-	1794	1495	-	1486	1419	-
Critical Hdwy	4.1	-	-	4.1	-	-	7.1	6.5	6.2	7.1	6.5	6.2
Critical Hdwy Stg 1	-	-	-	-	-	-	6.1	5.5	-	6.1	5.5	-
Critical Hdwy Stg 2	-	-	-	-	-	-	6.1	5.5	-	6.1	5.5	-
Follow-up Hdwy	2.2	-	-	2.2	-	-	3.5	4	3.3	3.5	4	3.3
Pot Cap-1 Maneuver	594	-	-	780	-	-	~ 6	~ 16	365	~ 9	~ 16	~ 237
Stage 1	-	-	-	-	-	-	178	211	-	159	~ 192	-
Stage 2	-	-	-	-	-	-	104	188	-	157	~ 205	-
Platoon blocked, %	-	-	-	-	-	-	-	-	-	-	-	-
Mov Cap-1 Maneuver	594	-	-	778	-	-	~ 7	364	-	~ 7	~ 237	-
Mov Cap-2 Maneuver	-	-	-	-	-	-	~ 7	-	-	~ 7	-	-
Stage 1	-	-	-	-	-	-	96	114	-	86	~ 154	-
Stage 2	-	-	-	-	-	-	~ 26	151	-	~ 23	~ 111	-

Approach	EB	WB	NB	SB
HCM Control Delay, s	3.8	1.2		
HCM LOS			-	-

Minor Lane/Major Mvmt	NBLn1	NBLn2	NBLn3	EBL	EBT	EBR	WBL	WBT	WBR	SBLn1	SBLn2	SBLn3
Capacity (veh/h)	-	7	364	594	-	-	778	-	-	-	-	7 237
HCM Lane V/C Ratio	-	9.472	0.361	0.457	-	-	0.197	-	-	-	-	31.056 1.761
HCM Control Delay (s)		\$ 4839.2	20.4	16.1	-	-	10.8	-	-		\$ 14556.5	\$ 394.8
HCM Lane LOS		-	F	C	C	-	-	B	-	-	-	F F
HCM 95th %tile Q(veh)		-	9.9	1.6	2.4	-	-	0.7	-	-	-	29.1 28.1

Notes
 -: Volume exceeds capacity \$: Delay exceeds 300s +: Computation Not Defined *: All major volume in platoon

Intersection	
Intersection Delay, s/veh	15.3
Intersection LOS	C

Movement	EBL	EBT	EBR	WBL	WBT	WBR	NBL	NBT	NBR	SBL	SBT	SBR
Lane Configurations	↶	↷		↶	↷		↶	↷	↶	↶	↷	↶
Traffic Vol, veh/h	42	153	55	77	192	21	72	194	61	24	211	59
Future Vol, veh/h	42	153	55	77	192	21	72	194	61	24	211	59
Peak Hour Factor	0.96	0.96	0.96	0.96	0.96	0.96	0.96	0.96	0.96	0.96	0.96	0.96
Heavy Vehicles, %	0	0	0	0	0	0	0	0	0	0	0	0
Mvmt Flow	44	159	57	80	200	22	75	202	64	25	220	61
Number of Lanes	1	1	0	1	1	0	1	1	1	1	1	1

Approach	EB	WB	NB	SB
Opposing Approach	WB	EB	SB	NB
Opposing Lanes	2	2	3	3
Conflicting Approach Left	SB	NB	EB	WB
Conflicting Lanes Left	3	3	2	2
Conflicting Approach Right	NB	SB	WB	EB
Conflicting Lanes Right	3	3	2	2
HCM Control Delay	15.7	15.7	14.4	15.6
HCM LOS	C	C	B	C

Lane	NBLn1	NBLn2	NBLn3	EBLn1	EBLn2	WBLn1	WBLn2	SBLn1	SBLn2	SBLn3
Vol Left, %	100%	0%	0%	100%	0%	100%	0%	100%	0%	0%
Vol Thru, %	0%	100%	0%	0%	74%	0%	90%	0%	100%	0%
Vol Right, %	0%	0%	100%	0%	26%	0%	10%	0%	0%	100%
Sign Control	Stop	Stop	Stop	Stop	Stop	Stop	Stop	Stop	Stop	Stop
Traffic Vol by Lane	72	194	61	42	208	77	213	24	211	59
LT Vol	72	0	0	42	0	77	0	24	0	0
Through Vol	0	194	0	0	153	0	192	0	211	0
RT Vol	0	0	61	0	55	0	21	0	0	59
Lane Flow Rate	75	202	64	44	217	80	222	25	220	61
Geometry Grp	8	8	8	8	8	8	8	8	8	8
Degree of Util (X)	0.171	0.431	0.123	0.1	0.455	0.181	0.466	0.057	0.474	0.12
Departure Headway (Hd)	8.195	7.681	6.963	8.246	7.554	8.128	7.553	8.273	7.76	7.041
Convergence, Y/N	Yes	Yes	Yes	Yes	Yes	Yes	Yes	Yes	Yes	Yes
Cap	437	467	513	434	475	440	475	432	464	507
Service Time	5.968	5.454	4.735	6.019	5.326	5.898	5.323	6.046	5.532	4.813
HCM Lane V/C Ratio	0.172	0.433	0.125	0.101	0.457	0.182	0.467	0.058	0.474	0.12
HCM Control Delay	12.7	16.2	10.7	11.9	16.5	12.7	16.8	11.5	17.4	10.8
HCM Lane LOS	B	C	B	B	C	B	C	B	C	B
HCM 95th-tile Q	0.6	2.1	0.4	0.3	2.3	0.7	2.4	0.2	2.5	0.4

Intersection												
Intersection Delay, s/veh	68.6											
Intersection LOS	F											

Movement	EBL	EBT	EBR	WBL	WBT	WBR	NBL	NBT	NBR	SBL	SBT	SBR
Lane Configurations		↕			↕			↕			↕	
Traffic Vol, veh/h	88	660	69	23	720	240	54	53	17	151	57	88
Future Vol, veh/h	88	660	69	23	720	240	54	53	17	151	57	88
Peak Hour Factor	0.92	0.92	0.92	0.92	0.92	0.92	0.92	0.92	0.92	0.92	0.92	0.92
Heavy Vehicles, %	3	3	3	3	3	3	0	0	0	0	0	0
Mvmt Flow	96	717	75	25	783	261	59	58	18	164	62	96
Number of Lanes	0	1	0	0	1	0	0	1	0	0	1	0

Approach	EB	WB	NB	SB
Opposing Approach	WB	EB	SB	NB
Opposing Lanes	1	1	1	1
Conflicting Approach Left	SB	NB	EB	WB
Conflicting Lanes Left	1	1	1	1
Conflicting Approach Right	NB	SB	WB	EB
Conflicting Lanes Right	1	1	1	1
HCM Control Delay	370.7	511	22.3	35
HCM LOS	F	F	C	D

Lane	NBLn1	EBLn1	WBLn1	SBLn1
Vol Left, %	44%	11%	2%	51%
Vol Thru, %	43%	81%	73%	19%
Vol Right, %	14%	8%	24%	30%
Sign Control	Stop	Stop	Stop	Stop
Traffic Vol by Lane	124	817	983	296
LT Vol	54	88	23	151
Through Vol	53	660	720	57
RT Vol	17	69	240	88
Lane Flow Rate	135	888	1068	322
Geometry Grp	1	1	1	1
Degree of Util (X)	0.329	1.754	2.076	0.694
Departure Headway (Hd)	13.05	8.88	8.28	10.782
Convergence, Y/N	Yes	Yes	Yes	Yes
Cap	278	417	449	338
Service Time	11.05	6.88	6.28	8.782
HCM Lane V/C Ratio	0.486	2.129	2.379	0.953
HCM Control Delay	22.3	370.7	511	35
HCM Lane LOS	C	F	F	D
HCM 95th-tile Q	1.4	44.2	63.8	4.9

Intersection												
Intersection Delay, s/veh	51.6											
Intersection LOS	F											

Movement	EBL	EBT	EBR	WBL	WBT	WBR	NBL	NBT	NBR	SBL	SBT	SBR
Lane Configurations		↕			↕	↕		↕	↕		↕	↕
Traffic Vol, veh/h	0	0	0	456	0	137	0	97	268	231	183	0
Future Vol, veh/h	0	0	0	456	0	137	0	97	268	231	183	0
Peak Hour Factor	0.92	0.92	0.92	0.92	0.92	0.92	0.92	0.92	0.92	0.92	0.92	0.92
Heavy Vehicles, %	0	0	0	1	1	1	0	0	0	0	0	0
Mvmt Flow	0	0	0	496	0	149	0	105	291	251	199	0
Number of Lanes	0	1	0	0	1	1	0	1	1	0	1	1

Approach	EB	WB	NB	SB
Opposing Approach	WB	EB	SB	NB
Opposing Lanes	2	1	2	2
Conflicting Approach Left	SB	NB	EB	WB
Conflicting Lanes Left	2	2	1	2
Conflicting Approach Right	NB	SB	WB	EB
Conflicting Lanes Right	2	2	2	1
HCM Control Delay	0	68.6	16.9	57.8
HCM LOS	-	F	C	F

Lane	NBLn1	NBLn2	EBLn1	WBLn1	WBLn2	SBLn1	SBLn2
Vol Left, %	0%	0%	0%	100%	0%	56%	0%
Vol Thru, %	100%	0%	100%	0%	0%	44%	100%
Vol Right, %	0%	100%	0%	0%	100%	0%	0%
Sign Control	Stop	Stop	Stop	Stop	Stop	Stop	Stop
Traffic Vol by Lane	97	268	0	456	137	414	0
LT Vol	0	0	0	456	0	231	0
Through Vol	97	0	0	0	0	183	0
RT Vol	0	268	0	0	137	0	0
Lane Flow Rate	105	291	0	496	149	450	0
Geometry Grp	7	7	6	7	7	7	7
Degree of Util (X)	0.222	0.555	0	1.058	0.267	0.947	0
Departure Headway (Hd)	7.865	7.141	9.48	7.687	6.46	7.88	7.593
Convergence, Y/N	Yes	Yes	Yes	Yes	Yes	Yes	Yes
Cap	460	510	0	471	552	464	0
Service Time	5.565	4.841	7.48	5.467	4.239	5.58	5.293
HCM Lane V/C Ratio	0.228	0.571	0	1.053	0.27	0.97	0
HCM Control Delay	12.8	18.4	12.5	85.7	11.6	57.8	10.3
HCM Lane LOS	B	C	N	F	B	F	N
HCM 95th-tile Q	0.8	3.3	0	15.3	1.1	11.3	0

Intersection	
Intersection Delay, s/veh	0
Intersection LOS	-

Movement	EBL	EBT	EBR	WBL	WBT	WBR	NBL	NBT	NBR	SBL	SBT	SBR
Lane Configurations	↵	↕		↵	↕		↵	↕	↵	↵	↕	↵
Traffic Vol, veh/h	0	0	0	0	0	0	0	0	0	0	0	0
Future Vol, veh/h	0	0	0	0	0	0	0	0	0	0	0	0
Peak Hour Factor	0.94	0.94	0.94	0.94	0.94	0.94	0.94	0.94	0.94	0.94	0.94	0.94
Heavy Vehicles, %	0	0	0	0	0	0	0	0	0	0	0	0
Mvmt Flow	0	0	0	0	0	0	0	0	0	0	0	0
Number of Lanes	1	2	0	1	2	0	1	1	1	1	1	1

Approach	EB	WB	NB	SB
Opposing Approach	WB	EB	SB	NB
Opposing Lanes	3	3	3	3
Conflicting Approach Left	SB	NB	EB	WB
Conflicting Lanes Left	3	3	3	3
Conflicting Approach Right	NB	SB	WB	EB
Conflicting Lanes Right	3	3	3	3
HCM Control Delay	0	0	0	0
HCM LOS	-	-	-	-

Lane	NBLn1	NBLn2	NBLn3	EBLn1	EBLn2	EBLn3	WBLn1	WBLn2	WBLn3	SBLn1	SBLn2
Vol Left, %	0%	0%	0%	0%	0%	0%	0%	0%	0%	0%	0%
Vol Thru, %	100%	100%	100%	100%	100%	100%	100%	100%	100%	100%	100%
Vol Right, %	0%	0%	0%	0%	0%	0%	0%	0%	0%	0%	0%
Sign Control	Stop	Stop	Stop	Stop	Stop	Stop	Stop	Stop	Stop	Stop	Stop
Traffic Vol by Lane	0	0	0	0	0	0	0	0	0	0	0
LT Vol	0	0	0	0	0	0	0	0	0	0	0
Through Vol	0	0	0	0	0	0	0	0	0	0	0
RT Vol	0	0	0	0	0	0	0	0	0	0	0
Lane Flow Rate	0	0	0	0	0	0	0	0	0	0	0
Geometry Grp	8	8	8	8	8	8	8	8	8	8	8
Degree of Util (X)	0	0	0	0	0	0	0	0	0	0	0
Departure Headway (Hd)	4.5	4.5	4.5	4.5	4.5	2.8	4.5	4.5	2.8	4.5	4.5
Convergence, Y/N	Yes	Yes	Yes	Yes	Yes	Yes	Yes	Yes	Yes	Yes	Yes
Cap	0	0	0	0	0	0	0	0	0	0	0
Service Time	2.2	2.2	2.2	2.2	2.2	0.5	2.2	2.2	0.5	2.2	2.2
HCM Lane V/C Ratio	0	0	0	0	0	0	0	0	0	0	0
HCM Control Delay	7.2	7.2	7.2	7.2	7.2	5.5	7.2	7.2	5.5	7.2	7.2
HCM Lane LOS	N	N	N	N	N	N	N	N	N	N	N
HCM 95th-tile Q	0	0	0	0	0	0	0	0	0	0	0

Intersection												
Intersection Delay, s/veh	53.6											
Intersection LOS	F											

Movement	EBL	EBT	EBR	WBL	WBT	WBR	NBL	NBT	NBR	SBL	SBT	SBR
Lane Configurations	↖	↗		↖	↗	↖	↖	↗		↖	↗	
Traffic Vol, veh/h	32	172	39	57	220	113	53	289	44	84	358	41
Future Vol, veh/h	32	172	39	57	220	113	53	289	44	84	358	41
Peak Hour Factor	0.93	0.93	0.93	0.93	0.93	0.93	0.93	0.93	0.93	0.93	0.93	0.93
Heavy Vehicles, %	0	0	0	0	0	0	1	1	1	1	1	1
Mvmt Flow	34	185	42	61	237	122	57	311	47	90	385	44
Number of Lanes	1	1	0	1	1	1	1	1	0	1	1	0

Approach	EB	WB	NB	SB
Opposing Approach	WB	EB	SB	NB
Opposing Lanes	3	2	2	2
Conflicting Approach Left SB		NB	EB	WB
Conflicting Lanes Left	2	2	2	3
Conflicting Approach Right NB		SB	WB	EB
Conflicting Lanes Right	2	2	3	2
HCM Control Delay	26.8	22.8	53.6	92
HCM LOS	D	C	F	F

Lane	NBLn1	NBLn2	EBLn1	EBLn2	WBLn1	WBLn2	WBLn3	SBLn1	SBLn2
Vol Left, %	100%	0%	100%	0%	100%	0%	0%	100%	0%
Vol Thru, %	0%	87%	0%	82%	0%	100%	0%	0%	90%
Vol Right, %	0%	13%	0%	18%	0%	0%	100%	0%	10%
Sign Control	Stop	Stop	Stop	Stop	Stop	Stop	Stop	Stop	Stop
Traffic Vol by Lane	53	333	32	211	57	220	113	84	399
LT Vol	53	0	32	0	57	0	0	84	0
Through Vol	0	289	0	172	0	220	0	0	358
RT Vol	0	44	0	39	0	0	113	0	41
Lane Flow Rate	57	358	34	227	61	237	122	90	429
Geometry Grp	8	8	8	8	8	8	8	8	8
Degree of Util (X)	0.155	0.918	0.1	0.621	0.172	0.63	0.3	0.248	1.106
Departure Headway (Hd)	10.29	9.674	11.033	10.367	10.526	10.002	9.268	9.871	9.278
Convergence, Y/N	Yes	Yes	Yes	Yes	Yes	Yes	Yes	Yes	Yes
Cap	350	376	327	352	343	364	390	365	395
Service Time	7.99	7.374	8.733	8.067	8.226	7.702	6.968	7.6	7.007
HCM Lane V/C Ratio	0.163	0.952	0.104	0.645	0.178	0.651	0.313	0.247	1.086
HCM Control Delay	14.9	59.8	15	28.6	15.4	28.3	15.9	15.8	108
HCM Lane LOS	B	F	B	D	C	D	C	C	F
HCM 95th-tile Q	0.5	9.6	0.3	4	0.6	4.1	1.2	1	15.5

HCM 6th Signalized Intersection Summary
 23: Avenue 16/Ellis Street & Kennedy Street

Village D Specific Plan
 Phase III WP - PM Peak Hour



Movement	WBL	WBR	NBT	NBR	SBL	SBT
Lane Configurations						
Traffic Volume (veh/h)	281	231	492	428	270	524
Future Volume (veh/h)	281	231	492	428	270	524
Initial Q (Qb), veh	0	0	0	0	0	0
Ped-Bike Adj(A_pbT)	1.00	1.00		1.00	1.00	
Parking Bus, Adj	1.00	1.00	1.00	1.00	1.00	1.00
Work Zone On Approach	No		No		No	
Adj Sat Flow, veh/h/ln	1870	1870	1885	1885	1885	1885
Adj Flow Rate, veh/h	305	251	535	465	293	570
Peak Hour Factor	0.92	0.92	0.92	0.92	0.92	0.92
Percent Heavy Veh, %	2	2	1	1	1	1
Cap, veh/h	355	556	807	701	336	2465
Arrive On Green	0.20	0.20	0.44	0.44	0.19	0.69
Sat Flow, veh/h	1781	2790	1909	1577	1795	3676
Grp Volume(v), veh/h	305	251	528	472	293	570
Grp Sat Flow(s),veh/h/ln	1781	1395	1791	1601	1795	1791
Q Serve(g_s), s	13.2	6.3	18.6	18.6	12.7	4.7
Cycle Q Clear(g_c), s	13.2	6.3	18.6	18.6	12.7	4.7
Prop In Lane	1.00	1.00		0.99	1.00	
Lane Grp Cap(c), veh/h	355	556	796	712	336	2465
V/C Ratio(X)	0.86	0.45	0.66	0.66	0.87	0.23
Avail Cap(c_a), veh/h	412	645	796	712	415	2465
HCM Platoon Ratio	1.00	1.00	1.00	1.00	1.00	1.00
Upstream Filter(I)	0.59	0.59	1.00	1.00	1.00	1.00
Uniform Delay (d), s/veh	30.9	28.2	17.5	17.5	31.6	4.6
Incr Delay (d2), s/veh	9.4	0.3	4.3	4.8	15.4	0.2
Initial Q Delay(d3),s/veh	0.0	0.0	0.0	0.0	0.0	0.0
%ile BackOfQ(50%),veh/ln	6.4	2.1	8.0	7.3	6.8	1.4
Unsig. Movement Delay, s/veh						
LnGrp Delay(d),s/veh	40.3	28.5	21.8	22.3	47.0	4.8
LnGrp LOS	D	C	C	C	D	A
Approach Vol, veh/h	556		1000			863
Approach Delay, s/veh	35.0		22.1			19.1
Approach LOS	D		C			B
Timer - Assigned Phs	1	2			6	8
Phs Duration (G+Y+Rc), s	19.5	40.1			59.6	20.4
Change Period (Y+Rc), s	4.5	4.5			4.5	4.5
Max Green Setting (Gmax), s	19.5	29.5			52.5	18.5
Max Q Clear Time (g_c+M), s	14.7	20.6			6.7	15.2
Green Ext Time (p_c), s	0.3	4.4			4.4	0.7
Intersection Summary						
HCM 6th Ctrl Delay			24.0			
HCM 6th LOS			C			

HCM 6th Signalized Intersection Summary
 24: Schnoor Avenue & Kennedy Street

Village D Specific Plan
 Phase III WP - PM Peak Hour



Movement	EBL	EBT	EBR	WBL	WBT	WBR	NBL	NBT	NBR	SBL	SBT	SBR
Lane Configurations												
Traffic Volume (veh/h)	101	338	237	272	307	183	202	89	367	203	69	43
Future Volume (veh/h)	101	338	237	272	307	183	202	89	367	203	69	43
Initial Q (Qb), veh	0	0	0	0	0	0	0	0	0	0	0	0
Ped-Bike Adj(A_pbT)	1.00		0.99	1.00		0.99	1.00		1.00	1.00		1.00
Parking Bus, Adj	1.00	1.00	1.00	1.00	1.00	1.00	1.00	1.00	1.00	1.00	1.00	1.00
Work Zone On Approach		No			No			No			No	
Adj Sat Flow, veh/h/ln	1870	1870	1870	1870	1870	1870	1885	1885	1885	1633	1633	1633
Adj Flow Rate, veh/h	107	360	252	289	327	195	215	95	390	216	73	46
Peak Hour Factor	0.94	0.94	0.94	0.94	0.94	0.94	0.94	0.94	0.94	0.94	0.94	0.94
Percent Heavy Veh, %	2	2	2	2	2	2	1	1	1	18	18	18
Cap, veh/h	121	425	293	329	360	215	490	86	354	172	388	328
Arrive On Green	0.07	0.21	0.21	0.18	0.33	0.33	0.14	0.27	0.27	0.11	0.24	0.24
Sat Flow, veh/h	1781	2006	1381	1781	1094	653	3483	322	1323	1555	1633	1382
Grp Volume(v), veh/h	107	318	294	289	0	522	215	0	485	216	73	46
Grp Sat Flow(s),veh/h/ln	1781	1777	1610	1781	0	1747	1742	0	1645	1555	1633	1382
Q Serve(g_s), s	4.8	13.7	14.1	12.6	0.0	22.9	4.5	0.0	21.4	8.9	2.9	2.1
Cycle Q Clear(g_c), s	4.8	13.7	14.1	12.6	0.0	22.9	4.5	0.0	21.4	8.9	2.9	2.1
Prop In Lane	1.00		0.86	1.00		0.37	1.00		0.80	1.00		1.00
Lane Grp Cap(c), veh/h	121	377	341	329	0	575	490	0	440	172	388	328
V/C Ratio(X)	0.89	0.84	0.86	0.88	0.00	0.91	0.44	0.00	1.10	1.25	0.19	0.14
Avail Cap(c_a), veh/h	121	400	362	367	0	644	490	0	440	172	388	328
HCM Platoon Ratio	1.00	1.00	1.00	1.00	1.00	1.00	1.00	1.00	1.00	1.00	1.00	1.00
Upstream Filter(I)	0.52	0.52	0.52	1.00	0.00	1.00	1.00	0.00	1.00	1.00	1.00	1.00
Uniform Delay (d), s/veh	37.0	30.3	30.4	31.7	0.0	25.7	31.5	0.0	29.3	35.6	24.3	24.1
Incr Delay (d2), s/veh	30.9	8.2	10.3	19.4	0.0	15.8	0.6	0.0	73.5	152.8	1.1	0.9
Initial Q Delay(d3),s/veh	0.0	0.0	0.0	0.0	0.0	0.0	0.0	0.0	0.0	0.0	0.0	0.0
%ile BackOfQ(50%),veh/ln	3.1	6.5	6.2	7.0	0.0	11.5	1.9	0.0	17.0	10.6	1.2	0.7
Unsig. Movement Delay, s/veh												
LnGrp Delay(d),s/veh	67.9	38.5	40.7	51.1	0.0	41.5	32.1	0.0	102.8	188.4	25.4	24.9
LnGrp LOS	E	D	D	D	A	D	C	A	F	F	C	C
Approach Vol, veh/h		719			811			700			335	
Approach Delay, s/veh		43.7			44.9			81.1			130.4	
Approach LOS		D			D			F			F	
Timer - Assigned Phs	1	2	3	4	5	6	7	8				
Phs Duration (G+Y+Rc), s	13.4	25.9	19.3	21.5	15.8	23.5	9.9	30.8				
Change Period (Y+Rc), s	4.5	4.5	4.5	4.5	4.5	4.5	4.5	4.5				
Max Green Setting (Gmax), s	13.4	21.4	16.5	18.0	8.5	19.0	5.0	29.5				
Max Q Clear Time (g_c+M), s	13.4	23.4	14.6	16.1	6.5	4.9	6.8	24.9				
Green Ext Time (p_c), s	0.0	0.0	0.2	0.8	0.1	0.4	0.0	1.4				

Intersection Summary

HCM 6th Ctrl Delay	65.6
HCM 6th LOS	E

Intersection						
Int Delay, s/veh	121.7					
Movement	EBL	EBT	WBT	WBR	SBL	SBR
Lane Configurations	↘	↑	↗		↘	↗
Traffic Vol, veh/h	387	500	553	3	138	249
Future Vol, veh/h	387	500	553	3	138	249
Conflicting Peds, #/hr	0	0	0	0	0	0
Sign Control	Free	Free	Free	Free	Stop	Stop
RT Channelized	-	None	-	Free	-	None
Storage Length	140	-	-	-	0	335
Veh in Median Storage, #	-	0	0	-	0	-
Grade, %	-	0	0	-	0	-
Peak Hour Factor	92	92	92	92	92	92
Heavy Vehicles, %	2	2	2	2	3	3
Mvmt Flow	421	543	601	3	150	271

Major/Minor	Major1	Major2	Minor2		
Conflicting Flow All	601	0	-	0	1986 601
Stage 1	-	-	-	-	601 -
Stage 2	-	-	-	-	1385 -
Critical Hdwy	4.12	-	-	-	6.43 6.23
Critical Hdwy Stg 1	-	-	-	-	5.43 -
Critical Hdwy Stg 2	-	-	-	-	5.43 -
Follow-up Hdwy	2.218	-	-	-	3.527 3.327
Pot Cap-1 Maneuver	976	-	-	0	- 67 498
Stage 1	-	-	-	0	546 -
Stage 2	-	-	-	0	231 -
Platoon blocked, %		-	-		
Mov Cap-1 Maneuver	976	-	-	-	- 38 498
Mov Cap-2 Maneuver	-	-	-	-	- 38 -
Stage 1	-	-	-	-	311 -
Stage 2	-	-	-	-	231 -

Approach	EB	WB	SB
HCM Control Delay, s	5	0	\$ 563.3
HCM LOS			F

Minor Lane/Major Mvmt	EBL	EBT	WBT	SBLn1	SBLn2
Capacity (veh/h)	976	-	-	38	498
HCM Lane V/C Ratio	0.431	-	-	3.947	0.543
HCM Control Delay (s)	11.5	-	-	\$ 1542.7	20.5
HCM Lane LOS	B	-	-	F	C
HCM 95th %tile Q(veh)	2.2	-	-	17.3	3.2

Notes
 -: Volume exceeds capacity \$: Delay exceeds 300s +: Computation Not Defined *: All major volume in platoon

Intersection						
Int Delay, s/veh	4.8					
Movement	EBL	EBT	WBT	WBR	SBL	SBR
Lane Configurations		↶	↷		↶	
Traffic Vol, veh/h	201	438	247	0	0	309
Future Vol, veh/h	201	438	247	0	0	309
Conflicting Peds, #/hr	0	0	0	0	0	0
Sign Control	Free	Free	Free	Free	Stop	Stop
RT Channelized	-	None	-	None	-	None
Storage Length	-	-	-	-	0	-
Veh in Median Storage, #	-	0	0	-	0	-
Grade, %	-	0	0	-	0	-
Peak Hour Factor	92	92	92	92	92	92
Heavy Vehicles, %	3	3	3	3	2	2
Mvmt Flow	218	476	268	0	0	336

Major/Minor	Major1	Major2	Minor2		
Conflicting Flow All	268	0	-	0	1180 268
Stage 1	-	-	-	-	268 -
Stage 2	-	-	-	-	912 -
Critical Hdwy	4.13	-	-	-	6.42 6.22
Critical Hdwy Stg 1	-	-	-	-	5.42 -
Critical Hdwy Stg 2	-	-	-	-	5.42 -
Follow-up Hdwy	2.227	-	-	-	3.518 3.318
Pot Cap-1 Maneuver	1290	-	-	-	210 771
Stage 1	-	-	-	-	777 -
Stage 2	-	-	-	-	392 -
Platoon blocked, %		-	-	-	
Mov Cap-1 Maneuver	1290	-	-	-	162 771
Mov Cap-2 Maneuver	-	-	-	-	162 -
Stage 1	-	-	-	-	598 -
Stage 2	-	-	-	-	392 -

Approach	EB	WB	SB
HCM Control Delay, s	2.6	0	13.2
HCM LOS			B

Minor Lane/Major Mvmt	EBL	EBT	WBT	WBR	SBLn1
Capacity (veh/h)	1290	-	-	-	771
HCM Lane V/C Ratio	0.169	-	-	-	0.436
HCM Control Delay (s)	8.4	0	-	-	13.2
HCM Lane LOS	A	A	-	-	B
HCM 95th %tile Q(veh)	0.6	-	-	-	2.2

Intersection						
Int Delay, s/veh	3.7					
Movement	EBL	EBR	NBL	NBT	SBT	SBR
Lane Configurations	↶			↷	↷	
Traffic Vol, veh/h	180	0	0	82	3	308
Future Vol, veh/h	180	0	0	82	3	308
Conflicting Peds, #/hr	0	0	0	0	0	0
Sign Control	Stop	Stop	Free	Free	Free	Free
RT Channelized	-	None	-	None	-	None
Storage Length	0	-	-	-	-	-
Veh in Median Storage, #	0	-	-	0	0	-
Grade, %	0	-	-	0	0	-
Peak Hour Factor	92	92	92	92	92	92
Heavy Vehicles, %	2	2	9	9	2	2
Mvmt Flow	196	0	0	89	3	335

Major/Minor	Minor2	Major1		Major2	
Conflicting Flow All	260	-	-	0	0
Stage 1	171	-	-	-	-
Stage 2	89	-	-	-	-
Critical Hdwy	6.42	-	-	-	-
Critical Hdwy Stg 1	5.42	-	-	-	-
Critical Hdwy Stg 2	5.42	-	-	-	-
Follow-up Hdwy	3.518	-	-	-	-
Pot Cap-1 Maneuver	729	0	0	-	-
Stage 1	859	0	0	-	-
Stage 2	934	0	0	-	-
Platoon blocked, %				-	-
Mov Cap-1 Maneuver	729	-	-	-	-
Mov Cap-2 Maneuver	729	-	-	-	-
Stage 1	859	-	-	-	-
Stage 2	934	-	-	-	-

Approach	EB	NB	SB
HCM Control Delay, s	11.7	0	0
HCM LOS	B		

Minor Lane/Major Mvmt	NBT EBLn1	SBT	SBR
Capacity (veh/h)	- 729	-	-
HCM Lane V/C Ratio	- 0.268	-	-
HCM Control Delay (s)	- 11.7	-	-
HCM Lane LOS	- B	-	-
HCM 95th %tile Q(veh)	- 1.1	-	-

Intersection						
Int Delay, s/veh	0.1					
Movement	EBL	EBT	WBT	WBR	SBL	SBR
Lane Configurations		↕	↕		↕	
Traffic Vol, veh/h	0	438	247	77	3	0
Future Vol, veh/h	0	438	247	77	3	0
Conflicting Peds, #/hr	0	0	0	0	0	0
Sign Control	Free	Free	Free	Free	Stop	Stop
RT Channelized	-	None	-	None	-	None
Storage Length	-	-	-	-	0	-
Veh in Median Storage, #	-	0	0	-	0	-
Grade, %	-	0	0	-	0	-
Peak Hour Factor	92	92	92	92	92	92
Heavy Vehicles, %	4	4	3	3	0	0
Mvmt Flow	0	476	268	84	3	0

Major/Minor	Major1	Major2	Minor2		
Conflicting Flow All	352	0	-	0	786 310
Stage 1	-	-	-	-	310 -
Stage 2	-	-	-	-	476 -
Critical Hdwy	4.14	-	-	-	6.4 6.2
Critical Hdwy Stg 1	-	-	-	-	5.4 -
Critical Hdwy Stg 2	-	-	-	-	5.4 -
Follow-up Hdwy	2.236	-	-	-	3.5 3.3
Pot Cap-1 Maneuver	1196	-	-	-	364 735
Stage 1	-	-	-	-	748 -
Stage 2	-	-	-	-	629 -
Platoon blocked, %		-	-	-	
Mov Cap-1 Maneuver	1196	-	-	-	364 735
Mov Cap-2 Maneuver	-	-	-	-	364 -
Stage 1	-	-	-	-	748 -
Stage 2	-	-	-	-	629 -

Approach	EB	WB	SB
HCM Control Delay, s	0	0	15
HCM LOS			C

Minor Lane/Major Mvmt	EBL	EBT	WBT	WBR	SBLn1
Capacity (veh/h)	1196	-	-	-	364
HCM Lane V/C Ratio	-	-	-	-	0.009
HCM Control Delay (s)	0	-	-	-	15
HCM Lane LOS	A	-	-	-	C
HCM 95th %tile Q(veh)	0	-	-	-	0

HCM 6th Signalized Intersection Summary
29: Schnoor Avenue & Cleveland Avenue

Village D Specific Plan
Phase III WP - PM Peak Hour



Movement	EBL	EBT	EBR	WBL	WBT	WBR	NBL	NBT	NBR	SBL	SBT	SBR
Lane Configurations												
Traffic Volume (veh/h)	201	928	61	297	1352	127	101	261	159	134	256	202
Future Volume (veh/h)	201	928	61	297	1352	127	101	261	159	134	256	202
Initial Q (Qb), veh	0	0	0	0	0	0	0	0	0	0	0	0
Ped-Bike Adj(A_pbT)	1.00		0.98	1.00		0.98	1.00		0.98	1.00		0.99
Parking Bus, Adj	1.00	1.00	1.00	1.00	1.00	1.00	1.00	1.00	1.00	1.00	1.00	1.00
Work Zone On Approach		No			No			No			No	
Adj Sat Flow, veh/h/ln	1885	1885	1885	1885	1885	1885	1885	1885	1885	1885	1885	1885
Adj Flow Rate, veh/h	207	957	63	306	1394	131	104	269	164	138	264	208
Peak Hour Factor	0.97	0.97	0.97	0.97	0.97	0.97	0.97	0.97	0.97	0.97	0.97	0.97
Percent Heavy Veh, %	1	1	1	1	1	1	1	1	1	1	1	1
Cap, veh/h	229	1138	497	635	1333	583	132	776	629	150	812	358
Arrive On Green	0.13	0.32	0.32	0.18	0.37	0.37	0.07	0.22	0.22	0.08	0.23	0.23
Sat Flow, veh/h	1795	3582	1564	3483	3582	1566	1795	3582	1559	1795	3582	1581
Grp Volume(v), veh/h	207	957	63	306	1394	131	104	269	164	138	264	208
Grp Sat Flow(s),veh/h/ln	1795	1791	1564	1742	1791	1566	1795	1791	1559	1795	1791	1581
Q Serve(g_s), s	10.2	22.4	1.9	7.1	33.5	3.7	5.1	5.7	0.0	6.9	5.5	10.5
Cycle Q Clear(g_c), s	10.2	22.4	1.9	7.1	33.5	3.7	5.1	5.7	0.0	6.9	5.5	10.5
Prop In Lane	1.00		1.00	1.00		1.00	1.00		1.00	1.00		1.00
Lane Grp Cap(c), veh/h	229	1138	497	635	1333	583	132	776	629	150	812	358
V/C Ratio(X)	0.90	0.84	0.13	0.48	1.05	0.22	0.79	0.35	0.26	0.92	0.33	0.58
Avail Cap(c_a), veh/h	229	1297	567	635	1333	583	136	776	629	150	812	358
HCM Platoon Ratio	1.00	1.00	1.00	1.00	1.00	1.00	1.00	1.00	1.00	1.00	1.00	1.00
Upstream Filter(I)	1.00	1.00	1.00	0.09	0.09	0.09	1.00	1.00	1.00	1.00	1.00	1.00
Uniform Delay (d), s/veh	38.7	28.6	12.1	33.0	28.3	9.7	41.0	29.9	18.1	41.0	29.1	31.0
Incr Delay (d2), s/veh	34.4	4.6	0.1	0.1	23.0	0.0	25.7	1.2	1.0	51.0	1.1	6.7
Initial Q Delay(d3),s/veh	0.0	0.0	0.0	0.0	0.0	0.0	0.0	0.0	0.0	0.0	0.0	0.0
%ile BackOfQ(50%),veh/ln	6.6	10.0	0.9	2.9	17.8	1.8	3.2	2.6	2.4	5.1	2.5	4.6
Unsig. Movement Delay, s/veh												
LnGrp Delay(d),s/veh	73.1	33.2	12.3	33.0	51.2	9.7	66.7	31.1	19.1	92.0	30.1	37.7
LnGrp LOS	E	C	B	C	F	A	E	C	B	F	C	D
Approach Vol, veh/h		1227			1831			537			610	
Approach Delay, s/veh		38.9			45.2			34.3			46.7	
Approach LOS		D			D			C			D	
Timer - Assigned Phs	1	2	3	4	5	6	7	8				
Phs Duration (G+Y+Rc), s	12.0	24.0	20.9	33.1	11.1	24.9	16.0	38.0				
Change Period (Y+Rc), s	4.5	4.5	4.5	4.5	4.5	4.5	4.5	4.5				
Max Green Setting (Gmax), s	7.5	19.5	12.4	32.6	6.8	20.2	11.5	33.5				
Max Q Clear Time (g_c+I1), s	8.9	7.7	9.1	24.4	7.1	12.5	12.2	35.5				
Green Ext Time (p_c), s	0.0	1.8	0.4	4.2	0.0	1.5	0.0	0.0				

Intersection Summary

HCM 6th Ctrl Delay	42.2
HCM 6th LOS	D

HCM 6th Signalized Intersection Summary
 30: Fairgrounds & Cleveland Avenue

Village D Specific Plan
 Phase III WP - PM Peak Hour



Movement	EBL	EBT	EBR	WBL	WBT	WBR	NBL	NBT	NBR	SBL	SBT	SBR
Lane Configurations	↖ ↑↑ ↗			↖ ↑↑ ↗		↖	↖ ↗	↖	↖	↖	↖	↖
Traffic Volume (veh/h)	105	1052	96	179	1456	207	100	44	116	365	36	126
Future Volume (veh/h)	105	1052	96	179	1456	207	100	44	116	365	36	126
Initial Q (Qb), veh	0	0	0	0	0	0	0	0	0	0	0	0
Ped-Bike Adj(A_pbT)	1.00		0.98	1.00		0.98	1.00		0.98	1.00		1.00
Parking Bus, Adj	1.00	1.00	1.00	1.00	1.00	1.00	1.00	1.00	1.00	1.00	1.00	1.00
Work Zone On Approach	No			No			No			No		
Adj Sat Flow, veh/h/ln	1885	1885	1885	1885	1885	1885	1900	1900	1900	1900	1900	1900
Adj Flow Rate, veh/h	111	1107	101	188	1533	218	105	103	84	384	38	133
Peak Hour Factor	0.95	0.95	0.95	0.95	0.95	0.95	0.95	0.95	0.95	0.95	0.95	0.95
Percent Heavy Veh, %	1	1	1	1	1	1	0	0	0	0	0	0
Cap, veh/h	130	1486	135	221	1293	564	257	391	325	292	109	382
Arrive On Green	0.14	0.62	0.62	0.16	0.48	0.48	0.07	0.21	0.21	0.16	0.30	0.30
Sat Flow, veh/h	1795	4793	437	1795	3582	1562	3619	1900	1582	1810	369	1293
Grp Volume(v), veh/h	111	792	416	188	1533	218	105	103	84	384	0	171
Grp Sat Flow(s),veh/h/ln	1795	1716	1799	1795	1791	1562	1810	1900	1582	1810	0	1663
Q Serve(g_s), s	5.4	14.7	14.7	9.2	32.5	8.0	2.5	4.1	2.9	14.5	0.0	7.3
Cycle Q Clear(g_c), s	5.4	14.7	14.7	9.2	32.5	8.0	2.5	4.1	2.9	14.5	0.0	7.3
Prop In Lane	1.00		0.24	1.00		1.00	1.00		1.00	1.00		0.78
Lane Grp Cap(c), veh/h	130	1064	558	221	1293	564	257	391	325	292	0	491
V/C Ratio(X)	0.86	0.74	0.75	0.85	1.19	0.39	0.41	0.26	0.26	1.32	0.00	0.35
Avail Cap(c_a), veh/h	130	1064	558	237	1293	564	257	391	325	292	0	491
HCM Platoon Ratio	2.00	2.00	2.00	1.33	1.33	1.33	1.00	1.00	1.00	1.00	1.00	1.00
Upstream Filter(I)	0.60	0.60	0.60	0.38	0.38	0.38	1.00	1.00	1.00	1.00	0.00	1.00
Uniform Delay (d), s/veh	38.0	14.6	14.6	36.8	23.4	17.0	40.0	30.0	15.5	37.8	0.0	24.9
Incr Delay (d2), s/veh	27.0	1.7	3.3	10.2	86.6	0.2	1.0	1.6	1.9	164.9	0.0	1.9
Initial Q Delay(d3),s/veh	0.0	0.0	0.0	0.0	0.0	0.0	0.0	0.0	0.0	0.0	0.0	0.0
%ile BackOfQ(50%),veh/ln	3.2	3.8	4.3	4.4	26.9	2.6	1.1	2.0	1.7	19.6	0.0	3.1
Unsig. Movement Delay, s/veh												
LnGrp Delay(d),s/veh	65.1	16.3	17.9	47.0	110.0	17.2	41.0	31.7	17.4	202.7	0.0	26.8
LnGrp LOS	E	B	B	D	F	B	D	C	B	F	A	C
Approach Vol, veh/h	1319			1939			292			555		
Approach Delay, s/veh	20.9			93.5			30.9			148.5		
Approach LOS	C			F			C			F		
Timer - Assigned Phs	1	2	3	4	5	6	7	8				
Phs Duration (G+Y+Rc), s	19.0	23.0	15.6	32.4	10.9	31.1	11.0	37.0				
Change Period (Y+Rc), s	4.5	4.5	4.5	4.5	4.5	4.5	4.5	4.5				
Max Green Setting (Gmax), s	14.5	18.5	11.9	27.1	6.4	26.6	6.5	32.5				
Max Q Clear Time (g_c+10), s	10.5	6.1	11.2	16.7	4.5	9.3	7.4	34.5				
Green Ext Time (p_c), s	0.0	0.6	0.0	5.7	0.0	0.9	0.0	0.0				

Intersection Summary

HCM 6th Ctrl Delay	73.1
HCM 6th LOS	E

Notes

User approved volume balancing among the lanes for turning movement.

HCM 6th Signalized Intersection Summary
 31: SR-99 Southbound Ramps & Cleveland Avenue

Village D Specific Plan
 Phase III WP - PM Peak Hour



Movement	EBL	EBT	EBR	WBL	WBT	WBR	NBL	NBT	NBR	SBL	SBT	SBR
Lane Configurations		↑↑	↗	↖	↑↑					↖		↗
Traffic Volume (veh/h)	0	1081	649	381	2081	0	0	0	0	290	0	100
Future Volume (veh/h)	0	1081	649	381	2081	0	0	0	0	290	0	100
Initial Q (Qb), veh	0	0	0	0	0	0				0	0	0
Ped-Bike Adj(A_pbT)	1.00		1.00	1.00		1.00				1.00		1.00
Parking Bus, Adj	1.00	1.00	1.00	1.00	1.00	1.00				1.00	1.00	1.00
Work Zone On Approach		No			No						No	
Adj Sat Flow, veh/h/ln	0	1885	1885	1900	1900	0				1856	0	1856
Adj Flow Rate, veh/h	0	1114	669	393	2145	0				299	0	103
Peak Hour Factor	0.97	0.97	0.97	0.97	0.97	0.97				0.97	0.97	0.97
Percent Heavy Veh, %	0	1	1	0	0	0				3	0	3
Cap, veh/h	0	1453	646	372	2387	0				422	0	376
Arrive On Green	0.00	0.41	0.41	0.41	1.00	0.00				0.24	0.00	0.24
Sat Flow, veh/h	0	3676	1592	1810	3705	0				1767	0	1572
Grp Volume(v), veh/h	0	1114	669	393	2145	0				299	0	103
Grp Sat Flow(s),veh/h/ln	0	1791	1592	1810	1805	0				1767	0	1572
Q Serve(g_s), s	0.0	24.2	36.5	18.5	0.0	0.0				14.0	0.0	4.8
Cycle Q Clear(g_c), s	0.0	24.2	36.5	18.5	0.0	0.0				14.0	0.0	4.8
Prop In Lane	0.00		1.00	1.00		0.00				1.00		1.00
Lane Grp Cap(c), veh/h	0	1453	646	372	2387	0				422	0	376
V/C Ratio(X)	0.00	0.77	1.04	1.06	0.90	0.00				0.71	0.00	0.27
Avail Cap(c_a), veh/h	0	1453	646	372	2387	0				422	0	376
HCM Platoon Ratio	1.00	1.00	1.00	2.00	2.00	1.00				1.00	1.00	1.00
Upstream Filter(I)	0.00	0.37	0.37	0.09	0.09	0.00				1.00	0.00	1.00
Uniform Delay (d), s/veh	0.0	23.1	26.8	26.5	0.0	0.0				31.4	0.0	27.9
Incr Delay (d2), s/veh	0.0	0.9	31.6	31.9	0.5	0.0				9.6	0.0	1.8
Initial Q Delay(d3),s/veh	0.0	0.0	0.0	0.0	0.0	0.0				0.0	0.0	0.0
%ile BackOfQ(50%),veh/ln	0.0	9.9	18.7	8.9	0.2	0.0				6.9	0.0	2.0
Unsig. Movement Delay, s/veh												
LnGrp Delay(d),s/veh	0.0	24.0	58.3	58.4	0.5	0.0				41.0	0.0	29.7
LnGrp LOS	A	C	F	F	A	A				D	A	C
Approach Vol, veh/h		1783			2538						402	
Approach Delay, s/veh		36.9			9.5						38.1	
Approach LOS		D			A						D	
Timer - Assigned Phs			3	4		6		8				
Phs Duration (G+Y+Rc), s			23.0	41.0		26.0		64.0				
Change Period (Y+Rc), s			4.5	4.5		4.5		4.5				
Max Green Setting (Gmax), s			18.5	36.5		21.5		59.5				
Max Q Clear Time (g_c+1), s			20.5	38.5		16.0		2.0				
Green Ext Time (p_c), s			0.0	0.0		0.7		35.8				
Intersection Summary												
HCM 6th Ctrl Delay			22.3									
HCM 6th LOS			C									

HCM 6th Signalized Intersection Summary
 32: SR-99 Northbound Ramps & Cleveland Avenue

Village D Specific Plan
 Phase III WP - PM Peak Hour



Movement	EBL	EBT	EBR	WBL	WBT	WBR	NBL	NBT	NBR	SBL	SBT	SBR
Lane Configurations	↘	↑↑			↑↑	↗	↘	↖	↗			
Traffic Volume (veh/h)	110	1259	0	0	1379	240	1090	6	349	0	0	0
Future Volume (veh/h)	110	1259	0	0	1379	240	1090	6	349	0	0	0
Initial Q (Qb), veh	0	0	0	0	0	0	0	0	0			
Ped-Bike Adj(A_pbT)	1.00		1.00	1.00		0.99	1.00		0.99			
Parking Bus, Adj	1.00	1.00	1.00	1.00	1.00	1.00	1.00	1.00	1.00			
Work Zone On Approach	No				No				No			
Adj Sat Flow, veh/h/ln	1885	1885	0	0	1885	1885	1885	1885	1885			
Adj Flow Rate, veh/h	116	1325	0	0	1452	253	1151	0	367			
Peak Hour Factor	0.95	0.95	0.95	0.95	0.95	0.95	0.95	0.95	0.95			
Percent Heavy Veh, %	1	1	0	0	1	1	1	1	1			
Cap, veh/h	146	1644	0	0	1174	519	1584	0	695			
Arrive On Green	0.16	0.92	0.00	0.00	0.33	0.33	0.44	0.00	0.44			
Sat Flow, veh/h	1795	3676	0	0	3676	1583	3591	0	1575			
Grp Volume(v), veh/h	116	1325	0	0	1452	253	1151	0	367			
Grp Sat Flow(s),veh/h/ln	1795	1791	0	0	1791	1583	1795	0	1575			
Q Serve(g_s), s	5.6	10.5	0.0	0.0	29.5	11.5	23.7	0.0	15.3			
Cycle Q Clear(g_c), s	5.6	10.5	0.0	0.0	29.5	11.5	23.7	0.0	15.3			
Prop In Lane	1.00		0.00	0.00		1.00	1.00		1.00			
Lane Grp Cap(c), veh/h	146	1644	0	0	1174	519	1584	0	695			
V/C Ratio(X)	0.80	0.81	0.00	0.00	1.24	0.49	0.73	0.00	0.53			
Avail Cap(c_a), veh/h	289	1930	0	0	1174	519	1584	0	695			
HCM Platoon Ratio	2.00	2.00	1.00	1.00	1.00	1.00	1.00	1.00	1.00			
Upstream Filter(I)	0.55	0.55	0.00	0.00	0.23	0.23	1.00	0.00	1.00			
Uniform Delay (d), s/veh	37.0	2.4	0.0	0.0	30.3	24.2	20.7	0.0	18.3			
Incr Delay (d2), s/veh	5.4	1.3	0.0	0.0	108.3	0.2	3.0	0.0	2.9			
Initial Q Delay(d3),s/veh	0.0	0.0	0.0	0.0	0.0	0.0	0.0	0.0	0.0			
%ile BackOfQ(50%),veh/ln	2.5	1.4	0.0	0.0	29.8	4.2	10.0	0.0	5.9			
Unsig. Movement Delay, s/veh												
LnGrp Delay(d),s/veh	42.4	3.7	0.0	0.0	138.6	24.4	23.6	0.0	21.2			
LnGrp LOS	D	A	A	A	F	C	C	A	C			
Approach Vol, veh/h	1441				1705				1518			
Approach Delay, s/veh	6.8				121.6				23.1			
Approach LOS	A				F				C			
Timer - Assigned Phs	2		4		7		8					
Phs Duration (G+Y+Rc), s	44.2		45.8		11.8		34.0					
Change Period (Y+Rc), s	4.5		4.5		4.5		4.5					
Max Green Setting (Gmax), s	32.5		48.5		14.5		29.5					
Max Q Clear Time (g_c+I1), s	25.7		12.5		7.6		31.5					
Green Ext Time (p_c), s	3.6		13.3		0.1		0.0					

Intersection Summary

HCM 6th Ctrl Delay	54.1
HCM 6th LOS	D

Notes

User approved volume balancing among the lanes for turning movement.

HCM 6th Signalized Intersection Summary
 33: Gateway Drive & Cleveland Avenue

Village D Specific Plan
 Phase III WP - PM Peak Hour



Movement	EBL	EBT	EBR	WBL	WBT	WBR	NBL	NBT	NBR	SBL	SBT	SBR
Lane Configurations	↖	↑↑↑	↗	↖↗	↑↑		↖↗	↑	↗	↖	↑↘	
Traffic Volume (veh/h)	17	1231	360	248	1234	175	361	154	309	233	179	24
Future Volume (veh/h)	17	1231	360	248	1234	175	361	154	309	233	179	24
Initial Q (Qb), veh	0	0	0	0	0	0	0	0	0	0	0	0
Ped-Bike Adj(A_pbT)	1.00		1.00	1.00		0.99	1.00		0.98	1.00		0.98
Parking Bus, Adj	1.00	1.00	1.00	1.00	1.00	1.00	1.00	1.00	1.00	1.00	1.00	1.00
Work Zone On Approach		No		No		No		No		No		No
Adj Sat Flow, veh/h/ln	1885	1885	1885	1870	1870	1870	1885	1885	1885	1856	1856	1856
Adj Flow Rate, veh/h	18	1310	0	264	1313	186	384	164	329	248	190	26
Peak Hour Factor	0.94	0.94	0.94	0.94	0.94	0.94	0.94	0.94	0.94	0.94	0.94	0.94
Percent Heavy Veh, %	1	1	1	2	2	2	1	1	1	3	3	3
Cap, veh/h	116	1546		364	1205	169	611	423	351	300	681	92
Arrive On Green	0.04	0.60	0.00	0.11	0.39	0.39	0.18	0.22	0.22	0.17	0.22	0.22
Sat Flow, veh/h	1795	5147	1598	3456	3126	440	3483	1885	1565	1767	3113	419
Grp Volume(v), veh/h	18	1310	0	264	742	757	384	164	329	248	106	110
Grp Sat Flow(s),veh/h/ln	1795	1716	1598	1728	1777	1789	1742	1885	1565	1767	1763	1770
Q Serve(g_s), s	0.0	18.6	0.0	6.7	34.7	34.7	9.2	6.7	18.6	12.2	4.5	4.6
Cycle Q Clear(g_c), s	0.0	18.6	0.0	6.7	34.7	34.7	9.2	6.7	18.6	12.2	4.5	4.6
Prop In Lane	1.00		1.00	1.00		0.25	1.00		1.00	1.00		0.24
Lane Grp Cap(c), veh/h	116	1546		364	685	690	611	423	351	300	386	387
V/C Ratio(X)	0.15	0.85		0.72	1.08	1.10	0.63	0.39	0.94	0.83	0.28	0.28
Avail Cap(c_a), veh/h	180	1784		364	685	690	611	423	351	300	386	387
HCM Platoon Ratio	2.00	2.00	2.00	1.00	1.00	1.00	1.00	1.00	1.00	1.00	1.00	1.00
Upstream Filter(l)	0.64	0.64	0.00	0.84	0.84	0.84	1.00	1.00	1.00	1.00	1.00	1.00
Uniform Delay (d), s/veh	42.3	16.3	0.0	39.0	27.6	27.7	34.4	29.6	34.3	36.1	29.2	29.3
Incr Delay (d2), s/veh	0.4	2.3	0.0	5.9	56.6	61.5	2.1	2.7	34.4	17.0	1.8	1.8
Initial Q Delay(d3),s/veh	0.0	0.0	0.0	0.0	0.0	0.0	0.0	0.0	0.0	0.0	0.0	0.0
%ile BackOfQ(50%),veh/ln	0.4	4.6	0.0	3.1	24.7	25.8	4.0	3.3	10.2	6.6	2.1	2.1
Unsig. Movement Delay, s/veh												
LnGrp Delay(d),s/veh	42.7	18.6	0.0	44.9	84.2	89.1	36.4	32.3	68.6	53.1	31.0	31.1
LnGrp LOS	D	B		D	F	F	D	C	E	D	C	C
Approach Vol, veh/h		1328	A		1763			877			464	
Approach Delay, s/veh		19.0			80.4			47.8			42.8	
Approach LOS		B			F			D			D	
Timer - Assigned Phs	1	2	3	4	5	6	7	8				
Phs Duration (G+Y+Rc), s	30.3	24.2	6.3	39.2	19.8	24.7	14.0	31.5				
Change Period (Y+Rc), s	4.5	4.5	4.5	4.5	4.5	4.5	4.5	4.5				
Max Green Setting (Gmax), s	12.6	19.7	5.0	34.7	12.1	20.2	8.5	31.2				
Max Q Clear Time (g_c+M), s	12.6	6.6	2.0	36.7	14.2	20.6	8.7	20.6				
Green Ext Time (p_c), s	0.2	0.9	0.0	0.0	0.0	0.0	0.0	6.4				

Intersection Summary

HCM 6th Ctrl Delay	51.6
HCM 6th LOS	D

Notes

Unsignalized Delay for [EBR] is excluded from calculations of the approach delay and intersection delay.

HCM 6th Signalized Intersection Summary
34: Cleveland Avenue & County Club Drive

Village D Specific Plan
Phase III WP - PM Peak Hour



Movement	WBL	WBR	NBT	NBR	SBL	SBT
Lane Configurations	←←←		↑↑	↗	←	↑↑↑
Traffic Volume (veh/h)	705	40	1007	765	147	954
Future Volume (veh/h)	705	40	1007	765	147	954
Initial Q (Qb), veh	0	0	0	0	0	0
Ped-Bike Adj(A_pbT)	1.00	1.00		1.00	1.00	
Parking Bus, Adj	1.00	1.00	1.00	1.00	1.00	1.00
Work Zone On Approach	No		No		No	
Adj Sat Flow, veh/h/ln	1900	1900	1870	1870	1870	1870
Adj Flow Rate, veh/h	781	0	1060	0	155	1004
Peak Hour Factor	0.95	0.95	0.95	0.95	0.95	0.95
Percent Heavy Veh, %	0	0	2	2	2	2
Cap, veh/h	931	414	2284		341	3282
Arrive On Green	0.26	0.00	0.64	0.00	0.64	0.64
Sat Flow, veh/h	3619	1610	3647	1585	532	5274
Grp Volume(v), veh/h	781	0	1060	0	155	1004
Grp Sat Flow(s),veh/h/ln	1810	1610	1777	1585	532	1702
Q Serve(g_s), s	18.4	0.0	13.7	0.0	18.8	7.9
Cycle Q Clear(g_c), s	18.4	0.0	13.7	0.0	32.5	7.9
Prop In Lane	1.00	1.00		1.00	1.00	
Lane Grp Cap(c), veh/h	931	414	2284		341	3282
V/C Ratio(X)	0.84	0.00	0.46		0.45	0.31
Avail Cap(c_a), veh/h	1428	635	2284		341	3282
HCM Platoon Ratio	1.00	1.00	1.00	1.00	1.00	1.00
Upstream Filter(I)	1.00	0.00	0.52	0.00	1.00	1.00
Uniform Delay (d), s/veh	31.7	0.0	8.2	0.0	16.5	7.1
Incr Delay (d2), s/veh	2.8	0.0	0.4	0.0	4.3	0.2
Initial Q Delay(d3),s/veh	0.0	0.0	0.0	0.0	0.0	0.0
%ile BackOfQ(50%),veh/ln	8.2	0.0	4.7	0.0	2.6	2.6
Unsig. Movement Delay, s/veh						
LnGrp Delay(d),s/veh	34.5	0.0	8.5	0.0	20.8	7.4
LnGrp LOS	C	A	A		C	A
Approach Vol, veh/h	781		1060	A		1159
Approach Delay, s/veh	34.5		8.5			9.2
Approach LOS	C		A			A
Timer - Assigned Phs		2			6	8
Phs Duration (G+Y+Rc), s		62.3			62.3	27.7
Change Period (Y+Rc), s		4.5			4.5	4.5
Max Green Setting (Gmax), s		45.5			45.5	35.5
Max Q Clear Time (g_c+I1), s		15.7			34.5	20.4
Green Ext Time (p_c), s		9.2			6.2	2.8

Intersection Summary

HCM 6th Ctrl Delay	15.5
HCM 6th LOS	B

Notes

User approved volume balancing among the lanes for turning movement.
Unsignalized Delay for [NBR] is excluded from calculations of the approach delay and intersection delay.

Intersection						
Int Delay, s/veh	0.2					
Movement	EBL	EBR	NBL	NBT	SBT	SBR
Lane Configurations	T			T		
Traffic Vol, veh/h	2	17	5	986	1002	1
Future Vol, veh/h	2	17	5	986	1002	1
Conflicting Peds, #/hr	0	0	0	0	0	0
Sign Control	Stop	Stop	Free	Free	Free	Free
RT Channelized	-	None	-	None	-	None
Storage Length	0	-	-	-	-	-
Veh in Median Storage, #	0	-	-	0	0	-
Grade, %	0	-	-	0	0	-
Peak Hour Factor	94	94	94	94	94	94
Heavy Vehicles, %	0	0	1	1	1	1
Mvmt Flow	2	18	5	1049	1066	1

Major/Minor	Minor2	Major1	Major2			
Conflicting Flow All	1602	534	1067	0	-	0
Stage 1	1067	-	-	-	-	-
Stage 2	535	-	-	-	-	-
Critical Hdwy	6.8	6.9	4.12	-	-	-
Critical Hdwy Stg 1	5.8	-	-	-	-	-
Critical Hdwy Stg 2	5.8	-	-	-	-	-
Follow-up Hdwy	3.5	3.3	2.21	-	-	-
Pot Cap-1 Maneuver	*206	496	655	-	-	-
Stage 1	*296	-	-	-	-	-
Stage 2	*655	-	-	-	-	-
Platoon blocked, %	1			-	-	-
Mov Cap-1 Maneuver	*202	496	655	-	-	-
Mov Cap-2 Maneuver	*252	-	-	-	-	-
Stage 1	*291	-	-	-	-	-
Stage 2	*655	-	-	-	-	-

Approach	EB	NB	SB
HCM Control Delay, s	13.4	0.2	0
HCM LOS	B		

Minor Lane/Major Mvmt	NBL	NBT	EBLn1	SBT	SBR
Capacity (veh/h)	655	-	450	-	-
HCM Lane V/C Ratio	0.008	-	0.045	-	-
HCM Control Delay (s)	10.5	0.1	13.4	-	-
HCM Lane LOS	B	A	B	-	-
HCM 95th %tile Q(veh)	0	-	0.1	-	-

Notes
 -: Volume exceeds capacity \$: Delay exceeds 300s +: Computation Not Defined *: All major volume in platoon

HCM 6th Signalized Intersection Summary
36: Pine Street & Howard Road

Village D Specific Plan
Phase III WP - PM Peak Hour



Movement	EBL	EBT	EBR	WBL	WBT	WBR	NBL	NBT	NBR	SBL	SBT	SBR
Lane Configurations												
Traffic Volume (veh/h)	89	791	146	111	873	4	234	197	171	18	167	120
Future Volume (veh/h)	89	791	146	111	873	4	234	197	171	18	167	120
Initial Q (Qb), veh	0	0	0	0	0	0	0	0	0	0	0	0
Ped-Bike Adj(A_pbT)	1.00		0.95	1.00		0.95	1.00		0.99	1.00		1.00
Parking Bus, Adj	1.00	1.00	1.00	1.00	1.00	1.00	1.00	1.00	1.00	1.00	1.00	1.00
Work Zone On Approach		No			No			No			No	
Adj Sat Flow, veh/h/ln	1870	1870	1870	1885	1885	1885	1885	1885	1885	1870	1870	1870
Adj Flow Rate, veh/h	96	851	157	119	939	4	252	212	184	19	180	129
Peak Hour Factor	0.93	0.93	0.93	0.93	0.93	0.93	0.93	0.93	0.93	0.93	0.93	0.93
Percent Heavy Veh, %	2	2	2	1	1	1	1	1	1	2	2	2
Cap, veh/h	157	903	167	130	1055	4	518	544	455	24	227	214
Arrive On Green	0.09	0.30	0.30	0.07	0.29	0.29	0.29	0.29	0.29	0.14	0.14	0.14
Sat Flow, veh/h	1781	2969	548	1795	3657	16	1795	1885	1577	178	1684	1585
Grp Volume(v), veh/h	96	509	499	119	460	483	252	212	184	199	0	129
Grp Sat Flow(s),veh/h/ln	1781	1777	1739	1795	1791	1881	1795	1885	1577	1861	0	1585
Q Serve(g_s), s	4.7	25.2	25.2	5.9	22.1	22.1	10.5	8.1	8.5	9.3	0.0	6.9
Cycle Q Clear(g_c), s	4.7	25.2	25.2	5.9	22.1	22.1	10.5	8.1	8.5	9.3	0.0	6.9
Prop In Lane	1.00		0.31	1.00		0.01	1.00		1.00	0.10		1.00
Lane Grp Cap(c), veh/h	157	541	529	130	517	543	518	544	455	251	0	214
V/C Ratio(X)	0.61	0.94	0.94	0.92	0.89	0.89	0.49	0.39	0.40	0.79	0.00	0.60
Avail Cap(c_a), veh/h	157	543	531	130	547	575	518	544	455	372	0	317
HCM Platoon Ratio	1.00	1.00	1.00	1.00	1.00	1.00	1.00	1.00	1.00	1.00	1.00	1.00
Upstream Filter(I)	1.00	1.00	1.00	0.86	0.86	0.86	1.00	1.00	1.00	1.00	0.00	1.00
Uniform Delay (d), s/veh	39.6	30.5	30.5	41.5	30.6	30.6	26.5	25.7	25.8	37.7	0.0	36.6
Incr Delay (d2), s/veh	6.9	25.0	25.3	49.6	14.1	13.6	3.2	2.1	2.7	6.8	0.0	2.7
Initial Q Delay(d3),s/veh	0.0	0.0	0.0	0.0	0.0	0.0	0.0	0.0	0.0	0.0	0.0	0.0
%ile BackOfQ(50%),veh/ln	2.3	14.1	13.9	4.4	11.3	11.7	4.8	3.9	3.4	4.7	0.0	2.8
Unsig. Movement Delay, s/veh												
LnGrp Delay(d),s/veh	46.4	55.5	55.9	91.1	44.8	44.2	29.8	27.8	28.5	44.5	0.0	39.4
LnGrp LOS	D	E	E	F	D	D	C	C	C	D	A	D
Approach Vol, veh/h		1104			1062			648			328	
Approach Delay, s/veh		54.9			49.7			28.7			42.5	
Approach LOS		D			D			C			D	
Timer - Assigned Phs		2	3	4		6	7	8				
Phs Duration (G+Y+Rc), s		30.5	11.0	31.9		16.7	12.4	30.5				
Change Period (Y+Rc), s		4.5	4.5	4.5		4.5	4.5	4.5				
Max Green Setting (Gmax), s		20.0	6.5	27.5		18.0	6.5	27.5				
Max Q Clear Time (g_c+I1), s		12.5	7.9	27.2		11.3	6.7	24.1				
Green Ext Time (p_c), s		1.7	0.0	0.2		0.8	0.0	1.8				
Intersection Summary												
HCM 6th Ctrl Delay			46.5									
HCM 6th LOS			D									

HCM 6th Signalized Intersection Summary
 37: Olive Avenue/Q Street & Howard Road/Yosemite Avenue

Village D Specific Plan
 Phase III WP - PM Peak Hour



Movement	EBL	EBT	EBR	WBL	WBT	WBR	NBL	NBT	NBR	SBL	SBT	SBR
Lane Configurations	↖	↑↑	↗	↖	↑↑		↖	↖	↗	↖	↑	↗
Traffic Volume (veh/h)	7	475	478	14	401	15	648	76	13	17	58	2
Future Volume (veh/h)	7	475	478	14	401	15	648	76	13	17	58	2
Initial Q (Qb), veh	0	0	0	0	0	0	0	0	0	0	0	0
Ped-Bike Adj(A_pbT)	1.00		1.00	1.00		0.99	1.00		0.99	1.00		0.99
Parking Bus, Adj	1.00	1.00	1.00	1.00	1.00	1.00	1.00	1.00	1.00	1.00	1.00	1.00
Work Zone On Approach		No			No			No			No	
Adj Sat Flow, veh/h/ln	1885	1885	1885	1885	1885	1885	1885	1885	1885	1885	1885	1885
Adj Flow Rate, veh/h	8	516	0	15	436	16	763	0	14	18	63	2
Peak Hour Factor	0.92	0.92	0.92	0.92	0.92	0.92	0.92	0.92	0.92	0.92	0.92	0.92
Percent Heavy Veh, %	1	1	1	1	1	1	1	1	1	1	1	1
Cap, veh/h	114	635		100	597	22	1843	0	809	97	102	85
Arrive On Green	0.02	0.06	0.00	0.06	0.17	0.17	0.51	0.00	0.51	0.05	0.05	0.05
Sat Flow, veh/h	1795	3582	1598	1795	3523	129	3591	0	1576	1795	1885	1580
Grp Volume(v), veh/h	8	516	0	15	221	231	763	0	14	18	63	2
Grp Sat Flow(s),veh/h/ln	1795	1791	1598	1795	1791	1861	1795	0	1576	1795	1885	1580
Q Serve(g_s), s	0.4	12.8	0.0	0.7	10.5	10.6	11.8	0.0	0.4	0.9	2.9	0.1
Cycle Q Clear(g_c), s	0.4	12.8	0.0	0.7	10.5	10.6	11.8	0.0	0.4	0.9	2.9	0.1
Prop In Lane	1.00		1.00	1.00		0.07	1.00		1.00	1.00		1.00
Lane Grp Cap(c), veh/h	114	635		100	303	315	1843	0	809	97	102	85
V/C Ratio(X)	0.07	0.81		0.15	0.73	0.73	0.41	0.00	0.02	0.19	0.62	0.02
Avail Cap(c_a), veh/h	114	716		359	617	641	1843	0	809	359	377	316
HCM Platoon Ratio	0.33	0.33	0.33	1.00	1.00	1.00	1.00	1.00	1.00	1.00	1.00	1.00
Upstream Filter(I)	0.40	0.40	0.00	1.00	1.00	1.00	1.00	0.00	1.00	1.00	1.00	1.00
Uniform Delay (d), s/veh	41.5	40.9	0.0	40.5	35.4	35.4	13.5	0.0	10.8	40.7	41.7	40.3
Incr Delay (d2), s/veh	0.1	2.7	0.0	0.7	3.4	3.3	0.7	0.0	0.0	0.9	6.0	0.1
Initial Q Delay(d3),s/veh	0.0	0.0	0.0	0.0	0.0	0.0	0.0	0.0	0.0	0.0	0.0	0.0
%ile BackOfQ(50%),veh/ln	0.2	6.4	0.0	0.3	4.8	5.0	4.7	0.0	0.1	0.4	1.5	0.0
Unsig. Movement Delay, s/veh												
LnGrp Delay(d),s/veh	41.6	43.6	0.0	41.2	38.8	38.7	14.2	0.0	10.8	41.6	47.7	40.4
LnGrp LOS	D	D		D	D	D	B	A	B	D	D	D
Approach Vol, veh/h		524	A		467		777				83	
Approach Delay, s/veh		43.5			38.8		14.2				46.2	
Approach LOS		D			D		B				D	
Timer - Assigned Phs		2	3	4		6	7	8				
Phs Duration (G+Y+Rc), s		50.7	9.5	20.4		9.4	10.2	19.7				
Change Period (Y+Rc), s		4.5	4.5	4.5		4.5	4.5	4.5				
Max Green Setting (Gmax), s		18.0	18.0	18.0		18.0	5.0	31.0				
Max Q Clear Time (g_c+1), s		13.8	2.7	14.8		4.9	2.4	12.6				
Green Ext Time (p_c), s		1.3	0.0	1.0		0.2	0.0	2.5				

Intersection Summary

HCM 6th Ctrl Delay	30.1
HCM 6th LOS	C

Notes

User approved volume balancing among the lanes for turning movement.
 Unsignalized Delay for [EBR] is excluded from calculations of the approach delay and intersection delay.

HCM 6th TWSC
 38: I Street & 2nd Street/SR-99 Southbound Off-Ramp

Village D Specific Plan
 Phase III WP - PM Peak Hour

Intersection												
Int Delay, s/veh	13.2											
Movement	EBL	EBT	EBR	WBL	WBT	WBR	NBL	NBT	NBR	SBL	SBT	SBR
Lane Configurations		↔			↔	↔	↔	↔			↔	
Traffic Vol, veh/h	0	0	44	347	15	5	54	160	0	0	122	0
Future Vol, veh/h	0	0	44	347	15	5	54	160	0	0	122	0
Conflicting Peds, #/hr	0	0	0	0	0	0	1	0	1	1	0	1
Sign Control	Stop	Stop	Stop	Stop	Stop	Stop	Free	Free	Free	Free	Free	Free
RT Channelized	-	-	None	-	-	Stop	-	-	None	-	-	None
Storage Length	-	-	-	-	-	50	75	-	-	-	-	-
Veh in Median Storage, #	-	0	-	-	0	-	-	0	-	-	0	-
Grade, %	-	0	-	-	0	-	-	0	-	-	0	-
Peak Hour Factor	98	98	98	98	98	98	98	98	98	98	98	98
Heavy Vehicles, %	0	0	0	2	2	2	0	0	0	0	0	0
Mvmt Flow	0	0	45	354	15	5	55	163	0	0	124	0

Major/Minor	Minor2		Minor1		Major1		Major2					
Conflicting Flow All	406	398	125	420	398	163	125	0	-	-	-	0
Stage 1	125	125	-	273	273	-	-	-	-	-	-	-
Stage 2	281	273	-	147	125	-	-	-	-	-	-	-
Critical Hdwy	7.1	6.5	6.2	7.12	6.52	6.22	4.1	-	-	-	-	-
Critical Hdwy Stg 1	6.1	5.5	-	6.12	5.52	-	-	-	-	-	-	-
Critical Hdwy Stg 2	6.1	5.5	-	6.12	5.52	-	-	-	-	-	-	-
Follow-up Hdwy	3.5	4	3.3	3.518	4.018	3.318	2.2	-	-	-	-	-
Pot Cap-1 Maneuver	602	570	931	585	567	954	1474	-	0	0	-	-
Stage 1	884	796	-	777	704	-	-	-	0	0	-	-
Stage 2	773	707	-	856	792	-	-	-	0	0	-	-
Platoon blocked, %	1	1		1	1	1		-			-	-
Mov Cap-1 Maneuver	569	549	930	541	545	954	1473	-	-	-	-	-
Mov Cap-2 Maneuver	569	549	-	541	545	-	-	-	-	-	-	-
Stage 1	850	795	-	748	678	-	-	-	-	-	-	-
Stage 2	723	681	-	815	791	-	-	-	-	-	-	-

Approach	EB	WB	NB	SB
HCM Control Delay, s	9.1	24.6	1.9	0
HCM LOS	A	C		

Minor Lane/Major Mvmt	NBL	NBT	EBLn1	WBLn1	WBLn2	SBT	SBR
Capacity (veh/h)	1473	-	930	541	954	-	-
HCM Lane V/C Ratio	0.037	-	0.048	0.683	0.005	-	-
HCM Control Delay (s)	7.5	-	9.1	24.8	8.8	-	-
HCM Lane LOS	A	-	A	C	A	-	-
HCM 95th %tile Q(veh)	0.1	-	0.2	5.2	0	-	-

HCM 6th Signalized Intersection Summary
 39: 4th Street & Sunset Avenue

Village D Specific Plan
 Phase III WP - PM Peak Hour



Movement	EBL	EBR	NBL	NBT	SBT	SBR
Lane Configurations						
Traffic Volume (veh/h)	251	14	14	403	436	395
Future Volume (veh/h)	251	14	14	403	436	395
Initial Q (Qb), veh	0	0	0	0	0	0
Ped-Bike Adj(A_pbT)	1.00	1.00	1.00			1.00
Parking Bus, Adj	1.00	1.00	1.00	1.00	1.00	1.00
Work Zone On Approach	No			No	No	
Adj Sat Flow, veh/h/ln	1900	1900	1870	1870	1870	1870
Adj Flow Rate, veh/h	287	0	15	438	474	429
Peak Hour Factor	0.92	0.92	0.92	0.92	0.92	0.92
Percent Heavy Veh, %	0	0	2	2	2	2
Cap, veh/h	384	171	702	2857	683	746
Arrive On Green	0.11	0.00	0.39	0.80	0.73	0.73
Sat Flow, veh/h	3619	1610	1781	3647	1870	1583
Grp Volume(v), veh/h	287	0	15	438	474	429
Grp Sat Flow(s),veh/h/ln	1810	1610	1781	1777	1870	1583
Q Serve(g_s), s	7.7	0.0	0.5	2.8	13.9	13.3
Cycle Q Clear(g_c), s	7.7	0.0	0.5	2.8	13.9	13.3
Prop In Lane	1.00	1.00	1.00			1.00
Lane Grp Cap(c), veh/h	384	171	702	2857	683	746
V/C Ratio(X)	0.75	0.00	0.02	0.15	0.69	0.58
Avail Cap(c_a), veh/h	995	443	702	2857	683	746
HCM Platoon Ratio	1.00	1.00	1.00	1.00	2.00	2.00
Upstream Filter(I)	1.00	0.00	1.00	1.00	0.75	0.75
Uniform Delay (d), s/veh	43.4	0.0	18.5	2.2	10.4	7.4
Incr Delay (d2), s/veh	2.9	0.0	0.0	0.1	4.4	2.4
Initial Q Delay(d3),s/veh	0.0	0.0	0.0	0.0	0.0	0.0
%ile BackOfQ(50%),veh/ln	3.6	0.0	0.2	0.7	4.2	3.5
Unsig. Movement Delay, s/veh						
LnGrp Delay(d),s/veh	46.3	0.0	18.5	2.3	14.8	9.9
LnGrp LOS	D	A	B	A	B	A
Approach Vol, veh/h	287			453	903	
Approach Delay, s/veh	46.3			2.8	12.5	
Approach LOS	D			A	B	
Timer - Assigned Phs		2		4	5	6
Phs Duration (G+Y+Rc), s		84.9		15.1	43.9	41.0
Change Period (Y+Rc), s		4.5		4.5	4.5	4.5
Max Green Setting (Gmax), s		63.5		27.5	22.5	36.5
Max Q Clear Time (g_c+I1), s		4.8		9.7	2.5	15.9
Green Ext Time (p_c), s		3.3		0.9	0.0	4.7

Intersection Summary

HCM 6th Ctrl Delay	15.7
HCM 6th LOS	B

Notes

User approved volume balancing among the lanes for turning movement.

40: H Street & SR-99 Southbound On-Ramp/2nd Street Performance by movement

Movement	WBL	WBT	WBR	NBL	NBT	NBR	SBL	SBT	All
Denied Delay (hr)	0.0	0.0	0.0	0.0	0.0	0.0	0.0	0.0	0.0
Denied Del/Veh (s)	0.1	0.1	0.1	0.0	0.0	0.0	0.1	0.1	0.0
Total Delay (hr)	0.2	0.2	0.0	0.3	0.0	0.0	0.0	0.1	0.9
Total Del/Veh (s)	17.3	21.4	8.3	3.3	3.8	3.5	3.7	17.3	6.7
Stop Delay (hr)	0.2	0.2	0.0	0.0	0.0	0.0	0.0	0.1	0.5
Stop Del/Veh (s)	14.8	17.9	7.0	0.1	0.0	0.1	2.5	14.4	3.6

HCM 6th Signalized Intersection Summary
41: I Street & 4th Street

Village D Specific Plan
Phase III WP - PM Peak Hour



Movement	EBL	EBT	EBR	WBL	WBT	WBR	NBL	NBT	NBR	SBL	SBT	SBR
Lane Configurations												
Traffic Volume (veh/h)	42	611	62	62	551	117	105	75	256	217	173	159
Future Volume (veh/h)	42	611	62	62	551	117	105	75	256	217	173	159
Initial Q (Qb), veh	0	0	0	0	0	0	0	0	0	0	0	0
Ped-Bike Adj(A_pbT)	1.00		0.99	1.00		0.99	1.00		1.00	1.00		0.99
Parking Bus, Adj	1.00	1.00	1.00	1.00	1.00	1.00	1.00	1.00	1.00	1.00	1.00	1.00
Work Zone On Approach		No			No			No			No	
Adj Sat Flow, veh/h/ln	1856	1856	1856	1885	1885	1885	1885	1885	1885	1870	1870	1870
Adj Flow Rate, veh/h	46	664	67	67	599	127	114	82	278	236	188	173
Peak Hour Factor	0.92	0.92	0.92	0.92	0.92	0.92	0.92	0.92	0.92	0.92	0.92	0.92
Percent Heavy Veh, %	3	3	3	1	1	1	1	1	1	2	2	2
Cap, veh/h	76	774	78	87	719	152	375	443	375	529	604	505
Arrive On Green	0.04	0.24	0.24	0.05	0.24	0.24	0.21	0.23	0.23	0.30	0.32	0.32
Sat Flow, veh/h	1767	3231	326	1795	2937	621	1795	1885	1598	1781	1870	1564
Grp Volume(v), veh/h	46	362	369	67	365	361	114	82	278	236	188	173
Grp Sat Flow(s),veh/h/ln	1767	1763	1794	1795	1791	1767	1795	1885	1598	1781	1870	1564
Q Serve(g_s), s	2.6	19.6	19.7	3.7	19.3	19.4	5.4	3.5	16.1	10.7	7.6	8.4
Cycle Q Clear(g_c), s	2.6	19.6	19.7	3.7	19.3	19.4	5.4	3.5	16.1	10.7	7.6	8.4
Prop In Lane	1.00		0.18	1.00		0.35	1.00		1.00	1.00		1.00
Lane Grp Cap(c), veh/h	76	422	430	87	439	433	375	443	375	529	604	505
V/C Ratio(X)	0.61	0.86	0.86	0.77	0.83	0.83	0.30	0.19	0.74	0.45	0.31	0.34
Avail Cap(c_a), veh/h	115	485	493	171	546	539	375	443	375	529	604	505
HCM Platoon Ratio	1.00	1.00	1.00	1.00	1.00	1.00	1.00	1.00	1.00	1.00	1.00	1.00
Upstream Filter(l)	0.95	0.95	0.95	1.00	1.00	1.00	1.00	1.00	1.00	1.00	1.00	1.00
Uniform Delay (d), s/veh	47.0	36.4	36.4	47.0	35.8	35.8	33.4	30.6	35.4	28.5	25.5	25.8
Incr Delay (d2), s/veh	7.2	12.3	12.3	13.4	8.7	9.0	0.5	0.9	12.4	0.6	1.3	1.8
Initial Q Delay(d3),s/veh	0.0	0.0	0.0	0.0	0.0	0.0	0.0	0.0	0.0	0.0	0.0	0.0
%ile BackOfQ(50%),veh/ln	1.3	9.7	9.9	2.0	9.3	9.3	2.4	1.7	7.5	4.6	3.6	3.4
Unsig. Movement Delay, s/veh												
LnGrp Delay(d),s/veh	54.2	48.7	48.7	60.5	44.5	44.9	33.8	31.5	47.8	29.1	26.8	27.6
LnGrp LOS	D	D	D	E	D	D	C	C	D	C	C	C
Approach Vol, veh/h		777			793			474			597	
Approach Delay, s/veh		49.0			46.0			41.6			27.9	
Approach LOS		D			D			D			C	
Timer - Assigned Phs	1	2	3	4	5	6	7	8				
Phs Duration (G+Y+Rc), s	34.2	28.0	9.3	28.5	25.4	36.8	8.8	29.0				
Change Period (Y+Rc), s	4.5	4.5	4.5	4.5	4.5	4.5	4.5	4.5				
Max Green Setting (Gmax), s	21.5	23.5	9.5	27.5	12.7	32.3	6.5	30.5				
Max Q Clear Time (g_c+1/2), s	11.7	18.1	5.7	21.7	7.4	10.4	4.6	21.4				
Green Ext Time (p_c), s	0.4	0.7	0.0	2.3	0.1	1.6	0.0	3.1				
Intersection Summary												
HCM 6th Ctrl Delay											42.0	
HCM 6th LOS											D	

HCM 6th Signalized Intersection Summary
 43: SR-99 Northbound Off-Ramp/H Street & 4th Street

Village D Specific Plan
 Phase III WP - PM Peak Hour



Movement	EBL	EBT	EBR	WBL	WBT	WBR	NBL	NBT	NBR	SBL	SBT	SBR
Lane Configurations												
Traffic Volume (veh/h)	324	444	0	0	579	225	285	40	208	34	0	92
Future Volume (veh/h)	324	444	0	0	579	225	285	40	208	34	0	92
Initial Q (Qb), veh	0	0	0	0	0	0	0	0	0	0	0	0
Ped-Bike Adj(A_pbT)	1.00		1.00	1.00		0.99	1.00		0.98	1.00		0.99
Parking Bus, Adj	1.00	1.00	1.00	1.00	1.00	1.00	1.00	1.00	1.00	1.00	1.00	1.00
Work Zone On Approach	No				No				No			
Adj Sat Flow, veh/h/ln	1885	1885	0	0	1885	1885	1885	1885	1885	1900	1900	1900
Adj Flow Rate, veh/h	345	472	0	0	616	239	303	43	221	36	0	98
Peak Hour Factor	0.94	0.94	0.94	0.94	0.94	0.94	0.94	0.94	0.94	0.94	0.94	0.94
Percent Heavy Veh, %	1	1	0	0	1	1	1	1	1	0	0	0
Cap, veh/h	350	1701	0	0	591	229	377	55	284	79	0	216
Arrive On Green	0.19	0.47	0.00	0.00	0.23	0.23	0.21	0.21	0.21	0.18	0.00	0.18
Sat Flow, veh/h	1795	3676	0	0	2608	974	1795	263	1354	441	0	1201
Grp Volume(v), veh/h	345	472	0	0	439	416	303	0	264	134	0	0
Grp Sat Flow(s),veh/h/ln	1795	1791	0	0	1791	1697	1795	0	1617	1643	0	0
Q Serve(g_s), s	19.1	8.0	0.0	0.0	23.5	23.5	16.0	0.0	15.4	7.3	0.0	0.0
Cycle Q Clear(g_c), s	19.1	8.0	0.0	0.0	23.5	23.5	16.0	0.0	15.4	7.3	0.0	0.0
Prop In Lane	1.00		0.00	0.00		0.57	1.00		0.84	0.27		0.73
Lane Grp Cap(c), veh/h	350	1701	0	0	421	399	377	0	340	296	0	0
V/C Ratio(X)	0.99	0.28	0.00	0.00	1.04	1.04	0.80	0.00	0.78	0.45	0.00	0.00
Avail Cap(c_a), veh/h	350	1701	0	0	421	399	377	0	340	296	0	0
HCM Platoon Ratio	1.00	1.00	1.00	1.00	1.00	1.00	1.00	1.00	1.00	1.00	1.00	1.00
Upstream Filter(l)	1.00	1.00	0.00	0.00	1.00	1.00	1.00	0.00	1.00	1.00	0.00	0.00
Uniform Delay (d), s/veh	40.1	15.9	0.0	0.0	38.3	38.3	37.5	0.0	37.3	36.6	0.0	0.0
Incr Delay (d2), s/veh	44.0	0.1	0.0	0.0	55.3	56.9	16.5	0.0	16.0	4.9	0.0	0.0
Initial Q Delay(d3),s/veh	0.0	0.0	0.0	0.0	0.0	0.0	0.0	0.0	0.0	0.0	0.0	0.0
%ile BackOfQ(50%),veh/ln	12.6	3.2	0.0	0.0	16.6	15.9	8.7	0.0	7.5	3.3	0.0	0.0
Unsig. Movement Delay, s/veh												
LnGrp Delay(d),s/veh	84.1	16.0	0.0	0.0	93.5	95.2	54.0	0.0	53.3	41.6	0.0	0.0
LnGrp LOS	F	B	A	A	F	F	D	A	D	D	A	A
Approach Vol, veh/h	817				855				567		134	
Approach Delay, s/veh	44.8				94.3				53.7		41.6	
Approach LOS	D				F				D		D	
Timer - Assigned Phs	2		4		6		7		8			
Phs Duration (G+Y+Rc), s	25.5		52.0		22.5		24.0		28.0			
Change Period (Y+Rc), s	4.5		4.5		4.5		4.5		4.5			
Max Green Setting (Gmax), s	21.0		47.5		18.0		19.5		23.5			
Max Q Clear Time (g_c+1), s	18.0		10.0		9.3		21.1		25.5			
Green Ext Time (p_c), s	0.8		3.5		0.4		0.0		0.0			
Intersection Summary												
HCM 6th Ctrl Delay			64.6									
HCM 6th LOS			E									

Intersection						
Int Delay, s/veh	6.2					
Movement	EBL	EBT	WBT	WBR	SBL	SBR
Lane Configurations	↖	↗	↖		↖	↖
Traffic Vol, veh/h	90	654	742	113	160	111
Future Vol, veh/h	90	654	742	113	160	111
Conflicting Peds, #/hr	0	0	0	0	0	0
Sign Control	Free	Free	Free	Free	Stop	Stop
RT Channelized	-	None	-	None	-	None
Storage Length	145	-	-	-	65	0
Veh in Median Storage, #	-	0	0	-	0	-
Grade, %	-	0	0	-	0	-
Peak Hour Factor	95	95	95	95	95	95
Heavy Vehicles, %	1	1	1	1	1	1
Mvmt Flow	95	688	781	119	168	117

Major/Minor	Major1	Major2	Minor2		
Conflicting Flow All	900	0	-	0	1375 450
Stage 1	-	-	-	-	841 -
Stage 2	-	-	-	-	534 -
Critical Hdwy	4.12	-	-	-	6.82 6.92
Critical Hdwy Stg 1	-	-	-	-	5.82 -
Critical Hdwy Stg 2	-	-	-	-	5.82 -
Follow-up Hdwy	2.21	-	-	-	3.51 3.31
Pot Cap-1 Maneuver	1064	-	-	-	243 *797
Stage 1	-	-	-	-	704 -
Stage 2	-	-	-	-	555 -
Platoon blocked, %	1	-	-	-	1 1
Mov Cap-1 Maneuver	1064	-	-	-	221 *797
Mov Cap-2 Maneuver	-	-	-	-	221 -
Stage 1	-	-	-	-	641 -
Stage 2	-	-	-	-	555 -

Approach	EB	WB	SB
HCM Control Delay, s	1.1	0	39.5
HCM LOS			E

Minor Lane/Major Mvmt	EBL	EBT	WBT	WBR	SBLn1	SBLn2
Capacity (veh/h)	1064	-	-	-	221	797
HCM Lane V/C Ratio	0.089	-	-	-	0.762	0.147
HCM Control Delay (s)	8.7	-	-	-	59.7	10.3
HCM Lane LOS	A	-	-	-	F	B
HCM 95th %tile Q(veh)	0.3	-	-	-	5.3	0.5

Notes
 -: Volume exceeds capacity \$: Delay exceeds 300s +: Computation Not Defined *: All major volume in platoon

HCM 6th Signalized Intersection Summary
45: Olive Avenue & SR-99 Southbound Off-Ramp

Village D Specific Plan
Phase III WP - PM Peak Hour



Movement	EBL	EBT	WBT	WBR	SBL	SBR
Lane Configurations		↑↑↑	↑↑		↵	↵
Traffic Volume (veh/h)	0	813	753	0	776	102
Future Volume (veh/h)	0	813	753	0	776	102
Initial Q (Qb), veh	0	0	0	0	0	0
Ped-Bike Adj(A_pbT)	1.00			1.00	1.00	1.00
Parking Bus, Adj	1.00	1.00	1.00	1.00	1.00	1.00
Work Zone On Approach		No	No		No	
Adj Sat Flow, veh/h/ln	0	1885	1885	0	1841	1841
Adj Flow Rate, veh/h	0	856	793	0	817	107
Peak Hour Factor	0.95	0.95	0.95	0.95	0.95	0.95
Percent Heavy Veh, %	0	1	1	0	4	4
Cap, veh/h	0	1281	891	0	1141	1016
Arrive On Green	0.00	0.25	0.25	0.00	0.65	0.65
Sat Flow, veh/h	0	5486	3770	0	1753	1560
Grp Volume(v), veh/h	0	856	793	0	817	107
Grp Sat Flow(s),veh/h/ln	0	1716	1791	0	1753	1560
Q Serve(g_s), s	0.0	13.5	19.2	0.0	27.4	2.3
Cycle Q Clear(g_c), s	0.0	13.5	19.2	0.0	27.4	2.3
Prop In Lane	0.00			0.00	1.00	1.00
Lane Grp Cap(c), veh/h	0	1281	891	0	1141	1016
V/C Ratio(X)	0.00	0.67	0.89	0.00	0.72	0.11
Avail Cap(c_a), veh/h	0	1344	935	0	1141	1016
HCM Platoon Ratio	1.00	1.00	1.00	1.00	1.00	1.00
Upstream Filter(I)	0.00	1.00	0.73	0.00	1.00	1.00
Uniform Delay (d), s/veh	0.0	30.5	32.6	0.0	10.3	5.9
Incr Delay (d2), s/veh	0.0	1.2	7.8	0.0	3.9	0.2
Initial Q Delay(d3),s/veh	0.0	0.0	0.0	0.0	0.0	0.0
%ile BackOfQ(50%),veh/ln	0.0	5.6	9.1	0.0	10.2	0.7
Unsig. Movement Delay, s/veh						
LnGrp Delay(d),s/veh	0.0	31.7	40.4	0.0	14.1	6.1
LnGrp LOS	A	C	D	A	B	A
Approach Vol, veh/h		856	793		924	
Approach Delay, s/veh		31.7	40.4		13.2	
Approach LOS		C	D		B	
Timer - Assigned Phs				4	6	8
Phs Duration (G+Y+Rc), s				26.9	63.1	26.9
Change Period (Y+Rc), s				4.5	4.5	4.5
Max Green Setting (Gmax), s				23.5	57.5	23.5
Max Q Clear Time (g_c+I1), s				15.5	29.4	21.2
Green Ext Time (p_c), s				3.6	3.7	1.2
Intersection Summary						
HCM 6th Ctrl Delay			27.7			
HCM 6th LOS			C			

HCM 6th Signalized Intersection Summary
46: Madera Avenue & SR-99 Northbound Ramps

Village D Specific Plan
Phase III WP - PM Peak Hour



Movement	EBL	EBT	EBR	WBL	WBT	WBR	NBL	NBT	NBR	SBL	SBT	SBR
Lane Configurations				↶	↷	↶	↶↷	↶↷			↶↷	
Traffic Volume (veh/h)	0	0	0	374	1	34	947	819	0	0	731	246
Future Volume (veh/h)	0	0	0	374	1	34	947	819	0	0	731	246
Initial Q (Qb), veh				0	0	0	0	0	0	0	0	0
Ped-Bike Adj(A_pbT)				1.00		0.99	1.00		1.00	1.00		1.00
Parking Bus, Adj				1.00	1.00	1.00	1.00	1.00	1.00	1.00	1.00	1.00
Work Zone On Approach				No			No			No		
Adj Sat Flow, veh/h/ln				1885	1885	1885	1870	1870	0	0	1870	1870
Adj Flow Rate, veh/h				408	0	37	1029	890	0	0	795	267
Peak Hour Factor				0.92	0.92	0.92	0.92	0.92	0.92	0.92	0.92	0.92
Percent Heavy Veh, %				1	1	1	2	2	0	0	2	2
Cap, veh/h				512	0	225	1085	2691	0	0	1027	345
Arrive On Green				0.14	0.00	0.14	0.52	1.00	0.00	0.00	0.39	0.39
Sat Flow, veh/h				3591	0	1576	3456	3647	0	0	2704	876
Grp Volume(v), veh/h				408	0	37	1029	890	0	0	541	521
Grp Sat Flow(s),veh/h/ln				1795	0	1576	1728	1777	0	0	1777	1709
Q Serve(g_s), s				9.9	0.0	1.9	25.4	0.0	0.0	0.0	23.9	23.9
Cycle Q Clear(g_c), s				9.9	0.0	1.9	25.4	0.0	0.0	0.0	23.9	23.9
Prop In Lane				1.00		1.00	1.00		0.00	0.00		0.51
Lane Grp Cap(c), veh/h				512	0	225	1085	2691	0	0	699	672
V/C Ratio(X)				0.80	0.00	0.16	0.95	0.33	0.00	0.00	0.77	0.77
Avail Cap(c_a), veh/h				742	0	326	1085	2691	0	0	699	672
HCM Platoon Ratio				1.00	1.00	1.00	1.67	1.67	1.00	1.00	1.00	1.00
Upstream Filter(I)				1.00	0.00	1.00	0.44	0.44	0.00	0.00	1.00	1.00
Uniform Delay (d), s/veh				37.3	0.0	33.9	20.7	0.0	0.0	0.0	23.8	23.8
Incr Delay (d2), s/veh				3.9	0.0	0.3	8.9	0.1	0.0	0.0	8.2	8.5
Initial Q Delay(d3),s/veh				0.0	0.0	0.0	0.0	0.0	0.0	0.0	0.0	0.0
%ile BackOfQ(50%),veh/ln				4.5	0.0	0.7	8.6	0.1	0.0	0.0	11.1	10.8
Unsig. Movement Delay, s/veh												
LnGrp Delay(d),s/veh				41.2	0.0	34.2	29.6	0.1	0.0	0.0	32.0	32.3
LnGrp LOS				D	A	C	C	A	A	A	C	C
Approach Vol, veh/h								1919			1062	
Approach Delay, s/veh								15.9			32.1	
Approach LOS								B			C	
Timer - Assigned Phs		2			5	6		8				
Phs Duration (G+Y+Rc), s		72.7			32.8	39.9		17.3				
Change Period (Y+Rc), s		4.5			4.5	4.5		4.5				
Max Green Setting (Gmax), s		62.4			22.5	35.4		18.6				
Max Q Clear Time (g_c+I1), s		2.0			27.4	25.9		11.9				
Green Ext Time (p_c), s		8.0			0.0	4.8		0.9				

Intersection Summary

HCM 6th Ctrl Delay	24.2
HCM 6th LOS	C

Notes

User approved volume balancing among the lanes for turning movement.

HCM 6th Signalized Intersection Summary
 47: Madera Avenue & Olive Avenue/SR-99 Southbound On-Ramp

Village D Specific Plan
 Phase III WP - PM Peak Hour



Movement	EBL	EBT	EBR	WBL	WBT	WBR	NBL	NBT	NBR	SBL	SBT	SBR
Lane Configurations												
Traffic Volume (veh/h)	558	287	744	0	0	0	245	1208	52	137	458	510
Future Volume (veh/h)	558	287	744	0	0	0	245	1208	52	137	458	510
Initial Q (Qb), veh	0	0	0				0	0	0	0	0	0
Ped-Bike Adj(A_pbT)	1.00		1.00				1.00		1.00	1.00		1.00
Parking Bus, Adj	1.00	1.00	1.00				1.00	1.00	1.00	1.00	1.00	1.00
Work Zone On Approach		No						No			No	
Adj Sat Flow, veh/h/ln	1856	1856	1856				1870	1870	1870	1885	1885	1885
Adj Flow Rate, veh/h	436	491	767				253	1245	54	141	472	526
Peak Hour Factor	0.97	0.97	0.97				0.97	0.97	0.97	0.97	0.97	0.97
Percent Heavy Veh, %	3	3	3				2	2	2	1	1	1
Cap, veh/h	717	753	787				330	1210	52	172	625	557
Arrive On Green	0.68	0.68	0.68				0.10	0.35	0.35	0.16	0.58	0.58
Sat Flow, veh/h	1767	1856	1571				3456	3470	150	1795	1791	1598
Grp Volume(v), veh/h	436	491	767				253	637	662	141	472	526
Grp Sat Flow(s),veh/h/ln	1767	1856	1571				1728	1777	1843	1795	1791	1598
Q Serve(g_s), s	12.2	13.8	36.5				6.4	31.4	31.4	6.8	17.7	27.5
Cycle Q Clear(g_c), s	12.2	13.8	36.5				6.4	31.4	31.4	6.8	17.7	27.5
Prop In Lane	1.00		1.00				1.00		0.08	1.00		1.00
Lane Grp Cap(c), veh/h	717	753	787				330	619	643	172	625	557
V/C Ratio(X)	0.61	0.65	0.97				0.77	1.03	1.03	0.82	0.76	0.94
Avail Cap(c_a), veh/h	717	753	787				403	619	643	209	625	557
HCM Platoon Ratio	1.67	1.67	1.67				1.00	1.00	1.00	1.67	1.67	1.67
Upstream Filter(I)	0.66	0.66	0.66				1.00	1.00	1.00	0.64	0.64	0.64
Uniform Delay (d), s/veh	10.6	10.9	13.6				39.7	29.3	29.3	37.0	15.9	18.0
Incr Delay (d2), s/veh	1.0	1.3	20.0				7.0	43.6	43.4	12.8	5.4	19.5
Initial Q Delay(d3),s/veh	0.0	0.0	0.0				0.0	0.0	0.0	0.0	0.0	0.0
%ile BackOfQ(50%),veh/ln	3.5	4.0	28.7				3.0	20.3	21.0	3.4	5.8	9.6
Unsig. Movement Delay, s/veh												
LnGrp Delay(d),s/veh	11.6	12.2	33.6				46.7	72.9	72.8	49.8	21.3	37.5
LnGrp LOS	B	B	C				D	F	F	D	C	D
Approach Vol, veh/h		1694						1552			1139	
Approach Delay, s/veh		21.7						68.6			32.3	
Approach LOS		C						E			C	
Timer - Assigned Phs	1	2		4	5	6						
Phs Duration (G+Y+Rc), s	13.1	35.9		41.0	13.1	35.9						
Change Period (Y+Rc), s	4.5	4.5		4.5	4.5	4.5						
Max Green Setting (Gmax), s	10.5	29.5		36.5	10.5	29.5						
Max Q Clear Time (g_c+I1), s	8.8	33.4		38.5	8.4	29.5						
Green Ext Time (p_c), s	0.1	0.0		0.0	0.2	0.0						

Intersection Summary

HCM 6th Ctrl Delay	41.1
HCM 6th LOS	D

Notes

User approved volume balancing among the lanes for turning movement.

Intersection						
Int Delay, s/veh	0.3					
Movement	WBL	WBR	NBT	NBR	SBL	SBT
Lane Configurations	↘↗		↑↓		↘↗	↑↑
Traffic Vol, veh/h	7	9	1538	7	33	1263
Future Vol, veh/h	7	9	1538	7	33	1263
Conflicting Peds, #/hr	0	0	0	2	2	0
Sign Control	Stop	Stop	Free	Free	Free	Free
RT Channelized	-	None	-	None	-	None
Storage Length	0	-	-	-	100	-
Veh in Median Storage, #	0	-	0	-	-	0
Grade, %	0	-	0	-	-	0
Peak Hour Factor	95	95	95	95	95	95
Heavy Vehicles, %	6	6	2	2	2	2
Mvmt Flow	7	9	1619	7	35	1329

Major/Minor	Minor1	Major1	Major2		
Conflicting Flow All	2360	815	0	0	1628
Stage 1	1625	-	-	-	-
Stage 2	735	-	-	-	-
Critical Hdwy	6.92	7.02	-	-	4.14
Critical Hdwy Stg 1	5.92	-	-	-	-
Critical Hdwy Stg 2	5.92	-	-	-	-
Follow-up Hdwy	3.56	3.36	-	-	2.22
Pot Cap-1 Maneuver	*38	312	-	-	395
Stage 1	*140	-	-	-	-
Stage 2	*515	-	-	-	-
Platoon blocked, %	1	-	-	-	-
Mov Cap-1 Maneuver	*34	311	-	-	394
Mov Cap-2 Maneuver	*109	-	-	-	-
Stage 1	*140	-	-	-	-
Stage 2	*469	-	-	-	-

Approach	WB	NB	SB
HCM Control Delay, s	28.2	0	0.4
HCM LOS	D		

Minor Lane/Major Mvmt	NBT	NBRWBLn1	SBL	SBT
Capacity (veh/h)	-	-	172	394
HCM Lane V/C Ratio	-	-	0.098	0.088
HCM Control Delay (s)	-	-	28.2	15
HCM Lane LOS	-	-	D	C
HCM 95th %tile Q(veh)	-	-	0.3	0.3

Notes
 -: Volume exceeds capacity \$: Delay exceeds 300s +: Computation Not Defined *: All major volume in platoon

HCM 6th Signalized Intersection Summary
 49: Yosemite Avenue & Cleveland Avenue/Tozer Street

Village D Specific Plan
 Phase III WP - PM Peak Hour



Movement	EBL	EBT	EBR	WBL	WBT	WBR	NBL	NBT	NBR	SBL	SBT	SBR
Lane Configurations												
Traffic Volume (veh/h)	320	478	203	52	524	49	320	329	100	83	188	361
Future Volume (veh/h)	320	478	203	52	524	49	320	329	100	83	188	361
Initial Q (Qb), veh	0	0	0	0	0	0	0	0	0	0	0	0
Ped-Bike Adj(A_pbT)	1.00		0.99	1.00		0.96	1.00		1.00	1.00		0.98
Parking Bus, Adj	1.00	1.00	1.00	1.00	1.00	1.00	1.00	1.00	1.00	1.00	1.00	1.00
Work Zone On Approach		No			No			No				No
Adj Sat Flow, veh/h/ln	1870	1870	1870	1900	1900	1900	1870	1870	1870	1870	1870	1870
Adj Flow Rate, veh/h	348	520	221	57	570	53	348	358	109	90	204	392
Peak Hour Factor	0.92	0.92	0.92	0.92	0.92	0.92	0.92	0.92	0.92	0.92	0.92	0.92
Percent Heavy Veh, %	2	2	2	0	0	0	2	2	2	2	2	2
Cap, veh/h	287	759	321	74	697	298	340	751	635	115	155	298
Arrive On Green	0.16	0.31	0.31	0.04	0.19	0.19	0.19	0.40	0.40	0.06	0.28	0.28
Sat Flow, veh/h	1781	2422	1025	1810	3610	1542	1781	1870	1580	1781	565	1085
Grp Volume(v), veh/h	348	381	360	57	570	53	348	358	109	90	0	596
Grp Sat Flow(s),veh/h/ln	1781	1777	1670	1810	1805	1542	1781	1870	1580	1781	0	1650
Q Serve(g_s), s	16.1	18.7	18.9	3.1	15.1	2.9	19.1	14.2	4.4	5.0	0.0	27.5
Cycle Q Clear(g_c), s	16.1	18.7	18.9	3.1	15.1	2.9	19.1	14.2	4.4	5.0	0.0	27.5
Prop In Lane	1.00		0.61	1.00		1.00	1.00		1.00	1.00		0.66
Lane Grp Cap(c), veh/h	287	557	523	74	697	298	340	751	635	115	0	454
V/C Ratio(X)	1.21	0.68	0.69	0.77	0.82	0.18	1.02	0.48	0.17	0.78	0.00	1.31
Avail Cap(c_a), veh/h	287	557	523	103	697	298	340	751	635	173	0	454
HCM Platoon Ratio	1.00	1.00	1.00	1.00	1.00	1.00	1.00	1.00	1.00	1.00	1.00	1.00
Upstream Filter(I)	1.00	1.00	1.00	1.00	1.00	1.00	1.00	1.00	1.00	1.00	0.00	1.00
Uniform Delay (d), s/veh	42.0	30.0	30.1	47.5	38.7	33.7	40.4	22.1	19.2	46.1	0.0	36.3
Incr Delay (d2), s/veh	123.7	6.7	7.2	20.7	10.3	1.3	54.8	0.5	0.1	12.5	0.0	156.2
Initial Q Delay(d3),s/veh	0.0	0.0	0.0	0.0	0.0	0.0	0.0	0.0	0.0	0.0	0.0	0.0
%ile BackOfQ(50%),veh/ln	16.8	8.9	8.5	1.8	7.6	1.2	13.4	6.2	1.6	2.6	0.0	30.5
Unsig. Movement Delay, s/veh												
LnGrp Delay(d),s/veh	165.7	36.7	37.3	68.2	49.0	35.0	95.2	22.6	19.4	58.6	0.0	192.5
LnGrp LOS	F	D	D	E	D	D	F	C	B	E	A	F
Approach Vol, veh/h		1089			680			815			686	
Approach Delay, s/veh		78.1			49.5			53.2			174.9	
Approach LOS		E			D			D			F	
Timer - Assigned Phs	1	2	3	4	5	6	7	8				
Phs Duration (G+Y+Rc), s	20.6	23.8	10.9	44.7	8.6	35.8	23.6	32.0				
Change Period (Y+Rc), s	4.5	4.5	4.5	4.5	4.5	4.5	4.5	4.5				
Max Green Setting (Gmax), s	16.1	19.3	9.7	36.9	5.7	29.7	19.1	27.5				
Max Q Clear Time (g_c+I1), s	18.1	17.1	7.0	16.2	5.1	20.9	21.1	29.5				
Green Ext Time (p_c), s	0.0	0.9	0.0	2.5	0.0	3.1	0.0	0.0				
Intersection Summary												
HCM 6th Ctrl Delay			86.3									
HCM 6th LOS			F									

Intersection						
Int Delay, s/veh	6.5					
Movement	WBL	WBR	NBT	NBR	SBL	SBT
Lane Configurations						
Traffic Vol, veh/h	0	9	2	0	14	2
Future Vol, veh/h	0	9	2	0	14	2
Conflicting Peds, #/hr	0	0	0	0	0	0
Sign Control	Stop	Stop	Free	Free	Free	Free
RT Channelized	-	None	-	None	-	None
Storage Length	0	-	-	-	50	-
Veh in Median Storage, #	0	-	0	-	-	0
Grade, %	0	-	0	-	-	0
Peak Hour Factor	92	92	92	92	92	92
Heavy Vehicles, %	0	0	0	0	0	0
Mvmt Flow	0	10	2	0	15	2

Major/Minor	Minor1	Major1	Major2			
Conflicting Flow All	34	2	0	0	2	0
Stage 1	2	-	-	-	-	-
Stage 2	32	-	-	-	-	-
Critical Hdwy	6.4	6.2	-	-	4.1	-
Critical Hdwy Stg 1	5.4	-	-	-	-	-
Critical Hdwy Stg 2	5.4	-	-	-	-	-
Follow-up Hdwy	3.5	3.3	-	-	2.2	-
Pot Cap-1 Maneuver	984	1088	-	-	1634	-
Stage 1	1026	-	-	-	-	-
Stage 2	996	-	-	-	-	-
Platoon blocked, %			-	-	-	-
Mov Cap-1 Maneuver	975	1088	-	-	1634	-
Mov Cap-2 Maneuver	975	-	-	-	-	-
Stage 1	1026	-	-	-	-	-
Stage 2	987	-	-	-	-	-

Approach	WB	NB	SB
HCM Control Delay, s	8.3	0	6.3
HCM LOS	A		

Minor Lane/Major Mvmt	NBT	NBRWBLn1	SBL	SBT
Capacity (veh/h)	-	- 1088	1634	-
HCM Lane V/C Ratio	-	- 0.009	0.009	-
HCM Control Delay (s)	-	- 8.3	7.2	-
HCM Lane LOS	-	- A	A	-
HCM 95th %tile Q(veh)	-	- 0	0	-

Intersection						
Int Delay, s/veh	10					
Movement	EBT	EBR	WBL	WBT	NBL	NBR
Lane Configurations	↔		↔	↑	↔	↔
Traffic Vol, veh/h	112	50	627	63	23	302
Future Vol, veh/h	112	50	627	63	23	302
Conflicting Peds, #/hr	0	0	0	0	0	0
Sign Control	Free	Free	Free	Free	Stop	Stop
RT Channelized	-	None	-	None	-	None
Storage Length	-	-	50	-	50	0
Veh in Median Storage, #	0	-	-	0	0	-
Grade, %	0	-	-	0	0	-
Peak Hour Factor	92	92	92	92	92	92
Heavy Vehicles, %	2	2	0	0	0	0
Mvmt Flow	122	54	682	68	25	328

Major/Minor	Major1	Major2	Minor1		
Conflicting Flow All	0	0	176	0	1581
Stage 1	-	-	-	-	149
Stage 2	-	-	-	-	1432
Critical Hdwy	-	-	4.1	-	6.4
Critical Hdwy Stg 1	-	-	-	-	5.4
Critical Hdwy Stg 2	-	-	-	-	5.4
Follow-up Hdwy	-	-	2.2	-	3.5
Pot Cap-1 Maneuver	-	-	1412	-	121
Stage 1	-	-	-	-	884
Stage 2	-	-	-	-	222
Platoon blocked, %	-	-	-	-	-
Mov Cap-1 Maneuver	-	-	1412	-	63
Mov Cap-2 Maneuver	-	-	-	-	63
Stage 1	-	-	-	-	884
Stage 2	-	-	-	-	115

Approach	EB	WB	NB
HCM Control Delay, s	0	9	17.2
HCM LOS			C

Minor Lane/Major Mvmt	NBLn1	NBLn2	EBT	EBR	WBL	WBT
Capacity (veh/h)	63	903	-	-	1412	-
HCM Lane V/C Ratio	0.397	0.364	-	-	0.483	-
HCM Control Delay (s)	95.6	11.2	-	-	9.9	-
HCM Lane LOS	F	B	-	-	A	-
HCM 95th %tile Q(veh)	1.5	1.7	-	-	2.7	-

Intersection												
Int Delay, s/veh	1.8											
Movement	EBL	EBT	EBR	WBL	WBT	WBR	NBL	NBT	NBR	SBL	SBT	SBR
Lane Configurations	↖	↗		↖	↗		↖	↗		↖	↗	
Traffic Vol, veh/h	0	202	15	296	15	225	6	178	148	142	179	0
Future Vol, veh/h	0	202	15	296	15	225	6	178	148	142	179	0
Conflicting Peds, #/hr	0	0	0	0	0	0	0	0	0	0	0	0
Sign Control	Free	Free	Free	Free	Free	Free	Stop	Stop	Stop	Stop	Stop	Stop
RT Channelized	-	-	None	-	-	None	-	-	None	-	-	None
Storage Length	50	-	-	50	-	-	50	-	-	50	-	-
Veh in Median Storage, #	-	0	-	-	0	-	-	0	-	-	0	-
Grade, %	-	0	-	-	0	-	-	0	-	-	0	-
Peak Hour Factor	92	92	92	92	92	92	92	92	92	92	92	92
Heavy Vehicles, %	12	12	12	0	0	0	0	0	0	0	0	0
Mvmt Flow	0	220	16	322	16	245	7	193	161	154	195	0

Major/Minor	Major1			Major2			Minor1			Minor2		
Conflicting Flow All	261	0	0	236	0	0	1108	1133	228	1188	1019	139
Stage 1	-	-	-	-	-	-	228	228	-	783	783	-
Stage 2	-	-	-	-	-	-	880	905	-	405	236	-
Critical Hdwy	4.22	-	-	4.1	-	-	7.1	6.5	6.2	7.1	6.5	6.2
Critical Hdwy Stg 1	-	-	-	-	-	-	6.1	5.5	-	6.1	5.5	-
Critical Hdwy Stg 2	-	-	-	-	-	-	6.1	5.5	-	6.1	5.5	-
Follow-up Hdwy	2.308	-	-	2.2	-	-	3.5	4	3.3	3.5	4	3.3
Pot Cap-1 Maneuver	1247	-	-	1343	-	-	189	205	816	167	239	915
Stage 1	-	-	-	-	-	-	779	719	-	390	407	-
Stage 2	-	-	-	-	-	-	345	358	-	626	713	-
Platoon blocked, %	-	-	-	-	-	-	-	-	-	-	-	-
Mov Cap-1 Maneuver	1247	-	-	1343	-	-	~ 156	816	-	~ 182	915	-
Mov Cap-2 Maneuver	-	-	-	-	-	-	~ 156	-	-	~ 182	-	-
Stage 1	-	-	-	-	-	-	779	719	-	390	309	-
Stage 2	-	-	-	-	-	-	97	272	-	367	713	-

Approach	EB	WB	NB	SB
HCM Control Delay, s	0	4.7		
HCM LOS			-	-

Minor Lane/Major Mvmt	NBLn1	NBLn2	EBL	EBT	EBR	WBL	WBT	WBR	SBLn1	SBLn2
Capacity (veh/h)	-	247	1247	-	-	1343	-	-	-	182
HCM Lane V/C Ratio	-	1.435	-	-	-	0.24	-	-	-	1.069
HCM Control Delay (s)	-	255.1	0	-	-	8.5	-	-	-	139.1
HCM Lane LOS	-	F	A	-	-	A	-	-	-	F
HCM 95th %tile Q(veh)	-	20	0	-	-	0.9	-	-	-	9.4

Notes
 -: Volume exceeds capacity \$: Delay exceeds 300s +: Computation Not Defined *: All major volume in platoon

Intersection												
Int Delay, s/veh	524.2											
Movement	EBL	EBT	EBR	WBL	WBT	WBR	NBL	NBT	NBR	SBL	SBT	SBR
Lane Configurations	↶	↷		↶	↷		↶	↷		↶	↷	
Traffic Vol, veh/h	8	417	16	113	524	449	14	29	62	330	30	8
Future Vol, veh/h	8	417	16	113	524	449	14	29	62	330	30	8
Conflicting Peds, #/hr	0	0	0	0	0	0	0	0	0	0	0	0
Sign Control	Free	Free	Free	Free	Free	Free	Stop	Stop	Stop	Stop	Stop	Stop
RT Channelized	-	-	None	-	-	None	-	-	None	-	-	None
Storage Length	50	-	-	50	-	-	50	-	-	50	-	-
Veh in Median Storage, #	-	0	-	-	0	-	-	0	-	-	0	-
Grade, %	-	0	-	-	0	-	-	0	-	-	0	-
Peak Hour Factor	92	92	92	92	92	92	92	92	92	92	92	92
Heavy Vehicles, %	0	0	0	0	0	0	0	0	0	0	0	0
Mvmt Flow	9	453	17	123	570	488	15	32	67	359	33	9

Major/Minor	Major1			Major2			Minor1			Minor2		
Conflicting Flow All	1058	0	0	470	0	0	1561	1784	462	1589	1548	814
Stage 1	-	-	-	-	-	-	480	480	-	1060	1060	-
Stage 2	-	-	-	-	-	-	1081	1304	-	529	488	-
Critical Hdwy	4.1	-	-	4.1	-	-	7.1	6.5	6.2	7.1	6.5	6.2
Critical Hdwy Stg 1	-	-	-	-	-	-	6.1	5.5	-	6.1	5.5	-
Critical Hdwy Stg 2	-	-	-	-	-	-	6.1	5.5	-	6.1	5.5	-
Follow-up Hdwy	2.2	-	-	2.2	-	-	3.5	4	3.3	3.5	4	3.3
Pot Cap-1 Maneuver	666	-	-	1102	-	-	92	83	604	~ 88	115	381
Stage 1	-	-	-	-	-	-	571	558	-	~ 273	303	-
Stage 2	-	-	-	-	-	-	266	232	-	537	553	-
Platoon blocked, %		-	-		-	-						
Mov Cap-1 Maneuver	666	-	-	1102	-	-	61	73	604	~ 47	101	381
Mov Cap-2 Maneuver	-	-	-	-	-	-	61	73	-	~ 47	101	-
Stage 1	-	-	-	-	-	-	563	550	-	~ 269	269	-
Stage 2	-	-	-	-	-	-	203	206	-	444	545	-

Approach	EB	WB	NB	SB
HCM Control Delay, s	0.2	0.9	51	\$ 2831.4
HCM LOS			F	F

Minor Lane/Major Mvmt	NBLn1	NBLn2	EBL	EBT	EBR	WBL	WBT	WBR	SBLn1	SBLn2
Capacity (veh/h)	61	182	666	-	-	1102	-	-	47	119
HCM Lane V/C Ratio	0.249	0.543	0.013	-	-	0.111	-	-	7.632	0.347
HCM Control Delay (s)	82.6	46.1	10.5	-	-	8.7	-	-	\$ 3151.6	50.5
HCM Lane LOS	F	E	B	-	-	A	-	-	F	F
HCM 95th %tile Q(veh)	0.9	2.8	0	-	-	0.4	-	-	42.2	1.4

Notes
 -: Volume exceeds capacity \$: Delay exceeds 300s +: Computation Not Defined *: All major volume in platoon

Intersection						
Int Delay, s/veh	1.3					
Movement	EBL	EBT	WBT	WBR	SBL	SBR
Lane Configurations						
Traffic Vol, veh/h	0	37	66	52	26	0
Future Vol, veh/h	0	37	66	52	26	0
Conflicting Peds, #/hr	0	0	0	0	0	0
Sign Control	Free	Free	Free	Free	Stop	Stop
RT Channelized	-	None	-	None	-	None
Storage Length	50	-	-	-	50	0
Veh in Median Storage, #	-	0	0	-	0	-
Grade, %	-	0	0	-	0	-
Peak Hour Factor	92	92	92	92	92	92
Heavy Vehicles, %	0	0	0	0	0	0
Mvmt Flow	0	40	72	57	28	0

Major/Minor	Major1	Major2	Minor2		
Conflicting Flow All	129	0	-	0	141
Stage 1	-	-	-	-	101
Stage 2	-	-	-	-	40
Critical Hdwy	4.1	-	-	-	6.4
Critical Hdwy Stg 1	-	-	-	-	5.4
Critical Hdwy Stg 2	-	-	-	-	5.4
Follow-up Hdwy	2.2	-	-	-	3.5
Pot Cap-1 Maneuver	1469	-	-	-	857
Stage 1	-	-	-	-	928
Stage 2	-	-	-	-	988
Platoon blocked, %		-	-	-	
Mov Cap-1 Maneuver	1469	-	-	-	857
Mov Cap-2 Maneuver	-	-	-	-	857
Stage 1	-	-	-	-	928
Stage 2	-	-	-	-	988

Approach	EB	WB	SB
HCM Control Delay, s	0	0	9.3
HCM LOS			A

Minor Lane/Major Mvmt	EBL	EBT	WBT	WBR	SBLn1	SBLn2
Capacity (veh/h)	1469	-	-	-	857	-
HCM Lane V/C Ratio	-	-	-	-	0.033	-
HCM Control Delay (s)	0	-	-	-	9.3	0
HCM Lane LOS	A	-	-	-	A	A
HCM 95th %tile Q(veh)	0	-	-	-	0.1	-

Intersection						
Int Delay, s/veh	13.4					
Movement	EBL	EBR	NBL	NBT	SBT	SBR
Lane Configurations						
Traffic Vol, veh/h	294	211	228	1255	1687	631
Future Vol, veh/h	294	211	228	1255	1687	631
Conflicting Peds, #/hr	0	0	0	0	0	0
Sign Control	Stop	Stop	Free	Free	Free	Free
RT Channelized	-	None	-	None	-	None
Storage Length	50	0	50	-	-	-
Veh in Median Storage, #	0	-	-	0	0	-
Grade, %	0	-	-	0	0	-
Peak Hour Factor	92	92	92	92	92	92
Heavy Vehicles, %	0	0	2	2	2	2
Mvmt Flow	320	229	248	1364	1834	686

Major/Minor	Minor2	Major1	Major2			
Conflicting Flow All	4037	2177	2520	0	-	0
Stage 1	2177	-	-	-	-	-
Stage 2	1860	-	-	-	-	-
Critical Hdwy	6.4	6.2	4.12	-	-	-
Critical Hdwy Stg 1	5.4	-	-	-	-	-
Critical Hdwy Stg 2	5.4	-	-	-	-	-
Follow-up Hdwy	3.5	3.3	2.218	-	-	-
Pot Cap-1 Maneuver	~ 3	~ 59	~ 179	-	-	-
Stage 1	~ 94	-	-	-	-	-
Stage 2	~ 137	-	-	-	-	-
Platoon blocked, %				-	-	-
Mov Cap-1 Maneuver	0	~ 59	~ 179	-	-	-
Mov Cap-2 Maneuver	0	-	-	-	-	-
Stage 1	0	-	-	-	-	-
Stage 2	~ 137	-	-	-	-	-

Approach	EB	NB	SB
HCM Control Delay, s		38.9	0
HCM LOS	-		

Minor Lane/Major Mvmt	NBL	NBT	EBLn1	EBLn2	SBT	SBR
Capacity (veh/h)	~ 179	-	-	59	-	-
HCM Lane V/C Ratio	1.385	-	-	3.887	-	-
HCM Control Delay (s)	253.1	-		\$ 1442.8	-	-
HCM Lane LOS	F	-	-	F	-	-
HCM 95th %tile Q(veh)	14.9	-	-	24.8	-	-

Notes
 -: Volume exceeds capacity \$: Delay exceeds 300s +: Computation Not Defined *: All major volume in platoon

Intersection						
Int Delay, s/veh	198.3					
Movement	WBL	WBR	NBT	NBR	SBL	SBT
Lane Configurations	↙	↗	↖		↙	↗
Traffic Vol, veh/h	370	890	1332	341	977	1014
Future Vol, veh/h	370	890	1332	341	977	1014
Conflicting Peds, #/hr	0	0	0	0	0	0
Sign Control	Stop	Stop	Free	Free	Free	Free
RT Channelized	-	None	-	None	-	None
Storage Length	50	0	-	-	50	-
Veh in Median Storage, #	0	-	0	-	-	0
Grade, %	0	-	0	-	-	0
Peak Hour Factor	92	92	92	92	92	92
Heavy Vehicles, %	0	0	2	2	2	2
Mvmt Flow	402	967	1448	371	1062	1102

Major/Minor	Minor1	Major1	Major2			
Conflicting Flow All	4860	1634	0	0	1819	0
Stage 1	1634	-	-	-	-	-
Stage 2	3226	-	-	-	-	-
Critical Hdwy	6.4	6.2	-	-	4.12	-
Critical Hdwy Stg 1	5.4	-	-	-	-	-
Critical Hdwy Stg 2	5.4	-	-	-	-	-
Follow-up Hdwy	3.5	3.3	-	-	2.218	-
Pot Cap-1 Maneuver	~ 1	~ 126	-	-	~ 337	-
Stage 1	~ 177	-	-	-	-	-
Stage 2	~ 27	-	-	-	-	-
Platoon blocked, %			-	-	-	-
Mov Cap-1 Maneuver	0	~ 126	-	-	~ 337	-
Mov Cap-2 Maneuver	0	-	-	-	-	-
Stage 1	~ 177	-	-	-	-	-
Stage 2	0	-	-	-	-	-

Approach	WB	NB	SB
HCM Control Delay, s		0	\$ 490.3
HCM LOS	-		

Minor Lane/Major Mvmt	NBT	NBRWBLn1WBLn2	SBL	SBT
Capacity (veh/h)	-	-	126	~ 337
HCM Lane V/C Ratio	-	-	7.678	3.151
HCM Control Delay (s)	-	-	\$ 3071	\$ 999.1
HCM Lane LOS	-	-	F	F
HCM 95th %tile Q(veh)	-	-	108.5	94.8

Notes
 -: Volume exceeds capacity \$: Delay exceeds 300s +: Computation Not Defined *: All major volume in platoon

Intersection						
Int Delay, s/veh	581.2					
Movement	EBL	EBR	NBL	NBT	SBT	SBR
Lane Configurations	Y		Y	↑	↑	
Traffic Vol, veh/h	131	62	94	1551	1256	136
Future Vol, veh/h	131	62	94	1551	1256	136
Conflicting Peds, #/hr	0	0	0	0	0	0
Sign Control	Stop	Stop	Free	Free	Free	Free
RT Channelized	-	None	-	None	-	None
Storage Length	0	-	50	-	-	-
Veh in Median Storage, #	0	-	-	0	0	-
Grade, %	0	-	-	0	0	-
Peak Hour Factor	92	92	92	92	92	92
Heavy Vehicles, %	0	0	2	2	2	2
Mvmt Flow	142	67	102	1686	1365	148

Major/Minor	Minor2	Major1	Major2			
Conflicting Flow All	3329	1439	1513	0	-	0
Stage 1	1439	-	-	-	-	-
Stage 2	1890	-	-	-	-	-
Critical Hdwy	6.4	6.2	4.12	-	-	-
Critical Hdwy Stg 1	5.4	-	-	-	-	-
Critical Hdwy Stg 2	5.4	-	-	-	-	-
Follow-up Hdwy	3.5	3.3	2.218	-	-	-
Pot Cap-1 Maneuver	~ 9	165	442	-	-	-
Stage 1	221	-	-	-	-	-
Stage 2	~ 132	-	-	-	-	-
Platoon blocked, %				-	-	-
Mov Cap-1 Maneuver	~ 7	165	442	-	-	-
Mov Cap-2 Maneuver	~ 7	-	-	-	-	-
Stage 1	170	-	-	-	-	-
Stage 2	~ 132	-	-	-	-	-

Approach	EB	NB	SB
HCM Control Delay, \$	9718.6	0.9	0
HCM LOS	F		

Minor Lane/Major Mvmt	NBL	NBT	EBLn1	SBT	SBR
Capacity (veh/h)	442	-	10	-	-
HCM Lane V/C Ratio	0.231	-	20.978	-	-
HCM Control Delay (s)	15.6	\$	9718.6	-	-
HCM Lane LOS	C	-	F	-	-
HCM 95th %tile Q(veh)	0.9	-	27.8	-	-

Notes
 -: Volume exceeds capacity \$: Delay exceeds 300s +: Computation Not Defined *: All major volume in platoon

Intersection

Int Delay, s/veh 143.1

Movement	EBT	EBR	WBL	WBT	NBL	NBR
Lane Configurations	↔		↔	↑	↔	↔
Traffic Vol, veh/h	870	145	332	1254	65	243
Future Vol, veh/h	870	145	332	1254	65	243
Conflicting Peds, #/hr	0	0	0	0	0	0
Sign Control	Free	Free	Free	Free	Stop	Stop
RT Channelized	-	None	-	None	-	None
Storage Length	-	-	50	-	50	0
Veh in Median Storage, #	0	-	-	0	0	-
Grade, %	0	-	-	0	0	-
Peak Hour Factor	92	92	92	92	92	92
Heavy Vehicles, %	1	1	0	0	0	0
Mvmt Flow	946	158	361	1363	71	264

Major/Minor

	Major1	Major2	Minor1		
Conflicting Flow All	0	0	1104	0	3110 1025
Stage 1	-	-	-	-	1025 -
Stage 2	-	-	-	-	2085 -
Critical Hdwy	-	-	4.1	-	6.4 6.2
Critical Hdwy Stg 1	-	-	-	-	5.4 -
Critical Hdwy Stg 2	-	-	-	-	5.4 -
Follow-up Hdwy	-	-	2.2	-	3.5 3.3
Pot Cap-1 Maneuver	-	-	640	-	~ 13 288
Stage 1	-	-	-	-	349 -
Stage 2	-	-	-	-	105 -
Platoon blocked, %	-	-	-	-	-
Mov Cap-1 Maneuver	-	-	640	-	~ 6 288
Mov Cap-2 Maneuver	-	-	-	-	~ 6 -
Stage 1	-	-	-	-	349 -
Stage 2	-	-	-	-	~ 46 -

Approach

	EB	WB	NB
HCM Control Delay, s	0	3.7	\$ 1332.1
HCM LOS			F

Minor Lane/Major Mvmt

	NBLn1	NBLn2	EBT	EBR	WBL	WBT
Capacity (veh/h)	6	288	-	-	640	-
HCM Lane V/C Ratio	11.775	0.917	-	-	0.564	-
HCM Control Delay (s)	\$ 6039	73.1	-	-	17.6	-
HCM Lane LOS	F	F	-	-	C	-
HCM 95th %tile Q(veh)	10.6	8.6	-	-	3.5	-

Notes

~: Volume exceeds capacity \$: Delay exceeds 300s +: Computation Not Defined *: All major volume in platoon

HCM 6th Signalized Intersection Summary
5: Road 23/SR-99 Southbound Off-Ramp & Avenue 18 1/2

Village D Specific Plan
Existing WP MIT - AM Peak Hour



Movement	EBL	EBT	EBR	WBL	WBT	WBR	NBL	NBT	NBR	SBL	SBT	SBR
Lane Configurations		↑	↗	↘	↑		↗	↘	↗		↕	↕
Traffic Volume (veh/h)	0	305	78	40	271	0	134	0	722	10	255	85
Future Volume (veh/h)	0	305	78	40	271	0	134	0	722	10	255	85
Initial Q (Qb), veh	0	0	0	0	0	0	0	0	0	0	0	0
Ped-Bike Adj(A_pbT)	1.00		1.00	1.00		1.00	1.00		1.00	1.00		1.00
Parking Bus, Adj	1.00	1.00	1.00	1.00	1.00	1.00	1.00	1.00	1.00	1.00	1.00	1.00
Work Zone On Approach		No			No			No			No	
Adj Sat Flow, veh/h/ln	0	1470	1470	1544	1544	0	1826	1826	1826	1693	1693	1693
Adj Flow Rate, veh/h	0	347	89	45	308	0	152	0	820	11	290	97
Peak Hour Factor	0.88	0.88	0.88	0.88	0.88	0.88	0.88	0.88	0.88	0.88	0.88	0.88
Percent Heavy Veh, %	0	29	29	24	24	0	5	5	5	14	14	14
Cap, veh/h	0	362	617	58	528	0	433	0	892	21	559	196
Arrive On Green	0.00	0.25	0.25	0.04	0.34	0.00	0.25	0.00	0.25	0.24	0.24	0.24
Sat Flow, veh/h	0	1470	1246	1471	1544	0	1739	0	3089	87	2330	815
Grp Volume(v), veh/h	0	347	89	45	308	0	152	0	820	214	0	184
Grp Sat Flow(s),veh/h/ln	0	1470	1246	1471	1544	0	1739	0	1544	1688	0	1544
Q Serve(g_s), s	0.0	18.6	3.1	2.4	13.1	0.0	5.8	0.0	19.9	8.8	0.0	8.2
Cycle Q Clear(g_c), s	0.0	18.6	3.1	2.4	13.1	0.0	5.8	0.0	19.9	8.8	0.0	8.2
Prop In Lane	0.00		1.00	1.00		0.00	1.00		1.00	0.05		0.53
Lane Grp Cap(c), veh/h	0	362	617	58	528	0	433	0	892	405	0	371
V/C Ratio(X)	0.00	0.96	0.14	0.77	0.58	0.00	0.35	0.00	0.92	0.53	0.00	0.50
Avail Cap(c_a), veh/h	0	362	617	94	566	0	433	0	892	405	0	371
HCM Platoon Ratio	1.00	1.00	1.00	1.00	1.00	1.00	1.00	1.00	1.00	1.00	1.00	1.00
Upstream Filter(I)	0.00	1.00	1.00	1.00	1.00	0.00	1.00	0.00	1.00	1.00	0.00	1.00
Uniform Delay (d), s/veh	0.0	29.7	11.0	38.1	21.6	0.0	24.7	0.0	27.5	26.5	0.0	26.2
Incr Delay (d2), s/veh	0.0	36.4	0.1	19.3	1.4	0.0	0.5	0.0	14.4	4.9	0.0	4.7
Initial Q Delay(d3),s/veh	0.0	0.0	0.0	0.0	0.0	0.0	0.0	0.0	0.0	0.0	0.0	0.0
%ile BackOfQ(50%),veh/ln	0.0	10.0	1.3	1.2	4.7	0.0	2.4	0.0	9.0	4.0	0.0	3.4
Unsig. Movement Delay, s/veh												
LnGrp Delay(d),s/veh	0.0	66.1	11.1	57.4	23.0	0.0	25.2	0.0	41.9	31.3	0.0	30.9
LnGrp LOS	A	E	B	E	C	A	C	A	D	C	A	C
Approach Vol, veh/h		436			353			972				398
Approach Delay, s/veh		54.9			27.4			39.3				31.1
Approach LOS		D			C			D				C
Timer - Assigned Phs		2	3	4		6		8				
Phs Duration (G+Y+Rc), s		24.4	7.7	24.2		23.7		31.9				
Change Period (Y+Rc), s		4.5	4.5	4.5		4.5		4.5				
Max Green Setting (Gmax), s		18.0	5.1	19.7		19.2		29.3				
Max Q Clear Time (g_c+I1), s		21.9	4.4	20.6		10.8		15.1				
Green Ext Time (p_c), s		0.0	0.0	0.0		1.5		1.5				

Intersection Summary

HCM 6th Ctrl Delay	39.0
HCM 6th LOS	D

Notes

User approved volume balancing among the lanes for turning movement.

HCM 6th Signalized Intersection Summary
6: SR-99 Northbound Ramps & Avenue 18 1/2

Village D Specific Plan
Existing WP MIT - AM Peak Hour



Movement	EBL	EBT	EBR	WBL	WBT	WBR	NBL	NBT	NBR	SBL	SBT	SBR
Lane Configurations	↔↔	↑			↔			↔				
Traffic Volume (veh/h)	795	54	0	0	134	22	213	1	18	0	0	0
Future Volume (veh/h)	795	54	0	0	134	22	213	1	18	0	0	0
Initial Q (Qb), veh	0	0	0	0	0	0	0	0	0			
Ped-Bike Adj(A_pbT)	1.00		1.00	1.00		1.00	1.00		1.00			
Parking Bus, Adj	1.00	1.00	1.00	1.00	1.00	1.00	1.00	1.00	1.00			
Work Zone On Approach		No			No			No				
Adj Sat Flow, veh/h/ln	1767	1767	0	0	1648	1648	1900	1500	1900			
Adj Flow Rate, veh/h	958	65	0	0	161	27	257	1	22			
Peak Hour Factor	0.83	0.83	0.83	0.83	0.83	0.83	0.83	0.83	0.83			
Percent Heavy Veh, %	9	9	0	0	17	17	0	27	0			
Cap, veh/h	1059	931	0	0	201	34	468	2	40			
Arrive On Green	0.32	0.53	0.00	0.00	0.15	0.15	0.36	0.36	0.36			
Sat Flow, veh/h	3264	1767	0	0	1375	231	1299	5	111			
Grp Volume(v), veh/h	958	65	0	0	0	188	280	0	0			
Grp Sat Flow(s),veh/h/ln	1632	1767	0	0	0	1606	1415	0	0			
Q Serve(g_s), s	22.5	1.4	0.0	0.0	0.0	9.1	12.6	0.0	0.0			
Cycle Q Clear(g_c), s	22.5	1.4	0.0	0.0	0.0	9.1	12.6	0.0	0.0			
Prop In Lane	1.00		0.00	0.00		0.14	0.92		0.08			
Lane Grp Cap(c), veh/h	1059	931	0	0	0	235	510	0	0			
V/C Ratio(X)	0.90	0.07	0.00	0.00	0.00	0.80	0.55	0.00	0.00			
Avail Cap(c_a), veh/h	1146	1117	0	0	0	361	510	0	0			
HCM Platoon Ratio	1.00	1.00	1.00	1.00	1.00	1.00	1.00	1.00	1.00			
Upstream Filter(I)	1.00	1.00	0.00	0.00	0.00	1.00	1.00	0.00	0.00			
Uniform Delay (d), s/veh	25.8	9.3	0.0	0.0	0.0	33.0	20.4	0.0	0.0			
Incr Delay (d2), s/veh	9.7	0.0	0.0	0.0	0.0	7.1	4.2	0.0	0.0			
Initial Q Delay(d3),s/veh	0.0	0.0	0.0	0.0	0.0	0.0	0.0	0.0	0.0			
%ile BackOfQ(50%),veh/ln	9.7	0.5	0.0	0.0	0.0	3.9	4.5	0.0	0.0			
Unsig. Movement Delay, s/veh												
LnGrp Delay(d),s/veh	35.6	9.3	0.0	0.0	0.0	40.2	24.6	0.0	0.0			
LnGrp LOS	D	A	A	A	A	D	C	A	A			
Approach Vol, veh/h		1023			188			280				
Approach Delay, s/veh		33.9			40.2			24.6				
Approach LOS		C			D			C				
Timer - Assigned Phs		2		4			7	8				
Phs Duration (G+Y+Rc), s		33.4		46.6			30.5	16.2				
Change Period (Y+Rc), s		4.5		4.5			4.5	4.5				
Max Green Setting (Gmax), s		20.4		50.6			28.1	18.0				
Max Q Clear Time (g_c+I1), s		14.6		3.4			24.5	11.1				
Green Ext Time (p_c), s		0.8		0.4			1.5	0.5				
Intersection Summary												
HCM 6th Ctrl Delay												32.9
HCM 6th LOS												C

HCM 6th Signalized Intersection Summary
7: Road 23 & Avenue 17

Village D Specific Plan
Existing WP MIT - AM Peak Hour



Movement	EBL	EBT	EBR	WBL	WBT	WBR	NBL	NBT	NBR	SBL	SBT	SBR
Lane Configurations	↖	↗		↖	↗		↖	↗	↖	↗	↖	↗
Traffic Volume (veh/h)	160	477	30	474	128	3	51	909	974	15	400	42
Future Volume (veh/h)	160	477	30	474	128	3	51	909	974	15	400	42
Initial Q (Qb), veh	0	0	0	0	0	0	0	0	0	0	0	0
Ped-Bike Adj(A_pbT)	1.00		1.00	1.00		1.00	1.00		1.00	1.00		1.00
Parking Bus, Adj	1.00	1.00	1.00	1.00	1.00	1.00	1.00	1.00	1.00	1.00	1.00	1.00
Work Zone On Approach		No			No			No			No	
Adj Sat Flow, veh/h/ln	1900	1900	1900	1870	1870	1870	1870	1870	1870	1811	1811	1811
Adj Flow Rate, veh/h	174	518	33	515	139	3	55	988	1059	16	435	46
Peak Hour Factor	0.92	0.92	0.92	0.92	0.92	0.92	0.92	0.92	0.92	0.92	0.92	0.92
Percent Heavy Veh, %	0	0	0	2	2	2	2	2	2	6	6	6
Cap, veh/h	211	597	38	623	841	18	71	1594	997	31	1340	141
Arrive On Green	0.04	0.06	0.06	0.18	0.24	0.24	0.01	0.15	0.15	0.02	0.43	0.43
Sat Flow, veh/h	1810	3446	219	3456	3557	77	1781	3554	1585	1725	3141	331
Grp Volume(v), veh/h	174	271	280	515	69	73	55	988	1059	16	237	244
Grp Sat Flow(s),veh/h/ln	1810	1805	1861	1728	1777	1857	1781	1777	1585	1725	1721	1752
Q Serve(g_s), s	9.5	14.9	14.9	14.4	3.1	3.1	3.1	26.1	44.9	0.9	9.2	9.3
Cycle Q Clear(g_c), s	9.5	14.9	14.9	14.4	3.1	3.1	3.1	26.1	44.9	0.9	9.2	9.3
Prop In Lane	1.00		0.12	1.00		0.04	1.00		1.00	1.00		0.19
Lane Grp Cap(c), veh/h	211	313	322	623	420	439	71	1594	997	31	734	747
V/C Ratio(X)	0.82	0.87	0.87	0.83	0.16	0.17	0.77	0.62	1.06	0.52	0.32	0.33
Avail Cap(c_a), veh/h	320	325	335	1054	547	572	155	1594	997	86	734	747
HCM Platoon Ratio	0.33	0.33	0.33	1.00	1.00	1.00	0.33	0.33	0.33	1.00	1.00	1.00
Upstream Filter(l)	0.84	0.84	0.84	1.00	1.00	1.00	0.21	0.21	0.21	1.00	1.00	1.00
Uniform Delay (d), s/veh	47.0	46.0	46.0	39.5	30.3	30.3	48.9	34.6	23.8	48.7	19.1	19.1
Incr Delay (d2), s/veh	8.5	17.9	17.9	2.9	0.2	0.2	3.8	0.4	33.5	12.7	1.2	1.2
Initial Q Delay(d3),s/veh	0.0	0.0	0.0	0.0	0.0	0.0	0.0	0.0	0.0	0.0	0.0	0.0
%ile BackOfQ(50%),veh/ln	5.1	8.7	9.0	6.3	1.3	1.4	1.5	12.4	28.1	0.5	3.8	3.9
Unsig. Movement Delay, s/veh												
LnGrp Delay(d),s/veh	55.6	63.8	63.9	42.4	30.5	30.5	52.7	35.0	57.2	61.4	20.2	20.3
LnGrp LOS	E	E	E	D	C	C	D	C	F	E	C	C
Approach Vol, veh/h		725		657			2102			497		
Approach Delay, s/veh		61.9		39.8			46.7			21.6		
Approach LOS		E		D			D			C		
Timer - Assigned Phs	1	2	3	4	5	6	7	8				
Phs Duration (G+Y+Rc), s	6.3	49.4	22.5	21.8	8.5	47.2	16.2	28.2				
Change Period (Y+Rc), s	4.5	4.5	4.5	4.5	4.5	4.5	4.5	4.5				
Max Green Setting (Gmax), s	30.8	28.5	30.5	18.0	8.7	24.8	17.7	30.8				
Max Q Clear Time (g_c+1), s	11.5	46.9	16.4	16.9	5.1	11.3	11.5	5.1				
Green Ext Time (p_c), s	0.7	0.0	0.0	1.7	0.4	0.0	2.4	0.2				
Intersection Summary												
HCM 6th Ctrl Delay				45.2								
HCM 6th LOS				D								

HCM 6th Signalized Intersection Summary
8: Road 23 & Avenue 16

Village D Specific Plan
Existing WP MIT - AM Peak Hour



Movement	EBL	EBT	EBR	WBL	WBT	WBR	NBL	NBT	NBR	SBL	SBT	SBR
Lane Configurations												
Traffic Volume (veh/h)	140	35	388	162	37	222	150	1018	49	58	663	64
Future Volume (veh/h)	140	35	388	162	37	222	150	1018	49	58	663	64
Initial Q (Qb), veh	0	0	0	0	0	0	0	0	0	0	0	0
Ped-Bike Adj(A_pbT)	1.00		1.00	1.00		1.00	1.00		1.00	1.00		1.00
Parking Bus, Adj	1.00	1.00	1.00	1.00	1.00	1.00	1.00	1.00	1.00	1.00	1.00	1.00
Work Zone On Approach		No			No			No			No	
Adj Sat Flow, veh/h/ln	1885	1885	1885	1900	1900	1900	1856	1856	1856	1841	1841	1841
Adj Flow Rate, veh/h	152	38	422	176	40	241	163	1107	53	63	721	70
Peak Hour Factor	0.92	0.92	0.92	0.92	0.92	0.92	0.92	0.92	0.92	0.92	0.92	0.92
Percent Heavy Veh, %	1	1	1	0	0	0	3	3	3	4	4	4
Cap, veh/h	185	443	375	209	470	398	230	1510	673	140	1296	126
Arrive On Green	0.10	0.23	0.23	0.12	0.25	0.25	0.02	0.14	0.14	0.01	0.13	0.13
Sat Flow, veh/h	1795	1885	1598	1810	1900	1610	3428	3526	1572	3401	3221	313
Grp Volume(v), veh/h	152	38	422	176	40	241	163	1107	53	63	391	400
Grp Sat Flow(s),veh/h/ln	1795	1885	1598	1810	1900	1610	1714	1763	1572	1700	1749	1784
Q Serve(g_s), s	8.3	1.6	23.5	9.5	1.6	13.2	4.7	30.1	2.9	1.8	21.0	21.0
Cycle Q Clear(g_c), s	8.3	1.6	23.5	9.5	1.6	13.2	4.7	30.1	2.9	1.8	21.0	21.0
Prop In Lane	1.00		1.00	1.00		1.00	1.00		1.00	1.00		0.18
Lane Grp Cap(c), veh/h	185	443	375	209	470	398	230	1510	673	140	704	718
V/C Ratio(X)	0.82	0.09	1.12	0.84	0.09	0.61	0.71	0.73	0.08	0.45	0.56	0.56
Avail Cap(c_a), veh/h	285	443	375	252	470	398	271	1510	673	170	704	718
HCM Platoon Ratio	1.00	1.00	1.00	1.00	1.00	1.00	0.33	0.33	0.33	0.33	0.33	0.33
Upstream Filter(I)	1.00	1.00	1.00	1.00	1.00	1.00	0.81	0.81	0.81	0.76	0.76	0.76
Uniform Delay (d), s/veh	43.9	29.9	38.3	43.3	28.9	33.3	47.9	37.5	25.8	48.2	35.0	35.0
Incr Delay (d2), s/veh	10.5	0.1	84.5	19.2	0.1	2.6	5.6	2.6	0.2	1.7	2.4	2.4
Initial Q Delay(d3),s/veh	0.0	0.0	0.0	0.0	0.0	0.0	0.0	0.0	0.0	0.0	0.0	0.0
%ile BackOfQ(50%),veh/ln	4.2	0.7	17.8	5.3	0.7	5.4	2.2	14.7	1.1	0.8	10.2	10.5
Unsig. Movement Delay, s/veh												
LnGrp Delay(d),s/veh	54.4	29.9	122.8	62.5	29.0	35.9	53.5	40.1	26.0	49.9	37.4	37.4
LnGrp LOS	D	C	F	E	C	D	D	D	C	D	D	D
Approach Vol, veh/h		612			457			1323			854	
Approach Delay, s/veh		100.0			45.6			41.2			38.3	
Approach LOS		F			D			D			D	
Timer - Assigned Phs	1	2	3	4	5	6	7	8				
Phs Duration (G+Y+Rc), s	8.6	47.3	16.0	28.0	11.2	44.7	14.8	29.2				
Change Period (Y+Rc), s	4.5	4.5	4.5	4.5	4.5	4.5	4.5	4.5				
Max Green Setting (Gmax), s	39.6	39.6	13.9	23.5	7.9	36.7	15.9	21.5				
Max Q Clear Time (g_c+1), s	32.1	32.1	11.5	25.5	6.7	23.0	10.3	15.2				
Green Ext Time (p_c), s	0.0	4.5	0.1	0.0	0.1	4.3	0.2	0.5				
Intersection Summary												
HCM 6th Ctrl Delay											52.1	
HCM 6th LOS											D	

HCM 6th Signalized Intersection Summary

9: Road 23 & Cleveland Avenue

Village D Specific Plan
Existing WP MIT - AM Peak Hour



Movement	EBL	EBT	EBR	WBL	WBT	WBR	NBL	NBT	NBR	SBL	SBT	SBR
Lane Configurations	↖↗	↑↑	↖↗	↖↗	↑↑	↖	↖↗	↑↑	↖	↖↗	↑↑	↖
Traffic Volume (veh/h)	407	230	622	303	236	234	352	583	296	354	666	213
Future Volume (veh/h)	407	230	622	303	236	234	352	583	296	354	666	213
Initial Q (Qb), veh	0	0	0	0	0	0	0	0	0	0	0	0
Ped-Bike Adj(A_pbT)	1.00		1.00	1.00		1.00	1.00		1.00	1.00		0.99
Parking Bus, Adj	1.00	1.00	1.00	1.00	1.00	1.00	1.00	1.00	1.00	1.00	1.00	1.00
Work Zone On Approach		No			No			No			No	
Adj Sat Flow, veh/h/ln	1900	1900	1900	1885	1885	1885	1856	1856	1856	1856	1856	1856
Adj Flow Rate, veh/h	442	250	676	329	257	254	383	634	322	385	724	232
Peak Hour Factor	0.92	0.92	0.92	0.92	0.92	0.92	0.92	0.92	0.92	0.92	0.92	0.92
Percent Heavy Veh, %	0	0	0	1	1	1	3	3	3	3	3	3
Cap, veh/h	528	692	926	416	575	470	463	1324	778	458	1318	817
Arrive On Green	0.15	0.19	0.19	0.12	0.16	0.16	0.23	0.63	0.63	0.04	0.12	0.12
Sat Flow, veh/h	3510	3610	2834	3483	3582	1598	3428	3526	1572	3428	3526	1553
Grp Volume(v), veh/h	442	250	676	329	257	254	383	634	322	385	724	232
Grp Sat Flow(s),veh/h/ln	1755	1805	1417	1742	1791	1598	1714	1763	1572	1714	1763	1553
Q Serve(g_s), s	12.2	6.0	19.2	9.2	6.5	13.3	10.6	9.6	9.4	11.1	19.3	10.5
Cycle Q Clear(g_c), s	12.2	6.0	19.2	9.2	6.5	13.3	10.6	9.6	9.4	11.1	19.3	10.5
Prop In Lane	1.00		1.00	1.00		1.00	1.00		1.00	1.00		1.00
Lane Grp Cap(c), veh/h	528	692	926	416	575	470	463	1324	778	458	1318	817
V/C Ratio(X)	0.84	0.36	0.73	0.79	0.45	0.54	0.83	0.48	0.41	0.84	0.55	0.28
Avail Cap(c_a), veh/h	681	692	926	679	648	502	703	1324	778	494	1318	817
HCM Platoon Ratio	1.00	1.00	1.00	1.00	1.00	1.00	1.67	1.67	1.67	0.33	0.33	0.33
Upstream Filter(I)	0.68	0.68	0.68	0.97	0.97	0.97	0.89	0.89	0.89	0.67	0.67	0.67
Uniform Delay (d), s/veh	41.3	35.1	29.8	42.8	37.9	29.6	37.6	13.4	9.0	46.7	35.9	19.3
Incr Delay (d2), s/veh	5.0	0.2	2.0	3.3	0.5	1.0	4.5	1.1	1.4	8.2	1.1	0.6
Initial Q Delay(d3),s/veh	0.0	0.0	0.0	0.0	0.0	0.0	0.0	0.0	0.0	0.0	0.0	0.0
%ile BackOfQ(50%),veh/ln	5.6	2.6	7.3	4.1	2.9	5.2	4.3	3.3	2.8	5.6	9.3	4.4
Unsig. Movement Delay, s/veh												
LnGrp Delay(d),s/veh	46.3	35.3	31.8	46.1	38.5	30.6	42.1	14.5	10.5	54.9	37.0	19.9
LnGrp LOS	D	D	C	D	D	C	D	B	B	D	D	B
Approach Vol, veh/h		1368			840			1339			1341	
Approach Delay, s/veh		37.1			39.1			21.4			39.2	
Approach LOS		D			D			C			D	
Timer - Assigned Phs	1	2	3	4	5	6	7	8				
Phs Duration (G+Y+Rc), s	17.9	42.1	16.4	23.7	18.0	41.9	19.5	20.6				
Change Period (Y+Rc), s	4.5	4.5	4.5	4.5	4.5	4.5	4.5	4.5				
Max Green Setting (Gmax), s	11.4	30.1	19.5	18.0	20.5	24.0	19.4	18.1				
Max Q Clear Time (g_c+M), s	11.6	11.6	11.2	21.2	12.6	21.3	14.2	15.3				
Green Ext Time (p_c), s	0.2	5.4	0.8	0.0	0.9	1.5	0.8	0.7				
Intersection Summary												
HCM 6th Ctrl Delay											33.7	
HCM 6th LOS											C	

HCM 6th Signalized Intersection Summary
 10: Road 23 & Avenue 14 1/2

Village D Specific Plan
 Existing WP MIT - AM Peak Hour



Movement	EBL	EBT	EBR	WBL	WBT	WBR	NBL	NBT	NBR	SBL	SBT	SBR
Lane Configurations		↕			↕	↕	↕	↕↕		↕	↕↕	
Traffic Volume (veh/h)	0	5	0	16	3	182	3	584	4	216	1121	0
Future Volume (veh/h)	0	5	0	16	3	182	3	584	4	216	1121	0
Initial Q (Qb), veh	0	0	0	0	0	0	0	0	0	0	0	0
Ped-Bike Adj(A_pbT)	1.00		1.00	1.00		1.00	1.00		1.00	1.00		1.00
Parking Bus, Adj	1.00	1.00	1.00	1.00	1.00	1.00	1.00	1.00	1.00	1.00	1.00	1.00
Work Zone On Approach		No			No			No			No	
Adj Sat Flow, veh/h/ln	1900	1900	1900	1900	1900	1900	1811	1811	1811	1856	1856	1856
Adj Flow Rate, veh/h	0	6	0	19	4	214	4	687	5	254	1319	0
Peak Hour Factor	0.85	0.85	0.85	0.85	0.85	0.85	0.85	0.85	0.85	0.85	0.85	0.85
Percent Heavy Veh, %	0	0	0	0	0	0	6	6	6	3	3	3
Cap, veh/h	0	291	0	250	47	247	9	1911	14	293	2490	0
Arrive On Green	0.00	0.15	0.00	0.15	0.15	0.15	0.01	1.00	1.00	0.17	0.71	0.00
Sat Flow, veh/h	0	1900	0	1202	305	1610	1725	3502	25	1767	3618	0
Grp Volume(v), veh/h	0	6	0	23	0	214	4	338	354	254	1319	0
Grp Sat Flow(s),veh/h/ln	0	1900	0	1507	0	1610	1725	1721	1806	1767	1763	0
Q Serve(g_s), s	0.0	0.3	0.0	0.8	0.0	13.0	0.2	0.0	0.0	14.0	17.6	0.0
Cycle Q Clear(g_c), s	0.0	0.3	0.0	1.2	0.0	13.0	0.2	0.0	0.0	14.0	17.6	0.0
Prop In Lane	0.00		0.00	0.83		1.00	1.00		0.01	1.00		0.00
Lane Grp Cap(c), veh/h	0	291	0	297	0	247	9	939	986	293	2490	0
V/C Ratio(X)	0.00	0.02	0.00	0.08	0.00	0.87	0.44	0.36	0.36	0.87	0.53	0.00
Avail Cap(c_a), veh/h	0	390	0	374	0	330	95	939	986	504	2490	0
HCM Platoon Ratio	1.00	1.00	1.00	1.00	1.00	1.00	2.00	2.00	2.00	1.00	1.00	1.00
Upstream Filter(I)	0.00	1.00	0.00	1.00	0.00	1.00	0.95	0.95	0.95	0.78	0.78	0.00
Uniform Delay (d), s/veh	0.0	36.0	0.0	36.3	0.0	41.3	49.3	0.0	0.0	40.6	6.9	0.0
Incr Delay (d2), s/veh	0.0	0.0	0.0	0.1	0.0	16.6	28.8	1.0	1.0	6.3	0.6	0.0
Initial Q Delay(d3),s/veh	0.0	0.0	0.0	0.0	0.0	0.0	0.0	0.0	0.0	0.0	0.0	0.0
%ile BackOfQ(50%),veh/ln	0.0	0.1	0.0	0.5	0.0	6.2	0.2	0.3	0.3	6.5	5.8	0.0
Unsig. Movement Delay, s/veh												
LnGrp Delay(d),s/veh	0.0	36.0	0.0	36.4	0.0	58.0	78.2	1.0	1.0	46.9	7.5	0.0
LnGrp LOS	A	D	A	D	A	E	E	A	A	D	A	A
Approach Vol, veh/h		6			237			696			1573	
Approach Delay, s/veh		36.0			55.9			1.4			13.9	
Approach LOS		D			E			A			B	
Timer - Assigned Phs	1	2		4	5	6		8				
Phs Duration (G+Y+Rc), s	31.1	59.1		19.8	5.0	75.1		19.8				
Change Period (Y+Rc), s	4.5	4.5		4.5	4.5	4.5		4.5				
Max Green Setting (Gmax), s	20.5	37.5		20.5	5.5	60.5		20.5				
Max Q Clear Time (g_c+10), s	10.0	2.0		2.3	2.2	19.6		15.0				
Green Ext Time (p_c), s	0.6	4.9		0.0	0.0	13.8		0.4				

Intersection Summary

HCM 6th Ctrl Delay	14.5
HCM 6th LOS	B

HCM 6th Signalized Intersection Summary
 11: Road 23 & Avenue 14

Village D Specific Plan
 Existing WP MIT - AM Peak Hour



Movement	EBL	EBT	EBR	WBL	WBT	WBR	NBL	NBT	NBR	SBL	SBT	SBR
Lane Configurations	↖	↗		↖	↑	↗	↖	↗		↖	↗	↖
Traffic Volume (veh/h)	84	145	18	19	176	332	24	177	8	688	305	144
Future Volume (veh/h)	84	145	18	19	176	332	24	177	8	688	305	144
Initial Q (Qb), veh	0	0	0	0	0	0	0	0	0	0	0	0
Ped-Bike Adj(A_pbT)	1.00		1.00	1.00		1.00	1.00		1.00	1.00		1.00
Parking Bus, Adj	1.00	1.00	1.00	1.00	1.00	1.00	1.00	1.00	1.00	1.00	1.00	1.00
Work Zone On Approach		No			No			No			No	
Adj Sat Flow, veh/h/ln	1826	1826	1826	1841	1841	1841	1663	1663	1663	1856	1856	1856
Adj Flow Rate, veh/h	111	191	24	25	232	437	32	233	11	905	401	189
Peak Hour Factor	0.76	0.76	0.76	0.76	0.76	0.76	0.76	0.76	0.76	0.76	0.76	0.76
Percent Heavy Veh, %	5	5	5	4	4	4	16	16	16	3	3	3
Cap, veh/h	138	334	42	44	286	1242	47	885	42	1019	1959	874
Arrive On Green	0.08	0.21	0.21	0.03	0.16	0.16	0.03	0.29	0.29	0.10	0.18	0.18
Sat Flow, veh/h	1739	1590	200	1753	1841	2745	1584	3072	144	3428	3526	1572
Grp Volume(v), veh/h	111	0	215	25	232	437	32	119	125	905	401	189
Grp Sat Flow(s),veh/h/ln	1739	0	1790	1753	1841	1373	1584	1580	1637	1714	1763	1572
Q Serve(g_s), s	6.3	0.0	10.8	1.4	12.2	10.4	2.0	5.8	5.9	26.1	9.7	10.2
Cycle Q Clear(g_c), s	6.3	0.0	10.8	1.4	12.2	10.4	2.0	5.8	5.9	26.1	9.7	10.2
Prop In Lane	1.00		0.11	1.00		1.00	1.00		0.09	1.00		1.00
Lane Grp Cap(c), veh/h	138	0	375	44	286	1242	47	455	471	1019	1959	874
V/C Ratio(X)	0.80	0.00	0.57	0.57	0.81	0.35	0.69	0.26	0.26	0.89	0.20	0.22
Avail Cap(c_a), veh/h	183	0	415	102	341	1324	108	455	471	1114	1959	874
HCM Platoon Ratio	1.00	1.00	1.00	1.00	1.00	1.00	1.00	1.00	1.00	0.33	0.33	0.33
Upstream Filter(I)	1.00	0.00	1.00	0.83	0.83	0.83	1.00	1.00	1.00	0.88	0.88	0.88
Uniform Delay (d), s/veh	45.3	0.0	35.5	48.2	40.8	17.8	48.1	27.4	27.4	43.5	22.1	22.3
Incr Delay (d2), s/veh	17.2	0.0	1.6	9.3	10.0	0.1	16.3	1.4	1.4	7.6	0.2	0.5
Initial Q Delay(d3),s/veh	0.0	0.0	0.0	0.0	0.0	0.0	0.0	0.0	0.0	0.0	0.0	0.0
%ile BackOfQ(50%),veh/ln	8.3	0.0	4.8	0.7	6.3	3.2	1.0	2.4	2.5	13.0	4.5	4.3
Unsig. Movement Delay, s/veh												
LnGrp Delay(d),s/veh	62.4	0.0	37.0	57.5	50.9	18.0	64.4	28.8	28.8	51.0	22.3	22.8
LnGrp LOS	E	A	D	E	D	B	E	C	C	D	C	C
Approach Vol, veh/h		326			694			276			1495	
Approach Delay, s/veh		45.7			30.4			32.9			39.8	
Approach LOS		D			C			C			D	
Timer - Assigned Phs	1	2	3	4	5	6	7	8				
Phs Duration (G+Y+Rc), s	34.2	33.3	7.0	25.5	7.4	60.1	12.4	20.0				
Change Period (Y+Rc), s	4.5	4.5	4.5	4.5	4.5	4.5	4.5	4.5				
Max Green Setting (Gmax), s	32.5	20.5	5.8	23.2	6.8	46.2	10.5	18.5				
Max Q Clear Time (g_c+20), s	20.1	7.9	3.4	12.8	4.0	12.2	8.3	14.2				
Green Ext Time (p_c), s	1.6	1.0	0.0	0.8	0.0	3.6	0.0	1.4				
Intersection Summary												
HCM 6th Ctrl Delay											37.4	
HCM 6th LOS											D	

HCM 6th Signalized Intersection Summary
 13: Airport Drive/Golden State Boulevard & Avenue 17

Village D Specific Plan
 Existing WP MIT - AM Peak Hour



Movement	EBL	EBT	EBR	WBL	WBT	WBR	NBL	NBT	NBR	SBL	SBT	SBR
Lane Configurations	↘	↑↑	↗	↘	↑↑	↗	↘	↑	↗	↘	↗	↘
Traffic Volume (veh/h)	4	1146	240	127	478	85	100	25	64	88	19	4
Future Volume (veh/h)	4	1146	240	127	478	85	100	25	64	88	19	4
Initial Q (Qb), veh	0	0	0	0	0	0	0	0	0	0	0	0
Ped-Bike Adj(A_pbT)	1.00		1.00	1.00		1.00	1.00		1.00	1.00		1.00
Parking Bus, Adj	1.00	1.00	1.00	1.00	1.00	1.00	1.00	1.00	1.00	1.00	1.00	1.00
Work Zone On Approach		No			No			No			No	
Adj Sat Flow, veh/h/ln	1885	1885	1885	1841	1841	1841	1796	1796	1796	1767	1767	1767
Adj Flow Rate, veh/h	4	1259	264	140	525	93	110	27	70	97	21	4
Peak Hour Factor	0.91	0.91	0.91	0.91	0.91	0.91	0.91	0.91	0.91	0.91	0.91	0.91
Percent Heavy Veh, %	1	1	1	4	4	4	7	7	7	9	9	9
Cap, veh/h	9	1398	624	167	1681	750	136	471	399	121	367	70
Arrive On Green	0.01	0.39	0.39	0.19	0.96	0.96	0.08	0.26	0.26	0.07	0.25	0.25
Sat Flow, veh/h	1795	3582	1598	1753	3497	1560	1711	1796	1521	1682	1442	275
Grp Volume(v), veh/h	4	1259	264	140	525	93	110	27	70	97	0	25
Grp Sat Flow(s),veh/h/ln	1795	1791	1598	1753	1749	1560	1711	1796	1521	1682	0	1717
Q Serve(g_s), s	0.2	33.0	12.1	7.7	0.8	0.3	6.3	1.1	3.6	5.7	0.0	1.1
Cycle Q Clear(g_c), s	0.2	33.0	12.1	7.7	0.8	0.3	6.3	1.1	3.6	5.7	0.0	1.1
Prop In Lane	1.00		1.00	1.00		1.00	1.00		1.00	1.00		0.16
Lane Grp Cap(c), veh/h	9	1398	624	167	1681	750	136	471	399	121	0	437
V/C Ratio(X)	0.42	0.90	0.42	0.84	0.31	0.12	0.81	0.06	0.18	0.80	0.00	0.06
Avail Cap(c_a), veh/h	90	1451	647	202	1681	750	166	471	399	160	0	437
HCM Platoon Ratio	1.00	1.00	1.00	2.00	2.00	2.00	1.00	1.00	1.00	1.00	1.00	1.00
Upstream Filter(I)	1.00	1.00	1.00	0.95	0.95	0.95	1.00	1.00	1.00	1.00	0.00	1.00
Uniform Delay (d), s/veh	49.6	28.7	22.3	39.7	1.0	1.0	45.3	27.6	28.5	45.7	0.0	28.2
Incr Delay (d2), s/veh	27.4	7.9	0.5	21.1	0.1	0.1	21.0	0.2	1.0	19.0	0.0	0.2
Initial Q Delay(d3),s/veh	0.0	0.0	0.0	0.0	0.0	0.0	0.0	0.0	0.0	0.0	0.0	0.0
%ile BackOfQ(50%),veh/ln	0.2	15.2	4.5	4.0	0.3	0.1	3.5	0.5	1.4	3.0	0.0	0.5
Unsig. Movement Delay, s/veh												
LnGrp Delay(d),s/veh	77.0	36.5	22.7	60.8	1.1	1.1	66.3	27.9	29.5	64.7	0.0	28.4
LnGrp LOS	E	D	C	E	A	A	E	C	C	E	A	C
Approach Vol, veh/h		1527			758			207			122	
Approach Delay, s/veh		34.2			12.1			48.8			57.3	
Approach LOS		C			B			D			E	
Timer - Assigned Phs	1	2	3	4	5	6	7	8				
Phs Duration (G+Y+Rc), s	1.7	30.7	14.0	43.5	12.5	30.0	5.0	52.6				
Change Period (Y+Rc), s	4.5	4.5	4.5	4.5	4.5	4.5	4.5	4.5				
Max Green Setting (Gmax), s	5	20.5	11.5	40.5	9.7	20.3	5.0	47.0				
Max Q Clear Time (g_c+1T), s	5	5.6	9.7	35.0	8.3	3.1	2.2	2.8				
Green Ext Time (p_c), s	0.0	0.2	0.1	4.0	0.0	0.1	0.0	4.4				
Intersection Summary												
HCM 6th Ctrl Delay											30.1	
HCM 6th LOS											C	

HCM 6th Signalized Intersection Summary
 14: Avenue 17 & SR-99 Southbound Off-Ramp

Village D Specific Plan
 Existing WP MIT - AM Peak Hour

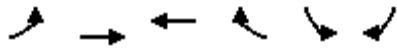

Movement	EBL	EBT	WBT	WBR	SBL	SBR
Lane Configurations		↑↑	↑↑		↵	↵
Traffic Volume (veh/h)	0	1301	653	0	59	42
Future Volume (veh/h)	0	1301	653	0	59	42
Initial Q (Qb), veh	0	0	0	0	0	0
Ped-Bike Adj(A_pbT)	1.00			1.00	1.00	1.00
Parking Bus, Adj	1.00	1.00	1.00	1.00	1.00	1.00
Work Zone On Approach		No	No		No	
Adj Sat Flow, veh/h/ln	0	1870	1841	0	1618	1618
Adj Flow Rate, veh/h	0	1462	734	0	66	47
Peak Hour Factor	0.89	0.89	0.89	0.89	0.89	0.89
Percent Heavy Veh, %	0	2	4	0	19	19
Cap, veh/h	0	1495	1471	0	754	671
Arrive On Green	0.00	0.84	0.84	0.00	0.49	0.49
Sat Flow, veh/h	0	3741	3681	0	1541	1372
Grp Volume(v), veh/h	0	1462	734	0	66	47
Grp Sat Flow(s),veh/h/ln	0	1777	1749	0	1541	1372
Q Serve(g_s), s	0.0	36.8	5.7	0.0	2.3	1.8
Cycle Q Clear(g_c), s	0.0	36.8	5.7	0.0	2.3	1.8
Prop In Lane	0.00			0.00	1.00	1.00
Lane Grp Cap(c), veh/h	0	1495	1471	0	754	671
V/C Ratio(X)	0.00	0.98	0.50	0.00	0.09	0.07
Avail Cap(c_a), veh/h	0	2434	2396	0	754	671
HCM Platoon Ratio	1.00	2.00	2.00	1.00	1.00	1.00
Upstream Filter(I)	0.00	0.45	1.00	0.00	1.00	1.00
Uniform Delay (d), s/veh	0.0	7.5	5.0	0.0	13.6	13.5
Incr Delay (d2), s/veh	0.0	5.7	0.3	0.0	0.2	0.2
Initial Q Delay(d3),s/veh	0.0	0.0	0.0	0.0	0.0	0.0
%ile BackOfQ(50%),veh/ln	0.0	4.2	1.5	0.0	0.8	0.6
Unsig. Movement Delay, s/veh						
LnGrp Delay(d),s/veh	0.0	13.2	5.3	0.0	13.9	13.7
LnGrp LOS	A	B	A	A	B	B
Approach Vol, veh/h		1462	734		113	
Approach Delay, s/veh		13.2	5.3		13.8	
Approach LOS		B	A		B	
Timer - Assigned Phs				4	6	8
Phs Duration (G+Y+Rc), s				52.0	48.0	52.0
Change Period (Y+Rc), s				4.5	4.5	4.5
Max Green Setting (Gmax), s				68.5	22.5	68.5
Max Q Clear Time (g_c+I1), s				38.8	4.3	7.7
Green Ext Time (p_c), s				14.2	0.3	6.2
Intersection Summary						
HCM 6th Ctrl Delay			10.7			
HCM 6th LOS			B			

HCM 6th Signalized Intersection Summary
 15: SR-99 Northbound Ramps & Avenue 17

Village D Specific Plan
 Existing WP MIT - AM Peak Hour



Movement	EBL	EBT	EBR	WBL	WBT	WBR	NBL	NBT	NBR	SBL	SBT	SBR
Lane Configurations												
Traffic Volume (veh/h)	52	557	0	0	818	100	333	1	0	0	0	0
Future Volume (veh/h)	52	557	0	0	818	100	333	1	0	0	0	0
Initial Q (Qb), veh	0	0	0	0	0	0	0	0	0			
Ped-Bike Adj(A_pbT)	1.00		1.00	1.00		1.00	1.00		1.00			
Parking Bus, Adj	1.00	1.00	1.00	1.00	1.00	1.00	1.00	1.00	1.00			
Work Zone On Approach	No				No				No			
Adj Sat Flow, veh/h/ln	1856	1856	0	0	1856	1856	1841	1841	1841			
Adj Flow Rate, veh/h	57	605	0	0	889	109	363	0	0			
Peak Hour Factor	0.92	0.92	0.92	0.92	0.92	0.92	0.92	0.92	0.92			
Percent Heavy Veh, %	3	3	0	0	3	3	4	4	4			
Cap, veh/h	73	1516	0	0	1086	133	1683	0	749			
Arrive On Green	0.08	0.86	0.00	0.00	0.34	0.34	0.48	0.00	0.00			
Sat Flow, veh/h	1767	3618	0	0	3254	388	3506	0	1560			
Grp Volume(v), veh/h	57	605	0	0	496	502	363	0	0			
Grp Sat Flow(s),veh/h/ln	1767	1763	0	0	1763	1786	1753	0	1560			
Q Serve(g_s), s	3.2	3.7	0.0	0.0	25.7	25.7	6.0	0.0	0.0			
Cycle Q Clear(g_c), s	3.2	3.7	0.0	0.0	25.7	25.7	6.0	0.0	0.0			
Prop In Lane	1.00		0.00	0.00		0.22	1.00		1.00			
Lane Grp Cap(c), veh/h	73	1516	0	0	606	614	1683	0	749			
V/C Ratio(X)	0.78	0.40	0.00	0.00	0.82	0.82	0.22	0.00	0.00			
Avail Cap(c_a), veh/h	203	2239	0	0	837	848	1683	0	749			
HCM Platoon Ratio	2.00	2.00	1.00	1.00	1.00	1.00	1.00	1.00	1.00			
Upstream Filter(I)	1.00	1.00	0.00	0.00	1.00	1.00	1.00	0.00	0.00			
Uniform Delay (d), s/veh	45.4	4.2	0.0	0.0	30.0	30.0	15.1	0.0	0.0			
Incr Delay (d2), s/veh	16.2	0.2	0.0	0.0	4.6	4.5	0.3	0.0	0.0			
Initial Q Delay(d3),s/veh	0.0	0.0	0.0	0.0	0.0	0.0	0.0	0.0	0.0			
%ile BackOfQ(50%),veh/ln	1.7	1.0	0.0	0.0	11.4	11.5	2.4	0.0	0.0			
Unsig. Movement Delay, s/veh												
LnGrp Delay(d),s/veh	61.6	4.4	0.0	0.0	34.5	34.5	15.4	0.0	0.0			
LnGrp LOS	E	A	A	A	C	C	B	A	A			
Approach Vol, veh/h	662				998		363					
Approach Delay, s/veh	9.3				34.5		15.4					
Approach LOS	A				C		B					
Timer - Assigned Phs	2		4		7		8					
Phs Duration (G+Y+Rc), s	52.5		47.5		8.6		38.9					
Change Period (Y+Rc), s	4.5		4.5		4.5		4.5					
Max Green Setting (Gmax), s	27.5		63.5		11.5		47.5					
Max Q Clear Time (g_c+I1), s	8.0		5.7		5.2		27.7					
Green Ext Time (p_c), s	1.2		4.8		0.0		6.7					

Intersection Summary

HCM 6th Ctrl Delay	22.8
HCM 6th LOS	C

Notes

User approved volume balancing among the lanes for turning movement.

HCM 6th Signalized Intersection Summary
 17: Westberry Boulevard & Cleveland Avenue

Village D Specific Plan
 Existing WP MIT - AM Peak Hour



Movement	EBL	EBT	EBR	WBL	WBT	WBR	NBL	NBT	NBR	SBL	SBT	SBR
Lane Configurations												
Traffic Volume (veh/h)	377	899	55	20	394	12	26	35	57	14	19	140
Future Volume (veh/h)	377	899	55	20	394	12	26	35	57	14	19	140
Initial Q (Qb), veh	0	0	0	0	0	0	0	0	0	0	0	0
Ped-Bike Adj(A_pbT)	1.00		1.00	1.00		0.99	1.00		1.00	1.00		0.99
Parking Bus, Adj	1.00	1.00	1.00	1.00	1.00	1.00	1.00	1.00	1.00	1.00	1.00	1.00
Work Zone On Approach		No		No		No		No		No		No
Adj Sat Flow, veh/h/ln	1900	1900	1900	1885	1885	1885	1900	1900	1900	1900	1900	1900
Adj Flow Rate, veh/h	454	1083	66	24	475	14	31	42	69	17	23	169
Peak Hour Factor	0.83	0.83	0.83	0.83	0.83	0.83	0.83	0.83	0.83	0.83	0.83	0.83
Percent Heavy Veh, %	0	0	0	1	1	1	0	0	0	0	0	0
Cap, veh/h	496	1425	87	44	577	17	52	693	586	34	673	563
Arrive On Green	0.27	0.41	0.41	0.02	0.16	0.16	0.03	0.36	0.36	0.02	0.35	0.35
Sat Flow, veh/h	1810	3456	211	1795	3552	105	1810	1900	1609	1810	1900	1589
Grp Volume(v), veh/h	454	565	584	24	239	250	31	42	69	17	23	169
Grp Sat Flow(s),veh/h/ln	1810	1805	1861	1795	1791	1866	1810	1900	1609	1810	1900	1589
Q Serve(g_s), s	24.3	26.8	26.8	1.3	12.9	12.9	1.7	1.4	2.8	0.9	0.8	7.7
Cycle Q Clear(g_c), s	24.3	26.8	26.8	1.3	12.9	12.9	1.7	1.4	2.8	0.9	0.8	7.7
Prop In Lane	1.00		0.11	1.00		0.06	1.00		1.00	1.00		1.00
Lane Grp Cap(c), veh/h	496	744	768	44	291	303	52	693	586	34	673	563
V/C Ratio(X)	0.91	0.76	0.76	0.55	0.82	0.82	0.59	0.06	0.12	0.50	0.03	0.30
Avail Cap(c_a), veh/h	660	910	938	101	349	364	100	693	586	90	673	563
HCM Platoon Ratio	1.00	1.00	1.00	1.00	1.00	1.00	1.00	1.00	1.00	1.00	1.00	1.00
Upstream Filter(I)	1.00	1.00	1.00	1.00	1.00	1.00	1.00	1.00	1.00	1.00	1.00	1.00
Uniform Delay (d), s/veh	35.2	25.1	25.2	48.2	40.5	40.5	48.0	20.6	21.1	48.6	21.1	23.3
Incr Delay (d2), s/veh	14.4	3.0	2.9	10.3	12.5	12.3	10.3	0.2	0.4	10.9	0.1	1.4
Initial Q Delay(d3),s/veh	0.0	0.0	0.0	0.0	0.0	0.0	0.0	0.0	0.0	0.0	0.0	0.0
%ile BackOfQ(50%),veh/ln	12.5	11.7	12.1	0.7	6.6	6.9	0.9	0.7	1.1	0.5	0.4	3.1
Unsig. Movement Delay, s/veh												
LnGrp Delay(d),s/veh	49.6	28.2	28.1	58.6	53.0	52.8	58.3	20.8	21.5	59.5	21.2	24.7
LnGrp LOS	D	C	C	E	D	D	E	C	C	E	C	C
Approach Vol, veh/h		1603			513			142			209	
Approach Delay, s/veh		34.2			53.1			29.3			27.1	
Approach LOS		C			D			C			C	
Timer - Assigned Phs	1	2	3	4	5	6	7	8				
Phs Duration (G+Y+Rc), s	6.4	41.0	6.9	45.7	7.4	39.9	31.9	20.7				
Change Period (Y+Rc), s	4.5	4.5	4.5	4.5	4.5	4.5	4.5	4.5				
Max Green Setting (Gmax), s	5.0	21.0	5.6	50.4	5.5	20.5	36.5	19.5				
Max Q Clear Time (g_c+1/2), s	12.0	4.8	3.3	28.8	3.7	9.7	26.3	14.9				
Green Ext Time (p_c), s	0.0	0.3	0.0	8.2	0.0	0.5	1.1	1.2				
Intersection Summary												
HCM 6th Ctrl Delay												37.3
HCM 6th LOS												D

HCM 6th Signalized Intersection Summary
 18: Westberry Boulevard & Sunset Avenue

Village D Specific Plan
 Existing WP MIT - AM Peak Hour



Movement	EBL	EBT	EBR	WBL	WBT	WBR	NBL	NBT	NBR	SBL	SBT	SBR
Lane Configurations												
Traffic Volume (veh/h)	63	282	85	47	203	22	122	102	101	110	81	41
Future Volume (veh/h)	63	282	85	47	203	22	122	102	101	110	81	41
Initial Q (Qb), veh	0	0	0	0	0	0	0	0	0	0	0	0
Ped-Bike Adj(A_pbT)	1.00		1.00	1.00		1.00	1.00		0.99	1.00		0.99
Parking Bus, Adj	1.00	1.00	1.00	1.00	1.00	1.00	1.00	1.00	1.00	1.00	1.00	1.00
Work Zone On Approach		No			No			No			No	
Adj Sat Flow, veh/h/ln	1870	1870	1870	1870	1870	1870	1900	1900	1900	1900	1900	1900
Adj Flow Rate, veh/h	91	409	123	68	294	32	177	148	146	159	117	59
Peak Hour Factor	0.69	0.69	0.69	0.69	0.69	0.69	0.69	0.69	0.69	0.69	0.69	0.69
Percent Heavy Veh, %	2	2	2	2	2	2	0	0	0	0	0	0
Cap, veh/h	463	568	171	306	683	74	233	318	266	210	293	245
Arrive On Green	0.41	0.41	0.41	0.41	0.41	0.41	0.13	0.17	0.17	0.12	0.15	0.15
Sat Flow, veh/h	1053	1380	415	871	1657	180	1810	1900	1591	1810	1900	1589
Grp Volume(v), veh/h	91	0	532	68	0	326	177	148	146	159	117	59
Grp Sat Flow(s),veh/h/ln1053	0	1794	871	0	1837	1810	1900	1591	1810	1900	1589	
Q Serve(g_s), s	3.0	0.0	11.0	3.1	0.0	5.6	4.2	3.1	3.7	3.8	2.5	1.4
Cycle Q Clear(g_c), s	8.6	0.0	11.0	14.1	0.0	5.6	4.2	3.1	3.7	3.8	2.5	1.4
Prop In Lane	1.00		0.23	1.00		0.10	1.00		1.00	1.00		1.00
Lane Grp Cap(c), veh/h	463	0	739	306	0	757	233	318	266	210	293	245
V/C Ratio(X)	0.20	0.00	0.72	0.22	0.00	0.43	0.76	0.47	0.55	0.76	0.40	0.24
Avail Cap(c_a), veh/h	802	0	1317	586	0	1348	552	922	772	511	880	736
HCM Platoon Ratio	1.00	1.00	1.00	1.00	1.00	1.00	1.00	1.00	1.00	1.00	1.00	1.00
Upstream Filter(l)	1.00	0.00	1.00	1.00	0.00	1.00	1.00	1.00	1.00	1.00	1.00	1.00
Uniform Delay (d), s/veh	12.4	0.0	10.9	16.8	0.0	9.3	18.6	16.7	16.9	19.0	16.9	16.5
Incr Delay (d2), s/veh	0.2	0.0	1.3	0.4	0.0	0.4	5.0	1.1	1.8	5.5	0.9	0.5
Initial Q Delay(d3),s/veh	0.0	0.0	0.0	0.0	0.0	0.0	0.0	0.0	0.0	0.0	0.0	0.0
%ile BackOfQ(50%),veh/ln	0.6	0.0	3.6	0.6	0.0	1.8	1.9	1.3	1.3	1.7	1.0	0.5
Unsig. Movement Delay, s/veh												
LnGrp Delay(d),s/veh	12.6	0.0	12.2	17.1	0.0	9.7	23.6	17.7	18.7	24.5	17.8	17.0
LnGrp LOS	B	A	B	B	A	A	C	B	B	C	B	B
Approach Vol, veh/h		623			394			471			335	
Approach Delay, s/veh		12.3			11.0			20.2			20.8	
Approach LOS		B			B			C			C	
Timer - Assigned Phs	1	2		4	5	6		8				
Phs Duration (G+Y+Rc), s	9.6	11.9		22.7	10.2	11.3		22.7				
Change Period (Y+Rc), s	4.5	4.5		4.5	4.5	4.5		4.5				
Max Green Setting (Gmax), s	12.5	21.5		32.5	13.5	20.5		32.5				
Max Q Clear Time (g_c+1), s	11.8	5.7		13.0	6.2	4.5		16.1				
Green Ext Time (p_c), s	0.2	1.1		3.9	0.3	0.7		2.1				

Intersection Summary

HCM 6th Ctrl Delay	15.6
HCM 6th LOS	B

HCM 6th Signalized Intersection Summary
 19: Westberry Boulevard & Avenue 14

Village D Specific Plan
 Existing WP MIT - AM Peak Hour



Movement	EBL	EBT	EBR	WBL	WBT	WBR	NBL	NBT	NBR	SBL	SBT	SBR
Lane Configurations												
Traffic Volume (veh/h)	101	731	54	11	390	95	82	36	24	162	55	76
Future Volume (veh/h)	101	731	54	11	390	95	82	36	24	162	55	76
Initial Q (Qb), veh	0	0	0	0	0	0	0	0	0	0	0	0
Ped-Bike Adj(A_pbT)	1.00		1.00	1.00		0.99	1.00		1.00	1.00		0.98
Parking Bus, Adj	1.00	1.00	1.00	1.00	1.00	1.00	1.00	1.00	1.00	1.00	1.00	1.00
Work Zone On Approach		No			No			No			No	
Adj Sat Flow, veh/h/ln	1900	1900	1900	1900	1900	1900	1900	1900	1900	1900	1900	1900
Adj Flow Rate, veh/h	117	850	63	13	453	110	95	42	28	188	64	88
Peak Hour Factor	0.86	0.86	0.86	0.86	0.86	0.86	0.86	0.86	0.86	0.86	0.86	0.86
Percent Heavy Veh, %	0	0	0	0	0	0	0	0	0	0	0	0
Cap, veh/h	153	1220	90	30	836	202	137	113	76	245	119	163
Arrive On Green	0.08	0.36	0.36	0.02	0.29	0.29	0.08	0.11	0.11	0.14	0.17	0.17
Sat Flow, veh/h	1810	3406	252	1810	2881	694	1810	1063	709	1810	714	982
Grp Volume(v), veh/h	117	450	463	13	282	281	95	0	70	188	0	152
Grp Sat Flow(s),veh/h/ln	1810	1805	1853	1810	1805	1771	1810	0	1772	1810	0	1697
Q Serve(g_s), s	3.0	10.0	10.0	0.3	6.2	6.3	2.4	0.0	1.7	4.7	0.0	3.9
Cycle Q Clear(g_c), s	3.0	10.0	10.0	0.3	6.2	6.3	2.4	0.0	1.7	4.7	0.0	3.9
Prop In Lane	1.00		0.14	1.00		0.39	1.00		0.40	1.00		0.58
Lane Grp Cap(c), veh/h	153	647	664	30	524	514	137	0	189	245	0	282
V/C Ratio(X)	0.77	0.70	0.70	0.43	0.54	0.55	0.69	0.00	0.37	0.77	0.00	0.54
Avail Cap(c_a), veh/h	366	942	967	193	769	754	374	0	755	482	0	824
HCM Platoon Ratio	1.00	1.00	1.00	1.00	1.00	1.00	1.00	1.00	1.00	1.00	1.00	1.00
Upstream Filter(I)	1.00	1.00	1.00	1.00	1.00	1.00	1.00	0.00	1.00	1.00	0.00	1.00
Uniform Delay (d), s/veh	21.0	12.9	12.9	22.9	14.0	14.0	21.2	0.0	19.5	19.6	0.0	17.9
Incr Delay (d2), s/veh	7.7	1.4	1.3	9.5	0.9	0.9	6.2	0.0	1.2	5.0	0.0	1.6
Initial Q Delay(d3),s/veh	0.0	0.0	0.0	0.0	0.0	0.0	0.0	0.0	0.0	0.0	0.0	0.0
%ile BackOfQ(50%),veh/ln	1.5	3.5	3.6	0.2	2.3	2.3	1.2	0.0	0.7	2.1	0.0	1.5
Unsig. Movement Delay, s/veh												
LnGrp Delay(d),s/veh	28.8	14.3	14.2	32.4	14.9	15.0	27.3	0.0	20.7	24.6	0.0	19.5
LnGrp LOS	C	B	B	C	B	B	C	A	C	C	A	B
Approach Vol, veh/h		1030			576			165			340	
Approach Delay, s/veh		15.9			15.3			24.5			22.3	
Approach LOS		B			B			C			C	
Timer - Assigned Phs	1	2	3	4	5	6	7	8				
Phs Duration (G+Y+Rc), s	10.8	9.5	5.3	21.3	8.1	12.3	8.5	18.1				
Change Period (Y+Rc), s	4.5	4.5	4.5	4.5	4.5	4.5	4.5	4.5				
Max Green Setting (Gmax), s	12.5	20.0	5.0	24.5	9.7	22.8	9.5	20.0				
Max Q Clear Time (g_c+10), s	10.7	3.7	2.3	12.0	4.4	5.9	5.0	8.3				
Green Ext Time (p_c), s	0.2	0.2	0.0	4.7	0.1	0.7	0.1	2.7				

Intersection Summary

HCM 6th Ctrl Delay	17.4
HCM 6th LOS	B

HCM 6th Signalized Intersection Summary
21: Granada Drive & Cleveland Avenue

Village D Specific Plan
Existing WP MIT - AM Peak Hour



Movement	EBL	EBT	EBR	WBL	WBT	WBR	NBL	NBT	NBR	SBL	SBT	SBR
Lane Configurations												
Traffic Volume (veh/h)	16	909	28	185	375	10	25	286	268	4	215	5
Future Volume (veh/h)	16	909	28	185	375	10	25	286	268	4	215	5
Initial Q (Qb), veh	0	0	0	0	0	0	0	0	0	0	0	0
Ped-Bike Adj(A_pbT)	1.00		0.98	1.00		1.00	1.00		0.99	1.00		1.00
Parking Bus, Adj	1.00	1.00	1.00	1.00	1.00	1.00	1.00	1.00	1.00	1.00	1.00	1.00
Work Zone On Approach		No			No			No			No	
Adj Sat Flow, veh/h/ln	1885	1885	1885	1870	1870	1870	1900	1900	1900	1900	1900	1900
Adj Flow Rate, veh/h	19	1082	33	220	446	12	30	340	319	5	256	6
Peak Hour Factor	0.84	0.84	0.84	0.84	0.84	0.84	0.84	0.84	0.84	0.84	0.84	0.84
Percent Heavy Veh, %	1	1	1	2	2	2	0	0	0	0	0	0
Cap, veh/h	39	1139	35	256	1568	42	55	577	481	12	531	449
Arrive On Green	0.02	0.32	0.32	0.10	0.30	0.30	0.03	0.30	0.30	0.01	0.28	0.28
Sat Flow, veh/h	1795	3545	108	1781	3535	95	1810	1900	1587	1810	1900	1607
Grp Volume(v), veh/h	19	546	569	220	224	234	30	340	319	5	256	6
Grp Sat Flow(s),veh/h/ln	1795	1791	1863	1781	1777	1853	1810	1900	1587	1810	1900	1607
Q Serve(g_s), s	0.8	23.8	23.9	9.7	7.7	7.8	1.3	12.1	14.0	0.2	9.0	0.2
Cycle Q Clear(g_c), s	0.8	23.8	23.9	9.7	7.7	7.8	1.3	12.1	14.0	0.2	9.0	0.2
Prop In Lane	1.00		0.06	1.00		0.05	1.00		1.00	1.00		1.00
Lane Grp Cap(c), veh/h	39	575	598	256	788	822	55	577	481	12	531	449
V/C Ratio(X)	0.49	0.95	0.95	0.86	0.28	0.28	0.55	0.59	0.66	0.42	0.48	0.01
Avail Cap(c_a), veh/h	112	575	598	256	788	822	115	577	481	113	531	449
HCM Platoon Ratio	1.00	1.00	1.00	0.67	0.67	0.67	1.00	1.00	1.00	1.00	1.00	1.00
Upstream Filter(I)	1.00	1.00	1.00	0.88	0.88	0.88	1.00	1.00	1.00	1.00	1.00	1.00
Uniform Delay (d), s/veh	38.7	26.5	26.5	35.3	18.4	18.4	38.2	23.6	24.3	39.6	24.0	20.8
Incr Delay (d2), s/veh	9.3	25.6	25.0	21.9	0.2	0.2	8.1	4.4	7.0	21.9	3.1	0.1
Initial Q Delay(d3),s/veh	0.0	0.0	0.0	0.0	0.0	0.0	0.0	0.0	0.0	0.0	0.0	0.0
%ile BackOfQ(50%),veh/ln	0.5	13.7	14.1	5.9	3.2	3.4	0.7	5.9	6.0	0.2	4.3	0.1
Unsig. Movement Delay, s/veh												
LnGrp Delay(d),s/veh	48.1	52.1	51.5	57.2	18.5	18.5	46.4	28.0	31.3	61.5	27.1	20.9
LnGrp LOS	D	D	D	E	B	B	D	C	C	E	C	C
Approach Vol, veh/h		1134			678			689			267	
Approach Delay, s/veh		51.7			31.1			30.3			27.6	
Approach LOS		D			C			C			C	
Timer - Assigned Phs	1	2	3	4	5	6	7	8				
Phs Duration (G+Y+Rc), s	5.0	28.8	16.0	30.2	6.9	26.9	6.2	40.0				
Change Period (Y+Rc), s	4.5	4.5	4.5	4.5	4.5	4.5	4.5	4.5				
Max Green Setting (Gmax), s	5.0	19.8	11.5	25.7	5.1	19.7	5.0	32.2				
Max Q Clear Time (g_c+I1), s	2.2	16.0	11.7	25.9	3.3	11.0	2.8	9.8				
Green Ext Time (p_c), s	0.0	1.2	0.0	0.0	0.0	0.9	0.0	2.7				

Intersection Summary

HCM 6th Ctrl Delay	39.0
HCM 6th LOS	D

HCM 6th Signalized Intersection Summary
 22: Granada Drive & Sunset Avenue

Village D Specific Plan
 Existing WP MIT - AM Peak Hour



Movement	EBL	EBT	EBR	WBL	WBT	WBR	NBL	NBT	NBR	SBL	SBT	SBR
Lane Configurations												
Traffic Volume (veh/h)	59	301	69	25	126	65	47	207	24	127	270	48
Future Volume (veh/h)	59	301	69	25	126	65	47	207	24	127	270	48
Initial Q (Qb), veh	0	0	0	0	0	0	0	0	0	0	0	0
Ped-Bike Adj(A_pbT)	1.00		1.00	1.00		1.00	1.00		0.99	1.00		0.97
Parking Bus, Adj	1.00	1.00	1.00	1.00	1.00	1.00	1.00	1.00	1.00	1.00	1.00	1.00
Work Zone On Approach		No			No			No			No	
Adj Sat Flow, veh/h/ln	1870	1870	1870	1826	1826	1826	1870	1870	1870	1870	1870	1870
Adj Flow Rate, veh/h	72	367	84	30	154	79	57	252	29	155	329	59
Peak Hour Factor	0.82	0.82	0.82	0.82	0.82	0.82	0.82	0.82	0.82	0.82	0.82	0.82
Percent Heavy Veh, %	2	2	2	5	5	5	2	2	2	2	2	2
Cap, veh/h	109	452	103	58	510	432	95	355	41	199	422	76
Arrive On Green	0.06	0.31	0.31	0.03	0.28	0.28	0.05	0.22	0.22	0.11	0.27	0.27
Sat Flow, veh/h	1781	1473	337	1739	1826	1547	1781	1645	189	1781	1536	275
Grp Volume(v), veh/h	72	0	451	30	154	79	57	0	281	155	0	388
Grp Sat Flow(s),veh/h/ln	1781	0	1810	1739	1826	1547	1781	0	1834	1781	0	1811
Q Serve(g_s), s	2.1	0.0	12.5	0.9	3.6	2.1	1.7	0.0	7.7	4.6	0.0	10.7
Cycle Q Clear(g_c), s	2.1	0.0	12.5	0.9	3.6	2.1	1.7	0.0	7.7	4.6	0.0	10.7
Prop In Lane	1.00		0.19	1.00		1.00	1.00		0.10	1.00		0.15
Lane Grp Cap(c), veh/h	109	0	555	58	510	432	95	0	396	199	0	497
V/C Ratio(X)	0.66	0.00	0.81	0.51	0.30	0.18	0.60	0.00	0.71	0.78	0.00	0.78
Avail Cap(c_a), veh/h	292	0	851	164	730	619	181	0	707	345	0	865
HCM Platoon Ratio	1.00	1.00	1.00	1.00	1.00	1.00	1.00	1.00	1.00	1.00	1.00	1.00
Upstream Filter(I)	1.00	0.00	1.00	1.00	1.00	1.00	1.00	0.00	1.00	1.00	0.00	1.00
Uniform Delay (d), s/veh	24.9	0.0	17.4	25.8	15.4	14.8	25.1	0.0	19.7	23.4	0.0	18.2
Incr Delay (d2), s/veh	6.7	0.0	3.5	6.9	0.3	0.2	6.0	0.0	2.4	6.4	0.0	2.7
Initial Q Delay(d3),s/veh	0.0	0.0	0.0	0.0	0.0	0.0	0.0	0.0	0.0	0.0	0.0	0.0
%ile BackOfQ(50%),veh/ln	0.0	0.0	5.1	0.5	1.4	0.7	0.8	0.0	3.2	2.1	0.0	4.3
Unsig. Movement Delay, s/veh												
LnGrp Delay(d),s/veh	31.6	0.0	20.9	32.6	15.7	15.0	31.1	0.0	22.1	29.8	0.0	20.9
LnGrp LOS	C	A	C	C	B	B	C	A	C	C	A	C
Approach Vol, veh/h		523			263			338			543	
Approach Delay, s/veh		22.4			17.4			23.6			23.4	
Approach LOS		C			B			C			C	
Timer - Assigned Phs	1	2	3	4	5	6	7	8				
Phs Duration (G+Y+Rc), s	10.6	16.2	6.3	21.1	7.4	19.4	7.8	19.7				
Change Period (Y+Rc), s	4.5	4.5	4.5	4.5	4.5	4.5	4.5	4.5				
Max Green Setting (Gmax), s	10.5	20.9	5.1	25.5	5.5	25.9	8.9	21.7				
Max Q Clear Time (g_c+1), s	10.6	9.7	2.9	14.5	3.7	12.7	4.1	5.6				
Green Ext Time (p_c), s	0.1	1.2	0.0	2.2	0.0	2.0	0.0	0.9				
Intersection Summary												
HCM 6th Ctrl Delay												22.2
HCM 6th LOS												C

Intersection

Intersection Delay, s/veh 13.7

Intersection LOS B

Movement	EBL	EBT	WBT	WBR	SBL	SBR
Lane Configurations						
Traffic Vol, veh/h	299	243	195	1	64	145
Future Vol, veh/h	299	243	195	1	64	145
Peak Hour Factor	0.86	0.86	0.86	0.86	0.86	0.86
Heavy Vehicles, %	2	2	6	6	3	3
Mvmt Flow	348	283	227	1	74	169
Number of Lanes	1	1	1	0	1	1

Approach	EB	WB	SB
Opposing Approach	WB	EB	
Opposing Lanes	1	2	0
Conflicting Approach Left SB			WB
Conflicting Lanes Left	2	0	1
Conflicting Approach Right		SB	EB
Conflicting Lanes Right	0	2	2
HCM Control Delay	15.2	12.4	11.1
HCM LOS	C	B	B

Lane	EBLn1	EBLn2	WBLn1	SBLn1	SBLn2
Vol Left, %	100%	0%	0%	100%	0%
Vol Thru, %	0%	100%	99%	0%	0%
Vol Right, %	0%	0%	1%	0%	100%
Sign Control	Stop	Stop	Stop	Stop	Stop
Traffic Vol by Lane	299	243	196	64	145
LT Vol	299	0	0	64	0
Through Vol	0	243	195	0	0
RT Vol	0	0	1	0	145
Lane Flow Rate	348	283	228	74	169
Geometry Grp	7	7	4	7	7
Degree of Util (X)	0.59	0.44	0.374	0.149	0.281
Departure Headway (Hd)	6.11	5.605	5.91	7.209	5.991
Convergence, Y/N	Yes	Yes	Yes	Yes	Yes
Cap	591	644	611	498	600
Service Time	3.834	3.329	3.937	4.942	3.724
HCM Lane V/C Ratio	0.589	0.439	0.373	0.149	0.282
HCM Control Delay	17.3	12.7	12.4	11.2	11.1
HCM Lane LOS	C	B	B	B	B
HCM 95th-tile Q	3.8	2.2	1.7	0.5	1.1

HCM 6th Signalized Intersection Summary
 31: SR-99 Southbound Ramps & Cleveland Avenue























Village D Specific Plan
 Existing WP MIT - AM Peak Hour



Movement	EBL	EBT	EBR	WBL	WBT	WBR	NBL	NBT	NBR	SBL	SBT	SBR
Lane Configurations		↑↑	↑	↑	↑↑					↑		↑
Traffic Volume (veh/h)	0	661	724	313	917	0	0	0	0	239	0	80
Future Volume (veh/h)	0	661	724	313	917	0	0	0	0	239	0	80
Initial Q (Qb), veh	0	0	0	0	0	0				0	0	0
Ped-Bike Adj(A_pbT)	1.00		1.00	1.00		1.00				1.00		1.00
Parking Bus, Adj	1.00	1.00	1.00	1.00	1.00	1.00				1.00	1.00	1.00
Work Zone On Approach		No			No						No	
Adj Sat Flow, veh/h/ln	0	1870	1870	1870	1870	0				1826	0	1826
Adj Flow Rate, veh/h	0	760	832	360	1054	0				275	0	92
Peak Hour Factor	0.87	0.87	0.87	0.87	0.87	0.87				0.87	0.87	0.87
Percent Heavy Veh, %	0	2	2	2	2	0				5	0	5
Cap, veh/h	0	1343	599	389	2296	0				442	0	393
Arrive On Green	0.00	0.38	0.38	0.44	1.00	0.00				0.25	0.00	0.25
Sat Flow, veh/h	0	3647	1585	1781	3647	0				1739	0	1547
Grp Volume(v), veh/h	0	760	832	360	1054	0				275	0	92
Grp Sat Flow(s),veh/h/ln	0	1777	1585	1781	1777	0				1739	0	1547
Q Serve(g_s), s	0.0	15.2	34.0	17.2	0.0	0.0				12.6	0.0	4.2
Cycle Q Clear(g_c), s	0.0	15.2	34.0	17.2	0.0	0.0				12.6	0.0	4.2
Prop In Lane	0.00		1.00	1.00		0.00				1.00		1.00
Lane Grp Cap(c), veh/h	0	1343	599	389	2296	0				442	0	393
V/C Ratio(X)	0.00	0.57	1.39	0.93	0.46	0.00				0.62	0.00	0.23
Avail Cap(c_a), veh/h	0	1343	599	457	2432	0				442	0	393
HCM Platoon Ratio	1.00	1.00	1.00	2.00	2.00	1.00				1.00	1.00	1.00
Upstream Filter(I)	0.00	0.59	0.59	0.65	0.65	0.00				1.00	0.00	1.00
Uniform Delay (d), s/veh	0.0	22.2	28.0	24.7	0.0	0.0				29.8	0.0	26.6
Incr Delay (d2), s/veh	0.0	0.3	181.4	16.7	0.1	0.0				2.7	0.0	0.3
Initial Q Delay(d3),s/veh	0.0	0.0	0.0	0.0	0.0	0.0				0.0	0.0	0.0
%ile BackOfQ(50%),veh/ln	0.0	6.2	42.3	6.9	0.0	0.0				5.5	0.0	1.6
Unsig. Movement Delay, s/veh												
LnGrp Delay(d),s/veh	0.0	22.5	209.4	41.4	0.1	0.0				32.5	0.0	26.9
LnGrp LOS	A	C	F	D	A	A				C	A	C
Approach Vol, veh/h		1592			1414					367		
Approach Delay, s/veh		120.2			10.6					31.1		
Approach LOS		F			B					C		
Timer - Assigned Phs			3	4		6		8				
Phs Duration (G+Y+Rc), s			24.1	38.5		27.4		62.6				
Change Period (Y+Rc), s			4.5	4.5		4.5		4.5				
Max Green Setting (Gmax), s			23.1	34.0		19.4		61.6				
Max Q Clear Time (g_c+I1), s			19.2	36.0		14.6		2.0				
Green Ext Time (p_c), s			0.4	0.0		0.5		10.3				
Intersection Summary												
HCM 6th Ctrl Delay		64.5										
HCM 6th LOS		E										

HCM 6th Signalized Intersection Summary
36: Pine Street & Howard Road

Village D Specific Plan
Existing WP MIT - AM Peak Hour

												
Movement	EBL	EBT	EBR	WBL	WBT	WBR	NBL	NBT	NBR	SBL	SBT	SBR
Lane Configurations												
Traffic Volume (veh/h)	33	998	175	126	575	6	153	154	222	16	253	97
Future Volume (veh/h)	33	998	175	126	575	6	153	154	222	16	253	97
Initial Q (Qb), veh	0	0	0	0	0	0	0	0	0	0	0	0
Ped-Bike Adj(A_pbT)	1.00		0.98	1.00		0.98	1.00		1.00	1.00		0.98
Parking Bus, Adj	1.00	1.00	1.00	1.00	1.00	1.00	1.00	1.00	1.00	1.00	1.00	1.00
Work Zone On Approach		No			No			No			No	
Adj Sat Flow, veh/h/ln	1885	1885	1885	1870	1870	1870	1811	1811	1811	1841	1841	1841
Adj Flow Rate, veh/h	39	1174	206	148	676	7	180	181	261	19	298	114
Peak Hour Factor	0.85	0.85	0.85	0.85	0.85	0.85	0.85	0.85	0.85	0.85	0.85	0.85
Percent Heavy Veh, %	1	1	1	2	2	2	6	6	6	4	4	4
Cap, veh/h	54	1203	210	171	1662	17	260	574	485	73	382	316
Arrive On Green	0.03	0.40	0.40	0.10	0.46	0.46	0.15	0.32	0.32	0.04	0.21	0.21
Sat Flow, veh/h	1795	3039	530	1781	3602	37	1725	1811	1530	1753	1841	1525
Grp Volume(v), veh/h	39	689	691	148	333	350	180	181	261	19	298	114
Grp Sat Flow(s),veh/h/ln	1795	1791	1778	1781	1777	1863	1725	1811	1530	1753	1841	1525
Q Serve(g_s), s	2.6	45.3	46.1	9.8	14.9	14.9	11.9	9.1	12.6	1.3	18.4	7.7
Cycle Q Clear(g_c), s	2.6	45.3	46.1	9.8	14.9	14.9	11.9	9.1	12.6	1.3	18.4	7.7
Prop In Lane	1.00		0.30	1.00		0.02	1.00		1.00	1.00		1.00
Lane Grp Cap(c), veh/h	54	709	704	171	820	859	260	574	485	73	382	316
V/C Ratio(X)	0.72	0.97	0.98	0.87	0.41	0.41	0.69	0.32	0.54	0.26	0.78	0.36
Avail Cap(c_a), veh/h	102	709	704	171	820	859	260	574	485	263	382	316
HCM Platoon Ratio	1.00	1.00	1.00	1.00	1.00	1.00	1.00	1.00	1.00	1.00	1.00	1.00
Upstream Filter(I)	1.00	1.00	1.00	0.90	0.90	0.90	1.00	1.00	1.00	1.00	1.00	1.00
Uniform Delay (d), s/veh	57.7	35.6	35.8	53.5	21.4	21.4	48.3	31.1	19.0	55.7	45.0	40.7
Incr Delay (d2), s/veh	16.1	26.9	29.3	31.9	0.3	0.3	14.1	1.4	4.2	1.9	10.0	0.7
Initial Q Delay(d3),s/veh	0.0	0.0	0.0	0.0	0.0	0.0	0.0	0.0	0.0	0.0	0.0	0.0
%ile BackOfQ(50%),veh/ln	1.4	24.6	25.2	5.9	6.3	6.6	6.1	4.2	5.0	0.6	9.4	3.0
Unsig. Movement Delay, s/veh												
LnGrp Delay(d),s/veh	73.7	62.5	65.1	85.4	21.7	21.7	62.4	32.6	23.2	57.6	54.9	41.4
LnGrp LOS	E	E	E	F	C	C	E	C	C	E	D	D
Approach Vol, veh/h		1419			831			622			431	
Approach Delay, s/veh		64.1			33.1			37.3			51.5	
Approach LOS		E			C			D			D	
Timer - Assigned Phs	1	2	3	4	5	6	7	8				
Phs Duration (G+Y+Rc), s	9.5	42.5	16.0	52.0	22.6	29.4	8.1	59.9				
Change Period (Y+Rc), s	4.5	4.5	4.5	4.5	4.5	4.5	4.5	4.5				
Max Green Setting (Gmax), s	18.0	25.0	11.5	47.5	18.1	24.9	6.8	52.2				
Max Q Clear Time (g_c+I1), s	3.3	14.6	11.8	48.1	13.9	20.4	4.6	16.9				
Green Ext Time (p_c), s	0.0	1.5	0.0	0.0	0.2	0.9	0.0	4.7				
Intersection Summary												
HCM 6th Ctrl Delay			49.6									
HCM 6th LOS			D									

HCM 6th Signalized Intersection Summary
 38: I Street & 2nd Street/SR-99 Southbound Off-Ramp























Village D Specific Plan
 Existing WP MIT - AM Peak Hour



Movement	EBL	EBT	EBR	WBL	WBT	WBR	NBL	NBT	NBR	SBL	SBT	SBR
Lane Configurations		↕			↕	↕	↕	↕			↕	
Traffic Volume (veh/h)	2	0	53	482	17	11	15	82	0	0	132	2
Future Volume (veh/h)	2	0	53	482	17	11	15	82	0	0	132	2
Initial Q (Qb), veh	0	0	0	0	0	0	0	0	0	0	0	0
Ped-Bike Adj(A_pbT)	1.00		0.99	1.00		0.98	1.00		1.00	1.00		1.00
Parking Bus, Adj	1.00	1.00	1.00	1.00	1.00	1.00	1.00	1.00	1.00	1.00	1.00	1.00
Work Zone On Approach		No			No			No			No	
Adj Sat Flow, veh/h/ln	1900	1900	1900	1856	1856	1856	1841	1841	0	0	1885	1885
Adj Flow Rate, veh/h	2	0	60	542	19	12	17	92	0	0	148	2
Peak Hour Factor	0.89	0.89	0.89	0.89	0.89	0.89	0.89	0.89	0.89	0.89	0.89	0.89
Percent Heavy Veh, %	0	0	0	3	3	3	4	4	0	0	1	1
Cap, veh/h	3	0	79	607	21	545	562	818	0	0	824	11
Arrive On Green	0.05	0.00	0.05	0.35	0.35	0.35	0.89	0.89	0.00	0.00	0.44	0.44
Sat Flow, veh/h	52	0	1550	1710	60	1536	1218	1841	0	0	1856	25
Grp Volume(v), veh/h	62	0	0	561	0	12	17	92	0	0	0	150
Grp Sat Flow(s),veh/h/ln	1602	0	0	1770	0	1536	1218	1841	0	0	0	1881
Q Serve(g_s), s	3.4	0.0	0.0	26.9	0.0	0.5	0.3	0.6	0.0	0.0	0.0	4.3
Cycle Q Clear(g_c), s	3.4	0.0	0.0	26.9	0.0	0.5	4.6	0.6	0.0	0.0	0.0	4.3
Prop In Lane	0.03		0.97	0.97		1.00	1.00		0.00	0.00		0.01
Lane Grp Cap(c), veh/h	82	0	0	628	0	545	562	818	0	0	0	835
V/C Ratio(X)	0.76	0.00	0.00	0.89	0.00	0.02	0.03	0.11	0.00	0.00	0.00	0.18
Avail Cap(c_a), veh/h	320	0	0	797	0	691	562	818	0	0	0	835
HCM Platoon Ratio	1.00	1.00	1.00	1.00	1.00	1.00	2.00	2.00	1.00	1.00	1.00	1.00
Upstream Filter(I)	1.00	0.00	0.00	1.00	0.00	1.00	0.99	0.99	0.00	0.00	0.00	1.00
Uniform Delay (d), s/veh	42.1	0.0	0.0	27.4	0.0	18.9	3.5	2.8	0.0	0.0	0.0	15.1
Incr Delay (d2), s/veh	13.2	0.0	0.0	10.6	0.0	0.0	0.1	0.3	0.0	0.0	0.0	0.5
Initial Q Delay(d3),s/veh	0.0	0.0	0.0	0.0	0.0	0.0	0.0	0.0	0.0	0.0	0.0	0.0
%ile BackOfQ(50%),veh/ln	6	0.0	0.0	12.7	0.0	0.2	0.1	0.3	0.0	0.0	0.0	1.9
Unsig. Movement Delay, s/veh												
LnGrp Delay(d),s/veh	55.4	0.0	0.0	38.0	0.0	18.9	3.6	3.1	0.0	0.0	0.0	15.6
LnGrp LOS	E	A	A	D	A	B	A	A	A	A	A	B
Approach Vol, veh/h		62			573			109			150	
Approach Delay, s/veh		55.4			37.6			3.2			15.6	
Approach LOS		E			D			A			B	
Timer - Assigned Phs		2		4		6		8				
Phs Duration (G+Y+Rc), s		44.5		9.1		44.5		36.4				
Change Period (Y+Rc), s		4.5		4.5		4.5		4.5				
Max Green Setting (Gmax), s		18.0		18.0		18.0		40.5				
Max Q Clear Time (g_c+I1), s		6.6		5.4		6.3		28.9				
Green Ext Time (p_c), s		0.3		0.2		0.5		3.0				
Intersection Summary												
HCM 6th Ctrl Delay				30.9								
HCM 6th LOS				C								

HCM 6th Signalized Intersection Summary
 49: Yosemite Avenue & Cleveland Avenue/Tozer Street

Village D Specific Plan
 Existing WP MIT - AM Peak Hour

												
Movement	EBL	EBT	EBR	WBL	WBT	WBR	NBL	NBT	NBR	SBL	SBT	SBR
Lane Configurations												
Traffic Volume (veh/h)	283	540	248	110	297	41	131	105	74	60	229	214
Future Volume (veh/h)	283	540	248	110	297	41	131	105	74	60	229	214
Initial Q (Qb), veh	0	0	0	0	0	0	0	0	0	0	0	0
Ped-Bike Adj(A_pbT)	1.00		0.93	1.00		0.92	1.00		1.00	1.00		1.00
Parking Bus, Adj	1.00	1.00	1.00	1.00	1.00	1.00	1.00	1.00	1.00	1.00	1.00	1.00
Work Zone On Approach		No			No			No			No	
Adj Sat Flow, veh/h/ln	1856	1856	1856	1841	1841	1841	1856	1856	1856	1870	1870	1870
Adj Flow Rate, veh/h	337	643	295	131	354	49	156	125	88	71	273	255
Peak Hour Factor	0.84	0.84	0.84	0.84	0.84	0.84	0.84	0.84	0.84	0.84	0.84	0.84
Percent Heavy Veh, %	3	3	3	4	4	4	3	3	3	2	2	2
Cap, veh/h	376	863	396	163	901	371	191	462	390	92	360	641
Arrive On Green	0.21	0.38	0.38	0.09	0.26	0.26	0.11	0.25	0.25	0.05	0.19	0.19
Sat Flow, veh/h	1767	2285	1048	1753	3497	1439	1767	1856	1567	1781	1870	1578
Grp Volume(v), veh/h	337	496	442	131	354	49	156	125	88	71	273	255
Grp Sat Flow(s),veh/h/ln	1767	1763	1570	1753	1749	1439	1767	1856	1567	1781	1870	1578
Q Serve(g_s), s	14.6	19.2	19.2	5.8	6.6	2.1	6.8	4.3	3.5	3.1	10.9	9.0
Cycle Q Clear(g_c), s	14.6	19.2	19.2	5.8	6.6	2.1	6.8	4.3	3.5	3.1	10.9	9.0
Prop In Lane	1.00		0.67	1.00		1.00	1.00		1.00	1.00		1.00
Lane Grp Cap(c), veh/h	376	666	593	163	901	371	191	462	390	92	360	641
V/C Ratio(X)	0.90	0.75	0.75	0.80	0.39	0.13	0.82	0.27	0.23	0.77	0.76	0.40
Avail Cap(c_a), veh/h	407	666	593	181	901	371	195	587	496	211	606	849
HCM Platoon Ratio	1.00	1.00	1.00	1.00	1.00	1.00	1.00	1.00	1.00	1.00	1.00	1.00
Upstream Filter(I)	1.00	1.00	1.00	1.00	1.00	1.00	1.00	1.00	1.00	1.00	1.00	1.00
Uniform Delay (d), s/veh	30.1	21.2	21.2	35.0	24.1	22.4	34.3	23.8	23.5	36.8	30.0	16.6
Incr Delay (d2), s/veh	20.7	7.4	8.3	20.7	1.3	0.7	22.5	0.3	0.3	12.9	3.3	0.4
Initial Q Delay(d3),s/veh	0.0	0.0	0.0	0.0	0.0	0.0	0.0	0.0	0.0	0.0	0.0	0.0
%ile BackOfQ(50%),veh/ln	8.1	8.8	8.0	3.3	2.8	0.8	4.0	1.9	1.3	1.6	5.0	3.1
Unsig. Movement Delay, s/veh												
LnGrp Delay(d),s/veh	50.8	28.6	29.5	55.6	25.4	23.2	56.9	24.1	23.8	49.7	33.3	17.0
LnGrp LOS	D	C	C	E	C	C	E	C	C	D	C	B
Approach Vol, veh/h		1275			534			369			599	
Approach Delay, s/veh		34.8			32.6			37.9			28.3	
Approach LOS		C			C			D			C	
Timer - Assigned Phs	1	2	3	4	5	6	7	8				
Phs Duration (G+Y+Rc), s	21.3	24.8	8.6	24.1	11.8	34.2	13.0	19.6				
Change Period (Y+Rc), s	4.5	4.5	4.5	4.5	4.5	4.5	4.5	4.5				
Max Green Setting (Gmax), s	18.1	19.7	9.3	24.9	8.1	29.7	8.7	25.5				
Max Q Clear Time (g_c+I1), s	16.6	8.6	5.1	6.3	7.8	21.2	8.8	12.9				
Green Ext Time (p_c), s	0.2	1.8	0.0	0.9	0.0	4.0	0.0	2.1				
Intersection Summary												
HCM 6th Ctrl Delay				33.4								
HCM 6th LOS				C								

HCM 6th Signalized Intersection Summary
 51: Project Driveway 1 & Avenue 17

Village D Specific Plan
 Existing WP MIT - AM Peak Hour



Movement	EBT	EBR	WBL	WBT	NBL	NBR
Lane Configurations	↩		↩	↩	↩	↩
Traffic Volume (veh/h)	49	16	155	66	56	629
Future Volume (veh/h)	49	16	155	66	56	629
Initial Q (Qb), veh	0	0	0	0	0	0
Ped-Bike Adj(A_pbT)		1.00	1.00		1.00	1.00
Parking Bus, Adj	1.00	1.00	1.00	1.00	1.00	1.00
Work Zone On Approach	No			No	No	
Adj Sat Flow, veh/h/ln	1796	1796	1870	1870	1900	1900
Adj Flow Rate, veh/h	53	17	168	72	61	684
Peak Hour Factor	0.92	0.92	0.92	0.92	0.92	0.92
Percent Heavy Veh, %	7	7	2	2	0	0
Cap, veh/h	79	25	203	411	1250	1112
Arrive On Green	0.06	0.06	0.11	0.22	0.69	0.69
Sat Flow, veh/h	1303	418	1781	1870	1810	1610
Grp Volume(v), veh/h	0	70	168	72	61	684
Grp Sat Flow(s),veh/h/ln	0	1721	1781	1870	1810	1610
Q Serve(g_s), s	0.0	4.0	9.2	3.1	1.1	22.9
Cycle Q Clear(g_c), s	0.0	4.0	9.2	3.1	1.1	22.9
Prop In Lane		0.24	1.00		1.00	1.00
Lane Grp Cap(c), veh/h	0	104	203	411	1250	1112
V/C Ratio(X)	0.00	0.67	0.83	0.18	0.05	0.62
Avail Cap(c_a), veh/h	0	318	347	795	1250	1112
HCM Platoon Ratio	1.00	1.00	1.00	1.00	1.00	1.00
Upstream Filter(I)	0.00	1.00	0.99	0.99	1.00	1.00
Uniform Delay (d), s/veh	0.0	46.0	43.4	31.7	5.0	8.3
Incr Delay (d2), s/veh	0.0	7.2	8.3	0.2	0.1	2.6
Initial Q Delay(d3),s/veh	0.0	0.0	0.0	0.0	0.0	0.0
%ile BackOfQ(50%),veh/ln	0.0	1.9	4.5	1.4	0.4	7.6
Unsig. Movement Delay, s/veh						
LnGrp Delay(d),s/veh	0.0	53.2	51.6	31.9	5.0	10.9
LnGrp LOS	A	D	D	C	A	B
Approach Vol, veh/h	70			240	745	
Approach Delay, s/veh	53.2			45.7	10.4	
Approach LOS	D			D	B	
Timer - Assigned Phs		2	3	4		8
Phs Duration (G+Y+Rc), s		73.6	15.9	10.6		26.4
Change Period (Y+Rc), s		4.5	4.5	4.5		4.5
Max Green Setting (Gmax), s		48.5	19.5	18.5		42.5
Max Q Clear Time (g_c+I1), s		24.9	11.2	6.0		5.1
Green Ext Time (p_c), s		3.1	0.3	0.2		0.4
Intersection Summary						
HCM 6th Ctrl Delay			21.3			
HCM 6th LOS			C			

Intersection												
Intersection Delay, s/veh	16.5											
Intersection LOS	C											

Movement	EBL	EBT	EBR	WBL	WBT	WBR	NBL	NBT	NBR	SBL	SBT	SBR
Lane Configurations	↶	↷		↶	↷		↶	↷		↶	↷	
Traffic Vol, veh/h	0	12	5	88	33	111	16	131	317	233	126	0
Future Vol, veh/h	0	12	5	88	33	111	16	131	317	233	126	0
Peak Hour Factor	0.92	0.92	0.92	0.92	0.92	0.92	0.92	0.92	0.92	0.92	0.92	0.92
Heavy Vehicles, %	9	9	9	2	2	2	0	0	0	0	0	0
Mvmt Flow	0	13	5	96	36	121	17	142	345	253	137	0
Number of Lanes	1	1	0	1	1	0	1	1	0	1	1	0

Approach	EB	WB	NB	SB
Opposing Approach	WB	EB	SB	NB
Opposing Lanes	2	2	2	2
Conflicting Approach Left SB		NB	EB	WB
Conflicting Lanes Left	2	2	2	2
Conflicting Approach Right NB		SB	WB	EB
Conflicting Lanes Right	2	2	2	2
HCM Control Delay	10.4	11.7	21.6	13.3
HCM LOS	B	B	C	B

Lane	NBLn1	NBLn2	EBLn1	EBLn2	WBLn1	WBLn2	SBLn1	SBLn2
Vol Left, %	100%	0%	0%	0%	100%	0%	100%	0%
Vol Thru, %	0%	29%	100%	71%	0%	23%	0%	100%
Vol Right, %	0%	71%	0%	29%	0%	77%	0%	0%
Sign Control	Stop	Stop	Stop	Stop	Stop	Stop	Stop	Stop
Traffic Vol by Lane	16	448	0	17	88	144	233	126
LT Vol	16	0	0	0	88	0	233	0
Through Vol	0	131	0	12	0	33	0	126
RT Vol	0	317	0	5	0	111	0	0
Lane Flow Rate	17	487	0	18	96	157	253	137
Geometry Grp	7	7	7	7	7	7	7	7
Degree of Util (X)	0.031	0.737	0	0.038	0.196	0.275	0.459	0.229
Departure Headway (Hd)	6.457	5.448	7.58	7.368	7.376	6.318	6.525	6.017
Convergence, Y/N	Yes	Yes	Yes	Yes	Yes	Yes	Yes	Yes
Cap	554	662	0	483	486	567	552	596
Service Time	4.207	3.197	5.364	5.152	5.135	4.076	4.278	3.77
HCM Lane V/C Ratio	0.031	0.736	0	0.037	0.198	0.277	0.458	0.23
HCM Control Delay	9.4	22	10.4	10.4	11.9	11.5	14.7	10.6
HCM Lane LOS	A	C	N	B	B	B	B	B
HCM 95th-tile Q	0.1	6.5	0	0.1	0.7	1.1	2.4	0.9

HCM 6th Signalized Intersection Summary
53: Road 22 1/2 & Cleveland Avenue

Village D Specific Plan
Existing WP MIT - AM Peak Hour



Movement	EBL	EBT	EBR	WBL	WBT	WBR	NBL	NBT	NBR	SBL	SBT	SBR
Lane Configurations												
Traffic Volume (veh/h)	12	395	11	88	232	144	14	25	163	333	25	10
Future Volume (veh/h)	12	395	11	88	232	144	14	25	163	333	25	10
Initial Q (Qb), veh	0	0	0	0	0	0	0	0	0	0	0	0
Ped-Bike Adj(A_pbT)	1.00		1.00	1.00		1.00	1.00		1.00	1.00		1.00
Parking Bus, Adj	1.00	1.00	1.00	1.00	1.00	1.00	1.00	1.00	1.00	1.00	1.00	1.00
Work Zone On Approach		No			No			No			No	
Adj Sat Flow, veh/h/ln	1900	1900	1900	1900	1900	1900	1900	1900	1900	1900	1900	1900
Adj Flow Rate, veh/h	13	429	12	96	252	157	15	27	177	362	27	11
Peak Hour Factor	0.92	0.92	0.92	0.92	0.92	0.92	0.92	0.92	0.92	0.92	0.92	0.92
Percent Heavy Veh, %	0	0	0	0	0	0	0	0	0	0	0	0
Cap, veh/h	27	547	15	124	391	332	31	102	670	452	747	304
Arrive On Green	0.02	0.15	0.15	0.02	0.07	0.07	0.02	0.47	0.47	0.13	0.58	0.58
Sat Flow, veh/h	1810	3587	100	1810	1900	1610	1810	218	1426	3510	1283	523
Grp Volume(v), veh/h	13	216	225	96	252	157	15	0	204	362	0	38
Grp Sat Flow(s),veh/h/ln	1810	1805	1882	1810	1900	1610	1810	0	1643	1755	0	1806
Q Serve(g_s), s	0.7	11.5	11.5	5.3	12.9	9.4	0.8	0.0	7.5	10.0	0.0	0.9
Cycle Q Clear(g_c), s	0.7	11.5	11.5	5.3	12.9	9.4	0.8	0.0	7.5	10.0	0.0	0.9
Prop In Lane	1.00		0.05	1.00		1.00	1.00		0.87	1.00		0.29
Lane Grp Cap(c), veh/h	27	275	287	124	391	332	31	0	773	452	0	1051
V/C Ratio(X)	0.47	0.78	0.79	0.77	0.64	0.47	0.49	0.00	0.26	0.80	0.00	0.04
Avail Cap(c_a), veh/h	100	406	423	262	599	507	100	0	773	720	0	1051
HCM Platoon Ratio	1.00	1.00	1.00	0.33	0.33	0.33	1.00	1.00	1.00	1.00	1.00	1.00
Upstream Filter(l)	1.00	1.00	1.00	0.84	0.84	0.84	1.00	0.00	1.00	1.00	0.00	1.00
Uniform Delay (d), s/veh	48.8	40.8	40.8	48.1	43.0	41.4	48.7	0.0	16.0	42.3	0.0	8.9
Incr Delay (d2), s/veh	12.2	5.9	5.8	8.2	1.5	0.9	11.4	0.0	0.8	3.4	0.0	0.1
Initial Q Delay(d3),s/veh	0.0	0.0	0.0	0.0	0.0	0.0	0.0	0.0	0.0	0.0	0.0	0.0
%ile BackOfQ(50%),veh/ln	0.4	5.5	5.8	2.7	6.7	4.1	0.5	0.0	2.9	4.5	0.0	0.4
Unsig. Movement Delay, s/veh												
LnGrp Delay(d),s/veh	61.0	46.7	46.6	56.3	44.5	42.3	60.1	0.0	16.9	45.7	0.0	9.0
LnGrp LOS	E	D	D	E	D	D	E	A	B	D	A	A
Approach Vol, veh/h		454			505			219			400	
Approach Delay, s/veh		47.1			46.1			19.8			42.2	
Approach LOS		D			D			B			D	
Timer - Assigned Phs	1	2	3	4	5	6	7	8				
Phs Duration (G+Y+Rc), s	17.4	51.5	11.4	19.7	6.2	62.7	6.0	25.1				
Change Period (Y+Rc), s	4.5	4.5	4.5	4.5	4.5	4.5	4.5	4.5				
Max Green Setting (Gmax), s	20.5	24.5	14.5	22.5	5.5	39.5	5.5	31.5				
Max Q Clear Time (g_c+1/2), s	12.0	9.5	7.3	13.5	2.8	2.9	2.7	14.9				
Green Ext Time (p_c), s	0.9	1.0	0.1	1.7	0.0	0.2	0.0	1.8				
Intersection Summary												
HCM 6th Ctrl Delay											41.7	
HCM 6th LOS											D	

HCM 6th Signalized Intersection Summary
55: Road 23 & Project Driveway 3

Village D Specific Plan
Existing WP MIT - AM Peak Hour



Movement	EBL	EBR	NBL	NBT	SBT	SBR
Lane Configurations						
Traffic Volume (veh/h)	806	122	93	1240	633	333
Future Volume (veh/h)	806	122	93	1240	633	333
Initial Q (Qb), veh	0	0	0	0	0	0
Ped-Bike Adj(A_pbT)	1.00	1.00	1.00			1.00
Parking Bus, Adj	1.00	1.00	1.00	1.00	1.00	1.00
Work Zone On Approach	No			No	No	
Adj Sat Flow, veh/h/ln	1900	1900	1856	1856	1856	1856
Adj Flow Rate, veh/h	876	133	101	1348	688	362
Peak Hour Factor	0.92	0.92	0.92	0.92	0.92	0.92
Percent Heavy Veh, %	0	0	3	3	3	3
Cap, veh/h	901	917	127	1453	1041	464
Arrive On Green	0.50	0.50	0.07	0.41	0.10	0.10
Sat Flow, veh/h	1810	1610	1767	3618	3618	1572
Grp Volume(v), veh/h	876	133	101	1348	688	362
Grp Sat Flow(s),veh/h/ln	1810	1610	1767	1763	1763	1572
Q Serve(g_s), s	47.1	3.9	5.6	36.4	18.8	22.5
Cycle Q Clear(g_c), s	47.1	3.9	5.6	36.4	18.8	22.5
Prop In Lane	1.00	1.00	1.00			1.00
Lane Grp Cap(c), veh/h	901	917	127	1453	1041	464
V/C Ratio(X)	0.97	0.14	0.80	0.93	0.66	0.78
Avail Cap(c_a), veh/h	914	929	157	1453	1041	464
HCM Platoon Ratio	1.00	1.00	1.00	1.00	0.33	0.33
Upstream Filter(I)	1.00	1.00	0.71	0.71	0.86	0.86
Uniform Delay (d), s/veh	24.4	10.1	45.7	28.0	40.3	42.0
Incr Delay (d2), s/veh	23.0	0.1	14.8	8.9	2.8	10.7
Initial Q Delay(d3),s/veh	0.0	0.0	0.0	0.0	0.0	0.0
%ile BackOfQ(50%),veh/ln	24.6	5.3	3.0	16.4	9.3	10.8
Unsig. Movement Delay, s/veh						
LnGrp Delay(d),s/veh	47.5	10.2	60.5	36.8	43.1	52.6
LnGrp LOS	D	B	E	D	D	D
Approach Vol, veh/h	1009			1449	1050	
Approach Delay, s/veh	42.6			38.5	46.4	
Approach LOS	D			D	D	
Timer - Assigned Phs		2		4	5	6
Phs Duration (G+Y+Rc), s		45.7		54.3	11.7	34.0
Change Period (Y+Rc), s		4.5		4.5	4.5	4.5
Max Green Setting (Gmax), s		40.5		50.5	8.9	27.1
Max Q Clear Time (g_c+I1), s		38.4		49.1	7.6	24.5
Green Ext Time (p_c), s		1.6		0.7	0.0	1.5
Intersection Summary						
HCM 6th Ctrl Delay			42.0			
HCM 6th LOS			D			

HCM 6th Signalized Intersection Summary
56: Road 23 & Project Driveway 4

Village D Specific Plan
Existing WP MIT - AM Peak Hour



Movement	WBL	WBR	NBT	NBR	SBL	SBT
Lane Configurations						
Traffic Volume (veh/h)	106	537	696	137	420	1167
Future Volume (veh/h)	106	537	696	137	420	1167
Initial Q (Qb), veh	0	0	0	0	0	0
Ped-Bike Adj(A_pbT)	1.00	1.00		1.00	1.00	
Parking Bus, Adj	1.00	1.00	1.00	1.00	1.00	1.00
Work Zone On Approach	No		No		No	
Adj Sat Flow, veh/h/ln	1900	1900	1826	1826	1870	1870
Adj Flow Rate, veh/h	115	584	757	149	457	1268
Peak Hour Factor	0.92	0.92	0.92	0.92	0.92	0.92
Percent Heavy Veh, %	0	0	5	5	2	2
Cap, veh/h	360	1006	1770	789	540	2528
Arrive On Green	0.20	0.20	1.00	1.00	0.31	1.00
Sat Flow, veh/h	1810	2834	3561	1547	3456	3647
Grp Volume(v), veh/h	115	584	757	149	457	1268
Grp Sat Flow(s),veh/h/ln	1810	1417	1735	1547	1728	1777
Q Serve(g_s), s	5.4	16.7	0.0	0.0	12.4	0.0
Cycle Q Clear(g_c), s	5.4	16.7	0.0	0.0	12.4	0.0
Prop In Lane	1.00	1.00		1.00	1.00	
Lane Grp Cap(c), veh/h	360	1006	1770	789	540	2528
V/C Ratio(X)	0.32	0.58	0.43	0.19	0.85	0.50
Avail Cap(c_a), veh/h	407	1080	1770	789	847	2528
HCM Platoon Ratio	1.00	1.00	2.00	2.00	2.00	2.00
Upstream Filter(I)	1.00	1.00	0.95	0.95	0.76	0.76
Uniform Delay (d), s/veh	34.3	26.2	0.0	0.0	33.3	0.0
Incr Delay (d2), s/veh	0.5	0.7	0.7	0.5	3.7	0.5
Initial Q Delay(d3),s/veh	0.0	0.0	0.0	0.0	0.0	0.0
%ile BackOfQ(50%),veh/ln	2.4	5.6	0.2	0.1	4.6	0.2
Unsig. Movement Delay, s/veh						
LnGrp Delay(d),s/veh	34.8	26.9	0.7	0.5	37.0	0.5
LnGrp LOS	C	C	A	A	D	A
Approach Vol, veh/h	699		906			1725
Approach Delay, s/veh	28.2		0.7			10.2
Approach LOS	C		A			B
Timer - Assigned Phs	1	2			6	8
Phs Duration (G+Y+Rc), s	30.1	55.5			75.6	24.4
Change Period (Y+Rc), s	4.5	4.5			4.5	4.5
Max Green Setting (Gmax), s	21.5	39.5			68.5	22.5
Max Q Clear Time (g_c+M), s	11.4	2.0			2.0	18.7
Green Ext Time (p_c), s	1.3	6.9			14.2	1.1
Intersection Summary						
HCM 6th Ctrl Delay			11.4			
HCM 6th LOS			B			

HCM 6th Signalized Intersection Summary
57: Road 23 & Project Driveway 5

Village D Specific Plan
Existing WP MIT - AM Peak Hour



Movement	EBL	EBR	NBL	NBT	SBT	SBR
Lane Configurations						
Traffic Volume (veh/h)	117	147	66	722	1205	73
Future Volume (veh/h)	117	147	66	722	1205	73
Initial Q (Qb), veh	0	0	0	0	0	0
Ped-Bike Adj(A_pbT)	1.00	1.00	1.00			1.00
Parking Bus, Adj	1.00	1.00	1.00	1.00	1.00	1.00
Work Zone On Approach	No			No	No	
Adj Sat Flow, veh/h/ln	1900	1900	1811	1811	1856	1856
Adj Flow Rate, veh/h	127	160	72	785	1310	79
Peak Hour Factor	0.92	0.92	0.92	0.92	0.92	0.92
Percent Heavy Veh, %	0	0	6	6	3	3
Cap, veh/h	221	196	92	2712	2330	140
Arrive On Green	0.12	0.12	0.05	0.79	1.00	1.00
Sat Flow, veh/h	1810	1610	1725	3532	3471	203
Grp Volume(v), veh/h	127	160	72	785	682	707
Grp Sat Flow(s),veh/h/ln	1810	1610	1725	1721	1763	1819
Q Serve(g_s), s	6.6	9.7	4.1	6.3	0.0	0.0
Cycle Q Clear(g_c), s	6.6	9.7	4.1	6.3	0.0	0.0
Prop In Lane	1.00	1.00	1.00			0.11
Lane Grp Cap(c), veh/h	221	196	92	2712	1216	1255
V/C Ratio(X)	0.58	0.81	0.78	0.29	0.56	0.56
Avail Cap(c_a), veh/h	338	301	181	2712	1216	1255
HCM Platoon Ratio	1.00	1.00	1.00	1.00	2.00	2.00
Upstream Filter(I)	1.00	1.00	0.91	0.91	0.89	0.89
Uniform Delay (d), s/veh	41.5	42.8	46.8	2.9	0.0	0.0
Incr Delay (d2), s/veh	2.4	9.6	12.3	0.2	1.7	1.6
Initial Q Delay(d3),s/veh	0.0	0.0	0.0	0.0	0.0	0.0
%ile BackOfQ(50%),veh/ln	8.1	8.9	2.1	1.6	0.6	0.6
Unsig. Movement Delay, s/veh						
LnGrp Delay(d),s/veh	43.8	52.4	59.1	3.2	1.7	1.6
LnGrp LOS	D	D	E	A	A	A
Approach Vol, veh/h	287			857	1389	
Approach Delay, s/veh	48.6			7.9	1.7	
Approach LOS	D			A	A	
Timer - Assigned Phs		2		4	5	6
Phs Duration (G+Y+Rc), s		83.3		16.7	9.8	73.5
Change Period (Y+Rc), s		4.5		4.5	4.5	4.5
Max Green Setting (Gmax), s		72.3		18.7	10.5	57.3
Max Q Clear Time (g_c+I1), s		8.3		11.7	6.1	2.0
Green Ext Time (p_c), s		6.8		0.5	0.0	14.7
Intersection Summary						
HCM 6th Ctrl Delay			9.1			
HCM 6th LOS			A			

HCM 6th Signalized Intersection Summary
58: Project Driveway 6 & Cleveland Avenue

Village D Specific Plan
Existing WP MIT - AM Peak Hour

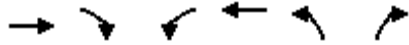

Movement	EBT	EBR	WBL	WBT	NBL	NBR
Lane Configurations	↑↑		↵	↑↑	↵	↵
Traffic Volume (veh/h)	1123	77	154	463	195	292
Future Volume (veh/h)	1123	77	154	463	195	292
Initial Q (Qb), veh	0	0	0	0	0	0
Ped-Bike Adj(A_pbT)		1.00	1.00		1.00	1.00
Parking Bus, Adj	1.00	1.00	1.00	1.00	1.00	1.00
Work Zone On Approach	No			No	No	
Adj Sat Flow, veh/h/ln	1885	1885	1885	1885	1900	1900
Adj Flow Rate, veh/h	1221	84	167	503	212	317
Peak Hour Factor	0.92	0.92	0.92	0.92	0.92	0.92
Percent Heavy Veh, %	1	1	1	1	0	0
Cap, veh/h	1401	96	201	2038	617	549
Arrive On Green	0.41	0.41	0.11	0.57	0.34	0.34
Sat Flow, veh/h	3495	234	1795	3676	1810	1610
Grp Volume(v), veh/h	642	663	167	503	212	317
Grp Sat Flow(s),veh/h/ln	1791	1843	1795	1791	1810	1610
Q Serve(g_s), s	32.9	33.0	9.1	7.0	8.7	16.2
Cycle Q Clear(g_c), s	32.9	33.0	9.1	7.0	8.7	16.2
Prop In Lane		0.13	1.00		1.00	1.00
Lane Grp Cap(c), veh/h	738	759	201	2038	617	549
V/C Ratio(X)	0.87	0.87	0.83	0.25	0.34	0.58
Avail Cap(c_a), veh/h	815	839	296	2382	617	549
HCM Platoon Ratio	1.00	1.00	1.00	1.00	1.00	1.00
Upstream Filter(I)	0.84	0.84	1.00	1.00	1.00	1.00
Uniform Delay (d), s/veh	27.0	27.0	43.5	10.8	24.6	27.0
Incr Delay (d2), s/veh	8.1	8.0	12.0	0.1	1.5	4.4
Initial Q Delay(d3),s/veh	0.0	0.0	0.0	0.0	0.0	0.0
%ile BackOfQ(50%),veh/ln	15.1	15.6	4.7	2.7	4.0	6.8
Unsig. Movement Delay, s/veh						
LnGrp Delay(d),s/veh	35.0	35.0	55.5	10.9	26.1	31.4
LnGrp LOS	D	D	E	B	C	C
Approach Vol, veh/h	1305			670	529	
Approach Delay, s/veh	35.0			22.0	29.3	
Approach LOS	D			C	C	
Timer - Assigned Phs		2	3	4		8
Phs Duration (G+Y+Rc), s		38.6	15.7	45.7		61.4
Change Period (Y+Rc), s		4.5	4.5	4.5		4.5
Max Green Setting (Gmax), s		24.5	16.5	45.5		66.5
Max Q Clear Time (g_c+1), s		18.2	11.1	35.0		9.0
Green Ext Time (p_c), s		1.0	0.2	6.2		3.9
Intersection Summary						
HCM 6th Ctrl Delay			30.3			
HCM 6th LOS			C			

HCM 6th Signalized Intersection Summary
 5: Road 23/SR-99 Southbound Off-Ramp & Avenue 18 1/2

Village D Specific Plan
 Existing WP MIT - PM Peak Hour



Movement	EBL	EBT	EBR	WBL	WBT	WBR	NBL	NBT	NBR	SBL	SBT	SBR
Lane Configurations		↑	↗	↘	↑		↗	↘	↗		↕	↕
Traffic Volume (veh/h)	0	380	295	39	191	0	89	0	382	19	652	120
Future Volume (veh/h)	0	380	295	39	191	0	89	0	382	19	652	120
Initial Q (Qb), veh	0	0	0	0	0	0	0	0	0	0	0	0
Ped-Bike Adj(A_pbT)	1.00		0.99	1.00		1.00	1.00		1.00	1.00		0.98
Parking Bus, Adj	1.00	1.00	1.00	1.00	1.00	1.00	1.00	1.00	1.00	1.00	1.00	1.00
Work Zone On Approach		No			No			No			No	
Adj Sat Flow, veh/h/ln	0	1693	1693	1455	1455	0	1841	1841	1841	1781	1781	1781
Adj Flow Rate, veh/h	0	404	314	41	203	0	95	0	406	20	694	128
Peak Hour Factor	0.94	0.94	0.94	0.94	0.94	0.94	0.94	0.94	0.94	0.94	0.94	0.94
Percent Heavy Veh, %	0	14	14	30	30	0	4	4	4	8	8	8
Cap, veh/h	0	436	690	49	500	0	398	0	819	22	789	154
Arrive On Green	0.00	0.26	0.26	0.04	0.34	0.00	0.23	0.00	0.23	0.28	0.28	0.28
Sat Flow, veh/h	0	1693	1416	1386	1455	0	1753	0	3120	78	2817	550
Grp Volume(v), veh/h	0	404	314	41	203	0	95	0	406	454	0	388
Grp Sat Flow(s),veh/h/ln	0	1693	1416	1386	1455	0	1753	0	1560	1778	0	1668
Q Serve(g_s), s	0.0	20.9	13.2	2.6	9.6	0.0	4.0	0.0	9.9	22.2	0.0	19.6
Cycle Q Clear(g_c), s	0.0	20.9	13.2	2.6	9.6	0.0	4.0	0.0	9.9	22.2	0.0	19.6
Prop In Lane	0.00		1.00	1.00		0.00	1.00		1.00	0.04		0.33
Lane Grp Cap(c), veh/h	0	436	690	49	500	0	398	0	819	498	0	467
V/C Ratio(X)	0.00	0.93	0.46	0.83	0.41	0.00	0.24	0.00	0.50	0.91	0.00	0.83
Avail Cap(c_a), veh/h	0	442	695	82	538	0	398	0	819	498	0	467
HCM Platoon Ratio	1.00	1.00	1.00	1.00	1.00	1.00	1.00	1.00	1.00	1.00	1.00	1.00
Upstream Filter(I)	0.00	1.00	1.00	1.00	1.00	0.00	1.00	0.00	1.00	1.00	0.00	1.00
Uniform Delay (d), s/veh	0.0	32.6	15.4	43.1	22.6	0.0	28.4	0.0	28.1	31.3	0.0	30.4
Incr Delay (d2), s/veh	0.0	25.5	0.5	28.5	0.5	0.0	0.3	0.0	0.5	23.5	0.0	15.7
Initial Q Delay(d3),s/veh	0.0	0.0	0.0	0.0	0.0	0.0	0.0	0.0	0.0	0.0	0.0	0.0
%ile BackOfQ(50%),veh/ln	0.0	11.4	6.4	1.3	3.3	0.0	1.7	0.0	3.7	12.5	0.0	9.7
Unsig. Movement Delay, s/veh												
LnGrp Delay(d),s/veh	0.0	58.0	15.8	71.7	23.1	0.0	28.8	0.0	28.6	54.8	0.0	46.1
LnGrp LOS	A	E	B	E	C	A	C	A	C	D	A	D
Approach Vol, veh/h		718			244			501				842
Approach Delay, s/veh		39.6			31.2			28.6				50.8
Approach LOS		D			C			C				D
Timer - Assigned Phs		2	3	4		6		8				
Phs Duration (G+Y+Rc), s		24.9	7.7	27.7		29.7		35.4				
Change Period (Y+Rc), s		4.5	4.5	4.5		4.5		4.5				
Max Green Setting (Gmax), s		18.0	5.3	23.5		25.2		33.3				
Max Q Clear Time (g_c+I1), s		11.9	4.6	22.9		24.2		11.6				
Green Ext Time (p_c), s		1.1	0.0	0.2		0.5		1.1				

Intersection Summary

HCM 6th Ctrl Delay	40.4
HCM 6th LOS	D

Notes

User approved volume balancing among the lanes for turning movement.

HCM 6th Signalized Intersection Summary
 6: SR-99 Northbound Ramps & Avenue 18 1/2

Village D Specific Plan
 Existing WP MIT - PM Peak Hour



Movement	EBL	EBT	EBR	WBL	WBT	WBR	NBL	NBT	NBR	SBL	SBT	SBR
Lane Configurations	↔↔	↑			↔			↔				
Traffic Volume (veh/h)	478	81	0	0	78	13	179	2	0	0	0	0
Future Volume (veh/h)	478	81	0	0	78	13	179	2	0	0	0	0
Initial Q (Qb), veh	0	0	0	0	0	0	0	0	0			
Ped-Bike Adj(A_pbT)	1.00		1.00	1.00		1.00	1.00		1.00			
Parking Bus, Adj	1.00	1.00	1.00	1.00	1.00	1.00	1.00	1.00	1.00			
Work Zone On Approach		No			No			No				
Adj Sat Flow, veh/h/ln	1781	1781	0	0	1722	1722	1900	1530	1900			
Adj Flow Rate, veh/h	520	88	0	0	85	14	195	2	0			
Peak Hour Factor	0.92	0.92	0.92	0.92	0.92	0.92	0.92	0.92	0.92			
Percent Heavy Veh, %	8	8	0	0	12	12	0	25	0			
Cap, veh/h	630	577	0	0	119	20	831	9	0			
Arrive On Green	0.19	0.32	0.00	0.00	0.08	0.08	0.58	0.58	0.00			
Sat Flow, veh/h	3291	1781	0	0	1442	237	1443	15	0			
Grp Volume(v), veh/h	520	88	0	0	0	99	197	0	0			
Grp Sat Flow(s),veh/h/ln	1646	1781	0	0	0	1679	1457	0	0			
Q Serve(g_s), s	13.7	3.2	0.0	0.0	0.0	5.2	6.0	0.0	0.0			
Cycle Q Clear(g_c), s	13.7	3.2	0.0	0.0	0.0	5.2	6.0	0.0	0.0			
Prop In Lane	1.00		0.00	0.00		0.14	0.99		0.00			
Lane Grp Cap(c), veh/h	630	577	0	0	0	139	839	0	0			
V/C Ratio(X)	0.82	0.15	0.00	0.00	0.00	0.71	0.23	0.00	0.00			
Avail Cap(c_a), veh/h	1006	1019	0	0	0	364	839	0	0			
HCM Platoon Ratio	1.00	1.00	1.00	1.00	1.00	1.00	1.00	1.00	1.00			
Upstream Filter(I)	1.00	1.00	0.00	0.00	0.00	1.00	1.00	0.00	0.00			
Uniform Delay (d), s/veh	34.9	21.6	0.0	0.0	0.0	40.3	9.4	0.0	0.0			
Incr Delay (d2), s/veh	3.1	0.1	0.0	0.0	0.0	6.7	0.7	0.0	0.0			
Initial Q Delay(d3),s/veh	0.0	0.0	0.0	0.0	0.0	0.0	0.0	0.0	0.0			
%ile BackOfQ(50%),veh/ln	5.6	1.3	0.0	0.0	0.0	2.4	1.9	0.0	0.0			
Unsig. Movement Delay, s/veh												
LnGrp Delay(d),s/veh	38.1	21.8	0.0	0.0	0.0	46.9	10.0	0.0	0.0			
LnGrp LOS	D	C	A	A	A	D	B	A	A			
Approach Vol, veh/h		608			99		197					
Approach Delay, s/veh		35.7			46.9		10.0					
Approach LOS		D			D		B					
Timer - Assigned Phs		2		4		7	8					
Phs Duration (G+Y+Rc), s		56.3		33.7		21.7	11.9					
Change Period (Y+Rc), s		4.5		4.5		4.5	4.5					
Max Green Setting (Gmax), s		29.5		51.5		27.5	19.5					
Max Q Clear Time (g_c+I1), s		8.0		5.2		15.7	7.2					
Green Ext Time (p_c), s		1.1		0.5		1.6	0.3					
Intersection Summary												
HCM 6th Ctrl Delay				31.3								
HCM 6th LOS				C								

HCM 6th Signalized Intersection Summary
7: Road 23 & Avenue 17

Village D Specific Plan
Existing WP MIT - PM Peak Hour



Movement	EBL	EBT	EBR	WBL	WBT	WBR	NBL	NBT	NBR	SBL	SBT	SBR
Lane Configurations	↖	↗		↖	↗		↖	↗	↖	↗	↗	↗
Traffic Volume (veh/h)	83	258	58	967	467	9	35	536	641	61	990	165
Future Volume (veh/h)	83	258	58	967	467	9	35	536	641	61	990	165
Initial Q (Qb), veh	0	0	0	0	0	0	0	0	0	0	0	0
Ped-Bike Adj(A_pbT)	1.00		1.00	1.00		1.00	1.00		1.00	1.00		1.00
Parking Bus, Adj	1.00	1.00	1.00	1.00	1.00	1.00	1.00	1.00	1.00	1.00	1.00	1.00
Work Zone On Approach		No			No			No			No	
Adj Sat Flow, veh/h/ln	1885	1885	1885	1900	1900	1900	1885	1885	1885	1870	1870	1870
Adj Flow Rate, veh/h	90	280	63	1051	508	10	38	583	697	66	1076	179
Peak Hour Factor	0.92	0.92	0.92	0.92	0.92	0.92	0.92	0.92	0.92	0.92	0.92	0.92
Percent Heavy Veh, %	1	1	1	0	0	0	1	1	1	2	2	2
Cap, veh/h	113	340	75	1056	1285	25	148	1379	1096	85	1228	204
Arrive On Green	0.13	0.23	0.23	0.30	0.35	0.35	0.01	0.13	0.13	0.05	0.40	0.40
Sat Flow, veh/h	1795	2915	645	3510	3621	71	1795	3582	1598	1781	3050	506
Grp Volume(v), veh/h	90	170	173	1051	253	265	38	583	697	66	626	629
Grp Sat Flow(s),veh/h/ln	1795	1791	1769	1755	1805	1887	1795	1791	1598	1781	1777	1779
Q Serve(g_s), s	5.8	10.8	11.2	35.9	12.6	12.6	1.5	18.0	27.3	4.4	39.0	39.2
Cycle Q Clear(g_c), s	5.8	10.8	11.2	35.9	12.6	12.6	1.5	18.0	27.3	4.4	39.0	39.2
Prop In Lane	1.00		0.36	1.00		0.04	1.00		1.00	1.00		0.28
Lane Grp Cap(c), veh/h	113	209	206	1056	640	669	148	1379	1096	85	715	716
V/C Ratio(X)	0.80	0.82	0.84	1.00	0.40	0.40	0.26	0.42	0.64	0.78	0.87	0.88
Avail Cap(c_a), veh/h	189	269	265	1056	640	669	170	1379	1096	147	715	716
HCM Platoon Ratio	2.00	2.00	2.00	1.00	1.00	1.00	0.33	0.33	0.33	1.00	1.00	1.00
Upstream Filter(l)	0.84	0.84	0.84	1.00	1.00	1.00	0.81	0.81	0.81	1.00	1.00	1.00
Uniform Delay (d), s/veh	51.7	44.8	44.9	41.9	29.1	29.1	27.8	40.1	14.5	56.5	33.1	33.1
Incr Delay (d2), s/veh	10.4	11.9	14.3	26.5	0.4	0.4	0.7	0.8	2.3	14.1	14.1	14.4
Initial Q Delay(d3),s/veh	0.0	0.0	0.0	0.0	0.0	0.0	0.0	0.0	0.0	0.0	0.0	0.0
%ile BackOfQ(50%),veh/ln	2.8	5.0	5.2	19.2	5.6	5.8	0.7	8.8	12.0	2.3	19.2	19.4
Unsig. Movement Delay, s/veh												
LnGrp Delay(d),s/veh	62.1	56.7	59.2	68.3	29.4	29.4	28.6	40.9	16.8	70.6	47.1	47.5
LnGrp LOS	E	E	E	E	C	C	C	D	B	E	D	D
Approach Vol, veh/h		433		1569			1318			1321		
Approach Delay, s/veh		58.8		55.5			27.8			48.5		
Approach LOS		E		E			C			D		
Timer - Assigned Phs	1	2	3	4	5	6	7	8				
Phs Duration (G+Y+Rc), s	30.2	50.7	40.6	18.5	8.1	52.8	12.0	47.1				
Change Period (Y+Rc), s	4.5	4.5	4.5	4.5	4.5	4.5	4.5	4.5				
Max Green Setting (Gmax), s	38.0	36.1	18.0	5.1	42.8	12.6	41.5					
Max Q Clear Time (g_c+1), s	29.3	37.9	13.2	3.5	41.2	7.8	14.6					
Green Ext Time (p_c), s	0.0	4.5	0.0	0.8	0.0	1.2	0.1	3.3				

Intersection Summary

HCM 6th Ctrl Delay	45.9
HCM 6th LOS	D

HCM 6th Signalized Intersection Summary
8: Road 23 & Avenue 16

Village D Specific Plan
Existing WP MIT - PM Peak Hour



Movement	EBL	EBT	EBR	WBL	WBT	WBR	NBL	NBT	NBR	SBL	SBT	SBR
Lane Configurations												
Traffic Volume (veh/h)	134	25	250	93	26	109	386	1072	171	222	1385	183
Future Volume (veh/h)	134	25	250	93	26	109	386	1072	171	222	1385	183
Initial Q (Qb), veh	0	0	0	0	0	0	0	0	0	0	0	0
Ped-Bike Adj(A_pbT)	1.00		1.00	1.00		1.00	1.00		1.00	1.00		1.00
Parking Bus, Adj	1.00	1.00	1.00	1.00	1.00	1.00	1.00	1.00	1.00	1.00	1.00	1.00
Work Zone On Approach		No			No			No			No	
Adj Sat Flow, veh/h/ln	1885	1885	1885	1900	1900	1900	1885	1885	1885	1885	1885	1885
Adj Flow Rate, veh/h	141	26	263	98	27	115	406	1128	180	234	1458	193
Peak Hour Factor	0.95	0.95	0.95	0.95	0.95	0.95	0.95	0.95	0.95	0.95	0.95	0.95
Percent Heavy Veh, %	1	1	1	0	0	0	1	1	1	1	1	1
Cap, veh/h	165	300	254	122	257	218	450	1930	861	294	1573	206
Arrive On Green	0.09	0.16	0.16	0.07	0.14	0.14	0.04	0.18	0.18	0.11	0.66	0.66
Sat Flow, veh/h	1795	1885	1598	1810	1900	1610	3483	3582	1598	3483	3184	417
Grp Volume(v), veh/h	141	26	263	98	27	115	406	1128	180	234	813	838
Grp Sat Flow(s),veh/h/ln	1795	1885	1598	1810	1900	1610	1742	1791	1598	1742	1791	1810
Q Serve(g_s), s	9.3	1.4	19.1	6.4	1.5	8.0	13.9	34.7	11.5	7.9	47.1	49.6
Cycle Q Clear(g_c), s	9.3	1.4	19.1	6.4	1.5	8.0	13.9	34.7	11.5	7.9	47.1	49.6
Prop In Lane	1.00		1.00	1.00		1.00	1.00		1.00	1.00		0.23
Lane Grp Cap(c), veh/h	165	300	254	122	257	218	450	1930	861	294	885	894
V/C Ratio(X)	0.86	0.09	1.03	0.80	0.11	0.53	0.90	0.58	0.21	0.80	0.92	0.94
Avail Cap(c_a), veh/h	165	300	254	149	285	242	450	1930	861	398	885	894
HCM Platoon Ratio	1.00	1.00	1.00	1.00	1.00	1.00	0.33	0.33	0.33	1.33	1.33	1.33
Upstream Filter(l)	1.00	1.00	1.00	1.00	1.00	1.00	0.57	0.57	0.57	0.47	0.47	0.47
Uniform Delay (d), s/veh	53.7	43.0	50.4	55.1	45.5	48.3	56.7	37.0	27.5	52.3	18.5	18.9
Incr Delay (d2), s/veh	33.4	0.1	65.6	22.0	0.2	2.0	13.6	0.7	0.3	3.8	8.7	10.3
Initial Q Delay(d3),s/veh	0.0	0.0	0.0	0.0	0.0	0.0	0.0	0.0	0.0	0.0	0.0	0.0
%ile BackOfQ(50%),veh/ln	5.7	0.7	12.2	3.7	0.7	3.3	7.4	16.9	5.0	3.5	17.7	19.1
Unsig. Movement Delay, s/veh												
LnGrp Delay(d),s/veh	87.1	43.1	116.1	77.1	45.7	50.3	70.3	37.8	27.8	56.1	27.2	29.2
LnGrp LOS	F	D	F	E	D	D	E	D	C	E	C	C
Approach Vol, veh/h		430			240			1714			1885	
Approach Delay, s/veh		102.2			60.7			44.4			31.7	
Approach LOS		F			E			D			C	
Timer - Assigned Phs	1	2	3	4	5	6	7	8				
Phs Duration (G+Y+Rc), s	14.6	69.2	12.6	23.6	20.0	63.8	15.5	20.7				
Change Period (Y+Rc), s	4.5	4.5	4.5	4.5	4.5	4.5	4.5	4.5				
Max Green Setting (Gmax), s	13.8	59.3	9.9	19.1	15.5	57.5	11.0	18.0				
Max Q Clear Time (g_c+1/9), s	19.9	36.7	8.4	21.1	15.9	51.6	11.3	10.0				
Green Ext Time (p_c), s	0.3	9.7	0.0	0.0	0.0	4.7	0.0	0.3				
Intersection Summary												
HCM 6th Ctrl Delay											45.5	
HCM 6th LOS											D	

HCM 6th Signalized Intersection Summary
9: Road 23 & Cleveland Avenue

Village D Specific Plan
Existing WP MIT - PM Peak Hour



Movement	EBL	EBT	EBR	WBL	WBT	WBR	NBL	NBT	NBR	SBL	SBT	SBR
Lane Configurations	↖↗	↑↑	↖↗	↖↗	↑↑	↖	↖↗	↑↑	↖	↖↗	↑↑	↖
Traffic Volume (veh/h)	477	502	788	250	494	358	968	922	286	300	921	608
Future Volume (veh/h)	477	502	788	250	494	358	968	922	286	300	921	608
Initial Q (Qb), veh	0	0	0	0	0	0	0	0	0	0	0	0
Ped-Bike Adj(A_pbT)	1.00		1.00	1.00		1.00	1.00		1.00	1.00		1.00
Parking Bus, Adj	1.00	1.00	1.00	1.00	1.00	1.00	1.00	1.00	1.00	1.00	1.00	1.00
Work Zone On Approach		No			No			No			No	
Adj Sat Flow, veh/h/ln	1900	1900	1900	1900	1900	1900	1885	1885	1885	1885	1885	1885
Adj Flow Rate, veh/h	513	540	847	269	531	385	1041	991	308	323	990	654
Peak Hour Factor	0.93	0.93	0.93	0.93	0.93	0.93	0.93	0.93	0.93	0.93	0.93	0.93
Percent Heavy Veh, %	0	0	0	0	0	0	1	1	1	1	1	1
Cap, veh/h	500	720	1357	326	542	426	972	1587	857	398	997	672
Arrive On Green	0.14	0.20	0.20	0.09	0.15	0.15	0.47	0.74	0.74	0.04	0.09	0.09
Sat Flow, veh/h	3510	3610	2834	3510	3610	1610	3483	3582	1598	3483	3582	1598
Grp Volume(v), veh/h	513	540	847	269	531	385	1041	991	308	323	990	654
Grp Sat Flow(s),veh/h/ln	1755	1805	1417	1755	1805	1610	1742	1791	1598	1742	1791	1598
Q Serve(g_s), s	17.1	16.9	23.9	9.0	17.6	18.0	33.5	16.0	7.4	11.0	33.1	33.4
Cycle Q Clear(g_c), s	17.1	16.9	23.9	9.0	17.6	18.0	33.5	16.0	7.4	11.0	33.1	33.4
Prop In Lane	1.00		1.00	1.00		1.00	1.00		1.00	1.00		1.00
Lane Grp Cap(c), veh/h	500	720	1357	326	542	426	972	1587	857	398	997	672
V/C Ratio(X)	1.03	0.75	0.62	0.82	0.98	0.90	1.07	0.62	0.36	0.81	0.99	0.97
Avail Cap(c_a), veh/h	500	720	1357	360	542	426	972	1587	857	589	997	672
HCM Platoon Ratio	1.00	1.00	1.00	1.00	1.00	1.00	1.67	1.67	1.67	0.33	0.33	0.33
Upstream Filter(I)	0.76	0.76	0.76	0.81	0.81	0.81	0.43	0.43	0.43	0.38	0.38	0.38
Uniform Delay (d), s/veh	51.5	45.2	23.3	53.5	50.8	42.7	32.0	10.8	6.8	56.4	54.4	40.9
Incr Delay (d2), s/veh	41.7	3.4	0.7	11.1	29.9	19.1	41.1	0.8	0.5	2.1	16.0	15.8
Initial Q Delay(d3),s/veh	0.0	0.0	0.0	0.0	0.0	0.0	0.0	0.0	0.0	0.0	0.0	0.0
%ile BackOfQ(50%),veh/ln	10.4	7.9	8.9	4.5	10.2	13.2	17.4	4.3	2.1	5.3	18.2	20.6
Unsig. Movement Delay, s/veh												
LnGrp Delay(d),s/veh	93.2	48.6	23.9	64.6	80.7	61.8	73.1	11.6	7.3	58.5	70.4	56.7
LnGrp LOS	F	D	C	E	F	E	F	B	A	E	E	E
Approach Vol, veh/h		1900			1185			2340			1967	
Approach Delay, s/veh		49.6			70.9			38.4			63.9	
Approach LOS		D			E			D			E	
Timer - Assigned Phs	1	2	3	4	5	6	7	8				
Phs Duration (G+Y+Rc), s	18.2	57.7	15.7	28.4	38.0	37.9	21.6	22.5				
Change Period (Y+Rc), s	4.5	4.5	4.5	4.5	4.5	4.5	4.5	4.5				
Max Green Setting (Gmax), s	20.3	46.6	12.3	22.8	33.5	33.4	17.1	18.0				
Max Q Clear Time (g_c+1/3), s	11.0	18.0	11.0	25.9	35.5	35.4	19.1	20.0				
Green Ext Time (p_c), s	0.7	9.8	0.1	0.0	0.0	0.0	0.0	0.0				
Intersection Summary												
HCM 6th Ctrl Delay											53.3	
HCM 6th LOS											D	

HCM 6th Signalized Intersection Summary
 10: Road 23 & Avenue 14 1/2

Village D Specific Plan
 Existing WP MIT - PM Peak Hour



Movement	EBL	EBT	EBR	WBL	WBT	WBR	NBL	NBT	NBR	SBL	SBT	SBR
Lane Configurations		↕			↕	↕	↕	↕↕		↕	↕↕	
Traffic Volume (veh/h)	1	2	3	4	3	300	2	1256	2	302	923	0
Future Volume (veh/h)	1	2	3	4	3	300	2	1256	2	302	923	0
Initial Q (Qb), veh	0	0	0	0	0	0	0	0	0	0	0	0
Ped-Bike Adj(A_pbT)	1.00		1.00	1.00		1.00	1.00		1.00	1.00		1.00
Parking Bus, Adj	1.00	1.00	1.00	1.00	1.00	1.00	1.00	1.00	1.00	1.00	1.00	1.00
Work Zone On Approach		No			No			No			No	
Adj Sat Flow, veh/h/ln	1900	1900	1900	1900	1900	1900	1885	1885	1885	1870	1870	1870
Adj Flow Rate, veh/h	1	2	3	5	3	341	2	1427	2	343	1049	0
Peak Hour Factor	0.88	0.88	0.88	0.88	0.88	0.88	0.88	0.88	0.88	0.88	0.88	0.88
Percent Heavy Veh, %	0	0	0	0	0	0	1	1	1	2	2	2
Cap, veh/h	57	104	126	191	104	248	5	1921	3	374	2596	0
Arrive On Green	0.15	0.15	0.15	0.15	0.15	0.15	0.01	1.00	1.00	0.21	0.73	0.00
Sat Flow, veh/h	145	673	818	923	677	1610	1795	3670	5	1781	3647	0
Grp Volume(v), veh/h	6	0	0	8	0	341	2	696	733	343	1049	0
Grp Sat Flow(s),veh/h/ln	1636	0	0	1600	0	1610	1795	1791	1884	1781	1777	0
Q Serve(g_s), s	0.0	0.0	0.0	0.0	0.0	18.5	0.1	0.0	0.0	22.6	13.5	0.0
Cycle Q Clear(g_c), s	0.4	0.0	0.0	0.4	0.0	18.5	0.1	0.0	0.0	22.6	13.5	0.0
Prop In Lane	0.17		0.50	0.62		1.00	1.00		0.00	1.00		0.00
Lane Grp Cap(c), veh/h	287	0	0	295	0	248	5	938	986	374	2596	0
V/C Ratio(X)	0.02	0.00	0.00	0.03	0.00	1.37	0.41	0.74	0.74	0.92	0.40	0.00
Avail Cap(c_a), veh/h	287	0	0	295	0	248	75	938	986	453	2596	0
HCM Platoon Ratio	1.00	1.00	1.00	1.00	1.00	1.00	2.00	2.00	2.00	1.00	1.00	1.00
Upstream Filter(I)	1.00	0.00	0.00	1.00	0.00	1.00	0.79	0.79	0.79	0.80	0.80	0.00
Uniform Delay (d), s/veh	43.1	0.0	0.0	43.1	0.0	50.8	59.6	0.0	0.0	46.4	6.2	0.0
Incr Delay (d2), s/veh	0.0	0.0	0.0	0.0	0.0	191.6	39.2	4.2	4.0	18.0	0.4	0.0
Initial Q Delay(d3),s/veh	0.0	0.0	0.0	0.0	0.0	0.0	0.0	0.0	0.0	0.0	0.0	0.0
%ile BackOfQ(50%),veh/ln	0.2	0.0	0.0	0.2	0.0	20.6	0.1	1.1	1.1	11.8	4.7	0.0
Unsig. Movement Delay, s/veh												
LnGrp Delay(d),s/veh	43.1	0.0	0.0	43.1	0.0	242.3	98.8	4.2	4.0	64.4	6.6	0.0
LnGrp LOS	D	A	A	D	A	F	F	A	A	E	A	A
Approach Vol, veh/h		6			349			1431			1392	
Approach Delay, s/veh		43.1			237.7			4.3			20.8	
Approach LOS		D			F			A			C	
Timer - Assigned Phs	1	2		4	5	6		8				
Phs Duration (G+Y+Rc), s	29.7	67.3		23.0	4.8	92.2		23.0				
Change Period (Y+Rc), s	4.5	4.5		4.5	4.5	4.5		4.5				
Max Green Setting (Gmax), s	30.5	57.5		18.5	5.0	83.0		18.5				
Max Q Clear Time (g_c+Y), s	24.6	2.0		2.4	2.1	15.5		20.5				
Green Ext Time (p_c), s	0.6	15.4		0.0	0.0	10.3		0.0				
Intersection Summary												
HCM 6th Ctrl Delay											37.2	
HCM 6th LOS											D	

HCM 6th Signalized Intersection Summary
 11: Road 23 & Avenue 14

Village D Specific Plan
 Existing WP MIT - PM Peak Hour



Movement	EBL	EBT	EBR	WBL	WBT	WBR	NBL	NBT	NBR	SBL	SBT	SBR
Lane Configurations												
Traffic Volume (veh/h)	141	89	34	11	36	779	14	341	21	548	291	86
Future Volume (veh/h)	141	89	34	11	36	779	14	341	21	548	291	86
Initial Q (Qb), veh	0	0	0	0	0	0	0	0	0	0	0	0
Ped-Bike Adj(A_pbT)	1.00		1.00	1.00		1.00	1.00		1.00	1.00		1.00
Parking Bus, Adj	1.00	1.00	1.00	1.00	1.00	1.00	1.00	1.00	1.00	1.00	1.00	1.00
Work Zone On Approach		No			No			No			No	
Adj Sat Flow, veh/h/ln	1826	1826	1826	1885	1885	1885	1841	1841	1841	1856	1856	1856
Adj Flow Rate, veh/h	148	94	36	12	38	820	15	359	22	577	306	91
Peak Hour Factor	0.95	0.95	0.95	0.95	0.95	0.95	0.95	0.95	0.95	0.95	0.95	0.95
Percent Heavy Veh, %	5	5	5	1	1	1	4	4	4	3	3	3
Cap, veh/h	177	304	117	25	291	991	29	1325	81	680	2037	909
Arrive On Green	0.10	0.24	0.24	0.01	0.15	0.15	0.02	0.40	0.40	0.07	0.19	0.19
Sat Flow, veh/h	1739	1258	482	1795	1885	2812	1753	3348	204	3428	3526	1572
Grp Volume(v), veh/h	148	0	130	12	38	820	15	187	194	577	306	91
Grp Sat Flow(s),veh/h/ln	1739	0	1739	1795	1885	1406	1753	1749	1804	1714	1763	1572
Q Serve(g_s), s	10.0	0.0	7.3	0.8	2.1	18.5	1.0	8.7	8.7	20.0	8.7	5.7
Cycle Q Clear(g_c), s	10.0	0.0	7.3	0.8	2.1	18.5	1.0	8.7	8.7	20.0	8.7	5.7
Prop In Lane	1.00		0.28	1.00		1.00	1.00		0.11	1.00		1.00
Lane Grp Cap(c), veh/h	177	0	421	25	291	991	29	692	714	680	2037	909
V/C Ratio(X)	0.84	0.00	0.31	0.49	0.13	0.83	0.52	0.27	0.27	0.85	0.15	0.10
Avail Cap(c_a), veh/h	326	0	515	82	291	991	95	692	714	986	2037	909
HCM Platoon Ratio	1.00	1.00	1.00	1.00	1.00	1.00	1.00	1.00	1.00	0.33	0.33	0.33
Upstream Filter(I)	1.00	0.00	1.00	0.70	0.70	0.70	1.00	1.00	1.00	0.94	0.94	0.94
Uniform Delay (d), s/veh	52.9	0.0	37.2	58.8	43.8	35.5	58.5	24.5	24.5	54.3	24.0	22.8
Incr Delay (d2), s/veh	9.9	0.0	0.4	10.0	0.1	4.2	13.9	1.0	0.9	4.6	0.1	0.2
Initial Q Delay(d3),s/veh	0.0	0.0	0.0	0.0	0.0	0.0	0.0	0.0	0.0	0.0	0.0	0.0
%ile BackOfQ(50%),veh/ln	4.9	0.0	3.2	0.4	1.0	11.4	0.6	3.8	3.9	9.7	4.0	2.2
Unsig. Movement Delay, s/veh												
LnGrp Delay(d),s/veh	62.9	0.0	37.7	68.8	43.9	39.7	72.4	25.5	25.5	58.9	24.2	23.0
LnGrp LOS	E	A	D	E	D	D	E	C	C	E	C	C
Approach Vol, veh/h		278			870			396			974	
Approach Delay, s/veh		51.1			40.3			27.3			44.6	
Approach LOS		D			D			C			D	
Timer - Assigned Phs	1	2	3	4	5	6	7	8				
Phs Duration (G+Y+Rc), s	28.3	52.0	6.1	33.6	6.5	73.8	16.7	23.0				
Change Period (Y+Rc), s	4.5	4.5	4.5	4.5	4.5	4.5	4.5	4.5				
Max Green Setting (Gmax), s	21.5	26.5	5.5	35.5	6.5	54.5	22.5	18.5				
Max Q Clear Time (g_c+2.0), s	10.7	10.7	2.8	9.3	3.0	10.7	12.0	20.5				
Green Ext Time (p_c), s	1.8	2.0	0.0	0.7	0.0	2.5	0.3	0.0				

Intersection Summary

HCM 6th Ctrl Delay	41.1
HCM 6th LOS	D

HCM 6th Signalized Intersection Summary
 13: Airport Drive/Golden State Boulevard & Avenue 17

Village D Specific Plan
 Existing WP MIT - PM Peak Hour



Movement	EBL	EBT	EBR	WBL	WBT	WBR	NBL	NBT	NBR	SBL	SBT	SBR
Lane Configurations												
Traffic Volume (veh/h)	7	813	153	81	1138	85	244	27	152	120	25	7
Future Volume (veh/h)	7	813	153	81	1138	85	244	27	152	120	25	7
Initial Q (Qb), veh	0	0	0	0	0	0	0	0	0	0	0	0
Ped-Bike Adj(A_pbT)	1.00		1.00	1.00		1.00	1.00		1.00	1.00		1.00
Parking Bus, Adj	1.00	1.00	1.00	1.00	1.00	1.00	1.00	1.00	1.00	1.00	1.00	1.00
Work Zone On Approach		No		No		No		No		No		No
Adj Sat Flow, veh/h/ln	1885	1885	1885	1885	1885	1885	1870	1870	1870	1856	1856	1856
Adj Flow Rate, veh/h	8	913	172	91	1279	96	274	30	171	135	28	8
Peak Hour Factor	0.89	0.89	0.89	0.89	0.89	0.89	0.89	0.89	0.89	0.89	0.89	0.89
Percent Heavy Veh, %	1	1	1	1	1	1	2	2	2	3	3	3
Cap, veh/h	18	1151	514	115	1345	600	306	637	540	166	365	104
Arrive On Green	0.01	0.32	0.32	0.13	0.75	0.75	0.17	0.34	0.34	0.09	0.26	0.26
Sat Flow, veh/h	1795	3582	1598	1795	3582	1598	1781	1870	1585	1767	1388	396
Grp Volume(v), veh/h	8	913	172	91	1279	96	274	30	171	135	0	36
Grp Sat Flow(s),veh/h/ln	1795	1791	1598	1795	1791	1598	1781	1870	1585	1767	0	1784
Q Serve(g_s), s	0.4	23.2	8.2	4.9	31.1	1.7	15.1	1.1	8.0	7.5	0.0	1.5
Cycle Q Clear(g_c), s	0.4	23.2	8.2	4.9	31.1	1.7	15.1	1.1	8.0	7.5	0.0	1.5
Prop In Lane	1.00		1.00	1.00		1.00	1.00		1.00	1.00		0.22
Lane Grp Cap(c), veh/h	18	1151	514	115	1345	600	306	637	540	166	0	469
V/C Ratio(X)	0.45	0.79	0.33	0.79	0.95	0.16	0.90	0.05	0.32	0.81	0.00	0.08
Avail Cap(c_a), veh/h	90	1300	580	147	1415	631	330	637	540	270	0	469
HCM Platoon Ratio	1.00	1.00	1.00	2.00	2.00	2.00	1.00	1.00	1.00	1.00	1.00	1.00
Upstream Filter(I)	1.00	1.00	1.00	0.67	0.67	0.67	1.00	1.00	1.00	1.00	0.00	1.00
Uniform Delay (d), s/veh	49.2	30.9	25.8	43.0	11.7	8.0	40.5	22.1	24.4	44.4	0.0	27.7
Incr Delay (d2), s/veh	16.5	3.1	0.4	14.1	10.2	0.1	24.4	0.1	1.5	9.1	0.0	0.3
Initial Q Delay(d3),s/veh	0.0	0.0	0.0	0.0	0.0	0.0	0.0	0.0	0.0	0.0	0.0	0.0
%ile BackOfQ(50%),veh/ln	0.3	10.3	3.1	2.5	6.2	0.6	8.6	0.5	3.2	3.7	0.0	0.7
Unsig. Movement Delay, s/veh												
LnGrp Delay(d),s/veh	65.7	34.0	26.2	57.1	21.8	8.1	65.0	22.2	25.9	53.5	0.0	28.0
LnGrp LOS	E	C	C	E	C	A	E	C	C	D	A	C
Approach Vol, veh/h		1093			1466			475			171	
Approach Delay, s/veh		33.0			23.1			48.2			48.1	
Approach LOS		C			C			D			D	
Timer - Assigned Phs	1	2	3	4	5	6	7	8				
Phs Duration (G+Y+Rc), s	13.9	38.5	10.9	36.6	21.7	30.8	5.5	42.0				
Change Period (Y+Rc), s	4.5	4.5	4.5	4.5	4.5	4.5	4.5	4.5				
Max Green Setting (Gmax), s	15.3	22.2	8.2	36.3	18.5	19.0	5.0	39.5				
Max Q Clear Time (g_c+1), s	19.5	10.0	6.9	25.2	17.1	3.5	2.4	33.1				
Green Ext Time (p_c), s	0.2	0.5	0.0	5.2	0.1	0.1	0.0	4.4				
Intersection Summary												
HCM 6th Ctrl Delay											31.5	
HCM 6th LOS											C	

HCM 6th Signalized Intersection Summary
 14: Avenue 17 & SR-99 Southbound Off-Ramp

Village D Specific Plan
 Existing WP MIT - PM Peak Hour

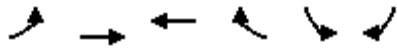

Movement	EBL	EBT	WBT	WBR	SBL	SBR
Lane Configurations		↑↑	↑↑		↙	↘
Traffic Volume (veh/h)	0	1092	1258	0	153	43
Future Volume (veh/h)	0	1092	1258	0	153	43
Initial Q (Qb), veh	0	0	0	0	0	0
Ped-Bike Adj(A_pbT)	1.00			1.00	1.00	1.00
Parking Bus, Adj	1.00	1.00	1.00	1.00	1.00	1.00
Work Zone On Approach		No	No		No	
Adj Sat Flow, veh/h/ln	0	1870	1885	0	1826	1826
Adj Flow Rate, veh/h	0	1187	1367	0	166	47
Peak Hour Factor	0.92	0.92	0.92	0.92	0.92	0.92
Percent Heavy Veh, %	0	2	1	0	5	5
Cap, veh/h	0	1628	1641	0	786	699
Arrive On Green	0.00	0.92	0.61	0.00	0.45	0.45
Sat Flow, veh/h	0	3741	3770	0	1739	1547
Grp Volume(v), veh/h	0	1187	1367	0	166	47
Grp Sat Flow(s),veh/h/ln	0	1777	1791	0	1739	1547
Q Serve(g_s), s	0.0	8.4	30.3	0.0	5.8	1.7
Cycle Q Clear(g_c), s	0.0	8.4	30.3	0.0	5.8	1.7
Prop In Lane	0.00			0.00	1.00	1.00
Lane Grp Cap(c), veh/h	0	1628	1641	0	786	699
V/C Ratio(X)	0.00	0.73	0.83	0.00	0.21	0.07
Avail Cap(c_a), veh/h	0	2328	2346	0	786	699
HCM Platoon Ratio	1.00	2.00	1.33	1.00	1.00	1.00
Upstream Filter(I)	0.00	0.71	1.00	0.00	1.00	1.00
Uniform Delay (d), s/veh	0.0	2.6	16.5	0.0	16.6	15.5
Incr Delay (d2), s/veh	0.0	0.5	1.8	0.0	0.6	0.2
Initial Q Delay(d3),s/veh	0.0	0.0	0.0	0.0	0.0	0.0
%ile BackOfQ(50%),veh/ln	0.0	1.3	10.1	0.0	2.4	0.6
Unsig. Movement Delay, s/veh						
LnGrp Delay(d),s/veh	0.0	3.1	18.3	0.0	17.2	15.7
LnGrp LOS	A	A	B	A	B	B
Approach Vol, veh/h		1187	1367		213	
Approach Delay, s/veh		3.1	18.3		16.9	
Approach LOS		A	B		B	
Timer - Assigned Phs				4	6	8
Phs Duration (G+Y+Rc), s				50.3	49.7	50.3
Change Period (Y+Rc), s				4.5	4.5	4.5
Max Green Setting (Gmax), s				65.5	25.5	65.5
Max Q Clear Time (g_c+I1), s				10.4	7.8	32.3
Green Ext Time (p_c), s				12.4	0.6	13.5
Intersection Summary						
HCM 6th Ctrl Delay			11.7			
HCM 6th LOS			B			

HCM 6th Signalized Intersection Summary
 15: SR-99 Northbound Ramps & Avenue 17

Village D Specific Plan
 Existing WP MIT - PM Peak Hour



Movement	EBL	EBT	EBR	WBL	WBT	WBR	NBL	NBT	NBR	SBL	SBT	SBR
Lane Configurations	↖	↑↑			↑↑		↖	↖	↖			
Traffic Volume (veh/h)	64	710	0	0	761	66	676	1	0	0	0	0
Future Volume (veh/h)	64	710	0	0	761	66	676	1	0	0	0	0
Initial Q (Qb), veh	0	0	0	0	0	0	0	0	0			
Ped-Bike Adj(A_pbT)	1.00		1.00	1.00		1.00	1.00		1.00			
Parking Bus, Adj	1.00	1.00	1.00	1.00	1.00	1.00	1.00	1.00	1.00			
Work Zone On Approach		No			No			No				
Adj Sat Flow, veh/h/ln	1870	1870	0	0	1870	1870	1885	1885	1885			
Adj Flow Rate, veh/h	67	747	0	0	801	69	713	0	0			
Peak Hour Factor	0.95	0.95	0.95	0.95	0.95	0.95	0.95	0.95	0.95			
Percent Heavy Veh, %	2	2	0	0	2	2	1	1	1			
Cap, veh/h	86	1363	0	0	961	83	1890	0	841			
Arrive On Green	0.10	0.77	0.00	0.00	0.29	0.29	0.53	0.00	0.00			
Sat Flow, veh/h	1781	3647	0	0	3404	285	3591	0	1598			
Grp Volume(v), veh/h	67	747	0	0	430	440	713	0	0			
Grp Sat Flow(s),veh/h/ln	1781	1777	0	0	1777	1819	1795	0	1598			
Q Serve(g_s), s	3.7	8.4	0.0	0.0	22.6	22.7	11.7	0.0	0.0			
Cycle Q Clear(g_c), s	3.7	8.4	0.0	0.0	22.6	22.7	11.7	0.0	0.0			
Prop In Lane	1.00		0.00	0.00		0.16	1.00		1.00			
Lane Grp Cap(c), veh/h	86	1363	0	0	516	528	1890	0	841			
V/C Ratio(X)	0.78	0.55	0.00	0.00	0.83	0.83	0.38	0.00	0.00			
Avail Cap(c_a), veh/h	187	1830	0	0	649	664	1890	0	841			
HCM Platoon Ratio	2.00	2.00	1.00	1.00	1.00	1.00	1.00	1.00	1.00			
Upstream Filter(I)	1.00	1.00	0.00	0.00	1.00	1.00	1.00	0.00	0.00			
Uniform Delay (d), s/veh	44.6	8.2	0.0	0.0	33.2	33.2	14.0	0.0	0.0			
Incr Delay (d2), s/veh	14.0	0.3	0.0	0.0	7.5	7.3	0.6	0.0	0.0			
Initial Q Delay(d3),s/veh	0.0	0.0	0.0	0.0	0.0	0.0	0.0	0.0	0.0			
%ile BackOfQ(50%),veh/ln	1.9	2.2	0.0	0.0	10.6	10.8	4.7	0.0	0.0			
Unsig. Movement Delay, s/veh												
LnGrp Delay(d),s/veh	58.6	8.5	0.0	0.0	40.7	40.5	14.6	0.0	0.0			
LnGrp LOS	E	A	A	A	D	D	B	A	A			
Approach Vol, veh/h		814			870			713				
Approach Delay, s/veh		12.6			40.6			14.6				
Approach LOS		B			D			B				
Timer - Assigned Phs		2		4			7	8				
Phs Duration (G+Y+Rc), s		57.1		42.9			9.3	33.5				
Change Period (Y+Rc), s		4.5		4.5			4.5	4.5				
Max Green Setting (Gmax), s		39.5		51.5			10.5	36.5				
Max Q Clear Time (g_c+I1), s		13.7		10.4			5.7	24.7				
Green Ext Time (p_c), s		2.8		6.2			0.0	4.4				

Intersection Summary

HCM 6th Ctrl Delay	23.4
HCM 6th LOS	C

Notes

User approved volume balancing among the lanes for turning movement.

HCM 6th Signalized Intersection Summary
 17: Westberry Boulevard & Cleveland Avenue

Village D Specific Plan
 Existing WP MIT - PM Peak Hour



Movement	EBL	EBT	EBR	WBL	WBT	WBR	NBL	NBT	NBR	SBL	SBT	SBR
Lane Configurations												
Traffic Volume (veh/h)	220	743	26	27	1027	11	46	8	34	13	22	369
Future Volume (veh/h)	220	743	26	27	1027	11	46	8	34	13	22	369
Initial Q (Qb), veh	0	0	0	0	0	0	0	0	0	0	0	0
Ped-Bike Adj(A_pbT)	1.00		1.00	1.00		1.00	1.00		1.00	1.00		1.00
Parking Bus, Adj	1.00	1.00	1.00	1.00	1.00	1.00	1.00	1.00	1.00	1.00	1.00	1.00
Work Zone On Approach		No		No		No		No		No		No
Adj Sat Flow, veh/h/ln	1900	1900	1900	1900	1900	1900	1900	1900	1900	1900	1900	1900
Adj Flow Rate, veh/h	262	885	31	32	1223	13	55	10	40	15	26	439
Peak Hour Factor	0.84	0.84	0.84	0.84	0.84	0.84	0.84	0.84	0.84	0.84	0.84	0.84
Percent Heavy Veh, %	0	0	0	0	0	0	0	0	0	0	0	0
Cap, veh/h	294	1749	61	53	1311	14	71	536	454	31	493	418
Arrive On Green	0.16	0.49	0.49	0.03	0.36	0.36	0.04	0.28	0.28	0.02	0.26	0.26
Sat Flow, veh/h	1810	3558	125	1810	3659	39	1810	1900	1610	1810	1900	1610
Grp Volume(v), veh/h	262	449	467	32	603	633	55	10	40	15	26	439
Grp Sat Flow(s),veh/h/ln	1810	1805	1877	1810	1805	1893	1810	1900	1610	1810	1900	1610
Q Serve(g_s), s	14.2	16.8	16.8	1.7	32.2	32.2	3.0	0.4	1.8	0.8	1.0	26.0
Cycle Q Clear(g_c), s	14.2	16.8	16.8	1.7	32.2	32.2	3.0	0.4	1.8	0.8	1.0	26.0
Prop In Lane	1.00		0.07	1.00		0.02	1.00		1.00	1.00		1.00
Lane Grp Cap(c), veh/h	294	887	923	53	647	678	71	536	454	31	493	418
V/C Ratio(X)	0.89	0.51	0.51	0.60	0.93	0.93	0.77	0.02	0.09	0.49	0.05	1.05
Avail Cap(c_a), veh/h	317	887	923	109	659	691	100	536	454	90	493	418
HCM Platoon Ratio	1.00	1.00	1.00	1.00	1.00	1.00	1.00	1.00	1.00	1.00	1.00	1.00
Upstream Filter(I)	1.00	1.00	1.00	1.00	1.00	1.00	1.00	1.00	1.00	1.00	1.00	1.00
Uniform Delay (d), s/veh	41.0	17.2	17.2	47.9	30.9	30.9	47.6	25.9	26.4	48.7	27.8	37.0
Incr Delay (d2), s/veh	24.2	0.5	0.4	10.4	20.1	19.5	21.4	0.1	0.4	11.4	0.2	57.7
Initial Q Delay(d3),s/veh	0.0	0.0	0.0	0.0	0.0	0.0	0.0	0.0	0.0	0.0	0.0	0.0
%ile BackOfQ(50%),veh/ln	8.2	6.8	7.1	0.9	17.2	17.9	1.8	0.2	0.7	0.5	0.5	16.7
Unsig. Movement Delay, s/veh												
LnGrp Delay(d),s/veh	65.2	17.7	17.7	58.3	51.0	50.4	69.0	26.0	26.8	60.1	28.0	94.8
LnGrp LOS	E	B	B	E	D	D	E	C	C	E	C	F
Approach Vol, veh/h		1178			1268			105			480	
Approach Delay, s/veh		28.2			50.9			48.8			90.1	
Approach LOS		C			D			D			F	
Timer - Assigned Phs	1	2	3	4	5	6	7	8				
Phs Duration (G+Y+Rc), s	6.2	32.7	7.4	53.7	8.4	30.5	20.8	40.3				
Change Period (Y+Rc), s	4.5	4.5	4.5	4.5	4.5	4.5	4.5	4.5				
Max Green Setting (Gmax), s	5.0	23.0	6.0	48.0	5.5	22.5	17.5	36.5				
Max Q Clear Time (g_c+1), s	12.8	3.8	3.7	18.8	5.0	28.0	16.2	34.2				
Green Ext Time (p_c), s	0.0	0.1	0.0	6.7	0.0	0.0	0.1	1.6				
Intersection Summary												
HCM 6th Ctrl Delay											48.2	
HCM 6th LOS											D	

HCM 6th Signalized Intersection Summary
 18: Westberry Boulevard & Sunset Avenue

Village D Specific Plan
 Existing WP MIT - PM Peak Hour



Movement	EBL	EBT	EBR	WBL	WBT	WBR	NBL	NBT	NBR	SBL	SBT	SBR
Lane Configurations	↖	↗		↖	↗		↖	↗	↖	↗	↖	↗
Traffic Volume (veh/h)	40	150	51	64	188	16	67	108	55	16	95	52
Future Volume (veh/h)	40	150	51	64	188	16	67	108	55	16	95	52
Initial Q (Qb), veh	0	0	0	0	0	0	0	0	0	0	0	0
Ped-Bike Adj(A_pbT)	1.00		0.98	1.00		1.00	1.00		1.00	1.00		1.00
Parking Bus, Adj	1.00	1.00	1.00	1.00	1.00	1.00	1.00	1.00	1.00	1.00	1.00	1.00
Work Zone On Approach		No			No			No			No	
Adj Sat Flow, veh/h/ln	1900	1900	1900	1900	1900	1900	1900	1900	1900	1900	1900	1900
Adj Flow Rate, veh/h	42	156	53	67	196	17	70	112	57	17	99	54
Peak Hour Factor	0.96	0.96	0.96	0.96	0.96	0.96	0.96	0.96	0.96	0.96	0.96	0.96
Percent Heavy Veh, %	0	0	0	0	0	0	0	0	0	0	0	0
Cap, veh/h	457	354	120	456	453	39	136	440	373	40	340	288
Arrive On Green	0.26	0.26	0.26	0.26	0.26	0.26	0.08	0.23	0.23	0.02	0.18	0.18
Sat Flow, veh/h	1187	1347	458	1191	1724	149	1810	1900	1610	1810	1900	1610
Grp Volume(v), veh/h	42	0	209	67	0	213	70	112	57	17	99	54
Grp Sat Flow(s),veh/h/ln	1187	0	1805	1191	0	1873	1810	1900	1610	1810	1900	1610
Q Serve(g_s), s	0.9	0.0	2.7	1.4	0.0	2.6	1.0	1.3	0.8	0.3	1.3	0.8
Cycle Q Clear(g_c), s	3.5	0.0	2.7	4.1	0.0	2.6	1.0	1.3	0.8	0.3	1.3	0.8
Prop In Lane	1.00		0.25	1.00		0.08	1.00		1.00	1.00		1.00
Lane Grp Cap(c), veh/h	457	0	475	456	0	492	136	440	373	40	340	288
V/C Ratio(X)	0.09	0.00	0.44	0.15	0.00	0.43	0.52	0.25	0.15	0.42	0.29	0.19
Avail Cap(c_a), veh/h	1271	0	1712	1273	0	1776	939	2210	1873	486	1734	1469
HCM Platoon Ratio	1.00	1.00	1.00	1.00	1.00	1.00	1.00	1.00	1.00	1.00	1.00	1.00
Upstream Filter(I)	1.00	0.00	1.00	1.00	0.00	1.00	1.00	1.00	1.00	1.00	1.00	1.00
Uniform Delay (d), s/veh	10.0	0.0	8.6	10.3	0.0	8.6	12.4	8.8	8.5	13.5	9.9	9.7
Incr Delay (d2), s/veh	0.1	0.0	0.6	0.1	0.0	0.6	3.0	0.3	0.2	7.0	0.5	0.3
Initial Q Delay(d3),s/veh	0.0	0.0	0.0	0.0	0.0	0.0	0.0	0.0	0.0	0.0	0.0	0.0
%ile BackOfQ(50%),veh/ln	0.2	0.0	0.8	0.3	0.0	0.8	0.4	0.4	0.2	0.2	0.4	0.2
Unsig. Movement Delay, s/veh												
LnGrp Delay(d),s/veh	10.1	0.0	9.2	10.4	0.0	9.2	15.4	9.1	8.7	20.5	10.4	10.1
LnGrp LOS	B	A	A	B	A	A	B	A	A	C	B	B
Approach Vol, veh/h		251			280			239			170	
Approach Delay, s/veh		9.4			9.5			10.9			11.3	
Approach LOS		A			A			B			B	
Timer - Assigned Phs	1	2		4	5	6		8				
Phs Duration (G+Y+Rc), s	5.1	11.0		11.8	6.6	9.5		11.8				
Change Period (Y+Rc), s	4.5	4.5		4.5	4.5	4.5		4.5				
Max Green Setting (Gmax), s	5	32.5		26.5	14.5	25.5		26.5				
Max Q Clear Time (g_c+1/2), s	12	3.3		5.5	3.0	3.3		6.1				
Green Ext Time (p_c), s	0.0	0.8		1.3	0.1	0.6		1.4				

Intersection Summary

HCM 6th Ctrl Delay	10.1
HCM 6th LOS	B

HCM 6th Signalized Intersection Summary
 19: Westberry Boulevard & Avenue 14

Village D Specific Plan
 Existing WP MIT - PM Peak Hour



Movement	EBL	EBT	EBR	WBL	WBT	WBR	NBL	NBT	NBR	SBL	SBT	SBR
Lane Configurations	↖	↗		↖	↗		↖	↗		↖	↗	
Traffic Volume (veh/h)	68	647	67	22	714	130	53	41	16	88	42	80
Future Volume (veh/h)	68	647	67	22	714	130	53	41	16	88	42	80
Initial Q (Qb), veh	0	0	0	0	0	0	0	0	0	0	0	0
Ped-Bike Adj(A_pbT)	1.00		1.00	1.00		1.00	1.00		1.00	1.00		1.00
Parking Bus, Adj	1.00	1.00	1.00	1.00	1.00	1.00	1.00	1.00	1.00	1.00	1.00	1.00
Work Zone On Approach		No		No		No		No		No		No
Adj Sat Flow, veh/h/ln	1900	1900	1900	1900	1900	1900	1900	1900	1900	1900	1900	1900
Adj Flow Rate, veh/h	76	727	75	25	802	146	60	46	18	99	47	90
Peak Hour Factor	0.89	0.89	0.89	0.89	0.89	0.89	0.89	0.89	0.89	0.89	0.89	0.89
Percent Heavy Veh, %	0	0	0	0	0	0	0	0	0	0	0	0
Cap, veh/h	119	1353	139	53	1137	207	103	149	58	137	77	148
Arrive On Green	0.07	0.41	0.41	0.03	0.37	0.37	0.06	0.11	0.11	0.08	0.13	0.13
Sat Flow, veh/h	1810	3302	340	1810	3048	555	1810	1299	508	1810	581	1113
Grp Volume(v), veh/h	76	397	405	25	475	473	60	0	64	99	0	137
Grp Sat Flow(s),veh/h/ln	1810	1805	1837	1810	1805	1797	1810	0	1807	1810	0	1695
Q Serve(g_s), s	2.0	8.1	8.1	0.7	10.9	10.9	1.6	0.0	1.6	2.6	0.0	3.7
Cycle Q Clear(g_c), s	2.0	8.1	8.1	0.7	10.9	10.9	1.6	0.0	1.6	2.6	0.0	3.7
Prop In Lane	1.00		0.19	1.00		0.31	1.00		0.28	1.00		0.66
Lane Grp Cap(c), veh/h	119	739	753	53	673	671	103	0	207	137	0	226
V/C Ratio(X)	0.64	0.54	0.54	0.47	0.71	0.71	0.58	0.00	0.31	0.72	0.00	0.61
Avail Cap(c_a), veh/h	279	1063	1082	201	985	981	257	0	725	317	0	736
HCM Platoon Ratio	1.00	1.00	1.00	1.00	1.00	1.00	1.00	1.00	1.00	1.00	1.00	1.00
Upstream Filter(I)	1.00	1.00	1.00	1.00	1.00	1.00	1.00	0.00	1.00	1.00	0.00	1.00
Uniform Delay (d), s/veh	22.1	10.9	10.9	23.2	13.0	13.0	22.3	0.0	19.7	21.9	0.0	19.9
Incr Delay (d2), s/veh	5.5	0.6	0.6	6.3	1.4	1.4	5.1	0.0	0.8	6.9	0.0	2.6
Initial Q Delay(d3),s/veh	0.0	0.0	0.0	0.0	0.0	0.0	0.0	0.0	0.0	0.0	0.0	0.0
%ile BackOfQ(50%),veh/ln	0	2.7	2.8	0.4	3.8	3.8	0.8	0.0	0.7	1.3	0.0	1.5
Unsig. Movement Delay, s/veh												
LnGrp Delay(d),s/veh	27.6	11.5	11.5	29.5	14.3	14.3	27.4	0.0	20.6	28.9	0.0	22.5
LnGrp LOS	C	B	B	C	B	B	C	A	C	C	A	C
Approach Vol, veh/h		878			973			124				236
Approach Delay, s/veh		12.9			14.7			23.9				25.2
Approach LOS		B			B			C				C
Timer - Assigned Phs	1	2	3	4	5	6	7	8				
Phs Duration (G+Y+Rc), s	8.2	10.1	5.9	24.4	7.3	11.0	7.7	22.6				
Change Period (Y+Rc), s	4.5	4.5	4.5	4.5	4.5	4.5	4.5	4.5				
Max Green Setting (Gmax), s	5	19.5	5.4	28.6	6.9	21.1	7.5	26.5				
Max Q Clear Time (g_c+1), s	11.6	3.6	2.7	10.1	3.6	5.7	4.0	12.9				
Green Ext Time (p_c), s	0.1	0.2	0.0	5.0	0.0	0.6	0.0	5.2				

Intersection Summary

HCM 6th Ctrl Delay		15.6										
HCM 6th LOS			B									

HCM 6th Signalized Intersection Summary
21: Granada Drive & Cleveland Avenue

Village D Specific Plan
Existing WP MIT - PM Peak Hour



Movement	EBL	EBT	EBR	WBL	WBT	WBR	NBL	NBT	NBR	SBL	SBT	SBR
Lane Configurations												
Traffic Volume (veh/h)	13	675	25	320	1000	20	28	191	229	19	233	21
Future Volume (veh/h)	13	675	25	320	1000	20	28	191	229	19	233	21
Initial Q (Qb), veh	0	0	0	0	0	0	0	0	0	0	0	0
Ped-Bike Adj(A_pbT)	1.00		1.00	1.00		0.98	1.00		0.99	1.00		1.00
Parking Bus, Adj	1.00	1.00	1.00	1.00	1.00	1.00	1.00	1.00	1.00	1.00	1.00	1.00
Work Zone On Approach		No			No			No			No	
Adj Sat Flow, veh/h/ln	1900	1900	1900	1900	1900	1900	1900	1900	1900	1900	1900	1900
Adj Flow Rate, veh/h	14	718	27	340	1064	21	30	203	244	20	248	22
Peak Hour Factor	0.94	0.94	0.94	0.94	0.94	0.94	0.94	0.94	0.94	0.94	0.94	0.94
Percent Heavy Veh, %	0	0	0	0	0	0	0	0	0	0	0	0
Cap, veh/h	30	822	31	384	1547	31	53	635	531	40	621	526
Arrive On Green	0.02	0.23	0.23	0.14	0.29	0.29	0.03	0.33	0.33	0.02	0.33	0.33
Sat Flow, veh/h	1810	3547	133	1810	3619	71	1810	1900	1590	1810	1900	1610
Grp Volume(v), veh/h	14	365	380	340	531	554	30	203	244	20	248	22
Grp Sat Flow(s),veh/h/ln	1810	1805	1875	1810	1805	1885	1810	1900	1590	1810	1900	1610
Q Serve(g_s), s	0.7	17.5	17.6	16.6	23.5	23.5	1.5	7.2	10.9	1.0	9.1	0.8
Cycle Q Clear(g_c), s	0.7	17.5	17.6	16.6	23.5	23.5	1.5	7.2	10.9	1.0	9.1	0.8
Prop In Lane	1.00		0.07	1.00		0.04	1.00		1.00	1.00		1.00
Lane Grp Cap(c), veh/h	30	418	435	384	772	806	53	635	531	40	621	526
V/C Ratio(X)	0.47	0.87	0.87	0.89	0.69	0.69	0.57	0.32	0.46	0.51	0.40	0.04
Avail Cap(c_a), veh/h	101	451	469	472	822	859	103	635	531	103	621	526
HCM Platoon Ratio	1.00	1.00	1.00	0.67	0.67	0.67	1.00	1.00	1.00	1.00	1.00	1.00
Upstream Filter(I)	1.00	1.00	1.00	0.45	0.45	0.45	1.00	1.00	1.00	1.00	1.00	1.00
Uniform Delay (d), s/veh	43.9	33.3	33.3	37.5	26.8	26.8	43.1	22.3	23.6	43.5	23.5	20.7
Incr Delay (d2), s/veh	11.2	16.1	15.7	8.0	1.0	1.0	9.1	1.3	2.8	9.6	1.9	0.1
Initial Q Delay(d3),s/veh	0.0	0.0	0.0	0.0	0.0	0.0	0.0	0.0	0.0	0.0	0.0	0.0
%ile BackOfQ(50%),veh/ln	0.4	9.4	9.7	8.4	10.7	11.2	0.8	3.4	4.4	0.5	4.3	0.3
Unsig. Movement Delay, s/veh												
LnGrp Delay(d),s/veh	55.0	49.4	49.0	45.5	27.8	27.8	52.2	23.7	26.4	53.2	25.4	20.8
LnGrp LOS	E	D	D	D	C	C	D	C	C	D	C	C
Approach Vol, veh/h		759			1425			477			290	
Approach Delay, s/veh		49.3			32.0			26.9			26.9	
Approach LOS		D			C			C			C	
Timer - Assigned Phs	1	2	3	4	5	6	7	8				
Phs Duration (G+Y+Rc), s	6.5	34.6	23.6	25.4	7.1	33.9	6.0	43.0				
Change Period (Y+Rc), s	4.5	4.5	4.5	4.5	4.5	4.5	4.5	4.5				
Max Green Setting (Gmax), s	5.1	20.9	23.5	22.5	5.1	20.9	5.0	41.0				
Max Q Clear Time (g_c+I1), s	3.0	12.9	18.6	19.6	3.5	11.1	2.7	25.5				
Green Ext Time (p_c), s	0.0	1.3	0.5	1.3	0.0	1.0	0.0	6.5				

Intersection Summary

HCM 6th Ctrl Delay	35.1
HCM 6th LOS	D

HCM 6th Signalized Intersection Summary
22: Granada Drive & Sunset Avenue

Village D Specific Plan
Existing WP MIT - PM Peak Hour



Movement	EBL	EBT	EBR	WBL	WBT	WBR	NBL	NBT	NBR	SBL	SBT	SBR
Lane Configurations												
Traffic Volume (veh/h)	28	167	34	54	216	108	46	262	42	76	293	32
Future Volume (veh/h)	28	167	34	54	216	108	46	262	42	76	293	32
Initial Q (Qb), veh	0	0	0	0	0	0	0	0	0	0	0	0
Ped-Bike Adj(A_pbT)	1.00		0.99	1.00		0.99	1.00		0.99	1.00		0.99
Parking Bus, Adj	1.00	1.00	1.00	1.00	1.00	1.00	1.00	1.00	1.00	1.00	1.00	1.00
Work Zone On Approach		No		No		No		No		No		No
Adj Sat Flow, veh/h/ln	1900	1900	1900	1900	1900	1900	1885	1885	1885	1885	1885	1885
Adj Flow Rate, veh/h	30	180	37	58	232	116	49	282	45	82	315	34
Peak Hour Factor	0.93	0.93	0.93	0.93	0.93	0.93	0.93	0.93	0.93	0.93	0.93	0.93
Percent Heavy Veh, %	0	0	0	0	0	0	1	1	1	1	1	1
Cap, veh/h	63	283	58	105	396	333	93	415	66	131	473	51
Arrive On Green	0.04	0.19	0.19	0.06	0.21	0.21	0.05	0.26	0.26	0.07	0.28	0.28
Sat Flow, veh/h	1810	1527	314	1810	1900	1599	1795	1584	253	1795	1670	180
Grp Volume(v), veh/h	30	0	217	58	232	116	49	0	327	82	0	349
Grp Sat Flow(s),veh/h/ln	1810	0	1840	1810	1900	1599	1795	0	1836	1795	0	1850
Q Serve(g_s), s	0.7	0.0	4.6	1.3	4.7	2.6	1.1	0.0	6.8	1.9	0.0	7.1
Cycle Q Clear(g_c), s	0.7	0.0	4.6	1.3	4.7	2.6	1.1	0.0	6.8	1.9	0.0	7.1
Prop In Lane	1.00		0.17	1.00		1.00	1.00		0.14	1.00		0.10
Lane Grp Cap(c), veh/h	63	0	341	105	396	333	93	0	481	131	0	524
V/C Ratio(X)	0.47	0.00	0.64	0.55	0.59	0.35	0.53	0.00	0.68	0.63	0.00	0.67
Avail Cap(c_a), veh/h	233	0	798	293	886	745	273	0	1166	400	0	1305
HCM Platoon Ratio	1.00	1.00	1.00	1.00	1.00	1.00	1.00	1.00	1.00	1.00	1.00	1.00
Upstream Filter(I)	1.00	0.00	1.00	1.00	1.00	1.00	1.00	0.00	1.00	1.00	0.00	1.00
Uniform Delay (d), s/veh	20.2	0.0	16.1	19.6	15.2	14.4	19.7	0.0	14.1	19.2	0.0	13.5
Incr Delay (d2), s/veh	5.4	0.0	2.0	4.4	1.4	0.6	4.6	0.0	1.7	4.9	0.0	1.5
Initial Q Delay(d3),s/veh	0.0	0.0	0.0	0.0	0.0	0.0	0.0	0.0	0.0	0.0	0.0	0.0
%ile BackOfQ(50%),veh/ln	0.4	0.0	1.9	0.6	1.9	0.9	0.5	0.0	2.6	0.9	0.0	2.6
Unsig. Movement Delay, s/veh												
LnGrp Delay(d),s/veh	25.6	0.0	18.0	24.0	16.6	15.0	24.3	0.0	15.8	24.1	0.0	15.0
LnGrp LOS	C	A	B	C	B	B	C	A	B	C	A	B
Approach Vol, veh/h		247		406		376		431				
Approach Delay, s/veh		18.9		17.2		17.0		16.7				
Approach LOS		B		B		B		B				
Timer - Assigned Phs	1	2	3	4	5	6	7	8				
Phs Duration (G+Y+Rc), s	7.6	15.7	7.0	12.4	6.7	16.6	6.0	13.4				
Change Period (Y+Rc), s	4.5	4.5	4.5	4.5	4.5	4.5	4.5	4.5				
Max Green Setting (Gmax), s	5	27.1	6.9	18.5	6.5	30.1	5.5	19.9				
Max Q Clear Time (g_c+1), s	5	8.8	3.3	6.6	3.1	9.1	2.7	6.7				
Green Ext Time (p_c), s	0.1	1.8	0.0	0.9	0.0	2.1	0.0	1.4				

Intersection Summary

HCM 6th Ctrl Delay	17.3
HCM 6th LOS	B

Intersection	
Intersection Delay, s/veh	21.9
Intersection LOS	C

Movement	EBL	EBT	WBT	WBR	SBL	SBR
Lane Configurations						
Traffic Vol, veh/h	143	353	375	1	128	184
Future Vol, veh/h	143	353	375	1	128	184
Peak Hour Factor	0.85	0.85	0.85	0.85	0.85	0.85
Heavy Vehicles, %	2	2	2	2	3	3
Mvmt Flow	168	415	441	1	151	216
Number of Lanes	1	1	1	0	1	1

Approach	EB	WB	SB
Opposing Approach	WB	EB	
Opposing Lanes	1	2	0
Conflicting Approach Left SB			WB
Conflicting Lanes Left	2	0	1
Conflicting Approach Right		SB	EB
Conflicting Lanes Right	0	2	2
HCM Control Delay	22	28.4	13.9
HCM LOS	C	D	B

Lane	EBLn1	EBLn2	WBLn1	SBLn1	SBLn2
Vol Left, %	100%	0%	0%	100%	0%
Vol Thru, %	0%	100%	100%	0%	0%
Vol Right, %	0%	0%	0%	0%	100%
Sign Control	Stop	Stop	Stop	Stop	Stop
Traffic Vol by Lane	143	353	376	128	184
LT Vol	143	0	0	128	0
Through Vol	0	353	375	0	0
RT Vol	0	0	1	0	184
Lane Flow Rate	168	415	442	151	216
Geometry Grp	7	7	4	7	7
Degree of Util (X)	0.324	0.742	0.779	0.325	0.394
Departure Headway (Hd)	6.943	6.433	6.341	7.773	6.545
Convergence, Y/N	Yes	Yes	Yes	Yes	Yes
Cap	516	561	571	461	548
Service Time	4.712	4.202	4.403	5.546	4.317
HCM Lane V/C Ratio	0.326	0.74	0.774	0.328	0.394
HCM Control Delay	13	25.6	28.4	14.3	13.6
HCM Lane LOS	B	D	D	B	B
HCM 95th-tile Q	1.4	6.4	7.2	1.4	1.9

HCM 6th Signalized Intersection Summary
 31: SR-99 Southbound Ramps & Cleveland Avenue

Village D Specific Plan
 Existing WP MIT - PM Peak Hour



Movement	EBL	EBT	EBR	WBL	WBT	WBR	NBL	NBT	NBR	SBL	SBT	SBR
Lane Configurations		↑↑	↑	↑	↑↑					↑		↑
Traffic Volume (veh/h)	0	946	568	193	1787	0	0	0	0	212	0	92
Future Volume (veh/h)	0	946	568	193	1787	0	0	0	0	212	0	92
Initial Q (Qb), veh	0	0	0	0	0	0				0	0	0
Ped-Bike Adj(A_pbT)	1.00		1.00	1.00		1.00				1.00		1.00
Parking Bus, Adj	1.00	1.00	1.00	1.00	1.00	1.00				1.00	1.00	1.00
Work Zone On Approach		No		No						No		
Adj Sat Flow, veh/h/ln	0	1885	1885	1900	1900	0				1856	0	1856
Adj Flow Rate, veh/h	0	975	0	199	1842	0				219	0	95
Peak Hour Factor	0.97	0.97	0.97	0.97	0.97	0.97				0.97	0.97	0.97
Percent Heavy Veh, %	0	1	1	0	0	0				3	0	3
Cap, veh/h	0	1189		234	1845	0				687	0	612
Arrive On Green	0.00	0.33	0.00	0.26	1.00	0.00				0.39	0.00	0.39
Sat Flow, veh/h	0	3676	1598	1810	3705	0				1767	0	1572
Grp Volume(v), veh/h	0	975	0	199	1842	0				219	0	95
Grp Sat Flow(s),veh/h/ln	0	1791	1598	1810	1805	0				1767	0	1572
Q Serve(g_s), s	0.0	22.5	0.0	9.4	0.0	0.0				7.8	0.0	3.5
Cycle Q Clear(g_c), s	0.0	22.5	0.0	9.4	0.0	0.0				7.8	0.0	3.5
Prop In Lane	0.00		1.00	1.00		0.00				1.00		1.00
Lane Grp Cap(c), veh/h	0	1189		234	1845	0				687	0	612
V/C Ratio(X)	0.00	0.82		0.85	1.00	0.00				0.32	0.00	0.16
Avail Cap(c_a), veh/h	0	1453		372	2387	0				687	0	612
HCM Platoon Ratio	1.00	1.00	1.00	2.00	2.00	1.00				1.00	1.00	1.00
Upstream Filter(I)	0.00	0.62	0.00	0.29	0.29	0.00				1.00	0.00	1.00
Uniform Delay (d), s/veh	0.0	27.6	0.0	32.5	0.0	0.0				19.2	0.0	17.9
Incr Delay (d2), s/veh	0.0	2.0	0.0	3.3	8.7	0.0				1.2	0.0	0.5
Initial Q Delay(d3),s/veh	0.0	0.0	0.0	0.0	0.0	0.0				0.0	0.0	0.0
%ile BackOfQ(50%),veh/ln	0.0	9.6	0.0	3.7	2.2	0.0				3.3	0.0	1.3
Unsig. Movement Delay, s/veh												
LnGrp Delay(d),s/veh	0.0	29.6	0.0	35.8	8.7	0.0				20.4	0.0	18.4
LnGrp LOS	A	C		D	A	A				C	A	B
Approach Vol, veh/h		975	A		2041						314	
Approach Delay, s/veh		29.6			11.3						19.8	
Approach LOS		C			B						B	
Timer - Assigned Phs			3	4		6		8				
Phs Duration (G+Y+Rc), s			16.1	34.4		39.5		50.5				
Change Period (Y+Rc), s			4.5	4.5		4.5		4.5				
Max Green Setting (Gmax), s			18.5	36.5		21.5		59.5				
Max Q Clear Time (g_c+1), s			11.4	24.5		9.8		2.0				
Green Ext Time (p_c), s			0.3	5.4		0.8		27.4				
Intersection Summary												
HCM 6th Ctrl Delay			17.5									
HCM 6th LOS			B									
Notes												
Unsignalized Delay for [EBR] is excluded from calculations of the approach delay and intersection delay.												

HCM 6th Signalized Intersection Summary

36: Pine Street & Howard Road

Village D Specific Plan
Existing WP MIT - PM Peak Hour



Movement	EBL	EBT	EBR	WBL	WBT	WBR	NBL	NBT	NBR	SBL	SBT	SBR
Lane Configurations												
Traffic Volume (veh/h)	85	760	140	86	844	3	232	169	138	15	137	119
Future Volume (veh/h)	85	760	140	86	844	3	232	169	138	15	137	119
Initial Q (Qb), veh	0	0	0	0	0	0	0	0	0	0	0	0
Ped-Bike Adj(A_pbT)	1.00		0.95	1.00		0.95	1.00		0.99	1.00		1.00
Parking Bus, Adj	1.00	1.00	1.00	1.00	1.00	1.00	1.00	1.00	1.00	1.00	1.00	1.00
Work Zone On Approach		No			No			No			No	
Adj Sat Flow, veh/h/ln	1870	1870	1870	1885	1885	1885	1885	1885	1885	1870	1870	1870
Adj Flow Rate, veh/h	91	817	151	92	908	3	249	182	148	16	147	128
Peak Hour Factor	0.93	0.93	0.93	0.93	0.93	0.93	0.93	0.93	0.93	0.93	0.93	0.93
Percent Heavy Veh, %	2	2	2	1	1	1	1	1	1	2	2	2
Cap, veh/h	148	887	164	117	1029	3	361	717	600	99	439	372
Arrive On Green	0.08	0.30	0.30	0.07	0.28	0.28	0.20	0.38	0.38	0.06	0.23	0.23
Sat Flow, veh/h	1781	2967	548	1795	3661	12	1795	1885	1578	1781	1870	1585
Grp Volume(v), veh/h	91	489	479	92	444	467	249	182	148	16	147	128
Grp Sat Flow(s),veh/h/ln	1781	1777	1739	1795	1791	1882	1795	1885	1578	1781	1870	1585
Q Serve(g_s), s	4.4	24.0	24.0	4.5	21.3	21.3	11.6	6.0	5.8	0.8	5.9	4.6
Cycle Q Clear(g_c), s	4.4	24.0	24.0	4.5	21.3	21.3	11.6	6.0	5.8	0.8	5.9	4.6
Prop In Lane	1.00		0.32	1.00		0.01	1.00		1.00	1.00		1.00
Lane Grp Cap(c), veh/h	148	531	520	117	503	529	361	717	600	99	439	372
V/C Ratio(X)	0.61	0.92	0.92	0.78	0.88	0.88	0.69	0.25	0.25	0.16	0.34	0.34
Avail Cap(c_a), veh/h	148	543	531	130	539	567	361	717	600	356	439	372
HCM Platoon Ratio	1.00	1.00	1.00	1.00	1.00	1.00	1.00	1.00	1.00	1.00	1.00	1.00
Upstream Filter(I)	1.00	1.00	1.00	0.86	0.86	0.86	1.00	1.00	1.00	1.00	1.00	1.00
Uniform Delay (d), s/veh	39.9	30.5	30.5	41.4	30.9	30.9	33.3	19.1	19.1	40.5	28.6	16.6
Incr Delay (d2), s/veh	7.3	21.0	21.3	21.3	13.3	12.8	10.3	0.9	1.0	0.8	0.4	0.5
Initial Q Delay(d3),s/veh	0.0	0.0	0.0	0.0	0.0	0.0	0.0	0.0	0.0	0.0	0.0	0.0
%ile BackOfQ(50%),veh/ln	2.2	13.0	12.7	2.7	10.8	11.3	6.0	2.7	2.2	0.4	2.6	2.3
Unsig. Movement Delay, s/veh												
LnGrp Delay(d),s/veh	47.2	51.5	51.9	62.7	44.3	43.7	43.7	20.0	20.1	41.3	29.1	17.1
LnGrp LOS	D	D	D	E	D	D	D	B	C	D	C	B
Approach Vol, veh/h		1059			1003			579			291	
Approach Delay, s/veh		51.3			45.7			30.2			24.5	
Approach LOS		D			D			C			C	
Timer - Assigned Phs	1	2	3	4	5	6	7	8				
Phs Duration (G+Y+Rc), s	9.5	38.7	10.4	31.4	22.6	25.6	12.0	29.8				
Change Period (Y+Rc), s	4.5	4.5	4.5	4.5	4.5	4.5	4.5	4.5				
Max Green Setting (Gmax), s	18.0	20.0	6.5	27.5	18.1	19.9	6.9	27.1				
Max Q Clear Time (g_c+I1), s	2.8	8.0	6.5	26.0	13.6	7.9	6.4	23.3				
Green Ext Time (p_c), s	0.0	1.2	0.0	0.9	0.3	0.9	0.0	2.0				
Intersection Summary												
HCM 6th Ctrl Delay			42.6									
HCM 6th LOS			D									

HCM 6th Signalized Intersection Summary
 38: I Street & 2nd Street/SR-99 Southbound Off-Ramp

Village D Specific Plan
 Existing WP MIT - PM Peak Hour



Movement	EBL	EBT	EBR	WBL	WBT	WBR	NBL	NBT	NBR	SBL	SBT	SBR
Lane Configurations		↕			↕	↕	↕	↑			↕	
Traffic Volume (veh/h)	0	0	32	287	10	4	42	141	0	0	112	0
Future Volume (veh/h)	0	0	32	287	10	4	42	141	0	0	112	0
Initial Q (Qb), veh	0	0	0	0	0	0	0	0	0	0	0	0
Ped-Bike Adj(A_pbT)	1.00		1.00	1.00		1.00	1.00		1.00	1.00		1.00
Parking Bus, Adj	1.00	1.00	1.00	1.00	1.00	1.00	1.00	1.00	1.00	1.00	1.00	1.00
Work Zone On Approach		No			No			No			No	
Adj Sat Flow, veh/h/ln	1900	1900	1900	1870	1870	1870	1900	1900	0	0	1900	1900
Adj Flow Rate, veh/h	0	0	33	293	10	4	43	144	0	0	114	0
Peak Hour Factor	0.98	0.98	0.98	0.98	0.98	0.98	0.98	0.98	0.98	0.98	0.98	0.98
Percent Heavy Veh, %	0	0	0	2	2	2	0	0	0	0	0	0
Cap, veh/h	0	0	48	348	12	320	864	1203	0	0	1203	0
Arrive On Green	0.00	0.00	0.03	0.20	0.20	0.20	1.00	1.00	0.00	0.00	0.63	0.00
Sat Flow, veh/h	0	0	1610	1725	59	1585	1298	1900	0	0	1900	0
Grp Volume(v), veh/h	0	0	33	303	0	4	43	144	0	0	114	0
Grp Sat Flow(s),veh/h/ln	0	0	1610	1784	0	1585	1298	1900	0	0	1900	0
Q Serve(g_s), s	0.0	0.0	2.0	16.3	0.0	0.2	0.1	0.0	0.0	0.0	2.3	0.0
Cycle Q Clear(g_c), s	0.0	0.0	2.0	16.3	0.0	0.2	2.5	0.0	0.0	0.0	2.3	0.0
Prop In Lane	0.00		1.00	0.97		1.00	1.00		0.00	0.00		0.00
Lane Grp Cap(c), veh/h	0	0	48	360	0	320	864	1203	0	0	1203	0
V/C Ratio(X)	0.00	0.00	0.68	0.84	0.00	0.01	0.05	0.12	0.00	0.00	0.09	0.00
Avail Cap(c_a), veh/h	0	0	298	723	0	642	864	1203	0	0	1203	0
HCM Platoon Ratio	1.00	1.00	1.00	1.00	1.00	1.00	2.00	2.00	1.00	1.00	1.00	1.00
Upstream Filter(I)	0.00	0.00	1.00	1.00	0.00	1.00	0.99	0.99	0.00	0.00	1.00	0.00
Uniform Delay (d), s/veh	0.0	0.0	48.0	38.4	0.0	31.9	0.0	0.0	0.0	0.0	7.2	0.0
Incr Delay (d2), s/veh	0.0	0.0	15.6	5.4	0.0	0.0	0.1	0.2	0.0	0.0	0.2	0.0
Initial Q Delay(d3),s/veh	0.0	0.0	0.0	0.0	0.0	0.0	0.0	0.0	0.0	0.0	0.0	0.0
%ile BackOfQ(50%),veh/ln	0.0	0.0	1.0	7.6	0.0	0.1	0.0	0.1	0.0	0.0	0.9	0.0
Unsig. Movement Delay, s/veh												
LnGrp Delay(d),s/veh	0.0	0.0	63.7	43.8	0.0	32.0	0.2	0.2	0.0	0.0	7.3	0.0
LnGrp LOS	A	A	E	D	A	C	A	A	A	A	A	A
Approach Vol, veh/h		33			307			187			114	
Approach Delay, s/veh		63.7			43.6			0.2			7.3	
Approach LOS		E			D			A			A	
Timer - Assigned Phs		2		4		6		8				
Phs Duration (G+Y+Rc), s		67.8		7.5		67.8		24.7				
Change Period (Y+Rc), s		4.5		4.5		4.5		4.5				
Max Green Setting (Gmax), s		27.5		18.5		27.5		40.5				
Max Q Clear Time (g_c+I1), s		4.5		4.0		4.3		18.3				
Green Ext Time (p_c), s		0.9		0.1		0.5		1.8				
Intersection Summary												
HCM 6th Ctrl Delay				25.5								
HCM 6th LOS				C								

HCM 6th Signalized Intersection Summary

49: Yosemite Avenue & Cleveland Avenue/Tozer Street

Village D Specific Plan
Existing WP MIT - PM Peak Hour



Movement	EBL	EBT	EBR	WBL	WBT	WBR	NBL	NBT	NBR	SBL	SBT	SBR
Lane Configurations	↗	↗↘		↗	↗↘	↗	↗	↗	↗	↗	↗	↗
Traffic Volume (veh/h)	257	419	195	48	472	35	305	283	95	67	167	330
Future Volume (veh/h)	257	419	195	48	472	35	305	283	95	67	167	330
Initial Q (Qb), veh	0	0	0	0	0	0	0	0	0	0	0	0
Ped-Bike Adj(A_pbT)	1.00		0.99	1.00		0.96	1.00		1.00	1.00		0.98
Parking Bus, Adj	1.00	1.00	1.00	1.00	1.00	1.00	1.00	1.00	1.00	1.00	1.00	1.00
Work Zone On Approach		No			No			No			No	
Adj Sat Flow, veh/h/ln	1870	1870	1870	1900	1900	1900	1870	1870	1870	1870	1870	1870
Adj Flow Rate, veh/h	279	455	212	52	513	38	332	308	103	73	182	359
Peak Hour Factor	0.92	0.92	0.92	0.92	0.92	0.92	0.92	0.92	0.92	0.92	0.92	0.92
Percent Heavy Veh, %	2	2	2	0	0	0	2	2	2	2	2	2
Cap, veh/h	309	802	371	72	750	321	363	696	588	94	414	618
Arrive On Green	0.17	0.34	0.34	0.04	0.21	0.21	0.20	0.37	0.37	0.05	0.22	0.22
Sat Flow, veh/h	1781	2351	1086	1810	3610	1545	1781	1870	1580	1781	1870	1551
Grp Volume(v), veh/h	279	343	324	52	513	38	332	308	103	73	182	359
Grp Sat Flow(s),veh/h/ln	1781	1777	1660	1810	1805	1545	1781	1870	1580	1781	1870	1551
Q Serve(g_s), s	14.3	14.6	14.8	2.6	12.2	1.9	16.9	11.5	4.1	3.8	7.8	16.9
Cycle Q Clear(g_c), s	14.3	14.6	14.8	2.6	12.2	1.9	16.9	11.5	4.1	3.8	7.8	16.9
Prop In Lane	1.00		0.65	1.00		1.00	1.00		1.00	1.00		1.00
Lane Grp Cap(c), veh/h	309	606	566	72	750	321	363	696	588	94	414	618
V/C Ratio(X)	0.90	0.57	0.57	0.72	0.68	0.12	0.91	0.44	0.18	0.77	0.44	0.58
Avail Cap(c_a), veh/h	309	606	566	111	750	321	366	743	627	186	554	734
HCM Platoon Ratio	1.00	1.00	1.00	1.00	1.00	1.00	1.00	1.00	1.00	1.00	1.00	1.00
Upstream Filter(I)	1.00	1.00	1.00	1.00	1.00	1.00	1.00	1.00	1.00	1.00	1.00	1.00
Uniform Delay (d), s/veh	37.7	25.0	25.1	44.1	34.0	29.9	36.2	21.9	19.6	43.5	31.2	22.2
Incr Delay (d2), s/veh	28.2	3.8	4.2	12.8	5.0	0.8	26.5	0.4	0.1	12.6	0.7	0.9
Initial Q Delay(d3),s/veh	0.0	0.0	0.0	0.0	0.0	0.0	0.0	0.0	0.0	0.0	0.0	0.0
%ile BackOfQ(50%),veh/ln	8.5	6.6	6.3	1.4	5.8	0.8	9.9	5.0	1.5	2.0	3.6	6.1
Unsig. Movement Delay, s/veh												
LnGrp Delay(d),s/veh	65.9	28.8	29.2	56.9	39.0	30.7	62.7	22.4	19.7	56.0	31.9	23.0
LnGrp LOS	E	C	C	E	D	C	E	C	B	E	C	C
Approach Vol, veh/h		946			603			743				614
Approach Delay, s/veh		39.9			40.0			40.0				29.6
Approach LOS		D			D			D				C
Timer - Assigned Phs	1	2	3	4	5	6	7	8				
Phs Duration (G+Y+Rc), s	20.6	23.8	9.4	39.1	8.2	36.2	23.5	25.1				
Change Period (Y+Rc), s	4.5	4.5	4.5	4.5	4.5	4.5	4.5	4.5				
Max Green Setting (Gmax), s	16.1	19.3	9.7	36.9	5.7	29.7	19.1	27.5				
Max Q Clear Time (g_c+I1), s	16.3	14.2	5.8	13.5	4.6	16.8	18.9	18.9				
Green Ext Time (p_c), s	0.0	1.6	0.0	2.2	0.0	3.5	0.0	1.6				

Intersection Summary		
HCM 6th Ctrl Delay		37.8
HCM 6th LOS		D

HCM 6th Signalized Intersection Summary
 51: Project Driveway 1 & Avenue 17

Village D Specific Plan
 Existing WP MIT - PM Peak Hour



Movement	EBT	EBR	WBL	WBT	NBL	NBR
Lane Configurations	↩		↩	↩	↩	↩
Traffic Volume (veh/h)	99	50	627	49	23	302
Future Volume (veh/h)	99	50	627	49	23	302
Initial Q (Qb), veh	0	0	0	0	0	0
Ped-Bike Adj(A_pbT)		1.00	1.00		1.00	1.00
Parking Bus, Adj	1.00	1.00	1.00	1.00	1.00	1.00
Work Zone On Approach	No			No	No	
Adj Sat Flow, veh/h/ln	1885	1885	1900	1900	1900	1900
Adj Flow Rate, veh/h	108	54	682	53	25	328
Peak Hour Factor	0.92	0.92	0.92	0.92	0.92	0.92
Percent Heavy Veh, %	1	1	0	0	0	0
Cap, veh/h	129	65	739	1054	670	596
Arrive On Green	0.11	0.11	0.13	0.18	0.37	0.37
Sat Flow, veh/h	1186	593	1810	1900	1810	1610
Grp Volume(v), veh/h	0	162	682	53	25	328
Grp Sat Flow(s),veh/h/ln	0	1778	1810	1900	1810	1610
Q Serve(g_s), s	0.0	10.7	44.7	2.8	1.1	19.3
Cycle Q Clear(g_c), s	0.0	10.7	44.7	2.8	1.1	19.3
Prop In Lane		0.33	1.00		1.00	1.00
Lane Grp Cap(c), veh/h	0	194	739	1054	670	596
V/C Ratio(X)	0.00	0.84	0.92	0.05	0.04	0.55
Avail Cap(c_a), veh/h	0	274	958	1370	670	596
HCM Platoon Ratio	1.00	1.00	0.33	0.33	1.00	1.00
Upstream Filter(I)	0.00	1.00	0.92	0.92	1.00	1.00
Uniform Delay (d), s/veh	0.0	52.4	50.1	23.0	24.1	29.9
Incr Delay (d2), s/veh	0.0	14.2	11.2	0.0	0.1	3.6
Initial Q Delay(d3),s/veh	0.0	0.0	0.0	0.0	0.0	0.0
%ile BackOfQ(50%),veh/ln	0.0	5.5	24.0	1.2	0.5	8.0
Unsig. Movement Delay, s/veh						
LnGrp Delay(d),s/veh	0.0	66.6	61.2	23.0	24.2	33.5
LnGrp LOS	A	E	E	C	C	C
Approach Vol, veh/h	162			735	353	
Approach Delay, s/veh	66.6			58.5	32.8	
Approach LOS	E			E	C	
Timer - Assigned Phs		2	3	4		8
Phs Duration (G+Y+Rc), s		48.9	53.5	17.6		71.1
Change Period (Y+Rc), s		4.5	4.5	4.5		4.5
Max Green Setting (Gmax), s		24.5	63.5	18.5		86.5
Max Q Clear Time (g_c+I1), s		21.3	46.7	12.7		4.8
Green Ext Time (p_c), s		0.4	2.3	0.4		0.3
Intersection Summary						
HCM 6th Ctrl Delay			52.3			
HCM 6th LOS			D			

Intersection												
Intersection Delay, s/veh	18.8											
Intersection LOS	C											

Movement	EBL	EBT	EBR	WBL	WBT	WBR	NBL	NBT	NBR	SBL	SBT	SBR
Lane Configurations	↶	↷		↶	↷		↶	↷		↶	↷	
Traffic Vol, veh/h	0	49	15	296	14	225	6	178	148	139	179	0
Future Vol, veh/h	0	49	15	296	14	225	6	178	148	139	179	0
Peak Hour Factor	0.92	0.92	0.92	0.92	0.92	0.92	0.92	0.92	0.92	0.92	0.92	0.92
Heavy Vehicles, %	10	10	10	0	0	0	0	0	0	0	0	0
Mvmt Flow	0	53	16	322	15	245	7	193	161	151	195	0
Number of Lanes	1	1	0	1	1	0	1	1	0	1	1	0

Approach	EB	WB	NB	SB
Opposing Approach	WB	EB	SB	NB
Opposing Lanes	2	2	2	2
Conflicting Approach Left	SB	NB	EB	WB
Conflicting Lanes Left	2	2	2	2
Conflicting Approach Right	NB	SB	WB	EB
Conflicting Lanes Right	2	2	2	2
HCM Control Delay	12.3	19.6	23	14.5
HCM LOS	B	C	C	B

Lane	NBLn1	NBLn2	EBLn1	EBLn2	WBLn1	WBLn2	SBLn1	SBLn2
Vol Left, %	100%	0%	0%	0%	100%	0%	100%	0%
Vol Thru, %	0%	55%	100%	77%	0%	6%	0%	100%
Vol Right, %	0%	45%	0%	23%	0%	94%	0%	0%
Sign Control	Stop	Stop	Stop	Stop	Stop	Stop	Stop	Stop
Traffic Vol by Lane	6	326	0	64	296	239	139	179
LT Vol	6	0	0	0	296	0	139	0
Through Vol	0	178	0	49	0	14	0	179
RT Vol	0	148	0	15	0	225	0	0
Lane Flow Rate	7	354	0	70	322	260	151	195
Geometry Grp	7	7	7	7	7	7	7	7
Degree of Util (X)	0.014	0.681	0	0.156	0.667	0.454	0.327	0.393
Departure Headway (Hd)	7.758	6.919	8.227	8.057	7.468	6.287	7.79	7.276
Convergence, Y/N	Yes	Yes	Yes	Yes	Yes	Yes	Yes	Yes
Cap	462	524	0	445	486	574	462	494
Service Time	5.495	4.656	5.981	5.812	5.205	4.023	5.531	5.017
HCM Lane V/C Ratio	0.015	0.676	0	0.157	0.663	0.453	0.327	0.395
HCM Control Delay	10.6	23.2	11	12.3	24	14.2	14.3	14.7
HCM Lane LOS	B	C	N	B	C	B	B	B
HCM 95th-tile Q	0	5.1	0	0.5	4.8	2.4	1.4	1.9

HCM 6th Signalized Intersection Summary
53: Road 22 1/2 & Cleveland Avenue

Village D Specific Plan
Existing WP MIT - PM Peak Hour



Movement	EBL	EBT	EBR	WBL	WBT	WBR	NBL	NBT	NBR	SBL	SBT	SBR
Lane Configurations												
Traffic Volume (veh/h)	8	417	16	113	524	449	14	29	62	330	30	8
Future Volume (veh/h)	8	417	16	113	524	449	14	29	62	330	30	8
Initial Q (Qb), veh	0	0	0	0	0	0	0	0	0	0	0	0
Ped-Bike Adj(A_pbT)	1.00		1.00	1.00		1.00	1.00		1.00	1.00		1.00
Parking Bus, Adj	1.00	1.00	1.00	1.00	1.00	1.00	1.00	1.00	1.00	1.00	1.00	1.00
Work Zone On Approach		No			No			No			No	
Adj Sat Flow, veh/h/ln	1900	1900	1900	1900	1900	1900	1900	1900	1900	1900	1900	1900
Adj Flow Rate, veh/h	9	453	17	123	570	488	15	32	67	359	33	9
Peak Hour Factor	0.92	0.92	0.92	0.92	0.92	0.92	0.92	0.92	0.92	0.92	0.92	0.92
Percent Heavy Veh, %	0	0	0	0	0	0	0	0	0	0	0	0
Cap, veh/h	20	1012	38	152	681	577	30	196	411	430	668	182
Arrive On Green	0.01	0.29	0.29	0.03	0.12	0.12	0.02	0.36	0.36	0.12	0.46	0.46
Sat Flow, veh/h	1810	3548	133	1810	1900	1610	1810	547	1146	3510	1437	392
Grp Volume(v), veh/h	9	230	240	123	570	488	15	0	99	359	0	42
Grp Sat Flow(s),veh/h/ln	1810	1805	1876	1810	1900	1610	1810	0	1694	1755	0	1829
Q Serve(g_s), s	0.6	12.5	12.6	8.1	35.2	35.6	1.0	0.0	4.8	12.0	0.0	1.5
Cycle Q Clear(g_c), s	0.6	12.5	12.6	8.1	35.2	35.6	1.0	0.0	4.8	12.0	0.0	1.5
Prop In Lane	1.00		0.07	1.00		1.00	1.00		0.68	1.00		0.21
Lane Grp Cap(c), veh/h	20	515	535	152	681	577	30	0	607	430	0	850
V/C Ratio(X)	0.46	0.45	0.45	0.81	0.84	0.85	0.51	0.00	0.16	0.83	0.00	0.05
Avail Cap(c_a), veh/h	83	654	680	249	863	731	83	0	607	600	0	850
HCM Platoon Ratio	1.00	1.00	1.00	0.33	0.33	0.33	1.00	1.00	1.00	1.00	1.00	1.00
Upstream Filter(l)	1.00	1.00	1.00	0.13	0.13	0.13	1.00	0.00	1.00	1.00	0.00	1.00
Uniform Delay (d), s/veh	59.0	35.1	35.2	57.4	49.5	49.7	58.5	0.0	26.2	51.5	0.0	17.6
Incr Delay (d2), s/veh	15.9	0.6	0.6	1.4	0.8	1.0	12.7	0.0	0.6	7.1	0.0	0.1
Initial Q Delay(d3),s/veh	0.0	0.0	0.0	0.0	0.0	0.0	0.0	0.0	0.0	0.0	0.0	0.0
%ile BackOfQ(50%),veh/ln	0.4	5.6	5.8	3.9	18.1	15.6	0.6	0.0	2.0	5.7	0.0	0.7
Unsig. Movement Delay, s/veh												
LnGrp Delay(d),s/veh	74.9	35.7	35.7	58.8	50.3	50.7	71.2	0.0	26.8	58.6	0.0	17.7
LnGrp LOS	E	D	D	E	D	D	E	A	C	E	A	B
Approach Vol, veh/h		479			1181			114			401	
Approach Delay, s/veh		36.5			51.3			32.7			54.3	
Approach LOS		D			D			C			D	
Timer - Assigned Phs	1	2	3	4	5	6	7	8				
Phs Duration (G+Y+Rc), s	19.2	47.5	14.6	38.7	6.5	60.2	5.8	47.5				
Change Period (Y+Rc), s	4.5	4.5	4.5	4.5	4.5	4.5	4.5	4.5				
Max Green Setting (Gmax), s	20.5	21.5	16.5	43.5	5.5	36.5	5.5	54.5				
Max Q Clear Time (g_c+M), s	11.0	6.8	10.1	14.6	3.0	3.5	2.6	37.6				
Green Ext Time (p_c), s	0.7	0.4	0.1	3.0	0.0	0.2	0.0	5.4				

Intersection Summary

HCM 6th Ctrl Delay	47.6
HCM 6th LOS	D

HCM 6th Signalized Intersection Summary
55: Road 23 & Project Driveway 3

Village D Specific Plan
Existing WP MIT - PM Peak Hour



Movement	EBL	EBR	NBL	NBT	SBT	SBR
Lane Configurations						
Traffic Volume (veh/h)	294	211	228	1101	1544	631
Future Volume (veh/h)	294	211	228	1101	1544	631
Initial Q (Qb), veh	0	0	0	0	0	0
Ped-Bike Adj(A_pbT)	1.00	1.00	1.00			1.00
Parking Bus, Adj	1.00	1.00	1.00	1.00	1.00	1.00
Work Zone On Approach	No			No	No	
Adj Sat Flow, veh/h/ln	1900	1900	1885	1885	1885	1885
Adj Flow Rate, veh/h	320	229	248	1197	1678	686
Peak Hour Factor	0.92	0.92	0.92	0.92	0.92	0.92
Percent Heavy Veh, %	0	0	1	1	1	1
Cap, veh/h	350	559	276	2621	1936	863
Arrive On Green	0.19	0.19	0.10	0.49	0.36	0.36
Sat Flow, veh/h	1810	1610	1795	3676	3676	1598
Grp Volume(v), veh/h	320	229	248	1197	1678	686
Grp Sat Flow(s),veh/h/ln	1810	1610	1795	1791	1791	1598
Q Serve(g_s), s	20.8	13.0	16.4	26.3	52.3	46.1
Cycle Q Clear(g_c), s	20.8	13.0	16.4	26.3	52.3	46.1
Prop In Lane	1.00	1.00	1.00			1.00
Lane Grp Cap(c), veh/h	350	559	276	2621	1936	863
V/C Ratio(X)	0.92	0.41	0.90	0.46	0.87	0.79
Avail Cap(c_a), veh/h	369	577	292	2621	1936	863
HCM Platoon Ratio	1.00	1.00	0.67	0.67	0.67	0.67
Upstream Filter(I)	1.00	1.00	0.79	0.79	0.23	0.23
Uniform Delay (d), s/veh	47.4	29.8	52.9	14.9	34.3	32.3
Incr Delay (d2), s/veh	26.1	0.5	23.0	0.5	1.4	1.8
Initial Q Delay(d3),s/veh	0.0	0.0	0.0	0.0	0.0	0.0
%ile BackOfQ(50%),veh/ln	11.9	12.7	9.4	11.8	24.0	19.1
Unsig. Movement Delay, s/veh						
LnGrp Delay(d),s/veh	73.6	30.3	75.9	15.4	35.6	34.1
LnGrp LOS	E	C	E	B	D	C
Approach Vol, veh/h	549			1445	2364	
Approach Delay, s/veh	55.5			25.8	35.2	
Approach LOS	E			C	D	
Timer - Assigned Phs		2		4	5	6
Phs Duration (G+Y+Rc), s		92.3		27.7	23.0	69.4
Change Period (Y+Rc), s		4.5		4.5	4.5	4.5
Max Green Setting (Gmax), s		86.5		24.5	19.5	62.5
Max Q Clear Time (g_c+I1), s		28.3		22.8	18.4	54.3
Green Ext Time (p_c), s		12.6		0.4	0.1	7.2
Intersection Summary						
HCM 6th Ctrl Delay			34.6			
HCM 6th LOS			C			

HCM 6th Signalized Intersection Summary
56: Road 23 & Project Driveway 4

Village D Specific Plan
Existing WP MIT - PM Peak Hour



Movement	WBL	WBR	NBT	NBR	SBL	SBT
Lane Configurations						
Traffic Volume (veh/h)	370	890	1241	341	977	973
Future Volume (veh/h)	370	890	1241	341	977	973
Initial Q (Qb), veh	0	0	0	0	0	0
Ped-Bike Adj(A_pbT)	1.00	1.00		1.00	1.00	
Parking Bus, Adj	1.00	1.00	1.00	1.00	1.00	1.00
Work Zone On Approach	No		No		No	
Adj Sat Flow, veh/h/ln	1900	1900	1885	1885	1870	1870
Adj Flow Rate, veh/h	402	967	1349	371	1062	1058
Peak Hour Factor	0.92	0.92	0.92	0.92	0.92	0.92
Percent Heavy Veh, %	0	0	1	1	2	2
Cap, veh/h	385	1441	1358	606	1022	2532
Arrive On Green	0.21	0.21	0.76	0.76	0.49	1.00
Sat Flow, veh/h	1810	2834	3676	1598	3456	3647
Grp Volume(v), veh/h	402	967	1349	371	1062	1058
Grp Sat Flow(s),veh/h/ln	1810	1417	1791	1598	1728	1777
Q Serve(g_s), s	25.5	25.5	44.3	12.6	35.5	0.0
Cycle Q Clear(g_c), s	25.5	25.5	44.3	12.6	35.5	0.0
Prop In Lane	1.00	1.00		1.00	1.00	
Lane Grp Cap(c), veh/h	385	1441	1358	606	1022	2532
V/C Ratio(X)	1.05	0.67	0.99	0.61	1.04	0.42
Avail Cap(c_a), veh/h	385	1441	1358	606	1022	2532
HCM Platoon Ratio	1.00	1.00	2.00	2.00	1.67	1.67
Upstream Filter(I)	1.00	1.00	0.83	0.83	0.50	0.50
Uniform Delay (d), s/veh	47.3	22.0	14.4	10.5	30.4	0.0
Incr Delay (d2), s/veh	58.3	1.2	20.7	3.8	30.8	0.3
Initial Q Delay(d3),s/veh	0.0	0.0	0.0	0.0	0.0	0.0
%ile BackOfQ(50%),veh/ln	17.6	10.1	10.1	3.5	16.5	0.1
Unsig. Movement Delay, s/veh						
LnGrp Delay(d),s/veh	105.5	23.2	35.1	14.3	61.2	0.3
LnGrp LOS	F	C	D	B	F	A
Approach Vol, veh/h	1369		1720			2120
Approach Delay, s/veh	47.4		30.6			30.8
Approach LOS	D		C			C
Timer - Assigned Phs	1	2			6	8
Phs Duration (G+Y+Rc), s	40.0	50.0			90.0	30.0
Change Period (Y+Rc), s	4.5	4.5			4.5	4.5
Max Green Setting (Gmax), s	35.5	45.5			85.5	25.5
Max Q Clear Time (g_c+R), s	47.5	46.3			2.0	27.5
Green Ext Time (p_c), s	0.0	0.0			10.5	0.0
Intersection Summary						
HCM 6th Ctrl Delay			35.1			
HCM 6th LOS			D			

HCM 6th Signalized Intersection Summary
57: Road 23 & Project Driveway 5

Village D Specific Plan
Existing WP MIT - PM Peak Hour



Movement	EBL	EBR	NBL	NBT	SBT	SBR
Lane Configurations						
Traffic Volume (veh/h)	72	41	94	1512	1239	101
Future Volume (veh/h)	72	41	94	1512	1239	101
Initial Q (Qb), veh	0	0	0	0	0	0
Ped-Bike Adj(A_pbT)	1.00	1.00	1.00			1.00
Parking Bus, Adj	1.00	1.00	1.00	1.00	1.00	1.00
Work Zone On Approach	No			No	No	
Adj Sat Flow, veh/h/ln	1900	1900	1885	1885	1870	1870
Adj Flow Rate, veh/h	78	45	102	1643	1347	110
Peak Hour Factor	0.92	0.92	0.92	0.92	0.92	0.92
Percent Heavy Veh, %	0	0	1	1	2	2
Cap, veh/h	108	96	128	3099	2518	205
Arrive On Green	0.06	0.06	0.07	0.87	1.00	1.00
Sat Flow, veh/h	1810	1610	1795	3676	3421	271
Grp Volume(v), veh/h	78	45	102	1643	717	740
Grp Sat Flow(s),veh/h/ln	1810	1610	1795	1791	1777	1822
Q Serve(g_s), s	5.1	3.2	6.7	13.7	0.0	0.0
Cycle Q Clear(g_c), s	5.1	3.2	6.7	13.7	0.0	0.0
Prop In Lane	1.00	1.00	1.00			0.15
Lane Grp Cap(c), veh/h	108	96	128	3099	1344	1378
V/C Ratio(X)	0.72	0.47	0.80	0.53	0.53	0.54
Avail Cap(c_a), veh/h	279	248	232	3099	1344	1378
HCM Platoon Ratio	1.00	1.00	1.00	1.00	2.00	2.00
Upstream Filter(I)	1.00	1.00	0.65	0.65	0.78	0.78
Uniform Delay (d), s/veh	55.4	54.6	54.9	2.0	0.0	0.0
Incr Delay (d2), s/veh	8.7	3.5	7.3	0.4	1.2	1.2
Initial Q Delay(d3),s/veh	0.0	0.0	0.0	0.0	0.0	0.0
%ile BackOfQ(50%),veh/ln	2.6	3.0	3.3	2.6	0.4	0.4
Unsig. Movement Delay, s/veh						
LnGrp Delay(d),s/veh	64.1	58.0	62.2	2.4	1.2	1.2
LnGrp LOS	E	E	E	A	A	A
Approach Vol, veh/h	123			1745	1457	
Approach Delay, s/veh	61.9			5.9	1.2	
Approach LOS	E			A	A	
Timer - Assigned Phs		2		4	5	6
Phs Duration (G+Y+Rc), s		108.3		11.7	13.0	95.3
Change Period (Y+Rc), s		4.5		4.5	4.5	4.5
Max Green Setting (Gmax), s		92.5		18.5	15.5	72.5
Max Q Clear Time (g_c+I1), s		15.7		7.1	8.7	2.0
Green Ext Time (p_c), s		23.9		0.2	0.1	16.8
Intersection Summary						
HCM 6th Ctrl Delay			5.9			
HCM 6th LOS			A			

HCM 6th Signalized Intersection Summary
58: Project Driveway 6 & Cleveland Avenue

Village D Specific Plan
Existing WP MIT - PM Peak Hour

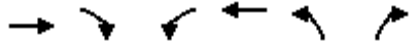

Movement	EBT	EBR	WBL	WBT	NBL	NBR
Lane Configurations	↑↑		↵	↑↑	↵	↵
Traffic Volume (veh/h)	861	145	332	1251	65	243
Future Volume (veh/h)	861	145	332	1251	65	243
Initial Q (Qb), veh	0	0	0	0	0	0
Ped-Bike Adj(A_pbT)		1.00	1.00		1.00	1.00
Parking Bus, Adj	1.00	1.00	1.00	1.00	1.00	1.00
Work Zone On Approach	No			No	No	
Adj Sat Flow, veh/h/ln	1885	1885	1900	1900	1900	1900
Adj Flow Rate, veh/h	936	158	361	1360	71	264
Peak Hour Factor	0.92	0.92	0.92	0.92	0.92	0.92
Percent Heavy Veh, %	1	1	0	0	0	0
Cap, veh/h	1068	180	396	2183	580	516
Arrive On Green	0.35	0.35	0.22	0.60	0.32	0.32
Sat Flow, veh/h	3160	517	1810	3705	1810	1610
Grp Volume(v), veh/h	547	547	361	1360	71	264
Grp Sat Flow(s),veh/h/ln	1791	1792	1810	1805	1810	1610
Q Serve(g_s), s	34.3	34.4	23.4	28.7	3.3	16.0
Cycle Q Clear(g_c), s	34.3	34.4	23.4	28.7	3.3	16.0
Prop In Lane		0.29	1.00		1.00	1.00
Lane Grp Cap(c), veh/h	624	624	396	2183	580	516
V/C Ratio(X)	0.88	0.88	0.91	0.62	0.12	0.51
Avail Cap(c_a), veh/h	709	709	556	2674	580	516
HCM Platoon Ratio	1.00	1.00	1.00	1.00	1.00	1.00
Upstream Filter(I)	0.73	0.73	1.00	1.00	1.00	1.00
Uniform Delay (d), s/veh	36.7	36.7	45.8	15.0	28.8	33.1
Incr Delay (d2), s/veh	8.3	8.4	15.3	0.3	0.4	3.6
Initial Q Delay(d3),s/veh	0.0	0.0	0.0	0.0	0.0	0.0
%ile BackOfQ(50%),veh/ln	16.2	16.3	12.1	11.3	1.5	6.8
Unsig. Movement Delay, s/veh						
LnGrp Delay(d),s/veh	45.0	45.0	61.0	15.4	29.3	36.7
LnGrp LOS	D	D	E	B	C	D
Approach Vol, veh/h	1094			1721	335	
Approach Delay, s/veh	45.0			24.9	35.2	
Approach LOS	D			C	D	
Timer - Assigned Phs		2	3	4		8
Phs Duration (G+Y+Rc), s		42.9	30.7	46.3		77.1
Change Period (Y+Rc), s		4.5	4.5	4.5		4.5
Max Green Setting (Gmax), s		22.1	36.9	47.5		88.9
Max Q Clear Time (g_c+I1), s		18.0	25.4	36.4		30.7
Green Ext Time (p_c), s		0.4	0.9	5.4		15.7
Intersection Summary						
HCM 6th Ctrl Delay			33.0			
HCM 6th LOS			C			

HCM 6th Signalized Intersection Summary
 5: Road 23/SR-99 Southbound Off-Ramp & Avenue 18 1/2

Village D Specific Plan
 Phase I WP MIT - AM Peak Hour



Movement	EBL	EBT	EBR	WBL	WBT	WBR	NBL	NBT	NBR	SBL	SBT	SBR
Lane Configurations		↑	↗	↘	↑		↗	↘	↗		↕	↘
Traffic Volume (veh/h)	0	311	58	43	276	0	76	0	339	11	116	85
Future Volume (veh/h)	0	311	58	43	276	0	76	0	339	11	116	85
Initial Q (Qb), veh	0	0	0	0	0	0	0	0	0	0	0	0
Ped-Bike Adj(A_pbT)	1.00		1.00	1.00		1.00	1.00		1.00	1.00		1.00
Parking Bus, Adj	1.00	1.00	1.00	1.00	1.00	1.00	1.00	1.00	1.00	1.00	1.00	1.00
Work Zone On Approach		No			No			No			No	
Adj Sat Flow, veh/h/ln	0	1426	1426	1515	1515	0	1752	1752	1752	1544	1544	1544
Adj Flow Rate, veh/h	0	338	63	47	300	0	83	0	368	12	126	92
Peak Hour Factor	0.92	0.92	0.92	0.92	0.92	0.92	0.92	0.92	0.92	0.92	0.92	0.92
Percent Heavy Veh, %	0	32	32	26	26	0	10	10	10	24	24	24
Cap, veh/h	0	351	616	58	520	0	439	0	900	33	352	260
Arrive On Green	0.00	0.25	0.25	0.04	0.34	0.00	0.26	0.00	0.26	0.22	0.22	0.22
Sat Flow, veh/h	0	1426	1208	1443	1515	0	1668	0	2964	149	1565	1157
Grp Volume(v), veh/h	0	338	63	47	300	0	83	0	368	124	0	106
Grp Sat Flow(s),veh/h/ln	0	1426	1208	1443	1515	0	1668	0	1482	1537	0	1333
Q Serve(g_s), s	0.0	18.7	2.2	2.6	13.0	0.0	3.1	0.0	7.9	5.4	0.0	5.4
Cycle Q Clear(g_c), s	0.0	18.7	2.2	2.6	13.0	0.0	3.1	0.0	7.9	5.4	0.0	5.4
Prop In Lane	0.00		1.00	1.00		0.00	1.00		1.00	0.10		0.87
Lane Grp Cap(c), veh/h	0	351	616	58	520	0	439	0	900	346	0	300
V/C Ratio(X)	0.00	0.96	0.10	0.80	0.58	0.00	0.19	0.00	0.41	0.36	0.00	0.35
Avail Cap(c_a), veh/h	0	351	616	92	555	0	439	0	900	346	0	300
HCM Platoon Ratio	1.00	1.00	1.00	1.00	1.00	1.00	1.00	1.00	1.00	1.00	1.00	1.00
Upstream Filter(I)	0.00	1.00	1.00	1.00	1.00	0.00	1.00	0.00	1.00	1.00	0.00	1.00
Uniform Delay (d), s/veh	0.0	29.8	10.2	38.1	21.5	0.0	22.8	0.0	22.1	26.1	0.0	26.1
Incr Delay (d2), s/veh	0.0	38.1	0.1	23.4	1.3	0.0	1.0	0.0	1.4	2.9	0.0	3.2
Initial Q Delay(d3),s/veh	0.0	0.0	0.0	0.0	0.0	0.0	0.0	0.0	0.0	0.0	0.0	0.0
%ile BackOfQ(50%),veh/ln	0.0	9.9	0.9	1.3	4.6	0.0	1.3	0.0	2.8	2.2	0.0	1.9
Unsig. Movement Delay, s/veh												
LnGrp Delay(d),s/veh	0.0	67.9	10.2	61.4	22.8	0.0	23.8	0.0	23.5	29.0	0.0	29.3
LnGrp LOS	A	E	B	E	C	A	C	A	C	C	A	C
Approach Vol, veh/h		401			347			451			230	
Approach Delay, s/veh		58.8			28.1			23.6			29.2	
Approach LOS		E			C			C			C	
Timer - Assigned Phs		2	3	4		6		8				
Phs Duration (G+Y+Rc), s		25.6	7.7	24.2		22.5		31.9				
Change Period (Y+Rc), s		4.5	4.5	4.5		4.5		4.5				
Max Green Setting (Gmax), s		19.2	5.1	19.7		18.0		29.3				
Max Q Clear Time (g_c+I1), s		9.9	4.6	20.7		7.4		15.0				
Green Ext Time (p_c), s		1.3	0.0	0.0		0.9		1.5				

Intersection Summary

HCM 6th Ctrl Delay	35.5
HCM 6th LOS	D

Notes

User approved volume balancing among the lanes for turning movement.

HCM 6th Signalized Intersection Summary
 6: SR-99 Northbound Ramps & Avenue 18 1/2

Village D Specific Plan
 Phase I WP MIT - AM Peak Hour



Movement	EBL	EBT	EBR	WBL	WBT	WBR	NBL	NBT	NBR	SBL	SBT	SBR
Lane Configurations	↔↔	↑			↔			↔				
Traffic Volume (veh/h)	411	57	0	0	142	27	214	1	21	0	0	0
Future Volume (veh/h)	411	57	0	0	142	27	214	1	21	0	0	0
Initial Q (Qb), veh	0	0	0	0	0	0	0	0	0			
Ped-Bike Adj(A_pbT)	1.00		1.00	1.00		1.00	1.00		1.00			
Parking Bus, Adj	1.00	1.00	1.00	1.00	1.00	1.00	1.00	1.00	1.00			
Work Zone On Approach		No			No			No				
Adj Sat Flow, veh/h/ln	1633	1633	0	0	1633	1633	1900	1470	1900			
Adj Flow Rate, veh/h	447	62	0	0	154	29	233	1	23			
Peak Hour Factor	0.92	0.92	0.92	0.92	0.92	0.92	0.92	0.92	0.92			
Percent Heavy Veh, %	18	18	0	0	18	18	0	29	0			
Cap, veh/h	541	621	0	0	193	36	637	3	63			
Arrive On Green	0.18	0.38	0.00	0.00	0.14	0.14	0.51	0.51	0.51			
Sat Flow, veh/h	3018	1633	0	0	1336	252	1256	5	124			
Grp Volume(v), veh/h	447	62	0	0	0	183	257	0	0			
Grp Sat Flow(s),veh/h/ln	1509	1633	0	0	0	1587	1385	0	0			
Q Serve(g_s), s	11.4	2.0	0.0	0.0	0.0	8.9	9.0	0.0	0.0			
Cycle Q Clear(g_c), s	11.4	2.0	0.0	0.0	0.0	8.9	9.0	0.0	0.0			
Prop In Lane	1.00		0.00	0.00		0.16	0.91		0.09			
Lane Grp Cap(c), veh/h	541	621	0	0	0	229	703	0	0			
V/C Ratio(X)	0.83	0.10	0.00	0.00	0.00	0.80	0.37	0.00	0.00			
Avail Cap(c_a), veh/h	736	868	0	0	0	367	703	0	0			
HCM Platoon Ratio	1.00	1.00	1.00	1.00	1.00	1.00	1.00	1.00	1.00			
Upstream Filter(I)	1.00	1.00	0.00	0.00	0.00	1.00	1.00	0.00	0.00			
Uniform Delay (d), s/veh	31.6	16.0	0.0	0.0	0.0	33.1	11.9	0.0	0.0			
Incr Delay (d2), s/veh	5.7	0.1	0.0	0.0	0.0	6.3	1.5	0.0	0.0			
Initial Q Delay(d3),s/veh	0.0	0.0	0.0	0.0	0.0	0.0	0.0	0.0	0.0			
%ile BackOfQ(50%),veh/ln	4.5	0.7	0.0	0.0	0.0	3.7	2.8	0.0	0.0			
Unsig. Movement Delay, s/veh												
LnGrp Delay(d),s/veh	37.3	16.1	0.0	0.0	0.0	39.4	13.4	0.0	0.0			
LnGrp LOS	D	B	A	A	A	D	B	A	A			
Approach Vol, veh/h		509			183		257					
Approach Delay, s/veh		34.7			39.4		13.4					
Approach LOS		C			D		B					
Timer - Assigned Phs		2		4		7	8					
Phs Duration (G+Y+Rc), s		45.1		34.9		18.8	16.1					
Change Period (Y+Rc), s		4.5		4.5		4.5	4.5					
Max Green Setting (Gmax), s		28.5		42.5		19.5	18.5					
Max Q Clear Time (g_c+I1), s		11.0		4.0		13.4	10.9					
Green Ext Time (p_c), s		1.4		0.3		0.9	0.5					
Intersection Summary												
HCM 6th Ctrl Delay												29.8
HCM 6th LOS												C

HCM 6th Signalized Intersection Summary
7: Road 23 & Avenue 17

Village D Specific Plan
Phase I WP MIT - AM Peak Hour



Movement	EBL	EBT	EBR	WBL	WBT	WBR	NBL	NBT	NBR	SBL	SBT	SBR
Lane Configurations	↖	↗		↖	↗		↖	↑	↗	↖	↑	↗
Traffic Volume (veh/h)	2	27	19	85	20	3	42	435	120	15	200	0
Future Volume (veh/h)	2	27	19	85	20	3	42	435	120	15	200	0
Initial Q (Qb), veh	0	0	0	0	0	0	0	0	0	0	0	0
Ped-Bike Adj(A_pbT)	1.00		1.00	1.00		1.00	1.00		1.00	1.00		1.00
Parking Bus, Adj	1.00	1.00	1.00	1.00	1.00	1.00	1.00	1.00	1.00	1.00	1.00	1.00
Work Zone On Approach		No			No			No			No	
Adj Sat Flow, veh/h/ln	1826	1826	1826	1693	1693	1693	1811	1811	1811	1707	1707	1707
Adj Flow Rate, veh/h	2	29	21	92	22	3	46	473	130	16	217	0
Peak Hour Factor	0.92	0.92	0.92	0.92	0.92	0.92	0.92	0.92	0.92	0.92	0.92	0.92
Percent Heavy Veh, %	5	5	5	14	14	14	6	6	6	13	13	13
Cap, veh/h	5	43	31	114	163	22	59	1301	1103	28	1198	1015
Arrive On Green	0.00	0.04	0.04	0.07	0.11	0.11	0.03	0.72	0.72	0.02	0.70	0.00
Sat Flow, veh/h	1739	985	713	1612	1458	199	1725	1811	1535	1626	1707	1447
Grp Volume(v), veh/h	2	0	50	92	0	25	46	473	130	16	217	0
Grp Sat Flow(s),veh/h/ln	1739	0	1698	1612	0	1657	1725	1811	1535	1626	1707	1447
Q Serve(g_s), s	0.1	0.0	3.5	6.7	0.0	1.6	3.2	11.9	3.1	1.2	5.2	0.0
Cycle Q Clear(g_c), s	0.1	0.0	3.5	6.7	0.0	1.6	3.2	11.9	3.1	1.2	5.2	0.0
Prop In Lane	1.00		0.42	1.00		0.12	1.00		1.00	1.00		1.00
Lane Grp Cap(c), veh/h	5	0	74	114	0	185	59	1301	1103	28	1198	1015
V/C Ratio(X)	0.43	0.00	0.68	0.80	0.00	0.14	0.78	0.36	0.12	0.57	0.18	0.00
Avail Cap(c_a), veh/h	123	0	318	329	0	532	237	1301	1103	156	1198	1015
HCM Platoon Ratio	1.00	1.00	1.00	1.00	1.00	1.00	1.00	1.00	1.00	1.00	1.00	1.00
Upstream Filter(l)	1.00	0.00	1.00	1.00	0.00	1.00	1.00	1.00	1.00	1.00	1.00	0.00
Uniform Delay (d), s/veh	59.7	0.0	56.6	54.9	0.0	48.1	57.5	6.4	5.2	58.5	6.1	0.0
Incr Delay (d2), s/veh	51.8	0.0	10.4	12.3	0.0	0.3	19.6	0.8	0.2	17.0	0.3	0.0
Initial Q Delay(d3),s/veh	0.0	0.0	0.0	0.0	0.0	0.0	0.0	0.0	0.0	0.0	0.0	0.0
%ile BackOfQ(50%),veh/ln	0.1	0.0	1.7	3.1	0.0	0.7	1.7	4.4	1.0	0.6	1.9	0.0
Unsig. Movement Delay, s/veh												
LnGrp Delay(d),s/veh	111.6	0.0	67.0	67.2	0.0	48.4	77.1	7.2	5.4	75.5	6.5	0.0
LnGrp LOS	F	A	E	E	A	D	E	A	A	E	A	A
Approach Vol, veh/h		52			117			649			233	
Approach Delay, s/veh		68.7			63.2			11.8			11.2	
Approach LOS		E			E			B			B	
Timer - Assigned Phs	1	2	3	4	5	6	7	8				
Phs Duration (G+Y+Rc), s	6.6	90.7	13.0	9.7	8.6	88.7	4.8	17.9				
Change Period (Y+Rc), s	4.5	4.5	4.5	4.5	4.5	4.5	4.5	4.5				
Max Green Setting (Gmax), s	5	43.5	24.5	22.5	16.5	38.5	8.5	38.5				
Max Q Clear Time (g_c+1), s	13.9	13.9	8.7	5.5	5.2	7.2	2.1	3.6				
Green Ext Time (p_c), s	0.0	3.7	0.2	0.2	0.0	1.3	0.0	0.1				
Intersection Summary												
HCM 6th Ctrl Delay				20.2								
HCM 6th LOS				C								

Intersection	
Intersection Delay, s/veh	30
Intersection LOS	D

Movement	EBL	EBT	EBR	WBL	WBT	WBR	NBL	NBT	NBR	SBL	SBT	SBR
Lane Configurations	↶	↷		↶	↷		↶	↶	↶	↶	↶	↶
Traffic Vol, veh/h	0	0	0	303	0	220	0	305	295	196	262	0
Future Vol, veh/h	0	0	0	303	0	220	0	305	295	196	262	0
Peak Hour Factor	0.92	0.92	0.92	0.92	0.92	0.92	0.92	0.92	0.92	0.92	0.92	0.92
Heavy Vehicles, %	0	0	0	2	2	2	7	7	7	11	11	11
Mvmt Flow	0	0	0	329	0	239	0	332	321	213	285	0
Number of Lanes	1	1	0	1	1	0	1	1	1	1	1	1

Approach	EB	WB	NB	SB
Opposing Approach	WB	EB	SB	NB
Opposing Lanes	2	2	3	3
Conflicting Approach Left	SB	NB	EB	WB
Conflicting Lanes Left	3	3	2	2
Conflicting Approach Right	NB	SB	WB	EB
Conflicting Lanes Right	3	3	2	2
HCM Control Delay	0	32.3	30.8	26.4
HCM LOS	-	D	D	D

Lane	NBLn1	NBLn2	NBLn3	EBLn1	EBLn2	WBLn1	WBLn2	SBLn1	SBLn2	SBLn3
Vol Left, %	0%	0%	0%	0%	0%	100%	0%	100%	0%	0%
Vol Thru, %	100%	100%	0%	100%	100%	0%	0%	0%	100%	100%
Vol Right, %	0%	0%	100%	0%	0%	0%	100%	0%	0%	0%
Sign Control	Stop	Stop	Stop	Stop	Stop	Stop	Stop	Stop	Stop	Stop
Traffic Vol by Lane	0	305	295	0	0	303	220	196	262	0
LT Vol	0	0	0	0	0	303	0	196	0	0
Through Vol	0	305	0	0	0	0	0	0	262	0
RT Vol	0	0	295	0	0	0	220	0	0	0
Lane Flow Rate	0	332	321	0	0	329	239	213	285	0
Geometry Grp	8	8	8	8	8	8	8	8	8	8
Degree of Util (X)	0	0.779	0.689	0	0	0.823	0.516	0.548	0.692	0
Departure Headway (Hd)	8.455	8.455	7.733	10.809	10.809	8.992	7.762	9.263	8.747	8.747
Convergence, Y/N	Yes	Yes	Yes	Yes	Yes	Yes	Yes	Yes	Yes	Yes
Cap	0	428	465	0	0	402	464	388	413	0
Service Time	6.223	6.223	5.501	8.509	8.509	6.758	5.527	7.037	6.52	6.52
HCM Lane V/C Ratio	0	0.776	0.69	0	0	0.818	0.515	0.549	0.69	0
HCM Control Delay	11.2	35.4	26.1	13.5	13.5	42.2	18.6	22.8	29.1	11.5
HCM Lane LOS	N	E	D	N	N	E	C	C	D	N
HCM 95th-tile Q	0	6.7	5.2	0	0	7.5	2.9	3.2	5.1	0

Intersection	
Intersection Delay, s/veh	19.6
Intersection LOS	C

Movement	EBL	EBT	EBR	WBL	WBT	WBR	NBL	NBT	NBR	SBL	SBT	SBR
Lane Configurations		↕			↕		↕	↕		↕	↕	
Traffic Vol, veh/h	71	147	32	19	179	139	34	132	8	163	199	102
Future Vol, veh/h	71	147	32	19	179	139	34	132	8	163	199	102
Peak Hour Factor	0.92	0.92	0.92	0.92	0.92	0.92	0.92	0.92	0.92	0.92	0.92	0.92
Heavy Vehicles, %	6	6	6	6	6	6	23	23	23	8	8	8
Mvmt Flow	77	160	35	21	195	151	37	143	9	177	216	111
Number of Lanes	0	1	0	0	1	0	1	1	0	1	1	0

Approach	EB	WB	NB	SB
Opposing Approach	WB	EB	SB	NB
Opposing Lanes	1	1	2	2
Conflicting Approach Left	SB	NB	EB	WB
Conflicting Lanes Left	2	2	1	1
Conflicting Approach Right	NB	SB	WB	EB
Conflicting Lanes Right	2	2	1	1
HCM Control Delay	18.3	22.8	14.7	19.8
HCM LOS	C	C	B	C

Lane	NBLn1	NBLn2	EBLn1	WBLn1	SBLn1	SBLn2
Vol Left, %	100%	0%	28%	6%	100%	0%
Vol Thru, %	0%	94%	59%	53%	0%	66%
Vol Right, %	0%	6%	13%	41%	0%	34%
Sign Control	Stop	Stop	Stop	Stop	Stop	Stop
Traffic Vol by Lane	34	140	250	337	163	301
LT Vol	34	0	71	19	163	0
Through Vol	0	132	147	179	0	199
RT Vol	0	8	32	139	0	102
Lane Flow Rate	37	152	272	366	177	327
Geometry Grp	7	7	2	2	7	7
Degree of Util (X)	0.09	0.346	0.538	0.679	0.387	0.645
Departure Headway (Hd)	8.737	8.179	7.124	6.672	7.856	7.098
Convergence, Y/N	Yes	Yes	Yes	Yes	Yes	Yes
Cap	408	438	503	538	457	507
Service Time	6.527	5.968	5.202	4.743	5.632	4.873
HCM Lane V/C Ratio	0.091	0.347	0.541	0.68	0.387	0.645
HCM Control Delay	12.4	15.3	18.3	22.8	15.6	22
HCM Lane LOS	B	C	C	C	C	C
HCM 95th-tile Q	0.3	1.5	3.1	5.1	1.8	4.5

HCM 6th Signalized Intersection Summary
 13: Airport Drive/Golden State Boulevard & Avenue 17

Village D Specific Plan
 Phase I WP MIT - AM Peak Hour



Movement	EBL	EBT	EBR	WBL	WBT	WBR	NBL	NBT	NBR	SBL	SBT	SBR
Lane Configurations	↖	↑	↗	↖	↑	↗	↖	↑	↗	↖↗	↖	↗
Traffic Volume (veh/h)	4	129	19	188	100	154	17	55	107	134	31	4
Future Volume (veh/h)	4	129	19	188	100	154	17	55	107	134	31	4
Initial Q (Qb), veh	0	0	0	0	0	0	0	0	0	0	0	0
Ped-Bike Adj(A_pbT)	1.00		1.00	1.00		1.00	1.00		1.00	1.00		1.00
Parking Bus, Adj	1.00	1.00	1.00	1.00	1.00	1.00	1.00	1.00	1.00	1.00	1.00	1.00
Work Zone On Approach		No			No			No			No	
Adj Sat Flow, veh/h/ln	1811	1811	1811	1781	1781	1781	1707	1707	1707	1767	1767	1767
Adj Flow Rate, veh/h	4	140	21	204	109	167	18	60	116	146	34	4
Peak Hour Factor	0.92	0.92	0.92	0.92	0.92	0.92	0.92	0.92	0.92	0.92	0.92	0.92
Percent Heavy Veh, %	6	6	6	8	8	8	13	13	13	9	9	9
Cap, veh/h	9	192	163	241	433	367	34	785	665	219	785	92
Arrive On Green	0.01	0.11	0.11	0.24	0.41	0.41	0.02	0.46	0.46	0.07	0.51	0.51
Sat Flow, veh/h	1725	1811	1535	1697	1781	1510	1626	1707	1446	3264	1551	182
Grp Volume(v), veh/h	4	140	21	204	109	167	18	60	116	146	0	38
Grp Sat Flow(s),veh/h/ln	1725	1811	1535	1697	1781	1510	1626	1707	1446	1632	0	1734
Q Serve(g_s), s	0.2	6.0	1.0	9.2	3.2	6.4	0.9	1.6	3.8	3.5	0.0	0.9
Cycle Q Clear(g_c), s	0.2	6.0	1.0	9.2	3.2	6.4	0.9	1.6	3.8	3.5	0.0	0.9
Prop In Lane	1.00		1.00	1.00		1.00	1.00		1.00	1.00		0.11
Lane Grp Cap(c), veh/h	9	192	163	241	433	367	34	785	665	219	0	877
V/C Ratio(X)	0.44	0.73	0.13	0.85	0.25	0.46	0.54	0.08	0.17	0.67	0.00	0.04
Avail Cap(c_a), veh/h	108	407	345	388	697	591	102	785	665	314	0	877
HCM Platoon Ratio	1.00	1.00	1.00	1.67	1.67	1.67	1.00	1.00	1.00	1.00	1.00	1.00
Upstream Filter(I)	1.00	1.00	1.00	0.83	0.83	0.83	1.00	1.00	1.00	1.00	0.00	1.00
Uniform Delay (d), s/veh	39.7	34.6	32.4	29.7	19.0	19.9	38.8	12.1	12.7	36.4	0.0	10.0
Incr Delay (d2), s/veh	29.4	5.2	0.4	7.8	0.3	0.7	12.7	0.2	0.6	3.5	0.0	0.1
Initial Q Delay(d3),s/veh	0.0	0.0	0.0	0.0	0.0	0.0	0.0	0.0	0.0	0.0	0.0	0.0
%ile BackOfQ(50%),veh/ln	0.2	2.9	0.4	3.8	1.3	2.1	0.5	0.6	1.3	1.5	0.0	0.3
Unsig. Movement Delay, s/veh												
LnGrp Delay(d),s/veh	69.1	39.8	32.8	37.5	19.2	20.6	51.5	12.3	13.3	39.9	0.0	10.1
LnGrp LOS	E	D	C	D	B	C	D	B	B	D	A	B
Approach Vol, veh/h		165			480			194			184	
Approach Delay, s/veh		39.6			27.5			16.5			33.8	
Approach LOS		D			C			B			C	
Timer - Assigned Phs	1	2	3	4	5	6	7	8				
Phs Duration (G+Y+Rc), s	9.9	41.3	15.9	13.0	6.1	45.0	4.9	23.9				
Change Period (Y+Rc), s	4.5	4.5	4.5	4.5	4.5	4.5	4.5	4.5				
Max Green Setting (Gmax), s	7.8	18.0	18.3	18.0	5.0	20.7	5.0	31.3				
Max Q Clear Time (g_c+1/3), s	5.8	5.8	11.2	8.0	2.9	2.9	2.2	8.4				
Green Ext Time (p_c), s	0.1	0.5	0.3	0.5	0.0	0.1	0.0	1.1				

Intersection Summary

HCM 6th Ctrl Delay	28.5
HCM 6th LOS	C

HCM 6th Signalized Intersection Summary
 14: Avenue 17 & SR-99 Southbound Off-Ramp

Village D Specific Plan
 Phase I WP MIT - AM Peak Hour

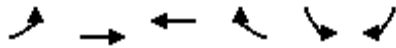

Movement	EBL	EBT	WBT	WBR	SBL	SBR
Lane Configurations		↑↑	↑↑		↵	↵
Traffic Volume (veh/h)	0	373	370	0	251	75
Future Volume (veh/h)	0	373	370	0	251	75
Initial Q (Qb), veh	0	0	0	0	0	0
Ped-Bike Adj(A_pbT)	1.00			1.00	1.00	1.00
Parking Bus, Adj	1.00	1.00	1.00	1.00	1.00	1.00
Work Zone On Approach		No	No		No	
Adj Sat Flow, veh/h/ln	0	1752	1767	0	1767	1767
Adj Flow Rate, veh/h	0	405	402	0	273	82
Peak Hour Factor	0.92	0.92	0.92	0.92	0.92	0.92
Percent Heavy Veh, %	0	10	9	0	9	9
Cap, veh/h	0	566	571	0	1207	1074
Arrive On Green	0.00	0.17	0.17	0.00	0.72	0.72
Sat Flow, veh/h	0	3504	3533	0	1682	1497
Grp Volume(v), veh/h	0	405	402	0	273	82
Grp Sat Flow(s),veh/h/ln	0	1664	1678	0	1682	1497
Q Serve(g_s), s	0.0	9.2	9.0	0.0	4.4	1.3
Cycle Q Clear(g_c), s	0.0	9.2	9.0	0.0	4.4	1.3
Prop In Lane	0.00			0.00	1.00	1.00
Lane Grp Cap(c), veh/h	0	566	571	0	1207	1074
V/C Ratio(X)	0.00	0.72	0.70	0.00	0.23	0.08
Avail Cap(c_a), veh/h	0	1144	1154	0	1207	1074
HCM Platoon Ratio	1.00	1.00	1.00	1.00	1.00	1.00
Upstream Filter(I)	0.00	0.92	1.00	0.00	1.00	1.00
Uniform Delay (d), s/veh	0.0	31.4	31.3	0.0	3.8	3.4
Incr Delay (d2), s/veh	0.0	1.6	1.6	0.0	0.4	0.1
Initial Q Delay(d3),s/veh	0.0	0.0	0.0	0.0	0.0	0.0
%ile BackOfQ(50%),veh/ln	0.0	3.7	3.7	0.0	1.2	0.3
Unsig. Movement Delay, s/veh						
LnGrp Delay(d),s/veh	0.0	32.9	32.9	0.0	4.2	3.5
LnGrp LOS	A	C	C	A	A	A
Approach Vol, veh/h		405	402		355	
Approach Delay, s/veh		32.9	32.9		4.1	
Approach LOS		C	C		A	
Timer - Assigned Phs				4	6	8
Phs Duration (G+Y+Rc), s				18.1	61.9	18.1
Change Period (Y+Rc), s				4.5	4.5	4.5
Max Green Setting (Gmax), s				27.5	43.5	27.5
Max Q Clear Time (g_c+I1), s				11.2	6.4	11.0
Green Ext Time (p_c), s				2.4	1.1	2.4
Intersection Summary						
HCM 6th Ctrl Delay			24.1			
HCM 6th LOS			C			

HCM 6th Signalized Intersection Summary
 15: SR-99 Northbound Ramps & Avenue 17

Village D Specific Plan
 Phase I WP MIT - AM Peak Hour



Movement	EBL	EBT	EBR	WBL	WBT	WBR	NBL	NBT	NBR	SBL	SBT	SBR
Lane Configurations	↖	↑↑			↑↑		↖	↖	↖			
Traffic Volume (veh/h)	83	430	0	0	908	236	157	2	240	0	0	0
Future Volume (veh/h)	83	430	0	0	908	236	157	2	240	0	0	0
Initial Q (Qb), veh	0	0	0	0	0	0	0	0	0			
Ped-Bike Adj(A_pbT)	1.00		1.00	1.00		1.00	1.00		1.00			
Parking Bus, Adj	1.00	1.00	1.00	1.00	1.00	1.00	1.00	1.00	1.00			
Work Zone On Approach		No			No			No				
Adj Sat Flow, veh/h/ln	1826	1826	0	0	1870	1870	1811	1811	1811			
Adj Flow Rate, veh/h	90	467	0	0	987	257	172	0	261			
Peak Hour Factor	0.92	0.92	0.92	0.92	0.92	0.92	0.92	0.92	0.92			
Percent Heavy Veh, %	5	5	0	0	2	2	6	6	6			
Cap, veh/h	115	1872	0	0	1164	302	1200	0	534			
Arrive On Green	0.07	0.54	0.00	0.00	0.42	0.42	0.35	0.00	0.35			
Sat Flow, veh/h	1739	3561	0	0	2886	725	3450	0	1535			
Grp Volume(v), veh/h	90	467	0	0	627	617	172	0	261			
Grp Sat Flow(s),veh/h/ln	1739	1735	0	0	1777	1740	1725	0	1535			
Q Serve(g_s), s	4.1	5.7	0.0	0.0	25.4	25.6	2.7	0.0	10.7			
Cycle Q Clear(g_c), s	4.1	5.7	0.0	0.0	25.4	25.6	2.7	0.0	10.7			
Prop In Lane	1.00		0.00	0.00		0.42	1.00		1.00			
Lane Grp Cap(c), veh/h	115	1872	0	0	741	725	1200	0	534			
V/C Ratio(X)	0.78	0.25	0.00	0.00	0.85	0.85	0.14	0.00	0.49			
Avail Cap(c_a), veh/h	220	2259	0	0	833	816	1200	0	534			
HCM Platoon Ratio	1.00	1.00	1.00	1.00	1.00	1.00	1.00	1.00	1.00			
Upstream Filter(l)	1.00	1.00	0.00	0.00	1.00	1.00	1.00	0.00	1.00			
Uniform Delay (d), s/veh	36.8	9.8	0.0	0.0	21.0	21.1	17.9	0.0	20.5			
Incr Delay (d2), s/veh	10.8	0.1	0.0	0.0	7.4	7.8	0.1	0.0	0.7			
Initial Q Delay(d3),s/veh	0.0	0.0	0.0	0.0	0.0	0.0	0.0	0.0	0.0			
%ile BackOfQ(50%),veh/ln	2.0	2.0	0.0	0.0	11.3	11.2	1.1	0.0	3.7			
Unsig. Movement Delay, s/veh												
LnGrp Delay(d),s/veh	47.6	9.9	0.0	0.0	28.4	28.9	18.0	0.0	21.2			
LnGrp LOS	D	A	A	A	C	C	B	A	C			
Approach Vol, veh/h		557			1244			433				
Approach Delay, s/veh		16.0			28.7			19.9				
Approach LOS		B			C			B				
Timer - Assigned Phs		2		4			7	8				
Phs Duration (G+Y+Rc), s		32.3		47.7			9.8	37.9				
Change Period (Y+Rc), s		4.5		4.5			4.5	4.5				
Max Green Setting (Gmax), s		18.9		52.1			10.1	37.5				
Max Q Clear Time (g_c+1), s		12.7		7.7			6.1	27.6				
Green Ext Time (p_c), s		0.9		3.5			0.1	5.7				

Intersection Summary

HCM 6th Ctrl Delay	23.8
HCM 6th LOS	C

Notes

User approved volume balancing among the lanes for turning movement.

HCM 6th Signalized Intersection Summary
 16: Love's Truck Stop Driveway/Driveway & Avenue 17

Village D Specific Plan
 Phase I WP MIT - AM Peak Hour



Movement	EBL	EBT	EBR	WBL	WBT	WBR	NBL	NBT	NBR	SBL	SBT	SBR
Lane Configurations	↔↔	↑↑↑	↔	↔	↑↑↑	↔	↔	↔		↔	↔	
Traffic Volume (veh/h)	162	372	132	45	858	56	136	0	22	48	0	90
Future Volume (veh/h)	162	372	132	45	858	56	136	0	22	48	0	90
Initial Q (Qb), veh	0	0	0	0	0	0	0	0	0	0	0	0
Ped-Bike Adj(A_pbT)	1.00		1.00	1.00		1.00	1.00		1.00	1.00		1.00
Parking Bus, Adj	1.00	1.00	1.00	1.00	1.00	1.00	1.00	1.00	1.00	1.00	1.00	1.00
Work Zone On Approach		No			No			No			No	
Adj Sat Flow, veh/h/ln	1870	1870	1870	1856	1856	1856	1900	1900	1900	1900	1900	1900
Adj Flow Rate, veh/h	176	404	143	49	933	61	148	0	24	52	0	98
Peak Hour Factor	0.92	0.92	0.92	0.92	0.92	0.92	0.92	0.92	0.92	0.92	0.92	0.92
Percent Heavy Veh, %	2	2	2	3	3	3	0	0	0	0	0	0
Cap, veh/h	258	1375	427	73	1195	371	186	0	679	77	0	582
Arrive On Green	0.07	0.27	0.27	0.04	0.24	0.24	0.10	0.00	0.42	0.04	0.00	0.36
Sat Flow, veh/h	3456	5106	1585	1767	5066	1572	1810	0	1610	1810	0	1610
Grp Volume(v), veh/h	176	404	143	49	933	61	148	0	24	52	0	98
Grp Sat Flow(s),veh/h/ln	1728	1702	1585	1767	1689	1572	1810	0	1610	1810	0	1610
Q Serve(g_s), s	4.0	5.0	5.8	2.2	13.8	2.5	6.4	0.0	0.7	2.3	0.0	3.3
Cycle Q Clear(g_c), s	4.0	5.0	5.8	2.2	13.8	2.5	6.4	0.0	0.7	2.3	0.0	3.3
Prop In Lane	1.00		1.00	1.00		1.00	1.00		1.00	1.00		1.00
Lane Grp Cap(c), veh/h	258	1375	427	73	1195	371	186	0	679	77	0	582
V/C Ratio(X)	0.68	0.29	0.34	0.67	0.78	0.16	0.80	0.00	0.04	0.67	0.00	0.17
Avail Cap(c_a), veh/h	367	1500	466	144	1361	423	294	0	679	147	0	582
HCM Platoon Ratio	1.00	1.00	1.00	1.00	1.00	1.00	1.00	1.00	1.00	1.00	1.00	1.00
Upstream Filter(I)	1.00	1.00	1.00	1.00	1.00	1.00	1.00	0.00	1.00	1.00	0.00	1.00
Uniform Delay (d), s/veh	36.1	23.2	23.5	37.8	28.6	24.3	35.1	0.0	13.6	37.7	0.0	17.4
Incr Delay (d2), s/veh	3.2	0.1	0.5	10.0	2.6	0.2	7.7	0.0	0.1	9.6	0.0	0.6
Initial Q Delay(d3),s/veh	0.0	0.0	0.0	0.0	0.0	0.0	0.0	0.0	0.0	0.0	0.0	0.0
%ile BackOfQ(50%),veh/ln	1.8	2.0	2.1	1.1	5.7	0.9	3.1	0.0	0.3	1.2	0.0	1.3
Unsig. Movement Delay, s/veh												
LnGrp Delay(d),s/veh	39.2	23.3	23.9	47.8	31.3	24.5	42.8	0.0	13.7	47.3	0.0	18.0
LnGrp LOS	D	C	C	D	C	C	D	A	B	D	A	B
Approach Vol, veh/h		723			1043			172				150
Approach Delay, s/veh		27.3			31.6			38.7				28.2
Approach LOS		C			C			D				C
Timer - Assigned Phs	1	2	3	4	5	6	7	8				
Phs Duration (G+Y+Rc), s	7.9	38.2	7.8	26.0	12.7	33.4	10.5	23.4				
Change Period (Y+Rc), s	4.5	4.5	4.5	4.5	4.5	4.5	4.5	4.5				
Max Green Setting (Gmax), s	5	25.5	6.5	23.5	13.0	19.0	8.5	21.5				
Max Q Clear Time (g_c+1), s	11.3	2.7	4.2	7.8	8.4	5.3	6.0	15.8				
Green Ext Time (p_c), s	0.0	0.1	0.0	2.9	0.1	0.4	0.1	3.1				
Intersection Summary												
HCM 6th Ctrl Delay												30.5
HCM 6th LOS												C

HCM 6th Signalized Intersection Summary
 17: Westberry Boulevard & Cleveland Avenue

Village D Specific Plan
 Phase I WP MIT - AM Peak Hour



Movement	EBL	EBT	EBR	WBL	WBT	WBR	NBL	NBT	NBR	SBL	SBT	SBR
Lane Configurations	↖	↖↗		↖	↖↗		↖	↑	↖↗	↖	↑	↖↗
Traffic Volume (veh/h)	254	801	64	27	296	12	38	102	98	14	39	106
Future Volume (veh/h)	254	801	64	27	296	12	38	102	98	14	39	106
Initial Q (Qb), veh	0	0	0	0	0	0	0	0	0	0	0	0
Ped-Bike Adj(A_pbT)	1.00		1.00	1.00		0.99	1.00		1.00	1.00		0.99
Parking Bus, Adj	1.00	1.00	1.00	1.00	1.00	1.00	1.00	1.00	1.00	1.00	1.00	1.00
Work Zone On Approach		No		No		No		No		No		No
Adj Sat Flow, veh/h/ln	1900	1900	1900	1885	1885	1885	1900	1900	1900	1900	1900	1900
Adj Flow Rate, veh/h	276	871	70	29	322	13	41	111	107	15	42	115
Peak Hour Factor	0.92	0.92	0.92	0.92	0.92	0.92	0.92	0.92	0.92	0.92	0.92	0.92
Percent Heavy Veh, %	0	0	0	1	1	1	0	0	0	0	0	0
Cap, veh/h	322	1078	87	53	598	24	68	777	658	32	740	619
Arrive On Green	0.18	0.32	0.32	0.03	0.17	0.17	0.04	0.41	0.41	0.02	0.39	0.39
Sat Flow, veh/h	1810	3383	272	1795	3508	141	1810	1900	1609	1810	1900	1589
Grp Volume(v), veh/h	276	465	476	29	164	171	41	111	107	15	42	115
Grp Sat Flow(s),veh/h/ln	1810	1805	1850	1795	1791	1859	1810	1900	1609	1810	1900	1589
Q Serve(g_s), s	11.8	18.9	18.9	1.3	6.7	6.7	1.8	2.9	3.4	0.7	1.1	3.8
Cycle Q Clear(g_c), s	11.8	18.9	18.9	1.3	6.7	6.7	1.8	2.9	3.4	0.7	1.1	3.8
Prop In Lane	1.00		0.15	1.00		0.08	1.00		1.00	1.00		1.00
Lane Grp Cap(c), veh/h	322	575	589	53	305	317	68	777	658	32	740	619
V/C Ratio(X)	0.86	0.81	0.81	0.54	0.54	0.54	0.61	0.14	0.16	0.47	0.06	0.19
Avail Cap(c_a), veh/h	441	722	740	123	403	418	124	777	658	113	740	619
HCM Platoon Ratio	1.00	1.00	1.00	1.00	1.00	1.00	1.00	1.00	1.00	1.00	1.00	1.00
Upstream Filter(I)	1.00	1.00	1.00	1.00	1.00	1.00	1.00	1.00	1.00	1.00	1.00	1.00
Uniform Delay (d), s/veh	31.9	25.0	25.0	38.3	30.3	30.3	37.9	14.8	15.0	38.9	15.2	16.1
Incr Delay (d2), s/veh	11.8	5.5	5.4	8.4	1.5	1.4	8.5	0.4	0.5	10.2	0.1	0.7
Initial Q Delay(d3),s/veh	0.0	0.0	0.0	0.0	0.0	0.0	0.0	0.0	0.0	0.0	0.0	0.0
%ile BackOfQ(50%),veh/ln	6.1	8.6	8.7	0.7	2.9	3.1	0.9	1.3	1.3	0.4	0.5	1.4
Unsig. Movement Delay, s/veh												
LnGrp Delay(d),s/veh	43.7	30.5	30.4	46.6	31.8	31.7	46.4	15.2	15.5	49.1	15.4	16.7
LnGrp LOS	D	C	C	D	C	C	D	B	B	D	B	B
Approach Vol, veh/h		1217			364			259			172	
Approach Delay, s/veh		33.5			32.9			20.3			19.2	
Approach LOS		C			C			C			B	
Timer - Assigned Phs	1	2	3	4	5	6	7	8				
Phs Duration (G+Y+Rc), s	5.9	37.2	6.9	30.0	7.5	35.7	18.7	18.1				
Change Period (Y+Rc), s	4.5	4.5	4.5	4.5	4.5	4.5	4.5	4.5				
Max Green Setting (Gmax), s	5.0	19.5	5.5	32.0	5.5	19.0	19.5	18.0				
Max Q Clear Time (g_c+1/2), s	12.5	5.4	3.3	20.9	3.8	5.8	13.8	8.7				
Green Ext Time (p_c), s	0.0	0.7	0.0	4.6	0.0	0.4	0.4	1.3				
Intersection Summary												
HCM 6th Ctrl Delay				30.4								
HCM 6th LOS				C								

Intersection												
Intersection Delay, s/veh	19.5											
Intersection LOS	C											

Movement	EBL	EBT	EBR	WBL	WBT	WBR	NBL	NBT	NBR	SBL	SBT	SBR
Lane Configurations	↵	↕		↵	↕			↕			↕	
Traffic Vol, veh/h	105	250	38	11	210	108	75	42	24	211	61	84
Future Vol, veh/h	105	250	38	11	210	108	75	42	24	211	61	84
Peak Hour Factor	0.92	0.92	0.92	0.92	0.92	0.92	0.92	0.92	0.92	0.92	0.92	0.92
Heavy Vehicles, %	5	5	5	6	6	6	0	0	0	0	0	0
Mvmt Flow	114	272	41	12	228	117	82	46	26	229	66	91
Number of Lanes	1	2	0	1	2	0	0	1	0	0	1	0

Approach	EB	WB	NB	SB
Opposing Approach	WB	EB	SB	NB
Opposing Lanes	3	3	1	1
Conflicting Approach Left	SB	NB	EB	WB
Conflicting Lanes Left	1	1	3	3
Conflicting Approach Right	NB	SB	WB	EB
Conflicting Lanes Right	1	1	3	3
HCM Control Delay	13.8	14.2	14.9	32.4
HCM LOS	B	B	B	D

Lane	NBLn1	EBLn1	EBLn2	EBLn3	WBLn1	WBLn2	WBLn3	SBLn1
Vol Left, %	53%	100%	0%	0%	100%	0%	0%	59%
Vol Thru, %	30%	0%	100%	69%	0%	100%	39%	17%
Vol Right, %	17%	0%	0%	31%	0%	0%	61%	24%
Sign Control	Stop	Stop	Stop	Stop	Stop	Stop	Stop	Stop
Traffic Vol by Lane	141	105	167	121	11	140	178	356
LT Vol	75	105	0	0	11	0	0	211
Through Vol	42	0	167	83	0	140	70	61
RT Vol	24	0	0	38	0	0	108	84
Lane Flow Rate	153	114	181	132	12	152	193	387
Geometry Grp	7	7	7	7	7	7	7	7
Degree of Util (X)	0.34	0.254	0.378	0.267	0.027	0.323	0.387	0.788
Departure Headway (Hd)	7.995	8.022	7.503	7.276	8.168	7.649	7.208	7.335
Convergence, Y/N	Yes	Yes	Yes	Yes	Yes	Yes	Yes	Yes
Cap	449	447	478	492	437	469	497	491
Service Time	5.766	5.787	5.268	5.04	5.936	5.417	4.975	5.09
HCM Lane V/C Ratio	0.341	0.255	0.379	0.268	0.027	0.324	0.388	0.788
HCM Control Delay	14.9	13.5	14.8	12.7	11.2	14.1	14.5	32.4
HCM Lane LOS	B	B	B	B	B	B	B	D
HCM 95th-tile Q	1.5	1	1.7	1.1	0.1	1.4	1.8	7.2

HCM 6th Signalized Intersection Summary

21: Granada Drive & Cleveland Avenue

Village D Specific Plan
Phase I WP MIT - AM Peak Hour



Movement	EBL	EBT	EBR	WBL	WBT	WBR	NBL	NBT	NBR	SBL	SBT	SBR
Lane Configurations												
Traffic Volume (veh/h)	22	868	28	188	286	17	25	338	295	7	238	5
Future Volume (veh/h)	22	868	28	188	286	17	25	338	295	7	238	5
Initial Q (Qb), veh	0	0	0	0	0	0	0	0	0	0	0	0
Ped-Bike Adj(A_pbT)	1.00		0.98	1.00		1.00	1.00		0.99	1.00		1.00
Parking Bus, Adj	1.00	1.00	1.00	1.00	1.00	1.00	1.00	1.00	1.00	1.00	1.00	1.00
Work Zone On Approach		No			No			No			No	
Adj Sat Flow, veh/h/ln	1885	1885	1885	1870	1870	1870	1900	1900	1900	1900	1900	1900
Adj Flow Rate, veh/h	24	943	30	204	311	18	27	367	321	8	259	5
Peak Hour Factor	0.92	0.92	0.92	0.92	0.92	0.92	0.92	0.92	0.92	0.92	0.92	0.92
Percent Heavy Veh, %	1	1	1	2	2	2	0	0	0	0	0	0
Cap, veh/h	46	1025	33	245	1370	79	51	642	536	18	607	514
Arrive On Green	0.03	0.29	0.29	0.05	0.13	0.13	0.03	0.34	0.34	0.01	0.32	0.32
Sat Flow, veh/h	1795	3540	113	1781	3414	197	1810	1900	1587	1810	1900	1607
Grp Volume(v), veh/h	24	477	496	204	161	168	27	367	321	8	259	5
Grp Sat Flow(s),veh/h/ln	1795	1791	1862	1781	1777	1834	1810	1900	1587	1810	1900	1607
Q Serve(g_s), s	1.1	20.6	20.6	9.1	6.5	6.5	1.2	12.7	13.4	0.4	8.6	0.2
Cycle Q Clear(g_c), s	1.1	20.6	20.6	9.1	6.5	6.5	1.2	12.7	13.4	0.4	8.6	0.2
Prop In Lane	1.00		0.06	1.00		0.11	1.00		1.00	1.00		1.00
Lane Grp Cap(c), veh/h	46	519	539	245	713	736	51	642	536	18	607	514
V/C Ratio(X)	0.52	0.92	0.92	0.83	0.23	0.23	0.53	0.57	0.60	0.43	0.43	0.01
Avail Cap(c_a), veh/h	119	526	547	256	713	736	115	642	536	113	607	514
HCM Platoon Ratio	1.00	1.00	1.00	0.33	0.33	0.33	1.00	1.00	1.00	1.00	1.00	1.00
Upstream Filter(I)	1.00	1.00	1.00	0.94	0.94	0.94	1.00	1.00	1.00	1.00	1.00	1.00
Uniform Delay (d), s/veh	38.5	27.5	27.5	37.3	23.6	23.6	38.3	21.7	22.0	39.4	21.4	18.6
Incr Delay (d2), s/veh	8.6	21.3	20.7	18.8	0.1	0.1	8.2	3.7	4.9	15.3	2.2	0.0
Initial Q Delay(d3),s/veh	0.0	0.0	0.0	0.0	0.0	0.0	0.0	0.0	0.0	0.0	0.0	0.0
%ile BackOfQ(50%),veh/ln	0.6	11.5	11.8	5.5	2.8	2.9	0.6	6.0	5.5	0.2	4.0	0.1
Unsig. Movement Delay, s/veh												
LnGrp Delay(d),s/veh	47.1	48.9	48.3	56.1	23.7	23.8	46.6	25.4	26.9	54.7	23.6	18.6
LnGrp LOS	D	D	D	E	C	C	D	C	C	D	C	B
Approach Vol, veh/h		997			533			715			272	
Approach Delay, s/veh		48.5			36.1			26.9			24.4	
Approach LOS		D			D			C			C	
Timer - Assigned Phs	1	2	3	4	5	6	7	8				
Phs Duration (G+Y+Rc), s	5.3	31.5	15.5	27.7	6.8	30.1	6.6	36.6				
Change Period (Y+Rc), s	4.5	4.5	4.5	4.5	4.5	4.5	4.5	4.5				
Max Green Setting (Gmax), s	5.0	22.0	11.5	23.5	5.1	21.9	5.3	29.7				
Max Q Clear Time (g_c+I1), s	2.4	15.4	11.1	22.6	3.2	10.6	3.1	8.5				
Green Ext Time (p_c), s	0.0	1.9	0.0	0.5	0.0	1.1	0.0	1.8				
Intersection Summary												
HCM 6th Ctrl Delay				37.1								
HCM 6th LOS				D								

HCM 6th Signalized Intersection Summary
 25: Kennedy Street/Gateway Drive & SR-99 Southbound Ramps

Village D Specific Plan
 Phase I WP MIT - AM Peak Hour

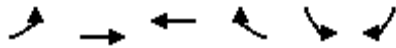

Movement	EBL	EBT	WBT	WBR	SBL	SBR	
Lane Configurations							
Traffic Volume (veh/h)	251	235	284	2	65	111	
Future Volume (veh/h)	251	235	284	2	65	111	
Initial Q (Qb), veh	0	0	0	0	0	0	
Ped-Bike Adj(A_pbT)	1.00			1.00	1.00	1.00	
Parking Bus, Adj	1.00	1.00	1.00	1.00	1.00	1.00	
Work Zone On Approach		No	No		No		
Adj Sat Flow, veh/h/ln	1870	1870	1811	1811	1841	1841	
Adj Flow Rate, veh/h	273	255	309	0	71	121	
Peak Hour Factor	0.92	0.92	0.92	0.92	0.92	0.92	
Percent Heavy Veh, %	2	2	6	6	4	4	
Cap, veh/h	312	862	382		682	880	
Arrive On Green	0.17	0.46	0.21	0.00	0.39	0.39	
Sat Flow, veh/h	1781	1870	1811	0	1753	1560	
Grp Volume(v), veh/h	273	255	309	0	71	121	
Grp Sat Flow(s),veh/h/ln	1781	1870	1811	0	1753	1560	
Q Serve(g_s), s	9.0	5.1	9.7	0.0	1.5	2.2	
Cycle Q Clear(g_c), s	9.0	5.1	9.7	0.0	1.5	2.2	
Prop In Lane	1.00			0.00	1.00	1.00	
Lane Grp Cap(c), veh/h	312	862	382		682	880	
V/C Ratio(X)	0.88	0.30	0.81		0.10	0.14	
Avail Cap(c_a), veh/h	312	1029	543		682	880	
HCM Platoon Ratio	1.00	1.00	1.00	1.00	1.00	1.00	
Upstream Filter(I)	1.00	1.00	1.00	0.00	1.00	1.00	
Uniform Delay (d), s/veh	24.1	10.1	22.5	0.0	11.7	6.2	
Incr Delay (d2), s/veh	23.2	0.2	6.0	0.0	0.3	0.3	
Initial Q Delay(d3),s/veh	0.0	0.0	0.0	0.0	0.0	0.0	
%ile BackOfQ(50%),veh/ln	5.5	1.8	4.5	0.0	0.6	3.0	
Unsig. Movement Delay, s/veh							
LnGrp Delay(d),s/veh	47.3	10.3	28.6	0.0	12.0	6.5	
LnGrp LOS	D	B	C		B	A	
Approach Vol, veh/h		528	309	A	192		
Approach Delay, s/veh		29.4	28.6		8.5		
Approach LOS		C	C		A		
Timer - Assigned Phs				4	6	7	8
Phs Duration (G+Y+Rc), s				32.2	27.8	15.0	17.2
Change Period (Y+Rc), s				4.5	4.5	4.5	4.5
Max Green Setting (Gmax), s				33.0	18.0	10.5	18.0
Max Q Clear Time (g_c+I1), s				7.1	4.2	11.0	11.7
Green Ext Time (p_c), s				1.5	0.5	0.0	0.9
Intersection Summary							
HCM 6th Ctrl Delay			25.3				
HCM 6th LOS			C				
Notes							
Unsignalized Delay for [WBR] is excluded from calculations of the approach delay and intersection delay.							

HCM 6th Signalized Intersection Summary
 31: SR-99 Southbound Ramps & Cleveland Avenue

Village D Specific Plan
 Phase I WP MIT - AM Peak Hour



Movement	EBL	EBT	EBR	WBL	WBT	WBR	NBL	NBT	NBR	SBL	SBT	SBR
Lane Configurations		↑↑	↑	↑	↑↑					↑		↑
Traffic Volume (veh/h)	0	661	769	339	869	0	0	0	0	65	0	54
Future Volume (veh/h)	0	661	769	339	869	0	0	0	0	65	0	54
Initial Q (Qb), veh	0	0	0	0	0	0				0	0	0
Ped-Bike Adj(A_pbT)	1.00		1.00	1.00		1.00				1.00		1.00
Parking Bus, Adj	1.00	1.00	1.00	1.00	1.00	1.00				1.00	1.00	1.00
Work Zone On Approach		No			No						No	
Adj Sat Flow, veh/h/ln	0	1870	1870	1856	1856	0				1678	0	1678
Adj Flow Rate, veh/h	0	718	836	368	945	0				71	0	59
Peak Hour Factor	0.92	0.92	0.92	0.92	0.92	0.92				0.92	0.92	0.92
Percent Heavy Veh, %	0	2	2	3	3	0				15	0	15
Cap, veh/h	0	1614	720	399	2529	0				332	0	295
Arrive On Green	0.00	0.45	0.45	0.23	0.72	0.00				0.21	0.00	0.21
Sat Flow, veh/h	0	3647	1585	1767	3618	0				1598	0	1422
Grp Volume(v), veh/h	0	718	836	368	945	0				71	0	59
Grp Sat Flow(s),veh/h/ln	0	1777	1585	1767	1763	0				1598	0	1422
Q Serve(g_s), s	0.0	16.6	54.5	24.4	12.4	0.0				4.4	0.0	4.1
Cycle Q Clear(g_c), s	0.0	16.6	54.5	24.4	12.4	0.0				4.4	0.0	4.1
Prop In Lane	0.00		1.00	1.00		0.00				1.00		1.00
Lane Grp Cap(c), veh/h	0	1614	720	399	2529	0				332	0	295
V/C Ratio(X)	0.00	0.44	1.16	0.92	0.37	0.00				0.21	0.00	0.20
Avail Cap(c_a), veh/h	0	1614	720	479	2688	0				332	0	295
HCM Platoon Ratio	1.00	1.00	1.00	1.00	1.00	1.00				1.00	1.00	1.00
Upstream Filter(I)	0.00	0.57	0.57	0.68	0.68	0.00				1.00	0.00	1.00
Uniform Delay (d), s/veh	0.0	22.4	32.7	45.4	6.6	0.0				39.4	0.0	39.3
Incr Delay (d2), s/veh	0.0	0.1	81.7	16.0	0.1	0.0				0.3	0.0	0.3
Initial Q Delay(d3),s/veh	0.0	0.0	0.0	0.0	0.0	0.0				0.0	0.0	0.0
%ile BackOfQ(50%),veh/ln	0.0	6.9	36.5	12.4	4.2	0.0				1.8	0.0	1.5
Unsig. Movement Delay, s/veh												
LnGrp Delay(d),s/veh	0.0	22.5	114.5	61.5	6.6	0.0				39.7	0.0	39.6
LnGrp LOS	A	C	F	E	A	A				D	A	D
Approach Vol, veh/h		1554			1313						130	
Approach Delay, s/veh		72.0			22.0						39.7	
Approach LOS		E			C						D	
Timer - Assigned Phs			3	4		6		8				
Phs Duration (G+Y+Rc), s			31.6	59.0		29.4		90.6				
Change Period (Y+Rc), s			4.5	4.5		4.5		4.5				
Max Green Setting (Gmax), s			32.5	54.5		19.5		91.5				
Max Q Clear Time (g_c+I1), s			26.4	56.5		6.4		14.4				
Green Ext Time (p_c), s			0.6	0.0		0.3		8.9				
Intersection Summary												
HCM 6th Ctrl Delay			48.7									
HCM 6th LOS			D									

HCM 6th Signalized Intersection Summary
 49: Yosemite Avenue & Cleveland Avenue/Tozer Street

Village D Specific Plan
 Phase I WP MIT - AM Peak Hour



Movement	EBL	EBT	EBR	WBL	WBT	WBR	NBL	NBT	NBR	SBL	SBT	SBR
Lane Configurations												
Traffic Volume (veh/h)	248	520	252	112	309	47	134	116	75	66	243	210
Future Volume (veh/h)	248	520	252	112	309	47	134	116	75	66	243	210
Initial Q (Qb), veh	0	0	0	0	0	0	0	0	0	0	0	0
Ped-Bike Adj(A_pbT)	1.00		0.93	1.00		0.93	1.00		1.00	1.00		1.00
Parking Bus, Adj	1.00	1.00	1.00	1.00	1.00	1.00	1.00	1.00	1.00	1.00	1.00	1.00
Work Zone On Approach		No			No			No			No	
Adj Sat Flow, veh/h/ln	1856	1856	1856	1841	1841	1841	1856	1856	1856	1870	1870	1870
Adj Flow Rate, veh/h	270	565	274	122	336	51	146	126	82	72	264	228
Peak Hour Factor	0.92	0.92	0.92	0.92	0.92	0.92	0.92	0.92	0.92	0.92	0.92	0.92
Percent Heavy Veh, %	3	3	3	4	4	4	3	3	3	2	2	2
Cap, veh/h	315	867	420	154	1037	431	181	442	373	93	352	579
Arrive On Green	0.18	0.39	0.39	0.09	0.30	0.30	0.10	0.24	0.24	0.05	0.19	0.19
Sat Flow, veh/h	1767	2241	1084	1753	3497	1455	1767	1856	1567	1781	1870	1577
Grp Volume(v), veh/h	270	444	395	122	336	51	146	126	82	72	264	228
Grp Sat Flow(s),veh/h/ln	1767	1763	1562	1753	1749	1455	1767	1856	1567	1781	1870	1577
Q Serve(g_s), s	11.4	15.8	15.9	5.2	5.7	2.0	6.2	4.3	3.2	3.1	10.2	8.2
Cycle Q Clear(g_c), s	11.4	15.8	15.9	5.2	5.7	2.0	6.2	4.3	3.2	3.1	10.2	8.2
Prop In Lane	1.00		0.69	1.00		1.00	1.00		1.00	1.00		1.00
Lane Grp Cap(c), veh/h	315	682	605	154	1037	431	181	442	373	93	352	579
V/C Ratio(X)	0.86	0.65	0.65	0.79	0.32	0.12	0.81	0.28	0.22	0.77	0.75	0.39
Avail Cap(c_a), veh/h	417	682	605	185	1037	431	200	602	508	216	622	807
HCM Platoon Ratio	1.00	1.00	1.00	1.00	1.00	1.00	1.00	1.00	1.00	1.00	1.00	1.00
Upstream Filter(I)	1.00	1.00	1.00	1.00	1.00	1.00	1.00	1.00	1.00	1.00	1.00	1.00
Uniform Delay (d), s/veh	30.6	19.3	19.3	34.3	21.0	19.7	33.7	23.9	23.5	35.9	29.4	18.0
Incr Delay (d2), s/veh	12.8	4.8	5.4	17.7	0.8	0.6	19.5	0.3	0.3	12.7	3.2	0.4
Initial Q Delay(d3),s/veh	0.0	0.0	0.0	0.0	0.0	0.0	0.0	0.0	0.0	0.0	0.0	0.0
%ile BackOfQ(50%),veh/ln	5.8	7.0	6.3	2.9	2.4	0.7	3.6	1.8	1.2	1.6	4.7	2.9
Unsig. Movement Delay, s/veh												
LnGrp Delay(d),s/veh	43.4	24.0	24.7	52.0	21.8	20.2	53.2	24.2	23.8	48.6	32.6	18.4
LnGrp LOS	D	C	C	D	C	C	D	C	C	D	C	B
Approach Vol, veh/h		1109			509			354			564	
Approach Delay, s/veh		29.0			28.9			36.1			28.9	
Approach LOS		C			C			D			C	
Timer - Assigned Phs	1	2	3	4	5	6	7	8				
Phs Duration (G+Y+Rc), s	18.2	27.2	8.5	22.8	11.2	34.2	12.4	18.9				
Change Period (Y+Rc), s	4.5	4.5	4.5	4.5	4.5	4.5	4.5	4.5				
Max Green Setting (Gmax), s	18.1	19.7	9.3	24.9	8.1	29.7	8.7	25.5				
Max Q Clear Time (g_c+I1), s	13.4	7.7	5.1	6.3	7.2	17.9	8.2	12.2				
Green Ext Time (p_c), s	0.3	1.8	0.0	0.8	0.0	4.4	0.0	2.0				
Intersection Summary												
HCM 6th Ctrl Delay				29.9								
HCM 6th LOS				C								

HCM 6th Signalized Intersection Summary
56: Road 23 & Project Driveway 4

Village D Specific Plan
Phase I WP MIT - AM Peak Hour



Movement	WBL	WBR	NBT	NBR	SBL	SBT
Lane Configurations						
Traffic Volume (veh/h)	80	263	319	110	132	404
Future Volume (veh/h)	80	263	319	110	132	404
Initial Q (Qb), veh	0	0	0	0	0	0
Ped-Bike Adj(A_pbT)	1.00	1.00		1.00	1.00	
Parking Bus, Adj	1.00	1.00	1.00	1.00	1.00	1.00
Work Zone On Approach	No		No			No
Adj Sat Flow, veh/h/ln	1900	1900	1737	1737	1796	1796
Adj Flow Rate, veh/h	87	286	347	120	143	439
Peak Hour Factor	0.92	0.92	0.92	0.92	0.92	0.92
Percent Heavy Veh, %	0	0	11	11	7	7
Cap, veh/h	365	325	648	224	178	1232
Arrive On Green	0.20	0.20	0.53	0.53	0.10	0.69
Sat Flow, veh/h	1810	1610	1234	427	1711	1796
Grp Volume(v), veh/h	87	286	0	467	143	439
Grp Sat Flow(s),veh/h/ln	1810	1610	0	1660	1711	1796
Q Serve(g_s), s	3.2	13.8	0.0	14.9	6.5	8.1
Cycle Q Clear(g_c), s	3.2	13.8	0.0	14.9	6.5	8.1
Prop In Lane	1.00	1.00		0.26	1.00	
Lane Grp Cap(c), veh/h	365	325	0	872	178	1232
V/C Ratio(X)	0.24	0.88	0.00	0.54	0.80	0.36
Avail Cap(c_a), veh/h	414	368	0	872	297	1232
HCM Platoon Ratio	1.00	1.00	1.00	1.00	1.00	1.00
Upstream Filter(I)	1.00	1.00	0.00	1.00	1.00	1.00
Uniform Delay (d), s/veh	26.8	31.0	0.0	12.5	35.0	5.2
Incr Delay (d2), s/veh	0.3	19.5	0.0	2.4	8.1	0.8
Initial Q Delay(d3),s/veh	0.0	0.0	0.0	0.0	0.0	0.0
%ile BackOfQ(50%),veh/ln	1.4	6.9	0.0	5.6	3.1	2.7
Unsig. Movement Delay, s/veh						
LnGrp Delay(d),s/veh	27.1	50.5	0.0	14.9	43.2	6.0
LnGrp LOS	C	D	A	B	D	A
Approach Vol, veh/h	373		467			582
Approach Delay, s/veh	45.1		14.9			15.2
Approach LOS	D		B			B
Timer - Assigned Phs	1	2			6	8
Phs Duration (G+Y+Rc), s	12.8	46.5			59.4	20.6
Change Period (Y+Rc), s	4.5	4.5			4.5	4.5
Max Green Setting (Gmax), s	13.9	34.3			52.7	18.3
Max Q Clear Time (g_c+I1), s	8.5	16.9			10.1	15.8
Green Ext Time (p_c), s	0.2	2.9			3.1	0.3
Intersection Summary						
HCM 6th Ctrl Delay			22.9			
HCM 6th LOS			C			

HCM 6th Signalized Intersection Summary
58: Project Driveway 6 & Cleveland Avenue

Village D Specific Plan
Phase I WP MIT - AM Peak Hour



Movement	EBT	EBR	WBL	WBT	NBL	NBR
Lane Configurations	↩		↩	↩	↩	↩
Traffic Volume (veh/h)	887	88	154	327	207	292
Future Volume (veh/h)	887	88	154	327	207	292
Initial Q (Qb), veh	0	0	0	0	0	0
Ped-Bike Adj(A_pbT)		1.00	1.00		1.00	1.00
Parking Bus, Adj	1.00	1.00	1.00	1.00	1.00	1.00
Work Zone On Approach	No			No	No	
Adj Sat Flow, veh/h/ln	1885	1885	1885	1885	1900	1900
Adj Flow Rate, veh/h	964	96	167	355	225	317
Peak Hour Factor	0.92	0.92	0.92	0.92	0.92	0.92
Percent Heavy Veh, %	1	1	1	1	0	0
Cap, veh/h	990	99	194	1381	348	310
Arrive On Green	0.59	0.59	0.11	0.73	0.19	0.19
Sat Flow, veh/h	1687	168	1795	1885	1810	1610
Grp Volume(v), veh/h	0	1060	167	355	225	317
Grp Sat Flow(s),veh/h/ln	0	1855	1795	1885	1810	1610
Q Serve(g_s), s	0.0	66.1	11.0	7.4	13.8	23.1
Cycle Q Clear(g_c), s	0.0	66.1	11.0	7.4	13.8	23.1
Prop In Lane		0.09	1.00		1.00	1.00
Lane Grp Cap(c), veh/h	0	1089	194	1381	348	310
V/C Ratio(X)	0.00	0.97	0.86	0.26	0.65	1.02
Avail Cap(c_a), veh/h	0	1105	202	1406	348	310
HCM Platoon Ratio	1.00	1.00	1.00	1.00	1.00	1.00
Upstream Filter(I)	0.00	1.00	1.00	1.00	1.00	1.00
Uniform Delay (d), s/veh	0.0	23.9	52.6	5.3	44.7	48.5
Incr Delay (d2), s/veh	0.0	20.7	28.8	0.1	8.9	57.1
Initial Q Delay(d3),s/veh	0.0	0.0	0.0	0.0	0.0	0.0
%ile BackOfQ(50%),veh/ln	0.0	33.2	6.5	2.7	7.0	14.1
Unsig. Movement Delay, s/veh						
LnGrp Delay(d),s/veh	0.0	44.6	81.5	5.4	53.6	105.5
LnGrp LOS	A	D	F	A	D	F
Approach Vol, veh/h	1060			522	542	
Approach Delay, s/veh	44.6			29.7	84.0	
Approach LOS	D			C	F	
Timer - Assigned Phs		2	3	4		8
Phs Duration (G+Y+Rc), s		27.6	17.5	74.9		92.4
Change Period (Y+Rc), s		4.5	4.5	4.5		4.5
Max Green Setting (Gmax), s		21.5	13.5	71.5		89.5
Max Q Clear Time (g_c+I1), s		25.1	13.0	68.1		9.4
Green Ext Time (p_c), s		0.0	0.0	2.4		2.4
Intersection Summary						
HCM 6th Ctrl Delay			51.0			
HCM 6th LOS			D			

HCM 6th Signalized Intersection Summary
5: Road 23/SR-99 Southbound Off-Ramp & Avenue 18 1/2

Village D Specific Plan
Phase I WP MIT - PM Peak Hour



Movement	EBL	EBT	EBR	WBL	WBT	WBR	NBL	NBT	NBR	SBL	SBT	SBR
Lane Configurations		↑	↗	↘	↑		↘	↗	↗		↕	↕
Traffic Volume (veh/h)	0	388	231	45	196	0	52	0	206	22	293	122
Future Volume (veh/h)	0	388	231	45	196	0	52	0	206	22	293	122
Initial Q (Qb), veh	0	0	0	0	0	0	0	0	0	0	0	0
Ped-Bike Adj(A_pbT)	1.00		0.99	1.00		1.00	1.00		1.00	1.00		0.98
Parking Bus, Adj	1.00	1.00	1.00	1.00	1.00	1.00	1.00	1.00	1.00	1.00	1.00	1.00
Work Zone On Approach		No			No			No			No	
Adj Sat Flow, veh/h/ln	0	1618	1618	1455	1455	0	1767	1767	1767	1678	1678	1678
Adj Flow Rate, veh/h	0	413	246	48	209	0	55	0	219	23	312	130
Peak Hour Factor	0.94	0.94	0.94	0.94	0.94	0.94	0.94	0.94	0.94	0.94	0.94	0.94
Percent Heavy Veh, %	0	19	19	30	30	0	9	9	9	15	15	15
Cap, veh/h	0	419	694	57	518	0	421	0	872	34	471	206
Arrive On Green	0.00	0.26	0.26	0.04	0.36	0.00	0.25	0.00	0.25	0.22	0.22	0.22
Sat Flow, veh/h	0	1618	1354	1386	1455	0	1682	0	2994	152	2093	914
Grp Volume(v), veh/h	0	413	246	48	209	0	55	0	219	253	0	212
Grp Sat Flow(s),veh/h/ln	0	1618	1354	1386	1455	0	1682	0	1497	1670	0	1489
Q Serve(g_s), s	0.0	20.3	8.7	2.8	8.6	0.0	2.0	0.0	4.5	11.1	0.0	10.3
Cycle Q Clear(g_c), s	0.0	20.3	8.7	2.8	8.6	0.0	2.0	0.0	4.5	11.1	0.0	10.3
Prop In Lane	0.00		1.00	1.00		0.00	1.00		1.00	0.09		0.61
Lane Grp Cap(c), veh/h	0	419	694	57	518	0	421	0	872	376	0	335
V/C Ratio(X)	0.00	0.99	0.35	0.84	0.40	0.00	0.13	0.00	0.25	0.67	0.00	0.63
Avail Cap(c_a), veh/h	0	419	694	87	549	0	421	0	872	376	0	335
HCM Platoon Ratio	1.00	1.00	1.00	1.00	1.00	1.00	1.00	1.00	1.00	1.00	1.00	1.00
Upstream Filter(I)	0.00	1.00	1.00	1.00	1.00	0.00	1.00	0.00	1.00	1.00	0.00	1.00
Uniform Delay (d), s/veh	0.0	29.5	11.8	38.1	19.4	0.0	23.2	0.0	21.7	28.3	0.0	28.0
Incr Delay (d2), s/veh	0.0	40.2	0.3	34.7	0.5	0.0	0.6	0.0	0.7	9.3	0.0	8.8
Initial Q Delay(d3),s/veh	0.0	0.0	0.0	0.0	0.0	0.0	0.0	0.0	0.0	0.0	0.0	0.0
%ile BackOfQ(50%),veh/ln	0.0	12.2	4.1	1.5	2.9	0.0	0.9	0.0	1.6	5.2	0.0	4.4
Unsig. Movement Delay, s/veh												
LnGrp Delay(d),s/veh	0.0	69.7	12.1	72.8	19.9	0.0	23.9	0.0	22.4	37.6	0.0	36.8
LnGrp LOS	A	E	B	E	B	A	C	A	C	D	A	D
Approach Vol, veh/h		659			257			274				465
Approach Delay, s/veh		48.2			29.8			22.7				37.2
Approach LOS		D			C			C				D
Timer - Assigned Phs		2	3	4		6		8				
Phs Duration (G+Y+Rc), s		24.5	7.8	25.2		22.5		33.0				
Change Period (Y+Rc), s		4.5	4.5	4.5		4.5		4.5				
Max Green Setting (Gmax), s		18.3	5.0	20.7		18.0		30.2				
Max Q Clear Time (g_c+I1), s		6.5	4.8	22.3		13.1		10.6				
Green Ext Time (p_c), s		0.8	0.0	0.0		1.3		1.1				

Intersection Summary

HCM 6th Ctrl Delay	38.0
HCM 6th LOS	D

Notes

User approved volume balancing among the lanes for turning movement.

HCM 6th Signalized Intersection Summary
6: SR-99 Northbound Ramps & Avenue 18 1/2

Village D Specific Plan
Phase I WP MIT - PM Peak Hour



Movement	EBL	EBT	EBR	WBL	WBT	WBR	NBL	NBT	NBR	SBL	SBT	SBR
Lane Configurations	↔↔	↑			↔			↔				
Traffic Volume (veh/h)	294	95	0	0	85	16	185	2	0	0	0	0
Future Volume (veh/h)	294	95	0	0	85	16	185	2	0	0	0	0
Initial Q (Qb), veh	0	0	0	0	0	0	0	0	0			
Ped-Bike Adj(A_pbT)	1.00		1.00	1.00		1.00	1.00		1.00			
Parking Bus, Adj	1.00	1.00	1.00	1.00	1.00	1.00	1.00	1.00	1.00			
Work Zone On Approach		No			No			No				
Adj Sat Flow, veh/h/ln	1678	1678	0	0	1722	1722	1900	1544	1900			
Adj Flow Rate, veh/h	320	103	0	0	92	17	201	2	0			
Peak Hour Factor	0.92	0.92	0.92	0.92	0.92	0.92	0.92	0.92	0.92			
Percent Heavy Veh, %	15	15	0	0	12	12	0	24	0			
Cap, veh/h	415	474	0	0	130	24	882	9	0			
Arrive On Green	0.13	0.28	0.00	0.00	0.09	0.09	0.61	0.61	0.00			
Sat Flow, veh/h	3100	1678	0	0	1414	261	1457	14	0			
Grp Volume(v), veh/h	320	103	0	0	0	109	203	0	0			
Grp Sat Flow(s),veh/h/ln	1550	1678	0	0	0	1675	1471	0	0			
Q Serve(g_s), s	8.0	3.8	0.0	0.0	0.0	5.1	5.1	0.0	0.0			
Cycle Q Clear(g_c), s	8.0	3.8	0.0	0.0	0.0	5.1	5.1	0.0	0.0			
Prop In Lane	1.00		0.00	0.00		0.16	0.99		0.00			
Lane Grp Cap(c), veh/h	415	474	0	0	0	154	891	0	0			
V/C Ratio(X)	0.77	0.22	0.00	0.00	0.00	0.71	0.23	0.00	0.00			
Avail Cap(c_a), veh/h	717	891	0	0	0	408	891	0	0			
HCM Platoon Ratio	1.00	1.00	1.00	1.00	1.00	1.00	1.00	1.00	1.00			
Upstream Filter(l)	1.00	1.00	0.00	0.00	0.00	1.00	1.00	0.00	0.00			
Uniform Delay (d), s/veh	33.4	22.0	0.0	0.0	0.0	35.3	7.2	0.0	0.0			
Incr Delay (d2), s/veh	3.0	0.2	0.0	0.0	0.0	5.8	0.6	0.0	0.0			
Initial Q Delay(d3),s/veh	0.0	0.0	0.0	0.0	0.0	0.0	0.0	0.0	0.0			
%ile BackOfQ(50%),veh/ln	8.1	1.5	0.0	0.0	0.0	2.3	1.5	0.0	0.0			
Unsig. Movement Delay, s/veh												
LnGrp Delay(d),s/veh	36.5	22.2	0.0	0.0	0.0	41.1	7.8	0.0	0.0			
LnGrp LOS	D	C	A	A	A	D	A	A	A			
Approach Vol, veh/h		423			109			203				
Approach Delay, s/veh		33.0			41.1			7.8				
Approach LOS		C			D			A				
Timer - Assigned Phs		2		4			7	8				
Phs Duration (G+Y+Rc), s		52.9		27.1			15.2	11.9				
Change Period (Y+Rc), s		4.5		4.5			4.5	4.5				
Max Green Setting (Gmax), s		28.5		42.5			18.5	19.5				
Max Q Clear Time (g_c+I1), s		7.1		5.8			10.0	7.1				
Green Ext Time (p_c), s		1.1		0.6			0.8	0.4				
Intersection Summary												
HCM 6th Ctrl Delay												27.3
HCM 6th LOS												C

HCM 6th Signalized Intersection Summary
7: Road 23 & Avenue 17

Village D Specific Plan
Phase I WP MIT - PM Peak Hour



Movement	EBL	EBT	EBR	WBL	WBT	WBR	NBL	NBT	NBR	SBL	SBT	SBR
Lane Configurations												
Traffic Volume (veh/h)	1	50	39	130	22	9	17	231	134	62	493	2
Future Volume (veh/h)	1	50	39	130	22	9	17	231	134	62	493	2
Initial Q (Qb), veh	0	0	0	0	0	0	0	0	0	0	0	0
Ped-Bike Adj(A_pbT)	1.00		1.00	1.00		1.00	1.00		1.00	1.00		1.00
Parking Bus, Adj	1.00	1.00	1.00	1.00	1.00	1.00	1.00	1.00	1.00	1.00	1.00	1.00
Work Zone On Approach		No			No			No			No	
Adj Sat Flow, veh/h/ln	1870	1870	1870	1870	1870	1870	1856	1856	1856	1841	1841	1841
Adj Flow Rate, veh/h	1	54	42	141	24	10	18	251	146	67	536	2
Peak Hour Factor	0.92	0.92	0.92	0.92	0.92	0.92	0.92	0.92	0.92	0.92	0.92	0.92
Percent Heavy Veh, %	2	2	2	2	2	2	3	3	3	4	4	4
Cap, veh/h	2	71	55	171	210	88	33	1172	993	86	1219	1033
Arrive On Green	0.00	0.07	0.07	0.10	0.17	0.17	0.02	0.63	0.63	0.05	0.66	0.66
Sat Flow, veh/h	1781	975	759	1781	1254	522	1767	1856	1572	1753	1841	1560
Grp Volume(v), veh/h	1	0	96	141	0	34	18	251	146	67	536	2
Grp Sat Flow(s),veh/h/ln	1781	0	1734	1781	0	1776	1767	1856	1572	1753	1841	1560
Q Serve(g_s), s	0.1	0.0	6.5	9.3	0.0	1.9	1.2	6.9	4.5	4.5	16.7	0.1
Cycle Q Clear(g_c), s	0.1	0.0	6.5	9.3	0.0	1.9	1.2	6.9	4.5	4.5	16.7	0.1
Prop In Lane	1.00		0.44	1.00		0.29	1.00		1.00	1.00		1.00
Lane Grp Cap(c), veh/h	2	0	127	171	0	298	33	1172	993	86	1219	1033
V/C Ratio(X)	0.41	0.00	0.76	0.82	0.00	0.11	0.54	0.21	0.15	0.78	0.44	0.00
Avail Cap(c_a), veh/h	111	0	340	393	0	629	140	1172	993	241	1219	1033
HCM Platoon Ratio	1.00	1.00	1.00	1.00	1.00	1.00	1.00	1.00	1.00	1.00	1.00	1.00
Upstream Filter(I)	1.00	0.00	1.00	1.00	0.00	1.00	1.00	1.00	1.00	1.00	1.00	1.00
Uniform Delay (d), s/veh	59.9	0.0	54.6	53.2	0.0	42.4	58.4	9.4	9.0	56.4	9.7	6.9
Incr Delay (d2), s/veh	84.5	0.0	8.9	9.5	0.0	0.2	13.0	0.4	0.3	13.8	1.2	0.0
Initial Q Delay(d3),s/veh	0.0	0.0	0.0	0.0	0.0	0.0	0.0	0.0	0.0	0.0	0.0	0.0
%ile BackOfQ(50%),veh/ln	0.1	0.0	3.2	4.6	0.0	0.9	0.7	2.9	1.6	2.3	6.7	0.0
Unsig. Movement Delay, s/veh												
LnGrp Delay(d),s/veh	144.4	0.0	63.5	62.8	0.0	42.5	71.4	9.8	9.3	70.2	10.8	6.9
LnGrp LOS	F	A	E	E	A	D	E	A	A	E	B	A
Approach Vol, veh/h		97			175			415			605	
Approach Delay, s/veh		64.3			58.9			12.3			17.4	
Approach LOS		E			E			B			B	
Timer - Assigned Phs	1	2	3	4	5	6	7	8				
Phs Duration (G+Y+Rc), s	10.4	80.3	16.0	13.3	6.8	84.0	4.7	24.6				
Change Period (Y+Rc), s	4.5	4.5	4.5	4.5	4.5	4.5	4.5	4.5				
Max Green Setting (Gmax), s	10.5	35.5	26.5	23.5	9.5	42.5	7.5	42.5				
Max Q Clear Time (g_c+10), s	10.5	8.9	11.3	8.5	3.2	18.7	2.1	3.9				
Green Ext Time (p_c), s	0.1	2.0	0.3	0.4	0.0	3.7	0.0	0.1				
Intersection Summary												
HCM 6th Ctrl Delay				24.9								
HCM 6th LOS				C								

Intersection												
Intersection Delay, s/veh	31.8											
Intersection LOS	D											

Movement	EBL	EBT	EBR	WBL	WBT	WBR	NBL	NBT	NBR	SBL	SBT	SBR
Lane Configurations	↖	↗		↖	↗		↖	↗	↖	↗	↖	↗
Traffic Vol, veh/h	1	0	1	245	0	166	0	295	288	184	384	1
Future Vol, veh/h	1	0	1	245	0	166	0	295	288	184	384	1
Peak Hour Factor	0.93	0.93	0.93	0.93	0.93	0.93	0.93	0.93	0.93	0.93	0.93	0.93
Heavy Vehicles, %	0	0	0	1	1	1	3	3	3	5	5	5
Mvmt Flow	1	0	1	263	0	178	0	317	310	198	413	1
Number of Lanes	1	1	0	1	1	0	1	1	1	1	1	1

Approach	EB	WB	NB	SB
Opposing Approach	WB	EB	SB	NB
Opposing Lanes	2	2	3	3
Conflicting Approach Left	SB	NB	EB	WB
Conflicting Lanes Left	3	3	2	2
Conflicting Approach Right	NB	SB	WB	EB
Conflicting Lanes Right	3	3	2	2
HCM Control Delay	13.1	22.8	26.1	44.1
HCM LOS	B	C	D	E

Lane	NBLn1	NBLn2	NBLn3	EBLn1	EBLn2	WBLn1	WBLn2	SBLn1	SBLn2	SBLn3
Vol Left, %	0%	0%	0%	100%	0%	100%	0%	100%	0%	0%
Vol Thru, %	100%	100%	0%	0%	0%	0%	0%	0%	100%	0%
Vol Right, %	0%	0%	100%	0%	100%	0%	100%	0%	0%	100%
Sign Control	Stop	Stop	Stop	Stop	Stop	Stop	Stop	Stop	Stop	Stop
Traffic Vol by Lane	0	295	288	1	1	245	166	184	384	1
LT Vol	0	0	0	1	0	245	0	184	0	0
Through Vol	0	295	0	0	0	0	0	0	384	0
RT Vol	0	0	288	0	1	0	166	0	0	1
Lane Flow Rate	0	317	310	1	1	263	178	198	413	1
Geometry Grp	8	8	8	8	8	8	8	8	8	8
Degree of Util (X)	0	0.72	0.641	0.003	0.003	0.66	0.387	0.475	0.932	0.002
Departure Headway (Hd)	8.169	8.169	7.451	11.003	9.751	9.025	7.799	8.641	8.129	7.412
Convergence, Y/N	Yes	Yes	Yes	Yes	Yes	Yes	Yes	Yes	Yes	Yes
Cap	0	441	483	327	369	400	461	417	446	482
Service Time	5.931	5.931	5.213	8.703	7.451	6.79	5.564	6.405	5.893	5.176
HCM Lane V/C Ratio	0	0.719	0.642	0.003	0.003	0.657	0.386	0.475	0.926	0.002
HCM Control Delay	10.9	29.4	22.7	13.7	12.5	27.8	15.4	19	56.2	10.2
HCM Lane LOS	N	D	C	B	B	D	C	C	F	B
HCM 95th-tile Q	0	5.6	4.4	0	0	4.6	1.8	2.5	10.7	0

Intersection	
Intersection Delay, s/veh	18.4
Intersection LOS	C

Movement	EBL	EBT	EBR	WBL	WBT	WBR	NBL	NBT	NBR	SBL	SBT	SBR
Lane Configurations		↕			↕		↕	↕		↕	↕	
Traffic Vol, veh/h	97	90	35	11	37	273	14	207	21	259	194	55
Future Vol, veh/h	97	90	35	11	37	273	14	207	21	259	194	55
Peak Hour Factor	0.95	0.95	0.95	0.95	0.95	0.95	0.95	0.95	0.95	0.95	0.95	0.95
Heavy Vehicles, %	7	7	7	1	1	1	6	6	6	5	5	5
Mvmt Flow	102	95	37	12	39	287	15	218	22	273	204	58
Number of Lanes	0	1	0	0	1	0	1	1	0	1	1	0

Approach	EB	WB	NB	SB
Opposing Approach	WB	EB	SB	NB
Opposing Lanes	1	1	2	2
Conflicting Approach Left	SB	NB	EB	WB
Conflicting Lanes Left	2	2	1	1
Conflicting Approach Right	NB	SB	WB	EB
Conflicting Lanes Right	2	2	1	1
HCM Control Delay	16.9	19.1	17.6	18.9
HCM LOS	C	C	C	C

Lane	NBLn1	NBLn2	EBLn1	WBLn1	SBLn1	SBLn2
Vol Left, %	100%	0%	44%	3%	100%	0%
Vol Thru, %	0%	91%	41%	12%	0%	78%
Vol Right, %	0%	9%	16%	85%	0%	22%
Sign Control	Stop	Stop	Stop	Stop	Stop	Stop
Traffic Vol by Lane	14	228	222	321	259	249
LT Vol	14	0	97	11	259	0
Through Vol	0	207	90	37	0	194
RT Vol	0	21	35	273	0	55
Lane Flow Rate	15	240	234	338	273	262
Geometry Grp	7	7	2	2	7	7
Degree of Util (X)	0.034	0.507	0.475	0.607	0.583	0.512
Departure Headway (Hd)	8.195	7.612	7.318	6.47	7.704	7.031
Convergence, Y/N	Yes	Yes	Yes	Yes	Yes	Yes
Cap	435	470	491	554	466	511
Service Time	5.978	5.395	5.399	4.542	5.481	4.808
HCM Lane V/C Ratio	0.034	0.511	0.477	0.61	0.586	0.513
HCM Control Delay	11.3	18	16.9	19.1	20.8	17
HCM Lane LOS	B	C	C	C	C	C
HCM 95th-tile Q	0.1	2.8	2.5	4	3.6	2.9

HCM 6th Signalized Intersection Summary
 13: Airport Drive/Golden State Boulevard & Avenue 17

Village D Specific Plan
 Phase I WP MIT - PM Peak Hour



Movement	EBL	EBT	EBR	WBL	WBT	WBR	NBL	NBT	NBR	SBL	SBT	SBR
Lane Configurations												
Traffic Volume (veh/h)	9	306	27	142	175	165	21	53	242	232	52	9
Future Volume (veh/h)	9	306	27	142	175	165	21	53	242	232	52	9
Initial Q (Qb), veh	0	0	0	0	0	0	0	0	0	0	0	0
Ped-Bike Adj(A_pbT)	1.00		1.00	1.00		1.00	1.00		1.00	1.00		1.00
Parking Bus, Adj	1.00	1.00	1.00	1.00	1.00	1.00	1.00	1.00	1.00	1.00	1.00	1.00
Work Zone On Approach		No			No			No			No	
Adj Sat Flow, veh/h/ln	1870	1870	1870	1856	1856	1856	1826	1826	1826	1856	1856	1856
Adj Flow Rate, veh/h	10	333	29	154	190	179	23	58	263	252	57	10
Peak Hour Factor	0.92	0.92	0.92	0.92	0.92	0.92	0.92	0.92	0.92	0.92	0.92	0.92
Percent Heavy Veh, %	2	2	2	3	3	3	5	5	5	3	3	3
Cap, veh/h	22	391	331	188	562	476	43	660	559	336	668	117
Arrive On Green	0.01	0.21	0.21	0.18	0.51	0.51	0.03	0.36	0.36	0.10	0.43	0.43
Sat Flow, veh/h	1781	1870	1585	1767	1856	1572	1739	1826	1547	3428	1537	270
Grp Volume(v), veh/h	10	333	29	154	190	179	23	58	263	252	0	67
Grp Sat Flow(s),veh/h/ln	1781	1870	1585	1767	1856	1572	1739	1826	1547	1714	0	1807
Q Serve(g_s), s	0.4	13.7	1.2	6.7	4.9	5.6	1.0	1.7	10.5	5.7	0.0	1.7
Cycle Q Clear(g_c), s	0.4	13.7	1.2	6.7	4.9	5.6	1.0	1.7	10.5	5.7	0.0	1.7
Prop In Lane	1.00		1.00	1.00		1.00	1.00		1.00	1.00		0.15
Lane Grp Cap(c), veh/h	22	391	331	188	562	476	43	660	559	336	0	785
V/C Ratio(X)	0.45	0.85	0.09	0.82	0.34	0.38	0.53	0.09	0.47	0.75	0.00	0.09
Avail Cap(c_a), veh/h	111	503	426	254	649	550	117	660	559	407	0	785
HCM Platoon Ratio	1.00	1.00	1.00	1.67	1.67	1.67	1.00	1.00	1.00	1.00	1.00	1.00
Upstream Filter(I)	1.00	1.00	1.00	0.93	0.93	0.93	1.00	1.00	1.00	1.00	0.00	1.00
Uniform Delay (d), s/veh	39.2	30.5	25.5	32.1	15.0	15.1	38.5	16.8	19.7	35.1	0.0	13.3
Incr Delay (d2), s/veh	13.6	10.8	0.1	13.2	0.3	0.5	9.6	0.3	2.8	6.1	0.0	0.2
Initial Q Delay(d3),s/veh	0.0	0.0	0.0	0.0	0.0	0.0	0.0	0.0	0.0	0.0	0.0	0.0
%ile BackOfQ(50%),veh/ln	0.3	7.1	0.4	3.3	1.9	1.8	0.6	0.7	4.0	2.6	0.0	0.7
Unsig. Movement Delay, s/veh												
LnGrp Delay(d),s/veh	52.9	41.2	25.6	45.3	15.3	15.6	48.1	17.1	22.5	41.2	0.0	13.5
LnGrp LOS	D	D	C	D	B	B	D	B	C	D	A	B
Approach Vol, veh/h		372			523			344			319	
Approach Delay, s/veh		40.3			24.3			23.3			35.4	
Approach LOS		D			C			C			D	
Timer - Assigned Phs	1	2	3	4	5	6	7	8				
Phs Duration (G+Y+Rc), s	12.4	33.4	13.0	21.2	6.5	39.3	5.5	28.7				
Change Period (Y+Rc), s	4.5	4.5	4.5	4.5	4.5	4.5	4.5	4.5				
Max Green Setting (Gmax), s	5	19.5	11.5	21.5	5.4	23.6	5.0	28.0				
Max Q Clear Time (g_c+1), s	5	12.5	8.7	15.7	3.0	3.7	2.4	7.6				
Green Ext Time (p_c), s	0.2	0.7	0.1	1.0	0.0	0.3	0.0	1.6				
Intersection Summary												
HCM 6th Ctrl Delay											30.2	
HCM 6th LOS											C	

HCM 6th Signalized Intersection Summary
 14: Avenue 17 & SR-99 Southbound Off-Ramp

Village D Specific Plan
 Phase I WP MIT - PM Peak Hour

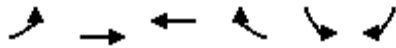

Movement	EBL	EBT	WBT	WBR	SBL	SBR
Lane Configurations		↑↑	↑↑		↘	↘
Traffic Volume (veh/h)	0	784	421	0	418	59
Future Volume (veh/h)	0	784	421	0	418	59
Initial Q (Qb), veh	0	0	0	0	0	0
Ped-Bike Adj(A_pbT)	1.00			1.00	1.00	1.00
Parking Bus, Adj	1.00	1.00	1.00	1.00	1.00	1.00
Work Zone On Approach		No	No		No	
Adj Sat Flow, veh/h/ln	0	1856	1826	0	1870	1870
Adj Flow Rate, veh/h	0	852	458	0	454	64
Peak Hour Factor	0.92	0.92	0.92	0.92	0.92	0.92
Percent Heavy Veh, %	0	3	5	0	2	2
Cap, veh/h	0	978	962	0	1087	967
Arrive On Green	0.00	0.55	0.28	0.00	0.61	0.61
Sat Flow, veh/h	0	3711	3652	0	1781	1585
Grp Volume(v), veh/h	0	852	458	0	454	64
Grp Sat Flow(s),veh/h/ln	0	1763	1735	0	1781	1585
Q Serve(g_s), s	0.0	16.7	8.8	0.0	10.7	1.3
Cycle Q Clear(g_c), s	0.0	16.7	8.8	0.0	10.7	1.3
Prop In Lane	0.00			0.00	1.00	1.00
Lane Grp Cap(c), veh/h	0	978	962	0	1087	967
V/C Ratio(X)	0.00	0.87	0.48	0.00	0.42	0.07
Avail Cap(c_a), veh/h	0	1168	1149	0	1087	967
HCM Platoon Ratio	1.00	2.00	1.00	1.00	1.00	1.00
Upstream Filter(I)	0.00	0.75	1.00	0.00	1.00	1.00
Uniform Delay (d), s/veh	0.0	16.6	24.1	0.0	8.2	6.3
Incr Delay (d2), s/veh	0.0	5.0	0.4	0.0	1.2	0.1
Initial Q Delay(d3),s/veh	0.0	0.0	0.0	0.0	0.0	0.0
%ile BackOfQ(50%),veh/ln	0.0	4.7	3.5	0.0	3.9	0.4
Unsig. Movement Delay, s/veh						
LnGrp Delay(d),s/veh	0.0	21.5	24.4	0.0	9.3	6.5
LnGrp LOS	A	C	C	A	A	A
Approach Vol, veh/h		852	458		518	
Approach Delay, s/veh		21.5	24.4		9.0	
Approach LOS		C	C		A	
Timer - Assigned Phs				4	6	8
Phs Duration (G+Y+Rc), s				26.7	53.3	26.7
Change Period (Y+Rc), s				4.5	4.5	4.5
Max Green Setting (Gmax), s				26.5	44.5	26.5
Max Q Clear Time (g_c+I1), s				18.7	12.7	10.8
Green Ext Time (p_c), s				3.5	1.7	2.7
Intersection Summary						
HCM 6th Ctrl Delay			18.7			
HCM 6th LOS			B			

HCM 6th Signalized Intersection Summary
 15: SR-99 Northbound Ramps & Avenue 17

Village D Specific Plan
 Phase I WP MIT - PM Peak Hour



Movement	EBL	EBT	EBR	WBL	WBT	WBR	NBL	NBT	NBR	SBL	SBT	SBR
Lane Configurations	↘	↑↑			↑↑		↘	↙	↗			
Traffic Volume (veh/h)	103	860	0	0	1005	309	114	2	529	0	0	0
Future Volume (veh/h)	103	860	0	0	1005	309	114	2	529	0	0	0
Initial Q (Qb), veh	0	0	0	0	0	0	0	0	0			
Ped-Bike Adj(A_pbT)	1.00		1.00	1.00		1.00	1.00		1.00			
Parking Bus, Adj	1.00	1.00	1.00	1.00	1.00	1.00	1.00	1.00	1.00			
Work Zone On Approach		No			No			No				
Adj Sat Flow, veh/h/ln	1870	1870	0	0	1885	1885	1870	1870	1870			
Adj Flow Rate, veh/h	108	905	0	0	1058	325	121	0	557			
Peak Hour Factor	0.95	0.95	0.95	0.95	0.95	0.95	0.95	0.95	0.95			
Percent Heavy Veh, %	2	2	0	0	1	1	2	2	2			
Cap, veh/h	137	1890	0	0	1079	328	1267	0	564			
Arrive On Green	0.08	0.53	0.00	0.00	0.40	0.40	0.36	0.00	0.36			
Sat Flow, veh/h	1781	3647	0	0	2799	823	3563	0	1585			
Grp Volume(v), veh/h	108	905	0	0	697	686	121	0	557			
Grp Sat Flow(s),veh/h/ln	1781	1777	0	0	1791	1737	1781	0	1585			
Q Serve(g_s), s	4.8	12.8	0.0	0.0	30.7	31.4	1.8	0.0	27.9			
Cycle Q Clear(g_c), s	4.8	12.8	0.0	0.0	30.7	31.4	1.8	0.0	27.9			
Prop In Lane	1.00		0.00	0.00		0.47	1.00		1.00			
Lane Grp Cap(c), veh/h	137	1890	0	0	714	693	1267	0	564			
V/C Ratio(X)	0.79	0.48	0.00	0.00	0.98	0.99	0.10	0.00	0.99			
Avail Cap(c_a), veh/h	145	1906	0	0	714	693	1267	0	564			
HCM Platoon Ratio	1.00	1.00	1.00	1.00	1.00	1.00	1.00	1.00	1.00			
Upstream Filter(I)	1.00	1.00	0.00	0.00	1.00	1.00	1.00	0.00	1.00			
Uniform Delay (d), s/veh	36.3	11.8	0.0	0.0	23.7	23.9	17.2	0.0	25.6			
Incr Delay (d2), s/veh	23.6	0.2	0.0	0.0	27.8	31.6	0.0	0.0	34.8			
Initial Q Delay(d3),s/veh	0.0	0.0	0.0	0.0	0.0	0.0	0.0	0.0	0.0			
%ile BackOfQ(50%),veh/ln	2.9	4.6	0.0	0.0	17.5	17.9	0.7	0.0	15.3			
Unsig. Movement Delay, s/veh												
LnGrp Delay(d),s/veh	59.9	11.9	0.0	0.0	51.4	55.5	17.2	0.0	60.4			
LnGrp LOS	E	B	A	A	D	E	B	A	E			
Approach Vol, veh/h		1013			1383			678				
Approach Delay, s/veh		17.1			53.5			52.7				
Approach LOS		B			D			D				
Timer - Assigned Phs		2		4			7	8				
Phs Duration (G+Y+Rc), s		32.9		47.1			10.7	36.4				
Change Period (Y+Rc), s		4.5		4.5			4.5	4.5				
Max Green Setting (Gmax), s		28.1		42.9			6.5	31.9				
Max Q Clear Time (g_c+I1), s		29.9		14.8			6.8	33.4				
Green Ext Time (p_c), s		0.0		7.3			0.0	0.0				

Intersection Summary

HCM 6th Ctrl Delay	41.3
HCM 6th LOS	D

Notes

User approved volume balancing among the lanes for turning movement.

HCM 6th Signalized Intersection Summary
 16: Love's Truck Stop Driveway/Driveway & Avenue 17

Village D Specific Plan
 Phase I WP MIT - PM Peak Hour



Movement	EBL	EBT	EBR	WBL	WBT	WBR	NBL	NBT	NBR	SBL	SBT	SBR
Lane Configurations	↔↔	↑↑↑	↔	↔	↑↑↑	↔	↔	↔		↔	↔	
Traffic Volume (veh/h)	556	687	141	32	629	189	160	0	31	279	0	519
Future Volume (veh/h)	556	687	141	32	629	189	160	0	31	279	0	519
Initial Q (Qb), veh	0	0	0	0	0	0	0	0	0	0	0	0
Ped-Bike Adj(A_pbT)	1.00		1.00	1.00		1.00	1.00		1.00	1.00		1.00
Parking Bus, Adj	1.00	1.00	1.00	1.00	1.00	1.00	1.00	1.00	1.00	1.00	1.00	1.00
Work Zone On Approach		No		No		No		No		No		No
Adj Sat Flow, veh/h/ln	1885	1885	1885	1870	1870	1870	1900	1900	1900	1900	1900	1900
Adj Flow Rate, veh/h	604	747	153	35	684	205	174	0	34	303	0	564
Peak Hour Factor	0.92	0.92	0.92	0.92	0.92	0.92	0.92	0.92	0.92	0.92	0.92	0.92
Percent Heavy Veh, %	1	1	1	2	2	2	0	0	0	0	0	0
Cap, veh/h	670	1719	534	58	888	276	208	0	398	338	0	513
Arrive On Green	0.19	0.33	0.33	0.03	0.17	0.17	0.11	0.00	0.25	0.19	0.00	0.32
Sat Flow, veh/h	3483	5147	1598	1781	5106	1585	1810	0	1610	1810	0	1610
Grp Volume(v), veh/h	604	747	153	35	684	205	174	0	34	303	0	564
Grp Sat Flow(s),veh/h/ln	1742	1716	1598	1781	1702	1585	1810	0	1610	1810	0	1610
Q Serve(g_s), s	15.2	10.2	6.3	1.7	11.5	11.0	8.5	0.0	1.5	14.7	0.0	28.7
Cycle Q Clear(g_c), s	15.2	10.2	6.3	1.7	11.5	11.0	8.5	0.0	1.5	14.7	0.0	28.7
Prop In Lane	1.00		1.00	1.00		1.00	1.00		1.00	1.00		1.00
Lane Grp Cap(c), veh/h	670	1719	534	58	888	276	208	0	398	338	0	513
V/C Ratio(X)	0.90	0.43	0.29	0.61	0.77	0.74	0.84	0.00	0.09	0.90	0.00	1.10
Avail Cap(c_a), veh/h	677	1719	534	119	1021	317	211	0	398	352	0	513
HCM Platoon Ratio	1.00	1.00	1.00	1.00	1.00	1.00	1.00	1.00	1.00	1.00	1.00	1.00
Upstream Filter(I)	1.00	1.00	1.00	1.00	1.00	1.00	1.00	0.00	1.00	1.00	0.00	1.00
Uniform Delay (d), s/veh	35.5	23.3	22.1	43.0	35.5	35.3	39.0	0.0	26.1	35.8	0.0	30.7
Incr Delay (d2), s/veh	15.1	0.2	0.3	9.8	3.2	7.9	24.2	0.0	0.4	24.0	0.0	69.6
Initial Q Delay(d3),s/veh	0.0	0.0	0.0	0.0	0.0	0.0	0.0	0.0	0.0	0.0	0.0	0.0
%ile BackOfQ(50%),veh/ln	7.7	4.0	0.0	0.9	4.9	4.8	5.1	0.0	0.6	8.6	0.0	20.6
Unsig. Movement Delay, s/veh												
LnGrp Delay(d),s/veh	50.6	23.5	22.4	52.8	38.6	43.2	63.2	0.0	26.5	59.7	0.0	100.3
LnGrp LOS	D	C	C	D	D	D	E	A	C	E	A	F
Approach Vol, veh/h		1504			924			208				867
Approach Delay, s/veh		34.3			40.2			57.2				86.1
Approach LOS		C			D			E				F
Timer - Assigned Phs	1	2	3	4	5	6	7	8				
Phs Duration (G+Y+Rc), s	31.3	26.7	7.4	34.6	14.8	33.2	21.8	20.2				
Change Period (Y+Rc), s	4.5	4.5	4.5	4.5	4.5	4.5	4.5	4.5				
Max Green Setting (Gmax), s	19.0	19.0	6.0	29.5	10.5	26.0	17.5	18.0				
Max Q Clear Time (g_c+M0), s	3.5	3.5	3.7	12.2	10.5	30.7	17.2	13.5				
Green Ext Time (p_c), s	0.1	0.1	0.0	5.4	0.0	0.0	0.1	2.2				

Intersection Summary

HCM 6th Ctrl Delay	50.0
HCM 6th LOS	D

HCM 6th Signalized Intersection Summary
 17: Westberry Boulevard & Cleveland Avenue

Village D Specific Plan
 Phase I WP MIT - PM Peak Hour



Movement	EBL	EBT	EBR	WBL	WBT	WBR	NBL	NBT	NBR	SBL	SBT	SBR
Lane Configurations												
Traffic Volume (veh/h)	150	463	35	65	756	19	51	24	63	18	79	234
Future Volume (veh/h)	150	463	35	65	756	19	51	24	63	18	79	234
Initial Q (Qb), veh	0	0	0	0	0	0	0	0	0	0	0	0
Ped-Bike Adj(A_pbT)	1.00		1.00	1.00		0.99	1.00		1.00	1.00		1.00
Parking Bus, Adj	1.00	1.00	1.00	1.00	1.00	1.00	1.00	1.00	1.00	1.00	1.00	1.00
Work Zone On Approach		No			No			No			No	
Adj Sat Flow, veh/h/ln	1900	1900	1900	1900	1900	1900	1900	1900	1900	1900	1900	1900
Adj Flow Rate, veh/h	163	503	38	71	822	21	55	26	68	20	86	254
Peak Hour Factor	0.92	0.92	0.92	0.92	0.92	0.92	0.92	0.92	0.92	0.92	0.92	0.92
Percent Heavy Veh, %	0	0	0	0	0	0	0	0	0	0	0	0
Cap, veh/h	202	1114	84	92	960	25	80	711	603	41	670	568
Arrive On Green	0.11	0.33	0.33	0.05	0.27	0.27	0.04	0.37	0.37	0.02	0.35	0.35
Sat Flow, veh/h	1810	3401	256	1810	3596	92	1810	1900	1610	1810	1900	1610
Grp Volume(v), veh/h	163	266	275	71	413	430	55	26	68	20	86	254
Grp Sat Flow(s),veh/h/ln	1810	1805	1852	1810	1805	1883	1810	1900	1610	1810	1900	1610
Q Serve(g_s), s	7.0	9.3	9.4	3.1	17.4	17.4	2.4	0.7	2.2	0.9	2.5	9.7
Cycle Q Clear(g_c), s	7.0	9.3	9.4	3.1	17.4	17.4	2.4	0.7	2.2	0.9	2.5	9.7
Prop In Lane	1.00		0.14	1.00		0.05	1.00		1.00	1.00		1.00
Lane Grp Cap(c), veh/h	202	591	607	92	482	502	80	711	603	41	670	568
V/C Ratio(X)	0.81	0.45	0.45	0.77	0.86	0.86	0.69	0.04	0.11	0.49	0.13	0.45
Avail Cap(c_a), veh/h	283	616	632	197	530	553	124	711	603	115	670	568
HCM Platoon Ratio	1.00	1.00	1.00	1.00	1.00	1.00	1.00	1.00	1.00	1.00	1.00	1.00
Upstream Filter(l)	1.00	1.00	1.00	1.00	1.00	1.00	1.00	1.00	1.00	1.00	1.00	1.00
Uniform Delay (d), s/veh	34.7	21.2	21.2	37.5	27.9	27.9	37.7	15.9	16.4	38.7	17.6	19.9
Incr Delay (d2), s/veh	11.2	0.5	0.5	12.6	12.2	11.8	10.1	0.1	0.4	9.0	0.4	2.5
Initial Q Delay(d3),s/veh	0.0	0.0	0.0	0.0	0.0	0.0	0.0	0.0	0.0	0.0	0.0	0.0
%ile BackOfQ(50%),veh/ln	3.6	3.9	4.0	1.7	8.8	9.1	1.3	0.3	0.8	0.5	1.1	3.9
Unsig. Movement Delay, s/veh												
LnGrp Delay(d),s/veh	45.9	21.8	21.8	50.1	40.1	39.7	47.8	16.0	16.7	47.6	18.0	22.5
LnGrp LOS	D	C	C	D	D	D	D	B	B	D	B	C
Approach Vol, veh/h		704			914			149			360	
Approach Delay, s/veh		27.3			40.7			28.1			22.8	
Approach LOS		C			D			C			C	
Timer - Assigned Phs	1	2	3	4	5	6	7	8				
Phs Duration (G+Y+Rc), s	6.3	34.4	8.6	30.7	8.0	32.7	13.4	25.8				
Change Period (Y+Rc), s	4.5	4.5	4.5	4.5	4.5	4.5	4.5	4.5				
Max Green Setting (Gmax), s	15.1	20.9	8.7	27.3	5.5	20.5	12.5	23.5				
Max Q Clear Time (g_c+1/2g), s	12.9	4.2	5.1	11.4	4.4	11.7	9.0	19.4				
Green Ext Time (p_c), s	0.0	0.2	0.0	2.9	0.0	0.9	0.1	2.0				

Intersection Summary

HCM 6th Ctrl Delay		32.4										
HCM 6th LOS			C									

Intersection												
Intersection Delay, s/veh	15.3											
Intersection LOS	C											

Movement	EBL	EBT	EBR	WBL	WBT	WBR	NBL	NBT	NBR	SBL	SBT	SBR
Lane Configurations	↵	↕		↵	↕			↕			↕	
Traffic Vol, veh/h	75	397	44	22	262	167	23	45	16	109	47	83
Future Vol, veh/h	75	397	44	22	262	167	23	45	16	109	47	83
Peak Hour Factor	0.92	0.92	0.92	0.92	0.92	0.92	0.92	0.92	0.92	0.92	0.92	0.92
Heavy Vehicles, %	4	4	4	4	4	4	0	0	0	0	0	0
Mvmt Flow	82	432	48	24	285	182	25	49	17	118	51	90
Number of Lanes	1	2	0	1	2	0	0	1	0	0	1	0

Approach	EB	WB	NB	SB
Opposing Approach	WB	EB	SB	NB
Opposing Lanes	3	3	1	1
Conflicting Approach Left	SB	NB	EB	WB
Conflicting Lanes Left	1	1	3	3
Conflicting Approach Right	NB	SB	WB	EB
Conflicting Lanes Right	1	1	3	3
HCM Control Delay	15	14.5	12.7	18.2
HCM LOS	B	B	B	C

Lane	NBLn1	EBLn1	EBLn2	EBLn3	WBLn1	WBLn2	WBLn3	SBLn1
Vol Left, %	27%	100%	0%	0%	100%	0%	0%	46%
Vol Thru, %	54%	0%	100%	75%	0%	100%	34%	20%
Vol Right, %	19%	0%	0%	25%	0%	0%	66%	35%
Sign Control	Stop	Stop	Stop	Stop	Stop	Stop	Stop	Stop
Traffic Vol by Lane	84	75	265	176	22	175	254	239
LT Vol	23	75	0	0	22	0	0	109
Through Vol	45	0	265	132	0	175	87	47
RT Vol	16	0	0	44	0	0	167	83
Lane Flow Rate	91	82	288	192	24	190	276	260
Geometry Grp	7	7	7	7	7	7	7	7
Degree of Util (X)	0.201	0.166	0.544	0.353	0.049	0.365	0.496	0.532
Departure Headway (Hd)	7.913	7.325	6.812	6.633	7.442	6.929	6.456	7.373
Convergence, Y/N	Yes	Yes	Yes	Yes	Yes	Yes	Yes	Yes
Cap	454	490	529	542	481	520	558	488
Service Time	5.663	5.065	4.552	4.372	5.184	4.67	4.198	5.113
HCM Lane V/C Ratio	0.2	0.167	0.544	0.354	0.05	0.365	0.495	0.533
HCM Control Delay	12.7	11.5	17.4	13	10.6	13.6	15.4	18.2
HCM Lane LOS	B	B	C	B	B	B	C	C
HCM 95th-tile Q	0.7	0.6	3.2	1.6	0.2	1.7	2.7	3.1

HCM 6th Signalized Intersection Summary
21: Granada Drive & Cleveland Avenue

Village D Specific Plan
Phase I WP MIT - PM Peak Hour



Movement	EBL	EBT	EBR	WBL	WBT	WBR	NBL	NBT	NBR	SBL	SBT	SBR
Lane Configurations												
Traffic Volume (veh/h)	18	442	25	340	797	37	28	217	231	34	274	33
Future Volume (veh/h)	18	442	25	340	797	37	28	217	231	34	274	33
Initial Q (Qb), veh	0	0	0	0	0	0	0	0	0	0	0	0
Ped-Bike Adj(A_pbT)	1.00		0.99	1.00		0.98	1.00		0.99	1.00		1.00
Parking Bus, Adj	1.00	1.00	1.00	1.00	1.00	1.00	1.00	1.00	1.00	1.00	1.00	1.00
Work Zone On Approach		No			No			No			No	
Adj Sat Flow, veh/h/ln	1900	1900	1900	1900	1900	1900	1900	1900	1900	1900	1900	1900
Adj Flow Rate, veh/h	19	470	27	362	848	39	30	231	246	36	291	35
Peak Hour Factor	0.94	0.94	0.94	0.94	0.94	0.94	0.94	0.94	0.94	0.94	0.94	0.94
Percent Heavy Veh, %	0	0	0	0	0	0	0	0	0	0	0	0
Cap, veh/h	39	607	35	405	1323	61	55	650	544	62	658	557
Arrive On Green	0.02	0.17	0.17	0.22	0.38	0.38	0.03	0.34	0.34	0.03	0.35	0.35
Sat Flow, veh/h	1810	3469	199	1810	3510	161	1810	1900	1590	1810	1900	1610
Grp Volume(v), veh/h	19	244	253	362	436	451	30	231	246	36	291	35
Grp Sat Flow(s),veh/h/ln	1810	1805	1863	1810	1805	1866	1810	1900	1590	1810	1900	1610
Q Serve(g_s), s	0.8	10.3	10.4	15.5	15.9	15.9	1.3	7.3	9.6	1.6	9.5	1.2
Cycle Q Clear(g_c), s	0.8	10.3	10.4	15.5	15.9	15.9	1.3	7.3	9.6	1.6	9.5	1.2
Prop In Lane	1.00		0.11	1.00		0.09	1.00		1.00	1.00		1.00
Lane Grp Cap(c), veh/h	39	316	326	405	680	704	55	650	544	62	658	557
V/C Ratio(X)	0.49	0.77	0.78	0.89	0.64	0.64	0.55	0.36	0.45	0.58	0.44	0.06
Avail Cap(c_a), veh/h	113	406	419	464	756	782	113	650	544	113	658	557
HCM Platoon Ratio	1.00	1.00	1.00	1.00	1.00	1.00	1.00	1.00	1.00	1.00	1.00	1.00
Upstream Filter(I)	1.00	1.00	1.00	0.55	0.55	0.55	1.00	1.00	1.00	1.00	1.00	1.00
Uniform Delay (d), s/veh	38.7	31.5	31.5	30.1	20.5	20.5	38.2	19.7	20.5	38.1	20.2	17.5
Incr Delay (d2), s/veh	9.1	6.8	6.8	11.1	0.9	0.8	8.1	1.5	2.7	8.2	2.2	0.2
Initial Q Delay(d3),s/veh	0.0	0.0	0.0	0.0	0.0	0.0	0.0	0.0	0.0	0.0	0.0	0.0
%ile BackOfQ(50%),veh/ln	0.5	5.0	5.1	7.7	6.5	6.7	0.7	3.4	3.8	0.8	4.4	0.4
Unsig. Movement Delay, s/veh												
LnGrp Delay(d),s/veh	47.8	38.3	38.3	41.2	21.3	21.3	46.4	21.2	23.2	46.3	22.4	17.7
LnGrp LOS	D	D	D	D	C	C	D	C	C	D	C	B
Approach Vol, veh/h		516			1249			507			362	
Approach Delay, s/veh		38.7			27.1			23.7			24.3	
Approach LOS		D			C			C			C	
Timer - Assigned Phs	1	2	3	4	5	6	7	8				
Phs Duration (G+Y+Rc), s	7.3	31.9	22.4	18.5	6.9	32.2	6.2	34.7				
Change Period (Y+Rc), s	4.5	4.5	4.5	4.5	4.5	4.5	4.5	4.5				
Max Green Setting (Gmax), s	5.0	18.5	20.5	18.0	5.0	18.5	5.0	33.5				
Max Q Clear Time (g_c+I1), s	3.6	11.6	17.5	12.4	3.3	11.5	2.8	17.9				
Green Ext Time (p_c), s	0.0	1.3	0.4	1.4	0.0	1.0	0.0	5.2				
Intersection Summary												
HCM 6th Ctrl Delay				28.3								
HCM 6th LOS				C								

HCM 6th Signalized Intersection Summary
 25: Kennedy Street/Gateway Drive & SR-99 Southbound Ramps

Village D Specific Plan
 Phase I WP MIT - PM Peak Hour

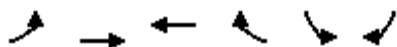

Movement	EBL	EBT	WBT	WBR	SBL	SBR	
Lane Configurations							
Traffic Volume (veh/h)	183	362	311	2	131	180	
Future Volume (veh/h)	183	362	311	2	131	180	
Initial Q (Qb), veh	0	0	0	0	0	0	
Ped-Bike Adj(A_pbT)	1.00			1.00	1.00	1.00	
Parking Bus, Adj	1.00	1.00	1.00	1.00	1.00	1.00	
Work Zone On Approach		No	No		No		
Adj Sat Flow, veh/h/ln	1856	1856	1856	1856	1841	1841	
Adj Flow Rate, veh/h	199	393	338	0	142	196	
Peak Hour Factor	0.92	0.92	0.92	0.92	0.92	0.92	
Percent Heavy Veh, %	3	3	3	3	4	4	
Cap, veh/h	242	763	405		835	956	
Arrive On Green	0.14	0.41	0.22	0.00	0.48	0.48	
Sat Flow, veh/h	1767	1856	1856	0	1753	1560	
Grp Volume(v), veh/h	199	393	338	0	142	196	
Grp Sat Flow(s),veh/h/ln	1767	1856	1856	0	1753	1560	
Q Serve(g_s), s	8.8	12.7	13.9	0.0	3.7	4.4	
Cycle Q Clear(g_c), s	8.8	12.7	13.9	0.0	3.7	4.4	
Prop In Lane	1.00			0.00	1.00	1.00	
Lane Grp Cap(c), veh/h	242	763	405		835	956	
V/C Ratio(X)	0.82	0.51	0.84		0.17	0.20	
Avail Cap(c_a), veh/h	409	1171	638		835	956	
HCM Platoon Ratio	1.00	1.00	1.00	1.00	1.00	1.00	
Upstream Filter(l)	1.00	1.00	1.00	0.00	1.00	1.00	
Uniform Delay (d), s/veh	33.6	17.6	29.9	0.0	11.9	6.8	
Incr Delay (d2), s/veh	6.9	0.5	5.5	0.0	0.4	0.5	
Initial Q Delay(d3),s/veh	0.0	0.0	0.0	0.0	0.0	0.0	
%ile BackOfQ(50%),veh/ln	4.1	5.2	6.6	0.0	1.5	6.2	
Unsig. Movement Delay, s/veh							
LnGrp Delay(d),s/veh	40.4	18.1	35.4	0.0	12.4	7.3	
LnGrp LOS	D	B	D		B	A	
Approach Vol, veh/h		592	338	A	338		
Approach Delay, s/veh		25.6	35.4		9.5		
Approach LOS		C	D		A		
Timer - Assigned Phs				4	6	7	8
Phs Duration (G+Y+Rc), s				37.4	42.6	15.5	22.0
Change Period (Y+Rc), s				4.5	4.5	4.5	4.5
Max Green Setting (Gmax), s				50.5	20.5	18.5	27.5
Max Q Clear Time (g_c+1), s				14.7	6.4	10.8	15.9
Green Ext Time (p_c), s				2.7	0.9	0.3	1.5
Intersection Summary							
HCM 6th Ctrl Delay			23.9				
HCM 6th LOS			C				
Notes							
Unsignalized Delay for [WBR] is excluded from calculations of the approach delay and intersection delay.							

HCM 6th Signalized Intersection Summary
 31: SR-99 Southbound Ramps & Cleveland Avenue























Village D Specific Plan
 Phase I WP MIT - PM Peak Hour



Movement	EBL	EBT	EBR	WBL	WBT	WBR	NBL	NBT	NBR	SBL	SBT	SBR
Lane Configurations		↑↑	↑	↑	↑↑					↑		↑
Traffic Volume (veh/h)	0	848	495	256	1703	0	0	0	0	151	0	80
Future Volume (veh/h)	0	848	495	256	1703	0	0	0	0	151	0	80
Initial Q (Qb), veh	0	0	0	0	0	0				0	0	0
Ped-Bike Adj(A_pbT)	1.00		1.00	1.00		1.00				1.00		1.00
Parking Bus, Adj	1.00	1.00	1.00	1.00	1.00	1.00				1.00	1.00	1.00
Work Zone On Approach		No			No						No	
Adj Sat Flow, veh/h/ln	0	1885	1885	1900	1900	0				1841	0	1841
Adj Flow Rate, veh/h	0	874	510	264	1756	0				156	0	82
Peak Hour Factor	0.97	0.97	0.97	0.97	0.97	0.97				0.97	0.97	0.97
Percent Heavy Veh, %	0	1	1	0	0	0				4	0	4
Cap, veh/h	0	1328	590	296	2110	0				553	0	492
Arrive On Green	0.00	0.37	0.37	0.33	1.00	0.00				0.32	0.00	0.32
Sat Flow, veh/h	0	3676	1591	1810	3705	0				1753	0	1560
Grp Volume(v), veh/h	0	874	510	264	1756	0				156	0	82
Grp Sat Flow(s),veh/h/ln	0	1791	1591	1810	1805	0				1753	0	1560
Q Serve(g_s), s	0.0	18.3	26.7	12.5	0.0	0.0				6.0	0.0	3.4
Cycle Q Clear(g_c), s	0.0	18.3	26.7	12.5	0.0	0.0				6.0	0.0	3.4
Prop In Lane	0.00		1.00	1.00		0.00				1.00		1.00
Lane Grp Cap(c), veh/h	0	1328	590	296	2110	0				553	0	492
V/C Ratio(X)	0.00	0.66	0.86	0.89	0.83	0.00				0.28	0.00	0.17
Avail Cap(c_a), veh/h	0	1453	645	372	2387	0				553	0	492
HCM Platoon Ratio	1.00	1.00	1.00	2.00	2.00	1.00				1.00	1.00	1.00
Upstream Filter(I)	0.00	0.66	0.66	0.33	0.33	0.00				1.00	0.00	1.00
Uniform Delay (d), s/veh	0.0	23.6	26.2	29.5	0.0	0.0				23.1	0.0	22.3
Incr Delay (d2), s/veh	0.0	0.6	7.7	7.7	0.8	0.0				1.3	0.0	0.7
Initial Q Delay(d3),s/veh	0.0	0.0	0.0	0.0	0.0	0.0				0.0	0.0	0.0
%ile BackOfQ(50%),veh/ln	0.0	7.5	10.9	5.0	0.2	0.0				2.6	0.0	1.3
Unsig. Movement Delay, s/veh												
LnGrp Delay(d),s/veh	0.0	24.2	33.9	37.2	0.8	0.0				24.4	0.0	23.0
LnGrp LOS	A	C	C	D	A	A				C	A	C
Approach Vol, veh/h		1384			2020						238	
Approach Delay, s/veh		27.8			5.6						23.9	
Approach LOS		C			A						C	
Timer - Assigned Phs			3	4		6		8				
Phs Duration (G+Y+Rc), s			19.2	37.9		32.9		57.1				
Change Period (Y+Rc), s			4.5	4.5		4.5		4.5				
Max Green Setting (Gmax), s			18.5	36.5		21.5		59.5				
Max Q Clear Time (g_c+I1), s			14.5	28.7		8.0		2.0				
Green Ext Time (p_c), s			0.3	4.6		0.6		25.1				
Intersection Summary												
HCM 6th Ctrl Delay			15.2									
HCM 6th LOS			B									

HCM 6th Signalized Intersection Summary
 49: Yosemite Avenue & Cleveland Avenue/Tozer Street

Village D Specific Plan
 Phase I WP MIT - PM Peak Hour

												
Movement	EBL	EBT	EBR	WBL	WBT	WBR	NBL	NBT	NBR	SBL	SBT	SBR
Lane Configurations												
Traffic Volume (veh/h)	242	428	198	49	464	40	310	298	97	72	174	285
Future Volume (veh/h)	242	428	198	49	464	40	310	298	97	72	174	285
Initial Q (Qb), veh	0	0	0	0	0	0	0	0	0	0	0	0
Ped-Bike Adj(A_pbT)	1.00		0.99	1.00		0.96	1.00		1.00	1.00		0.98
Parking Bus, Adj	1.00	1.00	1.00	1.00	1.00	1.00	1.00	1.00	1.00	1.00	1.00	1.00
Work Zone On Approach		No			No			No			No	
Adj Sat Flow, veh/h/ln	1870	1870	1870	1900	1900	1900	1870	1870	1870	1870	1870	1870
Adj Flow Rate, veh/h	263	465	215	53	504	43	337	324	105	78	189	310
Peak Hour Factor	0.92	0.92	0.92	0.92	0.92	0.92	0.92	0.92	0.92	0.92	0.92	0.92
Percent Heavy Veh, %	2	2	2	0	0	0	2	2	2	2	2	2
Cap, veh/h	299	814	374	75	790	338	371	660	557	101	376	577
Arrive On Green	0.17	0.35	0.35	0.04	0.22	0.22	0.21	0.35	0.35	0.06	0.20	0.20
Sat Flow, veh/h	1781	2356	1081	1810	3610	1546	1781	1870	1580	1781	1870	1550
Grp Volume(v), veh/h	263	350	330	53	504	43	337	324	105	78	189	310
Grp Sat Flow(s),veh/h/ln	1781	1777	1661	1810	1805	1546	1781	1870	1580	1781	1870	1550
Q Serve(g_s), s	12.7	14.1	14.3	2.6	11.2	2.0	16.3	12.0	4.1	3.8	7.9	13.9
Cycle Q Clear(g_c), s	12.7	14.1	14.3	2.6	11.2	2.0	16.3	12.0	4.1	3.8	7.9	13.9
Prop In Lane	1.00		0.65	1.00		1.00	1.00		1.00	1.00		1.00
Lane Grp Cap(c), veh/h	299	614	574	75	790	338	371	660	557	101	376	577
V/C Ratio(X)	0.88	0.57	0.58	0.71	0.64	0.13	0.91	0.49	0.19	0.77	0.50	0.54
Avail Cap(c_a), veh/h	325	614	574	117	790	338	386	782	661	196	583	749
HCM Platoon Ratio	1.00	1.00	1.00	1.00	1.00	1.00	1.00	1.00	1.00	1.00	1.00	1.00
Upstream Filter(I)	1.00	1.00	1.00	1.00	1.00	1.00	1.00	1.00	1.00	1.00	1.00	1.00
Uniform Delay (d), s/veh	35.8	23.5	23.6	41.8	31.3	27.7	34.1	22.4	19.8	41.1	31.3	22.0
Incr Delay (d2), s/veh	21.9	3.8	4.2	11.7	3.9	0.8	24.2	0.6	0.2	11.8	1.0	0.8
Initial Q Delay(d3),s/veh	0.0	0.0	0.0	0.0	0.0	0.0	0.0	0.0	0.0	0.0	0.0	0.0
%ile BackOfQ(50%),veh/ln	7.2	6.4	6.1	1.4	5.2	0.8	9.4	5.2	1.5	2.0	3.6	5.0
Unsig. Movement Delay, s/veh												
LnGrp Delay(d),s/veh	57.7	27.3	27.7	53.5	35.2	28.5	58.2	22.9	20.0	52.9	32.4	22.8
LnGrp LOS	E	C	C	D	D	C	E	C	B	D	C	C
Approach Vol, veh/h		943			600			766			577	
Approach Delay, s/veh		36.0			36.3			38.0			30.0	
Approach LOS		D			D			D			C	
Timer - Assigned Phs	1	2	3	4	5	6	7	8				
Phs Duration (G+Y+Rc), s	19.3	23.8	9.5	35.6	8.1	35.0	22.9	22.2				
Change Period (Y+Rc), s	4.5	4.5	4.5	4.5	4.5	4.5	4.5	4.5				
Max Green Setting (Gmax), s	16.1	19.3	9.7	36.9	5.7	29.7	19.1	27.5				
Max Q Clear Time (g_c+I1), s	14.7	13.2	5.8	14.0	4.6	16.3	18.3	15.9				
Green Ext Time (p_c), s	0.1	1.8	0.0	2.3	0.0	3.6	0.1	1.8				
Intersection Summary												
HCM 6th Ctrl Delay			35.4									
HCM 6th LOS			D									

HCM 6th Signalized Intersection Summary
56: Road 23 & Project Driveway 4

Village D Specific Plan
Phase I WP MIT - PM Peak Hour



Movement	WBL	WBR	NBT	NBR	SBL	SBT
Lane Configurations						
Traffic Volume (veh/h)	330	213	414	301	302	389
Future Volume (veh/h)	330	213	414	301	302	389
Initial Q (Qb), veh	0	0	0	0	0	0
Ped-Bike Adj(A_pbT)	1.00	1.00		1.00	1.00	
Parking Bus, Adj	1.00	1.00	1.00	1.00	1.00	1.00
Work Zone On Approach	No		No			No
Adj Sat Flow, veh/h/ln	1900	1900	1856	1856	1841	1841
Adj Flow Rate, veh/h	359	232	450	327	328	423
Peak Hour Factor	0.92	0.92	0.92	0.92	0.92	0.92
Percent Heavy Veh, %	0	0	3	3	4	4
Cap, veh/h	399	355	421	306	331	1227
Arrive On Green	0.22	0.22	0.42	0.42	0.19	0.67
Sat Flow, veh/h	1810	1610	999	726	1753	1841
Grp Volume(v), veh/h	359	232	0	777	328	423
Grp Sat Flow(s),veh/h/ln	1810	1610	0	1725	1753	1841
Q Serve(g_s), s	15.4	10.5	0.0	33.7	14.9	8.0
Cycle Q Clear(g_c), s	15.4	10.5	0.0	33.7	14.9	8.0
Prop In Lane	1.00	1.00		0.42	1.00	
Lane Grp Cap(c), veh/h	399	355	0	728	331	1227
V/C Ratio(X)	0.90	0.65	0.00	1.07	0.99	0.34
Avail Cap(c_a), veh/h	414	368	0	728	331	1227
HCM Platoon Ratio	1.00	1.00	1.00	1.00	1.00	1.00
Upstream Filter(I)	1.00	1.00	0.00	1.00	1.00	1.00
Uniform Delay (d), s/veh	30.3	28.4	0.0	23.1	32.4	5.8
Incr Delay (d2), s/veh	21.5	3.9	0.0	53.0	47.0	0.8
Initial Q Delay(d3),s/veh	0.0	0.0	0.0	0.0	0.0	0.0
%ile BackOfQ(50%),veh/ln	8.9	4.3	0.0	23.2	10.4	2.7
Unsig. Movement Delay, s/veh						
LnGrp Delay(d),s/veh	51.8	32.3	0.0	76.1	79.4	6.5
LnGrp LOS	D	C	A	F	E	A
Approach Vol, veh/h	591		777			751
Approach Delay, s/veh	44.2		76.1			38.3
Approach LOS	D		E			D
Timer - Assigned Phs	1	2			6	8
Phs Duration (G+Y+Rc), s	19.6	38.2			57.8	22.2
Change Period (Y+Rc), s	4.5	4.5			4.5	4.5
Max Green Setting (Gmax), s	15.1	33.1			52.7	18.3
Max Q Clear Time (g_c+I1), s	16.9	35.7			10.0	17.4
Green Ext Time (p_c), s	0.0	0.0			3.0	0.2
Intersection Summary						
HCM 6th Ctrl Delay			53.8			
HCM 6th LOS			D			

HCM 6th Signalized Intersection Summary
58: Project Driveway 6 & Cleveland Avenue

Village D Specific Plan
Phase I WP MIT - PM Peak Hour



Movement	EBT	EBR	WBL	WBT	NBL	NBR
Lane Configurations	↩		↩	↩	↩	↩
Traffic Volume (veh/h)	474	158	332	796	78	243
Future Volume (veh/h)	474	158	332	796	78	243
Initial Q (Qb), veh	0	0	0	0	0	0
Ped-Bike Adj(A_pbT)		1.00	1.00		1.00	1.00
Parking Bus, Adj	1.00	1.00	1.00	1.00	1.00	1.00
Work Zone On Approach	No			No	No	
Adj Sat Flow, veh/h/ln	1885	1885	1900	1900	1900	1900
Adj Flow Rate, veh/h	515	172	361	865	85	264
Peak Hour Factor	0.92	0.92	0.92	0.92	0.92	0.92
Percent Heavy Veh, %	1	1	0	0	0	0
Cap, veh/h	533	178	395	1259	429	382
Arrive On Green	0.39	0.39	0.22	0.66	0.24	0.24
Sat Flow, veh/h	1352	452	1810	1900	1810	1610
Grp Volume(v), veh/h	0	687	361	865	85	264
Grp Sat Flow(s),veh/h/ln	0	1804	1810	1900	1810	1610
Q Serve(g_s), s	0.0	33.5	17.5	25.4	3.4	13.5
Cycle Q Clear(g_c), s	0.0	33.5	17.5	25.4	3.4	13.5
Prop In Lane		0.25	1.00		1.00	1.00
Lane Grp Cap(c), veh/h	0	712	395	1259	429	382
V/C Ratio(X)	0.00	0.97	0.91	0.69	0.20	0.69
Avail Cap(c_a), veh/h	0	712	412	1277	429	382
HCM Platoon Ratio	1.00	1.00	1.00	1.00	1.00	1.00
Upstream Filter(I)	0.00	1.00	1.00	1.00	1.00	1.00
Uniform Delay (d), s/veh	0.0	26.7	34.3	9.4	27.5	31.3
Incr Delay (d2), s/veh	0.0	25.4	23.9	1.5	1.0	9.9
Initial Q Delay(d3),s/veh	0.0	0.0	0.0	0.0	0.0	0.0
%ile BackOfQ(50%),veh/ln	0.0	18.6	10.1	9.4	1.6	6.2
Unsig. Movement Delay, s/veh						
LnGrp Delay(d),s/veh	0.0	52.1	58.3	10.9	28.5	41.2
LnGrp LOS	A	D	E	B	C	D
Approach Vol, veh/h	687			1226	349	
Approach Delay, s/veh	52.1			24.9	38.1	
Approach LOS	D			C	D	
Timer - Assigned Phs		2	3	4		8
Phs Duration (G+Y+Rc), s		25.8	24.2	40.0		64.2
Change Period (Y+Rc), s		4.5	4.5	4.5		4.5
Max Green Setting (Gmax), s		20.5	20.5	35.5		60.5
Max Q Clear Time (g_c+I1), s		15.5	19.5	35.5		27.4
Green Ext Time (p_c), s		0.5	0.1	0.0		8.0
Intersection Summary						
HCM 6th Ctrl Delay			35.2			
HCM 6th LOS			D			

HCM 6th Signalized Intersection Summary
 5: Road 23/SR-99 Southbound Off-Ramp & Avenue 18 1/2

Village D Specific Plan
 Phase II WP MIT - AM Peak Hour



Movement	EBL	EBT	EBR	WBL	WBT	WBR	NBL	NBT	NBR	SBL	SBT	SBR
Lane Configurations		↑↑	↗	↖	↑↑			↑	↗		↖	
Traffic Volume (veh/h)	0	317	73	47	281	0	119	0	551	11	196	86
Future Volume (veh/h)	0	317	73	47	281	0	119	0	551	11	196	86
Initial Q (Qb), veh	0	0	0	0	0	0	0	0	0	0	0	0
Ped-Bike Adj(A_pbT)	1.00		1.00	1.00		1.00	1.00		1.00	1.00		1.00
Parking Bus, Adj	1.00	1.00	1.00	1.00	1.00	1.00	1.00	1.00	1.00	1.00	1.00	1.00
Work Zone On Approach		No			No			No			No	
Adj Sat Flow, veh/h/ln	0	1441	1441	1515	1515	0	1796	1796	1796	1633	1633	1633
Adj Flow Rate, veh/h	0	345	79	51	305	0	129	0	599	12	213	93
Peak Hour Factor	0.92	0.92	0.92	0.92	0.92	0.92	0.92	0.92	0.92	0.92	0.92	0.92
Percent Heavy Veh, %	0	31	31	26	26	0	7	7	7	18	18	18
Cap, veh/h	0	445	620	61	752	0	590	0	589	26	461	209
Arrive On Green	0.00	0.16	0.16	0.04	0.26	0.00	0.35	0.00	0.35	0.22	0.22	0.22
Sat Flow, veh/h	0	2809	1221	1443	2954	0	1711	0	1520	114	2050	928
Grp Volume(v), veh/h	0	345	79	51	305	0	129	0	599	171	0	147
Grp Sat Flow(s),veh/h/ln	0	1369	1221	1443	1439	0	1711	0	1520	1628	0	1465
Q Serve(g_s), s	0.0	9.7	2.7	2.8	7.0	0.0	4.3	0.0	27.6	7.3	0.0	6.9
Cycle Q Clear(g_c), s	0.0	9.7	2.7	2.8	7.0	0.0	4.3	0.0	27.6	7.3	0.0	6.9
Prop In Lane	0.00		1.00	1.00		0.00	1.00		1.00	0.07		0.63
Lane Grp Cap(c), veh/h	0	445	620	61	752	0	590	0	589	366	0	330
V/C Ratio(X)	0.00	0.78	0.13	0.83	0.41	0.00	0.22	0.00	1.02	0.47	0.00	0.45
Avail Cap(c_a), veh/h	0	616	696	135	1079	0	590	0	589	366	0	330
HCM Platoon Ratio	1.00	1.00	1.00	1.00	1.00	1.00	1.00	1.00	1.00	1.00	1.00	1.00
Upstream Filter(I)	0.00	1.00	1.00	1.00	1.00	0.00	1.00	0.00	1.00	1.00	0.00	1.00
Uniform Delay (d), s/veh	0.0	32.1	10.4	38.0	24.4	0.0	18.6	0.0	24.5	26.8	0.0	26.7
Incr Delay (d2), s/veh	0.0	4.2	0.1	24.2	0.4	0.0	0.9	0.0	41.4	4.2	0.0	4.3
Initial Q Delay(d3),s/veh	0.0	0.0	0.0	0.0	0.0	0.0	0.0	0.0	0.0	0.0	0.0	0.0
%ile BackOfQ(50%),veh/ln	0.0	3.4	1.3	1.4	2.3	0.0	1.8	0.0	17.1	3.2	0.0	2.7
Unsig. Movement Delay, s/veh												
LnGrp Delay(d),s/veh	0.0	36.3	10.5	62.2	24.8	0.0	19.4	0.0	65.9	31.1	0.0	31.0
LnGrp LOS	A	D	B	E	C	A	B	A	F	C	A	C
Approach Vol, veh/h		424			356			728				318
Approach Delay, s/veh		31.5			30.1			57.7				31.1
Approach LOS		C			C			E				C
Timer - Assigned Phs		2	3	4		6		8				
Phs Duration (G+Y+Rc), s		32.1	7.9	17.5		22.5		25.4				
Change Period (Y+Rc), s		4.5	4.5	4.5		4.5		4.5				
Max Green Setting (Gmax), s		18.5	7.5	18.0		18.0		30.0				
Max Q Clear Time (g_c+I1), s		29.6	4.8	11.7		9.3		9.0				
Green Ext Time (p_c), s		0.0	0.0	1.3		1.2		2.0				
Intersection Summary												
HCM 6th Ctrl Delay			41.6									
HCM 6th LOS			D									

HCM 6th Signalized Intersection Summary
6: SR-99 Northbound Ramps & Avenue 18 1/2

Village D Specific Plan
Phase II WP MIT - AM Peak Hour



Movement	EBL	EBT	EBR	WBL	WBT	WBR	NBL	NBT	NBR	SBL	SBT	SBR
Lane Configurations	↔↔	↑			↔		↔	↔				
Traffic Volume (veh/h)	620	61	0	0	150	31	215	1	25	0	0	0
Future Volume (veh/h)	620	61	0	0	150	31	215	1	25	0	0	0
Initial Q (Qb), veh	0	0	0	0	0	0	0	0	0			
Ped-Bike Adj(A_pbT)	1.00		1.00	1.00		1.00	1.00		1.00			
Parking Bus, Adj	1.00	1.00	1.00	1.00	1.00	1.00	1.00	1.00	1.00			
Work Zone On Approach		No			No			No				
Adj Sat Flow, veh/h/ln	1707	1707	0	0	1633	1633	1470	1470	1470			
Adj Flow Rate, veh/h	674	66	0	0	163	34	234	1	27			
Peak Hour Factor	0.92	0.92	0.92	0.92	0.92	0.92	0.92	0.92	0.92			
Percent Heavy Veh, %	13	13	0	0	18	18	29	29	29			
Cap, veh/h	783	781	0	0	201	42	602	19	519			
Arrive On Green	0.25	0.46	0.00	0.00	0.15	0.15	0.43	0.43	0.43			
Sat Flow, veh/h	3155	1707	0	0	1310	273	1400	45	1208			
Grp Volume(v), veh/h	674	66	0	0	0	197	234	0	28			
Grp Sat Flow(s),veh/h/ln	1577	1707	0	0	0	1583	1400	0	1253			
Q Serve(g_s), s	16.3	1.7	0.0	0.0	0.0	9.6	9.2	0.0	1.0			
Cycle Q Clear(g_c), s	16.3	1.7	0.0	0.0	0.0	9.6	9.2	0.0	1.0			
Prop In Lane	1.00		0.00	0.00		0.17	1.00		0.96			
Lane Grp Cap(c), veh/h	783	781	0	0	0	242	602	0	539			
V/C Ratio(X)	0.86	0.08	0.00	0.00	0.00	0.81	0.39	0.00	0.05			
Avail Cap(c_a), veh/h	966	1003	0	0	0	356	602	0	539			
HCM Platoon Ratio	1.00	1.00	1.00	1.00	1.00	1.00	1.00	1.00	1.00			
Upstream Filter(I)	1.00	1.00	0.00	0.00	0.00	1.00	1.00	0.00	1.00			
Uniform Delay (d), s/veh	28.8	12.2	0.0	0.0	0.0	32.8	15.6	0.0	13.3			
Incr Delay (d2), s/veh	6.8	0.0	0.0	0.0	0.0	8.7	0.4	0.0	0.0			
Initial Q Delay(d3),s/veh	0.0	0.0	0.0	0.0	0.0	0.0	0.0	0.0	0.0			
%ile BackOfQ(50%),veh/ln	6.7	0.6	0.0	0.0	0.0	4.2	2.8	0.0	0.3			
Unsig. Movement Delay, s/veh												
LnGrp Delay(d),s/veh	35.5	12.3	0.0	0.0	0.0	41.5	16.0	0.0	13.3			
LnGrp LOS	D	B	A	A	A	D	B	A	B			
Approach Vol, veh/h		740			197			262				
Approach Delay, s/veh		33.4			41.5			15.7				
Approach LOS		C			D			B				
Timer - Assigned Phs		2		4			7	8				
Phs Duration (G+Y+Rc), s		38.9		41.1			24.4	16.7				
Change Period (Y+Rc), s		4.5		4.5			4.5	4.5				
Max Green Setting (Gmax), s		5.0		47.0			24.5	18.0				
Max Q Clear Time (g_c+1), s		11.2		3.7			18.3	11.6				
Green Ext Time (p_c), s		0.0		0.4			1.5	0.5				
Intersection Summary												
HCM 6th Ctrl Delay				30.9								
HCM 6th LOS				C								

HCM 6th Signalized Intersection Summary
7: Road 23 & Avenue 17

Village D Specific Plan
Phase II WP MIT - AM Peak Hour



Movement	EBL	EBT	EBR	WBL	WBT	WBR	NBL	NBT	NBR	SBL	SBT	SBR
Lane Configurations												
Traffic Volume (veh/h)	161	486	53	370	131	3	74	642	717	16	291	42
Future Volume (veh/h)	161	486	53	370	131	3	74	642	717	16	291	42
Initial Q (Qb), veh	0	0	0	0	0	0	0	0	0	0	0	0
Ped-Bike Adj(A_pbT)	1.00		1.00	1.00		1.00	1.00		1.00	1.00		1.00
Parking Bus, Adj	1.00	1.00	1.00	1.00	1.00	1.00	1.00	1.00	1.00	1.00	1.00	1.00
Work Zone On Approach		No			No			No			No	
Adj Sat Flow, veh/h/ln	1900	1900	1900	1856	1856	1856	1856	1856	1856	1781	1781	1781
Adj Flow Rate, veh/h	175	528	58	402	142	3	80	698	779	17	316	46
Peak Hour Factor	0.92	0.92	0.92	0.92	0.92	0.92	0.92	0.92	0.92	0.92	0.92	0.92
Percent Heavy Veh, %	0	0	0	3	3	3	3	3	3	8	8	8
Cap, veh/h	205	597	65	463	719	15	102	1816	810	31	1610	718
Arrive On Green	0.11	0.18	0.18	0.14	0.20	0.20	0.06	0.52	0.52	0.02	0.48	0.48
Sat Flow, veh/h	1810	3281	359	3428	3531	74	1767	3526	1572	1697	3385	1510
Grp Volume(v), veh/h	175	290	296	402	71	74	80	698	779	17	316	46
Grp Sat Flow(s),veh/h/ln	1810	1805	1835	1714	1763	1842	1767	1763	1572	1697	1692	1510
Q Serve(g_s), s	11.4	18.8	18.9	13.8	4.0	4.0	5.4	14.4	57.1	1.2	6.5	2.0
Cycle Q Clear(g_c), s	11.4	18.8	18.9	13.8	4.0	4.0	5.4	14.4	57.1	1.2	6.5	2.0
Prop In Lane	1.00		0.20	1.00		0.04	1.00		1.00	1.00		1.00
Lane Grp Cap(c), veh/h	205	328	334	463	359	375	102	1816	810	31	1610	718
V/C Ratio(X)	0.85	0.88	0.89	0.87	0.20	0.20	0.79	0.38	0.96	0.56	0.20	0.06
Avail Cap(c_a), veh/h	309	353	359	529	359	375	180	1816	810	72	1610	718
HCM Platoon Ratio	1.00	1.00	1.00	1.00	1.00	1.00	1.00	1.00	1.00	1.00	1.00	1.00
Upstream Filter(I)	0.81	0.81	0.81	1.00	1.00	1.00	0.48	0.48	0.48	1.00	1.00	1.00
Uniform Delay (d), s/veh	52.2	47.8	47.9	50.8	39.6	39.7	55.8	17.6	28.0	58.4	18.2	17.0
Incr Delay (d2), s/veh	11.3	17.9	18.4	13.1	0.3	0.3	6.4	0.3	14.6	14.8	0.3	0.2
Initial Q Delay(d3),s/veh	0.0	0.0	0.0	0.0	0.0	0.0	0.0	0.0	0.0	0.0	0.0	0.0
%ile BackOfQ(50%),veh/ln	5.8	10.0	10.3	6.7	1.8	1.9	2.6	5.9	23.8	0.6	2.6	0.7
Unsig. Movement Delay, s/veh												
LnGrp Delay(d),s/veh	63.5	65.8	66.3	63.9	39.9	39.9	62.2	17.9	42.5	73.3	18.5	17.2
LnGrp LOS	E	E	E	E	D	D	E	B	D	E	B	B
Approach Vol, veh/h		761			547			1557			379	
Approach Delay, s/veh		65.4			57.5			32.5			20.8	
Approach LOS		E			E			C			C	
Timer - Assigned Phs	1	2	3	4	5	6	7	8				
Phs Duration (G+Y+Rc), s	6.7	66.3	20.7	26.3	11.4	61.6	18.1	28.9				
Change Period (Y+Rc), s	4.5	4.5	4.5	4.5	4.5	4.5	4.5	4.5				
Max Green Setting (Gmax), s	5.1	54.9	18.5	23.5	12.2	47.8	20.5	21.5				
Max Q Clear Time (g_c+1), s	13.2	59.1	15.8	20.9	7.4	8.5	13.4	6.0				
Green Ext Time (p_c), s	0.0	0.0	0.4	0.9	0.1	2.4	0.3	0.6				
Intersection Summary												
HCM 6th Ctrl Delay				43.1								
HCM 6th LOS				D								

HCM 6th Signalized Intersection Summary
8: Road 23 & Avenue 16

Village D Specific Plan
Phase II WP MIT - AM Peak Hour



Movement	EBL	EBT	EBR	WBL	WBT	WBR	NBL	NBT	NBR	SBL	SBT	SBR
Lane Configurations												
Traffic Volume (veh/h)	50	66	275	137	47	277	158	731	23	117	692	52
Future Volume (veh/h)	50	66	275	137	47	277	158	731	23	117	692	52
Initial Q (Qb), veh	0	0	0	0	0	0	0	0	0	0	0	0
Ped-Bike Adj(A_pbT)	1.00		1.00	1.00		1.00	1.00		1.00	1.00		1.00
Parking Bus, Adj	1.00	1.00	1.00	1.00	1.00	1.00	1.00	1.00	1.00	1.00	1.00	1.00
Work Zone On Approach		No			No			No			No	
Adj Sat Flow, veh/h/ln	1841	1841	1841	1900	1900	1900	1826	1826	1826	1811	1811	1811
Adj Flow Rate, veh/h	54	72	299	149	51	301	172	795	25	127	752	57
Peak Hour Factor	0.92	0.92	0.92	0.92	0.92	0.92	0.92	0.92	0.92	0.92	0.92	0.92
Percent Heavy Veh, %	4	4	4	0	0	0	5	5	5	6	6	6
Cap, veh/h	77	70	291	185	68	399	209	1235	709	158	1128	570
Arrive On Green	0.04	0.22	0.22	0.10	0.28	0.28	0.12	0.36	0.36	0.09	0.33	0.33
Sat Flow, veh/h	1753	312	1296	1810	239	1408	1739	3469	1547	1725	3441	1535
Grp Volume(v), veh/h	54	0	371	149	0	352	172	795	25	127	752	57
Grp Sat Flow(s),veh/h/ln	1753	0	1608	1810	0	1647	1739	1735	1547	1725	1721	1535
Q Serve(g_s), s	2.4	0.0	18.0	6.4	0.0	15.6	7.7	15.3	0.7	5.8	15.0	1.9
Cycle Q Clear(g_c), s	2.4	0.0	18.0	6.4	0.0	15.6	7.7	15.3	0.7	5.8	15.0	1.9
Prop In Lane	1.00		0.81	1.00		0.86	1.00		1.00	1.00		1.00
Lane Grp Cap(c), veh/h	77	0	362	185	0	467	209	1235	709	158	1128	570
V/C Ratio(X)	0.71	0.00	1.03	0.81	0.00	0.75	0.82	0.64	0.04	0.80	0.67	0.10
Avail Cap(c_a), veh/h	149	0	362	217	0	467	250	1235	709	196	1128	570
HCM Platoon Ratio	1.00	1.00	1.00	1.00	1.00	1.00	1.00	1.00	1.00	1.00	1.00	1.00
Upstream Filter(l)	1.00	0.00	1.00	1.00	0.00	1.00	0.63	0.63	0.63	0.65	0.65	0.65
Uniform Delay (d), s/veh	37.7	0.0	31.0	35.1	0.0	26.1	34.4	21.5	11.9	35.6	23.1	16.4
Incr Delay (d2), s/veh	11.2	0.0	54.1	17.1	0.0	6.8	11.4	1.6	0.1	11.8	2.0	0.2
Initial Q Delay(d3),s/veh	0.0	0.0	0.0	0.0	0.0	0.0	0.0	0.0	0.0	0.0	0.0	0.0
%ile BackOfQ(50%),veh/ln	1.3	0.0	12.1	3.7	0.0	6.7	3.8	6.2	0.2	2.9	6.1	0.7
Unsig. Movement Delay, s/veh												
LnGrp Delay(d),s/veh	49.0	0.0	85.1	52.3	0.0	33.0	45.8	23.2	12.0	47.4	25.2	16.6
LnGrp LOS	D	A	F	D	A	C	D	C	B	D	C	B
Approach Vol, veh/h		425			501			992			936	
Approach Delay, s/veh		80.5			38.7			26.8			27.7	
Approach LOS		F			D			C			C	
Timer - Assigned Phs	1	2	3	4	5	6	7	8				
Phs Duration (G+Y+Rc), s	1.8	33.0	12.7	22.5	14.1	30.7	8.0	27.2				
Change Period (Y+Rc), s	4.5	4.5	4.5	4.5	4.5	4.5	4.5	4.5				
Max Green Setting (Gmax), s	25.3	9.6	18.0	11.5	22.9	6.8	20.8					
Max Q Clear Time (g_c+1T), s	17.3	8.4	20.0	9.7	17.0	4.4	17.6					
Green Ext Time (p_c), s	0.0	3.4	0.0	0.0	0.1	2.6	0.0	0.7				
Intersection Summary												
HCM 6th Ctrl Delay											37.2	
HCM 6th LOS											D	

HCM 6th Signalized Intersection Summary

9: Road 23 & Cleveland Avenue

Village D Specific Plan
Phase II WP MIT - AM Peak Hour



Movement	EBL	EBT	EBR	WBL	WBT	WBR	NBL	NBT	NBR	SBL	SBT	SBR
Lane Configurations	↖	↗		↖	↗		↖	↑↑	↗	↖	↑↑	↗
Traffic Volume (veh/h)	0	19	9	311	19	327	9	681	301	299	777	0
Future Volume (veh/h)	0	19	9	311	19	327	9	681	301	299	777	0
Initial Q (Qb), veh	0	0	0	0	0	0	0	0	0	0	0	0
Ped-Bike Adj(A_pbT)	1.00		1.00	1.00		1.00	1.00		1.00	1.00		1.00
Parking Bus, Adj	1.00	1.00	1.00	1.00	1.00	1.00	1.00	1.00	1.00	1.00	1.00	1.00
Work Zone On Approach		No			No			No			No	
Adj Sat Flow, veh/h/ln	1900	1900	1900	1870	1870	1870	1826	1826	1826	1811	1811	1811
Adj Flow Rate, veh/h	0	21	10	338	21	355	10	740	327	325	845	0
Peak Hour Factor	0.92	0.92	0.92	0.92	0.92	0.92	0.92	0.92	0.92	0.92	0.92	0.92
Percent Heavy Veh, %	0	0	0	2	2	2	5	5	5	6	6	6
Cap, veh/h	2	68	32	342	27	449	21	1249	854	332	1858	752
Arrive On Green	0.00	0.06	0.06	0.19	0.30	0.30	0.01	0.36	0.36	0.19	0.54	0.00
Sat Flow, veh/h	1810	1216	579	1781	89	1509	1739	3469	1547	1725	3441	1535
Grp Volume(v), veh/h	0	0	31	338	0	376	10	740	327	325	845	0
Grp Sat Flow(s),veh/h/ln	1810	0	1796	1781	0	1599	1739	1735	1547	1725	1721	1535
Q Serve(g_s), s	0.0	0.0	1.5	17.0	0.0	19.4	0.5	15.6	10.8	16.9	13.5	4.5
Cycle Q Clear(g_c), s	0.0	0.0	1.5	17.0	0.0	19.4	0.5	15.6	10.8	16.9	13.5	4.5
Prop In Lane	1.00		0.32	1.00		0.94	1.00		1.00	1.00		1.00
Lane Grp Cap(c), veh/h	2	0	100	342	0	476	21	1249	854	332	1858	752
V/C Ratio(X)	0.00	0.00	0.31	0.99	0.00	0.79	0.47	0.59	0.38	0.98	0.45	0.00
Avail Cap(c_a), veh/h	101	0	359	342	0	538	97	1249	854	332	1858	752
HCM Platoon Ratio	1.00	1.00	1.00	1.00	1.00	1.00	1.00	1.00	1.00	1.00	1.00	1.00
Upstream Filter(I)	0.00	0.00	1.00	0.92	0.00	0.92	0.87	0.87	0.87	0.73	0.73	0.00
Uniform Delay (d), s/veh	0.0	0.0	40.8	36.2	0.0	29.0	44.2	23.4	11.4	36.2	12.6	0.0
Incr Delay (d2), s/veh	0.0	0.0	1.7	43.1	0.0	6.5	13.2	1.8	1.1	37.0	0.6	0.0
Initial Q Delay(d3),s/veh	0.0	0.0	0.0	0.0	0.0	0.0	0.0	0.0	0.0	0.0	0.0	0.0
%ile BackOfQ(50%),veh/ln	0.0	0.0	0.7	11.3	0.0	8.1	0.3	6.5	3.7	10.3	5.0	0.0
Unsig. Movement Delay, s/veh												
LnGrp Delay(d),s/veh	0.0	0.0	42.6	79.3	0.0	35.5	57.4	25.2	12.6	73.1	13.2	0.0
LnGrp LOS	A	A	D	E	A	D	E	C	B	E	B	A
Approach Vol, veh/h		31		714				1077			1170	
Approach Delay, s/veh		42.6		56.2				21.7			29.9	
Approach LOS		D		E				C			C	
Timer - Assigned Phs	1	2	3	4	5	6	7	8				
Phs Duration (G+Y+Rc), s	31.8	36.9	21.8	9.5	5.6	53.1	0.0	31.3				
Change Period (Y+Rc), s	4.5	4.5	4.5	4.5	4.5	4.5	4.5	4.5				
Max Green Setting (Gmax), s	19.4	17.3	18.0	5.0	31.7	5.0	30.3					
Max Q Clear Time (g_c+1/3), s	17.6	19.0	3.5	2.5	15.5	0.0	21.4					
Green Ext Time (p_c), s	0.0	1.1	0.0	0.1	0.0	5.5	0.0	1.6				
Intersection Summary												
HCM 6th Ctrl Delay				33.3								
HCM 6th LOS				C								

HCM 6th Signalized Intersection Summary
 10: Road 23 & Avenue 14 1/2

Village D Specific Plan
 Phase II WP MIT - AM Peak Hour



Movement	EBL	EBT	EBR	WBL	WBT	WBR	NBL	NBT	NBR	SBL	SBT	SBR
Lane Configurations		↕			↕		↕	↕		↕	↕	
Traffic Volume (veh/h)	0	5	0	17	3	141	4	416	4	122	627	0
Future Volume (veh/h)	0	5	0	17	3	141	4	416	4	122	627	0
Initial Q (Qb), veh	0	0	0	0	0	0	0	0	0	0	0	0
Ped-Bike Adj(A_pbT)	1.00		1.00	1.00		1.00	1.00		1.00	1.00		1.00
Parking Bus, Adj	1.00	1.00	1.00	1.00	1.00	1.00	1.00	1.00	1.00	1.00	1.00	1.00
Work Zone On Approach		No			No			No			No	
Adj Sat Flow, veh/h/ln	1900	1900	1900	1900	1900	1900	1752	1752	1752	1796	1796	1796
Adj Flow Rate, veh/h	0	5	0	18	3	153	4	452	4	133	682	0
Peak Hour Factor	0.92	0.92	0.92	0.92	0.92	0.92	0.92	0.92	0.92	0.92	0.92	0.92
Percent Heavy Veh, %	0	0	0	0	0	0	10	10	10	7	7	7
Cap, veh/h	0	258	0	62	14	193	9	2019	18	168	2356	0
Arrive On Green	0.00	0.14	0.00	0.14	0.14	0.14	0.01	0.60	0.60	0.10	0.69	0.00
Sat Flow, veh/h	0	1900	0	94	101	1419	1668	3381	30	1711	3503	0
Grp Volume(v), veh/h	0	5	0	174	0	0	4	222	234	133	682	0
Grp Sat Flow(s),veh/h/ln	0	1900	0	1614	0	0	1668	1664	1746	1711	1706	0
Q Serve(g_s), s	0.0	0.2	0.0	3.6	0.0	0.0	0.2	5.0	5.0	6.1	6.2	0.0
Cycle Q Clear(g_c), s	0.0	0.2	0.0	8.3	0.0	0.0	0.2	5.0	5.0	6.1	6.2	0.0
Prop In Lane	0.00		0.00	0.10		0.88	1.00		0.02	1.00		0.00
Lane Grp Cap(c), veh/h	0	258	0	269	0	0	9	994	1043	168	2356	0
V/C Ratio(X)	0.00	0.02	0.00	0.65	0.00	0.00	0.45	0.22	0.22	0.79	0.29	0.00
Avail Cap(c_a), veh/h	0	534	0	501	0	0	136	994	1043	396	2356	0
HCM Platoon Ratio	1.00	1.00	1.00	1.00	1.00	1.00	1.00	1.00	1.00	1.00	1.00	1.00
Upstream Filter(I)	0.00	1.00	0.00	1.00	0.00	0.00	1.00	1.00	1.00	1.00	1.00	0.00
Uniform Delay (d), s/veh	0.0	30.0	0.0	33.5	0.0	0.0	39.7	7.5	7.5	35.3	4.8	0.0
Incr Delay (d2), s/veh	0.0	0.0	0.0	2.6	0.0	0.0	31.9	0.5	0.5	8.0	0.3	0.0
Initial Q Delay(d3),s/veh	0.0	0.0	0.0	0.0	0.0	0.0	0.0	0.0	0.0	0.0	0.0	0.0
%ile BackOfQ(50%),veh/ln	0.0	0.1	0.0	3.4	0.0	0.0	0.2	1.7	1.8	2.8	1.8	0.0
Unsig. Movement Delay, s/veh												
LnGrp Delay(d),s/veh	0.0	30.0	0.0	36.1	0.0	0.0	71.6	8.0	8.0	43.3	5.1	0.0
LnGrp LOS	A	C	A	D	A	A	E	A	A	D	A	A
Approach Vol, veh/h		5		174			460			815		
Approach Delay, s/veh		30.0		36.1			8.6			11.3		
Approach LOS		C		D			A			B		
Timer - Assigned Phs	1	2		4	5	6		8				
Phs Duration (G+Y+Rc), s	12.4	52.3		15.4	4.9	59.7		15.4				
Change Period (Y+Rc), s	4.5	4.5		4.5	4.5	4.5		4.5				
Max Green Setting (Gmax), s	10.5	25.5		22.5	6.5	37.5		22.5				
Max Q Clear Time (g_c+10), s	10.5	7.0		2.2	2.2	8.2		10.3				
Green Ext Time (p_c), s	0.2	2.6		0.0	0.0	5.3		0.7				

Intersection Summary

HCM 6th Ctrl Delay	13.5
HCM 6th LOS	B

Intersection

Intersection Delay, s/veh 31.6

Intersection LOS D

Movement	EBL	EBT	EBR	WBL	WBT	WBR	NBL	NBT	NBR	SBL	SBT	SBR
Lane Configurations		↕			↕		↕	↕		↕	↕	
Traffic Vol, veh/h	86	150	46	20	182	173	44	165	8	241	264	137
Future Vol, veh/h	86	150	46	20	182	173	44	165	8	241	264	137
Peak Hour Factor	0.92	0.92	0.92	0.92	0.92	0.92	0.92	0.92	0.92	0.92	0.92	0.92
Heavy Vehicles, %	6	6	6	6	6	6	22	22	22	7	7	7
Mvmt Flow	93	163	50	22	198	188	48	179	9	262	287	149
Number of Lanes	0	1	0	0	1	0	1	2	0	1	2	0

Approach	EB	WB	NB	SB
Opposing Approach	WB	EB	SB	NB
Opposing Lanes	1	1	3	3
Conflicting Approach Left SB		NB	EB	WB
Conflicting Lanes Left	3	3	1	1
Conflicting Approach Right NB		SB	WB	EB
Conflicting Lanes Right	3	3	1	1
HCM Control Delay	33.7	55.4	15.7	22.2
HCM LOS	D	F	C	C

Lane	NBLn1	NBLn2	NBLn3	EBLn1	WBLn1	SBLn1	SBLn2	SBLn3
Vol Left, %	100%	0%	0%	30%	5%	100%	0%	0%
Vol Thru, %	0%	100%	87%	53%	49%	0%	100%	39%
Vol Right, %	0%	0%	13%	16%	46%	0%	0%	61%
Sign Control	Stop	Stop	Stop	Stop	Stop	Stop	Stop	Stop
Traffic Vol by Lane	44	110	63	282	375	241	176	225
LT Vol	44	0	0	86	20	241	0	0
Through Vol	0	110	55	150	182	0	176	88
RT Vol	0	0	8	46	173	0	0	137
Lane Flow Rate	48	120	68	307	408	262	191	245
Geometry Grp	7	7	7	7	7	7	7	7
Degree of Util (X)	0.135	0.32	0.181	0.749	0.927	0.654	0.45	0.545
Departure Headway (Hd)	10.152	9.622	9.528	8.801	8.189	8.993	8.468	8.02
Convergence, Y/N	Yes	Yes	Yes	Yes	Yes	Yes	Yes	Yes
Cap	353	373	377	411	444	401	425	450
Service Time	7.912	7.382	7.287	6.554	5.938	6.748	6.222	5.774
HCM Lane V/C Ratio	0.136	0.322	0.18	0.747	0.919	0.653	0.449	0.544
HCM Control Delay	14.5	16.9	14.4	33.7	55.4	27.3	18	20
HCM Lane LOS	B	C	B	D	F	D	C	C
HCM 95th-tile Q	0.5	1.4	0.7	6.1	10.5	4.5	2.3	3.2

HCM 6th Signalized Intersection Summary
 13: Airport Drive/Golden State Boulevard & Avenue 17

Village D Specific Plan
 Phase II WP MIT - AM Peak Hour



Movement	EBL	EBT	EBR	WBL	WBT	WBR	NBL	NBT	NBR	SBL	SBT	SBR
Lane Configurations												
Traffic Volume (veh/h)	5	1028	146	245	434	220	65	84	144	175	42	4
Future Volume (veh/h)	5	1028	146	245	434	220	65	84	144	175	42	4
Initial Q (Qb), veh	0	0	0	0	0	0	0	0	0	0	0	0
Ped-Bike Adj(A_pbT)	1.00		1.00	1.00		1.00	1.00		1.00	1.00		1.00
Parking Bus, Adj	1.00	1.00	1.00	1.00	1.00	1.00	1.00	1.00	1.00	1.00	1.00	1.00
Work Zone On Approach		No			No			No			No	
Adj Sat Flow, veh/h/ln	1885	1885	1885	1826	1826	1826	1737	1737	1737	1767	1767	1767
Adj Flow Rate, veh/h	5	1117	159	266	472	239	71	91	157	190	46	4
Peak Hour Factor	0.92	0.92	0.92	0.92	0.92	0.92	0.92	0.92	0.92	0.92	0.92	0.92
Percent Heavy Veh, %	1	1	1	5	5	5	11	11	11	9	9	9
Cap, veh/h	12	1200	535	300	1738	775	89	595	504	655	383	33
Arrive On Green	0.01	0.33	0.33	0.17	0.50	0.50	0.05	0.34	0.34	0.24	0.24	0.24
Sat Flow, veh/h	1795	3582	1598	1739	3469	1547	1654	1737	1471	2072	1602	139
Grp Volume(v), veh/h	5	1117	159	266	472	239	71	91	157	190	0	50
Grp Sat Flow(s),veh/h/ln	1795	1791	1598	1739	1735	1547	1654	1737	1471	1036	0	1741
Q Serve(g_s), s	0.2	27.1	6.6	13.4	7.1	8.2	3.8	3.3	7.1	6.9	0.0	2.0
Cycle Q Clear(g_c), s	0.2	27.1	6.6	13.4	7.1	8.2	3.8	3.3	7.1	6.9	0.0	2.0
Prop In Lane	1.00		1.00	1.00		1.00	1.00		1.00	1.00		0.08
Lane Grp Cap(c), veh/h	12	1200	535	300	1738	775	89	595	504	655	0	416
V/C Ratio(X)	0.43	0.93	0.30	0.89	0.27	0.31	0.80	0.15	0.31	0.29	0.00	0.12
Avail Cap(c_a), veh/h	100	1214	541	319	1738	775	101	595	504	655	0	416
HCM Platoon Ratio	1.00	1.00	1.00	1.00	1.00	1.00	1.00	1.00	1.00	1.00	1.00	1.00
Upstream Filter(I)	1.00	1.00	1.00	0.94	0.94	0.94	1.00	1.00	1.00	1.00	0.00	1.00
Uniform Delay (d), s/veh	44.5	28.9	22.1	36.4	13.0	13.3	42.1	20.5	21.8	28.7	0.0	26.8
Incr Delay (d2), s/veh	22.7	12.6	0.3	22.7	0.1	0.2	31.8	0.5	1.6	1.1	0.0	0.6
Initial Q Delay(d3),s/veh	0.0	0.0	0.0	0.0	0.0	0.0	0.0	0.0	0.0	0.0	0.0	0.0
%ile BackOfQ(50%),veh/ln	0.2	13.3	2.5	7.5	2.6	2.8	2.3	1.4	2.6	1.8	0.0	0.9
Unsig. Movement Delay, s/veh												
LnGrp Delay(d),s/veh	67.2	41.5	22.4	59.0	13.1	13.5	73.9	21.1	23.4	29.8	0.0	27.4
LnGrp LOS	E	D	C	E	B	B	E	C	C	C	A	C
Approach Vol, veh/h		1281			977			319			240	
Approach Delay, s/veh		39.3			25.7			34.0			29.3	
Approach LOS		D			C			C			C	
Timer - Assigned Phs		2	3	4	5	6	7	8				
Phs Duration (G+Y+Rc), s		35.3	20.0	34.6	9.3	26.0	5.1	49.6				
Change Period (Y+Rc), s		4.5	4.5	4.5	4.5	4.5	4.5	4.5				
Max Green Setting (Gmax), s		29.5	16.5	30.5	5.5	19.5	5.0	42.0				
Max Q Clear Time (g_c+I1), s		9.1	15.4	29.1	5.8	8.9	2.2	10.2				
Green Ext Time (p_c), s		1.0	0.1	1.0	0.0	0.9	0.0	4.4				
Intersection Summary												
HCM 6th Ctrl Delay											33.1	
HCM 6th LOS											C	

HCM 6th Signalized Intersection Summary
 14: Avenue 17 & SR-99 Southbound Off-Ramp

Village D Specific Plan
 Phase II WP MIT - AM Peak Hour

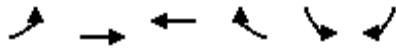

Movement	EBL	EBT	WBT	WBR	SBL	SBR
Lane Configurations		↑↑↑	↑↑↑		↵	↵
Traffic Volume (veh/h)	0	1349	792	0	275	108
Future Volume (veh/h)	0	1349	792	0	275	108
Initial Q (Qb), veh	0	0	0	0	0	0
Ped-Bike Adj(A_pbT)	1.00			1.00	1.00	1.00
Parking Bus, Adj	1.00	1.00	1.00	1.00	1.00	1.00
Work Zone On Approach		No	No		No	
Adj Sat Flow, veh/h/ln	0	1841	1826	0	1737	1737
Adj Flow Rate, veh/h	0	1466	861	0	299	117
Peak Hour Factor	0.92	0.92	0.92	0.92	0.92	0.92
Percent Heavy Veh, %	0	4	5	0	11	11
Cap, veh/h	0	1988	1972	0	814	724
Arrive On Green	0.00	0.40	0.40	0.00	0.49	0.49
Sat Flow, veh/h	0	5356	5313	0	1654	1472
Grp Volume(v), veh/h	0	1466	861	0	299	117
Grp Sat Flow(s),veh/h/ln	0	1675	1662	0	1654	1472
Q Serve(g_s), s	0.0	19.9	10.1	0.0	9.0	3.5
Cycle Q Clear(g_c), s	0.0	19.9	10.1	0.0	9.0	3.5
Prop In Lane	0.00			0.00	1.00	1.00
Lane Grp Cap(c), veh/h	0	1988	1972	0	814	724
V/C Ratio(X)	0.00	0.74	0.44	0.00	0.37	0.16
Avail Cap(c_a), veh/h	0	2418	2399	0	814	724
HCM Platoon Ratio	1.00	1.00	1.00	1.00	1.00	1.00
Upstream Filter(I)	0.00	0.54	1.00	0.00	1.00	1.00
Uniform Delay (d), s/veh	0.0	20.6	17.7	0.0	12.6	11.2
Incr Delay (d2), s/veh	0.0	0.5	0.2	0.0	1.3	0.5
Initial Q Delay(d3),s/veh	0.0	0.0	0.0	0.0	0.0	0.0
%ile BackOfQ(50%),veh/ln	0.0	7.4	3.7	0.0	3.4	1.2
Unsig. Movement Delay, s/veh						
LnGrp Delay(d),s/veh	0.0	21.2	17.8	0.0	13.9	11.7
LnGrp LOS	A	C	B	A	B	B
Approach Vol, veh/h		1466	861		416	
Approach Delay, s/veh		21.2	17.8		13.3	
Approach LOS		C	B		B	
Timer - Assigned Phs				4	6	8
Phs Duration (G+Y+Rc), s				36.1	43.9	36.1
Change Period (Y+Rc), s				4.5	4.5	4.5
Max Green Setting (Gmax), s				38.5	32.5	38.5
Max Q Clear Time (g_c+I1), s				21.9	11.0	12.1
Green Ext Time (p_c), s				9.7	1.3	6.7
Intersection Summary						
HCM 6th Ctrl Delay			18.9			
HCM 6th LOS			B			

HCM 6th Signalized Intersection Summary
15: SR-99 Northbound Ramps & Avenue 17

Village D Specific Plan
Phase II WP MIT - AM Peak Hour



Movement	EBL	EBT	EBR	WBL	WBT	WBR	NBL	NBT	NBR	SBL	SBT	SBR
Lane Configurations	↖	↑↑			↑↑		↖	↖	↖			
Traffic Volume (veh/h)	114	698	0	0	1018	245	475	3	240	0	0	0
Future Volume (veh/h)	114	698	0	0	1018	245	475	3	240	0	0	0
Initial Q (Qb), veh	0	0	0	0	0	0	0	0	0			
Ped-Bike Adj(A_pbT)	1.00		1.00	1.00		1.00	1.00		1.00			
Parking Bus, Adj	1.00	1.00	1.00	1.00	1.00	1.00	1.00	1.00	1.00			
Work Zone On Approach		No			No			No				
Adj Sat Flow, veh/h/ln	1841	1841	0	0	1870	1870	1841	1841	1841			
Adj Flow Rate, veh/h	124	759	0	0	1107	266	518	0	261			
Peak Hour Factor	0.92	0.92	0.92	0.92	0.92	0.92	0.92	0.92	0.92			
Percent Heavy Veh, %	4	4	0	0	2	2	4	4	4			
Cap, veh/h	154	2011	0	0	1227	293	1095	0	487			
Arrive On Green	0.18	1.00	0.00	0.00	0.43	0.43	0.31	0.00	0.31			
Sat Flow, veh/h	1753	3589	0	0	2939	679	3506	0	1560			
Grp Volume(v), veh/h	124	759	0	0	688	685	518	0	261			
Grp Sat Flow(s),veh/h/ln	1753	1749	0	0	1777	1748	1753	0	1560			
Q Serve(g_s), s	5.4	0.0	0.0	0.0	28.8	29.3	9.5	0.0	11.1			
Cycle Q Clear(g_c), s	5.4	0.0	0.0	0.0	28.8	29.3	9.5	0.0	11.1			
Prop In Lane	1.00		0.00	0.00		0.39	1.00		1.00			
Lane Grp Cap(c), veh/h	154	2011	0	0	766	754	1095	0	487			
V/C Ratio(X)	0.81	0.38	0.00	0.00	0.90	0.91	0.47	0.00	0.54			
Avail Cap(c_a), veh/h	208	2173	0	0	793	780	1095	0	487			
HCM Platoon Ratio	2.00	2.00	1.00	1.00	1.00	1.00	1.00	1.00	1.00			
Upstream Filter(I)	1.00	1.00	0.00	0.00	1.00	1.00	1.00	0.00	1.00			
Uniform Delay (d), s/veh	32.3	0.0	0.0	0.0	21.1	21.3	22.2	0.0	22.7			
Incr Delay (d2), s/veh	15.2	0.1	0.0	0.0	12.8	14.2	0.3	0.0	1.2			
Initial Q Delay(d3),s/veh	0.0	0.0	0.0	0.0	0.0	0.0	0.0	0.0	0.0			
%ile BackOfQ(50%),veh/ln	2.7	0.0	0.0	0.0	13.7	14.0	3.8	0.0	4.0			
Unsig. Movement Delay, s/veh												
LnGrp Delay(d),s/veh	47.6	0.1	0.0	0.0	34.0	35.5	22.5	0.0	23.9			
LnGrp LOS	D	A	A	A	C	D	C	A	C			
Approach Vol, veh/h		883			1373			779				
Approach Delay, s/veh		6.8			34.7			23.0				
Approach LOS		A			C			C				
Timer - Assigned Phs		2		4			7	8				
Phs Duration (G+Y+Rc), s		29.5		50.5			11.5	39.0				
Change Period (Y+Rc), s		4.5		4.5			4.5	4.5				
Max Green Setting (Gmax), s		5.0		49.7			9.5	35.7				
Max Q Clear Time (g_c+I1), s		13.1		2.0			7.4	31.3				
Green Ext Time (p_c), s		0.0		6.4			0.1	3.2				

Intersection Summary

HCM 6th Ctrl Delay	23.6
HCM 6th LOS	C

Notes

User approved volume balancing among the lanes for turning movement.

HCM 6th Signalized Intersection Summary
 16: Love's Truck Stop Driveway/Driveway & Avenue 17

Village D Specific Plan
 Phase II WP MIT - AM Peak Hour



Movement	EBL	EBT	EBR	WBL	WBT	WBR	NBL	NBT	NBR	SBL	SBT	SBR
Lane Configurations	↔↔	↑↑↑	↔	↔	↑↑↑	↔	↔	↔		↔	↑	↔
Traffic Volume (veh/h)	162	636	132	45	965	56	136	0	22	48	0	90
Future Volume (veh/h)	162	636	132	45	965	56	136	0	22	48	0	90
Initial Q (Qb), veh	0	0	0	0	0	0	0	0	0	0	0	0
Ped-Bike Adj(A_pbT)	1.00		1.00	1.00		1.00	1.00		1.00	1.00		1.00
Parking Bus, Adj	1.00	1.00	1.00	1.00	1.00	1.00	1.00	1.00	1.00	1.00	1.00	1.00
Work Zone On Approach		No			No			No			No	
Adj Sat Flow, veh/h/ln	1870	1870	1870	1870	1870	1870	1900	1900	1900	1900	1900	1900
Adj Flow Rate, veh/h	176	691	143	49	1049	61	148	0	24	52	0	98
Peak Hour Factor	0.92	0.92	0.92	0.92	0.92	0.92	0.92	0.92	0.92	0.92	0.92	0.92
Percent Heavy Veh, %	2	2	2	2	2	2	0	0	0	0	0	0
Cap, veh/h	260	1563	485	74	1391	432	179	0	619	77	624	650
Arrive On Green	0.08	0.31	0.31	0.04	0.27	0.27	0.10	0.00	0.38	0.04	0.00	0.33
Sat Flow, veh/h	3456	5106	1585	1781	5106	1585	1810	0	1610	1810	1900	1610
Grp Volume(v), veh/h	176	691	143	49	1049	61	148	0	24	52	0	98
Grp Sat Flow(s),veh/h/ln	1728	1702	1585	1781	1702	1585	1810	0	1610	1810	1900	1610
Q Serve(g_s), s	4.0	8.7	5.5	2.2	15.0	2.3	6.4	0.0	0.7	2.3	0.0	3.1
Cycle Q Clear(g_c), s	4.0	8.7	5.5	2.2	15.0	2.3	6.4	0.0	0.7	2.3	0.0	3.1
Prop In Lane	1.00		1.00	1.00		1.00	1.00		1.00	1.00		1.00
Lane Grp Cap(c), veh/h	260	1563	485	74	1391	432	179	0	619	77	624	650
V/C Ratio(X)	0.68	0.44	0.29	0.66	0.75	0.14	0.83	0.00	0.04	0.67	0.00	0.15
Avail Cap(c_a), veh/h	402	1832	569	145	1653	513	179	0	619	147	624	650
HCM Platoon Ratio	1.00	1.00	1.00	1.00	1.00	1.00	1.00	1.00	1.00	1.00	1.00	1.00
Upstream Filter(I)	1.00	1.00	1.00	1.00	1.00	1.00	1.00	0.00	1.00	1.00	0.00	1.00
Uniform Delay (d), s/veh	36.1	22.3	21.2	37.8	26.6	22.0	35.4	0.0	15.4	37.7	0.0	15.1
Incr Delay (d2), s/veh	3.1	0.2	0.3	9.8	1.7	0.1	26.4	0.0	0.1	9.6	0.0	0.5
Initial Q Delay(d3),s/veh	0.0	0.0	0.0	0.0	0.0	0.0	0.0	0.0	0.0	0.0	0.0	0.0
%ile BackOfQ(50%),veh/ln	1.7	3.4	2.0	1.1	6.1	0.9	4.1	0.0	0.3	1.2	0.0	1.2
Unsig. Movement Delay, s/veh												
LnGrp Delay(d),s/veh	39.1	22.5	21.5	47.5	28.3	22.2	61.8	0.0	15.5	47.3	0.0	15.6
LnGrp LOS	D	C	C	D	C	C	E	A	B	D	A	B
Approach Vol, veh/h		1010			1159			172			150	
Approach Delay, s/veh		25.2			28.8			55.4			26.6	
Approach LOS		C			C			E			C	
Timer - Assigned Phs	1	2	3	4	5	6	7	8				
Phs Duration (G+Y+Rc), s	7.9	35.3	7.8	29.0	12.4	30.8	10.5	26.3				
Change Period (Y+Rc), s	4.5	4.5	4.5	4.5	4.5	4.5	4.5	4.5				
Max Green Setting (Gmax), s	5	20.3	6.5	28.7	7.9	18.9	9.3	25.9				
Max Q Clear Time (g_c+1), s	11	3	2.7	4.2	10.7	8.4	5.1	6.0	17.0			
Green Ext Time (p_c), s	0.0	0.1	0.0	5.1	0.0	0.2	0.2	4.8				
Intersection Summary												
HCM 6th Ctrl Delay												29.1
HCM 6th LOS												C

HCM 6th Signalized Intersection Summary
 17: Westberry Boulevard & Cleveland Avenue

Village D Specific Plan
 Phase II WP MIT - AM Peak Hour



Movement	EBL	EBT	EBR	WBL	WBT	WBR	NBL	NBT	NBR	SBL	SBT	SBR
Lane Configurations	↖	↖↗		↖	↖↗		↖	↑	↖↗	↖	↑	↖↗
Traffic Volume (veh/h)	257	802	73	34	297	12	51	172	140	14	60	107
Future Volume (veh/h)	257	802	73	34	297	12	51	172	140	14	60	107
Initial Q (Qb), veh	0	0	0	0	0	0	0	0	0	0	0	0
Ped-Bike Adj(A_pbT)	1.00		1.00	1.00		0.99	1.00		1.00	1.00		0.99
Parking Bus, Adj	1.00	1.00	1.00	1.00	1.00	1.00	1.00	1.00	1.00	1.00	1.00	1.00
Work Zone On Approach		No		No		No		No		No		No
Adj Sat Flow, veh/h/ln	1900	1900	1900	1885	1885	1885	1900	1900	1900	1900	1900	1900
Adj Flow Rate, veh/h	279	872	79	37	323	13	55	187	152	15	65	116
Peak Hour Factor	0.92	0.92	0.92	0.92	0.92	0.92	0.92	0.92	0.92	0.92	0.92	0.92
Percent Heavy Veh, %	0	0	0	1	1	1	0	0	0	0	0	0
Cap, veh/h	324	1072	97	63	618	25	80	764	647	32	714	597
Arrive On Green	0.18	0.32	0.32	0.04	0.18	0.18	0.04	0.40	0.40	0.02	0.38	0.38
Sat Flow, veh/h	1810	3346	303	1795	3509	141	1810	1900	1609	1810	1900	1589
Grp Volume(v), veh/h	279	470	481	37	164	172	55	187	152	15	65	116
Grp Sat Flow(s),veh/h/ln	1810	1805	1844	1795	1791	1859	1810	1900	1609	1810	1900	1589
Q Serve(g_s), s	12.0	19.2	19.2	1.6	6.7	6.7	2.4	5.2	5.0	0.7	1.8	3.9
Cycle Q Clear(g_c), s	12.0	19.2	19.2	1.6	6.7	6.7	2.4	5.2	5.0	0.7	1.8	3.9
Prop In Lane	1.00		0.16	1.00		0.08	1.00		1.00	1.00		1.00
Lane Grp Cap(c), veh/h	324	578	591	63	315	327	80	764	647	32	714	597
V/C Ratio(X)	0.86	0.81	0.81	0.59	0.52	0.52	0.69	0.24	0.24	0.47	0.09	0.19
Avail Cap(c_a), veh/h	441	713	729	132	403	418	124	764	647	113	714	597
HCM Platoon Ratio	1.00	1.00	1.00	1.00	1.00	1.00	1.00	1.00	1.00	1.00	1.00	1.00
Upstream Filter(I)	1.00	1.00	1.00	1.00	1.00	1.00	1.00	1.00	1.00	1.00	1.00	1.00
Uniform Delay (d), s/veh	31.9	25.0	25.0	38.0	29.9	29.9	37.7	15.9	15.8	38.9	16.1	16.8
Incr Delay (d2), s/veh	12.1	5.9	5.8	8.4	1.3	1.3	10.1	0.8	0.9	10.2	0.3	0.7
Initial Q Delay(d3),s/veh	0.0	0.0	0.0	0.0	0.0	0.0	0.0	0.0	0.0	0.0	0.0	0.0
%ile BackOfQ(50%),veh/ln	6.2	8.7	8.9	0.8	2.9	3.0	1.3	2.3	1.9	0.4	0.8	1.5
Unsig. Movement Delay, s/veh												
LnGrp Delay(d),s/veh	44.0	30.9	30.8	46.5	31.2	31.2	47.8	16.6	16.7	49.1	16.4	17.6
LnGrp LOS	D	C	C	D	C	C	D	B	B	D	B	B
Approach Vol, veh/h		1230			373			394			196	
Approach Delay, s/veh		33.8			32.7			21.0			19.6	
Approach LOS		C			C			C			B	
Timer - Assigned Phs	1	2	3	4	5	6	7	8				
Phs Duration (G+Y+Rc), s	5.9	36.7	7.3	30.1	8.0	34.5	18.8	18.6				
Change Period (Y+Rc), s	4.5	4.5	4.5	4.5	4.5	4.5	4.5	4.5				
Max Green Setting (Gmax), s	5.0	19.5	5.9	31.6	5.5	19.0	19.5	18.0				
Max Q Clear Time (g_c+1), s	12.5	7.2	3.6	21.2	4.4	5.9	14.0	8.7				
Green Ext Time (p_c), s	0.0	1.2	0.0	4.5	0.0	0.5	0.4	1.3				
Intersection Summary												
HCM 6th Ctrl Delay				30.1								
HCM 6th LOS				C								

Intersection												
Intersection Delay, s/veh	19.8											
Intersection LOS	C											

Movement	EBL	EBT	EBR	WBL	WBT	WBR	NBL	NBT	NBR	SBL	SBT	SBR
Lane Configurations	↶	↶↷		↶	↶↷		↶	↷		↶	↷	
Traffic Vol, veh/h	109	315	38	11	233	120	76	47	25	260	67	93
Future Vol, veh/h	109	315	38	11	233	120	76	47	25	260	67	93
Peak Hour Factor	0.92	0.92	0.92	0.92	0.92	0.92	0.92	0.92	0.92	0.92	0.92	0.92
Heavy Vehicles, %	4	4	4	5	5	5	0	0	0	0	0	0
Mvmt Flow	118	342	41	12	253	130	83	51	27	283	73	101
Number of Lanes	1	2	0	1	2	0	1	1	0	1	1	0

Approach	EB	WB	NB	SB
Opposing Approach	WB	EB	SB	NB
Opposing Lanes	3	3	2	2
Conflicting Approach Left	SB	NB	EB	WB
Conflicting Lanes Left	2	2	3	3
Conflicting Approach Right	NB	SB	WB	EB
Conflicting Lanes Right	2	2	3	3
HCM Control Delay	18.1	18.5	14.9	24.6
HCM LOS	C	C	B	C

Lane	NBLn1	NBLn2	EBLn1	EBLn2	EBLn3	WBLn1	WBLn2	WBLn3	SBLn1	SBLn2
Vol Left, %	100%	0%	100%	0%	0%	100%	0%	0%	100%	0%
Vol Thru, %	0%	65%	0%	100%	73%	0%	100%	39%	0%	42%
Vol Right, %	0%	35%	0%	0%	27%	0%	0%	61%	0%	58%
Sign Control	Stop	Stop	Stop	Stop	Stop	Stop	Stop	Stop	Stop	Stop
Traffic Vol by Lane	76	72	109	210	143	11	155	198	260	160
LT Vol	76	0	109	0	0	11	0	0	260	0
Through Vol	0	47	0	210	105	0	155	78	0	67
RT Vol	0	25	0	0	38	0	0	120	0	93
Lane Flow Rate	83	78	118	228	155	12	169	215	283	174
Geometry Grp	8	8	8	8	8	8	8	8	8	8
Degree of Util (X)	0.227	0.199	0.299	0.542	0.361	0.031	0.415	0.502	0.7	0.386
Departure Headway (Hd)	9.902	9.143	9.071	8.554	8.362	9.373	8.856	8.416	8.915	7.997
Convergence, Y/N	Yes	Yes	Yes	Yes	Yes	Yes	Yes	Yes	Yes	Yes
Cap	363	393	397	422	431	382	407	428	407	450
Service Time	7.657	6.898	6.815	6.299	6.106	7.122	6.604	6.165	6.66	5.742
HCM Lane V/C Ratio	0.229	0.198	0.297	0.54	0.36	0.031	0.415	0.502	0.695	0.387
HCM Control Delay	15.6	14.2	15.7	21	15.8	12.4	17.8	19.4	30.1	15.7
HCM Lane LOS	C	B	C	C	C	B	C	C	D	C
HCM 95th-tile Q	0.9	0.7	1.2	3.1	1.6	0.1	2	2.7	5.2	1.8

HCM 6th Signalized Intersection Summary
21: Granada Drive & Cleveland Avenue

Village D Specific Plan
Phase II WP MIT - AM Peak Hour



Movement	EBL	EBT	EBR	WBL	WBT	WBR	NBL	NBT	NBR	SBL	SBT	SBR
Lane Configurations												
Traffic Volume (veh/h)	29	901	28	191	287	25	26	391	323	11	261	5
Future Volume (veh/h)	29	901	28	191	287	25	26	391	323	11	261	5
Initial Q (Qb), veh	0	0	0	0	0	0	0	0	0	0	0	0
Ped-Bike Adj(A_pbT)	1.00		0.98	1.00		1.00	1.00		0.99	1.00		1.00
Parking Bus, Adj	1.00	1.00	1.00	1.00	1.00	1.00	1.00	1.00	1.00	1.00	1.00	1.00
Work Zone On Approach		No			No			No			No	
Adj Sat Flow, veh/h/ln	1885	1885	1885	1870	1870	1870	1900	1900	1900	1900	1900	1900
Adj Flow Rate, veh/h	32	979	30	208	312	27	28	425	351	12	284	5
Peak Hour Factor	0.92	0.92	0.92	0.92	0.92	0.92	0.92	0.92	0.92	0.92	0.92	0.92
Percent Heavy Veh, %	1	1	1	2	2	2	0	0	0	0	0	0
Cap, veh/h	55	1062	33	243	1342	115	51	664	555	26	639	540
Arrive On Green	0.03	0.30	0.30	0.14	0.41	0.41	0.03	0.35	0.35	0.01	0.34	0.34
Sat Flow, veh/h	1795	3545	109	1781	3310	285	1810	1900	1587	1810	1900	1607
Grp Volume(v), veh/h	32	495	514	208	167	172	28	425	351	12	284	5
Grp Sat Flow(s),veh/h/ln	1795	1791	1862	1781	1777	1818	1810	1900	1587	1810	1900	1607
Q Serve(g_s), s	1.6	24.1	24.1	10.3	5.5	5.6	1.4	16.9	16.6	0.6	10.5	0.2
Cycle Q Clear(g_c), s	1.6	24.1	24.1	10.3	5.5	5.6	1.4	16.9	16.6	0.6	10.5	0.2
Prop In Lane	1.00		0.06	1.00		0.16	1.00		1.00	1.00		1.00
Lane Grp Cap(c), veh/h	55	536	558	243	720	737	51	664	555	26	639	540
V/C Ratio(X)	0.58	0.92	0.92	0.86	0.23	0.23	0.55	0.64	0.63	0.46	0.44	0.01
Avail Cap(c_a), veh/h	116	547	569	267	720	737	113	664	555	101	639	540
HCM Platoon Ratio	1.00	1.00	1.00	1.00	1.00	1.00	1.00	1.00	1.00	1.00	1.00	1.00
Upstream Filter(I)	1.00	1.00	1.00	0.92	0.92	0.92	1.00	1.00	1.00	1.00	1.00	1.00
Uniform Delay (d), s/veh	43.1	30.5	30.5	38.0	17.6	17.6	43.2	24.5	24.4	44.0	23.3	19.9
Incr Delay (d2), s/veh	9.4	21.1	20.5	20.1	0.1	0.1	9.1	4.7	5.4	12.1	2.2	0.0
Initial Q Delay(d3),s/veh	0.0	0.0	0.0	0.0	0.0	0.0	0.0	0.0	0.0	0.0	0.0	0.0
%ile BackOfQ(50%),veh/ln	0.8	13.1	13.6	5.8	2.2	2.3	0.7	8.2	6.9	0.4	5.0	0.1
Unsig. Movement Delay, s/veh												
LnGrp Delay(d),s/veh	52.5	51.6	51.0	58.1	17.7	17.7	52.3	29.2	29.8	56.1	25.6	19.9
LnGrp LOS	D	D	D	E	B	B	D	C	C	E	C	B
Approach Vol, veh/h		1041			547			804			301	
Approach Delay, s/veh		51.3			33.1			30.3			26.7	
Approach LOS		D			C			C			C	
Timer - Assigned Phs	1	2	3	4	5	6	7	8				
Phs Duration (G+Y+Rc), s	5.8	36.0	16.8	31.5	7.0	34.7	7.3	41.0				
Change Period (Y+Rc), s	4.5	4.5	4.5	4.5	4.5	4.5	4.5	4.5				
Max Green Setting (Gmax), s	5.0	26.0	13.5	27.5	5.6	25.4	5.8	35.2				
Max Q Clear Time (g_c+I1), s	2.6	18.9	12.3	26.1	3.4	12.5	3.6	7.6				
Green Ext Time (p_c), s	0.0	2.4	0.1	0.9	0.0	1.3	0.0	2.0				
Intersection Summary												
HCM 6th Ctrl Delay				38.6								
HCM 6th LOS				D								

HCM 6th Signalized Intersection Summary
22: Granada Drive & Sunset Avenue

Village D Specific Plan
Phase II WP MIT - AM Peak Hour



Movement	EBL	EBT	EBR	WBL	WBT	WBR	NBL	NBT	NBR	SBL	SBT	SBR
Lane Configurations												
Traffic Volume (veh/h)	65	268	72	26	110	66	48	242	25	131	285	50
Future Volume (veh/h)	65	268	72	26	110	66	48	242	25	131	285	50
Initial Q (Qb), veh	0	0	0	0	0	0	0	0	0	0	0	0
Ped-Bike Adj(A_pbT)	1.00		1.00	1.00		1.00	1.00		0.99	1.00		0.97
Parking Bus, Adj	1.00	1.00	1.00	1.00	1.00	1.00	1.00	1.00	1.00	1.00	1.00	1.00
Work Zone On Approach		No			No			No			No	
Adj Sat Flow, veh/h/ln	1870	1870	1870	1811	1811	1811	1870	1870	1870	1870	1870	1870
Adj Flow Rate, veh/h	71	291	78	28	120	72	52	263	27	142	310	54
Peak Hour Factor	0.92	0.92	0.92	0.92	0.92	0.92	0.92	0.92	0.92	0.92	0.92	0.92
Percent Heavy Veh, %	2	2	2	6	6	6	2	2	2	2	2	2
Cap, veh/h	99	338	91	53	385	326	83	605	62	164	630	110
Arrive On Green	0.06	0.24	0.24	0.03	0.21	0.21	0.05	0.36	0.36	0.09	0.41	0.41
Sat Flow, veh/h	1781	1421	381	1725	1811	1535	1781	1667	171	1781	1545	269
Grp Volume(v), veh/h	71	0	369	28	120	72	52	0	290	142	0	364
Grp Sat Flow(s),veh/h/ln	1781	0	1802	1725	1811	1535	1781	0	1838	1781	0	1814
Q Serve(g_s), s	2.5	0.0	12.8	1.0	3.6	2.5	1.9	0.0	7.8	5.1	0.0	9.7
Cycle Q Clear(g_c), s	2.5	0.0	12.8	1.0	3.6	2.5	1.9	0.0	7.8	5.1	0.0	9.7
Prop In Lane	1.00		0.21	1.00		1.00	1.00		0.09	1.00		0.15
Lane Grp Cap(c), veh/h	99	0	428	53	385	326	83	0	667	164	0	740
V/C Ratio(X)	0.72	0.00	0.86	0.53	0.31	0.22	0.62	0.00	0.44	0.86	0.00	0.49
Avail Cap(c_a), veh/h	137	0	499	133	502	425	137	0	667	164	0	740
HCM Platoon Ratio	1.00	1.00	1.00	1.00	1.00	1.00	1.00	1.00	1.00	1.00	1.00	1.00
Upstream Filter(I)	1.00	0.00	1.00	0.98	0.98	0.98	1.00	0.00	1.00	1.00	0.00	1.00
Uniform Delay (d), s/veh	30.2	0.0	23.8	31.1	21.6	21.1	30.4	0.0	15.7	29.1	0.0	14.2
Incr Delay (d2), s/veh	10.4	0.0	12.8	7.9	0.4	0.3	7.4	0.0	2.1	34.8	0.0	2.3
Initial Q Delay(d3),s/veh	0.0	0.0	0.0	0.0	0.0	0.0	0.0	0.0	0.0	0.0	0.0	0.0
%ile BackOfQ(50%),veh/ln	3	0.0	6.6	0.5	1.5	0.9	0.9	0.0	3.4	3.7	0.0	4.0
Unsig. Movement Delay, s/veh												
LnGrp Delay(d),s/veh	40.6	0.0	36.6	39.0	22.0	21.5	37.8	0.0	17.7	63.9	0.0	16.6
LnGrp LOS	D	A	D	D	C	C	D	A	B	E	A	B
Approach Vol, veh/h		440			220			342			506	
Approach Delay, s/veh		37.2			24.0			20.8			29.9	
Approach LOS		D			C			C			C	
Timer - Assigned Phs	1	2	3	4	5	6	7	8				
Phs Duration (G+Y+Rc), s	10.5	28.1	6.5	19.9	7.5	31.0	8.1	18.3				
Change Period (Y+Rc), s	4.5	4.5	4.5	4.5	4.5	4.5	4.5	4.5				
Max Green Setting (Gmax), s	18.0	18.0	5.0	18.0	5.0	19.0	5.0	18.0				
Max Q Clear Time (g_c+1T), s	9.8	9.8	3.0	14.8	3.9	11.7	4.5	5.6				
Green Ext Time (p_c), s	0.0	1.0	0.0	0.7	0.0	1.3	0.0	0.6				
Intersection Summary												
HCM 6th Ctrl Delay											29.1	
HCM 6th LOS											C	

HCM 6th Signalized Intersection Summary
 25: Kennedy Street/Gateway Drive & SR-99 Southbound Ramps

Village D Specific Plan
 Phase II WP MIT - AM Peak Hour

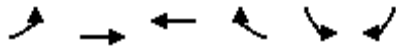

Movement	EBL	EBT	WBT	WBR	SBL	SBR
Lane Configurations	↶	↷	↶		↶	↷
Traffic Volume (veh/h)	316	259	400	3	66	160
Future Volume (veh/h)	316	259	400	3	66	160
Initial Q (Qb), veh	0	0	0	0	0	0
Ped-Bike Adj(A_pbT)	1.00			1.00	1.00	1.00
Parking Bus, Adj	1.00	1.00	1.00	1.00	1.00	1.00
Work Zone On Approach		No	No		No	
Adj Sat Flow, veh/h/ln	1870	1870	1811	1811	1856	1856
Adj Flow Rate, veh/h	343	282	435	0	72	174
Peak Hour Factor	0.92	0.92	0.92	0.92	0.92	0.92
Percent Heavy Veh, %	2	2	6	6	3	3
Cap, veh/h	387	1021	493		604	879
Arrive On Green	0.22	0.55	0.27	0.00	0.34	0.34
Sat Flow, veh/h	1781	1870	1811	0	1767	1572
Grp Volume(v), veh/h	343	282	435	0	72	174
Grp Sat Flow(s),veh/h/ln	1781	1870	1811	0	1767	1572
Q Serve(g_s), s	14.9	6.4	18.4	0.0	2.2	4.4
Cycle Q Clear(g_c), s	14.9	6.4	18.4	0.0	2.2	4.4
Prop In Lane	1.00			0.00	1.00	1.00
Lane Grp Cap(c), veh/h	387	1021	493		604	879
V/C Ratio(X)	0.89	0.28	0.88		0.12	0.20
Avail Cap(c_a), veh/h	479	1227	600		604	879
HCM Platoon Ratio	1.00	1.00	1.00	1.00	1.00	1.00
Upstream Filter(I)	1.00	1.00	1.00	0.00	1.00	1.00
Uniform Delay (d), s/veh	30.3	9.7	27.9	0.0	18.1	8.7
Incr Delay (d2), s/veh	15.4	0.1	12.6	0.0	0.4	0.5
Initial Q Delay(d3),s/veh	0.0	0.0	0.0	0.0	0.0	0.0
%ile BackOfQ(50%),veh/ln	7.8	2.4	9.3	0.0	0.9	5.7
Unsig. Movement Delay, s/veh						
LnGrp Delay(d),s/veh	45.7	9.9	40.4	0.0	18.5	9.3
LnGrp LOS	D	A	D		B	A
Approach Vol, veh/h		625	435	A	246	
Approach Delay, s/veh		29.5	40.4		12.0	
Approach LOS		C	D		B	
Timer - Assigned Phs			4		6	7 8
Phs Duration (G+Y+Rc), s			48.2		31.8	21.9 26.3
Change Period (Y+Rc), s			4.5		4.5	4.5 4.5
Max Green Setting (Gmax), s			52.5		18.5	21.5 26.5
Max Q Clear Time (g_c+I1), s			8.4		6.4	16.9 20.4
Green Ext Time (p_c), s			1.8		0.6	0.5 1.4
Intersection Summary						
HCM 6th Ctrl Delay			29.9			
HCM 6th LOS			C			

Notes

Unsignalized Delay for [WBR] is excluded from calculations of the approach delay and intersection delay.

HCM 6th Signalized Intersection Summary
 31: SR-99 Southbound Ramps & Cleveland Avenue

Village D Specific Plan
 Phase II WP MIT - AM Peak Hour



Movement	EBL	EBT	EBR	WBL	WBT	WBR	NBL	NBT	NBR	SBL	SBT	SBR
Lane Configurations		↑↑	↑	↑	↑↑					↑		↑
Traffic Volume (veh/h)	0	701	816	364	885	0	0	0	0	200	0	96
Future Volume (veh/h)	0	701	816	364	885	0	0	0	0	200	0	96
Initial Q (Qb), veh	0	0	0	0	0	0				0	0	0
Ped-Bike Adj(A_pbT)	1.00		1.00	1.00		1.00				1.00		1.00
Parking Bus, Adj	1.00	1.00	1.00	1.00	1.00	1.00				1.00	1.00	1.00
Work Zone On Approach		No			No						No	
Adj Sat Flow, veh/h/ln	0	1856	1856	1856	1856	0				1796	0	1796
Adj Flow Rate, veh/h	0	762	887	396	962	0				217	0	104
Peak Hour Factor	0.92	0.92	0.92	0.92	0.92	0.92				0.92	0.92	0.92
Percent Heavy Veh, %	0	3	3	3	3	0				7	0	7
Cap, veh/h	0	1428	637	428	2441	0				372	0	331
Arrive On Green	0.00	0.41	0.41	0.24	0.69	0.00				0.22	0.00	0.22
Sat Flow, veh/h	0	3618	1572	1767	3618	0				1711	0	1522
Grp Volume(v), veh/h	0	762	887	396	962	0				217	0	104
Grp Sat Flow(s),veh/h/ln	0	1763	1572	1767	1763	0				1711	0	1522
Q Serve(g_s), s	0.0	16.4	40.5	21.9	11.5	0.0				11.4	0.0	5.7
Cycle Q Clear(g_c), s	0.0	16.4	40.5	21.9	11.5	0.0				11.4	0.0	5.7
Prop In Lane	0.00		1.00	1.00		0.00				1.00		1.00
Lane Grp Cap(c), veh/h	0	1428	637	428	2441	0				372	0	331
V/C Ratio(X)	0.00	0.53	1.39	0.92	0.39	0.00				0.58	0.00	0.31
Avail Cap(c_a), veh/h	0	1428	637	468	2521	0				372	0	331
HCM Platoon Ratio	1.00	1.00	1.00	1.00	1.00	1.00				1.00	1.00	1.00
Upstream Filter(I)	0.00	0.56	0.56	0.68	0.68	0.00				1.00	0.00	1.00
Uniform Delay (d), s/veh	0.0	22.6	29.8	37.0	6.5	0.0				35.1	0.0	32.9
Incr Delay (d2), s/veh	0.0	0.2	182.2	17.5	0.1	0.0				2.3	0.0	0.5
Initial Q Delay(d3),s/veh	0.0	0.0	0.0	0.0	0.0	0.0				0.0	0.0	0.0
%ile BackOfQ(50%),veh/ln	0.0	6.7	46.8	11.3	3.8	0.0				4.9	0.0	2.2
Unsig. Movement Delay, s/veh												
LnGrp Delay(d),s/veh	0.0	22.8	211.9	54.4	6.6	0.0				37.4	0.0	33.4
LnGrp LOS	A	C	F	D	A	A				D	A	C
Approach Vol, veh/h		1649			1358						321	
Approach Delay, s/veh		124.5			20.5						36.1	
Approach LOS		F			C						D	
Timer - Assigned Phs			3	4		6		8				
Phs Duration (G+Y+Rc), s			28.7	45.0		26.3		73.7				
Change Period (Y+Rc), s			4.5	4.5		4.5		4.5				
Max Green Setting (Gmax), s			26.5	40.5		19.5		71.5				
Max Q Clear Time (g_c+I1), s			23.9	42.5		13.4		13.5				
Green Ext Time (p_c), s			0.4	0.0		0.5		9.0				
Intersection Summary												
HCM 6th Ctrl Delay			73.6									
HCM 6th LOS			E									

HCM 6th Signalized Intersection Summary
 38: I Street & 2nd Street/SR-99 Southbound Off-Ramp

Village D Specific Plan
 Phase II WP MIT - AM Peak Hour



Movement	EBL	EBT	EBR	WBL	WBT	WBR	NBL	NBT	NBR	SBL	SBT	SBR
Lane Configurations		↕			↕	↕	↕	↕			↕	
Traffic Volume (veh/h)	2	0	63	493	20	11	21	87	0	0	148	3
Future Volume (veh/h)	2	0	63	493	20	11	21	87	0	0	148	3
Initial Q (Qb), veh	0	0	0	0	0	0	0	0	0	0	0	0
Ped-Bike Adj(A_pbT)	1.00		0.99	1.00		0.98	1.00		1.00	1.00		1.00
Parking Bus, Adj	1.00	1.00	1.00	1.00	1.00	1.00	1.00	1.00	1.00	1.00	1.00	1.00
Work Zone On Approach		No			No			No			No	
Adj Sat Flow, veh/h/ln	1900	1900	1900	1856	1856	1856	1841	1841	0	0	1885	1885
Adj Flow Rate, veh/h	2	0	68	536	22	12	23	95	0	0	161	3
Peak Hour Factor	0.92	0.92	0.92	0.92	0.92	0.92	0.92	0.92	0.92	0.92	0.92	0.92
Percent Heavy Veh, %	0	0	0	3	3	3	4	4	0	0	1	1
Cap, veh/h	3	0	90	587	24	530	539	789	0	0	790	15
Arrive On Green	0.06	0.00	0.06	0.35	0.35	0.35	0.43	0.43	0.00	0.00	0.43	0.43
Sat Flow, veh/h	46	0	1557	1701	70	1535	1202	1841	0	0	1845	34
Grp Volume(v), veh/h	70	0	0	558	0	12	23	95	0	0	0	164
Grp Sat Flow(s),veh/h/ln1603	0	0	0	1771	0	1535	1202	1841	0	0	0	1879
Q Serve(g_s), s	3.4	0.0	0.0	24.1	0.0	0.4	1.0	2.5	0.0	0.0	0.0	4.4
Cycle Q Clear(g_c), s	3.4	0.0	0.0	24.1	0.0	0.4	5.3	2.5	0.0	0.0	0.0	4.4
Prop In Lane	0.03		0.97	0.96		1.00	1.00		0.00	0.00		0.02
Lane Grp Cap(c), veh/h	93	0	0	611	0	530	539	789	0	0	0	805
V/C Ratio(X)	0.76	0.00	0.00	0.91	0.00	0.02	0.04	0.12	0.00	0.00	0.00	0.20
Avail Cap(c_a), veh/h	361	0	0	675	0	585	539	789	0	0	0	805
HCM Platoon Ratio	1.00	1.00	1.00	1.00	1.00	1.00	1.00	1.00	1.00	1.00	1.00	1.00
Upstream Filter(I)	1.00	0.00	0.00	1.00	0.00	1.00	0.99	0.99	0.00	0.00	0.00	1.00
Uniform Delay (d), s/veh	37.1	0.0	0.0	25.0	0.0	17.3	16.0	13.8	0.0	0.0	0.0	14.3
Incr Delay (d2), s/veh	11.8	0.0	0.0	16.0	0.0	0.0	0.1	0.3	0.0	0.0	0.0	0.6
Initial Q Delay(d3),s/veh	0.0	0.0	0.0	0.0	0.0	0.0	0.0	0.0	0.0	0.0	0.0	0.0
%ile BackOfQ(50%),veh/ln1.6	0.0	0.0	0.0	12.2	0.0	0.1	0.3	1.1	0.0	0.0	0.0	1.9
Unsig. Movement Delay, s/veh												
LnGrp Delay(d),s/veh	48.9	0.0	0.0	41.0	0.0	17.3	16.1	14.1	0.0	0.0	0.0	14.9
LnGrp LOS	D	A	A	D	A	B	B	B	A	A	A	B
Approach Vol, veh/h		70			570			118			164	
Approach Delay, s/veh		48.9			40.5			14.5			14.9	
Approach LOS		D			D			B			B	
Timer - Assigned Phs		2		4		6		8				
Phs Duration (G+Y+Rc), s		38.8		9.1		38.8		32.1				
Change Period (Y+Rc), s		4.5		4.5		4.5		4.5				
Max Green Setting (Gmax), s		18.0		18.0		18.0		30.5				
Max Q Clear Time (g_c+11), s		7.3		5.4		6.4		26.1				
Green Ext Time (p_c), s		0.3		0.2		0.6		1.5				
Intersection Summary												
HCM 6th Ctrl Delay				33.3								
HCM 6th LOS				C								

HCM 6th Signalized Intersection Summary
 49: Yosemite Avenue & Cleveland Avenue/Tozer Street

Village D Specific Plan
 Phase II WP MIT - AM Peak Hour



Movement	EBL	EBT	EBR	WBL	WBT	WBR	NBL	NBT	NBR	SBL	SBT	SBR
Lane Configurations												
Traffic Volume (veh/h)	284	535	256	114	334	54	138	126	77	73	256	239
Future Volume (veh/h)	284	535	256	114	334	54	138	126	77	73	256	239
Initial Q (Qb), veh	0	0	0	0	0	0	0	0	0	0	0	0
Ped-Bike Adj(A_pbT)	1.00		0.93	1.00		0.93	1.00		1.00	1.00		1.00
Parking Bus, Adj	1.00	1.00	1.00	1.00	1.00	1.00	1.00	1.00	1.00	1.00	1.00	1.00
Work Zone On Approach		No			No			No			No	
Adj Sat Flow, veh/h/ln	1856	1856	1856	1841	1841	1841	1856	1856	1856	1870	1870	1870
Adj Flow Rate, veh/h	309	582	278	124	363	59	150	137	84	79	278	260
Peak Hour Factor	0.92	0.92	0.92	0.92	0.92	0.92	0.92	0.92	0.92	0.92	0.92	0.92
Percent Heavy Veh, %	3	3	3	4	4	4	3	3	3	2	2	2
Cap, veh/h	351	857	409	156	946	391	185	450	380	102	366	623
Arrive On Green	0.20	0.38	0.38	0.09	0.27	0.27	0.10	0.24	0.24	0.06	0.20	0.20
Sat Flow, veh/h	1767	2252	1074	1753	3497	1445	1767	1856	1567	1781	1870	1578
Grp Volume(v), veh/h	309	455	405	124	363	59	150	137	84	79	278	260
Grp Sat Flow(s),veh/h/ln	1767	1763	1563	1753	1749	1445	1767	1856	1567	1781	1870	1578
Q Serve(g_s), s	13.3	16.8	16.9	5.4	6.6	2.4	6.5	4.7	3.3	3.4	11.0	9.3
Cycle Q Clear(g_c), s	13.3	16.8	16.9	5.4	6.6	2.4	6.5	4.7	3.3	3.4	11.0	9.3
Prop In Lane	1.00		0.69	1.00		1.00	1.00		1.00	1.00		1.00
Lane Grp Cap(c), veh/h	351	671	595	156	946	391	185	450	380	102	366	623
V/C Ratio(X)	0.88	0.68	0.68	0.80	0.38	0.15	0.81	0.30	0.22	0.77	0.76	0.42
Avail Cap(c_a), veh/h	410	671	595	182	946	391	197	592	500	212	611	831
HCM Platoon Ratio	1.00	1.00	1.00	1.00	1.00	1.00	1.00	1.00	1.00	1.00	1.00	1.00
Upstream Filter(I)	1.00	1.00	1.00	1.00	1.00	1.00	1.00	1.00	1.00	1.00	1.00	1.00
Uniform Delay (d), s/veh	30.4	20.2	20.2	34.9	23.2	21.6	34.2	24.2	23.6	36.3	29.7	17.1
Incr Delay (d2), s/veh	17.4	5.5	6.2	18.8	1.2	0.8	21.0	0.4	0.3	11.7	3.3	0.4
Initial Q Delay(d3),s/veh	0.0	0.0	0.0	0.0	0.0	0.0	0.0	0.0	0.0	0.0	0.0	0.0
%ile BackOfQ(50%),veh/ln	7.1	7.5	6.8	3.1	2.8	0.9	3.8	2.0	1.2	1.8	5.1	3.3
Unsig. Movement Delay, s/veh												
LnGrp Delay(d),s/veh	47.8	25.7	26.4	53.7	24.3	22.5	55.2	24.5	23.9	47.9	32.9	17.6
LnGrp LOS	D	C	C	D	C	C	E	C	C	D	C	B
Approach Vol, veh/h		1169			546			371			617	
Approach Delay, s/veh		31.8			30.8			36.8			28.4	
Approach LOS		C			C			D			C	
Timer - Assigned Phs	1	2	3	4	5	6	7	8				
Phs Duration (G+Y+Rc), s	20.0	25.6	9.0	23.4	11.4	34.2	12.7	19.8				
Change Period (Y+Rc), s	4.5	4.5	4.5	4.5	4.5	4.5	4.5	4.5				
Max Green Setting (Gmax), s	18.1	19.7	9.3	24.9	8.1	29.7	8.7	25.5				
Max Q Clear Time (g_c+I1), s	15.3	8.6	5.4	6.7	7.4	18.9	8.5	13.0				
Green Ext Time (p_c), s	0.3	1.9	0.0	0.9	0.0	4.3	0.0	2.1				

Intersection Summary												
HCM 6th Ctrl Delay				31.5								
HCM 6th LOS				C								

HCM 6th Signalized Intersection Summary
51: Project Driveway 1 & Avenue 17

Village D Specific Plan
Phase II WP MIT - AM Peak Hour



Movement	EBT	EBR	WBL	WBT	NBL	NBR
Lane Configurations	↩		↩	↩	↩	↩
Traffic Volume (veh/h)	66	16	174	72	56	646
Future Volume (veh/h)	66	16	174	72	56	646
Initial Q (Qb), veh	0	0	0	0	0	0
Ped-Bike Adj(A_pbT)		1.00	1.00		1.00	1.00
Parking Bus, Adj	1.00	1.00	1.00	1.00	1.00	1.00
Work Zone On Approach	No			No	No	
Adj Sat Flow, veh/h/ln	1781	1781	1870	1870	1900	1900
Adj Flow Rate, veh/h	72	17	189	78	61	702
Peak Hour Factor	0.92	0.92	0.92	0.92	0.92	0.92
Percent Heavy Veh, %	8	8	2	2	0	0
Cap, veh/h	107	25	230	490	1131	1007
Arrive On Green	0.08	0.08	0.13	0.26	0.63	0.63
Sat Flow, veh/h	1393	329	1781	1870	1810	1610
Grp Volume(v), veh/h	0	89	189	78	61	702
Grp Sat Flow(s),veh/h/ln	0	1722	1781	1870	1810	1610
Q Serve(g_s), s	0.0	4.0	8.3	2.6	1.0	23.2
Cycle Q Clear(g_c), s	0.0	4.0	8.3	2.6	1.0	23.2
Prop In Lane		0.19	1.00		1.00	1.00
Lane Grp Cap(c), veh/h	0	132	230	490	1131	1007
V/C Ratio(X)	0.00	0.67	0.82	0.16	0.05	0.70
Avail Cap(c_a), veh/h	0	388	345	888	1131	1007
HCM Platoon Ratio	1.00	1.00	1.00	1.00	1.00	1.00
Upstream Filter(I)	0.00	1.00	0.97	0.97	1.00	1.00
Uniform Delay (d), s/veh	0.0	36.0	33.9	22.7	5.8	10.0
Incr Delay (d2), s/veh	0.0	5.8	9.1	0.1	0.1	4.0
Initial Q Delay(d3),s/veh	0.0	0.0	0.0	0.0	0.0	0.0
%ile BackOfQ(50%),veh/ln	0.0	1.9	4.1	1.1	0.4	7.9
Unsig. Movement Delay, s/veh						
LnGrp Delay(d),s/veh	0.0	41.8	43.0	22.9	5.9	14.0
LnGrp LOS	A	D	D	C	A	B
Approach Vol, veh/h	89			267	763	
Approach Delay, s/veh	41.8			37.1	13.3	
Approach LOS	D			D	B	
Timer - Assigned Phs		2	3	4		8
Phs Duration (G+Y+Rc), s		54.5	14.8	10.6		25.5
Change Period (Y+Rc), s		4.5	4.5	4.5		4.5
Max Green Setting (Gmax), s		33.0	15.5	18.0		38.0
Max Q Clear Time (g_c+I1), s		25.2	10.3	6.0		4.6
Green Ext Time (p_c), s		2.1	0.2	0.3		0.4
Intersection Summary						
HCM 6th Ctrl Delay			21.3			
HCM 6th LOS			C			

HCM 6th Signalized Intersection Summary
55: Road 23 & Project Driveway 3

Village D Specific Plan
Phase II WP MIT - AM Peak Hour



Movement	EBL	EBR	NBL	NBT	SBT	SBR
Lane Configurations						
Traffic Volume (veh/h)	820	262	229	789	566	348
Future Volume (veh/h)	820	262	229	789	566	348
Initial Q (Qb), veh	0	0	0	0	0	0
Ped-Bike Adj(A_pbT)	1.00	1.00	1.00			1.00
Parking Bus, Adj	1.00	1.00	1.00	1.00	1.00	1.00
Work Zone On Approach	No			No	No	
Adj Sat Flow, veh/h/ln	1900	1900	1826	1826	1811	1811
Adj Flow Rate, veh/h	891	285	249	858	615	378
Peak Hour Factor	0.92	0.92	0.92	0.92	0.92	0.92
Percent Heavy Veh, %	0	0	5	5	6	6
Cap, veh/h	895	796	261	1407	707	315
Arrive On Green	0.49	0.49	0.15	0.41	0.21	0.21
Sat Flow, veh/h	1810	1610	1739	3561	3532	1535
Grp Volume(v), veh/h	891	285	249	858	615	378
Grp Sat Flow(s),veh/h/ln	1810	1610	1739	1735	1721	1535
Q Serve(g_s), s	44.1	9.8	12.8	17.6	15.6	18.5
Cycle Q Clear(g_c), s	44.1	9.8	12.8	17.6	15.6	18.5
Prop In Lane	1.00	1.00	1.00			1.00
Lane Grp Cap(c), veh/h	895	796	261	1407	707	315
V/C Ratio(X)	1.00	0.36	0.95	0.61	0.87	1.20
Avail Cap(c_a), veh/h	895	796	261	1407	707	315
HCM Platoon Ratio	1.00	1.00	1.00	1.00	1.00	1.00
Upstream Filter(I)	1.00	1.00	0.78	0.78	0.82	0.82
Uniform Delay (d), s/veh	22.7	14.0	37.9	21.1	34.6	35.8
Incr Delay (d2), s/veh	29.0	0.3	37.2	1.5	11.6	111.7
Initial Q Delay(d3),s/veh	0.0	0.0	0.0	0.0	0.0	0.0
%ile BackOfQ(50%),veh/ln	24.3	10.8	8.0	7.1	7.5	16.5
Unsig. Movement Delay, s/veh						
LnGrp Delay(d),s/veh	51.7	14.2	75.2	22.7	46.2	147.5
LnGrp LOS	D	B	E	C	D	F
Approach Vol, veh/h	1176			1107	993	
Approach Delay, s/veh	42.6			34.5	84.7	
Approach LOS	D			C	F	
Timer - Assigned Phs		2		4	5	6
Phs Duration (G+Y+Rc), s		41.0		49.0	18.0	23.0
Change Period (Y+Rc), s		4.5		4.5	4.5	4.5
Max Green Setting (Gmax), s		36.5		44.5	13.5	18.5
Max Q Clear Time (g_c+I1), s		19.6		46.1	14.8	20.5
Green Ext Time (p_c), s		5.7		0.0	0.0	0.0
Intersection Summary						
HCM 6th Ctrl Delay			52.6			
HCM 6th LOS			D			

HCM 6th Signalized Intersection Summary
56: Road 23 & Project Driveway 4

Village D Specific Plan
Phase II WP MIT - AM Peak Hour



Movement	WBL	WBR	NBT	NBR	SBL	SBT
Lane Configurations						
Traffic Volume (veh/h)	80	545	396	110	428	603
Future Volume (veh/h)	80	545	396	110	428	603
Initial Q (Qb), veh	0	0	0	0	0	0
Ped-Bike Adj(A_pbT)	1.00	1.00		1.00	1.00	
Parking Bus, Adj	1.00	1.00	1.00	1.00	1.00	1.00
Work Zone On Approach	No		No		No	
Adj Sat Flow, veh/h/ln	1900	1900	1767	1767	1841	1841
Adj Flow Rate, veh/h	87	592	430	120	465	655
Peak Hour Factor	0.92	0.92	0.92	0.92	0.92	0.92
Percent Heavy Veh, %	0	0	9	9	4	4
Cap, veh/h	429	673	2350	730	554	3456
Arrive On Green	0.24	0.24	0.49	0.49	0.16	0.69
Sat Flow, veh/h	1810	2834	4982	1497	3401	5191
Grp Volume(v), veh/h	87	592	430	120	465	655
Grp Sat Flow(s),veh/h/ln	1810	1417	1608	1497	1700	1675
Q Serve(g_s), s	4.6	24.2	6.0	5.4	15.9	5.6
Cycle Q Clear(g_c), s	4.6	24.2	6.0	5.4	15.9	5.6
Prop In Lane	1.00	1.00		1.00	1.00	
Lane Grp Cap(c), veh/h	429	673	2350	730	554	3456
V/C Ratio(X)	0.20	0.88	0.18	0.16	0.84	0.19
Avail Cap(c_a), veh/h	581	909	2350	730	1063	3456
HCM Platoon Ratio	1.00	1.00	1.00	1.00	1.00	1.00
Upstream Filter(I)	1.00	1.00	1.00	1.00	0.79	0.79
Uniform Delay (d), s/veh	36.7	44.1	17.3	17.1	48.7	6.7
Incr Delay (d2), s/veh	0.2	7.8	0.2	0.5	2.8	0.1
Initial Q Delay(d3),s/veh	0.0	0.0	0.0	0.0	0.0	0.0
%ile BackOfQ(50%),veh/ln	2.1	9.2	2.3	2.0	7.0	1.9
Unsig. Movement Delay, s/veh						
LnGrp Delay(d),s/veh	36.9	51.9	17.5	17.6	51.5	6.8
LnGrp LOS	D	D	B	B	D	A
Approach Vol, veh/h	679		550			1120
Approach Delay, s/veh	50.0		17.5			25.4
Approach LOS	D		B			C
Timer - Assigned Phs	1	2			6	8
Phs Duration (G+Y+Rc), s	34.0	63.0			87.0	33.0
Change Period (Y+Rc), s	4.5	4.5			4.5	4.5
Max Green Setting (Gmax), s	37.5	30.5			72.5	38.5
Max Q Clear Time (g_c+M), s	17.9	8.0			7.6	26.2
Green Ext Time (p_c), s	1.6	3.4			5.4	2.3
Intersection Summary						
HCM 6th Ctrl Delay			30.6			
HCM 6th LOS			C			

Intersection						
Int Delay, s/veh	0					
Movement	EBL	EBR	NBL	NBT	SBT	SBR
Lane Configurations	↘↗		↘	↑↑↑	↑↑↑	
Traffic Vol, veh/h	0	1	1	506	1188	0
Future Vol, veh/h	0	1	1	506	1188	0
Conflicting Peds, #/hr	0	0	0	0	0	0
Sign Control	Stop	Stop	Free	Free	Free	Free
RT Channelized	-	None	-	None	-	None
Storage Length	0	-	50	-	-	-
Veh in Median Storage, #	0	-	-	0	0	-
Grade, %	0	-	-	0	0	-
Peak Hour Factor	92	92	92	92	92	92
Heavy Vehicles, %	0	0	9	9	10	10
Mvmt Flow	0	1	1	550	1291	0

Major/Minor	Minor2	Major1	Major2			
Conflicting Flow All	1513	646	1291	0	-	0
Stage 1	1291	-	-	-	-	-
Stage 2	222	-	-	-	-	-
Critical Hdwy	5.7	7.1	5.48	-	-	-
Critical Hdwy Stg 1	6.6	-	-	-	-	-
Critical Hdwy Stg 2	6	-	-	-	-	-
Follow-up Hdwy	3.8	3.9	3.19	-	-	-
Pot Cap-1 Maneuver	173	359	265	-	-	-
Stage 1	163	-	-	-	-	-
Stage 2	734	-	-	-	-	-
Platoon blocked, %				-	-	-
Mov Cap-1 Maneuver	172	359	265	-	-	-
Mov Cap-2 Maneuver	172	-	-	-	-	-
Stage 1	162	-	-	-	-	-
Stage 2	734	-	-	-	-	-

Approach	EB	NB	SB
HCM Control Delay, s	15.1	0	0
HCM LOS	C		

Minor Lane/Major Mvmt	NBL	NBT	EBLn1	SBT	SBR
Capacity (veh/h)	265	-	359	-	-
HCM Lane V/C Ratio	0.004	-	0.003	-	-
HCM Control Delay (s)	18.6	-	15.1	-	-
HCM Lane LOS	C	-	C	-	-
HCM 95th %tile Q(veh)	0	-	0	-	-

HCM 6th Signalized Intersection Summary
58: Project Driveway 6 & Cleveland Avenue

Village D Specific Plan
Phase II WP MIT - AM Peak Hour

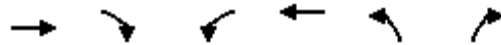

Movement	EBT	EBR	WBL	WBT	NBL	NBR
Lane Configurations	↩		↩	↩	↩	↩
Traffic Volume (veh/h)	905	80	154	323	199	292
Future Volume (veh/h)	905	80	154	323	199	292
Initial Q (Qb), veh	0	0	0	0	0	0
Ped-Bike Adj(A_pbT)		1.00	1.00		1.00	1.00
Parking Bus, Adj	1.00	1.00	1.00	1.00	1.00	1.00
Work Zone On Approach	No			No	No	
Adj Sat Flow, veh/h/ln	1885	1885	1885	1885	1900	1900
Adj Flow Rate, veh/h	984	87	167	351	216	317
Peak Hour Factor	0.92	0.92	0.92	0.92	0.92	0.92
Percent Heavy Veh, %	1	1	1	1	0	0
Cap, veh/h	965	85	189	1348	353	314
Arrive On Green	0.56	0.56	0.10	0.71	0.19	0.19
Sat Flow, veh/h	1707	151	1795	1885	1810	1610
Grp Volume(v), veh/h	0	1071	167	351	216	317
Grp Sat Flow(s),veh/h/ln	0	1858	1795	1885	1810	1610
Q Serve(g_s), s	0.0	56.5	9.2	6.5	10.9	19.5
Cycle Q Clear(g_c), s	0.0	56.5	9.2	6.5	10.9	19.5
Prop In Lane		0.08	1.00		1.00	1.00
Lane Grp Cap(c), veh/h	0	1050	189	1348	353	314
V/C Ratio(X)	0.00	1.02	0.89	0.26	0.61	1.01
Avail Cap(c_a), veh/h	0	1050	189	1348	353	314
HCM Platoon Ratio	1.00	1.00	1.00	1.00	1.00	1.00
Upstream Filter(I)	0.00	0.86	1.00	1.00	1.00	1.00
Uniform Delay (d), s/veh	0.0	21.8	44.2	5.0	36.8	40.2
Incr Delay (d2), s/veh	0.0	31.0	35.8	0.1	7.7	53.2
Initial Q Delay(d3),s/veh	0.0	0.0	0.0	0.0	0.0	0.0
%ile BackOfQ(50%),veh/ln	0.0	31.2	5.9	2.2	5.5	12.2
Unsig. Movement Delay, s/veh						
LnGrp Delay(d),s/veh	0.0	52.7	80.0	5.1	44.5	93.5
LnGrp LOS	A	F	E	A	D	F
Approach Vol, veh/h	1071			518	533	
Approach Delay, s/veh	52.7			29.2	73.6	
Approach LOS	D			C	E	
Timer - Assigned Phs		2	3	4		8
Phs Duration (G+Y+Rc), s		24.0	15.0	61.0		76.0
Change Period (Y+Rc), s		4.5	4.5	4.5		4.5
Max Green Setting (Gmax), s		19.5	10.5	56.5		71.5
Max Q Clear Time (g_c+I1), s		21.5	11.2	58.5		8.5
Green Ext Time (p_c), s		0.0	0.0	0.0		2.4
Intersection Summary						
HCM 6th Ctrl Delay			52.2			
HCM 6th LOS			D			

HCM 6th Signalized Intersection Summary
 5: Road 23/SR-99 Southbound Off-Ramp & Avenue 18 1/2

Village D Specific Plan
 Phase II WP MIT - PM Peak Hour



Movement	EBL	EBT	EBR	WBL	WBT	WBR	NBL	NBT	NBR	SBL	SBT	SBR
Lane Configurations		↑↑	↑	↑	↑↑			↑	↑		↑↑	
Traffic Volume (veh/h)	0	397	273	52	201	0	76	0	327	25	492	125
Future Volume (veh/h)	0	397	273	52	201	0	76	0	327	25	492	125
Initial Q (Qb), veh	0	0	0	0	0	0	0	0	0	0	0	0
Ped-Bike Adj(A_pbT)	1.00		0.99	1.00		1.00	1.00		1.00	1.00		0.98
Parking Bus, Adj	1.00	1.00	1.00	1.00	1.00	1.00	1.00	1.00	1.00	1.00	1.00	1.00
Work Zone On Approach		No			No			No			No	
Adj Sat Flow, veh/h/ln	0	1633	1633	1455	1455	0	1826	1826	1826	1737	1737	1737
Adj Flow Rate, veh/h	0	422	290	55	214	0	81	0	348	27	523	133
Peak Hour Factor	0.94	0.94	0.94	0.94	0.94	0.94	0.94	0.94	0.94	0.94	0.94	0.94
Percent Heavy Veh, %	0	18	18	30	30	0	5	5	5	11	11	11
Cap, veh/h	0	568	686	63	788	0	548	0	558	29	583	157
Arrive On Green	0.00	0.18	0.18	0.05	0.28	0.00	0.32	0.00	0.32	0.23	0.23	0.23
Sat Flow, veh/h	0	3185	1366	1386	2838	0	1739	0	1547	126	2523	679
Grp Volume(v), veh/h	0	422	290	55	214	0	81	0	348	370	0	313
Grp Sat Flow(s),veh/h/ln	0	1552	1366	1386	1383	0	1739	0	1547	1731	0	1597
Q Serve(g_s), s	0.0	10.3	10.8	3.2	4.8	0.0	2.7	0.0	14.8	16.7	0.0	15.0
Cycle Q Clear(g_c), s	0.0	10.3	10.8	3.2	4.8	0.0	2.7	0.0	14.8	16.7	0.0	15.0
Prop In Lane	0.00		1.00	1.00		0.00	1.00		1.00	0.07		0.43
Lane Grp Cap(c), veh/h	0	568	686	63	788	0	548	0	558	400	0	369
V/C Ratio(X)	0.00	0.74	0.42	0.87	0.27	0.00	0.15	0.00	0.62	0.92	0.00	0.85
Avail Cap(c_a), veh/h	0	698	743	95	968	0	548	0	558	400	0	369
HCM Platoon Ratio	1.00	1.00	1.00	1.00	1.00	1.00	1.00	1.00	1.00	1.00	1.00	1.00
Upstream Filter(I)	0.00	1.00	1.00	1.00	1.00	0.00	1.00	0.00	1.00	1.00	0.00	1.00
Uniform Delay (d), s/veh	0.0	30.9	12.8	38.0	22.2	0.0	19.7	0.0	21.1	30.1	0.0	29.4
Incr Delay (d2), s/veh	0.0	3.4	0.4	39.1	0.2	0.0	0.6	0.0	5.2	29.5	0.0	20.8
Initial Q Delay(d3),s/veh	0.0	0.0	0.0	0.0	0.0	0.0	0.0	0.0	0.0	0.0	0.0	0.0
%ile BackOfQ(50%),veh/ln	0.0	4.0	5.7	1.7	1.5	0.0	1.1	0.0	5.9	10.0	0.0	7.6
Unsig. Movement Delay, s/veh												
LnGrp Delay(d),s/veh	0.0	34.3	13.2	77.1	22.4	0.0	20.2	0.0	26.3	59.6	0.0	50.2
LnGrp LOS	A	C	B	E	C	A	C	A	C	E	A	D
Approach Vol, veh/h		712			269			429			683	
Approach Delay, s/veh		25.7			33.5			25.1			55.3	
Approach LOS		C			C			C			E	
Timer - Assigned Phs		2	3	4		6		8				
Phs Duration (G+Y+Rc), s		29.7	8.1	19.2		23.0		27.3				
Change Period (Y+Rc), s		4.5	4.5	4.5		4.5		4.5				
Max Green Setting (Gmax), s		20.0	5.5	18.0		18.5		28.0				
Max Q Clear Time (g_c+I1), s		16.8	5.2	12.8		18.7		6.8				
Green Ext Time (p_c), s		0.6	0.0	1.8		0.0		1.3				
Intersection Summary												
HCM 6th Ctrl Delay				36.2								
HCM 6th LOS				D								

HCM 6th Signalized Intersection Summary
6: SR-99 Northbound Ramps & Avenue 18 1/2

Village D Specific Plan
Phase II WP MIT - PM Peak Hour



Movement	EBL	EBT	EBR	WBL	WBT	WBR	NBL	NBT	NBR	SBL	SBT	SBR
Lane Configurations	↔↔	↑			↔		↔	↔				
Traffic Volume (veh/h)	408	110	0	0	92	19	190	3	0	0	0	0
Future Volume (veh/h)	408	110	0	0	92	19	190	3	0	0	0	0
Initial Q (Qb), veh	0	0	0	0	0	0	0	0	0			
Ped-Bike Adj(A_pbT)	1.00		1.00	1.00		1.00	1.00		1.00			
Parking Bus, Adj	1.00	1.00	1.00	1.00	1.00	1.00	1.00	1.00	1.00			
Work Zone On Approach		No			No		No					
Adj Sat Flow, veh/h/ln	1707	1707	0	0	1722	1722	1900	1900	1900			
Adj Flow Rate, veh/h	443	120	0	0	100	21	207	3	0			
Peak Hour Factor	0.92	0.92	0.92	0.92	0.92	0.92	0.92	0.92	0.92			
Percent Heavy Veh, %	13	13	0	0	12	12	0	0	0			
Cap, veh/h	552	565	0	0	138	29	1007	1057	0			
Arrive On Green	0.17	0.33	0.00	0.00	0.10	0.10	0.56	0.56	0.00			
Sat Flow, veh/h	3155	1707	0	0	1380	290	1810	1900	0			
Grp Volume(v), veh/h	443	120	0	0	0	121	207	3	0			
Grp Sat Flow(s),veh/h/ln	1577	1707	0	0	0	1670	1810	1900	0			
Q Serve(g_s), s	10.8	4.0	0.0	0.0	0.0	5.6	4.6	0.1	0.0			
Cycle Q Clear(g_c), s	10.8	4.0	0.0	0.0	0.0	5.6	4.6	0.1	0.0			
Prop In Lane	1.00		0.00	0.00		0.17	1.00		0.00			
Lane Grp Cap(c), veh/h	552	565	0	0	0	167	1007	1057	0			
V/C Ratio(X)	0.80	0.21	0.00	0.00	0.00	0.72	0.21	0.00	0.00			
Avail Cap(c_a), veh/h	887	992	0	0	0	407	1007	1057	0			
HCM Platoon Ratio	1.00	1.00	1.00	1.00	1.00	1.00	1.00	1.00	1.00			
Upstream Filter(l)	1.00	1.00	0.00	0.00	0.00	1.00	1.00	1.00	0.00			
Uniform Delay (d), s/veh	31.7	19.2	0.0	0.0	0.0	34.9	8.9	7.9	0.0			
Incr Delay (d2), s/veh	2.8	0.2	0.0	0.0	0.0	5.8	0.1	0.0	0.0			
Initial Q Delay(d3),s/veh	0.0	0.0	0.0	0.0	0.0	0.0	0.0	0.0	0.0			
%ile BackOfQ(50%),veh/ln	4.2	1.6	0.0	0.0	0.0	2.5	1.7	0.0	0.0			
Unsig. Movement Delay, s/veh												
LnGrp Delay(d),s/veh	34.5	19.4	0.0	0.0	0.0	40.8	9.0	7.9	0.0			
LnGrp LOS	C	B	A	A	A	D	A	A	A			
Approach Vol, veh/h		563			121			210				
Approach Delay, s/veh		31.3			40.8			9.0				
Approach LOS		C			D			A				
Timer - Assigned Phs		2		4			7	8				
Phs Duration (G+Y+Rc), s		49.0		31.0			18.5	12.5				
Change Period (Y+Rc), s		4.5		4.5			4.5	4.5				
Max Green Setting (Gmax), s		24.5		46.5			22.5	19.5				
Max Q Clear Time (g_c+I1), s		6.6		6.0			12.8	7.6				
Green Ext Time (p_c), s		0.5		0.7			1.2	0.4				
Intersection Summary												
HCM 6th Ctrl Delay												27.3
HCM 6th LOS												C

HCM 6th Signalized Intersection Summary
7: Road 23 & Avenue 17

Village D Specific Plan
Phase II WP MIT - PM Peak Hour



Movement	EBL	EBT	EBR	WBL	WBT	WBR	NBL	NBT	NBR	SBL	SBT	SBR
Lane Configurations	↖	↖↗		↖↗	↖↗		↖	↖↗	↖	↖	↖↗	↖
Traffic Volume (veh/h)	83	261	107	646	474	10	85	317	424	63	661	166
Future Volume (veh/h)	83	261	107	646	474	10	85	317	424	63	661	166
Initial Q (Qb), veh	0	0	0	0	0	0	0	0	0	0	0	0
Ped-Bike Adj(A_pbT)	1.00		1.00	1.00		1.00	1.00		1.00	1.00		1.00
Parking Bus, Adj	1.00	1.00	1.00	1.00	1.00	1.00	1.00	1.00	1.00	1.00	1.00	1.00
Work Zone On Approach		No			No			No			No	
Adj Sat Flow, veh/h/ln	1885	1885	1885	1900	1900	1900	1870	1870	1870	1856	1856	1856
Adj Flow Rate, veh/h	90	284	116	702	515	11	92	345	461	68	718	180
Peak Hour Factor	0.92	0.92	0.92	0.92	0.92	0.92	0.92	0.92	0.92	0.92	0.92	0.92
Percent Heavy Veh, %	1	1	1	0	0	0	2	2	2	3	3	3
Cap, veh/h	114	345	138	792	1086	23	117	1552	692	87	1483	662
Arrive On Green	0.06	0.14	0.14	0.23	0.30	0.30	0.02	0.14	0.14	0.05	0.42	0.42
Sat Flow, veh/h	1795	2500	997	3510	3614	77	1781	3554	1585	1767	3526	1572
Grp Volume(v), veh/h	90	202	198	702	257	269	92	345	461	68	718	180
Grp Sat Flow(s),veh/h/ln	1795	1791	1706	1755	1805	1886	1781	1777	1585	1767	1763	1572
Q Serve(g_s), s	5.9	13.1	13.6	23.2	13.9	14.0	6.2	10.3	33.0	4.6	17.8	9.0
Cycle Q Clear(g_c), s	5.9	13.1	13.6	23.2	13.9	14.0	6.2	10.3	33.0	4.6	17.8	9.0
Prop In Lane	1.00		0.58	1.00		0.04	1.00		1.00	1.00		1.00
Lane Grp Cap(c), veh/h	114	247	236	792	542	567	117	1552	692	87	1483	662
V/C Ratio(X)	0.79	0.81	0.84	0.89	0.47	0.47	0.79	0.22	0.67	0.78	0.48	0.27
Avail Cap(c_a), veh/h	189	300	286	980	617	644	191	1552	692	152	1483	662
HCM Platoon Ratio	1.00	1.00	1.00	1.00	1.00	1.00	0.33	0.33	0.33	1.00	1.00	1.00
Upstream Filter(I)	0.81	0.81	0.81	1.00	1.00	1.00	0.90	0.90	0.90	1.00	1.00	1.00
Uniform Delay (d), s/veh	55.4	50.2	50.4	45.0	34.2	34.2	57.9	33.3	43.1	56.4	25.3	22.7
Incr Delay (d2), s/veh	9.5	11.1	14.4	8.4	0.6	0.6	10.1	0.3	4.5	13.9	1.1	1.0
Initial Q Delay(d3),s/veh	0.0	0.0	0.0	0.0	0.0	0.0	0.0	0.0	0.0	0.0	0.0	0.0
%ile BackOfQ(50%),veh/ln	8.0	6.6	6.7	11.0	6.2	6.5	3.2	5.0	14.9	2.4	7.6	3.5
Unsig. Movement Delay, s/veh												
LnGrp Delay(d),s/veh	65.0	61.3	64.8	53.4	34.9	34.9	68.0	33.6	47.6	70.3	26.4	23.8
LnGrp LOS	E	E	E	D	C	C	E	C	D	E	C	C
Approach Vol, veh/h		490			1228			898			966	
Approach Delay, s/veh		63.4			45.5			44.3			29.0	
Approach LOS		E			D			D			C	
Timer - Assigned Phs	1	2	3	4	5	6	7	8				
Phs Duration (G+Y+Rc), s	10.4	56.9	31.6	21.1	12.4	55.0	12.1	40.6				
Change Period (Y+Rc), s	4.5	4.5	4.5	4.5	4.5	4.5	4.5	4.5				
Max Green Setting (Gmax), s	10.3	38.1	33.5	20.1	12.9	35.5	12.6	41.0				
Max Q Clear Time (g_c+10), s	10.6	35.0	25.2	15.6	8.2	19.8	7.9	16.0				
Green Ext Time (p_c), s	0.0	1.3	1.9	1.0	0.1	5.1	0.1	3.3				
Intersection Summary												
HCM 6th Ctrl Delay				43.2								
HCM 6th LOS				D								

HCM 6th Signalized Intersection Summary
8: Road 23 & Avenue 16

Village D Specific Plan
Phase II WP MIT - PM Peak Hour



Movement	EBL	EBT	EBR	WBL	WBT	WBR	NBL	NBT	NBR	SBL	SBT	SBR
Lane Configurations												
Traffic Volume (veh/h)	104	52	227	48	53	204	283	973	126	317	1074	117
Future Volume (veh/h)	104	52	227	48	53	204	283	973	126	317	1074	117
Initial Q (Qb), veh	0	0	0	0	0	0	0	0	0	0	0	0
Ped-Bike Adj(A_pbT)	1.00		1.00	1.00		1.00	1.00		1.00	1.00		1.00
Parking Bus, Adj	1.00	1.00	1.00	1.00	1.00	1.00	1.00	1.00	1.00	1.00	1.00	1.00
Work Zone On Approach		No			No			No			No	
Adj Sat Flow, veh/h/ln	1885	1885	1885	1900	1900	1900	1885	1885	1885	1870	1870	1870
Adj Flow Rate, veh/h	109	55	239	51	56	215	298	1024	133	334	1131	123
Peak Hour Factor	0.95	0.95	0.95	0.95	0.95	0.95	0.95	0.95	0.95	0.95	0.95	0.95
Percent Heavy Veh, %	1	1	1	0	0	0	1	1	1	2	2	2
Cap, veh/h	134	59	258	66	53	204	327	1505	729	357	1417	154
Arrive On Green	0.07	0.19	0.19	0.04	0.15	0.15	0.18	0.42	0.42	0.40	0.88	0.88
Sat Flow, veh/h	1795	308	1337	1810	344	1319	1795	3582	1598	1781	3233	351
Grp Volume(v), veh/h	109	0	294	51	0	271	298	1024	133	334	621	633
Grp Sat Flow(s),veh/h/ln	1795	0	1645	1810	0	1663	1795	1791	1598	1781	1777	1807
Q Serve(g_s), s	7.2	0.0	21.1	3.4	0.0	18.6	19.5	27.9	5.9	21.6	17.2	17.4
Cycle Q Clear(g_c), s	7.2	0.0	21.1	3.4	0.0	18.6	19.5	27.9	5.9	21.6	17.2	17.4
Prop In Lane	1.00		0.81	1.00		0.79	1.00		1.00	1.00		0.19
Lane Grp Cap(c), veh/h	134	0	317	66	0	257	327	1505	729	357	779	792
V/C Ratio(X)	0.81	0.00	0.93	0.77	0.00	1.05	0.91	0.68	0.18	0.94	0.80	0.80
Avail Cap(c_a), veh/h	172	0	322	98	0	257	382	1505	729	423	779	792
HCM Platoon Ratio	1.00	1.00	1.00	1.00	1.00	1.00	1.00	1.00	1.00	2.00	2.00	2.00
Upstream Filter(l)	1.00	0.00	1.00	1.00	0.00	1.00	0.49	0.49	0.49	0.84	0.84	0.84
Uniform Delay (d), s/veh	54.7	0.0	47.6	57.3	0.0	50.7	48.1	28.3	19.3	35.2	5.2	5.2
Incr Delay (d2), s/veh	19.8	0.0	31.5	19.3	0.0	71.0	13.5	1.2	0.3	23.0	7.1	7.1
Initial Q Delay(d3),s/veh	0.0	0.0	0.0	0.0	0.0	0.0	0.0	0.0	0.0	0.0	0.0	0.0
%ile BackOfQ(50%),veh/ln	0.0	0.0	11.4	1.9	0.0	12.8	9.9	12.0	2.3	9.9	3.9	3.9
Unsig. Movement Delay, s/veh												
LnGrp Delay(d),s/veh	74.5	0.0	79.1	76.6	0.0	121.7	61.6	29.5	19.6	58.2	12.3	12.3
LnGrp LOS	E	A	E	E	A	F	E	C	B	E	B	B
Approach Vol, veh/h		403			322			1455			1588	
Approach Delay, s/veh		77.9			114.6			35.2			22.0	
Approach LOS		E			F			D			C	
Timer - Assigned Phs	1	2	3	4	5	6	7	8				
Phs Duration (G+Y+Rc), s	38.5	54.9	8.9	27.7	26.4	57.1	13.5	23.1				
Change Period (Y+Rc), s	4.5	4.5	4.5	4.5	4.5	4.5	4.5	4.5				
Max Green Setting (Gmax), s	28.5	43.5	6.5	23.5	25.5	46.5	11.5	18.5				
Max Q Clear Time (g_c+Q), s	23.6	29.9	5.4	23.1	21.5	19.4	9.2	20.6				
Green Ext Time (p_c), s	0.5	6.5	0.0	0.1	0.3	10.2	0.0	0.0				
Intersection Summary												
HCM 6th Ctrl Delay											41.0	
HCM 6th LOS											D	

HCM 6th Signalized Intersection Summary
 9: Road 23 & Cleveland Avenue

Village D Specific Plan
 Phase II WP MIT - PM Peak Hour



Movement	EBL	EBT	EBR	WBL	WBT	WBR	NBL	NBT	NBR	SBL	SBT	SBR
Lane Configurations	↖	↗		↖	↗		↖	↑↑	↗	↖	↑↑	↗
Traffic Volume (veh/h)	1	25	14	248	25	275	13	1046	299	279	1027	1
Future Volume (veh/h)	1	25	14	248	25	275	13	1046	299	279	1027	1
Initial Q (Qb), veh	0	0	0	0	0	0	0	0	0	0	0	0
Ped-Bike Adj(A_pbT)	1.00		1.00	1.00		1.00	1.00		1.00	1.00		1.00
Parking Bus, Adj	1.00	1.00	1.00	1.00	1.00	1.00	1.00	1.00	1.00	1.00	1.00	1.00
Work Zone On Approach		No		No		No		No		No		No
Adj Sat Flow, veh/h/ln	1900	1900	1900	1885	1885	1885	1885	1885	1885	1870	1870	1870
Adj Flow Rate, veh/h	1	27	15	267	27	296	14	1125	322	300	1104	1
Peak Hour Factor	0.93	0.93	0.93	0.93	0.93	0.93	0.93	0.93	0.93	0.93	0.93	0.93
Percent Heavy Veh, %	0	0	0	1	1	1	1	1	1	2	2	2
Cap, veh/h	2	85	47	273	30	333	29	1515	919	305	2054	918
Arrive On Green	0.00	0.07	0.07	0.15	0.22	0.22	0.02	0.42	0.42	0.17	0.58	0.58
Sat Flow, veh/h	1810	1148	638	1795	135	1483	1795	3582	1598	1781	3554	1585
Grp Volume(v), veh/h	1	0	42	267	0	323	14	1125	322	300	1104	1
Grp Sat Flow(s),veh/h/ln	1810	0	1785	1795	0	1618	1795	1791	1598	1781	1777	1585
Q Serve(g_s), s	0.1	0.0	2.2	14.8	0.0	19.3	0.8	26.4	10.7	16.8	19.0	0.0
Cycle Q Clear(g_c), s	0.1	0.0	2.2	14.8	0.0	19.3	0.8	26.4	10.7	16.8	19.0	0.0
Prop In Lane	1.00		0.36	1.00		0.92	1.00		1.00	1.00		1.00
Lane Grp Cap(c), veh/h	2	0	132	273	0	364	29	1515	919	305	2054	918
V/C Ratio(X)	0.40	0.00	0.32	0.98	0.00	0.89	0.48	0.74	0.35	0.98	0.54	0.00
Avail Cap(c_a), veh/h	90	0	321	273	0	456	90	1515	919	305	2054	918
HCM Platoon Ratio	1.00	1.00	1.00	1.00	1.00	1.00	1.00	1.00	1.00	1.00	1.00	1.00
Upstream Filter(I)	1.00	0.00	1.00	0.71	0.00	0.71	0.82	0.82	0.82	0.51	0.51	0.51
Uniform Delay (d), s/veh	49.9	0.0	43.9	42.2	0.0	37.6	48.8	24.3	11.3	41.3	12.9	8.9
Incr Delay (d2), s/veh	81.4	0.0	1.4	40.0	0.0	12.2	9.9	2.7	0.9	32.9	0.5	0.0
Initial Q Delay(d3),s/veh	0.0	0.0	0.0	0.0	0.0	0.0	0.0	0.0	0.0	0.0	0.0	0.0
%ile BackOfQ(50%),veh/ln	0.1	0.0	1.0	9.5	0.0	8.8	0.4	11.4	3.8	10.0	7.2	0.0
Unsig. Movement Delay, s/veh												
LnGrp Delay(d),s/veh	131.3	0.0	45.3	82.3	0.0	49.8	58.7	27.0	12.2	74.2	13.4	8.9
LnGrp LOS	F	A	D	F	A	D	E	C	B	E	B	A
Approach Vol, veh/h		43		590		1461		1405				
Approach Delay, s/veh		47.3		64.5		24.0		26.4				
Approach LOS		D		E		C		C				
Timer - Assigned Phs	1	2	3	4	5	6	7	8				
Phs Duration (G+Y+Rc), s	31.6	46.8	19.7	11.9	6.1	62.3	4.6	27.0				
Change Period (Y+Rc), s	4.5	4.5	4.5	4.5	4.5	4.5	4.5	4.5				
Max Green Setting (Gmax), s	31.7	15.2	18.0	5.0	43.8	5.0	28.2					
Max Q Clear Time (g_c+10), s	28.4	16.8	4.2	2.8	21.0	2.1	21.3					
Green Ext Time (p_c), s	0.0	2.4	0.0	0.1	0.0	8.7	0.0	1.1				
Intersection Summary												
HCM 6th Ctrl Delay				32.1								
HCM 6th LOS				C								

HCM 6th Signalized Intersection Summary
10: Road 23 & Avenue 14 1/2

Village D Specific Plan
Phase II WP MIT - PM Peak Hour



Movement	EBL	EBT	EBR	WBL	WBT	WBR	NBL	NBT	NBR	SBL	SBT	SBR
Lane Configurations		↕			↕		↙	↕		↙	↕	
Traffic Volume (veh/h)	1	2	3	5	3	144	2	725	2	175	565	0
Future Volume (veh/h)	1	2	3	5	3	144	2	725	2	175	565	0
Initial Q (Qb), veh	0	0	0	0	0	0	0	0	0	0	0	0
Ped-Bike Adj(A_pbT)	1.00		1.00	1.00		1.00	1.00		1.00	1.00		1.00
Parking Bus, Adj	1.00	1.00	1.00	1.00	1.00	1.00	1.00	1.00	1.00	1.00	1.00	1.00
Work Zone On Approach		No			No			No			No	
Adj Sat Flow, veh/h/ln	1900	1900	1900	1900	1900	1900	1856	1856	1856	1856	1856	1856
Adj Flow Rate, veh/h	1	2	3	5	3	157	2	788	2	190	614	0
Peak Hour Factor	0.92	0.92	0.92	0.92	0.92	0.92	0.92	0.92	0.92	0.92	0.92	0.92
Percent Heavy Veh, %	0	0	0	0	0	0	3	3	3	3	3	3
Cap, veh/h	68	96	111	49	8	197	5	2064	5	232	2470	0
Arrive On Green	0.13	0.13	0.13	0.13	0.13	0.13	0.00	0.57	0.57	0.13	0.70	0.00
Sat Flow, veh/h	118	752	870	19	59	1538	1767	3607	9	1767	3618	0
Grp Volume(v), veh/h	6	0	0	165	0	0	2	385	405	190	614	0
Grp Sat Flow(s),veh/h/ln	1739	0	0	1617	0	0	1767	1763	1854	1767	1763	0
Q Serve(g_s), s	0.0	0.0	0.0	1.7	0.0	0.0	0.1	9.6	9.6	8.4	5.1	0.0
Cycle Q Clear(g_c), s	0.2	0.0	0.0	7.9	0.0	0.0	0.1	9.6	9.6	8.4	5.1	0.0
Prop In Lane	0.17		0.50	0.03		0.95	1.00		0.00	1.00		0.00
Lane Grp Cap(c), veh/h	275	0	0	253	0	0	5	1008	1061	232	2470	0
V/C Ratio(X)	0.02	0.00	0.00	0.65	0.00	0.00	0.42	0.38	0.38	0.82	0.25	0.00
Avail Cap(c_a), veh/h	442	0	0	419	0	0	121	1008	1061	387	2470	0
HCM Platoon Ratio	1.00	1.00	1.00	1.00	1.00	1.00	1.00	1.00	1.00	1.00	1.00	1.00
Upstream Filter(I)	1.00	0.00	0.00	1.00	0.00	0.00	1.00	1.00	1.00	1.00	1.00	0.00
Uniform Delay (d), s/veh	30.5	0.0	0.0	33.9	0.0	0.0	39.8	9.4	9.4	33.8	4.3	0.0
Incr Delay (d2), s/veh	0.0	0.0	0.0	2.8	0.0	0.0	48.8	1.1	1.0	7.0	0.2	0.0
Initial Q Delay(d3),s/veh	0.0	0.0	0.0	0.0	0.0	0.0	0.0	0.0	0.0	0.0	0.0	0.0
%ile BackOfQ(50%),veh/ln	0.1	0.0	0.0	3.2	0.0	0.0	0.1	3.6	3.7	3.9	1.5	0.0
Unsig. Movement Delay, s/veh												
LnGrp Delay(d),s/veh	30.6	0.0	0.0	36.7	0.0	0.0	88.6	10.5	10.4	40.8	4.6	0.0
LnGrp LOS	C	A	A	D	A	A	F	B	B	D	A	A
Approach Vol, veh/h		6			165			792			804	
Approach Delay, s/veh		30.6			36.7			10.6			13.1	
Approach LOS		C			D			B			B	
Timer - Assigned Phs	1	2		4	5	6		8				
Phs Duration (G+Y+Rc), s	5.0	50.3		14.7	4.7	60.6		14.7				
Change Period (Y+Rc), s	4.5	4.5		4.5	4.5	4.5		4.5				
Max Green Setting (Gmax), s	5	30.5		18.5	5.5	42.5		18.5				
Max Q Clear Time (g_c+M), s	11.6			2.2	2.1	7.1		9.9				
Green Ext Time (p_c), s	0.3	4.9		0.0	0.0	4.8		0.5				

Intersection Summary

HCM 6th Ctrl Delay	14.3
HCM 6th LOS	B

Intersection

Intersection Delay, s/veh 29.2

Intersection LOS D

Movement	EBL	EBT	EBR	WBL	WBT	WBR	NBL	NBT	NBR	SBL	SBT	SBR
Lane Configurations		↕			↕		↕	↕		↕	↕	
Traffic Vol, veh/h	134	92	35	11	37	340	14	256	22	288	213	70
Future Vol, veh/h	134	92	35	11	37	340	14	256	22	288	213	70
Peak Hour Factor	0.95	0.95	0.95	0.95	0.95	0.95	0.95	0.95	0.95	0.95	0.95	0.95
Heavy Vehicles, %	7	7	7	1	1	1	5	5	5	4	4	4
Mvmt Flow	141	97	37	12	39	358	15	269	23	303	224	74
Number of Lanes	0	1	0	0	1	0	1	2	0	1	2	0

Approach	EB	WB	NB	SB
Opposing Approach	WB	EB	SB	NB
Opposing Lanes	1	1	3	3
Conflicting Approach Left SB		NB	EB	WB
Conflicting Lanes Left	3	3	1	1
Conflicting Approach Right NB		SB	WB	EB
Conflicting Lanes Right	3	3	1	1
HCM Control Delay	28.9	44.9	17.2	24.7
HCM LOS	D	E	C	C

Lane	NBLn1	NBLn2	NBLn3	EBLn1	WBLn1	SBLn1	SBLn2	SBLn3
Vol Left, %	100%	0%	0%	51%	3%	100%	0%	0%
Vol Thru, %	0%	100%	80%	35%	10%	0%	100%	50%
Vol Right, %	0%	0%	20%	13%	88%	0%	0%	50%
Sign Control	Stop	Stop	Stop	Stop	Stop	Stop	Stop	Stop
Traffic Vol by Lane	14	171	107	261	388	288	142	141
LT Vol	14	0	0	134	11	288	0	0
Through Vol	0	171	85	92	37	0	142	71
RT Vol	0	0	22	35	340	0	0	70
Lane Flow Rate	15	180	113	275	408	303	149	148
Geometry Grp	7	7	7	7	7	7	7	7
Degree of Util (X)	0.039	0.448	0.277	0.682	0.878	0.749	0.348	0.33
Departure Headway (Hd)	9.503	8.975	8.823	8.935	7.737	8.896	8.371	8.006
Convergence, Y/N	Yes	Yes	Yes	Yes	Yes	Yes	Yes	Yes
Cap	376	401	407	404	470	406	429	448
Service Time	7.27	6.741	6.59	6.699	5.492	6.66	6.135	5.769
HCM Lane V/C Ratio	0.04	0.449	0.278	0.681	0.868	0.746	0.347	0.33
HCM Control Delay	12.7	18.9	15	28.9	44.9	34	15.6	14.7
HCM Lane LOS	B	C	B	D	E	D	C	B
HCM 95th-tile Q	0.1	2.3	1.1	4.9	9.3	6	1.5	1.4

HCM 6th Signalized Intersection Summary
 13: Airport Drive/Golden State Boulevard & Avenue 17

Village D Specific Plan
 Phase II WP MIT - PM Peak Hour



Movement	EBL	EBT	EBR	WBL	WBT	WBR	NBL	NBT	NBR	SBL	SBT	SBR
Lane Configurations												
Traffic Volume (veh/h)	10	729	91	179	996	230	141	79	305	327	78	10
Future Volume (veh/h)	10	729	91	179	996	230	141	79	305	327	78	10
Initial Q (Qb), veh	0	0	0	0	0	0	0	0	0	0	0	0
Ped-Bike Adj(A_pbT)	1.00		1.00	1.00		1.00	1.00		1.00	1.00		1.00
Parking Bus, Adj	1.00	1.00	1.00	1.00	1.00	1.00	1.00	1.00	1.00	1.00	1.00	1.00
Work Zone On Approach		No			No			No			No	
Adj Sat Flow, veh/h/ln	1885	1885	1885	1885	1885	1885	1856	1856	1856	1856	1856	1856
Adj Flow Rate, veh/h	11	792	99	195	1083	250	153	86	332	355	85	11
Peak Hour Factor	0.92	0.92	0.92	0.92	0.92	0.92	0.92	0.92	0.92	0.92	0.92	0.92
Percent Heavy Veh, %	1	1	1	1	1	1	3	3	3	3	3	3
Cap, veh/h	24	901	402	229	1309	584	188	500	424	434	466	60
Arrive On Green	0.01	0.25	0.25	0.26	0.73	0.73	0.11	0.27	0.27	0.13	0.29	0.29
Sat Flow, veh/h	1795	3582	1598	1795	3582	1598	1767	1856	1572	3428	1610	208
Grp Volume(v), veh/h	11	792	99	195	1083	250	153	86	332	355	0	96
Grp Sat Flow(s),veh/h/ln	1795	1791	1598	1795	1791	1598	1767	1856	1572	1714	0	1818
Q Serve(g_s), s	0.5	17.0	4.0	8.3	16.5	4.9	6.8	2.8	15.6	8.1	0.0	3.2
Cycle Q Clear(g_c), s	0.5	17.0	4.0	8.3	16.5	4.9	6.8	2.8	15.6	8.1	0.0	3.2
Prop In Lane	1.00		1.00	1.00		1.00	1.00		1.00	1.00		0.11
Lane Grp Cap(c), veh/h	24	901	402	229	1309	584	188	500	424	434	0	526
V/C Ratio(X)	0.45	0.88	0.25	0.85	0.83	0.43	0.81	0.17	0.78	0.82	0.00	0.18
Avail Cap(c_a), veh/h	112	940	419	258	1309	584	223	500	424	450	0	526
HCM Platoon Ratio	1.00	1.00	1.00	2.00	2.00	2.00	1.00	1.00	1.00	1.00	1.00	1.00
Upstream Filter(I)	1.00	1.00	1.00	0.69	0.69	0.69	1.00	1.00	1.00	1.00	0.00	1.00
Uniform Delay (d), s/veh	39.2	28.8	23.9	29.1	9.1	7.5	35.0	22.4	27.1	34.0	0.0	21.3
Incr Delay (d2), s/veh	12.5	9.4	0.3	15.6	3.2	0.3	17.4	0.7	13.5	11.0	0.0	0.8
Initial Q Delay(d3),s/veh	0.0	0.0	0.0	0.0	0.0	0.0	0.0	0.0	0.0	0.0	0.0	0.0
%ile BackOfQ(50%),veh/ln	0.3	8.2	1.5	4.0	3.5	1.3	3.7	1.3	7.2	3.9	0.0	1.4
Unsig. Movement Delay, s/veh												
LnGrp Delay(d),s/veh	51.7	38.1	24.2	44.7	12.2	7.8	52.3	23.1	40.6	45.0	0.0	22.1
LnGrp LOS	D	D	C	D	B	A	D	C	D	D	A	C
Approach Vol, veh/h		902			1528			571			451	
Approach Delay, s/veh		36.8			15.7			41.1			40.1	
Approach LOS		D			B			D			D	
Timer - Assigned Phs	1	2	3	4	5	6	7	8				
Phs Duration (G+Y+Rc), s	14.6	26.1	14.7	24.6	13.0	27.7	5.6	33.7				
Change Period (Y+Rc), s	4.5	4.5	4.5	4.5	4.5	4.5	4.5	4.5				
Max Green Setting (Gmax), s	10.5	19.0	11.5	21.0	10.1	19.4	5.0	27.5				
Max Q Clear Time (g_c+M), s	10.5	17.6	10.3	19.0	8.8	5.2	2.5	18.5				
Green Ext Time (p_c), s	0.1	0.3	0.1	1.1	0.0	0.3	0.0	5.4				
Intersection Summary												
HCM 6th Ctrl Delay											28.6	
HCM 6th LOS											C	

HCM 6th Signalized Intersection Summary
 14: Avenue 17 & SR-99 Southbound Off-Ramp

Village D Specific Plan
 Phase II WP MIT - PM Peak Hour

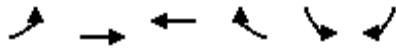

Movement	EBL	EBT	WBT	WBR	SBL	SBR
Lane Configurations		↑↑↑	↑↑↑		↘	↗
Traffic Volume (veh/h)	0	1364	1328	0	435	76
Future Volume (veh/h)	0	1364	1328	0	435	76
Initial Q (Qb), veh	0	0	0	0	0	0
Ped-Bike Adj(A_pbT)	1.00			1.00	1.00	1.00
Parking Bus, Adj	1.00	1.00	1.00	1.00	1.00	1.00
Work Zone On Approach		No	No		No	
Adj Sat Flow, veh/h/ln	0	1856	1870	0	1870	1870
Adj Flow Rate, veh/h	0	1483	1443	0	473	83
Peak Hour Factor	0.92	0.92	0.92	0.92	0.92	0.92
Percent Heavy Veh, %	0	3	2	0	2	2
Cap, veh/h	0	1859	1874	0	927	825
Arrive On Green	0.00	0.73	0.37	0.00	0.52	0.52
Sat Flow, veh/h	0	5400	5443	0	1781	1585
Grp Volume(v), veh/h	0	1483	1443	0	473	83
Grp Sat Flow(s),veh/h/ln	0	1689	1702	0	1781	1585
Q Serve(g_s), s	0.0	15.0	19.9	0.0	13.9	2.1
Cycle Q Clear(g_c), s	0.0	15.0	19.9	0.0	13.9	2.1
Prop In Lane	0.00			0.00	1.00	1.00
Lane Grp Cap(c), veh/h	0	1859	1874	0	927	825
V/C Ratio(X)	0.00	0.80	0.77	0.00	0.51	0.10
Avail Cap(c_a), veh/h	0	2121	2138	0	927	825
HCM Platoon Ratio	1.00	2.00	1.00	1.00	1.00	1.00
Upstream Filter(I)	0.00	0.52	1.00	0.00	1.00	1.00
Uniform Delay (d), s/veh	0.0	8.7	22.3	0.0	12.5	9.7
Incr Delay (d2), s/veh	0.0	1.0	1.6	0.0	2.0	0.2
Initial Q Delay(d3),s/veh	0.0	0.0	0.0	0.0	0.0	0.0
%ile BackOfQ(50%),veh/ln	0.0	2.8	7.8	0.0	5.5	0.7
Unsig. Movement Delay, s/veh						
LnGrp Delay(d),s/veh	0.0	9.8	23.9	0.0	14.5	10.0
LnGrp LOS	A	A	C	A	B	A
Approach Vol, veh/h		1483	1443		556	
Approach Delay, s/veh		9.8	23.9		13.8	
Approach LOS		A	C		B	
Timer - Assigned Phs				4	6	8
Phs Duration (G+Y+Rc), s				33.9	46.1	33.9
Change Period (Y+Rc), s				4.5	4.5	4.5
Max Green Setting (Gmax), s				33.5	37.5	33.5
Max Q Clear Time (g_c+I1), s				17.0	15.9	21.9
Green Ext Time (p_c), s				9.8	1.8	7.4
Intersection Summary						
HCM 6th Ctrl Delay			16.3			
HCM 6th LOS			B			

HCM 6th Signalized Intersection Summary
 15: SR-99 Northbound Ramps & Avenue 17

Village D Specific Plan
 Phase II WP MIT - PM Peak Hour



Movement	EBL	EBT	EBR	WBL	WBT	WBR	NBL	NBT	NBR	SBL	SBT	SBR
Lane Configurations												
Traffic Volume (veh/h)	141	1027	0	0	1255	330	773	3	529	0	0	0
Future Volume (veh/h)	141	1027	0	0	1255	330	773	3	529	0	0	0
Initial Q (Qb), veh	0	0	0	0	0	0	0	0	0			
Ped-Bike Adj(A_pbT)	1.00		1.00	1.00		1.00	1.00		1.00			
Parking Bus, Adj	1.00	1.00	1.00	1.00	1.00	1.00	1.00	1.00	1.00			
Work Zone On Approach	No				No				No			
Adj Sat Flow, veh/h/ln	1870	1870	0	0	1885	1885	1900	1900	1900			
Adj Flow Rate, veh/h	148	1081	0	0	1321	347	816	0	557			
Peak Hour Factor	0.95	0.95	0.95	0.95	0.95	0.95	0.95	0.95	0.95			
Percent Heavy Veh, %	2	2	0	0	1	1	0	0	0			
Cap, veh/h	166	2107	0	0	1284	330	1147	0	510			
Arrive On Green	0.09	0.59	0.00	0.00	0.46	0.46	0.32	0.00	0.32			
Sat Flow, veh/h	1781	3647	0	0	2915	724	3619	0	1610			
Grp Volume(v), veh/h	148	1081	0	0	828	840	816	0	557			
Grp Sat Flow(s),veh/h/ln	1781	1777	0	0	1791	1755	1810	0	1610			
Q Serve(g_s), s	8.2	17.8	0.0	0.0	45.5	45.5	19.9	0.0	31.7			
Cycle Q Clear(g_c), s	8.2	17.8	0.0	0.0	45.5	45.5	19.9	0.0	31.7			
Prop In Lane	1.00		0.00	0.00		0.41	1.00		1.00			
Lane Grp Cap(c), veh/h	166	2107	0	0	815	798	1147	0	510			
V/C Ratio(X)	0.89	0.51	0.00	0.00	1.02	1.05	0.71	0.00	1.09			
Avail Cap(c_a), veh/h	166	2107	0	0	815	798	1147	0	510			
HCM Platoon Ratio	1.00	1.00	1.00	1.00	1.00	1.00	1.00	1.00	1.00			
Upstream Filter(l)	1.00	1.00	0.00	0.00	1.00	1.00	1.00	0.00	1.00			
Uniform Delay (d), s/veh	44.9	11.9	0.0	0.0	27.3	27.3	30.1	0.0	34.2			
Incr Delay (d2), s/veh	40.9	0.2	0.0	0.0	35.5	46.6	2.1	0.0	66.9			
Initial Q Delay(d3),s/veh	0.0	0.0	0.0	0.0	0.0	0.0	0.0	0.0	0.0			
%ile BackOfQ(50%),veh/ln	5.5	6.6	0.0	0.0	26.3	28.3	8.8	0.0	21.5			
Unsig. Movement Delay, s/veh												
LnGrp Delay(d),s/veh	85.8	12.1	0.0	0.0	62.7	73.9	32.2	0.0	101.1			
LnGrp LOS	F	B	A	A	F	F	C	A	F			
Approach Vol, veh/h	1229				1668				1373			
Approach Delay, s/veh	21.0				68.3				60.1			
Approach LOS	C				E				E			
Timer - Assigned Phs	2		4		7		8					
Phs Duration (G+Y+Rc), s	36.2		63.8		13.8		50.0					
Change Period (Y+Rc), s	4.5		4.5		4.5		4.5					
Max Green Setting (Gmax), s	31.7		59.3		9.3		45.5					
Max Q Clear Time (g_c+I1), s	33.7		19.8		10.2		47.5					
Green Ext Time (p_c), s	0.0		10.1		0.0		0.0					

Intersection Summary

HCM 6th Ctrl Delay	52.1
HCM 6th LOS	D

Notes

User approved volume balancing among the lanes for turning movement.

HCM 6th Signalized Intersection Summary
 16: Love's Truck Stop Driveway/Driveway & Avenue 17

Village D Specific Plan
 Phase II WP MIT - PM Peak Hour



Movement	EBL	EBT	EBR	WBL	WBT	WBR	NBL	NBT	NBR	SBL	SBT	SBR
Lane Configurations	↔↔	↑↑↑	↔	↔	↑↑↑	↔	↔	↔		↔	↑	↔
Traffic Volume (veh/h)	556	850	141	32	894	189	160	0	31	279	0	519
Future Volume (veh/h)	556	850	141	32	894	189	160	0	31	279	0	519
Initial Q (Qb), veh	0	0	0	0	0	0	0	0	0	0	0	0
Ped-Bike Adj(A_pbT)	1.00		1.00	1.00		1.00	1.00		1.00	1.00		1.00
Parking Bus, Adj	1.00	1.00	1.00	1.00	1.00	1.00	1.00	1.00	1.00	1.00	1.00	1.00
Work Zone On Approach		No		No		No		No		No		No
Adj Sat Flow, veh/h/ln	1885	1885	1885	1870	1870	1870	1900	1900	1900	1900	1900	1900
Adj Flow Rate, veh/h	604	924	153	35	972	205	174	0	34	303	0	564
Peak Hour Factor	0.92	0.92	0.92	0.92	0.92	0.92	0.92	0.92	0.92	0.92	0.92	0.92
Percent Heavy Veh, %	1	1	1	2	2	2	0	0	0	0	0	0
Cap, veh/h	670	1882	584	58	1050	326	212	0	352	332	541	769
Arrive On Green	0.19	0.37	0.37	0.03	0.21	0.21	0.12	0.00	0.22	0.18	0.00	0.28
Sat Flow, veh/h	3483	5147	1598	1781	5106	1585	1810	0	1610	1810	1900	1610
Grp Volume(v), veh/h	604	924	153	35	972	205	174	0	34	303	0	564
Grp Sat Flow(s),veh/h/ln	1742	1716	1598	1781	1702	1585	1810	0	1610	1810	1900	1610
Q Serve(g_s), s	15.2	12.5	6.0	1.7	16.8	10.6	8.5	0.0	1.5	14.8	0.0	25.4
Cycle Q Clear(g_c), s	15.2	12.5	6.0	1.7	16.8	10.6	8.5	0.0	1.5	14.8	0.0	25.4
Prop In Lane	1.00		1.00	1.00		1.00	1.00		1.00	1.00		1.00
Lane Grp Cap(c), veh/h	670	1882	584	58	1050	326	212	0	352	332	541	769
V/C Ratio(X)	0.90	0.49	0.26	0.61	0.93	0.63	0.82	0.00	0.10	0.91	0.00	0.73
Avail Cap(c_a), veh/h	677	1882	584	119	1050	326	324	0	352	332	541	769
HCM Platoon Ratio	1.00	1.00	1.00	1.00	1.00	1.00	1.00	1.00	1.00	1.00	1.00	1.00
Upstream Filter(I)	1.00	1.00	1.00	1.00	1.00	1.00	1.00	0.00	1.00	1.00	0.00	1.00
Uniform Delay (d), s/veh	35.5	22.1	20.0	43.0	35.1	32.6	38.8	0.0	28.1	36.0	0.0	18.9
Incr Delay (d2), s/veh	15.1	0.2	0.2	9.8	13.5	3.8	9.6	0.0	0.5	28.5	0.0	6.1
Initial Q Delay(d3),s/veh	0.0	0.0	0.0	0.0	0.0	0.0	0.0	0.0	0.0	0.0	0.0	0.0
%ile BackOfQ(50%),veh/ln	7.7	4.9	2.2	0.9	8.1	4.3	4.3	0.0	0.6	9.0	0.0	10.1
Unsig. Movement Delay, s/veh												
LnGrp Delay(d),s/veh	50.6	22.3	20.3	52.8	48.6	36.5	48.5	0.0	28.6	64.6	0.0	25.0
LnGrp LOS	D	C	C	D	D	D	D	A	C	E	A	C
Approach Vol, veh/h		1681			1212			208				867
Approach Delay, s/veh		32.3			46.7			45.2				38.9
Approach LOS		C			D			D				D
Timer - Assigned Phs	1	2	3	4	5	6	7	8				
Phs Duration (G+Y+Rc), s	31.0	24.2	7.4	37.4	15.0	30.1	21.8	23.0				
Change Period (Y+Rc), s	4.5	4.5	4.5	4.5	4.5	4.5	4.5	4.5				
Max Green Setting (Gmax), s	10.5	19.5	6.0	30.0	16.1	19.9	17.5	18.5				
Max Q Clear Time (g_c+M), s	10.8	3.5	3.7	14.5	10.5	27.4	17.2	18.8				
Green Ext Time (p_c), s	0.0	0.1	0.0	6.3	0.2	0.0	0.1	0.0				

Intersection Summary

HCM 6th Ctrl Delay	38.8
HCM 6th LOS	D

HCM 6th Signalized Intersection Summary
 17: Westberry Boulevard & Cleveland Avenue

Village D Specific Plan
 Phase II WP MIT - PM Peak Hour



Movement	EBL	EBT	EBR	WBL	WBT	WBR	NBL	NBT	NBR	SBL	SBT	SBR
Lane Configurations	↖	↖↗		↖	↖↗		↖	↖	↖↗	↖	↖	↖↗
Traffic Volume (veh/h)	160	465	44	103	767	26	57	43	92	22	141	239
Future Volume (veh/h)	160	465	44	103	767	26	57	43	92	22	141	239
Initial Q (Qb), veh	0	0	0	0	0	0	0	0	0	0	0	0
Ped-Bike Adj(A_pbT)	1.00		1.00	1.00		0.99	1.00		1.00	1.00		1.00
Parking Bus, Adj	1.00	1.00	1.00	1.00	1.00	1.00	1.00	1.00	1.00	1.00	1.00	1.00
Work Zone On Approach		No			No			No			No	
Adj Sat Flow, veh/h/ln	1900	1900	1900	1900	1900	1900	1900	1900	1900	1900	1900	1900
Adj Flow Rate, veh/h	174	505	48	112	834	28	62	47	100	24	153	260
Peak Hour Factor	0.92	0.92	0.92	0.92	0.92	0.92	0.92	0.92	0.92	0.92	0.92	0.92
Percent Heavy Veh, %	0	0	0	0	0	0	0	0	0	0	0	0
Cap, veh/h	213	1030	98	144	964	32	85	685	581	47	645	547
Arrive On Green	0.12	0.31	0.31	0.08	0.27	0.27	0.05	0.36	0.36	0.03	0.34	0.34
Sat Flow, veh/h	1810	3331	316	1810	3563	120	1810	1900	1610	1810	1900	1610
Grp Volume(v), veh/h	174	273	280	112	422	440	62	47	100	24	153	260
Grp Sat Flow(s),veh/h/ln	1810	1805	1841	1810	1805	1878	1810	1900	1610	1810	1900	1610
Q Serve(g_s), s	7.5	9.8	9.9	4.9	17.8	17.8	2.7	1.3	3.4	1.0	4.6	10.2
Cycle Q Clear(g_c), s	7.5	9.8	9.9	4.9	17.8	17.8	2.7	1.3	3.4	1.0	4.6	10.2
Prop In Lane	1.00		0.17	1.00		0.06	1.00		1.00	1.00		1.00
Lane Grp Cap(c), veh/h	213	558	569	144	489	508	85	685	581	47	645	547
V/C Ratio(X)	0.82	0.49	0.49	0.78	0.86	0.86	0.73	0.07	0.17	0.51	0.24	0.48
Avail Cap(c_a), veh/h	283	575	587	238	530	552	124	685	581	120	645	547
HCM Platoon Ratio	1.00	1.00	1.00	1.00	1.00	1.00	1.00	1.00	1.00	1.00	1.00	1.00
Upstream Filter(l)	1.00	1.00	1.00	1.00	1.00	1.00	1.00	1.00	1.00	1.00	1.00	1.00
Uniform Delay (d), s/veh	34.4	22.5	22.5	36.1	27.8	27.8	37.6	16.8	17.4	38.5	19.0	20.8
Incr Delay (d2), s/veh	12.8	0.7	0.7	8.7	13.2	12.8	11.5	0.2	0.6	8.5	0.9	2.9
Initial Q Delay(d3),s/veh	0.0	0.0	0.0	0.0	0.0	0.0	0.0	0.0	0.0	0.0	0.0	0.0
%ile BackOfQ(50%),veh/ln	4.0	4.1	4.2	2.4	9.1	9.4	1.4	0.6	1.3	0.6	2.1	4.1
Unsig. Movement Delay, s/veh												
LnGrp Delay(d),s/veh	47.3	23.2	23.2	44.9	41.0	40.5	49.2	17.0	18.1	46.9	19.8	23.7
LnGrp LOS	D	C	C	D	D	D	D	B	B	D	B	C
Approach Vol, veh/h		727			974			209			437	
Approach Delay, s/veh		28.9			41.2			27.0			23.6	
Approach LOS		C			D			C			C	
Timer - Assigned Phs	1	2	3	4	5	6	7	8				
Phs Duration (G+Y+Rc), s	6.6	33.3	10.9	29.2	8.2	31.7	13.9	26.2				
Change Period (Y+Rc), s	4.5	4.5	4.5	4.5	4.5	4.5	4.5	4.5				
Max Green Setting (Gmax), s	3	20.7	10.5	25.5	5.5	20.5	12.5	23.5				
Max Q Clear Time (g_c+1), s	3	5.4	6.9	11.9	4.7	12.2	9.5	19.8				
Green Ext Time (p_c), s	0.0	0.4	0.1	2.8	0.0	1.2	0.1	1.8				
Intersection Summary												
HCM 6th Ctrl Delay											32.9	
HCM 6th LOS											C	

Intersection												
Intersection Delay, s/veh	20.2											
Intersection LOS	C											

Movement	EBL	EBT	EBR	WBL	WBT	WBR	NBL	NBT	NBR	SBL	SBT	SBR
Lane Configurations	↖	↕		↖	↕		↖	↕		↖	↕	
Traffic Vol, veh/h	81	425	44	23	315	203	23	49	17	130	52	85
Future Vol, veh/h	81	425	44	23	315	203	23	49	17	130	52	85
Peak Hour Factor	0.92	0.92	0.92	0.92	0.92	0.92	0.92	0.92	0.92	0.92	0.92	0.92
Heavy Vehicles, %	4	4	4	4	4	4	0	0	0	0	0	0
Mvmt Flow	88	462	48	25	342	221	25	53	18	141	57	92
Number of Lanes	1	2	0	1	2	0	1	1	0	1	1	0

Approach	EB	WB	NB	SB
Opposing Approach	WB	EB	SB	NB
Opposing Lanes	3	3	2	2
Conflicting Approach Left	SB	NB	EB	WB
Conflicting Lanes Left	2	2	3	3
Conflicting Approach Right	NB	SB	WB	EB
Conflicting Lanes Right	2	2	3	3
HCM Control Delay	20.9	22.6	13.9	16
HCM LOS	C	C	B	C

Lane	NBLn1	NBLn2	EBLn1	EBLn2	EBLn3	WBLn1	WBLn2	WBLn3	SBLn1	SBLn2
Vol Left, %	100%	0%	100%	0%	0%	100%	0%	0%	100%	0%
Vol Thru, %	0%	74%	0%	100%	76%	0%	100%	34%	0%	38%
Vol Right, %	0%	26%	0%	0%	24%	0%	0%	66%	0%	62%
Sign Control	Stop	Stop	Stop	Stop	Stop	Stop	Stop	Stop	Stop	Stop
Traffic Vol by Lane	23	66	81	283	186	23	210	308	130	137
LT Vol	23	0	81	0	0	23	0	0	130	0
Through Vol	0	49	0	283	142	0	210	105	0	52
RT Vol	0	17	0	0	44	0	0	203	0	85
Lane Flow Rate	25	72	88	308	202	25	228	335	141	149
Geometry Grp	8	8	8	8	8	8	8	8	8	8
Degree of Util (X)	0.069	0.185	0.206	0.678	0.435	0.059	0.506	0.698	0.358	0.338
Departure Headway (Hd)	9.96	9.266	8.441	7.929	7.759	8.488	7.976	7.504	9.115	8.17
Convergence, Y/N	Yes	Yes	Yes	Yes	Yes	Yes	Yes	Yes	Yes	Yes
Cap	362	390	423	453	462	420	450	479	393	438
Service Time	7.66	6.966	6.232	5.72	5.55	6.278	5.766	5.293	6.914	5.969
HCM Lane V/C Ratio	0.069	0.185	0.208	0.68	0.437	0.06	0.507	0.699	0.359	0.34
HCM Control Delay	13.4	14.1	13.4	26	16.5	11.8	18.7	26	17	15.1
HCM Lane LOS	B	B	B	D	C	B	C	D	C	C
HCM 95th-tile Q	0.2	0.7	0.8	5	2.2	0.2	2.8	5.3	1.6	1.5

HCM 6th Signalized Intersection Summary
21: Granada Drive & Cleveland Avenue

Village D Specific Plan
Phase II WP MIT - PM Peak Hour



Movement	EBL	EBT	EBR	WBL	WBT	WBR	NBL	NBT	NBR	SBL	SBT	SBR
Lane Configurations												
Traffic Volume (veh/h)	24	463	26	359	839	55	28	247	234	49	319	46
Future Volume (veh/h)	24	463	26	359	839	55	28	247	234	49	319	46
Initial Q (Qb), veh	0	0	0	0	0	0	0	0	0	0	0	0
Ped-Bike Adj(A_pbT)	1.00		0.99	1.00		0.98	1.00		0.99	1.00		1.00
Parking Bus, Adj	1.00	1.00	1.00	1.00	1.00	1.00	1.00	1.00	1.00	1.00	1.00	1.00
Work Zone On Approach		No			No			No			No	
Adj Sat Flow, veh/h/ln	1900	1900	1900	1885	1885	1885	1900	1900	1900	1900	1900	1900
Adj Flow Rate, veh/h	26	493	28	382	893	59	30	263	249	52	339	49
Peak Hour Factor	0.94	0.94	0.94	0.94	0.94	0.94	0.94	0.94	0.94	0.94	0.94	0.94
Percent Heavy Veh, %	0	0	0	1	1	1	0	0	0	0	0	0
Cap, veh/h	50	627	36	422	1322	87	55	601	503	77	625	530
Arrive On Green	0.03	0.18	0.18	0.24	0.39	0.39	0.03	0.32	0.32	0.04	0.33	0.33
Sat Flow, veh/h	1810	3472	197	1795	3404	225	1810	1900	1590	1810	1900	1610
Grp Volume(v), veh/h	26	256	265	382	470	482	30	263	249	52	339	49
Grp Sat Flow(s),veh/h/ln	1810	1805	1863	1795	1791	1838	1810	1900	1590	1810	1900	1610
Q Serve(g_s), s	1.1	10.8	10.9	16.5	17.4	17.4	1.3	8.8	10.2	2.3	11.7	1.7
Cycle Q Clear(g_c), s	1.1	10.8	10.9	16.5	17.4	17.4	1.3	8.8	10.2	2.3	11.7	1.7
Prop In Lane	1.00		0.11	1.00		0.12	1.00		1.00	1.00		1.00
Lane Grp Cap(c), veh/h	50	326	337	422	695	714	55	601	503	77	625	530
V/C Ratio(X)	0.52	0.78	0.79	0.91	0.68	0.68	0.55	0.44	0.49	0.67	0.54	0.09
Avail Cap(c_a), veh/h	120	406	419	460	743	763	113	601	503	113	625	530
HCM Platoon Ratio	1.00	1.00	1.00	1.00	1.00	1.00	1.00	1.00	1.00	1.00	1.00	1.00
Upstream Filter(I)	1.00	1.00	1.00	0.50	0.50	0.50	1.00	1.00	1.00	1.00	1.00	1.00
Uniform Delay (d), s/veh	38.4	31.3	31.3	29.7	20.3	20.3	38.2	21.7	22.2	37.7	21.9	18.6
Incr Delay (d2), s/veh	8.3	7.8	7.8	11.7	1.1	1.1	8.1	2.3	3.5	9.6	3.4	0.3
Initial Q Delay(d3),s/veh	0.0	0.0	0.0	0.0	0.0	0.0	0.0	0.0	0.0	0.0	0.0	0.0
%ile BackOfQ(50%),veh/ln	0.6	5.3	5.5	8.2	7.0	7.2	0.7	4.1	4.1	1.2	5.5	0.7
Unsig. Movement Delay, s/veh												
LnGrp Delay(d),s/veh	46.7	39.1	39.1	41.4	21.4	21.4	46.4	24.0	25.6	47.3	25.3	18.9
LnGrp LOS	D	D	D	D	C	C	D	C	C	D	C	B
Approach Vol, veh/h		547			1334			542			440	
Approach Delay, s/veh		39.5			27.1			26.0			27.2	
Approach LOS		D			C			C			C	
Timer - Assigned Phs	1	2	3	4	5	6	7	8				
Phs Duration (G+Y+Rc), s	7.9	29.8	23.3	19.0	6.9	30.8	6.7	35.6				
Change Period (Y+Rc), s	4.5	4.5	4.5	4.5	4.5	4.5	4.5	4.5				
Max Green Setting (Gmax), s	5.0	18.5	20.5	18.0	5.0	18.5	5.3	33.2				
Max Q Clear Time (g_c+I1), s	4.3	12.2	18.5	12.9	3.3	13.7	3.1	19.4				
Green Ext Time (p_c), s	0.0	1.3	0.3	1.4	0.0	0.9	0.0	5.3				

Intersection Summary

HCM 6th Ctrl Delay	29.3
HCM 6th LOS	C

HCM 6th Signalized Intersection Summary
 22: Granada Drive & Sunset Avenue

Village D Specific Plan
 Phase II WP MIT - PM Peak Hour



Movement	EBL	EBT	EBR	WBL	WBT	WBR	NBL	NBT	NBR	SBL	SBT	SBR
Lane Configurations												
Traffic Volume (veh/h)	31	139	37	56	173	112	51	280	43	81	336	38
Future Volume (veh/h)	31	139	37	56	173	112	51	280	43	81	336	38
Initial Q (Qb), veh	0	0	0	0	0	0	0	0	0	0	0	0
Ped-Bike Adj(A_pbT)	1.00		0.99	1.00		0.99	1.00		0.99	1.00		0.99
Parking Bus, Adj	1.00	1.00	1.00	1.00	1.00	1.00	1.00	1.00	1.00	1.00	1.00	1.00
Work Zone On Approach		No		No		No		No		No		No
Adj Sat Flow, veh/h/ln	1885	1885	1885	1900	1900	1900	1885	1885	1885	1885	1885	1885
Adj Flow Rate, veh/h	33	149	40	60	186	120	55	301	46	87	361	41
Peak Hour Factor	0.93	0.93	0.93	0.93	0.93	0.93	0.93	0.93	0.93	0.93	0.93	0.93
Percent Heavy Veh, %	1	1	1	0	0	0	1	1	1	1	1	1
Cap, veh/h	62	211	57	92	311	261	87	738	113	112	791	90
Arrive On Green	0.03	0.15	0.15	0.05	0.16	0.16	0.05	0.46	0.46	0.06	0.48	0.48
Sat Flow, veh/h	1795	1428	383	1810	1900	1595	1795	1596	244	1795	1661	189
Grp Volume(v), veh/h	33	0	189	60	186	120	55	0	347	87	0	402
Grp Sat Flow(s),veh/h/ln	1795	0	1812	1810	1900	1595	1795	0	1839	1795	0	1850
Q Serve(g_s), s	1.2	0.0	6.5	2.1	5.9	4.4	2.0	0.0	8.1	3.1	0.0	9.5
Cycle Q Clear(g_c), s	1.2	0.0	6.5	2.1	5.9	4.4	2.0	0.0	8.1	3.1	0.0	9.5
Prop In Lane	1.00		0.21	1.00		1.00	1.00		0.13	1.00		0.10
Lane Grp Cap(c), veh/h	62	0	267	92	311	261	87	0	850	112	0	881
V/C Ratio(X)	0.53	0.00	0.71	0.65	0.60	0.46	0.63	0.00	0.41	0.78	0.00	0.46
Avail Cap(c_a), veh/h	138	0	502	139	526	442	138	0	850	163	0	881
HCM Platoon Ratio	1.00	1.00	1.00	1.00	1.00	1.00	1.00	1.00	1.00	1.00	1.00	1.00
Upstream Filter(I)	1.00	0.00	1.00	0.96	0.96	0.96	1.00	0.00	1.00	1.00	0.00	1.00
Uniform Delay (d), s/veh	30.9	0.0	26.4	30.3	25.2	24.6	30.4	0.0	11.6	30.0	0.0	11.4
Incr Delay (d2), s/veh	6.9	0.0	3.4	7.2	1.8	1.2	7.4	0.0	1.5	13.3	0.0	1.7
Initial Q Delay(d3),s/veh	0.0	0.0	0.0	0.0	0.0	0.0	0.0	0.0	0.0	0.0	0.0	0.0
%ile BackOfQ(50%),veh/ln	0.6	0.0	2.9	1.1	2.7	1.7	1.0	0.0	3.3	1.7	0.0	3.8
Unsig. Movement Delay, s/veh												
LnGrp Delay(d),s/veh	37.8	0.0	29.8	37.5	27.0	25.8	37.7	0.0	13.0	43.4	0.0	13.1
LnGrp LOS	D	A	C	D	C	C	D	A	B	D	A	B
Approach Vol, veh/h		222		366		402		489				
Approach Delay, s/veh		31.0		28.3		16.4		18.5				
Approach LOS		C		C		B		B				
Timer - Assigned Phs	1	2	3	4	5	6	7	8				
Phs Duration (G+Y+Rc), s	8.6	34.6	7.8	14.1	7.6	35.5	6.7	15.1				
Change Period (Y+Rc), s	4.5	4.5	4.5	4.5	4.5	4.5	4.5	4.5				
Max Green Setting (Gmax), s	18.1	18.1	5.0	18.0	5.0	19.0	5.0	18.0				
Max Q Clear Time (g_c+1), s	10.1	10.1	4.1	8.5	4.0	11.5	3.2	7.9				
Green Ext Time (p_c), s	0.0	1.3	0.0	0.7	0.0	1.5	0.0	1.0				
Intersection Summary												
HCM 6th Ctrl Delay				22.2								
HCM 6th LOS				C								

HCM 6th Signalized Intersection Summary
 25: Kennedy Street/Gateway Drive & SR-99 Southbound Ramps

Village D Specific Plan
 Phase II WP MIT - PM Peak Hour

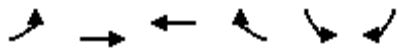

Movement	EBL	EBT	WBT	WBR	SBL	SBR	
Lane Configurations							
Traffic Volume (veh/h)	265	451	392	2	135	227	
Future Volume (veh/h)	265	451	392	2	135	227	
Initial Q (Qb), veh	0	0	0	0	0	0	
Ped-Bike Adj(A_pbT)	1.00			1.00	1.00	1.00	
Parking Bus, Adj	1.00	1.00	1.00	1.00	1.00	1.00	
Work Zone On Approach		No	No		No		
Adj Sat Flow, veh/h/ln	1870	1870	1856	1856	1856	1856	
Adj Flow Rate, veh/h	288	490	426	0	147	247	
Peak Hour Factor	0.92	0.92	0.92	0.92	0.92	0.92	
Percent Heavy Veh, %	2	2	3	3	3	3	
Cap, veh/h	332	949	491		672	891	
Arrive On Green	0.19	0.51	0.26	0.00	0.38	0.38	
Sat Flow, veh/h	1781	1870	1856	0	1767	1572	
Grp Volume(v), veh/h	288	490	426	0	147	247	
Grp Sat Flow(s),veh/h/ln	1781	1870	1856	0	1767	1572	
Q Serve(g_s), s	12.6	14.0	17.5	0.0	4.5	6.5	
Cycle Q Clear(g_c), s	12.6	14.0	17.5	0.0	4.5	6.5	
Prop In Lane	1.00			0.00	1.00	1.00	
Lane Grp Cap(c), veh/h	332	949	491		672	891	
V/C Ratio(X)	0.87	0.52	0.87		0.22	0.28	
Avail Cap(c_a), veh/h	434	1204	638		672	891	
HCM Platoon Ratio	1.00	1.00	1.00	1.00	1.00	1.00	
Upstream Filter(I)	1.00	1.00	1.00	0.00	1.00	1.00	
Uniform Delay (d), s/veh	31.6	13.2	28.1	0.0	16.8	8.9	
Incr Delay (d2), s/veh	13.6	0.4	9.9	0.0	0.7	0.8	
Initial Q Delay(d3),s/veh	0.0	0.0	0.0	0.0	0.0	0.0	
%ile BackOfQ(50%),veh/ln	6.5	5.5	8.8	0.0	1.9	8.1	
Unsig. Movement Delay, s/veh							
LnGrp Delay(d),s/veh	45.2	13.6	38.0	0.0	17.5	9.7	
LnGrp LOS	D	B	D		B	A	
Approach Vol, veh/h		778	426	A	394		
Approach Delay, s/veh		25.3	38.0		12.6		
Approach LOS		C	D		B		
Timer - Assigned Phs				4	6	7	8
Phs Duration (G+Y+Rc), s				45.1	34.9	19.4	25.7
Change Period (Y+Rc), s				4.5	4.5	4.5	4.5
Max Green Setting (Gmax), s				51.5	19.5	19.5	27.5
Max Q Clear Time (g_c+I1), s				16.0	8.5	14.6	19.5
Green Ext Time (p_c), s				3.5	1.0	0.4	1.6

Intersection Summary

HCM 6th Ctrl Delay	25.6
HCM 6th LOS	C

Notes

Unsignalized Delay for [WBR] is excluded from calculations of the approach delay and intersection delay.

HCM 6th Signalized Intersection Summary
 31: SR-99 Southbound Ramps & Cleveland Avenue

Village D Specific Plan
 Phase II WP MIT - PM Peak Hour



Movement	EBL	EBT	EBR	WBL	WBT	WBR	NBL	NBT	NBR	SBL	SBT	SBR
Lane Configurations		↑↑	↗	↖	↑↑					↘		↗
Traffic Volume (veh/h)	0	924	522	318	1801	0	0	0	0	243	0	97
Future Volume (veh/h)	0	924	522	318	1801	0	0	0	0	243	0	97
Initial Q (Qb), veh	0	0	0	0	0	0				0	0	0
Ped-Bike Adj(A_pbT)	1.00		1.00	1.00		1.00				1.00		1.00
Parking Bus, Adj	1.00	1.00	1.00	1.00	1.00	1.00				1.00	1.00	1.00
Work Zone On Approach		No			No						No	
Adj Sat Flow, veh/h/ln	0	1885	1885	1900	1900	0				1856	0	1856
Adj Flow Rate, veh/h	0	953	538	328	1857	0				251	0	100
Peak Hour Factor	0.97	0.97	0.97	0.97	0.97	0.97				0.97	0.97	0.97
Percent Heavy Veh, %	0	1	1	0	0	0				3	0	3
Cap, veh/h	0	1371	609	355	2271	0				479	0	426
Arrive On Green	0.00	0.38	0.38	0.39	1.00	0.00				0.27	0.00	0.27
Sat Flow, veh/h	0	3676	1591	1810	3705	0				1767	0	1572
Grp Volume(v), veh/h	0	953	538	328	1857	0				251	0	100
Grp Sat Flow(s),veh/h/ln	0	1791	1591	1810	1805	0				1767	0	1572
Q Serve(g_s), s	0.0	20.1	28.4	15.5	0.0	0.0				10.9	0.0	4.5
Cycle Q Clear(g_c), s	0.0	20.1	28.4	15.5	0.0	0.0				10.9	0.0	4.5
Prop In Lane	0.00		1.00	1.00		0.00				1.00		1.00
Lane Grp Cap(c), veh/h	0	1371	609	355	2271	0				479	0	426
V/C Ratio(X)	0.00	0.69	0.88	0.92	0.82	0.00				0.52	0.00	0.23
Avail Cap(c_a), veh/h	0	1453	645	372	2387	0				479	0	426
HCM Platoon Ratio	1.00	1.00	1.00	2.00	2.00	1.00				1.00	1.00	1.00
Upstream Filter(I)	0.00	0.61	0.61	0.18	0.18	0.00				1.00	0.00	1.00
Uniform Delay (d), s/veh	0.0	23.4	25.9	26.7	0.0	0.0				27.9	0.0	25.5
Incr Delay (d2), s/veh	0.0	0.8	8.6	7.4	0.4	0.0				4.1	0.0	1.3
Initial Q Delay(d3),s/veh	0.0	0.0	0.0	0.0	0.0	0.0				0.0	0.0	0.0
%ile BackOfQ(50%),veh/ln	0.0	8.3	11.7	5.7	0.1	0.0				5.0	0.0	1.8
Unsig. Movement Delay, s/veh												
LnGrp Delay(d),s/veh	0.0	24.2	34.5	34.1	0.4	0.0				31.9	0.0	26.8
LnGrp LOS	A	C	C	C	A	A				C	A	C
Approach Vol, veh/h		1491			2185						351	
Approach Delay, s/veh		27.9			5.5						30.5	
Approach LOS		C			A						C	
Timer - Assigned Phs			3	4		6		8				
Phs Duration (G+Y+Rc), s			22.2	39.0		28.9		61.1				
Change Period (Y+Rc), s			4.5	4.5		4.5		4.5				
Max Green Setting (Gmax), s			18.5	36.5		21.5		59.5				
Max Q Clear Time (g_c+I1), s			17.5	30.4		12.9		2.0				
Green Ext Time (p_c), s			0.1	4.1		0.7		27.8				
Intersection Summary												
HCM 6th Ctrl Delay			16.0									
HCM 6th LOS			B									

HCM 6th Signalized Intersection Summary
 38: I Street & 2nd Street/SR-99 Southbound Off-Ramp

Village D Specific Plan
 Phase II WP MIT - PM Peak Hour



Movement	EBL	EBT	EBR	WBL	WBT	WBR	NBL	NBT	NBR	SBL	SBT	SBR
Lane Configurations		↕			↕	↕	↕	↕			↕	
Traffic Volume (veh/h)	0	0	40	321	13	5	50	154	0	0	119	0
Future Volume (veh/h)	0	0	40	321	13	5	50	154	0	0	119	0
Initial Q (Qb), veh	0	0	0	0	0	0	0	0	0	0	0	0
Ped-Bike Adj(A_pbT)	1.00		1.00	1.00		1.00	1.00		1.00	1.00		1.00
Parking Bus, Adj	1.00	1.00	1.00	1.00	1.00	1.00	1.00	1.00	1.00	1.00	1.00	1.00
Work Zone On Approach		No			No			No			No	
Adj Sat Flow, veh/h/ln	1900	1900	1900	1870	1870	1870	1900	1900	0	0	1900	1900
Adj Flow Rate, veh/h	0	0	41	328	13	5	51	157	0	0	121	0
Peak Hour Factor	0.98	0.98	0.98	0.98	0.98	0.98	0.98	0.98	0.98	0.98	0.98	0.98
Percent Heavy Veh, %	0	0	0	2	2	2	0	0	0	0	0	0
Cap, veh/h	0	0	60	389	15	360	783	1077	0	0	1077	0
Arrive On Green	0.00	0.00	0.04	0.23	0.23	0.23	0.57	0.57	0.00	0.00	0.57	0.00
Sat Flow, veh/h	0	0	1610	1717	68	1585	1290	1900	0	0	1900	0
Grp Volume(v), veh/h	0	0	41	341	0	5	51	157	0	0	121	0
Grp Sat Flow(s),veh/h/ln	0	0	1610	1785	0	1585	1290	1900	0	0	1900	0
Q Serve(g_s), s	0.0	0.0	2.0	14.6	0.0	0.2	1.5	3.1	0.0	0.0	2.4	0.0
Cycle Q Clear(g_c), s	0.0	0.0	2.0	14.6	0.0	0.2	3.9	3.1	0.0	0.0	2.4	0.0
Prop In Lane	0.00		1.00	0.96		1.00	1.00		0.00	0.00		0.00
Lane Grp Cap(c), veh/h	0	0	60	405	0	360	783	1077	0	0	1077	0
V/C Ratio(X)	0.00	0.00	0.68	0.84	0.00	0.01	0.07	0.15	0.00	0.00	0.11	0.00
Avail Cap(c_a), veh/h	0	0	362	613	0	545	783	1077	0	0	1077	0
HCM Platoon Ratio	1.00	1.00	1.00	1.00	1.00	1.00	1.00	1.00	1.00	1.00	1.00	1.00
Upstream Filter(I)	0.00	0.00	1.00	1.00	0.00	1.00	0.99	0.99	0.00	0.00	1.00	0.00
Uniform Delay (d), s/veh	0.0	0.0	38.0	29.6	0.0	24.0	8.9	8.2	0.0	0.0	8.0	0.0
Incr Delay (d2), s/veh	0.0	0.0	12.7	6.6	0.0	0.0	0.2	0.3	0.0	0.0	0.2	0.0
Initial Q Delay(d3),s/veh	0.0	0.0	0.0	0.0	0.0	0.0	0.0	0.0	0.0	0.0	0.0	0.0
%ile BackOfQ(50%),veh/ln	0.0	0.0	1.0	6.8	0.0	0.1	0.4	1.2	0.0	0.0	0.9	0.0
Unsig. Movement Delay, s/veh												
LnGrp Delay(d),s/veh	0.0	0.0	50.7	36.2	0.0	24.0	9.1	8.5	0.0	0.0	8.2	0.0
LnGrp LOS	A	A	D	D	A	C	A	A	A	A	A	A
Approach Vol, veh/h		41			346			208			121	
Approach Delay, s/veh		50.7			36.0			8.6			8.2	
Approach LOS		D			D			A			A	
Timer - Assigned Phs		2		4		6		8				
Phs Duration (G+Y+Rc), s		49.9		7.5		49.9		22.6				
Change Period (Y+Rc), s		4.5		4.5		4.5		4.5				
Max Green Setting (Gmax), s		21.0		18.0		21.0		27.5				
Max Q Clear Time (g_c+I1), s		5.9		4.0		4.4		16.6				
Green Ext Time (p_c), s		0.8		0.1		0.5		1.5				
Intersection Summary												
HCM 6th Ctrl Delay				24.2								
HCM 6th LOS				C								

HCM 6th Signalized Intersection Summary
 49: Yosemite Avenue & Cleveland Avenue/Tozer Street

Village D Specific Plan
 Phase II WP MIT - PM Peak Hour



Movement	EBL	EBT	EBR	WBL	WBT	WBR	NBL	NBT	NBR	SBL	SBT	SBR
Lane Configurations												
Traffic Volume (veh/h)	272	452	200	51	492	44	315	314	98	78	181	313
Future Volume (veh/h)	272	452	200	51	492	44	315	314	98	78	181	313
Initial Q (Qb), veh	0	0	0	0	0	0	0	0	0	0	0	0
Ped-Bike Adj(A_pbT)	1.00		0.99	1.00		0.96	1.00		1.00	1.00		0.98
Parking Bus, Adj	1.00	1.00	1.00	1.00	1.00	1.00	1.00	1.00	1.00	1.00	1.00	1.00
Work Zone On Approach		No			No			No			No	
Adj Sat Flow, veh/h/ln	1870	1870	1870	1900	1900	1900	1885	1885	1885	1870	1870	1870
Adj Flow Rate, veh/h	296	491	217	55	535	48	342	341	107	85	197	340
Peak Hour Factor	0.92	0.92	0.92	0.92	0.92	0.92	0.92	0.92	0.92	0.92	0.92	0.92
Percent Heavy Veh, %	2	2	2	0	0	0	1	1	1	2	2	2
Cap, veh/h	311	822	361	74	757	324	372	676	571	109	398	607
Arrive On Green	0.17	0.34	0.34	0.04	0.21	0.21	0.21	0.36	0.36	0.06	0.21	0.21
Sat Flow, veh/h	1781	2392	1051	1810	3610	1545	1795	1885	1592	1781	1870	1551
Grp Volume(v), veh/h	296	364	344	55	535	48	342	341	107	85	197	340
Grp Sat Flow(s),veh/h/ln	1781	1777	1667	1810	1805	1545	1795	1885	1592	1781	1870	1551
Q Serve(g_s), s	15.1	15.6	15.7	2.8	12.7	2.3	17.2	13.0	4.3	4.3	8.5	15.8
Cycle Q Clear(g_c), s	15.1	15.6	15.7	2.8	12.7	2.3	17.2	13.0	4.3	4.3	8.5	15.8
Prop In Lane	1.00		0.63	1.00		1.00	1.00		1.00	1.00		1.00
Lane Grp Cap(c), veh/h	311	610	572	74	757	324	372	676	571	109	398	607
V/C Ratio(X)	0.95	0.60	0.60	0.74	0.71	0.15	0.92	0.50	0.19	0.78	0.50	0.56
Avail Cap(c_a), veh/h	311	610	572	112	757	324	372	755	638	188	559	740
HCM Platoon Ratio	1.00	1.00	1.00	1.00	1.00	1.00	1.00	1.00	1.00	1.00	1.00	1.00
Upstream Filter(I)	1.00	1.00	1.00	1.00	1.00	1.00	1.00	1.00	1.00	1.00	1.00	1.00
Uniform Delay (d), s/veh	37.6	25.0	25.0	43.7	33.8	29.7	35.7	23.1	20.3	42.6	31.9	22.1
Incr Delay (d2), s/veh	37.9	4.3	4.6	13.5	5.5	1.0	27.2	0.6	0.2	11.2	1.0	0.8
Initial Q Delay(d3),s/veh	0.0	0.0	0.0	0.0	0.0	0.0	0.0	0.0	0.0	0.0	0.0	0.0
%ile BackOfQ(50%),veh/ln	9.7	7.1	6.8	1.5	6.0	0.9	10.2	5.7	1.6	2.2	3.9	5.7
Unsig. Movement Delay, s/veh												
LnGrp Delay(d),s/veh	75.5	29.2	29.6	57.1	39.3	30.6	62.9	23.7	20.5	53.8	32.9	22.9
LnGrp LOS	E	C	C	E	D	C	E	C	C	D	C	C
Approach Vol, veh/h		1004			638			790			622	
Approach Delay, s/veh		43.0			40.2			40.3			30.3	
Approach LOS		D			D			D			C	
Timer - Assigned Phs	1	2	3	4	5	6	7	8				
Phs Duration (G+Y+Rc), s	20.6	23.8	10.2	37.5	8.3	36.1	23.6	24.1				
Change Period (Y+Rc), s	4.5	4.5	4.5	4.5	4.5	4.5	4.5	4.5				
Max Green Setting (Gmax), s	16.1	19.3	9.7	36.9	5.7	29.7	19.1	27.5				
Max Q Clear Time (g_c+I1), s	17.1	14.7	6.3	15.0	4.8	17.7	19.2	17.8				
Green Ext Time (p_c), s	0.0	1.5	0.0	2.4	0.0	3.6	0.0	1.7				

Intersection Summary

HCM 6th Ctrl Delay	39.1
HCM 6th LOS	D

HCM 6th Signalized Intersection Summary
51: Project Driveway 1 & Avenue 17

Village D Specific Plan
Phase II WP MIT - PM Peak Hour



Movement	EBT	EBR	WBL	WBT	NBL	NBR
Lane Configurations	↩		↩	↩	↩	↩
Traffic Volume (veh/h)	116	50	659	66	23	334
Future Volume (veh/h)	116	50	659	66	23	334
Initial Q (Qb), veh	0	0	0	0	0	0
Ped-Bike Adj(A_pbT)		1.00	1.00		1.00	1.00
Parking Bus, Adj	1.00	1.00	1.00	1.00	1.00	1.00
Work Zone On Approach	No			No	No	
Adj Sat Flow, veh/h/ln	1885	1885	1900	1900	1900	1900
Adj Flow Rate, veh/h	126	54	716	72	25	363
Peak Hour Factor	0.92	0.92	0.92	0.92	0.92	0.92
Percent Heavy Veh, %	1	1	0	0	0	0
Cap, veh/h	157	67	754	1125	557	495
Arrive On Green	0.13	0.13	0.42	0.59	0.31	0.31
Sat Flow, veh/h	1252	537	1810	1900	1810	1610
Grp Volume(v), veh/h	0	180	716	72	25	363
Grp Sat Flow(s),veh/h/ln	0	1789	1810	1900	1810	1610
Q Serve(g_s), s	0.0	8.8	34.4	1.4	0.9	18.1
Cycle Q Clear(g_c), s	0.0	8.8	34.4	1.4	0.9	18.1
Prop In Lane		0.30	1.00		1.00	1.00
Lane Grp Cap(c), veh/h	0	224	754	1125	557	495
V/C Ratio(X)	0.00	0.80	0.95	0.06	0.04	0.73
Avail Cap(c_a), veh/h	0	358	814	1330	557	495
HCM Platoon Ratio	1.00	1.00	1.00	1.00	1.00	1.00
Upstream Filter(I)	0.00	1.00	0.89	0.89	1.00	1.00
Uniform Delay (d), s/veh	0.0	38.3	25.3	7.8	21.9	27.8
Incr Delay (d2), s/veh	0.0	6.7	18.0	0.0	0.2	9.3
Initial Q Delay(d3),s/veh	0.0	0.0	0.0	0.0	0.0	0.0
%ile BackOfQ(50%),veh/ln	0.0	4.2	17.6	0.6	0.4	8.0
Unsig. Movement Delay, s/veh						
LnGrp Delay(d),s/veh	0.0	45.0	43.3	7.8	22.0	37.1
LnGrp LOS	A	D	D	A	C	D
Approach Vol, veh/h	180			788	388	
Approach Delay, s/veh	45.0			40.1	36.1	
Approach LOS	D			D	D	
Timer - Assigned Phs		2	3	4		8
Phs Duration (G+Y+Rc), s		32.2	42.0	15.8		57.8
Change Period (Y+Rc), s		4.5	4.5	4.5		4.5
Max Green Setting (Gmax), s		18.0	40.5	18.0		63.0
Max Q Clear Time (g_c+I1), s		20.1	36.4	10.8		3.4
Green Ext Time (p_c), s		0.0	1.2	0.5		0.4
Intersection Summary						
HCM 6th Ctrl Delay			39.6			
HCM 6th LOS			D			

HCM 6th Signalized Intersection Summary
55: Road 23 & Project Driveway 3

Village D Specific Plan
Phase II WP MIT - PM Peak Hour



Movement	EBL	EBR	NBL	NBT	SBT	SBR
Lane Configurations	↶↶	↷	↶	↶↶	↶↶↶	↷
Traffic Volume (veh/h)	323	413	431	818	1048	660
Future Volume (veh/h)	323	413	431	818	1048	660
Initial Q (Qb), veh	0	0	0	0	0	0
Ped-Bike Adj(A_pbT)	1.00	1.00	1.00			1.00
Parking Bus, Adj	1.00	1.00	1.00	1.00	1.00	1.00
Work Zone On Approach	No			No	No	
Adj Sat Flow, veh/h/ln	1900	1900	1870	1870	1870	1870
Adj Flow Rate, veh/h	351	449	468	889	1139	717
Peak Hour Factor	0.92	0.92	0.92	0.92	0.92	0.92
Percent Heavy Veh, %	0	0	2	2	2	2
Cap, veh/h	570	719	506	2710	2252	699
Arrive On Green	0.16	0.16	0.09	0.25	0.30	0.30
Sat Flow, veh/h	3510	1610	1781	3647	5274	1585
Grp Volume(v), veh/h	351	449	468	889	1139	717
Grp Sat Flow(s),veh/h/ln	1755	1610	1781	1777	1702	1585
Q Serve(g_s), s	11.2	19.5	31.3	24.5	22.2	52.9
Cycle Q Clear(g_c), s	11.2	19.5	31.3	24.5	22.2	52.9
Prop In Lane	1.00	1.00	1.00			1.00
Lane Grp Cap(c), veh/h	570	719	506	2710	2252	699
V/C Ratio(X)	0.62	0.62	0.93	0.33	0.51	1.03
Avail Cap(c_a), veh/h	570	719	571	2710	2252	699
HCM Platoon Ratio	1.00	1.00	0.33	0.33	0.67	0.67
Upstream Filter(I)	1.00	1.00	0.68	0.68	0.67	0.67
Uniform Delay (d), s/veh	46.8	25.5	53.1	19.8	31.4	42.3
Incr Delay (d2), s/veh	2.0	1.7	14.9	0.2	0.5	34.5
Initial Q Delay(d3),s/veh	0.0	0.0	0.0	0.0	0.0	0.0
%ile BackOfQ(50%),veh/ln	5.0	23.6	17.1	11.7	9.7	28.1
Unsig. Movement Delay, s/veh						
LnGrp Delay(d),s/veh	48.7	27.2	68.0	20.0	32.0	76.8
LnGrp LOS	D	C	E	C	C	F
Approach Vol, veh/h	800			1357	1856	
Approach Delay, s/veh	36.6			36.6	49.3	
Approach LOS	D			D	D	
Timer - Assigned Phs		2		4	5	6
Phs Duration (G+Y+Rc), s		96.0		24.0	38.6	57.4
Change Period (Y+Rc), s		4.5		4.5	4.5	4.5
Max Green Setting (Gmax), s		91.5		19.5	38.5	48.5
Max Q Clear Time (g_c+I1), s		26.5		21.5	33.3	54.9
Green Ext Time (p_c), s		8.0		0.0	0.8	0.0
Intersection Summary						
HCM 6th Ctrl Delay			42.5			
HCM 6th LOS			D			

HCM 6th Signalized Intersection Summary
56: Road 23 & Project Driveway 4

Village D Specific Plan
Phase II WP MIT - PM Peak Hour



Movement	WBL	WBR	NBT	NBR	SBL	SBT
Lane Configurations						
Traffic Volume (veh/h)	330	789	611	301	875	481
Future Volume (veh/h)	330	789	611	301	875	481
Initial Q (Qb), veh	0	0	0	0	0	0
Ped-Bike Adj(A_pbT)	1.00	1.00		1.00	1.00	
Parking Bus, Adj	1.00	1.00	1.00	1.00	1.00	1.00
Work Zone On Approach	No		No		No	
Adj Sat Flow, veh/h/ln	1900	1900	1856	1856	1870	1870
Adj Flow Rate, veh/h	359	858	664	327	951	523
Peak Hour Factor	0.92	0.92	0.92	0.92	0.92	0.92
Percent Heavy Veh, %	0	0	3	3	2	2
Cap, veh/h	550	862	1406	437	1056	3170
Arrive On Green	0.30	0.30	0.28	0.28	0.31	0.62
Sat Flow, veh/h	1810	2834	5233	1572	3456	5274
Grp Volume(v), veh/h	359	858	664	327	951	523
Grp Sat Flow(s),veh/h/ln	1810	1417	1689	1572	1728	1702
Q Serve(g_s), s	20.7	36.3	13.1	22.8	31.6	5.2
Cycle Q Clear(g_c), s	20.7	36.3	13.1	22.8	31.6	5.2
Prop In Lane	1.00	1.00		1.00	1.00	
Lane Grp Cap(c), veh/h	550	862	1406	437	1056	3170
V/C Ratio(X)	0.65	1.00	0.47	0.75	0.90	0.16
Avail Cap(c_a), veh/h	550	862	1406	437	1281	3170
HCM Platoon Ratio	1.00	1.00	1.00	1.00	1.00	1.00
Upstream Filter(I)	1.00	1.00	1.00	1.00	0.79	0.79
Uniform Delay (d), s/veh	36.2	41.7	36.0	39.5	39.9	9.6
Incr Delay (d2), s/veh	2.7	29.5	1.1	11.2	6.3	0.1
Initial Q Delay(d3),s/veh	0.0	0.0	0.0	0.0	0.0	0.0
%ile BackOfQ(50%),veh/ln	9.5	16.0	5.5	10.1	14.2	1.9
Unsig. Movement Delay, s/veh						
LnGrp Delay(d),s/veh	39.0	71.1	37.2	50.7	46.2	9.7
LnGrp LOS	D	E	D	D	D	A
Approach Vol, veh/h	1217		991			1474
Approach Delay, s/veh	61.6		41.6			33.3
Approach LOS	E		D			C
Timer - Assigned Phs	1	2			6	8
Phs Duration (G+Y+Rc), s	41.2	37.8			79.0	41.0
Change Period (Y+Rc), s	4.5	4.5			4.5	4.5
Max Green Setting (Gmax), s	41.5	25.5			74.5	36.5
Max Q Clear Time (g_c+Rc), s	33.6	24.8			7.2	38.3
Green Ext Time (p_c), s	3.1	0.4			4.1	0.0
Intersection Summary						
HCM 6th Ctrl Delay			44.9			
HCM 6th LOS			D			

Intersection						
Int Delay, s/veh	0.7					
Movement	EBL	EBR	NBL	NBT	SBT	SBR
Lane Configurations	T		T		T	
Traffic Vol, veh/h	40	16	0	876	789	24
Future Vol, veh/h	40	16	0	876	789	24
Conflicting Peds, #/hr	0	0	0	0	0	0
Sign Control	Stop	Stop	Free	Free	Free	Free
RT Channelized	-	None	-	None	-	None
Storage Length	0	-	50	-	-	-
Veh in Median Storage, #	0	-	-	0	0	-
Grade, %	0	-	-	0	0	-
Peak Hour Factor	92	92	92	92	92	92
Heavy Vehicles, %	0	0	3	3	4	4
Mvmt Flow	43	17	0	952	858	26

Major/Minor	Minor2	Major1		Major2	
Conflicting Flow All	1252	442	884	0	0
Stage 1	871	-	-	-	-
Stage 2	381	-	-	-	-
Critical Hdwy	5.7	7.1	5.36	-	-
Critical Hdwy Stg 1	6.6	-	-	-	-
Critical Hdwy Stg 2	6	-	-	-	-
Follow-up Hdwy	3.8	3.9	3.13	-	-
Pot Cap-1 Maneuver	235	486	442	-	-
Stage 1	293	-	-	-	-
Stage 2	610	-	-	-	-
Platoon blocked, %				-	-
Mov Cap-1 Maneuver	235	486	442	-	-
Mov Cap-2 Maneuver	235	-	-	-	-
Stage 1	293	-	-	-	-
Stage 2	610	-	-	-	-

Approach	EB	NB	SB
HCM Control Delay, s	21.7	0	0
HCM LOS	C		

Minor Lane/Major Mvmt	NBL	NBT	EBLn1	SBT	SBR
Capacity (veh/h)	442	-	276	-	-
HCM Lane V/C Ratio	-	-	0.221	-	-
HCM Control Delay (s)	0	-	21.7	-	-
HCM Lane LOS	A	-	C	-	-
HCM 95th %tile Q(veh)	0	-	0.8	-	-

HCM 6th Signalized Intersection Summary
58: Project Driveway 6 & Cleveland Avenue

Village D Specific Plan
Phase II WP MIT - PM Peak Hour



Movement	EBT	EBR	WBL	WBT	NBL	NBR
Lane Configurations	↩		↩	↩	↩	↩
Traffic Volume (veh/h)	460	148	332	797	69	243
Future Volume (veh/h)	460	148	332	797	69	243
Initial Q (Qb), veh	0	0	0	0	0	0
Ped-Bike Adj(A_pbT)		1.00	1.00		1.00	1.00
Parking Bus, Adj	1.00	1.00	1.00	1.00	1.00	1.00
Work Zone On Approach	No			No	No	
Adj Sat Flow, veh/h/ln	1885	1885	1900	1900	1900	1900
Adj Flow Rate, veh/h	500	161	361	866	75	264
Peak Hour Factor	0.92	0.92	0.92	0.92	0.92	0.92
Percent Heavy Veh, %	1	1	0	0	0	0
Cap, veh/h	526	169	397	1244	444	395
Arrive On Green	0.39	0.39	0.22	0.65	0.25	0.25
Sat Flow, veh/h	1366	440	1810	1900	1810	1610
Grp Volume(v), veh/h	0	661	361	866	75	264
Grp Sat Flow(s),veh/h/ln	0	1806	1810	1900	1810	1610
Q Serve(g_s), s	0.0	31.9	17.5	26.0	2.9	13.3
Cycle Q Clear(g_c), s	0.0	31.9	17.5	26.0	2.9	13.3
Prop In Lane		0.24	1.00		1.00	1.00
Lane Grp Cap(c), veh/h	0	696	397	1244	444	395
V/C Ratio(X)	0.00	0.95	0.91	0.70	0.17	0.67
Avail Cap(c_a), veh/h	0	712	432	1298	444	395
HCM Platoon Ratio	1.00	1.00	1.00	1.00	1.00	1.00
Upstream Filter(I)	0.00	0.87	1.00	1.00	1.00	1.00
Uniform Delay (d), s/veh	0.0	26.8	34.2	9.9	26.7	30.7
Incr Delay (d2), s/veh	0.0	20.1	21.8	1.6	0.8	8.7
Initial Q Delay(d3),s/veh	0.0	0.0	0.0	0.0	0.0	0.0
%ile BackOfQ(50%),veh/ln	0.0	16.9	9.9	9.7	1.4	6.0
Unsig. Movement Delay, s/veh						
LnGrp Delay(d),s/veh	0.0	46.9	56.1	11.4	27.6	39.3
LnGrp LOS	A	D	E	B	C	D
Approach Vol, veh/h	661			1227	339	
Approach Delay, s/veh	46.9			24.6	36.7	
Approach LOS	D			C	D	
Timer - Assigned Phs		2	3	4		8
Phs Duration (G+Y+Rc), s		26.6	24.3	39.2		63.4
Change Period (Y+Rc), s		4.5	4.5	4.5		4.5
Max Green Setting (Gmax), s		19.5	21.5	35.5		61.5
Max Q Clear Time (g_c+I1), s		15.3	19.5	33.9		28.0
Green Ext Time (p_c), s		0.5	0.3	0.7		8.0
Intersection Summary						
HCM 6th Ctrl Delay			33.1			
HCM 6th LOS			C			

HCM 6th TWSC
4: Truck Parking Lot/Pistachio Drive & Avenue 18 1/2

Village D Specific Plan
Phase III WP MIT - AM Peak Hour

Intersection												
Int Delay, s/veh	1.4											
Movement	EBL	EBT	EBR	WBL	WBT	WBR	NBL	NBT	NBR	SBL	SBT	SBR
Lane Configurations	↖	↕			↕	↖		↕			↕	
Traffic Vol, veh/h	8	295	1	3	295	206	0	0	1	110	0	9
Future Vol, veh/h	8	295	1	3	295	206	0	0	1	110	0	9
Conflicting Peds, #/hr	0	0	0	0	0	0	0	0	0	0	0	0
Sign Control	Free	Free	Free	Free	Free	Free	Stop	Stop	Stop	Stop	Stop	Stop
RT Channelized	-	-	None	-	-	None	-	-	None	-	-	None
Storage Length	50	-	-	-	-	0	-	-	-	-	-	-
Veh in Median Storage, #	-	0	-	-	0	-	-	0	-	-	0	-
Grade, %	-	0	-	-	0	-	-	0	-	-	0	-
Peak Hour Factor	93	93	93	93	93	93	93	93	93	93	93	93
Heavy Vehicles, %	31	31	31	22	22	22	100	100	100	12	12	12
Mvmt Flow	9	317	1	3	317	222	0	0	1	118	0	10

Major/Minor	Major1			Major2			Minor1			Minor2		
Conflicting Flow All	539	0	0	318	0	0	775	881	159	500	659	317
Stage 1	-	-	-	-	-	-	336	336	-	323	323	-
Stage 2	-	-	-	-	-	-	439	545	-	177	336	-
Critical Hdwy	4.565	-	-	4.43	-	-	8.8	8	8.4	7.48	6.68	6.38
Critical Hdwy Stg 1	-	-	-	-	-	-	8	7	-	6.28	5.68	-
Critical Hdwy Stg 2	-	-	-	-	-	-	7.6	7	-	6.68	5.68	-
Follow-up Hdwy	2.4945	-	-	2.409	-	-	4.45	4.95	4.25	3.614	4.114	3.414
Pot Cap-1 Maneuver	*1120	-	-	1122	-	-	*491	*370	641	*773	*679	*818
Stage 1	-	-	-	-	-	-	*469	*473	-	*773	*679	-
Stage 2	-	-	-	-	-	-	*627	*564	-	*783	*620	-
Platoon blocked, %	1	-	-	-	-	-	1	1	-	1	1	1
Mov Cap-1 Maneuver	*1120	-	-	1122	-	-	*480	*366	641	*764	*671	*818
Mov Cap-2 Maneuver	-	-	-	-	-	-	*480	*366	-	*764	*671	-
Stage 1	-	-	-	-	-	-	*465	*469	-	*766	*676	-
Stage 2	-	-	-	-	-	-	*618	*562	-	*775	*615	-

Approach	EB	WB	NB	SB
HCM Control Delay, s	0.2	0	10.6	10.6
HCM LOS			B	B

Minor Lane/Major Mvmt	NBLn1	EBL	EBT	EBR	WBL	WBT	WBR	SBLn1
Capacity (veh/h)	641	* 1120	-	-	1122	-	-	768
HCM Lane V/C Ratio	0.002	0.008	-	-	0.003	-	-	0.167
HCM Control Delay (s)	10.6	8.2	-	-	8.2	0	-	10.6
HCM Lane LOS	B	A	-	-	A	A	-	B
HCM 95th %tile Q(veh)	0	0	-	-	0	-	-	0.6

Notes
 -: Volume exceeds capacity \$: Delay exceeds 300s +: Computation Not Defined *: All major volume in platoon

HCM 6th Signalized Intersection Summary
 5: Road 23/SR-99 Southbound Off-Ramp & Avenue 18 1/2

Village D Specific Plan
 Phase III WP MIT - AM Peak Hour



Movement	EBL	EBT	EBR	WBL	WBT	WBR	NBL	NBT	NBR	SBL	SBT	SBR
Lane Configurations		↑↑	↗	↖	↑↑			↕	↗		↕	
Traffic Volume (veh/h)	0	323	83	50	286	0	137	0	738	12	265	86
Future Volume (veh/h)	0	323	83	50	286	0	137	0	738	12	265	86
Initial Q (Qb), veh	0	0	0	0	0	0	0	0	0	0	0	0
Ped-Bike Adj(A_pbT)	1.00		1.00	1.00		1.00	1.00		1.00	1.00		1.00
Parking Bus, Adj	1.00	1.00	1.00	1.00	1.00	1.00	1.00	1.00	1.00	1.00	1.00	1.00
Work Zone On Approach		No			No			No			No	
Adj Sat Flow, veh/h/ln	0	1441	1441	1515	1515	0	1826	1826	1826	1678	1678	1678
Adj Flow Rate, veh/h	0	351	90	54	311	0	0	0	962	13	288	93
Peak Hour Factor	0.92	0.92	0.92	0.92	0.92	0.92	0.92	0.92	0.92	0.92	0.92	0.92
Percent Heavy Veh, %	0	31	31	26	26	0	5	5	5	15	15	15
Cap, veh/h	0	441	794	66	703	0	0	893	1653	16	358	121
Arrive On Green	0.00	0.16	0.16	0.05	0.24	0.00	0.00	0.00	0.49	0.15	0.15	0.15
Sat Flow, veh/h	0	2809	1221	1443	2954	0	0	1826	3092	103	2321	784
Grp Volume(v), veh/h	0	351	90	54	311	0	0	0	962	212	0	182
Grp Sat Flow(s),veh/h/ln	0	1369	1221	1443	1439	0	0	1826	1546	1673	0	1535
Q Serve(g_s), s	0.0	14.8	3.3	4.5	11.0	0.0	0.0	0.0	25.2	14.7	0.0	13.7
Cycle Q Clear(g_c), s	0.0	14.8	3.3	4.5	11.0	0.0	0.0	0.0	25.2	14.7	0.0	13.7
Prop In Lane	0.00		1.00	1.00		0.00	0.00		1.00	0.06		0.51
Lane Grp Cap(c), veh/h	0	441	794	66	703	0	0	893	1653	258	0	237
V/C Ratio(X)	0.00	0.80	0.11	0.82	0.44	0.00	0.00	0.00	0.58	0.82	0.00	0.77
Avail Cap(c_a), veh/h	0	810	958	331	1619	0	0	893	1653	258	0	237
HCM Platoon Ratio	1.00	1.00	1.00	1.00	1.00	1.00	1.00	1.00	1.00	1.00	1.00	1.00
Upstream Filter(I)	0.00	1.00	1.00	1.00	1.00	0.00	0.00	0.00	1.00	1.00	0.00	1.00
Uniform Delay (d), s/veh	0.0	48.4	7.9	56.8	38.4	0.0	0.0	0.0	18.9	49.2	0.0	48.7
Incr Delay (d2), s/veh	0.0	3.3	0.1	21.4	0.4	0.0	0.0	0.0	1.5	24.6	0.0	21.1
Initial Q Delay(d3),s/veh	0.0	0.0	0.0	0.0	0.0	0.0	0.0	0.0	0.0	0.0	0.0	0.0
%ile BackOfQ(50%),veh/ln	0.0	5.2	2.4	2.0	3.9	0.0	0.0	0.0	9.2	7.9	0.0	6.6
Unsig. Movement Delay, s/veh												
LnGrp Delay(d),s/veh	0.0	51.7	8.0	78.2	38.9	0.0	0.0	0.0	20.4	73.7	0.0	69.8
LnGrp LOS	A	D	A	E	D	A	A	A	C	E	A	E
Approach Vol, veh/h		441			365			962			394	
Approach Delay, s/veh		42.8			44.7			20.4			71.9	
Approach LOS		D			D			C			E	
Timer - Assigned Phs		2	3	4		6		8				
Phs Duration (G+Y+Rc), s		63.2	10.0	23.8		23.0		33.8				
Change Period (Y+Rc), s		4.5	4.5	4.5		4.5		4.5				
Max Green Setting (Gmax), s		20.5	27.5	35.5		18.5		67.5				
Max Q Clear Time (g_c+I1), s		27.2	6.5	16.8		16.7		13.0				
Green Ext Time (p_c), s		0.0	0.1	2.5		0.4		2.3				

Intersection Summary

HCM 6th Ctrl Delay	38.4
HCM 6th LOS	D

Notes

User approved volume balancing among the lanes for turning movement.

HCM 6th Signalized Intersection Summary
6: SR-99 Northbound Ramps & Avenue 18 1/2

Village D Specific Plan
Phase III WP MIT - AM Peak Hour



Movement	EBL	EBT	EBR	WBL	WBT	WBR	NBL	NBT	NBR	SBL	SBT	SBR
Lane Configurations	↖↗	↑↑			↑↓		↖	↗				
Traffic Volume (veh/h)	806	64	0	0	158	36	216	1	28	0	0	0
Future Volume (veh/h)	806	64	0	0	158	36	216	1	28	0	0	0
Initial Q (Qb), veh	0	0	0	0	0	0	0	0	0			
Ped-Bike Adj(A_pbT)	1.00		1.00	1.00		1.00	1.00		1.00			
Parking Bus, Adj	1.00	1.00	1.00	1.00	1.00	1.00	1.00	1.00	1.00			
Work Zone On Approach		No			No			No				
Adj Sat Flow, veh/h/ln	1752	1752	0	0	1633	1633	1470	1470	1470			
Adj Flow Rate, veh/h	876	70	0	0	172	39	235	1	30			
Peak Hour Factor	0.92	0.92	0.92	0.92	0.92	0.92	0.92	0.92	0.92			
Percent Heavy Veh, %	10	10	0	0	18	18	29	29	29			
Cap, veh/h	979	1440	0	0	233	52	690	20	597			
Arrive On Green	0.30	0.43	0.00	0.00	0.09	0.09	0.49	0.49	0.49			
Sat Flow, veh/h	3237	3416	0	0	2605	559	1400	40	1212			
Grp Volume(v), veh/h	876	70	0	0	104	107	235	0	31			
Grp Sat Flow(s),veh/h/ln	1618	1664	0	0	1552	1531	1400	0	1252			
Q Serve(g_s), s	31.1	1.5	0.0	0.0	7.8	8.2	12.3	0.0	1.5			
Cycle Q Clear(g_c), s	31.1	1.5	0.0	0.0	7.8	8.2	12.3	0.0	1.5			
Prop In Lane	1.00		0.00	0.00		0.36	1.00		0.97			
Lane Grp Cap(c), veh/h	979	1440	0	0	143	142	690	0	617			
V/C Ratio(X)	0.89	0.05	0.00	0.00	0.73	0.76	0.34	0.00	0.05			
Avail Cap(c_a), veh/h	1308	1983	0	0	239	236	690	0	617			
HCM Platoon Ratio	1.00	1.00	1.00	1.00	1.00	1.00	1.00	1.00	1.00			
Upstream Filter(I)	1.00	1.00	0.00	0.00	1.00	1.00	1.00	0.00	1.00			
Uniform Delay (d), s/veh	40.0	19.7	0.0	0.0	53.0	53.1	18.6	0.0	15.8			
Incr Delay (d2), s/veh	6.6	0.0	0.0	0.0	6.8	7.9	1.3	0.0	0.2			
Initial Q Delay(d3),s/veh	0.0	0.0	0.0	0.0	0.0	0.0	0.0	0.0	0.0			
%ile BackOfQ(50%),veh/ln	13.1	0.6	0.0	0.0	3.3	3.5	4.2	0.0	0.5			
Unsig. Movement Delay, s/veh												
LnGrp Delay(d),s/veh	46.6	19.8	0.0	0.0	59.8	61.0	19.9	0.0	16.0			
LnGrp LOS	D	B	A	A	E	E	B	A	B			
Approach Vol, veh/h		946			211		266					
Approach Delay, s/veh		44.6			60.4		19.5					
Approach LOS		D			E		B					
Timer - Assigned Phs		2		4			7	8				
Phs Duration (G+Y+Rc), s		63.6		56.4			40.8	15.6				
Change Period (Y+Rc), s		4.5		4.5			4.5	4.5				
Max Green Setting (Gmax), s		39.5		71.5			48.5	18.5				
Max Q Clear Time (g_c+I1), s		14.3		3.5			33.1	10.2				
Green Ext Time (p_c), s		0.9		0.5			3.2	0.7				
Intersection Summary												
HCM 6th Ctrl Delay					42.3							
HCM 6th LOS					D							

HCM 6th Signalized Intersection Summary
7: Road 23 & Avenue 17

Village D Specific Plan
Phase III WP MIT - AM Peak Hour



Movement	EBL	EBT	EBR	WBL	WBT	WBR	NBL	NBT	NBR	SBL	SBT	SBR
Lane Configurations	↖	↗		↖	↗		↖	↗	↗	↖	↗	↗
Traffic Volume (veh/h)	162	491	30	477	132	3	52	917	976	16	405	42
Future Volume (veh/h)	162	491	30	477	132	3	52	917	976	16	405	42
Initial Q (Qb), veh	0	0	0	0	0	0	0	0	0	0	0	0
Ped-Bike Adj(A_pbT)	1.00		1.00	1.00		1.00	1.00		1.00	1.00		1.00
Parking Bus, Adj	1.00	1.00	1.00	1.00	1.00	1.00	1.00	1.00	1.00	1.00	1.00	1.00
Work Zone On Approach		No			No			No			No	
Adj Sat Flow, veh/h/ln	1900	1900	1900	1856	1856	1856	1870	1870	1870	1811	1811	1811
Adj Flow Rate, veh/h	176	534	33	518	143	3	57	997	1061	17	440	46
Peak Hour Factor	0.92	0.92	0.92	0.92	0.92	0.92	0.92	0.92	0.92	0.92	0.92	0.92
Percent Heavy Veh, %	0	0	0	3	3	3	2	2	2	6	6	6
Cap, veh/h	211	603	37	625	848	18	74	1579	993	32	1451	647
Arrive On Green	0.12	0.17	0.17	0.18	0.24	0.24	0.01	0.15	0.15	0.02	0.42	0.42
Sat Flow, veh/h	1810	3454	213	3428	3531	74	1781	3554	1585	1725	3441	1535
Grp Volume(v), veh/h	176	279	288	518	71	75	57	997	1061	17	440	46
Grp Sat Flow(s),veh/h/ln	1810	1805	1862	1714	1763	1842	1781	1777	1585	1725	1721	1535
Q Serve(g_s), s	9.5	15.1	15.1	14.6	3.2	3.2	3.2	26.4	44.4	1.0	8.5	1.8
Cycle Q Clear(g_c), s	9.5	15.1	15.1	14.6	3.2	3.2	3.2	26.4	44.4	1.0	8.5	1.8
Prop In Lane	1.00		0.11	1.00		0.04	1.00		1.00	1.00		1.00
Lane Grp Cap(c), veh/h	211	315	325	625	423	442	74	1579	993	32	1451	647
V/C Ratio(X)	0.83	0.88	0.89	0.83	0.17	0.17	0.77	0.63	1.07	0.52	0.30	0.07
Avail Cap(c_a), veh/h	322	325	335	1046	541	566	157	1579	993	86	1451	647
HCM Platoon Ratio	1.00	1.00	1.00	1.00	1.00	1.00	0.33	0.33	0.33	1.00	1.00	1.00
Upstream Filter(I)	0.82	0.82	0.82	1.00	1.00	1.00	0.77	0.77	0.77	1.00	1.00	1.00
Uniform Delay (d), s/veh	43.2	40.3	40.3	39.4	30.1	30.1	48.8	35.0	23.8	48.6	19.2	17.2
Incr Delay (d2), s/veh	9.1	20.1	20.1	2.9	0.2	0.2	12.3	1.5	45.4	12.5	0.5	0.2
Initial Q Delay(d3),s/veh	0.0	0.0	0.0	0.0	0.0	0.0	0.0	0.0	0.0	0.0	0.0	0.0
%ile BackOfQ(50%),veh/ln	4.8	8.4	8.7	6.3	1.4	1.4	1.7	12.8	31.3	0.5	3.4	0.7
Unsig. Movement Delay, s/veh												
LnGrp Delay(d),s/veh	52.3	60.4	60.4	42.3	30.3	30.3	61.1	36.5	69.2	61.1	19.7	17.4
LnGrp LOS	D	E	E	D	C	C	E	D	F	E	B	B
Approach Vol, veh/h		743		664			2115				503	
Approach Delay, s/veh		58.5		39.7			53.6				20.9	
Approach LOS		E		D			D				C	
Timer - Assigned Phs	1	2	3	4	5	6	7	8				
Phs Duration (G+Y+Rc), s	6.4	48.9	22.7	22.0	8.6	46.7	16.2	28.5				
Change Period (Y+Rc), s	4.5	4.5	4.5	4.5	4.5	4.5	4.5	4.5				
Max Green Setting (Gmax), s	30	28.5	30.5	18.0	8.8	24.7	17.8	30.7				
Max Q Clear Time (g_c+1), s	13	46.4	16.6	17.1	5.2	10.5	11.5	5.2				
Green Ext Time (p_c), s	0.0	0.0	1.7	0.3	0.0	2.6	0.2	0.8				
Intersection Summary												
HCM 6th Ctrl Delay				48.1								
HCM 6th LOS				D								

HCM 6th Signalized Intersection Summary
8: Road 23 & Avenue 16

Village D Specific Plan
Phase III WP MIT - AM Peak Hour



Movement	EBL	EBT	EBR	WBL	WBT	WBR	NBL	NBT	NBR	SBL	SBT	SBR
Lane Configurations												
Traffic Volume (veh/h)	146	64	413	162	37	222	167	1096	49	58	836	66
Future Volume (veh/h)	146	64	413	162	37	222	167	1096	49	58	836	66
Initial Q (Qb), veh	0	0	0	0	0	0	0	0	0	0	0	0
Ped-Bike Adj(A_pbT)	1.00		1.00	1.00		1.00	1.00		1.00	1.00		1.00
Parking Bus, Adj	1.00	1.00	1.00	1.00	1.00	1.00	1.00	1.00	1.00	1.00	1.00	1.00
Work Zone On Approach		No			No			No			No	
Adj Sat Flow, veh/h/ln	1856	1856	1856	1900	1900	1900	1841	1841	1841	1811	1811	1811
Adj Flow Rate, veh/h	159	70	449	176	40	241	182	1191	53	63	909	72
Peak Hour Factor	0.92	0.92	0.92	0.92	0.92	0.92	0.92	0.92	0.92	0.92	0.92	0.92
Percent Heavy Veh, %	3	3	3	0	0	0	4	4	4	6	6	6
Cap, veh/h	194	547	464	210	572	485	249	1848	574	138	1660	515
Arrive On Green	0.04	0.10	0.10	0.12	0.30	0.30	0.02	0.12	0.12	0.01	0.11	0.11
Sat Flow, veh/h	1767	1856	1572	1810	1900	1610	3401	5025	1560	3346	4944	1535
Grp Volume(v), veh/h	159	70	449	176	40	241	182	1191	53	63	909	72
Grp Sat Flow(s),veh/h/ln	1767	1856	1572	1810	1900	1610	1700	1675	1560	1673	1648	1535
Q Serve(g_s), s	8.9	3.4	28.5	9.5	1.5	12.3	5.3	22.6	3.0	1.9	17.4	4.2
Cycle Q Clear(g_c), s	8.9	3.4	28.5	9.5	1.5	12.3	5.3	22.6	3.0	1.9	17.4	4.2
Prop In Lane	1.00		1.00	1.00		1.00	1.00		1.00	1.00		1.00
Lane Grp Cap(c), veh/h	194	547	464	210	572	485	249	1848	574	138	1660	515
V/C Ratio(X)	0.82	0.13	0.97	0.84	0.07	0.50	0.73	0.64	0.09	0.46	0.55	0.14
Avail Cap(c_a), veh/h	293	547	464	280	572	485	289	1848	574	171	1660	515
HCM Platoon Ratio	0.33	0.33	0.33	1.00	1.00	1.00	0.33	0.33	0.33	0.33	0.33	0.33
Upstream Filter(I)	0.84	0.84	0.84	1.00	1.00	1.00	0.78	0.78	0.78	0.94	0.94	0.94
Uniform Delay (d), s/veh	47.2	33.4	44.7	43.3	24.9	28.7	47.8	37.7	29.1	48.2	37.3	31.4
Incr Delay (d2), s/veh	8.9	0.1	30.2	15.3	0.1	0.8	6.1	1.4	0.2	2.2	1.2	0.5
Initial Q Delay(d3),s/veh	0.0	0.0	0.0	0.0	0.0	0.0	0.0	0.0	0.0	0.0	0.0	0.0
%ile BackOfQ(50%),veh/ln	4.6	1.6	15.8	5.1	0.7	4.8	2.5	10.3	1.2	0.8	7.9	1.7
Unsig. Movement Delay, s/veh												
LnGrp Delay(d),s/veh	56.1	33.5	74.9	58.6	25.0	29.5	53.9	39.1	29.4	50.4	38.5	32.0
LnGrp LOS	E	C	E	E	C	C	D	D	C	D	D	C
Approach Vol, veh/h		678			457			1426			1044	
Approach Delay, s/veh		66.2			40.3			40.6			38.8	
Approach LOS		E			D			D			D	
Timer - Assigned Phs	1	2	3	4	5	6	7	8				
Phs Duration (G+Y+Rc), s	8.6	41.3	16.1	34.0	11.8	38.1	15.5	34.6				
Change Period (Y+Rc), s	4.5	4.5	4.5	4.5	4.5	4.5	4.5	4.5				
Max Green Setting (Gmax), s	15.1	31.9	15.5	29.5	8.5	28.5	16.6	28.4				
Max Q Clear Time (g_c+1), s	13.9	24.6	11.5	30.5	7.3	19.4	10.9	14.3				
Green Ext Time (p_c), s	0.0	4.5	0.2	0.0	0.1	4.3	0.2	0.8				
Intersection Summary												
HCM 6th Ctrl Delay											44.8	
HCM 6th LOS											D	

HCM 6th Signalized Intersection Summary
9: Road 23 & Cleveland Avenue

Village D Specific Plan
Phase III WP MIT - AM Peak Hour



Movement	EBL	EBT	EBR	WBL	WBT	WBR	NBL	NBT	NBR	SBL	SBT	SBR
Lane Configurations	↖↗	↑↑↑	↖↗	↖↗	↑↑↑	↖	↖↗	↑↑↑	↖↗	↖↗	↑↑↑	↖↗
Traffic Volume (veh/h)	407	230	622	325	236	394	352	681	314	427	771	213
Future Volume (veh/h)	407	230	622	325	236	394	352	681	314	427	771	213
Initial Q (Qb), veh	0	0	0	0	0	0	0	0	0	0	0	0
Ped-Bike Adj(A_pbT)	1.00		1.00	1.00		1.00	1.00		1.00	1.00		0.99
Parking Bus, Adj	1.00	1.00	1.00	1.00	1.00	1.00	1.00	1.00	1.00	1.00	1.00	1.00
Work Zone On Approach		No			No			No			No	
Adj Sat Flow, veh/h/ln	1900	1900	1900	1870	1870	1870	1841	1841	1841	1811	1811	1811
Adj Flow Rate, veh/h	442	250	676	353	257	428	383	740	341	464	838	232
Peak Hour Factor	0.92	0.92	0.92	0.92	0.92	0.92	0.92	0.92	0.92	0.92	0.92	0.92
Percent Heavy Veh, %	0	0	0	2	2	2	4	4	4	6	6	6
Cap, veh/h	528	1084	984	432	938	557	470	1599	1217	561	1720	1334
Arrive On Green	0.15	0.21	0.21	0.13	0.18	0.18	0.05	0.11	0.11	0.06	0.11	0.11
Sat Flow, veh/h	3510	5187	2834	3456	5106	1585	3401	5025	2745	3346	4944	2667
Grp Volume(v), veh/h	442	250	676	353	257	428	383	740	341	464	838	232
Grp Sat Flow(s),veh/h/ln	1755	1729	1417	1728	1702	1585	1700	1675	1373	1673	1648	1334
Q Serve(g_s), s	12.2	4.0	20.5	10.0	4.3	18.4	11.2	13.9	9.5	13.7	15.9	6.1
Cycle Q Clear(g_c), s	12.2	4.0	20.5	10.0	4.3	18.4	11.2	13.9	9.5	13.7	15.9	6.1
Prop In Lane	1.00		1.00	1.00		1.00	1.00		1.00	1.00		1.00
Lane Grp Cap(c), veh/h	528	1084	984	432	938	557	470	1599	1217	561	1720	1334
V/C Ratio(X)	0.84	0.23	0.69	0.82	0.27	0.77	0.82	0.46	0.28	0.83	0.49	0.17
Avail Cap(c_a), veh/h	685	1084	984	574	938	557	616	1599	1217	760	1720	1334
HCM Platoon Ratio	1.00	1.00	1.00	1.00	1.00	1.00	0.33	0.33	0.33	0.33	0.33	0.33
Upstream Filter(I)	0.69	0.69	0.69	0.98	0.98	0.98	0.92	0.92	0.92	0.72	0.72	0.72
Uniform Delay (d), s/veh	41.3	32.9	28.0	42.6	35.1	28.8	46.5	36.7	23.8	45.8	35.9	19.2
Incr Delay (d2), s/veh	5.0	0.1	1.4	6.7	0.2	6.3	5.9	0.9	0.5	4.1	0.7	0.2
Initial Q Delay(d3),s/veh	0.0	0.0	0.0	0.0	0.0	0.0	0.0	0.0	0.0	0.0	0.0	0.0
%ile BackOfQ(50%),veh/ln	5.6	1.7	7.0	4.6	1.8	9.8	5.5	6.3	3.4	6.5	7.1	2.0
Unsig. Movement Delay, s/veh												
LnGrp Delay(d),s/veh	46.3	32.9	29.4	49.3	35.2	35.1	52.4	37.6	24.3	49.9	36.6	19.4
LnGrp LOS	D	C	C	D	D	D	D	D	C	D	D	B
Approach Vol, veh/h		1368			1038			1464			1534	
Approach Delay, s/veh		35.5			40.0			38.4			38.0	
Approach LOS		D			D			D			D	
Timer - Assigned Phs	1	2	3	4	5	6	7	8				
Phs Duration (G+Y+Rc), s	31.3	36.3	17.0	25.4	18.3	39.3	19.5	22.9				
Change Period (Y+Rc), s	4.5	4.5	4.5	4.5	4.5	4.5	4.5	4.5				
Max Green Setting (Gmax), s	22.7	21.8	16.6	20.9	18.1	26.4	19.5	18.0				
Max Q Clear Time (g_c+1/3), s	11.7	15.9	12.0	22.5	13.2	17.9	14.2	20.4				
Green Ext Time (p_c), s	1.0	3.2	0.6	0.0	0.6	4.2	0.8	0.0				
Intersection Summary												
HCM 6th Ctrl Delay											37.9	
HCM 6th LOS											D	

HCM 6th Signalized Intersection Summary
 10: Road 23 & Avenue 14 1/2

Village D Specific Plan
 Phase III WP MIT - AM Peak Hour



Movement	EBL	EBT	EBR	WBL	WBT	WBR	NBL	NBT	NBR	SBL	SBT	SBR
Lane Configurations		↕			↕	↕	↕	↕↕		↕	↕↕	↕
Traffic Volume (veh/h)	0	5	0	18	3	215	4	672	4	235	1235	0
Future Volume (veh/h)	0	5	0	18	3	215	4	672	4	235	1235	0
Initial Q (Qb), veh	0	0	0	0	0	0	0	0	0	0	0	0
Ped-Bike Adj(A_pbT)	1.00		1.00	1.00		1.00	1.00		1.00	1.00		1.00
Parking Bus, Adj	1.00	1.00	1.00	1.00	1.00	1.00	1.00	1.00	1.00	1.00	1.00	1.00
Work Zone On Approach		No			No			No			No	
Adj Sat Flow, veh/h/ln	1900	1900	1900	1900	1900	1900	1796	1796	1796	1841	1841	1841
Adj Flow Rate, veh/h	0	5	0	20	3	234	4	730	4	255	1342	0
Peak Hour Factor	0.92	0.92	0.92	0.92	0.92	0.92	0.92	0.92	0.92	0.92	0.92	0.92
Percent Heavy Veh, %	0	0	0	0	0	0	7	7	7	4	4	4
Cap, veh/h	0	314	0	276	37	266	9	1852	10	294	2429	1083
Arrive On Green	0.00	0.17	0.00	0.17	0.17	0.17	0.01	0.53	0.53	0.17	0.69	0.00
Sat Flow, veh/h	0	1900	0	1264	224	1610	1711	3480	19	1753	3497	1560
Grp Volume(v), veh/h	0	5	0	23	0	234	4	358	376	255	1342	0
Grp Sat Flow(s),veh/h/ln	0	1900	0	1489	0	1610	1711	1706	1793	1753	1749	1560
Q Serve(g_s), s	0.0	0.2	0.0	0.9	0.0	14.2	0.2	12.4	12.4	14.2	19.0	0.0
Cycle Q Clear(g_c), s	0.0	0.2	0.0	1.2	0.0	14.2	0.2	12.4	12.4	14.2	19.0	0.0
Prop In Lane	0.00		0.00	0.87		1.00	1.00		0.01	1.00		1.00
Lane Grp Cap(c), veh/h	0	314	0	313	0	266	9	908	954	294	2429	1083
V/C Ratio(X)	0.00	0.02	0.00	0.07	0.00	0.88	0.44	0.39	0.39	0.87	0.55	0.00
Avail Cap(c_a), veh/h	0	390	0	372	0	330	94	908	954	500	2429	1083
HCM Platoon Ratio	1.00	1.00	1.00	1.00	1.00	1.00	1.00	1.00	1.00	1.00	1.00	1.00
Upstream Filter(I)	0.00	1.00	0.00	1.00	0.00	1.00	0.92	0.92	0.92	0.68	0.68	0.00
Uniform Delay (d), s/veh	0.0	34.9	0.0	35.3	0.0	40.8	49.6	13.8	13.8	40.6	7.6	0.0
Incr Delay (d2), s/veh	0.0	0.0	0.0	0.1	0.0	19.6	28.6	1.2	1.1	5.8	0.6	0.0
Initial Q Delay(d3),s/veh	0.0	0.0	0.0	0.0	0.0	0.0	0.0	0.0	0.0	0.0	0.0	0.0
%ile BackOfQ(50%),veh/ln	0.0	0.1	0.0	0.5	0.0	7.0	0.2	4.9	5.1	6.5	6.3	0.0
Unsig. Movement Delay, s/veh												
LnGrp Delay(d),s/veh	0.0	34.9	0.0	35.4	0.0	60.4	78.2	15.0	15.0	46.4	8.2	0.0
LnGrp LOS	A	C	A	D	A	E	E	B	B	D	A	A
Approach Vol, veh/h		5			257			738			1597	
Approach Delay, s/veh		34.9			58.2			15.3			14.3	
Approach LOS		C			E			B			B	
Timer - Assigned Phs	1	2		4	5	6		8				
Phs Duration (G+Y+Rc), s	31.2	57.7		21.0	5.0	73.9		21.0				
Change Period (Y+Rc), s	4.5	4.5		4.5	4.5	4.5		4.5				
Max Green Setting (Gmax), s	20.5	37.5		20.5	5.5	60.5		20.5				
Max Q Clear Time (g_c+10), s	10.2	14.4		2.2	2.2	21.0		16.2				
Green Ext Time (p_c), s	0.6	4.8		0.0	0.0	14.1		0.3				

Intersection Summary

HCM 6th Ctrl Delay	19.0
HCM 6th LOS	B

HCM 6th Signalized Intersection Summary
 11: Road 23 & Avenue 14

Village D Specific Plan
 Phase III WP MIT - AM Peak Hour



Movement	EBL	EBT	EBR	WBL	WBT	WBR	NBL	NBT	NBR	SBL	SBT	SBR
Lane Configurations												
Traffic Volume (veh/h)	107	152	60	20	185	358	54	217	8	710	364	179
Future Volume (veh/h)	107	152	60	20	185	358	54	217	8	710	364	179
Initial Q (Qb), veh	0	0	0	0	0	0	0	0	0	0	0	0
Ped-Bike Adj(A_pbT)	1.00		1.00	1.00		1.00	1.00		1.00	1.00		1.00
Parking Bus, Adj	1.00	1.00	1.00	1.00	1.00	1.00	1.00	1.00	1.00	1.00	1.00	1.00
Work Zone On Approach		No			No			No			No	
Adj Sat Flow, veh/h/ln	1811	1811	1811	1841	1841	1841	1618	1618	1618	1841	1841	1841
Adj Flow Rate, veh/h	116	165	65	22	201	389	59	236	9	772	396	195
Peak Hour Factor	0.92	0.92	0.92	0.92	0.92	0.92	0.92	0.92	0.92	0.92	0.92	0.92
Percent Heavy Veh, %	6	6	6	4	4	4	19	19	19	4	4	4
Cap, veh/h	147	291	115	46	325	1250	83	392	15	948	1239	553
Arrive On Green	0.09	0.24	0.24	0.03	0.18	0.18	0.05	0.13	0.13	0.28	0.35	0.35
Sat Flow, veh/h	1725	1236	487	1753	1841	2745	1541	3020	115	3401	3497	1560
Grp Volume(v), veh/h	116	0	230	22	201	389	59	120	125	772	396	195
Grp Sat Flow(s),veh/h/ln	1725	0	1723	1753	1841	1373	1541	1537	1598	1700	1749	1560
Q Serve(g_s), s	3.6	0.0	6.4	0.7	5.5	4.9	2.1	4.0	4.0	11.6	4.5	5.0
Cycle Q Clear(g_c), s	3.6	0.0	6.4	0.7	5.5	4.9	2.1	4.0	4.0	11.6	4.5	5.0
Prop In Lane	1.00		0.28	1.00		1.00	1.00		0.07	1.00		1.00
Lane Grp Cap(c), veh/h	147	0	406	46	325	1250	83	199	207	948	1239	553
V/C Ratio(X)	0.79	0.00	0.57	0.48	0.62	0.31	0.71	0.60	0.60	0.81	0.32	0.35
Avail Cap(c_a), veh/h	205	0	616	161	607	1671	223	513	533	1203	1897	846
HCM Platoon Ratio	1.00	1.00	1.00	1.00	1.00	1.00	1.00	1.00	1.00	1.00	1.00	1.00
Upstream Filter(I)	1.00	0.00	1.00	1.00	1.00	1.00	1.00	1.00	1.00	1.00	1.00	1.00
Uniform Delay (d), s/veh	24.5	0.0	18.4	26.2	20.8	9.4	25.4	22.4	22.4	18.4	12.8	13.0
Incr Delay (d2), s/veh	12.8	0.0	1.2	7.7	1.9	0.1	10.4	2.9	2.8	3.5	0.1	0.4
Initial Q Delay(d3),s/veh	0.0	0.0	0.0	0.0	0.0	0.0	0.0	0.0	0.0	0.0	0.0	0.0
%ile BackOfQ(50%),veh/ln	9	0.0	2.5	0.4	2.3	1.2	0.9	1.5	1.6	4.5	1.6	1.6
Unsig. Movement Delay, s/veh												
LnGrp Delay(d),s/veh	37.3	0.0	19.6	33.9	22.7	9.6	35.8	25.3	25.3	21.8	13.0	13.4
LnGrp LOS	D	A	B	C	C	A	D	C	C	C	B	B
Approach Vol, veh/h		346			612			304			1363	
Approach Delay, s/veh		25.5			14.8			27.3			18.1	
Approach LOS		C			B			C			B	
Timer - Assigned Phs	1	2	3	4	5	6	7	8				
Phs Duration (G+Y+Rc), s	19.7	11.6	5.9	17.4	7.5	23.8	9.2	14.1				
Change Period (Y+Rc), s	4.5	4.5	4.5	4.5	4.5	4.5	4.5	4.5				
Max Green Setting (Gmax), s	19.3	18.2	5.0	19.5	7.9	29.6	6.5	18.0				
Max Q Clear Time (g_c+M), s	13.6	6.0	2.7	8.4	4.1	7.0	5.6	7.5				
Green Ext Time (p_c), s	1.7	1.0	0.0	0.9	0.0	3.3	0.0	2.1				
Intersection Summary												
HCM 6th Ctrl Delay											19.3	
HCM 6th LOS											B	

HCM 6th Signalized Intersection Summary
 13: Airport Drive/Golden State Boulevard & Avenue 17

Village D Specific Plan
 Phase III WP MIT - AM Peak Hour



Movement	EBL	EBT	EBR	WBL	WBT	WBR	NBL	NBT	NBR	SBL	SBT	SBR
Lane Configurations	↙	↑↑	↗	↙	↑↑	↗	↙	↑	↗	↙↗	↗	↙
Traffic Volume (veh/h)	5	1177	241	302	503	286	101	114	180	216	54	4
Future Volume (veh/h)	5	1177	241	302	503	286	101	114	180	216	54	4
Initial Q (Qb), veh	0	0	0	0	0	0	0	0	0	0	0	0
Ped-Bike Adj(A_pbT)	1.00		1.00	1.00		1.00	1.00		1.00	1.00		1.00
Parking Bus, Adj	1.00	1.00	1.00	1.00	1.00	1.00	1.00	1.00	1.00	1.00	1.00	1.00
Work Zone On Approach		No		No		No		No		No		No
Adj Sat Flow, veh/h/ln	1885	1885	1885	1826	1826	1826	1752	1752	1752	1767	1767	1767
Adj Flow Rate, veh/h	5	1279	262	328	547	311	110	124	196	235	59	4
Peak Hour Factor	0.92	0.92	0.92	0.92	0.92	0.92	0.92	0.92	0.92	0.92	0.92	0.92
Percent Heavy Veh, %	1	1	1	5	5	5	10	10	10	9	9	9
Cap, veh/h	12	1272	567	339	1886	841	128	335	573	258	316	21
Arrive On Green	0.01	0.35	0.35	0.33	0.91	0.91	0.08	0.19	0.19	0.08	0.19	0.19
Sat Flow, veh/h	1795	3582	1598	1739	3469	1547	1668	1752	1482	3264	1636	111
Grp Volume(v), veh/h	5	1279	262	328	547	311	110	124	196	235	0	63
Grp Sat Flow(s),veh/h/ln	1795	1791	1598	1739	1735	1547	1668	1752	1482	1632	0	1746
Q Serve(g_s), s	0.3	35.5	12.7	18.6	2.0	2.8	6.5	6.2	9.4	7.1	0.0	3.0
Cycle Q Clear(g_c), s	0.3	35.5	12.7	18.6	2.0	2.8	6.5	6.2	9.4	7.1	0.0	3.0
Prop In Lane	1.00		1.00	1.00		1.00	1.00		1.00	1.00		0.06
Lane Grp Cap(c), veh/h	12	1272	567	339	1886	841	128	335	573	258	0	337
V/C Ratio(X)	0.43	1.01	0.46	0.97	0.29	0.37	0.86	0.37	0.34	0.91	0.00	0.19
Avail Cap(c_a), veh/h	90	1272	567	339	1886	841	128	335	573	258	0	337
HCM Platoon Ratio	1.00	1.00	1.00	1.67	1.67	1.67	1.00	1.00	1.00	1.00	1.00	1.00
Upstream Filter(I)	1.00	1.00	1.00	0.94	0.94	0.94	1.00	1.00	1.00	1.00	0.00	1.00
Uniform Delay (d), s/veh	49.5	32.3	24.9	33.4	2.2	2.2	45.6	35.2	21.7	45.7	0.0	33.8
Incr Delay (d2), s/veh	23.1	26.7	0.6	38.6	0.1	0.3	40.0	3.1	1.6	33.6	0.0	1.2
Initial Q Delay(d3),s/veh	0.0	0.0	0.0	0.0	0.0	0.0	0.0	0.0	0.0	0.0	0.0	0.0
%ile BackOfQ(50%),veh/ln	0.2	19.5	4.8	10.3	0.6	0.7	4.1	2.9	3.5	4.1	0.0	1.4
Unsig. Movement Delay, s/veh												
LnGrp Delay(d),s/veh	72.6	58.9	25.5	72.0	2.3	2.5	85.6	38.3	23.3	79.3	0.0	35.0
LnGrp LOS	E	F	C	E	A	A	F	D	C	E	A	D
Approach Vol, veh/h		1546			1186			430			298	
Approach Delay, s/veh		53.3			21.6			43.6			69.9	
Approach LOS		D			C			D			E	
Timer - Assigned Phs	1	2	3	4	5	6	7	8				
Phs Duration (G+Y+Rc), s	12.4	23.6	24.0	40.0	12.2	23.8	5.1	58.9				
Change Period (Y+Rc), s	4.5	4.5	4.5	4.5	4.5	4.5	4.5	4.5				
Max Green Setting (Gmax), s	19.1	19.5	35.5	7.7	19.3	5.0	50.0					
Max Q Clear Time (g_c+19), s	11.4	20.6	37.5	8.5	5.0	2.3	4.8					
Green Ext Time (p_c), s	0.0	0.8	0.0	0.0	0.0	0.2	0.0	5.6				

Intersection Summary

HCM 6th Ctrl Delay	42.7
HCM 6th LOS	D

HCM 6th Signalized Intersection Summary
 14: Avenue 17 & SR-99 Southbound Off-Ramp

Village D Specific Plan
 Phase III WP MIT - AM Peak Hour

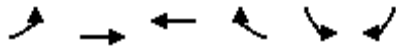

Movement	EBL	EBT	WBT	WBR	SBL	SBR
Lane Configurations		↑↑↑	↑↑↑		↑↑	↑
Traffic Volume (veh/h)	0	1574	949	0	298	141
Future Volume (veh/h)	0	1574	949	0	298	141
Initial Q (Qb), veh	0	0	0	0	0	0
Ped-Bike Adj(A_pbT)	1.00			1.00	1.00	1.00
Parking Bus, Adj	1.00	1.00	1.00	1.00	1.00	1.00
Work Zone On Approach		No	No		No	
Adj Sat Flow, veh/h/ln	0	1841	1826	0	1722	1722
Adj Flow Rate, veh/h	0	1711	1032	0	324	153
Peak Hour Factor	0.92	0.92	0.92	0.92	0.92	0.92
Percent Heavy Veh, %	0	4	5	0	12	12
Cap, veh/h	0	2058	2041	0	1593	730
Arrive On Green	0.00	0.82	0.82	0.00	0.50	0.50
Sat Flow, veh/h	0	5356	5313	0	3182	1459
Grp Volume(v), veh/h	0	1711	1032	0	324	153
Grp Sat Flow(s),veh/h/ln	0	1675	1662	0	1591	1459
Q Serve(g_s), s	0.0	19.3	6.4	0.0	5.7	5.8
Cycle Q Clear(g_c), s	0.0	19.3	6.4	0.0	5.7	5.8
Prop In Lane	0.00			0.00	1.00	1.00
Lane Grp Cap(c), veh/h	0	2058	2041	0	1593	730
V/C Ratio(X)	0.00	0.83	0.51	0.00	0.20	0.21
Avail Cap(c_a), veh/h	0	3191	3165	0	1593	730
HCM Platoon Ratio	1.00	2.00	2.00	1.00	1.00	1.00
Upstream Filter(I)	0.00	0.28	1.00	0.00	1.00	1.00
Uniform Delay (d), s/veh	0.0	7.1	5.9	0.0	13.9	13.9
Incr Delay (d2), s/veh	0.0	0.3	0.2	0.0	0.3	0.7
Initial Q Delay(d3),s/veh	0.0	0.0	0.0	0.0	0.0	0.0
%ile BackOfQ(50%),veh/ln	0.0	2.7	1.6	0.0	2.0	2.0
Unsig. Movement Delay, s/veh						
LnGrp Delay(d),s/veh	0.0	7.4	6.1	0.0	14.2	14.6
LnGrp LOS	A	A	A	A	B	B
Approach Vol, veh/h		1711	1032		477	
Approach Delay, s/veh		7.4	6.1		14.3	
Approach LOS		A	A		B	
Timer - Assigned Phs				4	6	8
Phs Duration (G+Y+Rc), s				45.4	54.6	45.4
Change Period (Y+Rc), s				4.5	4.5	4.5
Max Green Setting (Gmax), s				63.5	27.5	63.5
Max Q Clear Time (g_c+I1), s				21.3	7.8	8.4
Green Ext Time (p_c), s				19.6	1.6	9.7
Intersection Summary						
HCM 6th Ctrl Delay			8.0			
HCM 6th LOS			A			

HCM 6th Signalized Intersection Summary
 15: SR-99 Northbound Ramps & Avenue 17

Village D Specific Plan
 Phase III WP MIT - AM Peak Hour



Movement	EBL	EBT	EBR	WBL	WBT	WBR	NBL	NBT	NBR	SBL	SBT	SBR
Lane Configurations	↖	↑↑↑			↑↑↑	↖	↖	↖	↖			
Traffic Volume (veh/h)	145	885	0	0	1111	253	546	4	240	0	0	0
Future Volume (veh/h)	145	885	0	0	1111	253	546	4	240	0	0	0
Initial Q (Qb), veh	0	0	0	0	0	0	0	0	0			
Ped-Bike Adj(A_pbT)	1.00		1.00	1.00		1.00	1.00		1.00			
Parking Bus, Adj	1.00	1.00	1.00	1.00	1.00	1.00	1.00	1.00	1.00			
Work Zone On Approach		No			No			No				
Adj Sat Flow, veh/h/ln	1841	1841	0	0	1870	1870	1826	1826	1826			
Adj Flow Rate, veh/h	158	962	0	0	1208	275	596	0	261			
Peak Hour Factor	0.92	0.92	0.92	0.92	0.92	0.92	0.92	0.92	0.92			
Percent Heavy Veh, %	4	4	0	0	2	2	5	5	5			
Cap, veh/h	188	2289	0	0	1547	480	1581	0	1407			
Arrive On Green	0.21	0.91	0.00	0.00	0.30	0.30	0.45	0.00	0.45			
Sat Flow, veh/h	1753	5191	0	0	5274	1585	3478	0	3095			
Grp Volume(v), veh/h	158	962	0	0	1208	275	596	0	261			
Grp Sat Flow(s),veh/h/ln	1753	1675	0	0	1702	1585	1739	0	1547			
Q Serve(g_s), s	8.6	2.8	0.0	0.0	21.6	14.6	11.3	0.0	5.0			
Cycle Q Clear(g_c), s	8.6	2.8	0.0	0.0	21.6	14.6	11.3	0.0	5.0			
Prop In Lane	1.00		0.00	0.00		1.00	1.00		1.00			
Lane Grp Cap(c), veh/h	188	2289	0	0	1547	480	1581	0	1407			
V/C Ratio(X)	0.84	0.42	0.00	0.00	0.78	0.57	0.38	0.00	0.19			
Avail Cap(c_a), veh/h	324	2889	0	0	1762	547	1581	0	1407			
HCM Platoon Ratio	2.00	2.00	1.00	1.00	1.00	1.00	1.00	1.00	1.00			
Upstream Filter(I)	1.00	1.00	0.00	0.00	1.00	1.00	1.00	0.00	1.00			
Uniform Delay (d), s/veh	38.4	2.6	0.0	0.0	31.8	29.4	18.0	0.0	16.2			
Incr Delay (d2), s/veh	9.5	0.1	0.0	0.0	2.1	1.1	0.7	0.0	0.3			
Initial Q Delay(d3),s/veh	0.0	0.0	0.0	0.0	0.0	0.0	0.0	0.0	0.0			
%ile BackOfQ(50%),veh/ln	3.8	0.7	0.0	0.0	9.0	5.6	4.6	0.0	1.8			
Unsig. Movement Delay, s/veh												
LnGrp Delay(d),s/veh	48.0	2.7	0.0	0.0	33.9	30.5	18.6	0.0	16.5			
LnGrp LOS	D	A	A	A	C	C	B	A	B			
Approach Vol, veh/h		1120			1483			857				
Approach Delay, s/veh		9.1			33.2			18.0				
Approach LOS		A			C			B				
Timer - Assigned Phs		2		4			7	8				
Phs Duration (G+Y+Rc), s		50.0		50.0			15.2	34.8				
Change Period (Y+Rc), s		4.5		4.5			4.5	4.5				
Max Green Setting (Gmax), s		33.5		57.5			18.5	34.5				
Max Q Clear Time (g_c+I1), s		13.3		4.8			10.6	23.6				
Green Ext Time (p_c), s		3.3		8.8			0.2	6.7				

Intersection Summary

HCM 6th Ctrl Delay	21.6
HCM 6th LOS	C

Notes

User approved volume balancing among the lanes for turning movement.

HCM 6th Signalized Intersection Summary
 16: Love's Truck Stop Driveway/Driveway & Avenue 17

Village D Specific Plan
 Phase III WP MIT - AM Peak Hour



Movement	EBL	EBT	EBR	WBL	WBT	WBR	NBL	NBT	NBR	SBL	SBT	SBR
Lane Configurations	↔↔	↑↑↑	↔	↔	↑↑↑	↔	↔	↔		↔	↑	↔
Traffic Volume (veh/h)	162	819	132	45	1054	56	136	0	22	48	0	90
Future Volume (veh/h)	162	819	132	45	1054	56	136	0	22	48	0	90
Initial Q (Qb), veh	0	0	0	0	0	0	0	0	0	0	0	0
Ped-Bike Adj(A_pbT)	1.00		1.00	1.00		1.00	1.00		1.00	1.00		1.00
Parking Bus, Adj	1.00	1.00	1.00	1.00	1.00	1.00	1.00	1.00	1.00	1.00	1.00	1.00
Work Zone On Approach		No			No			No			No	
Adj Sat Flow, veh/h/ln	1870	1870	1870	1870	1870	1870	1900	1900	1900	1900	1900	1900
Adj Flow Rate, veh/h	176	890	143	49	1146	61	148	0	24	52	0	98
Peak Hour Factor	0.92	0.92	0.92	0.92	0.92	0.92	0.92	0.92	0.92	0.92	0.92	0.92
Percent Heavy Veh, %	2	2	2	2	2	2	0	0	0	0	0	0
Cap, veh/h	173	2797	868	66	2732	848	90	0	317	69	352	378
Arrive On Green	0.05	0.55	0.55	0.04	0.54	0.54	0.05	0.00	0.20	0.04	0.00	0.19
Sat Flow, veh/h	3456	5106	1585	1781	5106	1585	1810	0	1610	1810	1900	1610
Grp Volume(v), veh/h	176	890	143	49	1146	61	148	0	24	52	0	98
Grp Sat Flow(s),veh/h/ln	1728	1702	1585	1781	1702	1585	1810	0	1610	1810	1900	1610
Q Serve(g_s), s	5.0	9.5	4.5	2.7	13.5	1.9	5.0	0.0	1.2	2.8	0.0	5.0
Cycle Q Clear(g_c), s	5.0	9.5	4.5	2.7	13.5	1.9	5.0	0.0	1.2	2.8	0.0	5.0
Prop In Lane	1.00		1.00	1.00		1.00	1.00		1.00	1.00		1.00
Lane Grp Cap(c), veh/h	173	2797	868	66	2732	848	90	0	317	69	352	378
V/C Ratio(X)	1.02	0.32	0.16	0.74	0.42	0.07	1.64	0.00	0.08	0.75	0.00	0.26
Avail Cap(c_a), veh/h	173	2797	868	89	2732	848	90	0	317	90	352	378
HCM Platoon Ratio	1.00	1.00	1.00	1.00	1.00	1.00	1.00	1.00	1.00	1.00	1.00	1.00
Upstream Filter(I)	1.00	1.00	1.00	1.00	1.00	1.00	1.00	0.00	1.00	1.00	0.00	1.00
Uniform Delay (d), s/veh	47.5	12.4	11.2	47.7	13.9	11.2	47.5	0.0	32.7	47.6	0.0	31.2
Incr Delay (d2), s/veh	73.4	0.3	0.4	19.5	0.5	0.2	330.4	0.0	0.5	22.0	0.0	1.7
Initial Q Delay(d3),s/veh	0.0	0.0	0.0	0.0	0.0	0.0	0.0	0.0	0.0	0.0	0.0	0.0
%ile BackOfQ(50%),veh/ln	8.9	3.6	1.6	1.6	5.1	0.7	10.5	0.0	0.5	1.7	0.0	2.1
Unsig. Movement Delay, s/veh												
LnGrp Delay(d),s/veh	120.9	12.7	11.6	67.2	14.4	11.4	377.9	0.0	33.2	69.6	0.0	32.8
LnGrp LOS	F	B	B	E	B	B	F	A	C	E	A	C
Approach Vol, veh/h		1209			1256			172			150	
Approach Delay, s/veh		28.3			16.3			329.8			45.6	
Approach LOS		C			B			F			D	
Timer - Assigned Phs	1	2	3	4	5	6	7	8				
Phs Duration (G+Y+Rc), s	59.3	9.5	23.0	9.5	58.0	8.3	24.2					
Change Period (Y+Rc), s	4.5	4.5	4.5	4.5	4.5	4.5	4.5					
Max Green Setting (Gmax), s	53.5	5.0	18.5	5.0	53.5	5.0	18.5					
Max Q Clear Time (g_c+1), s	11.5	7.0	7.0	7.0	15.5	4.8	3.2					
Green Ext Time (p_c), s	0.0	8.4	0.0	0.2	0.0	10.9	0.0					

Intersection Summary

HCM 6th Ctrl Delay	42.4
HCM 6th LOS	D

HCM 6th Signalized Intersection Summary
 17: Westberry Boulevard & Cleveland Avenue

Village D Specific Plan
 Phase III WP MIT - AM Peak Hour



Movement	EBL	EBT	EBR	WBL	WBT	WBR	NBL	NBT	NBR	SBL	SBT	SBR
Lane Configurations												
Traffic Volume (veh/h)	386	901	82	41	397	13	63	240	181	15	80	141
Future Volume (veh/h)	386	901	82	41	397	13	63	240	181	15	80	141
Initial Q (Qb), veh	0	0	0	0	0	0	0	0	0	0	0	0
Ped-Bike Adj(A_pbT)	1.00		1.00	1.00		1.00	1.00		1.00	1.00		0.99
Parking Bus, Adj	1.00	1.00	1.00	1.00	1.00	1.00	1.00	1.00	1.00	1.00	1.00	1.00
Work Zone On Approach		No			No			No			No	
Adj Sat Flow, veh/h/ln	1900	1900	1900	1885	1885	1885	1900	1900	1900	1900	1900	1900
Adj Flow Rate, veh/h	420	979	89	45	432	14	68	261	197	16	87	153
Peak Hour Factor	0.92	0.92	0.92	0.92	0.92	0.92	0.92	0.92	0.92	0.92	0.92	0.92
Percent Heavy Veh, %	0	0	0	1	1	1	0	0	0	0	0	0
Cap, veh/h	456	1353	602	71	575	19	88	650	550	34	593	495
Arrive On Green	0.25	0.37	0.37	0.04	0.16	0.16	0.05	0.34	0.34	0.02	0.31	0.31
Sat Flow, veh/h	1810	3610	1606	1795	3540	115	1810	1900	1609	1810	1900	1588
Grp Volume(v), veh/h	420	979	89	45	218	228	68	261	197	16	87	153
Grp Sat Flow(s),veh/h/ln	1810	1805	1606	1795	1791	1864	1810	1900	1609	1810	1900	1588
Q Serve(g_s), s	18.1	18.6	2.9	2.0	9.3	9.3	3.0	8.4	7.3	0.7	2.6	5.9
Cycle Q Clear(g_c), s	18.1	18.6	2.9	2.0	9.3	9.3	3.0	8.4	7.3	0.7	2.6	5.9
Prop In Lane	1.00		1.00	1.00		0.06	1.00		1.00	1.00		1.00
Lane Grp Cap(c), veh/h	456	1353	602	71	291	303	88	650	550	34	593	495
V/C Ratio(X)	0.92	0.72	0.15	0.63	0.75	0.75	0.77	0.40	0.36	0.47	0.15	0.31
Avail Cap(c_a), veh/h	464	1458	648	139	403	419	113	650	550	113	593	495
HCM Platoon Ratio	1.00	1.00	1.00	1.00	1.00	1.00	1.00	1.00	1.00	1.00	1.00	1.00
Upstream Filter(I)	1.00	1.00	1.00	1.00	1.00	1.00	1.00	1.00	1.00	0.96	0.96	0.96
Uniform Delay (d), s/veh	29.1	21.4	16.5	37.9	32.0	32.0	37.6	20.1	19.7	38.9	19.8	21.0
Incr Delay (d2), s/veh	23.6	1.7	0.1	9.0	5.0	4.9	21.4	1.8	1.8	9.5	0.5	1.6
Initial Q Delay(d3),s/veh	0.0	0.0	0.0	0.0	0.0	0.0	0.0	0.0	0.0	0.0	0.0	0.0
%ile BackOfQ(50%),veh/ln	10.5	7.7	1.1	1.0	4.3	4.5	1.8	3.9	2.9	0.4	1.2	2.3
Unsig. Movement Delay, s/veh												
LnGrp Delay(d),s/veh	52.8	23.1	16.7	46.9	37.0	36.9	59.0	21.9	21.6	48.4	20.3	22.5
LnGrp LOS	D	C	B	D	D	D	E	C	C	D	C	C
Approach Vol, veh/h		1488			491			526			256	
Approach Delay, s/veh		31.1			37.8			26.6			23.4	
Approach LOS		C			D			C			C	
Timer - Assigned Phs	1	2	3	4	5	6	7	8				
Phs Duration (G+Y+Rc), s	6.0	31.9	7.7	34.5	8.4	29.5	24.7	17.5				
Change Period (Y+Rc), s	4.5	4.5	4.5	4.5	4.5	4.5	4.5	4.5				
Max Green Setting (Gmax), s	5.0	18.5	6.2	32.3	5.0	18.5	20.5	18.0				
Max Q Clear Time (g_c+1/2), s	11.5	10.4	4.0	20.6	5.0	7.9	20.1	11.3				
Green Ext Time (p_c), s	0.0	1.4	0.0	5.5	0.0	0.7	0.1	1.4				

Intersection Summary

HCM 6th Ctrl Delay	30.7
HCM 6th LOS	C

HCM 6th Signalized Intersection Summary
18: Westberry Boulevard & Sunset Avenue

Village D Specific Plan
Phase III WP MIT - AM Peak Hour



Movement	EBL	EBT	EBR	WBL	WBT	WBR	NBL	NBT	NBR	SBL	SBT	SBR
Lane Configurations												
Traffic Volume (veh/h)	76	293	98	60	211	31	127	211	124	132	147	42
Future Volume (veh/h)	76	293	98	60	211	31	127	211	124	132	147	42
Initial Q (Qb), veh	0	0	0	0	0	0	0	0	0	0	0	0
Ped-Bike Adj(A_pbT)	1.00		1.00	1.00		1.00	1.00		0.99	1.00		0.99
Parking Bus, Adj	1.00	1.00	1.00	1.00	1.00	1.00	1.00	1.00	1.00	1.00	1.00	1.00
Work Zone On Approach	No			No			No			No		
Adj Sat Flow, veh/h/ln	1870	1870	1870	1856	1856	1856	1900	1900	1900	1900	1900	1900
Adj Flow Rate, veh/h	83	318	107	65	229	34	138	229	135	143	160	46
Peak Hour Factor	0.92	0.92	0.92	0.92	0.92	0.92	0.92	0.92	0.92	0.92	0.92	0.92
Percent Heavy Veh, %	2	2	2	3	3	3	0	0	0	0	0	0
Cap, veh/h	452	476	160	325	562	83	183	394	331	190	401	337
Arrive On Green	0.36	0.36	0.36	0.36	0.36	0.36	0.10	0.21	0.21	0.11	0.21	0.21
Sat Flow, veh/h	1115	1338	450	954	1578	234	1810	1900	1595	1810	1900	1595
Grp Volume(v), veh/h	83	0	425	65	0	263	138	229	135	143	160	46
Grp Sat Flow(s),veh/h/ln	1115	0	1788	954	0	1813	1810	1900	1595	1810	1900	1595
Q Serve(g_s), s	2.5	0.0	8.2	2.5	0.0	4.5	3.0	4.4	3.0	3.1	3.0	1.0
Cycle Q Clear(g_c), s	6.9	0.0	8.2	10.7	0.0	4.5	3.0	4.4	3.0	3.1	3.0	1.0
Prop In Lane	1.00		0.25	1.00		0.13	1.00		1.00	1.00		1.00
Lane Grp Cap(c), veh/h	452	0	637	325	0	646	183	394	331	190	401	337
V/C Ratio(X)	0.18	0.00	0.67	0.20	0.00	0.41	0.75	0.58	0.41	0.75	0.40	0.14
Avail Cap(c_a), veh/h	889	0	1339	699	0	1357	600	1049	881	600	1049	881
HCM Platoon Ratio	1.00	1.00	1.00	1.00	1.00	1.00	1.00	1.00	1.00	1.00	1.00	1.00
Upstream Filter(I)	1.00	0.00	1.00	1.00	0.00	1.00	1.00	1.00	1.00	1.00	1.00	1.00
Uniform Delay (d), s/veh	12.5	0.0	11.1	15.6	0.0	9.9	17.8	14.6	14.0	17.7	13.8	13.1
Incr Delay (d2), s/veh	0.2	0.0	1.2	0.3	0.0	0.4	6.1	1.4	0.8	5.9	0.6	0.2
Initial Q Delay(d3),s/veh	0.0	0.0	0.0	0.0	0.0	0.0	0.0	0.0	0.0	0.0	0.0	0.0
%ile BackOfQ(50%),veh/ln	0.5	0.0	2.7	0.5	0.0	1.4	1.4	1.7	1.0	1.4	1.1	0.3
Unsig. Movement Delay, s/veh												
LnGrp Delay(d),s/veh	12.7	0.0	12.3	15.9	0.0	10.3	23.9	15.9	14.8	23.6	14.5	13.2
LnGrp LOS	B	A	B	B	A	B	C	B	B	C	B	B
Approach Vol, veh/h	508			328			502			349		
Approach Delay, s/veh	12.4			11.4			17.8			18.1		
Approach LOS	B			B			B			B		
Timer - Assigned Phs	1	2	4		5	6	8					
Phs Duration (G+Y+Rc), s	8.8	12.9	19.0		8.6	13.1	19.0					
Change Period (Y+Rc), s	4.5	4.5	4.5		4.5	4.5	4.5					
Max Green Setting (Gmax), s	13.5	22.5	30.5		13.5	22.5	30.5					
Max Q Clear Time (g_c+1), s	11.5	6.4	10.2		5.0	5.0	12.7					
Green Ext Time (p_c), s	0.2	1.6	3.0		0.2	0.9	1.7					

Intersection Summary

HCM 6th Ctrl Delay	15.0
HCM 6th LOS	B

HCM 6th Signalized Intersection Summary
 19: Westberry Boulevard & Avenue 14

Village D Specific Plan
 Phase III WP MIT - AM Peak Hour



Movement	EBL	EBT	EBR	WBL	WBT	WBR	NBL	NBT	NBR	SBL	SBT	SBR
Lane Configurations												
Traffic Volume (veh/h)	113	741	56	12	398	133	86	53	25	309	73	101
Future Volume (veh/h)	113	741	56	12	398	133	86	53	25	309	73	101
Initial Q (Qb), veh	0	0	0	0	0	0	0	0	0	0	0	0
Ped-Bike Adj(A_pbT)	1.00		1.00	1.00		0.99	1.00		1.00	1.00		0.98
Parking Bus, Adj	1.00	1.00	1.00	1.00	1.00	1.00	1.00	1.00	1.00	1.00	1.00	1.00
Work Zone On Approach		No			No			No			No	
Adj Sat Flow, veh/h/ln	1870	1870	1870	1841	1841	1841	1900	1900	1900	1900	1900	1900
Adj Flow Rate, veh/h	123	805	61	13	433	145	93	58	27	336	79	110
Peak Hour Factor	0.92	0.92	0.92	0.92	0.92	0.92	0.92	0.92	0.92	0.92	0.92	0.92
Percent Heavy Veh, %	2	2	2	4	4	4	0	0	0	0	0	0
Cap, veh/h	158	1061	80	29	856	379	129	118	55	405	176	246
Arrive On Green	0.09	0.32	0.32	0.02	0.24	0.24	0.07	0.10	0.10	0.22	0.25	0.25
Sat Flow, veh/h	1781	3347	254	1753	3497	1550	1810	1226	571	1810	709	987
Grp Volume(v), veh/h	123	427	439	13	433	145	93	0	85	336	0	189
Grp Sat Flow(s),veh/h/ln	1781	1777	1823	1753	1749	1550	1810	0	1797	1810	0	1697
Q Serve(g_s), s	3.5	11.2	11.2	0.4	5.5	4.0	2.6	0.0	2.3	9.2	0.0	4.9
Cycle Q Clear(g_c), s	3.5	11.2	11.2	0.4	5.5	4.0	2.6	0.0	2.3	9.2	0.0	4.9
Prop In Lane	1.00		0.14	1.00		1.00	1.00		0.32	1.00		0.58
Lane Grp Cap(c), veh/h	158	563	578	29	856	379	129	0	173	405	0	422
V/C Ratio(X)	0.78	0.76	0.76	0.45	0.51	0.38	0.72	0.00	0.49	0.83	0.00	0.45
Avail Cap(c_a), veh/h	257	701	720	169	1212	537	335	0	692	575	0	879
HCM Platoon Ratio	1.00	1.00	1.00	1.00	1.00	1.00	1.00	1.00	1.00	1.00	1.00	1.00
Upstream Filter(I)	1.00	1.00	1.00	1.00	1.00	1.00	1.00	0.00	1.00	1.00	0.00	1.00
Uniform Delay (d), s/veh	23.2	15.9	15.9	25.3	16.9	16.3	23.6	0.0	22.3	19.2	0.0	16.5
Incr Delay (d2), s/veh	7.9	3.8	3.7	10.6	0.5	0.6	7.4	0.0	2.1	7.0	0.0	0.7
Initial Q Delay(d3),s/veh	0.0	0.0	0.0	0.0	0.0	0.0	0.0	0.0	0.0	0.0	0.0	0.0
%ile BackOfQ(50%),veh/ln	1.7	4.5	4.6	0.2	2.0	1.3	1.3	0.0	1.0	4.2	0.0	1.8
Unsig. Movement Delay, s/veh												
LnGrp Delay(d),s/veh	31.1	19.7	19.6	35.9	17.4	17.0	31.1	0.0	24.4	26.2	0.0	17.2
LnGrp LOS	C	B	B	D	B	B	C	A	C	C	A	B
Approach Vol, veh/h		989			591			178			525	
Approach Delay, s/veh		21.1			17.7			27.9			23.0	
Approach LOS		C			B			C			C	
Timer - Assigned Phs	1	2	3	4	5	6	7	8				
Phs Duration (G+Y+Rc), s	16.1	9.5	5.4	21.0	8.2	17.4	9.1	17.2				
Change Period (Y+Rc), s	4.5	4.5	4.5	4.5	4.5	4.5	4.5	4.5				
Max Green Setting (Gmax), s	10.5	20.0	5.0	20.5	9.6	26.9	7.5	18.0				
Max Q Clear Time (g_c+I), s	11.2	4.3	2.4	13.2	4.6	6.9	5.5	7.5				
Green Ext Time (p_c), s	0.5	0.3	0.0	3.2	0.1	1.0	0.1	2.5				
Intersection Summary												
HCM 6th Ctrl Delay					21.2							
HCM 6th LOS					C							

HCM 6th Signalized Intersection Summary
 20: Westberry Boulevard & Avenue 16

Village D Specific Plan
 Phase III WP MIT - AM Peak Hour



Movement	EBL	EBT	EBR	WBL	WBT	WBR	NBL	NBT	NBR	SBL	SBT	SBR
Lane Configurations												
Traffic Volume (veh/h)	0	0	0	144	0	235	0	211	545	100	64	0
Future Volume (veh/h)	0	0	0	144	0	235	0	211	545	100	64	0
Initial Q (Qb), veh	0	0	0	0	0	0	0	0	0	0	0	0
Ped-Bike Adj(A_pbT)	1.00		1.00	1.00		1.00	1.00		1.00	1.00		1.00
Parking Bus, Adj	1.00	1.00	1.00	1.00	1.00	1.00	1.00	1.00	1.00	1.00	1.00	1.00
Work Zone On Approach	No			No			No			No		
Adj Sat Flow, veh/h/ln	1900	1900	1900	1856	1856	1856	1900	1900	1900	1900	1900	1900
Adj Flow Rate, veh/h	0	0	0	157	0	255	0	229	592	109	70	0
Peak Hour Factor	0.92	0.92	0.92	0.92	0.92	0.92	0.92	0.92	0.92	0.92	0.92	0.92
Percent Heavy Veh, %	0	0	0	3	3	3	0	0	0	0	0	0
Cap, veh/h	4	4	0	203	392	331	4	811	687	145	1141	0
Arrive On Green	0.00	0.00	0.00	0.11	0.00	0.21	0.00	0.43	0.43	0.08	0.60	0.00
Sat Flow, veh/h	1810	1900	0	1767	1856	1569	1810	1900	1610	1810	1900	0
Grp Volume(v), veh/h	0	0	0	157	0	255	0	229	592	109	70	0
Grp Sat Flow(s),veh/h/ln	1810	1900	0	1767	1856	1569	1810	1900	1610	1810	1900	0
Q Serve(g_s), s	0.0	0.0	0.0	4.1	0.0	7.3	0.0	3.8	15.9	2.8	0.7	0.0
Cycle Q Clear(g_c), s	0.0	0.0	0.0	4.1	0.0	7.3	0.0	3.8	15.9	2.8	0.7	0.0
Prop In Lane	1.00		0.00	1.00		1.00	1.00		1.00	1.00		0.00
Lane Grp Cap(c), veh/h	4	4	0	203	392	331	4	811	687	145	1141	0
V/C Ratio(X)	0.00	0.00	0.00	0.77	0.00	0.77	0.00	0.28	0.86	0.75	0.06	0.00
Avail Cap(c_a), veh/h	189	715	0	388	911	771	189	1033	875	284	1141	0
HCM Platoon Ratio	1.00	1.00	1.00	1.00	1.00	1.00	1.00	1.00	1.00	1.00	1.00	1.00
Upstream Filter(I)	0.00	0.00	0.00	1.00	0.00	1.00	0.00	1.00	1.00	1.00	1.00	0.00
Uniform Delay (d), s/veh	0.0	0.0	0.0	20.6	0.0	17.8	0.0	8.9	12.4	21.5	4.0	0.0
Incr Delay (d2), s/veh	0.0	0.0	0.0	6.1	0.0	3.8	0.0	0.2	7.2	7.7	0.0	0.0
Initial Q Delay(d3),s/veh	0.0	0.0	0.0	0.0	0.0	0.0	0.0	0.0	0.0	0.0	0.0	0.0
%ile BackOfQ(50%),veh/ln	0.0	0.0	0.0	1.9	0.0	0.3	0.0	1.3	5.8	1.4	0.2	0.0
Unsig. Movement Delay, s/veh												
LnGrp Delay(d),s/veh	0.0	0.0	0.0	26.7	0.0	21.6	0.0	9.1	19.6	29.2	4.0	0.0
LnGrp LOS	A	A	A	C	A	C	A	A	B	C	A	A
Approach Vol, veh/h	0			412			821			179		
Approach Delay, s/veh	0.0			23.5			16.7			19.4		
Approach LOS				C			B			B		
Timer - Assigned Phs	1	2	3	4	5	6	7	8				
Phs Duration (G+Y+Rc), s	8.3	24.9	10.0	4.6	0.0	33.2	0.0	14.6				
Change Period (Y+Rc), s	4.5	4.5	4.5	4.5	4.5	4.5	4.5	4.5				
Max Green Setting (Gmax), s	5	26.0	10.5	18.0	5.0	28.5	5.0	23.5				
Max Q Clear Time (g_c+1), s	8	17.9	6.1	0.0	0.0	2.7	0.0	9.3				
Green Ext Time (p_c), s		0.1	2.5	0.1	0.0	0.3	0.0	0.7				























Intersection Summary

HCM 6th Ctrl Delay	19.0
HCM 6th LOS	B

HCM 6th Signalized Intersection Summary

21: Granada Drive & Cleveland Avenue

Village D Specific Plan
Phase III WP MIT - AM Peak Hour

												
Movement	EBL	EBT	EBR	WBL	WBT	WBR	NBL	NBT	NBR	SBL	SBT	SBR
Lane Configurations												
Traffic Volume (veh/h)	35	1008	28	194	378	32	26	444	350	14	284	5
Future Volume (veh/h)	35	1008	28	194	378	32	26	444	350	14	284	5
Initial Q (Qb), veh	0	0	0	0	0	0	0	0	0	0	0	0
Ped-Bike Adj(A_pbT)	1.00		0.98	1.00		1.00	1.00		0.99	1.00		1.00
Parking Bus, Adj	1.00	1.00	1.00	1.00	1.00	1.00	1.00	1.00	1.00	1.00	1.00	1.00
Work Zone On Approach		No			No			No			No	
Adj Sat Flow, veh/h/ln	1885	1885	1885	1870	1870	1870	1900	1900	1900	1900	1900	1900
Adj Flow Rate, veh/h	38	1096	30	211	411	35	28	483	380	15	309	5
Peak Hour Factor	0.92	0.92	0.92	0.92	0.92	0.92	0.92	0.92	0.92	0.92	0.92	0.92
Percent Heavy Veh, %	1	1	1	2	2	2	0	0	0	0	0	0
Cap, veh/h	64	1099	30	229	1428	635	52	608	507	32	586	496
Arrive On Green	0.04	0.31	0.31	0.04	0.13	0.13	0.03	0.32	0.32	0.02	0.31	0.31
Sat Flow, veh/h	1795	3558	97	1781	3554	1581	1810	1900	1587	1810	1900	1607
Grp Volume(v), veh/h	38	552	574	211	411	35	28	483	380	15	309	5
Grp Sat Flow(s),veh/h/ln	1795	1791	1865	1781	1777	1581	1810	1900	1587	1810	1900	1607
Q Serve(g_s), s	1.7	24.6	24.6	9.4	8.3	1.5	1.2	18.5	17.1	0.7	10.7	0.2
Cycle Q Clear(g_c), s	1.7	24.6	24.6	9.4	8.3	1.5	1.2	18.5	17.1	0.7	10.7	0.2
Prop In Lane	1.00		0.05	1.00		1.00	1.00		1.00	1.00		1.00
Lane Grp Cap(c), veh/h	64	553	576	229	1428	635	52	608	507	32	586	496
V/C Ratio(X)	0.59	1.00	1.00	0.92	0.29	0.06	0.53	0.79	0.75	0.47	0.53	0.01
Avail Cap(c_a), veh/h	132	553	576	229	1428	635	115	608	507	113	586	496
HCM Platoon Ratio	1.00	1.00	1.00	0.33	0.33	0.33	1.00	1.00	1.00	1.00	1.00	1.00
Upstream Filter(I)	1.00	1.00	1.00	0.88	0.88	0.88	1.00	1.00	1.00	1.00	1.00	1.00
Uniform Delay (d), s/veh	38.0	27.6	27.6	37.9	24.4	21.4	38.3	24.8	24.3	38.9	22.8	19.2
Incr Delay (d2), s/veh	8.5	37.6	36.9	35.2	0.1	0.0	8.2	10.3	9.7	10.2	3.4	0.0
Initial Q Delay(d3),s/veh	0.0	0.0	0.0	0.0	0.0	0.0	0.0	0.0	0.0	0.0	0.0	0.0
%ile BackOfQ(50%),veh/ln	0.9	15.7	16.2	6.6	3.7	0.5	0.7	9.7	7.5	0.4	5.2	0.1
Unsig. Movement Delay, s/veh												
LnGrp Delay(d),s/veh	46.5	65.2	64.5	73.0	24.5	21.5	46.5	35.1	34.1	49.1	26.2	19.2
LnGrp LOS	D	E	E	E	C	C	D	D	C	D	C	B
Approach Vol, veh/h		1164			657			891			329	
Approach Delay, s/veh		64.3			39.9			35.0			27.1	
Approach LOS		E			D			D			C	
Timer - Assigned Phs	1	2	3	4	5	6	7	8				
Phs Duration (G+Y+Rc), s	5.9	30.1	14.8	29.2	6.8	29.2	7.4	36.6				
Change Period (Y+Rc), s	4.5	4.5	4.5	4.5	4.5	4.5	4.5	4.5				
Max Green Setting (Gmax), s	5.0	22.0	10.3	24.7	5.1	21.9	5.9	29.1				
Max Q Clear Time (g_c+I1), s	2.7	20.5	11.4	26.6	3.2	12.7	3.7	10.3				
Green Ext Time (p_c), s	0.0	0.7	0.0	0.0	0.0	1.2	0.0	2.7				
Intersection Summary												
HCM 6th Ctrl Delay				46.4								
HCM 6th LOS				D								

HCM 6th Signalized Intersection Summary
 22: Granada Drive & Sunset Avenue

Village D Specific Plan
 Phase III WP MIT - AM Peak Hour



Movement	EBL	EBT	EBR	WBL	WBT	WBR	NBL	NBT	NBR	SBL	SBT	SBR
Lane Configurations												
Traffic Volume (veh/h)	68	314	74	26	131	67	49	260	26	133	292	50
Future Volume (veh/h)	68	314	74	26	131	67	49	260	26	133	292	50
Initial Q (Qb), veh	0	0	0	0	0	0	0	0	0	0	0	0
Ped-Bike Adj(A_pbT)	1.00		1.00	1.00		1.00	1.00		0.99	1.00		0.97
Parking Bus, Adj	1.00	1.00	1.00	1.00	1.00	1.00	1.00	1.00	1.00	1.00	1.00	1.00
Work Zone On Approach		No			No			No			No	
Adj Sat Flow, veh/h/ln	1870	1870	1870	1826	1826	1826	1870	1870	1870	1870	1870	1870
Adj Flow Rate, veh/h	74	341	80	28	142	73	53	283	28	145	317	54
Peak Hour Factor	0.92	0.92	0.92	0.92	0.92	0.92	0.92	0.92	0.92	0.92	0.92	0.92
Percent Heavy Veh, %	2	2	2	5	5	5	2	2	2	2	2	2
Cap, veh/h	97	381	89	52	430	364	82	587	58	182	631	107
Arrive On Green	0.05	0.26	0.26	0.03	0.24	0.24	0.05	0.35	0.35	0.10	0.41	0.41
Sat Flow, veh/h	1781	1465	344	1739	1826	1547	1781	1674	166	1781	1550	264
Grp Volume(v), veh/h	74	0	421	28	142	73	53	0	311	145	0	371
Grp Sat Flow(s),veh/h/ln	1781	0	1809	1739	1826	1547	1781	0	1839	1781	0	1815
Q Serve(g_s), s	2.9	0.0	15.7	1.1	4.5	2.6	2.0	0.0	9.2	5.6	0.0	10.7
Cycle Q Clear(g_c), s	2.9	0.0	15.7	1.1	4.5	2.6	2.0	0.0	9.2	5.6	0.0	10.7
Prop In Lane	1.00		0.19	1.00		1.00	1.00		0.09	1.00		0.15
Lane Grp Cap(c), veh/h	97	0	470	52	430	364	82	0	645	182	0	739
V/C Ratio(X)	0.76	0.00	0.90	0.54	0.33	0.20	0.65	0.00	0.48	0.80	0.00	0.50
Avail Cap(c_a), veh/h	155	0	504	127	483	409	130	0	645	216	0	739
HCM Platoon Ratio	1.00	1.00	1.00	1.00	1.00	1.00	1.00	1.00	1.00	1.00	1.00	1.00
Upstream Filter(I)	1.00	0.00	1.00	0.98	0.98	0.98	1.00	0.00	1.00	1.00	0.00	1.00
Uniform Delay (d), s/veh	32.6	0.0	25.0	33.5	22.2	21.5	32.8	0.0	17.8	30.7	0.0	15.5
Incr Delay (d2), s/veh	11.6	0.0	17.7	8.2	0.4	0.3	8.3	0.0	2.6	16.0	0.0	2.4
Initial Q Delay(d3),s/veh	0.0	0.0	0.0	0.0	0.0	0.0	0.0	0.0	0.0	0.0	0.0	0.0
%ile BackOfQ(50%),veh/ln	1.5	0.0	8.6	0.6	1.9	0.9	1.0	0.0	4.1	3.1	0.0	4.5
Unsig. Movement Delay, s/veh												
LnGrp Delay(d),s/veh	44.2	0.0	42.7	41.6	22.6	21.7	41.1	0.0	20.3	46.7	0.0	17.9
LnGrp LOS	D	A	D	D	C	C	D	A	C	D	A	B
Approach Vol, veh/h		495			243			364			516	
Approach Delay, s/veh		42.9			24.5			23.3			26.0	
Approach LOS		D			C			C			C	
Timer - Assigned Phs	1	2	3	4	5	6	7	8				
Phs Duration (G+Y+Rc), s	11.6	29.1	6.6	22.7	7.7	33.0	8.3	21.0				
Change Period (Y+Rc), s	4.5	4.5	4.5	4.5	4.5	4.5	4.5	4.5				
Max Green Setting (Gmax), s	18.5	18.9	5.1	19.5	5.1	22.3	6.1	18.5				
Max Q Clear Time (g_c+1), s	17.6	11.2	3.1	17.7	4.0	12.7	4.9	6.5				
Green Ext Time (p_c), s	0.0	1.1	0.0	0.5	0.0	1.6	0.0	0.7				

Intersection Summary

HCM 6th Ctrl Delay	30.4
HCM 6th LOS	C

HCM 6th Signalized Intersection Summary

24: Schnoor Avenue & Kennedy Street

Village D Specific Plan
Phase III WP MIT - AM Peak Hour



Movement	EBL	EBT	EBR	WBL	WBT	WBR	NBL	NBT	NBR	SBL	SBT	SBR
Lane Configurations												
Traffic Volume (veh/h)	116	323	170	244	281	214	125	46	307	138	43	34
Future Volume (veh/h)	116	323	170	244	281	214	125	46	307	138	43	34
Initial Q (Qb), veh	0	0	0	0	0	0	0	0	0	0	0	0
Ped-Bike Adj(A_pbT)	1.00		1.00	1.00		1.00	1.00		1.00	1.00		1.00
Parking Bus, Adj	1.00	1.00	1.00	1.00	1.00	1.00	1.00	1.00	1.00	1.00	1.00	1.00
Work Zone On Approach		No			No			No			No	
Adj Sat Flow, veh/h/ln	1856	1856	1856	1826	1826	1826	1900	1900	1900	1366	1366	1366
Adj Flow Rate, veh/h	126	351	185	265	305	233	136	50	334	150	47	37
Peak Hour Factor	0.92	0.92	0.92	0.92	0.92	0.92	0.92	0.92	0.92	0.92	0.92	0.92
Percent Heavy Veh, %	3	3	3	5	5	5	0	0	0	36	36	36
Cap, veh/h	152	426	220	414	328	251	531	74	494	190	370	312
Arrive On Green	0.09	0.19	0.19	0.24	0.34	0.34	0.15	0.35	0.35	0.08	0.27	0.27
Sat Flow, veh/h	1767	2245	1162	1739	960	733	3510	213	1425	2525	1366	1153
Grp Volume(v), veh/h	126	274	262	265	0	538	136	0	384	150	47	37
Grp Sat Flow(s),veh/h/ln	1767	1763	1644	1739	0	1693	1755	0	1638	1262	1366	1153
Q Serve(g_s), s	8.4	17.9	18.4	16.4	0.0	36.8	4.1	0.0	24.0	7.0	3.1	2.3
Cycle Q Clear(g_c), s	8.4	17.9	18.4	16.4	0.0	36.8	4.1	0.0	24.0	7.0	3.1	2.3
Prop In Lane	1.00		0.71	1.00		0.43	1.00		0.87	1.00		1.00
Lane Grp Cap(c), veh/h	152	334	312	414	0	579	531	0	568	190	370	312
V/C Ratio(X)	0.83	0.82	0.84	0.64	0.00	0.93	0.26	0.00	0.68	0.79	0.13	0.12
Avail Cap(c_a), veh/h	199	442	412	433	0	656	531	0	568	242	370	312
HCM Platoon Ratio	1.00	1.00	1.00	1.00	1.00	1.00	1.00	1.00	1.00	1.00	1.00	1.00
Upstream Filter(l)	0.80	0.80	0.80	1.00	0.00	1.00	1.00	0.00	1.00	1.00	1.00	1.00
Uniform Delay (d), s/veh	54.0	46.7	46.9	41.1	0.0	38.1	45.0	0.0	33.5	54.5	33.0	20.0
Incr Delay (d2), s/veh	16.0	7.3	9.2	3.0	0.0	18.6	0.3	0.0	6.4	12.5	0.7	0.8
Initial Q Delay(d3),s/veh	0.0	0.0	0.0	0.0	0.0	0.0	0.0	0.0	0.0	0.0	0.0	0.0
%ile BackOfQ(50%),veh/ln	4	8.5	8.3	7.4	0.0	18.0	1.8	0.0	10.5	2.6	1.1	0.9
Unsig. Movement Delay, s/veh												
LnGrp Delay(d),s/veh	70.0	54.0	56.0	44.0	0.0	56.8	45.2	0.0	39.8	67.1	33.7	20.8
LnGrp LOS	E	D	E	D	A	E	D	A	D	E	C	C
Approach Vol, veh/h		662			803			520			234	
Approach Delay, s/veh		57.8			52.6			41.2			53.0	
Approach LOS		E			D			D			D	
Timer - Assigned Phs	1	2	3	4	5	6	7	8				
Phs Duration (G+Y+Rc), s	33.6	46.1	33.1	27.3	22.6	37.0	14.8	45.5				
Change Period (Y+Rc), s	4.5	4.5	4.5	4.5	4.5	4.5	4.5	4.5				
Max Green Setting (Gmax), s	5	30.5	29.9	30.1	9.5	32.5	13.5	46.5				
Max Q Clear Time (g_c+19), s	19.0	26.0	18.4	20.4	6.1	5.1	10.4	38.8				
Green Ext Time (p_c), s	0.1	1.0	0.6	2.3	0.1	0.3	0.1	2.2				
Intersection Summary												
HCM 6th Ctrl Delay											51.5	
HCM 6th LOS											D	

HCM 6th Signalized Intersection Summary
 25: Kennedy Street/Gateway Drive & SR-99 Southbound Ramps

Village D Specific Plan
 Phase III WP MIT - AM Peak Hour

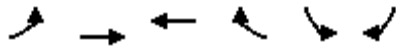

Movement	EBL	EBT	WBT	WBR	SBL	SBR	
Lane Configurations	↖	↑	↗		↙	↘	
Traffic Volume (veh/h)	492	267	530	4	67	168	
Future Volume (veh/h)	492	267	530	4	67	168	
Initial Q (Qb), veh	0	0	0	0	0	0	
Ped-Bike Adj(A_pbT)	1.00			1.00	1.00	1.00	
Parking Bus, Adj	1.00	1.00	1.00	1.00	1.00	1.00	
Work Zone On Approach		No	No		No		
Adj Sat Flow, veh/h/ln	1870	1870	1811	1811	1856	1856	
Adj Flow Rate, veh/h	535	290	576	0	73	183	
Peak Hour Factor	0.92	0.92	0.92	0.92	0.92	0.92	
Percent Heavy Veh, %	2	2	6	6	3	3	
Cap, veh/h	566	1302	618		404	859	
Arrive On Green	0.32	0.70	0.34	0.00	0.23	0.23	
Sat Flow, veh/h	1781	1870	1811	0	1767	1572	
Grp Volume(v), veh/h	535	290	576	0	73	183	
Grp Sat Flow(s),veh/h/ln	1781	1870	1811	0	1767	1572	
Q Serve(g_s), s	35.2	6.7	36.9	0.0	4.0	7.2	
Cycle Q Clear(g_c), s	35.2	6.7	36.9	0.0	4.0	7.2	
Prop In Lane	1.00			0.00	1.00	1.00	
Lane Grp Cap(c), veh/h	566	1302	618		404	859	
V/C Ratio(X)	0.95	0.22	0.93		0.18	0.21	
Avail Cap(c_a), veh/h	631	1442	687		404	859	
HCM Platoon Ratio	1.00	1.00	1.00	1.00	1.00	1.00	
Upstream Filter(I)	1.00	1.00	1.00	0.00	1.00	1.00	
Uniform Delay (d), s/veh	39.9	6.6	38.2	0.0	37.2	14.0	
Incr Delay (d2), s/veh	22.2	0.1	18.6	0.0	1.0	0.6	
Initial Q Delay(d3),s/veh	0.0	0.0	0.0	0.0	0.0	0.0	
%ile BackOfQ(50%),veh/ln	18.7	2.5	19.3	0.0	1.8	9.0	
Unsig. Movement Delay, s/veh							
LnGrp Delay(d),s/veh	62.1	6.6	56.8	0.0	38.2	14.5	
LnGrp LOS	E	A	E		D	B	
Approach Vol, veh/h		825	576	A	256		
Approach Delay, s/veh		42.6	56.8		21.3		
Approach LOS		D	E		C		
Timer - Assigned Phs				4	6	7	8
Phs Duration (G+Y+Rc), s				88.0	32.0	42.6	45.4
Change Period (Y+Rc), s				4.5	4.5	4.5	4.5
Max Green Setting (Gmax), s				92.5	18.5	42.5	45.5
Max Q Clear Time (g_c+I1), s				8.7	9.2	37.2	38.9
Green Ext Time (p_c), s				1.9	0.5	1.0	2.1
Intersection Summary							
HCM 6th Ctrl Delay			44.2				
HCM 6th LOS			D				
Notes							
Unsignalized Delay for [WBR] is excluded from calculations of the approach delay and intersection delay.							

HCM 6th Signalized Intersection Summary
30: Fairgrounds & Cleveland Avenue

Village D Specific Plan
Phase III WP MIT - AM Peak Hour



Movement	EBL	EBT	EBR	WBL	WBT	WBR	NBL	NBT	NBR	SBL	SBT	SBR
Lane Configurations	↵ ↑↑↑			↵ ↑↑↑			↵↵		↵	↵	↵	↵
Traffic Volume (veh/h)	109	1329	30	39	651	161	14	8	29	169	5	40
Future Volume (veh/h)	109	1329	30	39	651	161	14	8	29	169	5	40
Initial Q (Qb), veh	0	0	0	0	0	0	0	0	0	0	0	0
Ped-Bike Adj(A_pbT)	1.00		1.00	1.00		1.00	1.00		1.00	1.00		0.99
Parking Bus, Adj	1.00	1.00	1.00	1.00	1.00	1.00	1.00	1.00	1.00	1.00	1.00	1.00
Work Zone On Approach	No			No			No		No			
Adj Sat Flow, veh/h/ln	1870	1870	1870	1856	1856	1856	1900	1900	1900	1900	1900	1900
Adj Flow Rate, veh/h	116	1414	32	41	693	171	15	26	20	180	5	43
Peak Hour Factor	0.94	0.94	0.94	0.94	0.94	0.94	0.94	0.94	0.94	0.94	0.94	0.94
Percent Heavy Veh, %	2	2	2	3	3	3	0	0	0	0	0	0
Cap, veh/h	146	1341	30	66	879	214	594	463	392	421	53	452
Arrive On Green	0.16	0.52	0.52	0.04	0.22	0.22	0.16	0.24	0.24	0.23	0.31	0.31
Sat Flow, veh/h	1781	5137	116	1767	4065	990	3619	1900	1608	1810	168	1447
Grp Volume(v), veh/h	116	937	509	41	574	290	15	26	20	180	0	48
Grp Sat Flow(s),veh/h/ln	1781	1702	1849	1767	1689	1677	1810	1900	1608	1810	0	1615
Q Serve(g_s), s	5.0	20.9	20.9	1.8	12.8	13.1	0.3	0.8	0.6	6.8	0.0	1.7
Cycle Q Clear(g_c), s	5.0	20.9	20.9	1.8	12.8	13.1	0.3	0.8	0.6	6.8	0.0	1.7
Prop In Lane	1.00		0.06	1.00		0.59	1.00		1.00	1.00		0.90
Lane Grp Cap(c), veh/h	146	889	483	66	730	363	594	463	392	421	0	505
V/C Ratio(X)	0.79	1.05	1.05	0.62	0.79	0.80	0.03	0.06	0.05	0.43	0.00	0.10
Avail Cap(c_a), veh/h	278	889	483	254	823	409	594	463	392	421	0	505
HCM Platoon Ratio	2.00	2.00	2.00	1.00	1.00	1.00	1.00	1.00	1.00	1.00	1.00	1.00
Upstream Filter(I)	0.42	0.42	0.42	0.91	0.91	0.91	1.00	1.00	1.00	1.00	0.00	1.00
Uniform Delay (d), s/veh	32.8	19.1	19.1	37.9	29.6	29.7	28.1	23.2	14.9	26.1	0.0	19.5
Incr Delay (d2), s/veh	4.1	35.7	42.1	8.4	4.2	8.9	0.0	0.2	0.2	0.7	0.0	0.4
Initial Q Delay(d3),s/veh	0.0	0.0	0.0	0.0	0.0	0.0	0.0	0.0	0.0	0.0	0.0	0.0
%ile BackOfQ(50%),veh/ln	2.1	9.1	10.7	0.9	5.5	6.0	0.1	0.4	0.3	2.9	0.0	0.7
Unsig. Movement Delay, s/veh												
LnGrp Delay(d),s/veh	36.8	54.8	61.2	46.3	33.8	38.6	28.1	23.4	15.1	26.8	0.0	19.9
LnGrp LOS	D	F	F	D	C	D	C	C	B	C	A	B
Approach Vol, veh/h	1562			905			61		228			
Approach Delay, s/veh	55.6			35.9			21.9		25.4			
Approach LOS	E			D			C		C			
Timer - Assigned Phs	1	2	3	4	5	6	7	8				
Phs Duration (G+Y+Rc), s	23.1	24.0	7.5	25.4	17.6	29.5	11.1	21.8				
Change Period (Y+Rc), s	4.5	4.5	4.5	4.5	4.5	4.5	4.5	4.5				
Max Green Setting (Gmax), s	10.5	19.5	11.5	20.5	5.0	25.0	12.5	19.5				
Max Q Clear Time (g_c+1), s	10.8	2.8	3.8	22.9	2.3	3.7	7.0	15.1				
Green Ext Time (p_c), s	0.1	0.1	0.0	0.0	0.0	0.2	0.1	2.2				

Intersection Summary

HCM 6th Ctrl Delay	45.9
HCM 6th LOS	D

Notes

User approved volume balancing among the lanes for turning movement.

HCM 6th Signalized Intersection Summary
 31: SR-99 Southbound Ramps & Cleveland Avenue

Village D Specific Plan
 Phase III WP MIT - AM Peak Hour



Movement	EBL	EBT	EBR	WBL	WBT	WBR	NBL	NBT	NBR	SBL	SBT	SBR
Lane Configurations		↑↑	↑	↑	↑↑					↑		↑
Traffic Volume (veh/h)	0	745	867	390	965	0	0	0	0	264	0	104
Future Volume (veh/h)	0	745	867	390	965	0	0	0	0	264	0	104
Initial Q (Qb), veh	0	0	0	0	0	0				0	0	0
Ped-Bike Adj(A_pbT)	1.00		1.00	1.00		1.00				1.00		1.00
Parking Bus, Adj	1.00	1.00	1.00	1.00	1.00	1.00				1.00	1.00	1.00
Work Zone On Approach		No			No						No	
Adj Sat Flow, veh/h/ln	0	1856	1856	1856	1856	0				1811	0	1811
Adj Flow Rate, veh/h	0	810	942	424	1049	0				287	0	113
Peak Hour Factor	0.92	0.92	0.92	0.92	0.92	0.92				0.92	0.92	0.92
Percent Heavy Veh, %	0	3	3	3	3	0				6	0	6
Cap, veh/h	0	1375	613	445	2440	0				359	0	319
Arrive On Green	0.00	0.39	0.39	0.50	1.00	0.00				0.21	0.00	0.21
Sat Flow, veh/h	0	3618	1572	1767	3618	0				1725	0	1535
Grp Volume(v), veh/h	0	810	942	424	1049	0				287	0	113
Grp Sat Flow(s),veh/h/ln	0	1763	1572	1767	1763	0				1725	0	1535
Q Serve(g_s), s	0.0	16.4	35.1	20.6	0.0	0.0				14.2	0.0	5.7
Cycle Q Clear(g_c), s	0.0	16.4	35.1	20.6	0.0	0.0				14.2	0.0	5.7
Prop In Lane	0.00		1.00	1.00		0.00				1.00		1.00
Lane Grp Cap(c), veh/h	0	1375	613	445	2440	0				359	0	319
V/C Ratio(X)	0.00	0.59	1.54	0.95	0.43	0.00				0.80	0.00	0.35
Avail Cap(c_a), veh/h	0	1375	613	454	2456	0				359	0	319
HCM Platoon Ratio	1.00	1.00	1.00	2.00	2.00	1.00				1.00	1.00	1.00
Upstream Filter(I)	0.00	0.54	0.54	0.65	0.65	0.00				1.00	0.00	1.00
Uniform Delay (d), s/veh	0.0	21.7	27.5	21.8	0.0	0.0				33.9	0.0	30.5
Incr Delay (d2), s/veh	0.0	0.4	245.7	22.8	0.1	0.0				12.1	0.0	0.7
Initial Q Delay(d3),s/veh	0.0	0.0	0.0	0.0	0.0	0.0				0.0	0.0	0.0
%ile BackOfQ(50%),veh/ln	0.0	6.6	54.3	8.2	0.0	0.0				7.0	0.0	2.1
Unsig. Movement Delay, s/veh												
LnGrp Delay(d),s/veh	0.0	22.1	273.1	44.6	0.1	0.0				46.0	0.0	31.1
LnGrp LOS	A	C	F	D	A	A				D	A	C
Approach Vol, veh/h		1752			1473					400		
Approach Delay, s/veh		157.1			12.9					41.8		
Approach LOS		F			B					D		
Timer - Assigned Phs			3	4		6		8				
Phs Duration (G+Y+Rc), s			27.2	39.6		23.2		66.8				
Change Period (Y+Rc), s			4.5	4.5		4.5		4.5				
Max Green Setting (Gmax), s			23.1	35.1		18.3		62.7				
Max Q Clear Time (g_c+I1), s			22.6	37.1		16.2		2.0				
Green Ext Time (p_c), s			0.1	0.0		0.3		10.3				
Intersection Summary												
HCM 6th Ctrl Delay			85.8									
HCM 6th LOS			F									

HCM 6th Signalized Intersection Summary
 32: SR-99 Northbound Ramps & Cleveland Avenue

Village D Specific Plan
 Phase III WP MIT - AM Peak Hour



Movement	EBL	EBT	EBR	WBL	WBT	WBR	NBL	NBT	NBR	SBL	SBT	SBR
Lane Configurations	↘	↑↑			↑↑	↗	↘	↖	↗			
Traffic Volume (veh/h)	83	928	0	0	925	175	438	0	389	0	0	0
Future Volume (veh/h)	83	928	0	0	925	175	438	0	389	0	0	0
Initial Q (Qb), veh	0	0	0	0	0	0	0	0	0			
Ped-Bike Adj(A_pbT)	1.00		1.00	1.00		1.00	1.00		1.00			
Parking Bus, Adj	1.00	1.00	1.00	1.00	1.00	1.00	1.00	1.00	1.00			
Work Zone On Approach	No				No				No			
Adj Sat Flow, veh/h/ln	1856	1856	0	0	1870	1870	1841	1841	1841			
Adj Flow Rate, veh/h	90	1009	0	0	1005	190	476	0	423			
Peak Hour Factor	0.92	0.92	0.92	0.92	0.92	0.92	0.92	0.92	0.92			
Percent Heavy Veh, %	3	3	0	0	2	2	4	4	4			
Cap, veh/h	117	1522	0	0	1122	500	1642	0	730			
Arrive On Green	0.07	0.43	0.00	0.00	0.32	0.32	0.47	0.00	0.47			
Sat Flow, veh/h	1767	3618	0	0	3647	1585	3506	0	1560			
Grp Volume(v), veh/h	90	1009	0	0	1005	190	476	0	423			
Grp Sat Flow(s),veh/h/ln	1767	1763	0	0	1777	1585	1753	0	1560			
Q Serve(g_s), s	4.5	20.5	0.0	0.0	24.3	8.4	7.5	0.0	17.8			
Cycle Q Clear(g_c), s	4.5	20.5	0.0	0.0	24.3	8.4	7.5	0.0	17.8			
Prop In Lane	1.00		0.00	0.00		1.00	1.00		1.00			
Lane Grp Cap(c), veh/h	117	1522	0	0	1122	500	1642	0	730			
V/C Ratio(X)	0.77	0.66	0.00	0.00	0.90	0.38	0.29	0.00	0.58			
Avail Cap(c_a), veh/h	363	2057	0	0	1165	520	1642	0	730			
HCM Platoon Ratio	1.00	1.00	1.00	1.00	1.00	1.00	1.00	1.00	1.00			
Upstream Filter(I)	0.71	0.71	0.00	0.00	0.69	0.69	1.00	0.00	1.00			
Uniform Delay (d), s/veh	41.4	20.4	0.0	0.0	29.4	23.9	14.7	0.0	17.5			
Incr Delay (d2), s/veh	7.4	0.4	0.0	0.0	6.6	0.3	0.4	0.0	3.3			
Initial Q Delay(d3),s/veh	0.0	0.0	0.0	0.0	0.0	0.0	0.0	0.0	0.0			
%ile BackOfQ(50%),veh/ln	2.2	8.1	0.0	0.0	11.0	3.1	3.0	0.0	6.7			
Unsig. Movement Delay, s/veh												
LnGrp Delay(d),s/veh	48.7	20.7	0.0	0.0	35.9	24.3	15.2	0.0	20.8			
LnGrp LOS	D	C	A	A	D	C	B	A	C			
Approach Vol, veh/h	1099				1195				899			
Approach Delay, s/veh	23.0				34.1				17.8			
Approach LOS	C				C				B			
Timer - Assigned Phs	2		4		7		8					
Phs Duration (G+Y+Rc), s	46.6		43.4		10.5		32.9					
Change Period (Y+Rc), s	4.5		4.5		4.5		4.5					
Max Green Setting (Gmax), s	28.5		52.5		18.5		29.5					
Max Q Clear Time (g_c+I1), s	19.8		22.5		6.5		26.3					
Green Ext Time (p_c), s	2.4		8.6		0.1		2.1					

Intersection Summary























HCM 6th Ctrl Delay	25.7
HCM 6th LOS	C

Notes

User approved volume balancing among the lanes for turning movement.

HCM 6th Signalized Intersection Summary
36: Pine Street & Howard Road

Village D Specific Plan
Phase III WP MIT - AM Peak Hour

												
Movement	EBL	EBT	EBR	WBL	WBT	WBR	NBL	NBT	NBR	SBL	SBT	SBR
Lane Configurations												
Traffic Volume (veh/h)	35	1031	187	163	581	7	159	174	253	17	295	102
Future Volume (veh/h)	35	1031	187	163	581	7	159	174	253	17	295	102
Initial Q (Qb), veh	0	0	0	0	0	0	0	0	0	0	0	0
Ped-Bike Adj(A_pbT)	1.00		0.98	1.00		0.98	1.00		1.00	1.00		0.98
Parking Bus, Adj	1.00	1.00	1.00	1.00	1.00	1.00	1.00	1.00	1.00	1.00	1.00	1.00
Work Zone On Approach		No			No			No			No	
Adj Sat Flow, veh/h/ln	1885	1885	1885	1870	1870	1870	1811	1811	1811	1841	1841	1841
Adj Flow Rate, veh/h	38	1121	203	177	632	8	173	189	275	18	321	111
Peak Hour Factor	0.92	0.92	0.92	0.92	0.92	0.92	0.92	0.92	0.92	0.92	0.92	0.92
Percent Heavy Veh, %	1	1	1	2	2	2	6	6	6	4	4	4
Cap, veh/h	54	1145	206	200	1659	21	260	574	485	73	382	316
Arrive On Green	0.03	0.38	0.38	0.11	0.46	0.46	0.15	0.32	0.32	0.04	0.21	0.21
Sat Flow, veh/h	1795	3021	545	1781	3593	45	1725	1811	1530	1753	1841	1525
Grp Volume(v), veh/h	38	663	661	177	312	328	173	189	275	18	321	111
Grp Sat Flow(s),veh/h/ln	1795	1791	1774	1781	1777	1861	1725	1811	1530	1753	1841	1525
Q Serve(g_s), s	2.5	43.7	44.3	11.8	13.8	13.8	11.4	9.6	13.0	1.2	20.1	7.5
Cycle Q Clear(g_c), s	2.5	43.7	44.3	11.8	13.8	13.8	11.4	9.6	13.0	1.2	20.1	7.5
Prop In Lane	1.00		0.31	1.00		0.02	1.00		1.00	1.00		1.00
Lane Grp Cap(c), veh/h	54	679	673	200	820	859	260	574	485	73	382	316
V/C Ratio(X)	0.71	0.98	0.98	0.88	0.38	0.38	0.66	0.33	0.57	0.25	0.84	0.35
Avail Cap(c_a), veh/h	102	679	673	200	820	859	260	574	485	263	382	316
HCM Platoon Ratio	1.00	1.00	1.00	1.00	1.00	1.00	1.00	1.00	1.00	1.00	1.00	1.00
Upstream Filter(I)	1.00	1.00	1.00	0.93	0.93	0.93	1.00	1.00	1.00	1.00	1.00	1.00
Uniform Delay (d), s/veh	57.7	36.7	36.9	52.5	21.1	21.1	48.1	31.3	18.0	55.7	45.6	40.6
Incr Delay (d2), s/veh	15.6	28.4	30.4	32.1	0.3	0.3	12.7	1.5	4.8	1.7	15.3	0.7
Initial Q Delay(d3),s/veh	0.0	0.0	0.0	0.0	0.0	0.0	0.0	0.0	0.0	0.0	0.0	0.0
%ile BackOfQ(50%),veh/ln	1.4	24.1	24.5	7.0	5.8	6.0	5.8	4.4	5.2	0.6	10.8	2.9
Unsig. Movement Delay, s/veh												
LnGrp Delay(d),s/veh	73.3	65.1	67.3	84.5	21.4	21.4	60.8	32.8	22.7	57.4	61.0	41.3
LnGrp LOS	E	E	E	F	C	C	E	C	C	E	E	D
Approach Vol, veh/h		1362			817			637			450	
Approach Delay, s/veh		66.4			35.0			36.1			56.0	
Approach LOS		E			D			D			E	
Timer - Assigned Phs	1	2	3	4	5	6	7	8				
Phs Duration (G+Y+Rc), s	9.5	42.5	18.0	50.0	22.6	29.4	8.1	59.9				
Change Period (Y+Rc), s	4.5	4.5	4.5	4.5	4.5	4.5	4.5	4.5				
Max Green Setting (Gmax), s	18.0	25.0	13.5	45.5	18.1	24.9	6.8	52.2				
Max Q Clear Time (g_c+I1), s	3.2	15.0	13.8	46.3	13.4	22.1	4.5	15.8				
Green Ext Time (p_c), s	0.0	1.5	0.0	0.0	0.2	0.6	0.0	4.4				
Intersection Summary												
HCM 6th Ctrl Delay				51.2								
HCM 6th LOS				D								

HCM 6th Signalized Intersection Summary
 38: I Street & 2nd Street/SR-99 Southbound Off-Ramp

Village D Specific Plan
 Phase III WP MIT - AM Peak Hour



Movement	EBL	EBT	EBR	WBL	WBT	WBR	NBL	NBT	NBR	SBL	SBT	SBR
Lane Configurations		↕			↕	↕	↕	↑			↕	
Traffic Volume (veh/h)	2	0	68	523	22	12	24	89	0	0	156	3
Future Volume (veh/h)	2	0	68	523	22	12	24	89	0	0	156	3
Initial Q (Qb), veh	0	0	0	0	0	0	0	0	0	0	0	0
Ped-Bike Adj(A_pbT)	1.00		0.99	1.00		0.98	1.00		1.00	1.00		1.00
Parking Bus, Adj	1.00	1.00	1.00	1.00	1.00	1.00	1.00	1.00	1.00	1.00	1.00	1.00
Work Zone On Approach		No			No			No			No	
Adj Sat Flow, veh/h/ln	1900	1900	1900	1856	1856	1856	1841	1841	0	0	1885	1885
Adj Flow Rate, veh/h	2	0	74	568	24	13	26	97	0	0	170	3
Peak Hour Factor	0.92	0.92	0.92	0.92	0.92	0.92	0.92	0.92	0.92	0.92	0.92	0.92
Percent Heavy Veh, %	0	0	0	3	3	3	4	4	0	0	1	1
Cap, veh/h	3	0	98	630	27	570	506	767	0	0	769	14
Arrive On Green	0.06	0.00	0.06	0.37	0.37	0.37	0.83	0.83	0.00	0.00	0.42	0.42
Sat Flow, veh/h	42	0	1560	1699	72	1536	1193	1841	0	0	1847	33
Grp Volume(v), veh/h	76	0	0	592	0	13	26	97	0	0	0	173
Grp Sat Flow(s),veh/h/ln1602	0	0	0	1771	0	1536	1193	1841	0	0	0	1879
Q Serve(g_s), s	4.2	0.0	0.0	28.4	0.0	0.5	0.6	0.9	0.0	0.0	0.0	5.3
Cycle Q Clear(g_c), s	4.2	0.0	0.0	28.4	0.0	0.5	5.9	0.9	0.0	0.0	0.0	5.3
Prop In Lane	0.03		0.97	0.96		1.00	1.00		0.00	0.00		0.02
Lane Grp Cap(c), veh/h	100	0	0	657	0	570	506	767	0	0	0	783
V/C Ratio(X)	0.76	0.00	0.00	0.90	0.00	0.02	0.05	0.13	0.00	0.00	0.00	0.22
Avail Cap(c_a), veh/h	320	0	0	797	0	691	506	767	0	0	0	783
HCM Platoon Ratio	1.00	1.00	1.00	1.00	1.00	1.00	2.00	2.00	1.00	1.00	1.00	1.00
Upstream Filter(I)	1.00	0.00	0.00	1.00	0.00	1.00	0.99	0.99	0.00	0.00	0.00	1.00
Uniform Delay (d), s/veh	41.5	0.0	0.0	26.8	0.0	18.0	5.7	4.5	0.0	0.0	0.0	16.9
Incr Delay (d2), s/veh	11.0	0.0	0.0	11.8	0.0	0.0	0.2	0.3	0.0	0.0	0.0	0.7
Initial Q Delay(d3),s/veh	0.0	0.0	0.0	0.0	0.0	0.0	0.0	0.0	0.0	0.0	0.0	0.0
%ile BackOfQ(50%),veh/ln1.9	0.0	0.0	0.0	13.6	0.0	0.2	0.1	0.4	0.0	0.0	0.0	2.4
Unsig. Movement Delay, s/veh												
LnGrp Delay(d),s/veh	52.6	0.0	0.0	38.6	0.0	18.0	5.9	4.8	0.0	0.0	0.0	17.5
LnGrp LOS	D	A	A	D	A	B	A	A	A	A	A	B
Approach Vol, veh/h		76			605			123			173	
Approach Delay, s/veh		52.6			38.1			5.0			17.5	
Approach LOS		D			D			A			B	
Timer - Assigned Phs		2		4		6		8				
Phs Duration (G+Y+Rc), s		42.0		10.1		42.0		37.9				
Change Period (Y+Rc), s		4.5		4.5		4.5		4.5				
Max Green Setting (Gmax), s		18.0		18.0		18.0		40.5				
Max Q Clear Time (g_c+11), s		7.9		6.2		7.3		30.4				
Green Ext Time (p_c), s		0.3		0.2		0.6		2.9				
Intersection Summary												
HCM 6th Ctrl Delay				31.4								
HCM 6th LOS				C								

HCM 6th Signalized Intersection Summary
 43: SR-99 Northbound Off-Ramp/H Street & 4th Street

Village D Specific Plan
 Phase III WP MIT - AM Peak Hour



Movement	EBL	EBT	EBR	WBL	WBT	WBR	NBL	NBT	NBR	SBL	SBT	SBR
Lane Configurations	↗	↑↑			↑↑		↗	↑			↔	
Traffic Volume (veh/h)	285	542	0	0	568	98	281	35	240	8	0	84
Future Volume (veh/h)	285	542	0	0	568	98	281	35	240	8	0	84
Initial Q (Qb), veh	0	0	0	0	0	0	0	0	0	0	0	0
Ped-Bike Adj(A_pbT)	1.00		1.00	1.00		0.94	1.00		1.00	1.00		0.99
Parking Bus, Adj	1.00	1.00	1.00	1.00	1.00	1.00	1.00	1.00	1.00	1.00	1.00	1.00
Work Zone On Approach		No			No			No			No	
Adj Sat Flow, veh/h/ln	1885	1885	0	0	1856	1856	1870	1870	1870	1900	1900	1900
Adj Flow Rate, veh/h	310	589	0	0	617	107	305	38	261	9	0	91
Peak Hour Factor	0.92	0.92	0.92	0.92	0.92	0.92	0.92	0.92	0.92	0.92	0.92	0.92
Percent Heavy Veh, %	1	1	0	0	3	3	2	2	2	0	0	0
Cap, veh/h	329	1572	0	0	612	106	376	43	298	29	0	292
Arrive On Green	0.18	0.44	0.00	0.00	0.21	0.21	0.21	0.21	0.21	0.20	0.00	0.20
Sat Flow, veh/h	1795	3676	0	0	3068	515	1781	205	1411	145	0	1462
Grp Volume(v), veh/h	310	589	0	0	365	359	305	0	299	100	0	0
Grp Sat Flow(s),veh/h/ln	1795	1791	0	0	1763	1727	1781	0	1616	1607	0	0
Q Serve(g_s), s	15.3	9.9	0.0	0.0	18.5	18.5	14.7	0.0	16.1	4.8	0.0	0.0
Cycle Q Clear(g_c), s	15.3	9.9	0.0	0.0	18.5	18.5	14.7	0.0	16.1	4.8	0.0	0.0
Prop In Lane	1.00		0.00	0.00		0.30	1.00		0.87	0.09		0.91
Lane Grp Cap(c), veh/h	329	1572	0	0	362	355	376	0	341	321	0	0
V/C Ratio(X)	0.94	0.37	0.00	0.00	1.01	1.01	0.81	0.00	0.88	0.31	0.00	0.00
Avail Cap(c_a), veh/h	329	1572	0	0	362	355	376	0	341	321	0	0
HCM Platoon Ratio	1.00	1.00	1.00	1.00	1.00	1.00	1.00	1.00	1.00	1.00	1.00	1.00
Upstream Filter(I)	1.00	1.00	0.00	0.00	1.00	1.00	1.00	0.00	1.00	1.00	0.00	0.00
Uniform Delay (d), s/veh	36.3	17.0	0.0	0.0	35.8	35.8	33.8	0.0	34.4	30.7	0.0	0.0
Incr Delay (d2), s/veh	34.6	0.1	0.0	0.0	49.1	50.7	17.1	0.0	25.6	2.5	0.0	0.0
Initial Q Delay(d3),s/veh	0.0	0.0	0.0	0.0	0.0	0.0	0.0	0.0	0.0	0.0	0.0	0.0
%ile BackOfQ(50%),veh/ln	9.7	4.0	0.0	0.0	12.7	12.6	8.0	0.0	8.6	2.0	0.0	0.0
Unsig. Movement Delay, s/veh												
LnGrp Delay(d),s/veh	70.9	17.1	0.0	0.0	84.8	86.5	50.9	0.0	59.9	33.2	0.0	0.0
LnGrp LOS	E	B	A	A	F	F	D	A	E	C	A	A
Approach Vol, veh/h		899			724			604			100	
Approach Delay, s/veh		35.7			85.6			55.4			33.2	
Approach LOS		D			F			E			C	
Timer - Assigned Phs		2		4		6	7	8				
Phs Duration (G+Y+Rc), s		23.5		44.0		22.5	21.0	23.0				
Change Period (Y+Rc), s		4.5		4.5		4.5	4.5	4.5				
Max Green Setting (Gmax), s		19.0		39.5		18.0	16.5	18.5				
Max Q Clear Time (g_c+I1), s		18.1		11.9		6.8	17.3	20.5				
Green Ext Time (p_c), s		0.3		4.3		0.3	0.0	0.0				
Intersection Summary												
HCM 6th Ctrl Delay					56.2							
HCM 6th LOS					E							

Intersection						
Int Delay, s/veh	1.2					
Movement	EBL	EBT	WBT	WBR	SBL	SBR
Lane Configurations	↙	↑↑	↑↑			↗
Traffic Vol, veh/h	134	822	682	82	0	102
Future Vol, veh/h	134	822	682	82	0	102
Conflicting Peds, #/hr	16	0	0	16	0	0
Sign Control	Free	Free	Free	Free	Stop	Stop
RT Channelized	-	None	-	None	-	None
Storage Length	145	-	-	-	-	0
Veh in Median Storage, #	-	0	0	-	0	-
Grade, %	-	0	0	-	0	-
Peak Hour Factor	98	98	98	98	98	98
Heavy Vehicles, %	3	3	4	4	5	5
Mvmt Flow	137	839	696	84	0	104

Major/Minor	Major1	Major2	Minor2		
Conflicting Flow All	796	0	-	0	- 406
Stage 1	-	-	-	-	-
Stage 2	-	-	-	-	-
Critical Hdwy	4.16	-	-	-	- 7
Critical Hdwy Stg 1	-	-	-	-	-
Critical Hdwy Stg 2	-	-	-	-	-
Follow-up Hdwy	2.23	-	-	-	- 3.35
Pot Cap-1 Maneuver	1180	-	-	-	0 *791
Stage 1	-	-	-	-	0 -
Stage 2	-	-	-	-	0 -
Platoon blocked, %	1	-	-	-	- 1
Mov Cap-1 Maneuver	1162	-	-	-	- *779
Mov Cap-2 Maneuver	-	-	-	-	- -
Stage 1	-	-	-	-	- -
Stage 2	-	-	-	-	- -

Approach	EB	WB	SB
HCM Control Delay, s	1.2	0	10.3
HCM LOS			B

Minor Lane/Major Mvmt	EBL	EBT	WBT	WBR	SBLn1
Capacity (veh/h)	1162	-	-	-	- 779
HCM Lane V/C Ratio	0.118	-	-	-	- 0.134
HCM Control Delay (s)	8.5	-	-	-	- 10.3
HCM Lane LOS	A	-	-	-	- B
HCM 95th %tile Q(veh)	0.4	-	-	-	- 0.5

Notes			
-: Volume exceeds capacity	\$: Delay exceeds 300s	+: Computation Not Defined	*: All major volume in platoon

HCM 6th Signalized Intersection Summary
49: Yosemite Avenue & Cleveland Avenue/Tozer Street

Village D Specific Plan
Phase III WP MIT - AM Peak Hour



Movement	EBL	EBT	EBR	WBL	WBT	WBR	NBL	NBT	NBR	SBL	SBT	SBR
Lane Configurations												
Traffic Volume (veh/h)	329	557	260	116	357	60	141	137	78	79	270	272
Future Volume (veh/h)	329	557	260	116	357	60	141	137	78	79	270	272
Initial Q (Qb), veh	0	0	0	0	0	0	0	0	0	0	0	0
Ped-Bike Adj(A_pbT)	1.00		0.93	1.00		0.92	1.00		1.00	1.00		1.00
Parking Bus, Adj	1.00	1.00	1.00	1.00	1.00	1.00	1.00	1.00	1.00	1.00	1.00	1.00
Work Zone On Approach		No			No			No			No	
Adj Sat Flow, veh/h/ln	1856	1856	1856	1841	1841	1841	1856	1856	1856	1870	1870	1870
Adj Flow Rate, veh/h	358	605	283	126	388	65	153	149	85	86	293	296
Peak Hour Factor	0.92	0.92	0.92	0.92	0.92	0.92	0.92	0.92	0.92	0.92	0.92	0.92
Percent Heavy Veh, %	3	3	3	4	4	4	3	3	3	2	2	2
Cap, veh/h	402	890	416	158	891	366	189	437	369	111	357	662
Arrive On Green	0.23	0.39	0.39	0.09	0.25	0.25	0.11	0.24	0.24	0.06	0.19	0.19
Sat Flow, veh/h	1767	2271	1061	1753	3497	1437	1767	1856	1566	1781	1870	1578
Grp Volume(v), veh/h	358	470	418	126	388	65	153	149	85	86	293	296
Grp Sat Flow(s),veh/h/ln	1767	1763	1569	1753	1749	1437	1767	1856	1566	1781	1870	1578
Q Serve(g_s), s	16.1	18.1	18.1	5.8	7.6	2.9	6.9	5.5	3.6	3.9	12.3	11.0
Cycle Q Clear(g_c), s	16.1	18.1	18.1	5.8	7.6	2.9	6.9	5.5	3.6	3.9	12.3	11.0
Prop In Lane	1.00		0.68	1.00		1.00	1.00		1.00	1.00		1.00
Lane Grp Cap(c), veh/h	402	691	615	158	891	366	189	437	369	111	357	662
V/C Ratio(X)	0.89	0.68	0.68	0.80	0.44	0.18	0.81	0.34	0.23	0.77	0.82	0.45
Avail Cap(c_a), veh/h	507	691	615	212	891	366	248	456	385	215	423	717
HCM Platoon Ratio	1.00	1.00	1.00	1.00	1.00	1.00	1.00	1.00	1.00	1.00	1.00	1.00
Upstream Filter(I)	1.00	1.00	1.00	1.00	1.00	1.00	1.00	1.00	1.00	1.00	1.00	1.00
Uniform Delay (d), s/veh	30.6	20.6	20.6	36.5	25.6	23.8	35.7	26.0	25.3	37.8	31.8	17.0
Incr Delay (d2), s/veh	15.0	5.3	6.0	14.1	1.5	1.1	14.0	0.5	0.3	10.8	10.6	0.5
Initial Q Delay(d3),s/veh	0.0	0.0	0.0	0.0	0.0	0.0	0.0	0.0	0.0	0.0	0.0	0.0
%ile BackOfQ(50%),veh/ln	8.3	8.0	7.3	3.0	3.3	1.1	3.7	2.4	1.3	2.0	6.4	3.9
Unsig. Movement Delay, s/veh												
LnGrp Delay(d),s/veh	45.6	25.9	26.6	50.6	27.1	24.9	49.7	26.5	25.6	48.6	42.3	17.5
LnGrp LOS	D	C	C	D	C	C	D	C	C	D	D	B
Approach Vol, veh/h		1246			579			387			675	
Approach Delay, s/veh		31.8			32.0			35.5			32.2	
Approach LOS		C			C			D			C	
Timer - Assigned Phs	1	2	3	4	5	6	7	8				
Phs Duration (G+Y+Rc), s	23.1	25.4	9.6	23.8	11.9	36.6	13.2	20.1				
Change Period (Y+Rc), s	4.5	4.5	4.5	4.5	4.5	4.5	4.5	4.5				
Max Green Setting (Gmax), s	23.5	18.5	9.9	20.1	9.9	32.1	11.5	18.5				
Max Q Clear Time (g_c+I1), s	18.1	9.6	5.9	7.5	7.8	20.1	8.9	14.3				
Green Ext Time (p_c), s	0.6	1.8	0.1	0.8	0.1	4.7	0.1	1.2				

Intersection Summary												
HCM 6th Ctrl Delay											32.4	
HCM 6th LOS											C	

HCM 6th Signalized Intersection Summary
51: Project Driveway 1 & Avenue 17

Village D Specific Plan
Phase III WP MIT - AM Peak Hour



Movement	EBT	EBR	WBL	WBT	NBL	NBR
Lane Configurations	↩		↩	↩	↩	↩
Traffic Volume (veh/h)	68	16	155	71	56	629
Future Volume (veh/h)	68	16	155	71	56	629
Initial Q (Qb), veh	0	0	0	0	0	0
Ped-Bike Adj(A_pbT)		1.00	1.00		1.00	1.00
Parking Bus, Adj	1.00	1.00	1.00	1.00	1.00	1.00
Work Zone On Approach	No			No	No	
Adj Sat Flow, veh/h/ln	1767	1767	1870	1870	1900	1900
Adj Flow Rate, veh/h	74	17	168	77	61	684
Peak Hour Factor	0.92	0.92	0.92	0.92	0.92	0.92
Percent Heavy Veh, %	9	9	2	2	0	0
Cap, veh/h	109	25	208	470	1151	1024
Arrive On Green	0.08	0.08	0.12	0.25	0.64	0.64
Sat Flow, veh/h	1390	319	1781	1870	1810	1610
Grp Volume(v), veh/h	0	91	168	77	61	684
Grp Sat Flow(s),veh/h/ln	0	1709	1781	1870	1810	1610
Q Serve(g_s), s	0.0	4.1	7.4	2.6	1.0	21.5
Cycle Q Clear(g_c), s	0.0	4.1	7.4	2.6	1.0	21.5
Prop In Lane		0.19	1.00		1.00	1.00
Lane Grp Cap(c), veh/h	0	134	208	470	1151	1024
V/C Ratio(X)	0.00	0.68	0.81	0.16	0.05	0.67
Avail Cap(c_a), veh/h	0	387	338	884	1151	1024
HCM Platoon Ratio	1.00	1.00	1.00	1.00	1.00	1.00
Upstream Filter(I)	0.00	1.00	0.99	0.99	1.00	1.00
Uniform Delay (d), s/veh	0.0	35.9	34.5	23.4	5.5	9.2
Incr Delay (d2), s/veh	0.0	5.9	7.2	0.2	0.1	3.5
Initial Q Delay(d3),s/veh	0.0	0.0	0.0	0.0	0.0	0.0
%ile BackOfQ(50%),veh/ln	0.0	1.9	3.5	1.1	0.4	7.2
Unsig. Movement Delay, s/veh						
LnGrp Delay(d),s/veh	0.0	41.8	41.7	23.5	5.6	12.7
LnGrp LOS	A	D	D	C	A	B
Approach Vol, veh/h	91			245	745	
Approach Delay, s/veh	41.8			36.0	12.1	
Approach LOS	D			D	B	
Timer - Assigned Phs		2	3	4		8
Phs Duration (G+Y+Rc), s		55.4	13.8	10.8		24.6
Change Period (Y+Rc), s		4.5	4.5	4.5		4.5
Max Green Setting (Gmax), s		33.2	15.2	18.1		37.8
Max Q Clear Time (g_c+I1), s		23.5	9.4	6.1		4.6
Green Ext Time (p_c), s		2.3	0.2	0.3		0.4
Intersection Summary						
HCM 6th Ctrl Delay			20.0			
HCM 6th LOS			B			

HCM 6th Signalized Intersection Summary
52: Road 22 1/2/Project Driveway 2 & Avenue 16

Village D Specific Plan
Phase III WP MIT - AM Peak Hour



Movement	EBL	EBT	EBR	WBL	WBT	WBR	NBL	NBT	NBR	SBL	SBT	SBR
Lane Configurations	↖	↗		↖	↗	↖	↖	↗	↖	↖	↗	↗
Traffic Volume (veh/h)	0	65	5	88	35	111	16	131	320	236	126	0
Future Volume (veh/h)	0	65	5	88	35	111	16	131	320	236	126	0
Initial Q (Qb), veh	0	0	0	0	0	0	0	0	0	0	0	0
Ped-Bike Adj(A_pbT)	1.00		1.00	1.00		1.00	1.00		1.00	1.00		1.00
Parking Bus, Adj	1.00	1.00	1.00	1.00	1.00	1.00	1.00	1.00	1.00	1.00	1.00	1.00
Work Zone On Approach		No		No		No		No		No		No
Adj Sat Flow, veh/h/ln	1737	1737	1737	1870	1870	1870	1900	1900	1900	1900	1900	1900
Adj Flow Rate, veh/h	0	71	5	96	38	121	17	142	348	257	137	0
Peak Hour Factor	0.92	0.92	0.92	0.92	0.92	0.92	0.92	0.92	0.92	0.92	0.92	0.92
Percent Heavy Veh, %	11	11	11	2	2	2	0	0	0	0	0	0
Cap, veh/h	2	105	7	122	335	284	34	993	842	295	1267	0
Arrive On Green	0.00	0.07	0.07	0.07	0.18	0.18	0.01	0.35	0.35	0.16	0.67	0.00
Sat Flow, veh/h	1654	1604	113	1781	1870	1585	1810	1900	1610	1810	1900	0
Grp Volume(v), veh/h	0	0	76	96	38	121	17	142	348	257	137	0
Grp Sat Flow(s),veh/h/ln	1654	0	1717	1781	1870	1585	1810	1900	1610	1810	1900	0
Q Serve(g_s), s	0.0	0.0	4.3	5.3	1.7	6.8	0.9	5.1	16.4	13.9	2.6	0.0
Cycle Q Clear(g_c), s	0.0	0.0	4.3	5.3	1.7	6.8	0.9	5.1	16.4	13.9	2.6	0.0
Prop In Lane	1.00		0.07	1.00		1.00	1.00		1.00	1.00		0.00
Lane Grp Cap(c), veh/h	2	0	112	122	335	284	34	993	842	295	1267	0
V/C Ratio(X)	0.00	0.00	0.68	0.78	0.11	0.43	0.50	0.14	0.41	0.87	0.11	0.00
Avail Cap(c_a), veh/h	83	0	318	223	486	412	100	993	842	443	1267	0
HCM Platoon Ratio	1.00	1.00	1.00	1.00	1.00	1.00	0.67	0.67	0.67	1.00	1.00	1.00
Upstream Filter(I)	0.00	0.00	1.00	0.92	0.92	0.92	0.98	0.98	0.98	1.00	1.00	0.00
Uniform Delay (d), s/veh	0.0	0.0	45.7	45.8	34.4	36.5	48.9	17.2	20.8	40.8	6.0	0.0
Incr Delay (d2), s/veh	0.0	0.0	6.9	9.7	0.1	0.9	10.7	0.3	1.5	11.6	0.2	0.0
Initial Q Delay(d3),s/veh	0.0	0.0	0.0	0.0	0.0	0.0	0.0	0.0	0.0	0.0	0.0	0.0
%ile BackOfQ(50%),veh/ln	0.0	0.0	2.1	2.7	0.8	2.7	0.5	2.3	6.9	7.0	1.0	0.0
Unsig. Movement Delay, s/veh												
LnGrp Delay(d),s/veh	0.0	0.0	52.6	55.5	34.5	37.4	59.6	17.5	22.3	52.4	6.1	0.0
LnGrp LOS	A	A	D	E	C	D	E	B	C	D	A	A
Approach Vol, veh/h		76		255		507		394				
Approach Delay, s/veh		52.6		43.8		22.2		36.3				
Approach LOS		D		D		C		D				
Timer - Assigned Phs	1	2	3	4	5	6	7	8				
Phs Duration (G+Y+Rc), s	30.8	56.8	11.4	11.0	6.4	71.2	0.0	22.4				
Change Period (Y+Rc), s	4.5	4.5	4.5	4.5	4.5	4.5	4.5	4.5				
Max Green Setting (Gmax), s	21.5	26.5	12.5	18.5	5.5	45.5	5.0	26.0				
Max Q Clear Time (g_c+1/3), s	11.9	18.4	7.3	6.3	2.9	4.6	0.0	8.8				
Green Ext Time (p_c), s	0.5	1.3	0.1	0.2	0.0	0.8	0.0	0.5				
Intersection Summary												
HCM 6th Ctrl Delay				33.1								
HCM 6th LOS				C								

HCM 6th Signalized Intersection Summary
 53: Road 22 1/2 & Cleveland Avenue

Village D Specific Plan
 Phase III WP MIT - AM Peak Hour



Movement	EBL	EBT	EBR	WBL	WBT	WBR	NBL	NBT	NBR	SBL	SBT	SBR
Lane Configurations												
Traffic Volume (veh/h)	12	395	11	88	232	144	14	25	163	333	25	10
Future Volume (veh/h)	12	395	11	88	232	144	14	25	163	333	25	10
Initial Q (Qb), veh	0	0	0	0	0	0	0	0	0	0	0	0
Ped-Bike Adj(A_pbT)	1.00		1.00	1.00		1.00	1.00		1.00	1.00		1.00
Parking Bus, Adj	1.00	1.00	1.00	1.00	1.00	1.00	1.00	1.00	1.00	1.00	1.00	1.00
Work Zone On Approach		No			No			No			No	
Adj Sat Flow, veh/h/ln	1900	1900	1900	1900	1900	1900	1900	1900	1900	1900	1900	1900
Adj Flow Rate, veh/h	13	429	12	96	252	157	15	27	177	362	27	11
Peak Hour Factor	0.92	0.92	0.92	0.92	0.92	0.92	0.92	0.92	0.92	0.92	0.92	0.92
Percent Heavy Veh, %	0	0	0	0	0	0	0	0	0	0	0	0
Cap, veh/h	27	573	16	124	769	546	31	101	664	444	738	300
Arrive On Green	0.02	0.16	0.16	0.02	0.07	0.07	0.02	0.47	0.47	0.13	0.57	0.57
Sat Flow, veh/h	1810	3587	100	1810	3610	1610	1810	218	1426	3510	1283	523
Grp Volume(v), veh/h	13	216	225	96	252	157	15	0	204	362	0	38
Grp Sat Flow(s),veh/h/ln	1810	1805	1882	1810	1805	1610	1810	0	1643	1755	0	1806
Q Serve(g_s), s	0.7	11.4	11.4	5.3	6.6	7.9	0.8	0.0	7.6	10.0	0.0	0.9
Cycle Q Clear(g_c), s	0.7	11.4	11.4	5.3	6.6	7.9	0.8	0.0	7.6	10.0	0.0	0.9
Prop In Lane	1.00		0.05	1.00		1.00	1.00		0.87	1.00		0.29
Lane Grp Cap(c), veh/h	27	288	301	124	769	546	31	0	765	444	0	1038
V/C Ratio(X)	0.47	0.75	0.75	0.78	0.33	0.29	0.49	0.00	0.27	0.82	0.00	0.04
Avail Cap(c_a), veh/h	92	619	646	215	1484	865	92	0	765	593	0	1038
HCM Platoon Ratio	1.00	1.00	1.00	0.33	0.33	0.33	1.00	1.00	1.00	1.00	1.00	1.00
Upstream Filter(I)	1.00	1.00	1.00	0.88	0.88	0.88	1.00	0.00	1.00	0.97	0.00	0.97
Uniform Delay (d), s/veh	48.8	40.1	40.1	48.1	39.7	28.8	48.7	0.0	16.3	42.6	0.0	9.2
Incr Delay (d2), s/veh	12.2	3.9	3.8	8.8	0.2	0.3	11.4	0.0	0.9	6.3	0.0	0.1
Initial Q Delay(d3),s/veh	0.0	0.0	0.0	0.0	0.0	0.0	0.0	0.0	0.0	0.0	0.0	0.0
%ile BackOfQ(50%),veh/ln	0.4	5.3	5.6	2.8	3.1	3.3	0.5	0.0	3.0	4.7	0.0	0.4
Unsig. Movement Delay, s/veh												
LnGrp Delay(d),s/veh	61.0	44.0	43.9	56.9	39.9	29.1	60.1	0.0	17.2	48.9	0.0	9.3
LnGrp LOS	E	D	D	E	D	C	E	A	B	D	A	A
Approach Vol, veh/h		454			505			219			400	
Approach Delay, s/veh		44.4			39.8			20.1			45.1	
Approach LOS		D			D			C			D	
Timer - Assigned Phs	1	2	3	4	5	6	7	8				
Phs Duration (G+Y+Rc), s	7.1	51.1	11.3	20.5	6.2	62.0	6.0	25.8				
Change Period (Y+Rc), s	4.5	4.5	4.5	4.5	4.5	4.5	4.5	4.5				
Max Green Setting (Gmax), s	10.9	18.9	11.9	34.3	5.1	30.7	5.1	41.1				
Max Q Clear Time (g_c+M), s	10.9	9.6	7.3	13.4	2.8	2.9	2.7	9.9				
Green Ext Time (p_c), s	0.6	0.8	0.1	2.5	0.0	0.1	0.0	2.2				

Intersection Summary

HCM 6th Ctrl Delay	39.7
HCM 6th LOS	D

HCM 6th Signalized Intersection Summary
55: Road 23 & Project Driveway 3

Village D Specific Plan
Phase III WP MIT - AM Peak Hour



Movement	EBL	EBR	NBL	NBT	SBT	SBR
Lane Configurations	↔↔	↔	↔	↑↑↑	↑↑↑	↔
Traffic Volume (veh/h)	806	122	93	1308	798	333
Future Volume (veh/h)	806	122	93	1308	798	333
Initial Q (Qb), veh	0	0	0	0	0	0
Ped-Bike Adj(A_pbT)	1.00	1.00	1.00			1.00
Parking Bus, Adj	1.00	1.00	1.00	1.00	1.00	1.00
Work Zone On Approach	No			No	No	
Adj Sat Flow, veh/h/ln	1900	1900	1841	1841	1811	1811
Adj Flow Rate, veh/h	876	133	101	1422	867	362
Peak Hour Factor	0.92	0.92	0.92	0.92	0.92	0.92
Percent Heavy Veh, %	0	0	4	4	6	6
Cap, veh/h	1018	585	128	3115	2481	770
Arrive On Green	0.29	0.29	0.07	0.62	0.17	0.17
Sat Flow, veh/h	3510	1610	1753	5191	5107	1535
Grp Volume(v), veh/h	876	133	101	1422	867	362
Grp Sat Flow(s),veh/h/ln	1755	1610	1753	1675	1648	1535
Q Serve(g_s), s	23.6	5.7	5.7	15.0	15.5	21.3
Cycle Q Clear(g_c), s	23.6	5.7	5.7	15.0	15.5	21.3
Prop In Lane	1.00	1.00	1.00			1.00
Lane Grp Cap(c), veh/h	1018	585	128	3115	2481	770
V/C Ratio(X)	0.86	0.23	0.79	0.46	0.35	0.47
Avail Cap(c_a), veh/h	1352	738	254	3115	2481	770
HCM Platoon Ratio	1.00	1.00	1.00	1.00	0.33	0.33
Upstream Filter(I)	1.00	1.00	0.80	0.80	0.87	0.87
Uniform Delay (d), s/veh	33.6	22.1	45.6	10.1	27.3	29.7
Incr Delay (d2), s/veh	4.5	0.2	8.3	0.4	0.3	1.8
Initial Q Delay(d3),s/veh	0.0	0.0	0.0	0.0	0.0	0.0
%ile BackOfQ(50%),veh/ln	10.5	6.1	2.7	5.2	6.9	9.1
Unsig. Movement Delay, s/veh						
LnGrp Delay(d),s/veh	38.1	22.3	53.9	10.5	27.6	31.5
LnGrp LOS	D	C	D	B	C	C
Approach Vol, veh/h	1009			1523	1229	
Approach Delay, s/veh	36.0			13.3	28.7	
Approach LOS	D			B	C	
Timer - Assigned Phs		2		4	5	6
Phs Duration (G+Y+Rc), s		66.5		33.5	11.8	54.7
Change Period (Y+Rc), s		4.5		4.5	4.5	4.5
Max Green Setting (Gmax), s		52.5		38.5	14.5	33.5
Max Q Clear Time (g_c+I1), s		17.0		25.6	7.7	23.3
Green Ext Time (p_c), s		14.0		3.4	0.1	5.2
Intersection Summary						
HCM 6th Ctrl Delay			24.5			
HCM 6th LOS			C			

HCM 6th Signalized Intersection Summary
56: Road 23 & Project Driveway 4

Village D Specific Plan
Phase III WP MIT - AM Peak Hour



Movement	WBL	WBR	NBT	NBR	SBL	SBT
Lane Configurations						
Traffic Volume (veh/h)	106	537	709	137	420	1177
Future Volume (veh/h)	106	537	709	137	420	1177
Initial Q (Qb), veh	0	0	0	0	0	0
Ped-Bike Adj(A_pbT)	1.00	1.00		1.00	1.00	
Parking Bus, Adj	1.00	1.00	1.00	1.00	1.00	1.00
Work Zone On Approach	No		No		No	
Adj Sat Flow, veh/h/ln	1900	1900	1811	1811	1870	1870
Adj Flow Rate, veh/h	115	584	771	149	457	1279
Peak Hour Factor	0.92	0.92	0.92	0.92	0.92	0.92
Percent Heavy Veh, %	0	0	6	6	2	2
Cap, veh/h	369	1035	2470	767	559	3606
Arrive On Green	0.20	0.20	1.00	1.00	0.16	0.71
Sat Flow, veh/h	1810	2834	5107	1535	3456	5274
Grp Volume(v), veh/h	115	584	771	149	457	1279
Grp Sat Flow(s),veh/h/ln	1810	1417	1648	1535	1728	1702
Q Serve(g_s), s	5.4	16.5	0.0	0.0	12.8	9.8
Cycle Q Clear(g_c), s	5.4	16.5	0.0	0.0	12.8	9.8
Prop In Lane	1.00	1.00		1.00	1.00	
Lane Grp Cap(c), veh/h	369	1035	2470	767	559	3606
V/C Ratio(X)	0.31	0.56	0.31	0.19	0.82	0.35
Avail Cap(c_a), veh/h	480	1209	2470	767	950	3606
HCM Platoon Ratio	1.00	1.00	2.00	2.00	1.00	1.00
Upstream Filter(I)	1.00	1.00	0.98	0.98	0.80	0.80
Uniform Delay (d), s/veh	33.9	25.4	0.0	0.0	40.5	5.8
Incr Delay (d2), s/veh	0.5	0.5	0.3	0.6	2.4	0.2
Initial Q Delay(d3),s/veh	0.0	0.0	0.0	0.0	0.0	0.0
%ile BackOfQ(50%),veh/ln	2.4	5.5	0.1	0.1	5.6	3.1
Unsig. Movement Delay, s/veh						
LnGrp Delay(d),s/veh	34.3	25.8	0.3	0.6	42.9	6.0
LnGrp LOS	C	C	A	A	D	A
Approach Vol, veh/h	699		920			1736
Approach Delay, s/veh	27.2		0.4			15.7
Approach LOS	C		A			B
Timer - Assigned Phs	1	2			6	8
Phs Duration (G+Y+Rc), s	30.7	54.5			75.1	24.9
Change Period (Y+Rc), s	4.5	4.5			4.5	4.5
Max Green Setting (Gmax), s	27.5	32.5			64.5	26.5
Max Q Clear Time (g_c+M), s	14.8	2.0			11.8	18.5
Green Ext Time (p_c), s	1.4	6.7			13.2	1.9
Intersection Summary						
HCM 6th Ctrl Delay			13.9			
HCM 6th LOS			B			

HCM 6th Signalized Intersection Summary
57: Road 23 & Project Driveway 5

Village D Specific Plan
Phase III WP MIT - AM Peak Hour



Movement	EBL	EBR	NBL	NBT	SBT	SBR
Lane Configurations						
Traffic Volume (veh/h)	117	147	66	735	1975	73
Future Volume (veh/h)	117	147	66	735	1975	73
Initial Q (Qb), veh	0	0	0	0	0	0
Ped-Bike Adj(A_pbT)	1.00	1.00	1.00			1.00
Parking Bus, Adj	1.00	1.00	1.00	1.00	1.00	1.00
Work Zone On Approach	No			No	No	
Adj Sat Flow, veh/h/ln	1900	1900	1811	1811	1781	1781
Adj Flow Rate, veh/h	127	160	72	799	2147	79
Peak Hour Factor	0.92	0.92	0.92	0.92	0.92	0.92
Percent Heavy Veh, %	0	0	6	6	8	8
Cap, veh/h	220	196	92	3897	3322	122
Arrive On Green	0.12	0.12	0.05	0.79	1.00	1.00
Sat Flow, veh/h	1810	1610	1725	5107	4976	177
Grp Volume(v), veh/h	127	160	72	799	1443	783
Grp Sat Flow(s),veh/h/ln	1810	1610	1725	1648	1621	1750
Q Serve(g_s), s	6.6	9.7	4.1	4.1	0.0	0.0
Cycle Q Clear(g_c), s	6.6	9.7	4.1	4.1	0.0	0.0
Prop In Lane	1.00	1.00	1.00			0.10
Lane Grp Cap(c), veh/h	220	196	92	3897	2237	1207
V/C Ratio(X)	0.58	0.82	0.78	0.21	0.65	0.65
Avail Cap(c_a), veh/h	331	295	181	3897	2237	1207
HCM Platoon Ratio	1.00	1.00	1.00	1.00	2.00	2.00
Upstream Filter(I)	1.00	1.00	0.90	0.90	0.95	0.95
Uniform Delay (d), s/veh	41.5	42.8	46.8	2.7	0.0	0.0
Incr Delay (d2), s/veh	2.4	10.3	12.2	0.1	1.4	2.6
Initial Q Delay(d3),s/veh	0.0	0.0	0.0	0.0	0.0	0.0
%ile BackOfQ(50%),veh/ln	8.1	8.9	2.1	1.0	0.4	0.9
Unsig. Movement Delay, s/veh						
LnGrp Delay(d),s/veh	43.8	53.1	58.9	2.8	1.4	2.6
LnGrp LOS	D	D	E	A	A	A
Approach Vol, veh/h	287			871	2226	
Approach Delay, s/veh	49.0			7.4	1.8	
Approach LOS	D			A	A	
Timer - Assigned Phs		2		4	5	6
Phs Duration (G+Y+Rc), s		83.3		16.7	9.8	73.5
Change Period (Y+Rc), s		4.5		4.5	4.5	4.5
Max Green Setting (Gmax), s		72.7		18.3	10.5	57.7
Max Q Clear Time (g_c+I1), s		6.1		11.7	6.1	2.0
Green Ext Time (p_c), s		6.9		0.5	0.0	32.3
Intersection Summary						
HCM 6th Ctrl Delay			7.2			
HCM 6th LOS			A			

HCM 6th Signalized Intersection Summary
58: Project Driveway 6 & Cleveland Avenue

Village D Specific Plan
Phase III WP MIT - AM Peak Hour

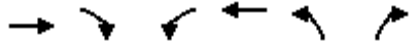

Movement	EBT	EBR	WBL	WBT	NBL	NBR
Lane Configurations	↑↑↑	↑	↑	↑↑↑	↑	↑
Traffic Volume (veh/h)	1126	77	154	467	195	292
Future Volume (veh/h)	1126	77	154	467	195	292
Initial Q (Qb), veh	0	0	0	0	0	0
Ped-Bike Adj(A_pbT)		1.00	1.00		1.00	1.00
Parking Bus, Adj	1.00	1.00	1.00	1.00	1.00	1.00
Work Zone On Approach	No			No	No	
Adj Sat Flow, veh/h/ln	1885	1885	1885	1885	1900	1900
Adj Flow Rate, veh/h	1224	84	167	508	212	317
Peak Hour Factor	0.92	0.92	0.92	0.92	0.92	0.92
Percent Heavy Veh, %	1	1	1	1	0	0
Cap, veh/h	1597	496	202	2409	800	711
Arrive On Green	0.31	0.31	0.11	0.47	0.44	0.44
Sat Flow, veh/h	5316	1598	1795	5316	1810	1610
Grp Volume(v), veh/h	1224	84	167	508	212	317
Grp Sat Flow(s),veh/h/ln	1716	1598	1795	1716	1810	1610
Q Serve(g_s), s	21.5	3.8	9.1	5.8	7.4	13.7
Cycle Q Clear(g_c), s	21.5	3.8	9.1	5.8	7.4	13.7
Prop In Lane		1.00	1.00		1.00	1.00
Lane Grp Cap(c), veh/h	1597	496	202	2409	800	711
V/C Ratio(X)	0.77	0.17	0.82	0.21	0.27	0.45
Avail Cap(c_a), veh/h	1930	599	368	3217	800	711
HCM Platoon Ratio	1.00	1.00	1.00	1.00	1.00	1.00
Upstream Filter(I)	0.89	0.89	1.00	1.00	1.00	1.00
Uniform Delay (d), s/veh	31.2	25.1	43.4	15.7	17.6	19.4
Incr Delay (d2), s/veh	1.4	0.1	8.2	0.0	0.8	2.0
Initial Q Delay(d3),s/veh	0.0	0.0	0.0	0.0	0.0	0.0
%ile BackOfQ(50%),veh/ln	8.9	1.5	4.5	2.2	3.2	5.4
Unsig. Movement Delay, s/veh						
LnGrp Delay(d),s/veh	32.6	25.2	51.6	15.7	18.5	21.4
LnGrp LOS	C	C	D	B	B	C
Approach Vol, veh/h	1308			675	529	
Approach Delay, s/veh	32.1			24.6	20.2	
Approach LOS	C			C	C	
Timer - Assigned Phs		2	3	4		8
Phs Duration (G+Y+Rc), s		48.7	15.8	35.5		51.3
Change Period (Y+Rc), s		4.5	4.5	4.5		4.5
Max Green Setting (Gmax), s		28.5	20.5	37.5		62.5
Max Q Clear Time (g_c+I1), s		15.7	11.1	23.5		7.8
Green Ext Time (p_c), s		1.5	0.3	7.5		4.0
Intersection Summary						
HCM 6th Ctrl Delay			27.6			
HCM 6th LOS			C			

HCM 6th TWSC
4: Truck Parking Lot/Pistachio Drive & Avenue 18 1/2

Village D Specific Plan
Phase III WP MIT - PM Peak Hour

Intersection												
Int Delay, s/veh	2											
Movement	EBL	EBT	EBR	WBL	WBT	WBR	NBL	NBT	NBR	SBL	SBT	SBR
Lane Configurations	↖	↕			↕	↖		↕			↕	
Traffic Vol, veh/h	13	537	1	6	225	206	2	0	5	170	0	13
Future Vol, veh/h	13	537	1	6	225	206	2	0	5	170	0	13
Conflicting Peds, #/hr	0	0	0	0	0	0	0	0	1	1	0	0
Sign Control	Free	Free	Free	Free	Free	Free	Stop	Stop	Stop	Stop	Stop	Stop
RT Channelized	-	-	None	-	-	None	-	-	None	-	-	None
Storage Length	50	-	-	-	-	0	-	-	-	-	-	-
Veh in Median Storage, #	-	0	-	-	0	-	-	0	-	-	0	-
Grade, %	-	0	-	-	0	-	-	0	-	-	0	-
Peak Hour Factor	93	93	93	93	93	93	93	93	93	93	93	93
Heavy Vehicles, %	19	19	19	22	22	22	71	71	71	5	5	5
Mvmt Flow	14	577	1	6	242	222	2	0	5	183	0	14

Major/Minor	Major1			Major2			Minor1			Minor2		
Conflicting Flow All	464	0	0	578	0	0	978	1082	290	572	860	242
Stage 1	-	-	-	-	-	-	606	606	-	254	254	-
Stage 2	-	-	-	-	-	-	372	476	-	318	606	-
Critical Hdwy	4.385	-	-	4.43	-	-	8.365	7.565	7.965	7.375	6.575	6.275
Critical Hdwy Stg 1	-	-	-	-	-	-	7.565	6.565	-	6.175	5.575	-
Critical Hdwy Stg 2	-	-	-	-	-	-	7.165	6.565	-	6.575	5.575	-
Follow-up Hdwy	2.3805	-	-	2.409	-	-	4.1745	4.6745	3.9745	3.5475	4.0475	3.3475
Pot Cap-1 Maneuver	*1246	-	-	885	-	-	*269	*231	557	*767	*435	*886
Stage 1	-	-	-	-	-	-	*336	*368	-	*836	*733	-
Stage 2	-	-	-	-	-	-	*710	*634	-	*661	*480	-
Platoon blocked, %	1	-	-	-	-	-	1	1	-	1	1	1
Mov Cap-1 Maneuver	*1246	-	-	885	-	-	*261	*226	556	*747	*427	*886
Mov Cap-2 Maneuver	-	-	-	-	-	-	*261	*226	-	*747	*427	-
Stage 1	-	-	-	-	-	-	*332	*364	-	*827	*727	-
Stage 2	-	-	-	-	-	-	*693	*628	-	*647	*475	-

Approach	EB	WB	NB	SB
HCM Control Delay, s	0.2	0.1	13.7	11.4
HCM LOS			B	B

Minor Lane/Major Mvmt	NBLn1	EBL	EBT	EBR	WBL	WBT	WBR	SBLn1
Capacity (veh/h)	420	*1246	-	-	885	-	-	755
HCM Lane V/C Ratio	0.018	0.011	-	-	0.007	-	-	0.261
HCM Control Delay (s)	13.7	7.9	-	-	9.1	0	-	11.4
HCM Lane LOS	B	A	-	-	A	A	-	B
HCM 95th %tile Q(veh)	0.1	0	-	-	0	-	-	1

Notes
 -: Volume exceeds capacity \$: Delay exceeds 300s +: Computation Not Defined *: All major volume in platoon

HCM 6th Signalized Intersection Summary
5: Road 23/SR-99 Southbound Off-Ramp & Avenue 18 1/2

Village D Specific Plan
Phase III WP MIT - PM Peak Hour



Movement	EBL	EBT	EBR	WBL	WBT	WBR	NBL	NBT	NBR	SBL	SBT	SBR
Lane Configurations		↑↑	↗	↖	↑↑			↕	↗		↕	
Traffic Volume (veh/h)	0	405	307	58	206	0	106	0	469	28	695	127
Future Volume (veh/h)	0	405	307	58	206	0	106	0	469	28	695	127
Initial Q (Qb), veh	0	0	0	0	0	0	0	0	0	0	0	0
Ped-Bike Adj(A_pbT)	1.00		0.99	1.00		1.00	1.00		1.00	1.00		0.99
Parking Bus, Adj	1.00	1.00	1.00	1.00	1.00	1.00	1.00	1.00	1.00	1.00	1.00	1.00
Work Zone On Approach		No			No			No			No	
Adj Sat Flow, veh/h/ln	0	1633	1633	1455	1455	0	1811	1811	1811	1767	1767	1767
Adj Flow Rate, veh/h	0	431	327	62	219	0	0	0	620	30	739	135
Peak Hour Factor	0.94	0.94	0.94	0.94	0.94	0.94	0.94	0.94	0.94	0.94	0.94	0.94
Percent Heavy Veh, %	0	18	18	30	30	0	6	6	6	9	9	9
Cap, veh/h	0	597	666	75	784	0	0	528	1059	34	868	168
Arrive On Green	0.00	0.19	0.19	0.05	0.28	0.00	0.00	0.00	0.29	0.31	0.31	0.31
Sat Flow, veh/h	0	3185	1366	1386	2838	0	0	1811	3070	109	2777	537
Grp Volume(v), veh/h	0	431	327	62	219	0	0	0	620	486	0	418
Grp Sat Flow(s),veh/h/ln	0	1552	1366	1386	1383	0	0	1811	1535	1761	0	1662
Q Serve(g_s), s	0.0	15.6	19.5	5.3	7.4	0.0	0.0	0.0	19.9	31.5	0.0	27.7
Cycle Q Clear(g_c), s	0.0	15.6	19.5	5.3	7.4	0.0	0.0	0.0	19.9	31.5	0.0	27.7
Prop In Lane	0.00		1.00	1.00		0.00	0.00		1.00	0.06		0.32
Lane Grp Cap(c), veh/h	0	597	666	75	784	0	0	528	1059	550	0	519
V/C Ratio(X)	0.00	0.72	0.49	0.83	0.28	0.00	0.00	0.00	0.59	0.88	0.00	0.80
Avail Cap(c_a), veh/h	0	659	694	202	1095	0	0	528	1059	550	0	519
HCM Platoon Ratio	1.00	1.00	1.00	1.00	1.00	1.00	1.00	1.00	1.00	1.00	1.00	1.00
Upstream Filter(I)	0.00	1.00	1.00	1.00	1.00	0.00	0.00	0.00	1.00	1.00	0.00	1.00
Uniform Delay (d), s/veh	0.0	45.5	21.0	56.2	33.4	0.0	0.0	0.0	32.2	39.2	0.0	37.9
Incr Delay (d2), s/veh	0.0	3.5	0.6	20.3	0.2	0.0	0.0	0.0	2.4	18.4	0.0	12.5
Initial Q Delay(d3),s/veh	0.0	0.0	0.0	0.0	0.0	0.0	0.0	0.0	0.0	0.0	0.0	0.0
%ile BackOfQ(50%),veh/ln	0.0	6.3	10.1	2.3	2.5	0.0	0.0	0.0	7.7	16.3	0.0	13.0
Unsig. Movement Delay, s/veh												
LnGrp Delay(d),s/veh	0.0	48.9	21.6	76.5	33.6	0.0	0.0	0.0	34.6	57.6	0.0	50.4
LnGrp LOS	A	D	C	E	C	A	A	A	C	E	A	D
Approach Vol, veh/h		758			281			620			904	
Approach Delay, s/veh		37.1			43.1			34.6			54.2	
Approach LOS		D			D			C			D	
Timer - Assigned Phs		2	3	4		6		8				
Phs Duration (G+Y+Rc), s		39.5	11.0	27.6		42.0		38.5				
Change Period (Y+Rc), s		4.5	4.5	4.5		4.5		4.5				
Max Green Setting (Gmax), s		21.5	17.5	25.5		37.5		47.5				
Max Q Clear Time (g_c+I1), s		21.9	7.3	21.5		33.5		9.4				
Green Ext Time (p_c), s		0.0	0.1	1.6		2.1		1.6				

Intersection Summary

HCM 6th Ctrl Delay	43.2
HCM 6th LOS	D

Notes

User approved volume balancing among the lanes for turning movement.

HCM 6th Signalized Intersection Summary
 6: SR-99 Northbound Ramps & Avenue 18 1/2

Village D Specific Plan
 Phase III WP MIT - PM Peak Hour



Movement	EBL	EBT	EBR	WBL	WBT	WBR	NBL	NBT	NBR	SBL	SBT	SBR
Lane Configurations	↖↗	↑↑			↑↗		↖	↗				
Traffic Volume (veh/h)	542	124	0	0	99	22	196	3	0	0	0	0
Future Volume (veh/h)	542	124	0	0	99	22	196	3	0	0	0	0
Initial Q (Qb), veh	0	0	0	0	0	0	0	0	0			
Ped-Bike Adj(A_pbT)	1.00		1.00	1.00		1.00	1.00		1.00			
Parking Bus, Adj	1.00	1.00	1.00	1.00	1.00	1.00	1.00	1.00	1.00			
Work Zone On Approach		No			No			No				
Adj Sat Flow, veh/h/ln	1737	1737	0	0	1722	1722	1544	1544	1544			
Adj Flow Rate, veh/h	589	135	0	0	108	24	213	3	0			
Peak Hour Factor	0.92	0.92	0.92	0.92	0.92	0.92	0.92	0.92	0.92			
Percent Heavy Veh, %	11	11	0	0	12	12	24	24	24			
Cap, veh/h	680	1026	0	0	165	36	903	948	0			
Arrive On Green	0.21	0.31	0.00	0.00	0.06	0.06	0.61	0.61	0.00			
Sat Flow, veh/h	3209	3387	0	0	2762	578	1471	1544	0			
Grp Volume(v), veh/h	589	135	0	0	65	67	213	3	0			
Grp Sat Flow(s),veh/h/ln	1605	1650	0	0	1636	1618	1471	1544	0			
Q Serve(g_s), s	21.3	3.5	0.0	0.0	4.6	4.9	7.8	0.1	0.0			
Cycle Q Clear(g_c), s	21.3	3.5	0.0	0.0	4.6	4.9	7.8	0.1	0.0			
Prop In Lane	1.00		0.00	0.00		0.36	1.00		0.00			
Lane Grp Cap(c), veh/h	680	1026	0	0	101	100	903	948	0			
V/C Ratio(X)	0.87	0.13	0.00	0.00	0.64	0.67	0.24	0.00	0.00			
Avail Cap(c_a), veh/h	1163	1884	0	0	279	276	903	948	0			
HCM Platoon Ratio	1.00	1.00	1.00	1.00	1.00	1.00	1.00	1.00	1.00			
Upstream Filter(I)	1.00	1.00	0.00	0.00	1.00	1.00	1.00	1.00	0.00			
Uniform Delay (d), s/veh	45.6	29.7	0.0	0.0	55.0	55.1	10.5	9.0	0.0			
Incr Delay (d2), s/veh	3.6	0.1	0.0	0.0	6.7	7.7	0.6	0.0	0.0			
Initial Q Delay(d3),s/veh	0.0	0.0	0.0	0.0	0.0	0.0	0.0	0.0	0.0			
%ile BackOfQ(50%),veh/ln	8.8	1.4	0.0	0.0	2.1	2.2	2.6	0.0	0.0			
Unsig. Movement Delay, s/veh												
LnGrp Delay(d),s/veh	49.3	29.8	0.0	0.0	61.8	62.8	11.1	9.0	0.0			
LnGrp LOS	D	C	A	A	E	E	B	A	A			
Approach Vol, veh/h		724			132			216				
Approach Delay, s/veh		45.6			62.3			11.0				
Approach LOS		D			E			B				
Timer - Assigned Phs		2		4			7	8				
Phs Duration (G+Y+Rc), s		78.2		41.8			29.9	11.9				
Change Period (Y+Rc), s		4.5		4.5			4.5	4.5				
Max Green Setting (Gmax), s		42.5		68.5			43.5	20.5				
Max Q Clear Time (g_c+I1), s		9.8		5.5			23.3	6.9				
Green Ext Time (p_c), s		0.7		1.0			2.2	0.5				
Intersection Summary												
HCM 6th Ctrl Delay												40.7
HCM 6th LOS												D

HCM 6th Signalized Intersection Summary
7: Road 23 & Avenue 17

Village D Specific Plan
Phase III WP MIT - PM Peak Hour



Movement	EBL	EBT	EBR	WBL	WBT	WBR	NBL	NBT	NBR	SBL	SBT	SBR
Lane Configurations	↖	↖↗		↖↗	↖↗		↖	↖↗	↖	↖	↖↗	↖
Traffic Volume (veh/h)	83	263	59	968	477	10	38	544	646	64	992	166
Future Volume (veh/h)	83	263	59	968	477	10	38	544	646	64	992	166
Initial Q (Qb), veh	0	0	0	0	0	0	0	0	0	0	0	0
Ped-Bike Adj(A_pbT)	1.00		1.00	1.00		1.00	1.00		1.00	1.00		1.00
Parking Bus, Adj	1.00	1.00	1.00	1.00	1.00	1.00	1.00	1.00	1.00	1.00	1.00	1.00
Work Zone On Approach		No			No			No			No	
Adj Sat Flow, veh/h/ln	1885	1885	1885	1900	1900	1900	1885	1885	1885	1870	1870	1870
Adj Flow Rate, veh/h	90	286	64	1052	518	11	41	591	702	70	1078	180
Peak Hour Factor	0.92	0.92	0.92	0.92	0.92	0.92	0.92	0.92	0.92	0.92	0.92	0.92
Percent Heavy Veh, %	1	1	1	0	0	0	1	1	1	2	2	2
Cap, veh/h	114	363	80	1068	1320	28	56	1330	1079	89	1387	619
Arrive On Green	0.06	0.12	0.12	0.30	0.37	0.37	0.01	0.12	0.12	0.05	0.39	0.39
Sat Flow, veh/h	1795	2918	643	3510	3614	77	1795	3582	1598	1781	3554	1585
Grp Volume(v), veh/h	90	174	176	1052	258	271	41	591	702	70	1078	180
Grp Sat Flow(s),veh/h/ln	1795	1791	1769	1755	1805	1886	1795	1791	1598	1781	1777	1585
Q Serve(g_s), s	5.9	11.3	11.6	35.7	12.7	12.8	2.7	18.4	27.9	4.7	31.9	9.4
Cycle Q Clear(g_c), s	5.9	11.3	11.6	35.7	12.7	12.8	2.7	18.4	27.9	4.7	31.9	9.4
Prop In Lane	1.00		0.36	1.00		0.04	1.00		1.00	1.00		1.00
Lane Grp Cap(c), veh/h	114	223	220	1068	659	689	56	1330	1079	89	1387	619
V/C Ratio(X)	0.79	0.78	0.80	0.99	0.39	0.39	0.74	0.44	0.65	0.78	0.78	0.29
Avail Cap(c_a), veh/h	189	336	332	1068	698	729	75	1330	1079	110	1387	619
HCM Platoon Ratio	1.00	1.00	1.00	1.00	1.00	1.00	0.33	0.33	0.33	1.00	1.00	1.00
Upstream Filter(I)	0.85	0.85	0.85	1.00	1.00	1.00	0.92	0.92	0.92	1.00	1.00	1.00
Uniform Delay (d), s/veh	55.4	50.9	51.1	41.5	28.2	28.2	58.9	41.2	15.2	56.3	32.0	25.2
Incr Delay (d2), s/veh	10.0	5.6	6.8	23.9	0.4	0.4	20.5	1.0	2.8	24.9	4.3	1.2
Initial Q Delay(d3),s/veh	0.0	0.0	0.0	0.0	0.0	0.0	0.0	0.0	0.0	0.0	0.0	0.0
%ile BackOfQ(50%),veh/ln	8.0	5.4	5.6	18.8	5.6	5.8	1.6	9.0	12.5	2.7	14.3	3.7
Unsig. Movement Delay, s/veh												
LnGrp Delay(d),s/veh	65.4	56.5	57.9	65.4	28.6	28.6	79.4	42.2	18.0	81.3	36.3	26.3
LnGrp LOS	E	E	E	E	C	C	E	D	B	F	D	C
Approach Vol, veh/h		440			1581			1334			1328	
Approach Delay, s/veh		58.9			53.1			30.6			37.4	
Approach LOS		E			D			C			D	
Timer - Assigned Phs	1	2	3	4	5	6	7	8				
Phs Duration (G+Y+Rc), s	40.5	49.0	41.0	19.4	8.2	51.3	12.1	48.3				
Change Period (Y+Rc), s	4.5	4.5	4.5	4.5	4.5	4.5	4.5	4.5				
Max Green Setting (Gmax), s	35.6	36.5	22.5	5.0	38.0	12.6	46.4					
Max Q Clear Time (g_c+1), s	29.9	37.7	13.6	4.7	33.9	7.9	14.8					
Green Ext Time (p_c), s	0.0	3.3	0.0	1.3	0.0	2.8	0.1	3.4				
Intersection Summary												
HCM 6th Ctrl Delay				42.8								
HCM 6th LOS				D								

HCM 6th Signalized Intersection Summary
8: Road 23 & Avenue 16

Village D Specific Plan
Phase III WP MIT - PM Peak Hour



Movement	EBL	EBT	EBR	WBL	WBT	WBR	NBL	NBT	NBR	SBL	SBT	SBR
Lane Configurations												
Traffic Volume (veh/h)	156	25	252	93	26	109	393	1210	171	222	1442	228
Future Volume (veh/h)	156	25	252	93	26	109	393	1210	171	222	1442	228
Initial Q (Qb), veh	0	0	0	0	0	0	0	0	0	0	0	0
Ped-Bike Adj(A_pbT)	1.00		1.00	1.00		1.00	1.00		1.00	1.00		1.00
Parking Bus, Adj	1.00	1.00	1.00	1.00	1.00	1.00	1.00	1.00	1.00	1.00	1.00	1.00
Work Zone On Approach	No			No			No			No		
Adj Sat Flow, veh/h/ln	1885	1885	1885	1885	1885	1885	1885	1885	1885	1870	1870	1870
Adj Flow Rate, veh/h	164	26	265	98	27	115	414	1274	180	234	1518	240
Peak Hour Factor	0.95	0.95	0.95	0.95	0.95	0.95	0.95	0.95	0.95	0.95	0.95	0.95
Percent Heavy Veh, %	1	1	1	1	1	1	1	1	1	2	2	2
Cap, veh/h	193	342	289	123	268	227	488	2657	825	291	2351	730
Arrive On Green	0.11	0.18	0.18	0.07	0.14	0.14	0.05	0.17	0.17	0.17	0.92	0.92
Sat Flow, veh/h	1795	1885	1598	1795	1885	1598	3483	5147	1598	3456	5106	1585
Grp Volume(v), veh/h	164	26	265	98	27	115	414	1274	180	234	1518	240
Grp Sat Flow(s),veh/h/ln	1795	1885	1598	1795	1885	1598	3483	5147	1598	3456	5106	1585
Q Serve(g_s), s	10.8	1.4	19.5	6.5	1.5	8.0	14.2	26.8	11.7	7.8	7.0	2.1
Cycle Q Clear(g_c), s	10.8	1.4	19.5	6.5	1.5	8.0	14.2	26.8	11.7	7.8	7.0	2.1
Prop In Lane	1.00		1.00	1.00		1.00	1.00		1.00	1.00		1.00
Lane Grp Cap(c), veh/h	193	342	289	123	268	227	488	2657	825	291	2351	730
V/C Ratio(X)	0.85	0.08	0.92	0.80	0.10	0.51	0.85	0.48	0.22	0.80	0.65	0.33
Avail Cap(c_a), veh/h	277	368	312	196	283	240	595	2657	825	400	2351	730
HCM Platoon Ratio	1.00	1.00	1.00	1.00	1.00	1.00	0.33	0.33	0.33	2.00	2.00	2.00
Upstream Filter(I)	0.77	0.77	0.77	1.00	1.00	1.00	0.69	0.69	0.69	0.77	0.77	0.77
Uniform Delay (d), s/veh	52.6	40.8	48.2	55.1	44.8	47.6	56.0	35.2	28.9	48.9	2.8	2.6
Incr Delay (d2), s/veh	12.3	0.1	24.2	11.2	0.2	1.7	6.8	0.4	0.4	6.4	1.1	0.9
Initial Q Delay(d3),s/veh	0.0	0.0	0.0	0.0	0.0	0.0	0.0	0.0	0.0	0.0	0.0	0.0
%ile BackOfQ(50%),veh/ln	15.5	0.7	9.7	3.3	0.7	3.3	7.1	12.5	5.1	3.4	1.4	0.7
Unsig. Movement Delay, s/veh												
LnGrp Delay(d),s/veh	64.9	40.9	72.5	66.2	45.0	49.3	62.8	35.6	29.3	55.3	3.9	3.6
LnGrp LOS	E	D	E	E	D	D	E	D	C	E	A	A
Approach Vol, veh/h	455			240			1868			1992		
Approach Delay, s/veh	68.0			55.8			41.0			9.9		
Approach LOS	E			E			D			A		
Timer - Assigned Phs	1	2	3	4	5	6	7	8				
Phs Duration (G+Y+Rc), s	14.6	66.4	12.7	26.2	21.3	59.7	17.4	21.5				
Change Period (Y+Rc), s	4.5	4.5	4.5	4.5	4.5	4.5	4.5	4.5				
Max Green Setting (Gmax), s	13.9	51.6	13.1	23.4	20.5	45.0	18.5	18.0				
Max Q Clear Time (g_c+1), s	19.8	28.8	8.5	21.5	16.2	9.0	12.8	10.0				
Green Ext Time (p_c), s	0.3	10.8	0.1	0.2	0.6	16.9	0.2	0.3				
Intersection Summary												
HCM 6th Ctrl Delay	30.9											
HCM 6th LOS	C											

HCM 6th Signalized Intersection Summary
9: Road 23 & Cleveland Avenue

Village D Specific Plan
Phase III WP MIT - PM Peak Hour



Movement	EBL	EBT	EBR	WBL	WBT	WBR	NBL	NBT	NBR	SBL	SBT	SBR
Lane Configurations	↖↗	↑↑↑	↖↗	↖↗	↑↑↑	↖	↖↗	↑↑↑	↖	↖↗	↑↑↑	↖↗
Traffic Volume (veh/h)	477	502	788	261	494	388	968	983	317	334	932	608
Future Volume (veh/h)	477	502	788	261	494	388	968	983	317	334	932	608
Initial Q (Qb), veh	0	0	0	0	0	0	0	0	0	0	0	0
Ped-Bike Adj(A_pbT)	1.00		1.00	1.00		1.00	1.00		1.00	1.00		1.00
Parking Bus, Adj	1.00	1.00	1.00	1.00	1.00	1.00	1.00	1.00	1.00	1.00	1.00	1.00
Work Zone On Approach		No			No			No			No	
Adj Sat Flow, veh/h/ln	1900	1900	1900	1900	1900	1900	1885	1885	1885	1870	1870	1870
Adj Flow Rate, veh/h	513	540	847	281	531	417	1041	1057	341	359	1002	654
Peak Hour Factor	0.93	0.93	0.93	0.93	0.93	0.93	0.93	0.93	0.93	0.93	0.93	0.93
Percent Heavy Veh, %	0	0	0	0	0	0	1	1	1	2	2	2
Cap, veh/h	544	1144	1501	352	860	472	1077	2067	802	441	1124	1046
Arrive On Green	0.16	0.22	0.22	0.10	0.17	0.17	0.52	0.67	0.67	0.04	0.07	0.07
Sat Flow, veh/h	3510	5187	2834	3510	5187	1610	3483	5147	1598	3456	5106	2790
Grp Volume(v), veh/h	513	540	847	281	531	417	1041	1057	341	359	1002	654
Grp Sat Flow(s),veh/h/ln	1755	1729	1417	1755	1729	1610	1742	1716	1598	1728	1702	1395
Q Serve(g_s), s	17.4	10.9	24.1	9.4	11.4	19.9	34.6	12.4	10.9	12.4	23.4	22.7
Cycle Q Clear(g_c), s	17.4	10.9	24.1	9.4	11.4	19.9	34.6	12.4	10.9	12.4	23.4	22.7
Prop In Lane	1.00		1.00	1.00		1.00	1.00		1.00	1.00		1.00
Lane Grp Cap(c), veh/h	544	1144	1501	352	860	472	1077	2067	802	441	1124	1046
V/C Ratio(X)	0.94	0.47	0.56	0.80	0.62	0.88	0.97	0.51	0.43	0.81	0.89	0.63
Avail Cap(c_a), veh/h	544	1144	1501	600	860	472	1088	2067	802	706	1124	1046
HCM Platoon Ratio	1.00	1.00	1.00	1.00	1.00	1.00	1.67	1.67	1.67	0.33	0.33	0.33
Upstream Filter(I)	0.65	0.65	0.65	0.89	0.89	0.89	0.56	0.56	0.56	0.76	0.76	0.76
Uniform Delay (d), s/veh	50.2	40.7	18.9	52.8	46.5	40.4	28.4	13.9	9.7	56.1	54.2	36.3
Incr Delay (d2), s/veh	18.7	0.2	0.3	3.7	1.2	16.0	13.4	0.5	0.9	3.0	8.5	2.2
Initial Q Delay(d3),s/veh	0.0	0.0	0.0	0.0	0.0	0.0	0.0	0.0	0.0	0.0	0.0	0.0
%ile BackOfQ(50%),veh/ln	9.0	4.7	7.8	4.3	5.0	13.7	13.8	3.8	3.1	5.9	11.6	8.8
Unsig. Movement Delay, s/veh												
LnGrp Delay(d),s/veh	68.9	40.9	19.3	56.5	47.7	56.4	41.9	14.4	10.6	59.1	62.7	38.4
LnGrp LOS	E	D	B	E	D	E	D	B	B	E	E	D
Approach Vol, veh/h		1900			1229			2439			2015	
Approach Delay, s/veh		38.8			52.7			25.6			54.2	
Approach LOS		D			D			C			D	
Timer - Assigned Phs	1	2	3	4	5	6	7	8				
Phs Duration (G+Y+Rc), s	19.8	52.7	16.5	31.0	41.6	30.9	23.1	24.4				
Change Period (Y+Rc), s	4.5	4.5	4.5	4.5	4.5	4.5	4.5	4.5				
Max Green Setting (Gmax), s	21.5	39.0	20.5	18.0	37.5	26.0	18.6	19.9				
Max Q Clear Time (g_c+1), s	11.4	14.4	11.4	26.1	36.6	25.4	19.4	21.9				
Green Ext Time (p_c), s	0.9	9.9	0.6	0.0	0.4	0.5	0.0	0.0				
Intersection Summary												
HCM 6th Ctrl Delay											40.9	
HCM 6th LOS											D	

HCM 6th Signalized Intersection Summary
 10: Road 23 & Avenue 14 1/2

Village D Specific Plan
 Phase III WP MIT - PM Peak Hour



Movement	EBL	EBT	EBR	WBL	WBT	WBR	NBL	NBT	NBR	SBL	SBT	SBR
Lane Configurations		↕			↕	↕	↕	↕↕		↕	↕↕	↕
Traffic Volume (veh/h)	1	2	3	6	3	308	2	1354	2	309	939	0
Future Volume (veh/h)	1	2	3	6	3	308	2	1354	2	309	939	0
Initial Q (Qb), veh	0	0	0	0	0	0	0	0	0	0	0	0
Ped-Bike Adj(A_pbT)	1.00		1.00	1.00		1.00	1.00		1.00	1.00		1.00
Parking Bus, Adj	1.00	1.00	1.00	1.00	1.00	1.00	1.00	1.00	1.00	1.00	1.00	1.00
Work Zone On Approach		No			No			No			No	
Adj Sat Flow, veh/h/ln	1900	1900	1900	1900	1900	1900	1870	1870	1870	1870	1870	1870
Adj Flow Rate, veh/h	1	2	3	7	3	335	2	1472	2	336	1021	0
Peak Hour Factor	0.92	0.92	0.92	0.92	0.92	0.92	0.92	0.92	0.92	0.92	0.92	0.92
Percent Heavy Veh, %	0	0	0	0	0	0	2	2	2	2	2	2
Cap, veh/h	57	104	126	210	82	248	5	1922	3	366	2596	1158
Arrive On Green	0.15	0.15	0.15	0.15	0.15	0.15	0.00	0.53	0.53	0.21	0.73	0.00
Sat Flow, veh/h	145	674	819	1033	531	1610	1781	3641	5	1781	3554	1585
Grp Volume(v), veh/h	6	0	0	10	0	335	2	718	756	336	1021	0
Grp Sat Flow(s),veh/h/ln	1637	0	0	1564	0	1610	1781	1777	1869	1781	1777	1585
Q Serve(g_s), s	0.0	0.0	0.0	0.0	0.0	18.5	0.1	38.5	38.5	22.2	13.0	0.0
Cycle Q Clear(g_c), s	0.4	0.0	0.0	0.5	0.0	18.5	0.1	38.5	38.5	22.2	13.0	0.0
Prop In Lane	0.17		0.50	0.70		1.00	1.00		0.00	1.00		1.00
Lane Grp Cap(c), veh/h	287	0	0	292	0	248	5	938	987	366	2596	1158
V/C Ratio(X)	0.02	0.00	0.00	0.03	0.00	1.35	0.42	0.77	0.77	0.92	0.39	0.00
Avail Cap(c_a), veh/h	287	0	0	292	0	248	74	938	987	438	2596	1158
HCM Platoon Ratio	1.00	1.00	1.00	1.00	1.00	1.00	1.00	1.00	1.00	1.00	1.00	1.00
Upstream Filter(l)	1.00	0.00	0.00	1.00	0.00	1.00	0.68	0.68	0.68	0.90	0.90	0.00
Uniform Delay (d), s/veh	43.1	0.0	0.0	43.2	0.0	50.8	59.7	22.5	22.5	46.7	6.1	0.0
Incr Delay (d2), s/veh	0.0	0.0	0.0	0.0	0.0	181.5	35.0	4.1	3.9	20.2	0.4	0.0
Initial Q Delay(d3),s/veh	0.0	0.0	0.0	0.0	0.0	0.0	0.0	0.0	0.0	0.0	0.0	0.0
%ile BackOfQ(50%),veh/ln	0.2	0.0	0.0	0.3	0.0	19.9	0.1	16.6	17.4	11.8	4.5	0.0
Unsig. Movement Delay, s/veh												
LnGrp Delay(d),s/veh	43.1	0.0	0.0	43.2	0.0	232.3	94.7	26.6	26.4	66.9	6.5	0.0
LnGrp LOS	D	A	A	D	A	F	F	C	C	E	A	A
Approach Vol, veh/h		6			345			1476			1357	
Approach Delay, s/veh		43.1			226.8			26.6			21.5	
Approach LOS		D			F			C			C	
Timer - Assigned Phs	1	2		4	5	6		8				
Phs Duration (G+Y+Rc), s	29.2	67.8		23.0	4.8	92.2		23.0				
Change Period (Y+Rc), s	4.5	4.5		4.5	4.5	4.5		4.5				
Max Green Setting (Gmax), s	29.5	58.5		18.5	5.0	83.0		18.5				
Max Q Clear Time (g_c+Y), s	24.2	40.5		2.4	2.1	15.0		20.5				
Green Ext Time (p_c), s	0.5	10.2		0.0	0.0	9.9		0.0				

Intersection Summary

HCM 6th Ctrl Delay	46.1
HCM 6th LOS	D

HCM 6th Signalized Intersection Summary
 11: Road 23 & Avenue 14

Village D Specific Plan
 Phase III WP MIT - PM Peak Hour



Movement	EBL	EBT	EBR	WBL	WBT	WBR	NBL	NBT	NBR	SBL	SBT	SBR
Lane Configurations												
Traffic Volume (veh/h)	188	93	36	12	38	796	15	374	22	550	294	102
Future Volume (veh/h)	188	93	36	12	38	796	15	374	22	550	294	102
Initial Q (Qb), veh	0	0	0	0	0	0	0	0	0	0	0	0
Ped-Bike Adj(A_pbT)	1.00		1.00	1.00		1.00	1.00		1.00	1.00		1.00
Parking Bus, Adj	1.00	1.00	1.00	1.00	1.00	1.00	1.00	1.00	1.00	1.00	1.00	1.00
Work Zone On Approach		No			No			No			No	
Adj Sat Flow, veh/h/ln	1811	1811	1811	1885	1885	1885	1841	1841	1841	1856	1856	1856
Adj Flow Rate, veh/h	198	98	38	13	40	838	16	394	23	579	309	107
Peak Hour Factor	0.95	0.95	0.95	0.95	0.95	0.95	0.95	0.95	0.95	0.95	0.95	0.95
Percent Heavy Veh, %	6	6	6	1	1	1	4	4	4	3	3	3
Cap, veh/h	237	465	180	29	476	1259	33	545	32	669	1194	532
Arrive On Green	0.14	0.37	0.37	0.02	0.25	0.25	0.02	0.16	0.16	0.20	0.34	0.34
Sat Flow, veh/h	1725	1243	482	1795	1885	2812	1753	3359	195	3428	3526	1572
Grp Volume(v), veh/h	198	0	136	13	40	838	16	205	212	579	309	107
Grp Sat Flow(s),veh/h/ln	1725	0	1724	1795	1885	1406	1753	1749	1806	1714	1763	1572
Q Serve(g_s), s	8.0	0.0	3.8	0.5	1.2	16.7	0.6	7.9	8.0	11.7	4.5	3.4
Cycle Q Clear(g_c), s	8.0	0.0	3.8	0.5	1.2	16.7	0.6	7.9	8.0	11.7	4.5	3.4
Prop In Lane	1.00		0.28	1.00		1.00	1.00		0.11	1.00		1.00
Lane Grp Cap(c), veh/h	237	0	645	29	476	1259	33	284	293	669	1194	532
V/C Ratio(X)	0.83	0.00	0.21	0.45	0.08	0.67	0.48	0.72	0.72	0.87	0.26	0.20
Avail Cap(c_a), veh/h	254	0	645	126	476	1259	123	463	479	702	1409	628
HCM Platoon Ratio	1.00	1.00	1.00	1.00	1.00	1.00	1.00	1.00	1.00	1.00	1.00	1.00
Upstream Filter(I)	1.00	0.00	1.00	1.00	1.00	1.00	1.00	1.00	1.00	1.00	1.00	1.00
Uniform Delay (d), s/veh	30.0	0.0	15.2	34.8	20.4	15.5	34.6	28.3	28.4	27.8	17.1	16.7
Incr Delay (d2), s/veh	19.8	0.0	0.2	10.9	0.1	1.3	10.3	3.4	3.4	10.6	0.1	0.2
Initial Q Delay(d3),s/veh	0.0	0.0	0.0	0.0	0.0	0.0	0.0	0.0	0.0	0.0	0.0	0.0
%ile BackOfQ(50%),veh/ln	4.5	0.0	1.4	0.3	0.5	5.0	0.4	3.4	3.6	5.5	1.7	1.2
Unsig. Movement Delay, s/veh												
LnGrp Delay(d),s/veh	49.8	0.0	15.3	45.7	20.4	16.8	44.9	31.8	31.8	38.4	17.2	16.9
LnGrp LOS	D	A	B	D	C	B	D	C	C	D	B	B
Approach Vol, veh/h		334			891			433			995	
Approach Delay, s/veh		35.7			17.4			32.2			29.5	
Approach LOS		D			B			C			C	
Timer - Assigned Phs	1	2	3	4	5	6	7	8				
Phs Duration (G+Y+Rc), s	18.4	16.1	5.6	31.2	5.9	28.6	14.3	22.5				
Change Period (Y+Rc), s	4.5	4.5	4.5	4.5	4.5	4.5	4.5	4.5				
Max Green Setting (Gmax), s	14.6	18.9	5.0	23.5	5.0	28.5	10.5	18.0				
Max Q Clear Time (g_c+M), s	11.7	10.0	2.5	5.8	2.6	6.5	10.0	18.7				
Green Ext Time (p_c), s	0.3	1.6	0.0	0.6	0.0	2.3	0.0	0.0				

Intersection Summary

HCM 6th Ctrl Delay	26.7
HCM 6th LOS	C

HCM 6th Signalized Intersection Summary
 13: Airport Drive/Golden State Boulevard & Avenue 17

Village D Specific Plan
 Phase III WP MIT - PM Peak Hour



Movement	EBL	EBT	EBR	WBL	WBT	WBR	NBL	NBT	NBR	SBL	SBT	SBR
Lane Configurations	↘	↑↑	↗	↘	↑↑	↗	↘	↑	↗	↘↗	↘	
Traffic Volume (veh/h)	12	877	160	216	1197	294	248	105	369	422	105	12
Future Volume (veh/h)	12	877	160	216	1197	294	248	105	369	422	105	12
Initial Q (Qb), veh	0	0	0	0	0	0	0	0	0	0	0	0
Ped-Bike Adj(A_pbT)	1.00		1.00	1.00		1.00	1.00		1.00	1.00		1.00
Parking Bus, Adj	1.00	1.00	1.00	1.00	1.00	1.00	1.00	1.00	1.00	1.00	1.00	1.00
Work Zone On Approach		No			No			No			No	
Adj Sat Flow, veh/h/ln	1885	1885	1885	1870	1870	1870	1856	1856	1856	1856	1856	1856
Adj Flow Rate, veh/h	13	953	174	235	1301	320	270	114	401	459	114	13
Peak Hour Factor	0.92	0.92	0.92	0.92	0.92	0.92	0.92	0.92	0.92	0.92	0.92	0.92
Percent Heavy Veh, %	1	1	1	2	2	2	3	3	3	3	3	3
Cap, veh/h	27	1026	458	262	1486	663	301	431	597	529	354	40
Arrive On Green	0.02	0.29	0.29	0.29	0.84	0.84	0.17	0.23	0.23	0.15	0.22	0.22
Sat Flow, veh/h	1795	3582	1598	1781	3554	1585	1767	1856	1572	3428	1635	187
Grp Volume(v), veh/h	13	953	174	235	1301	320	270	114	401	459	0	127
Grp Sat Flow(s),veh/h/ln	1795	1791	1598	1781	1777	1585	1767	1856	1572	1714	0	1822
Q Serve(g_s), s	0.7	25.9	8.7	12.7	22.4	5.5	15.0	5.0	21.2	13.1	0.0	5.9
Cycle Q Clear(g_c), s	0.7	25.9	8.7	12.7	22.4	5.5	15.0	5.0	21.2	13.1	0.0	5.9
Prop In Lane	1.00		1.00	1.00		1.00	1.00		1.00	1.00		0.10
Lane Grp Cap(c), veh/h	27	1026	458	262	1486	663	301	431	597	529	0	395
V/C Ratio(X)	0.48	0.93	0.38	0.90	0.88	0.48	0.90	0.26	0.67	0.87	0.00	0.32
Avail Cap(c_a), veh/h	90	1039	463	276	1486	663	309	431	597	576	0	395
HCM Platoon Ratio	1.00	1.00	1.00	2.00	2.00	2.00	1.00	1.00	1.00	1.00	1.00	1.00
Upstream Filter(I)	1.00	1.00	1.00	0.76	0.76	0.76	1.00	1.00	1.00	1.00	0.00	1.00
Uniform Delay (d), s/veh	48.8	34.7	28.6	34.6	6.6	5.2	40.7	31.4	25.8	41.3	0.0	33.0
Incr Delay (d2), s/veh	12.4	13.9	0.5	23.3	4.8	0.4	26.8	1.5	5.9	12.6	0.0	2.1
Initial Q Delay(d3),s/veh	0.0	0.0	0.0	0.0	0.0	0.0	0.0	0.0	0.0	0.0	0.0	0.0
%ile BackOfQ(50%),veh/ln	0.4	13.0	3.4	6.2	3.7	1.3	8.7	2.4	8.7	6.4	0.0	2.8
Unsig. Movement Delay, s/veh												
LnGrp Delay(d),s/veh	61.3	48.6	29.1	57.9	11.4	5.6	67.4	32.9	31.8	53.9	0.0	35.1
LnGrp LOS	E	D	C	E	B	A	E	C	C	D	A	D
Approach Vol, veh/h		1140			1856			785			586	
Approach Delay, s/veh		45.8			16.3			44.2			49.9	
Approach LOS		D			B			D			D	
Timer - Assigned Phs	1	2	3	4	5	6	7	8				
Phs Duration (G+Y+Rc), s	19.9	27.7	19.2	33.1	21.5	26.2	6.0	46.3				
Change Period (Y+Rc), s	4.5	4.5	4.5	4.5	4.5	4.5	4.5	4.5				
Max Green Setting (Gmax), s	10.8	20.7	15.5	29.0	17.5	20.0	5.0	39.5				
Max Q Clear Time (g_c+Tb), s	11.5	23.2	14.7	27.9	17.0	7.9	2.7	24.4				
Green Ext Time (p_c), s	0.3	0.0	0.1	0.8	0.0	0.4	0.0	9.3				
Intersection Summary												
HCM 6th Ctrl Delay											33.5	
HCM 6th LOS											C	

HCM 6th Signalized Intersection Summary
 14: Avenue 17 & SR-99 Southbound Off-Ramp

Village D Specific Plan
 Phase III WP MIT - PM Peak Hour

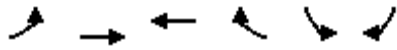

Movement	EBL	EBT	WBT	WBR	SBL	SBR
Lane Configurations		↑↑↑	↑↑↑		↑↑	↑
Traffic Volume (veh/h)	0	1668	1615	0	452	92
Future Volume (veh/h)	0	1668	1615	0	452	92
Initial Q (Qb), veh	0	0	0	0	0	0
Ped-Bike Adj(A_pbT)	1.00			1.00	1.00	1.00
Parking Bus, Adj	1.00	1.00	1.00	1.00	1.00	1.00
Work Zone On Approach		No	No		No	
Adj Sat Flow, veh/h/ln	0	1870	1870	0	1856	1856
Adj Flow Rate, veh/h	0	1813	1755	0	491	100
Peak Hour Factor	0.92	0.92	0.92	0.92	0.92	0.92
Percent Heavy Veh, %	0	2	2	0	3	3
Cap, veh/h	0	2146	2146	0	1679	770
Arrive On Green	0.00	0.84	0.84	0.00	0.49	0.49
Sat Flow, veh/h	0	5443	5443	0	3428	1572
Grp Volume(v), veh/h	0	1813	1755	0	491	100
Grp Sat Flow(s),veh/h/ln	0	1702	1702	0	1714	1572
Q Serve(g_s), s	0.0	19.5	17.5	0.0	8.5	3.5
Cycle Q Clear(g_c), s	0.0	19.5	17.5	0.0	8.5	3.5
Prop In Lane	0.00			0.00	1.00	1.00
Lane Grp Cap(c), veh/h	0	2146	2146	0	1679	770
V/C Ratio(X)	0.00	0.84	0.82	0.00	0.29	0.13
Avail Cap(c_a), veh/h	0	3089	3089	0	1679	770
HCM Platoon Ratio	1.00	2.00	2.00	1.00	1.00	1.00
Upstream Filter(I)	0.00	0.46	1.00	0.00	1.00	1.00
Uniform Delay (d), s/veh	0.0	6.2	6.0	0.0	15.2	13.9
Incr Delay (d2), s/veh	0.0	0.7	1.2	0.0	0.4	0.3
Initial Q Delay(d3),s/veh	0.0	0.0	0.0	0.0	0.0	0.0
%ile BackOfQ(50%),veh/ln	0.0	2.6	2.6	0.0	3.3	1.3
Unsig. Movement Delay, s/veh						
LnGrp Delay(d),s/veh	0.0	6.9	7.2	0.0	15.6	14.3
LnGrp LOS	A	A	A	A	B	B
Approach Vol, veh/h		1813	1755		591	
Approach Delay, s/veh		6.9	7.2		15.4	
Approach LOS		A	A		B	
Timer - Assigned Phs				4	6	8
Phs Duration (G+Y+Rc), s				46.5	53.5	46.5
Change Period (Y+Rc), s				4.5	4.5	4.5
Max Green Setting (Gmax), s				60.5	30.5	60.5
Max Q Clear Time (g_c+I1), s				21.5	10.5	19.5
Green Ext Time (p_c), s				20.5	2.1	20.1
Intersection Summary						
HCM 6th Ctrl Delay			8.2			
HCM 6th LOS			A			

HCM 6th Signalized Intersection Summary
15: SR-99 Northbound Ramps & Avenue 17

Village D Specific Plan
Phase III WP MIT - PM Peak Hour



Movement	EBL	EBT	EBR	WBL	WBT	WBR	NBL	NBT	NBR	SBL	SBT	SBR
Lane Configurations	↖ ↗	↑ ↑ ↑			↑ ↑ ↑	↖ ↗	↖ ↗	↖ ↗	↖ ↗			
Traffic Volume (veh/h)	180	1230	0	0	1494	351	821	4	529	0	0	0
Future Volume (veh/h)	180	1230	0	0	1494	351	821	4	529	0	0	0
Initial Q (Qb), veh	0	0	0	0	0	0	0	0	0			
Ped-Bike Adj(A_pbT)	1.00		1.00	1.00		1.00	1.00		1.00			
Parking Bus, Adj	1.00	1.00	1.00	1.00	1.00	1.00	1.00	1.00	1.00			
Work Zone On Approach		No			No			No				
Adj Sat Flow, veh/h/ln	1870	1870	0	0	1885	1885	1870	1870	1870			
Adj Flow Rate, veh/h	189	1295	0	0	1573	369	867	0	557			
Peak Hour Factor	0.95	0.95	0.95	0.95	0.95	0.95	0.95	0.95	0.95			
Percent Heavy Veh, %	2	2	0	0	1	1	2	2	2			
Cap, veh/h	218	2629	0	0	1787	555	1408	0	1253			
Arrive On Green	0.25	1.00	0.00	0.00	0.35	0.35	0.40	0.00	0.40			
Sat Flow, veh/h	1781	5274	0	0	5316	1598	3563	0	3170			
Grp Volume(v), veh/h	189	1295	0	0	1573	369	867	0	557			
Grp Sat Flow(s),veh/h/ln	1781	1702	0	0	1716	1598	1781	0	1585			
Q Serve(g_s), s	10.2	0.0	0.0	0.0	28.7	19.6	19.5	0.0	12.9			
Cycle Q Clear(g_c), s	10.2	0.0	0.0	0.0	28.7	19.6	19.5	0.0	12.9			
Prop In Lane	1.00		0.00	0.00		1.00	1.00		1.00			
Lane Grp Cap(c), veh/h	218	2629	0	0	1787	555	1408	0	1253			
V/C Ratio(X)	0.87	0.49	0.00	0.00	0.88	0.67	0.62	0.00	0.44			
Avail Cap(c_a), veh/h	276	2834	0	0	1827	567	1408	0	1253			
HCM Platoon Ratio	2.00	2.00	1.00	1.00	1.00	1.00	1.00	1.00	1.00			
Upstream Filter(l)	1.00	1.00	0.00	0.00	1.00	1.00	1.00	0.00	1.00			
Uniform Delay (d), s/veh	37.0	0.0	0.0	0.0	30.7	27.7	24.2	0.0	22.2			
Incr Delay (d2), s/veh	20.1	0.1	0.0	0.0	5.3	2.9	2.0	0.0	1.1			
Initial Q Delay(d3),s/veh	0.0	0.0	0.0	0.0	0.0	0.0	0.0	0.0	0.0			
%ile BackOfQ(50%),veh/ln	5.1	0.0	0.0	0.0	12.4	7.7	8.4	0.0	4.9			
Unsig. Movement Delay, s/veh												
LnGrp Delay(d),s/veh	57.1	0.1	0.0	0.0	36.0	30.6	26.2	0.0	23.3			
LnGrp LOS	E	A	A	A	D	C	C	A	C			
Approach Vol, veh/h		1484			1942			1424				
Approach Delay, s/veh		7.4			34.9			25.1				
Approach LOS		A			C			C				
Timer - Assigned Phs		2		4			7	8				
Phs Duration (G+Y+Rc), s		44.0		56.0			16.8	39.2				
Change Period (Y+Rc), s		4.5		4.5			4.5	4.5				
Max Green Setting (Gmax), s		35.5		55.5			15.5	35.5				
Max Q Clear Time (g_c+1), s		21.5		2.0			12.2	30.7				
Green Ext Time (p_c), s		5.3		13.5			0.2	4.0				

Intersection Summary

HCM 6th Ctrl Delay	23.6
HCM 6th LOS	C

Notes

User approved volume balancing among the lanes for turning movement.

HCM 6th Signalized Intersection Summary
 16: Love's Truck Stop Driveway/Driveway & Avenue 17

Village D Specific Plan
 Phase III WP MIT - PM Peak Hour



Movement	EBL	EBT	EBR	WBL	WBT	WBR	NBL	NBT	NBR	SBL	SBT	SBR
Lane Configurations	↖↗	↑↑↑	↖	↖	↑↑↑	↖	↖	↖		↖	↑	↖
Traffic Volume (veh/h)	556	1048	141	32	1149	189	160	0	31	279	0	519
Future Volume (veh/h)	556	1048	141	32	1149	189	160	0	31	279	0	519
Initial Q (Qb), veh	0	0	0	0	0	0	0	0	0	0	0	0
Ped-Bike Adj(A_pbT)	1.00		1.00	1.00		1.00	1.00		1.00	1.00		1.00
Parking Bus, Adj	1.00	1.00	1.00	1.00	1.00	1.00	1.00	1.00	1.00	1.00	1.00	1.00
Work Zone On Approach		No		No		No		No		No		No
Adj Sat Flow, veh/h/ln	1885	1885	1885	1885	1885	1885	1900	1900	1900	1900	1900	1900
Adj Flow Rate, veh/h	604	1139	153	35	1249	205	174	0	34	303	0	564
Peak Hour Factor	0.92	0.92	0.92	0.92	0.92	0.92	0.92	0.92	0.92	0.92	0.92	0.92
Percent Heavy Veh, %	1	1	1	1	1	1	0	0	0	0	0	0
Cap, veh/h	623	2177	676	56	1415	439	197	0	311	313	488	702
Arrive On Green	0.18	0.42	0.42	0.03	0.28	0.28	0.11	0.00	0.19	0.17	0.00	0.26
Sat Flow, veh/h	3483	5147	1598	1795	5147	1598	1810	0	1610	1810	1900	1610
Grp Volume(v), veh/h	604	1139	153	35	1249	205	174	0	34	303	0	564
Grp Sat Flow(s),veh/h/ln	1742	1716	1598	1795	1716	1598	1810	0	1610	1810	1900	1610
Q Serve(g_s), s	17.2	16.4	6.1	1.9	23.2	10.7	9.5	0.0	1.7	16.6	0.0	25.7
Cycle Q Clear(g_c), s	17.2	16.4	6.1	1.9	23.2	10.7	9.5	0.0	1.7	16.6	0.0	25.7
Prop In Lane	1.00		1.00	1.00		1.00	1.00		1.00	1.00		1.00
Lane Grp Cap(c), veh/h	623	2177	676	56	1415	439	197	0	311	313	488	702
V/C Ratio(X)	0.97	0.52	0.23	0.63	0.88	0.47	0.88	0.00	0.11	0.97	0.00	0.80
Avail Cap(c_a), veh/h	623	2177	676	111	1415	439	197	0	311	313	488	702
HCM Platoon Ratio	1.00	1.00	1.00	1.00	1.00	1.00	1.00	1.00	1.00	1.00	1.00	1.00
Upstream Filter(I)	1.00	1.00	1.00	1.00	1.00	1.00	1.00	0.00	1.00	1.00	0.00	1.00
Uniform Delay (d), s/veh	40.8	21.4	18.4	47.9	34.7	30.1	43.9	0.0	33.3	41.1	0.0	24.5
Incr Delay (d2), s/veh	28.3	0.9	0.8	11.0	8.3	3.5	34.0	0.0	0.7	42.1	0.0	9.5
Initial Q Delay(d3),s/veh	0.0	0.0	0.0	0.0	0.0	0.0	0.0	0.0	0.0	0.0	0.0	0.0
%ile BackOfQ(50%),veh/ln	9.7	6.6	2.4	1.0	10.6	4.5	6.1	0.0	0.7	11.0	0.0	12.9
Unsig. Movement Delay, s/veh												
LnGrp Delay(d),s/veh	69.0	22.3	19.2	58.9	43.0	33.7	77.9	0.0	34.0	83.2	0.0	33.9
LnGrp LOS	E	C	B	E	D	C	E	A	C	F	A	C
Approach Vol, veh/h		1896			1489			208				867
Approach Delay, s/veh		36.9			42.1			70.7				51.1
Approach LOS		D			D			E				D
Timer - Assigned Phs	1	2	3	4	5	6	7	8				
Phs Duration (G+Y+Rc), s	7.6	46.8	15.4	30.2	22.4	32.0	21.8	23.8				
Change Period (Y+Rc), s	4.5	4.5	4.5	4.5	4.5	4.5	4.5	4.5				
Max Green Setting (Gmax), s	39.2	39.2	10.9	25.7	17.9	27.5	17.3	19.3				
Max Q Clear Time (g_c+1), s	18.4	18.4	11.5	27.7	19.2	25.2	18.6	3.7				
Green Ext Time (p_c), s	0.0	9.0	0.0	0.0	0.0	1.7	0.0	0.1				

Intersection Summary

HCM 6th Ctrl Delay				43.0								
HCM 6th LOS				D								

HCM 6th Signalized Intersection Summary
 17: Westberry Boulevard & Cleveland Avenue

Village D Specific Plan
 Phase III WP MIT - PM Peak Hour



Movement	EBL	EBT	EBR	WBL	WBT	WBR	NBL	NBT	NBR	SBL	SBT	SBR
Lane Configurations												
Traffic Volume (veh/h)	250	749	53	141	1060	34	62	61	121	27	200	384
Future Volume (veh/h)	250	749	53	141	1060	34	62	61	121	27	200	384
Initial Q (Qb), veh	0	0	0	0	0	0	0	0	0	0	0	0
Ped-Bike Adj(A_pbT)	1.00		1.00	1.00		1.00	1.00		1.00	1.00		1.00
Parking Bus, Adj	1.00	1.00	1.00	1.00	1.00	1.00	1.00	1.00	1.00	1.00	1.00	1.00
Work Zone On Approach		No			No			No			No	
Adj Sat Flow, veh/h/ln	1900	1900	1900	1900	1900	1900	1900	1900	1900	1900	1900	1900
Adj Flow Rate, veh/h	272	814	58	153	1152	37	67	66	132	29	217	417
Peak Hour Factor	0.92	0.92	0.92	0.92	0.92	0.92	0.92	0.92	0.92	0.92	0.92	0.92
Percent Heavy Veh, %	0	0	0	0	0	0	0	0	0	0	0	0
Cap, veh/h	306	1456	647	189	1208	39	87	501	424	52	464	393
Arrive On Green	0.17	0.40	0.40	0.10	0.34	0.34	0.05	0.26	0.26	0.03	0.24	0.24
Sat Flow, veh/h	1810	3610	1604	1810	3569	115	1810	1900	1610	1810	1900	1610
Grp Volume(v), veh/h	272	814	58	153	582	607	67	66	132	29	217	417
Grp Sat Flow(s),veh/h/ln	1810	1805	1604	1810	1805	1879	1810	1900	1610	1810	1900	1610
Q Serve(g_s), s	13.2	15.6	2.0	7.4	28.4	28.4	3.3	2.4	5.9	1.4	8.8	22.0
Cycle Q Clear(g_c), s	13.2	15.6	2.0	7.4	28.4	28.4	3.3	2.4	5.9	1.4	8.8	22.0
Prop In Lane	1.00		1.00	1.00		0.06	1.00		1.00	1.00		1.00
Lane Grp Cap(c), veh/h	306	1456	647	189	611	636	87	501	424	52	464	393
V/C Ratio(X)	0.89	0.56	0.09	0.81	0.95	0.95	0.77	0.13	0.31	0.56	0.47	1.06
Avail Cap(c_a), veh/h	312	1456	647	300	612	637	107	501	424	103	464	393
HCM Platoon Ratio	1.00	1.00	1.00	1.00	1.00	1.00	1.00	1.00	1.00	1.00	1.00	1.00
Upstream Filter(I)	1.00	1.00	1.00	1.00	1.00	1.00	1.00	1.00	1.00	0.74	0.74	0.74
Uniform Delay (d), s/veh	36.5	20.7	16.6	39.4	29.1	29.1	42.4	25.3	26.6	43.2	29.0	34.0
Incr Delay (d2), s/veh	24.9	0.5	0.1	8.5	25.2	24.7	24.1	0.5	1.9	6.8	2.5	55.8
Initial Q Delay(d3),s/veh	0.0	0.0	0.0	0.0	0.0	0.0	0.0	0.0	0.0	0.0	0.0	0.0
%ile BackOfQ(50%),veh/ln	7.8	6.4	0.7	3.7	16.0	16.6	2.0	1.1	2.5	0.7	4.2	14.4
Unsig. Movement Delay, s/veh												
LnGrp Delay(d),s/veh	61.5	21.2	16.7	48.0	54.3	53.7	66.5	25.8	28.5	50.0	31.5	89.8
LnGrp LOS	E	C	B	D	D	D	E	C	C	D	C	F
Approach Vol, veh/h		1144			1342			265			663	
Approach Delay, s/veh		30.5			53.3			37.4			69.0	
Approach LOS		C			D			D			E	
Timer - Assigned Phs	1	2	3	4	5	6	7	8				
Phs Duration (G+Y+Rc), s	7.1	28.2	13.9	40.8	8.8	26.5	19.7	35.0				
Change Period (Y+Rc), s	4.5	4.5	4.5	4.5	4.5	4.5	4.5	4.5				
Max Green Setting (Gmax), s	5.1	20.9	14.9	31.1	5.3	20.7	15.5	30.5				
Max Q Clear Time (g_c+1), s	4.5	7.9	9.4	17.6	5.3	24.0	15.2	30.4				
Green Ext Time (p_c), s	0.0	0.6	0.2	4.9	0.0	0.0	0.0	0.1				

Intersection Summary

HCM 6th Ctrl Delay	47.5
HCM 6th LOS	D

HCM 6th Signalized Intersection Summary
18: Westberry Boulevard & Sunset Avenue

Village D Specific Plan
Phase III WP MIT - PM Peak Hour



Movement	EBL	EBT	EBR	WBL	WBT	WBR	NBL	NBT	NBR	SBL	SBT	SBR
Lane Configurations												
Traffic Volume (veh/h)	42	153	55	77	192	21	72	194	61	24	211	59
Future Volume (veh/h)	42	153	55	77	192	21	72	194	61	24	211	59
Initial Q (Qb), veh	0	0	0	0	0	0	0	0	0	0	0	0
Ped-Bike Adj(A_pbT)	1.00		0.98	1.00		1.00	1.00		1.00	1.00		1.00
Parking Bus, Adj	1.00	1.00	1.00	1.00	1.00	1.00	1.00	1.00	1.00	1.00	1.00	1.00
Work Zone On Approach		No		No		No		No		No		No
Adj Sat Flow, veh/h/ln	1900	1900	1900	1900	1900	1900	1900	1900	1900	1900	1900	1900
Adj Flow Rate, veh/h	44	159	57	80	200	22	75	202	64	25	220	61
Peak Hour Factor	0.96	0.96	0.96	0.96	0.96	0.96	0.96	0.96	0.96	0.96	0.96	0.96
Percent Heavy Veh, %	0	0	0	0	0	0	0	0	0	0	0	0
Cap, veh/h	435	357	128	435	452	50	139	494	419	57	407	345
Arrive On Green	0.27	0.27	0.27	0.27	0.27	0.27	0.08	0.26	0.26	0.03	0.21	0.21
Sat Flow, veh/h	1177	1326	475	1184	1682	185	1810	1900	1610	1810	1900	1610
Grp Volume(v), veh/h	44	0	216	80	0	222	75	202	64	25	220	61
Grp Sat Flow(s),veh/h/ln	1177	0	1801	1184	0	1867	1810	1900	1610	1810	1900	1610
Q Serve(g_s), s	1.0	0.0	3.1	1.8	0.0	3.0	1.2	2.7	0.9	0.4	3.2	0.9
Cycle Q Clear(g_c), s	4.0	0.0	3.1	4.9	0.0	3.0	1.2	2.7	0.9	0.4	3.2	0.9
Prop In Lane	1.00		0.26	1.00		0.10	1.00		1.00	1.00		1.00
Lane Grp Cap(c), veh/h	435	0	484	435	0	502	139	494	419	57	407	345
V/C Ratio(X)	0.10	0.00	0.45	0.18	0.00	0.44	0.54	0.41	0.15	0.44	0.54	0.18
Avail Cap(c_a), veh/h	1058	0	1437	1061	0	1489	796	2073	1757	501	1764	1495
HCM Platoon Ratio	1.00	1.00	1.00	1.00	1.00	1.00	1.00	1.00	1.00	1.00	1.00	1.00
Upstream Filter(I)	1.00	0.00	1.00	1.00	0.00	1.00	1.00	1.00	1.00	1.00	1.00	1.00
Uniform Delay (d), s/veh	11.0	0.0	9.3	11.4	0.0	9.3	13.6	9.4	8.8	14.6	10.7	9.8
Incr Delay (d2), s/veh	0.1	0.0	0.6	0.2	0.0	0.6	3.2	0.5	0.2	5.3	1.1	0.2
Initial Q Delay(d3),s/veh	0.0	0.0	0.0	0.0	0.0	0.0	0.0	0.0	0.0	0.0	0.0	0.0
%ile BackOfQ(50%),veh/ln	0.2	0.0	0.9	0.4	0.0	0.9	0.5	0.8	0.2	0.2	1.1	0.3
Unsig. Movement Delay, s/veh												
LnGrp Delay(d),s/veh	11.1	0.0	10.0	11.6	0.0	9.9	16.9	9.9	8.9	19.9	11.8	10.1
LnGrp LOS	B	A	A	B	A	A	B	A	A	B	B	B
Approach Vol, veh/h		260		302		341		306				
Approach Delay, s/veh		10.2		10.4		11.3		12.1				
Approach LOS		B		B		B		B				
Timer - Assigned Phs	1	2	4	5	6	8						
Phs Duration (G+Y+Rc), s	5.5	12.5		12.8	6.9	11.1		12.8				
Change Period (Y+Rc), s	4.5	4.5		4.5	4.5	4.5		4.5				
Max Green Setting (Gmax), s	5	33.5		24.5	13.5	28.5		24.5				
Max Q Clear Time (g_c+1), s	12.4	4.7		6.0	3.2	5.2		6.9				
Green Ext Time (p_c), s	0.0	1.4		1.3	0.1	1.4		1.4				
Intersection Summary												
HCM 6th Ctrl Delay				11.0								
HCM 6th LOS				B								

HCM 6th Signalized Intersection Summary
 19: Westberry Boulevard & Avenue 14

Village D Specific Plan
 Phase III WP MIT - PM Peak Hour



Movement	EBL	EBT	EBR	WBL	WBT	WBR	NBL	NBT	NBR	SBL	SBT	SBR
Lane Configurations	↖	↖↗		↖	↖↗	↖	↖	↗		↖	↗	
Traffic Volume (veh/h)	88	660	69	23	720	240	54	53	17	151	57	88
Future Volume (veh/h)	88	660	69	23	720	240	54	53	17	151	57	88
Initial Q (Qb), veh	0	0	0	0	0	0	0	0	0	0	0	0
Ped-Bike Adj(A_pbT)	1.00		1.00	1.00		1.00	1.00		1.00	1.00		1.00
Parking Bus, Adj	1.00	1.00	1.00	1.00	1.00	1.00	1.00	1.00	1.00	1.00	1.00	1.00
Work Zone On Approach		No			No			No			No	
Adj Sat Flow, veh/h/ln	1856	1856	1856	1856	1856	1856	1900	1900	1900	1900	1900	1900
Adj Flow Rate, veh/h	96	717	75	25	783	261	59	58	18	164	62	96
Peak Hour Factor	0.92	0.92	0.92	0.92	0.92	0.92	0.92	0.92	0.92	0.92	0.92	0.92
Percent Heavy Veh, %	3	3	3	3	3	3	0	0	0	0	0	0
Cap, veh/h	132	1215	127	52	1171	520	102	147	46	214	113	174
Arrive On Green	0.07	0.38	0.38	0.03	0.33	0.33	0.06	0.11	0.11	0.12	0.17	0.17
Sat Flow, veh/h	1767	3220	337	1767	3526	1565	1810	1390	431	1810	671	1039
Grp Volume(v), veh/h	96	392	400	25	783	261	59	0	76	164	0	158
Grp Sat Flow(s),veh/h/ln	1767	1763	1793	1767	1763	1565	1810	0	1821	1810	0	1709
Q Serve(g_s), s	2.6	8.7	8.7	0.7	9.3	6.5	1.6	0.0	1.9	4.3	0.0	4.1
Cycle Q Clear(g_c), s	2.6	8.7	8.7	0.7	9.3	6.5	1.6	0.0	1.9	4.3	0.0	4.1
Prop In Lane	1.00		0.19	1.00		1.00	1.00		0.24	1.00		0.61
Lane Grp Cap(c), veh/h	132	665	677	52	1171	520	102	0	193	214	0	287
V/C Ratio(X)	0.73	0.59	0.59	0.48	0.67	0.50	0.58	0.00	0.39	0.77	0.00	0.55
Avail Cap(c_a), veh/h	272	900	915	185	1626	722	252	0	765	426	0	883
HCM Platoon Ratio	1.00	1.00	1.00	1.00	1.00	1.00	1.00	1.00	1.00	1.00	1.00	1.00
Upstream Filter(l)	1.00	1.00	1.00	1.00	1.00	1.00	1.00	0.00	1.00	1.00	0.00	1.00
Uniform Delay (d), s/veh	22.1	12.2	12.2	23.3	14.0	13.1	22.5	0.0	20.3	20.9	0.0	18.6
Incr Delay (d2), s/veh	7.5	0.8	0.8	6.7	0.7	0.8	5.1	0.0	1.3	5.7	0.0	1.6
Initial Q Delay(d3),s/veh	0.0	0.0	0.0	0.0	0.0	0.0	0.0	0.0	0.0	0.0	0.0	0.0
%ile BackOfQ(50%),veh/ln	1.3	3.0	3.0	0.4	3.2	2.0	0.7	0.0	0.8	2.0	0.0	1.6
Unsig. Movement Delay, s/veh												
LnGrp Delay(d),s/veh	29.6	13.0	13.0	30.0	14.7	13.8	27.5	0.0	21.6	26.5	0.0	20.3
LnGrp LOS	C	B	B	C	B	B	C	A	C	C	A	C
Approach Vol, veh/h		888			1069			135			322	
Approach Delay, s/veh		14.8			14.8			24.2			23.4	
Approach LOS		B			B			C			C	
Timer - Assigned Phs	1	2	3	4	5	6	7	8				
Phs Duration (G+Y+Rc), s	10.3	9.7	5.9	22.9	7.3	12.7	8.1	20.7				
Change Period (Y+Rc), s	4.5	4.5	4.5	4.5	4.5	4.5	4.5	4.5				
Max Green Setting (Gmax), s	5	20.5	5.1	24.9	6.8	25.2	7.5	22.5				
Max Q Clear Time (g_c+10), s	3	3.9	2.7	10.7	3.6	6.1	4.6	11.3				
Green Ext Time (p_c), s	0.2	0.3	0.0	4.4	0.0	0.8	0.0	4.8				
Intersection Summary												
HCM 6th Ctrl Delay				16.5								
HCM 6th LOS				B								

HCM 6th Signalized Intersection Summary
 20: Westberry Boulevard & Avenue 16

Village D Specific Plan
 Phase III WP MIT - PM Peak Hour



Movement	EBL	EBT	EBR	WBL	WBT	WBR	NBL	NBT	NBR	SBL	SBT	SBR
Lane Configurations												
Traffic Volume (veh/h)	0	0	0	456	0	137	0	97	268	231	183	0
Future Volume (veh/h)	0	0	0	456	0	137	0	97	268	231	183	0
Initial Q (Qb), veh	0	0	0	0	0	0	0	0	0	0	0	0
Ped-Bike Adj(A_pbT)	1.00		1.00	1.00		0.98	1.00		1.00	1.00		1.00
Parking Bus, Adj	1.00	1.00	1.00	1.00	1.00	1.00	1.00	1.00	1.00	1.00	1.00	1.00
Work Zone On Approach	No			No			No			No		
Adj Sat Flow, veh/h/ln	1900	1900	1900	1885	1885	1885	1900	1900	1900	1900	1900	1900
Adj Flow Rate, veh/h	0	0	0	496	0	149	0	105	291	251	199	0
Peak Hour Factor	0.92	0.92	0.92	0.92	0.92	0.92	0.92	0.92	0.92	0.92	0.92	0.92
Percent Heavy Veh, %	0	0	0	1	1	1	0	0	0	0	0	0
Cap, veh/h	4	4	0	561	589	489	4	445	377	307	947	0
Arrive On Green	0.00	0.00	0.00	0.31	0.00	0.31	0.00	0.23	0.23	0.17	0.50	0.00
Sat Flow, veh/h	1810	1900	0	1795	1885	1564	1810	1900	1610	1810	1900	0
Grp Volume(v), veh/h	0	0	0	496	0	149	0	105	291	251	199	0
Grp Sat Flow(s),veh/h/ln	1810	1900	0	1795	1885	1564	1810	1900	1610	1810	1900	0
Q Serve(g_s), s	0.0	0.0	0.0	12.5	0.0	3.4	0.0	2.1	8.0	6.4	2.8	0.0
Cycle Q Clear(g_c), s	0.0	0.0	0.0	12.5	0.0	3.4	0.0	2.1	8.0	6.4	2.8	0.0
Prop In Lane	1.00		0.00	1.00		1.00	1.00		1.00	1.00		0.00
Lane Grp Cap(c), veh/h	4	4	0	561	589	489	4	445	377	307	947	0
V/C Ratio(X)	0.00	0.00	0.00	0.88	0.00	0.30	0.00	0.24	0.77	0.82	0.21	0.00
Avail Cap(c_a), veh/h	190	719	0	623	1170	970	190	759	643	323	947	0
HCM Platoon Ratio	1.00	1.00	1.00	1.00	1.00	1.00	1.00	1.00	1.00	1.00	1.00	1.00
Upstream Filter(I)	0.00	0.00	0.00	1.00	0.00	1.00	0.00	1.00	1.00	1.00	1.00	0.00
Uniform Delay (d), s/veh	0.0	0.0	0.0	15.5	0.0	12.4	0.0	14.8	17.0	19.0	6.7	0.0
Incr Delay (d2), s/veh	0.0	0.0	0.0	13.3	0.0	0.3	0.0	0.3	3.4	14.5	0.1	0.0
Initial Q Delay(d3),s/veh	0.0	0.0	0.0	0.0	0.0	0.0	0.0	0.0	0.0	0.0	0.0	0.0
%ile BackOfQ(50%),veh/ln	0.0	0.0	0.0	6.3	0.0	1.1	0.0	0.8	2.9	3.6	0.9	0.0
Unsig. Movement Delay, s/veh												
LnGrp Delay(d),s/veh	0.0	0.0	0.0	28.8	0.0	12.8	0.0	15.0	20.4	33.5	6.8	0.0
LnGrp LOS	A	A	A	C	A	B	A	B	C	C	A	A
Approach Vol, veh/h	0			645			396			450		
Approach Delay, s/veh	0.0			25.1			19.0			21.7		
Approach LOS				C			B			C		
Timer - Assigned Phs	1	2	3	4	5	6	7	8				
Phs Duration (G+Y+Rc), s	12.6	15.6	19.4	0.0	0.0	28.2	0.0	19.4				
Change Period (Y+Rc), s	4.5	4.5	4.5	4.5	4.5	4.5	4.5	4.5				
Max Green Setting (Gmax), s	19.0	19.0	16.5	18.0	5.0	22.5	5.0	29.5				
Max Q Clear Time (g_c+1), s	10.4	10.0	14.5	0.0	0.0	4.8	0.0	5.4				
Green Ext Time (p_c), s	0.0	1.1	0.4	0.0	0.0	1.0	0.0	0.5				
Intersection Summary												
HCM 6th Ctrl Delay				22.5								
HCM 6th LOS				C								

HCM 6th Signalized Intersection Summary

21: Granada Drive & Cleveland Avenue

Village D Specific Plan
Phase III WP MIT - PM Peak Hour



Movement	EBL	EBT	EBR	WBL	WBT	WBR	NBL	NBT	NBR	SBL	SBT	SBR
Lane Configurations												
Traffic Volume (veh/h)	29	740	26	379	1126	72	29	275	236	64	362	58
Future Volume (veh/h)	29	740	26	379	1126	72	29	275	236	64	362	58
Initial Q (Qb), veh	0	0	0	0	0	0	0	0	0	0	0	0
Ped-Bike Adj(A_pbT)	1.00		1.00	1.00		0.98	1.00		0.99	1.00		1.00
Parking Bus, Adj	1.00	1.00	1.00	1.00	1.00	1.00	1.00	1.00	1.00	1.00	1.00	1.00
Work Zone On Approach		No			No			No			No	
Adj Sat Flow, veh/h/ln	1900	1900	1900	1900	1900	1900	1900	1900	1900	1900	1900	1900
Adj Flow Rate, veh/h	31	787	28	403	1198	77	31	293	251	68	385	62
Peak Hour Factor	0.94	0.94	0.94	0.94	0.94	0.94	0.94	0.94	0.94	0.94	0.94	0.94
Percent Heavy Veh, %	0	0	0	0	0	0	0	0	0	0	0	0
Cap, veh/h	54	849	30	439	1630	710	54	513	429	88	548	464
Arrive On Green	0.03	0.24	0.24	0.16	0.30	0.30	0.03	0.27	0.27	0.05	0.29	0.29
Sat Flow, veh/h	1810	3555	126	1810	3610	1573	1810	1900	1590	1810	1900	1610
Grp Volume(v), veh/h	31	400	415	403	1198	77	31	293	251	68	385	62
Grp Sat Flow(s),veh/h/ln	1810	1805	1877	1810	1805	1573	1810	1900	1590	1810	1900	1610
Q Serve(g_s), s	1.5	19.5	19.5	19.7	26.8	3.2	1.5	12.0	12.3	3.3	16.3	2.6
Cycle Q Clear(g_c), s	1.5	19.5	19.5	19.7	26.8	3.2	1.5	12.0	12.3	3.3	16.3	2.6
Prop In Lane	1.00		0.07	1.00		1.00	1.00		1.00	1.00		1.00
Lane Grp Cap(c), veh/h	54	431	448	439	1630	710	54	513	429	88	548	464
V/C Ratio(X)	0.57	0.93	0.93	0.92	0.73	0.11	0.57	0.57	0.59	0.77	0.70	0.13
Avail Cap(c_a), veh/h	103	431	448	452	1630	710	101	513	429	123	548	464
HCM Platoon Ratio	1.00	1.00	1.00	0.67	0.67	0.67	1.00	1.00	1.00	1.00	1.00	1.00
Upstream Filter(I)	1.00	1.00	1.00	0.20	0.20	0.20	1.00	1.00	1.00	1.00	1.00	1.00
Uniform Delay (d), s/veh	43.1	33.5	33.5	36.8	26.6	18.3	43.1	28.4	28.5	42.3	28.6	23.7
Incr Delay (d2), s/veh	9.1	26.1	25.5	6.4	0.4	0.0	9.1	4.6	5.7	17.9	7.4	0.6
Initial Q Delay(d3),s/veh	0.0	0.0	0.0	0.0	0.0	0.0	0.0	0.0	0.0	0.0	0.0	0.0
%ile BackOfQ(50%),veh/ln	0.8	11.4	11.8	9.8	12.0	1.1	0.8	6.0	5.3	1.9	8.3	1.0
Unsig. Movement Delay, s/veh												
LnGrp Delay(d),s/veh	52.2	59.6	59.0	43.2	26.9	18.3	52.2	32.9	34.2	60.2	35.9	24.3
LnGrp LOS	D	E	E	D	C	B	D	C	C	E	D	C
Approach Vol, veh/h		846			1678			575			515	
Approach Delay, s/veh		59.0			30.4			34.5			37.7	
Approach LOS		E			C			C			D	
Timer - Assigned Phs	1	2	3	4	5	6	7	8				
Phs Duration (G+Y+Rc), s	8.9	28.8	26.4	26.0	7.2	30.5	7.2	45.1				
Change Period (Y+Rc), s	4.5	4.5	4.5	4.5	4.5	4.5	4.5	4.5				
Max Green Setting (Gmax), s	6.1	21.9	22.5	21.5	5.0	23.0	5.1	38.9				
Max Q Clear Time (g_c+I1), s	5.3	14.3	21.7	21.5	3.5	18.3	3.5	28.8				
Green Ext Time (p_c), s	0.0	1.6	0.1	0.0	0.0	1.1	0.0	6.0				
Intersection Summary												
HCM 6th Ctrl Delay				38.8								
HCM 6th LOS				D								

HCM 6th Signalized Intersection Summary
 22: Granada Drive & Sunset Avenue

Village D Specific Plan
 Phase III WP MIT - PM Peak Hour



Movement	EBL	EBT	EBR	WBL	WBT	WBR	NBL	NBT	NBR	SBL	SBT	SBR
Lane Configurations												
Traffic Volume (veh/h)	32	172	39	57	220	113	53	289	44	84	358	41
Future Volume (veh/h)	32	172	39	57	220	113	53	289	44	84	358	41
Initial Q (Qb), veh	0	0	0	0	0	0	0	0	0	0	0	0
Ped-Bike Adj(A_pbT)	1.00		0.99	1.00		0.99	1.00		0.99	1.00		0.99
Parking Bus, Adj	1.00	1.00	1.00	1.00	1.00	1.00	1.00	1.00	1.00	1.00	1.00	1.00
Work Zone On Approach		No			No			No			No	
Adj Sat Flow, veh/h/ln	1900	1900	1900	1900	1900	1900	1885	1885	1885	1885	1885	1885
Adj Flow Rate, veh/h	34	185	42	61	237	122	57	311	47	90	385	44
Peak Hour Factor	0.93	0.93	0.93	0.93	0.93	0.93	0.93	0.93	0.93	0.93	0.93	0.93
Percent Heavy Veh, %	0	0	0	0	0	0	1	1	1	1	1	1
Cap, veh/h	64	250	57	94	348	293	89	696	105	116	747	85
Arrive On Green	0.04	0.17	0.17	0.05	0.18	0.18	0.05	0.44	0.44	0.06	0.45	0.45
Sat Flow, veh/h	1810	1496	340	1810	1900	1597	1795	1598	242	1795	1660	190
Grp Volume(v), veh/h	34	0	227	61	237	122	57	0	358	90	0	429
Grp Sat Flow(s),veh/h/ln	1810	0	1835	1810	1900	1597	1795	0	1840	1795	0	1850
Q Serve(g_s), s	1.2	0.0	7.5	2.1	7.4	4.3	2.0	0.0	8.7	3.2	0.0	10.6
Cycle Q Clear(g_c), s	1.2	0.0	7.5	2.1	7.4	4.3	2.0	0.0	8.7	3.2	0.0	10.6
Prop In Lane	1.00		0.19	1.00		1.00	1.00		0.13	1.00		0.10
Lane Grp Cap(c), veh/h	64	0	307	94	348	293	89	0	801	116	0	833
V/C Ratio(X)	0.53	0.00	0.74	0.65	0.68	0.42	0.64	0.00	0.45	0.78	0.00	0.52
Avail Cap(c_a), veh/h	141	0	516	141	534	449	140	0	801	140	0	833
HCM Platoon Ratio	1.00	1.00	1.00	1.00	1.00	1.00	1.00	1.00	1.00	1.00	1.00	1.00
Upstream Filter(I)	1.00	0.00	1.00	0.96	0.96	0.96	1.00	0.00	1.00	1.00	0.00	1.00
Uniform Delay (d), s/veh	30.3	0.0	25.3	29.8	24.4	23.1	29.8	0.0	12.7	29.5	0.0	12.6
Incr Delay (d2), s/veh	6.6	0.0	3.5	7.1	2.2	0.9	7.3	0.0	1.8	20.0	0.0	2.3
Initial Q Delay(d3),s/veh	0.0	0.0	0.0	0.0	0.0	0.0	0.0	0.0	0.0	0.0	0.0	0.0
%ile BackOfQ(50%),veh/ln	0.6	0.0	3.4	1.1	3.4	1.6	1.0	0.0	3.6	1.9	0.0	4.4
Unsig. Movement Delay, s/veh												
LnGrp Delay(d),s/veh	37.0	0.0	28.8	36.9	26.6	24.0	37.2	0.0	14.5	49.5	0.0	14.9
LnGrp LOS	D	A	C	D	C	C	D	A	B	D	A	B
Approach Vol, veh/h		261			420			415			519	
Approach Delay, s/veh		29.9			27.4			17.6			20.9	
Approach LOS		C			C			B			C	
Timer - Assigned Phs	1	2	3	4	5	6	7	8				
Phs Duration (G+Y+Rc), s	8.6	32.4	7.8	15.2	7.7	33.3	6.8	16.2				
Change Period (Y+Rc), s	4.5	4.5	4.5	4.5	4.5	4.5	4.5	4.5				
Max Green Setting (Gmax), s	18.0	18.0	5.0	18.0	5.0	18.0	5.0	18.0				
Max Q Clear Time (g_c+1), s	10.7	10.7	4.1	9.5	4.0	12.6	3.2	9.4				
Green Ext Time (p_c), s	0.0	1.2	0.0	0.8	0.0	1.2	0.0	1.1				
Intersection Summary												
HCM 6th Ctrl Delay												23.2
HCM 6th LOS												C

HCM 6th Signalized Intersection Summary

24: Schnoor Avenue & Kennedy Street

Village D Specific Plan
Phase III WP MIT - PM Peak Hour



Movement	EBL	EBT	EBR	WBL	WBT	WBR	NBL	NBT	NBR	SBL	SBT	SBR
Lane Configurations	↖	↖↗		↖	↖		↖↗	↖		↖↗	↖	↖↗
Traffic Volume (veh/h)	101	338	237	272	307	183	202	89	367	203	69	43
Future Volume (veh/h)	101	338	237	272	307	183	202	89	367	203	69	43
Initial Q (Qb), veh	0	0	0	0	0	0	0	0	0	0	0	0
Ped-Bike Adj(A_pbT)	1.00		0.99	1.00		0.99	1.00		1.00	1.00		1.00
Parking Bus, Adj	1.00	1.00	1.00	1.00	1.00	1.00	1.00	1.00	1.00	1.00	1.00	1.00
Work Zone On Approach		No			No			No			No	
Adj Sat Flow, veh/h/ln	1870	1870	1870	1870	1870	1870	1885	1885	1885	1633	1633	1633
Adj Flow Rate, veh/h	107	360	252	289	327	195	215	95	390	216	73	46
Peak Hour Factor	0.94	0.94	0.94	0.94	0.94	0.94	0.94	0.94	0.94	0.94	0.94	0.94
Percent Heavy Veh, %	2	2	2	2	2	2	1	1	1	18	18	18
Cap, veh/h	121	425	293	329	360	215	490	86	354	334	388	328
Arrive On Green	0.07	0.21	0.21	0.18	0.33	0.33	0.14	0.27	0.27	0.11	0.24	0.24
Sat Flow, veh/h	1781	2006	1381	1781	1094	653	3483	322	1323	3018	1633	1382
Grp Volume(v), veh/h	107	318	294	289	0	522	215	0	485	216	73	46
Grp Sat Flow(s),veh/h/ln	1781	1777	1610	1781	0	1747	1742	0	1645	1509	1633	1382
Q Serve(g_s), s	4.8	13.7	14.1	12.6	0.0	22.9	4.5	0.0	21.4	5.5	2.9	2.1
Cycle Q Clear(g_c), s	4.8	13.7	14.1	12.6	0.0	22.9	4.5	0.0	21.4	5.5	2.9	2.1
Prop In Lane	1.00		0.86	1.00		0.37	1.00		0.80	1.00		1.00
Lane Grp Cap(c), veh/h	121	377	341	329	0	575	490	0	440	334	388	328
V/C Ratio(X)	0.89	0.84	0.86	0.88	0.00	0.91	0.44	0.00	1.10	0.65	0.19	0.14
Avail Cap(c_a), veh/h	121	400	362	367	0	644	490	0	440	334	388	328
HCM Platoon Ratio	1.00	1.00	1.00	1.00	1.00	1.00	1.00	1.00	1.00	1.00	1.00	1.00
Upstream Filter(I)	0.52	0.52	0.52	1.00	0.00	1.00	1.00	0.00	1.00	1.00	1.00	1.00
Uniform Delay (d), s/veh	37.0	30.3	30.4	31.7	0.0	25.7	31.5	0.0	29.3	34.1	24.3	24.1
Incr Delay (d2), s/veh	30.9	8.2	10.3	19.4	0.0	15.8	0.6	0.0	73.5	4.3	1.1	0.9
Initial Q Delay(d3),s/veh	0.0	0.0	0.0	0.0	0.0	0.0	0.0	0.0	0.0	0.0	0.0	0.0
%ile BackOfQ(50%),veh/ln	8.1	6.5	6.2	7.0	0.0	11.5	1.9	0.0	17.0	2.2	1.2	0.7
Unsig. Movement Delay, s/veh												
LnGrp Delay(d),s/veh	67.9	38.5	40.7	51.1	0.0	41.5	32.1	0.0	102.8	38.3	25.4	24.9
LnGrp LOS	E	D	D	D	A	D	C	A	F	D	C	C
Approach Vol, veh/h		719			811			700			335	
Approach Delay, s/veh		43.7			44.9			81.1			33.7	
Approach LOS		D			D			F			C	
Timer - Assigned Phs	1	2	3	4	5	6	7	8				
Phs Duration (G+Y+Rc), s	3.4	25.9	19.3	21.5	15.8	23.5	9.9	30.8				
Change Period (Y+Rc), s	4.5	4.5	4.5	4.5	4.5	4.5	4.5	4.5				
Max Green Setting (Gmax), s	1.5	21.4	16.5	18.0	8.5	19.0	5.0	29.5				
Max Q Clear Time (g_c+1T), s	1.5	23.4	14.6	16.1	6.5	4.9	6.8	24.9				
Green Ext Time (p_c), s	0.0	0.0	0.2	0.8	0.1	0.4	0.0	1.4				
Intersection Summary												
HCM 6th Ctrl Delay											53.0	
HCM 6th LOS											D	

HCM 6th Signalized Intersection Summary
 25: Kennedy Street/Gateway Drive & SR-99 Southbound Ramps

Village D Specific Plan
 Phase III WP MIT - PM Peak Hour

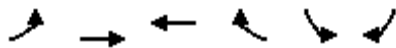

Movement	EBL	EBT	WBT	WBR	SBL	SBR	
Lane Configurations							
Traffic Volume (veh/h)	387	500	553	3	138	249	
Future Volume (veh/h)	387	500	553	3	138	249	
Initial Q (Qb), veh	0	0	0	0	0	0	
Ped-Bike Adj(A_pbT)	1.00			1.00	1.00	1.00	
Parking Bus, Adj	1.00	1.00	1.00	1.00	1.00	1.00	
Work Zone On Approach		No	No		No		
Adj Sat Flow, veh/h/ln	1870	1870	1870	1870	1856	1856	
Adj Flow Rate, veh/h	421	543	601	0	150	271	
Peak Hour Factor	0.92	0.92	0.92	0.92	0.92	0.92	
Percent Heavy Veh, %	2	2	2	2	3	3	
Cap, veh/h	455	1219	636		416	772	
Arrive On Green	0.26	0.65	0.34	0.00	0.24	0.24	
Sat Flow, veh/h	1781	1870	1870	0	1767	1572	
Grp Volume(v), veh/h	421	543	601	0	150	271	
Grp Sat Flow(s),veh/h/ln	1781	1870	1870	0	1767	1572	
Q Serve(g_s), s	18.4	11.4	25.0	0.0	5.7	8.5	
Cycle Q Clear(g_c), s	18.4	11.4	25.0	0.0	5.7	8.5	
Prop In Lane	1.00			0.00	1.00	1.00	
Lane Grp Cap(c), veh/h	455	1219	636		416	772	
V/C Ratio(X)	0.92	0.45	0.94		0.36	0.35	
Avail Cap(c_a), veh/h	456	1227	643		416	772	
HCM Platoon Ratio	1.00	1.00	1.00	1.00	1.00	1.00	
Upstream Filter(I)	1.00	1.00	1.00	0.00	1.00	1.00	
Uniform Delay (d), s/veh	29.0	6.8	25.7	0.0	25.5	12.5	
Incr Delay (d2), s/veh	24.7	0.3	22.7	0.0	2.4	1.3	
Initial Q Delay(d3),s/veh	0.0	0.0	0.0	0.0	0.0	0.0	
%ile BackOfQ(50%),veh/ln	10.7	3.8	14.4	0.0	2.6	9.3	
Unsig. Movement Delay, s/veh							
LnGrp Delay(d),s/veh	53.7	7.1	48.4	0.0	28.0	13.8	
LnGrp LOS	D	A	D		C	B	
Approach Vol, veh/h		964	601	A	421		
Approach Delay, s/veh		27.5	48.4		18.8		
Approach LOS		C	D		B		
Timer - Assigned Phs				4	6	7	8
Phs Duration (G+Y+Rc), s				56.7	23.3	24.9	31.7
Change Period (Y+Rc), s				4.5	4.5	4.5	4.5
Max Green Setting (Gmax), s				52.5	18.5	20.5	27.5
Max Q Clear Time (g_c+I1), s				13.4	10.5	20.4	27.0
Green Ext Time (p_c), s				4.0	0.9	0.0	0.2
Intersection Summary							
HCM 6th Ctrl Delay			32.0				
HCM 6th LOS			C				
Notes							
Unsignalized Delay for [WBR] is excluded from calculations of the approach delay and intersection delay.							

HCM 6th Signalized Intersection Summary

30: Fairgrounds & Cleveland Avenue

Village D Specific Plan
Phase III WP MIT - PM Peak Hour



Movement	EBL	EBT	EBR	WBL	WBT	WBR	NBL	NBT	NBR	SBL	SBT	SBR
Lane Configurations	↖ ↑↑↑ ↗			↖ ↑↑↑ ↗			↖ ↗	↖ ↗	↖ ↗	↖ ↗	↖ ↗	↖ ↗
Traffic Volume (veh/h)	105	1052	96	179	1456	207	100	44	116	365	36	126
Future Volume (veh/h)	105	1052	96	179	1456	207	100	44	116	365	36	126
Initial Q (Qb), veh	0	0	0	0	0	0	0	0	0	0	0	0
Ped-Bike Adj(A_pbT)	1.00		0.98	1.00		0.98	1.00		0.98	1.00		1.00
Parking Bus, Adj	1.00	1.00	1.00	1.00	1.00	1.00	1.00	1.00	1.00	1.00	1.00	1.00
Work Zone On Approach	No			No			No			No		
Adj Sat Flow, veh/h/ln	1885	1885	1885	1885	1885	1885	1900	1900	1900	1900	1900	1900
Adj Flow Rate, veh/h	111	1107	101	188	1533	218	105	103	84	384	38	133
Peak Hour Factor	0.95	0.95	0.95	0.95	0.95	0.95	0.95	0.95	0.95	0.95	0.95	0.95
Percent Heavy Veh, %	1	1	1	1	1	1	0	0	0	0	0	0
Cap, veh/h	130	1476	135	223	1633	232	262	391	325	294	109	382
Arrive On Green	0.14	0.62	0.62	0.12	0.36	0.36	0.07	0.21	0.21	0.16	0.30	0.30
Sat Flow, veh/h	1795	4793	437	1795	4539	644	3619	1900	1582	1810	369	1293
Grp Volume(v), veh/h	111	792	416	188	1158	593	105	103	84	384	0	171
Grp Sat Flow(s),veh/h/ln	1795	1716	1799	1795	1716	1752	1810	1900	1582	1810	0	1663
Q Serve(g_s), s	5.4	14.8	14.9	9.2	29.4	29.5	2.5	4.1	2.9	14.6	0.0	7.3
Cycle Q Clear(g_c), s	5.4	14.8	14.9	9.2	29.4	29.5	2.5	4.1	2.9	14.6	0.0	7.3
Prop In Lane	1.00		0.24	1.00		0.37	1.00		1.00	1.00		0.78
Lane Grp Cap(c), veh/h	130	1057	554	223	1234	630	262	391	325	294	0	491
V/C Ratio(X)	0.86	0.75	0.75	0.84	0.94	0.94	0.40	0.26	0.26	1.31	0.00	0.35
Avail Cap(c_a), veh/h	130	1057	554	237	1239	633	262	391	325	294	0	491
HCM Platoon Ratio	2.00	2.00	2.00	1.00	1.00	1.00	1.00	1.00	1.00	1.00	1.00	1.00
Upstream Filter(I)	0.60	0.60	0.60	0.38	0.38	0.38	1.00	1.00	1.00	1.00	0.00	1.00
Uniform Delay (d), s/veh	38.0	14.8	14.8	38.6	27.8	27.9	39.9	30.0	15.5	37.7	0.0	24.9
Incr Delay (d2), s/veh	27.0	1.8	3.5	9.9	6.2	11.0	1.0	1.6	1.9	160.2	0.0	1.9
Initial Q Delay(d3),s/veh	0.0	0.0	0.0	0.0	0.0	0.0	0.0	0.0	0.0	0.0	0.0	0.0
%ile BackOfQ(50%),veh/ln	3.2	3.9	4.3	4.6	12.5	13.7	1.1	2.0	1.7	19.4	0.0	3.1
Unsig. Movement Delay, s/veh												
LnGrp Delay(d),s/veh	65.1	16.6	18.3	48.5	34.0	38.9	40.9	31.7	17.4	197.9	0.0	26.8
LnGrp LOS	E	B	B	D	C	D	D	C	B	F	A	C
Approach Vol, veh/h	1319				1939		292				555	
Approach Delay, s/veh	21.2				36.9		30.9				145.2	
Approach LOS	C				D		C				F	
Timer - Assigned Phs	1	2	3	4	5	6	7	8				
Phs Duration (G+Y+Rc), s	19.1	23.0	15.7	32.2	11.0	31.1	11.0	36.9				
Change Period (Y+Rc), s	4.5	4.5	4.5	4.5	4.5	4.5	4.5	4.5				
Max Green Setting (Gmax), s	14.5	18.5	11.9	27.1	6.4	26.6	6.5	32.5				
Max Q Clear Time (g_c+10), s	10.6	6.1	11.2	16.9	4.5	9.3	7.4	31.5				
Green Ext Time (p_c), s	0.0	0.6	0.0	5.6	0.0	0.9	0.0	0.9				

Intersection Summary

HCM 6th Ctrl Delay	46.1
HCM 6th LOS	D

Notes

User approved volume balancing among the lanes for turning movement.

HCM 6th Signalized Intersection Summary
 31: SR-99 Southbound Ramps & Cleveland Avenue

Village D Specific Plan
 Phase III WP MIT - PM Peak Hour



Movement	EBL	EBT	EBR	WBL	WBT	WBR	NBL	NBT	NBR	SBL	SBT	SBR
Lane Configurations		↑↑	↑	↑	↑↑					↑		↑
Traffic Volume (veh/h)	0	1081	649	381	2081	0	0	0	0	290	0	100
Future Volume (veh/h)	0	1081	649	381	2081	0	0	0	0	290	0	100
Initial Q (Qb), veh	0	0	0	0	0	0				0	0	0
Ped-Bike Adj(A_pbT)	1.00		1.00	1.00		1.00				1.00		1.00
Parking Bus, Adj	1.00	1.00	1.00	1.00	1.00	1.00				1.00	1.00	1.00
Work Zone On Approach		No			No						No	
Adj Sat Flow, veh/h/ln	0	1885	1885	1900	1900	0				1856	0	1856
Adj Flow Rate, veh/h	0	1114	669	393	2145	0				299	0	103
Peak Hour Factor	0.97	0.97	0.97	0.97	0.97	0.97				0.97	0.97	0.97
Percent Heavy Veh, %	0	1	1	0	0	0				3	0	3
Cap, veh/h	0	1453	646	372	2387	0				422	0	376
Arrive On Green	0.00	0.41	0.41	0.41	1.00	0.00				0.24	0.00	0.24
Sat Flow, veh/h	0	3676	1592	1810	3705	0				1767	0	1572
Grp Volume(v), veh/h	0	1114	669	393	2145	0				299	0	103
Grp Sat Flow(s),veh/h/ln	0	1791	1592	1810	1805	0				1767	0	1572
Q Serve(g_s), s	0.0	24.2	36.5	18.5	0.0	0.0				14.0	0.0	4.8
Cycle Q Clear(g_c), s	0.0	24.2	36.5	18.5	0.0	0.0				14.0	0.0	4.8
Prop In Lane	0.00		1.00	1.00		0.00				1.00		1.00
Lane Grp Cap(c), veh/h	0	1453	646	372	2387	0				422	0	376
V/C Ratio(X)	0.00	0.77	1.04	1.06	0.90	0.00				0.71	0.00	0.27
Avail Cap(c_a), veh/h	0	1453	646	372	2387	0				422	0	376
HCM Platoon Ratio	1.00	1.00	1.00	2.00	2.00	1.00				1.00	1.00	1.00
Upstream Filter(I)	0.00	0.37	0.37	0.09	0.09	0.00				1.00	0.00	1.00
Uniform Delay (d), s/veh	0.0	23.1	26.8	26.5	0.0	0.0				31.4	0.0	27.9
Incr Delay (d2), s/veh	0.0	0.9	31.6	31.9	0.5	0.0				9.6	0.0	1.8
Initial Q Delay(d3),s/veh	0.0	0.0	0.0	0.0	0.0	0.0				0.0	0.0	0.0
%ile BackOfQ(50%),veh/ln	0.0	9.9	18.7	8.9	0.2	0.0				6.9	0.0	2.0
Unsig. Movement Delay, s/veh												
LnGrp Delay(d),s/veh	0.0	24.0	58.3	58.4	0.5	0.0				41.0	0.0	29.7
LnGrp LOS	A	C	F	F	A	A				D	A	C
Approach Vol, veh/h		1783			2538						402	
Approach Delay, s/veh		36.9			9.5						38.1	
Approach LOS		D			A						D	
Timer - Assigned Phs			3	4		6		8				
Phs Duration (G+Y+Rc), s			23.0	41.0		26.0		64.0				
Change Period (Y+Rc), s			4.5	4.5		4.5		4.5				
Max Green Setting (Gmax), s			18.5	36.5		21.5		59.5				
Max Q Clear Time (g_c+1), s			20.5	38.5		16.0		2.0				
Green Ext Time (p_c), s			0.0	0.0		0.7		35.8				
Intersection Summary												
HCM 6th Ctrl Delay			22.3									
HCM 6th LOS			C									

HCM 6th Signalized Intersection Summary
 32: SR-99 Northbound Ramps & Cleveland Avenue

Village D Specific Plan
 Phase III WP MIT - PM Peak Hour



Movement	EBL	EBT	EBR	WBL	WBT	WBR	NBL	NBT	NBR	SBL	SBT	SBR
Lane Configurations	↘	↑↑			↑↑	↗	↘	↖	↗			
Traffic Volume (veh/h)	110	1259	0	0	1379	240	1090	6	349	0	0	0
Future Volume (veh/h)	110	1259	0	0	1379	240	1090	6	349	0	0	0
Initial Q (Qb), veh	0	0	0	0	0	0	0	0	0			
Ped-Bike Adj(A_pbT)	1.00		1.00	1.00		0.99	1.00		0.99			
Parking Bus, Adj	1.00	1.00	1.00	1.00	1.00	1.00	1.00	1.00	1.00			
Work Zone On Approach	No				No				No			
Adj Sat Flow, veh/h/ln	1885	1885	0	0	1885	1885	1885	1885	1885			
Adj Flow Rate, veh/h	116	1325	0	0	1452	253	1151	0	367			
Peak Hour Factor	0.95	0.95	0.95	0.95	0.95	0.95	0.95	0.95	0.95			
Percent Heavy Veh, %	1	1	0	0	1	1	1	1	1			
Cap, veh/h	146	1644	0	0	1174	519	1584	0	695			
Arrive On Green	0.16	0.92	0.00	0.00	0.33	0.33	0.44	0.00	0.44			
Sat Flow, veh/h	1795	3676	0	0	3676	1583	3591	0	1575			
Grp Volume(v), veh/h	116	1325	0	0	1452	253	1151	0	367			
Grp Sat Flow(s),veh/h/ln	1795	1791	0	0	1791	1583	1795	0	1575			
Q Serve(g_s), s	5.6	10.5	0.0	0.0	29.5	11.5	23.7	0.0	15.3			
Cycle Q Clear(g_c), s	5.6	10.5	0.0	0.0	29.5	11.5	23.7	0.0	15.3			
Prop In Lane	1.00		0.00	0.00		1.00	1.00		1.00			
Lane Grp Cap(c), veh/h	146	1644	0	0	1174	519	1584	0	695			
V/C Ratio(X)	0.80	0.81	0.00	0.00	1.24	0.49	0.73	0.00	0.53			
Avail Cap(c_a), veh/h	289	1930	0	0	1174	519	1584	0	695			
HCM Platoon Ratio	2.00	2.00	1.00	1.00	1.00	1.00	1.00	1.00	1.00			
Upstream Filter(I)	0.55	0.55	0.00	0.00	0.23	0.23	1.00	0.00	1.00			
Uniform Delay (d), s/veh	37.0	2.4	0.0	0.0	30.3	24.2	20.7	0.0	18.3			
Incr Delay (d2), s/veh	5.4	1.3	0.0	0.0	108.3	0.2	3.0	0.0	2.9			
Initial Q Delay(d3),s/veh	0.0	0.0	0.0	0.0	0.0	0.0	0.0	0.0	0.0			
%ile BackOfQ(50%),veh/ln	2.5	1.4	0.0	0.0	29.8	4.2	10.0	0.0	5.9			
Unsig. Movement Delay, s/veh												
LnGrp Delay(d),s/veh	42.4	3.7	0.0	0.0	138.6	24.4	23.6	0.0	21.2			
LnGrp LOS	D	A	A	A	F	C	C	A	C			
Approach Vol, veh/h	1441				1705				1518			
Approach Delay, s/veh	6.8				121.6				23.1			
Approach LOS	A				F				C			
Timer - Assigned Phs	2		4		7		8					
Phs Duration (G+Y+Rc), s	44.2		45.8		11.8		34.0					
Change Period (Y+Rc), s	4.5		4.5		4.5		4.5					
Max Green Setting (Gmax), s	32.5		48.5		14.5		29.5					
Max Q Clear Time (g_c+1), s	25.7		12.5		7.6		31.5					
Green Ext Time (p_c), s	3.6		13.3		0.1		0.0					

Intersection Summary

HCM 6th Ctrl Delay	54.1
HCM 6th LOS	D

Notes

User approved volume balancing among the lanes for turning movement.

HCM 6th Signalized Intersection Summary
36: Pine Street & Howard Road

Village D Specific Plan
Phase III WP MIT - PM Peak Hour



Movement	EBL	EBT	EBR	WBL	WBT	WBR	NBL	NBT	NBR	SBL	SBT	SBR
Lane Configurations												
Traffic Volume (veh/h)	89	791	146	111	873	4	234	197	171	18	167	120
Future Volume (veh/h)	89	791	146	111	873	4	234	197	171	18	167	120
Initial Q (Qb), veh	0	0	0	0	0	0	0	0	0	0	0	0
Ped-Bike Adj(A_pbT)	1.00		0.95	1.00		0.95	1.00		0.99	1.00		1.00
Parking Bus, Adj	1.00	1.00	1.00	1.00	1.00	1.00	1.00	1.00	1.00	1.00	1.00	1.00
Work Zone On Approach		No			No			No			No	
Adj Sat Flow, veh/h/ln	1870	1870	1870	1885	1885	1885	1885	1885	1885	1870	1870	1870
Adj Flow Rate, veh/h	96	851	157	119	939	4	252	212	184	19	180	129
Peak Hour Factor	0.93	0.93	0.93	0.93	0.93	0.93	0.93	0.93	0.93	0.93	0.93	0.93
Percent Heavy Veh, %	2	2	2	1	1	1	1	1	1	2	2	2
Cap, veh/h	171	903	167	149	1065	5	359	674	564	99	398	337
Arrive On Green	0.10	0.30	0.30	0.08	0.29	0.29	0.20	0.36	0.36	0.06	0.21	0.21
Sat Flow, veh/h	1781	2969	548	1795	3657	16	1795	1885	1577	1781	1870	1585
Grp Volume(v), veh/h	96	509	499	119	460	483	252	212	184	19	180	129
Grp Sat Flow(s),veh/h/ln	1781	1777	1739	1795	1791	1881	1795	1885	1577	1781	1870	1585
Q Serve(g_s), s	4.6	25.2	25.2	5.9	22.0	22.0	11.8	7.3	7.6	0.9	7.5	4.7
Cycle Q Clear(g_c), s	4.6	25.2	25.2	5.9	22.0	22.0	11.8	7.3	7.6	0.9	7.5	4.7
Prop In Lane	1.00		0.31	1.00		0.01	1.00		1.00	1.00		1.00
Lane Grp Cap(c), veh/h	171	541	529	149	521	548	359	674	564	99	398	337
V/C Ratio(X)	0.56	0.94	0.94	0.80	0.88	0.88	0.70	0.31	0.33	0.19	0.45	0.38
Avail Cap(c_a), veh/h	171	543	531	150	559	587	359	674	564	356	398	337
HCM Platoon Ratio	1.00	1.00	1.00	1.00	1.00	1.00	1.00	1.00	1.00	1.00	1.00	1.00
Upstream Filter(I)	1.00	1.00	1.00	0.86	0.86	0.86	1.00	1.00	1.00	1.00	1.00	1.00
Uniform Delay (d), s/veh	38.9	30.5	30.5	40.5	30.4	30.4	33.5	20.9	21.0	40.6	30.9	17.1
Incr Delay (d2), s/veh	4.1	25.0	25.3	22.6	12.9	12.4	10.9	1.2	1.5	0.9	0.8	0.7
Initial Q Delay(d3),s/veh	0.0	0.0	0.0	0.0	0.0	0.0	0.0	0.0	0.0	0.0	0.0	0.0
%ile BackOfQ(50%),veh/ln	2.2	14.1	13.9	3.5	11.0	11.5	6.1	3.4	3.0	0.4	3.4	2.4
Unsig. Movement Delay, s/veh												
LnGrp Delay(d),s/veh	43.0	55.5	55.9	63.1	43.3	42.8	44.4	22.2	22.6	41.5	31.7	17.8
LnGrp LOS	D	E	E	E	D	D	D	C	C	D	C	B
Approach Vol, veh/h		1104			1062			648			328	
Approach Delay, s/veh		54.6			45.3			30.9			26.8	
Approach LOS		D			D			C			C	
Timer - Assigned Phs	1	2	3	4	5	6	7	8				
Phs Duration (G+Y+Rc), s	9.5	36.7	12.0	31.9	22.5	23.7	13.1	30.7				
Change Period (Y+Rc), s	4.5	4.5	4.5	4.5	4.5	4.5	4.5	4.5				
Max Green Setting (Gmax), s	18.0	19.0	7.5	27.5	18.0	19.0	6.9	28.1				
Max Q Clear Time (g_c+I1), s	2.9	9.6	7.9	27.2	13.8	9.5	6.6	24.0				
Green Ext Time (p_c), s	0.0	1.3	0.0	0.2	0.3	1.0	0.0	2.2				
Intersection Summary												
HCM 6th Ctrl Delay				43.7								
HCM 6th LOS				D								

HCM 6th Signalized Intersection Summary
 38: I Street & 2nd Street/SR-99 Southbound Off-Ramp

Village D Specific Plan
 Phase III WP MIT - PM Peak Hour



Movement	EBL	EBT	EBR	WBL	WBT	WBR	NBL	NBT	NBR	SBL	SBT	SBR
Lane Configurations		↕			↕	↕	↕	↕			↕	
Traffic Volume (veh/h)	0	0	44	347	15	5	54	160	0	0	122	0
Future Volume (veh/h)	0	0	44	347	15	5	54	160	0	0	122	0
Initial Q (Qb), veh	0	0	0	0	0	0	0	0	0	0	0	0
Ped-Bike Adj(A_pbT)	1.00		1.00	1.00		1.00	1.00		1.00	1.00		1.00
Parking Bus, Adj	1.00	1.00	1.00	1.00	1.00	1.00	1.00	1.00	1.00	1.00	1.00	1.00
Work Zone On Approach		No			No			No			No	
Adj Sat Flow, veh/h/ln	1900	1900	1900	1870	1870	1870	1900	1900	0	0	1900	1900
Adj Flow Rate, veh/h	0	0	45	354	15	5	55	163	0	0	124	0
Peak Hour Factor	0.98	0.98	0.98	0.98	0.98	0.98	0.98	0.98	0.98	0.98	0.98	0.98
Percent Heavy Veh, %	0	0	0	2	2	2	0	0	0	0	0	0
Cap, veh/h	0	0	57	412	17	382	792	1118	0	0	1118	0
Arrive On Green	0.00	0.00	0.04	0.24	0.24	0.24	1.00	1.00	0.00	0.00	0.59	0.00
Sat Flow, veh/h	0	0	1610	1712	73	1585	1286	1900	0	0	1900	0
Grp Volume(v), veh/h	0	0	45	369	0	5	55	163	0	0	124	0
Grp Sat Flow(s),veh/h/ln	0	0	1610	1785	0	1585	1286	1900	0	0	1900	0
Q Serve(g_s), s	0.0	0.0	2.8	19.8	0.0	0.2	0.2	0.0	0.0	0.0	2.9	0.0
Cycle Q Clear(g_c), s	0.0	0.0	2.8	19.8	0.0	0.2	3.1	0.0	0.0	0.0	2.9	0.0
Prop In Lane	0.00		1.00	0.96		1.00	1.00		0.00	0.00		0.00
Lane Grp Cap(c), veh/h	0	0	57	430	0	382	792	1118	0	0	1118	0
V/C Ratio(X)	0.00	0.00	0.78	0.86	0.00	0.01	0.07	0.15	0.00	0.00	0.11	0.00
Avail Cap(c_a), veh/h	0	0	314	759	0	674	792	1118	0	0	1118	0
HCM Platoon Ratio	1.00	1.00	1.00	1.00	1.00	1.00	2.00	2.00	1.00	1.00	1.00	1.00
Upstream Filter(I)	0.00	0.00	1.00	1.00	0.00	1.00	0.98	0.98	0.00	0.00	1.00	0.00
Uniform Delay (d), s/veh	0.0	0.0	47.8	36.3	0.0	28.9	0.1	0.0	0.0	0.0	9.1	0.0
Incr Delay (d2), s/veh	0.0	0.0	20.3	5.1	0.0	0.0	0.2	0.3	0.0	0.0	0.2	0.0
Initial Q Delay(d3),s/veh	0.0	0.0	0.0	0.0	0.0	0.0	0.0	0.0	0.0	0.0	0.0	0.0
%ile BackOfQ(50%),veh/ln	0.0	0.0	1.4	9.1	0.0	0.1	0.0	0.1	0.0	0.0	1.2	0.0
Unsig. Movement Delay, s/veh												
LnGrp Delay(d),s/veh	0.0	0.0	68.1	41.4	0.0	28.9	0.2	0.3	0.0	0.0	9.3	0.0
LnGrp LOS	A	A	E	D	A	C	A	A	A	A	A	A
Approach Vol, veh/h		45			374			218			124	
Approach Delay, s/veh		68.1			41.3			0.3			9.3	
Approach LOS		E			D			A			A	
Timer - Assigned Phs		2		4		6		8				
Phs Duration (G+Y+Rc), s		63.4		8.1		63.4		28.6				
Change Period (Y+Rc), s		4.5		4.5		4.5		4.5				
Max Green Setting (Gmax), s		24.5		19.5		24.5		42.5				
Max Q Clear Time (g_c+I1), s		5.1		4.8		4.9		21.8				
Green Ext Time (p_c), s		1.0		0.1		0.6		2.3				
Intersection Summary												
HCM 6th Ctrl Delay				25.9								
HCM 6th LOS				C								

HCM 6th Signalized Intersection Summary
 43: SR-99 Northbound Off-Ramp/H Street & 4th Street

Village D Specific Plan
 Phase III WP MIT - PM Peak Hour



Movement	EBL	EBT	EBR	WBL	WBT	WBR	NBL	NBT	NBR	SBL	SBT	SBR
Lane Configurations	↖	↗			↖	↗	↖	↗			↕	
Traffic Volume (veh/h)	324	444	0	0	579	225	285	40	208	34	0	92
Future Volume (veh/h)	324	444	0	0	579	225	285	40	208	34	0	92
Initial Q (Qb), veh	0	0	0	0	0	0	0	0	0	0	0	0
Ped-Bike Adj(A_pbT)	1.00		1.00	1.00		0.99	1.00		0.98	1.00		0.99
Parking Bus, Adj	1.00	1.00	1.00	1.00	1.00	1.00	1.00	1.00	1.00	1.00	1.00	1.00
Work Zone On Approach		No			No			No			No	
Adj Sat Flow, veh/h/ln	1885	1885	0	0	1885	1885	1885	1885	1885	1900	1900	1900
Adj Flow Rate, veh/h	345	472	0	0	616	239	303	43	221	36	0	98
Peak Hour Factor	0.94	0.94	0.94	0.94	0.94	0.94	0.94	0.94	0.94	0.94	0.94	0.94
Percent Heavy Veh, %	1	1	0	0	1	1	1	1	1	0	0	0
Cap, veh/h	350	1701	0	0	591	229	377	55	284	79	0	216
Arrive On Green	0.19	0.47	0.00	0.00	0.23	0.23	0.21	0.21	0.21	0.18	0.00	0.18
Sat Flow, veh/h	1795	3676	0	0	2608	974	1795	263	1354	441	0	1201
Grp Volume(v), veh/h	345	472	0	0	439	416	303	0	264	134	0	0
Grp Sat Flow(s),veh/h/ln	1795	1791	0	0	1791	1697	1795	0	1617	1643	0	0
Q Serve(g_s), s	19.1	8.0	0.0	0.0	23.5	23.5	16.0	0.0	15.4	7.3	0.0	0.0
Cycle Q Clear(g_c), s	19.1	8.0	0.0	0.0	23.5	23.5	16.0	0.0	15.4	7.3	0.0	0.0
Prop In Lane	1.00		0.00	0.00		0.57	1.00		0.84	0.27		0.73
Lane Grp Cap(c), veh/h	350	1701	0	0	421	399	377	0	340	296	0	0
V/C Ratio(X)	0.99	0.28	0.00	0.00	1.04	1.04	0.80	0.00	0.78	0.45	0.00	0.00
Avail Cap(c_a), veh/h	350	1701	0	0	421	399	377	0	340	296	0	0
HCM Platoon Ratio	1.00	1.00	1.00	1.00	1.00	1.00	1.00	1.00	1.00	1.00	1.00	1.00
Upstream Filter(I)	1.00	1.00	0.00	0.00	1.00	1.00	1.00	0.00	1.00	1.00	0.00	0.00
Uniform Delay (d), s/veh	40.1	15.9	0.0	0.0	38.3	38.3	37.5	0.0	37.3	36.6	0.0	0.0
Incr Delay (d2), s/veh	44.0	0.1	0.0	0.0	55.3	56.9	16.5	0.0	16.0	4.9	0.0	0.0
Initial Q Delay(d3),s/veh	0.0	0.0	0.0	0.0	0.0	0.0	0.0	0.0	0.0	0.0	0.0	0.0
%ile BackOfQ(50%),veh/ln	12.6	3.2	0.0	0.0	16.6	15.9	8.7	0.0	7.5	3.3	0.0	0.0
Unsig. Movement Delay, s/veh												
LnGrp Delay(d),s/veh	84.1	16.0	0.0	0.0	93.5	95.2	54.0	0.0	53.3	41.6	0.0	0.0
LnGrp LOS	F	B	A	A	F	F	D	A	D	D	A	A
Approach Vol, veh/h		817			855			567			134	
Approach Delay, s/veh		44.8			94.3			53.7			41.6	
Approach LOS		D			F			D			D	
Timer - Assigned Phs		2		4		6	7	8				
Phs Duration (G+Y+Rc), s		25.5		52.0		22.5	24.0	28.0				
Change Period (Y+Rc), s		4.5		4.5		4.5	4.5	4.5				
Max Green Setting (Gmax), s		21.0		47.5		18.0	19.5	23.5				
Max Q Clear Time (g_c+I1), s		18.0		10.0		9.3	21.1	25.5				
Green Ext Time (p_c), s		0.8		3.5		0.4	0.0	0.0				
Intersection Summary												
HCM 6th Ctrl Delay											64.6	
HCM 6th LOS											E	

Intersection						
Int Delay, s/veh	1					
Movement	EBL	EBT	WBT	WBR	SBL	SBR
Lane Configurations	↖	↗	↗			↖
Traffic Vol, veh/h	90	814	742	113	0	111
Future Vol, veh/h	90	814	742	113	0	111
Conflicting Peds, #/hr	0	0	0	0	0	0
Sign Control	Free	Free	Free	Free	Stop	Stop
RT Channelized	-	None	-	None	-	None
Storage Length	145	-	-	-	-	0
Veh in Median Storage, #	-	0	0	-	0	-
Grade, %	-	0	0	-	0	-
Peak Hour Factor	95	95	95	95	95	95
Heavy Vehicles, %	1	1	1	1	1	1
Mvmt Flow	95	857	781	119	0	117

Major/Minor	Major1	Major2	Minor2
Conflicting Flow All	900	0	0
Stage 1	-	-	-
Stage 2	-	-	-
Critical Hdwy	4.12	-	6.92
Critical Hdwy Stg 1	-	-	-
Critical Hdwy Stg 2	-	-	-
Follow-up Hdwy	2.21	-	3.31
Pot Cap-1 Maneuver	1064	-	*797
Stage 1	-	-	0
Stage 2	-	-	0
Platoon blocked, %	1	-	1
Mov Cap-1 Maneuver	1064	-	*797
Mov Cap-2 Maneuver	-	-	-
Stage 1	-	-	-
Stage 2	-	-	-

Approach	EB	WB	SB
HCM Control Delay, s	0.9	0	10.3
HCM LOS			B

Minor Lane/Major Mvmt	EBL	EBT	WBT	WBR	SBLn1
Capacity (veh/h)	1064	-	-	-	797
HCM Lane V/C Ratio	0.089	-	-	-	0.147
HCM Control Delay (s)	8.7	-	-	-	10.3
HCM Lane LOS	A	-	-	-	B
HCM 95th %tile Q(veh)	0.3	-	-	-	0.5

Notes
 -: Volume exceeds capacity \$: Delay exceeds 300s +: Computation Not Defined *: All major volume in platoon

HCM 6th Signalized Intersection Summary
 49: Yosemite Avenue & Cleveland Avenue/Tozer Street

Village D Specific Plan
 Phase III WP MIT - PM Peak Hour



Movement	EBL	EBT	EBR	WBL	WBT	WBR	NBL	NBT	NBR	SBL	SBT	SBR
Lane Configurations												
Traffic Volume (veh/h)	320	478	203	52	524	49	320	329	100	83	188	361
Future Volume (veh/h)	320	478	203	52	524	49	320	329	100	83	188	361
Initial Q (Qb), veh	0	0	0	0	0	0	0	0	0	0	0	0
Ped-Bike Adj(A_pbT)	1.00		0.99	1.00		0.96	1.00		1.00	1.00		0.98
Parking Bus, Adj	1.00	1.00	1.00	1.00	1.00	1.00	1.00	1.00	1.00	1.00	1.00	1.00
Work Zone On Approach		No			No			No			No	
Adj Sat Flow, veh/h/ln	1870	1870	1870	1900	1900	1900	1870	1870	1870	1870	1870	1870
Adj Flow Rate, veh/h	348	520	221	57	570	53	348	358	109	90	204	392
Peak Hour Factor	0.92	0.92	0.92	0.92	0.92	0.92	0.92	0.92	0.92	0.92	0.92	0.92
Percent Heavy Veh, %	2	2	2	0	0	0	2	2	2	2	2	2
Cap, veh/h	378	929	393	74	766	328	378	617	521	115	340	618
Arrive On Green	0.21	0.38	0.38	0.04	0.21	0.21	0.21	0.33	0.33	0.06	0.18	0.18
Sat Flow, veh/h	1781	2424	1026	1810	3610	1545	1781	1870	1579	1781	1870	1548
Grp Volume(v), veh/h	348	381	360	57	570	53	348	358	109	90	204	392
Grp Sat Flow(s),veh/h/ln	1781	1777	1673	1810	1805	1545	1781	1870	1579	1781	1870	1548
Q Serve(g_s), s	18.9	16.6	16.8	3.1	14.6	2.8	18.9	15.7	4.9	4.9	9.9	18.0
Cycle Q Clear(g_c), s	18.9	16.6	16.8	3.1	14.6	2.8	18.9	15.7	4.9	4.9	9.9	18.0
Prop In Lane	1.00		0.61	1.00		1.00	1.00		1.00	1.00		1.00
Lane Grp Cap(c), veh/h	378	681	641	74	766	328	378	617	521	115	340	618
V/C Ratio(X)	0.92	0.56	0.56	0.77	0.74	0.16	0.92	0.58	0.21	0.79	0.60	0.63
Avail Cap(c_a), veh/h	387	681	641	157	766	328	387	617	521	147	340	618
HCM Platoon Ratio	1.00	1.00	1.00	1.00	1.00	1.00	1.00	1.00	1.00	1.00	1.00	1.00
Upstream Filter(I)	1.00	1.00	1.00	1.00	1.00	1.00	1.00	1.00	1.00	1.00	1.00	1.00
Uniform Delay (d), s/veh	38.2	24.0	24.0	47.0	36.5	31.8	38.2	27.5	23.9	45.7	37.2	24.3
Incr Delay (d2), s/veh	26.7	3.3	3.5	15.4	6.5	1.1	26.7	1.4	0.2	18.8	2.9	2.1
Initial Q Delay(d3),s/veh	0.0	0.0	0.0	0.0	0.0	0.0	0.0	0.0	0.0	0.0	0.0	0.0
%ile BackOfQ(50%),veh/ln	10.9	7.4	7.1	1.7	7.0	1.1	10.9	7.1	1.8	2.8	4.8	7.6
Unsig. Movement Delay, s/veh												
LnGrp Delay(d),s/veh	64.9	27.2	27.5	62.4	43.0	32.9	64.9	28.9	24.1	64.4	40.1	26.5
LnGrp LOS	E	C	C	E	D	C	E	C	C	E	D	C
Approach Vol, veh/h		1089			680			815			686	
Approach Delay, s/veh		39.4			43.8			43.6			35.5	
Approach LOS		D			D			D			D	
Timer - Assigned Phs	1	2	3	4	5	6	7	8				
Phs Duration (G+Y+Rc), s	25.5	25.5	10.9	37.1	8.5	42.5	25.5	22.5				
Change Period (Y+Rc), s	4.5	4.5	4.5	4.5	4.5	4.5	4.5	4.5				
Max Green Setting (Gmax), s	21.5	21.0	8.2	31.3	8.6	33.9	21.5	18.0				
Max Q Clear Time (g_c+I1), s	20.9	16.6	6.9	17.7	5.1	18.8	20.9	20.0				
Green Ext Time (p_c), s	0.1	1.6	0.0	2.1	0.0	4.3	0.1	0.0				

Intersection Summary												
HCM 6th Ctrl Delay			40.5									
HCM 6th LOS			D									

HCM 6th Signalized Intersection Summary
51: Project Driveway 1 & Avenue 17

Village D Specific Plan
Phase III WP MIT - PM Peak Hour

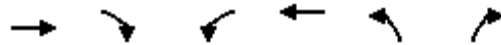

Movement	EBT	EBR	WBL	WBT	NBL	NBR
Lane Configurations	↩		↩	↩	↩	↩
Traffic Volume (veh/h)	112	50	627	63	23	302
Future Volume (veh/h)	112	50	627	63	23	302
Initial Q (Qb), veh	0	0	0	0	0	0
Ped-Bike Adj(A_pbT)		1.00	1.00		1.00	1.00
Parking Bus, Adj	1.00	1.00	1.00	1.00	1.00	1.00
Work Zone On Approach	No			No	No	
Adj Sat Flow, veh/h/ln	1870	1870	1900	1900	1900	1900
Adj Flow Rate, veh/h	122	54	682	68	25	328
Peak Hour Factor	0.92	0.92	0.92	0.92	0.92	0.92
Percent Heavy Veh, %	2	2	0	0	0	0
Cap, veh/h	157	69	690	1073	584	519
Arrive On Green	0.13	0.13	0.38	0.56	0.32	0.32
Sat Flow, veh/h	1229	544	1810	1900	1810	1610
Grp Volume(v), veh/h	0	176	682	68	25	328
Grp Sat Flow(s),veh/h/ln	0	1772	1810	1900	1810	1610
Q Serve(g_s), s	0.0	7.7	29.9	1.3	0.8	13.9
Cycle Q Clear(g_c), s	0.0	7.7	29.9	1.3	0.8	13.9
Prop In Lane		0.31	1.00		1.00	1.00
Lane Grp Cap(c), veh/h	0	226	690	1073	584	519
V/C Ratio(X)	0.00	0.78	0.99	0.06	0.04	0.63
Avail Cap(c_a), veh/h	0	399	690	1259	584	519
HCM Platoon Ratio	1.00	1.00	1.00	1.00	1.00	1.00
Upstream Filter(I)	0.00	1.00	0.93	0.93	1.00	1.00
Uniform Delay (d), s/veh	0.0	33.8	24.6	7.9	18.6	23.1
Incr Delay (d2), s/veh	0.0	5.7	30.1	0.0	0.1	5.7
Initial Q Delay(d3),s/veh	0.0	0.0	0.0	0.0	0.0	0.0
%ile BackOfQ(50%),veh/ln	0.0	3.6	17.6	0.5	0.3	5.8
Unsig. Movement Delay, s/veh						
LnGrp Delay(d),s/veh	0.0	39.6	54.7	7.9	18.8	28.8
LnGrp LOS	A	D	D	A	B	C
Approach Vol, veh/h	176			750	353	
Approach Delay, s/veh	39.6			50.4	28.1	
Approach LOS	D			D	C	
Timer - Assigned Phs		2	3	4		8
Phs Duration (G+Y+Rc), s		30.3	35.0	14.7		49.7
Change Period (Y+Rc), s		4.5	4.5	4.5		4.5
Max Green Setting (Gmax), s		18.0	30.5	18.0		53.0
Max Q Clear Time (g_c+I1), s		15.9	31.9	9.7		3.3
Green Ext Time (p_c), s		0.3	0.0	0.5		0.4
Intersection Summary						
HCM 6th Ctrl Delay			42.8			
HCM 6th LOS			D			

HCM 6th Signalized Intersection Summary
 52: Road 22 1/2/Project Driveway 2 & Avenue 16

Village D Specific Plan
 Phase III WP MIT - PM Peak Hour



Movement	EBL	EBT	EBR	WBL	WBT	WBR	NBL	NBT	NBR	SBL	SBT	SBR
Lane Configurations												
Traffic Volume (veh/h)	0	202	15	296	15	225	6	178	148	142	179	0
Future Volume (veh/h)	0	202	15	296	15	225	6	178	148	142	179	0
Initial Q (Qb), veh	0	0	0	0	0	0	0	0	0	0	0	0
Ped-Bike Adj(A_pbT)	1.00		1.00	1.00		1.00	1.00		1.00	1.00		1.00
Parking Bus, Adj	1.00	1.00	1.00	1.00	1.00	1.00	1.00	1.00	1.00	1.00	1.00	1.00
Work Zone On Approach		No			No			No			No	
Adj Sat Flow, veh/h/ln	1722	1722	1722	1900	1900	1900	1900	1900	1900	1900	1900	1900
Adj Flow Rate, veh/h	0	220	16	322	16	245	7	193	161	154	195	0
Peak Hour Factor	0.92	0.92	0.92	0.92	0.92	0.92	0.92	0.92	0.92	0.92	0.92	0.92
Percent Heavy Veh, %	12	12	12	0	0	0	0	0	0	0	0	0
Cap, veh/h	1	252	18	356	747	633	16	747	633	183	923	0
Arrive On Green	0.00	0.16	0.16	0.20	0.39	0.39	0.00	0.13	0.13	0.10	0.49	0.00
Sat Flow, veh/h	1640	1586	115	1810	1900	1610	1810	1900	1610	1810	1900	0
Grp Volume(v), veh/h	0	0	236	322	16	245	7	193	161	154	195	0
Grp Sat Flow(s),veh/h/ln	1640	0	1701	1810	1900	1610	1810	1900	1610	1810	1900	0
Q Serve(g_s), s	0.0	0.0	16.3	20.9	0.6	13.1	0.5	11.0	10.8	10.0	7.1	0.0
Cycle Q Clear(g_c), s	0.0	0.0	16.3	20.9	0.6	13.1	0.5	11.0	10.8	10.0	7.1	0.0
Prop In Lane	1.00		0.07	1.00		1.00	1.00		1.00	1.00		0.00
Lane Grp Cap(c), veh/h	1	0	270	356	747	633	16	747	633	183	923	0
V/C Ratio(X)	0.00	0.00	0.87	0.90	0.02	0.39	0.45	0.26	0.25	0.84	0.21	0.00
Avail Cap(c_a), veh/h	68	0	381	505	877	743	77	747	633	279	923	0
HCM Platoon Ratio	1.00	1.00	1.00	1.00	1.00	1.00	0.33	0.33	0.33	1.00	1.00	1.00
Upstream Filter(I)	0.00	0.00	1.00	0.81	0.81	0.81	0.92	0.92	0.92	1.00	1.00	0.00
Uniform Delay (d), s/veh	0.0	0.0	49.3	47.1	22.3	26.1	59.5	36.5	36.4	53.0	17.7	0.0
Incr Delay (d2), s/veh	0.0	0.0	14.6	12.9	0.0	0.3	17.2	0.8	0.9	13.0	0.5	0.0
Initial Q Delay(d3),s/veh	0.0	0.0	0.0	0.0	0.0	0.0	0.0	0.0	0.0	0.0	0.0	0.0
%ile BackOfQ(50%),veh/ln	0.0	0.0	8.0	10.6	0.3	5.1	0.3	5.8	4.8	5.2	3.2	0.0
Unsig. Movement Delay, s/veh												
LnGrp Delay(d),s/veh	0.0	0.0	63.9	60.0	22.3	26.4	76.7	37.2	37.3	66.0	18.2	0.0
LnGrp LOS	A	A	E	E	C	C	E	D	D	E	B	A
Approach Vol, veh/h		236		583		361		349				
Approach Delay, s/veh		63.9		44.8		38.0		39.3				
Approach LOS		E		D		D		D				
Timer - Assigned Phs	1	2	3	4	5	6	7	8				
Phs Duration (G+Y+Rc), s	66.7	51.7	28.1	23.6	5.5	62.8	0.0	51.7				
Change Period (Y+Rc), s	4.5	4.5	4.5	4.5	4.5	4.5	4.5	4.5				
Max Green Setting (Gmax), s	10.5	23.1	33.5	26.9	5.1	36.5	5.0	55.4				
Max Q Clear Time (g_c+1/2g), s	12.0	13.0	22.9	18.3	2.5	9.1	0.0	15.1				
Green Ext Time (p_c), s	0.2	1.2	0.7	0.8	0.0	1.1	0.0	0.9				

Intersection Summary

HCM 6th Ctrl Delay	44.9
HCM 6th LOS	D

HCM 6th Signalized Intersection Summary
53: Road 22 1/2 & Cleveland Avenue

Village D Specific Plan
Phase III WP MIT - PM Peak Hour



Movement	EBL	EBT	EBR	WBL	WBT	WBR	NBL	NBT	NBR	SBL	SBT	SBR
Lane Configurations												
Traffic Volume (veh/h)	8	417	16	113	524	449	14	29	62	330	30	8
Future Volume (veh/h)	8	417	16	113	524	449	14	29	62	330	30	8
Initial Q (Qb), veh	0	0	0	0	0	0	0	0	0	0	0	0
Ped-Bike Adj(A_pbT)	1.00		1.00	1.00		1.00	1.00		1.00	1.00		1.00
Parking Bus, Adj	1.00	1.00	1.00	1.00	1.00	1.00	1.00	1.00	1.00	1.00	1.00	1.00
Work Zone On Approach		No			No			No			No	
Adj Sat Flow, veh/h/ln	1900	1900	1900	1900	1900	1900	1900	1900	1900	1900	1900	1900
Adj Flow Rate, veh/h	9	453	17	123	570	488	15	32	67	359	33	9
Peak Hour Factor	0.92	0.92	0.92	0.92	0.92	0.92	0.92	0.92	0.92	0.92	0.92	0.92
Percent Heavy Veh, %	0	0	0	0	0	0	0	0	0	0	0	0
Cap, veh/h	20	860	32	152	1139	705	30	220	460	428	729	199
Arrive On Green	0.01	0.24	0.24	0.03	0.10	0.10	0.02	0.40	0.40	0.12	0.51	0.51
Sat Flow, veh/h	1810	3548	133	1810	3610	1610	1810	547	1146	3510	1437	392
Grp Volume(v), veh/h	9	230	240	123	570	488	15	0	99	359	0	42
Grp Sat Flow(s),veh/h/ln	1810	1805	1876	1810	1805	1610	1810	0	1694	1755	0	1829
Q Serve(g_s), s	0.6	13.3	13.3	8.1	17.9	29.7	1.0	0.0	4.5	12.0	0.0	1.4
Cycle Q Clear(g_c), s	0.6	13.3	13.3	8.1	17.9	29.7	1.0	0.0	4.5	12.0	0.0	1.4
Prop In Lane	1.00		0.07	1.00		1.00	1.00		0.68	1.00		0.21
Lane Grp Cap(c), veh/h	20	437	455	152	1139	705	30	0	680	428	0	928
V/C Ratio(X)	0.46	0.53	0.53	0.81	0.50	0.69	0.51	0.00	0.15	0.84	0.00	0.05
Avail Cap(c_a), veh/h	83	669	696	249	1670	941	83	0	680	570	0	928
HCM Platoon Ratio	1.00	1.00	1.00	0.33	0.33	0.33	1.00	1.00	1.00	1.00	1.00	1.00
Upstream Filter(l)	1.00	1.00	1.00	0.57	0.57	0.57	1.00	0.00	1.00	0.78	0.00	0.78
Uniform Delay (d), s/veh	59.0	39.5	39.5	57.4	44.8	35.8	58.5	0.0	22.8	51.5	0.0	14.9
Incr Delay (d2), s/veh	15.9	1.0	1.0	5.8	0.2	0.8	12.7	0.0	0.5	6.5	0.0	0.1
Initial Q Delay(d3),s/veh	0.0	0.0	0.0	0.0	0.0	0.0	0.0	0.0	0.0	0.0	0.0	0.0
%ile BackOfQ(50%),veh/ln	0.4	6.0	6.3	4.1	8.7	12.9	0.6	0.0	1.9	5.7	0.0	0.6
Unsig. Movement Delay, s/veh												
LnGrp Delay(d),s/veh	74.9	40.5	40.4	63.2	45.0	36.6	71.2	0.0	23.3	58.0	0.0	15.0
LnGrp LOS	E	D	D	E	D	D	E	A	C	E	A	B
Approach Vol, veh/h		479			1181			114			401	
Approach Delay, s/veh		41.1			43.4			29.6			53.5	
Approach LOS		D			D			C			D	
Timer - Assigned Phs	1	2	3	4	5	6	7	8				
Phs Duration (G+Y+Rc), s	19.1	52.7	14.6	33.6	6.5	65.4	5.8	42.4				
Change Period (Y+Rc), s	4.5	4.5	4.5	4.5	4.5	4.5	4.5	4.5				
Max Green Setting (Gmax), s	19.5	21.5	16.5	44.5	5.5	35.5	5.5	55.5				
Max Q Clear Time (g_c+M), s	14.0	6.5	10.1	15.3	3.0	3.4	2.6	31.7				
Green Ext Time (p_c), s	0.6	0.4	0.1	3.0	0.0	0.2	0.0	6.1				
Intersection Summary												
HCM 6th Ctrl Delay												44.0
HCM 6th LOS												D

HCM 6th Signalized Intersection Summary
55: Road 23 & Project Driveway 3

Village D Specific Plan
Phase III WP MIT - PM Peak Hour



Movement	EBL	EBR	NBL	NBT	SBT	SBR
Lane Configurations	↔↔	↗	↖	↑↑↑	↑↑↑	↗
Traffic Volume (veh/h)	294	211	228	1255	1687	631
Future Volume (veh/h)	294	211	228	1255	1687	631
Initial Q (Qb), veh	0	0	0	0	0	0
Ped-Bike Adj(A_pbT)	1.00	1.00	1.00			1.00
Parking Bus, Adj	1.00	1.00	1.00	1.00	1.00	1.00
Work Zone On Approach	No			No	No	
Adj Sat Flow, veh/h/ln	1900	1900	1870	1870	1870	1870
Adj Flow Rate, veh/h	320	229	248	1364	1834	686
Peak Hour Factor	0.92	0.92	0.92	0.92	0.92	0.92
Percent Heavy Veh, %	0	0	2	2	2	2
Cap, veh/h	483	474	279	4020	3028	940
Arrive On Green	0.14	0.14	0.16	0.79	0.59	0.59
Sat Flow, veh/h	3510	1610	1781	5274	5274	1585
Grp Volume(v), veh/h	320	229	248	1364	1834	686
Grp Sat Flow(s),veh/h/ln	1755	1610	1781	1702	1702	1585
Q Serve(g_s), s	10.4	14.0	16.4	9.3	27.4	37.3
Cycle Q Clear(g_c), s	10.4	14.0	16.4	9.3	27.4	37.3
Prop In Lane	1.00	1.00	1.00			1.00
Lane Grp Cap(c), veh/h	483	474	279	4020	3028	940
V/C Ratio(X)	0.66	0.48	0.89	0.34	0.61	0.73
Avail Cap(c_a), veh/h	529	495	401	4020	3028	940
HCM Platoon Ratio	1.00	1.00	1.00	1.00	1.00	1.00
Upstream Filter(I)	1.00	1.00	0.87	0.87	0.29	0.29
Uniform Delay (d), s/veh	49.1	34.8	49.5	3.7	15.5	17.5
Incr Delay (d2), s/veh	2.7	0.8	13.9	0.2	0.3	1.5
Initial Q Delay(d3),s/veh	0.0	0.0	0.0	0.0	0.0	0.0
%ile BackOfQ(50%),veh/ln	4.7	13.1	8.3	2.7	10.3	13.3
Unsig. Movement Delay, s/veh						
LnGrp Delay(d),s/veh	51.8	35.6	63.5	3.9	15.8	19.0
LnGrp LOS	D	D	E	A	B	B
Approach Vol, veh/h	549			1612	2520	
Approach Delay, s/veh	45.0			13.1	16.7	
Approach LOS	D			B	B	
Timer - Assigned Phs		2		4	5	6
Phs Duration (G+Y+Rc), s		99.0		21.0	23.3	75.7
Change Period (Y+Rc), s		4.5		4.5	4.5	4.5
Max Green Setting (Gmax), s		92.9		18.1	27.0	61.4
Max Q Clear Time (g_c+I1), s		11.3		16.0	18.4	39.3
Green Ext Time (p_c), s		15.5		0.5	0.5	17.2
Intersection Summary						
HCM 6th Ctrl Delay			18.8			
HCM 6th LOS			B			

HCM 6th Signalized Intersection Summary
56: Road 23 & Project Driveway 4

Village D Specific Plan
Phase III WP MIT - PM Peak Hour



Movement	WBL	WBR	NBT	NBR	SBL	SBT
Lane Configurations						
Traffic Volume (veh/h)	370	890	1332	341	977	1014
Future Volume (veh/h)	370	890	1332	341	977	1014
Initial Q (Qb), veh	0	0	0	0	0	0
Ped-Bike Adj(A_pbT)	1.00	1.00		1.00	1.00	
Parking Bus, Adj	1.00	1.00	1.00	1.00	1.00	1.00
Work Zone On Approach	No		No		No	
Adj Sat Flow, veh/h/ln	1900	1900	1870	1870	1870	1870
Adj Flow Rate, veh/h	402	967	1448	371	1062	1102
Peak Hour Factor	0.92	0.92	0.92	0.92	0.92	0.92
Percent Heavy Veh, %	0	0	2	2	2	2
Cap, veh/h	443	1595	1658	515	1098	3472
Arrive On Green	0.24	0.24	0.65	0.65	0.64	1.00
Sat Flow, veh/h	1810	2834	5274	1585	3456	5274
Grp Volume(v), veh/h	402	967	1448	371	1062	1102
Grp Sat Flow(s),veh/h/ln	1810	1417	1702	1585	1728	1702
Q Serve(g_s), s	25.9	27.2	27.6	18.5	34.9	0.0
Cycle Q Clear(g_c), s	25.9	27.2	27.6	18.5	34.9	0.0
Prop In Lane	1.00	1.00		1.00	1.00	
Lane Grp Cap(c), veh/h	443	1595	1658	515	1098	3472
V/C Ratio(X)	0.91	0.61	0.87	0.72	0.97	0.32
Avail Cap(c_a), veh/h	445	1597	1658	515	1138	3472
HCM Platoon Ratio	1.00	1.00	2.00	2.00	2.00	2.00
Upstream Filter(I)	1.00	1.00	0.90	0.90	0.63	0.63
Uniform Delay (d), s/veh	44.0	17.4	19.0	17.4	21.3	0.0
Incr Delay (d2), s/veh	22.0	0.7	6.1	7.7	14.0	0.2
Initial Q Delay(d3),s/veh	0.0	0.0	0.0	0.0	0.0	0.0
%ile BackOfQ(50%),veh/ln	14.2	8.7	7.5	5.4	10.9	0.0
Unsig. Movement Delay, s/veh						
LnGrp Delay(d),s/veh	66.0	18.1	25.1	25.1	35.2	0.2
LnGrp LOS	E	B	C	C	D	A
Approach Vol, veh/h	1369		1819			2164
Approach Delay, s/veh	32.1		25.1			17.4
Approach LOS	C		C			B
Timer - Assigned Phs	1	2			6	8
Phs Duration (G+Y+Rc), s	42.6	43.5			86.1	33.9
Change Period (Y+Rc), s	4.5	4.5			4.5	4.5
Max Green Setting (Gmax), s	39.5	37.5			81.5	29.5
Max Q Clear Time (g_c+Rc), s	30.9	29.6			2.0	29.2
Green Ext Time (p_c), s	1.3	6.0			10.9	0.2
Intersection Summary						
HCM 6th Ctrl Delay			23.8			
HCM 6th LOS			C			

HCM 6th Signalized Intersection Summary
57: Road 23 & Project Driveway 5

Village D Specific Plan
Phase III WP MIT - PM Peak Hour



Movement	EBL	EBR	NBL	NBT	SBT	SBR
Lane Configurations						
Traffic Volume (veh/h)	131	62	94	1551	1256	136
Future Volume (veh/h)	131	62	94	1551	1256	136
Initial Q (Qb), veh	0	0	0	0	0	0
Ped-Bike Adj(A_pbT)	1.00	1.00	1.00			1.00
Parking Bus, Adj	1.00	1.00	1.00	1.00	1.00	1.00
Work Zone On Approach	No			No	No	
Adj Sat Flow, veh/h/ln	1900	1900	1870	1870	1870	1870
Adj Flow Rate, veh/h	142	67	102	1686	1365	148
Peak Hour Factor	0.92	0.92	0.92	0.92	0.92	0.92
Percent Heavy Veh, %	0	0	2	2	2	2
Cap, veh/h	176	157	128	4226	3359	364
Arrive On Green	0.10	0.10	0.07	0.83	1.00	1.00
Sat Flow, veh/h	1810	1610	1781	5274	4845	507
Grp Volume(v), veh/h	142	67	102	1686	994	519
Grp Sat Flow(s),veh/h/ln	1810	1610	1781	1702	1702	1779
Q Serve(g_s), s	9.2	4.7	6.8	10.2	0.0	0.0
Cycle Q Clear(g_c), s	9.2	4.7	6.8	10.2	0.0	0.0
Prop In Lane	1.00	1.00	1.00			0.28
Lane Grp Cap(c), veh/h	176	157	128	4226	2445	1278
V/C Ratio(X)	0.81	0.43	0.80	0.40	0.41	0.41
Avail Cap(c_a), veh/h	369	329	275	4226	2445	1278
HCM Platoon Ratio	1.00	1.00	1.00	1.00	2.00	2.00
Upstream Filter(I)	1.00	1.00	0.62	0.62	0.87	0.87
Uniform Delay (d), s/veh	53.0	51.0	54.8	2.7	0.0	0.0
Incr Delay (d2), s/veh	8.3	1.8	6.9	0.2	0.4	0.8
Initial Q Delay(d3),s/veh	0.0	0.0	0.0	0.0	0.0	0.0
%ile BackOfQ(50%),veh/ln	4.6	4.3	3.3	2.5	0.1	0.3
Unsig. Movement Delay, s/veh						
LnGrp Delay(d),s/veh	61.4	52.8	61.7	2.8	0.4	0.8
LnGrp LOS	E	D	E	A	A	A
Approach Vol, veh/h	209			1788	1513	
Approach Delay, s/veh	58.6			6.2	0.6	
Approach LOS	E			A	A	
Timer - Assigned Phs		2		4	5	6
Phs Duration (G+Y+Rc), s		103.8		16.2	13.1	90.7
Change Period (Y+Rc), s		4.5		4.5	4.5	4.5
Max Green Setting (Gmax), s		86.5		24.5	18.5	63.5
Max Q Clear Time (g_c+I1), s		12.2		11.2	8.8	2.0
Green Ext Time (p_c), s		22.8		0.5	0.1	16.8
Intersection Summary						
HCM 6th Ctrl Delay			6.9			
HCM 6th LOS			A			

HCM 6th Signalized Intersection Summary
58: Project Driveway 6 & Cleveland Avenue

Village D Specific Plan
Phase III WP MIT - PM Peak Hour

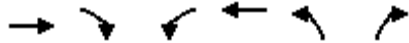

Movement	EBT	EBR	WBL	WBT	NBL	NBR
Lane Configurations	↑↑↑	↑	↑	↑↑↑	↑	↑
Traffic Volume (veh/h)	870	145	332	1254	65	243
Future Volume (veh/h)	870	145	332	1254	65	243
Initial Q (Qb), veh	0	0	0	0	0	0
Ped-Bike Adj(A_pbT)		1.00	1.00		1.00	1.00
Parking Bus, Adj	1.00	1.00	1.00	1.00	1.00	1.00
Work Zone On Approach	No			No	No	
Adj Sat Flow, veh/h/ln	1885	1885	1900	1900	1900	1900
Adj Flow Rate, veh/h	946	158	361	1363	71	264
Peak Hour Factor	0.92	0.92	0.92	0.92	0.92	0.92
Percent Heavy Veh, %	1	1	0	0	0	0
Cap, veh/h	1220	379	398	2564	780	694
Arrive On Green	0.24	0.24	0.22	0.49	0.43	0.43
Sat Flow, veh/h	5316	1598	1810	5358	1810	1610
Grp Volume(v), veh/h	946	158	361	1363	71	264
Grp Sat Flow(s),veh/h/ln	1716	1598	1810	1729	1810	1610
Q Serve(g_s), s	20.6	10.0	23.3	21.6	2.8	13.4
Cycle Q Clear(g_c), s	20.6	10.0	23.3	21.6	2.8	13.4
Prop In Lane		1.00	1.00		1.00	1.00
Lane Grp Cap(c), veh/h	1220	379	398	2564	780	694
V/C Ratio(X)	0.78	0.42	0.91	0.53	0.09	0.38
Avail Cap(c_a), veh/h	1523	473	656	3609	780	694
HCM Platoon Ratio	1.00	1.00	1.00	1.00	1.00	1.00
Upstream Filter(I)	0.81	0.81	1.00	1.00	1.00	1.00
Uniform Delay (d), s/veh	42.8	38.8	45.6	20.8	20.2	23.3
Incr Delay (d2), s/veh	1.7	0.6	10.5	0.2	0.2	1.6
Initial Q Delay(d3),s/veh	0.0	0.0	0.0	0.0	0.0	0.0
%ile BackOfQ(50%),veh/ln	8.9	4.0	11.6	8.6	1.2	5.4
Unsig. Movement Delay, s/veh						
LnGrp Delay(d),s/veh	44.5	39.4	56.1	21.0	20.5	24.8
LnGrp LOS	D	D	E	C	C	C
Approach Vol, veh/h	1104			1724	335	
Approach Delay, s/veh	43.7			28.4	23.9	
Approach LOS	D			C	C	
Timer - Assigned Phs		2	3	4		8
Phs Duration (G+Y+Rc), s		56.2	30.9	32.9		63.8
Change Period (Y+Rc), s		4.5	4.5	4.5		4.5
Max Green Setting (Gmax), s		27.5	43.5	35.5		83.5
Max Q Clear Time (g_c+I1), s		15.4	25.3	22.6		23.6
Green Ext Time (p_c), s		0.9	1.0	5.8		14.9
Intersection Summary						
HCM 6th Ctrl Delay			33.2			
HCM 6th LOS			C			

APPENDIX E:

FREEWAY LEVEL OF SERVICE WORKSHEETS

HCS7 Basic Freeway Report

Project Information

Analyst	LSA	Date	12/11/2019
Agency	LSA	Analysis Year	Existing NP
Jurisdiction	Caltrans	Time Period Analyzed	AM Peak Hour
Project Description	CMD1801 - Village D Specific Plan	Unit	United States Customary

Geometric Data

Number of Lanes, ln	2	Terrain Type	Level
Segment Length (L), ft	-	Percent Grade, %	-
Measured or Base Free-Flow Speed	Base	Grade Length, mi	-
Base Free-Flow Speed (BFFS), mi/h	65.0	Total Ramp Density (TRD), ramps/mi	1.83
Lane Width, ft	12	Free-Flow Speed (FFS), mi/h	59.7
Right-Side Lateral Clearance, ft	10		

Adjustment Factors

Driver Population	All Familiar	Final Speed Adjustment Factor (SAF)	1.000
Weather Type	Non-Severe Weather	Final Capacity Adjustment Factor (CAF)	1.000
Incident Type	No Incident	Demand Adjustment Factor (DAF)	1.000

Demand and Capacity

Demand Volume veh/h	2679	Heavy Vehicle Adjustment Factor (fhv)	0.851
Peak Hour Factor	0.94	Flow Rate (Vp), pc/h/ln	1674
Total Trucks, %	17.57	Capacity (c), pc/h/ln	2296
Single-Unit Trucks (SUT), %	-	Adjusted Capacity (cadj), pc/h/ln	2296
Tractor-Trailers (TT), %	-	Volume-to-Capacity Ratio (v/c)	0.73
Passenger Car Equivalent (Et)	2.000		

Speed and Density

Lane Width Adjustment (fLW)	0.0	Average Speed (S), mi/h	59.5
Right-Side Lateral Clearance Adj. (fRLC)	0.0	Density (D), pc/mi/ln	28.1
Total Ramp Density Adjustment	5.4	Level of Service (LOS)	D
Adjusted Free-Flow Speed (FFSadj), mi/h	59.6		

HCS7 Freeway Diverge Report

Project Information

Analyst	LSA	Date	12/11/2019
Agency	LSA	Analysis Year	Existing NP
Jurisdiction	Caltrans	Time Period Analyzed	AM Peak Hour
Project Description	CMD1801 - Village D Specific Plan	Unit	United States Customary

Geometric Data

	Freeway	Ramp
Number of Lanes (N), ln	2	1
Free-Flow Speed (FFS), mi/h	65.0	35.0
Segment Length (L) / Deceleration Length (LA),ft	1500	150
Terrain Type	Level	Level
Percent Grade, %	-	-
Segment Type / Ramp Side	Freeway	Right

Adjustment Factors

Driver Population	All Familiar	All Familiar
Weather Type	Non-Severe Weather	Non-Severe Weather
Incident Type	No Incident	-
Final Speed Adjustment Factor (SAF)	1.000	1.000
Final Capacity Adjustment Factor (CAF)	1.000	1.000
Demand Adjustment Factor (DAF)	1.000	1.000

Demand and Capacity

Demand Volume (Vi)	2679	215
Peak Hour Factor (PHF)	0.94	0.94
Total Trucks, %	17.57	4.65
Single-Unit Trucks (SUT), %	-	-
Tractor-Trailers (TT), %	-	-
Heavy Vehicle Adjustment Factor (fHV)	0.851	0.956
Flow Rate (vi),pc/h	3349	239
Capacity (c), pc/h	4700	2000
Volume-to-Capacity Ratio (v/c)	0.71	0.12

Speed and Density

Upstream Equilibrium Distance (LEQ), ft	-	Number of Outer Lanes on Freeway (NO)	0
Distance to Upstream Ramp (LUP), ft	-	Speed Index (DS)	0.450
Downstream Equilibrium Distance (LEQ), ft	-	Flow Outer Lanes (vOA), pc/h/ln	-
Distance to Downstream Ramp (LDOWN), ft	-	Off-Ramp Influence Area Speed (SR), mi/h	54.6
Prop. Freeway Vehicles in Lane 1 and 2 (PFD)	1.000	Outer Lanes Freeway Speed (SO), mi/h	71.3
Flow in Lanes 1 and 2 (v12), pc/h	3349	Ramp Junction Speed (S), mi/h	54.6
Flow Entering Ramp-Infl. Area (vR12), pc/h	-	Average Density (D), pc/mi/ln	30.7
Level of Service (LOS)	D	Density in Ramp Influence Area (DR), pc/mi/ln	31.7

HCS7 Basic Freeway Report

Project Information

Analyst	LSA	Date	12/11/2019
Agency	LSA	Analysis Year	Existing NP
Jurisdiction	Caltrans	Time Period Analyzed	AM Peak Hour
Project Description	CMD1801 - Village D Specific Plan	Unit	United States Customary

Geometric Data

Number of Lanes, ln	2	Terrain Type	Level
Segment Length (L), ft	-	Percent Grade, %	-
Measured or Base Free-Flow Speed	Base	Grade Length, mi	-
Base Free-Flow Speed (BFFS), mi/h	65.0	Total Ramp Density (TRD), ramps/mi	1.83
Lane Width, ft	12	Free-Flow Speed (FFS), mi/h	59.7
Right-Side Lateral Clearance, ft	10		

Adjustment Factors

Driver Population	All Familiar	Final Speed Adjustment Factor (SAF)	1.000
Weather Type	Non-Severe Weather	Final Capacity Adjustment Factor (CAF)	1.000
Incident Type	No Incident	Demand Adjustment Factor (DAF)	1.000

Demand and Capacity

Demand Volume veh/h	2464	Heavy Vehicle Adjustment Factor (fhv)	0.842
Peak Hour Factor	0.94	Flow Rate (Vp), pc/h/ln	1556
Total Trucks, %	18.70	Capacity (c), pc/h/ln	2296
Single-Unit Trucks (SUT), %	-	Adjusted Capacity (cadj), pc/h/ln	2296
Tractor-Trailers (TT), %	-	Volume-to-Capacity Ratio (v/c)	0.68
Passenger Car Equivalent (Et)	2.000		

Speed and Density

Lane Width Adjustment (fLW)	0.0	Average Speed (S), mi/h	59.6
Right-Side Lateral Clearance Adj. (fRLC)	0.0	Density (D), pc/mi/ln	26.1
Total Ramp Density Adjustment	5.4	Level of Service (LOS)	D
Adjusted Free-Flow Speed (FFSadj), mi/h	59.6		

HCS7 Freeway Merge Report

Project Information

Analyst	LSA	Date	12/11/2019
Agency	LSA	Analysis Year	Existing NP
Jurisdiction	Caltrans	Time Period Analyzed	AM Peak Hour
Project Description	CMD1801 - Village D Specific Plan	Unit	United States Customary

Geometric Data

	Freeway	Ramp
Number of Lanes (N), ln	2	1
Free-Flow Speed (FFS), mi/h	65.0	35.0
Segment Length (L) / Acceleration Length (LA),ft	1500	445
Terrain Type	Level	Level
Percent Grade, %	-	-
Segment Type / Ramp Side	Freeway	Right

Adjustment Factors

Driver Population	All Familiar	All Familiar
Weather Type	Non-Severe Weather	Non-Severe Weather
Incident Type	No Incident	-
Final Speed Adjustment Factor (SAF)	1.000	1.000
Final Capacity Adjustment Factor (CAF)	1.000	1.000
Demand Adjustment Factor (DAF)	1.000	1.000

Demand and Capacity

Demand Volume (Vi)	2464	504
Peak Hour Factor (PHF)	0.94	0.94
Total Trucks, %	18.70	9.94
Single-Unit Trucks (SUT), %	-	-
Tractor-Trailers (TT), %	-	-
Heavy Vehicle Adjustment Factor (fHV)	0.842	0.910
Flow Rate (vi),pc/h	3113	589
Capacity (c), pc/h	4700	2000
Volume-to-Capacity Ratio (v/c)	0.79	0.29

Speed and Density

Upstream Equilibrium Distance (LEQ), ft	-	Number of Outer Lanes on Freeway (NO)	0
Distance to Upstream Ramp (LUP), ft	-	Speed Index (MS)	0.448
Downstream Equilibrium Distance (LEQ), ft	-	Flow Outer Lanes (vOA), pc/h/ln	-
Distance to Downstream Ramp (LDOWN), ft	-	On-Ramp Influence Area Speed (SR), mi/h	54.7
Prop. Freeway Vehicles in Lane 1 and 2 (PFM)	1.000	Outer Lanes Freeway Speed (SO), mi/h	65.0
Flow in Lanes 1 and 2 (v12), pc/h	3113	Ramp Junction Speed (S), mi/h	54.7
Flow Entering Ramp-Infl. Area (vR12), pc/h	3702	Average Density (D), pc/mi/ln	33.8
Level of Service (LOS)	D	Density in Ramp Influence Area (DR), pc/mi/ln	31.4

HCS7 Basic Freeway Report

Project Information

Analyst	LSA	Date	12/11/2019
Agency	LSA	Analysis Year	Existing NP
Jurisdiction	Caltrans	Time Period Analyzed	AM Peak Hour
Project Description	CMD1801 - Village D Specific Plan	Unit	United States Customary

Geometric Data

Number of Lanes, ln	2	Terrain Type	Level
Segment Length (L), ft	-	Percent Grade, %	-
Measured or Base Free-Flow Speed	Base	Grade Length, mi	-
Base Free-Flow Speed (BFFS), mi/h	65.0	Total Ramp Density (TRD), ramps/mi	1.50
Lane Width, ft	12	Free-Flow Speed (FFS), mi/h	60.5
Right-Side Lateral Clearance, ft	10		

Adjustment Factors

Driver Population	All Familiar	Final Speed Adjustment Factor (SAF)	1.000
Weather Type	Non-Severe Weather	Final Capacity Adjustment Factor (CAF)	1.000
Incident Type	No Incident	Demand Adjustment Factor (DAF)	1.000

Demand and Capacity

Demand Volume veh/h	2968	Heavy Vehicle Adjustment Factor (fhv)	0.853
Peak Hour Factor	0.94	Flow Rate (Vp), pc/h/ln	1851
Total Trucks, %	17.21	Capacity (c), pc/h/ln	2305
Single-Unit Trucks (SUT), %	-	Adjusted Capacity (cadj), pc/h/ln	2305
Tractor-Trailers (TT), %	-	Volume-to-Capacity Ratio (v/c)	0.80
Passenger Car Equivalent (Et)	2.000		

Speed and Density

Lane Width Adjustment (fLW)	0.0	Average Speed (S), mi/h	59.2
Right-Side Lateral Clearance Adj. (fRLC)	0.0	Density (D), pc/mi/ln	31.3
Total Ramp Density Adjustment	4.5	Level of Service (LOS)	D
Adjusted Free-Flow Speed (FFSadj), mi/h	60.5		

HCS7 Freeway Diverge Report

Project Information

Analyst	LSA	Date	12/11/2019
Agency	LSA	Analysis Year	Existing NP
Jurisdiction	Caltrans	Time Period Analyzed	AM Peak Hour
Project Description	CMD1801 - Village D Specific Plan	Unit	United States Customary

Geometric Data

	Freeway	Ramp
Number of Lanes (N), In	2	1
Free-Flow Speed (FFS), mi/h	65.0	35.0
Segment Length (L) / Deceleration Length (LA),ft	1500	130
Terrain Type	Level	Level
Percent Grade, %	-	-
Segment Type / Ramp Side	Freeway	Right

Adjustment Factors

Driver Population	All Familiar	All Familiar
Weather Type	Non-Severe Weather	Non-Severe Weather
Incident Type	No Incident	-
Final Speed Adjustment Factor (SAF)	1.000	1.000
Final Capacity Adjustment Factor (CAF)	1.000	1.000
Demand Adjustment Factor (DAF)	1.000	1.000

Demand and Capacity

Demand Volume (Vi)	2968	458
Peak Hour Factor (PHF)	0.94	0.94
Total Trucks, %	17.21	1.77
Single-Unit Trucks (SUT), %	-	-
Tractor-Trailers (TT), %	-	-
Heavy Vehicle Adjustment Factor (fHV)	0.853	0.983
Flow Rate (vi),pc/h	3702	496
Capacity (c), pc/h	4700	2000
Volume-to-Capacity Ratio (v/c)	0.79	0.25

Speed and Density

Upstream Equilibrium Distance (LEQ), ft	-	Number of Outer Lanes on Freeway (NO)	0
Distance to Upstream Ramp (LUP), ft	-	Speed Index (DS)	0.473
Downstream Equilibrium Distance (LEQ), ft	-	Flow Outer Lanes (vOA), pc/h/ln	-
Distance to Downstream Ramp (LDOWN), ft	-	Off-Ramp Influence Area Speed (SR), mi/h	54.1
Prop. Freeway Vehicles in Lane 1 and 2 (PFD)	1.000	Outer Lanes Freeway Speed (SO), mi/h	71.3
Flow in Lanes 1 and 2 (v12), pc/h	3702	Ramp Junction Speed (S), mi/h	54.1
Flow Entering Ramp-Infl. Area (vR12), pc/h	-	Average Density (D), pc/mi/ln	34.2
Level of Service (LOS)	D	Density in Ramp Influence Area (DR), pc/mi/ln	34.9

HCS7 Basic Freeway Report

Project Information

Analyst	LSA	Date	12/11/2019
Agency	LSA	Analysis Year	Existing NP
Jurisdiction	Caltrans	Time Period Analyzed	AM Peak Hour
Project Description	CMD1801 - Village D Specific Plan	Unit	United States Customary

Geometric Data

Number of Lanes, ln	2	Terrain Type	Level
Segment Length (L), ft	-	Percent Grade, %	-
Measured or Base Free-Flow Speed	Base	Grade Length, mi	-
Base Free-Flow Speed (BFFS), mi/h	65.0	Total Ramp Density (TRD), ramps/mi	1.67
Lane Width, ft	12	Free-Flow Speed (FFS), mi/h	60.0
Right-Side Lateral Clearance, ft	10		

Adjustment Factors

Driver Population	All Familiar	Final Speed Adjustment Factor (SAF)	1.000
Weather Type	Non-Severe Weather	Final Capacity Adjustment Factor (CAF)	1.000
Incident Type	No Incident	Demand Adjustment Factor (DAF)	1.000

Demand and Capacity

Demand Volume veh/h	2510	Heavy Vehicle Adjustment Factor (fhv)	0.833
Peak Hour Factor	0.94	Flow Rate (Vp), pc/h/ln	1603
Total Trucks, %	20.03	Capacity (c), pc/h/ln	2300
Single-Unit Trucks (SUT), %	-	Adjusted Capacity (cadj), pc/h/ln	2300
Tractor-Trailers (TT), %	-	Volume-to-Capacity Ratio (v/c)	0.70
Passenger Car Equivalent (Et)	2.000		

Speed and Density

Lane Width Adjustment (fLW)	0.0	Average Speed (S), mi/h	60.0
Right-Side Lateral Clearance Adj. (fRLC)	0.0	Density (D), pc/mi/ln	26.7
Total Ramp Density Adjustment	5.0	Level of Service (LOS)	D
Adjusted Free-Flow Speed (FFSadj), mi/h	60.0		

HCS7 Freeway Merge Report

Project Information

Analyst	LSA	Date	12/11/2019
Agency	LSA	Analysis Year	Existing NP
Jurisdiction	Caltrans	Time Period Analyzed	AM Peak Hour
Project Description	CMD1801 - Village D Specific Plan	Unit	United States Customary

Geometric Data

	Freeway	Ramp
Number of Lanes (N), ln	2	1
Free-Flow Speed (FFS), mi/h	65.0	35.0
Segment Length (L) / Acceleration Length (LA),ft	1500	500
Terrain Type	Level	Level
Percent Grade, %	-	-
Segment Type / Ramp Side	Freeway	Right

Adjustment Factors

Driver Population	All Familiar	All Familiar
Weather Type	Non-Severe Weather	Non-Severe Weather
Incident Type	No Incident	-
Final Speed Adjustment Factor (SAF)	1.000	1.000
Final Capacity Adjustment Factor (CAF)	1.000	1.000
Demand Adjustment Factor (DAF)	1.000	1.000

Demand and Capacity

Demand Volume (Vi)	2510	274
Peak Hour Factor (PHF)	0.94	0.94
Total Trucks, %	20.03	2.92
Single-Unit Trucks (SUT), %	-	-
Tractor-Trailers (TT), %	-	-
Heavy Vehicle Adjustment Factor (fHV)	0.833	0.972
Flow Rate (vi),pc/h	3206	300
Capacity (c), pc/h	4700	2000
Volume-to-Capacity Ratio (v/c)	0.75	0.15

Speed and Density

Upstream Equilibrium Distance (LEQ), ft	-	Number of Outer Lanes on Freeway (NO)	0
Distance to Upstream Ramp (LUP), ft	-	Speed Index (MS)	0.416
Downstream Equilibrium Distance (LEQ), ft	-	Flow Outer Lanes (vOA), pc/h/ln	-
Distance to Downstream Ramp (LDOWN), ft	-	On-Ramp Influence Area Speed (SR), mi/h	55.4
Prop. Freeway Vehicles in Lane 1 and 2 (PFM)	1.000	Outer Lanes Freeway Speed (SO), mi/h	65.0
Flow in Lanes 1 and 2 (v12), pc/h	3206	Ramp Junction Speed (S), mi/h	55.4
Flow Entering Ramp-Infl. Area (vR12), pc/h	3506	Average Density (D), pc/mi/ln	31.6
Level of Service (LOS)	D	Density in Ramp Influence Area (DR), pc/mi/ln	29.6

HCS7 Basic Freeway Report

Project Information

Analyst	LSA	Date	12/11/2019
Agency	LSA	Analysis Year	Existing NP
Jurisdiction	Caltrans	Time Period Analyzed	AM Peak Hour
Project Description	CMD1801 - Village D Specific Plan	Unit	United States Customary

Geometric Data

Number of Lanes, ln	2	Terrain Type	Level
Segment Length (L), ft	-	Percent Grade, %	-
Measured or Base Free-Flow Speed	Base	Grade Length, mi	-
Base Free-Flow Speed (BFFS), mi/h	65.0	Total Ramp Density (TRD), ramps/mi	1.83
Lane Width, ft	12	Free-Flow Speed (FFS), mi/h	59.7
Right-Side Lateral Clearance, ft	10		

Adjustment Factors

Driver Population	All Familiar	Final Speed Adjustment Factor (SAF)	1.000
Weather Type	Non-Severe Weather	Final Capacity Adjustment Factor (CAF)	1.000
Incident Type	No Incident	Demand Adjustment Factor (DAF)	1.000

Demand and Capacity

Demand Volume veh/h	2784	Heavy Vehicle Adjustment Factor (fhv)	0.845
Peak Hour Factor	0.94	Flow Rate (Vp), pc/h/ln	1752
Total Trucks, %	18.34	Capacity (c), pc/h/ln	2296
Single-Unit Trucks (SUT), %	-	Adjusted Capacity (cadj), pc/h/ln	2296
Tractor-Trailers (TT), %	-	Volume-to-Capacity Ratio (v/c)	0.76
Passenger Car Equivalent (Et)	2.000		

Speed and Density

Lane Width Adjustment (fLW)	0.0	Average Speed (S), mi/h	59.3
Right-Side Lateral Clearance Adj. (fRLC)	0.0	Density (D), pc/mi/ln	29.5
Total Ramp Density Adjustment	5.4	Level of Service (LOS)	D
Adjusted Free-Flow Speed (FFSadj), mi/h	59.6		

HCS7 Freeway Diverge Report

Project Information

Analyst	LSA	Date	12/11/2019
Agency	LSA	Analysis Year	Existing NP
Jurisdiction	Caltrans	Time Period Analyzed	AM Peak Hour
Project Description	CMD1801 - Village D Specific Plan	Unit	United States Customary

Geometric Data

	Freeway	Ramp
Number of Lanes (N), ln	2	1
Free-Flow Speed (FFS), mi/h	65.0	35.0
Segment Length (L) / Deceleration Length (LA),ft	1500	245
Terrain Type	Level	Level
Percent Grade, %	-	-
Segment Type / Ramp Side	Freeway	Right

Adjustment Factors

Driver Population	All Familiar	All Familiar
Weather Type	Non-Severe Weather	Non-Severe Weather
Incident Type	No Incident	-
Final Speed Adjustment Factor (SAF)	1.000	1.000
Final Capacity Adjustment Factor (CAF)	1.000	1.000
Demand Adjustment Factor (DAF)	1.000	1.000

Demand and Capacity

Demand Volume (Vi)	2784	477
Peak Hour Factor (PHF)	0.94	0.94
Total Trucks, %	18.34	4.61
Single-Unit Trucks (SUT), %	-	-
Tractor-Trailers (TT), %	-	-
Heavy Vehicle Adjustment Factor (fHV)	0.845	0.956
Flow Rate (vi),pc/h	3505	531
Capacity (c), pc/h	4700	2000
Volume-to-Capacity Ratio (v/c)	0.75	0.27

Speed and Density

Upstream Equilibrium Distance (LEQ), ft	-	Number of Outer Lanes on Freeway (NO)	0
Distance to Upstream Ramp (LUP), ft	-	Speed Index (DS)	0.476
Downstream Equilibrium Distance (LEQ), ft	-	Flow Outer Lanes (vOA), pc/h/ln	-
Distance to Downstream Ramp (LDOWN), ft	-	Off-Ramp Influence Area Speed (SR), mi/h	54.1
Prop. Freeway Vehicles in Lane 1 and 2 (PFD)	1.000	Outer Lanes Freeway Speed (SO), mi/h	71.3
Flow in Lanes 1 and 2 (v12), pc/h	3505	Ramp Junction Speed (S), mi/h	54.1
Flow Entering Ramp-Infl. Area (vR12), pc/h	-	Average Density (D), pc/mi/ln	32.4
Level of Service (LOS)	D	Density in Ramp Influence Area (DR), pc/mi/ln	32.2

HCS7 Basic Freeway Report

Project Information

Analyst	LSA	Date	12/11/2019
Agency	LSA	Analysis Year	Existing NP
Jurisdiction	Caltrans	Time Period Analyzed	AM Peak Hour
Project Description	CMD1801 - Village D Specific Plan	Unit	United States Customary

Geometric Data

Number of Lanes, ln	2	Terrain Type	Level
Segment Length (L), ft	-	Percent Grade, %	-
Measured or Base Free-Flow Speed	Base	Grade Length, mi	-
Base Free-Flow Speed (BFFS), mi/h	65.0	Total Ramp Density (TRD), ramps/mi	1.83
Lane Width, ft	12	Free-Flow Speed (FFS), mi/h	59.7
Right-Side Lateral Clearance, ft	10		

Adjustment Factors

Driver Population	All Familiar	Final Speed Adjustment Factor (SAF)	1.000
Weather Type	Non-Severe Weather	Final Capacity Adjustment Factor (CAF)	1.000
Incident Type	No Incident	Demand Adjustment Factor (DAF)	1.000

Demand and Capacity

Demand Volume veh/h	2307	Heavy Vehicle Adjustment Factor (fhv)	0.825
Peak Hour Factor	0.94	Flow Rate (Vp), pc/h/ln	1488
Total Trucks, %	21.18	Capacity (c), pc/h/ln	2296
Single-Unit Trucks (SUT), %	-	Adjusted Capacity (cadj), pc/h/ln	2296
Tractor-Trailers (TT), %	-	Volume-to-Capacity Ratio (v/c)	0.65
Passenger Car Equivalent (Et)	2.000		

Speed and Density

Lane Width Adjustment (fLW)	0.0	Average Speed (S), mi/h	59.6
Right-Side Lateral Clearance Adj. (fRLC)	0.0	Density (D), pc/mi/ln	25.0
Total Ramp Density Adjustment	5.4	Level of Service (LOS)	C
Adjusted Free-Flow Speed (FFSadj), mi/h	59.6		

HCS7 Freeway Merge Report

Project Information

Analyst	LSA	Date	12/11/2019
Agency	LSA	Analysis Year	Existing NP
Jurisdiction	Caltrans	Time Period Analyzed	AM Peak Hour
Project Description	CMD1801 - Village D Specific Plan	Unit	United States Customary

Geometric Data

	Freeway	Ramp
Number of Lanes (N), ln	2	1
Free-Flow Speed (FFS), mi/h	65.0	35.0
Segment Length (L) / Acceleration Length (LA),ft	1500	350
Terrain Type	Level	Level
Percent Grade, %	-	-
Segment Type / Ramp Side	Freeway	Right

Adjustment Factors

Driver Population	All Familiar	All Familiar
Weather Type	Non-Severe Weather	Non-Severe Weather
Incident Type	No Incident	-
Final Speed Adjustment Factor (SAF)	1.000	1.000
Final Capacity Adjustment Factor (CAF)	1.000	1.000
Demand Adjustment Factor (DAF)	1.000	1.000

Demand and Capacity

Demand Volume (Vi)	2307	102
Peak Hour Factor (PHF)	0.94	0.94
Total Trucks, %	21.18	2.94
Single-Unit Trucks (SUT), %	-	-
Tractor-Trailers (TT), %	-	-
Heavy Vehicle Adjustment Factor (fHV)	0.825	0.971
Flow Rate (vi),pc/h	2975	112
Capacity (c), pc/h	4700	2000
Volume-to-Capacity Ratio (v/c)	0.66	0.06

Speed and Density

Upstream Equilibrium Distance (LEQ), ft	-	Number of Outer Lanes on Freeway (NO)	0
Distance to Upstream Ramp (LUP), ft	-	Speed Index (MS)	0.382
Downstream Equilibrium Distance (LEQ), ft	-	Flow Outer Lanes (vOA), pc/h/ln	-
Distance to Downstream Ramp (LDOWN), ft	-	On-Ramp Influence Area Speed (SR), mi/h	56.2
Prop. Freeway Vehicles in Lane 1 and 2 (PFM)	1.000	Outer Lanes Freeway Speed (SO), mi/h	65.0
Flow in Lanes 1 and 2 (v12), pc/h	2975	Ramp Junction Speed (S), mi/h	56.2
Flow Entering Ramp-Infl. Area (vR12), pc/h	3087	Average Density (D), pc/mi/ln	27.5
Level of Service (LOS)	C	Density in Ramp Influence Area (DR), pc/mi/ln	27.4

HCS7 Basic Freeway Report

Project Information

Analyst	LSA	Date	12/11/2019
Agency	LSA	Analysis Year	Existing NP
Jurisdiction	Caltrans	Time Period Analyzed	AM Peak Hour
Project Description	CMD1801 - Village D Specific Plan	Unit	United States Customary

Geometric Data

Number of Lanes, ln	2	Terrain Type	Level
Segment Length (L), ft	-	Percent Grade, %	-
Measured or Base Free-Flow Speed	Base	Grade Length, mi	-
Base Free-Flow Speed (BFFS), mi/h	65.0	Total Ramp Density (TRD), ramps/mi	1.83
Lane Width, ft	12	Free-Flow Speed (FFS), mi/h	59.7
Right-Side Lateral Clearance, ft	10		

Adjustment Factors

Driver Population	All Familiar	Final Speed Adjustment Factor (SAF)	1.000
Weather Type	Non-Severe Weather	Final Capacity Adjustment Factor (CAF)	1.000
Incident Type	No Incident	Demand Adjustment Factor (DAF)	1.000

Demand and Capacity

Demand Volume veh/h	2409	Heavy Vehicle Adjustment Factor (fhv)	0.830
Peak Hour Factor	0.94	Flow Rate (Vp), pc/h/ln	1544
Total Trucks, %	20.41	Capacity (c), pc/h/ln	2296
Single-Unit Trucks (SUT), %	-	Adjusted Capacity (cadj), pc/h/ln	2296
Tractor-Trailers (TT), %	-	Volume-to-Capacity Ratio (v/c)	0.67
Passenger Car Equivalent (Et)	2.000		

Speed and Density

Lane Width Adjustment (fLW)	0.0	Average Speed (S), mi/h	59.6
Right-Side Lateral Clearance Adj. (fRLC)	0.0	Density (D), pc/mi/ln	25.9
Total Ramp Density Adjustment	5.4	Level of Service (LOS)	C
Adjusted Free-Flow Speed (FFSadj), mi/h	59.6		

HCS7 Freeway Diverge Report

Project Information

Analyst	LSA	Date	12/11/2019
Agency	LSA	Analysis Year	Existing NP
Jurisdiction	Caltrans	Time Period Analyzed	AM Peak Hour
Project Description	CMD1801 - Village D Specific Plan	Unit	United States Customary

Geometric Data

	Freeway	Ramp
Number of Lanes (N), ln	2	1
Free-Flow Speed (FFS), mi/h	65.0	15.0
Segment Length (L) / Deceleration Length (LA),ft	1500	150
Terrain Type	Level	Level
Percent Grade, %	-	-
Segment Type / Ramp Side	Freeway	Right

Adjustment Factors

Driver Population	All Familiar	All Familiar
Weather Type	Non-Severe Weather	Non-Severe Weather
Incident Type	No Incident	-
Final Speed Adjustment Factor (SAF)	1.000	1.000
Final Capacity Adjustment Factor (CAF)	1.000	1.000
Demand Adjustment Factor (DAF)	1.000	1.000

Demand and Capacity

Demand Volume (Vi)	2409	107
Peak Hour Factor (PHF)	0.94	0.94
Total Trucks, %	20.41	6.54
Single-Unit Trucks (SUT), %	-	-
Tractor-Trailers (TT), %	-	-
Heavy Vehicle Adjustment Factor (fHV)	0.830	0.939
Flow Rate (vi),pc/h	3088	121
Capacity (c), pc/h	4700	1800
Volume-to-Capacity Ratio (v/c)	0.66	0.07

Speed and Density

Upstream Equilibrium Distance (LEQ), ft	-	Number of Outer Lanes on Freeway (NO)	0
Distance to Upstream Ramp (LUP), ft	-	Speed Index (DS)	0.699
Downstream Equilibrium Distance (LEQ), ft	-	Flow Outer Lanes (vOA), pc/h/ln	-
Distance to Downstream Ramp (LDOWN), ft	-	Off-Ramp Influence Area Speed (SR), mi/h	48.9
Prop. Freeway Vehicles in Lane 1 and 2 (PFD)	1.000	Outer Lanes Freeway Speed (SO), mi/h	71.3
Flow in Lanes 1 and 2 (v12), pc/h	3088	Ramp Junction Speed (S), mi/h	48.9
Flow Entering Ramp-Infl. Area (vR12), pc/h	-	Average Density (D), pc/mi/ln	31.6
Level of Service (LOS)	D	Density in Ramp Influence Area (DR), pc/mi/ln	29.5

HCS7 Basic Freeway Report

Project Information

Analyst	LSA	Date	12/11/2019
Agency	LSA	Analysis Year	Existing NP
Jurisdiction	Caltrans	Time Period Analyzed	AM Peak Hour
Project Description	CMD1801 - Village D Specific Plan	Unit	United States Customary

Geometric Data

Number of Lanes, ln	2	Terrain Type	Level
Segment Length (L), ft	-	Percent Grade, %	-
Measured or Base Free-Flow Speed	Base	Grade Length, mi	-
Base Free-Flow Speed (BFFS), mi/h	65.0	Total Ramp Density (TRD), ramps/mi	1.67
Lane Width, ft	12	Free-Flow Speed (FFS), mi/h	60.0
Right-Side Lateral Clearance, ft	10		

Adjustment Factors

Driver Population	All Familiar	Final Speed Adjustment Factor (SAF)	1.000
Weather Type	Non-Severe Weather	Final Capacity Adjustment Factor (CAF)	1.000
Incident Type	No Incident	Demand Adjustment Factor (DAF)	1.000

Demand and Capacity

Demand Volume veh/h	2302	Heavy Vehicle Adjustment Factor (fhv)	0.826
Peak Hour Factor	0.94	Flow Rate (Vp), pc/h/ln	1482
Total Trucks, %	21.06	Capacity (c), pc/h/ln	2300
Single-Unit Trucks (SUT), %	-	Adjusted Capacity (cadj), pc/h/ln	2300
Tractor-Trailers (TT), %	-	Volume-to-Capacity Ratio (v/c)	0.64
Passenger Car Equivalent (Et)	2.000		

Speed and Density

Lane Width Adjustment (fLW)	0.0	Average Speed (S), mi/h	60.0
Right-Side Lateral Clearance Adj. (fRLC)	0.0	Density (D), pc/mi/ln	24.7
Total Ramp Density Adjustment	5.0	Level of Service (LOS)	C
Adjusted Free-Flow Speed (FFSadj), mi/h	60.0		

HCS7 Freeway Merge Report

Project Information

Analyst	LSA	Date	12/11/2019
Agency	LSA	Analysis Year	Existing NP
Jurisdiction	Caltrans	Time Period Analyzed	AM Peak Hour
Project Description	CMD1801 - Village D Specific Plan	Unit	United States Customary

Geometric Data

	Freeway	Ramp
Number of Lanes (N), ln	2	1
Free-Flow Speed (FFS), mi/h	65.0	35.0
Segment Length (L) / Acceleration Length (LA),ft	1500	525
Terrain Type	Level	Level
Percent Grade, %	-	-
Segment Type / Ramp Side	Freeway	Right

Adjustment Factors

Driver Population	All Familiar	All Familiar
Weather Type	Non-Severe Weather	Non-Severe Weather
Incident Type	No Incident	-
Final Speed Adjustment Factor (SAF)	1.000	1.000
Final Capacity Adjustment Factor (CAF)	1.000	1.000
Demand Adjustment Factor (DAF)	1.000	1.000

Demand and Capacity

Demand Volume (Vi)	2302	202
Peak Hour Factor (PHF)	0.94	0.94
Total Trucks, %	21.06	4.46
Single-Unit Trucks (SUT), %	-	-
Tractor-Trailers (TT), %	-	-
Heavy Vehicle Adjustment Factor (fHV)	0.826	0.957
Flow Rate (vi),pc/h	2965	225
Capacity (c), pc/h	4700	2000
Volume-to-Capacity Ratio (v/c)	0.68	0.11

Speed and Density

Upstream Equilibrium Distance (LEQ), ft	-	Number of Outer Lanes on Freeway (NO)	0
Distance to Upstream Ramp (LUP), ft	-	Speed Index (MS)	0.379
Downstream Equilibrium Distance (LEQ), ft	-	Flow Outer Lanes (vOA), pc/h/ln	-
Distance to Downstream Ramp (LDOWN), ft	-	On-Ramp Influence Area Speed (SR), mi/h	56.3
Prop. Freeway Vehicles in Lane 1 and 2 (PFM)	1.000	Outer Lanes Freeway Speed (SO), mi/h	65.0
Flow in Lanes 1 and 2 (v12), pc/h	2965	Ramp Junction Speed (S), mi/h	56.3
Flow Entering Ramp-Infl. Area (vR12), pc/h	3190	Average Density (D), pc/mi/ln	28.3
Level of Service (LOS)	C	Density in Ramp Influence Area (DR), pc/mi/ln	27.0

HCS7 Basic Freeway Report

Project Information

Analyst	LSA	Date	12/11/2019
Agency	LSA	Analysis Year	Existing NP
Jurisdiction	Caltrans	Time Period Analyzed	AM Peak Hour
Project Description	CMD1801 - Village D Specific Plan	Unit	United States Customary

Geometric Data

Number of Lanes, ln	2	Terrain Type	Level
Segment Length (L), ft	-	Percent Grade, %	-
Measured or Base Free-Flow Speed	Base	Grade Length, mi	-
Base Free-Flow Speed (BFFS), mi/h	65.0	Total Ramp Density (TRD), ramps/mi	1.67
Lane Width, ft	12	Free-Flow Speed (FFS), mi/h	60.0
Right-Side Lateral Clearance, ft	10		

Adjustment Factors

Driver Population	All Familiar	Final Speed Adjustment Factor (SAF)	1.000
Weather Type	Non-Severe Weather	Final Capacity Adjustment Factor (CAF)	1.000
Incident Type	No Incident	Demand Adjustment Factor (DAF)	1.000

Demand and Capacity

Demand Volume veh/h	2504	Heavy Vehicle Adjustment Factor (fhv)	0.835
Peak Hour Factor	0.94	Flow Rate (Vp), pc/h/ln	1595
Total Trucks, %	19.72	Capacity (c), pc/h/ln	2300
Single-Unit Trucks (SUT), %	-	Adjusted Capacity (cadj), pc/h/ln	2300
Tractor-Trailers (TT), %	-	Volume-to-Capacity Ratio (v/c)	0.69
Passenger Car Equivalent (Et)	2.000		

Speed and Density

Lane Width Adjustment (fLW)	0.0	Average Speed (S), mi/h	60.0
Right-Side Lateral Clearance Adj. (fRLC)	0.0	Density (D), pc/mi/ln	26.6
Total Ramp Density Adjustment	5.0	Level of Service (LOS)	D
Adjusted Free-Flow Speed (FFSadj), mi/h	60.0		

HCS7 Freeway Diverge Report

Project Information

Analyst	LSA	Date	12/11/2019
Agency	LSA	Analysis Year	Existing NP
Jurisdiction	Caltrans	Time Period Analyzed	AM Peak Hour
Project Description	CMD1801 - Village D Specific Plan	Unit	United States Customary

Geometric Data

	Freeway	Ramp
Number of Lanes (N), ln	2	1
Free-Flow Speed (FFS), mi/h	65.0	35.0
Segment Length (L) / Deceleration Length (LA),ft	1500	200
Terrain Type	Level	Level
Percent Grade, %	-	-
Segment Type / Ramp Side	Freeway	Right

Adjustment Factors

Driver Population	All Familiar	All Familiar
Weather Type	Non-Severe Weather	Non-Severe Weather
Incident Type	No Incident	-
Final Speed Adjustment Factor (SAF)	1.000	1.000
Final Capacity Adjustment Factor (CAF)	1.000	1.000
Demand Adjustment Factor (DAF)	1.000	1.000

Demand and Capacity

Demand Volume (Vi)	2504	87
Peak Hour Factor (PHF)	0.94	0.94
Total Trucks, %	19.72	13.79
Single-Unit Trucks (SUT), %	-	-
Tractor-Trailers (TT), %	-	-
Heavy Vehicle Adjustment Factor (fHV)	0.835	0.879
Flow Rate (vi),pc/h	3190	105
Capacity (c), pc/h	4700	2000
Volume-to-Capacity Ratio (v/c)	0.68	0.05

Speed and Density

Upstream Equilibrium Distance (LEQ), ft	-	Number of Outer Lanes on Freeway (NO)	0
Distance to Upstream Ramp (LUP), ft	-	Speed Index (DS)	0.437
Downstream Equilibrium Distance (LEQ), ft	-	Flow Outer Lanes (vOA), pc/h/ln	-
Distance to Downstream Ramp (LDOWN), ft	-	Off-Ramp Influence Area Speed (SR), mi/h	54.9
Prop. Freeway Vehicles in Lane 1 and 2 (PFD)	1.000	Outer Lanes Freeway Speed (SO), mi/h	71.3
Flow in Lanes 1 and 2 (v12), pc/h	3190	Ramp Junction Speed (S), mi/h	54.9
Flow Entering Ramp-Infl. Area (vR12), pc/h	-	Average Density (D), pc/mi/ln	29.1
Level of Service (LOS)	D	Density in Ramp Influence Area (DR), pc/mi/ln	29.9

HCS7 Basic Freeway Report

Project Information

Analyst	LSA	Date	12/11/2019
Agency	LSA	Analysis Year	Existing NP
Jurisdiction	Caltrans	Time Period Analyzed	AM Peak Hour
Project Description	CMD1801 - Village D Specific Plan	Unit	United States Customary

Geometric Data

Number of Lanes, ln	2	Terrain Type	Level
Segment Length (L), ft	-	Percent Grade, %	-
Measured or Base Free-Flow Speed	Base	Grade Length, mi	-
Base Free-Flow Speed (BFFS), mi/h	70.0	Total Ramp Density (TRD), ramps/mi	1.50
Lane Width, ft	12	Free-Flow Speed (FFS), mi/h	65.5
Right-Side Lateral Clearance, ft	10		

Adjustment Factors

Driver Population	All Familiar	Final Speed Adjustment Factor (SAF)	1.000
Weather Type	Non-Severe Weather	Final Capacity Adjustment Factor (CAF)	1.000
Incident Type	No Incident	Demand Adjustment Factor (DAF)	1.000

Demand and Capacity

Demand Volume veh/h	2417	Heavy Vehicle Adjustment Factor (fhv)	0.834
Peak Hour Factor	0.94	Flow Rate (Vp), pc/h/ln	1542
Total Trucks, %	19.93	Capacity (c), pc/h/ln	2355
Single-Unit Trucks (SUT), %	-	Adjusted Capacity (cadj), pc/h/ln	2355
Tractor-Trailers (TT), %	-	Volume-to-Capacity Ratio (v/c)	0.65
Passenger Car Equivalent (Et)	2.000		

Speed and Density

Lane Width Adjustment (fLW)	0.0	Average Speed (S), mi/h	65.1
Right-Side Lateral Clearance Adj. (fRLC)	0.0	Density (D), pc/mi/ln	23.7
Total Ramp Density Adjustment	4.5	Level of Service (LOS)	C
Adjusted Free-Flow Speed (FFSadj), mi/h	65.5		

HCS7 Freeway Merge Report

Project Information

Analyst	LSA	Date	12/11/2019
Agency	LSA	Analysis Year	Existing NP
Jurisdiction	Caltrans	Time Period Analyzed	AM Peak Hour
Project Description	CMD1801 - Village D Specific Plan	Unit	United States Customary

Geometric Data

	Freeway	Ramp
Number of Lanes (N), ln	2	1
Free-Flow Speed (FFS), mi/h	70.0	35.0
Segment Length (L) / Acceleration Length (LA),ft	1500	400
Terrain Type	Level	Level
Percent Grade, %	-	-
Segment Type / Ramp Side	Freeway	Right

Adjustment Factors

Driver Population	All Familiar	All Familiar
Weather Type	Non-Severe Weather	Non-Severe Weather
Incident Type	No Incident	-
Final Speed Adjustment Factor (SAF)	1.000	1.000
Final Capacity Adjustment Factor (CAF)	1.000	1.000
Demand Adjustment Factor (DAF)	1.000	1.000

Demand and Capacity

Demand Volume (Vi)	2417	153
Peak Hour Factor (PHF)	0.94	0.94
Total Trucks, %	19.93	10.46
Single-Unit Trucks (SUT), %	-	-
Tractor-Trailers (TT), %	-	-
Heavy Vehicle Adjustment Factor (fHV)	0.834	0.905
Flow Rate (vi),pc/h	3083	180
Capacity (c), pc/h	4800	2000
Volume-to-Capacity Ratio (v/c)	0.68	0.09

Speed and Density

Upstream Equilibrium Distance (LEQ), ft	-	Number of Outer Lanes on Freeway (NO)	0
Distance to Upstream Ramp (LUP), ft	-	Speed Index (MS)	0.395
Downstream Equilibrium Distance (LEQ), ft	-	Flow Outer Lanes (vOA), pc/h/ln	-
Distance to Downstream Ramp (LDOWN), ft	-	On-Ramp Influence Area Speed (SR), mi/h	58.9
Prop. Freeway Vehicles in Lane 1 and 2 (PFM)	1.000	Outer Lanes Freeway Speed (SO), mi/h	70.0
Flow in Lanes 1 and 2 (v12), pc/h	3083	Ramp Junction Speed (S), mi/h	58.9
Flow Entering Ramp-Infl. Area (vR12), pc/h	3263	Average Density (D), pc/mi/ln	27.7
Level of Service (LOS)	D	Density in Ramp Influence Area (DR), pc/mi/ln	28.4

HCS7 Basic Freeway Report

Project Information

Analyst	LSA	Date	12/11/2019
Agency	LSA	Analysis Year	Existing NP
Jurisdiction	Caltrans	Time Period Analyzed	AM Peak Hour
Project Description	CMD1801 - Village D Specific Plan	Unit	United States Customary

Geometric Data

Number of Lanes, ln	2	Terrain Type	Level
Segment Length (L), ft	-	Percent Grade, %	-
Measured or Base Free-Flow Speed	Base	Grade Length, mi	-
Base Free-Flow Speed (BFFS), mi/h	70.0	Total Ramp Density (TRD), ramps/mi	1.00
Lane Width, ft	12	Free-Flow Speed (FFS), mi/h	66.8
Right-Side Lateral Clearance, ft	10		

Adjustment Factors

Driver Population	All Familiar	Final Speed Adjustment Factor (SAF)	1.000
Weather Type	Non-Severe Weather	Final Capacity Adjustment Factor (CAF)	1.000
Incident Type	No Incident	Demand Adjustment Factor (DAF)	1.000

Demand and Capacity

Demand Volume veh/h	2570	Heavy Vehicle Adjustment Factor (fhv)	0.838
Peak Hour Factor	0.94	Flow Rate (Vp), pc/h/ln	1632
Total Trucks, %	19.37	Capacity (c), pc/h/ln	2368
Single-Unit Trucks (SUT), %	-	Adjusted Capacity (cadj), pc/h/ln	2368
Tractor-Trailers (TT), %	-	Volume-to-Capacity Ratio (v/c)	0.69
Passenger Car Equivalent (Et)	2.000		

Speed and Density

Lane Width Adjustment (fLW)	0.0	Average Speed (S), mi/h	65.6
Right-Side Lateral Clearance Adj. (fRLC)	0.0	Density (D), pc/mi/ln	24.9
Total Ramp Density Adjustment	3.2	Level of Service (LOS)	C
Adjusted Free-Flow Speed (FFSadj), mi/h	66.8		

HCS7 Freeway Diverge Report

Project Information

Analyst	LSA	Date	12/11/2019
Agency	LSA	Analysis Year	Existing NP
Jurisdiction	Caltrans	Time Period Analyzed	AM Peak Hour
Project Description	CMD1801 - Village D Specific Plan	Unit	United States Customary

Geometric Data

	Freeway	Ramp
Number of Lanes (N), ln	2	1
Free-Flow Speed (FFS), mi/h	70.0	35.0
Segment Length (L) / Deceleration Length (LA),ft	1500	200
Terrain Type	Level	Level
Percent Grade, %	-	-
Segment Type / Ramp Side	Freeway	Right

Adjustment Factors

Driver Population	All Familiar	All Familiar
Weather Type	Non-Severe Weather	Non-Severe Weather
Incident Type	No Incident	-
Final Speed Adjustment Factor (SAF)	1.000	1.000
Final Capacity Adjustment Factor (CAF)	1.000	1.000
Demand Adjustment Factor (DAF)	1.000	1.000

Demand and Capacity

Demand Volume (Vi)	2570	232
Peak Hour Factor (PHF)	0.94	0.94
Total Trucks, %	19.37	28.64
Single-Unit Trucks (SUT), %	-	-
Tractor-Trailers (TT), %	-	-
Heavy Vehicle Adjustment Factor (fHV)	0.838	0.777
Flow Rate (vi),pc/h	3263	318
Capacity (c), pc/h	4800	2000
Volume-to-Capacity Ratio (v/c)	0.68	0.16

Speed and Density

Upstream Equilibrium Distance (LEQ), ft	-	Number of Outer Lanes on Freeway (NO)	0
Distance to Upstream Ramp (LUP), ft	-	Speed Index (DS)	0.457
Downstream Equilibrium Distance (LEQ), ft	-	Flow Outer Lanes (vOA), pc/h/ln	-
Distance to Downstream Ramp (LDOWN), ft	-	Off-Ramp Influence Area Speed (SR), mi/h	57.2
Prop. Freeway Vehicles in Lane 1 and 2 (PFD)	1.000	Outer Lanes Freeway Speed (SO), mi/h	76.8
Flow in Lanes 1 and 2 (v12), pc/h	3263	Ramp Junction Speed (S), mi/h	57.2
Flow Entering Ramp-Infl. Area (vR12), pc/h	-	Average Density (D), pc/mi/ln	28.5
Level of Service (LOS)	D	Density in Ramp Influence Area (DR), pc/mi/ln	30.5

HCS7 Basic Freeway Report

Project Information

Analyst	LSA	Date	12/11/2019
Agency	LSA	Analysis Year	Existing NP
Jurisdiction	Caltrans	Time Period Analyzed	AM Peak Hour
Project Description	CMD1801 - Village D Specific Plan	Unit	United States Customary

Geometric Data

Number of Lanes, ln	2	Terrain Type	Level
Segment Length (L), ft	-	Percent Grade, %	-
Measured or Base Free-Flow Speed	Base	Grade Length, mi	-
Base Free-Flow Speed (BFFS), mi/h	70.0	Total Ramp Density (TRD), ramps/mi	1.00
Lane Width, ft	12	Free-Flow Speed (FFS), mi/h	66.8
Right-Side Lateral Clearance, ft	10		

Adjustment Factors

Driver Population	All Familiar	Final Speed Adjustment Factor (SAF)	1.000
Weather Type	Non-Severe Weather	Final Capacity Adjustment Factor (CAF)	1.000
Incident Type	No Incident	Demand Adjustment Factor (DAF)	1.000

Demand and Capacity

Demand Volume veh/h	2338	Heavy Vehicle Adjustment Factor (fhv)	0.844
Peak Hour Factor	0.94	Flow Rate (Vp), pc/h/ln	1474
Total Trucks, %	18.47	Capacity (c), pc/h/ln	2368
Single-Unit Trucks (SUT), %	-	Adjusted Capacity (cadj), pc/h/ln	2368
Tractor-Trailers (TT), %	-	Volume-to-Capacity Ratio (v/c)	0.62
Passenger Car Equivalent (Et)	2.000		

Speed and Density

Lane Width Adjustment (fLW)	0.0	Average Speed (S), mi/h	66.5
Right-Side Lateral Clearance Adj. (fRLC)	0.0	Density (D), pc/mi/ln	22.2
Total Ramp Density Adjustment	3.2	Level of Service (LOS)	C
Adjusted Free-Flow Speed (FFSadj), mi/h	66.8		

HCS7 Freeway Merge Report

Project Information

Analyst	LSA	Date	12/11/2019
Agency	LSA	Analysis Year	Existing NP
Jurisdiction	Caltrans	Time Period Analyzed	AM Peak Hour
Project Description	CMD1801 - Village D Specific Plan	Unit	United States Customary

Geometric Data

	Freeway	Ramp
Number of Lanes (N), In	2	1
Free-Flow Speed (FFS), mi/h	70.0	35.0
Segment Length (L) / Acceleration Length (LA),ft	1500	700
Terrain Type	Level	Level
Percent Grade, %	-	-
Segment Type / Ramp Side	Freeway	Right

Adjustment Factors

Driver Population	All Familiar	All Familiar
Weather Type	Non-Severe Weather	Non-Severe Weather
Incident Type	No Incident	-
Final Speed Adjustment Factor (SAF)	1.000	1.000
Final Capacity Adjustment Factor (CAF)	1.000	1.000
Demand Adjustment Factor (DAF)	1.000	1.000

Demand and Capacity

Demand Volume (Vi)	2338	239
Peak Hour Factor (PHF)	0.94	0.94
Total Trucks, %	18.47	32.90
Single-Unit Trucks (SUT), %	-	-
Tractor-Trailers (TT), %	-	-
Heavy Vehicle Adjustment Factor (fHV)	0.844	0.752
Flow Rate (vi),pc/h	2947	338
Capacity (c), pc/h	4800	2000
Volume-to-Capacity Ratio (v/c)	0.68	0.17

Speed and Density

Upstream Equilibrium Distance (LEQ), ft	-	Number of Outer Lanes on Freeway (NO)	0
Distance to Upstream Ramp (LUP), ft	-	Speed Index (MS)	0.376
Downstream Equilibrium Distance (LEQ), ft	-	Flow Outer Lanes (vOA), pc/h/ln	-
Distance to Downstream Ramp (LDOWN), ft	-	On-Ramp Influence Area Speed (SR), mi/h	59.5
Prop. Freeway Vehicles in Lane 1 and 2 (PFM)	1.000	Outer Lanes Freeway Speed (SO), mi/h	70.0
Flow in Lanes 1 and 2 (v12), pc/h	2947	Ramp Junction Speed (S), mi/h	59.5
Flow Entering Ramp-Infl. Area (vR12), pc/h	3285	Average Density (D), pc/mi/ln	27.6
Level of Service (LOS)	C	Density in Ramp Influence Area (DR), pc/mi/ln	26.6

HCS7 Basic Freeway Report

Project Information

Analyst	LSA	Date	12/11/2019
Agency	LSA	Analysis Year	Existing NP
Jurisdiction	Caltrans	Time Period Analyzed	AM Peak Hour
Project Description	CMD1801 - Village D Specific Plan	Unit	United States Customary

Geometric Data

Number of Lanes, ln	2	Terrain Type	Level
Segment Length (L), ft	-	Percent Grade, %	-
Measured or Base Free-Flow Speed	Base	Grade Length, mi	-
Base Free-Flow Speed (BFFS), mi/h	70.0	Total Ramp Density (TRD), ramps/mi	1.00
Lane Width, ft	12	Free-Flow Speed (FFS), mi/h	66.8
Right-Side Lateral Clearance, ft	10		

Adjustment Factors

Driver Population	All Familiar	Final Speed Adjustment Factor (SAF)	1.000
Weather Type	Non-Severe Weather	Final Capacity Adjustment Factor (CAF)	1.000
Incident Type	No Incident	Demand Adjustment Factor (DAF)	1.000

Demand and Capacity

Demand Volume veh/h	2577	Heavy Vehicle Adjustment Factor (fhv)	0.835
Peak Hour Factor	0.94	Flow Rate (Vp), pc/h/ln	1642
Total Trucks, %	19.82	Capacity (c), pc/h/ln	2368
Single-Unit Trucks (SUT), %	-	Adjusted Capacity (cadj), pc/h/ln	2368
Tractor-Trailers (TT), %	-	Volume-to-Capacity Ratio (v/c)	0.69
Passenger Car Equivalent (Et)	2.000		

Speed and Density

Lane Width Adjustment (fLW)	0.0	Average Speed (S), mi/h	65.5
Right-Side Lateral Clearance Adj. (fRLC)	0.0	Density (D), pc/mi/ln	25.1
Total Ramp Density Adjustment	3.2	Level of Service (LOS)	C
Adjusted Free-Flow Speed (FFSadj), mi/h	66.8		

HCS7 Basic Freeway Report

Project Information

Analyst	LSA	Date	12/11/2019
Agency	LSA	Analysis Year	Existing NP
Jurisdiction	Caltrans	Time Period Analyzed	AM Peak Hour
Project Description	CMD1801 - Village D Specific Plan	Unit	United States Customary

Geometric Data

Number of Lanes, ln	2	Terrain Type	Level
Segment Length (L), ft	-	Percent Grade, %	-
Measured or Base Free-Flow Speed	Base	Grade Length, mi	-
Base Free-Flow Speed (BFFS), mi/h	70.0	Total Ramp Density (TRD), ramps/mi	1.00
Lane Width, ft	12	Free-Flow Speed (FFS), mi/h	66.8
Right-Side Lateral Clearance, ft	10		

Adjustment Factors

Driver Population	All Familiar	Final Speed Adjustment Factor (SAF)	1.000
Weather Type	Non-Severe Weather	Final Capacity Adjustment Factor (CAF)	1.000
Incident Type	No Incident	Demand Adjustment Factor (DAF)	1.000

Demand and Capacity

Demand Volume veh/h	2083	Heavy Vehicle Adjustment Factor (fhv)	0.786
Peak Hour Factor	0.94	Flow Rate (Vp), pc/h/ln	1410
Total Trucks, %	27.23	Capacity (c), pc/h/ln	2368
Single-Unit Trucks (SUT), %	-	Adjusted Capacity (cadj), pc/h/ln	2368
Tractor-Trailers (TT), %	-	Volume-to-Capacity Ratio (v/c)	0.60
Passenger Car Equivalent (Et)	2.000		

Speed and Density

Lane Width Adjustment (fLW)	0.0	Average Speed (S), mi/h	66.7
Right-Side Lateral Clearance Adj. (fRLC)	0.0	Density (D), pc/mi/ln	21.1
Total Ramp Density Adjustment	3.2	Level of Service (LOS)	C
Adjusted Free-Flow Speed (FFSadj), mi/h	66.8		

HCS7 Freeway Diverge Report

Project Information

Analyst	LSA	Date	12/11/2019
Agency	LSA	Analysis Year	Existing NP
Jurisdiction	Caltrans	Time Period Analyzed	AM Peak Hour
Project Description	CMD1801 - Village D Specific Plan	Unit	United States Customary

Geometric Data

	Freeway	Ramp
Number of Lanes (N), ln	2	1
Free-Flow Speed (FFS), mi/h	70.0	50.0
Segment Length (L) / Deceleration Length (LA),ft	1500	150
Terrain Type	Level	Level
Percent Grade, %	-	-
Segment Type / Ramp Side	Freeway	Right

Adjustment Factors

Driver Population	All Familiar	All Familiar
Weather Type	Non-Severe Weather	Non-Severe Weather
Incident Type	No Incident	-
Final Speed Adjustment Factor (SAF)	1.000	1.000
Final Capacity Adjustment Factor (CAF)	1.000	1.000
Demand Adjustment Factor (DAF)	1.000	1.000

Demand and Capacity

Demand Volume (Vi)	2083	142
Peak Hour Factor (PHF)	0.94	0.94
Total Trucks, %	27.23	35.29
Single-Unit Trucks (SUT), %	-	-
Tractor-Trailers (TT), %	-	-
Heavy Vehicle Adjustment Factor (fHV)	0.786	0.739
Flow Rate (vi),pc/h	2819	204
Capacity (c), pc/h	4800	2100
Volume-to-Capacity Ratio (v/c)	0.59	0.10

Speed and Density

Upstream Equilibrium Distance (LEQ), ft	-	Number of Outer Lanes on Freeway (NO)	0
Distance to Upstream Ramp (LUP), ft	-	Speed Index (DS)	0.251
Downstream Equilibrium Distance (LEQ), ft	-	Flow Outer Lanes (vOA), pc/h/ln	-
Distance to Downstream Ramp (LDOWN), ft	-	Off-Ramp Influence Area Speed (SR), mi/h	63.0
Prop. Freeway Vehicles in Lane 1 and 2 (PFD)	1.000	Outer Lanes Freeway Speed (SO), mi/h	76.8
Flow in Lanes 1 and 2 (v12), pc/h	2819	Ramp Junction Speed (S), mi/h	63.0
Flow Entering Ramp-Infl. Area (vR12), pc/h	-	Average Density (D), pc/mi/ln	22.4
Level of Service (LOS)	C	Density in Ramp Influence Area (DR), pc/mi/ln	27.1

HCS7 Basic Freeway Report

Project Information

Analyst	LSA	Date	12/11/2019
Agency	LSA	Analysis Year	Existing NP
Jurisdiction	Caltrans	Time Period Analyzed	AM Peak Hour
Project Description	CMD1801 - Village D Specific Plan	Unit	United States Customary

Geometric Data

Number of Lanes, ln	2	Terrain Type	Level
Segment Length (L), ft	-	Percent Grade, %	-
Measured or Base Free-Flow Speed	Base	Grade Length, mi	-
Base Free-Flow Speed (BFFS), mi/h	70.0	Total Ramp Density (TRD), ramps/mi	1.33
Lane Width, ft	12	Free-Flow Speed (FFS), mi/h	65.9
Right-Side Lateral Clearance, ft	10		

Adjustment Factors

Driver Population	All Familiar	Final Speed Adjustment Factor (SAF)	1.000
Weather Type	Non-Severe Weather	Final Capacity Adjustment Factor (CAF)	1.000
Incident Type	No Incident	Demand Adjustment Factor (DAF)	1.000

Demand and Capacity

Demand Volume veh/h	1941	Heavy Vehicle Adjustment Factor (fhv)	0.790
Peak Hour Factor	0.94	Flow Rate (Vp), pc/h/ln	1307
Total Trucks, %	26.65	Capacity (c), pc/h/ln	2359
Single-Unit Trucks (SUT), %	-	Adjusted Capacity (cadj), pc/h/ln	2359
Tractor-Trailers (TT), %	-	Volume-to-Capacity Ratio (v/c)	0.55
Passenger Car Equivalent (Et)	2.000		

Speed and Density

Lane Width Adjustment (fLW)	0.0	Average Speed (S), mi/h	65.9
Right-Side Lateral Clearance Adj. (fRLC)	0.0	Density (D), pc/mi/ln	19.8
Total Ramp Density Adjustment	4.1	Level of Service (LOS)	C
Adjusted Free-Flow Speed (FFSadj), mi/h	65.9		

HCS7 Freeway Merge Report

Project Information

Analyst	LSA	Date	12/11/2019
Agency	LSA	Analysis Year	Existing NP
Jurisdiction	Caltrans	Time Period Analyzed	AM Peak Hour
Project Description	CMD1801 - Village D Specific Plan	Unit	United States Customary

Geometric Data

	Freeway	Ramp
Number of Lanes (N), ln	2	1
Free-Flow Speed (FFS), mi/h	70.0	35.0
Segment Length (L) / Acceleration Length (LA),ft	1000	600
Terrain Type	Level	Level
Percent Grade, %	-	-
Segment Type / Ramp Side	Freeway	Right

Adjustment Factors

Driver Population	All Familiar	All Familiar
Weather Type	Non-Severe Weather	Non-Severe Weather
Incident Type	No Incident	-
Final Speed Adjustment Factor (SAF)	1.000	1.000
Final Capacity Adjustment Factor (CAF)	1.000	1.000
Demand Adjustment Factor (DAF)	1.000	1.000

Demand and Capacity

Demand Volume (Vi)	1941	36
Peak Hour Factor (PHF)	0.94	0.94
Total Trucks, %	26.65	13.89
Single-Unit Trucks (SUT), %	-	-
Tractor-Trailers (TT), %	-	-
Heavy Vehicle Adjustment Factor (fHV)	0.790	0.878
Flow Rate (vi),pc/h	2614	44
Capacity (c), pc/h	4800	2000
Volume-to-Capacity Ratio (v/c)	0.55	0.02

Speed and Density

Upstream Equilibrium Distance (LEQ), ft	-	Number of Outer Lanes on Freeway (NO)	0
Distance to Upstream Ramp (LUP), ft	-	Speed Index (MS)	0.335
Downstream Equilibrium Distance (LEQ), ft	-	Flow Outer Lanes (vOA), pc/h/ln	-
Distance to Downstream Ramp (LDOWN), ft	-	On-Ramp Influence Area Speed (SR), mi/h	60.6
Prop. Freeway Vehicles in Lane 1 and 2 (PFM)	1.000	Outer Lanes Freeway Speed (SO), mi/h	70.0
Flow in Lanes 1 and 2 (v12), pc/h	2614	Ramp Junction Speed (S), mi/h	60.6
Flow Entering Ramp-Infl. Area (vR12), pc/h	2658	Average Density (D), pc/mi/ln	21.9
Level of Service (LOS)	C	Density in Ramp Influence Area (DR), pc/mi/ln	22.5

HCS7 Basic Freeway Report

Project Information

Analyst	LSA	Date	12/11/2019
Agency	LSA	Analysis Year	Existing NP
Jurisdiction	Caltrans	Time Period Analyzed	AM Peak Hour
Project Description	CMD1801 - Village D Specific Plan	Unit	United States Customary

Geometric Data

Number of Lanes, ln	2	Terrain Type	Level
Segment Length (L), ft	-	Percent Grade, %	-
Measured or Base Free-Flow Speed	Base	Grade Length, mi	-
Base Free-Flow Speed (BFFS), mi/h	70.0	Total Ramp Density (TRD), ramps/mi	1.33
Lane Width, ft	12	Free-Flow Speed (FFS), mi/h	65.9
Right-Side Lateral Clearance, ft	10		

Adjustment Factors

Driver Population	All Familiar	Final Speed Adjustment Factor (SAF)	1.000
Weather Type	Non-Severe Weather	Final Capacity Adjustment Factor (CAF)	1.000
Incident Type	No Incident	Demand Adjustment Factor (DAF)	1.000

Demand and Capacity

Demand Volume veh/h	1977	Heavy Vehicle Adjustment Factor (fhv)	0.791
Peak Hour Factor	0.94	Flow Rate (Vp), pc/h/ln	1330
Total Trucks, %	26.42	Capacity (c), pc/h/ln	2359
Single-Unit Trucks (SUT), %	-	Adjusted Capacity (cadj), pc/h/ln	2359
Tractor-Trailers (TT), %	-	Volume-to-Capacity Ratio (v/c)	0.56
Passenger Car Equivalent (Et)	2.000		

Speed and Density

Lane Width Adjustment (fLW)	0.0	Average Speed (S), mi/h	65.9
Right-Side Lateral Clearance Adj. (fRLC)	0.0	Density (D), pc/mi/ln	20.2
Total Ramp Density Adjustment	4.1	Level of Service (LOS)	C
Adjusted Free-Flow Speed (FFSadj), mi/h	65.9		

HCS7 Freeway Merge Report

Project Information

Analyst	LSA	Date	12/11/2019
Agency	LSA	Analysis Year	Existing NP
Jurisdiction	Caltrans	Time Period Analyzed	AM Peak Hour
Project Description	CMD1801 - Village D Specific Plan	Unit	United States Customary

Geometric Data

	Freeway	Ramp
Number of Lanes (N), ln	2	1
Free-Flow Speed (FFS), mi/h	70.0	35.0
Segment Length (L) / Acceleration Length (LA),ft	1500	500
Terrain Type	Level	Level
Percent Grade, %	-	-
Segment Type / Ramp Side	Freeway	Right

Adjustment Factors

Driver Population	All Familiar	All Familiar
Weather Type	Non-Severe Weather	Non-Severe Weather
Incident Type	No Incident	-
Final Speed Adjustment Factor (SAF)	1.000	1.000
Final Capacity Adjustment Factor (CAF)	1.000	1.000
Demand Adjustment Factor (DAF)	1.000	1.000

Demand and Capacity

Demand Volume (Vi)	1977	188
Peak Hour Factor (PHF)	0.94	0.94
Total Trucks, %	26.42	32.07
Single-Unit Trucks (SUT), %	-	-
Tractor-Trailers (TT), %	-	-
Heavy Vehicle Adjustment Factor (fHV)	0.791	0.757
Flow Rate (vi),pc/h	2659	264
Capacity (c), pc/h	4800	2000
Volume-to-Capacity Ratio (v/c)	0.61	0.13

Speed and Density

Upstream Equilibrium Distance (LEQ), ft	-	Number of Outer Lanes on Freeway (NO)	0
Distance to Upstream Ramp (LUP), ft	-	Speed Index (MS)	0.359
Downstream Equilibrium Distance (LEQ), ft	-	Flow Outer Lanes (vOA), pc/h/ln	-
Distance to Downstream Ramp (LDOWN), ft	-	On-Ramp Influence Area Speed (SR), mi/h	59.9
Prop. Freeway Vehicles in Lane 1 and 2 (PFM)	1.000	Outer Lanes Freeway Speed (SO), mi/h	70.0
Flow in Lanes 1 and 2 (v12), pc/h	2659	Ramp Junction Speed (S), mi/h	59.9
Flow Entering Ramp-Infl. Area (vR12), pc/h	2923	Average Density (D), pc/mi/ln	24.4
Level of Service (LOS)	C	Density in Ramp Influence Area (DR), pc/mi/ln	25.1

HCS7 Basic Freeway Report

Project Information

Analyst	LSA	Date	12/11/2019
Agency	LSA	Analysis Year	Existing NP
Jurisdiction	Caltrans	Time Period Analyzed	AM Peak Hour
Project Description	CMD1801 - Village D Specific Plan	Unit	United States Customary

Geometric Data

Number of Lanes, ln	2	Terrain Type	Level
Segment Length (L), ft	-	Percent Grade, %	-
Measured or Base Free-Flow Speed	Base	Grade Length, mi	-
Base Free-Flow Speed (BFFS), mi/h	70.0	Total Ramp Density (TRD), ramps/mi	1.33
Lane Width, ft	12	Free-Flow Speed (FFS), mi/h	65.9
Right-Side Lateral Clearance, ft	10		

Adjustment Factors

Driver Population	All Familiar	Final Speed Adjustment Factor (SAF)	1.000
Weather Type	Non-Severe Weather	Final Capacity Adjustment Factor (CAF)	1.000
Incident Type	No Incident	Demand Adjustment Factor (DAF)	1.000

Demand and Capacity

Demand Volume veh/h	2165	Heavy Vehicle Adjustment Factor (fhv)	0.788
Peak Hour Factor	0.94	Flow Rate (Vp), pc/h/ln	1462
Total Trucks, %	26.89	Capacity (c), pc/h/ln	2359
Single-Unit Trucks (SUT), %	-	Adjusted Capacity (cadj), pc/h/ln	2359
Tractor-Trailers (TT), %	-	Volume-to-Capacity Ratio (v/c)	0.62
Passenger Car Equivalent (Et)	2.000		

Speed and Density

Lane Width Adjustment (fLW)	0.0	Average Speed (S), mi/h	65.8
Right-Side Lateral Clearance Adj. (fRLC)	0.0	Density (D), pc/mi/ln	22.2
Total Ramp Density Adjustment	4.1	Level of Service (LOS)	C
Adjusted Free-Flow Speed (FFSadj), mi/h	65.9		

HCS7 Freeway Diverge Report

Project Information

Analyst	LSA	Date	12/11/2019
Agency	LSA	Analysis Year	Existing NP
Jurisdiction	Caltrans	Time Period Analyzed	AM Peak Hour
Project Description	CMD1801 - Village D Specific Plan	Unit	United States Customary

Geometric Data

	Freeway	Ramp
Number of Lanes (N), ln	2	1
Free-Flow Speed (FFS), mi/h	70.0	35.0
Segment Length (L) / Deceleration Length (LA),ft	1500	150
Terrain Type	Level	Level
Percent Grade, %	-	-
Segment Type / Ramp Side	Freeway	Right

Adjustment Factors

Driver Population	All Familiar	All Familiar
Weather Type	Non-Severe Weather	Non-Severe Weather
Incident Type	No Incident	-
Final Speed Adjustment Factor (SAF)	1.000	1.000
Final Capacity Adjustment Factor (CAF)	1.000	1.000
Demand Adjustment Factor (DAF)	1.000	1.000

Demand and Capacity

Demand Volume (Vi)	2165	101
Peak Hour Factor (PHF)	0.94	0.94
Total Trucks, %	26.89	18.81
Single-Unit Trucks (SUT), %	-	-
Tractor-Trailers (TT), %	-	-
Heavy Vehicle Adjustment Factor (fHV)	0.788	0.842
Flow Rate (vi),pc/h	2923	128
Capacity (c), pc/h	4800	2000
Volume-to-Capacity Ratio (v/c)	0.61	0.06

Speed and Density

Upstream Equilibrium Distance (LEQ), ft	-	Number of Outer Lanes on Freeway (NO)	0
Distance to Upstream Ramp (LUP), ft	-	Speed Index (DS)	0.440
Downstream Equilibrium Distance (LEQ), ft	-	Flow Outer Lanes (vOA), pc/h/ln	-
Distance to Downstream Ramp (LDOWN), ft	-	Off-Ramp Influence Area Speed (SR), mi/h	57.7
Prop. Freeway Vehicles in Lane 1 and 2 (PFD)	1.000	Outer Lanes Freeway Speed (SO), mi/h	76.8
Flow in Lanes 1 and 2 (v12), pc/h	2923	Ramp Junction Speed (S), mi/h	57.7
Flow Entering Ramp-Infl. Area (vR12), pc/h	-	Average Density (D), pc/mi/ln	25.3
Level of Service (LOS)	C	Density in Ramp Influence Area (DR), pc/mi/ln	28.0

HCS7 Basic Freeway Report

Project Information

Analyst	LSA	Date	12/11/2019
Agency	LSA	Analysis Year	Existing NP
Jurisdiction	Caltrans	Time Period Analyzed	AM Peak Hour
Project Description	CMD1801 - Village D Specific Plan	Unit	United States Customary

Geometric Data

Number of Lanes, ln	2	Terrain Type	Level
Segment Length (L), ft	-	Percent Grade, %	-
Measured or Base Free-Flow Speed	Base	Grade Length, mi	-
Base Free-Flow Speed (BFFS), mi/h	70.0	Total Ramp Density (TRD), ramps/mi	1.67
Lane Width, ft	12	Free-Flow Speed (FFS), mi/h	65.0
Right-Side Lateral Clearance, ft	10		

Adjustment Factors

Driver Population	All Familiar	Final Speed Adjustment Factor (SAF)	1.000
Weather Type	Non-Severe Weather	Final Capacity Adjustment Factor (CAF)	1.000
Incident Type	No Incident	Demand Adjustment Factor (DAF)	1.000

Demand and Capacity

Demand Volume veh/h	2064	Heavy Vehicle Adjustment Factor (fhv)	0.786
Peak Hour Factor	0.94	Flow Rate (Vp), pc/h/ln	1397
Total Trucks, %	27.29	Capacity (c), pc/h/ln	2350
Single-Unit Trucks (SUT), %	-	Adjusted Capacity (cadj), pc/h/ln	2350
Tractor-Trailers (TT), %	-	Volume-to-Capacity Ratio (v/c)	0.59
Passenger Car Equivalent (Et)	2.000		

Speed and Density

Lane Width Adjustment (fLW)	0.0	Average Speed (S), mi/h	65.0
Right-Side Lateral Clearance Adj. (fRLC)	0.0	Density (D), pc/mi/ln	21.5
Total Ramp Density Adjustment	5.0	Level of Service (LOS)	C
Adjusted Free-Flow Speed (FFSadj), mi/h	65.0		

HCS7 Freeway Merge Report

Project Information

Analyst	LSA	Date	12/11/2019
Agency	LSA	Analysis Year	Existing NP
Jurisdiction	Caltrans	Time Period Analyzed	AM Peak Hour
Project Description	CMD1801 - Village D Specific Plan	Unit	United States Customary

Geometric Data

	Freeway	Ramp
Number of Lanes (N), ln	2	1
Free-Flow Speed (FFS), mi/h	65.0	35.0
Segment Length (L) / Acceleration Length (LA),ft	1500	600
Terrain Type	Level	Level
Percent Grade, %	-	-
Segment Type / Ramp Side	Freeway	Right

Adjustment Factors

Driver Population	All Familiar	All Familiar
Weather Type	Non-Severe Weather	Non-Severe Weather
Incident Type	No Incident	-
Final Speed Adjustment Factor (SAF)	1.000	1.000
Final Capacity Adjustment Factor (CAF)	1.000	1.000
Demand Adjustment Factor (DAF)	1.000	1.000

Demand and Capacity

Demand Volume (Vi)	2064	494
Peak Hour Factor (PHF)	0.94	0.94
Total Trucks, %	27.29	4.05
Single-Unit Trucks (SUT), %	-	-
Tractor-Trailers (TT), %	-	-
Heavy Vehicle Adjustment Factor (fHV)	0.786	0.961
Flow Rate (vi),pc/h	2794	547
Capacity (c), pc/h	4700	2000
Volume-to-Capacity Ratio (v/c)	0.71	0.27

Speed and Density

Upstream Equilibrium Distance (LEQ), ft	-	Number of Outer Lanes on Freeway (NO)	0
Distance to Upstream Ramp (LUP), ft	-	Speed Index (MS)	0.389
Downstream Equilibrium Distance (LEQ), ft	-	Flow Outer Lanes (vOA), pc/h/ln	-
Distance to Downstream Ramp (LDOWN), ft	-	On-Ramp Influence Area Speed (SR), mi/h	56.1
Prop. Freeway Vehicles in Lane 1 and 2 (PFM)	1.000	Outer Lanes Freeway Speed (SO), mi/h	65.0
Flow in Lanes 1 and 2 (v12), pc/h	2794	Ramp Junction Speed (S), mi/h	56.1
Flow Entering Ramp-Infl. Area (vR12), pc/h	3341	Average Density (D), pc/mi/ln	29.8
Level of Service (LOS)	C	Density in Ramp Influence Area (DR), pc/mi/ln	27.6

HCS7 Basic Freeway Report

Project Information

Analyst	LSA	Date	12/11/2019
Agency	LSA	Analysis Year	Existing NP
Jurisdiction	Caltrans	Time Period Analyzed	AM Peak Hour
Project Description	CMD1801 - Village D Specific Plan	Unit	United States Customary

Geometric Data

Number of Lanes, ln	2	Terrain Type	Level
Segment Length (L), ft	-	Percent Grade, %	-
Measured or Base Free-Flow Speed	Base	Grade Length, mi	-
Base Free-Flow Speed (BFFS), mi/h	65.0	Total Ramp Density (TRD), ramps/mi	1.83
Lane Width, ft	12	Free-Flow Speed (FFS), mi/h	59.7
Right-Side Lateral Clearance, ft	10		

Adjustment Factors

Driver Population	All Familiar	Final Speed Adjustment Factor (SAF)	1.000
Weather Type	Non-Severe Weather	Final Capacity Adjustment Factor (CAF)	1.000
Incident Type	No Incident	Demand Adjustment Factor (DAF)	1.000

Demand and Capacity

Demand Volume veh/h	2558	Heavy Vehicle Adjustment Factor (fhv)	0.814
Peak Hour Factor	0.94	Flow Rate (Vp), pc/h/ln	1672
Total Trucks, %	22.80	Capacity (c), pc/h/ln	2296
Single-Unit Trucks (SUT), %	-	Adjusted Capacity (cadj), pc/h/ln	2296
Tractor-Trailers (TT), %	-	Volume-to-Capacity Ratio (v/c)	0.73
Passenger Car Equivalent (Et)	2.000		

Speed and Density

Lane Width Adjustment (fLW)	0.0	Average Speed (S), mi/h	59.5
Right-Side Lateral Clearance Adj. (fRLC)	0.0	Density (D), pc/mi/ln	28.1
Total Ramp Density Adjustment	5.4	Level of Service (LOS)	D
Adjusted Free-Flow Speed (FFSadj), mi/h	59.6		

HCS7 Freeway Merge Report

Project Information

Analyst	LSA	Date	12/11/2019
Agency	LSA	Analysis Year	Existing NP
Jurisdiction	Caltrans	Time Period Analyzed	AM Peak Hour
Project Description	CMD1801 - Village D Specific Plan	Unit	United States Customary

Geometric Data

	Freeway	Ramp
Number of Lanes (N), In	2	1
Free-Flow Speed (FFS), mi/h	65.0	35.0
Segment Length (L) / Acceleration Length (LA),ft	1500	600
Terrain Type	Level	Level
Percent Grade, %	-	-
Segment Type / Ramp Side	Freeway	Right

Adjustment Factors

Driver Population	All Familiar	All Familiar
Weather Type	Non-Severe Weather	Non-Severe Weather
Incident Type	No Incident	-
Final Speed Adjustment Factor (SAF)	1.000	1.000
Final Capacity Adjustment Factor (CAF)	1.000	1.000
Demand Adjustment Factor (DAF)	1.000	1.000

Demand and Capacity

Demand Volume (Vi)	2558	75
Peak Hour Factor (PHF)	0.94	0.94
Total Trucks, %	22.80	14.67
Single-Unit Trucks (SUT), %	-	-
Tractor-Trailers (TT), %	-	-
Heavy Vehicle Adjustment Factor (fHV)	0.814	0.872
Flow Rate (vi),pc/h	3343	91
Capacity (c), pc/h	4700	2000
Volume-to-Capacity Ratio (v/c)	0.73	0.05

Speed and Density

Upstream Equilibrium Distance (LEQ), ft	-	Number of Outer Lanes on Freeway (NO)	0
Distance to Upstream Ramp (LUP), ft	-	Speed Index (MS)	0.400
Downstream Equilibrium Distance (LEQ), ft	-	Flow Outer Lanes (vOA), pc/h/ln	-
Distance to Downstream Ramp (LDOWN), ft	-	On-Ramp Influence Area Speed (SR), mi/h	55.8
Prop. Freeway Vehicles in Lane 1 and 2 (PFM)	1.000	Outer Lanes Freeway Speed (SO), mi/h	65.0
Flow in Lanes 1 and 2 (v12), pc/h	3343	Ramp Junction Speed (S), mi/h	55.8
Flow Entering Ramp-Infl. Area (vR12), pc/h	3434	Average Density (D), pc/mi/ln	30.8
Level of Service (LOS)	D	Density in Ramp Influence Area (DR), pc/mi/ln	28.5

HCS7 Basic Freeway Report

Project Information

Analyst	LSA	Date	12/11/2019
Agency	LSA	Analysis Year	Existing NP
Jurisdiction	Caltrans	Time Period Analyzed	AM Peak Hour
Project Description	CMD1801 - Village D Specific Plan	Unit	United States Customary

Geometric Data

Number of Lanes, ln	2	Terrain Type	Level
Segment Length (L), ft	-	Percent Grade, %	-
Measured or Base Free-Flow Speed	Base	Grade Length, mi	-
Base Free-Flow Speed (BFFS), mi/h	65.0	Total Ramp Density (TRD), ramps/mi	2.17
Lane Width, ft	12	Free-Flow Speed (FFS), mi/h	58.8
Right-Side Lateral Clearance, ft	10		

Adjustment Factors

Driver Population	All Familiar	Final Speed Adjustment Factor (SAF)	1.000
Weather Type	Non-Severe Weather	Final Capacity Adjustment Factor (CAF)	1.000
Incident Type	No Incident	Demand Adjustment Factor (DAF)	1.000

Demand and Capacity

Demand Volume veh/h	2633	Heavy Vehicle Adjustment Factor (fhv)	0.816
Peak Hour Factor	0.94	Flow Rate (Vp), pc/h/ln	1716
Total Trucks, %	22.57	Capacity (c), pc/h/ln	2288
Single-Unit Trucks (SUT), %	-	Adjusted Capacity (cadj), pc/h/ln	2288
Tractor-Trailers (TT), %	-	Volume-to-Capacity Ratio (v/c)	0.75
Passenger Car Equivalent (Et)	2.000		

Speed and Density

Lane Width Adjustment (fLW)	0.0	Average Speed (S), mi/h	58.7
Right-Side Lateral Clearance Adj. (fRLC)	0.0	Density (D), pc/mi/ln	29.2
Total Ramp Density Adjustment	6.2	Level of Service (LOS)	D
Adjusted Free-Flow Speed (FFSadj), mi/h	58.8		

HCS7 Freeway Diverge Report

Project Information

Analyst	LSA	Date	12/11/2019
Agency	LSA	Analysis Year	Existing NP
Jurisdiction	Caltrans	Time Period Analyzed	AM Peak Hour
Project Description	CMD1801 - Village D Specific Plan	Unit	United States Customary

Geometric Data

	Freeway	Ramp
Number of Lanes (N), ln	2	1
Free-Flow Speed (FFS), mi/h	65.0	40.0
Segment Length (L) / Deceleration Length (LA),ft	1500	150
Terrain Type	Level	Level
Percent Grade, %	-	-
Segment Type / Ramp Side	Freeway	Right

Adjustment Factors

Driver Population	All Familiar	All Familiar
Weather Type	Non-Severe Weather	Non-Severe Weather
Incident Type	No Incident	-
Final Speed Adjustment Factor (SAF)	1.000	1.000
Final Capacity Adjustment Factor (CAF)	1.000	1.000
Demand Adjustment Factor (DAF)	1.000	1.000

Demand and Capacity

Demand Volume (Vi)	2633	167
Peak Hour Factor (PHF)	0.94	0.94
Total Trucks, %	22.57	4.19
Single-Unit Trucks (SUT), %	-	-
Tractor-Trailers (TT), %	-	-
Heavy Vehicle Adjustment Factor (fHV)	0.816	0.960
Flow Rate (vi),pc/h	3433	185
Capacity (c), pc/h	4700	2000
Volume-to-Capacity Ratio (v/c)	0.73	0.09

Speed and Density

Upstream Equilibrium Distance (LEQ), ft	-	Number of Outer Lanes on Freeway (NO)	0
Distance to Upstream Ramp (LUP), ft	-	Speed Index (DS)	0.380
Downstream Equilibrium Distance (LEQ), ft	-	Flow Outer Lanes (vOA), pc/h/ln	-
Distance to Downstream Ramp (LDOWN), ft	-	Off-Ramp Influence Area Speed (SR), mi/h	56.3
Prop. Freeway Vehicles in Lane 1 and 2 (PFD)	1.000	Outer Lanes Freeway Speed (SO), mi/h	71.3
Flow in Lanes 1 and 2 (v12), pc/h	3433	Ramp Junction Speed (S), mi/h	56.3
Flow Entering Ramp-Infl. Area (vR12), pc/h	-	Average Density (D), pc/mi/ln	30.5
Level of Service (LOS)	D	Density in Ramp Influence Area (DR), pc/mi/ln	32.4

HCS7 Basic Freeway Report

Project Information

Analyst	LSA	Date	12/11/2019
Agency	LSA	Analysis Year	Existing NP
Jurisdiction	Caltrans	Time Period Analyzed	AM Peak Hour
Project Description	CMD1801 - Village D Specific Plan	Unit	United States Customary

Geometric Data

Number of Lanes, ln	2	Terrain Type	Level
Segment Length (L), ft	-	Percent Grade, %	-
Measured or Base Free-Flow Speed	Base	Grade Length, mi	-
Base Free-Flow Speed (BFFS), mi/h	65.0	Total Ramp Density (TRD), ramps/mi	1.83
Lane Width, ft	12	Free-Flow Speed (FFS), mi/h	59.7
Right-Side Lateral Clearance, ft	10		

Adjustment Factors

Driver Population	All Familiar	Final Speed Adjustment Factor (SAF)	1.000
Weather Type	Non-Severe Weather	Final Capacity Adjustment Factor (CAF)	1.000
Incident Type	No Incident	Demand Adjustment Factor (DAF)	1.000

Demand and Capacity

Demand Volume veh/h	2466	Heavy Vehicle Adjustment Factor (fhv)	0.808
Peak Hour Factor	0.94	Flow Rate (Vp), pc/h/ln	1624
Total Trucks, %	23.81	Capacity (c), pc/h/ln	2296
Single-Unit Trucks (SUT), %	-	Adjusted Capacity (cadj), pc/h/ln	2296
Tractor-Trailers (TT), %	-	Volume-to-Capacity Ratio (v/c)	0.71
Passenger Car Equivalent (Et)	2.000		

Speed and Density

Lane Width Adjustment (fLW)	0.0	Average Speed (S), mi/h	59.6
Right-Side Lateral Clearance Adj. (fRLC)	0.0	Density (D), pc/mi/ln	27.2
Total Ramp Density Adjustment	5.4	Level of Service (LOS)	D
Adjusted Free-Flow Speed (FFSadj), mi/h	59.6		

HCS7 Freeway Merge Report

Project Information

Analyst	LSA	Date	12/11/2019
Agency	LSA	Analysis Year	Existing NP
Jurisdiction	Caltrans	Time Period Analyzed	AM Peak Hour
Project Description	CMD1801 - Village D Specific Plan	Unit	United States Customary

Geometric Data

	Freeway	Ramp
Number of Lanes (N), ln	2	1
Free-Flow Speed (FFS), mi/h	65.0	35.0
Segment Length (L) / Acceleration Length (LA),ft	1500	800
Terrain Type	Level	Level
Percent Grade, %	-	-
Segment Type / Ramp Side	Freeway	Right

Adjustment Factors

Driver Population	All Familiar	All Familiar
Weather Type	Non-Severe Weather	Non-Severe Weather
Incident Type	No Incident	-
Final Speed Adjustment Factor (SAF)	1.000	1.000
Final Capacity Adjustment Factor (CAF)	1.000	1.000
Demand Adjustment Factor (DAF)	1.000	1.000

Demand and Capacity

Demand Volume (Vi)	2466	188
Peak Hour Factor (PHF)	0.94	0.94
Total Trucks, %	23.81	2.66
Single-Unit Trucks (SUT), %	-	-
Tractor-Trailers (TT), %	-	-
Heavy Vehicle Adjustment Factor (fHV)	0.808	0.974
Flow Rate (vi),pc/h	3247	205
Capacity (c), pc/h	4700	2000
Volume-to-Capacity Ratio (v/c)	0.73	0.10

Speed and Density

Upstream Equilibrium Distance (LEQ), ft	-	Number of Outer Lanes on Freeway (NO)	0
Distance to Upstream Ramp (LUP), ft	-	Speed Index (MS)	0.388
Downstream Equilibrium Distance (LEQ), ft	-	Flow Outer Lanes (vOA), pc/h/ln	-
Distance to Downstream Ramp (LDOWN), ft	-	On-Ramp Influence Area Speed (SR), mi/h	56.1
Prop. Freeway Vehicles in Lane 1 and 2 (PFM)	1.000	Outer Lanes Freeway Speed (SO), mi/h	65.0
Flow in Lanes 1 and 2 (v12), pc/h	3247	Ramp Junction Speed (S), mi/h	56.1
Flow Entering Ramp-Infl. Area (vR12), pc/h	3452	Average Density (D), pc/mi/ln	30.8
Level of Service (LOS)	C	Density in Ramp Influence Area (DR), pc/mi/ln	27.4

HCS7 Basic Freeway Report

Project Information

Analyst	LSA	Date	12/11/2019
Agency	LSA	Analysis Year	Existing NP
Jurisdiction	Caltrans	Time Period Analyzed	AM Peak Hour
Project Description	CMD1801 - Village D Specific Plan	Unit	United States Customary

Geometric Data

Number of Lanes, ln	2	Terrain Type	Level
Segment Length (L), ft	-	Percent Grade, %	-
Measured or Base Free-Flow Speed	Base	Grade Length, mi	-
Base Free-Flow Speed (BFFS), mi/h	65.0	Total Ramp Density (TRD), ramps/mi	2.17
Lane Width, ft	12	Free-Flow Speed (FFS), mi/h	58.8
Right-Side Lateral Clearance, ft	10		

Adjustment Factors

Driver Population	All Familiar	Final Speed Adjustment Factor (SAF)	1.000
Weather Type	Non-Severe Weather	Final Capacity Adjustment Factor (CAF)	1.000
Incident Type	No Incident	Demand Adjustment Factor (DAF)	1.000

Demand and Capacity

Demand Volume veh/h	2654	Heavy Vehicle Adjustment Factor (fhv)	0.818
Peak Hour Factor	0.94	Flow Rate (Vp), pc/h/ln	1726
Total Trucks, %	22.32	Capacity (c), pc/h/ln	2288
Single-Unit Trucks (SUT), %	-	Adjusted Capacity (cadj), pc/h/ln	2288
Tractor-Trailers (TT), %	-	Volume-to-Capacity Ratio (v/c)	0.75
Passenger Car Equivalent (Et)	2.000		

Speed and Density

Lane Width Adjustment (fLW)	0.0	Average Speed (S), mi/h	58.7
Right-Side Lateral Clearance Adj. (fRLC)	0.0	Density (D), pc/mi/ln	29.4
Total Ramp Density Adjustment	6.2	Level of Service (LOS)	D
Adjusted Free-Flow Speed (FFSadj), mi/h	58.8		

HCS7 Freeway Diverge Report

Project Information

Analyst	LSA	Date	12/11/2019
Agency	LSA	Analysis Year	Existing NP
Jurisdiction	Caltrans	Time Period Analyzed	AM Peak Hour
Project Description	CMD1801 - Village D Specific Plan	Unit	United States Customary

Geometric Data

	Freeway	Ramp
Number of Lanes (N), ln	2	1
Free-Flow Speed (FFS), mi/h	65.0	35.0
Segment Length (L) / Deceleration Length (LA),ft	1500	200
Terrain Type	Level	Level
Percent Grade, %	-	-
Segment Type / Ramp Side	Freeway	Right

Adjustment Factors

Driver Population	All Familiar	All Familiar
Weather Type	Non-Severe Weather	Non-Severe Weather
Incident Type	No Incident	-
Final Speed Adjustment Factor (SAF)	1.000	1.000
Final Capacity Adjustment Factor (CAF)	1.000	1.000
Demand Adjustment Factor (DAF)	1.000	1.000

Demand and Capacity

Demand Volume (Vi)	2654	104
Peak Hour Factor (PHF)	0.94	0.94
Total Trucks, %	22.32	14.71
Single-Unit Trucks (SUT), %	-	-
Tractor-Trailers (TT), %	-	-
Heavy Vehicle Adjustment Factor (fHV)	0.818	0.872
Flow Rate (vi),pc/h	3452	127
Capacity (c), pc/h	4700	2000
Volume-to-Capacity Ratio (v/c)	0.73	0.06

Speed and Density

Upstream Equilibrium Distance (LEQ), ft	-	Number of Outer Lanes on Freeway (NO)	0
Distance to Upstream Ramp (LUP), ft	-	Speed Index (DS)	0.439
Downstream Equilibrium Distance (LEQ), ft	-	Flow Outer Lanes (vOA), pc/h/ln	-
Distance to Downstream Ramp (LDOWN), ft	-	Off-Ramp Influence Area Speed (SR), mi/h	54.9
Prop. Freeway Vehicles in Lane 1 and 2 (PFD)	1.000	Outer Lanes Freeway Speed (SO), mi/h	71.3
Flow in Lanes 1 and 2 (v12), pc/h	3452	Ramp Junction Speed (S), mi/h	54.9
Flow Entering Ramp-Infl. Area (vR12), pc/h	-	Average Density (D), pc/mi/ln	31.4
Level of Service (LOS)	D	Density in Ramp Influence Area (DR), pc/mi/ln	32.1

HCS7 Basic Freeway Report

Project Information

Analyst	LSA	Date	12/11/2019
Agency	LSA	Analysis Year	Existing NP
Jurisdiction	Caltrans	Time Period Analyzed	AM Peak Hour
Project Description	CMD1801 - Village D Specific Plan	Unit	United States Customary

Geometric Data

Number of Lanes, ln	2	Terrain Type	Level
Segment Length (L), ft	-	Percent Grade, %	-
Measured or Base Free-Flow Speed	Base	Grade Length, mi	-
Base Free-Flow Speed (BFFS), mi/h	65.0	Total Ramp Density (TRD), ramps/mi	2.17
Lane Width, ft	12	Free-Flow Speed (FFS), mi/h	58.8
Right-Side Lateral Clearance, ft	10		

Adjustment Factors

Driver Population	All Familiar	Final Speed Adjustment Factor (SAF)	1.000
Weather Type	Non-Severe Weather	Final Capacity Adjustment Factor (CAF)	1.000
Incident Type	No Incident	Demand Adjustment Factor (DAF)	1.000

Demand and Capacity

Demand Volume veh/h	2550	Heavy Vehicle Adjustment Factor (fhv)	0.815
Peak Hour Factor	0.94	Flow Rate (Vp), pc/h/ln	1664
Total Trucks, %	22.64	Capacity (c), pc/h/ln	2288
Single-Unit Trucks (SUT), %	-	Adjusted Capacity (cadj), pc/h/ln	2288
Tractor-Trailers (TT), %	-	Volume-to-Capacity Ratio (v/c)	0.73
Passenger Car Equivalent (Et)	2.000		

Speed and Density

Lane Width Adjustment (fLW)	0.0	Average Speed (S), mi/h	58.8
Right-Side Lateral Clearance Adj. (fRLC)	0.0	Density (D), pc/mi/ln	28.3
Total Ramp Density Adjustment	6.2	Level of Service (LOS)	D
Adjusted Free-Flow Speed (FFSadj), mi/h	58.8		

HCS7 Freeway Merge Report

Project Information

Analyst	LSA	Date	12/11/2019
Agency	LSA	Analysis Year	Existing NP
Jurisdiction	Caltrans	Time Period Analyzed	AM Peak Hour
Project Description	CMD1801 - Village D Specific Plan	Unit	United States Customary

Geometric Data

	Freeway	Ramp
Number of Lanes (N), ln	2	1
Free-Flow Speed (FFS), mi/h	65.0	35.0
Segment Length (L) / Acceleration Length (LA),ft	1500	350
Terrain Type	Level	Level
Percent Grade, %	-	-
Segment Type / Ramp Side	Freeway	Right

Adjustment Factors

Driver Population	All Familiar	All Familiar
Weather Type	Non-Severe Weather	Non-Severe Weather
Incident Type	No Incident	-
Final Speed Adjustment Factor (SAF)	1.000	1.000
Final Capacity Adjustment Factor (CAF)	1.000	1.000
Demand Adjustment Factor (DAF)	1.000	1.000

Demand and Capacity

Demand Volume (Vi)	2550	620
Peak Hour Factor (PHF)	0.94	0.94
Total Trucks, %	22.64	3.10
Single-Unit Trucks (SUT), %	-	-
Tractor-Trailers (TT), %	-	-
Heavy Vehicle Adjustment Factor (fHV)	0.815	0.970
Flow Rate (vi),pc/h	3329	680
Capacity (c), pc/h	4700	2000
Volume-to-Capacity Ratio (v/c)	0.85	0.34

Speed and Density

Upstream Equilibrium Distance (LEQ), ft	-	Number of Outer Lanes on Freeway (NO)	0
Distance to Upstream Ramp (LUP), ft	-	Speed Index (MS)	0.511
Downstream Equilibrium Distance (LEQ), ft	-	Flow Outer Lanes (vOA), pc/h/ln	-
Distance to Downstream Ramp (LDOWN), ft	-	On-Ramp Influence Area Speed (SR), mi/h	53.2
Prop. Freeway Vehicles in Lane 1 and 2 (PFM)	1.000	Outer Lanes Freeway Speed (SO), mi/h	65.0
Flow in Lanes 1 and 2 (v12), pc/h	3329	Ramp Junction Speed (S), mi/h	53.2
Flow Entering Ramp-Infl. Area (vR12), pc/h	4009	Average Density (D), pc/mi/ln	37.7
Level of Service (LOS)	D	Density in Ramp Influence Area (DR), pc/mi/ln	34.3

HCS7 Basic Freeway Report

Project Information

Analyst	LSA	Date	12/11/2019
Agency	LSA	Analysis Year	Existing NP
Jurisdiction	Caltrans	Time Period Analyzed	AM Peak Hour
Project Description	CMD1801 - Village D Specific Plan	Unit	United States Customary

Geometric Data

Number of Lanes, ln	2	Terrain Type	Level
Segment Length (L), ft	-	Percent Grade, %	-
Measured or Base Free-Flow Speed	Base	Grade Length, mi	-
Base Free-Flow Speed (BFFS), mi/h	65.0	Total Ramp Density (TRD), ramps/mi	2.17
Lane Width, ft	12	Free-Flow Speed (FFS), mi/h	58.8
Right-Side Lateral Clearance, ft	10		

Adjustment Factors

Driver Population	All Familiar	Final Speed Adjustment Factor (SAF)	1.000
Weather Type	Non-Severe Weather	Final Capacity Adjustment Factor (CAF)	1.000
Incident Type	No Incident	Demand Adjustment Factor (DAF)	1.000

Demand and Capacity

Demand Volume veh/h	3170	Heavy Vehicle Adjustment Factor (fhv)	0.842
Peak Hour Factor	0.94	Flow Rate (Vp), pc/h/ln	2002
Total Trucks, %	18.81	Capacity (c), pc/h/ln	2288
Single-Unit Trucks (SUT), %	-	Adjusted Capacity (cadj), pc/h/ln	2288
Tractor-Trailers (TT), %	-	Volume-to-Capacity Ratio (v/c)	0.88
Passenger Car Equivalent (Et)	2.000		

Speed and Density

Lane Width Adjustment (fLW)	0.0	Average Speed (S), mi/h	56.4
Right-Side Lateral Clearance Adj. (fRLC)	0.0	Density (D), pc/mi/ln	35.5
Total Ramp Density Adjustment	6.2	Level of Service (LOS)	E
Adjusted Free-Flow Speed (FFSadj), mi/h	58.8		

HCS7 Freeway Diverge Report

Project Information

Analyst	LSA	Date	12/11/2019
Agency	LSA	Analysis Year	Existing NP
Jurisdiction	Caltrans	Time Period Analyzed	AM Peak Hour
Project Description	CMD1801 - Village D Specific Plan	Unit	United States Customary

Geometric Data

	Freeway	Ramp
Number of Lanes (N), ln	2	1
Free-Flow Speed (FFS), mi/h	65.0	15.0
Segment Length (L) / Deceleration Length (LA),ft	1500	150
Terrain Type	Level	Level
Percent Grade, %	-	-
Segment Type / Ramp Side	Highway/CD Roadway	Right

Adjustment Factors

Driver Population	All Familiar	All Familiar
Weather Type	Non-Severe Weather	Non-Severe Weather
Incident Type	No Incident	-
Final Speed Adjustment Factor (SAF)	1.000	1.000
Final Capacity Adjustment Factor (CAF)	1.000	1.000
Demand Adjustment Factor (DAF)	1.000	1.000

Demand and Capacity

Demand Volume (Vi)	3170	391
Peak Hour Factor (PHF)	0.94	0.94
Total Trucks, %	18.81	3.32
Single-Unit Trucks (SUT), %	-	-
Tractor-Trailers (TT), %	-	-
Heavy Vehicle Adjustment Factor (fHV)	0.842	0.968
Flow Rate (vi),pc/h	4005	430
Capacity (c), pc/h	4400	1800
Volume-to-Capacity Ratio (v/c)	0.91	0.24

Speed and Density

Upstream Equilibrium Distance (LEQ), ft	-	Number of Outer Lanes on Freeway (NO)	0
Distance to Upstream Ramp (LUP), ft	-	Speed Index (DS)	0.727
Downstream Equilibrium Distance (LEQ), ft	-	Flow Outer Lanes (vOA), pc/h/ln	-
Distance to Downstream Ramp (LDOWN), ft	-	Off-Ramp Influence Area Speed (SR), mi/h	48.3
Prop. Freeway Vehicles in Lane 1 and 2 (PFD)	1.000	Outer Lanes Freeway Speed (SO), mi/h	71.3
Flow in Lanes 1 and 2 (v12), pc/h	4005	Ramp Junction Speed (S), mi/h	48.3
Flow Entering Ramp-Infl. Area (vR12), pc/h	-	Average Density (D), pc/mi/ln	41.5
Level of Service (LOS)	E	Density in Ramp Influence Area (DR), pc/mi/ln	37.3

HCS7 Basic Freeway Report

Project Information

Analyst	LSA	Date	12/11/2019
Agency	LSA	Analysis Year	Existing NP
Jurisdiction	Caltrans	Time Period Analyzed	AM Peak Hour
Project Description	CMD1801 - Village D Specific Plan	Unit	United States Customary

Geometric Data

Number of Lanes, ln	2	Terrain Type	Level
Segment Length (L), ft	-	Percent Grade, %	-
Measured or Base Free-Flow Speed	Base	Grade Length, mi	-
Base Free-Flow Speed (BFFS), mi/h	65.0	Total Ramp Density (TRD), ramps/mi	1.83
Lane Width, ft	12	Free-Flow Speed (FFS), mi/h	59.7
Right-Side Lateral Clearance, ft	10		

Adjustment Factors

Driver Population	All Familiar	Final Speed Adjustment Factor (SAF)	1.000
Weather Type	Non-Severe Weather	Final Capacity Adjustment Factor (CAF)	1.000
Incident Type	No Incident	Demand Adjustment Factor (DAF)	1.000

Demand and Capacity

Demand Volume veh/h	2779	Heavy Vehicle Adjustment Factor (fhv)	0.827
Peak Hour Factor	0.94	Flow Rate (Vp), pc/h/ln	1788
Total Trucks, %	20.99	Capacity (c), pc/h/ln	2296
Single-Unit Trucks (SUT), %	-	Adjusted Capacity (cadj), pc/h/ln	2296
Tractor-Trailers (TT), %	-	Volume-to-Capacity Ratio (v/c)	0.78
Passenger Car Equivalent (Et)	2.000		

Speed and Density

Lane Width Adjustment (fLW)	0.0	Average Speed (S), mi/h	59.1
Right-Side Lateral Clearance Adj. (fRLC)	0.0	Density (D), pc/mi/ln	30.3
Total Ramp Density Adjustment	5.4	Level of Service (LOS)	D
Adjusted Free-Flow Speed (FFSadj), mi/h	59.6		

HCS7 Freeway Merge Report

Project Information

Analyst	LSA	Date	12/11/2019
Agency	LSA	Analysis Year	Existing NP
Jurisdiction	Caltrans	Time Period Analyzed	AM Peak Hour
Project Description	CMD1801 - Village D Specific Plan	Unit	United States Customary

Geometric Data

	Freeway	Ramp
Number of Lanes (N), ln	2	1
Free-Flow Speed (FFS), mi/h	65.0	35.0
Segment Length (L) / Acceleration Length (LA),ft	1500	450
Terrain Type	Level	Level
Percent Grade, %	-	-
Segment Type / Ramp Side	Freeway	Right

Adjustment Factors

Driver Population	All Familiar	All Familiar
Weather Type	Non-Severe Weather	Non-Severe Weather
Incident Type	No Incident	-
Final Speed Adjustment Factor (SAF)	1.000	1.000
Final Capacity Adjustment Factor (CAF)	1.000	1.000
Demand Adjustment Factor (DAF)	1.000	1.000

Demand and Capacity

Demand Volume (Vi)	2779	475
Peak Hour Factor (PHF)	0.94	0.94
Total Trucks, %	20.99	0.84
Single-Unit Trucks (SUT), %	-	-
Tractor-Trailers (TT), %	-	-
Heavy Vehicle Adjustment Factor (fHV)	0.827	0.992
Flow Rate (vi),pc/h	3575	509
Capacity (c), pc/h	4700	2000
Volume-to-Capacity Ratio (v/c)	0.87	0.25

Speed and Density

Upstream Equilibrium Distance (LEQ), ft	-	Number of Outer Lanes on Freeway (NO)	0
Distance to Upstream Ramp (LUP), ft	-	Speed Index (MS)	0.521
Downstream Equilibrium Distance (LEQ), ft	-	Flow Outer Lanes (vOA), pc/h/ln	-
Distance to Downstream Ramp (LDOWN), ft	-	On-Ramp Influence Area Speed (SR), mi/h	53.0
Prop. Freeway Vehicles in Lane 1 and 2 (PFM)	1.000	Outer Lanes Freeway Speed (SO), mi/h	65.0
Flow in Lanes 1 and 2 (v12), pc/h	3575	Ramp Junction Speed (S), mi/h	53.0
Flow Entering Ramp-Infl. Area (vR12), pc/h	4084	Average Density (D), pc/mi/ln	38.5
Level of Service (LOS)	D	Density in Ramp Influence Area (DR), pc/mi/ln	34.3

HCS7 Basic Freeway Report

Project Information

Analyst	LSA	Date	12/11/2019
Agency	LSA	Analysis Year	Existing NP
Jurisdiction	Caltrans	Time Period Analyzed	AM Peak Hour
Project Description	CMD1801 - Village D Specific Plan	Unit	United States Customary

Geometric Data

Number of Lanes, ln	2	Terrain Type	Level
Segment Length (L), ft	-	Percent Grade, %	-
Measured or Base Free-Flow Speed	Base	Grade Length, mi	-
Base Free-Flow Speed (BFFS), mi/h	65.0	Total Ramp Density (TRD), ramps/mi	1.83
Lane Width, ft	12	Free-Flow Speed (FFS), mi/h	59.7
Right-Side Lateral Clearance, ft	10		

Adjustment Factors

Driver Population	All Familiar	Final Speed Adjustment Factor (SAF)	1.000
Weather Type	Non-Severe Weather	Final Capacity Adjustment Factor (CAF)	1.000
Incident Type	No Incident	Demand Adjustment Factor (DAF)	1.000

Demand and Capacity

Demand Volume veh/h	3254	Heavy Vehicle Adjustment Factor (fhv)	0.847
Peak Hour Factor	0.94	Flow Rate (Vp), pc/h/ln	2044
Total Trucks, %	18.05	Capacity (c), pc/h/ln	2296
Single-Unit Trucks (SUT), %	-	Adjusted Capacity (cadj), pc/h/ln	2296
Tractor-Trailers (TT), %	-	Volume-to-Capacity Ratio (v/c)	0.89
Passenger Car Equivalent (Et)	2.000		

Speed and Density

Lane Width Adjustment (fLW)	0.0	Average Speed (S), mi/h	56.2
Right-Side Lateral Clearance Adj. (fRLC)	0.0	Density (D), pc/mi/ln	36.4
Total Ramp Density Adjustment	5.4	Level of Service (LOS)	E
Adjusted Free-Flow Speed (FFSadj), mi/h	59.6		

HCS7 Freeway Diverge Report

Project Information

Analyst	LSA	Date	12/11/2019
Agency	LSA	Analysis Year	Existing NP
Jurisdiction	Caltrans	Time Period Analyzed	AM Peak Hour
Project Description	CMD1801 - Village D Specific Plan	Unit	United States Customary

Geometric Data

	Freeway	Ramp
Number of Lanes (N), In	2	1
Free-Flow Speed (FFS), mi/h	65.0	35.0
Segment Length (L) / Deceleration Length (LA),ft	1500	140
Terrain Type	Level	Level
Percent Grade, %	-	-
Segment Type / Ramp Side	Freeway	Right

Adjustment Factors

Driver Population	All Familiar	All Familiar
Weather Type	Non-Severe Weather	Non-Severe Weather
Incident Type	No Incident	-
Final Speed Adjustment Factor (SAF)	1.000	1.000
Final Capacity Adjustment Factor (CAF)	1.000	1.000
Demand Adjustment Factor (DAF)	1.000	1.000

Demand and Capacity

Demand Volume (Vi)	3254	402
Peak Hour Factor (PHF)	0.94	0.94
Total Trucks, %	18.05	9.70
Single-Unit Trucks (SUT), %	-	-
Tractor-Trailers (TT), %	-	-
Heavy Vehicle Adjustment Factor (fHV)	0.847	0.912
Flow Rate (vi),pc/h	4087	469
Capacity (c), pc/h	4700	2000
Volume-to-Capacity Ratio (v/c)	0.87	0.23

Speed and Density

Upstream Equilibrium Distance (LEQ), ft	-	Number of Outer Lanes on Freeway (NO)	0
Distance to Upstream Ramp (LUP), ft	-	Speed Index (DS)	0.470
Downstream Equilibrium Distance (LEQ), ft	-	Flow Outer Lanes (vOA), pc/h/ln	-
Distance to Downstream Ramp (LDOWN), ft	-	Off-Ramp Influence Area Speed (SR), mi/h	54.2
Prop. Freeway Vehicles in Lane 1 and 2 (PFD)	1.000	Outer Lanes Freeway Speed (SO), mi/h	71.3
Flow in Lanes 1 and 2 (v12), pc/h	4087	Ramp Junction Speed (S), mi/h	54.2
Flow Entering Ramp-Infl. Area (vR12), pc/h	-	Average Density (D), pc/mi/ln	37.7
Level of Service (LOS)	E	Density in Ramp Influence Area (DR), pc/mi/ln	38.1

HCS7 Basic Freeway Report

Project Information

Analyst	LSA	Date	12/11/2019
Agency	LSA	Analysis Year	Existing NP
Jurisdiction	Caltrans	Time Period Analyzed	AM Peak Hour
Project Description	CMD1801 - Village D Specific Plan	Unit	United States Customary

Geometric Data

Number of Lanes, ln	2	Terrain Type	Level
Segment Length (L), ft	-	Percent Grade, %	-
Measured or Base Free-Flow Speed	Base	Grade Length, mi	-
Base Free-Flow Speed (BFFS), mi/h	65.0	Total Ramp Density (TRD), ramps/mi	2.17
Lane Width, ft	12	Free-Flow Speed (FFS), mi/h	58.8
Right-Side Lateral Clearance, ft	10		

Adjustment Factors

Driver Population	All Familiar	Final Speed Adjustment Factor (SAF)	1.000
Weather Type	Non-Severe Weather	Final Capacity Adjustment Factor (CAF)	1.000
Incident Type	No Incident	Demand Adjustment Factor (DAF)	1.000

Demand and Capacity

Demand Volume veh/h	2852	Heavy Vehicle Adjustment Factor (fhv)	0.839
Peak Hour Factor	0.94	Flow Rate (Vp), pc/h/ln	1808
Total Trucks, %	19.22	Capacity (c), pc/h/ln	2288
Single-Unit Trucks (SUT), %	-	Adjusted Capacity (cadj), pc/h/ln	2288
Tractor-Trailers (TT), %	-	Volume-to-Capacity Ratio (v/c)	0.79
Passenger Car Equivalent (Et)	2.000		

Speed and Density

Lane Width Adjustment (fLW)	0.0	Average Speed (S), mi/h	58.3
Right-Side Lateral Clearance Adj. (fRLC)	0.0	Density (D), pc/mi/ln	31.0
Total Ramp Density Adjustment	6.2	Level of Service (LOS)	D
Adjusted Free-Flow Speed (FFSadj), mi/h	58.8		

HCS7 Freeway Merge Report

Project Information

Analyst	LSA	Date	12/11/2019
Agency	LSA	Analysis Year	Existing NP
Jurisdiction	Caltrans	Time Period Analyzed	AM Peak Hour
Project Description	CMD1801 - Village D Specific Plan	Unit	United States Customary

Geometric Data

	Freeway	Ramp
Number of Lanes (N), ln	2	1
Free-Flow Speed (FFS), mi/h	65.0	35.0
Segment Length (L) / Acceleration Length (LA),ft	1500	450
Terrain Type	Level	Level
Percent Grade, %	-	-
Segment Type / Ramp Side	Freeway	Right

Adjustment Factors

Driver Population	All Familiar	All Familiar
Weather Type	Non-Severe Weather	Non-Severe Weather
Incident Type	No Incident	-
Final Speed Adjustment Factor (SAF)	1.000	1.000
Final Capacity Adjustment Factor (CAF)	1.000	1.000
Demand Adjustment Factor (DAF)	1.000	1.000

Demand and Capacity

Demand Volume (Vi)	2852	314
Peak Hour Factor (PHF)	0.94	0.94
Total Trucks, %	19.22	2.57
Single-Unit Trucks (SUT), %	-	-
Tractor-Trailers (TT), %	-	-
Heavy Vehicle Adjustment Factor (fHV)	0.839	0.975
Flow Rate (vi),pc/h	3616	343
Capacity (c), pc/h	4700	2000
Volume-to-Capacity Ratio (v/c)	0.84	0.17

Speed and Density

Upstream Equilibrium Distance (LEQ), ft	-	Number of Outer Lanes on Freeway (NO)	0
Distance to Upstream Ramp (LUP), ft	-	Speed Index (MS)	0.494
Downstream Equilibrium Distance (LEQ), ft	-	Flow Outer Lanes (vOA), pc/h/ln	-
Distance to Downstream Ramp (LDOWN), ft	-	On-Ramp Influence Area Speed (SR), mi/h	53.6
Prop. Freeway Vehicles in Lane 1 and 2 (PFM)	1.000	Outer Lanes Freeway Speed (SO), mi/h	65.0
Flow in Lanes 1 and 2 (v12), pc/h	3616	Ramp Junction Speed (S), mi/h	53.6
Flow Entering Ramp-Infl. Area (vR12), pc/h	3959	Average Density (D), pc/mi/ln	36.9
Level of Service (LOS)	D	Density in Ramp Influence Area (DR), pc/mi/ln	33.4

HCS7 Basic Freeway Report

Project Information

Analyst	LSA	Date	12/11/2019
Agency	LSA	Analysis Year	Existing NP
Jurisdiction	Caltrans	Time Period Analyzed	AM Peak Hour
Project Description	CMD1801 - Village D Specific Plan	Unit	United States Customary

Geometric Data

Number of Lanes, ln	2	Terrain Type	Level
Segment Length (L), ft	-	Percent Grade, %	-
Measured or Base Free-Flow Speed	Base	Grade Length, mi	-
Base Free-Flow Speed (BFFS), mi/h	65.0	Total Ramp Density (TRD), ramps/mi	2.17
Lane Width, ft	12	Free-Flow Speed (FFS), mi/h	58.8
Right-Side Lateral Clearance, ft	10		

Adjustment Factors

Driver Population	All Familiar	Final Speed Adjustment Factor (SAF)	1.000
Weather Type	Non-Severe Weather	Final Capacity Adjustment Factor (CAF)	1.000
Incident Type	No Incident	Demand Adjustment Factor (DAF)	1.000

Demand and Capacity

Demand Volume veh/h	3166	Heavy Vehicle Adjustment Factor (fhv)	0.851
Peak Hour Factor	0.94	Flow Rate (Vp), pc/h/ln	1979
Total Trucks, %	17.57	Capacity (c), pc/h/ln	2288
Single-Unit Trucks (SUT), %	-	Adjusted Capacity (cadj), pc/h/ln	2288
Tractor-Trailers (TT), %	-	Volume-to-Capacity Ratio (v/c)	0.86
Passenger Car Equivalent (Et)	2.000		

Speed and Density

Lane Width Adjustment (fLW)	0.0	Average Speed (S), mi/h	56.7
Right-Side Lateral Clearance Adj. (fRLC)	0.0	Density (D), pc/mi/ln	34.9
Total Ramp Density Adjustment	6.2	Level of Service (LOS)	D
Adjusted Free-Flow Speed (FFSadj), mi/h	58.8		

HCS7 Basic Freeway Report

Project Information

Analyst	LSA	Date	12/11/2019
Agency	LSA	Analysis Year	Existing NP
Jurisdiction	Caltrans	Time Period Analyzed	PM Peak Hour
Project Description	CMD1801 - Village D Specific Plan	Unit	United States Customary

Geometric Data

Number of Lanes, ln	2	Terrain Type	Level
Segment Length (L), ft	-	Percent Grade, %	-
Measured or Base Free-Flow Speed	Base	Grade Length, mi	-
Base Free-Flow Speed (BFFS), mi/h	65.0	Total Ramp Density (TRD), ramps/mi	1.83
Lane Width, ft	12	Free-Flow Speed (FFS), mi/h	59.7
Right-Side Lateral Clearance, ft	10		

Adjustment Factors

Driver Population	All Familiar	Final Speed Adjustment Factor (SAF)	1.000
Weather Type	Non-Severe Weather	Final Capacity Adjustment Factor (CAF)	1.000
Incident Type	No Incident	Demand Adjustment Factor (DAF)	1.000

Demand and Capacity

Demand Volume veh/h	2974	Heavy Vehicle Adjustment Factor (fhv)	0.851
Peak Hour Factor	0.94	Flow Rate (Vp), pc/h/ln	1859
Total Trucks, %	17.57	Capacity (c), pc/h/ln	2296
Single-Unit Trucks (SUT), %	-	Adjusted Capacity (cadj), pc/h/ln	2296
Tractor-Trailers (TT), %	-	Volume-to-Capacity Ratio (v/c)	0.81
Passenger Car Equivalent (Et)	2.000		

Speed and Density

Lane Width Adjustment (fLW)	0.0	Average Speed (S), mi/h	58.5
Right-Side Lateral Clearance Adj. (fRLC)	0.0	Density (D), pc/mi/ln	31.8
Total Ramp Density Adjustment	5.4	Level of Service (LOS)	D
Adjusted Free-Flow Speed (FFSadj), mi/h	59.6		

HCS7 Freeway Diverge Report

Project Information

Analyst	LSA	Date	12/11/2019
Agency	LSA	Analysis Year	Existing NP
Jurisdiction	Caltrans	Time Period Analyzed	PM Peak Hour
Project Description	CMD1801 - Village D Specific Plan	Unit	United States Customary

Geometric Data

	Freeway	Ramp
Number of Lanes (N), ln	2	1
Free-Flow Speed (FFS), mi/h	65.0	35.0
Segment Length (L) / Deceleration Length (LA),ft	1500	1200
Terrain Type	Level	Level
Percent Grade, %	-	-
Segment Type / Ramp Side	Freeway	Right

Adjustment Factors

Driver Population	All Familiar	All Familiar
Weather Type	Non-Severe Weather	Non-Severe Weather
Incident Type	No Incident	-
Final Speed Adjustment Factor (SAF)	1.000	1.000
Final Capacity Adjustment Factor (CAF)	1.000	1.000
Demand Adjustment Factor (DAF)	1.000	1.000

Demand and Capacity

Demand Volume (Vi)	2974	204
Peak Hour Factor (PHF)	0.94	0.94
Total Trucks, %	17.57	0.99
Single-Unit Trucks (SUT), %	-	-
Tractor-Trailers (TT), %	-	-
Heavy Vehicle Adjustment Factor (fHV)	0.851	0.990
Flow Rate (vi),pc/h	3718	219
Capacity (c), pc/h	4700	2000
Volume-to-Capacity Ratio (v/c)	0.79	0.11

Speed and Density

Upstream Equilibrium Distance (LEQ), ft	-	Number of Outer Lanes on Freeway (NO)	0
Distance to Upstream Ramp (LUP), ft	-	Speed Index (DS)	0.448
Downstream Equilibrium Distance (LEQ), ft	-	Flow Outer Lanes (vOA), pc/h/ln	-
Distance to Downstream Ramp (LDOWN), ft	-	Off-Ramp Influence Area Speed (SR), mi/h	54.7
Prop. Freeway Vehicles in Lane 1 and 2 (PFD)	1.000	Outer Lanes Freeway Speed (SO), mi/h	71.3
Flow in Lanes 1 and 2 (v12), pc/h	3718	Ramp Junction Speed (S), mi/h	54.7
Flow Entering Ramp-Infl. Area (vR12), pc/h	-	Average Density (D), pc/mi/ln	34.0
Level of Service (LOS)	C	Density in Ramp Influence Area (DR), pc/mi/ln	25.4

HCS7 Basic Freeway Report

Project Information

Analyst	LSA	Date	12/11/2019
Agency	LSA	Analysis Year	Existing NP
Jurisdiction	Caltrans	Time Period Analyzed	PM Peak Hour
Project Description	CMD1801 - Village D Specific Plan	Unit	United States Customary

Geometric Data

Number of Lanes, ln	2	Terrain Type	Level
Segment Length (L), ft	-	Percent Grade, %	-
Measured or Base Free-Flow Speed	Base	Grade Length, mi	-
Base Free-Flow Speed (BFFS), mi/h	65.0	Total Ramp Density (TRD), ramps/mi	1.83
Lane Width, ft	12	Free-Flow Speed (FFS), mi/h	59.7
Right-Side Lateral Clearance, ft	10		

Adjustment Factors

Driver Population	All Familiar	Final Speed Adjustment Factor (SAF)	1.000
Weather Type	Non-Severe Weather	Final Capacity Adjustment Factor (CAF)	1.000
Incident Type	No Incident	Demand Adjustment Factor (DAF)	1.000

Demand and Capacity

Demand Volume veh/h	2770	Heavy Vehicle Adjustment Factor (fhv)	0.842
Peak Hour Factor	0.94	Flow Rate (Vp), pc/h/ln	1750
Total Trucks, %	18.79	Capacity (c), pc/h/ln	2296
Single-Unit Trucks (SUT), %	-	Adjusted Capacity (cadj), pc/h/ln	2296
Tractor-Trailers (TT), %	-	Volume-to-Capacity Ratio (v/c)	0.76
Passenger Car Equivalent (Et)	2.000		

Speed and Density

Lane Width Adjustment (fLW)	0.0	Average Speed (S), mi/h	59.3
Right-Side Lateral Clearance Adj. (fRLC)	0.0	Density (D), pc/mi/ln	29.5
Total Ramp Density Adjustment	5.4	Level of Service (LOS)	D
Adjusted Free-Flow Speed (FFSadj), mi/h	59.6		

HCS7 Freeway Merge Report

Project Information

Analyst	LSA	Date	12/11/2019
Agency	LSA	Analysis Year	Existing NP
Jurisdiction	Caltrans	Time Period Analyzed	PM Peak Hour
Project Description	CMD1801 - Village D Specific Plan	Unit	United States Customary

Geometric Data

	Freeway	Ramp
Number of Lanes (N), ln	2	1
Free-Flow Speed (FFS), mi/h	65.0	35.0
Segment Length (L) / Acceleration Length (LA),ft	1500	445
Terrain Type	Level	Level
Percent Grade, %	-	-
Segment Type / Ramp Side	Freeway	Right

Adjustment Factors

Driver Population	All Familiar	All Familiar
Weather Type	Non-Severe Weather	Non-Severe Weather
Incident Type	No Incident	-
Final Speed Adjustment Factor (SAF)	1.000	1.000
Final Capacity Adjustment Factor (CAF)	1.000	1.000
Demand Adjustment Factor (DAF)	1.000	1.000

Demand and Capacity

Demand Volume (Vi)	2770	549
Peak Hour Factor (PHF)	0.94	0.94
Total Trucks, %	18.79	2.75
Single-Unit Trucks (SUT), %	-	-
Tractor-Trailers (TT), %	-	-
Heavy Vehicle Adjustment Factor (fHV)	0.842	0.973
Flow Rate (vi),pc/h	3500	600
Capacity (c), pc/h	4700	2000
Volume-to-Capacity Ratio (v/c)	0.87	0.30

Speed and Density

Upstream Equilibrium Distance (LEQ), ft	-	Number of Outer Lanes on Freeway (NO)	0
Distance to Upstream Ramp (LUP), ft	-	Speed Index (MS)	0.525
Downstream Equilibrium Distance (LEQ), ft	-	Flow Outer Lanes (vOA), pc/h/ln	-
Distance to Downstream Ramp (LDOWN), ft	-	On-Ramp Influence Area Speed (SR), mi/h	52.9
Prop. Freeway Vehicles in Lane 1 and 2 (PFM)	1.000	Outer Lanes Freeway Speed (SO), mi/h	65.0
Flow in Lanes 1 and 2 (v12), pc/h	3500	Ramp Junction Speed (S), mi/h	52.9
Flow Entering Ramp-Infl. Area (vR12), pc/h	4100	Average Density (D), pc/mi/ln	38.8
Level of Service (LOS)	D	Density in Ramp Influence Area (DR), pc/mi/ln	34.5

HCS7 Basic Freeway Report

Project Information

Analyst	LSA	Date	12/11/2019
Agency	LSA	Analysis Year	Existing NP
Jurisdiction	Caltrans	Time Period Analyzed	PM Peak Hour
Project Description	CMD1801 - Village D Specific Plan	Unit	United States Customary

Geometric Data

Number of Lanes, ln	2	Terrain Type	Level
Segment Length (L), ft	-	Percent Grade, %	-
Measured or Base Free-Flow Speed	Base	Grade Length, mi	-
Base Free-Flow Speed (BFFS), mi/h	65.0	Total Ramp Density (TRD), ramps/mi	1.50
Lane Width, ft	12	Free-Flow Speed (FFS), mi/h	60.5
Right-Side Lateral Clearance, ft	10		

Adjustment Factors

Driver Population	All Familiar	Final Speed Adjustment Factor (SAF)	1.000
Weather Type	Non-Severe Weather	Final Capacity Adjustment Factor (CAF)	1.000
Incident Type	No Incident	Demand Adjustment Factor (DAF)	1.000

Demand and Capacity

Demand Volume veh/h	3319	Heavy Vehicle Adjustment Factor (fhv)	0.861
Peak Hour Factor	0.94	Flow Rate (Vp), pc/h/ln	2050
Total Trucks, %	16.14	Capacity (c), pc/h/ln	2305
Single-Unit Trucks (SUT), %	-	Adjusted Capacity (cadj), pc/h/ln	2305
Tractor-Trailers (TT), %	-	Volume-to-Capacity Ratio (v/c)	0.89
Passenger Car Equivalent (Et)	2.000		

Speed and Density

Lane Width Adjustment (fLW)	0.0	Average Speed (S), mi/h	56.6
Right-Side Lateral Clearance Adj. (fRLC)	0.0	Density (D), pc/mi/ln	36.2
Total Ramp Density Adjustment	4.5	Level of Service (LOS)	E
Adjusted Free-Flow Speed (FFSadj), mi/h	60.5		

HCS7 Freeway Diverge Report

Project Information

Analyst	LSA	Date	12/11/2019
Agency	LSA	Analysis Year	Existing NP
Jurisdiction	Caltrans	Time Period Analyzed	PM Peak Hour
Project Description	CMD1801 - Village D Specific Plan	Unit	United States Customary

Geometric Data

	Freeway	Ramp
Number of Lanes (N), ln	2	1
Free-Flow Speed (FFS), mi/h	65.0	35.0
Segment Length (L) / Deceleration Length (LA),ft	1500	130
Terrain Type	Level	Level
Percent Grade, %	-	-
Segment Type / Ramp Side	Freeway	Right

Adjustment Factors

Driver Population	All Familiar	All Familiar
Weather Type	Non-Severe Weather	Non-Severe Weather
Incident Type	No Incident	-
Final Speed Adjustment Factor (SAF)	1.000	1.000
Final Capacity Adjustment Factor (CAF)	1.000	1.000
Demand Adjustment Factor (DAF)	1.000	1.000

Demand and Capacity

Demand Volume (Vi)	3319	402
Peak Hour Factor (PHF)	0.94	0.94
Total Trucks, %	16.14	1.24
Single-Unit Trucks (SUT), %	-	-
Tractor-Trailers (TT), %	-	-
Heavy Vehicle Adjustment Factor (fHV)	0.861	0.988
Flow Rate (vi),pc/h	4101	433
Capacity (c), pc/h	4700	2000
Volume-to-Capacity Ratio (v/c)	0.87	0.22

Speed and Density

Upstream Equilibrium Distance (LEQ), ft	-	Number of Outer Lanes on Freeway (NO)	0
Distance to Upstream Ramp (LUP), ft	-	Speed Index (DS)	0.467
Downstream Equilibrium Distance (LEQ), ft	-	Flow Outer Lanes (vOA), pc/h/ln	-
Distance to Downstream Ramp (LDOWN), ft	-	Off-Ramp Influence Area Speed (SR), mi/h	54.3
Prop. Freeway Vehicles in Lane 1 and 2 (PFD)	1.000	Outer Lanes Freeway Speed (SO), mi/h	71.3
Flow in Lanes 1 and 2 (v12), pc/h	4101	Ramp Junction Speed (S), mi/h	54.3
Flow Entering Ramp-Infl. Area (vR12), pc/h	-	Average Density (D), pc/mi/ln	37.8
Level of Service (LOS)	E	Density in Ramp Influence Area (DR), pc/mi/ln	38.4

HCS7 Basic Freeway Report

Project Information

Analyst	LSA	Date	12/11/2019
Agency	LSA	Analysis Year	Existing NP
Jurisdiction	Caltrans	Time Period Analyzed	PM Peak Hour
Project Description	CMD1801 - Village D Specific Plan	Unit	United States Customary

Geometric Data

Number of Lanes, ln	2	Terrain Type	Level
Segment Length (L), ft	-	Percent Grade, %	-
Measured or Base Free-Flow Speed	Base	Grade Length, mi	-
Base Free-Flow Speed (BFFS), mi/h	65.0	Total Ramp Density (TRD), ramps/mi	1.67
Lane Width, ft	12	Free-Flow Speed (FFS), mi/h	60.0
Right-Side Lateral Clearance, ft	10		

Adjustment Factors

Driver Population	All Familiar	Final Speed Adjustment Factor (SAF)	1.000
Weather Type	Non-Severe Weather	Final Capacity Adjustment Factor (CAF)	1.000
Incident Type	No Incident	Demand Adjustment Factor (DAF)	1.000

Demand and Capacity

Demand Volume veh/h	2917	Heavy Vehicle Adjustment Factor (fhv)	0.846
Peak Hour Factor	0.94	Flow Rate (Vp), pc/h/ln	1834
Total Trucks, %	18.19	Capacity (c), pc/h/ln	2300
Single-Unit Trucks (SUT), %	-	Adjusted Capacity (cadj), pc/h/ln	2300
Tractor-Trailers (TT), %	-	Volume-to-Capacity Ratio (v/c)	0.80
Passenger Car Equivalent (Et)	2.000		

Speed and Density

Lane Width Adjustment (fLW)	0.0	Average Speed (S), mi/h	59.0
Right-Side Lateral Clearance Adj. (fRLC)	0.0	Density (D), pc/mi/ln	31.1
Total Ramp Density Adjustment	5.0	Level of Service (LOS)	D
Adjusted Free-Flow Speed (FFSadj), mi/h	60.0		

HCS7 Freeway Merge Report

Project Information

Analyst	LSA	Date	12/11/2019
Agency	LSA	Analysis Year	Existing NP
Jurisdiction	Caltrans	Time Period Analyzed	PM Peak Hour
Project Description	CMD1801 - Village D Specific Plan	Unit	United States Customary

Geometric Data

	Freeway	Ramp
Number of Lanes (N), ln	2	1
Free-Flow Speed (FFS), mi/h	65.0	35.0
Segment Length (L) / Acceleration Length (LA),ft	1500	500
Terrain Type	Level	Level
Percent Grade, %	-	-
Segment Type / Ramp Side	Freeway	Right

Adjustment Factors

Driver Population	All Familiar	All Familiar
Weather Type	Non-Severe Weather	Non-Severe Weather
Incident Type	No Incident	-
Final Speed Adjustment Factor (SAF)	1.000	1.000
Final Capacity Adjustment Factor (CAF)	1.000	1.000
Demand Adjustment Factor (DAF)	1.000	1.000

Demand and Capacity

Demand Volume (Vi)	2917	314
Peak Hour Factor (PHF)	0.94	0.94
Total Trucks, %	18.19	2.23
Single-Unit Trucks (SUT), %	-	-
Tractor-Trailers (TT), %	-	-
Heavy Vehicle Adjustment Factor (fHV)	0.846	0.978
Flow Rate (vi),pc/h	3668	342
Capacity (c), pc/h	4700	2000
Volume-to-Capacity Ratio (v/c)	0.85	0.17

Speed and Density

Upstream Equilibrium Distance (LEQ), ft	-	Number of Outer Lanes on Freeway (NO)	0
Distance to Upstream Ramp (LUP), ft	-	Speed Index (MS)	0.501
Downstream Equilibrium Distance (LEQ), ft	-	Flow Outer Lanes (vOA), pc/h/ln	-
Distance to Downstream Ramp (LDOWN), ft	-	On-Ramp Influence Area Speed (SR), mi/h	53.5
Prop. Freeway Vehicles in Lane 1 and 2 (PFM)	1.000	Outer Lanes Freeway Speed (SO), mi/h	65.0
Flow in Lanes 1 and 2 (v12), pc/h	3668	Ramp Junction Speed (S), mi/h	53.5
Flow Entering Ramp-Infl. Area (vR12), pc/h	4010	Average Density (D), pc/mi/ln	37.5
Level of Service (LOS)	D	Density in Ramp Influence Area (DR), pc/mi/ln	33.5

HCS7 Basic Freeway Report

Project Information

Analyst	LSA	Date	12/11/2019
Agency	LSA	Analysis Year	Existing NP
Jurisdiction	Caltrans	Time Period Analyzed	PM Peak Hour
Project Description	CMD1801 - Village D Specific Plan	Unit	United States Customary

Geometric Data

Number of Lanes, ln	2	Terrain Type	Level
Segment Length (L), ft	-	Percent Grade, %	-
Measured or Base Free-Flow Speed	Base	Grade Length, mi	-
Base Free-Flow Speed (BFFS), mi/h	65.0	Total Ramp Density (TRD), ramps/mi	1.83
Lane Width, ft	12	Free-Flow Speed (FFS), mi/h	59.7
Right-Side Lateral Clearance, ft	10		

Adjustment Factors

Driver Population	All Familiar	Final Speed Adjustment Factor (SAF)	1.000
Weather Type	Non-Severe Weather	Final Capacity Adjustment Factor (CAF)	1.000
Incident Type	No Incident	Demand Adjustment Factor (DAF)	1.000

Demand and Capacity

Demand Volume veh/h	3231	Heavy Vehicle Adjustment Factor (fhv)	0.857
Peak Hour Factor	0.94	Flow Rate (Vp), pc/h/ln	2006
Total Trucks, %	16.64	Capacity (c), pc/h/ln	2296
Single-Unit Trucks (SUT), %	-	Adjusted Capacity (cadj), pc/h/ln	2296
Tractor-Trailers (TT), %	-	Volume-to-Capacity Ratio (v/c)	0.87
Passenger Car Equivalent (Et)	2.000		

Speed and Density

Lane Width Adjustment (fLW)	0.0	Average Speed (S), mi/h	56.8
Right-Side Lateral Clearance Adj. (fRLC)	0.0	Density (D), pc/mi/ln	35.3
Total Ramp Density Adjustment	5.4	Level of Service (LOS)	E
Adjusted Free-Flow Speed (FFSadj), mi/h	59.6		

HCS7 Freeway Diverge Report

Project Information

Analyst	LSA	Date	12/11/2019
Agency	LSA	Analysis Year	Existing NP
Jurisdiction	Caltrans	Time Period Analyzed	PM Peak Hour
Project Description	CMD1801 - Village D Specific Plan	Unit	United States Customary

Geometric Data

	Freeway	Ramp
Number of Lanes (N), In	2	1
Free-Flow Speed (FFS), mi/h	65.0	35.0
Segment Length (L) / Deceleration Length (LA),ft	1500	245
Terrain Type	Level	Level
Percent Grade, %	-	-
Segment Type / Ramp Side	Freeway	Right

Adjustment Factors

Driver Population	All Familiar	All Familiar
Weather Type	Non-Severe Weather	Non-Severe Weather
Incident Type	No Incident	-
Final Speed Adjustment Factor (SAF)	1.000	1.000
Final Capacity Adjustment Factor (CAF)	1.000	1.000
Demand Adjustment Factor (DAF)	1.000	1.000

Demand and Capacity

Demand Volume (Vi)	3231	687
Peak Hour Factor (PHF)	0.94	0.94
Total Trucks, %	16.64	1.02
Single-Unit Trucks (SUT), %	-	-
Tractor-Trailers (TT), %	-	-
Heavy Vehicle Adjustment Factor (fHV)	0.857	0.990
Flow Rate (vi),pc/h	4011	738
Capacity (c), pc/h	4700	2000
Volume-to-Capacity Ratio (v/c)	0.85	0.37

Speed and Density

Upstream Equilibrium Distance (LEQ), ft	-	Number of Outer Lanes on Freeway (NO)	0
Distance to Upstream Ramp (LUP), ft	-	Speed Index (DS)	0.494
Downstream Equilibrium Distance (LEQ), ft	-	Flow Outer Lanes (vOA), pc/h/ln	-
Distance to Downstream Ramp (LDOWN), ft	-	Off-Ramp Influence Area Speed (SR), mi/h	53.6
Prop. Freeway Vehicles in Lane 1 and 2 (PFD)	1.000	Outer Lanes Freeway Speed (SO), mi/h	71.3
Flow in Lanes 1 and 2 (v12), pc/h	4011	Ramp Junction Speed (S), mi/h	53.6
Flow Entering Ramp-Infl. Area (vR12), pc/h	-	Average Density (D), pc/mi/ln	37.4
Level of Service (LOS)	E	Density in Ramp Influence Area (DR), pc/mi/ln	36.5

HCS7 Basic Freeway Report

Project Information

Analyst	LSA	Date	12/11/2019
Agency	LSA	Analysis Year	Existing NP
Jurisdiction	Caltrans	Time Period Analyzed	PM Peak Hour
Project Description	CMD1801 - Village D Specific Plan	Unit	United States Customary

Geometric Data

Number of Lanes, ln	2	Terrain Type	Level
Segment Length (L), ft	-	Percent Grade, %	-
Measured or Base Free-Flow Speed	Base	Grade Length, mi	-
Base Free-Flow Speed (BFFS), mi/h	65.0	Total Ramp Density (TRD), ramps/mi	1.83
Lane Width, ft	12	Free-Flow Speed (FFS), mi/h	59.7
Right-Side Lateral Clearance, ft	10		

Adjustment Factors

Driver Population	All Familiar	Final Speed Adjustment Factor (SAF)	1.000
Weather Type	Non-Severe Weather	Final Capacity Adjustment Factor (CAF)	1.000
Incident Type	No Incident	Demand Adjustment Factor (DAF)	1.000

Demand and Capacity

Demand Volume veh/h	2544	Heavy Vehicle Adjustment Factor (fhv)	0.827
Peak Hour Factor	0.94	Flow Rate (Vp), pc/h/ln	1636
Total Trucks, %	20.85	Capacity (c), pc/h/ln	2296
Single-Unit Trucks (SUT), %	-	Adjusted Capacity (cadj), pc/h/ln	2296
Tractor-Trailers (TT), %	-	Volume-to-Capacity Ratio (v/c)	0.71
Passenger Car Equivalent (Et)	2.000		

Speed and Density

Lane Width Adjustment (fLW)	0.0	Average Speed (S), mi/h	59.6
Right-Side Lateral Clearance Adj. (fRLC)	0.0	Density (D), pc/mi/ln	27.4
Total Ramp Density Adjustment	5.4	Level of Service (LOS)	D
Adjusted Free-Flow Speed (FFSadj), mi/h	59.6		

HCS7 Freeway Merge Report

Project Information

Analyst	LSA	Date	12/11/2019
Agency	LSA	Analysis Year	Existing NP
Jurisdiction	Caltrans	Time Period Analyzed	PM Peak Hour
Project Description	CMD1801 - Village D Specific Plan	Unit	United States Customary

Geometric Data

	Freeway	Ramp
Number of Lanes (N), ln	2	1
Free-Flow Speed (FFS), mi/h	65.0	35.0
Segment Length (L) / Acceleration Length (LA),ft	1500	350
Terrain Type	Level	Level
Percent Grade, %	-	-
Segment Type / Ramp Side	Freeway	Right

Adjustment Factors

Driver Population	All Familiar	All Familiar
Weather Type	Non-Severe Weather	Non-Severe Weather
Incident Type	No Incident	-
Final Speed Adjustment Factor (SAF)	1.000	1.000
Final Capacity Adjustment Factor (CAF)	1.000	1.000
Demand Adjustment Factor (DAF)	1.000	1.000

Demand and Capacity

Demand Volume (Vi)	2544	141
Peak Hour Factor (PHF)	0.94	0.94
Total Trucks, %	20.85	5.67
Single-Unit Trucks (SUT), %	-	-
Tractor-Trailers (TT), %	-	-
Heavy Vehicle Adjustment Factor (fHV)	0.827	0.946
Flow Rate (vi),pc/h	3273	159
Capacity (c), pc/h	4700	2000
Volume-to-Capacity Ratio (v/c)	0.73	0.08

Speed and Density

Upstream Equilibrium Distance (LEQ), ft	-	Number of Outer Lanes on Freeway (NO)	0
Distance to Upstream Ramp (LUP), ft	-	Speed Index (MS)	0.417
Downstream Equilibrium Distance (LEQ), ft	-	Flow Outer Lanes (vOA), pc/h/ln	-
Distance to Downstream Ramp (LDOWN), ft	-	On-Ramp Influence Area Speed (SR), mi/h	55.4
Prop. Freeway Vehicles in Lane 1 and 2 (PFM)	1.000	Outer Lanes Freeway Speed (SO), mi/h	65.0
Flow in Lanes 1 and 2 (v12), pc/h	3273	Ramp Junction Speed (S), mi/h	55.4
Flow Entering Ramp-Infl. Area (vR12), pc/h	3432	Average Density (D), pc/mi/ln	31.0
Level of Service (LOS)	D	Density in Ramp Influence Area (DR), pc/mi/ln	30.0

HCS7 Basic Freeway Report

Project Information

Analyst	LSA	Date	12/11/2019
Agency	LSA	Analysis Year	Existing NP
Jurisdiction	Caltrans	Time Period Analyzed	PM Peak Hour
Project Description	CMD1801 - Village D Specific Plan	Unit	United States Customary

Geometric Data

Number of Lanes, ln	2	Terrain Type	Level
Segment Length (L), ft	-	Percent Grade, %	-
Measured or Base Free-Flow Speed	Base	Grade Length, mi	-
Base Free-Flow Speed (BFFS), mi/h	65.0	Total Ramp Density (TRD), ramps/mi	1.83
Lane Width, ft	12	Free-Flow Speed (FFS), mi/h	59.7
Right-Side Lateral Clearance, ft	10		

Adjustment Factors

Driver Population	All Familiar	Final Speed Adjustment Factor (SAF)	1.000
Weather Type	Non-Severe Weather	Final Capacity Adjustment Factor (CAF)	1.000
Incident Type	No Incident	Demand Adjustment Factor (DAF)	1.000

Demand and Capacity

Demand Volume veh/h	2685	Heavy Vehicle Adjustment Factor (fhv)	0.833
Peak Hour Factor	0.94	Flow Rate (Vp), pc/h/ln	1714
Total Trucks, %	20.06	Capacity (c), pc/h/ln	2296
Single-Unit Trucks (SUT), %	-	Adjusted Capacity (cadj), pc/h/ln	2296
Tractor-Trailers (TT), %	-	Volume-to-Capacity Ratio (v/c)	0.75
Passenger Car Equivalent (Et)	2.000		

Speed and Density

Lane Width Adjustment (fLW)	0.0	Average Speed (S), mi/h	59.4
Right-Side Lateral Clearance Adj. (fRLC)	0.0	Density (D), pc/mi/ln	28.9
Total Ramp Density Adjustment	5.4	Level of Service (LOS)	D
Adjusted Free-Flow Speed (FFSadj), mi/h	59.6		

HCS7 Freeway Diverge Report

Project Information

Analyst	LSA	Date	12/11/2019
Agency	LSA	Analysis Year	Existing NP
Jurisdiction	Caltrans	Time Period Analyzed	PM Peak Hour
Project Description	CMD1801 - Village D Specific Plan	Unit	United States Customary

Geometric Data

	Freeway	Ramp
Number of Lanes (N), In	2	1
Free-Flow Speed (FFS), mi/h	65.0	15.0
Segment Length (L) / Deceleration Length (LA),ft	1500	150
Terrain Type	Level	Level
Percent Grade, %	-	-
Segment Type / Ramp Side	Freeway	Right

Adjustment Factors

Driver Population	All Familiar	All Familiar
Weather Type	Non-Severe Weather	Non-Severe Weather
Incident Type	No Incident	-
Final Speed Adjustment Factor (SAF)	1.000	1.000
Final Capacity Adjustment Factor (CAF)	1.000	1.000
Demand Adjustment Factor (DAF)	1.000	1.000

Demand and Capacity

Demand Volume (Vi)	2685	138
Peak Hour Factor (PHF)	0.94	0.94
Total Trucks, %	20.06	3.62
Single-Unit Trucks (SUT), %	-	-
Tractor-Trailers (TT), %	-	-
Heavy Vehicle Adjustment Factor (fHV)	0.833	0.965
Flow Rate (vi),pc/h	3429	152
Capacity (c), pc/h	4700	1800
Volume-to-Capacity Ratio (v/c)	0.73	0.08

Speed and Density

Upstream Equilibrium Distance (LEQ), ft	-	Number of Outer Lanes on Freeway (NO)	0
Distance to Upstream Ramp (LUP), ft	-	Speed Index (DS)	0.702
Downstream Equilibrium Distance (LEQ), ft	-	Flow Outer Lanes (vOA), pc/h/ln	-
Distance to Downstream Ramp (LDOWN), ft	-	Off-Ramp Influence Area Speed (SR), mi/h	48.9
Prop. Freeway Vehicles in Lane 1 and 2 (PFD)	1.000	Outer Lanes Freeway Speed (SO), mi/h	71.3
Flow in Lanes 1 and 2 (v12), pc/h	3429	Ramp Junction Speed (S), mi/h	48.9
Flow Entering Ramp-Infl. Area (vR12), pc/h	-	Average Density (D), pc/mi/ln	35.1
Level of Service (LOS)	D	Density in Ramp Influence Area (DR), pc/mi/ln	32.4

HCS7 Basic Freeway Report

Project Information

Analyst	LSA	Date	12/11/2019
Agency	LSA	Analysis Year	Existing NP
Jurisdiction	Caltrans	Time Period Analyzed	PM Peak Hour
Project Description	CMD1801 - Village D Specific Plan	Unit	United States Customary

Geometric Data

Number of Lanes, ln	2	Terrain Type	Level
Segment Length (L), ft	-	Percent Grade, %	-
Measured or Base Free-Flow Speed	Base	Grade Length, mi	-
Base Free-Flow Speed (BFFS), mi/h	65.0	Total Ramp Density (TRD), ramps/mi	1.67
Lane Width, ft	12	Free-Flow Speed (FFS), mi/h	60.0
Right-Side Lateral Clearance, ft	10		

Adjustment Factors

Driver Population	All Familiar	Final Speed Adjustment Factor (SAF)	1.000
Weather Type	Non-Severe Weather	Final Capacity Adjustment Factor (CAF)	1.000
Incident Type	No Incident	Demand Adjustment Factor (DAF)	1.000

Demand and Capacity

Demand Volume veh/h	2547	Heavy Vehicle Adjustment Factor (fhv)	0.827
Peak Hour Factor	0.94	Flow Rate (Vp), pc/h/ln	1638
Total Trucks, %	20.95	Capacity (c), pc/h/ln	2300
Single-Unit Trucks (SUT), %	-	Adjusted Capacity (cadj), pc/h/ln	2300
Tractor-Trailers (TT), %	-	Volume-to-Capacity Ratio (v/c)	0.71
Passenger Car Equivalent (Et)	2.000		

Speed and Density

Lane Width Adjustment (fLW)	0.0	Average Speed (S), mi/h	60.0
Right-Side Lateral Clearance Adj. (fRLC)	0.0	Density (D), pc/mi/ln	27.3
Total Ramp Density Adjustment	5.0	Level of Service (LOS)	D
Adjusted Free-Flow Speed (FFSadj), mi/h	60.0		

HCS7 Freeway Merge Report

Project Information

Analyst	LSA	Date	12/11/2019
Agency	LSA	Analysis Year	Existing NP
Jurisdiction	Caltrans	Time Period Analyzed	PM Peak Hour
Project Description	CMD1801 - Village D Specific Plan	Unit	United States Customary

Geometric Data

	Freeway	Ramp
Number of Lanes (N), ln	2	1
Free-Flow Speed (FFS), mi/h	65.0	35.0
Segment Length (L) / Acceleration Length (LA),ft	1500	525
Terrain Type	Level	Level
Percent Grade, %	-	-
Segment Type / Ramp Side	Freeway	Right

Adjustment Factors

Driver Population	All Familiar	All Familiar
Weather Type	Non-Severe Weather	Non-Severe Weather
Incident Type	No Incident	-
Final Speed Adjustment Factor (SAF)	1.000	1.000
Final Capacity Adjustment Factor (CAF)	1.000	1.000
Demand Adjustment Factor (DAF)	1.000	1.000

Demand and Capacity

Demand Volume (Vi)	2547	231
Peak Hour Factor (PHF)	0.94	0.94
Total Trucks, %	20.95	4.33
Single-Unit Trucks (SUT), %	-	-
Tractor-Trailers (TT), %	-	-
Heavy Vehicle Adjustment Factor (fHV)	0.827	0.958
Flow Rate (vi),pc/h	3276	257
Capacity (c), pc/h	4700	2000
Volume-to-Capacity Ratio (v/c)	0.75	0.13

Speed and Density

Upstream Equilibrium Distance (LEQ), ft	-	Number of Outer Lanes on Freeway (NO)	0
Distance to Upstream Ramp (LUP), ft	-	Speed Index (MS)	0.418
Downstream Equilibrium Distance (LEQ), ft	-	Flow Outer Lanes (vOA), pc/h/ln	-
Distance to Downstream Ramp (LDOWN), ft	-	On-Ramp Influence Area Speed (SR), mi/h	55.4
Prop. Freeway Vehicles in Lane 1 and 2 (PFM)	1.000	Outer Lanes Freeway Speed (SO), mi/h	65.0
Flow in Lanes 1 and 2 (v12), pc/h	3276	Ramp Junction Speed (S), mi/h	55.4
Flow Entering Ramp-Infl. Area (vR12), pc/h	3533	Average Density (D), pc/mi/ln	31.9
Level of Service (LOS)	D	Density in Ramp Influence Area (DR), pc/mi/ln	29.7

HCS7 Basic Freeway Report

Project Information

Analyst	LSA	Date	12/11/2019
Agency	LSA	Analysis Year	Existing NP
Jurisdiction	Caltrans	Time Period Analyzed	PM Peak Hour
Project Description	CMD1801 - Village D Specific Plan	Unit	United States Customary

Geometric Data

Number of Lanes, ln	2	Terrain Type	Level
Segment Length (L), ft	-	Percent Grade, %	-
Measured or Base Free-Flow Speed	Base	Grade Length, mi	-
Base Free-Flow Speed (BFFS), mi/h	65.0	Total Ramp Density (TRD), ramps/mi	1.67
Lane Width, ft	12	Free-Flow Speed (FFS), mi/h	60.0
Right-Side Lateral Clearance, ft	10		

Adjustment Factors

Driver Population	All Familiar	Final Speed Adjustment Factor (SAF)	1.000
Weather Type	Non-Severe Weather	Final Capacity Adjustment Factor (CAF)	1.000
Incident Type	No Incident	Demand Adjustment Factor (DAF)	1.000

Demand and Capacity

Demand Volume veh/h	2778	Heavy Vehicle Adjustment Factor (fhv)	0.836
Peak Hour Factor	0.94	Flow Rate (Vp), pc/h/ln	1768
Total Trucks, %	19.57	Capacity (c), pc/h/ln	2300
Single-Unit Trucks (SUT), %	-	Adjusted Capacity (cadj), pc/h/ln	2300
Tractor-Trailers (TT), %	-	Volume-to-Capacity Ratio (v/c)	0.77
Passenger Car Equivalent (Et)	2.000		

Speed and Density

Lane Width Adjustment (fLW)	0.0	Average Speed (S), mi/h	59.5
Right-Side Lateral Clearance Adj. (fRLC)	0.0	Density (D), pc/mi/ln	29.7
Total Ramp Density Adjustment	5.0	Level of Service (LOS)	D
Adjusted Free-Flow Speed (FFSadj), mi/h	60.0		

HCS7 Freeway Diverge Report

Project Information

Analyst	LSA	Date	12/11/2019
Agency	LSA	Analysis Year	Existing NP
Jurisdiction	Caltrans	Time Period Analyzed	PM Peak Hour
Project Description	CMD1801 - Village D Specific Plan	Unit	United States Customary

Geometric Data

	Freeway	Ramp
Number of Lanes (N), ln	2	1
Free-Flow Speed (FFS), mi/h	65.0	35.0
Segment Length (L) / Deceleration Length (LA),ft	1500	200
Terrain Type	Level	Level
Percent Grade, %	-	-
Segment Type / Ramp Side	Freeway	Right

Adjustment Factors

Driver Population	All Familiar	All Familiar
Weather Type	Non-Severe Weather	Non-Severe Weather
Incident Type	No Incident	-
Final Speed Adjustment Factor (SAF)	1.000	1.000
Final Capacity Adjustment Factor (CAF)	1.000	1.000
Demand Adjustment Factor (DAF)	1.000	1.000

Demand and Capacity

Demand Volume (Vi)	2778	67
Peak Hour Factor (PHF)	0.94	0.94
Total Trucks, %	19.57	10.45
Single-Unit Trucks (SUT), %	-	-
Tractor-Trailers (TT), %	-	-
Heavy Vehicle Adjustment Factor (fHV)	0.836	0.905
Flow Rate (vi),pc/h	3535	79
Capacity (c), pc/h	4700	2000
Volume-to-Capacity Ratio (v/c)	0.75	0.04

Speed and Density

Upstream Equilibrium Distance (LEQ), ft	-	Number of Outer Lanes on Freeway (NO)	0
Distance to Upstream Ramp (LUP), ft	-	Speed Index (DS)	0.435
Downstream Equilibrium Distance (LEQ), ft	-	Flow Outer Lanes (vOA), pc/h/ln	-
Distance to Downstream Ramp (LDOWN), ft	-	Off-Ramp Influence Area Speed (SR), mi/h	55.0
Prop. Freeway Vehicles in Lane 1 and 2 (PFD)	1.000	Outer Lanes Freeway Speed (SO), mi/h	71.3
Flow in Lanes 1 and 2 (v12), pc/h	3535	Ramp Junction Speed (S), mi/h	55.0
Flow Entering Ramp-Infl. Area (vR12), pc/h	-	Average Density (D), pc/mi/ln	32.1
Level of Service (LOS)	D	Density in Ramp Influence Area (DR), pc/mi/ln	32.9

HCS7 Basic Freeway Report

Project Information

Analyst	LSA	Date	12/11/2019
Agency	LSA	Analysis Year	Existing NP
Jurisdiction	Caltrans	Time Period Analyzed	PM Peak Hour
Project Description	CMD1801 - Village D Specific Plan	Unit	United States Customary

Geometric Data

Number of Lanes, ln	2	Terrain Type	Level
Segment Length (L), ft	-	Percent Grade, %	-
Measured or Base Free-Flow Speed	Base	Grade Length, mi	-
Base Free-Flow Speed (BFFS), mi/h	70.0	Total Ramp Density (TRD), ramps/mi	1.50
Lane Width, ft	12	Free-Flow Speed (FFS), mi/h	65.5
Right-Side Lateral Clearance, ft	10		

Adjustment Factors

Driver Population	All Familiar	Final Speed Adjustment Factor (SAF)	1.000
Weather Type	Non-Severe Weather	Final Capacity Adjustment Factor (CAF)	1.000
Incident Type	No Incident	Demand Adjustment Factor (DAF)	1.000

Demand and Capacity

Demand Volume veh/h	2711	Heavy Vehicle Adjustment Factor (fhv)	0.835
Peak Hour Factor	0.94	Flow Rate (Vp), pc/h/ln	1727
Total Trucks, %	19.79	Capacity (c), pc/h/ln	2355
Single-Unit Trucks (SUT), %	-	Adjusted Capacity (cadj), pc/h/ln	2355
Tractor-Trailers (TT), %	-	Volume-to-Capacity Ratio (v/c)	0.73
Passenger Car Equivalent (Et)	2.000		

Speed and Density

Lane Width Adjustment (fLW)	0.0	Average Speed (S), mi/h	63.8
Right-Side Lateral Clearance Adj. (fRLC)	0.0	Density (D), pc/mi/ln	27.1
Total Ramp Density Adjustment	4.5	Level of Service (LOS)	D
Adjusted Free-Flow Speed (FFSadj), mi/h	65.5		

HCS7 Freeway Merge Report

Project Information

Analyst	LSA	Date	12/11/2019
Agency	LSA	Analysis Year	Existing NP
Jurisdiction	Caltrans	Time Period Analyzed	PM Peak Hour
Project Description	CMD1801 - Village D Specific Plan	Unit	United States Customary

Geometric Data

	Freeway	Ramp
Number of Lanes (N), ln	2	1
Free-Flow Speed (FFS), mi/h	70.0	35.0
Segment Length (L) / Acceleration Length (LA),ft	1500	400
Terrain Type	Level	Level
Percent Grade, %	-	-
Segment Type / Ramp Side	Freeway	Right

Adjustment Factors

Driver Population	All Familiar	All Familiar
Weather Type	Non-Severe Weather	Non-Severe Weather
Incident Type	No Incident	-
Final Speed Adjustment Factor (SAF)	1.000	1.000
Final Capacity Adjustment Factor (CAF)	1.000	1.000
Demand Adjustment Factor (DAF)	1.000	1.000

Demand and Capacity

Demand Volume (Vi)	2711	131
Peak Hour Factor (PHF)	0.94	0.94
Total Trucks, %	19.79	6.87
Single-Unit Trucks (SUT), %	-	-
Tractor-Trailers (TT), %	-	-
Heavy Vehicle Adjustment Factor (fHV)	0.835	0.936
Flow Rate (vi),pc/h	3454	149
Capacity (c), pc/h	4800	2000
Volume-to-Capacity Ratio (v/c)	0.75	0.07

Speed and Density

Upstream Equilibrium Distance (LEQ), ft	-	Number of Outer Lanes on Freeway (NO)	0
Distance to Upstream Ramp (LUP), ft	-	Speed Index (MS)	0.436
Downstream Equilibrium Distance (LEQ), ft	-	Flow Outer Lanes (vOA), pc/h/ln	-
Distance to Downstream Ramp (LDOWN), ft	-	On-Ramp Influence Area Speed (SR), mi/h	57.8
Prop. Freeway Vehicles in Lane 1 and 2 (PFM)	1.000	Outer Lanes Freeway Speed (SO), mi/h	70.0
Flow in Lanes 1 and 2 (v12), pc/h	3454	Ramp Junction Speed (S), mi/h	57.8
Flow Entering Ramp-Infl. Area (vR12), pc/h	3603	Average Density (D), pc/mi/ln	31.2
Level of Service (LOS)	D	Density in Ramp Influence Area (DR), pc/mi/ln	31.1

HCS7 Basic Freeway Report

Project Information

Analyst	LSA	Date	12/11/2019
Agency	LSA	Analysis Year	Existing NP
Jurisdiction	Caltrans	Time Period Analyzed	PM Peak Hour
Project Description	CMD1801 - Village D Specific Plan	Unit	United States Customary

Geometric Data

Number of Lanes, ln	2	Terrain Type	Level
Segment Length (L), ft	-	Percent Grade, %	-
Measured or Base Free-Flow Speed	Base	Grade Length, mi	-
Base Free-Flow Speed (BFFS), mi/h	70.0	Total Ramp Density (TRD), ramps/mi	1.00
Lane Width, ft	12	Free-Flow Speed (FFS), mi/h	66.8
Right-Side Lateral Clearance, ft	10		

Adjustment Factors

Driver Population	All Familiar	Final Speed Adjustment Factor (SAF)	1.000
Weather Type	Non-Severe Weather	Final Capacity Adjustment Factor (CAF)	1.000
Incident Type	No Incident	Demand Adjustment Factor (DAF)	1.000

Demand and Capacity

Demand Volume veh/h	2842	Heavy Vehicle Adjustment Factor (fhv)	0.839
Peak Hour Factor	0.94	Flow Rate (Vp), pc/h/ln	1802
Total Trucks, %	19.20	Capacity (c), pc/h/ln	2368
Single-Unit Trucks (SUT), %	-	Adjusted Capacity (cadj), pc/h/ln	2368
Tractor-Trailers (TT), %	-	Volume-to-Capacity Ratio (v/c)	0.76
Passenger Car Equivalent (Et)	2.000		

Speed and Density

Lane Width Adjustment (fLW)	0.0	Average Speed (S), mi/h	63.9
Right-Side Lateral Clearance Adj. (fRLC)	0.0	Density (D), pc/mi/ln	28.2
Total Ramp Density Adjustment	3.2	Level of Service (LOS)	D
Adjusted Free-Flow Speed (FFSadj), mi/h	66.8		

HCS7 Freeway Diverge Report

Project Information

Analyst	LSA	Date	12/11/2019
Agency	LSA	Analysis Year	Existing NP
Jurisdiction	Caltrans	Time Period Analyzed	PM Peak Hour
Project Description	CMD1801 - Village D Specific Plan	Unit	United States Customary

Geometric Data

	Freeway	Ramp
Number of Lanes (N), ln	2	1
Free-Flow Speed (FFS), mi/h	70.0	35.0
Segment Length (L) / Deceleration Length (LA),ft	1500	200
Terrain Type	Level	Level
Percent Grade, %	-	-
Segment Type / Ramp Side	Freeway	Right

Adjustment Factors

Driver Population	All Familiar	All Familiar
Weather Type	Non-Severe Weather	Non-Severe Weather
Incident Type	No Incident	-
Final Speed Adjustment Factor (SAF)	1.000	1.000
Final Capacity Adjustment Factor (CAF)	1.000	1.000
Demand Adjustment Factor (DAF)	1.000	1.000

Demand and Capacity

Demand Volume (Vi)	2842	181
Peak Hour Factor (PHF)	0.94	0.94
Total Trucks, %	19.20	24.06
Single-Unit Trucks (SUT), %	-	-
Tractor-Trailers (TT), %	-	-
Heavy Vehicle Adjustment Factor (fHV)	0.839	0.806
Flow Rate (vi),pc/h	3604	239
Capacity (c), pc/h	4800	2000
Volume-to-Capacity Ratio (v/c)	0.75	0.12

Speed and Density

Upstream Equilibrium Distance (LEQ), ft	-	Number of Outer Lanes on Freeway (NO)	0
Distance to Upstream Ramp (LUP), ft	-	Speed Index (DS)	0.450
Downstream Equilibrium Distance (LEQ), ft	-	Flow Outer Lanes (vOA), pc/h/ln	-
Distance to Downstream Ramp (LDOWN), ft	-	Off-Ramp Influence Area Speed (SR), mi/h	57.4
Prop. Freeway Vehicles in Lane 1 and 2 (PFD)	1.000	Outer Lanes Freeway Speed (SO), mi/h	76.8
Flow in Lanes 1 and 2 (v12), pc/h	3604	Ramp Junction Speed (S), mi/h	57.4
Flow Entering Ramp-Infl. Area (vR12), pc/h	-	Average Density (D), pc/mi/ln	31.4
Level of Service (LOS)	D	Density in Ramp Influence Area (DR), pc/mi/ln	33.4

HCS7 Basic Freeway Report

Project Information

Analyst	LSA	Date	12/11/2019
Agency	LSA	Analysis Year	Existing NP
Jurisdiction	Caltrans	Time Period Analyzed	PM Peak Hour
Project Description	CMD1801 - Village D Specific Plan	Unit	United States Customary

Geometric Data

Number of Lanes, ln	2	Terrain Type	Level
Segment Length (L), ft	-	Percent Grade, %	-
Measured or Base Free-Flow Speed	Base	Grade Length, mi	-
Base Free-Flow Speed (BFFS), mi/h	70.0	Total Ramp Density (TRD), ramps/mi	1.00
Lane Width, ft	12	Free-Flow Speed (FFS), mi/h	66.8
Right-Side Lateral Clearance, ft	10		

Adjustment Factors

Driver Population	All Familiar	Final Speed Adjustment Factor (SAF)	1.000
Weather Type	Non-Severe Weather	Final Capacity Adjustment Factor (CAF)	1.000
Incident Type	No Incident	Demand Adjustment Factor (DAF)	1.000

Demand and Capacity

Demand Volume veh/h	2661	Heavy Vehicle Adjustment Factor (fhv)	0.841
Peak Hour Factor	0.94	Flow Rate (Vp), pc/h/ln	1683
Total Trucks, %	18.85	Capacity (c), pc/h/ln	2368
Single-Unit Trucks (SUT), %	-	Adjusted Capacity (cadj), pc/h/ln	2368
Tractor-Trailers (TT), %	-	Volume-to-Capacity Ratio (v/c)	0.71
Passenger Car Equivalent (Et)	2.000		

Speed and Density

Lane Width Adjustment (fLW)	0.0	Average Speed (S), mi/h	65.1
Right-Side Lateral Clearance Adj. (fRLC)	0.0	Density (D), pc/mi/ln	25.9
Total Ramp Density Adjustment	3.2	Level of Service (LOS)	C
Adjusted Free-Flow Speed (FFSadj), mi/h	66.8		

HCS7 Freeway Merge Report

Project Information

Analyst	LSA	Date	12/11/2019
Agency	LSA	Analysis Year	Existing NP
Jurisdiction	Caltrans	Time Period Analyzed	PM Peak Hour
Project Description	CMD1801 - Village D Specific Plan	Unit	United States Customary

Geometric Data

	Freeway	Ramp
Number of Lanes (N), ln	2	1
Free-Flow Speed (FFS), mi/h	70.0	35.0
Segment Length (L) / Acceleration Length (LA),ft	1500	700
Terrain Type	Level	Level
Percent Grade, %	-	-
Segment Type / Ramp Side	Freeway	Right

Adjustment Factors

Driver Population	All Familiar	All Familiar
Weather Type	Non-Severe Weather	Non-Severe Weather
Incident Type	No Incident	-
Final Speed Adjustment Factor (SAF)	1.000	1.000
Final Capacity Adjustment Factor (CAF)	1.000	1.000
Demand Adjustment Factor (DAF)	1.000	1.000

Demand and Capacity

Demand Volume (Vi)	2661	186
Peak Hour Factor (PHF)	0.94	0.94
Total Trucks, %	18.85	23.78
Single-Unit Trucks (SUT), %	-	-
Tractor-Trailers (TT), %	-	-
Heavy Vehicle Adjustment Factor (fHV)	0.841	0.808
Flow Rate (vi),pc/h	3366	245
Capacity (c), pc/h	4800	2000
Volume-to-Capacity Ratio (v/c)	0.75	0.12

Speed and Density

Upstream Equilibrium Distance (LEQ), ft	-	Number of Outer Lanes on Freeway (NO)	0
Distance to Upstream Ramp (LUP), ft	-	Speed Index (MS)	0.416
Downstream Equilibrium Distance (LEQ), ft	-	Flow Outer Lanes (vOA), pc/h/ln	-
Distance to Downstream Ramp (LDOWN), ft	-	On-Ramp Influence Area Speed (SR), mi/h	58.4
Prop. Freeway Vehicles in Lane 1 and 2 (PFM)	1.000	Outer Lanes Freeway Speed (SO), mi/h	70.0
Flow in Lanes 1 and 2 (v12), pc/h	3366	Ramp Junction Speed (S), mi/h	58.4
Flow Entering Ramp-Infl. Area (vR12), pc/h	3611	Average Density (D), pc/mi/ln	30.9
Level of Service (LOS)	D	Density in Ramp Influence Area (DR), pc/mi/ln	29.2

HCS7 Basic Freeway Report

Project Information

Analyst	LSA	Date	12/11/2019
Agency	LSA	Analysis Year	Existing NP
Jurisdiction	Caltrans	Time Period Analyzed	PM Peak Hour
Project Description	CMD1801 - Village D Specific Plan	Unit	United States Customary

Geometric Data

Number of Lanes, ln	2	Terrain Type	Level
Segment Length (L), ft	-	Percent Grade, %	-
Measured or Base Free-Flow Speed	Base	Grade Length, mi	-
Base Free-Flow Speed (BFFS), mi/h	70.0	Total Ramp Density (TRD), ramps/mi	1.00
Lane Width, ft	12	Free-Flow Speed (FFS), mi/h	66.8
Right-Side Lateral Clearance, ft	10		

Adjustment Factors

Driver Population	All Familiar	Final Speed Adjustment Factor (SAF)	1.000
Weather Type	Non-Severe Weather	Final Capacity Adjustment Factor (CAF)	1.000
Incident Type	No Incident	Demand Adjustment Factor (DAF)	1.000

Demand and Capacity

Demand Volume veh/h	2847	Heavy Vehicle Adjustment Factor (fhv)	0.839
Peak Hour Factor	0.94	Flow Rate (Vp), pc/h/ln	1805
Total Trucks, %	19.16	Capacity (c), pc/h/ln	2368
Single-Unit Trucks (SUT), %	-	Adjusted Capacity (cadj), pc/h/ln	2368
Tractor-Trailers (TT), %	-	Volume-to-Capacity Ratio (v/c)	0.76
Passenger Car Equivalent (Et)	2.000		

Speed and Density

Lane Width Adjustment (fLW)	0.0	Average Speed (S), mi/h	63.8
Right-Side Lateral Clearance Adj. (fRLC)	0.0	Density (D), pc/mi/ln	28.3
Total Ramp Density Adjustment	3.2	Level of Service (LOS)	D
Adjusted Free-Flow Speed (FFSadj), mi/h	66.8		

HCS7 Basic Freeway Report

Project Information

Analyst	LSA	Date	12/11/2019
Agency	LSA	Analysis Year	Existing NP
Jurisdiction	Caltrans	Time Period Analyzed	PM Peak Hour
Project Description	CMD1801 - Village D Specific Plan	Unit	United States Customary

Geometric Data

Number of Lanes, ln	2	Terrain Type	Level
Segment Length (L), ft	-	Percent Grade, %	-
Measured or Base Free-Flow Speed	Base	Grade Length, mi	-
Base Free-Flow Speed (BFFS), mi/h	70.0	Total Ramp Density (TRD), ramps/mi	1.00
Lane Width, ft	12	Free-Flow Speed (FFS), mi/h	66.8
Right-Side Lateral Clearance, ft	10		

Adjustment Factors

Driver Population	All Familiar	Final Speed Adjustment Factor (SAF)	1.000
Weather Type	Non-Severe Weather	Final Capacity Adjustment Factor (CAF)	1.000
Incident Type	No Incident	Demand Adjustment Factor (DAF)	1.000

Demand and Capacity

Demand Volume veh/h	3048	Heavy Vehicle Adjustment Factor (fhv)	0.828
Peak Hour Factor	0.94	Flow Rate (Vp), pc/h/ln	1958
Total Trucks, %	20.73	Capacity (c), pc/h/ln	2368
Single-Unit Trucks (SUT), %	-	Adjusted Capacity (cadj), pc/h/ln	2368
Tractor-Trailers (TT), %	-	Volume-to-Capacity Ratio (v/c)	0.83
Passenger Car Equivalent (Et)	2.000		

Speed and Density

Lane Width Adjustment (fLW)	0.0	Average Speed (S), mi/h	61.6
Right-Side Lateral Clearance Adj. (fRLC)	0.0	Density (D), pc/mi/ln	31.8
Total Ramp Density Adjustment	3.2	Level of Service (LOS)	D
Adjusted Free-Flow Speed (FFSadj), mi/h	66.8		

HCS7 Freeway Diverge Report

Project Information

Analyst	LSA	Date	12/11/2019
Agency	LSA	Analysis Year	Existing NP
Jurisdiction	Caltrans	Time Period Analyzed	PM Peak Hour
Project Description	CMD1801 - Village D Specific Plan	Unit	United States Customary

Geometric Data

	Freeway	Ramp
Number of Lanes (N), ln	2	1
Free-Flow Speed (FFS), mi/h	70.0	50.0
Segment Length (L) / Deceleration Length (LA),ft	1500	150
Terrain Type	Level	Level
Percent Grade, %	-	-
Segment Type / Ramp Side	Freeway	Right

Adjustment Factors

Driver Population	All Familiar	All Familiar
Weather Type	Non-Severe Weather	Non-Severe Weather
Incident Type	No Incident	-
Final Speed Adjustment Factor (SAF)	1.000	1.000
Final Capacity Adjustment Factor (CAF)	1.000	1.000
Demand Adjustment Factor (DAF)	1.000	1.000

Demand and Capacity

Demand Volume (Vi)	3048	232
Peak Hour Factor (PHF)	0.94	0.94
Total Trucks, %	20.73	26.18
Single-Unit Trucks (SUT), %	-	-
Tractor-Trailers (TT), %	-	-
Heavy Vehicle Adjustment Factor (fHV)	0.828	0.793
Flow Rate (vi),pc/h	3916	311
Capacity (c), pc/h	4800	2100
Volume-to-Capacity Ratio (v/c)	0.82	0.15

Speed and Density

Upstream Equilibrium Distance (LEQ), ft	-	Number of Outer Lanes on Freeway (NO)	0
Distance to Upstream Ramp (LUP), ft	-	Speed Index (DS)	0.261
Downstream Equilibrium Distance (LEQ), ft	-	Flow Outer Lanes (vOA), pc/h/ln	-
Distance to Downstream Ramp (LDOWN), ft	-	Off-Ramp Influence Area Speed (SR), mi/h	62.7
Prop. Freeway Vehicles in Lane 1 and 2 (PFD)	1.000	Outer Lanes Freeway Speed (SO), mi/h	76.8
Flow in Lanes 1 and 2 (v12), pc/h	3916	Ramp Junction Speed (S), mi/h	62.7
Flow Entering Ramp-Infl. Area (vR12), pc/h	-	Average Density (D), pc/mi/ln	31.2
Level of Service (LOS)	E	Density in Ramp Influence Area (DR), pc/mi/ln	36.6

HCS7 Basic Freeway Report

Project Information

Analyst	LSA	Date	12/11/2019
Agency	LSA	Analysis Year	Existing NP
Jurisdiction	Caltrans	Time Period Analyzed	PM Peak Hour
Project Description	CMD1801 - Village D Specific Plan	Unit	United States Customary

Geometric Data

Number of Lanes, ln	2	Terrain Type	Level
Segment Length (L), ft	-	Percent Grade, %	-
Measured or Base Free-Flow Speed	Base	Grade Length, mi	-
Base Free-Flow Speed (BFFS), mi/h	70.0	Total Ramp Density (TRD), ramps/mi	1.33
Lane Width, ft	12	Free-Flow Speed (FFS), mi/h	65.9
Right-Side Lateral Clearance, ft	10		

Adjustment Factors

Driver Population	All Familiar	Final Speed Adjustment Factor (SAF)	1.000
Weather Type	Non-Severe Weather	Final Capacity Adjustment Factor (CAF)	1.000
Incident Type	No Incident	Demand Adjustment Factor (DAF)	1.000

Demand and Capacity

Demand Volume veh/h	2816	Heavy Vehicle Adjustment Factor (fhv)	0.831
Peak Hour Factor	0.94	Flow Rate (Vp), pc/h/ln	1802
Total Trucks, %	20.28	Capacity (c), pc/h/ln	2359
Single-Unit Trucks (SUT), %	-	Adjusted Capacity (cadj), pc/h/ln	2359
Tractor-Trailers (TT), %	-	Volume-to-Capacity Ratio (v/c)	0.76
Passenger Car Equivalent (Et)	2.000		

Speed and Density

Lane Width Adjustment (fLW)	0.0	Average Speed (S), mi/h	63.3
Right-Side Lateral Clearance Adj. (fRLC)	0.0	Density (D), pc/mi/ln	28.5
Total Ramp Density Adjustment	4.1	Level of Service (LOS)	D
Adjusted Free-Flow Speed (FFSadj), mi/h	65.9		

HCS7 Freeway Merge Report

Project Information

Analyst	LSA	Date	12/11/2019
Agency	LSA	Analysis Year	Existing NP
Jurisdiction	Caltrans	Time Period Analyzed	PM Peak Hour
Project Description	CMD1801 - Village D Specific Plan	Unit	United States Customary

Geometric Data

	Freeway	Ramp
Number of Lanes (N), ln	2	1
Free-Flow Speed (FFS), mi/h	70.0	35.0
Segment Length (L) / Acceleration Length (LA),ft	1000	600
Terrain Type	Level	Level
Percent Grade, %	-	-
Segment Type / Ramp Side	Freeway	Right

Adjustment Factors

Driver Population	All Familiar	All Familiar
Weather Type	Non-Severe Weather	Non-Severe Weather
Incident Type	No Incident	-
Final Speed Adjustment Factor (SAF)	1.000	1.000
Final Capacity Adjustment Factor (CAF)	1.000	1.000
Demand Adjustment Factor (DAF)	1.000	1.000

Demand and Capacity

Demand Volume (Vi)	2816	27
Peak Hour Factor (PHF)	0.94	0.94
Total Trucks, %	20.28	7.41
Single-Unit Trucks (SUT), %	-	-
Tractor-Trailers (TT), %	-	-
Heavy Vehicle Adjustment Factor (fHV)	0.831	0.931
Flow Rate (vi),pc/h	3605	31
Capacity (c), pc/h	4800	2000
Volume-to-Capacity Ratio (v/c)	0.76	0.02

Speed and Density

Upstream Equilibrium Distance (LEQ), ft	-	Number of Outer Lanes on Freeway (NO)	0
Distance to Upstream Ramp (LUP), ft	-	Speed Index (MS)	0.427
Downstream Equilibrium Distance (LEQ), ft	-	Flow Outer Lanes (vOA), pc/h/ln	-
Distance to Downstream Ramp (LDOWN), ft	-	On-Ramp Influence Area Speed (SR), mi/h	58.0
Prop. Freeway Vehicles in Lane 1 and 2 (PFM)	1.000	Outer Lanes Freeway Speed (SO), mi/h	70.0
Flow in Lanes 1 and 2 (v12), pc/h	3605	Ramp Junction Speed (S), mi/h	58.0
Flow Entering Ramp-Infl. Area (vR12), pc/h	3636	Average Density (D), pc/mi/ln	31.3
Level of Service (LOS)	D	Density in Ramp Influence Area (DR), pc/mi/ln	30.1

HCS7 Basic Freeway Report

Project Information

Analyst	LSA	Date	12/11/2019
Agency	LSA	Analysis Year	Existing NP
Jurisdiction	Caltrans	Time Period Analyzed	PM Peak Hour
Project Description	CMD1801 - Village D Specific Plan	Unit	United States Customary

Geometric Data

Number of Lanes, In	2	Terrain Type	Level
Segment Length (L), ft	-	Percent Grade, %	-
Measured or Base Free-Flow Speed	Base	Grade Length, mi	-
Base Free-Flow Speed (BFFS), mi/h	70.0	Total Ramp Density (TRD), ramps/mi	1.33
Lane Width, ft	12	Free-Flow Speed (FFS), mi/h	65.9
Right-Side Lateral Clearance, ft	10		

Adjustment Factors

Driver Population	All Familiar	Final Speed Adjustment Factor (SAF)	1.000
Weather Type	Non-Severe Weather	Final Capacity Adjustment Factor (CAF)	1.000
Incident Type	No Incident	Demand Adjustment Factor (DAF)	1.000

Demand and Capacity

Demand Volume veh/h	2843	Heavy Vehicle Adjustment Factor (fhv)	0.832
Peak Hour Factor	0.94	Flow Rate (Vp), pc/h/ln	1818
Total Trucks, %	20.15	Capacity (c), pc/h/ln	2359
Single-Unit Trucks (SUT), %	-	Adjusted Capacity (cadj), pc/h/ln	2359
Tractor-Trailers (TT), %	-	Volume-to-Capacity Ratio (v/c)	0.77
Passenger Car Equivalent (Et)	2.000		

Speed and Density

Lane Width Adjustment (fLW)	0.0	Average Speed (S), mi/h	63.1
Right-Side Lateral Clearance Adj. (fRLC)	0.0	Density (D), pc/mi/ln	28.8
Total Ramp Density Adjustment	4.1	Level of Service (LOS)	D
Adjusted Free-Flow Speed (FFSadj), mi/h	65.9		

HCS7 Freeway Merge Report

Project Information

Analyst	LSA	Date	12/11/2019
Agency	LSA	Analysis Year	Existing NP
Jurisdiction	Caltrans	Time Period Analyzed	PM Peak Hour
Project Description	CMD1801 - Village D Specific Plan	Unit	United States Customary

Geometric Data

	Freeway	Ramp
Number of Lanes (N), ln	2	1
Free-Flow Speed (FFS), mi/h	70.0	35.0
Segment Length (L) / Acceleration Length (LA),ft	1500	500
Terrain Type	Level	Level
Percent Grade, %	-	-
Segment Type / Ramp Side	Freeway	Right

Adjustment Factors

Driver Population	All Familiar	All Familiar
Weather Type	Non-Severe Weather	Non-Severe Weather
Incident Type	No Incident	-
Final Speed Adjustment Factor (SAF)	1.000	1.000
Final Capacity Adjustment Factor (CAF)	1.000	1.000
Demand Adjustment Factor (DAF)	1.000	1.000

Demand and Capacity

Demand Volume (Vi)	2843	222
Peak Hour Factor (PHF)	0.94	0.94
Total Trucks, %	20.15	21.94
Single-Unit Trucks (SUT), %	-	-
Tractor-Trailers (TT), %	-	-
Heavy Vehicle Adjustment Factor (fHV)	0.832	0.820
Flow Rate (vi),pc/h	3635	288
Capacity (c), pc/h	4800	2000
Volume-to-Capacity Ratio (v/c)	0.82	0.14

Speed and Density

Upstream Equilibrium Distance (LEQ), ft	-	Number of Outer Lanes on Freeway (NO)	0
Distance to Upstream Ramp (LUP), ft	-	Speed Index (MS)	0.483
Downstream Equilibrium Distance (LEQ), ft	-	Flow Outer Lanes (vOA), pc/h/ln	-
Distance to Downstream Ramp (LDOWN), ft	-	On-Ramp Influence Area Speed (SR), mi/h	56.5
Prop. Freeway Vehicles in Lane 1 and 2 (PFM)	1.000	Outer Lanes Freeway Speed (SO), mi/h	70.0
Flow in Lanes 1 and 2 (v12), pc/h	3635	Ramp Junction Speed (S), mi/h	56.5
Flow Entering Ramp-Infl. Area (vR12), pc/h	3923	Average Density (D), pc/mi/ln	34.7
Level of Service (LOS)	D	Density in Ramp Influence Area (DR), pc/mi/ln	32.9

HCS7 Basic Freeway Report

Project Information

Analyst	LSA	Date	12/11/2019
Agency	LSA	Analysis Year	Existing NP
Jurisdiction	Caltrans	Time Period Analyzed	PM Peak Hour
Project Description	CMD1801 - Village D Specific Plan	Unit	United States Customary

Geometric Data

Number of Lanes, ln	2	Terrain Type	Level
Segment Length (L), ft	-	Percent Grade, %	-
Measured or Base Free-Flow Speed	Base	Grade Length, mi	-
Base Free-Flow Speed (BFFS), mi/h	70.0	Total Ramp Density (TRD), ramps/mi	1.33
Lane Width, ft	12	Free-Flow Speed (FFS), mi/h	65.9
Right-Side Lateral Clearance, ft	10		

Adjustment Factors

Driver Population	All Familiar	Final Speed Adjustment Factor (SAF)	1.000
Weather Type	Non-Severe Weather	Final Capacity Adjustment Factor (CAF)	1.000
Incident Type	No Incident	Demand Adjustment Factor (DAF)	1.000

Demand and Capacity

Demand Volume veh/h	3065	Heavy Vehicle Adjustment Factor (fhv)	0.831
Peak Hour Factor	0.94	Flow Rate (Vp), pc/h/ln	1962
Total Trucks, %	20.29	Capacity (c), pc/h/ln	2359
Single-Unit Trucks (SUT), %	-	Adjusted Capacity (cadj), pc/h/ln	2359
Tractor-Trailers (TT), %	-	Volume-to-Capacity Ratio (v/c)	0.83
Passenger Car Equivalent (Et)	2.000		

Speed and Density

Lane Width Adjustment (fLW)	0.0	Average Speed (S), mi/h	61.0
Right-Side Lateral Clearance Adj. (fRLC)	0.0	Density (D), pc/mi/ln	32.2
Total Ramp Density Adjustment	4.1	Level of Service (LOS)	D
Adjusted Free-Flow Speed (FFSadj), mi/h	65.9		

HCS7 Freeway Diverge Report

Project Information

Analyst	LSA	Date	12/11/2019
Agency	LSA	Analysis Year	Existing NP
Jurisdiction	Caltrans	Time Period Analyzed	PM Peak Hour
Project Description	CMD1801 - Village D Specific Plan	Unit	United States Customary

Geometric Data

	Freeway	Ramp
Number of Lanes (N), ln	2	1
Free-Flow Speed (FFS), mi/h	70.0	35.0
Segment Length (L) / Deceleration Length (LA),ft	1500	150
Terrain Type	Level	Level
Percent Grade, %	-	-
Segment Type / Ramp Side	Freeway	Right

Adjustment Factors

Driver Population	All Familiar	All Familiar
Weather Type	Non-Severe Weather	Non-Severe Weather
Incident Type	No Incident	-
Final Speed Adjustment Factor (SAF)	1.000	1.000
Final Capacity Adjustment Factor (CAF)	1.000	1.000
Demand Adjustment Factor (DAF)	1.000	1.000

Demand and Capacity

Demand Volume (Vi)	3065	196
Peak Hour Factor (PHF)	0.94	0.94
Total Trucks, %	20.29	4.59
Single-Unit Trucks (SUT), %	-	-
Tractor-Trailers (TT), %	-	-
Heavy Vehicle Adjustment Factor (fHV)	0.831	0.956
Flow Rate (vi),pc/h	3924	218
Capacity (c), pc/h	4800	2000
Volume-to-Capacity Ratio (v/c)	0.82	0.11

Speed and Density

Upstream Equilibrium Distance (LEQ), ft	-	Number of Outer Lanes on Freeway (NO)	0
Distance to Upstream Ramp (LUP), ft	-	Speed Index (DS)	0.448
Downstream Equilibrium Distance (LEQ), ft	-	Flow Outer Lanes (vOA), pc/h/ln	-
Distance to Downstream Ramp (LDOWN), ft	-	Off-Ramp Influence Area Speed (SR), mi/h	57.5
Prop. Freeway Vehicles in Lane 1 and 2 (PFD)	1.000	Outer Lanes Freeway Speed (SO), mi/h	76.8
Flow in Lanes 1 and 2 (v12), pc/h	3924	Ramp Junction Speed (S), mi/h	57.5
Flow Entering Ramp-Infl. Area (vR12), pc/h	-	Average Density (D), pc/mi/ln	34.1
Level of Service (LOS)	E	Density in Ramp Influence Area (DR), pc/mi/ln	36.6

HCS7 Basic Freeway Report

Project Information

Analyst	LSA	Date	12/11/2019
Agency	LSA	Analysis Year	Existing NP
Jurisdiction	Caltrans	Time Period Analyzed	PM Peak Hour
Project Description	CMD1801 - Village D Specific Plan	Unit	United States Customary

Geometric Data

Number of Lanes, ln	2	Terrain Type	Level
Segment Length (L), ft	-	Percent Grade, %	-
Measured or Base Free-Flow Speed	Base	Grade Length, mi	-
Base Free-Flow Speed (BFFS), mi/h	70.0	Total Ramp Density (TRD), ramps/mi	1.67
Lane Width, ft	12	Free-Flow Speed (FFS), mi/h	65.0
Right-Side Lateral Clearance, ft	10		

Adjustment Factors

Driver Population	All Familiar	Final Speed Adjustment Factor (SAF)	1.000
Weather Type	Non-Severe Weather	Final Capacity Adjustment Factor (CAF)	1.000
Incident Type	No Incident	Demand Adjustment Factor (DAF)	1.000

Demand and Capacity

Demand Volume veh/h	2869	Heavy Vehicle Adjustment Factor (fhv)	0.824
Peak Hour Factor	0.94	Flow Rate (Vp), pc/h/ln	1852
Total Trucks, %	21.37	Capacity (c), pc/h/ln	2350
Single-Unit Trucks (SUT), %	-	Adjusted Capacity (cadj), pc/h/ln	2350
Tractor-Trailers (TT), %	-	Volume-to-Capacity Ratio (v/c)	0.79
Passenger Car Equivalent (Et)	2.000		

Speed and Density

Lane Width Adjustment (fLW)	0.0	Average Speed (S), mi/h	62.1
Right-Side Lateral Clearance Adj. (fRLC)	0.0	Density (D), pc/mi/ln	29.8
Total Ramp Density Adjustment	5.0	Level of Service (LOS)	D
Adjusted Free-Flow Speed (FFSadj), mi/h	65.0		

HCS7 Freeway Merge Report

Project Information

Analyst	LSA	Date	12/11/2019
Agency	LSA	Analysis Year	Existing NP
Jurisdiction	Caltrans	Time Period Analyzed	PM Peak Hour
Project Description	CMD1801 - Village D Specific Plan	Unit	United States Customary

Geometric Data

	Freeway	Ramp
Number of Lanes (N), ln	2	1
Free-Flow Speed (FFS), mi/h	65.0	35.0
Segment Length (L) / Acceleration Length (LA),ft	1500	600
Terrain Type	Level	Level
Percent Grade, %	-	-
Segment Type / Ramp Side	Freeway	Right

Adjustment Factors

Driver Population	All Familiar	All Familiar
Weather Type	Non-Severe Weather	Non-Severe Weather
Incident Type	No Incident	-
Final Speed Adjustment Factor (SAF)	1.000	1.000
Final Capacity Adjustment Factor (CAF)	1.000	1.000
Demand Adjustment Factor (DAF)	1.000	1.000

Demand and Capacity

Demand Volume (Vi)	2869	173
Peak Hour Factor (PHF)	0.94	0.94
Total Trucks, %	21.37	6.36
Single-Unit Trucks (SUT), %	-	-
Tractor-Trailers (TT), %	-	-
Heavy Vehicle Adjustment Factor (fHV)	0.824	0.940
Flow Rate (vi),pc/h	3704	196
Capacity (c), pc/h	4700	2000
Volume-to-Capacity Ratio (v/c)	0.83	0.10

Speed and Density

Upstream Equilibrium Distance (LEQ), ft	-	Number of Outer Lanes on Freeway (NO)	0
Distance to Upstream Ramp (LUP), ft	-	Speed Index (MS)	0.472
Downstream Equilibrium Distance (LEQ), ft	-	Flow Outer Lanes (vOA), pc/h/ln	-
Distance to Downstream Ramp (LDOWN), ft	-	On-Ramp Influence Area Speed (SR), mi/h	54.1
Prop. Freeway Vehicles in Lane 1 and 2 (PFM)	1.000	Outer Lanes Freeway Speed (SO), mi/h	65.0
Flow in Lanes 1 and 2 (v12), pc/h	3704	Ramp Junction Speed (S), mi/h	54.1
Flow Entering Ramp-Infl. Area (vR12), pc/h	3900	Average Density (D), pc/mi/ln	36.0
Level of Service (LOS)	D	Density in Ramp Influence Area (DR), pc/mi/ln	32.1

HCS7 Basic Freeway Report

Project Information

Analyst	LSA	Date	12/11/2019
Agency	LSA	Analysis Year	Existing NP
Jurisdiction	Caltrans	Time Period Analyzed	PM Peak Hour
Project Description	CMD1801 - Village D Specific Plan	Unit	United States Customary

Geometric Data

Number of Lanes, ln	2	Terrain Type	Level
Segment Length (L), ft	-	Percent Grade, %	-
Measured or Base Free-Flow Speed	Base	Grade Length, mi	-
Base Free-Flow Speed (BFFS), mi/h	65.0	Total Ramp Density (TRD), ramps/mi	1.83
Lane Width, ft	12	Free-Flow Speed (FFS), mi/h	59.7
Right-Side Lateral Clearance, ft	10		

Adjustment Factors

Driver Population	All Familiar	Final Speed Adjustment Factor (SAF)	1.000
Weather Type	Non-Severe Weather	Final Capacity Adjustment Factor (CAF)	1.000
Incident Type	No Incident	Demand Adjustment Factor (DAF)	1.000

Demand and Capacity

Demand Volume veh/h	3042	Heavy Vehicle Adjustment Factor (fhv)	0.830
Peak Hour Factor	0.94	Flow Rate (Vp), pc/h/ln	1950
Total Trucks, %	20.51	Capacity (c), pc/h/ln	2296
Single-Unit Trucks (SUT), %	-	Adjusted Capacity (cadj), pc/h/ln	2296
Tractor-Trailers (TT), %	-	Volume-to-Capacity Ratio (v/c)	0.85
Passenger Car Equivalent (Et)	2.000		

Speed and Density

Lane Width Adjustment (fLW)	0.0	Average Speed (S), mi/h	57.5
Right-Side Lateral Clearance Adj. (fRLC)	0.0	Density (D), pc/mi/ln	33.9
Total Ramp Density Adjustment	5.4	Level of Service (LOS)	D
Adjusted Free-Flow Speed (FFSadj), mi/h	59.6		

HCS7 Freeway Merge Report

Project Information

Analyst	LSA	Date	12/11/2019
Agency	LSA	Analysis Year	Existing NP
Jurisdiction	Caltrans	Time Period Analyzed	PM Peak Hour
Project Description	CMD1801 - Village D Specific Plan	Unit	United States Customary

Geometric Data

	Freeway	Ramp
Number of Lanes (N), ln	2	1
Free-Flow Speed (FFS), mi/h	65.0	35.0
Segment Length (L) / Acceleration Length (LA),ft	1500	600
Terrain Type	Level	Level
Percent Grade, %	-	-
Segment Type / Ramp Side	Freeway	Right

Adjustment Factors

Driver Population	All Familiar	All Familiar
Weather Type	Non-Severe Weather	Non-Severe Weather
Incident Type	No Incident	-
Final Speed Adjustment Factor (SAF)	1.000	1.000
Final Capacity Adjustment Factor (CAF)	1.000	1.000
Demand Adjustment Factor (DAF)	1.000	1.000

Demand and Capacity

Demand Volume (Vi)	3042	147
Peak Hour Factor (PHF)	0.94	0.94
Total Trucks, %	20.51	3.40
Single-Unit Trucks (SUT), %	-	-
Tractor-Trailers (TT), %	-	-
Heavy Vehicle Adjustment Factor (fHV)	0.830	0.967
Flow Rate (vi),pc/h	3899	162
Capacity (c), pc/h	4700	2000
Volume-to-Capacity Ratio (v/c)	0.86	0.08

Speed and Density

Upstream Equilibrium Distance (LEQ), ft	-	Number of Outer Lanes on Freeway (NO)	0
Distance to Upstream Ramp (LUP), ft	-	Speed Index (MS)	0.505
Downstream Equilibrium Distance (LEQ), ft	-	Flow Outer Lanes (vOA), pc/h/ln	-
Distance to Downstream Ramp (LDOWN), ft	-	On-Ramp Influence Area Speed (SR), mi/h	53.4
Prop. Freeway Vehicles in Lane 1 and 2 (PFM)	1.000	Outer Lanes Freeway Speed (SO), mi/h	65.0
Flow in Lanes 1 and 2 (v12), pc/h	3899	Ramp Junction Speed (S), mi/h	53.4
Flow Entering Ramp-Infl. Area (vR12), pc/h	4061	Average Density (D), pc/mi/ln	38.0
Level of Service (LOS)	D	Density in Ramp Influence Area (DR), pc/mi/ln	33.4

HCS7 Basic Freeway Report

Project Information

Analyst	LSA	Date	12/11/2019
Agency	LSA	Analysis Year	Existing NP
Jurisdiction	Caltrans	Time Period Analyzed	AM Peak Hour
Project Description	CMD1801 - Village D Specific Plan	Unit	United States Customary

Geometric Data

Number of Lanes, ln	2	Terrain Type	Level
Segment Length (L), ft	-	Percent Grade, %	-
Measured or Base Free-Flow Speed	Base	Grade Length, mi	-
Base Free-Flow Speed (BFFS), mi/h	65.0	Total Ramp Density (TRD), ramps/mi	2.17
Lane Width, ft	12	Free-Flow Speed (FFS), mi/h	58.8
Right-Side Lateral Clearance, ft	10		

Adjustment Factors

Driver Population	All Familiar	Final Speed Adjustment Factor (SAF)	1.000
Weather Type	Non-Severe Weather	Final Capacity Adjustment Factor (CAF)	1.000
Incident Type	No Incident	Demand Adjustment Factor (DAF)	1.000

Demand and Capacity

Demand Volume veh/h	3189	Heavy Vehicle Adjustment Factor (fhv)	0.835
Peak Hour Factor	0.94	Flow Rate (Vp), pc/h/ln	2032
Total Trucks, %	19.72	Capacity (c), pc/h/ln	2288
Single-Unit Trucks (SUT), %	-	Adjusted Capacity (cadj), pc/h/ln	2288
Tractor-Trailers (TT), %	-	Volume-to-Capacity Ratio (v/c)	0.89
Passenger Car Equivalent (Et)	2.000		

Speed and Density

Lane Width Adjustment (fLW)	0.0	Average Speed (S), mi/h	55.9
Right-Side Lateral Clearance Adj. (fRLC)	0.0	Density (D), pc/mi/ln	36.4
Total Ramp Density Adjustment	6.2	Level of Service (LOS)	E
Adjusted Free-Flow Speed (FFSadj), mi/h	58.8		

HCS7 Freeway Diverge Report

Project Information

Analyst	LSA	Date	12/11/2019
Agency	LSA	Analysis Year	Existing NP
Jurisdiction	Caltrans	Time Period Analyzed	PM Peak Hour
Project Description	CMD1801 - Village D Specific Plan	Unit	United States Customary

Geometric Data

	Freeway	Ramp
Number of Lanes (N), In	2	1
Free-Flow Speed (FFS), mi/h	65.0	40.0
Segment Length (L) / Deceleration Length (LA),ft	1500	150
Terrain Type	Level	Level
Percent Grade, %	-	-
Segment Type / Ramp Side	Freeway	Right

Adjustment Factors

Driver Population	All Familiar	All Familiar
Weather Type	Non-Severe Weather	Non-Severe Weather
Incident Type	No Incident	-
Final Speed Adjustment Factor (SAF)	1.000	1.000
Final Capacity Adjustment Factor (CAF)	1.000	1.000
Demand Adjustment Factor (DAF)	1.000	1.000

Demand and Capacity

Demand Volume (Vi)	3189	286
Peak Hour Factor (PHF)	0.94	0.94
Total Trucks, %	19.72	3.62
Single-Unit Trucks (SUT), %	-	-
Tractor-Trailers (TT), %	-	-
Heavy Vehicle Adjustment Factor (fHV)	0.835	0.965
Flow Rate (vi),pc/h	4063	315
Capacity (c), pc/h	4700	2000
Volume-to-Capacity Ratio (v/c)	0.86	0.16

Speed and Density

Upstream Equilibrium Distance (LEQ), ft	-	Number of Outer Lanes on Freeway (NO)	0
Distance to Upstream Ramp (LUP), ft	-	Speed Index (DS)	0.391
Downstream Equilibrium Distance (LEQ), ft	-	Flow Outer Lanes (vOA), pc/h/ln	-
Distance to Downstream Ramp (LDOWN), ft	-	Off-Ramp Influence Area Speed (SR), mi/h	56.0
Prop. Freeway Vehicles in Lane 1 and 2 (PFD)	1.000	Outer Lanes Freeway Speed (SO), mi/h	71.3
Flow in Lanes 1 and 2 (v12), pc/h	4063	Ramp Junction Speed (S), mi/h	56.0
Flow Entering Ramp-Infl. Area (vR12), pc/h	-	Average Density (D), pc/mi/ln	36.3
Level of Service (LOS)	E	Density in Ramp Influence Area (DR), pc/mi/ln	37.8

HCS7 Basic Freeway Report

Project Information

Analyst	LSA	Date	12/11/2019
Agency	LSA	Analysis Year	Existing NP
Jurisdiction	Caltrans	Time Period Analyzed	PM Peak Hour
Project Description	CMD1801 - Village D Specific Plan	Unit	United States Customary

Geometric Data

Number of Lanes, ln	2	Terrain Type	Level
Segment Length (L), ft	-	Percent Grade, %	-
Measured or Base Free-Flow Speed	Base	Grade Length, mi	-
Base Free-Flow Speed (BFFS), mi/h	65.0	Total Ramp Density (TRD), ramps/mi	1.83
Lane Width, ft	12	Free-Flow Speed (FFS), mi/h	59.7
Right-Side Lateral Clearance, ft	10		

Adjustment Factors

Driver Population	All Familiar	Final Speed Adjustment Factor (SAF)	1.000
Weather Type	Non-Severe Weather	Final Capacity Adjustment Factor (CAF)	1.000
Incident Type	No Incident	Demand Adjustment Factor (DAF)	1.000

Demand and Capacity

Demand Volume veh/h	2903	Heavy Vehicle Adjustment Factor (fhv)	0.824
Peak Hour Factor	0.94	Flow Rate (Vp), pc/h/ln	1874
Total Trucks, %	21.32	Capacity (c), pc/h/ln	2296
Single-Unit Trucks (SUT), %	-	Adjusted Capacity (cadj), pc/h/ln	2296
Tractor-Trailers (TT), %	-	Volume-to-Capacity Ratio (v/c)	0.82
Passenger Car Equivalent (Et)	2.000		

Speed and Density

Lane Width Adjustment (fLW)	0.0	Average Speed (S), mi/h	58.4
Right-Side Lateral Clearance Adj. (fRLC)	0.0	Density (D), pc/mi/ln	32.1
Total Ramp Density Adjustment	5.4	Level of Service (LOS)	D
Adjusted Free-Flow Speed (FFSadj), mi/h	59.6		

HCS7 Freeway Merge Report

Project Information

Analyst	LSA	Date	12/11/2019
Agency	LSA	Analysis Year	Existing NP
Jurisdiction	Caltrans	Time Period Analyzed	PM Peak Hour
Project Description	CMD1801 - Village D Specific Plan	Unit	United States Customary

Geometric Data

	Freeway	Ramp
Number of Lanes (N), ln	2	1
Free-Flow Speed (FFS), mi/h	65.0	35.0
Segment Length (L) / Acceleration Length (LA),ft	1500	800
Terrain Type	Level	Level
Percent Grade, %	-	-
Segment Type / Ramp Side	Freeway	Right

Adjustment Factors

Driver Population	All Familiar	All Familiar
Weather Type	Non-Severe Weather	Non-Severe Weather
Incident Type	No Incident	-
Final Speed Adjustment Factor (SAF)	1.000	1.000
Final Capacity Adjustment Factor (CAF)	1.000	1.000
Demand Adjustment Factor (DAF)	1.000	1.000

Demand and Capacity

Demand Volume (Vi)	2903	103
Peak Hour Factor (PHF)	0.94	0.94
Total Trucks, %	21.32	5.83
Single-Unit Trucks (SUT), %	-	-
Tractor-Trailers (TT), %	-	-
Heavy Vehicle Adjustment Factor (fHV)	0.824	0.945
Flow Rate (vi),pc/h	3748	116
Capacity (c), pc/h	4700	2000
Volume-to-Capacity Ratio (v/c)	0.82	0.06

Speed and Density

Upstream Equilibrium Distance (LEQ), ft	-	Number of Outer Lanes on Freeway (NO)	0
Distance to Upstream Ramp (LUP), ft	-	Speed Index (MS)	0.451
Downstream Equilibrium Distance (LEQ), ft	-	Flow Outer Lanes (vOA), pc/h/ln	-
Distance to Downstream Ramp (LDOWN), ft	-	On-Ramp Influence Area Speed (SR), mi/h	54.6
Prop. Freeway Vehicles in Lane 1 and 2 (PFM)	1.000	Outer Lanes Freeway Speed (SO), mi/h	65.0
Flow in Lanes 1 and 2 (v12), pc/h	3748	Ramp Junction Speed (S), mi/h	54.6
Flow Entering Ramp-Infl. Area (vR12), pc/h	3864	Average Density (D), pc/mi/ln	35.4
Level of Service (LOS)	D	Density in Ramp Influence Area (DR), pc/mi/ln	30.6

HCS7 Basic Freeway Report

Project Information

Analyst	LSA	Date	12/11/2019
Agency	LSA	Analysis Year	Existing NP
Jurisdiction	Caltrans	Time Period Analyzed	PM Peak Hour
Project Description	CMD1801 - Village D Specific Plan	Unit	United States Customary

Geometric Data

Number of Lanes, ln	2	Terrain Type	Level
Segment Length (L), ft	-	Percent Grade, %	-
Measured or Base Free-Flow Speed	Base	Grade Length, mi	-
Base Free-Flow Speed (BFFS), mi/h	65.0	Total Ramp Density (TRD), ramps/mi	2.17
Lane Width, ft	12	Free-Flow Speed (FFS), mi/h	58.8
Right-Side Lateral Clearance, ft	10		

Adjustment Factors

Driver Population	All Familiar	Final Speed Adjustment Factor (SAF)	1.000
Weather Type	Non-Severe Weather	Final Capacity Adjustment Factor (CAF)	1.000
Incident Type	No Incident	Demand Adjustment Factor (DAF)	1.000

Demand and Capacity

Demand Volume veh/h	3006	Heavy Vehicle Adjustment Factor (fhv)	0.828
Peak Hour Factor	0.94	Flow Rate (Vp), pc/h/ln	1931
Total Trucks, %	20.79	Capacity (c), pc/h/ln	2288
Single-Unit Trucks (SUT), %	-	Adjusted Capacity (cadj), pc/h/ln	2288
Tractor-Trailers (TT), %	-	Volume-to-Capacity Ratio (v/c)	0.84
Passenger Car Equivalent (Et)	2.000		

Speed and Density

Lane Width Adjustment (fLW)	0.0	Average Speed (S), mi/h	57.2
Right-Side Lateral Clearance Adj. (fRLC)	0.0	Density (D), pc/mi/ln	33.8
Total Ramp Density Adjustment	6.2	Level of Service (LOS)	D
Adjusted Free-Flow Speed (FFSadj), mi/h	58.8		

HCS7 Freeway Diverge Report

Project Information

Analyst	LSA	Date	12/11/2019
Agency	LSA	Analysis Year	Existing NP
Jurisdiction	Caltrans	Time Period Analyzed	PM Peak Hour
Project Description	CMD1801 - Village D Specific Plan	Unit	United States Customary

Geometric Data

	Freeway	Ramp
Number of Lanes (N), ln	2	1
Free-Flow Speed (FFS), mi/h	65.0	35.0
Segment Length (L) / Deceleration Length (LA),ft	1500	200
Terrain Type	Level	Level
Percent Grade, %	-	-
Segment Type / Ramp Side	Freeway	Right

Adjustment Factors

Driver Population	All Familiar	All Familiar
Weather Type	Non-Severe Weather	Non-Severe Weather
Incident Type	No Incident	-
Final Speed Adjustment Factor (SAF)	1.000	1.000
Final Capacity Adjustment Factor (CAF)	1.000	1.000
Demand Adjustment Factor (DAF)	1.000	1.000

Demand and Capacity

Demand Volume (Vi)	3006	202
Peak Hour Factor (PHF)	0.94	0.94
Total Trucks, %	20.79	3.96
Single-Unit Trucks (SUT), %	-	-
Tractor-Trailers (TT), %	-	-
Heavy Vehicle Adjustment Factor (fHV)	0.828	0.962
Flow Rate (vi),pc/h	3862	223
Capacity (c), pc/h	4700	2000
Volume-to-Capacity Ratio (v/c)	0.82	0.11

Speed and Density

Upstream Equilibrium Distance (LEQ), ft	-	Number of Outer Lanes on Freeway (NO)	0
Distance to Upstream Ramp (LUP), ft	-	Speed Index (DS)	0.448
Downstream Equilibrium Distance (LEQ), ft	-	Flow Outer Lanes (vOA), pc/h/ln	-
Distance to Downstream Ramp (LDOWN), ft	-	Off-Ramp Influence Area Speed (SR), mi/h	54.7
Prop. Freeway Vehicles in Lane 1 and 2 (PFD)	1.000	Outer Lanes Freeway Speed (SO), mi/h	71.3
Flow in Lanes 1 and 2 (v12), pc/h	3862	Ramp Junction Speed (S), mi/h	54.7
Flow Entering Ramp-Infl. Area (vR12), pc/h	-	Average Density (D), pc/mi/ln	35.3
Level of Service (LOS)	E	Density in Ramp Influence Area (DR), pc/mi/ln	35.7

HCS7 Basic Freeway Report

Project Information

Analyst	LSA	Date	12/11/2019
Agency	LSA	Analysis Year	Existing NP
Jurisdiction	Caltrans	Time Period Analyzed	PM Peak Hour
Project Description	CMD1801 - Village D Specific Plan	Unit	United States Customary

Geometric Data

Number of Lanes, ln	2	Terrain Type	Level
Segment Length (L), ft	-	Percent Grade, %	-
Measured or Base Free-Flow Speed	Base	Grade Length, mi	-
Base Free-Flow Speed (BFFS), mi/h	65.0	Total Ramp Density (TRD), ramps/mi	2.17
Lane Width, ft	12	Free-Flow Speed (FFS), mi/h	58.8
Right-Side Lateral Clearance, ft	10		

Adjustment Factors

Driver Population	All Familiar	Final Speed Adjustment Factor (SAF)	1.000
Weather Type	Non-Severe Weather	Final Capacity Adjustment Factor (CAF)	1.000
Incident Type	No Incident	Demand Adjustment Factor (DAF)	1.000

Demand and Capacity

Demand Volume veh/h	2804	Heavy Vehicle Adjustment Factor (fhv)	0.820
Peak Hour Factor	0.94	Flow Rate (Vp), pc/h/ln	1819
Total Trucks, %	22.00	Capacity (c), pc/h/ln	2288
Single-Unit Trucks (SUT), %	-	Adjusted Capacity (cadj), pc/h/ln	2288
Tractor-Trailers (TT), %	-	Volume-to-Capacity Ratio (v/c)	0.80
Passenger Car Equivalent (Et)	2.000		

Speed and Density

Lane Width Adjustment (fLW)	0.0	Average Speed (S), mi/h	58.2
Right-Side Lateral Clearance Adj. (fRLC)	0.0	Density (D), pc/mi/ln	31.3
Total Ramp Density Adjustment	6.2	Level of Service (LOS)	D
Adjusted Free-Flow Speed (FFSadj), mi/h	58.8		

HCS7 Freeway Merge Report

Project Information

Analyst	LSA	Date	12/11/2019
Agency	LSA	Analysis Year	Existing NP
Jurisdiction	Caltrans	Time Period Analyzed	PM Peak Hour
Project Description	CMD1801 - Village D Specific Plan	Unit	United States Customary

Geometric Data

	Freeway	Ramp
Number of Lanes (N), ln	2	1
Free-Flow Speed (FFS), mi/h	65.0	35.0
Segment Length (L) / Acceleration Length (LA),ft	1500	350
Terrain Type	Level	Level
Percent Grade, %	-	-
Segment Type / Ramp Side	Freeway	Right

Adjustment Factors

Driver Population	All Familiar	All Familiar
Weather Type	Non-Severe Weather	Non-Severe Weather
Incident Type	No Incident	-
Final Speed Adjustment Factor (SAF)	1.000	1.000
Final Capacity Adjustment Factor (CAF)	1.000	1.000
Demand Adjustment Factor (DAF)	1.000	1.000

Demand and Capacity

Demand Volume (Vi)	2804	520
Peak Hour Factor (PHF)	0.94	0.94
Total Trucks, %	22.00	1.56
Single-Unit Trucks (SUT), %	-	-
Tractor-Trailers (TT), %	-	-
Heavy Vehicle Adjustment Factor (fHV)	0.820	0.985
Flow Rate (vi),pc/h	3638	562
Capacity (c), pc/h	4700	2000
Volume-to-Capacity Ratio (v/c)	0.89	0.28

Speed and Density

Upstream Equilibrium Distance (LEQ), ft	-	Number of Outer Lanes on Freeway (NO)	0
Distance to Upstream Ramp (LUP), ft	-	Speed Index (MS)	0.557
Downstream Equilibrium Distance (LEQ), ft	-	Flow Outer Lanes (vOA), pc/h/ln	-
Distance to Downstream Ramp (LDOWN), ft	-	On-Ramp Influence Area Speed (SR), mi/h	52.2
Prop. Freeway Vehicles in Lane 1 and 2 (PFM)	1.000	Outer Lanes Freeway Speed (SO), mi/h	65.0
Flow in Lanes 1 and 2 (v12), pc/h	3638	Ramp Junction Speed (S), mi/h	52.2
Flow Entering Ramp-Infl. Area (vR12), pc/h	4200	Average Density (D), pc/mi/ln	40.2
Level of Service (LOS)	E	Density in Ramp Influence Area (DR), pc/mi/ln	35.9

HCS7 Basic Freeway Report

Project Information

Analyst	LSA	Date	12/11/2019
Agency	LSA	Analysis Year	Existing NP
Jurisdiction	Caltrans	Time Period Analyzed	PM Peak Hour
Project Description	CMD1801 - Village D Specific Plan	Unit	United States Customary

Geometric Data

Number of Lanes, ln	2	Terrain Type	Level
Segment Length (L), ft	-	Percent Grade, %	-
Measured or Base Free-Flow Speed	Base	Grade Length, mi	-
Base Free-Flow Speed (BFFS), mi/h	65.0	Total Ramp Density (TRD), ramps/mi	2.17
Lane Width, ft	12	Free-Flow Speed (FFS), mi/h	58.8
Right-Side Lateral Clearance, ft	10		

Adjustment Factors

Driver Population	All Familiar	Final Speed Adjustment Factor (SAF)	1.000
Weather Type	Non-Severe Weather	Final Capacity Adjustment Factor (CAF)	1.000
Incident Type	No Incident	Demand Adjustment Factor (DAF)	1.000

Demand and Capacity

Demand Volume veh/h	3324	Heavy Vehicle Adjustment Factor (fhv)	0.842
Peak Hour Factor	0.94	Flow Rate (Vp), pc/h/ln	2100
Total Trucks, %	18.80	Capacity (c), pc/h/ln	2288
Single-Unit Trucks (SUT), %	-	Adjusted Capacity (cadj), pc/h/ln	2288
Tractor-Trailers (TT), %	-	Volume-to-Capacity Ratio (v/c)	0.92
Passenger Car Equivalent (Et)	2.000		

Speed and Density

Lane Width Adjustment (fLW)	0.0	Average Speed (S), mi/h	54.8
Right-Side Lateral Clearance Adj. (fRLC)	0.0	Density (D), pc/mi/ln	38.3
Total Ramp Density Adjustment	6.2	Level of Service (LOS)	E
Adjusted Free-Flow Speed (FFSadj), mi/h	58.8		

HCS7 Freeway Diverge Report

Project Information

Analyst	LSA	Date	12/11/2019
Agency	LSA	Analysis Year	Existing NP
Jurisdiction	Caltrans	Time Period Analyzed	PM Peak Hour
Project Description	CMD1801 - Village D Specific Plan	Unit	United States Customary

Geometric Data

	Freeway	Ramp
Number of Lanes (N), ln	2	1
Free-Flow Speed (FFS), mi/h	65.0	15.0
Segment Length (L) / Deceleration Length (LA),ft	1500	150
Terrain Type	Level	Level
Percent Grade, %	-	-
Segment Type / Ramp Side	Freeway	Right

Adjustment Factors

Driver Population	All Familiar	All Familiar
Weather Type	Non-Severe Weather	Non-Severe Weather
Incident Type	No Incident	-
Final Speed Adjustment Factor (SAF)	1.000	1.000
Final Capacity Adjustment Factor (CAF)	1.000	1.000
Demand Adjustment Factor (DAF)	1.000	1.000

Demand and Capacity

Demand Volume (Vi)	3324	250
Peak Hour Factor (PHF)	0.94	0.94
Total Trucks, %	18.80	2.80
Single-Unit Trucks (SUT), %	-	-
Tractor-Trailers (TT), %	-	-
Heavy Vehicle Adjustment Factor (fHV)	0.842	0.973
Flow Rate (vi),pc/h	4200	273
Capacity (c), pc/h	4700	1800
Volume-to-Capacity Ratio (v/c)	0.89	0.15

Speed and Density

Upstream Equilibrium Distance (LEQ), ft	-	Number of Outer Lanes on Freeway (NO)	0
Distance to Upstream Ramp (LUP), ft	-	Speed Index (DS)	0.713
Downstream Equilibrium Distance (LEQ), ft	-	Flow Outer Lanes (vOA), pc/h/ln	-
Distance to Downstream Ramp (LDOWN), ft	-	Off-Ramp Influence Area Speed (SR), mi/h	48.6
Prop. Freeway Vehicles in Lane 1 and 2 (PFD)	1.000	Outer Lanes Freeway Speed (SO), mi/h	71.3
Flow in Lanes 1 and 2 (v12), pc/h	4200	Ramp Junction Speed (S), mi/h	48.6
Flow Entering Ramp-Infl. Area (vR12), pc/h	-	Average Density (D), pc/mi/ln	43.2
Level of Service (LOS)	E	Density in Ramp Influence Area (DR), pc/mi/ln	39.0

HCS7 Basic Freeway Report

Project Information

Analyst	LSA	Date	12/11/2019
Agency	LSA	Analysis Year	Existing NP
Jurisdiction	Caltrans	Time Period Analyzed	AM Peak Hour
Project Description	CMD1801 - Village D Specific Plan	Unit	United States Customary

Geometric Data

Number of Lanes, ln	2	Terrain Type	Level
Segment Length (L), ft	-	Percent Grade, %	-
Measured or Base Free-Flow Speed	Base	Grade Length, mi	-
Base Free-Flow Speed (BFFS), mi/h	65.0	Total Ramp Density (TRD), ramps/mi	1.83
Lane Width, ft	12	Free-Flow Speed (FFS), mi/h	59.7
Right-Side Lateral Clearance, ft	10		

Adjustment Factors

Driver Population	All Familiar	Final Speed Adjustment Factor (SAF)	1.000
Weather Type	Non-Severe Weather	Final Capacity Adjustment Factor (CAF)	1.000
Incident Type	No Incident	Demand Adjustment Factor (DAF)	1.000

Demand and Capacity

Demand Volume veh/h	3074	Heavy Vehicle Adjustment Factor (fhv)	0.833
Peak Hour Factor	0.94	Flow Rate (Vp), pc/h/ln	1963
Total Trucks, %	20.10	Capacity (c), pc/h/ln	2296
Single-Unit Trucks (SUT), %	-	Adjusted Capacity (cadj), pc/h/ln	2296
Tractor-Trailers (TT), %	-	Volume-to-Capacity Ratio (v/c)	0.85
Passenger Car Equivalent (Et)	2.000		

Speed and Density

Lane Width Adjustment (fLW)	0.0	Average Speed (S), mi/h	57.4
Right-Side Lateral Clearance Adj. (fRLC)	0.0	Density (D), pc/mi/ln	34.2
Total Ramp Density Adjustment	5.4	Level of Service (LOS)	D
Adjusted Free-Flow Speed (FFSadj), mi/h	59.6		

HCS7 Freeway Merge Report

Project Information

Analyst	LSA	Date	12/11/2019
Agency	LSA	Analysis Year	Existing NP
Jurisdiction	Caltrans	Time Period Analyzed	PM Peak Hour
Project Description	CMD1801 - Village D Specific Plan	Unit	United States Customary

Geometric Data

	Freeway	Ramp
Number of Lanes (N), ln	2	1
Free-Flow Speed (FFS), mi/h	65.0	35.0
Segment Length (L) / Acceleration Length (LA),ft	1500	450
Terrain Type	Level	Level
Percent Grade, %	-	-
Segment Type / Ramp Side	Freeway	Right

Adjustment Factors

Driver Population	All Familiar	All Familiar
Weather Type	Non-Severe Weather	Non-Severe Weather
Incident Type	No Incident	-
Final Speed Adjustment Factor (SAF)	1.000	1.000
Final Capacity Adjustment Factor (CAF)	1.000	1.000
Demand Adjustment Factor (DAF)	1.000	1.000

Demand and Capacity

Demand Volume (Vi)	3074	426
Peak Hour Factor (PHF)	0.94	0.94
Total Trucks, %	20.10	1.18
Single-Unit Trucks (SUT), %	-	-
Tractor-Trailers (TT), %	-	-
Heavy Vehicle Adjustment Factor (fHV)	0.833	0.988
Flow Rate (vi),pc/h	3926	459
Capacity (c), pc/h	4700	2000
Volume-to-Capacity Ratio (v/c)	0.93	0.23

Speed and Density

Upstream Equilibrium Distance (LEQ), ft	-	Number of Outer Lanes on Freeway (NO)	0
Distance to Upstream Ramp (LUP), ft	-	Speed Index (MS)	0.602
Downstream Equilibrium Distance (LEQ), ft	-	Flow Outer Lanes (vOA), pc/h/ln	-
Distance to Downstream Ramp (LDOWN), ft	-	On-Ramp Influence Area Speed (SR), mi/h	51.2
Prop. Freeway Vehicles in Lane 1 and 2 (PFM)	1.000	Outer Lanes Freeway Speed (SO), mi/h	65.0
Flow in Lanes 1 and 2 (v12), pc/h	3926	Ramp Junction Speed (S), mi/h	51.2
Flow Entering Ramp-Infl. Area (vR12), pc/h	4385	Average Density (D), pc/mi/ln	42.8
Level of Service (LOS)	E	Density in Ramp Influence Area (DR), pc/mi/ln	36.7

HCS7 Basic Freeway Report

Project Information

Analyst	LSA	Date	12/11/2019
Agency	LSA	Analysis Year	Existing NP
Jurisdiction	Caltrans	Time Period Analyzed	AM Peak Hour
Project Description	CMD1801 - Village D Specific Plan	Unit	United States Customary

Geometric Data

Number of Lanes, ln	2	Terrain Type	Level
Segment Length (L), ft	-	Percent Grade, %	-
Measured or Base Free-Flow Speed	Base	Grade Length, mi	-
Base Free-Flow Speed (BFFS), mi/h	65.0	Total Ramp Density (TRD), ramps/mi	1.83
Lane Width, ft	12	Free-Flow Speed (FFS), mi/h	59.7
Right-Side Lateral Clearance, ft	10		

Adjustment Factors

Driver Population	All Familiar	Final Speed Adjustment Factor (SAF)	1.000
Weather Type	Non-Severe Weather	Final Capacity Adjustment Factor (CAF)	1.000
Incident Type	No Incident	Demand Adjustment Factor (DAF)	1.000

Demand and Capacity

Demand Volume veh/h	3500	Heavy Vehicle Adjustment Factor (fhv)	0.849
Peak Hour Factor	0.94	Flow Rate (Vp), pc/h/ln	2193
Total Trucks, %	17.80	Capacity (c), pc/h/ln	2296
Single-Unit Trucks (SUT), %	-	Adjusted Capacity (cadj), pc/h/ln	2296
Tractor-Trailers (TT), %	-	Volume-to-Capacity Ratio (v/c)	0.96
Passenger Car Equivalent (Et)	2.000		

Speed and Density

Lane Width Adjustment (fLW)	0.0	Average Speed (S), mi/h	53.4
Right-Side Lateral Clearance Adj. (fRLC)	0.0	Density (D), pc/mi/ln	41.1
Total Ramp Density Adjustment	5.4	Level of Service (LOS)	E
Adjusted Free-Flow Speed (FFSadj), mi/h	59.6		

HCS7 Freeway Diverge Report

Project Information

Analyst	LSA	Date	12/11/2019
Agency	LSA	Analysis Year	Existing NP
Jurisdiction	Caltrans	Time Period Analyzed	PM Peak Hour
Project Description	CMD1801 - Village D Specific Plan	Unit	United States Customary

Geometric Data

	Freeway	Ramp
Number of Lanes (N), ln	2	1
Free-Flow Speed (FFS), mi/h	65.0	35.0
Segment Length (L) / Deceleration Length (LA),ft	1500	140
Terrain Type	Level	Level
Percent Grade, %	-	-
Segment Type / Ramp Side	Freeway	Right

Adjustment Factors

Driver Population	All Familiar	All Familiar
Weather Type	Non-Severe Weather	Non-Severe Weather
Incident Type	No Incident	-
Final Speed Adjustment Factor (SAF)	1.000	1.000
Final Capacity Adjustment Factor (CAF)	1.000	1.000
Demand Adjustment Factor (DAF)	1.000	1.000

Demand and Capacity

Demand Volume (Vi)	3500	294
Peak Hour Factor (PHF)	0.94	0.94
Total Trucks, %	17.80	4.45
Single-Unit Trucks (SUT), %	-	-
Tractor-Trailers (TT), %	-	-
Heavy Vehicle Adjustment Factor (fHV)	0.849	0.957
Flow Rate (vi),pc/h	4386	327
Capacity (c), pc/h	4700	2000
Volume-to-Capacity Ratio (v/c)	0.93	0.16

Speed and Density

Upstream Equilibrium Distance (LEQ), ft	-	Number of Outer Lanes on Freeway (NO)	0
Distance to Upstream Ramp (LUP), ft	-	Speed Index (DS)	0.457
Downstream Equilibrium Distance (LEQ), ft	-	Flow Outer Lanes (vOA), pc/h/ln	-
Distance to Downstream Ramp (LDOWN), ft	-	Off-Ramp Influence Area Speed (SR), mi/h	54.5
Prop. Freeway Vehicles in Lane 1 and 2 (PFD)	1.000	Outer Lanes Freeway Speed (SO), mi/h	71.3
Flow in Lanes 1 and 2 (v12), pc/h	4386	Ramp Junction Speed (S), mi/h	54.5
Flow Entering Ramp-Infl. Area (vR12), pc/h	-	Average Density (D), pc/mi/ln	40.2
Level of Service (LOS)	E	Density in Ramp Influence Area (DR), pc/mi/ln	40.7

HCS7 Basic Freeway Report

Project Information

Analyst	LSA	Date	12/11/2019
Agency	LSA	Analysis Year	Existing NP
Jurisdiction	Caltrans	Time Period Analyzed	PM Peak Hour
Project Description	CMD1801 - Village D Specific Plan	Unit	United States Customary

Geometric Data

Number of Lanes, ln	2	Terrain Type	Level
Segment Length (L), ft	-	Percent Grade, %	-
Measured or Base Free-Flow Speed	Base	Grade Length, mi	-
Base Free-Flow Speed (BFFS), mi/h	65.0	Total Ramp Density (TRD), ramps/mi	2.17
Lane Width, ft	12	Free-Flow Speed (FFS), mi/h	58.8
Right-Side Lateral Clearance, ft	10		

Adjustment Factors

Driver Population	All Familiar	Final Speed Adjustment Factor (SAF)	1.000
Weather Type	Non-Severe Weather	Final Capacity Adjustment Factor (CAF)	1.000
Incident Type	No Incident	Demand Adjustment Factor (DAF)	1.000

Demand and Capacity

Demand Volume veh/h	3206	Heavy Vehicle Adjustment Factor (fhv)	0.840
Peak Hour Factor	0.94	Flow Rate (Vp), pc/h/ln	2030
Total Trucks, %	19.03	Capacity (c), pc/h/ln	2288
Single-Unit Trucks (SUT), %	-	Adjusted Capacity (cadj), pc/h/ln	2288
Tractor-Trailers (TT), %	-	Volume-to-Capacity Ratio (v/c)	0.89
Passenger Car Equivalent (Et)	2.000		

Speed and Density

Lane Width Adjustment (fLW)	0.0	Average Speed (S), mi/h	56.0
Right-Side Lateral Clearance Adj. (fRLC)	0.0	Density (D), pc/mi/ln	36.2
Total Ramp Density Adjustment	6.2	Level of Service (LOS)	E
Adjusted Free-Flow Speed (FFSadj), mi/h	58.8		

HCS7 Freeway Merge Report

Project Information

Analyst	LSA	Date	12/11/2019
Agency	LSA	Analysis Year	Existing NP
Jurisdiction	Caltrans	Time Period Analyzed	PM Peak Hour
Project Description	CMD1801 - Village D Specific Plan	Unit	United States Customary

Geometric Data

	Freeway	Ramp
Number of Lanes (N), ln	2	1
Free-Flow Speed (FFS), mi/h	65.0	35.0
Segment Length (L) / Acceleration Length (LA),ft	1500	450
Terrain Type	Level	Level
Percent Grade, %	-	-
Segment Type / Ramp Side	Freeway	Right

Adjustment Factors

Driver Population	All Familiar	All Familiar
Weather Type	Non-Severe Weather	Non-Severe Weather
Incident Type	No Incident	-
Final Speed Adjustment Factor (SAF)	1.000	1.000
Final Capacity Adjustment Factor (CAF)	1.000	1.000
Demand Adjustment Factor (DAF)	1.000	1.000

Demand and Capacity

Demand Volume (Vi)	3206	294
Peak Hour Factor (PHF)	0.94	0.94
Total Trucks, %	19.03	1.70
Single-Unit Trucks (SUT), %	-	-
Tractor-Trailers (TT), %	-	-
Heavy Vehicle Adjustment Factor (fHV)	0.840	0.983
Flow Rate (vi),pc/h	4060	318
Capacity (c), pc/h	4700	2000
Volume-to-Capacity Ratio (v/c)	0.93	0.16

Speed and Density

Upstream Equilibrium Distance (LEQ), ft	-	Number of Outer Lanes on Freeway (NO)	0
Distance to Upstream Ramp (LUP), ft	-	Speed Index (MS)	0.600
Downstream Equilibrium Distance (LEQ), ft	-	Flow Outer Lanes (vOA), pc/h/ln	-
Distance to Downstream Ramp (LDOWN), ft	-	On-Ramp Influence Area Speed (SR), mi/h	51.2
Prop. Freeway Vehicles in Lane 1 and 2 (PFM)	1.000	Outer Lanes Freeway Speed (SO), mi/h	65.0
Flow in Lanes 1 and 2 (v12), pc/h	4060	Ramp Junction Speed (S), mi/h	51.2
Flow Entering Ramp-Infl. Area (vR12), pc/h	4378	Average Density (D), pc/mi/ln	42.8
Level of Service (LOS)	E	Density in Ramp Influence Area (DR), pc/mi/ln	36.7

HCS7 Basic Freeway Report

Project Information

Analyst	LSA	Date	12/11/2019
Agency	LSA	Analysis Year	Existing NP
Jurisdiction	Caltrans	Time Period Analyzed	PM Peak Hour
Project Description	CMD1801 - Village D Specific Plan	Unit	United States Customary

Geometric Data

Number of Lanes, ln	2	Terrain Type	Level
Segment Length (L), ft	-	Percent Grade, %	-
Measured or Base Free-Flow Speed	Base	Grade Length, mi	-
Base Free-Flow Speed (BFFS), mi/h	65.0	Total Ramp Density (TRD), ramps/mi	2.17
Lane Width, ft	12	Free-Flow Speed (FFS), mi/h	58.8
Right-Side Lateral Clearance, ft	10		

Adjustment Factors

Driver Population	All Familiar	Final Speed Adjustment Factor (SAF)	1.000
Weather Type	Non-Severe Weather	Final Capacity Adjustment Factor (CAF)	1.000
Incident Type	No Incident	Demand Adjustment Factor (DAF)	1.000

Demand and Capacity

Demand Volume veh/h	3500	Heavy Vehicle Adjustment Factor (fhv)	0.851
Peak Hour Factor	0.94	Flow Rate (Vp), pc/h/ln	2188
Total Trucks, %	17.57	Capacity (c), pc/h/ln	2288
Single-Unit Trucks (SUT), %	-	Adjusted Capacity (cadj), pc/h/ln	2288
Tractor-Trailers (TT), %	-	Volume-to-Capacity Ratio (v/c)	0.96
Passenger Car Equivalent (Et)	2.000		

Speed and Density

Lane Width Adjustment (fLW)	0.0	Average Speed (S), mi/h	53.1
Right-Side Lateral Clearance Adj. (fRLC)	0.0	Density (D), pc/mi/ln	41.2
Total Ramp Density Adjustment	6.2	Level of Service (LOS)	E
Adjusted Free-Flow Speed (FFSadj), mi/h	58.8		

HCS7 Basic Freeway Report

Project Information

Analyst	LSA	Date	12/11/2019
Agency	LSA	Analysis Year	Existing WP
Jurisdiction	Caltrans	Time Period Analyzed	AM Peak Hour
Project Description	CMD1801 - Village D Specific Plan	Unit	United States Customary

Geometric Data

Number of Lanes, ln	2	Terrain Type	Level
Segment Length (L), ft	-	Percent Grade, %	-
Measured or Base Free-Flow Speed	Base	Grade Length, mi	-
Base Free-Flow Speed (BFFS), mi/h	65.0	Total Ramp Density (TRD), ramps/mi	1.83
Lane Width, ft	12	Free-Flow Speed (FFS), mi/h	59.7
Right-Side Lateral Clearance, ft	10		

Adjustment Factors

Driver Population	All Familiar	Final Speed Adjustment Factor (SAF)	1.000
Weather Type	Non-Severe Weather	Final Capacity Adjustment Factor (CAF)	1.000
Incident Type	No Incident	Demand Adjustment Factor (DAF)	1.000

Demand and Capacity

Demand Volume veh/h	2972	Heavy Vehicle Adjustment Factor (fhv)	0.863
Peak Hour Factor	0.94	Flow Rate (Vp), pc/h/ln	1832
Total Trucks, %	15.84	Capacity (c), pc/h/ln	2296
Single-Unit Trucks (SUT), %	-	Adjusted Capacity (cadj), pc/h/ln	2296
Tractor-Trailers (TT), %	-	Volume-to-Capacity Ratio (v/c)	0.80
Passenger Car Equivalent (Et)	2.000		

Speed and Density

Lane Width Adjustment (fLW)	0.0	Average Speed (S), mi/h	58.7
Right-Side Lateral Clearance Adj. (fRLC)	0.0	Density (D), pc/mi/ln	31.2
Total Ramp Density Adjustment	5.4	Level of Service (LOS)	D
Adjusted Free-Flow Speed (FFSadj), mi/h	59.6		

HCS7 Freeway Diverge Report

Project Information

Analyst	LSA	Date	12/11/2019
Agency	LSA	Analysis Year	Existing WP
Jurisdiction	Caltrans	Time Period Analyzed	AM Peak Hour
Project Description	CMD1801 - Village D Specific Plan	Unit	United States Customary

Geometric Data

	Freeway	Ramp
Number of Lanes (N), ln	2	1
Free-Flow Speed (FFS), mi/h	65.0	35.0
Segment Length (L) / Deceleration Length (LA),ft	1500	150
Terrain Type	Level	Level
Percent Grade, %	-	-
Segment Type / Ramp Side	Freeway	Right

Adjustment Factors

Driver Population	All Familiar	All Familiar
Weather Type	Non-Severe Weather	Non-Severe Weather
Incident Type	No Incident	-
Final Speed Adjustment Factor (SAF)	1.000	1.000
Final Capacity Adjustment Factor (CAF)	1.000	1.000
Demand Adjustment Factor (DAF)	1.000	1.000

Demand and Capacity

Demand Volume (Vi)	2972	281
Peak Hour Factor (PHF)	0.94	0.94
Total Trucks, %	15.84	3.56
Single-Unit Trucks (SUT), %	-	-
Tractor-Trailers (TT), %	-	-
Heavy Vehicle Adjustment Factor (fHV)	0.863	0.966
Flow Rate (vi),pc/h	3664	309
Capacity (c), pc/h	4700	2000
Volume-to-Capacity Ratio (v/c)	0.78	0.15

Speed and Density

Upstream Equilibrium Distance (LEQ), ft	-	Number of Outer Lanes on Freeway (NO)	0
Distance to Upstream Ramp (LUP), ft	-	Speed Index (DS)	0.456
Downstream Equilibrium Distance (LEQ), ft	-	Flow Outer Lanes (vOA), pc/h/ln	-
Distance to Downstream Ramp (LDOWN), ft	-	Off-Ramp Influence Area Speed (SR), mi/h	54.5
Prop. Freeway Vehicles in Lane 1 and 2 (PFD)	1.000	Outer Lanes Freeway Speed (SO), mi/h	71.3
Flow in Lanes 1 and 2 (v12), pc/h	3664	Ramp Junction Speed (S), mi/h	54.5
Flow Entering Ramp-Infl. Area (vR12), pc/h	-	Average Density (D), pc/mi/ln	33.6
Level of Service (LOS)	D	Density in Ramp Influence Area (DR), pc/mi/ln	34.4

HCS7 Basic Freeway Report

Project Information

Analyst	LSA	Date	12/11/2019
Agency	LSA	Analysis Year	Existing WP
Jurisdiction	Caltrans	Time Period Analyzed	AM Peak Hour
Project Description	CMD1801 - Village D Specific Plan	Unit	United States Customary

Geometric Data

Number of Lanes, ln	2	Terrain Type	Level
Segment Length (L), ft	-	Percent Grade, %	-
Measured or Base Free-Flow Speed	Base	Grade Length, mi	-
Base Free-Flow Speed (BFFS), mi/h	65.0	Total Ramp Density (TRD), ramps/mi	1.83
Lane Width, ft	12	Free-Flow Speed (FFS), mi/h	59.7
Right-Side Lateral Clearance, ft	10		

Adjustment Factors

Driver Population	All Familiar	Final Speed Adjustment Factor (SAF)	1.000
Weather Type	Non-Severe Weather	Final Capacity Adjustment Factor (CAF)	1.000
Incident Type	No Incident	Demand Adjustment Factor (DAF)	1.000

Demand and Capacity

Demand Volume veh/h	2691	Heavy Vehicle Adjustment Factor (fhv)	0.854
Peak Hour Factor	0.94	Flow Rate (Vp), pc/h/ln	1676
Total Trucks, %	17.12	Capacity (c), pc/h/ln	2296
Single-Unit Trucks (SUT), %	-	Adjusted Capacity (cadj), pc/h/ln	2296
Tractor-Trailers (TT), %	-	Volume-to-Capacity Ratio (v/c)	0.73
Passenger Car Equivalent (Et)	2.000		

Speed and Density

Lane Width Adjustment (fLW)	0.0	Average Speed (S), mi/h	59.5
Right-Side Lateral Clearance Adj. (fRLC)	0.0	Density (D), pc/mi/ln	28.2
Total Ramp Density Adjustment	5.4	Level of Service (LOS)	D
Adjusted Free-Flow Speed (FFSadj), mi/h	59.6		

HCS7 Freeway Merge Report

Project Information

Analyst	LSA	Date	12/11/2019
Agency	LSA	Analysis Year	Existing WP
Jurisdiction	Caltrans	Time Period Analyzed	AM Peak Hour
Project Description	CMD1801 - Village D Specific Plan	Unit	United States Customary

Geometric Data

	Freeway	Ramp
Number of Lanes (N), ln	2	1
Free-Flow Speed (FFS), mi/h	65.0	35.0
Segment Length (L) / Acceleration Length (LA),ft	1500	445
Terrain Type	Level	Level
Percent Grade, %	-	-
Segment Type / Ramp Side	Freeway	Right

Adjustment Factors

Driver Population	All Familiar	All Familiar
Weather Type	Non-Severe Weather	Non-Severe Weather
Incident Type	No Incident	-
Final Speed Adjustment Factor (SAF)	1.000	1.000
Final Capacity Adjustment Factor (CAF)	1.000	1.000
Demand Adjustment Factor (DAF)	1.000	1.000

Demand and Capacity

Demand Volume (Vi)	2691	575
Peak Hour Factor (PHF)	0.94	0.94
Total Trucks, %	17.12	8.70
Single-Unit Trucks (SUT), %	-	-
Tractor-Trailers (TT), %	-	-
Heavy Vehicle Adjustment Factor (fHV)	0.854	0.920
Flow Rate (vi),pc/h	3352	665
Capacity (c), pc/h	4700	2000
Volume-to-Capacity Ratio (v/c)	0.85	0.33

Speed and Density

Upstream Equilibrium Distance (LEQ), ft	-	Number of Outer Lanes on Freeway (NO)	0
Distance to Upstream Ramp (LUP), ft	-	Speed Index (MS)	0.506
Downstream Equilibrium Distance (LEQ), ft	-	Flow Outer Lanes (vOA), pc/h/ln	-
Distance to Downstream Ramp (LDOWN), ft	-	On-Ramp Influence Area Speed (SR), mi/h	53.4
Prop. Freeway Vehicles in Lane 1 and 2 (PFM)	1.000	Outer Lanes Freeway Speed (SO), mi/h	65.0
Flow in Lanes 1 and 2 (v12), pc/h	3352	Ramp Junction Speed (S), mi/h	53.4
Flow Entering Ramp-Infl. Area (vR12), pc/h	4017	Average Density (D), pc/mi/ln	37.6
Level of Service (LOS)	D	Density in Ramp Influence Area (DR), pc/mi/ln	33.8

HCS7 Basic Freeway Report

Project Information

Analyst	LSA	Date	12/11/2019
Agency	LSA	Analysis Year	Existing WP
Jurisdiction	Caltrans	Time Period Analyzed	AM Peak Hour
Project Description	CMD1801 - Village D Specific Plan	Unit	United States Customary

Geometric Data

Number of Lanes, ln	2	Terrain Type	Level
Segment Length (L), ft	-	Percent Grade, %	-
Measured or Base Free-Flow Speed	Base	Grade Length, mi	-
Base Free-Flow Speed (BFFS), mi/h	65.0	Total Ramp Density (TRD), ramps/mi	1.50
Lane Width, ft	12	Free-Flow Speed (FFS), mi/h	60.5
Right-Side Lateral Clearance, ft	10		

Adjustment Factors

Driver Population	All Familiar	Final Speed Adjustment Factor (SAF)	1.000
Weather Type	Non-Severe Weather	Final Capacity Adjustment Factor (CAF)	1.000
Incident Type	No Incident	Demand Adjustment Factor (DAF)	1.000

Demand and Capacity

Demand Volume veh/h	3266	Heavy Vehicle Adjustment Factor (fhv)	0.865
Peak Hour Factor	0.94	Flow Rate (Vp), pc/h/ln	2008
Total Trucks, %	15.64	Capacity (c), pc/h/ln	2305
Single-Unit Trucks (SUT), %	-	Adjusted Capacity (cadj), pc/h/ln	2305
Tractor-Trailers (TT), %	-	Volume-to-Capacity Ratio (v/c)	0.87
Passenger Car Equivalent (Et)	2.000		

Speed and Density

Lane Width Adjustment (fLW)	0.0	Average Speed (S), mi/h	57.3
Right-Side Lateral Clearance Adj. (fRLC)	0.0	Density (D), pc/mi/ln	35.0
Total Ramp Density Adjustment	4.5	Level of Service (LOS)	D
Adjusted Free-Flow Speed (FFSadj), mi/h	60.5		

HCS7 Freeway Diverge Report

Project Information

Analyst	LSA	Date	12/11/2019
Agency	LSA	Analysis Year	Existing WP
Jurisdiction	Caltrans	Time Period Analyzed	AM Peak Hour
Project Description	CMD1801 - Village D Specific Plan	Unit	United States Customary

Geometric Data

	Freeway	Ramp
Number of Lanes (N), ln	2	1
Free-Flow Speed (FFS), mi/h	65.0	35.0
Segment Length (L) / Deceleration Length (LA),ft	1500	130
Terrain Type	Level	Level
Percent Grade, %	-	-
Segment Type / Ramp Side	Freeway	Right

Adjustment Factors

Driver Population	All Familiar	All Familiar
Weather Type	Non-Severe Weather	Non-Severe Weather
Incident Type	No Incident	-
Final Speed Adjustment Factor (SAF)	1.000	1.000
Final Capacity Adjustment Factor (CAF)	1.000	1.000
Demand Adjustment Factor (DAF)	1.000	1.000

Demand and Capacity

Demand Volume (Vi)	3266	458
Peak Hour Factor (PHF)	0.94	0.94
Total Trucks, %	15.64	1.75
Single-Unit Trucks (SUT), %	-	-
Tractor-Trailers (TT), %	-	-
Heavy Vehicle Adjustment Factor (fHV)	0.865	0.983
Flow Rate (vi),pc/h	4017	496
Capacity (c), pc/h	4700	2000
Volume-to-Capacity Ratio (v/c)	0.85	0.25

Speed and Density

Upstream Equilibrium Distance (LEQ), ft	-	Number of Outer Lanes on Freeway (NO)	0
Distance to Upstream Ramp (LUP), ft	-	Speed Index (DS)	0.473
Downstream Equilibrium Distance (LEQ), ft	-	Flow Outer Lanes (vOA), pc/h/ln	-
Distance to Downstream Ramp (LDOWN), ft	-	Off-Ramp Influence Area Speed (SR), mi/h	54.1
Prop. Freeway Vehicles in Lane 1 and 2 (PFD)	1.000	Outer Lanes Freeway Speed (SO), mi/h	71.3
Flow in Lanes 1 and 2 (v12), pc/h	4017	Ramp Junction Speed (S), mi/h	54.1
Flow Entering Ramp-Infl. Area (vR12), pc/h	-	Average Density (D), pc/mi/ln	37.1
Level of Service (LOS)	E	Density in Ramp Influence Area (DR), pc/mi/ln	37.6

HCS7 Basic Freeway Report

Project Information

Analyst	LSA	Date	12/11/2019
Agency	LSA	Analysis Year	Existing WP
Jurisdiction	Caltrans	Time Period Analyzed	AM Peak Hour
Project Description	CMD1801 - Village D Specific Plan	Unit	United States Customary

Geometric Data

Number of Lanes, ln	2	Terrain Type	Level
Segment Length (L), ft	-	Percent Grade, %	-
Measured or Base Free-Flow Speed	Base	Grade Length, mi	-
Base Free-Flow Speed (BFFS), mi/h	65.0	Total Ramp Density (TRD), ramps/mi	1.67
Lane Width, ft	12	Free-Flow Speed (FFS), mi/h	60.0
Right-Side Lateral Clearance, ft	10		

Adjustment Factors

Driver Population	All Familiar	Final Speed Adjustment Factor (SAF)	1.000
Weather Type	Non-Severe Weather	Final Capacity Adjustment Factor (CAF)	1.000
Incident Type	No Incident	Demand Adjustment Factor (DAF)	1.000

Demand and Capacity

Demand Volume veh/h	2808	Heavy Vehicle Adjustment Factor (fhv)	0.848
Peak Hour Factor	0.94	Flow Rate (Vp), pc/h/ln	1762
Total Trucks, %	17.90	Capacity (c), pc/h/ln	2300
Single-Unit Trucks (SUT), %	-	Adjusted Capacity (cadj), pc/h/ln	2300
Tractor-Trailers (TT), %	-	Volume-to-Capacity Ratio (v/c)	0.77
Passenger Car Equivalent (Et)	2.000		

Speed and Density

Lane Width Adjustment (fLW)	0.0	Average Speed (S), mi/h	59.5
Right-Side Lateral Clearance Adj. (fRLC)	0.0	Density (D), pc/mi/ln	29.6
Total Ramp Density Adjustment	5.0	Level of Service (LOS)	D
Adjusted Free-Flow Speed (FFSadj), mi/h	60.0		

HCS7 Freeway Merge Report

Project Information

Analyst	LSA	Date	12/11/2019
Agency	LSA	Analysis Year	Existing WP
Jurisdiction	Caltrans	Time Period Analyzed	AM Peak Hour
Project Description	CMD1801 - Village D Specific Plan	Unit	United States Customary

Geometric Data

	Freeway	Ramp
Number of Lanes (N), ln	2	1
Free-Flow Speed (FFS), mi/h	65.0	35.0
Segment Length (L) / Acceleration Length (LA),ft	1500	500
Terrain Type	Level	Level
Percent Grade, %	-	-
Segment Type / Ramp Side	Freeway	Right

Adjustment Factors

Driver Population	All Familiar	All Familiar
Weather Type	Non-Severe Weather	Non-Severe Weather
Incident Type	No Incident	-
Final Speed Adjustment Factor (SAF)	1.000	1.000
Final Capacity Adjustment Factor (CAF)	1.000	1.000
Demand Adjustment Factor (DAF)	1.000	1.000

Demand and Capacity

Demand Volume (Vi)	2808	313
Peak Hour Factor (PHF)	0.94	0.94
Total Trucks, %	17.90	2.56
Single-Unit Trucks (SUT), %	-	-
Tractor-Trailers (TT), %	-	-
Heavy Vehicle Adjustment Factor (fHV)	0.848	0.975
Flow Rate (vi),pc/h	3523	342
Capacity (c), pc/h	4700	2000
Volume-to-Capacity Ratio (v/c)	0.82	0.17

Speed and Density

Upstream Equilibrium Distance (LEQ), ft	-	Number of Outer Lanes on Freeway (NO)	0
Distance to Upstream Ramp (LUP), ft	-	Speed Index (MS)	0.472
Downstream Equilibrium Distance (LEQ), ft	-	Flow Outer Lanes (vOA), pc/h/ln	-
Distance to Downstream Ramp (LDOWN), ft	-	On-Ramp Influence Area Speed (SR), mi/h	54.1
Prop. Freeway Vehicles in Lane 1 and 2 (PFM)	1.000	Outer Lanes Freeway Speed (SO), mi/h	65.0
Flow in Lanes 1 and 2 (v12), pc/h	3523	Ramp Junction Speed (S), mi/h	54.1
Flow Entering Ramp-Infl. Area (vR12), pc/h	3865	Average Density (D), pc/mi/ln	35.7
Level of Service (LOS)	D	Density in Ramp Influence Area (DR), pc/mi/ln	32.4

HCS7 Basic Freeway Report

Project Information

Analyst	LSA	Date	12/11/2019
Agency	LSA	Analysis Year	Existing WP
Jurisdiction	Caltrans	Time Period Analyzed	AM Peak Hour
Project Description	CMD1801 - Village D Specific Plan	Unit	United States Customary

Geometric Data

Number of Lanes, ln	2	Terrain Type	Level
Segment Length (L), ft	-	Percent Grade, %	-
Measured or Base Free-Flow Speed	Base	Grade Length, mi	-
Base Free-Flow Speed (BFFS), mi/h	65.0	Total Ramp Density (TRD), ramps/mi	1.83
Lane Width, ft	12	Free-Flow Speed (FFS), mi/h	59.7
Right-Side Lateral Clearance, ft	10		

Adjustment Factors

Driver Population	All Familiar	Final Speed Adjustment Factor (SAF)	1.000
Weather Type	Non-Severe Weather	Final Capacity Adjustment Factor (CAF)	1.000
Incident Type	No Incident	Demand Adjustment Factor (DAF)	1.000

Demand and Capacity

Demand Volume veh/h	3121	Heavy Vehicle Adjustment Factor (fhv)	0.859
Peak Hour Factor	0.94	Flow Rate (Vp), pc/h/ln	1932
Total Trucks, %	16.36	Capacity (c), pc/h/ln	2296
Single-Unit Trucks (SUT), %	-	Adjusted Capacity (cadj), pc/h/ln	2296
Tractor-Trailers (TT), %	-	Volume-to-Capacity Ratio (v/c)	0.84
Passenger Car Equivalent (Et)	2.000		

Speed and Density

Lane Width Adjustment (fLW)	0.0	Average Speed (S), mi/h	57.7
Right-Side Lateral Clearance Adj. (fRLC)	0.0	Density (D), pc/mi/ln	33.5
Total Ramp Density Adjustment	5.4	Level of Service (LOS)	D
Adjusted Free-Flow Speed (FFSadj), mi/h	59.6		

HCS7 Freeway Diverge Report

Project Information

Analyst	LSA	Date	12/11/2019
Agency	LSA	Analysis Year	Existing WP
Jurisdiction	Caltrans	Time Period Analyzed	AM Peak Hour
Project Description	CMD1801 - Village D Specific Plan	Unit	United States Customary

Geometric Data

	Freeway	Ramp
Number of Lanes (N), ln	2	1
Free-Flow Speed (FFS), mi/h	65.0	35.0
Segment Length (L) / Deceleration Length (LA),ft	1500	245
Terrain Type	Level	Level
Percent Grade, %	-	-
Segment Type / Ramp Side	Freeway	Right

Adjustment Factors

Driver Population	All Familiar	All Familiar
Weather Type	Non-Severe Weather	Non-Severe Weather
Incident Type	No Incident	-
Final Speed Adjustment Factor (SAF)	1.000	1.000
Final Capacity Adjustment Factor (CAF)	1.000	1.000
Demand Adjustment Factor (DAF)	1.000	1.000

Demand and Capacity

Demand Volume (Vi)	3121	626
Peak Hour Factor (PHF)	0.94	0.94
Total Trucks, %	16.36	3.51
Single-Unit Trucks (SUT), %	-	-
Tractor-Trailers (TT), %	-	-
Heavy Vehicle Adjustment Factor (fHV)	0.859	0.966
Flow Rate (vi),pc/h	3865	689
Capacity (c), pc/h	4700	2000
Volume-to-Capacity Ratio (v/c)	0.82	0.34

Speed and Density

Upstream Equilibrium Distance (LEQ), ft	-	Number of Outer Lanes on Freeway (NO)	0
Distance to Upstream Ramp (LUP), ft	-	Speed Index (DS)	0.490
Downstream Equilibrium Distance (LEQ), ft	-	Flow Outer Lanes (vOA), pc/h/ln	-
Distance to Downstream Ramp (LDOWN), ft	-	Off-Ramp Influence Area Speed (SR), mi/h	53.7
Prop. Freeway Vehicles in Lane 1 and 2 (PFD)	1.000	Outer Lanes Freeway Speed (SO), mi/h	71.3
Flow in Lanes 1 and 2 (v12), pc/h	3865	Ramp Junction Speed (S), mi/h	53.7
Flow Entering Ramp-Infl. Area (vR12), pc/h	-	Average Density (D), pc/mi/ln	36.0
Level of Service (LOS)	E	Density in Ramp Influence Area (DR), pc/mi/ln	35.3

HCS7 Basic Freeway Report

Project Information

Analyst	LSA	Date	12/11/2019
Agency	LSA	Analysis Year	Existing WP
Jurisdiction	Caltrans	Time Period Analyzed	AM Peak Hour
Project Description	CMD1801 - Village D Specific Plan	Unit	United States Customary

Geometric Data

Number of Lanes, ln	2	Terrain Type	Level
Segment Length (L), ft	-	Percent Grade, %	-
Measured or Base Free-Flow Speed	Base	Grade Length, mi	-
Base Free-Flow Speed (BFFS), mi/h	65.0	Total Ramp Density (TRD), ramps/mi	1.83
Lane Width, ft	12	Free-Flow Speed (FFS), mi/h	59.7
Right-Side Lateral Clearance, ft	10		

Adjustment Factors

Driver Population	All Familiar	Final Speed Adjustment Factor (SAF)	1.000
Weather Type	Non-Severe Weather	Final Capacity Adjustment Factor (CAF)	1.000
Incident Type	No Incident	Demand Adjustment Factor (DAF)	1.000

Demand and Capacity

Demand Volume veh/h	2495	Heavy Vehicle Adjustment Factor (fhv)	0.836
Peak Hour Factor	0.94	Flow Rate (Vp), pc/h/ln	1588
Total Trucks, %	19.59	Capacity (c), pc/h/ln	2296
Single-Unit Trucks (SUT), %	-	Adjusted Capacity (cadj), pc/h/ln	2296
Tractor-Trailers (TT), %	-	Volume-to-Capacity Ratio (v/c)	0.69
Passenger Car Equivalent (Et)	2.000		

Speed and Density

Lane Width Adjustment (fLW)	0.0	Average Speed (S), mi/h	59.6
Right-Side Lateral Clearance Adj. (fRLC)	0.0	Density (D), pc/mi/ln	26.6
Total Ramp Density Adjustment	5.4	Level of Service (LOS)	D
Adjusted Free-Flow Speed (FFSadj), mi/h	59.6		

HCS7 Freeway Merge Report

Project Information

Analyst	LSA	Date	12/11/2019
Agency	LSA	Analysis Year	Existing WP
Jurisdiction	Caltrans	Time Period Analyzed	AM Peak Hour
Project Description	CMD1801 - Village D Specific Plan	Unit	United States Customary

Geometric Data

	Freeway	Ramp
Number of Lanes (N), ln	2	1
Free-Flow Speed (FFS), mi/h	65.0	35.0
Segment Length (L) / Acceleration Length (LA),ft	1500	350
Terrain Type	Level	Level
Percent Grade, %	-	-
Segment Type / Ramp Side	Freeway	Right

Adjustment Factors

Driver Population	All Familiar	All Familiar
Weather Type	Non-Severe Weather	Non-Severe Weather
Incident Type	No Incident	-
Final Speed Adjustment Factor (SAF)	1.000	1.000
Final Capacity Adjustment Factor (CAF)	1.000	1.000
Demand Adjustment Factor (DAF)	1.000	1.000

Demand and Capacity

Demand Volume (Vi)	2495	173
Peak Hour Factor (PHF)	0.94	0.94
Total Trucks, %	19.59	1.73
Single-Unit Trucks (SUT), %	-	-
Tractor-Trailers (TT), %	-	-
Heavy Vehicle Adjustment Factor (fHV)	0.836	0.983
Flow Rate (vi),pc/h	3175	187
Capacity (c), pc/h	4700	2000
Volume-to-Capacity Ratio (v/c)	0.72	0.09

Speed and Density

Upstream Equilibrium Distance (LEQ), ft	-	Number of Outer Lanes on Freeway (NO)	0
Distance to Upstream Ramp (LUP), ft	-	Speed Index (MS)	0.409
Downstream Equilibrium Distance (LEQ), ft	-	Flow Outer Lanes (vOA), pc/h/ln	-
Distance to Downstream Ramp (LDOWN), ft	-	On-Ramp Influence Area Speed (SR), mi/h	55.6
Prop. Freeway Vehicles in Lane 1 and 2 (PFM)	1.000	Outer Lanes Freeway Speed (SO), mi/h	65.0
Flow in Lanes 1 and 2 (v12), pc/h	3175	Ramp Junction Speed (S), mi/h	55.6
Flow Entering Ramp-Infl. Area (vR12), pc/h	3362	Average Density (D), pc/mi/ln	30.2
Level of Service (LOS)	D	Density in Ramp Influence Area (DR), pc/mi/ln	29.5

HCS7 Basic Freeway Report

Project Information

Analyst	LSA	Date	12/11/2019
Agency	LSA	Analysis Year	Existing WP
Jurisdiction	Caltrans	Time Period Analyzed	AM Peak Hour
Project Description	CMD1801 - Village D Specific Plan	Unit	United States Customary

Geometric Data

Number of Lanes, ln	2	Terrain Type	Level
Segment Length (L), ft	-	Percent Grade, %	-
Measured or Base Free-Flow Speed	Base	Grade Length, mi	-
Base Free-Flow Speed (BFFS), mi/h	65.0	Total Ramp Density (TRD), ramps/mi	1.83
Lane Width, ft	12	Free-Flow Speed (FFS), mi/h	59.7
Right-Side Lateral Clearance, ft	10		

Adjustment Factors

Driver Population	All Familiar	Final Speed Adjustment Factor (SAF)	1.000
Weather Type	Non-Severe Weather	Final Capacity Adjustment Factor (CAF)	1.000
Incident Type	No Incident	Demand Adjustment Factor (DAF)	1.000

Demand and Capacity

Demand Volume veh/h	2668	Heavy Vehicle Adjustment Factor (fhv)	0.844
Peak Hour Factor	0.94	Flow Rate (Vp), pc/h/ln	1682
Total Trucks, %	18.43	Capacity (c), pc/h/ln	2296
Single-Unit Trucks (SUT), %	-	Adjusted Capacity (cadj), pc/h/ln	2296
Tractor-Trailers (TT), %	-	Volume-to-Capacity Ratio (v/c)	0.73
Passenger Car Equivalent (Et)	2.000		

Speed and Density

Lane Width Adjustment (fLW)	0.0	Average Speed (S), mi/h	59.5
Right-Side Lateral Clearance Adj. (fRLC)	0.0	Density (D), pc/mi/ln	28.3
Total Ramp Density Adjustment	5.4	Level of Service (LOS)	D
Adjusted Free-Flow Speed (FFSadj), mi/h	59.6		

HCS7 Freeway Diverge Report

Project Information

Analyst	LSA	Date	12/11/2019
Agency	LSA	Analysis Year	Existing WP
Jurisdiction	Caltrans	Time Period Analyzed	AM Peak Hour
Project Description	CMD1801 - Village D Specific Plan	Unit	United States Customary

Geometric Data

	Freeway	Ramp
Number of Lanes (N), ln	2	1
Free-Flow Speed (FFS), mi/h	65.0	15.0
Segment Length (L) / Deceleration Length (LA),ft	1500	150
Terrain Type	Level	Level
Percent Grade, %	-	-
Segment Type / Ramp Side	Freeway	Right

Adjustment Factors

Driver Population	All Familiar	All Familiar
Weather Type	Non-Severe Weather	Non-Severe Weather
Incident Type	No Incident	-
Final Speed Adjustment Factor (SAF)	1.000	1.000
Final Capacity Adjustment Factor (CAF)	1.000	1.000
Demand Adjustment Factor (DAF)	1.000	1.000

Demand and Capacity

Demand Volume (Vi)	2668	130
Peak Hour Factor (PHF)	0.94	0.94
Total Trucks, %	18.43	5.38
Single-Unit Trucks (SUT), %	-	-
Tractor-Trailers (TT), %	-	-
Heavy Vehicle Adjustment Factor (fHV)	0.844	0.949
Flow Rate (vi),pc/h	3363	146
Capacity (c), pc/h	4700	1800
Volume-to-Capacity Ratio (v/c)	0.72	0.08

Speed and Density

Upstream Equilibrium Distance (LEQ), ft	-	Number of Outer Lanes on Freeway (NO)	0
Distance to Upstream Ramp (LUP), ft	-	Speed Index (DS)	0.701
Downstream Equilibrium Distance (LEQ), ft	-	Flow Outer Lanes (vOA), pc/h/ln	-
Distance to Downstream Ramp (LDOWN), ft	-	Off-Ramp Influence Area Speed (SR), mi/h	48.9
Prop. Freeway Vehicles in Lane 1 and 2 (PFD)	1.000	Outer Lanes Freeway Speed (SO), mi/h	71.3
Flow in Lanes 1 and 2 (v12), pc/h	3363	Ramp Junction Speed (S), mi/h	48.9
Flow Entering Ramp-Infl. Area (vR12), pc/h	-	Average Density (D), pc/mi/ln	34.4
Level of Service (LOS)	D	Density in Ramp Influence Area (DR), pc/mi/ln	31.8

HCS7 Basic Freeway Report

Project Information

Analyst	LSA	Date	12/11/2019
Agency	LSA	Analysis Year	Existing WP
Jurisdiction	Caltrans	Time Period Analyzed	AM Peak Hour
Project Description	CMD1801 - Village D Specific Plan	Unit	United States Customary

Geometric Data

Number of Lanes, ln	2	Terrain Type	Level
Segment Length (L), ft	-	Percent Grade, %	-
Measured or Base Free-Flow Speed	Base	Grade Length, mi	-
Base Free-Flow Speed (BFFS), mi/h	65.0	Total Ramp Density (TRD), ramps/mi	1.67
Lane Width, ft	12	Free-Flow Speed (FFS), mi/h	60.0
Right-Side Lateral Clearance, ft	10		

Adjustment Factors

Driver Population	All Familiar	Final Speed Adjustment Factor (SAF)	1.000
Weather Type	Non-Severe Weather	Final Capacity Adjustment Factor (CAF)	1.000
Incident Type	No Incident	Demand Adjustment Factor (DAF)	1.000

Demand and Capacity

Demand Volume veh/h	2538	Heavy Vehicle Adjustment Factor (fhv)	0.840
Peak Hour Factor	0.94	Flow Rate (Vp), pc/h/ln	1607
Total Trucks, %	19.10	Capacity (c), pc/h/ln	2300
Single-Unit Trucks (SUT), %	-	Adjusted Capacity (cadj), pc/h/ln	2300
Tractor-Trailers (TT), %	-	Volume-to-Capacity Ratio (v/c)	0.70
Passenger Car Equivalent (Et)	2.000		

Speed and Density

Lane Width Adjustment (fLW)	0.0	Average Speed (S), mi/h	60.0
Right-Side Lateral Clearance Adj. (fRLC)	0.0	Density (D), pc/mi/ln	26.8
Total Ramp Density Adjustment	5.0	Level of Service (LOS)	D
Adjusted Free-Flow Speed (FFSadj), mi/h	60.0		

HCS7 Freeway Merge Report

Project Information

Analyst	LSA	Date	12/11/2019
Agency	LSA	Analysis Year	Existing WP
Jurisdiction	Caltrans	Time Period Analyzed	AM Peak Hour
Project Description	CMD1801 - Village D Specific Plan	Unit	United States Customary

Geometric Data

	Freeway	Ramp
Number of Lanes (N), ln	2	1
Free-Flow Speed (FFS), mi/h	65.0	35.0
Segment Length (L) / Acceleration Length (LA),ft	1500	525
Terrain Type	Level	Level
Percent Grade, %	-	-
Segment Type / Ramp Side	Freeway	Right

Adjustment Factors

Driver Population	All Familiar	All Familiar
Weather Type	Non-Severe Weather	Non-Severe Weather
Incident Type	No Incident	-
Final Speed Adjustment Factor (SAF)	1.000	1.000
Final Capacity Adjustment Factor (CAF)	1.000	1.000
Demand Adjustment Factor (DAF)	1.000	1.000

Demand and Capacity

Demand Volume (Vi)	2538	213
Peak Hour Factor (PHF)	0.94	0.94
Total Trucks, %	19.10	4.23
Single-Unit Trucks (SUT), %	-	-
Tractor-Trailers (TT), %	-	-
Heavy Vehicle Adjustment Factor (fHV)	0.840	0.959
Flow Rate (vi),pc/h	3214	236
Capacity (c), pc/h	4700	2000
Volume-to-Capacity Ratio (v/c)	0.73	0.12

Speed and Density

Upstream Equilibrium Distance (LEQ), ft	-	Number of Outer Lanes on Freeway (NO)	0
Distance to Upstream Ramp (LUP), ft	-	Speed Index (MS)	0.407
Downstream Equilibrium Distance (LEQ), ft	-	Flow Outer Lanes (vOA), pc/h/ln	-
Distance to Downstream Ramp (LDOWN), ft	-	On-Ramp Influence Area Speed (SR), mi/h	55.6
Prop. Freeway Vehicles in Lane 1 and 2 (PFM)	1.000	Outer Lanes Freeway Speed (SO), mi/h	65.0
Flow in Lanes 1 and 2 (v12), pc/h	3214	Ramp Junction Speed (S), mi/h	55.6
Flow Entering Ramp-Infl. Area (vR12), pc/h	3450	Average Density (D), pc/mi/ln	31.0
Level of Service (LOS)	D	Density in Ramp Influence Area (DR), pc/mi/ln	29.1

HCS7 Basic Freeway Report

Project Information

Analyst	LSA	Date	12/11/2019
Agency	LSA	Analysis Year	Existing WP
Jurisdiction	Caltrans	Time Period Analyzed	AM Peak Hour
Project Description	CMD1801 - Village D Specific Plan	Unit	United States Customary

Geometric Data

Number of Lanes, ln	2	Terrain Type	Level
Segment Length (L), ft	-	Percent Grade, %	-
Measured or Base Free-Flow Speed	Base	Grade Length, mi	-
Base Free-Flow Speed (BFFS), mi/h	65.0	Total Ramp Density (TRD), ramps/mi	1.67
Lane Width, ft	12	Free-Flow Speed (FFS), mi/h	60.0
Right-Side Lateral Clearance, ft	10		

Adjustment Factors

Driver Population	All Familiar	Final Speed Adjustment Factor (SAF)	1.000
Weather Type	Non-Severe Weather	Final Capacity Adjustment Factor (CAF)	1.000
Incident Type	No Incident	Demand Adjustment Factor (DAF)	1.000

Demand and Capacity

Demand Volume veh/h	2751	Heavy Vehicle Adjustment Factor (fhv)	0.848
Peak Hour Factor	0.94	Flow Rate (Vp), pc/h/ln	1726
Total Trucks, %	17.95	Capacity (c), pc/h/ln	2300
Single-Unit Trucks (SUT), %	-	Adjusted Capacity (cadj), pc/h/ln	2300
Tractor-Trailers (TT), %	-	Volume-to-Capacity Ratio (v/c)	0.75
Passenger Car Equivalent (Et)	2.000		

Speed and Density

Lane Width Adjustment (fLW)	0.0	Average Speed (S), mi/h	59.7
Right-Side Lateral Clearance Adj. (fRLC)	0.0	Density (D), pc/mi/ln	28.9
Total Ramp Density Adjustment	5.0	Level of Service (LOS)	D
Adjusted Free-Flow Speed (FFSadj), mi/h	60.0		

HCS7 Freeway Diverge Report

Project Information

Analyst	LSA	Date	12/11/2019
Agency	LSA	Analysis Year	Existing WP
Jurisdiction	Caltrans	Time Period Analyzed	AM Peak Hour
Project Description	CMD1801 - Village D Specific Plan	Unit	United States Customary

Geometric Data

	Freeway	Ramp
Number of Lanes (N), In	2	1
Free-Flow Speed (FFS), mi/h	65.0	35.0
Segment Length (L) / Deceleration Length (LA),ft	1500	200
Terrain Type	Level	Level
Percent Grade, %	-	-
Segment Type / Ramp Side	Freeway	Right

Adjustment Factors

Driver Population	All Familiar	All Familiar
Weather Type	Non-Severe Weather	Non-Severe Weather
Incident Type	No Incident	-
Final Speed Adjustment Factor (SAF)	1.000	1.000
Final Capacity Adjustment Factor (CAF)	1.000	1.000
Demand Adjustment Factor (DAF)	1.000	1.000

Demand and Capacity

Demand Volume (Vi)	2751	334
Peak Hour Factor (PHF)	0.94	0.94
Total Trucks, %	17.95	3.59
Single-Unit Trucks (SUT), %	-	-
Tractor-Trailers (TT), %	-	-
Heavy Vehicle Adjustment Factor (fHV)	0.848	0.965
Flow Rate (vi),pc/h	3451	368
Capacity (c), pc/h	4700	2000
Volume-to-Capacity Ratio (v/c)	0.73	0.18

Speed and Density

Upstream Equilibrium Distance (LEQ), ft	-	Number of Outer Lanes on Freeway (NO)	0
Distance to Upstream Ramp (LUP), ft	-	Speed Index (DS)	0.461
Downstream Equilibrium Distance (LEQ), ft	-	Flow Outer Lanes (vOA), pc/h/ln	-
Distance to Downstream Ramp (LDOWN), ft	-	Off-Ramp Influence Area Speed (SR), mi/h	54.4
Prop. Freeway Vehicles in Lane 1 and 2 (PFD)	1.000	Outer Lanes Freeway Speed (SO), mi/h	71.3
Flow in Lanes 1 and 2 (v12), pc/h	3451	Ramp Junction Speed (S), mi/h	54.4
Flow Entering Ramp-Infl. Area (vR12), pc/h	-	Average Density (D), pc/mi/ln	31.7
Level of Service (LOS)	D	Density in Ramp Influence Area (DR), pc/mi/ln	32.1

HCS7 Basic Freeway Report

Project Information

Analyst	LSA	Date	12/11/2019
Agency	LSA	Analysis Year	Existing WP
Jurisdiction	Caltrans	Time Period Analyzed	AM Peak Hour
Project Description	CMD1801 - Village D Specific Plan	Unit	United States Customary

Geometric Data

Number of Lanes, ln	2	Terrain Type	Level
Segment Length (L), ft	-	Percent Grade, %	-
Measured or Base Free-Flow Speed	Base	Grade Length, mi	-
Base Free-Flow Speed (BFFS), mi/h	70.0	Total Ramp Density (TRD), ramps/mi	1.50
Lane Width, ft	12	Free-Flow Speed (FFS), mi/h	65.5
Right-Side Lateral Clearance, ft	10		

Adjustment Factors

Driver Population	All Familiar	Final Speed Adjustment Factor (SAF)	1.000
Weather Type	Non-Severe Weather	Final Capacity Adjustment Factor (CAF)	1.000
Incident Type	No Incident	Demand Adjustment Factor (DAF)	1.000

Demand and Capacity

Demand Volume veh/h	2417	Heavy Vehicle Adjustment Factor (fhv)	0.834
Peak Hour Factor	0.94	Flow Rate (Vp), pc/h/ln	1542
Total Trucks, %	19.93	Capacity (c), pc/h/ln	2355
Single-Unit Trucks (SUT), %	-	Adjusted Capacity (cadj), pc/h/ln	2355
Tractor-Trailers (TT), %	-	Volume-to-Capacity Ratio (v/c)	0.65
Passenger Car Equivalent (Et)	2.000		

Speed and Density

Lane Width Adjustment (fLW)	0.0	Average Speed (S), mi/h	65.1
Right-Side Lateral Clearance Adj. (fRLC)	0.0	Density (D), pc/mi/ln	23.7
Total Ramp Density Adjustment	4.5	Level of Service (LOS)	C
Adjusted Free-Flow Speed (FFSadj), mi/h	65.5		

HCS7 Freeway Merge Report

Project Information

Analyst	LSA	Date	12/11/2019
Agency	LSA	Analysis Year	Existing WP
Jurisdiction	Caltrans	Time Period Analyzed	AM Peak Hour
Project Description	CMD1801 - Village D Specific Plan	Unit	United States Customary

Geometric Data

	Freeway	Ramp
Number of Lanes (N), ln	2	1
Free-Flow Speed (FFS), mi/h	70.0	35.0
Segment Length (L) / Acceleration Length (LA),ft	1500	400
Terrain Type	Level	Level
Percent Grade, %	-	-
Segment Type / Ramp Side	Freeway	Right

Adjustment Factors

Driver Population	All Familiar	All Familiar
Weather Type	Non-Severe Weather	Non-Severe Weather
Incident Type	No Incident	-
Final Speed Adjustment Factor (SAF)	1.000	1.000
Final Capacity Adjustment Factor (CAF)	1.000	1.000
Demand Adjustment Factor (DAF)	1.000	1.000

Demand and Capacity

Demand Volume (Vi)	2417	153
Peak Hour Factor (PHF)	0.94	0.94
Total Trucks, %	19.93	10.46
Single-Unit Trucks (SUT), %	-	-
Tractor-Trailers (TT), %	-	-
Heavy Vehicle Adjustment Factor (fHV)	0.834	0.905
Flow Rate (vi),pc/h	3083	180
Capacity (c), pc/h	4800	2000
Volume-to-Capacity Ratio (v/c)	0.68	0.09

Speed and Density

Upstream Equilibrium Distance (LEQ), ft	-	Number of Outer Lanes on Freeway (NO)	0
Distance to Upstream Ramp (LUP), ft	-	Speed Index (MS)	0.395
Downstream Equilibrium Distance (LEQ), ft	-	Flow Outer Lanes (vOA), pc/h/ln	-
Distance to Downstream Ramp (LDOWN), ft	-	On-Ramp Influence Area Speed (SR), mi/h	58.9
Prop. Freeway Vehicles in Lane 1 and 2 (PFM)	1.000	Outer Lanes Freeway Speed (SO), mi/h	70.0
Flow in Lanes 1 and 2 (v12), pc/h	3083	Ramp Junction Speed (S), mi/h	58.9
Flow Entering Ramp-Infl. Area (vR12), pc/h	3263	Average Density (D), pc/mi/ln	27.7
Level of Service (LOS)	D	Density in Ramp Influence Area (DR), pc/mi/ln	28.4

HCS7 Basic Freeway Report

Project Information

Analyst	LSA	Date	12/11/2019
Agency	LSA	Analysis Year	Existing WP
Jurisdiction	Caltrans	Time Period Analyzed	AM Peak Hour
Project Description	CMD1801 - Village D Specific Plan	Unit	United States Customary

Geometric Data

Number of Lanes, ln	2	Terrain Type	Level
Segment Length (L), ft	-	Percent Grade, %	-
Measured or Base Free-Flow Speed	Base	Grade Length, mi	-
Base Free-Flow Speed (BFFS), mi/h	70.0	Total Ramp Density (TRD), ramps/mi	1.00
Lane Width, ft	12	Free-Flow Speed (FFS), mi/h	66.8
Right-Side Lateral Clearance, ft	10		

Adjustment Factors

Driver Population	All Familiar	Final Speed Adjustment Factor (SAF)	1.000
Weather Type	Non-Severe Weather	Final Capacity Adjustment Factor (CAF)	1.000
Incident Type	No Incident	Demand Adjustment Factor (DAF)	1.000

Demand and Capacity

Demand Volume veh/h	2570	Heavy Vehicle Adjustment Factor (fhv)	0.838
Peak Hour Factor	0.94	Flow Rate (Vp), pc/h/ln	1632
Total Trucks, %	19.37	Capacity (c), pc/h/ln	2368
Single-Unit Trucks (SUT), %	-	Adjusted Capacity (cadj), pc/h/ln	2368
Tractor-Trailers (TT), %	-	Volume-to-Capacity Ratio (v/c)	0.69
Passenger Car Equivalent (Et)	2.000		

Speed and Density

Lane Width Adjustment (fLW)	0.0	Average Speed (S), mi/h	65.6
Right-Side Lateral Clearance Adj. (fRLC)	0.0	Density (D), pc/mi/ln	24.9
Total Ramp Density Adjustment	3.2	Level of Service (LOS)	C
Adjusted Free-Flow Speed (FFSadj), mi/h	66.8		

HCS7 Freeway Diverge Report

Project Information

Analyst	LSA	Date	12/11/2019
Agency	LSA	Analysis Year	Existing WP
Jurisdiction	Caltrans	Time Period Analyzed	AM Peak Hour
Project Description	CMD1801 - Village D Specific Plan	Unit	United States Customary

Geometric Data

	Freeway	Ramp
Number of Lanes (N), ln	2	1
Free-Flow Speed (FFS), mi/h	70.0	35.0
Segment Length (L) / Deceleration Length (LA),ft	1500	200
Terrain Type	Level	Level
Percent Grade, %	-	-
Segment Type / Ramp Side	Freeway	Right

Adjustment Factors

Driver Population	All Familiar	All Familiar
Weather Type	Non-Severe Weather	Non-Severe Weather
Incident Type	No Incident	-
Final Speed Adjustment Factor (SAF)	1.000	1.000
Final Capacity Adjustment Factor (CAF)	1.000	1.000
Demand Adjustment Factor (DAF)	1.000	1.000

Demand and Capacity

Demand Volume (Vi)	2570	232
Peak Hour Factor (PHF)	0.94	0.94
Total Trucks, %	19.37	28.45
Single-Unit Trucks (SUT), %	-	-
Tractor-Trailers (TT), %	-	-
Heavy Vehicle Adjustment Factor (fHV)	0.838	0.779
Flow Rate (vi),pc/h	3263	317
Capacity (c), pc/h	4800	2000
Volume-to-Capacity Ratio (v/c)	0.68	0.16

Speed and Density

Upstream Equilibrium Distance (LEQ), ft	-	Number of Outer Lanes on Freeway (NO)	0
Distance to Upstream Ramp (LUP), ft	-	Speed Index (DS)	0.457
Downstream Equilibrium Distance (LEQ), ft	-	Flow Outer Lanes (vOA), pc/h/ln	-
Distance to Downstream Ramp (LDOWN), ft	-	Off-Ramp Influence Area Speed (SR), mi/h	57.2
Prop. Freeway Vehicles in Lane 1 and 2 (PFD)	1.000	Outer Lanes Freeway Speed (SO), mi/h	76.8
Flow in Lanes 1 and 2 (v12), pc/h	3263	Ramp Junction Speed (S), mi/h	57.2
Flow Entering Ramp-Infl. Area (vR12), pc/h	-	Average Density (D), pc/mi/ln	28.5
Level of Service (LOS)	D	Density in Ramp Influence Area (DR), pc/mi/ln	30.5

HCS7 Basic Freeway Report

Project Information

Analyst	LSA	Date	12/11/2019
Agency	LSA	Analysis Year	Existing WP
Jurisdiction	Caltrans	Time Period Analyzed	AM Peak Hour
Project Description	CMD1801 - Village D Specific Plan	Unit	United States Customary

Geometric Data

Number of Lanes, ln	2	Terrain Type	Level
Segment Length (L), ft	-	Percent Grade, %	-
Measured or Base Free-Flow Speed	Base	Grade Length, mi	-
Base Free-Flow Speed (BFFS), mi/h	70.0	Total Ramp Density (TRD), ramps/mi	1.00
Lane Width, ft	12	Free-Flow Speed (FFS), mi/h	66.8
Right-Side Lateral Clearance, ft	10		

Adjustment Factors

Driver Population	All Familiar	Final Speed Adjustment Factor (SAF)	1.000
Weather Type	Non-Severe Weather	Final Capacity Adjustment Factor (CAF)	1.000
Incident Type	No Incident	Demand Adjustment Factor (DAF)	1.000

Demand and Capacity

Demand Volume veh/h	2338	Heavy Vehicle Adjustment Factor (fhv)	0.844
Peak Hour Factor	0.94	Flow Rate (Vp), pc/h/ln	1474
Total Trucks, %	18.47	Capacity (c), pc/h/ln	2368
Single-Unit Trucks (SUT), %	-	Adjusted Capacity (cadj), pc/h/ln	2368
Tractor-Trailers (TT), %	-	Volume-to-Capacity Ratio (v/c)	0.62
Passenger Car Equivalent (Et)	2.000		

Speed and Density

Lane Width Adjustment (fLW)	0.0	Average Speed (S), mi/h	66.5
Right-Side Lateral Clearance Adj. (fRLC)	0.0	Density (D), pc/mi/ln	22.2
Total Ramp Density Adjustment	3.2	Level of Service (LOS)	C
Adjusted Free-Flow Speed (FFSadj), mi/h	66.8		

HCS7 Freeway Merge Report

Project Information

Analyst	LSA	Date	12/11/2019
Agency	LSA	Analysis Year	Existing WP
Jurisdiction	Caltrans	Time Period Analyzed	AM Peak Hour
Project Description	CMD1801 - Village D Specific Plan	Unit	United States Customary

Geometric Data

	Freeway	Ramp
Number of Lanes (N), ln	2	1
Free-Flow Speed (FFS), mi/h	70.0	35.0
Segment Length (L) / Acceleration Length (LA),ft	1500	700
Terrain Type	Level	Level
Percent Grade, %	-	-
Segment Type / Ramp Side	Freeway	Right

Adjustment Factors

Driver Population	All Familiar	All Familiar
Weather Type	Non-Severe Weather	Non-Severe Weather
Incident Type	No Incident	-
Final Speed Adjustment Factor (SAF)	1.000	1.000
Final Capacity Adjustment Factor (CAF)	1.000	1.000
Demand Adjustment Factor (DAF)	1.000	1.000

Demand and Capacity

Demand Volume (Vi)	2338	818
Peak Hour Factor (PHF)	0.94	0.94
Total Trucks, %	18.47	9.66
Single-Unit Trucks (SUT), %	-	-
Tractor-Trailers (TT), %	-	-
Heavy Vehicle Adjustment Factor (fHV)	0.844	0.912
Flow Rate (vi),pc/h	2947	954
Capacity (c), pc/h	4800	2000
Volume-to-Capacity Ratio (v/c)	0.81	0.48

Speed and Density

Upstream Equilibrium Distance (LEQ), ft	-	Number of Outer Lanes on Freeway (NO)	0
Distance to Upstream Ramp (LUP), ft	-	Speed Index (MS)	0.465
Downstream Equilibrium Distance (LEQ), ft	-	Flow Outer Lanes (vOA), pc/h/ln	-
Distance to Downstream Ramp (LDOWN), ft	-	On-Ramp Influence Area Speed (SR), mi/h	57.0
Prop. Freeway Vehicles in Lane 1 and 2 (PFM)	1.000	Outer Lanes Freeway Speed (SO), mi/h	70.0
Flow in Lanes 1 and 2 (v12), pc/h	2947	Ramp Junction Speed (S), mi/h	57.0
Flow Entering Ramp-Infl. Area (vR12), pc/h	3901	Average Density (D), pc/mi/ln	34.2
Level of Service (LOS)	D	Density in Ramp Influence Area (DR), pc/mi/ln	31.1

HCS7 Basic Freeway Report

Project Information

Analyst	LSA	Date	12/11/2019
Agency	LSA	Analysis Year	Existing WP
Jurisdiction	Caltrans	Time Period Analyzed	AM Peak Hour
Project Description	CMD1801 - Village D Specific Plan	Unit	United States Customary

Geometric Data

Number of Lanes, ln	2	Terrain Type	Level
Segment Length (L), ft	-	Percent Grade, %	-
Measured or Base Free-Flow Speed	Base	Grade Length, mi	-
Base Free-Flow Speed (BFFS), mi/h	70.0	Total Ramp Density (TRD), ramps/mi	1.00
Lane Width, ft	12	Free-Flow Speed (FFS), mi/h	66.8
Right-Side Lateral Clearance, ft	10		

Adjustment Factors

Driver Population	All Familiar	Final Speed Adjustment Factor (SAF)	1.000
Weather Type	Non-Severe Weather	Final Capacity Adjustment Factor (CAF)	1.000
Incident Type	No Incident	Demand Adjustment Factor (DAF)	1.000

Demand and Capacity

Demand Volume veh/h	3156	Heavy Vehicle Adjustment Factor (fhv)	0.861
Peak Hour Factor	0.94	Flow Rate (Vp), pc/h/ln	1950
Total Trucks, %	16.18	Capacity (c), pc/h/ln	2368
Single-Unit Trucks (SUT), %	-	Adjusted Capacity (cadj), pc/h/ln	2368
Tractor-Trailers (TT), %	-	Volume-to-Capacity Ratio (v/c)	0.82
Passenger Car Equivalent (Et)	2.000		

Speed and Density

Lane Width Adjustment (fLW)	0.0	Average Speed (S), mi/h	61.7
Right-Side Lateral Clearance Adj. (fRLC)	0.0	Density (D), pc/mi/ln	31.6
Total Ramp Density Adjustment	3.2	Level of Service (LOS)	D
Adjusted Free-Flow Speed (FFSadj), mi/h	66.8		

HCS7 Basic Freeway Report

Project Information

Analyst	LSA	Date	12/11/2019
Agency	LSA	Analysis Year	Existing WP
Jurisdiction	Caltrans	Time Period Analyzed	AM Peak Hour
Project Description	CMD1801 - Village D Specific Plan	Unit	United States Customary

Geometric Data

Number of Lanes, ln	2	Terrain Type	Level
Segment Length (L), ft	-	Percent Grade, %	-
Measured or Base Free-Flow Speed	Base	Grade Length, mi	-
Base Free-Flow Speed (BFFS), mi/h	70.0	Total Ramp Density (TRD), ramps/mi	1.00
Lane Width, ft	12	Free-Flow Speed (FFS), mi/h	66.8
Right-Side Lateral Clearance, ft	10		

Adjustment Factors

Driver Population	All Familiar	Final Speed Adjustment Factor (SAF)	1.000
Weather Type	Non-Severe Weather	Final Capacity Adjustment Factor (CAF)	1.000
Incident Type	No Incident	Demand Adjustment Factor (DAF)	1.000

Demand and Capacity

Demand Volume veh/h	2291	Heavy Vehicle Adjustment Factor (fhv)	0.802
Peak Hour Factor	0.94	Flow Rate (Vp), pc/h/ln	1520
Total Trucks, %	24.76	Capacity (c), pc/h/ln	2368
Single-Unit Trucks (SUT), %	-	Adjusted Capacity (cadj), pc/h/ln	2368
Tractor-Trailers (TT), %	-	Volume-to-Capacity Ratio (v/c)	0.64
Passenger Car Equivalent (Et)	2.000		

Speed and Density

Lane Width Adjustment (fLW)	0.0	Average Speed (S), mi/h	66.3
Right-Side Lateral Clearance Adj. (fRLC)	0.0	Density (D), pc/mi/ln	22.9
Total Ramp Density Adjustment	3.2	Level of Service (LOS)	C
Adjusted Free-Flow Speed (FFSadj), mi/h	66.8		

HCS7 Freeway Diverge Report

Project Information

Analyst	LSA	Date	12/11/2019
Agency	LSA	Analysis Year	Existing WP
Jurisdiction	Caltrans	Time Period Analyzed	AM Peak Hour
Project Description	CMD1801 - Village D Specific Plan	Unit	United States Customary

Geometric Data

	Freeway	Ramp
Number of Lanes (N), ln	2	1
Free-Flow Speed (FFS), mi/h	70.0	50.0
Segment Length (L) / Deceleration Length (LA),ft	1500	150
Terrain Type	Level	Level
Percent Grade, %	-	-
Segment Type / Ramp Side	Freeway	Right

Adjustment Factors

Driver Population	All Familiar	All Familiar
Weather Type	Non-Severe Weather	Non-Severe Weather
Incident Type	No Incident	-
Final Speed Adjustment Factor (SAF)	1.000	1.000
Final Capacity Adjustment Factor (CAF)	1.000	1.000
Demand Adjustment Factor (DAF)	1.000	1.000

Demand and Capacity

Demand Volume (Vi)	2291	350
Peak Hour Factor (PHF)	0.94	0.94
Total Trucks, %	24.76	14.29
Single-Unit Trucks (SUT), %	-	-
Tractor-Trailers (TT), %	-	-
Heavy Vehicle Adjustment Factor (fHV)	0.802	0.875
Flow Rate (vi),pc/h	3039	426
Capacity (c), pc/h	4800	2100
Volume-to-Capacity Ratio (v/c)	0.63	0.20

Speed and Density

Upstream Equilibrium Distance (LEQ), ft	-	Number of Outer Lanes on Freeway (NO)	0
Distance to Upstream Ramp (LUP), ft	-	Speed Index (DS)	0.271
Downstream Equilibrium Distance (LEQ), ft	-	Flow Outer Lanes (vOA), pc/h/ln	-
Distance to Downstream Ramp (LDOWN), ft	-	Off-Ramp Influence Area Speed (SR), mi/h	62.4
Prop. Freeway Vehicles in Lane 1 and 2 (PFD)	1.000	Outer Lanes Freeway Speed (SO), mi/h	76.8
Flow in Lanes 1 and 2 (v12), pc/h	3039	Ramp Junction Speed (S), mi/h	62.4
Flow Entering Ramp-Infl. Area (vR12), pc/h	-	Average Density (D), pc/mi/ln	24.4
Level of Service (LOS)	D	Density in Ramp Influence Area (DR), pc/mi/ln	29.0

HCS7 Basic Freeway Report

Project Information

Analyst	LSA	Date	12/11/2019
Agency	LSA	Analysis Year	Existing WP
Jurisdiction	Caltrans	Time Period Analyzed	AM Peak Hour
Project Description	CMD1801 - Village D Specific Plan	Unit	United States Customary

Geometric Data

Number of Lanes, ln	2	Terrain Type	Level
Segment Length (L), ft	-	Percent Grade, %	-
Measured or Base Free-Flow Speed	Base	Grade Length, mi	-
Base Free-Flow Speed (BFFS), mi/h	70.0	Total Ramp Density (TRD), ramps/mi	1.33
Lane Width, ft	12	Free-Flow Speed (FFS), mi/h	65.9
Right-Side Lateral Clearance, ft	10		

Adjustment Factors

Driver Population	All Familiar	Final Speed Adjustment Factor (SAF)	1.000
Weather Type	Non-Severe Weather	Final Capacity Adjustment Factor (CAF)	1.000
Incident Type	No Incident	Demand Adjustment Factor (DAF)	1.000

Demand and Capacity

Demand Volume veh/h	1941	Heavy Vehicle Adjustment Factor (fhv)	0.790
Peak Hour Factor	0.94	Flow Rate (Vp), pc/h/ln	1307
Total Trucks, %	26.65	Capacity (c), pc/h/ln	2359
Single-Unit Trucks (SUT), %	-	Adjusted Capacity (cadj), pc/h/ln	2359
Tractor-Trailers (TT), %	-	Volume-to-Capacity Ratio (v/c)	0.55
Passenger Car Equivalent (Et)	2.000		

Speed and Density

Lane Width Adjustment (fLW)	0.0	Average Speed (S), mi/h	65.9
Right-Side Lateral Clearance Adj. (fRLC)	0.0	Density (D), pc/mi/ln	19.8
Total Ramp Density Adjustment	4.1	Level of Service (LOS)	C
Adjusted Free-Flow Speed (FFSadj), mi/h	65.9		

HCS7 Freeway Merge Report

Project Information

Analyst	LSA	Date	12/11/2019
Agency	LSA	Analysis Year	Existing WP
Jurisdiction	Caltrans	Time Period Analyzed	AM Peak Hour
Project Description	CMD1801 - Village D Specific Plan	Unit	United States Customary

Geometric Data

	Freeway	Ramp
Number of Lanes (N), ln	2	1
Free-Flow Speed (FFS), mi/h	70.0	35.0
Segment Length (L) / Acceleration Length (LA),ft	1000	600
Terrain Type	Level	Level
Percent Grade, %	-	-
Segment Type / Ramp Side	Freeway	Right

Adjustment Factors

Driver Population	All Familiar	All Familiar
Weather Type	Non-Severe Weather	Non-Severe Weather
Incident Type	No Incident	-
Final Speed Adjustment Factor (SAF)	1.000	1.000
Final Capacity Adjustment Factor (CAF)	1.000	1.000
Demand Adjustment Factor (DAF)	1.000	1.000

Demand and Capacity

Demand Volume (Vi)	1941	36
Peak Hour Factor (PHF)	0.94	0.94
Total Trucks, %	26.65	13.89
Single-Unit Trucks (SUT), %	-	-
Tractor-Trailers (TT), %	-	-
Heavy Vehicle Adjustment Factor (fHV)	0.790	0.878
Flow Rate (vi),pc/h	2614	44
Capacity (c), pc/h	4800	2000
Volume-to-Capacity Ratio (v/c)	0.55	0.02

Speed and Density

Upstream Equilibrium Distance (LEQ), ft	-	Number of Outer Lanes on Freeway (NO)	0
Distance to Upstream Ramp (LUP), ft	-	Speed Index (MS)	0.335
Downstream Equilibrium Distance (LEQ), ft	-	Flow Outer Lanes (vOA), pc/h/ln	-
Distance to Downstream Ramp (LDOWN), ft	-	On-Ramp Influence Area Speed (SR), mi/h	60.6
Prop. Freeway Vehicles in Lane 1 and 2 (PFM)	1.000	Outer Lanes Freeway Speed (SO), mi/h	70.0
Flow in Lanes 1 and 2 (v12), pc/h	2614	Ramp Junction Speed (S), mi/h	60.6
Flow Entering Ramp-Infl. Area (vR12), pc/h	2658	Average Density (D), pc/mi/ln	21.9
Level of Service (LOS)	C	Density in Ramp Influence Area (DR), pc/mi/ln	22.5

HCS7 Basic Freeway Report

Project Information

Analyst	LSA	Date	12/11/2019
Agency	LSA	Analysis Year	Existing WP
Jurisdiction	Caltrans	Time Period Analyzed	AM Peak Hour
Project Description	CMD1801 - Village D Specific Plan	Unit	United States Customary

Geometric Data

Number of Lanes, ln	2	Terrain Type	Level
Segment Length (L), ft	-	Percent Grade, %	-
Measured or Base Free-Flow Speed	Base	Grade Length, mi	-
Base Free-Flow Speed (BFFS), mi/h	70.0	Total Ramp Density (TRD), ramps/mi	1.33
Lane Width, ft	12	Free-Flow Speed (FFS), mi/h	65.9
Right-Side Lateral Clearance, ft	10		

Adjustment Factors

Driver Population	All Familiar	Final Speed Adjustment Factor (SAF)	1.000
Weather Type	Non-Severe Weather	Final Capacity Adjustment Factor (CAF)	1.000
Incident Type	No Incident	Demand Adjustment Factor (DAF)	1.000

Demand and Capacity

Demand Volume veh/h	1977	Heavy Vehicle Adjustment Factor (fhv)	0.791
Peak Hour Factor	0.94	Flow Rate (Vp), pc/h/ln	1330
Total Trucks, %	26.42	Capacity (c), pc/h/ln	2359
Single-Unit Trucks (SUT), %	-	Adjusted Capacity (cadj), pc/h/ln	2359
Tractor-Trailers (TT), %	-	Volume-to-Capacity Ratio (v/c)	0.56
Passenger Car Equivalent (Et)	2.000		

Speed and Density

Lane Width Adjustment (fLW)	0.0	Average Speed (S), mi/h	65.9
Right-Side Lateral Clearance Adj. (fRLC)	0.0	Density (D), pc/mi/ln	20.2
Total Ramp Density Adjustment	4.1	Level of Service (LOS)	C
Adjusted Free-Flow Speed (FFSadj), mi/h	65.9		

HCS7 Freeway Merge Report

Project Information

Analyst	LSA	Date	12/11/2019
Agency	LSA	Analysis Year	Existing WP
Jurisdiction	Caltrans	Time Period Analyzed	AM Peak Hour
Project Description	CMD1801 - Village D Specific Plan	Unit	United States Customary

Geometric Data

	Freeway	Ramp
Number of Lanes (N), ln	2	1
Free-Flow Speed (FFS), mi/h	70.0	35.0
Segment Length (L) / Acceleration Length (LA),ft	1500	500
Terrain Type	Level	Level
Percent Grade, %	-	-
Segment Type / Ramp Side	Freeway	Right

Adjustment Factors

Driver Population	All Familiar	All Familiar
Weather Type	Non-Severe Weather	Non-Severe Weather
Incident Type	No Incident	-
Final Speed Adjustment Factor (SAF)	1.000	1.000
Final Capacity Adjustment Factor (CAF)	1.000	1.000
Demand Adjustment Factor (DAF)	1.000	1.000

Demand and Capacity

Demand Volume (Vi)	1977	188
Peak Hour Factor (PHF)	0.94	0.94
Total Trucks, %	26.42	31.91
Single-Unit Trucks (SUT), %	-	-
Tractor-Trailers (TT), %	-	-
Heavy Vehicle Adjustment Factor (fHV)	0.791	0.758
Flow Rate (vi),pc/h	2659	264
Capacity (c), pc/h	4800	2000
Volume-to-Capacity Ratio (v/c)	0.61	0.13

Speed and Density

Upstream Equilibrium Distance (LEQ), ft	-	Number of Outer Lanes on Freeway (NO)	0
Distance to Upstream Ramp (LUP), ft	-	Speed Index (MS)	0.359
Downstream Equilibrium Distance (LEQ), ft	-	Flow Outer Lanes (vOA), pc/h/ln	-
Distance to Downstream Ramp (LDOWN), ft	-	On-Ramp Influence Area Speed (SR), mi/h	59.9
Prop. Freeway Vehicles in Lane 1 and 2 (PFM)	1.000	Outer Lanes Freeway Speed (SO), mi/h	70.0
Flow in Lanes 1 and 2 (v12), pc/h	2659	Ramp Junction Speed (S), mi/h	59.9
Flow Entering Ramp-Infl. Area (vR12), pc/h	2923	Average Density (D), pc/mi/ln	24.4
Level of Service (LOS)	C	Density in Ramp Influence Area (DR), pc/mi/ln	25.1

HCS7 Basic Freeway Report

Project Information

Analyst	LSA	Date	12/11/2019
Agency	LSA	Analysis Year	Existing WP
Jurisdiction	Caltrans	Time Period Analyzed	AM Peak Hour
Project Description	CMD1801 - Village D Specific Plan	Unit	United States Customary

Geometric Data

Number of Lanes, ln	2	Terrain Type	Level
Segment Length (L), ft	-	Percent Grade, %	-
Measured or Base Free-Flow Speed	Base	Grade Length, mi	-
Base Free-Flow Speed (BFFS), mi/h	70.0	Total Ramp Density (TRD), ramps/mi	1.33
Lane Width, ft	12	Free-Flow Speed (FFS), mi/h	65.9
Right-Side Lateral Clearance, ft	10		

Adjustment Factors

Driver Population	All Familiar	Final Speed Adjustment Factor (SAF)	1.000
Weather Type	Non-Severe Weather	Final Capacity Adjustment Factor (CAF)	1.000
Incident Type	No Incident	Demand Adjustment Factor (DAF)	1.000

Demand and Capacity

Demand Volume veh/h	2165	Heavy Vehicle Adjustment Factor (fhv)	0.788
Peak Hour Factor	0.94	Flow Rate (Vp), pc/h/ln	1462
Total Trucks, %	26.89	Capacity (c), pc/h/ln	2359
Single-Unit Trucks (SUT), %	-	Adjusted Capacity (cadj), pc/h/ln	2359
Tractor-Trailers (TT), %	-	Volume-to-Capacity Ratio (v/c)	0.62
Passenger Car Equivalent (Et)	2.000		

Speed and Density

Lane Width Adjustment (fLW)	0.0	Average Speed (S), mi/h	65.8
Right-Side Lateral Clearance Adj. (fRLC)	0.0	Density (D), pc/mi/ln	22.2
Total Ramp Density Adjustment	4.1	Level of Service (LOS)	C
Adjusted Free-Flow Speed (FFSadj), mi/h	65.9		

HCS7 Freeway Diverge Report

Project Information

Analyst	LSA	Date	12/11/2019
Agency	LSA	Analysis Year	Existing WP
Jurisdiction	Caltrans	Time Period Analyzed	AM Peak Hour
Project Description	CMD1801 - Village D Specific Plan	Unit	United States Customary

Geometric Data

	Freeway	Ramp
Number of Lanes (N), ln	2	1
Free-Flow Speed (FFS), mi/h	70.0	35.0
Segment Length (L) / Deceleration Length (LA),ft	1500	150
Terrain Type	Level	Level
Percent Grade, %	-	-
Segment Type / Ramp Side	Freeway	Right

Adjustment Factors

Driver Population	All Familiar	All Familiar
Weather Type	Non-Severe Weather	Non-Severe Weather
Incident Type	No Incident	-
Final Speed Adjustment Factor (SAF)	1.000	1.000
Final Capacity Adjustment Factor (CAF)	1.000	1.000
Demand Adjustment Factor (DAF)	1.000	1.000

Demand and Capacity

Demand Volume (Vi)	2165	101
Peak Hour Factor (PHF)	0.94	0.94
Total Trucks, %	26.89	18.81
Single-Unit Trucks (SUT), %	-	-
Tractor-Trailers (TT), %	-	-
Heavy Vehicle Adjustment Factor (fHV)	0.788	0.842
Flow Rate (vi),pc/h	2923	128
Capacity (c), pc/h	4800	2000
Volume-to-Capacity Ratio (v/c)	0.61	0.06

Speed and Density

Upstream Equilibrium Distance (LEQ), ft	-	Number of Outer Lanes on Freeway (NO)	0
Distance to Upstream Ramp (LUP), ft	-	Speed Index (DS)	0.440
Downstream Equilibrium Distance (LEQ), ft	-	Flow Outer Lanes (vOA), pc/h/ln	-
Distance to Downstream Ramp (LDOWN), ft	-	Off-Ramp Influence Area Speed (SR), mi/h	57.7
Prop. Freeway Vehicles in Lane 1 and 2 (PFD)	1.000	Outer Lanes Freeway Speed (SO), mi/h	76.8
Flow in Lanes 1 and 2 (v12), pc/h	2923	Ramp Junction Speed (S), mi/h	57.7
Flow Entering Ramp-Infl. Area (vR12), pc/h	-	Average Density (D), pc/mi/ln	25.3
Level of Service (LOS)	C	Density in Ramp Influence Area (DR), pc/mi/ln	28.0

HCS7 Basic Freeway Report

Project Information

Analyst	LSA	Date	12/11/2019
Agency	LSA	Analysis Year	Existing NP
Jurisdiction	Caltrans	Time Period Analyzed	AM Peak Hour
Project Description	CMD1801 - Village D Specific Plan	Unit	United States Customary

Geometric Data

Number of Lanes, ln	2	Terrain Type	Level
Segment Length (L), ft	-	Percent Grade, %	-
Measured or Base Free-Flow Speed	Base	Grade Length, mi	-
Base Free-Flow Speed (BFFS), mi/h	70.0	Total Ramp Density (TRD), ramps/mi	1.67
Lane Width, ft	12	Free-Flow Speed (FFS), mi/h	65.0
Right-Side Lateral Clearance, ft	10		

Adjustment Factors

Driver Population	All Familiar	Final Speed Adjustment Factor (SAF)	1.000
Weather Type	Non-Severe Weather	Final Capacity Adjustment Factor (CAF)	1.000
Incident Type	No Incident	Demand Adjustment Factor (DAF)	1.000

Demand and Capacity

Demand Volume veh/h	2064	Heavy Vehicle Adjustment Factor (fhv)	0.786
Peak Hour Factor	0.94	Flow Rate (Vp), pc/h/ln	1397
Total Trucks, %	27.29	Capacity (c), pc/h/ln	2350
Single-Unit Trucks (SUT), %	-	Adjusted Capacity (cadj), pc/h/ln	2350
Tractor-Trailers (TT), %	-	Volume-to-Capacity Ratio (v/c)	0.59
Passenger Car Equivalent (Et)	2.000		

Speed and Density

Lane Width Adjustment (fLW)	0.0	Average Speed (S), mi/h	65.0
Right-Side Lateral Clearance Adj. (fRLC)	0.0	Density (D), pc/mi/ln	21.5
Total Ramp Density Adjustment	5.0	Level of Service (LOS)	C
Adjusted Free-Flow Speed (FFSadj), mi/h	65.0		

HCS7 Freeway Merge Report

Project Information

Analyst	LSA	Date	12/11/2019
Agency	LSA	Analysis Year	Existing WP
Jurisdiction	Caltrans	Time Period Analyzed	AM Peak Hour
Project Description	CMD1801 - Village D Specific Plan	Unit	United States Customary

Geometric Data

	Freeway	Ramp
Number of Lanes (N), ln	2	1
Free-Flow Speed (FFS), mi/h	65.0	35.0
Segment Length (L) / Acceleration Length (LA),ft	1500	600
Terrain Type	Level	Level
Percent Grade, %	-	-
Segment Type / Ramp Side	Freeway	Right

Adjustment Factors

Driver Population	All Familiar	All Familiar
Weather Type	Non-Severe Weather	Non-Severe Weather
Incident Type	No Incident	-
Final Speed Adjustment Factor (SAF)	1.000	1.000
Final Capacity Adjustment Factor (CAF)	1.000	1.000
Demand Adjustment Factor (DAF)	1.000	1.000

Demand and Capacity

Demand Volume (Vi)	2064	494
Peak Hour Factor (PHF)	0.94	0.94
Total Trucks, %	27.29	4.05
Single-Unit Trucks (SUT), %	-	-
Tractor-Trailers (TT), %	-	-
Heavy Vehicle Adjustment Factor (fHV)	0.786	0.961
Flow Rate (vi),pc/h	2794	547
Capacity (c), pc/h	4700	2000
Volume-to-Capacity Ratio (v/c)	0.71	0.27

Speed and Density

Upstream Equilibrium Distance (LEQ), ft	-	Number of Outer Lanes on Freeway (NO)	0
Distance to Upstream Ramp (LUP), ft	-	Speed Index (MS)	0.389
Downstream Equilibrium Distance (LEQ), ft	-	Flow Outer Lanes (vOA), pc/h/ln	-
Distance to Downstream Ramp (LDOWN), ft	-	On-Ramp Influence Area Speed (SR), mi/h	56.1
Prop. Freeway Vehicles in Lane 1 and 2 (PFM)	1.000	Outer Lanes Freeway Speed (SO), mi/h	65.0
Flow in Lanes 1 and 2 (v12), pc/h	2794	Ramp Junction Speed (S), mi/h	56.1
Flow Entering Ramp-Infl. Area (vR12), pc/h	3341	Average Density (D), pc/mi/ln	29.8
Level of Service (LOS)	C	Density in Ramp Influence Area (DR), pc/mi/ln	27.6

HCS7 Basic Freeway Report

Project Information

Analyst	LSA	Date	12/11/2019
Agency	LSA	Analysis Year	Existing WP
Jurisdiction	Caltrans	Time Period Analyzed	AM Peak Hour
Project Description	CMD1801 - Village D Specific Plan	Unit	United States Customary

Geometric Data

Number of Lanes, ln	2	Terrain Type	Level
Segment Length (L), ft	-	Percent Grade, %	-
Measured or Base Free-Flow Speed	Base	Grade Length, mi	-
Base Free-Flow Speed (BFFS), mi/h	65.0	Total Ramp Density (TRD), ramps/mi	1.83
Lane Width, ft	12	Free-Flow Speed (FFS), mi/h	59.7
Right-Side Lateral Clearance, ft	10		

Adjustment Factors

Driver Population	All Familiar	Final Speed Adjustment Factor (SAF)	1.000
Weather Type	Non-Severe Weather	Final Capacity Adjustment Factor (CAF)	1.000
Incident Type	No Incident	Demand Adjustment Factor (DAF)	1.000

Demand and Capacity

Demand Volume veh/h	2558	Heavy Vehicle Adjustment Factor (fhv)	0.814
Peak Hour Factor	0.94	Flow Rate (Vp), pc/h/ln	1672
Total Trucks, %	22.80	Capacity (c), pc/h/ln	2296
Single-Unit Trucks (SUT), %	-	Adjusted Capacity (cadj), pc/h/ln	2296
Tractor-Trailers (TT), %	-	Volume-to-Capacity Ratio (v/c)	0.73
Passenger Car Equivalent (Et)	2.000		

Speed and Density

Lane Width Adjustment (fLW)	0.0	Average Speed (S), mi/h	59.5
Right-Side Lateral Clearance Adj. (fRLC)	0.0	Density (D), pc/mi/ln	28.1
Total Ramp Density Adjustment	5.4	Level of Service (LOS)	D
Adjusted Free-Flow Speed (FFSadj), mi/h	59.6		

HCS7 Freeway Merge Report

Project Information

Analyst	LSA	Date	12/11/2019
Agency	LSA	Analysis Year	Existing WP
Jurisdiction	Caltrans	Time Period Analyzed	AM Peak Hour
Project Description	CMD1801 - Village D Specific Plan	Unit	United States Customary

Geometric Data

	Freeway	Ramp
Number of Lanes (N), ln	2	1
Free-Flow Speed (FFS), mi/h	65.0	35.0
Segment Length (L) / Acceleration Length (LA),ft	1500	600
Terrain Type	Level	Level
Percent Grade, %	-	-
Segment Type / Ramp Side	Freeway	Right

Adjustment Factors

Driver Population	All Familiar	All Familiar
Weather Type	Non-Severe Weather	Non-Severe Weather
Incident Type	No Incident	-
Final Speed Adjustment Factor (SAF)	1.000	1.000
Final Capacity Adjustment Factor (CAF)	1.000	1.000
Demand Adjustment Factor (DAF)	1.000	1.000

Demand and Capacity

Demand Volume (Vi)	2558	745
Peak Hour Factor (PHF)	0.94	0.94
Total Trucks, %	22.80	1.48
Single-Unit Trucks (SUT), %	-	-
Tractor-Trailers (TT), %	-	-
Heavy Vehicle Adjustment Factor (fHV)	0.814	0.985
Flow Rate (vi),pc/h	3343	805
Capacity (c), pc/h	4700	2000
Volume-to-Capacity Ratio (v/c)	0.88	0.40

Speed and Density

Upstream Equilibrium Distance (LEQ), ft	-	Number of Outer Lanes on Freeway (NO)	0
Distance to Upstream Ramp (LUP), ft	-	Speed Index (MS)	0.526
Downstream Equilibrium Distance (LEQ), ft	-	Flow Outer Lanes (vOA), pc/h/ln	-
Distance to Downstream Ramp (LDOWN), ft	-	On-Ramp Influence Area Speed (SR), mi/h	52.9
Prop. Freeway Vehicles in Lane 1 and 2 (PFM)	1.000	Outer Lanes Freeway Speed (SO), mi/h	65.0
Flow in Lanes 1 and 2 (v12), pc/h	3343	Ramp Junction Speed (S), mi/h	52.9
Flow Entering Ramp-Infl. Area (vR12), pc/h	4148	Average Density (D), pc/mi/ln	39.2
Level of Service (LOS)	D	Density in Ramp Influence Area (DR), pc/mi/ln	33.8

HCS7 Basic Freeway Report

Project Information

Analyst	LSA	Date	12/11/2019
Agency	LSA	Analysis Year	Existing WP
Jurisdiction	Caltrans	Time Period Analyzed	AM Peak Hour
Project Description	CMD1801 - Village D Specific Plan	Unit	United States Customary

Geometric Data

Number of Lanes, ln	2	Terrain Type	Level
Segment Length (L), ft	-	Percent Grade, %	-
Measured or Base Free-Flow Speed	Base	Grade Length, mi	-
Base Free-Flow Speed (BFFS), mi/h	65.0	Total Ramp Density (TRD), ramps/mi	2.17
Lane Width, ft	12	Free-Flow Speed (FFS), mi/h	58.8
Right-Side Lateral Clearance, ft	10		

Adjustment Factors

Driver Population	All Familiar	Final Speed Adjustment Factor (SAF)	1.000
Weather Type	Non-Severe Weather	Final Capacity Adjustment Factor (CAF)	1.000
Incident Type	No Incident	Demand Adjustment Factor (DAF)	1.000

Demand and Capacity

Demand Volume veh/h	3303	Heavy Vehicle Adjustment Factor (fhv)	0.848
Peak Hour Factor	0.94	Flow Rate (Vp), pc/h/ln	2072
Total Trucks, %	17.99	Capacity (c), pc/h/ln	2288
Single-Unit Trucks (SUT), %	-	Adjusted Capacity (cadj), pc/h/ln	2288
Tractor-Trailers (TT), %	-	Volume-to-Capacity Ratio (v/c)	0.91
Passenger Car Equivalent (Et)	2.000		

Speed and Density

Lane Width Adjustment (fLW)	0.0	Average Speed (S), mi/h	55.3
Right-Side Lateral Clearance Adj. (fRLC)	0.0	Density (D), pc/mi/ln	37.5
Total Ramp Density Adjustment	6.2	Level of Service (LOS)	E
Adjusted Free-Flow Speed (FFSadj), mi/h	58.8		

HCS7 Freeway Diverge Report

Project Information

Analyst	LSA	Date	12/11/2019
Agency	LSA	Analysis Year	Existing WP
Jurisdiction	Caltrans	Time Period Analyzed	AM Peak Hour
Project Description	CMD1801 - Village D Specific Plan	Unit	United States Customary

Geometric Data

	Freeway	Ramp
Number of Lanes (N), ln	2	1
Free-Flow Speed (FFS), mi/h	65.0	40.0
Segment Length (L) / Deceleration Length (LA),ft	1500	150
Terrain Type	Level	Level
Percent Grade, %	-	-
Segment Type / Ramp Side	Freeway	Right

Adjustment Factors

Driver Population	All Familiar	All Familiar
Weather Type	Non-Severe Weather	Non-Severe Weather
Incident Type	No Incident	-
Final Speed Adjustment Factor (SAF)	1.000	1.000
Final Capacity Adjustment Factor (CAF)	1.000	1.000
Demand Adjustment Factor (DAF)	1.000	1.000

Demand and Capacity

Demand Volume (Vi)	3303	209
Peak Hour Factor (PHF)	0.94	0.94
Total Trucks, %	17.99	3.35
Single-Unit Trucks (SUT), %	-	-
Tractor-Trailers (TT), %	-	-
Heavy Vehicle Adjustment Factor (fHV)	0.848	0.968
Flow Rate (vi),pc/h	4144	230
Capacity (c), pc/h	4700	2000
Volume-to-Capacity Ratio (v/c)	0.88	0.12

Speed and Density

Upstream Equilibrium Distance (LEQ), ft	-	Number of Outer Lanes on Freeway (NO)	0
Distance to Upstream Ramp (LUP), ft	-	Speed Index (DS)	0.384
Downstream Equilibrium Distance (LEQ), ft	-	Flow Outer Lanes (vOA), pc/h/ln	-
Distance to Downstream Ramp (LDOWN), ft	-	Off-Ramp Influence Area Speed (SR), mi/h	56.2
Prop. Freeway Vehicles in Lane 1 and 2 (PFD)	1.000	Outer Lanes Freeway Speed (SO), mi/h	71.3
Flow in Lanes 1 and 2 (v12), pc/h	4144	Ramp Junction Speed (S), mi/h	56.2
Flow Entering Ramp-Infl. Area (vR12), pc/h	-	Average Density (D), pc/mi/ln	36.9
Level of Service (LOS)	E	Density in Ramp Influence Area (DR), pc/mi/ln	38.5

HCS7 Basic Freeway Report

Project Information

Analyst	LSA	Date	12/11/2019
Agency	LSA	Analysis Year	Existing WP
Jurisdiction	Caltrans	Time Period Analyzed	AM Peak Hour
Project Description	CMD1801 - Village D Specific Plan	Unit	United States Customary

Geometric Data

Number of Lanes, ln	2	Terrain Type	Level
Segment Length (L), ft	-	Percent Grade, %	-
Measured or Base Free-Flow Speed	Base	Grade Length, mi	-
Base Free-Flow Speed (BFFS), mi/h	65.0	Total Ramp Density (TRD), ramps/mi	1.83
Lane Width, ft	12	Free-Flow Speed (FFS), mi/h	59.7
Right-Side Lateral Clearance, ft	10		

Adjustment Factors

Driver Population	All Familiar	Final Speed Adjustment Factor (SAF)	1.000
Weather Type	Non-Severe Weather	Final Capacity Adjustment Factor (CAF)	1.000
Incident Type	No Incident	Demand Adjustment Factor (DAF)	1.000

Demand and Capacity

Demand Volume veh/h	3094	Heavy Vehicle Adjustment Factor (fhv)	0.840
Peak Hour Factor	0.94	Flow Rate (Vp), pc/h/ln	1959
Total Trucks, %	18.98	Capacity (c), pc/h/ln	2296
Single-Unit Trucks (SUT), %	-	Adjusted Capacity (cadj), pc/h/ln	2296
Tractor-Trailers (TT), %	-	Volume-to-Capacity Ratio (v/c)	0.85
Passenger Car Equivalent (Et)	2.000		

Speed and Density

Lane Width Adjustment (fLW)	0.0	Average Speed (S), mi/h	57.4
Right-Side Lateral Clearance Adj. (fRLC)	0.0	Density (D), pc/mi/ln	34.1
Total Ramp Density Adjustment	5.4	Level of Service (LOS)	D
Adjusted Free-Flow Speed (FFSadj), mi/h	59.6		

HCS7 Freeway Merge Report

Project Information

Analyst	LSA	Date	12/11/2019
Agency	LSA	Analysis Year	Existing WP
Jurisdiction	Caltrans	Time Period Analyzed	AM Peak Hour
Project Description	CMD1801 - Village D Specific Plan	Unit	United States Customary

Geometric Data

	Freeway	Ramp
Number of Lanes (N), ln	2	1
Free-Flow Speed (FFS), mi/h	65.0	35.0
Segment Length (L) / Acceleration Length (LA),ft	1500	800
Terrain Type	Level	Level
Percent Grade, %	-	-
Segment Type / Ramp Side	Freeway	Right

Adjustment Factors

Driver Population	All Familiar	All Familiar
Weather Type	Non-Severe Weather	Non-Severe Weather
Incident Type	No Incident	-
Final Speed Adjustment Factor (SAF)	1.000	1.000
Final Capacity Adjustment Factor (CAF)	1.000	1.000
Demand Adjustment Factor (DAF)	1.000	1.000

Demand and Capacity

Demand Volume (Vi)	3094	300
Peak Hour Factor (PHF)	0.94	0.94
Total Trucks, %	18.98	1.67
Single-Unit Trucks (SUT), %	-	-
Tractor-Trailers (TT), %	-	-
Heavy Vehicle Adjustment Factor (fHV)	0.840	0.984
Flow Rate (vi),pc/h	3918	324
Capacity (c), pc/h	4700	2000
Volume-to-Capacity Ratio (v/c)	0.90	0.16

Speed and Density

Upstream Equilibrium Distance (LEQ), ft	-	Number of Outer Lanes on Freeway (NO)	0
Distance to Upstream Ramp (LUP), ft	-	Speed Index (MS)	0.536
Downstream Equilibrium Distance (LEQ), ft	-	Flow Outer Lanes (vOA), pc/h/ln	-
Distance to Downstream Ramp (LDOWN), ft	-	On-Ramp Influence Area Speed (SR), mi/h	52.7
Prop. Freeway Vehicles in Lane 1 and 2 (PFM)	1.000	Outer Lanes Freeway Speed (SO), mi/h	65.0
Flow in Lanes 1 and 2 (v12), pc/h	3918	Ramp Junction Speed (S), mi/h	52.7
Flow Entering Ramp-Infl. Area (vR12), pc/h	4242	Average Density (D), pc/mi/ln	40.2
Level of Service (LOS)	D	Density in Ramp Influence Area (DR), pc/mi/ln	33.5

HCS7 Basic Freeway Report

Project Information

Analyst	LSA	Date	12/11/2019
Agency	LSA	Analysis Year	Existing WP
Jurisdiction	Caltrans	Time Period Analyzed	AM Peak Hour
Project Description	CMD1801 - Village D Specific Plan	Unit	United States Customary

Geometric Data

Number of Lanes, ln	2	Terrain Type	Level
Segment Length (L), ft	-	Percent Grade, %	-
Measured or Base Free-Flow Speed	Base	Grade Length, mi	-
Base Free-Flow Speed (BFFS), mi/h	65.0	Total Ramp Density (TRD), ramps/mi	2.17
Lane Width, ft	12	Free-Flow Speed (FFS), mi/h	58.8
Right-Side Lateral Clearance, ft	10		

Adjustment Factors

Driver Population	All Familiar	Final Speed Adjustment Factor (SAF)	1.000
Weather Type	Non-Severe Weather	Final Capacity Adjustment Factor (CAF)	1.000
Incident Type	No Incident	Demand Adjustment Factor (DAF)	1.000

Demand and Capacity

Demand Volume veh/h	3394	Heavy Vehicle Adjustment Factor (fhv)	0.851
Peak Hour Factor	0.94	Flow Rate (Vp), pc/h/ln	2122
Total Trucks, %	17.45	Capacity (c), pc/h/ln	2288
Single-Unit Trucks (SUT), %	-	Adjusted Capacity (cadj), pc/h/ln	2288
Tractor-Trailers (TT), %	-	Volume-to-Capacity Ratio (v/c)	0.93
Passenger Car Equivalent (Et)	2.000		

Speed and Density

Lane Width Adjustment (fLW)	0.0	Average Speed (S), mi/h	54.4
Right-Side Lateral Clearance Adj. (fRLC)	0.0	Density (D), pc/mi/ln	39.0
Total Ramp Density Adjustment	6.2	Level of Service (LOS)	E
Adjusted Free-Flow Speed (FFSadj), mi/h	58.8		

HCS7 Freeway Diverge Report

Project Information

Analyst	LSA	Date	12/11/2019
Agency	LSA	Analysis Year	Existing WP
Jurisdiction	Caltrans	Time Period Analyzed	AM Peak Hour
Project Description	CMD1801 - Village D Specific Plan	Unit	United States Customary

Geometric Data

	Freeway	Ramp
Number of Lanes (N), ln	2	1
Free-Flow Speed (FFS), mi/h	65.0	35.0
Segment Length (L) / Deceleration Length (LA),ft	1500	200
Terrain Type	Level	Level
Percent Grade, %	-	-
Segment Type / Ramp Side	Freeway	Right

Adjustment Factors

Driver Population	All Familiar	All Familiar
Weather Type	Non-Severe Weather	Non-Severe Weather
Incident Type	No Incident	-
Final Speed Adjustment Factor (SAF)	1.000	1.000
Final Capacity Adjustment Factor (CAF)	1.000	1.000
Demand Adjustment Factor (DAF)	1.000	1.000

Demand and Capacity

Demand Volume (Vi)	3394	320
Peak Hour Factor (PHF)	0.94	0.94
Total Trucks, %	17.45	4.69
Single-Unit Trucks (SUT), %	-	-
Tractor-Trailers (TT), %	-	-
Heavy Vehicle Adjustment Factor (fHV)	0.851	0.955
Flow Rate (vi),pc/h	4243	356
Capacity (c), pc/h	4700	2000
Volume-to-Capacity Ratio (v/c)	0.90	0.18

Speed and Density

Upstream Equilibrium Distance (LEQ), ft	-	Number of Outer Lanes on Freeway (NO)	0
Distance to Upstream Ramp (LUP), ft	-	Speed Index (DS)	0.460
Downstream Equilibrium Distance (LEQ), ft	-	Flow Outer Lanes (vOA), pc/h/ln	-
Distance to Downstream Ramp (LDOWN), ft	-	Off-Ramp Influence Area Speed (SR), mi/h	54.4
Prop. Freeway Vehicles in Lane 1 and 2 (PFD)	1.000	Outer Lanes Freeway Speed (SO), mi/h	71.3
Flow in Lanes 1 and 2 (v12), pc/h	4243	Ramp Junction Speed (S), mi/h	54.4
Flow Entering Ramp-Infl. Area (vR12), pc/h	-	Average Density (D), pc/mi/ln	39.0
Level of Service (LOS)	E	Density in Ramp Influence Area (DR), pc/mi/ln	38.9

HCS7 Basic Freeway Report

Project Information

Analyst	LSA	Date	12/11/2019
Agency	LSA	Analysis Year	Existing WP
Jurisdiction	Caltrans	Time Period Analyzed	AM Peak Hour
Project Description	CMD1801 - Village D Specific Plan	Unit	United States Customary

Geometric Data

Number of Lanes, ln	2	Terrain Type	Level
Segment Length (L), ft	-	Percent Grade, %	-
Measured or Base Free-Flow Speed	Base	Grade Length, mi	-
Base Free-Flow Speed (BFFS), mi/h	65.0	Total Ramp Density (TRD), ramps/mi	2.17
Lane Width, ft	12	Free-Flow Speed (FFS), mi/h	58.8
Right-Side Lateral Clearance, ft	10		

Adjustment Factors

Driver Population	All Familiar	Final Speed Adjustment Factor (SAF)	1.000
Weather Type	Non-Severe Weather	Final Capacity Adjustment Factor (CAF)	1.000
Incident Type	No Incident	Demand Adjustment Factor (DAF)	1.000

Demand and Capacity

Demand Volume veh/h	3074	Heavy Vehicle Adjustment Factor (fhv)	0.842
Peak Hour Factor	0.94	Flow Rate (Vp), pc/h/ln	1942
Total Trucks, %	18.78	Capacity (c), pc/h/ln	2288
Single-Unit Trucks (SUT), %	-	Adjusted Capacity (cadj), pc/h/ln	2288
Tractor-Trailers (TT), %	-	Volume-to-Capacity Ratio (v/c)	0.85
Passenger Car Equivalent (Et)	2.000		

Speed and Density

Lane Width Adjustment (fLW)	0.0	Average Speed (S), mi/h	57.1
Right-Side Lateral Clearance Adj. (fRLC)	0.0	Density (D), pc/mi/ln	34.0
Total Ramp Density Adjustment	6.2	Level of Service (LOS)	D
Adjusted Free-Flow Speed (FFSadj), mi/h	58.8		

HCS7 Freeway Merge Report

Project Information

Analyst	LSA	Date	12/11/2019
Agency	LSA	Analysis Year	Existing WP
Jurisdiction	Caltrans	Time Period Analyzed	AM Peak Hour
Project Description	CMD1801 - Village D Specific Plan	Unit	United States Customary

Geometric Data

	Freeway	Ramp
Number of Lanes (N), ln	2	1
Free-Flow Speed (FFS), mi/h	65.0	35.0
Segment Length (L) / Acceleration Length (LA),ft	1500	350
Terrain Type	Level	Level
Percent Grade, %	-	-
Segment Type / Ramp Side	Freeway	Right

Adjustment Factors

Driver Population	All Familiar	All Familiar
Weather Type	Non-Severe Weather	Non-Severe Weather
Incident Type	No Incident	-
Final Speed Adjustment Factor (SAF)	1.000	1.000
Final Capacity Adjustment Factor (CAF)	1.000	1.000
Demand Adjustment Factor (DAF)	1.000	1.000

Demand and Capacity

Demand Volume (Vi)	3074	1038
Peak Hour Factor (PHF)	0.94	0.94
Total Trucks, %	18.78	1.83
Single-Unit Trucks (SUT), %	-	-
Tractor-Trailers (TT), %	-	-
Heavy Vehicle Adjustment Factor (fHV)	0.842	0.982
Flow Rate (vi),pc/h	3884	1124
Capacity (c), pc/h	4700	2000
Volume-to-Capacity Ratio (v/c)	1.07	0.56

Speed and Density

Upstream Equilibrium Distance (LEQ), ft	-	Number of Outer Lanes on Freeway (NO)	0
Distance to Upstream Ramp (LUP), ft	-	Speed Index (MS)	-
Downstream Equilibrium Distance (LEQ), ft	-	Flow Outer Lanes (vOA), pc/h/ln	-
Distance to Downstream Ramp (LDOWN), ft	-	On-Ramp Influence Area Speed (SR), mi/h	44.8
Prop. Freeway Vehicles in Lane 1 and 2 (PFM)	1.000	Outer Lanes Freeway Speed (SO), mi/h	-
Flow in Lanes 1 and 2 (v12), pc/h	3884	Ramp Junction Speed (S), mi/h	-
Flow Entering Ramp-Infl. Area (vR12), pc/h	5008	Average Density (D), pc/mi/ln	-
Level of Service (LOS)	F	Density in Ramp Influence Area (DR), pc/mi/ln	41.9

HCS7 Basic Freeway Report

Project Information

Analyst	LSA	Date	12/11/2019
Agency	LSA	Analysis Year	Existing WP
Jurisdiction	Caltrans	Time Period Analyzed	AM Peak Hour
Project Description	CMD1801 - Village D Specific Plan	Unit	United States Customary

Geometric Data

Number of Lanes, ln	2	Terrain Type	Level
Segment Length (L), ft	-	Percent Grade, %	-
Measured or Base Free-Flow Speed	Base	Grade Length, mi	-
Base Free-Flow Speed (BFFS), mi/h	65.0	Total Ramp Density (TRD), ramps/mi	2.17
Lane Width, ft	12	Free-Flow Speed (FFS), mi/h	58.8
Right-Side Lateral Clearance, ft	10		

Adjustment Factors

Driver Population	All Familiar	Final Speed Adjustment Factor (SAF)	1.000
Weather Type	Non-Severe Weather	Final Capacity Adjustment Factor (CAF)	1.000
Incident Type	No Incident	Demand Adjustment Factor (DAF)	1.000

Demand and Capacity

Demand Volume veh/h	4112	Heavy Vehicle Adjustment Factor (fhv)	0.873
Peak Hour Factor	0.94	Flow Rate (Vp), pc/h/ln	2506
Total Trucks, %	14.50	Capacity (c), pc/h/ln	2288
Single-Unit Trucks (SUT), %	-	Adjusted Capacity (cadj), pc/h/ln	2288
Tractor-Trailers (TT), %	-	Volume-to-Capacity Ratio (v/c)	1.10
Passenger Car Equivalent (Et)	2.000		

Speed and Density

Lane Width Adjustment (fLW)	0.0	Average Speed (S), mi/h	-
Right-Side Lateral Clearance Adj. (fRLC)	0.0	Density (D), pc/mi/ln	-
Total Ramp Density Adjustment	6.2	Level of Service (LOS)	F
Adjusted Free-Flow Speed (FFSadj), mi/h	58.8		

HCS7 Freeway Diverge Report

Project Information

Analyst	LSA	Date	12/11/2019
Agency	LSA	Analysis Year	Existing WP
Jurisdiction	Caltrans	Time Period Analyzed	AM Peak Hour
Project Description	CMD1801 - Village D Specific Plan	Unit	United States Customary

Geometric Data

	Freeway	Ramp
Number of Lanes (N), ln	2	1
Free-Flow Speed (FFS), mi/h	65.0	15.0
Segment Length (L) / Deceleration Length (LA),ft	1500	150
Terrain Type	Level	Level
Percent Grade, %	-	-
Segment Type / Ramp Side	Freeway	Right

Adjustment Factors

Driver Population	All Familiar	All Familiar
Weather Type	Non-Severe Weather	Non-Severe Weather
Incident Type	No Incident	-
Final Speed Adjustment Factor (SAF)	1.000	1.000
Final Capacity Adjustment Factor (CAF)	1.000	1.000
Demand Adjustment Factor (DAF)	1.000	1.000

Demand and Capacity

Demand Volume (Vi)	4112	510
Peak Hour Factor (PHF)	0.94	0.94
Total Trucks, %	14.50	2.55
Single-Unit Trucks (SUT), %	-	-
Tractor-Trailers (TT), %	-	-
Heavy Vehicle Adjustment Factor (fHV)	0.873	0.975
Flow Rate (vi),pc/h	5011	556
Capacity (c), pc/h	4700	1800
Volume-to-Capacity Ratio (v/c)	1.07	0.31

Speed and Density

Upstream Equilibrium Distance (LEQ), ft	-	Number of Outer Lanes on Freeway (NO)	0
Distance to Upstream Ramp (LUP), ft	-	Speed Index (DS)	-
Downstream Equilibrium Distance (LEQ), ft	-	Flow Outer Lanes (vOA), pc/h/ln	-
Distance to Downstream Ramp (LDOWN), ft	-	Off-Ramp Influence Area Speed (SR), mi/h	48.0
Prop. Freeway Vehicles in Lane 1 and 2 (PFD)	1.000	Outer Lanes Freeway Speed (SO), mi/h	-
Flow in Lanes 1 and 2 (v12), pc/h	5011	Ramp Junction Speed (S), mi/h	-
Flow Entering Ramp-Infl. Area (vR12), pc/h	-	Average Density (D), pc/mi/ln	-
Level of Service (LOS)	F	Density in Ramp Influence Area (DR), pc/mi/ln	46.0

HCS7 Basic Freeway Report

Project Information

Analyst	LSA	Date	12/11/2019
Agency	LSA	Analysis Year	Existing WP
Jurisdiction	Caltrans	Time Period Analyzed	AM Peak Hour
Project Description	CMD1801 - Village D Specific Plan	Unit	United States Customary

Geometric Data

Number of Lanes, ln	2	Terrain Type	Level
Segment Length (L), ft	-	Percent Grade, %	-
Measured or Base Free-Flow Speed	Base	Grade Length, mi	-
Base Free-Flow Speed (BFFS), mi/h	65.0	Total Ramp Density (TRD), ramps/mi	1.83
Lane Width, ft	12	Free-Flow Speed (FFS), mi/h	59.7
Right-Side Lateral Clearance, ft	10		

Adjustment Factors

Driver Population	All Familiar	Final Speed Adjustment Factor (SAF)	1.000
Weather Type	Non-Severe Weather	Final Capacity Adjustment Factor (CAF)	1.000
Incident Type	No Incident	Demand Adjustment Factor (DAF)	1.000

Demand and Capacity

Demand Volume veh/h	3602	Heavy Vehicle Adjustment Factor (fhv)	0.861
Peak Hour Factor	0.94	Flow Rate (Vp), pc/h/ln	2226
Total Trucks, %	16.19	Capacity (c), pc/h/ln	2296
Single-Unit Trucks (SUT), %	-	Adjusted Capacity (cadj), pc/h/ln	2296
Tractor-Trailers (TT), %	-	Volume-to-Capacity Ratio (v/c)	0.97
Passenger Car Equivalent (Et)	2.000		

Speed and Density

Lane Width Adjustment (fLW)	0.0	Average Speed (S), mi/h	52.7
Right-Side Lateral Clearance Adj. (fRLC)	0.0	Density (D), pc/mi/ln	42.2
Total Ramp Density Adjustment	5.4	Level of Service (LOS)	E
Adjusted Free-Flow Speed (FFSadj), mi/h	59.6		

HCS7 Freeway Merge Report

Project Information

Analyst	LSA	Date	12/11/2019
Agency	LSA	Analysis Year	Existing WP
Jurisdiction	Caltrans	Time Period Analyzed	AM Peak Hour
Project Description	CMD1801 - Village D Specific Plan	Unit	United States Customary

Geometric Data

	Freeway	Ramp
Number of Lanes (N), ln	2	1
Free-Flow Speed (FFS), mi/h	65.0	35.0
Segment Length (L) / Acceleration Length (LA),ft	1500	450
Terrain Type	Level	Level
Percent Grade, %	-	-
Segment Type / Ramp Side	Freeway	Right

Adjustment Factors

Driver Population	All Familiar	All Familiar
Weather Type	Non-Severe Weather	Non-Severe Weather
Incident Type	No Incident	-
Final Speed Adjustment Factor (SAF)	1.000	1.000
Final Capacity Adjustment Factor (CAF)	1.000	1.000
Demand Adjustment Factor (DAF)	1.000	1.000

Demand and Capacity

Demand Volume (Vi)	3602	475
Peak Hour Factor (PHF)	0.94	0.94
Total Trucks, %	16.19	0.84
Single-Unit Trucks (SUT), %	-	-
Tractor-Trailers (TT), %	-	-
Heavy Vehicle Adjustment Factor (fHV)	0.861	0.992
Flow Rate (vi),pc/h	4451	509
Capacity (c), pc/h	4700	2000
Volume-to-Capacity Ratio (v/c)	1.06	0.25

Speed and Density

Upstream Equilibrium Distance (LEQ), ft	-	Number of Outer Lanes on Freeway (NO)	0
Distance to Upstream Ramp (LUP), ft	-	Speed Index (MS)	-
Downstream Equilibrium Distance (LEQ), ft	-	Flow Outer Lanes (vOA), pc/h/ln	-
Distance to Downstream Ramp (LDOWN), ft	-	On-Ramp Influence Area Speed (SR), mi/h	45.5
Prop. Freeway Vehicles in Lane 1 and 2 (PFM)	1.000	Outer Lanes Freeway Speed (SO), mi/h	-
Flow in Lanes 1 and 2 (v12), pc/h	4451	Ramp Junction Speed (S), mi/h	-
Flow Entering Ramp-Infl. Area (vR12), pc/h	4960	Average Density (D), pc/mi/ln	-
Level of Service (LOS)	F	Density in Ramp Influence Area (DR), pc/mi/ln	41.2

HCS7 Basic Freeway Report

Project Information

Analyst	LSA	Date	12/11/2019
Agency	LSA	Analysis Year	Existing WP
Jurisdiction	Caltrans	Time Period Analyzed	AM Peak Hour
Project Description	CMD1801 - Village D Specific Plan	Unit	United States Customary

Geometric Data

Number of Lanes, ln	2	Terrain Type	Level
Segment Length (L), ft	-	Percent Grade, %	-
Measured or Base Free-Flow Speed	Base	Grade Length, mi	-
Base Free-Flow Speed (BFFS), mi/h	65.0	Total Ramp Density (TRD), ramps/mi	1.83
Lane Width, ft	12	Free-Flow Speed (FFS), mi/h	59.7
Right-Side Lateral Clearance, ft	10		

Adjustment Factors

Driver Population	All Familiar	Final Speed Adjustment Factor (SAF)	1.000
Weather Type	Non-Severe Weather	Final Capacity Adjustment Factor (CAF)	1.000
Incident Type	No Incident	Demand Adjustment Factor (DAF)	1.000

Demand and Capacity

Demand Volume veh/h	4077	Heavy Vehicle Adjustment Factor (fhv)	0.874
Peak Hour Factor	0.94	Flow Rate (Vp), pc/h/ln	2482
Total Trucks, %	14.40	Capacity (c), pc/h/ln	2296
Single-Unit Trucks (SUT), %	-	Adjusted Capacity (cadj), pc/h/ln	2296
Tractor-Trailers (TT), %	-	Volume-to-Capacity Ratio (v/c)	1.08
Passenger Car Equivalent (Et)	2.000		

Speed and Density

Lane Width Adjustment (fLW)	0.0	Average Speed (S), mi/h	-
Right-Side Lateral Clearance Adj. (fRLC)	0.0	Density (D), pc/mi/ln	-
Total Ramp Density Adjustment	5.4	Level of Service (LOS)	F
Adjusted Free-Flow Speed (FFSadj), mi/h	59.6		

HCS7 Freeway Diverge Report

Project Information

Analyst	LSA	Date	12/11/2019
Agency	LSA	Analysis Year	Existing WP
Jurisdiction	Caltrans	Time Period Analyzed	AM Peak Hour
Project Description	CMD1801 - Village D Specific Plan	Unit	United States Customary

Geometric Data

	Freeway	Ramp
Number of Lanes (N), ln	2	1
Free-Flow Speed (FFS), mi/h	65.0	35.0
Segment Length (L) / Deceleration Length (LA),ft	1500	140
Terrain Type	Level	Level
Percent Grade, %	-	-
Segment Type / Ramp Side	Freeway	Right

Adjustment Factors

Driver Population	All Familiar	All Familiar
Weather Type	Non-Severe Weather	Non-Severe Weather
Incident Type	No Incident	-
Final Speed Adjustment Factor (SAF)	1.000	1.000
Final Capacity Adjustment Factor (CAF)	1.000	1.000
Demand Adjustment Factor (DAF)	1.000	1.000

Demand and Capacity

Demand Volume (Vi)	4077	604
Peak Hour Factor (PHF)	0.94	0.94
Total Trucks, %	14.40	6.46
Single-Unit Trucks (SUT), %	-	-
Tractor-Trailers (TT), %	-	-
Heavy Vehicle Adjustment Factor (fHV)	0.874	0.939
Flow Rate (vi),pc/h	4963	684
Capacity (c), pc/h	4700	2000
Volume-to-Capacity Ratio (v/c)	1.06	0.34

Speed and Density

Upstream Equilibrium Distance (LEQ), ft	-	Number of Outer Lanes on Freeway (NO)	0
Distance to Upstream Ramp (LUP), ft	-	Speed Index (DS)	-
Downstream Equilibrium Distance (LEQ), ft	-	Flow Outer Lanes (vOA), pc/h/ln	-
Distance to Downstream Ramp (LDOWN), ft	-	Off-Ramp Influence Area Speed (SR), mi/h	53.7
Prop. Freeway Vehicles in Lane 1 and 2 (PFD)	1.000	Outer Lanes Freeway Speed (SO), mi/h	-
Flow in Lanes 1 and 2 (v12), pc/h	4963	Ramp Junction Speed (S), mi/h	-
Flow Entering Ramp-Infl. Area (vR12), pc/h	-	Average Density (D), pc/mi/ln	-
Level of Service (LOS)	F	Density in Ramp Influence Area (DR), pc/mi/ln	45.7

HCS7 Basic Freeway Report

Project Information

Analyst	LSA	Date	12/11/2019
Agency	LSA	Analysis Year	Existing WP
Jurisdiction	Caltrans	Time Period Analyzed	AM Peak Hour
Project Description	CMD1801 - Village D Specific Plan	Unit	United States Customary

Geometric Data

Number of Lanes, ln	2	Terrain Type	Level
Segment Length (L), ft	-	Percent Grade, %	-
Measured or Base Free-Flow Speed	Base	Grade Length, mi	-
Base Free-Flow Speed (BFFS), mi/h	65.0	Total Ramp Density (TRD), ramps/mi	2.17
Lane Width, ft	12	Free-Flow Speed (FFS), mi/h	58.8
Right-Side Lateral Clearance, ft	10		

Adjustment Factors

Driver Population	All Familiar	Final Speed Adjustment Factor (SAF)	1.000
Weather Type	Non-Severe Weather	Final Capacity Adjustment Factor (CAF)	1.000
Incident Type	No Incident	Demand Adjustment Factor (DAF)	1.000

Demand and Capacity

Demand Volume veh/h	3473	Heavy Vehicle Adjustment Factor (fhv)	0.864
Peak Hour Factor	0.94	Flow Rate (Vp), pc/h/ln	2138
Total Trucks, %	15.79	Capacity (c), pc/h/ln	2288
Single-Unit Trucks (SUT), %	-	Adjusted Capacity (cadj), pc/h/ln	2288
Tractor-Trailers (TT), %	-	Volume-to-Capacity Ratio (v/c)	0.93
Passenger Car Equivalent (Et)	2.000		

Speed and Density

Lane Width Adjustment (fLW)	0.0	Average Speed (S), mi/h	54.1
Right-Side Lateral Clearance Adj. (fRLC)	0.0	Density (D), pc/mi/ln	39.5
Total Ramp Density Adjustment	6.2	Level of Service (LOS)	E
Adjusted Free-Flow Speed (FFSadj), mi/h	58.8		

HCS7 Freeway Merge Report

Project Information

Analyst	LSA	Date	12/11/2019
Agency	LSA	Analysis Year	Existing WP
Jurisdiction	Caltrans	Time Period Analyzed	AM Peak Hour
Project Description	CMD1801 - Village D Specific Plan	Unit	United States Customary

Geometric Data

	Freeway	Ramp
Number of Lanes (N), ln	2	1
Free-Flow Speed (FFS), mi/h	65.0	35.0
Segment Length (L) / Acceleration Length (LA),ft	1500	450
Terrain Type	Level	Level
Percent Grade, %	-	-
Segment Type / Ramp Side	Freeway	Right

Adjustment Factors

Driver Population	All Familiar	All Familiar
Weather Type	Non-Severe Weather	Non-Severe Weather
Incident Type	No Incident	-
Final Speed Adjustment Factor (SAF)	1.000	1.000
Final Capacity Adjustment Factor (CAF)	1.000	1.000
Demand Adjustment Factor (DAF)	1.000	1.000

Demand and Capacity

Demand Volume (Vi)	3473	489
Peak Hour Factor (PHF)	0.94	0.94
Total Trucks, %	15.79	1.64
Single-Unit Trucks (SUT), %	-	-
Tractor-Trailers (TT), %	-	-
Heavy Vehicle Adjustment Factor (fHV)	0.864	0.984
Flow Rate (vi),pc/h	4276	529
Capacity (c), pc/h	4700	2000
Volume-to-Capacity Ratio (v/c)	1.02	0.26

Speed and Density

Upstream Equilibrium Distance (LEQ), ft	-	Number of Outer Lanes on Freeway (NO)	0
Distance to Upstream Ramp (LUP), ft	-	Speed Index (MS)	-
Downstream Equilibrium Distance (LEQ), ft	-	Flow Outer Lanes (vOA), pc/h/ln	-
Distance to Downstream Ramp (LDOWN), ft	-	On-Ramp Influence Area Speed (SR), mi/h	47.4
Prop. Freeway Vehicles in Lane 1 and 2 (PFM)	1.000	Outer Lanes Freeway Speed (SO), mi/h	-
Flow in Lanes 1 and 2 (v12), pc/h	4276	Ramp Junction Speed (S), mi/h	-
Flow Entering Ramp-Infl. Area (vR12), pc/h	4805	Average Density (D), pc/mi/ln	-
Level of Service (LOS)	F	Density in Ramp Influence Area (DR), pc/mi/ln	40.0

HCS7 Basic Freeway Report

Project Information

Analyst	LSA	Date	12/11/2019
Agency	LSA	Analysis Year	Existing WP
Jurisdiction	Caltrans	Time Period Analyzed	AM Peak Hour
Project Description	CMD1801 - Village D Specific Plan	Unit	United States Customary

Geometric Data

Number of Lanes, ln	2	Terrain Type	Level
Segment Length (L), ft	-	Percent Grade, %	-
Measured or Base Free-Flow Speed	Base	Grade Length, mi	-
Base Free-Flow Speed (BFFS), mi/h	65.0	Total Ramp Density (TRD), ramps/mi	2.17
Lane Width, ft	12	Free-Flow Speed (FFS), mi/h	58.8
Right-Side Lateral Clearance, ft	10		

Adjustment Factors

Driver Population	All Familiar	Final Speed Adjustment Factor (SAF)	1.000
Weather Type	Non-Severe Weather	Final Capacity Adjustment Factor (CAF)	1.000
Incident Type	No Incident	Demand Adjustment Factor (DAF)	1.000

Demand and Capacity

Demand Volume veh/h	3962	Heavy Vehicle Adjustment Factor (fhv)	0.877
Peak Hour Factor	0.94	Flow Rate (Vp), pc/h/ln	2403
Total Trucks, %	14.04	Capacity (c), pc/h/ln	2288
Single-Unit Trucks (SUT), %	-	Adjusted Capacity (cadj), pc/h/ln	2288
Tractor-Trailers (TT), %	-	Volume-to-Capacity Ratio (v/c)	1.05
Passenger Car Equivalent (Et)	2.000		

Speed and Density

Lane Width Adjustment (fLW)	0.0	Average Speed (S), mi/h	-
Right-Side Lateral Clearance Adj. (fRLC)	0.0	Density (D), pc/mi/ln	-
Total Ramp Density Adjustment	6.2	Level of Service (LOS)	F
Adjusted Free-Flow Speed (FFSadj), mi/h	58.8		

HCS7 Basic Freeway Report

Project Information

Analyst	LSA	Date	12/11/2019
Agency	LSA	Analysis Year	Existing WP
Jurisdiction	Caltrans	Time Period Analyzed	PM Peak Hour
Project Description	CMD1801 - Village D Specific Plan	Unit	United States Customary

Geometric Data

Number of Lanes, ln	2	Terrain Type	Level
Segment Length (L), ft	-	Percent Grade, %	-
Measured or Base Free-Flow Speed	Base	Grade Length, mi	-
Base Free-Flow Speed (BFFS), mi/h	65.0	Total Ramp Density (TRD), ramps/mi	1.83
Lane Width, ft	12	Free-Flow Speed (FFS), mi/h	59.7
Right-Side Lateral Clearance, ft	10		

Adjustment Factors

Driver Population	All Familiar	Final Speed Adjustment Factor (SAF)	1.000
Weather Type	Non-Severe Weather	Final Capacity Adjustment Factor (CAF)	1.000
Incident Type	No Incident	Demand Adjustment Factor (DAF)	1.000

Demand and Capacity

Demand Volume veh/h	3772	Heavy Vehicle Adjustment Factor (fhv)	0.878
Peak Hour Factor	0.94	Flow Rate (Vp), pc/h/ln	2285
Total Trucks, %	13.85	Capacity (c), pc/h/ln	2296
Single-Unit Trucks (SUT), %	-	Adjusted Capacity (cadj), pc/h/ln	2296
Tractor-Trailers (TT), %	-	Volume-to-Capacity Ratio (v/c)	1.00
Passenger Car Equivalent (Et)	2.000		

Speed and Density

Lane Width Adjustment (fLW)	0.0	Average Speed (S), mi/h	51.3
Right-Side Lateral Clearance Adj. (fRLC)	0.0	Density (D), pc/mi/ln	44.5
Total Ramp Density Adjustment	5.4	Level of Service (LOS)	E
Adjusted Free-Flow Speed (FFSadj), mi/h	59.6		

HCS7 Freeway Diverge Report

Project Information

Analyst	LSA	Date	12/11/2019
Agency	LSA	Analysis Year	Existing WP
Jurisdiction	Caltrans	Time Period Analyzed	PM Peak Hour
Project Description	CMD1801 - Village D Specific Plan	Unit	United States Customary

Geometric Data

	Freeway	Ramp
Number of Lanes (N), ln	2	1
Free-Flow Speed (FFS), mi/h	65.0	35.0
Segment Length (L) / Deceleration Length (LA),ft	1500	1200
Terrain Type	Level	Level
Percent Grade, %	-	-
Segment Type / Ramp Side	Freeway	Right

Adjustment Factors

Driver Population	All Familiar	All Familiar
Weather Type	Non-Severe Weather	Non-Severe Weather
Incident Type	No Incident	-
Final Speed Adjustment Factor (SAF)	1.000	1.000
Final Capacity Adjustment Factor (CAF)	1.000	1.000
Demand Adjustment Factor (DAF)	1.000	1.000

Demand and Capacity

Demand Volume (Vi)	3772	369
Peak Hour Factor (PHF)	0.94	0.94
Total Trucks, %	13.85	0.54
Single-Unit Trucks (SUT), %	-	-
Tractor-Trailers (TT), %	-	-
Heavy Vehicle Adjustment Factor (fHV)	0.878	0.995
Flow Rate (vi),pc/h	4570	395
Capacity (c), pc/h	4700	2000
Volume-to-Capacity Ratio (v/c)	0.97	0.20

Speed and Density

Upstream Equilibrium Distance (LEQ), ft	-	Number of Outer Lanes on Freeway (NO)	0
Distance to Upstream Ramp (LUP), ft	-	Speed Index (DS)	0.464
Downstream Equilibrium Distance (LEQ), ft	-	Flow Outer Lanes (vOA), pc/h/ln	-
Distance to Downstream Ramp (LDOWN), ft	-	Off-Ramp Influence Area Speed (SR), mi/h	54.3
Prop. Freeway Vehicles in Lane 1 and 2 (PFD)	1.000	Outer Lanes Freeway Speed (SO), mi/h	71.3
Flow in Lanes 1 and 2 (v12), pc/h	4570	Ramp Junction Speed (S), mi/h	54.3
Flow Entering Ramp-Infl. Area (vR12), pc/h	-	Average Density (D), pc/mi/ln	42.1
Level of Service (LOS)	D	Density in Ramp Influence Area (DR), pc/mi/ln	32.8

HCS7 Basic Freeway Report

Project Information

Analyst	LSA	Date	12/11/2019
Agency	LSA	Analysis Year	Existing WP
Jurisdiction	Caltrans	Time Period Analyzed	PM Peak Hour
Project Description	CMD1801 - Village D Specific Plan	Unit	United States Customary

Geometric Data

Number of Lanes, ln	2	Terrain Type	Level
Segment Length (L), ft	-	Percent Grade, %	-
Measured or Base Free-Flow Speed	Base	Grade Length, mi	-
Base Free-Flow Speed (BFFS), mi/h	65.0	Total Ramp Density (TRD), ramps/mi	1.83
Lane Width, ft	12	Free-Flow Speed (FFS), mi/h	59.7
Right-Side Lateral Clearance, ft	10		

Adjustment Factors

Driver Population	All Familiar	Final Speed Adjustment Factor (SAF)	1.000
Weather Type	Non-Severe Weather	Final Capacity Adjustment Factor (CAF)	1.000
Incident Type	No Incident	Demand Adjustment Factor (DAF)	1.000

Demand and Capacity

Demand Volume veh/h	3403	Heavy Vehicle Adjustment Factor (fhv)	0.867
Peak Hour Factor	0.94	Flow Rate (Vp), pc/h/ln	2088
Total Trucks, %	15.30	Capacity (c), pc/h/ln	2296
Single-Unit Trucks (SUT), %	-	Adjusted Capacity (cadj), pc/h/ln	2296
Tractor-Trailers (TT), %	-	Volume-to-Capacity Ratio (v/c)	0.91
Passenger Car Equivalent (Et)	2.000		

Speed and Density

Lane Width Adjustment (fLW)	0.0	Average Speed (S), mi/h	55.5
Right-Side Lateral Clearance Adj. (fRLC)	0.0	Density (D), pc/mi/ln	37.6
Total Ramp Density Adjustment	5.4	Level of Service (LOS)	E
Adjusted Free-Flow Speed (FFSadj), mi/h	59.6		

HCS7 Freeway Merge Report

Project Information

Analyst	LSA	Date	12/11/2019
Agency	LSA	Analysis Year	Existing WP
Jurisdiction	Caltrans	Time Period Analyzed	PM Peak Hour
Project Description	CMD1801 - Village D Specific Plan	Unit	United States Customary

Geometric Data

	Freeway	Ramp
Number of Lanes (N), ln	2	1
Free-Flow Speed (FFS), mi/h	65.0	35.0
Segment Length (L) / Acceleration Length (LA),ft	1500	445
Terrain Type	Level	Level
Percent Grade, %	-	-
Segment Type / Ramp Side	Freeway	Right

Adjustment Factors

Driver Population	All Familiar	All Familiar
Weather Type	Non-Severe Weather	Non-Severe Weather
Incident Type	No Incident	-
Final Speed Adjustment Factor (SAF)	1.000	1.000
Final Capacity Adjustment Factor (CAF)	1.000	1.000
Demand Adjustment Factor (DAF)	1.000	1.000

Demand and Capacity

Demand Volume (Vi)	3403	744
Peak Hour Factor (PHF)	0.94	0.94
Total Trucks, %	15.30	2.02
Single-Unit Trucks (SUT), %	-	-
Tractor-Trailers (TT), %	-	-
Heavy Vehicle Adjustment Factor (fHV)	0.867	0.980
Flow Rate (vi),pc/h	4176	808
Capacity (c), pc/h	4700	2000
Volume-to-Capacity Ratio (v/c)	1.06	0.40

Speed and Density

Upstream Equilibrium Distance (LEQ), ft	-	Number of Outer Lanes on Freeway (NO)	0
Distance to Upstream Ramp (LUP), ft	-	Speed Index (MS)	-
Downstream Equilibrium Distance (LEQ), ft	-	Flow Outer Lanes (vOA), pc/h/ln	-
Distance to Downstream Ramp (LDOWN), ft	-	On-Ramp Influence Area Speed (SR), mi/h	45.2
Prop. Freeway Vehicles in Lane 1 and 2 (PFM)	1.000	Outer Lanes Freeway Speed (SO), mi/h	-
Flow in Lanes 1 and 2 (v12), pc/h	4176	Ramp Junction Speed (S), mi/h	-
Flow Entering Ramp-Infl. Area (vR12), pc/h	4984	Average Density (D), pc/mi/ln	-
Level of Service (LOS)	F	Density in Ramp Influence Area (DR), pc/mi/ln	41.3

HCS7 Basic Freeway Report

Project Information

Analyst	LSA	Date	12/11/2019
Agency	LSA	Analysis Year	Existing WP
Jurisdiction	Caltrans	Time Period Analyzed	PM Peak Hour
Project Description	CMD1801 - Village D Specific Plan	Unit	United States Customary

Geometric Data

Number of Lanes, ln	2	Terrain Type	Level
Segment Length (L), ft	-	Percent Grade, %	-
Measured or Base Free-Flow Speed	Base	Grade Length, mi	-
Base Free-Flow Speed (BFFS), mi/h	65.0	Total Ramp Density (TRD), ramps/mi	1.50
Lane Width, ft	12	Free-Flow Speed (FFS), mi/h	60.5
Right-Side Lateral Clearance, ft	10		

Adjustment Factors

Driver Population	All Familiar	Final Speed Adjustment Factor (SAF)	1.000
Weather Type	Non-Severe Weather	Final Capacity Adjustment Factor (CAF)	1.000
Incident Type	No Incident	Demand Adjustment Factor (DAF)	1.000

Demand and Capacity

Demand Volume veh/h	4147	Heavy Vehicle Adjustment Factor (fhv)	0.886
Peak Hour Factor	0.94	Flow Rate (Vp), pc/h/ln	2490
Total Trucks, %	12.91	Capacity (c), pc/h/ln	2305
Single-Unit Trucks (SUT), %	-	Adjusted Capacity (cadj), pc/h/ln	2305
Tractor-Trailers (TT), %	-	Volume-to-Capacity Ratio (v/c)	1.08
Passenger Car Equivalent (Et)	2.000		

Speed and Density

Lane Width Adjustment (fLW)	0.0	Average Speed (S), mi/h	-
Right-Side Lateral Clearance Adj. (fRLC)	0.0	Density (D), pc/mi/ln	-
Total Ramp Density Adjustment	4.5	Level of Service (LOS)	F
Adjusted Free-Flow Speed (FFSadj), mi/h	60.5		

HCS7 Freeway Diverge Report

Project Information

Analyst	LSA	Date	12/11/2019
Agency	LSA	Analysis Year	Existing WP
Jurisdiction	Caltrans	Time Period Analyzed	PM Peak Hour
Project Description	CMD1801 - Village D Specific Plan	Unit	United States Customary

Geometric Data

	Freeway	Ramp
Number of Lanes (N), ln	2	1
Free-Flow Speed (FFS), mi/h	65.0	35.0
Segment Length (L) / Deceleration Length (LA),ft	1500	130
Terrain Type	Level	Level
Percent Grade, %	-	-
Segment Type / Ramp Side	Freeway	Right

Adjustment Factors

Driver Population	All Familiar	All Familiar
Weather Type	Non-Severe Weather	Non-Severe Weather
Incident Type	No Incident	-
Final Speed Adjustment Factor (SAF)	1.000	1.000
Final Capacity Adjustment Factor (CAF)	1.000	1.000
Demand Adjustment Factor (DAF)	1.000	1.000

Demand and Capacity

Demand Volume (Vi)	4147	402
Peak Hour Factor (PHF)	0.94	0.94
Total Trucks, %	12.91	1.24
Single-Unit Trucks (SUT), %	-	-
Tractor-Trailers (TT), %	-	-
Heavy Vehicle Adjustment Factor (fHV)	0.886	0.988
Flow Rate (vi),pc/h	4979	433
Capacity (c), pc/h	4700	2000
Volume-to-Capacity Ratio (v/c)	1.06	0.22

Speed and Density

Upstream Equilibrium Distance (LEQ), ft	-	Number of Outer Lanes on Freeway (NO)	0
Distance to Upstream Ramp (LUP), ft	-	Speed Index (DS)	-
Downstream Equilibrium Distance (LEQ), ft	-	Flow Outer Lanes (vOA), pc/h/ln	-
Distance to Downstream Ramp (LDOWN), ft	-	Off-Ramp Influence Area Speed (SR), mi/h	54.3
Prop. Freeway Vehicles in Lane 1 and 2 (PFD)	1.000	Outer Lanes Freeway Speed (SO), mi/h	-
Flow in Lanes 1 and 2 (v12), pc/h	4979	Ramp Junction Speed (S), mi/h	-
Flow Entering Ramp-Infl. Area (vR12), pc/h	-	Average Density (D), pc/mi/ln	-
Level of Service (LOS)	F	Density in Ramp Influence Area (DR), pc/mi/ln	45.9

HCS7 Basic Freeway Report

Project Information

Analyst	LSA	Date	12/11/2019
Agency	LSA	Analysis Year	Existing WP
Jurisdiction	Caltrans	Time Period Analyzed	PM Peak Hour
Project Description	CMD1801 - Village D Specific Plan	Unit	United States Customary

Geometric Data

Number of Lanes, ln	2	Terrain Type	Level
Segment Length (L), ft	-	Percent Grade, %	-
Measured or Base Free-Flow Speed	Base	Grade Length, mi	-
Base Free-Flow Speed (BFFS), mi/h	65.0	Total Ramp Density (TRD), ramps/mi	1.67
Lane Width, ft	12	Free-Flow Speed (FFS), mi/h	60.0
Right-Side Lateral Clearance, ft	10		

Adjustment Factors

Driver Population	All Familiar	Final Speed Adjustment Factor (SAF)	1.000
Weather Type	Non-Severe Weather	Final Capacity Adjustment Factor (CAF)	1.000
Incident Type	No Incident	Demand Adjustment Factor (DAF)	1.000

Demand and Capacity

Demand Volume veh/h	3745	Heavy Vehicle Adjustment Factor (fhv)	0.876
Peak Hour Factor	0.94	Flow Rate (Vp), pc/h/ln	2274
Total Trucks, %	14.17	Capacity (c), pc/h/ln	2300
Single-Unit Trucks (SUT), %	-	Adjusted Capacity (cadj), pc/h/ln	2300
Tractor-Trailers (TT), %	-	Volume-to-Capacity Ratio (v/c)	0.99
Passenger Car Equivalent (Et)	2.000		

Speed and Density

Lane Width Adjustment (fLW)	0.0	Average Speed (S), mi/h	51.8
Right-Side Lateral Clearance Adj. (fRLC)	0.0	Density (D), pc/mi/ln	43.9
Total Ramp Density Adjustment	5.0	Level of Service (LOS)	E
Adjusted Free-Flow Speed (FFSadj), mi/h	60.0		

HCS7 Freeway Merge Report

Project Information

Analyst	LSA	Date	12/11/2019
Agency	LSA	Analysis Year	Existing WP
Jurisdiction	Caltrans	Time Period Analyzed	PM Peak Hour
Project Description	CMD1801 - Village D Specific Plan	Unit	United States Customary

Geometric Data

	Freeway	Ramp
Number of Lanes (N), ln	2	1
Free-Flow Speed (FFS), mi/h	65.0	35.0
Segment Length (L) / Acceleration Length (LA),ft	1500	500
Terrain Type	Level	Level
Percent Grade, %	-	-
Segment Type / Ramp Side	Freeway	Right

Adjustment Factors

Driver Population	All Familiar	All Familiar
Weather Type	Non-Severe Weather	Non-Severe Weather
Incident Type	No Incident	-
Final Speed Adjustment Factor (SAF)	1.000	1.000
Final Capacity Adjustment Factor (CAF)	1.000	1.000
Demand Adjustment Factor (DAF)	1.000	1.000

Demand and Capacity

Demand Volume (Vi)	3745	420
Peak Hour Factor (PHF)	0.94	0.94
Total Trucks, %	14.17	1.67
Single-Unit Trucks (SUT), %	-	-
Tractor-Trailers (TT), %	-	-
Heavy Vehicle Adjustment Factor (fHV)	0.876	0.984
Flow Rate (vi),pc/h	4548	454
Capacity (c), pc/h	4700	2000
Volume-to-Capacity Ratio (v/c)	1.06	0.23

Speed and Density

Upstream Equilibrium Distance (LEQ), ft	720.6	Number of Outer Lanes on Freeway (NO)	0
Distance to Upstream Ramp (LUP), ft	-	Speed Index (MS)	-
Downstream Equilibrium Distance (LEQ), ft	0.0	Flow Outer Lanes (vOA), pc/h/ln	-
Distance to Downstream Ramp (LDOWN), ft	-	On-Ramp Influence Area Speed (SR), mi/h	45.1
Prop. Freeway Vehicles in Lane 1 and 2 (PFM)	1.000	Outer Lanes Freeway Speed (SO), mi/h	-
Flow in Lanes 1 and 2 (v12), pc/h	4548	Ramp Junction Speed (S), mi/h	-
Flow Entering Ramp-Infl. Area (vR12), pc/h	5002	Average Density (D), pc/mi/ln	-
Level of Service (LOS)	F	Density in Ramp Influence Area (DR), pc/mi/ln	41.2

HCS7 Basic Freeway Report

Project Information

Analyst	LSA	Date	12/11/2019
Agency	LSA	Analysis Year	Existing WP
Jurisdiction	Caltrans	Time Period Analyzed	PM Peak Hour
Project Description	CMD1801 - Village D Specific Plan	Unit	United States Customary

Geometric Data

Number of Lanes, ln	2	Terrain Type	Level
Segment Length (L), ft	-	Percent Grade, %	-
Measured or Base Free-Flow Speed	Base	Grade Length, mi	-
Base Free-Flow Speed (BFFS), mi/h	65.0	Total Ramp Density (TRD), ramps/mi	1.83
Lane Width, ft	12	Free-Flow Speed (FFS), mi/h	59.7
Right-Side Lateral Clearance, ft	10		

Adjustment Factors

Driver Population	All Familiar	Final Speed Adjustment Factor (SAF)	1.000
Weather Type	Non-Severe Weather	Final Capacity Adjustment Factor (CAF)	1.000
Incident Type	No Incident	Demand Adjustment Factor (DAF)	1.000

Demand and Capacity

Demand Volume veh/h	4165	Heavy Vehicle Adjustment Factor (fhv)	0.886
Peak Hour Factor	0.94	Flow Rate (Vp), pc/h/ln	2500
Total Trucks, %	12.91	Capacity (c), pc/h/ln	2296
Single-Unit Trucks (SUT), %	-	Adjusted Capacity (cadj), pc/h/ln	2296
Tractor-Trailers (TT), %	-	Volume-to-Capacity Ratio (v/c)	1.09
Passenger Car Equivalent (Et)	2.000		

Speed and Density

Lane Width Adjustment (fLW)	0.0	Average Speed (S), mi/h	-
Right-Side Lateral Clearance Adj. (fRLC)	0.0	Density (D), pc/mi/ln	-
Total Ramp Density Adjustment	5.4	Level of Service (LOS)	F
Adjusted Free-Flow Speed (FFSadj), mi/h	59.6		

HCS7 Freeway Diverge Report

Project Information

Analyst	LSA	Date	12/11/2019
Agency	LSA	Analysis Year	Existing WP
Jurisdiction	Caltrans	Time Period Analyzed	PM Peak Hour
Project Description	CMD1801 - Village D Specific Plan	Unit	United States Customary

Geometric Data

	Freeway	Ramp
Number of Lanes (N), ln	2	1
Free-Flow Speed (FFS), mi/h	65.0	35.0
Segment Length (L) / Deceleration Length (LA),ft	1500	245
Terrain Type	Level	Level
Percent Grade, %	-	-
Segment Type / Ramp Side	Freeway	Right

Adjustment Factors

Driver Population	All Familiar	All Familiar
Weather Type	Non-Severe Weather	Non-Severe Weather
Incident Type	No Incident	-
Final Speed Adjustment Factor (SAF)	1.000	1.000
Final Capacity Adjustment Factor (CAF)	1.000	1.000
Demand Adjustment Factor (DAF)	1.000	1.000

Demand and Capacity

Demand Volume (Vi)	4165	1110
Peak Hour Factor (PHF)	0.94	0.94
Total Trucks, %	12.91	0.63
Single-Unit Trucks (SUT), %	-	-
Tractor-Trailers (TT), %	-	-
Heavy Vehicle Adjustment Factor (fHV)	0.886	0.994
Flow Rate (vi),pc/h	5001	1188
Capacity (c), pc/h	4700	2000
Volume-to-Capacity Ratio (v/c)	1.06	0.59

Speed and Density

Upstream Equilibrium Distance (LEQ), ft	-	Number of Outer Lanes on Freeway (NO)	0
Distance to Upstream Ramp (LUP), ft	-	Speed Index (DS)	-
Downstream Equilibrium Distance (LEQ), ft	-	Flow Outer Lanes (vOA), pc/h/ln	-
Distance to Downstream Ramp (LDOWN), ft	-	Off-Ramp Influence Area Speed (SR), mi/h	52.7
Prop. Freeway Vehicles in Lane 1 and 2 (PFD)	1.000	Outer Lanes Freeway Speed (SO), mi/h	-
Flow in Lanes 1 and 2 (v12), pc/h	5001	Ramp Junction Speed (S), mi/h	-
Flow Entering Ramp-Infl. Area (vR12), pc/h	-	Average Density (D), pc/mi/ln	-
Level of Service (LOS)	F	Density in Ramp Influence Area (DR), pc/mi/ln	45.1

HCS7 Basic Freeway Report

Project Information

Analyst	LSA	Date	12/11/2019
Agency	LSA	Analysis Year	Existing WP
Jurisdiction	Caltrans	Time Period Analyzed	PM Peak Hour
Project Description	CMD1801 - Village D Specific Plan	Unit	United States Customary

Geometric Data

Number of Lanes, ln	2	Terrain Type	Level
Segment Length (L), ft	-	Percent Grade, %	-
Measured or Base Free-Flow Speed	Base	Grade Length, mi	-
Base Free-Flow Speed (BFFS), mi/h	65.0	Total Ramp Density (TRD), ramps/mi	1.83
Lane Width, ft	12	Free-Flow Speed (FFS), mi/h	59.7
Right-Side Lateral Clearance, ft	10		

Adjustment Factors

Driver Population	All Familiar	Final Speed Adjustment Factor (SAF)	1.000
Weather Type	Non-Severe Weather	Final Capacity Adjustment Factor (CAF)	1.000
Incident Type	No Incident	Demand Adjustment Factor (DAF)	1.000

Demand and Capacity

Demand Volume veh/h	3055	Heavy Vehicle Adjustment Factor (fhv)	0.852
Peak Hour Factor	0.94	Flow Rate (Vp), pc/h/ln	1908
Total Trucks, %	17.37	Capacity (c), pc/h/ln	2296
Single-Unit Trucks (SUT), %	-	Adjusted Capacity (cadj), pc/h/ln	2296
Tractor-Trailers (TT), %	-	Volume-to-Capacity Ratio (v/c)	0.83
Passenger Car Equivalent (Et)	2.000		

Speed and Density

Lane Width Adjustment (fLW)	0.0	Average Speed (S), mi/h	58.0
Right-Side Lateral Clearance Adj. (fRLC)	0.0	Density (D), pc/mi/ln	32.9
Total Ramp Density Adjustment	5.4	Level of Service (LOS)	D
Adjusted Free-Flow Speed (FFSadj), mi/h	59.6		

HCS7 Freeway Merge Report

Project Information

Analyst	LSA	Date	12/11/2019
Agency	LSA	Analysis Year	Existing WP
Jurisdiction	Caltrans	Time Period Analyzed	PM Peak Hour
Project Description	CMD1801 - Village D Specific Plan	Unit	United States Customary

Geometric Data

	Freeway	Ramp
Number of Lanes (N), ln	2	1
Free-Flow Speed (FFS), mi/h	65.0	35.0
Segment Length (L) / Acceleration Length (LA),ft	1500	350
Terrain Type	Level	Level
Percent Grade, %	-	-
Segment Type / Ramp Side	Freeway	Right

Adjustment Factors

Driver Population	All Familiar	All Familiar
Weather Type	Non-Severe Weather	Non-Severe Weather
Incident Type	No Incident	-
Final Speed Adjustment Factor (SAF)	1.000	1.000
Final Capacity Adjustment Factor (CAF)	1.000	1.000
Demand Adjustment Factor (DAF)	1.000	1.000

Demand and Capacity

Demand Volume (Vi)	3055	344
Peak Hour Factor (PHF)	0.94	0.94
Total Trucks, %	17.37	2.33
Single-Unit Trucks (SUT), %	-	-
Tractor-Trailers (TT), %	-	-
Heavy Vehicle Adjustment Factor (fHV)	0.852	0.977
Flow Rate (vi),pc/h	3815	375
Capacity (c), pc/h	4700	2000
Volume-to-Capacity Ratio (v/c)	0.89	0.19

Speed and Density

Upstream Equilibrium Distance (LEQ), ft	-	Number of Outer Lanes on Freeway (NO)	0
Distance to Upstream Ramp (LUP), ft	-	Speed Index (MS)	0.554
Downstream Equilibrium Distance (LEQ), ft	-	Flow Outer Lanes (vOA), pc/h/ln	-
Distance to Downstream Ramp (LDOWN), ft	-	On-Ramp Influence Area Speed (SR), mi/h	52.3
Prop. Freeway Vehicles in Lane 1 and 2 (PFM)	1.000	Outer Lanes Freeway Speed (SO), mi/h	65.0
Flow in Lanes 1 and 2 (v12), pc/h	3815	Ramp Junction Speed (S), mi/h	52.3
Flow Entering Ramp-Infl. Area (vR12), pc/h	4190	Average Density (D), pc/mi/ln	40.1
Level of Service (LOS)	E	Density in Ramp Influence Area (DR), pc/mi/ln	35.9

HCS7 Basic Freeway Report

Project Information

Analyst	LSA	Date	12/11/2019
Agency	LSA	Analysis Year	Existing WP
Jurisdiction	Caltrans	Time Period Analyzed	PM Peak Hour
Project Description	CMD1801 - Village D Specific Plan	Unit	United States Customary

Geometric Data

Number of Lanes, ln	2	Terrain Type	Level
Segment Length (L), ft	-	Percent Grade, %	-
Measured or Base Free-Flow Speed	Base	Grade Length, mi	-
Base Free-Flow Speed (BFFS), mi/h	65.0	Total Ramp Density (TRD), ramps/mi	1.83
Lane Width, ft	12	Free-Flow Speed (FFS), mi/h	59.7
Right-Side Lateral Clearance, ft	10		

Adjustment Factors

Driver Population	All Familiar	Final Speed Adjustment Factor (SAF)	1.000
Weather Type	Non-Severe Weather	Final Capacity Adjustment Factor (CAF)	1.000
Incident Type	No Incident	Demand Adjustment Factor (DAF)	1.000

Demand and Capacity

Demand Volume veh/h	3399	Heavy Vehicle Adjustment Factor (fhv)	0.863
Peak Hour Factor	0.94	Flow Rate (Vp), pc/h/ln	2095
Total Trucks, %	15.84	Capacity (c), pc/h/ln	2296
Single-Unit Trucks (SUT), %	-	Adjusted Capacity (cadj), pc/h/ln	2296
Tractor-Trailers (TT), %	-	Volume-to-Capacity Ratio (v/c)	0.91
Passenger Car Equivalent (Et)	2.000		

Speed and Density

Lane Width Adjustment (fLW)	0.0	Average Speed (S), mi/h	55.3
Right-Side Lateral Clearance Adj. (fRLC)	0.0	Density (D), pc/mi/ln	37.9
Total Ramp Density Adjustment	5.4	Level of Service (LOS)	E
Adjusted Free-Flow Speed (FFSadj), mi/h	59.6		

HCS7 Freeway Diverge Report

Project Information

Analyst	LSA	Date	12/11/2019
Agency	LSA	Analysis Year	Existing WP
Jurisdiction	Caltrans	Time Period Analyzed	PM Peak Hour
Project Description	CMD1801 - Village D Specific Plan	Unit	United States Customary

Geometric Data

	Freeway	Ramp
Number of Lanes (N), ln	2	1
Free-Flow Speed (FFS), mi/h	65.0	15.0
Segment Length (L) / Deceleration Length (LA),ft	1500	150
Terrain Type	Level	Level
Percent Grade, %	-	-
Segment Type / Ramp Side	Freeway	Right

Adjustment Factors

Driver Population	All Familiar	All Familiar
Weather Type	Non-Severe Weather	Non-Severe Weather
Incident Type	No Incident	-
Final Speed Adjustment Factor (SAF)	1.000	1.000
Final Capacity Adjustment Factor (CAF)	1.000	1.000
Demand Adjustment Factor (DAF)	1.000	1.000

Demand and Capacity

Demand Volume (Vi)	3399	261
Peak Hour Factor (PHF)	0.94	0.94
Total Trucks, %	15.84	1.92
Single-Unit Trucks (SUT), %	-	-
Tractor-Trailers (TT), %	-	-
Heavy Vehicle Adjustment Factor (fHV)	0.863	0.981
Flow Rate (vi),pc/h	4190	283
Capacity (c), pc/h	4700	1800
Volume-to-Capacity Ratio (v/c)	0.89	0.16

Speed and Density

Upstream Equilibrium Distance (LEQ), ft	-	Number of Outer Lanes on Freeway (NO)	0
Distance to Upstream Ramp (LUP), ft	-	Speed Index (DS)	0.713
Downstream Equilibrium Distance (LEQ), ft	-	Flow Outer Lanes (vOA), pc/h/ln	-
Distance to Downstream Ramp (LDOWN), ft	-	Off-Ramp Influence Area Speed (SR), mi/h	48.6
Prop. Freeway Vehicles in Lane 1 and 2 (PFD)	1.000	Outer Lanes Freeway Speed (SO), mi/h	71.3
Flow in Lanes 1 and 2 (v12), pc/h	4190	Ramp Junction Speed (S), mi/h	48.6
Flow Entering Ramp-Infl. Area (vR12), pc/h	-	Average Density (D), pc/mi/ln	43.1
Level of Service (LOS)	E	Density in Ramp Influence Area (DR), pc/mi/ln	38.9

HCS7 Basic Freeway Report

Project Information

Analyst	LSA	Date	12/11/2019
Agency	LSA	Analysis Year	Existing WP
Jurisdiction	Caltrans	Time Period Analyzed	PM Peak Hour
Project Description	CMD1801 - Village D Specific Plan	Unit	United States Customary

Geometric Data

Number of Lanes, ln	2	Terrain Type	Level
Segment Length (L), ft	-	Percent Grade, %	-
Measured or Base Free-Flow Speed	Base	Grade Length, mi	-
Base Free-Flow Speed (BFFS), mi/h	65.0	Total Ramp Density (TRD), ramps/mi	1.67
Lane Width, ft	12	Free-Flow Speed (FFS), mi/h	60.0
Right-Side Lateral Clearance, ft	10		

Adjustment Factors

Driver Population	All Familiar	Final Speed Adjustment Factor (SAF)	1.000
Weather Type	Non-Severe Weather	Final Capacity Adjustment Factor (CAF)	1.000
Incident Type	No Incident	Demand Adjustment Factor (DAF)	1.000

Demand and Capacity

Demand Volume veh/h	3138	Heavy Vehicle Adjustment Factor (fhv)	0.855
Peak Hour Factor	0.94	Flow Rate (Vp), pc/h/ln	1952
Total Trucks, %	17.00	Capacity (c), pc/h/ln	2300
Single-Unit Trucks (SUT), %	-	Adjusted Capacity (cadj), pc/h/ln	2300
Tractor-Trailers (TT), %	-	Volume-to-Capacity Ratio (v/c)	0.85
Passenger Car Equivalent (Et)	2.000		

Speed and Density

Lane Width Adjustment (fLW)	0.0	Average Speed (S), mi/h	57.8
Right-Side Lateral Clearance Adj. (fRLC)	0.0	Density (D), pc/mi/ln	33.8
Total Ramp Density Adjustment	5.0	Level of Service (LOS)	D
Adjusted Free-Flow Speed (FFSadj), mi/h	60.0		

HCS7 Freeway Merge Report

Project Information

Analyst	LSA	Date	12/11/2019
Agency	LSA	Analysis Year	Existing WP
Jurisdiction	Caltrans	Time Period Analyzed	PM Peak Hour
Project Description	CMD1801 - Village D Specific Plan	Unit	United States Customary

Geometric Data

	Freeway	Ramp
Number of Lanes (N), ln	2	1
Free-Flow Speed (FFS), mi/h	65.0	35.0
Segment Length (L) / Acceleration Length (LA),ft	1500	525
Terrain Type	Level	Level
Percent Grade, %	-	-
Segment Type / Ramp Side	Freeway	Right

Adjustment Factors

Driver Population	All Familiar	All Familiar
Weather Type	Non-Severe Weather	Non-Severe Weather
Incident Type	No Incident	-
Final Speed Adjustment Factor (SAF)	1.000	1.000
Final Capacity Adjustment Factor (CAF)	1.000	1.000
Demand Adjustment Factor (DAF)	1.000	1.000

Demand and Capacity

Demand Volume (Vi)	3138	250
Peak Hour Factor (PHF)	0.94	0.94
Total Trucks, %	17.00	4.00
Single-Unit Trucks (SUT), %	-	-
Tractor-Trailers (TT), %	-	-
Heavy Vehicle Adjustment Factor (fHV)	0.855	0.962
Flow Rate (vi),pc/h	3904	276
Capacity (c), pc/h	4700	2000
Volume-to-Capacity Ratio (v/c)	0.89	0.14

Speed and Density

Upstream Equilibrium Distance (LEQ), ft	-	Number of Outer Lanes on Freeway (NO)	0
Distance to Upstream Ramp (LUP), ft	-	Speed Index (MS)	0.539
Downstream Equilibrium Distance (LEQ), ft	-	Flow Outer Lanes (vOA), pc/h/ln	-
Distance to Downstream Ramp (LDOWN), ft	-	On-Ramp Influence Area Speed (SR), mi/h	52.6
Prop. Freeway Vehicles in Lane 1 and 2 (PFM)	1.000	Outer Lanes Freeway Speed (SO), mi/h	65.0
Flow in Lanes 1 and 2 (v12), pc/h	3904	Ramp Junction Speed (S), mi/h	52.6
Flow Entering Ramp-Infl. Area (vR12), pc/h	4180	Average Density (D), pc/mi/ln	39.7
Level of Service (LOS)	D	Density in Ramp Influence Area (DR), pc/mi/ln	34.7

HCS7 Basic Freeway Report

Project Information

Analyst	LSA	Date	12/11/2019
Agency	LSA	Analysis Year	Existing WP
Jurisdiction	Caltrans	Time Period Analyzed	PM Peak Hour
Project Description	CMD1801 - Village D Specific Plan	Unit	United States Customary

Geometric Data

Number of Lanes, ln	2	Terrain Type	Level
Segment Length (L), ft	-	Percent Grade, %	-
Measured or Base Free-Flow Speed	Base	Grade Length, mi	-
Base Free-Flow Speed (BFFS), mi/h	65.0	Total Ramp Density (TRD), ramps/mi	1.67
Lane Width, ft	12	Free-Flow Speed (FFS), mi/h	60.0
Right-Side Lateral Clearance, ft	10		

Adjustment Factors

Driver Population	All Familiar	Final Speed Adjustment Factor (SAF)	1.000
Weather Type	Non-Severe Weather	Final Capacity Adjustment Factor (CAF)	1.000
Incident Type	No Incident	Demand Adjustment Factor (DAF)	1.000

Demand and Capacity

Demand Volume veh/h	3388	Heavy Vehicle Adjustment Factor (fhv)	0.862
Peak Hour Factor	0.94	Flow Rate (Vp), pc/h/ln	2090
Total Trucks, %	16.04	Capacity (c), pc/h/ln	2300
Single-Unit Trucks (SUT), %	-	Adjusted Capacity (cadj), pc/h/ln	2300
Tractor-Trailers (TT), %	-	Volume-to-Capacity Ratio (v/c)	0.91
Passenger Car Equivalent (Et)	2.000		

Speed and Density

Lane Width Adjustment (fLW)	0.0	Average Speed (S), mi/h	55.6
Right-Side Lateral Clearance Adj. (fRLC)	0.0	Density (D), pc/mi/ln	37.6
Total Ramp Density Adjustment	5.0	Level of Service (LOS)	E
Adjusted Free-Flow Speed (FFSadj), mi/h	60.0		

HCS7 Freeway Diverge Report

Project Information

Analyst	LSA	Date	12/11/2019
Agency	LSA	Analysis Year	Existing WP
Jurisdiction	Caltrans	Time Period Analyzed	PM Peak Hour
Project Description	CMD1801 - Village D Specific Plan	Unit	United States Customary

Geometric Data

	Freeway	Ramp
Number of Lanes (N), ln	2	1
Free-Flow Speed (FFS), mi/h	65.0	35.0
Segment Length (L) / Deceleration Length (LA),ft	1500	200
Terrain Type	Level	Level
Percent Grade, %	-	-
Segment Type / Ramp Side	Freeway	Right

Adjustment Factors

Driver Population	All Familiar	All Familiar
Weather Type	Non-Severe Weather	Non-Severe Weather
Incident Type	No Incident	-
Final Speed Adjustment Factor (SAF)	1.000	1.000
Final Capacity Adjustment Factor (CAF)	1.000	1.000
Demand Adjustment Factor (DAF)	1.000	1.000

Demand and Capacity

Demand Volume (Vi)	3388	677
Peak Hour Factor (PHF)	0.94	0.94
Total Trucks, %	16.04	1.03
Single-Unit Trucks (SUT), %	-	-
Tractor-Trailers (TT), %	-	-
Heavy Vehicle Adjustment Factor (fHV)	0.862	0.990
Flow Rate (vi),pc/h	4181	727
Capacity (c), pc/h	4700	2000
Volume-to-Capacity Ratio (v/c)	0.89	0.36

Speed and Density

Upstream Equilibrium Distance (LEQ), ft	-	Number of Outer Lanes on Freeway (NO)	0
Distance to Upstream Ramp (LUP), ft	-	Speed Index (DS)	0.493
Downstream Equilibrium Distance (LEQ), ft	-	Flow Outer Lanes (vOA), pc/h/ln	-
Distance to Downstream Ramp (LDOWN), ft	-	Off-Ramp Influence Area Speed (SR), mi/h	53.7
Prop. Freeway Vehicles in Lane 1 and 2 (PFD)	1.000	Outer Lanes Freeway Speed (SO), mi/h	71.3
Flow in Lanes 1 and 2 (v12), pc/h	4181	Ramp Junction Speed (S), mi/h	53.7
Flow Entering Ramp-Infl. Area (vR12), pc/h	-	Average Density (D), pc/mi/ln	38.9
Level of Service (LOS)	E	Density in Ramp Influence Area (DR), pc/mi/ln	38.4

HCS7 Basic Freeway Report

Project Information

Analyst	LSA	Date	12/11/2019
Agency	LSA	Analysis Year	Existing WP
Jurisdiction	Caltrans	Time Period Analyzed	PM Peak Hour
Project Description	CMD1801 - Village D Specific Plan	Unit	United States Customary

Geometric Data

Number of Lanes, ln	2	Terrain Type	Level
Segment Length (L), ft	-	Percent Grade, %	-
Measured or Base Free-Flow Speed	Base	Grade Length, mi	-
Base Free-Flow Speed (BFFS), mi/h	70.0	Total Ramp Density (TRD), ramps/mi	1.50
Lane Width, ft	12	Free-Flow Speed (FFS), mi/h	65.5
Right-Side Lateral Clearance, ft	10		

Adjustment Factors

Driver Population	All Familiar	Final Speed Adjustment Factor (SAF)	1.000
Weather Type	Non-Severe Weather	Final Capacity Adjustment Factor (CAF)	1.000
Incident Type	No Incident	Demand Adjustment Factor (DAF)	1.000

Demand and Capacity

Demand Volume veh/h	2711	Heavy Vehicle Adjustment Factor (fhv)	0.835
Peak Hour Factor	0.94	Flow Rate (Vp), pc/h/ln	1727
Total Trucks, %	19.79	Capacity (c), pc/h/ln	2355
Single-Unit Trucks (SUT), %	-	Adjusted Capacity (cadj), pc/h/ln	2355
Tractor-Trailers (TT), %	-	Volume-to-Capacity Ratio (v/c)	0.73
Passenger Car Equivalent (Et)	2.000		

Speed and Density

Lane Width Adjustment (fLW)	0.0	Average Speed (S), mi/h	63.8
Right-Side Lateral Clearance Adj. (fRLC)	0.0	Density (D), pc/mi/ln	27.1
Total Ramp Density Adjustment	4.5	Level of Service (LOS)	D
Adjusted Free-Flow Speed (FFSadj), mi/h	65.5		

HCS7 Freeway Merge Report

Project Information

Analyst	LSA	Date	12/11/2019
Agency	LSA	Analysis Year	Existing WP
Jurisdiction	Caltrans	Time Period Analyzed	PM Peak Hour
Project Description	CMD1801 - Village D Specific Plan	Unit	United States Customary

Geometric Data

	Freeway	Ramp
Number of Lanes (N), ln	2	1
Free-Flow Speed (FFS), mi/h	70.0	35.0
Segment Length (L) / Acceleration Length (LA),ft	1500	400
Terrain Type	Level	Level
Percent Grade, %	-	-
Segment Type / Ramp Side	Freeway	Right

Adjustment Factors

Driver Population	All Familiar	All Familiar
Weather Type	Non-Severe Weather	Non-Severe Weather
Incident Type	No Incident	-
Final Speed Adjustment Factor (SAF)	1.000	1.000
Final Capacity Adjustment Factor (CAF)	1.000	1.000
Demand Adjustment Factor (DAF)	1.000	1.000

Demand and Capacity

Demand Volume (Vi)	2711	131
Peak Hour Factor (PHF)	0.94	0.94
Total Trucks, %	19.79	6.87
Single-Unit Trucks (SUT), %	-	-
Tractor-Trailers (TT), %	-	-
Heavy Vehicle Adjustment Factor (fHV)	0.835	0.936
Flow Rate (vi),pc/h	3454	149
Capacity (c), pc/h	4800	2000
Volume-to-Capacity Ratio (v/c)	0.75	0.07

Speed and Density

Upstream Equilibrium Distance (LEQ), ft	-	Number of Outer Lanes on Freeway (NO)	0
Distance to Upstream Ramp (LUP), ft	-	Speed Index (MS)	0.436
Downstream Equilibrium Distance (LEQ), ft	-	Flow Outer Lanes (vOA), pc/h/ln	-
Distance to Downstream Ramp (LDOWN), ft	-	On-Ramp Influence Area Speed (SR), mi/h	57.8
Prop. Freeway Vehicles in Lane 1 and 2 (PFM)	1.000	Outer Lanes Freeway Speed (SO), mi/h	70.0
Flow in Lanes 1 and 2 (v12), pc/h	3454	Ramp Junction Speed (S), mi/h	57.8
Flow Entering Ramp-Infl. Area (vR12), pc/h	3603	Average Density (D), pc/mi/ln	31.2
Level of Service (LOS)	D	Density in Ramp Influence Area (DR), pc/mi/ln	31.1

HCS7 Basic Freeway Report

Project Information

Analyst	LSA	Date	12/11/2019
Agency	LSA	Analysis Year	Existing WP
Jurisdiction	Caltrans	Time Period Analyzed	PM Peak Hour
Project Description	CMD1801 - Village D Specific Plan	Unit	United States Customary

Geometric Data

Number of Lanes, ln	2	Terrain Type	Level
Segment Length (L), ft	-	Percent Grade, %	-
Measured or Base Free-Flow Speed	Base	Grade Length, mi	-
Base Free-Flow Speed (BFFS), mi/h	70.0	Total Ramp Density (TRD), ramps/mi	1.00
Lane Width, ft	12	Free-Flow Speed (FFS), mi/h	66.8
Right-Side Lateral Clearance, ft	10		

Adjustment Factors

Driver Population	All Familiar	Final Speed Adjustment Factor (SAF)	1.000
Weather Type	Non-Severe Weather	Final Capacity Adjustment Factor (CAF)	1.000
Incident Type	No Incident	Demand Adjustment Factor (DAF)	1.000

Demand and Capacity

Demand Volume veh/h	2842	Heavy Vehicle Adjustment Factor (fhv)	0.839
Peak Hour Factor	0.94	Flow Rate (Vp), pc/h/ln	1802
Total Trucks, %	19.20	Capacity (c), pc/h/ln	2368
Single-Unit Trucks (SUT), %	-	Adjusted Capacity (cadj), pc/h/ln	2368
Tractor-Trailers (TT), %	-	Volume-to-Capacity Ratio (v/c)	0.76
Passenger Car Equivalent (Et)	2.000		

Speed and Density

Lane Width Adjustment (fLW)	0.0	Average Speed (S), mi/h	63.9
Right-Side Lateral Clearance Adj. (fRLC)	0.0	Density (D), pc/mi/ln	28.2
Total Ramp Density Adjustment	3.2	Level of Service (LOS)	D
Adjusted Free-Flow Speed (FFSadj), mi/h	66.8		

HCS7 Freeway Diverge Report

Project Information

Analyst	LSA	Date	12/11/2019
Agency	LSA	Analysis Year	Existing WP
Jurisdiction	Caltrans	Time Period Analyzed	PM Peak Hour
Project Description	CMD1801 - Village D Specific Plan	Unit	United States Customary

Geometric Data

	Freeway	Ramp
Number of Lanes (N), ln	2	1
Free-Flow Speed (FFS), mi/h	70.0	35.0
Segment Length (L) / Deceleration Length (LA),ft	1500	200
Terrain Type	Level	Level
Percent Grade, %	-	-
Segment Type / Ramp Side	Freeway	Right

Adjustment Factors

Driver Population	All Familiar	All Familiar
Weather Type	Non-Severe Weather	Non-Severe Weather
Incident Type	No Incident	-
Final Speed Adjustment Factor (SAF)	1.000	1.000
Final Capacity Adjustment Factor (CAF)	1.000	1.000
Demand Adjustment Factor (DAF)	1.000	1.000

Demand and Capacity

Demand Volume (Vi)	2842	181
Peak Hour Factor (PHF)	0.94	0.94
Total Trucks, %	19.20	24.31
Single-Unit Trucks (SUT), %	-	-
Tractor-Trailers (TT), %	-	-
Heavy Vehicle Adjustment Factor (fHV)	0.839	0.804
Flow Rate (vi),pc/h	3604	239
Capacity (c), pc/h	4800	2000
Volume-to-Capacity Ratio (v/c)	0.75	0.12

Speed and Density

Upstream Equilibrium Distance (LEQ), ft	-	Number of Outer Lanes on Freeway (NO)	0
Distance to Upstream Ramp (LUP), ft	-	Speed Index (DS)	0.450
Downstream Equilibrium Distance (LEQ), ft	-	Flow Outer Lanes (vOA), pc/h/ln	-
Distance to Downstream Ramp (LDOWN), ft	-	Off-Ramp Influence Area Speed (SR), mi/h	57.4
Prop. Freeway Vehicles in Lane 1 and 2 (PFD)	1.000	Outer Lanes Freeway Speed (SO), mi/h	76.8
Flow in Lanes 1 and 2 (v12), pc/h	3604	Ramp Junction Speed (S), mi/h	57.4
Flow Entering Ramp-Infl. Area (vR12), pc/h	-	Average Density (D), pc/mi/ln	31.4
Level of Service (LOS)	D	Density in Ramp Influence Area (DR), pc/mi/ln	33.4

HCS7 Basic Freeway Report

Project Information

Analyst	LSA	Date	12/11/2019
Agency	LSA	Analysis Year	Existing WP
Jurisdiction	Caltrans	Time Period Analyzed	PM Peak Hour
Project Description	CMD1801 - Village D Specific Plan	Unit	United States Customary

Geometric Data

Number of Lanes, ln	2	Terrain Type	Level
Segment Length (L), ft	-	Percent Grade, %	-
Measured or Base Free-Flow Speed	Base	Grade Length, mi	-
Base Free-Flow Speed (BFFS), mi/h	70.0	Total Ramp Density (TRD), ramps/mi	1.00
Lane Width, ft	12	Free-Flow Speed (FFS), mi/h	66.8
Right-Side Lateral Clearance, ft	10		

Adjustment Factors

Driver Population	All Familiar	Final Speed Adjustment Factor (SAF)	1.000
Weather Type	Non-Severe Weather	Final Capacity Adjustment Factor (CAF)	1.000
Incident Type	No Incident	Demand Adjustment Factor (DAF)	1.000

Demand and Capacity

Demand Volume veh/h	2661	Heavy Vehicle Adjustment Factor (fhv)	0.841
Peak Hour Factor	0.94	Flow Rate (Vp), pc/h/ln	1683
Total Trucks, %	18.85	Capacity (c), pc/h/ln	2368
Single-Unit Trucks (SUT), %	-	Adjusted Capacity (cadj), pc/h/ln	2368
Tractor-Trailers (TT), %	-	Volume-to-Capacity Ratio (v/c)	0.71
Passenger Car Equivalent (Et)	2.000		

Speed and Density

Lane Width Adjustment (fLW)	0.0	Average Speed (S), mi/h	65.1
Right-Side Lateral Clearance Adj. (fRLC)	0.0	Density (D), pc/mi/ln	25.9
Total Ramp Density Adjustment	3.2	Level of Service (LOS)	C
Adjusted Free-Flow Speed (FFSadj), mi/h	66.8		

HCS7 Freeway Merge Report

Project Information

Analyst	LSA	Date	12/11/2019
Agency	LSA	Analysis Year	Existing WP
Jurisdiction	Caltrans	Time Period Analyzed	PM Peak Hour
Project Description	CMD1801 - Village D Specific Plan	Unit	United States Customary

Geometric Data

	Freeway	Ramp
Number of Lanes (N), ln	2	1
Free-Flow Speed (FFS), mi/h	70.0	35.0
Segment Length (L) / Acceleration Length (LA),ft	1500	700
Terrain Type	Level	Level
Percent Grade, %	-	-
Segment Type / Ramp Side	Freeway	Right

Adjustment Factors

Driver Population	All Familiar	All Familiar
Weather Type	Non-Severe Weather	Non-Severe Weather
Incident Type	No Incident	-
Final Speed Adjustment Factor (SAF)	1.000	1.000
Final Capacity Adjustment Factor (CAF)	1.000	1.000
Demand Adjustment Factor (DAF)	1.000	1.000

Demand and Capacity

Demand Volume (Vi)	2661	493
Peak Hour Factor (PHF)	0.94	0.94
Total Trucks, %	18.85	8.92
Single-Unit Trucks (SUT), %	-	-
Tractor-Trailers (TT), %	-	-
Heavy Vehicle Adjustment Factor (fHV)	0.841	0.918
Flow Rate (vi),pc/h	3366	571
Capacity (c), pc/h	4800	2000
Volume-to-Capacity Ratio (v/c)	0.82	0.29

Speed and Density

Upstream Equilibrium Distance (LEQ), ft	-	Number of Outer Lanes on Freeway (NO)	0
Distance to Upstream Ramp (LUP), ft	-	Speed Index (MS)	0.472
Downstream Equilibrium Distance (LEQ), ft	-	Flow Outer Lanes (vOA), pc/h/ln	-
Distance to Downstream Ramp (LDOWN), ft	-	On-Ramp Influence Area Speed (SR), mi/h	56.8
Prop. Freeway Vehicles in Lane 1 and 2 (PFM)	1.000	Outer Lanes Freeway Speed (SO), mi/h	70.0
Flow in Lanes 1 and 2 (v12), pc/h	3366	Ramp Junction Speed (S), mi/h	56.8
Flow Entering Ramp-Infl. Area (vR12), pc/h	3937	Average Density (D), pc/mi/ln	34.7
Level of Service (LOS)	D	Density in Ramp Influence Area (DR), pc/mi/ln	31.6

HCS7 Basic Freeway Report

Project Information

Analyst	LSA	Date	12/11/2019
Agency	LSA	Analysis Year	Existing WP
Jurisdiction	Caltrans	Time Period Analyzed	PM Peak Hour
Project Description	CMD1801 - Village D Specific Plan	Unit	United States Customary

Geometric Data

Number of Lanes, ln	2	Terrain Type	Level
Segment Length (L), ft	-	Percent Grade, %	-
Measured or Base Free-Flow Speed	Base	Grade Length, mi	-
Base Free-Flow Speed (BFFS), mi/h	70.0	Total Ramp Density (TRD), ramps/mi	1.00
Lane Width, ft	12	Free-Flow Speed (FFS), mi/h	66.8
Right-Side Lateral Clearance, ft	10		

Adjustment Factors

Driver Population	All Familiar	Final Speed Adjustment Factor (SAF)	1.000
Weather Type	Non-Severe Weather	Final Capacity Adjustment Factor (CAF)	1.000
Incident Type	No Incident	Demand Adjustment Factor (DAF)	1.000

Demand and Capacity

Demand Volume veh/h	3154	Heavy Vehicle Adjustment Factor (fhv)	0.853
Peak Hour Factor	0.94	Flow Rate (Vp), pc/h/ln	1967
Total Trucks, %	17.30	Capacity (c), pc/h/ln	2368
Single-Unit Trucks (SUT), %	-	Adjusted Capacity (cadj), pc/h/ln	2368
Tractor-Trailers (TT), %	-	Volume-to-Capacity Ratio (v/c)	0.83
Passenger Car Equivalent (Et)	2.000		

Speed and Density

Lane Width Adjustment (fLW)	0.0	Average Speed (S), mi/h	61.4
Right-Side Lateral Clearance Adj. (fRLC)	0.0	Density (D), pc/mi/ln	32.0
Total Ramp Density Adjustment	3.2	Level of Service (LOS)	D
Adjusted Free-Flow Speed (FFSadj), mi/h	66.8		

HCS7 Basic Freeway Report

Project Information

Analyst	LSA	Date	12/11/2019
Agency	LSA	Analysis Year	Existing WP
Jurisdiction	Caltrans	Time Period Analyzed	PM Peak Hour
Project Description	CMD1801 - Village D Specific Plan	Unit	United States Customary

Geometric Data

Number of Lanes, ln	2	Terrain Type	Level
Segment Length (L), ft	-	Percent Grade, %	-
Measured or Base Free-Flow Speed	Base	Grade Length, mi	-
Base Free-Flow Speed (BFFS), mi/h	70.0	Total Ramp Density (TRD), ramps/mi	1.00
Lane Width, ft	12	Free-Flow Speed (FFS), mi/h	66.8
Right-Side Lateral Clearance, ft	10		

Adjustment Factors

Driver Population	All Familiar	Final Speed Adjustment Factor (SAF)	1.000
Weather Type	Non-Severe Weather	Final Capacity Adjustment Factor (CAF)	1.000
Incident Type	No Incident	Demand Adjustment Factor (DAF)	1.000

Demand and Capacity

Demand Volume veh/h	3607	Heavy Vehicle Adjustment Factor (fhv)	0.851
Peak Hour Factor	0.94	Flow Rate (Vp), pc/h/ln	2254
Total Trucks, %	17.52	Capacity (c), pc/h/ln	2368
Single-Unit Trucks (SUT), %	-	Adjusted Capacity (cadj), pc/h/ln	2368
Tractor-Trailers (TT), %	-	Volume-to-Capacity Ratio (v/c)	0.95
Passenger Car Equivalent (Et)	2.000		

Speed and Density

Lane Width Adjustment (fLW)	0.0	Average Speed (S), mi/h	55.6
Right-Side Lateral Clearance Adj. (fRLC)	0.0	Density (D), pc/mi/ln	40.5
Total Ramp Density Adjustment	3.2	Level of Service (LOS)	E
Adjusted Free-Flow Speed (FFSadj), mi/h	66.8		

HCS7 Freeway Diverge Report

Project Information

Analyst	LSA	Date	12/11/2019
Agency	LSA	Analysis Year	Existing WP
Jurisdiction	Caltrans	Time Period Analyzed	PM Peak Hour
Project Description	CMD1801 - Village D Specific Plan	Unit	United States Customary

Geometric Data

	Freeway	Ramp
Number of Lanes (N), ln	2	1
Free-Flow Speed (FFS), mi/h	70.0	50.0
Segment Length (L) / Deceleration Length (LA),ft	1500	150
Terrain Type	Level	Level
Percent Grade, %	-	-
Segment Type / Ramp Side	Freeway	Right

Adjustment Factors

Driver Population	All Familiar	All Familiar
Weather Type	Non-Severe Weather	Non-Severe Weather
Incident Type	No Incident	-
Final Speed Adjustment Factor (SAF)	1.000	1.000
Final Capacity Adjustment Factor (CAF)	1.000	1.000
Demand Adjustment Factor (DAF)	1.000	1.000

Demand and Capacity

Demand Volume (Vi)	3607	791
Peak Hour Factor (PHF)	0.94	0.94
Total Trucks, %	17.52	7.71
Single-Unit Trucks (SUT), %	-	-
Tractor-Trailers (TT), %	-	-
Heavy Vehicle Adjustment Factor (fHV)	0.851	0.928
Flow Rate (vi),pc/h	4509	907
Capacity (c), pc/h	4800	2100
Volume-to-Capacity Ratio (v/c)	0.94	0.43

Speed and Density

Upstream Equilibrium Distance (LEQ), ft	-	Number of Outer Lanes on Freeway (NO)	0
Distance to Upstream Ramp (LUP), ft	-	Speed Index (DS)	0.315
Downstream Equilibrium Distance (LEQ), ft	-	Flow Outer Lanes (vOA), pc/h/ln	-
Distance to Downstream Ramp (LDOWN), ft	-	Off-Ramp Influence Area Speed (SR), mi/h	61.2
Prop. Freeway Vehicles in Lane 1 and 2 (PFD)	1.000	Outer Lanes Freeway Speed (SO), mi/h	76.8
Flow in Lanes 1 and 2 (v12), pc/h	4509	Ramp Junction Speed (S), mi/h	61.2
Flow Entering Ramp-Infl. Area (vR12), pc/h	-	Average Density (D), pc/mi/ln	36.8
Level of Service (LOS)	E	Density in Ramp Influence Area (DR), pc/mi/ln	41.7

HCS7 Basic Freeway Report

Project Information

Analyst	LSA	Date	12/11/2019
Agency	LSA	Analysis Year	Existing WP
Jurisdiction	Caltrans	Time Period Analyzed	PM Peak Hour
Project Description	CMD1801 - Village D Specific Plan	Unit	United States Customary

Geometric Data

Number of Lanes, ln	2	Terrain Type	Level
Segment Length (L), ft	-	Percent Grade, %	-
Measured or Base Free-Flow Speed	Base	Grade Length, mi	-
Base Free-Flow Speed (BFFS), mi/h	70.0	Total Ramp Density (TRD), ramps/mi	1.33
Lane Width, ft	12	Free-Flow Speed (FFS), mi/h	65.9
Right-Side Lateral Clearance, ft	10		

Adjustment Factors

Driver Population	All Familiar	Final Speed Adjustment Factor (SAF)	1.000
Weather Type	Non-Severe Weather	Final Capacity Adjustment Factor (CAF)	1.000
Incident Type	No Incident	Demand Adjustment Factor (DAF)	1.000

Demand and Capacity

Demand Volume veh/h	2816	Heavy Vehicle Adjustment Factor (fhv)	0.831
Peak Hour Factor	0.94	Flow Rate (Vp), pc/h/ln	1802
Total Trucks, %	20.28	Capacity (c), pc/h/ln	2359
Single-Unit Trucks (SUT), %	-	Adjusted Capacity (cadj), pc/h/ln	2359
Tractor-Trailers (TT), %	-	Volume-to-Capacity Ratio (v/c)	0.76
Passenger Car Equivalent (Et)	2.000		

Speed and Density

Lane Width Adjustment (fLW)	0.0	Average Speed (S), mi/h	63.3
Right-Side Lateral Clearance Adj. (fRLC)	0.0	Density (D), pc/mi/ln	28.5
Total Ramp Density Adjustment	4.1	Level of Service (LOS)	D
Adjusted Free-Flow Speed (FFSadj), mi/h	65.9		

HCS7 Freeway Merge Report

Project Information

Analyst	LSA	Date	12/11/2019
Agency	LSA	Analysis Year	Existing WP
Jurisdiction	Caltrans	Time Period Analyzed	PM Peak Hour
Project Description	CMD1801 - Village D Specific Plan	Unit	United States Customary

Geometric Data

	Freeway	Ramp
Number of Lanes (N), ln	2	1
Free-Flow Speed (FFS), mi/h	70.0	35.0
Segment Length (L) / Acceleration Length (LA),ft	1000	600
Terrain Type	Level	Level
Percent Grade, %	-	-
Segment Type / Ramp Side	Freeway	Right

Adjustment Factors

Driver Population	All Familiar	All Familiar
Weather Type	Non-Severe Weather	Non-Severe Weather
Incident Type	No Incident	-
Final Speed Adjustment Factor (SAF)	1.000	1.000
Final Capacity Adjustment Factor (CAF)	1.000	1.000
Demand Adjustment Factor (DAF)	1.000	1.000

Demand and Capacity

Demand Volume (Vi)	2816	27
Peak Hour Factor (PHF)	0.94	0.94
Total Trucks, %	20.28	7.41
Single-Unit Trucks (SUT), %	-	-
Tractor-Trailers (TT), %	-	-
Heavy Vehicle Adjustment Factor (fHV)	0.831	0.931
Flow Rate (vi),pc/h	3605	31
Capacity (c), pc/h	4800	2000
Volume-to-Capacity Ratio (v/c)	0.76	0.02

Speed and Density

Upstream Equilibrium Distance (LEQ), ft	-	Number of Outer Lanes on Freeway (NO)	0
Distance to Upstream Ramp (LUP), ft	-	Speed Index (MS)	0.427
Downstream Equilibrium Distance (LEQ), ft	-	Flow Outer Lanes (vOA), pc/h/ln	-
Distance to Downstream Ramp (LDOWN), ft	-	On-Ramp Influence Area Speed (SR), mi/h	58.0
Prop. Freeway Vehicles in Lane 1 and 2 (PFM)	1.000	Outer Lanes Freeway Speed (SO), mi/h	70.0
Flow in Lanes 1 and 2 (v12), pc/h	3605	Ramp Junction Speed (S), mi/h	58.0
Flow Entering Ramp-Infl. Area (vR12), pc/h	3636	Average Density (D), pc/mi/ln	31.3
Level of Service (LOS)	D	Density in Ramp Influence Area (DR), pc/mi/ln	30.1

HCS7 Basic Freeway Report

Project Information

Analyst	LSA	Date	12/11/2019
Agency	LSA	Analysis Year	Existing WP
Jurisdiction	Caltrans	Time Period Analyzed	PM Peak Hour
Project Description	CMD1801 - Village D Specific Plan	Unit	United States Customary

Geometric Data

Number of Lanes, ln	2	Terrain Type	Level
Segment Length (L), ft	-	Percent Grade, %	-
Measured or Base Free-Flow Speed	Base	Grade Length, mi	-
Base Free-Flow Speed (BFFS), mi/h	70.0	Total Ramp Density (TRD), ramps/mi	1.33
Lane Width, ft	12	Free-Flow Speed (FFS), mi/h	65.9
Right-Side Lateral Clearance, ft	10		

Adjustment Factors

Driver Population	All Familiar	Final Speed Adjustment Factor (SAF)	1.000
Weather Type	Non-Severe Weather	Final Capacity Adjustment Factor (CAF)	1.000
Incident Type	No Incident	Demand Adjustment Factor (DAF)	1.000

Demand and Capacity

Demand Volume veh/h	2843	Heavy Vehicle Adjustment Factor (fhv)	0.832
Peak Hour Factor	0.94	Flow Rate (Vp), pc/h/ln	1818
Total Trucks, %	20.15	Capacity (c), pc/h/ln	2359
Single-Unit Trucks (SUT), %	-	Adjusted Capacity (cadj), pc/h/ln	2359
Tractor-Trailers (TT), %	-	Volume-to-Capacity Ratio (v/c)	0.77
Passenger Car Equivalent (Et)	2.000		

Speed and Density

Lane Width Adjustment (fLW)	0.0	Average Speed (S), mi/h	63.1
Right-Side Lateral Clearance Adj. (fRLC)	0.0	Density (D), pc/mi/ln	28.8
Total Ramp Density Adjustment	4.1	Level of Service (LOS)	D
Adjusted Free-Flow Speed (FFSadj), mi/h	65.9		

HCS7 Freeway Merge Report

Project Information

Analyst	LSA	Date	12/11/2019
Agency	LSA	Analysis Year	Existing WP
Jurisdiction	Caltrans	Time Period Analyzed	PM Peak Hour
Project Description	CMD1801 - Village D Specific Plan	Unit	United States Customary

Geometric Data

	Freeway	Ramp
Number of Lanes (N), ln	2	1
Free-Flow Speed (FFS), mi/h	70.0	35.0
Segment Length (L) / Acceleration Length (LA),ft	1500	500
Terrain Type	Level	Level
Percent Grade, %	-	-
Segment Type / Ramp Side	Freeway	Right

Adjustment Factors

Driver Population	All Familiar	All Familiar
Weather Type	Non-Severe Weather	Non-Severe Weather
Incident Type	No Incident	-
Final Speed Adjustment Factor (SAF)	1.000	1.000
Final Capacity Adjustment Factor (CAF)	1.000	1.000
Demand Adjustment Factor (DAF)	1.000	1.000

Demand and Capacity

Demand Volume (Vi)	2843	222
Peak Hour Factor (PHF)	0.94	0.94
Total Trucks, %	20.15	22.07
Single-Unit Trucks (SUT), %	-	-
Tractor-Trailers (TT), %	-	-
Heavy Vehicle Adjustment Factor (fHV)	0.832	0.819
Flow Rate (vi),pc/h	3635	288
Capacity (c), pc/h	4800	2000
Volume-to-Capacity Ratio (v/c)	0.82	0.14

Speed and Density

Upstream Equilibrium Distance (LEQ), ft	-	Number of Outer Lanes on Freeway (NO)	0
Distance to Upstream Ramp (LUP), ft	-	Speed Index (MS)	0.483
Downstream Equilibrium Distance (LEQ), ft	-	Flow Outer Lanes (vOA), pc/h/ln	-
Distance to Downstream Ramp (LDOWN), ft	-	On-Ramp Influence Area Speed (SR), mi/h	56.5
Prop. Freeway Vehicles in Lane 1 and 2 (PFM)	1.000	Outer Lanes Freeway Speed (SO), mi/h	70.0
Flow in Lanes 1 and 2 (v12), pc/h	3635	Ramp Junction Speed (S), mi/h	56.5
Flow Entering Ramp-Infl. Area (vR12), pc/h	3923	Average Density (D), pc/mi/ln	34.7
Level of Service (LOS)	D	Density in Ramp Influence Area (DR), pc/mi/ln	32.9

HCS7 Basic Freeway Report

Project Information

Analyst	LSA	Date	12/11/2019
Agency	LSA	Analysis Year	Existing WP
Jurisdiction	Caltrans	Time Period Analyzed	PM Peak Hour
Project Description	CMD1801 - Village D Specific Plan	Unit	United States Customary

Geometric Data

Number of Lanes, ln	2	Terrain Type	Level
Segment Length (L), ft	-	Percent Grade, %	-
Measured or Base Free-Flow Speed	Base	Grade Length, mi	-
Base Free-Flow Speed (BFFS), mi/h	70.0	Total Ramp Density (TRD), ramps/mi	1.33
Lane Width, ft	12	Free-Flow Speed (FFS), mi/h	65.9
Right-Side Lateral Clearance, ft	10		

Adjustment Factors

Driver Population	All Familiar	Final Speed Adjustment Factor (SAF)	1.000
Weather Type	Non-Severe Weather	Final Capacity Adjustment Factor (CAF)	1.000
Incident Type	No Incident	Demand Adjustment Factor (DAF)	1.000

Demand and Capacity

Demand Volume veh/h	3065	Heavy Vehicle Adjustment Factor (fhv)	0.831
Peak Hour Factor	0.94	Flow Rate (Vp), pc/h/ln	1962
Total Trucks, %	20.29	Capacity (c), pc/h/ln	2359
Single-Unit Trucks (SUT), %	-	Adjusted Capacity (cadj), pc/h/ln	2359
Tractor-Trailers (TT), %	-	Volume-to-Capacity Ratio (v/c)	0.83
Passenger Car Equivalent (Et)	2.000		

Speed and Density

Lane Width Adjustment (fLW)	0.0	Average Speed (S), mi/h	61.0
Right-Side Lateral Clearance Adj. (fRLC)	0.0	Density (D), pc/mi/ln	32.2
Total Ramp Density Adjustment	4.1	Level of Service (LOS)	D
Adjusted Free-Flow Speed (FFSadj), mi/h	65.9		

HCS7 Freeway Diverge Report

Project Information

Analyst	LSA	Date	12/11/2019
Agency	LSA	Analysis Year	Existing WP
Jurisdiction	Caltrans	Time Period Analyzed	PM Peak Hour
Project Description	CMD1801 - Village D Specific Plan	Unit	United States Customary

Geometric Data

	Freeway	Ramp
Number of Lanes (N), ln	2	1
Free-Flow Speed (FFS), mi/h	70.0	35.0
Segment Length (L) / Deceleration Length (LA),ft	1500	150
Terrain Type	Level	Level
Percent Grade, %	-	-
Segment Type / Ramp Side	Freeway	Right

Adjustment Factors

Driver Population	All Familiar	All Familiar
Weather Type	Non-Severe Weather	Non-Severe Weather
Incident Type	No Incident	-
Final Speed Adjustment Factor (SAF)	1.000	1.000
Final Capacity Adjustment Factor (CAF)	1.000	1.000
Demand Adjustment Factor (DAF)	1.000	1.000

Demand and Capacity

Demand Volume (Vi)	3065	196
Peak Hour Factor (PHF)	0.94	0.94
Total Trucks, %	20.29	4.59
Single-Unit Trucks (SUT), %	-	-
Tractor-Trailers (TT), %	-	-
Heavy Vehicle Adjustment Factor (fHV)	0.831	0.956
Flow Rate (vi),pc/h	3924	218
Capacity (c), pc/h	4800	2000
Volume-to-Capacity Ratio (v/c)	0.82	0.11

Speed and Density

Upstream Equilibrium Distance (LEQ), ft	-	Number of Outer Lanes on Freeway (NO)	0
Distance to Upstream Ramp (LUP), ft	-	Speed Index (DS)	0.448
Downstream Equilibrium Distance (LEQ), ft	-	Flow Outer Lanes (vOA), pc/h/ln	-
Distance to Downstream Ramp (LDOWN), ft	-	Off-Ramp Influence Area Speed (SR), mi/h	57.5
Prop. Freeway Vehicles in Lane 1 and 2 (PFD)	1.000	Outer Lanes Freeway Speed (SO), mi/h	76.8
Flow in Lanes 1 and 2 (v12), pc/h	3924	Ramp Junction Speed (S), mi/h	57.5
Flow Entering Ramp-Infl. Area (vR12), pc/h	-	Average Density (D), pc/mi/ln	34.1
Level of Service (LOS)	E	Density in Ramp Influence Area (DR), pc/mi/ln	36.6

HCS7 Basic Freeway Report

Project Information

Analyst	LSA	Date	12/11/2019
Agency	LSA	Analysis Year	Existing WP
Jurisdiction	Caltrans	Time Period Analyzed	PM Peak Hour
Project Description	CMD1801 - Village D Specific Plan	Unit	United States Customary

Geometric Data

Number of Lanes, ln	2	Terrain Type	Level
Segment Length (L), ft	-	Percent Grade, %	-
Measured or Base Free-Flow Speed	Base	Grade Length, mi	-
Base Free-Flow Speed (BFFS), mi/h	70.0	Total Ramp Density (TRD), ramps/mi	1.67
Lane Width, ft	12	Free-Flow Speed (FFS), mi/h	65.0
Right-Side Lateral Clearance, ft	10		

Adjustment Factors

Driver Population	All Familiar	Final Speed Adjustment Factor (SAF)	1.000
Weather Type	Non-Severe Weather	Final Capacity Adjustment Factor (CAF)	1.000
Incident Type	No Incident	Demand Adjustment Factor (DAF)	1.000

Demand and Capacity

Demand Volume veh/h	2869	Heavy Vehicle Adjustment Factor (fhv)	0.824
Peak Hour Factor	0.94	Flow Rate (Vp), pc/h/ln	1852
Total Trucks, %	21.37	Capacity (c), pc/h/ln	2350
Single-Unit Trucks (SUT), %	-	Adjusted Capacity (cadj), pc/h/ln	2350
Tractor-Trailers (TT), %	-	Volume-to-Capacity Ratio (v/c)	0.79
Passenger Car Equivalent (Et)	2.000		

Speed and Density

Lane Width Adjustment (fLW)	0.0	Average Speed (S), mi/h	62.1
Right-Side Lateral Clearance Adj. (fRLC)	0.0	Density (D), pc/mi/ln	29.8
Total Ramp Density Adjustment	5.0	Level of Service (LOS)	D
Adjusted Free-Flow Speed (FFSadj), mi/h	65.0		

HCS7 Freeway Merge Report

Project Information

Analyst	LSA	Date	12/11/2019
Agency	LSA	Analysis Year	Existing WP
Jurisdiction	Caltrans	Time Period Analyzed	PM Peak Hour
Project Description	CMD1801 - Village D Specific Plan	Unit	United States Customary

Geometric Data

	Freeway	Ramp
Number of Lanes (N), ln	2	1
Free-Flow Speed (FFS), mi/h	65.0	35.0
Segment Length (L) / Acceleration Length (LA),ft	1500	600
Terrain Type	Level	Level
Percent Grade, %	-	-
Segment Type / Ramp Side	Freeway	Right

Adjustment Factors

Driver Population	All Familiar	All Familiar
Weather Type	Non-Severe Weather	Non-Severe Weather
Incident Type	No Incident	-
Final Speed Adjustment Factor (SAF)	1.000	1.000
Final Capacity Adjustment Factor (CAF)	1.000	1.000
Demand Adjustment Factor (DAF)	1.000	1.000

Demand and Capacity

Demand Volume (Vi)	2869	173
Peak Hour Factor (PHF)	0.94	0.94
Total Trucks, %	21.37	6.36
Single-Unit Trucks (SUT), %	-	-
Tractor-Trailers (TT), %	-	-
Heavy Vehicle Adjustment Factor (fHV)	0.824	0.940
Flow Rate (vi),pc/h	3704	196
Capacity (c), pc/h	4700	2000
Volume-to-Capacity Ratio (v/c)	0.83	0.10

Speed and Density

Upstream Equilibrium Distance (LEQ), ft	-	Number of Outer Lanes on Freeway (NO)	0
Distance to Upstream Ramp (LUP), ft	-	Speed Index (MS)	0.472
Downstream Equilibrium Distance (LEQ), ft	-	Flow Outer Lanes (vOA), pc/h/ln	-
Distance to Downstream Ramp (LDOWN), ft	-	On-Ramp Influence Area Speed (SR), mi/h	54.1
Prop. Freeway Vehicles in Lane 1 and 2 (PFM)	1.000	Outer Lanes Freeway Speed (SO), mi/h	65.0
Flow in Lanes 1 and 2 (v12), pc/h	3704	Ramp Junction Speed (S), mi/h	54.1
Flow Entering Ramp-Infl. Area (vR12), pc/h	3900	Average Density (D), pc/mi/ln	36.0
Level of Service (LOS)	D	Density in Ramp Influence Area (DR), pc/mi/ln	32.1

HCS7 Basic Freeway Report

Project Information

Analyst	LSA	Date	12/11/2019
Agency	LSA	Analysis Year	Existing WP
Jurisdiction	Caltrans	Time Period Analyzed	PM Peak Hour
Project Description	CMD1801 - Village D Specific Plan	Unit	United States Customary

Geometric Data

Number of Lanes, ln	2	Terrain Type	Level
Segment Length (L), ft	-	Percent Grade, %	-
Measured or Base Free-Flow Speed	Base	Grade Length, mi	-
Base Free-Flow Speed (BFFS), mi/h	65.0	Total Ramp Density (TRD), ramps/mi	1.83
Lane Width, ft	12	Free-Flow Speed (FFS), mi/h	59.7
Right-Side Lateral Clearance, ft	10		

Adjustment Factors

Driver Population	All Familiar	Final Speed Adjustment Factor (SAF)	1.000
Weather Type	Non-Severe Weather	Final Capacity Adjustment Factor (CAF)	1.000
Incident Type	No Incident	Demand Adjustment Factor (DAF)	1.000

Demand and Capacity

Demand Volume veh/h	3042	Heavy Vehicle Adjustment Factor (fhv)	0.830
Peak Hour Factor	0.94	Flow Rate (Vp), pc/h/ln	1950
Total Trucks, %	20.51	Capacity (c), pc/h/ln	2296
Single-Unit Trucks (SUT), %	-	Adjusted Capacity (cadj), pc/h/ln	2296
Tractor-Trailers (TT), %	-	Volume-to-Capacity Ratio (v/c)	0.85
Passenger Car Equivalent (Et)	2.000		

Speed and Density

Lane Width Adjustment (fLW)	0.0	Average Speed (S), mi/h	57.5
Right-Side Lateral Clearance Adj. (fRLC)	0.0	Density (D), pc/mi/ln	33.9
Total Ramp Density Adjustment	5.4	Level of Service (LOS)	D
Adjusted Free-Flow Speed (FFSadj), mi/h	59.6		

HCS7 Freeway Merge Report

Project Information

Analyst	LSA	Date	12/11/2019
Agency	LSA	Analysis Year	Existing WP
Jurisdiction	Caltrans	Time Period Analyzed	PM Peak Hour
Project Description	CMD1801 - Village D Specific Plan	Unit	United States Customary

Geometric Data

	Freeway	Ramp
Number of Lanes (N), ln	2	1
Free-Flow Speed (FFS), mi/h	65.0	35.0
Segment Length (L) / Acceleration Length (LA),ft	1500	600
Terrain Type	Level	Level
Percent Grade, %	-	-
Segment Type / Ramp Side	Freeway	Right

Adjustment Factors

Driver Population	All Familiar	All Familiar
Weather Type	Non-Severe Weather	Non-Severe Weather
Incident Type	No Incident	-
Final Speed Adjustment Factor (SAF)	1.000	1.000
Final Capacity Adjustment Factor (CAF)	1.000	1.000
Demand Adjustment Factor (DAF)	1.000	1.000

Demand and Capacity

Demand Volume (Vi)	3042	460
Peak Hour Factor (PHF)	0.94	0.94
Total Trucks, %	20.51	1.09
Single-Unit Trucks (SUT), %	-	-
Tractor-Trailers (TT), %	-	-
Heavy Vehicle Adjustment Factor (fHV)	0.830	0.989
Flow Rate (vi),pc/h	3899	495
Capacity (c), pc/h	4700	2000
Volume-to-Capacity Ratio (v/c)	0.93	0.25

Speed and Density

Upstream Equilibrium Distance (LEQ), ft	-	Number of Outer Lanes on Freeway (NO)	0
Distance to Upstream Ramp (LUP), ft	-	Speed Index (MS)	0.595
Downstream Equilibrium Distance (LEQ), ft	-	Flow Outer Lanes (vOA), pc/h/ln	-
Distance to Downstream Ramp (LDOWN), ft	-	On-Ramp Influence Area Speed (SR), mi/h	51.3
Prop. Freeway Vehicles in Lane 1 and 2 (PFM)	1.000	Outer Lanes Freeway Speed (SO), mi/h	65.0
Flow in Lanes 1 and 2 (v12), pc/h	3899	Ramp Junction Speed (S), mi/h	51.3
Flow Entering Ramp-Infl. Area (vR12), pc/h	4394	Average Density (D), pc/mi/ln	42.8
Level of Service (LOS)	E	Density in Ramp Influence Area (DR), pc/mi/ln	35.8

HCS7 Basic Freeway Report

Project Information

Analyst	LSA	Date	12/11/2019
Agency	LSA	Analysis Year	Existing WP
Jurisdiction	Caltrans	Time Period Analyzed	AM Peak Hour
Project Description	CMD1801 - Village D Specific Plan	Unit	United States Customary

Geometric Data

Number of Lanes, ln	2	Terrain Type	Level
Segment Length (L), ft	-	Percent Grade, %	-
Measured or Base Free-Flow Speed	Base	Grade Length, mi	-
Base Free-Flow Speed (BFFS), mi/h	65.0	Total Ramp Density (TRD), ramps/mi	2.17
Lane Width, ft	12	Free-Flow Speed (FFS), mi/h	58.8
Right-Side Lateral Clearance, ft	10		

Adjustment Factors

Driver Population	All Familiar	Final Speed Adjustment Factor (SAF)	1.000
Weather Type	Non-Severe Weather	Final Capacity Adjustment Factor (CAF)	1.000
Incident Type	No Incident	Demand Adjustment Factor (DAF)	1.000

Demand and Capacity

Demand Volume veh/h	3502	Heavy Vehicle Adjustment Factor (fhv)	0.848
Peak Hour Factor	0.94	Flow Rate (Vp), pc/h/ln	2196
Total Trucks, %	17.96	Capacity (c), pc/h/ln	2288
Single-Unit Trucks (SUT), %	-	Adjusted Capacity (cadj), pc/h/ln	2288
Tractor-Trailers (TT), %	-	Volume-to-Capacity Ratio (v/c)	0.96
Passenger Car Equivalent (Et)	2.000		

Speed and Density

Lane Width Adjustment (fLW)	0.0	Average Speed (S), mi/h	53.0
Right-Side Lateral Clearance Adj. (fRLC)	0.0	Density (D), pc/mi/ln	41.4
Total Ramp Density Adjustment	6.2	Level of Service (LOS)	E
Adjusted Free-Flow Speed (FFSadj), mi/h	58.8		

HCS7 Freeway Diverge Report

Project Information

Analyst	LSA	Date	12/11/2019
Agency	LSA	Analysis Year	Existing WP
Jurisdiction	Caltrans	Time Period Analyzed	PM Peak Hour
Project Description	CMD1801 - Village D Specific Plan	Unit	United States Customary

Geometric Data

	Freeway	Ramp
Number of Lanes (N), ln	2	1
Free-Flow Speed (FFS), mi/h	65.0	40.0
Segment Length (L) / Deceleration Length (LA),ft	1500	150
Terrain Type	Level	Level
Percent Grade, %	-	-
Segment Type / Ramp Side	Freeway	Right

Adjustment Factors

Driver Population	All Familiar	All Familiar
Weather Type	Non-Severe Weather	Non-Severe Weather
Incident Type	No Incident	-
Final Speed Adjustment Factor (SAF)	1.000	1.000
Final Capacity Adjustment Factor (CAF)	1.000	1.000
Demand Adjustment Factor (DAF)	1.000	1.000

Demand and Capacity

Demand Volume (Vi)	3502	312
Peak Hour Factor (PHF)	0.94	0.94
Total Trucks, %	17.96	3.21
Single-Unit Trucks (SUT), %	-	-
Tractor-Trailers (TT), %	-	-
Heavy Vehicle Adjustment Factor (fHV)	0.848	0.969
Flow Rate (vi),pc/h	4393	343
Capacity (c), pc/h	4700	2000
Volume-to-Capacity Ratio (v/c)	0.93	0.17

Speed and Density

Upstream Equilibrium Distance (LEQ), ft	-	Number of Outer Lanes on Freeway (NO)	0
Distance to Upstream Ramp (LUP), ft	-	Speed Index (DS)	0.394
Downstream Equilibrium Distance (LEQ), ft	-	Flow Outer Lanes (vOA), pc/h/ln	-
Distance to Downstream Ramp (LDOWN), ft	-	Off-Ramp Influence Area Speed (SR), mi/h	55.9
Prop. Freeway Vehicles in Lane 1 and 2 (PFD)	1.000	Outer Lanes Freeway Speed (SO), mi/h	71.3
Flow in Lanes 1 and 2 (v12), pc/h	4393	Ramp Junction Speed (S), mi/h	55.9
Flow Entering Ramp-Infl. Area (vR12), pc/h	-	Average Density (D), pc/mi/ln	39.3
Level of Service (LOS)	E	Density in Ramp Influence Area (DR), pc/mi/ln	40.7

HCS7 Basic Freeway Report

Project Information

Analyst	LSA	Date	12/11/2019
Agency	LSA	Analysis Year	Existing WP
Jurisdiction	Caltrans	Time Period Analyzed	PM Peak Hour
Project Description	CMD1801 - Village D Specific Plan	Unit	United States Customary

Geometric Data

Number of Lanes, ln	2	Terrain Type	Level
Segment Length (L), ft	-	Percent Grade, %	-
Measured or Base Free-Flow Speed	Base	Grade Length, mi	-
Base Free-Flow Speed (BFFS), mi/h	65.0	Total Ramp Density (TRD), ramps/mi	1.83
Lane Width, ft	12	Free-Flow Speed (FFS), mi/h	59.7
Right-Side Lateral Clearance, ft	10		

Adjustment Factors

Driver Population	All Familiar	Final Speed Adjustment Factor (SAF)	1.000
Weather Type	Non-Severe Weather	Final Capacity Adjustment Factor (CAF)	1.000
Incident Type	No Incident	Demand Adjustment Factor (DAF)	1.000

Demand and Capacity

Demand Volume veh/h	3190	Heavy Vehicle Adjustment Factor (fhv)	0.838
Peak Hour Factor	0.94	Flow Rate (Vp), pc/h/ln	2025
Total Trucks, %	19.40	Capacity (c), pc/h/ln	2296
Single-Unit Trucks (SUT), %	-	Adjusted Capacity (cadj), pc/h/ln	2296
Tractor-Trailers (TT), %	-	Volume-to-Capacity Ratio (v/c)	0.88
Passenger Car Equivalent (Et)	2.000		

Speed and Density

Lane Width Adjustment (fLW)	0.0	Average Speed (S), mi/h	56.5
Right-Side Lateral Clearance Adj. (fRLC)	0.0	Density (D), pc/mi/ln	35.8
Total Ramp Density Adjustment	5.4	Level of Service (LOS)	E
Adjusted Free-Flow Speed (FFSadj), mi/h	59.6		

HCS7 Freeway Merge Report

Project Information

Analyst	LSA	Date	12/11/2019
Agency	LSA	Analysis Year	Existing WP
Jurisdiction	Caltrans	Time Period Analyzed	PM Peak Hour
Project Description	CMD1801 - Village D Specific Plan	Unit	United States Customary

Geometric Data

	Freeway	Ramp
Number of Lanes (N), ln	2	1
Free-Flow Speed (FFS), mi/h	65.0	35.0
Segment Length (L) / Acceleration Length (LA),ft	1500	800
Terrain Type	Level	Level
Percent Grade, %	-	-
Segment Type / Ramp Side	Freeway	Right

Adjustment Factors

Driver Population	All Familiar	All Familiar
Weather Type	Non-Severe Weather	Non-Severe Weather
Incident Type	No Incident	-
Final Speed Adjustment Factor (SAF)	1.000	1.000
Final Capacity Adjustment Factor (CAF)	1.000	1.000
Demand Adjustment Factor (DAF)	1.000	1.000

Demand and Capacity

Demand Volume (Vi)	3190	144
Peak Hour Factor (PHF)	0.94	0.94
Total Trucks, %	19.40	4.17
Single-Unit Trucks (SUT), %	-	-
Tractor-Trailers (TT), %	-	-
Heavy Vehicle Adjustment Factor (fHV)	0.838	0.960
Flow Rate (vi),pc/h	4050	160
Capacity (c), pc/h	4700	2000
Volume-to-Capacity Ratio (v/c)	0.90	0.08

Speed and Density

Upstream Equilibrium Distance (LEQ), ft	-	Number of Outer Lanes on Freeway (NO)	0
Distance to Upstream Ramp (LUP), ft	-	Speed Index (MS)	0.528
Downstream Equilibrium Distance (LEQ), ft	-	Flow Outer Lanes (vOA), pc/h/ln	-
Distance to Downstream Ramp (LDOWN), ft	-	On-Ramp Influence Area Speed (SR), mi/h	52.9
Prop. Freeway Vehicles in Lane 1 and 2 (PFM)	1.000	Outer Lanes Freeway Speed (SO), mi/h	65.0
Flow in Lanes 1 and 2 (v12), pc/h	4050	Ramp Junction Speed (S), mi/h	52.9
Flow Entering Ramp-Infl. Area (vR12), pc/h	4210	Average Density (D), pc/mi/ln	39.8
Level of Service (LOS)	D	Density in Ramp Influence Area (DR), pc/mi/ln	33.3

HCS7 Basic Freeway Report

Project Information

Analyst	LSA	Date	12/11/2019
Agency	LSA	Analysis Year	Existing WP
Jurisdiction	Caltrans	Time Period Analyzed	PM Peak Hour
Project Description	CMD1801 - Village D Specific Plan	Unit	United States Customary

Geometric Data

Number of Lanes, ln	2	Terrain Type	Level
Segment Length (L), ft	-	Percent Grade, %	-
Measured or Base Free-Flow Speed	Base	Grade Length, mi	-
Base Free-Flow Speed (BFFS), mi/h	65.0	Total Ramp Density (TRD), ramps/mi	2.17
Lane Width, ft	12	Free-Flow Speed (FFS), mi/h	58.8
Right-Side Lateral Clearance, ft	10		

Adjustment Factors

Driver Population	All Familiar	Final Speed Adjustment Factor (SAF)	1.000
Weather Type	Non-Severe Weather	Final Capacity Adjustment Factor (CAF)	1.000
Incident Type	No Incident	Demand Adjustment Factor (DAF)	1.000

Demand and Capacity

Demand Volume veh/h	3334	Heavy Vehicle Adjustment Factor (fhv)	0.842
Peak Hour Factor	0.94	Flow Rate (Vp), pc/h/ln	2106
Total Trucks, %	18.75	Capacity (c), pc/h/ln	2288
Single-Unit Trucks (SUT), %	-	Adjusted Capacity (cadj), pc/h/ln	2288
Tractor-Trailers (TT), %	-	Volume-to-Capacity Ratio (v/c)	0.92
Passenger Car Equivalent (Et)	2.000		

Speed and Density

Lane Width Adjustment (fLW)	0.0	Average Speed (S), mi/h	54.7
Right-Side Lateral Clearance Adj. (fRLC)	0.0	Density (D), pc/mi/ln	38.5
Total Ramp Density Adjustment	6.2	Level of Service (LOS)	E
Adjusted Free-Flow Speed (FFSadj), mi/h	58.8		

HCS7 Freeway Diverge Report

Project Information

Analyst	LSA	Date	12/11/2019
Agency	LSA	Analysis Year	Existing WP
Jurisdiction	Caltrans	Time Period Analyzed	PM Peak Hour
Project Description	CMD1801 - Village D Specific Plan	Unit	United States Customary

Geometric Data

	Freeway	Ramp
Number of Lanes (N), ln	2	1
Free-Flow Speed (FFS), mi/h	65.0	35.0
Segment Length (L) / Deceleration Length (LA),ft	1500	200
Terrain Type	Level	Level
Percent Grade, %	-	-
Segment Type / Ramp Side	Freeway	Right

Adjustment Factors

Driver Population	All Familiar	All Familiar
Weather Type	Non-Severe Weather	Non-Severe Weather
Incident Type	No Incident	-
Final Speed Adjustment Factor (SAF)	1.000	1.000
Final Capacity Adjustment Factor (CAF)	1.000	1.000
Demand Adjustment Factor (DAF)	1.000	1.000

Demand and Capacity

Demand Volume (Vi)	3334	304
Peak Hour Factor (PHF)	0.94	0.94
Total Trucks, %	18.75	2.63
Single-Unit Trucks (SUT), %	-	-
Tractor-Trailers (TT), %	-	-
Heavy Vehicle Adjustment Factor (fHV)	0.842	0.974
Flow Rate (vi),pc/h	4212	332
Capacity (c), pc/h	4700	2000
Volume-to-Capacity Ratio (v/c)	0.90	0.17

Speed and Density

Upstream Equilibrium Distance (LEQ), ft	-	Number of Outer Lanes on Freeway (NO)	0
Distance to Upstream Ramp (LUP), ft	-	Speed Index (DS)	0.458
Downstream Equilibrium Distance (LEQ), ft	-	Flow Outer Lanes (vOA), pc/h/ln	-
Distance to Downstream Ramp (LDOWN), ft	-	Off-Ramp Influence Area Speed (SR), mi/h	54.5
Prop. Freeway Vehicles in Lane 1 and 2 (PFD)	1.000	Outer Lanes Freeway Speed (SO), mi/h	71.3
Flow in Lanes 1 and 2 (v12), pc/h	4212	Ramp Junction Speed (S), mi/h	54.5
Flow Entering Ramp-Infl. Area (vR12), pc/h	-	Average Density (D), pc/mi/ln	38.6
Level of Service (LOS)	E	Density in Ramp Influence Area (DR), pc/mi/ln	38.7

HCS7 Basic Freeway Report

Project Information

Analyst	LSA	Date	12/11/2019
Agency	LSA	Analysis Year	Existing WP
Jurisdiction	Caltrans	Time Period Analyzed	PM Peak Hour
Project Description	CMD1801 - Village D Specific Plan	Unit	United States Customary

Geometric Data

Number of Lanes, ln	2	Terrain Type	Level
Segment Length (L), ft	-	Percent Grade, %	-
Measured or Base Free-Flow Speed	Base	Grade Length, mi	-
Base Free-Flow Speed (BFFS), mi/h	65.0	Total Ramp Density (TRD), ramps/mi	2.17
Lane Width, ft	12	Free-Flow Speed (FFS), mi/h	58.8
Right-Side Lateral Clearance, ft	10		

Adjustment Factors

Driver Population	All Familiar	Final Speed Adjustment Factor (SAF)	1.000
Weather Type	Non-Severe Weather	Final Capacity Adjustment Factor (CAF)	1.000
Incident Type	No Incident	Demand Adjustment Factor (DAF)	1.000

Demand and Capacity

Demand Volume veh/h	3030	Heavy Vehicle Adjustment Factor (fhv)	0.831
Peak Hour Factor	0.94	Flow Rate (Vp), pc/h/ln	1940
Total Trucks, %	20.36	Capacity (c), pc/h/ln	2288
Single-Unit Trucks (SUT), %	-	Adjusted Capacity (cadj), pc/h/ln	2288
Tractor-Trailers (TT), %	-	Volume-to-Capacity Ratio (v/c)	0.85
Passenger Car Equivalent (Et)	2.000		

Speed and Density

Lane Width Adjustment (fLW)	0.0	Average Speed (S), mi/h	57.1
Right-Side Lateral Clearance Adj. (fRLC)	0.0	Density (D), pc/mi/ln	34.0
Total Ramp Density Adjustment	6.2	Level of Service (LOS)	D
Adjusted Free-Flow Speed (FFSadj), mi/h	58.8		

HCS7 Freeway Merge Report

Project Information

Analyst	LSA	Date	12/11/2019
Agency	LSA	Analysis Year	Existing WP
Jurisdiction	Caltrans	Time Period Analyzed	PM Peak Hour
Project Description	CMD1801 - Village D Specific Plan	Unit	United States Customary

Geometric Data

	Freeway	Ramp
Number of Lanes (N), ln	2	1
Free-Flow Speed (FFS), mi/h	65.0	35.0
Segment Length (L) / Acceleration Length (LA),ft	1500	350
Terrain Type	Level	Level
Percent Grade, %	-	-
Segment Type / Ramp Side	Freeway	Right

Adjustment Factors

Driver Population	All Familiar	All Familiar
Weather Type	Non-Severe Weather	Non-Severe Weather
Incident Type	No Incident	-
Final Speed Adjustment Factor (SAF)	1.000	1.000
Final Capacity Adjustment Factor (CAF)	1.000	1.000
Demand Adjustment Factor (DAF)	1.000	1.000

Demand and Capacity

Demand Volume (Vi)	3030	761
Peak Hour Factor (PHF)	0.94	0.94
Total Trucks, %	20.36	1.05
Single-Unit Trucks (SUT), %	-	-
Tractor-Trailers (TT), %	-	-
Heavy Vehicle Adjustment Factor (fHV)	0.831	0.990
Flow Rate (vi),pc/h	3879	818
Capacity (c), pc/h	4700	2000
Volume-to-Capacity Ratio (v/c)	1.00	0.41

Speed and Density

Upstream Equilibrium Distance (LEQ), ft	-	Number of Outer Lanes on Freeway (NO)	0
Distance to Upstream Ramp (LUP), ft	-	Speed Index (MS)	0.724
Downstream Equilibrium Distance (LEQ), ft	-	Flow Outer Lanes (vOA), pc/h/ln	-
Distance to Downstream Ramp (LDOWN), ft	-	On-Ramp Influence Area Speed (SR), mi/h	48.3
Prop. Freeway Vehicles in Lane 1 and 2 (PFM)	1.000	Outer Lanes Freeway Speed (SO), mi/h	65.0
Flow in Lanes 1 and 2 (v12), pc/h	3879	Ramp Junction Speed (S), mi/h	48.3
Flow Entering Ramp-Infl. Area (vR12), pc/h	4697	Average Density (D), pc/mi/ln	48.6
Level of Service (LOS)	E	Density in Ramp Influence Area (DR), pc/mi/ln	39.6

HCS7 Basic Freeway Report

Project Information

Analyst	LSA	Date	12/11/2019
Agency	LSA	Analysis Year	Existing WP
Jurisdiction	Caltrans	Time Period Analyzed	PM Peak Hour
Project Description	CMD1801 - Village D Specific Plan	Unit	United States Customary

Geometric Data

Number of Lanes, ln	2	Terrain Type	Level
Segment Length (L), ft	-	Percent Grade, %	-
Measured or Base Free-Flow Speed	Base	Grade Length, mi	-
Base Free-Flow Speed (BFFS), mi/h	65.0	Total Ramp Density (TRD), ramps/mi	2.17
Lane Width, ft	12	Free-Flow Speed (FFS), mi/h	58.8
Right-Side Lateral Clearance, ft	10		

Adjustment Factors

Driver Population	All Familiar	Final Speed Adjustment Factor (SAF)	1.000
Weather Type	Non-Severe Weather	Final Capacity Adjustment Factor (CAF)	1.000
Incident Type	No Incident	Demand Adjustment Factor (DAF)	1.000

Demand and Capacity

Demand Volume veh/h	3791	Heavy Vehicle Adjustment Factor (fhv)	0.858
Peak Hour Factor	0.94	Flow Rate (Vp), pc/h/ln	2350
Total Trucks, %	16.49	Capacity (c), pc/h/ln	2288
Single-Unit Trucks (SUT), %	-	Adjusted Capacity (cadj), pc/h/ln	2288
Tractor-Trailers (TT), %	-	Volume-to-Capacity Ratio (v/c)	1.03
Passenger Car Equivalent (Et)	2.000		

Speed and Density

Lane Width Adjustment (fLW)	0.0	Average Speed (S), mi/h	-
Right-Side Lateral Clearance Adj. (fRLC)	0.0	Density (D), pc/mi/ln	-
Total Ramp Density Adjustment	6.2	Level of Service (LOS)	F
Adjusted Free-Flow Speed (FFSadj), mi/h	58.8		

HCS7 Freeway Diverge Report

Project Information

Analyst	LSA	Date	12/11/2019
Agency	LSA	Analysis Year	Existing WP
Jurisdiction	Caltrans	Time Period Analyzed	PM Peak Hour
Project Description	CMD1801 - Village D Specific Plan	Unit	United States Customary

Geometric Data

	Freeway	Ramp
Number of Lanes (N), ln	2	1
Free-Flow Speed (FFS), mi/h	65.0	15.0
Segment Length (L) / Deceleration Length (LA),ft	1500	150
Terrain Type	Level	Level
Percent Grade, %	-	-
Segment Type / Ramp Side	Freeway	Right

Adjustment Factors

Driver Population	All Familiar	All Familiar
Weather Type	Non-Severe Weather	Non-Severe Weather
Incident Type	No Incident	-
Final Speed Adjustment Factor (SAF)	1.000	1.000
Final Capacity Adjustment Factor (CAF)	1.000	1.000
Demand Adjustment Factor (DAF)	1.000	1.000

Demand and Capacity

Demand Volume (Vi)	3791	301
Peak Hour Factor (PHF)	0.94	0.94
Total Trucks, %	16.49	2.33
Single-Unit Trucks (SUT), %	-	-
Tractor-Trailers (TT), %	-	-
Heavy Vehicle Adjustment Factor (fHV)	0.858	0.977
Flow Rate (vi),pc/h	4700	328
Capacity (c), pc/h	4700	1800
Volume-to-Capacity Ratio (v/c)	1.00	0.18

Speed and Density

Upstream Equilibrium Distance (LEQ), ft	-	Number of Outer Lanes on Freeway (NO)	0
Distance to Upstream Ramp (LUP), ft	-	Speed Index (DS)	0.718
Downstream Equilibrium Distance (LEQ), ft	-	Flow Outer Lanes (vOA), pc/h/ln	-
Distance to Downstream Ramp (LDOWN), ft	-	Off-Ramp Influence Area Speed (SR), mi/h	48.5
Prop. Freeway Vehicles in Lane 1 and 2 (PFD)	1.000	Outer Lanes Freeway Speed (SO), mi/h	71.3
Flow in Lanes 1 and 2 (v12), pc/h	4700	Ramp Junction Speed (S), mi/h	48.5
Flow Entering Ramp-Infl. Area (vR12), pc/h	-	Average Density (D), pc/mi/ln	48.5
Level of Service (LOS)	E	Density in Ramp Influence Area (DR), pc/mi/ln	43.3

HCS7 Basic Freeway Report

Project Information

Analyst	LSA	Date	12/11/2019
Agency	LSA	Analysis Year	Existing WP
Jurisdiction	Caltrans	Time Period Analyzed	AM Peak Hour
Project Description	CMD1801 - Village D Specific Plan	Unit	United States Customary

Geometric Data

Number of Lanes, ln	2	Terrain Type	Level
Segment Length (L), ft	-	Percent Grade, %	-
Measured or Base Free-Flow Speed	Base	Grade Length, mi	-
Base Free-Flow Speed (BFFS), mi/h	65.0	Total Ramp Density (TRD), ramps/mi	1.83
Lane Width, ft	12	Free-Flow Speed (FFS), mi/h	59.7
Right-Side Lateral Clearance, ft	10		

Adjustment Factors

Driver Population	All Familiar	Final Speed Adjustment Factor (SAF)	1.000
Weather Type	Non-Severe Weather	Final Capacity Adjustment Factor (CAF)	1.000
Incident Type	No Incident	Demand Adjustment Factor (DAF)	1.000

Demand and Capacity

Demand Volume veh/h	3490	Heavy Vehicle Adjustment Factor (fhv)	0.850
Peak Hour Factor	0.94	Flow Rate (Vp), pc/h/ln	2184
Total Trucks, %	17.71	Capacity (c), pc/h/ln	2296
Single-Unit Trucks (SUT), %	-	Adjusted Capacity (cadj), pc/h/ln	2296
Tractor-Trailers (TT), %	-	Volume-to-Capacity Ratio (v/c)	0.95
Passenger Car Equivalent (Et)	2.000		

Speed and Density

Lane Width Adjustment (flw)	0.0	Average Speed (S), mi/h	53.6
Right-Side Lateral Clearance Adj. (fRLC)	0.0	Density (D), pc/mi/ln	40.7
Total Ramp Density Adjustment	5.4	Level of Service (LOS)	E
Adjusted Free-Flow Speed (FFSadj), mi/h	59.6		

HCS7 Freeway Merge Report

Project Information

Analyst	LSA	Date	12/11/2019
Agency	LSA	Analysis Year	Existing WP
Jurisdiction	Caltrans	Time Period Analyzed	PM Peak Hour
Project Description	CMD1801 - Village D Specific Plan	Unit	United States Customary

Geometric Data

	Freeway	Ramp
Number of Lanes (N), ln	2	1
Free-Flow Speed (FFS), mi/h	65.0	35.0
Segment Length (L) / Acceleration Length (LA),ft	1500	450
Terrain Type	Level	Level
Percent Grade, %	-	-
Segment Type / Ramp Side	Freeway	Right

Adjustment Factors

Driver Population	All Familiar	All Familiar
Weather Type	Non-Severe Weather	Non-Severe Weather
Incident Type	No Incident	-
Final Speed Adjustment Factor (SAF)	1.000	1.000
Final Capacity Adjustment Factor (CAF)	1.000	1.000
Demand Adjustment Factor (DAF)	1.000	1.000

Demand and Capacity

Demand Volume (Vi)	3490	426
Peak Hour Factor (PHF)	0.94	0.94
Total Trucks, %	17.71	1.17
Single-Unit Trucks (SUT), %	-	-
Tractor-Trailers (TT), %	-	-
Heavy Vehicle Adjustment Factor (fHV)	0.850	0.988
Flow Rate (vi),pc/h	4368	459
Capacity (c), pc/h	4700	2000
Volume-to-Capacity Ratio (v/c)	1.03	0.23

Speed and Density

Upstream Equilibrium Distance (LEQ), ft	-	Number of Outer Lanes on Freeway (NO)	0
Distance to Upstream Ramp (LUP), ft	-	Speed Index (MS)	-
Downstream Equilibrium Distance (LEQ), ft	-	Flow Outer Lanes (vOA), pc/h/ln	-
Distance to Downstream Ramp (LDOWN), ft	-	On-Ramp Influence Area Speed (SR), mi/h	47.2
Prop. Freeway Vehicles in Lane 1 and 2 (PFM)	1.000	Outer Lanes Freeway Speed (SO), mi/h	-
Flow in Lanes 1 and 2 (v12), pc/h	4368	Ramp Junction Speed (S), mi/h	-
Flow Entering Ramp-Infl. Area (vR12), pc/h	4827	Average Density (D), pc/mi/ln	-
Level of Service (LOS)	F	Density in Ramp Influence Area (DR), pc/mi/ln	40.2

HCS7 Basic Freeway Report

Project Information

Analyst	LSA	Date	12/11/2019
Agency	LSA	Analysis Year	Existing WP
Jurisdiction	Caltrans	Time Period Analyzed	AM Peak Hour
Project Description	CMD1801 - Village D Specific Plan	Unit	United States Customary

Geometric Data

Number of Lanes, ln	2	Terrain Type	Level
Segment Length (L), ft	-	Percent Grade, %	-
Measured or Base Free-Flow Speed	Base	Grade Length, mi	-
Base Free-Flow Speed (BFFS), mi/h	65.0	Total Ramp Density (TRD), ramps/mi	1.83
Lane Width, ft	12	Free-Flow Speed (FFS), mi/h	59.7
Right-Side Lateral Clearance, ft	10		

Adjustment Factors

Driver Population	All Familiar	Final Speed Adjustment Factor (SAF)	1.000
Weather Type	Non-Severe Weather	Final Capacity Adjustment Factor (CAF)	1.000
Incident Type	No Incident	Demand Adjustment Factor (DAF)	1.000

Demand and Capacity

Demand Volume veh/h	3916	Heavy Vehicle Adjustment Factor (fhv)	0.863
Peak Hour Factor	0.94	Flow Rate (Vp), pc/h/ln	2414
Total Trucks, %	15.91	Capacity (c), pc/h/ln	2296
Single-Unit Trucks (SUT), %	-	Adjusted Capacity (cadj), pc/h/ln	2296
Tractor-Trailers (TT), %	-	Volume-to-Capacity Ratio (v/c)	1.05
Passenger Car Equivalent (Et)	2.000		

Speed and Density

Lane Width Adjustment (fLW)	0.0	Average Speed (S), mi/h	-
Right-Side Lateral Clearance Adj. (fRLC)	0.0	Density (D), pc/mi/ln	-
Total Ramp Density Adjustment	5.4	Level of Service (LOS)	F
Adjusted Free-Flow Speed (FFSadj), mi/h	59.6		

HCS7 Freeway Diverge Report

Project Information

Analyst	LSA	Date	12/11/2019
Agency	LSA	Analysis Year	Existing WP
Jurisdiction	Caltrans	Time Period Analyzed	PM Peak Hour
Project Description	CMD1801 - Village D Specific Plan	Unit	United States Customary

Geometric Data

	Freeway	Ramp
Number of Lanes (N), ln	2	1
Free-Flow Speed (FFS), mi/h	65.0	35.0
Segment Length (L) / Deceleration Length (LA),ft	1500	140
Terrain Type	Level	Level
Percent Grade, %	-	-
Segment Type / Ramp Side	Freeway	Right

Adjustment Factors

Driver Population	All Familiar	All Familiar
Weather Type	Non-Severe Weather	Non-Severe Weather
Incident Type	No Incident	-
Final Speed Adjustment Factor (SAF)	1.000	1.000
Final Capacity Adjustment Factor (CAF)	1.000	1.000
Demand Adjustment Factor (DAF)	1.000	1.000

Demand and Capacity

Demand Volume (Vi)	3916	396
Peak Hour Factor (PHF)	0.94	0.94
Total Trucks, %	15.91	3.28
Single-Unit Trucks (SUT), %	-	-
Tractor-Trailers (TT), %	-	-
Heavy Vehicle Adjustment Factor (fHV)	0.863	0.968
Flow Rate (vi),pc/h	4827	435
Capacity (c), pc/h	4700	2000
Volume-to-Capacity Ratio (v/c)	1.03	0.22

Speed and Density

Upstream Equilibrium Distance (LEQ), ft	-	Number of Outer Lanes on Freeway (NO)	0
Distance to Upstream Ramp (LUP), ft	-	Speed Index (DS)	-
Downstream Equilibrium Distance (LEQ), ft	-	Flow Outer Lanes (vOA), pc/h/ln	-
Distance to Downstream Ramp (LDOWN), ft	-	Off-Ramp Influence Area Speed (SR), mi/h	54.3
Prop. Freeway Vehicles in Lane 1 and 2 (PFD)	1.000	Outer Lanes Freeway Speed (SO), mi/h	-
Flow in Lanes 1 and 2 (v12), pc/h	4827	Ramp Junction Speed (S), mi/h	-
Flow Entering Ramp-Infl. Area (vR12), pc/h	-	Average Density (D), pc/mi/ln	-
Level of Service (LOS)	F	Density in Ramp Influence Area (DR), pc/mi/ln	44.5

HCS7 Basic Freeway Report

Project Information

Analyst	LSA	Date	12/11/2019
Agency	LSA	Analysis Year	Existing WP
Jurisdiction	Caltrans	Time Period Analyzed	PM Peak Hour
Project Description	CMD1801 - Village D Specific Plan	Unit	United States Customary

Geometric Data

Number of Lanes, ln	2	Terrain Type	Level
Segment Length (L), ft	-	Percent Grade, %	-
Measured or Base Free-Flow Speed	Base	Grade Length, mi	-
Base Free-Flow Speed (BFFS), mi/h	65.0	Total Ramp Density (TRD), ramps/mi	2.17
Lane Width, ft	12	Free-Flow Speed (FFS), mi/h	58.8
Right-Side Lateral Clearance, ft	10		

Adjustment Factors

Driver Population	All Familiar	Final Speed Adjustment Factor (SAF)	1.000
Weather Type	Non-Severe Weather	Final Capacity Adjustment Factor (CAF)	1.000
Incident Type	No Incident	Demand Adjustment Factor (DAF)	1.000

Demand and Capacity

Demand Volume veh/h	3520	Heavy Vehicle Adjustment Factor (fhv)	0.852
Peak Hour Factor	0.94	Flow Rate (Vp), pc/h/ln	2198
Total Trucks, %	17.33	Capacity (c), pc/h/ln	2288
Single-Unit Trucks (SUT), %	-	Adjusted Capacity (cadj), pc/h/ln	2288
Tractor-Trailers (TT), %	-	Volume-to-Capacity Ratio (v/c)	0.96
Passenger Car Equivalent (Et)	2.000		

Speed and Density

Lane Width Adjustment (fLW)	0.0	Average Speed (S), mi/h	52.9
Right-Side Lateral Clearance Adj. (fRLC)	0.0	Density (D), pc/mi/ln	41.6
Total Ramp Density Adjustment	6.2	Level of Service (LOS)	E
Adjusted Free-Flow Speed (FFSadj), mi/h	58.8		

HCS7 Freeway Merge Report

Project Information

Analyst	LSA	Date	12/11/2019
Agency	LSA	Analysis Year	Existing WP
Jurisdiction	Caltrans	Time Period Analyzed	PM Peak Hour
Project Description	CMD1801 - Village D Specific Plan	Unit	United States Customary

Geometric Data

	Freeway	Ramp
Number of Lanes (N), ln	2	1
Free-Flow Speed (FFS), mi/h	65.0	35.0
Segment Length (L) / Acceleration Length (LA),ft	1500	450
Terrain Type	Level	Level
Percent Grade, %	-	-
Segment Type / Ramp Side	Freeway	Right

Adjustment Factors

Driver Population	All Familiar	All Familiar
Weather Type	Non-Severe Weather	Non-Severe Weather
Incident Type	No Incident	-
Final Speed Adjustment Factor (SAF)	1.000	1.000
Final Capacity Adjustment Factor (CAF)	1.000	1.000
Demand Adjustment Factor (DAF)	1.000	1.000

Demand and Capacity

Demand Volume (Vi)	3520	385
Peak Hour Factor (PHF)	0.94	0.94
Total Trucks, %	17.33	1.30
Single-Unit Trucks (SUT), %	-	-
Tractor-Trailers (TT), %	-	-
Heavy Vehicle Adjustment Factor (fHV)	0.852	0.987
Flow Rate (vi),pc/h	4395	415
Capacity (c), pc/h	4700	2000
Volume-to-Capacity Ratio (v/c)	1.02	0.21

Speed and Density

Upstream Equilibrium Distance (LEQ), ft	-	Number of Outer Lanes on Freeway (NO)	0
Distance to Upstream Ramp (LUP), ft	-	Speed Index (MS)	-
Downstream Equilibrium Distance (LEQ), ft	-	Flow Outer Lanes (vOA), pc/h/ln	-
Distance to Downstream Ramp (LDOWN), ft	-	On-Ramp Influence Area Speed (SR), mi/h	47.3
Prop. Freeway Vehicles in Lane 1 and 2 (PFM)	1.000	Outer Lanes Freeway Speed (SO), mi/h	-
Flow in Lanes 1 and 2 (v12), pc/h	4395	Ramp Junction Speed (S), mi/h	-
Flow Entering Ramp-Infl. Area (vR12), pc/h	4810	Average Density (D), pc/mi/ln	-
Level of Service (LOS)	F	Density in Ramp Influence Area (DR), pc/mi/ln	40.1

HCS7 Basic Freeway Report

Project Information

Analyst	LSA	Date	12/11/2019
Agency	LSA	Analysis Year	Existing WP
Jurisdiction	Caltrans	Time Period Analyzed	PM Peak Hour
Project Description	CMD1801 - Village D Specific Plan	Unit	United States Customary

Geometric Data

Number of Lanes, ln	2	Terrain Type	Level
Segment Length (L), ft	-	Percent Grade, %	-
Measured or Base Free-Flow Speed	Base	Grade Length, mi	-
Base Free-Flow Speed (BFFS), mi/h	65.0	Total Ramp Density (TRD), ramps/mi	2.17
Lane Width, ft	12	Free-Flow Speed (FFS), mi/h	58.8
Right-Side Lateral Clearance, ft	10		

Adjustment Factors

Driver Population	All Familiar	Final Speed Adjustment Factor (SAF)	1.000
Weather Type	Non-Severe Weather	Final Capacity Adjustment Factor (CAF)	1.000
Incident Type	No Incident	Demand Adjustment Factor (DAF)	1.000

Demand and Capacity

Demand Volume veh/h	3905	Heavy Vehicle Adjustment Factor (fhv)	0.864
Peak Hour Factor	0.94	Flow Rate (Vp), pc/h/ln	2404
Total Trucks, %	15.75	Capacity (c), pc/h/ln	2288
Single-Unit Trucks (SUT), %	-	Adjusted Capacity (cadj), pc/h/ln	2288
Tractor-Trailers (TT), %	-	Volume-to-Capacity Ratio (v/c)	1.05
Passenger Car Equivalent (Et)	2.000		

Speed and Density

Lane Width Adjustment (fLW)	0.0	Average Speed (S), mi/h	-
Right-Side Lateral Clearance Adj. (fRLC)	0.0	Density (D), pc/mi/ln	-
Total Ramp Density Adjustment	6.2	Level of Service (LOS)	F
Adjusted Free-Flow Speed (FFSadj), mi/h	58.8		

HCS7 Basic Freeway Report

Project Information

Analyst	LSA	Date	12/11/2019
Agency	LSA	Analysis Year	Phase I Proj Comp Yr (2029) NP
Jurisdiction	Caltrans	Time Period Analyzed	AM Peak Hour
Project Description	CMD1801 - Village D Specific Plan	Unit	United States Customary

Geometric Data

Number of Lanes, ln	3	Terrain Type	Level
Segment Length (L), ft	-	Percent Grade, %	-
Measured or Base Free-Flow Speed	Base	Grade Length, mi	-
Base Free-Flow Speed (BFFS), mi/h	65.0	Total Ramp Density (TRD), ramps/mi	1.83
Lane Width, ft	12	Free-Flow Speed (FFS), mi/h	59.7
Right-Side Lateral Clearance, ft	10		

Adjustment Factors

Driver Population	All Familiar	Final Speed Adjustment Factor (SAF)	1.000
Weather Type	Non-Severe Weather	Final Capacity Adjustment Factor (CAF)	1.000
Incident Type	No Incident	Demand Adjustment Factor (DAF)	1.000

Demand and Capacity

Demand Volume veh/h	2977	Heavy Vehicle Adjustment Factor (fhv)	0.851
Peak Hour Factor	0.94	Flow Rate (Vp), pc/h/ln	1241
Total Trucks, %	17.57	Capacity (c), pc/h/ln	2296
Single-Unit Trucks (SUT), %	-	Adjusted Capacity (cadj), pc/h/ln	2296
Tractor-Trailers (TT), %	-	Volume-to-Capacity Ratio (v/c)	0.54
Passenger Car Equivalent (ET)	2.000		

Speed and Density

Lane Width Adjustment (fLW)	0.0	Average Speed (S), mi/h	59.6
Right-Side Lateral Clearance Adj. (fRLC)	0.0	Density (D), pc/mi/ln	20.8
Total Ramp Density Adjustment	5.4	Level of Service (LOS)	C
Adjusted Free-Flow Speed (FFSadj), mi/h	59.6		

HCS7 Freeway Diverge Report

Project Information

Analyst	LSA	Date	12/11/2019
Agency	LSA	Analysis Year	Phase I Proj Comp Yr (2029) NP
Jurisdiction	Caltrans	Time Period Analyzed	AM Peak Hour
Project Description	CMD1801 - Village D Specific Plan	Unit	United States Customary

Geometric Data

	Freeway	Ramp
Number of Lanes (N), ln	3	1
Free-Flow Speed (FFS), mi/h	65.0	35.0
Segment Length (L) / Deceleration Length (LA),ft	1500	150
Terrain Type	Level	Level
Percent Grade, %	-	-
Segment Type / Ramp Side	Freeway	Right

Adjustment Factors

Driver Population	All Familiar	All Familiar
Weather Type	Non-Severe Weather	Non-Severe Weather
Incident Type	No Incident	-
Final Speed Adjustment Factor (SAF)	1.000	1.000
Final Capacity Adjustment Factor (CAF)	1.000	1.000
Demand Adjustment Factor (DAF)	1.000	1.000

Demand and Capacity

Demand Volume (Vi)	2977	254
Peak Hour Factor (PHF)	0.94	0.94
Total Trucks, %	17.57	4.65
Single-Unit Trucks (SUT), %	-	-
Tractor-Trailers (TT), %	-	-
Heavy Vehicle Adjustment Factor (fHV)	0.851	0.956
Flow Rate (vi),pc/h	3722	283
Capacity (c), pc/h	7050	2000
Volume-to-Capacity Ratio (v/c)	0.53	0.14

Speed and Density

Upstream Equilibrium Distance (LEQ), ft	-	Number of Outer Lanes on Freeway (NO)	1
Distance to Upstream Ramp (LUP), ft	-	Speed Index (DS)	0.453
Downstream Equilibrium Distance (LEQ), ft	-	Flow Outer Lanes (vOA), pc/h/ln	1190
Distance to Downstream Ramp (LDOWN), ft	-	Off-Ramp Influence Area Speed (SR), mi/h	54.6
Prop. Freeway Vehicles in Lane 1 and 2 (PFD)	0.654	Outer Lanes Freeway Speed (SO), mi/h	70.6
Flow in Lanes 1 and 2 (v12), pc/h	2532	Ramp Junction Speed (S), mi/h	58.9
Flow Entering Ramp-Infl. Area (vR12), pc/h	-	Average Density (D), pc/mi/ln	21.1
Level of Service (LOS)	C	Density in Ramp Influence Area (DR), pc/mi/ln	24.7

HCS7 Basic Freeway Report

Project Information

Analyst	LSA	Date	12/11/2019
Agency	LSA	Analysis Year	Phase I Proj Comp Yr (2029) NP
Jurisdiction	Caltrans	Time Period Analyzed	AM Peak Hour
Project Description	CMD1801 - Village D Specific Plan	Unit	United States Customary

Geometric Data

Number of Lanes, ln	3	Terrain Type	Level
Segment Length (L), ft	-	Percent Grade, %	-
Measured or Base Free-Flow Speed	Base	Grade Length, mi	-
Base Free-Flow Speed (BFFS), mi/h	65.0	Total Ramp Density (TRD), ramps/mi	1.83
Lane Width, ft	12	Free-Flow Speed (FFS), mi/h	59.7
Right-Side Lateral Clearance, ft	10		

Adjustment Factors

Driver Population	All Familiar	Final Speed Adjustment Factor (SAF)	1.000
Weather Type	Non-Severe Weather	Final Capacity Adjustment Factor (CAF)	1.000
Incident Type	No Incident	Demand Adjustment Factor (DAF)	1.000

Demand and Capacity

Demand Volume veh/h	2723	Heavy Vehicle Adjustment Factor (fhv)	0.842
Peak Hour Factor	0.94	Flow Rate (Vp), pc/h/ln	1147
Total Trucks, %	18.78	Capacity (c), pc/h/ln	2296
Single-Unit Trucks (SUT), %	-	Adjusted Capacity (cadj), pc/h/ln	2296
Tractor-Trailers (TT), %	-	Volume-to-Capacity Ratio (v/c)	0.50
Passenger Car Equivalent (ET)	2.000		

Speed and Density

Lane Width Adjustment (fLW)	0.0	Average Speed (S), mi/h	59.6
Right-Side Lateral Clearance Adj. (fRLC)	0.0	Density (D), pc/mi/ln	19.2
Total Ramp Density Adjustment	5.4	Level of Service (LOS)	C
Adjusted Free-Flow Speed (FFSadj), mi/h	59.6		

HCS7 Freeway Merge Report

Project Information

Analyst	LSA	Date	12/11/2019
Agency	LSA	Analysis Year	Phase I Proj Comp Yr (2029) NP
Jurisdiction	Caltrans	Time Period Analyzed	AM Peak Hour
Project Description	CMD1801 - Village D Specific Plan	Unit	United States Customary

Geometric Data

	Freeway	Ramp
Number of Lanes (N), ln	3	1
Free-Flow Speed (FFS), mi/h	65.0	35.0
Segment Length (L) / Acceleration Length (LA),ft	1500	445
Terrain Type	Level	Level
Percent Grade, %	-	-
Segment Type / Ramp Side	Freeway	Right

Adjustment Factors

Driver Population	All Familiar	All Familiar
Weather Type	Non-Severe Weather	Non-Severe Weather
Incident Type	No Incident	-
Final Speed Adjustment Factor (SAF)	1.000	1.000
Final Capacity Adjustment Factor (CAF)	1.000	1.000
Demand Adjustment Factor (DAF)	1.000	1.000

Demand and Capacity

Demand Volume (Vi)	2723	650
Peak Hour Factor (PHF)	0.94	0.94
Total Trucks, %	18.78	9.94
Single-Unit Trucks (SUT), %	-	-
Tractor-Trailers (TT), %	-	-
Heavy Vehicle Adjustment Factor (fHV)	0.842	0.910
Flow Rate (vi),pc/h	3440	760
Capacity (c), pc/h	7050	2000
Volume-to-Capacity Ratio (v/c)	0.60	0.38

Speed and Density

Upstream Equilibrium Distance (LEQ), ft	-	Number of Outer Lanes on Freeway (NO)	1
Distance to Upstream Ramp (LUP), ft	-	Speed Index (MS)	0.353
Downstream Equilibrium Distance (LEQ), ft	-	Flow Outer Lanes (vOA), pc/h/ln	1410
Distance to Downstream Ramp (LDOWN), ft	-	On-Ramp Influence Area Speed (SR), mi/h	56.9
Prop. Freeway Vehicles in Lane 1 and 2 (PFM)	0.590	Outer Lanes Freeway Speed (SO), mi/h	61.7
Flow in Lanes 1 and 2 (v12), pc/h	2030	Ramp Junction Speed (S), mi/h	58.4
Flow Entering Ramp-Infl. Area (vR12), pc/h	2790	Average Density (D), pc/mi/ln	24.0
Level of Service (LOS)	C	Density in Ramp Influence Area (DR), pc/mi/ln	24.2

HCS7 Basic Freeway Report

Project Information

Analyst	LSA	Date	12/11/2019
Agency	LSA	Analysis Year	Phase I Proj Comp Yr (2029) NP
Jurisdiction	Caltrans	Time Period Analyzed	AM Peak Hour
Project Description	CMD1801 - Village D Specific Plan	Unit	United States Customary

Geometric Data

Number of Lanes, ln	3	Terrain Type	Level
Segment Length (L), ft	-	Percent Grade, %	-
Measured or Base Free-Flow Speed	Base	Grade Length, mi	-
Base Free-Flow Speed (BFFS), mi/h	65.0	Total Ramp Density (TRD), ramps/mi	1.50
Lane Width, ft	12	Free-Flow Speed (FFS), mi/h	60.5
Right-Side Lateral Clearance, ft	10		

Adjustment Factors

Driver Population	All Familiar	Final Speed Adjustment Factor (SAF)	1.000
Weather Type	Non-Severe Weather	Final Capacity Adjustment Factor (CAF)	1.000
Incident Type	No Incident	Demand Adjustment Factor (DAF)	1.000

Demand and Capacity

Demand Volume veh/h	3373	Heavy Vehicle Adjustment Factor (fhv)	0.854
Peak Hour Factor	0.94	Flow Rate (Vp), pc/h/ln	1401
Total Trucks, %	17.08	Capacity (c), pc/h/ln	2305
Single-Unit Trucks (SUT), %	-	Adjusted Capacity (cadj), pc/h/ln	2305
Tractor-Trailers (TT), %	-	Volume-to-Capacity Ratio (v/c)	0.61
Passenger Car Equivalent (ET)	2.000		

Speed and Density

Lane Width Adjustment (fLW)	0.0	Average Speed (S), mi/h	60.5
Right-Side Lateral Clearance Adj. (fRLC)	0.0	Density (D), pc/mi/ln	23.2
Total Ramp Density Adjustment	4.5	Level of Service (LOS)	C
Adjusted Free-Flow Speed (FFSadj), mi/h	60.5		

HCS7 Freeway Diverge Report

Project Information

Analyst	LSA	Date	12/11/2019
Agency	LSA	Analysis Year	Phase I Proj Comp Yr (2029) NP
Jurisdiction	Caltrans	Time Period Analyzed	AM Peak Hour
Project Description	CMD1801 - Village D Specific Plan	Unit	United States Customary

Geometric Data

	Freeway	Ramp
Number of Lanes (N), ln	3	1
Free-Flow Speed (FFS), mi/h	65.0	35.0
Segment Length (L) / Deceleration Length (LA),ft	1500	130
Terrain Type	Level	Level
Percent Grade, %	-	-
Segment Type / Ramp Side	Freeway	Right

Adjustment Factors

Driver Population	All Familiar	All Familiar
Weather Type	Non-Severe Weather	Non-Severe Weather
Incident Type	No Incident	-
Final Speed Adjustment Factor (SAF)	1.000	1.000
Final Capacity Adjustment Factor (CAF)	1.000	1.000
Demand Adjustment Factor (DAF)	1.000	1.000

Demand and Capacity

Demand Volume (Vi)	3373	491
Peak Hour Factor (PHF)	0.94	0.94
Total Trucks, %	17.08	1.77
Single-Unit Trucks (SUT), %	-	-
Tractor-Trailers (TT), %	-	-
Heavy Vehicle Adjustment Factor (fHV)	0.854	0.983
Flow Rate (vi),pc/h	4202	531
Capacity (c), pc/h	7050	2000
Volume-to-Capacity Ratio (v/c)	0.60	0.27

Speed and Density

Upstream Equilibrium Distance (LEQ), ft	-	Number of Outer Lanes on Freeway (NO)	1
Distance to Upstream Ramp (LUP), ft	-	Speed Index (DS)	0.476
Downstream Equilibrium Distance (LEQ), ft	-	Flow Outer Lanes (vOA), pc/h/ln	1355
Distance to Downstream Ramp (LDOWN), ft	-	Off-Ramp Influence Area Speed (SR), mi/h	54.1
Prop. Freeway Vehicles in Lane 1 and 2 (PFD)	0.631	Outer Lanes Freeway Speed (SO), mi/h	69.9
Flow in Lanes 1 and 2 (v12), pc/h	2847	Ramp Junction Speed (S), mi/h	58.4
Flow Entering Ramp-Infl. Area (vR12), pc/h	-	Average Density (D), pc/mi/ln	24.0
Level of Service (LOS)	C	Density in Ramp Influence Area (DR), pc/mi/ln	27.6

HCS7 Basic Freeway Report

Project Information

Analyst	LSA	Date	12/11/2019
Agency	LSA	Analysis Year	Phase I Proj Comp Yr (2029) NP
Jurisdiction	Caltrans	Time Period Analyzed	AM Peak Hour
Project Description	CMD1801 - Village D Specific Plan	Unit	United States Customary

Geometric Data

Number of Lanes, ln	3	Terrain Type	Level
Segment Length (L), ft	-	Percent Grade, %	-
Measured or Base Free-Flow Speed	Base	Grade Length, mi	-
Base Free-Flow Speed (BFFS), mi/h	65.0	Total Ramp Density (TRD), ramps/mi	1.67
Lane Width, ft	12	Free-Flow Speed (FFS), mi/h	60.0
Right-Side Lateral Clearance, ft	10		

Adjustment Factors

Driver Population	All Familiar	Final Speed Adjustment Factor (SAF)	1.000
Weather Type	Non-Severe Weather	Final Capacity Adjustment Factor (CAF)	1.000
Incident Type	No Incident	Demand Adjustment Factor (DAF)	1.000

Demand and Capacity

Demand Volume veh/h	2882	Heavy Vehicle Adjustment Factor (fhv)	0.835
Peak Hour Factor	0.94	Flow Rate (Vp), pc/h/ln	1224
Total Trucks, %	19.69	Capacity (c), pc/h/ln	2300
Single-Unit Trucks (SUT), %	-	Adjusted Capacity (cadj), pc/h/ln	2300
Tractor-Trailers (TT), %	-	Volume-to-Capacity Ratio (v/c)	0.53
Passenger Car Equivalent (ET)	2.000		

Speed and Density

Lane Width Adjustment (fLW)	0.0	Average Speed (S), mi/h	60.0
Right-Side Lateral Clearance Adj. (fRLC)	0.0	Density (D), pc/mi/ln	20.4
Total Ramp Density Adjustment	5.0	Level of Service (LOS)	C
Adjusted Free-Flow Speed (FFSadj), mi/h	60.0		

HCS7 Freeway Merge Report

Project Information

Analyst	LSA	Date	12/11/2019
Agency	LSA	Analysis Year	Phase I Proj Comp Yr (2029) NP
Jurisdiction	Caltrans	Time Period Analyzed	AM Peak Hour
Project Description	CMD1801 - Village D Specific Plan	Unit	United States Customary

Geometric Data

	Freeway	Ramp
Number of Lanes (N), ln	3	1
Free-Flow Speed (FFS), mi/h	65.0	35.0
Segment Length (L) / Acceleration Length (LA),ft	1500	500
Terrain Type	Level	Level
Percent Grade, %	-	-
Segment Type / Ramp Side	Freeway	Right

Adjustment Factors

Driver Population	All Familiar	All Familiar
Weather Type	Non-Severe Weather	Non-Severe Weather
Incident Type	No Incident	-
Final Speed Adjustment Factor (SAF)	1.000	1.000
Final Capacity Adjustment Factor (CAF)	1.000	1.000
Demand Adjustment Factor (DAF)	1.000	1.000

Demand and Capacity

Demand Volume (Vi)	2882	302
Peak Hour Factor (PHF)	0.94	0.94
Total Trucks, %	19.69	2.92
Single-Unit Trucks (SUT), %	-	-
Tractor-Trailers (TT), %	-	-
Heavy Vehicle Adjustment Factor (fHV)	0.835	0.972
Flow Rate (vi),pc/h	3672	331
Capacity (c), pc/h	7050	2000
Volume-to-Capacity Ratio (v/c)	0.57	0.17

Speed and Density

Upstream Equilibrium Distance (LEQ), ft	-	Number of Outer Lanes on Freeway (NO)	1
Distance to Upstream Ramp (LUP), ft	-	Speed Index (MS)	0.334
Downstream Equilibrium Distance (LEQ), ft	-	Flow Outer Lanes (vOA), pc/h/ln	1498
Distance to Downstream Ramp (LDOWN), ft	-	On-Ramp Influence Area Speed (SR), mi/h	57.3
Prop. Freeway Vehicles in Lane 1 and 2 (PFM)	0.592	Outer Lanes Freeway Speed (SO), mi/h	61.4
Flow in Lanes 1 and 2 (v12), pc/h	2174	Ramp Junction Speed (S), mi/h	58.8
Flow Entering Ramp-Infl. Area (vR12), pc/h	2505	Average Density (D), pc/mi/ln	22.7
Level of Service (LOS)	C	Density in Ramp Influence Area (DR), pc/mi/ln	21.8

HCS7 Basic Freeway Report

Project Information

Analyst	LSA	Date	12/11/2019
Agency	LSA	Analysis Year	Phase I Proj Comp Yr (2029) NP
Jurisdiction	Caltrans	Time Period Analyzed	AM Peak Hour
Project Description	CMD1801 - Village D Specific Plan	Unit	United States Customary

Geometric Data

Number of Lanes, ln	3	Terrain Type	Level
Segment Length (L), ft	-	Percent Grade, %	-
Measured or Base Free-Flow Speed	Base	Grade Length, mi	-
Base Free-Flow Speed (BFFS), mi/h	65.0	Total Ramp Density (TRD), ramps/mi	1.83
Lane Width, ft	12	Free-Flow Speed (FFS), mi/h	59.7
Right-Side Lateral Clearance, ft	10		

Adjustment Factors

Driver Population	All Familiar	Final Speed Adjustment Factor (SAF)	1.000
Weather Type	Non-Severe Weather	Final Capacity Adjustment Factor (CAF)	1.000
Incident Type	No Incident	Demand Adjustment Factor (DAF)	1.000

Demand and Capacity

Demand Volume veh/h	3184	Heavy Vehicle Adjustment Factor (fhv)	0.847
Peak Hour Factor	0.94	Flow Rate (Vp), pc/h/ln	1333
Total Trucks, %	18.09	Capacity (c), pc/h/ln	2296
Single-Unit Trucks (SUT), %	-	Adjusted Capacity (cadj), pc/h/ln	2296
Tractor-Trailers (TT), %	-	Volume-to-Capacity Ratio (v/c)	0.58
Passenger Car Equivalent (ET)	2.000		

Speed and Density

Lane Width Adjustment (fLW)	0.0	Average Speed (S), mi/h	59.6
Right-Side Lateral Clearance Adj. (fRLC)	0.0	Density (D), pc/mi/ln	22.4
Total Ramp Density Adjustment	5.4	Level of Service (LOS)	C
Adjusted Free-Flow Speed (FFSadj), mi/h	59.6		

HCS7 Freeway Diverge Report

Project Information

Analyst	LSA	Date	12/11/2019
Agency	LSA	Analysis Year	Phase I Proj Comp Yr (2029) NP
Jurisdiction	Caltrans	Time Period Analyzed	AM Peak Hour
Project Description	CMD1801 - Village D Specific Plan	Unit	United States Customary

Geometric Data

	Freeway	Ramp
Number of Lanes (N), In	3	1
Free-Flow Speed (FFS), mi/h	65.0	35.0
Segment Length (L) / Deceleration Length (LA),ft	1500	245
Terrain Type	Level	Level
Percent Grade, %	-	-
Segment Type / Ramp Side	Freeway	Right

Adjustment Factors

Driver Population	All Familiar	All Familiar
Weather Type	Non-Severe Weather	Non-Severe Weather
Incident Type	No Incident	-
Final Speed Adjustment Factor (SAF)	1.000	1.000
Final Capacity Adjustment Factor (CAF)	1.000	1.000
Demand Adjustment Factor (DAF)	1.000	1.000

Demand and Capacity

Demand Volume (Vi)	3184	544
Peak Hour Factor (PHF)	0.94	0.94
Total Trucks, %	18.09	4.61
Single-Unit Trucks (SUT), %	-	-
Tractor-Trailers (TT), %	-	-
Heavy Vehicle Adjustment Factor (fHV)	0.847	0.956
Flow Rate (vi),pc/h	3999	605
Capacity (c), pc/h	7050	2000
Volume-to-Capacity Ratio (v/c)	0.57	0.30

Speed and Density

Upstream Equilibrium Distance (LEQ), ft	-	Number of Outer Lanes on Freeway (NO)	1
Distance to Upstream Ramp (LUP), ft	-	Speed Index (DS)	0.482
Downstream Equilibrium Distance (LEQ), ft	-	Flow Outer Lanes (vOA), pc/h/ln	1249
Distance to Downstream Ramp (LDOWN), ft	-	Off-Ramp Influence Area Speed (SR), mi/h	53.9
Prop. Freeway Vehicles in Lane 1 and 2 (PFD)	0.632	Outer Lanes Freeway Speed (SO), mi/h	70.3
Flow in Lanes 1 and 2 (v12), pc/h	2750	Ramp Junction Speed (S), mi/h	58.1
Flow Entering Ramp-Infl. Area (vR12), pc/h	-	Average Density (D), pc/mi/ln	22.9
Level of Service (LOS)	C	Density in Ramp Influence Area (DR), pc/mi/ln	25.7

HCS7 Basic Freeway Report

Project Information

Analyst	LSA	Date	12/11/2019
Agency	LSA	Analysis Year	Phase I Proj Comp Yr (2029) NP
Jurisdiction	Caltrans	Time Period Analyzed	AM Peak Hour
Project Description	CMD1801 - Village D Specific Plan	Unit	United States Customary

Geometric Data

Number of Lanes, ln	3	Terrain Type	Level
Segment Length (L), ft	-	Percent Grade, %	-
Measured or Base Free-Flow Speed	Base	Grade Length, mi	-
Base Free-Flow Speed (BFFS), mi/h	65.0	Total Ramp Density (TRD), ramps/mi	1.83
Lane Width, ft	12	Free-Flow Speed (FFS), mi/h	59.7
Right-Side Lateral Clearance, ft	10		

Adjustment Factors

Driver Population	All Familiar	Final Speed Adjustment Factor (SAF)	1.000
Weather Type	Non-Severe Weather	Final Capacity Adjustment Factor (CAF)	1.000
Incident Type	No Incident	Demand Adjustment Factor (DAF)	1.000

Demand and Capacity

Demand Volume veh/h	2640	Heavy Vehicle Adjustment Factor (fhv)	0.827
Peak Hour Factor	0.94	Flow Rate (Vp), pc/h/ln	1132
Total Trucks, %	20.88	Capacity (c), pc/h/ln	2296
Single-Unit Trucks (SUT), %	-	Adjusted Capacity (cadj), pc/h/ln	2296
Tractor-Trailers (TT), %	-	Volume-to-Capacity Ratio (v/c)	0.49
Passenger Car Equivalent (ET)	2.000		

Speed and Density

Lane Width Adjustment (fLW)	0.0	Average Speed (S), mi/h	59.6
Right-Side Lateral Clearance Adj. (fRLC)	0.0	Density (D), pc/mi/ln	19.0
Total Ramp Density Adjustment	5.4	Level of Service (LOS)	C
Adjusted Free-Flow Speed (FFSadj), mi/h	59.6		

HCS7 Freeway Merge Report

Project Information

Analyst	LSA	Date	12/11/2019
Agency	LSA	Analysis Year	Phase I Proj Comp Yr (2029) NP
Jurisdiction	Caltrans	Time Period Analyzed	AM Peak Hour
Project Description	CMD1801 - Village D Specific Plan	Unit	United States Customary

Geometric Data

	Freeway	Ramp
Number of Lanes (N), ln	3	1
Free-Flow Speed (FFS), mi/h	65.0	35.0
Segment Length (L) / Acceleration Length (LA),ft	1500	350
Terrain Type	Level	Level
Percent Grade, %	-	-
Segment Type / Ramp Side	Freeway	Right

Adjustment Factors

Driver Population	All Familiar	All Familiar
Weather Type	Non-Severe Weather	Non-Severe Weather
Incident Type	No Incident	-
Final Speed Adjustment Factor (SAF)	1.000	1.000
Final Capacity Adjustment Factor (CAF)	1.000	1.000
Demand Adjustment Factor (DAF)	1.000	1.000

Demand and Capacity

Demand Volume (Vi)	2640	130
Peak Hour Factor (PHF)	0.94	0.94
Total Trucks, %	20.88	2.94
Single-Unit Trucks (SUT), %	-	-
Tractor-Trailers (TT), %	-	-
Heavy Vehicle Adjustment Factor (fHV)	0.827	0.971
Flow Rate (vi),pc/h	3396	142
Capacity (c), pc/h	7050	2000
Volume-to-Capacity Ratio (v/c)	0.50	0.07

Speed and Density

Upstream Equilibrium Distance (LEQ), ft	-	Number of Outer Lanes on Freeway (NO)	1
Distance to Upstream Ramp (LUP), ft	-	Speed Index (MS)	0.329
Downstream Equilibrium Distance (LEQ), ft	-	Flow Outer Lanes (vOA), pc/h/ln	1403
Distance to Downstream Ramp (LDOWN), ft	-	On-Ramp Influence Area Speed (SR), mi/h	57.4
Prop. Freeway Vehicles in Lane 1 and 2 (PFM)	0.587	Outer Lanes Freeway Speed (SO), mi/h	61.7
Flow in Lanes 1 and 2 (v12), pc/h	1993	Ramp Junction Speed (S), mi/h	59.0
Flow Entering Ramp-Infl. Area (vR12), pc/h	2135	Average Density (D), pc/mi/ln	20.0
Level of Service (LOS)	B	Density in Ramp Influence Area (DR), pc/mi/ln	19.9

HCS7 Basic Freeway Report

Project Information

Analyst	LSA	Date	12/11/2019
Agency	LSA	Analysis Year	Phase I Proj Comp Yr (2029) NP
Jurisdiction	Caltrans	Time Period Analyzed	AM Peak Hour
Project Description	CMD1801 - Village D Specific Plan	Unit	United States Customary

Geometric Data

Number of Lanes, ln	3	Terrain Type	Level
Segment Length (L), ft	-	Percent Grade, %	-
Measured or Base Free-Flow Speed	Base	Grade Length, mi	-
Base Free-Flow Speed (BFFS), mi/h	65.0	Total Ramp Density (TRD), ramps/mi	1.83
Lane Width, ft	12	Free-Flow Speed (FFS), mi/h	59.7
Right-Side Lateral Clearance, ft	10		

Adjustment Factors

Driver Population	All Familiar	Final Speed Adjustment Factor (SAF)	1.000
Weather Type	Non-Severe Weather	Final Capacity Adjustment Factor (CAF)	1.000
Incident Type	No Incident	Demand Adjustment Factor (DAF)	1.000

Demand and Capacity

Demand Volume veh/h	2770	Heavy Vehicle Adjustment Factor (fhv)	0.833
Peak Hour Factor	0.94	Flow Rate (Vp), pc/h/ln	1179
Total Trucks, %	20.04	Capacity (c), pc/h/ln	2296
Single-Unit Trucks (SUT), %	-	Adjusted Capacity (cadj), pc/h/ln	2296
Tractor-Trailers (TT), %	-	Volume-to-Capacity Ratio (v/c)	0.51
Passenger Car Equivalent (ET)	2.000		

Speed and Density

Lane Width Adjustment (fLW)	0.0	Average Speed (S), mi/h	59.6
Right-Side Lateral Clearance Adj. (fRLC)	0.0	Density (D), pc/mi/ln	19.8
Total Ramp Density Adjustment	5.4	Level of Service (LOS)	C
Adjusted Free-Flow Speed (FFSadj), mi/h	59.6		

HCS7 Freeway Diverge Report

Project Information

Analyst	LSA	Date	12/11/2019
Agency	LSA	Analysis Year	Phase I Proj Comp Yr (2029) NP
Jurisdiction	Caltrans	Time Period Analyzed	AM Peak Hour
Project Description	CMD1801 - Village D Specific Plan	Unit	United States Customary

Geometric Data

	Freeway	Ramp
Number of Lanes (N), ln	3	1
Free-Flow Speed (FFS), mi/h	65.0	15.0
Segment Length (L) / Deceleration Length (LA),ft	1500	150
Terrain Type	Level	Level
Percent Grade, %	-	-
Segment Type / Ramp Side	Freeway	Right

Adjustment Factors

Driver Population	All Familiar	All Familiar
Weather Type	Non-Severe Weather	Non-Severe Weather
Incident Type	No Incident	-
Final Speed Adjustment Factor (SAF)	1.000	1.000
Final Capacity Adjustment Factor (CAF)	1.000	1.000
Demand Adjustment Factor (DAF)	1.000	1.000

Demand and Capacity

Demand Volume (Vi)	2770	209
Peak Hour Factor (PHF)	0.94	0.94
Total Trucks, %	20.04	6.54
Single-Unit Trucks (SUT), %	-	-
Tractor-Trailers (TT), %	-	-
Heavy Vehicle Adjustment Factor (fHV)	0.833	0.939
Flow Rate (vi),pc/h	3538	237
Capacity (c), pc/h	7050	1800
Volume-to-Capacity Ratio (v/c)	0.50	0.13

Speed and Density

Upstream Equilibrium Distance (LEQ), ft	-	Number of Outer Lanes on Freeway (NO)	1
Distance to Upstream Ramp (LUP), ft	-	Speed Index (DS)	0.709
Downstream Equilibrium Distance (LEQ), ft	-	Flow Outer Lanes (vOA), pc/h/ln	1119
Distance to Downstream Ramp (LDOWN), ft	-	Off-Ramp Influence Area Speed (SR), mi/h	48.7
Prop. Freeway Vehicles in Lane 1 and 2 (PFD)	0.661	Outer Lanes Freeway Speed (SO), mi/h	70.8
Flow in Lanes 1 and 2 (v12), pc/h	2419	Ramp Junction Speed (S), mi/h	54.0
Flow Entering Ramp-Infl. Area (vR12), pc/h	-	Average Density (D), pc/mi/ln	21.8
Level of Service (LOS)	C	Density in Ramp Influence Area (DR), pc/mi/ln	23.7

HCS7 Basic Freeway Report

Project Information

Analyst	LSA	Date	12/11/2019
Agency	LSA	Analysis Year	Phase I Proj Comp Yr (2029) NP
Jurisdiction	Caltrans	Time Period Analyzed	AM Peak Hour
Project Description	CMD1801 - Village D Specific Plan	Unit	United States Customary

Geometric Data

Number of Lanes, ln	3	Terrain Type	Level
Segment Length (L), ft	-	Percent Grade, %	-
Measured or Base Free-Flow Speed	Base	Grade Length, mi	-
Base Free-Flow Speed (BFFS), mi/h	65.0	Total Ramp Density (TRD), ramps/mi	1.67
Lane Width, ft	12	Free-Flow Speed (FFS), mi/h	60.0
Right-Side Lateral Clearance, ft	10		

Adjustment Factors

Driver Population	All Familiar	Final Speed Adjustment Factor (SAF)	1.000
Weather Type	Non-Severe Weather	Final Capacity Adjustment Factor (CAF)	1.000
Incident Type	No Incident	Demand Adjustment Factor (DAF)	1.000

Demand and Capacity

Demand Volume veh/h	2562	Heavy Vehicle Adjustment Factor (fhv)	0.825
Peak Hour Factor	0.94	Flow Rate (Vp), pc/h/ln	1101
Total Trucks, %	21.14	Capacity (c), pc/h/ln	2300
Single-Unit Trucks (SUT), %	-	Adjusted Capacity (cadj), pc/h/ln	2300
Tractor-Trailers (TT), %	-	Volume-to-Capacity Ratio (v/c)	0.48
Passenger Car Equivalent (ET)	2.000		

Speed and Density

Lane Width Adjustment (fLW)	0.0	Average Speed (S), mi/h	60.0
Right-Side Lateral Clearance Adj. (fRLC)	0.0	Density (D), pc/mi/ln	18.4
Total Ramp Density Adjustment	5.0	Level of Service (LOS)	C
Adjusted Free-Flow Speed (FFSadj), mi/h	60.0		

HCS7 Freeway Merge Report

Project Information

Analyst	LSA	Date	12/11/2019
Agency	LSA	Analysis Year	Phase I Proj Comp Yr (2029) NP
Jurisdiction	Caltrans	Time Period Analyzed	AM Peak Hour
Project Description	CMD1801 - Village D Specific Plan	Unit	United States Customary

Geometric Data

	Freeway	Ramp
Number of Lanes (N), ln	3	1
Free-Flow Speed (FFS), mi/h	65.0	35.0
Segment Length (L) / Acceleration Length (LA),ft	1500	525
Terrain Type	Level	Level
Percent Grade, %	-	-
Segment Type / Ramp Side	Freeway	Right

Adjustment Factors

Driver Population	All Familiar	All Familiar
Weather Type	Non-Severe Weather	Non-Severe Weather
Incident Type	No Incident	-
Final Speed Adjustment Factor (SAF)	1.000	1.000
Final Capacity Adjustment Factor (CAF)	1.000	1.000
Demand Adjustment Factor (DAF)	1.000	1.000

Demand and Capacity

Demand Volume (Vi)	2562	204
Peak Hour Factor (PHF)	0.94	0.94
Total Trucks, %	21.14	4.46
Single-Unit Trucks (SUT), %	-	-
Tractor-Trailers (TT), %	-	-
Heavy Vehicle Adjustment Factor (fHV)	0.825	0.957
Flow Rate (vi),pc/h	3304	227
Capacity (c), pc/h	7050	2000
Volume-to-Capacity Ratio (v/c)	0.50	0.11

Speed and Density

Upstream Equilibrium Distance (LEQ), ft	-	Number of Outer Lanes on Freeway (NO)	1
Distance to Upstream Ramp (LUP), ft	-	Speed Index (MS)	0.319
Downstream Equilibrium Distance (LEQ), ft	-	Flow Outer Lanes (vOA), pc/h/ln	1348
Distance to Downstream Ramp (LDOWN), ft	-	On-Ramp Influence Area Speed (SR), mi/h	57.7
Prop. Freeway Vehicles in Lane 1 and 2 (PFM)	0.592	Outer Lanes Freeway Speed (SO), mi/h	61.9
Flow in Lanes 1 and 2 (v12), pc/h	1956	Ramp Junction Speed (S), mi/h	59.2
Flow Entering Ramp-Infl. Area (vR12), pc/h	2183	Average Density (D), pc/mi/ln	19.9
Level of Service (LOS)	B	Density in Ramp Influence Area (DR), pc/mi/ln	19.2

HCS7 Basic Freeway Report

Project Information

Analyst	LSA	Date	12/11/2019
Agency	LSA	Analysis Year	Phase I Proj Comp Yr (2029) NP
Jurisdiction	Caltrans	Time Period Analyzed	AM Peak Hour
Project Description	CMD1801 - Village D Specific Plan	Unit	United States Customary

Geometric Data

Number of Lanes, ln	3	Terrain Type	Level
Segment Length (L), ft	-	Percent Grade, %	-
Measured or Base Free-Flow Speed	Base	Grade Length, mi	-
Base Free-Flow Speed (BFFS), mi/h	65.0	Total Ramp Density (TRD), ramps/mi	1.67
Lane Width, ft	12	Free-Flow Speed (FFS), mi/h	60.0
Right-Side Lateral Clearance, ft	10		

Adjustment Factors

Driver Population	All Familiar	Final Speed Adjustment Factor (SAF)	1.000
Weather Type	Non-Severe Weather	Final Capacity Adjustment Factor (CAF)	1.000
Incident Type	No Incident	Demand Adjustment Factor (DAF)	1.000

Demand and Capacity

Demand Volume veh/h	2765	Heavy Vehicle Adjustment Factor (fhv)	0.834
Peak Hour Factor	0.94	Flow Rate (Vp), pc/h/ln	1176
Total Trucks, %	19.91	Capacity (c), pc/h/ln	2300
Single-Unit Trucks (SUT), %	-	Adjusted Capacity (cadj), pc/h/ln	2300
Tractor-Trailers (TT), %	-	Volume-to-Capacity Ratio (v/c)	0.51
Passenger Car Equivalent (ET)	2.000		

Speed and Density

Lane Width Adjustment (fLW)	0.0	Average Speed (S), mi/h	60.0
Right-Side Lateral Clearance Adj. (fRLC)	0.0	Density (D), pc/mi/ln	19.6
Total Ramp Density Adjustment	5.0	Level of Service (LOS)	C
Adjusted Free-Flow Speed (FFSadj), mi/h	60.0		

HCS7 Freeway Diverge Report

Project Information

Analyst	LSA	Date	12/11/2019
Agency	LSA	Analysis Year	Phase I Proj Comp Yr (2029) NP
Jurisdiction	Caltrans	Time Period Analyzed	AM Peak Hour
Project Description	CMD1801 - Village D Specific Plan	Unit	United States Customary

Geometric Data

	Freeway	Ramp
Number of Lanes (N), In	3	1
Free-Flow Speed (FFS), mi/h	65.0	35.0
Segment Length (L) / Deceleration Length (LA),ft	1500	200
Terrain Type	Level	Level
Percent Grade, %	-	-
Segment Type / Ramp Side	Freeway	Right

Adjustment Factors

Driver Population	All Familiar	All Familiar
Weather Type	Non-Severe Weather	Non-Severe Weather
Incident Type	No Incident	-
Final Speed Adjustment Factor (SAF)	1.000	1.000
Final Capacity Adjustment Factor (CAF)	1.000	1.000
Demand Adjustment Factor (DAF)	1.000	1.000

Demand and Capacity

Demand Volume (Vi)	2765	399
Peak Hour Factor (PHF)	0.94	0.94
Total Trucks, %	19.91	13.79
Single-Unit Trucks (SUT), %	-	-
Tractor-Trailers (TT), %	-	-
Heavy Vehicle Adjustment Factor (fHV)	0.834	0.879
Flow Rate (vi),pc/h	3527	483
Capacity (c), pc/h	7050	2000
Volume-to-Capacity Ratio (v/c)	0.50	0.24

Speed and Density

Upstream Equilibrium Distance (LEQ), ft	-	Number of Outer Lanes on Freeway (NO)	1
Distance to Upstream Ramp (LUP), ft	-	Speed Index (DS)	0.471
Downstream Equilibrium Distance (LEQ), ft	-	Flow Outer Lanes (vOA), pc/h/ln	1065
Distance to Downstream Ramp (LDOWN), ft	-	Off-Ramp Influence Area Speed (SR), mi/h	54.2
Prop. Freeway Vehicles in Lane 1 and 2 (PFD)	0.650	Outer Lanes Freeway Speed (SO), mi/h	71.1
Flow in Lanes 1 and 2 (v12), pc/h	2462	Ramp Junction Speed (S), mi/h	58.4
Flow Entering Ramp-Infl. Area (vR12), pc/h	-	Average Density (D), pc/mi/ln	20.1
Level of Service (LOS)	C	Density in Ramp Influence Area (DR), pc/mi/ln	23.6

HCS7 Basic Freeway Report

Project Information

Analyst	LSA	Date	12/11/2019
Agency	LSA	Analysis Year	Phase I Proj Comp Yr (2029) NP
Jurisdiction	Caltrans	Time Period Analyzed	AM Peak Hour
Project Description	CMD1801 - Village D Specific Plan	Unit	United States Customary

Geometric Data

Number of Lanes, ln	3	Terrain Type	Level
Segment Length (L), ft	-	Percent Grade, %	-
Measured or Base Free-Flow Speed	Base	Grade Length, mi	-
Base Free-Flow Speed (BFFS), mi/h	70.0	Total Ramp Density (TRD), ramps/mi	1.50
Lane Width, ft	12	Free-Flow Speed (FFS), mi/h	65.5
Right-Side Lateral Clearance, ft	10		

Adjustment Factors

Driver Population	All Familiar	Final Speed Adjustment Factor (SAF)	1.000
Weather Type	Non-Severe Weather	Final Capacity Adjustment Factor (CAF)	1.000
Incident Type	No Incident	Demand Adjustment Factor (DAF)	1.000

Demand and Capacity

Demand Volume veh/h	2366	Heavy Vehicle Adjustment Factor (fhv)	0.827
Peak Hour Factor	0.94	Flow Rate (Vp), pc/h/ln	1015
Total Trucks, %	20.94	Capacity (c), pc/h/ln	2355
Single-Unit Trucks (SUT), %	-	Adjusted Capacity (cadj), pc/h/ln	2355
Tractor-Trailers (TT), %	-	Volume-to-Capacity Ratio (v/c)	0.43
Passenger Car Equivalent (ET)	2.000		

Speed and Density

Lane Width Adjustment (fLW)	0.0	Average Speed (S), mi/h	65.5
Right-Side Lateral Clearance Adj. (fRLC)	0.0	Density (D), pc/mi/ln	15.5
Total Ramp Density Adjustment	4.5	Level of Service (LOS)	B
Adjusted Free-Flow Speed (FFSadj), mi/h	65.5		

HCS7 Freeway Merge Report

Project Information

Analyst	LSA	Date	12/11/2019
Agency	LSA	Analysis Year	Phase I Proj Comp Yr (2029) NP
Jurisdiction	Caltrans	Time Period Analyzed	AM Peak Hour
Project Description	CMD1801 - Village D Specific Plan	Unit	United States Customary

Geometric Data

	Freeway	Ramp
Number of Lanes (N), ln	3	1
Free-Flow Speed (FFS), mi/h	70.0	35.0
Segment Length (L) / Acceleration Length (LA),ft	1500	400
Terrain Type	Level	Level
Percent Grade, %	-	-
Segment Type / Ramp Side	Freeway	Right

Adjustment Factors

Driver Population	All Familiar	All Familiar
Weather Type	Non-Severe Weather	Non-Severe Weather
Incident Type	No Incident	-
Final Speed Adjustment Factor (SAF)	1.000	1.000
Final Capacity Adjustment Factor (CAF)	1.000	1.000
Demand Adjustment Factor (DAF)	1.000	1.000

Demand and Capacity

Demand Volume (Vi)	2366	321
Peak Hour Factor (PHF)	0.94	0.94
Total Trucks, %	20.94	10.46
Single-Unit Trucks (SUT), %	-	-
Tractor-Trailers (TT), %	-	-
Heavy Vehicle Adjustment Factor (fHV)	0.827	0.905
Flow Rate (vi),pc/h	3044	377
Capacity (c), pc/h	7200	2000
Volume-to-Capacity Ratio (v/c)	0.48	0.19

Speed and Density

Upstream Equilibrium Distance (LEQ), ft	-	Number of Outer Lanes on Freeway (NO)	1
Distance to Upstream Ramp (LUP), ft	-	Speed Index (MS)	0.327
Downstream Equilibrium Distance (LEQ), ft	-	Flow Outer Lanes (vOA), pc/h/ln	1251
Distance to Downstream Ramp (LDOWN), ft	-	On-Ramp Influence Area Speed (SR), mi/h	60.8
Prop. Freeway Vehicles in Lane 1 and 2 (PFM)	0.589	Outer Lanes Freeway Speed (SO), mi/h	67.3
Flow in Lanes 1 and 2 (v12), pc/h	1793	Ramp Junction Speed (S), mi/h	63.0
Flow Entering Ramp-Infl. Area (vR12), pc/h	2170	Average Density (D), pc/mi/ln	18.1
Level of Service (LOS)	B	Density in Ramp Influence Area (DR), pc/mi/ln	19.8

HCS7 Basic Freeway Report

Project Information

Analyst	LSA	Date	12/11/2019
Agency	LSA	Analysis Year	Phase I Proj Comp Yr (2029) NP
Jurisdiction	Caltrans	Time Period Analyzed	AM Peak Hour
Project Description	CMD1801 - Village D Specific Plan	Unit	United States Customary

Geometric Data

Number of Lanes, ln	2	Terrain Type	Level
Segment Length (L), ft	-	Percent Grade, %	-
Measured or Base Free-Flow Speed	Base	Grade Length, mi	-
Base Free-Flow Speed (BFFS), mi/h	70.0	Total Ramp Density (TRD), ramps/mi	1.00
Lane Width, ft	12	Free-Flow Speed (FFS), mi/h	66.8
Right-Side Lateral Clearance, ft	10		

Adjustment Factors

Driver Population	All Familiar	Final Speed Adjustment Factor (SAF)	1.000
Weather Type	Non-Severe Weather	Final Capacity Adjustment Factor (CAF)	1.000
Incident Type	No Incident	Demand Adjustment Factor (DAF)	1.000

Demand and Capacity

Demand Volume veh/h	2688	Heavy Vehicle Adjustment Factor (fhv)	0.835
Peak Hour Factor	0.94	Flow Rate (Vp), pc/h/ln	1712
Total Trucks, %	19.70	Capacity (c), pc/h/ln	2368
Single-Unit Trucks (SUT), %	-	Adjusted Capacity (cadj), pc/h/ln	2368
Tractor-Trailers (TT), %	-	Volume-to-Capacity Ratio (v/c)	0.72
Passenger Car Equivalent (ET)	2.000		

Speed and Density

Lane Width Adjustment (fLW)	0.0	Average Speed (S), mi/h	64.9
Right-Side Lateral Clearance Adj. (fRLC)	0.0	Density (D), pc/mi/ln	26.4
Total Ramp Density Adjustment	3.2	Level of Service (LOS)	D
Adjusted Free-Flow Speed (FFSadj), mi/h	66.8		

HCS7 Freeway Diverge Report

Project Information

Analyst	LSA	Date	12/11/2019
Agency	LSA	Analysis Year	Phase I Proj Comp Yr (2029) NP
Jurisdiction	Caltrans	Time Period Analyzed	AM Peak Hour
Project Description	CMD1801 - Village D Specific Plan	Unit	United States Customary

Geometric Data

	Freeway	Ramp
Number of Lanes (N), ln	2	1
Free-Flow Speed (FFS), mi/h	70.0	35.0
Segment Length (L) / Deceleration Length (LA),ft	1500	200
Terrain Type	Level	Level
Percent Grade, %	-	-
Segment Type / Ramp Side	Freeway	Right

Adjustment Factors

Driver Population	All Familiar	All Familiar
Weather Type	Non-Severe Weather	Non-Severe Weather
Incident Type	No Incident	-
Final Speed Adjustment Factor (SAF)	1.000	1.000
Final Capacity Adjustment Factor (CAF)	1.000	1.000
Demand Adjustment Factor (DAF)	1.000	1.000

Demand and Capacity

Demand Volume (Vi)	2688	236
Peak Hour Factor (PHF)	0.94	0.94
Total Trucks, %	19.70	28.64
Single-Unit Trucks (SUT), %	-	-
Tractor-Trailers (TT), %	-	-
Heavy Vehicle Adjustment Factor (fHV)	0.835	0.777
Flow Rate (vi),pc/h	3425	323
Capacity (c), pc/h	4800	2000
Volume-to-Capacity Ratio (v/c)	0.71	0.16

Speed and Density

Upstream Equilibrium Distance (LEQ), ft	-	Number of Outer Lanes on Freeway (NO)	0
Distance to Upstream Ramp (LUP), ft	-	Speed Index (DS)	0.457
Downstream Equilibrium Distance (LEQ), ft	-	Flow Outer Lanes (vOA), pc/h/ln	-
Distance to Downstream Ramp (LDOWN), ft	-	Off-Ramp Influence Area Speed (SR), mi/h	57.2
Prop. Freeway Vehicles in Lane 1 and 2 (PFD)	1.000	Outer Lanes Freeway Speed (SO), mi/h	76.8
Flow in Lanes 1 and 2 (v12), pc/h	3425	Ramp Junction Speed (S), mi/h	57.2
Flow Entering Ramp-Infl. Area (vR12), pc/h	-	Average Density (D), pc/mi/ln	29.9
Level of Service (LOS)	D	Density in Ramp Influence Area (DR), pc/mi/ln	31.9

HCS7 Basic Freeway Report

Project Information

Analyst	LSA	Date	12/11/2019
Agency	LSA	Analysis Year	Phase I Proj Comp Yr (2029) NP
Jurisdiction	Caltrans	Time Period Analyzed	AM Peak Hour
Project Description	CMD1801 - Village D Specific Plan	Unit	United States Customary

Geometric Data

Number of Lanes, ln	2	Terrain Type	Level
Segment Length (L), ft	-	Percent Grade, %	-
Measured or Base Free-Flow Speed	Base	Grade Length, mi	-
Base Free-Flow Speed (BFFS), mi/h	70.0	Total Ramp Density (TRD), ramps/mi	1.00
Lane Width, ft	12	Free-Flow Speed (FFS), mi/h	66.8
Right-Side Lateral Clearance, ft	10		

Adjustment Factors

Driver Population	All Familiar	Final Speed Adjustment Factor (SAF)	1.000
Weather Type	Non-Severe Weather	Final Capacity Adjustment Factor (CAF)	1.000
Incident Type	No Incident	Demand Adjustment Factor (DAF)	1.000

Demand and Capacity

Demand Volume veh/h	2451	Heavy Vehicle Adjustment Factor (fhv)	0.842
Peak Hour Factor	0.94	Flow Rate (Vp), pc/h/ln	1548
Total Trucks, %	18.83	Capacity (c), pc/h/ln	2368
Single-Unit Trucks (SUT), %	-	Adjusted Capacity (cadj), pc/h/ln	2368
Tractor-Trailers (TT), %	-	Volume-to-Capacity Ratio (v/c)	0.65
Passenger Car Equivalent (ET)	2.000		

Speed and Density

Lane Width Adjustment (fLW)	0.0	Average Speed (S), mi/h	66.2
Right-Side Lateral Clearance Adj. (fRLC)	0.0	Density (D), pc/mi/ln	23.4
Total Ramp Density Adjustment	3.2	Level of Service (LOS)	C
Adjusted Free-Flow Speed (FFSadj), mi/h	66.8		

HCS7 Freeway Merge Report

Project Information

Analyst	LSA	Date	12/11/2019
Agency	LSA	Analysis Year	Phase I Proj Comp Yr (2029) NP
Jurisdiction	Caltrans	Time Period Analyzed	AM Peak Hour
Project Description	CMD1801 - Village D Specific Plan	Unit	United States Customary

Geometric Data

	Freeway	Ramp
Number of Lanes (N), ln	2	1
Free-Flow Speed (FFS), mi/h	70.0	35.0
Segment Length (L) / Acceleration Length (LA),ft	1500	700
Terrain Type	Level	Level
Percent Grade, %	-	-
Segment Type / Ramp Side	Freeway	Right

Adjustment Factors

Driver Population	All Familiar	All Familiar
Weather Type	Non-Severe Weather	Non-Severe Weather
Incident Type	No Incident	-
Final Speed Adjustment Factor (SAF)	1.000	1.000
Final Capacity Adjustment Factor (CAF)	1.000	1.000
Demand Adjustment Factor (DAF)	1.000	1.000

Demand and Capacity

Demand Volume (Vi)	2451	247
Peak Hour Factor (PHF)	0.94	0.94
Total Trucks, %	18.83	32.90
Single-Unit Trucks (SUT), %	-	-
Tractor-Trailers (TT), %	-	-
Heavy Vehicle Adjustment Factor (fHV)	0.842	0.752
Flow Rate (vi),pc/h	3097	349
Capacity (c), pc/h	4800	2000
Volume-to-Capacity Ratio (v/c)	0.72	0.17

Speed and Density

Upstream Equilibrium Distance (LEQ), ft	-	Number of Outer Lanes on Freeway (NO)	0
Distance to Upstream Ramp (LUP), ft	-	Speed Index (MS)	0.394
Downstream Equilibrium Distance (LEQ), ft	-	Flow Outer Lanes (vOA), pc/h/ln	-
Distance to Downstream Ramp (LDOWN), ft	-	On-Ramp Influence Area Speed (SR), mi/h	59.0
Prop. Freeway Vehicles in Lane 1 and 2 (PFM)	1.000	Outer Lanes Freeway Speed (SO), mi/h	70.0
Flow in Lanes 1 and 2 (v12), pc/h	3097	Ramp Junction Speed (S), mi/h	59.0
Flow Entering Ramp-Infl. Area (vR12), pc/h	3446	Average Density (D), pc/mi/ln	29.2
Level of Service (LOS)	C	Density in Ramp Influence Area (DR), pc/mi/ln	27.9

HCS7 Basic Freeway Report

Project Information

Analyst	LSA	Date	12/11/2019
Agency	LSA	Analysis Year	Phase I Proj Comp Yr (2029) NP
Jurisdiction	Caltrans	Time Period Analyzed	AM Peak Hour
Project Description	CMD1801 - Village D Specific Plan	Unit	United States Customary

Geometric Data

Number of Lanes, ln	2	Terrain Type	Level
Segment Length (L), ft	-	Percent Grade, %	-
Measured or Base Free-Flow Speed	Base	Grade Length, mi	-
Base Free-Flow Speed (BFFS), mi/h	70.0	Total Ramp Density (TRD), ramps/mi	1.00
Lane Width, ft	12	Free-Flow Speed (FFS), mi/h	66.8
Right-Side Lateral Clearance, ft	10		

Adjustment Factors

Driver Population	All Familiar	Final Speed Adjustment Factor (SAF)	1.000
Weather Type	Non-Severe Weather	Final Capacity Adjustment Factor (CAF)	1.000
Incident Type	No Incident	Demand Adjustment Factor (DAF)	1.000

Demand and Capacity

Demand Volume veh/h	2699	Heavy Vehicle Adjustment Factor (fhv)	0.833
Peak Hour Factor	0.94	Flow Rate (Vp), pc/h/ln	1724
Total Trucks, %	20.10	Capacity (c), pc/h/ln	2368
Single-Unit Trucks (SUT), %	-	Adjusted Capacity (cadj), pc/h/ln	2368
Tractor-Trailers (TT), %	-	Volume-to-Capacity Ratio (v/c)	0.73
Passenger Car Equivalent (ET)	2.000		

Speed and Density

Lane Width Adjustment (fLW)	0.0	Average Speed (S), mi/h	64.7
Right-Side Lateral Clearance Adj. (fRLC)	0.0	Density (D), pc/mi/ln	26.6
Total Ramp Density Adjustment	3.2	Level of Service (LOS)	D
Adjusted Free-Flow Speed (FFSadj), mi/h	66.8		

HCS7 Basic Freeway Report

Project Information

Analyst	LSA	Date	12/11/2019
Agency	LSA	Analysis Year	Phase I Proj Comp Yr (2029) NP
Jurisdiction	Caltrans	Time Period Analyzed	AM Peak Hour
Project Description	CMD1801 - Village D Specific Plan	Unit	United States Customary

Geometric Data

Number of Lanes, ln	2	Terrain Type	Level
Segment Length (L), ft	-	Percent Grade, %	-
Measured or Base Free-Flow Speed	Base	Grade Length, mi	-
Base Free-Flow Speed (BFFS), mi/h	70.0	Total Ramp Density (TRD), ramps/mi	1.00
Lane Width, ft	12	Free-Flow Speed (FFS), mi/h	66.8
Right-Side Lateral Clearance, ft	10		

Adjustment Factors

Driver Population	All Familiar	Final Speed Adjustment Factor (SAF)	1.000
Weather Type	Non-Severe Weather	Final Capacity Adjustment Factor (CAF)	1.000
Incident Type	No Incident	Demand Adjustment Factor (DAF)	1.000

Demand and Capacity

Demand Volume veh/h	2310	Heavy Vehicle Adjustment Factor (fhv)	0.780
Peak Hour Factor	0.94	Flow Rate (Vp), pc/h/ln	1576
Total Trucks, %	28.18	Capacity (c), pc/h/ln	2368
Single-Unit Trucks (SUT), %	-	Adjusted Capacity (cadj), pc/h/ln	2368
Tractor-Trailers (TT), %	-	Volume-to-Capacity Ratio (v/c)	0.67
Passenger Car Equivalent (ET)	2.000		

Speed and Density

Lane Width Adjustment (fLW)	0.0	Average Speed (S), mi/h	66.0
Right-Side Lateral Clearance Adj. (fRLC)	0.0	Density (D), pc/mi/ln	23.9
Total Ramp Density Adjustment	3.2	Level of Service (LOS)	C
Adjusted Free-Flow Speed (FFSadj), mi/h	66.8		

HCS7 Freeway Diverge Report

Project Information

Analyst	LSA	Date	12/11/2019
Agency	LSA	Analysis Year	Phase I Proj Comp Yr (2029) NP
Jurisdiction	Caltrans	Time Period Analyzed	AM Peak Hour
Project Description	CMD1801 - Village D Specific Plan	Unit	United States Customary

Geometric Data

	Freeway	Ramp
Number of Lanes (N), ln	2	1
Free-Flow Speed (FFS), mi/h	70.0	50.0
Segment Length (L) / Deceleration Length (LA),ft	1500	150
Terrain Type	Level	Level
Percent Grade, %	-	-
Segment Type / Ramp Side	Freeway	Right

Adjustment Factors

Driver Population	All Familiar	All Familiar
Weather Type	Non-Severe Weather	Non-Severe Weather
Incident Type	No Incident	-
Final Speed Adjustment Factor (SAF)	1.000	1.000
Final Capacity Adjustment Factor (CAF)	1.000	1.000
Demand Adjustment Factor (DAF)	1.000	1.000

Demand and Capacity

Demand Volume (Vi)	2310	146
Peak Hour Factor (PHF)	0.94	0.94
Total Trucks, %	28.18	35.29
Single-Unit Trucks (SUT), %	-	-
Tractor-Trailers (TT), %	-	-
Heavy Vehicle Adjustment Factor (fHV)	0.780	0.739
Flow Rate (vi),pc/h	3151	210
Capacity (c), pc/h	4800	2100
Volume-to-Capacity Ratio (v/c)	0.66	0.10

Speed and Density

Upstream Equilibrium Distance (LEQ), ft	-	Number of Outer Lanes on Freeway (NO)	0
Distance to Upstream Ramp (LUP), ft	-	Speed Index (DS)	0.252
Downstream Equilibrium Distance (LEQ), ft	-	Flow Outer Lanes (vOA), pc/h/ln	-
Distance to Downstream Ramp (LDOWN), ft	-	Off-Ramp Influence Area Speed (SR), mi/h	62.9
Prop. Freeway Vehicles in Lane 1 and 2 (PFD)	1.000	Outer Lanes Freeway Speed (SO), mi/h	76.8
Flow in Lanes 1 and 2 (v12), pc/h	3151	Ramp Junction Speed (S), mi/h	62.9
Flow Entering Ramp-Infl. Area (vR12), pc/h	-	Average Density (D), pc/mi/ln	25.0
Level of Service (LOS)	D	Density in Ramp Influence Area (DR), pc/mi/ln	30.0

HCS7 Basic Freeway Report

Project Information

Analyst	LSA	Date	12/11/2019
Agency	LSA	Analysis Year	Phase I Proj Comp Yr (2029) NP
Jurisdiction	Caltrans	Time Period Analyzed	AM Peak Hour
Project Description	CMD1801 - Village D Specific Plan	Unit	United States Customary

Geometric Data

Number of Lanes, ln	2	Terrain Type	Level
Segment Length (L), ft	-	Percent Grade, %	-
Measured or Base Free-Flow Speed	Base	Grade Length, mi	-
Base Free-Flow Speed (BFFS), mi/h	70.0	Total Ramp Density (TRD), ramps/mi	1.33
Lane Width, ft	12	Free-Flow Speed (FFS), mi/h	65.9
Right-Side Lateral Clearance, ft	10		

Adjustment Factors

Driver Population	All Familiar	Final Speed Adjustment Factor (SAF)	1.000
Weather Type	Non-Severe Weather	Final Capacity Adjustment Factor (CAF)	1.000
Incident Type	No Incident	Demand Adjustment Factor (DAF)	1.000

Demand and Capacity

Demand Volume veh/h	2163	Heavy Vehicle Adjustment Factor (fhv)	0.783
Peak Hour Factor	0.94	Flow Rate (Vp), pc/h/ln	1470
Total Trucks, %	27.68	Capacity (c), pc/h/ln	2359
Single-Unit Trucks (SUT), %	-	Adjusted Capacity (cadj), pc/h/ln	2359
Tractor-Trailers (TT), %	-	Volume-to-Capacity Ratio (v/c)	0.62
Passenger Car Equivalent (ET)	2.000		

Speed and Density

Lane Width Adjustment (fLW)	0.0	Average Speed (S), mi/h	65.7
Right-Side Lateral Clearance Adj. (fRLC)	0.0	Density (D), pc/mi/ln	22.4
Total Ramp Density Adjustment	4.1	Level of Service (LOS)	C
Adjusted Free-Flow Speed (FFSadj), mi/h	65.9		

HCS7 Freeway Merge Report

Project Information

Analyst	LSA	Date	12/11/2019
Agency	LSA	Analysis Year	Phase I Proj Comp Yr (2029) NP
Jurisdiction	Caltrans	Time Period Analyzed	AM Peak Hour
Project Description	CMD1801 - Village D Specific Plan	Unit	United States Customary

Geometric Data

	Freeway	Ramp
Number of Lanes (N), ln	2	1
Free-Flow Speed (FFS), mi/h	70.0	35.0
Segment Length (L) / Acceleration Length (LA),ft	1000	600
Terrain Type	Level	Level
Percent Grade, %	-	-
Segment Type / Ramp Side	Freeway	Right

Adjustment Factors

Driver Population	All Familiar	All Familiar
Weather Type	Non-Severe Weather	Non-Severe Weather
Incident Type	No Incident	-
Final Speed Adjustment Factor (SAF)	1.000	1.000
Final Capacity Adjustment Factor (CAF)	1.000	1.000
Demand Adjustment Factor (DAF)	1.000	1.000

Demand and Capacity

Demand Volume (Vi)	2163	36
Peak Hour Factor (PHF)	0.94	0.94
Total Trucks, %	27.68	13.89
Single-Unit Trucks (SUT), %	-	-
Tractor-Trailers (TT), %	-	-
Heavy Vehicle Adjustment Factor (fHV)	0.783	0.878
Flow Rate (vi),pc/h	2939	44
Capacity (c), pc/h	4800	2000
Volume-to-Capacity Ratio (v/c)	0.62	0.02

Speed and Density

Upstream Equilibrium Distance (LEQ), ft	-	Number of Outer Lanes on Freeway (NO)	0
Distance to Upstream Ramp (LUP), ft	-	Speed Index (MS)	0.356
Downstream Equilibrium Distance (LEQ), ft	-	Flow Outer Lanes (vOA), pc/h/ln	-
Distance to Downstream Ramp (LDOWN), ft	-	On-Ramp Influence Area Speed (SR), mi/h	60.0
Prop. Freeway Vehicles in Lane 1 and 2 (PFM)	1.000	Outer Lanes Freeway Speed (SO), mi/h	70.0
Flow in Lanes 1 and 2 (v12), pc/h	2939	Ramp Junction Speed (S), mi/h	60.0
Flow Entering Ramp-Infl. Area (vR12), pc/h	2983	Average Density (D), pc/mi/ln	24.9
Level of Service (LOS)	C	Density in Ramp Influence Area (DR), pc/mi/ln	25.0

HCS7 Basic Freeway Report

Project Information

Analyst	LSA	Date	12/11/2019
Agency	LSA	Analysis Year	Phase I Proj Comp Yr (2029) NP
Jurisdiction	Caltrans	Time Period Analyzed	AM Peak Hour
Project Description	CMD1801 - Village D Specific Plan	Unit	United States Customary

Geometric Data

Number of Lanes, ln	2	Terrain Type	Level
Segment Length (L), ft	-	Percent Grade, %	-
Measured or Base Free-Flow Speed	Base	Grade Length, mi	-
Base Free-Flow Speed (BFFS), mi/h	70.0	Total Ramp Density (TRD), ramps/mi	1.33
Lane Width, ft	12	Free-Flow Speed (FFS), mi/h	65.9
Right-Side Lateral Clearance, ft	10		

Adjustment Factors

Driver Population	All Familiar	Final Speed Adjustment Factor (SAF)	1.000
Weather Type	Non-Severe Weather	Final Capacity Adjustment Factor (CAF)	1.000
Incident Type	No Incident	Demand Adjustment Factor (DAF)	1.000

Demand and Capacity

Demand Volume veh/h	2200	Heavy Vehicle Adjustment Factor (fhv)	0.785
Peak Hour Factor	0.94	Flow Rate (Vp), pc/h/ln	1490
Total Trucks, %	27.45	Capacity (c), pc/h/ln	2359
Single-Unit Trucks (SUT), %	-	Adjusted Capacity (cadj), pc/h/ln	2359
Tractor-Trailers (TT), %	-	Volume-to-Capacity Ratio (v/c)	0.63
Passenger Car Equivalent (ET)	2.000		

Speed and Density

Lane Width Adjustment (fLW)	0.0	Average Speed (S), mi/h	65.7
Right-Side Lateral Clearance Adj. (fRLC)	0.0	Density (D), pc/mi/ln	22.7
Total Ramp Density Adjustment	4.1	Level of Service (LOS)	C
Adjusted Free-Flow Speed (FFSadj), mi/h	65.9		

HCS7 Freeway Merge Report

Project Information

Analyst	LSA	Date	12/11/2019
Agency	LSA	Analysis Year	Phase I Proj Comp Yr (2029) NP
Jurisdiction	Caltrans	Time Period Analyzed	AM Peak Hour
Project Description	CMD1801 - Village D Specific Plan	Unit	United States Customary

Geometric Data

	Freeway	Ramp
Number of Lanes (N), ln	2	1
Free-Flow Speed (FFS), mi/h	70.0	35.0
Segment Length (L) / Acceleration Length (LA),ft	1500	500
Terrain Type	Level	Level
Percent Grade, %	-	-
Segment Type / Ramp Side	Freeway	Right

Adjustment Factors

Driver Population	All Familiar	All Familiar
Weather Type	Non-Severe Weather	Non-Severe Weather
Incident Type	No Incident	-
Final Speed Adjustment Factor (SAF)	1.000	1.000
Final Capacity Adjustment Factor (CAF)	1.000	1.000
Demand Adjustment Factor (DAF)	1.000	1.000

Demand and Capacity

Demand Volume (Vi)	2200	193
Peak Hour Factor (PHF)	0.94	0.94
Total Trucks, %	27.45	32.07
Single-Unit Trucks (SUT), %	-	-
Tractor-Trailers (TT), %	-	-
Heavy Vehicle Adjustment Factor (fHV)	0.785	0.757
Flow Rate (vi),pc/h	2981	271
Capacity (c), pc/h	4800	2000
Volume-to-Capacity Ratio (v/c)	0.68	0.14

Speed and Density

Upstream Equilibrium Distance (LEQ), ft	-	Number of Outer Lanes on Freeway (NO)	0
Distance to Upstream Ramp (LUP), ft	-	Speed Index (MS)	0.387
Downstream Equilibrium Distance (LEQ), ft	-	Flow Outer Lanes (vOA), pc/h/ln	-
Distance to Downstream Ramp (LDOWN), ft	-	On-Ramp Influence Area Speed (SR), mi/h	59.2
Prop. Freeway Vehicles in Lane 1 and 2 (PFM)	1.000	Outer Lanes Freeway Speed (SO), mi/h	70.0
Flow in Lanes 1 and 2 (v12), pc/h	2981	Ramp Junction Speed (S), mi/h	59.2
Flow Entering Ramp-Infl. Area (vR12), pc/h	3252	Average Density (D), pc/mi/ln	27.5
Level of Service (LOS)	C	Density in Ramp Influence Area (DR), pc/mi/ln	27.7

HCS7 Basic Freeway Report

Project Information

Analyst	LSA	Date	12/11/2019
Agency	LSA	Analysis Year	Phase I Proj Comp Yr (2029) NP
Jurisdiction	Caltrans	Time Period Analyzed	AM Peak Hour
Project Description	CMD1801 - Village D Specific Plan	Unit	United States Customary

Geometric Data

Number of Lanes, ln	2	Terrain Type	Level
Segment Length (L), ft	-	Percent Grade, %	-
Measured or Base Free-Flow Speed	Base	Grade Length, mi	-
Base Free-Flow Speed (BFFS), mi/h	70.0	Total Ramp Density (TRD), ramps/mi	1.33
Lane Width, ft	12	Free-Flow Speed (FFS), mi/h	65.9
Right-Side Lateral Clearance, ft	10		

Adjustment Factors

Driver Population	All Familiar	Final Speed Adjustment Factor (SAF)	1.000
Weather Type	Non-Severe Weather	Final Capacity Adjustment Factor (CAF)	1.000
Incident Type	No Incident	Demand Adjustment Factor (DAF)	1.000

Demand and Capacity

Demand Volume veh/h	2393	Heavy Vehicle Adjustment Factor (fhv)	0.782
Peak Hour Factor	0.94	Flow Rate (Vp), pc/h/ln	1628
Total Trucks, %	27.82	Capacity (c), pc/h/ln	2359
Single-Unit Trucks (SUT), %	-	Adjusted Capacity (cadj), pc/h/ln	2359
Tractor-Trailers (TT), %	-	Volume-to-Capacity Ratio (v/c)	0.69
Passenger Car Equivalent (ET)	2.000		

Speed and Density

Lane Width Adjustment (fLW)	0.0	Average Speed (S), mi/h	65.0
Right-Side Lateral Clearance Adj. (fRLC)	0.0	Density (D), pc/mi/ln	25.0
Total Ramp Density Adjustment	4.1	Level of Service (LOS)	C
Adjusted Free-Flow Speed (FFSadj), mi/h	65.9		

HCS7 Freeway Diverge Report

Project Information

Analyst	LSA	Date	12/11/2019
Agency	LSA	Analysis Year	Phase I Proj Comp Yr (2029) NP
Jurisdiction	Caltrans	Time Period Analyzed	AM Peak Hour
Project Description	CMD1801 - Village D Specific Plan	Unit	United States Customary

Geometric Data

	Freeway	Ramp
Number of Lanes (N), ln	3	1
Free-Flow Speed (FFS), mi/h	70.0	35.0
Segment Length (L) / Deceleration Length (LA),ft	1500	150
Terrain Type	Level	Level
Percent Grade, %	-	-
Segment Type / Ramp Side	Freeway	Right

Adjustment Factors

Driver Population	All Familiar	All Familiar
Weather Type	Non-Severe Weather	Non-Severe Weather
Incident Type	No Incident	-
Final Speed Adjustment Factor (SAF)	1.000	1.000
Final Capacity Adjustment Factor (CAF)	1.000	1.000
Demand Adjustment Factor (DAF)	1.000	1.000

Demand and Capacity

Demand Volume (Vi)	2393	326
Peak Hour Factor (PHF)	0.94	0.94
Total Trucks, %	27.82	18.81
Single-Unit Trucks (SUT), %	-	-
Tractor-Trailers (TT), %	-	-
Heavy Vehicle Adjustment Factor (fHV)	0.782	0.842
Flow Rate (vi),pc/h	3255	412
Capacity (c), pc/h	7200	2000
Volume-to-Capacity Ratio (v/c)	0.45	0.21

Speed and Density

Upstream Equilibrium Distance (LEQ), ft	-	Number of Outer Lanes on Freeway (NO)	1
Distance to Upstream Ramp (LUP), ft	-	Speed Index (DS)	0.465
Downstream Equilibrium Distance (LEQ), ft	-	Flow Outer Lanes (vOA), pc/h/ln	967
Distance to Downstream Ramp (LDOWN), ft	-	Off-Ramp Influence Area Speed (SR), mi/h	57.0
Prop. Freeway Vehicles in Lane 1 and 2 (PFD)	0.660	Outer Lanes Freeway Speed (SO), mi/h	76.8
Flow in Lanes 1 and 2 (v12), pc/h	2288	Ramp Junction Speed (S), mi/h	61.7
Flow Entering Ramp-Infl. Area (vR12), pc/h	-	Average Density (D), pc/mi/ln	17.6
Level of Service (LOS)	C	Density in Ramp Influence Area (DR), pc/mi/ln	22.6

HCS7 Basic Freeway Report

Project Information

Analyst	LSA	Date	12/11/2019
Agency	LSA	Analysis Year	Phase I Proj Comp Yr (2029) NP
Jurisdiction	Caltrans	Time Period Analyzed	AM Peak Hour
Project Description	CMD1801 - Village D Specific Plan	Unit	United States Customary

Geometric Data

Number of Lanes, ln	3	Terrain Type	Level
Segment Length (L), ft	-	Percent Grade, %	-
Measured or Base Free-Flow Speed	Base	Grade Length, mi	-
Base Free-Flow Speed (BFFS), mi/h	70.0	Total Ramp Density (TRD), ramps/mi	1.67
Lane Width, ft	12	Free-Flow Speed (FFS), mi/h	65.0
Right-Side Lateral Clearance, ft	10		

Adjustment Factors

Driver Population	All Familiar	Final Speed Adjustment Factor (SAF)	1.000
Weather Type	Non-Severe Weather	Final Capacity Adjustment Factor (CAF)	1.000
Incident Type	No Incident	Demand Adjustment Factor (DAF)	1.000

Demand and Capacity

Demand Volume veh/h	2067	Heavy Vehicle Adjustment Factor (fhv)	0.774
Peak Hour Factor	0.94	Flow Rate (Vp), pc/h/ln	947
Total Trucks, %	29.27	Capacity (c), pc/h/ln	2350
Single-Unit Trucks (SUT), %	-	Adjusted Capacity (cadj), pc/h/ln	2350
Tractor-Trailers (TT), %	-	Volume-to-Capacity Ratio (v/c)	0.40
Passenger Car Equivalent (ET)	2.000		

Speed and Density

Lane Width Adjustment (fLW)	0.0	Average Speed (S), mi/h	65.0
Right-Side Lateral Clearance Adj. (fRLC)	0.0	Density (D), pc/mi/ln	14.6
Total Ramp Density Adjustment	5.0	Level of Service (LOS)	B
Adjusted Free-Flow Speed (FFSadj), mi/h	65.0		

HCS7 Freeway Merge Report

Project Information

Analyst	LSA	Date	12/11/2019
Agency	LSA	Analysis Year	Phase I Proj Comp Yr (2029) NP
Jurisdiction	Caltrans	Time Period Analyzed	AM Peak Hour
Project Description	CMD1801 - Village D Specific Plan	Unit	United States Customary

Geometric Data

	Freeway	Ramp
Number of Lanes (N), ln	3	1
Free-Flow Speed (FFS), mi/h	65.0	35.0
Segment Length (L) / Acceleration Length (LA),ft	1500	600
Terrain Type	Level	Level
Percent Grade, %	-	-
Segment Type / Ramp Side	Freeway	Right

Adjustment Factors

Driver Population	All Familiar	All Familiar
Weather Type	Non-Severe Weather	Non-Severe Weather
Incident Type	No Incident	-
Final Speed Adjustment Factor (SAF)	1.000	1.000
Final Capacity Adjustment Factor (CAF)	1.000	1.000
Demand Adjustment Factor (DAF)	1.000	1.000

Demand and Capacity

Demand Volume (Vi)	2067	692
Peak Hour Factor (PHF)	0.94	0.94
Total Trucks, %	29.27	4.05
Single-Unit Trucks (SUT), %	-	-
Tractor-Trailers (TT), %	-	-
Heavy Vehicle Adjustment Factor (fHV)	0.774	0.961
Flow Rate (vi),pc/h	2841	766
Capacity (c), pc/h	7050	2000
Volume-to-Capacity Ratio (v/c)	0.51	0.38

Speed and Density

Upstream Equilibrium Distance (LEQ), ft	-	Number of Outer Lanes on Freeway (NO)	1
Distance to Upstream Ramp (LUP), ft	-	Speed Index (MS)	0.324
Downstream Equilibrium Distance (LEQ), ft	-	Flow Outer Lanes (vOA), pc/h/ln	1153
Distance to Downstream Ramp (LDOWN), ft	-	On-Ramp Influence Area Speed (SR), mi/h	57.5
Prop. Freeway Vehicles in Lane 1 and 2 (PFM)	0.594	Outer Lanes Freeway Speed (SO), mi/h	62.6
Flow in Lanes 1 and 2 (v12), pc/h	1688	Ramp Junction Speed (S), mi/h	59.0
Flow Entering Ramp-Infl. Area (vR12), pc/h	2454	Average Density (D), pc/mi/ln	20.4
Level of Service (LOS)	C	Density in Ramp Influence Area (DR), pc/mi/ln	20.6

HCS7 Basic Freeway Report

Project Information

Analyst	LSA	Date	12/11/2019
Agency	LSA	Analysis Year	Phase I Proj Comp Yr (2029) NP
Jurisdiction	Caltrans	Time Period Analyzed	AM Peak Hour
Project Description	CMD1801 - Village D Specific Plan	Unit	United States Customary

Geometric Data

Number of Lanes, ln	3	Terrain Type	Level
Segment Length (L), ft	-	Percent Grade, %	-
Measured or Base Free-Flow Speed	Base	Grade Length, mi	-
Base Free-Flow Speed (BFFS), mi/h	65.0	Total Ramp Density (TRD), ramps/mi	1.83
Lane Width, ft	12	Free-Flow Speed (FFS), mi/h	59.7
Right-Side Lateral Clearance, ft	10		

Adjustment Factors

Driver Population	All Familiar	Final Speed Adjustment Factor (SAF)	1.000
Weather Type	Non-Severe Weather	Final Capacity Adjustment Factor (CAF)	1.000
Incident Type	No Incident	Demand Adjustment Factor (DAF)	1.000

Demand and Capacity

Demand Volume veh/h	2759	Heavy Vehicle Adjustment Factor (fhv)	0.813
Peak Hour Factor	0.94	Flow Rate (Vp), pc/h/ln	1203
Total Trucks, %	22.94	Capacity (c), pc/h/ln	2296
Single-Unit Trucks (SUT), %	-	Adjusted Capacity (cadj), pc/h/ln	2296
Tractor-Trailers (TT), %	-	Volume-to-Capacity Ratio (v/c)	0.52
Passenger Car Equivalent (ET)	2.000		

Speed and Density

Lane Width Adjustment (fLW)	0.0	Average Speed (S), mi/h	59.6
Right-Side Lateral Clearance Adj. (fRLC)	0.0	Density (D), pc/mi/ln	20.2
Total Ramp Density Adjustment	5.4	Level of Service (LOS)	C
Adjusted Free-Flow Speed (FFSadj), mi/h	59.6		

HCS7 Freeway Merge Report

Project Information

Analyst	LSA	Date	12/11/2019
Agency	LSA	Analysis Year	Phase I Proj Comp Yr (2029) NP
Jurisdiction	Caltrans	Time Period Analyzed	AM Peak Hour
Project Description	CMD1801 - Village D Specific Plan	Unit	United States Customary

Geometric Data

	Freeway	Ramp
Number of Lanes (N), ln	3	1
Free-Flow Speed (FFS), mi/h	65.0	35.0
Segment Length (L) / Acceleration Length (LA),ft	1500	600
Terrain Type	Level	Level
Percent Grade, %	-	-
Segment Type / Ramp Side	Freeway	Right

Adjustment Factors

Driver Population	All Familiar	All Familiar
Weather Type	Non-Severe Weather	Non-Severe Weather
Incident Type	No Incident	-
Final Speed Adjustment Factor (SAF)	1.000	1.000
Final Capacity Adjustment Factor (CAF)	1.000	1.000
Demand Adjustment Factor (DAF)	1.000	1.000

Demand and Capacity

Demand Volume (Vi)	2759	107
Peak Hour Factor (PHF)	0.94	0.94
Total Trucks, %	22.94	14.67
Single-Unit Trucks (SUT), %	-	-
Tractor-Trailers (TT), %	-	-
Heavy Vehicle Adjustment Factor (fHV)	0.813	0.872
Flow Rate (vi),pc/h	3610	131
Capacity (c), pc/h	7050	2000
Volume-to-Capacity Ratio (v/c)	0.53	0.07

Speed and Density

Upstream Equilibrium Distance (LEQ), ft	-	Number of Outer Lanes on Freeway (NO)	1
Distance to Upstream Ramp (LUP), ft	-	Speed Index (MS)	0.317
Downstream Equilibrium Distance (LEQ), ft	-	Flow Outer Lanes (vOA), pc/h/ln	1466
Distance to Downstream Ramp (LDOWN), ft	-	On-Ramp Influence Area Speed (SR), mi/h	57.7
Prop. Freeway Vehicles in Lane 1 and 2 (PFM)	0.594	Outer Lanes Freeway Speed (SO), mi/h	61.5
Flow in Lanes 1 and 2 (v12), pc/h	2144	Ramp Junction Speed (S), mi/h	59.1
Flow Entering Ramp-Infl. Area (vR12), pc/h	2275	Average Density (D), pc/mi/ln	21.1
Level of Service (LOS)	B	Density in Ramp Influence Area (DR), pc/mi/ln	19.5

HCS7 Basic Freeway Report

Project Information

Analyst	LSA	Date	12/11/2019
Agency	LSA	Analysis Year	Phase I Proj Comp Yr (2029) NP
Jurisdiction	Caltrans	Time Period Analyzed	AM Peak Hour
Project Description	CMD1801 - Village D Specific Plan	Unit	United States Customary

Geometric Data

Number of Lanes, ln	3	Terrain Type	Level
Segment Length (L), ft	-	Percent Grade, %	-
Measured or Base Free-Flow Speed	Base	Grade Length, mi	-
Base Free-Flow Speed (BFFS), mi/h	65.0	Total Ramp Density (TRD), ramps/mi	2.17
Lane Width, ft	12	Free-Flow Speed (FFS), mi/h	58.8
Right-Side Lateral Clearance, ft	10		

Adjustment Factors

Driver Population	All Familiar	Final Speed Adjustment Factor (SAF)	1.000
Weather Type	Non-Severe Weather	Final Capacity Adjustment Factor (CAF)	1.000
Incident Type	No Incident	Demand Adjustment Factor (DAF)	1.000

Demand and Capacity

Demand Volume veh/h	2866	Heavy Vehicle Adjustment Factor (fhv)	0.815
Peak Hour Factor	0.94	Flow Rate (Vp), pc/h/ln	1247
Total Trucks, %	22.63	Capacity (c), pc/h/ln	2288
Single-Unit Trucks (SUT), %	-	Adjusted Capacity (cadj), pc/h/ln	2288
Tractor-Trailers (TT), %	-	Volume-to-Capacity Ratio (v/c)	0.55
Passenger Car Equivalent (ET)	2.000		

Speed and Density

Lane Width Adjustment (fLW)	0.0	Average Speed (S), mi/h	58.8
Right-Side Lateral Clearance Adj. (fRLC)	0.0	Density (D), pc/mi/ln	21.2
Total Ramp Density Adjustment	6.2	Level of Service (LOS)	C
Adjusted Free-Flow Speed (FFSadj), mi/h	58.8		

HCS7 Freeway Diverge Report

Project Information

Analyst	LSA	Date	12/11/2019
Agency	LSA	Analysis Year	Phase I Proj Comp Yr (2029) NP
Jurisdiction	Caltrans	Time Period Analyzed	AM Peak Hour
Project Description	CMD1801 - Village D Specific Plan	Unit	United States Customary

Geometric Data

	Freeway	Ramp
Number of Lanes (N), ln	3	1
Free-Flow Speed (FFS), mi/h	65.0	40.0
Segment Length (L) / Deceleration Length (LA),ft	1500	150
Terrain Type	Level	Level
Percent Grade, %	-	-
Segment Type / Ramp Side	Freeway	Right

Adjustment Factors

Driver Population	All Familiar	All Familiar
Weather Type	Non-Severe Weather	Non-Severe Weather
Incident Type	No Incident	-
Final Speed Adjustment Factor (SAF)	1.000	1.000
Final Capacity Adjustment Factor (CAF)	1.000	1.000
Demand Adjustment Factor (DAF)	1.000	1.000

Demand and Capacity

Demand Volume (Vi)	2866	176
Peak Hour Factor (PHF)	0.94	0.94
Total Trucks, %	22.63	4.19
Single-Unit Trucks (SUT), %	-	-
Tractor-Trailers (TT), %	-	-
Heavy Vehicle Adjustment Factor (fHV)	0.815	0.960
Flow Rate (vi),pc/h	3741	195
Capacity (c), pc/h	7050	2000
Volume-to-Capacity Ratio (v/c)	0.53	0.10

Speed and Density

Upstream Equilibrium Distance (LEQ), ft	-	Number of Outer Lanes on Freeway (NO)	1
Distance to Upstream Ramp (LUP), ft	-	Speed Index (DS)	0.381
Downstream Equilibrium Distance (LEQ), ft	-	Flow Outer Lanes (vOA), pc/h/ln	1213
Distance to Downstream Ramp (LDOWN), ft	-	Off-Ramp Influence Area Speed (SR), mi/h	56.2
Prop. Freeway Vehicles in Lane 1 and 2 (PFD)	0.658	Outer Lanes Freeway Speed (SO), mi/h	70.5
Flow in Lanes 1 and 2 (v12), pc/h	2528	Ramp Junction Speed (S), mi/h	60.2
Flow Entering Ramp-Infl. Area (vR12), pc/h	-	Average Density (D), pc/mi/ln	20.7
Level of Service (LOS)	C	Density in Ramp Influence Area (DR), pc/mi/ln	24.6

HCS7 Basic Freeway Report

Project Information

Analyst	LSA	Date	12/11/2019
Agency	LSA	Analysis Year	Phase I Proj Comp Yr (2029) NP
Jurisdiction	Caltrans	Time Period Analyzed	AM Peak Hour
Project Description	CMD1801 - Village D Specific Plan	Unit	United States Customary

Geometric Data

Number of Lanes, ln	3	Terrain Type	Level
Segment Length (L), ft	-	Percent Grade, %	-
Measured or Base Free-Flow Speed	Base	Grade Length, mi	-
Base Free-Flow Speed (BFFS), mi/h	65.0	Total Ramp Density (TRD), ramps/mi	1.83
Lane Width, ft	12	Free-Flow Speed (FFS), mi/h	59.7
Right-Side Lateral Clearance, ft	10		

Adjustment Factors

Driver Population	All Familiar	Final Speed Adjustment Factor (SAF)	1.000
Weather Type	Non-Severe Weather	Final Capacity Adjustment Factor (CAF)	1.000
Incident Type	No Incident	Demand Adjustment Factor (DAF)	1.000

Demand and Capacity

Demand Volume veh/h	2691	Heavy Vehicle Adjustment Factor (fhv)	0.808
Peak Hour Factor	0.94	Flow Rate (Vp), pc/h/ln	1181
Total Trucks, %	23.83	Capacity (c), pc/h/ln	2296
Single-Unit Trucks (SUT), %	-	Adjusted Capacity (cadj), pc/h/ln	2296
Tractor-Trailers (TT), %	-	Volume-to-Capacity Ratio (v/c)	0.51
Passenger Car Equivalent (ET)	2.000		

Speed and Density

Lane Width Adjustment (fLW)	0.0	Average Speed (S), mi/h	59.6
Right-Side Lateral Clearance Adj. (fRLC)	0.0	Density (D), pc/mi/ln	19.8
Total Ramp Density Adjustment	5.4	Level of Service (LOS)	C
Adjusted Free-Flow Speed (FFSadj), mi/h	59.6		

HCS7 Freeway Merge Report

Project Information

Analyst	LSA	Date	12/11/2019
Agency	LSA	Analysis Year	Phase I Proj Comp Yr (2029) NP
Jurisdiction	Caltrans	Time Period Analyzed	AM Peak Hour
Project Description	CMD1801 - Village D Specific Plan	Unit	United States Customary

Geometric Data

	Freeway	Ramp
Number of Lanes (N), ln	3	1
Free-Flow Speed (FFS), mi/h	65.0	35.0
Segment Length (L) / Acceleration Length (LA),ft	1500	800
Terrain Type	Level	Level
Percent Grade, %	-	-
Segment Type / Ramp Side	Freeway	Right

Adjustment Factors

Driver Population	All Familiar	All Familiar
Weather Type	Non-Severe Weather	Non-Severe Weather
Incident Type	No Incident	-
Final Speed Adjustment Factor (SAF)	1.000	1.000
Final Capacity Adjustment Factor (CAF)	1.000	1.000
Demand Adjustment Factor (DAF)	1.000	1.000

Demand and Capacity

Demand Volume (Vi)	2691	253
Peak Hour Factor (PHF)	0.94	0.94
Total Trucks, %	23.83	2.66
Single-Unit Trucks (SUT), %	-	-
Tractor-Trailers (TT), %	-	-
Heavy Vehicle Adjustment Factor (fHV)	0.808	0.974
Flow Rate (vi),pc/h	3543	276
Capacity (c), pc/h	7050	2000
Volume-to-Capacity Ratio (v/c)	0.54	0.14

Speed and Density

Upstream Equilibrium Distance (LEQ), ft	-	Number of Outer Lanes on Freeway (NO)	1
Distance to Upstream Ramp (LUP), ft	-	Speed Index (MS)	0.308
Downstream Equilibrium Distance (LEQ), ft	-	Flow Outer Lanes (vOA), pc/h/ln	1417
Distance to Downstream Ramp (LDOWN), ft	-	On-Ramp Influence Area Speed (SR), mi/h	57.9
Prop. Freeway Vehicles in Lane 1 and 2 (PFM)	0.600	Outer Lanes Freeway Speed (SO), mi/h	61.7
Flow in Lanes 1 and 2 (v12), pc/h	2126	Ramp Junction Speed (S), mi/h	59.3
Flow Entering Ramp-Infl. Area (vR12), pc/h	2402	Average Density (D), pc/mi/ln	21.5
Level of Service (LOS)	B	Density in Ramp Influence Area (DR), pc/mi/ln	19.1

HCS7 Basic Freeway Report

Project Information

Analyst	LSA	Date	12/11/2019
Agency	LSA	Analysis Year	Phase I Proj Comp Yr (2029) NP
Jurisdiction	Caltrans	Time Period Analyzed	AM Peak Hour
Project Description	CMD1801 - Village D Specific Plan	Unit	United States Customary

Geometric Data

Number of Lanes, ln	3	Terrain Type	Level
Segment Length (L), ft	-	Percent Grade, %	-
Measured or Base Free-Flow Speed	Base	Grade Length, mi	-
Base Free-Flow Speed (BFFS), mi/h	65.0	Total Ramp Density (TRD), ramps/mi	2.17
Lane Width, ft	12	Free-Flow Speed (FFS), mi/h	58.8
Right-Side Lateral Clearance, ft	10		

Adjustment Factors

Driver Population	All Familiar	Final Speed Adjustment Factor (SAF)	1.000
Weather Type	Non-Severe Weather	Final Capacity Adjustment Factor (CAF)	1.000
Incident Type	No Incident	Demand Adjustment Factor (DAF)	1.000

Demand and Capacity

Demand Volume veh/h	2944	Heavy Vehicle Adjustment Factor (fhv)	0.820
Peak Hour Factor	0.94	Flow Rate (Vp), pc/h/ln	1273
Total Trucks, %	22.01	Capacity (c), pc/h/ln	2288
Single-Unit Trucks (SUT), %	-	Adjusted Capacity (cadj), pc/h/ln	2288
Tractor-Trailers (TT), %	-	Volume-to-Capacity Ratio (v/c)	0.56
Passenger Car Equivalent (ET)	2.000		

Speed and Density

Lane Width Adjustment (fLW)	0.0	Average Speed (S), mi/h	58.8
Right-Side Lateral Clearance Adj. (fRLC)	0.0	Density (D), pc/mi/ln	21.6
Total Ramp Density Adjustment	6.2	Level of Service (LOS)	C
Adjusted Free-Flow Speed (FFSadj), mi/h	58.8		

HCS7 Freeway Diverge Report

Project Information

Analyst	LSA	Date	12/11/2019
Agency	LSA	Analysis Year	Phase I Proj Comp Yr (2029) NP
Jurisdiction	Caltrans	Time Period Analyzed	AM Peak Hour
Project Description	CMD1801 - Village D Specific Plan	Unit	United States Customary

Geometric Data

	Freeway	Ramp
Number of Lanes (N), ln	3	1
Free-Flow Speed (FFS), mi/h	65.0	35.0
Segment Length (L) / Deceleration Length (LA),ft	1500	200
Terrain Type	Level	Level
Percent Grade, %	-	-
Segment Type / Ramp Side	Freeway	Right

Adjustment Factors

Driver Population	All Familiar	All Familiar
Weather Type	Non-Severe Weather	Non-Severe Weather
Incident Type	No Incident	-
Final Speed Adjustment Factor (SAF)	1.000	1.000
Final Capacity Adjustment Factor (CAF)	1.000	1.000
Demand Adjustment Factor (DAF)	1.000	1.000

Demand and Capacity

Demand Volume (Vi)	2944	119
Peak Hour Factor (PHF)	0.94	0.94
Total Trucks, %	22.01	14.71
Single-Unit Trucks (SUT), %	-	-
Tractor-Trailers (TT), %	-	-
Heavy Vehicle Adjustment Factor (fHV)	0.820	0.872
Flow Rate (vi),pc/h	3819	145
Capacity (c), pc/h	7050	2000
Volume-to-Capacity Ratio (v/c)	0.54	0.07

Speed and Density

Upstream Equilibrium Distance (LEQ), ft	-	Number of Outer Lanes on Freeway (NO)	1
Distance to Upstream Ramp (LUP), ft	-	Speed Index (DS)	0.441
Downstream Equilibrium Distance (LEQ), ft	-	Flow Outer Lanes (vOA), pc/h/ln	1257
Distance to Downstream Ramp (LDOWN), ft	-	Off-Ramp Influence Area Speed (SR), mi/h	54.9
Prop. Freeway Vehicles in Lane 1 and 2 (PFD)	0.658	Outer Lanes Freeway Speed (SO), mi/h	70.3
Flow in Lanes 1 and 2 (v12), pc/h	2562	Ramp Junction Speed (S), mi/h	59.2
Flow Entering Ramp-Infl. Area (vR12), pc/h	-	Average Density (D), pc/mi/ln	21.5
Level of Service (LOS)	C	Density in Ramp Influence Area (DR), pc/mi/ln	24.5

HCS7 Basic Freeway Report

Project Information

Analyst	LSA	Date	12/11/2019
Agency	LSA	Analysis Year	Phase I Proj Comp Yr (2029) NP
Jurisdiction	Caltrans	Time Period Analyzed	AM Peak Hour
Project Description	CMD1801 - Village D Specific Plan	Unit	United States Customary

Geometric Data

Number of Lanes, ln	3	Terrain Type	Level
Segment Length (L), ft	-	Percent Grade, %	-
Measured or Base Free-Flow Speed	Base	Grade Length, mi	-
Base Free-Flow Speed (BFFS), mi/h	65.0	Total Ramp Density (TRD), ramps/mi	2.17
Lane Width, ft	12	Free-Flow Speed (FFS), mi/h	58.8
Right-Side Lateral Clearance, ft	10		

Adjustment Factors

Driver Population	All Familiar	Final Speed Adjustment Factor (SAF)	1.000
Weather Type	Non-Severe Weather	Final Capacity Adjustment Factor (CAF)	1.000
Incident Type	No Incident	Demand Adjustment Factor (DAF)	1.000

Demand and Capacity

Demand Volume veh/h	2825	Heavy Vehicle Adjustment Factor (fhv)	0.818
Peak Hour Factor	0.94	Flow Rate (Vp), pc/h/ln	1225
Total Trucks, %	22.32	Capacity (c), pc/h/ln	2288
Single-Unit Trucks (SUT), %	-	Adjusted Capacity (cadj), pc/h/ln	2288
Tractor-Trailers (TT), %	-	Volume-to-Capacity Ratio (v/c)	0.54
Passenger Car Equivalent (ET)	2.000		

Speed and Density

Lane Width Adjustment (fLW)	0.0	Average Speed (S), mi/h	58.8
Right-Side Lateral Clearance Adj. (fRLC)	0.0	Density (D), pc/mi/ln	20.8
Total Ramp Density Adjustment	6.2	Level of Service (LOS)	C
Adjusted Free-Flow Speed (FFSadj), mi/h	58.8		

HCS7 Freeway Merge Report

Project Information

Analyst	LSA	Date	12/11/2019
Agency	LSA	Analysis Year	Phase I Proj Comp Yr (2029) NP
Jurisdiction	Caltrans	Time Period Analyzed	AM Peak Hour
Project Description	CMD1801 - Village D Specific Plan	Unit	United States Customary

Geometric Data

	Freeway	Ramp
Number of Lanes (N), ln	3	1
Free-Flow Speed (FFS), mi/h	65.0	35.0
Segment Length (L) / Acceleration Length (LA),ft	1500	350
Terrain Type	Level	Level
Percent Grade, %	-	-
Segment Type / Ramp Side	Freeway	Right

Adjustment Factors

Driver Population	All Familiar	All Familiar
Weather Type	Non-Severe Weather	Non-Severe Weather
Incident Type	No Incident	-
Final Speed Adjustment Factor (SAF)	1.000	1.000
Final Capacity Adjustment Factor (CAF)	1.000	1.000
Demand Adjustment Factor (DAF)	1.000	1.000

Demand and Capacity

Demand Volume (Vi)	2825	692
Peak Hour Factor (PHF)	0.94	0.94
Total Trucks, %	22.32	3.10
Single-Unit Trucks (SUT), %	-	-
Tractor-Trailers (TT), %	-	-
Heavy Vehicle Adjustment Factor (fHV)	0.818	0.970
Flow Rate (vi),pc/h	3674	759
Capacity (c), pc/h	7050	2000
Volume-to-Capacity Ratio (v/c)	0.63	0.38

Speed and Density

Upstream Equilibrium Distance (LEQ), ft	-	Number of Outer Lanes on Freeway (NO)	1
Distance to Upstream Ramp (LUP), ft	-	Speed Index (MS)	0.369
Downstream Equilibrium Distance (LEQ), ft	-	Flow Outer Lanes (vOA), pc/h/ln	1517
Distance to Downstream Ramp (LDOWN), ft	-	On-Ramp Influence Area Speed (SR), mi/h	56.5
Prop. Freeway Vehicles in Lane 1 and 2 (PFM)	0.587	Outer Lanes Freeway Speed (SO), mi/h	61.3
Flow in Lanes 1 and 2 (v12), pc/h	2157	Ramp Junction Speed (S), mi/h	58.1
Flow Entering Ramp-Infl. Area (vR12), pc/h	2916	Average Density (D), pc/mi/ln	25.4
Level of Service (LOS)	C	Density in Ramp Influence Area (DR), pc/mi/ln	25.7

HCS7 Basic Freeway Report

Project Information

Analyst	LSA	Date	12/11/2019
Agency	LSA	Analysis Year	Phase I Proj Comp Yr (2029) NP
Jurisdiction	Caltrans	Time Period Analyzed	AM Peak Hour
Project Description	CMD1801 - Village D Specific Plan	Unit	United States Customary

Geometric Data

Number of Lanes, ln	3	Terrain Type	Level
Segment Length (L), ft	-	Percent Grade, %	-
Measured or Base Free-Flow Speed	Base	Grade Length, mi	-
Base Free-Flow Speed (BFFS), mi/h	65.0	Total Ramp Density (TRD), ramps/mi	2.17
Lane Width, ft	12	Free-Flow Speed (FFS), mi/h	58.8
Right-Side Lateral Clearance, ft	10		

Adjustment Factors

Driver Population	All Familiar	Final Speed Adjustment Factor (SAF)	1.000
Weather Type	Non-Severe Weather	Final Capacity Adjustment Factor (CAF)	1.000
Incident Type	No Incident	Demand Adjustment Factor (DAF)	1.000

Demand and Capacity

Demand Volume veh/h	3517	Heavy Vehicle Adjustment Factor (fhv)	0.844
Peak Hour Factor	0.94	Flow Rate (Vp), pc/h/ln	1478
Total Trucks, %	18.54	Capacity (c), pc/h/ln	2288
Single-Unit Trucks (SUT), %	-	Adjusted Capacity (cadj), pc/h/ln	2288
Tractor-Trailers (TT), %	-	Volume-to-Capacity Ratio (v/c)	0.65
Passenger Car Equivalent (ET)	2.000		

Speed and Density

Lane Width Adjustment (fLW)	0.0	Average Speed (S), mi/h	58.8
Right-Side Lateral Clearance Adj. (fRLC)	0.0	Density (D), pc/mi/ln	25.1
Total Ramp Density Adjustment	6.2	Level of Service (LOS)	C
Adjusted Free-Flow Speed (FFSadj), mi/h	58.8		

HCS7 Freeway Diverge Report

Project Information

Analyst	LSA	Date	12/11/2019
Agency	LSA	Analysis Year	Phase I Proj Comp Yr (2029) NP
Jurisdiction	Caltrans	Time Period Analyzed	AM Peak Hour
Project Description	CMD1801 - Village D Specific Plan	Unit	United States Customary

Geometric Data

	Freeway	Ramp
Number of Lanes (N), In	3	1
Free-Flow Speed (FFS), mi/h	65.0	15.0
Segment Length (L) / Deceleration Length (LA),ft	1500	150
Terrain Type	Level	Level
Percent Grade, %	-	-
Segment Type / Ramp Side	Freeway	Right

Adjustment Factors

Driver Population	All Familiar	All Familiar
Weather Type	Non-Severe Weather	Non-Severe Weather
Incident Type	No Incident	-
Final Speed Adjustment Factor (SAF)	1.000	1.000
Final Capacity Adjustment Factor (CAF)	1.000	1.000
Demand Adjustment Factor (DAF)	1.000	1.000

Demand and Capacity

Demand Volume (Vi)	3517	407
Peak Hour Factor (PHF)	0.94	0.94
Total Trucks, %	18.54	3.32
Single-Unit Trucks (SUT), %	-	-
Tractor-Trailers (TT), %	-	-
Heavy Vehicle Adjustment Factor (fHV)	0.844	0.968
Flow Rate (vi),pc/h	4433	447
Capacity (c), pc/h	7050	1800
Volume-to-Capacity Ratio (v/c)	0.63	0.25

Speed and Density

Upstream Equilibrium Distance (LEQ), ft	-	Number of Outer Lanes on Freeway (NO)	1
Distance to Upstream Ramp (LUP), ft	-	Speed Index (DS)	0.728
Downstream Equilibrium Distance (LEQ), ft	-	Flow Outer Lanes (vOA), pc/h/ln	1479
Distance to Downstream Ramp (LDOWN), ft	-	Off-Ramp Influence Area Speed (SR), mi/h	48.3
Prop. Freeway Vehicles in Lane 1 and 2 (PFD)	0.629	Outer Lanes Freeway Speed (SO), mi/h	69.4
Flow in Lanes 1 and 2 (v12), pc/h	2954	Ramp Junction Speed (S), mi/h	53.8
Flow Entering Ramp-Infl. Area (vR12), pc/h	-	Average Density (D), pc/mi/ln	27.5
Level of Service (LOS)	D	Density in Ramp Influence Area (DR), pc/mi/ln	28.3

HCS7 Basic Freeway Report

Project Information

Analyst	LSA	Date	12/11/2019
Agency	LSA	Analysis Year	Phase I Proj Comp Yr (2029) NP
Jurisdiction	Caltrans	Time Period Analyzed	AM Peak Hour
Project Description	CMD1801 - Village D Specific Plan	Unit	United States Customary

Geometric Data

Number of Lanes, ln	3	Terrain Type	Level
Segment Length (L), ft	-	Percent Grade, %	-
Measured or Base Free-Flow Speed	Base	Grade Length, mi	-
Base Free-Flow Speed (BFFS), mi/h	65.0	Total Ramp Density (TRD), ramps/mi	1.83
Lane Width, ft	12	Free-Flow Speed (FFS), mi/h	59.7
Right-Side Lateral Clearance, ft	10		

Adjustment Factors

Driver Population	All Familiar	Final Speed Adjustment Factor (SAF)	1.000
Weather Type	Non-Severe Weather	Final Capacity Adjustment Factor (CAF)	1.000
Incident Type	No Incident	Demand Adjustment Factor (DAF)	1.000

Demand and Capacity

Demand Volume veh/h	3110	Heavy Vehicle Adjustment Factor (fhv)	0.830
Peak Hour Factor	0.94	Flow Rate (Vp), pc/h/ln	1329
Total Trucks, %	20.52	Capacity (c), pc/h/ln	2296
Single-Unit Trucks (SUT), %	-	Adjusted Capacity (cadj), pc/h/ln	2296
Tractor-Trailers (TT), %	-	Volume-to-Capacity Ratio (v/c)	0.58
Passenger Car Equivalent (ET)	2.000		

Speed and Density

Lane Width Adjustment (fLW)	0.0	Average Speed (S), mi/h	59.6
Right-Side Lateral Clearance Adj. (fRLC)	0.0	Density (D), pc/mi/ln	22.3
Total Ramp Density Adjustment	5.4	Level of Service (LOS)	C
Adjusted Free-Flow Speed (FFSadj), mi/h	59.6		

HCS7 Freeway Merge Report

Project Information

Analyst	LSA	Date	12/11/2019
Agency	LSA	Analysis Year	Phase I Proj Comp Yr (2029) NP
Jurisdiction	Caltrans	Time Period Analyzed	AM Peak Hour
Project Description	CMD1801 - Village D Specific Plan	Unit	United States Customary

Geometric Data

	Freeway	Ramp
Number of Lanes (N), ln	3	1
Free-Flow Speed (FFS), mi/h	65.0	35.0
Segment Length (L) / Acceleration Length (LA),ft	1500	450
Terrain Type	Level	Level
Percent Grade, %	-	-
Segment Type / Ramp Side	Freeway	Right

Adjustment Factors

Driver Population	All Familiar	All Familiar
Weather Type	Non-Severe Weather	Non-Severe Weather
Incident Type	No Incident	-
Final Speed Adjustment Factor (SAF)	1.000	1.000
Final Capacity Adjustment Factor (CAF)	1.000	1.000
Demand Adjustment Factor (DAF)	1.000	1.000

Demand and Capacity

Demand Volume (Vi)	3110	516
Peak Hour Factor (PHF)	0.94	0.94
Total Trucks, %	20.52	0.84
Single-Unit Trucks (SUT), %	-	-
Tractor-Trailers (TT), %	-	-
Heavy Vehicle Adjustment Factor (fHV)	0.830	0.992
Flow Rate (vi),pc/h	3986	553
Capacity (c), pc/h	7050	2000
Volume-to-Capacity Ratio (v/c)	0.64	0.28

Speed and Density

Upstream Equilibrium Distance (LEQ), ft	-	Number of Outer Lanes on Freeway (NO)	1
Distance to Upstream Ramp (LUP), ft	-	Speed Index (MS)	0.361
Downstream Equilibrium Distance (LEQ), ft	-	Flow Outer Lanes (vOA), pc/h/ln	1634
Distance to Downstream Ramp (LDOWN), ft	-	On-Ramp Influence Area Speed (SR), mi/h	56.7
Prop. Freeway Vehicles in Lane 1 and 2 (PFM)	0.590	Outer Lanes Freeway Speed (SO), mi/h	60.9
Flow in Lanes 1 and 2 (v12), pc/h	2352	Ramp Junction Speed (S), mi/h	58.1
Flow Entering Ramp-Infl. Area (vR12), pc/h	2905	Average Density (D), pc/mi/ln	26.0
Level of Service (LOS)	C	Density in Ramp Influence Area (DR), pc/mi/ln	25.1

HCS7 Basic Freeway Report

Project Information

Analyst	LSA	Date	12/11/2019
Agency	LSA	Analysis Year	Phase I Proj Comp Yr (2029) NP
Jurisdiction	Caltrans	Time Period Analyzed	AM Peak Hour
Project Description	CMD1801 - Village D Specific Plan	Unit	United States Customary

Geometric Data

Number of Lanes, ln	3	Terrain Type	Level
Segment Length (L), ft	-	Percent Grade, %	-
Measured or Base Free-Flow Speed	Base	Grade Length, mi	-
Base Free-Flow Speed (BFFS), mi/h	65.0	Total Ramp Density (TRD), ramps/mi	1.83
Lane Width, ft	12	Free-Flow Speed (FFS), mi/h	59.7
Right-Side Lateral Clearance, ft	10		

Adjustment Factors

Driver Population	All Familiar	Final Speed Adjustment Factor (SAF)	1.000
Weather Type	Non-Severe Weather	Final Capacity Adjustment Factor (CAF)	1.000
Incident Type	No Incident	Demand Adjustment Factor (DAF)	1.000

Demand and Capacity

Demand Volume veh/h	3627	Heavy Vehicle Adjustment Factor (fhv)	0.849
Peak Hour Factor	0.94	Flow Rate (Vp), pc/h/ln	1515
Total Trucks, %	17.72	Capacity (c), pc/h/ln	2296
Single-Unit Trucks (SUT), %	-	Adjusted Capacity (cadj), pc/h/ln	2296
Tractor-Trailers (TT), %	-	Volume-to-Capacity Ratio (v/c)	0.66
Passenger Car Equivalent (ET)	2.000		

Speed and Density

Lane Width Adjustment (fLW)	0.0	Average Speed (S), mi/h	59.6
Right-Side Lateral Clearance Adj. (fRLC)	0.0	Density (D), pc/mi/ln	25.4
Total Ramp Density Adjustment	5.4	Level of Service (LOS)	C
Adjusted Free-Flow Speed (FFSadj), mi/h	59.6		

HCS7 Freeway Diverge Report

Project Information

Analyst	LSA	Date	12/11/2019
Agency	LSA	Analysis Year	Phase I Proj Comp Yr (2029) NP
Jurisdiction	Caltrans	Time Period Analyzed	AM Peak Hour
Project Description	CMD1801 - Village D Specific Plan	Unit	United States Customary

Geometric Data

	Freeway	Ramp
Number of Lanes (N), ln	3	1
Free-Flow Speed (FFS), mi/h	65.0	35.0
Segment Length (L) / Deceleration Length (LA),ft	1500	140
Terrain Type	Level	Level
Percent Grade, %	-	-
Segment Type / Ramp Side	Freeway	Right

Adjustment Factors

Driver Population	All Familiar	All Familiar
Weather Type	Non-Severe Weather	Non-Severe Weather
Incident Type	No Incident	-
Final Speed Adjustment Factor (SAF)	1.000	1.000
Final Capacity Adjustment Factor (CAF)	1.000	1.000
Demand Adjustment Factor (DAF)	1.000	1.000

Demand and Capacity

Demand Volume (Vi)	3627	545
Peak Hour Factor (PHF)	0.94	0.94
Total Trucks, %	17.72	9.70
Single-Unit Trucks (SUT), %	-	-
Tractor-Trailers (TT), %	-	-
Heavy Vehicle Adjustment Factor (fHV)	0.849	0.912
Flow Rate (vi),pc/h	4545	636
Capacity (c), pc/h	7050	2000
Volume-to-Capacity Ratio (v/c)	0.64	0.32

Speed and Density

Upstream Equilibrium Distance (LEQ), ft	-	Number of Outer Lanes on Freeway (NO)	1
Distance to Upstream Ramp (LUP), ft	-	Speed Index (DS)	0.485
Downstream Equilibrium Distance (LEQ), ft	-	Flow Outer Lanes (vOA), pc/h/ln	1497
Distance to Downstream Ramp (LDOWN), ft	-	Off-Ramp Influence Area Speed (SR), mi/h	53.8
Prop. Freeway Vehicles in Lane 1 and 2 (PFD)	0.617	Outer Lanes Freeway Speed (SO), mi/h	69.4
Flow in Lanes 1 and 2 (v12), pc/h	3048	Ramp Junction Speed (S), mi/h	58.1
Flow Entering Ramp-Infl. Area (vR12), pc/h	-	Average Density (D), pc/mi/ln	26.1
Level of Service (LOS)	D	Density in Ramp Influence Area (DR), pc/mi/ln	29.2

HCS7 Basic Freeway Report

Project Information

Analyst	LSA	Date	12/11/2019
Agency	LSA	Analysis Year	Phase I Proj Comp Yr (2029) NP
Jurisdiction	Caltrans	Time Period Analyzed	AM Peak Hour
Project Description	CMD1801 - Village D Specific Plan	Unit	United States Customary

Geometric Data

Number of Lanes, ln	3	Terrain Type	Level
Segment Length (L), ft	-	Percent Grade, %	-
Measured or Base Free-Flow Speed	Base	Grade Length, mi	-
Base Free-Flow Speed (BFFS), mi/h	65.0	Total Ramp Density (TRD), ramps/mi	2.17
Lane Width, ft	12	Free-Flow Speed (FFS), mi/h	58.8
Right-Side Lateral Clearance, ft	10		

Adjustment Factors

Driver Population	All Familiar	Final Speed Adjustment Factor (SAF)	1.000
Weather Type	Non-Severe Weather	Final Capacity Adjustment Factor (CAF)	1.000
Incident Type	No Incident	Demand Adjustment Factor (DAF)	1.000

Demand and Capacity

Demand Volume veh/h	3081	Heavy Vehicle Adjustment Factor (fhv)	0.839
Peak Hour Factor	0.94	Flow Rate (Vp), pc/h/ln	1302
Total Trucks, %	19.13	Capacity (c), pc/h/ln	2288
Single-Unit Trucks (SUT), %	-	Adjusted Capacity (cadj), pc/h/ln	2288
Tractor-Trailers (TT), %	-	Volume-to-Capacity Ratio (v/c)	0.57
Passenger Car Equivalent (ET)	2.000		

Speed and Density

Lane Width Adjustment (fLW)	0.0	Average Speed (S), mi/h	58.8
Right-Side Lateral Clearance Adj. (fRLC)	0.0	Density (D), pc/mi/ln	22.1
Total Ramp Density Adjustment	6.2	Level of Service (LOS)	C
Adjusted Free-Flow Speed (FFSadj), mi/h	58.8		

HCS7 Freeway Merge Report

Project Information

Analyst	LSA	Date	12/11/2019
Agency	LSA	Analysis Year	Phase I Proj Comp Yr (2029) NP
Jurisdiction	Caltrans	Time Period Analyzed	AM Peak Hour
Project Description	CMD1801 - Village D Specific Plan	Unit	United States Customary

Geometric Data

	Freeway	Ramp
Number of Lanes (N), ln	3	1
Free-Flow Speed (FFS), mi/h	65.0	35.0
Segment Length (L) / Acceleration Length (LA),ft	1500	450
Terrain Type	Level	Level
Percent Grade, %	-	-
Segment Type / Ramp Side	Freeway	Right

Adjustment Factors

Driver Population	All Familiar	All Familiar
Weather Type	Non-Severe Weather	Non-Severe Weather
Incident Type	No Incident	-
Final Speed Adjustment Factor (SAF)	1.000	1.000
Final Capacity Adjustment Factor (CAF)	1.000	1.000
Demand Adjustment Factor (DAF)	1.000	1.000

Demand and Capacity

Demand Volume (Vi)	3081	321
Peak Hour Factor (PHF)	0.94	0.94
Total Trucks, %	19.13	2.57
Single-Unit Trucks (SUT), %	-	-
Tractor-Trailers (TT), %	-	-
Heavy Vehicle Adjustment Factor (fHV)	0.839	0.975
Flow Rate (vi),pc/h	3907	350
Capacity (c), pc/h	7050	2000
Volume-to-Capacity Ratio (v/c)	0.60	0.18

Speed and Density

Upstream Equilibrium Distance (LEQ), ft	-	Number of Outer Lanes on Freeway (NO)	1
Distance to Upstream Ramp (LUP), ft	-	Speed Index (MS)	0.345
Downstream Equilibrium Distance (LEQ), ft	-	Flow Outer Lanes (vOA), pc/h/ln	1602
Distance to Downstream Ramp (LDOWN), ft	-	On-Ramp Influence Area Speed (SR), mi/h	57.1
Prop. Freeway Vehicles in Lane 1 and 2 (PFM)	0.590	Outer Lanes Freeway Speed (SO), mi/h	61.0
Flow in Lanes 1 and 2 (v12), pc/h	2305	Ramp Junction Speed (S), mi/h	58.5
Flow Entering Ramp-Infl. Area (vR12), pc/h	2655	Average Density (D), pc/mi/ln	24.3
Level of Service (LOS)	C	Density in Ramp Influence Area (DR), pc/mi/ln	23.3

HCS7 Basic Freeway Report

Project Information

Analyst	LSA	Date	12/11/2019
Agency	LSA	Analysis Year	Phase I Proj Comp Yr (2029) NP
Jurisdiction	Caltrans	Time Period Analyzed	AM Peak Hour
Project Description	CMD1801 - Village D Specific Plan	Unit	United States Customary

Geometric Data

Number of Lanes, ln	3	Terrain Type	Level
Segment Length (L), ft	-	Percent Grade, %	-
Measured or Base Free-Flow Speed	Base	Grade Length, mi	-
Base Free-Flow Speed (BFFS), mi/h	65.0	Total Ramp Density (TRD), ramps/mi	2.17
Lane Width, ft	12	Free-Flow Speed (FFS), mi/h	58.8
Right-Side Lateral Clearance, ft	10		

Adjustment Factors

Driver Population	All Familiar	Final Speed Adjustment Factor (SAF)	1.000
Weather Type	Non-Severe Weather	Final Capacity Adjustment Factor (CAF)	1.000
Incident Type	No Incident	Demand Adjustment Factor (DAF)	1.000

Demand and Capacity

Demand Volume veh/h	3402	Heavy Vehicle Adjustment Factor (fhv)	0.851
Peak Hour Factor	0.94	Flow Rate (Vp), pc/h/ln	1418
Total Trucks, %	17.57	Capacity (c), pc/h/ln	2288
Single-Unit Trucks (SUT), %	-	Adjusted Capacity (cadj), pc/h/ln	2288
Tractor-Trailers (TT), %	-	Volume-to-Capacity Ratio (v/c)	0.62
Passenger Car Equivalent (ET)	2.000		

Speed and Density

Lane Width Adjustment (fLW)	0.0	Average Speed (S), mi/h	58.8
Right-Side Lateral Clearance Adj. (fRLC)	0.0	Density (D), pc/mi/ln	24.1
Total Ramp Density Adjustment	6.2	Level of Service (LOS)	C
Adjusted Free-Flow Speed (FFSadj), mi/h	58.8		

HCS7 Basic Freeway Report

Project Information

Analyst	LSA	Date	12/11/2019
Agency	LSA	Analysis Year	Phase I Proj Comp Yr (2029) NP
Jurisdiction	Caltrans	Time Period Analyzed	PM Peak Hour
Project Description	CMD1801 - Village D Specific Plan	Unit	United States Customary

Geometric Data

Number of Lanes, ln	3	Terrain Type	Level
Segment Length (L), ft	-	Percent Grade, %	-
Measured or Base Free-Flow Speed	Base	Grade Length, mi	-
Base Free-Flow Speed (BFFS), mi/h	65.0	Total Ramp Density (TRD), ramps/mi	1.83
Lane Width, ft	12	Free-Flow Speed (FFS), mi/h	59.7
Right-Side Lateral Clearance, ft	10		

Adjustment Factors

Driver Population	All Familiar	Final Speed Adjustment Factor (SAF)	1.000
Weather Type	Non-Severe Weather	Final Capacity Adjustment Factor (CAF)	1.000
Incident Type	No Incident	Demand Adjustment Factor (DAF)	1.000

Demand and Capacity

Demand Volume veh/h	3210	Heavy Vehicle Adjustment Factor (fhv)	0.851
Peak Hour Factor	0.94	Flow Rate (Vp), pc/h/ln	1338
Total Trucks, %	17.57	Capacity (c), pc/h/ln	2296
Single-Unit Trucks (SUT), %	-	Adjusted Capacity (cadj), pc/h/ln	2296
Tractor-Trailers (TT), %	-	Volume-to-Capacity Ratio (v/c)	0.58
Passenger Car Equivalent (ET)	2.000		

Speed and Density

Lane Width Adjustment (fLW)	0.0	Average Speed (S), mi/h	59.6
Right-Side Lateral Clearance Adj. (fRLC)	0.0	Density (D), pc/mi/ln	22.4
Total Ramp Density Adjustment	5.4	Level of Service (LOS)	C
Adjusted Free-Flow Speed (FFSadj), mi/h	59.6		

HCS7 Freeway Diverge Report

Project Information

Analyst	LSA	Date	12/11/2019
Agency	LSA	Analysis Year	Phase I Proj Comp Yr (2029) NP
Jurisdiction	Caltrans	Time Period Analyzed	PM Peak Hour
Project Description	CMD1801 - Village D Specific Plan	Unit	United States Customary

Geometric Data

	Freeway	Ramp
Number of Lanes (N), ln	3	1
Free-Flow Speed (FFS), mi/h	65.0	35.0
Segment Length (L) / Deceleration Length (LA),ft	1500	150
Terrain Type	Level	Level
Percent Grade, %	-	-
Segment Type / Ramp Side	Freeway	Right

Adjustment Factors

Driver Population	All Familiar	All Familiar
Weather Type	Non-Severe Weather	Non-Severe Weather
Incident Type	No Incident	-
Final Speed Adjustment Factor (SAF)	1.000	1.000
Final Capacity Adjustment Factor (CAF)	1.000	1.000
Demand Adjustment Factor (DAF)	1.000	1.000

Demand and Capacity

Demand Volume (Vi)	3210	217
Peak Hour Factor (PHF)	0.94	0.94
Total Trucks, %	17.57	0.99
Single-Unit Trucks (SUT), %	-	-
Tractor-Trailers (TT), %	-	-
Heavy Vehicle Adjustment Factor (fHV)	0.851	0.990
Flow Rate (vi),pc/h	4013	233
Capacity (c), pc/h	7050	2000
Volume-to-Capacity Ratio (v/c)	0.57	0.12

Speed and Density

Upstream Equilibrium Distance (LEQ), ft	-	Number of Outer Lanes on Freeway (NO)	1
Distance to Upstream Ramp (LUP), ft	-	Speed Index (DS)	0.449
Downstream Equilibrium Distance (LEQ), ft	-	Flow Outer Lanes (vOA), pc/h/ln	1327
Distance to Downstream Ramp (LDOWN), ft	-	Off-Ramp Influence Area Speed (SR), mi/h	54.7
Prop. Freeway Vehicles in Lane 1 and 2 (PFD)	0.649	Outer Lanes Freeway Speed (SO), mi/h	70.0
Flow in Lanes 1 and 2 (v12), pc/h	2686	Ramp Junction Speed (S), mi/h	59.0
Flow Entering Ramp-Infl. Area (vR12), pc/h	-	Average Density (D), pc/mi/ln	22.7
Level of Service (LOS)	C	Density in Ramp Influence Area (DR), pc/mi/ln	26.0

HCS7 Basic Freeway Report

Project Information

Analyst	LSA	Date	12/11/2019
Agency	LSA	Analysis Year	Phase I Proj Comp Yr (2029) NP
Jurisdiction	Caltrans	Time Period Analyzed	PM Peak Hour
Project Description	CMD1801 - Village D Specific Plan	Unit	United States Customary

Geometric Data

Number of Lanes, ln	3	Terrain Type	Level
Segment Length (L), ft	-	Percent Grade, %	-
Measured or Base Free-Flow Speed	Base	Grade Length, mi	-
Base Free-Flow Speed (BFFS), mi/h	65.0	Total Ramp Density (TRD), ramps/mi	1.83
Lane Width, ft	12	Free-Flow Speed (FFS), mi/h	59.7
Right-Side Lateral Clearance, ft	10		

Adjustment Factors

Driver Population	All Familiar	Final Speed Adjustment Factor (SAF)	1.000
Weather Type	Non-Severe Weather	Final Capacity Adjustment Factor (CAF)	1.000
Incident Type	No Incident	Demand Adjustment Factor (DAF)	1.000

Demand and Capacity

Demand Volume veh/h	2994	Heavy Vehicle Adjustment Factor (fhv)	0.842
Peak Hour Factor	0.94	Flow Rate (Vp), pc/h/ln	1261
Total Trucks, %	18.77	Capacity (c), pc/h/ln	2296
Single-Unit Trucks (SUT), %	-	Adjusted Capacity (cadj), pc/h/ln	2296
Tractor-Trailers (TT), %	-	Volume-to-Capacity Ratio (v/c)	0.55
Passenger Car Equivalent (ET)	2.000		

Speed and Density

Lane Width Adjustment (fLW)	0.0	Average Speed (S), mi/h	59.6
Right-Side Lateral Clearance Adj. (fRLC)	0.0	Density (D), pc/mi/ln	21.2
Total Ramp Density Adjustment	5.4	Level of Service (LOS)	C
Adjusted Free-Flow Speed (FFSadj), mi/h	59.6		

HCS7 Freeway Merge Report

Project Information

Analyst	LSA	Date	12/11/2019
Agency	LSA	Analysis Year	Phase I Proj Comp Yr (2029) NP
Jurisdiction	Caltrans	Time Period Analyzed	PM Peak Hour
Project Description	CMD1801 - Village D Specific Plan	Unit	United States Customary

Geometric Data

	Freeway	Ramp
Number of Lanes (N), ln	3	1
Free-Flow Speed (FFS), mi/h	65.0	35.0
Segment Length (L) / Acceleration Length (LA),ft	1500	445
Terrain Type	Level	Level
Percent Grade, %	-	-
Segment Type / Ramp Side	Freeway	Right

Adjustment Factors

Driver Population	All Familiar	All Familiar
Weather Type	Non-Severe Weather	Non-Severe Weather
Incident Type	No Incident	-
Final Speed Adjustment Factor (SAF)	1.000	1.000
Final Capacity Adjustment Factor (CAF)	1.000	1.000
Demand Adjustment Factor (DAF)	1.000	1.000

Demand and Capacity

Demand Volume (Vi)	2994	699
Peak Hour Factor (PHF)	0.94	0.94
Total Trucks, %	18.77	2.75
Single-Unit Trucks (SUT), %	-	-
Tractor-Trailers (TT), %	-	-
Heavy Vehicle Adjustment Factor (fHV)	0.842	0.973
Flow Rate (vi),pc/h	3783	764
Capacity (c), pc/h	7050	2000
Volume-to-Capacity Ratio (v/c)	0.64	0.38

Speed and Density

Upstream Equilibrium Distance (LEQ), ft	-	Number of Outer Lanes on Freeway (NO)	1
Distance to Upstream Ramp (LUP), ft	-	Speed Index (MS)	0.368
Downstream Equilibrium Distance (LEQ), ft	-	Flow Outer Lanes (vOA), pc/h/ln	1551
Distance to Downstream Ramp (LDOWN), ft	-	On-Ramp Influence Area Speed (SR), mi/h	56.5
Prop. Freeway Vehicles in Lane 1 and 2 (PFM)	0.590	Outer Lanes Freeway Speed (SO), mi/h	61.2
Flow in Lanes 1 and 2 (v12), pc/h	2232	Ramp Junction Speed (S), mi/h	58.0
Flow Entering Ramp-Infl. Area (vR12), pc/h	2996	Average Density (D), pc/mi/ln	26.1
Level of Service (LOS)	C	Density in Ramp Influence Area (DR), pc/mi/ln	25.8

HCS7 Basic Freeway Report

Project Information

Analyst	LSA	Date	12/11/2019
Agency	LSA	Analysis Year	Phase I Proj Comp Yr (2029) NP
Jurisdiction	Caltrans	Time Period Analyzed	PM Peak Hour
Project Description	CMD1801 - Village D Specific Plan	Unit	United States Customary

Geometric Data

Number of Lanes, ln	3	Terrain Type	Level
Segment Length (L), ft	-	Percent Grade, %	-
Measured or Base Free-Flow Speed	Base	Grade Length, mi	-
Base Free-Flow Speed (BFFS), mi/h	65.0	Total Ramp Density (TRD), ramps/mi	1.50
Lane Width, ft	12	Free-Flow Speed (FFS), mi/h	60.5
Right-Side Lateral Clearance, ft	10		

Adjustment Factors

Driver Population	All Familiar	Final Speed Adjustment Factor (SAF)	1.000
Weather Type	Non-Severe Weather	Final Capacity Adjustment Factor (CAF)	1.000
Incident Type	No Incident	Demand Adjustment Factor (DAF)	1.000

Demand and Capacity

Demand Volume veh/h	3692	Heavy Vehicle Adjustment Factor (fhv)	0.864
Peak Hour Factor	0.94	Flow Rate (Vp), pc/h/ln	1515
Total Trucks, %	15.74	Capacity (c), pc/h/ln	2305
Single-Unit Trucks (SUT), %	-	Adjusted Capacity (cadj), pc/h/ln	2305
Tractor-Trailers (TT), %	-	Volume-to-Capacity Ratio (v/c)	0.66
Passenger Car Equivalent (ET)	2.000		

Speed and Density

Lane Width Adjustment (fLW)	0.0	Average Speed (S), mi/h	60.5
Right-Side Lateral Clearance Adj. (fRLC)	0.0	Density (D), pc/mi/ln	25.0
Total Ramp Density Adjustment	4.5	Level of Service (LOS)	C
Adjusted Free-Flow Speed (FFSadj), mi/h	60.5		

HCS7 Freeway Diverge Report

Project Information

Analyst	LSA	Date	12/11/2019
Agency	LSA	Analysis Year	Phase I Proj Comp Yr (2029) NP
Jurisdiction	Caltrans	Time Period Analyzed	PM Peak Hour
Project Description	CMD1801 - Village D Specific Plan	Unit	United States Customary

Geometric Data

	Freeway	Ramp
Number of Lanes (N), In	3	1
Free-Flow Speed (FFS), mi/h	65.0	35.0
Segment Length (L) / Deceleration Length (LA),ft	1500	130
Terrain Type	Level	Level
Percent Grade, %	-	-
Segment Type / Ramp Side	Freeway	Right

Adjustment Factors

Driver Population	All Familiar	All Familiar
Weather Type	Non-Severe Weather	Non-Severe Weather
Incident Type	No Incident	-
Final Speed Adjustment Factor (SAF)	1.000	1.000
Final Capacity Adjustment Factor (CAF)	1.000	1.000
Demand Adjustment Factor (DAF)	1.000	1.000

Demand and Capacity

Demand Volume (Vi)	3692	446
Peak Hour Factor (PHF)	0.94	0.94
Total Trucks, %	15.74	1.24
Single-Unit Trucks (SUT), %	-	-
Tractor-Trailers (TT), %	-	-
Heavy Vehicle Adjustment Factor (fHV)	0.864	0.988
Flow Rate (vi),pc/h	4546	480
Capacity (c), pc/h	7050	2000
Volume-to-Capacity Ratio (v/c)	0.64	0.24

Speed and Density

Upstream Equilibrium Distance (LEQ), ft	-	Number of Outer Lanes on Freeway (NO)	1
Distance to Upstream Ramp (LUP), ft	-	Speed Index (DS)	0.471
Downstream Equilibrium Distance (LEQ), ft	-	Flow Outer Lanes (vOA), pc/h/ln	1529
Distance to Downstream Ramp (LDOWN), ft	-	Off-Ramp Influence Area Speed (SR), mi/h	54.2
Prop. Freeway Vehicles in Lane 1 and 2 (PFD)	0.624	Outer Lanes Freeway Speed (SO), mi/h	69.2
Flow in Lanes 1 and 2 (v12), pc/h	3017	Ramp Junction Speed (S), mi/h	58.5
Flow Entering Ramp-Infl. Area (vR12), pc/h	-	Average Density (D), pc/mi/ln	25.9
Level of Service (LOS)	D	Density in Ramp Influence Area (DR), pc/mi/ln	29.0

HCS7 Basic Freeway Report

Project Information

Analyst	LSA	Date	12/11/2019
Agency	LSA	Analysis Year	Phase I Proj Comp Yr (2029) NP
Jurisdiction	Caltrans	Time Period Analyzed	PM Peak Hour
Project Description	CMD1801 - Village D Specific Plan	Unit	United States Customary

Geometric Data

Number of Lanes, ln	3	Terrain Type	Level
Segment Length (L), ft	-	Percent Grade, %	-
Measured or Base Free-Flow Speed	Base	Grade Length, mi	-
Base Free-Flow Speed (BFFS), mi/h	65.0	Total Ramp Density (TRD), ramps/mi	1.67
Lane Width, ft	12	Free-Flow Speed (FFS), mi/h	60.0
Right-Side Lateral Clearance, ft	10		

Adjustment Factors

Driver Population	All Familiar	Final Speed Adjustment Factor (SAF)	1.000
Weather Type	Non-Severe Weather	Final Capacity Adjustment Factor (CAF)	1.000
Incident Type	No Incident	Demand Adjustment Factor (DAF)	1.000

Demand and Capacity

Demand Volume veh/h	3246	Heavy Vehicle Adjustment Factor (fhv)	0.849
Peak Hour Factor	0.94	Flow Rate (Vp), pc/h/ln	1356
Total Trucks, %	17.72	Capacity (c), pc/h/ln	2300
Single-Unit Trucks (SUT), %	-	Adjusted Capacity (cadj), pc/h/ln	2300
Tractor-Trailers (TT), %	-	Volume-to-Capacity Ratio (v/c)	0.59
Passenger Car Equivalent (ET)	2.000		

Speed and Density

Lane Width Adjustment (fLW)	0.0	Average Speed (S), mi/h	60.0
Right-Side Lateral Clearance Adj. (fRLC)	0.0	Density (D), pc/mi/ln	22.6
Total Ramp Density Adjustment	5.0	Level of Service (LOS)	C
Adjusted Free-Flow Speed (FFSadj), mi/h	60.0		

HCS7 Freeway Merge Report

Project Information

Analyst	LSA	Date	12/11/2019
Agency	LSA	Analysis Year	Phase I Proj Comp Yr (2029) NP
Jurisdiction	Caltrans	Time Period Analyzed	PM Peak Hour
Project Description	CMD1801 - Village D Specific Plan	Unit	United States Customary

Geometric Data

	Freeway	Ramp
Number of Lanes (N), ln	3	1
Free-Flow Speed (FFS), mi/h	65.0	35.0
Segment Length (L) / Acceleration Length (LA),ft	1500	500
Terrain Type	Level	Level
Percent Grade, %	-	-
Segment Type / Ramp Side	Freeway	Right

Adjustment Factors

Driver Population	All Familiar	All Familiar
Weather Type	Non-Severe Weather	Non-Severe Weather
Incident Type	No Incident	-
Final Speed Adjustment Factor (SAF)	1.000	1.000
Final Capacity Adjustment Factor (CAF)	1.000	1.000
Demand Adjustment Factor (DAF)	1.000	1.000

Demand and Capacity

Demand Volume (Vi)	3246	362
Peak Hour Factor (PHF)	0.94	0.94
Total Trucks, %	17.72	2.23
Single-Unit Trucks (SUT), %	-	-
Tractor-Trailers (TT), %	-	-
Heavy Vehicle Adjustment Factor (fHV)	0.849	0.978
Flow Rate (vi),pc/h	4067	394
Capacity (c), pc/h	7050	2000
Volume-to-Capacity Ratio (v/c)	0.63	0.20

Speed and Density

Upstream Equilibrium Distance (LEQ), ft	-	Number of Outer Lanes on Freeway (NO)	1
Distance to Upstream Ramp (LUP), ft	-	Speed Index (MS)	0.350
Downstream Equilibrium Distance (LEQ), ft	-	Flow Outer Lanes (vOA), pc/h/ln	1659
Distance to Downstream Ramp (LDOWN), ft	-	On-Ramp Influence Area Speed (SR), mi/h	57.0
Prop. Freeway Vehicles in Lane 1 and 2 (PFM)	0.592	Outer Lanes Freeway Speed (SO), mi/h	60.8
Flow in Lanes 1 and 2 (v12), pc/h	2408	Ramp Junction Speed (S), mi/h	58.4
Flow Entering Ramp-Infl. Area (vR12), pc/h	2802	Average Density (D), pc/mi/ln	25.5
Level of Service (LOS)	C	Density in Ramp Influence Area (DR), pc/mi/ln	24.1

HCS7 Basic Freeway Report

Project Information

Analyst	LSA	Date	12/11/2019
Agency	LSA	Analysis Year	Phase I Proj Comp Yr (2029) NP
Jurisdiction	Caltrans	Time Period Analyzed	PM Peak Hour
Project Description	CMD1801 - Village D Specific Plan	Unit	United States Customary

Geometric Data

Number of Lanes, ln	3	Terrain Type	Level
Segment Length (L), ft	-	Percent Grade, %	-
Measured or Base Free-Flow Speed	Base	Grade Length, mi	-
Base Free-Flow Speed (BFFS), mi/h	65.0	Total Ramp Density (TRD), ramps/mi	1.83
Lane Width, ft	12	Free-Flow Speed (FFS), mi/h	59.7
Right-Side Lateral Clearance, ft	10		

Adjustment Factors

Driver Population	All Familiar	Final Speed Adjustment Factor (SAF)	1.000
Weather Type	Non-Severe Weather	Final Capacity Adjustment Factor (CAF)	1.000
Incident Type	No Incident	Demand Adjustment Factor (DAF)	1.000

Demand and Capacity

Demand Volume veh/h	3609	Heavy Vehicle Adjustment Factor (fhv)	0.861
Peak Hour Factor	0.94	Flow Rate (Vp), pc/h/ln	1486
Total Trucks, %	16.17	Capacity (c), pc/h/ln	2296
Single-Unit Trucks (SUT), %	-	Adjusted Capacity (cadj), pc/h/ln	2296
Tractor-Trailers (TT), %	-	Volume-to-Capacity Ratio (v/c)	0.65
Passenger Car Equivalent (ET)	2.000		

Speed and Density

Lane Width Adjustment (fLW)	0.0	Average Speed (S), mi/h	59.6
Right-Side Lateral Clearance Adj. (fRLC)	0.0	Density (D), pc/mi/ln	24.9
Total Ramp Density Adjustment	5.4	Level of Service (LOS)	C
Adjusted Free-Flow Speed (FFSadj), mi/h	59.6		

HCS7 Freeway Diverge Report

Project Information

Analyst	LSA	Date	12/11/2019
Agency	LSA	Analysis Year	Phase I Proj Comp Yr (2029) NP
Jurisdiction	Caltrans	Time Period Analyzed	PM Peak Hour
Project Description	CMD1801 - Village D Specific Plan	Unit	United States Customary

Geometric Data

	Freeway	Ramp
Number of Lanes (N), ln	3	1
Free-Flow Speed (FFS), mi/h	65.0	35.0
Segment Length (L) / Deceleration Length (LA),ft	1500	245
Terrain Type	Level	Level
Percent Grade, %	-	-
Segment Type / Ramp Side	Freeway	Right

Adjustment Factors

Driver Population	All Familiar	All Familiar
Weather Type	Non-Severe Weather	Non-Severe Weather
Incident Type	No Incident	-
Final Speed Adjustment Factor (SAF)	1.000	1.000
Final Capacity Adjustment Factor (CAF)	1.000	1.000
Demand Adjustment Factor (DAF)	1.000	1.000

Demand and Capacity

Demand Volume (Vi)	3609	799
Peak Hour Factor (PHF)	0.94	0.94
Total Trucks, %	16.17	1.02
Single-Unit Trucks (SUT), %	-	-
Tractor-Trailers (TT), %	-	-
Heavy Vehicle Adjustment Factor (fHV)	0.861	0.990
Flow Rate (vi),pc/h	4459	859
Capacity (c), pc/h	7050	2000
Volume-to-Capacity Ratio (v/c)	0.63	0.43

Speed and Density

Upstream Equilibrium Distance (LEQ), ft	-	Number of Outer Lanes on Freeway (NO)	1
Distance to Upstream Ramp (LUP), ft	-	Speed Index (DS)	0.505
Downstream Equilibrium Distance (LEQ), ft	-	Flow Outer Lanes (vOA), pc/h/ln	1408
Distance to Downstream Ramp (LDOWN), ft	-	Off-Ramp Influence Area Speed (SR), mi/h	53.4
Prop. Freeway Vehicles in Lane 1 and 2 (PFD)	0.609	Outer Lanes Freeway Speed (SO), mi/h	69.7
Flow in Lanes 1 and 2 (v12), pc/h	3051	Ramp Junction Speed (S), mi/h	57.7
Flow Entering Ramp-Infl. Area (vR12), pc/h	-	Average Density (D), pc/mi/ln	25.8
Level of Service (LOS)	D	Density in Ramp Influence Area (DR), pc/mi/ln	28.3

HCS7 Basic Freeway Report

Project Information

Analyst	LSA	Date	12/11/2019
Agency	LSA	Analysis Year	Phase I Proj Comp Yr (2029) NP
Jurisdiction	Caltrans	Time Period Analyzed	PM Peak Hour
Project Description	CMD1801 - Village D Specific Plan	Unit	United States Customary

Geometric Data

Number of Lanes, ln	3	Terrain Type	Level
Segment Length (L), ft	-	Percent Grade, %	-
Measured or Base Free-Flow Speed	Base	Grade Length, mi	-
Base Free-Flow Speed (BFFS), mi/h	65.0	Total Ramp Density (TRD), ramps/mi	1.83
Lane Width, ft	12	Free-Flow Speed (FFS), mi/h	59.7
Right-Side Lateral Clearance, ft	10		

Adjustment Factors

Driver Population	All Familiar	Final Speed Adjustment Factor (SAF)	1.000
Weather Type	Non-Severe Weather	Final Capacity Adjustment Factor (CAF)	1.000
Incident Type	No Incident	Demand Adjustment Factor (DAF)	1.000

Demand and Capacity

Demand Volume veh/h	2810	Heavy Vehicle Adjustment Factor (fhv)	0.830
Peak Hour Factor	0.94	Flow Rate (Vp), pc/h/ln	1201
Total Trucks, %	20.48	Capacity (c), pc/h/ln	2296
Single-Unit Trucks (SUT), %	-	Adjusted Capacity (cadj), pc/h/ln	2296
Tractor-Trailers (TT), %	-	Volume-to-Capacity Ratio (v/c)	0.52
Passenger Car Equivalent (ET)	2.000		

Speed and Density

Lane Width Adjustment (fLW)	0.0	Average Speed (S), mi/h	59.6
Right-Side Lateral Clearance Adj. (fRLC)	0.0	Density (D), pc/mi/ln	20.2
Total Ramp Density Adjustment	5.4	Level of Service (LOS)	C
Adjusted Free-Flow Speed (FFSadj), mi/h	59.6		

HCS7 Freeway Merge Report

Project Information

Analyst	LSA	Date	12/11/2019
Agency	LSA	Analysis Year	Phase I Proj Comp Yr (2029) NP
Jurisdiction	Caltrans	Time Period Analyzed	PM Peak Hour
Project Description	CMD1801 - Village D Specific Plan	Unit	United States Customary

Geometric Data

	Freeway	Ramp
Number of Lanes (N), ln	3	1
Free-Flow Speed (FFS), mi/h	65.0	35.0
Segment Length (L) / Acceleration Length (LA),ft	1500	350
Terrain Type	Level	Level
Percent Grade, %	-	-
Segment Type / Ramp Side	Freeway	Right

Adjustment Factors

Driver Population	All Familiar	All Familiar
Weather Type	Non-Severe Weather	Non-Severe Weather
Incident Type	No Incident	-
Final Speed Adjustment Factor (SAF)	1.000	1.000
Final Capacity Adjustment Factor (CAF)	1.000	1.000
Demand Adjustment Factor (DAF)	1.000	1.000

Demand and Capacity

Demand Volume (Vi)	2810	145
Peak Hour Factor (PHF)	0.94	0.94
Total Trucks, %	20.48	5.67
Single-Unit Trucks (SUT), %	-	-
Tractor-Trailers (TT), %	-	-
Heavy Vehicle Adjustment Factor (fHV)	0.830	0.946
Flow Rate (vi),pc/h	3602	163
Capacity (c), pc/h	7050	2000
Volume-to-Capacity Ratio (v/c)	0.53	0.08

Speed and Density

Upstream Equilibrium Distance (LEQ), ft	-	Number of Outer Lanes on Freeway (NO)	1
Distance to Upstream Ramp (LUP), ft	-	Speed Index (MS)	0.335
Downstream Equilibrium Distance (LEQ), ft	-	Flow Outer Lanes (vOA), pc/h/ln	1488
Distance to Downstream Ramp (LDOWN), ft	-	On-Ramp Influence Area Speed (SR), mi/h	57.3
Prop. Freeway Vehicles in Lane 1 and 2 (PFM)	0.587	Outer Lanes Freeway Speed (SO), mi/h	61.4
Flow in Lanes 1 and 2 (v12), pc/h	2114	Ramp Junction Speed (S), mi/h	58.9
Flow Entering Ramp-Infl. Area (vR12), pc/h	2277	Average Density (D), pc/mi/ln	21.3
Level of Service (LOS)	C	Density in Ramp Influence Area (DR), pc/mi/ln	21.0

HCS7 Basic Freeway Report

Project Information

Analyst	LSA	Date	12/11/2019
Agency	LSA	Analysis Year	Phase I Proj Comp Yr (2029) NP
Jurisdiction	Caltrans	Time Period Analyzed	PM Peak Hour
Project Description	CMD1801 - Village D Specific Plan	Unit	United States Customary

Geometric Data

Number of Lanes, ln	3	Terrain Type	Level
Segment Length (L), ft	-	Percent Grade, %	-
Measured or Base Free-Flow Speed	Base	Grade Length, mi	-
Base Free-Flow Speed (BFFS), mi/h	65.0	Total Ramp Density (TRD), ramps/mi	1.83
Lane Width, ft	12	Free-Flow Speed (FFS), mi/h	59.7
Right-Side Lateral Clearance, ft	10		

Adjustment Factors

Driver Population	All Familiar	Final Speed Adjustment Factor (SAF)	1.000
Weather Type	Non-Severe Weather	Final Capacity Adjustment Factor (CAF)	1.000
Incident Type	No Incident	Demand Adjustment Factor (DAF)	1.000

Demand and Capacity

Demand Volume veh/h	2955	Heavy Vehicle Adjustment Factor (fhv)	0.835
Peak Hour Factor	0.94	Flow Rate (Vp), pc/h/ln	1255
Total Trucks, %	19.75	Capacity (c), pc/h/ln	2296
Single-Unit Trucks (SUT), %	-	Adjusted Capacity (cadj), pc/h/ln	2296
Tractor-Trailers (TT), %	-	Volume-to-Capacity Ratio (v/c)	0.55
Passenger Car Equivalent (ET)	2.000		

Speed and Density

Lane Width Adjustment (fLW)	0.0	Average Speed (S), mi/h	59.6
Right-Side Lateral Clearance Adj. (fRLC)	0.0	Density (D), pc/mi/ln	21.1
Total Ramp Density Adjustment	5.4	Level of Service (LOS)	C
Adjusted Free-Flow Speed (FFSadj), mi/h	59.6		

HCS7 Freeway Diverge Report

Project Information

Analyst	LSA	Date	12/11/2019
Agency	LSA	Analysis Year	Phase I Proj Comp Yr (2029) NP
Jurisdiction	Caltrans	Time Period Analyzed	PM Peak Hour
Project Description	CMD1801 - Village D Specific Plan	Unit	United States Customary

Geometric Data

	Freeway	Ramp
Number of Lanes (N), In	3	1
Free-Flow Speed (FFS), mi/h	65.0	15.0
Segment Length (L) / Deceleration Length (LA),ft	1500	150
Terrain Type	Level	Level
Percent Grade, %	-	-
Segment Type / Ramp Side	Freeway	Right

Adjustment Factors

Driver Population	All Familiar	All Familiar
Weather Type	Non-Severe Weather	Non-Severe Weather
Incident Type	No Incident	-
Final Speed Adjustment Factor (SAF)	1.000	1.000
Final Capacity Adjustment Factor (CAF)	1.000	1.000
Demand Adjustment Factor (DAF)	1.000	1.000

Demand and Capacity

Demand Volume (Vi)	2955	155
Peak Hour Factor (PHF)	0.94	0.94
Total Trucks, %	19.75	3.62
Single-Unit Trucks (SUT), %	-	-
Tractor-Trailers (TT), %	-	-
Heavy Vehicle Adjustment Factor (fHV)	0.835	0.965
Flow Rate (vi),pc/h	3765	171
Capacity (c), pc/h	7050	1800
Volume-to-Capacity Ratio (v/c)	0.53	0.10

Speed and Density

Upstream Equilibrium Distance (LEQ), ft	-	Number of Outer Lanes on Freeway (NO)	1
Distance to Upstream Ramp (LUP), ft	-	Speed Index (DS)	0.703
Downstream Equilibrium Distance (LEQ), ft	-	Flow Outer Lanes (vOA), pc/h/ln	1229
Distance to Downstream Ramp (LDOWN), ft	-	Off-Ramp Influence Area Speed (SR), mi/h	48.8
Prop. Freeway Vehicles in Lane 1 and 2 (PFD)	0.658	Outer Lanes Freeway Speed (SO), mi/h	70.4
Flow in Lanes 1 and 2 (v12), pc/h	2536	Ramp Junction Speed (S), mi/h	54.2
Flow Entering Ramp-Infl. Area (vR12), pc/h	-	Average Density (D), pc/mi/ln	23.2
Level of Service (LOS)	C	Density in Ramp Influence Area (DR), pc/mi/ln	24.7

HCS7 Basic Freeway Report

Project Information

Analyst	LSA	Date	12/11/2019
Agency	LSA	Analysis Year	Phase I Proj Comp Yr (2029) NP
Jurisdiction	Caltrans	Time Period Analyzed	PM Peak Hour
Project Description	CMD1801 - Village D Specific Plan	Unit	United States Customary

Geometric Data

Number of Lanes, ln	3	Terrain Type	Level
Segment Length (L), ft	-	Percent Grade, %	-
Measured or Base Free-Flow Speed	Base	Grade Length, mi	-
Base Free-Flow Speed (BFFS), mi/h	65.0	Total Ramp Density (TRD), ramps/mi	1.67
Lane Width, ft	12	Free-Flow Speed (FFS), mi/h	60.0
Right-Side Lateral Clearance, ft	10		

Adjustment Factors

Driver Population	All Familiar	Final Speed Adjustment Factor (SAF)	1.000
Weather Type	Non-Severe Weather	Final Capacity Adjustment Factor (CAF)	1.000
Incident Type	No Incident	Demand Adjustment Factor (DAF)	1.000

Demand and Capacity

Demand Volume veh/h	2800	Heavy Vehicle Adjustment Factor (fhv)	0.829
Peak Hour Factor	0.94	Flow Rate (Vp), pc/h/ln	1198
Total Trucks, %	20.64	Capacity (c), pc/h/ln	2300
Single-Unit Trucks (SUT), %	-	Adjusted Capacity (cadj), pc/h/ln	2300
Tractor-Trailers (TT), %	-	Volume-to-Capacity Ratio (v/c)	0.52
Passenger Car Equivalent (ET)	2.000		

Speed and Density

Lane Width Adjustment (fLW)	0.0	Average Speed (S), mi/h	60.0
Right-Side Lateral Clearance Adj. (fRLC)	0.0	Density (D), pc/mi/ln	20.0
Total Ramp Density Adjustment	5.0	Level of Service (LOS)	C
Adjusted Free-Flow Speed (FFSadj), mi/h	60.0		

HCS7 Freeway Merge Report

Project Information

Analyst	LSA	Date	12/11/2019
Agency	LSA	Analysis Year	Phase I Proj Comp Yr (2029) NP
Jurisdiction	Caltrans	Time Period Analyzed	PM Peak Hour
Project Description	CMD1801 - Village D Specific Plan	Unit	United States Customary

Geometric Data

	Freeway	Ramp
Number of Lanes (N), ln	3	1
Free-Flow Speed (FFS), mi/h	65.0	35.0
Segment Length (L) / Acceleration Length (LA),ft	1500	525
Terrain Type	Level	Level
Percent Grade, %	-	-
Segment Type / Ramp Side	Freeway	Right

Adjustment Factors

Driver Population	All Familiar	All Familiar
Weather Type	Non-Severe Weather	Non-Severe Weather
Incident Type	No Incident	-
Final Speed Adjustment Factor (SAF)	1.000	1.000
Final Capacity Adjustment Factor (CAF)	1.000	1.000
Demand Adjustment Factor (DAF)	1.000	1.000

Demand and Capacity

Demand Volume (Vi)	2800	235
Peak Hour Factor (PHF)	0.94	0.94
Total Trucks, %	20.64	4.33
Single-Unit Trucks (SUT), %	-	-
Tractor-Trailers (TT), %	-	-
Heavy Vehicle Adjustment Factor (fHV)	0.829	0.958
Flow Rate (vi),pc/h	3593	261
Capacity (c), pc/h	7050	2000
Volume-to-Capacity Ratio (v/c)	0.55	0.13

Speed and Density

Upstream Equilibrium Distance (LEQ), ft	-	Number of Outer Lanes on Freeway (NO)	1
Distance to Upstream Ramp (LUP), ft	-	Speed Index (MS)	0.327
Downstream Equilibrium Distance (LEQ), ft	-	Flow Outer Lanes (vOA), pc/h/ln	1466
Distance to Downstream Ramp (LDOWN), ft	-	On-Ramp Influence Area Speed (SR), mi/h	57.5
Prop. Freeway Vehicles in Lane 1 and 2 (PFM)	0.592	Outer Lanes Freeway Speed (SO), mi/h	61.5
Flow in Lanes 1 and 2 (v12), pc/h	2127	Ramp Junction Speed (S), mi/h	59.0
Flow Entering Ramp-Infl. Area (vR12), pc/h	2388	Average Density (D), pc/mi/ln	21.8
Level of Service (LOS)	C	Density in Ramp Influence Area (DR), pc/mi/ln	20.8

HCS7 Basic Freeway Report

Project Information

Analyst	LSA	Date	12/11/2019
Agency	LSA	Analysis Year	Phase I Proj Comp Yr (2029) NP
Jurisdiction	Caltrans	Time Period Analyzed	PM Peak Hour
Project Description	CMD1801 - Village D Specific Plan	Unit	United States Customary

Geometric Data

Number of Lanes, ln	3	Terrain Type	Level
Segment Length (L), ft	-	Percent Grade, %	-
Measured or Base Free-Flow Speed	Base	Grade Length, mi	-
Base Free-Flow Speed (BFFS), mi/h	65.0	Total Ramp Density (TRD), ramps/mi	1.67
Lane Width, ft	12	Free-Flow Speed (FFS), mi/h	60.0
Right-Side Lateral Clearance, ft	10		

Adjustment Factors

Driver Population	All Familiar	Final Speed Adjustment Factor (SAF)	1.000
Weather Type	Non-Severe Weather	Final Capacity Adjustment Factor (CAF)	1.000
Incident Type	No Incident	Demand Adjustment Factor (DAF)	1.000

Demand and Capacity

Demand Volume veh/h	3035	Heavy Vehicle Adjustment Factor (fhv)	0.838
Peak Hour Factor	0.94	Flow Rate (Vp), pc/h/ln	1284
Total Trucks, %	19.39	Capacity (c), pc/h/ln	2300
Single-Unit Trucks (SUT), %	-	Adjusted Capacity (cadj), pc/h/ln	2300
Tractor-Trailers (TT), %	-	Volume-to-Capacity Ratio (v/c)	0.56
Passenger Car Equivalent (ET)	2.000		

Speed and Density

Lane Width Adjustment (fLW)	0.0	Average Speed (S), mi/h	60.0
Right-Side Lateral Clearance Adj. (fRLC)	0.0	Density (D), pc/mi/ln	21.4
Total Ramp Density Adjustment	5.0	Level of Service (LOS)	C
Adjusted Free-Flow Speed (FFSadj), mi/h	60.0		

HCS7 Freeway Diverge Report

Project Information

Analyst	LSA	Date	12/11/2019
Agency	LSA	Analysis Year	Phase I Proj Comp Yr (2029) NP
Jurisdiction	Caltrans	Time Period Analyzed	PM Peak Hour
Project Description	CMD1801 - Village D Specific Plan	Unit	United States Customary

Geometric Data

	Freeway	Ramp
Number of Lanes (N), ln	3	1
Free-Flow Speed (FFS), mi/h	65.0	35.0
Segment Length (L) / Deceleration Length (LA),ft	1500	200
Terrain Type	Level	Level
Percent Grade, %	-	-
Segment Type / Ramp Side	Freeway	Right

Adjustment Factors

Driver Population	All Familiar	All Familiar
Weather Type	Non-Severe Weather	Non-Severe Weather
Incident Type	No Incident	-
Final Speed Adjustment Factor (SAF)	1.000	1.000
Final Capacity Adjustment Factor (CAF)	1.000	1.000
Demand Adjustment Factor (DAF)	1.000	1.000

Demand and Capacity

Demand Volume (Vi)	3035	645
Peak Hour Factor (PHF)	0.94	0.94
Total Trucks, %	19.39	10.45
Single-Unit Trucks (SUT), %	-	-
Tractor-Trailers (TT), %	-	-
Heavy Vehicle Adjustment Factor (fHV)	0.838	0.905
Flow Rate (vi),pc/h	3853	758
Capacity (c), pc/h	7050	2000
Volume-to-Capacity Ratio (v/c)	0.55	0.38

Speed and Density

Upstream Equilibrium Distance (LEQ), ft	-	Number of Outer Lanes on Freeway (NO)	1
Distance to Upstream Ramp (LUP), ft	-	Speed Index (DS)	0.496
Downstream Equilibrium Distance (LEQ), ft	-	Flow Outer Lanes (vOA), pc/h/ln	1148
Distance to Downstream Ramp (LDOWN), ft	-	Off-Ramp Influence Area Speed (SR), mi/h	53.6
Prop. Freeway Vehicles in Lane 1 and 2 (PFD)	0.629	Outer Lanes Freeway Speed (SO), mi/h	70.7
Flow in Lanes 1 and 2 (v12), pc/h	2705	Ramp Junction Speed (S), mi/h	57.8
Flow Entering Ramp-Infl. Area (vR12), pc/h	-	Average Density (D), pc/mi/ln	22.2
Level of Service (LOS)	C	Density in Ramp Influence Area (DR), pc/mi/ln	25.7

HCS7 Basic Freeway Report

Project Information

Analyst	LSA	Date	12/11/2019
Agency	LSA	Analysis Year	Phase I Proj Comp Yr (2029) NP
Jurisdiction	Caltrans	Time Period Analyzed	PM Peak Hour
Project Description	CMD1801 - Village D Specific Plan	Unit	United States Customary

Geometric Data

Number of Lanes, ln	3	Terrain Type	Level
Segment Length (L), ft	-	Percent Grade, %	-
Measured or Base Free-Flow Speed	Base	Grade Length, mi	-
Base Free-Flow Speed (BFFS), mi/h	70.0	Total Ramp Density (TRD), ramps/mi	1.50
Lane Width, ft	12	Free-Flow Speed (FFS), mi/h	65.5
Right-Side Lateral Clearance, ft	10		

Adjustment Factors

Driver Population	All Familiar	Final Speed Adjustment Factor (SAF)	1.000
Weather Type	Non-Severe Weather	Final Capacity Adjustment Factor (CAF)	1.000
Incident Type	No Incident	Demand Adjustment Factor (DAF)	1.000

Demand and Capacity

Demand Volume veh/h	2390	Heavy Vehicle Adjustment Factor (fhv)	0.821
Peak Hour Factor	0.94	Flow Rate (Vp), pc/h/ln	1032
Total Trucks, %	21.82	Capacity (c), pc/h/ln	2355
Single-Unit Trucks (SUT), %	-	Adjusted Capacity (cadj), pc/h/ln	2355
Tractor-Trailers (TT), %	-	Volume-to-Capacity Ratio (v/c)	0.44
Passenger Car Equivalent (ET)	2.000		

Speed and Density

Lane Width Adjustment (fLW)	0.0	Average Speed (S), mi/h	65.5
Right-Side Lateral Clearance Adj. (fRLC)	0.0	Density (D), pc/mi/ln	15.8
Total Ramp Density Adjustment	4.5	Level of Service (LOS)	B
Adjusted Free-Flow Speed (FFSadj), mi/h	65.5		

HCS7 Freeway Merge Report

Project Information

Analyst	LSA	Date	12/11/2019
Agency	LSA	Analysis Year	Phase I Proj Comp Yr (2029) NP
Jurisdiction	Caltrans	Time Period Analyzed	PM Peak Hour
Project Description	CMD1801 - Village D Specific Plan	Unit	United States Customary

Geometric Data

	Freeway	Ramp
Number of Lanes (N), ln	3	1
Free-Flow Speed (FFS), mi/h	70.0	35.0
Segment Length (L) / Acceleration Length (LA),ft	1500	400
Terrain Type	Level	Level
Percent Grade, %	-	-
Segment Type / Ramp Side	Freeway	Right

Adjustment Factors

Driver Population	All Familiar	All Familiar
Weather Type	Non-Severe Weather	Non-Severe Weather
Incident Type	No Incident	-
Final Speed Adjustment Factor (SAF)	1.000	1.000
Final Capacity Adjustment Factor (CAF)	1.000	1.000
Demand Adjustment Factor (DAF)	1.000	1.000

Demand and Capacity

Demand Volume (Vi)	2390	414
Peak Hour Factor (PHF)	0.94	0.94
Total Trucks, %	21.82	6.87
Single-Unit Trucks (SUT), %	-	-
Tractor-Trailers (TT), %	-	-
Heavy Vehicle Adjustment Factor (fHV)	0.821	0.936
Flow Rate (vi),pc/h	3097	471
Capacity (c), pc/h	7200	2000
Volume-to-Capacity Ratio (v/c)	0.50	0.24

Speed and Density

Upstream Equilibrium Distance (LEQ), ft	-	Number of Outer Lanes on Freeway (NO)	1
Distance to Upstream Ramp (LUP), ft	-	Speed Index (MS)	0.332
Downstream Equilibrium Distance (LEQ), ft	-	Flow Outer Lanes (vOA), pc/h/ln	1273
Distance to Downstream Ramp (LDOWN), ft	-	On-Ramp Influence Area Speed (SR), mi/h	60.7
Prop. Freeway Vehicles in Lane 1 and 2 (PFM)	0.589	Outer Lanes Freeway Speed (SO), mi/h	67.2
Flow in Lanes 1 and 2 (v12), pc/h	1824	Ramp Junction Speed (S), mi/h	62.9
Flow Entering Ramp-Infl. Area (vR12), pc/h	2295	Average Density (D), pc/mi/ln	18.9
Level of Service (LOS)	C	Density in Ramp Influence Area (DR), pc/mi/ln	20.7

HCS7 Basic Freeway Report

Project Information

Analyst	LSA	Date	12/11/2019
Agency	LSA	Analysis Year	Phase I Proj Comp Yr (2029) NP
Jurisdiction	Caltrans	Time Period Analyzed	PM Peak Hour
Project Description	CMD1801 - Village D Specific Plan	Unit	United States Customary

Geometric Data

Number of Lanes, ln	2	Terrain Type	Level
Segment Length (L), ft	-	Percent Grade, %	-
Measured or Base Free-Flow Speed	Base	Grade Length, mi	-
Base Free-Flow Speed (BFFS), mi/h	70.0	Total Ramp Density (TRD), ramps/mi	1.00
Lane Width, ft	12	Free-Flow Speed (FFS), mi/h	66.8
Right-Side Lateral Clearance, ft	10		

Adjustment Factors

Driver Population	All Familiar	Final Speed Adjustment Factor (SAF)	1.000
Weather Type	Non-Severe Weather	Final Capacity Adjustment Factor (CAF)	1.000
Incident Type	No Incident	Demand Adjustment Factor (DAF)	1.000

Demand and Capacity

Demand Volume veh/h	2804	Heavy Vehicle Adjustment Factor (fhv)	0.836
Peak Hour Factor	0.94	Flow Rate (Vp), pc/h/ln	1784
Total Trucks, %	19.60	Capacity (c), pc/h/ln	2368
Single-Unit Trucks (SUT), %	-	Adjusted Capacity (cadj), pc/h/ln	2368
Tractor-Trailers (TT), %	-	Volume-to-Capacity Ratio (v/c)	0.75
Passenger Car Equivalent (ET)	2.000		

Speed and Density

Lane Width Adjustment (fLW)	0.0	Average Speed (S), mi/h	64.1
Right-Side Lateral Clearance Adj. (fRLC)	0.0	Density (D), pc/mi/ln	27.8
Total Ramp Density Adjustment	3.2	Level of Service (LOS)	D
Adjusted Free-Flow Speed (FFSadj), mi/h	66.8		

HCS7 Freeway Diverge Report

Project Information

Analyst	LSA	Date	12/11/2019
Agency	LSA	Analysis Year	Phase I Proj Comp Yr (2029) NP
Jurisdiction	Caltrans	Time Period Analyzed	PM Peak Hour
Project Description	CMD1801 - Village D Specific Plan	Unit	United States Customary

Geometric Data

	Freeway	Ramp
Number of Lanes (N), ln	2	1
Free-Flow Speed (FFS), mi/h	70.0	35.0
Segment Length (L) / Deceleration Length (LA),ft	1500	200
Terrain Type	Level	Level
Percent Grade, %	-	-
Segment Type / Ramp Side	Freeway	Right

Adjustment Factors

Driver Population	All Familiar	All Familiar
Weather Type	Non-Severe Weather	Non-Severe Weather
Incident Type	No Incident	-
Final Speed Adjustment Factor (SAF)	1.000	1.000
Final Capacity Adjustment Factor (CAF)	1.000	1.000
Demand Adjustment Factor (DAF)	1.000	1.000

Demand and Capacity

Demand Volume (Vi)	2804	187
Peak Hour Factor (PHF)	0.94	0.94
Total Trucks, %	19.60	24.06
Single-Unit Trucks (SUT), %	-	-
Tractor-Trailers (TT), %	-	-
Heavy Vehicle Adjustment Factor (fHV)	0.836	0.806
Flow Rate (vi),pc/h	3568	247
Capacity (c), pc/h	4800	2000
Volume-to-Capacity Ratio (v/c)	0.74	0.12

Speed and Density

Upstream Equilibrium Distance (LEQ), ft	-	Number of Outer Lanes on Freeway (NO)	0
Distance to Upstream Ramp (LUP), ft	-	Speed Index (DS)	0.450
Downstream Equilibrium Distance (LEQ), ft	-	Flow Outer Lanes (vOA), pc/h/ln	-
Distance to Downstream Ramp (LDOWN), ft	-	Off-Ramp Influence Area Speed (SR), mi/h	57.4
Prop. Freeway Vehicles in Lane 1 and 2 (PFD)	1.000	Outer Lanes Freeway Speed (SO), mi/h	76.8
Flow in Lanes 1 and 2 (v12), pc/h	3568	Ramp Junction Speed (S), mi/h	57.4
Flow Entering Ramp-Infl. Area (vR12), pc/h	-	Average Density (D), pc/mi/ln	31.1
Level of Service (LOS)	D	Density in Ramp Influence Area (DR), pc/mi/ln	33.1

HCS7 Basic Freeway Report

Project Information

Analyst	LSA	Date	12/11/2019
Agency	LSA	Analysis Year	Phase I Proj Comp Yr (2029) NP
Jurisdiction	Caltrans	Time Period Analyzed	PM Peak Hour
Project Description	CMD1801 - Village D Specific Plan	Unit	United States Customary

Geometric Data

Number of Lanes, ln	2	Terrain Type	Level
Segment Length (L), ft	-	Percent Grade, %	-
Measured or Base Free-Flow Speed	Base	Grade Length, mi	-
Base Free-Flow Speed (BFFS), mi/h	70.0	Total Ramp Density (TRD), ramps/mi	1.00
Lane Width, ft	12	Free-Flow Speed (FFS), mi/h	66.8
Right-Side Lateral Clearance, ft	10		

Adjustment Factors

Driver Population	All Familiar	Final Speed Adjustment Factor (SAF)	1.000
Weather Type	Non-Severe Weather	Final Capacity Adjustment Factor (CAF)	1.000
Incident Type	No Incident	Demand Adjustment Factor (DAF)	1.000

Demand and Capacity

Demand Volume veh/h	2617	Heavy Vehicle Adjustment Factor (fhv)	0.838
Peak Hour Factor	0.94	Flow Rate (Vp), pc/h/ln	1661
Total Trucks, %	19.28	Capacity (c), pc/h/ln	2368
Single-Unit Trucks (SUT), %	-	Adjusted Capacity (cadj), pc/h/ln	2368
Tractor-Trailers (TT), %	-	Volume-to-Capacity Ratio (v/c)	0.70
Passenger Car Equivalent (ET)	2.000		

Speed and Density

Lane Width Adjustment (fLW)	0.0	Average Speed (S), mi/h	65.3
Right-Side Lateral Clearance Adj. (fRLC)	0.0	Density (D), pc/mi/ln	25.4
Total Ramp Density Adjustment	3.2	Level of Service (LOS)	C
Adjusted Free-Flow Speed (FFSadj), mi/h	66.8		

HCS7 Freeway Merge Report

Project Information

Analyst	LSA	Date	12/11/2019
Agency	LSA	Analysis Year	Phase I Proj Comp Yr (2029) NP
Jurisdiction	Caltrans	Time Period Analyzed	PM Peak Hour
Project Description	CMD1801 - Village D Specific Plan	Unit	United States Customary

Geometric Data

	Freeway	Ramp
Number of Lanes (N), ln	2	1
Free-Flow Speed (FFS), mi/h	70.0	35.0
Segment Length (L) / Acceleration Length (LA),ft	1500	700
Terrain Type	Level	Level
Percent Grade, %	-	-
Segment Type / Ramp Side	Freeway	Right

Adjustment Factors

Driver Population	All Familiar	All Familiar
Weather Type	Non-Severe Weather	Non-Severe Weather
Incident Type	No Incident	-
Final Speed Adjustment Factor (SAF)	1.000	1.000
Final Capacity Adjustment Factor (CAF)	1.000	1.000
Demand Adjustment Factor (DAF)	1.000	1.000

Demand and Capacity

Demand Volume (Vi)	2617	211
Peak Hour Factor (PHF)	0.94	0.94
Total Trucks, %	19.28	23.78
Single-Unit Trucks (SUT), %	-	-
Tractor-Trailers (TT), %	-	-
Heavy Vehicle Adjustment Factor (fHV)	0.838	0.808
Flow Rate (vi),pc/h	3322	278
Capacity (c), pc/h	4800	2000
Volume-to-Capacity Ratio (v/c)	0.75	0.14

Speed and Density

Upstream Equilibrium Distance (LEQ), ft	-	Number of Outer Lanes on Freeway (NO)	0
Distance to Upstream Ramp (LUP), ft	-	Speed Index (MS)	0.415
Downstream Equilibrium Distance (LEQ), ft	-	Flow Outer Lanes (vOA), pc/h/ln	-
Distance to Downstream Ramp (LDOWN), ft	-	On-Ramp Influence Area Speed (SR), mi/h	58.4
Prop. Freeway Vehicles in Lane 1 and 2 (PFM)	1.000	Outer Lanes Freeway Speed (SO), mi/h	70.0
Flow in Lanes 1 and 2 (v12), pc/h	3322	Ramp Junction Speed (S), mi/h	58.4
Flow Entering Ramp-Infl. Area (vR12), pc/h	3600	Average Density (D), pc/mi/ln	30.8
Level of Service (LOS)	D	Density in Ramp Influence Area (DR), pc/mi/ln	29.1

HCS7 Basic Freeway Report

Project Information

Analyst	LSA	Date	12/11/2019
Agency	LSA	Analysis Year	Phase I Proj Comp Yr (2029) NP
Jurisdiction	Caltrans	Time Period Analyzed	PM Peak Hour
Project Description	CMD1801 - Village D Specific Plan	Unit	United States Customary

Geometric Data

Number of Lanes, ln	2	Terrain Type	Level
Segment Length (L), ft	-	Percent Grade, %	-
Measured or Base Free-Flow Speed	Base	Grade Length, mi	-
Base Free-Flow Speed (BFFS), mi/h	70.0	Total Ramp Density (TRD), ramps/mi	1.00
Lane Width, ft	12	Free-Flow Speed (FFS), mi/h	66.8
Right-Side Lateral Clearance, ft	10		

Adjustment Factors

Driver Population	All Familiar	Final Speed Adjustment Factor (SAF)	1.000
Weather Type	Non-Severe Weather	Final Capacity Adjustment Factor (CAF)	1.000
Incident Type	No Incident	Demand Adjustment Factor (DAF)	1.000

Demand and Capacity

Demand Volume veh/h	2827	Heavy Vehicle Adjustment Factor (fhv)	0.836
Peak Hour Factor	0.94	Flow Rate (Vp), pc/h/ln	1798
Total Trucks, %	19.61	Capacity (c), pc/h/ln	2368
Single-Unit Trucks (SUT), %	-	Adjusted Capacity (cadj), pc/h/ln	2368
Tractor-Trailers (TT), %	-	Volume-to-Capacity Ratio (v/c)	0.76
Passenger Car Equivalent (ET)	2.000		

Speed and Density

Lane Width Adjustment (fLW)	0.0	Average Speed (S), mi/h	63.9
Right-Side Lateral Clearance Adj. (fRLC)	0.0	Density (D), pc/mi/ln	28.1
Total Ramp Density Adjustment	3.2	Level of Service (LOS)	D
Adjusted Free-Flow Speed (FFSadj), mi/h	66.8		

HCS7 Basic Freeway Report

Project Information

Analyst	LSA	Date	12/11/2019
Agency	LSA	Analysis Year	Phase I Proj Comp Yr (2029) NP
Jurisdiction	Caltrans	Time Period Analyzed	PM Peak Hour
Project Description	CMD1801 - Village D Specific Plan	Unit	United States Customary

Geometric Data

Number of Lanes, ln	2	Terrain Type	Level
Segment Length (L), ft	-	Percent Grade, %	-
Measured or Base Free-Flow Speed	Base	Grade Length, mi	-
Base Free-Flow Speed (BFFS), mi/h	70.0	Total Ramp Density (TRD), ramps/mi	1.00
Lane Width, ft	12	Free-Flow Speed (FFS), mi/h	66.8
Right-Side Lateral Clearance, ft	10		

Adjustment Factors

Driver Population	All Familiar	Final Speed Adjustment Factor (SAF)	1.000
Weather Type	Non-Severe Weather	Final Capacity Adjustment Factor (CAF)	1.000
Incident Type	No Incident	Demand Adjustment Factor (DAF)	1.000

Demand and Capacity

Demand Volume veh/h	3028	Heavy Vehicle Adjustment Factor (fhv)	0.819
Peak Hour Factor	0.94	Flow Rate (Vp), pc/h/ln	1966
Total Trucks, %	22.06	Capacity (c), pc/h/ln	2368
Single-Unit Trucks (SUT), %	-	Adjusted Capacity (cadj), pc/h/ln	2368
Tractor-Trailers (TT), %	-	Volume-to-Capacity Ratio (v/c)	0.83
Passenger Car Equivalent (ET)	2.000		

Speed and Density

Lane Width Adjustment (fLW)	0.0	Average Speed (S), mi/h	61.5
Right-Side Lateral Clearance Adj. (fRLC)	0.0	Density (D), pc/mi/ln	32.0
Total Ramp Density Adjustment	3.2	Level of Service (LOS)	D
Adjusted Free-Flow Speed (FFSadj), mi/h	66.8		

HCS7 Freeway Diverge Report

Project Information

Analyst	LSA	Date	12/11/2019
Agency	LSA	Analysis Year	Phase I Proj Comp Yr (2029) NP
Jurisdiction	Caltrans	Time Period Analyzed	PM Peak Hour
Project Description	CMD1801 - Village D Specific Plan	Unit	United States Customary

Geometric Data

	Freeway	Ramp
Number of Lanes (N), ln	2	1
Free-Flow Speed (FFS), mi/h	70.0	50.0
Segment Length (L) / Deceleration Length (LA),ft	1500	150
Terrain Type	Level	Level
Percent Grade, %	-	-
Segment Type / Ramp Side	Freeway	Right

Adjustment Factors

Driver Population	All Familiar	All Familiar
Weather Type	Non-Severe Weather	Non-Severe Weather
Incident Type	No Incident	-
Final Speed Adjustment Factor (SAF)	1.000	1.000
Final Capacity Adjustment Factor (CAF)	1.000	1.000
Demand Adjustment Factor (DAF)	1.000	1.000

Demand and Capacity

Demand Volume (Vi)	3028	252
Peak Hour Factor (PHF)	0.94	0.94
Total Trucks, %	22.06	26.18
Single-Unit Trucks (SUT), %	-	-
Tractor-Trailers (TT), %	-	-
Heavy Vehicle Adjustment Factor (fHV)	0.819	0.793
Flow Rate (vi),pc/h	3933	338
Capacity (c), pc/h	4800	2100
Volume-to-Capacity Ratio (v/c)	0.82	0.16

Speed and Density

Upstream Equilibrium Distance (LEQ), ft	-	Number of Outer Lanes on Freeway (NO)	0
Distance to Upstream Ramp (LUP), ft	-	Speed Index (DS)	0.263
Downstream Equilibrium Distance (LEQ), ft	-	Flow Outer Lanes (vOA), pc/h/ln	-
Distance to Downstream Ramp (LDOWN), ft	-	Off-Ramp Influence Area Speed (SR), mi/h	62.6
Prop. Freeway Vehicles in Lane 1 and 2 (PFD)	1.000	Outer Lanes Freeway Speed (SO), mi/h	76.8
Flow in Lanes 1 and 2 (v12), pc/h	3933	Ramp Junction Speed (S), mi/h	62.6
Flow Entering Ramp-Infl. Area (vR12), pc/h	-	Average Density (D), pc/mi/ln	31.4
Level of Service (LOS)	E	Density in Ramp Influence Area (DR), pc/mi/ln	36.7

HCS7 Basic Freeway Report

Project Information

Analyst	LSA	Date	12/11/2019
Agency	LSA	Analysis Year	Phase I Proj Comp Yr (2029) NP
Jurisdiction	Caltrans	Time Period Analyzed	PM Peak Hour
Project Description	CMD1801 - Village D Specific Plan	Unit	United States Customary

Geometric Data

Number of Lanes, ln	2	Terrain Type	Level
Segment Length (L), ft	-	Percent Grade, %	-
Measured or Base Free-Flow Speed	Base	Grade Length, mi	-
Base Free-Flow Speed (BFFS), mi/h	70.0	Total Ramp Density (TRD), ramps/mi	1.33
Lane Width, ft	12	Free-Flow Speed (FFS), mi/h	65.9
Right-Side Lateral Clearance, ft	10		

Adjustment Factors

Driver Population	All Familiar	Final Speed Adjustment Factor (SAF)	1.000
Weather Type	Non-Severe Weather	Final Capacity Adjustment Factor (CAF)	1.000
Incident Type	No Incident	Demand Adjustment Factor (DAF)	1.000

Demand and Capacity

Demand Volume veh/h	2777	Heavy Vehicle Adjustment Factor (fhv)	0.822
Peak Hour Factor	0.94	Flow Rate (Vp), pc/h/ln	1797
Total Trucks, %	21.68	Capacity (c), pc/h/ln	2359
Single-Unit Trucks (SUT), %	-	Adjusted Capacity (cadj), pc/h/ln	2359
Tractor-Trailers (TT), %	-	Volume-to-Capacity Ratio (v/c)	0.76
Passenger Car Equivalent (ET)	2.000		

Speed and Density

Lane Width Adjustment (fLW)	0.0	Average Speed (S), mi/h	63.3
Right-Side Lateral Clearance Adj. (fRLC)	0.0	Density (D), pc/mi/ln	28.4
Total Ramp Density Adjustment	4.1	Level of Service (LOS)	D
Adjusted Free-Flow Speed (FFSadj), mi/h	65.9		

HCS7 Freeway Merge Report

Project Information

Analyst	LSA	Date	12/11/2019
Agency	LSA	Analysis Year	Phase I Proj Comp Yr (2029) NP
Jurisdiction	Caltrans	Time Period Analyzed	PM Peak Hour
Project Description	CMD1801 - Village D Specific Plan	Unit	United States Customary

Geometric Data

	Freeway	Ramp
Number of Lanes (N), ln	2	1
Free-Flow Speed (FFS), mi/h	70.0	35.0
Segment Length (L) / Acceleration Length (LA),ft	1000	600
Terrain Type	Level	Level
Percent Grade, %	-	-
Segment Type / Ramp Side	Freeway	Right

Adjustment Factors

Driver Population	All Familiar	All Familiar
Weather Type	Non-Severe Weather	Non-Severe Weather
Incident Type	No Incident	-
Final Speed Adjustment Factor (SAF)	1.000	1.000
Final Capacity Adjustment Factor (CAF)	1.000	1.000
Demand Adjustment Factor (DAF)	1.000	1.000

Demand and Capacity

Demand Volume (Vi)	2777	28
Peak Hour Factor (PHF)	0.94	0.94
Total Trucks, %	21.68	7.41
Single-Unit Trucks (SUT), %	-	-
Tractor-Trailers (TT), %	-	-
Heavy Vehicle Adjustment Factor (fHV)	0.822	0.931
Flow Rate (vi),pc/h	3594	32
Capacity (c), pc/h	4800	2000
Volume-to-Capacity Ratio (v/c)	0.76	0.02

Speed and Density

Upstream Equilibrium Distance (LEQ), ft	-	Number of Outer Lanes on Freeway (NO)	0
Distance to Upstream Ramp (LUP), ft	-	Speed Index (MS)	0.425
Downstream Equilibrium Distance (LEQ), ft	-	Flow Outer Lanes (vOA), pc/h/ln	-
Distance to Downstream Ramp (LDOWN), ft	-	On-Ramp Influence Area Speed (SR), mi/h	58.1
Prop. Freeway Vehicles in Lane 1 and 2 (PFM)	1.000	Outer Lanes Freeway Speed (SO), mi/h	70.0
Flow in Lanes 1 and 2 (v12), pc/h	3594	Ramp Junction Speed (S), mi/h	58.1
Flow Entering Ramp-Infl. Area (vR12), pc/h	3626	Average Density (D), pc/mi/ln	31.2
Level of Service (LOS)	D	Density in Ramp Influence Area (DR), pc/mi/ln	30.1

HCS7 Basic Freeway Report

Project Information

Analyst	LSA	Date	12/11/2019
Agency	LSA	Analysis Year	Phase I Proj Comp Yr (2029) NP
Jurisdiction	Caltrans	Time Period Analyzed	PM Peak Hour
Project Description	CMD1801 - Village D Specific Plan	Unit	United States Customary

Geometric Data

Number of Lanes, ln	2	Terrain Type	Level
Segment Length (L), ft	-	Percent Grade, %	-
Measured or Base Free-Flow Speed	Base	Grade Length, mi	-
Base Free-Flow Speed (BFFS), mi/h	70.0	Total Ramp Density (TRD), ramps/mi	1.33
Lane Width, ft	12	Free-Flow Speed (FFS), mi/h	65.9
Right-Side Lateral Clearance, ft	10		

Adjustment Factors

Driver Population	All Familiar	Final Speed Adjustment Factor (SAF)	1.000
Weather Type	Non-Severe Weather	Final Capacity Adjustment Factor (CAF)	1.000
Incident Type	No Incident	Demand Adjustment Factor (DAF)	1.000

Demand and Capacity

Demand Volume veh/h	2805	Heavy Vehicle Adjustment Factor (fhv)	0.823
Peak Hour Factor	0.94	Flow Rate (Vp), pc/h/ln	1813
Total Trucks, %	21.54	Capacity (c), pc/h/ln	2359
Single-Unit Trucks (SUT), %	-	Adjusted Capacity (cadj), pc/h/ln	2359
Tractor-Trailers (TT), %	-	Volume-to-Capacity Ratio (v/c)	0.77
Passenger Car Equivalent (ET)	2.000		

Speed and Density

Lane Width Adjustment (fLW)	0.0	Average Speed (S), mi/h	63.2
Right-Side Lateral Clearance Adj. (fRLC)	0.0	Density (D), pc/mi/ln	28.7
Total Ramp Density Adjustment	4.1	Level of Service (LOS)	D
Adjusted Free-Flow Speed (FFSadj), mi/h	65.9		

HCS7 Freeway Merge Report

Project Information

Analyst	LSA	Date	12/11/2019
Agency	LSA	Analysis Year	Phase I Proj Comp Yr (2029) NP
Jurisdiction	Caltrans	Time Period Analyzed	PM Peak Hour
Project Description	CMD1801 - Village D Specific Plan	Unit	United States Customary

Geometric Data

	Freeway	Ramp
Number of Lanes (N), ln	2	1
Free-Flow Speed (FFS), mi/h	70.0	35.0
Segment Length (L) / Acceleration Length (LA),ft	1500	500
Terrain Type	Level	Level
Percent Grade, %	-	-
Segment Type / Ramp Side	Freeway	Right

Adjustment Factors

Driver Population	All Familiar	All Familiar
Weather Type	Non-Severe Weather	Non-Severe Weather
Incident Type	No Incident	-
Final Speed Adjustment Factor (SAF)	1.000	1.000
Final Capacity Adjustment Factor (CAF)	1.000	1.000
Demand Adjustment Factor (DAF)	1.000	1.000

Demand and Capacity

Demand Volume (Vi)	2805	229
Peak Hour Factor (PHF)	0.94	0.94
Total Trucks, %	21.54	21.94
Single-Unit Trucks (SUT), %	-	-
Tractor-Trailers (TT), %	-	-
Heavy Vehicle Adjustment Factor (fHV)	0.823	0.820
Flow Rate (vi),pc/h	3626	297
Capacity (c), pc/h	4800	2000
Volume-to-Capacity Ratio (v/c)	0.82	0.15

Speed and Density

Upstream Equilibrium Distance (LEQ), ft	-	Number of Outer Lanes on Freeway (NO)	0
Distance to Upstream Ramp (LUP), ft	-	Speed Index (MS)	0.483
Downstream Equilibrium Distance (LEQ), ft	-	Flow Outer Lanes (vOA), pc/h/ln	-
Distance to Downstream Ramp (LDOWN), ft	-	On-Ramp Influence Area Speed (SR), mi/h	56.5
Prop. Freeway Vehicles in Lane 1 and 2 (PFM)	1.000	Outer Lanes Freeway Speed (SO), mi/h	70.0
Flow in Lanes 1 and 2 (v12), pc/h	3626	Ramp Junction Speed (S), mi/h	56.5
Flow Entering Ramp-Infl. Area (vR12), pc/h	3923	Average Density (D), pc/mi/ln	34.7
Level of Service (LOS)	D	Density in Ramp Influence Area (DR), pc/mi/ln	32.9

HCS7 Basic Freeway Report

Project Information

Analyst	LSA	Date	12/11/2019
Agency	LSA	Analysis Year	Phase I Proj Comp Yr (2029) NP
Jurisdiction	Caltrans	Time Period Analyzed	PM Peak Hour
Project Description	CMD1801 - Village D Specific Plan	Unit	United States Customary

Geometric Data

Number of Lanes, ln	2	Terrain Type	Level
Segment Length (L), ft	-	Percent Grade, %	-
Measured or Base Free-Flow Speed	Base	Grade Length, mi	-
Base Free-Flow Speed (BFFS), mi/h	70.0	Total Ramp Density (TRD), ramps/mi	1.33
Lane Width, ft	12	Free-Flow Speed (FFS), mi/h	65.9
Right-Side Lateral Clearance, ft	10		

Adjustment Factors

Driver Population	All Familiar	Final Speed Adjustment Factor (SAF)	1.000
Weather Type	Non-Severe Weather	Final Capacity Adjustment Factor (CAF)	1.000
Incident Type	No Incident	Demand Adjustment Factor (DAF)	1.000

Demand and Capacity

Demand Volume veh/h	3034	Heavy Vehicle Adjustment Factor (fhv)	0.823
Peak Hour Factor	0.94	Flow Rate (Vp), pc/h/ln	1961
Total Trucks, %	21.56	Capacity (c), pc/h/ln	2359
Single-Unit Trucks (SUT), %	-	Adjusted Capacity (cadj), pc/h/ln	2359
Tractor-Trailers (TT), %	-	Volume-to-Capacity Ratio (v/c)	0.83
Passenger Car Equivalent (ET)	2.000		

Speed and Density

Lane Width Adjustment (fLW)	0.0	Average Speed (S), mi/h	61.0
Right-Side Lateral Clearance Adj. (fRLC)	0.0	Density (D), pc/mi/ln	32.1
Total Ramp Density Adjustment	4.1	Level of Service (LOS)	D
Adjusted Free-Flow Speed (FFSadj), mi/h	65.9		

HCS7 Freeway Diverge Report

Project Information

Analyst	LSA	Date	12/11/2019
Agency	LSA	Analysis Year	Phase I Proj Comp Yr (2029) NP
Jurisdiction	Caltrans	Time Period Analyzed	PM Peak Hour
Project Description	CMD1801 - Village D Specific Plan	Unit	United States Customary

Geometric Data

	Freeway	Ramp
Number of Lanes (N), ln	3	1
Free-Flow Speed (FFS), mi/h	70.0	35.0
Segment Length (L) / Deceleration Length (LA),ft	1500	150
Terrain Type	Level	Level
Percent Grade, %	-	-
Segment Type / Ramp Side	Freeway	Right

Adjustment Factors

Driver Population	All Familiar	All Familiar
Weather Type	Non-Severe Weather	Non-Severe Weather
Incident Type	No Incident	-
Final Speed Adjustment Factor (SAF)	1.000	1.000
Final Capacity Adjustment Factor (CAF)	1.000	1.000
Demand Adjustment Factor (DAF)	1.000	1.000

Demand and Capacity

Demand Volume (Vi)	3034	477
Peak Hour Factor (PHF)	0.94	0.94
Total Trucks, %	21.56	4.59
Single-Unit Trucks (SUT), %	-	-
Tractor-Trailers (TT), %	-	-
Heavy Vehicle Adjustment Factor (fHV)	0.823	0.956
Flow Rate (vi),pc/h	3922	531
Capacity (c), pc/h	7200	2000
Volume-to-Capacity Ratio (v/c)	0.54	0.27

Speed and Density

Upstream Equilibrium Distance (LEQ), ft	-	Number of Outer Lanes on Freeway (NO)	1
Distance to Upstream Ramp (LUP), ft	-	Speed Index (DS)	0.476
Downstream Equilibrium Distance (LEQ), ft	-	Flow Outer Lanes (vOA), pc/h/ln	1228
Distance to Downstream Ramp (LDOWN), ft	-	Off-Ramp Influence Area Speed (SR), mi/h	56.7
Prop. Freeway Vehicles in Lane 1 and 2 (PFD)	0.638	Outer Lanes Freeway Speed (SO), mi/h	75.9
Flow in Lanes 1 and 2 (v12), pc/h	2694	Ramp Junction Speed (S), mi/h	61.6
Flow Entering Ramp-Infl. Area (vR12), pc/h	-	Average Density (D), pc/mi/ln	21.2
Level of Service (LOS)	C	Density in Ramp Influence Area (DR), pc/mi/ln	26.1

HCS7 Basic Freeway Report

Project Information

Analyst	LSA	Date	12/11/2019
Agency	LSA	Analysis Year	Phase I Proj Comp Yr (2029) NP
Jurisdiction	Caltrans	Time Period Analyzed	PM Peak Hour
Project Description	CMD1801 - Village D Specific Plan	Unit	United States Customary

Geometric Data

Number of Lanes, ln	3	Terrain Type	Level
Segment Length (L), ft	-	Percent Grade, %	-
Measured or Base Free-Flow Speed	Base	Grade Length, mi	-
Base Free-Flow Speed (BFFS), mi/h	70.0	Total Ramp Density (TRD), ramps/mi	1.67
Lane Width, ft	12	Free-Flow Speed (FFS), mi/h	65.0
Right-Side Lateral Clearance, ft	10		

Adjustment Factors

Driver Population	All Familiar	Final Speed Adjustment Factor (SAF)	1.000
Weather Type	Non-Severe Weather	Final Capacity Adjustment Factor (CAF)	1.000
Incident Type	No Incident	Demand Adjustment Factor (DAF)	1.000

Demand and Capacity

Demand Volume veh/h	2556	Heavy Vehicle Adjustment Factor (fhv)	0.802
Peak Hour Factor	0.94	Flow Rate (Vp), pc/h/ln	1130
Total Trucks, %	24.72	Capacity (c), pc/h/ln	2350
Single-Unit Trucks (SUT), %	-	Adjusted Capacity (cadj), pc/h/ln	2350
Tractor-Trailers (TT), %	-	Volume-to-Capacity Ratio (v/c)	0.48
Passenger Car Equivalent (ET)	2.000		

Speed and Density

Lane Width Adjustment (fLW)	0.0	Average Speed (S), mi/h	65.0
Right-Side Lateral Clearance Adj. (fRLC)	0.0	Density (D), pc/mi/ln	17.4
Total Ramp Density Adjustment	5.0	Level of Service (LOS)	B
Adjusted Free-Flow Speed (FFSadj), mi/h	65.0		

HCS7 Freeway Merge Report

Project Information

Analyst	LSA	Date	12/11/2019
Agency	LSA	Analysis Year	Phase I Proj Comp Yr (2029) NP
Jurisdiction	Caltrans	Time Period Analyzed	PM Peak Hour
Project Description	CMD1801 - Village D Specific Plan	Unit	United States Customary

Geometric Data

	Freeway	Ramp
Number of Lanes (N), ln	3	1
Free-Flow Speed (FFS), mi/h	65.0	35.0
Segment Length (L) / Acceleration Length (LA),ft	1500	600
Terrain Type	Level	Level
Percent Grade, %	-	-
Segment Type / Ramp Side	Freeway	Right

Adjustment Factors

Driver Population	All Familiar	All Familiar
Weather Type	Non-Severe Weather	Non-Severe Weather
Incident Type	No Incident	-
Final Speed Adjustment Factor (SAF)	1.000	1.000
Final Capacity Adjustment Factor (CAF)	1.000	1.000
Demand Adjustment Factor (DAF)	1.000	1.000

Demand and Capacity

Demand Volume (Vi)	2556	695
Peak Hour Factor (PHF)	0.94	0.94
Total Trucks, %	24.72	6.36
Single-Unit Trucks (SUT), %	-	-
Tractor-Trailers (TT), %	-	-
Heavy Vehicle Adjustment Factor (fHV)	0.802	0.940
Flow Rate (vi),pc/h	3390	787
Capacity (c), pc/h	7050	2000
Volume-to-Capacity Ratio (v/c)	0.59	0.39

Speed and Density

Upstream Equilibrium Distance (LEQ), ft	-	Number of Outer Lanes on Freeway (NO)	1
Distance to Upstream Ramp (LUP), ft	-	Speed Index (MS)	0.343
Downstream Equilibrium Distance (LEQ), ft	-	Flow Outer Lanes (vOA), pc/h/ln	1376
Distance to Downstream Ramp (LDOWN), ft	-	On-Ramp Influence Area Speed (SR), mi/h	57.1
Prop. Freeway Vehicles in Lane 1 and 2 (PFM)	0.594	Outer Lanes Freeway Speed (SO), mi/h	61.8
Flow in Lanes 1 and 2 (v12), pc/h	2014	Ramp Junction Speed (S), mi/h	58.6
Flow Entering Ramp-Infl. Area (vR12), pc/h	2801	Average Density (D), pc/mi/ln	23.8
Level of Service (LOS)	C	Density in Ramp Influence Area (DR), pc/mi/ln	23.3

HCS7 Basic Freeway Report

Project Information

Analyst	LSA	Date	12/11/2019
Agency	LSA	Analysis Year	Phase I Proj Comp Yr (2029) NP
Jurisdiction	Caltrans	Time Period Analyzed	PM Peak Hour
Project Description	CMD1801 - Village D Specific Plan	Unit	United States Customary

Geometric Data

Number of Lanes, ln	3	Terrain Type	Level
Segment Length (L), ft	-	Percent Grade, %	-
Measured or Base Free-Flow Speed	Base	Grade Length, mi	-
Base Free-Flow Speed (BFFS), mi/h	65.0	Total Ramp Density (TRD), ramps/mi	1.83
Lane Width, ft	12	Free-Flow Speed (FFS), mi/h	59.7
Right-Side Lateral Clearance, ft	10		

Adjustment Factors

Driver Population	All Familiar	Final Speed Adjustment Factor (SAF)	1.000
Weather Type	Non-Severe Weather	Final Capacity Adjustment Factor (CAF)	1.000
Incident Type	No Incident	Demand Adjustment Factor (DAF)	1.000

Demand and Capacity

Demand Volume veh/h	3251	Heavy Vehicle Adjustment Factor (fhv)	0.828
Peak Hour Factor	0.94	Flow Rate (Vp), pc/h/ln	1392
Total Trucks, %	20.79	Capacity (c), pc/h/ln	2296
Single-Unit Trucks (SUT), %	-	Adjusted Capacity (cadj), pc/h/ln	2296
Tractor-Trailers (TT), %	-	Volume-to-Capacity Ratio (v/c)	0.61
Passenger Car Equivalent (ET)	2.000		

Speed and Density

Lane Width Adjustment (fLW)	0.0	Average Speed (S), mi/h	59.6
Right-Side Lateral Clearance Adj. (fRLC)	0.0	Density (D), pc/mi/ln	23.4
Total Ramp Density Adjustment	5.4	Level of Service (LOS)	C
Adjusted Free-Flow Speed (FFSadj), mi/h	59.6		

HCS7 Freeway Merge Report

Project Information

Analyst	LSA	Date	12/11/2019
Agency	LSA	Analysis Year	Phase I Proj Comp Yr (2029) NP
Jurisdiction	Caltrans	Time Period Analyzed	PM Peak Hour
Project Description	CMD1801 - Village D Specific Plan	Unit	United States Customary

Geometric Data

	Freeway	Ramp
Number of Lanes (N), ln	3	1
Free-Flow Speed (FFS), mi/h	65.0	35.0
Segment Length (L) / Acceleration Length (LA),ft	1500	600
Terrain Type	Level	Level
Percent Grade, %	-	-
Segment Type / Ramp Side	Freeway	Right

Adjustment Factors

Driver Population	All Familiar	All Familiar
Weather Type	Non-Severe Weather	Non-Severe Weather
Incident Type	No Incident	-
Final Speed Adjustment Factor (SAF)	1.000	1.000
Final Capacity Adjustment Factor (CAF)	1.000	1.000
Demand Adjustment Factor (DAF)	1.000	1.000

Demand and Capacity

Demand Volume (Vi)	3251	230
Peak Hour Factor (PHF)	0.94	0.94
Total Trucks, %	20.79	3.40
Single-Unit Trucks (SUT), %	-	-
Tractor-Trailers (TT), %	-	-
Heavy Vehicle Adjustment Factor (fHV)	0.828	0.967
Flow Rate (vi),pc/h	4177	253
Capacity (c), pc/h	7050	2000
Volume-to-Capacity Ratio (v/c)	0.63	0.13

Speed and Density

Upstream Equilibrium Distance (LEQ), ft	-	Number of Outer Lanes on Freeway (NO)	1
Distance to Upstream Ramp (LUP), ft	-	Speed Index (MS)	0.339
Downstream Equilibrium Distance (LEQ), ft	-	Flow Outer Lanes (vOA), pc/h/ln	1696
Distance to Downstream Ramp (LDOWN), ft	-	On-Ramp Influence Area Speed (SR), mi/h	57.2
Prop. Freeway Vehicles in Lane 1 and 2 (PFM)	0.594	Outer Lanes Freeway Speed (SO), mi/h	60.7
Flow in Lanes 1 and 2 (v12), pc/h	2481	Ramp Junction Speed (S), mi/h	58.5
Flow Entering Ramp-Infl. Area (vR12), pc/h	2734	Average Density (D), pc/mi/ln	25.2
Level of Service (LOS)	C	Density in Ramp Influence Area (DR), pc/mi/ln	23.0

HCS7 Basic Freeway Report

Project Information

Analyst	LSA	Date	12/11/2019
Agency	LSA	Analysis Year	Phase I Proj Comp Yr (2029) NP
Jurisdiction	Caltrans	Time Period Analyzed	PM Peak Hour
Project Description	CMD1801 - Village D Specific Plan	Unit	United States Customary

Geometric Data

Number of Lanes, ln	3	Terrain Type	Level
Segment Length (L), ft	-	Percent Grade, %	-
Measured or Base Free-Flow Speed	Base	Grade Length, mi	-
Base Free-Flow Speed (BFFS), mi/h	65.0	Total Ramp Density (TRD), ramps/mi	2.17
Lane Width, ft	12	Free-Flow Speed (FFS), mi/h	58.8
Right-Side Lateral Clearance, ft	10		

Adjustment Factors

Driver Population	All Familiar	Final Speed Adjustment Factor (SAF)	1.000
Weather Type	Non-Severe Weather	Final Capacity Adjustment Factor (CAF)	1.000
Incident Type	No Incident	Demand Adjustment Factor (DAF)	1.000

Demand and Capacity

Demand Volume veh/h	3482	Heavy Vehicle Adjustment Factor (fhv)	0.836
Peak Hour Factor	0.94	Flow Rate (Vp), pc/h/ln	1477
Total Trucks, %	19.64	Capacity (c), pc/h/ln	2288
Single-Unit Trucks (SUT), %	-	Adjusted Capacity (cadj), pc/h/ln	2288
Tractor-Trailers (TT), %	-	Volume-to-Capacity Ratio (v/c)	0.65
Passenger Car Equivalent (ET)	2.000		

Speed and Density

Lane Width Adjustment (fLW)	0.0	Average Speed (S), mi/h	58.8
Right-Side Lateral Clearance Adj. (fRLC)	0.0	Density (D), pc/mi/ln	25.1
Total Ramp Density Adjustment	6.2	Level of Service (LOS)	C
Adjusted Free-Flow Speed (FFSadj), mi/h	58.8		

HCS7 Freeway Diverge Report

Project Information

Analyst	LSA	Date	12/11/2019
Agency	LSA	Analysis Year	Phase I Proj Comp Yr (2029) NP
Jurisdiction	Caltrans	Time Period Analyzed	PM Peak Hour
Project Description	CMD1801 - Village D Specific Plan	Unit	United States Customary

Geometric Data

	Freeway	Ramp
Number of Lanes (N), ln	3	1
Free-Flow Speed (FFS), mi/h	65.0	40.0
Segment Length (L) / Deceleration Length (LA),ft	1500	150
Terrain Type	Level	Level
Percent Grade, %	-	-
Segment Type / Ramp Side	Freeway	Right

Adjustment Factors

Driver Population	All Familiar	All Familiar
Weather Type	Non-Severe Weather	Non-Severe Weather
Incident Type	No Incident	-
Final Speed Adjustment Factor (SAF)	1.000	1.000
Final Capacity Adjustment Factor (CAF)	1.000	1.000
Demand Adjustment Factor (DAF)	1.000	1.000

Demand and Capacity

Demand Volume (Vi)	3482	311
Peak Hour Factor (PHF)	0.94	0.94
Total Trucks, %	19.64	3.62
Single-Unit Trucks (SUT), %	-	-
Tractor-Trailers (TT), %	-	-
Heavy Vehicle Adjustment Factor (fHV)	0.836	0.965
Flow Rate (vi),pc/h	4431	343
Capacity (c), pc/h	7050	2000
Volume-to-Capacity Ratio (v/c)	0.63	0.17

Speed and Density

Upstream Equilibrium Distance (LEQ), ft	-	Number of Outer Lanes on Freeway (NO)	1
Distance to Upstream Ramp (LUP), ft	-	Speed Index (DS)	0.394
Downstream Equilibrium Distance (LEQ), ft	-	Flow Outer Lanes (vOA), pc/h/ln	1500
Distance to Downstream Ramp (LDOWN), ft	-	Off-Ramp Influence Area Speed (SR), mi/h	55.9
Prop. Freeway Vehicles in Lane 1 and 2 (PFD)	0.633	Outer Lanes Freeway Speed (SO), mi/h	69.4
Flow in Lanes 1 and 2 (v12), pc/h	2931	Ramp Junction Speed (S), mi/h	59.8
Flow Entering Ramp-Infl. Area (vR12), pc/h	-	Average Density (D), pc/mi/ln	24.7
Level of Service (LOS)	D	Density in Ramp Influence Area (DR), pc/mi/ln	28.1

HCS7 Basic Freeway Report

Project Information

Analyst	LSA	Date	12/11/2019
Agency	LSA	Analysis Year	Phase I Proj Comp Yr (2029) NP
Jurisdiction	Caltrans	Time Period Analyzed	PM Peak Hour
Project Description	CMD1801 - Village D Specific Plan	Unit	United States Customary

Geometric Data

Number of Lanes, ln	3	Terrain Type	Level
Segment Length (L), ft	-	Percent Grade, %	-
Measured or Base Free-Flow Speed	Base	Grade Length, mi	-
Base Free-Flow Speed (BFFS), mi/h	65.0	Total Ramp Density (TRD), ramps/mi	1.83
Lane Width, ft	12	Free-Flow Speed (FFS), mi/h	59.7
Right-Side Lateral Clearance, ft	10		

Adjustment Factors

Driver Population	All Familiar	Final Speed Adjustment Factor (SAF)	1.000
Weather Type	Non-Severe Weather	Final Capacity Adjustment Factor (CAF)	1.000
Incident Type	No Incident	Demand Adjustment Factor (DAF)	1.000

Demand and Capacity

Demand Volume veh/h	3171	Heavy Vehicle Adjustment Factor (fhv)	0.825
Peak Hour Factor	0.94	Flow Rate (Vp), pc/h/ln	1363
Total Trucks, %	21.22	Capacity (c), pc/h/ln	2296
Single-Unit Trucks (SUT), %	-	Adjusted Capacity (cadj), pc/h/ln	2296
Tractor-Trailers (TT), %	-	Volume-to-Capacity Ratio (v/c)	0.59
Passenger Car Equivalent (ET)	2.000		

Speed and Density

Lane Width Adjustment (fLW)	0.0	Average Speed (S), mi/h	59.6
Right-Side Lateral Clearance Adj. (fRLC)	0.0	Density (D), pc/mi/ln	22.9
Total Ramp Density Adjustment	5.4	Level of Service (LOS)	C
Adjusted Free-Flow Speed (FFSadj), mi/h	59.6		

HCS7 Freeway Merge Report

Project Information

Analyst	LSA	Date	12/11/2019
Agency	LSA	Analysis Year	Phase I Proj Comp Yr (2029) NP
Jurisdiction	Caltrans	Time Period Analyzed	PM Peak Hour
Project Description	CMD1801 - Village D Specific Plan	Unit	United States Customary

Geometric Data

	Freeway	Ramp
Number of Lanes (N), ln	3	1
Free-Flow Speed (FFS), mi/h	65.0	35.0
Segment Length (L) / Acceleration Length (LA),ft	1500	800
Terrain Type	Level	Level
Percent Grade, %	-	-
Segment Type / Ramp Side	Freeway	Right

Adjustment Factors

Driver Population	All Familiar	All Familiar
Weather Type	Non-Severe Weather	Non-Severe Weather
Incident Type	No Incident	-
Final Speed Adjustment Factor (SAF)	1.000	1.000
Final Capacity Adjustment Factor (CAF)	1.000	1.000
Demand Adjustment Factor (DAF)	1.000	1.000

Demand and Capacity

Demand Volume (Vi)	3171	185
Peak Hour Factor (PHF)	0.94	0.94
Total Trucks, %	21.22	5.83
Single-Unit Trucks (SUT), %	-	-
Tractor-Trailers (TT), %	-	-
Heavy Vehicle Adjustment Factor (fHV)	0.825	0.945
Flow Rate (vi),pc/h	4089	208
Capacity (c), pc/h	7050	2000
Volume-to-Capacity Ratio (v/c)	0.61	0.10

Speed and Density

Upstream Equilibrium Distance (LEQ), ft	-	Number of Outer Lanes on Freeway (NO)	1
Distance to Upstream Ramp (LUP), ft	-	Speed Index (MS)	0.321
Downstream Equilibrium Distance (LEQ), ft	-	Flow Outer Lanes (vOA), pc/h/ln	1636
Distance to Downstream Ramp (LDOWN), ft	-	On-Ramp Influence Area Speed (SR), mi/h	57.6
Prop. Freeway Vehicles in Lane 1 and 2 (PFM)	0.600	Outer Lanes Freeway Speed (SO), mi/h	60.9
Flow in Lanes 1 and 2 (v12), pc/h	2453	Ramp Junction Speed (S), mi/h	58.8
Flow Entering Ramp-Infl. Area (vR12), pc/h	2661	Average Density (D), pc/mi/ln	24.4
Level of Service (LOS)	C	Density in Ramp Influence Area (DR), pc/mi/ln	21.2

HCS7 Basic Freeway Report

Project Information

Analyst	LSA	Date	12/11/2019
Agency	LSA	Analysis Year	Phase I Proj Comp Yr (2029) NP
Jurisdiction	Caltrans	Time Period Analyzed	PM Peak Hour
Project Description	CMD1801 - Village D Specific Plan	Unit	United States Customary

Geometric Data

Number of Lanes, ln	3	Terrain Type	Level
Segment Length (L), ft	-	Percent Grade, %	-
Measured or Base Free-Flow Speed	Base	Grade Length, mi	-
Base Free-Flow Speed (BFFS), mi/h	65.0	Total Ramp Density (TRD), ramps/mi	2.17
Lane Width, ft	12	Free-Flow Speed (FFS), mi/h	58.8
Right-Side Lateral Clearance, ft	10		

Adjustment Factors

Driver Population	All Familiar	Final Speed Adjustment Factor (SAF)	1.000
Weather Type	Non-Severe Weather	Final Capacity Adjustment Factor (CAF)	1.000
Incident Type	No Incident	Demand Adjustment Factor (DAF)	1.000

Demand and Capacity

Demand Volume veh/h	3356	Heavy Vehicle Adjustment Factor (fhv)	0.831
Peak Hour Factor	0.94	Flow Rate (Vp), pc/h/ln	1432
Total Trucks, %	20.37	Capacity (c), pc/h/ln	2288
Single-Unit Trucks (SUT), %	-	Adjusted Capacity (cadj), pc/h/ln	2288
Tractor-Trailers (TT), %	-	Volume-to-Capacity Ratio (v/c)	0.63
Passenger Car Equivalent (ET)	2.000		

Speed and Density

Lane Width Adjustment (fLW)	0.0	Average Speed (S), mi/h	58.8
Right-Side Lateral Clearance Adj. (fRLC)	0.0	Density (D), pc/mi/ln	24.4
Total Ramp Density Adjustment	6.2	Level of Service (LOS)	C
Adjusted Free-Flow Speed (FFSadj), mi/h	58.8		

HCS7 Freeway Diverge Report

Project Information

Analyst	LSA	Date	12/11/2019
Agency	LSA	Analysis Year	Phase I Proj Comp Yr (2029) NP
Jurisdiction	Caltrans	Time Period Analyzed	PM Peak Hour
Project Description	CMD1801 - Village D Specific Plan	Unit	United States Customary

Geometric Data

	Freeway	Ramp
Number of Lanes (N), In	3	1
Free-Flow Speed (FFS), mi/h	65.0	35.0
Segment Length (L) / Deceleration Length (LA),ft	1500	200
Terrain Type	Level	Level
Percent Grade, %	-	-
Segment Type / Ramp Side	Freeway	Right

Adjustment Factors

Driver Population	All Familiar	All Familiar
Weather Type	Non-Severe Weather	Non-Severe Weather
Incident Type	No Incident	-
Final Speed Adjustment Factor (SAF)	1.000	1.000
Final Capacity Adjustment Factor (CAF)	1.000	1.000
Demand Adjustment Factor (DAF)	1.000	1.000

Demand and Capacity

Demand Volume (Vi)	3356	231
Peak Hour Factor (PHF)	0.94	0.94
Total Trucks, %	20.37	3.96
Single-Unit Trucks (SUT), %	-	-
Tractor-Trailers (TT), %	-	-
Heavy Vehicle Adjustment Factor (fHV)	0.831	0.962
Flow Rate (vi),pc/h	4296	255
Capacity (c), pc/h	7050	2000
Volume-to-Capacity Ratio (v/c)	0.61	0.13

Speed and Density

Upstream Equilibrium Distance (LEQ), ft	-	Number of Outer Lanes on Freeway (NO)	1
Distance to Upstream Ramp (LUP), ft	-	Speed Index (DS)	0.451
Downstream Equilibrium Distance (LEQ), ft	-	Flow Outer Lanes (vOA), pc/h/ln	1451
Distance to Downstream Ramp (LDOWN), ft	-	Off-Ramp Influence Area Speed (SR), mi/h	54.6
Prop. Freeway Vehicles in Lane 1 and 2 (PFD)	0.641	Outer Lanes Freeway Speed (SO), mi/h	69.5
Flow in Lanes 1 and 2 (v12), pc/h	2845	Ramp Junction Speed (S), mi/h	58.9
Flow Entering Ramp-Infl. Area (vR12), pc/h	-	Average Density (D), pc/mi/ln	24.3
Level of Service (LOS)	C	Density in Ramp Influence Area (DR), pc/mi/ln	26.9

HCS7 Basic Freeway Report

Project Information

Analyst	LSA	Date	12/11/2019
Agency	LSA	Analysis Year	Phase I Proj Comp Yr (2029) NP
Jurisdiction	Caltrans	Time Period Analyzed	PM Peak Hour
Project Description	CMD1801 - Village D Specific Plan	Unit	United States Customary

Geometric Data

Number of Lanes, ln	3	Terrain Type	Level
Segment Length (L), ft	-	Percent Grade, %	-
Measured or Base Free-Flow Speed	Base	Grade Length, mi	-
Base Free-Flow Speed (BFFS), mi/h	65.0	Total Ramp Density (TRD), ramps/mi	2.17
Lane Width, ft	12	Free-Flow Speed (FFS), mi/h	58.8
Right-Side Lateral Clearance, ft	10		

Adjustment Factors

Driver Population	All Familiar	Final Speed Adjustment Factor (SAF)	1.000
Weather Type	Non-Severe Weather	Final Capacity Adjustment Factor (CAF)	1.000
Incident Type	No Incident	Demand Adjustment Factor (DAF)	1.000

Demand and Capacity

Demand Volume veh/h	3125	Heavy Vehicle Adjustment Factor (fhv)	0.822
Peak Hour Factor	0.94	Flow Rate (Vp), pc/h/ln	1348
Total Trucks, %	21.59	Capacity (c), pc/h/ln	2288
Single-Unit Trucks (SUT), %	-	Adjusted Capacity (cadj), pc/h/ln	2288
Tractor-Trailers (TT), %	-	Volume-to-Capacity Ratio (v/c)	0.59
Passenger Car Equivalent (ET)	2.000		

Speed and Density

Lane Width Adjustment (fLW)	0.0	Average Speed (S), mi/h	58.8
Right-Side Lateral Clearance Adj. (fRLC)	0.0	Density (D), pc/mi/ln	22.9
Total Ramp Density Adjustment	6.2	Level of Service (LOS)	C
Adjusted Free-Flow Speed (FFSadj), mi/h	58.8		

HCS7 Freeway Merge Report

Project Information

Analyst	LSA	Date	12/11/2019
Agency	LSA	Analysis Year	Phase I Proj Comp Yr (2029) NP
Jurisdiction	Caltrans	Time Period Analyzed	PM Peak Hour
Project Description	CMD1801 - Village D Specific Plan	Unit	United States Customary

Geometric Data

	Freeway	Ramp
Number of Lanes (N), ln	3	1
Free-Flow Speed (FFS), mi/h	65.0	35.0
Segment Length (L) / Acceleration Length (LA),ft	1500	350
Terrain Type	Level	Level
Percent Grade, %	-	-
Segment Type / Ramp Side	Freeway	Right

Adjustment Factors

Driver Population	All Familiar	All Familiar
Weather Type	Non-Severe Weather	Non-Severe Weather
Incident Type	No Incident	-
Final Speed Adjustment Factor (SAF)	1.000	1.000
Final Capacity Adjustment Factor (CAF)	1.000	1.000
Demand Adjustment Factor (DAF)	1.000	1.000

Demand and Capacity

Demand Volume (Vi)	3125	610
Peak Hour Factor (PHF)	0.94	0.94
Total Trucks, %	21.59	1.56
Single-Unit Trucks (SUT), %	-	-
Tractor-Trailers (TT), %	-	-
Heavy Vehicle Adjustment Factor (fHV)	0.822	0.985
Flow Rate (vi),pc/h	4044	659
Capacity (c), pc/h	7050	2000
Volume-to-Capacity Ratio (v/c)	0.67	0.33

Speed and Density

Upstream Equilibrium Distance (LEQ), ft	-	Number of Outer Lanes on Freeway (NO)	1
Distance to Upstream Ramp (LUP), ft	-	Speed Index (MS)	0.377
Downstream Equilibrium Distance (LEQ), ft	-	Flow Outer Lanes (vOA), pc/h/ln	1670
Distance to Downstream Ramp (LDOWN), ft	-	On-Ramp Influence Area Speed (SR), mi/h	56.3
Prop. Freeway Vehicles in Lane 1 and 2 (PFM)	0.587	Outer Lanes Freeway Speed (SO), mi/h	60.8
Flow in Lanes 1 and 2 (v12), pc/h	2374	Ramp Junction Speed (S), mi/h	57.8
Flow Entering Ramp-Infl. Area (vR12), pc/h	3033	Average Density (D), pc/mi/ln	27.1
Level of Service (LOS)	C	Density in Ramp Influence Area (DR), pc/mi/ln	26.7

HCS7 Basic Freeway Report

Project Information

Analyst	LSA	Date	12/11/2019
Agency	LSA	Analysis Year	Phase I Proj Comp Yr (2029) NP
Jurisdiction	Caltrans	Time Period Analyzed	PM Peak Hour
Project Description	CMD1801 - Village D Specific Plan	Unit	United States Customary

Geometric Data

Number of Lanes, ln	3	Terrain Type	Level
Segment Length (L), ft	-	Percent Grade, %	-
Measured or Base Free-Flow Speed	Base	Grade Length, mi	-
Base Free-Flow Speed (BFFS), mi/h	65.0	Total Ramp Density (TRD), ramps/mi	2.17
Lane Width, ft	12	Free-Flow Speed (FFS), mi/h	58.8
Right-Side Lateral Clearance, ft	10		

Adjustment Factors

Driver Population	All Familiar	Final Speed Adjustment Factor (SAF)	1.000
Weather Type	Non-Severe Weather	Final Capacity Adjustment Factor (CAF)	1.000
Incident Type	No Incident	Demand Adjustment Factor (DAF)	1.000

Demand and Capacity

Demand Volume veh/h	3735	Heavy Vehicle Adjustment Factor (fhv)	0.845
Peak Hour Factor	0.94	Flow Rate (Vp), pc/h/ln	1567
Total Trucks, %	18.31	Capacity (c), pc/h/ln	2288
Single-Unit Trucks (SUT), %	-	Adjusted Capacity (cadj), pc/h/ln	2288
Tractor-Trailers (TT), %	-	Volume-to-Capacity Ratio (v/c)	0.69
Passenger Car Equivalent (ET)	2.000		

Speed and Density

Lane Width Adjustment (fLW)	0.0	Average Speed (S), mi/h	58.8
Right-Side Lateral Clearance Adj. (fRLC)	0.0	Density (D), pc/mi/ln	26.6
Total Ramp Density Adjustment	6.2	Level of Service (LOS)	D
Adjusted Free-Flow Speed (FFSadj), mi/h	58.8		

HCS7 Freeway Diverge Report

Project Information

Analyst	LSA	Date	12/11/2019
Agency	LSA	Analysis Year	Phase I Proj Comp Yr (2029) NP
Jurisdiction	Caltrans	Time Period Analyzed	PM Peak Hour
Project Description	CMD1801 - Village D Specific Plan	Unit	United States Customary

Geometric Data

	Freeway	Ramp
Number of Lanes (N), ln	3	1
Free-Flow Speed (FFS), mi/h	65.0	15.0
Segment Length (L) / Deceleration Length (LA),ft	1500	150
Terrain Type	Level	Level
Percent Grade, %	-	-
Segment Type / Ramp Side	Freeway	Right

Adjustment Factors

Driver Population	All Familiar	All Familiar
Weather Type	Non-Severe Weather	Non-Severe Weather
Incident Type	No Incident	-
Final Speed Adjustment Factor (SAF)	1.000	1.000
Final Capacity Adjustment Factor (CAF)	1.000	1.000
Demand Adjustment Factor (DAF)	1.000	1.000

Demand and Capacity

Demand Volume (Vi)	3735	272
Peak Hour Factor (PHF)	0.94	0.94
Total Trucks, %	18.31	2.80
Single-Unit Trucks (SUT), %	-	-
Tractor-Trailers (TT), %	-	-
Heavy Vehicle Adjustment Factor (fHV)	0.845	0.973
Flow Rate (vi),pc/h	4702	297
Capacity (c), pc/h	7050	1800
Volume-to-Capacity Ratio (v/c)	0.67	0.17

Speed and Density

Upstream Equilibrium Distance (LEQ), ft	-	Number of Outer Lanes on Freeway (NO)	1
Distance to Upstream Ramp (LUP), ft	-	Speed Index (DS)	0.715
Downstream Equilibrium Distance (LEQ), ft	-	Flow Outer Lanes (vOA), pc/h/ln	1634
Distance to Downstream Ramp (LDOWN), ft	-	Off-Ramp Influence Area Speed (SR), mi/h	48.6
Prop. Freeway Vehicles in Lane 1 and 2 (PFD)	0.629	Outer Lanes Freeway Speed (SO), mi/h	68.8
Flow in Lanes 1 and 2 (v12), pc/h	3068	Ramp Junction Speed (S), mi/h	54.1
Flow Entering Ramp-Infl. Area (vR12), pc/h	-	Average Density (D), pc/mi/ln	29.0
Level of Service (LOS)	D	Density in Ramp Influence Area (DR), pc/mi/ln	29.3

HCS7 Basic Freeway Report

Project Information

Analyst	LSA	Date	12/11/2019
Agency	LSA	Analysis Year	Phase I Proj Comp Yr (2029) NP
Jurisdiction	Caltrans	Time Period Analyzed	PM Peak Hour
Project Description	CMD1801 - Village D Specific Plan	Unit	United States Customary

Geometric Data

Number of Lanes, ln	3	Terrain Type	Level
Segment Length (L), ft	-	Percent Grade, %	-
Measured or Base Free-Flow Speed	Base	Grade Length, mi	-
Base Free-Flow Speed (BFFS), mi/h	65.0	Total Ramp Density (TRD), ramps/mi	1.83
Lane Width, ft	12	Free-Flow Speed (FFS), mi/h	59.7
Right-Side Lateral Clearance, ft	10		

Adjustment Factors

Driver Population	All Familiar	Final Speed Adjustment Factor (SAF)	1.000
Weather Type	Non-Severe Weather	Final Capacity Adjustment Factor (CAF)	1.000
Incident Type	No Incident	Demand Adjustment Factor (DAF)	1.000

Demand and Capacity

Demand Volume veh/h	3462	Heavy Vehicle Adjustment Factor (fhv)	0.837
Peak Hour Factor	0.94	Flow Rate (Vp), pc/h/ln	1467
Total Trucks, %	19.53	Capacity (c), pc/h/ln	2296
Single-Unit Trucks (SUT), %	-	Adjusted Capacity (cadj), pc/h/ln	2296
Tractor-Trailers (TT), %	-	Volume-to-Capacity Ratio (v/c)	0.64
Passenger Car Equivalent (ET)	2.000		

Speed and Density

Lane Width Adjustment (fLW)	0.0	Average Speed (S), mi/h	59.6
Right-Side Lateral Clearance Adj. (fRLC)	0.0	Density (D), pc/mi/ln	24.6
Total Ramp Density Adjustment	5.4	Level of Service (LOS)	C
Adjusted Free-Flow Speed (FFSadj), mi/h	59.6		

HCS7 Freeway Merge Report

Project Information

Analyst	LSA	Date	12/11/2019
Agency	LSA	Analysis Year	Phase I Proj Comp Yr (2029) NP
Jurisdiction	Caltrans	Time Period Analyzed	PM Peak Hour
Project Description	CMD1801 - Village D Specific Plan	Unit	United States Customary

Geometric Data

	Freeway	Ramp
Number of Lanes (N), ln	3	1
Free-Flow Speed (FFS), mi/h	65.0	35.0
Segment Length (L) / Acceleration Length (LA),ft	1500	450
Terrain Type	Level	Level
Percent Grade, %	-	-
Segment Type / Ramp Side	Freeway	Right

Adjustment Factors

Driver Population	All Familiar	All Familiar
Weather Type	Non-Severe Weather	Non-Severe Weather
Incident Type	No Incident	-
Final Speed Adjustment Factor (SAF)	1.000	1.000
Final Capacity Adjustment Factor (CAF)	1.000	1.000
Demand Adjustment Factor (DAF)	1.000	1.000

Demand and Capacity

Demand Volume (Vi)	3462	465
Peak Hour Factor (PHF)	0.94	0.94
Total Trucks, %	19.53	1.18
Single-Unit Trucks (SUT), %	-	-
Tractor-Trailers (TT), %	-	-
Heavy Vehicle Adjustment Factor (fHV)	0.837	0.988
Flow Rate (vi),pc/h	4400	501
Capacity (c), pc/h	7050	2000
Volume-to-Capacity Ratio (v/c)	0.70	0.25

Speed and Density

Upstream Equilibrium Distance (LEQ), ft	-	Number of Outer Lanes on Freeway (NO)	1
Distance to Upstream Ramp (LUP), ft	-	Speed Index (MS)	0.376
Downstream Equilibrium Distance (LEQ), ft	-	Flow Outer Lanes (vOA), pc/h/ln	1804
Distance to Downstream Ramp (LDOWN), ft	-	On-Ramp Influence Area Speed (SR), mi/h	56.4
Prop. Freeway Vehicles in Lane 1 and 2 (PFM)	0.590	Outer Lanes Freeway Speed (SO), mi/h	60.3
Flow in Lanes 1 and 2 (v12), pc/h	2596	Ramp Junction Speed (S), mi/h	57.8
Flow Entering Ramp-Infl. Area (vR12), pc/h	3097	Average Density (D), pc/mi/ln	28.3
Level of Service (LOS)	C	Density in Ramp Influence Area (DR), pc/mi/ln	26.7

HCS7 Basic Freeway Report

Project Information

Analyst	LSA	Date	12/11/2019
Agency	LSA	Analysis Year	Phase I Proj Comp Yr (2029) NP
Jurisdiction	Caltrans	Time Period Analyzed	PM Peak Hour
Project Description	CMD1801 - Village D Specific Plan	Unit	United States Customary

Geometric Data

Number of Lanes, ln	3	Terrain Type	Level
Segment Length (L), ft	-	Percent Grade, %	-
Measured or Base Free-Flow Speed	Base	Grade Length, mi	-
Base Free-Flow Speed (BFFS), mi/h	65.0	Total Ramp Density (TRD), ramps/mi	1.83
Lane Width, ft	12	Free-Flow Speed (FFS), mi/h	59.7
Right-Side Lateral Clearance, ft	10		

Adjustment Factors

Driver Population	All Familiar	Final Speed Adjustment Factor (SAF)	1.000
Weather Type	Non-Severe Weather	Final Capacity Adjustment Factor (CAF)	1.000
Incident Type	No Incident	Demand Adjustment Factor (DAF)	1.000

Demand and Capacity

Demand Volume veh/h	3928	Heavy Vehicle Adjustment Factor (fhv)	0.852
Peak Hour Factor	0.94	Flow Rate (Vp), pc/h/ln	1635
Total Trucks, %	17.35	Capacity (c), pc/h/ln	2296
Single-Unit Trucks (SUT), %	-	Adjusted Capacity (cadj), pc/h/ln	2296
Tractor-Trailers (TT), %	-	Volume-to-Capacity Ratio (v/c)	0.71
Passenger Car Equivalent (ET)	2.000		

Speed and Density

Lane Width Adjustment (fLW)	0.0	Average Speed (S), mi/h	59.6
Right-Side Lateral Clearance Adj. (fRLC)	0.0	Density (D), pc/mi/ln	27.4
Total Ramp Density Adjustment	5.4	Level of Service (LOS)	D
Adjusted Free-Flow Speed (FFSadj), mi/h	59.6		

HCS7 Freeway Diverge Report

Project Information

Analyst	LSA	Date	12/11/2019
Agency	LSA	Analysis Year	Phase I Proj Comp Yr (2029) NP
Jurisdiction	Caltrans	Time Period Analyzed	PM Peak Hour
Project Description	CMD1801 - Village D Specific Plan	Unit	United States Customary

Geometric Data

	Freeway	Ramp
Number of Lanes (N), In	3	1
Free-Flow Speed (FFS), mi/h	65.0	35.0
Segment Length (L) / Deceleration Length (LA),ft	1500	140
Terrain Type	Level	Level
Percent Grade, %	-	-
Segment Type / Ramp Side	Freeway	Right

Adjustment Factors

Driver Population	All Familiar	All Familiar
Weather Type	Non-Severe Weather	Non-Severe Weather
Incident Type	No Incident	-
Final Speed Adjustment Factor (SAF)	1.000	1.000
Final Capacity Adjustment Factor (CAF)	1.000	1.000
Demand Adjustment Factor (DAF)	1.000	1.000

Demand and Capacity

Demand Volume (Vi)	3928	455
Peak Hour Factor (PHF)	0.94	0.94
Total Trucks, %	17.35	4.45
Single-Unit Trucks (SUT), %	-	-
Tractor-Trailers (TT), %	-	-
Heavy Vehicle Adjustment Factor (fHV)	0.852	0.957
Flow Rate (vi),pc/h	4905	506
Capacity (c), pc/h	7050	2000
Volume-to-Capacity Ratio (v/c)	0.70	0.25

Speed and Density

Upstream Equilibrium Distance (LEQ), ft	-	Number of Outer Lanes on Freeway (NO)	1
Distance to Upstream Ramp (LUP), ft	-	Speed Index (DS)	0.474
Downstream Equilibrium Distance (LEQ), ft	-	Flow Outer Lanes (vOA), pc/h/ln	1698
Distance to Downstream Ramp (LDOWN), ft	-	Off-Ramp Influence Area Speed (SR), mi/h	54.1
Prop. Freeway Vehicles in Lane 1 and 2 (PFD)	0.614	Outer Lanes Freeway Speed (SO), mi/h	68.6
Flow in Lanes 1 and 2 (v12), pc/h	3207	Ramp Junction Speed (S), mi/h	58.4
Flow Entering Ramp-Infl. Area (vR12), pc/h	-	Average Density (D), pc/mi/ln	28.0
Level of Service (LOS)	D	Density in Ramp Influence Area (DR), pc/mi/ln	30.6

HCS7 Basic Freeway Report

Project Information

Analyst	LSA	Date	12/11/2019
Agency	LSA	Analysis Year	Phase I Proj Comp Yr (2029) NP
Jurisdiction	Caltrans	Time Period Analyzed	PM Peak Hour
Project Description	CMD1801 - Village D Specific Plan	Unit	United States Customary

Geometric Data

Number of Lanes, ln	3	Terrain Type	Level
Segment Length (L), ft	-	Percent Grade, %	-
Measured or Base Free-Flow Speed	Base	Grade Length, mi	-
Base Free-Flow Speed (BFFS), mi/h	65.0	Total Ramp Density (TRD), ramps/mi	2.17
Lane Width, ft	12	Free-Flow Speed (FFS), mi/h	58.8
Right-Side Lateral Clearance, ft	10		

Adjustment Factors

Driver Population	All Familiar	Final Speed Adjustment Factor (SAF)	1.000
Weather Type	Non-Severe Weather	Final Capacity Adjustment Factor (CAF)	1.000
Incident Type	No Incident	Demand Adjustment Factor (DAF)	1.000

Demand and Capacity

Demand Volume veh/h	3472	Heavy Vehicle Adjustment Factor (fhv)	0.840
Peak Hour Factor	0.94	Flow Rate (Vp), pc/h/ln	1466
Total Trucks, %	19.04	Capacity (c), pc/h/ln	2288
Single-Unit Trucks (SUT), %	-	Adjusted Capacity (cadj), pc/h/ln	2288
Tractor-Trailers (TT), %	-	Volume-to-Capacity Ratio (v/c)	0.64
Passenger Car Equivalent (ET)	2.000		

Speed and Density

Lane Width Adjustment (fLW)	0.0	Average Speed (S), mi/h	58.8
Right-Side Lateral Clearance Adj. (fRLC)	0.0	Density (D), pc/mi/ln	24.9
Total Ramp Density Adjustment	6.2	Level of Service (LOS)	C
Adjusted Free-Flow Speed (FFSadj), mi/h	58.8		

HCS7 Freeway Merge Report

Project Information

Analyst	LSA	Date	12/11/2019
Agency	LSA	Analysis Year	Phase I Proj Comp Yr (2029) NP
Jurisdiction	Caltrans	Time Period Analyzed	PM Peak Hour
Project Description	CMD1801 - Village D Specific Plan	Unit	United States Customary

Geometric Data

	Freeway	Ramp
Number of Lanes (N), ln	3	1
Free-Flow Speed (FFS), mi/h	65.0	35.0
Segment Length (L) / Acceleration Length (LA),ft	1500	450
Terrain Type	Level	Level
Percent Grade, %	-	-
Segment Type / Ramp Side	Freeway	Right

Adjustment Factors

Driver Population	All Familiar	All Familiar
Weather Type	Non-Severe Weather	Non-Severe Weather
Incident Type	No Incident	-
Final Speed Adjustment Factor (SAF)	1.000	1.000
Final Capacity Adjustment Factor (CAF)	1.000	1.000
Demand Adjustment Factor (DAF)	1.000	1.000

Demand and Capacity

Demand Volume (Vi)	3472	324
Peak Hour Factor (PHF)	0.94	0.94
Total Trucks, %	19.04	1.70
Single-Unit Trucks (SUT), %	-	-
Tractor-Trailers (TT), %	-	-
Heavy Vehicle Adjustment Factor (fHV)	0.840	0.983
Flow Rate (vi),pc/h	4397	351
Capacity (c), pc/h	7050	2000
Volume-to-Capacity Ratio (v/c)	0.67	0.18

Speed and Density

Upstream Equilibrium Distance (LEQ), ft	-	Number of Outer Lanes on Freeway (NO)	1
Distance to Upstream Ramp (LUP), ft	-	Speed Index (MS)	0.364
Downstream Equilibrium Distance (LEQ), ft	-	Flow Outer Lanes (vOA), pc/h/ln	1803
Distance to Downstream Ramp (LDOWN), ft	-	On-Ramp Influence Area Speed (SR), mi/h	56.6
Prop. Freeway Vehicles in Lane 1 and 2 (PFM)	0.590	Outer Lanes Freeway Speed (SO), mi/h	60.3
Flow in Lanes 1 and 2 (v12), pc/h	2594	Ramp Junction Speed (S), mi/h	58.0
Flow Entering Ramp-Infl. Area (vR12), pc/h	2945	Average Density (D), pc/mi/ln	27.3
Level of Service (LOS)	C	Density in Ramp Influence Area (DR), pc/mi/ln	25.5

HCS7 Basic Freeway Report

Project Information

Analyst	LSA	Date	12/11/2019
Agency	LSA	Analysis Year	Phase I Proj Comp Yr (2029) NP
Jurisdiction	Caltrans	Time Period Analyzed	PM Peak Hour
Project Description	CMD1801 - Village D Specific Plan	Unit	United States Customary

Geometric Data

Number of Lanes, ln	3	Terrain Type	Level
Segment Length (L), ft	-	Percent Grade, %	-
Measured or Base Free-Flow Speed	Base	Grade Length, mi	-
Base Free-Flow Speed (BFFS), mi/h	65.0	Total Ramp Density (TRD), ramps/mi	2.17
Lane Width, ft	12	Free-Flow Speed (FFS), mi/h	58.8
Right-Side Lateral Clearance, ft	10		

Adjustment Factors

Driver Population	All Familiar	Final Speed Adjustment Factor (SAF)	1.000
Weather Type	Non-Severe Weather	Final Capacity Adjustment Factor (CAF)	1.000
Incident Type	No Incident	Demand Adjustment Factor (DAF)	1.000

Demand and Capacity

Demand Volume veh/h	3797	Heavy Vehicle Adjustment Factor (fhv)	0.851
Peak Hour Factor	0.94	Flow Rate (Vp), pc/h/ln	1582
Total Trucks, %	17.57	Capacity (c), pc/h/ln	2288
Single-Unit Trucks (SUT), %	-	Adjusted Capacity (cadj), pc/h/ln	2288
Tractor-Trailers (TT), %	-	Volume-to-Capacity Ratio (v/c)	0.69
Passenger Car Equivalent (ET)	2.000		

Speed and Density

Lane Width Adjustment (fLW)	0.0	Average Speed (S), mi/h	58.8
Right-Side Lateral Clearance Adj. (fRLC)	0.0	Density (D), pc/mi/ln	26.9
Total Ramp Density Adjustment	6.2	Level of Service (LOS)	D
Adjusted Free-Flow Speed (FFSadj), mi/h	58.8		

HCS7 Basic Freeway Report

Project Information

Analyst	LSA	Date	12/11/2019
Agency	LSA	Analysis Year	Phase I Proj Comp Yr (2029) WP
Jurisdiction	Caltrans	Time Period Analyzed	AM Peak Hour
Project Description	CMD1801 - Village D Specific Plan	Unit	United States Customary

Geometric Data

Number of Lanes, ln	3	Terrain Type	Level
Segment Length (L), ft	-	Percent Grade, %	-
Measured or Base Free-Flow Speed	Base	Grade Length, mi	-
Base Free-Flow Speed (BFFS), mi/h	65.0	Total Ramp Density (TRD), ramps/mi	1.83
Lane Width, ft	12	Free-Flow Speed (FFS), mi/h	59.7
Right-Side Lateral Clearance, ft	10		

Adjustment Factors

Driver Population	All Familiar	Final Speed Adjustment Factor (SAF)	1.000
Weather Type	Non-Severe Weather	Final Capacity Adjustment Factor (CAF)	1.000
Incident Type	No Incident	Demand Adjustment Factor (DAF)	1.000

Demand and Capacity

Demand Volume veh/h	3077	Heavy Vehicle Adjustment Factor (fhv)	0.855
Peak Hour Factor	0.94	Flow Rate (Vp), pc/h/ln	1276
Total Trucks, %	17.00	Capacity (c), pc/h/ln	2296
Single-Unit Trucks (SUT), %	-	Adjusted Capacity (cadj), pc/h/ln	2296
Tractor-Trailers (TT), %	-	Volume-to-Capacity Ratio (v/c)	0.56
Passenger Car Equivalent (ET)	2.000		

Speed and Density

Lane Width Adjustment (fLW)	0.0	Average Speed (S), mi/h	59.6
Right-Side Lateral Clearance Adj. (fRLC)	0.0	Density (D), pc/mi/ln	21.4
Total Ramp Density Adjustment	5.4	Level of Service (LOS)	C
Adjusted Free-Flow Speed (FFSadj), mi/h	59.6		

HCS7 Freeway Diverge Report

Project Information

Analyst	LSA	Date	12/11/2019
Agency	LSA	Analysis Year	Phase I Proj Comp Yr (2029) WP
Jurisdiction	Caltrans	Time Period Analyzed	AM Peak Hour
Project Description	CMD1801 - Village D Specific Plan	Unit	United States Customary

Geometric Data

	Freeway	Ramp
Number of Lanes (N), ln	3	1
Free-Flow Speed (FFS), mi/h	65.0	35.0
Segment Length (L) / Deceleration Length (LA),ft	1500	150
Terrain Type	Level	Level
Percent Grade, %	-	-
Segment Type / Ramp Side	Freeway	Right

Adjustment Factors

Driver Population	All Familiar	All Familiar
Weather Type	Non-Severe Weather	Non-Severe Weather
Incident Type	No Incident	-
Final Speed Adjustment Factor (SAF)	1.000	1.000
Final Capacity Adjustment Factor (CAF)	1.000	1.000
Demand Adjustment Factor (DAF)	1.000	1.000

Demand and Capacity

Demand Volume (Vi)	3077	265
Peak Hour Factor (PHF)	0.94	0.94
Total Trucks, %	17.00	4.53
Single-Unit Trucks (SUT), %	-	-
Tractor-Trailers (TT), %	-	-
Heavy Vehicle Adjustment Factor (fHV)	0.855	0.957
Flow Rate (vi),pc/h	3829	295
Capacity (c), pc/h	7050	2000
Volume-to-Capacity Ratio (v/c)	0.54	0.15

Speed and Density

Upstream Equilibrium Distance (LEQ), ft	-	Number of Outer Lanes on Freeway (NO)	1
Distance to Upstream Ramp (LUP), ft	-	Speed Index (DS)	0.455
Downstream Equilibrium Distance (LEQ), ft	-	Flow Outer Lanes (vOA), pc/h/ln	1233
Distance to Downstream Ramp (LDOWN), ft	-	Off-Ramp Influence Area Speed (SR), mi/h	54.5
Prop. Freeway Vehicles in Lane 1 and 2 (PFD)	0.651	Outer Lanes Freeway Speed (SO), mi/h	70.4
Flow in Lanes 1 and 2 (v12), pc/h	2596	Ramp Junction Speed (S), mi/h	58.8
Flow Entering Ramp-Infl. Area (vR12), pc/h	-	Average Density (D), pc/mi/ln	21.7
Level of Service (LOS)	C	Density in Ramp Influence Area (DR), pc/mi/ln	25.2

HCS7 Basic Freeway Report

Project Information

Analyst	LSA	Date	12/11/2019
Agency	LSA	Analysis Year	Phase I Proj Comp Yr (2029) WP
Jurisdiction	Caltrans	Time Period Analyzed	AM Peak Hour
Project Description	CMD1801 - Village D Specific Plan	Unit	United States Customary

Geometric Data

Number of Lanes, ln	3	Terrain Type	Level
Segment Length (L), ft	-	Percent Grade, %	-
Measured or Base Free-Flow Speed	Base	Grade Length, mi	-
Base Free-Flow Speed (BFFS), mi/h	65.0	Total Ramp Density (TRD), ramps/mi	1.83
Lane Width, ft	12	Free-Flow Speed (FFS), mi/h	59.7
Right-Side Lateral Clearance, ft	10		

Adjustment Factors

Driver Population	All Familiar	Final Speed Adjustment Factor (SAF)	1.000
Weather Type	Non-Severe Weather	Final Capacity Adjustment Factor (CAF)	1.000
Incident Type	No Incident	Demand Adjustment Factor (DAF)	1.000

Demand and Capacity

Demand Volume veh/h	2812	Heavy Vehicle Adjustment Factor (fhv)	0.846
Peak Hour Factor	0.94	Flow Rate (Vp), pc/h/ln	1179
Total Trucks, %	18.19	Capacity (c), pc/h/ln	2296
Single-Unit Trucks (SUT), %	-	Adjusted Capacity (cadj), pc/h/ln	2296
Tractor-Trailers (TT), %	-	Volume-to-Capacity Ratio (v/c)	0.51
Passenger Car Equivalent (ET)	2.000		

Speed and Density

Lane Width Adjustment (fLW)	0.0	Average Speed (S), mi/h	59.6
Right-Side Lateral Clearance Adj. (fRLC)	0.0	Density (D), pc/mi/ln	19.8
Total Ramp Density Adjustment	5.4	Level of Service (LOS)	C
Adjusted Free-Flow Speed (FFSadj), mi/h	59.6		

HCS7 Freeway Merge Report

Project Information

Analyst	LSA	Date	12/11/2019
Agency	LSA	Analysis Year	Phase I Proj Comp Yr (2029) WP
Jurisdiction	Caltrans	Time Period Analyzed	AM Peak Hour
Project Description	CMD1801 - Village D Specific Plan	Unit	United States Customary

Geometric Data

	Freeway	Ramp
Number of Lanes (N), ln	3	1
Free-Flow Speed (FFS), mi/h	65.0	35.0
Segment Length (L) / Acceleration Length (LA),ft	1500	445
Terrain Type	Level	Level
Percent Grade, %	-	-
Segment Type / Ramp Side	Freeway	Right

Adjustment Factors

Driver Population	All Familiar	All Familiar
Weather Type	Non-Severe Weather	Non-Severe Weather
Incident Type	No Incident	-
Final Speed Adjustment Factor (SAF)	1.000	1.000
Final Capacity Adjustment Factor (CAF)	1.000	1.000
Demand Adjustment Factor (DAF)	1.000	1.000

Demand and Capacity

Demand Volume (Vi)	2812	677
Peak Hour Factor (PHF)	0.94	0.94
Total Trucks, %	18.19	9.60
Single-Unit Trucks (SUT), %	-	-
Tractor-Trailers (TT), %	-	-
Heavy Vehicle Adjustment Factor (fHV)	0.846	0.912
Flow Rate (vi),pc/h	3536	790
Capacity (c), pc/h	7050	2000
Volume-to-Capacity Ratio (v/c)	0.61	0.40

Speed and Density

Upstream Equilibrium Distance (LEQ), ft	-	Number of Outer Lanes on Freeway (NO)	1
Distance to Upstream Ramp (LUP), ft	-	Speed Index (MS)	0.359
Downstream Equilibrium Distance (LEQ), ft	-	Flow Outer Lanes (vOA), pc/h/ln	1450
Distance to Downstream Ramp (LDOWN), ft	-	On-Ramp Influence Area Speed (SR), mi/h	56.7
Prop. Freeway Vehicles in Lane 1 and 2 (PFM)	0.590	Outer Lanes Freeway Speed (SO), mi/h	61.6
Flow in Lanes 1 and 2 (v12), pc/h	2086	Ramp Junction Speed (S), mi/h	58.3
Flow Entering Ramp-Infl. Area (vR12), pc/h	2876	Average Density (D), pc/mi/ln	24.7
Level of Service (LOS)	C	Density in Ramp Influence Area (DR), pc/mi/ln	24.8

HCS7 Basic Freeway Report

Project Information

Analyst	LSA	Date	12/11/2019
Agency	LSA	Analysis Year	Phase I Proj Comp Yr (2029) WP
Jurisdiction	Caltrans	Time Period Analyzed	AM Peak Hour
Project Description	CMD1801 - Village D Specific Plan	Unit	United States Customary

Geometric Data

Number of Lanes, ln	3	Terrain Type	Level
Segment Length (L), ft	-	Percent Grade, %	-
Measured or Base Free-Flow Speed	Base	Grade Length, mi	-
Base Free-Flow Speed (BFFS), mi/h	65.0	Total Ramp Density (TRD), ramps/mi	1.50
Lane Width, ft	12	Free-Flow Speed (FFS), mi/h	60.5
Right-Side Lateral Clearance, ft	10		

Adjustment Factors

Driver Population	All Familiar	Final Speed Adjustment Factor (SAF)	1.000
Weather Type	Non-Severe Weather	Final Capacity Adjustment Factor (CAF)	1.000
Incident Type	No Incident	Demand Adjustment Factor (DAF)	1.000

Demand and Capacity

Demand Volume veh/h	3489	Heavy Vehicle Adjustment Factor (fhv)	0.858
Peak Hour Factor	0.94	Flow Rate (Vp), pc/h/ln	1442
Total Trucks, %	16.51	Capacity (c), pc/h/ln	2305
Single-Unit Trucks (SUT), %	-	Adjusted Capacity (cadj), pc/h/ln	2305
Tractor-Trailers (TT), %	-	Volume-to-Capacity Ratio (v/c)	0.63
Passenger Car Equivalent (ET)	2.000		

Speed and Density

Lane Width Adjustment (fLW)	0.0	Average Speed (S), mi/h	60.5
Right-Side Lateral Clearance Adj. (fRLC)	0.0	Density (D), pc/mi/ln	23.8
Total Ramp Density Adjustment	4.5	Level of Service (LOS)	C
Adjusted Free-Flow Speed (FFSadj), mi/h	60.5		

HCS7 Freeway Diverge Report

Project Information

Analyst	LSA	Date	12/11/2019
Agency	LSA	Analysis Year	Phase I Proj Comp Yr (2029) WP
Jurisdiction	Caltrans	Time Period Analyzed	AM Peak Hour
Project Description	CMD1801 - Village D Specific Plan	Unit	United States Customary

Geometric Data

	Freeway	Ramp
Number of Lanes (N), ln	3	1
Free-Flow Speed (FFS), mi/h	65.0	35.0
Segment Length (L) / Deceleration Length (LA),ft	1500	130
Terrain Type	Level	Level
Percent Grade, %	-	-
Segment Type / Ramp Side	Freeway	Right

Adjustment Factors

Driver Population	All Familiar	All Familiar
Weather Type	Non-Severe Weather	Non-Severe Weather
Incident Type	No Incident	-
Final Speed Adjustment Factor (SAF)	1.000	1.000
Final Capacity Adjustment Factor (CAF)	1.000	1.000
Demand Adjustment Factor (DAF)	1.000	1.000

Demand and Capacity

Demand Volume (Vi)	3489	491
Peak Hour Factor (PHF)	0.94	0.94
Total Trucks, %	16.51	1.83
Single-Unit Trucks (SUT), %	-	-
Tractor-Trailers (TT), %	-	-
Heavy Vehicle Adjustment Factor (fHV)	0.858	0.982
Flow Rate (vi),pc/h	4326	532
Capacity (c), pc/h	7050	2000
Volume-to-Capacity Ratio (v/c)	0.61	0.27

Speed and Density

Upstream Equilibrium Distance (LEQ), ft	-	Number of Outer Lanes on Freeway (NO)	1
Distance to Upstream Ramp (LUP), ft	-	Speed Index (DS)	0.476
Downstream Equilibrium Distance (LEQ), ft	-	Flow Outer Lanes (vOA), pc/h/ln	1415
Distance to Downstream Ramp (LDOWN), ft	-	Off-Ramp Influence Area Speed (SR), mi/h	54.1
Prop. Freeway Vehicles in Lane 1 and 2 (PFD)	0.627	Outer Lanes Freeway Speed (SO), mi/h	69.7
Flow in Lanes 1 and 2 (v12), pc/h	2911	Ramp Junction Speed (S), mi/h	58.4
Flow Entering Ramp-Infl. Area (vR12), pc/h	-	Average Density (D), pc/mi/ln	24.7
Level of Service (LOS)	D	Density in Ramp Influence Area (DR), pc/mi/ln	28.1

HCS7 Basic Freeway Report

Project Information

Analyst	LSA	Date	12/11/2019
Agency	LSA	Analysis Year	Phase I Proj Comp Yr (2029) WP
Jurisdiction	Caltrans	Time Period Analyzed	AM Peak Hour
Project Description	CMD1801 - Village D Specific Plan	Unit	United States Customary

Geometric Data

Number of Lanes, ln	3	Terrain Type	Level
Segment Length (L), ft	-	Percent Grade, %	-
Measured or Base Free-Flow Speed	Base	Grade Length, mi	-
Base Free-Flow Speed (BFFS), mi/h	65.0	Total Ramp Density (TRD), ramps/mi	1.67
Lane Width, ft	12	Free-Flow Speed (FFS), mi/h	60.0
Right-Side Lateral Clearance, ft	10		

Adjustment Factors

Driver Population	All Familiar	Final Speed Adjustment Factor (SAF)	1.000
Weather Type	Non-Severe Weather	Final Capacity Adjustment Factor (CAF)	1.000
Incident Type	No Incident	Demand Adjustment Factor (DAF)	1.000

Demand and Capacity

Demand Volume veh/h	2998	Heavy Vehicle Adjustment Factor (fhv)	0.841
Peak Hour Factor	0.94	Flow Rate (Vp), pc/h/ln	1264
Total Trucks, %	18.93	Capacity (c), pc/h/ln	2300
Single-Unit Trucks (SUT), %	-	Adjusted Capacity (cadj), pc/h/ln	2300
Tractor-Trailers (TT), %	-	Volume-to-Capacity Ratio (v/c)	0.55
Passenger Car Equivalent (ET)	2.000		

Speed and Density

Lane Width Adjustment (fLW)	0.0	Average Speed (S), mi/h	60.0
Right-Side Lateral Clearance Adj. (fRLC)	0.0	Density (D), pc/mi/ln	21.1
Total Ramp Density Adjustment	5.0	Level of Service (LOS)	C
Adjusted Free-Flow Speed (FFSadj), mi/h	60.0		

HCS7 Freeway Merge Report

Project Information

Analyst	LSA	Date	12/11/2019
Agency	LSA	Analysis Year	Phase I Proj Comp Yr (2029) WP
Jurisdiction	Caltrans	Time Period Analyzed	AM Peak Hour
Project Description	CMD1801 - Village D Specific Plan	Unit	United States Customary

Geometric Data

	Freeway	Ramp
Number of Lanes (N), ln	3	1
Free-Flow Speed (FFS), mi/h	65.0	35.0
Segment Length (L) / Acceleration Length (LA),ft	1500	500
Terrain Type	Level	Level
Percent Grade, %	-	-
Segment Type / Ramp Side	Freeway	Right

Adjustment Factors

Driver Population	All Familiar	All Familiar
Weather Type	Non-Severe Weather	Non-Severe Weather
Incident Type	No Incident	-
Final Speed Adjustment Factor (SAF)	1.000	1.000
Final Capacity Adjustment Factor (CAF)	1.000	1.000
Demand Adjustment Factor (DAF)	1.000	1.000

Demand and Capacity

Demand Volume (Vi)	2998	307
Peak Hour Factor (PHF)	0.94	0.94
Total Trucks, %	18.93	2.93
Single-Unit Trucks (SUT), %	-	-
Tractor-Trailers (TT), %	-	-
Heavy Vehicle Adjustment Factor (fHV)	0.841	0.972
Flow Rate (vi),pc/h	3792	336
Capacity (c), pc/h	7050	2000
Volume-to-Capacity Ratio (v/c)	0.59	0.17

Speed and Density

Upstream Equilibrium Distance (LEQ), ft	-	Number of Outer Lanes on Freeway (NO)	1
Distance to Upstream Ramp (LUP), ft	-	Speed Index (MS)	0.338
Downstream Equilibrium Distance (LEQ), ft	-	Flow Outer Lanes (vOA), pc/h/ln	1547
Distance to Downstream Ramp (LDOWN), ft	-	On-Ramp Influence Area Speed (SR), mi/h	57.2
Prop. Freeway Vehicles in Lane 1 and 2 (PFM)	0.592	Outer Lanes Freeway Speed (SO), mi/h	61.2
Flow in Lanes 1 and 2 (v12), pc/h	2245	Ramp Junction Speed (S), mi/h	58.6
Flow Entering Ramp-Infl. Area (vR12), pc/h	2581	Average Density (D), pc/mi/ln	23.5
Level of Service (LOS)	C	Density in Ramp Influence Area (DR), pc/mi/ln	22.4

HCS7 Basic Freeway Report

Project Information

Analyst	LSA	Date	12/11/2019
Agency	LSA	Analysis Year	Phase I Proj Comp Yr (2029) WP
Jurisdiction	Caltrans	Time Period Analyzed	AM Peak Hour
Project Description	CMD1801 - Village D Specific Plan	Unit	United States Customary

Geometric Data

Number of Lanes, ln	3	Terrain Type	Level
Segment Length (L), ft	-	Percent Grade, %	-
Measured or Base Free-Flow Speed	Base	Grade Length, mi	-
Base Free-Flow Speed (BFFS), mi/h	65.0	Total Ramp Density (TRD), ramps/mi	1.83
Lane Width, ft	12	Free-Flow Speed (FFS), mi/h	59.7
Right-Side Lateral Clearance, ft	10		

Adjustment Factors

Driver Population	All Familiar	Final Speed Adjustment Factor (SAF)	1.000
Weather Type	Non-Severe Weather	Final Capacity Adjustment Factor (CAF)	1.000
Incident Type	No Incident	Demand Adjustment Factor (DAF)	1.000

Demand and Capacity

Demand Volume veh/h	3305	Heavy Vehicle Adjustment Factor (fhv)	0.852
Peak Hour Factor	0.94	Flow Rate (Vp), pc/h/ln	1376
Total Trucks, %	17.43	Capacity (c), pc/h/ln	2296
Single-Unit Trucks (SUT), %	-	Adjusted Capacity (cadj), pc/h/ln	2296
Tractor-Trailers (TT), %	-	Volume-to-Capacity Ratio (v/c)	0.60
Passenger Car Equivalent (ET)	2.000		

Speed and Density

Lane Width Adjustment (fLW)	0.0	Average Speed (S), mi/h	59.6
Right-Side Lateral Clearance Adj. (fRLC)	0.0	Density (D), pc/mi/ln	23.1
Total Ramp Density Adjustment	5.4	Level of Service (LOS)	C
Adjusted Free-Flow Speed (FFSadj), mi/h	59.6		

HCS7 Freeway Diverge Report

Project Information

Analyst	LSA	Date	12/11/2019
Agency	LSA	Analysis Year	Phase I Proj Comp Yr (2029) WP
Jurisdiction	Caltrans	Time Period Analyzed	AM Peak Hour
Project Description	CMD1801 - Village D Specific Plan	Unit	United States Customary

Geometric Data

	Freeway	Ramp
Number of Lanes (N), ln	3	1
Free-Flow Speed (FFS), mi/h	65.0	35.0
Segment Length (L) / Deceleration Length (LA),ft	1500	245
Terrain Type	Level	Level
Percent Grade, %	-	-
Segment Type / Ramp Side	Freeway	Right

Adjustment Factors

Driver Population	All Familiar	All Familiar
Weather Type	Non-Severe Weather	Non-Severe Weather
Incident Type	No Incident	-
Final Speed Adjustment Factor (SAF)	1.000	1.000
Final Capacity Adjustment Factor (CAF)	1.000	1.000
Demand Adjustment Factor (DAF)	1.000	1.000

Demand and Capacity

Demand Volume (Vi)	3305	665
Peak Hour Factor (PHF)	0.94	0.94
Total Trucks, %	17.43	3.76
Single-Unit Trucks (SUT), %	-	-
Tractor-Trailers (TT), %	-	-
Heavy Vehicle Adjustment Factor (fHV)	0.852	0.964
Flow Rate (vi),pc/h	4127	734
Capacity (c), pc/h	7050	2000
Volume-to-Capacity Ratio (v/c)	0.59	0.37

Speed and Density

Upstream Equilibrium Distance (LEQ), ft	-	Number of Outer Lanes on Freeway (NO)	1
Distance to Upstream Ramp (LUP), ft	-	Speed Index (DS)	0.494
Downstream Equilibrium Distance (LEQ), ft	-	Flow Outer Lanes (vOA), pc/h/ln	1279
Distance to Downstream Ramp (LDOWN), ft	-	Off-Ramp Influence Area Speed (SR), mi/h	53.6
Prop. Freeway Vehicles in Lane 1 and 2 (PFD)	0.623	Outer Lanes Freeway Speed (SO), mi/h	70.2
Flow in Lanes 1 and 2 (v12), pc/h	2848	Ramp Junction Speed (S), mi/h	57.8
Flow Entering Ramp-Infl. Area (vR12), pc/h	-	Average Density (D), pc/mi/ln	23.8
Level of Service (LOS)	C	Density in Ramp Influence Area (DR), pc/mi/ln	26.5

HCS7 Basic Freeway Report

Project Information

Analyst	LSA	Date	12/11/2019
Agency	LSA	Analysis Year	Phase I Proj Comp Yr (2029) WP
Jurisdiction	Caltrans	Time Period Analyzed	AM Peak Hour
Project Description	CMD1801 - Village D Specific Plan	Unit	United States Customary

Geometric Data

Number of Lanes, ln	3	Terrain Type	Level
Segment Length (L), ft	-	Percent Grade, %	-
Measured or Base Free-Flow Speed	Base	Grade Length, mi	-
Base Free-Flow Speed (BFFS), mi/h	65.0	Total Ramp Density (TRD), ramps/mi	1.83
Lane Width, ft	12	Free-Flow Speed (FFS), mi/h	59.7
Right-Side Lateral Clearance, ft	10		

Adjustment Factors

Driver Population	All Familiar	Final Speed Adjustment Factor (SAF)	1.000
Weather Type	Non-Severe Weather	Final Capacity Adjustment Factor (CAF)	1.000
Incident Type	No Incident	Demand Adjustment Factor (DAF)	1.000

Demand and Capacity

Demand Volume veh/h	2640	Heavy Vehicle Adjustment Factor (fhv)	0.827
Peak Hour Factor	0.94	Flow Rate (Vp), pc/h/ln	1132
Total Trucks, %	20.88	Capacity (c), pc/h/ln	2296
Single-Unit Trucks (SUT), %	-	Adjusted Capacity (cadj), pc/h/ln	2296
Tractor-Trailers (TT), %	-	Volume-to-Capacity Ratio (v/c)	0.49
Passenger Car Equivalent (ET)	2.000		

Speed and Density

Lane Width Adjustment (fLW)	0.0	Average Speed (S), mi/h	59.6
Right-Side Lateral Clearance Adj. (fRLC)	0.0	Density (D), pc/mi/ln	19.0
Total Ramp Density Adjustment	5.4	Level of Service (LOS)	C
Adjusted Free-Flow Speed (FFSadj), mi/h	59.6		

HCS7 Freeway Merge Report

Project Information

Analyst	LSA	Date	12/11/2019
Agency	LSA	Analysis Year	Phase I Proj Comp Yr (2029) WP
Jurisdiction	Caltrans	Time Period Analyzed	AM Peak Hour
Project Description	CMD1801 - Village D Specific Plan	Unit	United States Customary

Geometric Data

	Freeway	Ramp
Number of Lanes (N), ln	3	1
Free-Flow Speed (FFS), mi/h	65.0	35.0
Segment Length (L) / Acceleration Length (LA),ft	1500	350
Terrain Type	Level	Level
Percent Grade, %	-	-
Segment Type / Ramp Side	Freeway	Right

Adjustment Factors

Driver Population	All Familiar	All Familiar
Weather Type	Non-Severe Weather	Non-Severe Weather
Incident Type	No Incident	-
Final Speed Adjustment Factor (SAF)	1.000	1.000
Final Capacity Adjustment Factor (CAF)	1.000	1.000
Demand Adjustment Factor (DAF)	1.000	1.000

Demand and Capacity

Demand Volume (Vi)	2640	130
Peak Hour Factor (PHF)	0.94	0.94
Total Trucks, %	20.88	3.07
Single-Unit Trucks (SUT), %	-	-
Tractor-Trailers (TT), %	-	-
Heavy Vehicle Adjustment Factor (fHV)	0.827	0.970
Flow Rate (vi),pc/h	3396	143
Capacity (c), pc/h	7050	2000
Volume-to-Capacity Ratio (v/c)	0.50	0.07

Speed and Density

Upstream Equilibrium Distance (LEQ), ft	-	Number of Outer Lanes on Freeway (NO)	1
Distance to Upstream Ramp (LUP), ft	-	Speed Index (MS)	0.330
Downstream Equilibrium Distance (LEQ), ft	-	Flow Outer Lanes (vOA), pc/h/ln	1403
Distance to Downstream Ramp (LDOWN), ft	-	On-Ramp Influence Area Speed (SR), mi/h	57.4
Prop. Freeway Vehicles in Lane 1 and 2 (PFM)	0.587	Outer Lanes Freeway Speed (SO), mi/h	61.7
Flow in Lanes 1 and 2 (v12), pc/h	1993	Ramp Junction Speed (S), mi/h	59.0
Flow Entering Ramp-Infl. Area (vR12), pc/h	2136	Average Density (D), pc/mi/ln	20.0
Level of Service (LOS)	B	Density in Ramp Influence Area (DR), pc/mi/ln	19.9

HCS7 Basic Freeway Report

Project Information

Analyst	LSA	Date	12/11/2019
Agency	LSA	Analysis Year	Phase I Proj Comp Yr (2029) WP
Jurisdiction	Caltrans	Time Period Analyzed	AM Peak Hour
Project Description	CMD1801 - Village D Specific Plan	Unit	United States Customary

Geometric Data

Number of Lanes, ln	3	Terrain Type	Level
Segment Length (L), ft	-	Percent Grade, %	-
Measured or Base Free-Flow Speed	Base	Grade Length, mi	-
Base Free-Flow Speed (BFFS), mi/h	65.0	Total Ramp Density (TRD), ramps/mi	1.83
Lane Width, ft	12	Free-Flow Speed (FFS), mi/h	59.7
Right-Side Lateral Clearance, ft	10		

Adjustment Factors

Driver Population	All Familiar	Final Speed Adjustment Factor (SAF)	1.000
Weather Type	Non-Severe Weather	Final Capacity Adjustment Factor (CAF)	1.000
Incident Type	No Incident	Demand Adjustment Factor (DAF)	1.000

Demand and Capacity

Demand Volume veh/h	2770	Heavy Vehicle Adjustment Factor (fhv)	0.833
Peak Hour Factor	0.94	Flow Rate (Vp), pc/h/ln	1179
Total Trucks, %	20.04	Capacity (c), pc/h/ln	2296
Single-Unit Trucks (SUT), %	-	Adjusted Capacity (cadj), pc/h/ln	2296
Tractor-Trailers (TT), %	-	Volume-to-Capacity Ratio (v/c)	0.51
Passenger Car Equivalent (ET)	2.000		

Speed and Density

Lane Width Adjustment (fLW)	0.0	Average Speed (S), mi/h	59.6
Right-Side Lateral Clearance Adj. (fRLC)	0.0	Density (D), pc/mi/ln	19.8
Total Ramp Density Adjustment	5.4	Level of Service (LOS)	C
Adjusted Free-Flow Speed (FFSadj), mi/h	59.6		

HCS7 Freeway Diverge Report

Project Information

Analyst	LSA	Date	12/11/2019
Agency	LSA	Analysis Year	Phase I Proj Comp Yr (2029) WP
Jurisdiction	Caltrans	Time Period Analyzed	AM Peak Hour
Project Description	CMD1801 - Village D Specific Plan	Unit	United States Customary

Geometric Data

	Freeway	Ramp
Number of Lanes (N), ln	3	1
Free-Flow Speed (FFS), mi/h	65.0	15.0
Segment Length (L) / Deceleration Length (LA),ft	1500	150
Terrain Type	Level	Level
Percent Grade, %	-	-
Segment Type / Ramp Side	Freeway	Right

Adjustment Factors

Driver Population	All Familiar	All Familiar
Weather Type	Non-Severe Weather	Non-Severe Weather
Incident Type	No Incident	-
Final Speed Adjustment Factor (SAF)	1.000	1.000
Final Capacity Adjustment Factor (CAF)	1.000	1.000
Demand Adjustment Factor (DAF)	1.000	1.000

Demand and Capacity

Demand Volume (Vi)	2770	209
Peak Hour Factor (PHF)	0.94	0.94
Total Trucks, %	20.04	6.71
Single-Unit Trucks (SUT), %	-	-
Tractor-Trailers (TT), %	-	-
Heavy Vehicle Adjustment Factor (fHV)	0.833	0.937
Flow Rate (vi),pc/h	3538	237
Capacity (c), pc/h	7050	1800
Volume-to-Capacity Ratio (v/c)	0.50	0.13

Speed and Density

Upstream Equilibrium Distance (LEQ), ft	-	Number of Outer Lanes on Freeway (NO)	1
Distance to Upstream Ramp (LUP), ft	-	Speed Index (DS)	0.709
Downstream Equilibrium Distance (LEQ), ft	-	Flow Outer Lanes (vOA), pc/h/ln	1119
Distance to Downstream Ramp (LDOWN), ft	-	Off-Ramp Influence Area Speed (SR), mi/h	48.7
Prop. Freeway Vehicles in Lane 1 and 2 (PFD)	0.661	Outer Lanes Freeway Speed (SO), mi/h	70.8
Flow in Lanes 1 and 2 (v12), pc/h	2419	Ramp Junction Speed (S), mi/h	54.0
Flow Entering Ramp-Infl. Area (vR12), pc/h	-	Average Density (D), pc/mi/ln	21.8
Level of Service (LOS)	C	Density in Ramp Influence Area (DR), pc/mi/ln	23.7

HCS7 Basic Freeway Report

Project Information

Analyst	LSA	Date	12/11/2019
Agency	LSA	Analysis Year	Phase I Proj Comp Yr (2029) WP
Jurisdiction	Caltrans	Time Period Analyzed	AM Peak Hour
Project Description	CMD1801 - Village D Specific Plan	Unit	United States Customary

Geometric Data

Number of Lanes, ln	3	Terrain Type	Level
Segment Length (L), ft	-	Percent Grade, %	-
Measured or Base Free-Flow Speed	Base	Grade Length, mi	-
Base Free-Flow Speed (BFFS), mi/h	65.0	Total Ramp Density (TRD), ramps/mi	1.67
Lane Width, ft	12	Free-Flow Speed (FFS), mi/h	60.0
Right-Side Lateral Clearance, ft	10		

Adjustment Factors

Driver Population	All Familiar	Final Speed Adjustment Factor (SAF)	1.000
Weather Type	Non-Severe Weather	Final Capacity Adjustment Factor (CAF)	1.000
Incident Type	No Incident	Demand Adjustment Factor (DAF)	1.000

Demand and Capacity

Demand Volume veh/h	2562	Heavy Vehicle Adjustment Factor (fhv)	0.825
Peak Hour Factor	0.94	Flow Rate (Vp), pc/h/ln	1101
Total Trucks, %	21.14	Capacity (c), pc/h/ln	2300
Single-Unit Trucks (SUT), %	-	Adjusted Capacity (cadj), pc/h/ln	2300
Tractor-Trailers (TT), %	-	Volume-to-Capacity Ratio (v/c)	0.48
Passenger Car Equivalent (ET)	2.000		

Speed and Density

Lane Width Adjustment (fLW)	0.0	Average Speed (S), mi/h	60.0
Right-Side Lateral Clearance Adj. (fRLC)	0.0	Density (D), pc/mi/ln	18.4
Total Ramp Density Adjustment	5.0	Level of Service (LOS)	C
Adjusted Free-Flow Speed (FFSadj), mi/h	60.0		

HCS7 Freeway Merge Report

Project Information

Analyst	LSA	Date	12/11/2019
Agency	LSA	Analysis Year	Phase I Proj Comp Yr (2029) WP
Jurisdiction	Caltrans	Time Period Analyzed	AM Peak Hour
Project Description	CMD1801 - Village D Specific Plan	Unit	United States Customary

Geometric Data

	Freeway	Ramp
Number of Lanes (N), ln	3	1
Free-Flow Speed (FFS), mi/h	65.0	35.0
Segment Length (L) / Acceleration Length (LA),ft	1500	525
Terrain Type	Level	Level
Percent Grade, %	-	-
Segment Type / Ramp Side	Freeway	Right

Adjustment Factors

Driver Population	All Familiar	All Familiar
Weather Type	Non-Severe Weather	Non-Severe Weather
Incident Type	No Incident	-
Final Speed Adjustment Factor (SAF)	1.000	1.000
Final Capacity Adjustment Factor (CAF)	1.000	1.000
Demand Adjustment Factor (DAF)	1.000	1.000

Demand and Capacity

Demand Volume (Vi)	2562	204
Peak Hour Factor (PHF)	0.94	0.94
Total Trucks, %	21.14	4.42
Single-Unit Trucks (SUT), %	-	-
Tractor-Trailers (TT), %	-	-
Heavy Vehicle Adjustment Factor (fHV)	0.825	0.958
Flow Rate (vi),pc/h	3304	227
Capacity (c), pc/h	7050	2000
Volume-to-Capacity Ratio (v/c)	0.50	0.11

Speed and Density

Upstream Equilibrium Distance (LEQ), ft	-	Number of Outer Lanes on Freeway (NO)	1
Distance to Upstream Ramp (LUP), ft	-	Speed Index (MS)	0.319
Downstream Equilibrium Distance (LEQ), ft	-	Flow Outer Lanes (vOA), pc/h/ln	1348
Distance to Downstream Ramp (LDOWN), ft	-	On-Ramp Influence Area Speed (SR), mi/h	57.7
Prop. Freeway Vehicles in Lane 1 and 2 (PFM)	0.592	Outer Lanes Freeway Speed (SO), mi/h	61.9
Flow in Lanes 1 and 2 (v12), pc/h	1956	Ramp Junction Speed (S), mi/h	59.2
Flow Entering Ramp-Infl. Area (vR12), pc/h	2183	Average Density (D), pc/mi/ln	19.9
Level of Service (LOS)	B	Density in Ramp Influence Area (DR), pc/mi/ln	19.2

HCS7 Basic Freeway Report

Project Information

Analyst	LSA	Date	12/11/2019
Agency	LSA	Analysis Year	Phase I Proj Comp Yr (2029) WP
Jurisdiction	Caltrans	Time Period Analyzed	AM Peak Hour
Project Description	CMD1801 - Village D Specific Plan	Unit	United States Customary

Geometric Data

Number of Lanes, ln	3	Terrain Type	Level
Segment Length (L), ft	-	Percent Grade, %	-
Measured or Base Free-Flow Speed	Base	Grade Length, mi	-
Base Free-Flow Speed (BFFS), mi/h	65.0	Total Ramp Density (TRD), ramps/mi	1.67
Lane Width, ft	12	Free-Flow Speed (FFS), mi/h	60.0
Right-Side Lateral Clearance, ft	10		

Adjustment Factors

Driver Population	All Familiar	Final Speed Adjustment Factor (SAF)	1.000
Weather Type	Non-Severe Weather	Final Capacity Adjustment Factor (CAF)	1.000
Incident Type	No Incident	Demand Adjustment Factor (DAF)	1.000

Demand and Capacity

Demand Volume veh/h	2765	Heavy Vehicle Adjustment Factor (fhv)	0.834
Peak Hour Factor	0.94	Flow Rate (Vp), pc/h/ln	1176
Total Trucks, %	19.91	Capacity (c), pc/h/ln	2300
Single-Unit Trucks (SUT), %	-	Adjusted Capacity (cadj), pc/h/ln	2300
Tractor-Trailers (TT), %	-	Volume-to-Capacity Ratio (v/c)	0.51
Passenger Car Equivalent (ET)	2.000		

Speed and Density

Lane Width Adjustment (fLW)	0.0	Average Speed (S), mi/h	60.0
Right-Side Lateral Clearance Adj. (fRLC)	0.0	Density (D), pc/mi/ln	19.6
Total Ramp Density Adjustment	5.0	Level of Service (LOS)	C
Adjusted Free-Flow Speed (FFSadj), mi/h	60.0		

HCS7 Freeway Diverge Report

Project Information

Analyst	LSA	Date	12/11/2019
Agency	LSA	Analysis Year	Phase I Proj Comp Yr (2029) WP
Jurisdiction	Caltrans	Time Period Analyzed	AM Peak Hour
Project Description	CMD1801 - Village D Specific Plan	Unit	United States Customary

Geometric Data

	Freeway	Ramp
Number of Lanes (N), ln	3	1
Free-Flow Speed (FFS), mi/h	65.0	35.0
Segment Length (L) / Deceleration Length (LA),ft	1500	200
Terrain Type	Level	Level
Percent Grade, %	-	-
Segment Type / Ramp Side	Freeway	Right

Adjustment Factors

Driver Population	All Familiar	All Familiar
Weather Type	Non-Severe Weather	Non-Severe Weather
Incident Type	No Incident	-
Final Speed Adjustment Factor (SAF)	1.000	1.000
Final Capacity Adjustment Factor (CAF)	1.000	1.000
Demand Adjustment Factor (DAF)	1.000	1.000

Demand and Capacity

Demand Volume (Vi)	2765	399
Peak Hour Factor (PHF)	0.94	0.94
Total Trucks, %	19.91	13.78
Single-Unit Trucks (SUT), %	-	-
Tractor-Trailers (TT), %	-	-
Heavy Vehicle Adjustment Factor (fHV)	0.834	0.879
Flow Rate (vi),pc/h	3527	483
Capacity (c), pc/h	7050	2000
Volume-to-Capacity Ratio (v/c)	0.50	0.24

Speed and Density

Upstream Equilibrium Distance (LEQ), ft	-	Number of Outer Lanes on Freeway (NO)	1
Distance to Upstream Ramp (LUP), ft	-	Speed Index (DS)	0.471
Downstream Equilibrium Distance (LEQ), ft	-	Flow Outer Lanes (vOA), pc/h/ln	1065
Distance to Downstream Ramp (LDOWN), ft	-	Off-Ramp Influence Area Speed (SR), mi/h	54.2
Prop. Freeway Vehicles in Lane 1 and 2 (PFD)	0.650	Outer Lanes Freeway Speed (SO), mi/h	71.1
Flow in Lanes 1 and 2 (v12), pc/h	2462	Ramp Junction Speed (S), mi/h	58.4
Flow Entering Ramp-Infl. Area (vR12), pc/h	-	Average Density (D), pc/mi/ln	20.1
Level of Service (LOS)	C	Density in Ramp Influence Area (DR), pc/mi/ln	23.6

HCS7 Basic Freeway Report

Project Information

Analyst	LSA	Date	12/11/2019
Agency	LSA	Analysis Year	Phase I Proj Comp Yr (2029) WP
Jurisdiction	Caltrans	Time Period Analyzed	AM Peak Hour
Project Description	CMD1801 - Village D Specific Plan	Unit	United States Customary

Geometric Data

Number of Lanes, ln	3	Terrain Type	Level
Segment Length (L), ft	-	Percent Grade, %	-
Measured or Base Free-Flow Speed	Base	Grade Length, mi	-
Base Free-Flow Speed (BFFS), mi/h	70.0	Total Ramp Density (TRD), ramps/mi	1.50
Lane Width, ft	12	Free-Flow Speed (FFS), mi/h	65.5
Right-Side Lateral Clearance, ft	10		

Adjustment Factors

Driver Population	All Familiar	Final Speed Adjustment Factor (SAF)	1.000
Weather Type	Non-Severe Weather	Final Capacity Adjustment Factor (CAF)	1.000
Incident Type	No Incident	Demand Adjustment Factor (DAF)	1.000

Demand and Capacity

Demand Volume veh/h	2366	Heavy Vehicle Adjustment Factor (fhv)	0.827
Peak Hour Factor	0.94	Flow Rate (Vp), pc/h/ln	1015
Total Trucks, %	20.94	Capacity (c), pc/h/ln	2355
Single-Unit Trucks (SUT), %	-	Adjusted Capacity (cadj), pc/h/ln	2355
Tractor-Trailers (TT), %	-	Volume-to-Capacity Ratio (v/c)	0.43
Passenger Car Equivalent (ET)	2.000		

Speed and Density

Lane Width Adjustment (fLW)	0.0	Average Speed (S), mi/h	65.5
Right-Side Lateral Clearance Adj. (fRLC)	0.0	Density (D), pc/mi/ln	15.5
Total Ramp Density Adjustment	4.5	Level of Service (LOS)	B
Adjusted Free-Flow Speed (FFSadj), mi/h	65.5		

HCS7 Freeway Merge Report

Project Information

Analyst	LSA	Date	12/11/2019
Agency	LSA	Analysis Year	Phase I Proj Comp Yr (2029) WP
Jurisdiction	Caltrans	Time Period Analyzed	AM Peak Hour
Project Description	CMD1801 - Village D Specific Plan	Unit	United States Customary

Geometric Data

	Freeway	Ramp
Number of Lanes (N), ln	3	1
Free-Flow Speed (FFS), mi/h	70.0	35.0
Segment Length (L) / Acceleration Length (LA),ft	1500	400
Terrain Type	Level	Level
Percent Grade, %	-	-
Segment Type / Ramp Side	Freeway	Right

Adjustment Factors

Driver Population	All Familiar	All Familiar
Weather Type	Non-Severe Weather	Non-Severe Weather
Incident Type	No Incident	-
Final Speed Adjustment Factor (SAF)	1.000	1.000
Final Capacity Adjustment Factor (CAF)	1.000	1.000
Demand Adjustment Factor (DAF)	1.000	1.000

Demand and Capacity

Demand Volume (Vi)	2366	321
Peak Hour Factor (PHF)	0.94	0.94
Total Trucks, %	20.94	10.58
Single-Unit Trucks (SUT), %	-	-
Tractor-Trailers (TT), %	-	-
Heavy Vehicle Adjustment Factor (fHV)	0.827	0.904
Flow Rate (vi),pc/h	3044	378
Capacity (c), pc/h	7200	2000
Volume-to-Capacity Ratio (v/c)	0.48	0.19

Speed and Density

Upstream Equilibrium Distance (LEQ), ft	-	Number of Outer Lanes on Freeway (NO)	1
Distance to Upstream Ramp (LUP), ft	-	Speed Index (MS)	0.327
Downstream Equilibrium Distance (LEQ), ft	-	Flow Outer Lanes (vOA), pc/h/ln	1251
Distance to Downstream Ramp (LDOWN), ft	-	On-Ramp Influence Area Speed (SR), mi/h	60.8
Prop. Freeway Vehicles in Lane 1 and 2 (PFM)	0.589	Outer Lanes Freeway Speed (SO), mi/h	67.3
Flow in Lanes 1 and 2 (v12), pc/h	1793	Ramp Junction Speed (S), mi/h	63.0
Flow Entering Ramp-Infl. Area (vR12), pc/h	2171	Average Density (D), pc/mi/ln	18.1
Level of Service (LOS)	B	Density in Ramp Influence Area (DR), pc/mi/ln	19.8

HCS7 Basic Freeway Report

Project Information

Analyst	LSA	Date	12/11/2019
Agency	LSA	Analysis Year	Phase I Proj Comp Yr (2029) WP
Jurisdiction	Caltrans	Time Period Analyzed	AM Peak Hour
Project Description	CMD1801 - Village D Specific Plan	Unit	United States Customary

Geometric Data

Number of Lanes, ln	2	Terrain Type	Level
Segment Length (L), ft	-	Percent Grade, %	-
Measured or Base Free-Flow Speed	Base	Grade Length, mi	-
Base Free-Flow Speed (BFFS), mi/h	70.0	Total Ramp Density (TRD), ramps/mi	1.00
Lane Width, ft	12	Free-Flow Speed (FFS), mi/h	66.8
Right-Side Lateral Clearance, ft	10		

Adjustment Factors

Driver Population	All Familiar	Final Speed Adjustment Factor (SAF)	1.000
Weather Type	Non-Severe Weather	Final Capacity Adjustment Factor (CAF)	1.000
Incident Type	No Incident	Demand Adjustment Factor (DAF)	1.000

Demand and Capacity

Demand Volume veh/h	2688	Heavy Vehicle Adjustment Factor (fhv)	0.835
Peak Hour Factor	0.94	Flow Rate (Vp), pc/h/ln	1712
Total Trucks, %	19.70	Capacity (c), pc/h/ln	2368
Single-Unit Trucks (SUT), %	-	Adjusted Capacity (cadj), pc/h/ln	2368
Tractor-Trailers (TT), %	-	Volume-to-Capacity Ratio (v/c)	0.72
Passenger Car Equivalent (ET)	2.000		

Speed and Density

Lane Width Adjustment (fLW)	0.0	Average Speed (S), mi/h	64.9
Right-Side Lateral Clearance Adj. (fRLC)	0.0	Density (D), pc/mi/ln	26.4
Total Ramp Density Adjustment	3.2	Level of Service (LOS)	D
Adjusted Free-Flow Speed (FFSadj), mi/h	66.8		

HCS7 Freeway Diverge Report

Project Information

Analyst	LSA	Date	12/11/2019
Agency	LSA	Analysis Year	Phase I Proj Comp Yr (2029) WP
Jurisdiction	Caltrans	Time Period Analyzed	AM Peak Hour
Project Description	CMD1801 - Village D Specific Plan	Unit	United States Customary

Geometric Data

	Freeway	Ramp
Number of Lanes (N), ln	2	1
Free-Flow Speed (FFS), mi/h	70.0	35.0
Segment Length (L) / Deceleration Length (LA),ft	1500	200
Terrain Type	Level	Level
Percent Grade, %	-	-
Segment Type / Ramp Side	Freeway	Right

Adjustment Factors

Driver Population	All Familiar	All Familiar
Weather Type	Non-Severe Weather	Non-Severe Weather
Incident Type	No Incident	-
Final Speed Adjustment Factor (SAF)	1.000	1.000
Final Capacity Adjustment Factor (CAF)	1.000	1.000
Demand Adjustment Factor (DAF)	1.000	1.000

Demand and Capacity

Demand Volume (Vi)	2688	236
Peak Hour Factor (PHF)	0.94	0.94
Total Trucks, %	19.70	28.77
Single-Unit Trucks (SUT), %	-	-
Tractor-Trailers (TT), %	-	-
Heavy Vehicle Adjustment Factor (fHV)	0.835	0.777
Flow Rate (vi),pc/h	3425	323
Capacity (c), pc/h	4800	2000
Volume-to-Capacity Ratio (v/c)	0.71	0.16

Speed and Density

Upstream Equilibrium Distance (LEQ), ft	-	Number of Outer Lanes on Freeway (NO)	0
Distance to Upstream Ramp (LUP), ft	-	Speed Index (DS)	0.457
Downstream Equilibrium Distance (LEQ), ft	-	Flow Outer Lanes (vOA), pc/h/ln	-
Distance to Downstream Ramp (LDOWN), ft	-	Off-Ramp Influence Area Speed (SR), mi/h	57.2
Prop. Freeway Vehicles in Lane 1 and 2 (PFD)	1.000	Outer Lanes Freeway Speed (SO), mi/h	76.8
Flow in Lanes 1 and 2 (v12), pc/h	3425	Ramp Junction Speed (S), mi/h	57.2
Flow Entering Ramp-Infl. Area (vR12), pc/h	-	Average Density (D), pc/mi/ln	29.9
Level of Service (LOS)	D	Density in Ramp Influence Area (DR), pc/mi/ln	31.9

HCS7 Basic Freeway Report

Project Information

Analyst	LSA	Date	12/11/2019
Agency	LSA	Analysis Year	Phase I Proj Comp Yr (2029) WP
Jurisdiction	Caltrans	Time Period Analyzed	AM Peak Hour
Project Description	CMD1801 - Village D Specific Plan	Unit	United States Customary

Geometric Data

Number of Lanes, ln	2	Terrain Type	Level
Segment Length (L), ft	-	Percent Grade, %	-
Measured or Base Free-Flow Speed	Base	Grade Length, mi	-
Base Free-Flow Speed (BFFS), mi/h	70.0	Total Ramp Density (TRD), ramps/mi	1.00
Lane Width, ft	12	Free-Flow Speed (FFS), mi/h	66.8
Right-Side Lateral Clearance, ft	10		

Adjustment Factors

Driver Population	All Familiar	Final Speed Adjustment Factor (SAF)	1.000
Weather Type	Non-Severe Weather	Final Capacity Adjustment Factor (CAF)	1.000
Incident Type	No Incident	Demand Adjustment Factor (DAF)	1.000

Demand and Capacity

Demand Volume veh/h	2451	Heavy Vehicle Adjustment Factor (fhv)	0.842
Peak Hour Factor	0.94	Flow Rate (Vp), pc/h/ln	1548
Total Trucks, %	18.83	Capacity (c), pc/h/ln	2368
Single-Unit Trucks (SUT), %	-	Adjusted Capacity (cadj), pc/h/ln	2368
Tractor-Trailers (TT), %	-	Volume-to-Capacity Ratio (v/c)	0.65
Passenger Car Equivalent (ET)	2.000		

Speed and Density

Lane Width Adjustment (fLW)	0.0	Average Speed (S), mi/h	66.2
Right-Side Lateral Clearance Adj. (fRLC)	0.0	Density (D), pc/mi/ln	23.4
Total Ramp Density Adjustment	3.2	Level of Service (LOS)	C
Adjusted Free-Flow Speed (FFSadj), mi/h	66.8		

HCS7 Freeway Merge Report

Project Information

Analyst	LSA	Date	12/11/2019
Agency	LSA	Analysis Year	Phase I Proj Comp Yr (2029) WP
Jurisdiction	Caltrans	Time Period Analyzed	AM Peak Hour
Project Description	CMD1801 - Village D Specific Plan	Unit	United States Customary

Geometric Data

	Freeway	Ramp
Number of Lanes (N), ln	2	1
Free-Flow Speed (FFS), mi/h	70.0	35.0
Segment Length (L) / Acceleration Length (LA),ft	1500	700
Terrain Type	Level	Level
Percent Grade, %	-	-
Segment Type / Ramp Side	Freeway	Right

Adjustment Factors

Driver Population	All Familiar	All Familiar
Weather Type	Non-Severe Weather	Non-Severe Weather
Incident Type	No Incident	-
Final Speed Adjustment Factor (SAF)	1.000	1.000
Final Capacity Adjustment Factor (CAF)	1.000	1.000
Demand Adjustment Factor (DAF)	1.000	1.000

Demand and Capacity

Demand Volume (Vi)	2451	438
Peak Hour Factor (PHF)	0.94	0.94
Total Trucks, %	18.83	18.48
Single-Unit Trucks (SUT), %	-	-
Tractor-Trailers (TT), %	-	-
Heavy Vehicle Adjustment Factor (fHV)	0.842	0.844
Flow Rate (vi),pc/h	3097	552
Capacity (c), pc/h	4800	2000
Volume-to-Capacity Ratio (v/c)	0.76	0.28

Speed and Density

Upstream Equilibrium Distance (LEQ), ft	-	Number of Outer Lanes on Freeway (NO)	0
Distance to Upstream Ramp (LUP), ft	-	Speed Index (MS)	0.422
Downstream Equilibrium Distance (LEQ), ft	-	Flow Outer Lanes (vOA), pc/h/ln	-
Distance to Downstream Ramp (LDOWN), ft	-	On-Ramp Influence Area Speed (SR), mi/h	58.2
Prop. Freeway Vehicles in Lane 1 and 2 (PFM)	1.000	Outer Lanes Freeway Speed (SO), mi/h	70.0
Flow in Lanes 1 and 2 (v12), pc/h	3097	Ramp Junction Speed (S), mi/h	58.2
Flow Entering Ramp-Infl. Area (vR12), pc/h	3649	Average Density (D), pc/mi/ln	31.3
Level of Service (LOS)	D	Density in Ramp Influence Area (DR), pc/mi/ln	29.4

HCS7 Basic Freeway Report

Project Information

Analyst	LSA	Date	12/11/2019
Agency	LSA	Analysis Year	Phase I Proj Comp Yr (2029) WP
Jurisdiction	Caltrans	Time Period Analyzed	AM Peak Hour
Project Description	CMD1801 - Village D Specific Plan	Unit	United States Customary

Geometric Data

Number of Lanes, ln	2	Terrain Type	Level
Segment Length (L), ft	-	Percent Grade, %	-
Measured or Base Free-Flow Speed	Base	Grade Length, mi	-
Base Free-Flow Speed (BFFS), mi/h	70.0	Total Ramp Density (TRD), ramps/mi	1.00
Lane Width, ft	12	Free-Flow Speed (FFS), mi/h	66.8
Right-Side Lateral Clearance, ft	10		

Adjustment Factors

Driver Population	All Familiar	Final Speed Adjustment Factor (SAF)	1.000
Weather Type	Non-Severe Weather	Final Capacity Adjustment Factor (CAF)	1.000
Incident Type	No Incident	Demand Adjustment Factor (DAF)	1.000

Demand and Capacity

Demand Volume veh/h	2890	Heavy Vehicle Adjustment Factor (fhv)	0.842
Peak Hour Factor	0.94	Flow Rate (Vp), pc/h/ln	1826
Total Trucks, %	18.77	Capacity (c), pc/h/ln	2368
Single-Unit Trucks (SUT), %	-	Adjusted Capacity (cadj), pc/h/ln	2368
Tractor-Trailers (TT), %	-	Volume-to-Capacity Ratio (v/c)	0.77
Passenger Car Equivalent (ET)	2.000		

Speed and Density

Lane Width Adjustment (fLW)	0.0	Average Speed (S), mi/h	63.5
Right-Side Lateral Clearance Adj. (fRLC)	0.0	Density (D), pc/mi/ln	28.8
Total Ramp Density Adjustment	3.2	Level of Service (LOS)	D
Adjusted Free-Flow Speed (FFSadj), mi/h	66.8		

HCS7 Basic Freeway Report

Project Information

Analyst	LSA	Date	12/11/2019
Agency	LSA	Analysis Year	Phase I Proj Comp Yr (2029) WP
Jurisdiction	Caltrans	Time Period Analyzed	AM Peak Hour
Project Description	CMD1801 - Village D Specific Plan	Unit	United States Customary

Geometric Data

Number of Lanes, ln	2	Terrain Type	Level
Segment Length (L), ft	-	Percent Grade, %	-
Measured or Base Free-Flow Speed	Base	Grade Length, mi	-
Base Free-Flow Speed (BFFS), mi/h	70.0	Total Ramp Density (TRD), ramps/mi	1.00
Lane Width, ft	12	Free-Flow Speed (FFS), mi/h	66.8
Right-Side Lateral Clearance, ft	10		

Adjustment Factors

Driver Population	All Familiar	Final Speed Adjustment Factor (SAF)	1.000
Weather Type	Non-Severe Weather	Final Capacity Adjustment Factor (CAF)	1.000
Incident Type	No Incident	Demand Adjustment Factor (DAF)	1.000

Demand and Capacity

Demand Volume veh/h	2376	Heavy Vehicle Adjustment Factor (fhv)	0.785
Peak Hour Factor	0.94	Flow Rate (Vp), pc/h/ln	1610
Total Trucks, %	27.40	Capacity (c), pc/h/ln	2368
Single-Unit Trucks (SUT), %	-	Adjusted Capacity (cadj), pc/h/ln	2368
Tractor-Trailers (TT), %	-	Volume-to-Capacity Ratio (v/c)	0.68
Passenger Car Equivalent (ET)	2.000		

Speed and Density

Lane Width Adjustment (fLW)	0.0	Average Speed (S), mi/h	65.8
Right-Side Lateral Clearance Adj. (fRLC)	0.0	Density (D), pc/mi/ln	24.5
Total Ramp Density Adjustment	3.2	Level of Service (LOS)	C
Adjusted Free-Flow Speed (FFSadj), mi/h	66.8		

HCS7 Freeway Diverge Report

Project Information

Analyst	LSA	Date	12/11/2019
Agency	LSA	Analysis Year	Phase I Proj Comp Yr (2029) WP
Jurisdiction	Caltrans	Time Period Analyzed	AM Peak Hour
Project Description	CMD1801 - Village D Specific Plan	Unit	United States Customary

Geometric Data

	Freeway	Ramp
Number of Lanes (N), ln	2	1
Free-Flow Speed (FFS), mi/h	70.0	50.0
Segment Length (L) / Deceleration Length (LA),ft	1500	150
Terrain Type	Level	Level
Percent Grade, %	-	-
Segment Type / Ramp Side	Freeway	Right

Adjustment Factors

Driver Population	All Familiar	All Familiar
Weather Type	Non-Severe Weather	Non-Severe Weather
Incident Type	No Incident	-
Final Speed Adjustment Factor (SAF)	1.000	1.000
Final Capacity Adjustment Factor (CAF)	1.000	1.000
Demand Adjustment Factor (DAF)	1.000	1.000

Demand and Capacity

Demand Volume (Vi)	2376	212
Peak Hour Factor (PHF)	0.94	0.94
Total Trucks, %	27.40	24.49
Single-Unit Trucks (SUT), %	-	-
Tractor-Trailers (TT), %	-	-
Heavy Vehicle Adjustment Factor (fHV)	0.785	0.803
Flow Rate (vi),pc/h	3220	281
Capacity (c), pc/h	4800	2100
Volume-to-Capacity Ratio (v/c)	0.67	0.13

Speed and Density

Upstream Equilibrium Distance (LEQ), ft	-	Number of Outer Lanes on Freeway (NO)	0
Distance to Upstream Ramp (LUP), ft	-	Speed Index (DS)	0.258
Downstream Equilibrium Distance (LEQ), ft	-	Flow Outer Lanes (vOA), pc/h/ln	-
Distance to Downstream Ramp (LDOWN), ft	-	Off-Ramp Influence Area Speed (SR), mi/h	62.8
Prop. Freeway Vehicles in Lane 1 and 2 (PFD)	1.000	Outer Lanes Freeway Speed (SO), mi/h	76.8
Flow in Lanes 1 and 2 (v12), pc/h	3220	Ramp Junction Speed (S), mi/h	62.8
Flow Entering Ramp-Infl. Area (vR12), pc/h	-	Average Density (D), pc/mi/ln	25.6
Level of Service (LOS)	D	Density in Ramp Influence Area (DR), pc/mi/ln	30.6

HCS7 Basic Freeway Report

Project Information

Analyst	LSA	Date	12/11/2019
Agency	LSA	Analysis Year	Phase I Proj Comp Yr (2029) WP
Jurisdiction	Caltrans	Time Period Analyzed	AM Peak Hour
Project Description	CMD1801 - Village D Specific Plan	Unit	United States Customary

Geometric Data

Number of Lanes, ln	2	Terrain Type	Level
Segment Length (L), ft	-	Percent Grade, %	-
Measured or Base Free-Flow Speed	Base	Grade Length, mi	-
Base Free-Flow Speed (BFFS), mi/h	70.0	Total Ramp Density (TRD), ramps/mi	1.33
Lane Width, ft	12	Free-Flow Speed (FFS), mi/h	65.9
Right-Side Lateral Clearance, ft	10		

Adjustment Factors

Driver Population	All Familiar	Final Speed Adjustment Factor (SAF)	1.000
Weather Type	Non-Severe Weather	Final Capacity Adjustment Factor (CAF)	1.000
Incident Type	No Incident	Demand Adjustment Factor (DAF)	1.000

Demand and Capacity

Demand Volume veh/h	2163	Heavy Vehicle Adjustment Factor (fhv)	0.783
Peak Hour Factor	0.94	Flow Rate (Vp), pc/h/ln	1470
Total Trucks, %	27.68	Capacity (c), pc/h/ln	2359
Single-Unit Trucks (SUT), %	-	Adjusted Capacity (cadj), pc/h/ln	2359
Tractor-Trailers (TT), %	-	Volume-to-Capacity Ratio (v/c)	0.62
Passenger Car Equivalent (ET)	2.000		

Speed and Density

Lane Width Adjustment (fLW)	0.0	Average Speed (S), mi/h	65.7
Right-Side Lateral Clearance Adj. (fRLC)	0.0	Density (D), pc/mi/ln	22.4
Total Ramp Density Adjustment	4.1	Level of Service (LOS)	C
Adjusted Free-Flow Speed (FFSadj), mi/h	65.9		

HCS7 Freeway Merge Report

Project Information

Analyst	LSA	Date	12/11/2019
Agency	LSA	Analysis Year	Phase I Proj Comp Yr (2029) WP
Jurisdiction	Caltrans	Time Period Analyzed	AM Peak Hour
Project Description	CMD1801 - Village D Specific Plan	Unit	United States Customary

Geometric Data

	Freeway	Ramp
Number of Lanes (N), ln	2	1
Free-Flow Speed (FFS), mi/h	70.0	35.0
Segment Length (L) / Acceleration Length (LA),ft	1000	600
Terrain Type	Level	Level
Percent Grade, %	-	-
Segment Type / Ramp Side	Freeway	Right

Adjustment Factors

Driver Population	All Familiar	All Familiar
Weather Type	Non-Severe Weather	Non-Severe Weather
Incident Type	No Incident	-
Final Speed Adjustment Factor (SAF)	1.000	1.000
Final Capacity Adjustment Factor (CAF)	1.000	1.000
Demand Adjustment Factor (DAF)	1.000	1.000

Demand and Capacity

Demand Volume (Vi)	2163	36
Peak Hour Factor (PHF)	0.94	0.94
Total Trucks, %	27.68	13.76
Single-Unit Trucks (SUT), %	-	-
Tractor-Trailers (TT), %	-	-
Heavy Vehicle Adjustment Factor (fHV)	0.783	0.879
Flow Rate (vi),pc/h	2939	44
Capacity (c), pc/h	4800	2000
Volume-to-Capacity Ratio (v/c)	0.62	0.02

Speed and Density

Upstream Equilibrium Distance (LEQ), ft	-	Number of Outer Lanes on Freeway (NO)	0
Distance to Upstream Ramp (LUP), ft	-	Speed Index (MS)	0.356
Downstream Equilibrium Distance (LEQ), ft	-	Flow Outer Lanes (vOA), pc/h/ln	-
Distance to Downstream Ramp (LDOWN), ft	-	On-Ramp Influence Area Speed (SR), mi/h	60.0
Prop. Freeway Vehicles in Lane 1 and 2 (PFM)	1.000	Outer Lanes Freeway Speed (SO), mi/h	70.0
Flow in Lanes 1 and 2 (v12), pc/h	2939	Ramp Junction Speed (S), mi/h	60.0
Flow Entering Ramp-Infl. Area (vR12), pc/h	2983	Average Density (D), pc/mi/ln	24.9
Level of Service (LOS)	C	Density in Ramp Influence Area (DR), pc/mi/ln	25.0

HCS7 Basic Freeway Report

Project Information

Analyst	LSA	Date	12/11/2019
Agency	LSA	Analysis Year	Phase I Proj Comp Yr (2029) WP
Jurisdiction	Caltrans	Time Period Analyzed	AM Peak Hour
Project Description	CMD1801 - Village D Specific Plan	Unit	United States Customary

Geometric Data

Number of Lanes, ln	2	Terrain Type	Level
Segment Length (L), ft	-	Percent Grade, %	-
Measured or Base Free-Flow Speed	Base	Grade Length, mi	-
Base Free-Flow Speed (BFFS), mi/h	70.0	Total Ramp Density (TRD), ramps/mi	1.33
Lane Width, ft	12	Free-Flow Speed (FFS), mi/h	65.9
Right-Side Lateral Clearance, ft	10		

Adjustment Factors

Driver Population	All Familiar	Final Speed Adjustment Factor (SAF)	1.000
Weather Type	Non-Severe Weather	Final Capacity Adjustment Factor (CAF)	1.000
Incident Type	No Incident	Demand Adjustment Factor (DAF)	1.000

Demand and Capacity

Demand Volume veh/h	2200	Heavy Vehicle Adjustment Factor (fhv)	0.785
Peak Hour Factor	0.94	Flow Rate (Vp), pc/h/ln	1490
Total Trucks, %	27.45	Capacity (c), pc/h/ln	2359
Single-Unit Trucks (SUT), %	-	Adjusted Capacity (cadj), pc/h/ln	2359
Tractor-Trailers (TT), %	-	Volume-to-Capacity Ratio (v/c)	0.63
Passenger Car Equivalent (ET)	2.000		

Speed and Density

Lane Width Adjustment (fLW)	0.0	Average Speed (S), mi/h	65.7
Right-Side Lateral Clearance Adj. (fRLC)	0.0	Density (D), pc/mi/ln	22.7
Total Ramp Density Adjustment	4.1	Level of Service (LOS)	C
Adjusted Free-Flow Speed (FFSadj), mi/h	65.9		

HCS7 Freeway Merge Report

Project Information

Analyst	LSA	Date	12/11/2019
Agency	LSA	Analysis Year	Phase I Proj Comp Yr (2029) WP
Jurisdiction	Caltrans	Time Period Analyzed	AM Peak Hour
Project Description	CMD1801 - Village D Specific Plan	Unit	United States Customary

Geometric Data

	Freeway	Ramp
Number of Lanes (N), ln	2	1
Free-Flow Speed (FFS), mi/h	70.0	35.0
Segment Length (L) / Acceleration Length (LA),ft	1500	500
Terrain Type	Level	Level
Percent Grade, %	-	-
Segment Type / Ramp Side	Freeway	Right

Adjustment Factors

Driver Population	All Familiar	All Familiar
Weather Type	Non-Severe Weather	Non-Severe Weather
Incident Type	No Incident	-
Final Speed Adjustment Factor (SAF)	1.000	1.000
Final Capacity Adjustment Factor (CAF)	1.000	1.000
Demand Adjustment Factor (DAF)	1.000	1.000

Demand and Capacity

Demand Volume (Vi)	2200	193
Peak Hour Factor (PHF)	0.94	0.94
Total Trucks, %	27.45	32.07
Single-Unit Trucks (SUT), %	-	-
Tractor-Trailers (TT), %	-	-
Heavy Vehicle Adjustment Factor (fHV)	0.785	0.757
Flow Rate (vi),pc/h	2981	271
Capacity (c), pc/h	4800	2000
Volume-to-Capacity Ratio (v/c)	0.68	0.14

Speed and Density

Upstream Equilibrium Distance (LEQ), ft	-	Number of Outer Lanes on Freeway (NO)	0
Distance to Upstream Ramp (LUP), ft	-	Speed Index (MS)	0.387
Downstream Equilibrium Distance (LEQ), ft	-	Flow Outer Lanes (vOA), pc/h/ln	-
Distance to Downstream Ramp (LDOWN), ft	-	On-Ramp Influence Area Speed (SR), mi/h	59.2
Prop. Freeway Vehicles in Lane 1 and 2 (PFM)	1.000	Outer Lanes Freeway Speed (SO), mi/h	70.0
Flow in Lanes 1 and 2 (v12), pc/h	2981	Ramp Junction Speed (S), mi/h	59.2
Flow Entering Ramp-Infl. Area (vR12), pc/h	3252	Average Density (D), pc/mi/ln	27.5
Level of Service (LOS)	C	Density in Ramp Influence Area (DR), pc/mi/ln	27.7

HCS7 Basic Freeway Report

Project Information

Analyst	LSA	Date	12/11/2019
Agency	LSA	Analysis Year	Phase I Proj Comp Yr (2029) WP
Jurisdiction	Caltrans	Time Period Analyzed	AM Peak Hour
Project Description	CMD1801 - Village D Specific Plan	Unit	United States Customary

Geometric Data

Number of Lanes, ln	2	Terrain Type	Level
Segment Length (L), ft	-	Percent Grade, %	-
Measured or Base Free-Flow Speed	Base	Grade Length, mi	-
Base Free-Flow Speed (BFFS), mi/h	70.0	Total Ramp Density (TRD), ramps/mi	1.33
Lane Width, ft	12	Free-Flow Speed (FFS), mi/h	65.9
Right-Side Lateral Clearance, ft	10		

Adjustment Factors

Driver Population	All Familiar	Final Speed Adjustment Factor (SAF)	1.000
Weather Type	Non-Severe Weather	Final Capacity Adjustment Factor (CAF)	1.000
Incident Type	No Incident	Demand Adjustment Factor (DAF)	1.000

Demand and Capacity

Demand Volume veh/h	2393	Heavy Vehicle Adjustment Factor (fhv)	0.782
Peak Hour Factor	0.94	Flow Rate (Vp), pc/h/ln	1628
Total Trucks, %	27.82	Capacity (c), pc/h/ln	2359
Single-Unit Trucks (SUT), %	-	Adjusted Capacity (cadj), pc/h/ln	2359
Tractor-Trailers (TT), %	-	Volume-to-Capacity Ratio (v/c)	0.69
Passenger Car Equivalent (ET)	2.000		

Speed and Density

Lane Width Adjustment (fLW)	0.0	Average Speed (S), mi/h	65.0
Right-Side Lateral Clearance Adj. (fRLC)	0.0	Density (D), pc/mi/ln	25.0
Total Ramp Density Adjustment	4.1	Level of Service (LOS)	C
Adjusted Free-Flow Speed (FFSadj), mi/h	65.9		

HCS7 Freeway Diverge Report

Project Information

Analyst	LSA	Date	12/11/2019
Agency	LSA	Analysis Year	Phase I Proj Comp Yr (2029) WP
Jurisdiction	Caltrans	Time Period Analyzed	AM Peak Hour
Project Description	CMD1801 - Village D Specific Plan	Unit	United States Customary

Geometric Data

	Freeway	Ramp
Number of Lanes (N), ln	3	1
Free-Flow Speed (FFS), mi/h	70.0	35.0
Segment Length (L) / Deceleration Length (LA),ft	1500	150
Terrain Type	Level	Level
Percent Grade, %	-	-
Segment Type / Ramp Side	Freeway	Right

Adjustment Factors

Driver Population	All Familiar	All Familiar
Weather Type	Non-Severe Weather	Non-Severe Weather
Incident Type	No Incident	-
Final Speed Adjustment Factor (SAF)	1.000	1.000
Final Capacity Adjustment Factor (CAF)	1.000	1.000
Demand Adjustment Factor (DAF)	1.000	1.000

Demand and Capacity

Demand Volume (Vi)	2393	326
Peak Hour Factor (PHF)	0.94	0.94
Total Trucks, %	27.82	18.69
Single-Unit Trucks (SUT), %	-	-
Tractor-Trailers (TT), %	-	-
Heavy Vehicle Adjustment Factor (fHV)	0.782	0.843
Flow Rate (vi),pc/h	3255	411
Capacity (c), pc/h	7200	2000
Volume-to-Capacity Ratio (v/c)	0.45	0.21

Speed and Density

Upstream Equilibrium Distance (LEQ), ft	-	Number of Outer Lanes on Freeway (NO)	1
Distance to Upstream Ramp (LUP), ft	-	Speed Index (DS)	0.465
Downstream Equilibrium Distance (LEQ), ft	-	Flow Outer Lanes (vOA), pc/h/ln	967
Distance to Downstream Ramp (LDOWN), ft	-	Off-Ramp Influence Area Speed (SR), mi/h	57.0
Prop. Freeway Vehicles in Lane 1 and 2 (PFD)	0.660	Outer Lanes Freeway Speed (SO), mi/h	76.8
Flow in Lanes 1 and 2 (v12), pc/h	2288	Ramp Junction Speed (S), mi/h	61.7
Flow Entering Ramp-Infl. Area (vR12), pc/h	-	Average Density (D), pc/mi/ln	17.6
Level of Service (LOS)	C	Density in Ramp Influence Area (DR), pc/mi/ln	22.6

HCS7 Basic Freeway Report

Project Information

Analyst	LSA	Date	12/11/2019
Agency	LSA	Analysis Year	Phase I Proj Comp Yr (2029) WP
Jurisdiction	Caltrans	Time Period Analyzed	AM Peak Hour
Project Description	CMD1801 - Village D Specific Plan	Unit	United States Customary

Geometric Data

Number of Lanes, ln	3	Terrain Type	Level
Segment Length (L), ft	-	Percent Grade, %	-
Measured or Base Free-Flow Speed	Base	Grade Length, mi	-
Base Free-Flow Speed (BFFS), mi/h	70.0	Total Ramp Density (TRD), ramps/mi	1.67
Lane Width, ft	12	Free-Flow Speed (FFS), mi/h	65.0
Right-Side Lateral Clearance, ft	10		

Adjustment Factors

Driver Population	All Familiar	Final Speed Adjustment Factor (SAF)	1.000
Weather Type	Non-Severe Weather	Final Capacity Adjustment Factor (CAF)	1.000
Incident Type	No Incident	Demand Adjustment Factor (DAF)	1.000

Demand and Capacity

Demand Volume veh/h	2067	Heavy Vehicle Adjustment Factor (fhv)	0.774
Peak Hour Factor	0.94	Flow Rate (Vp), pc/h/ln	947
Total Trucks, %	29.27	Capacity (c), pc/h/ln	2350
Single-Unit Trucks (SUT), %	-	Adjusted Capacity (cadj), pc/h/ln	2350
Tractor-Trailers (TT), %	-	Volume-to-Capacity Ratio (v/c)	0.40
Passenger Car Equivalent (ET)	2.000		

Speed and Density

Lane Width Adjustment (fLW)	0.0	Average Speed (S), mi/h	65.0
Right-Side Lateral Clearance Adj. (fRLC)	0.0	Density (D), pc/mi/ln	14.6
Total Ramp Density Adjustment	5.0	Level of Service (LOS)	B
Adjusted Free-Flow Speed (FFSadj), mi/h	65.0		

HCS7 Freeway Merge Report

Project Information

Analyst	LSA	Date	12/11/2019
Agency	LSA	Analysis Year	Phase I Proj Comp Yr (2029) WP
Jurisdiction	Caltrans	Time Period Analyzed	AM Peak Hour
Project Description	CMD1801 - Village D Specific Plan	Unit	United States Customary

Geometric Data

	Freeway	Ramp
Number of Lanes (N), ln	3	1
Free-Flow Speed (FFS), mi/h	65.0	35.0
Segment Length (L) / Acceleration Length (LA),ft	1500	600
Terrain Type	Level	Level
Percent Grade, %	-	-
Segment Type / Ramp Side	Freeway	Right

Adjustment Factors

Driver Population	All Familiar	All Familiar
Weather Type	Non-Severe Weather	Non-Severe Weather
Incident Type	No Incident	-
Final Speed Adjustment Factor (SAF)	1.000	1.000
Final Capacity Adjustment Factor (CAF)	1.000	1.000
Demand Adjustment Factor (DAF)	1.000	1.000

Demand and Capacity

Demand Volume (Vi)	2067	692
Peak Hour Factor (PHF)	0.94	0.94
Total Trucks, %	29.27	4.04
Single-Unit Trucks (SUT), %	-	-
Tractor-Trailers (TT), %	-	-
Heavy Vehicle Adjustment Factor (fHV)	0.774	0.961
Flow Rate (vi),pc/h	2841	766
Capacity (c), pc/h	7050	2000
Volume-to-Capacity Ratio (v/c)	0.51	0.38

Speed and Density

Upstream Equilibrium Distance (LEQ), ft	-	Number of Outer Lanes on Freeway (NO)	1
Distance to Upstream Ramp (LUP), ft	-	Speed Index (MS)	0.324
Downstream Equilibrium Distance (LEQ), ft	-	Flow Outer Lanes (vOA), pc/h/ln	1153
Distance to Downstream Ramp (LDOWN), ft	-	On-Ramp Influence Area Speed (SR), mi/h	57.5
Prop. Freeway Vehicles in Lane 1 and 2 (PFM)	0.594	Outer Lanes Freeway Speed (SO), mi/h	62.6
Flow in Lanes 1 and 2 (v12), pc/h	1688	Ramp Junction Speed (S), mi/h	59.0
Flow Entering Ramp-Infl. Area (vR12), pc/h	2454	Average Density (D), pc/mi/ln	20.4
Level of Service (LOS)	C	Density in Ramp Influence Area (DR), pc/mi/ln	20.6

HCS7 Basic Freeway Report

Project Information

Analyst	LSA	Date	12/11/2019
Agency	LSA	Analysis Year	Phase I Proj Comp Yr (2029) WP
Jurisdiction	Caltrans	Time Period Analyzed	AM Peak Hour
Project Description	CMD1801 - Village D Specific Plan	Unit	United States Customary

Geometric Data

Number of Lanes, ln	3	Terrain Type	Level
Segment Length (L), ft	-	Percent Grade, %	-
Measured or Base Free-Flow Speed	Base	Grade Length, mi	-
Base Free-Flow Speed (BFFS), mi/h	65.0	Total Ramp Density (TRD), ramps/mi	1.83
Lane Width, ft	12	Free-Flow Speed (FFS), mi/h	59.7
Right-Side Lateral Clearance, ft	10		

Adjustment Factors

Driver Population	All Familiar	Final Speed Adjustment Factor (SAF)	1.000
Weather Type	Non-Severe Weather	Final Capacity Adjustment Factor (CAF)	1.000
Incident Type	No Incident	Demand Adjustment Factor (DAF)	1.000

Demand and Capacity

Demand Volume veh/h	2759	Heavy Vehicle Adjustment Factor (fhv)	0.813
Peak Hour Factor	0.94	Flow Rate (Vp), pc/h/ln	1203
Total Trucks, %	22.94	Capacity (c), pc/h/ln	2296
Single-Unit Trucks (SUT), %	-	Adjusted Capacity (cadj), pc/h/ln	2296
Tractor-Trailers (TT), %	-	Volume-to-Capacity Ratio (v/c)	0.52
Passenger Car Equivalent (ET)	2.000		

Speed and Density

Lane Width Adjustment (fLW)	0.0	Average Speed (S), mi/h	59.6
Right-Side Lateral Clearance Adj. (fRLC)	0.0	Density (D), pc/mi/ln	20.2
Total Ramp Density Adjustment	5.4	Level of Service (LOS)	C
Adjusted Free-Flow Speed (FFSadj), mi/h	59.6		

HCS7 Freeway Merge Report

Project Information

Analyst	LSA	Date	12/11/2019
Agency	LSA	Analysis Year	Phase I Proj Comp Yr (2029) WP
Jurisdiction	Caltrans	Time Period Analyzed	AM Peak Hour
Project Description	CMD1801 - Village D Specific Plan	Unit	United States Customary

Geometric Data

	Freeway	Ramp
Number of Lanes (N), ln	3	1
Free-Flow Speed (FFS), mi/h	65.0	35.0
Segment Length (L) / Acceleration Length (LA),ft	1500	600
Terrain Type	Level	Level
Percent Grade, %	-	-
Segment Type / Ramp Side	Freeway	Right

Adjustment Factors

Driver Population	All Familiar	All Familiar
Weather Type	Non-Severe Weather	Non-Severe Weather
Incident Type	No Incident	-
Final Speed Adjustment Factor (SAF)	1.000	1.000
Final Capacity Adjustment Factor (CAF)	1.000	1.000
Demand Adjustment Factor (DAF)	1.000	1.000

Demand and Capacity

Demand Volume (Vi)	2759	107
Peak Hour Factor (PHF)	0.94	0.94
Total Trucks, %	22.94	14.91
Single-Unit Trucks (SUT), %	-	-
Tractor-Trailers (TT), %	-	-
Heavy Vehicle Adjustment Factor (fHV)	0.813	0.870
Flow Rate (vi),pc/h	3610	131
Capacity (c), pc/h	7050	2000
Volume-to-Capacity Ratio (v/c)	0.53	0.07

Speed and Density

Upstream Equilibrium Distance (LEQ), ft	-	Number of Outer Lanes on Freeway (NO)	1
Distance to Upstream Ramp (LUP), ft	-	Speed Index (MS)	0.317
Downstream Equilibrium Distance (LEQ), ft	-	Flow Outer Lanes (vOA), pc/h/ln	1466
Distance to Downstream Ramp (LDOWN), ft	-	On-Ramp Influence Area Speed (SR), mi/h	57.7
Prop. Freeway Vehicles in Lane 1 and 2 (PFM)	0.594	Outer Lanes Freeway Speed (SO), mi/h	61.5
Flow in Lanes 1 and 2 (v12), pc/h	2144	Ramp Junction Speed (S), mi/h	59.1
Flow Entering Ramp-Infl. Area (vR12), pc/h	2275	Average Density (D), pc/mi/ln	21.1
Level of Service (LOS)	B	Density in Ramp Influence Area (DR), pc/mi/ln	19.5

HCS7 Basic Freeway Report

Project Information

Analyst	LSA	Date	12/11/2019
Agency	LSA	Analysis Year	Phase I Proj Comp Yr (2029) WP
Jurisdiction	Caltrans	Time Period Analyzed	AM Peak Hour
Project Description	CMD1801 - Village D Specific Plan	Unit	United States Customary

Geometric Data

Number of Lanes, ln	3	Terrain Type	Level
Segment Length (L), ft	-	Percent Grade, %	-
Measured or Base Free-Flow Speed	Base	Grade Length, mi	-
Base Free-Flow Speed (BFFS), mi/h	65.0	Total Ramp Density (TRD), ramps/mi	2.17
Lane Width, ft	12	Free-Flow Speed (FFS), mi/h	58.8
Right-Side Lateral Clearance, ft	10		

Adjustment Factors

Driver Population	All Familiar	Final Speed Adjustment Factor (SAF)	1.000
Weather Type	Non-Severe Weather	Final Capacity Adjustment Factor (CAF)	1.000
Incident Type	No Incident	Demand Adjustment Factor (DAF)	1.000

Demand and Capacity

Demand Volume veh/h	2866	Heavy Vehicle Adjustment Factor (fhv)	0.815
Peak Hour Factor	0.94	Flow Rate (Vp), pc/h/ln	1247
Total Trucks, %	22.63	Capacity (c), pc/h/ln	2288
Single-Unit Trucks (SUT), %	-	Adjusted Capacity (cadj), pc/h/ln	2288
Tractor-Trailers (TT), %	-	Volume-to-Capacity Ratio (v/c)	0.55
Passenger Car Equivalent (ET)	2.000		

Speed and Density

Lane Width Adjustment (fLW)	0.0	Average Speed (S), mi/h	58.8
Right-Side Lateral Clearance Adj. (fRLC)	0.0	Density (D), pc/mi/ln	21.2
Total Ramp Density Adjustment	6.2	Level of Service (LOS)	C
Adjusted Free-Flow Speed (FFSadj), mi/h	58.8		

HCS7 Freeway Diverge Report

Project Information

Analyst	LSA	Date	12/11/2019
Agency	LSA	Analysis Year	Phase I Proj Comp Yr (2029) WP
Jurisdiction	Caltrans	Time Period Analyzed	AM Peak Hour
Project Description	CMD1801 - Village D Specific Plan	Unit	United States Customary

Geometric Data

	Freeway	Ramp
Number of Lanes (N), ln	3	1
Free-Flow Speed (FFS), mi/h	65.0	40.0
Segment Length (L) / Deceleration Length (LA),ft	1500	150
Terrain Type	Level	Level
Percent Grade, %	-	-
Segment Type / Ramp Side	Freeway	Right

Adjustment Factors

Driver Population	All Familiar	All Familiar
Weather Type	Non-Severe Weather	Non-Severe Weather
Incident Type	No Incident	-
Final Speed Adjustment Factor (SAF)	1.000	1.000
Final Capacity Adjustment Factor (CAF)	1.000	1.000
Demand Adjustment Factor (DAF)	1.000	1.000

Demand and Capacity

Demand Volume (Vi)	2866	176
Peak Hour Factor (PHF)	0.94	0.94
Total Trucks, %	22.63	3.98
Single-Unit Trucks (SUT), %	-	-
Tractor-Trailers (TT), %	-	-
Heavy Vehicle Adjustment Factor (fHV)	0.815	0.962
Flow Rate (vi),pc/h	3741	195
Capacity (c), pc/h	7050	2000
Volume-to-Capacity Ratio (v/c)	0.53	0.10

Speed and Density

Upstream Equilibrium Distance (LEQ), ft	-	Number of Outer Lanes on Freeway (NO)	1
Distance to Upstream Ramp (LUP), ft	-	Speed Index (DS)	0.381
Downstream Equilibrium Distance (LEQ), ft	-	Flow Outer Lanes (vOA), pc/h/ln	1213
Distance to Downstream Ramp (LDOWN), ft	-	Off-Ramp Influence Area Speed (SR), mi/h	56.2
Prop. Freeway Vehicles in Lane 1 and 2 (PFD)	0.658	Outer Lanes Freeway Speed (SO), mi/h	70.5
Flow in Lanes 1 and 2 (v12), pc/h	2528	Ramp Junction Speed (S), mi/h	60.2
Flow Entering Ramp-Infl. Area (vR12), pc/h	-	Average Density (D), pc/mi/ln	20.7
Level of Service (LOS)	C	Density in Ramp Influence Area (DR), pc/mi/ln	24.6

HCS7 Basic Freeway Report

Project Information

Analyst	LSA	Date	12/11/2019
Agency	LSA	Analysis Year	Phase I Proj Comp Yr (2029) WP
Jurisdiction	Caltrans	Time Period Analyzed	AM Peak Hour
Project Description	CMD1801 - Village D Specific Plan	Unit	United States Customary

Geometric Data

Number of Lanes, ln	3	Terrain Type	Level
Segment Length (L), ft	-	Percent Grade, %	-
Measured or Base Free-Flow Speed	Base	Grade Length, mi	-
Base Free-Flow Speed (BFFS), mi/h	65.0	Total Ramp Density (TRD), ramps/mi	1.83
Lane Width, ft	12	Free-Flow Speed (FFS), mi/h	59.7
Right-Side Lateral Clearance, ft	10		

Adjustment Factors

Driver Population	All Familiar	Final Speed Adjustment Factor (SAF)	1.000
Weather Type	Non-Severe Weather	Final Capacity Adjustment Factor (CAF)	1.000
Incident Type	No Incident	Demand Adjustment Factor (DAF)	1.000

Demand and Capacity

Demand Volume veh/h	2691	Heavy Vehicle Adjustment Factor (fhv)	0.808
Peak Hour Factor	0.94	Flow Rate (Vp), pc/h/ln	1181
Total Trucks, %	23.83	Capacity (c), pc/h/ln	2296
Single-Unit Trucks (SUT), %	-	Adjusted Capacity (cadj), pc/h/ln	2296
Tractor-Trailers (TT), %	-	Volume-to-Capacity Ratio (v/c)	0.51
Passenger Car Equivalent (ET)	2.000		

Speed and Density

Lane Width Adjustment (fLW)	0.0	Average Speed (S), mi/h	59.6
Right-Side Lateral Clearance Adj. (fRLC)	0.0	Density (D), pc/mi/ln	19.8
Total Ramp Density Adjustment	5.4	Level of Service (LOS)	C
Adjusted Free-Flow Speed (FFSadj), mi/h	59.6		

HCS7 Freeway Merge Report

Project Information

Analyst	LSA	Date	12/11/2019
Agency	LSA	Analysis Year	Phase I Proj Comp Yr (2029) WP
Jurisdiction	Caltrans	Time Period Analyzed	AM Peak Hour
Project Description	CMD1801 - Village D Specific Plan	Unit	United States Customary

Geometric Data

	Freeway	Ramp
Number of Lanes (N), ln	3	1
Free-Flow Speed (FFS), mi/h	65.0	35.0
Segment Length (L) / Acceleration Length (LA),ft	1500	800
Terrain Type	Level	Level
Percent Grade, %	-	-
Segment Type / Ramp Side	Freeway	Right

Adjustment Factors

Driver Population	All Familiar	All Familiar
Weather Type	Non-Severe Weather	Non-Severe Weather
Incident Type	No Incident	-
Final Speed Adjustment Factor (SAF)	1.000	1.000
Final Capacity Adjustment Factor (CAF)	1.000	1.000
Demand Adjustment Factor (DAF)	1.000	1.000

Demand and Capacity

Demand Volume (Vi)	2691	253
Peak Hour Factor (PHF)	0.94	0.94
Total Trucks, %	23.83	2.76
Single-Unit Trucks (SUT), %	-	-
Tractor-Trailers (TT), %	-	-
Heavy Vehicle Adjustment Factor (fHV)	0.808	0.973
Flow Rate (vi),pc/h	3543	277
Capacity (c), pc/h	7050	2000
Volume-to-Capacity Ratio (v/c)	0.54	0.14

Speed and Density

Upstream Equilibrium Distance (LEQ), ft	-	Number of Outer Lanes on Freeway (NO)	1
Distance to Upstream Ramp (LUP), ft	-	Speed Index (MS)	0.308
Downstream Equilibrium Distance (LEQ), ft	-	Flow Outer Lanes (vOA), pc/h/ln	1417
Distance to Downstream Ramp (LDOWN), ft	-	On-Ramp Influence Area Speed (SR), mi/h	57.9
Prop. Freeway Vehicles in Lane 1 and 2 (PFM)	0.600	Outer Lanes Freeway Speed (SO), mi/h	61.7
Flow in Lanes 1 and 2 (v12), pc/h	2126	Ramp Junction Speed (S), mi/h	59.3
Flow Entering Ramp-Infl. Area (vR12), pc/h	2403	Average Density (D), pc/mi/ln	21.5
Level of Service (LOS)	B	Density in Ramp Influence Area (DR), pc/mi/ln	19.1

HCS7 Basic Freeway Report

Project Information

Analyst	LSA	Date	12/11/2019
Agency	LSA	Analysis Year	Phase I Proj Comp Yr (2029) WP
Jurisdiction	Caltrans	Time Period Analyzed	AM Peak Hour
Project Description	CMD1801 - Village D Specific Plan	Unit	United States Customary

Geometric Data

Number of Lanes, ln	3	Terrain Type	Level
Segment Length (L), ft	-	Percent Grade, %	-
Measured or Base Free-Flow Speed	Base	Grade Length, mi	-
Base Free-Flow Speed (BFFS), mi/h	65.0	Total Ramp Density (TRD), ramps/mi	2.17
Lane Width, ft	12	Free-Flow Speed (FFS), mi/h	58.8
Right-Side Lateral Clearance, ft	10		

Adjustment Factors

Driver Population	All Familiar	Final Speed Adjustment Factor (SAF)	1.000
Weather Type	Non-Severe Weather	Final Capacity Adjustment Factor (CAF)	1.000
Incident Type	No Incident	Demand Adjustment Factor (DAF)	1.000

Demand and Capacity

Demand Volume veh/h	2944	Heavy Vehicle Adjustment Factor (fhv)	0.820
Peak Hour Factor	0.94	Flow Rate (Vp), pc/h/ln	1273
Total Trucks, %	22.01	Capacity (c), pc/h/ln	2288
Single-Unit Trucks (SUT), %	-	Adjusted Capacity (cadj), pc/h/ln	2288
Tractor-Trailers (TT), %	-	Volume-to-Capacity Ratio (v/c)	0.56
Passenger Car Equivalent (ET)	2.000		

Speed and Density

Lane Width Adjustment (fLW)	0.0	Average Speed (S), mi/h	58.8
Right-Side Lateral Clearance Adj. (fRLC)	0.0	Density (D), pc/mi/ln	21.6
Total Ramp Density Adjustment	6.2	Level of Service (LOS)	C
Adjusted Free-Flow Speed (FFSadj), mi/h	58.8		

HCS7 Freeway Diverge Report

Project Information

Analyst	LSA	Date	12/11/2019
Agency	LSA	Analysis Year	Phase I Proj Comp Yr (2029) WP
Jurisdiction	Caltrans	Time Period Analyzed	AM Peak Hour
Project Description	CMD1801 - Village D Specific Plan	Unit	United States Customary

Geometric Data

	Freeway	Ramp
Number of Lanes (N), ln	3	1
Free-Flow Speed (FFS), mi/h	65.0	35.0
Segment Length (L) / Deceleration Length (LA),ft	1500	200
Terrain Type	Level	Level
Percent Grade, %	-	-
Segment Type / Ramp Side	Freeway	Right

Adjustment Factors

Driver Population	All Familiar	All Familiar
Weather Type	Non-Severe Weather	Non-Severe Weather
Incident Type	No Incident	-
Final Speed Adjustment Factor (SAF)	1.000	1.000
Final Capacity Adjustment Factor (CAF)	1.000	1.000
Demand Adjustment Factor (DAF)	1.000	1.000

Demand and Capacity

Demand Volume (Vi)	2944	119
Peak Hour Factor (PHF)	0.94	0.94
Total Trucks, %	22.01	15.08
Single-Unit Trucks (SUT), %	-	-
Tractor-Trailers (TT), %	-	-
Heavy Vehicle Adjustment Factor (fHV)	0.820	0.869
Flow Rate (vi),pc/h	3819	146
Capacity (c), pc/h	7050	2000
Volume-to-Capacity Ratio (v/c)	0.54	0.07

Speed and Density

Upstream Equilibrium Distance (LEQ), ft	-	Number of Outer Lanes on Freeway (NO)	1
Distance to Upstream Ramp (LUP), ft	-	Speed Index (DS)	0.441
Downstream Equilibrium Distance (LEQ), ft	-	Flow Outer Lanes (vOA), pc/h/ln	1256
Distance to Downstream Ramp (LDOWN), ft	-	Off-Ramp Influence Area Speed (SR), mi/h	54.9
Prop. Freeway Vehicles in Lane 1 and 2 (PFD)	0.658	Outer Lanes Freeway Speed (SO), mi/h	70.3
Flow in Lanes 1 and 2 (v12), pc/h	2563	Ramp Junction Speed (S), mi/h	59.2
Flow Entering Ramp-Infl. Area (vR12), pc/h	-	Average Density (D), pc/mi/ln	21.5
Level of Service (LOS)	C	Density in Ramp Influence Area (DR), pc/mi/ln	24.5

HCS7 Basic Freeway Report

Project Information

Analyst	LSA	Date	12/11/2019
Agency	LSA	Analysis Year	Phase I Proj Comp Yr (2029) WP
Jurisdiction	Caltrans	Time Period Analyzed	AM Peak Hour
Project Description	CMD1801 - Village D Specific Plan	Unit	United States Customary

Geometric Data

Number of Lanes, ln	3	Terrain Type	Level
Segment Length (L), ft	-	Percent Grade, %	-
Measured or Base Free-Flow Speed	Base	Grade Length, mi	-
Base Free-Flow Speed (BFFS), mi/h	65.0	Total Ramp Density (TRD), ramps/mi	2.17
Lane Width, ft	12	Free-Flow Speed (FFS), mi/h	58.8
Right-Side Lateral Clearance, ft	10		

Adjustment Factors

Driver Population	All Familiar	Final Speed Adjustment Factor (SAF)	1.000
Weather Type	Non-Severe Weather	Final Capacity Adjustment Factor (CAF)	1.000
Incident Type	No Incident	Demand Adjustment Factor (DAF)	1.000

Demand and Capacity

Demand Volume veh/h	2825	Heavy Vehicle Adjustment Factor (fhv)	0.818
Peak Hour Factor	0.94	Flow Rate (Vp), pc/h/ln	1225
Total Trucks, %	22.32	Capacity (c), pc/h/ln	2288
Single-Unit Trucks (SUT), %	-	Adjusted Capacity (cadj), pc/h/ln	2288
Tractor-Trailers (TT), %	-	Volume-to-Capacity Ratio (v/c)	0.54
Passenger Car Equivalent (ET)	2.000		

Speed and Density

Lane Width Adjustment (fLW)	0.0	Average Speed (S), mi/h	58.8
Right-Side Lateral Clearance Adj. (fRLC)	0.0	Density (D), pc/mi/ln	20.8
Total Ramp Density Adjustment	6.2	Level of Service (LOS)	C
Adjusted Free-Flow Speed (FFSadj), mi/h	58.8		

HCS7 Freeway Merge Report

Project Information

Analyst	LSA	Date	12/11/2019
Agency	LSA	Analysis Year	Phase I Proj Comp Yr (2029) WP
Jurisdiction	Caltrans	Time Period Analyzed	AM Peak Hour
Project Description	CMD1801 - Village D Specific Plan	Unit	United States Customary

Geometric Data

	Freeway	Ramp
Number of Lanes (N), ln	3	1
Free-Flow Speed (FFS), mi/h	65.0	35.0
Segment Length (L) / Acceleration Length (LA),ft	1500	350
Terrain Type	Level	Level
Percent Grade, %	-	-
Segment Type / Ramp Side	Freeway	Right

Adjustment Factors

Driver Population	All Familiar	All Familiar
Weather Type	Non-Severe Weather	Non-Severe Weather
Incident Type	No Incident	-
Final Speed Adjustment Factor (SAF)	1.000	1.000
Final Capacity Adjustment Factor (CAF)	1.000	1.000
Demand Adjustment Factor (DAF)	1.000	1.000

Demand and Capacity

Demand Volume (Vi)	2825	1107
Peak Hour Factor (PHF)	0.94	0.94
Total Trucks, %	22.32	1.90
Single-Unit Trucks (SUT), %	-	-
Tractor-Trailers (TT), %	-	-
Heavy Vehicle Adjustment Factor (fHV)	0.818	0.981
Flow Rate (vi),pc/h	3674	1200
Capacity (c), pc/h	7050	2000
Volume-to-Capacity Ratio (v/c)	0.69	0.60

Speed and Density

Upstream Equilibrium Distance (LEQ), ft	-	Number of Outer Lanes on Freeway (NO)	1
Distance to Upstream Ramp (LUP), ft	-	Speed Index (MS)	0.408
Downstream Equilibrium Distance (LEQ), ft	-	Flow Outer Lanes (vOA), pc/h/ln	1517
Distance to Downstream Ramp (LDOWN), ft	-	On-Ramp Influence Area Speed (SR), mi/h	55.6
Prop. Freeway Vehicles in Lane 1 and 2 (PFM)	0.587	Outer Lanes Freeway Speed (SO), mi/h	61.3
Flow in Lanes 1 and 2 (v12), pc/h	2157	Ramp Junction Speed (S), mi/h	57.3
Flow Entering Ramp-Infl. Area (vR12), pc/h	3357	Average Density (D), pc/mi/ln	28.4
Level of Service (LOS)	D	Density in Ramp Influence Area (DR), pc/mi/ln	29.0

HCS7 Basic Freeway Report

Project Information

Analyst	LSA	Date	12/11/2019
Agency	LSA	Analysis Year	Phase I Proj Comp Yr (2029) WP
Jurisdiction	Caltrans	Time Period Analyzed	AM Peak Hour
Project Description	CMD1801 - Village D Specific Plan	Unit	United States Customary

Geometric Data

Number of Lanes, ln	3	Terrain Type	Level
Segment Length (L), ft	-	Percent Grade, %	-
Measured or Base Free-Flow Speed	Base	Grade Length, mi	-
Base Free-Flow Speed (BFFS), mi/h	65.0	Total Ramp Density (TRD), ramps/mi	2.17
Lane Width, ft	12	Free-Flow Speed (FFS), mi/h	58.8
Right-Side Lateral Clearance, ft	10		

Adjustment Factors

Driver Population	All Familiar	Final Speed Adjustment Factor (SAF)	1.000
Weather Type	Non-Severe Weather	Final Capacity Adjustment Factor (CAF)	1.000
Incident Type	No Incident	Demand Adjustment Factor (DAF)	1.000

Demand and Capacity

Demand Volume veh/h	3932	Heavy Vehicle Adjustment Factor (fhv)	0.858
Peak Hour Factor	0.94	Flow Rate (Vp), pc/h/ln	1625
Total Trucks, %	16.58	Capacity (c), pc/h/ln	2288
Single-Unit Trucks (SUT), %	-	Adjusted Capacity (cadj), pc/h/ln	2288
Tractor-Trailers (TT), %	-	Volume-to-Capacity Ratio (v/c)	0.71
Passenger Car Equivalent (ET)	2.000		

Speed and Density

Lane Width Adjustment (fLW)	0.0	Average Speed (S), mi/h	58.8
Right-Side Lateral Clearance Adj. (fRLC)	0.0	Density (D), pc/mi/ln	27.6
Total Ramp Density Adjustment	6.2	Level of Service (LOS)	D
Adjusted Free-Flow Speed (FFSadj), mi/h	58.8		

HCS7 Freeway Diverge Report

Project Information

Analyst	LSA	Date	12/11/2019
Agency	LSA	Analysis Year	Phase I Proj Comp Yr (2029) WP
Jurisdiction	Caltrans	Time Period Analyzed	AM Peak Hour
Project Description	CMD1801 - Village D Specific Plan	Unit	United States Customary

Geometric Data

	Freeway	Ramp
Number of Lanes (N), ln	3	1
Free-Flow Speed (FFS), mi/h	65.0	15.0
Segment Length (L) / Deceleration Length (LA),ft	1500	150
Terrain Type	Level	Level
Percent Grade, %	-	-
Segment Type / Ramp Side	Freeway	Right

Adjustment Factors

Driver Population	All Familiar	All Familiar
Weather Type	Non-Severe Weather	Non-Severe Weather
Incident Type	No Incident	-
Final Speed Adjustment Factor (SAF)	1.000	1.000
Final Capacity Adjustment Factor (CAF)	1.000	1.000
Demand Adjustment Factor (DAF)	1.000	1.000

Demand and Capacity

Demand Volume (Vi)	3932	425
Peak Hour Factor (PHF)	0.94	0.94
Total Trucks, %	16.58	3.30
Single-Unit Trucks (SUT), %	-	-
Tractor-Trailers (TT), %	-	-
Heavy Vehicle Adjustment Factor (fHV)	0.858	0.968
Flow Rate (vi),pc/h	4875	467
Capacity (c), pc/h	7050	1800
Volume-to-Capacity Ratio (v/c)	0.69	0.26

Speed and Density

Upstream Equilibrium Distance (LEQ), ft	-	Number of Outer Lanes on Freeway (NO)	1
Distance to Upstream Ramp (LUP), ft	-	Speed Index (DS)	0.730
Downstream Equilibrium Distance (LEQ), ft	-	Flow Outer Lanes (vOA), pc/h/ln	1688
Distance to Downstream Ramp (LDOWN), ft	-	Off-Ramp Influence Area Speed (SR), mi/h	48.2
Prop. Freeway Vehicles in Lane 1 and 2 (PFD)	0.617	Outer Lanes Freeway Speed (SO), mi/h	68.6
Flow in Lanes 1 and 2 (v12), pc/h	3187	Ramp Junction Speed (S), mi/h	53.7
Flow Entering Ramp-Infl. Area (vR12), pc/h	-	Average Density (D), pc/mi/ln	30.3
Level of Service (LOS)	D	Density in Ramp Influence Area (DR), pc/mi/ln	30.3

HCS7 Basic Freeway Report

Project Information

Analyst	LSA	Date	12/11/2019
Agency	LSA	Analysis Year	Phase I Proj Comp Yr (2029) WP
Jurisdiction	Caltrans	Time Period Analyzed	AM Peak Hour
Project Description	CMD1801 - Village D Specific Plan	Unit	United States Customary

Geometric Data

Number of Lanes, ln	3	Terrain Type	Level
Segment Length (L), ft	-	Percent Grade, %	-
Measured or Base Free-Flow Speed	Base	Grade Length, mi	-
Base Free-Flow Speed (BFFS), mi/h	65.0	Total Ramp Density (TRD), ramps/mi	1.83
Lane Width, ft	12	Free-Flow Speed (FFS), mi/h	59.7
Right-Side Lateral Clearance, ft	10		

Adjustment Factors

Driver Population	All Familiar	Final Speed Adjustment Factor (SAF)	1.000
Weather Type	Non-Severe Weather	Final Capacity Adjustment Factor (CAF)	1.000
Incident Type	No Incident	Demand Adjustment Factor (DAF)	1.000

Demand and Capacity

Demand Volume veh/h	3507	Heavy Vehicle Adjustment Factor (fhv)	0.846
Peak Hour Factor	0.94	Flow Rate (Vp), pc/h/ln	1470
Total Trucks, %	18.20	Capacity (c), pc/h/ln	2296
Single-Unit Trucks (SUT), %	-	Adjusted Capacity (cadj), pc/h/ln	2296
Tractor-Trailers (TT), %	-	Volume-to-Capacity Ratio (v/c)	0.64
Passenger Car Equivalent (ET)	2.000		

Speed and Density

Lane Width Adjustment (fLW)	0.0	Average Speed (S), mi/h	59.6
Right-Side Lateral Clearance Adj. (fRLC)	0.0	Density (D), pc/mi/ln	24.7
Total Ramp Density Adjustment	5.4	Level of Service (LOS)	C
Adjusted Free-Flow Speed (FFSadj), mi/h	59.6		

HCS7 Freeway Merge Report

Project Information

Analyst	LSA	Date	12/11/2019
Agency	LSA	Analysis Year	Phase I Proj Comp Yr (2029) WP
Jurisdiction	Caltrans	Time Period Analyzed	AM Peak Hour
Project Description	CMD1801 - Village D Specific Plan	Unit	United States Customary

Geometric Data

	Freeway	Ramp
Number of Lanes (N), ln	3	1
Free-Flow Speed (FFS), mi/h	65.0	35.0
Segment Length (L) / Acceleration Length (LA),ft	1500	450
Terrain Type	Level	Level
Percent Grade, %	-	-
Segment Type / Ramp Side	Freeway	Right

Adjustment Factors

Driver Population	All Familiar	All Familiar
Weather Type	Non-Severe Weather	Non-Severe Weather
Incident Type	No Incident	-
Final Speed Adjustment Factor (SAF)	1.000	1.000
Final Capacity Adjustment Factor (CAF)	1.000	1.000
Demand Adjustment Factor (DAF)	1.000	1.000

Demand and Capacity

Demand Volume (Vi)	3507	516
Peak Hour Factor (PHF)	0.94	0.94
Total Trucks, %	18.20	0.77
Single-Unit Trucks (SUT), %	-	-
Tractor-Trailers (TT), %	-	-
Heavy Vehicle Adjustment Factor (fHV)	0.846	0.992
Flow Rate (vi),pc/h	4410	553
Capacity (c), pc/h	7050	2000
Volume-to-Capacity Ratio (v/c)	0.70	0.28

Speed and Density

Upstream Equilibrium Distance (LEQ), ft	-	Number of Outer Lanes on Freeway (NO)	1
Distance to Upstream Ramp (LUP), ft	-	Speed Index (MS)	0.381
Downstream Equilibrium Distance (LEQ), ft	-	Flow Outer Lanes (vOA), pc/h/ln	1808
Distance to Downstream Ramp (LDOWN), ft	-	On-Ramp Influence Area Speed (SR), mi/h	56.2
Prop. Freeway Vehicles in Lane 1 and 2 (PFM)	0.590	Outer Lanes Freeway Speed (SO), mi/h	60.3
Flow in Lanes 1 and 2 (v12), pc/h	2602	Ramp Junction Speed (S), mi/h	57.6
Flow Entering Ramp-Infl. Area (vR12), pc/h	3155	Average Density (D), pc/mi/ln	28.7
Level of Service (LOS)	C	Density in Ramp Influence Area (DR), pc/mi/ln	27.1

HCS7 Basic Freeway Report

Project Information

Analyst	LSA	Date	12/11/2019
Agency	LSA	Analysis Year	Phase I Proj Comp Yr (2029) WP
Jurisdiction	Caltrans	Time Period Analyzed	AM Peak Hour
Project Description	CMD1801 - Village D Specific Plan	Unit	United States Customary

Geometric Data

Number of Lanes, ln	3	Terrain Type	Level
Segment Length (L), ft	-	Percent Grade, %	-
Measured or Base Free-Flow Speed	Base	Grade Length, mi	-
Base Free-Flow Speed (BFFS), mi/h	65.0	Total Ramp Density (TRD), ramps/mi	1.83
Lane Width, ft	12	Free-Flow Speed (FFS), mi/h	59.7
Right-Side Lateral Clearance, ft	10		

Adjustment Factors

Driver Population	All Familiar	Final Speed Adjustment Factor (SAF)	1.000
Weather Type	Non-Severe Weather	Final Capacity Adjustment Factor (CAF)	1.000
Incident Type	No Incident	Demand Adjustment Factor (DAF)	1.000

Demand and Capacity

Demand Volume veh/h	4024	Heavy Vehicle Adjustment Factor (fhv)	0.862
Peak Hour Factor	0.94	Flow Rate (Vp), pc/h/ln	1655
Total Trucks, %	15.97	Capacity (c), pc/h/ln	2296
Single-Unit Trucks (SUT), %	-	Adjusted Capacity (cadj), pc/h/ln	2296
Tractor-Trailers (TT), %	-	Volume-to-Capacity Ratio (v/c)	0.72
Passenger Car Equivalent (ET)	2.000		

Speed and Density

Lane Width Adjustment (fLW)	0.0	Average Speed (S), mi/h	59.6
Right-Side Lateral Clearance Adj. (fRLC)	0.0	Density (D), pc/mi/ln	27.8
Total Ramp Density Adjustment	5.4	Level of Service (LOS)	D
Adjusted Free-Flow Speed (FFSadj), mi/h	59.6		

HCS7 Freeway Diverge Report

Project Information

Analyst	LSA	Date	12/11/2019
Agency	LSA	Analysis Year	Phase I Proj Comp Yr (2029) WP
Jurisdiction	Caltrans	Time Period Analyzed	AM Peak Hour
Project Description	CMD1801 - Village D Specific Plan	Unit	United States Customary

Geometric Data

	Freeway	Ramp
Number of Lanes (N), ln	3	1
Free-Flow Speed (FFS), mi/h	65.0	35.0
Segment Length (L) / Deceleration Length (LA),ft	1500	140
Terrain Type	Level	Level
Percent Grade, %	-	-
Segment Type / Ramp Side	Freeway	Right

Adjustment Factors

Driver Population	All Familiar	All Familiar
Weather Type	Non-Severe Weather	Non-Severe Weather
Incident Type	No Incident	-
Final Speed Adjustment Factor (SAF)	1.000	1.000
Final Capacity Adjustment Factor (CAF)	1.000	1.000
Demand Adjustment Factor (DAF)	1.000	1.000

Demand and Capacity

Demand Volume (Vi)	4024	639
Peak Hour Factor (PHF)	0.94	0.94
Total Trucks, %	15.97	8.29
Single-Unit Trucks (SUT), %	-	-
Tractor-Trailers (TT), %	-	-
Heavy Vehicle Adjustment Factor (fHV)	0.862	0.923
Flow Rate (vi),pc/h	4966	736
Capacity (c), pc/h	7050	2000
Volume-to-Capacity Ratio (v/c)	0.70	0.37

Speed and Density

Upstream Equilibrium Distance (LEQ), ft	-	Number of Outer Lanes on Freeway (NO)	1
Distance to Upstream Ramp (LUP), ft	-	Speed Index (DS)	0.494
Downstream Equilibrium Distance (LEQ), ft	-	Flow Outer Lanes (vOA), pc/h/ln	1684
Distance to Downstream Ramp (LDOWN), ft	-	Off-Ramp Influence Area Speed (SR), mi/h	53.6
Prop. Freeway Vehicles in Lane 1 and 2 (PFD)	0.602	Outer Lanes Freeway Speed (SO), mi/h	68.6
Flow in Lanes 1 and 2 (v12), pc/h	3282	Ramp Junction Speed (S), mi/h	57.9
Flow Entering Ramp-Infl. Area (vR12), pc/h	-	Average Density (D), pc/mi/ln	28.6
Level of Service (LOS)	D	Density in Ramp Influence Area (DR), pc/mi/ln	31.2

HCS7 Basic Freeway Report

Project Information

Analyst	LSA	Date	12/11/2019
Agency	LSA	Analysis Year	Phase I Proj Comp Yr (2029) WP
Jurisdiction	Caltrans	Time Period Analyzed	AM Peak Hour
Project Description	CMD1801 - Village D Specific Plan	Unit	United States Customary

Geometric Data

Number of Lanes, ln	3	Terrain Type	Level
Segment Length (L), ft	-	Percent Grade, %	-
Measured or Base Free-Flow Speed	Base	Grade Length, mi	-
Base Free-Flow Speed (BFFS), mi/h	65.0	Total Ramp Density (TRD), ramps/mi	2.17
Lane Width, ft	12	Free-Flow Speed (FFS), mi/h	58.8
Right-Side Lateral Clearance, ft	10		

Adjustment Factors

Driver Population	All Familiar	Final Speed Adjustment Factor (SAF)	1.000
Weather Type	Non-Severe Weather	Final Capacity Adjustment Factor (CAF)	1.000
Incident Type	No Incident	Demand Adjustment Factor (DAF)	1.000

Demand and Capacity

Demand Volume veh/h	3384	Heavy Vehicle Adjustment Factor (fhv)	0.852
Peak Hour Factor	0.94	Flow Rate (Vp), pc/h/ln	1408
Total Trucks, %	17.42	Capacity (c), pc/h/ln	2288
Single-Unit Trucks (SUT), %	-	Adjusted Capacity (cadj), pc/h/ln	2288
Tractor-Trailers (TT), %	-	Volume-to-Capacity Ratio (v/c)	0.62
Passenger Car Equivalent (ET)	2.000		

Speed and Density

Lane Width Adjustment (fLW)	0.0	Average Speed (S), mi/h	58.8
Right-Side Lateral Clearance Adj. (fRLC)	0.0	Density (D), pc/mi/ln	23.9
Total Ramp Density Adjustment	6.2	Level of Service (LOS)	C
Adjusted Free-Flow Speed (FFSadj), mi/h	58.8		

HCS7 Freeway Merge Report

Project Information

Analyst	LSA	Date	12/11/2019
Agency	LSA	Analysis Year	Phase I Proj Comp Yr (2029) WP
Jurisdiction	Caltrans	Time Period Analyzed	AM Peak Hour
Project Description	CMD1801 - Village D Specific Plan	Unit	United States Customary

Geometric Data

	Freeway	Ramp
Number of Lanes (N), ln	3	1
Free-Flow Speed (FFS), mi/h	65.0	35.0
Segment Length (L) / Acceleration Length (LA),ft	1500	450
Terrain Type	Level	Level
Percent Grade, %	-	-
Segment Type / Ramp Side	Freeway	Right

Adjustment Factors

Driver Population	All Familiar	All Familiar
Weather Type	Non-Severe Weather	Non-Severe Weather
Incident Type	No Incident	-
Final Speed Adjustment Factor (SAF)	1.000	1.000
Final Capacity Adjustment Factor (CAF)	1.000	1.000
Demand Adjustment Factor (DAF)	1.000	1.000

Demand and Capacity

Demand Volume (Vi)	3384	321
Peak Hour Factor (PHF)	0.94	0.94
Total Trucks, %	17.42	2.49
Single-Unit Trucks (SUT), %	-	-
Tractor-Trailers (TT), %	-	-
Heavy Vehicle Adjustment Factor (fHV)	0.852	0.976
Flow Rate (vi),pc/h	4225	350
Capacity (c), pc/h	7050	2000
Volume-to-Capacity Ratio (v/c)	0.65	0.18

Speed and Density

Upstream Equilibrium Distance (LEQ), ft	-	Number of Outer Lanes on Freeway (NO)	1
Distance to Upstream Ramp (LUP), ft	-	Speed Index (MS)	0.356
Downstream Equilibrium Distance (LEQ), ft	-	Flow Outer Lanes (vOA), pc/h/ln	1732
Distance to Downstream Ramp (LDOWN), ft	-	On-Ramp Influence Area Speed (SR), mi/h	56.8
Prop. Freeway Vehicles in Lane 1 and 2 (PFM)	0.590	Outer Lanes Freeway Speed (SO), mi/h	60.6
Flow in Lanes 1 and 2 (v12), pc/h	2493	Ramp Junction Speed (S), mi/h	58.2
Flow Entering Ramp-Infl. Area (vR12), pc/h	2843	Average Density (D), pc/mi/ln	26.2
Level of Service (LOS)	C	Density in Ramp Influence Area (DR), pc/mi/ln	24.7

HCS7 Basic Freeway Report

Project Information

Analyst	LSA	Date	12/11/2019
Agency	LSA	Analysis Year	Phase I Proj Comp Yr (2029) WP
Jurisdiction	Caltrans	Time Period Analyzed	AM Peak Hour
Project Description	CMD1801 - Village D Specific Plan	Unit	United States Customary

Geometric Data

Number of Lanes, ln	3	Terrain Type	Level
Segment Length (L), ft	-	Percent Grade, %	-
Measured or Base Free-Flow Speed	Base	Grade Length, mi	-
Base Free-Flow Speed (BFFS), mi/h	65.0	Total Ramp Density (TRD), ramps/mi	2.17
Lane Width, ft	12	Free-Flow Speed (FFS), mi/h	58.8
Right-Side Lateral Clearance, ft	10		

Adjustment Factors

Driver Population	All Familiar	Final Speed Adjustment Factor (SAF)	1.000
Weather Type	Non-Severe Weather	Final Capacity Adjustment Factor (CAF)	1.000
Incident Type	No Incident	Demand Adjustment Factor (DAF)	1.000

Demand and Capacity

Demand Volume veh/h	3705	Heavy Vehicle Adjustment Factor (fhv)	0.861
Peak Hour Factor	0.94	Flow Rate (Vp), pc/h/ln	1526
Total Trucks, %	16.14	Capacity (c), pc/h/ln	2288
Single-Unit Trucks (SUT), %	-	Adjusted Capacity (cadj), pc/h/ln	2288
Tractor-Trailers (TT), %	-	Volume-to-Capacity Ratio (v/c)	0.67
Passenger Car Equivalent (ET)	2.000		

Speed and Density

Lane Width Adjustment (fLW)	0.0	Average Speed (S), mi/h	58.8
Right-Side Lateral Clearance Adj. (fRLC)	0.0	Density (D), pc/mi/ln	26.0
Total Ramp Density Adjustment	6.2	Level of Service (LOS)	C
Adjusted Free-Flow Speed (FFSadj), mi/h	58.8		

HCS7 Basic Freeway Report

Project Information

Analyst	LSA	Date	12/11/2019
Agency	LSA	Analysis Year	Phase I Proj Comp Yr (2029) WP
Jurisdiction	Caltrans	Time Period Analyzed	PM Peak Hour
Project Description	CMD1801 - Village D Specific Plan	Unit	United States Customary

Geometric Data

Number of Lanes, ln	3	Terrain Type	Level
Segment Length (L), ft	-	Percent Grade, %	-
Measured or Base Free-Flow Speed	Base	Grade Length, mi	-
Base Free-Flow Speed (BFFS), mi/h	65.0	Total Ramp Density (TRD), ramps/mi	1.83
Lane Width, ft	12	Free-Flow Speed (FFS), mi/h	59.7
Right-Side Lateral Clearance, ft	10		

Adjustment Factors

Driver Population	All Familiar	Final Speed Adjustment Factor (SAF)	1.000
Weather Type	Non-Severe Weather	Final Capacity Adjustment Factor (CAF)	1.000
Incident Type	No Incident	Demand Adjustment Factor (DAF)	1.000

Demand and Capacity

Demand Volume veh/h	3488	Heavy Vehicle Adjustment Factor (fhv)	0.861
Peak Hour Factor	0.94	Flow Rate (Vp), pc/h/ln	1437
Total Trucks, %	16.17	Capacity (c), pc/h/ln	2296
Single-Unit Trucks (SUT), %	-	Adjusted Capacity (cadj), pc/h/ln	2296
Tractor-Trailers (TT), %	-	Volume-to-Capacity Ratio (v/c)	0.63
Passenger Car Equivalent (ET)	2.000		

Speed and Density

Lane Width Adjustment (fLW)	0.0	Average Speed (S), mi/h	59.6
Right-Side Lateral Clearance Adj. (fRLC)	0.0	Density (D), pc/mi/ln	24.1
Total Ramp Density Adjustment	5.4	Level of Service (LOS)	C
Adjusted Free-Flow Speed (FFSadj), mi/h	59.6		

HCS7 Freeway Diverge Report

Project Information

Analyst	LSA	Date	12/11/2019
Agency	LSA	Analysis Year	Phase I Proj Comp Yr (2029) WP
Jurisdiction	Caltrans	Time Period Analyzed	PM Peak Hour
Project Description	CMD1801 - Village D Specific Plan	Unit	United States Customary

Geometric Data

	Freeway	Ramp
Number of Lanes (N), ln	3	1
Free-Flow Speed (FFS), mi/h	65.0	35.0
Segment Length (L) / Deceleration Length (LA),ft	1500	150
Terrain Type	Level	Level
Percent Grade, %	-	-
Segment Type / Ramp Side	Freeway	Right

Adjustment Factors

Driver Population	All Familiar	All Familiar
Weather Type	Non-Severe Weather	Non-Severe Weather
Incident Type	No Incident	-
Final Speed Adjustment Factor (SAF)	1.000	1.000
Final Capacity Adjustment Factor (CAF)	1.000	1.000
Demand Adjustment Factor (DAF)	1.000	1.000

Demand and Capacity

Demand Volume (Vi)	3488	247
Peak Hour Factor (PHF)	0.94	0.94
Total Trucks, %	16.17	0.81
Single-Unit Trucks (SUT), %	-	-
Tractor-Trailers (TT), %	-	-
Heavy Vehicle Adjustment Factor (fHV)	0.861	0.992
Flow Rate (vi),pc/h	4310	265
Capacity (c), pc/h	7050	2000
Volume-to-Capacity Ratio (v/c)	0.61	0.13

Speed and Density

Upstream Equilibrium Distance (LEQ), ft	-	Number of Outer Lanes on Freeway (NO)	1
Distance to Upstream Ramp (LUP), ft	-	Speed Index (DS)	0.452
Downstream Equilibrium Distance (LEQ), ft	-	Flow Outer Lanes (vOA), pc/h/ln	1456
Distance to Downstream Ramp (LDOWN), ft	-	Off-Ramp Influence Area Speed (SR), mi/h	54.6
Prop. Freeway Vehicles in Lane 1 and 2 (PFD)	0.640	Outer Lanes Freeway Speed (SO), mi/h	69.5
Flow in Lanes 1 and 2 (v12), pc/h	2854	Ramp Junction Speed (S), mi/h	58.9
Flow Entering Ramp-Infl. Area (vR12), pc/h	-	Average Density (D), pc/mi/ln	24.4
Level of Service (LOS)	C	Density in Ramp Influence Area (DR), pc/mi/ln	27.4

HCS7 Basic Freeway Report

Project Information

Analyst	LSA	Date	12/11/2019
Agency	LSA	Analysis Year	Phase I Proj Comp Yr (2029) WP
Jurisdiction	Caltrans	Time Period Analyzed	PM Peak Hour
Project Description	CMD1801 - Village D Specific Plan	Unit	United States Customary

Geometric Data

Number of Lanes, ln	3	Terrain Type	Level
Segment Length (L), ft	-	Percent Grade, %	-
Measured or Base Free-Flow Speed	Base	Grade Length, mi	-
Base Free-Flow Speed (BFFS), mi/h	65.0	Total Ramp Density (TRD), ramps/mi	1.83
Lane Width, ft	12	Free-Flow Speed (FFS), mi/h	59.7
Right-Side Lateral Clearance, ft	10		

Adjustment Factors

Driver Population	All Familiar	Final Speed Adjustment Factor (SAF)	1.000
Weather Type	Non-Severe Weather	Final Capacity Adjustment Factor (CAF)	1.000
Incident Type	No Incident	Demand Adjustment Factor (DAF)	1.000

Demand and Capacity

Demand Volume veh/h	3241	Heavy Vehicle Adjustment Factor (fhv)	0.852
Peak Hour Factor	0.94	Flow Rate (Vp), pc/h/ln	1349
Total Trucks, %	17.34	Capacity (c), pc/h/ln	2296
Single-Unit Trucks (SUT), %	-	Adjusted Capacity (cadj), pc/h/ln	2296
Tractor-Trailers (TT), %	-	Volume-to-Capacity Ratio (v/c)	0.59
Passenger Car Equivalent (ET)	2.000		

Speed and Density

Lane Width Adjustment (fLW)	0.0	Average Speed (S), mi/h	59.6
Right-Side Lateral Clearance Adj. (fRLC)	0.0	Density (D), pc/mi/ln	22.6
Total Ramp Density Adjustment	5.4	Level of Service (LOS)	C
Adjusted Free-Flow Speed (FFSadj), mi/h	59.6		

HCS7 Freeway Merge Report

Project Information

Analyst	LSA	Date	12/11/2019
Agency	LSA	Analysis Year	Phase I Proj Comp Yr (2029) WP
Jurisdiction	Caltrans	Time Period Analyzed	PM Peak Hour
Project Description	CMD1801 - Village D Specific Plan	Unit	United States Customary

Geometric Data

	Freeway	Ramp
Number of Lanes (N), ln	3	1
Free-Flow Speed (FFS), mi/h	65.0	35.0
Segment Length (L) / Acceleration Length (LA),ft	1500	445
Terrain Type	Level	Level
Percent Grade, %	-	-
Segment Type / Ramp Side	Freeway	Right

Adjustment Factors

Driver Population	All Familiar	All Familiar
Weather Type	Non-Severe Weather	Non-Severe Weather
Incident Type	No Incident	-
Final Speed Adjustment Factor (SAF)	1.000	1.000
Final Capacity Adjustment Factor (CAF)	1.000	1.000
Demand Adjustment Factor (DAF)	1.000	1.000

Demand and Capacity

Demand Volume (Vi)	3241	777
Peak Hour Factor (PHF)	0.94	0.94
Total Trucks, %	17.34	2.45
Single-Unit Trucks (SUT), %	-	-
Tractor-Trailers (TT), %	-	-
Heavy Vehicle Adjustment Factor (fHV)	0.852	0.976
Flow Rate (vi),pc/h	4047	847
Capacity (c), pc/h	7050	2000
Volume-to-Capacity Ratio (v/c)	0.69	0.42

Speed and Density

Upstream Equilibrium Distance (LEQ), ft	-	Number of Outer Lanes on Freeway (NO)	1
Distance to Upstream Ramp (LUP), ft	-	Speed Index (MS)	0.389
Downstream Equilibrium Distance (LEQ), ft	-	Flow Outer Lanes (vOA), pc/h/ln	1659
Distance to Downstream Ramp (LDOWN), ft	-	On-Ramp Influence Area Speed (SR), mi/h	56.1
Prop. Freeway Vehicles in Lane 1 and 2 (PFM)	0.590	Outer Lanes Freeway Speed (SO), mi/h	60.8
Flow in Lanes 1 and 2 (v12), pc/h	2388	Ramp Junction Speed (S), mi/h	57.6
Flow Entering Ramp-Infl. Area (vR12), pc/h	3235	Average Density (D), pc/mi/ln	28.3
Level of Service (LOS)	C	Density in Ramp Influence Area (DR), pc/mi/ln	27.6

HCS7 Basic Freeway Report

Project Information

Analyst	LSA	Date	12/11/2019
Agency	LSA	Analysis Year	Phase I Proj Comp Yr (2029) WP
Jurisdiction	Caltrans	Time Period Analyzed	PM Peak Hour
Project Description	CMD1801 - Village D Specific Plan	Unit	United States Customary

Geometric Data

Number of Lanes, ln	3	Terrain Type	Level
Segment Length (L), ft	-	Percent Grade, %	-
Measured or Base Free-Flow Speed	Base	Grade Length, mi	-
Base Free-Flow Speed (BFFS), mi/h	65.0	Total Ramp Density (TRD), ramps/mi	1.50
Lane Width, ft	12	Free-Flow Speed (FFS), mi/h	60.5
Right-Side Lateral Clearance, ft	10		

Adjustment Factors

Driver Population	All Familiar	Final Speed Adjustment Factor (SAF)	1.000
Weather Type	Non-Severe Weather	Final Capacity Adjustment Factor (CAF)	1.000
Incident Type	No Incident	Demand Adjustment Factor (DAF)	1.000

Demand and Capacity

Demand Volume veh/h	4018	Heavy Vehicle Adjustment Factor (fhv)	0.874
Peak Hour Factor	0.94	Flow Rate (Vp), pc/h/ln	1630
Total Trucks, %	14.46	Capacity (c), pc/h/ln	2305
Single-Unit Trucks (SUT), %	-	Adjusted Capacity (cadj), pc/h/ln	2305
Tractor-Trailers (TT), %	-	Volume-to-Capacity Ratio (v/c)	0.71
Passenger Car Equivalent (ET)	2.000		

Speed and Density

Lane Width Adjustment (fLW)	0.0	Average Speed (S), mi/h	60.5
Right-Side Lateral Clearance Adj. (fRLC)	0.0	Density (D), pc/mi/ln	26.9
Total Ramp Density Adjustment	4.5	Level of Service (LOS)	D
Adjusted Free-Flow Speed (FFSadj), mi/h	60.5		

HCS7 Freeway Diverge Report

Project Information

Analyst	LSA	Date	12/11/2019
Agency	LSA	Analysis Year	Phase I Proj Comp Yr (2029) WP
Jurisdiction	Caltrans	Time Period Analyzed	PM Peak Hour
Project Description	CMD1801 - Village D Specific Plan	Unit	United States Customary

Geometric Data

	Freeway	Ramp
Number of Lanes (N), ln	3	1
Free-Flow Speed (FFS), mi/h	65.0	35.0
Segment Length (L) / Deceleration Length (LA),ft	1500	130
Terrain Type	Level	Level
Percent Grade, %	-	-
Segment Type / Ramp Side	Freeway	Right

Adjustment Factors

Driver Population	All Familiar	All Familiar
Weather Type	Non-Severe Weather	Non-Severe Weather
Incident Type	No Incident	-
Final Speed Adjustment Factor (SAF)	1.000	1.000
Final Capacity Adjustment Factor (CAF)	1.000	1.000
Demand Adjustment Factor (DAF)	1.000	1.000

Demand and Capacity

Demand Volume (Vi)	4018	446
Peak Hour Factor (PHF)	0.94	0.94
Total Trucks, %	14.46	1.35
Single-Unit Trucks (SUT), %	-	-
Tractor-Trailers (TT), %	-	-
Heavy Vehicle Adjustment Factor (fHV)	0.874	0.987
Flow Rate (vi),pc/h	4891	481
Capacity (c), pc/h	7050	2000
Volume-to-Capacity Ratio (v/c)	0.69	0.24

Speed and Density

Upstream Equilibrium Distance (LEQ), ft	-	Number of Outer Lanes on Freeway (NO)	1
Distance to Upstream Ramp (LUP), ft	-	Speed Index (DS)	0.471
Downstream Equilibrium Distance (LEQ), ft	-	Flow Outer Lanes (vOA), pc/h/ln	1693
Distance to Downstream Ramp (LDOWN), ft	-	Off-Ramp Influence Area Speed (SR), mi/h	54.2
Prop. Freeway Vehicles in Lane 1 and 2 (PFD)	0.616	Outer Lanes Freeway Speed (SO), mi/h	68.6
Flow in Lanes 1 and 2 (v12), pc/h	3198	Ramp Junction Speed (S), mi/h	58.4
Flow Entering Ramp-Infl. Area (vR12), pc/h	-	Average Density (D), pc/mi/ln	27.9
Level of Service (LOS)	D	Density in Ramp Influence Area (DR), pc/mi/ln	30.6

HCS7 Basic Freeway Report

Project Information

Analyst	LSA	Date	12/11/2019
Agency	LSA	Analysis Year	Phase I Proj Comp Yr (2029) WP
Jurisdiction	Caltrans	Time Period Analyzed	PM Peak Hour
Project Description	CMD1801 - Village D Specific Plan	Unit	United States Customary

Geometric Data

Number of Lanes, ln	3	Terrain Type	Level
Segment Length (L), ft	-	Percent Grade, %	-
Measured or Base Free-Flow Speed	Base	Grade Length, mi	-
Base Free-Flow Speed (BFFS), mi/h	65.0	Total Ramp Density (TRD), ramps/mi	1.67
Lane Width, ft	12	Free-Flow Speed (FFS), mi/h	60.0
Right-Side Lateral Clearance, ft	10		

Adjustment Factors

Driver Population	All Familiar	Final Speed Adjustment Factor (SAF)	1.000
Weather Type	Non-Severe Weather	Final Capacity Adjustment Factor (CAF)	1.000
Incident Type	No Incident	Demand Adjustment Factor (DAF)	1.000

Demand and Capacity

Demand Volume veh/h	3572	Heavy Vehicle Adjustment Factor (fhv)	0.861
Peak Hour Factor	0.94	Flow Rate (Vp), pc/h/ln	1471
Total Trucks, %	16.11	Capacity (c), pc/h/ln	2300
Single-Unit Trucks (SUT), %	-	Adjusted Capacity (cadj), pc/h/ln	2300
Tractor-Trailers (TT), %	-	Volume-to-Capacity Ratio (v/c)	0.64
Passenger Car Equivalent (ET)	2.000		

Speed and Density

Lane Width Adjustment (fLW)	0.0	Average Speed (S), mi/h	60.0
Right-Side Lateral Clearance Adj. (fRLC)	0.0	Density (D), pc/mi/ln	24.5
Total Ramp Density Adjustment	5.0	Level of Service (LOS)	C
Adjusted Free-Flow Speed (FFSadj), mi/h	60.0		

HCS7 Freeway Merge Report

Project Information

Analyst	LSA	Date	12/11/2019
Agency	LSA	Analysis Year	Phase I Proj Comp Yr (2029) WP
Jurisdiction	Caltrans	Time Period Analyzed	PM Peak Hour
Project Description	CMD1801 - Village D Specific Plan	Unit	United States Customary

Geometric Data

	Freeway	Ramp
Number of Lanes (N), ln	3	1
Free-Flow Speed (FFS), mi/h	65.0	35.0
Segment Length (L) / Acceleration Length (LA),ft	1500	500
Terrain Type	Level	Level
Percent Grade, %	-	-
Segment Type / Ramp Side	Freeway	Right

Adjustment Factors

Driver Population	All Familiar	All Familiar
Weather Type	Non-Severe Weather	Non-Severe Weather
Incident Type	No Incident	-
Final Speed Adjustment Factor (SAF)	1.000	1.000
Final Capacity Adjustment Factor (CAF)	1.000	1.000
Demand Adjustment Factor (DAF)	1.000	1.000

Demand and Capacity

Demand Volume (Vi)	3572	376
Peak Hour Factor (PHF)	0.94	0.94
Total Trucks, %	16.11	2.13
Single-Unit Trucks (SUT), %	-	-
Tractor-Trailers (TT), %	-	-
Heavy Vehicle Adjustment Factor (fHV)	0.861	0.979
Flow Rate (vi),pc/h	4413	409
Capacity (c), pc/h	7050	2000
Volume-to-Capacity Ratio (v/c)	0.68	0.20

Speed and Density

Upstream Equilibrium Distance (LEQ), ft	-	Number of Outer Lanes on Freeway (NO)	1
Distance to Upstream Ramp (LUP), ft	-	Speed Index (MS)	0.366
Downstream Equilibrium Distance (LEQ), ft	-	Flow Outer Lanes (vOA), pc/h/ln	1801
Distance to Downstream Ramp (LDOWN), ft	-	On-Ramp Influence Area Speed (SR), mi/h	56.6
Prop. Freeway Vehicles in Lane 1 and 2 (PFM)	0.592	Outer Lanes Freeway Speed (SO), mi/h	60.3
Flow in Lanes 1 and 2 (v12), pc/h	2612	Ramp Junction Speed (S), mi/h	57.9
Flow Entering Ramp-Infl. Area (vR12), pc/h	3021	Average Density (D), pc/mi/ln	27.8
Level of Service (LOS)	C	Density in Ramp Influence Area (DR), pc/mi/ln	25.8

HCS7 Basic Freeway Report

Project Information

Analyst	LSA	Date	12/11/2019
Agency	LSA	Analysis Year	Phase I Proj Comp Yr (2029) WP
Jurisdiction	Caltrans	Time Period Analyzed	PM Peak Hour
Project Description	CMD1801 - Village D Specific Plan	Unit	United States Customary

Geometric Data

Number of Lanes, ln	3	Terrain Type	Level
Segment Length (L), ft	-	Percent Grade, %	-
Measured or Base Free-Flow Speed	Base	Grade Length, mi	-
Base Free-Flow Speed (BFFS), mi/h	65.0	Total Ramp Density (TRD), ramps/mi	1.83
Lane Width, ft	12	Free-Flow Speed (FFS), mi/h	59.7
Right-Side Lateral Clearance, ft	10		

Adjustment Factors

Driver Population	All Familiar	Final Speed Adjustment Factor (SAF)	1.000
Weather Type	Non-Severe Weather	Final Capacity Adjustment Factor (CAF)	1.000
Incident Type	No Incident	Demand Adjustment Factor (DAF)	1.000

Demand and Capacity

Demand Volume veh/h	3949	Heavy Vehicle Adjustment Factor (fhv)	0.871
Peak Hour Factor	0.94	Flow Rate (Vp), pc/h/ln	1608
Total Trucks, %	14.77	Capacity (c), pc/h/ln	2296
Single-Unit Trucks (SUT), %	-	Adjusted Capacity (cadj), pc/h/ln	2296
Tractor-Trailers (TT), %	-	Volume-to-Capacity Ratio (v/c)	0.70
Passenger Car Equivalent (ET)	2.000		

Speed and Density

Lane Width Adjustment (fLW)	0.0	Average Speed (S), mi/h	59.6
Right-Side Lateral Clearance Adj. (fRLC)	0.0	Density (D), pc/mi/ln	27.0
Total Ramp Density Adjustment	5.4	Level of Service (LOS)	D
Adjusted Free-Flow Speed (FFSadj), mi/h	59.6		

HCS7 Freeway Diverge Report

Project Information

Analyst	LSA	Date	12/11/2019
Agency	LSA	Analysis Year	Phase I Proj Comp Yr (2029) WP
Jurisdiction	Caltrans	Time Period Analyzed	PM Peak Hour
Project Description	CMD1801 - Village D Specific Plan	Unit	United States Customary

Geometric Data

	Freeway	Ramp
Number of Lanes (N), ln	3	1
Free-Flow Speed (FFS), mi/h	65.0	35.0
Segment Length (L) / Deceleration Length (LA),ft	1500	245
Terrain Type	Level	Level
Percent Grade, %	-	-
Segment Type / Ramp Side	Freeway	Right

Adjustment Factors

Driver Population	All Familiar	All Familiar
Weather Type	Non-Severe Weather	Non-Severe Weather
Incident Type	No Incident	-
Final Speed Adjustment Factor (SAF)	1.000	1.000
Final Capacity Adjustment Factor (CAF)	1.000	1.000
Demand Adjustment Factor (DAF)	1.000	1.000

Demand and Capacity

Demand Volume (Vi)	3949	1139
Peak Hour Factor (PHF)	0.94	0.94
Total Trucks, %	14.77	0.70
Single-Unit Trucks (SUT), %	-	-
Tractor-Trailers (TT), %	-	-
Heavy Vehicle Adjustment Factor (fHV)	0.871	0.993
Flow Rate (vi),pc/h	4823	1220
Capacity (c), pc/h	7050	2000
Volume-to-Capacity Ratio (v/c)	0.68	0.61

Speed and Density

Upstream Equilibrium Distance (LEQ), ft	-	Number of Outer Lanes on Freeway (NO)	1
Distance to Upstream Ramp (LUP), ft	-	Speed Index (DS)	0.538
Downstream Equilibrium Distance (LEQ), ft	-	Flow Outer Lanes (vOA), pc/h/ln	1502
Distance to Downstream Ramp (LDOWN), ft	-	Off-Ramp Influence Area Speed (SR), mi/h	52.6
Prop. Freeway Vehicles in Lane 1 and 2 (PFD)	0.583	Outer Lanes Freeway Speed (SO), mi/h	69.3
Flow in Lanes 1 and 2 (v12), pc/h	3321	Ramp Junction Speed (S), mi/h	56.9
Flow Entering Ramp-Infl. Area (vR12), pc/h	-	Average Density (D), pc/mi/ln	28.3
Level of Service (LOS)	D	Density in Ramp Influence Area (DR), pc/mi/ln	30.6

HCS7 Basic Freeway Report

Project Information

Analyst	LSA	Date	12/11/2019
Agency	LSA	Analysis Year	Phase I Proj Comp Yr (2029) WP
Jurisdiction	Caltrans	Time Period Analyzed	PM Peak Hour
Project Description	CMD1801 - Village D Specific Plan	Unit	United States Customary

Geometric Data

Number of Lanes, ln	3	Terrain Type	Level
Segment Length (L), ft	-	Percent Grade, %	-
Measured or Base Free-Flow Speed	Base	Grade Length, mi	-
Base Free-Flow Speed (BFFS), mi/h	65.0	Total Ramp Density (TRD), ramps/mi	1.83
Lane Width, ft	12	Free-Flow Speed (FFS), mi/h	59.7
Right-Side Lateral Clearance, ft	10		

Adjustment Factors

Driver Population	All Familiar	Final Speed Adjustment Factor (SAF)	1.000
Weather Type	Non-Severe Weather	Final Capacity Adjustment Factor (CAF)	1.000
Incident Type	No Incident	Demand Adjustment Factor (DAF)	1.000

Demand and Capacity

Demand Volume veh/h	2810	Heavy Vehicle Adjustment Factor (fhv)	0.830
Peak Hour Factor	0.94	Flow Rate (Vp), pc/h/ln	1201
Total Trucks, %	20.48	Capacity (c), pc/h/ln	2296
Single-Unit Trucks (SUT), %	-	Adjusted Capacity (cadj), pc/h/ln	2296
Tractor-Trailers (TT), %	-	Volume-to-Capacity Ratio (v/c)	0.52
Passenger Car Equivalent (ET)	2.000		

Speed and Density

Lane Width Adjustment (fLW)	0.0	Average Speed (S), mi/h	59.6
Right-Side Lateral Clearance Adj. (fRLC)	0.0	Density (D), pc/mi/ln	20.2
Total Ramp Density Adjustment	5.4	Level of Service (LOS)	C
Adjusted Free-Flow Speed (FFSadj), mi/h	59.6		

HCS7 Freeway Merge Report

Project Information

Analyst	LSA	Date	12/11/2019
Agency	LSA	Analysis Year	Phase I Proj Comp Yr (2029) WP
Jurisdiction	Caltrans	Time Period Analyzed	PM Peak Hour
Project Description	CMD1801 - Village D Specific Plan	Unit	United States Customary

Geometric Data

	Freeway	Ramp
Number of Lanes (N), ln	3	1
Free-Flow Speed (FFS), mi/h	65.0	35.0
Segment Length (L) / Acceleration Length (LA),ft	1500	350
Terrain Type	Level	Level
Percent Grade, %	-	-
Segment Type / Ramp Side	Freeway	Right

Adjustment Factors

Driver Population	All Familiar	All Familiar
Weather Type	Non-Severe Weather	Non-Severe Weather
Incident Type	No Incident	-
Final Speed Adjustment Factor (SAF)	1.000	1.000
Final Capacity Adjustment Factor (CAF)	1.000	1.000
Demand Adjustment Factor (DAF)	1.000	1.000

Demand and Capacity

Demand Volume (Vi)	2810	145
Peak Hour Factor (PHF)	0.94	0.94
Total Trucks, %	20.48	5.51
Single-Unit Trucks (SUT), %	-	-
Tractor-Trailers (TT), %	-	-
Heavy Vehicle Adjustment Factor (fHV)	0.830	0.948
Flow Rate (vi),pc/h	3602	163
Capacity (c), pc/h	7050	2000
Volume-to-Capacity Ratio (v/c)	0.53	0.08

Speed and Density

Upstream Equilibrium Distance (LEQ), ft	-	Number of Outer Lanes on Freeway (NO)	1
Distance to Upstream Ramp (LUP), ft	-	Speed Index (MS)	0.335
Downstream Equilibrium Distance (LEQ), ft	-	Flow Outer Lanes (vOA), pc/h/ln	1488
Distance to Downstream Ramp (LDOWN), ft	-	On-Ramp Influence Area Speed (SR), mi/h	57.3
Prop. Freeway Vehicles in Lane 1 and 2 (PFM)	0.587	Outer Lanes Freeway Speed (SO), mi/h	61.4
Flow in Lanes 1 and 2 (v12), pc/h	2114	Ramp Junction Speed (S), mi/h	58.9
Flow Entering Ramp-Infl. Area (vR12), pc/h	2277	Average Density (D), pc/mi/ln	21.3
Level of Service (LOS)	C	Density in Ramp Influence Area (DR), pc/mi/ln	21.0

HCS7 Basic Freeway Report

Project Information

Analyst	LSA	Date	12/11/2019
Agency	LSA	Analysis Year	Phase I Proj Comp Yr (2029) WP
Jurisdiction	Caltrans	Time Period Analyzed	PM Peak Hour
Project Description	CMD1801 - Village D Specific Plan	Unit	United States Customary

Geometric Data

Number of Lanes, ln	3	Terrain Type	Level
Segment Length (L), ft	-	Percent Grade, %	-
Measured or Base Free-Flow Speed	Base	Grade Length, mi	-
Base Free-Flow Speed (BFFS), mi/h	65.0	Total Ramp Density (TRD), ramps/mi	1.83
Lane Width, ft	12	Free-Flow Speed (FFS), mi/h	59.7
Right-Side Lateral Clearance, ft	10		

Adjustment Factors

Driver Population	All Familiar	Final Speed Adjustment Factor (SAF)	1.000
Weather Type	Non-Severe Weather	Final Capacity Adjustment Factor (CAF)	1.000
Incident Type	No Incident	Demand Adjustment Factor (DAF)	1.000

Demand and Capacity

Demand Volume veh/h	2955	Heavy Vehicle Adjustment Factor (fhv)	0.835
Peak Hour Factor	0.94	Flow Rate (Vp), pc/h/ln	1255
Total Trucks, %	19.75	Capacity (c), pc/h/ln	2296
Single-Unit Trucks (SUT), %	-	Adjusted Capacity (cadj), pc/h/ln	2296
Tractor-Trailers (TT), %	-	Volume-to-Capacity Ratio (v/c)	0.55
Passenger Car Equivalent (ET)	2.000		

Speed and Density

Lane Width Adjustment (fLW)	0.0	Average Speed (S), mi/h	59.6
Right-Side Lateral Clearance Adj. (fRLC)	0.0	Density (D), pc/mi/ln	21.1
Total Ramp Density Adjustment	5.4	Level of Service (LOS)	C
Adjusted Free-Flow Speed (FFSadj), mi/h	59.6		

HCS7 Freeway Diverge Report

Project Information

Analyst	LSA	Date	12/11/2019
Agency	LSA	Analysis Year	Phase I Proj Comp Yr (2029) WP
Jurisdiction	Caltrans	Time Period Analyzed	PM Peak Hour
Project Description	CMD1801 - Village D Specific Plan	Unit	United States Customary

Geometric Data

	Freeway	Ramp
Number of Lanes (N), ln	3	1
Free-Flow Speed (FFS), mi/h	65.0	15.0
Segment Length (L) / Deceleration Length (LA),ft	1500	150
Terrain Type	Level	Level
Percent Grade, %	-	-
Segment Type / Ramp Side	Freeway	Right

Adjustment Factors

Driver Population	All Familiar	All Familiar
Weather Type	Non-Severe Weather	Non-Severe Weather
Incident Type	No Incident	-
Final Speed Adjustment Factor (SAF)	1.000	1.000
Final Capacity Adjustment Factor (CAF)	1.000	1.000
Demand Adjustment Factor (DAF)	1.000	1.000

Demand and Capacity

Demand Volume (Vi)	2955	155
Peak Hour Factor (PHF)	0.94	0.94
Total Trucks, %	19.75	3.88
Single-Unit Trucks (SUT), %	-	-
Tractor-Trailers (TT), %	-	-
Heavy Vehicle Adjustment Factor (fHV)	0.835	0.963
Flow Rate (vi),pc/h	3765	171
Capacity (c), pc/h	7050	1800
Volume-to-Capacity Ratio (v/c)	0.53	0.10

Speed and Density

Upstream Equilibrium Distance (LEQ), ft	-	Number of Outer Lanes on Freeway (NO)	1
Distance to Upstream Ramp (LUP), ft	-	Speed Index (DS)	0.703
Downstream Equilibrium Distance (LEQ), ft	-	Flow Outer Lanes (vOA), pc/h/ln	1229
Distance to Downstream Ramp (LDOWN), ft	-	Off-Ramp Influence Area Speed (SR), mi/h	48.8
Prop. Freeway Vehicles in Lane 1 and 2 (PFD)	0.658	Outer Lanes Freeway Speed (SO), mi/h	70.4
Flow in Lanes 1 and 2 (v12), pc/h	2536	Ramp Junction Speed (S), mi/h	54.2
Flow Entering Ramp-Infl. Area (vR12), pc/h	-	Average Density (D), pc/mi/ln	23.2
Level of Service (LOS)	C	Density in Ramp Influence Area (DR), pc/mi/ln	24.7

HCS7 Basic Freeway Report

Project Information

Analyst	LSA	Date	12/11/2019
Agency	LSA	Analysis Year	Phase I Proj Comp Yr (2029) WP
Jurisdiction	Caltrans	Time Period Analyzed	PM Peak Hour
Project Description	CMD1801 - Village D Specific Plan	Unit	United States Customary

Geometric Data

Number of Lanes, ln	3	Terrain Type	Level
Segment Length (L), ft	-	Percent Grade, %	-
Measured or Base Free-Flow Speed	Base	Grade Length, mi	-
Base Free-Flow Speed (BFFS), mi/h	65.0	Total Ramp Density (TRD), ramps/mi	1.67
Lane Width, ft	12	Free-Flow Speed (FFS), mi/h	60.0
Right-Side Lateral Clearance, ft	10		

Adjustment Factors

Driver Population	All Familiar	Final Speed Adjustment Factor (SAF)	1.000
Weather Type	Non-Severe Weather	Final Capacity Adjustment Factor (CAF)	1.000
Incident Type	No Incident	Demand Adjustment Factor (DAF)	1.000

Demand and Capacity

Demand Volume veh/h	2800	Heavy Vehicle Adjustment Factor (fhv)	0.829
Peak Hour Factor	0.94	Flow Rate (Vp), pc/h/ln	1198
Total Trucks, %	20.64	Capacity (c), pc/h/ln	2300
Single-Unit Trucks (SUT), %	-	Adjusted Capacity (cadj), pc/h/ln	2300
Tractor-Trailers (TT), %	-	Volume-to-Capacity Ratio (v/c)	0.52
Passenger Car Equivalent (ET)	2.000		

Speed and Density

Lane Width Adjustment (fLW)	0.0	Average Speed (S), mi/h	60.0
Right-Side Lateral Clearance Adj. (fRLC)	0.0	Density (D), pc/mi/ln	20.0
Total Ramp Density Adjustment	5.0	Level of Service (LOS)	C
Adjusted Free-Flow Speed (FFSadj), mi/h	60.0		

HCS7 Freeway Merge Report

Project Information

Analyst	LSA	Date	12/11/2019
Agency	LSA	Analysis Year	Phase I Proj Comp Yr (2029) WP
Jurisdiction	Caltrans	Time Period Analyzed	PM Peak Hour
Project Description	CMD1801 - Village D Specific Plan	Unit	United States Customary

Geometric Data

	Freeway	Ramp
Number of Lanes (N), ln	3	1
Free-Flow Speed (FFS), mi/h	65.0	35.0
Segment Length (L) / Acceleration Length (LA),ft	1500	525
Terrain Type	Level	Level
Percent Grade, %	-	-
Segment Type / Ramp Side	Freeway	Right

Adjustment Factors

Driver Population	All Familiar	All Familiar
Weather Type	Non-Severe Weather	Non-Severe Weather
Incident Type	No Incident	-
Final Speed Adjustment Factor (SAF)	1.000	1.000
Final Capacity Adjustment Factor (CAF)	1.000	1.000
Demand Adjustment Factor (DAF)	1.000	1.000

Demand and Capacity

Demand Volume (Vi)	2800	235
Peak Hour Factor (PHF)	0.94	0.94
Total Trucks, %	20.64	4.26
Single-Unit Trucks (SUT), %	-	-
Tractor-Trailers (TT), %	-	-
Heavy Vehicle Adjustment Factor (fHV)	0.829	0.959
Flow Rate (vi),pc/h	3593	261
Capacity (c), pc/h	7050	2000
Volume-to-Capacity Ratio (v/c)	0.55	0.13

Speed and Density

Upstream Equilibrium Distance (LEQ), ft	-	Number of Outer Lanes on Freeway (NO)	1
Distance to Upstream Ramp (LUP), ft	-	Speed Index (MS)	0.327
Downstream Equilibrium Distance (LEQ), ft	-	Flow Outer Lanes (vOA), pc/h/ln	1466
Distance to Downstream Ramp (LDOWN), ft	-	On-Ramp Influence Area Speed (SR), mi/h	57.5
Prop. Freeway Vehicles in Lane 1 and 2 (PFM)	0.592	Outer Lanes Freeway Speed (SO), mi/h	61.5
Flow in Lanes 1 and 2 (v12), pc/h	2127	Ramp Junction Speed (S), mi/h	59.0
Flow Entering Ramp-Infl. Area (vR12), pc/h	2388	Average Density (D), pc/mi/ln	21.8
Level of Service (LOS)	C	Density in Ramp Influence Area (DR), pc/mi/ln	20.8

HCS7 Basic Freeway Report

Project Information

Analyst	LSA	Date	12/11/2019
Agency	LSA	Analysis Year	Phase I Proj Comp Yr (2029) WP
Jurisdiction	Caltrans	Time Period Analyzed	PM Peak Hour
Project Description	CMD1801 - Village D Specific Plan	Unit	United States Customary

Geometric Data

Number of Lanes, ln	2	Terrain Type	Level
Segment Length (L), ft	-	Percent Grade, %	-
Measured or Base Free-Flow Speed	Base	Grade Length, mi	-
Base Free-Flow Speed (BFFS), mi/h	65.0	Total Ramp Density (TRD), ramps/mi	1.67
Lane Width, ft	12	Free-Flow Speed (FFS), mi/h	60.0
Right-Side Lateral Clearance, ft	10		

Adjustment Factors

Driver Population	All Familiar	Final Speed Adjustment Factor (SAF)	1.000
Weather Type	Non-Severe Weather	Final Capacity Adjustment Factor (CAF)	1.000
Incident Type	No Incident	Demand Adjustment Factor (DAF)	1.000

Demand and Capacity

Demand Volume veh/h	3035	Heavy Vehicle Adjustment Factor (fhv)	0.838
Peak Hour Factor	0.94	Flow Rate (Vp), pc/h/ln	1926
Total Trucks, %	19.39	Capacity (c), pc/h/ln	2300
Single-Unit Trucks (SUT), %	-	Adjusted Capacity (cadj), pc/h/ln	2300
Tractor-Trailers (TT), %	-	Volume-to-Capacity Ratio (v/c)	0.84
Passenger Car Equivalent (ET)	2.000		

Speed and Density

Lane Width Adjustment (fLW)	0.0	Average Speed (S), mi/h	58.1
Right-Side Lateral Clearance Adj. (fRLC)	0.0	Density (D), pc/mi/ln	33.1
Total Ramp Density Adjustment	5.0	Level of Service (LOS)	D
Adjusted Free-Flow Speed (FFSadj), mi/h	60.0		

HCS7 Freeway Diverge Report

Project Information

Analyst	LSA	Date	12/11/2019
Agency	LSA	Analysis Year	Phase I Proj Comp Yr (2029) WP
Jurisdiction	Caltrans	Time Period Analyzed	PM Peak Hour
Project Description	CMD1801 - Village D Specific Plan	Unit	United States Customary

Geometric Data

	Freeway	Ramp
Number of Lanes (N), ln	3	1
Free-Flow Speed (FFS), mi/h	65.0	35.0
Segment Length (L) / Deceleration Length (LA),ft	1500	200
Terrain Type	Level	Level
Percent Grade, %	-	-
Segment Type / Ramp Side	Freeway	Right

Adjustment Factors

Driver Population	All Familiar	All Familiar
Weather Type	Non-Severe Weather	Non-Severe Weather
Incident Type	No Incident	-
Final Speed Adjustment Factor (SAF)	1.000	1.000
Final Capacity Adjustment Factor (CAF)	1.000	1.000
Demand Adjustment Factor (DAF)	1.000	1.000

Demand and Capacity

Demand Volume (Vi)	3035	645
Peak Hour Factor (PHF)	0.94	0.94
Total Trucks, %	19.39	10.38
Single-Unit Trucks (SUT), %	-	-
Tractor-Trailers (TT), %	-	-
Heavy Vehicle Adjustment Factor (fHV)	0.838	0.906
Flow Rate (vi),pc/h	3853	757
Capacity (c), pc/h	7050	2000
Volume-to-Capacity Ratio (v/c)	0.55	0.38

Speed and Density

Upstream Equilibrium Distance (LEQ), ft	-	Number of Outer Lanes on Freeway (NO)	1
Distance to Upstream Ramp (LUP), ft	-	Speed Index (DS)	0.496
Downstream Equilibrium Distance (LEQ), ft	-	Flow Outer Lanes (vOA), pc/h/ln	1149
Distance to Downstream Ramp (LDOWN), ft	-	Off-Ramp Influence Area Speed (SR), mi/h	53.6
Prop. Freeway Vehicles in Lane 1 and 2 (PFD)	0.629	Outer Lanes Freeway Speed (SO), mi/h	70.7
Flow in Lanes 1 and 2 (v12), pc/h	2704	Ramp Junction Speed (S), mi/h	57.8
Flow Entering Ramp-Infl. Area (vR12), pc/h	-	Average Density (D), pc/mi/ln	22.2
Level of Service (LOS)	C	Density in Ramp Influence Area (DR), pc/mi/ln	25.7

HCS7 Basic Freeway Report

Project Information

Analyst	LSA	Date	12/11/2019
Agency	LSA	Analysis Year	Phase I Proj Comp Yr (2029) WP
Jurisdiction	Caltrans	Time Period Analyzed	PM Peak Hour
Project Description	CMD1801 - Village D Specific Plan	Unit	United States Customary

Geometric Data

Number of Lanes, ln	3	Terrain Type	Level
Segment Length (L), ft	-	Percent Grade, %	-
Measured or Base Free-Flow Speed	Base	Grade Length, mi	-
Base Free-Flow Speed (BFFS), mi/h	70.0	Total Ramp Density (TRD), ramps/mi	1.50
Lane Width, ft	12	Free-Flow Speed (FFS), mi/h	65.5
Right-Side Lateral Clearance, ft	10		

Adjustment Factors

Driver Population	All Familiar	Final Speed Adjustment Factor (SAF)	1.000
Weather Type	Non-Severe Weather	Final Capacity Adjustment Factor (CAF)	1.000
Incident Type	No Incident	Demand Adjustment Factor (DAF)	1.000

Demand and Capacity

Demand Volume veh/h	2390	Heavy Vehicle Adjustment Factor (fhv)	0.821
Peak Hour Factor	0.94	Flow Rate (Vp), pc/h/ln	1032
Total Trucks, %	21.82	Capacity (c), pc/h/ln	2355
Single-Unit Trucks (SUT), %	-	Adjusted Capacity (cadj), pc/h/ln	2355
Tractor-Trailers (TT), %	-	Volume-to-Capacity Ratio (v/c)	0.44
Passenger Car Equivalent (ET)	2.000		

Speed and Density

Lane Width Adjustment (fLW)	0.0	Average Speed (S), mi/h	65.5
Right-Side Lateral Clearance Adj. (fRLC)	0.0	Density (D), pc/mi/ln	15.8
Total Ramp Density Adjustment	4.5	Level of Service (LOS)	B
Adjusted Free-Flow Speed (FFSadj), mi/h	65.5		

HCS7 Freeway Merge Report

Project Information

Analyst	LSA	Date	12/11/2019
Agency	LSA	Analysis Year	Phase I Proj Comp Yr (2029) WP
Jurisdiction	Caltrans	Time Period Analyzed	PM Peak Hour
Project Description	CMD1801 - Village D Specific Plan	Unit	United States Customary

Geometric Data

	Freeway	Ramp
Number of Lanes (N), ln	3	1
Free-Flow Speed (FFS), mi/h	70.0	35.0
Segment Length (L) / Acceleration Length (LA),ft	1500	400
Terrain Type	Level	Level
Percent Grade, %	-	-
Segment Type / Ramp Side	Freeway	Right

Adjustment Factors

Driver Population	All Familiar	All Familiar
Weather Type	Non-Severe Weather	Non-Severe Weather
Incident Type	No Incident	-
Final Speed Adjustment Factor (SAF)	1.000	1.000
Final Capacity Adjustment Factor (CAF)	1.000	1.000
Demand Adjustment Factor (DAF)	1.000	1.000

Demand and Capacity

Demand Volume (Vi)	2390	414
Peak Hour Factor (PHF)	0.94	0.94
Total Trucks, %	21.82	6.77
Single-Unit Trucks (SUT), %	-	-
Tractor-Trailers (TT), %	-	-
Heavy Vehicle Adjustment Factor (fHV)	0.821	0.937
Flow Rate (vi),pc/h	3097	470
Capacity (c), pc/h	7200	2000
Volume-to-Capacity Ratio (v/c)	0.50	0.24

Speed and Density

Upstream Equilibrium Distance (LEQ), ft	-	Number of Outer Lanes on Freeway (NO)	1
Distance to Upstream Ramp (LUP), ft	-	Speed Index (MS)	0.332
Downstream Equilibrium Distance (LEQ), ft	-	Flow Outer Lanes (vOA), pc/h/ln	1273
Distance to Downstream Ramp (LDOWN), ft	-	On-Ramp Influence Area Speed (SR), mi/h	60.7
Prop. Freeway Vehicles in Lane 1 and 2 (PFM)	0.589	Outer Lanes Freeway Speed (SO), mi/h	67.2
Flow in Lanes 1 and 2 (v12), pc/h	1824	Ramp Junction Speed (S), mi/h	62.9
Flow Entering Ramp-Infl. Area (vR12), pc/h	2294	Average Density (D), pc/mi/ln	18.9
Level of Service (LOS)	C	Density in Ramp Influence Area (DR), pc/mi/ln	20.7

HCS7 Basic Freeway Report

Project Information

Analyst	LSA	Date	12/11/2019
Agency	LSA	Analysis Year	Phase I Proj Comp Yr (2029) WP
Jurisdiction	Caltrans	Time Period Analyzed	PM Peak Hour
Project Description	CMD1801 - Village D Specific Plan	Unit	United States Customary

Geometric Data

Number of Lanes, ln	2	Terrain Type	Level
Segment Length (L), ft	-	Percent Grade, %	-
Measured or Base Free-Flow Speed	Base	Grade Length, mi	-
Base Free-Flow Speed (BFFS), mi/h	70.0	Total Ramp Density (TRD), ramps/mi	1.00
Lane Width, ft	12	Free-Flow Speed (FFS), mi/h	66.8
Right-Side Lateral Clearance, ft	10		

Adjustment Factors

Driver Population	All Familiar	Final Speed Adjustment Factor (SAF)	1.000
Weather Type	Non-Severe Weather	Final Capacity Adjustment Factor (CAF)	1.000
Incident Type	No Incident	Demand Adjustment Factor (DAF)	1.000

Demand and Capacity

Demand Volume veh/h	2804	Heavy Vehicle Adjustment Factor (fhv)	0.836
Peak Hour Factor	0.94	Flow Rate (Vp), pc/h/ln	1784
Total Trucks, %	19.60	Capacity (c), pc/h/ln	2368
Single-Unit Trucks (SUT), %	-	Adjusted Capacity (cadj), pc/h/ln	2368
Tractor-Trailers (TT), %	-	Volume-to-Capacity Ratio (v/c)	0.75
Passenger Car Equivalent (ET)	2.000		

Speed and Density

Lane Width Adjustment (fLW)	0.0	Average Speed (S), mi/h	64.1
Right-Side Lateral Clearance Adj. (fRLC)	0.0	Density (D), pc/mi/ln	27.8
Total Ramp Density Adjustment	3.2	Level of Service (LOS)	D
Adjusted Free-Flow Speed (FFSadj), mi/h	66.8		

HCS7 Freeway Diverge Report

Project Information

Analyst	LSA	Date	12/11/2019
Agency	LSA	Analysis Year	Phase I Proj Comp Yr (2029) WP
Jurisdiction	Caltrans	Time Period Analyzed	PM Peak Hour
Project Description	CMD1801 - Village D Specific Plan	Unit	United States Customary

Geometric Data

	Freeway	Ramp
Number of Lanes (N), ln	2	1
Free-Flow Speed (FFS), mi/h	70.0	35.0
Segment Length (L) / Deceleration Length (LA),ft	1500	200
Terrain Type	Level	Level
Percent Grade, %	-	-
Segment Type / Ramp Side	Freeway	Right

Adjustment Factors

Driver Population	All Familiar	All Familiar
Weather Type	Non-Severe Weather	Non-Severe Weather
Incident Type	No Incident	-
Final Speed Adjustment Factor (SAF)	1.000	1.000
Final Capacity Adjustment Factor (CAF)	1.000	1.000
Demand Adjustment Factor (DAF)	1.000	1.000

Demand and Capacity

Demand Volume (Vi)	2804	187
Peak Hour Factor (PHF)	0.94	0.94
Total Trucks, %	19.60	24.06
Single-Unit Trucks (SUT), %	-	-
Tractor-Trailers (TT), %	-	-
Heavy Vehicle Adjustment Factor (fHV)	0.836	0.806
Flow Rate (vi),pc/h	3568	247
Capacity (c), pc/h	4800	2000
Volume-to-Capacity Ratio (v/c)	0.74	0.12

Speed and Density

Upstream Equilibrium Distance (LEQ), ft	-	Number of Outer Lanes on Freeway (NO)	0
Distance to Upstream Ramp (LUP), ft	-	Speed Index (DS)	0.450
Downstream Equilibrium Distance (LEQ), ft	-	Flow Outer Lanes (vOA), pc/h/ln	-
Distance to Downstream Ramp (LDOWN), ft	-	Off-Ramp Influence Area Speed (SR), mi/h	57.4
Prop. Freeway Vehicles in Lane 1 and 2 (PFD)	1.000	Outer Lanes Freeway Speed (SO), mi/h	76.8
Flow in Lanes 1 and 2 (v12), pc/h	3568	Ramp Junction Speed (S), mi/h	57.4
Flow Entering Ramp-Infl. Area (vR12), pc/h	-	Average Density (D), pc/mi/ln	31.1
Level of Service (LOS)	D	Density in Ramp Influence Area (DR), pc/mi/ln	33.1

HCS7 Basic Freeway Report

Project Information

Analyst	LSA	Date	12/11/2019
Agency	LSA	Analysis Year	Phase I Proj Comp Yr (2029) WP
Jurisdiction	Caltrans	Time Period Analyzed	PM Peak Hour
Project Description	CMD1801 - Village D Specific Plan	Unit	United States Customary

Geometric Data

Number of Lanes, ln	2	Terrain Type	Level
Segment Length (L), ft	-	Percent Grade, %	-
Measured or Base Free-Flow Speed	Base	Grade Length, mi	-
Base Free-Flow Speed (BFFS), mi/h	70.0	Total Ramp Density (TRD), ramps/mi	1.00
Lane Width, ft	12	Free-Flow Speed (FFS), mi/h	66.8
Right-Side Lateral Clearance, ft	10		

Adjustment Factors

Driver Population	All Familiar	Final Speed Adjustment Factor (SAF)	1.000
Weather Type	Non-Severe Weather	Final Capacity Adjustment Factor (CAF)	1.000
Incident Type	No Incident	Demand Adjustment Factor (DAF)	1.000

Demand and Capacity

Demand Volume veh/h	2617	Heavy Vehicle Adjustment Factor (fhv)	0.838
Peak Hour Factor	0.94	Flow Rate (Vp), pc/h/ln	1661
Total Trucks, %	19.28	Capacity (c), pc/h/ln	2368
Single-Unit Trucks (SUT), %	-	Adjusted Capacity (cadj), pc/h/ln	2368
Tractor-Trailers (TT), %	-	Volume-to-Capacity Ratio (v/c)	0.70
Passenger Car Equivalent (ET)	2.000		

Speed and Density

Lane Width Adjustment (fLW)	0.0	Average Speed (S), mi/h	65.3
Right-Side Lateral Clearance Adj. (fRLC)	0.0	Density (D), pc/mi/ln	25.4
Total Ramp Density Adjustment	3.2	Level of Service (LOS)	C
Adjusted Free-Flow Speed (FFSadj), mi/h	66.8		

HCS7 Freeway Merge Report

Project Information

Analyst	LSA	Date	12/11/2019
Agency	LSA	Analysis Year	Phase I Proj Comp Yr (2029) WP
Jurisdiction	Caltrans	Time Period Analyzed	PM Peak Hour
Project Description	CMD1801 - Village D Specific Plan	Unit	United States Customary

Geometric Data

	Freeway	Ramp
Number of Lanes (N), ln	2	1
Free-Flow Speed (FFS), mi/h	70.0	35.0
Segment Length (L) / Acceleration Length (LA),ft	1500	700
Terrain Type	Level	Level
Percent Grade, %	-	-
Segment Type / Ramp Side	Freeway	Right

Adjustment Factors

Driver Population	All Familiar	All Familiar
Weather Type	Non-Severe Weather	Non-Severe Weather
Incident Type	No Incident	-
Final Speed Adjustment Factor (SAF)	1.000	1.000
Final Capacity Adjustment Factor (CAF)	1.000	1.000
Demand Adjustment Factor (DAF)	1.000	1.000

Demand and Capacity

Demand Volume (Vi)	2617	313
Peak Hour Factor (PHF)	0.94	0.94
Total Trucks, %	19.28	15.99
Single-Unit Trucks (SUT), %	-	-
Tractor-Trailers (TT), %	-	-
Heavy Vehicle Adjustment Factor (fHV)	0.838	0.862
Flow Rate (vi),pc/h	3322	386
Capacity (c), pc/h	4800	2000
Volume-to-Capacity Ratio (v/c)	0.77	0.19

Speed and Density

Upstream Equilibrium Distance (LEQ), ft	-	Number of Outer Lanes on Freeway (NO)	0
Distance to Upstream Ramp (LUP), ft	-	Speed Index (MS)	0.431
Downstream Equilibrium Distance (LEQ), ft	-	Flow Outer Lanes (vOA), pc/h/ln	-
Distance to Downstream Ramp (LDOWN), ft	-	On-Ramp Influence Area Speed (SR), mi/h	57.9
Prop. Freeway Vehicles in Lane 1 and 2 (PFM)	1.000	Outer Lanes Freeway Speed (SO), mi/h	70.0
Flow in Lanes 1 and 2 (v12), pc/h	3322	Ramp Junction Speed (S), mi/h	57.9
Flow Entering Ramp-Infl. Area (vR12), pc/h	3708	Average Density (D), pc/mi/ln	32.0
Level of Service (LOS)	D	Density in Ramp Influence Area (DR), pc/mi/ln	29.9

HCS7 Basic Freeway Report

Project Information

Analyst	LSA	Date	12/11/2019
Agency	LSA	Analysis Year	Phase I Proj Comp Yr (2029) WP
Jurisdiction	Caltrans	Time Period Analyzed	PM Peak Hour
Project Description	CMD1801 - Village D Specific Plan	Unit	United States Customary

Geometric Data

Number of Lanes, ln	2	Terrain Type	Level
Segment Length (L), ft	-	Percent Grade, %	-
Measured or Base Free-Flow Speed	Base	Grade Length, mi	-
Base Free-Flow Speed (BFFS), mi/h	70.0	Total Ramp Density (TRD), ramps/mi	1.00
Lane Width, ft	12	Free-Flow Speed (FFS), mi/h	66.8
Right-Side Lateral Clearance, ft	10		

Adjustment Factors

Driver Population	All Familiar	Final Speed Adjustment Factor (SAF)	1.000
Weather Type	Non-Severe Weather	Final Capacity Adjustment Factor (CAF)	1.000
Incident Type	No Incident	Demand Adjustment Factor (DAF)	1.000

Demand and Capacity

Demand Volume veh/h	2929	Heavy Vehicle Adjustment Factor (fhv)	0.842
Peak Hour Factor	0.94	Flow Rate (Vp), pc/h/ln	1850
Total Trucks, %	18.83	Capacity (c), pc/h/ln	2368
Single-Unit Trucks (SUT), %	-	Adjusted Capacity (cadj), pc/h/ln	2368
Tractor-Trailers (TT), %	-	Volume-to-Capacity Ratio (v/c)	0.78
Passenger Car Equivalent (ET)	2.000		

Speed and Density

Lane Width Adjustment (fLW)	0.0	Average Speed (S), mi/h	63.2
Right-Side Lateral Clearance Adj. (fRLC)	0.0	Density (D), pc/mi/ln	29.3
Total Ramp Density Adjustment	3.2	Level of Service (LOS)	D
Adjusted Free-Flow Speed (FFSadj), mi/h	66.8		

HCS7 Basic Freeway Report

Project Information

Analyst	LSA	Date	12/11/2019
Agency	LSA	Analysis Year	Phase I Proj Comp Yr (2029) WP
Jurisdiction	Caltrans	Time Period Analyzed	PM Peak Hour
Project Description	CMD1801 - Village D Specific Plan	Unit	United States Customary

Geometric Data

Number of Lanes, ln	2	Terrain Type	Level
Segment Length (L), ft	-	Percent Grade, %	-
Measured or Base Free-Flow Speed	Base	Grade Length, mi	-
Base Free-Flow Speed (BFFS), mi/h	70.0	Total Ramp Density (TRD), ramps/mi	1.00
Lane Width, ft	12	Free-Flow Speed (FFS), mi/h	66.8
Right-Side Lateral Clearance, ft	10		

Adjustment Factors

Driver Population	All Familiar	Final Speed Adjustment Factor (SAF)	1.000
Weather Type	Non-Severe Weather	Final Capacity Adjustment Factor (CAF)	1.000
Incident Type	No Incident	Demand Adjustment Factor (DAF)	1.000

Demand and Capacity

Demand Volume veh/h	3215	Heavy Vehicle Adjustment Factor (fhv)	0.828
Peak Hour Factor	0.94	Flow Rate (Vp), pc/h/ln	2066
Total Trucks, %	20.78	Capacity (c), pc/h/ln	2368
Single-Unit Trucks (SUT), %	-	Adjusted Capacity (cadj), pc/h/ln	2368
Tractor-Trailers (TT), %	-	Volume-to-Capacity Ratio (v/c)	0.87
Passenger Car Equivalent (ET)	2.000		

Speed and Density

Lane Width Adjustment (fLW)	0.0	Average Speed (S), mi/h	59.7
Right-Side Lateral Clearance Adj. (fRLC)	0.0	Density (D), pc/mi/ln	34.6
Total Ramp Density Adjustment	3.2	Level of Service (LOS)	D
Adjusted Free-Flow Speed (FFSadj), mi/h	66.8		

HCS7 Freeway Diverge Report

Project Information

Analyst	LSA	Date	12/11/2019
Agency	LSA	Analysis Year	Phase I Proj Comp Yr (2029) WP
Jurisdiction	Caltrans	Time Period Analyzed	PM Peak Hour
Project Description	CMD1801 - Village D Specific Plan	Unit	United States Customary

Geometric Data

	Freeway	Ramp
Number of Lanes (N), ln	2	1
Free-Flow Speed (FFS), mi/h	70.0	50.0
Segment Length (L) / Deceleration Length (LA),ft	1500	150
Terrain Type	Level	Level
Percent Grade, %	-	-
Segment Type / Ramp Side	Freeway	Right

Adjustment Factors

Driver Population	All Familiar	All Familiar
Weather Type	Non-Severe Weather	Non-Severe Weather
Incident Type	No Incident	-
Final Speed Adjustment Factor (SAF)	1.000	1.000
Final Capacity Adjustment Factor (CAF)	1.000	1.000
Demand Adjustment Factor (DAF)	1.000	1.000

Demand and Capacity

Demand Volume (Vi)	3215	438
Peak Hour Factor (PHF)	0.94	0.94
Total Trucks, %	20.78	15.08
Single-Unit Trucks (SUT), %	-	-
Tractor-Trailers (TT), %	-	-
Heavy Vehicle Adjustment Factor (fHV)	0.828	0.869
Flow Rate (vi),pc/h	4131	536
Capacity (c), pc/h	4800	2100
Volume-to-Capacity Ratio (v/c)	0.86	0.26

Speed and Density

Upstream Equilibrium Distance (LEQ), ft	-	Number of Outer Lanes on Freeway (NO)	0
Distance to Upstream Ramp (LUP), ft	-	Speed Index (DS)	0.281
Downstream Equilibrium Distance (LEQ), ft	-	Flow Outer Lanes (vOA), pc/h/ln	-
Distance to Downstream Ramp (LDOWN), ft	-	Off-Ramp Influence Area Speed (SR), mi/h	62.1
Prop. Freeway Vehicles in Lane 1 and 2 (PFD)	1.000	Outer Lanes Freeway Speed (SO), mi/h	76.8
Flow in Lanes 1 and 2 (v12), pc/h	4131	Ramp Junction Speed (S), mi/h	62.1
Flow Entering Ramp-Infl. Area (vR12), pc/h	-	Average Density (D), pc/mi/ln	33.3
Level of Service (LOS)	E	Density in Ramp Influence Area (DR), pc/mi/ln	38.4

HCS7 Basic Freeway Report

Project Information

Analyst	LSA	Date	12/11/2019
Agency	LSA	Analysis Year	Phase I Proj Comp Yr (2029) WP
Jurisdiction	Caltrans	Time Period Analyzed	PM Peak Hour
Project Description	CMD1801 - Village D Specific Plan	Unit	United States Customary

Geometric Data

Number of Lanes, ln	2	Terrain Type	Level
Segment Length (L), ft	-	Percent Grade, %	-
Measured or Base Free-Flow Speed	Base	Grade Length, mi	-
Base Free-Flow Speed (BFFS), mi/h	70.0	Total Ramp Density (TRD), ramps/mi	1.33
Lane Width, ft	12	Free-Flow Speed (FFS), mi/h	65.9
Right-Side Lateral Clearance, ft	10		

Adjustment Factors

Driver Population	All Familiar	Final Speed Adjustment Factor (SAF)	1.000
Weather Type	Non-Severe Weather	Final Capacity Adjustment Factor (CAF)	1.000
Incident Type	No Incident	Demand Adjustment Factor (DAF)	1.000

Demand and Capacity

Demand Volume veh/h	2777	Heavy Vehicle Adjustment Factor (fhv)	0.822
Peak Hour Factor	0.94	Flow Rate (Vp), pc/h/ln	1797
Total Trucks, %	21.68	Capacity (c), pc/h/ln	2359
Single-Unit Trucks (SUT), %	-	Adjusted Capacity (cadj), pc/h/ln	2359
Tractor-Trailers (TT), %	-	Volume-to-Capacity Ratio (v/c)	0.76
Passenger Car Equivalent (ET)	2.000		

Speed and Density

Lane Width Adjustment (fLW)	0.0	Average Speed (S), mi/h	63.3
Right-Side Lateral Clearance Adj. (fRLC)	0.0	Density (D), pc/mi/ln	28.4
Total Ramp Density Adjustment	4.1	Level of Service (LOS)	D
Adjusted Free-Flow Speed (FFSadj), mi/h	65.9		

HCS7 Freeway Merge Report

Project Information

Analyst	LSA	Date	12/11/2019
Agency	LSA	Analysis Year	Phase I Proj Comp Yr (2029) WP
Jurisdiction	Caltrans	Time Period Analyzed	PM Peak Hour
Project Description	CMD1801 - Village D Specific Plan	Unit	United States Customary

Geometric Data

	Freeway	Ramp
Number of Lanes (N), ln	2	1
Free-Flow Speed (FFS), mi/h	70.0	35.0
Segment Length (L) / Acceleration Length (LA),ft	1000	600
Terrain Type	Level	Level
Percent Grade, %	-	-
Segment Type / Ramp Side	Freeway	Right

Adjustment Factors

Driver Population	All Familiar	All Familiar
Weather Type	Non-Severe Weather	Non-Severe Weather
Incident Type	No Incident	-
Final Speed Adjustment Factor (SAF)	1.000	1.000
Final Capacity Adjustment Factor (CAF)	1.000	1.000
Demand Adjustment Factor (DAF)	1.000	1.000

Demand and Capacity

Demand Volume (Vi)	2777	28
Peak Hour Factor (PHF)	0.94	0.94
Total Trucks, %	21.68	7.14
Single-Unit Trucks (SUT), %	-	-
Tractor-Trailers (TT), %	-	-
Heavy Vehicle Adjustment Factor (fHV)	0.822	0.933
Flow Rate (vi),pc/h	3594	32
Capacity (c), pc/h	4800	2000
Volume-to-Capacity Ratio (v/c)	0.76	0.02

Speed and Density

Upstream Equilibrium Distance (LEQ), ft	-	Number of Outer Lanes on Freeway (NO)	0
Distance to Upstream Ramp (LUP), ft	-	Speed Index (MS)	0.425
Downstream Equilibrium Distance (LEQ), ft	-	Flow Outer Lanes (vOA), pc/h/ln	-
Distance to Downstream Ramp (LDOWN), ft	-	On-Ramp Influence Area Speed (SR), mi/h	58.1
Prop. Freeway Vehicles in Lane 1 and 2 (PFM)	1.000	Outer Lanes Freeway Speed (SO), mi/h	70.0
Flow in Lanes 1 and 2 (v12), pc/h	3594	Ramp Junction Speed (S), mi/h	58.1
Flow Entering Ramp-Infl. Area (vR12), pc/h	3626	Average Density (D), pc/mi/ln	31.2
Level of Service (LOS)	D	Density in Ramp Influence Area (DR), pc/mi/ln	30.1

HCS7 Basic Freeway Report

Project Information

Analyst	LSA	Date	12/11/2019
Agency	LSA	Analysis Year	Phase I Proj Comp Yr (2029) WP
Jurisdiction	Caltrans	Time Period Analyzed	PM Peak Hour
Project Description	CMD1801 - Village D Specific Plan	Unit	United States Customary

Geometric Data

Number of Lanes, ln	2	Terrain Type	Level
Segment Length (L), ft	-	Percent Grade, %	-
Measured or Base Free-Flow Speed	Base	Grade Length, mi	-
Base Free-Flow Speed (BFFS), mi/h	70.0	Total Ramp Density (TRD), ramps/mi	1.33
Lane Width, ft	12	Free-Flow Speed (FFS), mi/h	65.9
Right-Side Lateral Clearance, ft	10		

Adjustment Factors

Driver Population	All Familiar	Final Speed Adjustment Factor (SAF)	1.000
Weather Type	Non-Severe Weather	Final Capacity Adjustment Factor (CAF)	1.000
Incident Type	No Incident	Demand Adjustment Factor (DAF)	1.000

Demand and Capacity

Demand Volume veh/h	2805	Heavy Vehicle Adjustment Factor (fhv)	0.823
Peak Hour Factor	0.94	Flow Rate (Vp), pc/h/ln	1813
Total Trucks, %	21.53	Capacity (c), pc/h/ln	2359
Single-Unit Trucks (SUT), %	-	Adjusted Capacity (cadj), pc/h/ln	2359
Tractor-Trailers (TT), %	-	Volume-to-Capacity Ratio (v/c)	0.77
Passenger Car Equivalent (ET)	2.000		

Speed and Density

Lane Width Adjustment (fLW)	0.0	Average Speed (S), mi/h	63.2
Right-Side Lateral Clearance Adj. (fRLC)	0.0	Density (D), pc/mi/ln	28.7
Total Ramp Density Adjustment	4.1	Level of Service (LOS)	D
Adjusted Free-Flow Speed (FFSadj), mi/h	65.9		

HCS7 Freeway Merge Report

Project Information

Analyst	LSA	Date	12/11/2019
Agency	LSA	Analysis Year	Phase I Proj Comp Yr (2029) WP
Jurisdiction	Caltrans	Time Period Analyzed	PM Peak Hour
Project Description	CMD1801 - Village D Specific Plan	Unit	United States Customary

Geometric Data

	Freeway	Ramp
Number of Lanes (N), ln	2	1
Free-Flow Speed (FFS), mi/h	70.0	35.0
Segment Length (L) / Acceleration Length (LA),ft	1500	500
Terrain Type	Level	Level
Percent Grade, %	-	-
Segment Type / Ramp Side	Freeway	Right

Adjustment Factors

Driver Population	All Familiar	All Familiar
Weather Type	Non-Severe Weather	Non-Severe Weather
Incident Type	No Incident	-
Final Speed Adjustment Factor (SAF)	1.000	1.000
Final Capacity Adjustment Factor (CAF)	1.000	1.000
Demand Adjustment Factor (DAF)	1.000	1.000

Demand and Capacity

Demand Volume (Vi)	2805	229
Peak Hour Factor (PHF)	0.94	0.94
Total Trucks, %	21.53	21.83
Single-Unit Trucks (SUT), %	-	-
Tractor-Trailers (TT), %	-	-
Heavy Vehicle Adjustment Factor (fHV)	0.823	0.821
Flow Rate (vi),pc/h	3626	297
Capacity (c), pc/h	4800	2000
Volume-to-Capacity Ratio (v/c)	0.82	0.15

Speed and Density

Upstream Equilibrium Distance (LEQ), ft	-	Number of Outer Lanes on Freeway (NO)	0
Distance to Upstream Ramp (LUP), ft	-	Speed Index (MS)	0.483
Downstream Equilibrium Distance (LEQ), ft	-	Flow Outer Lanes (vOA), pc/h/ln	-
Distance to Downstream Ramp (LDOWN), ft	-	On-Ramp Influence Area Speed (SR), mi/h	56.5
Prop. Freeway Vehicles in Lane 1 and 2 (PFM)	1.000	Outer Lanes Freeway Speed (SO), mi/h	70.0
Flow in Lanes 1 and 2 (v12), pc/h	3626	Ramp Junction Speed (S), mi/h	56.5
Flow Entering Ramp-Infl. Area (vR12), pc/h	3923	Average Density (D), pc/mi/ln	34.7
Level of Service (LOS)	D	Density in Ramp Influence Area (DR), pc/mi/ln	32.9

HCS7 Basic Freeway Report

Project Information

Analyst	LSA	Date	12/11/2019
Agency	LSA	Analysis Year	Phase I Proj Comp Yr (2029) WP
Jurisdiction	Caltrans	Time Period Analyzed	PM Peak Hour
Project Description	CMD1801 - Village D Specific Plan	Unit	United States Customary

Geometric Data

Number of Lanes, ln	2	Terrain Type	Level
Segment Length (L), ft	-	Percent Grade, %	-
Measured or Base Free-Flow Speed	Base	Grade Length, mi	-
Base Free-Flow Speed (BFFS), mi/h	70.0	Total Ramp Density (TRD), ramps/mi	1.33
Lane Width, ft	12	Free-Flow Speed (FFS), mi/h	65.9
Right-Side Lateral Clearance, ft	10		

Adjustment Factors

Driver Population	All Familiar	Final Speed Adjustment Factor (SAF)	1.000
Weather Type	Non-Severe Weather	Final Capacity Adjustment Factor (CAF)	1.000
Incident Type	No Incident	Demand Adjustment Factor (DAF)	1.000

Demand and Capacity

Demand Volume veh/h	3034	Heavy Vehicle Adjustment Factor (fhv)	0.823
Peak Hour Factor	0.94	Flow Rate (Vp), pc/h/ln	1961
Total Trucks, %	21.55	Capacity (c), pc/h/ln	2359
Single-Unit Trucks (SUT), %	-	Adjusted Capacity (cadj), pc/h/ln	2359
Tractor-Trailers (TT), %	-	Volume-to-Capacity Ratio (v/c)	0.83
Passenger Car Equivalent (ET)	2.000		

Speed and Density

Lane Width Adjustment (fLW)	0.0	Average Speed (S), mi/h	61.0
Right-Side Lateral Clearance Adj. (fRLC)	0.0	Density (D), pc/mi/ln	32.1
Total Ramp Density Adjustment	4.1	Level of Service (LOS)	D
Adjusted Free-Flow Speed (FFSadj), mi/h	65.9		

HCS7 Freeway Diverge Report

Project Information

Analyst	LSA	Date	12/11/2019
Agency	LSA	Analysis Year	Phase I Proj Comp Yr (2029) WP
Jurisdiction	Caltrans	Time Period Analyzed	PM Peak Hour
Project Description	CMD1801 - Village D Specific Plan	Unit	United States Customary

Geometric Data

	Freeway	Ramp
Number of Lanes (N), ln	3	1
Free-Flow Speed (FFS), mi/h	70.0	35.0
Segment Length (L) / Deceleration Length (LA),ft	1500	150
Terrain Type	Level	Level
Percent Grade, %	-	-
Segment Type / Ramp Side	Freeway	Right

Adjustment Factors

Driver Population	All Familiar	All Familiar
Weather Type	Non-Severe Weather	Non-Severe Weather
Incident Type	No Incident	-
Final Speed Adjustment Factor (SAF)	1.000	1.000
Final Capacity Adjustment Factor (CAF)	1.000	1.000
Demand Adjustment Factor (DAF)	1.000	1.000

Demand and Capacity

Demand Volume (Vi)	3034	477
Peak Hour Factor (PHF)	0.94	0.94
Total Trucks, %	21.55	4.61
Single-Unit Trucks (SUT), %	-	-
Tractor-Trailers (TT), %	-	-
Heavy Vehicle Adjustment Factor (fHV)	0.823	0.956
Flow Rate (vi),pc/h	3922	531
Capacity (c), pc/h	7200	2000
Volume-to-Capacity Ratio (v/c)	0.54	0.27

Speed and Density

Upstream Equilibrium Distance (LEQ), ft	-	Number of Outer Lanes on Freeway (NO)	1
Distance to Upstream Ramp (LUP), ft	-	Speed Index (DS)	0.476
Downstream Equilibrium Distance (LEQ), ft	-	Flow Outer Lanes (vOA), pc/h/ln	1228
Distance to Downstream Ramp (LDOWN), ft	-	Off-Ramp Influence Area Speed (SR), mi/h	56.7
Prop. Freeway Vehicles in Lane 1 and 2 (PFD)	0.638	Outer Lanes Freeway Speed (SO), mi/h	75.9
Flow in Lanes 1 and 2 (v12), pc/h	2694	Ramp Junction Speed (S), mi/h	61.6
Flow Entering Ramp-Infl. Area (vR12), pc/h	-	Average Density (D), pc/mi/ln	21.2
Level of Service (LOS)	C	Density in Ramp Influence Area (DR), pc/mi/ln	26.1

HCS7 Basic Freeway Report

Project Information

Analyst	LSA	Date	12/11/2019
Agency	LSA	Analysis Year	Phase I Proj Comp Yr (2029) WP
Jurisdiction	Caltrans	Time Period Analyzed	PM Peak Hour
Project Description	CMD1801 - Village D Specific Plan	Unit	United States Customary

Geometric Data

Number of Lanes, ln	3	Terrain Type	Level
Segment Length (L), ft	-	Percent Grade, %	-
Measured or Base Free-Flow Speed	Base	Grade Length, mi	-
Base Free-Flow Speed (BFFS), mi/h	70.0	Total Ramp Density (TRD), ramps/mi	1.67
Lane Width, ft	12	Free-Flow Speed (FFS), mi/h	65.0
Right-Side Lateral Clearance, ft	10		

Adjustment Factors

Driver Population	All Familiar	Final Speed Adjustment Factor (SAF)	1.000
Weather Type	Non-Severe Weather	Final Capacity Adjustment Factor (CAF)	1.000
Incident Type	No Incident	Demand Adjustment Factor (DAF)	1.000

Demand and Capacity

Demand Volume veh/h	2557	Heavy Vehicle Adjustment Factor (fhv)	0.802
Peak Hour Factor	0.94	Flow Rate (Vp), pc/h/ln	1131
Total Trucks, %	24.72	Capacity (c), pc/h/ln	2350
Single-Unit Trucks (SUT), %	-	Adjusted Capacity (cadj), pc/h/ln	2350
Tractor-Trailers (TT), %	-	Volume-to-Capacity Ratio (v/c)	0.48
Passenger Car Equivalent (ET)	2.000		

Speed and Density

Lane Width Adjustment (fLW)	0.0	Average Speed (S), mi/h	65.0
Right-Side Lateral Clearance Adj. (fRLC)	0.0	Density (D), pc/mi/ln	17.4
Total Ramp Density Adjustment	5.0	Level of Service (LOS)	B
Adjusted Free-Flow Speed (FFSadj), mi/h	65.0		

HCS7 Freeway Merge Report

Project Information

Analyst	LSA	Date	12/11/2019
Agency	LSA	Analysis Year	Phase I Proj Comp Yr (2029) WP
Jurisdiction	Caltrans	Time Period Analyzed	PM Peak Hour
Project Description	CMD1801 - Village D Specific Plan	Unit	United States Customary

Geometric Data

	Freeway	Ramp
Number of Lanes (N), ln	3	1
Free-Flow Speed (FFS), mi/h	65.0	35.0
Segment Length (L) / Acceleration Length (LA),ft	1500	600
Terrain Type	Level	Level
Percent Grade, %	-	-
Segment Type / Ramp Side	Freeway	Right

Adjustment Factors

Driver Population	All Familiar	All Familiar
Weather Type	Non-Severe Weather	Non-Severe Weather
Incident Type	No Incident	-
Final Speed Adjustment Factor (SAF)	1.000	1.000
Final Capacity Adjustment Factor (CAF)	1.000	1.000
Demand Adjustment Factor (DAF)	1.000	1.000

Demand and Capacity

Demand Volume (Vi)	2557	695
Peak Hour Factor (PHF)	0.94	0.94
Total Trucks, %	24.72	6.33
Single-Unit Trucks (SUT), %	-	-
Tractor-Trailers (TT), %	-	-
Heavy Vehicle Adjustment Factor (fHV)	0.802	0.940
Flow Rate (vi),pc/h	3392	787
Capacity (c), pc/h	7050	2000
Volume-to-Capacity Ratio (v/c)	0.59	0.39

Speed and Density

Upstream Equilibrium Distance (LEQ), ft	-	Number of Outer Lanes on Freeway (NO)	1
Distance to Upstream Ramp (LUP), ft	-	Speed Index (MS)	0.343
Downstream Equilibrium Distance (LEQ), ft	-	Flow Outer Lanes (vOA), pc/h/ln	1377
Distance to Downstream Ramp (LDOWN), ft	-	On-Ramp Influence Area Speed (SR), mi/h	57.1
Prop. Freeway Vehicles in Lane 1 and 2 (PFM)	0.594	Outer Lanes Freeway Speed (SO), mi/h	61.8
Flow in Lanes 1 and 2 (v12), pc/h	2015	Ramp Junction Speed (S), mi/h	58.6
Flow Entering Ramp-Infl. Area (vR12), pc/h	2802	Average Density (D), pc/mi/ln	23.8
Level of Service (LOS)	C	Density in Ramp Influence Area (DR), pc/mi/ln	23.3

HCS7 Basic Freeway Report

Project Information

Analyst	LSA	Date	12/11/2019
Agency	LSA	Analysis Year	Phase I Proj Comp Yr (2029) WP
Jurisdiction	Caltrans	Time Period Analyzed	PM Peak Hour
Project Description	CMD1801 - Village D Specific Plan	Unit	United States Customary

Geometric Data

Number of Lanes, ln	3	Terrain Type	Level
Segment Length (L), ft	-	Percent Grade, %	-
Measured or Base Free-Flow Speed	Base	Grade Length, mi	-
Base Free-Flow Speed (BFFS), mi/h	65.0	Total Ramp Density (TRD), ramps/mi	1.83
Lane Width, ft	12	Free-Flow Speed (FFS), mi/h	59.7
Right-Side Lateral Clearance, ft	10		

Adjustment Factors

Driver Population	All Familiar	Final Speed Adjustment Factor (SAF)	1.000
Weather Type	Non-Severe Weather	Final Capacity Adjustment Factor (CAF)	1.000
Incident Type	No Incident	Demand Adjustment Factor (DAF)	1.000

Demand and Capacity

Demand Volume veh/h	3252	Heavy Vehicle Adjustment Factor (fhv)	0.828
Peak Hour Factor	0.94	Flow Rate (Vp), pc/h/ln	1393
Total Trucks, %	20.79	Capacity (c), pc/h/ln	2296
Single-Unit Trucks (SUT), %	-	Adjusted Capacity (cadj), pc/h/ln	2296
Tractor-Trailers (TT), %	-	Volume-to-Capacity Ratio (v/c)	0.61
Passenger Car Equivalent (ET)	2.000		

Speed and Density

Lane Width Adjustment (fLW)	0.0	Average Speed (S), mi/h	59.6
Right-Side Lateral Clearance Adj. (fRLC)	0.0	Density (D), pc/mi/ln	23.4
Total Ramp Density Adjustment	5.4	Level of Service (LOS)	C
Adjusted Free-Flow Speed (FFSadj), mi/h	59.6		

HCS7 Freeway Merge Report

Project Information

Analyst	LSA	Date	12/11/2019
Agency	LSA	Analysis Year	Phase I Proj Comp Yr (2029) WP
Jurisdiction	Caltrans	Time Period Analyzed	PM Peak Hour
Project Description	CMD1801 - Village D Specific Plan	Unit	United States Customary

Geometric Data

	Freeway	Ramp
Number of Lanes (N), ln	3	1
Free-Flow Speed (FFS), mi/h	65.0	35.0
Segment Length (L) / Acceleration Length (LA),ft	1500	600
Terrain Type	Level	Level
Percent Grade, %	-	-
Segment Type / Ramp Side	Freeway	Right

Adjustment Factors

Driver Population	All Familiar	All Familiar
Weather Type	Non-Severe Weather	Non-Severe Weather
Incident Type	No Incident	-
Final Speed Adjustment Factor (SAF)	1.000	1.000
Final Capacity Adjustment Factor (CAF)	1.000	1.000
Demand Adjustment Factor (DAF)	1.000	1.000

Demand and Capacity

Demand Volume (Vi)	3252	230
Peak Hour Factor (PHF)	0.94	0.94
Total Trucks, %	20.79	3.47
Single-Unit Trucks (SUT), %	-	-
Tractor-Trailers (TT), %	-	-
Heavy Vehicle Adjustment Factor (fHV)	0.828	0.966
Flow Rate (vi),pc/h	4178	253
Capacity (c), pc/h	7050	2000
Volume-to-Capacity Ratio (v/c)	0.63	0.13

Speed and Density

Upstream Equilibrium Distance (LEQ), ft	-	Number of Outer Lanes on Freeway (NO)	1
Distance to Upstream Ramp (LUP), ft	-	Speed Index (MS)	0.339
Downstream Equilibrium Distance (LEQ), ft	-	Flow Outer Lanes (vOA), pc/h/ln	1696
Distance to Downstream Ramp (LDOWN), ft	-	On-Ramp Influence Area Speed (SR), mi/h	57.2
Prop. Freeway Vehicles in Lane 1 and 2 (PFM)	0.594	Outer Lanes Freeway Speed (SO), mi/h	60.7
Flow in Lanes 1 and 2 (v12), pc/h	2482	Ramp Junction Speed (S), mi/h	58.5
Flow Entering Ramp-Infl. Area (vR12), pc/h	2735	Average Density (D), pc/mi/ln	25.2
Level of Service (LOS)	C	Density in Ramp Influence Area (DR), pc/mi/ln	23.0

HCS7 Basic Freeway Report

Project Information

Analyst	LSA	Date	12/11/2019
Agency	LSA	Analysis Year	Phase I Proj Comp Yr (2029) WP
Jurisdiction	Caltrans	Time Period Analyzed	PM Peak Hour
Project Description	CMD1801 - Village D Specific Plan	Unit	United States Customary

Geometric Data

Number of Lanes, ln	3	Terrain Type	Level
Segment Length (L), ft	-	Percent Grade, %	-
Measured or Base Free-Flow Speed	Base	Grade Length, mi	-
Base Free-Flow Speed (BFFS), mi/h	65.0	Total Ramp Density (TRD), ramps/mi	2.17
Lane Width, ft	12	Free-Flow Speed (FFS), mi/h	58.8
Right-Side Lateral Clearance, ft	10		

Adjustment Factors

Driver Population	All Familiar	Final Speed Adjustment Factor (SAF)	1.000
Weather Type	Non-Severe Weather	Final Capacity Adjustment Factor (CAF)	1.000
Incident Type	No Incident	Demand Adjustment Factor (DAF)	1.000

Demand and Capacity

Demand Volume veh/h	3482	Heavy Vehicle Adjustment Factor (fhv)	0.836
Peak Hour Factor	0.94	Flow Rate (Vp), pc/h/ln	1477
Total Trucks, %	19.64	Capacity (c), pc/h/ln	2288
Single-Unit Trucks (SUT), %	-	Adjusted Capacity (cadj), pc/h/ln	2288
Tractor-Trailers (TT), %	-	Volume-to-Capacity Ratio (v/c)	0.65
Passenger Car Equivalent (ET)	2.000		

Speed and Density

Lane Width Adjustment (fLW)	0.0	Average Speed (S), mi/h	58.8
Right-Side Lateral Clearance Adj. (fRLC)	0.0	Density (D), pc/mi/ln	25.1
Total Ramp Density Adjustment	6.2	Level of Service (LOS)	C
Adjusted Free-Flow Speed (FFSadj), mi/h	58.8		

HCS7 Freeway Diverge Report

Project Information

Analyst	LSA	Date	12/11/2019
Agency	LSA	Analysis Year	Phase I Proj Comp Yr (2029) WP
Jurisdiction	Caltrans	Time Period Analyzed	PM Peak Hour
Project Description	CMD1801 - Village D Specific Plan	Unit	United States Customary

Geometric Data

	Freeway	Ramp
Number of Lanes (N), ln	3	1
Free-Flow Speed (FFS), mi/h	65.0	40.0
Segment Length (L) / Deceleration Length (LA),ft	1500	150
Terrain Type	Level	Level
Percent Grade, %	-	-
Segment Type / Ramp Side	Freeway	Right

Adjustment Factors

Driver Population	All Familiar	All Familiar
Weather Type	Non-Severe Weather	Non-Severe Weather
Incident Type	No Incident	-
Final Speed Adjustment Factor (SAF)	1.000	1.000
Final Capacity Adjustment Factor (CAF)	1.000	1.000
Demand Adjustment Factor (DAF)	1.000	1.000

Demand and Capacity

Demand Volume (Vi)	3482	311
Peak Hour Factor (PHF)	0.94	0.94
Total Trucks, %	19.64	3.54
Single-Unit Trucks (SUT), %	-	-
Tractor-Trailers (TT), %	-	-
Heavy Vehicle Adjustment Factor (fHV)	0.836	0.966
Flow Rate (vi),pc/h	4431	342
Capacity (c), pc/h	7050	2000
Volume-to-Capacity Ratio (v/c)	0.63	0.17

Speed and Density

Upstream Equilibrium Distance (LEQ), ft	-	Number of Outer Lanes on Freeway (NO)	1
Distance to Upstream Ramp (LUP), ft	-	Speed Index (DS)	0.394
Downstream Equilibrium Distance (LEQ), ft	-	Flow Outer Lanes (vOA), pc/h/ln	1501
Distance to Downstream Ramp (LDOWN), ft	-	Off-Ramp Influence Area Speed (SR), mi/h	55.9
Prop. Freeway Vehicles in Lane 1 and 2 (PFD)	0.633	Outer Lanes Freeway Speed (SO), mi/h	69.4
Flow in Lanes 1 and 2 (v12), pc/h	2930	Ramp Junction Speed (S), mi/h	59.8
Flow Entering Ramp-Infl. Area (vR12), pc/h	-	Average Density (D), pc/mi/ln	24.7
Level of Service (LOS)	D	Density in Ramp Influence Area (DR), pc/mi/ln	28.1

HCS7 Basic Freeway Report

Project Information

Analyst	LSA	Date	12/11/2019
Agency	LSA	Analysis Year	Phase I Proj Comp Yr (2029) WP
Jurisdiction	Caltrans	Time Period Analyzed	PM Peak Hour
Project Description	CMD1801 - Village D Specific Plan	Unit	United States Customary

Geometric Data

Number of Lanes, ln	3	Terrain Type	Level
Segment Length (L), ft	-	Percent Grade, %	-
Measured or Base Free-Flow Speed	Base	Grade Length, mi	-
Base Free-Flow Speed (BFFS), mi/h	65.0	Total Ramp Density (TRD), ramps/mi	1.83
Lane Width, ft	12	Free-Flow Speed (FFS), mi/h	59.7
Right-Side Lateral Clearance, ft	10		

Adjustment Factors

Driver Population	All Familiar	Final Speed Adjustment Factor (SAF)	1.000
Weather Type	Non-Severe Weather	Final Capacity Adjustment Factor (CAF)	1.000
Incident Type	No Incident	Demand Adjustment Factor (DAF)	1.000

Demand and Capacity

Demand Volume veh/h	3171	Heavy Vehicle Adjustment Factor (fhv)	0.825
Peak Hour Factor	0.94	Flow Rate (Vp), pc/h/ln	1363
Total Trucks, %	21.22	Capacity (c), pc/h/ln	2296
Single-Unit Trucks (SUT), %	-	Adjusted Capacity (cadj), pc/h/ln	2296
Tractor-Trailers (TT), %	-	Volume-to-Capacity Ratio (v/c)	0.59
Passenger Car Equivalent (ET)	2.000		

Speed and Density

Lane Width Adjustment (fLW)	0.0	Average Speed (S), mi/h	59.6
Right-Side Lateral Clearance Adj. (fRLC)	0.0	Density (D), pc/mi/ln	22.9
Total Ramp Density Adjustment	5.4	Level of Service (LOS)	C
Adjusted Free-Flow Speed (FFSadj), mi/h	59.6		

HCS7 Freeway Merge Report

Project Information

Analyst	LSA	Date	12/11/2019
Agency	LSA	Analysis Year	Phase I Proj Comp Yr (2029) WP
Jurisdiction	Caltrans	Time Period Analyzed	PM Peak Hour
Project Description	CMD1801 - Village D Specific Plan	Unit	United States Customary

Geometric Data

	Freeway	Ramp
Number of Lanes (N), ln	3	1
Free-Flow Speed (FFS), mi/h	65.0	35.0
Segment Length (L) / Acceleration Length (LA),ft	1500	800
Terrain Type	Level	Level
Percent Grade, %	-	-
Segment Type / Ramp Side	Freeway	Right

Adjustment Factors

Driver Population	All Familiar	All Familiar
Weather Type	Non-Severe Weather	Non-Severe Weather
Incident Type	No Incident	-
Final Speed Adjustment Factor (SAF)	1.000	1.000
Final Capacity Adjustment Factor (CAF)	1.000	1.000
Demand Adjustment Factor (DAF)	1.000	1.000

Demand and Capacity

Demand Volume (Vi)	3171	185
Peak Hour Factor (PHF)	0.94	0.94
Total Trucks, %	21.22	5.95
Single-Unit Trucks (SUT), %	-	-
Tractor-Trailers (TT), %	-	-
Heavy Vehicle Adjustment Factor (fHV)	0.825	0.944
Flow Rate (vi),pc/h	4089	208
Capacity (c), pc/h	7050	2000
Volume-to-Capacity Ratio (v/c)	0.61	0.10

Speed and Density

Upstream Equilibrium Distance (LEQ), ft	-	Number of Outer Lanes on Freeway (NO)	1
Distance to Upstream Ramp (LUP), ft	-	Speed Index (MS)	0.321
Downstream Equilibrium Distance (LEQ), ft	-	Flow Outer Lanes (vOA), pc/h/ln	1636
Distance to Downstream Ramp (LDOWN), ft	-	On-Ramp Influence Area Speed (SR), mi/h	57.6
Prop. Freeway Vehicles in Lane 1 and 2 (PFM)	0.600	Outer Lanes Freeway Speed (SO), mi/h	60.9
Flow in Lanes 1 and 2 (v12), pc/h	2453	Ramp Junction Speed (S), mi/h	58.8
Flow Entering Ramp-Infl. Area (vR12), pc/h	2661	Average Density (D), pc/mi/ln	24.4
Level of Service (LOS)	C	Density in Ramp Influence Area (DR), pc/mi/ln	21.2

HCS7 Basic Freeway Report

Project Information

Analyst	LSA	Date	12/11/2019
Agency	LSA	Analysis Year	Phase I Proj Comp Yr (2029) WP
Jurisdiction	Caltrans	Time Period Analyzed	PM Peak Hour
Project Description	CMD1801 - Village D Specific Plan	Unit	United States Customary

Geometric Data

Number of Lanes, ln	3	Terrain Type	Level
Segment Length (L), ft	-	Percent Grade, %	-
Measured or Base Free-Flow Speed	Base	Grade Length, mi	-
Base Free-Flow Speed (BFFS), mi/h	65.0	Total Ramp Density (TRD), ramps/mi	2.17
Lane Width, ft	12	Free-Flow Speed (FFS), mi/h	58.8
Right-Side Lateral Clearance, ft	10		

Adjustment Factors

Driver Population	All Familiar	Final Speed Adjustment Factor (SAF)	1.000
Weather Type	Non-Severe Weather	Final Capacity Adjustment Factor (CAF)	1.000
Incident Type	No Incident	Demand Adjustment Factor (DAF)	1.000

Demand and Capacity

Demand Volume veh/h	3356	Heavy Vehicle Adjustment Factor (fhv)	0.831
Peak Hour Factor	0.94	Flow Rate (Vp), pc/h/ln	1432
Total Trucks, %	20.37	Capacity (c), pc/h/ln	2288
Single-Unit Trucks (SUT), %	-	Adjusted Capacity (cadj), pc/h/ln	2288
Tractor-Trailers (TT), %	-	Volume-to-Capacity Ratio (v/c)	0.63
Passenger Car Equivalent (ET)	2.000		

Speed and Density

Lane Width Adjustment (fLW)	0.0	Average Speed (S), mi/h	58.8
Right-Side Lateral Clearance Adj. (fRLC)	0.0	Density (D), pc/mi/ln	24.4
Total Ramp Density Adjustment	6.2	Level of Service (LOS)	C
Adjusted Free-Flow Speed (FFSadj), mi/h	58.8		

HCS7 Freeway Diverge Report

Project Information

Analyst	LSA	Date	12/11/2019
Agency	LSA	Analysis Year	Phase I Proj Comp Yr (2029) WP
Jurisdiction	Caltrans	Time Period Analyzed	PM Peak Hour
Project Description	CMD1801 - Village D Specific Plan	Unit	United States Customary

Geometric Data

	Freeway	Ramp
Number of Lanes (N), ln	3	1
Free-Flow Speed (FFS), mi/h	65.0	35.0
Segment Length (L) / Deceleration Length (LA),ft	1500	200
Terrain Type	Level	Level
Percent Grade, %	-	-
Segment Type / Ramp Side	Freeway	Right

Adjustment Factors

Driver Population	All Familiar	All Familiar
Weather Type	Non-Severe Weather	Non-Severe Weather
Incident Type	No Incident	-
Final Speed Adjustment Factor (SAF)	1.000	1.000
Final Capacity Adjustment Factor (CAF)	1.000	1.000
Demand Adjustment Factor (DAF)	1.000	1.000

Demand and Capacity

Demand Volume (Vi)	3356	231
Peak Hour Factor (PHF)	0.94	0.94
Total Trucks, %	20.37	3.90
Single-Unit Trucks (SUT), %	-	-
Tractor-Trailers (TT), %	-	-
Heavy Vehicle Adjustment Factor (fHV)	0.831	0.962
Flow Rate (vi),pc/h	4296	255
Capacity (c), pc/h	7050	2000
Volume-to-Capacity Ratio (v/c)	0.61	0.13

Speed and Density

Upstream Equilibrium Distance (LEQ), ft	-	Number of Outer Lanes on Freeway (NO)	1
Distance to Upstream Ramp (LUP), ft	-	Speed Index (DS)	0.451
Downstream Equilibrium Distance (LEQ), ft	-	Flow Outer Lanes (vOA), pc/h/ln	1451
Distance to Downstream Ramp (LDOWN), ft	-	Off-Ramp Influence Area Speed (SR), mi/h	54.6
Prop. Freeway Vehicles in Lane 1 and 2 (PFD)	0.641	Outer Lanes Freeway Speed (SO), mi/h	69.5
Flow in Lanes 1 and 2 (v12), pc/h	2845	Ramp Junction Speed (S), mi/h	58.9
Flow Entering Ramp-Infl. Area (vR12), pc/h	-	Average Density (D), pc/mi/ln	24.3
Level of Service (LOS)	C	Density in Ramp Influence Area (DR), pc/mi/ln	26.9

HCS7 Basic Freeway Report

Project Information

Analyst	LSA	Date	12/11/2019
Agency	LSA	Analysis Year	Phase I Proj Comp Yr (2029) WP
Jurisdiction	Caltrans	Time Period Analyzed	PM Peak Hour
Project Description	CMD1801 - Village D Specific Plan	Unit	United States Customary

Geometric Data

Number of Lanes, ln	3	Terrain Type	Level
Segment Length (L), ft	-	Percent Grade, %	-
Measured or Base Free-Flow Speed	Base	Grade Length, mi	-
Base Free-Flow Speed (BFFS), mi/h	65.0	Total Ramp Density (TRD), ramps/mi	2.17
Lane Width, ft	12	Free-Flow Speed (FFS), mi/h	58.8
Right-Side Lateral Clearance, ft	10		

Adjustment Factors

Driver Population	All Familiar	Final Speed Adjustment Factor (SAF)	1.000
Weather Type	Non-Severe Weather	Final Capacity Adjustment Factor (CAF)	1.000
Incident Type	No Incident	Demand Adjustment Factor (DAF)	1.000

Demand and Capacity

Demand Volume veh/h	3125	Heavy Vehicle Adjustment Factor (fhv)	0.822
Peak Hour Factor	0.94	Flow Rate (Vp), pc/h/ln	1348
Total Trucks, %	21.59	Capacity (c), pc/h/ln	2288
Single-Unit Trucks (SUT), %	-	Adjusted Capacity (cadj), pc/h/ln	2288
Tractor-Trailers (TT), %	-	Volume-to-Capacity Ratio (v/c)	0.59
Passenger Car Equivalent (ET)	2.000		

Speed and Density

Lane Width Adjustment (fLW)	0.0	Average Speed (S), mi/h	58.8
Right-Side Lateral Clearance Adj. (fRLC)	0.0	Density (D), pc/mi/ln	22.9
Total Ramp Density Adjustment	6.2	Level of Service (LOS)	C
Adjusted Free-Flow Speed (FFSadj), mi/h	58.8		

HCS7 Freeway Merge Report

Project Information

Analyst	LSA	Date	12/11/2019
Agency	LSA	Analysis Year	Phase I Proj Comp Yr (2029) WP
Jurisdiction	Caltrans	Time Period Analyzed	PM Peak Hour
Project Description	CMD1801 - Village D Specific Plan	Unit	United States Customary

Geometric Data

	Freeway	Ramp
Number of Lanes (N), ln	3	1
Free-Flow Speed (FFS), mi/h	65.0	35.0
Segment Length (L) / Acceleration Length (LA),ft	1500	350
Terrain Type	Level	Level
Percent Grade, %	-	-
Segment Type / Ramp Side	Freeway	Right

Adjustment Factors

Driver Population	All Familiar	All Familiar
Weather Type	Non-Severe Weather	Non-Severe Weather
Incident Type	No Incident	-
Final Speed Adjustment Factor (SAF)	1.000	1.000
Final Capacity Adjustment Factor (CAF)	1.000	1.000
Demand Adjustment Factor (DAF)	1.000	1.000

Demand and Capacity

Demand Volume (Vi)	3125	751
Peak Hour Factor (PHF)	0.94	0.94
Total Trucks, %	21.59	1.33
Single-Unit Trucks (SUT), %	-	-
Tractor-Trailers (TT), %	-	-
Heavy Vehicle Adjustment Factor (fHV)	0.822	0.987
Flow Rate (vi),pc/h	4044	809
Capacity (c), pc/h	7050	2000
Volume-to-Capacity Ratio (v/c)	0.69	0.40

Speed and Density

Upstream Equilibrium Distance (LEQ), ft	-	Number of Outer Lanes on Freeway (NO)	1
Distance to Upstream Ramp (LUP), ft	-	Speed Index (MS)	0.391
Downstream Equilibrium Distance (LEQ), ft	-	Flow Outer Lanes (vOA), pc/h/ln	1670
Distance to Downstream Ramp (LDOWN), ft	-	On-Ramp Influence Area Speed (SR), mi/h	56.0
Prop. Freeway Vehicles in Lane 1 and 2 (PFM)	0.587	Outer Lanes Freeway Speed (SO), mi/h	60.8
Flow in Lanes 1 and 2 (v12), pc/h	2374	Ramp Junction Speed (S), mi/h	57.6
Flow Entering Ramp-Infl. Area (vR12), pc/h	3183	Average Density (D), pc/mi/ln	28.1
Level of Service (LOS)	C	Density in Ramp Influence Area (DR), pc/mi/ln	27.8

HCS7 Basic Freeway Report

Project Information

Analyst	LSA	Date	12/11/2019
Agency	LSA	Analysis Year	Phase I Proj Comp Yr (2029) WP
Jurisdiction	Caltrans	Time Period Analyzed	PM Peak Hour
Project Description	CMD1801 - Village D Specific Plan	Unit	United States Customary

Geometric Data

Number of Lanes, ln	3	Terrain Type	Level
Segment Length (L), ft	-	Percent Grade, %	-
Measured or Base Free-Flow Speed	Base	Grade Length, mi	-
Base Free-Flow Speed (BFFS), mi/h	65.0	Total Ramp Density (TRD), ramps/mi	2.17
Lane Width, ft	12	Free-Flow Speed (FFS), mi/h	58.8
Right-Side Lateral Clearance, ft	10		

Adjustment Factors

Driver Population	All Familiar	Final Speed Adjustment Factor (SAF)	1.000
Weather Type	Non-Severe Weather	Final Capacity Adjustment Factor (CAF)	1.000
Incident Type	No Incident	Demand Adjustment Factor (DAF)	1.000

Demand and Capacity

Demand Volume veh/h	3876	Heavy Vehicle Adjustment Factor (fhv)	0.850
Peak Hour Factor	0.94	Flow Rate (Vp), pc/h/ln	1617
Total Trucks, %	17.65	Capacity (c), pc/h/ln	2288
Single-Unit Trucks (SUT), %	-	Adjusted Capacity (cadj), pc/h/ln	2288
Tractor-Trailers (TT), %	-	Volume-to-Capacity Ratio (v/c)	0.71
Passenger Car Equivalent (ET)	2.000		

Speed and Density

Lane Width Adjustment (fLW)	0.0	Average Speed (S), mi/h	58.8
Right-Side Lateral Clearance Adj. (fRLC)	0.0	Density (D), pc/mi/ln	27.5
Total Ramp Density Adjustment	6.2	Level of Service (LOS)	D
Adjusted Free-Flow Speed (FFSadj), mi/h	58.8		

HCS7 Freeway Diverge Report

Project Information

Analyst	LSA	Date	12/11/2019
Agency	LSA	Analysis Year	Phase I Proj Comp Yr (2029) WP
Jurisdiction	Caltrans	Time Period Analyzed	PM Peak Hour
Project Description	CMD1801 - Village D Specific Plan	Unit	United States Customary

Geometric Data

	Freeway	Ramp
Number of Lanes (N), ln	3	1
Free-Flow Speed (FFS), mi/h	65.0	15.0
Segment Length (L) / Deceleration Length (LA),ft	1500	150
Terrain Type	Level	Level
Percent Grade, %	-	-
Segment Type / Ramp Side	Freeway	Right

Adjustment Factors

Driver Population	All Familiar	All Familiar
Weather Type	Non-Severe Weather	Non-Severe Weather
Incident Type	No Incident	-
Final Speed Adjustment Factor (SAF)	1.000	1.000
Final Capacity Adjustment Factor (CAF)	1.000	1.000
Demand Adjustment Factor (DAF)	1.000	1.000

Demand and Capacity

Demand Volume (Vi)	3876	278
Peak Hour Factor (PHF)	0.94	0.94
Total Trucks, %	17.65	2.88
Single-Unit Trucks (SUT), %	-	-
Tractor-Trailers (TT), %	-	-
Heavy Vehicle Adjustment Factor (fHV)	0.850	0.972
Flow Rate (vi),pc/h	4851	304
Capacity (c), pc/h	7050	1800
Volume-to-Capacity Ratio (v/c)	0.69	0.17

Speed and Density

Upstream Equilibrium Distance (LEQ), ft	-	Number of Outer Lanes on Freeway (NO)	1
Distance to Upstream Ramp (LUP), ft	-	Speed Index (DS)	0.715
Downstream Equilibrium Distance (LEQ), ft	-	Flow Outer Lanes (vOA), pc/h/ln	1705
Distance to Downstream Ramp (LDOWN), ft	-	Off-Ramp Influence Area Speed (SR), mi/h	48.6
Prop. Freeway Vehicles in Lane 1 and 2 (PFD)	0.625	Outer Lanes Freeway Speed (SO), mi/h	68.6
Flow in Lanes 1 and 2 (v12), pc/h	3146	Ramp Junction Speed (S), mi/h	54.1
Flow Entering Ramp-Infl. Area (vR12), pc/h	-	Average Density (D), pc/mi/ln	29.9
Level of Service (LOS)	D	Density in Ramp Influence Area (DR), pc/mi/ln	30.0

HCS7 Basic Freeway Report

Project Information

Analyst	LSA	Date	12/11/2019
Agency	LSA	Analysis Year	Phase I Proj Comp Yr (2029) WP
Jurisdiction	Caltrans	Time Period Analyzed	PM Peak Hour
Project Description	CMD1801 - Village D Specific Plan	Unit	United States Customary

Geometric Data

Number of Lanes, ln	3	Terrain Type	Level
Segment Length (L), ft	-	Percent Grade, %	-
Measured or Base Free-Flow Speed	Base	Grade Length, mi	-
Base Free-Flow Speed (BFFS), mi/h	65.0	Total Ramp Density (TRD), ramps/mi	1.83
Lane Width, ft	12	Free-Flow Speed (FFS), mi/h	59.7
Right-Side Lateral Clearance, ft	10		

Adjustment Factors

Driver Population	All Familiar	Final Speed Adjustment Factor (SAF)	1.000
Weather Type	Non-Severe Weather	Final Capacity Adjustment Factor (CAF)	1.000
Incident Type	No Incident	Demand Adjustment Factor (DAF)	1.000

Demand and Capacity

Demand Volume veh/h	3598	Heavy Vehicle Adjustment Factor (fhv)	0.842
Peak Hour Factor	0.94	Flow Rate (Vp), pc/h/ln	1515
Total Trucks, %	18.80	Capacity (c), pc/h/ln	2296
Single-Unit Trucks (SUT), %	-	Adjusted Capacity (cadj), pc/h/ln	2296
Tractor-Trailers (TT), %	-	Volume-to-Capacity Ratio (v/c)	0.66
Passenger Car Equivalent (ET)	2.000		

Speed and Density

Lane Width Adjustment (fLW)	0.0	Average Speed (S), mi/h	59.6
Right-Side Lateral Clearance Adj. (fRLC)	0.0	Density (D), pc/mi/ln	25.4
Total Ramp Density Adjustment	5.4	Level of Service (LOS)	C
Adjusted Free-Flow Speed (FFSadj), mi/h	59.6		

HCS7 Freeway Merge Report

Project Information

Analyst	LSA	Date	12/11/2019
Agency	LSA	Analysis Year	Phase I Proj Comp Yr (2029) WP
Jurisdiction	Caltrans	Time Period Analyzed	PM Peak Hour
Project Description	CMD1801 - Village D Specific Plan	Unit	United States Customary

Geometric Data

	Freeway	Ramp
Number of Lanes (N), ln	3	1
Free-Flow Speed (FFS), mi/h	65.0	35.0
Segment Length (L) / Acceleration Length (LA),ft	1500	450
Terrain Type	Level	Level
Percent Grade, %	-	-
Segment Type / Ramp Side	Freeway	Right

Adjustment Factors

Driver Population	All Familiar	All Familiar
Weather Type	Non-Severe Weather	Non-Severe Weather
Incident Type	No Incident	-
Final Speed Adjustment Factor (SAF)	1.000	1.000
Final Capacity Adjustment Factor (CAF)	1.000	1.000
Demand Adjustment Factor (DAF)	1.000	1.000

Demand and Capacity

Demand Volume (Vi)	3598	465
Peak Hour Factor (PHF)	0.94	0.94
Total Trucks, %	18.80	1.08
Single-Unit Trucks (SUT), %	-	-
Tractor-Trailers (TT), %	-	-
Heavy Vehicle Adjustment Factor (fHV)	0.842	0.989
Flow Rate (vi),pc/h	4546	500
Capacity (c), pc/h	7050	2000
Volume-to-Capacity Ratio (v/c)	0.72	0.25

Speed and Density

Upstream Equilibrium Distance (LEQ), ft	-	Number of Outer Lanes on Freeway (NO)	1
Distance to Upstream Ramp (LUP), ft	-	Speed Index (MS)	0.383
Downstream Equilibrium Distance (LEQ), ft	-	Flow Outer Lanes (vOA), pc/h/ln	1864
Distance to Downstream Ramp (LDOWN), ft	-	On-Ramp Influence Area Speed (SR), mi/h	56.2
Prop. Freeway Vehicles in Lane 1 and 2 (PFM)	0.590	Outer Lanes Freeway Speed (SO), mi/h	60.1
Flow in Lanes 1 and 2 (v12), pc/h	2682	Ramp Junction Speed (S), mi/h	57.6
Flow Entering Ramp-Infl. Area (vR12), pc/h	3182	Average Density (D), pc/mi/ln	29.2
Level of Service (LOS)	C	Density in Ramp Influence Area (DR), pc/mi/ln	27.3

HCS7 Basic Freeway Report

Project Information

Analyst	LSA	Date	12/11/2019
Agency	LSA	Analysis Year	Phase I Proj Comp Yr (2029) WP
Jurisdiction	Caltrans	Time Period Analyzed	PM Peak Hour
Project Description	CMD1801 - Village D Specific Plan	Unit	United States Customary

Geometric Data

Number of Lanes, ln	3	Terrain Type	Level
Segment Length (L), ft	-	Percent Grade, %	-
Measured or Base Free-Flow Speed	Base	Grade Length, mi	-
Base Free-Flow Speed (BFFS), mi/h	65.0	Total Ramp Density (TRD), ramps/mi	1.83
Lane Width, ft	12	Free-Flow Speed (FFS), mi/h	59.7
Right-Side Lateral Clearance, ft	10		

Adjustment Factors

Driver Population	All Familiar	Final Speed Adjustment Factor (SAF)	1.000
Weather Type	Non-Severe Weather	Final Capacity Adjustment Factor (CAF)	1.000
Incident Type	No Incident	Demand Adjustment Factor (DAF)	1.000

Demand and Capacity

Demand Volume veh/h	4063	Heavy Vehicle Adjustment Factor (fhv)	0.856
Peak Hour Factor	0.94	Flow Rate (Vp), pc/h/ln	1683
Total Trucks, %	16.78	Capacity (c), pc/h/ln	2296
Single-Unit Trucks (SUT), %	-	Adjusted Capacity (cadj), pc/h/ln	2296
Tractor-Trailers (TT), %	-	Volume-to-Capacity Ratio (v/c)	0.73
Passenger Car Equivalent (ET)	2.000		

Speed and Density

Lane Width Adjustment (fLW)	0.0	Average Speed (S), mi/h	59.5
Right-Side Lateral Clearance Adj. (fRLC)	0.0	Density (D), pc/mi/ln	28.3
Total Ramp Density Adjustment	5.4	Level of Service (LOS)	D
Adjusted Free-Flow Speed (FFSadj), mi/h	59.6		

HCS7 Freeway Diverge Report

Project Information

Analyst	LSA	Date	12/11/2019
Agency	LSA	Analysis Year	Phase I Proj Comp Yr (2029) WP
Jurisdiction	Caltrans	Time Period Analyzed	PM Peak Hour
Project Description	CMD1801 - Village D Specific Plan	Unit	United States Customary

Geometric Data

	Freeway	Ramp
Number of Lanes (N), In	3	1
Free-Flow Speed (FFS), mi/h	65.0	35.0
Segment Length (L) / Deceleration Length (LA),ft	1500	140
Terrain Type	Level	Level
Percent Grade, %	-	-
Segment Type / Ramp Side	Freeway	Right

Adjustment Factors

Driver Population	All Familiar	All Familiar
Weather Type	Non-Severe Weather	Non-Severe Weather
Incident Type	No Incident	-
Final Speed Adjustment Factor (SAF)	1.000	1.000
Final Capacity Adjustment Factor (CAF)	1.000	1.000
Demand Adjustment Factor (DAF)	1.000	1.000

Demand and Capacity

Demand Volume (Vi)	4063	487
Peak Hour Factor (PHF)	0.94	0.94
Total Trucks, %	16.78	4.11
Single-Unit Trucks (SUT), %	-	-
Tractor-Trailers (TT), %	-	-
Heavy Vehicle Adjustment Factor (fHV)	0.856	0.961
Flow Rate (vi),pc/h	5049	539
Capacity (c), pc/h	7050	2000
Volume-to-Capacity Ratio (v/c)	0.72	0.27

Speed and Density

Upstream Equilibrium Distance (LEQ), ft	-	Number of Outer Lanes on Freeway (NO)	1
Distance to Upstream Ramp (LUP), ft	-	Speed Index (DS)	0.477
Downstream Equilibrium Distance (LEQ), ft	-	Flow Outer Lanes (vOA), pc/h/ln	1763
Distance to Downstream Ramp (LDOWN), ft	-	Off-Ramp Influence Area Speed (SR), mi/h	54.0
Prop. Freeway Vehicles in Lane 1 and 2 (PFD)	0.609	Outer Lanes Freeway Speed (SO), mi/h	68.3
Flow in Lanes 1 and 2 (v12), pc/h	3286	Ramp Junction Speed (S), mi/h	58.3
Flow Entering Ramp-Infl. Area (vR12), pc/h	-	Average Density (D), pc/mi/ln	28.9
Level of Service (LOS)	D	Density in Ramp Influence Area (DR), pc/mi/ln	31.3

HCS7 Basic Freeway Report

Project Information

Analyst	LSA	Date	12/11/2019
Agency	LSA	Analysis Year	Phase I Proj Comp Yr (2029) WP
Jurisdiction	Caltrans	Time Period Analyzed	PM Peak Hour
Project Description	CMD1801 - Village D Specific Plan	Unit	United States Customary

Geometric Data

Number of Lanes, ln	3	Terrain Type	Level
Segment Length (L), ft	-	Percent Grade, %	-
Measured or Base Free-Flow Speed	Base	Grade Length, mi	-
Base Free-Flow Speed (BFFS), mi/h	65.0	Total Ramp Density (TRD), ramps/mi	2.17
Lane Width, ft	12	Free-Flow Speed (FFS), mi/h	58.8
Right-Side Lateral Clearance, ft	10		

Adjustment Factors

Driver Population	All Familiar	Final Speed Adjustment Factor (SAF)	1.000
Weather Type	Non-Severe Weather	Final Capacity Adjustment Factor (CAF)	1.000
Incident Type	No Incident	Demand Adjustment Factor (DAF)	1.000

Demand and Capacity

Demand Volume veh/h	3576	Heavy Vehicle Adjustment Factor (fhv)	0.844
Peak Hour Factor	0.94	Flow Rate (Vp), pc/h/ln	1502
Total Trucks, %	18.49	Capacity (c), pc/h/ln	2288
Single-Unit Trucks (SUT), %	-	Adjusted Capacity (cadj), pc/h/ln	2288
Tractor-Trailers (TT), %	-	Volume-to-Capacity Ratio (v/c)	0.66
Passenger Car Equivalent (ET)	2.000		

Speed and Density

Lane Width Adjustment (fLW)	0.0	Average Speed (S), mi/h	58.8
Right-Side Lateral Clearance Adj. (fRLC)	0.0	Density (D), pc/mi/ln	25.5
Total Ramp Density Adjustment	6.2	Level of Service (LOS)	C
Adjusted Free-Flow Speed (FFSadj), mi/h	58.8		

HCS7 Freeway Merge Report

Project Information

Analyst	LSA	Date	12/11/2019
Agency	LSA	Analysis Year	Phase I Proj Comp Yr (2029) WP
Jurisdiction	Caltrans	Time Period Analyzed	PM Peak Hour
Project Description	CMD1801 - Village D Specific Plan	Unit	United States Customary

Geometric Data

	Freeway	Ramp
Number of Lanes (N), ln	3	1
Free-Flow Speed (FFS), mi/h	65.0	35.0
Segment Length (L) / Acceleration Length (LA),ft	1500	450
Terrain Type	Level	Level
Percent Grade, %	-	-
Segment Type / Ramp Side	Freeway	Right

Adjustment Factors

Driver Population	All Familiar	All Familiar
Weather Type	Non-Severe Weather	Non-Severe Weather
Incident Type	No Incident	-
Final Speed Adjustment Factor (SAF)	1.000	1.000
Final Capacity Adjustment Factor (CAF)	1.000	1.000
Demand Adjustment Factor (DAF)	1.000	1.000

Demand and Capacity

Demand Volume (Vi)	3576	361
Peak Hour Factor (PHF)	0.94	0.94
Total Trucks, %	18.49	1.66
Single-Unit Trucks (SUT), %	-	-
Tractor-Trailers (TT), %	-	-
Heavy Vehicle Adjustment Factor (fHV)	0.844	0.984
Flow Rate (vi),pc/h	4507	390
Capacity (c), pc/h	7050	2000
Volume-to-Capacity Ratio (v/c)	0.69	0.20

Speed and Density

Upstream Equilibrium Distance (LEQ), ft	-	Number of Outer Lanes on Freeway (NO)	1
Distance to Upstream Ramp (LUP), ft	-	Speed Index (MS)	0.372
Downstream Equilibrium Distance (LEQ), ft	-	Flow Outer Lanes (vOA), pc/h/ln	1848
Distance to Downstream Ramp (LDOWN), ft	-	On-Ramp Influence Area Speed (SR), mi/h	56.4
Prop. Freeway Vehicles in Lane 1 and 2 (PFM)	0.590	Outer Lanes Freeway Speed (SO), mi/h	60.1
Flow in Lanes 1 and 2 (v12), pc/h	2659	Ramp Junction Speed (S), mi/h	57.7
Flow Entering Ramp-Infl. Area (vR12), pc/h	3049	Average Density (D), pc/mi/ln	28.3
Level of Service (LOS)	C	Density in Ramp Influence Area (DR), pc/mi/ln	26.3

HCS7 Basic Freeway Report

Project Information

Analyst	LSA	Date	12/11/2019
Agency	LSA	Analysis Year	Phase I Proj Comp Yr (2029) WP
Jurisdiction	Caltrans	Time Period Analyzed	PM Peak Hour
Project Description	CMD1801 - Village D Specific Plan	Unit	United States Customary

Geometric Data

Number of Lanes, ln	3	Terrain Type	Level
Segment Length (L), ft	-	Percent Grade, %	-
Measured or Base Free-Flow Speed	Base	Grade Length, mi	-
Base Free-Flow Speed (BFFS), mi/h	65.0	Total Ramp Density (TRD), ramps/mi	2.17
Lane Width, ft	12	Free-Flow Speed (FFS), mi/h	58.8
Right-Side Lateral Clearance, ft	10		

Adjustment Factors

Driver Population	All Familiar	Final Speed Adjustment Factor (SAF)	1.000
Weather Type	Non-Severe Weather	Final Capacity Adjustment Factor (CAF)	1.000
Incident Type	No Incident	Demand Adjustment Factor (DAF)	1.000

Demand and Capacity

Demand Volume veh/h	3937	Heavy Vehicle Adjustment Factor (fhv)	0.855
Peak Hour Factor	0.94	Flow Rate (Vp), pc/h/ln	1633
Total Trucks, %	16.94	Capacity (c), pc/h/ln	2288
Single-Unit Trucks (SUT), %	-	Adjusted Capacity (cadj), pc/h/ln	2288
Tractor-Trailers (TT), %	-	Volume-to-Capacity Ratio (v/c)	0.71
Passenger Car Equivalent (ET)	2.000		

Speed and Density

Lane Width Adjustment (fLW)	0.0	Average Speed (S), mi/h	58.8
Right-Side Lateral Clearance Adj. (fRLC)	0.0	Density (D), pc/mi/ln	27.8
Total Ramp Density Adjustment	6.2	Level of Service (LOS)	D
Adjusted Free-Flow Speed (FFSadj), mi/h	58.8		

HCS7 Basic Freeway Report

Project Information

Analyst	LSA	Date	12/11/2019
Agency	LSA	Analysis Year	Phase II Proj Comp Yr (2039) NP
Jurisdiction	Caltrans	Time Period Analyzed	AM Peak Hour
Project Description	CMD1801 - Village D Specific Plan	Unit	United States Customary

Geometric Data

Number of Lanes, ln	3	Terrain Type	Level
Segment Length (L), ft	-	Percent Grade, %	-
Measured or Base Free-Flow Speed	Base	Grade Length, mi	-
Base Free-Flow Speed (BFFS), mi/h	65.0	Total Ramp Density (TRD), ramps/mi	1.83
Lane Width, ft	12	Free-Flow Speed (FFS), mi/h	59.7
Right-Side Lateral Clearance, ft	10		

Adjustment Factors

Driver Population	All Familiar	Final Speed Adjustment Factor (SAF)	1.000
Weather Type	Non-Severe Weather	Final Capacity Adjustment Factor (CAF)	1.000
Incident Type	No Incident	Demand Adjustment Factor (DAF)	1.000

Demand and Capacity

Demand Volume veh/h	3275	Heavy Vehicle Adjustment Factor (fhv)	0.851
Peak Hour Factor	0.94	Flow Rate (Vp), pc/h/ln	1365
Total Trucks, %	17.57	Capacity (c), pc/h/ln	2296
Single-Unit Trucks (SUT), %	-	Adjusted Capacity (cadj), pc/h/ln	2296
Tractor-Trailers (TT), %	-	Volume-to-Capacity Ratio (v/c)	0.59
Passenger Car Equivalent (ET)	2.000		

Speed and Density

Lane Width Adjustment (fLW)	0.0	Average Speed (S), mi/h	59.6
Right-Side Lateral Clearance Adj. (fRLC)	0.0	Density (D), pc/mi/ln	22.9
Total Ramp Density Adjustment	5.4	Level of Service (LOS)	C
Adjusted Free-Flow Speed (FFSadj), mi/h	59.6		

HCS7 Freeway Diverge Report

Project Information

Analyst	LSA	Date	12/11/2019
Agency	LSA	Analysis Year	Phase II Proj Comp Yr (2039) NP
Jurisdiction	Caltrans	Time Period Analyzed	AM Peak Hour
Project Description	CMD1801 - Village D Specific Plan	Unit	United States Customary

Geometric Data

	Freeway	Ramp
Number of Lanes (N), ln	3	1
Free-Flow Speed (FFS), mi/h	65.0	35.0
Segment Length (L) / Deceleration Length (LA),ft	1500	150
Terrain Type	Level	Level
Percent Grade, %	-	-
Segment Type / Ramp Side	Freeway	Right

Adjustment Factors

Driver Population	All Familiar	All Familiar
Weather Type	Non-Severe Weather	Non-Severe Weather
Incident Type	No Incident	-
Final Speed Adjustment Factor (SAF)	1.000	1.000
Final Capacity Adjustment Factor (CAF)	1.000	1.000
Demand Adjustment Factor (DAF)	1.000	1.000

Demand and Capacity

Demand Volume (Vi)	3275	293
Peak Hour Factor (PHF)	0.94	0.94
Total Trucks, %	17.57	4.65
Single-Unit Trucks (SUT), %	-	-
Tractor-Trailers (TT), %	-	-
Heavy Vehicle Adjustment Factor (fHV)	0.851	0.956
Flow Rate (vi),pc/h	4094	326
Capacity (c), pc/h	7050	2000
Volume-to-Capacity Ratio (v/c)	0.58	0.16

Speed and Density

Upstream Equilibrium Distance (LEQ), ft	-	Number of Outer Lanes on Freeway (NO)	1
Distance to Upstream Ramp (LUP), ft	-	Speed Index (DS)	0.457
Downstream Equilibrium Distance (LEQ), ft	-	Flow Outer Lanes (vOA), pc/h/ln	1345
Distance to Downstream Ramp (LDOWN), ft	-	Off-Ramp Influence Area Speed (SR), mi/h	54.5
Prop. Freeway Vehicles in Lane 1 and 2 (PFD)	0.643	Outer Lanes Freeway Speed (SO), mi/h	70.0
Flow in Lanes 1 and 2 (v12), pc/h	2749	Ramp Junction Speed (S), mi/h	58.8
Flow Entering Ramp-Infl. Area (vR12), pc/h	-	Average Density (D), pc/mi/ln	23.2
Level of Service (LOS)	C	Density in Ramp Influence Area (DR), pc/mi/ln	26.5

HCS7 Basic Freeway Report

Project Information

Analyst	LSA	Date	12/11/2019
Agency	LSA	Analysis Year	Phase II Proj Comp Yr (2039) NP
Jurisdiction	Caltrans	Time Period Analyzed	AM Peak Hour
Project Description	CMD1801 - Village D Specific Plan	Unit	United States Customary

Geometric Data

Number of Lanes, ln	3	Terrain Type	Level
Segment Length (L), ft	-	Percent Grade, %	-
Measured or Base Free-Flow Speed	Base	Grade Length, mi	-
Base Free-Flow Speed (BFFS), mi/h	65.0	Total Ramp Density (TRD), ramps/mi	1.83
Lane Width, ft	12	Free-Flow Speed (FFS), mi/h	59.7
Right-Side Lateral Clearance, ft	10		

Adjustment Factors

Driver Population	All Familiar	Final Speed Adjustment Factor (SAF)	1.000
Weather Type	Non-Severe Weather	Final Capacity Adjustment Factor (CAF)	1.000
Incident Type	No Incident	Demand Adjustment Factor (DAF)	1.000

Demand and Capacity

Demand Volume veh/h	2982	Heavy Vehicle Adjustment Factor (fhv)	0.841
Peak Hour Factor	0.94	Flow Rate (Vp), pc/h/ln	1257
Total Trucks, %	18.85	Capacity (c), pc/h/ln	2296
Single-Unit Trucks (SUT), %	-	Adjusted Capacity (cadj), pc/h/ln	2296
Tractor-Trailers (TT), %	-	Volume-to-Capacity Ratio (v/c)	0.55
Passenger Car Equivalent (ET)	2.000		

Speed and Density

Lane Width Adjustment (fLW)	0.0	Average Speed (S), mi/h	59.6
Right-Side Lateral Clearance Adj. (fRLC)	0.0	Density (D), pc/mi/ln	21.1
Total Ramp Density Adjustment	5.4	Level of Service (LOS)	C
Adjusted Free-Flow Speed (FFSadj), mi/h	59.6		

HCS7 Freeway Merge Report

Project Information

Analyst	LSA	Date	12/11/2019
Agency	LSA	Analysis Year	Phase II Proj Comp Yr (2039) NP
Jurisdiction	Caltrans	Time Period Analyzed	AM Peak Hour
Project Description	CMD1801 - Village D Specific Plan	Unit	United States Customary

Geometric Data

	Freeway	Ramp
Number of Lanes (N), ln	3	1
Free-Flow Speed (FFS), mi/h	65.0	35.0
Segment Length (L) / Acceleration Length (LA),ft	1500	445
Terrain Type	Level	Level
Percent Grade, %	-	-
Segment Type / Ramp Side	Freeway	Right

Adjustment Factors

Driver Population	All Familiar	All Familiar
Weather Type	Non-Severe Weather	Non-Severe Weather
Incident Type	No Incident	-
Final Speed Adjustment Factor (SAF)	1.000	1.000
Final Capacity Adjustment Factor (CAF)	1.000	1.000
Demand Adjustment Factor (DAF)	1.000	1.000

Demand and Capacity

Demand Volume (Vi)	2982	796
Peak Hour Factor (PHF)	0.94	0.94
Total Trucks, %	18.85	9.94
Single-Unit Trucks (SUT), %	-	-
Tractor-Trailers (TT), %	-	-
Heavy Vehicle Adjustment Factor (fHV)	0.841	0.910
Flow Rate (vi),pc/h	3772	931
Capacity (c), pc/h	7050	2000
Volume-to-Capacity Ratio (v/c)	0.67	0.47

Speed and Density

Upstream Equilibrium Distance (LEQ), ft	-	Number of Outer Lanes on Freeway (NO)	1
Distance to Upstream Ramp (LUP), ft	-	Speed Index (MS)	0.381
Downstream Equilibrium Distance (LEQ), ft	-	Flow Outer Lanes (vOA), pc/h/ln	1547
Distance to Downstream Ramp (LDOWN), ft	-	On-Ramp Influence Area Speed (SR), mi/h	56.2
Prop. Freeway Vehicles in Lane 1 and 2 (PFM)	0.590	Outer Lanes Freeway Speed (SO), mi/h	61.2
Flow in Lanes 1 and 2 (v12), pc/h	2225	Ramp Junction Speed (S), mi/h	57.8
Flow Entering Ramp-Infl. Area (vR12), pc/h	3156	Average Density (D), pc/mi/ln	27.1
Level of Service (LOS)	C	Density in Ramp Influence Area (DR), pc/mi/ln	26.9

HCS7 Basic Freeway Report

Project Information

Analyst	LSA	Date	12/11/2019
Agency	LSA	Analysis Year	Phase II Proj Comp Yr (2039) NP
Jurisdiction	Caltrans	Time Period Analyzed	AM Peak Hour
Project Description	CMD1801 - Village D Specific Plan	Unit	United States Customary

Geometric Data

Number of Lanes, ln	3	Terrain Type	Level
Segment Length (L), ft	-	Percent Grade, %	-
Measured or Base Free-Flow Speed	Base	Grade Length, mi	-
Base Free-Flow Speed (BFFS), mi/h	65.0	Total Ramp Density (TRD), ramps/mi	1.50
Lane Width, ft	12	Free-Flow Speed (FFS), mi/h	60.5
Right-Side Lateral Clearance, ft	10		

Adjustment Factors

Driver Population	All Familiar	Final Speed Adjustment Factor (SAF)	1.000
Weather Type	Non-Severe Weather	Final Capacity Adjustment Factor (CAF)	1.000
Incident Type	No Incident	Demand Adjustment Factor (DAF)	1.000

Demand and Capacity

Demand Volume veh/h	3778	Heavy Vehicle Adjustment Factor (fhv)	0.855
Peak Hour Factor	0.94	Flow Rate (Vp), pc/h/ln	1567
Total Trucks, %	16.98	Capacity (c), pc/h/ln	2305
Single-Unit Trucks (SUT), %	-	Adjusted Capacity (cadj), pc/h/ln	2305
Tractor-Trailers (TT), %	-	Volume-to-Capacity Ratio (v/c)	0.68
Passenger Car Equivalent (ET)	2.000		

Speed and Density

Lane Width Adjustment (fLW)	0.0	Average Speed (S), mi/h	60.5
Right-Side Lateral Clearance Adj. (fRLC)	0.0	Density (D), pc/mi/ln	25.9
Total Ramp Density Adjustment	4.5	Level of Service (LOS)	C
Adjusted Free-Flow Speed (FFSadj), mi/h	60.5		

HCS7 Freeway Diverge Report

Project Information

Analyst	LSA	Date	12/11/2019
Agency	LSA	Analysis Year	Phase II Proj Comp Yr (2039) NP
Jurisdiction	Caltrans	Time Period Analyzed	AM Peak Hour
Project Description	CMD1801 - Village D Specific Plan	Unit	United States Customary

Geometric Data

	Freeway	Ramp
Number of Lanes (N), ln	3	1
Free-Flow Speed (FFS), mi/h	65.0	35.0
Segment Length (L) / Deceleration Length (LA),ft	1500	130
Terrain Type	Level	Level
Percent Grade, %	-	-
Segment Type / Ramp Side	Freeway	Right

Adjustment Factors

Driver Population	All Familiar	All Familiar
Weather Type	Non-Severe Weather	Non-Severe Weather
Incident Type	No Incident	-
Final Speed Adjustment Factor (SAF)	1.000	1.000
Final Capacity Adjustment Factor (CAF)	1.000	1.000
Demand Adjustment Factor (DAF)	1.000	1.000

Demand and Capacity

Demand Volume (Vi)	3778	523
Peak Hour Factor (PHF)	0.94	0.94
Total Trucks, %	16.98	1.77
Single-Unit Trucks (SUT), %	-	-
Tractor-Trailers (TT), %	-	-
Heavy Vehicle Adjustment Factor (fHV)	0.855	0.983
Flow Rate (vi),pc/h	4701	566
Capacity (c), pc/h	7050	2000
Volume-to-Capacity Ratio (v/c)	0.67	0.28

Speed and Density

Upstream Equilibrium Distance (LEQ), ft	-	Number of Outer Lanes on Freeway (NO)	1
Distance to Upstream Ramp (LUP), ft	-	Speed Index (DS)	0.479
Downstream Equilibrium Distance (LEQ), ft	-	Flow Outer Lanes (vOA), pc/h/ln	1588
Distance to Downstream Ramp (LDOWN), ft	-	Off-Ramp Influence Area Speed (SR), mi/h	54.0
Prop. Freeway Vehicles in Lane 1 and 2 (PFD)	0.616	Outer Lanes Freeway Speed (SO), mi/h	69.0
Flow in Lanes 1 and 2 (v12), pc/h	3113	Ramp Junction Speed (S), mi/h	58.3
Flow Entering Ramp-Infl. Area (vR12), pc/h	-	Average Density (D), pc/mi/ln	26.9
Level of Service (LOS)	D	Density in Ramp Influence Area (DR), pc/mi/ln	29.9

HCS7 Basic Freeway Report

Project Information

Analyst	LSA	Date	12/11/2019
Agency	LSA	Analysis Year	Phase II Proj Comp Yr (2039) NP
Jurisdiction	Caltrans	Time Period Analyzed	AM Peak Hour
Project Description	CMD1801 - Village D Specific Plan	Unit	United States Customary

Geometric Data

Number of Lanes, ln	3	Terrain Type	Level
Segment Length (L), ft	-	Percent Grade, %	-
Measured or Base Free-Flow Speed	Base	Grade Length, mi	-
Base Free-Flow Speed (BFFS), mi/h	65.0	Total Ramp Density (TRD), ramps/mi	1.67
Lane Width, ft	12	Free-Flow Speed (FFS), mi/h	60.0
Right-Side Lateral Clearance, ft	10		

Adjustment Factors

Driver Population	All Familiar	Final Speed Adjustment Factor (SAF)	1.000
Weather Type	Non-Severe Weather	Final Capacity Adjustment Factor (CAF)	1.000
Incident Type	No Incident	Demand Adjustment Factor (DAF)	1.000

Demand and Capacity

Demand Volume veh/h	3255	Heavy Vehicle Adjustment Factor (fhv)	0.837
Peak Hour Factor	0.94	Flow Rate (Vp), pc/h/ln	1379
Total Trucks, %	19.43	Capacity (c), pc/h/ln	2300
Single-Unit Trucks (SUT), %	-	Adjusted Capacity (cadj), pc/h/ln	2300
Tractor-Trailers (TT), %	-	Volume-to-Capacity Ratio (v/c)	0.60
Passenger Car Equivalent (ET)	2.000		

Speed and Density

Lane Width Adjustment (fLW)	0.0	Average Speed (S), mi/h	60.0
Right-Side Lateral Clearance Adj. (fRLC)	0.0	Density (D), pc/mi/ln	23.0
Total Ramp Density Adjustment	5.0	Level of Service (LOS)	C
Adjusted Free-Flow Speed (FFSadj), mi/h	60.0		

HCS7 Freeway Merge Report

Project Information

Analyst	LSA	Date	12/11/2019
Agency	LSA	Analysis Year	Phase II Proj Comp Yr (2039) NP
Jurisdiction	Caltrans	Time Period Analyzed	AM Peak Hour
Project Description	CMD1801 - Village D Specific Plan	Unit	United States Customary

Geometric Data

	Freeway	Ramp
Number of Lanes (N), ln	3	1
Free-Flow Speed (FFS), mi/h	65.0	35.0
Segment Length (L) / Acceleration Length (LA),ft	1500	500
Terrain Type	Level	Level
Percent Grade, %	-	-
Segment Type / Ramp Side	Freeway	Right

Adjustment Factors

Driver Population	All Familiar	All Familiar
Weather Type	Non-Severe Weather	Non-Severe Weather
Incident Type	No Incident	-
Final Speed Adjustment Factor (SAF)	1.000	1.000
Final Capacity Adjustment Factor (CAF)	1.000	1.000
Demand Adjustment Factor (DAF)	1.000	1.000

Demand and Capacity

Demand Volume (Vi)	3255	329
Peak Hour Factor (PHF)	0.94	0.94
Total Trucks, %	19.43	2.92
Single-Unit Trucks (SUT), %	-	-
Tractor-Trailers (TT), %	-	-
Heavy Vehicle Adjustment Factor (fHV)	0.837	0.972
Flow Rate (vi),pc/h	4137	360
Capacity (c), pc/h	7050	2000
Volume-to-Capacity Ratio (v/c)	0.64	0.18

Speed and Density

Upstream Equilibrium Distance (LEQ), ft	-	Number of Outer Lanes on Freeway (NO)	1
Distance to Upstream Ramp (LUP), ft	-	Speed Index (MS)	0.351
Downstream Equilibrium Distance (LEQ), ft	-	Flow Outer Lanes (vOA), pc/h/ln	1688
Distance to Downstream Ramp (LDOWN), ft	-	On-Ramp Influence Area Speed (SR), mi/h	56.9
Prop. Freeway Vehicles in Lane 1 and 2 (PFM)	0.592	Outer Lanes Freeway Speed (SO), mi/h	60.7
Flow in Lanes 1 and 2 (v12), pc/h	2449	Ramp Junction Speed (S), mi/h	58.3
Flow Entering Ramp-Infl. Area (vR12), pc/h	2809	Average Density (D), pc/mi/ln	25.7
Level of Service (LOS)	C	Density in Ramp Influence Area (DR), pc/mi/ln	24.2

HCS7 Basic Freeway Report

Project Information

Analyst	LSA	Date	12/11/2019
Agency	LSA	Analysis Year	Phase II Proj Comp Yr (2039) NP
Jurisdiction	Caltrans	Time Period Analyzed	AM Peak Hour
Project Description	CMD1801 - Village D Specific Plan	Unit	United States Customary

Geometric Data

Number of Lanes, ln	3	Terrain Type	Level
Segment Length (L), ft	-	Percent Grade, %	-
Measured or Base Free-Flow Speed	Base	Grade Length, mi	-
Base Free-Flow Speed (BFFS), mi/h	65.0	Total Ramp Density (TRD), ramps/mi	1.83
Lane Width, ft	12	Free-Flow Speed (FFS), mi/h	59.7
Right-Side Lateral Clearance, ft	10		

Adjustment Factors

Driver Population	All Familiar	Final Speed Adjustment Factor (SAF)	1.000
Weather Type	Non-Severe Weather	Final Capacity Adjustment Factor (CAF)	1.000
Incident Type	No Incident	Demand Adjustment Factor (DAF)	1.000

Demand and Capacity

Demand Volume veh/h	3584	Heavy Vehicle Adjustment Factor (fhv)	0.848
Peak Hour Factor	0.94	Flow Rate (Vp), pc/h/ln	1499
Total Trucks, %	17.90	Capacity (c), pc/h/ln	2296
Single-Unit Trucks (SUT), %	-	Adjusted Capacity (cadj), pc/h/ln	2296
Tractor-Trailers (TT), %	-	Volume-to-Capacity Ratio (v/c)	0.65
Passenger Car Equivalent (ET)	2.000		

Speed and Density

Lane Width Adjustment (fLW)	0.0	Average Speed (S), mi/h	59.6
Right-Side Lateral Clearance Adj. (fRLC)	0.0	Density (D), pc/mi/ln	25.2
Total Ramp Density Adjustment	5.4	Level of Service (LOS)	C
Adjusted Free-Flow Speed (FFSadj), mi/h	59.6		

HCS7 Freeway Diverge Report

Project Information

Analyst	LSA	Date	12/11/2019
Agency	LSA	Analysis Year	Phase II Proj Comp Yr (2039) NP
Jurisdiction	Caltrans	Time Period Analyzed	AM Peak Hour
Project Description	CMD1801 - Village D Specific Plan	Unit	United States Customary

Geometric Data

	Freeway	Ramp
Number of Lanes (N), ln	3	1
Free-Flow Speed (FFS), mi/h	65.0	35.0
Segment Length (L) / Deceleration Length (LA),ft	1500	245
Terrain Type	Level	Level
Percent Grade, %	-	-
Segment Type / Ramp Side	Freeway	Right

Adjustment Factors

Driver Population	All Familiar	All Familiar
Weather Type	Non-Severe Weather	Non-Severe Weather
Incident Type	No Incident	-
Final Speed Adjustment Factor (SAF)	1.000	1.000
Final Capacity Adjustment Factor (CAF)	1.000	1.000
Demand Adjustment Factor (DAF)	1.000	1.000

Demand and Capacity

Demand Volume (Vi)	3584	611
Peak Hour Factor (PHF)	0.94	0.94
Total Trucks, %	17.90	4.61
Single-Unit Trucks (SUT), %	-	-
Tractor-Trailers (TT), %	-	-
Heavy Vehicle Adjustment Factor (fHV)	0.848	0.956
Flow Rate (vi),pc/h	4496	680
Capacity (c), pc/h	7050	2000
Volume-to-Capacity Ratio (v/c)	0.64	0.34

Speed and Density

Upstream Equilibrium Distance (LEQ), ft	-	Number of Outer Lanes on Freeway (NO)	1
Distance to Upstream Ramp (LUP), ft	-	Speed Index (DS)	0.489
Downstream Equilibrium Distance (LEQ), ft	-	Flow Outer Lanes (vOA), pc/h/ln	1465
Distance to Downstream Ramp (LDOWN), ft	-	Off-Ramp Influence Area Speed (SR), mi/h	53.8
Prop. Freeway Vehicles in Lane 1 and 2 (PFD)	0.616	Outer Lanes Freeway Speed (SO), mi/h	69.5
Flow in Lanes 1 and 2 (v12), pc/h	3031	Ramp Junction Speed (S), mi/h	58.1
Flow Entering Ramp-Infl. Area (vR12), pc/h	-	Average Density (D), pc/mi/ln	25.8
Level of Service (LOS)	D	Density in Ramp Influence Area (DR), pc/mi/ln	28.1

HCS7 Basic Freeway Report

Project Information

Analyst	LSA	Date	12/11/2019
Agency	LSA	Analysis Year	Phase II Proj Comp Yr (2039) NP
Jurisdiction	Caltrans	Time Period Analyzed	AM Peak Hour
Project Description	CMD1801 - Village D Specific Plan	Unit	United States Customary

Geometric Data

Number of Lanes, ln	3	Terrain Type	Level
Segment Length (L), ft	-	Percent Grade, %	-
Measured or Base Free-Flow Speed	Base	Grade Length, mi	-
Base Free-Flow Speed (BFFS), mi/h	65.0	Total Ramp Density (TRD), ramps/mi	1.83
Lane Width, ft	12	Free-Flow Speed (FFS), mi/h	59.7
Right-Side Lateral Clearance, ft	10		

Adjustment Factors

Driver Population	All Familiar	Final Speed Adjustment Factor (SAF)	1.000
Weather Type	Non-Severe Weather	Final Capacity Adjustment Factor (CAF)	1.000
Incident Type	No Incident	Demand Adjustment Factor (DAF)	1.000

Demand and Capacity

Demand Volume veh/h	2973	Heavy Vehicle Adjustment Factor (fhv)	0.829
Peak Hour Factor	0.94	Flow Rate (Vp), pc/h/ln	1272
Total Trucks, %	20.64	Capacity (c), pc/h/ln	2296
Single-Unit Trucks (SUT), %	-	Adjusted Capacity (cadj), pc/h/ln	2296
Tractor-Trailers (TT), %	-	Volume-to-Capacity Ratio (v/c)	0.55
Passenger Car Equivalent (ET)	2.000		

Speed and Density

Lane Width Adjustment (fLW)	0.0	Average Speed (S), mi/h	59.6
Right-Side Lateral Clearance Adj. (fRLC)	0.0	Density (D), pc/mi/ln	21.3
Total Ramp Density Adjustment	5.4	Level of Service (LOS)	C
Adjusted Free-Flow Speed (FFSadj), mi/h	59.6		

HCS7 Freeway Merge Report

Project Information

Analyst	LSA	Date	12/11/2019
Agency	LSA	Analysis Year	Phase II Proj Comp Yr (2039) NP
Jurisdiction	Caltrans	Time Period Analyzed	AM Peak Hour
Project Description	CMD1801 - Village D Specific Plan	Unit	United States Customary

Geometric Data

	Freeway	Ramp
Number of Lanes (N), ln	3	1
Free-Flow Speed (FFS), mi/h	65.0	35.0
Segment Length (L) / Acceleration Length (LA),ft	1500	350
Terrain Type	Level	Level
Percent Grade, %	-	-
Segment Type / Ramp Side	Freeway	Right

Adjustment Factors

Driver Population	All Familiar	All Familiar
Weather Type	Non-Severe Weather	Non-Severe Weather
Incident Type	No Incident	-
Final Speed Adjustment Factor (SAF)	1.000	1.000
Final Capacity Adjustment Factor (CAF)	1.000	1.000
Demand Adjustment Factor (DAF)	1.000	1.000

Demand and Capacity

Demand Volume (Vi)	2973	159
Peak Hour Factor (PHF)	0.94	0.94
Total Trucks, %	20.64	2.94
Single-Unit Trucks (SUT), %	-	-
Tractor-Trailers (TT), %	-	-
Heavy Vehicle Adjustment Factor (fHV)	0.829	0.971
Flow Rate (vi),pc/h	3815	174
Capacity (c), pc/h	7050	2000
Volume-to-Capacity Ratio (v/c)	0.57	0.09

Speed and Density

Upstream Equilibrium Distance (LEQ), ft	-	Number of Outer Lanes on Freeway (NO)	1
Distance to Upstream Ramp (LUP), ft	-	Speed Index (MS)	0.340
Downstream Equilibrium Distance (LEQ), ft	-	Flow Outer Lanes (vOA), pc/h/ln	1576
Distance to Downstream Ramp (LDOWN), ft	-	On-Ramp Influence Area Speed (SR), mi/h	57.2
Prop. Freeway Vehicles in Lane 1 and 2 (PFM)	0.587	Outer Lanes Freeway Speed (SO), mi/h	61.1
Flow in Lanes 1 and 2 (v12), pc/h	2239	Ramp Junction Speed (S), mi/h	58.7
Flow Entering Ramp-Infl. Area (vR12), pc/h	2413	Average Density (D), pc/mi/ln	22.7
Level of Service (LOS)	C	Density in Ramp Influence Area (DR), pc/mi/ln	22.1

HCS7 Basic Freeway Report

Project Information

Analyst	LSA	Date	12/11/2019
Agency	LSA	Analysis Year	Phase II Proj Comp Yr (2039) NP
Jurisdiction	Caltrans	Time Period Analyzed	AM Peak Hour
Project Description	CMD1801 - Village D Specific Plan	Unit	United States Customary

Geometric Data

Number of Lanes, ln	3	Terrain Type	Level
Segment Length (L), ft	-	Percent Grade, %	-
Measured or Base Free-Flow Speed	Base	Grade Length, mi	-
Base Free-Flow Speed (BFFS), mi/h	65.0	Total Ramp Density (TRD), ramps/mi	1.83
Lane Width, ft	12	Free-Flow Speed (FFS), mi/h	59.7
Right-Side Lateral Clearance, ft	10		

Adjustment Factors

Driver Population	All Familiar	Final Speed Adjustment Factor (SAF)	1.000
Weather Type	Non-Severe Weather	Final Capacity Adjustment Factor (CAF)	1.000
Incident Type	No Incident	Demand Adjustment Factor (DAF)	1.000

Demand and Capacity

Demand Volume veh/h	3132	Heavy Vehicle Adjustment Factor (fhv)	0.835
Peak Hour Factor	0.94	Flow Rate (Vp), pc/h/ln	1330
Total Trucks, %	19.75	Capacity (c), pc/h/ln	2296
Single-Unit Trucks (SUT), %	-	Adjusted Capacity (cadj), pc/h/ln	2296
Tractor-Trailers (TT), %	-	Volume-to-Capacity Ratio (v/c)	0.58
Passenger Car Equivalent (ET)	2.000		

Speed and Density

Lane Width Adjustment (fLW)	0.0	Average Speed (S), mi/h	59.6
Right-Side Lateral Clearance Adj. (fRLC)	0.0	Density (D), pc/mi/ln	22.3
Total Ramp Density Adjustment	5.4	Level of Service (LOS)	C
Adjusted Free-Flow Speed (FFSadj), mi/h	59.6		

HCS7 Freeway Diverge Report

Project Information

Analyst	LSA	Date	12/11/2019
Agency	LSA	Analysis Year	Phase II Proj Comp Yr (2039) NP
Jurisdiction	Caltrans	Time Period Analyzed	AM Peak Hour
Project Description	CMD1801 - Village D Specific Plan	Unit	United States Customary

Geometric Data

	Freeway	Ramp
Number of Lanes (N), In	3	1
Free-Flow Speed (FFS), mi/h	65.0	15.0
Segment Length (L) / Deceleration Length (LA),ft	1500	150
Terrain Type	Level	Level
Percent Grade, %	-	-
Segment Type / Ramp Side	Freeway	Right

Adjustment Factors

Driver Population	All Familiar	All Familiar
Weather Type	Non-Severe Weather	Non-Severe Weather
Incident Type	No Incident	-
Final Speed Adjustment Factor (SAF)	1.000	1.000
Final Capacity Adjustment Factor (CAF)	1.000	1.000
Demand Adjustment Factor (DAF)	1.000	1.000

Demand and Capacity

Demand Volume (Vi)	3132	310
Peak Hour Factor (PHF)	0.94	0.94
Total Trucks, %	19.75	6.54
Single-Unit Trucks (SUT), %	-	-
Tractor-Trailers (TT), %	-	-
Heavy Vehicle Adjustment Factor (fHV)	0.835	0.939
Flow Rate (vi),pc/h	3990	351
Capacity (c), pc/h	7050	1800
Volume-to-Capacity Ratio (v/c)	0.57	0.20

Speed and Density

Upstream Equilibrium Distance (LEQ), ft	-	Number of Outer Lanes on Freeway (NO)	1
Distance to Upstream Ramp (LUP), ft	-	Speed Index (DS)	0.720
Downstream Equilibrium Distance (LEQ), ft	-	Flow Outer Lanes (vOA), pc/h/ln	1295
Distance to Downstream Ramp (LDOWN), ft	-	Off-Ramp Influence Area Speed (SR), mi/h	48.4
Prop. Freeway Vehicles in Lane 1 and 2 (PFD)	0.644	Outer Lanes Freeway Speed (SO), mi/h	70.2
Flow in Lanes 1 and 2 (v12), pc/h	2695	Ramp Junction Speed (S), mi/h	53.8
Flow Entering Ramp-Infl. Area (vR12), pc/h	-	Average Density (D), pc/mi/ln	24.7
Level of Service (LOS)	C	Density in Ramp Influence Area (DR), pc/mi/ln	26.1

HCS7 Basic Freeway Report

Project Information

Analyst	LSA	Date	12/11/2019
Agency	LSA	Analysis Year	Phase II Proj Comp Yr (2039) NP
Jurisdiction	Caltrans	Time Period Analyzed	AM Peak Hour
Project Description	CMD1801 - Village D Specific Plan	Unit	United States Customary

Geometric Data

Number of Lanes, ln	3	Terrain Type	Level
Segment Length (L), ft	-	Percent Grade, %	-
Measured or Base Free-Flow Speed	Base	Grade Length, mi	-
Base Free-Flow Speed (BFFS), mi/h	65.0	Total Ramp Density (TRD), ramps/mi	1.67
Lane Width, ft	12	Free-Flow Speed (FFS), mi/h	60.0
Right-Side Lateral Clearance, ft	10		

Adjustment Factors

Driver Population	All Familiar	Final Speed Adjustment Factor (SAF)	1.000
Weather Type	Non-Severe Weather	Final Capacity Adjustment Factor (CAF)	1.000
Incident Type	No Incident	Demand Adjustment Factor (DAF)	1.000

Demand and Capacity

Demand Volume veh/h	2821	Heavy Vehicle Adjustment Factor (fhv)	0.825
Peak Hour Factor	0.94	Flow Rate (Vp), pc/h/ln	1213
Total Trucks, %	21.20	Capacity (c), pc/h/ln	2300
Single-Unit Trucks (SUT), %	-	Adjusted Capacity (cadj), pc/h/ln	2300
Tractor-Trailers (TT), %	-	Volume-to-Capacity Ratio (v/c)	0.53
Passenger Car Equivalent (ET)	2.000		

Speed and Density

Lane Width Adjustment (fLW)	0.0	Average Speed (S), mi/h	60.0
Right-Side Lateral Clearance Adj. (fRLC)	0.0	Density (D), pc/mi/ln	20.2
Total Ramp Density Adjustment	5.0	Level of Service (LOS)	C
Adjusted Free-Flow Speed (FFSadj), mi/h	60.0		

HCS7 Freeway Merge Report

Project Information

Analyst	LSA	Date	12/11/2019
Agency	LSA	Analysis Year	Phase II Proj Comp Yr (2039) NP
Jurisdiction	Caltrans	Time Period Analyzed	AM Peak Hour
Project Description	CMD1801 - Village D Specific Plan	Unit	United States Customary

Geometric Data

	Freeway	Ramp
Number of Lanes (N), ln	3	1
Free-Flow Speed (FFS), mi/h	65.0	35.0
Segment Length (L) / Acceleration Length (LA),ft	1500	525
Terrain Type	Level	Level
Percent Grade, %	-	-
Segment Type / Ramp Side	Freeway	Right

Adjustment Factors

Driver Population	All Familiar	All Familiar
Weather Type	Non-Severe Weather	Non-Severe Weather
Incident Type	No Incident	-
Final Speed Adjustment Factor (SAF)	1.000	1.000
Final Capacity Adjustment Factor (CAF)	1.000	1.000
Demand Adjustment Factor (DAF)	1.000	1.000

Demand and Capacity

Demand Volume (Vi)	2821	205
Peak Hour Factor (PHF)	0.94	0.94
Total Trucks, %	21.20	4.46
Single-Unit Trucks (SUT), %	-	-
Tractor-Trailers (TT), %	-	-
Heavy Vehicle Adjustment Factor (fHV)	0.825	0.957
Flow Rate (vi),pc/h	3638	228
Capacity (c), pc/h	7050	2000
Volume-to-Capacity Ratio (v/c)	0.55	0.11

Speed and Density

Upstream Equilibrium Distance (LEQ), ft	-	Number of Outer Lanes on Freeway (NO)	1
Distance to Upstream Ramp (LUP), ft	-	Speed Index (MS)	0.326
Downstream Equilibrium Distance (LEQ), ft	-	Flow Outer Lanes (vOA), pc/h/ln	1484
Distance to Downstream Ramp (LDOWN), ft	-	On-Ramp Influence Area Speed (SR), mi/h	57.5
Prop. Freeway Vehicles in Lane 1 and 2 (PFM)	0.592	Outer Lanes Freeway Speed (SO), mi/h	61.5
Flow in Lanes 1 and 2 (v12), pc/h	2154	Ramp Junction Speed (S), mi/h	59.0
Flow Entering Ramp-Infl. Area (vR12), pc/h	2382	Average Density (D), pc/mi/ln	21.8
Level of Service (LOS)	C	Density in Ramp Influence Area (DR), pc/mi/ln	20.7

HCS7 Basic Freeway Report

Project Information

Analyst	LSA	Date	12/11/2019
Agency	LSA	Analysis Year	Phase II Proj Comp Yr (2039) NP
Jurisdiction	Caltrans	Time Period Analyzed	AM Peak Hour
Project Description	CMD1801 - Village D Specific Plan	Unit	United States Customary

Geometric Data

Number of Lanes, ln	3	Terrain Type	Level
Segment Length (L), ft	-	Percent Grade, %	-
Measured or Base Free-Flow Speed	Base	Grade Length, mi	-
Base Free-Flow Speed (BFFS), mi/h	65.0	Total Ramp Density (TRD), ramps/mi	1.67
Lane Width, ft	12	Free-Flow Speed (FFS), mi/h	60.0
Right-Side Lateral Clearance, ft	10		

Adjustment Factors

Driver Population	All Familiar	Final Speed Adjustment Factor (SAF)	1.000
Weather Type	Non-Severe Weather	Final Capacity Adjustment Factor (CAF)	1.000
Incident Type	No Incident	Demand Adjustment Factor (DAF)	1.000

Demand and Capacity

Demand Volume veh/h	3027	Heavy Vehicle Adjustment Factor (fhv)	0.833
Peak Hour Factor	0.94	Flow Rate (Vp), pc/h/ln	1289
Total Trucks, %	20.06	Capacity (c), pc/h/ln	2300
Single-Unit Trucks (SUT), %	-	Adjusted Capacity (cadj), pc/h/ln	2300
Tractor-Trailers (TT), %	-	Volume-to-Capacity Ratio (v/c)	0.56
Passenger Car Equivalent (ET)	2.000		

Speed and Density

Lane Width Adjustment (fLW)	0.0	Average Speed (S), mi/h	60.0
Right-Side Lateral Clearance Adj. (fRLC)	0.0	Density (D), pc/mi/ln	21.5
Total Ramp Density Adjustment	5.0	Level of Service (LOS)	C
Adjusted Free-Flow Speed (FFSadj), mi/h	60.0		

HCS7 Freeway Diverge Report

Project Information

Analyst	LSA	Date	12/11/2019
Agency	LSA	Analysis Year	Phase II Proj Comp Yr (2039) NP
Jurisdiction	Caltrans	Time Period Analyzed	AM Peak Hour
Project Description	CMD1801 - Village D Specific Plan	Unit	United States Customary

Geometric Data

	Freeway	Ramp
Number of Lanes (N), In	3	1
Free-Flow Speed (FFS), mi/h	65.0	35.0
Segment Length (L) / Deceleration Length (LA),ft	1500	200
Terrain Type	Level	Level
Percent Grade, %	-	-
Segment Type / Ramp Side	Freeway	Right

Adjustment Factors

Driver Population	All Familiar	All Familiar
Weather Type	Non-Severe Weather	Non-Severe Weather
Incident Type	No Incident	-
Final Speed Adjustment Factor (SAF)	1.000	1.000
Final Capacity Adjustment Factor (CAF)	1.000	1.000
Demand Adjustment Factor (DAF)	1.000	1.000

Demand and Capacity

Demand Volume (Vi)	3027	471
Peak Hour Factor (PHF)	0.94	0.94
Total Trucks, %	20.06	13.79
Single-Unit Trucks (SUT), %	-	-
Tractor-Trailers (TT), %	-	-
Heavy Vehicle Adjustment Factor (fHV)	0.833	0.879
Flow Rate (vi),pc/h	3866	570
Capacity (c), pc/h	7050	2000
Volume-to-Capacity Ratio (v/c)	0.55	0.29

Speed and Density

Upstream Equilibrium Distance (LEQ), ft	-	Number of Outer Lanes on Freeway (NO)	1
Distance to Upstream Ramp (LUP), ft	-	Speed Index (DS)	0.479
Downstream Equilibrium Distance (LEQ), ft	-	Flow Outer Lanes (vOA), pc/h/ln	1196
Distance to Downstream Ramp (LDOWN), ft	-	Off-Ramp Influence Area Speed (SR), mi/h	54.0
Prop. Freeway Vehicles in Lane 1 and 2 (PFD)	0.637	Outer Lanes Freeway Speed (SO), mi/h	70.5
Flow in Lanes 1 and 2 (v12), pc/h	2670	Ramp Junction Speed (S), mi/h	58.2
Flow Entering Ramp-Infl. Area (vR12), pc/h	-	Average Density (D), pc/mi/ln	22.1
Level of Service (LOS)	C	Density in Ramp Influence Area (DR), pc/mi/ln	25.4

HCS7 Basic Freeway Report

Project Information

Analyst	LSA	Date	12/11/2019
Agency	LSA	Analysis Year	Phase II Proj Comp Yr (2039) NP
Jurisdiction	Caltrans	Time Period Analyzed	AM Peak Hour
Project Description	CMD1801 - Village D Specific Plan	Unit	United States Customary

Geometric Data

Number of Lanes, ln	3	Terrain Type	Level
Segment Length (L), ft	-	Percent Grade, %	-
Measured or Base Free-Flow Speed	Base	Grade Length, mi	-
Base Free-Flow Speed (BFFS), mi/h	70.0	Total Ramp Density (TRD), ramps/mi	1.50
Lane Width, ft	12	Free-Flow Speed (FFS), mi/h	65.5
Right-Side Lateral Clearance, ft	10		

Adjustment Factors

Driver Population	All Familiar	Final Speed Adjustment Factor (SAF)	1.000
Weather Type	Non-Severe Weather	Final Capacity Adjustment Factor (CAF)	1.000
Incident Type	No Incident	Demand Adjustment Factor (DAF)	1.000

Demand and Capacity

Demand Volume veh/h	2556	Heavy Vehicle Adjustment Factor (fhv)	0.825
Peak Hour Factor	0.94	Flow Rate (Vp), pc/h/ln	1099
Total Trucks, %	21.22	Capacity (c), pc/h/ln	2355
Single-Unit Trucks (SUT), %	-	Adjusted Capacity (cadj), pc/h/ln	2355
Tractor-Trailers (TT), %	-	Volume-to-Capacity Ratio (v/c)	0.47
Passenger Car Equivalent (ET)	2.000		

Speed and Density

Lane Width Adjustment (fLW)	0.0	Average Speed (S), mi/h	65.5
Right-Side Lateral Clearance Adj. (fRLC)	0.0	Density (D), pc/mi/ln	16.8
Total Ramp Density Adjustment	4.5	Level of Service (LOS)	B
Adjusted Free-Flow Speed (FFSadj), mi/h	65.5		

HCS7 Freeway Merge Report

Project Information

Analyst	LSA	Date	12/11/2019
Agency	LSA	Analysis Year	Phase II Proj Comp Yr (2039) NP
Jurisdiction	Caltrans	Time Period Analyzed	AM Peak Hour
Project Description	CMD1801 - Village D Specific Plan	Unit	United States Customary

Geometric Data

	Freeway	Ramp
Number of Lanes (N), ln	3	1
Free-Flow Speed (FFS), mi/h	70.0	35.0
Segment Length (L) / Acceleration Length (LA),ft	1500	400
Terrain Type	Level	Level
Percent Grade, %	-	-
Segment Type / Ramp Side	Freeway	Right

Adjustment Factors

Driver Population	All Familiar	All Familiar
Weather Type	Non-Severe Weather	Non-Severe Weather
Incident Type	No Incident	-
Final Speed Adjustment Factor (SAF)	1.000	1.000
Final Capacity Adjustment Factor (CAF)	1.000	1.000
Demand Adjustment Factor (DAF)	1.000	1.000

Demand and Capacity

Demand Volume (Vi)	2556	362
Peak Hour Factor (PHF)	0.94	0.94
Total Trucks, %	21.22	10.46
Single-Unit Trucks (SUT), %	-	-
Tractor-Trailers (TT), %	-	-
Heavy Vehicle Adjustment Factor (fHV)	0.825	0.905
Flow Rate (vi),pc/h	3296	426
Capacity (c), pc/h	7200	2000
Volume-to-Capacity Ratio (v/c)	0.52	0.21

Speed and Density

Upstream Equilibrium Distance (LEQ), ft	-	Number of Outer Lanes on Freeway (NO)	1
Distance to Upstream Ramp (LUP), ft	-	Speed Index (MS)	0.335
Downstream Equilibrium Distance (LEQ), ft	-	Flow Outer Lanes (vOA), pc/h/ln	1355
Distance to Downstream Ramp (LDOWN), ft	-	On-Ramp Influence Area Speed (SR), mi/h	60.6
Prop. Freeway Vehicles in Lane 1 and 2 (PFM)	0.589	Outer Lanes Freeway Speed (SO), mi/h	66.9
Flow in Lanes 1 and 2 (v12), pc/h	1941	Ramp Junction Speed (S), mi/h	62.8
Flow Entering Ramp-Infl. Area (vR12), pc/h	2367	Average Density (D), pc/mi/ln	19.8
Level of Service (LOS)	C	Density in Ramp Influence Area (DR), pc/mi/ln	21.3

HCS7 Basic Freeway Report

Project Information

Analyst	LSA	Date	12/11/2019
Agency	LSA	Analysis Year	Phase II Proj Comp Yr (2039) NP
Jurisdiction	Caltrans	Time Period Analyzed	AM Peak Hour
Project Description	CMD1801 - Village D Specific Plan	Unit	United States Customary

Geometric Data

Number of Lanes, ln	2	Terrain Type	Level
Segment Length (L), ft	-	Percent Grade, %	-
Measured or Base Free-Flow Speed	Base	Grade Length, mi	-
Base Free-Flow Speed (BFFS), mi/h	70.0	Total Ramp Density (TRD), ramps/mi	1.00
Lane Width, ft	12	Free-Flow Speed (FFS), mi/h	66.8
Right-Side Lateral Clearance, ft	10		

Adjustment Factors

Driver Population	All Familiar	Final Speed Adjustment Factor (SAF)	1.000
Weather Type	Non-Severe Weather	Final Capacity Adjustment Factor (CAF)	1.000
Incident Type	No Incident	Demand Adjustment Factor (DAF)	1.000

Demand and Capacity

Demand Volume veh/h	2917	Heavy Vehicle Adjustment Factor (fhv)	0.834
Peak Hour Factor	0.94	Flow Rate (Vp), pc/h/ln	1860
Total Trucks, %	19.89	Capacity (c), pc/h/ln	2368
Single-Unit Trucks (SUT), %	-	Adjusted Capacity (cadj), pc/h/ln	2368
Tractor-Trailers (TT), %	-	Volume-to-Capacity Ratio (v/c)	0.79
Passenger Car Equivalent (ET)	2.000		

Speed and Density

Lane Width Adjustment (fLW)	0.0	Average Speed (S), mi/h	63.1
Right-Side Lateral Clearance Adj. (fRLC)	0.0	Density (D), pc/mi/ln	29.5
Total Ramp Density Adjustment	3.2	Level of Service (LOS)	D
Adjusted Free-Flow Speed (FFSadj), mi/h	66.8		

HCS7 Freeway Diverge Report

Project Information

Analyst	LSA	Date	12/11/2019
Agency	LSA	Analysis Year	Phase II Proj Comp Yr (2039) NP
Jurisdiction	Caltrans	Time Period Analyzed	AM Peak Hour
Project Description	CMD1801 - Village D Specific Plan	Unit	United States Customary

Geometric Data

	Freeway	Ramp
Number of Lanes (N), ln	2	1
Free-Flow Speed (FFS), mi/h	70.0	35.0
Segment Length (L) / Deceleration Length (LA),ft	1500	200
Terrain Type	Level	Level
Percent Grade, %	-	-
Segment Type / Ramp Side	Freeway	Right

Adjustment Factors

Driver Population	All Familiar	All Familiar
Weather Type	Non-Severe Weather	Non-Severe Weather
Incident Type	No Incident	-
Final Speed Adjustment Factor (SAF)	1.000	1.000
Final Capacity Adjustment Factor (CAF)	1.000	1.000
Demand Adjustment Factor (DAF)	1.000	1.000

Demand and Capacity

Demand Volume (Vi)	2917	241
Peak Hour Factor (PHF)	0.94	0.94
Total Trucks, %	19.89	28.64
Single-Unit Trucks (SUT), %	-	-
Tractor-Trailers (TT), %	-	-
Heavy Vehicle Adjustment Factor (fHV)	0.834	0.777
Flow Rate (vi),pc/h	3721	330
Capacity (c), pc/h	4800	2000
Volume-to-Capacity Ratio (v/c)	0.78	0.17

Speed and Density

Upstream Equilibrium Distance (LEQ), ft	-	Number of Outer Lanes on Freeway (NO)	0
Distance to Upstream Ramp (LUP), ft	-	Speed Index (DS)	0.458
Downstream Equilibrium Distance (LEQ), ft	-	Flow Outer Lanes (vOA), pc/h/ln	-
Distance to Downstream Ramp (LDOWN), ft	-	Off-Ramp Influence Area Speed (SR), mi/h	57.2
Prop. Freeway Vehicles in Lane 1 and 2 (PFD)	1.000	Outer Lanes Freeway Speed (SO), mi/h	76.8
Flow in Lanes 1 and 2 (v12), pc/h	3721	Ramp Junction Speed (S), mi/h	57.2
Flow Entering Ramp-Infl. Area (vR12), pc/h	-	Average Density (D), pc/mi/ln	32.5
Level of Service (LOS)	D	Density in Ramp Influence Area (DR), pc/mi/ln	34.5

HCS7 Basic Freeway Report

Project Information

Analyst	LSA	Date	12/11/2019
Agency	LSA	Analysis Year	Phase II Proj Comp Yr (2039) NP
Jurisdiction	Caltrans	Time Period Analyzed	AM Peak Hour
Project Description	CMD1801 - Village D Specific Plan	Unit	United States Customary

Geometric Data

Number of Lanes, ln	2	Terrain Type	Level
Segment Length (L), ft	-	Percent Grade, %	-
Measured or Base Free-Flow Speed	Base	Grade Length, mi	-
Base Free-Flow Speed (BFFS), mi/h	70.0	Total Ramp Density (TRD), ramps/mi	1.00
Lane Width, ft	12	Free-Flow Speed (FFS), mi/h	66.8
Right-Side Lateral Clearance, ft	10		

Adjustment Factors

Driver Population	All Familiar	Final Speed Adjustment Factor (SAF)	1.000
Weather Type	Non-Severe Weather	Final Capacity Adjustment Factor (CAF)	1.000
Incident Type	No Incident	Demand Adjustment Factor (DAF)	1.000

Demand and Capacity

Demand Volume veh/h	2677	Heavy Vehicle Adjustment Factor (fhv)	0.840
Peak Hour Factor	0.94	Flow Rate (Vp), pc/h/ln	1695
Total Trucks, %	19.10	Capacity (c), pc/h/ln	2368
Single-Unit Trucks (SUT), %	-	Adjusted Capacity (cadj), pc/h/ln	2368
Tractor-Trailers (TT), %	-	Volume-to-Capacity Ratio (v/c)	0.72
Passenger Car Equivalent (ET)	2.000		

Speed and Density

Lane Width Adjustment (fLW)	0.0	Average Speed (S), mi/h	65.0
Right-Side Lateral Clearance Adj. (fRLC)	0.0	Density (D), pc/mi/ln	26.1
Total Ramp Density Adjustment	3.2	Level of Service (LOS)	D
Adjusted Free-Flow Speed (FFSadj), mi/h	66.8		

HCS7 Freeway Merge Report

Project Information

Analyst	LSA	Date	12/11/2019
Agency	LSA	Analysis Year	Phase II Proj Comp Yr (2039) NP
Jurisdiction	Caltrans	Time Period Analyzed	AM Peak Hour
Project Description	CMD1801 - Village D Specific Plan	Unit	United States Customary

Geometric Data

	Freeway	Ramp
Number of Lanes (N), ln	2	1
Free-Flow Speed (FFS), mi/h	70.0	35.0
Segment Length (L) / Acceleration Length (LA),ft	1500	700
Terrain Type	Level	Level
Percent Grade, %	-	-
Segment Type / Ramp Side	Freeway	Right

Adjustment Factors

Driver Population	All Familiar	All Familiar
Weather Type	Non-Severe Weather	Non-Severe Weather
Incident Type	No Incident	-
Final Speed Adjustment Factor (SAF)	1.000	1.000
Final Capacity Adjustment Factor (CAF)	1.000	1.000
Demand Adjustment Factor (DAF)	1.000	1.000

Demand and Capacity

Demand Volume (Vi)	2677	256
Peak Hour Factor (PHF)	0.94	0.94
Total Trucks, %	19.10	32.90
Single-Unit Trucks (SUT), %	-	-
Tractor-Trailers (TT), %	-	-
Heavy Vehicle Adjustment Factor (fHV)	0.840	0.752
Flow Rate (vi),pc/h	3390	362
Capacity (c), pc/h	4800	2000
Volume-to-Capacity Ratio (v/c)	0.78	0.18

Speed and Density

Upstream Equilibrium Distance (LEQ), ft	-	Number of Outer Lanes on Freeway (NO)	0
Distance to Upstream Ramp (LUP), ft	-	Speed Index (MS)	0.438
Downstream Equilibrium Distance (LEQ), ft	-	Flow Outer Lanes (vOA), pc/h/ln	-
Distance to Downstream Ramp (LDOWN), ft	-	On-Ramp Influence Area Speed (SR), mi/h	57.7
Prop. Freeway Vehicles in Lane 1 and 2 (PFM)	1.000	Outer Lanes Freeway Speed (SO), mi/h	70.0
Flow in Lanes 1 and 2 (v12), pc/h	3390	Ramp Junction Speed (S), mi/h	57.7
Flow Entering Ramp-Infl. Area (vR12), pc/h	3752	Average Density (D), pc/mi/ln	32.5
Level of Service (LOS)	D	Density in Ramp Influence Area (DR), pc/mi/ln	30.3

HCS7 Basic Freeway Report

Project Information

Analyst	LSA	Date	12/11/2019
Agency	LSA	Analysis Year	Phase II Proj Comp Yr (2039) NP
Jurisdiction	Caltrans	Time Period Analyzed	AM Peak Hour
Project Description	CMD1801 - Village D Specific Plan	Unit	United States Customary

Geometric Data

Number of Lanes, ln	2	Terrain Type	Level
Segment Length (L), ft	-	Percent Grade, %	-
Measured or Base Free-Flow Speed	Base	Grade Length, mi	-
Base Free-Flow Speed (BFFS), mi/h	70.0	Total Ramp Density (TRD), ramps/mi	1.00
Lane Width, ft	12	Free-Flow Speed (FFS), mi/h	66.8
Right-Side Lateral Clearance, ft	10		

Adjustment Factors

Driver Population	All Familiar	Final Speed Adjustment Factor (SAF)	1.000
Weather Type	Non-Severe Weather	Final Capacity Adjustment Factor (CAF)	1.000
Incident Type	No Incident	Demand Adjustment Factor (DAF)	1.000

Demand and Capacity

Demand Volume veh/h	2932	Heavy Vehicle Adjustment Factor (fhv)	0.831
Peak Hour Factor	0.94	Flow Rate (Vp), pc/h/ln	1876
Total Trucks, %	20.30	Capacity (c), pc/h/ln	2368
Single-Unit Trucks (SUT), %	-	Adjusted Capacity (cadj), pc/h/ln	2368
Tractor-Trailers (TT), %	-	Volume-to-Capacity Ratio (v/c)	0.79
Passenger Car Equivalent (ET)	2.000		

Speed and Density

Lane Width Adjustment (fLW)	0.0	Average Speed (S), mi/h	62.9
Right-Side Lateral Clearance Adj. (fRLC)	0.0	Density (D), pc/mi/ln	29.8
Total Ramp Density Adjustment	3.2	Level of Service (LOS)	D
Adjusted Free-Flow Speed (FFSadj), mi/h	66.8		

HCS7 Basic Freeway Report

Project Information

Analyst	LSA	Date	12/11/2019
Agency	LSA	Analysis Year	Phase II Proj Comp Yr (2039) NP
Jurisdiction	Caltrans	Time Period Analyzed	AM Peak Hour
Project Description	CMD1801 - Village D Specific Plan	Unit	United States Customary

Geometric Data

Number of Lanes, ln	2	Terrain Type	Level
Segment Length (L), ft	-	Percent Grade, %	-
Measured or Base Free-Flow Speed	Base	Grade Length, mi	-
Base Free-Flow Speed (BFFS), mi/h	70.0	Total Ramp Density (TRD), ramps/mi	1.00
Lane Width, ft	12	Free-Flow Speed (FFS), mi/h	66.8
Right-Side Lateral Clearance, ft	10		

Adjustment Factors

Driver Population	All Familiar	Final Speed Adjustment Factor (SAF)	1.000
Weather Type	Non-Severe Weather	Final Capacity Adjustment Factor (CAF)	1.000
Incident Type	No Incident	Demand Adjustment Factor (DAF)	1.000

Demand and Capacity

Demand Volume veh/h	2557	Heavy Vehicle Adjustment Factor (fhv)	0.783
Peak Hour Factor	0.94	Flow Rate (Vp), pc/h/ln	1737
Total Trucks, %	27.78	Capacity (c), pc/h/ln	2368
Single-Unit Trucks (SUT), %	-	Adjusted Capacity (cadj), pc/h/ln	2368
Tractor-Trailers (TT), %	-	Volume-to-Capacity Ratio (v/c)	0.73
Passenger Car Equivalent (ET)	2.000		

Speed and Density

Lane Width Adjustment (fLW)	0.0	Average Speed (S), mi/h	64.6
Right-Side Lateral Clearance Adj. (fRLC)	0.0	Density (D), pc/mi/ln	26.9
Total Ramp Density Adjustment	3.2	Level of Service (LOS)	D
Adjusted Free-Flow Speed (FFSadj), mi/h	66.8		

HCS7 Freeway Diverge Report

Project Information

Analyst	LSA	Date	12/11/2019
Agency	LSA	Analysis Year	Phase II Proj Comp Yr (2039) NP
Jurisdiction	Caltrans	Time Period Analyzed	AM Peak Hour
Project Description	CMD1801 - Village D Specific Plan	Unit	United States Customary

Geometric Data

	Freeway	Ramp
Number of Lanes (N), In	2	1
Free-Flow Speed (FFS), mi/h	70.0	50.0
Segment Length (L) / Deceleration Length (LA),ft	1500	150
Terrain Type	Level	Level
Percent Grade, %	-	-
Segment Type / Ramp Side	Freeway	Right

Adjustment Factors

Driver Population	All Familiar	All Familiar
Weather Type	Non-Severe Weather	Non-Severe Weather
Incident Type	No Incident	-
Final Speed Adjustment Factor (SAF)	1.000	1.000
Final Capacity Adjustment Factor (CAF)	1.000	1.000
Demand Adjustment Factor (DAF)	1.000	1.000

Demand and Capacity

Demand Volume (Vi)	2557	151
Peak Hour Factor (PHF)	0.94	0.94
Total Trucks, %	27.78	35.29
Single-Unit Trucks (SUT), %	-	-
Tractor-Trailers (TT), %	-	-
Heavy Vehicle Adjustment Factor (fHV)	0.783	0.739
Flow Rate (vi),pc/h	3474	217
Capacity (c), pc/h	4800	2100
Volume-to-Capacity Ratio (v/c)	0.72	0.10

Speed and Density

Upstream Equilibrium Distance (LEQ), ft	-	Number of Outer Lanes on Freeway (NO)	0
Distance to Upstream Ramp (LUP), ft	-	Speed Index (DS)	0.253
Downstream Equilibrium Distance (LEQ), ft	-	Flow Outer Lanes (vOA), pc/h/ln	-
Distance to Downstream Ramp (LDOWN), ft	-	Off-Ramp Influence Area Speed (SR), mi/h	62.9
Prop. Freeway Vehicles in Lane 1 and 2 (PFD)	1.000	Outer Lanes Freeway Speed (SO), mi/h	76.8
Flow in Lanes 1 and 2 (v12), pc/h	3474	Ramp Junction Speed (S), mi/h	62.9
Flow Entering Ramp-Infl. Area (vR12), pc/h	-	Average Density (D), pc/mi/ln	27.6
Level of Service (LOS)	D	Density in Ramp Influence Area (DR), pc/mi/ln	32.8

HCS7 Basic Freeway Report

Project Information

Analyst	LSA	Date	12/11/2019
Agency	LSA	Analysis Year	Phase II Proj Comp Yr (2039) NP
Jurisdiction	Caltrans	Time Period Analyzed	AM Peak Hour
Project Description	CMD1801 - Village D Specific Plan	Unit	United States Customary

Geometric Data

Number of Lanes, ln	2	Terrain Type	Level
Segment Length (L), ft	-	Percent Grade, %	-
Measured or Base Free-Flow Speed	Base	Grade Length, mi	-
Base Free-Flow Speed (BFFS), mi/h	70.0	Total Ramp Density (TRD), ramps/mi	1.33
Lane Width, ft	12	Free-Flow Speed (FFS), mi/h	65.9
Right-Side Lateral Clearance, ft	10		

Adjustment Factors

Driver Population	All Familiar	Final Speed Adjustment Factor (SAF)	1.000
Weather Type	Non-Severe Weather	Final Capacity Adjustment Factor (CAF)	1.000
Incident Type	No Incident	Demand Adjustment Factor (DAF)	1.000

Demand and Capacity

Demand Volume veh/h	2407	Heavy Vehicle Adjustment Factor (fhv)	0.785
Peak Hour Factor	0.94	Flow Rate (Vp), pc/h/ln	1631
Total Trucks, %	27.32	Capacity (c), pc/h/ln	2359
Single-Unit Trucks (SUT), %	-	Adjusted Capacity (cadj), pc/h/ln	2359
Tractor-Trailers (TT), %	-	Volume-to-Capacity Ratio (v/c)	0.69
Passenger Car Equivalent (ET)	2.000		

Speed and Density

Lane Width Adjustment (fLW)	0.0	Average Speed (S), mi/h	64.9
Right-Side Lateral Clearance Adj. (fRLC)	0.0	Density (D), pc/mi/ln	25.1
Total Ramp Density Adjustment	4.1	Level of Service (LOS)	C
Adjusted Free-Flow Speed (FFSadj), mi/h	65.9		

HCS7 Freeway Merge Report

Project Information

Analyst	LSA	Date	12/11/2019
Agency	LSA	Analysis Year	Phase II Proj Comp Yr (2039) NP
Jurisdiction	Caltrans	Time Period Analyzed	AM Peak Hour
Project Description	CMD1801 - Village D Specific Plan	Unit	United States Customary

Geometric Data

	Freeway	Ramp
Number of Lanes (N), ln	2	1
Free-Flow Speed (FFS), mi/h	70.0	35.0
Segment Length (L) / Acceleration Length (LA),ft	1000	600
Terrain Type	Level	Level
Percent Grade, %	-	-
Segment Type / Ramp Side	Freeway	Right

Adjustment Factors

Driver Population	All Familiar	All Familiar
Weather Type	Non-Severe Weather	Non-Severe Weather
Incident Type	No Incident	-
Final Speed Adjustment Factor (SAF)	1.000	1.000
Final Capacity Adjustment Factor (CAF)	1.000	1.000
Demand Adjustment Factor (DAF)	1.000	1.000

Demand and Capacity

Demand Volume (Vi)	2407	37
Peak Hour Factor (PHF)	0.94	0.94
Total Trucks, %	27.32	13.89
Single-Unit Trucks (SUT), %	-	-
Tractor-Trailers (TT), %	-	-
Heavy Vehicle Adjustment Factor (fHV)	0.785	0.878
Flow Rate (vi),pc/h	3262	45
Capacity (c), pc/h	4800	2000
Volume-to-Capacity Ratio (v/c)	0.69	0.02

Speed and Density

Upstream Equilibrium Distance (LEQ), ft	-	Number of Outer Lanes on Freeway (NO)	0
Distance to Upstream Ramp (LUP), ft	-	Speed Index (MS)	0.385
Downstream Equilibrium Distance (LEQ), ft	-	Flow Outer Lanes (vOA), pc/h/ln	-
Distance to Downstream Ramp (LDOWN), ft	-	On-Ramp Influence Area Speed (SR), mi/h	59.2
Prop. Freeway Vehicles in Lane 1 and 2 (PFM)	1.000	Outer Lanes Freeway Speed (SO), mi/h	70.0
Flow in Lanes 1 and 2 (v12), pc/h	3262	Ramp Junction Speed (S), mi/h	59.2
Flow Entering Ramp-Infl. Area (vR12), pc/h	3307	Average Density (D), pc/mi/ln	27.9
Level of Service (LOS)	C	Density in Ramp Influence Area (DR), pc/mi/ln	27.6

HCS7 Basic Freeway Report

Project Information

Analyst	LSA	Date	12/11/2019
Agency	LSA	Analysis Year	Phase II Proj Comp Yr (2039) NP
Jurisdiction	Caltrans	Time Period Analyzed	AM Peak Hour
Project Description	CMD1801 - Village D Specific Plan	Unit	United States Customary

Geometric Data

Number of Lanes, ln	2	Terrain Type	Level
Segment Length (L), ft	-	Percent Grade, %	-
Measured or Base Free-Flow Speed	Base	Grade Length, mi	-
Base Free-Flow Speed (BFFS), mi/h	70.0	Total Ramp Density (TRD), ramps/mi	1.33
Lane Width, ft	12	Free-Flow Speed (FFS), mi/h	65.9
Right-Side Lateral Clearance, ft	10		

Adjustment Factors

Driver Population	All Familiar	Final Speed Adjustment Factor (SAF)	1.000
Weather Type	Non-Severe Weather	Final Capacity Adjustment Factor (CAF)	1.000
Incident Type	No Incident	Demand Adjustment Factor (DAF)	1.000

Demand and Capacity

Demand Volume veh/h	2443	Heavy Vehicle Adjustment Factor (fhv)	0.787
Peak Hour Factor	0.94	Flow Rate (Vp), pc/h/ln	1651
Total Trucks, %	27.11	Capacity (c), pc/h/ln	2359
Single-Unit Trucks (SUT), %	-	Adjusted Capacity (cadj), pc/h/ln	2359
Tractor-Trailers (TT), %	-	Volume-to-Capacity Ratio (v/c)	0.70
Passenger Car Equivalent (ET)	2.000		

Speed and Density

Lane Width Adjustment (fLW)	0.0	Average Speed (S), mi/h	64.8
Right-Side Lateral Clearance Adj. (fRLC)	0.0	Density (D), pc/mi/ln	25.5
Total Ramp Density Adjustment	4.1	Level of Service (LOS)	C
Adjusted Free-Flow Speed (FFSadj), mi/h	65.9		

HCS7 Freeway Merge Report

Project Information

Analyst	LSA	Date	12/11/2019
Agency	LSA	Analysis Year	Phase II Proj Comp Yr (2039) NP
Jurisdiction	Caltrans	Time Period Analyzed	AM Peak Hour
Project Description	CMD1801 - Village D Specific Plan	Unit	United States Customary

Geometric Data

	Freeway	Ramp
Number of Lanes (N), ln	2	1
Free-Flow Speed (FFS), mi/h	70.0	35.0
Segment Length (L) / Acceleration Length (LA),ft	1500	500
Terrain Type	Level	Level
Percent Grade, %	-	-
Segment Type / Ramp Side	Freeway	Right

Adjustment Factors

Driver Population	All Familiar	All Familiar
Weather Type	Non-Severe Weather	Non-Severe Weather
Incident Type	No Incident	-
Final Speed Adjustment Factor (SAF)	1.000	1.000
Final Capacity Adjustment Factor (CAF)	1.000	1.000
Demand Adjustment Factor (DAF)	1.000	1.000

Demand and Capacity

Demand Volume (Vi)	2443	199
Peak Hour Factor (PHF)	0.94	0.94
Total Trucks, %	27.11	32.07
Single-Unit Trucks (SUT), %	-	-
Tractor-Trailers (TT), %	-	-
Heavy Vehicle Adjustment Factor (fHV)	0.787	0.757
Flow Rate (vi),pc/h	3302	280
Capacity (c), pc/h	4800	2000
Volume-to-Capacity Ratio (v/c)	0.75	0.14

Speed and Density

Upstream Equilibrium Distance (LEQ), ft	-	Number of Outer Lanes on Freeway (NO)	0
Distance to Upstream Ramp (LUP), ft	-	Speed Index (MS)	0.426
Downstream Equilibrium Distance (LEQ), ft	-	Flow Outer Lanes (vOA), pc/h/ln	-
Distance to Downstream Ramp (LDOWN), ft	-	On-Ramp Influence Area Speed (SR), mi/h	58.1
Prop. Freeway Vehicles in Lane 1 and 2 (PFM)	1.000	Outer Lanes Freeway Speed (SO), mi/h	70.0
Flow in Lanes 1 and 2 (v12), pc/h	3302	Ramp Junction Speed (S), mi/h	58.1
Flow Entering Ramp-Infl. Area (vR12), pc/h	3582	Average Density (D), pc/mi/ln	30.8
Level of Service (LOS)	D	Density in Ramp Influence Area (DR), pc/mi/ln	30.2

HCS7 Basic Freeway Report

Project Information

Analyst	LSA	Date	12/11/2019
Agency	LSA	Analysis Year	Phase II Proj Comp Yr (2039) NP
Jurisdiction	Caltrans	Time Period Analyzed	AM Peak Hour
Project Description	CMD1801 - Village D Specific Plan	Unit	United States Customary

Geometric Data

Number of Lanes, ln	2	Terrain Type	Level
Segment Length (L), ft	-	Percent Grade, %	-
Measured or Base Free-Flow Speed	Base	Grade Length, mi	-
Base Free-Flow Speed (BFFS), mi/h	70.0	Total Ramp Density (TRD), ramps/mi	1.33
Lane Width, ft	12	Free-Flow Speed (FFS), mi/h	65.9
Right-Side Lateral Clearance, ft	10		

Adjustment Factors

Driver Population	All Familiar	Final Speed Adjustment Factor (SAF)	1.000
Weather Type	Non-Severe Weather	Final Capacity Adjustment Factor (CAF)	1.000
Incident Type	No Incident	Demand Adjustment Factor (DAF)	1.000

Demand and Capacity

Demand Volume veh/h	2642	Heavy Vehicle Adjustment Factor (fhv)	0.784
Peak Hour Factor	0.94	Flow Rate (Vp), pc/h/ln	1792
Total Trucks, %	27.50	Capacity (c), pc/h/ln	2359
Single-Unit Trucks (SUT), %	-	Adjusted Capacity (cadj), pc/h/ln	2359
Tractor-Trailers (TT), %	-	Volume-to-Capacity Ratio (v/c)	0.76
Passenger Car Equivalent (ET)	2.000		

Speed and Density

Lane Width Adjustment (fLW)	0.0	Average Speed (S), mi/h	63.4
Right-Side Lateral Clearance Adj. (fRLC)	0.0	Density (D), pc/mi/ln	28.3
Total Ramp Density Adjustment	4.1	Level of Service (LOS)	D
Adjusted Free-Flow Speed (FFSadj), mi/h	65.9		

HCS7 Freeway Diverge Report

Project Information

Analyst	LSA	Date	12/11/2019
Agency	LSA	Analysis Year	Phase II Proj Comp Yr (2039) NP
Jurisdiction	Caltrans	Time Period Analyzed	AM Peak Hour
Project Description	CMD1801 - Village D Specific Plan	Unit	United States Customary

Geometric Data

	Freeway	Ramp
Number of Lanes (N), ln	3	1
Free-Flow Speed (FFS), mi/h	70.0	35.0
Segment Length (L) / Deceleration Length (LA),ft	1500	150
Terrain Type	Level	Level
Percent Grade, %	-	-
Segment Type / Ramp Side	Freeway	Right

Adjustment Factors

Driver Population	All Familiar	All Familiar
Weather Type	Non-Severe Weather	Non-Severe Weather
Incident Type	No Incident	-
Final Speed Adjustment Factor (SAF)	1.000	1.000
Final Capacity Adjustment Factor (CAF)	1.000	1.000
Demand Adjustment Factor (DAF)	1.000	1.000

Demand and Capacity

Demand Volume (Vi)	2642	383
Peak Hour Factor (PHF)	0.94	0.94
Total Trucks, %	27.50	18.81
Single-Unit Trucks (SUT), %	-	-
Tractor-Trailers (TT), %	-	-
Heavy Vehicle Adjustment Factor (fHV)	0.784	0.842
Flow Rate (vi),pc/h	3585	484
Capacity (c), pc/h	7200	2000
Volume-to-Capacity Ratio (v/c)	0.50	0.24

Speed and Density

Upstream Equilibrium Distance (LEQ), ft	-	Number of Outer Lanes on Freeway (NO)	1
Distance to Upstream Ramp (LUP), ft	-	Speed Index (DS)	0.472
Downstream Equilibrium Distance (LEQ), ft	-	Flow Outer Lanes (vOA), pc/h/ln	1092
Distance to Downstream Ramp (LDOWN), ft	-	Off-Ramp Influence Area Speed (SR), mi/h	56.8
Prop. Freeway Vehicles in Lane 1 and 2 (PFD)	0.648	Outer Lanes Freeway Speed (SO), mi/h	76.4
Flow in Lanes 1 and 2 (v12), pc/h	2493	Ramp Junction Speed (S), mi/h	61.6
Flow Entering Ramp-Infl. Area (vR12), pc/h	-	Average Density (D), pc/mi/ln	19.4
Level of Service (LOS)	C	Density in Ramp Influence Area (DR), pc/mi/ln	24.3

HCS7 Basic Freeway Report

Project Information

Analyst	LSA	Date	12/11/2019
Agency	LSA	Analysis Year	Phase II Proj Comp Yr (2039) NP
Jurisdiction	Caltrans	Time Period Analyzed	AM Peak Hour
Project Description	CMD1801 - Village D Specific Plan	Unit	United States Customary

Geometric Data

Number of Lanes, ln	3	Terrain Type	Level
Segment Length (L), ft	-	Percent Grade, %	-
Measured or Base Free-Flow Speed	Base	Grade Length, mi	-
Base Free-Flow Speed (BFFS), mi/h	70.0	Total Ramp Density (TRD), ramps/mi	1.67
Lane Width, ft	12	Free-Flow Speed (FFS), mi/h	65.0
Right-Side Lateral Clearance, ft	10		

Adjustment Factors

Driver Population	All Familiar	Final Speed Adjustment Factor (SAF)	1.000
Weather Type	Non-Severe Weather	Final Capacity Adjustment Factor (CAF)	1.000
Incident Type	No Incident	Demand Adjustment Factor (DAF)	1.000

Demand and Capacity

Demand Volume veh/h	2259	Heavy Vehicle Adjustment Factor (fhv)	0.775
Peak Hour Factor	0.94	Flow Rate (Vp), pc/h/ln	1034
Total Trucks, %	28.97	Capacity (c), pc/h/ln	2350
Single-Unit Trucks (SUT), %	-	Adjusted Capacity (cadj), pc/h/ln	2350
Tractor-Trailers (TT), %	-	Volume-to-Capacity Ratio (v/c)	0.44
Passenger Car Equivalent (ET)	2.000		

Speed and Density

Lane Width Adjustment (fLW)	0.0	Average Speed (S), mi/h	65.0
Right-Side Lateral Clearance Adj. (fRLC)	0.0	Density (D), pc/mi/ln	15.9
Total Ramp Density Adjustment	5.0	Level of Service (LOS)	B
Adjusted Free-Flow Speed (FFSadj), mi/h	65.0		

HCS7 Freeway Merge Report

Project Information

Analyst	LSA	Date	12/11/2019
Agency	LSA	Analysis Year	Phase II Proj Comp Yr (2039) NP
Jurisdiction	Caltrans	Time Period Analyzed	AM Peak Hour
Project Description	CMD1801 - Village D Specific Plan	Unit	United States Customary

Geometric Data

	Freeway	Ramp
Number of Lanes (N), ln	3	1
Free-Flow Speed (FFS), mi/h	65.0	35.0
Segment Length (L) / Acceleration Length (LA),ft	1500	600
Terrain Type	Level	Level
Percent Grade, %	-	-
Segment Type / Ramp Side	Freeway	Right

Adjustment Factors

Driver Population	All Familiar	All Familiar
Weather Type	Non-Severe Weather	Non-Severe Weather
Incident Type	No Incident	-
Final Speed Adjustment Factor (SAF)	1.000	1.000
Final Capacity Adjustment Factor (CAF)	1.000	1.000
Demand Adjustment Factor (DAF)	1.000	1.000

Demand and Capacity

Demand Volume (Vi)	2259	700
Peak Hour Factor (PHF)	0.94	0.94
Total Trucks, %	28.97	4.05
Single-Unit Trucks (SUT), %	-	-
Tractor-Trailers (TT), %	-	-
Heavy Vehicle Adjustment Factor (fHV)	0.775	0.961
Flow Rate (vi),pc/h	3101	775
Capacity (c), pc/h	7050	2000
Volume-to-Capacity Ratio (v/c)	0.55	0.39

Speed and Density

Upstream Equilibrium Distance (LEQ), ft	-	Number of Outer Lanes on Freeway (NO)	1
Distance to Upstream Ramp (LUP), ft	-	Speed Index (MS)	0.332
Downstream Equilibrium Distance (LEQ), ft	-	Flow Outer Lanes (vOA), pc/h/ln	1259
Distance to Downstream Ramp (LDOWN), ft	-	On-Ramp Influence Area Speed (SR), mi/h	57.4
Prop. Freeway Vehicles in Lane 1 and 2 (PFM)	0.594	Outer Lanes Freeway Speed (SO), mi/h	62.3
Flow in Lanes 1 and 2 (v12), pc/h	1842	Ramp Junction Speed (S), mi/h	58.9
Flow Entering Ramp-Infl. Area (vR12), pc/h	2617	Average Density (D), pc/mi/ln	21.9
Level of Service (LOS)	C	Density in Ramp Influence Area (DR), pc/mi/ln	21.8

HCS7 Basic Freeway Report

Project Information

Analyst	LSA	Date	12/11/2019
Agency	LSA	Analysis Year	Phase II Proj Comp Yr (2039) NP
Jurisdiction	Caltrans	Time Period Analyzed	AM Peak Hour
Project Description	CMD1801 - Village D Specific Plan	Unit	United States Customary

Geometric Data

Number of Lanes, ln	3	Terrain Type	Level
Segment Length (L), ft	-	Percent Grade, %	-
Measured or Base Free-Flow Speed	Base	Grade Length, mi	-
Base Free-Flow Speed (BFFS), mi/h	65.0	Total Ramp Density (TRD), ramps/mi	1.83
Lane Width, ft	12	Free-Flow Speed (FFS), mi/h	59.7
Right-Side Lateral Clearance, ft	10		

Adjustment Factors

Driver Population	All Familiar	Final Speed Adjustment Factor (SAF)	1.000
Weather Type	Non-Severe Weather	Final Capacity Adjustment Factor (CAF)	1.000
Incident Type	No Incident	Demand Adjustment Factor (DAF)	1.000

Demand and Capacity

Demand Volume veh/h	2960	Heavy Vehicle Adjustment Factor (fhv)	0.813
Peak Hour Factor	0.94	Flow Rate (Vp), pc/h/ln	1291
Total Trucks, %	23.06	Capacity (c), pc/h/ln	2296
Single-Unit Trucks (SUT), %	-	Adjusted Capacity (cadj), pc/h/ln	2296
Tractor-Trailers (TT), %	-	Volume-to-Capacity Ratio (v/c)	0.56
Passenger Car Equivalent (ET)	2.000		

Speed and Density

Lane Width Adjustment (fLW)	0.0	Average Speed (S), mi/h	59.6
Right-Side Lateral Clearance Adj. (fRLC)	0.0	Density (D), pc/mi/ln	21.7
Total Ramp Density Adjustment	5.4	Level of Service (LOS)	C
Adjusted Free-Flow Speed (FFSadj), mi/h	59.6		

HCS7 Freeway Merge Report

Project Information

Analyst	LSA	Date	12/11/2019
Agency	LSA	Analysis Year	Phase II Proj Comp Yr (2039) NP
Jurisdiction	Caltrans	Time Period Analyzed	AM Peak Hour
Project Description	CMD1801 - Village D Specific Plan	Unit	United States Customary

Geometric Data

	Freeway	Ramp
Number of Lanes (N), ln	3	1
Free-Flow Speed (FFS), mi/h	65.0	35.0
Segment Length (L) / Acceleration Length (LA),ft	1500	600
Terrain Type	Level	Level
Percent Grade, %	-	-
Segment Type / Ramp Side	Freeway	Right

Adjustment Factors

Driver Population	All Familiar	All Familiar
Weather Type	Non-Severe Weather	Non-Severe Weather
Incident Type	No Incident	-
Final Speed Adjustment Factor (SAF)	1.000	1.000
Final Capacity Adjustment Factor (CAF)	1.000	1.000
Demand Adjustment Factor (DAF)	1.000	1.000

Demand and Capacity

Demand Volume (Vi)	2960	140
Peak Hour Factor (PHF)	0.94	0.94
Total Trucks, %	23.06	14.67
Single-Unit Trucks (SUT), %	-	-
Tractor-Trailers (TT), %	-	-
Heavy Vehicle Adjustment Factor (fHV)	0.813	0.872
Flow Rate (vi),pc/h	3873	171
Capacity (c), pc/h	7050	2000
Volume-to-Capacity Ratio (v/c)	0.57	0.09

Speed and Density

Upstream Equilibrium Distance (LEQ), ft	-	Number of Outer Lanes on Freeway (NO)	1
Distance to Upstream Ramp (LUP), ft	-	Speed Index (MS)	0.325
Downstream Equilibrium Distance (LEQ), ft	-	Flow Outer Lanes (vOA), pc/h/ln	1572
Distance to Downstream Ramp (LDOWN), ft	-	On-Ramp Influence Area Speed (SR), mi/h	57.5
Prop. Freeway Vehicles in Lane 1 and 2 (PFM)	0.594	Outer Lanes Freeway Speed (SO), mi/h	61.1
Flow in Lanes 1 and 2 (v12), pc/h	2301	Ramp Junction Speed (S), mi/h	58.8
Flow Entering Ramp-Infl. Area (vR12), pc/h	2472	Average Density (D), pc/mi/ln	22.9
Level of Service (LOS)	C	Density in Ramp Influence Area (DR), pc/mi/ln	21.0

HCS7 Basic Freeway Report

Project Information

Analyst	LSA	Date	12/11/2019
Agency	LSA	Analysis Year	Phase II Proj Comp Yr (2039) NP
Jurisdiction	Caltrans	Time Period Analyzed	AM Peak Hour
Project Description	CMD1801 - Village D Specific Plan	Unit	United States Customary

Geometric Data

Number of Lanes, ln	3	Terrain Type	Level
Segment Length (L), ft	-	Percent Grade, %	-
Measured or Base Free-Flow Speed	Base	Grade Length, mi	-
Base Free-Flow Speed (BFFS), mi/h	65.0	Total Ramp Density (TRD), ramps/mi	2.17
Lane Width, ft	12	Free-Flow Speed (FFS), mi/h	58.8
Right-Side Lateral Clearance, ft	10		

Adjustment Factors

Driver Population	All Familiar	Final Speed Adjustment Factor (SAF)	1.000
Weather Type	Non-Severe Weather	Final Capacity Adjustment Factor (CAF)	1.000
Incident Type	No Incident	Demand Adjustment Factor (DAF)	1.000

Demand and Capacity

Demand Volume veh/h	3099	Heavy Vehicle Adjustment Factor (fhv)	0.815
Peak Hour Factor	0.94	Flow Rate (Vp), pc/h/ln	1348
Total Trucks, %	22.67	Capacity (c), pc/h/ln	2288
Single-Unit Trucks (SUT), %	-	Adjusted Capacity (cadj), pc/h/ln	2288
Tractor-Trailers (TT), %	-	Volume-to-Capacity Ratio (v/c)	0.59
Passenger Car Equivalent (ET)	2.000		

Speed and Density

Lane Width Adjustment (fLW)	0.0	Average Speed (S), mi/h	58.8
Right-Side Lateral Clearance Adj. (fRLC)	0.0	Density (D), pc/mi/ln	22.9
Total Ramp Density Adjustment	6.2	Level of Service (LOS)	C
Adjusted Free-Flow Speed (FFSadj), mi/h	58.8		

HCS7 Freeway Diverge Report

Project Information

Analyst	LSA	Date	12/11/2019
Agency	LSA	Analysis Year	Phase II Proj Comp Yr (2039) NP
Jurisdiction	Caltrans	Time Period Analyzed	AM Peak Hour
Project Description	CMD1801 - Village D Specific Plan	Unit	United States Customary

Geometric Data

	Freeway	Ramp
Number of Lanes (N), ln	3	1
Free-Flow Speed (FFS), mi/h	65.0	40.0
Segment Length (L) / Deceleration Length (LA),ft	1500	150
Terrain Type	Level	Level
Percent Grade, %	-	-
Segment Type / Ramp Side	Freeway	Right

Adjustment Factors

Driver Population	All Familiar	All Familiar
Weather Type	Non-Severe Weather	Non-Severe Weather
Incident Type	No Incident	-
Final Speed Adjustment Factor (SAF)	1.000	1.000
Final Capacity Adjustment Factor (CAF)	1.000	1.000
Demand Adjustment Factor (DAF)	1.000	1.000

Demand and Capacity

Demand Volume (Vi)	3099	184
Peak Hour Factor (PHF)	0.94	0.94
Total Trucks, %	22.67	4.19
Single-Unit Trucks (SUT), %	-	-
Tractor-Trailers (TT), %	-	-
Heavy Vehicle Adjustment Factor (fHV)	0.815	0.960
Flow Rate (vi),pc/h	4045	204
Capacity (c), pc/h	7050	2000
Volume-to-Capacity Ratio (v/c)	0.57	0.10

Speed and Density

Upstream Equilibrium Distance (LEQ), ft	-	Number of Outer Lanes on Freeway (NO)	1
Distance to Upstream Ramp (LUP), ft	-	Speed Index (DS)	0.381
Downstream Equilibrium Distance (LEQ), ft	-	Flow Outer Lanes (vOA), pc/h/ln	1348
Distance to Downstream Ramp (LDOWN), ft	-	Off-Ramp Influence Area Speed (SR), mi/h	56.2
Prop. Freeway Vehicles in Lane 1 and 2 (PFD)	0.649	Outer Lanes Freeway Speed (SO), mi/h	69.9
Flow in Lanes 1 and 2 (v12), pc/h	2697	Ramp Junction Speed (S), mi/h	60.1
Flow Entering Ramp-Infl. Area (vR12), pc/h	-	Average Density (D), pc/mi/ln	22.4
Level of Service (LOS)	C	Density in Ramp Influence Area (DR), pc/mi/ln	26.1

HCS7 Basic Freeway Report

Project Information

Analyst	LSA	Date	12/11/2019
Agency	LSA	Analysis Year	Phase II Proj Comp Yr (2039) NP
Jurisdiction	Caltrans	Time Period Analyzed	AM Peak Hour
Project Description	CMD1801 - Village D Specific Plan	Unit	United States Customary

Geometric Data

Number of Lanes, ln	3	Terrain Type	Level
Segment Length (L), ft	-	Percent Grade, %	-
Measured or Base Free-Flow Speed	Base	Grade Length, mi	-
Base Free-Flow Speed (BFFS), mi/h	65.0	Total Ramp Density (TRD), ramps/mi	1.83
Lane Width, ft	12	Free-Flow Speed (FFS), mi/h	59.7
Right-Side Lateral Clearance, ft	10		

Adjustment Factors

Driver Population	All Familiar	Final Speed Adjustment Factor (SAF)	1.000
Weather Type	Non-Severe Weather	Final Capacity Adjustment Factor (CAF)	1.000
Incident Type	No Incident	Demand Adjustment Factor (DAF)	1.000

Demand and Capacity

Demand Volume veh/h	2915	Heavy Vehicle Adjustment Factor (fhv)	0.807
Peak Hour Factor	0.94	Flow Rate (Vp), pc/h/ln	1281
Total Trucks, %	23.85	Capacity (c), pc/h/ln	2296
Single-Unit Trucks (SUT), %	-	Adjusted Capacity (cadj), pc/h/ln	2296
Tractor-Trailers (TT), %	-	Volume-to-Capacity Ratio (v/c)	0.56
Passenger Car Equivalent (ET)	2.000		

Speed and Density

Lane Width Adjustment (fLW)	0.0	Average Speed (S), mi/h	59.6
Right-Side Lateral Clearance Adj. (fRLC)	0.0	Density (D), pc/mi/ln	21.5
Total Ramp Density Adjustment	5.4	Level of Service (LOS)	C
Adjusted Free-Flow Speed (FFSadj), mi/h	59.6		

HCS7 Freeway Merge Report

Project Information

Analyst	LSA	Date	12/11/2019
Agency	LSA	Analysis Year	Phase II Proj Comp Yr (2039) NP
Jurisdiction	Caltrans	Time Period Analyzed	AM Peak Hour
Project Description	CMD1801 - Village D Specific Plan	Unit	United States Customary

Geometric Data

	Freeway	Ramp
Number of Lanes (N), ln	3	1
Free-Flow Speed (FFS), mi/h	65.0	35.0
Segment Length (L) / Acceleration Length (LA),ft	1500	800
Terrain Type	Level	Level
Percent Grade, %	-	-
Segment Type / Ramp Side	Freeway	Right

Adjustment Factors

Driver Population	All Familiar	All Familiar
Weather Type	Non-Severe Weather	Non-Severe Weather
Incident Type	No Incident	-
Final Speed Adjustment Factor (SAF)	1.000	1.000
Final Capacity Adjustment Factor (CAF)	1.000	1.000
Demand Adjustment Factor (DAF)	1.000	1.000

Demand and Capacity

Demand Volume (Vi)	2915	319
Peak Hour Factor (PHF)	0.94	0.94
Total Trucks, %	23.85	2.66
Single-Unit Trucks (SUT), %	-	-
Tractor-Trailers (TT), %	-	-
Heavy Vehicle Adjustment Factor (fHV)	0.807	0.974
Flow Rate (vi),pc/h	3843	348
Capacity (c), pc/h	7050	2000
Volume-to-Capacity Ratio (v/c)	0.59	0.17

Speed and Density

Upstream Equilibrium Distance (LEQ), ft	-	Number of Outer Lanes on Freeway (NO)	1
Distance to Upstream Ramp (LUP), ft	-	Speed Index (MS)	0.320
Downstream Equilibrium Distance (LEQ), ft	-	Flow Outer Lanes (vOA), pc/h/ln	1537
Distance to Downstream Ramp (LDOWN), ft	-	On-Ramp Influence Area Speed (SR), mi/h	57.6
Prop. Freeway Vehicles in Lane 1 and 2 (PFM)	0.600	Outer Lanes Freeway Speed (SO), mi/h	61.3
Flow in Lanes 1 and 2 (v12), pc/h	2306	Ramp Junction Speed (S), mi/h	58.9
Flow Entering Ramp-Infl. Area (vR12), pc/h	2654	Average Density (D), pc/mi/ln	23.7
Level of Service (LOS)	C	Density in Ramp Influence Area (DR), pc/mi/ln	21.1

HCS7 Basic Freeway Report

Project Information

Analyst	LSA	Date	12/11/2019
Agency	LSA	Analysis Year	Phase II Proj Comp Yr (2039) NP
Jurisdiction	Caltrans	Time Period Analyzed	AM Peak Hour
Project Description	CMD1801 - Village D Specific Plan	Unit	United States Customary

Geometric Data

Number of Lanes, ln	3	Terrain Type	Level
Segment Length (L), ft	-	Percent Grade, %	-
Measured or Base Free-Flow Speed	Base	Grade Length, mi	-
Base Free-Flow Speed (BFFS), mi/h	65.0	Total Ramp Density (TRD), ramps/mi	2.17
Lane Width, ft	12	Free-Flow Speed (FFS), mi/h	58.8
Right-Side Lateral Clearance, ft	10		

Adjustment Factors

Driver Population	All Familiar	Final Speed Adjustment Factor (SAF)	1.000
Weather Type	Non-Severe Weather	Final Capacity Adjustment Factor (CAF)	1.000
Incident Type	No Incident	Demand Adjustment Factor (DAF)	1.000

Demand and Capacity

Demand Volume veh/h	3234	Heavy Vehicle Adjustment Factor (fhv)	0.821
Peak Hour Factor	0.94	Flow Rate (Vp), pc/h/ln	1397
Total Trucks, %	21.75	Capacity (c), pc/h/ln	2288
Single-Unit Trucks (SUT), %	-	Adjusted Capacity (cadj), pc/h/ln	2288
Tractor-Trailers (TT), %	-	Volume-to-Capacity Ratio (v/c)	0.61
Passenger Car Equivalent (ET)	2.000		

Speed and Density

Lane Width Adjustment (fLW)	0.0	Average Speed (S), mi/h	58.8
Right-Side Lateral Clearance Adj. (fRLC)	0.0	Density (D), pc/mi/ln	23.8
Total Ramp Density Adjustment	6.2	Level of Service (LOS)	C
Adjusted Free-Flow Speed (FFSadj), mi/h	58.8		

HCS7 Freeway Diverge Report

Project Information

Analyst	LSA	Date	12/11/2019
Agency	LSA	Analysis Year	Phase II Proj Comp Yr (2039) NP
Jurisdiction	Caltrans	Time Period Analyzed	AM Peak Hour
Project Description	CMD1801 - Village D Specific Plan	Unit	United States Customary

Geometric Data

	Freeway	Ramp
Number of Lanes (N), ln	3	1
Free-Flow Speed (FFS), mi/h	65.0	35.0
Segment Length (L) / Deceleration Length (LA),ft	1500	200
Terrain Type	Level	Level
Percent Grade, %	-	-
Segment Type / Ramp Side	Freeway	Right

Adjustment Factors

Driver Population	All Familiar	All Familiar
Weather Type	Non-Severe Weather	Non-Severe Weather
Incident Type	No Incident	-
Final Speed Adjustment Factor (SAF)	1.000	1.000
Final Capacity Adjustment Factor (CAF)	1.000	1.000
Demand Adjustment Factor (DAF)	1.000	1.000

Demand and Capacity

Demand Volume (Vi)	3234	137
Peak Hour Factor (PHF)	0.94	0.94
Total Trucks, %	21.75	14.71
Single-Unit Trucks (SUT), %	-	-
Tractor-Trailers (TT), %	-	-
Heavy Vehicle Adjustment Factor (fHV)	0.821	0.872
Flow Rate (vi),pc/h	4191	167
Capacity (c), pc/h	7050	2000
Volume-to-Capacity Ratio (v/c)	0.59	0.08

Speed and Density

Upstream Equilibrium Distance (LEQ), ft	-	Number of Outer Lanes on Freeway (NO)	1
Distance to Upstream Ramp (LUP), ft	-	Speed Index (DS)	0.443
Downstream Equilibrium Distance (LEQ), ft	-	Flow Outer Lanes (vOA), pc/h/ln	1416
Distance to Downstream Ramp (LDOWN), ft	-	Off-Ramp Influence Area Speed (SR), mi/h	54.8
Prop. Freeway Vehicles in Lane 1 and 2 (PFD)	0.648	Outer Lanes Freeway Speed (SO), mi/h	69.7
Flow in Lanes 1 and 2 (v12), pc/h	2775	Ramp Junction Speed (S), mi/h	59.1
Flow Entering Ramp-Infl. Area (vR12), pc/h	-	Average Density (D), pc/mi/ln	23.6
Level of Service (LOS)	C	Density in Ramp Influence Area (DR), pc/mi/ln	26.3

HCS7 Basic Freeway Report

Project Information

Analyst	LSA	Date	12/11/2019
Agency	LSA	Analysis Year	Phase II Proj Comp Yr (2039) NP
Jurisdiction	Caltrans	Time Period Analyzed	AM Peak Hour
Project Description	CMD1801 - Village D Specific Plan	Unit	United States Customary

Geometric Data

Number of Lanes, ln	3	Terrain Type	Level
Segment Length (L), ft	-	Percent Grade, %	-
Measured or Base Free-Flow Speed	Base	Grade Length, mi	-
Base Free-Flow Speed (BFFS), mi/h	65.0	Total Ramp Density (TRD), ramps/mi	2.17
Lane Width, ft	12	Free-Flow Speed (FFS), mi/h	58.8
Right-Side Lateral Clearance, ft	10		

Adjustment Factors

Driver Population	All Familiar	Final Speed Adjustment Factor (SAF)	1.000
Weather Type	Non-Severe Weather	Final Capacity Adjustment Factor (CAF)	1.000
Incident Type	No Incident	Demand Adjustment Factor (DAF)	1.000

Demand and Capacity

Demand Volume veh/h	3098	Heavy Vehicle Adjustment Factor (fhv)	0.819
Peak Hour Factor	0.94	Flow Rate (Vp), pc/h/ln	1341
Total Trucks, %	22.07	Capacity (c), pc/h/ln	2288
Single-Unit Trucks (SUT), %	-	Adjusted Capacity (cadj), pc/h/ln	2288
Tractor-Trailers (TT), %	-	Volume-to-Capacity Ratio (v/c)	0.59
Passenger Car Equivalent (ET)	2.000		

Speed and Density

Lane Width Adjustment (fLW)	0.0	Average Speed (S), mi/h	58.8
Right-Side Lateral Clearance Adj. (fRLC)	0.0	Density (D), pc/mi/ln	22.8
Total Ramp Density Adjustment	6.2	Level of Service (LOS)	C
Adjusted Free-Flow Speed (FFSadj), mi/h	58.8		

HCS7 Freeway Merge Report

Project Information

Analyst	LSA	Date	12/11/2019
Agency	LSA	Analysis Year	Phase II Proj Comp Yr (2039) NP
Jurisdiction	Caltrans	Time Period Analyzed	AM Peak Hour
Project Description	CMD1801 - Village D Specific Plan	Unit	United States Customary

Geometric Data

	Freeway	Ramp
Number of Lanes (N), ln	3	1
Free-Flow Speed (FFS), mi/h	65.0	35.0
Segment Length (L) / Acceleration Length (LA),ft	1500	350
Terrain Type	Level	Level
Percent Grade, %	-	-
Segment Type / Ramp Side	Freeway	Right

Adjustment Factors

Driver Population	All Familiar	All Familiar
Weather Type	Non-Severe Weather	Non-Severe Weather
Incident Type	No Incident	-
Final Speed Adjustment Factor (SAF)	1.000	1.000
Final Capacity Adjustment Factor (CAF)	1.000	1.000
Demand Adjustment Factor (DAF)	1.000	1.000

Demand and Capacity

Demand Volume (Vi)	3098	766
Peak Hour Factor (PHF)	0.94	0.94
Total Trucks, %	22.07	3.10
Single-Unit Trucks (SUT), %	-	-
Tractor-Trailers (TT), %	-	-
Heavy Vehicle Adjustment Factor (fHV)	0.819	0.970
Flow Rate (vi),pc/h	4024	840
Capacity (c), pc/h	7050	2000
Volume-to-Capacity Ratio (v/c)	0.69	0.42

Speed and Density

Upstream Equilibrium Distance (LEQ), ft	-	Number of Outer Lanes on Freeway (NO)	1
Distance to Upstream Ramp (LUP), ft	-	Speed Index (MS)	0.392
Downstream Equilibrium Distance (LEQ), ft	-	Flow Outer Lanes (vOA), pc/h/ln	1662
Distance to Downstream Ramp (LDOWN), ft	-	On-Ramp Influence Area Speed (SR), mi/h	56.0
Prop. Freeway Vehicles in Lane 1 and 2 (PFM)	0.587	Outer Lanes Freeway Speed (SO), mi/h	60.8
Flow in Lanes 1 and 2 (v12), pc/h	2362	Ramp Junction Speed (S), mi/h	57.6
Flow Entering Ramp-Infl. Area (vR12), pc/h	3202	Average Density (D), pc/mi/ln	28.1
Level of Service (LOS)	C	Density in Ramp Influence Area (DR), pc/mi/ln	27.9

HCS7 Basic Freeway Report

Project Information

Analyst	LSA	Date	12/11/2019
Agency	LSA	Analysis Year	Phase II Proj Comp Yr (2039) NP
Jurisdiction	Caltrans	Time Period Analyzed	AM Peak Hour
Project Description	CMD1801 - Village D Specific Plan	Unit	United States Customary

Geometric Data

Number of Lanes, ln	3	Terrain Type	Level
Segment Length (L), ft	-	Percent Grade, %	-
Measured or Base Free-Flow Speed	Base	Grade Length, mi	-
Base Free-Flow Speed (BFFS), mi/h	65.0	Total Ramp Density (TRD), ramps/mi	2.17
Lane Width, ft	12	Free-Flow Speed (FFS), mi/h	58.8
Right-Side Lateral Clearance, ft	10		

Adjustment Factors

Driver Population	All Familiar	Final Speed Adjustment Factor (SAF)	1.000
Weather Type	Non-Severe Weather	Final Capacity Adjustment Factor (CAF)	1.000
Incident Type	No Incident	Demand Adjustment Factor (DAF)	1.000

Demand and Capacity

Demand Volume veh/h	3864	Heavy Vehicle Adjustment Factor (fhv)	0.845
Peak Hour Factor	0.94	Flow Rate (Vp), pc/h/ln	1622
Total Trucks, %	18.31	Capacity (c), pc/h/ln	2288
Single-Unit Trucks (SUT), %	-	Adjusted Capacity (cadj), pc/h/ln	2288
Tractor-Trailers (TT), %	-	Volume-to-Capacity Ratio (v/c)	0.71
Passenger Car Equivalent (ET)	2.000		

Speed and Density

Lane Width Adjustment (fLW)	0.0	Average Speed (S), mi/h	58.8
Right-Side Lateral Clearance Adj. (fRLC)	0.0	Density (D), pc/mi/ln	27.6
Total Ramp Density Adjustment	6.2	Level of Service (LOS)	D
Adjusted Free-Flow Speed (FFSadj), mi/h	58.8		

HCS7 Freeway Diverge Report

Project Information

Analyst	LSA	Date	12/11/2019
Agency	LSA	Analysis Year	Phase II Proj Comp Yr (2039) NP
Jurisdiction	Caltrans	Time Period Analyzed	AM Peak Hour
Project Description	CMD1801 - Village D Specific Plan	Unit	United States Customary

Geometric Data

	Freeway	Ramp
Number of Lanes (N), In	3	1
Free-Flow Speed (FFS), mi/h	65.0	15.0
Segment Length (L) / Deceleration Length (LA),ft	1500	150
Terrain Type	Level	Level
Percent Grade, %	-	-
Segment Type / Ramp Side	Freeway	Right

Adjustment Factors

Driver Population	All Familiar	All Familiar
Weather Type	Non-Severe Weather	Non-Severe Weather
Incident Type	No Incident	-
Final Speed Adjustment Factor (SAF)	1.000	1.000
Final Capacity Adjustment Factor (CAF)	1.000	1.000
Demand Adjustment Factor (DAF)	1.000	1.000

Demand and Capacity

Demand Volume (Vi)	3864	422
Peak Hour Factor (PHF)	0.94	0.94
Total Trucks, %	18.31	3.32
Single-Unit Trucks (SUT), %	-	-
Tractor-Trailers (TT), %	-	-
Heavy Vehicle Adjustment Factor (fHV)	0.845	0.968
Flow Rate (vi),pc/h	4865	464
Capacity (c), pc/h	7050	1800
Volume-to-Capacity Ratio (v/c)	0.69	0.26

Speed and Density

Upstream Equilibrium Distance (LEQ), ft	-	Number of Outer Lanes on Freeway (NO)	1
Distance to Upstream Ramp (LUP), ft	-	Speed Index (DS)	0.730
Downstream Equilibrium Distance (LEQ), ft	-	Flow Outer Lanes (vOA), pc/h/ln	1686
Distance to Downstream Ramp (LDOWN), ft	-	Off-Ramp Influence Area Speed (SR), mi/h	48.2
Prop. Freeway Vehicles in Lane 1 and 2 (PFD)	0.617	Outer Lanes Freeway Speed (SO), mi/h	68.6
Flow in Lanes 1 and 2 (v12), pc/h	3179	Ramp Junction Speed (S), mi/h	53.7
Flow Entering Ramp-Infl. Area (vR12), pc/h	-	Average Density (D), pc/mi/ln	30.2
Level of Service (LOS)	D	Density in Ramp Influence Area (DR), pc/mi/ln	30.2

HCS7 Basic Freeway Report

Project Information

Analyst	LSA	Date	12/11/2019
Agency	LSA	Analysis Year	Phase II Proj Comp Yr (2039) NP
Jurisdiction	Caltrans	Time Period Analyzed	AM Peak Hour
Project Description	CMD1801 - Village D Specific Plan	Unit	United States Customary

Geometric Data

Number of Lanes, ln	3	Terrain Type	Level
Segment Length (L), ft	-	Percent Grade, %	-
Measured or Base Free-Flow Speed	Base	Grade Length, mi	-
Base Free-Flow Speed (BFFS), mi/h	65.0	Total Ramp Density (TRD), ramps/mi	1.83
Lane Width, ft	12	Free-Flow Speed (FFS), mi/h	59.7
Right-Side Lateral Clearance, ft	10		

Adjustment Factors

Driver Population	All Familiar	Final Speed Adjustment Factor (SAF)	1.000
Weather Type	Non-Severe Weather	Final Capacity Adjustment Factor (CAF)	1.000
Incident Type	No Incident	Demand Adjustment Factor (DAF)	1.000

Demand and Capacity

Demand Volume veh/h	3442	Heavy Vehicle Adjustment Factor (fhv)	0.832
Peak Hour Factor	0.94	Flow Rate (Vp), pc/h/ln	1467
Total Trucks, %	20.14	Capacity (c), pc/h/ln	2296
Single-Unit Trucks (SUT), %	-	Adjusted Capacity (cadj), pc/h/ln	2296
Tractor-Trailers (TT), %	-	Volume-to-Capacity Ratio (v/c)	0.64
Passenger Car Equivalent (ET)	2.000		

Speed and Density

Lane Width Adjustment (fLW)	0.0	Average Speed (S), mi/h	59.6
Right-Side Lateral Clearance Adj. (fRLC)	0.0	Density (D), pc/mi/ln	24.6
Total Ramp Density Adjustment	5.4	Level of Service (LOS)	C
Adjusted Free-Flow Speed (FFSadj), mi/h	59.6		

HCS7 Freeway Merge Report

Project Information

Analyst	LSA	Date	12/11/2019
Agency	LSA	Analysis Year	Phase II Proj Comp Yr (2039) NP
Jurisdiction	Caltrans	Time Period Analyzed	AM Peak Hour
Project Description	CMD1801 - Village D Specific Plan	Unit	United States Customary

Geometric Data

	Freeway	Ramp
Number of Lanes (N), ln	3	1
Free-Flow Speed (FFS), mi/h	65.0	35.0
Segment Length (L) / Acceleration Length (LA),ft	1500	450
Terrain Type	Level	Level
Percent Grade, %	-	-
Segment Type / Ramp Side	Freeway	Right

Adjustment Factors

Driver Population	All Familiar	All Familiar
Weather Type	Non-Severe Weather	Non-Severe Weather
Incident Type	No Incident	-
Final Speed Adjustment Factor (SAF)	1.000	1.000
Final Capacity Adjustment Factor (CAF)	1.000	1.000
Demand Adjustment Factor (DAF)	1.000	1.000

Demand and Capacity

Demand Volume (Vi)	3442	558
Peak Hour Factor (PHF)	0.94	0.94
Total Trucks, %	20.14	0.84
Single-Unit Trucks (SUT), %	-	-
Tractor-Trailers (TT), %	-	-
Heavy Vehicle Adjustment Factor (fHV)	0.832	0.992
Flow Rate (vi),pc/h	4401	598
Capacity (c), pc/h	7050	2000
Volume-to-Capacity Ratio (v/c)	0.71	0.30

Speed and Density

Upstream Equilibrium Distance (LEQ), ft	-	Number of Outer Lanes on Freeway (NO)	1
Distance to Upstream Ramp (LUP), ft	-	Speed Index (MS)	0.385
Downstream Equilibrium Distance (LEQ), ft	-	Flow Outer Lanes (vOA), pc/h/ln	1804
Distance to Downstream Ramp (LDOWN), ft	-	On-Ramp Influence Area Speed (SR), mi/h	56.1
Prop. Freeway Vehicles in Lane 1 and 2 (PFM)	0.590	Outer Lanes Freeway Speed (SO), mi/h	60.3
Flow in Lanes 1 and 2 (v12), pc/h	2597	Ramp Junction Speed (S), mi/h	57.5
Flow Entering Ramp-Infl. Area (vR12), pc/h	3195	Average Density (D), pc/mi/ln	29.0
Level of Service (LOS)	C	Density in Ramp Influence Area (DR), pc/mi/ln	27.4

HCS7 Basic Freeway Report

Project Information

Analyst	LSA	Date	12/11/2019
Agency	LSA	Analysis Year	Phase II Proj Comp Yr (2039) NP
Jurisdiction	Caltrans	Time Period Analyzed	AM Peak Hour
Project Description	CMD1801 - Village D Specific Plan	Unit	United States Customary

Geometric Data

Number of Lanes, ln	3	Terrain Type	Level
Segment Length (L), ft	-	Percent Grade, %	-
Measured or Base Free-Flow Speed	Base	Grade Length, mi	-
Base Free-Flow Speed (BFFS), mi/h	65.0	Total Ramp Density (TRD), ramps/mi	1.83
Lane Width, ft	12	Free-Flow Speed (FFS), mi/h	59.7
Right-Side Lateral Clearance, ft	10		

Adjustment Factors

Driver Population	All Familiar	Final Speed Adjustment Factor (SAF)	1.000
Weather Type	Non-Severe Weather	Final Capacity Adjustment Factor (CAF)	1.000
Incident Type	No Incident	Demand Adjustment Factor (DAF)	1.000

Demand and Capacity

Demand Volume veh/h	3999	Heavy Vehicle Adjustment Factor (fhv)	0.851
Peak Hour Factor	0.94	Flow Rate (Vp), pc/h/ln	1666
Total Trucks, %	17.45	Capacity (c), pc/h/ln	2296
Single-Unit Trucks (SUT), %	-	Adjusted Capacity (cadj), pc/h/ln	2296
Tractor-Trailers (TT), %	-	Volume-to-Capacity Ratio (v/c)	0.73
Passenger Car Equivalent (ET)	2.000		

Speed and Density

Lane Width Adjustment (fLW)	0.0	Average Speed (S), mi/h	59.6
Right-Side Lateral Clearance Adj. (fRLC)	0.0	Density (D), pc/mi/ln	28.0
Total Ramp Density Adjustment	5.4	Level of Service (LOS)	D
Adjusted Free-Flow Speed (FFSadj), mi/h	59.6		

HCS7 Freeway Diverge Report

Project Information

Analyst	LSA	Date	12/11/2019
Agency	LSA	Analysis Year	Phase II Proj Comp Yr (2039) NP
Jurisdiction	Caltrans	Time Period Analyzed	AM Peak Hour
Project Description	CMD1801 - Village D Specific Plan	Unit	United States Customary

Geometric Data

	Freeway	Ramp
Number of Lanes (N), In	3	1
Free-Flow Speed (FFS), mi/h	65.0	35.0
Segment Length (L) / Deceleration Length (LA),ft	1500	140
Terrain Type	Level	Level
Percent Grade, %	-	-
Segment Type / Ramp Side	Freeway	Right

Adjustment Factors

Driver Population	All Familiar	All Familiar
Weather Type	Non-Severe Weather	Non-Severe Weather
Incident Type	No Incident	-
Final Speed Adjustment Factor (SAF)	1.000	1.000
Final Capacity Adjustment Factor (CAF)	1.000	1.000
Demand Adjustment Factor (DAF)	1.000	1.000

Demand and Capacity

Demand Volume (Vi)	3999	689
Peak Hour Factor (PHF)	0.94	0.94
Total Trucks, %	17.45	9.70
Single-Unit Trucks (SUT), %	-	-
Tractor-Trailers (TT), %	-	-
Heavy Vehicle Adjustment Factor (fHV)	0.851	0.912
Flow Rate (vi),pc/h	4999	804
Capacity (c), pc/h	7050	2000
Volume-to-Capacity Ratio (v/c)	0.71	0.40

Speed and Density

Upstream Equilibrium Distance (LEQ), ft	-	Number of Outer Lanes on Freeway (NO)	1
Distance to Upstream Ramp (LUP), ft	-	Speed Index (DS)	0.500
Downstream Equilibrium Distance (LEQ), ft	-	Flow Outer Lanes (vOA), pc/h/ln	1686
Distance to Downstream Ramp (LDOWN), ft	-	Off-Ramp Influence Area Speed (SR), mi/h	53.5
Prop. Freeway Vehicles in Lane 1 and 2 (PFD)	0.598	Outer Lanes Freeway Speed (SO), mi/h	68.6
Flow in Lanes 1 and 2 (v12), pc/h	3313	Ramp Junction Speed (S), mi/h	57.8
Flow Entering Ramp-Infl. Area (vR12), pc/h	-	Average Density (D), pc/mi/ln	28.8
Level of Service (LOS)	D	Density in Ramp Influence Area (DR), pc/mi/ln	31.5

HCS7 Basic Freeway Report

Project Information

Analyst	LSA	Date	12/11/2019
Agency	LSA	Analysis Year	Phase II Proj Comp Yr (2039) NP
Jurisdiction	Caltrans	Time Period Analyzed	AM Peak Hour
Project Description	CMD1801 - Village D Specific Plan	Unit	United States Customary

Geometric Data

Number of Lanes, ln	3	Terrain Type	Level
Segment Length (L), ft	-	Percent Grade, %	-
Measured or Base Free-Flow Speed	Base	Grade Length, mi	-
Base Free-Flow Speed (BFFS), mi/h	65.0	Total Ramp Density (TRD), ramps/mi	2.17
Lane Width, ft	12	Free-Flow Speed (FFS), mi/h	58.8
Right-Side Lateral Clearance, ft	10		

Adjustment Factors

Driver Population	All Familiar	Final Speed Adjustment Factor (SAF)	1.000
Weather Type	Non-Severe Weather	Final Capacity Adjustment Factor (CAF)	1.000
Incident Type	No Incident	Demand Adjustment Factor (DAF)	1.000

Demand and Capacity

Demand Volume veh/h	3311	Heavy Vehicle Adjustment Factor (fhv)	0.840
Peak Hour Factor	0.94	Flow Rate (Vp), pc/h/ln	1398
Total Trucks, %	19.05	Capacity (c), pc/h/ln	2288
Single-Unit Trucks (SUT), %	-	Adjusted Capacity (cadj), pc/h/ln	2288
Tractor-Trailers (TT), %	-	Volume-to-Capacity Ratio (v/c)	0.61
Passenger Car Equivalent (ET)	2.000		

Speed and Density

Lane Width Adjustment (fLW)	0.0	Average Speed (S), mi/h	58.8
Right-Side Lateral Clearance Adj. (fRLC)	0.0	Density (D), pc/mi/ln	23.8
Total Ramp Density Adjustment	6.2	Level of Service (LOS)	C
Adjusted Free-Flow Speed (FFSadj), mi/h	58.8		

HCS7 Freeway Merge Report

Project Information

Analyst	LSA	Date	12/11/2019
Agency	LSA	Analysis Year	Phase II Proj Comp Yr (2039) NP
Jurisdiction	Caltrans	Time Period Analyzed	AM Peak Hour
Project Description	CMD1801 - Village D Specific Plan	Unit	United States Customary

Geometric Data

	Freeway	Ramp
Number of Lanes (N), ln	3	1
Free-Flow Speed (FFS), mi/h	65.0	35.0
Segment Length (L) / Acceleration Length (LA),ft	1500	450
Terrain Type	Level	Level
Percent Grade, %	-	-
Segment Type / Ramp Side	Freeway	Right

Adjustment Factors

Driver Population	All Familiar	All Familiar
Weather Type	Non-Severe Weather	Non-Severe Weather
Incident Type	No Incident	-
Final Speed Adjustment Factor (SAF)	1.000	1.000
Final Capacity Adjustment Factor (CAF)	1.000	1.000
Demand Adjustment Factor (DAF)	1.000	1.000

Demand and Capacity

Demand Volume (Vi)	3311	327
Peak Hour Factor (PHF)	0.94	0.94
Total Trucks, %	19.05	2.57
Single-Unit Trucks (SUT), %	-	-
Tractor-Trailers (TT), %	-	-
Heavy Vehicle Adjustment Factor (fHV)	0.840	0.975
Flow Rate (vi),pc/h	4193	357
Capacity (c), pc/h	7050	2000
Volume-to-Capacity Ratio (v/c)	0.65	0.18

Speed and Density

Upstream Equilibrium Distance (LEQ), ft	-	Number of Outer Lanes on Freeway (NO)	1
Distance to Upstream Ramp (LUP), ft	-	Speed Index (MS)	0.356
Downstream Equilibrium Distance (LEQ), ft	-	Flow Outer Lanes (vOA), pc/h/ln	1719
Distance to Downstream Ramp (LDOWN), ft	-	On-Ramp Influence Area Speed (SR), mi/h	56.8
Prop. Freeway Vehicles in Lane 1 and 2 (PFM)	0.590	Outer Lanes Freeway Speed (SO), mi/h	60.6
Flow in Lanes 1 and 2 (v12), pc/h	2474	Ramp Junction Speed (S), mi/h	58.2
Flow Entering Ramp-Infl. Area (vR12), pc/h	2831	Average Density (D), pc/mi/ln	26.1
Level of Service (LOS)	C	Density in Ramp Influence Area (DR), pc/mi/ln	24.6

HCS7 Basic Freeway Report

Project Information

Analyst	LSA	Date	12/11/2019
Agency	LSA	Analysis Year	Phase II Proj Comp Yr (2039) NP
Jurisdiction	Caltrans	Time Period Analyzed	AM Peak Hour
Project Description	CMD1801 - Village D Specific Plan	Unit	United States Customary

Geometric Data

Number of Lanes, ln	3	Terrain Type	Level
Segment Length (L), ft	-	Percent Grade, %	-
Measured or Base Free-Flow Speed	Base	Grade Length, mi	-
Base Free-Flow Speed (BFFS), mi/h	65.0	Total Ramp Density (TRD), ramps/mi	2.17
Lane Width, ft	12	Free-Flow Speed (FFS), mi/h	58.8
Right-Side Lateral Clearance, ft	10		

Adjustment Factors

Driver Population	All Familiar	Final Speed Adjustment Factor (SAF)	1.000
Weather Type	Non-Severe Weather	Final Capacity Adjustment Factor (CAF)	1.000
Incident Type	No Incident	Demand Adjustment Factor (DAF)	1.000

Demand and Capacity

Demand Volume veh/h	3638	Heavy Vehicle Adjustment Factor (fhv)	0.850
Peak Hour Factor	0.94	Flow Rate (Vp), pc/h/ln	1518
Total Trucks, %	17.58	Capacity (c), pc/h/ln	2288
Single-Unit Trucks (SUT), %	-	Adjusted Capacity (cadj), pc/h/ln	2288
Tractor-Trailers (TT), %	-	Volume-to-Capacity Ratio (v/c)	0.66
Passenger Car Equivalent (ET)	2.000		

Speed and Density

Lane Width Adjustment (fLW)	0.0	Average Speed (S), mi/h	58.8
Right-Side Lateral Clearance Adj. (fRLC)	0.0	Density (D), pc/mi/ln	25.8
Total Ramp Density Adjustment	6.2	Level of Service (LOS)	C
Adjusted Free-Flow Speed (FFSadj), mi/h	58.8		

HCS7 Basic Freeway Report

Project Information

Analyst	LSA	Date	12/11/2019
Agency	LSA	Analysis Year	Phase II Proj Comp Yr (2039) NP
Jurisdiction	Caltrans	Time Period Analyzed	PM Peak Hour
Project Description	CMD1801 - Village D Specific Plan	Unit	United States Customary

Geometric Data

Number of Lanes, ln	3	Terrain Type	Level
Segment Length (L), ft	-	Percent Grade, %	-
Measured or Base Free-Flow Speed	Base	Grade Length, mi	-
Base Free-Flow Speed (BFFS), mi/h	65.0	Total Ramp Density (TRD), ramps/mi	1.83
Lane Width, ft	12	Free-Flow Speed (FFS), mi/h	59.7
Right-Side Lateral Clearance, ft	10		

Adjustment Factors

Driver Population	All Familiar	Final Speed Adjustment Factor (SAF)	1.000
Weather Type	Non-Severe Weather	Final Capacity Adjustment Factor (CAF)	1.000
Incident Type	No Incident	Demand Adjustment Factor (DAF)	1.000

Demand and Capacity

Demand Volume veh/h	3446	Heavy Vehicle Adjustment Factor (fhv)	0.851
Peak Hour Factor	0.94	Flow Rate (Vp), pc/h/ln	1436
Total Trucks, %	17.57	Capacity (c), pc/h/ln	2296
Single-Unit Trucks (SUT), %	-	Adjusted Capacity (cadj), pc/h/ln	2296
Tractor-Trailers (TT), %	-	Volume-to-Capacity Ratio (v/c)	0.63
Passenger Car Equivalent (ET)	2.000		

Speed and Density

Lane Width Adjustment (fLW)	0.0	Average Speed (S), mi/h	59.6
Right-Side Lateral Clearance Adj. (fRLC)	0.0	Density (D), pc/mi/ln	24.1
Total Ramp Density Adjustment	5.4	Level of Service (LOS)	C
Adjusted Free-Flow Speed (FFSadj), mi/h	59.6		

HCS7 Freeway Diverge Report

Project Information

Analyst	LSA	Date	12/11/2019
Agency	LSA	Analysis Year	Phase II Proj Comp Yr (2039) NP
Jurisdiction	Caltrans	Time Period Analyzed	PM Peak Hour
Project Description	CMD1801 - Village D Specific Plan	Unit	United States Customary

Geometric Data

	Freeway	Ramp
Number of Lanes (N), In	3	1
Free-Flow Speed (FFS), mi/h	65.0	35.0
Segment Length (L) / Deceleration Length (LA),ft	1500	150
Terrain Type	Level	Level
Percent Grade, %	-	-
Segment Type / Ramp Side	Freeway	Right

Adjustment Factors

Driver Population	All Familiar	All Familiar
Weather Type	Non-Severe Weather	Non-Severe Weather
Incident Type	No Incident	-
Final Speed Adjustment Factor (SAF)	1.000	1.000
Final Capacity Adjustment Factor (CAF)	1.000	1.000
Demand Adjustment Factor (DAF)	1.000	1.000

Demand and Capacity

Demand Volume (Vi)	3446	230
Peak Hour Factor (PHF)	0.94	0.94
Total Trucks, %	17.57	0.99
Single-Unit Trucks (SUT), %	-	-
Tractor-Trailers (TT), %	-	-
Heavy Vehicle Adjustment Factor (fHV)	0.851	0.990
Flow Rate (vi),pc/h	4308	247
Capacity (c), pc/h	7050	2000
Volume-to-Capacity Ratio (v/c)	0.61	0.12

Speed and Density

Upstream Equilibrium Distance (LEQ), ft	-	Number of Outer Lanes on Freeway (NO)	1
Distance to Upstream Ramp (LUP), ft	-	Speed Index (DS)	0.450
Downstream Equilibrium Distance (LEQ), ft	-	Flow Outer Lanes (vOA), pc/h/ln	1458
Distance to Downstream Ramp (LDOWN), ft	-	Off-Ramp Influence Area Speed (SR), mi/h	54.6
Prop. Freeway Vehicles in Lane 1 and 2 (PFD)	0.641	Outer Lanes Freeway Speed (SO), mi/h	69.5
Flow in Lanes 1 and 2 (v12), pc/h	2850	Ramp Junction Speed (S), mi/h	58.9
Flow Entering Ramp-Infl. Area (vR12), pc/h	-	Average Density (D), pc/mi/ln	24.4
Level of Service (LOS)	C	Density in Ramp Influence Area (DR), pc/mi/ln	27.4

HCS7 Basic Freeway Report

Project Information

Analyst	LSA	Date	12/11/2019
Agency	LSA	Analysis Year	Phase II Proj Comp Yr (2039) NP
Jurisdiction	Caltrans	Time Period Analyzed	PM Peak Hour
Project Description	CMD1801 - Village D Specific Plan	Unit	United States Customary

Geometric Data

Number of Lanes, ln	3	Terrain Type	Level
Segment Length (L), ft	-	Percent Grade, %	-
Measured or Base Free-Flow Speed	Base	Grade Length, mi	-
Base Free-Flow Speed (BFFS), mi/h	65.0	Total Ramp Density (TRD), ramps/mi	1.83
Lane Width, ft	12	Free-Flow Speed (FFS), mi/h	59.7
Right-Side Lateral Clearance, ft	10		

Adjustment Factors

Driver Population	All Familiar	Final Speed Adjustment Factor (SAF)	1.000
Weather Type	Non-Severe Weather	Final Capacity Adjustment Factor (CAF)	1.000
Incident Type	No Incident	Demand Adjustment Factor (DAF)	1.000

Demand and Capacity

Demand Volume veh/h	3216	Heavy Vehicle Adjustment Factor (fhv)	0.842
Peak Hour Factor	0.94	Flow Rate (Vp), pc/h/ln	1354
Total Trucks, %	18.77	Capacity (c), pc/h/ln	2296
Single-Unit Trucks (SUT), %	-	Adjusted Capacity (cadj), pc/h/ln	2296
Tractor-Trailers (TT), %	-	Volume-to-Capacity Ratio (v/c)	0.59
Passenger Car Equivalent (ET)	2.000		

Speed and Density

Lane Width Adjustment (fLW)	0.0	Average Speed (S), mi/h	59.6
Right-Side Lateral Clearance Adj. (fRLC)	0.0	Density (D), pc/mi/ln	22.7
Total Ramp Density Adjustment	5.4	Level of Service (LOS)	C
Adjusted Free-Flow Speed (FFSadj), mi/h	59.6		

HCS7 Freeway Merge Report

Project Information

Analyst	LSA	Date	12/11/2019
Agency	LSA	Analysis Year	Phase II Proj Comp Yr (2039) NP
Jurisdiction	Caltrans	Time Period Analyzed	PM Peak Hour
Project Description	CMD1801 - Village D Specific Plan	Unit	United States Customary

Geometric Data

	Freeway	Ramp
Number of Lanes (N), In	3	1
Free-Flow Speed (FFS), mi/h	65.0	35.0
Segment Length (L) / Acceleration Length (LA),ft	1500	445
Terrain Type	Level	Level
Percent Grade, %	-	-
Segment Type / Ramp Side	Freeway	Right

Adjustment Factors

Driver Population	All Familiar	All Familiar
Weather Type	Non-Severe Weather	Non-Severe Weather
Incident Type	No Incident	-
Final Speed Adjustment Factor (SAF)	1.000	1.000
Final Capacity Adjustment Factor (CAF)	1.000	1.000
Demand Adjustment Factor (DAF)	1.000	1.000

Demand and Capacity

Demand Volume (Vi)	3216	849
Peak Hour Factor (PHF)	0.94	0.94
Total Trucks, %	18.77	2.75
Single-Unit Trucks (SUT), %	-	-
Tractor-Trailers (TT), %	-	-
Heavy Vehicle Adjustment Factor (fHV)	0.842	0.973
Flow Rate (vi),pc/h	4063	928
Capacity (c), pc/h	7050	2000
Volume-to-Capacity Ratio (v/c)	0.71	0.46

Speed and Density

Upstream Equilibrium Distance (LEQ), ft	-	Number of Outer Lanes on Freeway (NO)	1
Distance to Upstream Ramp (LUP), ft	-	Speed Index (MS)	0.398
Downstream Equilibrium Distance (LEQ), ft	-	Flow Outer Lanes (vOA), pc/h/ln	1666
Distance to Downstream Ramp (LDOWN), ft	-	On-Ramp Influence Area Speed (SR), mi/h	55.8
Prop. Freeway Vehicles in Lane 1 and 2 (PFM)	0.590	Outer Lanes Freeway Speed (SO), mi/h	60.8
Flow in Lanes 1 and 2 (v12), pc/h	2397	Ramp Junction Speed (S), mi/h	57.4
Flow Entering Ramp-Infl. Area (vR12), pc/h	3325	Average Density (D), pc/mi/ln	29.0
Level of Service (LOS)	D	Density in Ramp Influence Area (DR), pc/mi/ln	28.3

HCS7 Basic Freeway Report

Project Information

Analyst	LSA	Date	12/11/2019
Agency	LSA	Analysis Year	Phase II Proj Comp Yr (2039) NP
Jurisdiction	Caltrans	Time Period Analyzed	PM Peak Hour
Project Description	CMD1801 - Village D Specific Plan	Unit	United States Customary

Geometric Data

Number of Lanes, ln	3	Terrain Type	Level
Segment Length (L), ft	-	Percent Grade, %	-
Measured or Base Free-Flow Speed	Base	Grade Length, mi	-
Base Free-Flow Speed (BFFS), mi/h	65.0	Total Ramp Density (TRD), ramps/mi	1.50
Lane Width, ft	12	Free-Flow Speed (FFS), mi/h	60.5
Right-Side Lateral Clearance, ft	10		

Adjustment Factors

Driver Population	All Familiar	Final Speed Adjustment Factor (SAF)	1.000
Weather Type	Non-Severe Weather	Final Capacity Adjustment Factor (CAF)	1.000
Incident Type	No Incident	Demand Adjustment Factor (DAF)	1.000

Demand and Capacity

Demand Volume veh/h	4065	Heavy Vehicle Adjustment Factor (fhv)	0.866
Peak Hour Factor	0.94	Flow Rate (Vp), pc/h/ln	1665
Total Trucks, %	15.41	Capacity (c), pc/h/ln	2305
Single-Unit Trucks (SUT), %	-	Adjusted Capacity (cadj), pc/h/ln	2305
Tractor-Trailers (TT), %	-	Volume-to-Capacity Ratio (v/c)	0.72
Passenger Car Equivalent (ET)	2.000		

Speed and Density

Lane Width Adjustment (fLW)	0.0	Average Speed (S), mi/h	60.4
Right-Side Lateral Clearance Adj. (fRLC)	0.0	Density (D), pc/mi/ln	27.6
Total Ramp Density Adjustment	4.5	Level of Service (LOS)	D
Adjusted Free-Flow Speed (FFSadj), mi/h	60.5		

HCS7 Freeway Diverge Report

Project Information

Analyst	LSA	Date	12/11/2019
Agency	LSA	Analysis Year	Phase II Proj Comp Yr (2039) NP
Jurisdiction	Caltrans	Time Period Analyzed	PM Peak Hour
Project Description	CMD1801 - Village D Specific Plan	Unit	United States Customary

Geometric Data

	Freeway	Ramp
Number of Lanes (N), In	3	1
Free-Flow Speed (FFS), mi/h	65.0	35.0
Segment Length (L) / Deceleration Length (LA),ft	1500	130
Terrain Type	Level	Level
Percent Grade, %	-	-
Segment Type / Ramp Side	Freeway	Right

Adjustment Factors

Driver Population	All Familiar	All Familiar
Weather Type	Non-Severe Weather	Non-Severe Weather
Incident Type	No Incident	-
Final Speed Adjustment Factor (SAF)	1.000	1.000
Final Capacity Adjustment Factor (CAF)	1.000	1.000
Demand Adjustment Factor (DAF)	1.000	1.000

Demand and Capacity

Demand Volume (Vi)	4065	489
Peak Hour Factor (PHF)	0.94	0.94
Total Trucks, %	15.41	1.24
Single-Unit Trucks (SUT), %	-	-
Tractor-Trailers (TT), %	-	-
Heavy Vehicle Adjustment Factor (fHV)	0.866	0.988
Flow Rate (vi),pc/h	4994	527
Capacity (c), pc/h	7050	2000
Volume-to-Capacity Ratio (v/c)	0.71	0.26

Speed and Density

Upstream Equilibrium Distance (LEQ), ft	-	Number of Outer Lanes on Freeway (NO)	1
Distance to Upstream Ramp (LUP), ft	-	Speed Index (DS)	0.475
Downstream Equilibrium Distance (LEQ), ft	-	Flow Outer Lanes (vOA), pc/h/ln	1738
Distance to Downstream Ramp (LDOWN), ft	-	Off-Ramp Influence Area Speed (SR), mi/h	54.1
Prop. Freeway Vehicles in Lane 1 and 2 (PFD)	0.611	Outer Lanes Freeway Speed (SO), mi/h	68.4
Flow in Lanes 1 and 2 (v12), pc/h	3256	Ramp Junction Speed (S), mi/h	58.3
Flow Entering Ramp-Infl. Area (vR12), pc/h	-	Average Density (D), pc/mi/ln	28.6
Level of Service (LOS)	D	Density in Ramp Influence Area (DR), pc/mi/ln	31.1

HCS7 Basic Freeway Report

Project Information

Analyst	LSA	Date	12/11/2019
Agency	LSA	Analysis Year	Phase II Proj Comp Yr (2039) NP
Jurisdiction	Caltrans	Time Period Analyzed	PM Peak Hour
Project Description	CMD1801 - Village D Specific Plan	Unit	United States Customary

Geometric Data

Number of Lanes, ln	3	Terrain Type	Level
Segment Length (L), ft	-	Percent Grade, %	-
Measured or Base Free-Flow Speed	Base	Grade Length, mi	-
Base Free-Flow Speed (BFFS), mi/h	65.0	Total Ramp Density (TRD), ramps/mi	1.67
Lane Width, ft	12	Free-Flow Speed (FFS), mi/h	60.0
Right-Side Lateral Clearance, ft	10		

Adjustment Factors

Driver Population	All Familiar	Final Speed Adjustment Factor (SAF)	1.000
Weather Type	Non-Severe Weather	Final Capacity Adjustment Factor (CAF)	1.000
Incident Type	No Incident	Demand Adjustment Factor (DAF)	1.000

Demand and Capacity

Demand Volume veh/h	3575	Heavy Vehicle Adjustment Factor (fhv)	0.852
Peak Hour Factor	0.94	Flow Rate (Vp), pc/h/ln	1488
Total Trucks, %	17.35	Capacity (c), pc/h/ln	2300
Single-Unit Trucks (SUT), %	-	Adjusted Capacity (cadj), pc/h/ln	2300
Tractor-Trailers (TT), %	-	Volume-to-Capacity Ratio (v/c)	0.65
Passenger Car Equivalent (ET)	2.000		

Speed and Density

Lane Width Adjustment (fLW)	0.0	Average Speed (S), mi/h	60.0
Right-Side Lateral Clearance Adj. (fRLC)	0.0	Density (D), pc/mi/ln	24.8
Total Ramp Density Adjustment	5.0	Level of Service (LOS)	C
Adjusted Free-Flow Speed (FFSadj), mi/h	60.0		

HCS7 Freeway Merge Report

Project Information

Analyst	LSA	Date	12/11/2019
Agency	LSA	Analysis Year	Phase II Proj Comp Yr (2039) NP
Jurisdiction	Caltrans	Time Period Analyzed	PM Peak Hour
Project Description	CMD1801 - Village D Specific Plan	Unit	United States Customary

Geometric Data

	Freeway	Ramp
Number of Lanes (N), ln	3	1
Free-Flow Speed (FFS), mi/h	65.0	35.0
Segment Length (L) / Acceleration Length (LA),ft	1500	500
Terrain Type	Level	Level
Percent Grade, %	-	-
Segment Type / Ramp Side	Freeway	Right

Adjustment Factors

Driver Population	All Familiar	All Familiar
Weather Type	Non-Severe Weather	Non-Severe Weather
Incident Type	No Incident	-
Final Speed Adjustment Factor (SAF)	1.000	1.000
Final Capacity Adjustment Factor (CAF)	1.000	1.000
Demand Adjustment Factor (DAF)	1.000	1.000

Demand and Capacity

Demand Volume (Vi)	3575	411
Peak Hour Factor (PHF)	0.94	0.94
Total Trucks, %	17.35	2.23
Single-Unit Trucks (SUT), %	-	-
Tractor-Trailers (TT), %	-	-
Heavy Vehicle Adjustment Factor (fHV)	0.852	0.978
Flow Rate (vi),pc/h	4464	447
Capacity (c), pc/h	7050	2000
Volume-to-Capacity Ratio (v/c)	0.70	0.22

Speed and Density

Upstream Equilibrium Distance (LEQ), ft	-	Number of Outer Lanes on Freeway (NO)	1
Distance to Upstream Ramp (LUP), ft	-	Speed Index (MS)	0.372
Downstream Equilibrium Distance (LEQ), ft	-	Flow Outer Lanes (vOA), pc/h/ln	1821
Distance to Downstream Ramp (LDOWN), ft	-	On-Ramp Influence Area Speed (SR), mi/h	56.4
Prop. Freeway Vehicles in Lane 1 and 2 (PFM)	0.592	Outer Lanes Freeway Speed (SO), mi/h	60.2
Flow in Lanes 1 and 2 (v12), pc/h	2643	Ramp Junction Speed (S), mi/h	57.8
Flow Entering Ramp-Infl. Area (vR12), pc/h	3090	Average Density (D), pc/mi/ln	28.3
Level of Service (LOS)	C	Density in Ramp Influence Area (DR), pc/mi/ln	26.3

HCS7 Basic Freeway Report

Project Information

Analyst	LSA	Date	12/11/2019
Agency	LSA	Analysis Year	Phase II Proj Comp Yr (2039) NP
Jurisdiction	Caltrans	Time Period Analyzed	PM Peak Hour
Project Description	CMD1801 - Village D Specific Plan	Unit	United States Customary

Geometric Data

Number of Lanes, ln	3	Terrain Type	Level
Segment Length (L), ft	-	Percent Grade, %	-
Measured or Base Free-Flow Speed	Base	Grade Length, mi	-
Base Free-Flow Speed (BFFS), mi/h	65.0	Total Ramp Density (TRD), ramps/mi	1.83
Lane Width, ft	12	Free-Flow Speed (FFS), mi/h	59.7
Right-Side Lateral Clearance, ft	10		

Adjustment Factors

Driver Population	All Familiar	Final Speed Adjustment Factor (SAF)	1.000
Weather Type	Non-Severe Weather	Final Capacity Adjustment Factor (CAF)	1.000
Incident Type	No Incident	Demand Adjustment Factor (DAF)	1.000

Demand and Capacity

Demand Volume veh/h	3986	Heavy Vehicle Adjustment Factor (fhv)	0.864
Peak Hour Factor	0.94	Flow Rate (Vp), pc/h/ln	1636
Total Trucks, %	15.79	Capacity (c), pc/h/ln	2296
Single-Unit Trucks (SUT), %	-	Adjusted Capacity (cadj), pc/h/ln	2296
Tractor-Trailers (TT), %	-	Volume-to-Capacity Ratio (v/c)	0.71
Passenger Car Equivalent (ET)	2.000		

Speed and Density

Lane Width Adjustment (fLW)	0.0	Average Speed (S), mi/h	59.6
Right-Side Lateral Clearance Adj. (fRLC)	0.0	Density (D), pc/mi/ln	27.4
Total Ramp Density Adjustment	5.4	Level of Service (LOS)	D
Adjusted Free-Flow Speed (FFSadj), mi/h	59.6		

HCS7 Freeway Diverge Report

Project Information

Analyst	LSA	Date	12/11/2019
Agency	LSA	Analysis Year	Phase II Proj Comp Yr (2039) NP
Jurisdiction	Caltrans	Time Period Analyzed	PM Peak Hour
Project Description	CMD1801 - Village D Specific Plan	Unit	United States Customary

Geometric Data

	Freeway	Ramp
Number of Lanes (N), ln	3	1
Free-Flow Speed (FFS), mi/h	65.0	35.0
Segment Length (L) / Deceleration Length (LA),ft	1500	245
Terrain Type	Level	Level
Percent Grade, %	-	-
Segment Type / Ramp Side	Freeway	Right

Adjustment Factors

Driver Population	All Familiar	All Familiar
Weather Type	Non-Severe Weather	Non-Severe Weather
Incident Type	No Incident	-
Final Speed Adjustment Factor (SAF)	1.000	1.000
Final Capacity Adjustment Factor (CAF)	1.000	1.000
Demand Adjustment Factor (DAF)	1.000	1.000

Demand and Capacity

Demand Volume (Vi)	3986	910
Peak Hour Factor (PHF)	0.94	0.94
Total Trucks, %	15.79	1.02
Single-Unit Trucks (SUT), %	-	-
Tractor-Trailers (TT), %	-	-
Heavy Vehicle Adjustment Factor (fHV)	0.864	0.990
Flow Rate (vi),pc/h	4908	978
Capacity (c), pc/h	7050	2000
Volume-to-Capacity Ratio (v/c)	0.70	0.49

Speed and Density

Upstream Equilibrium Distance (LEQ), ft	-	Number of Outer Lanes on Freeway (NO)	1
Distance to Upstream Ramp (LUP), ft	-	Speed Index (DS)	0.516
Downstream Equilibrium Distance (LEQ), ft	-	Flow Outer Lanes (vOA), pc/h/ln	1603
Distance to Downstream Ramp (LDOWN), ft	-	Off-Ramp Influence Area Speed (SR), mi/h	53.1
Prop. Freeway Vehicles in Lane 1 and 2 (PFD)	0.592	Outer Lanes Freeway Speed (SO), mi/h	69.0
Flow in Lanes 1 and 2 (v12), pc/h	3305	Ramp Junction Speed (S), mi/h	57.4
Flow Entering Ramp-Infl. Area (vR12), pc/h	-	Average Density (D), pc/mi/ln	28.5
Level of Service (LOS)	D	Density in Ramp Influence Area (DR), pc/mi/ln	30.5

HCS7 Basic Freeway Report

Project Information

Analyst	LSA	Date	12/11/2019
Agency	LSA	Analysis Year	Phase II Proj Comp Yr (2039) NP
Jurisdiction	Caltrans	Time Period Analyzed	PM Peak Hour
Project Description	CMD1801 - Village D Specific Plan	Unit	United States Customary

Geometric Data

Number of Lanes, ln	3	Terrain Type	Level
Segment Length (L), ft	-	Percent Grade, %	-
Measured or Base Free-Flow Speed	Base	Grade Length, mi	-
Base Free-Flow Speed (BFFS), mi/h	65.0	Total Ramp Density (TRD), ramps/mi	1.83
Lane Width, ft	12	Free-Flow Speed (FFS), mi/h	59.7
Right-Side Lateral Clearance, ft	10		

Adjustment Factors

Driver Population	All Familiar	Final Speed Adjustment Factor (SAF)	1.000
Weather Type	Non-Severe Weather	Final Capacity Adjustment Factor (CAF)	1.000
Incident Type	No Incident	Demand Adjustment Factor (DAF)	1.000

Demand and Capacity

Demand Volume veh/h	3076	Heavy Vehicle Adjustment Factor (fhv)	0.832
Peak Hour Factor	0.94	Flow Rate (Vp), pc/h/ln	1311
Total Trucks, %	20.16	Capacity (c), pc/h/ln	2296
Single-Unit Trucks (SUT), %	-	Adjusted Capacity (cadj), pc/h/ln	2296
Tractor-Trailers (TT), %	-	Volume-to-Capacity Ratio (v/c)	0.57
Passenger Car Equivalent (ET)	2.000		

Speed and Density

Lane Width Adjustment (fLW)	0.0	Average Speed (S), mi/h	59.6
Right-Side Lateral Clearance Adj. (fRLC)	0.0	Density (D), pc/mi/ln	22.0
Total Ramp Density Adjustment	5.4	Level of Service (LOS)	C
Adjusted Free-Flow Speed (FFSadj), mi/h	59.6		

HCS7 Freeway Merge Report

Project Information

Analyst	LSA	Date	12/11/2019
Agency	LSA	Analysis Year	Phase II Proj Comp Yr (2039) NP
Jurisdiction	Caltrans	Time Period Analyzed	PM Peak Hour
Project Description	CMD1801 - Village D Specific Plan	Unit	United States Customary

Geometric Data

	Freeway	Ramp
Number of Lanes (N), ln	3	1
Free-Flow Speed (FFS), mi/h	65.0	35.0
Segment Length (L) / Acceleration Length (LA),ft	1500	350
Terrain Type	Level	Level
Percent Grade, %	-	-
Segment Type / Ramp Side	Freeway	Right

Adjustment Factors

Driver Population	All Familiar	All Familiar
Weather Type	Non-Severe Weather	Non-Severe Weather
Incident Type	No Incident	-
Final Speed Adjustment Factor (SAF)	1.000	1.000
Final Capacity Adjustment Factor (CAF)	1.000	1.000
Demand Adjustment Factor (DAF)	1.000	1.000

Demand and Capacity

Demand Volume (Vi)	3076	149
Peak Hour Factor (PHF)	0.94	0.94
Total Trucks, %	20.16	5.67
Single-Unit Trucks (SUT), %	-	-
Tractor-Trailers (TT), %	-	-
Heavy Vehicle Adjustment Factor (fHV)	0.832	0.946
Flow Rate (vi),pc/h	3933	168
Capacity (c), pc/h	7050	2000
Volume-to-Capacity Ratio (v/c)	0.58	0.08

Speed and Density

Upstream Equilibrium Distance (LEQ), ft	-	Number of Outer Lanes on Freeway (NO)	1
Distance to Upstream Ramp (LUP), ft	-	Speed Index (MS)	0.343
Downstream Equilibrium Distance (LEQ), ft	-	Flow Outer Lanes (vOA), pc/h/ln	1624
Distance to Downstream Ramp (LDOWN), ft	-	On-Ramp Influence Area Speed (SR), mi/h	57.1
Prop. Freeway Vehicles in Lane 1 and 2 (PFM)	0.587	Outer Lanes Freeway Speed (SO), mi/h	61.0
Flow in Lanes 1 and 2 (v12), pc/h	2309	Ramp Junction Speed (S), mi/h	58.6
Flow Entering Ramp-Infl. Area (vR12), pc/h	2477	Average Density (D), pc/mi/ln	23.3
Level of Service (LOS)	C	Density in Ramp Influence Area (DR), pc/mi/ln	22.6

HCS7 Basic Freeway Report

Project Information

Analyst	LSA	Date	12/11/2019
Agency	LSA	Analysis Year	Phase II Proj Comp Yr (2039) NP
Jurisdiction	Caltrans	Time Period Analyzed	PM Peak Hour
Project Description	CMD1801 - Village D Specific Plan	Unit	United States Customary

Geometric Data

Number of Lanes, ln	3	Terrain Type	Level
Segment Length (L), ft	-	Percent Grade, %	-
Measured or Base Free-Flow Speed	Base	Grade Length, mi	-
Base Free-Flow Speed (BFFS), mi/h	65.0	Total Ramp Density (TRD), ramps/mi	1.83
Lane Width, ft	12	Free-Flow Speed (FFS), mi/h	59.7
Right-Side Lateral Clearance, ft	10		

Adjustment Factors

Driver Population	All Familiar	Final Speed Adjustment Factor (SAF)	1.000
Weather Type	Non-Severe Weather	Final Capacity Adjustment Factor (CAF)	1.000
Incident Type	No Incident	Demand Adjustment Factor (DAF)	1.000

Demand and Capacity

Demand Volume veh/h	3225	Heavy Vehicle Adjustment Factor (fhv)	0.837
Peak Hour Factor	0.94	Flow Rate (Vp), pc/h/ln	1366
Total Trucks, %	19.50	Capacity (c), pc/h/ln	2296
Single-Unit Trucks (SUT), %	-	Adjusted Capacity (cadj), pc/h/ln	2296
Tractor-Trailers (TT), %	-	Volume-to-Capacity Ratio (v/c)	0.60
Passenger Car Equivalent (ET)	2.000		

Speed and Density

Lane Width Adjustment (fLW)	0.0	Average Speed (S), mi/h	59.6
Right-Side Lateral Clearance Adj. (fRLC)	0.0	Density (D), pc/mi/ln	22.9
Total Ramp Density Adjustment	5.4	Level of Service (LOS)	C
Adjusted Free-Flow Speed (FFSadj), mi/h	59.6		

HCS7 Freeway Diverge Report

Project Information

Analyst	LSA	Date	12/11/2019
Agency	LSA	Analysis Year	Phase II Proj Comp Yr (2039) NP
Jurisdiction	Caltrans	Time Period Analyzed	PM Peak Hour
Project Description	CMD1801 - Village D Specific Plan	Unit	United States Customary

Geometric Data

	Freeway	Ramp
Number of Lanes (N), In	3	1
Free-Flow Speed (FFS), mi/h	65.0	15.0
Segment Length (L) / Deceleration Length (LA),ft	1500	150
Terrain Type	Level	Level
Percent Grade, %	-	-
Segment Type / Ramp Side	Freeway	Right

Adjustment Factors

Driver Population	All Familiar	All Familiar
Weather Type	Non-Severe Weather	Non-Severe Weather
Incident Type	No Incident	-
Final Speed Adjustment Factor (SAF)	1.000	1.000
Final Capacity Adjustment Factor (CAF)	1.000	1.000
Demand Adjustment Factor (DAF)	1.000	1.000

Demand and Capacity

Demand Volume (Vi)	3225	171
Peak Hour Factor (PHF)	0.94	0.94
Total Trucks, %	19.50	3.62
Single-Unit Trucks (SUT), %	-	-
Tractor-Trailers (TT), %	-	-
Heavy Vehicle Adjustment Factor (fHV)	0.837	0.965
Flow Rate (vi),pc/h	4099	189
Capacity (c), pc/h	7050	1800
Volume-to-Capacity Ratio (v/c)	0.58	0.11

Speed and Density

Upstream Equilibrium Distance (LEQ), ft	-	Number of Outer Lanes on Freeway (NO)	1
Distance to Upstream Ramp (LUP), ft	-	Speed Index (DS)	0.705
Downstream Equilibrium Distance (LEQ), ft	-	Flow Outer Lanes (vOA), pc/h/ln	1372
Distance to Downstream Ramp (LDOWN), ft	-	Off-Ramp Influence Area Speed (SR), mi/h	48.8
Prop. Freeway Vehicles in Lane 1 and 2 (PFD)	0.649	Outer Lanes Freeway Speed (SO), mi/h	69.9
Flow in Lanes 1 and 2 (v12), pc/h	2727	Ramp Junction Speed (S), mi/h	54.3
Flow Entering Ramp-Infl. Area (vR12), pc/h	-	Average Density (D), pc/mi/ln	25.2
Level of Service (LOS)	C	Density in Ramp Influence Area (DR), pc/mi/ln	26.4

HCS7 Basic Freeway Report

Project Information

Analyst	LSA	Date	12/11/2019
Agency	LSA	Analysis Year	Phase II Proj Comp Yr (2039) NP
Jurisdiction	Caltrans	Time Period Analyzed	PM Peak Hour
Project Description	CMD1801 - Village D Specific Plan	Unit	United States Customary

Geometric Data

Number of Lanes, ln	3	Terrain Type	Level
Segment Length (L), ft	-	Percent Grade, %	-
Measured or Base Free-Flow Speed	Base	Grade Length, mi	-
Base Free-Flow Speed (BFFS), mi/h	65.0	Total Ramp Density (TRD), ramps/mi	1.67
Lane Width, ft	12	Free-Flow Speed (FFS), mi/h	60.0
Right-Side Lateral Clearance, ft	10		

Adjustment Factors

Driver Population	All Familiar	Final Speed Adjustment Factor (SAF)	1.000
Weather Type	Non-Severe Weather	Final Capacity Adjustment Factor (CAF)	1.000
Incident Type	No Incident	Demand Adjustment Factor (DAF)	1.000

Demand and Capacity

Demand Volume veh/h	3053	Heavy Vehicle Adjustment Factor (fhv)	0.831
Peak Hour Factor	0.94	Flow Rate (Vp), pc/h/ln	1303
Total Trucks, %	20.39	Capacity (c), pc/h/ln	2300
Single-Unit Trucks (SUT), %	-	Adjusted Capacity (cadj), pc/h/ln	2300
Tractor-Trailers (TT), %	-	Volume-to-Capacity Ratio (v/c)	0.57
Passenger Car Equivalent (ET)	2.000		

Speed and Density

Lane Width Adjustment (fLW)	0.0	Average Speed (S), mi/h	60.0
Right-Side Lateral Clearance Adj. (fRLC)	0.0	Density (D), pc/mi/ln	21.7
Total Ramp Density Adjustment	5.0	Level of Service (LOS)	C
Adjusted Free-Flow Speed (FFSadj), mi/h	60.0		

HCS7 Freeway Merge Report

Project Information

Analyst	LSA	Date	12/11/2019
Agency	LSA	Analysis Year	Phase II Proj Comp Yr (2039) NP
Jurisdiction	Caltrans	Time Period Analyzed	PM Peak Hour
Project Description	CMD1801 - Village D Specific Plan	Unit	United States Customary

Geometric Data

	Freeway	Ramp
Number of Lanes (N), ln	3	1
Free-Flow Speed (FFS), mi/h	65.0	35.0
Segment Length (L) / Acceleration Length (LA),ft	1500	525
Terrain Type	Level	Level
Percent Grade, %	-	-
Segment Type / Ramp Side	Freeway	Right

Adjustment Factors

Driver Population	All Familiar	All Familiar
Weather Type	Non-Severe Weather	Non-Severe Weather
Incident Type	No Incident	-
Final Speed Adjustment Factor (SAF)	1.000	1.000
Final Capacity Adjustment Factor (CAF)	1.000	1.000
Demand Adjustment Factor (DAF)	1.000	1.000

Demand and Capacity

Demand Volume (Vi)	3053	239
Peak Hour Factor (PHF)	0.94	0.94
Total Trucks, %	20.39	4.33
Single-Unit Trucks (SUT), %	-	-
Tractor-Trailers (TT), %	-	-
Heavy Vehicle Adjustment Factor (fHV)	0.831	0.958
Flow Rate (vi),pc/h	3908	265
Capacity (c), pc/h	7050	2000
Volume-to-Capacity Ratio (v/c)	0.59	0.13

Speed and Density

Upstream Equilibrium Distance (LEQ), ft	-	Number of Outer Lanes on Freeway (NO)	1
Distance to Upstream Ramp (LUP), ft	-	Speed Index (MS)	0.336
Downstream Equilibrium Distance (LEQ), ft	-	Flow Outer Lanes (vOA), pc/h/ln	1594
Distance to Downstream Ramp (LDOWN), ft	-	On-Ramp Influence Area Speed (SR), mi/h	57.3
Prop. Freeway Vehicles in Lane 1 and 2 (PFM)	0.592	Outer Lanes Freeway Speed (SO), mi/h	61.1
Flow in Lanes 1 and 2 (v12), pc/h	2314	Ramp Junction Speed (S), mi/h	58.7
Flow Entering Ramp-Infl. Area (vR12), pc/h	2579	Average Density (D), pc/mi/ln	23.7
Level of Service (LOS)	C	Density in Ramp Influence Area (DR), pc/mi/ln	22.3

HCS7 Basic Freeway Report

Project Information

Analyst	LSA	Date	12/11/2019
Agency	LSA	Analysis Year	Phase II Proj Comp Yr (2039) NP
Jurisdiction	Caltrans	Time Period Analyzed	PM Peak Hour
Project Description	CMD1801 - Village D Specific Plan	Unit	United States Customary

Geometric Data

Number of Lanes, ln	3	Terrain Type	Level
Segment Length (L), ft	-	Percent Grade, %	-
Measured or Base Free-Flow Speed	Base	Grade Length, mi	-
Base Free-Flow Speed (BFFS), mi/h	65.0	Total Ramp Density (TRD), ramps/mi	1.67
Lane Width, ft	12	Free-Flow Speed (FFS), mi/h	60.0
Right-Side Lateral Clearance, ft	10		

Adjustment Factors

Driver Population	All Familiar	Final Speed Adjustment Factor (SAF)	1.000
Weather Type	Non-Severe Weather	Final Capacity Adjustment Factor (CAF)	1.000
Incident Type	No Incident	Demand Adjustment Factor (DAF)	1.000

Demand and Capacity

Demand Volume veh/h	3292	Heavy Vehicle Adjustment Factor (fhv)	0.839
Peak Hour Factor	0.94	Flow Rate (Vp), pc/h/ln	1391
Total Trucks, %	19.23	Capacity (c), pc/h/ln	2300
Single-Unit Trucks (SUT), %	-	Adjusted Capacity (cadj), pc/h/ln	2300
Tractor-Trailers (TT), %	-	Volume-to-Capacity Ratio (v/c)	0.60
Passenger Car Equivalent (ET)	2.000		

Speed and Density

Lane Width Adjustment (fLW)	0.0	Average Speed (S), mi/h	60.0
Right-Side Lateral Clearance Adj. (fRLC)	0.0	Density (D), pc/mi/ln	23.2
Total Ramp Density Adjustment	5.0	Level of Service (LOS)	C
Adjusted Free-Flow Speed (FFSadj), mi/h	60.0		

HCS7 Freeway Diverge Report

Project Information

Analyst	LSA	Date	12/11/2019
Agency	LSA	Analysis Year	Phase II Proj Comp Yr (2039) NP
Jurisdiction	Caltrans	Time Period Analyzed	PM Peak Hour
Project Description	CMD1801 - Village D Specific Plan	Unit	United States Customary

Geometric Data

	Freeway	Ramp
Number of Lanes (N), ln	3	1
Free-Flow Speed (FFS), mi/h	65.0	35.0
Segment Length (L) / Deceleration Length (LA),ft	1500	200
Terrain Type	Level	Level
Percent Grade, %	-	-
Segment Type / Ramp Side	Freeway	Right

Adjustment Factors

Driver Population	All Familiar	All Familiar
Weather Type	Non-Severe Weather	Non-Severe Weather
Incident Type	No Incident	-
Final Speed Adjustment Factor (SAF)	1.000	1.000
Final Capacity Adjustment Factor (CAF)	1.000	1.000
Demand Adjustment Factor (DAF)	1.000	1.000

Demand and Capacity

Demand Volume (Vi)	3292	695
Peak Hour Factor (PHF)	0.94	0.94
Total Trucks, %	19.23	10.45
Single-Unit Trucks (SUT), %	-	-
Tractor-Trailers (TT), %	-	-
Heavy Vehicle Adjustment Factor (fHV)	0.839	0.905
Flow Rate (vi),pc/h	4174	817
Capacity (c), pc/h	7050	2000
Volume-to-Capacity Ratio (v/c)	0.59	0.41

Speed and Density

Upstream Equilibrium Distance (LEQ), ft	-	Number of Outer Lanes on Freeway (NO)	1
Distance to Upstream Ramp (LUP), ft	-	Speed Index (DS)	0.502
Downstream Equilibrium Distance (LEQ), ft	-	Flow Outer Lanes (vOA), pc/h/ln	1282
Distance to Downstream Ramp (LDOWN), ft	-	Off-Ramp Influence Area Speed (SR), mi/h	53.5
Prop. Freeway Vehicles in Lane 1 and 2 (PFD)	0.618	Outer Lanes Freeway Speed (SO), mi/h	70.2
Flow in Lanes 1 and 2 (v12), pc/h	2892	Ramp Junction Speed (S), mi/h	57.7
Flow Entering Ramp-Infl. Area (vR12), pc/h	-	Average Density (D), pc/mi/ln	24.1
Level of Service (LOS)	C	Density in Ramp Influence Area (DR), pc/mi/ln	27.3

HCS7 Basic Freeway Report

Project Information

Analyst	LSA	Date	12/11/2019
Agency	LSA	Analysis Year	Phase II Proj Comp Yr (2039) NP
Jurisdiction	Caltrans	Time Period Analyzed	PM Peak Hour
Project Description	CMD1801 - Village D Specific Plan	Unit	United States Customary

Geometric Data

Number of Lanes, ln	3	Terrain Type	Level
Segment Length (L), ft	-	Percent Grade, %	-
Measured or Base Free-Flow Speed	Base	Grade Length, mi	-
Base Free-Flow Speed (BFFS), mi/h	70.0	Total Ramp Density (TRD), ramps/mi	1.50
Lane Width, ft	12	Free-Flow Speed (FFS), mi/h	65.5
Right-Side Lateral Clearance, ft	10		

Adjustment Factors

Driver Population	All Familiar	Final Speed Adjustment Factor (SAF)	1.000
Weather Type	Non-Severe Weather	Final Capacity Adjustment Factor (CAF)	1.000
Incident Type	No Incident	Demand Adjustment Factor (DAF)	1.000

Demand and Capacity

Demand Volume veh/h	2597	Heavy Vehicle Adjustment Factor (fhv)	0.823
Peak Hour Factor	0.94	Flow Rate (Vp), pc/h/ln	1119
Total Trucks, %	21.57	Capacity (c), pc/h/ln	2355
Single-Unit Trucks (SUT), %	-	Adjusted Capacity (cadj), pc/h/ln	2355
Tractor-Trailers (TT), %	-	Volume-to-Capacity Ratio (v/c)	0.48
Passenger Car Equivalent (ET)	2.000		

Speed and Density

Lane Width Adjustment (fLW)	0.0	Average Speed (S), mi/h	65.5
Right-Side Lateral Clearance Adj. (fRLC)	0.0	Density (D), pc/mi/ln	17.1
Total Ramp Density Adjustment	4.5	Level of Service (LOS)	B
Adjusted Free-Flow Speed (FFSadj), mi/h	65.5		

HCS7 Freeway Merge Report

Project Information

Analyst	LSA	Date	12/11/2019
Agency	LSA	Analysis Year	Phase II Proj Comp Yr (2039) NP
Jurisdiction	Caltrans	Time Period Analyzed	PM Peak Hour
Project Description	CMD1801 - Village D Specific Plan	Unit	United States Customary

Geometric Data

	Freeway	Ramp
Number of Lanes (N), ln	3	1
Free-Flow Speed (FFS), mi/h	70.0	35.0
Segment Length (L) / Acceleration Length (LA),ft	1500	400
Terrain Type	Level	Level
Percent Grade, %	-	-
Segment Type / Ramp Side	Freeway	Right

Adjustment Factors

Driver Population	All Familiar	All Familiar
Weather Type	Non-Severe Weather	Non-Severe Weather
Incident Type	No Incident	-
Final Speed Adjustment Factor (SAF)	1.000	1.000
Final Capacity Adjustment Factor (CAF)	1.000	1.000
Demand Adjustment Factor (DAF)	1.000	1.000

Demand and Capacity

Demand Volume (Vi)	2597	474
Peak Hour Factor (PHF)	0.94	0.94
Total Trucks, %	21.57	6.87
Single-Unit Trucks (SUT), %	-	-
Tractor-Trailers (TT), %	-	-
Heavy Vehicle Adjustment Factor (fHV)	0.823	0.936
Flow Rate (vi),pc/h	3357	539
Capacity (c), pc/h	7200	2000
Volume-to-Capacity Ratio (v/c)	0.54	0.27

Speed and Density

Upstream Equilibrium Distance (LEQ), ft	-	Number of Outer Lanes on Freeway (NO)	1
Distance to Upstream Ramp (LUP), ft	-	Speed Index (MS)	0.341
Downstream Equilibrium Distance (LEQ), ft	-	Flow Outer Lanes (vOA), pc/h/ln	1380
Distance to Downstream Ramp (LDOWN), ft	-	On-Ramp Influence Area Speed (SR), mi/h	60.5
Prop. Freeway Vehicles in Lane 1 and 2 (PFM)	0.589	Outer Lanes Freeway Speed (SO), mi/h	66.8
Flow in Lanes 1 and 2 (v12), pc/h	1977	Ramp Junction Speed (S), mi/h	62.6
Flow Entering Ramp-Infl. Area (vR12), pc/h	2516	Average Density (D), pc/mi/ln	20.7
Level of Service (LOS)	C	Density in Ramp Influence Area (DR), pc/mi/ln	22.4

HCS7 Basic Freeway Report

Project Information

Analyst	LSA	Date	12/11/2019
Agency	LSA	Analysis Year	Phase II Proj Comp Yr (2039) NP
Jurisdiction	Caltrans	Time Period Analyzed	PM Peak Hour
Project Description	CMD1801 - Village D Specific Plan	Unit	United States Customary

Geometric Data

Number of Lanes, ln	2	Terrain Type	Level
Segment Length (L), ft	-	Percent Grade, %	-
Measured or Base Free-Flow Speed	Base	Grade Length, mi	-
Base Free-Flow Speed (BFFS), mi/h	70.0	Total Ramp Density (TRD), ramps/mi	1.00
Lane Width, ft	12	Free-Flow Speed (FFS), mi/h	66.8
Right-Side Lateral Clearance, ft	10		

Adjustment Factors

Driver Population	All Familiar	Final Speed Adjustment Factor (SAF)	1.000
Weather Type	Non-Severe Weather	Final Capacity Adjustment Factor (CAF)	1.000
Incident Type	No Incident	Demand Adjustment Factor (DAF)	1.000

Demand and Capacity

Demand Volume veh/h	3072	Heavy Vehicle Adjustment Factor (fhv)	0.838
Peak Hour Factor	0.94	Flow Rate (Vp), pc/h/ln	1950
Total Trucks, %	19.31	Capacity (c), pc/h/ln	2368
Single-Unit Trucks (SUT), %	-	Adjusted Capacity (cadj), pc/h/ln	2368
Tractor-Trailers (TT), %	-	Volume-to-Capacity Ratio (v/c)	0.82
Passenger Car Equivalent (ET)	2.000		

Speed and Density

Lane Width Adjustment (fLW)	0.0	Average Speed (S), mi/h	61.7
Right-Side Lateral Clearance Adj. (fRLC)	0.0	Density (D), pc/mi/ln	31.6
Total Ramp Density Adjustment	3.2	Level of Service (LOS)	D
Adjusted Free-Flow Speed (FFSadj), mi/h	66.8		

HCS7 Freeway Diverge Report

Project Information

Analyst	LSA	Date	12/11/2019
Agency	LSA	Analysis Year	Phase II Proj Comp Yr (2039) NP
Jurisdiction	Caltrans	Time Period Analyzed	PM Peak Hour
Project Description	CMD1801 - Village D Specific Plan	Unit	United States Customary

Geometric Data

	Freeway	Ramp
Number of Lanes (N), ln	2	1
Free-Flow Speed (FFS), mi/h	70.0	35.0
Segment Length (L) / Deceleration Length (LA),ft	1500	200
Terrain Type	Level	Level
Percent Grade, %	-	-
Segment Type / Ramp Side	Freeway	Right

Adjustment Factors

Driver Population	All Familiar	All Familiar
Weather Type	Non-Severe Weather	Non-Severe Weather
Incident Type	No Incident	-
Final Speed Adjustment Factor (SAF)	1.000	1.000
Final Capacity Adjustment Factor (CAF)	1.000	1.000
Demand Adjustment Factor (DAF)	1.000	1.000

Demand and Capacity

Demand Volume (Vi)	3072	193
Peak Hour Factor (PHF)	0.94	0.94
Total Trucks, %	19.31	24.06
Single-Unit Trucks (SUT), %	-	-
Tractor-Trailers (TT), %	-	-
Heavy Vehicle Adjustment Factor (fHV)	0.838	0.806
Flow Rate (vi),pc/h	3900	255
Capacity (c), pc/h	4800	2000
Volume-to-Capacity Ratio (v/c)	0.81	0.13

Speed and Density

Upstream Equilibrium Distance (LEQ), ft	-	Number of Outer Lanes on Freeway (NO)	0
Distance to Upstream Ramp (LUP), ft	-	Speed Index (DS)	0.451
Downstream Equilibrium Distance (LEQ), ft	-	Flow Outer Lanes (vOA), pc/h/ln	-
Distance to Downstream Ramp (LDOWN), ft	-	Off-Ramp Influence Area Speed (SR), mi/h	57.4
Prop. Freeway Vehicles in Lane 1 and 2 (PFD)	1.000	Outer Lanes Freeway Speed (SO), mi/h	76.8
Flow in Lanes 1 and 2 (v12), pc/h	3900	Ramp Junction Speed (S), mi/h	57.4
Flow Entering Ramp-Infl. Area (vR12), pc/h	-	Average Density (D), pc/mi/ln	34.0
Level of Service (LOS)	E	Density in Ramp Influence Area (DR), pc/mi/ln	36.0

HCS7 Basic Freeway Report

Project Information

Analyst	LSA	Date	12/11/2019
Agency	LSA	Analysis Year	Phase II Proj Comp Yr (2039) NP
Jurisdiction	Caltrans	Time Period Analyzed	PM Peak Hour
Project Description	CMD1801 - Village D Specific Plan	Unit	United States Customary

Geometric Data

Number of Lanes, ln	2	Terrain Type	Level
Segment Length (L), ft	-	Percent Grade, %	-
Measured or Base Free-Flow Speed	Base	Grade Length, mi	-
Base Free-Flow Speed (BFFS), mi/h	70.0	Total Ramp Density (TRD), ramps/mi	1.00
Lane Width, ft	12	Free-Flow Speed (FFS), mi/h	66.8
Right-Side Lateral Clearance, ft	10		

Adjustment Factors

Driver Population	All Familiar	Final Speed Adjustment Factor (SAF)	1.000
Weather Type	Non-Severe Weather	Final Capacity Adjustment Factor (CAF)	1.000
Incident Type	No Incident	Demand Adjustment Factor (DAF)	1.000

Demand and Capacity

Demand Volume veh/h	2879	Heavy Vehicle Adjustment Factor (fhv)	0.840
Peak Hour Factor	0.94	Flow Rate (Vp), pc/h/ln	1823
Total Trucks, %	19.01	Capacity (c), pc/h/ln	2368
Single-Unit Trucks (SUT), %	-	Adjusted Capacity (cadj), pc/h/ln	2368
Tractor-Trailers (TT), %	-	Volume-to-Capacity Ratio (v/c)	0.77
Passenger Car Equivalent (ET)	2.000		

Speed and Density

Lane Width Adjustment (fLW)	0.0	Average Speed (S), mi/h	63.6
Right-Side Lateral Clearance Adj. (fRLC)	0.0	Density (D), pc/mi/ln	28.7
Total Ramp Density Adjustment	3.2	Level of Service (LOS)	D
Adjusted Free-Flow Speed (FFSadj), mi/h	66.8		

HCS7 Freeway Merge Report

Project Information

Analyst	LSA	Date	12/11/2019
Agency	LSA	Analysis Year	Phase II Proj Comp Yr (2039) NP
Jurisdiction	Caltrans	Time Period Analyzed	PM Peak Hour
Project Description	CMD1801 - Village D Specific Plan	Unit	United States Customary

Geometric Data

	Freeway	Ramp
Number of Lanes (N), ln	2	1
Free-Flow Speed (FFS), mi/h	70.0	35.0
Segment Length (L) / Acceleration Length (LA),ft	1500	700
Terrain Type	Level	Level
Percent Grade, %	-	-
Segment Type / Ramp Side	Freeway	Right

Adjustment Factors

Driver Population	All Familiar	All Familiar
Weather Type	Non-Severe Weather	Non-Severe Weather
Incident Type	No Incident	-
Final Speed Adjustment Factor (SAF)	1.000	1.000
Final Capacity Adjustment Factor (CAF)	1.000	1.000
Demand Adjustment Factor (DAF)	1.000	1.000

Demand and Capacity

Demand Volume (Vi)	2879	235
Peak Hour Factor (PHF)	0.94	0.94
Total Trucks, %	19.01	23.78
Single-Unit Trucks (SUT), %	-	-
Tractor-Trailers (TT), %	-	-
Heavy Vehicle Adjustment Factor (fHV)	0.840	0.808
Flow Rate (vi),pc/h	3646	309
Capacity (c), pc/h	4800	2000
Volume-to-Capacity Ratio (v/c)	0.82	0.15

Speed and Density

Upstream Equilibrium Distance (LEQ), ft	-	Number of Outer Lanes on Freeway (NO)	0
Distance to Upstream Ramp (LUP), ft	-	Speed Index (MS)	0.476
Downstream Equilibrium Distance (LEQ), ft	-	Flow Outer Lanes (vOA), pc/h/ln	-
Distance to Downstream Ramp (LDOWN), ft	-	On-Ramp Influence Area Speed (SR), mi/h	56.7
Prop. Freeway Vehicles in Lane 1 and 2 (PFM)	1.000	Outer Lanes Freeway Speed (SO), mi/h	70.0
Flow in Lanes 1 and 2 (v12), pc/h	3646	Ramp Junction Speed (S), mi/h	56.7
Flow Entering Ramp-Infl. Area (vR12), pc/h	3955	Average Density (D), pc/mi/ln	34.9
Level of Service (LOS)	D	Density in Ramp Influence Area (DR), pc/mi/ln	31.9

HCS7 Basic Freeway Report

Project Information

Analyst	LSA	Date	12/11/2019
Agency	LSA	Analysis Year	Phase II Proj Comp Yr (2039) NP
Jurisdiction	Caltrans	Time Period Analyzed	PM Peak Hour
Project Description	CMD1801 - Village D Specific Plan	Unit	United States Customary

Geometric Data

Number of Lanes, ln	2	Terrain Type	Level
Segment Length (L), ft	-	Percent Grade, %	-
Measured or Base Free-Flow Speed	Base	Grade Length, mi	-
Base Free-Flow Speed (BFFS), mi/h	70.0	Total Ramp Density (TRD), ramps/mi	1.00
Lane Width, ft	12	Free-Flow Speed (FFS), mi/h	66.8
Right-Side Lateral Clearance, ft	10		

Adjustment Factors

Driver Population	All Familiar	Final Speed Adjustment Factor (SAF)	1.000
Weather Type	Non-Severe Weather	Final Capacity Adjustment Factor (CAF)	1.000
Incident Type	No Incident	Demand Adjustment Factor (DAF)	1.000

Demand and Capacity

Demand Volume veh/h	3114	Heavy Vehicle Adjustment Factor (fhv)	0.838
Peak Hour Factor	0.94	Flow Rate (Vp), pc/h/ln	1976
Total Trucks, %	19.37	Capacity (c), pc/h/ln	2368
Single-Unit Trucks (SUT), %	-	Adjusted Capacity (cadj), pc/h/ln	2368
Tractor-Trailers (TT), %	-	Volume-to-Capacity Ratio (v/c)	0.83
Passenger Car Equivalent (ET)	2.000		

Speed and Density

Lane Width Adjustment (fLW)	0.0	Average Speed (S), mi/h	61.3
Right-Side Lateral Clearance Adj. (fRLC)	0.0	Density (D), pc/mi/ln	32.2
Total Ramp Density Adjustment	3.2	Level of Service (LOS)	D
Adjusted Free-Flow Speed (FFSadj), mi/h	66.8		

HCS7 Basic Freeway Report

Project Information

Analyst	LSA	Date	12/11/2019
Agency	LSA	Analysis Year	Phase II Proj Comp Yr (2039) NP
Jurisdiction	Caltrans	Time Period Analyzed	PM Peak Hour
Project Description	CMD1801 - Village D Specific Plan	Unit	United States Customary

Geometric Data

Number of Lanes, ln	2	Terrain Type	Level
Segment Length (L), ft	-	Percent Grade, %	-
Measured or Base Free-Flow Speed	Base	Grade Length, mi	-
Base Free-Flow Speed (BFFS), mi/h	70.0	Total Ramp Density (TRD), ramps/mi	1.00
Lane Width, ft	12	Free-Flow Speed (FFS), mi/h	66.8
Right-Side Lateral Clearance, ft	10		

Adjustment Factors

Driver Population	All Familiar	Final Speed Adjustment Factor (SAF)	1.000
Weather Type	Non-Severe Weather	Final Capacity Adjustment Factor (CAF)	1.000
Incident Type	No Incident	Demand Adjustment Factor (DAF)	1.000

Demand and Capacity

Demand Volume veh/h	3279	Heavy Vehicle Adjustment Factor (fhv)	0.819
Peak Hour Factor	0.94	Flow Rate (Vp), pc/h/ln	2130
Total Trucks, %	22.08	Capacity (c), pc/h/ln	2368
Single-Unit Trucks (SUT), %	-	Adjusted Capacity (cadj), pc/h/ln	2368
Tractor-Trailers (TT), %	-	Volume-to-Capacity Ratio (v/c)	0.90
Passenger Car Equivalent (ET)	2.000		

Speed and Density

Lane Width Adjustment (fLW)	0.0	Average Speed (S), mi/h	58.4
Right-Side Lateral Clearance Adj. (fRLC)	0.0	Density (D), pc/mi/ln	36.5
Total Ramp Density Adjustment	3.2	Level of Service (LOS)	E
Adjusted Free-Flow Speed (FFSadj), mi/h	66.8		

HCS7 Freeway Diverge Report

Project Information

Analyst	LSA	Date	12/11/2019
Agency	LSA	Analysis Year	Phase II Proj Comp Yr (2039) NP
Jurisdiction	Caltrans	Time Period Analyzed	PM Peak Hour
Project Description	CMD1801 - Village D Specific Plan	Unit	United States Customary

Geometric Data

	Freeway	Ramp
Number of Lanes (N), ln	2	1
Free-Flow Speed (FFS), mi/h	70.0	50.0
Segment Length (L) / Deceleration Length (LA),ft	1500	150
Terrain Type	Level	Level
Percent Grade, %	-	-
Segment Type / Ramp Side	Freeway	Right

Adjustment Factors

Driver Population	All Familiar	All Familiar
Weather Type	Non-Severe Weather	Non-Severe Weather
Incident Type	No Incident	-
Final Speed Adjustment Factor (SAF)	1.000	1.000
Final Capacity Adjustment Factor (CAF)	1.000	1.000
Demand Adjustment Factor (DAF)	1.000	1.000

Demand and Capacity

Demand Volume (Vi)	3279	271
Peak Hour Factor (PHF)	0.94	0.94
Total Trucks, %	22.08	26.18
Single-Unit Trucks (SUT), %	-	-
Tractor-Trailers (TT), %	-	-
Heavy Vehicle Adjustment Factor (fHV)	0.819	0.793
Flow Rate (vi),pc/h	4259	364
Capacity (c), pc/h	4800	2100
Volume-to-Capacity Ratio (v/c)	0.89	0.17

Speed and Density

Upstream Equilibrium Distance (LEQ), ft	-	Number of Outer Lanes on Freeway (NO)	0
Distance to Upstream Ramp (LUP), ft	-	Speed Index (DS)	0.266
Downstream Equilibrium Distance (LEQ), ft	-	Flow Outer Lanes (vOA), pc/h/ln	-
Distance to Downstream Ramp (LDOWN), ft	-	Off-Ramp Influence Area Speed (SR), mi/h	62.6
Prop. Freeway Vehicles in Lane 1 and 2 (PFD)	1.000	Outer Lanes Freeway Speed (SO), mi/h	76.8
Flow in Lanes 1 and 2 (v12), pc/h	4259	Ramp Junction Speed (S), mi/h	62.6
Flow Entering Ramp-Infl. Area (vR12), pc/h	-	Average Density (D), pc/mi/ln	34.0
Level of Service (LOS)	E	Density in Ramp Influence Area (DR), pc/mi/ln	39.5

HCS7 Basic Freeway Report

Project Information

Analyst	LSA	Date	12/11/2019
Agency	LSA	Analysis Year	Phase II Proj Comp Yr (2039) NP
Jurisdiction	Caltrans	Time Period Analyzed	PM Peak Hour
Project Description	CMD1801 - Village D Specific Plan	Unit	United States Customary

Geometric Data

Number of Lanes, ln	2	Terrain Type	Level
Segment Length (L), ft	-	Percent Grade, %	-
Measured or Base Free-Flow Speed	Base	Grade Length, mi	-
Base Free-Flow Speed (BFFS), mi/h	70.0	Total Ramp Density (TRD), ramps/mi	1.33
Lane Width, ft	12	Free-Flow Speed (FFS), mi/h	65.9
Right-Side Lateral Clearance, ft	10		

Adjustment Factors

Driver Population	All Familiar	Final Speed Adjustment Factor (SAF)	1.000
Weather Type	Non-Severe Weather	Final Capacity Adjustment Factor (CAF)	1.000
Incident Type	No Incident	Demand Adjustment Factor (DAF)	1.000

Demand and Capacity

Demand Volume veh/h	3008	Heavy Vehicle Adjustment Factor (fhv)	0.822
Peak Hour Factor	0.94	Flow Rate (Vp), pc/h/ln	1946
Total Trucks, %	21.71	Capacity (c), pc/h/ln	2359
Single-Unit Trucks (SUT), %	-	Adjusted Capacity (cadj), pc/h/ln	2359
Tractor-Trailers (TT), %	-	Volume-to-Capacity Ratio (v/c)	0.83
Passenger Car Equivalent (ET)	2.000		

Speed and Density

Lane Width Adjustment (fLW)	0.0	Average Speed (S), mi/h	61.3
Right-Side Lateral Clearance Adj. (fRLC)	0.0	Density (D), pc/mi/ln	31.7
Total Ramp Density Adjustment	4.1	Level of Service (LOS)	D
Adjusted Free-Flow Speed (FFSadj), mi/h	65.9		

HCS7 Freeway Merge Report

Project Information

Analyst	LSA	Date	12/11/2019
Agency	LSA	Analysis Year	Phase II Proj Comp Yr (2039) NP
Jurisdiction	Caltrans	Time Period Analyzed	PM Peak Hour
Project Description	CMD1801 - Village D Specific Plan	Unit	United States Customary

Geometric Data

	Freeway	Ramp
Number of Lanes (N), ln	2	1
Free-Flow Speed (FFS), mi/h	70.0	35.0
Segment Length (L) / Acceleration Length (LA),ft	1000	600
Terrain Type	Level	Level
Percent Grade, %	-	-
Segment Type / Ramp Side	Freeway	Right

Adjustment Factors

Driver Population	All Familiar	All Familiar
Weather Type	Non-Severe Weather	Non-Severe Weather
Incident Type	No Incident	-
Final Speed Adjustment Factor (SAF)	1.000	1.000
Final Capacity Adjustment Factor (CAF)	1.000	1.000
Demand Adjustment Factor (DAF)	1.000	1.000

Demand and Capacity

Demand Volume (Vi)	3008	29
Peak Hour Factor (PHF)	0.94	0.94
Total Trucks, %	21.71	7.41
Single-Unit Trucks (SUT), %	-	-
Tractor-Trailers (TT), %	-	-
Heavy Vehicle Adjustment Factor (fHV)	0.822	0.931
Flow Rate (vi),pc/h	3893	33
Capacity (c), pc/h	4800	2000
Volume-to-Capacity Ratio (v/c)	0.82	0.02

Speed and Density

Upstream Equilibrium Distance (LEQ), ft	-	Number of Outer Lanes on Freeway (NO)	0
Distance to Upstream Ramp (LUP), ft	-	Speed Index (MS)	0.477
Downstream Equilibrium Distance (LEQ), ft	-	Flow Outer Lanes (vOA), pc/h/ln	-
Distance to Downstream Ramp (LDOWN), ft	-	On-Ramp Influence Area Speed (SR), mi/h	56.6
Prop. Freeway Vehicles in Lane 1 and 2 (PFM)	1.000	Outer Lanes Freeway Speed (SO), mi/h	70.0
Flow in Lanes 1 and 2 (v12), pc/h	3893	Ramp Junction Speed (S), mi/h	56.6
Flow Entering Ramp-Infl. Area (vR12), pc/h	3926	Average Density (D), pc/mi/ln	34.7
Level of Service (LOS)	D	Density in Ramp Influence Area (DR), pc/mi/ln	32.4

HCS7 Basic Freeway Report

Project Information

Analyst	LSA	Date	12/11/2019
Agency	LSA	Analysis Year	Phase II Proj Comp Yr (2039) NP
Jurisdiction	Caltrans	Time Period Analyzed	PM Peak Hour
Project Description	CMD1801 - Village D Specific Plan	Unit	United States Customary

Geometric Data

Number of Lanes, ln	2	Terrain Type	Level
Segment Length (L), ft	-	Percent Grade, %	-
Measured or Base Free-Flow Speed	Base	Grade Length, mi	-
Base Free-Flow Speed (BFFS), mi/h	70.0	Total Ramp Density (TRD), ramps/mi	1.33
Lane Width, ft	12	Free-Flow Speed (FFS), mi/h	65.9
Right-Side Lateral Clearance, ft	10		

Adjustment Factors

Driver Population	All Familiar	Final Speed Adjustment Factor (SAF)	1.000
Weather Type	Non-Severe Weather	Final Capacity Adjustment Factor (CAF)	1.000
Incident Type	No Incident	Demand Adjustment Factor (DAF)	1.000

Demand and Capacity

Demand Volume veh/h	3037	Heavy Vehicle Adjustment Factor (fhv)	0.823
Peak Hour Factor	0.94	Flow Rate (Vp), pc/h/ln	1963
Total Trucks, %	21.57	Capacity (c), pc/h/ln	2359
Single-Unit Trucks (SUT), %	-	Adjusted Capacity (cadj), pc/h/ln	2359
Tractor-Trailers (TT), %	-	Volume-to-Capacity Ratio (v/c)	0.83
Passenger Car Equivalent (ET)	2.000		

Speed and Density

Lane Width Adjustment (fLW)	0.0	Average Speed (S), mi/h	61.0
Right-Side Lateral Clearance Adj. (fRLC)	0.0	Density (D), pc/mi/ln	32.2
Total Ramp Density Adjustment	4.1	Level of Service (LOS)	D
Adjusted Free-Flow Speed (FFSadj), mi/h	65.9		

HCS7 Freeway Merge Report

Project Information

Analyst	LSA	Date	12/11/2019
Agency	LSA	Analysis Year	Phase II Proj Comp Yr (2039) NP
Jurisdiction	Caltrans	Time Period Analyzed	PM Peak Hour
Project Description	CMD1801 - Village D Specific Plan	Unit	United States Customary

Geometric Data

	Freeway	Ramp
Number of Lanes (N), ln	2	1
Free-Flow Speed (FFS), mi/h	70.0	35.0
Segment Length (L) / Acceleration Length (LA),ft	1500	500
Terrain Type	Level	Level
Percent Grade, %	-	-
Segment Type / Ramp Side	Freeway	Right

Adjustment Factors

Driver Population	All Familiar	All Familiar
Weather Type	Non-Severe Weather	Non-Severe Weather
Incident Type	No Incident	-
Final Speed Adjustment Factor (SAF)	1.000	1.000
Final Capacity Adjustment Factor (CAF)	1.000	1.000
Demand Adjustment Factor (DAF)	1.000	1.000

Demand and Capacity

Demand Volume (Vi)	3037	236
Peak Hour Factor (PHF)	0.94	0.94
Total Trucks, %	21.57	21.94
Single-Unit Trucks (SUT), %	-	-
Tractor-Trailers (TT), %	-	-
Heavy Vehicle Adjustment Factor (fHV)	0.823	0.820
Flow Rate (vi),pc/h	3926	306
Capacity (c), pc/h	4800	2000
Volume-to-Capacity Ratio (v/c)	0.88	0.15

Speed and Density

Upstream Equilibrium Distance (LEQ), ft	-	Number of Outer Lanes on Freeway (NO)	0
Distance to Upstream Ramp (LUP), ft	-	Speed Index (MS)	0.555
Downstream Equilibrium Distance (LEQ), ft	-	Flow Outer Lanes (vOA), pc/h/ln	-
Distance to Downstream Ramp (LDOWN), ft	-	On-Ramp Influence Area Speed (SR), mi/h	54.5
Prop. Freeway Vehicles in Lane 1 and 2 (PFM)	1.000	Outer Lanes Freeway Speed (SO), mi/h	70.0
Flow in Lanes 1 and 2 (v12), pc/h	3926	Ramp Junction Speed (S), mi/h	54.5
Flow Entering Ramp-Infl. Area (vR12), pc/h	4232	Average Density (D), pc/mi/ln	38.8
Level of Service (LOS)	E	Density in Ramp Influence Area (DR), pc/mi/ln	35.3

HCS7 Basic Freeway Report

Project Information

Analyst	LSA	Date	12/11/2019
Agency	LSA	Analysis Year	Phase II Proj Comp Yr (2039) NP
Jurisdiction	Caltrans	Time Period Analyzed	PM Peak Hour
Project Description	CMD1801 - Village D Specific Plan	Unit	United States Customary

Geometric Data

Number of Lanes, ln	2	Terrain Type	Level
Segment Length (L), ft	-	Percent Grade, %	-
Measured or Base Free-Flow Speed	Base	Grade Length, mi	-
Base Free-Flow Speed (BFFS), mi/h	70.0	Total Ramp Density (TRD), ramps/mi	1.33
Lane Width, ft	12	Free-Flow Speed (FFS), mi/h	65.9
Right-Side Lateral Clearance, ft	10		

Adjustment Factors

Driver Population	All Familiar	Final Speed Adjustment Factor (SAF)	1.000
Weather Type	Non-Severe Weather	Final Capacity Adjustment Factor (CAF)	1.000
Incident Type	No Incident	Demand Adjustment Factor (DAF)	1.000

Demand and Capacity

Demand Volume veh/h	3273	Heavy Vehicle Adjustment Factor (fhv)	0.822
Peak Hour Factor	0.94	Flow Rate (Vp), pc/h/ln	2118
Total Trucks, %	21.60	Capacity (c), pc/h/ln	2359
Single-Unit Trucks (SUT), %	-	Adjusted Capacity (cadj), pc/h/ln	2359
Tractor-Trailers (TT), %	-	Volume-to-Capacity Ratio (v/c)	0.90
Passenger Car Equivalent (ET)	2.000		

Speed and Density

Lane Width Adjustment (fLW)	0.0	Average Speed (S), mi/h	58.2
Right-Side Lateral Clearance Adj. (fRLC)	0.0	Density (D), pc/mi/ln	36.4
Total Ramp Density Adjustment	4.1	Level of Service (LOS)	E
Adjusted Free-Flow Speed (FFSadj), mi/h	65.9		

HCS7 Freeway Diverge Report

Project Information

Analyst	LSA	Date	12/11/2019
Agency	LSA	Analysis Year	Phase II Proj Comp Yr (2039) NP
Jurisdiction	Caltrans	Time Period Analyzed	PM Peak Hour
Project Description	CMD1801 - Village D Specific Plan	Unit	United States Customary

Geometric Data

	Freeway	Ramp
Number of Lanes (N), ln	3	1
Free-Flow Speed (FFS), mi/h	70.0	35.0
Segment Length (L) / Deceleration Length (LA),ft	1500	150
Terrain Type	Level	Level
Percent Grade, %	-	-
Segment Type / Ramp Side	Freeway	Right

Adjustment Factors

Driver Population	All Familiar	All Familiar
Weather Type	Non-Severe Weather	Non-Severe Weather
Incident Type	No Incident	-
Final Speed Adjustment Factor (SAF)	1.000	1.000
Final Capacity Adjustment Factor (CAF)	1.000	1.000
Demand Adjustment Factor (DAF)	1.000	1.000

Demand and Capacity

Demand Volume (Vi)	3273	511
Peak Hour Factor (PHF)	0.94	0.94
Total Trucks, %	21.60	4.59
Single-Unit Trucks (SUT), %	-	-
Tractor-Trailers (TT), %	-	-
Heavy Vehicle Adjustment Factor (fHV)	0.822	0.956
Flow Rate (vi),pc/h	4236	569
Capacity (c), pc/h	7200	2000
Volume-to-Capacity Ratio (v/c)	0.59	0.28

Speed and Density

Upstream Equilibrium Distance (LEQ), ft	-	Number of Outer Lanes on Freeway (NO)	1
Distance to Upstream Ramp (LUP), ft	-	Speed Index (DS)	0.479
Downstream Equilibrium Distance (LEQ), ft	-	Flow Outer Lanes (vOA), pc/h/ln	1364
Distance to Downstream Ramp (LDOWN), ft	-	Off-Ramp Influence Area Speed (SR), mi/h	56.6
Prop. Freeway Vehicles in Lane 1 and 2 (PFD)	0.628	Outer Lanes Freeway Speed (SO), mi/h	75.4
Flow in Lanes 1 and 2 (v12), pc/h	2872	Ramp Junction Speed (S), mi/h	61.5
Flow Entering Ramp-Infl. Area (vR12), pc/h	-	Average Density (D), pc/mi/ln	23.0
Level of Service (LOS)	C	Density in Ramp Influence Area (DR), pc/mi/ln	27.6

HCS7 Basic Freeway Report

Project Information

Analyst	LSA	Date	12/11/2019
Agency	LSA	Analysis Year	Phase II Proj Comp Yr (2039) NP
Jurisdiction	Caltrans	Time Period Analyzed	PM Peak Hour
Project Description	CMD1801 - Village D Specific Plan	Unit	United States Customary

Geometric Data

Number of Lanes, ln	3	Terrain Type	Level
Segment Length (L), ft	-	Percent Grade, %	-
Measured or Base Free-Flow Speed	Base	Grade Length, mi	-
Base Free-Flow Speed (BFFS), mi/h	70.0	Total Ramp Density (TRD), ramps/mi	1.67
Lane Width, ft	12	Free-Flow Speed (FFS), mi/h	65.0
Right-Side Lateral Clearance, ft	10		

Adjustment Factors

Driver Population	All Familiar	Final Speed Adjustment Factor (SAF)	1.000
Weather Type	Non-Severe Weather	Final Capacity Adjustment Factor (CAF)	1.000
Incident Type	No Incident	Demand Adjustment Factor (DAF)	1.000

Demand and Capacity

Demand Volume veh/h	2762	Heavy Vehicle Adjustment Factor (fhv)	0.802
Peak Hour Factor	0.94	Flow Rate (Vp), pc/h/ln	1221
Total Trucks, %	24.76	Capacity (c), pc/h/ln	2350
Single-Unit Trucks (SUT), %	-	Adjusted Capacity (cadj), pc/h/ln	2350
Tractor-Trailers (TT), %	-	Volume-to-Capacity Ratio (v/c)	0.52
Passenger Car Equivalent (ET)	2.000		

Speed and Density

Lane Width Adjustment (fLW)	0.0	Average Speed (S), mi/h	65.0
Right-Side Lateral Clearance Adj. (fRLC)	0.0	Density (D), pc/mi/ln	18.8
Total Ramp Density Adjustment	5.0	Level of Service (LOS)	C
Adjusted Free-Flow Speed (FFSadj), mi/h	65.0		

HCS7 Freeway Merge Report

Project Information

Analyst	LSA	Date	12/11/2019
Agency	LSA	Analysis Year	Phase II Proj Comp Yr (2039) NP
Jurisdiction	Caltrans	Time Period Analyzed	PM Peak Hour
Project Description	CMD1801 - Village D Specific Plan	Unit	United States Customary

Geometric Data

	Freeway	Ramp
Number of Lanes (N), ln	3	1
Free-Flow Speed (FFS), mi/h	65.0	35.0
Segment Length (L) / Acceleration Length (LA),ft	1500	600
Terrain Type	Level	Level
Percent Grade, %	-	-
Segment Type / Ramp Side	Freeway	Right

Adjustment Factors

Driver Population	All Familiar	All Familiar
Weather Type	Non-Severe Weather	Non-Severe Weather
Incident Type	No Incident	-
Final Speed Adjustment Factor (SAF)	1.000	1.000
Final Capacity Adjustment Factor (CAF)	1.000	1.000
Demand Adjustment Factor (DAF)	1.000	1.000

Demand and Capacity

Demand Volume (Vi)	2762	698
Peak Hour Factor (PHF)	0.94	0.94
Total Trucks, %	24.76	6.36
Single-Unit Trucks (SUT), %	-	-
Tractor-Trailers (TT), %	-	-
Heavy Vehicle Adjustment Factor (fHV)	0.802	0.940
Flow Rate (vi),pc/h	3664	790
Capacity (c), pc/h	7050	2000
Volume-to-Capacity Ratio (v/c)	0.63	0.40

Speed and Density

Upstream Equilibrium Distance (LEQ), ft	-	Number of Outer Lanes on Freeway (NO)	1
Distance to Upstream Ramp (LUP), ft	-	Speed Index (MS)	0.355
Downstream Equilibrium Distance (LEQ), ft	-	Flow Outer Lanes (vOA), pc/h/ln	1488
Distance to Downstream Ramp (LDOWN), ft	-	On-Ramp Influence Area Speed (SR), mi/h	56.8
Prop. Freeway Vehicles in Lane 1 and 2 (PFM)	0.594	Outer Lanes Freeway Speed (SO), mi/h	61.4
Flow in Lanes 1 and 2 (v12), pc/h	2176	Ramp Junction Speed (S), mi/h	58.3
Flow Entering Ramp-Infl. Area (vR12), pc/h	2966	Average Density (D), pc/mi/ln	25.5
Level of Service (LOS)	C	Density in Ramp Influence Area (DR), pc/mi/ln	24.6

HCS7 Basic Freeway Report

Project Information

Analyst	LSA	Date	12/11/2019
Agency	LSA	Analysis Year	Phase II Proj Comp Yr (2039) NP
Jurisdiction	Caltrans	Time Period Analyzed	PM Peak Hour
Project Description	CMD1801 - Village D Specific Plan	Unit	United States Customary

Geometric Data

Number of Lanes, ln	3	Terrain Type	Level
Segment Length (L), ft	-	Percent Grade, %	-
Measured or Base Free-Flow Speed	Base	Grade Length, mi	-
Base Free-Flow Speed (BFFS), mi/h	65.0	Total Ramp Density (TRD), ramps/mi	1.83
Lane Width, ft	12	Free-Flow Speed (FFS), mi/h	59.7
Right-Side Lateral Clearance, ft	10		

Adjustment Factors

Driver Population	All Familiar	Final Speed Adjustment Factor (SAF)	1.000
Weather Type	Non-Severe Weather	Final Capacity Adjustment Factor (CAF)	1.000
Incident Type	No Incident	Demand Adjustment Factor (DAF)	1.000

Demand and Capacity

Demand Volume veh/h	3460	Heavy Vehicle Adjustment Factor (fhv)	0.826
Peak Hour Factor	0.94	Flow Rate (Vp), pc/h/ln	1485
Total Trucks, %	21.04	Capacity (c), pc/h/ln	2296
Single-Unit Trucks (SUT), %	-	Adjusted Capacity (cadj), pc/h/ln	2296
Tractor-Trailers (TT), %	-	Volume-to-Capacity Ratio (v/c)	0.65
Passenger Car Equivalent (ET)	2.000		

Speed and Density

Lane Width Adjustment (fLW)	0.0	Average Speed (S), mi/h	59.6
Right-Side Lateral Clearance Adj. (fRLC)	0.0	Density (D), pc/mi/ln	24.9
Total Ramp Density Adjustment	5.4	Level of Service (LOS)	C
Adjusted Free-Flow Speed (FFSadj), mi/h	59.6		

HCS7 Freeway Merge Report

Project Information

Analyst	LSA	Date	12/11/2019
Agency	LSA	Analysis Year	Phase II Proj Comp Yr (2039) NP
Jurisdiction	Caltrans	Time Period Analyzed	PM Peak Hour
Project Description	CMD1801 - Village D Specific Plan	Unit	United States Customary

Geometric Data

	Freeway	Ramp
Number of Lanes (N), ln	3	1
Free-Flow Speed (FFS), mi/h	65.0	35.0
Segment Length (L) / Acceleration Length (LA),ft	1500	600
Terrain Type	Level	Level
Percent Grade, %	-	-
Segment Type / Ramp Side	Freeway	Right

Adjustment Factors

Driver Population	All Familiar	All Familiar
Weather Type	Non-Severe Weather	Non-Severe Weather
Incident Type	No Incident	-
Final Speed Adjustment Factor (SAF)	1.000	1.000
Final Capacity Adjustment Factor (CAF)	1.000	1.000
Demand Adjustment Factor (DAF)	1.000	1.000

Demand and Capacity

Demand Volume (Vi)	3460	314
Peak Hour Factor (PHF)	0.94	0.94
Total Trucks, %	21.04	3.40
Single-Unit Trucks (SUT), %	-	-
Tractor-Trailers (TT), %	-	-
Heavy Vehicle Adjustment Factor (fHV)	0.826	0.967
Flow Rate (vi),pc/h	4456	345
Capacity (c), pc/h	7050	2000
Volume-to-Capacity Ratio (v/c)	0.68	0.17

Speed and Density

Upstream Equilibrium Distance (LEQ), ft	-	Number of Outer Lanes on Freeway (NO)	1
Distance to Upstream Ramp (LUP), ft	-	Speed Index (MS)	0.357
Downstream Equilibrium Distance (LEQ), ft	-	Flow Outer Lanes (vOA), pc/h/ln	1809
Distance to Downstream Ramp (LDOWN), ft	-	On-Ramp Influence Area Speed (SR), mi/h	56.8
Prop. Freeway Vehicles in Lane 1 and 2 (PFM)	0.594	Outer Lanes Freeway Speed (SO), mi/h	60.3
Flow in Lanes 1 and 2 (v12), pc/h	2647	Ramp Junction Speed (S), mi/h	58.1
Flow Entering Ramp-Infl. Area (vR12), pc/h	2992	Average Density (D), pc/mi/ln	27.5
Level of Service (LOS)	C	Density in Ramp Influence Area (DR), pc/mi/ln	25.0

HCS7 Basic Freeway Report

Project Information

Analyst	LSA	Date	12/11/2019
Agency	LSA	Analysis Year	Phase II Proj Comp Yr (2039) NP
Jurisdiction	Caltrans	Time Period Analyzed	PM Peak Hour
Project Description	CMD1801 - Village D Specific Plan	Unit	United States Customary

Geometric Data

Number of Lanes, ln	3	Terrain Type	Level
Segment Length (L), ft	-	Percent Grade, %	-
Measured or Base Free-Flow Speed	Base	Grade Length, mi	-
Base Free-Flow Speed (BFFS), mi/h	65.0	Total Ramp Density (TRD), ramps/mi	2.17
Lane Width, ft	12	Free-Flow Speed (FFS), mi/h	58.8
Right-Side Lateral Clearance, ft	10		

Adjustment Factors

Driver Population	All Familiar	Final Speed Adjustment Factor (SAF)	1.000
Weather Type	Non-Severe Weather	Final Capacity Adjustment Factor (CAF)	1.000
Incident Type	No Incident	Demand Adjustment Factor (DAF)	1.000

Demand and Capacity

Demand Volume veh/h	3774	Heavy Vehicle Adjustment Factor (fhv)	0.836
Peak Hour Factor	0.94	Flow Rate (Vp), pc/h/ln	1601
Total Trucks, %	19.58	Capacity (c), pc/h/ln	2288
Single-Unit Trucks (SUT), %	-	Adjusted Capacity (cadj), pc/h/ln	2288
Tractor-Trailers (TT), %	-	Volume-to-Capacity Ratio (v/c)	0.70
Passenger Car Equivalent (ET)	2.000		

Speed and Density

Lane Width Adjustment (fLW)	0.0	Average Speed (S), mi/h	58.8
Right-Side Lateral Clearance Adj. (fRLC)	0.0	Density (D), pc/mi/ln	27.2
Total Ramp Density Adjustment	6.2	Level of Service (LOS)	D
Adjusted Free-Flow Speed (FFSadj), mi/h	58.8		

HCS7 Freeway Diverge Report

Project Information

Analyst	LSA	Date	12/11/2019
Agency	LSA	Analysis Year	Phase II Proj Comp Yr (2039) NP
Jurisdiction	Caltrans	Time Period Analyzed	PM Peak Hour
Project Description	CMD1801 - Village D Specific Plan	Unit	United States Customary

Geometric Data

	Freeway	Ramp
Number of Lanes (N), ln	3	1
Free-Flow Speed (FFS), mi/h	65.0	40.0
Segment Length (L) / Deceleration Length (LA),ft	1500	150
Terrain Type	Level	Level
Percent Grade, %	-	-
Segment Type / Ramp Side	Freeway	Right

Adjustment Factors

Driver Population	All Familiar	All Familiar
Weather Type	Non-Severe Weather	Non-Severe Weather
Incident Type	No Incident	-
Final Speed Adjustment Factor (SAF)	1.000	1.000
Final Capacity Adjustment Factor (CAF)	1.000	1.000
Demand Adjustment Factor (DAF)	1.000	1.000

Demand and Capacity

Demand Volume (Vi)	3774	336
Peak Hour Factor (PHF)	0.94	0.94
Total Trucks, %	19.58	3.62
Single-Unit Trucks (SUT), %	-	-
Tractor-Trailers (TT), %	-	-
Heavy Vehicle Adjustment Factor (fHV)	0.836	0.965
Flow Rate (vi),pc/h	4803	370
Capacity (c), pc/h	7050	2000
Volume-to-Capacity Ratio (v/c)	0.68	0.19

Speed and Density

Upstream Equilibrium Distance (LEQ), ft	-	Number of Outer Lanes on Freeway (NO)	1
Distance to Upstream Ramp (LUP), ft	-	Speed Index (DS)	0.396
Downstream Equilibrium Distance (LEQ), ft	-	Flow Outer Lanes (vOA), pc/h/ln	1671
Distance to Downstream Ramp (LDOWN), ft	-	Off-Ramp Influence Area Speed (SR), mi/h	55.9
Prop. Freeway Vehicles in Lane 1 and 2 (PFD)	0.623	Outer Lanes Freeway Speed (SO), mi/h	68.7
Flow in Lanes 1 and 2 (v12), pc/h	3132	Ramp Junction Speed (S), mi/h	59.8
Flow Entering Ramp-Infl. Area (vR12), pc/h	-	Average Density (D), pc/mi/ln	26.8
Level of Service (LOS)	D	Density in Ramp Influence Area (DR), pc/mi/ln	29.8

HCS7 Basic Freeway Report

Project Information

Analyst	LSA	Date	12/11/2019
Agency	LSA	Analysis Year	Phase II Proj Comp Yr (2039) NP
Jurisdiction	Caltrans	Time Period Analyzed	PM Peak Hour
Project Description	CMD1801 - Village D Specific Plan	Unit	United States Customary

Geometric Data

Number of Lanes, ln	3	Terrain Type	Level
Segment Length (L), ft	-	Percent Grade, %	-
Measured or Base Free-Flow Speed	Base	Grade Length, mi	-
Base Free-Flow Speed (BFFS), mi/h	65.0	Total Ramp Density (TRD), ramps/mi	1.83
Lane Width, ft	12	Free-Flow Speed (FFS), mi/h	59.7
Right-Side Lateral Clearance, ft	10		

Adjustment Factors

Driver Population	All Familiar	Final Speed Adjustment Factor (SAF)	1.000
Weather Type	Non-Severe Weather	Final Capacity Adjustment Factor (CAF)	1.000
Incident Type	No Incident	Demand Adjustment Factor (DAF)	1.000

Demand and Capacity

Demand Volume veh/h	3438	Heavy Vehicle Adjustment Factor (fhv)	0.825
Peak Hour Factor	0.94	Flow Rate (Vp), pc/h/ln	1478
Total Trucks, %	21.15	Capacity (c), pc/h/ln	2296
Single-Unit Trucks (SUT), %	-	Adjusted Capacity (cadj), pc/h/ln	2296
Tractor-Trailers (TT), %	-	Volume-to-Capacity Ratio (v/c)	0.64
Passenger Car Equivalent (ET)	2.000		

Speed and Density

Lane Width Adjustment (fLW)	0.0	Average Speed (S), mi/h	59.6
Right-Side Lateral Clearance Adj. (fRLC)	0.0	Density (D), pc/mi/ln	24.8
Total Ramp Density Adjustment	5.4	Level of Service (LOS)	C
Adjusted Free-Flow Speed (FFSadj), mi/h	59.6		

HCS7 Freeway Merge Report

Project Information

Analyst	LSA	Date	12/11/2019
Agency	LSA	Analysis Year	Phase II Proj Comp Yr (2039) NP
Jurisdiction	Caltrans	Time Period Analyzed	PM Peak Hour
Project Description	CMD1801 - Village D Specific Plan	Unit	United States Customary

Geometric Data

	Freeway	Ramp
Number of Lanes (N), ln	3	1
Free-Flow Speed (FFS), mi/h	65.0	35.0
Segment Length (L) / Acceleration Length (LA),ft	1500	800
Terrain Type	Level	Level
Percent Grade, %	-	-
Segment Type / Ramp Side	Freeway	Right

Adjustment Factors

Driver Population	All Familiar	All Familiar
Weather Type	Non-Severe Weather	Non-Severe Weather
Incident Type	No Incident	-
Final Speed Adjustment Factor (SAF)	1.000	1.000
Final Capacity Adjustment Factor (CAF)	1.000	1.000
Demand Adjustment Factor (DAF)	1.000	1.000

Demand and Capacity

Demand Volume (Vi)	3438	267
Peak Hour Factor (PHF)	0.94	0.94
Total Trucks, %	21.15	5.83
Single-Unit Trucks (SUT), %	-	-
Tractor-Trailers (TT), %	-	-
Heavy Vehicle Adjustment Factor (fHV)	0.825	0.945
Flow Rate (vi),pc/h	4433	301
Capacity (c), pc/h	7050	2000
Volume-to-Capacity Ratio (v/c)	0.67	0.15

Speed and Density

Upstream Equilibrium Distance (LEQ), ft	-	Number of Outer Lanes on Freeway (NO)	1
Distance to Upstream Ramp (LUP), ft	-	Speed Index (MS)	0.340
Downstream Equilibrium Distance (LEQ), ft	-	Flow Outer Lanes (vOA), pc/h/ln	1773
Distance to Downstream Ramp (LDOWN), ft	-	On-Ramp Influence Area Speed (SR), mi/h	57.2
Prop. Freeway Vehicles in Lane 1 and 2 (PFM)	0.600	Outer Lanes Freeway Speed (SO), mi/h	60.4
Flow in Lanes 1 and 2 (v12), pc/h	2660	Ramp Junction Speed (S), mi/h	58.4
Flow Entering Ramp-Infl. Area (vR12), pc/h	2961	Average Density (D), pc/mi/ln	27.0
Level of Service (LOS)	C	Density in Ramp Influence Area (DR), pc/mi/ln	23.5

HCS7 Basic Freeway Report

Project Information

Analyst	LSA	Date	12/11/2019
Agency	LSA	Analysis Year	Phase II Proj Comp Yr (2039) NP
Jurisdiction	Caltrans	Time Period Analyzed	PM Peak Hour
Project Description	CMD1801 - Village D Specific Plan	Unit	United States Customary

Geometric Data

Number of Lanes, ln	3	Terrain Type	Level
Segment Length (L), ft	-	Percent Grade, %	-
Measured or Base Free-Flow Speed	Base	Grade Length, mi	-
Base Free-Flow Speed (BFFS), mi/h	65.0	Total Ramp Density (TRD), ramps/mi	2.17
Lane Width, ft	12	Free-Flow Speed (FFS), mi/h	58.8
Right-Side Lateral Clearance, ft	10		

Adjustment Factors

Driver Population	All Familiar	Final Speed Adjustment Factor (SAF)	1.000
Weather Type	Non-Severe Weather	Final Capacity Adjustment Factor (CAF)	1.000
Incident Type	No Incident	Demand Adjustment Factor (DAF)	1.000

Demand and Capacity

Demand Volume veh/h	3704	Heavy Vehicle Adjustment Factor (fhv)	0.833
Peak Hour Factor	0.94	Flow Rate (Vp), pc/h/ln	1577
Total Trucks, %	20.04	Capacity (c), pc/h/ln	2288
Single-Unit Trucks (SUT), %	-	Adjusted Capacity (cadj), pc/h/ln	2288
Tractor-Trailers (TT), %	-	Volume-to-Capacity Ratio (v/c)	0.69
Passenger Car Equivalent (ET)	2.000		

Speed and Density

Lane Width Adjustment (fLW)	0.0	Average Speed (S), mi/h	58.8
Right-Side Lateral Clearance Adj. (fRLC)	0.0	Density (D), pc/mi/ln	26.8
Total Ramp Density Adjustment	6.2	Level of Service (LOS)	D
Adjusted Free-Flow Speed (FFSadj), mi/h	58.8		

HCS7 Freeway Diverge Report

Project Information

Analyst	LSA	Date	12/11/2019
Agency	LSA	Analysis Year	Phase II Proj Comp Yr (2039) NP
Jurisdiction	Caltrans	Time Period Analyzed	PM Peak Hour
Project Description	CMD1801 - Village D Specific Plan	Unit	United States Customary

Geometric Data

	Freeway	Ramp
Number of Lanes (N), ln	3	1
Free-Flow Speed (FFS), mi/h	65.0	35.0
Segment Length (L) / Deceleration Length (LA),ft	1500	200
Terrain Type	Level	Level
Percent Grade, %	-	-
Segment Type / Ramp Side	Freeway	Right

Adjustment Factors

Driver Population	All Familiar	All Familiar
Weather Type	Non-Severe Weather	Non-Severe Weather
Incident Type	No Incident	-
Final Speed Adjustment Factor (SAF)	1.000	1.000
Final Capacity Adjustment Factor (CAF)	1.000	1.000
Demand Adjustment Factor (DAF)	1.000	1.000

Demand and Capacity

Demand Volume (Vi)	3704	259
Peak Hour Factor (PHF)	0.94	0.94
Total Trucks, %	20.04	3.96
Single-Unit Trucks (SUT), %	-	-
Tractor-Trailers (TT), %	-	-
Heavy Vehicle Adjustment Factor (fHV)	0.833	0.962
Flow Rate (vi),pc/h	4730	286
Capacity (c), pc/h	7050	2000
Volume-to-Capacity Ratio (v/c)	0.67	0.14

Speed and Density

Upstream Equilibrium Distance (LEQ), ft	-	Number of Outer Lanes on Freeway (NO)	1
Distance to Upstream Ramp (LUP), ft	-	Speed Index (DS)	0.454
Downstream Equilibrium Distance (LEQ), ft	-	Flow Outer Lanes (vOA), pc/h/ln	1649
Distance to Downstream Ramp (LDOWN), ft	-	Off-Ramp Influence Area Speed (SR), mi/h	54.6
Prop. Freeway Vehicles in Lane 1 and 2 (PFD)	0.629	Outer Lanes Freeway Speed (SO), mi/h	68.8
Flow in Lanes 1 and 2 (v12), pc/h	3081	Ramp Junction Speed (S), mi/h	58.8
Flow Entering Ramp-Infl. Area (vR12), pc/h	-	Average Density (D), pc/mi/ln	26.8
Level of Service (LOS)	D	Density in Ramp Influence Area (DR), pc/mi/ln	28.9

HCS7 Basic Freeway Report

Project Information

Analyst	LSA	Date	12/11/2019
Agency	LSA	Analysis Year	Phase II Proj Comp Yr (2039) NP
Jurisdiction	Caltrans	Time Period Analyzed	PM Peak Hour
Project Description	CMD1801 - Village D Specific Plan	Unit	United States Customary

Geometric Data

Number of Lanes, ln	3	Terrain Type	Level
Segment Length (L), ft	-	Percent Grade, %	-
Measured or Base Free-Flow Speed	Base	Grade Length, mi	-
Base Free-Flow Speed (BFFS), mi/h	65.0	Total Ramp Density (TRD), ramps/mi	2.17
Lane Width, ft	12	Free-Flow Speed (FFS), mi/h	58.8
Right-Side Lateral Clearance, ft	10		

Adjustment Factors

Driver Population	All Familiar	Final Speed Adjustment Factor (SAF)	1.000
Weather Type	Non-Severe Weather	Final Capacity Adjustment Factor (CAF)	1.000
Incident Type	No Incident	Demand Adjustment Factor (DAF)	1.000

Demand and Capacity

Demand Volume veh/h	3445	Heavy Vehicle Adjustment Factor (fhv)	0.825
Peak Hour Factor	0.94	Flow Rate (Vp), pc/h/ln	1481
Total Trucks, %	21.26	Capacity (c), pc/h/ln	2288
Single-Unit Trucks (SUT), %	-	Adjusted Capacity (cadj), pc/h/ln	2288
Tractor-Trailers (TT), %	-	Volume-to-Capacity Ratio (v/c)	0.65
Passenger Car Equivalent (ET)	2.000		

Speed and Density

Lane Width Adjustment (fLW)	0.0	Average Speed (S), mi/h	58.8
Right-Side Lateral Clearance Adj. (fRLC)	0.0	Density (D), pc/mi/ln	25.2
Total Ramp Density Adjustment	6.2	Level of Service (LOS)	C
Adjusted Free-Flow Speed (FFSadj), mi/h	58.8		

HCS7 Freeway Merge Report

Project Information

Analyst	LSA	Date	12/11/2019
Agency	LSA	Analysis Year	Phase II Proj Comp Yr (2039) NP
Jurisdiction	Caltrans	Time Period Analyzed	PM Peak Hour
Project Description	CMD1801 - Village D Specific Plan	Unit	United States Customary

Geometric Data

	Freeway	Ramp
Number of Lanes (N), ln	3	1
Free-Flow Speed (FFS), mi/h	65.0	35.0
Segment Length (L) / Acceleration Length (LA),ft	1500	350
Terrain Type	Level	Level
Percent Grade, %	-	-
Segment Type / Ramp Side	Freeway	Right

Adjustment Factors

Driver Population	All Familiar	All Familiar
Weather Type	Non-Severe Weather	Non-Severe Weather
Incident Type	No Incident	-
Final Speed Adjustment Factor (SAF)	1.000	1.000
Final Capacity Adjustment Factor (CAF)	1.000	1.000
Demand Adjustment Factor (DAF)	1.000	1.000

Demand and Capacity

Demand Volume (Vi)	3445	699
Peak Hour Factor (PHF)	0.94	0.94
Total Trucks, %	21.26	1.56
Single-Unit Trucks (SUT), %	-	-
Tractor-Trailers (TT), %	-	-
Heavy Vehicle Adjustment Factor (fHV)	0.825	0.985
Flow Rate (vi),pc/h	4442	755
Capacity (c), pc/h	7050	2000
Volume-to-Capacity Ratio (v/c)	0.74	0.38

Speed and Density

Upstream Equilibrium Distance (LEQ), ft	-	Number of Outer Lanes on Freeway (NO)	1
Distance to Upstream Ramp (LUP), ft	-	Speed Index (MS)	0.409
Downstream Equilibrium Distance (LEQ), ft	-	Flow Outer Lanes (vOA), pc/h/ln	1835
Distance to Downstream Ramp (LDOWN), ft	-	On-Ramp Influence Area Speed (SR), mi/h	55.6
Prop. Freeway Vehicles in Lane 1 and 2 (PFM)	0.587	Outer Lanes Freeway Speed (SO), mi/h	60.2
Flow in Lanes 1 and 2 (v12), pc/h	2607	Ramp Junction Speed (S), mi/h	57.1
Flow Entering Ramp-Infl. Area (vR12), pc/h	3362	Average Density (D), pc/mi/ln	30.3
Level of Service (LOS)	D	Density in Ramp Influence Area (DR), pc/mi/ln	29.2

HCS7 Basic Freeway Report

Project Information

Analyst	LSA	Date	12/11/2019
Agency	LSA	Analysis Year	Phase II Proj Comp Yr (2039) NP
Jurisdiction	Caltrans	Time Period Analyzed	PM Peak Hour
Project Description	CMD1801 - Village D Specific Plan	Unit	United States Customary

Geometric Data

Number of Lanes, ln	3	Terrain Type	Level
Segment Length (L), ft	-	Percent Grade, %	-
Measured or Base Free-Flow Speed	Base	Grade Length, mi	-
Base Free-Flow Speed (BFFS), mi/h	65.0	Total Ramp Density (TRD), ramps/mi	2.17
Lane Width, ft	12	Free-Flow Speed (FFS), mi/h	58.8
Right-Side Lateral Clearance, ft	10		

Adjustment Factors

Driver Population	All Familiar	Final Speed Adjustment Factor (SAF)	1.000
Weather Type	Non-Severe Weather	Final Capacity Adjustment Factor (CAF)	1.000
Incident Type	No Incident	Demand Adjustment Factor (DAF)	1.000

Demand and Capacity

Demand Volume veh/h	4145	Heavy Vehicle Adjustment Factor (fhv)	0.848
Peak Hour Factor	0.94	Flow Rate (Vp), pc/h/ln	1733
Total Trucks, %	17.92	Capacity (c), pc/h/ln	2288
Single-Unit Trucks (SUT), %	-	Adjusted Capacity (cadj), pc/h/ln	2288
Tractor-Trailers (TT), %	-	Volume-to-Capacity Ratio (v/c)	0.76
Passenger Car Equivalent (ET)	2.000		

Speed and Density

Lane Width Adjustment (fLW)	0.0	Average Speed (S), mi/h	58.7
Right-Side Lateral Clearance Adj. (fRLC)	0.0	Density (D), pc/mi/ln	29.5
Total Ramp Density Adjustment	6.2	Level of Service (LOS)	D
Adjusted Free-Flow Speed (FFSadj), mi/h	58.8		

HCS7 Freeway Diverge Report

Project Information

Analyst	LSA	Date	12/11/2019
Agency	LSA	Analysis Year	Phase II Proj Comp Yr (2039) NP
Jurisdiction	Caltrans	Time Period Analyzed	PM Peak Hour
Project Description	CMD1801 - Village D Specific Plan	Unit	United States Customary

Geometric Data

	Freeway	Ramp
Number of Lanes (N), ln	3	1
Free-Flow Speed (FFS), mi/h	65.0	15.0
Segment Length (L) / Deceleration Length (LA),ft	1500	150
Terrain Type	Level	Level
Percent Grade, %	-	-
Segment Type / Ramp Side	Freeway	Right

Adjustment Factors

Driver Population	All Familiar	All Familiar
Weather Type	Non-Severe Weather	Non-Severe Weather
Incident Type	No Incident	-
Final Speed Adjustment Factor (SAF)	1.000	1.000
Final Capacity Adjustment Factor (CAF)	1.000	1.000
Demand Adjustment Factor (DAF)	1.000	1.000

Demand and Capacity

Demand Volume (Vi)	4145	294
Peak Hour Factor (PHF)	0.94	0.94
Total Trucks, %	17.92	2.80
Single-Unit Trucks (SUT), %	-	-
Tractor-Trailers (TT), %	-	-
Heavy Vehicle Adjustment Factor (fHV)	0.848	0.973
Flow Rate (vi),pc/h	5200	321
Capacity (c), pc/h	7050	1800
Volume-to-Capacity Ratio (v/c)	0.74	0.18

Speed and Density

Upstream Equilibrium Distance (LEQ), ft	-	Number of Outer Lanes on Freeway (NO)	1
Distance to Upstream Ramp (LUP), ft	-	Speed Index (DS)	0.717
Downstream Equilibrium Distance (LEQ), ft	-	Flow Outer Lanes (vOA), pc/h/ln	1878
Distance to Downstream Ramp (LDOWN), ft	-	Off-Ramp Influence Area Speed (SR), mi/h	48.5
Prop. Freeway Vehicles in Lane 1 and 2 (PFD)	0.615	Outer Lanes Freeway Speed (SO), mi/h	67.9
Flow in Lanes 1 and 2 (v12), pc/h	3322	Ramp Junction Speed (S), mi/h	54.1
Flow Entering Ramp-Infl. Area (vR12), pc/h	-	Average Density (D), pc/mi/ln	32.0
Level of Service (LOS)	D	Density in Ramp Influence Area (DR), pc/mi/ln	31.5

HCS7 Basic Freeway Report

Project Information

Analyst	LSA	Date	12/11/2019
Agency	LSA	Analysis Year	Phase II Proj Comp Yr (2039) NP
Jurisdiction	Caltrans	Time Period Analyzed	PM Peak Hour
Project Description	CMD1801 - Village D Specific Plan	Unit	United States Customary

Geometric Data

Number of Lanes, ln	3	Terrain Type	Level
Segment Length (L), ft	-	Percent Grade, %	-
Measured or Base Free-Flow Speed	Base	Grade Length, mi	-
Base Free-Flow Speed (BFFS), mi/h	65.0	Total Ramp Density (TRD), ramps/mi	1.83
Lane Width, ft	12	Free-Flow Speed (FFS), mi/h	59.7
Right-Side Lateral Clearance, ft	10		

Adjustment Factors

Driver Population	All Familiar	Final Speed Adjustment Factor (SAF)	1.000
Weather Type	Non-Severe Weather	Final Capacity Adjustment Factor (CAF)	1.000
Incident Type	No Incident	Demand Adjustment Factor (DAF)	1.000

Demand and Capacity

Demand Volume veh/h	3851	Heavy Vehicle Adjustment Factor (fhv)	0.840
Peak Hour Factor	0.94	Flow Rate (Vp), pc/h/ln	1626
Total Trucks, %	19.08	Capacity (c), pc/h/ln	2296
Single-Unit Trucks (SUT), %	-	Adjusted Capacity (cadj), pc/h/ln	2296
Tractor-Trailers (TT), %	-	Volume-to-Capacity Ratio (v/c)	0.71
Passenger Car Equivalent (ET)	2.000		

Speed and Density

Lane Width Adjustment (fLW)	0.0	Average Speed (S), mi/h	59.6
Right-Side Lateral Clearance Adj. (fRLC)	0.0	Density (D), pc/mi/ln	27.3
Total Ramp Density Adjustment	5.4	Level of Service (LOS)	D
Adjusted Free-Flow Speed (FFSadj), mi/h	59.6		

HCS7 Freeway Merge Report

Project Information

Analyst	LSA	Date	12/11/2019
Agency	LSA	Analysis Year	Phase II Proj Comp Yr (2039) NP
Jurisdiction	Caltrans	Time Period Analyzed	PM Peak Hour
Project Description	CMD1801 - Village D Specific Plan	Unit	United States Customary

Geometric Data

	Freeway	Ramp
Number of Lanes (N), ln	3	1
Free-Flow Speed (FFS), mi/h	65.0	35.0
Segment Length (L) / Acceleration Length (LA),ft	1500	450
Terrain Type	Level	Level
Percent Grade, %	-	-
Segment Type / Ramp Side	Freeway	Right

Adjustment Factors

Driver Population	All Familiar	All Familiar
Weather Type	Non-Severe Weather	Non-Severe Weather
Incident Type	No Incident	-
Final Speed Adjustment Factor (SAF)	1.000	1.000
Final Capacity Adjustment Factor (CAF)	1.000	1.000
Demand Adjustment Factor (DAF)	1.000	1.000

Demand and Capacity

Demand Volume (Vi)	3851	503
Peak Hour Factor (PHF)	0.94	0.94
Total Trucks, %	19.08	1.18
Single-Unit Trucks (SUT), %	-	-
Tractor-Trailers (TT), %	-	-
Heavy Vehicle Adjustment Factor (fHV)	0.840	0.988
Flow Rate (vi),pc/h	4877	542
Capacity (c), pc/h	7050	2000
Volume-to-Capacity Ratio (v/c)	0.77	0.27

Speed and Density

Upstream Equilibrium Distance (LEQ), ft	-	Number of Outer Lanes on Freeway (NO)	1
Distance to Upstream Ramp (LUP), ft	-	Speed Index (MS)	0.409
Downstream Equilibrium Distance (LEQ), ft	-	Flow Outer Lanes (vOA), pc/h/ln	2000
Distance to Downstream Ramp (LDOWN), ft	-	On-Ramp Influence Area Speed (SR), mi/h	55.6
Prop. Freeway Vehicles in Lane 1 and 2 (PFM)	0.590	Outer Lanes Freeway Speed (SO), mi/h	59.6
Flow in Lanes 1 and 2 (v12), pc/h	2877	Ramp Junction Speed (S), mi/h	57.0
Flow Entering Ramp-Infl. Area (vR12), pc/h	3419	Average Density (D), pc/mi/ln	31.7
Level of Service (LOS)	D	Density in Ramp Influence Area (DR), pc/mi/ln	29.1

HCS7 Basic Freeway Report

Project Information

Analyst	LSA	Date	12/11/2019
Agency	LSA	Analysis Year	Phase II Proj Comp Yr (2039) NP
Jurisdiction	Caltrans	Time Period Analyzed	PM Peak Hour
Project Description	CMD1801 - Village D Specific Plan	Unit	United States Customary

Geometric Data

Number of Lanes, ln	3	Terrain Type	Level
Segment Length (L), ft	-	Percent Grade, %	-
Measured or Base Free-Flow Speed	Base	Grade Length, mi	-
Base Free-Flow Speed (BFFS), mi/h	65.0	Total Ramp Density (TRD), ramps/mi	1.83
Lane Width, ft	12	Free-Flow Speed (FFS), mi/h	59.7
Right-Side Lateral Clearance, ft	10		

Adjustment Factors

Driver Population	All Familiar	Final Speed Adjustment Factor (SAF)	1.000
Weather Type	Non-Severe Weather	Final Capacity Adjustment Factor (CAF)	1.000
Incident Type	No Incident	Demand Adjustment Factor (DAF)	1.000

Demand and Capacity

Demand Volume veh/h	4354	Heavy Vehicle Adjustment Factor (fhv)	0.855
Peak Hour Factor	0.94	Flow Rate (Vp), pc/h/ln	1806
Total Trucks, %	17.00	Capacity (c), pc/h/ln	2296
Single-Unit Trucks (SUT), %	-	Adjusted Capacity (cadj), pc/h/ln	2296
Tractor-Trailers (TT), %	-	Volume-to-Capacity Ratio (v/c)	0.79
Passenger Car Equivalent (ET)	2.000		

Speed and Density

Lane Width Adjustment (fLW)	0.0	Average Speed (S), mi/h	58.9
Right-Side Lateral Clearance Adj. (fRLC)	0.0	Density (D), pc/mi/ln	30.7
Total Ramp Density Adjustment	5.4	Level of Service (LOS)	D
Adjusted Free-Flow Speed (FFSadj), mi/h	59.6		

HCS7 Freeway Diverge Report

Project Information

Analyst	LSA	Date	12/11/2019
Agency	LSA	Analysis Year	Phase II Proj Comp Yr (2039) NP
Jurisdiction	Caltrans	Time Period Analyzed	PM Peak Hour
Project Description	CMD1801 - Village D Specific Plan	Unit	United States Customary

Geometric Data

	Freeway	Ramp
Number of Lanes (N), In	3	1
Free-Flow Speed (FFS), mi/h	65.0	35.0
Segment Length (L) / Deceleration Length (LA),ft	1500	140
Terrain Type	Level	Level
Percent Grade, %	-	-
Segment Type / Ramp Side	Freeway	Right

Adjustment Factors

Driver Population	All Familiar	All Familiar
Weather Type	Non-Severe Weather	Non-Severe Weather
Incident Type	No Incident	-
Final Speed Adjustment Factor (SAF)	1.000	1.000
Final Capacity Adjustment Factor (CAF)	1.000	1.000
Demand Adjustment Factor (DAF)	1.000	1.000

Demand and Capacity

Demand Volume (Vi)	4354	615
Peak Hour Factor (PHF)	0.94	0.94
Total Trucks, %	17.00	4.45
Single-Unit Trucks (SUT), %	-	-
Tractor-Trailers (TT), %	-	-
Heavy Vehicle Adjustment Factor (fHV)	0.855	0.957
Flow Rate (vi),pc/h	5417	684
Capacity (c), pc/h	7050	2000
Volume-to-Capacity Ratio (v/c)	0.77	0.34

Speed and Density

Upstream Equilibrium Distance (LEQ), ft	-	Number of Outer Lanes on Freeway (NO)	1
Distance to Upstream Ramp (LUP), ft	-	Speed Index (DS)	0.490
Downstream Equilibrium Distance (LEQ), ft	-	Flow Outer Lanes (vOA), pc/h/ln	1926
Distance to Downstream Ramp (LDOWN), ft	-	Off-Ramp Influence Area Speed (SR), mi/h	53.7
Prop. Freeway Vehicles in Lane 1 and 2 (PFD)	0.593	Outer Lanes Freeway Speed (SO), mi/h	67.7
Flow in Lanes 1 and 2 (v12), pc/h	3491	Ramp Junction Speed (S), mi/h	58.0
Flow Entering Ramp-Infl. Area (vR12), pc/h	-	Average Density (D), pc/mi/ln	31.1
Level of Service (LOS)	D	Density in Ramp Influence Area (DR), pc/mi/ln	33.0

HCS7 Basic Freeway Report

Project Information

Analyst	LSA	Date	12/11/2019
Agency	LSA	Analysis Year	Phase II Proj Comp Yr (2039) NP
Jurisdiction	Caltrans	Time Period Analyzed	PM Peak Hour
Project Description	CMD1801 - Village D Specific Plan	Unit	United States Customary

Geometric Data

Number of Lanes, ln	3	Terrain Type	Level
Segment Length (L), ft	-	Percent Grade, %	-
Measured or Base Free-Flow Speed	Base	Grade Length, mi	-
Base Free-Flow Speed (BFFS), mi/h	65.0	Total Ramp Density (TRD), ramps/mi	2.17
Lane Width, ft	12	Free-Flow Speed (FFS), mi/h	58.8
Right-Side Lateral Clearance, ft	10		

Adjustment Factors

Driver Population	All Familiar	Final Speed Adjustment Factor (SAF)	1.000
Weather Type	Non-Severe Weather	Final Capacity Adjustment Factor (CAF)	1.000
Incident Type	No Incident	Demand Adjustment Factor (DAF)	1.000

Demand and Capacity

Demand Volume veh/h	3739	Heavy Vehicle Adjustment Factor (fhv)	0.840
Peak Hour Factor	0.94	Flow Rate (Vp), pc/h/ln	1578
Total Trucks, %	19.06	Capacity (c), pc/h/ln	2288
Single-Unit Trucks (SUT), %	-	Adjusted Capacity (cadj), pc/h/ln	2288
Tractor-Trailers (TT), %	-	Volume-to-Capacity Ratio (v/c)	0.69
Passenger Car Equivalent (ET)	2.000		

Speed and Density

Lane Width Adjustment (fLW)	0.0	Average Speed (S), mi/h	58.8
Right-Side Lateral Clearance Adj. (fRLC)	0.0	Density (D), pc/mi/ln	26.8
Total Ramp Density Adjustment	6.2	Level of Service (LOS)	D
Adjusted Free-Flow Speed (FFSadj), mi/h	58.8		

HCS7 Freeway Merge Report

Project Information

Analyst	LSA	Date	12/11/2019
Agency	LSA	Analysis Year	Phase II Proj Comp Yr (2039) NP
Jurisdiction	Caltrans	Time Period Analyzed	PM Peak Hour
Project Description	CMD1801 - Village D Specific Plan	Unit	United States Customary

Geometric Data

	Freeway	Ramp
Number of Lanes (N), ln	3	1
Free-Flow Speed (FFS), mi/h	65.0	35.0
Segment Length (L) / Acceleration Length (LA),ft	1500	450
Terrain Type	Level	Level
Percent Grade, %	-	-
Segment Type / Ramp Side	Freeway	Right

Adjustment Factors

Driver Population	All Familiar	All Familiar
Weather Type	Non-Severe Weather	Non-Severe Weather
Incident Type	No Incident	-
Final Speed Adjustment Factor (SAF)	1.000	1.000
Final Capacity Adjustment Factor (CAF)	1.000	1.000
Demand Adjustment Factor (DAF)	1.000	1.000

Demand and Capacity

Demand Volume (Vi)	3739	354
Peak Hour Factor (PHF)	0.94	0.94
Total Trucks, %	19.06	1.70
Single-Unit Trucks (SUT), %	-	-
Tractor-Trailers (TT), %	-	-
Heavy Vehicle Adjustment Factor (fHV)	0.840	0.983
Flow Rate (vi),pc/h	4735	383
Capacity (c), pc/h	7050	2000
Volume-to-Capacity Ratio (v/c)	0.73	0.19

Speed and Density

Upstream Equilibrium Distance (LEQ), ft	-	Number of Outer Lanes on Freeway (NO)	1
Distance to Upstream Ramp (LUP), ft	-	Speed Index (MS)	0.383
Downstream Equilibrium Distance (LEQ), ft	-	Flow Outer Lanes (vOA), pc/h/ln	1941
Distance to Downstream Ramp (LDOWN), ft	-	On-Ramp Influence Area Speed (SR), mi/h	56.2
Prop. Freeway Vehicles in Lane 1 and 2 (PFM)	0.590	Outer Lanes Freeway Speed (SO), mi/h	59.8
Flow in Lanes 1 and 2 (v12), pc/h	2794	Ramp Junction Speed (S), mi/h	57.5
Flow Entering Ramp-Infl. Area (vR12), pc/h	3177	Average Density (D), pc/mi/ln	29.7
Level of Service (LOS)	C	Density in Ramp Influence Area (DR), pc/mi/ln	27.3

HCS7 Basic Freeway Report

Project Information

Analyst	LSA	Date	12/11/2019
Agency	LSA	Analysis Year	Phase II Proj Comp Yr (2039) NP
Jurisdiction	Caltrans	Time Period Analyzed	PM Peak Hour
Project Description	CMD1801 - Village D Specific Plan	Unit	United States Customary

Geometric Data

Number of Lanes, ln	3	Terrain Type	Level
Segment Length (L), ft	-	Percent Grade, %	-
Measured or Base Free-Flow Speed	Base	Grade Length, mi	-
Base Free-Flow Speed (BFFS), mi/h	65.0	Total Ramp Density (TRD), ramps/mi	2.17
Lane Width, ft	12	Free-Flow Speed (FFS), mi/h	58.8
Right-Side Lateral Clearance, ft	10		

Adjustment Factors

Driver Population	All Familiar	Final Speed Adjustment Factor (SAF)	1.000
Weather Type	Non-Severe Weather	Final Capacity Adjustment Factor (CAF)	1.000
Incident Type	No Incident	Demand Adjustment Factor (DAF)	1.000

Demand and Capacity

Demand Volume veh/h	4093	Heavy Vehicle Adjustment Factor (fhv)	0.851
Peak Hour Factor	0.94	Flow Rate (Vp), pc/h/ln	1706
Total Trucks, %	17.57	Capacity (c), pc/h/ln	2288
Single-Unit Trucks (SUT), %	-	Adjusted Capacity (cadj), pc/h/ln	2288
Tractor-Trailers (TT), %	-	Volume-to-Capacity Ratio (v/c)	0.75
Passenger Car Equivalent (ET)	2.000		

Speed and Density

Lane Width Adjustment (fLW)	0.0	Average Speed (S), mi/h	58.7
Right-Side Lateral Clearance Adj. (fRLC)	0.0	Density (D), pc/mi/ln	29.1
Total Ramp Density Adjustment	6.2	Level of Service (LOS)	D
Adjusted Free-Flow Speed (FFSadj), mi/h	58.8		

HCS7 Basic Freeway Report

Project Information

Analyst	LSA	Date	12/11/2019
Agency	LSA	Analysis Year	Phase II Proj Comp Yr (2039) WP
Jurisdiction	Caltrans	Time Period Analyzed	AM Peak Hour
Project Description	CMD1801 - Village D Specific Plan	Unit	United States Customary

Geometric Data

Number of Lanes, ln	3	Terrain Type	Level
Segment Length (L), ft	-	Percent Grade, %	-
Measured or Base Free-Flow Speed	Base	Grade Length, mi	-
Base Free-Flow Speed (BFFS), mi/h	65.0	Total Ramp Density (TRD), ramps/mi	1.83
Lane Width, ft	12	Free-Flow Speed (FFS), mi/h	59.7
Right-Side Lateral Clearance, ft	10		

Adjustment Factors

Driver Population	All Familiar	Final Speed Adjustment Factor (SAF)	1.000
Weather Type	Non-Severe Weather	Final Capacity Adjustment Factor (CAF)	1.000
Incident Type	No Incident	Demand Adjustment Factor (DAF)	1.000

Demand and Capacity

Demand Volume veh/h	3485	Heavy Vehicle Adjustment Factor (fhv)	0.858
Peak Hour Factor	0.94	Flow Rate (Vp), pc/h/ln	1440
Total Trucks, %	16.52	Capacity (c), pc/h/ln	2296
Single-Unit Trucks (SUT), %	-	Adjusted Capacity (cadj), pc/h/ln	2296
Tractor-Trailers (TT), %	-	Volume-to-Capacity Ratio (v/c)	0.63
Passenger Car Equivalent (ET)	2.000		

Speed and Density

Lane Width Adjustment (fLW)	0.0	Average Speed (S), mi/h	59.6
Right-Side Lateral Clearance Adj. (fRLC)	0.0	Density (D), pc/mi/ln	24.2
Total Ramp Density Adjustment	5.4	Level of Service (LOS)	C
Adjusted Free-Flow Speed (FFSadj), mi/h	59.6		

HCS7 Freeway Diverge Report

Project Information

Analyst	LSA	Date	12/11/2019
Agency	LSA	Analysis Year	Phase II Proj Comp Yr (2039) WP
Jurisdiction	Caltrans	Time Period Analyzed	AM Peak Hour
Project Description	CMD1801 - Village D Specific Plan	Unit	United States Customary

Geometric Data

	Freeway	Ramp
Number of Lanes (N), ln	3	1
Free-Flow Speed (FFS), mi/h	65.0	35.0
Segment Length (L) / Deceleration Length (LA),ft	1500	150
Terrain Type	Level	Level
Percent Grade, %	-	-
Segment Type / Ramp Side	Freeway	Right

Adjustment Factors

Driver Population	All Familiar	All Familiar
Weather Type	Non-Severe Weather	Non-Severe Weather
Incident Type	No Incident	-
Final Speed Adjustment Factor (SAF)	1.000	1.000
Final Capacity Adjustment Factor (CAF)	1.000	1.000
Demand Adjustment Factor (DAF)	1.000	1.000

Demand and Capacity

Demand Volume (Vi)	3485	304
Peak Hour Factor (PHF)	0.94	0.94
Total Trucks, %	16.52	4.61
Single-Unit Trucks (SUT), %	-	-
Tractor-Trailers (TT), %	-	-
Heavy Vehicle Adjustment Factor (fHV)	0.858	0.956
Flow Rate (vi),pc/h	4321	338
Capacity (c), pc/h	7050	2000
Volume-to-Capacity Ratio (v/c)	0.61	0.17

Speed and Density

Upstream Equilibrium Distance (LEQ), ft	-	Number of Outer Lanes on Freeway (NO)	1
Distance to Upstream Ramp (LUP), ft	-	Speed Index (DS)	0.458
Downstream Equilibrium Distance (LEQ), ft	-	Flow Outer Lanes (vOA), pc/h/ln	1450
Distance to Downstream Ramp (LDOWN), ft	-	Off-Ramp Influence Area Speed (SR), mi/h	54.5
Prop. Freeway Vehicles in Lane 1 and 2 (PFD)	0.636	Outer Lanes Freeway Speed (SO), mi/h	69.6
Flow in Lanes 1 and 2 (v12), pc/h	2871	Ramp Junction Speed (S), mi/h	58.8
Flow Entering Ramp-Infl. Area (vR12), pc/h	-	Average Density (D), pc/mi/ln	24.5
Level of Service (LOS)	C	Density in Ramp Influence Area (DR), pc/mi/ln	27.6

HCS7 Basic Freeway Report

Project Information

Analyst	LSA	Date	12/11/2019
Agency	LSA	Analysis Year	Phase II Proj Comp Yr (2039) WP
Jurisdiction	Caltrans	Time Period Analyzed	AM Peak Hour
Project Description	CMD1801 - Village D Specific Plan	Unit	United States Customary

Geometric Data

Number of Lanes, ln	3	Terrain Type	Level
Segment Length (L), ft	-	Percent Grade, %	-
Measured or Base Free-Flow Speed	Base	Grade Length, mi	-
Base Free-Flow Speed (BFFS), mi/h	65.0	Total Ramp Density (TRD), ramps/mi	1.83
Lane Width, ft	12	Free-Flow Speed (FFS), mi/h	59.7
Right-Side Lateral Clearance, ft	10		

Adjustment Factors

Driver Population	All Familiar	Final Speed Adjustment Factor (SAF)	1.000
Weather Type	Non-Severe Weather	Final Capacity Adjustment Factor (CAF)	1.000
Incident Type	No Incident	Demand Adjustment Factor (DAF)	1.000

Demand and Capacity

Demand Volume veh/h	3181	Heavy Vehicle Adjustment Factor (fhv)	0.850
Peak Hour Factor	0.94	Flow Rate (Vp), pc/h/ln	1327
Total Trucks, %	17.67	Capacity (c), pc/h/ln	2296
Single-Unit Trucks (SUT), %	-	Adjusted Capacity (cadj), pc/h/ln	2296
Tractor-Trailers (TT), %	-	Volume-to-Capacity Ratio (v/c)	0.58
Passenger Car Equivalent (ET)	2.000		

Speed and Density

Lane Width Adjustment (fLW)	0.0	Average Speed (S), mi/h	59.6
Right-Side Lateral Clearance Adj. (fRLC)	0.0	Density (D), pc/mi/ln	22.3
Total Ramp Density Adjustment	5.4	Level of Service (LOS)	C
Adjusted Free-Flow Speed (FFSadj), mi/h	59.6		

HCS7 Freeway Merge Report

Project Information

Analyst	LSA	Date	12/11/2019
Agency	LSA	Analysis Year	Phase II Proj Comp Yr (2039) WP
Jurisdiction	Caltrans	Time Period Analyzed	AM Peak Hour
Project Description	CMD1801 - Village D Specific Plan	Unit	United States Customary

Geometric Data

	Freeway	Ramp
Number of Lanes (N), ln	3	1
Free-Flow Speed (FFS), mi/h	65.0	35.0
Segment Length (L) / Acceleration Length (LA),ft	1500	445
Terrain Type	Level	Level
Percent Grade, %	-	-
Segment Type / Ramp Side	Freeway	Right

Adjustment Factors

Driver Population	All Familiar	All Familiar
Weather Type	Non-Severe Weather	Non-Severe Weather
Incident Type	No Incident	-
Final Speed Adjustment Factor (SAF)	1.000	1.000
Final Capacity Adjustment Factor (CAF)	1.000	1.000
Demand Adjustment Factor (DAF)	1.000	1.000

Demand and Capacity

Demand Volume (Vi)	3181	861
Peak Hour Factor (PHF)	0.94	0.94
Total Trucks, %	17.67	9.18
Single-Unit Trucks (SUT), %	-	-
Tractor-Trailers (TT), %	-	-
Heavy Vehicle Adjustment Factor (fHV)	0.850	0.916
Flow Rate (vi),pc/h	3981	1000
Capacity (c), pc/h	7050	2000
Volume-to-Capacity Ratio (v/c)	0.71	0.50

Speed and Density

Upstream Equilibrium Distance (LEQ), ft	-	Number of Outer Lanes on Freeway (NO)	1
Distance to Upstream Ramp (LUP), ft	-	Speed Index (MS)	0.401
Downstream Equilibrium Distance (LEQ), ft	-	Flow Outer Lanes (vOA), pc/h/ln	1632
Distance to Downstream Ramp (LDOWN), ft	-	On-Ramp Influence Area Speed (SR), mi/h	55.8
Prop. Freeway Vehicles in Lane 1 and 2 (PFM)	0.590	Outer Lanes Freeway Speed (SO), mi/h	60.9
Flow in Lanes 1 and 2 (v12), pc/h	2349	Ramp Junction Speed (S), mi/h	57.4
Flow Entering Ramp-Infl. Area (vR12), pc/h	3349	Average Density (D), pc/mi/ln	28.9
Level of Service (LOS)	D	Density in Ramp Influence Area (DR), pc/mi/ln	28.4

HCS7 Basic Freeway Report

Project Information

Analyst	LSA	Date	12/11/2019
Agency	LSA	Analysis Year	Phase II Proj Comp Yr (2039) WP
Jurisdiction	Caltrans	Time Period Analyzed	AM Peak Hour
Project Description	CMD1801 - Village D Specific Plan	Unit	United States Customary

Geometric Data

Number of Lanes, ln	3	Terrain Type	Level
Segment Length (L), ft	-	Percent Grade, %	-
Measured or Base Free-Flow Speed	Base	Grade Length, mi	-
Base Free-Flow Speed (BFFS), mi/h	65.0	Total Ramp Density (TRD), ramps/mi	1.50
Lane Width, ft	12	Free-Flow Speed (FFS), mi/h	60.5
Right-Side Lateral Clearance, ft	10		

Adjustment Factors

Driver Population	All Familiar	Final Speed Adjustment Factor (SAF)	1.000
Weather Type	Non-Severe Weather	Final Capacity Adjustment Factor (CAF)	1.000
Incident Type	No Incident	Demand Adjustment Factor (DAF)	1.000

Demand and Capacity

Demand Volume veh/h	4042	Heavy Vehicle Adjustment Factor (fhv)	0.863
Peak Hour Factor	0.94	Flow Rate (Vp), pc/h/ln	1661
Total Trucks, %	15.87	Capacity (c), pc/h/ln	2305
Single-Unit Trucks (SUT), %	-	Adjusted Capacity (cadj), pc/h/ln	2305
Tractor-Trailers (TT), %	-	Volume-to-Capacity Ratio (v/c)	0.72
Passenger Car Equivalent (ET)	2.000		

Speed and Density

Lane Width Adjustment (fLW)	0.0	Average Speed (S), mi/h	60.4
Right-Side Lateral Clearance Adj. (fRLC)	0.0	Density (D), pc/mi/ln	27.5
Total Ramp Density Adjustment	4.5	Level of Service (LOS)	D
Adjusted Free-Flow Speed (FFSadj), mi/h	60.5		

HCS7 Freeway Diverge Report

Project Information

Analyst	LSA	Date	12/11/2019
Agency	LSA	Analysis Year	Phase II Proj Comp Yr (2039) WP
Jurisdiction	Caltrans	Time Period Analyzed	AM Peak Hour
Project Description	CMD1801 - Village D Specific Plan	Unit	United States Customary

Geometric Data

	Freeway	Ramp
Number of Lanes (N), ln	3	1
Free-Flow Speed (FFS), mi/h	65.0	35.0
Segment Length (L) / Deceleration Length (LA),ft	1500	130
Terrain Type	Level	Level
Percent Grade, %	-	-
Segment Type / Ramp Side	Freeway	Right

Adjustment Factors

Driver Population	All Familiar	All Familiar
Weather Type	Non-Severe Weather	Non-Severe Weather
Incident Type	No Incident	-
Final Speed Adjustment Factor (SAF)	1.000	1.000
Final Capacity Adjustment Factor (CAF)	1.000	1.000
Demand Adjustment Factor (DAF)	1.000	1.000

Demand and Capacity

Demand Volume (Vi)	4042	523
Peak Hour Factor (PHF)	0.94	0.94
Total Trucks, %	15.87	1.72
Single-Unit Trucks (SUT), %	-	-
Tractor-Trailers (TT), %	-	-
Heavy Vehicle Adjustment Factor (fHV)	0.863	0.983
Flow Rate (vi),pc/h	4983	566
Capacity (c), pc/h	7050	2000
Volume-to-Capacity Ratio (v/c)	0.71	0.28

Speed and Density

Upstream Equilibrium Distance (LEQ), ft	-	Number of Outer Lanes on Freeway (NO)	1
Distance to Upstream Ramp (LUP), ft	-	Speed Index (DS)	0.479
Downstream Equilibrium Distance (LEQ), ft	-	Flow Outer Lanes (vOA), pc/h/ln	1727
Distance to Downstream Ramp (LDOWN), ft	-	Off-Ramp Influence Area Speed (SR), mi/h	54.0
Prop. Freeway Vehicles in Lane 1 and 2 (PFD)	0.609	Outer Lanes Freeway Speed (SO), mi/h	68.5
Flow in Lanes 1 and 2 (v12), pc/h	3256	Ramp Junction Speed (S), mi/h	58.3
Flow Entering Ramp-Infl. Area (vR12), pc/h	-	Average Density (D), pc/mi/ln	28.5
Level of Service (LOS)	D	Density in Ramp Influence Area (DR), pc/mi/ln	31.1

HCS7 Basic Freeway Report

Project Information

Analyst	LSA	Date	12/11/2019
Agency	LSA	Analysis Year	Phase II Proj Comp Yr (2039) WP
Jurisdiction	Caltrans	Time Period Analyzed	AM Peak Hour
Project Description	CMD1801 - Village D Specific Plan	Unit	United States Customary

Geometric Data

Number of Lanes, ln	3	Terrain Type	Level
Segment Length (L), ft	-	Percent Grade, %	-
Measured or Base Free-Flow Speed	Base	Grade Length, mi	-
Base Free-Flow Speed (BFFS), mi/h	65.0	Total Ramp Density (TRD), ramps/mi	1.67
Lane Width, ft	12	Free-Flow Speed (FFS), mi/h	60.0
Right-Side Lateral Clearance, ft	10		

Adjustment Factors

Driver Population	All Familiar	Final Speed Adjustment Factor (SAF)	1.000
Weather Type	Non-Severe Weather	Final Capacity Adjustment Factor (CAF)	1.000
Incident Type	No Incident	Demand Adjustment Factor (DAF)	1.000

Demand and Capacity

Demand Volume veh/h	3519	Heavy Vehicle Adjustment Factor (fhv)	0.848
Peak Hour Factor	0.94	Flow Rate (Vp), pc/h/ln	1472
Total Trucks, %	17.97	Capacity (c), pc/h/ln	2300
Single-Unit Trucks (SUT), %	-	Adjusted Capacity (cadj), pc/h/ln	2300
Tractor-Trailers (TT), %	-	Volume-to-Capacity Ratio (v/c)	0.64
Passenger Car Equivalent (ET)	2.000		

Speed and Density

Lane Width Adjustment (fLW)	0.0	Average Speed (S), mi/h	60.0
Right-Side Lateral Clearance Adj. (fRLC)	0.0	Density (D), pc/mi/ln	24.5
Total Ramp Density Adjustment	5.0	Level of Service (LOS)	C
Adjusted Free-Flow Speed (FFSadj), mi/h	60.0		

HCS7 Freeway Merge Report

Project Information

Analyst	LSA	Date	12/11/2019
Agency	LSA	Analysis Year	Phase II Proj Comp Yr (2039) WP
Jurisdiction	Caltrans	Time Period Analyzed	AM Peak Hour
Project Description	CMD1801 - Village D Specific Plan	Unit	United States Customary

Geometric Data

	Freeway	Ramp
Number of Lanes (N), ln	3	1
Free-Flow Speed (FFS), mi/h	65.0	35.0
Segment Length (L) / Acceleration Length (LA),ft	1500	500
Terrain Type	Level	Level
Percent Grade, %	-	-
Segment Type / Ramp Side	Freeway	Right

Adjustment Factors

Driver Population	All Familiar	All Familiar
Weather Type	Non-Severe Weather	Non-Severe Weather
Incident Type	No Incident	-
Final Speed Adjustment Factor (SAF)	1.000	1.000
Final Capacity Adjustment Factor (CAF)	1.000	1.000
Demand Adjustment Factor (DAF)	1.000	1.000

Demand and Capacity

Demand Volume (Vi)	3519	365
Peak Hour Factor (PHF)	0.94	0.94
Total Trucks, %	17.97	2.74
Single-Unit Trucks (SUT), %	-	-
Tractor-Trailers (TT), %	-	-
Heavy Vehicle Adjustment Factor (fHV)	0.848	0.973
Flow Rate (vi),pc/h	4415	399
Capacity (c), pc/h	7050	2000
Volume-to-Capacity Ratio (v/c)	0.68	0.20

Speed and Density

Upstream Equilibrium Distance (LEQ), ft	-	Number of Outer Lanes on Freeway (NO)	1
Distance to Upstream Ramp (LUP), ft	-	Speed Index (MS)	0.365
Downstream Equilibrium Distance (LEQ), ft	-	Flow Outer Lanes (vOA), pc/h/ln	1801
Distance to Downstream Ramp (LDOWN), ft	-	On-Ramp Influence Area Speed (SR), mi/h	56.6
Prop. Freeway Vehicles in Lane 1 and 2 (PFM)	0.592	Outer Lanes Freeway Speed (SO), mi/h	60.3
Flow in Lanes 1 and 2 (v12), pc/h	2614	Ramp Junction Speed (S), mi/h	57.9
Flow Entering Ramp-Infl. Area (vR12), pc/h	3013	Average Density (D), pc/mi/ln	27.7
Level of Service (LOS)	C	Density in Ramp Influence Area (DR), pc/mi/ln	25.7

HCS7 Basic Freeway Report

Project Information

Analyst	LSA	Date	12/11/2019
Agency	LSA	Analysis Year	Phase II Proj Comp Yr (2039) WP
Jurisdiction	Caltrans	Time Period Analyzed	AM Peak Hour
Project Description	CMD1801 - Village D Specific Plan	Unit	United States Customary

Geometric Data

Number of Lanes, ln	3	Terrain Type	Level
Segment Length (L), ft	-	Percent Grade, %	-
Measured or Base Free-Flow Speed	Base	Grade Length, mi	-
Base Free-Flow Speed (BFFS), mi/h	65.0	Total Ramp Density (TRD), ramps/mi	1.83
Lane Width, ft	12	Free-Flow Speed (FFS), mi/h	59.7
Right-Side Lateral Clearance, ft	10		

Adjustment Factors

Driver Population	All Familiar	Final Speed Adjustment Factor (SAF)	1.000
Weather Type	Non-Severe Weather	Final Capacity Adjustment Factor (CAF)	1.000
Incident Type	No Incident	Demand Adjustment Factor (DAF)	1.000

Demand and Capacity

Demand Volume veh/h	3884	Heavy Vehicle Adjustment Factor (fhv)	0.858
Peak Hour Factor	0.94	Flow Rate (Vp), pc/h/ln	1605
Total Trucks, %	16.52	Capacity (c), pc/h/ln	2296
Single-Unit Trucks (SUT), %	-	Adjusted Capacity (cadj), pc/h/ln	2296
Tractor-Trailers (TT), %	-	Volume-to-Capacity Ratio (v/c)	0.70
Passenger Car Equivalent (ET)	2.000		

Speed and Density

Lane Width Adjustment (fLW)	0.0	Average Speed (S), mi/h	59.6
Right-Side Lateral Clearance Adj. (fRLC)	0.0	Density (D), pc/mi/ln	26.9
Total Ramp Density Adjustment	5.4	Level of Service (LOS)	D
Adjusted Free-Flow Speed (FFSadj), mi/h	59.6		

HCS7 Freeway Diverge Report

Project Information

Analyst	LSA	Date	12/11/2019
Agency	LSA	Analysis Year	Phase II Proj Comp Yr (2039) WP
Jurisdiction	Caltrans	Time Period Analyzed	AM Peak Hour
Project Description	CMD1801 - Village D Specific Plan	Unit	United States Customary

Geometric Data

	Freeway	Ramp
Number of Lanes (N), ln	3	1
Free-Flow Speed (FFS), mi/h	65.0	35.0
Segment Length (L) / Deceleration Length (LA),ft	1500	245
Terrain Type	Level	Level
Percent Grade, %	-	-
Segment Type / Ramp Side	Freeway	Right

Adjustment Factors

Driver Population	All Familiar	All Familiar
Weather Type	Non-Severe Weather	Non-Severe Weather
Incident Type	No Incident	-
Final Speed Adjustment Factor (SAF)	1.000	1.000
Final Capacity Adjustment Factor (CAF)	1.000	1.000
Demand Adjustment Factor (DAF)	1.000	1.000

Demand and Capacity

Demand Volume (Vi)	3884	732
Peak Hour Factor (PHF)	0.94	0.94
Total Trucks, %	16.52	3.83
Single-Unit Trucks (SUT), %	-	-
Tractor-Trailers (TT), %	-	-
Heavy Vehicle Adjustment Factor (fHV)	0.858	0.963
Flow Rate (vi),pc/h	4816	809
Capacity (c), pc/h	7050	2000
Volume-to-Capacity Ratio (v/c)	0.68	0.40

Speed and Density

Upstream Equilibrium Distance (LEQ), ft	-	Number of Outer Lanes on Freeway (NO)	1
Distance to Upstream Ramp (LUP), ft	-	Speed Index (DS)	0.501
Downstream Equilibrium Distance (LEQ), ft	-	Flow Outer Lanes (vOA), pc/h/ln	1595
Distance to Downstream Ramp (LDOWN), ft	-	Off-Ramp Influence Area Speed (SR), mi/h	53.5
Prop. Freeway Vehicles in Lane 1 and 2 (PFD)	0.602	Outer Lanes Freeway Speed (SO), mi/h	69.0
Flow in Lanes 1 and 2 (v12), pc/h	3221	Ramp Junction Speed (S), mi/h	57.8
Flow Entering Ramp-Infl. Area (vR12), pc/h	-	Average Density (D), pc/mi/ln	27.8
Level of Service (LOS)	D	Density in Ramp Influence Area (DR), pc/mi/ln	29.7

HCS7 Basic Freeway Report

Project Information

Analyst	LSA	Date	12/11/2019
Agency	LSA	Analysis Year	Phase II Proj Comp Yr (2039) WP
Jurisdiction	Caltrans	Time Period Analyzed	AM Peak Hour
Project Description	CMD1801 - Village D Specific Plan	Unit	United States Customary

Geometric Data

Number of Lanes, ln	3	Terrain Type	Level
Segment Length (L), ft	-	Percent Grade, %	-
Measured or Base Free-Flow Speed	Base	Grade Length, mi	-
Base Free-Flow Speed (BFFS), mi/h	65.0	Total Ramp Density (TRD), ramps/mi	1.83
Lane Width, ft	12	Free-Flow Speed (FFS), mi/h	59.7
Right-Side Lateral Clearance, ft	10		

Adjustment Factors

Driver Population	All Familiar	Final Speed Adjustment Factor (SAF)	1.000
Weather Type	Non-Severe Weather	Final Capacity Adjustment Factor (CAF)	1.000
Incident Type	No Incident	Demand Adjustment Factor (DAF)	1.000

Demand and Capacity

Demand Volume veh/h	3152	Heavy Vehicle Adjustment Factor (fhv)	0.837
Peak Hour Factor	0.94	Flow Rate (Vp), pc/h/ln	1335
Total Trucks, %	19.47	Capacity (c), pc/h/ln	2296
Single-Unit Trucks (SUT), %	-	Adjusted Capacity (cadj), pc/h/ln	2296
Tractor-Trailers (TT), %	-	Volume-to-Capacity Ratio (v/c)	0.58
Passenger Car Equivalent (ET)	2.000		

Speed and Density

Lane Width Adjustment (fLW)	0.0	Average Speed (S), mi/h	59.6
Right-Side Lateral Clearance Adj. (fRLC)	0.0	Density (D), pc/mi/ln	22.4
Total Ramp Density Adjustment	5.4	Level of Service (LOS)	C
Adjusted Free-Flow Speed (FFSadj), mi/h	59.6		

HCS7 Freeway Merge Report

Project Information

Analyst	LSA	Date	12/11/2019
Agency	LSA	Analysis Year	Phase II Proj Comp Yr (2039) WP
Jurisdiction	Caltrans	Time Period Analyzed	AM Peak Hour
Project Description	CMD1801 - Village D Specific Plan	Unit	United States Customary

Geometric Data

	Freeway	Ramp
Number of Lanes (N), ln	3	1
Free-Flow Speed (FFS), mi/h	65.0	35.0
Segment Length (L) / Acceleration Length (LA),ft	1500	350
Terrain Type	Level	Level
Percent Grade, %	-	-
Segment Type / Ramp Side	Freeway	Right

Adjustment Factors

Driver Population	All Familiar	All Familiar
Weather Type	Non-Severe Weather	Non-Severe Weather
Incident Type	No Incident	-
Final Speed Adjustment Factor (SAF)	1.000	1.000
Final Capacity Adjustment Factor (CAF)	1.000	1.000
Demand Adjustment Factor (DAF)	1.000	1.000

Demand and Capacity

Demand Volume (Vi)	3152	221
Peak Hour Factor (PHF)	0.94	0.94
Total Trucks, %	19.47	2.27
Single-Unit Trucks (SUT), %	-	-
Tractor-Trailers (TT), %	-	-
Heavy Vehicle Adjustment Factor (fHV)	0.837	0.978
Flow Rate (vi),pc/h	4006	240
Capacity (c), pc/h	7050	2000
Volume-to-Capacity Ratio (v/c)	0.60	0.12

Speed and Density

Upstream Equilibrium Distance (LEQ), ft	-	Number of Outer Lanes on Freeway (NO)	1
Distance to Upstream Ramp (LUP), ft	-	Speed Index (MS)	0.349
Downstream Equilibrium Distance (LEQ), ft	-	Flow Outer Lanes (vOA), pc/h/ln	1654
Distance to Downstream Ramp (LDOWN), ft	-	On-Ramp Influence Area Speed (SR), mi/h	57.0
Prop. Freeway Vehicles in Lane 1 and 2 (PFM)	0.587	Outer Lanes Freeway Speed (SO), mi/h	60.8
Flow in Lanes 1 and 2 (v12), pc/h	2352	Ramp Junction Speed (S), mi/h	58.4
Flow Entering Ramp-Infl. Area (vR12), pc/h	2592	Average Density (D), pc/mi/ln	24.2
Level of Service (LOS)	C	Density in Ramp Influence Area (DR), pc/mi/ln	23.5

HCS7 Basic Freeway Report

Project Information

Analyst	LSA	Date	12/11/2019
Agency	LSA	Analysis Year	Phase II Proj Comp Yr (2039) WP
Jurisdiction	Caltrans	Time Period Analyzed	AM Peak Hour
Project Description	CMD1801 - Village D Specific Plan	Unit	United States Customary

Geometric Data

Number of Lanes, ln	3	Terrain Type	Level
Segment Length (L), ft	-	Percent Grade, %	-
Measured or Base Free-Flow Speed	Base	Grade Length, mi	-
Base Free-Flow Speed (BFFS), mi/h	65.0	Total Ramp Density (TRD), ramps/mi	1.83
Lane Width, ft	12	Free-Flow Speed (FFS), mi/h	59.7
Right-Side Lateral Clearance, ft	10		

Adjustment Factors

Driver Population	All Familiar	Final Speed Adjustment Factor (SAF)	1.000
Weather Type	Non-Severe Weather	Final Capacity Adjustment Factor (CAF)	1.000
Incident Type	No Incident	Demand Adjustment Factor (DAF)	1.000

Demand and Capacity

Demand Volume veh/h	3373	Heavy Vehicle Adjustment Factor (fhv)	0.845
Peak Hour Factor	0.94	Flow Rate (Vp), pc/h/ln	1416
Total Trucks, %	18.34	Capacity (c), pc/h/ln	2296
Single-Unit Trucks (SUT), %	-	Adjusted Capacity (cadj), pc/h/ln	2296
Tractor-Trailers (TT), %	-	Volume-to-Capacity Ratio (v/c)	0.62
Passenger Car Equivalent (ET)	2.000		

Speed and Density

Lane Width Adjustment (fLW)	0.0	Average Speed (S), mi/h	59.6
Right-Side Lateral Clearance Adj. (fRLC)	0.0	Density (D), pc/mi/ln	23.8
Total Ramp Density Adjustment	5.4	Level of Service (LOS)	C
Adjusted Free-Flow Speed (FFSadj), mi/h	59.6		

HCS7 Freeway Diverge Report

Project Information

Analyst	LSA	Date	12/11/2019
Agency	LSA	Analysis Year	Phase II Proj Comp Yr (2039) WP
Jurisdiction	Caltrans	Time Period Analyzed	AM Peak Hour
Project Description	CMD1801 - Village D Specific Plan	Unit	United States Customary

Geometric Data

	Freeway	Ramp
Number of Lanes (N), ln	3	1
Free-Flow Speed (FFS), mi/h	65.0	15.0
Segment Length (L) / Deceleration Length (LA),ft	1500	150
Terrain Type	Level	Level
Percent Grade, %	-	-
Segment Type / Ramp Side	Freeway	Right

Adjustment Factors

Driver Population	All Familiar	All Familiar
Weather Type	Non-Severe Weather	Non-Severe Weather
Incident Type	No Incident	-
Final Speed Adjustment Factor (SAF)	1.000	1.000
Final Capacity Adjustment Factor (CAF)	1.000	1.000
Demand Adjustment Factor (DAF)	1.000	1.000

Demand and Capacity

Demand Volume (Vi)	3373	315
Peak Hour Factor (PHF)	0.94	0.94
Total Trucks, %	18.34	6.34
Single-Unit Trucks (SUT), %	-	-
Tractor-Trailers (TT), %	-	-
Heavy Vehicle Adjustment Factor (fHV)	0.845	0.940
Flow Rate (vi),pc/h	4247	356
Capacity (c), pc/h	7050	1800
Volume-to-Capacity Ratio (v/c)	0.60	0.20

Speed and Density

Upstream Equilibrium Distance (LEQ), ft	-	Number of Outer Lanes on Freeway (NO)	1
Distance to Upstream Ramp (LUP), ft	-	Speed Index (DS)	0.720
Downstream Equilibrium Distance (LEQ), ft	-	Flow Outer Lanes (vOA), pc/h/ln	1412
Distance to Downstream Ramp (LDOWN), ft	-	Off-Ramp Influence Area Speed (SR), mi/h	48.4
Prop. Freeway Vehicles in Lane 1 and 2 (PFD)	0.637	Outer Lanes Freeway Speed (SO), mi/h	69.7
Flow in Lanes 1 and 2 (v12), pc/h	2835	Ramp Junction Speed (S), mi/h	53.9
Flow Entering Ramp-Infl. Area (vR12), pc/h	-	Average Density (D), pc/mi/ln	26.3
Level of Service (LOS)	C	Density in Ramp Influence Area (DR), pc/mi/ln	27.3

HCS7 Basic Freeway Report

Project Information

Analyst	LSA	Date	12/11/2019
Agency	LSA	Analysis Year	Phase II Proj Comp Yr (2039) WP
Jurisdiction	Caltrans	Time Period Analyzed	AM Peak Hour
Project Description	CMD1801 - Village D Specific Plan	Unit	United States Customary

Geometric Data

Number of Lanes, ln	3	Terrain Type	Level
Segment Length (L), ft	-	Percent Grade, %	-
Measured or Base Free-Flow Speed	Base	Grade Length, mi	-
Base Free-Flow Speed (BFFS), mi/h	65.0	Total Ramp Density (TRD), ramps/mi	1.67
Lane Width, ft	12	Free-Flow Speed (FFS), mi/h	60.0
Right-Side Lateral Clearance, ft	10		

Adjustment Factors

Driver Population	All Familiar	Final Speed Adjustment Factor (SAF)	1.000
Weather Type	Non-Severe Weather	Final Capacity Adjustment Factor (CAF)	1.000
Incident Type	No Incident	Demand Adjustment Factor (DAF)	1.000

Demand and Capacity

Demand Volume veh/h	3057	Heavy Vehicle Adjustment Factor (fhv)	0.836
Peak Hour Factor	0.94	Flow Rate (Vp), pc/h/ln	1297
Total Trucks, %	19.57	Capacity (c), pc/h/ln	2300
Single-Unit Trucks (SUT), %	-	Adjusted Capacity (cadj), pc/h/ln	2300
Tractor-Trailers (TT), %	-	Volume-to-Capacity Ratio (v/c)	0.56
Passenger Car Equivalent (ET)	2.000		

Speed and Density

Lane Width Adjustment (fLW)	0.0	Average Speed (S), mi/h	60.0
Right-Side Lateral Clearance Adj. (fRLC)	0.0	Density (D), pc/mi/ln	21.6
Total Ramp Density Adjustment	5.0	Level of Service (LOS)	C
Adjusted Free-Flow Speed (FFSadj), mi/h	60.0		

HCS7 Freeway Merge Report

Project Information

Analyst	LSA	Date	12/11/2019
Agency	LSA	Analysis Year	Phase II Proj Comp Yr (2039) WP
Jurisdiction	Caltrans	Time Period Analyzed	AM Peak Hour
Project Description	CMD1801 - Village D Specific Plan	Unit	United States Customary

Geometric Data

	Freeway	Ramp
Number of Lanes (N), In	3	1
Free-Flow Speed (FFS), mi/h	65.0	35.0
Segment Length (L) / Acceleration Length (LA),ft	1500	525
Terrain Type	Level	Level
Percent Grade, %	-	-
Segment Type / Ramp Side	Freeway	Right

Adjustment Factors

Driver Population	All Familiar	All Familiar
Weather Type	Non-Severe Weather	Non-Severe Weather
Incident Type	No Incident	-
Final Speed Adjustment Factor (SAF)	1.000	1.000
Final Capacity Adjustment Factor (CAF)	1.000	1.000
Demand Adjustment Factor (DAF)	1.000	1.000

Demand and Capacity

Demand Volume (Vi)	3057	216
Peak Hour Factor (PHF)	0.94	0.94
Total Trucks, %	19.57	4.16
Single-Unit Trucks (SUT), %	-	-
Tractor-Trailers (TT), %	-	-
Heavy Vehicle Adjustment Factor (fHV)	0.836	0.960
Flow Rate (vi),pc/h	3890	239
Capacity (c), pc/h	7050	2000
Volume-to-Capacity Ratio (v/c)	0.59	0.12

Speed and Density

Upstream Equilibrium Distance (LEQ), ft	-	Number of Outer Lanes on Freeway (NO)	1
Distance to Upstream Ramp (LUP), ft	-	Speed Index (MS)	0.334
Downstream Equilibrium Distance (LEQ), ft	-	Flow Outer Lanes (vOA), pc/h/ln	1587
Distance to Downstream Ramp (LDOWN), ft	-	On-Ramp Influence Area Speed (SR), mi/h	57.3
Prop. Freeway Vehicles in Lane 1 and 2 (PFM)	0.592	Outer Lanes Freeway Speed (SO), mi/h	61.1
Flow in Lanes 1 and 2 (v12), pc/h	2303	Ramp Junction Speed (S), mi/h	58.7
Flow Entering Ramp-Infl. Area (vR12), pc/h	2542	Average Density (D), pc/mi/ln	23.4
Level of Service (LOS)	C	Density in Ramp Influence Area (DR), pc/mi/ln	22.0

HCS7 Basic Freeway Report

Project Information

Analyst	LSA	Date	12/11/2019
Agency	LSA	Analysis Year	Phase II Proj Comp Yr (2039) WP
Jurisdiction	Caltrans	Time Period Analyzed	AM Peak Hour
Project Description	CMD1801 - Village D Specific Plan	Unit	United States Customary

Geometric Data

Number of Lanes, ln	3	Terrain Type	Level
Segment Length (L), ft	-	Percent Grade, %	-
Measured or Base Free-Flow Speed	Base	Grade Length, mi	-
Base Free-Flow Speed (BFFS), mi/h	65.0	Total Ramp Density (TRD), ramps/mi	1.67
Lane Width, ft	12	Free-Flow Speed (FFS), mi/h	60.0
Right-Side Lateral Clearance, ft	10		

Adjustment Factors

Driver Population	All Familiar	Final Speed Adjustment Factor (SAF)	1.000
Weather Type	Non-Severe Weather	Final Capacity Adjustment Factor (CAF)	1.000
Incident Type	No Incident	Demand Adjustment Factor (DAF)	1.000

Demand and Capacity

Demand Volume veh/h	3274	Heavy Vehicle Adjustment Factor (fhv)	0.844
Peak Hour Factor	0.94	Flow Rate (Vp), pc/h/ln	1376
Total Trucks, %	18.55	Capacity (c), pc/h/ln	2300
Single-Unit Trucks (SUT), %	-	Adjusted Capacity (cadj), pc/h/ln	2300
Tractor-Trailers (TT), %	-	Volume-to-Capacity Ratio (v/c)	0.60
Passenger Car Equivalent (ET)	2.000		

Speed and Density

Lane Width Adjustment (fLW)	0.0	Average Speed (S), mi/h	60.0
Right-Side Lateral Clearance Adj. (fRLC)	0.0	Density (D), pc/mi/ln	22.9
Total Ramp Density Adjustment	5.0	Level of Service (LOS)	C
Adjusted Free-Flow Speed (FFSadj), mi/h	60.0		

HCS7 Freeway Diverge Report

Project Information

Analyst	LSA	Date	12/11/2019
Agency	LSA	Analysis Year	Phase II Proj Comp Yr (2039) WP
Jurisdiction	Caltrans	Time Period Analyzed	AM Peak Hour
Project Description	CMD1801 - Village D Specific Plan	Unit	United States Customary

Geometric Data

	Freeway	Ramp
Number of Lanes (N), ln	3	1
Free-Flow Speed (FFS), mi/h	65.0	35.0
Segment Length (L) / Deceleration Length (LA),ft	1500	200
Terrain Type	Level	Level
Percent Grade, %	-	-
Segment Type / Ramp Side	Freeway	Right

Adjustment Factors

Driver Population	All Familiar	All Familiar
Weather Type	Non-Severe Weather	Non-Severe Weather
Incident Type	No Incident	-
Final Speed Adjustment Factor (SAF)	1.000	1.000
Final Capacity Adjustment Factor (CAF)	1.000	1.000
Demand Adjustment Factor (DAF)	1.000	1.000

Demand and Capacity

Demand Volume (Vi)	3274	718
Peak Hour Factor (PHF)	0.94	0.94
Total Trucks, %	18.55	9.05
Single-Unit Trucks (SUT), %	-	-
Tractor-Trailers (TT), %	-	-
Heavy Vehicle Adjustment Factor (fHV)	0.844	0.917
Flow Rate (vi),pc/h	4127	833
Capacity (c), pc/h	7050	2000
Volume-to-Capacity Ratio (v/c)	0.59	0.42

Speed and Density

Upstream Equilibrium Distance (LEQ), ft	-	Number of Outer Lanes on Freeway (NO)	1
Distance to Upstream Ramp (LUP), ft	-	Speed Index (DS)	0.503
Downstream Equilibrium Distance (LEQ), ft	-	Flow Outer Lanes (vOA), pc/h/ln	1255
Distance to Downstream Ramp (LDOWN), ft	-	Off-Ramp Influence Area Speed (SR), mi/h	53.4
Prop. Freeway Vehicles in Lane 1 and 2 (PFD)	0.619	Outer Lanes Freeway Speed (SO), mi/h	70.3
Flow in Lanes 1 and 2 (v12), pc/h	2872	Ramp Junction Speed (S), mi/h	57.6
Flow Entering Ramp-Infl. Area (vR12), pc/h	-	Average Density (D), pc/mi/ln	23.9
Level of Service (LOS)	C	Density in Ramp Influence Area (DR), pc/mi/ln	27.2

HCS7 Basic Freeway Report

Project Information

Analyst	LSA	Date	12/11/2019
Agency	LSA	Analysis Year	Phase II Proj Comp Yr (2039) WP
Jurisdiction	Caltrans	Time Period Analyzed	AM Peak Hour
Project Description	CMD1801 - Village D Specific Plan	Unit	United States Customary

Geometric Data

Number of Lanes, ln	3	Terrain Type	Level
Segment Length (L), ft	-	Percent Grade, %	-
Measured or Base Free-Flow Speed	Base	Grade Length, mi	-
Base Free-Flow Speed (BFFS), mi/h	70.0	Total Ramp Density (TRD), ramps/mi	1.50
Lane Width, ft	12	Free-Flow Speed (FFS), mi/h	65.5
Right-Side Lateral Clearance, ft	10		

Adjustment Factors

Driver Population	All Familiar	Final Speed Adjustment Factor (SAF)	1.000
Weather Type	Non-Severe Weather	Final Capacity Adjustment Factor (CAF)	1.000
Incident Type	No Incident	Demand Adjustment Factor (DAF)	1.000

Demand and Capacity

Demand Volume veh/h	2556	Heavy Vehicle Adjustment Factor (fhv)	0.825
Peak Hour Factor	0.94	Flow Rate (Vp), pc/h/ln	1099
Total Trucks, %	21.22	Capacity (c), pc/h/ln	2355
Single-Unit Trucks (SUT), %	-	Adjusted Capacity (cadj), pc/h/ln	2355
Tractor-Trailers (TT), %	-	Volume-to-Capacity Ratio (v/c)	0.47
Passenger Car Equivalent (ET)	2.000		

Speed and Density

Lane Width Adjustment (fLW)	0.0	Average Speed (S), mi/h	65.5
Right-Side Lateral Clearance Adj. (fRLC)	0.0	Density (D), pc/mi/ln	16.8
Total Ramp Density Adjustment	4.5	Level of Service (LOS)	B
Adjusted Free-Flow Speed (FFSadj), mi/h	65.5		

HCS7 Freeway Merge Report

Project Information

Analyst	LSA	Date	12/11/2019
Agency	LSA	Analysis Year	Phase II Proj Comp Yr (2039) WP
Jurisdiction	Caltrans	Time Period Analyzed	AM Peak Hour
Project Description	CMD1801 - Village D Specific Plan	Unit	United States Customary

Geometric Data

	Freeway	Ramp
Number of Lanes (N), ln	3	1
Free-Flow Speed (FFS), mi/h	70.0	35.0
Segment Length (L) / Acceleration Length (LA),ft	1500	400
Terrain Type	Level	Level
Percent Grade, %	-	-
Segment Type / Ramp Side	Freeway	Right

Adjustment Factors

Driver Population	All Familiar	All Familiar
Weather Type	Non-Severe Weather	Non-Severe Weather
Incident Type	No Incident	-
Final Speed Adjustment Factor (SAF)	1.000	1.000
Final Capacity Adjustment Factor (CAF)	1.000	1.000
Demand Adjustment Factor (DAF)	1.000	1.000

Demand and Capacity

Demand Volume (Vi)	2556	362
Peak Hour Factor (PHF)	0.94	0.94
Total Trucks, %	21.22	10.51
Single-Unit Trucks (SUT), %	-	-
Tractor-Trailers (TT), %	-	-
Heavy Vehicle Adjustment Factor (fHV)	0.825	0.905
Flow Rate (vi),pc/h	3296	426
Capacity (c), pc/h	7200	2000
Volume-to-Capacity Ratio (v/c)	0.52	0.21

Speed and Density

Upstream Equilibrium Distance (LEQ), ft	-	Number of Outer Lanes on Freeway (NO)	1
Distance to Upstream Ramp (LUP), ft	-	Speed Index (MS)	0.335
Downstream Equilibrium Distance (LEQ), ft	-	Flow Outer Lanes (vOA), pc/h/ln	1355
Distance to Downstream Ramp (LDOWN), ft	-	On-Ramp Influence Area Speed (SR), mi/h	60.6
Prop. Freeway Vehicles in Lane 1 and 2 (PFM)	0.589	Outer Lanes Freeway Speed (SO), mi/h	66.9
Flow in Lanes 1 and 2 (v12), pc/h	1941	Ramp Junction Speed (S), mi/h	62.8
Flow Entering Ramp-Infl. Area (vR12), pc/h	2367	Average Density (D), pc/mi/ln	19.8
Level of Service (LOS)	C	Density in Ramp Influence Area (DR), pc/mi/ln	21.3

HCS7 Basic Freeway Report

Project Information

Analyst	LSA	Date	12/11/2019
Agency	LSA	Analysis Year	Phase II Proj Comp Yr (2039) WP
Jurisdiction	Caltrans	Time Period Analyzed	AM Peak Hour
Project Description	CMD1801 - Village D Specific Plan	Unit	United States Customary

Geometric Data

Number of Lanes, ln	2	Terrain Type	Level
Segment Length (L), ft	-	Percent Grade, %	-
Measured or Base Free-Flow Speed	Base	Grade Length, mi	-
Base Free-Flow Speed (BFFS), mi/h	70.0	Total Ramp Density (TRD), ramps/mi	1.00
Lane Width, ft	12	Free-Flow Speed (FFS), mi/h	66.8
Right-Side Lateral Clearance, ft	10		

Adjustment Factors

Driver Population	All Familiar	Final Speed Adjustment Factor (SAF)	1.000
Weather Type	Non-Severe Weather	Final Capacity Adjustment Factor (CAF)	1.000
Incident Type	No Incident	Demand Adjustment Factor (DAF)	1.000

Demand and Capacity

Demand Volume veh/h	2917	Heavy Vehicle Adjustment Factor (fhv)	0.834
Peak Hour Factor	0.94	Flow Rate (Vp), pc/h/ln	1860
Total Trucks, %	19.89	Capacity (c), pc/h/ln	2368
Single-Unit Trucks (SUT), %	-	Adjusted Capacity (cadj), pc/h/ln	2368
Tractor-Trailers (TT), %	-	Volume-to-Capacity Ratio (v/c)	0.79
Passenger Car Equivalent (ET)	2.000		

Speed and Density

Lane Width Adjustment (fLW)	0.0	Average Speed (S), mi/h	63.1
Right-Side Lateral Clearance Adj. (fRLC)	0.0	Density (D), pc/mi/ln	29.5
Total Ramp Density Adjustment	3.2	Level of Service (LOS)	D
Adjusted Free-Flow Speed (FFSadj), mi/h	66.8		

HCS7 Freeway Diverge Report

Project Information

Analyst	LSA	Date	12/11/2019
Agency	LSA	Analysis Year	Phase II Proj Comp Yr (2039) WP
Jurisdiction	Caltrans	Time Period Analyzed	AM Peak Hour
Project Description	CMD1801 - Village D Specific Plan	Unit	United States Customary

Geometric Data

	Freeway	Ramp
Number of Lanes (N), ln	2	1
Free-Flow Speed (FFS), mi/h	70.0	35.0
Segment Length (L) / Deceleration Length (LA),ft	1500	200
Terrain Type	Level	Level
Percent Grade, %	-	-
Segment Type / Ramp Side	Freeway	Right

Adjustment Factors

Driver Population	All Familiar	All Familiar
Weather Type	Non-Severe Weather	Non-Severe Weather
Incident Type	No Incident	-
Final Speed Adjustment Factor (SAF)	1.000	1.000
Final Capacity Adjustment Factor (CAF)	1.000	1.000
Demand Adjustment Factor (DAF)	1.000	1.000

Demand and Capacity

Demand Volume (Vi)	2917	241
Peak Hour Factor (PHF)	0.94	0.94
Total Trucks, %	19.89	28.67
Single-Unit Trucks (SUT), %	-	-
Tractor-Trailers (TT), %	-	-
Heavy Vehicle Adjustment Factor (fHV)	0.834	0.777
Flow Rate (vi),pc/h	3721	330
Capacity (c), pc/h	4800	2000
Volume-to-Capacity Ratio (v/c)	0.78	0.17

Speed and Density

Upstream Equilibrium Distance (LEQ), ft	-	Number of Outer Lanes on Freeway (NO)	0
Distance to Upstream Ramp (LUP), ft	-	Speed Index (DS)	0.458
Downstream Equilibrium Distance (LEQ), ft	-	Flow Outer Lanes (vOA), pc/h/ln	-
Distance to Downstream Ramp (LDOWN), ft	-	Off-Ramp Influence Area Speed (SR), mi/h	57.2
Prop. Freeway Vehicles in Lane 1 and 2 (PFD)	1.000	Outer Lanes Freeway Speed (SO), mi/h	76.8
Flow in Lanes 1 and 2 (v12), pc/h	3721	Ramp Junction Speed (S), mi/h	57.2
Flow Entering Ramp-Infl. Area (vR12), pc/h	-	Average Density (D), pc/mi/ln	32.5
Level of Service (LOS)	D	Density in Ramp Influence Area (DR), pc/mi/ln	34.5

HCS7 Basic Freeway Report

Project Information

Analyst	LSA	Date	12/11/2019
Agency	LSA	Analysis Year	Phase II Proj Comp Yr (2039) WP
Jurisdiction	Caltrans	Time Period Analyzed	AM Peak Hour
Project Description	CMD1801 - Village D Specific Plan	Unit	United States Customary

Geometric Data

Number of Lanes, ln	2	Terrain Type	Level
Segment Length (L), ft	-	Percent Grade, %	-
Measured or Base Free-Flow Speed	Base	Grade Length, mi	-
Base Free-Flow Speed (BFFS), mi/h	70.0	Total Ramp Density (TRD), ramps/mi	1.00
Lane Width, ft	12	Free-Flow Speed (FFS), mi/h	66.8
Right-Side Lateral Clearance, ft	10		

Adjustment Factors

Driver Population	All Familiar	Final Speed Adjustment Factor (SAF)	1.000
Weather Type	Non-Severe Weather	Final Capacity Adjustment Factor (CAF)	1.000
Incident Type	No Incident	Demand Adjustment Factor (DAF)	1.000

Demand and Capacity

Demand Volume veh/h	2677	Heavy Vehicle Adjustment Factor (fhv)	0.840
Peak Hour Factor	0.94	Flow Rate (Vp), pc/h/ln	1695
Total Trucks, %	19.10	Capacity (c), pc/h/ln	2368
Single-Unit Trucks (SUT), %	-	Adjusted Capacity (cadj), pc/h/ln	2368
Tractor-Trailers (TT), %	-	Volume-to-Capacity Ratio (v/c)	0.72
Passenger Car Equivalent (ET)	2.000		

Speed and Density

Lane Width Adjustment (fLW)	0.0	Average Speed (S), mi/h	65.0
Right-Side Lateral Clearance Adj. (fRLC)	0.0	Density (D), pc/mi/ln	26.1
Total Ramp Density Adjustment	3.2	Level of Service (LOS)	D
Adjusted Free-Flow Speed (FFSadj), mi/h	66.8		

HCS7 Freeway Merge Report

Project Information

Analyst	LSA	Date	12/11/2019
Agency	LSA	Analysis Year	Phase II Proj Comp Yr (2039) WP
Jurisdiction	Caltrans	Time Period Analyzed	AM Peak Hour
Project Description	CMD1801 - Village D Specific Plan	Unit	United States Customary

Geometric Data

	Freeway	Ramp
Number of Lanes (N), ln	2	1
Free-Flow Speed (FFS), mi/h	70.0	35.0
Segment Length (L) / Acceleration Length (LA),ft	1500	700
Terrain Type	Level	Level
Percent Grade, %	-	-
Segment Type / Ramp Side	Freeway	Right

Adjustment Factors

Driver Population	All Familiar	All Familiar
Weather Type	Non-Severe Weather	Non-Severe Weather
Incident Type	No Incident	-
Final Speed Adjustment Factor (SAF)	1.000	1.000
Final Capacity Adjustment Factor (CAF)	1.000	1.000
Demand Adjustment Factor (DAF)	1.000	1.000

Demand and Capacity

Demand Volume (Vi)	2677	653
Peak Hour Factor (PHF)	0.94	0.94
Total Trucks, %	19.10	12.87
Single-Unit Trucks (SUT), %	-	-
Tractor-Trailers (TT), %	-	-
Heavy Vehicle Adjustment Factor (fHV)	0.840	0.886
Flow Rate (vi),pc/h	3390	784
Capacity (c), pc/h	4800	2000
Volume-to-Capacity Ratio (v/c)	0.87	0.39

Speed and Density

Upstream Equilibrium Distance (LEQ), ft	-	Number of Outer Lanes on Freeway (NO)	0
Distance to Upstream Ramp (LUP), ft	-	Speed Index (MS)	0.525
Downstream Equilibrium Distance (LEQ), ft	-	Flow Outer Lanes (vOA), pc/h/ln	-
Distance to Downstream Ramp (LDOWN), ft	-	On-Ramp Influence Area Speed (SR), mi/h	55.3
Prop. Freeway Vehicles in Lane 1 and 2 (PFM)	1.000	Outer Lanes Freeway Speed (SO), mi/h	70.0
Flow in Lanes 1 and 2 (v12), pc/h	3390	Ramp Junction Speed (S), mi/h	55.3
Flow Entering Ramp-Infl. Area (vR12), pc/h	4174	Average Density (D), pc/mi/ln	37.7
Level of Service (LOS)	D	Density in Ramp Influence Area (DR), pc/mi/ln	33.4

HCS7 Basic Freeway Report

Project Information

Analyst	LSA	Date	12/11/2019
Agency	LSA	Analysis Year	Phase II Proj Comp Yr (2039) WP
Jurisdiction	Caltrans	Time Period Analyzed	AM Peak Hour
Project Description	CMD1801 - Village D Specific Plan	Unit	United States Customary

Geometric Data

Number of Lanes, ln	2	Terrain Type	Level
Segment Length (L), ft	-	Percent Grade, %	-
Measured or Base Free-Flow Speed	Base	Grade Length, mi	-
Base Free-Flow Speed (BFFS), mi/h	70.0	Total Ramp Density (TRD), ramps/mi	1.00
Lane Width, ft	12	Free-Flow Speed (FFS), mi/h	66.8
Right-Side Lateral Clearance, ft	10		

Adjustment Factors

Driver Population	All Familiar	Final Speed Adjustment Factor (SAF)	1.000
Weather Type	Non-Severe Weather	Final Capacity Adjustment Factor (CAF)	1.000
Incident Type	No Incident	Demand Adjustment Factor (DAF)	1.000

Demand and Capacity

Demand Volume veh/h	3329	Heavy Vehicle Adjustment Factor (fhv)	0.848
Peak Hour Factor	0.94	Flow Rate (Vp), pc/h/ln	2088
Total Trucks, %	17.88	Capacity (c), pc/h/ln	2368
Single-Unit Trucks (SUT), %	-	Adjusted Capacity (cadj), pc/h/ln	2368
Tractor-Trailers (TT), %	-	Volume-to-Capacity Ratio (v/c)	0.88
Passenger Car Equivalent (ET)	2.000		

Speed and Density

Lane Width Adjustment (fLW)	0.0	Average Speed (S), mi/h	59.2
Right-Side Lateral Clearance Adj. (fRLC)	0.0	Density (D), pc/mi/ln	35.3
Total Ramp Density Adjustment	3.2	Level of Service (LOS)	E
Adjusted Free-Flow Speed (FFSadj), mi/h	66.8		

HCS7 Basic Freeway Report

Project Information

Analyst	LSA	Date	12/11/2019
Agency	LSA	Analysis Year	Phase II Proj Comp Yr (2039) WP
Jurisdiction	Caltrans	Time Period Analyzed	AM Peak Hour
Project Description	CMD1801 - Village D Specific Plan	Unit	United States Customary

Geometric Data

Number of Lanes, ln	2	Terrain Type	Level
Segment Length (L), ft	-	Percent Grade, %	-
Measured or Base Free-Flow Speed	Base	Grade Length, mi	-
Base Free-Flow Speed (BFFS), mi/h	70.0	Total Ramp Density (TRD), ramps/mi	1.00
Lane Width, ft	12	Free-Flow Speed (FFS), mi/h	66.8
Right-Side Lateral Clearance, ft	10		

Adjustment Factors

Driver Population	All Familiar	Final Speed Adjustment Factor (SAF)	1.000
Weather Type	Non-Severe Weather	Final Capacity Adjustment Factor (CAF)	1.000
Incident Type	No Incident	Demand Adjustment Factor (DAF)	1.000

Demand and Capacity

Demand Volume veh/h	2699	Heavy Vehicle Adjustment Factor (fhv)	0.792
Peak Hour Factor	0.94	Flow Rate (Vp), pc/h/ln	1812
Total Trucks, %	26.32	Capacity (c), pc/h/ln	2368
Single-Unit Trucks (SUT), %	-	Adjusted Capacity (cadj), pc/h/ln	2368
Tractor-Trailers (TT), %	-	Volume-to-Capacity Ratio (v/c)	0.77
Passenger Car Equivalent (ET)	2.000		

Speed and Density

Lane Width Adjustment (fLW)	0.0	Average Speed (S), mi/h	63.7
Right-Side Lateral Clearance Adj. (fRLC)	0.0	Density (D), pc/mi/ln	28.4
Total Ramp Density Adjustment	3.2	Level of Service (LOS)	D
Adjusted Free-Flow Speed (FFSadj), mi/h	66.8		

HCS7 Freeway Diverge Report

Project Information

Analyst	LSA	Date	12/11/2019
Agency	LSA	Analysis Year	Phase II Proj Comp Yr (2039) WP
Jurisdiction	Caltrans	Time Period Analyzed	AM Peak Hour
Project Description	CMD1801 - Village D Specific Plan	Unit	United States Customary

Geometric Data

	Freeway	Ramp
Number of Lanes (N), ln	2	1
Free-Flow Speed (FFS), mi/h	70.0	50.0
Segment Length (L) / Deceleration Length (LA),ft	1500	150
Terrain Type	Level	Level
Percent Grade, %	-	-
Segment Type / Ramp Side	Freeway	Right

Adjustment Factors

Driver Population	All Familiar	All Familiar
Weather Type	Non-Severe Weather	Non-Severe Weather
Incident Type	No Incident	-
Final Speed Adjustment Factor (SAF)	1.000	1.000
Final Capacity Adjustment Factor (CAF)	1.000	1.000
Demand Adjustment Factor (DAF)	1.000	1.000

Demand and Capacity

Demand Volume (Vi)	2699	293
Peak Hour Factor (PHF)	0.94	0.94
Total Trucks, %	26.32	18.11
Single-Unit Trucks (SUT), %	-	-
Tractor-Trailers (TT), %	-	-
Heavy Vehicle Adjustment Factor (fHV)	0.792	0.847
Flow Rate (vi),pc/h	3625	368
Capacity (c), pc/h	4800	2100
Volume-to-Capacity Ratio (v/c)	0.76	0.18

Speed and Density

Upstream Equilibrium Distance (LEQ), ft	-	Number of Outer Lanes on Freeway (NO)	0
Distance to Upstream Ramp (LUP), ft	-	Speed Index (DS)	0.266
Downstream Equilibrium Distance (LEQ), ft	-	Flow Outer Lanes (vOA), pc/h/ln	-
Distance to Downstream Ramp (LDOWN), ft	-	Off-Ramp Influence Area Speed (SR), mi/h	62.6
Prop. Freeway Vehicles in Lane 1 and 2 (PFD)	1.000	Outer Lanes Freeway Speed (SO), mi/h	76.8
Flow in Lanes 1 and 2 (v12), pc/h	3625	Ramp Junction Speed (S), mi/h	62.6
Flow Entering Ramp-Infl. Area (vR12), pc/h	-	Average Density (D), pc/mi/ln	29.0
Level of Service (LOS)	D	Density in Ramp Influence Area (DR), pc/mi/ln	34.1

HCS7 Basic Freeway Report

Project Information

Analyst	LSA	Date	12/11/2019
Agency	LSA	Analysis Year	Phase II Proj Comp Yr (2039) WP
Jurisdiction	Caltrans	Time Period Analyzed	AM Peak Hour
Project Description	CMD1801 - Village D Specific Plan	Unit	United States Customary

Geometric Data

Number of Lanes, ln	2	Terrain Type	Level
Segment Length (L), ft	-	Percent Grade, %	-
Measured or Base Free-Flow Speed	Base	Grade Length, mi	-
Base Free-Flow Speed (BFFS), mi/h	70.0	Total Ramp Density (TRD), ramps/mi	1.33
Lane Width, ft	12	Free-Flow Speed (FFS), mi/h	65.9
Right-Side Lateral Clearance, ft	10		

Adjustment Factors

Driver Population	All Familiar	Final Speed Adjustment Factor (SAF)	1.000
Weather Type	Non-Severe Weather	Final Capacity Adjustment Factor (CAF)	1.000
Incident Type	No Incident	Demand Adjustment Factor (DAF)	1.000

Demand and Capacity

Demand Volume veh/h	2407	Heavy Vehicle Adjustment Factor (fhv)	0.785
Peak Hour Factor	0.94	Flow Rate (Vp), pc/h/ln	1631
Total Trucks, %	27.32	Capacity (c), pc/h/ln	2359
Single-Unit Trucks (SUT), %	-	Adjusted Capacity (cadj), pc/h/ln	2359
Tractor-Trailers (TT), %	-	Volume-to-Capacity Ratio (v/c)	0.69
Passenger Car Equivalent (ET)	2.000		

Speed and Density

Lane Width Adjustment (fLW)	0.0	Average Speed (S), mi/h	64.9
Right-Side Lateral Clearance Adj. (fRLC)	0.0	Density (D), pc/mi/ln	25.1
Total Ramp Density Adjustment	4.1	Level of Service (LOS)	C
Adjusted Free-Flow Speed (FFSadj), mi/h	65.9		

HCS7 Freeway Merge Report

Project Information

Analyst	LSA	Date	12/11/2019
Agency	LSA	Analysis Year	Phase II Proj Comp Yr (2039) WP
Jurisdiction	Caltrans	Time Period Analyzed	AM Peak Hour
Project Description	CMD1801 - Village D Specific Plan	Unit	United States Customary

Geometric Data

	Freeway	Ramp
Number of Lanes (N), ln	2	1
Free-Flow Speed (FFS), mi/h	70.0	35.0
Segment Length (L) / Acceleration Length (LA),ft	1000	600
Terrain Type	Level	Level
Percent Grade, %	-	-
Segment Type / Ramp Side	Freeway	Right

Adjustment Factors

Driver Population	All Familiar	All Familiar
Weather Type	Non-Severe Weather	Non-Severe Weather
Incident Type	No Incident	-
Final Speed Adjustment Factor (SAF)	1.000	1.000
Final Capacity Adjustment Factor (CAF)	1.000	1.000
Demand Adjustment Factor (DAF)	1.000	1.000

Demand and Capacity

Demand Volume (Vi)	2407	37
Peak Hour Factor (PHF)	0.94	0.94
Total Trucks, %	27.32	13.64
Single-Unit Trucks (SUT), %	-	-
Tractor-Trailers (TT), %	-	-
Heavy Vehicle Adjustment Factor (fHV)	0.785	0.880
Flow Rate (vi),pc/h	3262	45
Capacity (c), pc/h	4800	2000
Volume-to-Capacity Ratio (v/c)	0.69	0.02

Speed and Density

Upstream Equilibrium Distance (LEQ), ft	-	Number of Outer Lanes on Freeway (NO)	0
Distance to Upstream Ramp (LUP), ft	-	Speed Index (MS)	0.385
Downstream Equilibrium Distance (LEQ), ft	-	Flow Outer Lanes (vOA), pc/h/ln	-
Distance to Downstream Ramp (LDOWN), ft	-	On-Ramp Influence Area Speed (SR), mi/h	59.2
Prop. Freeway Vehicles in Lane 1 and 2 (PFM)	1.000	Outer Lanes Freeway Speed (SO), mi/h	70.0
Flow in Lanes 1 and 2 (v12), pc/h	3262	Ramp Junction Speed (S), mi/h	59.2
Flow Entering Ramp-Infl. Area (vR12), pc/h	3307	Average Density (D), pc/mi/ln	27.9
Level of Service (LOS)	C	Density in Ramp Influence Area (DR), pc/mi/ln	27.6

HCS7 Basic Freeway Report

Project Information

Analyst	LSA	Date	12/11/2019
Agency	LSA	Analysis Year	Phase II Proj Comp Yr (2039) WP
Jurisdiction	Caltrans	Time Period Analyzed	AM Peak Hour
Project Description	CMD1801 - Village D Specific Plan	Unit	United States Customary

Geometric Data

Number of Lanes, ln	2	Terrain Type	Level
Segment Length (L), ft	-	Percent Grade, %	-
Measured or Base Free-Flow Speed	Base	Grade Length, mi	-
Base Free-Flow Speed (BFFS), mi/h	70.0	Total Ramp Density (TRD), ramps/mi	1.33
Lane Width, ft	12	Free-Flow Speed (FFS), mi/h	65.9
Right-Side Lateral Clearance, ft	10		

Adjustment Factors

Driver Population	All Familiar	Final Speed Adjustment Factor (SAF)	1.000
Weather Type	Non-Severe Weather	Final Capacity Adjustment Factor (CAF)	1.000
Incident Type	No Incident	Demand Adjustment Factor (DAF)	1.000

Demand and Capacity

Demand Volume veh/h	2443	Heavy Vehicle Adjustment Factor (fhv)	0.787
Peak Hour Factor	0.94	Flow Rate (Vp), pc/h/ln	1651
Total Trucks, %	27.11	Capacity (c), pc/h/ln	2359
Single-Unit Trucks (SUT), %	-	Adjusted Capacity (cadj), pc/h/ln	2359
Tractor-Trailers (TT), %	-	Volume-to-Capacity Ratio (v/c)	0.70
Passenger Car Equivalent (ET)	2.000		

Speed and Density

Lane Width Adjustment (fLW)	0.0	Average Speed (S), mi/h	64.8
Right-Side Lateral Clearance Adj. (fRLC)	0.0	Density (D), pc/mi/ln	25.5
Total Ramp Density Adjustment	4.1	Level of Service (LOS)	C
Adjusted Free-Flow Speed (FFSadj), mi/h	65.9		

HCS7 Freeway Merge Report

Project Information

Analyst	LSA	Date	12/11/2019
Agency	LSA	Analysis Year	Phase II Proj Comp Yr (2039) WP
Jurisdiction	Caltrans	Time Period Analyzed	AM Peak Hour
Project Description	CMD1801 - Village D Specific Plan	Unit	United States Customary

Geometric Data

	Freeway	Ramp
Number of Lanes (N), ln	2	1
Free-Flow Speed (FFS), mi/h	70.0	35.0
Segment Length (L) / Acceleration Length (LA),ft	1500	500
Terrain Type	Level	Level
Percent Grade, %	-	-
Segment Type / Ramp Side	Freeway	Right

Adjustment Factors

Driver Population	All Familiar	All Familiar
Weather Type	Non-Severe Weather	Non-Severe Weather
Incident Type	No Incident	-
Final Speed Adjustment Factor (SAF)	1.000	1.000
Final Capacity Adjustment Factor (CAF)	1.000	1.000
Demand Adjustment Factor (DAF)	1.000	1.000

Demand and Capacity

Demand Volume (Vi)	2443	199
Peak Hour Factor (PHF)	0.94	0.94
Total Trucks, %	27.11	32.21
Single-Unit Trucks (SUT), %	-	-
Tractor-Trailers (TT), %	-	-
Heavy Vehicle Adjustment Factor (fHV)	0.787	0.756
Flow Rate (vi),pc/h	3302	280
Capacity (c), pc/h	4800	2000
Volume-to-Capacity Ratio (v/c)	0.75	0.14

Speed and Density

Upstream Equilibrium Distance (LEQ), ft	-	Number of Outer Lanes on Freeway (NO)	0
Distance to Upstream Ramp (LUP), ft	-	Speed Index (MS)	0.426
Downstream Equilibrium Distance (LEQ), ft	-	Flow Outer Lanes (vOA), pc/h/ln	-
Distance to Downstream Ramp (LDOWN), ft	-	On-Ramp Influence Area Speed (SR), mi/h	58.1
Prop. Freeway Vehicles in Lane 1 and 2 (PFM)	1.000	Outer Lanes Freeway Speed (SO), mi/h	70.0
Flow in Lanes 1 and 2 (v12), pc/h	3302	Ramp Junction Speed (S), mi/h	58.1
Flow Entering Ramp-Infl. Area (vR12), pc/h	3582	Average Density (D), pc/mi/ln	30.8
Level of Service (LOS)	D	Density in Ramp Influence Area (DR), pc/mi/ln	30.2

HCS7 Basic Freeway Report

Project Information

Analyst	LSA	Date	12/11/2019
Agency	LSA	Analysis Year	Phase II Proj Comp Yr (2039) WP
Jurisdiction	Caltrans	Time Period Analyzed	AM Peak Hour
Project Description	CMD1801 - Village D Specific Plan	Unit	United States Customary

Geometric Data

Number of Lanes, ln	2	Terrain Type	Level
Segment Length (L), ft	-	Percent Grade, %	-
Measured or Base Free-Flow Speed	Base	Grade Length, mi	-
Base Free-Flow Speed (BFFS), mi/h	70.0	Total Ramp Density (TRD), ramps/mi	1.33
Lane Width, ft	12	Free-Flow Speed (FFS), mi/h	65.9
Right-Side Lateral Clearance, ft	10		

Adjustment Factors

Driver Population	All Familiar	Final Speed Adjustment Factor (SAF)	1.000
Weather Type	Non-Severe Weather	Final Capacity Adjustment Factor (CAF)	1.000
Incident Type	No Incident	Demand Adjustment Factor (DAF)	1.000

Demand and Capacity

Demand Volume veh/h	2642	Heavy Vehicle Adjustment Factor (fhv)	0.784
Peak Hour Factor	0.94	Flow Rate (Vp), pc/h/ln	1792
Total Trucks, %	27.50	Capacity (c), pc/h/ln	2359
Single-Unit Trucks (SUT), %	-	Adjusted Capacity (cadj), pc/h/ln	2359
Tractor-Trailers (TT), %	-	Volume-to-Capacity Ratio (v/c)	0.76
Passenger Car Equivalent (ET)	2.000		

Speed and Density

Lane Width Adjustment (fLW)	0.0	Average Speed (S), mi/h	63.4
Right-Side Lateral Clearance Adj. (fRLC)	0.0	Density (D), pc/mi/ln	28.3
Total Ramp Density Adjustment	4.1	Level of Service (LOS)	D
Adjusted Free-Flow Speed (FFSadj), mi/h	65.9		

HCS7 Freeway Diverge Report

Project Information

Analyst	LSA	Date	12/11/2019
Agency	LSA	Analysis Year	Phase II Proj Comp Yr (2039) WP
Jurisdiction	Caltrans	Time Period Analyzed	AM Peak Hour
Project Description	CMD1801 - Village D Specific Plan	Unit	United States Customary

Geometric Data

	Freeway	Ramp
Number of Lanes (N), ln	3	1
Free-Flow Speed (FFS), mi/h	70.0	35.0
Segment Length (L) / Deceleration Length (LA),ft	1500	150
Terrain Type	Level	Level
Percent Grade, %	-	-
Segment Type / Ramp Side	Freeway	Right

Adjustment Factors

Driver Population	All Familiar	All Familiar
Weather Type	Non-Severe Weather	Non-Severe Weather
Incident Type	No Incident	-
Final Speed Adjustment Factor (SAF)	1.000	1.000
Final Capacity Adjustment Factor (CAF)	1.000	1.000
Demand Adjustment Factor (DAF)	1.000	1.000

Demand and Capacity

Demand Volume (Vi)	2642	383
Peak Hour Factor (PHF)	0.94	0.94
Total Trucks, %	27.50	18.82
Single-Unit Trucks (SUT), %	-	-
Tractor-Trailers (TT), %	-	-
Heavy Vehicle Adjustment Factor (fHV)	0.784	0.842
Flow Rate (vi),pc/h	3585	484
Capacity (c), pc/h	7200	2000
Volume-to-Capacity Ratio (v/c)	0.50	0.24

Speed and Density

Upstream Equilibrium Distance (LEQ), ft	-	Number of Outer Lanes on Freeway (NO)	1
Distance to Upstream Ramp (LUP), ft	-	Speed Index (DS)	0.472
Downstream Equilibrium Distance (LEQ), ft	-	Flow Outer Lanes (vOA), pc/h/ln	1092
Distance to Downstream Ramp (LDOWN), ft	-	Off-Ramp Influence Area Speed (SR), mi/h	56.8
Prop. Freeway Vehicles in Lane 1 and 2 (PFD)	0.648	Outer Lanes Freeway Speed (SO), mi/h	76.4
Flow in Lanes 1 and 2 (v12), pc/h	2493	Ramp Junction Speed (S), mi/h	61.6
Flow Entering Ramp-Infl. Area (vR12), pc/h	-	Average Density (D), pc/mi/ln	19.4
Level of Service (LOS)	C	Density in Ramp Influence Area (DR), pc/mi/ln	24.3

HCS7 Basic Freeway Report

Project Information

Analyst	LSA	Date	12/11/2019
Agency	LSA	Analysis Year	Phase II Proj Comp Yr (2039) WP
Jurisdiction	Caltrans	Time Period Analyzed	AM Peak Hour
Project Description	CMD1801 - Village D Specific Plan	Unit	United States Customary

Geometric Data

Number of Lanes, ln	3	Terrain Type	Level
Segment Length (L), ft	-	Percent Grade, %	-
Measured or Base Free-Flow Speed	Base	Grade Length, mi	-
Base Free-Flow Speed (BFFS), mi/h	70.0	Total Ramp Density (TRD), ramps/mi	1.67
Lane Width, ft	12	Free-Flow Speed (FFS), mi/h	65.0
Right-Side Lateral Clearance, ft	10		

Adjustment Factors

Driver Population	All Familiar	Final Speed Adjustment Factor (SAF)	1.000
Weather Type	Non-Severe Weather	Final Capacity Adjustment Factor (CAF)	1.000
Incident Type	No Incident	Demand Adjustment Factor (DAF)	1.000

Demand and Capacity

Demand Volume veh/h	2259	Heavy Vehicle Adjustment Factor (fhv)	0.775
Peak Hour Factor	0.94	Flow Rate (Vp), pc/h/ln	1034
Total Trucks, %	28.97	Capacity (c), pc/h/ln	2350
Single-Unit Trucks (SUT), %	-	Adjusted Capacity (cadj), pc/h/ln	2350
Tractor-Trailers (TT), %	-	Volume-to-Capacity Ratio (v/c)	0.44
Passenger Car Equivalent (ET)	2.000		

Speed and Density

Lane Width Adjustment (fLW)	0.0	Average Speed (S), mi/h	65.0
Right-Side Lateral Clearance Adj. (fRLC)	0.0	Density (D), pc/mi/ln	15.9
Total Ramp Density Adjustment	5.0	Level of Service (LOS)	B
Adjusted Free-Flow Speed (FFSadj), mi/h	65.0		

HCS7 Freeway Merge Report

Project Information

Analyst	LSA	Date	12/11/2019
Agency	LSA	Analysis Year	Phase II Proj Comp Yr (2039) WP
Jurisdiction	Caltrans	Time Period Analyzed	AM Peak Hour
Project Description	CMD1801 - Village D Specific Plan	Unit	United States Customary

Geometric Data

	Freeway	Ramp
Number of Lanes (N), ln	3	1
Free-Flow Speed (FFS), mi/h	65.0	35.0
Segment Length (L) / Acceleration Length (LA),ft	1500	600
Terrain Type	Level	Level
Percent Grade, %	-	-
Segment Type / Ramp Side	Freeway	Right

Adjustment Factors

Driver Population	All Familiar	All Familiar
Weather Type	Non-Severe Weather	Non-Severe Weather
Incident Type	No Incident	-
Final Speed Adjustment Factor (SAF)	1.000	1.000
Final Capacity Adjustment Factor (CAF)	1.000	1.000
Demand Adjustment Factor (DAF)	1.000	1.000

Demand and Capacity

Demand Volume (Vi)	2259	700
Peak Hour Factor (PHF)	0.94	0.94
Total Trucks, %	28.97	4.00
Single-Unit Trucks (SUT), %	-	-
Tractor-Trailers (TT), %	-	-
Heavy Vehicle Adjustment Factor (fHV)	0.775	0.962
Flow Rate (vi),pc/h	3101	774
Capacity (c), pc/h	7050	2000
Volume-to-Capacity Ratio (v/c)	0.55	0.39

Speed and Density

Upstream Equilibrium Distance (LEQ), ft	-	Number of Outer Lanes on Freeway (NO)	1
Distance to Upstream Ramp (LUP), ft	-	Speed Index (MS)	0.332
Downstream Equilibrium Distance (LEQ), ft	-	Flow Outer Lanes (vOA), pc/h/ln	1259
Distance to Downstream Ramp (LDOWN), ft	-	On-Ramp Influence Area Speed (SR), mi/h	57.4
Prop. Freeway Vehicles in Lane 1 and 2 (PFM)	0.594	Outer Lanes Freeway Speed (SO), mi/h	62.3
Flow in Lanes 1 and 2 (v12), pc/h	1842	Ramp Junction Speed (S), mi/h	58.9
Flow Entering Ramp-Infl. Area (vR12), pc/h	2616	Average Density (D), pc/mi/ln	21.9
Level of Service (LOS)	C	Density in Ramp Influence Area (DR), pc/mi/ln	21.8

HCS7 Basic Freeway Report

Project Information

Analyst	LSA	Date	12/11/2019
Agency	LSA	Analysis Year	Phase II Proj Comp Yr (2039) WP
Jurisdiction	Caltrans	Time Period Analyzed	AM Peak Hour
Project Description	CMD1801 - Village D Specific Plan	Unit	United States Customary

Geometric Data

Number of Lanes, ln	3	Terrain Type	Level
Segment Length (L), ft	-	Percent Grade, %	-
Measured or Base Free-Flow Speed	Base	Grade Length, mi	-
Base Free-Flow Speed (BFFS), mi/h	65.0	Total Ramp Density (TRD), ramps/mi	1.83
Lane Width, ft	12	Free-Flow Speed (FFS), mi/h	59.7
Right-Side Lateral Clearance, ft	10		

Adjustment Factors

Driver Population	All Familiar	Final Speed Adjustment Factor (SAF)	1.000
Weather Type	Non-Severe Weather	Final Capacity Adjustment Factor (CAF)	1.000
Incident Type	No Incident	Demand Adjustment Factor (DAF)	1.000

Demand and Capacity

Demand Volume veh/h	2960	Heavy Vehicle Adjustment Factor (fhv)	0.813
Peak Hour Factor	0.94	Flow Rate (Vp), pc/h/ln	1291
Total Trucks, %	23.06	Capacity (c), pc/h/ln	2296
Single-Unit Trucks (SUT), %	-	Adjusted Capacity (cadj), pc/h/ln	2296
Tractor-Trailers (TT), %	-	Volume-to-Capacity Ratio (v/c)	0.56
Passenger Car Equivalent (ET)	2.000		

Speed and Density

Lane Width Adjustment (fLW)	0.0	Average Speed (S), mi/h	59.6
Right-Side Lateral Clearance Adj. (fRLC)	0.0	Density (D), pc/mi/ln	21.7
Total Ramp Density Adjustment	5.4	Level of Service (LOS)	C
Adjusted Free-Flow Speed (FFSadj), mi/h	59.6		

HCS7 Freeway Merge Report

Project Information

Analyst	LSA	Date	12/11/2019
Agency	LSA	Analysis Year	Phase II Proj Comp Yr (2039) WP
Jurisdiction	Caltrans	Time Period Analyzed	AM Peak Hour
Project Description	CMD1801 - Village D Specific Plan	Unit	United States Customary

Geometric Data

	Freeway	Ramp
Number of Lanes (N), ln	3	1
Free-Flow Speed (FFS), mi/h	65.0	35.0
Segment Length (L) / Acceleration Length (LA),ft	1500	600
Terrain Type	Level	Level
Percent Grade, %	-	-
Segment Type / Ramp Side	Freeway	Right

Adjustment Factors

Driver Population	All Familiar	All Familiar
Weather Type	Non-Severe Weather	Non-Severe Weather
Incident Type	No Incident	-
Final Speed Adjustment Factor (SAF)	1.000	1.000
Final Capacity Adjustment Factor (CAF)	1.000	1.000
Demand Adjustment Factor (DAF)	1.000	1.000

Demand and Capacity

Demand Volume (Vi)	2960	810
Peak Hour Factor (PHF)	0.94	0.94
Total Trucks, %	23.06	2.47
Single-Unit Trucks (SUT), %	-	-
Tractor-Trailers (TT), %	-	-
Heavy Vehicle Adjustment Factor (fHV)	0.813	0.976
Flow Rate (vi),pc/h	3873	883
Capacity (c), pc/h	7050	2000
Volume-to-Capacity Ratio (v/c)	0.67	0.44

Speed and Density

Upstream Equilibrium Distance (LEQ), ft	-	Number of Outer Lanes on Freeway (NO)	1
Distance to Upstream Ramp (LUP), ft	-	Speed Index (MS)	0.373
Downstream Equilibrium Distance (LEQ), ft	-	Flow Outer Lanes (vOA), pc/h/ln	1572
Distance to Downstream Ramp (LDOWN), ft	-	On-Ramp Influence Area Speed (SR), mi/h	56.4
Prop. Freeway Vehicles in Lane 1 and 2 (PFM)	0.594	Outer Lanes Freeway Speed (SO), mi/h	61.1
Flow in Lanes 1 and 2 (v12), pc/h	2301	Ramp Junction Speed (S), mi/h	57.9
Flow Entering Ramp-Infl. Area (vR12), pc/h	3184	Average Density (D), pc/mi/ln	27.4
Level of Service (LOS)	C	Density in Ramp Influence Area (DR), pc/mi/ln	26.2

HCS7 Basic Freeway Report

Project Information

Analyst	LSA	Date	12/11/2019
Agency	LSA	Analysis Year	Phase II Proj Comp Yr (2039) WP
Jurisdiction	Caltrans	Time Period Analyzed	AM Peak Hour
Project Description	CMD1801 - Village D Specific Plan	Unit	United States Customary

Geometric Data

Number of Lanes, ln	3	Terrain Type	Level
Segment Length (L), ft	-	Percent Grade, %	-
Measured or Base Free-Flow Speed	Base	Grade Length, mi	-
Base Free-Flow Speed (BFFS), mi/h	65.0	Total Ramp Density (TRD), ramps/mi	2.17
Lane Width, ft	12	Free-Flow Speed (FFS), mi/h	58.8
Right-Side Lateral Clearance, ft	10		

Adjustment Factors

Driver Population	All Familiar	Final Speed Adjustment Factor (SAF)	1.000
Weather Type	Non-Severe Weather	Final Capacity Adjustment Factor (CAF)	1.000
Incident Type	No Incident	Demand Adjustment Factor (DAF)	1.000

Demand and Capacity

Demand Volume veh/h	3769	Heavy Vehicle Adjustment Factor (fhv)	0.843
Peak Hour Factor	0.94	Flow Rate (Vp), pc/h/ln	1585
Total Trucks, %	18.64	Capacity (c), pc/h/ln	2288
Single-Unit Trucks (SUT), %	-	Adjusted Capacity (cadj), pc/h/ln	2288
Tractor-Trailers (TT), %	-	Volume-to-Capacity Ratio (v/c)	0.69
Passenger Car Equivalent (ET)	2.000		

Speed and Density

Lane Width Adjustment (fLW)	0.0	Average Speed (S), mi/h	58.8
Right-Side Lateral Clearance Adj. (fRLC)	0.0	Density (D), pc/mi/ln	27.0
Total Ramp Density Adjustment	6.2	Level of Service (LOS)	D
Adjusted Free-Flow Speed (FFSadj), mi/h	58.8		

HCS7 Freeway Diverge Report

Project Information

Analyst	LSA	Date	12/11/2019
Agency	LSA	Analysis Year	Phase II Proj Comp Yr (2039) WP
Jurisdiction	Caltrans	Time Period Analyzed	AM Peak Hour
Project Description	CMD1801 - Village D Specific Plan	Unit	United States Customary

Geometric Data

	Freeway	Ramp
Number of Lanes (N), In	3	1
Free-Flow Speed (FFS), mi/h	65.0	40.0
Segment Length (L) / Deceleration Length (LA),ft	1500	150
Terrain Type	Level	Level
Percent Grade, %	-	-
Segment Type / Ramp Side	Freeway	Right

Adjustment Factors

Driver Population	All Familiar	All Familiar
Weather Type	Non-Severe Weather	Non-Severe Weather
Incident Type	No Incident	-
Final Speed Adjustment Factor (SAF)	1.000	1.000
Final Capacity Adjustment Factor (CAF)	1.000	1.000
Demand Adjustment Factor (DAF)	1.000	1.000

Demand and Capacity

Demand Volume (Vi)	3769	226
Peak Hour Factor (PHF)	0.94	0.94
Total Trucks, %	18.64	3.53
Single-Unit Trucks (SUT), %	-	-
Tractor-Trailers (TT), %	-	-
Heavy Vehicle Adjustment Factor (fHV)	0.843	0.966
Flow Rate (vi),pc/h	4756	249
Capacity (c), pc/h	7050	2000
Volume-to-Capacity Ratio (v/c)	0.67	0.12

Speed and Density

Upstream Equilibrium Distance (LEQ), ft	-	Number of Outer Lanes on Freeway (NO)	1
Distance to Upstream Ramp (LUP), ft	-	Speed Index (DS)	0.385
Downstream Equilibrium Distance (LEQ), ft	-	Flow Outer Lanes (vOA), pc/h/ln	1668
Distance to Downstream Ramp (LDOWN), ft	-	Off-Ramp Influence Area Speed (SR), mi/h	56.1
Prop. Freeway Vehicles in Lane 1 and 2 (PFD)	0.630	Outer Lanes Freeway Speed (SO), mi/h	68.7
Flow in Lanes 1 and 2 (v12), pc/h	3088	Ramp Junction Speed (S), mi/h	60.0
Flow Entering Ramp-Infl. Area (vR12), pc/h	-	Average Density (D), pc/mi/ln	26.4
Level of Service (LOS)	D	Density in Ramp Influence Area (DR), pc/mi/ln	29.5

HCS7 Basic Freeway Report

Project Information

Analyst	LSA	Date	12/11/2019
Agency	LSA	Analysis Year	Phase II Proj Comp Yr (2039) WP
Jurisdiction	Caltrans	Time Period Analyzed	AM Peak Hour
Project Description	CMD1801 - Village D Specific Plan	Unit	United States Customary

Geometric Data

Number of Lanes, ln	3	Terrain Type	Level
Segment Length (L), ft	-	Percent Grade, %	-
Measured or Base Free-Flow Speed	Base	Grade Length, mi	-
Base Free-Flow Speed (BFFS), mi/h	65.0	Total Ramp Density (TRD), ramps/mi	1.83
Lane Width, ft	12	Free-Flow Speed (FFS), mi/h	59.7
Right-Side Lateral Clearance, ft	10		

Adjustment Factors

Driver Population	All Familiar	Final Speed Adjustment Factor (SAF)	1.000
Weather Type	Non-Severe Weather	Final Capacity Adjustment Factor (CAF)	1.000
Incident Type	No Incident	Demand Adjustment Factor (DAF)	1.000

Demand and Capacity

Demand Volume veh/h	3543	Heavy Vehicle Adjustment Factor (fhv)	0.836
Peak Hour Factor	0.94	Flow Rate (Vp), pc/h/ln	1503
Total Trucks, %	19.62	Capacity (c), pc/h/ln	2296
Single-Unit Trucks (SUT), %	-	Adjusted Capacity (cadj), pc/h/ln	2296
Tractor-Trailers (TT), %	-	Volume-to-Capacity Ratio (v/c)	0.65
Passenger Car Equivalent (ET)	2.000		

Speed and Density

Lane Width Adjustment (fLW)	0.0	Average Speed (S), mi/h	59.6
Right-Side Lateral Clearance Adj. (fRLC)	0.0	Density (D), pc/mi/ln	25.2
Total Ramp Density Adjustment	5.4	Level of Service (LOS)	C
Adjusted Free-Flow Speed (FFSadj), mi/h	59.6		

HCS7 Freeway Merge Report

Project Information

Analyst	LSA	Date	12/11/2019
Agency	LSA	Analysis Year	Phase II Proj Comp Yr (2039) WP
Jurisdiction	Caltrans	Time Period Analyzed	AM Peak Hour
Project Description	CMD1801 - Village D Specific Plan	Unit	United States Customary

Geometric Data

	Freeway	Ramp
Number of Lanes (N), ln	3	1
Free-Flow Speed (FFS), mi/h	65.0	35.0
Segment Length (L) / Acceleration Length (LA),ft	1500	800
Terrain Type	Level	Level
Percent Grade, %	-	-
Segment Type / Ramp Side	Freeway	Right

Adjustment Factors

Driver Population	All Familiar	All Familiar
Weather Type	Non-Severe Weather	Non-Severe Weather
Incident Type	No Incident	-
Final Speed Adjustment Factor (SAF)	1.000	1.000
Final Capacity Adjustment Factor (CAF)	1.000	1.000
Demand Adjustment Factor (DAF)	1.000	1.000

Demand and Capacity

Demand Volume (Vi)	3543	319
Peak Hour Factor (PHF)	0.94	0.94
Total Trucks, %	19.62	2.51
Single-Unit Trucks (SUT), %	-	-
Tractor-Trailers (TT), %	-	-
Heavy Vehicle Adjustment Factor (fHV)	0.836	0.976
Flow Rate (vi),pc/h	4509	348
Capacity (c), pc/h	7050	2000
Volume-to-Capacity Ratio (v/c)	0.69	0.17

Speed and Density

Upstream Equilibrium Distance (LEQ), ft	-	Number of Outer Lanes on Freeway (NO)	1
Distance to Upstream Ramp (LUP), ft	-	Speed Index (MS)	0.348
Downstream Equilibrium Distance (LEQ), ft	-	Flow Outer Lanes (vOA), pc/h/ln	1804
Distance to Downstream Ramp (LDOWN), ft	-	On-Ramp Influence Area Speed (SR), mi/h	57.0
Prop. Freeway Vehicles in Lane 1 and 2 (PFM)	0.600	Outer Lanes Freeway Speed (SO), mi/h	60.3
Flow in Lanes 1 and 2 (v12), pc/h	2705	Ramp Junction Speed (S), mi/h	58.2
Flow Entering Ramp-Infl. Area (vR12), pc/h	3053	Average Density (D), pc/mi/ln	27.8
Level of Service (LOS)	C	Density in Ramp Influence Area (DR), pc/mi/ln	24.2

HCS7 Basic Freeway Report

Project Information

Analyst	LSA	Date	12/11/2019
Agency	LSA	Analysis Year	Phase II Proj Comp Yr (2039) WP
Jurisdiction	Caltrans	Time Period Analyzed	AM Peak Hour
Project Description	CMD1801 - Village D Specific Plan	Unit	United States Customary

Geometric Data

Number of Lanes, ln	3	Terrain Type	Level
Segment Length (L), ft	-	Percent Grade, %	-
Measured or Base Free-Flow Speed	Base	Grade Length, mi	-
Base Free-Flow Speed (BFFS), mi/h	65.0	Total Ramp Density (TRD), ramps/mi	2.17
Lane Width, ft	12	Free-Flow Speed (FFS), mi/h	58.8
Right-Side Lateral Clearance, ft	10		

Adjustment Factors

Driver Population	All Familiar	Final Speed Adjustment Factor (SAF)	1.000
Weather Type	Non-Severe Weather	Final Capacity Adjustment Factor (CAF)	1.000
Incident Type	No Incident	Demand Adjustment Factor (DAF)	1.000

Demand and Capacity

Demand Volume veh/h	3862	Heavy Vehicle Adjustment Factor (fhv)	0.846
Peak Hour Factor	0.94	Flow Rate (Vp), pc/h/ln	1619
Total Trucks, %	18.22	Capacity (c), pc/h/ln	2288
Single-Unit Trucks (SUT), %	-	Adjusted Capacity (cadj), pc/h/ln	2288
Tractor-Trailers (TT), %	-	Volume-to-Capacity Ratio (v/c)	0.71
Passenger Car Equivalent (ET)	2.000		

Speed and Density

Lane Width Adjustment (fLW)	0.0	Average Speed (S), mi/h	58.8
Right-Side Lateral Clearance Adj. (fRLC)	0.0	Density (D), pc/mi/ln	27.5
Total Ramp Density Adjustment	6.2	Level of Service (LOS)	D
Adjusted Free-Flow Speed (FFSadj), mi/h	58.8		

HCS7 Freeway Diverge Report

Project Information

Analyst	LSA	Date	12/11/2019
Agency	LSA	Analysis Year	Phase II Proj Comp Yr (2039) WP
Jurisdiction	Caltrans	Time Period Analyzed	AM Peak Hour
Project Description	CMD1801 - Village D Specific Plan	Unit	United States Customary

Geometric Data

	Freeway	Ramp
Number of Lanes (N), ln	3	1
Free-Flow Speed (FFS), mi/h	65.0	35.0
Segment Length (L) / Deceleration Length (LA),ft	1500	200
Terrain Type	Level	Level
Percent Grade, %	-	-
Segment Type / Ramp Side	Freeway	Right

Adjustment Factors

Driver Population	All Familiar	All Familiar
Weather Type	Non-Severe Weather	Non-Severe Weather
Incident Type	No Incident	-
Final Speed Adjustment Factor (SAF)	1.000	1.000
Final Capacity Adjustment Factor (CAF)	1.000	1.000
Demand Adjustment Factor (DAF)	1.000	1.000

Demand and Capacity

Demand Volume (Vi)	3862	296
Peak Hour Factor (PHF)	0.94	0.94
Total Trucks, %	18.22	6.76
Single-Unit Trucks (SUT), %	-	-
Tractor-Trailers (TT), %	-	-
Heavy Vehicle Adjustment Factor (fHV)	0.846	0.937
Flow Rate (vi),pc/h	4856	336
Capacity (c), pc/h	7050	2000
Volume-to-Capacity Ratio (v/c)	0.69	0.17

Speed and Density

Upstream Equilibrium Distance (LEQ), ft	-	Number of Outer Lanes on Freeway (NO)	1
Distance to Upstream Ramp (LUP), ft	-	Speed Index (DS)	0.458
Downstream Equilibrium Distance (LEQ), ft	-	Flow Outer Lanes (vOA), pc/h/ln	1704
Distance to Downstream Ramp (LDOWN), ft	-	Off-Ramp Influence Area Speed (SR), mi/h	54.5
Prop. Freeway Vehicles in Lane 1 and 2 (PFD)	0.623	Outer Lanes Freeway Speed (SO), mi/h	68.6
Flow in Lanes 1 and 2 (v12), pc/h	3152	Ramp Junction Speed (S), mi/h	58.7
Flow Entering Ramp-Infl. Area (vR12), pc/h	-	Average Density (D), pc/mi/ln	27.6
Level of Service (LOS)	D	Density in Ramp Influence Area (DR), pc/mi/ln	29.6

HCS7 Basic Freeway Report

Project Information

Analyst	LSA	Date	12/11/2019
Agency	LSA	Analysis Year	Phase II Proj Comp Yr (2039) WP
Jurisdiction	Caltrans	Time Period Analyzed	AM Peak Hour
Project Description	CMD1801 - Village D Specific Plan	Unit	United States Customary

Geometric Data

Number of Lanes, ln	3	Terrain Type	Level
Segment Length (L), ft	-	Percent Grade, %	-
Measured or Base Free-Flow Speed	Base	Grade Length, mi	-
Base Free-Flow Speed (BFFS), mi/h	65.0	Total Ramp Density (TRD), ramps/mi	2.17
Lane Width, ft	12	Free-Flow Speed (FFS), mi/h	58.8
Right-Side Lateral Clearance, ft	10		

Adjustment Factors

Driver Population	All Familiar	Final Speed Adjustment Factor (SAF)	1.000
Weather Type	Non-Severe Weather	Final Capacity Adjustment Factor (CAF)	1.000
Incident Type	No Incident	Demand Adjustment Factor (DAF)	1.000

Demand and Capacity

Demand Volume veh/h	3566	Heavy Vehicle Adjustment Factor (fhv)	0.839
Peak Hour Factor	0.94	Flow Rate (Vp), pc/h/ln	1507
Total Trucks, %	19.17	Capacity (c), pc/h/ln	2288
Single-Unit Trucks (SUT), %	-	Adjusted Capacity (cadj), pc/h/ln	2288
Tractor-Trailers (TT), %	-	Volume-to-Capacity Ratio (v/c)	0.66
Passenger Car Equivalent (ET)	2.000		

Speed and Density

Lane Width Adjustment (fLW)	0.0	Average Speed (S), mi/h	58.8
Right-Side Lateral Clearance Adj. (fRLC)	0.0	Density (D), pc/mi/ln	25.6
Total Ramp Density Adjustment	6.2	Level of Service (LOS)	C
Adjusted Free-Flow Speed (FFSadj), mi/h	58.8		

HCS7 Freeway Merge Report

Project Information

Analyst	LSA	Date	12/11/2019
Agency	LSA	Analysis Year	Phase II Proj Comp Yr (2039) WP
Jurisdiction	Caltrans	Time Period Analyzed	AM Peak Hour
Project Description	CMD1801 - Village D Specific Plan	Unit	United States Customary

Geometric Data

	Freeway	Ramp
Number of Lanes (N), ln	3	1
Free-Flow Speed (FFS), mi/h	65.0	35.0
Segment Length (L) / Acceleration Length (LA),ft	1500	350
Terrain Type	Level	Level
Percent Grade, %	-	-
Segment Type / Ramp Side	Freeway	Right

Adjustment Factors

Driver Population	All Familiar	All Familiar
Weather Type	Non-Severe Weather	Non-Severe Weather
Incident Type	No Incident	-
Final Speed Adjustment Factor (SAF)	1.000	1.000
Final Capacity Adjustment Factor (CAF)	1.000	1.000
Demand Adjustment Factor (DAF)	1.000	1.000

Demand and Capacity

Demand Volume (Vi)	3566	1181
Peak Hour Factor (PHF)	0.94	0.94
Total Trucks, %	19.17	2.03
Single-Unit Trucks (SUT), %	-	-
Tractor-Trailers (TT), %	-	-
Heavy Vehicle Adjustment Factor (fHV)	0.839	0.980
Flow Rate (vi),pc/h	4522	1282
Capacity (c), pc/h	7050	2000
Volume-to-Capacity Ratio (v/c)	0.82	0.64

Speed and Density

Upstream Equilibrium Distance (LEQ), ft	-	Number of Outer Lanes on Freeway (NO)	1
Distance to Upstream Ramp (LUP), ft	-	Speed Index (MS)	0.496
Downstream Equilibrium Distance (LEQ), ft	-	Flow Outer Lanes (vOA), pc/h/ln	1868
Distance to Downstream Ramp (LDOWN), ft	-	On-Ramp Influence Area Speed (SR), mi/h	53.6
Prop. Freeway Vehicles in Lane 1 and 2 (PFM)	0.587	Outer Lanes Freeway Speed (SO), mi/h	60.1
Flow in Lanes 1 and 2 (v12), pc/h	2654	Ramp Junction Speed (S), mi/h	55.5
Flow Entering Ramp-Infl. Area (vR12), pc/h	3936	Average Density (D), pc/mi/ln	34.9
Level of Service (LOS)	D	Density in Ramp Influence Area (DR), pc/mi/ln	33.5

HCS7 Basic Freeway Report

Project Information

Analyst	LSA	Date	12/11/2019
Agency	LSA	Analysis Year	Phase II Proj Comp Yr (2039) WP
Jurisdiction	Caltrans	Time Period Analyzed	AM Peak Hour
Project Description	CMD1801 - Village D Specific Plan	Unit	United States Customary

Geometric Data

Number of Lanes, ln	3	Terrain Type	Level
Segment Length (L), ft	-	Percent Grade, %	-
Measured or Base Free-Flow Speed	Base	Grade Length, mi	-
Base Free-Flow Speed (BFFS), mi/h	65.0	Total Ramp Density (TRD), ramps/mi	2.17
Lane Width, ft	12	Free-Flow Speed (FFS), mi/h	58.8
Right-Side Lateral Clearance, ft	10		

Adjustment Factors

Driver Population	All Familiar	Final Speed Adjustment Factor (SAF)	1.000
Weather Type	Non-Severe Weather	Final Capacity Adjustment Factor (CAF)	1.000
Incident Type	No Incident	Demand Adjustment Factor (DAF)	1.000

Demand and Capacity

Demand Volume veh/h	4747	Heavy Vehicle Adjustment Factor (fhv)	0.870
Peak Hour Factor	0.94	Flow Rate (Vp), pc/h/ln	1935
Total Trucks, %	14.90	Capacity (c), pc/h/ln	2288
Single-Unit Trucks (SUT), %	-	Adjusted Capacity (cadj), pc/h/ln	2288
Tractor-Trailers (TT), %	-	Volume-to-Capacity Ratio (v/c)	0.85
Passenger Car Equivalent (ET)	2.000		

Speed and Density

Lane Width Adjustment (fLW)	0.0	Average Speed (S), mi/h	57.2
Right-Side Lateral Clearance Adj. (fRLC)	0.0	Density (D), pc/mi/ln	33.8
Total Ramp Density Adjustment	6.2	Level of Service (LOS)	D
Adjusted Free-Flow Speed (FFSadj), mi/h	58.8		

HCS7 Freeway Diverge Report

Project Information

Analyst	LSA	Date	12/11/2019
Agency	LSA	Analysis Year	Phase II Proj Comp Yr (2039) WP
Jurisdiction	Caltrans	Time Period Analyzed	AM Peak Hour
Project Description	CMD1801 - Village D Specific Plan	Unit	United States Customary

Geometric Data

	Freeway	Ramp
Number of Lanes (N), ln	3	1
Free-Flow Speed (FFS), mi/h	65.0	15.0
Segment Length (L) / Deceleration Length (LA),ft	1500	150
Terrain Type	Level	Level
Percent Grade, %	-	-
Segment Type / Ramp Side	Freeway	Right

Adjustment Factors

Driver Population	All Familiar	All Familiar
Weather Type	Non-Severe Weather	Non-Severe Weather
Incident Type	No Incident	-
Final Speed Adjustment Factor (SAF)	1.000	1.000
Final Capacity Adjustment Factor (CAF)	1.000	1.000
Demand Adjustment Factor (DAF)	1.000	1.000

Demand and Capacity

Demand Volume (Vi)	4747	525
Peak Hour Factor (PHF)	0.94	0.94
Total Trucks, %	14.90	2.67
Single-Unit Trucks (SUT), %	-	-
Tractor-Trailers (TT), %	-	-
Heavy Vehicle Adjustment Factor (fHV)	0.870	0.974
Flow Rate (vi),pc/h	5805	573
Capacity (c), pc/h	7050	1800
Volume-to-Capacity Ratio (v/c)	0.82	0.32

Speed and Density

Upstream Equilibrium Distance (LEQ), ft	-	Number of Outer Lanes on Freeway (NO)	1
Distance to Upstream Ramp (LUP), ft	-	Speed Index (DS)	0.740
Downstream Equilibrium Distance (LEQ), ft	-	Flow Outer Lanes (vOA), pc/h/ln	2150
Distance to Downstream Ramp (LDOWN), ft	-	Off-Ramp Influence Area Speed (SR), mi/h	48.0
Prop. Freeway Vehicles in Lane 1 and 2 (PFD)	0.589	Outer Lanes Freeway Speed (SO), mi/h	66.8
Flow in Lanes 1 and 2 (v12), pc/h	3655	Ramp Junction Speed (S), mi/h	53.6
Flow Entering Ramp-Infl. Area (vR12), pc/h	-	Average Density (D), pc/mi/ln	36.1
Level of Service (LOS)	D	Density in Ramp Influence Area (DR), pc/mi/ln	34.3

HCS7 Basic Freeway Report

Project Information

Analyst	LSA	Date	12/11/2019
Agency	LSA	Analysis Year	Phase II Proj Comp Yr (2039) WP
Jurisdiction	Caltrans	Time Period Analyzed	AM Peak Hour
Project Description	CMD1801 - Village D Specific Plan	Unit	United States Customary

Geometric Data

Number of Lanes, ln	3	Terrain Type	Level
Segment Length (L), ft	-	Percent Grade, %	-
Measured or Base Free-Flow Speed	Base	Grade Length, mi	-
Base Free-Flow Speed (BFFS), mi/h	65.0	Total Ramp Density (TRD), ramps/mi	1.83
Lane Width, ft	12	Free-Flow Speed (FFS), mi/h	59.7
Right-Side Lateral Clearance, ft	10		

Adjustment Factors

Driver Population	All Familiar	Final Speed Adjustment Factor (SAF)	1.000
Weather Type	Non-Severe Weather	Final Capacity Adjustment Factor (CAF)	1.000
Incident Type	No Incident	Demand Adjustment Factor (DAF)	1.000

Demand and Capacity

Demand Volume veh/h	4222	Heavy Vehicle Adjustment Factor (fhv)	0.859
Peak Hour Factor	0.94	Flow Rate (Vp), pc/h/ln	1743
Total Trucks, %	16.42	Capacity (c), pc/h/ln	2296
Single-Unit Trucks (SUT), %	-	Adjusted Capacity (cadj), pc/h/ln	2296
Tractor-Trailers (TT), %	-	Volume-to-Capacity Ratio (v/c)	0.76
Passenger Car Equivalent (ET)	2.000		

Speed and Density

Lane Width Adjustment (fLW)	0.0	Average Speed (S), mi/h	59.3
Right-Side Lateral Clearance Adj. (fRLC)	0.0	Density (D), pc/mi/ln	29.4
Total Ramp Density Adjustment	5.4	Level of Service (LOS)	D
Adjusted Free-Flow Speed (FFSadj), mi/h	59.6		

HCS7 Freeway Merge Report

Project Information

Analyst	LSA	Date	12/11/2019
Agency	LSA	Analysis Year	Phase II Proj Comp Yr (2039) WP
Jurisdiction	Caltrans	Time Period Analyzed	AM Peak Hour
Project Description	CMD1801 - Village D Specific Plan	Unit	United States Customary

Geometric Data

	Freeway	Ramp
Number of Lanes (N), ln	3	1
Free-Flow Speed (FFS), mi/h	65.0	35.0
Segment Length (L) / Acceleration Length (LA),ft	1500	450
Terrain Type	Level	Level
Percent Grade, %	-	-
Segment Type / Ramp Side	Freeway	Right

Adjustment Factors

Driver Population	All Familiar	All Familiar
Weather Type	Non-Severe Weather	Non-Severe Weather
Incident Type	No Incident	-
Final Speed Adjustment Factor (SAF)	1.000	1.000
Final Capacity Adjustment Factor (CAF)	1.000	1.000
Demand Adjustment Factor (DAF)	1.000	1.000

Demand and Capacity

Demand Volume (Vi)	4222	558
Peak Hour Factor (PHF)	0.94	0.94
Total Trucks, %	16.42	0.90
Single-Unit Trucks (SUT), %	-	-
Tractor-Trailers (TT), %	-	-
Heavy Vehicle Adjustment Factor (fHV)	0.859	0.991
Flow Rate (vi),pc/h	5229	599
Capacity (c), pc/h	7050	2000
Volume-to-Capacity Ratio (v/c)	0.83	0.30

Speed and Density

Upstream Equilibrium Distance (LEQ), ft	-	Number of Outer Lanes on Freeway (NO)	1
Distance to Upstream Ramp (LUP), ft	-	Speed Index (MS)	0.445
Downstream Equilibrium Distance (LEQ), ft	-	Flow Outer Lanes (vOA), pc/h/ln	2144
Distance to Downstream Ramp (LDOWN), ft	-	On-Ramp Influence Area Speed (SR), mi/h	54.8
Prop. Freeway Vehicles in Lane 1 and 2 (PFM)	0.590	Outer Lanes Freeway Speed (SO), mi/h	59.1
Flow in Lanes 1 and 2 (v12), pc/h	3085	Ramp Junction Speed (S), mi/h	56.3
Flow Entering Ramp-Infl. Area (vR12), pc/h	3684	Average Density (D), pc/mi/ln	34.5
Level of Service (LOS)	D	Density in Ramp Influence Area (DR), pc/mi/ln	31.2

HCS7 Basic Freeway Report

Project Information

Analyst	LSA	Date	12/11/2019
Agency	LSA	Analysis Year	Phase II Proj Comp Yr (2039) WP
Jurisdiction	Caltrans	Time Period Analyzed	AM Peak Hour
Project Description	CMD1801 - Village D Specific Plan	Unit	United States Customary

Geometric Data

Number of Lanes, ln	3	Terrain Type	Level
Segment Length (L), ft	-	Percent Grade, %	-
Measured or Base Free-Flow Speed	Base	Grade Length, mi	-
Base Free-Flow Speed (BFFS), mi/h	65.0	Total Ramp Density (TRD), ramps/mi	1.83
Lane Width, ft	12	Free-Flow Speed (FFS), mi/h	59.7
Right-Side Lateral Clearance, ft	10		

Adjustment Factors

Driver Population	All Familiar	Final Speed Adjustment Factor (SAF)	1.000
Weather Type	Non-Severe Weather	Final Capacity Adjustment Factor (CAF)	1.000
Incident Type	No Incident	Demand Adjustment Factor (DAF)	1.000

Demand and Capacity

Demand Volume veh/h	4779	Heavy Vehicle Adjustment Factor (fhv)	0.873
Peak Hour Factor	0.94	Flow Rate (Vp), pc/h/ln	1941
Total Trucks, %	14.60	Capacity (c), pc/h/ln	2296
Single-Unit Trucks (SUT), %	-	Adjusted Capacity (cadj), pc/h/ln	2296
Tractor-Trailers (TT), %	-	Volume-to-Capacity Ratio (v/c)	0.85
Passenger Car Equivalent (ET)	2.000		

Speed and Density

Lane Width Adjustment (fLW)	0.0	Average Speed (S), mi/h	57.6
Right-Side Lateral Clearance Adj. (fRLC)	0.0	Density (D), pc/mi/ln	33.7
Total Ramp Density Adjustment	5.4	Level of Service (LOS)	D
Adjusted Free-Flow Speed (FFSadj), mi/h	59.6		

HCS7 Freeway Diverge Report

Project Information

Analyst	LSA	Date	12/11/2019
Agency	LSA	Analysis Year	Phase II Proj Comp Yr (2039) WP
Jurisdiction	Caltrans	Time Period Analyzed	AM Peak Hour
Project Description	CMD1801 - Village D Specific Plan	Unit	United States Customary

Geometric Data

	Freeway	Ramp
Number of Lanes (N), ln	3	1
Free-Flow Speed (FFS), mi/h	65.0	35.0
Segment Length (L) / Deceleration Length (LA),ft	1500	140
Terrain Type	Level	Level
Percent Grade, %	-	-
Segment Type / Ramp Side	Freeway	Right

Adjustment Factors

Driver Population	All Familiar	All Familiar
Weather Type	Non-Severe Weather	Non-Severe Weather
Incident Type	No Incident	-
Final Speed Adjustment Factor (SAF)	1.000	1.000
Final Capacity Adjustment Factor (CAF)	1.000	1.000
Demand Adjustment Factor (DAF)	1.000	1.000

Demand and Capacity

Demand Volume (Vi)	4779	890
Peak Hour Factor (PHF)	0.94	0.94
Total Trucks, %	14.60	7.53
Single-Unit Trucks (SUT), %	-	-
Tractor-Trailers (TT), %	-	-
Heavy Vehicle Adjustment Factor (fHV)	0.873	0.930
Flow Rate (vi),pc/h	5824	1018
Capacity (c), pc/h	7050	2000
Volume-to-Capacity Ratio (v/c)	0.83	0.51

Speed and Density

Upstream Equilibrium Distance (LEQ), ft	-	Number of Outer Lanes on Freeway (NO)	1
Distance to Upstream Ramp (LUP), ft	-	Speed Index (DS)	0.520
Downstream Equilibrium Distance (LEQ), ft	-	Flow Outer Lanes (vOA), pc/h/ln	2076
Distance to Downstream Ramp (LDOWN), ft	-	Off-Ramp Influence Area Speed (SR), mi/h	53.0
Prop. Freeway Vehicles in Lane 1 and 2 (PFD)	0.568	Outer Lanes Freeway Speed (SO), mi/h	67.1
Flow in Lanes 1 and 2 (v12), pc/h	3748	Ramp Junction Speed (S), mi/h	57.3
Flow Entering Ramp-Infl. Area (vR12), pc/h	-	Average Density (D), pc/mi/ln	33.9
Level of Service (LOS)	E	Density in Ramp Influence Area (DR), pc/mi/ln	35.2

HCS7 Basic Freeway Report

Project Information

Analyst	LSA	Date	12/11/2019
Agency	LSA	Analysis Year	Phase II Proj Comp Yr (2039) WP
Jurisdiction	Caltrans	Time Period Analyzed	AM Peak Hour
Project Description	CMD1801 - Village D Specific Plan	Unit	United States Customary

Geometric Data

Number of Lanes, ln	3	Terrain Type	Level
Segment Length (L), ft	-	Percent Grade, %	-
Measured or Base Free-Flow Speed	Base	Grade Length, mi	-
Base Free-Flow Speed (BFFS), mi/h	65.0	Total Ramp Density (TRD), ramps/mi	2.17
Lane Width, ft	12	Free-Flow Speed (FFS), mi/h	58.8
Right-Side Lateral Clearance, ft	10		

Adjustment Factors

Driver Population	All Familiar	Final Speed Adjustment Factor (SAF)	1.000
Weather Type	Non-Severe Weather	Final Capacity Adjustment Factor (CAF)	1.000
Incident Type	No Incident	Demand Adjustment Factor (DAF)	1.000

Demand and Capacity

Demand Volume veh/h	3890	Heavy Vehicle Adjustment Factor (fhv)	0.860
Peak Hour Factor	0.94	Flow Rate (Vp), pc/h/ln	1604
Total Trucks, %	16.22	Capacity (c), pc/h/ln	2288
Single-Unit Trucks (SUT), %	-	Adjusted Capacity (cadj), pc/h/ln	2288
Tractor-Trailers (TT), %	-	Volume-to-Capacity Ratio (v/c)	0.70
Passenger Car Equivalent (ET)	2.000		

Speed and Density

Lane Width Adjustment (fLW)	0.0	Average Speed (S), mi/h	58.8
Right-Side Lateral Clearance Adj. (fRLC)	0.0	Density (D), pc/mi/ln	27.3
Total Ramp Density Adjustment	6.2	Level of Service (LOS)	D
Adjusted Free-Flow Speed (FFSadj), mi/h	58.8		

HCS7 Freeway Merge Report

Project Information

Analyst	LSA	Date	12/11/2019
Agency	LSA	Analysis Year	Phase II Proj Comp Yr (2039) WP
Jurisdiction	Caltrans	Time Period Analyzed	AM Peak Hour
Project Description	CMD1801 - Village D Specific Plan	Unit	United States Customary

Geometric Data

	Freeway	Ramp
Number of Lanes (N), ln	3	1
Free-Flow Speed (FFS), mi/h	65.0	35.0
Segment Length (L) / Acceleration Length (LA),ft	1500	450
Terrain Type	Level	Level
Percent Grade, %	-	-
Segment Type / Ramp Side	Freeway	Right

Adjustment Factors

Driver Population	All Familiar	All Familiar
Weather Type	Non-Severe Weather	Non-Severe Weather
Incident Type	No Incident	-
Final Speed Adjustment Factor (SAF)	1.000	1.000
Final Capacity Adjustment Factor (CAF)	1.000	1.000
Demand Adjustment Factor (DAF)	1.000	1.000

Demand and Capacity

Demand Volume (Vi)	3890	327
Peak Hour Factor (PHF)	0.94	0.94
Total Trucks, %	16.22	2.44
Single-Unit Trucks (SUT), %	-	-
Tractor-Trailers (TT), %	-	-
Heavy Vehicle Adjustment Factor (fHV)	0.860	0.976
Flow Rate (vi),pc/h	4812	356
Capacity (c), pc/h	7050	2000
Volume-to-Capacity Ratio (v/c)	0.73	0.18

Speed and Density

Upstream Equilibrium Distance (LEQ), ft	-	Number of Outer Lanes on Freeway (NO)	1
Distance to Upstream Ramp (LUP), ft	-	Speed Index (MS)	0.385
Downstream Equilibrium Distance (LEQ), ft	-	Flow Outer Lanes (vOA), pc/h/ln	1973
Distance to Downstream Ramp (LDOWN), ft	-	On-Ramp Influence Area Speed (SR), mi/h	56.1
Prop. Freeway Vehicles in Lane 1 and 2 (PFM)	0.590	Outer Lanes Freeway Speed (SO), mi/h	59.7
Flow in Lanes 1 and 2 (v12), pc/h	2839	Ramp Junction Speed (S), mi/h	57.4
Flow Entering Ramp-Infl. Area (vR12), pc/h	3195	Average Density (D), pc/mi/ln	30.0
Level of Service (LOS)	C	Density in Ramp Influence Area (DR), pc/mi/ln	27.5

HCS7 Basic Freeway Report

Project Information

Analyst	LSA	Date	12/11/2019
Agency	LSA	Analysis Year	Phase II Proj Comp Yr (2039) WP
Jurisdiction	Caltrans	Time Period Analyzed	AM Peak Hour
Project Description	CMD1801 - Village D Specific Plan	Unit	United States Customary

Geometric Data

Number of Lanes, ln	3	Terrain Type	Level
Segment Length (L), ft	-	Percent Grade, %	-
Measured or Base Free-Flow Speed	Base	Grade Length, mi	-
Base Free-Flow Speed (BFFS), mi/h	65.0	Total Ramp Density (TRD), ramps/mi	2.17
Lane Width, ft	12	Free-Flow Speed (FFS), mi/h	58.8
Right-Side Lateral Clearance, ft	10		

Adjustment Factors

Driver Population	All Familiar	Final Speed Adjustment Factor (SAF)	1.000
Weather Type	Non-Severe Weather	Final Capacity Adjustment Factor (CAF)	1.000
Incident Type	No Incident	Demand Adjustment Factor (DAF)	1.000

Demand and Capacity

Demand Volume veh/h	4217	Heavy Vehicle Adjustment Factor (fhv)	0.868
Peak Hour Factor	0.94	Flow Rate (Vp), pc/h/ln	1723
Total Trucks, %	15.16	Capacity (c), pc/h/ln	2288
Single-Unit Trucks (SUT), %	-	Adjusted Capacity (cadj), pc/h/ln	2288
Tractor-Trailers (TT), %	-	Volume-to-Capacity Ratio (v/c)	0.75
Passenger Car Equivalent (ET)	2.000		

Speed and Density

Lane Width Adjustment (fLW)	0.0	Average Speed (S), mi/h	58.7
Right-Side Lateral Clearance Adj. (fRLC)	0.0	Density (D), pc/mi/ln	29.4
Total Ramp Density Adjustment	6.2	Level of Service (LOS)	D
Adjusted Free-Flow Speed (FFSadj), mi/h	58.8		

HCS7 Basic Freeway Report

Project Information

Analyst	LSA	Date	12/11/2019
Agency	LSA	Analysis Year	Phase II Proj Comp Yr (2039) WP
Jurisdiction	Caltrans	Time Period Analyzed	PM Peak Hour
Project Description	CMD1801 - Village D Specific Plan	Unit	United States Customary

Geometric Data

Number of Lanes, ln	3	Terrain Type	Level
Segment Length (L), ft	-	Percent Grade, %	-
Measured or Base Free-Flow Speed	Base	Grade Length, mi	-
Base Free-Flow Speed (BFFS), mi/h	65.0	Total Ramp Density (TRD), ramps/mi	1.83
Lane Width, ft	12	Free-Flow Speed (FFS), mi/h	59.7
Right-Side Lateral Clearance, ft	10		

Adjustment Factors

Driver Population	All Familiar	Final Speed Adjustment Factor (SAF)	1.000
Weather Type	Non-Severe Weather	Final Capacity Adjustment Factor (CAF)	1.000
Incident Type	No Incident	Demand Adjustment Factor (DAF)	1.000

Demand and Capacity

Demand Volume veh/h	4006	Heavy Vehicle Adjustment Factor (fhv)	0.869
Peak Hour Factor	0.94	Flow Rate (Vp), pc/h/ln	1635
Total Trucks, %	15.12	Capacity (c), pc/h/ln	2296
Single-Unit Trucks (SUT), %	-	Adjusted Capacity (cadj), pc/h/ln	2296
Tractor-Trailers (TT), %	-	Volume-to-Capacity Ratio (v/c)	0.71
Passenger Car Equivalent (ET)	2.000		

Speed and Density

Lane Width Adjustment (fLW)	0.0	Average Speed (S), mi/h	59.6
Right-Side Lateral Clearance Adj. (fRLC)	0.0	Density (D), pc/mi/ln	27.4
Total Ramp Density Adjustment	5.4	Level of Service (LOS)	D
Adjusted Free-Flow Speed (FFSadj), mi/h	59.6		

HCS7 Freeway Diverge Report

Project Information

Analyst	LSA	Date	12/11/2019
Agency	LSA	Analysis Year	Phase II Proj Comp Yr (2039) WP
Jurisdiction	Caltrans	Time Period Analyzed	PM Peak Hour
Project Description	CMD1801 - Village D Specific Plan	Unit	United States Customary

Geometric Data

	Freeway	Ramp
Number of Lanes (N), ln	3	1
Free-Flow Speed (FFS), mi/h	65.0	35.0
Segment Length (L) / Deceleration Length (LA),ft	1500	150
Terrain Type	Level	Level
Percent Grade, %	-	-
Segment Type / Ramp Side	Freeway	Right

Adjustment Factors

Driver Population	All Familiar	All Familiar
Weather Type	Non-Severe Weather	Non-Severe Weather
Incident Type	No Incident	-
Final Speed Adjustment Factor (SAF)	1.000	1.000
Final Capacity Adjustment Factor (CAF)	1.000	1.000
Demand Adjustment Factor (DAF)	1.000	1.000

Demand and Capacity

Demand Volume (Vi)	4006	260
Peak Hour Factor (PHF)	0.94	0.94
Total Trucks, %	15.12	0.77
Single-Unit Trucks (SUT), %	-	-
Tractor-Trailers (TT), %	-	-
Heavy Vehicle Adjustment Factor (fHV)	0.869	0.992
Flow Rate (vi),pc/h	4904	279
Capacity (c), pc/h	7050	2000
Volume-to-Capacity Ratio (v/c)	0.70	0.14

Speed and Density

Upstream Equilibrium Distance (LEQ), ft	-	Number of Outer Lanes on Freeway (NO)	1
Distance to Upstream Ramp (LUP), ft	-	Speed Index (DS)	0.453
Downstream Equilibrium Distance (LEQ), ft	-	Flow Outer Lanes (vOA), pc/h/ln	1734
Distance to Downstream Ramp (LDOWN), ft	-	Off-Ramp Influence Area Speed (SR), mi/h	54.6
Prop. Freeway Vehicles in Lane 1 and 2 (PFD)	0.625	Outer Lanes Freeway Speed (SO), mi/h	68.4
Flow in Lanes 1 and 2 (v12), pc/h	3170	Ramp Junction Speed (S), mi/h	58.8
Flow Entering Ramp-Infl. Area (vR12), pc/h	-	Average Density (D), pc/mi/ln	27.8
Level of Service (LOS)	D	Density in Ramp Influence Area (DR), pc/mi/ln	30.2

HCS7 Basic Freeway Report

Project Information

Analyst	LSA	Date	12/11/2019
Agency	LSA	Analysis Year	Phase II Proj Comp Yr (2039) WP
Jurisdiction	Caltrans	Time Period Analyzed	PM Peak Hour
Project Description	CMD1801 - Village D Specific Plan	Unit	United States Customary

Geometric Data

Number of Lanes, ln	3	Terrain Type	Level
Segment Length (L), ft	-	Percent Grade, %	-
Measured or Base Free-Flow Speed	Base	Grade Length, mi	-
Base Free-Flow Speed (BFFS), mi/h	65.0	Total Ramp Density (TRD), ramps/mi	1.83
Lane Width, ft	12	Free-Flow Speed (FFS), mi/h	59.7
Right-Side Lateral Clearance, ft	10		

Adjustment Factors

Driver Population	All Familiar	Final Speed Adjustment Factor (SAF)	1.000
Weather Type	Non-Severe Weather	Final Capacity Adjustment Factor (CAF)	1.000
Incident Type	No Incident	Demand Adjustment Factor (DAF)	1.000

Demand and Capacity

Demand Volume veh/h	3746	Heavy Vehicle Adjustment Factor (fhv)	0.861
Peak Hour Factor	0.94	Flow Rate (Vp), pc/h/ln	1543
Total Trucks, %	16.11	Capacity (c), pc/h/ln	2296
Single-Unit Trucks (SUT), %	-	Adjusted Capacity (cadj), pc/h/ln	2296
Tractor-Trailers (TT), %	-	Volume-to-Capacity Ratio (v/c)	0.67
Passenger Car Equivalent (ET)	2.000		

Speed and Density

Lane Width Adjustment (fLW)	0.0	Average Speed (S), mi/h	59.6
Right-Side Lateral Clearance Adj. (fRLC)	0.0	Density (D), pc/mi/ln	25.9
Total Ramp Density Adjustment	5.4	Level of Service (LOS)	C
Adjusted Free-Flow Speed (FFSadj), mi/h	59.6		

HCS7 Freeway Merge Report

Project Information

Analyst	LSA	Date	12/11/2019
Agency	LSA	Analysis Year	Phase II Proj Comp Yr (2039) WP
Jurisdiction	Caltrans	Time Period Analyzed	PM Peak Hour
Project Description	CMD1801 - Village D Specific Plan	Unit	United States Customary

Geometric Data

	Freeway	Ramp
Number of Lanes (N), ln	3	1
Free-Flow Speed (FFS), mi/h	65.0	35.0
Segment Length (L) / Acceleration Length (LA),ft	1500	445
Terrain Type	Level	Level
Percent Grade, %	-	-
Segment Type / Ramp Side	Freeway	Right

Adjustment Factors

Driver Population	All Familiar	All Familiar
Weather Type	Non-Severe Weather	Non-Severe Weather
Incident Type	No Incident	-
Final Speed Adjustment Factor (SAF)	1.000	1.000
Final Capacity Adjustment Factor (CAF)	1.000	1.000
Demand Adjustment Factor (DAF)	1.000	1.000

Demand and Capacity

Demand Volume (Vi)	3746	1028
Peak Hour Factor (PHF)	0.94	0.94
Total Trucks, %	16.11	2.24
Single-Unit Trucks (SUT), %	-	-
Tractor-Trailers (TT), %	-	-
Heavy Vehicle Adjustment Factor (fHV)	0.861	0.978
Flow Rate (vi),pc/h	4628	1118
Capacity (c), pc/h	7050	2000
Volume-to-Capacity Ratio (v/c)	0.82	0.56

Speed and Density

Upstream Equilibrium Distance (LEQ), ft	-	Number of Outer Lanes on Freeway (NO)	1
Distance to Upstream Ramp (LUP), ft	-	Speed Index (MS)	0.473
Downstream Equilibrium Distance (LEQ), ft	-	Flow Outer Lanes (vOA), pc/h/ln	1897
Distance to Downstream Ramp (LDOWN), ft	-	On-Ramp Influence Area Speed (SR), mi/h	54.1
Prop. Freeway Vehicles in Lane 1 and 2 (PFM)	0.590	Outer Lanes Freeway Speed (SO), mi/h	60.0
Flow in Lanes 1 and 2 (v12), pc/h	2731	Ramp Junction Speed (S), mi/h	55.9
Flow Entering Ramp-Infl. Area (vR12), pc/h	3849	Average Density (D), pc/mi/ln	34.3
Level of Service (LOS)	D	Density in Ramp Influence Area (DR), pc/mi/ln	32.3

HCS7 Basic Freeway Report

Project Information

Analyst	LSA	Date	12/11/2019
Agency	LSA	Analysis Year	Phase II Proj Comp Yr (2039) WP
Jurisdiction	Caltrans	Time Period Analyzed	PM Peak Hour
Project Description	CMD1801 - Village D Specific Plan	Unit	United States Customary

Geometric Data

Number of Lanes, ln	3	Terrain Type	Level
Segment Length (L), ft	-	Percent Grade, %	-
Measured or Base Free-Flow Speed	Base	Grade Length, mi	-
Base Free-Flow Speed (BFFS), mi/h	65.0	Total Ramp Density (TRD), ramps/mi	1.50
Lane Width, ft	12	Free-Flow Speed (FFS), mi/h	60.5
Right-Side Lateral Clearance, ft	10		

Adjustment Factors

Driver Population	All Familiar	Final Speed Adjustment Factor (SAF)	1.000
Weather Type	Non-Severe Weather	Final Capacity Adjustment Factor (CAF)	1.000
Incident Type	No Incident	Demand Adjustment Factor (DAF)	1.000

Demand and Capacity

Demand Volume veh/h	4774	Heavy Vehicle Adjustment Factor (fhv)	0.884
Peak Hour Factor	0.94	Flow Rate (Vp), pc/h/ln	1915
Total Trucks, %	13.12	Capacity (c), pc/h/ln	2305
Single-Unit Trucks (SUT), %	-	Adjusted Capacity (cadj), pc/h/ln	2305
Tractor-Trailers (TT), %	-	Volume-to-Capacity Ratio (v/c)	0.83
Passenger Car Equivalent (ET)	2.000		

Speed and Density

Lane Width Adjustment (fLW)	0.0	Average Speed (S), mi/h	58.5
Right-Side Lateral Clearance Adj. (fRLC)	0.0	Density (D), pc/mi/ln	32.7
Total Ramp Density Adjustment	4.5	Level of Service (LOS)	D
Adjusted Free-Flow Speed (FFSadj), mi/h	60.5		

HCS7 Freeway Diverge Report

Project Information

Analyst	LSA	Date	12/11/2019
Agency	LSA	Analysis Year	Phase II Proj Comp Yr (2039) WP
Jurisdiction	Caltrans	Time Period Analyzed	PM Peak Hour
Project Description	CMD1801 - Village D Specific Plan	Unit	United States Customary

Geometric Data

	Freeway	Ramp
Number of Lanes (N), In	3	1
Free-Flow Speed (FFS), mi/h	65.0	35.0
Segment Length (L) / Deceleration Length (LA),ft	1500	130
Terrain Type	Level	Level
Percent Grade, %	-	-
Segment Type / Ramp Side	Freeway	Right

Adjustment Factors

Driver Population	All Familiar	All Familiar
Weather Type	Non-Severe Weather	Non-Severe Weather
Incident Type	No Incident	-
Final Speed Adjustment Factor (SAF)	1.000	1.000
Final Capacity Adjustment Factor (CAF)	1.000	1.000
Demand Adjustment Factor (DAF)	1.000	1.000

Demand and Capacity

Demand Volume (Vi)	4774	489
Peak Hour Factor (PHF)	0.94	0.94
Total Trucks, %	13.12	1.23
Single-Unit Trucks (SUT), %	-	-
Tractor-Trailers (TT), %	-	-
Heavy Vehicle Adjustment Factor (fHV)	0.884	0.988
Flow Rate (vi),pc/h	5745	527
Capacity (c), pc/h	7050	2000
Volume-to-Capacity Ratio (v/c)	0.81	0.26

Speed and Density

Upstream Equilibrium Distance (LEQ), ft	-	Number of Outer Lanes on Freeway (NO)	1
Distance to Upstream Ramp (LUP), ft	-	Speed Index (DS)	0.475
Downstream Equilibrium Distance (LEQ), ft	-	Flow Outer Lanes (vOA), pc/h/ln	2129
Distance to Downstream Ramp (LDOWN), ft	-	Off-Ramp Influence Area Speed (SR), mi/h	54.1
Prop. Freeway Vehicles in Lane 1 and 2 (PFD)	0.592	Outer Lanes Freeway Speed (SO), mi/h	66.9
Flow in Lanes 1 and 2 (v12), pc/h	3616	Ramp Junction Speed (S), mi/h	58.2
Flow Entering Ramp-Infl. Area (vR12), pc/h	-	Average Density (D), pc/mi/ln	32.9
Level of Service (LOS)	D	Density in Ramp Influence Area (DR), pc/mi/ln	34.2

HCS7 Basic Freeway Report

Project Information

Analyst	LSA	Date	12/11/2019
Agency	LSA	Analysis Year	Phase II Proj Comp Yr (2039) WP
Jurisdiction	Caltrans	Time Period Analyzed	PM Peak Hour
Project Description	CMD1801 - Village D Specific Plan	Unit	United States Customary

Geometric Data

Number of Lanes, ln	3	Terrain Type	Level
Segment Length (L), ft	-	Percent Grade, %	-
Measured or Base Free-Flow Speed	Base	Grade Length, mi	-
Base Free-Flow Speed (BFFS), mi/h	65.0	Total Ramp Density (TRD), ramps/mi	1.67
Lane Width, ft	12	Free-Flow Speed (FFS), mi/h	60.0
Right-Side Lateral Clearance, ft	10		

Adjustment Factors

Driver Population	All Familiar	Final Speed Adjustment Factor (SAF)	1.000
Weather Type	Non-Severe Weather	Final Capacity Adjustment Factor (CAF)	1.000
Incident Type	No Incident	Demand Adjustment Factor (DAF)	1.000

Demand and Capacity

Demand Volume veh/h	4284	Heavy Vehicle Adjustment Factor (fhv)	0.874
Peak Hour Factor	0.94	Flow Rate (Vp), pc/h/ln	1738
Total Trucks, %	14.48	Capacity (c), pc/h/ln	2300
Single-Unit Trucks (SUT), %	-	Adjusted Capacity (cadj), pc/h/ln	2300
Tractor-Trailers (TT), %	-	Volume-to-Capacity Ratio (v/c)	0.76
Passenger Car Equivalent (ET)	2.000		

Speed and Density

Lane Width Adjustment (fLW)	0.0	Average Speed (S), mi/h	59.7
Right-Side Lateral Clearance Adj. (fRLC)	0.0	Density (D), pc/mi/ln	29.1
Total Ramp Density Adjustment	5.0	Level of Service (LOS)	D
Adjusted Free-Flow Speed (FFSadj), mi/h	60.0		

HCS7 Freeway Merge Report

Project Information

Analyst	LSA	Date	12/11/2019
Agency	LSA	Analysis Year	Phase II Proj Comp Yr (2039) WP
Jurisdiction	Caltrans	Time Period Analyzed	PM Peak Hour
Project Description	CMD1801 - Village D Specific Plan	Unit	United States Customary

Geometric Data

	Freeway	Ramp
Number of Lanes (N), ln	3	1
Free-Flow Speed (FFS), mi/h	65.0	35.0
Segment Length (L) / Acceleration Length (LA),ft	1500	500
Terrain Type	Level	Level
Percent Grade, %	-	-
Segment Type / Ramp Side	Freeway	Right

Adjustment Factors

Driver Population	All Familiar	All Familiar
Weather Type	Non-Severe Weather	Non-Severe Weather
Incident Type	No Incident	-
Final Speed Adjustment Factor (SAF)	1.000	1.000
Final Capacity Adjustment Factor (CAF)	1.000	1.000
Demand Adjustment Factor (DAF)	1.000	1.000

Demand and Capacity

Demand Volume (Vi)	4284	502
Peak Hour Factor (PHF)	0.94	0.94
Total Trucks, %	14.48	1.79
Single-Unit Trucks (SUT), %	-	-
Tractor-Trailers (TT), %	-	-
Heavy Vehicle Adjustment Factor (fHV)	0.874	0.982
Flow Rate (vi),pc/h	5214	544
Capacity (c), pc/h	7050	2000
Volume-to-Capacity Ratio (v/c)	0.82	0.27

Speed and Density

Upstream Equilibrium Distance (LEQ), ft	-	Number of Outer Lanes on Freeway (NO)	1
Distance to Upstream Ramp (LUP), ft	-	Speed Index (MS)	0.433
Downstream Equilibrium Distance (LEQ), ft	-	Flow Outer Lanes (vOA), pc/h/ln	2127
Distance to Downstream Ramp (LDOWN), ft	-	On-Ramp Influence Area Speed (SR), mi/h	55.0
Prop. Freeway Vehicles in Lane 1 and 2 (PFM)	0.592	Outer Lanes Freeway Speed (SO), mi/h	59.1
Flow in Lanes 1 and 2 (v12), pc/h	3087	Ramp Junction Speed (S), mi/h	56.4
Flow Entering Ramp-Infl. Area (vR12), pc/h	3631	Average Density (D), pc/mi/ln	34.0
Level of Service (LOS)	D	Density in Ramp Influence Area (DR), pc/mi/ln	30.5

HCS7 Basic Freeway Report

Project Information

Analyst	LSA	Date	12/11/2019
Agency	LSA	Analysis Year	Phase II Proj Comp Yr (2039) WP
Jurisdiction	Caltrans	Time Period Analyzed	PM Peak Hour
Project Description	CMD1801 - Village D Specific Plan	Unit	United States Customary

Geometric Data

Number of Lanes, ln	3	Terrain Type	Level
Segment Length (L), ft	-	Percent Grade, %	-
Measured or Base Free-Flow Speed	Base	Grade Length, mi	-
Base Free-Flow Speed (BFFS), mi/h	65.0	Total Ramp Density (TRD), ramps/mi	1.83
Lane Width, ft	12	Free-Flow Speed (FFS), mi/h	59.7
Right-Side Lateral Clearance, ft	10		

Adjustment Factors

Driver Population	All Familiar	Final Speed Adjustment Factor (SAF)	1.000
Weather Type	Non-Severe Weather	Final Capacity Adjustment Factor (CAF)	1.000
Incident Type	No Incident	Demand Adjustment Factor (DAF)	1.000

Demand and Capacity

Demand Volume veh/h	4786	Heavy Vehicle Adjustment Factor (fhv)	0.884
Peak Hour Factor	0.94	Flow Rate (Vp), pc/h/ln	1920
Total Trucks, %	13.15	Capacity (c), pc/h/ln	2296
Single-Unit Trucks (SUT), %	-	Adjusted Capacity (cadj), pc/h/ln	2296
Tractor-Trailers (TT), %	-	Volume-to-Capacity Ratio (v/c)	0.84
Passenger Car Equivalent (ET)	2.000		

Speed and Density

Lane Width Adjustment (fLW)	0.0	Average Speed (S), mi/h	57.9
Right-Side Lateral Clearance Adj. (fRLC)	0.0	Density (D), pc/mi/ln	33.2
Total Ramp Density Adjustment	5.4	Level of Service (LOS)	D
Adjusted Free-Flow Speed (FFSadj), mi/h	59.6		

HCS7 Freeway Diverge Report

Project Information

Analyst	LSA	Date	12/11/2019
Agency	LSA	Analysis Year	Phase II Proj Comp Yr (2039) WP
Jurisdiction	Caltrans	Time Period Analyzed	PM Peak Hour
Project Description	CMD1801 - Village D Specific Plan	Unit	United States Customary

Geometric Data

	Freeway	Ramp
Number of Lanes (N), ln	3	1
Free-Flow Speed (FFS), mi/h	65.0	35.0
Segment Length (L) / Deceleration Length (LA),ft	1500	245
Terrain Type	Level	Level
Percent Grade, %	-	-
Segment Type / Ramp Side	Freeway	Right

Adjustment Factors

Driver Population	All Familiar	All Familiar
Weather Type	Non-Severe Weather	Non-Severe Weather
Incident Type	No Incident	-
Final Speed Adjustment Factor (SAF)	1.000	1.000
Final Capacity Adjustment Factor (CAF)	1.000	1.000
Demand Adjustment Factor (DAF)	1.000	1.000

Demand and Capacity

Demand Volume (Vi)	4786	1250
Peak Hour Factor (PHF)	0.94	0.94
Total Trucks, %	13.15	0.72
Single-Unit Trucks (SUT), %	-	-
Tractor-Trailers (TT), %	-	-
Heavy Vehicle Adjustment Factor (fHV)	0.884	0.993
Flow Rate (vi),pc/h	5760	1339
Capacity (c), pc/h	7050	2000
Volume-to-Capacity Ratio (v/c)	0.82	0.67

Speed and Density

Upstream Equilibrium Distance (LEQ), ft	-	Number of Outer Lanes on Freeway (NO)	1
Distance to Upstream Ramp (LUP), ft	-	Speed Index (DS)	0.549
Downstream Equilibrium Distance (LEQ), ft	-	Flow Outer Lanes (vOA), pc/h/ln	1972
Distance to Downstream Ramp (LDOWN), ft	-	Off-Ramp Influence Area Speed (SR), mi/h	52.4
Prop. Freeway Vehicles in Lane 1 and 2 (PFD)	0.554	Outer Lanes Freeway Speed (SO), mi/h	67.5
Flow in Lanes 1 and 2 (v12), pc/h	3788	Ramp Junction Speed (S), mi/h	56.7
Flow Entering Ramp-Infl. Area (vR12), pc/h	-	Average Density (D), pc/mi/ln	33.9
Level of Service (LOS)	D	Density in Ramp Influence Area (DR), pc/mi/ln	34.6

HCS7 Basic Freeway Report

Project Information

Analyst	LSA	Date	12/11/2019
Agency	LSA	Analysis Year	Phase II Proj Comp Yr (2039) WP
Jurisdiction	Caltrans	Time Period Analyzed	PM Peak Hour
Project Description	CMD1801 - Village D Specific Plan	Unit	United States Customary

Geometric Data

Number of Lanes, ln	3	Terrain Type	Level
Segment Length (L), ft	-	Percent Grade, %	-
Measured or Base Free-Flow Speed	Base	Grade Length, mi	-
Base Free-Flow Speed (BFFS), mi/h	65.0	Total Ramp Density (TRD), ramps/mi	1.83
Lane Width, ft	12	Free-Flow Speed (FFS), mi/h	59.7
Right-Side Lateral Clearance, ft	10		

Adjustment Factors

Driver Population	All Familiar	Final Speed Adjustment Factor (SAF)	1.000
Weather Type	Non-Severe Weather	Final Capacity Adjustment Factor (CAF)	1.000
Incident Type	No Incident	Demand Adjustment Factor (DAF)	1.000

Demand and Capacity

Demand Volume veh/h	3536	Heavy Vehicle Adjustment Factor (fhv)	0.851
Peak Hour Factor	0.94	Flow Rate (Vp), pc/h/ln	1473
Total Trucks, %	17.54	Capacity (c), pc/h/ln	2296
Single-Unit Trucks (SUT), %	-	Adjusted Capacity (cadj), pc/h/ln	2296
Tractor-Trailers (TT), %	-	Volume-to-Capacity Ratio (v/c)	0.64
Passenger Car Equivalent (ET)	2.000		

Speed and Density

Lane Width Adjustment (fLW)	0.0	Average Speed (S), mi/h	59.6
Right-Side Lateral Clearance Adj. (fRLC)	0.0	Density (D), pc/mi/ln	24.7
Total Ramp Density Adjustment	5.4	Level of Service (LOS)	C
Adjusted Free-Flow Speed (FFSadj), mi/h	59.6		

HCS7 Freeway Merge Report

Project Information

Analyst	LSA	Date	12/11/2019
Agency	LSA	Analysis Year	Phase II Proj Comp Yr (2039) WP
Jurisdiction	Caltrans	Time Period Analyzed	PM Peak Hour
Project Description	CMD1801 - Village D Specific Plan	Unit	United States Customary

Geometric Data

	Freeway	Ramp
Number of Lanes (N), ln	3	1
Free-Flow Speed (FFS), mi/h	65.0	35.0
Segment Length (L) / Acceleration Length (LA),ft	1500	350
Terrain Type	Level	Level
Percent Grade, %	-	-
Segment Type / Ramp Side	Freeway	Right

Adjustment Factors

Driver Population	All Familiar	All Familiar
Weather Type	Non-Severe Weather	Non-Severe Weather
Incident Type	No Incident	-
Final Speed Adjustment Factor (SAF)	1.000	1.000
Final Capacity Adjustment Factor (CAF)	1.000	1.000
Demand Adjustment Factor (DAF)	1.000	1.000

Demand and Capacity

Demand Volume (Vi)	3536	301
Peak Hour Factor (PHF)	0.94	0.94
Total Trucks, %	17.54	2.66
Single-Unit Trucks (SUT), %	-	-
Tractor-Trailers (TT), %	-	-
Heavy Vehicle Adjustment Factor (fHV)	0.851	0.974
Flow Rate (vi),pc/h	4420	329
Capacity (c), pc/h	7050	2000
Volume-to-Capacity Ratio (v/c)	0.67	0.16

Speed and Density

Upstream Equilibrium Distance (LEQ), ft	-	Number of Outer Lanes on Freeway (NO)	1
Distance to Upstream Ramp (LUP), ft	-	Speed Index (MS)	0.369
Downstream Equilibrium Distance (LEQ), ft	-	Flow Outer Lanes (vOA), pc/h/ln	1825
Distance to Downstream Ramp (LDOWN), ft	-	On-Ramp Influence Area Speed (SR), mi/h	56.5
Prop. Freeway Vehicles in Lane 1 and 2 (PFM)	0.587	Outer Lanes Freeway Speed (SO), mi/h	60.2
Flow in Lanes 1 and 2 (v12), pc/h	2595	Ramp Junction Speed (S), mi/h	57.9
Flow Entering Ramp-Infl. Area (vR12), pc/h	2924	Average Density (D), pc/mi/ln	27.3
Level of Service (LOS)	C	Density in Ramp Influence Area (DR), pc/mi/ln	26.0

HCS7 Basic Freeway Report

Project Information

Analyst	LSA	Date	12/11/2019
Agency	LSA	Analysis Year	Phase II Proj Comp Yr (2039) WP
Jurisdiction	Caltrans	Time Period Analyzed	PM Peak Hour
Project Description	CMD1801 - Village D Specific Plan	Unit	United States Customary

Geometric Data

Number of Lanes, ln	3	Terrain Type	Level
Segment Length (L), ft	-	Percent Grade, %	-
Measured or Base Free-Flow Speed	Base	Grade Length, mi	-
Base Free-Flow Speed (BFFS), mi/h	65.0	Total Ramp Density (TRD), ramps/mi	1.83
Lane Width, ft	12	Free-Flow Speed (FFS), mi/h	59.7
Right-Side Lateral Clearance, ft	10		

Adjustment Factors

Driver Population	All Familiar	Final Speed Adjustment Factor (SAF)	1.000
Weather Type	Non-Severe Weather	Final Capacity Adjustment Factor (CAF)	1.000
Incident Type	No Incident	Demand Adjustment Factor (DAF)	1.000

Demand and Capacity

Demand Volume veh/h	3837	Heavy Vehicle Adjustment Factor (fhv)	0.859
Peak Hour Factor	0.94	Flow Rate (Vp), pc/h/ln	1584
Total Trucks, %	16.39	Capacity (c), pc/h/ln	2296
Single-Unit Trucks (SUT), %	-	Adjusted Capacity (cadj), pc/h/ln	2296
Tractor-Trailers (TT), %	-	Volume-to-Capacity Ratio (v/c)	0.69
Passenger Car Equivalent (ET)	2.000		

Speed and Density

Lane Width Adjustment (fLW)	0.0	Average Speed (S), mi/h	59.6
Right-Side Lateral Clearance Adj. (fRLC)	0.0	Density (D), pc/mi/ln	26.6
Total Ramp Density Adjustment	5.4	Level of Service (LOS)	D
Adjusted Free-Flow Speed (FFSadj), mi/h	59.6		

HCS7 Freeway Diverge Report

Project Information

Analyst	LSA	Date	12/11/2019
Agency	LSA	Analysis Year	Phase II Proj Comp Yr (2039) WP
Jurisdiction	Caltrans	Time Period Analyzed	PM Peak Hour
Project Description	CMD1801 - Village D Specific Plan	Unit	United States Customary

Geometric Data

	Freeway	Ramp
Number of Lanes (N), ln	3	1
Free-Flow Speed (FFS), mi/h	65.0	15.0
Segment Length (L) / Deceleration Length (LA),ft	1500	150
Terrain Type	Level	Level
Percent Grade, %	-	-
Segment Type / Ramp Side	Freeway	Right

Adjustment Factors

Driver Population	All Familiar	All Familiar
Weather Type	Non-Severe Weather	Non-Severe Weather
Incident Type	No Incident	-
Final Speed Adjustment Factor (SAF)	1.000	1.000
Final Capacity Adjustment Factor (CAF)	1.000	1.000
Demand Adjustment Factor (DAF)	1.000	1.000

Demand and Capacity

Demand Volume (Vi)	3837	192
Peak Hour Factor (PHF)	0.94	0.94
Total Trucks, %	16.39	3.12
Single-Unit Trucks (SUT), %	-	-
Tractor-Trailers (TT), %	-	-
Heavy Vehicle Adjustment Factor (fHV)	0.859	0.970
Flow Rate (vi),pc/h	4752	211
Capacity (c), pc/h	7050	1800
Volume-to-Capacity Ratio (v/c)	0.67	0.12

Speed and Density

Upstream Equilibrium Distance (LEQ), ft	-	Number of Outer Lanes on Freeway (NO)	1
Distance to Upstream Ramp (LUP), ft	-	Speed Index (DS)	0.707
Downstream Equilibrium Distance (LEQ), ft	-	Flow Outer Lanes (vOA), pc/h/ln	1676
Distance to Downstream Ramp (LDOWN), ft	-	Off-Ramp Influence Area Speed (SR), mi/h	48.7
Prop. Freeway Vehicles in Lane 1 and 2 (PFD)	0.631	Outer Lanes Freeway Speed (SO), mi/h	68.7
Flow in Lanes 1 and 2 (v12), pc/h	3076	Ramp Junction Speed (S), mi/h	54.3
Flow Entering Ramp-Infl. Area (vR12), pc/h	-	Average Density (D), pc/mi/ln	29.2
Level of Service (LOS)	D	Density in Ramp Influence Area (DR), pc/mi/ln	29.4

HCS7 Basic Freeway Report

Project Information

Analyst	LSA	Date	12/11/2019
Agency	LSA	Analysis Year	Phase II Proj Comp Yr (2039) WP
Jurisdiction	Caltrans	Time Period Analyzed	PM Peak Hour
Project Description	CMD1801 - Village D Specific Plan	Unit	United States Customary

Geometric Data

Number of Lanes, ln	3	Terrain Type	Level
Segment Length (L), ft	-	Percent Grade, %	-
Measured or Base Free-Flow Speed	Base	Grade Length, mi	-
Base Free-Flow Speed (BFFS), mi/h	65.0	Total Ramp Density (TRD), ramps/mi	1.67
Lane Width, ft	12	Free-Flow Speed (FFS), mi/h	60.0
Right-Side Lateral Clearance, ft	10		

Adjustment Factors

Driver Population	All Familiar	Final Speed Adjustment Factor (SAF)	1.000
Weather Type	Non-Severe Weather	Final Capacity Adjustment Factor (CAF)	1.000
Incident Type	No Incident	Demand Adjustment Factor (DAF)	1.000

Demand and Capacity

Demand Volume veh/h	3644	Heavy Vehicle Adjustment Factor (fhv)	0.854
Peak Hour Factor	0.94	Flow Rate (Vp), pc/h/ln	1513
Total Trucks, %	17.08	Capacity (c), pc/h/ln	2300
Single-Unit Trucks (SUT), %	-	Adjusted Capacity (cadj), pc/h/ln	2300
Tractor-Trailers (TT), %	-	Volume-to-Capacity Ratio (v/c)	0.66
Passenger Car Equivalent (ET)	2.000		

Speed and Density

Lane Width Adjustment (fLW)	0.0	Average Speed (S), mi/h	60.0
Right-Side Lateral Clearance Adj. (fRLC)	0.0	Density (D), pc/mi/ln	25.2
Total Ramp Density Adjustment	5.0	Level of Service (LOS)	C
Adjusted Free-Flow Speed (FFSadj), mi/h	60.0		

HCS7 Freeway Merge Report

Project Information

Analyst	LSA	Date	12/11/2019
Agency	LSA	Analysis Year	Phase II Proj Comp Yr (2039) WP
Jurisdiction	Caltrans	Time Period Analyzed	PM Peak Hour
Project Description	CMD1801 - Village D Specific Plan	Unit	United States Customary

Geometric Data

	Freeway	Ramp
Number of Lanes (N), ln	3	1
Free-Flow Speed (FFS), mi/h	65.0	35.0
Segment Length (L) / Acceleration Length (LA),ft	1500	525
Terrain Type	Level	Level
Percent Grade, %	-	-
Segment Type / Ramp Side	Freeway	Right

Adjustment Factors

Driver Population	All Familiar	All Familiar
Weather Type	Non-Severe Weather	Non-Severe Weather
Incident Type	No Incident	-
Final Speed Adjustment Factor (SAF)	1.000	1.000
Final Capacity Adjustment Factor (CAF)	1.000	1.000
Demand Adjustment Factor (DAF)	1.000	1.000

Demand and Capacity

Demand Volume (Vi)	3644	258
Peak Hour Factor (PHF)	0.94	0.94
Total Trucks, %	17.08	3.88
Single-Unit Trucks (SUT), %	-	-
Tractor-Trailers (TT), %	-	-
Heavy Vehicle Adjustment Factor (fHV)	0.854	0.963
Flow Rate (vi),pc/h	4539	285
Capacity (c), pc/h	7050	2000
Volume-to-Capacity Ratio (v/c)	0.68	0.14

Speed and Density

Upstream Equilibrium Distance (LEQ), ft	-	Number of Outer Lanes on Freeway (NO)	1
Distance to Upstream Ramp (LUP), ft	-	Speed Index (MS)	0.360
Downstream Equilibrium Distance (LEQ), ft	-	Flow Outer Lanes (vOA), pc/h/ln	1852
Distance to Downstream Ramp (LDOWN), ft	-	On-Ramp Influence Area Speed (SR), mi/h	56.7
Prop. Freeway Vehicles in Lane 1 and 2 (PFM)	0.592	Outer Lanes Freeway Speed (SO), mi/h	60.1
Flow in Lanes 1 and 2 (v12), pc/h	2687	Ramp Junction Speed (S), mi/h	58.0
Flow Entering Ramp-Infl. Area (vR12), pc/h	2972	Average Density (D), pc/mi/ln	27.7
Level of Service (LOS)	C	Density in Ramp Influence Area (DR), pc/mi/ln	25.3

HCS7 Basic Freeway Report

Project Information

Analyst	LSA	Date	12/11/2019
Agency	LSA	Analysis Year	Phase II Proj Comp Yr (2039) WP
Jurisdiction	Caltrans	Time Period Analyzed	PM Peak Hour
Project Description	CMD1801 - Village D Specific Plan	Unit	United States Customary

Geometric Data

Number of Lanes, ln	3	Terrain Type	Level
Segment Length (L), ft	-	Percent Grade, %	-
Measured or Base Free-Flow Speed	Base	Grade Length, mi	-
Base Free-Flow Speed (BFFS), mi/h	65.0	Total Ramp Density (TRD), ramps/mi	1.67
Lane Width, ft	12	Free-Flow Speed (FFS), mi/h	60.0
Right-Side Lateral Clearance, ft	10		

Adjustment Factors

Driver Population	All Familiar	Final Speed Adjustment Factor (SAF)	1.000
Weather Type	Non-Severe Weather	Final Capacity Adjustment Factor (CAF)	1.000
Incident Type	No Incident	Demand Adjustment Factor (DAF)	1.000

Demand and Capacity

Demand Volume veh/h	3902	Heavy Vehicle Adjustment Factor (fhv)	0.860
Peak Hour Factor	0.94	Flow Rate (Vp), pc/h/ln	1609
Total Trucks, %	16.23	Capacity (c), pc/h/ln	2300
Single-Unit Trucks (SUT), %	-	Adjusted Capacity (cadj), pc/h/ln	2300
Tractor-Trailers (TT), %	-	Volume-to-Capacity Ratio (v/c)	0.70
Passenger Car Equivalent (ET)	2.000		

Speed and Density

Lane Width Adjustment (fLW)	0.0	Average Speed (S), mi/h	60.0
Right-Side Lateral Clearance Adj. (fRLC)	0.0	Density (D), pc/mi/ln	26.8
Total Ramp Density Adjustment	5.0	Level of Service (LOS)	D
Adjusted Free-Flow Speed (FFSadj), mi/h	60.0		

HCS7 Freeway Diverge Report

Project Information

Analyst	LSA	Date	12/11/2019
Agency	LSA	Analysis Year	Phase II Proj Comp Yr (2039) WP
Jurisdiction	Caltrans	Time Period Analyzed	PM Peak Hour
Project Description	CMD1801 - Village D Specific Plan	Unit	United States Customary

Geometric Data

	Freeway	Ramp
Number of Lanes (N), ln	3	1
Free-Flow Speed (FFS), mi/h	65.0	35.0
Segment Length (L) / Deceleration Length (LA),ft	1500	200
Terrain Type	Level	Level
Percent Grade, %	-	-
Segment Type / Ramp Side	Freeway	Right

Adjustment Factors

Driver Population	All Familiar	All Familiar
Weather Type	Non-Severe Weather	Non-Severe Weather
Incident Type	No Incident	-
Final Speed Adjustment Factor (SAF)	1.000	1.000
Final Capacity Adjustment Factor (CAF)	1.000	1.000
Demand Adjustment Factor (DAF)	1.000	1.000

Demand and Capacity

Demand Volume (Vi)	3902	1305
Peak Hour Factor (PHF)	0.94	0.94
Total Trucks, %	16.23	5.60
Single-Unit Trucks (SUT), %	-	-
Tractor-Trailers (TT), %	-	-
Heavy Vehicle Adjustment Factor (fHV)	0.860	0.947
Flow Rate (vi),pc/h	4827	1466
Capacity (c), pc/h	7050	2000
Volume-to-Capacity Ratio (v/c)	0.68	0.73

Speed and Density

Upstream Equilibrium Distance (LEQ), ft	-	Number of Outer Lanes on Freeway (NO)	1
Distance to Upstream Ramp (LUP), ft	-	Speed Index (DS)	0.560
Downstream Equilibrium Distance (LEQ), ft	-	Flow Outer Lanes (vOA), pc/h/ln	1439
Distance to Downstream Ramp (LDOWN), ft	-	Off-Ramp Influence Area Speed (SR), mi/h	52.1
Prop. Freeway Vehicles in Lane 1 and 2 (PFD)	0.572	Outer Lanes Freeway Speed (SO), mi/h	69.6
Flow in Lanes 1 and 2 (v12), pc/h	3388	Ramp Junction Speed (S), mi/h	56.3
Flow Entering Ramp-Infl. Area (vR12), pc/h	-	Average Density (D), pc/mi/ln	28.6
Level of Service (LOS)	D	Density in Ramp Influence Area (DR), pc/mi/ln	31.6

HCS7 Basic Freeway Report

Project Information

Analyst	LSA	Date	12/11/2019
Agency	LSA	Analysis Year	Phase II Proj Comp Yr (2039) WP
Jurisdiction	Caltrans	Time Period Analyzed	PM Peak Hour
Project Description	CMD1801 - Village D Specific Plan	Unit	United States Customary

Geometric Data

Number of Lanes, ln	3	Terrain Type	Level
Segment Length (L), ft	-	Percent Grade, %	-
Measured or Base Free-Flow Speed	Base	Grade Length, mi	-
Base Free-Flow Speed (BFFS), mi/h	70.0	Total Ramp Density (TRD), ramps/mi	1.50
Lane Width, ft	12	Free-Flow Speed (FFS), mi/h	65.5
Right-Side Lateral Clearance, ft	10		

Adjustment Factors

Driver Population	All Familiar	Final Speed Adjustment Factor (SAF)	1.000
Weather Type	Non-Severe Weather	Final Capacity Adjustment Factor (CAF)	1.000
Incident Type	No Incident	Demand Adjustment Factor (DAF)	1.000

Demand and Capacity

Demand Volume veh/h	2597	Heavy Vehicle Adjustment Factor (fhv)	0.823
Peak Hour Factor	0.94	Flow Rate (Vp), pc/h/ln	1119
Total Trucks, %	21.57	Capacity (c), pc/h/ln	2355
Single-Unit Trucks (SUT), %	-	Adjusted Capacity (cadj), pc/h/ln	2355
Tractor-Trailers (TT), %	-	Volume-to-Capacity Ratio (v/c)	0.48
Passenger Car Equivalent (ET)	2.000		

Speed and Density

Lane Width Adjustment (fLW)	0.0	Average Speed (S), mi/h	65.5
Right-Side Lateral Clearance Adj. (fRLC)	0.0	Density (D), pc/mi/ln	17.1
Total Ramp Density Adjustment	4.5	Level of Service (LOS)	B
Adjusted Free-Flow Speed (FFSadj), mi/h	65.5		

HCS7 Freeway Merge Report

Project Information

Analyst	LSA	Date	12/11/2019
Agency	LSA	Analysis Year	Phase II Proj Comp Yr (2039) WP
Jurisdiction	Caltrans	Time Period Analyzed	PM Peak Hour
Project Description	CMD1801 - Village D Specific Plan	Unit	United States Customary

Geometric Data

	Freeway	Ramp
Number of Lanes (N), ln	3	1
Free-Flow Speed (FFS), mi/h	70.0	35.0
Segment Length (L) / Acceleration Length (LA),ft	1500	400
Terrain Type	Level	Level
Percent Grade, %	-	-
Segment Type / Ramp Side	Freeway	Right

Adjustment Factors

Driver Population	All Familiar	All Familiar
Weather Type	Non-Severe Weather	Non-Severe Weather
Incident Type	No Incident	-
Final Speed Adjustment Factor (SAF)	1.000	1.000
Final Capacity Adjustment Factor (CAF)	1.000	1.000
Demand Adjustment Factor (DAF)	1.000	1.000

Demand and Capacity

Demand Volume (Vi)	2597	474
Peak Hour Factor (PHF)	0.94	0.94
Total Trucks, %	21.57	6.96
Single-Unit Trucks (SUT), %	-	-
Tractor-Trailers (TT), %	-	-
Heavy Vehicle Adjustment Factor (fHV)	0.823	0.935
Flow Rate (vi),pc/h	3357	539
Capacity (c), pc/h	7200	2000
Volume-to-Capacity Ratio (v/c)	0.54	0.27

Speed and Density

Upstream Equilibrium Distance (LEQ), ft	-	Number of Outer Lanes on Freeway (NO)	1
Distance to Upstream Ramp (LUP), ft	-	Speed Index (MS)	0.341
Downstream Equilibrium Distance (LEQ), ft	-	Flow Outer Lanes (vOA), pc/h/ln	1380
Distance to Downstream Ramp (LDOWN), ft	-	On-Ramp Influence Area Speed (SR), mi/h	60.5
Prop. Freeway Vehicles in Lane 1 and 2 (PFM)	0.589	Outer Lanes Freeway Speed (SO), mi/h	66.8
Flow in Lanes 1 and 2 (v12), pc/h	1977	Ramp Junction Speed (S), mi/h	62.6
Flow Entering Ramp-Infl. Area (vR12), pc/h	2516	Average Density (D), pc/mi/ln	20.7
Level of Service (LOS)	C	Density in Ramp Influence Area (DR), pc/mi/ln	22.4

HCS7 Basic Freeway Report

Project Information

Analyst	LSA	Date	12/11/2019
Agency	LSA	Analysis Year	Phase II Proj Comp Yr (2039) WP
Jurisdiction	Caltrans	Time Period Analyzed	PM Peak Hour
Project Description	CMD1801 - Village D Specific Plan	Unit	United States Customary

Geometric Data

Number of Lanes, ln	2	Terrain Type	Level
Segment Length (L), ft	-	Percent Grade, %	-
Measured or Base Free-Flow Speed	Base	Grade Length, mi	-
Base Free-Flow Speed (BFFS), mi/h	70.0	Total Ramp Density (TRD), ramps/mi	1.00
Lane Width, ft	12	Free-Flow Speed (FFS), mi/h	66.8
Right-Side Lateral Clearance, ft	10		

Adjustment Factors

Driver Population	All Familiar	Final Speed Adjustment Factor (SAF)	1.000
Weather Type	Non-Severe Weather	Final Capacity Adjustment Factor (CAF)	1.000
Incident Type	No Incident	Demand Adjustment Factor (DAF)	1.000

Demand and Capacity

Demand Volume veh/h	3072	Heavy Vehicle Adjustment Factor (fhv)	0.838
Peak Hour Factor	0.94	Flow Rate (Vp), pc/h/ln	1950
Total Trucks, %	19.31	Capacity (c), pc/h/ln	2368
Single-Unit Trucks (SUT), %	-	Adjusted Capacity (cadj), pc/h/ln	2368
Tractor-Trailers (TT), %	-	Volume-to-Capacity Ratio (v/c)	0.82
Passenger Car Equivalent (ET)	2.000		

Speed and Density

Lane Width Adjustment (fLW)	0.0	Average Speed (S), mi/h	61.7
Right-Side Lateral Clearance Adj. (fRLC)	0.0	Density (D), pc/mi/ln	31.6
Total Ramp Density Adjustment	3.2	Level of Service (LOS)	D
Adjusted Free-Flow Speed (FFSadj), mi/h	66.8		

HCS7 Freeway Diverge Report

Project Information

Analyst	LSA	Date	12/11/2019
Agency	LSA	Analysis Year	Phase II Proj Comp Yr (2039) WP
Jurisdiction	Caltrans	Time Period Analyzed	PM Peak Hour
Project Description	CMD1801 - Village D Specific Plan	Unit	United States Customary

Geometric Data

	Freeway	Ramp
Number of Lanes (N), ln	2	1
Free-Flow Speed (FFS), mi/h	70.0	35.0
Segment Length (L) / Deceleration Length (LA),ft	1500	200
Terrain Type	Level	Level
Percent Grade, %	-	-
Segment Type / Ramp Side	Freeway	Right

Adjustment Factors

Driver Population	All Familiar	All Familiar
Weather Type	Non-Severe Weather	Non-Severe Weather
Incident Type	No Incident	-
Final Speed Adjustment Factor (SAF)	1.000	1.000
Final Capacity Adjustment Factor (CAF)	1.000	1.000
Demand Adjustment Factor (DAF)	1.000	1.000

Demand and Capacity

Demand Volume (Vi)	3072	193
Peak Hour Factor (PHF)	0.94	0.94
Total Trucks, %	19.31	23.83
Single-Unit Trucks (SUT), %	-	-
Tractor-Trailers (TT), %	-	-
Heavy Vehicle Adjustment Factor (fHV)	0.838	0.808
Flow Rate (vi),pc/h	3900	254
Capacity (c), pc/h	4800	2000
Volume-to-Capacity Ratio (v/c)	0.81	0.13

Speed and Density

Upstream Equilibrium Distance (LEQ), ft	-	Number of Outer Lanes on Freeway (NO)	0
Distance to Upstream Ramp (LUP), ft	-	Speed Index (DS)	0.451
Downstream Equilibrium Distance (LEQ), ft	-	Flow Outer Lanes (vOA), pc/h/ln	-
Distance to Downstream Ramp (LDOWN), ft	-	Off-Ramp Influence Area Speed (SR), mi/h	57.4
Prop. Freeway Vehicles in Lane 1 and 2 (PFD)	1.000	Outer Lanes Freeway Speed (SO), mi/h	76.8
Flow in Lanes 1 and 2 (v12), pc/h	3900	Ramp Junction Speed (S), mi/h	57.4
Flow Entering Ramp-Infl. Area (vR12), pc/h	-	Average Density (D), pc/mi/ln	34.0
Level of Service (LOS)	E	Density in Ramp Influence Area (DR), pc/mi/ln	36.0

HCS7 Basic Freeway Report

Project Information

Analyst	LSA	Date	12/11/2019
Agency	LSA	Analysis Year	Phase II Proj Comp Yr (2039) WP
Jurisdiction	Caltrans	Time Period Analyzed	PM Peak Hour
Project Description	CMD1801 - Village D Specific Plan	Unit	United States Customary

Geometric Data

Number of Lanes, ln	2	Terrain Type	Level
Segment Length (L), ft	-	Percent Grade, %	-
Measured or Base Free-Flow Speed	Base	Grade Length, mi	-
Base Free-Flow Speed (BFFS), mi/h	70.0	Total Ramp Density (TRD), ramps/mi	1.00
Lane Width, ft	12	Free-Flow Speed (FFS), mi/h	66.8
Right-Side Lateral Clearance, ft	10		

Adjustment Factors

Driver Population	All Familiar	Final Speed Adjustment Factor (SAF)	1.000
Weather Type	Non-Severe Weather	Final Capacity Adjustment Factor (CAF)	1.000
Incident Type	No Incident	Demand Adjustment Factor (DAF)	1.000

Demand and Capacity

Demand Volume veh/h	2879	Heavy Vehicle Adjustment Factor (fhv)	0.840
Peak Hour Factor	0.94	Flow Rate (Vp), pc/h/ln	1823
Total Trucks, %	19.01	Capacity (c), pc/h/ln	2368
Single-Unit Trucks (SUT), %	-	Adjusted Capacity (cadj), pc/h/ln	2368
Tractor-Trailers (TT), %	-	Volume-to-Capacity Ratio (v/c)	0.77
Passenger Car Equivalent (ET)	2.000		

Speed and Density

Lane Width Adjustment (fLW)	0.0	Average Speed (S), mi/h	63.6
Right-Side Lateral Clearance Adj. (fRLC)	0.0	Density (D), pc/mi/ln	28.7
Total Ramp Density Adjustment	3.2	Level of Service (LOS)	D
Adjusted Free-Flow Speed (FFSadj), mi/h	66.8		

HCS7 Freeway Merge Report

Project Information

Analyst	LSA	Date	12/11/2019
Agency	LSA	Analysis Year	Phase II Proj Comp Yr (2039) WP
Jurisdiction	Caltrans	Time Period Analyzed	PM Peak Hour
Project Description	CMD1801 - Village D Specific Plan	Unit	United States Customary

Geometric Data

	Freeway	Ramp
Number of Lanes (N), ln	2	1
Free-Flow Speed (FFS), mi/h	70.0	35.0
Segment Length (L) / Acceleration Length (LA),ft	1500	700
Terrain Type	Level	Level
Percent Grade, %	-	-
Segment Type / Ramp Side	Freeway	Right

Adjustment Factors

Driver Population	All Familiar	All Familiar
Weather Type	Non-Severe Weather	Non-Severe Weather
Incident Type	No Incident	-
Final Speed Adjustment Factor (SAF)	1.000	1.000
Final Capacity Adjustment Factor (CAF)	1.000	1.000
Demand Adjustment Factor (DAF)	1.000	1.000

Demand and Capacity

Demand Volume (Vi)	2879	429
Peak Hour Factor (PHF)	0.94	0.94
Total Trucks, %	19.01	13.04
Single-Unit Trucks (SUT), %	-	-
Tractor-Trailers (TT), %	-	-
Heavy Vehicle Adjustment Factor (fHV)	0.840	0.885
Flow Rate (vi),pc/h	3646	516
Capacity (c), pc/h	4800	2000
Volume-to-Capacity Ratio (v/c)	0.87	0.26

Speed and Density

Upstream Equilibrium Distance (LEQ), ft	-	Number of Outer Lanes on Freeway (NO)	0
Distance to Upstream Ramp (LUP), ft	-	Speed Index (MS)	0.522
Downstream Equilibrium Distance (LEQ), ft	-	Flow Outer Lanes (vOA), pc/h/ln	-
Distance to Downstream Ramp (LDOWN), ft	-	On-Ramp Influence Area Speed (SR), mi/h	55.4
Prop. Freeway Vehicles in Lane 1 and 2 (PFM)	1.000	Outer Lanes Freeway Speed (SO), mi/h	70.0
Flow in Lanes 1 and 2 (v12), pc/h	3646	Ramp Junction Speed (S), mi/h	55.4
Flow Entering Ramp-Infl. Area (vR12), pc/h	4162	Average Density (D), pc/mi/ln	37.6
Level of Service (LOS)	D	Density in Ramp Influence Area (DR), pc/mi/ln	33.4

HCS7 Basic Freeway Report

Project Information

Analyst	LSA	Date	12/11/2019
Agency	LSA	Analysis Year	Phase II Proj Comp Yr (2039) WP
Jurisdiction	Caltrans	Time Period Analyzed	PM Peak Hour
Project Description	CMD1801 - Village D Specific Plan	Unit	United States Customary

Geometric Data

Number of Lanes, ln	2	Terrain Type	Level
Segment Length (L), ft	-	Percent Grade, %	-
Measured or Base Free-Flow Speed	Base	Grade Length, mi	-
Base Free-Flow Speed (BFFS), mi/h	70.0	Total Ramp Density (TRD), ramps/mi	1.00
Lane Width, ft	12	Free-Flow Speed (FFS), mi/h	66.8
Right-Side Lateral Clearance, ft	10		

Adjustment Factors

Driver Population	All Familiar	Final Speed Adjustment Factor (SAF)	1.000
Weather Type	Non-Severe Weather	Final Capacity Adjustment Factor (CAF)	1.000
Incident Type	No Incident	Demand Adjustment Factor (DAF)	1.000

Demand and Capacity

Demand Volume veh/h	3308	Heavy Vehicle Adjustment Factor (fhv)	0.846
Peak Hour Factor	0.94	Flow Rate (Vp), pc/h/ln	2080
Total Trucks, %	18.23	Capacity (c), pc/h/ln	2368
Single-Unit Trucks (SUT), %	-	Adjusted Capacity (cadj), pc/h/ln	2368
Tractor-Trailers (TT), %	-	Volume-to-Capacity Ratio (v/c)	0.88
Passenger Car Equivalent (ET)	2.000		

Speed and Density

Lane Width Adjustment (fLW)	0.0	Average Speed (S), mi/h	59.4
Right-Side Lateral Clearance Adj. (fRLC)	0.0	Density (D), pc/mi/ln	35.0
Total Ramp Density Adjustment	3.2	Level of Service (LOS)	D
Adjusted Free-Flow Speed (FFSadj), mi/h	66.8		

HCS7 Basic Freeway Report

Project Information

Analyst	LSA	Date	12/11/2019
Agency	LSA	Analysis Year	Phase II Proj Comp Yr (2039) WP
Jurisdiction	Caltrans	Time Period Analyzed	PM Peak Hour
Project Description	CMD1801 - Village D Specific Plan	Unit	United States Customary

Geometric Data

Number of Lanes, ln	2	Terrain Type	Level
Segment Length (L), ft	-	Percent Grade, %	-
Measured or Base Free-Flow Speed	Base	Grade Length, mi	-
Base Free-Flow Speed (BFFS), mi/h	70.0	Total Ramp Density (TRD), ramps/mi	1.00
Lane Width, ft	12	Free-Flow Speed (FFS), mi/h	66.8
Right-Side Lateral Clearance, ft	10		

Adjustment Factors

Driver Population	All Familiar	Final Speed Adjustment Factor (SAF)	1.000
Weather Type	Non-Severe Weather	Final Capacity Adjustment Factor (CAF)	1.000
Incident Type	No Incident	Demand Adjustment Factor (DAF)	1.000

Demand and Capacity

Demand Volume veh/h	3650	Heavy Vehicle Adjustment Factor (fhv)	0.834
Peak Hour Factor	0.94	Flow Rate (Vp), pc/h/ln	2328
Total Trucks, %	19.84	Capacity (c), pc/h/ln	2368
Single-Unit Trucks (SUT), %	-	Adjusted Capacity (cadj), pc/h/ln	2368
Tractor-Trailers (TT), %	-	Volume-to-Capacity Ratio (v/c)	0.98
Passenger Car Equivalent (ET)	2.000		

Speed and Density

Lane Width Adjustment (fLW)	0.0	Average Speed (S), mi/h	53.7
Right-Side Lateral Clearance Adj. (fRLC)	0.0	Density (D), pc/mi/ln	43.4
Total Ramp Density Adjustment	3.2	Level of Service (LOS)	E
Adjusted Free-Flow Speed (FFSadj), mi/h	66.8		

HCS7 Freeway Diverge Report

Project Information

Analyst	LSA	Date	12/11/2019
Agency	LSA	Analysis Year	Phase II Proj Comp Yr (2039) WP
Jurisdiction	Caltrans	Time Period Analyzed	PM Peak Hour
Project Description	CMD1801 - Village D Specific Plan	Unit	United States Customary

Geometric Data

	Freeway	Ramp
Number of Lanes (N), ln	2	1
Free-Flow Speed (FFS), mi/h	70.0	50.0
Segment Length (L) / Deceleration Length (LA),ft	1500	150
Terrain Type	Level	Level
Percent Grade, %	-	-
Segment Type / Ramp Side	Freeway	Right

Adjustment Factors

Driver Population	All Familiar	All Familiar
Weather Type	Non-Severe Weather	Non-Severe Weather
Incident Type	No Incident	-
Final Speed Adjustment Factor (SAF)	1.000	1.000
Final Capacity Adjustment Factor (CAF)	1.000	1.000
Demand Adjustment Factor (DAF)	1.000	1.000

Demand and Capacity

Demand Volume (Vi)	3650	641
Peak Hour Factor (PHF)	0.94	0.94
Total Trucks, %	19.84	11.07
Single-Unit Trucks (SUT), %	-	-
Tractor-Trailers (TT), %	-	-
Heavy Vehicle Adjustment Factor (fHV)	0.834	0.900
Flow Rate (vi),pc/h	4656	758
Capacity (c), pc/h	4800	2100
Volume-to-Capacity Ratio (v/c)	0.97	0.36

Speed and Density

Upstream Equilibrium Distance (LEQ), ft	-	Number of Outer Lanes on Freeway (NO)	0
Distance to Upstream Ramp (LUP), ft	-	Speed Index (DS)	0.301
Downstream Equilibrium Distance (LEQ), ft	-	Flow Outer Lanes (vOA), pc/h/ln	-
Distance to Downstream Ramp (LDOWN), ft	-	Off-Ramp Influence Area Speed (SR), mi/h	61.6
Prop. Freeway Vehicles in Lane 1 and 2 (PFD)	1.000	Outer Lanes Freeway Speed (SO), mi/h	76.8
Flow in Lanes 1 and 2 (v12), pc/h	4656	Ramp Junction Speed (S), mi/h	61.6
Flow Entering Ramp-Infl. Area (vR12), pc/h	-	Average Density (D), pc/mi/ln	37.8
Level of Service (LOS)	E	Density in Ramp Influence Area (DR), pc/mi/ln	42.9

HCS7 Basic Freeway Report

Project Information

Analyst	LSA	Date	12/11/2019
Agency	LSA	Analysis Year	Phase II Proj Comp Yr (2039) WP
Jurisdiction	Caltrans	Time Period Analyzed	PM Peak Hour
Project Description	CMD1801 - Village D Specific Plan	Unit	United States Customary

Geometric Data

Number of Lanes, ln	2	Terrain Type	Level
Segment Length (L), ft	-	Percent Grade, %	-
Measured or Base Free-Flow Speed	Base	Grade Length, mi	-
Base Free-Flow Speed (BFFS), mi/h	70.0	Total Ramp Density (TRD), ramps/mi	1.33
Lane Width, ft	12	Free-Flow Speed (FFS), mi/h	65.9
Right-Side Lateral Clearance, ft	10		

Adjustment Factors

Driver Population	All Familiar	Final Speed Adjustment Factor (SAF)	1.000
Weather Type	Non-Severe Weather	Final Capacity Adjustment Factor (CAF)	1.000
Incident Type	No Incident	Demand Adjustment Factor (DAF)	1.000

Demand and Capacity

Demand Volume veh/h	3008	Heavy Vehicle Adjustment Factor (fhv)	0.822
Peak Hour Factor	0.94	Flow Rate (Vp), pc/h/ln	1946
Total Trucks, %	21.71	Capacity (c), pc/h/ln	2359
Single-Unit Trucks (SUT), %	-	Adjusted Capacity (cadj), pc/h/ln	2359
Tractor-Trailers (TT), %	-	Volume-to-Capacity Ratio (v/c)	0.83
Passenger Car Equivalent (ET)	2.000		

Speed and Density

Lane Width Adjustment (fLW)	0.0	Average Speed (S), mi/h	61.3
Right-Side Lateral Clearance Adj. (fRLC)	0.0	Density (D), pc/mi/ln	31.7
Total Ramp Density Adjustment	4.1	Level of Service (LOS)	D
Adjusted Free-Flow Speed (FFSadj), mi/h	65.9		

HCS7 Freeway Merge Report

Project Information

Analyst	LSA	Date	12/11/2019
Agency	LSA	Analysis Year	Phase II Proj Comp Yr (2039) WP
Jurisdiction	Caltrans	Time Period Analyzed	PM Peak Hour
Project Description	CMD1801 - Village D Specific Plan	Unit	United States Customary

Geometric Data

	Freeway	Ramp
Number of Lanes (N), ln	2	1
Free-Flow Speed (FFS), mi/h	70.0	35.0
Segment Length (L) / Acceleration Length (LA),ft	1000	600
Terrain Type	Level	Level
Percent Grade, %	-	-
Segment Type / Ramp Side	Freeway	Right

Adjustment Factors

Driver Population	All Familiar	All Familiar
Weather Type	Non-Severe Weather	Non-Severe Weather
Incident Type	No Incident	-
Final Speed Adjustment Factor (SAF)	1.000	1.000
Final Capacity Adjustment Factor (CAF)	1.000	1.000
Demand Adjustment Factor (DAF)	1.000	1.000

Demand and Capacity

Demand Volume (Vi)	3008	29
Peak Hour Factor (PHF)	0.94	0.94
Total Trucks, %	21.71	6.90
Single-Unit Trucks (SUT), %	-	-
Tractor-Trailers (TT), %	-	-
Heavy Vehicle Adjustment Factor (fHV)	0.822	0.935
Flow Rate (vi),pc/h	3893	33
Capacity (c), pc/h	4800	2000
Volume-to-Capacity Ratio (v/c)	0.82	0.02

Speed and Density

Upstream Equilibrium Distance (LEQ), ft	-	Number of Outer Lanes on Freeway (NO)	0
Distance to Upstream Ramp (LUP), ft	-	Speed Index (MS)	0.477
Downstream Equilibrium Distance (LEQ), ft	-	Flow Outer Lanes (vOA), pc/h/ln	-
Distance to Downstream Ramp (LDOWN), ft	-	On-Ramp Influence Area Speed (SR), mi/h	56.6
Prop. Freeway Vehicles in Lane 1 and 2 (PFM)	1.000	Outer Lanes Freeway Speed (SO), mi/h	70.0
Flow in Lanes 1 and 2 (v12), pc/h	3893	Ramp Junction Speed (S), mi/h	56.6
Flow Entering Ramp-Infl. Area (vR12), pc/h	3926	Average Density (D), pc/mi/ln	34.7
Level of Service (LOS)	D	Density in Ramp Influence Area (DR), pc/mi/ln	32.4

HCS7 Basic Freeway Report

Project Information

Analyst	LSA	Date	12/11/2019
Agency	LSA	Analysis Year	Phase II Proj Comp Yr (2039) WP
Jurisdiction	Caltrans	Time Period Analyzed	PM Peak Hour
Project Description	CMD1801 - Village D Specific Plan	Unit	United States Customary

Geometric Data

Number of Lanes, ln	2	Terrain Type	Level
Segment Length (L), ft	-	Percent Grade, %	-
Measured or Base Free-Flow Speed	Base	Grade Length, mi	-
Base Free-Flow Speed (BFFS), mi/h	70.0	Total Ramp Density (TRD), ramps/mi	1.33
Lane Width, ft	12	Free-Flow Speed (FFS), mi/h	65.9
Right-Side Lateral Clearance, ft	10		

Adjustment Factors

Driver Population	All Familiar	Final Speed Adjustment Factor (SAF)	1.000
Weather Type	Non-Severe Weather	Final Capacity Adjustment Factor (CAF)	1.000
Incident Type	No Incident	Demand Adjustment Factor (DAF)	1.000

Demand and Capacity

Demand Volume veh/h	3037	Heavy Vehicle Adjustment Factor (fhv)	0.823
Peak Hour Factor	0.94	Flow Rate (Vp), pc/h/ln	1963
Total Trucks, %	21.57	Capacity (c), pc/h/ln	2359
Single-Unit Trucks (SUT), %	-	Adjusted Capacity (cadj), pc/h/ln	2359
Tractor-Trailers (TT), %	-	Volume-to-Capacity Ratio (v/c)	0.83
Passenger Car Equivalent (ET)	2.000		

Speed and Density

Lane Width Adjustment (fLW)	0.0	Average Speed (S), mi/h	61.0
Right-Side Lateral Clearance Adj. (fRLC)	0.0	Density (D), pc/mi/ln	32.2
Total Ramp Density Adjustment	4.1	Level of Service (LOS)	D
Adjusted Free-Flow Speed (FFSadj), mi/h	65.9		

HCS7 Freeway Merge Report

Project Information

Analyst	LSA	Date	12/11/2019
Agency	LSA	Analysis Year	Phase II Proj Comp Yr (2039) WP
Jurisdiction	Caltrans	Time Period Analyzed	PM Peak Hour
Project Description	CMD1801 - Village D Specific Plan	Unit	United States Customary

Geometric Data

	Freeway	Ramp
Number of Lanes (N), ln	2	1
Free-Flow Speed (FFS), mi/h	70.0	35.0
Segment Length (L) / Acceleration Length (LA),ft	1500	500
Terrain Type	Level	Level
Percent Grade, %	-	-
Segment Type / Ramp Side	Freeway	Right

Adjustment Factors

Driver Population	All Familiar	All Familiar
Weather Type	Non-Severe Weather	Non-Severe Weather
Incident Type	No Incident	-
Final Speed Adjustment Factor (SAF)	1.000	1.000
Final Capacity Adjustment Factor (CAF)	1.000	1.000
Demand Adjustment Factor (DAF)	1.000	1.000

Demand and Capacity

Demand Volume (Vi)	3037	236
Peak Hour Factor (PHF)	0.94	0.94
Total Trucks, %	21.57	22.03
Single-Unit Trucks (SUT), %	-	-
Tractor-Trailers (TT), %	-	-
Heavy Vehicle Adjustment Factor (fHV)	0.823	0.819
Flow Rate (vi),pc/h	3926	307
Capacity (c), pc/h	4800	2000
Volume-to-Capacity Ratio (v/c)	0.88	0.15

Speed and Density

Upstream Equilibrium Distance (LEQ), ft	-	Number of Outer Lanes on Freeway (NO)	0
Distance to Upstream Ramp (LUP), ft	-	Speed Index (MS)	0.555
Downstream Equilibrium Distance (LEQ), ft	-	Flow Outer Lanes (vOA), pc/h/ln	-
Distance to Downstream Ramp (LDOWN), ft	-	On-Ramp Influence Area Speed (SR), mi/h	54.5
Prop. Freeway Vehicles in Lane 1 and 2 (PFM)	1.000	Outer Lanes Freeway Speed (SO), mi/h	70.0
Flow in Lanes 1 and 2 (v12), pc/h	3926	Ramp Junction Speed (S), mi/h	54.5
Flow Entering Ramp-Infl. Area (vR12), pc/h	4233	Average Density (D), pc/mi/ln	38.8
Level of Service (LOS)	E	Density in Ramp Influence Area (DR), pc/mi/ln	35.3

HCS7 Basic Freeway Report

Project Information

Analyst	LSA	Date	12/11/2019
Agency	LSA	Analysis Year	Phase II Proj Comp Yr (2039) WP
Jurisdiction	Caltrans	Time Period Analyzed	PM Peak Hour
Project Description	CMD1801 - Village D Specific Plan	Unit	United States Customary

Geometric Data

Number of Lanes, ln	2	Terrain Type	Level
Segment Length (L), ft	-	Percent Grade, %	-
Measured or Base Free-Flow Speed	Base	Grade Length, mi	-
Base Free-Flow Speed (BFFS), mi/h	70.0	Total Ramp Density (TRD), ramps/mi	1.33
Lane Width, ft	12	Free-Flow Speed (FFS), mi/h	65.9
Right-Side Lateral Clearance, ft	10		

Adjustment Factors

Driver Population	All Familiar	Final Speed Adjustment Factor (SAF)	1.000
Weather Type	Non-Severe Weather	Final Capacity Adjustment Factor (CAF)	1.000
Incident Type	No Incident	Demand Adjustment Factor (DAF)	1.000

Demand and Capacity

Demand Volume veh/h	3273	Heavy Vehicle Adjustment Factor (fhv)	0.822
Peak Hour Factor	0.94	Flow Rate (Vp), pc/h/ln	2118
Total Trucks, %	21.60	Capacity (c), pc/h/ln	2359
Single-Unit Trucks (SUT), %	-	Adjusted Capacity (cadj), pc/h/ln	2359
Tractor-Trailers (TT), %	-	Volume-to-Capacity Ratio (v/c)	0.90
Passenger Car Equivalent (ET)	2.000		

Speed and Density

Lane Width Adjustment (fLW)	0.0	Average Speed (S), mi/h	58.2
Right-Side Lateral Clearance Adj. (fRLC)	0.0	Density (D), pc/mi/ln	36.4
Total Ramp Density Adjustment	4.1	Level of Service (LOS)	E
Adjusted Free-Flow Speed (FFSadj), mi/h	65.9		

HCS7 Freeway Diverge Report

Project Information

Analyst	LSA	Date	12/11/2019
Agency	LSA	Analysis Year	Phase II Proj Comp Yr (2039) WP
Jurisdiction	Caltrans	Time Period Analyzed	PM Peak Hour
Project Description	CMD1801 - Village D Specific Plan	Unit	United States Customary

Geometric Data

	Freeway	Ramp
Number of Lanes (N), ln	3	1
Free-Flow Speed (FFS), mi/h	70.0	35.0
Segment Length (L) / Deceleration Length (LA),ft	1500	150
Terrain Type	Level	Level
Percent Grade, %	-	-
Segment Type / Ramp Side	Freeway	Right

Adjustment Factors

Driver Population	All Familiar	All Familiar
Weather Type	Non-Severe Weather	Non-Severe Weather
Incident Type	No Incident	-
Final Speed Adjustment Factor (SAF)	1.000	1.000
Final Capacity Adjustment Factor (CAF)	1.000	1.000
Demand Adjustment Factor (DAF)	1.000	1.000

Demand and Capacity

Demand Volume (Vi)	3273	511
Peak Hour Factor (PHF)	0.94	0.94
Total Trucks, %	21.60	4.50
Single-Unit Trucks (SUT), %	-	-
Tractor-Trailers (TT), %	-	-
Heavy Vehicle Adjustment Factor (fHV)	0.822	0.957
Flow Rate (vi),pc/h	4236	568
Capacity (c), pc/h	7200	2000
Volume-to-Capacity Ratio (v/c)	0.59	0.28

Speed and Density

Upstream Equilibrium Distance (LEQ), ft	-	Number of Outer Lanes on Freeway (NO)	1
Distance to Upstream Ramp (LUP), ft	-	Speed Index (DS)	0.479
Downstream Equilibrium Distance (LEQ), ft	-	Flow Outer Lanes (vOA), pc/h/ln	1364
Distance to Downstream Ramp (LDOWN), ft	-	Off-Ramp Influence Area Speed (SR), mi/h	56.6
Prop. Freeway Vehicles in Lane 1 and 2 (PFD)	0.628	Outer Lanes Freeway Speed (SO), mi/h	75.4
Flow in Lanes 1 and 2 (v12), pc/h	2872	Ramp Junction Speed (S), mi/h	61.5
Flow Entering Ramp-Infl. Area (vR12), pc/h	-	Average Density (D), pc/mi/ln	23.0
Level of Service (LOS)	C	Density in Ramp Influence Area (DR), pc/mi/ln	27.6

HCS7 Basic Freeway Report

Project Information

Analyst	LSA	Date	12/11/2019
Agency	LSA	Analysis Year	Phase II Proj Comp Yr (2039) WP
Jurisdiction	Caltrans	Time Period Analyzed	PM Peak Hour
Project Description	CMD1801 - Village D Specific Plan	Unit	United States Customary

Geometric Data

Number of Lanes, ln	3	Terrain Type	Level
Segment Length (L), ft	-	Percent Grade, %	-
Measured or Base Free-Flow Speed	Base	Grade Length, mi	-
Base Free-Flow Speed (BFFS), mi/h	70.0	Total Ramp Density (TRD), ramps/mi	1.67
Lane Width, ft	12	Free-Flow Speed (FFS), mi/h	65.0
Right-Side Lateral Clearance, ft	10		

Adjustment Factors

Driver Population	All Familiar	Final Speed Adjustment Factor (SAF)	1.000
Weather Type	Non-Severe Weather	Final Capacity Adjustment Factor (CAF)	1.000
Incident Type	No Incident	Demand Adjustment Factor (DAF)	1.000

Demand and Capacity

Demand Volume veh/h	2763	Heavy Vehicle Adjustment Factor (fhv)	0.802
Peak Hour Factor	0.94	Flow Rate (Vp), pc/h/ln	1222
Total Trucks, %	24.76	Capacity (c), pc/h/ln	2350
Single-Unit Trucks (SUT), %	-	Adjusted Capacity (cadj), pc/h/ln	2350
Tractor-Trailers (TT), %	-	Volume-to-Capacity Ratio (v/c)	0.52
Passenger Car Equivalent (ET)	2.000		

Speed and Density

Lane Width Adjustment (fLW)	0.0	Average Speed (S), mi/h	65.0
Right-Side Lateral Clearance Adj. (fRLC)	0.0	Density (D), pc/mi/ln	18.8
Total Ramp Density Adjustment	5.0	Level of Service (LOS)	C
Adjusted Free-Flow Speed (FFSadj), mi/h	65.0		

HCS7 Freeway Merge Report

Project Information

Analyst	LSA	Date	12/11/2019
Agency	LSA	Analysis Year	Phase II Proj Comp Yr (2039) WP
Jurisdiction	Caltrans	Time Period Analyzed	PM Peak Hour
Project Description	CMD1801 - Village D Specific Plan	Unit	United States Customary

Geometric Data

	Freeway	Ramp
Number of Lanes (N), In	3	1
Free-Flow Speed (FFS), mi/h	65.0	35.0
Segment Length (L) / Acceleration Length (LA),ft	1500	600
Terrain Type	Level	Level
Percent Grade, %	-	-
Segment Type / Ramp Side	Freeway	Right

Adjustment Factors

Driver Population	All Familiar	All Familiar
Weather Type	Non-Severe Weather	Non-Severe Weather
Incident Type	No Incident	-
Final Speed Adjustment Factor (SAF)	1.000	1.000
Final Capacity Adjustment Factor (CAF)	1.000	1.000
Demand Adjustment Factor (DAF)	1.000	1.000

Demand and Capacity

Demand Volume (Vi)	2763	698
Peak Hour Factor (PHF)	0.94	0.94
Total Trucks, %	24.76	6.31
Single-Unit Trucks (SUT), %	-	-
Tractor-Trailers (TT), %	-	-
Heavy Vehicle Adjustment Factor (fHV)	0.802	0.941
Flow Rate (vi),pc/h	3665	789
Capacity (c), pc/h	7050	2000
Volume-to-Capacity Ratio (v/c)	0.63	0.39

Speed and Density

Upstream Equilibrium Distance (LEQ), ft	-	Number of Outer Lanes on Freeway (NO)	1
Distance to Upstream Ramp (LUP), ft	-	Speed Index (MS)	0.355
Downstream Equilibrium Distance (LEQ), ft	-	Flow Outer Lanes (vOA), pc/h/ln	1488
Distance to Downstream Ramp (LDOWN), ft	-	On-Ramp Influence Area Speed (SR), mi/h	56.8
Prop. Freeway Vehicles in Lane 1 and 2 (PFM)	0.594	Outer Lanes Freeway Speed (SO), mi/h	61.4
Flow in Lanes 1 and 2 (v12), pc/h	2177	Ramp Junction Speed (S), mi/h	58.3
Flow Entering Ramp-Infl. Area (vR12), pc/h	2966	Average Density (D), pc/mi/ln	25.5
Level of Service (LOS)	C	Density in Ramp Influence Area (DR), pc/mi/ln	24.6

HCS7 Basic Freeway Report

Project Information

Analyst	LSA	Date	12/11/2019
Agency	LSA	Analysis Year	Phase II Proj Comp Yr (2039) WP
Jurisdiction	Caltrans	Time Period Analyzed	PM Peak Hour
Project Description	CMD1801 - Village D Specific Plan	Unit	United States Customary

Geometric Data

Number of Lanes, ln	3	Terrain Type	Level
Segment Length (L), ft	-	Percent Grade, %	-
Measured or Base Free-Flow Speed	Base	Grade Length, mi	-
Base Free-Flow Speed (BFFS), mi/h	65.0	Total Ramp Density (TRD), ramps/mi	1.83
Lane Width, ft	12	Free-Flow Speed (FFS), mi/h	59.7
Right-Side Lateral Clearance, ft	10		

Adjustment Factors

Driver Population	All Familiar	Final Speed Adjustment Factor (SAF)	1.000
Weather Type	Non-Severe Weather	Final Capacity Adjustment Factor (CAF)	1.000
Incident Type	No Incident	Demand Adjustment Factor (DAF)	1.000

Demand and Capacity

Demand Volume veh/h	3460	Heavy Vehicle Adjustment Factor (fhv)	0.826
Peak Hour Factor	0.94	Flow Rate (Vp), pc/h/ln	1485
Total Trucks, %	21.04	Capacity (c), pc/h/ln	2296
Single-Unit Trucks (SUT), %	-	Adjusted Capacity (cadj), pc/h/ln	2296
Tractor-Trailers (TT), %	-	Volume-to-Capacity Ratio (v/c)	0.65
Passenger Car Equivalent (ET)	2.000		

Speed and Density

Lane Width Adjustment (fLW)	0.0	Average Speed (S), mi/h	59.6
Right-Side Lateral Clearance Adj. (fRLC)	0.0	Density (D), pc/mi/ln	24.9
Total Ramp Density Adjustment	5.4	Level of Service (LOS)	C
Adjusted Free-Flow Speed (FFSadj), mi/h	59.6		

HCS7 Freeway Merge Report

Project Information

Analyst	LSA	Date	12/11/2019
Agency	LSA	Analysis Year	Phase II Proj Comp Yr (2039) WP
Jurisdiction	Caltrans	Time Period Analyzed	PM Peak Hour
Project Description	CMD1801 - Village D Specific Plan	Unit	United States Customary

Geometric Data

	Freeway	Ramp
Number of Lanes (N), ln	3	1
Free-Flow Speed (FFS), mi/h	65.0	35.0
Segment Length (L) / Acceleration Length (LA),ft	1500	600
Terrain Type	Level	Level
Percent Grade, %	-	-
Segment Type / Ramp Side	Freeway	Right

Adjustment Factors

Driver Population	All Familiar	All Familiar
Weather Type	Non-Severe Weather	Non-Severe Weather
Incident Type	No Incident	-
Final Speed Adjustment Factor (SAF)	1.000	1.000
Final Capacity Adjustment Factor (CAF)	1.000	1.000
Demand Adjustment Factor (DAF)	1.000	1.000

Demand and Capacity

Demand Volume (Vi)	3460	627
Peak Hour Factor (PHF)	0.94	0.94
Total Trucks, %	21.04	1.76
Single-Unit Trucks (SUT), %	-	-
Tractor-Trailers (TT), %	-	-
Heavy Vehicle Adjustment Factor (fHV)	0.826	0.983
Flow Rate (vi),pc/h	4456	679
Capacity (c), pc/h	7050	2000
Volume-to-Capacity Ratio (v/c)	0.73	0.34

Speed and Density

Upstream Equilibrium Distance (LEQ), ft	-	Number of Outer Lanes on Freeway (NO)	1
Distance to Upstream Ramp (LUP), ft	-	Speed Index (MS)	0.388
Downstream Equilibrium Distance (LEQ), ft	-	Flow Outer Lanes (vOA), pc/h/ln	1809
Distance to Downstream Ramp (LDOWN), ft	-	On-Ramp Influence Area Speed (SR), mi/h	56.1
Prop. Freeway Vehicles in Lane 1 and 2 (PFM)	0.594	Outer Lanes Freeway Speed (SO), mi/h	60.3
Flow in Lanes 1 and 2 (v12), pc/h	2647	Ramp Junction Speed (S), mi/h	57.5
Flow Entering Ramp-Infl. Area (vR12), pc/h	3326	Average Density (D), pc/mi/ln	29.8
Level of Service (LOS)	C	Density in Ramp Influence Area (DR), pc/mi/ln	27.4

HCS7 Basic Freeway Report

Project Information

Analyst	LSA	Date	12/11/2019
Agency	LSA	Analysis Year	Phase II Proj Comp Yr (2039) WP
Jurisdiction	Caltrans	Time Period Analyzed	PM Peak Hour
Project Description	CMD1801 - Village D Specific Plan	Unit	United States Customary

Geometric Data

Number of Lanes, ln	3	Terrain Type	Level
Segment Length (L), ft	-	Percent Grade, %	-
Measured or Base Free-Flow Speed	Base	Grade Length, mi	-
Base Free-Flow Speed (BFFS), mi/h	65.0	Total Ramp Density (TRD), ramps/mi	2.17
Lane Width, ft	12	Free-Flow Speed (FFS), mi/h	58.8
Right-Side Lateral Clearance, ft	10		

Adjustment Factors

Driver Population	All Familiar	Final Speed Adjustment Factor (SAF)	1.000
Weather Type	Non-Severe Weather	Final Capacity Adjustment Factor (CAF)	1.000
Incident Type	No Incident	Demand Adjustment Factor (DAF)	1.000

Demand and Capacity

Demand Volume veh/h	4087	Heavy Vehicle Adjustment Factor (fhv)	0.847
Peak Hour Factor	0.94	Flow Rate (Vp), pc/h/ln	1711
Total Trucks, %	18.08	Capacity (c), pc/h/ln	2288
Single-Unit Trucks (SUT), %	-	Adjusted Capacity (cadj), pc/h/ln	2288
Tractor-Trailers (TT), %	-	Volume-to-Capacity Ratio (v/c)	0.75
Passenger Car Equivalent (ET)	2.000		

Speed and Density

Lane Width Adjustment (fLW)	0.0	Average Speed (S), mi/h	58.7
Right-Side Lateral Clearance Adj. (fRLC)	0.0	Density (D), pc/mi/ln	29.1
Total Ramp Density Adjustment	6.2	Level of Service (LOS)	D
Adjusted Free-Flow Speed (FFSadj), mi/h	58.8		

HCS7 Freeway Diverge Report

Project Information

Analyst	LSA	Date	12/11/2019
Agency	LSA	Analysis Year	Phase II Proj Comp Yr (2039) WP
Jurisdiction	Caltrans	Time Period Analyzed	PM Peak Hour
Project Description	CMD1801 - Village D Specific Plan	Unit	United States Customary

Geometric Data

	Freeway	Ramp
Number of Lanes (N), ln	3	1
Free-Flow Speed (FFS), mi/h	65.0	40.0
Segment Length (L) / Deceleration Length (LA),ft	1500	150
Terrain Type	Level	Level
Percent Grade, %	-	-
Segment Type / Ramp Side	Freeway	Right

Adjustment Factors

Driver Population	All Familiar	All Familiar
Weather Type	Non-Severe Weather	Non-Severe Weather
Incident Type	No Incident	-
Final Speed Adjustment Factor (SAF)	1.000	1.000
Final Capacity Adjustment Factor (CAF)	1.000	1.000
Demand Adjustment Factor (DAF)	1.000	1.000

Demand and Capacity

Demand Volume (Vi)	4087	362
Peak Hour Factor (PHF)	0.94	0.94
Total Trucks, %	18.08	3.31
Single-Unit Trucks (SUT), %	-	-
Tractor-Trailers (TT), %	-	-
Heavy Vehicle Adjustment Factor (fHV)	0.847	0.968
Flow Rate (vi),pc/h	5133	398
Capacity (c), pc/h	7050	2000
Volume-to-Capacity Ratio (v/c)	0.73	0.20

Speed and Density

Upstream Equilibrium Distance (LEQ), ft	-	Number of Outer Lanes on Freeway (NO)	1
Distance to Upstream Ramp (LUP), ft	-	Speed Index (DS)	0.399
Downstream Equilibrium Distance (LEQ), ft	-	Flow Outer Lanes (vOA), pc/h/ln	1832
Distance to Downstream Ramp (LDOWN), ft	-	Off-Ramp Influence Area Speed (SR), mi/h	55.8
Prop. Freeway Vehicles in Lane 1 and 2 (PFD)	0.613	Outer Lanes Freeway Speed (SO), mi/h	68.1
Flow in Lanes 1 and 2 (v12), pc/h	3301	Ramp Junction Speed (S), mi/h	59.6
Flow Entering Ramp-Infl. Area (vR12), pc/h	-	Average Density (D), pc/mi/ln	28.7
Level of Service (LOS)	D	Density in Ramp Influence Area (DR), pc/mi/ln	31.3

HCS7 Basic Freeway Report

Project Information

Analyst	LSA	Date	12/11/2019
Agency	LSA	Analysis Year	Phase II Proj Comp Yr (2039) WP
Jurisdiction	Caltrans	Time Period Analyzed	PM Peak Hour
Project Description	CMD1801 - Village D Specific Plan	Unit	United States Customary

Geometric Data

Number of Lanes, ln	3	Terrain Type	Level
Segment Length (L), ft	-	Percent Grade, %	-
Measured or Base Free-Flow Speed	Base	Grade Length, mi	-
Base Free-Flow Speed (BFFS), mi/h	65.0	Total Ramp Density (TRD), ramps/mi	1.83
Lane Width, ft	12	Free-Flow Speed (FFS), mi/h	59.7
Right-Side Lateral Clearance, ft	10		

Adjustment Factors

Driver Population	All Familiar	Final Speed Adjustment Factor (SAF)	1.000
Weather Type	Non-Severe Weather	Final Capacity Adjustment Factor (CAF)	1.000
Incident Type	No Incident	Demand Adjustment Factor (DAF)	1.000

Demand and Capacity

Demand Volume veh/h	3725	Heavy Vehicle Adjustment Factor (fhv)	0.837
Peak Hour Factor	0.94	Flow Rate (Vp), pc/h/ln	1578
Total Trucks, %	19.52	Capacity (c), pc/h/ln	2296
Single-Unit Trucks (SUT), %	-	Adjusted Capacity (cadj), pc/h/ln	2296
Tractor-Trailers (TT), %	-	Volume-to-Capacity Ratio (v/c)	0.69
Passenger Car Equivalent (ET)	2.000		

Speed and Density

Lane Width Adjustment (fLW)	0.0	Average Speed (S), mi/h	59.6
Right-Side Lateral Clearance Adj. (fRLC)	0.0	Density (D), pc/mi/ln	26.5
Total Ramp Density Adjustment	5.4	Level of Service (LOS)	D
Adjusted Free-Flow Speed (FFSadj), mi/h	59.6		

HCS7 Freeway Merge Report

Project Information

Analyst	LSA	Date	12/11/2019
Agency	LSA	Analysis Year	Phase II Proj Comp Yr (2039) WP
Jurisdiction	Caltrans	Time Period Analyzed	PM Peak Hour
Project Description	CMD1801 - Village D Specific Plan	Unit	United States Customary

Geometric Data

	Freeway	Ramp
Number of Lanes (N), ln	3	1
Free-Flow Speed (FFS), mi/h	65.0	35.0
Segment Length (L) / Acceleration Length (LA),ft	1500	800
Terrain Type	Level	Level
Percent Grade, %	-	-
Segment Type / Ramp Side	Freeway	Right

Adjustment Factors

Driver Population	All Familiar	All Familiar
Weather Type	Non-Severe Weather	Non-Severe Weather
Incident Type	No Incident	-
Final Speed Adjustment Factor (SAF)	1.000	1.000
Final Capacity Adjustment Factor (CAF)	1.000	1.000
Demand Adjustment Factor (DAF)	1.000	1.000

Demand and Capacity

Demand Volume (Vi)	3725	267
Peak Hour Factor (PHF)	0.94	0.94
Total Trucks, %	19.52	5.99
Single-Unit Trucks (SUT), %	-	-
Tractor-Trailers (TT), %	-	-
Heavy Vehicle Adjustment Factor (fHV)	0.837	0.943
Flow Rate (vi),pc/h	4734	301
Capacity (c), pc/h	7050	2000
Volume-to-Capacity Ratio (v/c)	0.71	0.15

Speed and Density

Upstream Equilibrium Distance (LEQ), ft	-	Number of Outer Lanes on Freeway (NO)	1
Distance to Upstream Ramp (LUP), ft	-	Speed Index (MS)	0.355
Downstream Equilibrium Distance (LEQ), ft	-	Flow Outer Lanes (vOA), pc/h/ln	1894
Distance to Downstream Ramp (LDOWN), ft	-	On-Ramp Influence Area Speed (SR), mi/h	56.8
Prop. Freeway Vehicles in Lane 1 and 2 (PFM)	0.600	Outer Lanes Freeway Speed (SO), mi/h	60.0
Flow in Lanes 1 and 2 (v12), pc/h	2840	Ramp Junction Speed (S), mi/h	58.0
Flow Entering Ramp-Infl. Area (vR12), pc/h	3141	Average Density (D), pc/mi/ln	28.9
Level of Service (LOS)	C	Density in Ramp Influence Area (DR), pc/mi/ln	24.9

HCS7 Basic Freeway Report

Project Information

Analyst	LSA	Date	12/11/2019
Agency	LSA	Analysis Year	Phase II Proj Comp Yr (2039) WP
Jurisdiction	Caltrans	Time Period Analyzed	PM Peak Hour
Project Description	CMD1801 - Village D Specific Plan	Unit	United States Customary

Geometric Data

Number of Lanes, ln	3	Terrain Type	Level
Segment Length (L), ft	-	Percent Grade, %	-
Measured or Base Free-Flow Speed	Base	Grade Length, mi	-
Base Free-Flow Speed (BFFS), mi/h	65.0	Total Ramp Density (TRD), ramps/mi	2.17
Lane Width, ft	12	Free-Flow Speed (FFS), mi/h	58.8
Right-Side Lateral Clearance, ft	10		

Adjustment Factors

Driver Population	All Familiar	Final Speed Adjustment Factor (SAF)	1.000
Weather Type	Non-Severe Weather	Final Capacity Adjustment Factor (CAF)	1.000
Incident Type	No Incident	Demand Adjustment Factor (DAF)	1.000

Demand and Capacity

Demand Volume veh/h	3992	Heavy Vehicle Adjustment Factor (fhv)	0.843
Peak Hour Factor	0.94	Flow Rate (Vp), pc/h/ln	1679
Total Trucks, %	18.60	Capacity (c), pc/h/ln	2288
Single-Unit Trucks (SUT), %	-	Adjusted Capacity (cadj), pc/h/ln	2288
Tractor-Trailers (TT), %	-	Volume-to-Capacity Ratio (v/c)	0.73
Passenger Car Equivalent (ET)	2.000		

Speed and Density

Lane Width Adjustment (fLW)	0.0	Average Speed (S), mi/h	58.8
Right-Side Lateral Clearance Adj. (fRLC)	0.0	Density (D), pc/mi/ln	28.6
Total Ramp Density Adjustment	6.2	Level of Service (LOS)	D
Adjusted Free-Flow Speed (FFSadj), mi/h	58.8		

HCS7 Freeway Diverge Report

Project Information

Analyst	LSA	Date	12/11/2019
Agency	LSA	Analysis Year	Phase II Proj Comp Yr (2039) WP
Jurisdiction	Caltrans	Time Period Analyzed	PM Peak Hour
Project Description	CMD1801 - Village D Specific Plan	Unit	United States Customary

Geometric Data

	Freeway	Ramp
Number of Lanes (N), In	3	1
Free-Flow Speed (FFS), mi/h	65.0	35.0
Segment Length (L) / Deceleration Length (LA),ft	1500	200
Terrain Type	Level	Level
Percent Grade, %	-	-
Segment Type / Ramp Side	Freeway	Right

Adjustment Factors

Driver Population	All Familiar	All Familiar
Weather Type	Non-Severe Weather	Non-Severe Weather
Incident Type	No Incident	-
Final Speed Adjustment Factor (SAF)	1.000	1.000
Final Capacity Adjustment Factor (CAF)	1.000	1.000
Demand Adjustment Factor (DAF)	1.000	1.000

Demand and Capacity

Demand Volume (Vi)	3992	340
Peak Hour Factor (PHF)	0.94	0.94
Total Trucks, %	18.60	2.94
Single-Unit Trucks (SUT), %	-	-
Tractor-Trailers (TT), %	-	-
Heavy Vehicle Adjustment Factor (fHV)	0.843	0.971
Flow Rate (vi),pc/h	5038	373
Capacity (c), pc/h	7050	2000
Volume-to-Capacity Ratio (v/c)	0.71	0.19

Speed and Density

Upstream Equilibrium Distance (LEQ), ft	-	Number of Outer Lanes on Freeway (NO)	1
Distance to Upstream Ramp (LUP), ft	-	Speed Index (DS)	0.462
Downstream Equilibrium Distance (LEQ), ft	-	Flow Outer Lanes (vOA), pc/h/ln	1787
Distance to Downstream Ramp (LDOWN), ft	-	Off-Ramp Influence Area Speed (SR), mi/h	54.4
Prop. Freeway Vehicles in Lane 1 and 2 (PFD)	0.617	Outer Lanes Freeway Speed (SO), mi/h	68.2
Flow in Lanes 1 and 2 (v12), pc/h	3251	Ramp Junction Speed (S), mi/h	58.6
Flow Entering Ramp-Infl. Area (vR12), pc/h	-	Average Density (D), pc/mi/ln	28.7
Level of Service (LOS)	D	Density in Ramp Influence Area (DR), pc/mi/ln	30.4

HCS7 Basic Freeway Report

Project Information

Analyst	LSA	Date	12/11/2019
Agency	LSA	Analysis Year	Phase II Proj Comp Yr (2039) WP
Jurisdiction	Caltrans	Time Period Analyzed	PM Peak Hour
Project Description	CMD1801 - Village D Specific Plan	Unit	United States Customary

Geometric Data

Number of Lanes, ln	3	Terrain Type	Level
Segment Length (L), ft	-	Percent Grade, %	-
Measured or Base Free-Flow Speed	Base	Grade Length, mi	-
Base Free-Flow Speed (BFFS), mi/h	65.0	Total Ramp Density (TRD), ramps/mi	2.17
Lane Width, ft	12	Free-Flow Speed (FFS), mi/h	58.8
Right-Side Lateral Clearance, ft	10		

Adjustment Factors

Driver Population	All Familiar	Final Speed Adjustment Factor (SAF)	1.000
Weather Type	Non-Severe Weather	Final Capacity Adjustment Factor (CAF)	1.000
Incident Type	No Incident	Demand Adjustment Factor (DAF)	1.000

Demand and Capacity

Demand Volume veh/h	3651	Heavy Vehicle Adjustment Factor (fhv)	0.833
Peak Hour Factor	0.94	Flow Rate (Vp), pc/h/ln	1554
Total Trucks, %	20.06	Capacity (c), pc/h/ln	2288
Single-Unit Trucks (SUT), %	-	Adjusted Capacity (cadj), pc/h/ln	2288
Tractor-Trailers (TT), %	-	Volume-to-Capacity Ratio (v/c)	0.68
Passenger Car Equivalent (ET)	2.000		

Speed and Density

Lane Width Adjustment (fLW)	0.0	Average Speed (S), mi/h	58.8
Right-Side Lateral Clearance Adj. (fRLC)	0.0	Density (D), pc/mi/ln	26.4
Total Ramp Density Adjustment	6.2	Level of Service (LOS)	D
Adjusted Free-Flow Speed (FFSadj), mi/h	58.8		

HCS7 Freeway Merge Report

Project Information

Analyst	LSA	Date	12/11/2019
Agency	LSA	Analysis Year	Phase II Proj Comp Yr (2039) WP
Jurisdiction	Caltrans	Time Period Analyzed	PM Peak Hour
Project Description	CMD1801 - Village D Specific Plan	Unit	United States Customary

Geometric Data

	Freeway	Ramp
Number of Lanes (N), ln	3	1
Free-Flow Speed (FFS), mi/h	65.0	35.0
Segment Length (L) / Acceleration Length (LA),ft	1500	350
Terrain Type	Level	Level
Percent Grade, %	-	-
Segment Type / Ramp Side	Freeway	Right

Adjustment Factors

Driver Population	All Familiar	All Familiar
Weather Type	Non-Severe Weather	Non-Severe Weather
Incident Type	No Incident	-
Final Speed Adjustment Factor (SAF)	1.000	1.000
Final Capacity Adjustment Factor (CAF)	1.000	1.000
Demand Adjustment Factor (DAF)	1.000	1.000

Demand and Capacity

Demand Volume (Vi)	3651	840
Peak Hour Factor (PHF)	0.94	0.94
Total Trucks, %	20.06	1.31
Single-Unit Trucks (SUT), %	-	-
Tractor-Trailers (TT), %	-	-
Heavy Vehicle Adjustment Factor (fHV)	0.833	0.987
Flow Rate (vi),pc/h	4663	905
Capacity (c), pc/h	7050	2000
Volume-to-Capacity Ratio (v/c)	0.79	0.45

Speed and Density

Upstream Equilibrium Distance (LEQ), ft	-	Number of Outer Lanes on Freeway (NO)	1
Distance to Upstream Ramp (LUP), ft	-	Speed Index (MS)	0.445
Downstream Equilibrium Distance (LEQ), ft	-	Flow Outer Lanes (vOA), pc/h/ln	1926
Distance to Downstream Ramp (LDOWN), ft	-	On-Ramp Influence Area Speed (SR), mi/h	54.8
Prop. Freeway Vehicles in Lane 1 and 2 (PFM)	0.587	Outer Lanes Freeway Speed (SO), mi/h	59.9
Flow in Lanes 1 and 2 (v12), pc/h	2737	Ramp Junction Speed (S), mi/h	56.5
Flow Entering Ramp-Infl. Area (vR12), pc/h	3642	Average Density (D), pc/mi/ln	32.8
Level of Service (LOS)	D	Density in Ramp Influence Area (DR), pc/mi/ln	31.3

HCS7 Basic Freeway Report

Project Information

Analyst	LSA	Date	12/11/2019
Agency	LSA	Analysis Year	Phase II Proj Comp Yr (2039) WP
Jurisdiction	Caltrans	Time Period Analyzed	PM Peak Hour
Project Description	CMD1801 - Village D Specific Plan	Unit	United States Customary

Geometric Data

Number of Lanes, ln	3	Terrain Type	Level
Segment Length (L), ft	-	Percent Grade, %	-
Measured or Base Free-Flow Speed	Base	Grade Length, mi	-
Base Free-Flow Speed (BFFS), mi/h	65.0	Total Ramp Density (TRD), ramps/mi	2.17
Lane Width, ft	12	Free-Flow Speed (FFS), mi/h	58.8
Right-Side Lateral Clearance, ft	10		

Adjustment Factors

Driver Population	All Familiar	Final Speed Adjustment Factor (SAF)	1.000
Weather Type	Non-Severe Weather	Final Capacity Adjustment Factor (CAF)	1.000
Incident Type	No Incident	Demand Adjustment Factor (DAF)	1.000

Demand and Capacity

Demand Volume veh/h	4492	Heavy Vehicle Adjustment Factor (fhv)	0.858
Peak Hour Factor	0.94	Flow Rate (Vp), pc/h/ln	1857
Total Trucks, %	16.54	Capacity (c), pc/h/ln	2288
Single-Unit Trucks (SUT), %	-	Adjusted Capacity (cadj), pc/h/ln	2288
Tractor-Trailers (TT), %	-	Volume-to-Capacity Ratio (v/c)	0.81
Passenger Car Equivalent (ET)	2.000		

Speed and Density

Lane Width Adjustment (fLW)	0.0	Average Speed (S), mi/h	58.0
Right-Side Lateral Clearance Adj. (fRLC)	0.0	Density (D), pc/mi/ln	32.0
Total Ramp Density Adjustment	6.2	Level of Service (LOS)	D
Adjusted Free-Flow Speed (FFSadj), mi/h	58.8		

HCS7 Freeway Diverge Report

Project Information

Analyst	LSA	Date	12/11/2019
Agency	LSA	Analysis Year	Phase II Proj Comp Yr (2039) WP
Jurisdiction	Caltrans	Time Period Analyzed	PM Peak Hour
Project Description	CMD1801 - Village D Specific Plan	Unit	United States Customary

Geometric Data

	Freeway	Ramp
Number of Lanes (N), ln	3	1
Free-Flow Speed (FFS), mi/h	65.0	15.0
Segment Length (L) / Deceleration Length (LA),ft	1500	150
Terrain Type	Level	Level
Percent Grade, %	-	-
Segment Type / Ramp Side	Freeway	Right

Adjustment Factors

Driver Population	All Familiar	All Familiar
Weather Type	Non-Severe Weather	Non-Severe Weather
Incident Type	No Incident	-
Final Speed Adjustment Factor (SAF)	1.000	1.000
Final Capacity Adjustment Factor (CAF)	1.000	1.000
Demand Adjustment Factor (DAF)	1.000	1.000

Demand and Capacity

Demand Volume (Vi)	4492	339
Peak Hour Factor (PHF)	0.94	0.94
Total Trucks, %	16.54	2.36
Single-Unit Trucks (SUT), %	-	-
Tractor-Trailers (TT), %	-	-
Heavy Vehicle Adjustment Factor (fHV)	0.858	0.977
Flow Rate (vi),pc/h	5570	369
Capacity (c), pc/h	7050	1800
Volume-to-Capacity Ratio (v/c)	0.79	0.21

Speed and Density

Upstream Equilibrium Distance (LEQ), ft	-	Number of Outer Lanes on Freeway (NO)	1
Distance to Upstream Ramp (LUP), ft	-	Speed Index (DS)	0.721
Downstream Equilibrium Distance (LEQ), ft	-	Flow Outer Lanes (vOA), pc/h/ln	2060
Distance to Downstream Ramp (LDOWN), ft	-	Off-Ramp Influence Area Speed (SR), mi/h	48.4
Prop. Freeway Vehicles in Lane 1 and 2 (PFD)	0.604	Outer Lanes Freeway Speed (SO), mi/h	67.2
Flow in Lanes 1 and 2 (v12), pc/h	3510	Ramp Junction Speed (S), mi/h	54.0
Flow Entering Ramp-Infl. Area (vR12), pc/h	-	Average Density (D), pc/mi/ln	34.4
Level of Service (LOS)	D	Density in Ramp Influence Area (DR), pc/mi/ln	33.1

HCS7 Basic Freeway Report

Project Information

Analyst	LSA	Date	12/11/2019
Agency	LSA	Analysis Year	Phase II Proj Comp Yr (2039) WP
Jurisdiction	Caltrans	Time Period Analyzed	PM Peak Hour
Project Description	CMD1801 - Village D Specific Plan	Unit	United States Customary

Geometric Data

Number of Lanes, ln	3	Terrain Type	Level
Segment Length (L), ft	-	Percent Grade, %	-
Measured or Base Free-Flow Speed	Base	Grade Length, mi	-
Base Free-Flow Speed (BFFS), mi/h	65.0	Total Ramp Density (TRD), ramps/mi	1.83
Lane Width, ft	12	Free-Flow Speed (FFS), mi/h	59.7
Right-Side Lateral Clearance, ft	10		

Adjustment Factors

Driver Population	All Familiar	Final Speed Adjustment Factor (SAF)	1.000
Weather Type	Non-Severe Weather	Final Capacity Adjustment Factor (CAF)	1.000
Incident Type	No Incident	Demand Adjustment Factor (DAF)	1.000

Demand and Capacity

Demand Volume veh/h	4153	Heavy Vehicle Adjustment Factor (fhv)	0.850
Peak Hour Factor	0.94	Flow Rate (Vp), pc/h/ln	1733
Total Trucks, %	17.69	Capacity (c), pc/h/ln	2296
Single-Unit Trucks (SUT), %	-	Adjusted Capacity (cadj), pc/h/ln	2296
Tractor-Trailers (TT), %	-	Volume-to-Capacity Ratio (v/c)	0.75
Passenger Car Equivalent (ET)	2.000		

Speed and Density

Lane Width Adjustment (fLW)	0.0	Average Speed (S), mi/h	59.3
Right-Side Lateral Clearance Adj. (fRLC)	0.0	Density (D), pc/mi/ln	29.2
Total Ramp Density Adjustment	5.4	Level of Service (LOS)	D
Adjusted Free-Flow Speed (FFSadj), mi/h	59.6		

HCS7 Freeway Merge Report

Project Information

Analyst	LSA	Date	12/11/2019
Agency	LSA	Analysis Year	Phase II Proj Comp Yr (2039) WP
Jurisdiction	Caltrans	Time Period Analyzed	PM Peak Hour
Project Description	CMD1801 - Village D Specific Plan	Unit	United States Customary

Geometric Data

	Freeway	Ramp
Number of Lanes (N), ln	3	1
Free-Flow Speed (FFS), mi/h	65.0	35.0
Segment Length (L) / Acceleration Length (LA),ft	1500	450
Terrain Type	Level	Level
Percent Grade, %	-	-
Segment Type / Ramp Side	Freeway	Right

Adjustment Factors

Driver Population	All Familiar	All Familiar
Weather Type	Non-Severe Weather	Non-Severe Weather
Incident Type	No Incident	-
Final Speed Adjustment Factor (SAF)	1.000	1.000
Final Capacity Adjustment Factor (CAF)	1.000	1.000
Demand Adjustment Factor (DAF)	1.000	1.000

Demand and Capacity

Demand Volume (Vi)	4153	503
Peak Hour Factor (PHF)	0.94	0.94
Total Trucks, %	17.69	1.19
Single-Unit Trucks (SUT), %	-	-
Tractor-Trailers (TT), %	-	-
Heavy Vehicle Adjustment Factor (fHV)	0.850	0.988
Flow Rate (vi),pc/h	5198	542
Capacity (c), pc/h	7050	2000
Volume-to-Capacity Ratio (v/c)	0.81	0.27

Speed and Density

Upstream Equilibrium Distance (LEQ), ft	-	Number of Outer Lanes on Freeway (NO)	1
Distance to Upstream Ramp (LUP), ft	-	Speed Index (MS)	0.434
Downstream Equilibrium Distance (LEQ), ft	-	Flow Outer Lanes (vOA), pc/h/ln	2131
Distance to Downstream Ramp (LDOWN), ft	-	On-Ramp Influence Area Speed (SR), mi/h	55.0
Prop. Freeway Vehicles in Lane 1 and 2 (PFM)	0.590	Outer Lanes Freeway Speed (SO), mi/h	59.1
Flow in Lanes 1 and 2 (v12), pc/h	3067	Ramp Junction Speed (S), mi/h	56.5
Flow Entering Ramp-Infl. Area (vR12), pc/h	3609	Average Density (D), pc/mi/ln	33.9
Level of Service (LOS)	D	Density in Ramp Influence Area (DR), pc/mi/ln	30.6

HCS7 Basic Freeway Report

Project Information

Analyst	LSA	Date	12/11/2019
Agency	LSA	Analysis Year	Phase II Proj Comp Yr (2039) WP
Jurisdiction	Caltrans	Time Period Analyzed	PM Peak Hour
Project Description	CMD1801 - Village D Specific Plan	Unit	United States Customary

Geometric Data

Number of Lanes, ln	3	Terrain Type	Level
Segment Length (L), ft	-	Percent Grade, %	-
Measured or Base Free-Flow Speed	Base	Grade Length, mi	-
Base Free-Flow Speed (BFFS), mi/h	65.0	Total Ramp Density (TRD), ramps/mi	1.83
Lane Width, ft	12	Free-Flow Speed (FFS), mi/h	59.7
Right-Side Lateral Clearance, ft	10		

Adjustment Factors

Driver Population	All Familiar	Final Speed Adjustment Factor (SAF)	1.000
Weather Type	Non-Severe Weather	Final Capacity Adjustment Factor (CAF)	1.000
Incident Type	No Incident	Demand Adjustment Factor (DAF)	1.000

Demand and Capacity

Demand Volume veh/h	4656	Heavy Vehicle Adjustment Factor (fhv)	0.863
Peak Hour Factor	0.94	Flow Rate (Vp), pc/h/ln	1913
Total Trucks, %	15.90	Capacity (c), pc/h/ln	2296
Single-Unit Trucks (SUT), %	-	Adjusted Capacity (cadj), pc/h/ln	2296
Tractor-Trailers (TT), %	-	Volume-to-Capacity Ratio (v/c)	0.83
Passenger Car Equivalent (ET)	2.000		

Speed and Density

Lane Width Adjustment (fLW)	0.0	Average Speed (S), mi/h	58.0
Right-Side Lateral Clearance Adj. (fRLC)	0.0	Density (D), pc/mi/ln	33.0
Total Ramp Density Adjustment	5.4	Level of Service (LOS)	D
Adjusted Free-Flow Speed (FFSadj), mi/h	59.6		

HCS7 Freeway Diverge Report

Project Information

Analyst	LSA	Date	12/11/2019
Agency	LSA	Analysis Year	Phase II Proj Comp Yr (2039) WP
Jurisdiction	Caltrans	Time Period Analyzed	PM Peak Hour
Project Description	CMD1801 - Village D Specific Plan	Unit	United States Customary

Geometric Data

	Freeway	Ramp
Number of Lanes (N), ln	3	1
Free-Flow Speed (FFS), mi/h	65.0	35.0
Segment Length (L) / Deceleration Length (LA),ft	1500	140
Terrain Type	Level	Level
Percent Grade, %	-	-
Segment Type / Ramp Side	Freeway	Right

Adjustment Factors

Driver Population	All Familiar	All Familiar
Weather Type	Non-Severe Weather	Non-Severe Weather
Incident Type	No Incident	-
Final Speed Adjustment Factor (SAF)	1.000	1.000
Final Capacity Adjustment Factor (CAF)	1.000	1.000
Demand Adjustment Factor (DAF)	1.000	1.000

Demand and Capacity

Demand Volume (Vi)	4656	699
Peak Hour Factor (PHF)	0.94	0.94
Total Trucks, %	15.90	3.86
Single-Unit Trucks (SUT), %	-	-
Tractor-Trailers (TT), %	-	-
Heavy Vehicle Adjustment Factor (fHV)	0.863	0.963
Flow Rate (vi),pc/h	5740	772
Capacity (c), pc/h	7050	2000
Volume-to-Capacity Ratio (v/c)	0.81	0.39

Speed and Density

Upstream Equilibrium Distance (LEQ), ft	-	Number of Outer Lanes on Freeway (NO)	1
Distance to Upstream Ramp (LUP), ft	-	Speed Index (DS)	0.497
Downstream Equilibrium Distance (LEQ), ft	-	Flow Outer Lanes (vOA), pc/h/ln	2082
Distance to Downstream Ramp (LDOWN), ft	-	Off-Ramp Influence Area Speed (SR), mi/h	53.6
Prop. Freeway Vehicles in Lane 1 and 2 (PFD)	0.581	Outer Lanes Freeway Speed (SO), mi/h	67.1
Flow in Lanes 1 and 2 (v12), pc/h	3658	Ramp Junction Speed (S), mi/h	57.8
Flow Entering Ramp-Infl. Area (vR12), pc/h	-	Average Density (D), pc/mi/ln	33.1
Level of Service (LOS)	D	Density in Ramp Influence Area (DR), pc/mi/ln	34.5

HCS7 Basic Freeway Report

Project Information

Analyst	LSA	Date	12/11/2019
Agency	LSA	Analysis Year	Phase II Proj Comp Yr (2039) WP
Jurisdiction	Caltrans	Time Period Analyzed	PM Peak Hour
Project Description	CMD1801 - Village D Specific Plan	Unit	United States Customary

Geometric Data

Number of Lanes, ln	3	Terrain Type	Level
Segment Length (L), ft	-	Percent Grade, %	-
Measured or Base Free-Flow Speed	Base	Grade Length, mi	-
Base Free-Flow Speed (BFFS), mi/h	65.0	Total Ramp Density (TRD), ramps/mi	2.17
Lane Width, ft	12	Free-Flow Speed (FFS), mi/h	58.8
Right-Side Lateral Clearance, ft	10		

Adjustment Factors

Driver Population	All Familiar	Final Speed Adjustment Factor (SAF)	1.000
Weather Type	Non-Severe Weather	Final Capacity Adjustment Factor (CAF)	1.000
Incident Type	No Incident	Demand Adjustment Factor (DAF)	1.000

Demand and Capacity

Demand Volume veh/h	3957	Heavy Vehicle Adjustment Factor (fhv)	0.847
Peak Hour Factor	0.94	Flow Rate (Vp), pc/h/ln	1657
Total Trucks, %	18.01	Capacity (c), pc/h/ln	2288
Single-Unit Trucks (SUT), %	-	Adjusted Capacity (cadj), pc/h/ln	2288
Tractor-Trailers (TT), %	-	Volume-to-Capacity Ratio (v/c)	0.72
Passenger Car Equivalent (ET)	2.000		

Speed and Density

Lane Width Adjustment (fLW)	0.0	Average Speed (S), mi/h	58.8
Right-Side Lateral Clearance Adj. (fRLC)	0.0	Density (D), pc/mi/ln	28.2
Total Ramp Density Adjustment	6.2	Level of Service (LOS)	D
Adjusted Free-Flow Speed (FFSadj), mi/h	58.8		

HCS7 Freeway Merge Report

Project Information

Analyst	LSA	Date	12/11/2019
Agency	LSA	Analysis Year	Phase II Proj Comp Yr (2039) WP
Jurisdiction	Caltrans	Time Period Analyzed	PM Peak Hour
Project Description	CMD1801 - Village D Specific Plan	Unit	United States Customary

Geometric Data

	Freeway	Ramp
Number of Lanes (N), ln	3	1
Free-Flow Speed (FFS), mi/h	65.0	35.0
Segment Length (L) / Acceleration Length (LA),ft	1500	450
Terrain Type	Level	Level
Percent Grade, %	-	-
Segment Type / Ramp Side	Freeway	Right

Adjustment Factors

Driver Population	All Familiar	All Familiar
Weather Type	Non-Severe Weather	Non-Severe Weather
Incident Type	No Incident	-
Final Speed Adjustment Factor (SAF)	1.000	1.000
Final Capacity Adjustment Factor (CAF)	1.000	1.000
Demand Adjustment Factor (DAF)	1.000	1.000

Demand and Capacity

Demand Volume (Vi)	3957	391
Peak Hour Factor (PHF)	0.94	0.94
Total Trucks, %	18.01	1.53
Single-Unit Trucks (SUT), %	-	-
Tractor-Trailers (TT), %	-	-
Heavy Vehicle Adjustment Factor (fHV)	0.847	0.985
Flow Rate (vi),pc/h	4970	422
Capacity (c), pc/h	7050	2000
Volume-to-Capacity Ratio (v/c)	0.76	0.21

Speed and Density

Upstream Equilibrium Distance (LEQ), ft	-	Number of Outer Lanes on Freeway (NO)	1
Distance to Upstream Ramp (LUP), ft	-	Speed Index (MS)	0.401
Downstream Equilibrium Distance (LEQ), ft	-	Flow Outer Lanes (vOA), pc/h/ln	2038
Distance to Downstream Ramp (LDOWN), ft	-	On-Ramp Influence Area Speed (SR), mi/h	55.8
Prop. Freeway Vehicles in Lane 1 and 2 (PFM)	0.590	Outer Lanes Freeway Speed (SO), mi/h	59.5
Flow in Lanes 1 and 2 (v12), pc/h	2932	Ramp Junction Speed (S), mi/h	57.1
Flow Entering Ramp-Infl. Area (vR12), pc/h	3354	Average Density (D), pc/mi/ln	31.5
Level of Service (LOS)	D	Density in Ramp Influence Area (DR), pc/mi/ln	28.7

HCS7 Basic Freeway Report

Project Information

Analyst	LSA	Date	12/11/2019
Agency	LSA	Analysis Year	Phase II Proj Comp Yr (2039) WP
Jurisdiction	Caltrans	Time Period Analyzed	PM Peak Hour
Project Description	CMD1801 - Village D Specific Plan	Unit	United States Customary

Geometric Data

Number of Lanes, ln	3	Terrain Type	Level
Segment Length (L), ft	-	Percent Grade, %	-
Measured or Base Free-Flow Speed	Base	Grade Length, mi	-
Base Free-Flow Speed (BFFS), mi/h	65.0	Total Ramp Density (TRD), ramps/mi	2.17
Lane Width, ft	12	Free-Flow Speed (FFS), mi/h	58.8
Right-Side Lateral Clearance, ft	10		

Adjustment Factors

Driver Population	All Familiar	Final Speed Adjustment Factor (SAF)	1.000
Weather Type	Non-Severe Weather	Final Capacity Adjustment Factor (CAF)	1.000
Incident Type	No Incident	Demand Adjustment Factor (DAF)	1.000

Demand and Capacity

Demand Volume veh/h	4348	Heavy Vehicle Adjustment Factor (fhv)	0.858
Peak Hour Factor	0.94	Flow Rate (Vp), pc/h/ln	1797
Total Trucks, %	16.54	Capacity (c), pc/h/ln	2288
Single-Unit Trucks (SUT), %	-	Adjusted Capacity (cadj), pc/h/ln	2288
Tractor-Trailers (TT), %	-	Volume-to-Capacity Ratio (v/c)	0.79
Passenger Car Equivalent (ET)	2.000		

Speed and Density

Lane Width Adjustment (fLW)	0.0	Average Speed (S), mi/h	58.4
Right-Side Lateral Clearance Adj. (fRLC)	0.0	Density (D), pc/mi/ln	30.8
Total Ramp Density Adjustment	6.2	Level of Service (LOS)	D
Adjusted Free-Flow Speed (FFSadj), mi/h	58.8		

HCS7 Basic Freeway Report

Project Information

Analyst	LSA	Date	12/11/2019
Agency	LSA	Analysis Year	Phase III Proj Comp Yr (2049) NP
Jurisdiction	Caltrans	Time Period Analyzed	AM Peak Hour
Project Description	CMD1801 - Village D Specific Plan	Unit	United States Customary

Geometric Data

Number of Lanes, ln	3	Terrain Type	Level
Segment Length (L), ft	-	Percent Grade, %	-
Measured or Base Free-Flow Speed	Base	Grade Length, mi	-
Base Free-Flow Speed (BFFS), mi/h	65.0	Total Ramp Density (TRD), ramps/mi	1.83
Lane Width, ft	12	Free-Flow Speed (FFS), mi/h	59.7
Right-Side Lateral Clearance, ft	10		

Adjustment Factors

Driver Population	All Familiar	Final Speed Adjustment Factor (SAF)	1.000
Weather Type	Non-Severe Weather	Final Capacity Adjustment Factor (CAF)	1.000
Incident Type	No Incident	Demand Adjustment Factor (DAF)	1.000

Demand and Capacity

Demand Volume veh/h	3573	Heavy Vehicle Adjustment Factor (fhv)	0.851
Peak Hour Factor	0.94	Flow Rate (Vp), pc/h/ln	1489
Total Trucks, %	17.57	Capacity (c), pc/h/ln	2296
Single-Unit Trucks (SUT), %	-	Adjusted Capacity (cadj), pc/h/ln	2296
Tractor-Trailers (TT), %	-	Volume-to-Capacity Ratio (v/c)	0.65
Passenger Car Equivalent (ET)	2.000		

Speed and Density

Lane Width Adjustment (fLW)	0.0	Average Speed (S), mi/h	59.6
Right-Side Lateral Clearance Adj. (fRLC)	0.0	Density (D), pc/mi/ln	25.0
Total Ramp Density Adjustment	5.4	Level of Service (LOS)	C
Adjusted Free-Flow Speed (FFSadj), mi/h	59.6		

HCS7 Freeway Diverge Report

Project Information

Analyst	LSA	Date	12/11/2019
Agency	LSA	Analysis Year	Phase III Proj Comp Yr (2049) NP
Jurisdiction	Caltrans	Time Period Analyzed	PM Peak Hour
Project Description	CMD1801 - Village D Specific Plan	Unit	United States Customary

Geometric Data

	Freeway	Ramp
Number of Lanes (N), ln	3	1
Free-Flow Speed (FFS), mi/h	65.0	35.0
Segment Length (L) / Deceleration Length (LA),ft	1500	150
Terrain Type	Level	Level
Percent Grade, %	-	-
Segment Type / Ramp Side	Freeway	Right

Adjustment Factors

Driver Population	All Familiar	All Familiar
Weather Type	Non-Severe Weather	Non-Severe Weather
Incident Type	No Incident	-
Final Speed Adjustment Factor (SAF)	1.000	1.000
Final Capacity Adjustment Factor (CAF)	1.000	1.000
Demand Adjustment Factor (DAF)	1.000	1.000

Demand and Capacity

Demand Volume (Vi)	3682	244
Peak Hour Factor (PHF)	0.94	0.94
Total Trucks, %	17.57	0.99
Single-Unit Trucks (SUT), %	-	-
Tractor-Trailers (TT), %	-	-
Heavy Vehicle Adjustment Factor (fHV)	0.851	0.990
Flow Rate (vi),pc/h	4603	262
Capacity (c), pc/h	7050	2000
Volume-to-Capacity Ratio (v/c)	0.65	0.13

Speed and Density

Upstream Equilibrium Distance (LEQ), ft	-	Number of Outer Lanes on Freeway (NO)	1
Distance to Upstream Ramp (LUP), ft	-	Speed Index (DS)	0.452
Downstream Equilibrium Distance (LEQ), ft	-	Flow Outer Lanes (vOA), pc/h/ln	1593
Distance to Downstream Ramp (LDOWN), ft	-	Off-Ramp Influence Area Speed (SR), mi/h	54.6
Prop. Freeway Vehicles in Lane 1 and 2 (PFD)	0.633	Outer Lanes Freeway Speed (SO), mi/h	69.0
Flow in Lanes 1 and 2 (v12), pc/h	3010	Ramp Junction Speed (S), mi/h	58.9
Flow Entering Ramp-Infl. Area (vR12), pc/h	-	Average Density (D), pc/mi/ln	26.0
Level of Service (LOS)	D	Density in Ramp Influence Area (DR), pc/mi/ln	28.8

HCS7 Basic Freeway Report

Project Information

Analyst	LSA	Date	12/11/2019
Agency	LSA	Analysis Year	Phase III Proj Comp Yr (2049) NP
Jurisdiction	Caltrans	Time Period Analyzed	AM Peak Hour
Project Description	CMD1801 - Village D Specific Plan	Unit	United States Customary

Geometric Data

Number of Lanes, ln	3	Terrain Type	Level
Segment Length (L), ft	-	Percent Grade, %	-
Measured or Base Free-Flow Speed	Base	Grade Length, mi	-
Base Free-Flow Speed (BFFS), mi/h	65.0	Total Ramp Density (TRD), ramps/mi	1.83
Lane Width, ft	12	Free-Flow Speed (FFS), mi/h	59.7
Right-Side Lateral Clearance, ft	10		

Adjustment Factors

Driver Population	All Familiar	Final Speed Adjustment Factor (SAF)	1.000
Weather Type	Non-Severe Weather	Final Capacity Adjustment Factor (CAF)	1.000
Incident Type	No Incident	Demand Adjustment Factor (DAF)	1.000

Demand and Capacity

Demand Volume veh/h	3241	Heavy Vehicle Adjustment Factor (fhv)	0.841
Peak Hour Factor	0.94	Flow Rate (Vp), pc/h/ln	1367
Total Trucks, %	18.91	Capacity (c), pc/h/ln	2296
Single-Unit Trucks (SUT), %	-	Adjusted Capacity (cadj), pc/h/ln	2296
Tractor-Trailers (TT), %	-	Volume-to-Capacity Ratio (v/c)	0.60
Passenger Car Equivalent (ET)	2.000		

Speed and Density

Lane Width Adjustment (fLW)	0.0	Average Speed (S), mi/h	59.6
Right-Side Lateral Clearance Adj. (fRLC)	0.0	Density (D), pc/mi/ln	22.9
Total Ramp Density Adjustment	5.4	Level of Service (LOS)	C
Adjusted Free-Flow Speed (FFSadj), mi/h	59.6		

HCS7 Freeway Merge Report

Project Information

Analyst	LSA	Date	12/11/2019
Agency	LSA	Analysis Year	Phase III Proj Comp Yr (2049) NP
Jurisdiction	Caltrans	Time Period Analyzed	AM Peak Hour
Project Description	CMD1801 - Village D Specific Plan	Unit	United States Customary

Geometric Data

	Freeway	Ramp
Number of Lanes (N), ln	3	1
Free-Flow Speed (FFS), mi/h	65.0	35.0
Segment Length (L) / Acceleration Length (LA),ft	1500	445
Terrain Type	Level	Level
Percent Grade, %	-	-
Segment Type / Ramp Side	Freeway	Right

Adjustment Factors

Driver Population	All Familiar	All Familiar
Weather Type	Non-Severe Weather	Non-Severe Weather
Incident Type	No Incident	-
Final Speed Adjustment Factor (SAF)	1.000	1.000
Final Capacity Adjustment Factor (CAF)	1.000	1.000
Demand Adjustment Factor (DAF)	1.000	1.000

Demand and Capacity

Demand Volume (Vi)	3241	942
Peak Hour Factor (PHF)	0.94	0.94
Total Trucks, %	18.91	9.94
Single-Unit Trucks (SUT), %	-	-
Tractor-Trailers (TT), %	-	-
Heavy Vehicle Adjustment Factor (fHV)	0.841	0.910
Flow Rate (vi),pc/h	4100	1101
Capacity (c), pc/h	7050	2000
Volume-to-Capacity Ratio (v/c)	0.74	0.55

Speed and Density

Upstream Equilibrium Distance (LEQ), ft	-	Number of Outer Lanes on Freeway (NO)	1
Distance to Upstream Ramp (LUP), ft	-	Speed Index (MS)	0.422
Downstream Equilibrium Distance (LEQ), ft	-	Flow Outer Lanes (vOA), pc/h/ln	1681
Distance to Downstream Ramp (LDOWN), ft	-	On-Ramp Influence Area Speed (SR), mi/h	55.3
Prop. Freeway Vehicles in Lane 1 and 2 (PFM)	0.590	Outer Lanes Freeway Speed (SO), mi/h	60.7
Flow in Lanes 1 and 2 (v12), pc/h	2419	Ramp Junction Speed (S), mi/h	56.9
Flow Entering Ramp-Infl. Area (vR12), pc/h	3520	Average Density (D), pc/mi/ln	30.5
Level of Service (LOS)	D	Density in Ramp Influence Area (DR), pc/mi/ln	29.7

HCS7 Basic Freeway Report

Project Information

Analyst	LSA	Date	12/11/2019
Agency	LSA	Analysis Year	Phase III Proj Comp Yr (2049) NP
Jurisdiction	Caltrans	Time Period Analyzed	AM Peak Hour
Project Description	CMD1801 - Village D Specific Plan	Unit	United States Customary

Geometric Data

Number of Lanes, ln	3	Terrain Type	Level
Segment Length (L), ft	-	Percent Grade, %	-
Measured or Base Free-Flow Speed	Base	Grade Length, mi	-
Base Free-Flow Speed (BFFS), mi/h	65.0	Total Ramp Density (TRD), ramps/mi	1.50
Lane Width, ft	12	Free-Flow Speed (FFS), mi/h	60.5
Right-Side Lateral Clearance, ft	10		

Adjustment Factors

Driver Population	All Familiar	Final Speed Adjustment Factor (SAF)	1.000
Weather Type	Non-Severe Weather	Final Capacity Adjustment Factor (CAF)	1.000
Incident Type	No Incident	Demand Adjustment Factor (DAF)	1.000

Demand and Capacity

Demand Volume veh/h	4183	Heavy Vehicle Adjustment Factor (fhv)	0.855
Peak Hour Factor	0.94	Flow Rate (Vp), pc/h/ln	1735
Total Trucks, %	16.90	Capacity (c), pc/h/ln	2305
Single-Unit Trucks (SUT), %	-	Adjusted Capacity (cadj), pc/h/ln	2305
Tractor-Trailers (TT), %	-	Volume-to-Capacity Ratio (v/c)	0.75
Passenger Car Equivalent (ET)	2.000		

Speed and Density

Lane Width Adjustment (fLW)	0.0	Average Speed (S), mi/h	60.1
Right-Side Lateral Clearance Adj. (fRLC)	0.0	Density (D), pc/mi/ln	28.9
Total Ramp Density Adjustment	4.5	Level of Service (LOS)	D
Adjusted Free-Flow Speed (FFSadj), mi/h	60.5		

HCS7 Freeway Diverge Report

Project Information

Analyst	LSA	Date	12/11/2019
Agency	LSA	Analysis Year	Phase III Proj Comp Yr (2049) NP
Jurisdiction	Caltrans	Time Period Analyzed	AM Peak Hour
Project Description	CMD1801 - Village D Specific Plan	Unit	United States Customary

Geometric Data

	Freeway	Ramp
Number of Lanes (N), ln	3	1
Free-Flow Speed (FFS), mi/h	65.0	35.0
Segment Length (L) / Deceleration Length (LA),ft	1500	130
Terrain Type	Level	Level
Percent Grade, %	-	-
Segment Type / Ramp Side	Freeway	Right

Adjustment Factors

Driver Population	All Familiar	All Familiar
Weather Type	Non-Severe Weather	Non-Severe Weather
Incident Type	No Incident	-
Final Speed Adjustment Factor (SAF)	1.000	1.000
Final Capacity Adjustment Factor (CAF)	1.000	1.000
Demand Adjustment Factor (DAF)	1.000	1.000

Demand and Capacity

Demand Volume (Vi)	4183	556
Peak Hour Factor (PHF)	0.94	0.94
Total Trucks, %	16.90	1.77
Single-Unit Trucks (SUT), %	-	-
Tractor-Trailers (TT), %	-	-
Heavy Vehicle Adjustment Factor (fHV)	0.855	0.983
Flow Rate (vi),pc/h	5205	602
Capacity (c), pc/h	7050	2000
Volume-to-Capacity Ratio (v/c)	0.74	0.30

Speed and Density

Upstream Equilibrium Distance (LEQ), ft	-	Number of Outer Lanes on Freeway (NO)	1
Distance to Upstream Ramp (LUP), ft	-	Speed Index (DS)	0.482
Downstream Equilibrium Distance (LEQ), ft	-	Flow Outer Lanes (vOA), pc/h/ln	1832
Distance to Downstream Ramp (LDOWN), ft	-	Off-Ramp Influence Area Speed (SR), mi/h	53.9
Prop. Freeway Vehicles in Lane 1 and 2 (PFD)	0.602	Outer Lanes Freeway Speed (SO), mi/h	68.1
Flow in Lanes 1 and 2 (v12), pc/h	3373	Ramp Junction Speed (S), mi/h	58.2
Flow Entering Ramp-Infl. Area (vR12), pc/h	-	Average Density (D), pc/mi/ln	29.8
Level of Service (LOS)	D	Density in Ramp Influence Area (DR), pc/mi/ln	32.1

HCS7 Basic Freeway Report

Project Information

Analyst	LSA	Date	12/11/2019
Agency	LSA	Analysis Year	Phase III Proj Comp Yr (2049) NP
Jurisdiction	Caltrans	Time Period Analyzed	AM Peak Hour
Project Description	CMD1801 - Village D Specific Plan	Unit	United States Customary

Geometric Data

Number of Lanes, ln	3	Terrain Type	Level
Segment Length (L), ft	-	Percent Grade, %	-
Measured or Base Free-Flow Speed	Base	Grade Length, mi	-
Base Free-Flow Speed (BFFS), mi/h	65.0	Total Ramp Density (TRD), ramps/mi	1.67
Lane Width, ft	12	Free-Flow Speed (FFS), mi/h	60.0
Right-Side Lateral Clearance, ft	10		

Adjustment Factors

Driver Population	All Familiar	Final Speed Adjustment Factor (SAF)	1.000
Weather Type	Non-Severe Weather	Final Capacity Adjustment Factor (CAF)	1.000
Incident Type	No Incident	Demand Adjustment Factor (DAF)	1.000

Demand and Capacity

Demand Volume veh/h	3627	Heavy Vehicle Adjustment Factor (fhv)	0.839
Peak Hour Factor	0.94	Flow Rate (Vp), pc/h/ln	1533
Total Trucks, %	19.22	Capacity (c), pc/h/ln	2300
Single-Unit Trucks (SUT), %	-	Adjusted Capacity (cadj), pc/h/ln	2300
Tractor-Trailers (TT), %	-	Volume-to-Capacity Ratio (v/c)	0.67
Passenger Car Equivalent (ET)	2.000		

Speed and Density

Lane Width Adjustment (fLW)	0.0	Average Speed (S), mi/h	60.0
Right-Side Lateral Clearance Adj. (fRLC)	0.0	Density (D), pc/mi/ln	25.6
Total Ramp Density Adjustment	5.0	Level of Service (LOS)	C
Adjusted Free-Flow Speed (FFSadj), mi/h	60.0		

HCS7 Freeway Merge Report

Project Information

Analyst	LSA	Date	12/11/2019
Agency	LSA	Analysis Year	Phase III Proj Comp Yr (2049) NP
Jurisdiction	Caltrans	Time Period Analyzed	AM Peak Hour
Project Description	CMD1801 - Village D Specific Plan	Unit	United States Customary

Geometric Data

	Freeway	Ramp
Number of Lanes (N), ln	3	1
Free-Flow Speed (FFS), mi/h	65.0	35.0
Segment Length (L) / Acceleration Length (LA),ft	1500	500
Terrain Type	Level	Level
Percent Grade, %	-	-
Segment Type / Ramp Side	Freeway	Right

Adjustment Factors

Driver Population	All Familiar	All Familiar
Weather Type	Non-Severe Weather	Non-Severe Weather
Incident Type	No Incident	-
Final Speed Adjustment Factor (SAF)	1.000	1.000
Final Capacity Adjustment Factor (CAF)	1.000	1.000
Demand Adjustment Factor (DAF)	1.000	1.000

Demand and Capacity

Demand Volume (Vi)	3627	357
Peak Hour Factor (PHF)	0.94	0.94
Total Trucks, %	19.22	2.92
Single-Unit Trucks (SUT), %	-	-
Tractor-Trailers (TT), %	-	-
Heavy Vehicle Adjustment Factor (fHV)	0.839	0.972
Flow Rate (vi),pc/h	4599	391
Capacity (c), pc/h	7050	2000
Volume-to-Capacity Ratio (v/c)	0.71	0.20

Speed and Density

Upstream Equilibrium Distance (LEQ), ft	-	Number of Outer Lanes on Freeway (NO)	1
Distance to Upstream Ramp (LUP), ft	-	Speed Index (MS)	0.374
Downstream Equilibrium Distance (LEQ), ft	-	Flow Outer Lanes (vOA), pc/h/ln	1876
Distance to Downstream Ramp (LDOWN), ft	-	On-Ramp Influence Area Speed (SR), mi/h	56.4
Prop. Freeway Vehicles in Lane 1 and 2 (PFM)	0.592	Outer Lanes Freeway Speed (SO), mi/h	60.0
Flow in Lanes 1 and 2 (v12), pc/h	2723	Ramp Junction Speed (S), mi/h	57.7
Flow Entering Ramp-Infl. Area (vR12), pc/h	3114	Average Density (D), pc/mi/ln	28.8
Level of Service (LOS)	C	Density in Ramp Influence Area (DR), pc/mi/ln	26.5

HCS7 Basic Freeway Report

Project Information

Analyst	LSA	Date	12/11/2019
Agency	LSA	Analysis Year	Phase III Proj Comp Yr (2049) NP
Jurisdiction	Caltrans	Time Period Analyzed	AM Peak Hour
Project Description	CMD1801 - Village D Specific Plan	Unit	United States Customary

Geometric Data

Number of Lanes, ln	3	Terrain Type	Level
Segment Length (L), ft	-	Percent Grade, %	-
Measured or Base Free-Flow Speed	Base	Grade Length, mi	-
Base Free-Flow Speed (BFFS), mi/h	65.0	Total Ramp Density (TRD), ramps/mi	1.83
Lane Width, ft	12	Free-Flow Speed (FFS), mi/h	59.7
Right-Side Lateral Clearance, ft	10		

Adjustment Factors

Driver Population	All Familiar	Final Speed Adjustment Factor (SAF)	1.000
Weather Type	Non-Severe Weather	Final Capacity Adjustment Factor (CAF)	1.000
Incident Type	No Incident	Demand Adjustment Factor (DAF)	1.000

Demand and Capacity

Demand Volume veh/h	3984	Heavy Vehicle Adjustment Factor (fhv)	0.849
Peak Hour Factor	0.94	Flow Rate (Vp), pc/h/ln	1664
Total Trucks, %	17.75	Capacity (c), pc/h/ln	2296
Single-Unit Trucks (SUT), %	-	Adjusted Capacity (cadj), pc/h/ln	2296
Tractor-Trailers (TT), %	-	Volume-to-Capacity Ratio (v/c)	0.72
Passenger Car Equivalent (ET)	2.000		

Speed and Density

Lane Width Adjustment (fLW)	0.0	Average Speed (S), mi/h	59.6
Right-Side Lateral Clearance Adj. (fRLC)	0.0	Density (D), pc/mi/ln	27.9
Total Ramp Density Adjustment	5.4	Level of Service (LOS)	D
Adjusted Free-Flow Speed (FFSadj), mi/h	59.6		

HCS7 Freeway Diverge Report

Project Information

Analyst	LSA	Date	12/11/2019
Agency	LSA	Analysis Year	Phase III Proj Comp Yr (2049) NP
Jurisdiction	Caltrans	Time Period Analyzed	AM Peak Hour
Project Description	CMD1801 - Village D Specific Plan	Unit	United States Customary

Geometric Data

	Freeway	Ramp
Number of Lanes (N), ln	3	1
Free-Flow Speed (FFS), mi/h	65.0	35.0
Segment Length (L) / Deceleration Length (LA),ft	1500	245
Terrain Type	Level	Level
Percent Grade, %	-	-
Segment Type / Ramp Side	Freeway	Right

Adjustment Factors

Driver Population	All Familiar	All Familiar
Weather Type	Non-Severe Weather	Non-Severe Weather
Incident Type	No Incident	-
Final Speed Adjustment Factor (SAF)	1.000	1.000
Final Capacity Adjustment Factor (CAF)	1.000	1.000
Demand Adjustment Factor (DAF)	1.000	1.000

Demand and Capacity

Demand Volume (Vi)	3984	678
Peak Hour Factor (PHF)	0.94	0.94
Total Trucks, %	17.75	4.61
Single-Unit Trucks (SUT), %	-	-
Tractor-Trailers (TT), %	-	-
Heavy Vehicle Adjustment Factor (fHV)	0.849	0.956
Flow Rate (vi),pc/h	4992	754
Capacity (c), pc/h	7050	2000
Volume-to-Capacity Ratio (v/c)	0.71	0.38

Speed and Density

Upstream Equilibrium Distance (LEQ), ft	-	Number of Outer Lanes on Freeway (NO)	1
Distance to Upstream Ramp (LUP), ft	-	Speed Index (DS)	0.496
Downstream Equilibrium Distance (LEQ), ft	-	Flow Outer Lanes (vOA), pc/h/ln	1691
Distance to Downstream Ramp (LDOWN), ft	-	Off-Ramp Influence Area Speed (SR), mi/h	53.6
Prop. Freeway Vehicles in Lane 1 and 2 (PFD)	0.601	Outer Lanes Freeway Speed (SO), mi/h	68.6
Flow in Lanes 1 and 2 (v12), pc/h	3301	Ramp Junction Speed (S), mi/h	57.9
Flow Entering Ramp-Infl. Area (vR12), pc/h	-	Average Density (D), pc/mi/ln	28.7
Level of Service (LOS)	D	Density in Ramp Influence Area (DR), pc/mi/ln	30.4

HCS7 Basic Freeway Report

Project Information

Analyst	LSA	Date	12/11/2019
Agency	LSA	Analysis Year	Phase III Proj Comp Yr (2049) NP
Jurisdiction	Caltrans	Time Period Analyzed	AM Peak Hour
Project Description	CMD1801 - Village D Specific Plan	Unit	United States Customary

Geometric Data

Number of Lanes, ln	3	Terrain Type	Level
Segment Length (L), ft	-	Percent Grade, %	-
Measured or Base Free-Flow Speed	Base	Grade Length, mi	-
Base Free-Flow Speed (BFFS), mi/h	65.0	Total Ramp Density (TRD), ramps/mi	1.83
Lane Width, ft	12	Free-Flow Speed (FFS), mi/h	59.7
Right-Side Lateral Clearance, ft	10		

Adjustment Factors

Driver Population	All Familiar	Final Speed Adjustment Factor (SAF)	1.000
Weather Type	Non-Severe Weather	Final Capacity Adjustment Factor (CAF)	1.000
Incident Type	No Incident	Demand Adjustment Factor (DAF)	1.000

Demand and Capacity

Demand Volume veh/h	3306	Heavy Vehicle Adjustment Factor (fhv)	0.830
Peak Hour Factor	0.94	Flow Rate (Vp), pc/h/ln	1412
Total Trucks, %	20.45	Capacity (c), pc/h/ln	2296
Single-Unit Trucks (SUT), %	-	Adjusted Capacity (cadj), pc/h/ln	2296
Tractor-Trailers (TT), %	-	Volume-to-Capacity Ratio (v/c)	0.62
Passenger Car Equivalent (ET)	2.000		

Speed and Density

Lane Width Adjustment (fLW)	0.0	Average Speed (S), mi/h	59.6
Right-Side Lateral Clearance Adj. (fRLC)	0.0	Density (D), pc/mi/ln	23.7
Total Ramp Density Adjustment	5.4	Level of Service (LOS)	C
Adjusted Free-Flow Speed (FFSadj), mi/h	59.6		

HCS7 Freeway Merge Report

Project Information

Analyst	LSA	Date	12/11/2019
Agency	LSA	Analysis Year	Phase III Proj Comp Yr (2049) NP
Jurisdiction	Caltrans	Time Period Analyzed	AM Peak Hour
Project Description	CMD1801 - Village D Specific Plan	Unit	United States Customary

Geometric Data

	Freeway	Ramp
Number of Lanes (N), ln	3	1
Free-Flow Speed (FFS), mi/h	65.0	35.0
Segment Length (L) / Acceleration Length (LA),ft	1500	350
Terrain Type	Level	Level
Percent Grade, %	-	-
Segment Type / Ramp Side	Freeway	Right

Adjustment Factors

Driver Population	All Familiar	All Familiar
Weather Type	Non-Severe Weather	Non-Severe Weather
Incident Type	No Incident	-
Final Speed Adjustment Factor (SAF)	1.000	1.000
Final Capacity Adjustment Factor (CAF)	1.000	1.000
Demand Adjustment Factor (DAF)	1.000	1.000

Demand and Capacity

Demand Volume (Vi)	3306	187
Peak Hour Factor (PHF)	0.94	0.94
Total Trucks, %	20.45	2.94
Single-Unit Trucks (SUT), %	-	-
Tractor-Trailers (TT), %	-	-
Heavy Vehicle Adjustment Factor (fHV)	0.830	0.971
Flow Rate (vi),pc/h	4237	205
Capacity (c), pc/h	7050	2000
Volume-to-Capacity Ratio (v/c)	0.63	0.10

Speed and Density

Upstream Equilibrium Distance (LEQ), ft	-	Number of Outer Lanes on Freeway (NO)	1
Distance to Upstream Ramp (LUP), ft	-	Speed Index (MS)	0.354
Downstream Equilibrium Distance (LEQ), ft	-	Flow Outer Lanes (vOA), pc/h/ln	1750
Distance to Downstream Ramp (LDOWN), ft	-	On-Ramp Influence Area Speed (SR), mi/h	56.9
Prop. Freeway Vehicles in Lane 1 and 2 (PFM)	0.587	Outer Lanes Freeway Speed (SO), mi/h	60.5
Flow in Lanes 1 and 2 (v12), pc/h	2487	Ramp Junction Speed (S), mi/h	58.3
Flow Entering Ramp-Infl. Area (vR12), pc/h	2692	Average Density (D), pc/mi/ln	25.4
Level of Service (LOS)	C	Density in Ramp Influence Area (DR), pc/mi/ln	24.3

HCS7 Basic Freeway Report

Project Information

Analyst	LSA	Date	12/11/2019
Agency	LSA	Analysis Year	Phase III Proj Comp Yr (2049) NP
Jurisdiction	Caltrans	Time Period Analyzed	AM Peak Hour
Project Description	CMD1801 - Village D Specific Plan	Unit	United States Customary

Geometric Data

Number of Lanes, ln	3	Terrain Type	Level
Segment Length (L), ft	-	Percent Grade, %	-
Measured or Base Free-Flow Speed	Base	Grade Length, mi	-
Base Free-Flow Speed (BFFS), mi/h	65.0	Total Ramp Density (TRD), ramps/mi	1.83
Lane Width, ft	12	Free-Flow Speed (FFS), mi/h	59.7
Right-Side Lateral Clearance, ft	10		

Adjustment Factors

Driver Population	All Familiar	Final Speed Adjustment Factor (SAF)	1.000
Weather Type	Non-Severe Weather	Final Capacity Adjustment Factor (CAF)	1.000
Incident Type	No Incident	Demand Adjustment Factor (DAF)	1.000

Demand and Capacity

Demand Volume veh/h	3493	Heavy Vehicle Adjustment Factor (fhv)	0.837
Peak Hour Factor	0.94	Flow Rate (Vp), pc/h/ln	1480
Total Trucks, %	19.52	Capacity (c), pc/h/ln	2296
Single-Unit Trucks (SUT), %	-	Adjusted Capacity (cadj), pc/h/ln	2296
Tractor-Trailers (TT), %	-	Volume-to-Capacity Ratio (v/c)	0.64
Passenger Car Equivalent (ET)	2.000		

Speed and Density

Lane Width Adjustment (fLW)	0.0	Average Speed (S), mi/h	59.6
Right-Side Lateral Clearance Adj. (fRLC)	0.0	Density (D), pc/mi/ln	24.8
Total Ramp Density Adjustment	5.4	Level of Service (LOS)	C
Adjusted Free-Flow Speed (FFSadj), mi/h	59.6		

HCS7 Freeway Diverge Report

Project Information

Analyst	LSA	Date	12/11/2019
Agency	LSA	Analysis Year	Phase III Proj Comp Yr (2049) NP
Jurisdiction	Caltrans	Time Period Analyzed	AM Peak Hour
Project Description	CMD1801 - Village D Specific Plan	Unit	United States Customary

Geometric Data

	Freeway	Ramp
Number of Lanes (N), ln	3	1
Free-Flow Speed (FFS), mi/h	65.0	15.0
Segment Length (L) / Deceleration Length (LA),ft	1500	150
Terrain Type	Level	Level
Percent Grade, %	-	-
Segment Type / Ramp Side	Freeway	Right

Adjustment Factors

Driver Population	All Familiar	All Familiar
Weather Type	Non-Severe Weather	Non-Severe Weather
Incident Type	No Incident	-
Final Speed Adjustment Factor (SAF)	1.000	1.000
Final Capacity Adjustment Factor (CAF)	1.000	1.000
Demand Adjustment Factor (DAF)	1.000	1.000

Demand and Capacity

Demand Volume (Vi)	3493	412
Peak Hour Factor (PHF)	0.94	0.94
Total Trucks, %	19.52	6.54
Single-Unit Trucks (SUT), %	-	-
Tractor-Trailers (TT), %	-	-
Heavy Vehicle Adjustment Factor (fHV)	0.837	0.939
Flow Rate (vi),pc/h	4440	467
Capacity (c), pc/h	7050	1800
Volume-to-Capacity Ratio (v/c)	0.63	0.26

Speed and Density

Upstream Equilibrium Distance (LEQ), ft	-	Number of Outer Lanes on Freeway (NO)	1
Distance to Upstream Ramp (LUP), ft	-	Speed Index (DS)	0.730
Downstream Equilibrium Distance (LEQ), ft	-	Flow Outer Lanes (vOA), pc/h/ln	1478
Distance to Downstream Ramp (LDOWN), ft	-	Off-Ramp Influence Area Speed (SR), mi/h	48.2
Prop. Freeway Vehicles in Lane 1 and 2 (PFD)	0.628	Outer Lanes Freeway Speed (SO), mi/h	69.4
Flow in Lanes 1 and 2 (v12), pc/h	2962	Ramp Junction Speed (S), mi/h	53.7
Flow Entering Ramp-Infl. Area (vR12), pc/h	-	Average Density (D), pc/mi/ln	27.6
Level of Service (LOS)	D	Density in Ramp Influence Area (DR), pc/mi/ln	28.4

HCS7 Basic Freeway Report

Project Information

Analyst	LSA	Date	12/11/2019
Agency	LSA	Analysis Year	Phase III Proj Comp Yr (2049) NP
Jurisdiction	Caltrans	Time Period Analyzed	AM Peak Hour
Project Description	CMD1801 - Village D Specific Plan	Unit	United States Customary

Geometric Data

Number of Lanes, ln	3	Terrain Type	Level
Segment Length (L), ft	-	Percent Grade, %	-
Measured or Base Free-Flow Speed	Base	Grade Length, mi	-
Base Free-Flow Speed (BFFS), mi/h	65.0	Total Ramp Density (TRD), ramps/mi	1.67
Lane Width, ft	12	Free-Flow Speed (FFS), mi/h	60.0
Right-Side Lateral Clearance, ft	10		

Adjustment Factors

Driver Population	All Familiar	Final Speed Adjustment Factor (SAF)	1.000
Weather Type	Non-Severe Weather	Final Capacity Adjustment Factor (CAF)	1.000
Incident Type	No Incident	Demand Adjustment Factor (DAF)	1.000

Demand and Capacity

Demand Volume veh/h	3081	Heavy Vehicle Adjustment Factor (fhv)	0.825
Peak Hour Factor	0.94	Flow Rate (Vp), pc/h/ln	1324
Total Trucks, %	21.26	Capacity (c), pc/h/ln	2300
Single-Unit Trucks (SUT), %	-	Adjusted Capacity (cadj), pc/h/ln	2300
Tractor-Trailers (TT), %	-	Volume-to-Capacity Ratio (v/c)	0.58
Passenger Car Equivalent (ET)	2.000		

Speed and Density

Lane Width Adjustment (fLW)	0.0	Average Speed (S), mi/h	60.0
Right-Side Lateral Clearance Adj. (fRLC)	0.0	Density (D), pc/mi/ln	22.1
Total Ramp Density Adjustment	5.0	Level of Service (LOS)	C
Adjusted Free-Flow Speed (FFSadj), mi/h	60.0		

HCS7 Freeway Merge Report

Project Information

Analyst	LSA	Date	12/11/2019
Agency	LSA	Analysis Year	Phase III Proj Comp Yr (2049) NP
Jurisdiction	Caltrans	Time Period Analyzed	AM Peak Hour
Project Description	CMD1801 - Village D Specific Plan	Unit	United States Customary

Geometric Data

	Freeway	Ramp
Number of Lanes (N), ln	3	1
Free-Flow Speed (FFS), mi/h	65.0	35.0
Segment Length (L) / Acceleration Length (LA),ft	1500	525
Terrain Type	Level	Level
Percent Grade, %	-	-
Segment Type / Ramp Side	Freeway	Right

Adjustment Factors

Driver Population	All Familiar	All Familiar
Weather Type	Non-Severe Weather	Non-Severe Weather
Incident Type	No Incident	-
Final Speed Adjustment Factor (SAF)	1.000	1.000
Final Capacity Adjustment Factor (CAF)	1.000	1.000
Demand Adjustment Factor (DAF)	1.000	1.000

Demand and Capacity

Demand Volume (Vi)	3081	207
Peak Hour Factor (PHF)	0.94	0.94
Total Trucks, %	21.26	4.46
Single-Unit Trucks (SUT), %	-	-
Tractor-Trailers (TT), %	-	-
Heavy Vehicle Adjustment Factor (fHV)	0.825	0.957
Flow Rate (vi),pc/h	3973	230
Capacity (c), pc/h	7050	2000
Volume-to-Capacity Ratio (v/c)	0.60	0.12

Speed and Density

Upstream Equilibrium Distance (LEQ), ft	-	Number of Outer Lanes on Freeway (NO)	1
Distance to Upstream Ramp (LUP), ft	-	Speed Index (MS)	0.336
Downstream Equilibrium Distance (LEQ), ft	-	Flow Outer Lanes (vOA), pc/h/ln	1621
Distance to Downstream Ramp (LDOWN), ft	-	On-Ramp Influence Area Speed (SR), mi/h	57.3
Prop. Freeway Vehicles in Lane 1 and 2 (PFM)	0.592	Outer Lanes Freeway Speed (SO), mi/h	61.0
Flow in Lanes 1 and 2 (v12), pc/h	2352	Ramp Junction Speed (S), mi/h	58.7
Flow Entering Ramp-Infl. Area (vR12), pc/h	2582	Average Density (D), pc/mi/ln	23.9
Level of Service (LOS)	C	Density in Ramp Influence Area (DR), pc/mi/ln	22.3

HCS7 Basic Freeway Report

Project Information

Analyst	LSA	Date	12/11/2019
Agency	LSA	Analysis Year	Phase III Proj Comp Yr (2049) NP
Jurisdiction	Caltrans	Time Period Analyzed	AM Peak Hour
Project Description	CMD1801 - Village D Specific Plan	Unit	United States Customary

Geometric Data

Number of Lanes, ln	3	Terrain Type	Level
Segment Length (L), ft	-	Percent Grade, %	-
Measured or Base Free-Flow Speed	Base	Grade Length, mi	-
Base Free-Flow Speed (BFFS), mi/h	65.0	Total Ramp Density (TRD), ramps/mi	1.67
Lane Width, ft	12	Free-Flow Speed (FFS), mi/h	60.0
Right-Side Lateral Clearance, ft	10		

Adjustment Factors

Driver Population	All Familiar	Final Speed Adjustment Factor (SAF)	1.000
Weather Type	Non-Severe Weather	Final Capacity Adjustment Factor (CAF)	1.000
Incident Type	No Incident	Demand Adjustment Factor (DAF)	1.000

Demand and Capacity

Demand Volume veh/h	3288	Heavy Vehicle Adjustment Factor (fhv)	0.832
Peak Hour Factor	0.94	Flow Rate (Vp), pc/h/ln	1401
Total Trucks, %	20.19	Capacity (c), pc/h/ln	2300
Single-Unit Trucks (SUT), %	-	Adjusted Capacity (cadj), pc/h/ln	2300
Tractor-Trailers (TT), %	-	Volume-to-Capacity Ratio (v/c)	0.61
Passenger Car Equivalent (ET)	2.000		

Speed and Density

Lane Width Adjustment (fLW)	0.0	Average Speed (S), mi/h	60.0
Right-Side Lateral Clearance Adj. (fRLC)	0.0	Density (D), pc/mi/ln	23.4
Total Ramp Density Adjustment	5.0	Level of Service (LOS)	C
Adjusted Free-Flow Speed (FFSadj), mi/h	60.0		

HCS7 Freeway Diverge Report

Project Information

Analyst	LSA	Date	12/11/2019
Agency	LSA	Analysis Year	Phase III Proj Comp Yr (2049) NP
Jurisdiction	Caltrans	Time Period Analyzed	AM Peak Hour
Project Description	CMD1801 - Village D Specific Plan	Unit	United States Customary

Geometric Data

	Freeway	Ramp
Number of Lanes (N), In	3	1
Free-Flow Speed (FFS), mi/h	65.0	35.0
Segment Length (L) / Deceleration Length (LA),ft	1500	200
Terrain Type	Level	Level
Percent Grade, %	-	-
Segment Type / Ramp Side	Freeway	Right

Adjustment Factors

Driver Population	All Familiar	All Familiar
Weather Type	Non-Severe Weather	Non-Severe Weather
Incident Type	No Incident	-
Final Speed Adjustment Factor (SAF)	1.000	1.000
Final Capacity Adjustment Factor (CAF)	1.000	1.000
Demand Adjustment Factor (DAF)	1.000	1.000

Demand and Capacity

Demand Volume (Vi)	3288	543
Peak Hour Factor (PHF)	0.94	0.94
Total Trucks, %	20.19	13.79
Single-Unit Trucks (SUT), %	-	-
Tractor-Trailers (TT), %	-	-
Heavy Vehicle Adjustment Factor (fHV)	0.832	0.879
Flow Rate (vi),pc/h	4204	657
Capacity (c), pc/h	7050	2000
Volume-to-Capacity Ratio (v/c)	0.60	0.33

Speed and Density

Upstream Equilibrium Distance (LEQ), ft	-	Number of Outer Lanes on Freeway (NO)	1
Distance to Upstream Ramp (LUP), ft	-	Speed Index (DS)	0.487
Downstream Equilibrium Distance (LEQ), ft	-	Flow Outer Lanes (vOA), pc/h/ln	1330
Distance to Downstream Ramp (LDOWN), ft	-	Off-Ramp Influence Area Speed (SR), mi/h	53.8
Prop. Freeway Vehicles in Lane 1 and 2 (PFD)	0.625	Outer Lanes Freeway Speed (SO), mi/h	70.0
Flow in Lanes 1 and 2 (v12), pc/h	2874	Ramp Junction Speed (S), mi/h	58.1
Flow Entering Ramp-Infl. Area (vR12), pc/h	-	Average Density (D), pc/mi/ln	24.1
Level of Service (LOS)	C	Density in Ramp Influence Area (DR), pc/mi/ln	27.2

HCS7 Basic Freeway Report

Project Information

Analyst	LSA	Date	12/11/2019
Agency	LSA	Analysis Year	Phase III Proj Comp Yr (2049) NP
Jurisdiction	Caltrans	Time Period Analyzed	AM Peak Hour
Project Description	CMD1801 - Village D Specific Plan	Unit	United States Customary

Geometric Data

Number of Lanes, ln	3	Terrain Type	Level
Segment Length (L), ft	-	Percent Grade, %	-
Measured or Base Free-Flow Speed	Base	Grade Length, mi	-
Base Free-Flow Speed (BFFS), mi/h	70.0	Total Ramp Density (TRD), ramps/mi	1.50
Lane Width, ft	12	Free-Flow Speed (FFS), mi/h	65.5
Right-Side Lateral Clearance, ft	10		

Adjustment Factors

Driver Population	All Familiar	Final Speed Adjustment Factor (SAF)	1.000
Weather Type	Non-Severe Weather	Final Capacity Adjustment Factor (CAF)	1.000
Incident Type	No Incident	Demand Adjustment Factor (DAF)	1.000

Demand and Capacity

Demand Volume veh/h	2745	Heavy Vehicle Adjustment Factor (fhv)	0.823
Peak Hour Factor	0.94	Flow Rate (Vp), pc/h/ln	1183
Total Trucks, %	21.46	Capacity (c), pc/h/ln	2355
Single-Unit Trucks (SUT), %	-	Adjusted Capacity (cadj), pc/h/ln	2355
Tractor-Trailers (TT), %	-	Volume-to-Capacity Ratio (v/c)	0.50
Passenger Car Equivalent (ET)	2.000		

Speed and Density

Lane Width Adjustment (fLW)	0.0	Average Speed (S), mi/h	65.5
Right-Side Lateral Clearance Adj. (fRLC)	0.0	Density (D), pc/mi/ln	18.1
Total Ramp Density Adjustment	4.5	Level of Service (LOS)	C
Adjusted Free-Flow Speed (FFSadj), mi/h	65.5		

HCS7 Freeway Merge Report

Project Information

Analyst	LSA	Date	12/11/2019
Agency	LSA	Analysis Year	Phase III Proj Comp Yr (2049) NP
Jurisdiction	Caltrans	Time Period Analyzed	AM Peak Hour
Project Description	CMD1801 - Village D Specific Plan	Unit	United States Customary

Geometric Data

	Freeway	Ramp
Number of Lanes (N), ln	3	1
Free-Flow Speed (FFS), mi/h	70.0	35.0
Segment Length (L) / Acceleration Length (LA),ft	1500	400
Terrain Type	Level	Level
Percent Grade, %	-	-
Segment Type / Ramp Side	Freeway	Right

Adjustment Factors

Driver Population	All Familiar	All Familiar
Weather Type	Non-Severe Weather	Non-Severe Weather
Incident Type	No Incident	-
Final Speed Adjustment Factor (SAF)	1.000	1.000
Final Capacity Adjustment Factor (CAF)	1.000	1.000
Demand Adjustment Factor (DAF)	1.000	1.000

Demand and Capacity

Demand Volume (Vi)	2745	402
Peak Hour Factor (PHF)	0.94	0.94
Total Trucks, %	21.46	10.46
Single-Unit Trucks (SUT), %	-	-
Tractor-Trailers (TT), %	-	-
Heavy Vehicle Adjustment Factor (fHV)	0.823	0.905
Flow Rate (vi),pc/h	3548	473
Capacity (c), pc/h	7200	2000
Volume-to-Capacity Ratio (v/c)	0.56	0.24

Speed and Density

Upstream Equilibrium Distance (LEQ), ft	-	Number of Outer Lanes on Freeway (NO)	1
Distance to Upstream Ramp (LUP), ft	-	Speed Index (MS)	0.344
Downstream Equilibrium Distance (LEQ), ft	-	Flow Outer Lanes (vOA), pc/h/ln	1458
Distance to Downstream Ramp (LDOWN), ft	-	On-Ramp Influence Area Speed (SR), mi/h	60.4
Prop. Freeway Vehicles in Lane 1 and 2 (PFM)	0.589	Outer Lanes Freeway Speed (SO), mi/h	66.6
Flow in Lanes 1 and 2 (v12), pc/h	2090	Ramp Junction Speed (S), mi/h	62.5
Flow Entering Ramp-Infl. Area (vR12), pc/h	2563	Average Density (D), pc/mi/ln	21.4
Level of Service (LOS)	C	Density in Ramp Influence Area (DR), pc/mi/ln	22.8

HCS7 Basic Freeway Report

Project Information

Analyst	LSA	Date	12/11/2019
Agency	LSA	Analysis Year	Phase III Proj Comp Yr (2049) NP
Jurisdiction	Caltrans	Time Period Analyzed	AM Peak Hour
Project Description	CMD1801 - Village D Specific Plan	Unit	United States Customary

Geometric Data

Number of Lanes, ln	2	Terrain Type	Level
Segment Length (L), ft	-	Percent Grade, %	-
Measured or Base Free-Flow Speed	Base	Grade Length, mi	-
Base Free-Flow Speed (BFFS), mi/h	70.0	Total Ramp Density (TRD), ramps/mi	1.00
Lane Width, ft	12	Free-Flow Speed (FFS), mi/h	66.8
Right-Side Lateral Clearance, ft	10		

Adjustment Factors

Driver Population	All Familiar	Final Speed Adjustment Factor (SAF)	1.000
Weather Type	Non-Severe Weather	Final Capacity Adjustment Factor (CAF)	1.000
Incident Type	No Incident	Demand Adjustment Factor (DAF)	1.000

Demand and Capacity

Demand Volume veh/h	3147	Heavy Vehicle Adjustment Factor (fhv)	0.833
Peak Hour Factor	0.94	Flow Rate (Vp), pc/h/ln	2010
Total Trucks, %	20.05	Capacity (c), pc/h/ln	2368
Single-Unit Trucks (SUT), %	-	Adjusted Capacity (cadj), pc/h/ln	2368
Tractor-Trailers (TT), %	-	Volume-to-Capacity Ratio (v/c)	0.85
Passenger Car Equivalent (ET)	2.000		

Speed and Density

Lane Width Adjustment (fLW)	0.0	Average Speed (S), mi/h	60.7
Right-Side Lateral Clearance Adj. (fRLC)	0.0	Density (D), pc/mi/ln	33.1
Total Ramp Density Adjustment	3.2	Level of Service (LOS)	D
Adjusted Free-Flow Speed (FFSadj), mi/h	66.8		

HCS7 Freeway Diverge Report

Project Information

Analyst	LSA	Date	12/11/2019
Agency	LSA	Analysis Year	Phase III Proj Comp Yr (2049) NP
Jurisdiction	Caltrans	Time Period Analyzed	AM Peak Hour
Project Description	CMD1801 - Village D Specific Plan	Unit	United States Customary

Geometric Data

	Freeway	Ramp
Number of Lanes (N), ln	2	1
Free-Flow Speed (FFS), mi/h	70.0	35.0
Segment Length (L) / Deceleration Length (LA),ft	1500	200
Terrain Type	Level	Level
Percent Grade, %	-	-
Segment Type / Ramp Side	Freeway	Right

Adjustment Factors

Driver Population	All Familiar	All Familiar
Weather Type	Non-Severe Weather	Non-Severe Weather
Incident Type	No Incident	-
Final Speed Adjustment Factor (SAF)	1.000	1.000
Final Capacity Adjustment Factor (CAF)	1.000	1.000
Demand Adjustment Factor (DAF)	1.000	1.000

Demand and Capacity

Demand Volume (Vi)	3147	245
Peak Hour Factor (PHF)	0.94	0.94
Total Trucks, %	20.05	28.64
Single-Unit Trucks (SUT), %	-	-
Tractor-Trailers (TT), %	-	-
Heavy Vehicle Adjustment Factor (fHV)	0.833	0.777
Flow Rate (vi),pc/h	4019	335
Capacity (c), pc/h	4800	2000
Volume-to-Capacity Ratio (v/c)	0.84	0.17

Speed and Density

Upstream Equilibrium Distance (LEQ), ft	-	Number of Outer Lanes on Freeway (NO)	0
Distance to Upstream Ramp (LUP), ft	-	Speed Index (DS)	0.458
Downstream Equilibrium Distance (LEQ), ft	-	Flow Outer Lanes (vOA), pc/h/ln	-
Distance to Downstream Ramp (LDOWN), ft	-	Off-Ramp Influence Area Speed (SR), mi/h	57.2
Prop. Freeway Vehicles in Lane 1 and 2 (PFD)	1.000	Outer Lanes Freeway Speed (SO), mi/h	76.8
Flow in Lanes 1 and 2 (v12), pc/h	4019	Ramp Junction Speed (S), mi/h	57.2
Flow Entering Ramp-Infl. Area (vR12), pc/h	-	Average Density (D), pc/mi/ln	35.1
Level of Service (LOS)	E	Density in Ramp Influence Area (DR), pc/mi/ln	37.0

HCS7 Basic Freeway Report

Project Information

Analyst	LSA	Date	12/11/2019
Agency	LSA	Analysis Year	Phase III Proj Comp Yr (2049) NP
Jurisdiction	Caltrans	Time Period Analyzed	AM Peak Hour
Project Description	CMD1801 - Village D Specific Plan	Unit	United States Customary

Geometric Data

Number of Lanes, ln	2	Terrain Type	Level
Segment Length (L), ft	-	Percent Grade, %	-
Measured or Base Free-Flow Speed	Base	Grade Length, mi	-
Base Free-Flow Speed (BFFS), mi/h	70.0	Total Ramp Density (TRD), ramps/mi	1.00
Lane Width, ft	12	Free-Flow Speed (FFS), mi/h	66.8
Right-Side Lateral Clearance, ft	10		

Adjustment Factors

Driver Population	All Familiar	Final Speed Adjustment Factor (SAF)	1.000
Weather Type	Non-Severe Weather	Final Capacity Adjustment Factor (CAF)	1.000
Incident Type	No Incident	Demand Adjustment Factor (DAF)	1.000

Demand and Capacity

Demand Volume veh/h	2902	Heavy Vehicle Adjustment Factor (fhv)	0.838
Peak Hour Factor	0.94	Flow Rate (Vp), pc/h/ln	1842
Total Trucks, %	19.33	Capacity (c), pc/h/ln	2368
Single-Unit Trucks (SUT), %	-	Adjusted Capacity (cadj), pc/h/ln	2368
Tractor-Trailers (TT), %	-	Volume-to-Capacity Ratio (v/c)	0.78
Passenger Car Equivalent (ET)	2.000		

Speed and Density

Lane Width Adjustment (fLW)	0.0	Average Speed (S), mi/h	63.3
Right-Side Lateral Clearance Adj. (fRLC)	0.0	Density (D), pc/mi/ln	29.1
Total Ramp Density Adjustment	3.2	Level of Service (LOS)	D
Adjusted Free-Flow Speed (FFSadj), mi/h	66.8		

HCS7 Freeway Merge Report

Project Information

Analyst	LSA	Date	12/11/2019
Agency	LSA	Analysis Year	Phase III Proj Comp Yr (2049) NP
Jurisdiction	Caltrans	Time Period Analyzed	AM Peak Hour
Project Description	CMD1801 - Village D Specific Plan	Unit	United States Customary

Geometric Data

	Freeway	Ramp
Number of Lanes (N), ln	2	1
Free-Flow Speed (FFS), mi/h	70.0	35.0
Segment Length (L) / Acceleration Length (LA),ft	1500	700
Terrain Type	Level	Level
Percent Grade, %	-	-
Segment Type / Ramp Side	Freeway	Right

Adjustment Factors

Driver Population	All Familiar	All Familiar
Weather Type	Non-Severe Weather	Non-Severe Weather
Incident Type	No Incident	-
Final Speed Adjustment Factor (SAF)	1.000	1.000
Final Capacity Adjustment Factor (CAF)	1.000	1.000
Demand Adjustment Factor (DAF)	1.000	1.000

Demand and Capacity

Demand Volume (Vi)	2902	264
Peak Hour Factor (PHF)	0.94	0.94
Total Trucks, %	19.33	32.90
Single-Unit Trucks (SUT), %	-	-
Tractor-Trailers (TT), %	-	-
Heavy Vehicle Adjustment Factor (fHV)	0.838	0.752
Flow Rate (vi),pc/h	3684	373
Capacity (c), pc/h	4800	2000
Volume-to-Capacity Ratio (v/c)	0.85	0.19

Speed and Density

Upstream Equilibrium Distance (LEQ), ft	-	Number of Outer Lanes on Freeway (NO)	0
Distance to Upstream Ramp (LUP), ft	-	Speed Index (MS)	0.497
Downstream Equilibrium Distance (LEQ), ft	-	Flow Outer Lanes (vOA), pc/h/ln	-
Distance to Downstream Ramp (LDOWN), ft	-	On-Ramp Influence Area Speed (SR), mi/h	56.1
Prop. Freeway Vehicles in Lane 1 and 2 (PFM)	1.000	Outer Lanes Freeway Speed (SO), mi/h	70.0
Flow in Lanes 1 and 2 (v12), pc/h	3684	Ramp Junction Speed (S), mi/h	56.1
Flow Entering Ramp-Infl. Area (vR12), pc/h	4057	Average Density (D), pc/mi/ln	36.2
Level of Service (LOS)	D	Density in Ramp Influence Area (DR), pc/mi/ln	32.6

HCS7 Basic Freeway Report

Project Information

Analyst	LSA	Date	12/11/2019
Agency	LSA	Analysis Year	Phase III Proj Comp Yr (2049) NP
Jurisdiction	Caltrans	Time Period Analyzed	AM Peak Hour
Project Description	CMD1801 - Village D Specific Plan	Unit	United States Customary

Geometric Data

Number of Lanes, ln	2	Terrain Type	Level
Segment Length (L), ft	-	Percent Grade, %	-
Measured or Base Free-Flow Speed	Base	Grade Length, mi	-
Base Free-Flow Speed (BFFS), mi/h	70.0	Total Ramp Density (TRD), ramps/mi	1.00
Lane Width, ft	12	Free-Flow Speed (FFS), mi/h	66.8
Right-Side Lateral Clearance, ft	10		

Adjustment Factors

Driver Population	All Familiar	Final Speed Adjustment Factor (SAF)	1.000
Weather Type	Non-Severe Weather	Final Capacity Adjustment Factor (CAF)	1.000
Incident Type	No Incident	Demand Adjustment Factor (DAF)	1.000

Demand and Capacity

Demand Volume veh/h	3166	Heavy Vehicle Adjustment Factor (fhv)	0.830
Peak Hour Factor	0.94	Flow Rate (Vp), pc/h/ln	2029
Total Trucks, %	20.47	Capacity (c), pc/h/ln	2368
Single-Unit Trucks (SUT), %	-	Adjusted Capacity (cadj), pc/h/ln	2368
Tractor-Trailers (TT), %	-	Volume-to-Capacity Ratio (v/c)	0.86
Passenger Car Equivalent (ET)	2.000		

Speed and Density

Lane Width Adjustment (fLW)	0.0	Average Speed (S), mi/h	60.4
Right-Side Lateral Clearance Adj. (fRLC)	0.0	Density (D), pc/mi/ln	33.6
Total Ramp Density Adjustment	3.2	Level of Service (LOS)	D
Adjusted Free-Flow Speed (FFSadj), mi/h	66.8		

HCS7 Basic Freeway Report

Project Information

Analyst	LSA	Date	12/11/2019
Agency	LSA	Analysis Year	Phase III Proj Comp Yr (2049) NP
Jurisdiction	Caltrans	Time Period Analyzed	AM Peak Hour
Project Description	CMD1801 - Village D Specific Plan	Unit	United States Customary

Geometric Data

Number of Lanes, ln	2	Terrain Type	Level
Segment Length (L), ft	-	Percent Grade, %	-
Measured or Base Free-Flow Speed	Base	Grade Length, mi	-
Base Free-Flow Speed (BFFS), mi/h	70.0	Total Ramp Density (TRD), ramps/mi	1.00
Lane Width, ft	12	Free-Flow Speed (FFS), mi/h	66.8
Right-Side Lateral Clearance, ft	10		

Adjustment Factors

Driver Population	All Familiar	Final Speed Adjustment Factor (SAF)	1.000
Weather Type	Non-Severe Weather	Final Capacity Adjustment Factor (CAF)	1.000
Incident Type	No Incident	Demand Adjustment Factor (DAF)	1.000

Demand and Capacity

Demand Volume veh/h	2805	Heavy Vehicle Adjustment Factor (fhv)	0.784
Peak Hour Factor	0.94	Flow Rate (Vp), pc/h/ln	1903
Total Trucks, %	27.49	Capacity (c), pc/h/ln	2368
Single-Unit Trucks (SUT), %	-	Adjusted Capacity (cadj), pc/h/ln	2368
Tractor-Trailers (TT), %	-	Volume-to-Capacity Ratio (v/c)	0.80
Passenger Car Equivalent (ET)	2.000		

Speed and Density

Lane Width Adjustment (fLW)	0.0	Average Speed (S), mi/h	62.5
Right-Side Lateral Clearance Adj. (fRLC)	0.0	Density (D), pc/mi/ln	30.4
Total Ramp Density Adjustment	3.2	Level of Service (LOS)	D
Adjusted Free-Flow Speed (FFSadj), mi/h	66.8		

HCS7 Freeway Diverge Report

Project Information

Analyst	LSA	Date	12/11/2019
Agency	LSA	Analysis Year	Phase III Proj Comp Yr (2049) NP
Jurisdiction	Caltrans	Time Period Analyzed	AM Peak Hour
Project Description	CMD1801 - Village D Specific Plan	Unit	United States Customary

Geometric Data

	Freeway	Ramp
Number of Lanes (N), ln	2	1
Free-Flow Speed (FFS), mi/h	70.0	50.0
Segment Length (L) / Deceleration Length (LA),ft	1500	150
Terrain Type	Level	Level
Percent Grade, %	-	-
Segment Type / Ramp Side	Freeway	Right

Adjustment Factors

Driver Population	All Familiar	All Familiar
Weather Type	Non-Severe Weather	Non-Severe Weather
Incident Type	No Incident	-
Final Speed Adjustment Factor (SAF)	1.000	1.000
Final Capacity Adjustment Factor (CAF)	1.000	1.000
Demand Adjustment Factor (DAF)	1.000	1.000

Demand and Capacity

Demand Volume (Vi)	2805	155
Peak Hour Factor (PHF)	0.94	0.94
Total Trucks, %	27.49	35.29
Single-Unit Trucks (SUT), %	-	-
Tractor-Trailers (TT), %	-	-
Heavy Vehicle Adjustment Factor (fHV)	0.784	0.739
Flow Rate (vi),pc/h	3806	223
Capacity (c), pc/h	4800	2100
Volume-to-Capacity Ratio (v/c)	0.79	0.11

Speed and Density

Upstream Equilibrium Distance (LEQ), ft	-	Number of Outer Lanes on Freeway (NO)	0
Distance to Upstream Ramp (LUP), ft	-	Speed Index (DS)	0.253
Downstream Equilibrium Distance (LEQ), ft	-	Flow Outer Lanes (vOA), pc/h/ln	-
Distance to Downstream Ramp (LDOWN), ft	-	Off-Ramp Influence Area Speed (SR), mi/h	62.9
Prop. Freeway Vehicles in Lane 1 and 2 (PFD)	1.000	Outer Lanes Freeway Speed (SO), mi/h	76.8
Flow in Lanes 1 and 2 (v12), pc/h	3806	Ramp Junction Speed (S), mi/h	62.9
Flow Entering Ramp-Infl. Area (vR12), pc/h	-	Average Density (D), pc/mi/ln	30.3
Level of Service (LOS)	E	Density in Ramp Influence Area (DR), pc/mi/ln	35.6

HCS7 Basic Freeway Report

Project Information

Analyst	LSA	Date	12/11/2019
Agency	LSA	Analysis Year	Phase III Proj Comp Yr (2049) NP
Jurisdiction	Caltrans	Time Period Analyzed	AM Peak Hour
Project Description	CMD1801 - Village D Specific Plan	Unit	United States Customary

Geometric Data

Number of Lanes, ln	2	Terrain Type	Level
Segment Length (L), ft	-	Percent Grade, %	-
Measured or Base Free-Flow Speed	Base	Grade Length, mi	-
Base Free-Flow Speed (BFFS), mi/h	70.0	Total Ramp Density (TRD), ramps/mi	1.33
Lane Width, ft	12	Free-Flow Speed (FFS), mi/h	65.9
Right-Side Lateral Clearance, ft	10		

Adjustment Factors

Driver Population	All Familiar	Final Speed Adjustment Factor (SAF)	1.000
Weather Type	Non-Severe Weather	Final Capacity Adjustment Factor (CAF)	1.000
Incident Type	No Incident	Demand Adjustment Factor (DAF)	1.000

Demand and Capacity

Demand Volume veh/h	2650	Heavy Vehicle Adjustment Factor (fhv)	0.787
Peak Hour Factor	0.94	Flow Rate (Vp), pc/h/ln	1791
Total Trucks, %	27.02	Capacity (c), pc/h/ln	2359
Single-Unit Trucks (SUT), %	-	Adjusted Capacity (cadj), pc/h/ln	2359
Tractor-Trailers (TT), %	-	Volume-to-Capacity Ratio (v/c)	0.76
Passenger Car Equivalent (ET)	2.000		

Speed and Density

Lane Width Adjustment (fLW)	0.0	Average Speed (S), mi/h	63.4
Right-Side Lateral Clearance Adj. (fRLC)	0.0	Density (D), pc/mi/ln	28.2
Total Ramp Density Adjustment	4.1	Level of Service (LOS)	D
Adjusted Free-Flow Speed (FFSadj), mi/h	65.9		

HCS7 Freeway Merge Report

Project Information

Analyst	LSA	Date	12/11/2019
Agency	LSA	Analysis Year	Phase III Proj Comp Yr (2049) NP
Jurisdiction	Caltrans	Time Period Analyzed	AM Peak Hour
Project Description	CMD1801 - Village D Specific Plan	Unit	United States Customary

Geometric Data

	Freeway	Ramp
Number of Lanes (N), ln	2	1
Free-Flow Speed (FFS), mi/h	70.0	35.0
Segment Length (L) / Acceleration Length (LA),ft	1000	600
Terrain Type	Level	Level
Percent Grade, %	-	-
Segment Type / Ramp Side	Freeway	Right

Adjustment Factors

Driver Population	All Familiar	All Familiar
Weather Type	Non-Severe Weather	Non-Severe Weather
Incident Type	No Incident	-
Final Speed Adjustment Factor (SAF)	1.000	1.000
Final Capacity Adjustment Factor (CAF)	1.000	1.000
Demand Adjustment Factor (DAF)	1.000	1.000

Demand and Capacity

Demand Volume (Vi)	2650	37
Peak Hour Factor (PHF)	0.94	0.94
Total Trucks, %	27.02	13.89
Single-Unit Trucks (SUT), %	-	-
Tractor-Trailers (TT), %	-	-
Heavy Vehicle Adjustment Factor (fHV)	0.787	0.878
Flow Rate (vi),pc/h	3582	45
Capacity (c), pc/h	4800	2000
Volume-to-Capacity Ratio (v/c)	0.76	0.02

Speed and Density

Upstream Equilibrium Distance (LEQ), ft	-	Number of Outer Lanes on Freeway (NO)	0
Distance to Upstream Ramp (LUP), ft	-	Speed Index (MS)	0.426
Downstream Equilibrium Distance (LEQ), ft	-	Flow Outer Lanes (vOA), pc/h/ln	-
Distance to Downstream Ramp (LDOWN), ft	-	On-Ramp Influence Area Speed (SR), mi/h	58.1
Prop. Freeway Vehicles in Lane 1 and 2 (PFM)	1.000	Outer Lanes Freeway Speed (SO), mi/h	70.0
Flow in Lanes 1 and 2 (v12), pc/h	3582	Ramp Junction Speed (S), mi/h	58.1
Flow Entering Ramp-Infl. Area (vR12), pc/h	3627	Average Density (D), pc/mi/ln	31.2
Level of Service (LOS)	D	Density in Ramp Influence Area (DR), pc/mi/ln	30.1

HCS7 Basic Freeway Report

Project Information

Analyst	LSA	Date	12/11/2019
Agency	LSA	Analysis Year	Phase III Proj Comp Yr (2049) NP
Jurisdiction	Caltrans	Time Period Analyzed	AM Peak Hour
Project Description	CMD1801 - Village D Specific Plan	Unit	United States Customary

Geometric Data

Number of Lanes, ln	2	Terrain Type	Level
Segment Length (L), ft	-	Percent Grade, %	-
Measured or Base Free-Flow Speed	Base	Grade Length, mi	-
Base Free-Flow Speed (BFFS), mi/h	70.0	Total Ramp Density (TRD), ramps/mi	1.33
Lane Width, ft	12	Free-Flow Speed (FFS), mi/h	65.9
Right-Side Lateral Clearance, ft	10		

Adjustment Factors

Driver Population	All Familiar	Final Speed Adjustment Factor (SAF)	1.000
Weather Type	Non-Severe Weather	Final Capacity Adjustment Factor (CAF)	1.000
Incident Type	No Incident	Demand Adjustment Factor (DAF)	1.000

Demand and Capacity

Demand Volume veh/h	2687	Heavy Vehicle Adjustment Factor (fhv)	0.788
Peak Hour Factor	0.94	Flow Rate (Vp), pc/h/ln	1814
Total Trucks, %	26.83	Capacity (c), pc/h/ln	2359
Single-Unit Trucks (SUT), %	-	Adjusted Capacity (cadj), pc/h/ln	2359
Tractor-Trailers (TT), %	-	Volume-to-Capacity Ratio (v/c)	0.77
Passenger Car Equivalent (ET)	2.000		

Speed and Density

Lane Width Adjustment (fLW)	0.0	Average Speed (S), mi/h	63.1
Right-Side Lateral Clearance Adj. (fRLC)	0.0	Density (D), pc/mi/ln	28.7
Total Ramp Density Adjustment	4.1	Level of Service (LOS)	D
Adjusted Free-Flow Speed (FFSadj), mi/h	65.9		

HCS7 Freeway Merge Report

Project Information

Analyst	LSA	Date	12/11/2019
Agency	LSA	Analysis Year	Phase III Proj Comp Yr (2049) NP
Jurisdiction	Caltrans	Time Period Analyzed	AM Peak Hour
Project Description	CMD1801 - Village D Specific Plan	Unit	United States Customary

Geometric Data

	Freeway	Ramp
Number of Lanes (N), ln	2	1
Free-Flow Speed (FFS), mi/h	70.0	35.0
Segment Length (L) / Acceleration Length (LA),ft	1500	500
Terrain Type	Level	Level
Percent Grade, %	-	-
Segment Type / Ramp Side	Freeway	Right

Adjustment Factors

Driver Population	All Familiar	All Familiar
Weather Type	Non-Severe Weather	Non-Severe Weather
Incident Type	No Incident	-
Final Speed Adjustment Factor (SAF)	1.000	1.000
Final Capacity Adjustment Factor (CAF)	1.000	1.000
Demand Adjustment Factor (DAF)	1.000	1.000

Demand and Capacity

Demand Volume (Vi)	2687	204
Peak Hour Factor (PHF)	0.94	0.94
Total Trucks, %	26.83	32.07
Single-Unit Trucks (SUT), %	-	-
Tractor-Trailers (TT), %	-	-
Heavy Vehicle Adjustment Factor (fHV)	0.788	0.757
Flow Rate (vi),pc/h	3628	287
Capacity (c), pc/h	4800	2000
Volume-to-Capacity Ratio (v/c)	0.82	0.14

Speed and Density

Upstream Equilibrium Distance (LEQ), ft	-	Number of Outer Lanes on Freeway (NO)	0
Distance to Upstream Ramp (LUP), ft	-	Speed Index (MS)	0.482
Downstream Equilibrium Distance (LEQ), ft	-	Flow Outer Lanes (vOA), pc/h/ln	-
Distance to Downstream Ramp (LDOWN), ft	-	On-Ramp Influence Area Speed (SR), mi/h	56.5
Prop. Freeway Vehicles in Lane 1 and 2 (PFM)	1.000	Outer Lanes Freeway Speed (SO), mi/h	70.0
Flow in Lanes 1 and 2 (v12), pc/h	3628	Ramp Junction Speed (S), mi/h	56.5
Flow Entering Ramp-Infl. Area (vR12), pc/h	3915	Average Density (D), pc/mi/ln	34.6
Level of Service (LOS)	D	Density in Ramp Influence Area (DR), pc/mi/ln	32.8

HCS7 Basic Freeway Report

Project Information

Analyst	LSA	Date	12/11/2019
Agency	LSA	Analysis Year	Phase III Proj Comp Yr (2049) NP
Jurisdiction	Caltrans	Time Period Analyzed	AM Peak Hour
Project Description	CMD1801 - Village D Specific Plan	Unit	United States Customary

Geometric Data

Number of Lanes, ln	2	Terrain Type	Level
Segment Length (L), ft	-	Percent Grade, %	-
Measured or Base Free-Flow Speed	Base	Grade Length, mi	-
Base Free-Flow Speed (BFFS), mi/h	70.0	Total Ramp Density (TRD), ramps/mi	1.33
Lane Width, ft	12	Free-Flow Speed (FFS), mi/h	65.9
Right-Side Lateral Clearance, ft	10		

Adjustment Factors

Driver Population	All Familiar	Final Speed Adjustment Factor (SAF)	1.000
Weather Type	Non-Severe Weather	Final Capacity Adjustment Factor (CAF)	1.000
Incident Type	No Incident	Demand Adjustment Factor (DAF)	1.000

Demand and Capacity

Demand Volume veh/h	2891	Heavy Vehicle Adjustment Factor (fhv)	0.786
Peak Hour Factor	0.94	Flow Rate (Vp), pc/h/ln	1956
Total Trucks, %	27.19	Capacity (c), pc/h/ln	2359
Single-Unit Trucks (SUT), %	-	Adjusted Capacity (cadj), pc/h/ln	2359
Tractor-Trailers (TT), %	-	Volume-to-Capacity Ratio (v/c)	0.83
Passenger Car Equivalent (ET)	2.000		

Speed and Density

Lane Width Adjustment (fLW)	0.0	Average Speed (S), mi/h	61.1
Right-Side Lateral Clearance Adj. (fRLC)	0.0	Density (D), pc/mi/ln	32.0
Total Ramp Density Adjustment	4.1	Level of Service (LOS)	D
Adjusted Free-Flow Speed (FFSadj), mi/h	65.9		

HCS7 Freeway Diverge Report

Project Information

Analyst	LSA	Date	12/11/2019
Agency	LSA	Analysis Year	Phase III Proj Comp Yr (2049) NP
Jurisdiction	Caltrans	Time Period Analyzed	AM Peak Hour
Project Description	CMD1801 - Village D Specific Plan	Unit	United States Customary

Geometric Data

	Freeway	Ramp
Number of Lanes (N), ln	3	1
Free-Flow Speed (FFS), mi/h	70.0	35.0
Segment Length (L) / Deceleration Length (LA),ft	1500	150
Terrain Type	Level	Level
Percent Grade, %	-	-
Segment Type / Ramp Side	Freeway	Right

Adjustment Factors

Driver Population	All Familiar	All Familiar
Weather Type	Non-Severe Weather	Non-Severe Weather
Incident Type	No Incident	-
Final Speed Adjustment Factor (SAF)	1.000	1.000
Final Capacity Adjustment Factor (CAF)	1.000	1.000
Demand Adjustment Factor (DAF)	1.000	1.000

Demand and Capacity

Demand Volume (Vi)	2891	439
Peak Hour Factor (PHF)	0.94	0.94
Total Trucks, %	27.19	18.81
Single-Unit Trucks (SUT), %	-	-
Tractor-Trailers (TT), %	-	-
Heavy Vehicle Adjustment Factor (fHV)	0.786	0.842
Flow Rate (vi),pc/h	3913	555
Capacity (c), pc/h	7200	2000
Volume-to-Capacity Ratio (v/c)	0.54	0.28

Speed and Density

Upstream Equilibrium Distance (LEQ), ft	-	Number of Outer Lanes on Freeway (NO)	1
Distance to Upstream Ramp (LUP), ft	-	Speed Index (DS)	0.478
Downstream Equilibrium Distance (LEQ), ft	-	Flow Outer Lanes (vOA), pc/h/ln	1219
Distance to Downstream Ramp (LDOWN), ft	-	Off-Ramp Influence Area Speed (SR), mi/h	56.6
Prop. Freeway Vehicles in Lane 1 and 2 (PFD)	0.637	Outer Lanes Freeway Speed (SO), mi/h	75.9
Flow in Lanes 1 and 2 (v12), pc/h	2694	Ramp Junction Speed (S), mi/h	61.5
Flow Entering Ramp-Infl. Area (vR12), pc/h	-	Average Density (D), pc/mi/ln	21.2
Level of Service (LOS)	C	Density in Ramp Influence Area (DR), pc/mi/ln	26.1

HCS7 Basic Freeway Report

Project Information

Analyst	LSA	Date	12/11/2019
Agency	LSA	Analysis Year	Phase III Proj Comp Yr (2049) NP
Jurisdiction	Caltrans	Time Period Analyzed	AM Peak Hour
Project Description	CMD1801 - Village D Specific Plan	Unit	United States Customary

Geometric Data

Number of Lanes, ln	3	Terrain Type	Level
Segment Length (L), ft	-	Percent Grade, %	-
Measured or Base Free-Flow Speed	Base	Grade Length, mi	-
Base Free-Flow Speed (BFFS), mi/h	70.0	Total Ramp Density (TRD), ramps/mi	1.67
Lane Width, ft	12	Free-Flow Speed (FFS), mi/h	65.0
Right-Side Lateral Clearance, ft	10		

Adjustment Factors

Driver Population	All Familiar	Final Speed Adjustment Factor (SAF)	1.000
Weather Type	Non-Severe Weather	Final Capacity Adjustment Factor (CAF)	1.000
Incident Type	No Incident	Demand Adjustment Factor (DAF)	1.000

Demand and Capacity

Demand Volume veh/h	2452	Heavy Vehicle Adjustment Factor (fhv)	0.777
Peak Hour Factor	0.94	Flow Rate (Vp), pc/h/ln	1119
Total Trucks, %	28.67	Capacity (c), pc/h/ln	2350
Single-Unit Trucks (SUT), %	-	Adjusted Capacity (cadj), pc/h/ln	2350
Tractor-Trailers (TT), %	-	Volume-to-Capacity Ratio (v/c)	0.48
Passenger Car Equivalent (ET)	2.000		

Speed and Density

Lane Width Adjustment (fLW)	0.0	Average Speed (S), mi/h	65.0
Right-Side Lateral Clearance Adj. (fRLC)	0.0	Density (D), pc/mi/ln	17.2
Total Ramp Density Adjustment	5.0	Level of Service (LOS)	B
Adjusted Free-Flow Speed (FFSadj), mi/h	65.0		

HCS7 Freeway Merge Report

Project Information

Analyst	LSA	Date	12/11/2019
Agency	LSA	Analysis Year	Phase III Proj Comp Yr (2049) NP
Jurisdiction	Caltrans	Time Period Analyzed	AM Peak Hour
Project Description	CMD1801 - Village D Specific Plan	Unit	United States Customary

Geometric Data

	Freeway	Ramp
Number of Lanes (N), ln	3	1
Free-Flow Speed (FFS), mi/h	65.0	35.0
Segment Length (L) / Acceleration Length (LA),ft	1500	600
Terrain Type	Level	Level
Percent Grade, %	-	-
Segment Type / Ramp Side	Freeway	Right

Adjustment Factors

Driver Population	All Familiar	All Familiar
Weather Type	Non-Severe Weather	Non-Severe Weather
Incident Type	No Incident	-
Final Speed Adjustment Factor (SAF)	1.000	1.000
Final Capacity Adjustment Factor (CAF)	1.000	1.000
Demand Adjustment Factor (DAF)	1.000	1.000

Demand and Capacity

Demand Volume (Vi)	2452	709
Peak Hour Factor (PHF)	0.94	0.94
Total Trucks, %	28.67	4.05
Single-Unit Trucks (SUT), %	-	-
Tractor-Trailers (TT), %	-	-
Heavy Vehicle Adjustment Factor (fHV)	0.777	0.961
Flow Rate (vi),pc/h	3357	785
Capacity (c), pc/h	7050	2000
Volume-to-Capacity Ratio (v/c)	0.59	0.39

Speed and Density

Upstream Equilibrium Distance (LEQ), ft	-	Number of Outer Lanes on Freeway (NO)	1
Distance to Upstream Ramp (LUP), ft	-	Speed Index (MS)	0.342
Downstream Equilibrium Distance (LEQ), ft	-	Flow Outer Lanes (vOA), pc/h/ln	1363
Distance to Downstream Ramp (LDOWN), ft	-	On-Ramp Influence Area Speed (SR), mi/h	57.1
Prop. Freeway Vehicles in Lane 1 and 2 (PFM)	0.594	Outer Lanes Freeway Speed (SO), mi/h	61.9
Flow in Lanes 1 and 2 (v12), pc/h	1994	Ramp Junction Speed (S), mi/h	58.6
Flow Entering Ramp-Infl. Area (vR12), pc/h	2779	Average Density (D), pc/mi/ln	23.6
Level of Service (LOS)	C	Density in Ramp Influence Area (DR), pc/mi/ln	23.1

HCS7 Basic Freeway Report

Project Information

Analyst	LSA	Date	12/11/2019
Agency	LSA	Analysis Year	Phase III Proj Comp Yr (2049) NP
Jurisdiction	Caltrans	Time Period Analyzed	AM Peak Hour
Project Description	CMD1801 - Village D Specific Plan	Unit	United States Customary

Geometric Data

Number of Lanes, ln	3	Terrain Type	Level
Segment Length (L), ft	-	Percent Grade, %	-
Measured or Base Free-Flow Speed	Base	Grade Length, mi	-
Base Free-Flow Speed (BFFS), mi/h	65.0	Total Ramp Density (TRD), ramps/mi	1.83
Lane Width, ft	12	Free-Flow Speed (FFS), mi/h	59.7
Right-Side Lateral Clearance, ft	10		

Adjustment Factors

Driver Population	All Familiar	Final Speed Adjustment Factor (SAF)	1.000
Weather Type	Non-Severe Weather	Final Capacity Adjustment Factor (CAF)	1.000
Incident Type	No Incident	Demand Adjustment Factor (DAF)	1.000

Demand and Capacity

Demand Volume veh/h	3161	Heavy Vehicle Adjustment Factor (fhv)	0.812
Peak Hour Factor	0.94	Flow Rate (Vp), pc/h/ln	1380
Total Trucks, %	23.16	Capacity (c), pc/h/ln	2296
Single-Unit Trucks (SUT), %	-	Adjusted Capacity (cadj), pc/h/ln	2296
Tractor-Trailers (TT), %	-	Volume-to-Capacity Ratio (v/c)	0.60
Passenger Car Equivalent (ET)	2.000		

Speed and Density

Lane Width Adjustment (fLW)	0.0	Average Speed (S), mi/h	59.6
Right-Side Lateral Clearance Adj. (fRLC)	0.0	Density (D), pc/mi/ln	23.2
Total Ramp Density Adjustment	5.4	Level of Service (LOS)	C
Adjusted Free-Flow Speed (FFSadj), mi/h	59.6		

HCS7 Freeway Merge Report

Project Information

Analyst	LSA	Date	12/11/2019
Agency	LSA	Analysis Year	Phase III Proj Comp Yr (2049) NP
Jurisdiction	Caltrans	Time Period Analyzed	AM Peak Hour
Project Description	CMD1801 - Village D Specific Plan	Unit	United States Customary

Geometric Data

	Freeway	Ramp
Number of Lanes (N), ln	3	1
Free-Flow Speed (FFS), mi/h	65.0	35.0
Segment Length (L) / Acceleration Length (LA),ft	1500	600
Terrain Type	Level	Level
Percent Grade, %	-	-
Segment Type / Ramp Side	Freeway	Right

Adjustment Factors

Driver Population	All Familiar	All Familiar
Weather Type	Non-Severe Weather	Non-Severe Weather
Incident Type	No Incident	-
Final Speed Adjustment Factor (SAF)	1.000	1.000
Final Capacity Adjustment Factor (CAF)	1.000	1.000
Demand Adjustment Factor (DAF)	1.000	1.000

Demand and Capacity

Demand Volume (Vi)	3161	172
Peak Hour Factor (PHF)	0.94	0.94
Total Trucks, %	23.16	14.67
Single-Unit Trucks (SUT), %	-	-
Tractor-Trailers (TT), %	-	-
Heavy Vehicle Adjustment Factor (fHV)	0.812	0.872
Flow Rate (vi),pc/h	4141	210
Capacity (c), pc/h	7050	2000
Volume-to-Capacity Ratio (v/c)	0.62	0.11

Speed and Density

Upstream Equilibrium Distance (LEQ), ft	-	Number of Outer Lanes on Freeway (NO)	1
Distance to Upstream Ramp (LUP), ft	-	Speed Index (MS)	0.335
Downstream Equilibrium Distance (LEQ), ft	-	Flow Outer Lanes (vOA), pc/h/ln	1681
Distance to Downstream Ramp (LDOWN), ft	-	On-Ramp Influence Area Speed (SR), mi/h	57.3
Prop. Freeway Vehicles in Lane 1 and 2 (PFM)	0.594	Outer Lanes Freeway Speed (SO), mi/h	60.7
Flow in Lanes 1 and 2 (v12), pc/h	2460	Ramp Junction Speed (S), mi/h	58.6
Flow Entering Ramp-Infl. Area (vR12), pc/h	2670	Average Density (D), pc/mi/ln	24.7
Level of Service (LOS)	C	Density in Ramp Influence Area (DR), pc/mi/ln	22.5

HCS7 Basic Freeway Report

Project Information

Analyst	LSA	Date	12/11/2019
Agency	LSA	Analysis Year	Phase III Proj Comp Yr (2049) NP
Jurisdiction	Caltrans	Time Period Analyzed	AM Peak Hour
Project Description	CMD1801 - Village D Specific Plan	Unit	United States Customary

Geometric Data

Number of Lanes, ln	3	Terrain Type	Level
Segment Length (L), ft	-	Percent Grade, %	-
Measured or Base Free-Flow Speed	Base	Grade Length, mi	-
Base Free-Flow Speed (BFFS), mi/h	65.0	Total Ramp Density (TRD), ramps/mi	2.17
Lane Width, ft	12	Free-Flow Speed (FFS), mi/h	58.8
Right-Side Lateral Clearance, ft	10		

Adjustment Factors

Driver Population	All Familiar	Final Speed Adjustment Factor (SAF)	1.000
Weather Type	Non-Severe Weather	Final Capacity Adjustment Factor (CAF)	1.000
Incident Type	No Incident	Demand Adjustment Factor (DAF)	1.000

Demand and Capacity

Demand Volume veh/h	3333	Heavy Vehicle Adjustment Factor (fhv)	0.815
Peak Hour Factor	0.94	Flow Rate (Vp), pc/h/ln	1450
Total Trucks, %	22.72	Capacity (c), pc/h/ln	2288
Single-Unit Trucks (SUT), %	-	Adjusted Capacity (cadj), pc/h/ln	2288
Tractor-Trailers (TT), %	-	Volume-to-Capacity Ratio (v/c)	0.63
Passenger Car Equivalent (ET)	2.000		

Speed and Density

Lane Width Adjustment (fLW)	0.0	Average Speed (S), mi/h	58.8
Right-Side Lateral Clearance Adj. (fRLC)	0.0	Density (D), pc/mi/ln	24.7
Total Ramp Density Adjustment	6.2	Level of Service (LOS)	C
Adjusted Free-Flow Speed (FFSadj), mi/h	58.8		

HCS7 Freeway Diverge Report

Project Information

Analyst	LSA	Date	12/11/2019
Agency	LSA	Analysis Year	Phase III Proj Comp Yr (2049) NP
Jurisdiction	Caltrans	Time Period Analyzed	AM Peak Hour
Project Description	CMD1801 - Village D Specific Plan	Unit	United States Customary

Geometric Data

	Freeway	Ramp
Number of Lanes (N), ln	3	1
Free-Flow Speed (FFS), mi/h	65.0	40.0
Segment Length (L) / Deceleration Length (LA),ft	1500	150
Terrain Type	Level	Level
Percent Grade, %	-	-
Segment Type / Ramp Side	Freeway	Right

Adjustment Factors

Driver Population	All Familiar	All Familiar
Weather Type	Non-Severe Weather	Non-Severe Weather
Incident Type	No Incident	-
Final Speed Adjustment Factor (SAF)	1.000	1.000
Final Capacity Adjustment Factor (CAF)	1.000	1.000
Demand Adjustment Factor (DAF)	1.000	1.000

Demand and Capacity

Demand Volume (Vi)	3333	193
Peak Hour Factor (PHF)	0.94	0.94
Total Trucks, %	22.72	4.19
Single-Unit Trucks (SUT), %	-	-
Tractor-Trailers (TT), %	-	-
Heavy Vehicle Adjustment Factor (fHV)	0.815	0.960
Flow Rate (vi),pc/h	4351	214
Capacity (c), pc/h	7050	2000
Volume-to-Capacity Ratio (v/c)	0.62	0.11

Speed and Density

Upstream Equilibrium Distance (LEQ), ft	-	Number of Outer Lanes on Freeway (NO)	1
Distance to Upstream Ramp (LUP), ft	-	Speed Index (DS)	0.382
Downstream Equilibrium Distance (LEQ), ft	-	Flow Outer Lanes (vOA), pc/h/ln	1485
Distance to Downstream Ramp (LDOWN), ft	-	Off-Ramp Influence Area Speed (SR), mi/h	56.2
Prop. Freeway Vehicles in Lane 1 and 2 (PFD)	0.641	Outer Lanes Freeway Speed (SO), mi/h	69.4
Flow in Lanes 1 and 2 (v12), pc/h	2866	Ramp Junction Speed (S), mi/h	60.1
Flow Entering Ramp-Infl. Area (vR12), pc/h	-	Average Density (D), pc/mi/ln	24.1
Level of Service (LOS)	C	Density in Ramp Influence Area (DR), pc/mi/ln	27.5

HCS7 Basic Freeway Report

Project Information

Analyst	LSA	Date	12/11/2019
Agency	LSA	Analysis Year	Phase III Proj Comp Yr (2049) NP
Jurisdiction	Caltrans	Time Period Analyzed	AM Peak Hour
Project Description	CMD1801 - Village D Specific Plan	Unit	United States Customary

Geometric Data

Number of Lanes, ln	3	Terrain Type	Level
Segment Length (L), ft	-	Percent Grade, %	-
Measured or Base Free-Flow Speed	Base	Grade Length, mi	-
Base Free-Flow Speed (BFFS), mi/h	65.0	Total Ramp Density (TRD), ramps/mi	1.83
Lane Width, ft	12	Free-Flow Speed (FFS), mi/h	59.7
Right-Side Lateral Clearance, ft	10		

Adjustment Factors

Driver Population	All Familiar	Final Speed Adjustment Factor (SAF)	1.000
Weather Type	Non-Severe Weather	Final Capacity Adjustment Factor (CAF)	1.000
Incident Type	No Incident	Demand Adjustment Factor (DAF)	1.000

Demand and Capacity

Demand Volume veh/h	3139	Heavy Vehicle Adjustment Factor (fhv)	0.807
Peak Hour Factor	0.94	Flow Rate (Vp), pc/h/ln	1379
Total Trucks, %	23.86	Capacity (c), pc/h/ln	2296
Single-Unit Trucks (SUT), %	-	Adjusted Capacity (cadj), pc/h/ln	2296
Tractor-Trailers (TT), %	-	Volume-to-Capacity Ratio (v/c)	0.60
Passenger Car Equivalent (ET)	2.000		

Speed and Density

Lane Width Adjustment (fLW)	0.0	Average Speed (S), mi/h	59.6
Right-Side Lateral Clearance Adj. (fRLC)	0.0	Density (D), pc/mi/ln	23.1
Total Ramp Density Adjustment	5.4	Level of Service (LOS)	C
Adjusted Free-Flow Speed (FFSadj), mi/h	59.6		

HCS7 Freeway Merge Report

Project Information

Analyst	LSA	Date	12/11/2019
Agency	LSA	Analysis Year	Phase III Proj Comp Yr (2049) NP
Jurisdiction	Caltrans	Time Period Analyzed	AM Peak Hour
Project Description	CMD1801 - Village D Specific Plan	Unit	United States Customary

Geometric Data

	Freeway	Ramp
Number of Lanes (N), ln	3	1
Free-Flow Speed (FFS), mi/h	65.0	35.0
Segment Length (L) / Acceleration Length (LA),ft	1500	800
Terrain Type	Level	Level
Percent Grade, %	-	-
Segment Type / Ramp Side	Freeway	Right

Adjustment Factors

Driver Population	All Familiar	All Familiar
Weather Type	Non-Severe Weather	Non-Severe Weather
Incident Type	No Incident	-
Final Speed Adjustment Factor (SAF)	1.000	1.000
Final Capacity Adjustment Factor (CAF)	1.000	1.000
Demand Adjustment Factor (DAF)	1.000	1.000

Demand and Capacity

Demand Volume (Vi)	3139	384
Peak Hour Factor (PHF)	0.94	0.94
Total Trucks, %	23.86	2.66
Single-Unit Trucks (SUT), %	-	-
Tractor-Trailers (TT), %	-	-
Heavy Vehicle Adjustment Factor (fHV)	0.807	0.974
Flow Rate (vi),pc/h	4138	419
Capacity (c), pc/h	7050	2000
Volume-to-Capacity Ratio (v/c)	0.65	0.21

Speed and Density

Upstream Equilibrium Distance (LEQ), ft	-	Number of Outer Lanes on Freeway (NO)	1
Distance to Upstream Ramp (LUP), ft	-	Speed Index (MS)	0.336
Downstream Equilibrium Distance (LEQ), ft	-	Flow Outer Lanes (vOA), pc/h/ln	1655
Distance to Downstream Ramp (LDOWN), ft	-	On-Ramp Influence Area Speed (SR), mi/h	57.3
Prop. Freeway Vehicles in Lane 1 and 2 (PFM)	0.600	Outer Lanes Freeway Speed (SO), mi/h	60.8
Flow in Lanes 1 and 2 (v12), pc/h	2483	Ramp Junction Speed (S), mi/h	58.5
Flow Entering Ramp-Infl. Area (vR12), pc/h	2902	Average Density (D), pc/mi/ln	26.0
Level of Service (LOS)	C	Density in Ramp Influence Area (DR), pc/mi/ln	23.0

HCS7 Basic Freeway Report

Project Information

Analyst	LSA	Date	12/11/2019
Agency	LSA	Analysis Year	Phase III Proj Comp Yr (2049) NP
Jurisdiction	Caltrans	Time Period Analyzed	AM Peak Hour
Project Description	CMD1801 - Village D Specific Plan	Unit	United States Customary

Geometric Data

Number of Lanes, ln	3	Terrain Type	Level
Segment Length (L), ft	-	Percent Grade, %	-
Measured or Base Free-Flow Speed	Base	Grade Length, mi	-
Base Free-Flow Speed (BFFS), mi/h	65.0	Total Ramp Density (TRD), ramps/mi	2.17
Lane Width, ft	12	Free-Flow Speed (FFS), mi/h	58.8
Right-Side Lateral Clearance, ft	10		

Adjustment Factors

Driver Population	All Familiar	Final Speed Adjustment Factor (SAF)	1.000
Weather Type	Non-Severe Weather	Final Capacity Adjustment Factor (CAF)	1.000
Incident Type	No Incident	Demand Adjustment Factor (DAF)	1.000

Demand and Capacity

Demand Volume veh/h	3523	Heavy Vehicle Adjustment Factor (fhv)	0.823
Peak Hour Factor	0.94	Flow Rate (Vp), pc/h/ln	1518
Total Trucks, %	21.54	Capacity (c), pc/h/ln	2288
Single-Unit Trucks (SUT), %	-	Adjusted Capacity (cadj), pc/h/ln	2288
Tractor-Trailers (TT), %	-	Volume-to-Capacity Ratio (v/c)	0.66
Passenger Car Equivalent (ET)	2.000		

Speed and Density

Lane Width Adjustment (fLW)	0.0	Average Speed (S), mi/h	58.8
Right-Side Lateral Clearance Adj. (fRLC)	0.0	Density (D), pc/mi/ln	25.8
Total Ramp Density Adjustment	6.2	Level of Service (LOS)	C
Adjusted Free-Flow Speed (FFSadj), mi/h	58.8		

HCS7 Freeway Diverge Report

Project Information

Analyst	LSA	Date	12/11/2019
Agency	LSA	Analysis Year	Phase III Proj Comp Yr (2049) NP
Jurisdiction	Caltrans	Time Period Analyzed	AM Peak Hour
Project Description	CMD1801 - Village D Specific Plan	Unit	United States Customary

Geometric Data

	Freeway	Ramp
Number of Lanes (N), ln	3	1
Free-Flow Speed (FFS), mi/h	65.0	35.0
Segment Length (L) / Deceleration Length (LA),ft	1500	200
Terrain Type	Level	Level
Percent Grade, %	-	-
Segment Type / Ramp Side	Freeway	Right

Adjustment Factors

Driver Population	All Familiar	All Familiar
Weather Type	Non-Severe Weather	Non-Severe Weather
Incident Type	No Incident	-
Final Speed Adjustment Factor (SAF)	1.000	1.000
Final Capacity Adjustment Factor (CAF)	1.000	1.000
Demand Adjustment Factor (DAF)	1.000	1.000

Demand and Capacity

Demand Volume (Vi)	3523	152
Peak Hour Factor (PHF)	0.94	0.94
Total Trucks, %	21.54	14.71
Single-Unit Trucks (SUT), %	-	-
Tractor-Trailers (TT), %	-	-
Heavy Vehicle Adjustment Factor (fHV)	0.823	0.872
Flow Rate (vi),pc/h	4554	185
Capacity (c), pc/h	7050	2000
Volume-to-Capacity Ratio (v/c)	0.65	0.09

Speed and Density

Upstream Equilibrium Distance (LEQ), ft	-	Number of Outer Lanes on Freeway (NO)	1
Distance to Upstream Ramp (LUP), ft	-	Speed Index (DS)	0.445
Downstream Equilibrium Distance (LEQ), ft	-	Flow Outer Lanes (vOA), pc/h/ln	1582
Distance to Downstream Ramp (LDOWN), ft	-	Off-Ramp Influence Area Speed (SR), mi/h	54.8
Prop. Freeway Vehicles in Lane 1 and 2 (PFD)	0.638	Outer Lanes Freeway Speed (SO), mi/h	69.0
Flow in Lanes 1 and 2 (v12), pc/h	2972	Ramp Junction Speed (S), mi/h	59.0
Flow Entering Ramp-Infl. Area (vR12), pc/h	-	Average Density (D), pc/mi/ln	25.7
Level of Service (LOS)	C	Density in Ramp Influence Area (DR), pc/mi/ln	28.0

HCS7 Basic Freeway Report

Project Information

Analyst	LSA	Date	12/11/2019
Agency	LSA	Analysis Year	Phase III Proj Comp Yr (2049) NP
Jurisdiction	Caltrans	Time Period Analyzed	AM Peak Hour
Project Description	CMD1801 - Village D Specific Plan	Unit	United States Customary

Geometric Data

Number of Lanes, ln	3	Terrain Type	Level
Segment Length (L), ft	-	Percent Grade, %	-
Measured or Base Free-Flow Speed	Base	Grade Length, mi	-
Base Free-Flow Speed (BFFS), mi/h	65.0	Total Ramp Density (TRD), ramps/mi	2.17
Lane Width, ft	12	Free-Flow Speed (FFS), mi/h	58.8
Right-Side Lateral Clearance, ft	10		

Adjustment Factors

Driver Population	All Familiar	Final Speed Adjustment Factor (SAF)	1.000
Weather Type	Non-Severe Weather	Final Capacity Adjustment Factor (CAF)	1.000
Incident Type	No Incident	Demand Adjustment Factor (DAF)	1.000

Demand and Capacity

Demand Volume veh/h	3371	Heavy Vehicle Adjustment Factor (fhv)	0.821
Peak Hour Factor	0.94	Flow Rate (Vp), pc/h/ln	1456
Total Trucks, %	21.86	Capacity (c), pc/h/ln	2288
Single-Unit Trucks (SUT), %	-	Adjusted Capacity (cadj), pc/h/ln	2288
Tractor-Trailers (TT), %	-	Volume-to-Capacity Ratio (v/c)	0.64
Passenger Car Equivalent (ET)	2.000		

Speed and Density

Lane Width Adjustment (fLW)	0.0	Average Speed (S), mi/h	58.8
Right-Side Lateral Clearance Adj. (fRLC)	0.0	Density (D), pc/mi/ln	24.8
Total Ramp Density Adjustment	6.2	Level of Service (LOS)	C
Adjusted Free-Flow Speed (FFSadj), mi/h	58.8		

HCS7 Freeway Merge Report

Project Information

Analyst	LSA	Date	12/11/2019
Agency	LSA	Analysis Year	Phase III Proj Comp Yr (2049) NP
Jurisdiction	Caltrans	Time Period Analyzed	AM Peak Hour
Project Description	CMD1801 - Village D Specific Plan	Unit	United States Customary

Geometric Data

	Freeway	Ramp
Number of Lanes (N), ln	3	1
Free-Flow Speed (FFS), mi/h	65.0	35.0
Segment Length (L) / Acceleration Length (LA),ft	1500	350
Terrain Type	Level	Level
Percent Grade, %	-	-
Segment Type / Ramp Side	Freeway	Right

Adjustment Factors

Driver Population	All Familiar	All Familiar
Weather Type	Non-Severe Weather	Non-Severe Weather
Incident Type	No Incident	-
Final Speed Adjustment Factor (SAF)	1.000	1.000
Final Capacity Adjustment Factor (CAF)	1.000	1.000
Demand Adjustment Factor (DAF)	1.000	1.000

Demand and Capacity

Demand Volume (Vi)	3371	839
Peak Hour Factor (PHF)	0.94	0.94
Total Trucks, %	21.86	3.10
Single-Unit Trucks (SUT), %	-	-
Tractor-Trailers (TT), %	-	-
Heavy Vehicle Adjustment Factor (fHV)	0.821	0.970
Flow Rate (vi),pc/h	4368	920
Capacity (c), pc/h	7050	2000
Volume-to-Capacity Ratio (v/c)	0.75	0.46

Speed and Density

Upstream Equilibrium Distance (LEQ), ft	-	Number of Outer Lanes on Freeway (NO)	1
Distance to Upstream Ramp (LUP), ft	-	Speed Index (MS)	0.424
Downstream Equilibrium Distance (LEQ), ft	-	Flow Outer Lanes (vOA), pc/h/ln	1804
Distance to Downstream Ramp (LDOWN), ft	-	On-Ramp Influence Area Speed (SR), mi/h	55.2
Prop. Freeway Vehicles in Lane 1 and 2 (PFM)	0.587	Outer Lanes Freeway Speed (SO), mi/h	60.3
Flow in Lanes 1 and 2 (v12), pc/h	2564	Ramp Junction Speed (S), mi/h	56.8
Flow Entering Ramp-Infl. Area (vR12), pc/h	3484	Average Density (D), pc/mi/ln	31.0
Level of Service (LOS)	D	Density in Ramp Influence Area (DR), pc/mi/ln	30.1

HCS7 Basic Freeway Report

Project Information

Analyst	LSA	Date	12/11/2019
Agency	LSA	Analysis Year	Phase III Proj Comp Yr (2049) NP
Jurisdiction	Caltrans	Time Period Analyzed	AM Peak Hour
Project Description	CMD1801 - Village D Specific Plan	Unit	United States Customary

Geometric Data

Number of Lanes, ln	3	Terrain Type	Level
Segment Length (L), ft	-	Percent Grade, %	-
Measured or Base Free-Flow Speed	Base	Grade Length, mi	-
Base Free-Flow Speed (BFFS), mi/h	65.0	Total Ramp Density (TRD), ramps/mi	2.17
Lane Width, ft	12	Free-Flow Speed (FFS), mi/h	58.8
Right-Side Lateral Clearance, ft	10		

Adjustment Factors

Driver Population	All Familiar	Final Speed Adjustment Factor (SAF)	1.000
Weather Type	Non-Severe Weather	Final Capacity Adjustment Factor (CAF)	1.000
Incident Type	No Incident	Demand Adjustment Factor (DAF)	1.000

Demand and Capacity

Demand Volume veh/h	4210	Heavy Vehicle Adjustment Factor (fhv)	0.847
Peak Hour Factor	0.94	Flow Rate (Vp), pc/h/ln	1763
Total Trucks, %	18.12	Capacity (c), pc/h/ln	2288
Single-Unit Trucks (SUT), %	-	Adjusted Capacity (cadj), pc/h/ln	2288
Tractor-Trailers (TT), %	-	Volume-to-Capacity Ratio (v/c)	0.77
Passenger Car Equivalent (ET)	2.000		

Speed and Density

Lane Width Adjustment (fLW)	0.0	Average Speed (S), mi/h	58.5
Right-Side Lateral Clearance Adj. (fRLC)	0.0	Density (D), pc/mi/ln	30.1
Total Ramp Density Adjustment	6.2	Level of Service (LOS)	D
Adjusted Free-Flow Speed (FFSadj), mi/h	58.8		

HCS7 Freeway Diverge Report

Project Information

Analyst	LSA	Date	12/11/2019
Agency	LSA	Analysis Year	Phase III Proj Comp Yr (2049) NP
Jurisdiction	Caltrans	Time Period Analyzed	AM Peak Hour
Project Description	CMD1801 - Village D Specific Plan	Unit	United States Customary

Geometric Data

	Freeway	Ramp
Number of Lanes (N), ln	3	1
Free-Flow Speed (FFS), mi/h	65.0	15.0
Segment Length (L) / Deceleration Length (LA),ft	1500	150
Terrain Type	Level	Level
Percent Grade, %	-	-
Segment Type / Ramp Side	Freeway	Right

Adjustment Factors

Driver Population	All Familiar	All Familiar
Weather Type	Non-Severe Weather	Non-Severe Weather
Incident Type	No Incident	-
Final Speed Adjustment Factor (SAF)	1.000	1.000
Final Capacity Adjustment Factor (CAF)	1.000	1.000
Demand Adjustment Factor (DAF)	1.000	1.000

Demand and Capacity

Demand Volume (Vi)	4210	438
Peak Hour Factor (PHF)	0.94	0.94
Total Trucks, %	18.12	3.32
Single-Unit Trucks (SUT), %	-	-
Tractor-Trailers (TT), %	-	-
Heavy Vehicle Adjustment Factor (fHV)	0.847	0.968
Flow Rate (vi),pc/h	5288	481
Capacity (c), pc/h	7050	1800
Volume-to-Capacity Ratio (v/c)	0.75	0.27

Speed and Density

Upstream Equilibrium Distance (LEQ), ft	-	Number of Outer Lanes on Freeway (NO)	1
Distance to Upstream Ramp (LUP), ft	-	Speed Index (DS)	0.731
Downstream Equilibrium Distance (LEQ), ft	-	Flow Outer Lanes (vOA), pc/h/ln	1894
Distance to Downstream Ramp (LDOWN), ft	-	Off-Ramp Influence Area Speed (SR), mi/h	48.2
Prop. Freeway Vehicles in Lane 1 and 2 (PFD)	0.606	Outer Lanes Freeway Speed (SO), mi/h	67.8
Flow in Lanes 1 and 2 (v12), pc/h	3394	Ramp Junction Speed (S), mi/h	53.8
Flow Entering Ramp-Infl. Area (vR12), pc/h	-	Average Density (D), pc/mi/ln	32.8
Level of Service (LOS)	D	Density in Ramp Influence Area (DR), pc/mi/ln	32.1

HCS7 Basic Freeway Report

Project Information

Analyst	LSA	Date	12/11/2019
Agency	LSA	Analysis Year	Phase III Proj Comp Yr (2049) NP
Jurisdiction	Caltrans	Time Period Analyzed	AM Peak Hour
Project Description	CMD1801 - Village D Specific Plan	Unit	United States Customary

Geometric Data

Number of Lanes, ln	3	Terrain Type	Level
Segment Length (L), ft	-	Percent Grade, %	-
Measured or Base Free-Flow Speed	Base	Grade Length, mi	-
Base Free-Flow Speed (BFFS), mi/h	65.0	Total Ramp Density (TRD), ramps/mi	1.83
Lane Width, ft	12	Free-Flow Speed (FFS), mi/h	59.7
Right-Side Lateral Clearance, ft	10		

Adjustment Factors

Driver Population	All Familiar	Final Speed Adjustment Factor (SAF)	1.000
Weather Type	Non-Severe Weather	Final Capacity Adjustment Factor (CAF)	1.000
Incident Type	No Incident	Demand Adjustment Factor (DAF)	1.000

Demand and Capacity

Demand Volume veh/h	3773	Heavy Vehicle Adjustment Factor (fhv)	0.835
Peak Hour Factor	0.94	Flow Rate (Vp), pc/h/ln	1602
Total Trucks, %	19.83	Capacity (c), pc/h/ln	2296
Single-Unit Trucks (SUT), %	-	Adjusted Capacity (cadj), pc/h/ln	2296
Tractor-Trailers (TT), %	-	Volume-to-Capacity Ratio (v/c)	0.70
Passenger Car Equivalent (ET)	2.000		

Speed and Density

Lane Width Adjustment (fLW)	0.0	Average Speed (S), mi/h	59.6
Right-Side Lateral Clearance Adj. (fRLC)	0.0	Density (D), pc/mi/ln	26.9
Total Ramp Density Adjustment	5.4	Level of Service (LOS)	D
Adjusted Free-Flow Speed (FFSadj), mi/h	59.6		

HCS7 Freeway Merge Report

Project Information

Analyst	LSA	Date	12/11/2019
Agency	LSA	Analysis Year	Phase III Proj Comp Yr (2049) NP
Jurisdiction	Caltrans	Time Period Analyzed	AM Peak Hour
Project Description	CMD1801 - Village D Specific Plan	Unit	United States Customary

Geometric Data

	Freeway	Ramp
Number of Lanes (N), ln	3	1
Free-Flow Speed (FFS), mi/h	65.0	35.0
Segment Length (L) / Acceleration Length (LA),ft	1500	450
Terrain Type	Level	Level
Percent Grade, %	-	-
Segment Type / Ramp Side	Freeway	Right

Adjustment Factors

Driver Population	All Familiar	All Familiar
Weather Type	Non-Severe Weather	Non-Severe Weather
Incident Type	No Incident	-
Final Speed Adjustment Factor (SAF)	1.000	1.000
Final Capacity Adjustment Factor (CAF)	1.000	1.000
Demand Adjustment Factor (DAF)	1.000	1.000

Demand and Capacity

Demand Volume (Vi)	3773	599
Peak Hour Factor (PHF)	0.94	0.94
Total Trucks, %	19.83	0.84
Single-Unit Trucks (SUT), %	-	-
Tractor-Trailers (TT), %	-	-
Heavy Vehicle Adjustment Factor (fHV)	0.835	0.992
Flow Rate (vi),pc/h	4807	642
Capacity (c), pc/h	7050	2000
Volume-to-Capacity Ratio (v/c)	0.77	0.32

Speed and Density

Upstream Equilibrium Distance (LEQ), ft	-	Number of Outer Lanes on Freeway (NO)	1
Distance to Upstream Ramp (LUP), ft	-	Speed Index (MS)	0.416
Downstream Equilibrium Distance (LEQ), ft	-	Flow Outer Lanes (vOA), pc/h/ln	1971
Distance to Downstream Ramp (LDOWN), ft	-	On-Ramp Influence Area Speed (SR), mi/h	55.4
Prop. Freeway Vehicles in Lane 1 and 2 (PFM)	0.590	Outer Lanes Freeway Speed (SO), mi/h	59.7
Flow in Lanes 1 and 2 (v12), pc/h	2836	Ramp Junction Speed (S), mi/h	56.9
Flow Entering Ramp-Infl. Area (vR12), pc/h	3478	Average Density (D), pc/mi/ln	31.9
Level of Service (LOS)	D	Density in Ramp Influence Area (DR), pc/mi/ln	29.6

HCS7 Basic Freeway Report

Project Information

Analyst	LSA	Date	12/11/2019
Agency	LSA	Analysis Year	Phase III Proj Comp Yr (2049) NP
Jurisdiction	Caltrans	Time Period Analyzed	AM Peak Hour
Project Description	CMD1801 - Village D Specific Plan	Unit	United States Customary

Geometric Data

Number of Lanes, ln	3	Terrain Type	Level
Segment Length (L), ft	-	Percent Grade, %	-
Measured or Base Free-Flow Speed	Base	Grade Length, mi	-
Base Free-Flow Speed (BFFS), mi/h	65.0	Total Ramp Density (TRD), ramps/mi	1.83
Lane Width, ft	12	Free-Flow Speed (FFS), mi/h	59.7
Right-Side Lateral Clearance, ft	10		

Adjustment Factors

Driver Population	All Familiar	Final Speed Adjustment Factor (SAF)	1.000
Weather Type	Non-Severe Weather	Final Capacity Adjustment Factor (CAF)	1.000
Incident Type	No Incident	Demand Adjustment Factor (DAF)	1.000

Demand and Capacity

Demand Volume veh/h	4372	Heavy Vehicle Adjustment Factor (fhv)	0.853
Peak Hour Factor	0.94	Flow Rate (Vp), pc/h/ln	1818
Total Trucks, %	17.22	Capacity (c), pc/h/ln	2296
Single-Unit Trucks (SUT), %	-	Adjusted Capacity (cadj), pc/h/ln	2296
Tractor-Trailers (TT), %	-	Volume-to-Capacity Ratio (v/c)	0.79
Passenger Car Equivalent (ET)	2.000		

Speed and Density

Lane Width Adjustment (fLW)	0.0	Average Speed (S), mi/h	58.8
Right-Side Lateral Clearance Adj. (fRLC)	0.0	Density (D), pc/mi/ln	30.9
Total Ramp Density Adjustment	5.4	Level of Service (LOS)	D
Adjusted Free-Flow Speed (FFSadj), mi/h	59.6		

HCS7 Freeway Diverge Report

Project Information

Analyst	LSA	Date	12/11/2019
Agency	LSA	Analysis Year	Phase III Proj Comp Yr (2049) NP
Jurisdiction	Caltrans	Time Period Analyzed	AM Peak Hour
Project Description	CMD1801 - Village D Specific Plan	Unit	United States Customary

Geometric Data

	Freeway	Ramp
Number of Lanes (N), ln	3	1
Free-Flow Speed (FFS), mi/h	65.0	35.0
Segment Length (L) / Deceleration Length (LA),ft	1500	140
Terrain Type	Level	Level
Percent Grade, %	-	-
Segment Type / Ramp Side	Freeway	Right

Adjustment Factors

Driver Population	All Familiar	All Familiar
Weather Type	Non-Severe Weather	Non-Severe Weather
Incident Type	No Incident	-
Final Speed Adjustment Factor (SAF)	1.000	1.000
Final Capacity Adjustment Factor (CAF)	1.000	1.000
Demand Adjustment Factor (DAF)	1.000	1.000

Demand and Capacity

Demand Volume (Vi)	4372	832
Peak Hour Factor (PHF)	0.94	0.94
Total Trucks, %	17.22	9.70
Single-Unit Trucks (SUT), %	-	-
Tractor-Trailers (TT), %	-	-
Heavy Vehicle Adjustment Factor (fHV)	0.853	0.912
Flow Rate (vi),pc/h	5453	971
Capacity (c), pc/h	7050	2000
Volume-to-Capacity Ratio (v/c)	0.77	0.49

Speed and Density

Upstream Equilibrium Distance (LEQ), ft	-	Number of Outer Lanes on Freeway (NO)	1
Distance to Upstream Ramp (LUP), ft	-	Speed Index (DS)	0.515
Downstream Equilibrium Distance (LEQ), ft	-	Flow Outer Lanes (vOA), pc/h/ln	1887
Distance to Downstream Ramp (LDOWN), ft	-	Off-Ramp Influence Area Speed (SR), mi/h	53.2
Prop. Freeway Vehicles in Lane 1 and 2 (PFD)	0.579	Outer Lanes Freeway Speed (SO), mi/h	67.8
Flow in Lanes 1 and 2 (v12), pc/h	3566	Ramp Junction Speed (S), mi/h	57.5
Flow Entering Ramp-Infl. Area (vR12), pc/h	-	Average Density (D), pc/mi/ln	31.6
Level of Service (LOS)	D	Density in Ramp Influence Area (DR), pc/mi/ln	33.7

HCS7 Basic Freeway Report

Project Information

Analyst	LSA	Date	12/11/2019
Agency	LSA	Analysis Year	Phase III Proj Comp Yr (2049) NP
Jurisdiction	Caltrans	Time Period Analyzed	AM Peak Hour
Project Description	CMD1801 - Village D Specific Plan	Unit	United States Customary

Geometric Data

Number of Lanes, ln	3	Terrain Type	Level
Segment Length (L), ft	-	Percent Grade, %	-
Measured or Base Free-Flow Speed	Base	Grade Length, mi	-
Base Free-Flow Speed (BFFS), mi/h	65.0	Total Ramp Density (TRD), ramps/mi	2.17
Lane Width, ft	12	Free-Flow Speed (FFS), mi/h	58.8
Right-Side Lateral Clearance, ft	10		

Adjustment Factors

Driver Population	All Familiar	Final Speed Adjustment Factor (SAF)	1.000
Weather Type	Non-Severe Weather	Final Capacity Adjustment Factor (CAF)	1.000
Incident Type	No Incident	Demand Adjustment Factor (DAF)	1.000

Demand and Capacity

Demand Volume veh/h	3540	Heavy Vehicle Adjustment Factor (fhv)	0.840
Peak Hour Factor	0.94	Flow Rate (Vp), pc/h/ln	1494
Total Trucks, %	18.98	Capacity (c), pc/h/ln	2288
Single-Unit Trucks (SUT), %	-	Adjusted Capacity (cadj), pc/h/ln	2288
Tractor-Trailers (TT), %	-	Volume-to-Capacity Ratio (v/c)	0.65
Passenger Car Equivalent (ET)	2.000		

Speed and Density

Lane Width Adjustment (fLW)	0.0	Average Speed (S), mi/h	58.8
Right-Side Lateral Clearance Adj. (fRLC)	0.0	Density (D), pc/mi/ln	25.4
Total Ramp Density Adjustment	6.2	Level of Service (LOS)	C
Adjusted Free-Flow Speed (FFSadj), mi/h	58.8		

HCS7 Freeway Merge Report

Project Information

Analyst	LSA	Date	12/11/2019
Agency	LSA	Analysis Year	Phase III Proj Comp Yr (2049) NP
Jurisdiction	Caltrans	Time Period Analyzed	AM Peak Hour
Project Description	CMD1801 - Village D Specific Plan	Unit	United States Customary

Geometric Data

	Freeway	Ramp
Number of Lanes (N), ln	3	1
Free-Flow Speed (FFS), mi/h	65.0	35.0
Segment Length (L) / Acceleration Length (LA),ft	1500	450
Terrain Type	Level	Level
Percent Grade, %	-	-
Segment Type / Ramp Side	Freeway	Right

Adjustment Factors

Driver Population	All Familiar	All Familiar
Weather Type	Non-Severe Weather	Non-Severe Weather
Incident Type	No Incident	-
Final Speed Adjustment Factor (SAF)	1.000	1.000
Final Capacity Adjustment Factor (CAF)	1.000	1.000
Demand Adjustment Factor (DAF)	1.000	1.000

Demand and Capacity

Demand Volume (Vi)	3540	334
Peak Hour Factor (PHF)	0.94	0.94
Total Trucks, %	18.98	2.57
Single-Unit Trucks (SUT), %	-	-
Tractor-Trailers (TT), %	-	-
Heavy Vehicle Adjustment Factor (fHV)	0.840	0.975
Flow Rate (vi),pc/h	4483	364
Capacity (c), pc/h	7050	2000
Volume-to-Capacity Ratio (v/c)	0.69	0.18

Speed and Density

Upstream Equilibrium Distance (LEQ), ft	-	Number of Outer Lanes on Freeway (NO)	1
Distance to Upstream Ramp (LUP), ft	-	Speed Index (MS)	0.369
Downstream Equilibrium Distance (LEQ), ft	-	Flow Outer Lanes (vOA), pc/h/ln	1838
Distance to Downstream Ramp (LDOWN), ft	-	On-Ramp Influence Area Speed (SR), mi/h	56.5
Prop. Freeway Vehicles in Lane 1 and 2 (PFM)	0.590	Outer Lanes Freeway Speed (SO), mi/h	60.2
Flow in Lanes 1 and 2 (v12), pc/h	2645	Ramp Junction Speed (S), mi/h	57.8
Flow Entering Ramp-Infl. Area (vR12), pc/h	3009	Average Density (D), pc/mi/ln	28.0
Level of Service (LOS)	C	Density in Ramp Influence Area (DR), pc/mi/ln	26.0

HCS7 Basic Freeway Report

Project Information

Analyst	LSA	Date	12/11/2019
Agency	LSA	Analysis Year	Phase III Proj Comp Yr (2049) NP
Jurisdiction	Caltrans	Time Period Analyzed	AM Peak Hour
Project Description	CMD1801 - Village D Specific Plan	Unit	United States Customary

Geometric Data

Number of Lanes, ln	3	Terrain Type	Level
Segment Length (L), ft	-	Percent Grade, %	-
Measured or Base Free-Flow Speed	Base	Grade Length, mi	-
Base Free-Flow Speed (BFFS), mi/h	65.0	Total Ramp Density (TRD), ramps/mi	2.17
Lane Width, ft	12	Free-Flow Speed (FFS), mi/h	58.8
Right-Side Lateral Clearance, ft	10		

Adjustment Factors

Driver Population	All Familiar	Final Speed Adjustment Factor (SAF)	1.000
Weather Type	Non-Severe Weather	Final Capacity Adjustment Factor (CAF)	1.000
Incident Type	No Incident	Demand Adjustment Factor (DAF)	1.000

Demand and Capacity

Demand Volume veh/h	3874	Heavy Vehicle Adjustment Factor (fhv)	0.851
Peak Hour Factor	0.94	Flow Rate (Vp), pc/h/ln	1614
Total Trucks, %	17.57	Capacity (c), pc/h/ln	2288
Single-Unit Trucks (SUT), %	-	Adjusted Capacity (cadj), pc/h/ln	2288
Tractor-Trailers (TT), %	-	Volume-to-Capacity Ratio (v/c)	0.71
Passenger Car Equivalent (ET)	2.000		

Speed and Density

Lane Width Adjustment (fLW)	0.0	Average Speed (S), mi/h	58.8
Right-Side Lateral Clearance Adj. (fRLC)	0.0	Density (D), pc/mi/ln	27.4
Total Ramp Density Adjustment	6.2	Level of Service (LOS)	D
Adjusted Free-Flow Speed (FFSadj), mi/h	58.8		

HCS7 Basic Freeway Report

Project Information

Analyst	LSA	Date	12/11/2019
Agency	LSA	Analysis Year	Phase III Proj Comp Yr (2049) NP
Jurisdiction	Caltrans	Time Period Analyzed	PM Peak Hour
Project Description	CMD1801 - Village D Specific Plan	Unit	United States Customary

Geometric Data

Number of Lanes, ln	3	Terrain Type	Level
Segment Length (L), ft	-	Percent Grade, %	-
Measured or Base Free-Flow Speed	Base	Grade Length, mi	-
Base Free-Flow Speed (BFFS), mi/h	65.0	Total Ramp Density (TRD), ramps/mi	1.83
Lane Width, ft	12	Free-Flow Speed (FFS), mi/h	59.7
Right-Side Lateral Clearance, ft	10		

Adjustment Factors

Driver Population	All Familiar	Final Speed Adjustment Factor (SAF)	1.000
Weather Type	Non-Severe Weather	Final Capacity Adjustment Factor (CAF)	1.000
Incident Type	No Incident	Demand Adjustment Factor (DAF)	1.000

Demand and Capacity

Demand Volume veh/h	3682	Heavy Vehicle Adjustment Factor (fhv)	0.851
Peak Hour Factor	0.94	Flow Rate (Vp), pc/h/ln	1534
Total Trucks, %	17.57	Capacity (c), pc/h/ln	2296
Single-Unit Trucks (SUT), %	-	Adjusted Capacity (cadj), pc/h/ln	2296
Tractor-Trailers (TT), %	-	Volume-to-Capacity Ratio (v/c)	0.67
Passenger Car Equivalent (ET)	2.000		

Speed and Density

Lane Width Adjustment (fLW)	0.0	Average Speed (S), mi/h	59.6
Right-Side Lateral Clearance Adj. (fRLC)	0.0	Density (D), pc/mi/ln	25.7
Total Ramp Density Adjustment	5.4	Level of Service (LOS)	C
Adjusted Free-Flow Speed (FFSadj), mi/h	59.6		

HCS7 Basic Freeway Report

Project Information

Analyst	LSA	Date	12/11/2019
Agency	LSA	Analysis Year	Phase III Proj Comp Yr (2049) NP
Jurisdiction	Caltrans	Time Period Analyzed	PM Peak Hour
Project Description	CMD1801 - Village D Specific Plan	Unit	United States Customary

Geometric Data

Number of Lanes, ln	3	Terrain Type	Level
Segment Length (L), ft	-	Percent Grade, %	-
Measured or Base Free-Flow Speed	Base	Grade Length, mi	-
Base Free-Flow Speed (BFFS), mi/h	65.0	Total Ramp Density (TRD), ramps/mi	1.83
Lane Width, ft	12	Free-Flow Speed (FFS), mi/h	59.7
Right-Side Lateral Clearance, ft	10		

Adjustment Factors

Driver Population	All Familiar	Final Speed Adjustment Factor (SAF)	1.000
Weather Type	Non-Severe Weather	Final Capacity Adjustment Factor (CAF)	1.000
Incident Type	No Incident	Demand Adjustment Factor (DAF)	1.000

Demand and Capacity

Demand Volume veh/h	3438	Heavy Vehicle Adjustment Factor (fhv)	0.842
Peak Hour Factor	0.94	Flow Rate (Vp), pc/h/ln	1448
Total Trucks, %	18.76	Capacity (c), pc/h/ln	2296
Single-Unit Trucks (SUT), %	-	Adjusted Capacity (cadj), pc/h/ln	2296
Tractor-Trailers (TT), %	-	Volume-to-Capacity Ratio (v/c)	0.63
Passenger Car Equivalent (ET)	2.000		

Speed and Density

Lane Width Adjustment (fLW)	0.0	Average Speed (S), mi/h	59.6
Right-Side Lateral Clearance Adj. (fRLC)	0.0	Density (D), pc/mi/ln	24.3
Total Ramp Density Adjustment	5.4	Level of Service (LOS)	C
Adjusted Free-Flow Speed (FFSadj), mi/h	59.6		

HCS7 Basic Freeway Report

Project Information

Analyst	LSA	Date	12/11/2019
Agency	LSA	Analysis Year	Phase III Proj Comp Yr (2049) NP
Jurisdiction	Caltrans	Time Period Analyzed	PM Peak Hour
Project Description	CMD1801 - Village D Specific Plan	Unit	United States Customary

Geometric Data

Number of Lanes, ln	3	Terrain Type	Level
Segment Length (L), ft	-	Percent Grade, %	-
Measured or Base Free-Flow Speed	Base	Grade Length, mi	-
Base Free-Flow Speed (BFFS), mi/h	65.0	Total Ramp Density (TRD), ramps/mi	1.83
Lane Width, ft	12	Free-Flow Speed (FFS), mi/h	59.7
Right-Side Lateral Clearance, ft	10		

Adjustment Factors

Driver Population	All Familiar	Final Speed Adjustment Factor (SAF)	1.000
Weather Type	Non-Severe Weather	Final Capacity Adjustment Factor (CAF)	1.000
Incident Type	No Incident	Demand Adjustment Factor (DAF)	1.000

Demand and Capacity

Demand Volume veh/h	3438	Heavy Vehicle Adjustment Factor (fhv)	0.842
Peak Hour Factor	0.94	Flow Rate (Vp), pc/h/ln	1448
Total Trucks, %	18.76	Capacity (c), pc/h/ln	2296
Single-Unit Trucks (SUT), %	-	Adjusted Capacity (cadj), pc/h/ln	2296
Tractor-Trailers (TT), %	-	Volume-to-Capacity Ratio (v/c)	0.63
Passenger Car Equivalent (ET)	2.000		

Speed and Density

Lane Width Adjustment (fLW)	0.0	Average Speed (S), mi/h	59.6
Right-Side Lateral Clearance Adj. (fRLC)	0.0	Density (D), pc/mi/ln	24.3
Total Ramp Density Adjustment	5.4	Level of Service (LOS)	C
Adjusted Free-Flow Speed (FFSadj), mi/h	59.6		

HCS7 Freeway Merge Report

Project Information

Analyst	LSA	Date	12/11/2019
Agency	LSA	Analysis Year	Phase III Proj Comp Yr (2049) WP
Jurisdiction	Caltrans	Time Period Analyzed	AM Peak Hour
Project Description	CMD1801 - Village D Specific Plan	Unit	United States Customary

Geometric Data

	Freeway	Ramp
Number of Lanes (N), ln	3	1
Free-Flow Speed (FFS), mi/h	65.0	35.0
Segment Length (L) / Acceleration Length (LA),ft	1500	445
Terrain Type	Level	Level
Percent Grade, %	-	-
Segment Type / Ramp Side	Freeway	Right

Adjustment Factors

Driver Population	All Familiar	All Familiar
Weather Type	Non-Severe Weather	Non-Severe Weather
Incident Type	No Incident	-
Final Speed Adjustment Factor (SAF)	1.000	1.000
Final Capacity Adjustment Factor (CAF)	1.000	1.000
Demand Adjustment Factor (DAF)	1.000	1.000

Demand and Capacity

Demand Volume (Vi)	3468	1013
Peak Hour Factor (PHF)	0.94	0.94
Total Trucks, %	17.68	9.28
Single-Unit Trucks (SUT), %	-	-
Tractor-Trailers (TT), %	-	-
Heavy Vehicle Adjustment Factor (fHV)	0.850	0.915
Flow Rate (vi),pc/h	4340	1178
Capacity (c), pc/h	7050	2000
Volume-to-Capacity Ratio (v/c)	0.78	0.59

Speed and Density

Upstream Equilibrium Distance (LEQ), ft	-	Number of Outer Lanes on Freeway (NO)	1
Distance to Upstream Ramp (LUP), ft	-	Speed Index (MS)	0.454
Downstream Equilibrium Distance (LEQ), ft	-	Flow Outer Lanes (vOA), pc/h/ln	1779
Distance to Downstream Ramp (LDOWN), ft	-	On-Ramp Influence Area Speed (SR), mi/h	54.6
Prop. Freeway Vehicles in Lane 1 and 2 (PFM)	0.590	Outer Lanes Freeway Speed (SO), mi/h	60.4
Flow in Lanes 1 and 2 (v12), pc/h	2561	Ramp Junction Speed (S), mi/h	56.3
Flow Entering Ramp-Infl. Area (vR12), pc/h	3739	Average Density (D), pc/mi/ln	32.7
Level of Service (LOS)	D	Density in Ramp Influence Area (DR), pc/mi/ln	31.4

HCS7 Basic Freeway Report

Project Information

Analyst	LSA	Date	12/11/2019
Agency	LSA	Analysis Year	Phase III Proj Comp Yr (2049) NP
Jurisdiction	Caltrans	Time Period Analyzed	PM Peak Hour
Project Description	CMD1801 - Village D Specific Plan	Unit	United States Customary

Geometric Data

Number of Lanes, ln	3	Terrain Type	Level
Segment Length (L), ft	-	Percent Grade, %	-
Measured or Base Free-Flow Speed	Base	Grade Length, mi	-
Base Free-Flow Speed (BFFS), mi/h	65.0	Total Ramp Density (TRD), ramps/mi	1.50
Lane Width, ft	12	Free-Flow Speed (FFS), mi/h	60.5
Right-Side Lateral Clearance, ft	10		

Adjustment Factors

Driver Population	All Familiar	Final Speed Adjustment Factor (SAF)	1.000
Weather Type	Non-Severe Weather	Final Capacity Adjustment Factor (CAF)	1.000
Incident Type	No Incident	Demand Adjustment Factor (DAF)	1.000

Demand and Capacity

Demand Volume veh/h	4437	Heavy Vehicle Adjustment Factor (fhv)	0.869
Peak Hour Factor	0.94	Flow Rate (Vp), pc/h/ln	1811
Total Trucks, %	15.14	Capacity (c), pc/h/ln	2305
Single-Unit Trucks (SUT), %	-	Adjusted Capacity (cadj), pc/h/ln	2305
Tractor-Trailers (TT), %	-	Volume-to-Capacity Ratio (v/c)	0.79
Passenger Car Equivalent (ET)	2.000		

Speed and Density

Lane Width Adjustment (fLW)	0.0	Average Speed (S), mi/h	59.6
Right-Side Lateral Clearance Adj. (fRLC)	0.0	Density (D), pc/mi/ln	30.4
Total Ramp Density Adjustment	4.5	Level of Service (LOS)	D
Adjusted Free-Flow Speed (FFSadj), mi/h	60.5		

HCS7 Freeway Diverge Report

Project Information

Analyst	LSA	Date	12/11/2019
Agency	LSA	Analysis Year	Phase III Proj Comp Yr (2049) NP
Jurisdiction	Caltrans	Time Period Analyzed	PM Peak Hour
Project Description	CMD1801 - Village D Specific Plan	Unit	United States Customary

Geometric Data

	Freeway	Ramp
Number of Lanes (N), ln	3	1
Free-Flow Speed (FFS), mi/h	65.0	35.0
Segment Length (L) / Deceleration Length (LA),ft	1500	130
Terrain Type	Level	Level
Percent Grade, %	-	-
Segment Type / Ramp Side	Freeway	Right

Adjustment Factors

Driver Population	All Familiar	All Familiar
Weather Type	Non-Severe Weather	Non-Severe Weather
Incident Type	No Incident	-
Final Speed Adjustment Factor (SAF)	1.000	1.000
Final Capacity Adjustment Factor (CAF)	1.000	1.000
Demand Adjustment Factor (DAF)	1.000	1.000

Demand and Capacity

Demand Volume (Vi)	4437	533
Peak Hour Factor (PHF)	0.94	0.94
Total Trucks, %	15.14	1.24
Single-Unit Trucks (SUT), %	-	-
Tractor-Trailers (TT), %	-	-
Heavy Vehicle Adjustment Factor (fHV)	0.869	0.988
Flow Rate (vi),pc/h	5432	574
Capacity (c), pc/h	7050	2000
Volume-to-Capacity Ratio (v/c)	0.77	0.29

Speed and Density

Upstream Equilibrium Distance (LEQ), ft	-	Number of Outer Lanes on Freeway (NO)	1
Distance to Upstream Ramp (LUP), ft	-	Speed Index (DS)	0.480
Downstream Equilibrium Distance (LEQ), ft	-	Flow Outer Lanes (vOA), pc/h/ln	1953
Distance to Downstream Ramp (LDOWN), ft	-	Off-Ramp Influence Area Speed (SR), mi/h	54.0
Prop. Freeway Vehicles in Lane 1 and 2 (PFD)	0.598	Outer Lanes Freeway Speed (SO), mi/h	67.6
Flow in Lanes 1 and 2 (v12), pc/h	3479	Ramp Junction Speed (S), mi/h	58.2
Flow Entering Ramp-Infl. Area (vR12), pc/h	-	Average Density (D), pc/mi/ln	31.1
Level of Service (LOS)	D	Density in Ramp Influence Area (DR), pc/mi/ln	33.0

HCS7 Basic Freeway Report

Project Information

Analyst	LSA	Date	12/11/2019
Agency	LSA	Analysis Year	Phase III Proj Comp Yr (2049) NP
Jurisdiction	Caltrans	Time Period Analyzed	PM Peak Hour
Project Description	CMD1801 - Village D Specific Plan	Unit	United States Customary

Geometric Data

Number of Lanes, ln	3	Terrain Type	Level
Segment Length (L), ft	-	Percent Grade, %	-
Measured or Base Free-Flow Speed	Base	Grade Length, mi	-
Base Free-Flow Speed (BFFS), mi/h	65.0	Total Ramp Density (TRD), ramps/mi	1.67
Lane Width, ft	12	Free-Flow Speed (FFS), mi/h	60.0
Right-Side Lateral Clearance, ft	10		

Adjustment Factors

Driver Population	All Familiar	Final Speed Adjustment Factor (SAF)	1.000
Weather Type	Non-Severe Weather	Final Capacity Adjustment Factor (CAF)	1.000
Incident Type	No Incident	Demand Adjustment Factor (DAF)	1.000

Demand and Capacity

Demand Volume veh/h	3904	Heavy Vehicle Adjustment Factor (fhv)	0.854
Peak Hour Factor	0.94	Flow Rate (Vp), pc/h/ln	1621
Total Trucks, %	17.03	Capacity (c), pc/h/ln	2300
Single-Unit Trucks (SUT), %	-	Adjusted Capacity (cadj), pc/h/ln	2300
Tractor-Trailers (TT), %	-	Volume-to-Capacity Ratio (v/c)	0.70
Passenger Car Equivalent (ET)	2.000		

Speed and Density

Lane Width Adjustment (fLW)	0.0	Average Speed (S), mi/h	60.0
Right-Side Lateral Clearance Adj. (fRLC)	0.0	Density (D), pc/mi/ln	27.0
Total Ramp Density Adjustment	5.0	Level of Service (LOS)	D
Adjusted Free-Flow Speed (FFSadj), mi/h	60.0		

HCS7 Freeway Merge Report

Project Information

Analyst	LSA	Date	12/11/2019
Agency	LSA	Analysis Year	Phase III Proj Comp Yr (2049) NP
Jurisdiction	Caltrans	Time Period Analyzed	PM Peak Hour
Project Description	CMD1801 - Village D Specific Plan	Unit	United States Customary

Geometric Data

	Freeway	Ramp
Number of Lanes (N), ln	3	1
Free-Flow Speed (FFS), mi/h	65.0	35.0
Segment Length (L) / Acceleration Length (LA),ft	1500	500
Terrain Type	Level	Level
Percent Grade, %	-	-
Segment Type / Ramp Side	Freeway	Right

Adjustment Factors

Driver Population	All Familiar	All Familiar
Weather Type	Non-Severe Weather	Non-Severe Weather
Incident Type	No Incident	-
Final Speed Adjustment Factor (SAF)	1.000	1.000
Final Capacity Adjustment Factor (CAF)	1.000	1.000
Demand Adjustment Factor (DAF)	1.000	1.000

Demand and Capacity

Demand Volume (Vi)	3904	459
Peak Hour Factor (PHF)	0.94	0.94
Total Trucks, %	17.03	2.23
Single-Unit Trucks (SUT), %	-	-
Tractor-Trailers (TT), %	-	-
Heavy Vehicle Adjustment Factor (fHV)	0.854	0.978
Flow Rate (vi),pc/h	4863	499
Capacity (c), pc/h	7050	2000
Volume-to-Capacity Ratio (v/c)	0.76	0.25

Speed and Density

Upstream Equilibrium Distance (LEQ), ft	-	Number of Outer Lanes on Freeway (NO)	1
Distance to Upstream Ramp (LUP), ft	-	Speed Index (MS)	0.400
Downstream Equilibrium Distance (LEQ), ft	-	Flow Outer Lanes (vOA), pc/h/ln	1984
Distance to Downstream Ramp (LDOWN), ft	-	On-Ramp Influence Area Speed (SR), mi/h	55.8
Prop. Freeway Vehicles in Lane 1 and 2 (PFM)	0.592	Outer Lanes Freeway Speed (SO), mi/h	59.7
Flow in Lanes 1 and 2 (v12), pc/h	2879	Ramp Junction Speed (S), mi/h	57.2
Flow Entering Ramp-Infl. Area (vR12), pc/h	3378	Average Density (D), pc/mi/ln	31.2
Level of Service (LOS)	D	Density in Ramp Influence Area (DR), pc/mi/ln	28.5

HCS7 Basic Freeway Report

Project Information

Analyst	LSA	Date	12/11/2019
Agency	LSA	Analysis Year	Phase III Proj Comp Yr (2049) NP
Jurisdiction	Caltrans	Time Period Analyzed	PM Peak Hour
Project Description	CMD1801 - Village D Specific Plan	Unit	United States Customary

Geometric Data

Number of Lanes, ln	3	Terrain Type	Level
Segment Length (L), ft	-	Percent Grade, %	-
Measured or Base Free-Flow Speed	Base	Grade Length, mi	-
Base Free-Flow Speed (BFFS), mi/h	65.0	Total Ramp Density (TRD), ramps/mi	1.83
Lane Width, ft	12	Free-Flow Speed (FFS), mi/h	59.7
Right-Side Lateral Clearance, ft	10		

Adjustment Factors

Driver Population	All Familiar	Final Speed Adjustment Factor (SAF)	1.000
Weather Type	Non-Severe Weather	Final Capacity Adjustment Factor (CAF)	1.000
Incident Type	No Incident	Demand Adjustment Factor (DAF)	1.000

Demand and Capacity

Demand Volume veh/h	4363	Heavy Vehicle Adjustment Factor (fhv)	0.866
Peak Hour Factor	0.94	Flow Rate (Vp), pc/h/ln	1787
Total Trucks, %	15.47	Capacity (c), pc/h/ln	2296
Single-Unit Trucks (SUT), %	-	Adjusted Capacity (cadj), pc/h/ln	2296
Tractor-Trailers (TT), %	-	Volume-to-Capacity Ratio (v/c)	0.78
Passenger Car Equivalent (ET)	2.000		

Speed and Density

Lane Width Adjustment (fLW)	0.0	Average Speed (S), mi/h	59.1
Right-Side Lateral Clearance Adj. (fRLC)	0.0	Density (D), pc/mi/ln	30.2
Total Ramp Density Adjustment	5.4	Level of Service (LOS)	D
Adjusted Free-Flow Speed (FFSadj), mi/h	59.6		

HCS7 Freeway Diverge Report

Project Information

Analyst	LSA	Date	12/11/2019
Agency	LSA	Analysis Year	Phase III Proj Comp Yr (2049) NP
Jurisdiction	Caltrans	Time Period Analyzed	PM Peak Hour
Project Description	CMD1801 - Village D Specific Plan	Unit	United States Customary

Geometric Data

	Freeway	Ramp
Number of Lanes (N), ln	3	1
Free-Flow Speed (FFS), mi/h	65.0	35.0
Segment Length (L) / Deceleration Length (LA),ft	1500	245
Terrain Type	Level	Level
Percent Grade, %	-	-
Segment Type / Ramp Side	Freeway	Right

Adjustment Factors

Driver Population	All Familiar	All Familiar
Weather Type	Non-Severe Weather	Non-Severe Weather
Incident Type	No Incident	-
Final Speed Adjustment Factor (SAF)	1.000	1.000
Final Capacity Adjustment Factor (CAF)	1.000	1.000
Demand Adjustment Factor (DAF)	1.000	1.000

Demand and Capacity

Demand Volume (Vi)	4363	1022
Peak Hour Factor (PHF)	0.94	0.94
Total Trucks, %	15.47	1.02
Single-Unit Trucks (SUT), %	-	-
Tractor-Trailers (TT), %	-	-
Heavy Vehicle Adjustment Factor (fHV)	0.866	0.990
Flow Rate (vi),pc/h	5360	1098
Capacity (c), pc/h	7050	2000
Volume-to-Capacity Ratio (v/c)	0.76	0.55

Speed and Density

Upstream Equilibrium Distance (LEQ), ft	-	Number of Outer Lanes on Freeway (NO)	1
Distance to Upstream Ramp (LUP), ft	-	Speed Index (DS)	0.527
Downstream Equilibrium Distance (LEQ), ft	-	Flow Outer Lanes (vOA), pc/h/ln	1811
Distance to Downstream Ramp (LDOWN), ft	-	Off-Ramp Influence Area Speed (SR), mi/h	52.9
Prop. Freeway Vehicles in Lane 1 and 2 (PFD)	0.575	Outer Lanes Freeway Speed (SO), mi/h	68.1
Flow in Lanes 1 and 2 (v12), pc/h	3549	Ramp Junction Speed (S), mi/h	57.2
Flow Entering Ramp-Infl. Area (vR12), pc/h	-	Average Density (D), pc/mi/ln	31.2
Level of Service (LOS)	D	Density in Ramp Influence Area (DR), pc/mi/ln	32.6

HCS7 Basic Freeway Report

Project Information

Analyst	LSA	Date	12/11/2019
Agency	LSA	Analysis Year	Phase III Proj Comp Yr (2049) NP
Jurisdiction	Caltrans	Time Period Analyzed	PM Peak Hour
Project Description	CMD1801 - Village D Specific Plan	Unit	United States Customary

Geometric Data

Number of Lanes, ln	3	Terrain Type	Level
Segment Length (L), ft	-	Percent Grade, %	-
Measured or Base Free-Flow Speed	Base	Grade Length, mi	-
Base Free-Flow Speed (BFFS), mi/h	65.0	Total Ramp Density (TRD), ramps/mi	1.83
Lane Width, ft	12	Free-Flow Speed (FFS), mi/h	59.7
Right-Side Lateral Clearance, ft	10		

Adjustment Factors

Driver Population	All Familiar	Final Speed Adjustment Factor (SAF)	1.000
Weather Type	Non-Severe Weather	Final Capacity Adjustment Factor (CAF)	1.000
Incident Type	No Incident	Demand Adjustment Factor (DAF)	1.000

Demand and Capacity

Demand Volume veh/h	3341	Heavy Vehicle Adjustment Factor (fhv)	0.834
Peak Hour Factor	0.94	Flow Rate (Vp), pc/h/ln	1421
Total Trucks, %	19.90	Capacity (c), pc/h/ln	2296
Single-Unit Trucks (SUT), %	-	Adjusted Capacity (cadj), pc/h/ln	2296
Tractor-Trailers (TT), %	-	Volume-to-Capacity Ratio (v/c)	0.62
Passenger Car Equivalent (ET)	2.000		

Speed and Density

Lane Width Adjustment (fLW)	0.0	Average Speed (S), mi/h	59.6
Right-Side Lateral Clearance Adj. (fRLC)	0.0	Density (D), pc/mi/ln	23.8
Total Ramp Density Adjustment	5.4	Level of Service (LOS)	C
Adjusted Free-Flow Speed (FFSadj), mi/h	59.6		

HCS7 Freeway Merge Report

Project Information

Analyst	LSA	Date	12/11/2019
Agency	LSA	Analysis Year	Phase III Proj Comp Yr (2049) NP
Jurisdiction	Caltrans	Time Period Analyzed	PM Peak Hour
Project Description	CMD1801 - Village D Specific Plan	Unit	United States Customary

Geometric Data

	Freeway	Ramp
Number of Lanes (N), ln	3	1
Free-Flow Speed (FFS), mi/h	65.0	35.0
Segment Length (L) / Acceleration Length (LA),ft	1500	350
Terrain Type	Level	Level
Percent Grade, %	-	-
Segment Type / Ramp Side	Freeway	Right

Adjustment Factors

Driver Population	All Familiar	All Familiar
Weather Type	Non-Severe Weather	Non-Severe Weather
Incident Type	No Incident	-
Final Speed Adjustment Factor (SAF)	1.000	1.000
Final Capacity Adjustment Factor (CAF)	1.000	1.000
Demand Adjustment Factor (DAF)	1.000	1.000

Demand and Capacity

Demand Volume (Vi)	3341	153
Peak Hour Factor (PHF)	0.94	0.94
Total Trucks, %	19.90	5.67
Single-Unit Trucks (SUT), %	-	-
Tractor-Trailers (TT), %	-	-
Heavy Vehicle Adjustment Factor (fHV)	0.834	0.946
Flow Rate (vi),pc/h	4262	172
Capacity (c), pc/h	7050	2000
Volume-to-Capacity Ratio (v/c)	0.63	0.09

Speed and Density

Upstream Equilibrium Distance (LEQ), ft	-	Number of Outer Lanes on Freeway (NO)	1
Distance to Upstream Ramp (LUP), ft	-	Speed Index (MS)	0.353
Downstream Equilibrium Distance (LEQ), ft	-	Flow Outer Lanes (vOA), pc/h/ln	1760
Distance to Downstream Ramp (LDOWN), ft	-	On-Ramp Influence Area Speed (SR), mi/h	56.9
Prop. Freeway Vehicles in Lane 1 and 2 (PFM)	0.587	Outer Lanes Freeway Speed (SO), mi/h	60.5
Flow in Lanes 1 and 2 (v12), pc/h	2502	Ramp Junction Speed (S), mi/h	58.3
Flow Entering Ramp-Infl. Area (vR12), pc/h	2674	Average Density (D), pc/mi/ln	25.4
Level of Service (LOS)	C	Density in Ramp Influence Area (DR), pc/mi/ln	24.1

HCS7 Basic Freeway Report

Project Information

Analyst	LSA	Date	12/11/2019
Agency	LSA	Analysis Year	Phase III Proj Comp Yr (2049) NP
Jurisdiction	Caltrans	Time Period Analyzed	PM Peak Hour
Project Description	CMD1801 - Village D Specific Plan	Unit	United States Customary

Geometric Data

Number of Lanes, ln	3	Terrain Type	Level
Segment Length (L), ft	-	Percent Grade, %	-
Measured or Base Free-Flow Speed	Base	Grade Length, mi	-
Base Free-Flow Speed (BFFS), mi/h	65.0	Total Ramp Density (TRD), ramps/mi	1.83
Lane Width, ft	12	Free-Flow Speed (FFS), mi/h	59.7
Right-Side Lateral Clearance, ft	10		

Adjustment Factors

Driver Population	All Familiar	Final Speed Adjustment Factor (SAF)	1.000
Weather Type	Non-Severe Weather	Final Capacity Adjustment Factor (CAF)	1.000
Incident Type	No Incident	Demand Adjustment Factor (DAF)	1.000

Demand and Capacity

Demand Volume veh/h	3495	Heavy Vehicle Adjustment Factor (fhv)	0.838
Peak Hour Factor	0.94	Flow Rate (Vp), pc/h/ln	1479
Total Trucks, %	19.29	Capacity (c), pc/h/ln	2296
Single-Unit Trucks (SUT), %	-	Adjusted Capacity (cadj), pc/h/ln	2296
Tractor-Trailers (TT), %	-	Volume-to-Capacity Ratio (v/c)	0.64
Passenger Car Equivalent (ET)	2.000		

Speed and Density

Lane Width Adjustment (fLW)	0.0	Average Speed (S), mi/h	59.6
Right-Side Lateral Clearance Adj. (fRLC)	0.0	Density (D), pc/mi/ln	24.8
Total Ramp Density Adjustment	5.4	Level of Service (LOS)	C
Adjusted Free-Flow Speed (FFSadj), mi/h	59.6		

HCS7 Freeway Diverge Report

Project Information

Analyst	LSA	Date	12/11/2019
Agency	LSA	Analysis Year	Phase III Proj Comp Yr (2049) NP
Jurisdiction	Caltrans	Time Period Analyzed	PM Peak Hour
Project Description	CMD1801 - Village D Specific Plan	Unit	United States Customary

Geometric Data

	Freeway	Ramp
Number of Lanes (N), ln	3	1
Free-Flow Speed (FFS), mi/h	65.0	15.0
Segment Length (L) / Deceleration Length (LA),ft	1500	150
Terrain Type	Level	Level
Percent Grade, %	-	-
Segment Type / Ramp Side	Freeway	Right

Adjustment Factors

Driver Population	All Familiar	All Familiar
Weather Type	Non-Severe Weather	Non-Severe Weather
Incident Type	No Incident	-
Final Speed Adjustment Factor (SAF)	1.000	1.000
Final Capacity Adjustment Factor (CAF)	1.000	1.000
Demand Adjustment Factor (DAF)	1.000	1.000

Demand and Capacity

Demand Volume (Vi)	3495	188
Peak Hour Factor (PHF)	0.94	0.94
Total Trucks, %	19.29	3.62
Single-Unit Trucks (SUT), %	-	-
Tractor-Trailers (TT), %	-	-
Heavy Vehicle Adjustment Factor (fHV)	0.838	0.965
Flow Rate (vi),pc/h	4437	207
Capacity (c), pc/h	7050	1800
Volume-to-Capacity Ratio (v/c)	0.63	0.12

Speed and Density

Upstream Equilibrium Distance (LEQ), ft	-	Number of Outer Lanes on Freeway (NO)	1
Distance to Upstream Ramp (LUP), ft	-	Speed Index (DS)	0.707
Downstream Equilibrium Distance (LEQ), ft	-	Flow Outer Lanes (vOA), pc/h/ln	1523
Distance to Downstream Ramp (LDOWN), ft	-	Off-Ramp Influence Area Speed (SR), mi/h	48.7
Prop. Freeway Vehicles in Lane 1 and 2 (PFD)	0.640	Outer Lanes Freeway Speed (SO), mi/h	69.3
Flow in Lanes 1 and 2 (v12), pc/h	2914	Ramp Junction Speed (S), mi/h	54.2
Flow Entering Ramp-Infl. Area (vR12), pc/h	-	Average Density (D), pc/mi/ln	27.3
Level of Service (LOS)	C	Density in Ramp Influence Area (DR), pc/mi/ln	28.0

HCS7 Basic Freeway Report

Project Information

Analyst	LSA	Date	12/11/2019
Agency	LSA	Analysis Year	Phase III Proj Comp Yr (2049) NP
Jurisdiction	Caltrans	Time Period Analyzed	PM Peak Hour
Project Description	CMD1801 - Village D Specific Plan	Unit	United States Customary

Geometric Data

Number of Lanes, ln	3	Terrain Type	Level
Segment Length (L), ft	-	Percent Grade, %	-
Measured or Base Free-Flow Speed	Base	Grade Length, mi	-
Base Free-Flow Speed (BFFS), mi/h	65.0	Total Ramp Density (TRD), ramps/mi	1.67
Lane Width, ft	12	Free-Flow Speed (FFS), mi/h	60.0
Right-Side Lateral Clearance, ft	10		

Adjustment Factors

Driver Population	All Familiar	Final Speed Adjustment Factor (SAF)	1.000
Weather Type	Non-Severe Weather	Final Capacity Adjustment Factor (CAF)	1.000
Incident Type	No Incident	Demand Adjustment Factor (DAF)	1.000

Demand and Capacity

Demand Volume veh/h	3307	Heavy Vehicle Adjustment Factor (fhv)	0.832
Peak Hour Factor	0.94	Flow Rate (Vp), pc/h/ln	1409
Total Trucks, %	20.17	Capacity (c), pc/h/ln	2300
Single-Unit Trucks (SUT), %	-	Adjusted Capacity (cadj), pc/h/ln	2300
Tractor-Trailers (TT), %	-	Volume-to-Capacity Ratio (v/c)	0.61
Passenger Car Equivalent (ET)	2.000		

Speed and Density

Lane Width Adjustment (fLW)	0.0	Average Speed (S), mi/h	60.0
Right-Side Lateral Clearance Adj. (fRLC)	0.0	Density (D), pc/mi/ln	23.5
Total Ramp Density Adjustment	5.0	Level of Service (LOS)	C
Adjusted Free-Flow Speed (FFSadj), mi/h	60.0		

HCS7 Freeway Merge Report

Project Information

Analyst	LSA	Date	12/11/2019
Agency	LSA	Analysis Year	Phase III Proj Comp Yr (2049) NP
Jurisdiction	Caltrans	Time Period Analyzed	PM Peak Hour
Project Description	CMD1801 - Village D Specific Plan	Unit	United States Customary

Geometric Data

	Freeway	Ramp
Number of Lanes (N), ln	3	1
Free-Flow Speed (FFS), mi/h	65.0	35.0
Segment Length (L) / Acceleration Length (LA),ft	1500	525
Terrain Type	Level	Level
Percent Grade, %	-	-
Segment Type / Ramp Side	Freeway	Right

Adjustment Factors

Driver Population	All Familiar	All Familiar
Weather Type	Non-Severe Weather	Non-Severe Weather
Incident Type	No Incident	-
Final Speed Adjustment Factor (SAF)	1.000	1.000
Final Capacity Adjustment Factor (CAF)	1.000	1.000
Demand Adjustment Factor (DAF)	1.000	1.000

Demand and Capacity

Demand Volume (Vi)	3307	243
Peak Hour Factor (PHF)	0.94	0.94
Total Trucks, %	20.17	4.33
Single-Unit Trucks (SUT), %	-	-
Tractor-Trailers (TT), %	-	-
Heavy Vehicle Adjustment Factor (fHV)	0.832	0.958
Flow Rate (vi),pc/h	4228	270
Capacity (c), pc/h	7050	2000
Volume-to-Capacity Ratio (v/c)	0.64	0.14

Speed and Density

Upstream Equilibrium Distance (LEQ), ft	-	Number of Outer Lanes on Freeway (NO)	1
Distance to Upstream Ramp (LUP), ft	-	Speed Index (MS)	0.347
Downstream Equilibrium Distance (LEQ), ft	-	Flow Outer Lanes (vOA), pc/h/ln	1725
Distance to Downstream Ramp (LDOWN), ft	-	On-Ramp Influence Area Speed (SR), mi/h	57.0
Prop. Freeway Vehicles in Lane 1 and 2 (PFM)	0.592	Outer Lanes Freeway Speed (SO), mi/h	60.6
Flow in Lanes 1 and 2 (v12), pc/h	2503	Ramp Junction Speed (S), mi/h	58.3
Flow Entering Ramp-Infl. Area (vR12), pc/h	2773	Average Density (D), pc/mi/ln	25.7
Level of Service (LOS)	C	Density in Ramp Influence Area (DR), pc/mi/ln	23.8

HCS7 Basic Freeway Report

Project Information

Analyst	LSA	Date	12/11/2019
Agency	LSA	Analysis Year	Phase III Proj Comp Yr (2049) NP
Jurisdiction	Caltrans	Time Period Analyzed	PM Peak Hour
Project Description	CMD1801 - Village D Specific Plan	Unit	United States Customary

Geometric Data

Number of Lanes, ln	3	Terrain Type	Level
Segment Length (L), ft	-	Percent Grade, %	-
Measured or Base Free-Flow Speed	Base	Grade Length, mi	-
Base Free-Flow Speed (BFFS), mi/h	65.0	Total Ramp Density (TRD), ramps/mi	1.67
Lane Width, ft	12	Free-Flow Speed (FFS), mi/h	60.0
Right-Side Lateral Clearance, ft	10		

Adjustment Factors

Driver Population	All Familiar	Final Speed Adjustment Factor (SAF)	1.000
Weather Type	Non-Severe Weather	Final Capacity Adjustment Factor (CAF)	1.000
Incident Type	No Incident	Demand Adjustment Factor (DAF)	1.000

Demand and Capacity

Demand Volume veh/h	3549	Heavy Vehicle Adjustment Factor (fhv)	0.840
Peak Hour Factor	0.94	Flow Rate (Vp), pc/h/ln	1498
Total Trucks, %	19.10	Capacity (c), pc/h/ln	2300
Single-Unit Trucks (SUT), %	-	Adjusted Capacity (cadj), pc/h/ln	2300
Tractor-Trailers (TT), %	-	Volume-to-Capacity Ratio (v/c)	0.65
Passenger Car Equivalent (ET)	2.000		

Speed and Density

Lane Width Adjustment (fLW)	0.0	Average Speed (S), mi/h	60.0
Right-Side Lateral Clearance Adj. (fRLC)	0.0	Density (D), pc/mi/ln	25.0
Total Ramp Density Adjustment	5.0	Level of Service (LOS)	C
Adjusted Free-Flow Speed (FFSadj), mi/h	60.0		

HCS7 Freeway Diverge Report

Project Information

Analyst	LSA	Date	12/11/2019
Agency	LSA	Analysis Year	Phase III Proj Comp Yr (2049) NP
Jurisdiction	Caltrans	Time Period Analyzed	PM Peak Hour
Project Description	CMD1801 - Village D Specific Plan	Unit	United States Customary

Geometric Data

	Freeway	Ramp
Number of Lanes (N), ln	3	1
Free-Flow Speed (FFS), mi/h	65.0	35.0
Segment Length (L) / Deceleration Length (LA),ft	1500	200
Terrain Type	Level	Level
Percent Grade, %	-	-
Segment Type / Ramp Side	Freeway	Right

Adjustment Factors

Driver Population	All Familiar	All Familiar
Weather Type	Non-Severe Weather	Non-Severe Weather
Incident Type	No Incident	-
Final Speed Adjustment Factor (SAF)	1.000	1.000
Final Capacity Adjustment Factor (CAF)	1.000	1.000
Demand Adjustment Factor (DAF)	1.000	1.000

Demand and Capacity

Demand Volume (Vi)	3459	744
Peak Hour Factor (PHF)	0.94	0.94
Total Trucks, %	19.10	10.45
Single-Unit Trucks (SUT), %	-	-
Tractor-Trailers (TT), %	-	-
Heavy Vehicle Adjustment Factor (fHV)	0.840	0.905
Flow Rate (vi),pc/h	4381	875
Capacity (c), pc/h	7050	2000
Volume-to-Capacity Ratio (v/c)	0.62	0.44

Speed and Density

Upstream Equilibrium Distance (LEQ), ft	-	Number of Outer Lanes on Freeway (NO)	1
Distance to Upstream Ramp (LUP), ft	-	Speed Index (DS)	0.507
Downstream Equilibrium Distance (LEQ), ft	-	Flow Outer Lanes (vOA), pc/h/ln	1367
Distance to Downstream Ramp (LDOWN), ft	-	Off-Ramp Influence Area Speed (SR), mi/h	53.3
Prop. Freeway Vehicles in Lane 1 and 2 (PFD)	0.610	Outer Lanes Freeway Speed (SO), mi/h	69.9
Flow in Lanes 1 and 2 (v12), pc/h	3014	Ramp Junction Speed (S), mi/h	57.6
Flow Entering Ramp-Infl. Area (vR12), pc/h	-	Average Density (D), pc/mi/ln	25.4
Level of Service (LOS)	D	Density in Ramp Influence Area (DR), pc/mi/ln	28.4

HCS7 Basic Freeway Report

Project Information

Analyst	LSA	Date	12/11/2019
Agency	LSA	Analysis Year	Phase III Proj Comp Yr (2049) NP
Jurisdiction	Caltrans	Time Period Analyzed	PM Peak Hour
Project Description	CMD1801 - Village D Specific Plan	Unit	United States Customary

Geometric Data

Number of Lanes, ln	3	Terrain Type	Level
Segment Length (L), ft	-	Percent Grade, %	-
Measured or Base Free-Flow Speed	Base	Grade Length, mi	-
Base Free-Flow Speed (BFFS), mi/h	70.0	Total Ramp Density (TRD), ramps/mi	1.50
Lane Width, ft	12	Free-Flow Speed (FFS), mi/h	65.5
Right-Side Lateral Clearance, ft	10		

Adjustment Factors

Driver Population	All Familiar	Final Speed Adjustment Factor (SAF)	1.000
Weather Type	Non-Severe Weather	Final Capacity Adjustment Factor (CAF)	1.000
Incident Type	No Incident	Demand Adjustment Factor (DAF)	1.000

Demand and Capacity

Demand Volume veh/h	2805	Heavy Vehicle Adjustment Factor (fhv)	0.824
Peak Hour Factor	0.94	Flow Rate (Vp), pc/h/ln	1207
Total Trucks, %	21.39	Capacity (c), pc/h/ln	2355
Single-Unit Trucks (SUT), %	-	Adjusted Capacity (cadj), pc/h/ln	2355
Tractor-Trailers (TT), %	-	Volume-to-Capacity Ratio (v/c)	0.51
Passenger Car Equivalent (ET)	2.000		

Speed and Density

Lane Width Adjustment (fLW)	0.0	Average Speed (S), mi/h	65.5
Right-Side Lateral Clearance Adj. (fRLC)	0.0	Density (D), pc/mi/ln	18.4
Total Ramp Density Adjustment	4.5	Level of Service (LOS)	C
Adjusted Free-Flow Speed (FFSadj), mi/h	65.5		

HCS7 Freeway Merge Report

Project Information

Analyst	LSA	Date	12/11/2019
Agency	LSA	Analysis Year	Phase III Proj Comp Yr (2049) NP
Jurisdiction	Caltrans	Time Period Analyzed	PM Peak Hour
Project Description	CMD1801 - Village D Specific Plan	Unit	United States Customary

Geometric Data

	Freeway	Ramp
Number of Lanes (N), ln	3	1
Free-Flow Speed (FFS), mi/h	70.0	35.0
Segment Length (L) / Acceleration Length (LA),ft	1500	400
Terrain Type	Level	Level
Percent Grade, %	-	-
Segment Type / Ramp Side	Freeway	Right

Adjustment Factors

Driver Population	All Familiar	All Familiar
Weather Type	Non-Severe Weather	Non-Severe Weather
Incident Type	No Incident	-
Final Speed Adjustment Factor (SAF)	1.000	1.000
Final Capacity Adjustment Factor (CAF)	1.000	1.000
Demand Adjustment Factor (DAF)	1.000	1.000

Demand and Capacity

Demand Volume (Vi)	2805	535
Peak Hour Factor (PHF)	0.94	0.94
Total Trucks, %	21.39	6.87
Single-Unit Trucks (SUT), %	-	-
Tractor-Trailers (TT), %	-	-
Heavy Vehicle Adjustment Factor (fHV)	0.824	0.936
Flow Rate (vi),pc/h	3621	608
Capacity (c), pc/h	7200	2000
Volume-to-Capacity Ratio (v/c)	0.59	0.30

Speed and Density

Upstream Equilibrium Distance (LEQ), ft	-	Number of Outer Lanes on Freeway (NO)	1
Distance to Upstream Ramp (LUP), ft	-	Speed Index (MS)	0.353
Downstream Equilibrium Distance (LEQ), ft	-	Flow Outer Lanes (vOA), pc/h/ln	1488
Distance to Downstream Ramp (LDOWN), ft	-	On-Ramp Influence Area Speed (SR), mi/h	60.1
Prop. Freeway Vehicles in Lane 1 and 2 (PFM)	0.589	Outer Lanes Freeway Speed (SO), mi/h	66.4
Flow in Lanes 1 and 2 (v12), pc/h	2133	Ramp Junction Speed (S), mi/h	62.2
Flow Entering Ramp-Infl. Area (vR12), pc/h	2741	Average Density (D), pc/mi/ln	22.7
Level of Service (LOS)	C	Density in Ramp Influence Area (DR), pc/mi/ln	24.1

HCS7 Basic Freeway Report

Project Information

Analyst	LSA	Date	12/11/2019
Agency	LSA	Analysis Year	Phase III Proj Comp Yr (2049) NP
Jurisdiction	Caltrans	Time Period Analyzed	PM Peak Hour
Project Description	CMD1801 - Village D Specific Plan	Unit	United States Customary

Geometric Data

Number of Lanes, ln	2	Terrain Type	Level
Segment Length (L), ft	-	Percent Grade, %	-
Measured or Base Free-Flow Speed	Base	Grade Length, mi	-
Base Free-Flow Speed (BFFS), mi/h	70.0	Total Ramp Density (TRD), ramps/mi	1.00
Lane Width, ft	12	Free-Flow Speed (FFS), mi/h	66.8
Right-Side Lateral Clearance, ft	10		

Adjustment Factors

Driver Population	All Familiar	Final Speed Adjustment Factor (SAF)	1.000
Weather Type	Non-Severe Weather	Final Capacity Adjustment Factor (CAF)	1.000
Incident Type	No Incident	Demand Adjustment Factor (DAF)	1.000

Demand and Capacity

Demand Volume veh/h	3340	Heavy Vehicle Adjustment Factor (fhv)	0.840
Peak Hour Factor	0.94	Flow Rate (Vp), pc/h/ln	2115
Total Trucks, %	19.07	Capacity (c), pc/h/ln	2368
Single-Unit Trucks (SUT), %	-	Adjusted Capacity (cadj), pc/h/ln	2368
Tractor-Trailers (TT), %	-	Volume-to-Capacity Ratio (v/c)	0.89
Passenger Car Equivalent (ET)	2.000		

Speed and Density

Lane Width Adjustment (flw)	0.0	Average Speed (S), mi/h	58.7
Right-Side Lateral Clearance Adj. (fRLC)	0.0	Density (D), pc/mi/ln	36.0
Total Ramp Density Adjustment	3.2	Level of Service (LOS)	E
Adjusted Free-Flow Speed (FFSadj), mi/h	66.8		

HCS7 Freeway Diverge Report

Project Information

Analyst	LSA	Date	12/11/2019
Agency	LSA	Analysis Year	Phase III Proj Comp Yr (2049) NP
Jurisdiction	Caltrans	Time Period Analyzed	PM Peak Hour
Project Description	CMD1801 - Village D Specific Plan	Unit	United States Customary

Geometric Data

	Freeway	Ramp
Number of Lanes (N), ln	2	1
Free-Flow Speed (FFS), mi/h	70.0	35.0
Segment Length (L) / Deceleration Length (LA),ft	1500	200
Terrain Type	Level	Level
Percent Grade, %	-	-
Segment Type / Ramp Side	Freeway	Right

Adjustment Factors

Driver Population	All Familiar	All Familiar
Weather Type	Non-Severe Weather	Non-Severe Weather
Incident Type	No Incident	-
Final Speed Adjustment Factor (SAF)	1.000	1.000
Final Capacity Adjustment Factor (CAF)	1.000	1.000
Demand Adjustment Factor (DAF)	1.000	1.000

Demand and Capacity

Demand Volume (Vi)	3340	199
Peak Hour Factor (PHF)	0.94	0.94
Total Trucks, %	19.07	24.06
Single-Unit Trucks (SUT), %	-	-
Tractor-Trailers (TT), %	-	-
Heavy Vehicle Adjustment Factor (fHV)	0.840	0.806
Flow Rate (vi),pc/h	4230	263
Capacity (c), pc/h	4800	2000
Volume-to-Capacity Ratio (v/c)	0.88	0.13

Speed and Density

Upstream Equilibrium Distance (LEQ), ft	-	Number of Outer Lanes on Freeway (NO)	0
Distance to Upstream Ramp (LUP), ft	-	Speed Index (DS)	0.452
Downstream Equilibrium Distance (LEQ), ft	-	Flow Outer Lanes (vOA), pc/h/ln	-
Distance to Downstream Ramp (LDOWN), ft	-	Off-Ramp Influence Area Speed (SR), mi/h	57.3
Prop. Freeway Vehicles in Lane 1 and 2 (PFD)	1.000	Outer Lanes Freeway Speed (SO), mi/h	76.8
Flow in Lanes 1 and 2 (v12), pc/h	4230	Ramp Junction Speed (S), mi/h	57.3
Flow Entering Ramp-Infl. Area (vR12), pc/h	-	Average Density (D), pc/mi/ln	36.9
Level of Service (LOS)	E	Density in Ramp Influence Area (DR), pc/mi/ln	38.8

HCS7 Basic Freeway Report

Project Information

Analyst	LSA	Date	12/11/2019
Agency	LSA	Analysis Year	Phase III Proj Comp Yr (2049) NP
Jurisdiction	Caltrans	Time Period Analyzed	PM Peak Hour
Project Description	CMD1801 - Village D Specific Plan	Unit	United States Customary

Geometric Data

Number of Lanes, ln	2	Terrain Type	Level
Segment Length (L), ft	-	Percent Grade, %	-
Measured or Base Free-Flow Speed	Base	Grade Length, mi	-
Base Free-Flow Speed (BFFS), mi/h	70.0	Total Ramp Density (TRD), ramps/mi	1.00
Lane Width, ft	12	Free-Flow Speed (FFS), mi/h	66.8
Right-Side Lateral Clearance, ft	10		

Adjustment Factors

Driver Population	All Familiar	Final Speed Adjustment Factor (SAF)	1.000
Weather Type	Non-Severe Weather	Final Capacity Adjustment Factor (CAF)	1.000
Incident Type	No Incident	Demand Adjustment Factor (DAF)	1.000

Demand and Capacity

Demand Volume veh/h	3141	Heavy Vehicle Adjustment Factor (fhv)	0.842
Peak Hour Factor	0.94	Flow Rate (Vp), pc/h/ln	1984
Total Trucks, %	18.75	Capacity (c), pc/h/ln	2368
Single-Unit Trucks (SUT), %	-	Adjusted Capacity (cadj), pc/h/ln	2368
Tractor-Trailers (TT), %	-	Volume-to-Capacity Ratio (v/c)	0.84
Passenger Car Equivalent (ET)	2.000		

Speed and Density

Lane Width Adjustment (fLW)	0.0	Average Speed (S), mi/h	61.2
Right-Side Lateral Clearance Adj. (fRLC)	0.0	Density (D), pc/mi/ln	32.4
Total Ramp Density Adjustment	3.2	Level of Service (LOS)	D
Adjusted Free-Flow Speed (FFSadj), mi/h	66.8		

HCS7 Freeway Merge Report

Project Information

Analyst	LSA	Date	12/11/2019
Agency	LSA	Analysis Year	Phase III Proj Comp Yr (2049) NP
Jurisdiction	Caltrans	Time Period Analyzed	PM Peak Hour
Project Description	CMD1801 - Village D Specific Plan	Unit	United States Customary

Geometric Data

	Freeway	Ramp
Number of Lanes (N), ln	2	1
Free-Flow Speed (FFS), mi/h	70.0	35.0
Segment Length (L) / Acceleration Length (LA),ft	1500	700
Terrain Type	Level	Level
Percent Grade, %	-	-
Segment Type / Ramp Side	Freeway	Right

Adjustment Factors

Driver Population	All Familiar	All Familiar
Weather Type	Non-Severe Weather	Non-Severe Weather
Incident Type	No Incident	-
Final Speed Adjustment Factor (SAF)	1.000	1.000
Final Capacity Adjustment Factor (CAF)	1.000	1.000
Demand Adjustment Factor (DAF)	1.000	1.000

Demand and Capacity

Demand Volume (Vi)	3141	260
Peak Hour Factor (PHF)	0.94	0.94
Total Trucks, %	18.75	23.78
Single-Unit Trucks (SUT), %	-	-
Tractor-Trailers (TT), %	-	-
Heavy Vehicle Adjustment Factor (fHV)	0.842	0.808
Flow Rate (vi),pc/h	3969	342
Capacity (c), pc/h	4800	2000
Volume-to-Capacity Ratio (v/c)	0.90	0.17

Speed and Density

Upstream Equilibrium Distance (LEQ), ft	-	Number of Outer Lanes on Freeway (NO)	0
Distance to Upstream Ramp (LUP), ft	-	Speed Index (MS)	0.563
Downstream Equilibrium Distance (LEQ), ft	-	Flow Outer Lanes (vOA), pc/h/ln	-
Distance to Downstream Ramp (LDOWN), ft	-	On-Ramp Influence Area Speed (SR), mi/h	54.2
Prop. Freeway Vehicles in Lane 1 and 2 (PFM)	1.000	Outer Lanes Freeway Speed (SO), mi/h	70.0
Flow in Lanes 1 and 2 (v12), pc/h	3969	Ramp Junction Speed (S), mi/h	54.2
Flow Entering Ramp-Infl. Area (vR12), pc/h	4311	Average Density (D), pc/mi/ln	39.8
Level of Service (LOS)	D	Density in Ramp Influence Area (DR), pc/mi/ln	34.6

HCS7 Basic Freeway Report

Project Information

Analyst	LSA	Date	12/11/2019
Agency	LSA	Analysis Year	Phase III Proj Comp Yr (2049) NP
Jurisdiction	Caltrans	Time Period Analyzed	PM Peak Hour
Project Description	CMD1801 - Village D Specific Plan	Unit	United States Customary

Geometric Data

Number of Lanes, ln	2	Terrain Type	Level
Segment Length (L), ft	-	Percent Grade, %	-
Measured or Base Free-Flow Speed	Base	Grade Length, mi	-
Base Free-Flow Speed (BFFS), mi/h	70.0	Total Ramp Density (TRD), ramps/mi	1.00
Lane Width, ft	12	Free-Flow Speed (FFS), mi/h	66.8
Right-Side Lateral Clearance, ft	10		

Adjustment Factors

Driver Population	All Familiar	Final Speed Adjustment Factor (SAF)	1.000
Weather Type	Non-Severe Weather	Final Capacity Adjustment Factor (CAF)	1.000
Incident Type	No Incident	Demand Adjustment Factor (DAF)	1.000

Demand and Capacity

Demand Volume veh/h	3401	Heavy Vehicle Adjustment Factor (fhv)	0.839
Peak Hour Factor	0.94	Flow Rate (Vp), pc/h/ln	2156
Total Trucks, %	19.14	Capacity (c), pc/h/ln	2368
Single-Unit Trucks (SUT), %	-	Adjusted Capacity (cadj), pc/h/ln	2368
Tractor-Trailers (TT), %	-	Volume-to-Capacity Ratio (v/c)	0.91
Passenger Car Equivalent (ET)	2.000		

Speed and Density

Lane Width Adjustment (fLW)	0.0	Average Speed (S), mi/h	57.8
Right-Side Lateral Clearance Adj. (fRLC)	0.0	Density (D), pc/mi/ln	37.3
Total Ramp Density Adjustment	3.2	Level of Service (LOS)	E
Adjusted Free-Flow Speed (FFSadj), mi/h	66.8		

HCS7 Basic Freeway Report

Project Information

Analyst	LSA	Date	12/11/2019
Agency	LSA	Analysis Year	Phase III Proj Comp Yr (2049) NP
Jurisdiction	Caltrans	Time Period Analyzed	PM Peak Hour
Project Description	CMD1801 - Village D Specific Plan	Unit	United States Customary

Geometric Data

Number of Lanes, ln	2	Terrain Type	Level
Segment Length (L), ft	-	Percent Grade, %	-
Measured or Base Free-Flow Speed	Base	Grade Length, mi	-
Base Free-Flow Speed (BFFS), mi/h	70.0	Total Ramp Density (TRD), ramps/mi	1.00
Lane Width, ft	12	Free-Flow Speed (FFS), mi/h	66.8
Right-Side Lateral Clearance, ft	10		

Adjustment Factors

Driver Population	All Familiar	Final Speed Adjustment Factor (SAF)	1.000
Weather Type	Non-Severe Weather	Final Capacity Adjustment Factor (CAF)	1.000
Incident Type	No Incident	Demand Adjustment Factor (DAF)	1.000

Demand and Capacity

Demand Volume veh/h	3530	Heavy Vehicle Adjustment Factor (fhv)	0.819
Peak Hour Factor	0.94	Flow Rate (Vp), pc/h/ln	2292
Total Trucks, %	22.12	Capacity (c), pc/h/ln	2368
Single-Unit Trucks (SUT), %	-	Adjusted Capacity (cadj), pc/h/ln	2368
Tractor-Trailers (TT), %	-	Volume-to-Capacity Ratio (v/c)	0.97
Passenger Car Equivalent (ET)	2.000		

Speed and Density

Lane Width Adjustment (fLW)	0.0	Average Speed (S), mi/h	54.6
Right-Side Lateral Clearance Adj. (fRLC)	0.0	Density (D), pc/mi/ln	42.0
Total Ramp Density Adjustment	3.2	Level of Service (LOS)	E
Adjusted Free-Flow Speed (FFSadj), mi/h	66.8		

HCS7 Freeway Diverge Report

Project Information

Analyst	LSA	Date	12/11/2019
Agency	LSA	Analysis Year	Phase III Proj Comp Yr (2049) NP
Jurisdiction	Caltrans	Time Period Analyzed	PM Peak Hour
Project Description	CMD1801 - Village D Specific Plan	Unit	United States Customary

Geometric Data

	Freeway	Ramp
Number of Lanes (N), ln	2	1
Free-Flow Speed (FFS), mi/h	70.0	50.0
Segment Length (L) / Deceleration Length (LA),ft	1500	150
Terrain Type	Level	Level
Percent Grade, %	-	-
Segment Type / Ramp Side	Freeway	Right

Adjustment Factors

Driver Population	All Familiar	All Familiar
Weather Type	Non-Severe Weather	Non-Severe Weather
Incident Type	No Incident	-
Final Speed Adjustment Factor (SAF)	1.000	1.000
Final Capacity Adjustment Factor (CAF)	1.000	1.000
Demand Adjustment Factor (DAF)	1.000	1.000

Demand and Capacity

Demand Volume (Vi)	3530	291
Peak Hour Factor (PHF)	0.94	0.94
Total Trucks, %	22.12	26.18
Single-Unit Trucks (SUT), %	-	-
Tractor-Trailers (TT), %	-	-
Heavy Vehicle Adjustment Factor (fHV)	0.819	0.793
Flow Rate (vi),pc/h	4585	390
Capacity (c), pc/h	4800	2100
Volume-to-Capacity Ratio (v/c)	0.96	0.19

Speed and Density

Upstream Equilibrium Distance (LEQ), ft	-	Number of Outer Lanes on Freeway (NO)	0
Distance to Upstream Ramp (LUP), ft	-	Speed Index (DS)	0.268
Downstream Equilibrium Distance (LEQ), ft	-	Flow Outer Lanes (vOA), pc/h/ln	-
Distance to Downstream Ramp (LDOWN), ft	-	Off-Ramp Influence Area Speed (SR), mi/h	62.5
Prop. Freeway Vehicles in Lane 1 and 2 (PFD)	1.000	Outer Lanes Freeway Speed (SO), mi/h	76.8
Flow in Lanes 1 and 2 (v12), pc/h	4585	Ramp Junction Speed (S), mi/h	62.5
Flow Entering Ramp-Infl. Area (vR12), pc/h	-	Average Density (D), pc/mi/ln	36.7
Level of Service (LOS)	E	Density in Ramp Influence Area (DR), pc/mi/ln	42.3

HCS7 Basic Freeway Report

Project Information

Analyst	LSA	Date	12/11/2019
Agency	LSA	Analysis Year	Phase III Proj Comp Yr (2049) NP
Jurisdiction	Caltrans	Time Period Analyzed	PM Peak Hour
Project Description	CMD1801 - Village D Specific Plan	Unit	United States Customary

Geometric Data

Number of Lanes, ln	2	Terrain Type	Level
Segment Length (L), ft	-	Percent Grade, %	-
Measured or Base Free-Flow Speed	Base	Grade Length, mi	-
Base Free-Flow Speed (BFFS), mi/h	70.0	Total Ramp Density (TRD), ramps/mi	1.33
Lane Width, ft	12	Free-Flow Speed (FFS), mi/h	65.9
Right-Side Lateral Clearance, ft	10		

Adjustment Factors

Driver Population	All Familiar	Final Speed Adjustment Factor (SAF)	1.000
Weather Type	Non-Severe Weather	Final Capacity Adjustment Factor (CAF)	1.000
Incident Type	No Incident	Demand Adjustment Factor (DAF)	1.000

Demand and Capacity

Demand Volume veh/h	3239	Heavy Vehicle Adjustment Factor (fhv)	0.821
Peak Hour Factor	0.94	Flow Rate (Vp), pc/h/ln	2098
Total Trucks, %	21.76	Capacity (c), pc/h/ln	2359
Single-Unit Trucks (SUT), %	-	Adjusted Capacity (cadj), pc/h/ln	2359
Tractor-Trailers (TT), %	-	Volume-to-Capacity Ratio (v/c)	0.89
Passenger Car Equivalent (ET)	2.000		

Speed and Density

Lane Width Adjustment (fLW)	0.0	Average Speed (S), mi/h	58.6
Right-Side Lateral Clearance Adj. (fRLC)	0.0	Density (D), pc/mi/ln	35.8
Total Ramp Density Adjustment	4.1	Level of Service (LOS)	E
Adjusted Free-Flow Speed (FFSadj), mi/h	65.9		

HCS7 Freeway Merge Report

Project Information

Analyst	LSA	Date	12/11/2019
Agency	LSA	Analysis Year	Phase III Proj Comp Yr (2049) NP
Jurisdiction	Caltrans	Time Period Analyzed	PM Peak Hour
Project Description	CMD1801 - Village D Specific Plan	Unit	United States Customary

Geometric Data

	Freeway	Ramp
Number of Lanes (N), ln	2	1
Free-Flow Speed (FFS), mi/h	70.0	35.0
Segment Length (L) / Acceleration Length (LA),ft	1000	600
Terrain Type	Level	Level
Percent Grade, %	-	-
Segment Type / Ramp Side	Freeway	Right

Adjustment Factors

Driver Population	All Familiar	All Familiar
Weather Type	Non-Severe Weather	Non-Severe Weather
Incident Type	No Incident	-
Final Speed Adjustment Factor (SAF)	1.000	1.000
Final Capacity Adjustment Factor (CAF)	1.000	1.000
Demand Adjustment Factor (DAF)	1.000	1.000

Demand and Capacity

Demand Volume (Vi)	3239	30
Peak Hour Factor (PHF)	0.94	0.94
Total Trucks, %	21.76	7.41
Single-Unit Trucks (SUT), %	-	-
Tractor-Trailers (TT), %	-	-
Heavy Vehicle Adjustment Factor (fHV)	0.821	0.931
Flow Rate (vi),pc/h	4197	34
Capacity (c), pc/h	4800	2000
Volume-to-Capacity Ratio (v/c)	0.88	0.02

Speed and Density

Upstream Equilibrium Distance (LEQ), ft	-	Number of Outer Lanes on Freeway (NO)	0
Distance to Upstream Ramp (LUP), ft	-	Speed Index (MS)	0.547
Downstream Equilibrium Distance (LEQ), ft	-	Flow Outer Lanes (vOA), pc/h/ln	-
Distance to Downstream Ramp (LDOWN), ft	-	On-Ramp Influence Area Speed (SR), mi/h	54.7
Prop. Freeway Vehicles in Lane 1 and 2 (PFM)	1.000	Outer Lanes Freeway Speed (SO), mi/h	70.0
Flow in Lanes 1 and 2 (v12), pc/h	4197	Ramp Junction Speed (S), mi/h	54.7
Flow Entering Ramp-Infl. Area (vR12), pc/h	4231	Average Density (D), pc/mi/ln	38.7
Level of Service (LOS)	D	Density in Ramp Influence Area (DR), pc/mi/ln	34.8

HCS7 Basic Freeway Report

Project Information

Analyst	LSA	Date	12/11/2019
Agency	LSA	Analysis Year	Phase III Proj Comp Yr (2049) NP
Jurisdiction	Caltrans	Time Period Analyzed	PM Peak Hour
Project Description	CMD1801 - Village D Specific Plan	Unit	United States Customary

Geometric Data

Number of Lanes, ln	2	Terrain Type	Level
Segment Length (L), ft	-	Percent Grade, %	-
Measured or Base Free-Flow Speed	Base	Grade Length, mi	-
Base Free-Flow Speed (BFFS), mi/h	70.0	Total Ramp Density (TRD), ramps/mi	1.33
Lane Width, ft	12	Free-Flow Speed (FFS), mi/h	65.9
Right-Side Lateral Clearance, ft	10		

Adjustment Factors

Driver Population	All Familiar	Final Speed Adjustment Factor (SAF)	1.000
Weather Type	Non-Severe Weather	Final Capacity Adjustment Factor (CAF)	1.000
Incident Type	No Incident	Demand Adjustment Factor (DAF)	1.000

Demand and Capacity

Demand Volume veh/h	3269	Heavy Vehicle Adjustment Factor (fhv)	0.822
Peak Hour Factor	0.94	Flow Rate (Vp), pc/h/ln	2116
Total Trucks, %	21.63	Capacity (c), pc/h/ln	2359
Single-Unit Trucks (SUT), %	-	Adjusted Capacity (cadj), pc/h/ln	2359
Tractor-Trailers (TT), %	-	Volume-to-Capacity Ratio (v/c)	0.90
Passenger Car Equivalent (ET)	2.000		

Speed and Density

Lane Width Adjustment (fLW)	0.0	Average Speed (S), mi/h	58.2
Right-Side Lateral Clearance Adj. (fRLC)	0.0	Density (D), pc/mi/ln	36.4
Total Ramp Density Adjustment	4.1	Level of Service (LOS)	E
Adjusted Free-Flow Speed (FFSadj), mi/h	65.9		

HCS7 Freeway Merge Report

Project Information

Analyst	LSA	Date	12/11/2019
Agency	LSA	Analysis Year	Phase III Proj Comp Yr (2049) NP
Jurisdiction	Caltrans	Time Period Analyzed	PM Peak Hour
Project Description	CMD1801 - Village D Specific Plan	Unit	United States Customary

Geometric Data

	Freeway	Ramp
Number of Lanes (N), ln	2	1
Free-Flow Speed (FFS), mi/h	70.0	35.0
Segment Length (L) / Acceleration Length (LA),ft	1500	500
Terrain Type	Level	Level
Percent Grade, %	-	-
Segment Type / Ramp Side	Freeway	Right

Adjustment Factors

Driver Population	All Familiar	All Familiar
Weather Type	Non-Severe Weather	Non-Severe Weather
Incident Type	No Incident	-
Final Speed Adjustment Factor (SAF)	1.000	1.000
Final Capacity Adjustment Factor (CAF)	1.000	1.000
Demand Adjustment Factor (DAF)	1.000	1.000

Demand and Capacity

Demand Volume (Vi)	3269	243
Peak Hour Factor (PHF)	0.94	0.94
Total Trucks, %	21.63	21.94
Single-Unit Trucks (SUT), %	-	-
Tractor-Trailers (TT), %	-	-
Heavy Vehicle Adjustment Factor (fHV)	0.822	0.820
Flow Rate (vi),pc/h	4231	315
Capacity (c), pc/h	4800	2000
Volume-to-Capacity Ratio (v/c)	0.95	0.16

Speed and Density

Upstream Equilibrium Distance (LEQ), ft	-	Number of Outer Lanes on Freeway (NO)	0
Distance to Upstream Ramp (LUP), ft	-	Speed Index (MS)	0.654
Downstream Equilibrium Distance (LEQ), ft	-	Flow Outer Lanes (vOA), pc/h/ln	-
Distance to Downstream Ramp (LDOWN), ft	-	On-Ramp Influence Area Speed (SR), mi/h	51.7
Prop. Freeway Vehicles in Lane 1 and 2 (PFM)	1.000	Outer Lanes Freeway Speed (SO), mi/h	70.0
Flow in Lanes 1 and 2 (v12), pc/h	4231	Ramp Junction Speed (S), mi/h	51.7
Flow Entering Ramp-Infl. Area (vR12), pc/h	4546	Average Density (D), pc/mi/ln	44.0
Level of Service (LOS)	E	Density in Ramp Influence Area (DR), pc/mi/ln	37.7

HCS7 Basic Freeway Report

Project Information

Analyst	LSA	Date	12/11/2019
Agency	LSA	Analysis Year	Phase III Proj Comp Yr (2049) NP
Jurisdiction	Caltrans	Time Period Analyzed	PM Peak Hour
Project Description	CMD1801 - Village D Specific Plan	Unit	United States Customary

Geometric Data

Number of Lanes, ln	2	Terrain Type	Level
Segment Length (L), ft	-	Percent Grade, %	-
Measured or Base Free-Flow Speed	Base	Grade Length, mi	-
Base Free-Flow Speed (BFFS), mi/h	70.0	Total Ramp Density (TRD), ramps/mi	1.33
Lane Width, ft	12	Free-Flow Speed (FFS), mi/h	65.9
Right-Side Lateral Clearance, ft	10		

Adjustment Factors

Driver Population	All Familiar	Final Speed Adjustment Factor (SAF)	1.000
Weather Type	Non-Severe Weather	Final Capacity Adjustment Factor (CAF)	1.000
Incident Type	No Incident	Demand Adjustment Factor (DAF)	1.000

Demand and Capacity

Demand Volume veh/h	3512	Heavy Vehicle Adjustment Factor (fhv)	0.822
Peak Hour Factor	0.94	Flow Rate (Vp), pc/h/ln	2272
Total Trucks, %	21.64	Capacity (c), pc/h/ln	2359
Single-Unit Trucks (SUT), %	-	Adjusted Capacity (cadj), pc/h/ln	2359
Tractor-Trailers (TT), %	-	Volume-to-Capacity Ratio (v/c)	0.96
Passenger Car Equivalent (ET)	2.000		

Speed and Density

Lane Width Adjustment (fLW)	0.0	Average Speed (S), mi/h	54.7
Right-Side Lateral Clearance Adj. (fRLC)	0.0	Density (D), pc/mi/ln	41.5
Total Ramp Density Adjustment	4.1	Level of Service (LOS)	E
Adjusted Free-Flow Speed (FFSadj), mi/h	65.9		

HCS7 Freeway Diverge Report

Project Information

Analyst	LSA	Date	12/11/2019
Agency	LSA	Analysis Year	Phase III Proj Comp Yr (2049) NP
Jurisdiction	Caltrans	Time Period Analyzed	PM Peak Hour
Project Description	CMD1801 - Village D Specific Plan	Unit	United States Customary

Geometric Data

	Freeway	Ramp
Number of Lanes (N), ln	3	1
Free-Flow Speed (FFS), mi/h	70.0	35.0
Segment Length (L) / Deceleration Length (LA),ft	1500	150
Terrain Type	Level	Level
Percent Grade, %	-	-
Segment Type / Ramp Side	Freeway	Right

Adjustment Factors

Driver Population	All Familiar	All Familiar
Weather Type	Non-Severe Weather	Non-Severe Weather
Incident Type	No Incident	-
Final Speed Adjustment Factor (SAF)	1.000	1.000
Final Capacity Adjustment Factor (CAF)	1.000	1.000
Demand Adjustment Factor (DAF)	1.000	1.000

Demand and Capacity

Demand Volume (Vi)	3512	544
Peak Hour Factor (PHF)	0.94	0.94
Total Trucks, %	21.64	4.59
Single-Unit Trucks (SUT), %	-	-
Tractor-Trailers (TT), %	-	-
Heavy Vehicle Adjustment Factor (fHV)	0.822	0.956
Flow Rate (vi),pc/h	4545	605
Capacity (c), pc/h	7200	2000
Volume-to-Capacity Ratio (v/c)	0.63	0.30

Speed and Density

Upstream Equilibrium Distance (LEQ), ft	-	Number of Outer Lanes on Freeway (NO)	1
Distance to Upstream Ramp (LUP), ft	-	Speed Index (DS)	0.482
Downstream Equilibrium Distance (LEQ), ft	-	Flow Outer Lanes (vOA), pc/h/ln	1501
Distance to Downstream Ramp (LDOWN), ft	-	Off-Ramp Influence Area Speed (SR), mi/h	56.5
Prop. Freeway Vehicles in Lane 1 and 2 (PFD)	0.619	Outer Lanes Freeway Speed (SO), mi/h	74.8
Flow in Lanes 1 and 2 (v12), pc/h	3044	Ramp Junction Speed (S), mi/h	61.5
Flow Entering Ramp-Infl. Area (vR12), pc/h	-	Average Density (D), pc/mi/ln	24.6
Level of Service (LOS)	D	Density in Ramp Influence Area (DR), pc/mi/ln	29.1

HCS7 Basic Freeway Report

Project Information

Analyst	LSA	Date	12/11/2019
Agency	LSA	Analysis Year	Phase III Proj Comp Yr (2049) WP
Jurisdiction	Caltrans	Time Period Analyzed	AM Peak Hour
Project Description	CMD1801 - Village D Specific Plan	Unit	United States Customary

Geometric Data

Number of Lanes, ln	3	Terrain Type	Level
Segment Length (L), ft	-	Percent Grade, %	-
Measured or Base Free-Flow Speed	Base	Grade Length, mi	-
Base Free-Flow Speed (BFFS), mi/h	70.0	Total Ramp Density (TRD), ramps/mi	1.67
Lane Width, ft	12	Free-Flow Speed (FFS), mi/h	65.0
Right-Side Lateral Clearance, ft	10		

Adjustment Factors

Driver Population	All Familiar	Final Speed Adjustment Factor (SAF)	1.000
Weather Type	Non-Severe Weather	Final Capacity Adjustment Factor (CAF)	1.000
Incident Type	No Incident	Demand Adjustment Factor (DAF)	1.000

Demand and Capacity

Demand Volume veh/h	2452	Heavy Vehicle Adjustment Factor (fhv)	0.777
Peak Hour Factor	0.94	Flow Rate (Vp), pc/h/ln	1119
Total Trucks, %	28.67	Capacity (c), pc/h/ln	2350
Single-Unit Trucks (SUT), %	-	Adjusted Capacity (cadj), pc/h/ln	2350
Tractor-Trailers (TT), %	-	Volume-to-Capacity Ratio (v/c)	0.48
Passenger Car Equivalent (ET)	2.000		

Speed and Density

Lane Width Adjustment (fLW)	0.0	Average Speed (S), mi/h	65.0
Right-Side Lateral Clearance Adj. (fRLC)	0.0	Density (D), pc/mi/ln	17.2
Total Ramp Density Adjustment	5.0	Level of Service (LOS)	B
Adjusted Free-Flow Speed (FFSadj), mi/h	65.0		

HCS7 Freeway Merge Report

Project Information

Analyst	LSA	Date	12/11/2019
Agency	LSA	Analysis Year	Phase III Proj Comp Yr (2049) NP
Jurisdiction	Caltrans	Time Period Analyzed	PM Peak Hour
Project Description	CMD1801 - Village D Specific Plan	Unit	United States Customary

Geometric Data

	Freeway	Ramp
Number of Lanes (N), ln	3	1
Free-Flow Speed (FFS), mi/h	65.0	35.0
Segment Length (L) / Acceleration Length (LA),ft	1500	600
Terrain Type	Level	Level
Percent Grade, %	-	-
Segment Type / Ramp Side	Freeway	Right

Adjustment Factors

Driver Population	All Familiar	All Familiar
Weather Type	Non-Severe Weather	Non-Severe Weather
Incident Type	No Incident	-
Final Speed Adjustment Factor (SAF)	1.000	1.000
Final Capacity Adjustment Factor (CAF)	1.000	1.000
Demand Adjustment Factor (DAF)	1.000	1.000

Demand and Capacity

Demand Volume (Vi)	2968	701
Peak Hour Factor (PHF)	0.94	0.94
Total Trucks, %	24.76	6.36
Single-Unit Trucks (SUT), %	-	-
Tractor-Trailers (TT), %	-	-
Heavy Vehicle Adjustment Factor (fHV)	0.802	0.940
Flow Rate (vi),pc/h	3937	793
Capacity (c), pc/h	7050	2000
Volume-to-Capacity Ratio (v/c)	0.67	0.40

Speed and Density

Upstream Equilibrium Distance (LEQ), ft	-	Number of Outer Lanes on Freeway (NO)	1
Distance to Upstream Ramp (LUP), ft	-	Speed Index (MS)	0.368
Downstream Equilibrium Distance (LEQ), ft	-	Flow Outer Lanes (vOA), pc/h/ln	1598
Distance to Downstream Ramp (LDOWN), ft	-	On-Ramp Influence Area Speed (SR), mi/h	56.5
Prop. Freeway Vehicles in Lane 1 and 2 (PFM)	0.594	Outer Lanes Freeway Speed (SO), mi/h	61.0
Flow in Lanes 1 and 2 (v12), pc/h	2339	Ramp Junction Speed (S), mi/h	57.9
Flow Entering Ramp-Infl. Area (vR12), pc/h	3132	Average Density (D), pc/mi/ln	27.2
Level of Service (LOS)	C	Density in Ramp Influence Area (DR), pc/mi/ln	25.9

HCS7 Basic Freeway Report

Project Information

Analyst	LSA	Date	12/11/2019
Agency	LSA	Analysis Year	Phase III Proj Comp Yr (2049) NP
Jurisdiction	Caltrans	Time Period Analyzed	PM Peak Hour
Project Description	CMD1801 - Village D Specific Plan	Unit	United States Customary

Geometric Data

Number of Lanes, ln	3	Terrain Type	Level
Segment Length (L), ft	-	Percent Grade, %	-
Measured or Base Free-Flow Speed	Base	Grade Length, mi	-
Base Free-Flow Speed (BFFS), mi/h	65.0	Total Ramp Density (TRD), ramps/mi	1.83
Lane Width, ft	12	Free-Flow Speed (FFS), mi/h	59.7
Right-Side Lateral Clearance, ft	10		

Adjustment Factors

Driver Population	All Familiar	Final Speed Adjustment Factor (SAF)	1.000
Weather Type	Non-Severe Weather	Final Capacity Adjustment Factor (CAF)	1.000
Incident Type	No Incident	Demand Adjustment Factor (DAF)	1.000

Demand and Capacity

Demand Volume veh/h	3669	Heavy Vehicle Adjustment Factor (fhv)	0.825
Peak Hour Factor	0.94	Flow Rate (Vp), pc/h/ln	1577
Total Trucks, %	21.26	Capacity (c), pc/h/ln	2296
Single-Unit Trucks (SUT), %	-	Adjusted Capacity (cadj), pc/h/ln	2296
Tractor-Trailers (TT), %	-	Volume-to-Capacity Ratio (v/c)	0.69
Passenger Car Equivalent (ET)	2.000		

Speed and Density

Lane Width Adjustment (fLW)	0.0	Average Speed (S), mi/h	59.6
Right-Side Lateral Clearance Adj. (fRLC)	0.0	Density (D), pc/mi/ln	26.5
Total Ramp Density Adjustment	5.4	Level of Service (LOS)	D
Adjusted Free-Flow Speed (FFSadj), mi/h	59.6		

HCS7 Freeway Merge Report

Project Information

Analyst	LSA	Date	12/11/2019
Agency	LSA	Analysis Year	Phase III Proj Comp Yr (2049) NP
Jurisdiction	Caltrans	Time Period Analyzed	PM Peak Hour
Project Description	CMD1801 - Village D Specific Plan	Unit	United States Customary

Geometric Data

	Freeway	Ramp
Number of Lanes (N), In	3	1
Free-Flow Speed (FFS), mi/h	65.0	35.0
Segment Length (L) / Acceleration Length (LA),ft	1500	600
Terrain Type	Level	Level
Percent Grade, %	-	-
Segment Type / Ramp Side	Freeway	Right

Adjustment Factors

Driver Population	All Familiar	All Familiar
Weather Type	Non-Severe Weather	Non-Severe Weather
Incident Type	No Incident	-
Final Speed Adjustment Factor (SAF)	1.000	1.000
Final Capacity Adjustment Factor (CAF)	1.000	1.000
Demand Adjustment Factor (DAF)	1.000	1.000

Demand and Capacity

Demand Volume (Vi)	3669	397
Peak Hour Factor (PHF)	0.94	0.94
Total Trucks, %	21.26	3.40
Single-Unit Trucks (SUT), %	-	-
Tractor-Trailers (TT), %	-	-
Heavy Vehicle Adjustment Factor (fHV)	0.825	0.967
Flow Rate (vi),pc/h	4731	437
Capacity (c), pc/h	7050	2000
Volume-to-Capacity Ratio (v/c)	0.73	0.22

Speed and Density

Upstream Equilibrium Distance (LEQ), ft	-	Number of Outer Lanes on Freeway (NO)	1
Distance to Upstream Ramp (LUP), ft	-	Speed Index (MS)	0.379
Downstream Equilibrium Distance (LEQ), ft	-	Flow Outer Lanes (vOA), pc/h/ln	1921
Distance to Downstream Ramp (LDOWN), ft	-	On-Ramp Influence Area Speed (SR), mi/h	56.3
Prop. Freeway Vehicles in Lane 1 and 2 (PFM)	0.594	Outer Lanes Freeway Speed (SO), mi/h	59.9
Flow in Lanes 1 and 2 (v12), pc/h	2810	Ramp Junction Speed (S), mi/h	57.6
Flow Entering Ramp-Infl. Area (vR12), pc/h	3247	Average Density (D), pc/mi/ln	29.9
Level of Service (LOS)	C	Density in Ramp Influence Area (DR), pc/mi/ln	26.9

HCS7 Basic Freeway Report

Project Information

Analyst	LSA	Date	12/11/2019
Agency	LSA	Analysis Year	Phase III Proj Comp Yr (2049) NP
Jurisdiction	Caltrans	Time Period Analyzed	PM Peak Hour
Project Description	CMD1801 - Village D Specific Plan	Unit	United States Customary

Geometric Data

Number of Lanes, ln	3	Terrain Type	Level
Segment Length (L), ft	-	Percent Grade, %	-
Measured or Base Free-Flow Speed	Base	Grade Length, mi	-
Base Free-Flow Speed (BFFS), mi/h	65.0	Total Ramp Density (TRD), ramps/mi	2.17
Lane Width, ft	12	Free-Flow Speed (FFS), mi/h	58.8
Right-Side Lateral Clearance, ft	10		

Adjustment Factors

Driver Population	All Familiar	Final Speed Adjustment Factor (SAF)	1.000
Weather Type	Non-Severe Weather	Final Capacity Adjustment Factor (CAF)	1.000
Incident Type	No Incident	Demand Adjustment Factor (DAF)	1.000

Demand and Capacity

Demand Volume veh/h	4066	Heavy Vehicle Adjustment Factor (fhv)	0.837
Peak Hour Factor	0.94	Flow Rate (Vp), pc/h/ln	1723
Total Trucks, %	19.53	Capacity (c), pc/h/ln	2288
Single-Unit Trucks (SUT), %	-	Adjusted Capacity (cadj), pc/h/ln	2288
Tractor-Trailers (TT), %	-	Volume-to-Capacity Ratio (v/c)	0.75
Passenger Car Equivalent (ET)	2.000		

Speed and Density

Lane Width Adjustment (fLW)	0.0	Average Speed (S), mi/h	58.7
Right-Side Lateral Clearance Adj. (fRLC)	0.0	Density (D), pc/mi/ln	29.4
Total Ramp Density Adjustment	6.2	Level of Service (LOS)	D
Adjusted Free-Flow Speed (FFSadj), mi/h	58.8		

HCS7 Freeway Diverge Report

Project Information

Analyst	LSA	Date	12/11/2019
Agency	LSA	Analysis Year	Phase III Proj Comp Yr (2049) NP
Jurisdiction	Caltrans	Time Period Analyzed	PM Peak Hour
Project Description	CMD1801 - Village D Specific Plan	Unit	United States Customary

Geometric Data

	Freeway	Ramp
Number of Lanes (N), In	3	1
Free-Flow Speed (FFS), mi/h	65.0	40.0
Segment Length (L) / Deceleration Length (LA),ft	1500	150
Terrain Type	Level	Level
Percent Grade, %	-	-
Segment Type / Ramp Side	Freeway	Right

Adjustment Factors

Driver Population	All Familiar	All Familiar
Weather Type	Non-Severe Weather	Non-Severe Weather
Incident Type	No Incident	-
Final Speed Adjustment Factor (SAF)	1.000	1.000
Final Capacity Adjustment Factor (CAF)	1.000	1.000
Demand Adjustment Factor (DAF)	1.000	1.000

Demand and Capacity

Demand Volume (Vi)	4066	361
Peak Hour Factor (PHF)	0.94	0.94
Total Trucks, %	19.53	3.62
Single-Unit Trucks (SUT), %	-	-
Tractor-Trailers (TT), %	-	-
Heavy Vehicle Adjustment Factor (fHV)	0.837	0.965
Flow Rate (vi),pc/h	5168	398
Capacity (c), pc/h	7050	2000
Volume-to-Capacity Ratio (v/c)	0.73	0.20

Speed and Density

Upstream Equilibrium Distance (LEQ), ft	-	Number of Outer Lanes on Freeway (NO)	1
Distance to Upstream Ramp (LUP), ft	-	Speed Index (DS)	0.399
Downstream Equilibrium Distance (LEQ), ft	-	Flow Outer Lanes (vOA), pc/h/ln	1851
Distance to Downstream Ramp (LDOWN), ft	-	Off-Ramp Influence Area Speed (SR), mi/h	55.8
Prop. Freeway Vehicles in Lane 1 and 2 (PFD)	0.612	Outer Lanes Freeway Speed (SO), mi/h	68.0
Flow in Lanes 1 and 2 (v12), pc/h	3317	Ramp Junction Speed (S), mi/h	59.6
Flow Entering Ramp-Infl. Area (vR12), pc/h	-	Average Density (D), pc/mi/ln	28.9
Level of Service (LOS)	D	Density in Ramp Influence Area (DR), pc/mi/ln	31.4

HCS7 Basic Freeway Report

Project Information

Analyst	LSA	Date	12/11/2019
Agency	LSA	Analysis Year	Phase III Proj Comp Yr (2049) NP
Jurisdiction	Caltrans	Time Period Analyzed	PM Peak Hour
Project Description	CMD1801 - Village D Specific Plan	Unit	United States Customary

Geometric Data

Number of Lanes, ln	3	Terrain Type	Level
Segment Length (L), ft	-	Percent Grade, %	-
Measured or Base Free-Flow Speed	Base	Grade Length, mi	-
Base Free-Flow Speed (BFFS), mi/h	65.0	Total Ramp Density (TRD), ramps/mi	1.83
Lane Width, ft	12	Free-Flow Speed (FFS), mi/h	59.7
Right-Side Lateral Clearance, ft	10		

Adjustment Factors

Driver Population	All Familiar	Final Speed Adjustment Factor (SAF)	1.000
Weather Type	Non-Severe Weather	Final Capacity Adjustment Factor (CAF)	1.000
Incident Type	No Incident	Demand Adjustment Factor (DAF)	1.000

Demand and Capacity

Demand Volume veh/h	3705	Heavy Vehicle Adjustment Factor (fhv)	0.826
Peak Hour Factor	0.94	Flow Rate (Vp), pc/h/ln	1591
Total Trucks, %	21.08	Capacity (c), pc/h/ln	2296
Single-Unit Trucks (SUT), %	-	Adjusted Capacity (cadj), pc/h/ln	2296
Tractor-Trailers (TT), %	-	Volume-to-Capacity Ratio (v/c)	0.69
Passenger Car Equivalent (ET)	2.000		

Speed and Density

Lane Width Adjustment (fLW)	0.0	Average Speed (S), mi/h	59.6
Right-Side Lateral Clearance Adj. (fRLC)	0.0	Density (D), pc/mi/ln	26.7
Total Ramp Density Adjustment	5.4	Level of Service (LOS)	D
Adjusted Free-Flow Speed (FFSadj), mi/h	59.6		

HCS7 Freeway Merge Report

Project Information

Analyst	LSA	Date	12/11/2019
Agency	LSA	Analysis Year	Phase III Proj Comp Yr (2049) NP
Jurisdiction	Caltrans	Time Period Analyzed	PM Peak Hour
Project Description	CMD1801 - Village D Specific Plan	Unit	United States Customary

Geometric Data

	Freeway	Ramp
Number of Lanes (N), ln	3	1
Free-Flow Speed (FFS), mi/h	65.0	35.0
Segment Length (L) / Acceleration Length (LA),ft	1500	800
Terrain Type	Level	Level
Percent Grade, %	-	-
Segment Type / Ramp Side	Freeway	Right

Adjustment Factors

Driver Population	All Familiar	All Familiar
Weather Type	Non-Severe Weather	Non-Severe Weather
Incident Type	No Incident	-
Final Speed Adjustment Factor (SAF)	1.000	1.000
Final Capacity Adjustment Factor (CAF)	1.000	1.000
Demand Adjustment Factor (DAF)	1.000	1.000

Demand and Capacity

Demand Volume (Vi)	3705	349
Peak Hour Factor (PHF)	0.94	0.94
Total Trucks, %	21.08	5.83
Single-Unit Trucks (SUT), %	-	-
Tractor-Trailers (TT), %	-	-
Heavy Vehicle Adjustment Factor (fHV)	0.826	0.945
Flow Rate (vi),pc/h	4772	393
Capacity (c), pc/h	7050	2000
Volume-to-Capacity Ratio (v/c)	0.73	0.20

Speed and Density

Upstream Equilibrium Distance (LEQ), ft	-	Number of Outer Lanes on Freeway (NO)	1
Distance to Upstream Ramp (LUP), ft	-	Speed Index (MS)	0.366
Downstream Equilibrium Distance (LEQ), ft	-	Flow Outer Lanes (vOA), pc/h/ln	1909
Distance to Downstream Ramp (LDOWN), ft	-	On-Ramp Influence Area Speed (SR), mi/h	56.6
Prop. Freeway Vehicles in Lane 1 and 2 (PFM)	0.600	Outer Lanes Freeway Speed (SO), mi/h	59.9
Flow in Lanes 1 and 2 (v12), pc/h	2863	Ramp Junction Speed (S), mi/h	57.8
Flow Entering Ramp-Infl. Area (vR12), pc/h	3256	Average Density (D), pc/mi/ln	29.8
Level of Service (LOS)	C	Density in Ramp Influence Area (DR), pc/mi/ln	25.7

HCS7 Basic Freeway Report

Project Information

Analyst	LSA	Date	12/11/2019
Agency	LSA	Analysis Year	Phase III Proj Comp Yr (2049) NP
Jurisdiction	Caltrans	Time Period Analyzed	PM Peak Hour
Project Description	CMD1801 - Village D Specific Plan	Unit	United States Customary

Geometric Data

Number of Lanes, ln	3	Terrain Type	Level
Segment Length (L), ft	-	Percent Grade, %	-
Measured or Base Free-Flow Speed	Base	Grade Length, mi	-
Base Free-Flow Speed (BFFS), mi/h	65.0	Total Ramp Density (TRD), ramps/mi	2.17
Lane Width, ft	12	Free-Flow Speed (FFS), mi/h	58.8
Right-Side Lateral Clearance, ft	10		

Adjustment Factors

Driver Population	All Familiar	Final Speed Adjustment Factor (SAF)	1.000
Weather Type	Non-Severe Weather	Final Capacity Adjustment Factor (CAF)	1.000
Incident Type	No Incident	Demand Adjustment Factor (DAF)	1.000

Demand and Capacity

Demand Volume veh/h	4054	Heavy Vehicle Adjustment Factor (fhv)	0.835
Peak Hour Factor	0.94	Flow Rate (Vp), pc/h/ln	1722
Total Trucks, %	19.76	Capacity (c), pc/h/ln	2288
Single-Unit Trucks (SUT), %	-	Adjusted Capacity (cadj), pc/h/ln	2288
Tractor-Trailers (TT), %	-	Volume-to-Capacity Ratio (v/c)	0.75
Passenger Car Equivalent (ET)	2.000		

Speed and Density

Lane Width Adjustment (fLW)	0.0	Average Speed (S), mi/h	58.7
Right-Side Lateral Clearance Adj. (fRLC)	0.0	Density (D), pc/mi/ln	29.3
Total Ramp Density Adjustment	6.2	Level of Service (LOS)	D
Adjusted Free-Flow Speed (FFSadj), mi/h	58.8		

HCS7 Freeway Diverge Report

Project Information

Analyst	LSA	Date	12/11/2019
Agency	LSA	Analysis Year	Phase III Proj Comp Yr (2049) NP
Jurisdiction	Caltrans	Time Period Analyzed	PM Peak Hour
Project Description	CMD1801 - Village D Specific Plan	Unit	United States Customary

Geometric Data

	Freeway	Ramp
Number of Lanes (N), ln	3	1
Free-Flow Speed (FFS), mi/h	65.0	35.0
Segment Length (L) / Deceleration Length (LA),ft	1500	200
Terrain Type	Level	Level
Percent Grade, %	-	-
Segment Type / Ramp Side	Freeway	Right

Adjustment Factors

Driver Population	All Familiar	All Familiar
Weather Type	Non-Severe Weather	Non-Severe Weather
Incident Type	No Incident	-
Final Speed Adjustment Factor (SAF)	1.000	1.000
Final Capacity Adjustment Factor (CAF)	1.000	1.000
Demand Adjustment Factor (DAF)	1.000	1.000

Demand and Capacity

Demand Volume (Vi)	4054	288
Peak Hour Factor (PHF)	0.94	0.94
Total Trucks, %	19.76	3.96
Single-Unit Trucks (SUT), %	-	-
Tractor-Trailers (TT), %	-	-
Heavy Vehicle Adjustment Factor (fHV)	0.835	0.962
Flow Rate (vi),pc/h	5165	318
Capacity (c), pc/h	7050	2000
Volume-to-Capacity Ratio (v/c)	0.73	0.16

Speed and Density

Upstream Equilibrium Distance (LEQ), ft	-	Number of Outer Lanes on Freeway (NO)	1
Distance to Upstream Ramp (LUP), ft	-	Speed Index (DS)	0.457
Downstream Equilibrium Distance (LEQ), ft	-	Flow Outer Lanes (vOA), pc/h/ln	1861
Distance to Downstream Ramp (LDOWN), ft	-	Off-Ramp Influence Area Speed (SR), mi/h	54.5
Prop. Freeway Vehicles in Lane 1 and 2 (PFD)	0.616	Outer Lanes Freeway Speed (SO), mi/h	67.9
Flow in Lanes 1 and 2 (v12), pc/h	3304	Ramp Junction Speed (S), mi/h	58.7
Flow Entering Ramp-Infl. Area (vR12), pc/h	-	Average Density (D), pc/mi/ln	29.3
Level of Service (LOS)	D	Density in Ramp Influence Area (DR), pc/mi/ln	30.9

HCS7 Basic Freeway Report

Project Information

Analyst	LSA	Date	12/11/2019
Agency	LSA	Analysis Year	Phase III Proj Comp Yr (2049) NP
Jurisdiction	Caltrans	Time Period Analyzed	PM Peak Hour
Project Description	CMD1801 - Village D Specific Plan	Unit	United States Customary

Geometric Data

Number of Lanes, ln	3	Terrain Type	Level
Segment Length (L), ft	-	Percent Grade, %	-
Measured or Base Free-Flow Speed	Base	Grade Length, mi	-
Base Free-Flow Speed (BFFS), mi/h	65.0	Total Ramp Density (TRD), ramps/mi	2.17
Lane Width, ft	12	Free-Flow Speed (FFS), mi/h	58.8
Right-Side Lateral Clearance, ft	10		

Adjustment Factors

Driver Population	All Familiar	Final Speed Adjustment Factor (SAF)	1.000
Weather Type	Non-Severe Weather	Final Capacity Adjustment Factor (CAF)	1.000
Incident Type	No Incident	Demand Adjustment Factor (DAF)	1.000

Demand and Capacity

Demand Volume veh/h	3766	Heavy Vehicle Adjustment Factor (fhv)	0.827
Peak Hour Factor	0.94	Flow Rate (Vp), pc/h/ln	1615
Total Trucks, %	20.98	Capacity (c), pc/h/ln	2288
Single-Unit Trucks (SUT), %	-	Adjusted Capacity (cadj), pc/h/ln	2288
Tractor-Trailers (TT), %	-	Volume-to-Capacity Ratio (v/c)	0.71
Passenger Car Equivalent (ET)	2.000		

Speed and Density

Lane Width Adjustment (fLW)	0.0	Average Speed (S), mi/h	58.8
Right-Side Lateral Clearance Adj. (fRLC)	0.0	Density (D), pc/mi/ln	27.5
Total Ramp Density Adjustment	6.2	Level of Service (LOS)	D
Adjusted Free-Flow Speed (FFSadj), mi/h	58.8		

HCS7 Freeway Merge Report

Project Information

Analyst	LSA	Date	12/11/2019
Agency	LSA	Analysis Year	Phase III Proj Comp Yr (2049) NP
Jurisdiction	Caltrans	Time Period Analyzed	PM Peak Hour
Project Description	CMD1801 - Village D Specific Plan	Unit	United States Customary

Geometric Data

	Freeway	Ramp
Number of Lanes (N), ln	3	1
Free-Flow Speed (FFS), mi/h	65.0	35.0
Segment Length (L) / Acceleration Length (LA),ft	1500	350
Terrain Type	Level	Level
Percent Grade, %	-	-
Segment Type / Ramp Side	Freeway	Right

Adjustment Factors

Driver Population	All Familiar	All Familiar
Weather Type	Non-Severe Weather	Non-Severe Weather
Incident Type	No Incident	-
Final Speed Adjustment Factor (SAF)	1.000	1.000
Final Capacity Adjustment Factor (CAF)	1.000	1.000
Demand Adjustment Factor (DAF)	1.000	1.000

Demand and Capacity

Demand Volume (Vi)	3766	789
Peak Hour Factor (PHF)	0.94	0.94
Total Trucks, %	20.98	1.56
Single-Unit Trucks (SUT), %	-	-
Tractor-Trailers (TT), %	-	-
Heavy Vehicle Adjustment Factor (fHV)	0.827	0.985
Flow Rate (vi),pc/h	4844	852
Capacity (c), pc/h	7050	2000
Volume-to-Capacity Ratio (v/c)	0.81	0.43

Speed and Density

Upstream Equilibrium Distance (LEQ), ft	-	Number of Outer Lanes on Freeway (NO)	1
Distance to Upstream Ramp (LUP), ft	-	Speed Index (MS)	0.453
Downstream Equilibrium Distance (LEQ), ft	-	Flow Outer Lanes (vOA), pc/h/ln	2001
Distance to Downstream Ramp (LDOWN), ft	-	On-Ramp Influence Area Speed (SR), mi/h	54.6
Prop. Freeway Vehicles in Lane 1 and 2 (PFM)	0.587	Outer Lanes Freeway Speed (SO), mi/h	59.6
Flow in Lanes 1 and 2 (v12), pc/h	2843	Ramp Junction Speed (S), mi/h	56.3
Flow Entering Ramp-Infl. Area (vR12), pc/h	3695	Average Density (D), pc/mi/ln	33.7
Level of Service (LOS)	D	Density in Ramp Influence Area (DR), pc/mi/ln	31.8

HCS7 Basic Freeway Report

Project Information

Analyst	LSA	Date	12/11/2019
Agency	LSA	Analysis Year	Phase III Proj Comp Yr (2049) NP
Jurisdiction	Caltrans	Time Period Analyzed	PM Peak Hour
Project Description	CMD1801 - Village D Specific Plan	Unit	United States Customary

Geometric Data

Number of Lanes, ln	3	Terrain Type	Level
Segment Length (L), ft	-	Percent Grade, %	-
Measured or Base Free-Flow Speed	Base	Grade Length, mi	-
Base Free-Flow Speed (BFFS), mi/h	65.0	Total Ramp Density (TRD), ramps/mi	2.17
Lane Width, ft	12	Free-Flow Speed (FFS), mi/h	58.8
Right-Side Lateral Clearance, ft	10		

Adjustment Factors

Driver Population	All Familiar	Final Speed Adjustment Factor (SAF)	1.000
Weather Type	Non-Severe Weather	Final Capacity Adjustment Factor (CAF)	1.000
Incident Type	No Incident	Demand Adjustment Factor (DAF)	1.000

Demand and Capacity

Demand Volume veh/h	4555	Heavy Vehicle Adjustment Factor (fhv)	0.850
Peak Hour Factor	0.94	Flow Rate (Vp), pc/h/ln	1900
Total Trucks, %	17.61	Capacity (c), pc/h/ln	2288
Single-Unit Trucks (SUT), %	-	Adjusted Capacity (cadj), pc/h/ln	2288
Tractor-Trailers (TT), %	-	Volume-to-Capacity Ratio (v/c)	0.83
Passenger Car Equivalent (ET)	2.000		

Speed and Density

Lane Width Adjustment (fLW)	0.0	Average Speed (S), mi/h	57.6
Right-Side Lateral Clearance Adj. (fRLC)	0.0	Density (D), pc/mi/ln	33.0
Total Ramp Density Adjustment	6.2	Level of Service (LOS)	D
Adjusted Free-Flow Speed (FFSadj), mi/h	58.8		

HCS7 Freeway Diverge Report

Project Information

Analyst	LSA	Date	12/11/2019
Agency	LSA	Analysis Year	Phase III Proj Comp Yr (2049) NP
Jurisdiction	Caltrans	Time Period Analyzed	PM Peak Hour
Project Description	CMD1801 - Village D Specific Plan	Unit	United States Customary

Geometric Data

	Freeway	Ramp
Number of Lanes (N), In	3	1
Free-Flow Speed (FFS), mi/h	65.0	15.0
Segment Length (L) / Deceleration Length (LA),ft	1500	150
Terrain Type	Level	Level
Percent Grade, %	-	-
Segment Type / Ramp Side	Freeway	Right

Adjustment Factors

Driver Population	All Familiar	All Familiar
Weather Type	Non-Severe Weather	Non-Severe Weather
Incident Type	No Incident	-
Final Speed Adjustment Factor (SAF)	1.000	1.000
Final Capacity Adjustment Factor (CAF)	1.000	1.000
Demand Adjustment Factor (DAF)	1.000	1.000

Demand and Capacity

Demand Volume (Vi)	4555	316
Peak Hour Factor (PHF)	0.94	0.94
Total Trucks, %	17.61	2.80
Single-Unit Trucks (SUT), %	-	-
Tractor-Trailers (TT), %	-	-
Heavy Vehicle Adjustment Factor (fHV)	0.850	0.973
Flow Rate (vi),pc/h	5701	345
Capacity (c), pc/h	7050	1800
Volume-to-Capacity Ratio (v/c)	0.81	0.19

Speed and Density

Upstream Equilibrium Distance (LEQ), ft	-	Number of Outer Lanes on Freeway (NO)	1
Distance to Upstream Ramp (LUP), ft	-	Speed Index (DS)	0.719
Downstream Equilibrium Distance (LEQ), ft	-	Flow Outer Lanes (vOA), pc/h/ln	2132
Distance to Downstream Ramp (LDOWN), ft	-	Off-Ramp Influence Area Speed (SR), mi/h	48.5
Prop. Freeway Vehicles in Lane 1 and 2 (PFD)	0.602	Outer Lanes Freeway Speed (SO), mi/h	66.9
Flow in Lanes 1 and 2 (v12), pc/h	3569	Ramp Junction Speed (S), mi/h	54.1
Flow Entering Ramp-Infl. Area (vR12), pc/h	-	Average Density (D), pc/mi/ln	35.1
Level of Service (LOS)	D	Density in Ramp Influence Area (DR), pc/mi/ln	33.6

HCS7 Basic Freeway Report

Project Information

Analyst	LSA	Date	12/11/2019
Agency	LSA	Analysis Year	Phase III Proj Comp Yr (2049) NP
Jurisdiction	Caltrans	Time Period Analyzed	PM Peak Hour
Project Description	CMD1801 - Village D Specific Plan	Unit	United States Customary

Geometric Data

Number of Lanes, ln	3	Terrain Type	Level
Segment Length (L), ft	-	Percent Grade, %	-
Measured or Base Free-Flow Speed	Base	Grade Length, mi	-
Base Free-Flow Speed (BFFS), mi/h	65.0	Total Ramp Density (TRD), ramps/mi	1.83
Lane Width, ft	12	Free-Flow Speed (FFS), mi/h	59.7
Right-Side Lateral Clearance, ft	10		

Adjustment Factors

Driver Population	All Familiar	Final Speed Adjustment Factor (SAF)	1.000
Weather Type	Non-Severe Weather	Final Capacity Adjustment Factor (CAF)	1.000
Incident Type	No Incident	Demand Adjustment Factor (DAF)	1.000

Demand and Capacity

Demand Volume veh/h	4239	Heavy Vehicle Adjustment Factor (fhv)	0.842
Peak Hour Factor	0.94	Flow Rate (Vp), pc/h/ln	1785
Total Trucks, %	18.71	Capacity (c), pc/h/ln	2296
Single-Unit Trucks (SUT), %	-	Adjusted Capacity (cadj), pc/h/ln	2296
Tractor-Trailers (TT), %	-	Volume-to-Capacity Ratio (v/c)	0.78
Passenger Car Equivalent (ET)	2.000		

Speed and Density

Lane Width Adjustment (fLW)	0.0	Average Speed (S), mi/h	59.1
Right-Side Lateral Clearance Adj. (fRLC)	0.0	Density (D), pc/mi/ln	30.2
Total Ramp Density Adjustment	5.4	Level of Service (LOS)	D
Adjusted Free-Flow Speed (FFSadj), mi/h	59.6		

HCS7 Freeway Merge Report

Project Information

Analyst	LSA	Date	12/11/2019
Agency	LSA	Analysis Year	Phase III Proj Comp Yr (2049) NP
Jurisdiction	Caltrans	Time Period Analyzed	PM Peak Hour
Project Description	CMD1801 - Village D Specific Plan	Unit	United States Customary

Geometric Data

	Freeway	Ramp
Number of Lanes (N), ln	3	1
Free-Flow Speed (FFS), mi/h	65.0	35.0
Segment Length (L) / Acceleration Length (LA),ft	1500	450
Terrain Type	Level	Level
Percent Grade, %	-	-
Segment Type / Ramp Side	Freeway	Right

Adjustment Factors

Driver Population	All Familiar	All Familiar
Weather Type	Non-Severe Weather	Non-Severe Weather
Incident Type	No Incident	-
Final Speed Adjustment Factor (SAF)	1.000	1.000
Final Capacity Adjustment Factor (CAF)	1.000	1.000
Demand Adjustment Factor (DAF)	1.000	1.000

Demand and Capacity

Demand Volume (Vi)	4239	542
Peak Hour Factor (PHF)	0.94	0.94
Total Trucks, %	18.71	1.18
Single-Unit Trucks (SUT), %	-	-
Tractor-Trailers (TT), %	-	-
Heavy Vehicle Adjustment Factor (fHV)	0.842	0.988
Flow Rate (vi),pc/h	5356	584
Capacity (c), pc/h	7050	2000
Volume-to-Capacity Ratio (v/c)	0.84	0.29

Speed and Density

Upstream Equilibrium Distance (LEQ), ft	-	Number of Outer Lanes on Freeway (NO)	1
Distance to Upstream Ramp (LUP), ft	-	Speed Index (MS)	0.454
Downstream Equilibrium Distance (LEQ), ft	-	Flow Outer Lanes (vOA), pc/h/ln	2196
Distance to Downstream Ramp (LDOWN), ft	-	On-Ramp Influence Area Speed (SR), mi/h	54.6
Prop. Freeway Vehicles in Lane 1 and 2 (PFM)	0.590	Outer Lanes Freeway Speed (SO), mi/h	58.9
Flow in Lanes 1 and 2 (v12), pc/h	3160	Ramp Junction Speed (S), mi/h	56.1
Flow Entering Ramp-Infl. Area (vR12), pc/h	3744	Average Density (D), pc/mi/ln	35.3
Level of Service (LOS)	D	Density in Ramp Influence Area (DR), pc/mi/ln	31.7

HCS7 Basic Freeway Report

Project Information

Analyst	LSA	Date	12/11/2019
Agency	LSA	Analysis Year	Phase III Proj Comp Yr (2049) NP
Jurisdiction	Caltrans	Time Period Analyzed	PM Peak Hour
Project Description	CMD1801 - Village D Specific Plan	Unit	United States Customary

Geometric Data

Number of Lanes, ln	3	Terrain Type	Level
Segment Length (L), ft	-	Percent Grade, %	-
Measured or Base Free-Flow Speed	Base	Grade Length, mi	-
Base Free-Flow Speed (BFFS), mi/h	65.0	Total Ramp Density (TRD), ramps/mi	1.83
Lane Width, ft	12	Free-Flow Speed (FFS), mi/h	59.7
Right-Side Lateral Clearance, ft	10		

Adjustment Factors

Driver Population	All Familiar	Final Speed Adjustment Factor (SAF)	1.000
Weather Type	Non-Severe Weather	Final Capacity Adjustment Factor (CAF)	1.000
Incident Type	No Incident	Demand Adjustment Factor (DAF)	1.000

Demand and Capacity

Demand Volume veh/h	4781	Heavy Vehicle Adjustment Factor (fhv)	0.857
Peak Hour Factor	0.94	Flow Rate (Vp), pc/h/ln	1978
Total Trucks, %	16.71	Capacity (c), pc/h/ln	2296
Single-Unit Trucks (SUT), %	-	Adjusted Capacity (cadj), pc/h/ln	2296
Tractor-Trailers (TT), %	-	Volume-to-Capacity Ratio (v/c)	0.86
Passenger Car Equivalent (ET)	2.000		

Speed and Density

Lane Width Adjustment (fLW)	0.0	Average Speed (S), mi/h	57.2
Right-Side Lateral Clearance Adj. (fRLC)	0.0	Density (D), pc/mi/ln	34.6
Total Ramp Density Adjustment	5.4	Level of Service (LOS)	D
Adjusted Free-Flow Speed (FFSadj), mi/h	59.6		

HCS7 Freeway Diverge Report

Project Information

Analyst	LSA	Date	12/11/2019
Agency	LSA	Analysis Year	Phase III Proj Comp Yr (2049) NP
Jurisdiction	Caltrans	Time Period Analyzed	PM Peak Hour
Project Description	CMD1801 - Village D Specific Plan	Unit	United States Customary

Geometric Data

	Freeway	Ramp
Number of Lanes (N), ln	3	1
Free-Flow Speed (FFS), mi/h	65.0	35.0
Segment Length (L) / Deceleration Length (LA),ft	1500	140
Terrain Type	Level	Level
Percent Grade, %	-	-
Segment Type / Ramp Side	Freeway	Right

Adjustment Factors

Driver Population	All Familiar	All Familiar
Weather Type	Non-Severe Weather	Non-Severe Weather
Incident Type	No Incident	-
Final Speed Adjustment Factor (SAF)	1.000	1.000
Final Capacity Adjustment Factor (CAF)	1.000	1.000
Demand Adjustment Factor (DAF)	1.000	1.000

Demand and Capacity

Demand Volume (Vi)	4781	776
Peak Hour Factor (PHF)	0.94	0.94
Total Trucks, %	16.71	4.45
Single-Unit Trucks (SUT), %	-	-
Tractor-Trailers (TT), %	-	-
Heavy Vehicle Adjustment Factor (fHV)	0.857	0.957
Flow Rate (vi),pc/h	5935	863
Capacity (c), pc/h	7050	2000
Volume-to-Capacity Ratio (v/c)	0.84	0.43

Speed and Density

Upstream Equilibrium Distance (LEQ), ft	-	Number of Outer Lanes on Freeway (NO)	1
Distance to Upstream Ramp (LUP), ft	-	Speed Index (DS)	0.506
Downstream Equilibrium Distance (LEQ), ft	-	Flow Outer Lanes (vOA), pc/h/ln	2171
Distance to Downstream Ramp (LDOWN), ft	-	Off-Ramp Influence Area Speed (SR), mi/h	53.4
Prop. Freeway Vehicles in Lane 1 and 2 (PFD)	0.572	Outer Lanes Freeway Speed (SO), mi/h	66.7
Flow in Lanes 1 and 2 (v12), pc/h	3764	Ramp Junction Speed (S), mi/h	57.6
Flow Entering Ramp-Infl. Area (vR12), pc/h	-	Average Density (D), pc/mi/ln	34.3
Level of Service (LOS)	E	Density in Ramp Influence Area (DR), pc/mi/ln	35.4

HCS7 Basic Freeway Report

Project Information

Analyst	LSA	Date	12/11/2019
Agency	LSA	Analysis Year	Phase III Proj Comp Yr (2049) NP
Jurisdiction	Caltrans	Time Period Analyzed	PM Peak Hour
Project Description	CMD1801 - Village D Specific Plan	Unit	United States Customary

Geometric Data

Number of Lanes, ln	3	Terrain Type	Level
Segment Length (L), ft	-	Percent Grade, %	-
Measured or Base Free-Flow Speed	Base	Grade Length, mi	-
Base Free-Flow Speed (BFFS), mi/h	65.0	Total Ramp Density (TRD), ramps/mi	2.17
Lane Width, ft	12	Free-Flow Speed (FFS), mi/h	58.8
Right-Side Lateral Clearance, ft	10		

Adjustment Factors

Driver Population	All Familiar	Final Speed Adjustment Factor (SAF)	1.000
Weather Type	Non-Severe Weather	Final Capacity Adjustment Factor (CAF)	1.000
Incident Type	No Incident	Demand Adjustment Factor (DAF)	1.000

Demand and Capacity

Demand Volume veh/h	4005	Heavy Vehicle Adjustment Factor (fhv)	0.840
Peak Hour Factor	0.94	Flow Rate (Vp), pc/h/ln	1691
Total Trucks, %	19.08	Capacity (c), pc/h/ln	2288
Single-Unit Trucks (SUT), %	-	Adjusted Capacity (cadj), pc/h/ln	2288
Tractor-Trailers (TT), %	-	Volume-to-Capacity Ratio (v/c)	0.74
Passenger Car Equivalent (ET)	2.000		

Speed and Density

Lane Width Adjustment (fLW)	0.0	Average Speed (S), mi/h	58.8
Right-Side Lateral Clearance Adj. (fRLC)	0.0	Density (D), pc/mi/ln	28.8
Total Ramp Density Adjustment	6.2	Level of Service (LOS)	D
Adjusted Free-Flow Speed (FFSadj), mi/h	58.8		

HCS7 Freeway Merge Report

Project Information

Analyst	LSA	Date	12/11/2019
Agency	LSA	Analysis Year	Phase III Proj Comp Yr (2049) NP
Jurisdiction	Caltrans	Time Period Analyzed	PM Peak Hour
Project Description	CMD1801 - Village D Specific Plan	Unit	United States Customary

Geometric Data

	Freeway	Ramp
Number of Lanes (N), ln	3	1
Free-Flow Speed (FFS), mi/h	65.0	35.0
Segment Length (L) / Acceleration Length (LA),ft	1500	450
Terrain Type	Level	Level
Percent Grade, %	-	-
Segment Type / Ramp Side	Freeway	Right

Adjustment Factors

Driver Population	All Familiar	All Familiar
Weather Type	Non-Severe Weather	Non-Severe Weather
Incident Type	No Incident	-
Final Speed Adjustment Factor (SAF)	1.000	1.000
Final Capacity Adjustment Factor (CAF)	1.000	1.000
Demand Adjustment Factor (DAF)	1.000	1.000

Demand and Capacity

Demand Volume (Vi)	4005	385
Peak Hour Factor (PHF)	0.94	0.94
Total Trucks, %	19.08	1.70
Single-Unit Trucks (SUT), %	-	-
Tractor-Trailers (TT), %	-	-
Heavy Vehicle Adjustment Factor (fHV)	0.840	0.983
Flow Rate (vi),pc/h	5072	417
Capacity (c), pc/h	7050	2000
Volume-to-Capacity Ratio (v/c)	0.78	0.21

Speed and Density

Upstream Equilibrium Distance (LEQ), ft	-	Number of Outer Lanes on Freeway (NO)	1
Distance to Upstream Ramp (LUP), ft	-	Speed Index (MS)	0.407
Downstream Equilibrium Distance (LEQ), ft	-	Flow Outer Lanes (vOA), pc/h/ln	2080
Distance to Downstream Ramp (LDOWN), ft	-	On-Ramp Influence Area Speed (SR), mi/h	55.6
Prop. Freeway Vehicles in Lane 1 and 2 (PFM)	0.590	Outer Lanes Freeway Speed (SO), mi/h	59.3
Flow in Lanes 1 and 2 (v12), pc/h	2992	Ramp Junction Speed (S), mi/h	56.9
Flow Entering Ramp-Infl. Area (vR12), pc/h	3409	Average Density (D), pc/mi/ln	32.2
Level of Service (LOS)	D	Density in Ramp Influence Area (DR), pc/mi/ln	29.1

HCS7 Basic Freeway Report

Project Information

Analyst	LSA	Date	12/11/2019
Agency	LSA	Analysis Year	Phase III Proj Comp Yr (2049) NP
Jurisdiction	Caltrans	Time Period Analyzed	PM Peak Hour
Project Description	CMD1801 - Village D Specific Plan	Unit	United States Customary

Geometric Data

Number of Lanes, ln	3	Terrain Type	Level
Segment Length (L), ft	-	Percent Grade, %	-
Measured or Base Free-Flow Speed	Base	Grade Length, mi	-
Base Free-Flow Speed (BFFS), mi/h	65.0	Total Ramp Density (TRD), ramps/mi	2.17
Lane Width, ft	12	Free-Flow Speed (FFS), mi/h	58.8
Right-Side Lateral Clearance, ft	10		

Adjustment Factors

Driver Population	All Familiar	Final Speed Adjustment Factor (SAF)	1.000
Weather Type	Non-Severe Weather	Final Capacity Adjustment Factor (CAF)	1.000
Incident Type	No Incident	Demand Adjustment Factor (DAF)	1.000

Demand and Capacity

Demand Volume veh/h	4389	Heavy Vehicle Adjustment Factor (fhv)	0.851
Peak Hour Factor	0.94	Flow Rate (Vp), pc/h/ln	1829
Total Trucks, %	17.57	Capacity (c), pc/h/ln	2288
Single-Unit Trucks (SUT), %	-	Adjusted Capacity (cadj), pc/h/ln	2288
Tractor-Trailers (TT), %	-	Volume-to-Capacity Ratio (v/c)	0.80
Passenger Car Equivalent (ET)	2.000		

Speed and Density

Lane Width Adjustment (fLW)	0.0	Average Speed (S), mi/h	58.2
Right-Side Lateral Clearance Adj. (fRLC)	0.0	Density (D), pc/mi/ln	31.4
Total Ramp Density Adjustment	6.2	Level of Service (LOS)	D
Adjusted Free-Flow Speed (FFSadj), mi/h	58.8		

HCS7 Basic Freeway Report

Project Information

Analyst	LSA	Date	12/11/2019
Agency	LSA	Analysis Year	Phase III Proj Comp Yr (2049) WP
Jurisdiction	Caltrans	Time Period Analyzed	AM Peak Hour
Project Description	CMD1801 - Village D Specific Plan	Unit	United States Customary

Geometric Data

Number of Lanes, ln	3	Terrain Type	Level
Segment Length (L), ft	-	Percent Grade, %	-
Measured or Base Free-Flow Speed	Base	Grade Length, mi	-
Base Free-Flow Speed (BFFS), mi/h	65.0	Total Ramp Density (TRD), ramps/mi	1.83
Lane Width, ft	12	Free-Flow Speed (FFS), mi/h	59.7
Right-Side Lateral Clearance, ft	10		

Adjustment Factors

Driver Population	All Familiar	Final Speed Adjustment Factor (SAF)	1.000
Weather Type	Non-Severe Weather	Final Capacity Adjustment Factor (CAF)	1.000
Incident Type	No Incident	Demand Adjustment Factor (DAF)	1.000

Demand and Capacity

Demand Volume veh/h	3866	Heavy Vehicle Adjustment Factor (fhv)	0.860
Peak Hour Factor	0.94	Flow Rate (Vp), pc/h/ln	1594
Total Trucks, %	16.24	Capacity (c), pc/h/ln	2296
Single-Unit Trucks (SUT), %	-	Adjusted Capacity (cadj), pc/h/ln	2296
Tractor-Trailers (TT), %	-	Volume-to-Capacity Ratio (v/c)	0.69
Passenger Car Equivalent (ET)	2.000		

Speed and Density

Lane Width Adjustment (fLW)	0.0	Average Speed (S), mi/h	59.6
Right-Side Lateral Clearance Adj. (fRLC)	0.0	Density (D), pc/mi/ln	26.7
Total Ramp Density Adjustment	5.4	Level of Service (LOS)	D
Adjusted Free-Flow Speed (FFSadj), mi/h	59.6		

HCS7 Freeway Diverge Report

Project Information

Analyst	LSA	Date	12/11/2019
Agency	LSA	Analysis Year	Phase III Proj Comp Yr (2049) WP
Jurisdiction	Caltrans	Time Period Analyzed	AM Peak Hour
Project Description	CMD1801 - Village D Specific Plan	Unit	United States Customary

Geometric Data

	Freeway	Ramp
Number of Lanes (N), ln	3	1
Free-Flow Speed (FFS), mi/h	65.0	35.0
Segment Length (L) / Deceleration Length (LA),ft	1500	150
Terrain Type	Level	Level
Percent Grade, %	-	-
Segment Type / Ramp Side	Freeway	Right

Adjustment Factors

Driver Population	All Familiar	All Familiar
Weather Type	Non-Severe Weather	Non-Severe Weather
Incident Type	No Incident	-
Final Speed Adjustment Factor (SAF)	1.000	1.000
Final Capacity Adjustment Factor (CAF)	1.000	1.000
Demand Adjustment Factor (DAF)	1.000	1.000

Demand and Capacity

Demand Volume (Vi)	3866	398
Peak Hour Factor (PHF)	0.94	0.94
Total Trucks, %	16.24	3.77
Single-Unit Trucks (SUT), %	-	-
Tractor-Trailers (TT), %	-	-
Heavy Vehicle Adjustment Factor (fHV)	0.860	0.964
Flow Rate (vi),pc/h	4782	439
Capacity (c), pc/h	7050	2000
Volume-to-Capacity Ratio (v/c)	0.68	0.22

Speed and Density

Upstream Equilibrium Distance (LEQ), ft	-	Number of Outer Lanes on Freeway (NO)	1
Distance to Upstream Ramp (LUP), ft	-	Speed Index (DS)	0.468
Downstream Equilibrium Distance (LEQ), ft	-	Flow Outer Lanes (vOA), pc/h/ln	1650
Distance to Downstream Ramp (LDOWN), ft	-	Off-Ramp Influence Area Speed (SR), mi/h	54.2
Prop. Freeway Vehicles in Lane 1 and 2 (PFD)	0.620	Outer Lanes Freeway Speed (SO), mi/h	68.8
Flow in Lanes 1 and 2 (v12), pc/h	3132	Ramp Junction Speed (S), mi/h	58.5
Flow Entering Ramp-Infl. Area (vR12), pc/h	-	Average Density (D), pc/mi/ln	27.2
Level of Service (LOS)	D	Density in Ramp Influence Area (DR), pc/mi/ln	29.8

HCS7 Basic Freeway Report

Project Information

Analyst	LSA	Date	12/11/2019
Agency	LSA	Analysis Year	Phase III Proj Comp Yr (2049) WP
Jurisdiction	Caltrans	Time Period Analyzed	AM Peak Hour
Project Description	CMD1801 - Village D Specific Plan	Unit	United States Customary

Geometric Data

Number of Lanes, ln	3	Terrain Type	Level
Segment Length (L), ft	-	Percent Grade, %	-
Measured or Base Free-Flow Speed	Base	Grade Length, mi	-
Base Free-Flow Speed (BFFS), mi/h	65.0	Total Ramp Density (TRD), ramps/mi	1.83
Lane Width, ft	12	Free-Flow Speed (FFS), mi/h	59.7
Right-Side Lateral Clearance, ft	10		

Adjustment Factors

Driver Population	All Familiar	Final Speed Adjustment Factor (SAF)	1.000
Weather Type	Non-Severe Weather	Final Capacity Adjustment Factor (CAF)	1.000
Incident Type	No Incident	Demand Adjustment Factor (DAF)	1.000

Demand and Capacity

Demand Volume veh/h	3468	Heavy Vehicle Adjustment Factor (fhv)	0.850
Peak Hour Factor	0.94	Flow Rate (Vp), pc/h/ln	1447
Total Trucks, %	17.68	Capacity (c), pc/h/ln	2296
Single-Unit Trucks (SUT), %	-	Adjusted Capacity (cadj), pc/h/ln	2296
Tractor-Trailers (TT), %	-	Volume-to-Capacity Ratio (v/c)	0.63
Passenger Car Equivalent (ET)	2.000		

Speed and Density

Lane Width Adjustment (fLW)	0.0	Average Speed (S), mi/h	59.6
Right-Side Lateral Clearance Adj. (fRLC)	0.0	Density (D), pc/mi/ln	24.3
Total Ramp Density Adjustment	5.4	Level of Service (LOS)	C
Adjusted Free-Flow Speed (FFSadj), mi/h	59.6		

HCS7 Freeway Merge Report

Project Information

Analyst	LSA	Date	12/11/2019
Agency	LSA	Analysis Year	Phase III Proj Comp Yr (2049) WP
Jurisdiction	Caltrans	Time Period Analyzed	AM Peak Hour
Project Description	CMD1801 - Village D Specific Plan	Unit	United States Customary

Geometric Data

	Freeway	Ramp
Number of Lanes (N), ln	2	1
Free-Flow Speed (FFS), mi/h	65.0	35.0
Segment Length (L) / Acceleration Length (LA),ft	1500	445
Terrain Type	Level	Level
Percent Grade, %	-	-
Segment Type / Ramp Side	Freeway	Right

Adjustment Factors

Driver Population	All Familiar	All Familiar
Weather Type	Non-Severe Weather	Non-Severe Weather
Incident Type	No Incident	-
Final Speed Adjustment Factor (SAF)	1.000	1.000
Final Capacity Adjustment Factor (CAF)	1.000	1.000
Demand Adjustment Factor (DAF)	1.000	1.000

Demand and Capacity

Demand Volume (Vi)	3468	1013
Peak Hour Factor (PHF)	0.94	0.94
Total Trucks, %	17.68	9.28
Single-Unit Trucks (SUT), %	-	-
Tractor-Trailers (TT), %	-	-
Heavy Vehicle Adjustment Factor (fHV)	0.850	0.915
Flow Rate (vi),pc/h	4340	1178
Capacity (c), pc/h	4700	2000
Volume-to-Capacity Ratio (v/c)	1.17	0.59

Speed and Density

Upstream Equilibrium Distance (LEQ), ft	-	Number of Outer Lanes on Freeway (NO)	0
Distance to Upstream Ramp (LUP), ft	-	Speed Index (MS)	-
Downstream Equilibrium Distance (LEQ), ft	-	Flow Outer Lanes (vOA), pc/h/ln	-
Distance to Downstream Ramp (LDOWN), ft	-	On-Ramp Influence Area Speed (SR), mi/h	36.0
Prop. Freeway Vehicles in Lane 1 and 2 (PFM)	1.000	Outer Lanes Freeway Speed (SO), mi/h	-
Flow in Lanes 1 and 2 (v12), pc/h	4340	Ramp Junction Speed (S), mi/h	-
Flow Entering Ramp-Infl. Area (vR12), pc/h	5518	Average Density (D), pc/mi/ln	-
Level of Service (LOS)	F	Density in Ramp Influence Area (DR), pc/mi/ln	45.3

HCS7 Basic Freeway Report

Project Information

Analyst	LSA	Date	12/11/2019
Agency	LSA	Analysis Year	Phase III Proj Comp Yr (2049) WP
Jurisdiction	Caltrans	Time Period Analyzed	AM Peak Hour
Project Description	CMD1801 - Village D Specific Plan	Unit	United States Customary

Geometric Data

Number of Lanes, ln	3	Terrain Type	Level
Segment Length (L), ft	-	Percent Grade, %	-
Measured or Base Free-Flow Speed	Base	Grade Length, mi	-
Base Free-Flow Speed (BFFS), mi/h	65.0	Total Ramp Density (TRD), ramps/mi	1.50
Lane Width, ft	12	Free-Flow Speed (FFS), mi/h	60.5
Right-Side Lateral Clearance, ft	10		

Adjustment Factors

Driver Population	All Familiar	Final Speed Adjustment Factor (SAF)	1.000
Weather Type	Non-Severe Weather	Final Capacity Adjustment Factor (CAF)	1.000
Incident Type	No Incident	Demand Adjustment Factor (DAF)	1.000

Demand and Capacity

Demand Volume veh/h	4481	Heavy Vehicle Adjustment Factor (fhv)	0.864
Peak Hour Factor	0.94	Flow Rate (Vp), pc/h/ln	1839
Total Trucks, %	15.78	Capacity (c), pc/h/ln	2305
Single-Unit Trucks (SUT), %	-	Adjusted Capacity (cadj), pc/h/ln	2305
Tractor-Trailers (TT), %	-	Volume-to-Capacity Ratio (v/c)	0.80
Passenger Car Equivalent (ET)	2.000		

Speed and Density

Lane Width Adjustment (fLW)	0.0	Average Speed (S), mi/h	59.3
Right-Side Lateral Clearance Adj. (fRLC)	0.0	Density (D), pc/mi/ln	31.0
Total Ramp Density Adjustment	4.5	Level of Service (LOS)	D
Adjusted Free-Flow Speed (FFSadj), mi/h	60.5		

HCS7 Freeway Diverge Report

Project Information

Analyst	LSA	Date	12/11/2019
Agency	LSA	Analysis Year	Phase III Proj Comp Yr (2049) WP
Jurisdiction	Caltrans	Time Period Analyzed	AM Peak Hour
Project Description	CMD1801 - Village D Specific Plan	Unit	United States Customary

Geometric Data

	Freeway	Ramp
Number of Lanes (N), In	3	1
Free-Flow Speed (FFS), mi/h	65.0	35.0
Segment Length (L) / Deceleration Length (LA),ft	1500	130
Terrain Type	Level	Level
Percent Grade, %	-	-
Segment Type / Ramp Side	Freeway	Right

Adjustment Factors

Driver Population	All Familiar	All Familiar
Weather Type	Non-Severe Weather	Non-Severe Weather
Incident Type	No Incident	-
Final Speed Adjustment Factor (SAF)	1.000	1.000
Final Capacity Adjustment Factor (CAF)	1.000	1.000
Demand Adjustment Factor (DAF)	1.000	1.000

Demand and Capacity

Demand Volume (Vi)	4481	556
Peak Hour Factor (PHF)	0.94	0.94
Total Trucks, %	15.78	1.80
Single-Unit Trucks (SUT), %	-	-
Tractor-Trailers (TT), %	-	-
Heavy Vehicle Adjustment Factor (fHV)	0.864	0.982
Flow Rate (vi),pc/h	5517	602
Capacity (c), pc/h	7050	2000
Volume-to-Capacity Ratio (v/c)	0.78	0.30

Speed and Density

Upstream Equilibrium Distance (LEQ), ft	-	Number of Outer Lanes on Freeway (NO)	1
Distance to Upstream Ramp (LUP), ft	-	Speed Index (DS)	0.482
Downstream Equilibrium Distance (LEQ), ft	-	Flow Outer Lanes (vOA), pc/h/ln	1995
Distance to Downstream Ramp (LDOWN), ft	-	Off-Ramp Influence Area Speed (SR), mi/h	53.9
Prop. Freeway Vehicles in Lane 1 and 2 (PFD)	0.594	Outer Lanes Freeway Speed (SO), mi/h	67.4
Flow in Lanes 1 and 2 (v12), pc/h	3522	Ramp Junction Speed (S), mi/h	58.1
Flow Entering Ramp-Infl. Area (vR12), pc/h	-	Average Density (D), pc/mi/ln	31.7
Level of Service (LOS)	D	Density in Ramp Influence Area (DR), pc/mi/ln	33.4

HCS7 Basic Freeway Report

Project Information

Analyst	LSA	Date	12/11/2019
Agency	LSA	Analysis Year	Phase III Proj Comp Yr (2049) WP
Jurisdiction	Caltrans	Time Period Analyzed	AM Peak Hour
Project Description	CMD1801 - Village D Specific Plan	Unit	United States Customary

Geometric Data

Number of Lanes, ln	3	Terrain Type	Level
Segment Length (L), ft	-	Percent Grade, %	-
Measured or Base Free-Flow Speed	Base	Grade Length, mi	-
Base Free-Flow Speed (BFFS), mi/h	65.0	Total Ramp Density (TRD), ramps/mi	1.67
Lane Width, ft	12	Free-Flow Speed (FFS), mi/h	60.0
Right-Side Lateral Clearance, ft	10		

Adjustment Factors

Driver Population	All Familiar	Final Speed Adjustment Factor (SAF)	1.000
Weather Type	Non-Severe Weather	Final Capacity Adjustment Factor (CAF)	1.000
Incident Type	No Incident	Demand Adjustment Factor (DAF)	1.000

Demand and Capacity

Demand Volume veh/h	3925	Heavy Vehicle Adjustment Factor (fhv)	0.849
Peak Hour Factor	0.94	Flow Rate (Vp), pc/h/ln	1639
Total Trucks, %	17.76	Capacity (c), pc/h/ln	2300
Single-Unit Trucks (SUT), %	-	Adjusted Capacity (cadj), pc/h/ln	2300
Tractor-Trailers (TT), %	-	Volume-to-Capacity Ratio (v/c)	0.71
Passenger Car Equivalent (ET)	2.000		

Speed and Density

Lane Width Adjustment (fLW)	0.0	Average Speed (S), mi/h	60.0
Right-Side Lateral Clearance Adj. (fRLC)	0.0	Density (D), pc/mi/ln	27.3
Total Ramp Density Adjustment	5.0	Level of Service (LOS)	D
Adjusted Free-Flow Speed (FFSadj), mi/h	60.0		

HCS7 Freeway Merge Report

Project Information

Analyst	LSA	Date	12/11/2019
Agency	LSA	Analysis Year	Phase III Proj Comp Yr (2049) WP
Jurisdiction	Caltrans	Time Period Analyzed	AM Peak Hour
Project Description	CMD1801 - Village D Specific Plan	Unit	United States Customary

Geometric Data

	Freeway	Ramp
Number of Lanes (N), ln	3	1
Free-Flow Speed (FFS), mi/h	65.0	35.0
Segment Length (L) / Acceleration Length (LA),ft	1500	500
Terrain Type	Level	Level
Percent Grade, %	-	-
Segment Type / Ramp Side	Freeway	Right

Adjustment Factors

Driver Population	All Familiar	All Familiar
Weather Type	Non-Severe Weather	Non-Severe Weather
Incident Type	No Incident	-
Final Speed Adjustment Factor (SAF)	1.000	1.000
Final Capacity Adjustment Factor (CAF)	1.000	1.000
Demand Adjustment Factor (DAF)	1.000	1.000

Demand and Capacity

Demand Volume (Vi)	3925	396
Peak Hour Factor (PHF)	0.94	0.94
Total Trucks, %	17.76	2.53
Single-Unit Trucks (SUT), %	-	-
Tractor-Trailers (TT), %	-	-
Heavy Vehicle Adjustment Factor (fHV)	0.849	0.975
Flow Rate (vi),pc/h	4918	432
Capacity (c), pc/h	7050	2000
Volume-to-Capacity Ratio (v/c)	0.76	0.22

Speed and Density

Upstream Equilibrium Distance (LEQ), ft	-	Number of Outer Lanes on Freeway (NO)	1
Distance to Upstream Ramp (LUP), ft	-	Speed Index (MS)	0.396
Downstream Equilibrium Distance (LEQ), ft	-	Flow Outer Lanes (vOA), pc/h/ln	2007
Distance to Downstream Ramp (LDOWN), ft	-	On-Ramp Influence Area Speed (SR), mi/h	55.9
Prop. Freeway Vehicles in Lane 1 and 2 (PFM)	0.592	Outer Lanes Freeway Speed (SO), mi/h	59.6
Flow in Lanes 1 and 2 (v12), pc/h	2911	Ramp Junction Speed (S), mi/h	57.2
Flow Entering Ramp-Infl. Area (vR12), pc/h	3343	Average Density (D), pc/mi/ln	31.2
Level of Service (LOS)	D	Density in Ramp Influence Area (DR), pc/mi/ln	28.3

HCS7 Basic Freeway Report

Project Information

Analyst	LSA	Date	12/11/2019
Agency	LSA	Analysis Year	Phase III Proj Comp Yr (2049) WP
Jurisdiction	Caltrans	Time Period Analyzed	AM Peak Hour
Project Description	CMD1801 - Village D Specific Plan	Unit	United States Customary

Geometric Data

Number of Lanes, ln	3	Terrain Type	Level
Segment Length (L), ft	-	Percent Grade, %	-
Measured or Base Free-Flow Speed	Base	Grade Length, mi	-
Base Free-Flow Speed (BFFS), mi/h	65.0	Total Ramp Density (TRD), ramps/mi	1.83
Lane Width, ft	12	Free-Flow Speed (FFS), mi/h	59.7
Right-Side Lateral Clearance, ft	10		

Adjustment Factors

Driver Population	All Familiar	Final Speed Adjustment Factor (SAF)	1.000
Weather Type	Non-Severe Weather	Final Capacity Adjustment Factor (CAF)	1.000
Incident Type	No Incident	Demand Adjustment Factor (DAF)	1.000

Demand and Capacity

Demand Volume veh/h	4321	Heavy Vehicle Adjustment Factor (fhv)	0.859
Peak Hour Factor	0.94	Flow Rate (Vp), pc/h/ln	1784
Total Trucks, %	16.36	Capacity (c), pc/h/ln	2296
Single-Unit Trucks (SUT), %	-	Adjusted Capacity (cadj), pc/h/ln	2296
Tractor-Trailers (TT), %	-	Volume-to-Capacity Ratio (v/c)	0.78
Passenger Car Equivalent (ET)	2.000		

Speed and Density

Lane Width Adjustment (fLW)	0.0	Average Speed (S), mi/h	59.1
Right-Side Lateral Clearance Adj. (fRLC)	0.0	Density (D), pc/mi/ln	30.2
Total Ramp Density Adjustment	5.4	Level of Service (LOS)	D
Adjusted Free-Flow Speed (FFSadj), mi/h	59.6		

HCS7 Freeway Diverge Report

Project Information

Analyst	LSA	Date	12/11/2019
Agency	LSA	Analysis Year	Phase III Proj Comp Yr (2049) WP
Jurisdiction	Caltrans	Time Period Analyzed	AM Peak Hour
Project Description	CMD1801 - Village D Specific Plan	Unit	United States Customary

Geometric Data

	Freeway	Ramp
Number of Lanes (N), ln	3	1
Free-Flow Speed (FFS), mi/h	65.0	35.0
Segment Length (L) / Deceleration Length (LA),ft	1500	245
Terrain Type	Level	Level
Percent Grade, %	-	-
Segment Type / Ramp Side	Freeway	Right

Adjustment Factors

Driver Population	All Familiar	All Familiar
Weather Type	Non-Severe Weather	Non-Severe Weather
Incident Type	No Incident	-
Final Speed Adjustment Factor (SAF)	1.000	1.000
Final Capacity Adjustment Factor (CAF)	1.000	1.000
Demand Adjustment Factor (DAF)	1.000	1.000

Demand and Capacity

Demand Volume (Vi)	4321	827
Peak Hour Factor (PHF)	0.94	0.94
Total Trucks, %	16.36	3.75
Single-Unit Trucks (SUT), %	-	-
Tractor-Trailers (TT), %	-	-
Heavy Vehicle Adjustment Factor (fHV)	0.859	0.964
Flow Rate (vi),pc/h	5351	913
Capacity (c), pc/h	7050	2000
Volume-to-Capacity Ratio (v/c)	0.76	0.46

Speed and Density

Upstream Equilibrium Distance (LEQ), ft	-	Number of Outer Lanes on Freeway (NO)	1
Distance to Upstream Ramp (LUP), ft	-	Speed Index (DS)	0.510
Downstream Equilibrium Distance (LEQ), ft	-	Flow Outer Lanes (vOA), pc/h/ln	1846
Distance to Downstream Ramp (LDOWN), ft	-	Off-Ramp Influence Area Speed (SR), mi/h	53.3
Prop. Freeway Vehicles in Lane 1 and 2 (PFD)	0.584	Outer Lanes Freeway Speed (SO), mi/h	68.0
Flow in Lanes 1 and 2 (v12), pc/h	3505	Ramp Junction Speed (S), mi/h	57.6
Flow Entering Ramp-Infl. Area (vR12), pc/h	-	Average Density (D), pc/mi/ln	31.0
Level of Service (LOS)	D	Density in Ramp Influence Area (DR), pc/mi/ln	32.2

HCS7 Basic Freeway Report

Project Information

Analyst	LSA	Date	12/11/2019
Agency	LSA	Analysis Year	Phase III Proj Comp Yr (2049) WP
Jurisdiction	Caltrans	Time Period Analyzed	AM Peak Hour
Project Description	CMD1801 - Village D Specific Plan	Unit	United States Customary

Geometric Data

Number of Lanes, ln	3	Terrain Type	Level
Segment Length (L), ft	-	Percent Grade, %	-
Measured or Base Free-Flow Speed	Base	Grade Length, mi	-
Base Free-Flow Speed (BFFS), mi/h	65.0	Total Ramp Density (TRD), ramps/mi	1.83
Lane Width, ft	12	Free-Flow Speed (FFS), mi/h	59.7
Right-Side Lateral Clearance, ft	10		

Adjustment Factors

Driver Population	All Familiar	Final Speed Adjustment Factor (SAF)	1.000
Weather Type	Non-Severe Weather	Final Capacity Adjustment Factor (CAF)	1.000
Incident Type	No Incident	Demand Adjustment Factor (DAF)	1.000

Demand and Capacity

Demand Volume veh/h	3494	Heavy Vehicle Adjustment Factor (fhv)	0.838
Peak Hour Factor	0.94	Flow Rate (Vp), pc/h/ln	1479
Total Trucks, %	19.35	Capacity (c), pc/h/ln	2296
Single-Unit Trucks (SUT), %	-	Adjusted Capacity (cadj), pc/h/ln	2296
Tractor-Trailers (TT), %	-	Volume-to-Capacity Ratio (v/c)	0.64
Passenger Car Equivalent (ET)	2.000		

Speed and Density

Lane Width Adjustment (fLW)	0.0	Average Speed (S), mi/h	59.6
Right-Side Lateral Clearance Adj. (fRLC)	0.0	Density (D), pc/mi/ln	24.8
Total Ramp Density Adjustment	5.4	Level of Service (LOS)	C
Adjusted Free-Flow Speed (FFSadj), mi/h	59.6		

HCS7 Freeway Merge Report

Project Information

Analyst	LSA	Date	12/11/2019
Agency	LSA	Analysis Year	Phase III Proj Comp Yr (2049) WP
Jurisdiction	Caltrans	Time Period Analyzed	AM Peak Hour
Project Description	CMD1801 - Village D Specific Plan	Unit	United States Customary

Geometric Data

	Freeway	Ramp
Number of Lanes (N), ln	3	1
Free-Flow Speed (FFS), mi/h	65.0	35.0
Segment Length (L) / Acceleration Length (LA),ft	1500	350
Terrain Type	Level	Level
Percent Grade, %	-	-
Segment Type / Ramp Side	Freeway	Right

Adjustment Factors

Driver Population	All Familiar	All Familiar
Weather Type	Non-Severe Weather	Non-Severe Weather
Incident Type	No Incident	-
Final Speed Adjustment Factor (SAF)	1.000	1.000
Final Capacity Adjustment Factor (CAF)	1.000	1.000
Demand Adjustment Factor (DAF)	1.000	1.000

Demand and Capacity

Demand Volume (Vi)	3494	258
Peak Hour Factor (PHF)	0.94	0.94
Total Trucks, %	19.35	2.33
Single-Unit Trucks (SUT), %	-	-
Tractor-Trailers (TT), %	-	-
Heavy Vehicle Adjustment Factor (fHV)	0.838	0.977
Flow Rate (vi),pc/h	4436	281
Capacity (c), pc/h	7050	2000
Volume-to-Capacity Ratio (v/c)	0.67	0.14

Speed and Density

Upstream Equilibrium Distance (LEQ), ft	-	Number of Outer Lanes on Freeway (NO)	1
Distance to Upstream Ramp (LUP), ft	-	Speed Index (MS)	0.366
Downstream Equilibrium Distance (LEQ), ft	-	Flow Outer Lanes (vOA), pc/h/ln	1832
Distance to Downstream Ramp (LDOWN), ft	-	On-Ramp Influence Area Speed (SR), mi/h	56.6
Prop. Freeway Vehicles in Lane 1 and 2 (PFM)	0.587	Outer Lanes Freeway Speed (SO), mi/h	60.2
Flow in Lanes 1 and 2 (v12), pc/h	2604	Ramp Junction Speed (S), mi/h	57.9
Flow Entering Ramp-Infl. Area (vR12), pc/h	2885	Average Density (D), pc/mi/ln	27.2
Level of Service (LOS)	C	Density in Ramp Influence Area (DR), pc/mi/ln	25.7

HCS7 Basic Freeway Report

Project Information

Analyst	LSA	Date	12/11/2019
Agency	LSA	Analysis Year	Phase III Proj Comp Yr (2049) WP
Jurisdiction	Caltrans	Time Period Analyzed	AM Peak Hour
Project Description	CMD1801 - Village D Specific Plan	Unit	United States Customary

Geometric Data

Number of Lanes, ln	3	Terrain Type	Level
Segment Length (L), ft	-	Percent Grade, %	-
Measured or Base Free-Flow Speed	Base	Grade Length, mi	-
Base Free-Flow Speed (BFFS), mi/h	65.0	Total Ramp Density (TRD), ramps/mi	1.83
Lane Width, ft	12	Free-Flow Speed (FFS), mi/h	59.7
Right-Side Lateral Clearance, ft	10		

Adjustment Factors

Driver Population	All Familiar	Final Speed Adjustment Factor (SAF)	1.000
Weather Type	Non-Severe Weather	Final Capacity Adjustment Factor (CAF)	1.000
Incident Type	No Incident	Demand Adjustment Factor (DAF)	1.000

Demand and Capacity

Demand Volume veh/h	3752	Heavy Vehicle Adjustment Factor (fhv)	0.846
Peak Hour Factor	0.94	Flow Rate (Vp), pc/h/ln	1573
Total Trucks, %	18.18	Capacity (c), pc/h/ln	2296
Single-Unit Trucks (SUT), %	-	Adjusted Capacity (cadj), pc/h/ln	2296
Tractor-Trailers (TT), %	-	Volume-to-Capacity Ratio (v/c)	0.68
Passenger Car Equivalent (ET)	2.000		

Speed and Density

Lane Width Adjustment (fLW)	0.0	Average Speed (S), mi/h	59.6
Right-Side Lateral Clearance Adj. (fRLC)	0.0	Density (D), pc/mi/ln	26.4
Total Ramp Density Adjustment	5.4	Level of Service (LOS)	D
Adjusted Free-Flow Speed (FFSadj), mi/h	59.6		

HCS7 Freeway Diverge Report

Project Information

Analyst	LSA	Date	12/11/2019
Agency	LSA	Analysis Year	Phase III Proj Comp Yr (2049) WP
Jurisdiction	Caltrans	Time Period Analyzed	AM Peak Hour
Project Description	CMD1801 - Village D Specific Plan	Unit	United States Customary

Geometric Data

	Freeway	Ramp
Number of Lanes (N), ln	3	1
Free-Flow Speed (FFS), mi/h	65.0	15.0
Segment Length (L) / Deceleration Length (LA),ft	1500	150
Terrain Type	Level	Level
Percent Grade, %	-	-
Segment Type / Ramp Side	Freeway	Right

Adjustment Factors

Driver Population	All Familiar	All Familiar
Weather Type	Non-Severe Weather	Non-Severe Weather
Incident Type	No Incident	-
Final Speed Adjustment Factor (SAF)	1.000	1.000
Final Capacity Adjustment Factor (CAF)	1.000	1.000
Demand Adjustment Factor (DAF)	1.000	1.000

Demand and Capacity

Demand Volume (Vi)	3752	435
Peak Hour Factor (PHF)	0.94	0.94
Total Trucks, %	18.18	6.20
Single-Unit Trucks (SUT), %	-	-
Tractor-Trailers (TT), %	-	-
Heavy Vehicle Adjustment Factor (fHV)	0.846	0.942
Flow Rate (vi),pc/h	4718	491
Capacity (c), pc/h	7050	1800
Volume-to-Capacity Ratio (v/c)	0.67	0.27

Speed and Density

Upstream Equilibrium Distance (LEQ), ft	-	Number of Outer Lanes on Freeway (NO)	1
Distance to Upstream Ramp (LUP), ft	-	Speed Index (DS)	0.732
Downstream Equilibrium Distance (LEQ), ft	-	Flow Outer Lanes (vOA), pc/h/ln	1610
Distance to Downstream Ramp (LDOWN), ft	-	Off-Ramp Influence Area Speed (SR), mi/h	48.2
Prop. Freeway Vehicles in Lane 1 and 2 (PFD)	0.619	Outer Lanes Freeway Speed (SO), mi/h	68.9
Flow in Lanes 1 and 2 (v12), pc/h	3108	Ramp Junction Speed (S), mi/h	53.7
Flow Entering Ramp-Infl. Area (vR12), pc/h	-	Average Density (D), pc/mi/ln	29.3
Level of Service (LOS)	D	Density in Ramp Influence Area (DR), pc/mi/ln	29.6

HCS7 Basic Freeway Report

Project Information

Analyst	LSA	Date	12/11/2019
Agency	LSA	Analysis Year	Phase III Proj Comp Yr (2049) WP
Jurisdiction	Caltrans	Time Period Analyzed	AM Peak Hour
Project Description	CMD1801 - Village D Specific Plan	Unit	United States Customary

Geometric Data

Number of Lanes, ln	3	Terrain Type	Level
Segment Length (L), ft	-	Percent Grade, %	-
Measured or Base Free-Flow Speed	Base	Grade Length, mi	-
Base Free-Flow Speed (BFFS), mi/h	65.0	Total Ramp Density (TRD), ramps/mi	1.67
Lane Width, ft	12	Free-Flow Speed (FFS), mi/h	60.0
Right-Side Lateral Clearance, ft	10		

Adjustment Factors

Driver Population	All Familiar	Final Speed Adjustment Factor (SAF)	1.000
Weather Type	Non-Severe Weather	Final Capacity Adjustment Factor (CAF)	1.000
Incident Type	No Incident	Demand Adjustment Factor (DAF)	1.000

Demand and Capacity

Demand Volume veh/h	3317	Heavy Vehicle Adjustment Factor (fhv)	0.835
Peak Hour Factor	0.94	Flow Rate (Vp), pc/h/ln	1409
Total Trucks, %	19.75	Capacity (c), pc/h/ln	2300
Single-Unit Trucks (SUT), %	-	Adjusted Capacity (cadj), pc/h/ln	2300
Tractor-Trailers (TT), %	-	Volume-to-Capacity Ratio (v/c)	0.61
Passenger Car Equivalent (ET)	2.000		

Speed and Density

Lane Width Adjustment (fLW)	0.0	Average Speed (S), mi/h	60.0
Right-Side Lateral Clearance Adj. (fRLC)	0.0	Density (D), pc/mi/ln	23.5
Total Ramp Density Adjustment	5.0	Level of Service (LOS)	C
Adjusted Free-Flow Speed (FFSadj), mi/h	60.0		

HCS7 Freeway Merge Report

Project Information

Analyst	LSA	Date	12/11/2019
Agency	LSA	Analysis Year	Phase III Proj Comp Yr (2049) WP
Jurisdiction	Caltrans	Time Period Analyzed	AM Peak Hour
Project Description	CMD1801 - Village D Specific Plan	Unit	United States Customary

Geometric Data

	Freeway	Ramp
Number of Lanes (N), ln	3	1
Free-Flow Speed (FFS), mi/h	65.0	35.0
Segment Length (L) / Acceleration Length (LA),ft	1500	525
Terrain Type	Level	Level
Percent Grade, %	-	-
Segment Type / Ramp Side	Freeway	Right

Adjustment Factors

Driver Population	All Familiar	All Familiar
Weather Type	Non-Severe Weather	Non-Severe Weather
Incident Type	No Incident	-
Final Speed Adjustment Factor (SAF)	1.000	1.000
Final Capacity Adjustment Factor (CAF)	1.000	1.000
Demand Adjustment Factor (DAF)	1.000	1.000

Demand and Capacity

Demand Volume (Vi)	3317	218
Peak Hour Factor (PHF)	0.94	0.94
Total Trucks, %	19.75	4.13
Single-Unit Trucks (SUT), %	-	-
Tractor-Trailers (TT), %	-	-
Heavy Vehicle Adjustment Factor (fHV)	0.835	0.960
Flow Rate (vi),pc/h	4226	242
Capacity (c), pc/h	7050	2000
Volume-to-Capacity Ratio (v/c)	0.63	0.12

Speed and Density

Upstream Equilibrium Distance (LEQ), ft	-	Number of Outer Lanes on Freeway (NO)	1
Distance to Upstream Ramp (LUP), ft	-	Speed Index (MS)	0.345
Downstream Equilibrium Distance (LEQ), ft	-	Flow Outer Lanes (vOA), pc/h/ln	1724
Distance to Downstream Ramp (LDOWN), ft	-	On-Ramp Influence Area Speed (SR), mi/h	57.1
Prop. Freeway Vehicles in Lane 1 and 2 (PFM)	0.592	Outer Lanes Freeway Speed (SO), mi/h	60.6
Flow in Lanes 1 and 2 (v12), pc/h	2502	Ramp Junction Speed (S), mi/h	58.4
Flow Entering Ramp-Infl. Area (vR12), pc/h	2744	Average Density (D), pc/mi/ln	25.5
Level of Service (LOS)	C	Density in Ramp Influence Area (DR), pc/mi/ln	23.5

HCS7 Basic Freeway Report

Project Information

Analyst	LSA	Date	12/11/2019
Agency	LSA	Analysis Year	Phase III Proj Comp Yr (2049) WP
Jurisdiction	Caltrans	Time Period Analyzed	AM Peak Hour
Project Description	CMD1801 - Village D Specific Plan	Unit	United States Customary

Geometric Data

Number of Lanes, ln	3	Terrain Type	Level
Segment Length (L), ft	-	Percent Grade, %	-
Measured or Base Free-Flow Speed	Base	Grade Length, mi	-
Base Free-Flow Speed (BFFS), mi/h	65.0	Total Ramp Density (TRD), ramps/mi	1.67
Lane Width, ft	12	Free-Flow Speed (FFS), mi/h	60.0
Right-Side Lateral Clearance, ft	10		

Adjustment Factors

Driver Population	All Familiar	Final Speed Adjustment Factor (SAF)	1.000
Weather Type	Non-Severe Weather	Final Capacity Adjustment Factor (CAF)	1.000
Incident Type	No Incident	Demand Adjustment Factor (DAF)	1.000

Demand and Capacity

Demand Volume veh/h	3535	Heavy Vehicle Adjustment Factor (fhv)	0.842
Peak Hour Factor	0.94	Flow Rate (Vp), pc/h/ln	1489
Total Trucks, %	18.78	Capacity (c), pc/h/ln	2300
Single-Unit Trucks (SUT), %	-	Adjusted Capacity (cadj), pc/h/ln	2300
Tractor-Trailers (TT), %	-	Volume-to-Capacity Ratio (v/c)	0.65
Passenger Car Equivalent (ET)	2.000		

Speed and Density

Lane Width Adjustment (fLW)	0.0	Average Speed (S), mi/h	60.0
Right-Side Lateral Clearance Adj. (fRLC)	0.0	Density (D), pc/mi/ln	24.8
Total Ramp Density Adjustment	5.0	Level of Service (LOS)	C
Adjusted Free-Flow Speed (FFSadj), mi/h	60.0		

HCS7 Freeway Diverge Report

Project Information

Analyst	LSA	Date	12/11/2019
Agency	LSA	Analysis Year	Phase III Proj Comp Yr (2049) WP
Jurisdiction	Caltrans	Time Period Analyzed	AM Peak Hour
Project Description	CMD1801 - Village D Specific Plan	Unit	United States Customary

Geometric Data

	Freeway	Ramp
Number of Lanes (N), ln	3	1
Free-Flow Speed (FFS), mi/h	65.0	35.0
Segment Length (L) / Deceleration Length (LA),ft	1500	200
Terrain Type	Level	Level
Percent Grade, %	-	-
Segment Type / Ramp Side	Freeway	Right

Adjustment Factors

Driver Population	All Familiar	All Familiar
Weather Type	Non-Severe Weather	Non-Severe Weather
Incident Type	No Incident	-
Final Speed Adjustment Factor (SAF)	1.000	1.000
Final Capacity Adjustment Factor (CAF)	1.000	1.000
Demand Adjustment Factor (DAF)	1.000	1.000

Demand and Capacity

Demand Volume (Vi)	3535	790
Peak Hour Factor (PHF)	0.94	0.94
Total Trucks, %	18.78	9.49
Single-Unit Trucks (SUT), %	-	-
Tractor-Trailers (TT), %	-	-
Heavy Vehicle Adjustment Factor (fHV)	0.842	0.913
Flow Rate (vi),pc/h	4466	921
Capacity (c), pc/h	7050	2000
Volume-to-Capacity Ratio (v/c)	0.63	0.46

Speed and Density

Upstream Equilibrium Distance (LEQ), ft	-	Number of Outer Lanes on Freeway (NO)	1
Distance to Upstream Ramp (LUP), ft	-	Speed Index (DS)	0.511
Downstream Equilibrium Distance (LEQ), ft	-	Flow Outer Lanes (vOA), pc/h/ln	1397
Distance to Downstream Ramp (LDOWN), ft	-	Off-Ramp Influence Area Speed (SR), mi/h	53.2
Prop. Freeway Vehicles in Lane 1 and 2 (PFD)	0.606	Outer Lanes Freeway Speed (SO), mi/h	69.8
Flow in Lanes 1 and 2 (v12), pc/h	3069	Ramp Junction Speed (S), mi/h	57.5
Flow Entering Ramp-Infl. Area (vR12), pc/h	-	Average Density (D), pc/mi/ln	25.9
Level of Service (LOS)	D	Density in Ramp Influence Area (DR), pc/mi/ln	28.8

HCS7 Basic Freeway Report

Project Information

Analyst	LSA	Date	12/11/2019
Agency	LSA	Analysis Year	Phase III Proj Comp Yr (2049) WP
Jurisdiction	Caltrans	Time Period Analyzed	AM Peak Hour
Project Description	CMD1801 - Village D Specific Plan	Unit	United States Customary

Geometric Data

Number of Lanes, ln	3	Terrain Type	Level
Segment Length (L), ft	-	Percent Grade, %	-
Measured or Base Free-Flow Speed	Base	Grade Length, mi	-
Base Free-Flow Speed (BFFS), mi/h	70.0	Total Ramp Density (TRD), ramps/mi	1.50
Lane Width, ft	12	Free-Flow Speed (FFS), mi/h	65.5
Right-Side Lateral Clearance, ft	10		

Adjustment Factors

Driver Population	All Familiar	Final Speed Adjustment Factor (SAF)	1.000
Weather Type	Non-Severe Weather	Final Capacity Adjustment Factor (CAF)	1.000
Incident Type	No Incident	Demand Adjustment Factor (DAF)	1.000

Demand and Capacity

Demand Volume veh/h	2745	Heavy Vehicle Adjustment Factor (fhv)	0.823
Peak Hour Factor	0.94	Flow Rate (Vp), pc/h/ln	1183
Total Trucks, %	21.46	Capacity (c), pc/h/ln	2355
Single-Unit Trucks (SUT), %	-	Adjusted Capacity (cadj), pc/h/ln	2355
Tractor-Trailers (TT), %	-	Volume-to-Capacity Ratio (v/c)	0.50
Passenger Car Equivalent (ET)	2.000		

Speed and Density

Lane Width Adjustment (fLW)	0.0	Average Speed (S), mi/h	65.5
Right-Side Lateral Clearance Adj. (fRLC)	0.0	Density (D), pc/mi/ln	18.1
Total Ramp Density Adjustment	4.5	Level of Service (LOS)	C
Adjusted Free-Flow Speed (FFSadj), mi/h	65.5		

HCS7 Freeway Merge Report

Project Information

Analyst	LSA	Date	12/11/2019
Agency	LSA	Analysis Year	Phase III Proj Comp Yr (2049) WP
Jurisdiction	Caltrans	Time Period Analyzed	AM Peak Hour
Project Description	CMD1801 - Village D Specific Plan	Unit	United States Customary

Geometric Data

	Freeway	Ramp
Number of Lanes (N), ln	3	1
Free-Flow Speed (FFS), mi/h	70.0	35.0
Segment Length (L) / Acceleration Length (LA),ft	1500	400
Terrain Type	Level	Level
Percent Grade, %	-	-
Segment Type / Ramp Side	Freeway	Right

Adjustment Factors

Driver Population	All Familiar	All Familiar
Weather Type	Non-Severe Weather	Non-Severe Weather
Incident Type	No Incident	-
Final Speed Adjustment Factor (SAF)	1.000	1.000
Final Capacity Adjustment Factor (CAF)	1.000	1.000
Demand Adjustment Factor (DAF)	1.000	1.000

Demand and Capacity

Demand Volume (Vi)	2745	402
Peak Hour Factor (PHF)	0.94	0.94
Total Trucks, %	21.46	10.45
Single-Unit Trucks (SUT), %	-	-
Tractor-Trailers (TT), %	-	-
Heavy Vehicle Adjustment Factor (fHV)	0.823	0.905
Flow Rate (vi),pc/h	3548	473
Capacity (c), pc/h	7200	2000
Volume-to-Capacity Ratio (v/c)	0.56	0.24

Speed and Density

Upstream Equilibrium Distance (LEQ), ft	-	Number of Outer Lanes on Freeway (NO)	1
Distance to Upstream Ramp (LUP), ft	-	Speed Index (MS)	0.344
Downstream Equilibrium Distance (LEQ), ft	-	Flow Outer Lanes (vOA), pc/h/ln	1458
Distance to Downstream Ramp (LDOWN), ft	-	On-Ramp Influence Area Speed (SR), mi/h	60.4
Prop. Freeway Vehicles in Lane 1 and 2 (PFM)	0.589	Outer Lanes Freeway Speed (SO), mi/h	66.6
Flow in Lanes 1 and 2 (v12), pc/h	2090	Ramp Junction Speed (S), mi/h	62.5
Flow Entering Ramp-Infl. Area (vR12), pc/h	2563	Average Density (D), pc/mi/ln	21.4
Level of Service (LOS)	C	Density in Ramp Influence Area (DR), pc/mi/ln	22.8

HCS7 Basic Freeway Report

Project Information

Analyst	LSA	Date	12/11/2019
Agency	LSA	Analysis Year	Phase III Proj Comp Yr (2049) WP
Jurisdiction	Caltrans	Time Period Analyzed	AM Peak Hour
Project Description	CMD1801 - Village D Specific Plan	Unit	United States Customary

Geometric Data

Number of Lanes, ln	2	Terrain Type	Level
Segment Length (L), ft	-	Percent Grade, %	-
Measured or Base Free-Flow Speed	Base	Grade Length, mi	-
Base Free-Flow Speed (BFFS), mi/h	70.0	Total Ramp Density (TRD), ramps/mi	1.00
Lane Width, ft	12	Free-Flow Speed (FFS), mi/h	66.8
Right-Side Lateral Clearance, ft	10		

Adjustment Factors

Driver Population	All Familiar	Final Speed Adjustment Factor (SAF)	1.000
Weather Type	Non-Severe Weather	Final Capacity Adjustment Factor (CAF)	1.000
Incident Type	No Incident	Demand Adjustment Factor (DAF)	1.000

Demand and Capacity

Demand Volume veh/h	3147	Heavy Vehicle Adjustment Factor (fhv)	0.833
Peak Hour Factor	0.94	Flow Rate (Vp), pc/h/ln	2010
Total Trucks, %	20.05	Capacity (c), pc/h/ln	2368
Single-Unit Trucks (SUT), %	-	Adjusted Capacity (cadj), pc/h/ln	2368
Tractor-Trailers (TT), %	-	Volume-to-Capacity Ratio (v/c)	0.85
Passenger Car Equivalent (ET)	2.000		

Speed and Density

Lane Width Adjustment (fLW)	0.0	Average Speed (S), mi/h	60.7
Right-Side Lateral Clearance Adj. (fRLC)	0.0	Density (D), pc/mi/ln	33.1
Total Ramp Density Adjustment	3.2	Level of Service (LOS)	D
Adjusted Free-Flow Speed (FFSadj), mi/h	66.8		

HCS7 Freeway Diverge Report

Project Information

Analyst	LSA	Date	12/11/2019
Agency	LSA	Analysis Year	Phase III Proj Comp Yr (2049) WP
Jurisdiction	Caltrans	Time Period Analyzed	AM Peak Hour
Project Description	CMD1801 - Village D Specific Plan	Unit	United States Customary

Geometric Data

	Freeway	Ramp
Number of Lanes (N), ln	2	1
Free-Flow Speed (FFS), mi/h	70.0	35.0
Segment Length (L) / Deceleration Length (LA),ft	1500	200
Terrain Type	Level	Level
Percent Grade, %	-	-
Segment Type / Ramp Side	Freeway	Right

Adjustment Factors

Driver Population	All Familiar	All Familiar
Weather Type	Non-Severe Weather	Non-Severe Weather
Incident Type	No Incident	-
Final Speed Adjustment Factor (SAF)	1.000	1.000
Final Capacity Adjustment Factor (CAF)	1.000	1.000
Demand Adjustment Factor (DAF)	1.000	1.000

Demand and Capacity

Demand Volume (Vi)	3147	245
Peak Hour Factor (PHF)	0.94	0.94
Total Trucks, %	20.05	28.57
Single-Unit Trucks (SUT), %	-	-
Tractor-Trailers (TT), %	-	-
Heavy Vehicle Adjustment Factor (fHV)	0.833	0.778
Flow Rate (vi),pc/h	4019	335
Capacity (c), pc/h	4800	2000
Volume-to-Capacity Ratio (v/c)	0.84	0.17

Speed and Density

Upstream Equilibrium Distance (LEQ), ft	-	Number of Outer Lanes on Freeway (NO)	0
Distance to Upstream Ramp (LUP), ft	-	Speed Index (DS)	0.458
Downstream Equilibrium Distance (LEQ), ft	-	Flow Outer Lanes (vOA), pc/h/ln	-
Distance to Downstream Ramp (LDOWN), ft	-	Off-Ramp Influence Area Speed (SR), mi/h	57.2
Prop. Freeway Vehicles in Lane 1 and 2 (PFD)	1.000	Outer Lanes Freeway Speed (SO), mi/h	76.8
Flow in Lanes 1 and 2 (v12), pc/h	4019	Ramp Junction Speed (S), mi/h	57.2
Flow Entering Ramp-Infl. Area (vR12), pc/h	-	Average Density (D), pc/mi/ln	35.1
Level of Service (LOS)	E	Density in Ramp Influence Area (DR), pc/mi/ln	37.0

HCS7 Basic Freeway Report

Project Information

Analyst	LSA	Date	12/11/2019
Agency	LSA	Analysis Year	Phase III Proj Comp Yr (2049) WP
Jurisdiction	Caltrans	Time Period Analyzed	AM Peak Hour
Project Description	CMD1801 - Village D Specific Plan	Unit	United States Customary

Geometric Data

Number of Lanes, ln	2	Terrain Type	Level
Segment Length (L), ft	-	Percent Grade, %	-
Measured or Base Free-Flow Speed	Base	Grade Length, mi	-
Base Free-Flow Speed (BFFS), mi/h	70.0	Total Ramp Density (TRD), ramps/mi	1.00
Lane Width, ft	12	Free-Flow Speed (FFS), mi/h	66.8
Right-Side Lateral Clearance, ft	10		

Adjustment Factors

Driver Population	All Familiar	Final Speed Adjustment Factor (SAF)	1.000
Weather Type	Non-Severe Weather	Final Capacity Adjustment Factor (CAF)	1.000
Incident Type	No Incident	Demand Adjustment Factor (DAF)	1.000

Demand and Capacity

Demand Volume veh/h	2902	Heavy Vehicle Adjustment Factor (fhv)	0.838
Peak Hour Factor	0.94	Flow Rate (Vp), pc/h/ln	1842
Total Trucks, %	19.33	Capacity (c), pc/h/ln	2368
Single-Unit Trucks (SUT), %	-	Adjusted Capacity (cadj), pc/h/ln	2368
Tractor-Trailers (TT), %	-	Volume-to-Capacity Ratio (v/c)	0.78
Passenger Car Equivalent (ET)	2.000		

Speed and Density

Lane Width Adjustment (fLW)	0.0	Average Speed (S), mi/h	63.3
Right-Side Lateral Clearance Adj. (fRLC)	0.0	Density (D), pc/mi/ln	29.1
Total Ramp Density Adjustment	3.2	Level of Service (LOS)	D
Adjusted Free-Flow Speed (FFSadj), mi/h	66.8		

HCS7 Freeway Merge Report

Project Information

Analyst	LSA	Date	12/11/2019
Agency	LSA	Analysis Year	Phase III Proj Comp Yr (2049) WP
Jurisdiction	Caltrans	Time Period Analyzed	AM Peak Hour
Project Description	CMD1801 - Village D Specific Plan	Unit	United States Customary

Geometric Data

	Freeway	Ramp
Number of Lanes (N), ln	2	1
Free-Flow Speed (FFS), mi/h	70.0	35.0
Segment Length (L) / Acceleration Length (LA),ft	1500	700
Terrain Type	Level	Level
Percent Grade, %	-	-
Segment Type / Ramp Side	Freeway	Right

Adjustment Factors

Driver Population	All Familiar	All Familiar
Weather Type	Non-Severe Weather	Non-Severe Weather
Incident Type	No Incident	-
Final Speed Adjustment Factor (SAF)	1.000	1.000
Final Capacity Adjustment Factor (CAF)	1.000	1.000
Demand Adjustment Factor (DAF)	1.000	1.000

Demand and Capacity

Demand Volume (Vi)	2902	843
Peak Hour Factor (PHF)	0.94	0.94
Total Trucks, %	19.33	10.32
Single-Unit Trucks (SUT), %	-	-
Tractor-Trailers (TT), %	-	-
Heavy Vehicle Adjustment Factor (fHV)	0.838	0.906
Flow Rate (vi),pc/h	3684	990
Capacity (c), pc/h	4800	2000
Volume-to-Capacity Ratio (v/c)	0.97	0.50

Speed and Density

Upstream Equilibrium Distance (LEQ), ft	-	Number of Outer Lanes on Freeway (NO)	0
Distance to Upstream Ramp (LUP), ft	-	Speed Index (MS)	0.690
Downstream Equilibrium Distance (LEQ), ft	-	Flow Outer Lanes (vOA), pc/h/ln	-
Distance to Downstream Ramp (LDOWN), ft	-	On-Ramp Influence Area Speed (SR), mi/h	50.7
Prop. Freeway Vehicles in Lane 1 and 2 (PFM)	1.000	Outer Lanes Freeway Speed (SO), mi/h	70.0
Flow in Lanes 1 and 2 (v12), pc/h	3684	Ramp Junction Speed (S), mi/h	50.7
Flow Entering Ramp-Infl. Area (vR12), pc/h	4674	Average Density (D), pc/mi/ln	46.1
Level of Service (LOS)	E	Density in Ramp Influence Area (DR), pc/mi/ln	37.2

HCS7 Basic Freeway Report

Project Information

Analyst	LSA	Date	12/11/2019
Agency	LSA	Analysis Year	Phase III Proj Comp Yr (2049) WP
Jurisdiction	Caltrans	Time Period Analyzed	AM Peak Hour
Project Description	CMD1801 - Village D Specific Plan	Unit	United States Customary

Geometric Data

Number of Lanes, ln	2	Terrain Type	Level
Segment Length (L), ft	-	Percent Grade, %	-
Measured or Base Free-Flow Speed	Base	Grade Length, mi	-
Base Free-Flow Speed (BFFS), mi/h	70.0	Total Ramp Density (TRD), ramps/mi	1.00
Lane Width, ft	12	Free-Flow Speed (FFS), mi/h	66.8
Right-Side Lateral Clearance, ft	10		

Adjustment Factors

Driver Population	All Familiar	Final Speed Adjustment Factor (SAF)	1.000
Weather Type	Non-Severe Weather	Final Capacity Adjustment Factor (CAF)	1.000
Incident Type	No Incident	Demand Adjustment Factor (DAF)	1.000

Demand and Capacity

Demand Volume veh/h	3745	Heavy Vehicle Adjustment Factor (fhv)	0.853
Peak Hour Factor	0.94	Flow Rate (Vp), pc/h/ln	2336
Total Trucks, %	17.30	Capacity (c), pc/h/ln	2368
Single-Unit Trucks (SUT), %	-	Adjusted Capacity (cadj), pc/h/ln	2368
Tractor-Trailers (TT), %	-	Volume-to-Capacity Ratio (v/c)	0.99
Passenger Car Equivalent (ET)	2.000		

Speed and Density

Lane Width Adjustment (fLW)	0.0	Average Speed (S), mi/h	53.5
Right-Side Lateral Clearance Adj. (fRLC)	0.0	Density (D), pc/mi/ln	43.7
Total Ramp Density Adjustment	3.2	Level of Service (LOS)	E
Adjusted Free-Flow Speed (FFSadj), mi/h	66.8		

HCS7 Basic Freeway Report

Project Information

Analyst	LSA	Date	12/11/2019
Agency	LSA	Analysis Year	Phase III Proj Comp Yr (2049) WP
Jurisdiction	Caltrans	Time Period Analyzed	AM Peak Hour
Project Description	CMD1801 - Village D Specific Plan	Unit	United States Customary

Geometric Data

Number of Lanes, ln	2	Terrain Type	Level
Segment Length (L), ft	-	Percent Grade, %	-
Measured or Base Free-Flow Speed	Base	Grade Length, mi	-
Base Free-Flow Speed (BFFS), mi/h	70.0	Total Ramp Density (TRD), ramps/mi	1.00
Lane Width, ft	12	Free-Flow Speed (FFS), mi/h	66.8
Right-Side Lateral Clearance, ft	10		

Adjustment Factors

Driver Population	All Familiar	Final Speed Adjustment Factor (SAF)	1.000
Weather Type	Non-Severe Weather	Final Capacity Adjustment Factor (CAF)	1.000
Incident Type	No Incident	Demand Adjustment Factor (DAF)	1.000

Demand and Capacity

Demand Volume veh/h	3013	Heavy Vehicle Adjustment Factor (fhv)	0.796
Peak Hour Factor	0.94	Flow Rate (Vp), pc/h/ln	2014
Total Trucks, %	25.59	Capacity (c), pc/h/ln	2368
Single-Unit Trucks (SUT), %	-	Adjusted Capacity (cadj), pc/h/ln	2368
Tractor-Trailers (TT), %	-	Volume-to-Capacity Ratio (v/c)	0.85
Passenger Car Equivalent (ET)	2.000		

Speed and Density

Lane Width Adjustment (fLW)	0.0	Average Speed (S), mi/h	60.6
Right-Side Lateral Clearance Adj. (fRLC)	0.0	Density (D), pc/mi/ln	33.2
Total Ramp Density Adjustment	3.2	Level of Service (LOS)	D
Adjusted Free-Flow Speed (FFSadj), mi/h	66.8		

HCS7 Freeway Diverge Report

Project Information

Analyst	LSA	Date	12/11/2019
Agency	LSA	Analysis Year	Phase III Proj Comp Yr (2049) WP
Jurisdiction	Caltrans	Time Period Analyzed	AM Peak Hour
Project Description	CMD1801 - Village D Specific Plan	Unit	United States Customary

Geometric Data

	Freeway	Ramp
Number of Lanes (N), ln	2	1
Free-Flow Speed (FFS), mi/h	70.0	50.0
Segment Length (L) / Deceleration Length (LA),ft	1500	150
Terrain Type	Level	Level
Percent Grade, %	-	-
Segment Type / Ramp Side	Freeway	Right

Adjustment Factors

Driver Population	All Familiar	All Familiar
Weather Type	Non-Severe Weather	Non-Severe Weather
Incident Type	No Incident	-
Final Speed Adjustment Factor (SAF)	1.000	1.000
Final Capacity Adjustment Factor (CAF)	1.000	1.000
Demand Adjustment Factor (DAF)	1.000	1.000

Demand and Capacity

Demand Volume (Vi)	3013	363
Peak Hour Factor (PHF)	0.94	0.94
Total Trucks, %	25.59	15.15
Single-Unit Trucks (SUT), %	-	-
Tractor-Trailers (TT), %	-	-
Heavy Vehicle Adjustment Factor (fHV)	0.796	0.868
Flow Rate (vi),pc/h	4027	445
Capacity (c), pc/h	4800	2100
Volume-to-Capacity Ratio (v/c)	0.84	0.21

Speed and Density

Upstream Equilibrium Distance (LEQ), ft	-	Number of Outer Lanes on Freeway (NO)	0
Distance to Upstream Ramp (LUP), ft	-	Speed Index (DS)	0.273
Downstream Equilibrium Distance (LEQ), ft	-	Flow Outer Lanes (vOA), pc/h/ln	-
Distance to Downstream Ramp (LDOWN), ft	-	Off-Ramp Influence Area Speed (SR), mi/h	62.4
Prop. Freeway Vehicles in Lane 1 and 2 (PFD)	1.000	Outer Lanes Freeway Speed (SO), mi/h	76.8
Flow in Lanes 1 and 2 (v12), pc/h	4027	Ramp Junction Speed (S), mi/h	62.4
Flow Entering Ramp-Infl. Area (vR12), pc/h	-	Average Density (D), pc/mi/ln	32.3
Level of Service (LOS)	E	Density in Ramp Influence Area (DR), pc/mi/ln	37.5

HCS7 Basic Freeway Report

Project Information

Analyst	LSA	Date	12/11/2019
Agency	LSA	Analysis Year	Phase III Proj Comp Yr (2049) WP
Jurisdiction	Caltrans	Time Period Analyzed	AM Peak Hour
Project Description	CMD1801 - Village D Specific Plan	Unit	United States Customary

Geometric Data

Number of Lanes, ln	2	Terrain Type	Level
Segment Length (L), ft	-	Percent Grade, %	-
Measured or Base Free-Flow Speed	Base	Grade Length, mi	-
Base Free-Flow Speed (BFFS), mi/h	70.0	Total Ramp Density (TRD), ramps/mi	1.33
Lane Width, ft	12	Free-Flow Speed (FFS), mi/h	65.9
Right-Side Lateral Clearance, ft	10		

Adjustment Factors

Driver Population	All Familiar	Final Speed Adjustment Factor (SAF)	1.000
Weather Type	Non-Severe Weather	Final Capacity Adjustment Factor (CAF)	1.000
Incident Type	No Incident	Demand Adjustment Factor (DAF)	1.000

Demand and Capacity

Demand Volume veh/h	2650	Heavy Vehicle Adjustment Factor (fhv)	0.787
Peak Hour Factor	0.94	Flow Rate (Vp), pc/h/ln	1791
Total Trucks, %	27.02	Capacity (c), pc/h/ln	2359
Single-Unit Trucks (SUT), %	-	Adjusted Capacity (cadj), pc/h/ln	2359
Tractor-Trailers (TT), %	-	Volume-to-Capacity Ratio (v/c)	0.76
Passenger Car Equivalent (ET)	2.000		

Speed and Density

Lane Width Adjustment (fLW)	0.0	Average Speed (S), mi/h	63.4
Right-Side Lateral Clearance Adj. (fRLC)	0.0	Density (D), pc/mi/ln	28.2
Total Ramp Density Adjustment	4.1	Level of Service (LOS)	D
Adjusted Free-Flow Speed (FFSadj), mi/h	65.9		

HCS7 Freeway Merge Report

Project Information

Analyst	LSA	Date	12/11/2019
Agency	LSA	Analysis Year	Phase III Proj Comp Yr (2049) WP
Jurisdiction	Caltrans	Time Period Analyzed	AM Peak Hour
Project Description	CMD1801 - Village D Specific Plan	Unit	United States Customary

Geometric Data

	Freeway	Ramp
Number of Lanes (N), ln	2	1
Free-Flow Speed (FFS), mi/h	70.0	35.0
Segment Length (L) / Acceleration Length (LA),ft	1000	600
Terrain Type	Level	Level
Percent Grade, %	-	-
Segment Type / Ramp Side	Freeway	Right

Adjustment Factors

Driver Population	All Familiar	All Familiar
Weather Type	Non-Severe Weather	Non-Severe Weather
Incident Type	No Incident	-
Final Speed Adjustment Factor (SAF)	1.000	1.000
Final Capacity Adjustment Factor (CAF)	1.000	1.000
Demand Adjustment Factor (DAF)	1.000	1.000

Demand and Capacity

Demand Volume (Vi)	2650	37
Peak Hour Factor (PHF)	0.94	0.94
Total Trucks, %	27.02	13.51
Single-Unit Trucks (SUT), %	-	-
Tractor-Trailers (TT), %	-	-
Heavy Vehicle Adjustment Factor (fHV)	0.787	0.881
Flow Rate (vi),pc/h	3582	45
Capacity (c), pc/h	4800	2000
Volume-to-Capacity Ratio (v/c)	0.76	0.02

Speed and Density

Upstream Equilibrium Distance (LEQ), ft	-	Number of Outer Lanes on Freeway (NO)	0
Distance to Upstream Ramp (LUP), ft	-	Speed Index (MS)	0.426
Downstream Equilibrium Distance (LEQ), ft	-	Flow Outer Lanes (vOA), pc/h/ln	-
Distance to Downstream Ramp (LDOWN), ft	-	On-Ramp Influence Area Speed (SR), mi/h	58.1
Prop. Freeway Vehicles in Lane 1 and 2 (PFM)	1.000	Outer Lanes Freeway Speed (SO), mi/h	70.0
Flow in Lanes 1 and 2 (v12), pc/h	3582	Ramp Junction Speed (S), mi/h	58.1
Flow Entering Ramp-Infl. Area (vR12), pc/h	3627	Average Density (D), pc/mi/ln	31.2
Level of Service (LOS)	D	Density in Ramp Influence Area (DR), pc/mi/ln	30.1

HCS7 Basic Freeway Report

Project Information

Analyst	LSA	Date	12/11/2019
Agency	LSA	Analysis Year	Phase III Proj Comp Yr (2049) WP
Jurisdiction	Caltrans	Time Period Analyzed	AM Peak Hour
Project Description	CMD1801 - Village D Specific Plan	Unit	United States Customary

Geometric Data

Number of Lanes, ln	2	Terrain Type	Level
Segment Length (L), ft	-	Percent Grade, %	-
Measured or Base Free-Flow Speed	Base	Grade Length, mi	-
Base Free-Flow Speed (BFFS), mi/h	70.0	Total Ramp Density (TRD), ramps/mi	1.33
Lane Width, ft	12	Free-Flow Speed (FFS), mi/h	65.9
Right-Side Lateral Clearance, ft	10		

Adjustment Factors

Driver Population	All Familiar	Final Speed Adjustment Factor (SAF)	1.000
Weather Type	Non-Severe Weather	Final Capacity Adjustment Factor (CAF)	1.000
Incident Type	No Incident	Demand Adjustment Factor (DAF)	1.000

Demand and Capacity

Demand Volume veh/h	2687	Heavy Vehicle Adjustment Factor (fhv)	0.788
Peak Hour Factor	0.94	Flow Rate (Vp), pc/h/ln	1814
Total Trucks, %	26.83	Capacity (c), pc/h/ln	2359
Single-Unit Trucks (SUT), %	-	Adjusted Capacity (cadj), pc/h/ln	2359
Tractor-Trailers (TT), %	-	Volume-to-Capacity Ratio (v/c)	0.77
Passenger Car Equivalent (ET)	2.000		

Speed and Density

Lane Width Adjustment (fLW)	0.0	Average Speed (S), mi/h	63.1
Right-Side Lateral Clearance Adj. (fRLC)	0.0	Density (D), pc/mi/ln	28.7
Total Ramp Density Adjustment	4.1	Level of Service (LOS)	D
Adjusted Free-Flow Speed (FFSadj), mi/h	65.9		

HCS7 Freeway Merge Report

Project Information

Analyst	LSA	Date	12/11/2019
Agency	LSA	Analysis Year	Phase III Proj Comp Yr (2049) WP
Jurisdiction	Caltrans	Time Period Analyzed	AM Peak Hour
Project Description	CMD1801 - Village D Specific Plan	Unit	United States Customary

Geometric Data

	Freeway	Ramp
Number of Lanes (N), ln	2	1
Free-Flow Speed (FFS), mi/h	70.0	35.0
Segment Length (L) / Acceleration Length (LA),ft	1500	500
Terrain Type	Level	Level
Percent Grade, %	-	-
Segment Type / Ramp Side	Freeway	Right

Adjustment Factors

Driver Population	All Familiar	All Familiar
Weather Type	Non-Severe Weather	Non-Severe Weather
Incident Type	No Incident	-
Final Speed Adjustment Factor (SAF)	1.000	1.000
Final Capacity Adjustment Factor (CAF)	1.000	1.000
Demand Adjustment Factor (DAF)	1.000	1.000

Demand and Capacity

Demand Volume (Vi)	2687	204
Peak Hour Factor (PHF)	0.94	0.94
Total Trucks, %	26.83	31.86
Single-Unit Trucks (SUT), %	-	-
Tractor-Trailers (TT), %	-	-
Heavy Vehicle Adjustment Factor (fHV)	0.788	0.758
Flow Rate (vi),pc/h	3628	286
Capacity (c), pc/h	4800	2000
Volume-to-Capacity Ratio (v/c)	0.82	0.14

Speed and Density

Upstream Equilibrium Distance (LEQ), ft	-	Number of Outer Lanes on Freeway (NO)	0
Distance to Upstream Ramp (LUP), ft	-	Speed Index (MS)	0.481
Downstream Equilibrium Distance (LEQ), ft	-	Flow Outer Lanes (vOA), pc/h/ln	-
Distance to Downstream Ramp (LDOWN), ft	-	On-Ramp Influence Area Speed (SR), mi/h	56.5
Prop. Freeway Vehicles in Lane 1 and 2 (PFM)	1.000	Outer Lanes Freeway Speed (SO), mi/h	70.0
Flow in Lanes 1 and 2 (v12), pc/h	3628	Ramp Junction Speed (S), mi/h	56.5
Flow Entering Ramp-Infl. Area (vR12), pc/h	3914	Average Density (D), pc/mi/ln	34.6
Level of Service (LOS)	D	Density in Ramp Influence Area (DR), pc/mi/ln	32.8

HCS7 Basic Freeway Report

Project Information

Analyst	LSA	Date	12/11/2019
Agency	LSA	Analysis Year	Phase III Proj Comp Yr (2049) WP
Jurisdiction	Caltrans	Time Period Analyzed	AM Peak Hour
Project Description	CMD1801 - Village D Specific Plan	Unit	United States Customary

Geometric Data

Number of Lanes, ln	2	Terrain Type	Level
Segment Length (L), ft	-	Percent Grade, %	-
Measured or Base Free-Flow Speed	Base	Grade Length, mi	-
Base Free-Flow Speed (BFFS), mi/h	70.0	Total Ramp Density (TRD), ramps/mi	1.33
Lane Width, ft	12	Free-Flow Speed (FFS), mi/h	65.9
Right-Side Lateral Clearance, ft	10		

Adjustment Factors

Driver Population	All Familiar	Final Speed Adjustment Factor (SAF)	1.000
Weather Type	Non-Severe Weather	Final Capacity Adjustment Factor (CAF)	1.000
Incident Type	No Incident	Demand Adjustment Factor (DAF)	1.000

Demand and Capacity

Demand Volume veh/h	2891	Heavy Vehicle Adjustment Factor (fhv)	0.786
Peak Hour Factor	0.94	Flow Rate (Vp), pc/h/ln	1956
Total Trucks, %	27.19	Capacity (c), pc/h/ln	2359
Single-Unit Trucks (SUT), %	-	Adjusted Capacity (cadj), pc/h/ln	2359
Tractor-Trailers (TT), %	-	Volume-to-Capacity Ratio (v/c)	0.83
Passenger Car Equivalent (ET)	2.000		

Speed and Density

Lane Width Adjustment (fLW)	0.0	Average Speed (S), mi/h	61.1
Right-Side Lateral Clearance Adj. (fRLC)	0.0	Density (D), pc/mi/ln	32.0
Total Ramp Density Adjustment	4.1	Level of Service (LOS)	D
Adjusted Free-Flow Speed (FFSadj), mi/h	65.9		

HCS7 Freeway Diverge Report

Project Information

Analyst	LSA	Date	12/11/2019
Agency	LSA	Analysis Year	Phase III Proj Comp Yr (2049) WP
Jurisdiction	Caltrans	Time Period Analyzed	AM Peak Hour
Project Description	CMD1801 - Village D Specific Plan	Unit	United States Customary

Geometric Data

	Freeway	Ramp
Number of Lanes (N), ln	3	1
Free-Flow Speed (FFS), mi/h	70.0	35.0
Segment Length (L) / Deceleration Length (LA),ft	1500	150
Terrain Type	Level	Level
Percent Grade, %	-	-
Segment Type / Ramp Side	Freeway	Right

Adjustment Factors

Driver Population	All Familiar	All Familiar
Weather Type	Non-Severe Weather	Non-Severe Weather
Incident Type	No Incident	-
Final Speed Adjustment Factor (SAF)	1.000	1.000
Final Capacity Adjustment Factor (CAF)	1.000	1.000
Demand Adjustment Factor (DAF)	1.000	1.000

Demand and Capacity

Demand Volume (Vi)	2891	439
Peak Hour Factor (PHF)	0.94	0.94
Total Trucks, %	27.19	18.91
Single-Unit Trucks (SUT), %	-	-
Tractor-Trailers (TT), %	-	-
Heavy Vehicle Adjustment Factor (fHV)	0.786	0.841
Flow Rate (vi),pc/h	3913	555
Capacity (c), pc/h	7200	2000
Volume-to-Capacity Ratio (v/c)	0.54	0.28

Speed and Density

Upstream Equilibrium Distance (LEQ), ft	-	Number of Outer Lanes on Freeway (NO)	1
Distance to Upstream Ramp (LUP), ft	-	Speed Index (DS)	0.478
Downstream Equilibrium Distance (LEQ), ft	-	Flow Outer Lanes (vOA), pc/h/ln	1219
Distance to Downstream Ramp (LDOWN), ft	-	Off-Ramp Influence Area Speed (SR), mi/h	56.6
Prop. Freeway Vehicles in Lane 1 and 2 (PFD)	0.637	Outer Lanes Freeway Speed (SO), mi/h	75.9
Flow in Lanes 1 and 2 (v12), pc/h	2694	Ramp Junction Speed (S), mi/h	61.5
Flow Entering Ramp-Infl. Area (vR12), pc/h	-	Average Density (D), pc/mi/ln	21.2
Level of Service (LOS)	C	Density in Ramp Influence Area (DR), pc/mi/ln	26.1

HCS7 Basic Freeway Report

Project Information

Analyst	LSA	Date	12/11/2019
Agency	LSA	Analysis Year	Phase III Proj Comp Yr (2049) WP
Jurisdiction	Caltrans	Time Period Analyzed	AM Peak Hour
Project Description	CMD1801 - Village D Specific Plan	Unit	United States Customary

Geometric Data

Number of Lanes, ln	2	Terrain Type	Level
Segment Length (L), ft	-	Percent Grade, %	-
Measured or Base Free-Flow Speed	Base	Grade Length, mi	-
Base Free-Flow Speed (BFFS), mi/h	70.0	Total Ramp Density (TRD), ramps/mi	1.67
Lane Width, ft	12	Free-Flow Speed (FFS), mi/h	65.0
Right-Side Lateral Clearance, ft	10		

Adjustment Factors

Driver Population	All Familiar	Final Speed Adjustment Factor (SAF)	1.000
Weather Type	Non-Severe Weather	Final Capacity Adjustment Factor (CAF)	1.000
Incident Type	No Incident	Demand Adjustment Factor (DAF)	1.000

Demand and Capacity

Demand Volume veh/h	2452	Heavy Vehicle Adjustment Factor (fhv)	0.777
Peak Hour Factor	0.94	Flow Rate (Vp), pc/h/ln	1678
Total Trucks, %	28.67	Capacity (c), pc/h/ln	2350
Single-Unit Trucks (SUT), %	-	Adjusted Capacity (cadj), pc/h/ln	2350
Tractor-Trailers (TT), %	-	Volume-to-Capacity Ratio (v/c)	0.71
Passenger Car Equivalent (ET)	2.000		

Speed and Density

Lane Width Adjustment (fLW)	0.0	Average Speed (S), mi/h	63.9
Right-Side Lateral Clearance Adj. (fRLC)	0.0	Density (D), pc/mi/ln	26.3
Total Ramp Density Adjustment	5.0	Level of Service (LOS)	D
Adjusted Free-Flow Speed (FFSadj), mi/h	65.0		

HCS7 Freeway Merge Report

Project Information

Analyst	LSA	Date	12/11/2019
Agency	LSA	Analysis Year	Phase III Proj Comp Yr (2049) WP
Jurisdiction	Caltrans	Time Period Analyzed	AM Peak Hour
Project Description	CMD1801 - Village D Specific Plan	Unit	United States Customary

Geometric Data

	Freeway	Ramp
Number of Lanes (N), ln	3	1
Free-Flow Speed (FFS), mi/h	65.0	35.0
Segment Length (L) / Acceleration Length (LA),ft	1500	600
Terrain Type	Level	Level
Percent Grade, %	-	-
Segment Type / Ramp Side	Freeway	Right

Adjustment Factors

Driver Population	All Familiar	All Familiar
Weather Type	Non-Severe Weather	Non-Severe Weather
Incident Type	No Incident	-
Final Speed Adjustment Factor (SAF)	1.000	1.000
Final Capacity Adjustment Factor (CAF)	1.000	1.000
Demand Adjustment Factor (DAF)	1.000	1.000

Demand and Capacity

Demand Volume (Vi)	2452	709
Peak Hour Factor (PHF)	0.94	0.94
Total Trucks, %	28.67	4.09
Single-Unit Trucks (SUT), %	-	-
Tractor-Trailers (TT), %	-	-
Heavy Vehicle Adjustment Factor (fHV)	0.777	0.961
Flow Rate (vi),pc/h	3357	785
Capacity (c), pc/h	7050	2000
Volume-to-Capacity Ratio (v/c)	0.59	0.39

Speed and Density

Upstream Equilibrium Distance (LEQ), ft	-	Number of Outer Lanes on Freeway (NO)	1
Distance to Upstream Ramp (LUP), ft	-	Speed Index (MS)	0.342
Downstream Equilibrium Distance (LEQ), ft	-	Flow Outer Lanes (vOA), pc/h/ln	1363
Distance to Downstream Ramp (LDOWN), ft	-	On-Ramp Influence Area Speed (SR), mi/h	57.1
Prop. Freeway Vehicles in Lane 1 and 2 (PFM)	0.594	Outer Lanes Freeway Speed (SO), mi/h	61.9
Flow in Lanes 1 and 2 (v12), pc/h	1994	Ramp Junction Speed (S), mi/h	58.6
Flow Entering Ramp-Infl. Area (vR12), pc/h	2779	Average Density (D), pc/mi/ln	23.6
Level of Service (LOS)	C	Density in Ramp Influence Area (DR), pc/mi/ln	23.1

HCS7 Basic Freeway Report

Project Information

Analyst	LSA	Date	12/11/2019
Agency	LSA	Analysis Year	Phase III Proj Comp Yr (2049) WP
Jurisdiction	Caltrans	Time Period Analyzed	AM Peak Hour
Project Description	CMD1801 - Village D Specific Plan	Unit	United States Customary

Geometric Data

Number of Lanes, ln	3	Terrain Type	Level
Segment Length (L), ft	-	Percent Grade, %	-
Measured or Base Free-Flow Speed	Base	Grade Length, mi	-
Base Free-Flow Speed (BFFS), mi/h	65.0	Total Ramp Density (TRD), ramps/mi	1.83
Lane Width, ft	12	Free-Flow Speed (FFS), mi/h	59.7
Right-Side Lateral Clearance, ft	10		

Adjustment Factors

Driver Population	All Familiar	Final Speed Adjustment Factor (SAF)	1.000
Weather Type	Non-Severe Weather	Final Capacity Adjustment Factor (CAF)	1.000
Incident Type	No Incident	Demand Adjustment Factor (DAF)	1.000

Demand and Capacity

Demand Volume veh/h	3161	Heavy Vehicle Adjustment Factor (fhv)	0.812
Peak Hour Factor	0.94	Flow Rate (Vp), pc/h/ln	1380
Total Trucks, %	23.16	Capacity (c), pc/h/ln	2296
Single-Unit Trucks (SUT), %	-	Adjusted Capacity (cadj), pc/h/ln	2296
Tractor-Trailers (TT), %	-	Volume-to-Capacity Ratio (v/c)	0.60
Passenger Car Equivalent (ET)	2.000		

Speed and Density

Lane Width Adjustment (fLW)	0.0	Average Speed (S), mi/h	59.6
Right-Side Lateral Clearance Adj. (fRLC)	0.0	Density (D), pc/mi/ln	23.2
Total Ramp Density Adjustment	5.4	Level of Service (LOS)	C
Adjusted Free-Flow Speed (FFSadj), mi/h	59.6		

HCS7 Freeway Merge Report

Project Information

Analyst	LSA	Date	12/11/2019
Agency	LSA	Analysis Year	Phase III Proj Comp Yr (2049) WP
Jurisdiction	Caltrans	Time Period Analyzed	AM Peak Hour
Project Description	CMD1801 - Village D Specific Plan	Unit	United States Customary

Geometric Data

	Freeway	Ramp
Number of Lanes (N), ln	3	1
Free-Flow Speed (FFS), mi/h	65.0	35.0
Segment Length (L) / Acceleration Length (LA),ft	1500	600
Terrain Type	Level	Level
Percent Grade, %	-	-
Segment Type / Ramp Side	Freeway	Right

Adjustment Factors

Driver Population	All Familiar	All Familiar
Weather Type	Non-Severe Weather	Non-Severe Weather
Incident Type	No Incident	-
Final Speed Adjustment Factor (SAF)	1.000	1.000
Final Capacity Adjustment Factor (CAF)	1.000	1.000
Demand Adjustment Factor (DAF)	1.000	1.000

Demand and Capacity

Demand Volume (Vi)	3161	842
Peak Hour Factor (PHF)	0.94	0.94
Total Trucks, %	23.16	2.97
Single-Unit Trucks (SUT), %	-	-
Tractor-Trailers (TT), %	-	-
Heavy Vehicle Adjustment Factor (fHV)	0.812	0.971
Flow Rate (vi),pc/h	4141	922
Capacity (c), pc/h	7050	2000
Volume-to-Capacity Ratio (v/c)	0.72	0.46

Speed and Density

Upstream Equilibrium Distance (LEQ), ft	-	Number of Outer Lanes on Freeway (NO)	1
Distance to Upstream Ramp (LUP), ft	-	Speed Index (MS)	0.394
Downstream Equilibrium Distance (LEQ), ft	-	Flow Outer Lanes (vOA), pc/h/ln	1681
Distance to Downstream Ramp (LDOWN), ft	-	On-Ramp Influence Area Speed (SR), mi/h	55.9
Prop. Freeway Vehicles in Lane 1 and 2 (PFM)	0.594	Outer Lanes Freeway Speed (SO), mi/h	60.7
Flow in Lanes 1 and 2 (v12), pc/h	2460	Ramp Junction Speed (S), mi/h	57.4
Flow Entering Ramp-Infl. Area (vR12), pc/h	3382	Average Density (D), pc/mi/ln	29.4
Level of Service (LOS)	C	Density in Ramp Influence Area (DR), pc/mi/ln	27.7

HCS7 Basic Freeway Report

Project Information

Analyst	LSA	Date	12/11/2019
Agency	LSA	Analysis Year	Phase III Proj Comp Yr (2049) WP
Jurisdiction	Caltrans	Time Period Analyzed	AM Peak Hour
Project Description	CMD1801 - Village D Specific Plan	Unit	United States Customary

Geometric Data

Number of Lanes, ln	3	Terrain Type	Level
Segment Length (L), ft	-	Percent Grade, %	-
Measured or Base Free-Flow Speed	Base	Grade Length, mi	-
Base Free-Flow Speed (BFFS), mi/h	65.0	Total Ramp Density (TRD), ramps/mi	2.17
Lane Width, ft	12	Free-Flow Speed (FFS), mi/h	58.8
Right-Side Lateral Clearance, ft	10		

Adjustment Factors

Driver Population	All Familiar	Final Speed Adjustment Factor (SAF)	1.000
Weather Type	Non-Severe Weather	Final Capacity Adjustment Factor (CAF)	1.000
Incident Type	No Incident	Demand Adjustment Factor (DAF)	1.000

Demand and Capacity

Demand Volume veh/h	4003	Heavy Vehicle Adjustment Factor (fhv)	0.841
Peak Hour Factor	0.94	Flow Rate (Vp), pc/h/ln	1688
Total Trucks, %	18.91	Capacity (c), pc/h/ln	2288
Single-Unit Trucks (SUT), %	-	Adjusted Capacity (cadj), pc/h/ln	2288
Tractor-Trailers (TT), %	-	Volume-to-Capacity Ratio (v/c)	0.74
Passenger Car Equivalent (ET)	2.000		

Speed and Density

Lane Width Adjustment (fLW)	0.0	Average Speed (S), mi/h	58.8
Right-Side Lateral Clearance Adj. (fRLC)	0.0	Density (D), pc/mi/ln	28.7
Total Ramp Density Adjustment	6.2	Level of Service (LOS)	D
Adjusted Free-Flow Speed (FFSadj), mi/h	58.8		

HCS7 Freeway Diverge Report

Project Information

Analyst	LSA	Date	12/11/2019
Agency	LSA	Analysis Year	Phase III Proj Comp Yr (2049) WP
Jurisdiction	Caltrans	Time Period Analyzed	AM Peak Hour
Project Description	CMD1801 - Village D Specific Plan	Unit	United States Customary

Geometric Data

	Freeway	Ramp
Number of Lanes (N), ln	3	1
Free-Flow Speed (FFS), mi/h	65.0	40.0
Segment Length (L) / Deceleration Length (LA),ft	1500	150
Terrain Type	Level	Level
Percent Grade, %	-	-
Segment Type / Ramp Side	Freeway	Right

Adjustment Factors

Driver Population	All Familiar	All Familiar
Weather Type	Non-Severe Weather	Non-Severe Weather
Incident Type	No Incident	-
Final Speed Adjustment Factor (SAF)	1.000	1.000
Final Capacity Adjustment Factor (CAF)	1.000	1.000
Demand Adjustment Factor (DAF)	1.000	1.000

Demand and Capacity

Demand Volume (Vi)	4003	235
Peak Hour Factor (PHF)	0.94	0.94
Total Trucks, %	18.91	3.40
Single-Unit Trucks (SUT), %	-	-
Tractor-Trailers (TT), %	-	-
Heavy Vehicle Adjustment Factor (fHV)	0.841	0.967
Flow Rate (vi),pc/h	5064	259
Capacity (c), pc/h	7050	2000
Volume-to-Capacity Ratio (v/c)	0.72	0.13

Speed and Density

Upstream Equilibrium Distance (LEQ), ft	-	Number of Outer Lanes on Freeway (NO)	1
Distance to Upstream Ramp (LUP), ft	-	Speed Index (DS)	0.386
Downstream Equilibrium Distance (LEQ), ft	-	Flow Outer Lanes (vOA), pc/h/ln	1821
Distance to Downstream Ramp (LDOWN), ft	-	Off-Ramp Influence Area Speed (SR), mi/h	56.1
Prop. Freeway Vehicles in Lane 1 and 2 (PFD)	0.621	Outer Lanes Freeway Speed (SO), mi/h	68.1
Flow in Lanes 1 and 2 (v12), pc/h	3243	Ramp Junction Speed (S), mi/h	59.9
Flow Entering Ramp-Infl. Area (vR12), pc/h	-	Average Density (D), pc/mi/ln	28.2
Level of Service (LOS)	D	Density in Ramp Influence Area (DR), pc/mi/ln	30.8

HCS7 Basic Freeway Report

Project Information

Analyst	LSA	Date	12/11/2019
Agency	LSA	Analysis Year	Phase III Proj Comp Yr (2049) WP
Jurisdiction	Caltrans	Time Period Analyzed	AM Peak Hour
Project Description	CMD1801 - Village D Specific Plan	Unit	United States Customary

Geometric Data

Number of Lanes, ln	3	Terrain Type	Level
Segment Length (L), ft	-	Percent Grade, %	-
Measured or Base Free-Flow Speed	Base	Grade Length, mi	-
Base Free-Flow Speed (BFFS), mi/h	65.0	Total Ramp Density (TRD), ramps/mi	1.83
Lane Width, ft	12	Free-Flow Speed (FFS), mi/h	59.7
Right-Side Lateral Clearance, ft	10		

Adjustment Factors

Driver Population	All Familiar	Final Speed Adjustment Factor (SAF)	1.000
Weather Type	Non-Severe Weather	Final Capacity Adjustment Factor (CAF)	1.000
Incident Type	No Incident	Demand Adjustment Factor (DAF)	1.000

Demand and Capacity

Demand Volume veh/h	3767	Heavy Vehicle Adjustment Factor (fhv)	0.834
Peak Hour Factor	0.94	Flow Rate (Vp), pc/h/ln	1602
Total Trucks, %	19.88	Capacity (c), pc/h/ln	2296
Single-Unit Trucks (SUT), %	-	Adjusted Capacity (cadj), pc/h/ln	2296
Tractor-Trailers (TT), %	-	Volume-to-Capacity Ratio (v/c)	0.70
Passenger Car Equivalent (ET)	2.000		

Speed and Density

Lane Width Adjustment (fLW)	0.0	Average Speed (S), mi/h	59.6
Right-Side Lateral Clearance Adj. (fRLC)	0.0	Density (D), pc/mi/ln	26.9
Total Ramp Density Adjustment	5.4	Level of Service (LOS)	D
Adjusted Free-Flow Speed (FFSadj), mi/h	59.6		

HCS7 Freeway Merge Report

Project Information

Analyst	LSA	Date	12/11/2019
Agency	LSA	Analysis Year	Phase III Proj Comp Yr (2049) WP
Jurisdiction	Caltrans	Time Period Analyzed	AM Peak Hour
Project Description	CMD1801 - Village D Specific Plan	Unit	United States Customary

Geometric Data

	Freeway	Ramp
Number of Lanes (N), ln	3	1
Free-Flow Speed (FFS), mi/h	65.0	35.0
Segment Length (L) / Acceleration Length (LA),ft	1500	800
Terrain Type	Level	Level
Percent Grade, %	-	-
Segment Type / Ramp Side	Freeway	Right

Adjustment Factors

Driver Population	All Familiar	All Familiar
Weather Type	Non-Severe Weather	Non-Severe Weather
Incident Type	No Incident	-
Final Speed Adjustment Factor (SAF)	1.000	1.000
Final Capacity Adjustment Factor (CAF)	1.000	1.000
Demand Adjustment Factor (DAF)	1.000	1.000

Demand and Capacity

Demand Volume (Vi)	3767	496
Peak Hour Factor (PHF)	0.94	0.94
Total Trucks, %	19.88	2.02
Single-Unit Trucks (SUT), %	-	-
Tractor-Trailers (TT), %	-	-
Heavy Vehicle Adjustment Factor (fHV)	0.834	0.980
Flow Rate (vi),pc/h	4805	538
Capacity (c), pc/h	7050	2000
Volume-to-Capacity Ratio (v/c)	0.76	0.27

Speed and Density

Upstream Equilibrium Distance (LEQ), ft	-	Number of Outer Lanes on Freeway (NO)	1
Distance to Upstream Ramp (LUP), ft	-	Speed Index (MS)	0.384
Downstream Equilibrium Distance (LEQ), ft	-	Flow Outer Lanes (vOA), pc/h/ln	1922
Distance to Downstream Ramp (LDOWN), ft	-	On-Ramp Influence Area Speed (SR), mi/h	56.2
Prop. Freeway Vehicles in Lane 1 and 2 (PFM)	0.600	Outer Lanes Freeway Speed (SO), mi/h	59.9
Flow in Lanes 1 and 2 (v12), pc/h	2883	Ramp Junction Speed (S), mi/h	57.5
Flow Entering Ramp-Infl. Area (vR12), pc/h	3421	Average Density (D), pc/mi/ln	31.0
Level of Service (LOS)	C	Density in Ramp Influence Area (DR), pc/mi/ln	27.0

HCS7 Basic Freeway Report

Project Information

Analyst	LSA	Date	12/11/2019
Agency	LSA	Analysis Year	Phase III Proj Comp Yr (2049) WP
Jurisdiction	Caltrans	Time Period Analyzed	AM Peak Hour
Project Description	CMD1801 - Village D Specific Plan	Unit	United States Customary

Geometric Data

Number of Lanes, ln	3	Terrain Type	Level
Segment Length (L), ft	-	Percent Grade, %	-
Measured or Base Free-Flow Speed	Base	Grade Length, mi	-
Base Free-Flow Speed (BFFS), mi/h	65.0	Total Ramp Density (TRD), ramps/mi	2.17
Lane Width, ft	12	Free-Flow Speed (FFS), mi/h	58.8
Right-Side Lateral Clearance, ft	10		

Adjustment Factors

Driver Population	All Familiar	Final Speed Adjustment Factor (SAF)	1.000
Weather Type	Non-Severe Weather	Final Capacity Adjustment Factor (CAF)	1.000
Incident Type	No Incident	Demand Adjustment Factor (DAF)	1.000

Demand and Capacity

Demand Volume veh/h	4263	Heavy Vehicle Adjustment Factor (fhv)	0.849
Peak Hour Factor	0.94	Flow Rate (Vp), pc/h/ln	1781
Total Trucks, %	17.80	Capacity (c), pc/h/ln	2288
Single-Unit Trucks (SUT), %	-	Adjusted Capacity (cadj), pc/h/ln	2288
Tractor-Trailers (TT), %	-	Volume-to-Capacity Ratio (v/c)	0.78
Passenger Car Equivalent (ET)	2.000		

Speed and Density

Lane Width Adjustment (fLW)	0.0	Average Speed (S), mi/h	58.5
Right-Side Lateral Clearance Adj. (fRLC)	0.0	Density (D), pc/mi/ln	30.4
Total Ramp Density Adjustment	6.2	Level of Service (LOS)	D
Adjusted Free-Flow Speed (FFSadj), mi/h	58.8		

HCS7 Freeway Diverge Report

Project Information

Analyst	LSA	Date	12/11/2019
Agency	LSA	Analysis Year	Phase III Proj Comp Yr (2049) WP
Jurisdiction	Caltrans	Time Period Analyzed	AM Peak Hour
Project Description	CMD1801 - Village D Specific Plan	Unit	United States Customary

Geometric Data

	Freeway	Ramp
Number of Lanes (N), ln	3	1
Free-Flow Speed (FFS), mi/h	65.0	35.0
Segment Length (L) / Deceleration Length (LA),ft	1500	200
Terrain Type	Level	Level
Percent Grade, %	-	-
Segment Type / Ramp Side	Freeway	Right

Adjustment Factors

Driver Population	All Familiar	All Familiar
Weather Type	Non-Severe Weather	Non-Severe Weather
Incident Type	No Incident	-
Final Speed Adjustment Factor (SAF)	1.000	1.000
Final Capacity Adjustment Factor (CAF)	1.000	1.000
Demand Adjustment Factor (DAF)	1.000	1.000

Demand and Capacity

Demand Volume (Vi)	4263	369
Peak Hour Factor (PHF)	0.94	0.94
Total Trucks, %	17.80	6.23
Single-Unit Trucks (SUT), %	-	-
Tractor-Trailers (TT), %	-	-
Heavy Vehicle Adjustment Factor (fHV)	0.849	0.941
Flow Rate (vi),pc/h	5342	417
Capacity (c), pc/h	7050	2000
Volume-to-Capacity Ratio (v/c)	0.76	0.21

Speed and Density

Upstream Equilibrium Distance (LEQ), ft	-	Number of Outer Lanes on Freeway (NO)	1
Distance to Upstream Ramp (LUP), ft	-	Speed Index (DS)	0.466
Downstream Equilibrium Distance (LEQ), ft	-	Flow Outer Lanes (vOA), pc/h/ln	1936
Distance to Downstream Ramp (LDOWN), ft	-	Off-Ramp Influence Area Speed (SR), mi/h	54.3
Prop. Freeway Vehicles in Lane 1 and 2 (PFD)	0.607	Outer Lanes Freeway Speed (SO), mi/h	67.7
Flow in Lanes 1 and 2 (v12), pc/h	3406	Ramp Junction Speed (S), mi/h	58.5
Flow Entering Ramp-Infl. Area (vR12), pc/h	-	Average Density (D), pc/mi/ln	30.4
Level of Service (LOS)	D	Density in Ramp Influence Area (DR), pc/mi/ln	31.7

HCS7 Basic Freeway Report

Project Information

Analyst	LSA	Date	12/11/2019
Agency	LSA	Analysis Year	Phase III Proj Comp Yr (2049) WP
Jurisdiction	Caltrans	Time Period Analyzed	AM Peak Hour
Project Description	CMD1801 - Village D Specific Plan	Unit	United States Customary

Geometric Data

Number of Lanes, ln	3	Terrain Type	Level
Segment Length (L), ft	-	Percent Grade, %	-
Measured or Base Free-Flow Speed	Base	Grade Length, mi	-
Base Free-Flow Speed (BFFS), mi/h	65.0	Total Ramp Density (TRD), ramps/mi	2.17
Lane Width, ft	12	Free-Flow Speed (FFS), mi/h	58.8
Right-Side Lateral Clearance, ft	10		

Adjustment Factors

Driver Population	All Familiar	Final Speed Adjustment Factor (SAF)	1.000
Weather Type	Non-Severe Weather	Final Capacity Adjustment Factor (CAF)	1.000
Incident Type	No Incident	Demand Adjustment Factor (DAF)	1.000

Demand and Capacity

Demand Volume veh/h	3895	Heavy Vehicle Adjustment Factor (fhv)	0.841
Peak Hour Factor	0.94	Flow Rate (Vp), pc/h/ln	1642
Total Trucks, %	18.92	Capacity (c), pc/h/ln	2288
Single-Unit Trucks (SUT), %	-	Adjusted Capacity (cadj), pc/h/ln	2288
Tractor-Trailers (TT), %	-	Volume-to-Capacity Ratio (v/c)	0.72
Passenger Car Equivalent (ET)	2.000		

Speed and Density

Lane Width Adjustment (fLW)	0.0	Average Speed (S), mi/h	58.8
Right-Side Lateral Clearance Adj. (fRLC)	0.0	Density (D), pc/mi/ln	27.9
Total Ramp Density Adjustment	6.2	Level of Service (LOS)	D
Adjusted Free-Flow Speed (FFSadj), mi/h	58.8		

HCS7 Freeway Merge Report

Project Information

Analyst	LSA	Date	12/11/2019
Agency	LSA	Analysis Year	Phase III Proj Comp Yr (2049) WP
Jurisdiction	Caltrans	Time Period Analyzed	AM Peak Hour
Project Description	CMD1801 - Village D Specific Plan	Unit	United States Customary

Geometric Data

	Freeway	Ramp
Number of Lanes (N), ln	3	1
Free-Flow Speed (FFS), mi/h	65.0	35.0
Segment Length (L) / Acceleration Length (LA),ft	1500	350
Terrain Type	Level	Level
Percent Grade, %	-	-
Segment Type / Ramp Side	Freeway	Right

Adjustment Factors

Driver Population	All Familiar	All Familiar
Weather Type	Non-Severe Weather	Non-Severe Weather
Incident Type	No Incident	-
Final Speed Adjustment Factor (SAF)	1.000	1.000
Final Capacity Adjustment Factor (CAF)	1.000	1.000
Demand Adjustment Factor (DAF)	1.000	1.000

Demand and Capacity

Demand Volume (Vi)	3895	1258
Peak Hour Factor (PHF)	0.94	0.94
Total Trucks, %	18.92	2.07
Single-Unit Trucks (SUT), %	-	-
Tractor-Trailers (TT), %	-	-
Heavy Vehicle Adjustment Factor (fHV)	0.841	0.980
Flow Rate (vi),pc/h	4927	1366
Capacity (c), pc/h	7050	2000
Volume-to-Capacity Ratio (v/c)	0.89	0.68

Speed and Density

Upstream Equilibrium Distance (LEQ), ft	-	Number of Outer Lanes on Freeway (NO)	1
Distance to Upstream Ramp (LUP), ft	-	Speed Index (MS)	0.572
Downstream Equilibrium Distance (LEQ), ft	-	Flow Outer Lanes (vOA), pc/h/ln	2035
Distance to Downstream Ramp (LDOWN), ft	-	On-Ramp Influence Area Speed (SR), mi/h	51.8
Prop. Freeway Vehicles in Lane 1 and 2 (PFM)	0.587	Outer Lanes Freeway Speed (SO), mi/h	59.5
Flow in Lanes 1 and 2 (v12), pc/h	2892	Ramp Junction Speed (S), mi/h	54.1
Flow Entering Ramp-Infl. Area (vR12), pc/h	4258	Average Density (D), pc/mi/ln	38.8
Level of Service (LOS)	E	Density in Ramp Influence Area (DR), pc/mi/ln	35.9

HCS7 Basic Freeway Report

Project Information

Analyst	LSA	Date	12/11/2019
Agency	LSA	Analysis Year	Phase III Proj Comp Yr (2049) WP
Jurisdiction	Caltrans	Time Period Analyzed	AM Peak Hour
Project Description	CMD1801 - Village D Specific Plan	Unit	United States Customary

Geometric Data

Number of Lanes, ln	3	Terrain Type	Level
Segment Length (L), ft	-	Percent Grade, %	-
Measured or Base Free-Flow Speed	Base	Grade Length, mi	-
Base Free-Flow Speed (BFFS), mi/h	65.0	Total Ramp Density (TRD), ramps/mi	2.17
Lane Width, ft	12	Free-Flow Speed (FFS), mi/h	58.8
Right-Side Lateral Clearance, ft	10		

Adjustment Factors

Driver Population	All Familiar	Final Speed Adjustment Factor (SAF)	1.000
Weather Type	Non-Severe Weather	Final Capacity Adjustment Factor (CAF)	1.000
Incident Type	No Incident	Demand Adjustment Factor (DAF)	1.000

Demand and Capacity

Demand Volume veh/h	5152	Heavy Vehicle Adjustment Factor (fhv)	0.871
Peak Hour Factor	0.94	Flow Rate (Vp), pc/h/ln	2098
Total Trucks, %	14.81	Capacity (c), pc/h/ln	2288
Single-Unit Trucks (SUT), %	-	Adjusted Capacity (cadj), pc/h/ln	2288
Tractor-Trailers (TT), %	-	Volume-to-Capacity Ratio (v/c)	0.92
Passenger Car Equivalent (ET)	2.000		

Speed and Density

Lane Width Adjustment (fLW)	0.0	Average Speed (S), mi/h	54.9
Right-Side Lateral Clearance Adj. (fRLC)	0.0	Density (D), pc/mi/ln	38.2
Total Ramp Density Adjustment	6.2	Level of Service (LOS)	E
Adjusted Free-Flow Speed (FFSadj), mi/h	58.8		

HCS7 Freeway Diverge Report

Project Information

Analyst	LSA	Date	12/11/2019
Agency	LSA	Analysis Year	Phase III Proj Comp Yr (2049) WP
Jurisdiction	Caltrans	Time Period Analyzed	AM Peak Hour
Project Description	CMD1801 - Village D Specific Plan	Unit	United States Customary

Geometric Data

	Freeway	Ramp
Number of Lanes (N), ln	3	1
Free-Flow Speed (FFS), mi/h	65.0	15.0
Segment Length (L) / Deceleration Length (LA),ft	1500	150
Terrain Type	Level	Level
Percent Grade, %	-	-
Segment Type / Ramp Side	Freeway	Right

Adjustment Factors

Driver Population	All Familiar	All Familiar
Weather Type	Non-Severe Weather	Non-Severe Weather
Incident Type	No Incident	-
Final Speed Adjustment Factor (SAF)	1.000	1.000
Final Capacity Adjustment Factor (CAF)	1.000	1.000
Demand Adjustment Factor (DAF)	1.000	1.000

Demand and Capacity

Demand Volume (Vi)	5152	557
Peak Hour Factor (PHF)	0.94	0.94
Total Trucks, %	14.81	2.70
Single-Unit Trucks (SUT), %	-	-
Tractor-Trailers (TT), %	-	-
Heavy Vehicle Adjustment Factor (fHV)	0.871	0.974
Flow Rate (vi),pc/h	6293	608
Capacity (c), pc/h	7050	1800
Volume-to-Capacity Ratio (v/c)	0.89	0.34

Speed and Density

Upstream Equilibrium Distance (LEQ), ft	-	Number of Outer Lanes on Freeway (NO)	1
Distance to Upstream Ramp (LUP), ft	-	Speed Index (DS)	0.743
Downstream Equilibrium Distance (LEQ), ft	-	Flow Outer Lanes (vOA), pc/h/ln	2416
Distance to Downstream Ramp (LDOWN), ft	-	Off-Ramp Influence Area Speed (SR), mi/h	47.9
Prop. Freeway Vehicles in Lane 1 and 2 (PFD)	0.575	Outer Lanes Freeway Speed (SO), mi/h	65.8
Flow in Lanes 1 and 2 (v12), pc/h	3877	Ramp Junction Speed (S), mi/h	53.5
Flow Entering Ramp-Infl. Area (vR12), pc/h	-	Average Density (D), pc/mi/ln	39.2
Level of Service (LOS)	E	Density in Ramp Influence Area (DR), pc/mi/ln	36.2

HCS7 Basic Freeway Report

Project Information

Analyst	LSA	Date	12/11/2019
Agency	LSA	Analysis Year	Phase III Proj Comp Yr (2049) WP
Jurisdiction	Caltrans	Time Period Analyzed	AM Peak Hour
Project Description	CMD1801 - Village D Specific Plan	Unit	United States Customary

Geometric Data

Number of Lanes, ln	3	Terrain Type	Level
Segment Length (L), ft	-	Percent Grade, %	-
Measured or Base Free-Flow Speed	Base	Grade Length, mi	-
Base Free-Flow Speed (BFFS), mi/h	65.0	Total Ramp Density (TRD), ramps/mi	1.83
Lane Width, ft	12	Free-Flow Speed (FFS), mi/h	59.7
Right-Side Lateral Clearance, ft	10		

Adjustment Factors

Driver Population	All Familiar	Final Speed Adjustment Factor (SAF)	1.000
Weather Type	Non-Severe Weather	Final Capacity Adjustment Factor (CAF)	1.000
Incident Type	No Incident	Demand Adjustment Factor (DAF)	1.000

Demand and Capacity

Demand Volume veh/h	4596	Heavy Vehicle Adjustment Factor (fhv)	0.860
Peak Hour Factor	0.94	Flow Rate (Vp), pc/h/ln	1895
Total Trucks, %	16.28	Capacity (c), pc/h/ln	2296
Single-Unit Trucks (SUT), %	-	Adjusted Capacity (cadj), pc/h/ln	2296
Tractor-Trailers (TT), %	-	Volume-to-Capacity Ratio (v/c)	0.83
Passenger Car Equivalent (ET)	2.000		

Speed and Density

Lane Width Adjustment (fLW)	0.0	Average Speed (S), mi/h	58.2
Right-Side Lateral Clearance Adj. (fRLC)	0.0	Density (D), pc/mi/ln	32.6
Total Ramp Density Adjustment	5.4	Level of Service (LOS)	D
Adjusted Free-Flow Speed (FFSadj), mi/h	59.6		

HCS7 Freeway Merge Report

Project Information

Analyst	LSA	Date	12/11/2019
Agency	LSA	Analysis Year	Phase III Proj Comp Yr (2049) WP
Jurisdiction	Caltrans	Time Period Analyzed	AM Peak Hour
Project Description	CMD1801 - Village D Specific Plan	Unit	United States Customary

Geometric Data

	Freeway	Ramp
Number of Lanes (N), ln	3	1
Free-Flow Speed (FFS), mi/h	65.0	35.0
Segment Length (L) / Acceleration Length (LA),ft	1500	450
Terrain Type	Level	Level
Percent Grade, %	-	-
Segment Type / Ramp Side	Freeway	Right

Adjustment Factors

Driver Population	All Familiar	All Familiar
Weather Type	Non-Severe Weather	Non-Severe Weather
Incident Type	No Incident	-
Final Speed Adjustment Factor (SAF)	1.000	1.000
Final Capacity Adjustment Factor (CAF)	1.000	1.000
Demand Adjustment Factor (DAF)	1.000	1.000

Demand and Capacity

Demand Volume (Vi)	4596	599
Peak Hour Factor (PHF)	0.94	0.94
Total Trucks, %	16.28	0.83
Single-Unit Trucks (SUT), %	-	-
Tractor-Trailers (TT), %	-	-
Heavy Vehicle Adjustment Factor (fHV)	0.860	0.992
Flow Rate (vi),pc/h	5685	642
Capacity (c), pc/h	7050	2000
Volume-to-Capacity Ratio (v/c)	0.90	0.32

Speed and Density

Upstream Equilibrium Distance (LEQ), ft	-	Number of Outer Lanes on Freeway (NO)	1
Distance to Upstream Ramp (LUP), ft	-	Speed Index (MS)	0.502
Downstream Equilibrium Distance (LEQ), ft	-	Flow Outer Lanes (vOA), pc/h/ln	2331
Distance to Downstream Ramp (LDOWN), ft	-	On-Ramp Influence Area Speed (SR), mi/h	53.5
Prop. Freeway Vehicles in Lane 1 and 2 (PFM)	0.590	Outer Lanes Freeway Speed (SO), mi/h	58.3
Flow in Lanes 1 and 2 (v12), pc/h	3354	Ramp Junction Speed (S), mi/h	55.2
Flow Entering Ramp-Infl. Area (vR12), pc/h	3996	Average Density (D), pc/mi/ln	38.2
Level of Service (LOS)	D	Density in Ramp Influence Area (DR), pc/mi/ln	33.6

HCS7 Basic Freeway Report

Project Information

Analyst	LSA	Date	12/11/2019
Agency	LSA	Analysis Year	Phase III Proj Comp Yr (2049) WP
Jurisdiction	Caltrans	Time Period Analyzed	AM Peak Hour
Project Description	CMD1801 - Village D Specific Plan	Unit	United States Customary

Geometric Data

Number of Lanes, ln	3	Terrain Type	Level
Segment Length (L), ft	-	Percent Grade, %	-
Measured or Base Free-Flow Speed	Base	Grade Length, mi	-
Base Free-Flow Speed (BFFS), mi/h	65.0	Total Ramp Density (TRD), ramps/mi	1.83
Lane Width, ft	12	Free-Flow Speed (FFS), mi/h	59.7
Right-Side Lateral Clearance, ft	10		

Adjustment Factors

Driver Population	All Familiar	Final Speed Adjustment Factor (SAF)	1.000
Weather Type	Non-Severe Weather	Final Capacity Adjustment Factor (CAF)	1.000
Incident Type	No Incident	Demand Adjustment Factor (DAF)	1.000

Demand and Capacity

Demand Volume veh/h	5195	Heavy Vehicle Adjustment Factor (fhv)	0.873
Peak Hour Factor	0.94	Flow Rate (Vp), pc/h/ln	2110
Total Trucks, %	14.50	Capacity (c), pc/h/ln	2296
Single-Unit Trucks (SUT), %	-	Adjusted Capacity (cadj), pc/h/ln	2296
Tractor-Trailers (TT), %	-	Volume-to-Capacity Ratio (v/c)	0.92
Passenger Car Equivalent (ET)	2.000		

Speed and Density

Lane Width Adjustment (fLW)	0.0	Average Speed (S), mi/h	55.1
Right-Side Lateral Clearance Adj. (fRLC)	0.0	Density (D), pc/mi/ln	38.3
Total Ramp Density Adjustment	5.4	Level of Service (LOS)	E
Adjusted Free-Flow Speed (FFSadj), mi/h	59.6		

HCS7 Freeway Diverge Report

Project Information

Analyst	LSA	Date	12/11/2019
Agency	LSA	Analysis Year	Phase III Proj Comp Yr (2049) WP
Jurisdiction	Caltrans	Time Period Analyzed	AM Peak Hour
Project Description	CMD1801 - Village D Specific Plan	Unit	United States Customary

Geometric Data

	Freeway	Ramp
Number of Lanes (N), ln	3	1
Free-Flow Speed (FFS), mi/h	65.0	35.0
Segment Length (L) / Deceleration Length (LA),ft	1500	140
Terrain Type	Level	Level
Percent Grade, %	-	-
Segment Type / Ramp Side	Freeway	Right

Adjustment Factors

Driver Population	All Familiar	All Familiar
Weather Type	Non-Severe Weather	Non-Severe Weather
Incident Type	No Incident	-
Final Speed Adjustment Factor (SAF)	1.000	1.000
Final Capacity Adjustment Factor (CAF)	1.000	1.000
Demand Adjustment Factor (DAF)	1.000	1.000

Demand and Capacity

Demand Volume (Vi)	5195	1034
Peak Hour Factor (PHF)	0.94	0.94
Total Trucks, %	14.50	7.83
Single-Unit Trucks (SUT), %	-	-
Tractor-Trailers (TT), %	-	-
Heavy Vehicle Adjustment Factor (fHV)	0.873	0.927
Flow Rate (vi),pc/h	6331	1187
Capacity (c), pc/h	7050	2000
Volume-to-Capacity Ratio (v/c)	0.90	0.59

Speed and Density

Upstream Equilibrium Distance (LEQ), ft	-	Number of Outer Lanes on Freeway (NO)	1
Distance to Upstream Ramp (LUP), ft	-	Speed Index (DS)	0.535
Downstream Equilibrium Distance (LEQ), ft	-	Flow Outer Lanes (vOA), pc/h/ln	2330
Distance to Downstream Ramp (LDOWN), ft	-	Off-Ramp Influence Area Speed (SR), mi/h	52.7
Prop. Freeway Vehicles in Lane 1 and 2 (PFD)	0.547	Outer Lanes Freeway Speed (SO), mi/h	66.1
Flow in Lanes 1 and 2 (v12), pc/h	4001	Ramp Junction Speed (S), mi/h	56.9
Flow Entering Ramp-Infl. Area (vR12), pc/h	-	Average Density (D), pc/mi/ln	37.1
Level of Service (LOS)	E	Density in Ramp Influence Area (DR), pc/mi/ln	37.4

HCS7 Basic Freeway Report

Project Information

Analyst	LSA	Date	12/11/2019
Agency	LSA	Analysis Year	Phase III Proj Comp Yr (2049) WP
Jurisdiction	Caltrans	Time Period Analyzed	AM Peak Hour
Project Description	CMD1801 - Village D Specific Plan	Unit	United States Customary

Geometric Data

Number of Lanes, ln	3	Terrain Type	Level
Segment Length (L), ft	-	Percent Grade, %	-
Measured or Base Free-Flow Speed	Base	Grade Length, mi	-
Base Free-Flow Speed (BFFS), mi/h	65.0	Total Ramp Density (TRD), ramps/mi	2.17
Lane Width, ft	12	Free-Flow Speed (FFS), mi/h	58.8
Right-Side Lateral Clearance, ft	10		

Adjustment Factors

Driver Population	All Familiar	Final Speed Adjustment Factor (SAF)	1.000
Weather Type	Non-Severe Weather	Final Capacity Adjustment Factor (CAF)	1.000
Incident Type	No Incident	Demand Adjustment Factor (DAF)	1.000

Demand and Capacity

Demand Volume veh/h	4161	Heavy Vehicle Adjustment Factor (fhv)	0.861
Peak Hour Factor	0.94	Flow Rate (Vp), pc/h/ln	1714
Total Trucks, %	16.15	Capacity (c), pc/h/ln	2288
Single-Unit Trucks (SUT), %	-	Adjusted Capacity (cadj), pc/h/ln	2288
Tractor-Trailers (TT), %	-	Volume-to-Capacity Ratio (v/c)	0.75
Passenger Car Equivalent (ET)	2.000		

Speed and Density

Lane Width Adjustment (fLW)	0.0	Average Speed (S), mi/h	58.7
Right-Side Lateral Clearance Adj. (fRLC)	0.0	Density (D), pc/mi/ln	29.2
Total Ramp Density Adjustment	6.2	Level of Service (LOS)	D
Adjusted Free-Flow Speed (FFSadj), mi/h	58.8		

HCS7 Freeway Merge Report

Project Information

Analyst	LSA	Date	12/11/2019
Agency	LSA	Analysis Year	Phase III Proj Comp Yr (2049) WP
Jurisdiction	Caltrans	Time Period Analyzed	AM Peak Hour
Project Description	CMD1801 - Village D Specific Plan	Unit	United States Customary

Geometric Data

	Freeway	Ramp
Number of Lanes (N), ln	3	1
Free-Flow Speed (FFS), mi/h	65.0	35.0
Segment Length (L) / Acceleration Length (LA),ft	1500	450
Terrain Type	Level	Level
Percent Grade, %	-	-
Segment Type / Ramp Side	Freeway	Right

Adjustment Factors

Driver Population	All Familiar	All Familiar
Weather Type	Non-Severe Weather	Non-Severe Weather
Incident Type	No Incident	-
Final Speed Adjustment Factor (SAF)	1.000	1.000
Final Capacity Adjustment Factor (CAF)	1.000	1.000
Demand Adjustment Factor (DAF)	1.000	1.000

Demand and Capacity

Demand Volume (Vi)	4161	509
Peak Hour Factor (PHF)	0.94	0.94
Total Trucks, %	16.15	1.77
Single-Unit Trucks (SUT), %	-	-
Tractor-Trailers (TT), %	-	-
Heavy Vehicle Adjustment Factor (fHV)	0.861	0.983
Flow Rate (vi),pc/h	5141	551
Capacity (c), pc/h	7050	2000
Volume-to-Capacity Ratio (v/c)	0.81	0.28

Speed and Density

Upstream Equilibrium Distance (LEQ), ft	-	Number of Outer Lanes on Freeway (NO)	1
Distance to Upstream Ramp (LUP), ft	-	Speed Index (MS)	0.430
Downstream Equilibrium Distance (LEQ), ft	-	Flow Outer Lanes (vOA), pc/h/ln	2108
Distance to Downstream Ramp (LDOWN), ft	-	On-Ramp Influence Area Speed (SR), mi/h	55.1
Prop. Freeway Vehicles in Lane 1 and 2 (PFM)	0.590	Outer Lanes Freeway Speed (SO), mi/h	59.2
Flow in Lanes 1 and 2 (v12), pc/h	3033	Ramp Junction Speed (S), mi/h	56.6
Flow Entering Ramp-Infl. Area (vR12), pc/h	3584	Average Density (D), pc/mi/ln	33.5
Level of Service (LOS)	D	Density in Ramp Influence Area (DR), pc/mi/ln	30.4

HCS7 Basic Freeway Report

Project Information

Analyst	LSA	Date	12/11/2019
Agency	LSA	Analysis Year	Phase III Proj Comp Yr (2049) WP
Jurisdiction	Caltrans	Time Period Analyzed	AM Peak Hour
Project Description	CMD1801 - Village D Specific Plan	Unit	United States Customary

Geometric Data

Number of Lanes, ln	3	Terrain Type	Level
Segment Length (L), ft	-	Percent Grade, %	-
Measured or Base Free-Flow Speed	Base	Grade Length, mi	-
Base Free-Flow Speed (BFFS), mi/h	65.0	Total Ramp Density (TRD), ramps/mi	2.17
Lane Width, ft	12	Free-Flow Speed (FFS), mi/h	58.8
Right-Side Lateral Clearance, ft	10		

Adjustment Factors

Driver Population	All Familiar	Final Speed Adjustment Factor (SAF)	1.000
Weather Type	Non-Severe Weather	Final Capacity Adjustment Factor (CAF)	1.000
Incident Type	No Incident	Demand Adjustment Factor (DAF)	1.000

Demand and Capacity

Demand Volume veh/h	4670	Heavy Vehicle Adjustment Factor (fhv)	0.873
Peak Hour Factor	0.94	Flow Rate (Vp), pc/h/ln	1897
Total Trucks, %	14.58	Capacity (c), pc/h/ln	2288
Single-Unit Trucks (SUT), %	-	Adjusted Capacity (cadj), pc/h/ln	2288
Tractor-Trailers (TT), %	-	Volume-to-Capacity Ratio (v/c)	0.83
Passenger Car Equivalent (ET)	2.000		

Speed and Density

Lane Width Adjustment (fLW)	0.0	Average Speed (S), mi/h	57.6
Right-Side Lateral Clearance Adj. (fRLC)	0.0	Density (D), pc/mi/ln	32.9
Total Ramp Density Adjustment	6.2	Level of Service (LOS)	D
Adjusted Free-Flow Speed (FFSadj), mi/h	58.8		

HCS7 Basic Freeway Report

Project Information

Analyst	LSA	Date	12/11/2019
Agency	LSA	Analysis Year	Phase III Proj Comp Yr (2049) WP
Jurisdiction	Caltrans	Time Period Analyzed	PM Peak Hour
Project Description	CMD1801 - Village D Specific Plan	Unit	United States Customary

Geometric Data

Number of Lanes, ln	3	Terrain Type	Level
Segment Length (L), ft	-	Percent Grade, %	-
Measured or Base Free-Flow Speed	Base	Grade Length, mi	-
Base Free-Flow Speed (BFFS), mi/h	65.0	Total Ramp Density (TRD), ramps/mi	1.83
Lane Width, ft	12	Free-Flow Speed (FFS), mi/h	59.7
Right-Side Lateral Clearance, ft	10		

Adjustment Factors

Driver Population	All Familiar	Final Speed Adjustment Factor (SAF)	1.000
Weather Type	Non-Severe Weather	Final Capacity Adjustment Factor (CAF)	1.000
Incident Type	No Incident	Demand Adjustment Factor (DAF)	1.000

Demand and Capacity

Demand Volume veh/h	4480	Heavy Vehicle Adjustment Factor (fhv)	0.874
Peak Hour Factor	0.94	Flow Rate (Vp), pc/h/ln	1818
Total Trucks, %	14.44	Capacity (c), pc/h/ln	2296
Single-Unit Trucks (SUT), %	-	Adjusted Capacity (cadj), pc/h/ln	2296
Tractor-Trailers (TT), %	-	Volume-to-Capacity Ratio (v/c)	0.79
Passenger Car Equivalent (ET)	2.000		

Speed and Density

Lane Width Adjustment (fLW)	0.0	Average Speed (S), mi/h	58.8
Right-Side Lateral Clearance Adj. (fRLC)	0.0	Density (D), pc/mi/ln	30.9
Total Ramp Density Adjustment	5.4	Level of Service (LOS)	D
Adjusted Free-Flow Speed (FFSadj), mi/h	59.6		

HCS7 Freeway Diverge Report

Project Information

Analyst	LSA	Date	12/11/2019
Agency	LSA	Analysis Year	Phase III Proj Comp Yr (2049) WP
Jurisdiction	Caltrans	Time Period Analyzed	PM Peak Hour
Project Description	CMD1801 - Village D Specific Plan	Unit	United States Customary

Geometric Data

	Freeway	Ramp
Number of Lanes (N), ln	3	1
Free-Flow Speed (FFS), mi/h	65.0	35.0
Segment Length (L) / Deceleration Length (LA),ft	1500	150
Terrain Type	Level	Level
Percent Grade, %	-	-
Segment Type / Ramp Side	Freeway	Right

Adjustment Factors

Driver Population	All Familiar	All Familiar
Weather Type	Non-Severe Weather	Non-Severe Weather
Incident Type	No Incident	-
Final Speed Adjustment Factor (SAF)	1.000	1.000
Final Capacity Adjustment Factor (CAF)	1.000	1.000
Demand Adjustment Factor (DAF)	1.000	1.000

Demand and Capacity

Demand Volume (Vi)	4480	409
Peak Hour Factor (PHF)	0.94	0.94
Total Trucks, %	14.44	0.49
Single-Unit Trucks (SUT), %	-	-
Tractor-Trailers (TT), %	-	-
Heavy Vehicle Adjustment Factor (fHV)	0.874	0.995
Flow Rate (vi),pc/h	5453	437
Capacity (c), pc/h	7050	2000
Volume-to-Capacity Ratio (v/c)	0.77	0.22

Speed and Density

Upstream Equilibrium Distance (LEQ), ft	-	Number of Outer Lanes on Freeway (NO)	1
Distance to Upstream Ramp (LUP), ft	-	Speed Index (DS)	0.467
Downstream Equilibrium Distance (LEQ), ft	-	Flow Outer Lanes (vOA), pc/h/ln	1986
Distance to Downstream Ramp (LDOWN), ft	-	Off-Ramp Influence Area Speed (SR), mi/h	54.3
Prop. Freeway Vehicles in Lane 1 and 2 (PFD)	0.604	Outer Lanes Freeway Speed (SO), mi/h	67.5
Flow in Lanes 1 and 2 (v12), pc/h	3467	Ramp Junction Speed (S), mi/h	58.5
Flow Entering Ramp-Infl. Area (vR12), pc/h	-	Average Density (D), pc/mi/ln	31.1
Level of Service (LOS)	D	Density in Ramp Influence Area (DR), pc/mi/ln	32.7

HCS7 Basic Freeway Report

Project Information

Analyst	LSA	Date	12/11/2019
Agency	LSA	Analysis Year	Phase III Proj Comp Yr (2049) WP
Jurisdiction	Caltrans	Time Period Analyzed	PM Peak Hour
Project Description	CMD1801 - Village D Specific Plan	Unit	United States Customary

Geometric Data

Number of Lanes, ln	3	Terrain Type	Level
Segment Length (L), ft	-	Percent Grade, %	-
Measured or Base Free-Flow Speed	Base	Grade Length, mi	-
Base Free-Flow Speed (BFFS), mi/h	65.0	Total Ramp Density (TRD), ramps/mi	1.83
Lane Width, ft	12	Free-Flow Speed (FFS), mi/h	59.7
Right-Side Lateral Clearance, ft	10		

Adjustment Factors

Driver Population	All Familiar	Final Speed Adjustment Factor (SAF)	1.000
Weather Type	Non-Severe Weather	Final Capacity Adjustment Factor (CAF)	1.000
Incident Type	No Incident	Demand Adjustment Factor (DAF)	1.000

Demand and Capacity

Demand Volume veh/h	4071	Heavy Vehicle Adjustment Factor (fhv)	0.863
Peak Hour Factor	0.94	Flow Rate (Vp), pc/h/ln	1673
Total Trucks, %	15.84	Capacity (c), pc/h/ln	2296
Single-Unit Trucks (SUT), %	-	Adjusted Capacity (cadj), pc/h/ln	2296
Tractor-Trailers (TT), %	-	Volume-to-Capacity Ratio (v/c)	0.73
Passenger Car Equivalent (ET)	2.000		

Speed and Density

Lane Width Adjustment (fLW)	0.0	Average Speed (S), mi/h	59.5
Right-Side Lateral Clearance Adj. (fRLC)	0.0	Density (D), pc/mi/ln	28.1
Total Ramp Density Adjustment	5.4	Level of Service (LOS)	D
Adjusted Free-Flow Speed (FFSadj), mi/h	59.6		

HCS7 Freeway Merge Report

Project Information

Analyst	LSA	Date	12/11/2019
Agency	LSA	Analysis Year	Phase III Proj Comp Yr (2049) WP
Jurisdiction	Caltrans	Time Period Analyzed	PM Peak Hour
Project Description	CMD1801 - Village D Specific Plan	Unit	United States Customary

Geometric Data

	Freeway	Ramp
Number of Lanes (N), ln	3	1
Free-Flow Speed (FFS), mi/h	65.0	35.0
Segment Length (L) / Acceleration Length (LA),ft	1500	445
Terrain Type	Level	Level
Percent Grade, %	-	-
Segment Type / Ramp Side	Freeway	Right

Adjustment Factors

Driver Population	All Familiar	All Familiar
Weather Type	Non-Severe Weather	Non-Severe Weather
Incident Type	No Incident	-
Final Speed Adjustment Factor (SAF)	1.000	1.000
Final Capacity Adjustment Factor (CAF)	1.000	1.000
Demand Adjustment Factor (DAF)	1.000	1.000

Demand and Capacity

Demand Volume (Vi)	4071	1194
Peak Hour Factor (PHF)	0.94	0.94
Total Trucks, %	15.84	2.26
Single-Unit Trucks (SUT), %	-	-
Tractor-Trailers (TT), %	-	-
Heavy Vehicle Adjustment Factor (fHV)	0.863	0.978
Flow Rate (vi),pc/h	5018	1299
Capacity (c), pc/h	7050	2000
Volume-to-Capacity Ratio (v/c)	0.90	0.65

Speed and Density

Upstream Equilibrium Distance (LEQ), ft	-	Number of Outer Lanes on Freeway (NO)	1
Distance to Upstream Ramp (LUP), ft	-	Speed Index (MS)	0.566
Downstream Equilibrium Distance (LEQ), ft	-	Flow Outer Lanes (vOA), pc/h/ln	2057
Distance to Downstream Ramp (LDOWN), ft	-	On-Ramp Influence Area Speed (SR), mi/h	52.0
Prop. Freeway Vehicles in Lane 1 and 2 (PFM)	0.590	Outer Lanes Freeway Speed (SO), mi/h	59.4
Flow in Lanes 1 and 2 (v12), pc/h	2961	Ramp Junction Speed (S), mi/h	54.2
Flow Entering Ramp-Infl. Area (vR12), pc/h	4260	Average Density (D), pc/mi/ln	38.8
Level of Service (LOS)	E	Density in Ramp Influence Area (DR), pc/mi/ln	35.4

HCS7 Basic Freeway Report

Project Information

Analyst	LSA	Date	12/11/2019
Agency	LSA	Analysis Year	Phase III Proj Comp Yr (2049) WP
Jurisdiction	Caltrans	Time Period Analyzed	PM Peak Hour
Project Description	CMD1801 - Village D Specific Plan	Unit	United States Customary

Geometric Data

Number of Lanes, ln	3	Terrain Type	Level
Segment Length (L), ft	-	Percent Grade, %	-
Measured or Base Free-Flow Speed	Base	Grade Length, mi	-
Base Free-Flow Speed (BFFS), mi/h	65.0	Total Ramp Density (TRD), ramps/mi	1.50
Lane Width, ft	12	Free-Flow Speed (FFS), mi/h	60.5
Right-Side Lateral Clearance, ft	10		

Adjustment Factors

Driver Population	All Familiar	Final Speed Adjustment Factor (SAF)	1.000
Weather Type	Non-Severe Weather	Final Capacity Adjustment Factor (CAF)	1.000
Incident Type	No Incident	Demand Adjustment Factor (DAF)	1.000

Demand and Capacity

Demand Volume veh/h	5265	Heavy Vehicle Adjustment Factor (fhv)	0.887
Peak Hour Factor	0.94	Flow Rate (Vp), pc/h/ln	2105
Total Trucks, %	12.76	Capacity (c), pc/h/ln	2305
Single-Unit Trucks (SUT), %	-	Adjusted Capacity (cadj), pc/h/ln	2305
Tractor-Trailers (TT), %	-	Volume-to-Capacity Ratio (v/c)	0.91
Passenger Car Equivalent (ET)	2.000		

Speed and Density

Lane Width Adjustment (fLW)	0.0	Average Speed (S), mi/h	55.6
Right-Side Lateral Clearance Adj. (fRLC)	0.0	Density (D), pc/mi/ln	37.9
Total Ramp Density Adjustment	4.5	Level of Service (LOS)	E
Adjusted Free-Flow Speed (FFSadj), mi/h	60.5		

HCS7 Freeway Diverge Report

Project Information

Analyst	LSA	Date	12/11/2019
Agency	LSA	Analysis Year	Phase III Proj Comp Yr (2049) WP
Jurisdiction	Caltrans	Time Period Analyzed	PM Peak Hour
Project Description	CMD1801 - Village D Specific Plan	Unit	United States Customary

Geometric Data

	Freeway	Ramp
Number of Lanes (N), ln	3	1
Free-Flow Speed (FFS), mi/h	65.0	35.0
Segment Length (L) / Deceleration Length (LA),ft	1500	130
Terrain Type	Level	Level
Percent Grade, %	-	-
Segment Type / Ramp Side	Freeway	Right

Adjustment Factors

Driver Population	All Familiar	All Familiar
Weather Type	Non-Severe Weather	Non-Severe Weather
Incident Type	No Incident	-
Final Speed Adjustment Factor (SAF)	1.000	1.000
Final Capacity Adjustment Factor (CAF)	1.000	1.000
Demand Adjustment Factor (DAF)	1.000	1.000

Demand and Capacity

Demand Volume (Vi)	5265	533
Peak Hour Factor (PHF)	0.94	0.94
Total Trucks, %	12.76	1.31
Single-Unit Trucks (SUT), %	-	-
Tractor-Trailers (TT), %	-	-
Heavy Vehicle Adjustment Factor (fHV)	0.887	0.987
Flow Rate (vi),pc/h	6315	574
Capacity (c), pc/h	7050	2000
Volume-to-Capacity Ratio (v/c)	0.90	0.29

Speed and Density

Upstream Equilibrium Distance (LEQ), ft	-	Number of Outer Lanes on Freeway (NO)	1
Distance to Upstream Ramp (LUP), ft	-	Speed Index (DS)	0.480
Downstream Equilibrium Distance (LEQ), ft	-	Flow Outer Lanes (vOA), pc/h/ln	2434
Distance to Downstream Ramp (LDOWN), ft	-	Off-Ramp Influence Area Speed (SR), mi/h	54.0
Prop. Freeway Vehicles in Lane 1 and 2 (PFD)	0.576	Outer Lanes Freeway Speed (SO), mi/h	65.7
Flow in Lanes 1 and 2 (v12), pc/h	3881	Ramp Junction Speed (S), mi/h	58.0
Flow Entering Ramp-Infl. Area (vR12), pc/h	-	Average Density (D), pc/mi/ln	36.3
Level of Service (LOS)	E	Density in Ramp Influence Area (DR), pc/mi/ln	36.5

HCS7 Basic Freeway Report

Project Information

Analyst	LSA	Date	12/11/2019
Agency	LSA	Analysis Year	Phase III Proj Comp Yr (2049) WP
Jurisdiction	Caltrans	Time Period Analyzed	PM Peak Hour
Project Description	CMD1801 - Village D Specific Plan	Unit	United States Customary

Geometric Data

Number of Lanes, ln	3	Terrain Type	Level
Segment Length (L), ft	-	Percent Grade, %	-
Measured or Base Free-Flow Speed	Base	Grade Length, mi	-
Base Free-Flow Speed (BFFS), mi/h	65.0	Total Ramp Density (TRD), ramps/mi	1.67
Lane Width, ft	12	Free-Flow Speed (FFS), mi/h	60.0
Right-Side Lateral Clearance, ft	10		

Adjustment Factors

Driver Population	All Familiar	Final Speed Adjustment Factor (SAF)	1.000
Weather Type	Non-Severe Weather	Final Capacity Adjustment Factor (CAF)	1.000
Incident Type	No Incident	Demand Adjustment Factor (DAF)	1.000

Demand and Capacity

Demand Volume veh/h	4732	Heavy Vehicle Adjustment Factor (fhv)	0.877
Peak Hour Factor	0.94	Flow Rate (Vp), pc/h/ln	1913
Total Trucks, %	14.05	Capacity (c), pc/h/ln	2300
Single-Unit Trucks (SUT), %	-	Adjusted Capacity (cadj), pc/h/ln	2300
Tractor-Trailers (TT), %	-	Volume-to-Capacity Ratio (v/c)	0.83
Passenger Car Equivalent (ET)	2.000		

Speed and Density

Lane Width Adjustment (fLW)	0.0	Average Speed (S), mi/h	58.2
Right-Side Lateral Clearance Adj. (fRLC)	0.0	Density (D), pc/mi/ln	32.9
Total Ramp Density Adjustment	5.0	Level of Service (LOS)	D
Adjusted Free-Flow Speed (FFSadj), mi/h	60.0		

HCS7 Freeway Merge Report

Project Information

Analyst	LSA	Date	12/11/2019
Agency	LSA	Analysis Year	Phase III Proj Comp Yr (2049) WP
Jurisdiction	Caltrans	Time Period Analyzed	PM Peak Hour
Project Description	CMD1801 - Village D Specific Plan	Unit	United States Customary

Geometric Data

	Freeway	Ramp
Number of Lanes (N), ln	3	1
Free-Flow Speed (FFS), mi/h	65.0	35.0
Segment Length (L) / Acceleration Length (LA),ft	1500	500
Terrain Type	Level	Level
Percent Grade, %	-	-
Segment Type / Ramp Side	Freeway	Right

Adjustment Factors

Driver Population	All Familiar	All Familiar
Weather Type	Non-Severe Weather	Non-Severe Weather
Incident Type	No Incident	-
Final Speed Adjustment Factor (SAF)	1.000	1.000
Final Capacity Adjustment Factor (CAF)	1.000	1.000
Demand Adjustment Factor (DAF)	1.000	1.000

Demand and Capacity

Demand Volume (Vi)	4732	565
Peak Hour Factor (PHF)	0.94	0.94
Total Trucks, %	14.05	1.77
Single-Unit Trucks (SUT), %	-	-
Tractor-Trailers (TT), %	-	-
Heavy Vehicle Adjustment Factor (fHV)	0.877	0.983
Flow Rate (vi),pc/h	5740	611
Capacity (c), pc/h	7050	2000
Volume-to-Capacity Ratio (v/c)	0.90	0.31

Speed and Density

Upstream Equilibrium Distance (LEQ), ft	-	Number of Outer Lanes on Freeway (NO)	1
Distance to Upstream Ramp (LUP), ft	-	Speed Index (MS)	0.501
Downstream Equilibrium Distance (LEQ), ft	-	Flow Outer Lanes (vOA), pc/h/ln	2342
Distance to Downstream Ramp (LDOWN), ft	-	On-Ramp Influence Area Speed (SR), mi/h	53.5
Prop. Freeway Vehicles in Lane 1 and 2 (PFM)	0.592	Outer Lanes Freeway Speed (SO), mi/h	58.2
Flow in Lanes 1 and 2 (v12), pc/h	3398	Ramp Junction Speed (S), mi/h	55.1
Flow Entering Ramp-Infl. Area (vR12), pc/h	4009	Average Density (D), pc/mi/ln	38.4
Level of Service (LOS)	D	Density in Ramp Influence Area (DR), pc/mi/ln	33.4

HCS7 Basic Freeway Report

Project Information

Analyst	LSA	Date	12/11/2019
Agency	LSA	Analysis Year	Phase III Proj Comp Yr (2049) WP
Jurisdiction	Caltrans	Time Period Analyzed	PM Peak Hour
Project Description	CMD1801 - Village D Specific Plan	Unit	United States Customary

Geometric Data

Number of Lanes, ln	2	Terrain Type	Level
Segment Length (L), ft	-	Percent Grade, %	-
Measured or Base Free-Flow Speed	Base	Grade Length, mi	-
Base Free-Flow Speed (BFFS), mi/h	65.0	Total Ramp Density (TRD), ramps/mi	1.83
Lane Width, ft	12	Free-Flow Speed (FFS), mi/h	59.7
Right-Side Lateral Clearance, ft	10		

Adjustment Factors

Driver Population	All Familiar	Final Speed Adjustment Factor (SAF)	1.000
Weather Type	Non-Severe Weather	Final Capacity Adjustment Factor (CAF)	1.000
Incident Type	No Incident	Demand Adjustment Factor (DAF)	1.000

Demand and Capacity

Demand Volume veh/h	5297	Heavy Vehicle Adjustment Factor (fHV)	0.887
Peak Hour Factor	0.94	Flow Rate (Vp), pc/h/ln	3176
Total Trucks, %	12.74	Capacity (c), pc/h/ln	2296
Single-Unit Trucks (SUT), %	-	Adjusted Capacity (cadj), pc/h/ln	2296
Tractor-Trailers (TT), %	-	Volume-to-Capacity Ratio (v/c)	1.38
Passenger Car Equivalent (ET)	2.000		

Speed and Density

Lane Width Adjustment (fLW)	0.0	Average Speed (S), mi/h	-
Right-Side Lateral Clearance Adj. (fRLC)	0.0	Density (D), pc/mi/ln	-
Total Ramp Density Adjustment	5.4	Level of Service (LOS)	F
Adjusted Free-Flow Speed (FFSadj), mi/h	59.6		

HCS7 Freeway Diverge Report

Project Information

Analyst	LSA	Date	12/11/2019
Agency	LSA	Analysis Year	Phase III Proj Comp Yr (2049) WP
Jurisdiction	Caltrans	Time Period Analyzed	PM Peak Hour
Project Description	CMD1801 - Village D Specific Plan	Unit	United States Customary

Geometric Data

	Freeway	Ramp
Number of Lanes (N), ln	3	1
Free-Flow Speed (FFS), mi/h	65.0	35.0
Segment Length (L) / Deceleration Length (LA),ft	1500	245
Terrain Type	Level	Level
Percent Grade, %	-	-
Segment Type / Ramp Side	Freeway	Right

Adjustment Factors

Driver Population	All Familiar	All Familiar
Weather Type	Non-Severe Weather	Non-Severe Weather
Incident Type	No Incident	-
Final Speed Adjustment Factor (SAF)	1.000	1.000
Final Capacity Adjustment Factor (CAF)	1.000	1.000
Demand Adjustment Factor (DAF)	1.000	1.000

Demand and Capacity

Demand Volume (Vi)	5297	1445
Peak Hour Factor (PHF)	0.94	0.94
Total Trucks, %	12.74	0.69
Single-Unit Trucks (SUT), %	-	-
Tractor-Trailers (TT), %	-	-
Heavy Vehicle Adjustment Factor (fHV)	0.887	0.993
Flow Rate (vi),pc/h	6353	1548
Capacity (c), pc/h	7050	2000
Volume-to-Capacity Ratio (v/c)	0.90	0.77

Speed and Density

Upstream Equilibrium Distance (LEQ), ft	-	Number of Outer Lanes on Freeway (NO)	1
Distance to Upstream Ramp (LUP), ft	-	Speed Index (DS)	0.567
Downstream Equilibrium Distance (LEQ), ft	-	Flow Outer Lanes (vOA), pc/h/ln	2258
Distance to Downstream Ramp (LDOWN), ft	-	Off-Ramp Influence Area Speed (SR), mi/h	52.0
Prop. Freeway Vehicles in Lane 1 and 2 (PFD)	0.530	Outer Lanes Freeway Speed (SO), mi/h	66.4
Flow in Lanes 1 and 2 (v12), pc/h	4095	Ramp Junction Speed (S), mi/h	56.3
Flow Entering Ramp-Infl. Area (vR12), pc/h	-	Average Density (D), pc/mi/ln	37.6
Level of Service (LOS)	E	Density in Ramp Influence Area (DR), pc/mi/ln	37.3

HCS7 Basic Freeway Report

Project Information

Analyst	LSA	Date	12/11/2019
Agency	LSA	Analysis Year	Phase III Proj Comp Yr (2049) WP
Jurisdiction	Caltrans	Time Period Analyzed	PM Peak Hour
Project Description	CMD1801 - Village D Specific Plan	Unit	United States Customary

Geometric Data

Number of Lanes, ln	3	Terrain Type	Level
Segment Length (L), ft	-	Percent Grade, %	-
Measured or Base Free-Flow Speed	Base	Grade Length, mi	-
Base Free-Flow Speed (BFFS), mi/h	65.0	Total Ramp Density (TRD), ramps/mi	1.83
Lane Width, ft	12	Free-Flow Speed (FFS), mi/h	59.7
Right-Side Lateral Clearance, ft	10		

Adjustment Factors

Driver Population	All Familiar	Final Speed Adjustment Factor (SAF)	1.000
Weather Type	Non-Severe Weather	Final Capacity Adjustment Factor (CAF)	1.000
Incident Type	No Incident	Demand Adjustment Factor (DAF)	1.000

Demand and Capacity

Demand Volume veh/h	3852	Heavy Vehicle Adjustment Factor (fhv)	0.853
Peak Hour Factor	0.94	Flow Rate (Vp), pc/h/ln	1601
Total Trucks, %	17.26	Capacity (c), pc/h/ln	2296
Single-Unit Trucks (SUT), %	-	Adjusted Capacity (cadj), pc/h/ln	2296
Tractor-Trailers (TT), %	-	Volume-to-Capacity Ratio (v/c)	0.70
Passenger Car Equivalent (ET)	2.000		

Speed and Density

Lane Width Adjustment (fLW)	0.0	Average Speed (S), mi/h	59.6
Right-Side Lateral Clearance Adj. (fRLC)	0.0	Density (D), pc/mi/ln	26.9
Total Ramp Density Adjustment	5.4	Level of Service (LOS)	D
Adjusted Free-Flow Speed (FFSadj), mi/h	59.6		

HCS7 Freeway Merge Report

Project Information

Analyst	LSA	Date	12/11/2019
Agency	LSA	Analysis Year	Phase III Proj Comp Yr (2049) WP
Jurisdiction	Caltrans	Time Period Analyzed	PM Peak Hour
Project Description	CMD1801 - Village D Specific Plan	Unit	United States Customary

Geometric Data

	Freeway	Ramp
Number of Lanes (N), ln	3	1
Free-Flow Speed (FFS), mi/h	65.0	35.0
Segment Length (L) / Acceleration Length (LA),ft	1500	350
Terrain Type	Level	Level
Percent Grade, %	-	-
Segment Type / Ramp Side	Freeway	Right

Adjustment Factors

Driver Population	All Familiar	All Familiar
Weather Type	Non-Severe Weather	Non-Severe Weather
Incident Type	No Incident	-
Final Speed Adjustment Factor (SAF)	1.000	1.000
Final Capacity Adjustment Factor (CAF)	1.000	1.000
Demand Adjustment Factor (DAF)	1.000	1.000

Demand and Capacity

Demand Volume (Vi)	3852	356
Peak Hour Factor (PHF)	0.94	0.94
Total Trucks, %	17.26	2.53
Single-Unit Trucks (SUT), %	-	-
Tractor-Trailers (TT), %	-	-
Heavy Vehicle Adjustment Factor (fHV)	0.853	0.975
Flow Rate (vi),pc/h	4804	388
Capacity (c), pc/h	7050	2000
Volume-to-Capacity Ratio (v/c)	0.74	0.19

Speed and Density

Upstream Equilibrium Distance (LEQ), ft	-	Number of Outer Lanes on Freeway (NO)	1
Distance to Upstream Ramp (LUP), ft	-	Speed Index (MS)	0.393
Downstream Equilibrium Distance (LEQ), ft	-	Flow Outer Lanes (vOA), pc/h/ln	1984
Distance to Downstream Ramp (LDOWN), ft	-	On-Ramp Influence Area Speed (SR), mi/h	56.0
Prop. Freeway Vehicles in Lane 1 and 2 (PFM)	0.587	Outer Lanes Freeway Speed (SO), mi/h	59.7
Flow in Lanes 1 and 2 (v12), pc/h	2820	Ramp Junction Speed (S), mi/h	57.4
Flow Entering Ramp-Infl. Area (vR12), pc/h	3208	Average Density (D), pc/mi/ln	30.2
Level of Service (LOS)	D	Density in Ramp Influence Area (DR), pc/mi/ln	28.2

HCS7 Basic Freeway Report

Project Information

Analyst	LSA	Date	12/11/2019
Agency	LSA	Analysis Year	Phase III Proj Comp Yr (2049) WP
Jurisdiction	Caltrans	Time Period Analyzed	PM Peak Hour
Project Description	CMD1801 - Village D Specific Plan	Unit	United States Customary

Geometric Data

Number of Lanes, ln	3	Terrain Type	Level
Segment Length (L), ft	-	Percent Grade, %	-
Measured or Base Free-Flow Speed	Base	Grade Length, mi	-
Base Free-Flow Speed (BFFS), mi/h	65.0	Total Ramp Density (TRD), ramps/mi	1.83
Lane Width, ft	12	Free-Flow Speed (FFS), mi/h	59.7
Right-Side Lateral Clearance, ft	10		

Adjustment Factors

Driver Population	All Familiar	Final Speed Adjustment Factor (SAF)	1.000
Weather Type	Non-Severe Weather	Final Capacity Adjustment Factor (CAF)	1.000
Incident Type	No Incident	Demand Adjustment Factor (DAF)	1.000

Demand and Capacity

Demand Volume veh/h	4209	Heavy Vehicle Adjustment Factor (fhv)	0.862
Peak Hour Factor	0.94	Flow Rate (Vp), pc/h/ln	1732
Total Trucks, %	16.01	Capacity (c), pc/h/ln	2296
Single-Unit Trucks (SUT), %	-	Adjusted Capacity (cadj), pc/h/ln	2296
Tractor-Trailers (TT), %	-	Volume-to-Capacity Ratio (v/c)	0.75
Passenger Car Equivalent (ET)	2.000		

Speed and Density

Lane Width Adjustment (fLW)	0.0	Average Speed (S), mi/h	59.4
Right-Side Lateral Clearance Adj. (fRLC)	0.0	Density (D), pc/mi/ln	29.2
Total Ramp Density Adjustment	5.4	Level of Service (LOS)	D
Adjusted Free-Flow Speed (FFSadj), mi/h	59.6		

HCS7 Freeway Diverge Report

Project Information

Analyst	LSA	Date	12/11/2019
Agency	LSA	Analysis Year	Phase III Proj Comp Yr (2049) WP
Jurisdiction	Caltrans	Time Period Analyzed	PM Peak Hour
Project Description	CMD1801 - Village D Specific Plan	Unit	United States Customary

Geometric Data

	Freeway	Ramp
Number of Lanes (N), ln	3	1
Free-Flow Speed (FFS), mi/h	65.0	15.0
Segment Length (L) / Deceleration Length (LA),ft	1500	150
Terrain Type	Level	Level
Percent Grade, %	-	-
Segment Type / Ramp Side	Freeway	Right

Adjustment Factors

Driver Population	All Familiar	All Familiar
Weather Type	Non-Severe Weather	Non-Severe Weather
Incident Type	No Incident	-
Final Speed Adjustment Factor (SAF)	1.000	1.000
Final Capacity Adjustment Factor (CAF)	1.000	1.000
Demand Adjustment Factor (DAF)	1.000	1.000

Demand and Capacity

Demand Volume (Vi)	4209	311
Peak Hour Factor (PHF)	0.94	0.94
Total Trucks, %	16.01	2.25
Single-Unit Trucks (SUT), %	-	-
Tractor-Trailers (TT), %	-	-
Heavy Vehicle Adjustment Factor (fHV)	0.862	0.978
Flow Rate (vi),pc/h	5195	338
Capacity (c), pc/h	7050	1800
Volume-to-Capacity Ratio (v/c)	0.74	0.19

Speed and Density

Upstream Equilibrium Distance (LEQ), ft	-	Number of Outer Lanes on Freeway (NO)	1
Distance to Upstream Ramp (LUP), ft	-	Speed Index (DS)	0.718
Downstream Equilibrium Distance (LEQ), ft	-	Flow Outer Lanes (vOA), pc/h/ln	1870
Distance to Downstream Ramp (LDOWN), ft	-	Off-Ramp Influence Area Speed (SR), mi/h	48.5
Prop. Freeway Vehicles in Lane 1 and 2 (PFD)	0.615	Outer Lanes Freeway Speed (SO), mi/h	67.9
Flow in Lanes 1 and 2 (v12), pc/h	3325	Ramp Junction Speed (S), mi/h	54.1
Flow Entering Ramp-Infl. Area (vR12), pc/h	-	Average Density (D), pc/mi/ln	32.0
Level of Service (LOS)	D	Density in Ramp Influence Area (DR), pc/mi/ln	31.5

HCS7 Basic Freeway Report

Project Information

Analyst	LSA	Date	12/11/2019
Agency	LSA	Analysis Year	Phase III Proj Comp Yr (2049) WP
Jurisdiction	Caltrans	Time Period Analyzed	PM Peak Hour
Project Description	CMD1801 - Village D Specific Plan	Unit	United States Customary

Geometric Data

Number of Lanes, ln	3	Terrain Type	Level
Segment Length (L), ft	-	Percent Grade, %	-
Measured or Base Free-Flow Speed	Base	Grade Length, mi	-
Base Free-Flow Speed (BFFS), mi/h	65.0	Total Ramp Density (TRD), ramps/mi	1.67
Lane Width, ft	12	Free-Flow Speed (FFS), mi/h	60.0
Right-Side Lateral Clearance, ft	10		

Adjustment Factors

Driver Population	All Familiar	Final Speed Adjustment Factor (SAF)	1.000
Weather Type	Non-Severe Weather	Final Capacity Adjustment Factor (CAF)	1.000
Incident Type	No Incident	Demand Adjustment Factor (DAF)	1.000

Demand and Capacity

Demand Volume veh/h	3898	Heavy Vehicle Adjustment Factor (fhv)	0.854
Peak Hour Factor	0.94	Flow Rate (Vp), pc/h/ln	1619
Total Trucks, %	17.11	Capacity (c), pc/h/ln	2300
Single-Unit Trucks (SUT), %	-	Adjusted Capacity (cadj), pc/h/ln	2300
Tractor-Trailers (TT), %	-	Volume-to-Capacity Ratio (v/c)	0.70
Passenger Car Equivalent (ET)	2.000		

Speed and Density

Lane Width Adjustment (fLW)	0.0	Average Speed (S), mi/h	60.0
Right-Side Lateral Clearance Adj. (fRLC)	0.0	Density (D), pc/mi/ln	27.0
Total Ramp Density Adjustment	5.0	Level of Service (LOS)	D
Adjusted Free-Flow Speed (FFSadj), mi/h	60.0		

HCS7 Freeway Merge Report

Project Information

Analyst	LSA	Date	12/11/2019
Agency	LSA	Analysis Year	Phase III Proj Comp Yr (2049) WP
Jurisdiction	Caltrans	Time Period Analyzed	PM Peak Hour
Project Description	CMD1801 - Village D Specific Plan	Unit	United States Customary

Geometric Data

	Freeway	Ramp
Number of Lanes (N), ln	3	1
Free-Flow Speed (FFS), mi/h	65.0	35.0
Segment Length (L) / Acceleration Length (LA),ft	1500	525
Terrain Type	Level	Level
Percent Grade, %	-	-
Segment Type / Ramp Side	Freeway	Right

Adjustment Factors

Driver Population	All Familiar	All Familiar
Weather Type	Non-Severe Weather	Non-Severe Weather
Incident Type	No Incident	-
Final Speed Adjustment Factor (SAF)	1.000	1.000
Final Capacity Adjustment Factor (CAF)	1.000	1.000
Demand Adjustment Factor (DAF)	1.000	1.000

Demand and Capacity

Demand Volume (Vi)	3898	262
Peak Hour Factor (PHF)	0.94	0.94
Total Trucks, %	17.11	4.21
Single-Unit Trucks (SUT), %	-	-
Tractor-Trailers (TT), %	-	-
Heavy Vehicle Adjustment Factor (fHV)	0.854	0.960
Flow Rate (vi),pc/h	4856	290
Capacity (c), pc/h	7050	2000
Volume-to-Capacity Ratio (v/c)	0.73	0.15

Speed and Density

Upstream Equilibrium Distance (LEQ), ft	-	Number of Outer Lanes on Freeway (NO)	1
Distance to Upstream Ramp (LUP), ft	-	Speed Index (MS)	0.377
Downstream Equilibrium Distance (LEQ), ft	-	Flow Outer Lanes (vOA), pc/h/ln	1981
Distance to Downstream Ramp (LDOWN), ft	-	On-Ramp Influence Area Speed (SR), mi/h	56.3
Prop. Freeway Vehicles in Lane 1 and 2 (PFM)	0.592	Outer Lanes Freeway Speed (SO), mi/h	59.7
Flow in Lanes 1 and 2 (v12), pc/h	2875	Ramp Junction Speed (S), mi/h	57.6
Flow Entering Ramp-Infl. Area (vR12), pc/h	3165	Average Density (D), pc/mi/ln	29.8
Level of Service (LOS)	C	Density in Ramp Influence Area (DR), pc/mi/ln	26.8

HCS7 Basic Freeway Report

Project Information

Analyst	LSA	Date	12/11/2019
Agency	LSA	Analysis Year	Phase I Proj Comp Yr (2029) WP
Jurisdiction	Caltrans	Time Period Analyzed	PM Peak Hour
Project Description	CMD1801 - Village D Specific Plan	Unit	United States Customary

Geometric Data

Number of Lanes, ln	3	Terrain Type	Level
Segment Length (L), ft	-	Percent Grade, %	-
Measured or Base Free-Flow Speed	Base	Grade Length, mi	-
Base Free-Flow Speed (BFFS), mi/h	65.0	Total Ramp Density (TRD), ramps/mi	1.67
Lane Width, ft	12	Free-Flow Speed (FFS), mi/h	60.0
Right-Side Lateral Clearance, ft	10		

Adjustment Factors

Driver Population	All Familiar	Final Speed Adjustment Factor (SAF)	1.000
Weather Type	Non-Severe Weather	Final Capacity Adjustment Factor (CAF)	1.000
Incident Type	No Incident	Demand Adjustment Factor (DAF)	1.000

Demand and Capacity

Demand Volume veh/h	3035	Heavy Vehicle Adjustment Factor (fhv)	0.838
Peak Hour Factor	0.94	Flow Rate (Vp), pc/h/ln	1284
Total Trucks, %	19.39	Capacity (c), pc/h/ln	2300
Single-Unit Trucks (SUT), %	-	Adjusted Capacity (cadj), pc/h/ln	2300
Tractor-Trailers (TT), %	-	Volume-to-Capacity Ratio (v/c)	0.56
Passenger Car Equivalent (ET)	2.000		

Speed and Density

Lane Width Adjustment (fLW)	0.0	Average Speed (S), mi/h	60.0
Right-Side Lateral Clearance Adj. (fRLC)	0.0	Density (D), pc/mi/ln	21.4
Total Ramp Density Adjustment	5.0	Level of Service (LOS)	C
Adjusted Free-Flow Speed (FFSadj), mi/h	60.0		

HCS7 Freeway Diverge Report

Project Information

Analyst	LSA	Date	12/11/2019
Agency	LSA	Analysis Year	Phase III Proj Comp Yr (2049) WP
Jurisdiction	Caltrans	Time Period Analyzed	PM Peak Hour
Project Description	CMD1801 - Village D Specific Plan	Unit	United States Customary

Geometric Data

	Freeway	Ramp
Number of Lanes (N), ln	3	1
Free-Flow Speed (FFS), mi/h	65.0	35.0
Segment Length (L) / Deceleration Length (LA),ft	1500	200
Terrain Type	Level	Level
Percent Grade, %	-	-
Segment Type / Ramp Side	Freeway	Right

Adjustment Factors

Driver Population	All Familiar	All Familiar
Weather Type	Non-Severe Weather	Non-Severe Weather
Incident Type	No Incident	-
Final Speed Adjustment Factor (SAF)	1.000	1.000
Final Capacity Adjustment Factor (CAF)	1.000	1.000
Demand Adjustment Factor (DAF)	1.000	1.000

Demand and Capacity

Demand Volume (Vi)	4159	1354
Peak Hour Factor (PHF)	0.94	0.94
Total Trucks, %	16.30	5.76
Single-Unit Trucks (SUT), %	-	-
Tractor-Trailers (TT), %	-	-
Heavy Vehicle Adjustment Factor (fHV)	0.860	0.946
Flow Rate (vi),pc/h	5145	1523
Capacity (c), pc/h	7050	2000
Volume-to-Capacity Ratio (v/c)	0.73	0.76

Speed and Density

Upstream Equilibrium Distance (LEQ), ft	-	Number of Outer Lanes on Freeway (NO)	1
Distance to Upstream Ramp (LUP), ft	-	Speed Index (DS)	0.565
Downstream Equilibrium Distance (LEQ), ft	-	Flow Outer Lanes (vOA), pc/h/ln	1590
Distance to Downstream Ramp (LDOWN), ft	-	Off-Ramp Influence Area Speed (SR), mi/h	52.0
Prop. Freeway Vehicles in Lane 1 and 2 (PFD)	0.561	Outer Lanes Freeway Speed (SO), mi/h	69.0
Flow in Lanes 1 and 2 (v12), pc/h	3555	Ramp Junction Speed (S), mi/h	56.3
Flow Entering Ramp-Infl. Area (vR12), pc/h	-	Average Density (D), pc/mi/ln	30.5
Level of Service (LOS)	D	Density in Ramp Influence Area (DR), pc/mi/ln	33.0

HCS7 Basic Freeway Report

Project Information

Analyst	LSA	Date	12/11/2019
Agency	LSA	Analysis Year	Phase III Proj Comp Yr (2049) WP
Jurisdiction	Caltrans	Time Period Analyzed	PM Peak Hour
Project Description	CMD1801 - Village D Specific Plan	Unit	United States Customary

Geometric Data

Number of Lanes, ln	3	Terrain Type	Level
Segment Length (L), ft	-	Percent Grade, %	-
Measured or Base Free-Flow Speed	Base	Grade Length, mi	-
Base Free-Flow Speed (BFFS), mi/h	70.0	Total Ramp Density (TRD), ramps/mi	1.50
Lane Width, ft	12	Free-Flow Speed (FFS), mi/h	65.5
Right-Side Lateral Clearance, ft	10		

Adjustment Factors

Driver Population	All Familiar	Final Speed Adjustment Factor (SAF)	1.000
Weather Type	Non-Severe Weather	Final Capacity Adjustment Factor (CAF)	1.000
Incident Type	No Incident	Demand Adjustment Factor (DAF)	1.000

Demand and Capacity

Demand Volume veh/h	2805	Heavy Vehicle Adjustment Factor (fhv)	0.824
Peak Hour Factor	0.94	Flow Rate (Vp), pc/h/ln	1207
Total Trucks, %	21.39	Capacity (c), pc/h/ln	2355
Single-Unit Trucks (SUT), %	-	Adjusted Capacity (cadj), pc/h/ln	2355
Tractor-Trailers (TT), %	-	Volume-to-Capacity Ratio (v/c)	0.51
Passenger Car Equivalent (ET)	2.000		

Speed and Density

Lane Width Adjustment (fLW)	0.0	Average Speed (S), mi/h	65.5
Right-Side Lateral Clearance Adj. (fRLC)	0.0	Density (D), pc/mi/ln	18.4
Total Ramp Density Adjustment	4.5	Level of Service (LOS)	C
Adjusted Free-Flow Speed (FFSadj), mi/h	65.5		

HCS7 Freeway Merge Report

Project Information

Analyst	LSA	Date	12/11/2019
Agency	LSA	Analysis Year	Phase III Proj Comp Yr (2049) WP
Jurisdiction	Caltrans	Time Period Analyzed	PM Peak Hour
Project Description	CMD1801 - Village D Specific Plan	Unit	United States Customary

Geometric Data

	Freeway	Ramp
Number of Lanes (N), ln	3	1
Free-Flow Speed (FFS), mi/h	70.0	35.0
Segment Length (L) / Acceleration Length (LA),ft	1500	400
Terrain Type	Level	Level
Percent Grade, %	-	-
Segment Type / Ramp Side	Freeway	Right

Adjustment Factors

Driver Population	All Familiar	All Familiar
Weather Type	Non-Severe Weather	Non-Severe Weather
Incident Type	No Incident	-
Final Speed Adjustment Factor (SAF)	1.000	1.000
Final Capacity Adjustment Factor (CAF)	1.000	1.000
Demand Adjustment Factor (DAF)	1.000	1.000

Demand and Capacity

Demand Volume (Vi)	2805	535
Peak Hour Factor (PHF)	0.94	0.94
Total Trucks, %	21.39	6.92
Single-Unit Trucks (SUT), %	-	-
Tractor-Trailers (TT), %	-	-
Heavy Vehicle Adjustment Factor (fHV)	0.824	0.935
Flow Rate (vi),pc/h	3621	609
Capacity (c), pc/h	7200	2000
Volume-to-Capacity Ratio (v/c)	0.59	0.30

Speed and Density

Upstream Equilibrium Distance (LEQ), ft	-	Number of Outer Lanes on Freeway (NO)	1
Distance to Upstream Ramp (LUP), ft	-	Speed Index (MS)	0.354
Downstream Equilibrium Distance (LEQ), ft	-	Flow Outer Lanes (vOA), pc/h/ln	1488
Distance to Downstream Ramp (LDOWN), ft	-	On-Ramp Influence Area Speed (SR), mi/h	60.1
Prop. Freeway Vehicles in Lane 1 and 2 (PFM)	0.589	Outer Lanes Freeway Speed (SO), mi/h	66.4
Flow in Lanes 1 and 2 (v12), pc/h	2133	Ramp Junction Speed (S), mi/h	62.2
Flow Entering Ramp-Infl. Area (vR12), pc/h	2742	Average Density (D), pc/mi/ln	22.7
Level of Service (LOS)	C	Density in Ramp Influence Area (DR), pc/mi/ln	24.1

HCS7 Basic Freeway Report

Project Information

Analyst	LSA	Date	12/11/2019
Agency	LSA	Analysis Year	Phase III Proj Comp Yr (2049) WP
Jurisdiction	Caltrans	Time Period Analyzed	PM Peak Hour
Project Description	CMD1801 - Village D Specific Plan	Unit	United States Customary

Geometric Data

Number of Lanes, ln	2	Terrain Type	Level
Segment Length (L), ft	-	Percent Grade, %	-
Measured or Base Free-Flow Speed	Base	Grade Length, mi	-
Base Free-Flow Speed (BFFS), mi/h	70.0	Total Ramp Density (TRD), ramps/mi	1.00
Lane Width, ft	12	Free-Flow Speed (FFS), mi/h	66.8
Right-Side Lateral Clearance, ft	10		

Adjustment Factors

Driver Population	All Familiar	Final Speed Adjustment Factor (SAF)	1.000
Weather Type	Non-Severe Weather	Final Capacity Adjustment Factor (CAF)	1.000
Incident Type	No Incident	Demand Adjustment Factor (DAF)	1.000

Demand and Capacity

Demand Volume veh/h	3340	Heavy Vehicle Adjustment Factor (fhv)	0.840
Peak Hour Factor	0.94	Flow Rate (Vp), pc/h/ln	2115
Total Trucks, %	19.07	Capacity (c), pc/h/ln	2368
Single-Unit Trucks (SUT), %	-	Adjusted Capacity (cadj), pc/h/ln	2368
Tractor-Trailers (TT), %	-	Volume-to-Capacity Ratio (v/c)	0.89
Passenger Car Equivalent (ET)	2.000		

Speed and Density

Lane Width Adjustment (fLW)	0.0	Average Speed (S), mi/h	58.7
Right-Side Lateral Clearance Adj. (fRLC)	0.0	Density (D), pc/mi/ln	36.0
Total Ramp Density Adjustment	3.2	Level of Service (LOS)	E
Adjusted Free-Flow Speed (FFSadj), mi/h	66.8		

HCS7 Freeway Diverge Report

Project Information

Analyst	LSA	Date	12/11/2019
Agency	LSA	Analysis Year	Phase III Proj Comp Yr (2049) WP
Jurisdiction	Caltrans	Time Period Analyzed	PM Peak Hour
Project Description	CMD1801 - Village D Specific Plan	Unit	United States Customary

Geometric Data

	Freeway	Ramp
Number of Lanes (N), ln	2	1
Free-Flow Speed (FFS), mi/h	70.0	35.0
Segment Length (L) / Deceleration Length (LA),ft	1500	200
Terrain Type	Level	Level
Percent Grade, %	-	-
Segment Type / Ramp Side	Freeway	Right

Adjustment Factors

Driver Population	All Familiar	All Familiar
Weather Type	Non-Severe Weather	Non-Severe Weather
Incident Type	No Incident	-
Final Speed Adjustment Factor (SAF)	1.000	1.000
Final Capacity Adjustment Factor (CAF)	1.000	1.000
Demand Adjustment Factor (DAF)	1.000	1.000

Demand and Capacity

Demand Volume (Vi)	3340	199
Peak Hour Factor (PHF)	0.94	0.94
Total Trucks, %	19.07	24.12
Single-Unit Trucks (SUT), %	-	-
Tractor-Trailers (TT), %	-	-
Heavy Vehicle Adjustment Factor (fHV)	0.840	0.806
Flow Rate (vi),pc/h	4230	263
Capacity (c), pc/h	4800	2000
Volume-to-Capacity Ratio (v/c)	0.88	0.13

Speed and Density

Upstream Equilibrium Distance (LEQ), ft	-	Number of Outer Lanes on Freeway (NO)	0
Distance to Upstream Ramp (LUP), ft	-	Speed Index (DS)	0.452
Downstream Equilibrium Distance (LEQ), ft	-	Flow Outer Lanes (vOA), pc/h/ln	-
Distance to Downstream Ramp (LDOWN), ft	-	Off-Ramp Influence Area Speed (SR), mi/h	57.3
Prop. Freeway Vehicles in Lane 1 and 2 (PFD)	1.000	Outer Lanes Freeway Speed (SO), mi/h	76.8
Flow in Lanes 1 and 2 (v12), pc/h	4230	Ramp Junction Speed (S), mi/h	57.3
Flow Entering Ramp-Infl. Area (vR12), pc/h	-	Average Density (D), pc/mi/ln	36.9
Level of Service (LOS)	E	Density in Ramp Influence Area (DR), pc/mi/ln	38.8

HCS7 Basic Freeway Report

Project Information

Analyst	LSA	Date	12/11/2019
Agency	LSA	Analysis Year	Phase III Proj Comp Yr (2049) WP
Jurisdiction	Caltrans	Time Period Analyzed	PM Peak Hour
Project Description	CMD1801 - Village D Specific Plan	Unit	United States Customary

Geometric Data

Number of Lanes, ln	2	Terrain Type	Level
Segment Length (L), ft	-	Percent Grade, %	-
Measured or Base Free-Flow Speed	Base	Grade Length, mi	-
Base Free-Flow Speed (BFFS), mi/h	70.0	Total Ramp Density (TRD), ramps/mi	1.00
Lane Width, ft	12	Free-Flow Speed (FFS), mi/h	66.8
Right-Side Lateral Clearance, ft	10		

Adjustment Factors

Driver Population	All Familiar	Final Speed Adjustment Factor (SAF)	1.000
Weather Type	Non-Severe Weather	Final Capacity Adjustment Factor (CAF)	1.000
Incident Type	No Incident	Demand Adjustment Factor (DAF)	1.000

Demand and Capacity

Demand Volume veh/h	3141	Heavy Vehicle Adjustment Factor (fhv)	0.842
Peak Hour Factor	0.94	Flow Rate (Vp), pc/h/ln	1984
Total Trucks, %	18.75	Capacity (c), pc/h/ln	2368
Single-Unit Trucks (SUT), %	-	Adjusted Capacity (cadj), pc/h/ln	2368
Tractor-Trailers (TT), %	-	Volume-to-Capacity Ratio (v/c)	0.84
Passenger Car Equivalent (ET)	2.000		

Speed and Density

Lane Width Adjustment (fLW)	0.0	Average Speed (S), mi/h	61.2
Right-Side Lateral Clearance Adj. (fRLC)	0.0	Density (D), pc/mi/ln	32.4
Total Ramp Density Adjustment	3.2	Level of Service (LOS)	D
Adjusted Free-Flow Speed (FFSadj), mi/h	66.8		

HCS7 Freeway Merge Report

Project Information

Analyst	LSA	Date	12/11/2019
Agency	LSA	Analysis Year	Phase III Proj Comp Yr (2049) WP
Jurisdiction	Caltrans	Time Period Analyzed	PM Peak Hour
Project Description	CMD1801 - Village D Specific Plan	Unit	United States Customary

Geometric Data

	Freeway	Ramp
Number of Lanes (N), ln	2	1
Free-Flow Speed (FFS), mi/h	70.0	35.0
Segment Length (L) / Acceleration Length (LA),ft	1500	700
Terrain Type	Level	Level
Percent Grade, %	-	-
Segment Type / Ramp Side	Freeway	Right

Adjustment Factors

Driver Population	All Familiar	All Familiar
Weather Type	Non-Severe Weather	Non-Severe Weather
Incident Type	No Incident	-
Final Speed Adjustment Factor (SAF)	1.000	1.000
Final Capacity Adjustment Factor (CAF)	1.000	1.000
Demand Adjustment Factor (DAF)	1.000	1.000

Demand and Capacity

Demand Volume (Vi)	3141	567
Peak Hour Factor (PHF)	0.94	0.94
Total Trucks, %	18.75	10.93
Single-Unit Trucks (SUT), %	-	-
Tractor-Trailers (TT), %	-	-
Heavy Vehicle Adjustment Factor (fHV)	0.842	0.901
Flow Rate (vi),pc/h	3969	669
Capacity (c), pc/h	4800	2000
Volume-to-Capacity Ratio (v/c)	0.97	0.33

Speed and Density

Upstream Equilibrium Distance (LEQ), ft	-	Number of Outer Lanes on Freeway (NO)	0
Distance to Upstream Ramp (LUP), ft	-	Speed Index (MS)	0.675
Downstream Equilibrium Distance (LEQ), ft	-	Flow Outer Lanes (vOA), pc/h/ln	-
Distance to Downstream Ramp (LDOWN), ft	-	On-Ramp Influence Area Speed (SR), mi/h	51.1
Prop. Freeway Vehicles in Lane 1 and 2 (PFM)	1.000	Outer Lanes Freeway Speed (SO), mi/h	70.0
Flow in Lanes 1 and 2 (v12), pc/h	3969	Ramp Junction Speed (S), mi/h	51.1
Flow Entering Ramp-Infl. Area (vR12), pc/h	4638	Average Density (D), pc/mi/ln	45.4
Level of Service (LOS)	E	Density in Ramp Influence Area (DR), pc/mi/ln	37.0

HCS7 Basic Freeway Report

Project Information

Analyst	LSA	Date	12/11/2019
Agency	LSA	Analysis Year	Phase III Proj Comp Yr (2049) WP
Jurisdiction	Caltrans	Time Period Analyzed	PM Peak Hour
Project Description	CMD1801 - Village D Specific Plan	Unit	United States Customary

Geometric Data

Number of Lanes, ln	2	Terrain Type	Level
Segment Length (L), ft	-	Percent Grade, %	-
Measured or Base Free-Flow Speed	Base	Grade Length, mi	-
Base Free-Flow Speed (BFFS), mi/h	70.0	Total Ramp Density (TRD), ramps/mi	1.00
Lane Width, ft	12	Free-Flow Speed (FFS), mi/h	66.8
Right-Side Lateral Clearance, ft	10		

Adjustment Factors

Driver Population	All Familiar	Final Speed Adjustment Factor (SAF)	1.000
Weather Type	Non-Severe Weather	Final Capacity Adjustment Factor (CAF)	1.000
Incident Type	No Incident	Demand Adjustment Factor (DAF)	1.000

Demand and Capacity

Demand Volume veh/h	3708	Heavy Vehicle Adjustment Factor (fhv)	0.851
Peak Hour Factor	0.94	Flow Rate (Vp), pc/h/ln	2318
Total Trucks, %	17.56	Capacity (c), pc/h/ln	2368
Single-Unit Trucks (SUT), %	-	Adjusted Capacity (cadj), pc/h/ln	2368
Tractor-Trailers (TT), %	-	Volume-to-Capacity Ratio (v/c)	0.98
Passenger Car Equivalent (ET)	2.000		

Speed and Density

Lane Width Adjustment (fLW)	0.0	Average Speed (S), mi/h	54.0
Right-Side Lateral Clearance Adj. (fRLC)	0.0	Density (D), pc/mi/ln	42.9
Total Ramp Density Adjustment	3.2	Level of Service (LOS)	E
Adjusted Free-Flow Speed (FFSadj), mi/h	66.8		

HCS7 Basic Freeway Report

Project Information

Analyst	LSA	Date	12/11/2019
Agency	LSA	Analysis Year	Phase III Proj Comp Yr (2049) WP
Jurisdiction	Caltrans	Time Period Analyzed	PM Peak Hour
Project Description	CMD1801 - Village D Specific Plan	Unit	United States Customary

Geometric Data

Number of Lanes, ln	2	Terrain Type	Level
Segment Length (L), ft	-	Percent Grade, %	-
Measured or Base Free-Flow Speed	Base	Grade Length, mi	-
Base Free-Flow Speed (BFFS), mi/h	70.0	Total Ramp Density (TRD), ramps/mi	1.00
Lane Width, ft	12	Free-Flow Speed (FFS), mi/h	66.8
Right-Side Lateral Clearance, ft	10		

Adjustment Factors

Driver Population	All Familiar	Final Speed Adjustment Factor (SAF)	1.000
Weather Type	Non-Severe Weather	Final Capacity Adjustment Factor (CAF)	1.000
Incident Type	No Incident	Demand Adjustment Factor (DAF)	1.000

Demand and Capacity

Demand Volume veh/h	4089	Heavy Vehicle Adjustment Factor (fhv)	0.840
Peak Hour Factor	0.94	Flow Rate (Vp), pc/h/ln	2590
Total Trucks, %	19.10	Capacity (c), pc/h/ln	2368
Single-Unit Trucks (SUT), %	-	Adjusted Capacity (cadj), pc/h/ln	2368
Tractor-Trailers (TT), %	-	Volume-to-Capacity Ratio (v/c)	1.09
Passenger Car Equivalent (ET)	2.000		

Speed and Density

Lane Width Adjustment (fLW)	0.0	Average Speed (S), mi/h	-
Right-Side Lateral Clearance Adj. (fRLC)	0.0	Density (D), pc/mi/ln	-
Total Ramp Density Adjustment	3.2	Level of Service (LOS)	F
Adjusted Free-Flow Speed (FFSadj), mi/h	66.8		

HCS7 Freeway Diverge Report

Project Information

Analyst	LSA	Date	12/11/2019
Agency	LSA	Analysis Year	Phase III Proj Comp Yr (2049) WP
Jurisdiction	Caltrans	Time Period Analyzed	PM Peak Hour
Project Description	CMD1801 - Village D Specific Plan	Unit	United States Customary

Geometric Data

	Freeway	Ramp
Number of Lanes (N), ln	2	1
Free-Flow Speed (FFS), mi/h	70.0	50.0
Segment Length (L) / Deceleration Length (LA),ft	1500	150
Terrain Type	Level	Level
Percent Grade, %	-	-
Segment Type / Ramp Side	Freeway	Right

Adjustment Factors

Driver Population	All Familiar	All Familiar
Weather Type	Non-Severe Weather	Non-Severe Weather
Incident Type	No Incident	-
Final Speed Adjustment Factor (SAF)	1.000	1.000
Final Capacity Adjustment Factor (CAF)	1.000	1.000
Demand Adjustment Factor (DAF)	1.000	1.000

Demand and Capacity

Demand Volume (Vi)	4089	850
Peak Hour Factor (PHF)	0.94	0.94
Total Trucks, %	19.10	8.94
Single-Unit Trucks (SUT), %	-	-
Tractor-Trailers (TT), %	-	-
Heavy Vehicle Adjustment Factor (fHV)	0.840	0.918
Flow Rate (vi),pc/h	5179	985
Capacity (c), pc/h	4800	2100
Volume-to-Capacity Ratio (v/c)	1.08	0.47

Speed and Density

Upstream Equilibrium Distance (LEQ), ft	0.0	Number of Outer Lanes on Freeway (NO)	0
Distance to Upstream Ramp (LUP), ft	-	Speed Index (DS)	-
Downstream Equilibrium Distance (LEQ), ft	0.0	Flow Outer Lanes (vOA), pc/h/ln	-
Distance to Downstream Ramp (LDOWN), ft	-	Off-Ramp Influence Area Speed (SR), mi/h	61.0
Prop. Freeway Vehicles in Lane 1 and 2 (PFD)	1.000	Outer Lanes Freeway Speed (SO), mi/h	-
Flow in Lanes 1 and 2 (v12), pc/h	5179	Ramp Junction Speed (S), mi/h	-
Flow Entering Ramp-Infl. Area (vR12), pc/h	5179	Average Density (D), pc/mi/ln	-
Level of Service (LOS)	F	Density in Ramp Influence Area (DR), pc/mi/ln	47.4

HCS7 Basic Freeway Report

Project Information

Analyst	LSA	Date	12/11/2019
Agency	LSA	Analysis Year	Phase III Proj Comp Yr (2049) WP
Jurisdiction	Caltrans	Time Period Analyzed	PM Peak Hour
Project Description	CMD1801 - Village D Specific Plan	Unit	United States Customary

Geometric Data

Number of Lanes, ln	2	Terrain Type	Level
Segment Length (L), ft	-	Percent Grade, %	-
Measured or Base Free-Flow Speed	Base	Grade Length, mi	-
Base Free-Flow Speed (BFFS), mi/h	70.0	Total Ramp Density (TRD), ramps/mi	1.33
Lane Width, ft	12	Free-Flow Speed (FFS), mi/h	65.9
Right-Side Lateral Clearance, ft	10		

Adjustment Factors

Driver Population	All Familiar	Final Speed Adjustment Factor (SAF)	1.000
Weather Type	Non-Severe Weather	Final Capacity Adjustment Factor (CAF)	1.000
Incident Type	No Incident	Demand Adjustment Factor (DAF)	1.000

Demand and Capacity

Demand Volume veh/h	3239	Heavy Vehicle Adjustment Factor (fhv)	0.821
Peak Hour Factor	0.94	Flow Rate (Vp), pc/h/ln	2098
Total Trucks, %	21.76	Capacity (c), pc/h/ln	2359
Single-Unit Trucks (SUT), %	-	Adjusted Capacity (cadj), pc/h/ln	2359
Tractor-Trailers (TT), %	-	Volume-to-Capacity Ratio (v/c)	0.89
Passenger Car Equivalent (ET)	2.000		

Speed and Density

Lane Width Adjustment (fLW)	0.0	Average Speed (S), mi/h	58.6
Right-Side Lateral Clearance Adj. (fRLC)	0.0	Density (D), pc/mi/ln	35.8
Total Ramp Density Adjustment	4.1	Level of Service (LOS)	E
Adjusted Free-Flow Speed (FFSadj), mi/h	65.9		

HCS7 Freeway Merge Report

Project Information

Analyst	LSA	Date	12/11/2019
Agency	LSA	Analysis Year	Phase III Proj Comp Yr (2049) WP
Jurisdiction	Caltrans	Time Period Analyzed	PM Peak Hour
Project Description	CMD1801 - Village D Specific Plan	Unit	United States Customary

Geometric Data

	Freeway	Ramp
Number of Lanes (N), ln	2	1
Free-Flow Speed (FFS), mi/h	70.0	35.0
Segment Length (L) / Acceleration Length (LA),ft	1000	600
Terrain Type	Level	Level
Percent Grade, %	-	-
Segment Type / Ramp Side	Freeway	Right

Adjustment Factors

Driver Population	All Familiar	All Familiar
Weather Type	Non-Severe Weather	Non-Severe Weather
Incident Type	No Incident	-
Final Speed Adjustment Factor (SAF)	1.000	1.000
Final Capacity Adjustment Factor (CAF)	1.000	1.000
Demand Adjustment Factor (DAF)	1.000	1.000

Demand and Capacity

Demand Volume (Vi)	3239	30
Peak Hour Factor (PHF)	0.94	0.94
Total Trucks, %	21.76	6.67
Single-Unit Trucks (SUT), %	-	-
Tractor-Trailers (TT), %	-	-
Heavy Vehicle Adjustment Factor (fHV)	0.821	0.937
Flow Rate (vi),pc/h	4197	34
Capacity (c), pc/h	4800	2000
Volume-to-Capacity Ratio (v/c)	0.88	0.02

Speed and Density

Upstream Equilibrium Distance (LEQ), ft	-	Number of Outer Lanes on Freeway (NO)	0
Distance to Upstream Ramp (LUP), ft	-	Speed Index (MS)	0.547
Downstream Equilibrium Distance (LEQ), ft	-	Flow Outer Lanes (vOA), pc/h/ln	-
Distance to Downstream Ramp (LDOWN), ft	-	On-Ramp Influence Area Speed (SR), mi/h	54.7
Prop. Freeway Vehicles in Lane 1 and 2 (PFM)	1.000	Outer Lanes Freeway Speed (SO), mi/h	70.0
Flow in Lanes 1 and 2 (v12), pc/h	4197	Ramp Junction Speed (S), mi/h	54.7
Flow Entering Ramp-Infl. Area (vR12), pc/h	4231	Average Density (D), pc/mi/ln	38.7
Level of Service (LOS)	D	Density in Ramp Influence Area (DR), pc/mi/ln	34.8

HCS7 Basic Freeway Report

Project Information

Analyst	LSA	Date	12/11/2019
Agency	LSA	Analysis Year	Phase III Proj Comp Yr (2049) WP
Jurisdiction	Caltrans	Time Period Analyzed	PM Peak Hour
Project Description	CMD1801 - Village D Specific Plan	Unit	United States Customary

Geometric Data

Number of Lanes, ln	2	Terrain Type	Level
Segment Length (L), ft	-	Percent Grade, %	-
Measured or Base Free-Flow Speed	Base	Grade Length, mi	-
Base Free-Flow Speed (BFFS), mi/h	70.0	Total Ramp Density (TRD), ramps/mi	1.33
Lane Width, ft	12	Free-Flow Speed (FFS), mi/h	65.9
Right-Side Lateral Clearance, ft	10		

Adjustment Factors

Driver Population	All Familiar	Final Speed Adjustment Factor (SAF)	1.000
Weather Type	Non-Severe Weather	Final Capacity Adjustment Factor (CAF)	1.000
Incident Type	No Incident	Demand Adjustment Factor (DAF)	1.000

Demand and Capacity

Demand Volume veh/h	3269	Heavy Vehicle Adjustment Factor (fhv)	0.822
Peak Hour Factor	0.94	Flow Rate (Vp), pc/h/ln	2116
Total Trucks, %	21.63	Capacity (c), pc/h/ln	2359
Single-Unit Trucks (SUT), %	-	Adjusted Capacity (cadj), pc/h/ln	2359
Tractor-Trailers (TT), %	-	Volume-to-Capacity Ratio (v/c)	0.90
Passenger Car Equivalent (ET)	2.000		

Speed and Density

Lane Width Adjustment (fLW)	0.0	Average Speed (S), mi/h	58.2
Right-Side Lateral Clearance Adj. (fRLC)	0.0	Density (D), pc/mi/ln	36.4
Total Ramp Density Adjustment	4.1	Level of Service (LOS)	E
Adjusted Free-Flow Speed (FFSadj), mi/h	65.9		

HCS7 Freeway Merge Report

Project Information

Analyst	LSA	Date	12/11/2019
Agency	LSA	Analysis Year	Phase III Proj Comp Yr (2049) WP
Jurisdiction	Caltrans	Time Period Analyzed	PM Peak Hour
Project Description	CMD1801 - Village D Specific Plan	Unit	United States Customary

Geometric Data

	Freeway	Ramp
Number of Lanes (N), ln	2	1
Free-Flow Speed (FFS), mi/h	70.0	35.0
Segment Length (L) / Acceleration Length (LA),ft	1500	500
Terrain Type	Level	Level
Percent Grade, %	-	-
Segment Type / Ramp Side	Freeway	Right

Adjustment Factors

Driver Population	All Familiar	All Familiar
Weather Type	Non-Severe Weather	Non-Severe Weather
Incident Type	No Incident	-
Final Speed Adjustment Factor (SAF)	1.000	1.000
Final Capacity Adjustment Factor (CAF)	1.000	1.000
Demand Adjustment Factor (DAF)	1.000	1.000

Demand and Capacity

Demand Volume (Vi)	3269	243
Peak Hour Factor (PHF)	0.94	0.94
Total Trucks, %	21.63	21.81
Single-Unit Trucks (SUT), %	-	-
Tractor-Trailers (TT), %	-	-
Heavy Vehicle Adjustment Factor (fHV)	0.822	0.821
Flow Rate (vi),pc/h	4231	315
Capacity (c), pc/h	4800	2000
Volume-to-Capacity Ratio (v/c)	0.95	0.16

Speed and Density

Upstream Equilibrium Distance (LEQ), ft	-	Number of Outer Lanes on Freeway (NO)	0
Distance to Upstream Ramp (LUP), ft	-	Speed Index (MS)	0.654
Downstream Equilibrium Distance (LEQ), ft	-	Flow Outer Lanes (vOA), pc/h/ln	-
Distance to Downstream Ramp (LDOWN), ft	-	On-Ramp Influence Area Speed (SR), mi/h	51.7
Prop. Freeway Vehicles in Lane 1 and 2 (PFM)	1.000	Outer Lanes Freeway Speed (SO), mi/h	70.0
Flow in Lanes 1 and 2 (v12), pc/h	4231	Ramp Junction Speed (S), mi/h	51.7
Flow Entering Ramp-Infl. Area (vR12), pc/h	4546	Average Density (D), pc/mi/ln	44.0
Level of Service (LOS)	E	Density in Ramp Influence Area (DR), pc/mi/ln	37.7

HCS7 Basic Freeway Report

Project Information

Analyst	LSA	Date	12/11/2019
Agency	LSA	Analysis Year	Phase III Proj Comp Yr (2049) WP
Jurisdiction	Caltrans	Time Period Analyzed	PM Peak Hour
Project Description	CMD1801 - Village D Specific Plan	Unit	United States Customary

Geometric Data

Number of Lanes, ln	2	Terrain Type	Level
Segment Length (L), ft	-	Percent Grade, %	-
Measured or Base Free-Flow Speed	Base	Grade Length, mi	-
Base Free-Flow Speed (BFFS), mi/h	70.0	Total Ramp Density (TRD), ramps/mi	1.33
Lane Width, ft	12	Free-Flow Speed (FFS), mi/h	65.9
Right-Side Lateral Clearance, ft	10		

Adjustment Factors

Driver Population	All Familiar	Final Speed Adjustment Factor (SAF)	1.000
Weather Type	Non-Severe Weather	Final Capacity Adjustment Factor (CAF)	1.000
Incident Type	No Incident	Demand Adjustment Factor (DAF)	1.000

Demand and Capacity

Demand Volume veh/h	3512	Heavy Vehicle Adjustment Factor (fhv)	0.822
Peak Hour Factor	0.94	Flow Rate (Vp), pc/h/ln	2272
Total Trucks, %	21.64	Capacity (c), pc/h/ln	2359
Single-Unit Trucks (SUT), %	-	Adjusted Capacity (cadj), pc/h/ln	2359
Tractor-Trailers (TT), %	-	Volume-to-Capacity Ratio (v/c)	0.96
Passenger Car Equivalent (ET)	2.000		

Speed and Density

Lane Width Adjustment (fLW)	0.0	Average Speed (S), mi/h	54.7
Right-Side Lateral Clearance Adj. (fRLC)	0.0	Density (D), pc/mi/ln	41.5
Total Ramp Density Adjustment	4.1	Level of Service (LOS)	E
Adjusted Free-Flow Speed (FFSadj), mi/h	65.9		

HCS7 Freeway Diverge Report

Project Information

Analyst	LSA	Date	12/11/2019
Agency	LSA	Analysis Year	Phase III Proj Comp Yr (2049) WP
Jurisdiction	Caltrans	Time Period Analyzed	PM Peak Hour
Project Description	CMD1801 - Village D Specific Plan	Unit	United States Customary

Geometric Data

	Freeway	Ramp
Number of Lanes (N), ln	3	1
Free-Flow Speed (FFS), mi/h	70.0	35.0
Segment Length (L) / Deceleration Length (LA),ft	1500	150
Terrain Type	Level	Level
Percent Grade, %	-	-
Segment Type / Ramp Side	Freeway	Right

Adjustment Factors

Driver Population	All Familiar	All Familiar
Weather Type	Non-Severe Weather	Non-Severe Weather
Incident Type	No Incident	-
Final Speed Adjustment Factor (SAF)	1.000	1.000
Final Capacity Adjustment Factor (CAF)	1.000	1.000
Demand Adjustment Factor (DAF)	1.000	1.000

Demand and Capacity

Demand Volume (Vi)	3512	544
Peak Hour Factor (PHF)	0.94	0.94
Total Trucks, %	21.64	4.60
Single-Unit Trucks (SUT), %	-	-
Tractor-Trailers (TT), %	-	-
Heavy Vehicle Adjustment Factor (fHV)	0.822	0.956
Flow Rate (vi),pc/h	4545	605
Capacity (c), pc/h	7200	2000
Volume-to-Capacity Ratio (v/c)	0.63	0.30

Speed and Density

Upstream Equilibrium Distance (LEQ), ft	-	Number of Outer Lanes on Freeway (NO)	1
Distance to Upstream Ramp (LUP), ft	-	Speed Index (DS)	0.482
Downstream Equilibrium Distance (LEQ), ft	-	Flow Outer Lanes (vOA), pc/h/ln	1501
Distance to Downstream Ramp (LDOWN), ft	-	Off-Ramp Influence Area Speed (SR), mi/h	56.5
Prop. Freeway Vehicles in Lane 1 and 2 (PFD)	0.619	Outer Lanes Freeway Speed (SO), mi/h	74.8
Flow in Lanes 1 and 2 (v12), pc/h	3044	Ramp Junction Speed (S), mi/h	61.5
Flow Entering Ramp-Infl. Area (vR12), pc/h	-	Average Density (D), pc/mi/ln	24.6
Level of Service (LOS)	D	Density in Ramp Influence Area (DR), pc/mi/ln	29.1

HCS7 Basic Freeway Report

Project Information

Analyst	LSA	Date	12/11/2019
Agency	LSA	Analysis Year	Phase III Proj Comp Yr (2049) WP
Jurisdiction	Caltrans	Time Period Analyzed	PM Peak Hour
Project Description	CMD1801 - Village D Specific Plan	Unit	United States Customary

Geometric Data

Number of Lanes, ln	3	Terrain Type	Level
Segment Length (L), ft	-	Percent Grade, %	-
Measured or Base Free-Flow Speed	Base	Grade Length, mi	-
Base Free-Flow Speed (BFFS), mi/h	70.0	Total Ramp Density (TRD), ramps/mi	1.67
Lane Width, ft	12	Free-Flow Speed (FFS), mi/h	65.0
Right-Side Lateral Clearance, ft	10		

Adjustment Factors

Driver Population	All Familiar	Final Speed Adjustment Factor (SAF)	1.000
Weather Type	Non-Severe Weather	Final Capacity Adjustment Factor (CAF)	1.000
Incident Type	No Incident	Demand Adjustment Factor (DAF)	1.000

Demand and Capacity

Demand Volume veh/h	2968	Heavy Vehicle Adjustment Factor (fhv)	0.802
Peak Hour Factor	0.94	Flow Rate (Vp), pc/h/ln	1312
Total Trucks, %	24.76	Capacity (c), pc/h/ln	2350
Single-Unit Trucks (SUT), %	-	Adjusted Capacity (cadj), pc/h/ln	2350
Tractor-Trailers (TT), %	-	Volume-to-Capacity Ratio (v/c)	0.56
Passenger Car Equivalent (ET)	2.000		

Speed and Density

Lane Width Adjustment (fLW)	0.0	Average Speed (S), mi/h	65.0
Right-Side Lateral Clearance Adj. (fRLC)	0.0	Density (D), pc/mi/ln	20.2
Total Ramp Density Adjustment	5.0	Level of Service (LOS)	C
Adjusted Free-Flow Speed (FFSadj), mi/h	65.0		

HCS7 Freeway Merge Report

Project Information

Analyst	LSA	Date	12/11/2019
Agency	LSA	Analysis Year	Phase III Proj Comp Yr (2049) WP
Jurisdiction	Caltrans	Time Period Analyzed	PM Peak Hour
Project Description	CMD1801 - Village D Specific Plan	Unit	United States Customary

Geometric Data

	Freeway	Ramp
Number of Lanes (N), ln	3	1
Free-Flow Speed (FFS), mi/h	65.0	35.0
Segment Length (L) / Acceleration Length (LA),ft	1500	600
Terrain Type	Level	Level
Percent Grade, %	-	-
Segment Type / Ramp Side	Freeway	Right

Adjustment Factors

Driver Population	All Familiar	All Familiar
Weather Type	Non-Severe Weather	Non-Severe Weather
Incident Type	No Incident	-
Final Speed Adjustment Factor (SAF)	1.000	1.000
Final Capacity Adjustment Factor (CAF)	1.000	1.000
Demand Adjustment Factor (DAF)	1.000	1.000

Demand and Capacity

Demand Volume (Vi)	2968	701
Peak Hour Factor (PHF)	0.94	0.94
Total Trucks, %	24.76	6.42
Single-Unit Trucks (SUT), %	-	-
Tractor-Trailers (TT), %	-	-
Heavy Vehicle Adjustment Factor (fHV)	0.802	0.940
Flow Rate (vi),pc/h	3937	793
Capacity (c), pc/h	7050	2000
Volume-to-Capacity Ratio (v/c)	0.67	0.40

Speed and Density

Upstream Equilibrium Distance (LEQ), ft	-	Number of Outer Lanes on Freeway (NO)	1
Distance to Upstream Ramp (LUP), ft	-	Speed Index (MS)	0.368
Downstream Equilibrium Distance (LEQ), ft	-	Flow Outer Lanes (vOA), pc/h/ln	1598
Distance to Downstream Ramp (LDOWN), ft	-	On-Ramp Influence Area Speed (SR), mi/h	56.5
Prop. Freeway Vehicles in Lane 1 and 2 (PFM)	0.594	Outer Lanes Freeway Speed (SO), mi/h	61.0
Flow in Lanes 1 and 2 (v12), pc/h	2339	Ramp Junction Speed (S), mi/h	57.9
Flow Entering Ramp-Infl. Area (vR12), pc/h	3132	Average Density (D), pc/mi/ln	27.2
Level of Service (LOS)	C	Density in Ramp Influence Area (DR), pc/mi/ln	25.9

HCS7 Basic Freeway Report

Project Information

Analyst	LSA	Date	12/11/2019
Agency	LSA	Analysis Year	Phase III Proj Comp Yr (2049) WP
Jurisdiction	Caltrans	Time Period Analyzed	PM Peak Hour
Project Description	CMD1801 - Village D Specific Plan	Unit	United States Customary

Geometric Data

Number of Lanes, ln	3	Terrain Type	Level
Segment Length (L), ft	-	Percent Grade, %	-
Measured or Base Free-Flow Speed	Base	Grade Length, mi	-
Base Free-Flow Speed (BFFS), mi/h	65.0	Total Ramp Density (TRD), ramps/mi	1.83
Lane Width, ft	12	Free-Flow Speed (FFS), mi/h	59.7
Right-Side Lateral Clearance, ft	10		

Adjustment Factors

Driver Population	All Familiar	Final Speed Adjustment Factor (SAF)	1.000
Weather Type	Non-Severe Weather	Final Capacity Adjustment Factor (CAF)	1.000
Incident Type	No Incident	Demand Adjustment Factor (DAF)	1.000

Demand and Capacity

Demand Volume veh/h	3669	Heavy Vehicle Adjustment Factor (fhv)	0.825
Peak Hour Factor	0.94	Flow Rate (Vp), pc/h/ln	1577
Total Trucks, %	21.26	Capacity (c), pc/h/ln	2296
Single-Unit Trucks (SUT), %	-	Adjusted Capacity (cadj), pc/h/ln	2296
Tractor-Trailers (TT), %	-	Volume-to-Capacity Ratio (v/c)	0.69
Passenger Car Equivalent (ET)	2.000		

Speed and Density

Lane Width Adjustment (fLW)	0.0	Average Speed (S), mi/h	59.6
Right-Side Lateral Clearance Adj. (fRLC)	0.0	Density (D), pc/mi/ln	26.5
Total Ramp Density Adjustment	5.4	Level of Service (LOS)	D
Adjusted Free-Flow Speed (FFSadj), mi/h	59.6		

HCS7 Freeway Merge Report

Project Information

Analyst	LSA	Date	12/11/2019
Agency	LSA	Analysis Year	Phase III Proj Comp Yr (2049) WP
Jurisdiction	Caltrans	Time Period Analyzed	PM Peak Hour
Project Description	CMD1801 - Village D Specific Plan	Unit	United States Customary

Geometric Data

	Freeway	Ramp
Number of Lanes (N), ln	3	1
Free-Flow Speed (FFS), mi/h	65.0	35.0
Segment Length (L) / Acceleration Length (LA),ft	1500	600
Terrain Type	Level	Level
Percent Grade, %	-	-
Segment Type / Ramp Side	Freeway	Right

Adjustment Factors

Driver Population	All Familiar	All Familiar
Weather Type	Non-Severe Weather	Non-Severe Weather
Incident Type	No Incident	-
Final Speed Adjustment Factor (SAF)	1.000	1.000
Final Capacity Adjustment Factor (CAF)	1.000	1.000
Demand Adjustment Factor (DAF)	1.000	1.000

Demand and Capacity

Demand Volume (Vi)	3669	710
Peak Hour Factor (PHF)	0.94	0.94
Total Trucks, %	21.26	1.97
Single-Unit Trucks (SUT), %	-	-
Tractor-Trailers (TT), %	-	-
Heavy Vehicle Adjustment Factor (fHV)	0.825	0.981
Flow Rate (vi),pc/h	4731	770
Capacity (c), pc/h	7050	2000
Volume-to-Capacity Ratio (v/c)	0.78	0.39

Speed and Density

Upstream Equilibrium Distance (LEQ), ft	-	Number of Outer Lanes on Freeway (NO)	1
Distance to Upstream Ramp (LUP), ft	-	Speed Index (MS)	0.419
Downstream Equilibrium Distance (LEQ), ft	-	Flow Outer Lanes (vOA), pc/h/ln	1921
Distance to Downstream Ramp (LDOWN), ft	-	On-Ramp Influence Area Speed (SR), mi/h	55.4
Prop. Freeway Vehicles in Lane 1 and 2 (PFM)	0.594	Outer Lanes Freeway Speed (SO), mi/h	59.9
Flow in Lanes 1 and 2 (v12), pc/h	2810	Ramp Junction Speed (S), mi/h	56.9
Flow Entering Ramp-Infl. Area (vR12), pc/h	3580	Average Density (D), pc/mi/ln	32.2
Level of Service (LOS)	D	Density in Ramp Influence Area (DR), pc/mi/ln	29.4

HCS7 Basic Freeway Report

Project Information

Analyst	LSA	Date	12/11/2019
Agency	LSA	Analysis Year	Phase III Proj Comp Yr (2049) WP
Jurisdiction	Caltrans	Time Period Analyzed	PM Peak Hour
Project Description	CMD1801 - Village D Specific Plan	Unit	United States Customary

Geometric Data

Number of Lanes, ln	3	Terrain Type	Level
Segment Length (L), ft	-	Percent Grade, %	-
Measured or Base Free-Flow Speed	Base	Grade Length, mi	-
Base Free-Flow Speed (BFFS), mi/h	65.0	Total Ramp Density (TRD), ramps/mi	2.17
Lane Width, ft	12	Free-Flow Speed (FFS), mi/h	58.8
Right-Side Lateral Clearance, ft	10		

Adjustment Factors

Driver Population	All Familiar	Final Speed Adjustment Factor (SAF)	1.000
Weather Type	Non-Severe Weather	Final Capacity Adjustment Factor (CAF)	1.000
Incident Type	No Incident	Demand Adjustment Factor (DAF)	1.000

Demand and Capacity

Demand Volume veh/h	4379	Heavy Vehicle Adjustment Factor (fhv)	0.847
Peak Hour Factor	0.94	Flow Rate (Vp), pc/h/ln	1833
Total Trucks, %	18.13	Capacity (c), pc/h/ln	2288
Single-Unit Trucks (SUT), %	-	Adjusted Capacity (cadj), pc/h/ln	2288
Tractor-Trailers (TT), %	-	Volume-to-Capacity Ratio (v/c)	0.80
Passenger Car Equivalent (ET)	2.000		

Speed and Density

Lane Width Adjustment (fLW)	0.0	Average Speed (S), mi/h	58.1
Right-Side Lateral Clearance Adj. (fRLC)	0.0	Density (D), pc/mi/ln	31.5
Total Ramp Density Adjustment	6.2	Level of Service (LOS)	D
Adjusted Free-Flow Speed (FFSadj), mi/h	58.8		

HCS7 Freeway Diverge Report

Project Information

Analyst	LSA	Date	12/11/2019
Agency	LSA	Analysis Year	Phase III Proj Comp Yr (2049) WP
Jurisdiction	Caltrans	Time Period Analyzed	PM Peak Hour
Project Description	CMD1801 - Village D Specific Plan	Unit	United States Customary

Geometric Data

	Freeway	Ramp
Number of Lanes (N), ln	3	1
Free-Flow Speed (FFS), mi/h	65.0	40.0
Segment Length (L) / Deceleration Length (LA),ft	1500	150
Terrain Type	Level	Level
Percent Grade, %	-	-
Segment Type / Ramp Side	Freeway	Right

Adjustment Factors

Driver Population	All Familiar	All Familiar
Weather Type	Non-Severe Weather	Non-Severe Weather
Incident Type	No Incident	-
Final Speed Adjustment Factor (SAF)	1.000	1.000
Final Capacity Adjustment Factor (CAF)	1.000	1.000
Demand Adjustment Factor (DAF)	1.000	1.000

Demand and Capacity

Demand Volume (Vi)	4379	387
Peak Hour Factor (PHF)	0.94	0.94
Total Trucks, %	18.13	3.36
Single-Unit Trucks (SUT), %	-	-
Tractor-Trailers (TT), %	-	-
Heavy Vehicle Adjustment Factor (fHV)	0.847	0.967
Flow Rate (vi),pc/h	5500	426
Capacity (c), pc/h	7050	2000
Volume-to-Capacity Ratio (v/c)	0.78	0.21

Speed and Density

Upstream Equilibrium Distance (LEQ), ft	-	Number of Outer Lanes on Freeway (NO)	1
Distance to Upstream Ramp (LUP), ft	-	Speed Index (DS)	0.401
Downstream Equilibrium Distance (LEQ), ft	-	Flow Outer Lanes (vOA), pc/h/ln	2014
Distance to Downstream Ramp (LDOWN), ft	-	Off-Ramp Influence Area Speed (SR), mi/h	55.8
Prop. Freeway Vehicles in Lane 1 and 2 (PFD)	0.603	Outer Lanes Freeway Speed (SO), mi/h	67.4
Flow in Lanes 1 and 2 (v12), pc/h	3486	Ramp Junction Speed (S), mi/h	59.6
Flow Entering Ramp-Infl. Area (vR12), pc/h	-	Average Density (D), pc/mi/ln	30.8
Level of Service (LOS)	D	Density in Ramp Influence Area (DR), pc/mi/ln	32.9

HCS7 Basic Freeway Report

Project Information

Analyst	LSA	Date	12/11/2019
Agency	LSA	Analysis Year	Phase III Proj Comp Yr (2049) WP
Jurisdiction	Caltrans	Time Period Analyzed	PM Peak Hour
Project Description	CMD1801 - Village D Specific Plan	Unit	United States Customary

Geometric Data

Number of Lanes, ln	3	Terrain Type	Level
Segment Length (L), ft	-	Percent Grade, %	-
Measured or Base Free-Flow Speed	Base	Grade Length, mi	-
Base Free-Flow Speed (BFFS), mi/h	65.0	Total Ramp Density (TRD), ramps/mi	1.83
Lane Width, ft	12	Free-Flow Speed (FFS), mi/h	59.7
Right-Side Lateral Clearance, ft	10		

Adjustment Factors

Driver Population	All Familiar	Final Speed Adjustment Factor (SAF)	1.000
Weather Type	Non-Severe Weather	Final Capacity Adjustment Factor (CAF)	1.000
Incident Type	No Incident	Demand Adjustment Factor (DAF)	1.000

Demand and Capacity

Demand Volume veh/h	3992	Heavy Vehicle Adjustment Factor (fhv)	0.836
Peak Hour Factor	0.94	Flow Rate (Vp), pc/h/ln	1693
Total Trucks, %	19.57	Capacity (c), pc/h/ln	2296
Single-Unit Trucks (SUT), %	-	Adjusted Capacity (cadj), pc/h/ln	2296
Tractor-Trailers (TT), %	-	Volume-to-Capacity Ratio (v/c)	0.74
Passenger Car Equivalent (ET)	2.000		

Speed and Density

Lane Width Adjustment (fLW)	0.0	Average Speed (S), mi/h	59.5
Right-Side Lateral Clearance Adj. (fRLC)	0.0	Density (D), pc/mi/ln	28.5
Total Ramp Density Adjustment	5.4	Level of Service (LOS)	D
Adjusted Free-Flow Speed (FFSadj), mi/h	59.6		

HCS7 Freeway Merge Report

Project Information

Analyst	LSA	Date	12/11/2019
Agency	LSA	Analysis Year	Phase III Proj Comp Yr (2049) WP
Jurisdiction	Caltrans	Time Period Analyzed	PM Peak Hour
Project Description	CMD1801 - Village D Specific Plan	Unit	United States Customary

Geometric Data

	Freeway	Ramp
Number of Lanes (N), ln	3	1
Free-Flow Speed (FFS), mi/h	65.0	35.0
Segment Length (L) / Acceleration Length (LA),ft	1500	800
Terrain Type	Level	Level
Percent Grade, %	-	-
Segment Type / Ramp Side	Freeway	Right

Adjustment Factors

Driver Population	All Familiar	All Familiar
Weather Type	Non-Severe Weather	Non-Severe Weather
Incident Type	No Incident	-
Final Speed Adjustment Factor (SAF)	1.000	1.000
Final Capacity Adjustment Factor (CAF)	1.000	1.000
Demand Adjustment Factor (DAF)	1.000	1.000

Demand and Capacity

Demand Volume (Vi)	3992	390
Peak Hour Factor (PHF)	0.94	0.94
Total Trucks, %	19.57	5.13
Single-Unit Trucks (SUT), %	-	-
Tractor-Trailers (TT), %	-	-
Heavy Vehicle Adjustment Factor (fHV)	0.836	0.951
Flow Rate (vi),pc/h	5080	436
Capacity (c), pc/h	7050	2000
Volume-to-Capacity Ratio (v/c)	0.78	0.22

Speed and Density

Upstream Equilibrium Distance (LEQ), ft	-	Number of Outer Lanes on Freeway (NO)	1
Distance to Upstream Ramp (LUP), ft	-	Speed Index (MS)	0.392
Downstream Equilibrium Distance (LEQ), ft	-	Flow Outer Lanes (vOA), pc/h/ln	2032
Distance to Downstream Ramp (LDOWN), ft	-	On-Ramp Influence Area Speed (SR), mi/h	56.0
Prop. Freeway Vehicles in Lane 1 and 2 (PFM)	0.600	Outer Lanes Freeway Speed (SO), mi/h	59.5
Flow in Lanes 1 and 2 (v12), pc/h	3048	Ramp Junction Speed (S), mi/h	57.2
Flow Entering Ramp-Infl. Area (vR12), pc/h	3484	Average Density (D), pc/mi/ln	32.1
Level of Service (LOS)	C	Density in Ramp Influence Area (DR), pc/mi/ln	27.5

HCS7 Basic Freeway Report

Project Information

Analyst	LSA	Date	12/11/2019
Agency	LSA	Analysis Year	Phase III Proj Comp Yr (2049) WP
Jurisdiction	Caltrans	Time Period Analyzed	PM Peak Hour
Project Description	CMD1801 - Village D Specific Plan	Unit	United States Customary

Geometric Data

Number of Lanes, ln	3	Terrain Type	Level
Segment Length (L), ft	-	Percent Grade, %	-
Measured or Base Free-Flow Speed	Base	Grade Length, mi	-
Base Free-Flow Speed (BFFS), mi/h	65.0	Total Ramp Density (TRD), ramps/mi	2.17
Lane Width, ft	12	Free-Flow Speed (FFS), mi/h	58.8
Right-Side Lateral Clearance, ft	10		

Adjustment Factors

Driver Population	All Familiar	Final Speed Adjustment Factor (SAF)	1.000
Weather Type	Non-Severe Weather	Final Capacity Adjustment Factor (CAF)	1.000
Incident Type	No Incident	Demand Adjustment Factor (DAF)	1.000

Demand and Capacity

Demand Volume veh/h	4382	Heavy Vehicle Adjustment Factor (fhv)	0.845
Peak Hour Factor	0.94	Flow Rate (Vp), pc/h/ln	1839
Total Trucks, %	18.28	Capacity (c), pc/h/ln	2288
Single-Unit Trucks (SUT), %	-	Adjusted Capacity (cadj), pc/h/ln	2288
Tractor-Trailers (TT), %	-	Volume-to-Capacity Ratio (v/c)	0.80
Passenger Car Equivalent (ET)	2.000		

Speed and Density

Lane Width Adjustment (fLW)	0.0	Average Speed (S), mi/h	58.1
Right-Side Lateral Clearance Adj. (fRLC)	0.0	Density (D), pc/mi/ln	31.7
Total Ramp Density Adjustment	6.2	Level of Service (LOS)	D
Adjusted Free-Flow Speed (FFSadj), mi/h	58.8		

HCS7 Freeway Diverge Report

Project Information

Analyst	LSA	Date	12/11/2019
Agency	LSA	Analysis Year	Phase III Proj Comp Yr (2049) WP
Jurisdiction	Caltrans	Time Period Analyzed	PM Peak Hour
Project Description	CMD1801 - Village D Specific Plan	Unit	United States Customary

Geometric Data

	Freeway	Ramp
Number of Lanes (N), ln	3	1
Free-Flow Speed (FFS), mi/h	65.0	35.0
Segment Length (L) / Deceleration Length (LA),ft	1500	200
Terrain Type	Level	Level
Percent Grade, %	-	-
Segment Type / Ramp Side	Freeway	Right

Adjustment Factors

Driver Population	All Familiar	All Familiar
Weather Type	Non-Severe Weather	Non-Severe Weather
Incident Type	No Incident	-
Final Speed Adjustment Factor (SAF)	1.000	1.000
Final Capacity Adjustment Factor (CAF)	1.000	1.000
Demand Adjustment Factor (DAF)	1.000	1.000

Demand and Capacity

Demand Volume (Vi)	4382	390
Peak Hour Factor (PHF)	0.94	0.94
Total Trucks, %	18.28	2.82
Single-Unit Trucks (SUT), %	-	-
Tractor-Trailers (TT), %	-	-
Heavy Vehicle Adjustment Factor (fHV)	0.845	0.973
Flow Rate (vi),pc/h	5517	426
Capacity (c), pc/h	7050	2000
Volume-to-Capacity Ratio (v/c)	0.78	0.21

Speed and Density

Upstream Equilibrium Distance (LEQ), ft	-	Number of Outer Lanes on Freeway (NO)	1
Distance to Upstream Ramp (LUP), ft	-	Speed Index (DS)	0.466
Downstream Equilibrium Distance (LEQ), ft	-	Flow Outer Lanes (vOA), pc/h/ln	2026
Distance to Downstream Ramp (LDOWN), ft	-	Off-Ramp Influence Area Speed (SR), mi/h	54.3
Prop. Freeway Vehicles in Lane 1 and 2 (PFD)	0.602	Outer Lanes Freeway Speed (SO), mi/h	67.3
Flow in Lanes 1 and 2 (v12), pc/h	3491	Ramp Junction Speed (S), mi/h	58.4
Flow Entering Ramp-Infl. Area (vR12), pc/h	-	Average Density (D), pc/mi/ln	31.5
Level of Service (LOS)	D	Density in Ramp Influence Area (DR), pc/mi/ln	32.5

HCS7 Basic Freeway Report

Project Information

Analyst	LSA	Date	12/11/2019
Agency	LSA	Analysis Year	Phase III Proj Comp Yr (2049) WP
Jurisdiction	Caltrans	Time Period Analyzed	PM Peak Hour
Project Description	CMD1801 - Village D Specific Plan	Unit	United States Customary

Geometric Data

Number of Lanes, ln	3	Terrain Type	Level
Segment Length (L), ft	-	Percent Grade, %	-
Measured or Base Free-Flow Speed	Base	Grade Length, mi	-
Base Free-Flow Speed (BFFS), mi/h	65.0	Total Ramp Density (TRD), ramps/mi	2.17
Lane Width, ft	12	Free-Flow Speed (FFS), mi/h	58.8
Right-Side Lateral Clearance, ft	10		

Adjustment Factors

Driver Population	All Familiar	Final Speed Adjustment Factor (SAF)	1.000
Weather Type	Non-Severe Weather	Final Capacity Adjustment Factor (CAF)	1.000
Incident Type	No Incident	Demand Adjustment Factor (DAF)	1.000

Demand and Capacity

Demand Volume veh/h	3992	Heavy Vehicle Adjustment Factor (fhv)	0.835
Peak Hour Factor	0.94	Flow Rate (Vp), pc/h/ln	1695
Total Trucks, %	19.79	Capacity (c), pc/h/ln	2288
Single-Unit Trucks (SUT), %	-	Adjusted Capacity (cadj), pc/h/ln	2288
Tractor-Trailers (TT), %	-	Volume-to-Capacity Ratio (v/c)	0.74
Passenger Car Equivalent (ET)	2.000		

Speed and Density

Lane Width Adjustment (fLW)	0.0	Average Speed (S), mi/h	58.8
Right-Side Lateral Clearance Adj. (fRLC)	0.0	Density (D), pc/mi/ln	28.8
Total Ramp Density Adjustment	6.2	Level of Service (LOS)	D
Adjusted Free-Flow Speed (FFSadj), mi/h	58.8		

HCS7 Freeway Merge Report

Project Information

Analyst	LSA	Date	12/11/2019
Agency	LSA	Analysis Year	Phase III Proj Comp Yr (2049) WP
Jurisdiction	Caltrans	Time Period Analyzed	PM Peak Hour
Project Description	CMD1801 - Village D Specific Plan	Unit	United States Customary

Geometric Data

	Freeway	Ramp
Number of Lanes (N), ln	3	1
Free-Flow Speed (FFS), mi/h	65.0	35.0
Segment Length (L) / Acceleration Length (LA),ft	1500	350
Terrain Type	Level	Level
Percent Grade, %	-	-
Segment Type / Ramp Side	Freeway	Right

Adjustment Factors

Driver Population	All Familiar	All Familiar
Weather Type	Non-Severe Weather	Non-Severe Weather
Incident Type	No Incident	-
Final Speed Adjustment Factor (SAF)	1.000	1.000
Final Capacity Adjustment Factor (CAF)	1.000	1.000
Demand Adjustment Factor (DAF)	1.000	1.000

Demand and Capacity

Demand Volume (Vi)	3992	1030
Peak Hour Factor (PHF)	0.94	0.94
Total Trucks, %	19.79	1.17
Single-Unit Trucks (SUT), %	-	-
Tractor-Trailers (TT), %	-	-
Heavy Vehicle Adjustment Factor (fHV)	0.835	0.988
Flow Rate (vi),pc/h	5086	1109
Capacity (c), pc/h	7050	2000
Volume-to-Capacity Ratio (v/c)	0.88	0.55

Speed and Density

Upstream Equilibrium Distance (LEQ), ft	-	Number of Outer Lanes on Freeway (NO)	1
Distance to Upstream Ramp (LUP), ft	-	Speed Index (MS)	0.530
Downstream Equilibrium Distance (LEQ), ft	-	Flow Outer Lanes (vOA), pc/h/ln	2101
Distance to Downstream Ramp (LDOWN), ft	-	On-Ramp Influence Area Speed (SR), mi/h	52.8
Prop. Freeway Vehicles in Lane 1 and 2 (PFM)	0.587	Outer Lanes Freeway Speed (SO), mi/h	59.2
Flow in Lanes 1 and 2 (v12), pc/h	2985	Ramp Junction Speed (S), mi/h	54.8
Flow Entering Ramp-Infl. Area (vR12), pc/h	4094	Average Density (D), pc/mi/ln	37.7
Level of Service (LOS)	D	Density in Ramp Influence Area (DR), pc/mi/ln	34.8

HCS7 Basic Freeway Report

Project Information

Analyst	LSA	Date	12/11/2019
Agency	LSA	Analysis Year	Phase III Proj Comp Yr (2049) WP
Jurisdiction	Caltrans	Time Period Analyzed	PM Peak Hour
Project Description	CMD1801 - Village D Specific Plan	Unit	United States Customary

Geometric Data

Number of Lanes, ln	3	Terrain Type	Level
Segment Length (L), ft	-	Percent Grade, %	-
Measured or Base Free-Flow Speed	Base	Grade Length, mi	-
Base Free-Flow Speed (BFFS), mi/h	65.0	Total Ramp Density (TRD), ramps/mi	2.17
Lane Width, ft	12	Free-Flow Speed (FFS), mi/h	58.8
Right-Side Lateral Clearance, ft	10		

Adjustment Factors

Driver Population	All Familiar	Final Speed Adjustment Factor (SAF)	1.000
Weather Type	Non-Severe Weather	Final Capacity Adjustment Factor (CAF)	1.000
Incident Type	No Incident	Demand Adjustment Factor (DAF)	1.000

Demand and Capacity

Demand Volume veh/h	5022	Heavy Vehicle Adjustment Factor (fhv)	0.862
Peak Hour Factor	0.94	Flow Rate (Vp), pc/h/ln	2066
Total Trucks, %	15.97	Capacity (c), pc/h/ln	2288
Single-Unit Trucks (SUT), %	-	Adjusted Capacity (cadj), pc/h/ln	2288
Tractor-Trailers (TT), %	-	Volume-to-Capacity Ratio (v/c)	0.90
Passenger Car Equivalent (ET)	2.000		

Speed and Density

Lane Width Adjustment (fLW)	0.0	Average Speed (S), mi/h	55.4
Right-Side Lateral Clearance Adj. (fRLC)	0.0	Density (D), pc/mi/ln	37.3
Total Ramp Density Adjustment	6.2	Level of Service (LOS)	E
Adjusted Free-Flow Speed (FFSadj), mi/h	58.8		

HCS7 Freeway Diverge Report

Project Information

Analyst	LSA	Date	12/11/2019
Agency	LSA	Analysis Year	Phase III Proj Comp Yr (2049) WP
Jurisdiction	Caltrans	Time Period Analyzed	PM Peak Hour
Project Description	CMD1801 - Village D Specific Plan	Unit	United States Customary

Geometric Data

	Freeway	Ramp
Number of Lanes (N), ln	3	1
Free-Flow Speed (FFS), mi/h	65.0	15.0
Segment Length (L) / Deceleration Length (LA),ft	1500	150
Terrain Type	Level	Level
Percent Grade, %	-	-
Segment Type / Ramp Side	Freeway	Right

Adjustment Factors

Driver Population	All Familiar	All Familiar
Weather Type	Non-Severe Weather	Non-Severe Weather
Incident Type	No Incident	-
Final Speed Adjustment Factor (SAF)	1.000	1.000
Final Capacity Adjustment Factor (CAF)	1.000	1.000
Demand Adjustment Factor (DAF)	1.000	1.000

Demand and Capacity

Demand Volume (Vi)	5022	367
Peak Hour Factor (PHF)	0.94	0.94
Total Trucks, %	15.97	2.45
Single-Unit Trucks (SUT), %	-	-
Tractor-Trailers (TT), %	-	-
Heavy Vehicle Adjustment Factor (fHV)	0.862	0.976
Flow Rate (vi),pc/h	6198	400
Capacity (c), pc/h	7050	1800
Volume-to-Capacity Ratio (v/c)	0.88	0.22

Speed and Density

Upstream Equilibrium Distance (LEQ), ft	-	Number of Outer Lanes on Freeway (NO)	1
Distance to Upstream Ramp (LUP), ft	-	Speed Index (DS)	0.724
Downstream Equilibrium Distance (LEQ), ft	-	Flow Outer Lanes (vOA), pc/h/ln	2395
Distance to Downstream Ramp (LDOWN), ft	-	Off-Ramp Influence Area Speed (SR), mi/h	48.3
Prop. Freeway Vehicles in Lane 1 and 2 (PFD)	0.587	Outer Lanes Freeway Speed (SO), mi/h	65.9
Flow in Lanes 1 and 2 (v12), pc/h	3803	Ramp Junction Speed (S), mi/h	53.9
Flow Entering Ramp-Infl. Area (vR12), pc/h	-	Average Density (D), pc/mi/ln	38.3
Level of Service (LOS)	E	Density in Ramp Influence Area (DR), pc/mi/ln	35.6

HCS7 Basic Freeway Report

Project Information

Analyst	LSA	Date	12/11/2019
Agency	LSA	Analysis Year	Phase III Proj Comp Yr (2049) WP
Jurisdiction	Caltrans	Time Period Analyzed	PM Peak Hour
Project Description	CMD1801 - Village D Specific Plan	Unit	United States Customary

Geometric Data

Number of Lanes, ln	3	Terrain Type	Level
Segment Length (L), ft	-	Percent Grade, %	-
Measured or Base Free-Flow Speed	Base	Grade Length, mi	-
Base Free-Flow Speed (BFFS), mi/h	65.0	Total Ramp Density (TRD), ramps/mi	1.83
Lane Width, ft	12	Free-Flow Speed (FFS), mi/h	59.7
Right-Side Lateral Clearance, ft	10		

Adjustment Factors

Driver Population	All Familiar	Final Speed Adjustment Factor (SAF)	1.000
Weather Type	Non-Severe Weather	Final Capacity Adjustment Factor (CAF)	1.000
Incident Type	No Incident	Demand Adjustment Factor (DAF)	1.000

Demand and Capacity

Demand Volume veh/h	4655	Heavy Vehicle Adjustment Factor (fhv)	0.854
Peak Hour Factor	0.94	Flow Rate (Vp), pc/h/ln	1933
Total Trucks, %	17.04	Capacity (c), pc/h/ln	2296
Single-Unit Trucks (SUT), %	-	Adjusted Capacity (cadj), pc/h/ln	2296
Tractor-Trailers (TT), %	-	Volume-to-Capacity Ratio (v/c)	0.84
Passenger Car Equivalent (ET)	2.000		

Speed and Density

Lane Width Adjustment (fLW)	0.0	Average Speed (S), mi/h	57.7
Right-Side Lateral Clearance Adj. (fRLC)	0.0	Density (D), pc/mi/ln	33.5
Total Ramp Density Adjustment	5.4	Level of Service (LOS)	D
Adjusted Free-Flow Speed (FFSadj), mi/h	59.6		

HCS7 Freeway Merge Report

Project Information

Analyst	LSA	Date	12/11/2019
Agency	LSA	Analysis Year	Phase III Proj Comp Yr (2049) WP
Jurisdiction	Caltrans	Time Period Analyzed	PM Peak Hour
Project Description	CMD1801 - Village D Specific Plan	Unit	United States Customary

Geometric Data

	Freeway	Ramp
Number of Lanes (N), ln	3	1
Free-Flow Speed (FFS), mi/h	65.0	35.0
Segment Length (L) / Acceleration Length (LA),ft	1500	450
Terrain Type	Level	Level
Percent Grade, %	-	-
Segment Type / Ramp Side	Freeway	Right

Adjustment Factors

Driver Population	All Familiar	All Familiar
Weather Type	Non-Severe Weather	Non-Severe Weather
Incident Type	No Incident	-
Final Speed Adjustment Factor (SAF)	1.000	1.000
Final Capacity Adjustment Factor (CAF)	1.000	1.000
Demand Adjustment Factor (DAF)	1.000	1.000

Demand and Capacity

Demand Volume (Vi)	4655	542
Peak Hour Factor (PHF)	0.94	0.94
Total Trucks, %	17.04	1.11
Single-Unit Trucks (SUT), %	-	-
Tractor-Trailers (TT), %	-	-
Heavy Vehicle Adjustment Factor (fHV)	0.854	0.989
Flow Rate (vi),pc/h	5799	583
Capacity (c), pc/h	7050	2000
Volume-to-Capacity Ratio (v/c)	0.91	0.29

Speed and Density

Upstream Equilibrium Distance (LEQ), ft	-	Number of Outer Lanes on Freeway (NO)	1
Distance to Upstream Ramp (LUP), ft	-	Speed Index (MS)	0.503
Downstream Equilibrium Distance (LEQ), ft	-	Flow Outer Lanes (vOA), pc/h/ln	2378
Distance to Downstream Ramp (LDOWN), ft	-	On-Ramp Influence Area Speed (SR), mi/h	53.4
Prop. Freeway Vehicles in Lane 1 and 2 (PFM)	0.590	Outer Lanes Freeway Speed (SO), mi/h	58.0
Flow in Lanes 1 and 2 (v12), pc/h	3421	Ramp Junction Speed (S), mi/h	55.0
Flow Entering Ramp-Infl. Area (vR12), pc/h	4004	Average Density (D), pc/mi/ln	38.7
Level of Service (LOS)	D	Density in Ramp Influence Area (DR), pc/mi/ln	33.7

HCS7 Basic Freeway Report

Project Information

Analyst	LSA	Date	12/11/2019
Agency	LSA	Analysis Year	Phase III Proj Comp Yr (2049) WP
Jurisdiction	Caltrans	Time Period Analyzed	PM Peak Hour
Project Description	CMD1801 - Village D Specific Plan	Unit	United States Customary

Geometric Data

Number of Lanes, ln	3	Terrain Type	Level
Segment Length (L), ft	-	Percent Grade, %	-
Measured or Base Free-Flow Speed	Base	Grade Length, mi	-
Base Free-Flow Speed (BFFS), mi/h	65.0	Total Ramp Density (TRD), ramps/mi	1.83
Lane Width, ft	12	Free-Flow Speed (FFS), mi/h	59.7
Right-Side Lateral Clearance, ft	10		

Adjustment Factors

Driver Population	All Familiar	Final Speed Adjustment Factor (SAF)	1.000
Weather Type	Non-Severe Weather	Final Capacity Adjustment Factor (CAF)	1.000
Incident Type	No Incident	Demand Adjustment Factor (DAF)	1.000

Demand and Capacity

Demand Volume veh/h	5197	Heavy Vehicle Adjustment Factor (fhv)	0.867
Peak Hour Factor	0.94	Flow Rate (Vp), pc/h/ln	2126
Total Trucks, %	15.38	Capacity (c), pc/h/ln	2296
Single-Unit Trucks (SUT), %	-	Adjusted Capacity (cadj), pc/h/ln	2296
Tractor-Trailers (TT), %	-	Volume-to-Capacity Ratio (v/c)	0.93
Passenger Car Equivalent (ET)	2.000		

Speed and Density

Lane Width Adjustment (fLW)	0.0	Average Speed (S), mi/h	54.8
Right-Side Lateral Clearance Adj. (fRLC)	0.0	Density (D), pc/mi/ln	38.8
Total Ramp Density Adjustment	5.4	Level of Service (LOS)	E
Adjusted Free-Flow Speed (FFSadj), mi/h	59.6		

HCS7 Freeway Diverge Report

Project Information

Analyst	LSA	Date	12/11/2019
Agency	LSA	Analysis Year	Phase III Proj Comp Yr (2049) WP
Jurisdiction	Caltrans	Time Period Analyzed	PM Peak Hour
Project Description	CMD1801 - Village D Specific Plan	Unit	United States Customary

Geometric Data

	Freeway	Ramp
Number of Lanes (N), In	3	1
Free-Flow Speed (FFS), mi/h	65.0	35.0
Segment Length (L) / Deceleration Length (LA),ft	1500	140
Terrain Type	Level	Level
Percent Grade, %	-	-
Segment Type / Ramp Side	Freeway	Right

Adjustment Factors

Driver Population	All Familiar	All Familiar
Weather Type	Non-Severe Weather	Non-Severe Weather
Incident Type	No Incident	-
Final Speed Adjustment Factor (SAF)	1.000	1.000
Final Capacity Adjustment Factor (CAF)	1.000	1.000
Demand Adjustment Factor (DAF)	1.000	1.000

Demand and Capacity

Demand Volume (Vi)	5197	878
Peak Hour Factor (PHF)	0.94	0.94
Total Trucks, %	15.38	3.99
Single-Unit Trucks (SUT), %	-	-
Tractor-Trailers (TT), %	-	-
Heavy Vehicle Adjustment Factor (fHV)	0.867	0.962
Flow Rate (vi),pc/h	6377	971
Capacity (c), pc/h	7050	2000
Volume-to-Capacity Ratio (v/c)	0.90	0.49

Speed and Density

Upstream Equilibrium Distance (LEQ), ft	-	Number of Outer Lanes on Freeway (NO)	1
Distance to Upstream Ramp (LUP), ft	-	Speed Index (DS)	0.515
Downstream Equilibrium Distance (LEQ), ft	-	Flow Outer Lanes (vOA), pc/h/ln	2400
Distance to Downstream Ramp (LDOWN), ft	-	Off-Ramp Influence Area Speed (SR), mi/h	53.2
Prop. Freeway Vehicles in Lane 1 and 2 (PFD)	0.556	Outer Lanes Freeway Speed (SO), mi/h	65.8
Flow in Lanes 1 and 2 (v12), pc/h	3977	Ramp Junction Speed (S), mi/h	57.3
Flow Entering Ramp-Infl. Area (vR12), pc/h	-	Average Density (D), pc/mi/ln	37.1
Level of Service (LOS)	E	Density in Ramp Influence Area (DR), pc/mi/ln	37.2

HCS7 Basic Freeway Report

Project Information

Analyst	LSA	Date	12/11/2019
Agency	LSA	Analysis Year	Phase III Proj Comp Yr (2049) WP
Jurisdiction	Caltrans	Time Period Analyzed	PM Peak Hour
Project Description	CMD1801 - Village D Specific Plan	Unit	United States Customary

Geometric Data

Number of Lanes, ln	3	Terrain Type	Level
Segment Length (L), ft	-	Percent Grade, %	-
Measured or Base Free-Flow Speed	Base	Grade Length, mi	-
Base Free-Flow Speed (BFFS), mi/h	65.0	Total Ramp Density (TRD), ramps/mi	2.17
Lane Width, ft	12	Free-Flow Speed (FFS), mi/h	58.8
Right-Side Lateral Clearance, ft	10		

Adjustment Factors

Driver Population	All Familiar	Final Speed Adjustment Factor (SAF)	1.000
Weather Type	Non-Severe Weather	Final Capacity Adjustment Factor (CAF)	1.000
Incident Type	No Incident	Demand Adjustment Factor (DAF)	1.000

Demand and Capacity

Demand Volume veh/h	4319	Heavy Vehicle Adjustment Factor (fhv)	0.850
Peak Hour Factor	0.94	Flow Rate (Vp), pc/h/ln	1802
Total Trucks, %	17.69	Capacity (c), pc/h/ln	2288
Single-Unit Trucks (SUT), %	-	Adjusted Capacity (cadj), pc/h/ln	2288
Tractor-Trailers (TT), %	-	Volume-to-Capacity Ratio (v/c)	0.79
Passenger Car Equivalent (ET)	2.000		

Speed and Density

Lane Width Adjustment (fLW)	0.0	Average Speed (S), mi/h	58.3
Right-Side Lateral Clearance Adj. (fRLC)	0.0	Density (D), pc/mi/ln	30.9
Total Ramp Density Adjustment	6.2	Level of Service (LOS)	D
Adjusted Free-Flow Speed (FFSadj), mi/h	58.8		

HCS7 Freeway Merge Report

Project Information

Analyst	LSA	Date	12/11/2019
Agency	LSA	Analysis Year	Phase III Proj Comp Yr (2049) WP
Jurisdiction	Caltrans	Time Period Analyzed	PM Peak Hour
Project Description	CMD1801 - Village D Specific Plan	Unit	United States Customary

Geometric Data

	Freeway	Ramp
Number of Lanes (N), ln	3	1
Free-Flow Speed (FFS), mi/h	65.0	35.0
Segment Length (L) / Acceleration Length (LA),ft	1500	450
Terrain Type	Level	Level
Percent Grade, %	-	-
Segment Type / Ramp Side	Freeway	Right

Adjustment Factors

Driver Population	All Familiar	All Familiar
Weather Type	Non-Severe Weather	Non-Severe Weather
Incident Type	No Incident	-
Final Speed Adjustment Factor (SAF)	1.000	1.000
Final Capacity Adjustment Factor (CAF)	1.000	1.000
Demand Adjustment Factor (DAF)	1.000	1.000

Demand and Capacity

Demand Volume (Vi)	4319	476
Peak Hour Factor (PHF)	0.94	0.94
Total Trucks, %	17.69	1.47
Single-Unit Trucks (SUT), %	-	-
Tractor-Trailers (TT), %	-	-
Heavy Vehicle Adjustment Factor (fHV)	0.850	0.986
Flow Rate (vi),pc/h	5406	514
Capacity (c), pc/h	7050	2000
Volume-to-Capacity Ratio (v/c)	0.84	0.26

Speed and Density

Upstream Equilibrium Distance (LEQ), ft	-	Number of Outer Lanes on Freeway (NO)	1
Distance to Upstream Ramp (LUP), ft	-	Speed Index (MS)	0.448
Downstream Equilibrium Distance (LEQ), ft	-	Flow Outer Lanes (vOA), pc/h/ln	2216
Distance to Downstream Ramp (LDOWN), ft	-	On-Ramp Influence Area Speed (SR), mi/h	54.7
Prop. Freeway Vehicles in Lane 1 and 2 (PFM)	0.590	Outer Lanes Freeway Speed (SO), mi/h	58.8
Flow in Lanes 1 and 2 (v12), pc/h	3190	Ramp Junction Speed (S), mi/h	56.2
Flow Entering Ramp-Infl. Area (vR12), pc/h	3704	Average Density (D), pc/mi/ln	35.1
Level of Service (LOS)	D	Density in Ramp Influence Area (DR), pc/mi/ln	31.4

HCS7 Basic Freeway Report

Project Information

Analyst	LSA	Date	12/11/2019
Agency	LSA	Analysis Year	Phase III Proj Comp Yr (2049) WP
Jurisdiction	Caltrans	Time Period Analyzed	PM Peak Hour
Project Description	CMD1801 - Village D Specific Plan	Unit	United States Customary

Geometric Data

Number of Lanes, ln	3	Terrain Type	Level
Segment Length (L), ft	-	Percent Grade, %	-
Measured or Base Free-Flow Speed	Base	Grade Length, mi	-
Base Free-Flow Speed (BFFS), mi/h	65.0	Total Ramp Density (TRD), ramps/mi	2.17
Lane Width, ft	12	Free-Flow Speed (FFS), mi/h	58.8
Right-Side Lateral Clearance, ft	10		

Adjustment Factors

Driver Population	All Familiar	Final Speed Adjustment Factor (SAF)	1.000
Weather Type	Non-Severe Weather	Final Capacity Adjustment Factor (CAF)	1.000
Incident Type	No Incident	Demand Adjustment Factor (DAF)	1.000

Demand and Capacity

Demand Volume veh/h	4794	Heavy Vehicle Adjustment Factor (fhv)	0.861
Peak Hour Factor	0.94	Flow Rate (Vp), pc/h/ln	1974
Total Trucks, %	16.08	Capacity (c), pc/h/ln	2288
Single-Unit Trucks (SUT), %	-	Adjusted Capacity (cadj), pc/h/ln	2288
Tractor-Trailers (TT), %	-	Volume-to-Capacity Ratio (v/c)	0.86
Passenger Car Equivalent (ET)	2.000		

Speed and Density

Lane Width Adjustment (fLW)	0.0	Average Speed (S), mi/h	56.7
Right-Side Lateral Clearance Adj. (fRLC)	0.0	Density (D), pc/mi/ln	34.8
Total Ramp Density Adjustment	6.2	Level of Service (LOS)	D
Adjusted Free-Flow Speed (FFSadj), mi/h	58.8		

APPENDIX F:

QUEUING ANALYSIS WORKSHEETS

Intersections Under Caltrans Jurisdiction

Queuing and Blocking Report

Intersection: 5: Road 23/SR-99 Southbound Off-Ramp & Avenue 18 1/2

Movement	EB	EB	WB	NB	NB	SB
Directions Served	T	R	LT	L	R	LTR
Maximum Queue (ft)	16	31	59	59	64	153
Average Queue (ft)	1	1	17	24	48	54
95th Queue (ft)	9	12	51	50	68	101
Link Distance (ft)	247		193	351		238
Upstream Blk Time (%)						
Queuing Penalty (veh)						
Storage Bay Dist (ft)		50			25	
Storage Blk Time (%)		0		16	17	
Queuing Penalty (veh)		0		23	10	

Queuing and Blocking Report

Intersection: 6: SR-99 Northbound Ramps & Avenue 18 1/2

Movement	EB	NB
Directions Served	L	LTR
Maximum Queue (ft)	65	202
Average Queue (ft)	21	107
95th Queue (ft)	56	173
Link Distance (ft)		648
Upstream Blk Time (%)		
Queuing Penalty (veh)		
Storage Bay Dist (ft)	145	
Storage Blk Time (%)		
Queuing Penalty (veh)		

Queuing and Blocking Report

Intersection: 14: Avenue 17 & SR-99 Southbound Off-Ramp

Movement	SB	SB
Directions Served	L	R
Maximum Queue (ft)	101	65
Average Queue (ft)	41	27
95th Queue (ft)	82	59
Link Distance (ft)	1017	
Upstream Blk Time (%)		
Queuing Penalty (veh)		
Storage Bay Dist (ft)		610
Storage Blk Time (%)		
Queuing Penalty (veh)		

Queuing and Blocking Report

Intersection: 15: SR-99 Northbound Ramps & Avenue 17

Movement	EB	NB
Directions Served	L	LT
Maximum Queue (ft)	82	112
Average Queue (ft)	26	52
95th Queue (ft)	66	110
Link Distance (ft)		628
Upstream Blk Time (%)		
Queuing Penalty (veh)		
Storage Bay Dist (ft)	125	
Storage Blk Time (%)		19
Queuing Penalty (veh)		0

Queuing and Blocking Report

Intersection: 25: Kennedy Street/Gateway Drive & SR-99 Southbound Ramps

Movement	EB	SB	SB
Directions Served	L	L	R
Maximum Queue (ft)	80	54	53
Average Queue (ft)	29	29	29
95th Queue (ft)	72	44	43
Link Distance (ft)		509	
Upstream Blk Time (%)			
Queuing Penalty (veh)			
Storage Bay Dist (ft)	140		335
Storage Blk Time (%)			
Queuing Penalty (veh)			

Queuing and Blocking Report

Intersection: 26: Gateway Drive & SR-99 Northbound Off-Ramp

Movement	EB	SB
Directions Served	LT	LR
Maximum Queue (ft)	50	70
Average Queue (ft)	9	41
95th Queue (ft)	35	70
Link Distance (ft)	841	55
Upstream Blk Time (%)		1
Queuing Penalty (veh)		1
Storage Bay Dist (ft)		
Storage Blk Time (%)		
Queuing Penalty (veh)		

Queuing and Blocking Report

Intersection: 27: SR-99 Northbound Off-Ramp

Movement	EB	SB
Directions Served	L	TR
Maximum Queue (ft)	66	50
Average Queue (ft)	37	4
95th Queue (ft)	57	24
Link Distance (ft)	55	503
Upstream Blk Time (%)	1	
Queuing Penalty (veh)	1	
Storage Bay Dist (ft)		
Storage Blk Time (%)		
Queuing Penalty (veh)		

Queuing and Blocking Report

Intersection: 28: Gateway Drive & SR-99 Northbound Off-Ramp

Movement
Directions Served
Maximum Queue (ft)
Average Queue (ft)
95th Queue (ft)
Link Distance (ft)
Upstream Blk Time (%)
Queuing Penalty (veh)
Storage Bay Dist (ft)
Storage Blk Time (%)
Queuing Penalty (veh)

Queues
 31: SR-99 Southbound Ramps & Cleveland Avenue

Village D Specific Plan
 Existing NP - AM Peak Hour



Lane Group	EBT	EBR	WBL	WBT	SBL	SBR
Lane Group Flow (vph)	475	352	360	748	66	53
v/c Ratio	0.63	0.58	0.78	0.40	0.11	0.10
Control Delay	35.5	7.2	61.1	7.6	24.0	4.5
Queue Delay	0.0	0.0	0.0	0.0	0.0	0.0
Total Delay	35.5	7.2	61.1	7.6	24.0	4.5
Queue Length 50th (ft)	128	0	225	88	25	0
Queue Length 95th (ft)	163	56	303	70	62	17
Internal Link Dist (ft)	1412		372			
Turn Bay Length (ft)			115		140	
Base Capacity (vph)	877	655	632	2317	579	557
Starvation Cap Reductn	0	0	0	0	0	0
Spillback Cap Reductn	0	0	0	0	0	0
Storage Cap Reductn	0	0	0	0	0	0
Reduced v/c Ratio	0.54	0.54	0.57	0.32	0.11	0.10
Intersection Summary						

Queues
32: SR-99 Northbound Ramps & Cleveland Avenue

Village D Specific Plan
Existing NP - AM Peak Hour



Lane Group	EBL	EBT	WBT	WBR	NBL	NBT	NBR
Lane Group Flow (vph)	53	527	901	73	144	145	300
v/c Ratio	0.35	0.35	0.73	0.12	0.19	0.19	0.35
Control Delay	51.8	22.8	14.6	3.2	19.3	19.3	4.1
Queue Delay	0.0	0.0	2.0	0.0	0.0	0.0	0.0
Total Delay	51.8	22.8	16.6	3.2	19.3	19.3	4.1
Queue Length 50th (ft)	33	36	273	9	54	54	0
Queue Length 95th (ft)	m62	62	158	m1	102	103	36
Internal Link Dist (ft)		372	207			441	
Turn Bay Length (ft)	90			50	145		325
Base Capacity (vph)	181	2005	1499	712	748	748	867
Starvation Cap Reductn	0	0	423	0	0	0	0
Spillback Cap Reductn	0	0	0	0	0	0	0
Storage Cap Reductn	0	0	0	0	0	0	0
Reduced v/c Ratio	0.29	0.26	0.84	0.10	0.19	0.19	0.35

Intersection Summary

m Volume for 95th percentile queue is metered by upstream signal.

Queuing and Blocking Report

Intersection: 38: I Street & 2nd Street/SR-99 Southbound Off-Ramp

Movement	EB	WB
Directions Served	LTR	LT
Maximum Queue (ft)	56	192
Average Queue (ft)	26	79
95th Queue (ft)	52	149
Link Distance (ft)	174	263
Upstream Blk Time (%)		
Queuing Penalty (veh)		
Storage Bay Dist (ft)		
Storage Blk Time (%)		18
Queuing Penalty (veh)		2

Queuing and Blocking Report

Intersection: 40: H Street & SR-99 Southbound On-Ramp/2nd Street

Movement	WB	SB
Directions Served	LTR	LT
Maximum Queue (ft)	53	32
Average Queue (ft)	27	12
95th Queue (ft)	50	29
Link Distance (ft)	278	153
Upstream Blk Time (%)		
Queuing Penalty (veh)		
Storage Bay Dist (ft)		
Storage Blk Time (%)		
Queuing Penalty (veh)		

Queuing and Blocking Report

Intersection: 42: SR-99 Southbound On-Ramp & 4th Street

Movement	EB	EB	WB	WB	WB
Directions Served	T	TR	L	T	T
Maximum Queue (ft)	31	135	72	75	230
Average Queue (ft)	3	22	46	26	157
95th Queue (ft)	17	51	74	67	260
Link Distance (ft)	38	38	226	226	226
Upstream Blk Time (%)	0	1			1
Queuing Penalty (veh)	0	6			4
Storage Bay Dist (ft)					
Storage Blk Time (%)					
Queuing Penalty (veh)					

Queues

43: SR-99 Northbound Off-Ramp/H Street & 4th Street

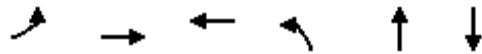

Lane Group	EBL	EBT	WBT	NBL	NBT	SBT
Lane Group Flow (vph)	248	528	596	278	255	72
v/c Ratio	0.82	0.35	0.87	0.69	0.47	0.17
Control Delay	61.0	26.3	48.6	43.0	9.3	2.0
Queue Delay	0.0	0.0	0.0	0.0	0.0	0.0
Total Delay	61.0	26.3	48.6	43.0	9.3	2.0
Queue Length 50th (ft)	128	126	169	149	13	0
Queue Length 95th (ft)	m183	m165	#234	#240	67	5
Internal Link Dist (ft)		197	236		443	771
Turn Bay Length (ft)						
Base Capacity (vph)	324	1553	706	403	543	429
Starvation Cap Reductn	0	0	0	0	0	0
Spillback Cap Reductn	0	0	0	0	0	0
Storage Cap Reductn	0	0	0	0	0	0
Reduced v/c Ratio	0.77	0.34	0.84	0.69	0.47	0.17

Intersection Summary

95th percentile volume exceeds capacity, queue may be longer.

Queue shown is maximum after two cycles.

m Volume for 95th percentile queue is metered by upstream signal.

Queues
 45: Olive Avenue & SR-99 Southbound Off-Ramp

Village D Specific Plan
 Existing NP - AM Peak Hour

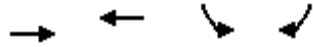

Lane Group	EBT	WBT	SBL	SBR
Lane Group Flow (vph)	536	414	322	105
v/c Ratio	0.57	0.63	0.28	0.10
Control Delay	31.5	31.5	5.8	1.4
Queue Delay	0.3	0.5	0.0	0.0
Total Delay	31.8	31.9	5.9	1.4
Queue Length 50th (ft)	90	120	50	0
Queue Length 95th (ft)	115	165	103	15
Internal Link Dist (ft)	103	112	135	
Turn Bay Length (ft)				
Base Capacity (vph)	1389	966	1144	1055
Starvation Cap Reductn	0	218	0	0
Spillback Cap Reductn	334	0	23	0
Storage Cap Reductn	0	0	0	0
Reduced v/c Ratio	0.51	0.55	0.29	0.10
Intersection Summary				

Queues

46: Madera Avenue & SR-99 Northbound Ramps



Lane Group	WBL	WBT	WBR	NBL	NBT	SBT
Lane Group Flow (vph)	75	77	82	386	432	762
v/c Ratio	0.41	0.41	0.33	0.54	0.16	0.43
Control Delay	38.5	38.8	11.8	32.0	3.7	12.9
Queue Delay	0.0	0.0	0.0	0.0	0.0	0.0
Total Delay	38.5	38.8	11.8	32.0	3.7	12.9
Queue Length 50th (ft)	37	37	0	67	12	114
Queue Length 95th (ft)	76	77	37	141	81	175
Internal Link Dist (ft)		337			388	217
Turn Bay Length (ft)	140			205		
Base Capacity (vph)	377	378	413	715	2732	1758
Starvation Cap Reductn	0	0	0	0	0	0
Spillback Cap Reductn	0	0	0	0	0	0
Storage Cap Reductn	0	0	0	0	0	0
Reduced v/c Ratio	0.20	0.20	0.20	0.54	0.16	0.43

Intersection Summary

Queues

47: Madera Avenue & Olive Avenue/SR-99 Southbound On-Ramp



Lane Group	EBL	EBT	EBR	NBL	NBT	SBL	SBT
Lane Group Flow (vph)	253	265	332	113	516	88	640
v/c Ratio	0.67	0.68	0.46	0.34	0.30	0.45	0.37
Control Delay	28.0	28.0	10.5	35.9	14.0	28.9	19.0
Queue Delay	3.1	3.3	2.3	0.0	0.0	0.0	0.2
Total Delay	31.1	31.3	12.8	35.9	14.0	28.9	19.2
Queue Length 50th (ft)	123	129	98	27	77	43	118
Queue Length 95th (ft)	178	186	143	50	140	86	182
Internal Link Dist (ft)		112			323		388
Turn Bay Length (ft)				120		90	
Base Capacity (vph)	556	578	848	628	1693	223	1725
Starvation Cap Reductn	206	219	378	0	0	0	0
Spillback Cap Reductn	0	0	0	0	0	0	343
Storage Cap Reductn	0	0	0	0	0	0	0
Reduced v/c Ratio	0.72	0.74	0.71	0.18	0.30	0.39	0.46

Intersection Summary

Queuing and Blocking Report

Intersection: 48: Madera Avenue & Lewis Street

Movement	WB	SB
Directions Served	LR	L
Maximum Queue (ft)	67	54
Average Queue (ft)	19	20
95th Queue (ft)	50	49
Link Distance (ft)	147	
Upstream Blk Time (%)		
Queuing Penalty (veh)		
Storage Bay Dist (ft)		100
Storage Blk Time (%)		
Queuing Penalty (veh)		

Queues
49: Yosemite Avenue & Cleveland Avenue/Tozer Street

Village D Specific Plan
Existing NP - AM Peak Hour



Lane Group	EBL	EBT	WBL	WBT	WBR	NBL	NBT	NBR	SBL	SBT
Lane Group Flow (vph)	195	907	131	344	49	156	125	88	71	473
v/c Ratio	0.69	0.78	0.82	0.37	0.10	0.92	0.22	0.15	0.44	0.94
Control Delay	47.8	29.4	79.4	29.5	0.4	94.5	26.0	0.5	47.4	57.3
Queue Delay	0.0	0.0	0.0	0.0	0.0	0.0	0.0	0.0	0.0	0.0
Total Delay	47.8	29.4	79.4	29.5	0.4	94.5	26.0	0.5	47.4	57.3
Queue Length 50th (ft)	105	219	75	85	0	90	55	0	39	239
Queue Length 95th (ft)	156	265	#158	121	0	#186	93	0	75	#374
Internal Link Dist (ft)		318		397			415			443
Turn Bay Length (ft)	210		150		60	240			150	
Base Capacity (vph)	352	1169	159	923	498	169	559	594	182	520
Starvation Cap Reductn	0	0	0	0	0	0	0	0	0	0
Spillback Cap Reductn	0	0	0	0	0	0	0	0	0	0
Storage Cap Reductn	0	0	0	0	0	0	0	0	0	0
Reduced v/c Ratio	0.55	0.78	0.82	0.37	0.10	0.92	0.22	0.15	0.39	0.91

Intersection Summary

95th percentile volume exceeds capacity, queue may be longer.
Queue shown is maximum after two cycles.

Queuing and Blocking Report

Intersection: 5: Road 23/SR-99 Southbound Off-Ramp & Avenue 18 1/2

Movement	EB	EB	WB	NB	NB	SB
Directions Served	T	R	LT	L	R	LTR
Maximum Queue (ft)	44	80	145	107	75	251
Average Queue (ft)	6	7	20	26	35	123
95th Queue (ft)	24	36	75	67	59	219
Link Distance (ft)	247		193	351		238
Upstream Blk Time (%)						0
Queuing Penalty (veh)						0
Storage Bay Dist (ft)		50			25	
Storage Blk Time (%)	0	0		11	15	
Queuing Penalty (veh)	0	0		8	5	

Queuing and Blocking Report

Intersection: 6: SR-99 Northbound Ramps & Avenue 18 1/2

Movement	EB	NB
Directions Served	L	LTR
Maximum Queue (ft)	59	185
Average Queue (ft)	18	80
95th Queue (ft)	50	147
Link Distance (ft)		648
Upstream Blk Time (%)		
Queuing Penalty (veh)		
Storage Bay Dist (ft)	145	
Storage Blk Time (%)		
Queuing Penalty (veh)		

Queuing and Blocking Report

Intersection: 14: Avenue 17 & SR-99 Southbound Off-Ramp

Movement	SB	SB
Directions Served	L	R
Maximum Queue (ft)	74	52
Average Queue (ft)	51	29
95th Queue (ft)	75	42
Link Distance (ft)	1017	
Upstream Blk Time (%)		
Queuing Penalty (veh)		
Storage Bay Dist (ft)		610
Storage Blk Time (%)		
Queuing Penalty (veh)		

Queuing and Blocking Report

Intersection: 15: SR-99 Northbound Ramps & Avenue 17

Movement	EB	NB
Directions Served	L	LT
Maximum Queue (ft)	36	76
Average Queue (ft)	6	16
95th Queue (ft)	23	48
Link Distance (ft)		629
Upstream Blk Time (%)		
Queuing Penalty (veh)		
Storage Bay Dist (ft)	125	
Storage Blk Time (%)		1
Queuing Penalty (veh)		0

Queuing and Blocking Report

Intersection: 25: Kennedy Street/Gateway Drive & SR-99 Southbound Ramps

Movement	EB	WB	SB	SB
Directions Served	L	TR	L	R
Maximum Queue (ft)	55	20	98	74
Average Queue (ft)	18	1	52	42
95th Queue (ft)	48	8	85	62
Link Distance (ft)		841	509	
Upstream Blk Time (%)				
Queuing Penalty (veh)				
Storage Bay Dist (ft)	140			335
Storage Blk Time (%)				
Queuing Penalty (veh)				

Queuing and Blocking Report

Intersection: 26: Gateway Drive & SR-99 Northbound Off-Ramp

Movement	EB	SB
Directions Served	LT	LR
Maximum Queue (ft)	92	66
Average Queue (ft)	27	36
95th Queue (ft)	68	59
Link Distance (ft)	841	55
Upstream Blk Time (%)		1
Queuing Penalty (veh)		1
Storage Bay Dist (ft)		
Storage Blk Time (%)		
Queuing Penalty (veh)		

Queuing and Blocking Report

Intersection: 27: SR-99 Northbound Off-Ramp

Movement	EB	SB
Directions Served	L	TR
Maximum Queue (ft)	69	31
Average Queue (ft)	39	1
95th Queue (ft)	62	12
Link Distance (ft)	55	503
Upstream Blk Time (%)	1	
Queuing Penalty (veh)	1	
Storage Bay Dist (ft)		
Storage Blk Time (%)		
Queuing Penalty (veh)		

Queuing and Blocking Report

Intersection: 28: Gateway Drive & SR-99 Northbound Off-Ramp

Movement	SB
Directions Served	LR
Maximum Queue (ft)	31
Average Queue (ft)	6
95th Queue (ft)	25
Link Distance (ft)	162
Upstream Blk Time (%)	
Queuing Penalty (veh)	
Storage Bay Dist (ft)	
Storage Blk Time (%)	
Queuing Penalty (veh)	

Queues
31: SR-99 Southbound Ramps & Cleveland Avenue

Village D Specific Plan
Existing NP - PM Peak Hour



Lane Group	EBT	EBR	WBL	WBT	SBL	SBR
Lane Group Flow (vph)	703	337	199	1082	129	79
v/c Ratio	0.65	0.47	0.67	0.58	0.20	0.13
Control Delay	24.5	4.7	34.7	10.1	23.3	7.0
Queue Delay	0.0	0.0	0.0	0.1	0.0	0.0
Total Delay	24.5	4.7	34.7	10.2	23.3	7.0
Queue Length 50th (ft)	154	18	95	133	48	0
Queue Length 95th (ft)	m137	m36	159	120	110	34
Internal Link Dist (ft)	1412			372		
Turn Bay Length (ft)			115			140
Base Capacity (vph)	1449	838	371	2362	661	630
Starvation Cap Reductn	0	0	0	193	0	0
Spillback Cap Reductn	0	0	0	0	0	0
Storage Cap Reductn	0	0	0	0	0	0
Reduced v/c Ratio	0.49	0.40	0.54	0.50	0.20	0.13

Intersection Summary

m Volume for 95th percentile queue is metered by upstream signal.

Queues
32: SR-99 Northbound Ramps & Cleveland Avenue

Village D Specific Plan
Existing NP - PM Peak Hour



Lane Group	EBL	EBT	WBT	WBR	NBL	NBT	NBR
Lane Group Flow (vph)	75	775	869	68	224	220	279
v/c Ratio	0.46	0.48	0.74	0.12	0.29	0.29	0.35
Control Delay	41.5	7.9	16.1	1.4	19.7	19.6	9.8
Queue Delay	0.0	0.0	0.3	0.0	0.0	0.0	0.0
Total Delay	41.5	7.9	16.4	1.4	19.7	19.6	9.8
Queue Length 50th (ft)	47	41	133	0	88	86	41
Queue Length 95th (ft)	93	51	111	m1	161	157	110
Internal Link Dist (ft)		372	207			441	
Turn Bay Length (ft)	90			50	145		325
Base Capacity (vph)	178	1925	1409	653	765	767	799
Starvation Cap Reductn	0	0	151	0	0	0	0
Spillback Cap Reductn	0	0	0	0	0	0	0
Storage Cap Reductn	0	0	0	0	0	0	0
Reduced v/c Ratio	0.42	0.40	0.69	0.10	0.29	0.29	0.35

Intersection Summary

m Volume for 95th percentile queue is metered by upstream signal.

Queuing and Blocking Report

Intersection: 38: I Street & 2nd Street/SR-99 Southbound Off-Ramp

Movement	EB	WB	NB
Directions Served	LTR	LT	L
Maximum Queue (ft)	49	96	26
Average Queue (ft)	23	59	2
95th Queue (ft)	47	84	14
Link Distance (ft)	174	263	
Upstream Blk Time (%)			
Queuing Penalty (veh)			
Storage Bay Dist (ft)			75
Storage Blk Time (%)		7	
Queuing Penalty (veh)		0	

Queuing and Blocking Report

Intersection: 40: H Street & SR-99 Southbound On-Ramp/2nd Street

Movement	WB	SB
Directions Served	LTR	LTR
Maximum Queue (ft)	72	27
Average Queue (ft)	33	6
95th Queue (ft)	64	16
Link Distance (ft)	278	139
Upstream Blk Time (%)		
Queuing Penalty (veh)		
Storage Bay Dist (ft)		
Storage Blk Time (%)		
Queuing Penalty (veh)		

Queuing and Blocking Report

Intersection: 42: SR-99 Southbound On-Ramp & 4th Street

Movement	EB	EB	WB	WB	WB
Directions Served	T	TR	L	T	T
Maximum Queue (ft)	38	55	134	74	231
Average Queue (ft)	12	27	50	14	136
95th Queue (ft)	38	60	97	54	247
Link Distance (ft)	38	38	226	226	226
Upstream Blk Time (%)	1	1			4
Queuing Penalty (veh)	4	6			10
Storage Bay Dist (ft)					
Storage Blk Time (%)					
Queuing Penalty (veh)					

Queues

43: SR-99 Northbound Off-Ramp/H Street & 4th Street

Village D Specific Plan

Existing NP - PM Peak Hour

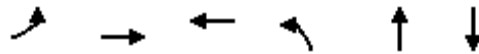

Lane Group	EBL	EBT	WBT	NBL	NBT	SBT
Lane Group Flow (vph)	213	424	626	254	173	91
v/c Ratio	0.73	0.28	0.81	0.55	0.33	0.23
Control Delay	39.4	7.9	45.1	39.1	9.4	5.5
Queue Delay	0.0	0.0	0.0	0.0	0.0	0.0
Total Delay	39.4	7.9	45.1	39.1	9.4	5.5
Queue Length 50th (ft)	143	49	191	145	10	0
Queue Length 95th (ft)	219	67	254	237	66	28
Internal Link Dist (ft)		197	236		443	771
Turn Bay Length (ft)						
Base Capacity (vph)	348	1697	831	463	530	394
Starvation Cap Reductn	0	0	0	0	0	0
Spillback Cap Reductn	0	0	0	0	0	0
Storage Cap Reductn	0	0	0	0	0	0
Reduced v/c Ratio	0.61	0.25	0.75	0.55	0.33	0.23
Intersection Summary						

Queues
 45: Olive Avenue & SR-99 Southbound Off-Ramp

Village D Specific Plan
 Existing NP - PM Peak Hour

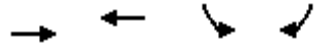

Lane Group	EBT	WBT	SBL	SBR
Lane Group Flow (vph)	556	416	241	68
v/c Ratio	0.60	0.64	0.20	0.06
Control Delay	36.1	29.4	5.1	1.5
Queue Delay	0.1	0.1	0.0	0.0
Total Delay	36.2	29.5	5.2	1.5
Queue Length 50th (ft)	107	136	37	0
Queue Length 95th (ft)	134	181	77	12
Internal Link Dist (ft)	103	112	135	
Turn Bay Length (ft)				
Base Capacity (vph)	2062	1449	1232	1108
Starvation Cap Reductn	0	260	0	0
Spillback Cap Reductn	443	0	72	0
Storage Cap Reductn	0	0	0	0
Reduced v/c Ratio	0.34	0.35	0.21	0.06
Intersection Summary				

Queues
46: Madera Avenue & SR-99 Northbound Ramps

Village D Specific Plan
Existing NP - PM Peak Hour



Lane Group	WBL	WBT	WBR	NBL	NBT	SBT
Lane Group Flow (vph)	94	95	35	414	571	826
v/c Ratio	0.48	0.49	0.14	0.48	0.21	0.49
Control Delay	44.9	45.0	2.9	28.8	2.6	16.4
Queue Delay	0.0	0.0	0.0	0.0	0.0	0.0
Total Delay	44.9	45.0	2.9	28.8	2.6	16.4
Queue Length 50th (ft)	53	54	0	77	20	149
Queue Length 95th (ft)	100	100	7	119	68	221
Internal Link Dist (ft)		337			388	217
Turn Bay Length (ft)	140			205		
Base Capacity (vph)	350	351	384	858	2778	1677
Starvation Cap Reductn	0	0	0	0	0	0
Spillback Cap Reductn	0	0	0	0	0	0
Storage Cap Reductn	0	0	0	0	0	0
Reduced v/c Ratio	0.27	0.27	0.09	0.48	0.21	0.49
Intersection Summary						

Queues

47: Madera Avenue & Olive Avenue/SR-99 Southbound On-Ramp

Village D Specific Plan

Existing NP - PM Peak Hour



Lane Group	EBL	EBT	EBR	NBL	NBT	SBL	SBT
Lane Group Flow (vph)	234	239	307	107	621	134	641
v/c Ratio	0.68	0.67	0.47	0.34	0.35	0.57	0.33
Control Delay	36.9	36.3	16.4	41.0	15.5	30.2	18.3
Queue Delay	1.4	1.4	0.8	0.0	0.0	0.0	0.1
Total Delay	38.3	37.7	17.1	41.0	15.5	30.2	18.4
Queue Length 50th (ft)	147	150	113	29	104	63	144
Queue Length 95th (ft)	222	225	176	54	186	110	221
Internal Link Dist (ft)		112			323		388
Turn Bay Length (ft)				120		90	
Base Capacity (vph)	601	620	755	572	1793	281	1950
Starvation Cap Reductn	206	217	209	0	0	0	0
Spillback Cap Reductn	0	0	0	0	0	0	320
Storage Cap Reductn	0	0	0	0	0	0	0
Reduced v/c Ratio	0.59	0.59	0.56	0.19	0.35	0.48	0.39

Intersection Summary

Queuing and Blocking Report

Intersection: 48: Madera Avenue & Lewis Street

Movement	WB	SB
Directions Served	LR	L
Maximum Queue (ft)	78	31
Average Queue (ft)	13	10
95th Queue (ft)	45	33
Link Distance (ft)	147	
Upstream Blk Time (%)		
Queuing Penalty (veh)		
Storage Bay Dist (ft)		100
Storage Blk Time (%)		
Queuing Penalty (veh)		

Queues
49: Yosemite Avenue & Cleveland Avenue/Tozer Street

Village D Specific Plan
Existing NP - PM Peak Hour



Lane Group	EBL	EBT	WBL	WBT	WBR	NBL	NBT	NBR	SBL	SBT
Lane Group Flow (vph)	203	655	52	486	38	332	308	103	73	409
v/c Ratio	0.77	0.55	0.48	0.58	0.07	0.98	0.44	0.15	0.48	0.88
Control Delay	61.2	26.6	60.9	38.5	0.3	86.5	26.4	1.1	54.3	51.9
Queue Delay	0.0	0.0	0.0	0.0	0.0	0.0	0.0	0.0	0.0	0.0
Total Delay	61.2	26.6	60.9	38.5	0.3	86.5	26.4	1.1	54.3	51.9
Queue Length 50th (ft)	123	165	33	153	0	212	147	0	45	209
Queue Length 95th (ft)	#223	226	#79	210	0	#390	224	8	90	#361
Internal Link Dist (ft)		318		397			415			443
Turn Bay Length (ft)	210		150		60	240			150	
Base Capacity (vph)	286	1189	109	843	531	338	704	700	171	509
Starvation Cap Reductn	0	0	0	0	0	0	0	0	0	0
Spillback Cap Reductn	0	0	0	0	0	0	0	0	0	0
Storage Cap Reductn	0	0	0	0	0	0	0	0	0	0
Reduced v/c Ratio	0.71	0.55	0.48	0.58	0.07	0.98	0.44	0.15	0.43	0.80

Intersection Summary

95th percentile volume exceeds capacity, queue may be longer.
Queue shown is maximum after two cycles.

Queuing and Blocking Report

Intersection: 5: Road 23/SR-99 Southbound Off-Ramp & Avenue 18 1/2

Movement	EB	EB	WB	NB	NB	SB
Directions Served	T	R	LT	L	R	LTR
Maximum Queue (ft)	54	60	71	414	75	301
Average Queue (ft)	7	5	15	385	75	272
95th Queue (ft)	30	28	50	412	75	303
Link Distance (ft)	247		193	351		238
Upstream Blk Time (%)				100		88
Queuing Penalty (veh)				0		0
Storage Bay Dist (ft)		50			25	
Storage Blk Time (%)	0	0		43	93	
Queuing Penalty (veh)	0	0		312	125	

Queuing and Blocking Report

Intersection: 6: SR-99 Northbound Ramps & Avenue 18 1/2

Movement	EB	WB	NB
Directions Served	L	TR	LTR
Maximum Queue (ft)	101	16	711
Average Queue (ft)	64	1	683
95th Queue (ft)	102	6	707
Link Distance (ft)		799	648
Upstream Blk Time (%)			100
Queuing Penalty (veh)			0
Storage Bay Dist (ft)	145		
Storage Blk Time (%)			
Queuing Penalty (veh)			

Queuing and Blocking Report

Intersection: 14: Avenue 17 & SR-99 Southbound Off-Ramp

Movement	WB	SB	SB
Directions Served	T	L	R
Maximum Queue (ft)	280	111	94
Average Queue (ft)	49	44	37
95th Queue (ft)	221	80	79
Link Distance (ft)	266	1017	
Upstream Blk Time (%)	15		
Queuing Penalty (veh)	99		
Storage Bay Dist (ft)			610
Storage Blk Time (%)			
Queuing Penalty (veh)			

Queuing and Blocking Report

Intersection: 15: SR-99 Northbound Ramps & Avenue 17

Movement	EB	WB	B81	NB
Directions Served	L	TR	T	LT
Maximum Queue (ft)	17	531	405	692
Average Queue (ft)	7	48	36	649
95th Queue (ft)	20	297	223	673
Link Distance (ft)		460	329	628
Upstream Blk Time (%)		9	8	100
Queuing Penalty (veh)		79	73	0
Storage Bay Dist (ft)	125			
Storage Blk Time (%)				100
Queuing Penalty (veh)				0

Queuing and Blocking Report

Intersection: 25: Kennedy Street/Gateway Drive & SR-99 Southbound Ramps

Movement	EB	SB	SB
Directions Served	L	L	R
Maximum Queue (ft)	137	91	74
Average Queue (ft)	54	35	38
95th Queue (ft)	117	72	58
Link Distance (ft)		509	
Upstream Blk Time (%)			
Queuing Penalty (veh)			
Storage Bay Dist (ft)	140		335
Storage Blk Time (%)	0		
Queuing Penalty (veh)	1		

Queuing and Blocking Report

Intersection: 26: Gateway Drive & SR-99 Northbound Off-Ramp

Movement	EB	SB
Directions Served	LT	LR
Maximum Queue (ft)	53	74
Average Queue (ft)	17	35
95th Queue (ft)	47	60
Link Distance (ft)	841	55
Upstream Blk Time (%)		1
Queuing Penalty (veh)		1
Storage Bay Dist (ft)		
Storage Blk Time (%)		
Queuing Penalty (veh)		

Queuing and Blocking Report

Intersection: 27: SR-99 Northbound Off-Ramp

Movement	EB	SB
Directions Served	L	TR
Maximum Queue (ft)	66	80
Average Queue (ft)	44	6
95th Queue (ft)	65	37
Link Distance (ft)	55	503
Upstream Blk Time (%)	1	
Queuing Penalty (veh)	2	
Storage Bay Dist (ft)		
Storage Blk Time (%)		
Queuing Penalty (veh)		

Queuing and Blocking Report

Intersection: 28: Gateway Drive & SR-99 Northbound Off-Ramp

Movement
Directions Served
Maximum Queue (ft)
Average Queue (ft)
95th Queue (ft)
Link Distance (ft)
Upstream Blk Time (%)
Queuing Penalty (veh)
Storage Bay Dist (ft)
Storage Blk Time (%)
Queuing Penalty (veh)

Queues
31: SR-99 Southbound Ramps & Cleveland Avenue

Village D Specific Plan
Existing WP - AM Peak Hour



Lane Group	EBT	EBR	WBL	WBT	SBL	SBR
Lane Group Flow (vph)	760	832	360	1054	275	92
v/c Ratio	0.62	0.89	0.86	0.47	0.60	0.20
Control Delay	26.5	20.6	64.9	6.7	37.9	7.9
Queue Delay	0.0	0.0	0.0	0.1	0.0	0.0
Total Delay	26.5	20.6	64.9	6.9	37.9	7.9
Queue Length 50th (ft)	177	124	223	104	147	0
Queue Length 95th (ft)	224	#328	m#306	124	#245	35
Internal Link Dist (ft)	1412			372		
Turn Bay Length (ft)			115			140
Base Capacity (vph)	1336	966	454	2422	456	469
Starvation Cap Reductn	0	0	0	445	0	0
Spillback Cap Reductn	0	0	0	0	0	0
Storage Cap Reductn	0	0	0	0	0	0
Reduced v/c Ratio	0.57	0.86	0.79	0.53	0.60	0.20

Intersection Summary

95th percentile volume exceeds capacity, queue may be longer.

Queue shown is maximum after two cycles.

m Volume for 95th percentile queue is metered by upstream signal.

Queues
32: SR-99 Northbound Ramps & Cleveland Avenue

Village D Specific Plan
Existing WP - AM Peak Hour



Lane Group	EBL	EBT	WBT	WBR	NBL	NBT	NBR
Lane Group Flow (vph)	68	1043	1046	146	236	237	300
v/c Ratio	0.40	0.59	0.78	0.23	0.36	0.37	0.45
Control Delay	39.2	23.1	13.2	3.5	24.1	24.1	17.5
Queue Delay	0.0	0.3	1.5	0.0	0.0	0.0	0.0
Total Delay	39.2	23.4	14.7	3.5	24.1	24.1	17.6
Queue Length 50th (ft)	39	201	72	0	106	106	84
Queue Length 95th (ft)	m67	217	120	m8	162	162	142
Internal Link Dist (ft)		372	207			441	
Turn Bay Length (ft)	90			50	145		325
Base Capacity (vph)	360	2044	1355	651	649	649	673
Starvation Cap Reductn	0	400	152	0	0	0	0
Spillback Cap Reductn	0	128	0	0	0	0	3
Storage Cap Reductn	0	0	0	0	0	0	0
Reduced v/c Ratio	0.19	0.63	0.87	0.22	0.36	0.37	0.45

Intersection Summary

m Volume for 95th percentile queue is metered by upstream signal.

Queuing and Blocking Report

Intersection: 38: I Street & 2nd Street/SR-99 Southbound Off-Ramp

Movement	EB	WB	WB
Directions Served	LTR	LT	R
Maximum Queue (ft)	55	237	100
Average Queue (ft)	31	128	9
95th Queue (ft)	47	203	54
Link Distance (ft)	174	263	
Upstream Blk Time (%)			
Queuing Penalty (veh)			
Storage Bay Dist (ft)			50
Storage Blk Time (%)		41	
Queuing Penalty (veh)		5	

Queuing and Blocking Report

Intersection: 40: H Street & SR-99 Southbound On-Ramp/2nd Street

Movement	WB	SB
Directions Served	LTR	LT
Maximum Queue (ft)	56	35
Average Queue (ft)	23	7
95th Queue (ft)	51	18
Link Distance (ft)	278	153
Upstream Blk Time (%)		
Queuing Penalty (veh)		
Storage Bay Dist (ft)		
Storage Blk Time (%)		
Queuing Penalty (veh)		

Queuing and Blocking Report

Intersection: 42: SR-99 Southbound On-Ramp & 4th Street

Movement	EB	EB	WB	WB	WB
Directions Served	T	TR	L	T	T
Maximum Queue (ft)	38	87	181	49	182
Average Queue (ft)	7	33	56	10	87
95th Queue (ft)	30	74	121	35	177
Link Distance (ft)	38	38	226	226	226
Upstream Blk Time (%)	0	2			
Queuing Penalty (veh)	2	10			
Storage Bay Dist (ft)					
Storage Blk Time (%)					
Queuing Penalty (veh)					

Queues

43: SR-99 Northbound Off-Ramp/H Street & 4th Street

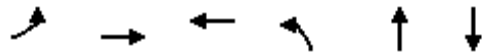

Lane Group	EBL	EBT	WBT	NBL	NBT	SBT
Lane Group Flow (vph)	271	612	630	278	255	72
v/c Ratio	0.86	0.40	0.90	0.71	0.48	0.17
Control Delay	46.0	7.7	51.5	44.6	9.5	2.0
Queue Delay	0.0	0.0	0.0	0.0	0.0	0.0
Total Delay	46.0	7.7	51.5	44.6	9.5	2.0
Queue Length 50th (ft)	166	69	179	149	13	0
Queue Length 95th (ft)	m#215	m86	#254	#240	67	5
Internal Link Dist (ft)		197	236		443	771
Turn Bay Length (ft)						
Base Capacity (vph)	327	1568	712	390	533	429
Starvation Cap Reductn	0	0	0	0	0	0
Spillback Cap Reductn	0	0	0	0	0	0
Storage Cap Reductn	0	0	0	0	0	0
Reduced v/c Ratio	0.83	0.39	0.88	0.71	0.48	0.17

Intersection Summary

95th percentile volume exceeds capacity, queue may be longer.

Queue shown is maximum after two cycles.

m Volume for 95th percentile queue is metered by upstream signal.

Queues
 45: Olive Avenue & SR-99 Southbound Off-Ramp

Village D Specific Plan
 Existing WP - AM Peak Hour

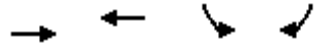

Lane Group	EBT	WBT	SBL	SBR
Lane Group Flow (vph)	799	519	537	105
v/c Ratio	0.70	0.66	0.48	0.10
Control Delay	31.7	35.7	8.9	3.4
Queue Delay	0.4	56.1	0.1	0.0
Total Delay	32.1	91.7	9.0	3.4
Queue Length 50th (ft)	131	141	123	9
Queue Length 95th (ft)	172	195	194	26
Internal Link Dist (ft)	103	112	135	
Turn Bay Length (ft)				
Base Capacity (vph)	1227	846	1112	1011
Starvation Cap Reductn	0	459	0	0
Spillback Cap Reductn	108	0	53	0
Storage Cap Reductn	0	0	0	0
Reduced v/c Ratio	0.71	1.34	0.51	0.10
Intersection Summary				

Queues
 46: Madera Avenue & SR-99 Northbound Ramps



Lane Group	WBL	WBT	WBR	NBL	NBT	SBT
Lane Group Flow (vph)	111	113	82	436	537	805
v/c Ratio	0.49	0.50	0.29	0.60	0.21	0.50
Control Delay	38.6	38.8	10.1	28.4	2.9	15.3
Queue Delay	0.0	0.0	0.0	0.0	0.0	0.0
Total Delay	38.6	38.8	10.1	28.4	2.9	15.3
Queue Length 50th (ft)	54	55	0	87	23	127
Queue Length 95th (ft)	98	101	35	m117	m36	202
Internal Link Dist (ft)		337			388	217
Turn Bay Length (ft)	140			205		
Base Capacity (vph)	381	382	416	729	2581	1598
Starvation Cap Reductn	0	0	0	0	0	0
Spillback Cap Reductn	0	0	0	0	0	0
Storage Cap Reductn	0	0	0	0	0	0
Reduced v/c Ratio	0.29	0.30	0.20	0.60	0.21	0.50

Intersection Summary

m Volume for 95th percentile queue is metered by upstream signal.

Queues

47: Madera Avenue & Olive Avenue/SR-99 Southbound On-Ramp



Lane Group	EBL	EBT	EBR	NBL	NBT	SBL	SBT
Lane Group Flow (vph)	376	428	517	134	564	88	725
v/c Ratio	0.87	0.94	0.61	0.37	0.35	0.48	0.44
Control Delay	37.8	48.6	4.8	35.1	14.1	54.6	2.4
Queue Delay	5.0	3.9	0.8	0.0	0.0	0.0	0.3
Total Delay	42.8	52.5	5.6	35.1	14.1	54.6	2.7
Queue Length 50th (ft)	90	103	20	32	91	49	5
Queue Length 95th (ft)	#344	#397	43	56	132	96	33
Internal Link Dist (ft)		112			323		388
Turn Bay Length (ft)				120		90	
Base Capacity (vph)	434	455	946	634	1629	214	1647
Starvation Cap Reductn	28	12	187	0	0	0	0
Spillback Cap Reductn	0	0	0	0	0	0	404
Storage Cap Reductn	0	0	0	0	0	0	0
Reduced v/c Ratio	0.93	0.97	0.68	0.21	0.35	0.41	0.58

Intersection Summary

95th percentile volume exceeds capacity, queue may be longer.
 Queue shown is maximum after two cycles.

Queuing and Blocking Report

Intersection: 48: Madera Avenue & Lewis Street

Movement	WB	NB	SB
Directions Served	LR	T	L
Maximum Queue (ft)	67	29	31
Average Queue (ft)	13	1	17
95th Queue (ft)	43	11	42
Link Distance (ft)	147	186	
Upstream Blk Time (%)			
Queuing Penalty (veh)			
Storage Bay Dist (ft)			100
Storage Blk Time (%)			
Queuing Penalty (veh)			

Queues
49: Yosemite Avenue & Cleveland Avenue/Tozer Street

Village D Specific Plan
Existing WP - AM Peak Hour



Lane Group	EBL	EBT	WBL	WBT	WBR	NBL	NBT	NBR	SBL	SBT
Lane Group Flow (vph)	337	938	131	354	49	156	125	88	71	528
v/c Ratio	0.96	0.82	0.84	0.47	0.11	0.92	0.22	0.15	0.44	1.01
Control Delay	76.0	32.1	81.9	32.9	0.5	94.5	25.9	0.5	47.4	72.7
Queue Delay	0.0	0.0	0.0	0.0	0.0	0.0	0.0	0.0	0.0	0.0
Total Delay	76.0	32.1	81.9	32.9	0.5	94.5	25.9	0.5	47.4	72.7
Queue Length 50th (ft)	191	232	75	92	0	90	55	0	39	-280
Queue Length 95th (ft)	#320	280	#158	125	0	#186	93	0	75	#437
Internal Link Dist (ft)		318		397			415			443
Turn Bay Length (ft)	210		150		60	240			150	
Base Capacity (vph)	352	1144	156	759	442	169	575	606	182	523
Starvation Cap Reductn	0	0	0	0	0	0	0	0	0	0
Spillback Cap Reductn	0	0	0	0	0	0	0	0	0	0
Storage Cap Reductn	0	0	0	0	0	0	0	0	0	0
Reduced v/c Ratio	0.96	0.82	0.84	0.47	0.11	0.92	0.22	0.15	0.39	1.01

Intersection Summary

- ~ Volume exceeds capacity, queue is theoretically infinite.
Queue shown is maximum after two cycles.
- # 95th percentile volume exceeds capacity, queue may be longer.
Queue shown is maximum after two cycles.

Queuing and Blocking Report

Intersection: 5: Road 23/SR-99 Southbound Off-Ramp & Avenue 18 1/2

Movement	EB	WB	NB	NB	SB
Directions Served	R	LT	L	R	LTR
Maximum Queue (ft)	85	131	366	76	301
Average Queue (ft)	14	34	190	73	266
95th Queue (ft)	49	100	346	79	291
Link Distance (ft)		193	351		238
Upstream Blk Time (%)			1		100
Queuing Penalty (veh)			0		0
Storage Bay Dist (ft)	50			25	
Storage Blk Time (%)	0		48	74	
Queuing Penalty (veh)	0		185	66	

Queuing and Blocking Report

Intersection: 6: SR-99 Northbound Ramps & Avenue 18 1/2

Movement	EB	NB
Directions Served	L	LTR
Maximum Queue (ft)	101	369
Average Queue (ft)	33	167
95th Queue (ft)	74	331
Link Distance (ft)		648
Upstream Blk Time (%)		
Queuing Penalty (veh)		
Storage Bay Dist (ft)	145	
Storage Blk Time (%)		
Queuing Penalty (veh)		

Queuing and Blocking Report

Intersection: 14: Avenue 17 & SR-99 Southbound Off-Ramp

Movement	WB	SB	SB
Directions Served	T	L	R
Maximum Queue (ft)	271	152	484
Average Queue (ft)	204	64	227
95th Queue (ft)	385	119	485
Link Distance (ft)	266	1017	
Upstream Blk Time (%)	72		
Queuing Penalty (veh)	901		
Storage Bay Dist (ft)			610
Storage Blk Time (%)			
Queuing Penalty (veh)			

Queuing and Blocking Report

Intersection: 15: SR-99 Northbound Ramps & Avenue 17

Movement	EB	WB	B82	NB
Directions Served	L	TR	T	LT
Maximum Queue (ft)	59	419	452	644
Average Queue (ft)	7	285	301	632
95th Queue (ft)	31	591	640	651
Link Distance (ft)		348	441	629
Upstream Blk Time (%)		67	63	100
Queuing Penalty (veh)		555	523	0
Storage Bay Dist (ft)	125			
Storage Blk Time (%)				100
Queuing Penalty (veh)				0

Queuing and Blocking Report

Intersection: 25: Kennedy Street/Gateway Drive & SR-99 Southbound Ramps

Movement	EB	WB	SB	SB
Directions Served	L	TR	L	R
Maximum Queue (ft)	75	22	159	127
Average Queue (ft)	34	1	57	50
95th Queue (ft)	71	9	115	96
Link Distance (ft)		841	509	
Upstream Blk Time (%)				
Queuing Penalty (veh)				
Storage Bay Dist (ft)	140			335
Storage Blk Time (%)				
Queuing Penalty (veh)				

Queuing and Blocking Report

Intersection: 26: Gateway Drive & SR-99 Northbound Off-Ramp

Movement	EB	SB
Directions Served	LT	LR
Maximum Queue (ft)	77	66
Average Queue (ft)	21	37
95th Queue (ft)	63	59
Link Distance (ft)	841	55
Upstream Blk Time (%)		1
Queuing Penalty (veh)		3
Storage Bay Dist (ft)		
Storage Blk Time (%)		
Queuing Penalty (veh)		

Queuing and Blocking Report

Intersection: 27: SR-99 Northbound Off-Ramp

Movement	EB	SB
Directions Served	L	TR
Maximum Queue (ft)	55	73
Average Queue (ft)	44	10
95th Queue (ft)	63	41
Link Distance (ft)	55	503
Upstream Blk Time (%)	1	
Queuing Penalty (veh)	2	
Storage Bay Dist (ft)		
Storage Blk Time (%)		
Queuing Penalty (veh)		

Queuing and Blocking Report

Intersection: 28: Gateway Drive & SR-99 Northbound Off-Ramp

Movement	SB
Directions Served	LR
Maximum Queue (ft)	31
Average Queue (ft)	1
95th Queue (ft)	12
Link Distance (ft)	162
Upstream Blk Time (%)	
Queuing Penalty (veh)	
Storage Bay Dist (ft)	
Storage Blk Time (%)	
Queuing Penalty (veh)	

Queues
31: SR-99 Southbound Ramps & Cleveland Avenue

Village D Specific Plan
Existing WP - PM Peak Hour



Lane Group	EBT	EBR	WBL	WBT	SBL	SBR
Lane Group Flow (vph)	975	586	199	1842	219	95
v/c Ratio	0.71	0.61	0.52	0.79	0.49	0.21
Control Delay	11.2	4.4	28.9	8.3	33.9	11.3
Queue Delay	0.1	0.0	0.0	3.4	0.0	0.0
Total Delay	11.3	4.4	28.9	11.7	33.9	11.3
Queue Length 50th (ft)	99	25	104	242	109	10
Queue Length 95th (ft)	m117	m39	m135	m190	181	48
Internal Link Dist (ft)	1412			372		
Turn Bay Length (ft)			115			140
Base Capacity (vph)	1449	986	386	2386	443	444
Starvation Cap Reductn	0	0	0	439	0	0
Spillback Cap Reductn	38	0	0	0	0	0
Storage Cap Reductn	0	0	0	0	0	0
Reduced v/c Ratio	0.69	0.59	0.52	0.95	0.49	0.21

Intersection Summary

m Volume for 95th percentile queue is metered by upstream signal.

Queues
32: SR-99 Northbound Ramps & Cleveland Avenue



Lane Group	EBL	EBT	WBT	WBR	NBL	NBT	NBR
Lane Group Flow (vph)	107	1112	1200	249	442	447	279
v/c Ratio	0.51	0.66	1.02	0.45	0.61	0.61	0.39
Control Delay	36.5	9.2	53.8	15.7	26.1	26.3	16.2
Queue Delay	0.0	0.8	29.0	1.1	0.0	0.0	0.0
Total Delay	36.5	10.0	82.8	16.8	26.1	26.3	16.2
Queue Length 50th (ft)	66	164	~302	43	208	211	79
Queue Length 95th (ft)	m103	195	#500	m66	345	348	157
Internal Link Dist (ft)		372	207			441	
Turn Bay Length (ft)	90			50	145		325
Base Capacity (vph)	287	1925	1171	555	728	730	717
Starvation Cap Reductn	0	462	148	135	0	0	0
Spillback Cap Reductn	0	0	15	0	0	0	0
Storage Cap Reductn	0	0	0	0	0	0	0
Reduced v/c Ratio	0.37	0.76	1.17	0.59	0.61	0.61	0.39

Intersection Summary

- ~ Volume exceeds capacity, queue is theoretically infinite.
Queue shown is maximum after two cycles.
- # 95th percentile volume exceeds capacity, queue may be longer.
Queue shown is maximum after two cycles.
- m Volume for 95th percentile queue is metered by upstream signal.

Queuing and Blocking Report

Intersection: 38: I Street & 2nd Street/SR-99 Southbound Off-Ramp

Movement	EB	WB	NB
Directions Served	LTR	LT	L
Maximum Queue (ft)	30	119	25
Average Queue (ft)	24	76	1
95th Queue (ft)	44	110	10
Link Distance (ft)	174	263	
Upstream Blk Time (%)			
Queuing Penalty (veh)			
Storage Bay Dist (ft)			75
Storage Blk Time (%)		13	
Queuing Penalty (veh)		1	

Queuing and Blocking Report

Intersection: 40: H Street & SR-99 Southbound On-Ramp/2nd Street

Movement	WB	NB	SB
Directions Served	LTR	LTR	LTR
Maximum Queue (ft)	95	20	32
Average Queue (ft)	37	1	9
95th Queue (ft)	70	8	24
Link Distance (ft)	278	766	139
Upstream Blk Time (%)			
Queuing Penalty (veh)			
Storage Bay Dist (ft)			
Storage Blk Time (%)			
Queuing Penalty (veh)			

Queuing and Blocking Report

Intersection: 42: SR-99 Southbound On-Ramp & 4th Street

Movement	EB	EB	WB	WB	WB
Directions Served	T	TR	L	T	T
Maximum Queue (ft)	38	57	160	52	230
Average Queue (ft)	15	26	64	15	128
95th Queue (ft)	42	56	118	48	235
Link Distance (ft)	38	38	226	226	226
Upstream Blk Time (%)	1	2			2
Queuing Penalty (veh)	3	7			6
Storage Bay Dist (ft)					
Storage Blk Time (%)					
Queuing Penalty (veh)					

Queues

43: SR-99 Northbound Off-Ramp/H Street & 4th Street

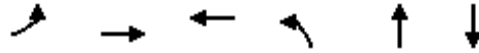

Lane Group	EBL	EBT	WBT	NBL	NBT	SBT
Lane Group Flow (vph)	269	464	701	254	173	91
v/c Ratio	0.84	0.29	0.87	0.62	0.35	0.23
Control Delay	45.9	6.9	47.9	42.9	9.8	5.5
Queue Delay	0.0	0.0	0.0	0.0	0.0	0.0
Total Delay	45.9	6.9	47.9	42.9	9.8	5.5
Queue Length 50th (ft)	180	51	215	150	10	0
Queue Length 95th (ft)	m#293	66	#307	237	66	28
Internal Link Dist (ft)		197	236		443	771
Turn Bay Length (ft)						
Base Capacity (vph)	348	1697	831	412	489	394
Starvation Cap Reductn	0	0	0	0	0	0
Spillback Cap Reductn	0	0	0	0	0	0
Storage Cap Reductn	0	0	0	0	0	0
Reduced v/c Ratio	0.77	0.27	0.84	0.62	0.35	0.23

Intersection Summary

95th percentile volume exceeds capacity, queue may be longer.

Queue shown is maximum after two cycles.

m Volume for 95th percentile queue is metered by upstream signal.

Queues
 45: Olive Avenue & SR-99 Southbound Off-Ramp

Village D Specific Plan
 Existing WP - PM Peak Hour

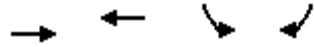

Lane Group	EBT	WBT	SBL	SBR
Lane Group Flow (vph)	716	679	348	68
v/c Ratio	0.60	0.81	0.30	0.07
Control Delay	32.7	50.6	7.4	4.0
Queue Delay	0.3	55.8	0.0	0.0
Total Delay	33.0	106.4	7.4	4.0
Queue Length 50th (ft)	130	222	77	7
Queue Length 95th (ft)	169	280	120	21
Internal Link Dist (ft)	103	112	135	
Turn Bay Length (ft)				
Base Capacity (vph)	1284	893	1166	1040
Starvation Cap Reductn	0	529	0	0
Spillback Cap Reductn	154	0	1	0
Storage Cap Reductn	0	0	0	0
Reduced v/c Ratio	0.63	1.87	0.30	0.07
Intersection Summary				

Queues

46: Madera Avenue & SR-99 Northbound Ramps



Lane Group	WBL	WBT	WBR	NBL	NBT	SBT
Lane Group Flow (vph)	184	186	35	554	644	945
v/c Ratio	0.66	0.67	0.11	0.64	0.24	0.62
Control Delay	46.5	46.8	2.2	40.0	6.7	20.9
Queue Delay	0.0	0.0	0.0	0.0	0.0	0.0
Total Delay	46.5	46.8	2.2	40.0	6.7	20.9
Queue Length 50th (ft)	104	105	0	161	71	196
Queue Length 95th (ft)	169	170	6	m204	m87	283
Internal Link Dist (ft)		337			388	217
Turn Bay Length (ft)	140			205		
Base Capacity (vph)	350	351	384	866	2631	1513
Starvation Cap Reductn	0	0	0	0	0	0
Spillback Cap Reductn	0	0	0	0	0	0
Storage Cap Reductn	0	0	0	0	0	0
Reduced v/c Ratio	0.53	0.53	0.09	0.64	0.24	0.62

Intersection Summary

m Volume for 95th percentile queue is metered by upstream signal.

Queues

47: Madera Avenue & Olive Avenue/SR-99 Southbound On-Ramp

Village D Specific Plan

Existing WP - PM Peak Hour



Lane Group	EBL	EBT	EBR	NBL	NBT	SBL	SBT
Lane Group Flow (vph)	314	321	407	157	752	134	851
v/c Ratio	0.93	0.91	0.57	0.73	0.40	0.68	0.40
Control Delay	55.1	51.8	5.2	62.0	13.1	60.0	1.9
Queue Delay	4.2	4.1	0.2	0.0	0.0	0.0	0.7
Total Delay	59.3	55.9	5.3	62.0	13.1	60.0	2.7
Queue Length 50th (ft)	193	196	0	46	126	62	14
Queue Length 95th (ft)	#355	#356	7	#94	167	m#131	6
Internal Link Dist (ft)		112			323		388
Turn Bay Length (ft)				120		90	
Base Capacity (vph)	342	355	712	216	1889	208	2110
Starvation Cap Reductn	11	13	30	0	0	0	0
Spillback Cap Reductn	0	0	0	0	0	0	858
Storage Cap Reductn	0	0	0	0	0	0	0
Reduced v/c Ratio	0.95	0.94	0.60	0.73	0.40	0.64	0.68

Intersection Summary

95th percentile volume exceeds capacity, queue may be longer.

Queue shown is maximum after two cycles.

m Volume for 95th percentile queue is metered by upstream signal.

Queuing and Blocking Report

Intersection: 48: Madera Avenue & Lewis Street

Movement	WB	SB
Directions Served	LR	L
Maximum Queue (ft)	54	49
Average Queue (ft)	15	18
95th Queue (ft)	47	45
Link Distance (ft)	147	
Upstream Blk Time (%)		
Queuing Penalty (veh)		
Storage Bay Dist (ft)		100
Storage Blk Time (%)		
Queuing Penalty (veh)		

Queues
49: Yosemite Avenue & Cleveland Avenue/Tozer Street

Village D Specific Plan
Existing WP - PM Peak Hour



Lane Group	EBL	EBT	WBL	WBT	WBR	NBL	NBT	NBR	SBL	SBT
Lane Group Flow (vph)	279	667	52	513	38	332	308	103	73	541
v/c Ratio	0.98	0.60	0.51	0.74	0.08	0.98	0.41	0.14	0.48	1.03
Control Delay	92.6	28.6	64.0	45.2	0.3	86.5	24.8	1.1	54.3	78.0
Queue Delay	0.0	0.0	0.0	0.0	0.0	0.0	0.0	0.0	0.0	0.0
Total Delay	92.6	28.6	64.0	45.2	0.3	86.5	24.8	1.1	54.3	78.0
Queue Length 50th (ft)	179	171	33	163	0	212	146	0	45	-322
Queue Length 95th (ft)	#344	233	#79	222	0	#390	224	8	90	#531
Internal Link Dist (ft)		318		397			415			443
Turn Bay Length (ft)	210		150		60	240			150	
Base Capacity (vph)	284	1108	102	696	475	338	747	733	171	525
Starvation Cap Reductn	0	0	0	0	0	0	0	0	0	0
Spillback Cap Reductn	0	0	0	0	0	0	0	0	0	0
Storage Cap Reductn	0	0	0	0	0	0	0	0	0	0
Reduced v/c Ratio	0.98	0.60	0.51	0.74	0.08	0.98	0.41	0.14	0.43	1.03

Intersection Summary

- ~ Volume exceeds capacity, queue is theoretically infinite.
Queue shown is maximum after two cycles.
- # 95th percentile volume exceeds capacity, queue may be longer.
Queue shown is maximum after two cycles.

Queuing and Blocking Report

Intersection: 5: Road 23/SR-99 Southbound Off-Ramp & Avenue 18 1/2

Movement	EB	EB	WB	NB	NB	SB
Directions Served	T	R	LT	L	R	LTR
Maximum Queue (ft)	25	32	128	142	78	253
Average Queue (ft)	1	2	26	46	63	73
95th Queue (ft)	10	13	80	115	87	156
Link Distance (ft)	247		193	351		238
Upstream Blk Time (%)						1
Queuing Penalty (veh)						0
Storage Bay Dist (ft)		50			25	
Storage Blk Time (%)		0		29	20	
Queuing Penalty (veh)		0		42	12	

Queuing and Blocking Report

Intersection: 6: SR-99 Northbound Ramps & Avenue 18 1/2

Movement	EB	NB
Directions Served	L	LTR
Maximum Queue (ft)	111	239
Average Queue (ft)	38	112
95th Queue (ft)	84	211
Link Distance (ft)		648
Upstream Blk Time (%)		
Queuing Penalty (veh)		
Storage Bay Dist (ft)	145	
Storage Blk Time (%)		
Queuing Penalty (veh)		

Queuing and Blocking Report

Intersection: 14: Avenue 17 & SR-99 Southbound Off-Ramp

Movement	WB	SB	SB
Directions Served	T	L	R
Maximum Queue (ft)	20	244	98
Average Queue (ft)	1	106	50
95th Queue (ft)	8	179	79
Link Distance (ft)	266	1017	
Upstream Blk Time (%)			
Queuing Penalty (veh)			
Storage Bay Dist (ft)			610
Storage Blk Time (%)			
Queuing Penalty (veh)			

Queuing and Blocking Report

Intersection: 15: SR-99 Northbound Ramps & Avenue 17

Movement	EB	EB	WB	NB	NB
Directions Served	L	T	TR	LT	R
Maximum Queue (ft)	108	159	37	692	100
Average Queue (ft)	52	8	3	652	59
95th Queue (ft)	97	62	18	679	139
Link Distance (ft)		511	460	628	
Upstream Blk Time (%)				99	
Queuing Penalty (veh)				0	
Storage Bay Dist (ft)	125				50
Storage Blk Time (%)	0	0		98	12
Queuing Penalty (veh)	0	0		235	19

Queuing and Blocking Report

Intersection: 25: Kennedy Street/Gateway Drive & SR-99 Southbound Ramps

Movement	EB	SB	SB
Directions Served	L	L	R
Maximum Queue (ft)	76	95	31
Average Queue (ft)	38	35	29
95th Queue (ft)	78	67	40
Link Distance (ft)		509	
Upstream Blk Time (%)			
Queuing Penalty (veh)			
Storage Bay Dist (ft)	140		335
Storage Blk Time (%)			
Queuing Penalty (veh)			

Queuing and Blocking Report

Intersection: 26: Gateway Drive & SR-99 Northbound Off-Ramp

Movement	EB	SB
Directions Served	LT	LR
Maximum Queue (ft)	32	75
Average Queue (ft)	13	47
95th Queue (ft)	38	72
Link Distance (ft)	841	55
Upstream Blk Time (%)		3
Queuing Penalty (veh)		6
Storage Bay Dist (ft)		
Storage Blk Time (%)		
Queuing Penalty (veh)		

Queuing and Blocking Report

Intersection: 27: SR-99 Northbound Off-Ramp

Movement	EB	SB
Directions Served	L	TR
Maximum Queue (ft)	54	91
Average Queue (ft)	32	20
95th Queue (ft)	45	67
Link Distance (ft)	55	503
Upstream Blk Time (%)	0	
Queuing Penalty (veh)	1	
Storage Bay Dist (ft)		
Storage Blk Time (%)		
Queuing Penalty (veh)		

Queuing and Blocking Report

Intersection: 28: Gateway Drive & SR-99 Northbound Off-Ramp

Movement
Directions Served
Maximum Queue (ft)
Average Queue (ft)
95th Queue (ft)
Link Distance (ft)
Upstream Blk Time (%)
Queuing Penalty (veh)
Storage Bay Dist (ft)
Storage Blk Time (%)
Queuing Penalty (veh)

Queues
31: SR-99 Southbound Ramps & Cleveland Avenue

Village D Specific Plan
Phase I NP - AM Peak Hour



Lane Group	EBT	EBR	WBL	WBT	SBL	SBR
Lane Group Flow (vph)	479	385	368	725	71	59
v/c Ratio	0.63	0.60	0.78	0.38	0.13	0.11
Control Delay	35.0	7.3	60.8	8.3	24.7	5.8
Queue Delay	0.0	0.0	0.1	0.0	0.0	0.0
Total Delay	35.0	7.3	61.0	8.3	24.7	5.8
Queue Length 50th (ft)	130	0	230	77	27	0
Queue Length 95th (ft)	170	67	320	70	69	24
Internal Link Dist (ft)	1412			372		
Turn Bay Length (ft)			115			140
Base Capacity (vph)	912	691	632	2356	565	545
Starvation Cap Reductn	0	0	18	0	0	0
Spillback Cap Reductn	0	0	0	0	0	0
Storage Cap Reductn	0	0	0	0	0	0
Reduced v/c Ratio	0.53	0.56	0.60	0.31	0.13	0.11
Intersection Summary						

Queues
32: SR-99 Northbound Ramps & Cleveland Avenue



Lane Group	EBL	EBT	WBT	WBR	NBL	NBT	NBR
Lane Group Flow (vph)	57	495	822	85	137	137	317
v/c Ratio	0.36	0.32	0.72	0.15	0.18	0.18	0.36
Control Delay	52.7	15.7	16.8	4.3	19.1	19.1	4.0
Queue Delay	0.0	0.0	1.6	0.0	0.0	0.0	0.0
Total Delay	52.7	15.7	18.3	4.3	19.1	19.1	4.0
Queue Length 50th (ft)	35	35	246	13	49	49	0
Queue Length 95th (ft)	m69	63	242	m2	109	109	57
Internal Link Dist (ft)		372	207			441	
Turn Bay Length (ft)	90			50	145		325
Base Capacity (vph)	238	2005	1389	665	741	741	871
Starvation Cap Reductn	0	0	369	0	0	0	0
Spillback Cap Reductn	0	0	0	0	0	0	0
Storage Cap Reductn	0	0	0	0	0	0	0
Reduced v/c Ratio	0.24	0.25	0.81	0.13	0.18	0.18	0.36

Intersection Summary

m Volume for 95th percentile queue is metered by upstream signal.

Queuing and Blocking Report

Intersection: 38: I Street & 2nd Street/SR-99 Southbound Off-Ramp

Movement	EB	WB	NB
Directions Served	LTR	LT	L
Maximum Queue (ft)	54	122	24
Average Queue (ft)	28	85	1
95th Queue (ft)	53	120	9
Link Distance (ft)	174	263	
Upstream Blk Time (%)			
Queuing Penalty (veh)			
Storage Bay Dist (ft)			75
Storage Blk Time (%)		20	
Queuing Penalty (veh)		2	

Queuing and Blocking Report

Intersection: 40: H Street & SR-99 Southbound On-Ramp/2nd Street

Movement	WB	NB	SB
Directions Served	LTR	LTR	LT
Maximum Queue (ft)	55	90	34
Average Queue (ft)	30	4	11
95th Queue (ft)	56	35	26
Link Distance (ft)	278	766	153
Upstream Blk Time (%)			
Queuing Penalty (veh)			
Storage Bay Dist (ft)			
Storage Blk Time (%)			
Queuing Penalty (veh)			

Queuing and Blocking Report

Intersection: 42: SR-99 Southbound On-Ramp & 4th Street

Movement	EB	EB	WB	WB	WB
Directions Served	T	TR	L	T	T
Maximum Queue (ft)	38	84	138	72	226
Average Queue (ft)	9	30	65	17	147
95th Queue (ft)	32	75	113	51	221
Link Distance (ft)	38	38	226	226	226
Upstream Blk Time (%)	1	3			1
Queuing Penalty (veh)	3	16			2
Storage Bay Dist (ft)					
Storage Blk Time (%)					
Queuing Penalty (veh)					

Queues

43: SR-99 Northbound Off-Ramp/H Street & 4th Street

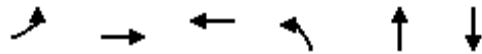

Lane Group	EBL	EBT	WBT	NBL	NBT	SBT
Lane Group Flow (vph)	250	499	603	275	258	79
v/c Ratio	0.82	0.33	0.88	0.69	0.48	0.18
Control Delay	61.1	26.7	49.4	42.8	9.5	2.7
Queue Delay	0.0	0.0	0.0	0.0	0.0	0.0
Total Delay	61.1	26.7	49.4	42.8	9.5	2.7
Queue Length 50th (ft)	128	119	171	147	14	0
Queue Length 95th (ft)	m#186	m158	#261	#258	79	13
Internal Link Dist (ft)		197	236		443	771
Turn Bay Length (ft)						
Base Capacity (vph)	324	1553	706	401	542	429
Starvation Cap Reductn	0	0	0	0	0	0
Spillback Cap Reductn	0	0	0	0	0	0
Storage Cap Reductn	0	0	0	0	0	0
Reduced v/c Ratio	0.77	0.32	0.85	0.69	0.48	0.18

Intersection Summary

95th percentile volume exceeds capacity, queue may be longer.

Queue shown is maximum after two cycles.

m Volume for 95th percentile queue is metered by upstream signal.

Queues
 45: Olive Avenue & SR-99 Southbound Off-Ramp

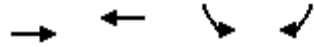

Lane Group	EBT	WBT	SBL	SBR
Lane Group Flow (vph)	562	470	467	113
v/c Ratio	0.57	0.68	0.41	0.11
Control Delay	30.9	32.8	7.3	3.0
Queue Delay	0.6	5.6	0.0	0.0
Total Delay	31.5	38.4	7.3	3.0
Queue Length 50th (ft)	92	132	90	8
Queue Length 95th (ft)	123	182	155	25
Internal Link Dist (ft)	103	112	135	
Turn Bay Length (ft)				
Base Capacity (vph)	1142	795	1127	1025
Starvation Cap Reductn	0	261	0	0
Spillback Cap Reductn	266	0	0	0
Storage Cap Reductn	0	0	0	0
Reduced v/c Ratio	0.64	0.88	0.41	0.11
Intersection Summary				

Queues
46: Madera Avenue & SR-99 Northbound Ramps



Lane Group	WBL	WBT	WBR	NBL	NBT	SBT
Lane Group Flow (vph)	91	92	93	498	450	862
v/c Ratio	0.45	0.45	0.34	0.70	0.17	0.50
Control Delay	38.5	38.6	10.7	36.7	4.6	14.2
Queue Delay	0.0	0.0	0.0	0.0	0.0	0.0
Total Delay	38.5	38.6	10.7	36.7	4.6	14.2
Queue Length 50th (ft)	45	46	0	86	14	136
Queue Length 95th (ft)	85	86	38	176	91	213
Internal Link Dist (ft)		337			388	217
Turn Bay Length (ft)	140			205		
Base Capacity (vph)	377	378	421	715	2699	1720
Starvation Cap Reductn	0	0	0	0	0	0
Spillback Cap Reductn	0	0	0	0	0	0
Storage Cap Reductn	0	0	0	0	0	0
Reduced v/c Ratio	0.24	0.24	0.22	0.70	0.17	0.50
Intersection Summary						

Queues

47: Madera Avenue & Olive Avenue/SR-99 Southbound On-Ramp



Lane Group	EBL	EBT	EBR	NBL	NBT	SBL	SBT
Lane Group Flow (vph)	275	287	455	146	602	89	720
v/c Ratio	0.69	0.69	0.62	0.39	0.36	0.47	0.44
Control Delay	26.4	26.3	11.2	35.1	15.2	28.8	23.0
Queue Delay	5.0	5.7	6.4	0.0	0.0	0.0	0.3
Total Delay	31.4	31.9	17.5	35.1	15.2	28.8	23.4
Queue Length 50th (ft)	128	134	129	35	96	43	151
Queue Length 95th (ft)	185	192	188	60	166	83	210
Internal Link Dist (ft)		112			323		388
Turn Bay Length (ft)				120		90	
Base Capacity (vph)	556	577	841	628	1657	218	1634
Starvation Cap Reductn	213	228	327	0	0	0	0
Spillback Cap Reductn	0	0	0	0	0	0	390
Storage Cap Reductn	0	0	0	0	0	0	0
Reduced v/c Ratio	0.80	0.82	0.89	0.23	0.36	0.41	0.58

Intersection Summary

Queuing and Blocking Report

Intersection: 48: Madera Avenue & Lewis Street

Movement	WB	SB
Directions Served	LR	L
Maximum Queue (ft)	72	31
Average Queue (ft)	22	10
95th Queue (ft)	57	33
Link Distance (ft)	147	
Upstream Blk Time (%)		
Queuing Penalty (veh)		
Storage Bay Dist (ft)		100
Storage Blk Time (%)		
Queuing Penalty (veh)		

Queues
49: Yosemite Avenue & Cleveland Avenue/Tozer Street

Village D Specific Plan
Phase I NP - AM Peak Hour



Lane Group	EBL	EBT	WBL	WBT	WBR	NBL	NBT	NBR	SBL	SBT
Lane Group Flow (vph)	195	839	122	336	51	146	126	82	72	467
v/c Ratio	0.69	0.66	0.85	0.34	0.10	1.09	0.23	0.14	0.51	0.93
Control Delay	47.8	23.6	89.0	27.7	0.4	145.7	26.5	0.5	53.1	55.7
Queue Delay	0.0	0.0	0.0	0.0	0.0	0.0	0.0	0.0	0.0	0.0
Total Delay	47.8	23.6	89.0	27.7	0.4	145.7	26.5	0.5	53.1	55.7
Queue Length 50th (ft)	105	181	71	81	0	~94	56	0	40	234
Queue Length 95th (ft)	170	246	#180	125	0	#213	102	0	83	#417
Internal Link Dist (ft)		318		397			415			443
Turn Bay Length (ft)	210		150		60	240			150	
Base Capacity (vph)	352	1270	143	999	524	134	540	580	147	521
Starvation Cap Reductn	0	0	0	0	0	0	0	0	0	0
Spillback Cap Reductn	0	0	0	0	0	0	0	0	0	0
Storage Cap Reductn	0	0	0	0	0	0	0	0	0	0
Reduced v/c Ratio	0.55	0.66	0.85	0.34	0.10	1.09	0.23	0.14	0.49	0.90

Intersection Summary

~ Volume exceeds capacity, queue is theoretically infinite.
Queue shown is maximum after two cycles.

95th percentile volume exceeds capacity, queue may be longer.
Queue shown is maximum after two cycles.

Queuing and Blocking Report

Intersection: 5: Road 23/SR-99 Southbound Off-Ramp & Avenue 18 1/2

Movement	EB	EB	WB	NB	NB	SB
Directions Served	T	R	LT	L	R	LTR
Maximum Queue (ft)	24	80	98	90	76	265
Average Queue (ft)	1	10	21	22	43	151
95th Queue (ft)	10	43	76	56	77	262
Link Distance (ft)	247		193	351		238
Upstream Blk Time (%)						2
Queuing Penalty (veh)						0
Storage Bay Dist (ft)		50			25	
Storage Blk Time (%)		0		11	17	
Queuing Penalty (veh)		0		12	6	

Queuing and Blocking Report

Intersection: 6: SR-99 Northbound Ramps & Avenue 18 1/2

Movement	EB	NB
Directions Served	L	LTR
Maximum Queue (ft)	42	150
Average Queue (ft)	17	73
95th Queue (ft)	44	136
Link Distance (ft)		648
Upstream Blk Time (%)		
Queuing Penalty (veh)		
Storage Bay Dist (ft)	145	
Storage Blk Time (%)		
Queuing Penalty (veh)		

Queuing and Blocking Report

Intersection: 14: Avenue 17 & SR-99 Southbound Off-Ramp

Movement	SB	SB
Directions Served	L	R
Maximum Queue (ft)	1080	760
Average Queue (ft)	985	385
95th Queue (ft)	1239	1004
Link Distance (ft)	1017	
Upstream Blk Time (%)	80	
Queuing Penalty (veh)	0	
Storage Bay Dist (ft)		610
Storage Blk Time (%)	93	
Queuing Penalty (veh)	55	

Queuing and Blocking Report

Intersection: 15: SR-99 Northbound Ramps & Avenue 17

Movement	EB	EB	WB	NB	NB
Directions Served	L	T	TR	LT	R
Maximum Queue (ft)	122	119	80	681	100
Average Queue (ft)	58	10	4	648	64
95th Queue (ft)	107	60	31	676	139
Link Distance (ft)		511	348	629	
Upstream Blk Time (%)				100	
Queuing Penalty (veh)				0	
Storage Bay Dist (ft)	125				50
Storage Blk Time (%)	0	0		86	45
Queuing Penalty (veh)	1	0		453	53

Queuing and Blocking Report

Intersection: 25: Kennedy Street/Gateway Drive & SR-99 Southbound Ramps

Movement	EB	SB	SB
Directions Served	L	L	R
Maximum Queue (ft)	74	133	90
Average Queue (ft)	31	50	47
95th Queue (ft)	63	80	74
Link Distance (ft)		509	
Upstream Blk Time (%)			
Queuing Penalty (veh)			
Storage Bay Dist (ft)	140		335
Storage Blk Time (%)			
Queuing Penalty (veh)			

Queuing and Blocking Report

Intersection: 26: Gateway Drive & SR-99 Northbound Off-Ramp

Movement	EB	SB
Directions Served	LT	LR
Maximum Queue (ft)	55	70
Average Queue (ft)	20	39
95th Queue (ft)	59	62
Link Distance (ft)	841	55
Upstream Blk Time (%)		1
Queuing Penalty (veh)		2
Storage Bay Dist (ft)		
Storage Blk Time (%)		
Queuing Penalty (veh)		

Queuing and Blocking Report

Intersection: 27: SR-99 Northbound Off-Ramp

Movement	EB	SB
Directions Served	L	TR
Maximum Queue (ft)	55	50
Average Queue (ft)	36	11
95th Queue (ft)	54	37
Link Distance (ft)	55	503
Upstream Blk Time (%)	1	
Queuing Penalty (veh)	1	
Storage Bay Dist (ft)		
Storage Blk Time (%)		
Queuing Penalty (veh)		

Queuing and Blocking Report

Intersection: 28: Gateway Drive & SR-99 Northbound Off-Ramp

Movement	SB
Directions Served	LR
Maximum Queue (ft)	31
Average Queue (ft)	1
95th Queue (ft)	12
Link Distance (ft)	162
Upstream Blk Time (%)	
Queuing Penalty (veh)	
Storage Bay Dist (ft)	
Storage Blk Time (%)	
Queuing Penalty (veh)	

Queues
31: SR-99 Southbound Ramps & Cleveland Avenue



Lane Group	EBT	EBR	WBL	WBT	SBL	SBR
Lane Group Flow (vph)	749	365	264	1184	156	82
v/c Ratio	0.65	0.48	0.76	0.58	0.27	0.15
Control Delay	17.1	3.9	40.3	7.6	25.8	6.8
Queue Delay	0.0	0.0	0.0	0.2	0.0	0.0
Total Delay	17.1	3.9	40.3	7.8	25.8	6.8
Queue Length 50th (ft)	118	23	138	122	68	0
Queue Length 95th (ft)	m135	m44	#302	147	125	33
Internal Link Dist (ft)	1412			372		
Turn Bay Length (ft)			115			140
Base Capacity (vph)	1489	868	348	2243	577	562
Starvation Cap Reductn	0	0	0	309	0	0
Spillback Cap Reductn	0	0	0	0	0	0
Storage Cap Reductn	0	0	0	0	0	0
Reduced v/c Ratio	0.50	0.42	0.76	0.61	0.27	0.15

Intersection Summary

95th percentile volume exceeds capacity, queue may be longer.

Queue shown is maximum after two cycles.

m Volume for 95th percentile queue is metered by upstream signal.

Queues
 32: SR-99 Northbound Ramps & Cleveland Avenue



Lane Group	EBL	EBT	WBT	WBR	NBL	NBT	NBR
Lane Group Flow (vph)	78	846	954	69	263	268	308
v/c Ratio	0.50	0.51	0.76	0.12	0.36	0.36	0.41
Control Delay	41.2	6.2	16.4	1.8	21.2	21.3	13.1
Queue Delay	0.0	0.4	0.6	0.0	0.0	0.0	0.0
Total Delay	41.2	6.5	17.0	1.8	21.2	21.3	13.1
Queue Length 50th (ft)	49	49	137	0	112	114	67
Queue Length 95th (ft)	95	60	144	m0	189	192	145
Internal Link Dist (ft)		372	207			441	
Turn Bay Length (ft)	90			50	145		325
Base Capacity (vph)	171	1925	1409	653	736	738	760
Starvation Cap Reductn	0	533	171	0	0	0	0
Spillback Cap Reductn	0	0	0	0	0	0	0
Storage Cap Reductn	0	0	0	0	0	0	0
Reduced v/c Ratio	0.46	0.61	0.77	0.11	0.36	0.36	0.41

Intersection Summary

m Volume for 95th percentile queue is metered by upstream signal.

Queuing and Blocking Report

Intersection: 38: I Street & 2nd Street/SR-99 Southbound Off-Ramp

Movement	EB	WB	NB
Directions Served	LTR	LT	L
Maximum Queue (ft)	31	114	26
Average Queue (ft)	23	68	8
95th Queue (ft)	44	103	27
Link Distance (ft)	174	263	
Upstream Blk Time (%)			
Queuing Penalty (veh)			
Storage Bay Dist (ft)			75
Storage Blk Time (%)		10	
Queuing Penalty (veh)		0	

Queuing and Blocking Report

Intersection: 40: H Street & SR-99 Southbound On-Ramp/2nd Street

Movement	WB	SB
Directions Served	LTR	LTR
Maximum Queue (ft)	94	32
Average Queue (ft)	38	3
95th Queue (ft)	71	15
Link Distance (ft)	278	139
Upstream Blk Time (%)		
Queuing Penalty (veh)		
Storage Bay Dist (ft)		
Storage Blk Time (%)		
Queuing Penalty (veh)		

Queuing and Blocking Report

Intersection: 42: SR-99 Southbound On-Ramp & 4th Street

Movement	EB	EB	WB	WB	WB
Directions Served	T	TR	L	T	T
Maximum Queue (ft)	38	54	166	75	227
Average Queue (ft)	13	27	75	14	138
95th Queue (ft)	40	57	141	50	252
Link Distance (ft)	38	38	226	226	226
Upstream Blk Time (%)	1	2			3
Queuing Penalty (veh)	4	9			9
Storage Bay Dist (ft)					
Storage Blk Time (%)					
Queuing Penalty (veh)					

Queues

43: SR-99 Northbound Off-Ramp/H Street & 4th Street

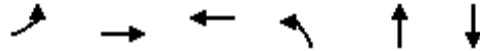

Lane Group	EBL	EBT	WBT	NBL	NBT	SBT
Lane Group Flow (vph)	238	428	676	270	204	107
v/c Ratio	0.78	0.27	0.85	0.62	0.39	0.27
Control Delay	42.4	7.4	46.7	42.4	10.0	8.0
Queue Delay	0.0	0.0	0.0	0.0	0.0	0.0
Total Delay	42.4	7.4	46.7	42.4	10.0	8.0
Queue Length 50th (ft)	160	48	207	159	14	0
Queue Length 95th (ft)	#242	65	#281	#269	76	40
Internal Link Dist (ft)		197	236		443	771
Turn Bay Length (ft)						
Base Capacity (vph)	348	1697	831	435	527	395
Starvation Cap Reductn	0	0	0	0	0	0
Spillback Cap Reductn	0	0	0	0	0	0
Storage Cap Reductn	0	0	0	0	0	0
Reduced v/c Ratio	0.68	0.25	0.81	0.62	0.39	0.27

Intersection Summary

95th percentile volume exceeds capacity, queue may be longer.
 Queue shown is maximum after two cycles.

Queues
 45: Olive Avenue & SR-99 Southbound Off-Ramp

Village D Specific Plan
 Phase I NP - PM Peak Hour

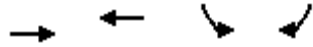

Lane Group	EBT	WBT	SBL	SBR
Lane Group Flow (vph)	602	454	397	81
v/c Ratio	0.66	0.70	0.32	0.07
Control Delay	37.6	45.3	5.8	2.1
Queue Delay	0.9	46.1	0.0	0.0
Total Delay	38.5	91.4	5.8	2.1
Queue Length 50th (ft)	116	147	71	4
Queue Length 95th (ft)	151	197	119	17
Internal Link Dist (ft)	103	112	135	
Turn Bay Length (ft)				
Base Capacity (vph)	1045	734	1236	1107
Starvation Cap Reductn	0	312	0	0
Spillback Cap Reductn	199	0	0	0
Storage Cap Reductn	0	0	0	0
Reduced v/c Ratio	0.71	1.08	0.32	0.07
Intersection Summary				

Queues

46: Madera Avenue & SR-99 Northbound Ramps



Lane Group	WBL	WBT	WBR	NBL	NBT	SBT
Lane Group Flow (vph)	101	102	36	577	657	869
v/c Ratio	0.50	0.50	0.14	0.62	0.24	0.55
Control Delay	45.0	45.1	3.2	31.5	4.0	18.7
Queue Delay	0.0	0.0	0.0	0.0	0.0	0.0
Total Delay	45.0	45.1	3.2	31.5	4.0	18.7
Queue Length 50th (ft)	57	57	0	96	25	171
Queue Length 95th (ft)	105	105	7	190	123	250
Internal Link Dist (ft)		337			388	217
Turn Bay Length (ft)	140			205		
Base Capacity (vph)	350	351	384	930	2764	1592
Starvation Cap Reductn	0	0	0	0	0	0
Spillback Cap Reductn	0	0	0	0	0	0
Storage Cap Reductn	0	0	0	0	0	0
Reduced v/c Ratio	0.29	0.29	0.09	0.62	0.24	0.55

Intersection Summary

Queues

47: Madera Avenue & Olive Avenue/SR-99 Southbound On-Ramp



Lane Group	EBL	EBT	EBR	NBL	NBT	SBL	SBT
Lane Group Flow (vph)	270	282	427	139	803	136	690
v/c Ratio	0.69	0.70	0.63	0.40	0.47	0.57	0.38
Control Delay	25.7	25.9	9.0	40.7	18.8	28.9	22.4
Queue Delay	2.8	2.9	2.4	0.0	0.0	0.0	0.4
Total Delay	28.5	28.8	11.4	40.7	18.8	28.9	22.8
Queue Length 50th (ft)	150	156	146	39	153	65	173
Queue Length 95th (ft)	214	222	207	64	266	112	238
Internal Link Dist (ft)		112			323		388
Turn Bay Length (ft)				120		90	
Base Capacity (vph)	601	619	760	572	1695	282	1828
Starvation Cap Reductn	224	231	210	0	0	0	0
Spillback Cap Reductn	0	0	0	0	0	0	605
Storage Cap Reductn	0	0	0	0	0	0	0
Reduced v/c Ratio	0.72	0.73	0.78	0.24	0.47	0.48	0.56
Intersection Summary							

Queuing and Blocking Report

Intersection: 48: Madera Avenue & Lewis Street

Movement	WB	NB	SB
Directions Served	LR	T	L
Maximum Queue (ft)	54	29	50
Average Queue (ft)	12	1	18
95th Queue (ft)	42	11	45
Link Distance (ft)	147	186	
Upstream Blk Time (%)			
Queuing Penalty (veh)			
Storage Bay Dist (ft)			100
Storage Blk Time (%)			
Queuing Penalty (veh)			

Queues
49: Yosemite Avenue & Cleveland Avenue/Tozer Street

Village D Specific Plan
Phase I NP - PM Peak Hour



Lane Group	EBL	EBT	WBL	WBT	WBR	NBL	NBT	NBR	SBL	SBT
Lane Group Flow (vph)	226	680	53	504	43	337	324	105	78	427
v/c Ratio	0.83	0.58	0.50	0.63	0.08	1.00	0.46	0.15	0.51	0.90
Control Delay	66.9	27.7	62.1	40.2	0.3	90.2	26.5	1.2	55.3	54.4
Queue Delay	0.0	0.0	0.0	0.0	0.0	0.0	0.0	0.0	0.0	0.0
Total Delay	66.9	27.7	62.1	40.2	0.3	90.2	26.5	1.2	55.3	54.4
Queue Length 50th (ft)	140	176	34	160	0	217	156	0	48	222
Queue Length 95th (ft)	#260	238	#82	217	0	#396	237	8	95	#388
Internal Link Dist (ft)		318		397			415			443
Turn Bay Length (ft)	210		150		60	240			150	
Base Capacity (vph)	284	1171	107	804	516	338	709	703	171	509
Starvation Cap Reductn	0	0	0	0	0	0	0	0	0	0
Spillback Cap Reductn	0	0	0	0	0	0	0	0	0	0
Storage Cap Reductn	0	0	0	0	0	0	0	0	0	0
Reduced v/c Ratio	0.80	0.58	0.50	0.63	0.08	1.00	0.46	0.15	0.46	0.84

Intersection Summary

95th percentile volume exceeds capacity, queue may be longer.
Queue shown is maximum after two cycles.

Queuing and Blocking Report

Intersection: 5: Road 23/SR-99 Southbound Off-Ramp & Avenue 18 1/2

Movement	EB	EB	WB	NB	NB	SB
Directions Served	T	R	LT	L	R	LTR
Maximum Queue (ft)	35	36	90	182	78	272
Average Queue (ft)	3	3	21	97	73	114
95th Queue (ft)	17	16	63	180	78	227
Link Distance (ft)	247		193	351		238
Upstream Blk Time (%)						4
Queuing Penalty (veh)						0
Storage Bay Dist (ft)		50			25	
Storage Blk Time (%)	0	0		26	58	
Queuing Penalty (veh)	0	0		87	44	

Queuing and Blocking Report

Intersection: 6: SR-99 Northbound Ramps & Avenue 18 1/2

Movement	EB	NB
Directions Served	L	LTR
Maximum Queue (ft)	123	711
Average Queue (ft)	40	683
95th Queue (ft)	92	715
Link Distance (ft)		648
Upstream Blk Time (%)		90
Queuing Penalty (veh)		0
Storage Bay Dist (ft)	145	
Storage Blk Time (%)		
Queuing Penalty (veh)		

Queuing and Blocking Report

Intersection: 14: Avenue 17 & SR-99 Southbound Off-Ramp

Movement	SB	SB
Directions Served	L	R
Maximum Queue (ft)	179	88
Average Queue (ft)	80	41
95th Queue (ft)	138	67
Link Distance (ft)	1017	
Upstream Blk Time (%)		
Queuing Penalty (veh)		
Storage Bay Dist (ft)		610
Storage Blk Time (%)		
Queuing Penalty (veh)		

Queuing and Blocking Report

Intersection: 15: SR-99 Northbound Ramps & Avenue 17

Movement	EB	EB	NB	NB
Directions Served	L	T	LT	R
Maximum Queue (ft)	224	529	668	100
Average Queue (ft)	81	113	641	71
95th Queue (ft)	187	425	668	143
Link Distance (ft)		511	628	
Upstream Blk Time (%)		1	100	
Queuing Penalty (veh)		7	0	
Storage Bay Dist (ft)	125			50
Storage Blk Time (%)	1	16	90	34
Queuing Penalty (veh)	4	13	216	55

Queuing and Blocking Report

Intersection: 25: Kennedy Street/Gateway Drive & SR-99 Southbound Ramps

Movement	EB	SB	SB
Directions Served	L	L	R
Maximum Queue (ft)	99	69	54
Average Queue (ft)	48	39	34
95th Queue (ft)	92	58	47
Link Distance (ft)		509	
Upstream Blk Time (%)			
Queuing Penalty (veh)			
Storage Bay Dist (ft)	140		335
Storage Blk Time (%)			
Queuing Penalty (veh)			

Queuing and Blocking Report

Intersection: 26: Gateway Drive & SR-99 Northbound Off-Ramp

Movement	EB	SB
Directions Served	LT	LR
Maximum Queue (ft)	78	70
Average Queue (ft)	32	47
95th Queue (ft)	73	68
Link Distance (ft)	841	55
Upstream Blk Time (%)		2
Queuing Penalty (veh)		5
Storage Bay Dist (ft)		
Storage Blk Time (%)		
Queuing Penalty (veh)		

Queuing and Blocking Report

Intersection: 27: SR-99 Northbound Off-Ramp

Movement	EB	SB
Directions Served	L	TR
Maximum Queue (ft)	66	68
Average Queue (ft)	42	16
95th Queue (ft)	63	55
Link Distance (ft)	55	503
Upstream Blk Time (%)	1	
Queuing Penalty (veh)	2	
Storage Bay Dist (ft)		
Storage Blk Time (%)		
Queuing Penalty (veh)		

Queuing and Blocking Report

Intersection: 28: Gateway Drive & SR-99 Northbound Off-Ramp

Movement
Directions Served
Maximum Queue (ft)
Average Queue (ft)
95th Queue (ft)
Link Distance (ft)
Upstream Blk Time (%)
Queuing Penalty (veh)
Storage Bay Dist (ft)
Storage Blk Time (%)
Queuing Penalty (veh)

Queues
31: SR-99 Southbound Ramps & Cleveland Avenue



Lane Group	EBT	EBR	WBL	WBT	SBL	SBR
Lane Group Flow (vph)	718	836	368	945	71	59
v/c Ratio	0.59	0.90	0.87	0.43	0.17	0.14
Control Delay	26.3	22.3	67.5	5.9	29.8	6.4
Queue Delay	0.0	0.0	0.0	0.1	0.0	0.0
Total Delay	26.3	22.3	67.5	6.0	29.8	6.4
Queue Length 50th (ft)	166	133	221	53	33	0
Queue Length 95th (ft)	221	#421	m#348	115	70	24
Internal Link Dist (ft)	1412			372		
Turn Bay Length (ft)			115			140
Base Capacity (vph)	1317	958	457	2395	418	422
Starvation Cap Reductn	0	0	0	477	0	0
Spillback Cap Reductn	0	0	0	0	0	0
Storage Cap Reductn	0	0	0	0	0	0
Reduced v/c Ratio	0.55	0.87	0.81	0.49	0.17	0.14

Intersection Summary

95th percentile volume exceeds capacity, queue may be longer.

Queue shown is maximum after two cycles.

m Volume for 95th percentile queue is metered by upstream signal.

Queues
32: SR-99 Northbound Ramps & Cleveland Avenue



Lane Group	EBL	EBT	WBT	WBR	NBL	NBT	NBR
Lane Group Flow (vph)	57	734	910	85	202	203	317
v/c Ratio	0.35	0.46	0.76	0.15	0.28	0.28	0.40
Control Delay	44.6	31.1	15.7	2.0	20.7	20.7	9.3
Queue Delay	0.0	0.0	0.6	0.0	0.0	0.0	0.0
Total Delay	44.6	31.1	16.4	2.0	20.7	20.7	9.3
Queue Length 50th (ft)	35	188	104	0	78	78	37
Queue Length 95th (ft)	m66	147	77	m2	157	158	120
Internal Link Dist (ft)		372	207			441	
Turn Bay Length (ft)	90			50	145		325
Base Capacity (vph)	356	2024	1250	606	722	722	798
Starvation Cap Reductn	0	0	105	0	0	0	0
Spillback Cap Reductn	0	63	0	0	0	0	3
Storage Cap Reductn	0	0	0	0	0	0	0
Reduced v/c Ratio	0.16	0.37	0.79	0.14	0.28	0.28	0.40

Intersection Summary

m Volume for 95th percentile queue is metered by upstream signal.

Queuing and Blocking Report

Intersection: 38: I Street & 2nd Street/SR-99 Southbound Off-Ramp

Movement	EB	WB	NB	SB
Directions Served	LTR	LT	L	TR
Maximum Queue (ft)	54	120	26	28
Average Queue (ft)	28	80	1	1
95th Queue (ft)	45	121	10	11
Link Distance (ft)	174	263		171
Upstream Blk Time (%)				
Queuing Penalty (veh)				
Storage Bay Dist (ft)			75	
Storage Blk Time (%)		22		
Queuing Penalty (veh)		2		

Queuing and Blocking Report

Intersection: 40: H Street & SR-99 Southbound On-Ramp/2nd Street

Movement	WB	SB
Directions Served	LTR	LT
Maximum Queue (ft)	52	34
Average Queue (ft)	29	9
95th Queue (ft)	46	20
Link Distance (ft)	278	153
Upstream Blk Time (%)		
Queuing Penalty (veh)		
Storage Bay Dist (ft)		
Storage Blk Time (%)		
Queuing Penalty (veh)		

Queuing and Blocking Report

Intersection: 42: SR-99 Southbound On-Ramp & 4th Street

Movement	EB	EB	WB	WB	WB
Directions Served	T	TR	L	T	T
Maximum Queue (ft)	38	135	126	95	206
Average Queue (ft)	9	35	70	26	90
95th Queue (ft)	34	82	114	79	178
Link Distance (ft)	38	38	226	226	226
Upstream Blk Time (%)	0	2			0
Queuing Penalty (veh)	2	12			0
Storage Bay Dist (ft)					
Storage Blk Time (%)					
Queuing Penalty (veh)					

Queues
43: SR-99 Northbound Off-Ramp/H Street & 4th Street

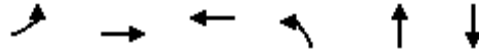

Lane Group	EBL	EBT	WBT	NBL	NBT	SBT
Lane Group Flow (vph)	255	499	606	275	258	79
v/c Ratio	0.83	0.33	0.88	0.69	0.48	0.18
Control Delay	43.3	6.9	49.6	43.2	9.5	2.7
Queue Delay	0.0	0.0	0.0	0.0	0.0	0.0
Total Delay	43.3	6.9	49.6	43.2	9.5	2.7
Queue Length 50th (ft)	156	49	172	147	14	0
Queue Length 95th (ft)	m#212	m64	#263	#258	79	13
Internal Link Dist (ft)		197	236		443	771
Turn Bay Length (ft)						
Base Capacity (vph)	324	1553	706	399	540	429
Starvation Cap Reductn	0	0	0	0	0	0
Spillback Cap Reductn	0	0	0	0	0	0
Storage Cap Reductn	0	0	0	0	0	0
Reduced v/c Ratio	0.79	0.32	0.86	0.69	0.48	0.18

Intersection Summary

95th percentile volume exceeds capacity, queue may be longer.

Queue shown is maximum after two cycles.

m Volume for 95th percentile queue is metered by upstream signal.

Queues
 45: Olive Avenue & SR-99 Southbound Off-Ramp

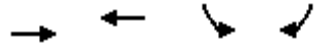

Lane Group	EBT	WBT	SBL	SBR
Lane Group Flow (vph)	562	488	567	113
v/c Ratio	0.55	0.69	0.50	0.11
Control Delay	30.2	38.8	8.6	3.1
Queue Delay	0.1	55.0	0.1	0.0
Total Delay	30.3	93.8	8.6	3.1
Queue Length 50th (ft)	91	136	121	8
Queue Length 95th (ft)	121	187	211	26
Internal Link Dist (ft)	103	112	135	
Turn Bay Length (ft)				
Base Capacity (vph)	1204	838	1137	1036
Starvation Cap Reductn	0	397	0	0
Spillback Cap Reductn	110	0	41	0
Storage Cap Reductn	0	0	0	0
Reduced v/c Ratio	0.51	1.11	0.52	0.11
Intersection Summary				

Queues
46: Madera Avenue & SR-99 Northbound Ramps



Lane Group	WBL	WBT	WBR	NBL	NBT	SBT
Lane Group Flow (vph)	96	98	93	520	477	873
v/c Ratio	0.46	0.47	0.34	0.72	0.18	0.54
Control Delay	38.4	38.7	10.5	30.4	2.3	15.4
Queue Delay	0.0	0.0	0.0	0.0	0.0	0.0
Total Delay	38.4	38.7	10.5	30.4	2.3	15.4
Queue Length 50th (ft)	47	48	0	101	11	139
Queue Length 95th (ft)	89	90	37	160	33	218
Internal Link Dist (ft)		337			388	217
Turn Bay Length (ft)	140			205		
Base Capacity (vph)	377	378	421	722	2585	1624
Starvation Cap Reductn	0	0	0	0	0	0
Spillback Cap Reductn	0	0	0	0	0	0
Storage Cap Reductn	0	0	0	0	0	0
Reduced v/c Ratio	0.25	0.26	0.22	0.72	0.18	0.54
Intersection Summary						

Queues

47: Madera Avenue & Olive Avenue/SR-99 Southbound On-Ramp

Village D Specific Plan

Phase I WP - AM Peak Hour



Lane Group	EBL	EBT	EBR	NBL	NBT	SBL	SBT
Lane Group Flow (vph)	287	301	527	149	623	89	735
v/c Ratio	0.79	0.80	0.68	0.38	0.36	0.48	0.43
Control Delay	37.3	37.4	8.6	34.1	13.2	53.3	3.2
Queue Delay	3.5	3.5	2.0	0.0	0.0	0.0	0.3
Total Delay	40.7	41.0	10.6	34.1	13.2	53.3	3.5
Queue Length 50th (ft)	84	88	23	36	101	49	9
Queue Length 95th (ft)	#255	#266	230	59	144	m93	37
Internal Link Dist (ft)		112			323		388
Turn Bay Length (ft)				120		90	
Base Capacity (vph)	406	421	862	628	1738	214	1703
Starvation Cap Reductn	57	58	195	0	0	0	0
Spillback Cap Reductn	0	0	0	0	0	0	397
Storage Cap Reductn	0	0	0	0	0	0	0
Reduced v/c Ratio	0.82	0.83	0.79	0.24	0.36	0.42	0.56

Intersection Summary

95th percentile volume exceeds capacity, queue may be longer.

Queue shown is maximum after two cycles.

m Volume for 95th percentile queue is metered by upstream signal.

Queuing and Blocking Report

Intersection: 48: Madera Avenue & Lewis Street

Movement	WB	NB	SB
Directions Served	LR	T	L
Maximum Queue (ft)	30	31	55
Average Queue (ft)	9	1	19
95th Queue (ft)	32	12	46
Link Distance (ft)	147	186	
Upstream Blk Time (%)			
Queuing Penalty (veh)			
Storage Bay Dist (ft)			100
Storage Blk Time (%)			
Queuing Penalty (veh)			

Queues
49: Yosemite Avenue & Cleveland Avenue/Tozer Street

Village D Specific Plan
Phase I WP - AM Peak Hour



Lane Group	EBL	EBT	WBL	WBT	WBR	NBL	NBT	NBR	SBL	SBT
Lane Group Flow (vph)	270	839	122	336	51	146	126	82	72	492
v/c Ratio	0.82	0.73	0.78	0.41	0.11	0.86	0.22	0.14	0.45	0.95
Control Delay	56.2	27.6	73.2	31.5	0.5	82.1	25.9	0.5	47.5	60.0
Queue Delay	0.0	0.0	0.0	0.0	0.0	0.0	0.0	0.0	0.0	0.0
Total Delay	56.2	27.6	73.2	31.5	0.5	82.1	25.9	0.5	47.5	60.0
Queue Length 50th (ft)	146	195	69	87	0	83	55	0	39	250
Queue Length 95th (ft)	#264	265	#161	128	0	#192	102	0	81	#448
Internal Link Dist (ft)		318		397			415			443
Turn Bay Length (ft)	210		150		60	240			150	
Base Capacity (vph)	354	1152	157	814	461	170	569	602	183	525
Starvation Cap Reductn	0	0	0	0	0	0	0	0	0	0
Spillback Cap Reductn	0	0	0	0	0	0	0	0	0	0
Storage Cap Reductn	0	0	0	0	0	0	0	0	0	0
Reduced v/c Ratio	0.76	0.73	0.78	0.41	0.11	0.86	0.22	0.14	0.39	0.94

Intersection Summary

95th percentile volume exceeds capacity, queue may be longer.
Queue shown is maximum after two cycles.

Queuing and Blocking Report

Intersection: 5: Road 23/SR-99 Southbound Off-Ramp & Avenue 18 1/2

Movement	EB	EB	WB	NB	NB	SB
Directions Served	T	R	LT	L	R	LTR
Maximum Queue (ft)	16	50	163	153	75	301
Average Queue (ft)	1	9	32	59	60	279
95th Queue (ft)	6	29	97	127	84	299
Link Distance (ft)	247		193	351		238
Upstream Blk Time (%)						100
Queuing Penalty (veh)						0
Storage Bay Dist (ft)		50			25	
Storage Blk Time (%)		0		25	38	
Queuing Penalty (veh)		0		52	20	

Queuing and Blocking Report

Intersection: 6: SR-99 Northbound Ramps & Avenue 18 1/2

Movement	EB	NB
Directions Served	L	LTR
Maximum Queue (ft)	83	266
Average Queue (ft)	16	92
95th Queue (ft)	46	188
Link Distance (ft)		648
Upstream Blk Time (%)		
Queuing Penalty (veh)		
Storage Bay Dist (ft)	145	
Storage Blk Time (%)		
Queuing Penalty (veh)		

Queuing and Blocking Report

Intersection: 14: Avenue 17 & SR-99 Southbound Off-Ramp

Movement	SB	SB
Directions Served	L	R
Maximum Queue (ft)	1032	760
Average Queue (ft)	745	322
95th Queue (ft)	1166	912
Link Distance (ft)	1017	
Upstream Blk Time (%)	24	
Queuing Penalty (veh)	0	
Storage Bay Dist (ft)		610
Storage Blk Time (%)	54	
Queuing Penalty (veh)	32	

Queuing and Blocking Report

Intersection: 15: SR-99 Northbound Ramps & Avenue 17

Movement	EB	EB	NB	NB
Directions Served	L	T	LT	R
Maximum Queue (ft)	225	537	644	94
Average Queue (ft)	137	514	632	94
95th Queue (ft)	311	591	636	94
Link Distance (ft)		511	629	
Upstream Blk Time (%)		44	100	
Queuing Penalty (veh)		430	0	
Storage Bay Dist (ft)	125			50
Storage Blk Time (%)		93	4	100
Queuing Penalty (veh)		96	19	116

Queuing and Blocking Report

Intersection: 25: Kennedy Street/Gateway Drive & SR-99 Southbound Ramps

Movement	EB	SB	SB
Directions Served	L	L	R
Maximum Queue (ft)	55	117	88
Average Queue (ft)	31	63	45
95th Queue (ft)	55	105	72
Link Distance (ft)		509	
Upstream Blk Time (%)			
Queuing Penalty (veh)			
Storage Bay Dist (ft)	140		335
Storage Blk Time (%)			
Queuing Penalty (veh)			

Queuing and Blocking Report

Intersection: 26: Gateway Drive & SR-99 Northbound Off-Ramp

Movement	EB	SB
Directions Served	LT	LR
Maximum Queue (ft)	79	75
Average Queue (ft)	31	40
95th Queue (ft)	73	65
Link Distance (ft)	841	55
Upstream Blk Time (%)		1
Queuing Penalty (veh)		1
Storage Bay Dist (ft)		
Storage Blk Time (%)		
Queuing Penalty (veh)		

Queuing and Blocking Report

Intersection: 27: SR-99 Northbound Off-Ramp

Movement	EB	SB
Directions Served	L	TR
Maximum Queue (ft)	63	32
Average Queue (ft)	40	3
95th Queue (ft)	61	17
Link Distance (ft)	55	503
Upstream Blk Time (%)	1	
Queuing Penalty (veh)	2	
Storage Bay Dist (ft)		
Storage Blk Time (%)		
Queuing Penalty (veh)		

Queuing and Blocking Report

Intersection: 28: Gateway Drive & SR-99 Northbound Off-Ramp

Movement	SB
Directions Served	LR
Maximum Queue (ft)	31
Average Queue (ft)	3
95th Queue (ft)	17
Link Distance (ft)	162
Upstream Blk Time (%)	
Queuing Penalty (veh)	
Storage Bay Dist (ft)	
Storage Blk Time (%)	
Queuing Penalty (veh)	

Queues
31: SR-99 Southbound Ramps & Cleveland Avenue

Village D Specific Plan
Phase I WP - PM Peak Hour



Lane Group	EBT	EBR	WBL	WBT	SBL	SBR
Lane Group Flow (vph)	874	510	264	1756	156	82
v/c Ratio	0.68	0.57	0.66	0.77	0.34	0.18
Control Delay	12.1	4.1	32.4	8.4	30.3	9.5
Queue Delay	0.0	0.0	0.0	1.8	0.0	0.0
Total Delay	12.1	4.1	32.4	10.2	30.3	9.5
Queue Length 50th (ft)	102	21	141	230	73	4
Queue Length 95th (ft)	m117	m37	m194	m209	131	39
Internal Link Dist (ft)	1412			372		
Turn Bay Length (ft)			115			140
Base Capacity (vph)	1449	941	401	2386	462	460
Starvation Cap Reductn	0	0	0	442	0	0
Spillback Cap Reductn	19	0	0	0	0	0
Storage Cap Reductn	0	0	0	0	0	0
Reduced v/c Ratio	0.61	0.54	0.66	0.90	0.34	0.18

Intersection Summary

m Volume for 95th percentile queue is metered by upstream signal.

Queues
32: SR-99 Northbound Ramps & Cleveland Avenue



Lane Group	EBL	EBT	WBT	WBR	NBL	NBT	NBR
Lane Group Flow (vph)	78	974	1180	69	442	447	308
v/c Ratio	0.43	0.60	1.01	0.12	0.59	0.59	0.41
Control Delay	35.6	7.9	48.5	4.8	24.6	24.7	14.6
Queue Delay	0.0	0.4	33.8	0.0	0.0	0.0	0.0
Total Delay	35.6	8.3	82.2	4.8	24.6	24.7	14.6
Queue Length 50th (ft)	49	51	~221	3	202	205	79
Queue Length 95th (ft)	m83	101	#487	m10	333	337	160
Internal Link Dist (ft)		372	207			441	
Turn Bay Length (ft)	90			50	145		325
Base Capacity (vph)	287	1925	1171	555	750	752	751
Starvation Cap Reductn	0	449	115	0	0	0	0
Spillback Cap Reductn	0	0	2	0	0	0	0
Storage Cap Reductn	0	0	0	0	0	0	0
Reduced v/c Ratio	0.27	0.66	1.12	0.12	0.59	0.59	0.41

Intersection Summary

- ~ Volume exceeds capacity, queue is theoretically infinite.
Queue shown is maximum after two cycles.
- # 95th percentile volume exceeds capacity, queue may be longer.
Queue shown is maximum after two cycles.
- m Volume for 95th percentile queue is metered by upstream signal.

Queuing and Blocking Report

Intersection: 38: I Street & 2nd Street/SR-99 Southbound Off-Ramp

Movement	EB	WB	NB
Directions Served	LTR	LT	L
Maximum Queue (ft)	31	142	48
Average Queue (ft)	21	58	9
95th Queue (ft)	43	104	32
Link Distance (ft)	174	263	
Upstream Blk Time (%)			
Queuing Penalty (veh)			
Storage Bay Dist (ft)			75
Storage Blk Time (%)		8	
Queuing Penalty (veh)		0	

Queuing and Blocking Report

Intersection: 40: H Street & SR-99 Southbound On-Ramp/2nd Street

Movement	WB	SB
Directions Served	LTR	LTR
Maximum Queue (ft)	75	31
Average Queue (ft)	41	10
95th Queue (ft)	63	30
Link Distance (ft)	278	139
Upstream Blk Time (%)		
Queuing Penalty (veh)		
Storage Bay Dist (ft)		
Storage Blk Time (%)		
Queuing Penalty (veh)		

Queuing and Blocking Report

Intersection: 42: SR-99 Southbound On-Ramp & 4th Street

Movement	EB	EB	WB	WB	WB
Directions Served	T	TR	L	T	T
Maximum Queue (ft)	53	53	142	72	228
Average Queue (ft)	14	25	69	15	134
95th Queue (ft)	49	59	125	51	240
Link Distance (ft)	38	38	226	226	226
Upstream Blk Time (%)	2	2			2
Queuing Penalty (veh)	9	12			6
Storage Bay Dist (ft)					
Storage Blk Time (%)					
Queuing Penalty (veh)					

Queues

43: SR-99 Northbound Off-Ramp/H Street & 4th Street

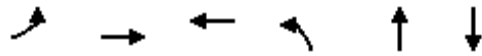

Lane Group	EBL	EBT	WBT	NBL	NBT	SBT
Lane Group Flow (vph)	253	438	686	270	204	107
v/c Ratio	0.80	0.27	0.85	0.64	0.40	0.27
Control Delay	43.5	7.1	47.3	43.6	10.2	8.0
Queue Delay	0.0	0.0	0.0	0.0	0.0	0.0
Total Delay	43.5	7.1	47.3	43.6	10.2	8.0
Queue Length 50th (ft)	170	48	212	161	14	0
Queue Length 95th (ft)	#269	65	#299	#269	76	40
Internal Link Dist (ft)		197	236		443	771
Turn Bay Length (ft)						
Base Capacity (vph)	348	1697	830	422	516	395
Starvation Cap Reductn	0	0	0	0	0	0
Spillback Cap Reductn	0	0	0	0	0	0
Storage Cap Reductn	0	0	0	0	0	0
Reduced v/c Ratio	0.73	0.26	0.83	0.64	0.40	0.27

Intersection Summary

95th percentile volume exceeds capacity, queue may be longer.
 Queue shown is maximum after two cycles.

Queues
 45: Olive Avenue & SR-99 Southbound Off-Ramp

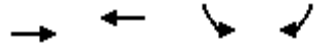

Lane Group	EBT	WBT	SBL	SBR
Lane Group Flow (vph)	663	503	431	81
v/c Ratio	0.65	0.70	0.36	0.07
Control Delay	35.8	48.3	6.8	2.1
Queue Delay	0.3	55.5	0.0	0.0
Total Delay	36.1	103.8	6.8	2.1
Queue Length 50th (ft)	126	164	86	3
Queue Length 95th (ft)	158	216	149	17
Internal Link Dist (ft)	103	112	135	
Turn Bay Length (ft)				
Base Capacity (vph)	1226	853	1214	1092
Starvation Cap Reductn	0	437	0	0
Spillback Cap Reductn	140	0	27	0
Storage Cap Reductn	0	0	0	0
Reduced v/c Ratio	0.61	1.21	0.36	0.07
Intersection Summary				

Queues
 46: Madera Avenue & SR-99 Northbound Ramps



Lane Group	WBL	WBT	WBR	NBL	NBT	SBT
Lane Group Flow (vph)	116	118	36	633	670	893
v/c Ratio	0.53	0.53	0.13	0.74	0.25	0.55
Control Delay	44.4	44.7	2.9	41.6	5.4	18.1
Queue Delay	0.0	0.0	0.0	0.0	0.0	0.0
Total Delay	44.4	44.7	2.9	41.6	5.4	18.1
Queue Length 50th (ft)	66	67	0	188	68	171
Queue Length 95th (ft)	114	115	7	m240	m85	257
Internal Link Dist (ft)		337			388	217
Turn Bay Length (ft)	140			205		
Base Capacity (vph)	350	351	384	858	2724	1626
Starvation Cap Reductn	0	0	0	0	0	0
Spillback Cap Reductn	0	0	0	0	0	0
Storage Cap Reductn	0	0	0	0	0	0
Reduced v/c Ratio	0.33	0.34	0.09	0.74	0.25	0.55

Intersection Summary

m Volume for 95th percentile queue is metered by upstream signal.

Queues

47: Madera Avenue & Olive Avenue/SR-99 Southbound On-Ramp



Lane Group	EBL	EBT	EBR	NBL	NBT	SBL	SBT
Lane Group Flow (vph)	299	309	462	148	862	136	729
v/c Ratio	0.90	0.90	0.60	0.43	0.45	0.69	0.37
Control Delay	52.4	51.9	5.1	41.7	13.7	62.2	2.3
Queue Delay	9.0	9.6	0.2	0.0	0.0	0.0	0.4
Total Delay	61.5	61.4	5.3	41.7	13.7	62.2	2.7
Queue Length 50th (ft)	144	151	0	41	151	64	0
Queue Length 95th (ft)	#334	#343	213	70	197	#144	46
Internal Link Dist (ft)		112			323		388
Turn Bay Length (ft)				120		90	
Base Capacity (vph)	342	353	783	400	1900	208	1980
Starvation Cap Reductn	28	30	48	0	0	0	0
Spillback Cap Reductn	0	0	0	0	0	0	714
Storage Cap Reductn	0	0	0	0	0	0	0
Reduced v/c Ratio	0.95	0.96	0.63	0.37	0.45	0.65	0.58

Intersection Summary

95th percentile volume exceeds capacity, queue may be longer.
 Queue shown is maximum after two cycles.

Queuing and Blocking Report

Intersection: 48: Madera Avenue & Lewis Street

Movement	WB	SB
Directions Served	LR	L
Maximum Queue (ft)	30	52
Average Queue (ft)	9	18
95th Queue (ft)	30	45
Link Distance (ft)	147	
Upstream Blk Time (%)		
Queuing Penalty (veh)		
Storage Bay Dist (ft)		100
Storage Blk Time (%)		
Queuing Penalty (veh)		

Queues
49: Yosemite Avenue & Cleveland Avenue/Tozer Street

Village D Specific Plan
Phase I WP - PM Peak Hour



Lane Group	EBL	EBT	WBL	WBT	WBR	NBL	NBT	NBR	SBL	SBT
Lane Group Flow (vph)	263	680	53	504	43	337	324	105	78	499
v/c Ratio	0.93	0.61	0.56	0.74	0.09	0.94	0.43	0.14	0.50	0.99
Control Delay	80.0	28.9	68.8	45.6	0.4	75.7	25.1	1.2	54.6	69.5
Queue Delay	0.0	0.0	0.0	0.0	0.0	0.0	0.0	0.0	0.0	0.0
Total Delay	80.0	28.9	68.8	45.6	0.4	75.7	25.1	1.2	54.6	69.5
Queue Length 50th (ft)	167	176	34	160	0	213	154	0	48	274
Queue Length 95th (ft)	#318	238	#87	218	0	#382	236	8	95	#489
Internal Link Dist (ft)		318		397			415			443
Turn Bay Length (ft)	210		150		60	240			150	
Base Capacity (vph)	284	1107	95	683	470	359	750	735	177	504
Starvation Cap Reductn	0	0	0	0	0	0	0	0	0	0
Spillback Cap Reductn	0	0	0	0	0	0	0	0	0	0
Storage Cap Reductn	0	0	0	0	0	0	0	0	0	0
Reduced v/c Ratio	0.93	0.61	0.56	0.74	0.09	0.94	0.43	0.14	0.44	0.99

Intersection Summary

95th percentile volume exceeds capacity, queue may be longer.
Queue shown is maximum after two cycles.

Queuing and Blocking Report

Intersection: 5: Road 23/SR-99 Southbound Off-Ramp & Avenue 18 1/2

Movement	EB	EB	WB	NB	NB	SB
Directions Served	T	R	LT	L	R	LTR
Maximum Queue (ft)	69	37	92	125	75	258
Average Queue (ft)	4	2	18	60	62	89
95th Queue (ft)	28	14	56	121	92	173
Link Distance (ft)	247		193	351		238
Upstream Blk Time (%)						0
Queuing Penalty (veh)						0
Storage Bay Dist (ft)		50			25	
Storage Blk Time (%)	0	0		35	21	
Queuing Penalty (veh)	0	0		54	13	

Queuing and Blocking Report

Intersection: 6: SR-99 Northbound Ramps & Avenue 18 1/2

Movement	EB	NB
Directions Served	L	LTR
Maximum Queue (ft)	75	453
Average Queue (ft)	27	154
95th Queue (ft)	61	331
Link Distance (ft)		648
Upstream Blk Time (%)		
Queuing Penalty (veh)		
Storage Bay Dist (ft)	145	
Storage Blk Time (%)		
Queuing Penalty (veh)		

Queuing and Blocking Report

Intersection: 14: Avenue 17 & SR-99 Southbound Off-Ramp

Movement	SB	SB
Directions Served	L	R
Maximum Queue (ft)	218	89
Average Queue (ft)	109	44
95th Queue (ft)	180	70
Link Distance (ft)	1017	
Upstream Blk Time (%)		
Queuing Penalty (veh)		
Storage Bay Dist (ft)		610
Storage Blk Time (%)		
Queuing Penalty (veh)		

Queuing and Blocking Report

Intersection: 15: SR-99 Northbound Ramps & Avenue 17

Movement	EB	EB	NB	NB
Directions Served	L	T	LT	R
Maximum Queue (ft)	141	169	680	100
Average Queue (ft)	69	15	652	68
95th Queue (ft)	132	93	676	145
Link Distance (ft)		511	628	
Upstream Blk Time (%)			100	
Queuing Penalty (veh)			0	
Storage Bay Dist (ft)	125			50
Storage Blk Time (%)	4	0	98	6
Queuing Penalty (veh)	15	0	235	14

Queuing and Blocking Report

Intersection: 25: Kennedy Street/Gateway Drive & SR-99 Southbound Ramps

Movement	EB	SB	SB
Directions Served	L	L	R
Maximum Queue (ft)	93	115	56
Average Queue (ft)	48	45	38
95th Queue (ft)	75	91	56
Link Distance (ft)		509	
Upstream Blk Time (%)			
Queuing Penalty (veh)			
Storage Bay Dist (ft)	140		335
Storage Blk Time (%)			
Queuing Penalty (veh)			

Queuing and Blocking Report

Intersection: 26: Gateway Drive & SR-99 Northbound Off-Ramp

Movement	EB	SB
Directions Served	LT	LR
Maximum Queue (ft)	53	79
Average Queue (ft)	13	57
95th Queue (ft)	43	72
Link Distance (ft)	841	55
Upstream Blk Time (%)		5
Queuing Penalty (veh)		15
Storage Bay Dist (ft)		
Storage Blk Time (%)		
Queuing Penalty (veh)		

Queuing and Blocking Report

Intersection: 27: SR-99 Northbound Off-Ramp

Movement	EB	SB
Directions Served	L	TR
Maximum Queue (ft)	55	183
Average Queue (ft)	41	49
95th Queue (ft)	61	125
Link Distance (ft)	55	503
Upstream Blk Time (%)	1	
Queuing Penalty (veh)	1	
Storage Bay Dist (ft)		
Storage Blk Time (%)		
Queuing Penalty (veh)		

Queuing and Blocking Report

Intersection: 28: Gateway Drive & SR-99 Northbound Off-Ramp

Movement
Directions Served
Maximum Queue (ft)
Average Queue (ft)
95th Queue (ft)
Link Distance (ft)
Upstream Blk Time (%)
Queuing Penalty (veh)
Storage Bay Dist (ft)
Storage Blk Time (%)
Queuing Penalty (veh)

Queues
31: SR-99 Southbound Ramps & Cleveland Avenue



Lane Group	EBT	EBR	WBL	WBT	SBL	SBR
Lane Group Flow (vph)	510	436	396	742	80	67
v/c Ratio	0.63	0.63	0.80	0.37	0.15	0.13
Control Delay	34.1	7.2	58.0	7.9	26.8	7.5
Queue Delay	0.0	0.0	0.2	0.0	0.0	0.0
Total Delay	34.1	7.2	58.2	7.9	26.8	7.5
Queue Length 50th (ft)	136	0	247	79	32	0
Queue Length 95th (ft)	180	72	339	85	79	30
Internal Link Dist (ft)	1412			372		
Turn Bay Length (ft)			115			140
Base Capacity (vph)	955	743	644	2426	520	508
Starvation Cap Reductn	0	0	27	0	0	0
Spillback Cap Reductn	0	0	0	0	0	0
Storage Cap Reductn	0	0	0	0	0	0
Reduced v/c Ratio	0.53	0.59	0.64	0.31	0.15	0.13
Intersection Summary						

Queues
32: SR-99 Northbound Ramps & Cleveland Avenue



Lane Group	EBL	EBT	WBT	WBR	NBL	NBT	NBR
Lane Group Flow (vph)	67	524	850	105	147	148	370
v/c Ratio	0.40	0.33	0.73	0.19	0.20	0.20	0.43
Control Delay	53.3	15.0	16.4	5.0	19.6	19.7	5.2
Queue Delay	0.0	0.0	26.8	0.0	0.0	0.0	0.0
Total Delay	53.3	15.0	43.2	5.0	19.6	19.7	5.2
Queue Length 50th (ft)	42	38	241	19	54	55	10
Queue Length 95th (ft)	m79	68	245	m7	117	118	79
Internal Link Dist (ft)		372	207			441	
Turn Bay Length (ft)	90			50	145		325
Base Capacity (vph)	448	2005	1167	570	722	722	870
Starvation Cap Reductn	0	0	348	0	0	0	0
Spillback Cap Reductn	0	0	0	0	0	0	0
Storage Cap Reductn	0	0	0	0	0	0	0
Reduced v/c Ratio	0.15	0.26	1.04	0.18	0.20	0.20	0.43

Intersection Summary

m Volume for 95th percentile queue is metered by upstream signal.

Queuing and Blocking Report

Intersection: 38: I Street & 2nd Street/SR-99 Southbound Off-Ramp

Movement	EB	WB	NB
Directions Served	LTR	LT	L
Maximum Queue (ft)	56	143	26
Average Queue (ft)	32	91	6
95th Queue (ft)	51	142	23
Link Distance (ft)	174	263	
Upstream Blk Time (%)			
Queuing Penalty (veh)			
Storage Bay Dist (ft)			75
Storage Blk Time (%)		25	
Queuing Penalty (veh)		3	

Queuing and Blocking Report

Intersection: 40: H Street & SR-99 Southbound On-Ramp/2nd Street

Movement	WB	SB
Directions Served	LTR	LT
Maximum Queue (ft)	53	31
Average Queue (ft)	31	7
95th Queue (ft)	55	19
Link Distance (ft)	278	153
Upstream Blk Time (%)		
Queuing Penalty (veh)		
Storage Bay Dist (ft)		
Storage Blk Time (%)		
Queuing Penalty (veh)		

Queuing and Blocking Report

Intersection: 42: SR-99 Southbound On-Ramp & 4th Street

Movement	EB	EB	WB	WB	WB
Directions Served	T	TR	L	T	T
Maximum Queue (ft)	38	104	100	115	232
Average Queue (ft)	14	27	68	37	137
95th Queue (ft)	41	68	103	87	221
Link Distance (ft)	38	38	226	226	226
Upstream Blk Time (%)	1	2			1
Queuing Penalty (veh)	5	9			3
Storage Bay Dist (ft)					
Storage Blk Time (%)					
Queuing Penalty (veh)					

Queues
 43: SR-99 Northbound Off-Ramp/H Street & 4th Street

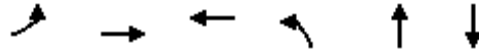

Lane Group	EBL	EBT	WBT	NBL	NBT	SBT
Lane Group Flow (vph)	270	505	648	290	279	90
v/c Ratio	0.86	0.33	0.92	0.75	0.51	0.21
Control Delay	64.6	26.1	55.1	47.2	9.9	3.7
Queue Delay	0.0	0.0	0.0	0.0	0.0	0.0
Total Delay	64.6	26.1	55.1	47.2	9.9	3.7
Queue Length 50th (ft)	140	120	187	157	16	0
Queue Length 95th (ft)	m#230	m162	#293	#279	85	20
Internal Link Dist (ft)		197	236		443	771
Turn Bay Length (ft)						
Base Capacity (vph)	324	1553	705	386	544	429
Starvation Cap Reductn	0	0	0	0	0	0
Spillback Cap Reductn	0	0	0	0	0	0
Storage Cap Reductn	0	0	0	0	0	0
Reduced v/c Ratio	0.83	0.33	0.92	0.75	0.51	0.21

Intersection Summary

95th percentile volume exceeds capacity, queue may be longer.

Queue shown is maximum after two cycles.

m Volume for 95th percentile queue is metered by upstream signal.

Queues
 45: Olive Avenue & SR-99 Southbound Off-Ramp

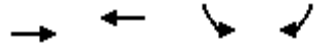

Lane Group	EBT	WBT	SBL	SBR
Lane Group Flow (vph)	586	526	613	120
v/c Ratio	0.53	0.69	0.56	0.12
Control Delay	28.7	27.3	10.5	3.1
Queue Delay	0.4	2.3	0.0	0.0
Total Delay	29.2	29.6	10.5	3.1
Queue Length 50th (ft)	94	152	145	7
Queue Length 95th (ft)	119	135	275	29
Internal Link Dist (ft)	103	112	135	
Turn Bay Length (ft)				
Base Capacity (vph)	1389	966	1090	999
Starvation Cap Reductn	0	299	0	0
Spillback Cap Reductn	365	0	10	0
Storage Cap Reductn	0	0	0	0
Reduced v/c Ratio	0.57	0.79	0.57	0.12
Intersection Summary				

Queues
46: Madera Avenue & SR-99 Northbound Ramps



Lane Group	WBL	WBT	WBR	NBL	NBT	SBT
Lane Group Flow (vph)	106	108	104	609	467	963
v/c Ratio	0.48	0.49	0.35	0.85	0.18	0.60
Control Delay	38.6	38.8	10.0	45.2	5.5	16.6
Queue Delay	0.0	0.0	0.0	0.0	0.0	0.0
Total Delay	38.6	38.8	10.0	45.2	5.5	16.6
Queue Length 50th (ft)	52	53	0	113	23	162
Queue Length 95th (ft)	95	97	39	#233	99	253
Internal Link Dist (ft)		337			388	217
Turn Bay Length (ft)	140			205		
Base Capacity (vph)	377	378	430	715	2541	1603
Starvation Cap Reductn	0	0	0	0	0	0
Spillback Cap Reductn	0	0	0	0	0	0
Storage Cap Reductn	0	0	0	0	0	0
Reduced v/c Ratio	0.28	0.29	0.24	0.85	0.18	0.60

Intersection Summary

95th percentile volume exceeds capacity, queue may be longer.
Queue shown is maximum after two cycles.

Queues

47: Madera Avenue & Olive Avenue/SR-99 Southbound On-Ramp

Village D Specific Plan

Phase II NP - AM Peak Hour



Lane Group	EBL	EBT	EBR	NBL	NBT	SBL	SBT
Lane Group Flow (vph)	299	309	579	179	688	92	800
v/c Ratio	0.71	0.71	0.77	0.41	0.43	0.48	0.52
Control Delay	30.7	30.3	18.8	33.8	16.5	27.8	25.6
Queue Delay	8.5	9.1	37.1	0.0	0.0	0.0	0.4
Total Delay	39.1	39.4	55.9	33.8	16.5	27.8	26.0
Queue Length 50th (ft)	133	137	200	42	118	42	181
Queue Length 95th (ft)	205	210	240	67	194	m65	238
Internal Link Dist (ft)		112			323		388
Turn Bay Length (ft)				120		90	
Base Capacity (vph)	556	576	838	628	1615	219	1542
Starvation Cap Reductn	215	228	291	0	0	0	0
Spillback Cap Reductn	0	0	0	0	0	0	297
Storage Cap Reductn	0	0	0	0	0	0	0
Reduced v/c Ratio	0.88	0.89	1.06	0.29	0.43	0.42	0.64

Intersection Summary

m Volume for 95th percentile queue is metered by upstream signal.

Queuing and Blocking Report

Intersection: 48: Madera Avenue & Lewis Street

Movement	WB	NB	SB
Directions Served	LR	T	L
Maximum Queue (ft)	49	134	79
Average Queue (ft)	11	11	24
95th Queue (ft)	37	71	63
Link Distance (ft)	147	186	
Upstream Blk Time (%)			
Queuing Penalty (veh)			
Storage Bay Dist (ft)			100
Storage Blk Time (%)			
Queuing Penalty (veh)			

Queues
49: Yosemite Avenue & Cleveland Avenue/Tozer Street

Village D Specific Plan
Phase II NP - AM Peak Hour



Lane Group	EBL	EBT	WBL	WBT	WBR	NBL	NBT	NBR	SBL	SBT
Lane Group Flow (vph)	212	849	124	358	59	150	137	84	79	503
v/c Ratio	0.72	0.74	0.79	0.41	0.12	0.89	0.24	0.14	0.48	0.97
Control Delay	49.0	28.1	75.2	30.7	0.5	87.4	26.2	0.5	48.7	62.6
Queue Delay	0.0	0.0	0.0	0.0	0.0	0.0	0.0	0.0	0.0	0.0
Total Delay	49.0	28.1	75.2	30.7	0.5	87.4	26.2	0.5	48.7	62.6
Queue Length 50th (ft)	114	198	70	90	0	86	61	0	43	260
Queue Length 95th (ft)	184	269	#165	137	0	#196	110	0	87	#463
Internal Link Dist (ft)		318		397			415			443
Turn Bay Length (ft)	210		150		60	240			150	
Base Capacity (vph)	352	1147	156	871	480	169	572	604	182	521
Starvation Cap Reductn	0	0	0	0	0	0	0	0	0	0
Spillback Cap Reductn	0	0	0	0	0	0	0	0	0	0
Storage Cap Reductn	0	0	0	0	0	0	0	0	0	0
Reduced v/c Ratio	0.60	0.74	0.79	0.41	0.12	0.89	0.24	0.14	0.43	0.97

Intersection Summary

95th percentile volume exceeds capacity, queue may be longer.
Queue shown is maximum after two cycles.

Queuing and Blocking Report

Intersection: 5: Road 23/SR-99 Southbound Off-Ramp & Avenue 18 1/2

Movement	EB	EB	WB	NB	NB	SB
Directions Served	T	R	LT	L	R	LTR
Maximum Queue (ft)	35	12	135	135	77	290
Average Queue (ft)	3	5	38	42	57	249
95th Queue (ft)	16	15	102	108	84	346
Link Distance (ft)	247		193	351		238
Upstream Blk Time (%)						65
Queuing Penalty (veh)						0
Storage Bay Dist (ft)		50			25	
Storage Blk Time (%)	0			22	28	
Queuing Penalty (veh)	0			29	12	

Queuing and Blocking Report

Intersection: 6: SR-99 Northbound Ramps & Avenue 18 1/2

Movement	EB	NB
Directions Served	L	LTR
Maximum Queue (ft)	102	212
Average Queue (ft)	23	80
95th Queue (ft)	65	154
Link Distance (ft)		648
Upstream Blk Time (%)		
Queuing Penalty (veh)		
Storage Bay Dist (ft)	145	
Storage Blk Time (%)		
Queuing Penalty (veh)		

Queuing and Blocking Report

Intersection: 14: Avenue 17 & SR-99 Southbound Off-Ramp

Movement	SB	SB
Directions Served	L	R
Maximum Queue (ft)	1056	760
Average Queue (ft)	1031	487
95th Queue (ft)	1076	1083
Link Distance (ft)	1017	
Upstream Blk Time (%)	95	
Queuing Penalty (veh)	0	
Storage Bay Dist (ft)		610
Storage Blk Time (%)	100	
Queuing Penalty (veh)	76	

Queuing and Blocking Report

Intersection: 15: SR-99 Northbound Ramps & Avenue 17

Movement	EB	EB	NB	NB
Directions Served	L	T	LT	R
Maximum Queue (ft)	222	297	681	100
Average Queue (ft)	75	37	647	47
95th Queue (ft)	168	190	668	127
Link Distance (ft)		511	629	
Upstream Blk Time (%)			100	
Queuing Penalty (veh)			0	
Storage Bay Dist (ft)	125			50
Storage Blk Time (%)	9		100	13
Queuing Penalty (veh)	80		529	22

Queuing and Blocking Report

Intersection: 25: Kennedy Street/Gateway Drive & SR-99 Southbound Ramps

Movement	EB	WB	SB	SB
Directions Served	L	TR	L	R
Maximum Queue (ft)	126	51	159	92
Average Queue (ft)	56	3	74	44
95th Queue (ft)	103	22	131	71
Link Distance (ft)		841	509	
Upstream Blk Time (%)				
Queuing Penalty (veh)				
Storage Bay Dist (ft)	140			335
Storage Blk Time (%)	0			
Queuing Penalty (veh)	0			

Queuing and Blocking Report

Intersection: 26: Gateway Drive & SR-99 Northbound Off-Ramp

Movement	EB	SB
Directions Served	LT	LR
Maximum Queue (ft)	116	71
Average Queue (ft)	38	42
95th Queue (ft)	93	67
Link Distance (ft)	841	55
Upstream Blk Time (%)		2
Queuing Penalty (veh)		3
Storage Bay Dist (ft)		
Storage Blk Time (%)		
Queuing Penalty (veh)		

Queuing and Blocking Report

Intersection: 27: SR-99 Northbound Off-Ramp

Movement	EB	SB
Directions Served	L	TR
Maximum Queue (ft)	55	54
Average Queue (ft)	42	8
95th Queue (ft)	62	38
Link Distance (ft)	55	503
Upstream Blk Time (%)	1	
Queuing Penalty (veh)	2	
Storage Bay Dist (ft)		
Storage Blk Time (%)		
Queuing Penalty (veh)		

Queuing and Blocking Report

Intersection: 28: Gateway Drive & SR-99 Northbound Off-Ramp

Movement	SB
Directions Served	LR
Maximum Queue (ft)	29
Average Queue (ft)	1
95th Queue (ft)	11
Link Distance (ft)	162
Upstream Blk Time (%)	
Queuing Penalty (veh)	
Storage Bay Dist (ft)	
Storage Blk Time (%)	
Queuing Penalty (veh)	

Queues
31: SR-99 Southbound Ramps & Cleveland Avenue



Lane Group	EBT	EBR	WBL	WBT	SBL	SBR
Lane Group Flow (vph)	796	393	328	1285	182	85
v/c Ratio	0.66	0.50	0.83	0.59	0.36	0.17
Control Delay	19.3	3.9	41.7	6.9	29.8	8.5
Queue Delay	0.0	0.0	0.0	0.2	0.0	0.0
Total Delay	19.3	3.9	41.7	7.1	29.8	8.5
Queue Length 50th (ft)	143	26	172	135	87	2
Queue Length 95th (ft)	m146	m46	m#326	161	151	38
Internal Link Dist (ft)	1412			372		
Turn Bay Length (ft)			115			140
Base Capacity (vph)	1449	871	404	2362	507	503
Starvation Cap Reductn	0	0	0	372	0	0
Spillback Cap Reductn	0	0	0	0	0	0
Storage Cap Reductn	0	0	0	0	0	0
Reduced v/c Ratio	0.55	0.45	0.81	0.65	0.36	0.17

Intersection Summary

95th percentile volume exceeds capacity, queue may be longer.

Queue shown is maximum after two cycles.

m Volume for 95th percentile queue is metered by upstream signal.

Queues
32: SR-99 Northbound Ramps & Cleveland Avenue



Lane Group	EBL	EBT	WBT	WBR	NBL	NBT	NBR
Lane Group Flow (vph)	80	917	1037	71	307	314	338
v/c Ratio	0.48	0.53	0.80	0.12	0.43	0.44	0.47
Control Delay	42.0	8.3	17.8	2.3	23.0	23.2	16.4
Queue Delay	0.0	0.9	1.8	0.0	0.0	0.0	0.0
Total Delay	42.0	9.2	19.6	2.3	23.0	23.2	16.4
Queue Length 50th (ft)	50	57	153	0	141	144	96
Queue Length 95th (ft)	m92	79	185	m3	224	229	179
Internal Link Dist (ft)		372	207			441	
Turn Bay Length (ft)	90			50	145		325
Base Capacity (vph)	188	1925	1370	636	711	713	725
Starvation Cap Reductn	0	659	183	0	0	0	0
Spillback Cap Reductn	0	0	0	0	0	0	0
Storage Cap Reductn	0	0	0	0	0	0	0
Reduced v/c Ratio	0.43	0.72	0.87	0.11	0.43	0.44	0.47

Intersection Summary

m Volume for 95th percentile queue is metered by upstream signal.

Queuing and Blocking Report

Intersection: 38: I Street & 2nd Street/SR-99 Southbound Off-Ramp

Movement	EB	WB	NB
Directions Served	LTR	LT	L
Maximum Queue (ft)	53	199	26
Average Queue (ft)	28	73	4
95th Queue (ft)	50	133	20
Link Distance (ft)	174	263	
Upstream Blk Time (%)			
Queuing Penalty (veh)			
Storage Bay Dist (ft)			75
Storage Blk Time (%)		12	
Queuing Penalty (veh)		1	

Queuing and Blocking Report

Intersection: 40: H Street & SR-99 Southbound On-Ramp/2nd Street

Movement	WB	SB
Directions Served	LTR	LTR
Maximum Queue (ft)	72	53
Average Queue (ft)	37	10
95th Queue (ft)	60	32
Link Distance (ft)	278	139
Upstream Blk Time (%)		
Queuing Penalty (veh)		
Storage Bay Dist (ft)		
Storage Blk Time (%)		
Queuing Penalty (veh)		

Queuing and Blocking Report

Intersection: 42: SR-99 Southbound On-Ramp & 4th Street

Movement	EB	EB	WB	WB	WB
Directions Served	T	TR	L	T	T
Maximum Queue (ft)	31	52	230	72	240
Average Queue (ft)	11	29	73	16	141
95th Queue (ft)	35	59	166	50	244
Link Distance (ft)	38	38	226	226	226
Upstream Blk Time (%)	0	2	2		2
Queuing Penalty (veh)	2	9	5		6
Storage Bay Dist (ft)					
Storage Blk Time (%)					
Queuing Penalty (veh)					

Queues

43: SR-99 Northbound Off-Ramp/H Street & 4th Street

Village D Specific Plan

Phase II NP - PM Peak Hour

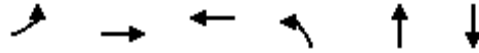

Lane Group	EBL	EBT	WBT	NBL	NBT	SBT
Lane Group Flow (vph)	263	430	729	287	234	119
v/c Ratio	0.82	0.26	0.89	0.70	0.44	0.30
Control Delay	45.6	7.0	50.5	46.6	10.6	9.7
Queue Delay	0.0	0.0	0.0	0.0	0.0	0.0
Total Delay	45.6	7.0	50.5	46.6	10.6	9.7
Queue Length 50th (ft)	177	48	227	174	18	2
Queue Length 95th (ft)	#287	63	#329	#295	85	50
Internal Link Dist (ft)		197	236		443	771
Turn Bay Length (ft)						
Base Capacity (vph)	348	1697	831	411	526	395
Starvation Cap Reductn	0	0	0	0	0	0
Spillback Cap Reductn	0	0	0	0	0	0
Storage Cap Reductn	0	0	0	0	0	0
Reduced v/c Ratio	0.76	0.25	0.88	0.70	0.44	0.30

Intersection Summary

95th percentile volume exceeds capacity, queue may be longer.
 Queue shown is maximum after two cycles.

Queues
45: Olive Avenue & SR-99 Southbound Off-Ramp

Village D Specific Plan
Phase II NP - PM Peak Hour

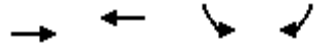

Lane Group	EBT	WBT	SBL	SBR
Lane Group Flow (vph)	649	492	554	95
v/c Ratio	0.68	0.73	0.45	0.09
Control Delay	37.8	43.5	7.2	2.9
Queue Delay	1.8	55.7	0.0	0.0
Total Delay	39.6	99.3	7.2	2.9
Queue Length 50th (ft)	124	160	121	8
Queue Length 95th (ft)	163	212	185	22
Internal Link Dist (ft)	103	112	135	
Turn Bay Length (ft)				
Base Capacity (vph)	1045	734	1224	1094
Starvation Cap Reductn	0	352	0	0
Spillback Cap Reductn	236	0	0	0
Storage Cap Reductn	0	0	0	0
Reduced v/c Ratio	0.80	1.29	0.45	0.09
Intersection Summary				

Queues
46: Madera Avenue & SR-99 Northbound Ramps

Village D Specific Plan
Phase II NP - PM Peak Hour



Lane Group	WBL	WBT	WBR	NBL	NBT	SBT
Lane Group Flow (vph)	106	108	36	730	734	902
v/c Ratio	0.51	0.52	0.14	0.72	0.27	0.60
Control Delay	45.0	45.2	3.1	33.2	4.9	21.2
Queue Delay	0.0	0.0	0.0	0.0	0.0	0.0
Total Delay	45.0	45.2	3.1	33.2	4.9	21.2
Queue Length 50th (ft)	60	61	0	119	30	191
Queue Length 95th (ft)	108	110	7	239	160	277
Internal Link Dist (ft)		337			388	217
Turn Bay Length (ft)	140			205		
Base Capacity (vph)	349	350	382	1010	2752	1502
Starvation Cap Reductn	0	0	0	0	0	0
Spillback Cap Reductn	0	0	0	0	0	0
Storage Cap Reductn	0	0	0	0	0	0
Reduced v/c Ratio	0.30	0.31	0.09	0.72	0.27	0.60
Intersection Summary						

Queues

47: Madera Avenue & Olive Avenue/SR-99 Southbound On-Ramp



Lane Group	EBL	EBT	EBR	NBL	NBT	SBL	SBT
Lane Group Flow (vph)	310	320	547	171	985	138	739
v/c Ratio	0.72	0.72	0.78	0.43	0.61	0.60	0.43
Control Delay	28.8	28.6	14.3	39.6	22.1	29.5	26.5
Queue Delay	6.2	6.2	12.8	0.0	0.0	0.0	0.6
Total Delay	35.0	34.8	27.1	39.6	22.1	29.5	27.1
Queue Length 50th (ft)	176	183	186	47	212	66	205
Queue Length 95th (ft)	236	242	262	74	345	m117	258
Internal Link Dist (ft)		112			323		388
Turn Bay Length (ft)				120		90	
Base Capacity (vph)	601	619	771	572	1628	272	1702
Starvation Cap Reductn	233	241	206	0	0	0	0
Spillback Cap Reductn	0	0	0	0	0	0	566
Storage Cap Reductn	0	0	0	0	0	0	0
Reduced v/c Ratio	0.84	0.85	0.97	0.30	0.61	0.51	0.65

Intersection Summary

m Volume for 95th percentile queue is metered by upstream signal.

Queuing and Blocking Report

Intersection: 48: Madera Avenue & Lewis Street

Movement	WB	NB	NB	SB
Directions Served	LR	T	TR	L
Maximum Queue (ft)	53	201	139	49
Average Queue (ft)	19	37	6	20
95th Queue (ft)	44	139	54	46
Link Distance (ft)	147	186	186	
Upstream Blk Time (%)		1		
Queuing Penalty (veh)		0		
Storage Bay Dist (ft)				100
Storage Blk Time (%)				
Queuing Penalty (veh)				

Queues
49: Yosemite Avenue & Cleveland Avenue/Tozer Street

Village D Specific Plan
Phase II NP - PM Peak Hour



Lane Group	EBL	EBT	WBL	WBT	WBR	NBL	NBT	NBR	SBL	SBT
Lane Group Flow (vph)	249	703	55	524	48	342	341	107	85	447
v/c Ratio	0.89	0.61	0.52	0.69	0.10	1.01	0.48	0.15	0.55	0.92
Control Delay	73.4	28.8	64.2	42.8	0.4	93.7	26.5	1.3	57.2	57.0
Queue Delay	0.0	0.0	0.0	0.0	0.0	0.0	0.0	0.0	0.0	0.0
Total Delay	73.4	28.8	64.2	42.8	0.4	93.7	26.5	1.3	57.2	57.0
Queue Length 50th (ft)	157	185	35	167	0	~224	166	0	52	238
Queue Length 95th (ft)	#297	251	#85	226	0	#405	250	10	102	#418
Internal Link Dist (ft)		318		397			415			443
Turn Bay Length (ft)	210		150		60	240			150	
Base Capacity (vph)	287	1150	105	755	497	338	717	710	171	509
Starvation Cap Reductn	0	0	0	0	0	0	0	0	0	0
Spillback Cap Reductn	0	0	0	0	0	0	0	0	0	0
Storage Cap Reductn	0	0	0	0	0	0	0	0	0	0
Reduced v/c Ratio	0.87	0.61	0.52	0.69	0.10	1.01	0.48	0.15	0.50	0.88

Intersection Summary

- ~ Volume exceeds capacity, queue is theoretically infinite.
Queue shown is maximum after two cycles.
- # 95th percentile volume exceeds capacity, queue may be longer.
Queue shown is maximum after two cycles.

Queuing and Blocking Report

Intersection: 5: Road 23/SR-99 Southbound Off-Ramp & Avenue 18 1/2

Movement	EB	EB	WB	NB	NB	SB
Directions Served	T	R	LT	L	R	LTR
Maximum Queue (ft)	16	37	149	414	75	277
Average Queue (ft)	2	5	18	387	75	184
95th Queue (ft)	10	21	79	408	75	314
Link Distance (ft)	247		193	351		238
Upstream Blk Time (%)				99		18
Queuing Penalty (veh)				0		0
Storage Bay Dist (ft)		50			25	
Storage Blk Time (%)		0		43	91	
Queuing Penalty (veh)		0		236	109	

Queuing and Blocking Report

Intersection: 6: SR-99 Northbound Ramps & Avenue 18 1/2

Movement	EB	NB
Directions Served	L	LTR
Maximum Queue (ft)	126	700
Average Queue (ft)	49	665
95th Queue (ft)	88	779
Link Distance (ft)		648
Upstream Blk Time (%)		91
Queuing Penalty (veh)		0
Storage Bay Dist (ft)	145	
Storage Blk Time (%)	0	
Queuing Penalty (veh)	0	

Queuing and Blocking Report

Intersection: 14: Avenue 17 & SR-99 Southbound Off-Ramp

Movement	WB	SB	SB
Directions Served	T	L	R
Maximum Queue (ft)	20	1051	760
Average Queue (ft)	1	658	343
95th Queue (ft)	8	1173	917
Link Distance (ft)	266	1017	
Upstream Blk Time (%)		8	
Queuing Penalty (veh)		0	
Storage Bay Dist (ft)			610
Storage Blk Time (%)		60	
Queuing Penalty (veh)		65	

Queuing and Blocking Report

Intersection: 15: SR-99 Northbound Ramps & Avenue 17

Movement	EB	NB	NB
Directions Served	L	LT	R
Maximum Queue (ft)	142	663	100
Average Queue (ft)	37	639	36
95th Queue (ft)	88	655	115
Link Distance (ft)		628	
Upstream Blk Time (%)		100	
Queuing Penalty (veh)		0	
Storage Bay Dist (ft)	125		50
Storage Blk Time (%)	1	100	0
Queuing Penalty (veh)	5	240	2

Queuing and Blocking Report

Intersection: 25: Kennedy Street/Gateway Drive & SR-99 Southbound Ramps

Movement	EB	EB	WB	SB	SB
Directions Served	L	T	TR	L	R
Maximum Queue (ft)	137	159	335	274	308
Average Queue (ft)	77	7	70	66	123
95th Queue (ft)	134	62	211	153	274
Link Distance (ft)		209	841	509	
Upstream Blk Time (%)					
Queuing Penalty (veh)					
Storage Bay Dist (ft)	140				335
Storage Blk Time (%)	1	0			
Queuing Penalty (veh)	3	0			

Queuing and Blocking Report

Intersection: 26: Gateway Drive & SR-99 Northbound Off-Ramp

Movement	EB	SB
Directions Served	LT	LR
Maximum Queue (ft)	54	90
Average Queue (ft)	23	59
95th Queue (ft)	54	82
Link Distance (ft)	841	55
Upstream Blk Time (%)		6
Queuing Penalty (veh)		19
Storage Bay Dist (ft)		
Storage Blk Time (%)		
Queuing Penalty (veh)		

Queuing and Blocking Report

Intersection: 27: SR-99 Northbound Off-Ramp

Movement	EB	SB
Directions Served	L	TR
Maximum Queue (ft)	66	113
Average Queue (ft)	43	53
95th Queue (ft)	64	107
Link Distance (ft)	55	503
Upstream Blk Time (%)	1	
Queuing Penalty (veh)	2	
Storage Bay Dist (ft)		
Storage Blk Time (%)		
Queuing Penalty (veh)		

Queuing and Blocking Report

Intersection: 28: Gateway Drive & SR-99 Northbound Off-Ramp

Movement

Directions Served

Maximum Queue (ft)

Average Queue (ft)

95th Queue (ft)

Link Distance (ft)

Upstream Blk Time (%)

Queuing Penalty (veh)

Storage Bay Dist (ft)

Storage Blk Time (%)

Queuing Penalty (veh)

Queues
31: SR-99 Southbound Ramps & Cleveland Avenue



Lane Group	EBT	EBR	WBL	WBT	SBL	SBR
Lane Group Flow (vph)	762	887	396	962	217	104
v/c Ratio	0.60	0.95	0.92	0.42	0.53	0.24
Control Delay	25.4	30.3	73.0	5.4	36.6	7.8
Queue Delay	0.0	0.0	0.0	0.1	0.0	0.0
Total Delay	25.4	30.3	73.0	5.6	36.6	7.8
Queue Length 50th (ft)	176	193	248	88	112	0
Queue Length 95th (ft)	233	#498	m#395	118	187	41
Internal Link Dist (ft)	1412			372		
Turn Bay Length (ft)			115			140
Base Capacity (vph)	1343	955	441	2402	409	439
Starvation Cap Reductn	0	0	0	465	0	0
Spillback Cap Reductn	0	0	0	0	0	0
Storage Cap Reductn	0	0	0	0	0	0
Reduced v/c Ratio	0.57	0.93	0.90	0.50	0.53	0.24

Intersection Summary

95th percentile volume exceeds capacity, queue may be longer.

Queue shown is maximum after two cycles.

m Volume for 95th percentile queue is metered by upstream signal.

Queues
32: SR-99 Northbound Ramps & Cleveland Avenue



Lane Group	EBL	EBT	WBT	WBR	NBL	NBT	NBR
Lane Group Flow (vph)	80	900	938	160	213	213	370
v/c Ratio	0.43	0.53	0.76	0.27	0.31	0.31	0.51
Control Delay	41.3	25.3	15.5	3.7	22.4	22.4	16.8
Queue Delay	0.0	0.2	1.2	0.0	0.0	0.0	0.0
Total Delay	41.3	25.5	16.7	3.7	22.4	22.4	16.8
Queue Length 50th (ft)	49	193	121	0	89	89	96
Queue Length 95th (ft)	m85	202	104	m7	166	166	204
Internal Link Dist (ft)		372	207			441	
Turn Bay Length (ft)	90			50	145		325
Base Capacity (vph)	379	2044	1264	612	684	684	728
Starvation Cap Reductn	0	406	146	0	0	0	0
Spillback Cap Reductn	0	92	0	0	0	0	3
Storage Cap Reductn	0	0	0	0	0	0	0
Reduced v/c Ratio	0.21	0.55	0.84	0.26	0.31	0.31	0.51

Intersection Summary

m Volume for 95th percentile queue is metered by upstream signal.

Queuing and Blocking Report

Intersection: 38: I Street & 2nd Street/SR-99 Southbound Off-Ramp

Movement	EB	WB	WB	NB
Directions Served	LTR	LT	R	L
Maximum Queue (ft)	54	302	99	26
Average Queue (ft)	31	134	9	2
95th Queue (ft)	51	261	55	15
Link Distance (ft)	174	263		
Upstream Blk Time (%)		7		
Queuing Penalty (veh)		0		
Storage Bay Dist (ft)			50	75
Storage Blk Time (%)		43		
Queuing Penalty (veh)		5		

Queuing and Blocking Report

Intersection: 40: H Street & SR-99 Southbound On-Ramp/2nd Street

Movement	WB	SB
Directions Served	LTR	LT
Maximum Queue (ft)	54	32
Average Queue (ft)	34	8
95th Queue (ft)	55	19
Link Distance (ft)	278	153
Upstream Blk Time (%)		
Queuing Penalty (veh)		
Storage Bay Dist (ft)		
Storage Blk Time (%)		
Queuing Penalty (veh)		

Queuing and Blocking Report

Intersection: 42: SR-99 Southbound On-Ramp & 4th Street

Movement	EB	EB	WB	WB	WB
Directions Served	T	TR	L	T	T
Maximum Queue (ft)	38	125	162	96	231
Average Queue (ft)	7	32	68	21	105
95th Queue (ft)	29	83	129	65	224
Link Distance (ft)	38	38	226	226	226
Upstream Blk Time (%)	0	2			1
Queuing Penalty (veh)	2	10			2
Storage Bay Dist (ft)					
Storage Blk Time (%)					
Queuing Penalty (veh)					

Queues
43: SR-99 Northbound Off-Ramp/H Street & 4th Street

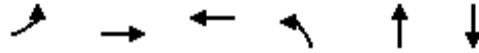

Lane Group	EBL	EBT	WBT	NBL	NBT	SBT
Lane Group Flow (vph)	291	552	668	290	279	90
v/c Ratio	0.91	0.35	0.95	0.77	0.52	0.21
Control Delay	51.2	6.9	58.8	48.5	10.0	3.7
Queue Delay	0.0	0.0	0.0	0.0	0.0	0.0
Total Delay	51.2	6.9	58.8	48.5	10.0	3.7
Queue Length 50th (ft)	180	60	193	157	16	0
Queue Length 95th (ft)	m#257	m74	#305	#279	85	20
Internal Link Dist (ft)		197	236		443	771
Turn Bay Length (ft)						
Base Capacity (vph)	327	1568	705	379	538	429
Starvation Cap Reductn	0	0	0	0	0	0
Spillback Cap Reductn	0	0	0	0	0	0
Storage Cap Reductn	0	0	0	0	0	0
Reduced v/c Ratio	0.89	0.35	0.95	0.77	0.52	0.21

Intersection Summary

95th percentile volume exceeds capacity, queue may be longer.

Queue shown is maximum after two cycles.

m Volume for 95th percentile queue is metered by upstream signal.

Queues
 45: Olive Avenue & SR-99 Southbound Off-Ramp

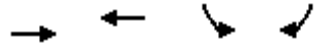

Lane Group	EBT	WBT	SBL	SBR
Lane Group Flow (vph)	586	544	827	120
v/c Ratio	0.54	0.72	0.74	0.12
Control Delay	29.0	40.6	15.0	3.8
Queue Delay	0.0	55.1	0.9	0.0
Total Delay	29.1	95.7	15.9	3.8
Queue Length 50th (ft)	93	154	246	11
Queue Length 95th (ft)	123	206	439	31
Internal Link Dist (ft)	103	112	135	
Turn Bay Length (ft)				
Base Capacity (vph)	1265	880	1113	1012
Starvation Cap Reductn	0	449	0	0
Spillback Cap Reductn	39	0	97	0
Storage Cap Reductn	0	0	0	0
Reduced v/c Ratio	0.48	1.26	0.81	0.12
Intersection Summary				

Queues

46: Madera Avenue & SR-99 Northbound Ramps



Lane Group	WBL	WBT	WBR	NBL	NBT	SBT
Lane Group Flow (vph)	112	114	104	655	540	990
v/c Ratio	0.50	0.50	0.35	0.91	0.21	0.62
Control Delay	38.6	38.8	9.8	41.6	1.5	17.1
Queue Delay	0.0	0.0	0.0	0.0	0.0	0.0
Total Delay	38.6	38.8	9.8	41.6	1.5	17.1
Queue Length 50th (ft)	55	56	0	145	2	168
Queue Length 95th (ft)	100	101	39	#260	22	264
Internal Link Dist (ft)		337			388	217
Turn Bay Length (ft)	140			205		
Base Capacity (vph)	377	378	430	722	2552	1591
Starvation Cap Reductn	0	0	0	0	0	0
Spillback Cap Reductn	0	0	0	0	0	0
Storage Cap Reductn	0	0	0	0	0	0
Reduced v/c Ratio	0.30	0.30	0.24	0.91	0.21	0.62

Intersection Summary

95th percentile volume exceeds capacity, queue may be longer.
 Queue shown is maximum after two cycles.

Queues

47: Madera Avenue & Olive Avenue/SR-99 Southbound On-Ramp



Lane Group	EBL	EBT	EBR	NBL	NBT	SBL	SBT
Lane Group Flow (vph)	333	345	720	182	733	92	815
v/c Ratio	0.75	0.75	0.83	0.29	0.46	0.49	0.61
Control Delay	29.0	28.9	18.5	28.7	17.3	51.1	12.1
Queue Delay	1.7	1.7	40.7	0.0	0.0	0.0	1.8
Total Delay	30.7	30.6	59.2	28.7	17.3	51.1	13.9
Queue Length 50th (ft)	116	121	261	38	135	51	24
Queue Length 95th (ft)	m161	m168	393	68	204	m86	162
Internal Link Dist (ft)		112			323		388
Turn Bay Length (ft)				120		90	
Base Capacity (vph)	540	558	882	659	1592	214	1331
Starvation Cap Reductn	89	94	213	0	0	0	0
Spillback Cap Reductn	0	0	0	0	0	0	341
Storage Cap Reductn	0	0	0	0	0	0	0
Reduced v/c Ratio	0.74	0.74	1.08	0.28	0.46	0.43	0.82

Intersection Summary

m Volume for 95th percentile queue is metered by upstream signal.

Queuing and Blocking Report

Intersection: 48: Madera Avenue & Lewis Street

Movement	WB	NB	SB
Directions Served	LR	T	L
Maximum Queue (ft)	49	109	68
Average Queue (ft)	15	7	17
95th Queue (ft)	41	48	47
Link Distance (ft)	147	186	
Upstream Blk Time (%)			
Queuing Penalty (veh)			
Storage Bay Dist (ft)			100
Storage Blk Time (%)			
Queuing Penalty (veh)			

Queues
49: Yosemite Avenue & Cleveland Avenue/Tozer Street

Village D Specific Plan
Phase II WP - AM Peak Hour



Lane Group	EBL	EBT	WBL	WBT	WBR	NBL	NBT	NBR	SBL	SBT
Lane Group Flow (vph)	309	860	124	363	59	150	137	84	79	538
v/c Ratio	0.90	0.75	0.79	0.47	0.13	0.89	0.24	0.14	0.48	1.03
Control Delay	66.0	28.6	75.2	32.8	0.6	87.4	26.2	0.5	48.7	77.6
Queue Delay	0.0	0.0	0.0	0.0	0.0	0.0	0.0	0.0	0.0	0.0
Total Delay	66.0	28.6	75.2	32.8	0.6	87.4	26.2	0.5	48.7	77.6
Queue Length 50th (ft)	172	203	70	95	0	86	61	0	43	-307
Queue Length 95th (ft)	#319	275	#165	138	0	#196	110	0	87	#506
Internal Link Dist (ft)		318		397			415			443
Turn Bay Length (ft)	210		150		60	240			150	
Base Capacity (vph)	352	1146	156	778	448	169	572	604	182	523
Starvation Cap Reductn	0	0	0	0	0	0	0	0	0	0
Spillback Cap Reductn	0	0	0	0	0	0	0	0	0	0
Storage Cap Reductn	0	0	0	0	0	0	0	0	0	0
Reduced v/c Ratio	0.88	0.75	0.79	0.47	0.13	0.89	0.24	0.14	0.43	1.03

Intersection Summary

- ~ Volume exceeds capacity, queue is theoretically infinite.
Queue shown is maximum after two cycles.
- # 95th percentile volume exceeds capacity, queue may be longer.
Queue shown is maximum after two cycles.

Queuing and Blocking Report

Intersection: 5: Road 23/SR-99 Southbound Off-Ramp & Avenue 18 1/2

Movement	EB	EB	WB	NB	NB	SB
Directions Served	T	R	LT	L	R	LTR
Maximum Queue (ft)	82	81	201	404	78	301
Average Queue (ft)	4	14	77	253	74	267
95th Queue (ft)	32	48	190	454	81	294
Link Distance (ft)	247		193	351		238
Upstream Blk Time (%)			0	19		100
Queuing Penalty (veh)			1	0		0
Storage Bay Dist (ft)		50			25	
Storage Blk Time (%)		0		62	71	
Queuing Penalty (veh)		1		202	54	

Queuing and Blocking Report

Intersection: 6: SR-99 Northbound Ramps & Avenue 18 1/2

Movement	EB	NB
Directions Served	L	LTR
Maximum Queue (ft)	98	282
Average Queue (ft)	29	142
95th Queue (ft)	69	259
Link Distance (ft)		648
Upstream Blk Time (%)		
Queuing Penalty (veh)		
Storage Bay Dist (ft)	145	
Storage Blk Time (%)		
Queuing Penalty (veh)		

Queuing and Blocking Report

Intersection: 14: Avenue 17 & SR-99 Southbound Off-Ramp

Movement	SB	SB
Directions Served	L	R
Maximum Queue (ft)	1032	760
Average Queue (ft)	905	331
95th Queue (ft)	1245	909
Link Distance (ft)	1017	
Upstream Blk Time (%)	46	
Queuing Penalty (veh)	0	
Storage Bay Dist (ft)		610
Storage Blk Time (%)	74	
Queuing Penalty (veh)	56	

Queuing and Blocking Report

Intersection: 15: SR-99 Northbound Ramps & Avenue 17

Movement	EB	EB	NB	NB
Directions Served	L	T	LT	R
Maximum Queue (ft)	225	536	644	100
Average Queue (ft)	97	245	640	76
95th Queue (ft)	248	657	652	143
Link Distance (ft)		511	629	
Upstream Blk Time (%)		16	100	
Queuing Penalty (veh)		192	0	
Storage Bay Dist (ft)	125			50
Storage Blk Time (%)	0	43	81	45
Queuing Penalty (veh)	1	61	427	347

Queuing and Blocking Report

Intersection: 25: Kennedy Street/Gateway Drive & SR-99 Southbound Ramps

Movement	EB	WB	SB	SB
Directions Served	L	TR	L	R
Maximum Queue (ft)	96	25	162	92
Average Queue (ft)	56	1	71	58
95th Queue (ft)	95	10	147	90
Link Distance (ft)		841	509	
Upstream Blk Time (%)				
Queuing Penalty (veh)				
Storage Bay Dist (ft)	140			335
Storage Blk Time (%)				
Queuing Penalty (veh)				

Queuing and Blocking Report

Intersection: 26: Gateway Drive & SR-99 Northbound Off-Ramp

Movement	EB	SB
Directions Served	LT	LR
Maximum Queue (ft)	95	72
Average Queue (ft)	38	43
95th Queue (ft)	79	70
Link Distance (ft)	841	55
Upstream Blk Time (%)		2
Queuing Penalty (veh)		4
Storage Bay Dist (ft)		
Storage Blk Time (%)		
Queuing Penalty (veh)		

Queuing and Blocking Report

Intersection: 27: SR-99 Northbound Off-Ramp

Movement	EB	SB
Directions Served	L	TR
Maximum Queue (ft)	75	55
Average Queue (ft)	39	10
95th Queue (ft)	63	40
Link Distance (ft)	55	503
Upstream Blk Time (%)	1	
Queuing Penalty (veh)	2	
Storage Bay Dist (ft)		
Storage Blk Time (%)		
Queuing Penalty (veh)		

Queuing and Blocking Report

Intersection: 28: Gateway Drive & SR-99 Northbound Off-Ramp

Movement	SB
Directions Served	LR
Maximum Queue (ft)	31
Average Queue (ft)	4
95th Queue (ft)	22
Link Distance (ft)	162
Upstream Blk Time (%)	
Queuing Penalty (veh)	
Storage Bay Dist (ft)	
Storage Blk Time (%)	
Queuing Penalty (veh)	

Queues
31: SR-99 Southbound Ramps & Cleveland Avenue



Lane Group	EBT	EBR	WBL	WBT	SBL	SBR
Lane Group Flow (vph)	953	538	328	1857	251	100
v/c Ratio	0.71	0.58	0.85	0.80	0.55	0.22
Control Delay	12.7	4.2	40.7	8.3	35.2	11.9
Queue Delay	0.2	0.0	0.0	6.5	0.0	0.0
Total Delay	12.9	4.2	40.7	14.7	35.2	11.9
Queue Length 50th (ft)	117	27	203	252	127	12
Queue Length 95th (ft)	m135	m46	m#236	m194	206	52
Internal Link Dist (ft)	1412			372		
Turn Bay Length (ft)			115			140
Base Capacity (vph)	1449	957	385	2386	453	453
Starvation Cap Reductn	0	0	0	487	0	0
Spillback Cap Reductn	78	0	0	0	0	0
Storage Cap Reductn	0	0	0	0	0	0
Reduced v/c Ratio	0.70	0.56	0.85	0.98	0.55	0.22

Intersection Summary

95th percentile volume exceeds capacity, queue may be longer.

Queue shown is maximum after two cycles.

m Volume for 95th percentile queue is metered by upstream signal.

Queues
32: SR-99 Northbound Ramps & Cleveland Avenue



Lane Group	EBL	EBT	WBT	WBR	NBL	NBT	NBR
Lane Group Flow (vph)	113	1114	1263	198	486	493	338
v/c Ratio	0.53	0.66	1.08	0.36	0.66	0.67	0.47
Control Delay	38.9	11.1	70.1	13.2	28.2	28.5	18.4
Queue Delay	0.0	0.8	9.4	0.7	0.0	0.0	0.0
Total Delay	38.9	11.9	79.5	13.9	28.2	28.5	18.4
Queue Length 50th (ft)	70	190	~408	22	237	242	108
Queue Length 95th (ft)	m111	297	#541	m39	#421	#429	201
Internal Link Dist (ft)		372	207			441	
Turn Bay Length (ft)	90			50	145		325
Base Capacity (vph)	287	1925	1171	555	731	734	721
Starvation Cap Reductn	0	472	149	151	0	0	0
Spillback Cap Reductn	0	0	23	0	0	0	0
Storage Cap Reductn	0	0	0	0	0	0	0
Reduced v/c Ratio	0.39	0.77	1.24	0.49	0.66	0.67	0.47

Intersection Summary

- ~ Volume exceeds capacity, queue is theoretically infinite.
Queue shown is maximum after two cycles.
- # 95th percentile volume exceeds capacity, queue may be longer.
Queue shown is maximum after two cycles.
- m Volume for 95th percentile queue is metered by upstream signal.

Queuing and Blocking Report

Intersection: 38: I Street & 2nd Street/SR-99 Southbound Off-Ramp

Movement	EB	WB	WB	NB
Directions Served	LTR	LT	R	L
Maximum Queue (ft)	31	176	99	26
Average Queue (ft)	26	76	5	5
95th Queue (ft)	44	134	39	21
Link Distance (ft)	174	263		
Upstream Blk Time (%)				
Queuing Penalty (veh)				
Storage Bay Dist (ft)			50	75
Storage Blk Time (%)		14		
Queuing Penalty (veh)		1		

Queuing and Blocking Report

Intersection: 40: H Street & SR-99 Southbound On-Ramp/2nd Street

Movement	WB	SB
Directions Served	LTR	LTR
Maximum Queue (ft)	102	28
Average Queue (ft)	41	7
95th Queue (ft)	75	22
Link Distance (ft)	278	139
Upstream Blk Time (%)		
Queuing Penalty (veh)		
Storage Bay Dist (ft)		
Storage Blk Time (%)		
Queuing Penalty (veh)		

Queuing and Blocking Report

Intersection: 42: SR-99 Southbound On-Ramp & 4th Street

Movement	EB	EB	WB	WB	WB
Directions Served	T	TR	L	T	T
Maximum Queue (ft)	53	52	139	52	232
Average Queue (ft)	28	31	65	10	117
95th Queue (ft)	65	61	120	36	216
Link Distance (ft)	38	38	226	226	226
Upstream Blk Time (%)	7	2			0
Queuing Penalty (veh)	38	13			1
Storage Bay Dist (ft)					
Storage Blk Time (%)					
Queuing Penalty (veh)					

Queues

43: SR-99 Northbound Off-Ramp/H Street & 4th Street

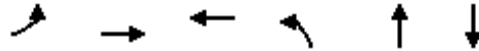

Lane Group	EBL	EBT	WBT	NBL	NBT	SBT
Lane Group Flow (vph)	319	460	780	287	234	119
v/c Ratio	0.93	0.27	0.94	0.76	0.47	0.30
Control Delay	57.7	6.4	55.2	51.3	11.0	9.7
Queue Delay	0.0	0.0	0.0	0.0	0.0	0.0
Total Delay	57.7	6.4	55.2	51.3	11.0	9.7
Queue Length 50th (ft)	218	48	245	174	18	2
Queue Length 95th (ft)	m#367	63	#364	#295	85	50
Internal Link Dist (ft)		197	236		443	771
Turn Bay Length (ft)						
Base Capacity (vph)	348	1697	834	379	500	395
Starvation Cap Reductn	0	0	0	0	0	0
Spillback Cap Reductn	0	0	0	0	0	0
Storage Cap Reductn	0	0	0	0	0	0
Reduced v/c Ratio	0.92	0.27	0.94	0.76	0.47	0.30

Intersection Summary

95th percentile volume exceeds capacity, queue may be longer.

Queue shown is maximum after two cycles.

m Volume for 95th percentile queue is metered by upstream signal.

Queues
 45: Olive Avenue & SR-99 Southbound Off-Ramp

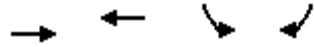

Lane Group	EBT	WBT	SBL	SBR
Lane Group Flow (vph)	711	541	642	95
v/c Ratio	0.71	0.78	0.52	0.09
Control Delay	38.3	54.9	8.3	3.3
Queue Delay	0.0	56.5	0.2	0.0
Total Delay	38.3	111.4	8.4	3.3
Queue Length 50th (ft)	137	176	152	10
Queue Length 95th (ft)	179	231	230	24
Internal Link Dist (ft)	103	112	135	
Turn Bay Length (ft)				
Base Capacity (vph)	1055	734	1225	1092
Starvation Cap Reductn	0	396	0	0
Spillback Cap Reductn	3	0	110	0
Storage Cap Reductn	0	0	0	0
Reduced v/c Ratio	0.68	1.60	0.58	0.09
Intersection Summary				

Queues
46: Madera Avenue & SR-99 Northbound Ramps



Lane Group	WBL	WBT	WBR	NBL	NBT	SBT
Lane Group Flow (vph)	123	124	36	860	776	978
v/c Ratio	0.55	0.55	0.13	0.99	0.28	0.61
Control Delay	44.7	44.8	2.8	58.5	3.6	19.2
Queue Delay	0.0	0.0	0.0	0.0	0.0	0.0
Total Delay	44.7	44.8	2.8	58.5	3.6	19.2
Queue Length 50th (ft)	70	70	0	245	52	194
Queue Length 95th (ft)	118	121	7	#379	73	291
Internal Link Dist (ft)		337			388	217
Turn Bay Length (ft)	140			205		
Base Capacity (vph)	350	351	384	866	2740	1615
Starvation Cap Reductn	0	0	0	0	0	0
Spillback Cap Reductn	0	0	0	0	0	0
Storage Cap Reductn	0	0	0	0	0	0
Reduced v/c Ratio	0.35	0.35	0.09	0.99	0.28	0.61

Intersection Summary

95th percentile volume exceeds capacity, queue may be longer.
Queue shown is maximum after two cycles.

Queues

47: Madera Avenue & Olive Avenue/SR-99 Southbound On-Ramp



Lane Group	EBL	EBT	EBR	NBL	NBT	SBL	SBT
Lane Group Flow (vph)	348	362	615	180	1108	138	778
v/c Ratio	0.84	0.84	0.81	0.50	0.64	0.70	0.43
Control Delay	36.1	36.3	13.4	42.6	19.9	62.5	2.6
Queue Delay	4.1	4.3	0.4	0.0	0.0	0.0	0.8
Total Delay	40.3	40.6	13.8	42.6	19.9	62.5	3.3
Queue Length 50th (ft)	110	115	62	50	250	65	5
Queue Length 95th (ft)	#306	#316	88	82	322	m#144	55
Internal Link Dist (ft)		112			323		388
Turn Bay Length (ft)				120		90	
Base Capacity (vph)	453	467	776	400	1723	208	1802
Starvation Cap Reductn	53	54	19	0	0	0	0
Spillback Cap Reductn	0	0	0	0	0	0	662
Storage Cap Reductn	0	0	0	0	0	0	0
Reduced v/c Ratio	0.87	0.88	0.81	0.45	0.64	0.66	0.68

Intersection Summary

95th percentile volume exceeds capacity, queue may be longer.

Queue shown is maximum after two cycles.

m Volume for 95th percentile queue is metered by upstream signal.

Queuing and Blocking Report

Intersection: 48: Madera Avenue & Lewis Street

Movement	WB	NB	NB	SB
Directions Served	LR	T	TR	L
Maximum Queue (ft)	30	201	140	51
Average Queue (ft)	12	59	6	24
95th Queue (ft)	35	167	54	47
Link Distance (ft)	147	186	186	
Upstream Blk Time (%)		2		
Queuing Penalty (veh)		0		
Storage Bay Dist (ft)				100
Storage Blk Time (%)				
Queuing Penalty (veh)				

Queues
49: Yosemite Avenue & Cleveland Avenue/Tozer Street

Village D Specific Plan
Phase II WP - PM Peak Hour



Lane Group	EBL	EBT	WBL	WBT	WBR	NBL	NBT	NBR	SBL	SBT
Lane Group Flow (vph)	296	708	55	535	48	342	341	107	85	537
v/c Ratio	1.04	0.64	0.54	0.77	0.10	1.00	0.45	0.15	0.55	1.03
Control Delay	107.1	29.9	65.9	46.7	0.4	91.4	25.6	1.3	57.2	80.1
Queue Delay	0.0	0.0	0.0	0.0	0.0	0.0	0.0	0.0	0.0	0.0
Total Delay	107.1	29.9	65.9	46.7	0.4	91.4	25.6	1.3	57.2	80.1
Queue Length 50th (ft)	~205	187	35	171	0	~221	165	0	52	~327
Queue Length 95th (ft)	#369	253	#85	231	0	#403	249	10	102	#534
Internal Link Dist (ft)		318		397			415			443
Turn Bay Length (ft)	210		150		60	240			150	
Base Capacity (vph)	284	1106	102	696	475	341	752	737	171	519
Starvation Cap Reductn	0	0	0	0	0	0	0	0	0	0
Spillback Cap Reductn	0	0	0	0	0	0	0	0	0	0
Storage Cap Reductn	0	0	0	0	0	0	0	0	0	0
Reduced v/c Ratio	1.04	0.64	0.54	0.77	0.10	1.00	0.45	0.15	0.50	1.03

Intersection Summary

- ~ Volume exceeds capacity, queue is theoretically infinite.
Queue shown is maximum after two cycles.
- # 95th percentile volume exceeds capacity, queue may be longer.
Queue shown is maximum after two cycles.

Queuing and Blocking Report

Intersection: 5: Road 23/SR-99 Southbound Off-Ramp & Avenue 18 1/2

Movement	EB	EB	WB	NB	NB	SB
Directions Served	T	R	LT	L	R	LTR
Maximum Queue (ft)	35	12	75	193	75	277
Average Queue (ft)	2	1	15	70	60	94
95th Queue (ft)	15	5	47	167	91	225
Link Distance (ft)	247		193	351		238
Upstream Blk Time (%)						8
Queuing Penalty (veh)						0
Storage Bay Dist (ft)		50			25	
Storage Blk Time (%)	0			32	26	
Queuing Penalty (veh)	0			51	16	

Queuing and Blocking Report

Intersection: 6: SR-99 Northbound Ramps & Avenue 18 1/2

Movement	EB	NB
Directions Served	L	LTR
Maximum Queue (ft)	79	377
Average Queue (ft)	36	159
95th Queue (ft)	76	304
Link Distance (ft)		648
Upstream Blk Time (%)		
Queuing Penalty (veh)		
Storage Bay Dist (ft)	145	
Storage Blk Time (%)		
Queuing Penalty (veh)		

Queuing and Blocking Report

Intersection: 14: Avenue 17 & SR-99 Southbound Off-Ramp

Movement	SB	SB
Directions Served	L	R
Maximum Queue (ft)	649	111
Average Queue (ft)	285	58
95th Queue (ft)	606	98
Link Distance (ft)	1017	
Upstream Blk Time (%)		
Queuing Penalty (veh)		
Storage Bay Dist (ft)		610
Storage Blk Time (%)	1	
Queuing Penalty (veh)	1	

Queuing and Blocking Report

Intersection: 15: SR-99 Northbound Ramps & Avenue 17

Movement	EB	EB	NB	NB
Directions Served	L	T	LT	R
Maximum Queue (ft)	198	237	663	100
Average Queue (ft)	110	49	643	27
95th Queue (ft)	187	186	657	101
Link Distance (ft)		511	628	
Upstream Blk Time (%)			100	
Queuing Penalty (veh)			0	
Storage Bay Dist (ft)	125			50
Storage Blk Time (%)	14	0	100	3
Queuing Penalty (veh)	67	1	240	8

Queuing and Blocking Report

Intersection: 25: Kennedy Street/Gateway Drive & SR-99 Southbound Ramps

Movement	EB	EB	B82	WB	SB	SB
Directions Served	L	T	T	TR	L	R
Maximum Queue (ft)	164	281	21	127	218	95
Average Queue (ft)	91	20	1	6	70	59
95th Queue (ft)	158	128	8	49	172	91
Link Distance (ft)		209	199	841	509	
Upstream Blk Time (%)		1				
Queuing Penalty (veh)		5				
Storage Bay Dist (ft)	140					335
Storage Blk Time (%)	4	0				
Queuing Penalty (veh)	10	0				

Queuing and Blocking Report

Intersection: 26: Gateway Drive & SR-99 Northbound Off-Ramp

Movement	EB	SB
Directions Served	LT	LR
Maximum Queue (ft)	104	75
Average Queue (ft)	18	61
95th Queue (ft)	64	77
Link Distance (ft)	841	55
Upstream Blk Time (%)		8
Queuing Penalty (veh)		32
Storage Bay Dist (ft)		
Storage Blk Time (%)		
Queuing Penalty (veh)		

Queuing and Blocking Report

Intersection: 27: SR-99 Northbound Off-Ramp

Movement	EB	SB
Directions Served	L	TR
Maximum Queue (ft)	66	121
Average Queue (ft)	41	59
95th Queue (ft)	61	121
Link Distance (ft)	55	503
Upstream Blk Time (%)	1	
Queuing Penalty (veh)	1	
Storage Bay Dist (ft)		
Storage Blk Time (%)		
Queuing Penalty (veh)		

Queuing and Blocking Report

Intersection: 28: Gateway Drive & SR-99 Northbound Off-Ramp

Movement
Directions Served
Maximum Queue (ft)
Average Queue (ft)
95th Queue (ft)
Link Distance (ft)
Upstream Blk Time (%)
Queuing Penalty (veh)
Storage Bay Dist (ft)
Storage Blk Time (%)
Queuing Penalty (veh)

Queues
 31: SR-99 Southbound Ramps & Cleveland Avenue

Village D Specific Plan
 Phase III NP - AM Peak Hour



Lane Group	EBT	EBR	WBL	WBT	SBL	SBR
Lane Group Flow (vph)	540	488	424	760	89	76
v/c Ratio	0.64	0.65	0.82	0.37	0.18	0.16
Control Delay	34.0	7.3	56.4	7.1	27.9	8.3
Queue Delay	0.0	0.0	0.1	0.0	0.0	0.0
Total Delay	34.0	7.3	56.5	7.1	27.9	8.3
Queue Length 50th (ft)	142	0	239	65	38	0
Queue Length 95th (ft)	195	79	308	88	84	35
Internal Link Dist (ft)	1412			372		
Turn Bay Length (ft)			115			140
Base Capacity (vph)	929	773	652	2395	487	482
Starvation Cap Reductn	0	0	6	0	0	0
Spillback Cap Reductn	0	0	0	0	0	0
Storage Cap Reductn	0	0	0	0	0	0
Reduced v/c Ratio	0.58	0.63	0.66	0.32	0.18	0.16
Intersection Summary						

Queues
32: SR-99 Northbound Ramps & Cleveland Avenue

Village D Specific Plan
Phase III NP - AM Peak Hour



Lane Group	EBL	EBT	WBT	WBR	NBL	NBT	NBR
Lane Group Flow (vph)	77	554	878	126	157	157	423
v/c Ratio	0.43	0.34	0.73	0.22	0.23	0.23	0.48
Control Delay	42.7	33.3	13.4	2.9	21.0	21.0	5.9
Queue Delay	0.0	0.0	1.1	0.0	0.0	0.0	0.0
Total Delay	42.7	33.3	14.5	2.9	21.0	21.0	5.9
Queue Length 50th (ft)	47	142	232	0	62	62	14
Queue Length 95th (ft)	m83	175	57	m1	127	127	94
Internal Link Dist (ft)		372	207			441	
Turn Bay Length (ft)	90			50	145		325
Base Capacity (vph)	620	2349	1202	585	694	694	873
Starvation Cap Reductn	0	0	138	0	0	0	0
Spillback Cap Reductn	0	2	0	0	0	0	0
Storage Cap Reductn	0	0	0	0	0	0	0
Reduced v/c Ratio	0.12	0.24	0.83	0.22	0.23	0.23	0.48

Intersection Summary

m Volume for 95th percentile queue is metered by upstream signal.

Queuing and Blocking Report

Intersection: 38: I Street & 2nd Street/SR-99 Southbound Off-Ramp

Movement	EB	WB	WB	NB
Directions Served	LTR	LT	R	L
Maximum Queue (ft)	53	186	100	26
Average Queue (ft)	31	76	5	3
95th Queue (ft)	46	127	39	18
Link Distance (ft)	174	263		
Upstream Blk Time (%)				
Queuing Penalty (veh)				
Storage Bay Dist (ft)			50	75
Storage Blk Time (%)		20		
Queuing Penalty (veh)		2		

Queuing and Blocking Report

Intersection: 40: H Street & SR-99 Southbound On-Ramp/2nd Street

Movement	WB	SB
Directions Served	LTR	LT
Maximum Queue (ft)	75	32
Average Queue (ft)	36	9
95th Queue (ft)	59	23
Link Distance (ft)	278	153
Upstream Blk Time (%)		
Queuing Penalty (veh)		
Storage Bay Dist (ft)		
Storage Blk Time (%)		
Queuing Penalty (veh)		

Queuing and Blocking Report

Intersection: 42: SR-99 Southbound On-Ramp & 4th Street

Movement	EB	EB	WB	WB	WB
Directions Served	T	TR	L	T	T
Maximum Queue (ft)	53	71	163	94	228
Average Queue (ft)	9	33	74	40	127
95th Queue (ft)	34	64	141	80	233
Link Distance (ft)	38	38	226	226	226
Upstream Blk Time (%)	1	2			1
Queuing Penalty (veh)	4	13			3
Storage Bay Dist (ft)					
Storage Blk Time (%)					
Queuing Penalty (veh)					

Queues

43: SR-99 Northbound Off-Ramp/H Street & 4th Street

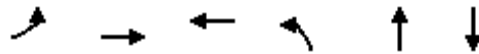

Lane Group	EBL	EBT	WBT	NBL	NBT	SBT
Lane Group Flow (vph)	288	511	694	305	299	100
v/c Ratio	0.91	0.33	0.98	0.80	0.54	0.23
Control Delay	69.3	26.2	66.2	51.6	10.3	4.8
Queue Delay	0.0	0.0	0.0	0.0	0.0	0.0
Total Delay	69.3	26.2	66.2	51.6	10.3	4.8
Queue Length 50th (ft)	151	121	203	166	18	0
Queue Length 95th (ft)	m#252	m163	#324	#300	90	27
Internal Link Dist (ft)		197	236		443	771
Turn Bay Length (ft)						
Base Capacity (vph)	324	1553	706	379	552	429
Starvation Cap Reductn	0	0	0	0	0	0
Spillback Cap Reductn	0	0	0	0	0	0
Storage Cap Reductn	0	0	0	0	0	0
Reduced v/c Ratio	0.89	0.33	0.98	0.80	0.54	0.23

Intersection Summary

95th percentile volume exceeds capacity, queue may be longer.

Queue shown is maximum after two cycles.

m Volume for 95th percentile queue is metered by upstream signal.

Queues
45: Olive Avenue & SR-99 Southbound Off-Ramp

Village D Specific Plan
Phase III NP - AM Peak Hour

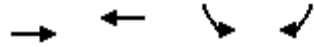

Lane Group	EBT	WBT	SBL	SBR
Lane Group Flow (vph)	612	582	757	128
v/c Ratio	0.52	0.71	0.71	0.13
Control Delay	27.7	23.4	14.8	4.1
Queue Delay	0.6	6.6	0.0	0.0
Total Delay	28.2	30.0	14.9	4.1
Queue Length 50th (ft)	97	126	220	12
Queue Length 95th (ft)	124	152	405	35
Internal Link Dist (ft)	103	112	135	
Turn Bay Length (ft)				
Base Capacity (vph)	1389	966	1064	971
Starvation Cap Reductn	0	328	0	0
Spillback Cap Reductn	401	0	4	0
Storage Cap Reductn	0	0	0	0
Reduced v/c Ratio	0.62	0.91	0.71	0.13
Intersection Summary				

Queues
46: Madera Avenue & SR-99 Northbound Ramps



Lane Group	WBL	WBT	WBR	NBL	NBT	SBT
Lane Group Flow (vph)	121	123	116	721	486	1063
v/c Ratio	0.50	0.51	0.36	1.01	0.19	0.68
Control Delay	37.6	37.8	9.1	70.7	6.6	18.9
Queue Delay	0.0	0.0	0.0	0.0	0.0	0.0
Total Delay	37.6	37.8	9.1	70.7	6.6	18.9
Queue Length 50th (ft)	60	61	0	~156	41	190
Queue Length 95th (ft)	104	105	40	#302	105	302
Internal Link Dist (ft)		337			388	217
Turn Bay Length (ft)	140			205		
Base Capacity (vph)	377	378	439	715	2496	1562
Starvation Cap Reductn	0	0	0	0	0	0
Spillback Cap Reductn	0	0	0	0	0	0
Storage Cap Reductn	0	0	0	0	0	0
Reduced v/c Ratio	0.32	0.33	0.26	1.01	0.19	0.68

Intersection Summary

- ~ Volume exceeds capacity, queue is theoretically infinite.
Queue shown is maximum after two cycles.
- # 95th percentile volume exceeds capacity, queue may be longer.
Queue shown is maximum after two cycles.

Queues

47: Madera Avenue & Olive Avenue/SR-99 Southbound On-Ramp



Lane Group	EBL	EBT	EBR	NBL	NBT	SBL	SBT
Lane Group Flow (vph)	321	332	702	213	774	93	880
v/c Ratio	0.73	0.73	0.82	0.32	0.49	0.48	0.69
Control Delay	32.4	32.2	20.6	28.4	18.1	28.9	32.4
Queue Delay	28.7	33.5	51.6	0.0	0.0	0.0	1.2
Total Delay	61.1	65.7	72.3	28.4	18.1	28.9	33.5
Queue Length 50th (ft)	147	152	233	44	145	41	201
Queue Length 95th (ft)	m224	m230	261	78	224	m62	265
Internal Link Dist (ft)		112			323		388
Turn Bay Length (ft)				120		90	
Base Capacity (vph)	556	574	866	683	1569	219	1279
Starvation Cap Reductn	238	251	330	0	0	0	0
Spillback Cap Reductn	0	0	0	0	0	0	196
Storage Cap Reductn	0	0	0	0	0	0	0
Reduced v/c Ratio	1.01	1.03	1.31	0.31	0.49	0.42	0.81

Intersection Summary

m Volume for 95th percentile queue is metered by upstream signal.

Queuing and Blocking Report

Intersection: 48: Madera Avenue & Lewis Street

Movement	WB	NB	SB
Directions Served	LR	T	L
Maximum Queue (ft)	30	31	52
Average Queue (ft)	12	1	16
95th Queue (ft)	36	12	41
Link Distance (ft)	147	186	
Upstream Blk Time (%)			
Queuing Penalty (veh)			
Storage Bay Dist (ft)			100
Storage Blk Time (%)			
Queuing Penalty (veh)			

Queues
49: Yosemite Avenue & Cleveland Avenue/Tozer Street

Village D Specific Plan
Phase III NP - AM Peak Hour



Lane Group	EBL	EBT	WBL	WBT	WBR	NBL	NBT	NBR	SBL	SBT
Lane Group Flow (vph)	228	860	126	379	65	153	149	85	86	539
v/c Ratio	0.75	0.75	0.81	0.44	0.14	0.91	0.26	0.14	0.52	1.03
Control Delay	50.8	28.4	77.0	31.4	0.6	90.8	26.5	0.5	50.2	79.0
Queue Delay	0.0	0.0	0.0	0.0	0.0	0.0	0.0	0.0	0.0	0.0
Total Delay	50.8	28.4	77.0	31.4	0.6	90.8	26.5	0.5	50.2	79.0
Queue Length 50th (ft)	122	201	72	97	0	88	67	0	47	-311
Queue Length 95th (ft)	198	274	#168	145	0	#202	118	0	94	#512
Internal Link Dist (ft)		318		397			415			443
Turn Bay Length (ft)	210		150		60	240			150	
Base Capacity (vph)	352	1148	156	855	475	169	571	603	182	522
Starvation Cap Reductn	0	0	0	0	0	0	0	0	0	0
Spillback Cap Reductn	0	0	0	0	0	0	0	0	0	0
Storage Cap Reductn	0	0	0	0	0	0	0	0	0	0
Reduced v/c Ratio	0.65	0.75	0.81	0.44	0.14	0.91	0.26	0.14	0.47	1.03

Intersection Summary

- ~ Volume exceeds capacity, queue is theoretically infinite.
Queue shown is maximum after two cycles.
- # 95th percentile volume exceeds capacity, queue may be longer.
Queue shown is maximum after two cycles.

Queuing and Blocking Report

Intersection: 5: Road 23/SR-99 Southbound Off-Ramp & Avenue 18 1/2

Movement	EB	EB	WB	NB	NB	SB
Directions Served	T	R	LT	L	R	LTR
Maximum Queue (ft)	16	81	91	251	75	301
Average Queue (ft)	1	12	27	69	58	245
95th Queue (ft)	6	46	70	176	90	364
Link Distance (ft)	247		193	351		238
Upstream Blk Time (%)						81
Queuing Penalty (veh)						0
Storage Bay Dist (ft)		50			25	
Storage Blk Time (%)		0		27	30	
Queuing Penalty (veh)		0		45	14	

Queuing and Blocking Report

Intersection: 6: SR-99 Northbound Ramps & Avenue 18 1/2

Movement	EB	EB	NB
Directions Served	L	T	LTR
Maximum Queue (ft)	115	18	275
Average Queue (ft)	23	1	90
95th Queue (ft)	64	7	183
Link Distance (ft)		530	648
Upstream Blk Time (%)			
Queuing Penalty (veh)			
Storage Bay Dist (ft)	145		
Storage Blk Time (%)			
Queuing Penalty (veh)			

Queuing and Blocking Report

Intersection: 14: Avenue 17 & SR-99 Southbound Off-Ramp

Movement	EB	SB	SB
Directions Served	T	L	R
Maximum Queue (ft)	388	1069	760
Average Queue (ft)	49	1046	453
95th Queue (ft)	255	1069	1062
Link Distance (ft)	380	1017	
Upstream Blk Time (%)	4	100	
Queuing Penalty (veh)	42	0	
Storage Bay Dist (ft)			610
Storage Blk Time (%)		100	
Queuing Penalty (veh)		92	

Queuing and Blocking Report

Intersection: 15: SR-99 Northbound Ramps & Avenue 17

Movement	EB	EB	WB	NB	NB
Directions Served	L	T	TR	LT	R
Maximum Queue (ft)	224	526	155	681	100
Average Queue (ft)	105	117	7	643	23
95th Queue (ft)	218	419	60	660	92
Link Distance (ft)		511	348	629	
Upstream Blk Time (%)		8		100	
Queuing Penalty (veh)		92		0	
Storage Bay Dist (ft)	125				50
Storage Blk Time (%)	28	0		100	5
Queuing Penalty (veh)	252	0		529	11

Queuing and Blocking Report

Intersection: 25: Kennedy Street/Gateway Drive & SR-99 Southbound Ramps

Movement	EB	EB	WB	SB	SB
Directions Served	L	T	TR	L	R
Maximum Queue (ft)	162	268	51	325	167
Average Queue (ft)	65	21	8	164	77
95th Queue (ft)	120	134	37	285	145
Link Distance (ft)		209	841	509	
Upstream Blk Time (%)		0			
Queuing Penalty (veh)		1			
Storage Bay Dist (ft)	140				335
Storage Blk Time (%)	1			0	
Queuing Penalty (veh)	4			0	

Queuing and Blocking Report

Intersection: 26: Gateway Drive & SR-99 Northbound Off-Ramp

Movement	EB	SB
Directions Served	LT	LR
Maximum Queue (ft)	140	72
Average Queue (ft)	37	48
95th Queue (ft)	88	73
Link Distance (ft)	841	55
Upstream Blk Time (%)		3
Queuing Penalty (veh)		6
Storage Bay Dist (ft)		
Storage Blk Time (%)		
Queuing Penalty (veh)		

Queuing and Blocking Report

Intersection: 27: SR-99 Northbound Off-Ramp

Movement	EB	SB
Directions Served	L	TR
Maximum Queue (ft)	66	68
Average Queue (ft)	42	10
95th Queue (ft)	62	42
Link Distance (ft)	55	503
Upstream Blk Time (%)	1	
Queuing Penalty (veh)	2	
Storage Bay Dist (ft)		
Storage Blk Time (%)		
Queuing Penalty (veh)		

Queuing and Blocking Report

Intersection: 28: Gateway Drive & SR-99 Northbound Off-Ramp

Movement	SB
Directions Served	LR
Maximum Queue (ft)	31
Average Queue (ft)	3
95th Queue (ft)	17
Link Distance (ft)	162
Upstream Blk Time (%)	
Queuing Penalty (veh)	
Storage Bay Dist (ft)	
Storage Blk Time (%)	
Queuing Penalty (veh)	

Queues
 31: SR-99 Southbound Ramps & Cleveland Avenue



Lane Group	EBT	EBR	WBL	WBT	SBL	SBR
Lane Group Flow (vph)	842	421	393	1386	209	88
v/c Ratio	0.73	0.53	0.87	0.62	0.44	0.19
Control Delay	25.9	5.4	41.1	6.7	32.6	10.6
Queue Delay	0.1	0.0	0.0	0.3	0.0	0.0
Total Delay	26.0	5.4	41.1	7.0	32.6	10.6
Queue Length 50th (ft)	162	28	217	152	105	7
Queue Length 95th (ft)	m209	m46	m#332	156	175	44
Internal Link Dist (ft)	1412			372		
Turn Bay Length (ft)			115			140
Base Capacity (vph)	1250	824	486	2402	472	469
Starvation Cap Reductn	0	0	0	394	0	0
Spillback Cap Reductn	29	0	0	0	0	0
Storage Cap Reductn	0	0	0	0	0	0
Reduced v/c Ratio	0.69	0.51	0.81	0.69	0.44	0.19

Intersection Summary

95th percentile volume exceeds capacity, queue may be longer.

Queue shown is maximum after two cycles.

m Volume for 95th percentile queue is metered by upstream signal.

Queues
32: SR-99 Northbound Ramps & Cleveland Avenue

Village D Specific Plan
Phase III NP - PM Peak Hour



Lane Group	EBL	EBT	WBT	WBR	NBL	NBT	NBR
Lane Group Flow (vph)	83	988	1121	72	351	357	367
v/c Ratio	0.53	0.56	0.83	0.11	0.51	0.51	0.52
Control Delay	47.0	9.9	18.8	2.6	24.8	25.0	19.4
Queue Delay	0.0	2.0	3.3	0.0	0.0	0.0	0.0
Total Delay	47.0	11.8	22.1	2.6	24.8	25.0	19.4
Queue Length 50th (ft)	52	206	170	1	166	170	122
Queue Length 95th (ft)	m82	242	199	m4	260	265	214
Internal Link Dist (ft)		372	207			441	
Turn Bay Length (ft)	90			50	145		325
Base Capacity (vph)	168	1925	1409	653	694	696	700
Starvation Cap Reductn	0	744	197	0	0	0	0
Spillback Cap Reductn	0	0	0	0	0	0	0
Storage Cap Reductn	0	0	0	0	0	0	0
Reduced v/c Ratio	0.49	0.84	0.92	0.11	0.51	0.51	0.52

Intersection Summary

m Volume for 95th percentile queue is metered by upstream signal.

Queuing and Blocking Report

Intersection: 38: I Street & 2nd Street/SR-99 Southbound Off-Ramp

Movement	EB	WB	NB
Directions Served	LTR	LT	L
Maximum Queue (ft)	51	181	49
Average Queue (ft)	29	68	7
95th Queue (ft)	46	120	29
Link Distance (ft)	174	263	
Upstream Blk Time (%)			
Queuing Penalty (veh)			
Storage Bay Dist (ft)			75
Storage Blk Time (%)		14	
Queuing Penalty (veh)		1	

Queuing and Blocking Report

Intersection: 40: H Street & SR-99 Southbound On-Ramp/2nd Street

Movement	WB	SB
Directions Served	LTR	LTR
Maximum Queue (ft)	93	56
Average Queue (ft)	44	8
95th Queue (ft)	74	29
Link Distance (ft)	278	139
Upstream Blk Time (%)		
Queuing Penalty (veh)		
Storage Bay Dist (ft)		
Storage Blk Time (%)		
Queuing Penalty (veh)		

Queuing and Blocking Report

Intersection: 42: SR-99 Southbound On-Ramp & 4th Street

Movement	EB	EB	WB	WB	WB
Directions Served	T	TR	L	T	T
Maximum Queue (ft)	53	101	138	31	231
Average Queue (ft)	23	24	72	4	128
95th Queue (ft)	54	66	126	20	236
Link Distance (ft)	38	38	226	226	226
Upstream Blk Time (%)	3	1			4
Queuing Penalty (veh)	15	7			13
Storage Bay Dist (ft)					
Storage Blk Time (%)					
Queuing Penalty (veh)					

Queues

43: SR-99 Northbound Off-Ramp/H Street & 4th Street

Village D Specific Plan

Phase III NP - PM Peak Hour

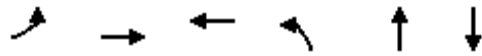

Lane Group	EBL	EBT	WBT	NBL	NBT	SBT
Lane Group Flow (vph)	288	433	780	303	264	134
v/c Ratio	0.87	0.26	0.94	0.77	0.50	0.34
Control Delay	49.8	6.7	55.8	52.3	11.3	12.0
Queue Delay	0.0	0.0	0.0	0.0	0.0	0.0
Total Delay	49.8	6.7	55.8	52.3	11.3	12.0
Queue Length 50th (ft)	195	47	246	185	22	10
Queue Length 95th (ft)	#327	62	#366	#321	95	61
Internal Link Dist (ft)		197	236		443	771
Turn Bay Length (ft)						
Base Capacity (vph)	348	1697	832	391	527	395
Starvation Cap Reductn	0	0	0	0	0	0
Spillback Cap Reductn	0	0	0	0	0	0
Storage Cap Reductn	0	0	0	0	0	0
Reduced v/c Ratio	0.83	0.26	0.94	0.77	0.50	0.34

Intersection Summary

95th percentile volume exceeds capacity, queue may be longer.
 Queue shown is maximum after two cycles.

Queues
 45: Olive Avenue & SR-99 Southbound Off-Ramp

Village D Specific Plan
 Phase III NP - PM Peak Hour

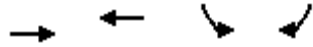

Lane Group	EBT	WBT	SBL	SBR
Lane Group Flow (vph)	696	529	709	107
v/c Ratio	0.71	0.77	0.58	0.10
Control Delay	38.2	42.0	9.2	3.4
Queue Delay	4.4	55.4	0.0	0.0
Total Delay	42.6	97.4	9.2	3.4
Queue Length 50th (ft)	134	172	180	12
Queue Length 95th (ft)	175	225	274	27
Internal Link Dist (ft)	103	112	135	
Turn Bay Length (ft)				
Base Capacity (vph)	1045	734	1215	1083
Starvation Cap Reductn	0	355	0	0
Spillback Cap Reductn	269	0	10	0
Storage Cap Reductn	0	0	0	0
Reduced v/c Ratio	0.90	1.40	0.59	0.10
Intersection Summary				

Queues
46: Madera Avenue & SR-99 Northbound Ramps



Lane Group	WBL	WBT	WBR	NBL	NBT	SBT
Lane Group Flow (vph)	113	115	37	891	818	944
v/c Ratio	0.52	0.53	0.14	1.04	0.30	0.58
Control Delay	44.3	44.6	3.1	73.3	6.3	18.8
Queue Delay	0.0	0.0	0.0	0.0	0.0	0.0
Total Delay	44.3	44.6	3.1	73.3	6.3	18.8
Queue Length 50th (ft)	64	65	0	~241	80	187
Queue Length 95th (ft)	112	113	8	#391	191	278
Internal Link Dist (ft)		337			388	217
Turn Bay Length (ft)	140			205		
Base Capacity (vph)	350	351	384	858	2731	1634
Starvation Cap Reductn	0	0	0	0	0	0
Spillback Cap Reductn	0	0	0	0	0	0
Storage Cap Reductn	0	0	0	0	0	0
Reduced v/c Ratio	0.32	0.33	0.10	1.04	0.30	0.58

Intersection Summary

- ~ Volume exceeds capacity, queue is theoretically infinite.
Queue shown is maximum after two cycles.
- # 95th percentile volume exceeds capacity, queue may be longer.
Queue shown is maximum after two cycles.

Queues

47: Madera Avenue & Olive Avenue/SR-99 Southbound On-Ramp



Lane Group	EBL	EBT	EBR	NBL	NBT	SBL	SBT
Lane Group Flow (vph)	350	359	667	203	1168	141	787
v/c Ratio	0.75	0.75	0.90	0.44	0.75	0.61	0.50
Control Delay	31.2	30.8	24.5	38.1	27.2	32.3	30.0
Queue Delay	30.6	30.2	50.0	0.0	0.0	0.0	1.3
Total Delay	61.9	61.0	74.5	38.1	27.2	32.3	31.3
Queue Length 50th (ft)	197	203	238	55	290	76	223
Queue Length 95th (ft)	267	272	356	86	#488	122	278
Internal Link Dist (ft)		112			323		388
Turn Bay Length (ft)				120		90	
Base Capacity (vph)	601	619	782	572	1554	271	1565
Starvation Cap Reductn	258	267	217	0	0	0	0
Spillback Cap Reductn	0	0	0	19	0	0	533
Storage Cap Reductn	0	0	0	0	0	0	0
Reduced v/c Ratio	1.02	1.02	1.18	0.37	0.75	0.52	0.76

Intersection Summary

95th percentile volume exceeds capacity, queue may be longer.
 Queue shown is maximum after two cycles.

Queuing and Blocking Report

Intersection: 48: Madera Avenue & Lewis Street

Movement	WB	NB	NB	SB
Directions Served	LR	T	TR	L
Maximum Queue (ft)	160	225	201	81
Average Queue (ft)	77	204	109	25
95th Queue (ft)	154	215	251	66
Link Distance (ft)	147	186	186	
Upstream Blk Time (%)	5	66	2	
Queuing Penalty (veh)	0	0	0	
Storage Bay Dist (ft)				100
Storage Blk Time (%)				0
Queuing Penalty (veh)				0

Queues
49: Yosemite Avenue & Cleveland Avenue/Tozer Street

Village D Specific Plan
Phase III NP - PM Peak Hour



Lane Group	EBL	EBT	WBL	WBT	WBR	NBL	NBT	NBR	SBL	SBT
Lane Group Flow (vph)	272	729	57	542	53	348	358	109	90	465
v/c Ratio	0.94	0.64	0.56	0.76	0.11	1.03	0.49	0.15	0.58	0.94
Control Delay	81.9	29.9	67.5	45.7	0.4	98.0	26.7	1.4	58.6	60.2
Queue Delay	0.0	0.0	0.0	0.0	0.0	0.0	0.0	0.0	0.0	0.0
Total Delay	81.9	29.9	67.5	45.7	0.4	98.0	26.7	1.4	58.6	60.2
Queue Length 50th (ft)	174	196	36	174	0	~239	176	0	56	252
Queue Length 95th (ft)	#333	263	#90	235	0	#414	264	11	107	#444
Internal Link Dist (ft)		318		397			415			443
Turn Bay Length (ft)	210		150		60	240			150	
Base Capacity (vph)	290	1136	102	717	483	338	726	717	171	509
Starvation Cap Reductn	0	0	0	0	0	0	0	0	0	0
Spillback Cap Reductn	0	0	0	0	0	0	0	0	0	0
Storage Cap Reductn	0	0	0	0	0	0	0	0	0	0
Reduced v/c Ratio	0.94	0.64	0.56	0.76	0.11	1.03	0.49	0.15	0.53	0.91

Intersection Summary

- ~ Volume exceeds capacity, queue is theoretically infinite.
Queue shown is maximum after two cycles.
- # 95th percentile volume exceeds capacity, queue may be longer.
Queue shown is maximum after two cycles.

Queuing and Blocking Report

Intersection: 5: Road 23/SR-99 Southbound Off-Ramp & Avenue 18 1/2

Movement	EB	EB	WB	NB	NB	SB
Directions Served	T	R	LT	L	R	LTR
Maximum Queue (ft)	16	32	56	414	76	301
Average Queue (ft)	1	4	15	382	75	272
95th Queue (ft)	8	16	43	405	75	291
Link Distance (ft)	247		193	351		238
Upstream Blk Time (%)				99		100
Queuing Penalty (veh)				0		0
Storage Bay Dist (ft)		50			25	
Storage Blk Time (%)		0		48	93	
Queuing Penalty (veh)		0		352	127	

Queuing and Blocking Report

Intersection: 6: SR-99 Northbound Ramps & Avenue 18 1/2

Movement	EB	NB
Directions Served	L	LTR
Maximum Queue (ft)	266	711
Average Queue (ft)	97	682
95th Queue (ft)	198	712
Link Distance (ft)		648
Upstream Blk Time (%)		100
Queuing Penalty (veh)		0
Storage Bay Dist (ft)	145	
Storage Blk Time (%)	4	
Queuing Penalty (veh)	3	

Queuing and Blocking Report

Intersection: 14: Avenue 17 & SR-99 Southbound Off-Ramp

Movement	SB	SB
Directions Served	L	R
Maximum Queue (ft)	1080	760
Average Queue (ft)	959	532
95th Queue (ft)	1273	1083
Link Distance (ft)	1017	
Upstream Blk Time (%)	73	
Queuing Penalty (veh)	0	
Storage Bay Dist (ft)		610
Storage Blk Time (%)	85	
Queuing Penalty (veh)	121	

Queuing and Blocking Report

Intersection: 15: SR-99 Northbound Ramps & Avenue 17

Movement	EB	WB	NB	NB
Directions Served	L	TR	LT	R
Maximum Queue (ft)	81	58	681	100
Average Queue (ft)	38	0	644	34
95th Queue (ft)	74	0	669	110
Link Distance (ft)		460	628	
Upstream Blk Time (%)			100	
Queuing Penalty (veh)			0	
Storage Bay Dist (ft)	125			50
Storage Blk Time (%)			100	1
Queuing Penalty (veh)			240	5

Queuing and Blocking Report

Intersection: 25: Kennedy Street/Gateway Drive & SR-99 Southbound Ramps

Movement	EB	EB	B82	WB	SB	SB
Directions Served	L	T	T	TR	L	R
Maximum Queue (ft)	165	300	273	276	327	246
Average Queue (ft)	125	88	43	73	160	71
95th Queue (ft)	180	300	179	240	338	154
Link Distance (ft)		209	199	841	509	
Upstream Blk Time (%)		16	2			
Queuing Penalty (veh)		121	8			
Storage Bay Dist (ft)	140					335
Storage Blk Time (%)	27	0			0	
Queuing Penalty (veh)	71	1			0	

Queuing and Blocking Report

Intersection: 26: Gateway Drive & SR-99 Northbound Off-Ramp

Movement	EB	SB
Directions Served	LT	LR
Maximum Queue (ft)	145	74
Average Queue (ft)	27	57
95th Queue (ft)	83	74
Link Distance (ft)	841	55
Upstream Blk Time (%)		8
Queuing Penalty (veh)		35
Storage Bay Dist (ft)		
Storage Blk Time (%)		
Queuing Penalty (veh)		

Queuing and Blocking Report

Intersection: 27: SR-99 Northbound Off-Ramp

Movement	EB	SB
Directions Served	L	TR
Maximum Queue (ft)	66	149
Average Queue (ft)	42	47
95th Queue (ft)	69	107
Link Distance (ft)	55	503
Upstream Blk Time (%)	1	
Queuing Penalty (veh)	2	
Storage Bay Dist (ft)		
Storage Blk Time (%)		
Queuing Penalty (veh)		

Queuing and Blocking Report

Intersection: 28: Gateway Drive & SR-99 Northbound Off-Ramp

Movement
Directions Served
Maximum Queue (ft)
Average Queue (ft)
95th Queue (ft)
Link Distance (ft)
Upstream Blk Time (%)
Queuing Penalty (veh)
Storage Bay Dist (ft)
Storage Blk Time (%)
Queuing Penalty (veh)

Queues
31: SR-99 Southbound Ramps & Cleveland Avenue



Lane Group	EBT	EBR	WBL	WBT	SBL	SBR
Lane Group Flow (vph)	810	942	424	1049	287	113
v/c Ratio	0.59	0.99	0.95	0.43	0.83	0.29
Control Delay	23.9	40.8	74.9	5.6	56.0	8.3
Queue Delay	0.0	0.0	0.0	0.1	0.0	0.0
Total Delay	23.9	40.8	74.9	5.7	56.0	8.3
Queue Length 50th (ft)	188	276	265	106	158	0
Queue Length 95th (ft)	248	#585	m#418	131	#291	43
Internal Link Dist (ft)	1412			372		
Turn Bay Length (ft)			115			140
Base Capacity (vph)	1372	949	449	2441	346	395
Starvation Cap Reductn	0	0	0	431	0	0
Spillback Cap Reductn	0	0	0	0	0	0
Storage Cap Reductn	0	0	0	0	0	0
Reduced v/c Ratio	0.59	0.99	0.94	0.52	0.83	0.29

Intersection Summary

95th percentile volume exceeds capacity, queue may be longer.

Queue shown is maximum after two cycles.

m Volume for 95th percentile queue is metered by upstream signal.

Queues
32: SR-99 Northbound Ramps & Cleveland Avenue



Lane Group	EBL	EBT	WBT	WBR	NBL	NBT	NBR
Lane Group Flow (vph)	90	1009	1005	190	238	238	423
v/c Ratio	0.47	0.57	0.78	0.30	0.36	0.36	0.62
Control Delay	39.8	22.2	16.8	4.9	23.9	23.9	22.9
Queue Delay	0.0	0.3	2.0	0.7	0.0	0.0	0.0
Total Delay	39.8	22.4	18.7	5.6	23.9	23.9	22.9
Queue Length 50th (ft)	52	195	178	0	106	106	149
Queue Length 95th (ft)	m81	234	118	m11	186	186	#280
Internal Link Dist (ft)		372	207			441	
Turn Bay Length (ft)	90			50	145		325
Base Capacity (vph)	360	2044	1311	632	656	656	684
Starvation Cap Reductn	0	390	170	216	0	0	0
Spillback Cap Reductn	0	235	0	0	0	0	6
Storage Cap Reductn	0	0	0	0	0	0	0
Reduced v/c Ratio	0.25	0.61	0.88	0.46	0.36	0.36	0.62

Intersection Summary

95th percentile volume exceeds capacity, queue may be longer.

Queue shown is maximum after two cycles.

m Volume for 95th percentile queue is metered by upstream signal.

Queuing and Blocking Report

Intersection: 38: I Street & 2nd Street/SR-99 Southbound Off-Ramp

Movement	EB	WB	WB	NB	SB
Directions Served	LTR	LT	R	L	TR
Maximum Queue (ft)	77	326	100	26	31
Average Queue (ft)	39	221	23	1	3
95th Queue (ft)	71	360	92	10	17
Link Distance (ft)	174	263			171
Upstream Blk Time (%)		35			
Queuing Penalty (veh)		0			
Storage Bay Dist (ft)			50	75	
Storage Blk Time (%)		76	0		
Queuing Penalty (veh)		9	0		

Queuing and Blocking Report

Intersection: 40: H Street & SR-99 Southbound On-Ramp/2nd Street

Movement	WB	SB
Directions Served	LTR	LT
Maximum Queue (ft)	72	52
Average Queue (ft)	34	12
95th Queue (ft)	56	31
Link Distance (ft)	278	153
Upstream Blk Time (%)		
Queuing Penalty (veh)		
Storage Bay Dist (ft)		
Storage Blk Time (%)		
Queuing Penalty (veh)		

Queuing and Blocking Report

Intersection: 42: SR-99 Southbound On-Ramp & 4th Street

Movement	EB	EB	WB	WB	WB
Directions Served	T	TR	L	T	T
Maximum Queue (ft)	53	97	204	97	222
Average Queue (ft)	14	37	95	29	100
95th Queue (ft)	45	78	154	85	188
Link Distance (ft)	38	38	226	226	226
Upstream Blk Time (%)	2	3			0
Queuing Penalty (veh)	12	18			0
Storage Bay Dist (ft)					
Storage Blk Time (%)					
Queuing Penalty (veh)					

Queues

43: SR-99 Northbound Off-Ramp/H Street & 4th Street

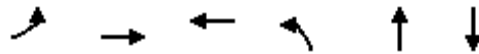

Lane Group	EBL	EBT	WBT	NBL	NBT	SBT
Lane Group Flow (vph)	310	589	724	305	299	100
v/c Ratio	0.95	0.38	1.02	0.82	0.55	0.23
Control Delay	57.2	6.9	73.9	53.1	10.4	4.8
Queue Delay	0.0	0.0	0.0	0.0	0.0	0.0
Total Delay	57.2	6.9	73.9	53.1	10.4	4.8
Queue Length 50th (ft)	192	66	~218	166	18	0
Queue Length 95th (ft)	m#264	m83	#342	#300	90	27
Internal Link Dist (ft)		197	236		443	771
Turn Bay Length (ft)						
Base Capacity (vph)	327	1568	712	373	547	429
Starvation Cap Reductn	0	0	0	0	0	0
Spillback Cap Reductn	0	0	0	0	0	0
Storage Cap Reductn	0	0	0	0	0	0
Reduced v/c Ratio	0.95	0.38	1.02	0.82	0.55	0.23

Intersection Summary

- ~ Volume exceeds capacity, queue is theoretically infinite.
Queue shown is maximum after two cycles.
- # 95th percentile volume exceeds capacity, queue may be longer.
Queue shown is maximum after two cycles.
- m Volume for 95th percentile queue is metered by upstream signal.

Queues
45: Olive Avenue & SR-99 Southbound Off-Ramp

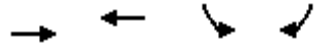

Lane Group	EBT	WBT	SBL	SBR
Lane Group Flow (vph)	874	687	972	128
v/c Ratio	0.72	0.82	0.90	0.13
Control Delay	31.3	42.7	26.6	5.2
Queue Delay	0.0	55.3	23.4	0.0
Total Delay	31.3	97.9	50.0	5.2
Queue Length 50th (ft)	143	195	380	19
Queue Length 95th (ft)	187	m229	#694	39
Internal Link Dist (ft)	103	112	135	
Turn Bay Length (ft)				
Base Capacity (vph)	1290	889	1077	971
Starvation Cap Reductn	0	509	0	0
Spillback Cap Reductn	0	0	142	0
Storage Cap Reductn	0	0	0	0
Reduced v/c Ratio	0.68	1.81	1.04	0.13

Intersection Summary

95th percentile volume exceeds capacity, queue may be longer.

Queue shown is maximum after two cycles.

m Volume for 95th percentile queue is metered by upstream signal.

Queues
46: Madera Avenue & SR-99 Northbound Ramps



Lane Group	WBL	WBT	WBR	NBL	NBT	SBT
Lane Group Flow (vph)	157	159	116	771	591	1106
v/c Ratio	0.58	0.58	0.33	1.07	0.24	0.73
Control Delay	38.7	38.9	8.3	77.4	2.1	21.3
Queue Delay	0.0	0.0	0.0	0.0	0.0	0.0
Total Delay	38.7	38.9	8.3	77.4	2.1	21.3
Queue Length 50th (ft)	77	78	0	~222	8	208
Queue Length 95th (ft)	128	129	40	#334	27	#341
Internal Link Dist (ft)		337			388	217
Turn Bay Length (ft)	140			205		
Base Capacity (vph)	381	382	442	722	2461	1508
Starvation Cap Reductn	0	0	0	0	0	0
Spillback Cap Reductn	0	0	0	0	0	0
Storage Cap Reductn	0	0	0	0	0	0
Reduced v/c Ratio	0.41	0.42	0.26	1.07	0.24	0.73

Intersection Summary

- ~ Volume exceeds capacity, queue is theoretically infinite.
Queue shown is maximum after two cycles.
- # 95th percentile volume exceeds capacity, queue may be longer.
Queue shown is maximum after two cycles.

Queues

47: Madera Avenue & Olive Avenue/SR-99 Southbound On-Ramp



Lane Group	EBL	EBT	EBR	NBL	NBT	SBL	SBT
Lane Group Flow (vph)	461	478	887	234	823	93	965
v/c Ratio	0.82	0.81	0.91	0.34	0.61	0.49	0.91
Control Delay	23.8	23.1	21.7	28.9	23.2	50.6	31.2
Queue Delay	9.9	11.8	46.9	0.0	0.0	0.0	48.0
Total Delay	33.7	34.9	68.6	28.9	23.2	50.6	79.2
Queue Length 50th (ft)	143	148	400	52	187	51	146
Queue Length 95th (ft)	m176	m183	m#561	85	256	m78	#305
Internal Link Dist (ft)		112			323		388
Turn Bay Length (ft)				120		90	
Base Capacity (vph)	622	650	970	696	1354	214	1063
Starvation Cap Reductn	133	151	254	0	0	0	0
Spillback Cap Reductn	0	0	0	13	0	0	383
Storage Cap Reductn	0	0	0	0	0	0	0
Reduced v/c Ratio	0.94	0.96	1.24	0.34	0.61	0.43	1.42

Intersection Summary

95th percentile volume exceeds capacity, queue may be longer.

Queue shown is maximum after two cycles.

m Volume for 95th percentile queue is metered by upstream signal.

Queuing and Blocking Report

Intersection: 48: Madera Avenue & Lewis Street

Movement	WB	NB	SB
Directions Served	LR	T	L
Maximum Queue (ft)	49	166	69
Average Queue (ft)	17	11	20
95th Queue (ft)	43	73	52
Link Distance (ft)	147	186	
Upstream Blk Time (%)		0	
Queuing Penalty (veh)		0	
Storage Bay Dist (ft)			100
Storage Blk Time (%)			
Queuing Penalty (veh)			

Queues
49: Yosemite Avenue & Cleveland Avenue/Tozer Street

Village D Specific Plan
Phase III WP - AM Peak Hour



Lane Group	EBL	EBT	WBL	WBT	WBR	NBL	NBT	NBR	SBL	SBT
Lane Group Flow (vph)	358	888	126	388	65	153	149	85	86	589
v/c Ratio	1.02	0.78	0.81	0.51	0.15	0.91	0.26	0.14	0.52	1.12
Control Delay	90.2	29.7	77.0	33.7	0.7	90.8	26.5	0.5	50.2	107.6
Queue Delay	0.0	0.0	0.0	0.0	0.0	0.0	0.0	0.0	0.0	0.0
Total Delay	90.2	29.7	77.0	33.7	0.7	90.8	26.5	0.5	50.2	107.6
Queue Length 50th (ft)	~210	213	72	102	0	88	67	0	47	~367
Queue Length 95th (ft)	#387	288	#168	148	0	#202	118	0	94	#572
Internal Link Dist (ft)		318		397			415			443
Turn Bay Length (ft)	210		150		60	240			150	
Base Capacity (vph)	352	1145	156	759	442	169	571	603	182	524
Starvation Cap Reductn	0	0	0	0	0	0	0	0	0	0
Spillback Cap Reductn	0	0	0	0	0	0	0	0	0	0
Storage Cap Reductn	0	0	0	0	0	0	0	0	0	0
Reduced v/c Ratio	1.02	0.78	0.81	0.51	0.15	0.91	0.26	0.14	0.47	1.12

Intersection Summary

- ~ Volume exceeds capacity, queue is theoretically infinite.
Queue shown is maximum after two cycles.
- # 95th percentile volume exceeds capacity, queue may be longer.
Queue shown is maximum after two cycles.

Queuing and Blocking Report

Intersection: 5: Road 23/SR-99 Southbound Off-Ramp & Avenue 18 1/2

Movement	EB	EB	WB	NB	NB	SB
Directions Served	T	R	LT	L	R	LTR
Maximum Queue (ft)	114	100	165	414	75	301
Average Queue (ft)	6	15	41	384	75	269
95th Queue (ft)	45	55	105	406	75	292
Link Distance (ft)	247		193	351		238
Upstream Blk Time (%)				100		100
Queuing Penalty (veh)				0		0
Storage Bay Dist (ft)		50			25	
Storage Blk Time (%)	0	0		63	90	
Queuing Penalty (veh)	1	0		295	95	

Queuing and Blocking Report

Intersection: 6: SR-99 Northbound Ramps & Avenue 18 1/2

Movement	EB	NB
Directions Served	L	LTR
Maximum Queue (ft)	89	711
Average Queue (ft)	38	681
95th Queue (ft)	81	704
Link Distance (ft)		648
Upstream Blk Time (%)		95
Queuing Penalty (veh)		0
Storage Bay Dist (ft)	145	
Storage Blk Time (%)		
Queuing Penalty (veh)		

Queuing and Blocking Report

Intersection: 14: Avenue 17 & SR-99 Southbound Off-Ramp

Movement	EB	WB	SB	SB
Directions Served	T	T	L	R
Maximum Queue (ft)	141	269	1069	760
Average Queue (ft)	35	137	1038	484
95th Queue (ft)	119	353	1054	1046
Link Distance (ft)	380	266	1017	
Upstream Blk Time (%)		49	96	
Queuing Penalty (veh)		787	0	
Storage Bay Dist (ft)				610
Storage Blk Time (%)			100	
Queuing Penalty (veh)			92	

Queuing and Blocking Report

Intersection: 15: SR-99 Northbound Ramps & Avenue 17

Movement	EB	EB	WB	B82	NB	NB
Directions Served	L	T	TR	T	LT	R
Maximum Queue (ft)	224	530	419	456	644	100
Average Queue (ft)	86	288	188	191	633	25
95th Queue (ft)	245	699	528	548	649	94
Link Distance (ft)		511	348	441	629	
Upstream Blk Time (%)		23	43	39	99	
Queuing Penalty (veh)		325	789	709	0	
Storage Bay Dist (ft)	125					50
Storage Blk Time (%)		52			100	1
Queuing Penalty (veh)		93			528	9

Queuing and Blocking Report

Intersection: 25: Kennedy Street/Gateway Drive & SR-99 Southbound Ramps

Movement	EB	EB	B82	WB	SB	SB
Directions Served	L	T	T	TR	L	R
Maximum Queue (ft)	165	281	159	157	562	495
Average Queue (ft)	109	36	13	34	505	375
95th Queue (ft)	168	186	84	111	622	702
Link Distance (ft)		209	199	841	509	
Upstream Blk Time (%)		2			77	2
Queuing Penalty (veh)		22			0	0
Storage Bay Dist (ft)	140					335
Storage Blk Time (%)	7				93	
Queuing Penalty (veh)	36				233	

Queuing and Blocking Report

Intersection: 26: Gateway Drive & SR-99 Northbound Off-Ramp

Movement	EB	SB
Directions Served	LT	LR
Maximum Queue (ft)	129	71
Average Queue (ft)	42	53
95th Queue (ft)	91	76
Link Distance (ft)	841	55
Upstream Blk Time (%)		6
Queuing Penalty (veh)		19
Storage Bay Dist (ft)		
Storage Blk Time (%)		
Queuing Penalty (veh)		

Queuing and Blocking Report

Intersection: 27: SR-99 Northbound Off-Ramp

Movement	EB	SB
Directions Served	L	TR
Maximum Queue (ft)	56	93
Average Queue (ft)	42	24
95th Queue (ft)	62	73
Link Distance (ft)	55	503
Upstream Blk Time (%)	1	
Queuing Penalty (veh)	2	
Storage Bay Dist (ft)		
Storage Blk Time (%)		
Queuing Penalty (veh)		

Queuing and Blocking Report

Intersection: 28: Gateway Drive & SR-99 Northbound Off-Ramp

Movement	SB
Directions Served	LR
Maximum Queue (ft)	31
Average Queue (ft)	4
95th Queue (ft)	19
Link Distance (ft)	162
Upstream Blk Time (%)	
Queuing Penalty (veh)	
Storage Bay Dist (ft)	
Storage Blk Time (%)	
Queuing Penalty (veh)	

Queues
31: SR-99 Southbound Ramps & Cleveland Avenue



Lane Group	EBT	EBR	WBL	WBT	SBL	SBR
Lane Group Flow (vph)	1114	669	393	2145	299	103
v/c Ratio	0.79	0.67	1.02	0.90	0.72	0.24
Control Delay	12.1	5.2	51.4	9.3	42.4	12.4
Queue Delay	2.6	0.0	0.0	46.0	0.0	0.0
Total Delay	14.7	5.2	51.4	55.3	42.4	12.4
Queue Length 50th (ft)	125	31	~259	311	157	13
Queue Length 95th (ft)	m143	m47	m#260	m265	#265	54
Internal Link Dist (ft)	1412			372		
Turn Bay Length (ft)			115			140
Base Capacity (vph)	1449	1010	387	2386	418	423
Starvation Cap Reductn	0	0	0	492	0	0
Spillback Cap Reductn	217	0	0	0	0	0
Storage Cap Reductn	0	0	0	0	0	0
Reduced v/c Ratio	0.90	0.66	1.02	1.13	0.72	0.24

Intersection Summary

- ~ Volume exceeds capacity, queue is theoretically infinite.
Queue shown is maximum after two cycles.
- # 95th percentile volume exceeds capacity, queue may be longer.
Queue shown is maximum after two cycles.
- m Volume for 95th percentile queue is metered by upstream signal.

Queues
32: SR-99 Northbound Ramps & Cleveland Avenue



Lane Group	EBL	EBT	WBT	WBR	NBL	NBT	NBR
Lane Group Flow (vph)	116	1325	1452	253	573	580	367
v/c Ratio	0.53	0.76	1.19	0.44	0.82	0.83	0.53
Control Delay	36.0	12.2	114.5	16.2	37.2	37.8	20.3
Queue Delay	0.0	2.9	0.6	1.0	0.0	0.0	0.0
Total Delay	36.0	15.1	115.0	17.3	37.2	37.8	20.3
Queue Length 50th (ft)	72	260	~534	52	304	309	124
Queue Length 95th (ft)	m97	412	m#579	m51	#545	#553	226
Internal Link Dist (ft)		372	207			441	
Turn Bay Length (ft)	90			50	145		325
Base Capacity (vph)	287	1925	1223	576	696	697	688
Starvation Cap Reductn	0	471	151	145	0	0	0
Spillback Cap Reductn	0	61	106	0	0	0	1
Storage Cap Reductn	0	0	0	0	0	0	0
Reduced v/c Ratio	0.40	0.91	1.35	0.59	0.82	0.83	0.53

Intersection Summary

- ~ Volume exceeds capacity, queue is theoretically infinite.
Queue shown is maximum after two cycles.
- # 95th percentile volume exceeds capacity, queue may be longer.
Queue shown is maximum after two cycles.
- m Volume for 95th percentile queue is metered by upstream signal.

Queuing and Blocking Report

Intersection: 38: I Street & 2nd Street/SR-99 Southbound Off-Ramp

Movement	EB	WB	WB	NB
Directions Served	LTR	LT	R	L
Maximum Queue (ft)	30	183	100	26
Average Queue (ft)	18	80	5	3
95th Queue (ft)	43	139	39	18
Link Distance (ft)	174	263		
Upstream Blk Time (%)				
Queuing Penalty (veh)				
Storage Bay Dist (ft)			50	75
Storage Blk Time (%)		19		
Queuing Penalty (veh)		1		

Queuing and Blocking Report

Intersection: 40: H Street & SR-99 Southbound On-Ramp/2nd Street

Movement	WB	SB
Directions Served	LTR	LTR
Maximum Queue (ft)	55	50
Average Queue (ft)	40	10
95th Queue (ft)	57	30
Link Distance (ft)	278	139
Upstream Blk Time (%)		
Queuing Penalty (veh)		
Storage Bay Dist (ft)		
Storage Blk Time (%)		
Queuing Penalty (veh)		

Queuing and Blocking Report

Intersection: 42: SR-99 Southbound On-Ramp & 4th Street

Movement	EB	EB	WB	WB	WB
Directions Served	T	TR	L	T	T
Maximum Queue (ft)	53	58	159	31	226
Average Queue (ft)	15	34	80	4	132
95th Queue (ft)	48	59	133	21	222
Link Distance (ft)	38	38	226	226	226
Upstream Blk Time (%)	2	2			2
Queuing Penalty (veh)	12	10			6
Storage Bay Dist (ft)					
Storage Blk Time (%)					
Queuing Penalty (veh)					

Queues
43: SR-99 Northbound Off-Ramp/H Street & 4th Street

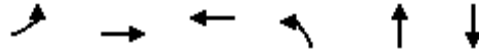

Lane Group	EBL	EBT	WBT	NBL	NBT	SBT
Lane Group Flow (vph)	345	472	855	303	264	134
v/c Ratio	0.99	0.28	1.02	0.81	0.51	0.34
Control Delay	70.4	6.5	73.0	55.6	11.6	12.0
Queue Delay	0.0	0.0	0.0	0.0	0.0	0.0
Total Delay	70.4	6.5	73.0	55.6	11.6	12.0
Queue Length 50th (ft)	237	50	~291	185	22	10
Queue Length 95th (ft)	m#398	m63	#416	#321	95	61
Internal Link Dist (ft)		197	236		443	771
Turn Bay Length (ft)						
Base Capacity (vph)	348	1697	837	375	515	395
Starvation Cap Reductn	0	0	0	0	0	0
Spillback Cap Reductn	0	0	0	0	0	0
Storage Cap Reductn	0	0	0	0	0	0
Reduced v/c Ratio	0.99	0.28	1.02	0.81	0.51	0.34

Intersection Summary

- ~ Volume exceeds capacity, queue is theoretically infinite.
Queue shown is maximum after two cycles.
- # 95th percentile volume exceeds capacity, queue may be longer.
Queue shown is maximum after two cycles.
- m Volume for 95th percentile queue is metered by upstream signal.

Queues
 45: Olive Avenue & SR-99 Southbound Off-Ramp

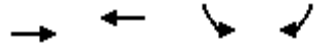

Lane Group	EBT	WBT	SBL	SBR
Lane Group Flow (vph)	856	793	817	107
v/c Ratio	0.65	0.87	0.73	0.11
Control Delay	32.6	53.9	15.8	5.6
Queue Delay	0.0	54.9	2.2	0.0
Total Delay	32.6	108.8	18.0	5.6
Queue Length 50th (ft)	158	254	284	18
Queue Length 95th (ft)	201	#333	438	37
Internal Link Dist (ft)	103	112	135	
Turn Bay Length (ft)				
Base Capacity (vph)	1341	933	1120	995
Starvation Cap Reductn	0	578	0	0
Spillback Cap Reductn	0	0	175	0
Storage Cap Reductn	0	0	0	0
Reduced v/c Ratio	0.64	2.23	0.86	0.11

Intersection Summary

95th percentile volume exceeds capacity, queue may be longer.
 Queue shown is maximum after two cycles.

Queues
46: Madera Avenue & SR-99 Northbound Ramps



Lane Group	WBL	WBT	WBR	NBL	NBT	SBT
Lane Group Flow (vph)	203	205	37	1029	890	1062
v/c Ratio	0.70	0.71	0.11	1.20	0.34	0.71
Control Delay	48.2	48.4	2.6	125.5	2.6	23.8
Queue Delay	0.0	0.0	0.0	0.0	0.3	0.0
Total Delay	48.2	48.4	2.6	125.5	2.8	23.8
Queue Length 50th (ft)	114	115	0	~374	34	243
Queue Length 95th (ft)	185	187	8	m#450	m46	337
Internal Link Dist (ft)		337			388	217
Turn Bay Length (ft)	140			205		
Base Capacity (vph)	350	351	384	858	2581	1490
Starvation Cap Reductn	0	0	0	0	912	0
Spillback Cap Reductn	0	0	0	0	0	0
Storage Cap Reductn	0	0	0	0	0	0
Reduced v/c Ratio	0.58	0.58	0.10	1.20	0.53	0.71

Intersection Summary

- ~ Volume exceeds capacity, queue is theoretically infinite.
Queue shown is maximum after two cycles.
- # 95th percentile volume exceeds capacity, queue may be longer.
Queue shown is maximum after two cycles.
- m Volume for 95th percentile queue is metered by upstream signal.

Queues

47: Madera Avenue & Olive Avenue/SR-99 Southbound On-Ramp



Lane Group	EBL	EBT	EBR	NBL	NBT	SBL	SBT
Lane Group Flow (vph)	431	440	767	253	1299	141	998
v/c Ratio	0.78	0.77	0.94	0.55	0.93	0.66	0.68
Control Delay	25.8	25.1	29.0	41.5	41.1	61.5	10.4
Queue Delay	4.4	4.4	44.2	0.3	0.0	0.0	50.2
Total Delay	30.2	29.5	73.2	41.8	41.1	61.5	60.6
Queue Length 50th (ft)	143	146	142	68	-391	77	95
Queue Length 95th (ft)	189	192	#567	111	#588	m#116	187
Internal Link Dist (ft)		112			323		388
Turn Bay Length (ft)				120		90	
Base Capacity (vph)	675	699	814	461	1399	223	1462
Starvation Cap Reductn	171	184	125	0	0	0	103
Spillback Cap Reductn	0	0	0	25	0	0	584
Storage Cap Reductn	0	0	0	0	0	0	0
Reduced v/c Ratio	0.86	0.85	1.11	0.58	0.93	0.63	1.14

Intersection Summary

- ~ Volume exceeds capacity, queue is theoretically infinite.
Queue shown is maximum after two cycles.
- # 95th percentile volume exceeds capacity, queue may be longer.
Queue shown is maximum after two cycles.
- m Volume for 95th percentile queue is metered by upstream signal.

Queuing and Blocking Report

Intersection: 48: Madera Avenue & Lewis Street

Movement	WB	NB	NB	SB
Directions Served	LR	T	TR	L
Maximum Queue (ft)	78	225	201	53
Average Queue (ft)	20	205	147	15
95th Queue (ft)	60	218	276	42
Link Distance (ft)	147	186	186	
Upstream Blk Time (%)		60	14	
Queuing Penalty (veh)		0	0	
Storage Bay Dist (ft)				100
Storage Blk Time (%)				
Queuing Penalty (veh)				

Queues
49: Yosemite Avenue & Cleveland Avenue/Tozer Street

Village D Specific Plan
Phase III WP - PM Peak Hour



Lane Group	EBL	EBT	WBL	WBT	WBR	NBL	NBT	NBR	SBL	SBT
Lane Group Flow (vph)	348	741	57	570	53	348	358	109	90	596
v/c Ratio	1.23	0.67	0.56	0.82	0.11	1.03	0.48	0.15	0.58	1.14
Control Delay	166.0	31.0	67.5	49.6	0.5	98.0	26.2	1.4	58.6	113.6
Queue Delay	0.0	0.0	0.0	0.0	0.0	0.0	0.0	0.0	0.0	0.0
Total Delay	166.0	31.0	67.5	49.6	0.5	98.0	26.2	1.4	58.6	113.6
Queue Length 50th (ft)	~274	201	36	184	0	~239	176	0	56	-400
Queue Length 95th (ft)	#449	270	#90	#264	0	#414	264	11	107	#614
Internal Link Dist (ft)		318		397			415			443
Turn Bay Length (ft)	210		150		60	240			150	
Base Capacity (vph)	284	1105	102	696	475	338	744	730	171	523
Starvation Cap Reductn	0	0	0	0	0	0	0	0	0	0
Spillback Cap Reductn	0	0	0	0	0	0	0	0	0	0
Storage Cap Reductn	0	0	0	0	0	0	0	0	0	0
Reduced v/c Ratio	1.23	0.67	0.56	0.82	0.11	1.03	0.48	0.15	0.53	1.14

Intersection Summary

- ~ Volume exceeds capacity, queue is theoretically infinite.
Queue shown is maximum after two cycles.
- # 95th percentile volume exceeds capacity, queue may be longer.
Queue shown is maximum after two cycles.

Intersections Under City of Madera Jurisdiction + Mitigation Scenarios

Queues
 23: Avenue 16/Ellis Street & Kennedy Street

Village D Specific Plan
 Existing NP - AM Peak Hour



Lane Group	WBL	WBR	NBT	SBL	SBT
Lane Group Flow (vph)	117	123	351	284	226
v/c Ratio	0.50	0.26	0.25	0.55	0.08
Control Delay	23.3	8.5	11.0	28.5	3.0
Queue Delay	0.0	0.0	0.0	0.0	0.0
Total Delay	23.3	8.5	11.0	28.5	3.0
Queue Length 50th (ft)	60	0	36	119	12
Queue Length 95th (ft)	62	0	65	184	24
Internal Link Dist (ft)	782		506		440
Turn Bay Length (ft)	175			280	
Base Capacity (vph)	423	759	1394	519	2667
Starvation Cap Reductn	0	0	0	0	0
Spillback Cap Reductn	0	0	0	0	0
Storage Cap Reductn	0	0	0	0	0
Reduced v/c Ratio	0.28	0.16	0.25	0.55	0.08
Intersection Summary					

Queues
24: Schnoor Avenue & Kennedy Street

Village D Specific Plan
Existing NP - AM Peak Hour



Lane Group	EBL	EBT	WBL	WBT	NBL	NBT	SBL	SBT	SBR
Lane Group Flow (vph)	16	369	121	148	105	230	16	7	4
v/c Ratio	0.13	0.63	0.52	0.30	0.41	0.23	0.18	0.01	0.01
Control Delay	47.1	17.3	39.3	21.5	40.5	3.4	39.9	17.0	0.0
Queue Delay	0.0	0.0	0.0	0.0	0.0	0.0	0.0	0.0	0.0
Total Delay	47.1	17.3	39.3	21.5	40.5	3.4	39.9	17.0	0.0
Queue Length 50th (ft)	9	22	57	51	26	1	8	2	0
Queue Length 95th (ft)	m20	6	102	97	50	48	27	11	0
Internal Link Dist (ft)		782		187		321		193	
Turn Bay Length (ft)	95		40		75		60		
Base Capacity (vph)	119	877	354	662	258	996	91	677	681
Starvation Cap Reductn	0	0	0	0	0	0	0	0	0
Spillback Cap Reductn	0	0	0	0	0	0	0	0	0
Storage Cap Reductn	0	0	0	0	0	0	0	0	0
Reduced v/c Ratio	0.13	0.42	0.34	0.22	0.41	0.23	0.18	0.01	0.01

Intersection Summary

m Volume for 95th percentile queue is metered by upstream signal.

Queues
29: Schnoor Avenue & Cleveland Avenue

Village D Specific Plan
Existing NP - AM Peak Hour



Lane Group	EBL	EBT	EBR	WBL	WBT	WBR	NBL	NBT	NBR	SBL	SBT	SBR
Lane Group Flow (vph)	78	353	35	177	231	47	55	233	170	87	171	65
v/c Ratio	0.40	0.59	0.08	0.44	0.33	0.10	0.31	0.15	0.18	0.62	0.11	0.08
Control Delay	38.4	34.1	0.4	11.6	7.6	0.4	37.4	16.7	2.2	55.6	17.4	0.2
Queue Delay	0.0	0.0	0.0	0.0	0.0	0.0	0.0	0.0	0.0	0.0	0.0	0.0
Total Delay	38.4	34.1	0.4	11.6	7.6	0.4	37.4	16.7	2.2	55.6	17.4	0.2
Queue Length 50th (ft)	37	86	0	9	10	0	26	37	0	43	28	0
Queue Length 95th (ft)	75	120	0	15	18	1	58	71	27	#104	59	0
Internal Link Dist (ft)		2178			574			393			326	
Turn Bay Length (ft)	120		60	220		95	75		75	105		65
Base Capacity (vph)	293	1292	694	401	971	574	177	1529	943	144	1530	783
Starvation Cap Reductn	0	0	0	0	0	0	0	0	0	0	0	0
Spillback Cap Reductn	0	0	0	0	0	0	0	0	0	0	0	0
Storage Cap Reductn	0	0	0	0	0	0	0	0	0	0	0	0
Reduced v/c Ratio	0.27	0.27	0.05	0.44	0.24	0.08	0.31	0.15	0.18	0.60	0.11	0.08

Intersection Summary

95th percentile volume exceeds capacity, queue may be longer.
Queue shown is maximum after two cycles.

Queues
30: Fairgrounds & Cleveland Avenue

Village D Specific Plan
Existing NP - AM Peak Hour



Lane Group	EBL	EBT	WBL	WBT	WBR	NBL	NBT	NBR	SBL	SBT
Lane Group Flow (vph)	85	569	34	385	69	14	15	15	101	45
v/c Ratio	0.43	0.45	0.27	0.60	0.15	0.06	0.02	0.02	0.50	0.05
Control Delay	24.4	13.9	41.2	33.5	0.7	36.1	15.1	0.1	41.6	6.8
Queue Delay	0.0	0.0	0.0	0.0	0.0	0.0	0.0	0.0	0.0	0.0
Total Delay	24.4	13.9	41.2	33.5	0.7	36.1	15.1	0.1	41.6	6.8
Queue Length 50th (ft)	32	42	16	94	0	3	2	0	48	1
Queue Length 95th (ft)	m81	48	44	127	0	12	17	0	94	24
Internal Link Dist (ft)		574		1412			192			168
Turn Bay Length (ft)	120		205					100		
Base Capacity (vph)	213	1647	124	1019	600	218	687	792	236	886
Starvation Cap Reductn	0	0	0	0	0	0	0	0	0	0
Spillback Cap Reductn	0	0	0	0	0	0	0	0	0	0
Storage Cap Reductn	0	0	0	0	0	0	0	0	0	0
Reduced v/c Ratio	0.40	0.35	0.27	0.38	0.12	0.06	0.02	0.02	0.43	0.05

Intersection Summary

m Volume for 95th percentile queue is metered by upstream signal.

Queues
33: Gateway Drive & Cleveland Avenue

Village D Specific Plan
Existing NP - AM Peak Hour

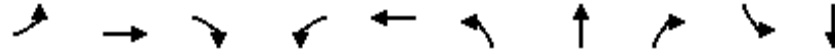

Lane Group	EBL	EBT	EBR	WBL	WBT	NBL	NBT	NBR	SBL	SBT
Lane Group Flow (vph)	5	642	173	190	882	160	58	140	63	110
v/c Ratio	0.03	0.63	0.28	0.44	0.71	0.38	0.08	0.20	0.40	0.09
Control Delay	25.5	39.9	8.7	44.0	33.3	38.7	22.4	2.7	46.1	22.3
Queue Delay	0.0	0.0	0.0	1.8	29.6	0.0	0.0	0.0	0.0	0.0
Total Delay	25.5	39.9	8.8	45.8	62.9	38.7	22.4	2.7	46.1	22.3
Queue Length 50th (ft)	2	117	31	53	228	43	21	0	34	21
Queue Length 95th (ft)	m8	124	51	61	203	65	51	14	66	42
Internal Link Dist (ft)		207			111		765			296
Turn Bay Length (ft)	110					245			45	
Base Capacity (vph)	158	1723	627	450	1400	425	718	709	180	1181
Starvation Cap Reductn	0	106	21	137	556	0	0	0	0	0
Spillback Cap Reductn	0	0	0	0	469	0	0	0	0	0
Storage Cap Reductn	0	0	0	0	0	0	0	0	0	0
Reduced v/c Ratio	0.03	0.40	0.29	0.61	1.05	0.38	0.08	0.20	0.35	0.09

Intersection Summary

m Volume for 95th percentile queue is metered by upstream signal.

Queues
34: Cleveland Avenue & County Club Drive

Village D Specific Plan
Existing NP - AM Peak Hour



Lane Group	WBL	NBT	NBR	SBL	SBT
Lane Group Flow (vph)	354	588	236	92	714
v/c Ratio	0.63	0.23	0.15	0.16	0.19
Control Delay	39.3	1.3	0.3	4.8	3.9
Queue Delay	0.1	0.3	0.0	0.0	0.1
Total Delay	39.4	1.6	0.3	4.8	4.0
Queue Length 50th (ft)	95	6	0	12	36
Queue Length 95th (ft)	121	16	0	30	53
Internal Link Dist (ft)	239	111			159
Turn Bay Length (ft)					
Base Capacity (vph)	1261	2595	1568	585	3730
Starvation Cap Reductn	0	1368	0	0	0
Spillback Cap Reductn	143	0	0	0	1252
Storage Cap Reductn	0	0	0	0	0
Reduced v/c Ratio	0.32	0.48	0.15	0.16	0.29
Intersection Summary					

Queues
36: Pine Street & Howard Road



Lane Group	EBL	EBT	WBL	WBT	NBL	NBT	NBR	SBT	SBR
Lane Group Flow (vph)	39	870	148	516	135	178	261	300	114
v/c Ratio	0.40	0.79	0.67	0.35	0.36	0.45	0.49	0.90	0.29
Control Delay	67.2	42.0	65.7	25.1	45.4	47.1	8.6	78.3	6.3
Queue Delay	0.0	0.0	0.0	0.0	0.0	0.0	0.0	0.0	0.0
Total Delay	67.2	42.0	65.7	25.1	45.4	47.1	8.6	78.3	6.3
Queue Length 50th (ft)	30	318	116	115	92	123	0	228	0
Queue Length 95th (ft)	63	331	#192	144	152	193	59	#348	28
Internal Link Dist (ft)		265		561		224		259	
Turn Bay Length (ft)	95		140		90				
Base Capacity (vph)	101	1388	221	1543	380	400	537	344	398
Starvation Cap Reductn	0	0	0	0	0	0	0	0	0
Spillback Cap Reductn	0	0	0	0	0	0	0	0	0
Storage Cap Reductn	0	0	0	0	0	0	0	0	0
Reduced v/c Ratio	0.39	0.63	0.67	0.33	0.36	0.45	0.49	0.87	0.29

Intersection Summary

95th percentile volume exceeds capacity, queue may be longer.
Queue shown is maximum after two cycles.

Queues

37: Olive Avenue/Q Street & Howard Road/Yosemite Avenue

Village D Specific Plan

Existing NP - AM Peak Hour



Lane Group	EBL	EBT	EBR	WBL	WBT	NBL	NBT	NBR	SBL	SBT	SBR
Lane Group Flow (vph)	8	721	411	35	468	249	257	27	132	196	16
v/c Ratio	0.11	0.72	0.57	0.30	0.40	0.38	0.38	0.04	0.55	0.78	0.05
Control Delay	86.7	23.3	4.2	59.4	30.0	32.1	32.1	0.1	57.1	70.7	0.2
Queue Delay	0.0	0.0	0.0	0.0	0.0	0.0	0.0	0.0	0.0	0.0	0.0
Total Delay	86.7	23.3	4.2	59.4	30.0	32.1	32.1	0.1	57.1	70.7	0.2
Queue Length 50th (ft)	7	157	0	26	131	154	160	0	95	146	0
Queue Length 95th (ft)	m12	161	12	49	138	215	221	0	131	186	0
Internal Link Dist (ft)		561			230		220			195	
Turn Bay Length (ft)	40			80		130			50		50
Base Capacity (vph)	76	1070	748	265	1415	652	668	670	265	279	353
Starvation Cap Reductn	0	0	0	0	0	0	0	0	0	0	0
Spillback Cap Reductn	0	0	0	0	0	0	0	0	0	0	0
Storage Cap Reductn	0	0	0	0	0	0	0	0	0	0	0
Reduced v/c Ratio	0.11	0.67	0.55	0.13	0.33	0.38	0.38	0.04	0.50	0.70	0.05

Intersection Summary

m Volume for 95th percentile queue is metered by upstream signal.

Queues
39: 4th Street & Sunset Avenue

Village D Specific Plan
Existing NP - AM Peak Hour



Lane Group	EBL	NBL	NBT	SBT	SBR
Lane Group Flow (vph)	438	34	316	435	290
v/c Ratio	0.66	0.25	0.13	0.37	0.22
Control Delay	37.9	43.3	4.7	3.1	0.3
Queue Delay	0.0	0.0	0.0	0.0	0.0
Total Delay	37.9	43.3	4.7	3.1	0.3
Queue Length 50th (ft)	118	19	25	22	0
Queue Length 95th (ft)	155	48	47	44	0
Internal Link Dist (ft)	7441		193	501	
Turn Bay Length (ft)	135				
Base Capacity (vph)	876	151	2516	1173	1377
Starvation Cap Reductn	0	0	0	0	0
Spillback Cap Reductn	0	0	0	0	0
Storage Cap Reductn	0	0	0	0	0
Reduced v/c Ratio	0.50	0.23	0.13	0.37	0.21
Intersection Summary					

Queues
41: I Street & 4th Street

Village D Specific Plan
Existing NP - AM Peak Hour



Lane Group	EBL	EBT	WBL	WBT	NBL	NBT	NBR	SBL	SBT	SBR
Lane Group Flow (vph)	29	800	99	605	59	64	186	243	322	141
v/c Ratio	0.26	0.85	0.66	0.53	0.44	0.13	0.32	0.66	0.42	0.19
Control Delay	35.5	36.5	57.6	24.6	50.2	30.6	3.4	41.6	23.2	2.1
Queue Delay	0.0	0.0	0.0	0.0	0.0	0.0	0.0	0.0	0.0	0.0
Total Delay	35.5	36.5	57.6	24.6	50.2	30.6	3.4	41.6	23.2	2.1
Queue Length 50th (ft)	15	242	60	126	33	30	0	124	141	0
Queue Length 95th (ft)	m37	293	m82	m187	69	62	22	191	208	17
Internal Link Dist (ft)		501		26		314			779	
Turn Bay Length (ft)	130				45		25	80		80
Base Capacity (vph)	113	971	154	1194	142	484	579	404	769	738
Starvation Cap Reductn	0	0	0	0	0	0	0	0	0	0
Spillback Cap Reductn	0	0	0	0	0	0	0	0	0	0
Storage Cap Reductn	0	0	0	0	0	0	0	0	0	0
Reduced v/c Ratio	0.26	0.82	0.64	0.51	0.42	0.13	0.32	0.60	0.42	0.19

Intersection Summary

m Volume for 95th percentile queue is metered by upstream signal.

Queues
 23: Avenue 16/Ellis Street & Kennedy Street

Village D Specific Plan
 Existing NP - PM Peak Hour



Lane Group	WBL	WBR	NBT	SBL	SBT
Lane Group Flow (vph)	107	234	308	201	193
v/c Ratio	0.48	0.42	0.17	0.64	0.07
Control Delay	17.9	6.8	6.7	39.1	2.9
Queue Delay	0.0	0.0	0.0	0.0	0.0
Total Delay	17.9	6.8	6.7	39.1	2.9
Queue Length 50th (ft)	42	0	20	94	10
Queue Length 95th (ft)	m69	40	51	148	21
Internal Link Dist (ft)	782		506		440
Turn Bay Length (ft)	175			280	
Base Capacity (vph)	497	952	1819	457	2717
Starvation Cap Reductn	0	0	0	0	0
Spillback Cap Reductn	0	0	0	0	0
Storage Cap Reductn	0	0	0	0	0
Reduced v/c Ratio	0.22	0.25	0.17	0.44	0.07

Intersection Summary

m Volume for 95th percentile queue is metered by upstream signal.

Queues
24: Schnoor Avenue & Kennedy Street

Village D Specific Plan
Existing NP - PM Peak Hour



Lane Group	EBL	EBT	WBL	WBT	NBL	NBT	SBL	SBT	SBR
Lane Group Flow (vph)	10	293	190	158	204	234	24	15	9
v/c Ratio	0.06	0.59	0.63	0.30	0.57	0.26	0.21	0.02	0.01
Control Delay	33.2	18.1	39.6	22.8	40.9	4.4	39.5	19.1	0.0
Queue Delay	0.0	0.0	0.0	0.0	0.0	0.0	0.0	0.0	0.0
Total Delay	33.2	18.1	39.6	22.8	40.9	4.4	39.5	19.1	0.0
Queue Length 50th (ft)	5	43	89	53	51	3	12	5	0
Queue Length 95th (ft)	m15	66	143	120	84	54	35	19	0
Internal Link Dist (ft)		782		187		321		193	
Turn Bay Length (ft)	95		40		75		60		
Base Capacity (vph)	166	851	371	679	368	904	116	629	659
Starvation Cap Reductn	0	0	0	0	0	0	0	0	0
Spillback Cap Reductn	0	0	0	0	0	0	0	0	0
Storage Cap Reductn	0	0	0	0	0	0	0	0	0
Reduced v/c Ratio	0.06	0.34	0.51	0.23	0.55	0.26	0.21	0.02	0.01

Intersection Summary

m Volume for 95th percentile queue is metered by upstream signal.

Queues
29: Schnoor Avenue & Cleveland Avenue

Village D Specific Plan
Existing NP - PM Peak Hour



Lane Group	EBL	EBT	EBR	WBL	WBT	WBR	NBL	NBT	NBR	SBL	SBT	SBR
Lane Group Flow (vph)	111	395	42	272	433	106	54	206	153	113	201	76
v/c Ratio	0.56	0.63	0.10	0.57	0.53	0.21	0.34	0.14	0.17	0.76	0.13	0.10
Control Delay	48.9	38.5	0.5	27.5	21.8	1.3	43.3	19.0	2.3	72.9	19.7	0.3
Queue Delay	0.0	0.0	0.0	0.0	0.0	0.0	0.0	0.0	0.0	0.0	0.0	0.0
Total Delay	48.9	38.5	0.5	27.5	21.8	1.3	43.3	19.0	2.3	72.9	19.7	0.3
Queue Length 50th (ft)	60	111	0	42	67	0	29	37	0	64	37	0
Queue Length 95th (ft)	113	146	0	61	70	1	64	72	27	#152	75	0
Internal Link Dist (ft)		2178			574			393			326	
Turn Bay Length (ft)	120		60	220		95	75		75	105		65
Base Capacity (vph)	228	1294	680	514	1330	701	166	1440	939	148	1494	758
Starvation Cap Reductn	0	0	0	0	0	0	0	0	0	0	0	0
Spillback Cap Reductn	0	0	0	0	0	0	0	0	0	0	0	0
Storage Cap Reductn	0	0	0	0	0	0	0	0	0	0	0	0
Reduced v/c Ratio	0.49	0.31	0.06	0.53	0.33	0.15	0.33	0.14	0.16	0.76	0.13	0.10

Intersection Summary

95th percentile volume exceeds capacity, queue may be longer.
Queue shown is maximum after two cycles.

Queues
30: Fairgrounds & Cleveland Avenue

Village D Specific Plan
Existing NP - PM Peak Hour



Lane Group	EBL	EBT	WBL	WBT	WBR	NBL	NBT	NBR	SBL	SBT
Lane Group Flow (vph)	94	599	163	529	129	100	81	73	243	139
v/c Ratio	0.44	0.53	0.73	0.66	0.26	0.41	0.15	0.12	0.86	0.19
Control Delay	30.4	15.7	44.9	19.7	4.5	45.3	17.3	0.4	66.0	8.3
Queue Delay	0.0	0.0	0.0	0.0	0.0	0.0	0.0	0.0	0.0	0.0
Total Delay	30.4	15.7	44.9	19.7	4.5	45.3	17.3	0.4	66.0	8.3
Queue Length 50th (ft)	57	120	72	123	9	28	18	0	136	13
Queue Length 95th (ft)	m97	145	#174	143	16	54	62	0	#262	58
Internal Link Dist (ft)		574		1412			192			168
Turn Bay Length (ft)	120		205					100		
Base Capacity (vph)	215	1537	236	1330	696	249	524	617	290	742
Starvation Cap Reductn	0	0	0	0	0	0	0	0	0	0
Spillback Cap Reductn	0	0	0	0	0	0	0	0	0	0
Storage Cap Reductn	0	0	0	0	0	0	0	0	0	0
Reduced v/c Ratio	0.44	0.39	0.69	0.40	0.19	0.40	0.15	0.12	0.84	0.19

Intersection Summary

95th percentile volume exceeds capacity, queue may be longer.

Queue shown is maximum after two cycles.

m Volume for 95th percentile queue is metered by upstream signal.

Queues
33: Gateway Drive & Cleveland Avenue

Village D Specific Plan
Existing NP - PM Peak Hour

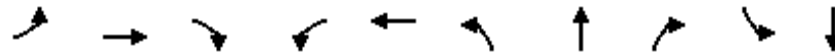

Lane Group	EBL	EBT	EBR	WBL	WBT	NBL	NBT	NBR	SBL	SBT
Lane Group Flow (vph)	15	781	246	153	807	232	119	223	165	155
v/c Ratio	0.08	0.64	0.33	0.42	0.62	0.50	0.19	0.34	0.74	0.14
Control Delay	7.9	22.8	3.1	31.4	21.3	40.2	25.5	7.2	58.7	21.5
Queue Delay	0.0	2.2	0.1	0.8	7.8	0.0	0.0	0.1	0.0	0.0
Total Delay	7.9	25.0	3.2	32.1	29.2	40.2	25.5	7.3	58.7	21.5
Queue Length 50th (ft)	2	72	0	39	116	63	49	9	91	28
Queue Length 95th (ft)	m5	95	14	60	205	100	104	68	#181	60
Internal Link Dist (ft)		207			111		765			296
Turn Bay Length (ft)	110					245			45	
Base Capacity (vph)	189	1762	745	376	1376	485	618	653	235	1118
Starvation Cap Reductn	0	198	52	70	524	0	0	0	0	0
Spillback Cap Reductn	0	804	0	0	0	0	0	34	0	0
Storage Cap Reductn	0	0	0	0	0	0	0	0	0	0
Reduced v/c Ratio	0.08	0.82	0.35	0.50	0.95	0.48	0.19	0.36	0.70	0.14

Intersection Summary

95th percentile volume exceeds capacity, queue may be longer.

Queue shown is maximum after two cycles.

m Volume for 95th percentile queue is metered by upstream signal.

Queues
34: Cleveland Avenue & County Club Drive

Village D Specific Plan
Existing NP - PM Peak Hour



Lane Group	WBL	NBT	NBR	SBL	SBT
Lane Group Flow (vph)	371	746	411	79	605
v/c Ratio	0.64	0.29	0.26	0.16	0.16
Control Delay	38.9	16.0	1.1	5.2	4.0
Queue Delay	0.0	17.0	0.0	0.0	0.0
Total Delay	38.9	33.1	1.1	5.2	4.0
Queue Length 50th (ft)	99	178	10	11	31
Queue Length 95th (ft)	137	218	27	31	50
Internal Link Dist (ft)	239	111			159
Turn Bay Length (ft)					
Base Capacity (vph)	1377	2603	1563	488	3740
Starvation Cap Reductn	0	1854	0	0	0
Spillback Cap Reductn	0	0	0	0	622
Storage Cap Reductn	0	0	0	0	0
Reduced v/c Ratio	0.27	1.00	0.26	0.16	0.19
Intersection Summary					

Queues
36: Pine Street & Howard Road

Village D Specific Plan
Existing NP - PM Peak Hour



Lane Group	EBL	EBT	WBL	WBT	NBL	NBT	NBR	SBT	SBR
Lane Group Flow (vph)	91	671	92	526	153	167	148	157	128
v/c Ratio	0.39	0.75	0.55	0.67	0.26	0.27	0.23	0.59	0.33
Control Delay	41.0	35.1	67.2	32.2	27.8	27.7	3.6	44.6	4.1
Queue Delay	0.0	0.0	0.0	0.0	0.0	0.0	0.0	0.0	0.0
Total Delay	41.0	35.1	67.2	32.2	27.8	27.7	3.6	44.6	4.1
Queue Length 50th (ft)	46	176	50	85	69	76	0	85	0
Queue Length 95th (ft)	98	225	#136	165	132	141	31	137	18
Internal Link Dist (ft)		265		561		224		259	
Turn Bay Length (ft)	95		140		90				
Base Capacity (vph)	232	1058	168	1091	585	616	638	370	462
Starvation Cap Reductn	0	0	0	0	0	0	0	0	0
Spillback Cap Reductn	0	0	0	0	0	0	0	0	0
Storage Cap Reductn	0	0	0	0	0	0	0	0	0
Reduced v/c Ratio	0.39	0.63	0.55	0.48	0.26	0.27	0.23	0.42	0.28

Intersection Summary

95th percentile volume exceeds capacity, queue may be longer.
Queue shown is maximum after two cycles.

Queues

37: Olive Avenue/Q Street & Howard Road/Yosemite Avenue

Village D Specific Plan

Existing NP - PM Peak Hour



Lane Group	EBL	EBT	EBR	WBL	WBT	NBL	NBT	NBR	SBL	SBT	SBR
Lane Group Flow (vph)	8	502	240	14	422	199	201	14	18	63	2
v/c Ratio	0.07	0.66	0.46	0.11	0.55	0.22	0.22	0.02	0.11	0.36	0.01
Control Delay	45.4	50.9	24.9	40.8	33.1	15.7	15.6	0.0	37.4	43.2	0.0
Queue Delay	0.0	0.0	0.0	0.0	0.0	0.0	0.0	0.0	0.0	0.0	0.0
Total Delay	45.4	50.9	24.9	40.8	33.1	15.7	15.6	0.0	37.4	43.2	0.0
Queue Length 50th (ft)	5	156	83	8	111	57	58	0	10	34	0
Queue Length 95th (ft)	m11	205	139	26	141	150	151	0	29	69	0
Internal Link Dist (ft)		561			230		220			195	
Turn Bay Length (ft)	40			80		130			50		50
Base Capacity (vph)	118	802	539	357	1226	912	933	929	357	376	465
Starvation Cap Reductn	0	0	0	0	0	0	0	0	0	0	0
Spillback Cap Reductn	0	0	0	0	0	0	0	0	0	0	0
Storage Cap Reductn	0	0	0	0	0	0	0	0	0	0	0
Reduced v/c Ratio	0.07	0.63	0.45	0.04	0.34	0.22	0.22	0.02	0.05	0.17	0.00

Intersection Summary

m Volume for 95th percentile queue is metered by upstream signal.

Queues
39: 4th Street & Sunset Avenue

Village D Specific Plan
Existing NP - PM Peak Hour



Lane Group	EBL	NBL	NBT	SBT	SBR
Lane Group Flow (vph)	265	15	312	358	404
v/c Ratio	0.57	0.13	0.11	0.27	0.29
Control Delay	44.6	46.2	3.1	2.2	0.8
Queue Delay	0.0	0.0	0.0	0.0	0.0
Total Delay	44.6	46.2	3.1	2.2	0.8
Queue Length 50th (ft)	81	9	20	28	1
Queue Length 95th (ft)	115	29	36	64	6
Internal Link Dist (ft)	7441		193	501	
Turn Bay Length (ft)	135				
Base Capacity (vph)	963	131	2729	1348	1437
Starvation Cap Reductn	0	0	0	0	0
Spillback Cap Reductn	0	0	0	0	0
Storage Cap Reductn	0	0	0	0	0
Reduced v/c Ratio	0.28	0.11	0.11	0.27	0.28
Intersection Summary					

Queues
41: I Street & 4th Street

Village D Specific Plan
Existing NP - PM Peak Hour



Lane Group	EBL	EBT	WBL	WBT	NBL	NBT	NBR	SBL	SBT	SBR
Lane Group Flow (vph)	35	598	66	670	108	76	274	179	183	104
v/c Ratio	0.29	0.74	0.43	0.70	0.57	0.12	0.39	0.52	0.24	0.15
Control Delay	43.5	27.7	42.9	20.4	54.1	28.9	5.7	41.6	23.1	4.4
Queue Delay	0.0	0.0	0.0	0.2	0.0	0.0	0.0	0.0	0.0	0.0
Total Delay	43.5	27.7	42.9	20.5	54.1	28.9	5.7	41.6	23.1	4.4
Queue Length 50th (ft)	22	177	44	94	66	36	0	102	79	0
Queue Length 95th (ft)	55	214	m70	112	119	76	61	165	143	30
Internal Link Dist (ft)		501		26		314			779	
Turn Bay Length (ft)	130				45		25	80		80
Base Capacity (vph)	123	954	174	1090	226	614	706	380	772	714
Starvation Cap Reductn	0	0	0	51	0	0	0	0	0	0
Spillback Cap Reductn	0	0	0	0	0	0	0	0	0	0
Storage Cap Reductn	0	0	0	0	0	0	0	0	0	0
Reduced v/c Ratio	0.28	0.63	0.38	0.64	0.48	0.12	0.39	0.47	0.24	0.15

Intersection Summary

m Volume for 95th percentile queue is metered by upstream signal.

Queues
 23: Avenue 16/Ellis Street & Kennedy Street

Village D Specific Plan
 Existing WP - AM Peak Hour



Lane Group	WBL	WBR	NBT	SBL	SBT
Lane Group Flow (vph)	138	123	619	284	280
v/c Ratio	0.55	0.25	0.43	0.54	0.11
Control Delay	25.6	7.7	12.4	28.3	3.4
Queue Delay	0.0	0.0	0.0	0.0	0.0
Total Delay	25.6	7.7	12.4	28.3	3.4
Queue Length 50th (ft)	70	0	68	118	16
Queue Length 95th (ft)	69	0	113	183	31
Internal Link Dist (ft)	782		506		440
Turn Bay Length (ft)	175			280	
Base Capacity (vph)	423	759	1434	524	2652
Starvation Cap Reductn	0	0	0	0	0
Spillback Cap Reductn	0	0	0	0	0
Storage Cap Reductn	0	0	0	0	0
Reduced v/c Ratio	0.33	0.16	0.43	0.54	0.11
Intersection Summary					

Queues
24: Schnoor Avenue & Kennedy Street

Village D Specific Plan
Existing WP - AM Peak Hour



Lane Group	EBL	EBT	WBL	WBT	NBL	NBT	SBL	SBT	SBR
Lane Group Flow (vph)	16	493	167	168	105	248	16	7	4
v/c Ratio	0.13	0.70	0.61	0.25	0.41	0.28	0.18	0.01	0.01
Control Delay	40.8	18.1	40.6	17.0	40.5	4.2	39.9	20.8	0.0
Queue Delay	0.0	0.0	0.0	0.0	0.0	0.0	0.0	0.0	0.0
Total Delay	40.8	18.1	40.6	17.0	40.5	4.2	39.9	20.8	0.0
Queue Length 50th (ft)	8	42	78	51	26	1	8	2	0
Queue Length 95th (ft)	m15	76	133	100	50	55	27	12	0
Internal Link Dist (ft)		782		187		321		193	
Turn Bay Length (ft)	95		40		75		60		
Base Capacity (vph)	120	862	358	714	258	872	91	540	585
Starvation Cap Reductn	0	0	0	0	0	0	0	0	0
Spillback Cap Reductn	0	0	0	0	0	0	0	0	0
Storage Cap Reductn	0	0	0	0	0	0	0	0	0
Reduced v/c Ratio	0.13	0.57	0.47	0.24	0.41	0.28	0.18	0.01	0.01

Intersection Summary

m Volume for 95th percentile queue is metered by upstream signal.

Queues
29: Schnoor Avenue & Cleveland Avenue

Village D Specific Plan
Existing WP - AM Peak Hour



Lane Group	EBL	EBT	EBR	WBL	WBT	WBR	NBL	NBT	NBR	SBL	SBT	SBR
Lane Group Flow (vph)	148	1098	73	177	535	47	67	237	170	87	187	99
v/c Ratio	0.59	0.85	0.11	0.63	0.50	0.08	0.57	0.24	0.26	0.61	0.18	0.17
Control Delay	41.9	31.5	0.3	21.5	4.4	0.2	56.5	24.5	5.6	54.8	23.1	0.6
Queue Delay	0.0	0.0	0.0	0.0	0.0	0.0	0.0	0.0	0.0	0.0	0.0	0.0
Total Delay	41.9	31.5	0.3	21.5	4.4	0.2	56.5	24.5	5.6	54.8	23.1	0.6
Queue Length 50th (ft)	70	257	0	38	15	0	33	50	8	43	38	0
Queue Length 95th (ft)	125	#340	0	m46	22	m0	#88	81	46	#104	64	0
Internal Link Dist (ft)		2178			574			393			326	
Turn Bay Length (ft)	120		60	220		95	75		75	105		65
Base Capacity (vph)	299	1317	705	280	1061	610	118	992	660	146	1032	596
Starvation Cap Reductn	0	0	0	0	0	0	0	0	0	0	0	0
Spillback Cap Reductn	0	0	0	0	0	0	0	0	0	0	0	0
Storage Cap Reductn	0	0	0	0	0	0	0	0	0	0	0	0
Reduced v/c Ratio	0.49	0.83	0.10	0.63	0.50	0.08	0.57	0.24	0.26	0.60	0.18	0.17

Intersection Summary

- # 95th percentile volume exceeds capacity, queue may be longer.
Queue shown is maximum after two cycles.
- m Volume for 95th percentile queue is metered by upstream signal.

Queues
30: Fairgrounds & Cleveland Avenue

Village D Specific Plan
Existing WP - AM Peak Hour



Lane Group	EBL	EBT	WBL	WBT	WBR	NBL	NBT	NBR	SBL	SBT
Lane Group Flow (vph)	85	1277	34	673	105	14	15	15	114	45
v/c Ratio	0.43	0.77	0.22	0.69	0.18	0.06	0.03	0.02	0.55	0.06
Control Delay	20.2	14.7	36.7	30.4	0.7	36.1	16.4	0.1	43.2	7.2
Queue Delay	0.0	0.0	0.0	0.0	0.0	0.0	0.0	0.0	0.0	0.0
Total Delay	20.2	14.7	36.7	30.4	0.7	36.1	16.4	0.1	43.2	7.2
Queue Length 50th (ft)	30	45	16	158	0	3	2	0	54	1
Queue Length 95th (ft)	m39	#206	42	218	0	12	17	0	104	24
Internal Link Dist (ft)		574		1412			192			168
Turn Bay Length (ft)	120		205					100		
Base Capacity (vph)	232	1658	254	996	592	218	535	674	236	743
Starvation Cap Reductn	0	0	0	0	0	0	0	0	0	0
Spillback Cap Reductn	0	0	0	0	0	0	0	0	0	0
Storage Cap Reductn	0	0	0	0	0	0	0	0	0	0
Reduced v/c Ratio	0.37	0.77	0.13	0.68	0.18	0.06	0.03	0.02	0.48	0.06

Intersection Summary

95th percentile volume exceeds capacity, queue may be longer.

Queue shown is maximum after two cycles.

m Volume for 95th percentile queue is metered by upstream signal.

Queues
33: Gateway Drive & Cleveland Avenue

Village D Specific Plan
Existing WP - AM Peak Hour

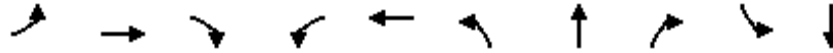

Lane Group	EBL	EBT	EBR	WBL	WBT	NBL	NBT	NBR	SBL	SBT
Lane Group Flow (vph)	5	994	337	190	1039	220	58	140	63	110
v/c Ratio	0.03	0.74	0.41	0.46	0.72	0.51	0.09	0.22	0.40	0.11
Control Delay	21.2	26.8	5.9	38.2	24.1	41.2	25.0	2.9	46.1	25.1
Queue Delay	0.0	1.2	0.1	0.3	32.9	0.0	0.0	0.0	0.0	0.0
Total Delay	21.2	27.9	6.0	38.5	57.0	41.2	25.0	2.9	46.1	25.1
Queue Length 50th (ft)	2	174	28	46	191	60	24	0	34	23
Queue Length 95th (ft)	m4	177	43	65	230	86	51	14	66	42
Internal Link Dist (ft)		207			111		765			296
Turn Bay Length (ft)	110					245			45	
Base Capacity (vph)	221	1426	818	587	1448	429	620	638	180	981
Starvation Cap Reductn	0	218	60	115	466	0	0	0	0	0
Spillback Cap Reductn	0	64	0	0	80	0	0	13	0	0
Storage Cap Reductn	0	0	0	0	0	0	0	0	0	0
Reduced v/c Ratio	0.02	0.82	0.44	0.40	1.06	0.51	0.09	0.22	0.35	0.11

Intersection Summary

m Volume for 95th percentile queue is metered by upstream signal.

Queues
34: Cleveland Avenue & County Club Drive

Village D Specific Plan
Existing WP - AM Peak Hour



Lane Group	WBL	NBT	NBR	SBL	SBT
Lane Group Flow (vph)	470	672	494	92	752
v/c Ratio	0.69	0.26	0.31	0.18	0.21
Control Delay	38.5	10.1	3.1	6.2	5.0
Queue Delay	0.0	1.5	0.0	0.0	0.1
Total Delay	38.5	11.6	3.1	6.2	5.1
Queue Length 50th (ft)	127	79	63	15	45
Queue Length 95th (ft)	151	118	71	35	65
Internal Link Dist (ft)	239	111			159
Turn Bay Length (ft)					
Base Capacity (vph)	1264	2551	1615	515	3665
Starvation Cap Reductn	0	1637	0	0	0
Spillback Cap Reductn	1	0	0	0	1151
Storage Cap Reductn	0	0	0	0	0
Reduced v/c Ratio	0.37	0.74	0.31	0.18	0.30
Intersection Summary					

Queues
36: Pine Street & Howard Road

Village D Specific Plan
Existing WP - AM Peak Hour



Lane Group	EBL	EBT	WBL	WBT	NBL	NBT	NBR	SBT	SBR
Lane Group Flow (vph)	39	1380	148	683	180	181	261	317	114
v/c Ratio	0.40	0.98	0.88	0.40	0.64	0.61	0.56	0.94	0.29
Control Delay	66.9	55.8	94.6	23.1	58.0	56.2	10.3	83.7	6.3
Queue Delay	0.0	1.2	0.0	0.0	0.0	0.0	0.1	0.0	0.0
Total Delay	66.9	57.0	94.6	23.1	58.0	56.2	10.4	83.7	6.3
Queue Length 50th (ft)	30	546	120	187	132	132	0	244	0
Queue Length 95th (ft)	63	#641	#221	217	197	196	59	#375	28
Internal Link Dist (ft)		265		565		224		259	
Turn Bay Length (ft)	95		140		90				
Base Capacity (vph)	102	1403	169	1690	282	297	465	344	398
Starvation Cap Reductn	0	0	0	0	0	0	0	0	0
Spillback Cap Reductn	0	9	0	0	0	0	5	0	0
Storage Cap Reductn	0	0	0	0	0	0	0	0	0
Reduced v/c Ratio	0.38	0.99	0.88	0.40	0.64	0.61	0.57	0.92	0.29

Intersection Summary

95th percentile volume exceeds capacity, queue may be longer.
Queue shown is maximum after two cycles.

Queues

37: Olive Avenue/Q Street & Howard Road/Yosemite Avenue

Village D Specific Plan

Existing WP - AM Peak Hour



Lane Group	EBL	EBT	EBR	WBL	WBT	NBL	NBT	NBR	SBL	SBT	SBR
Lane Group Flow (vph)	8	776	796	35	490	334	339	27	132	196	16
v/c Ratio	0.11	0.68	0.78	0.30	0.37	0.56	0.55	0.04	0.55	0.78	0.05
Control Delay	78.5	19.7	11.7	59.4	27.0	39.0	38.9	0.1	57.1	70.7	0.2
Queue Delay	0.0	0.0	4.0	0.0	0.0	0.0	0.0	0.0	0.0	0.0	0.0
Total Delay	78.5	19.7	15.7	59.4	27.0	39.0	38.9	0.1	57.1	70.7	0.2
Queue Length 50th (ft)	6	178	489	26	124	242	245	0	95	146	0
Queue Length 95th (ft)	m7	208	453	49	145	290	294	0	131	186	0
Internal Link Dist (ft)		565			230		220			195	
Turn Bay Length (ft)	40			80		130			50		50
Base Capacity (vph)	76	1166	1023	265	1484	600	611	628	265	279	353
Starvation Cap Reductn	0	0	153	0	0	0	0	0	0	0	0
Spillback Cap Reductn	0	0	0	0	0	0	0	0	0	0	0
Storage Cap Reductn	0	0	0	0	0	0	0	0	0	0	0
Reduced v/c Ratio	0.11	0.67	0.91	0.13	0.33	0.56	0.55	0.04	0.50	0.70	0.05

Intersection Summary

m Volume for 95th percentile queue is metered by upstream signal.

Queues
39: 4th Street & Sunset Avenue

Village D Specific Plan
Existing WP - AM Peak Hour



Lane Group	EBL	NBL	NBT	SBT	SBR
Lane Group Flow (vph)	452	34	338	500	300
v/c Ratio	0.69	0.25	0.13	0.42	0.23
Control Delay	39.5	43.7	4.5	4.9	0.6
Queue Delay	0.0	0.0	0.0	0.0	0.0
Total Delay	39.5	43.7	4.5	4.9	0.6
Queue Length 50th (ft)	121	19	27	139	0
Queue Length 95th (ft)	167	48	45	69	0
Internal Link Dist (ft)	7441		193	501	
Turn Bay Length (ft)	135				
Base Capacity (vph)	760	148	2528	1182	1360
Starvation Cap Reductn	0	0	0	0	0
Spillback Cap Reductn	0	0	0	0	0
Storage Cap Reductn	0	0	0	0	0
Reduced v/c Ratio	0.59	0.23	0.13	0.42	0.22
Intersection Summary					

Queues
41: I Street & 4th Street



Lane Group	EBL	EBT	WBL	WBT	NBL	NBT	NBR	SBL	SBT	SBR
Lane Group Flow (vph)	29	838	99	615	59	64	186	312	322	210
v/c Ratio	0.26	0.88	0.67	0.53	0.44	0.14	0.33	0.81	0.42	0.28
Control Delay	42.2	30.1	45.4	18.2	50.2	30.6	3.5	51.3	23.2	5.8
Queue Delay	0.0	0.0	0.0	0.0	0.0	0.0	0.0	0.0	0.0	0.0
Total Delay	42.2	30.1	45.4	18.2	50.2	30.6	3.5	51.3	23.2	5.8
Queue Length 50th (ft)	10	226	60	73	33	30	0	166	141	10
Queue Length 95th (ft)	m26	#272	m76	m90	69	62	22	#266	207	51
Internal Link Dist (ft)		501		26		314			779	
Turn Bay Length (ft)	130				45		25	80		80
Base Capacity (vph)	113	973	153	1196	142	466	567	409	773	741
Starvation Cap Reductn	0	0	0	0	0	0	0	0	0	0
Spillback Cap Reductn	0	0	0	0	0	0	0	0	0	0
Storage Cap Reductn	0	0	0	0	0	0	0	0	0	0
Reduced v/c Ratio	0.26	0.86	0.65	0.51	0.42	0.14	0.33	0.76	0.42	0.28

Intersection Summary

95th percentile volume exceeds capacity, queue may be longer.

Queue shown is maximum after two cycles.

m Volume for 95th percentile queue is metered by upstream signal.

Queues
 23: Avenue 16/Ellis Street & Kennedy Street

Village D Specific Plan
 Existing WP - PM Peak Hour



Lane Group	WBL	WBR	NBT	SBL	SBT
Lane Group Flow (vph)	222	234	430	201	322
v/c Ratio	0.68	0.33	0.25	0.72	0.13
Control Delay	27.2	9.9	7.5	47.7	4.4
Queue Delay	0.0	0.0	0.0	0.0	0.0
Total Delay	27.2	9.9	7.5	47.7	4.4
Queue Length 50th (ft)	113	23	35	94	23
Queue Length 95th (ft)	187	55	64	#190	42
Internal Link Dist (ft)	782		506		440
Turn Bay Length (ft)	175			280	
Base Capacity (vph)	409	824	1736	296	2539
Starvation Cap Reductn	0	0	0	0	0
Spillback Cap Reductn	0	0	0	0	0
Storage Cap Reductn	0	0	0	0	0
Reduced v/c Ratio	0.54	0.28	0.25	0.68	0.13

Intersection Summary

95th percentile volume exceeds capacity, queue may be longer.
 Queue shown is maximum after two cycles.

Queues
24: Schnoor Avenue & Kennedy Street

Village D Specific Plan
Existing WP - PM Peak Hour



Lane Group	EBL	EBT	WBL	WBT	NBL	NBT	SBL	SBT	SBR
Lane Group Flow (vph)	10	339	215	269	204	277	24	15	9
v/c Ratio	0.07	0.62	0.66	0.45	0.57	0.31	0.21	0.03	0.01
Control Delay	26.8	10.3	39.6	23.5	40.9	4.7	39.5	21.2	0.0
Queue Delay	0.0	0.0	0.0	0.0	0.0	0.0	0.0	0.0	0.0
Total Delay	26.8	10.3	39.6	23.5	40.9	4.7	39.5	21.2	0.0
Queue Length 50th (ft)	5	44	101	96	51	3	12	5	0
Queue Length 95th (ft)	m14	31	157	181	84	61	35	21	0
Internal Link Dist (ft)		782		187		321		193	
Turn Bay Length (ft)	95		40		75		60		
Base Capacity (vph)	153	862	383	699	368	889	116	586	628
Starvation Cap Reductn	0	0	0	0	0	0	0	0	0
Spillback Cap Reductn	0	0	0	0	0	0	0	0	0
Storage Cap Reductn	0	0	0	0	0	0	0	0	0
Reduced v/c Ratio	0.07	0.39	0.56	0.38	0.55	0.31	0.21	0.03	0.01

Intersection Summary

m Volume for 95th percentile queue is metered by upstream signal.

Queues
29: Schnoor Avenue & Cleveland Avenue

Village D Specific Plan
Existing WP - PM Peak Hour



Lane Group	EBL	EBT	EBR	WBL	WBT	WBR	NBL	NBT	NBR	SBL	SBT	SBR
Lane Group Flow (vph)	170	891	54	272	1210	106	82	223	153	113	209	162
v/c Ratio	0.78	0.77	0.09	0.47	0.92	0.15	0.62	0.28	0.22	0.76	0.23	0.30
Control Delay	62.8	31.9	0.3	14.2	12.1	0.2	61.7	30.3	5.6	72.9	28.7	5.1
Queue Delay	0.0	0.0	0.0	0.0	0.0	0.0	0.0	0.0	0.0	0.0	0.0	0.0
Total Delay	62.8	31.9	0.3	14.2	12.1	0.2	61.7	30.3	5.6	72.9	28.7	5.1
Queue Length 50th (ft)	95	232	0	51	54	0	46	56	8	64	51	0
Queue Length 95th (ft)	#192	291	0	m62	m58	m0	#108	88	46	#152	82	39
Internal Link Dist (ft)		2178			574			393			326	
Turn Bay Length (ft)	120		60	220		95	75		75	105		65
Base Capacity (vph)	228	1294	680	579	1330	701	135	800	696	148	918	536
Starvation Cap Reductn	0	0	0	0	0	0	0	0	0	0	0	0
Spillback Cap Reductn	0	0	0	0	0	0	0	0	0	0	0	0
Storage Cap Reductn	0	0	0	0	0	0	0	0	0	0	0	0
Reduced v/c Ratio	0.75	0.69	0.08	0.47	0.91	0.15	0.61	0.28	0.22	0.76	0.23	0.30

Intersection Summary

- # 95th percentile volume exceeds capacity, queue may be longer.
Queue shown is maximum after two cycles.
- m Volume for 95th percentile queue is metered by upstream signal.

Queues
30: Fairgrounds & Cleveland Avenue



Lane Group	EBL	EBT	WBL	WBT	WBR	NBL	NBT	NBR	SBL	SBT
Lane Group Flow (vph)	94	1102	163	1314	145	100	81	73	276	139
v/c Ratio	0.73	0.70	0.73	1.02	0.21	0.41	0.22	0.15	0.95	0.23
Control Delay	50.7	10.6	51.1	40.1	1.8	45.3	19.5	0.6	81.5	9.2
Queue Delay	0.0	0.0	0.0	0.0	0.0	0.0	0.0	0.0	0.0	0.0
Total Delay	50.7	10.6	51.1	40.1	1.8	45.3	19.5	0.6	81.5	9.2
Queue Length 50th (ft)	54	74	86	~336	8	28	21	0	157	15
Queue Length 95th (ft)	m#94	121	m113	#541	m10	54	62	0	#309	58
Internal Link Dist (ft)		574		1412			192			168
Turn Bay Length (ft)	120		205					100		
Base Capacity (vph)	129	1574	236	1290	681	249	373	498	290	603
Starvation Cap Reductn	0	0	0	0	0	0	0	0	0	0
Spillback Cap Reductn	0	0	0	0	0	0	0	0	0	0
Storage Cap Reductn	0	0	0	0	0	0	0	0	0	0
Reduced v/c Ratio	0.73	0.70	0.69	1.02	0.21	0.40	0.22	0.15	0.95	0.23

Intersection Summary

- ~ Volume exceeds capacity, queue is theoretically infinite.
Queue shown is maximum after two cycles.
- # 95th percentile volume exceeds capacity, queue may be longer.
Queue shown is maximum after two cycles.
- m Volume for 95th percentile queue is metered by upstream signal.

Queues
33: Gateway Drive & Cleveland Avenue

Village D Specific Plan
Existing WP - PM Peak Hour

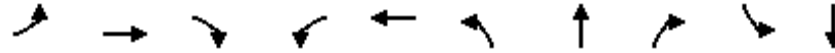

Lane Group	EBL	EBT	EBR	WBL	WBT	NBL	NBT	NBR	SBL	SBT
Lane Group Flow (vph)	15	1051	316	153	1192	364	119	223	165	155
v/c Ratio	0.08	0.68	0.36	0.47	0.80	0.77	0.23	0.40	0.72	0.17
Control Delay	6.3	13.3	1.3	38.9	24.4	49.6	28.8	10.1	56.6	24.2
Queue Delay	0.0	0.6	0.1	0.3	47.1	62.1	0.0	0.2	0.0	0.0
Total Delay	6.3	14.0	1.4	39.2	71.6	111.7	28.8	10.3	56.6	24.2
Queue Length 50th (ft)	2	58	1	38	191	104	54	19	91	31
Queue Length 95th (ft)	m3	84	2	72	#327	#162	104	82	#181	60
Internal Link Dist (ft)		207			111		765			296
Turn Bay Length (ft)	110					245			45	
Base Capacity (vph)	184	1780	872	340	1498	485	514	561	235	931
Starvation Cap Reductn	0	316	98	21	411	0	0	0	0	0
Spillback Cap Reductn	0	361	0	0	167	284	0	53	0	1
Storage Cap Reductn	0	0	0	0	0	0	0	0	0	0
Reduced v/c Ratio	0.08	0.74	0.41	0.48	1.10	1.81	0.23	0.44	0.70	0.17

Intersection Summary

95th percentile volume exceeds capacity, queue may be longer.

Queue shown is maximum after two cycles.

m Volume for 95th percentile queue is metered by upstream signal.

Queues
 34: Cleveland Avenue & County Club Drive

Village D Specific Plan
 Existing WP - PM Peak Hour



Lane Group	WBL	NBT	NBR	SBL	SBT
Lane Group Flow (vph)	667	803	620	79	693
v/c Ratio	0.75	0.34	0.39	0.20	0.21
Control Delay	35.7	14.7	2.3	9.5	7.2
Queue Delay	0.0	3.6	0.0	0.0	0.1
Total Delay	35.7	18.3	2.3	9.5	7.3
Queue Length 50th (ft)	179	133	20	16	52
Queue Length 95th (ft)	217	189	80	46	84
Internal Link Dist (ft)	239	111			159
Turn Bay Length (ft)					
Base Capacity (vph)	1380	2328	1594	387	3345
Starvation Cap Reductn	0	1405	0	0	0
Spillback Cap Reductn	5	0	0	0	1109
Storage Cap Reductn	0	0	0	0	0
Reduced v/c Ratio	0.49	0.87	0.39	0.20	0.31
Intersection Summary					

Queues
36: Pine Street & Howard Road

Village D Specific Plan
Existing WP - PM Peak Hour



Lane Group	EBL	EBT	WBL	WBT	NBL	NBT	NBR	SBT	SBR
Lane Group Flow (vph)	91	968	92	911	249	182	148	163	128
v/c Ratio	0.59	0.90	0.55	0.80	0.51	0.35	0.26	0.60	0.33
Control Delay	57.1	41.4	48.8	31.5	34.5	31.3	3.9	44.9	4.1
Queue Delay	0.0	0.0	0.0	0.0	0.0	0.0	0.0	0.0	0.0
Total Delay	57.1	41.4	48.8	31.5	34.5	31.3	3.9	44.9	4.1
Queue Length 50th (ft)	51	267	51	267	129	90	0	88	0
Queue Length 95th (ft)	#128	#394	#126	#271	209	152	31	142	18
Internal Link Dist (ft)		265		561		224		259	
Turn Bay Length (ft)	95		140		90				
Base Capacity (vph)	155	1087	167	1143	488	514	564	370	462
Starvation Cap Reductn	0	0	0	0	0	0	0	0	0
Spillback Cap Reductn	0	0	0	0	0	0	0	0	0
Storage Cap Reductn	0	0	0	0	0	0	0	0	0
Reduced v/c Ratio	0.59	0.89	0.55	0.80	0.51	0.35	0.26	0.44	0.28

Intersection Summary

95th percentile volume exceeds capacity, queue may be longer.
Queue shown is maximum after two cycles.

Queues

37: Olive Avenue/Q Street & Howard Road/Yosemite Avenue

Village D Specific Plan

Existing WP - PM Peak Hour



Lane Group	EBL	EBT	EBR	WBL	WBT	NBL	NBT	NBR	SBL	SBT	SBR
Lane Group Flow (vph)	8	528	477	14	467	379	382	14	18	63	2
v/c Ratio	0.06	0.62	0.65	0.11	0.56	0.43	0.43	0.02	0.11	0.36	0.01
Control Delay	23.3	11.9	7.0	40.8	32.6	19.3	19.2	0.0	37.4	43.2	0.0
Queue Delay	0.0	0.0	0.0	0.0	0.0	0.0	0.0	0.0	0.0	0.0	0.0
Total Delay	23.3	11.9	7.0	40.8	32.6	19.3	19.2	0.0	37.4	43.2	0.0
Queue Length 50th (ft)	4	44	0	8	120	135	136	0	10	34	0
Queue Length 95th (ft)	m7	m77	m40	26	163	296	297	0	29	69	0
Internal Link Dist (ft)		561			230		220			195	
Turn Bay Length (ft)	40			80		130			50		50
Base Capacity (vph)	287	865	743	357	895	883	893	879	357	376	421
Starvation Cap Reductn	0	0	0	0	0	0	0	0	0	0	0
Spillback Cap Reductn	0	0	0	0	0	0	0	0	0	0	0
Storage Cap Reductn	0	0	0	0	0	0	0	0	0	0	0
Reduced v/c Ratio	0.03	0.61	0.64	0.04	0.52	0.43	0.43	0.02	0.05	0.17	0.00

Intersection Summary

m Volume for 95th percentile queue is metered by upstream signal.

Queues
39: 4th Street & Sunset Avenue

Village D Specific Plan
Existing WP - PM Peak Hour



Lane Group	EBL	NBL	NBT	SBT	SBR
Lane Group Flow (vph)	279	15	372	389	424
v/c Ratio	0.58	0.12	0.14	0.29	0.31
Control Delay	44.1	44.2	3.3	2.7	0.8
Queue Delay	0.0	0.0	0.0	0.0	0.0
Total Delay	44.1	44.2	3.3	2.7	0.8
Queue Length 50th (ft)	86	9	24	37	1
Queue Length 95th (ft)	118	28	45	72	3
Internal Link Dist (ft)	7441		193	501	
Turn Bay Length (ft)	135				
Base Capacity (vph)	962	168	2734	1334	1443
Starvation Cap Reductn	0	0	0	0	0
Spillback Cap Reductn	0	0	0	0	0
Storage Cap Reductn	0	0	0	0	0
Reduced v/c Ratio	0.29	0.09	0.14	0.29	0.29
Intersection Summary					

Queues
41: I Street & 4th Street

Village D Specific Plan
Existing WP - PM Peak Hour



Lane Group	EBL	EBT	WBL	WBT	NBL	NBT	NBR	SBL	SBT	SBR
Lane Group Flow (vph)	35	672	66	689	108	76	274	206	183	135
v/c Ratio	0.28	0.78	0.45	0.70	0.57	0.13	0.39	0.60	0.24	0.19
Control Delay	42.5	29.8	43.5	20.0	54.1	29.5	5.8	44.2	23.7	5.1
Queue Delay	0.0	0.0	0.0	0.2	0.0	0.0	0.0	0.0	0.0	0.0
Total Delay	42.5	29.8	43.5	20.2	54.1	29.5	5.8	44.2	23.7	5.1
Queue Length 50th (ft)	22	196	45	97	66	37	0	120	82	0
Queue Length 95th (ft)	55	237	m64	m113	119	76	61	189	143	40
Internal Link Dist (ft)		501		26		314			779	
Turn Bay Length (ft)	130				45		25	80		80
Base Capacity (vph)	129	955	169	1103	226	596	694	380	754	712
Starvation Cap Reductn	0	0	0	59	0	0	0	0	0	0
Spillback Cap Reductn	0	0	0	0	0	0	0	0	0	0
Storage Cap Reductn	0	0	0	0	0	0	0	0	0	0
Reduced v/c Ratio	0.27	0.70	0.39	0.66	0.48	0.13	0.39	0.54	0.24	0.19

Intersection Summary

m Volume for 95th percentile queue is metered by upstream signal.

Queues
 16: Love's Truck Stop Driveway/Driveway & Avenue 17

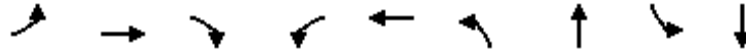

Lane Group	EBL	EBT	EBR	WBL	WBT	NBL	NBT	SBL	SBT
Lane Group Flow (vph)	176	354	143	49	970	148	24	52	98
v/c Ratio	0.97	0.19	0.16	0.43	1.07	0.94	0.03	0.44	0.22
Control Delay	113.9	14.3	2.7	65.1	80.1	112.9	0.1	65.2	1.2
Queue Delay	0.0	0.0	0.0	0.0	0.0	0.0	0.0	0.0	0.0
Total Delay	113.9	14.3	2.7	65.1	80.1	112.9	0.1	65.2	1.2
Queue Length 50th (ft)	138	72	0	37	-831	116	0	39	0
Queue Length 95th (ft)	#283	101	31	78	#1087	#247	0	81	0
Internal Link Dist (ft)		311			402		160		226
Turn Bay Length (ft)	100		100	100					
Base Capacity (vph)	181	1870	900	129	908	157	744	133	436
Starvation Cap Reductn	0	0	0	0	0	0	0	0	0
Spillback Cap Reductn	0	0	0	0	0	0	0	0	0
Storage Cap Reductn	0	0	0	0	0	0	0	0	0
Reduced v/c Ratio	0.97	0.19	0.16	0.38	1.07	0.94	0.03	0.39	0.22

Intersection Summary

~ Volume exceeds capacity, queue is theoretically infinite.
 Queue shown is maximum after two cycles.

95th percentile volume exceeds capacity, queue may be longer.
 Queue shown is maximum after two cycles.

Queues
 23: Avenue 16/Ellis Street & Kennedy Street

Village D Specific Plan
 Phase I NP - AM Peak Hour



Lane Group	WBL	WBR	NBT	SBL	SBT
Lane Group Flow (vph)	161	138	443	275	275
v/c Ratio	0.59	0.25	0.34	0.53	0.11
Control Delay	23.8	6.0	13.7	28.1	3.7
Queue Delay	0.0	0.0	0.0	0.0	0.0
Total Delay	23.8	6.0	13.7	28.1	3.7
Queue Length 50th (ft)	47	0	54	114	17
Queue Length 95th (ft)	81	1	100	188	34
Internal Link Dist (ft)	782		506		440
Turn Bay Length (ft)	175			280	
Base Capacity (vph)	423	770	1322	519	2580
Starvation Cap Reductn	0	0	0	0	0
Spillback Cap Reductn	0	0	0	0	0
Storage Cap Reductn	0	0	0	0	0
Reduced v/c Ratio	0.38	0.18	0.34	0.53	0.11
Intersection Summary					

Queues
24: Schnoor Avenue & Kennedy Street



Lane Group	EBL	EBT	WBL	WBT	NBL	NBT	SBL	SBT	SBR
Lane Group Flow (vph)	53	381	153	271	115	275	61	20	15
v/c Ratio	0.45	0.65	0.58	0.56	0.45	0.32	0.67	0.03	0.02
Control Delay	53.9	14.4	40.0	26.3	41.3	4.8	72.5	17.9	0.1
Queue Delay	0.0	0.0	0.0	0.0	0.0	0.0	0.0	0.0	0.0
Total Delay	53.9	14.4	40.0	26.3	41.3	4.8	72.5	17.9	0.1
Queue Length 50th (ft)	28	11	72	109	28	6	30	6	0
Queue Length 95th (ft)	m57	31	122	159	54	61	#91	23	0
Internal Link Dist (ft)		782		187		321		193	
Turn Bay Length (ft)	95		40		75		60		
Base Capacity (vph)	119	879	354	656	258	855	91	613	637
Starvation Cap Reductn	0	0	0	0	0	0	0	0	0
Spillback Cap Reductn	0	0	0	0	0	0	0	0	0
Storage Cap Reductn	0	0	0	0	0	0	0	0	0
Reduced v/c Ratio	0.45	0.43	0.43	0.41	0.45	0.32	0.67	0.03	0.02

Intersection Summary

95th percentile volume exceeds capacity, queue may be longer.

Queue shown is maximum after two cycles.

m Volume for 95th percentile queue is metered by upstream signal.

Queues
29: Schnoor Avenue & Cleveland Avenue

Village D Specific Plan
Phase I NP - AM Peak Hour



Lane Group	EBL	EBT	EBR	WBL	WBT	WBR	NBL	NBT	NBR	SBL	SBT	SBR
Lane Group Flow (vph)	92	400	40	177	233	49	54	251	177	91	183	65
v/c Ratio	0.53	0.61	0.09	0.44	0.29	0.10	0.32	0.17	0.19	0.64	0.12	0.08
Control Delay	45.9	33.4	0.4	21.3	10.9	2.4	38.5	17.7	2.4	57.5	17.9	0.2
Queue Delay	0.0	0.0	0.0	0.0	0.0	0.0	0.0	0.0	0.0	0.0	0.0	0.0
Total Delay	45.9	33.4	0.4	21.3	10.9	2.4	38.5	17.7	2.4	57.5	17.9	0.2
Queue Length 50th (ft)	44	98	0	48	56	3	26	42	0	45	31	0
Queue Length 95th (ft)	90	131	0	82	76	m9	59	80	29	#110	63	0
Internal Link Dist (ft)		2178			574			393			326	
Turn Bay Length (ft)	120		60	220		95	75		75	105		65
Base Capacity (vph)	186	1292	694	401	1181	655	169	1474	924	144	1491	769
Starvation Cap Reductn	0	0	0	0	0	0	0	0	0	0	0	0
Spillback Cap Reductn	0	0	0	0	0	0	0	0	0	0	0	0
Storage Cap Reductn	0	0	0	0	0	0	0	0	0	0	0	0
Reduced v/c Ratio	0.49	0.31	0.06	0.44	0.20	0.07	0.32	0.17	0.19	0.63	0.12	0.08

Intersection Summary

95th percentile volume exceeds capacity, queue may be longer.

Queue shown is maximum after two cycles.

m Volume for 95th percentile queue is metered by upstream signal.

Queues
30: Fairgrounds & Cleveland Avenue

Village D Specific Plan
Phase I NP - AM Peak Hour



Lane Group	EBL	EBT	WBL	WBT	WBR	NBL	NBT	NBR	SBL	SBT
Lane Group Flow (vph)	96	626	36	391	91	14	18	16	123	46
v/c Ratio	0.46	0.48	0.30	0.60	0.20	0.05	0.03	0.02	0.56	0.05
Control Delay	34.9	27.1	42.4	33.6	1.0	34.7	14.6	0.1	43.3	7.0
Queue Delay	0.0	0.0	0.0	0.0	0.0	0.0	0.0	0.0	0.0	0.0
Total Delay	34.9	27.1	42.4	33.6	1.0	34.7	14.6	0.1	43.3	7.0
Queue Length 50th (ft)	36	71	18	94	0	3	2	0	58	1
Queue Length 95th (ft)	m50	54	46	132	0	12	20	0	111	25
Internal Link Dist (ft)		574		1412			192			168
Turn Bay Length (ft)	120		205					100		
Base Capacity (vph)	292	1648	119	802	516	459	661	736	236	866
Starvation Cap Reductn	0	0	0	0	0	0	0	0	0	0
Spillback Cap Reductn	0	0	0	0	0	0	0	0	0	0
Storage Cap Reductn	0	0	0	0	0	0	0	0	0	0
Reduced v/c Ratio	0.33	0.38	0.30	0.49	0.18	0.03	0.03	0.02	0.52	0.05

Intersection Summary

m Volume for 95th percentile queue is metered by upstream signal.

Queues
33: Gateway Drive & Cleveland Avenue

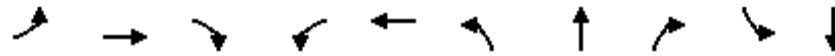

Lane Group	EBL	EBT	EBR	WBL	WBT	NBL	NBT	NBR	SBL	SBT
Lane Group Flow (vph)	4	648	154	198	832	143	52	153	61	97
v/c Ratio	0.03	0.64	0.25	0.46	0.66	0.34	0.07	0.22	0.39	0.08
Control Delay	26.0	38.2	8.7	44.3	32.3	38.1	22.5	3.5	45.4	22.4
Queue Delay	0.0	0.0	0.0	1.9	19.7	0.0	0.0	0.0	0.0	0.0
Total Delay	26.0	38.2	8.7	46.2	52.0	38.1	22.5	3.5	45.4	22.4
Queue Length 50th (ft)	2	119	26	55	212	38	19	0	33	18
Queue Length 95th (ft)	m6	144	58	68	210	67	53	33	71	43
Internal Link Dist (ft)		207			111		765			296
Turn Bay Length (ft)	110					245			45	
Base Capacity (vph)	158	1723	616	450	1402	425	714	706	181	1176
Starvation Cap Reductn	0	110	0	133	580	0	0	0	0	0
Spillback Cap Reductn	0	0	0	0	462	0	0	0	0	0
Storage Cap Reductn	0	0	0	0	0	0	0	0	0	0
Reduced v/c Ratio	0.03	0.40	0.25	0.62	1.01	0.34	0.07	0.22	0.34	0.08

Intersection Summary

m Volume for 95th percentile queue is metered by upstream signal.

Queues
 34: Cleveland Avenue & County Club Drive

Village D Specific Plan
 Phase I NP - AM Peak Hour



Lane Group	WBL	NBT	NBR	SBL	SBT
Lane Group Flow (vph)	387	637	225	92	674
v/c Ratio	0.65	0.25	0.14	0.17	0.18
Control Delay	38.9	1.5	0.2	5.2	4.2
Queue Delay	0.0	0.4	0.0	0.0	0.0
Total Delay	38.9	1.8	0.2	5.2	4.2
Queue Length 50th (ft)	104	8	0	13	35
Queue Length 95th (ft)	142	15	0	35	58
Internal Link Dist (ft)	239	111			159
Turn Bay Length (ft)					
Base Capacity (vph)	1261	2564	1568	544	3683
Starvation Cap Reductn	0	1313	0	0	0
Spillback Cap Reductn	14	0	0	0	852
Storage Cap Reductn	0	0	0	0	0
Reduced v/c Ratio	0.31	0.51	0.14	0.17	0.24
Intersection Summary					

Queues
36: Pine Street & Howard Road



Lane Group	EBL	EBT	WBL	WBT	NBL	NBT	NBR	SBT	SBR
Lane Group Flow (vph)	37	820	150	480	127	172	252	292	108
v/c Ratio	0.38	0.78	0.63	0.33	0.32	0.42	0.47	0.89	0.28
Control Delay	66.2	42.8	59.6	23.0	44.3	45.8	8.5	76.0	5.3
Queue Delay	0.0	0.0	0.0	0.0	0.0	0.0	0.0	0.0	0.0
Total Delay	66.2	42.8	59.6	23.0	44.3	45.8	8.5	76.0	5.3
Queue Length 50th (ft)	28	300	117	102	85	118	0	221	0
Queue Length 95th (ft)	65	339	#198	137	153	200	76	#369	30
Internal Link Dist (ft)		265		561		224		259	
Turn Bay Length (ft)	95		140		90				
Base Capacity (vph)	101	1406	237	1536	394	414	540	344	398
Starvation Cap Reductn	0	0	0	0	0	0	0	0	0
Spillback Cap Reductn	0	0	0	0	0	0	0	0	0
Storage Cap Reductn	0	0	0	0	0	0	0	0	0
Reduced v/c Ratio	0.37	0.58	0.63	0.31	0.32	0.42	0.47	0.85	0.27

Intersection Summary

95th percentile volume exceeds capacity, queue may be longer.
Queue shown is maximum after two cycles.

Queues

37: Olive Avenue/Q Street & Howard Road/Yosemite Avenue

Village D Specific Plan

Phase I NP - AM Peak Hour



Lane Group	EBL	EBT	EBR	WBL	WBT	NBL	NBT	NBR	SBL	SBT	SBR
Lane Group Flow (vph)	7	598	345	29	387	209	214	22	110	162	13
v/c Ratio	0.09	0.71	0.55	0.26	0.38	0.28	0.28	0.03	0.50	0.70	0.04
Control Delay	87.2	28.2	5.0	58.7	33.3	25.9	25.8	0.1	56.2	65.8	0.2
Queue Delay	0.0	0.0	0.0	0.0	0.0	0.0	0.0	0.0	0.0	0.0	0.0
Total Delay	87.2	28.2	5.0	58.7	33.3	25.9	25.8	0.1	56.2	65.8	0.2
Queue Length 50th (ft)	6	81	0	22	114	111	114	0	80	121	0
Queue Length 95th (ft)	m10	m167	m11	53	154	210	214	0	137	192	0
Internal Link Dist (ft)		561			230		220			195	
Turn Bay Length (ft)	40			80		130			50		50
Base Capacity (vph)	78	925	653	331	1393	744	762	745	265	279	353
Starvation Cap Reductn	0	0	0	0	0	0	0	0	0	0	0
Spillback Cap Reductn	0	0	0	0	0	0	0	0	0	0	0
Storage Cap Reductn	0	0	0	0	0	0	0	0	0	0	0
Reduced v/c Ratio	0.09	0.65	0.53	0.09	0.28	0.28	0.28	0.03	0.42	0.58	0.04

Intersection Summary

m Volume for 95th percentile queue is metered by upstream signal.

Queues
39: 4th Street & Sunset Avenue



Lane Group	EBL	NBL	NBT	SBT	SBR
Lane Group Flow (vph)	445	35	338	458	298
v/c Ratio	0.69	0.26	0.13	0.39	0.22
Control Delay	39.5	43.8	4.5	3.5	0.4
Queue Delay	0.0	0.0	0.0	0.0	0.0
Total Delay	39.5	43.8	4.5	3.5	0.4
Queue Length 50th (ft)	120	19	27	28	0
Queue Length 95th (ft)	164	49	45	51	0
Internal Link Dist (ft)	7441		193	501	
Turn Bay Length (ft)	135				
Base Capacity (vph)	760	149	2534	1184	1360
Starvation Cap Reductn	0	0	0	0	0
Spillback Cap Reductn	0	0	0	0	0
Storage Cap Reductn	0	0	0	0	0
Reduced v/c Ratio	0.59	0.23	0.13	0.39	0.22
Intersection Summary					

Queues
41: I Street & 4th Street



Lane Group	EBL	EBT	WBL	WBT	NBL	NBT	NBR	SBL	SBT	SBR
Lane Group Flow (vph)	28	765	93	591	57	61	177	242	304	141
v/c Ratio	0.25	0.86	0.56	0.52	0.43	0.12	0.30	0.66	0.39	0.19
Control Delay	34.1	35.5	48.9	24.3	49.6	30.4	3.0	41.5	22.7	2.1
Queue Delay	0.0	0.0	0.0	0.0	0.0	0.0	0.0	0.0	0.0	0.0
Total Delay	34.1	35.5	48.9	24.3	49.6	30.4	3.0	41.5	22.7	2.1
Queue Length 50th (ft)	15	234	57	123	31	29	0	123	132	0
Queue Length 95th (ft)	m34	#313	m72	m183	70	63	23	202	207	21
Internal Link Dist (ft)		501		26		314			779	
Turn Bay Length (ft)	130				45		25	80		80
Base Capacity (vph)	113	918	181	1189	142	489	583	404	775	742
Starvation Cap Reductn	0	0	0	0	0	0	0	0	0	0
Spillback Cap Reductn	0	0	0	0	0	0	0	0	0	0
Storage Cap Reductn	0	0	0	0	0	0	0	0	0	0
Reduced v/c Ratio	0.25	0.83	0.51	0.50	0.40	0.12	0.30	0.60	0.39	0.19

Intersection Summary

95th percentile volume exceeds capacity, queue may be longer.

Queue shown is maximum after two cycles.

m Volume for 95th percentile queue is metered by upstream signal.

Queues
 16: Love's Truck Stop Driveway/Driveway & Avenue 17

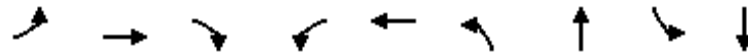

Lane Group	EBL	EBT	EBR	WBL	WBT	NBL	NBT	SBL	SBT
Lane Group Flow (vph)	604	678	153	35	802	174	34	303	564
v/c Ratio	1.44	0.35	0.17	0.38	1.36	1.01	0.07	1.39	0.88
Control Delay	245.1	16.5	4.1	66.6	207.3	125.7	0.3	240.6	29.1
Queue Delay	0.0	0.0	0.0	0.0	0.0	0.0	0.0	0.0	0.0
Total Delay	245.1	16.5	4.1	66.6	207.3	125.7	0.3	240.6	29.1
Queue Length 50th (ft)	~635	161	8	27	-816	~138	0	~313	118
Queue Length 95th (ft)	#859	206	42	62	#1060	#286	0	#492	#332
Internal Link Dist (ft)		423			402		160		227
Turn Bay Length (ft)	100		100	100					
Base Capacity (vph)	420	1939	926	96	588	172	470	218	640
Starvation Cap Reductn	0	0	0	0	0	0	0	0	0
Spillback Cap Reductn	0	0	0	0	0	0	0	0	0
Storage Cap Reductn	0	0	0	0	0	0	0	0	0
Reduced v/c Ratio	1.44	0.35	0.17	0.36	1.36	1.01	0.07	1.39	0.88

Intersection Summary

~ Volume exceeds capacity, queue is theoretically infinite.
 Queue shown is maximum after two cycles.

95th percentile volume exceeds capacity, queue may be longer.
 Queue shown is maximum after two cycles.

Queues
 23: Avenue 16/Ellis Street & Kennedy Street

Village D Specific Plan
 Phase I NP - PM Peak Hour



Lane Group	WBL	WBR	NBT	SBL	SBT
Lane Group Flow (vph)	134	237	495	229	274
v/c Ratio	0.53	0.40	0.28	0.65	0.10
Control Delay	21.7	9.4	7.7	38.3	3.3
Queue Delay	0.0	0.0	0.0	0.0	0.0
Total Delay	21.7	9.4	7.7	38.3	3.3
Queue Length 50th (ft)	54	0	36	106	15
Queue Length 95th (ft)	101	31	80	166	32
Internal Link Dist (ft)	782		506		440
Turn Bay Length (ft)	175			280	
Base Capacity (vph)	497	954	1757	363	2664
Starvation Cap Reductn	0	0	0	0	0
Spillback Cap Reductn	0	0	0	0	0
Storage Cap Reductn	0	0	0	0	0
Reduced v/c Ratio	0.27	0.25	0.28	0.63	0.10

Intersection Summary

Queues
24: Schnoor Avenue & Kennedy Street



Lane Group	EBL	EBT	WBL	WBT	NBL	NBT	SBL	SBT	SBR
Lane Group Flow (vph)	43	385	215	243	207	303	88	34	21
v/c Ratio	0.21	0.65	0.67	0.53	0.58	0.37	0.76	0.06	0.03
Control Delay	30.9	13.3	40.5	27.3	41.1	6.1	76.1	21.3	0.1
Queue Delay	0.0	0.0	0.0	0.0	0.0	0.0	0.0	0.0	0.0
Total Delay	30.9	13.3	40.5	27.3	41.1	6.1	76.1	21.3	0.1
Queue Length 50th (ft)	22	49	101	98	51	12	44	11	0
Queue Length 95th (ft)	m43	71	160	157	85	77	#121	36	0
Internal Link Dist (ft)		782		187		321		193	
Turn Bay Length (ft)	95		40		75		60		
Base Capacity (vph)	205	882	375	668	368	821	116	577	622
Starvation Cap Reductn	0	0	0	0	0	0	0	0	0
Spillback Cap Reductn	0	0	0	0	0	0	0	0	0
Storage Cap Reductn	0	0	0	0	0	0	0	0	0
Reduced v/c Ratio	0.21	0.44	0.57	0.36	0.56	0.37	0.76	0.06	0.03

Intersection Summary

95th percentile volume exceeds capacity, queue may be longer.

Queue shown is maximum after two cycles.

m Volume for 95th percentile queue is metered by upstream signal.

Queues
29: Schnoor Avenue & Cleveland Avenue

Village D Specific Plan
Phase I NP - PM Peak Hour



Lane Group	EBL	EBT	EBR	WBL	WBT	WBR	NBL	NBT	NBR	SBL	SBT	SBR
Lane Group Flow (vph)	124	416	45	284	494	114	61	222	157	122	220	92
v/c Ratio	0.61	0.64	0.10	0.56	0.64	0.24	0.37	0.16	0.17	0.82	0.15	0.13
Control Delay	50.9	38.3	0.5	26.5	24.1	1.3	43.6	20.1	2.3	81.4	21.0	0.3
Queue Delay	0.0	0.0	0.0	0.0	0.0	0.0	0.0	0.0	0.0	0.0	0.0	0.0
Total Delay	50.9	38.3	0.5	26.5	24.1	1.3	43.6	20.1	2.3	81.4	21.0	0.3
Queue Length 50th (ft)	67	117	0	39	68	0	33	43	0	70	43	0
Queue Length 95th (ft)	124	153	0	65	82	1	69	78	28	#166	83	0
Internal Link Dist (ft)		2178			574			393			326	
Turn Bay Length (ft)	120		60	220		95	75		75	105		65
Base Capacity (vph)	228	1294	680	536	1330	701	173	1384	928	148	1425	732
Starvation Cap Reductn	0	0	0	0	0	0	0	0	0	0	0	0
Spillback Cap Reductn	0	0	0	0	0	0	0	0	0	0	0	0
Storage Cap Reductn	0	0	0	0	0	0	0	0	0	0	0	0
Reduced v/c Ratio	0.54	0.32	0.07	0.53	0.37	0.16	0.35	0.16	0.17	0.82	0.15	0.13

Intersection Summary

95th percentile volume exceeds capacity, queue may be longer.
Queue shown is maximum after two cycles.

Queues
30: Fairgrounds & Cleveland Avenue



Lane Group	EBL	EBT	WBL	WBT	WBR	NBL	NBT	NBR	SBL	SBT
Lane Group Flow (vph)	99	635	172	602	154	102	83	76	279	150
v/c Ratio	0.47	0.51	0.76	0.68	0.29	0.42	0.17	0.13	0.96	0.21
Control Delay	33.3	15.8	48.4	18.6	4.8	45.5	18.0	0.5	83.7	8.4
Queue Delay	0.0	0.0	0.0	0.0	0.0	0.0	0.0	0.0	0.0	0.0
Total Delay	33.3	15.8	48.4	18.6	4.8	45.5	18.0	0.5	83.7	8.4
Queue Length 50th (ft)	59	128	81	142	9	29	20	0	159	14
Queue Length 95th (ft)	m105	m152	#188	162	27	54	62	0	#314	59
Internal Link Dist (ft)		574		1412			192			168
Turn Bay Length (ft)	120		205					100		
Base Capacity (vph)	212	1536	236	1330	696	249	479	581	290	709
Starvation Cap Reductn	0	0	0	0	0	0	0	0	0	0
Spillback Cap Reductn	0	0	0	0	0	0	0	0	0	0
Storage Cap Reductn	0	0	0	0	0	0	0	0	0	0
Reduced v/c Ratio	0.47	0.41	0.73	0.45	0.22	0.41	0.17	0.13	0.96	0.21

Intersection Summary

95th percentile volume exceeds capacity, queue may be longer.

Queue shown is maximum after two cycles.

m Volume for 95th percentile queue is metered by upstream signal.

Queues
33: Gateway Drive & Cleveland Avenue

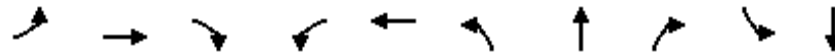

Lane Group	EBL	EBT	EBR	WBL	WBT	NBL	NBT	NBR	SBL	SBT
Lane Group Flow (vph)	16	867	268	190	909	238	134	259	193	175
v/c Ratio	0.08	0.66	0.34	0.51	0.66	0.50	0.24	0.43	0.84	0.17
Control Delay	8.0	25.4	3.0	33.4	20.8	40.0	27.3	12.2	69.2	23.4
Queue Delay	0.0	6.4	0.1	1.2	25.2	0.0	0.0	0.1	0.0	0.0
Total Delay	8.0	31.8	3.1	34.6	45.9	40.0	27.3	12.3	69.2	23.4
Queue Length 50th (ft)	2	102	16	47	124	65	58	34	108	34
Queue Length 95th (ft)	m5	99	8	72	233	102	116	110	#223	67
Internal Link Dist (ft)		207			111		765			296
Turn Bay Length (ft)	110					245			45	
Base Capacity (vph)	189	1762	783	379	1419	485	569	601	235	1029
Starvation Cap Reductn	0	234	64	66	539	0	0	0	0	0
Spillback Cap Reductn	0	834	0	0	0	0	0	33	0	0
Storage Cap Reductn	0	0	0	0	0	0	0	0	0	0
Reduced v/c Ratio	0.08	0.93	0.37	0.61	1.03	0.49	0.24	0.46	0.82	0.17

Intersection Summary

95th percentile volume exceeds capacity, queue may be longer.

Queue shown is maximum after two cycles.

m Volume for 95th percentile queue is metered by upstream signal.

Queues

34: Cleveland Avenue & County Club Drive



Lane Group	WBL	NBT	NBR	SBL	SBT
Lane Group Flow (vph)	411	832	473	104	709
v/c Ratio	0.66	0.32	0.30	0.24	0.19
Control Delay	38.6	16.9	1.4	6.5	4.4
Queue Delay	0.0	37.0	0.0	0.0	0.0
Total Delay	38.6	53.9	1.4	6.5	4.4
Queue Length 50th (ft)	110	193	23	16	39
Queue Length 95th (ft)	148	234	m29	45	63
Internal Link Dist (ft)	239	111			159
Turn Bay Length (ft)					
Base Capacity (vph)	1376	2562	1563	430	3682
Starvation Cap Reductn	0	1779	0	0	0
Spillback Cap Reductn	7	0	0	0	705
Storage Cap Reductn	0	0	0	0	0
Reduced v/c Ratio	0.30	1.06	0.30	0.24	0.24

Intersection Summary

m Volume for 95th percentile queue is metered by upstream signal.

Queues
36: Pine Street & Howard Road



Lane Group	EBL	EBT	WBL	WBT	NBL	NBT	NBR	SBT	SBR
Lane Group Flow (vph)	92	683	101	536	154	176	160	169	128
v/c Ratio	0.39	0.75	0.58	0.60	0.30	0.32	0.27	0.62	0.33
Control Delay	41.0	34.9	66.2	28.7	29.1	29.3	4.7	45.2	4.0
Queue Delay	0.0	0.0	0.0	0.0	0.0	0.0	0.0	0.0	0.0
Total Delay	41.0	34.9	66.2	28.7	29.1	29.3	4.7	45.2	4.0
Queue Length 50th (ft)	46	179	51	88	71	82	0	91	0
Queue Length 95th (ft)	100	230	#153	163	132	148	38	147	18
Internal Link Dist (ft)		265		561		224		259	
Turn Bay Length (ft)	95		140		90				
Base Capacity (vph)	234	1058	173	1110	520	547	587	370	462
Starvation Cap Reductn	0	0	0	0	0	0	0	0	0
Spillback Cap Reductn	0	0	0	0	0	0	0	0	0
Storage Cap Reductn	0	0	0	0	0	0	0	0	0
Reduced v/c Ratio	0.39	0.65	0.58	0.48	0.30	0.32	0.27	0.46	0.28

Intersection Summary

95th percentile volume exceeds capacity, queue may be longer.
Queue shown is maximum after two cycles.

Queues

37: Olive Avenue/Q Street & Howard Road/Yosemite Avenue

Village D Specific Plan

Phase I NP - PM Peak Hour



Lane Group	EBL	EBT	EBR	WBL	WBT	NBL	NBT	NBR	SBL	SBT	SBR
Lane Group Flow (vph)	8	484	250	14	404	199	204	13	17	61	2
v/c Ratio	0.07	0.65	0.48	0.11	0.53	0.22	0.22	0.01	0.10	0.35	0.01
Control Delay	44.6	48.9	25.0	40.8	33.1	15.5	15.4	0.0	37.5	43.2	0.0
Queue Delay	0.0	0.0	0.0	0.0	0.0	0.0	0.0	0.0	0.0	0.0	0.0
Total Delay	44.6	48.9	25.0	40.8	33.1	15.5	15.4	0.0	37.5	43.2	0.0
Queue Length 50th (ft)	5	151	87	8	106	57	58	0	9	33	0
Queue Length 95th (ft)	m9	203	151	26	138	154	158	0	28	69	0
Internal Link Dist (ft)		561			230		220			195	
Turn Bay Length (ft)	40			80		130			50		50
Base Capacity (vph)	118	796	544	357	1226	920	940	936	357	376	465
Starvation Cap Reductn	0	0	0	0	0	0	0	0	0	0	0
Spillback Cap Reductn	0	0	0	0	0	0	0	0	0	0	0
Storage Cap Reductn	0	0	0	0	0	0	0	0	0	0	0
Reduced v/c Ratio	0.07	0.61	0.46	0.04	0.33	0.22	0.22	0.01	0.05	0.16	0.00

Intersection Summary

m Volume for 95th percentile queue is metered by upstream signal.

Queues
39: 4th Street & Sunset Avenue



Lane Group	EBL	NBL	NBT	SBT	SBR
Lane Group Flow (vph)	263	14	328	379	398
v/c Ratio	0.57	0.12	0.12	0.27	0.28
Control Delay	44.4	45.7	3.1	2.2	0.7
Queue Delay	0.0	0.0	0.0	0.0	0.0
Total Delay	44.4	45.7	3.1	2.2	0.7
Queue Length 50th (ft)	80	9	21	32	0
Queue Length 95th (ft)	115	28	38	70	3
Internal Link Dist (ft)	7441		193	501	
Turn Bay Length (ft)	135				
Base Capacity (vph)	962	148	2730	1389	1461
Starvation Cap Reductn	0	0	0	0	0
Spillback Cap Reductn	0	0	0	0	0
Storage Cap Reductn	0	0	0	0	0
Reduced v/c Ratio	0.27	0.09	0.12	0.27	0.27
Intersection Summary					

Queues
41: I Street & 4th Street

Village D Specific Plan
 Phase I NP - PM Peak Hour



Lane Group	EBL	EBT	WBL	WBT	NBL	NBT	NBR	SBL	SBT	SBR
Lane Group Flow (vph)	38	605	65	669	108	76	270	185	180	115
v/c Ratio	0.31	0.74	0.42	0.70	0.57	0.12	0.38	0.54	0.23	0.16
Control Delay	44.0	28.4	42.0	19.9	54.1	28.9	5.8	42.1	23.1	5.3
Queue Delay	0.0	0.0	0.0	0.2	0.0	0.0	0.0	0.0	0.0	0.0
Total Delay	44.0	28.4	42.0	20.0	54.1	28.9	5.8	42.1	23.1	5.3
Queue Length 50th (ft)	25	180	43	93	66	36	0	106	78	0
Queue Length 95th (ft)	59	218	m64	m112	120	78	63	172	142	38
Internal Link Dist (ft)		501		26		314			779	
Turn Bay Length (ft)	130				45		25	80		80
Base Capacity (vph)	125	955	173	1092	226	613	703	380	771	714
Starvation Cap Reductn	0	0	0	52	0	0	0	0	0	0
Spillback Cap Reductn	0	0	0	0	0	0	0	0	0	0
Storage Cap Reductn	0	0	0	0	0	0	0	0	0	0
Reduced v/c Ratio	0.30	0.63	0.38	0.64	0.48	0.12	0.38	0.49	0.23	0.16

Intersection Summary

m Volume for 95th percentile queue is metered by upstream signal.

Queues

16: Love's Truck Stop Driveway/Driveway & Avenue 17

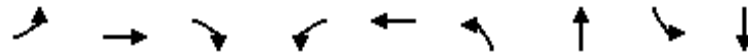

Lane Group	EBL	EBT	EBR	WBL	WBT	NBL	NBT	SBL	SBT
Lane Group Flow (vph)	176	404	143	49	994	148	24	52	98
v/c Ratio	2.00	0.21	0.15	0.56	1.01	1.64	0.03	0.58	0.22
Control Delay	514.7	12.0	2.4	71.6	56.8	366.4	0.1	72.0	1.1
Queue Delay	0.0	0.0	0.0	0.0	0.0	0.0	0.0	0.0	0.0
Total Delay	514.7	12.0	2.4	71.6	56.8	366.4	0.1	72.0	1.1
Queue Length 50th (ft)	~176	67	0	31	-631	~137	0	33	0
Queue Length 95th (ft)	#309	94	27	#83	#917	#261	0	#88	0
Internal Link Dist (ft)		311			402		160		226
Turn Bay Length (ft)	100		100	100					
Base Capacity (vph)	88	1960	940	87	980	90	691	90	444
Starvation Cap Reductn	0	0	0	0	0	0	0	0	0
Spillback Cap Reductn	0	0	0	0	0	0	0	0	0
Storage Cap Reductn	0	0	0	0	0	0	0	0	0
Reduced v/c Ratio	2.00	0.21	0.15	0.56	1.01	1.64	0.03	0.58	0.22

Intersection Summary

~ Volume exceeds capacity, queue is theoretically infinite.

Queue shown is maximum after two cycles.

95th percentile volume exceeds capacity, queue may be longer.

Queue shown is maximum after two cycles.

Queues
 23: Avenue 16/Ellis Street & Kennedy Street

Village D Specific Plan
 Phase I WP - AM Peak Hour



Lane Group	WBL	WBR	NBT	SBL	SBT
Lane Group Flow (vph)	161	138	570	275	321
v/c Ratio	0.59	0.25	0.43	0.53	0.12
Control Delay	23.8	6.0	18.0	28.1	3.8
Queue Delay	0.0	0.0	0.0	0.0	0.0
Total Delay	23.8	6.0	18.0	28.1	3.8
Queue Length 50th (ft)	47	0	94	114	20
Queue Length 95th (ft)	81	1	153	188	40
Internal Link Dist (ft)	782		506		440
Turn Bay Length (ft)	175			280	
Base Capacity (vph)	423	770	1313	519	2580
Starvation Cap Reductn	0	0	0	0	0
Spillback Cap Reductn	0	0	0	0	0
Storage Cap Reductn	0	0	0	0	0
Reduced v/c Ratio	0.38	0.18	0.43	0.53	0.12
Intersection Summary					

Queues
24: Schnoor Avenue & Kennedy Street



Lane Group	EBL	EBT	WBL	WBT	NBL	NBT	SBL	SBT	SBR
Lane Group Flow (vph)	53	381	153	271	115	275	61	20	15
v/c Ratio	0.45	0.65	0.58	0.56	0.45	0.32	0.67	0.03	0.02
Control Delay	52.2	14.2	40.0	26.3	41.3	4.8	72.5	17.9	0.1
Queue Delay	0.0	0.0	0.0	0.0	0.0	0.0	0.0	0.0	0.0
Total Delay	52.2	14.2	40.0	26.3	41.3	4.8	72.5	17.9	0.1
Queue Length 50th (ft)	28	10	72	109	28	6	30	6	0
Queue Length 95th (ft)	m53	36	122	159	54	61	#91	23	0
Internal Link Dist (ft)		782		187		321		193	
Turn Bay Length (ft)	95		40		75		60		
Base Capacity (vph)	119	879	354	656	258	855	91	613	637
Starvation Cap Reductn	0	0	0	0	0	0	0	0	0
Spillback Cap Reductn	0	0	0	0	0	0	0	0	0
Storage Cap Reductn	0	0	0	0	0	0	0	0	0
Reduced v/c Ratio	0.45	0.43	0.43	0.41	0.45	0.32	0.67	0.03	0.02

Intersection Summary

95th percentile volume exceeds capacity, queue may be longer.

Queue shown is maximum after two cycles.

m Volume for 95th percentile queue is metered by upstream signal.

Queues
29: Schnoor Avenue & Cleveland Avenue

Village D Specific Plan
Phase I WP - AM Peak Hour



Lane Group	EBL	EBT	EBR	WBL	WBT	WBR	NBL	NBT	NBR	SBL	SBT	SBR
Lane Group Flow (vph)	129	1089	77	177	452	49	66	251	177	91	183	80
v/c Ratio	0.54	0.85	0.11	0.63	0.38	0.07	0.56	0.25	0.27	0.64	0.18	0.14
Control Delay	40.6	31.1	0.3	22.2	3.5	0.2	55.9	24.6	6.0	57.5	23.1	0.5
Queue Delay	0.0	0.0	0.0	0.0	0.0	0.0	0.0	0.0	0.0	0.0	0.0	0.0
Total Delay	40.6	31.1	0.3	22.2	3.5	0.2	55.9	24.6	6.0	57.5	23.1	0.5
Queue Length 50th (ft)	61	254	0	40	7	0	33	53	11	45	37	0
Queue Length 95th (ft)	110	335	0	#66	19	m0	#87	85	50	#110	63	0
Internal Link Dist (ft)		2178			574			393			326	
Turn Bay Length (ft)	120		60	220		95	75		75	105		65
Base Capacity (vph)	299	1317	705	280	1182	656	118	994	661	144	1024	592
Starvation Cap Reductn	0	0	0	0	0	0	0	0	0	0	0	0
Spillback Cap Reductn	0	0	0	0	0	0	0	0	0	0	0	0
Storage Cap Reductn	0	0	0	0	0	0	0	0	0	0	0	0
Reduced v/c Ratio	0.43	0.83	0.11	0.63	0.38	0.07	0.56	0.25	0.27	0.63	0.18	0.14

Intersection Summary

- # 95th percentile volume exceeds capacity, queue may be longer.
Queue shown is maximum after two cycles.
- m Volume for 95th percentile queue is metered by upstream signal.

Queues
30: Fairgrounds & Cleveland Avenue



Lane Group	EBL	EBT	WBL	WBT	WBR	NBL	NBT	NBR	SBL	SBT
Lane Group Flow (vph)	96	1300	36	606	91	14	18	16	123	46
v/c Ratio	0.46	0.78	0.23	0.63	0.16	0.06	0.03	0.02	0.58	0.06
Control Delay	21.8	15.2	36.8	29.5	0.6	36.1	15.7	0.1	44.6	7.1
Queue Delay	0.0	0.0	0.0	0.0	0.0	0.0	0.0	0.0	0.0	0.0
Total Delay	21.8	15.2	36.8	29.5	0.6	36.1	15.7	0.1	44.6	7.1
Queue Length 50th (ft)	33	61	17	143	0	3	3	0	58	1
Queue Length 95th (ft)	m47	#295	44	195	0	12	20	0	111	24
Internal Link Dist (ft)		574		1412			192			168
Turn Bay Length (ft)	120		205					100		
Base Capacity (vph)	236	1659	251	999	593	218	531	671	236	740
Starvation Cap Reductn	0	0	0	0	0	0	0	0	0	0
Spillback Cap Reductn	0	0	0	0	0	0	0	0	0	0
Storage Cap Reductn	0	0	0	0	0	0	0	0	0	0
Reduced v/c Ratio	0.41	0.78	0.14	0.61	0.15	0.06	0.03	0.02	0.52	0.06

Intersection Summary

95th percentile volume exceeds capacity, queue may be longer.

Queue shown is maximum after two cycles.

m Volume for 95th percentile queue is metered by upstream signal.

Queues
33: Gateway Drive & Cleveland Avenue

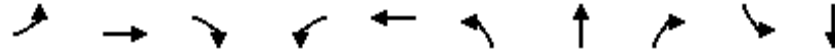

Lane Group	EBL	EBT	EBR	WBL	WBT	NBL	NBT	NBR	SBL	SBT
Lane Group Flow (vph)	4	779	261	198	885	177	52	153	61	97
v/c Ratio	0.02	0.66	0.36	0.48	0.66	0.42	0.08	0.23	0.39	0.09
Control Delay	18.8	23.4	2.0	38.3	24.6	39.3	23.6	3.7	45.8	23.8
Queue Delay	0.0	0.3	0.1	0.4	23.7	0.0	0.0	0.0	0.0	0.0
Total Delay	18.8	23.7	2.1	38.7	48.3	39.3	23.6	3.7	45.8	23.8
Queue Length 50th (ft)	1	84	0	42	162	48	20	0	33	19
Queue Length 95th (ft)	m3	141	11	79	224	80	53	33	72	43
Internal Link Dist (ft)		207			111		765			296
Turn Bay Length (ft)	110					245			45	
Base Capacity (vph)	217	1426	730	587	1371	425	670	674	179	1087
Starvation Cap Reductn	0	181	46	118	510	0	0	0	0	0
Spillback Cap Reductn	0	0	0	0	110	0	0	2	0	0
Storage Cap Reductn	0	0	0	0	0	0	0	0	0	0
Reduced v/c Ratio	0.02	0.63	0.38	0.42	1.03	0.42	0.08	0.23	0.34	0.09

Intersection Summary

m Volume for 95th percentile queue is metered by upstream signal.

Queues

34: Cleveland Avenue & County Club Drive



Lane Group	WBL	NBT	NBR	SBL	SBT
Lane Group Flow (vph)	427	674	318	92	689
v/c Ratio	0.67	0.27	0.20	0.18	0.19
Control Delay	38.7	6.2	0.8	5.8	4.5
Queue Delay	0.0	1.0	0.0	0.0	0.0
Total Delay	38.7	7.2	0.8	5.8	4.6
Queue Length 50th (ft)	114	48	5	14	39
Queue Length 95th (ft)	154	97	24	38	63
Internal Link Dist (ft)	239	111			159
Turn Bay Length (ft)					
Base Capacity (vph)	1262	2523	1568	511	3625
Starvation Cap Reductn	0	1512	0	0	0
Spillback Cap Reductn	1	0	0	0	985
Storage Cap Reductn	0	0	0	0	0
Reduced v/c Ratio	0.34	0.67	0.20	0.18	0.26
Intersection Summary					

Queues
36: Pine Street & Howard Road



Lane Group	EBL	EBT	WBL	WBT	NBL	NBT	NBR	SBT	SBR
Lane Group Flow (vph)	37	879	150	509	150	172	252	292	108
v/c Ratio	0.37	0.79	0.66	0.34	0.40	0.44	0.48	0.89	0.28
Control Delay	65.5	41.3	63.7	25.0	46.8	47.3	8.8	76.8	5.4
Queue Delay	0.0	0.0	0.0	0.0	0.0	0.0	0.0	0.0	0.0
Total Delay	65.5	41.3	63.7	25.0	46.8	47.3	8.8	76.8	5.4
Queue Length 50th (ft)	28	317	118	118	104	120	0	221	0
Queue Length 95th (ft)	65	356	#227	160	177	200	76	#371	30
Internal Link Dist (ft)		265		565		224		259	
Turn Bay Length (ft)	95		140		90				
Base Capacity (vph)	104	1399	227	1553	371	391	523	341	396
Starvation Cap Reductn	0	0	0	0	0	0	0	0	0
Spillback Cap Reductn	0	0	0	0	0	0	0	0	0
Storage Cap Reductn	0	0	0	0	0	0	0	0	0
Reduced v/c Ratio	0.36	0.63	0.66	0.33	0.40	0.44	0.48	0.86	0.27

Intersection Summary

95th percentile volume exceeds capacity, queue may be longer.
Queue shown is maximum after two cycles.

Queues

37: Olive Avenue/Q Street & Howard Road/Yosemite Avenue

Village D Specific Plan

Phase I WP - AM Peak Hour



Lane Group	EBL	EBT	EBR	WBL	WBT	NBL	NBT	NBR	SBL	SBT	SBR
Lane Group Flow (vph)	7	598	346	29	391	222	227	22	110	162	13
v/c Ratio	0.09	0.70	0.55	0.26	0.38	0.30	0.30	0.03	0.50	0.70	0.04
Control Delay	77.7	23.8	6.0	58.7	33.2	26.3	26.2	0.1	56.2	65.8	0.2
Queue Delay	0.0	0.0	0.0	0.0	0.0	0.0	0.0	0.0	0.0	0.0	0.0
Total Delay	77.7	23.8	6.0	58.7	33.2	26.3	26.2	0.1	56.2	65.8	0.2
Queue Length 50th (ft)	5	181	49	22	115	120	123	0	80	121	0
Queue Length 95th (ft)	m9	m270	m165	53	155	224	228	0	137	192	0
Internal Link Dist (ft)		565			230		220			195	
Turn Bay Length (ft)	40			80		130			50		50
Base Capacity (vph)	78	1023	686	265	1393	748	766	750	265	279	353
Starvation Cap Reductn	0	0	0	0	0	0	0	0	0	0	0
Spillback Cap Reductn	0	0	0	0	0	0	0	0	0	0	0
Storage Cap Reductn	0	0	0	0	0	0	0	0	0	0	0
Reduced v/c Ratio	0.09	0.58	0.50	0.11	0.28	0.30	0.30	0.03	0.42	0.58	0.04

Intersection Summary

m Volume for 95th percentile queue is metered by upstream signal.

Queues
39: 4th Street & Sunset Avenue



Lane Group	EBL	NBL	NBT	SBT	SBR
Lane Group Flow (vph)	445	35	343	477	301
v/c Ratio	0.70	0.26	0.13	0.40	0.23
Control Delay	40.3	44.1	4.3	5.0	0.6
Queue Delay	0.0	0.0	0.0	0.0	0.0
Total Delay	40.3	44.1	4.3	5.0	0.6
Queue Length 50th (ft)	120	19	28	131	0
Queue Length 95th (ft)	167	49	44	69	0
Internal Link Dist (ft)	7441		193	501	
Turn Bay Length (ft)	135				
Base Capacity (vph)	721	147	2546	1192	1355
Starvation Cap Reductn	0	0	0	0	0
Spillback Cap Reductn	0	0	0	0	0
Storage Cap Reductn	0	0	0	0	0
Reduced v/c Ratio	0.62	0.24	0.13	0.40	0.22
Intersection Summary					

Queues
41: I Street & 4th Street



Lane Group	EBL	EBT	WBL	WBT	NBL	NBT	NBR	SBL	SBT	SBR
Lane Group Flow (vph)	28	771	93	594	57	61	177	242	304	161
v/c Ratio	0.25	0.86	0.57	0.52	0.42	0.12	0.30	0.66	0.39	0.22
Control Delay	44.5	28.7	36.5	19.0	49.0	30.4	3.0	41.1	22.8	3.2
Queue Delay	0.0	0.0	0.0	0.0	0.0	0.0	0.0	0.0	0.0	0.0
Total Delay	44.5	28.7	36.5	19.0	49.0	30.4	3.0	41.1	22.8	3.2
Queue Length 50th (ft)	10	205	54	67	31	29	0	123	132	0
Queue Length 95th (ft)	m26	#283	m67	m86	70	63	23	201	207	31
Internal Link Dist (ft)		501		26		314			779	
Turn Bay Length (ft)	130				45		25	80		80
Base Capacity (vph)	110	921	177	1189	146	488	582	408	774	741
Starvation Cap Reductn	0	0	0	0	0	0	0	0	0	0
Spillback Cap Reductn	0	0	0	0	0	0	0	0	0	0
Storage Cap Reductn	0	0	0	0	0	0	0	0	0	0
Reduced v/c Ratio	0.25	0.84	0.53	0.50	0.39	0.13	0.30	0.59	0.39	0.22

Intersection Summary

95th percentile volume exceeds capacity, queue may be longer.

Queue shown is maximum after two cycles.

m Volume for 95th percentile queue is metered by upstream signal.

Queues
 16: Love's Truck Stop Driveway/Driveway & Avenue 17

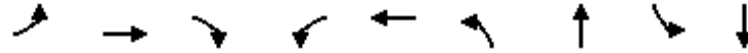

Lane Group	EBL	EBT	EBR	WBL	WBT	NBL	NBT	SBL	SBT
Lane Group Flow (vph)	604	747	153	35	889	174	34	303	564
v/c Ratio	4.35	0.56	0.22	0.25	1.70	1.23	0.06	2.15	0.91
Control Delay	1534.2	19.3	3.4	32.6	346.6	183.6	0.2	561.2	35.4
Queue Delay	0.0	0.0	0.0	0.0	0.0	0.0	0.0	0.0	0.0
Total Delay	1534.2	19.3	3.4	32.6	346.6	183.6	0.2	561.2	35.4
Queue Length 50th (ft)	~446	105	0	13	-526	~86	0	~194	127
Queue Length 95th (ft)	#622	196	28	38	#735	#194	0	#330	#315
Internal Link Dist (ft)		423			402		160		227
Turn Bay Length (ft)	100		100	100					
Base Capacity (vph)	139	1323	705	138	522	141	608	141	620
Starvation Cap Reductn	0	0	0	0	0	0	0	0	0
Spillback Cap Reductn	0	0	0	0	0	0	0	0	0
Storage Cap Reductn	0	0	0	0	0	0	0	0	0
Reduced v/c Ratio	4.35	0.56	0.22	0.25	1.70	1.23	0.06	2.15	0.91

Intersection Summary

- ~ Volume exceeds capacity, queue is theoretically infinite.
 Queue shown is maximum after two cycles.
- # 95th percentile volume exceeds capacity, queue may be longer.
 Queue shown is maximum after two cycles.

Queues
 23: Avenue 16/Ellis Street & Kennedy Street

Village D Specific Plan
 Phase I WP - PM Peak Hour



Lane Group	WBL	WBR	NBT	SBL	SBT
Lane Group Flow (vph)	134	237	548	229	384
v/c Ratio	0.54	0.40	0.31	0.66	0.14
Control Delay	27.0	13.2	7.6	40.9	3.4
Queue Delay	0.0	0.0	0.0	0.0	0.0
Total Delay	27.0	13.2	7.6	40.9	3.4
Queue Length 50th (ft)	72	28	46	103	22
Queue Length 95th (ft)	126	73	77	#219	43
Internal Link Dist (ft)	782		506		440
Turn Bay Length (ft)	175			280	
Base Capacity (vph)	409	826	1771	349	2667
Starvation Cap Reductn	0	0	0	0	0
Spillback Cap Reductn	0	0	0	0	0
Storage Cap Reductn	0	0	0	0	0
Reduced v/c Ratio	0.33	0.29	0.31	0.66	0.14

Intersection Summary

95th percentile volume exceeds capacity, queue may be longer.
 Queue shown is maximum after two cycles.

Queues
24: Schnoor Avenue & Kennedy Street



Lane Group	EBL	EBT	WBL	WBT	NBL	NBT	SBL	SBT	SBR
Lane Group Flow (vph)	43	385	215	243	207	303	88	34	21
v/c Ratio	0.21	0.65	0.67	0.53	0.58	0.37	0.76	0.06	0.03
Control Delay	28.5	11.8	40.5	27.3	41.1	6.1	76.1	21.3	0.1
Queue Delay	0.0	0.0	0.0	0.0	0.0	0.0	0.0	0.0	0.0
Total Delay	28.5	11.8	40.5	27.3	41.1	6.1	76.1	21.3	0.1
Queue Length 50th (ft)	22	47	101	98	51	12	44	11	0
Queue Length 95th (ft)	m43	41	160	157	85	77	#121	36	0
Internal Link Dist (ft)		782		187		321		193	
Turn Bay Length (ft)	95		40		75		60		
Base Capacity (vph)	205	882	375	668	368	821	116	577	622
Starvation Cap Reductn	0	0	0	0	0	0	0	0	0
Spillback Cap Reductn	0	0	0	0	0	0	0	0	0
Storage Cap Reductn	0	0	0	0	0	0	0	0	0
Reduced v/c Ratio	0.21	0.44	0.57	0.36	0.56	0.37	0.76	0.06	0.03

Intersection Summary

95th percentile volume exceeds capacity, queue may be longer.

Queue shown is maximum after two cycles.

m Volume for 95th percentile queue is metered by upstream signal.

Queues
29: Schnoor Avenue & Cleveland Avenue

Village D Specific Plan
Phase I WP - PM Peak Hour



Lane Group	EBL	EBT	EBR	WBL	WBT	WBR	NBL	NBT	NBR	SBL	SBT	SBR
Lane Group Flow (vph)	145	687	57	284	1066	114	90	222	157	122	220	130
v/c Ratio	0.69	0.71	0.10	0.40	0.83	0.17	0.73	0.26	0.20	0.82	0.24	0.24
Control Delay	55.4	33.3	0.4	13.0	10.5	0.4	76.4	29.6	5.1	81.4	28.2	2.7
Queue Delay	0.0	0.0	0.0	0.0	0.0	0.0	0.0	0.0	0.0	0.0	0.0	0.0
Total Delay	55.4	33.3	0.4	13.0	10.5	0.4	76.4	29.6	5.1	81.4	28.2	2.7
Queue Length 50th (ft)	80	185	0	43	52	1	52	55	8	70	53	0
Queue Length 95th (ft)	#154	219	0	m74	m62	m1	#138	88	46	#166	85	19
Internal Link Dist (ft)		2178			574			393			326	
Turn Bay Length (ft)	120		60	220		95	75		75	105		65
Base Capacity (vph)	228	1294	680	707	1330	701	123	860	775	148	912	534
Starvation Cap Reductn	0	0	0	0	0	0	0	0	0	0	0	0
Spillback Cap Reductn	0	0	0	0	0	0	0	0	0	0	0	0
Storage Cap Reductn	0	0	0	0	0	0	0	0	0	0	0	0
Reduced v/c Ratio	0.64	0.53	0.08	0.40	0.80	0.16	0.73	0.26	0.20	0.82	0.24	0.24

Intersection Summary

- # 95th percentile volume exceeds capacity, queue may be longer.
Queue shown is maximum after two cycles.
- m Volume for 95th percentile queue is metered by upstream signal.

Queues
30: Fairgrounds & Cleveland Avenue



Lane Group	EBL	EBT	WBL	WBT	WBR	NBL	NBT	NBR	SBL	SBT
Lane Group Flow (vph)	99	911	172	1186	154	102	83	76	279	150
v/c Ratio	0.76	0.58	0.76	0.92	0.23	0.42	0.19	0.14	1.21	0.25
Control Delay	58.3	10.1	53.5	21.5	2.1	45.5	17.6	0.5	165.3	9.0
Queue Delay	0.0	0.0	0.0	0.0	0.0	0.0	0.0	0.0	0.0	0.0
Total Delay	58.3	10.1	53.5	21.5	2.1	45.5	17.6	0.5	165.3	9.0
Queue Length 50th (ft)	59	51	94	243	11	29	21	0	~196	15
Queue Length 95th (ft)	m#134	98	m126	#457	m15	54	60	0	#350	59
Internal Link Dist (ft)		574		1412			192			168
Turn Bay Length (ft)	120		205					100		
Base Capacity (vph)	131	1565	236	1290	681	249	428	541	230	609
Starvation Cap Reductn	0	0	0	0	0	0	0	0	0	0
Spillback Cap Reductn	0	0	0	0	0	0	0	0	0	0
Storage Cap Reductn	0	0	0	0	0	0	0	0	0	0
Reduced v/c Ratio	0.76	0.58	0.73	0.92	0.23	0.41	0.19	0.14	1.21	0.25

Intersection Summary

- ~ Volume exceeds capacity, queue is theoretically infinite.
Queue shown is maximum after two cycles.
- # 95th percentile volume exceeds capacity, queue may be longer.
Queue shown is maximum after two cycles.
- m Volume for 95th percentile queue is metered by upstream signal.

Queues
33: Gateway Drive & Cleveland Avenue

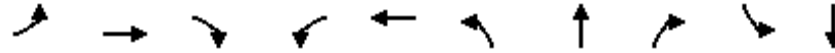

Lane Group	EBL	EBT	EBR	WBL	WBT	NBL	NBT	NBR	SBL	SBT
Lane Group Flow (vph)	16	961	303	190	1055	321	134	259	193	175
v/c Ratio	0.09	0.67	0.36	0.53	0.73	0.68	0.25	0.46	0.84	0.18
Control Delay	7.2	12.6	1.3	43.9	24.1	44.8	28.7	13.7	69.2	24.6
Queue Delay	0.0	0.5	0.1	0.9	35.8	60.7	0.0	0.1	0.0	0.0
Total Delay	7.2	13.1	1.4	44.8	59.9	105.5	28.7	13.8	69.2	24.6
Queue Length 50th (ft)	2	57	1	52	194	90	60	39	108	36
Queue Length 95th (ft)	m4	65	5	94	277	134	116	115	#223	67
Internal Link Dist (ft)		207			111		765			296
Turn Bay Length (ft)	110					245			45	
Base Capacity (vph)	186	1762	836	364	1473	485	530	567	235	959
Starvation Cap Reductn	0	271	75	48	483	0	0	0	0	0
Spillback Cap Reductn	0	381	0	0	167	247	0	28	0	1
Storage Cap Reductn	0	0	0	0	0	0	0	0	0	0
Reduced v/c Ratio	0.09	0.70	0.40	0.60	1.07	1.35	0.25	0.48	0.82	0.18

Intersection Summary

95th percentile volume exceeds capacity, queue may be longer.

Queue shown is maximum after two cycles.

m Volume for 95th percentile queue is metered by upstream signal.

Queues
 34: Cleveland Avenue & County Club Drive



Lane Group	WBL	NBT	NBR	SBL	SBT
Lane Group Flow (vph)	517	854	543	104	748
v/c Ratio	0.71	0.35	0.35	0.26	0.21
Control Delay	37.9	11.4	1.3	8.2	5.5
Queue Delay	0.0	2.8	0.0	0.0	0.1
Total Delay	37.9	14.2	1.3	8.2	5.6
Queue Length 50th (ft)	139	125	12	19	48
Queue Length 95th (ft)	179	170	m22	52	76
Internal Link Dist (ft)	239	111			159
Turn Bay Length (ft)					
Base Capacity (vph)	1376	2449	1563	393	3519
Starvation Cap Reductn	0	1444	0	0	0
Spillback Cap Reductn	17	0	0	0	1098
Storage Cap Reductn	0	0	0	0	0
Reduced v/c Ratio	0.38	0.85	0.35	0.26	0.31

Intersection Summary

m Volume for 95th percentile queue is metered by upstream signal.

Queues
36: Pine Street & Howard Road



Lane Group	EBL	EBT	WBL	WBT	NBL	NBT	NBR	SBT	SBR
Lane Group Flow (vph)	92	815	101	619	210	176	160	169	128
v/c Ratio	0.41	0.82	0.58	0.62	0.44	0.35	0.29	0.62	0.33
Control Delay	43.8	36.7	49.8	30.4	32.7	31.0	4.9	45.2	4.0
Queue Delay	0.0	0.0	0.0	0.0	0.0	0.0	0.0	0.0	0.0
Total Delay	43.8	36.7	49.8	30.4	32.7	31.0	4.9	45.2	4.0
Queue Length 50th (ft)	45	213	59	188	106	86	0	91	0
Queue Length 95th (ft)	#130	284	#139	198	177	148	38	147	18
Internal Link Dist (ft)		265		561		224		259	
Turn Bay Length (ft)	95		140		90				
Base Capacity (vph)	226	1056	173	1134	480	505	557	370	462
Starvation Cap Reductn	0	0	0	0	0	0	0	0	0
Spillback Cap Reductn	0	0	0	0	0	0	0	0	0
Storage Cap Reductn	0	0	0	0	0	0	0	0	0
Reduced v/c Ratio	0.41	0.77	0.58	0.55	0.44	0.35	0.29	0.46	0.28

Intersection Summary

95th percentile volume exceeds capacity, queue may be longer.
Queue shown is maximum after two cycles.

Queues

37: Olive Avenue/Q Street & Howard Road/Yosemite Avenue

Village D Specific Plan

Phase I WP - PM Peak Hour



Lane Group	EBL	EBT	EBR	WBL	WBT	NBL	NBT	NBR	SBL	SBT	SBR
Lane Group Flow (vph)	8	495	341	14	414	237	240	13	17	61	2
v/c Ratio	0.07	0.63	0.56	0.11	0.52	0.26	0.26	0.01	0.10	0.35	0.01
Control Delay	40.9	13.4	4.6	40.8	32.3	16.3	16.2	0.0	37.5	43.2	0.0
Queue Delay	0.0	0.0	0.0	0.0	0.0	0.0	0.0	0.0	0.0	0.0	0.0
Total Delay	40.9	13.4	4.6	40.8	32.3	16.3	16.2	0.0	37.5	43.2	0.0
Queue Length 50th (ft)	3	46	0	8	107	72	73	0	9	33	0
Queue Length 95th (ft)	m5	m91	m24	26	142	183	185	0	28	69	0
Internal Link Dist (ft)		561			230		220			195	
Turn Bay Length (ft)	40			80		130			50		50
Base Capacity (vph)	118	813	621	357	1227	904	920	922	357	376	465
Starvation Cap Reductn	0	0	0	0	0	0	0	0	0	0	0
Spillback Cap Reductn	0	0	0	0	0	0	0	0	0	0	0
Storage Cap Reductn	0	0	0	0	0	0	0	0	0	0	0
Reduced v/c Ratio	0.07	0.61	0.55	0.04	0.34	0.26	0.26	0.01	0.05	0.16	0.00

Intersection Summary

m Volume for 95th percentile queue is metered by upstream signal.

Queues
39: 4th Street & Sunset Avenue



Lane Group	EBL	NBL	NBT	SBT	SBR
Lane Group Flow (vph)	274	14	343	386	408
v/c Ratio	0.58	0.12	0.13	0.28	0.29
Control Delay	44.6	45.1	3.2	2.3	0.7
Queue Delay	0.0	0.0	0.0	0.0	0.0
Total Delay	44.6	45.1	3.2	2.3	0.7
Queue Length 50th (ft)	84	9	22	36	0
Queue Length 95th (ft)	119	28	41	71	3
Internal Link Dist (ft)	7441		193	501	
Turn Bay Length (ft)	135				
Base Capacity (vph)	962	166	2719	1379	1459
Starvation Cap Reductn	0	0	0	0	0
Spillback Cap Reductn	0	0	0	0	0
Storage Cap Reductn	0	0	0	0	0
Reduced v/c Ratio	0.28	0.08	0.13	0.28	0.28
Intersection Summary					

Queues
41: I Street & 4th Street



Lane Group	EBL	EBT	WBL	WBT	NBL	NBT	NBR	SBL	SBT	SBR
Lane Group Flow (vph)	38	631	65	679	108	76	270	185	180	122
v/c Ratio	0.31	0.76	0.43	0.70	0.57	0.13	0.39	0.54	0.24	0.17
Control Delay	43.7	28.7	42.1	19.5	54.1	29.2	5.8	42.1	23.4	5.3
Queue Delay	0.0	0.0	0.0	0.2	0.0	0.0	0.0	0.0	0.0	0.0
Total Delay	43.7	28.7	42.1	19.7	54.1	29.2	5.8	42.1	23.4	5.3
Queue Length 50th (ft)	25	187	44	93	66	36	0	106	79	0
Queue Length 95th (ft)	59	227	m62	m111	120	78	63	172	142	39
Internal Link Dist (ft)		501		26		314			779	
Turn Bay Length (ft)	130				45		25	80		80
Base Capacity (vph)	126	954	171	1096	226	606	698	380	763	712
Starvation Cap Reductn	0	0	0	54	0	0	0	0	0	0
Spillback Cap Reductn	0	0	0	0	0	0	0	0	0	0
Storage Cap Reductn	0	0	0	0	0	0	0	0	0	0
Reduced v/c Ratio	0.30	0.66	0.38	0.65	0.48	0.13	0.39	0.49	0.24	0.17

Intersection Summary

m Volume for 95th percentile queue is metered by upstream signal.

Queues
 16: Love's Truck Stop Driveway/Driveway & Avenue 17

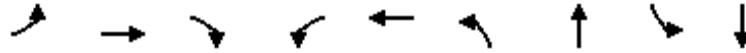

Lane Group	EBL	EBT	EBR	WBL	WBT	NBL	NBT	SBL	SBT
Lane Group Flow (vph)	176	393	143	49	993	148	24	52	98
v/c Ratio	0.97	0.21	0.16	0.43	1.09	0.96	0.03	0.44	0.23
Control Delay	113.9	14.5	2.7	65.1	88.8	117.9	0.1	65.2	1.2
Queue Delay	0.0	0.0	0.0	0.0	0.0	0.0	0.0	0.0	0.0
Total Delay	113.9	14.5	2.7	65.1	88.8	117.9	0.1	65.2	1.2
Queue Length 50th (ft)	138	81	0	37	-869	116	0	39	0
Queue Length 95th (ft)	#283	112	31	78	#1125	#249	0	81	0
Internal Link Dist (ft)		311			402		160		226
Turn Bay Length (ft)	100		100	100					
Base Capacity (vph)	181	1870	900	129	908	154	718	133	433
Starvation Cap Reductn	0	0	0	0	0	0	0	0	0
Spillback Cap Reductn	0	0	0	0	0	0	0	0	0
Storage Cap Reductn	0	0	0	0	0	0	0	0	0
Reduced v/c Ratio	0.97	0.21	0.16	0.38	1.09	0.96	0.03	0.39	0.23

Intersection Summary

~ Volume exceeds capacity, queue is theoretically infinite.
 Queue shown is maximum after two cycles.

95th percentile volume exceeds capacity, queue may be longer.
 Queue shown is maximum after two cycles.

Queues
23: Avenue 16/Ellis Street & Kennedy Street



Lane Group	WBL	WBR	NBT	SBL	SBT
Lane Group Flow (vph)	212	160	555	286	338
v/c Ratio	0.66	0.25	0.45	0.55	0.14
Control Delay	29.0	5.5	17.5	28.6	4.5
Queue Delay	0.0	0.0	0.0	0.0	0.0
Total Delay	29.0	5.5	17.5	28.6	4.5
Queue Length 50th (ft)	68	0	85	120	24
Queue Length 95th (ft)	118	m8	142	197	46
Internal Link Dist (ft)	782		506		440
Turn Bay Length (ft)	175			280	
Base Capacity (vph)	423	787	1234	519	2488
Starvation Cap Reductn	0	0	0	0	0
Spillback Cap Reductn	0	0	0	0	0
Storage Cap Reductn	0	0	0	0	0
Reduced v/c Ratio	0.50	0.20	0.45	0.55	0.14

Intersection Summary

m Volume for 95th percentile queue is metered by upstream signal.

Queues
24: Schnoor Avenue & Kennedy Street



Lane Group	EBL	EBT	WBL	WBT	NBL	NBT	SBL	SBT	SBR
Lane Group Flow (vph)	89	397	186	395	125	320	105	34	26
v/c Ratio	0.75	0.58	0.65	0.75	0.48	0.41	1.15	0.06	0.04
Control Delay	74.6	10.7	41.8	31.7	42.3	6.1	180.1	20.5	0.1
Queue Delay	0.0	0.0	0.0	0.0	0.0	0.0	0.0	0.0	0.0
Total Delay	74.6	10.7	41.8	31.7	42.3	6.1	180.1	20.5	0.1
Queue Length 50th (ft)	48	8	87	160	31	11	-63	11	0
Queue Length 95th (ft)	m#111	41	146	228	58	76	#159	35	0
Internal Link Dist (ft)		782		187		321		193	
Turn Bay Length (ft)	95		40		75		60		
Base Capacity (vph)	119	882	354	657	258	783	91	551	592
Starvation Cap Reductn	0	0	0	0	0	0	0	0	0
Spillback Cap Reductn	0	0	0	0	0	0	0	0	0
Storage Cap Reductn	0	0	0	0	0	0	0	0	0
Reduced v/c Ratio	0.75	0.45	0.53	0.60	0.48	0.41	1.15	0.06	0.04

Intersection Summary

- ~ Volume exceeds capacity, queue is theoretically infinite.
Queue shown is maximum after two cycles.
- # 95th percentile volume exceeds capacity, queue may be longer.
Queue shown is maximum after two cycles.
- m Volume for 95th percentile queue is metered by upstream signal.

Queues
29: Schnoor Avenue & Cleveland Avenue



Lane Group	EBL	EBT	EBR	WBL	WBT	WBR	NBL	NBT	NBR	SBL	SBT	SBR
Lane Group Flow (vph)	108	450	47	180	236	50	55	273	186	97	195	65
v/c Ratio	0.68	0.63	0.11	0.67	0.31	0.11	0.31	0.19	0.22	0.45	0.13	0.09
Control Delay	57.3	32.7	0.5	75.9	7.9	1.6	37.4	19.2	3.2	38.5	16.5	0.2
Queue Delay	0.0	0.0	0.0	0.0	0.0	0.0	0.0	0.0	0.0	0.0	0.0	0.0
Total Delay	57.3	32.7	0.5	75.9	7.9	1.6	37.4	19.2	3.2	38.5	16.5	0.2
Queue Length 50th (ft)	53	108	0	50	12	1	26	48	0	46	32	0
Queue Length 95th (ft)	#126	143	0	#90	25	1	58	90	37	87	63	0
Internal Link Dist (ft)		2178			574			393			326	
Turn Bay Length (ft)	120		60	220		95	75		75	105		65
Base Capacity (vph)	164	1292	655	270	1224	631	177	1406	846	221	1555	758
Starvation Cap Reductn	0	0	0	0	0	0	0	0	0	0	0	0
Spillback Cap Reductn	0	0	0	0	0	0	0	0	0	0	0	0
Storage Cap Reductn	0	0	0	0	0	0	0	0	0	0	0	0
Reduced v/c Ratio	0.66	0.35	0.07	0.67	0.19	0.08	0.31	0.19	0.22	0.44	0.13	0.09

Intersection Summary

95th percentile volume exceeds capacity, queue may be longer.
Queue shown is maximum after two cycles.

Queues
30: Fairgrounds & Cleveland Avenue



Lane Group	EBL	EBT	WBL	WBT	WBR	NBL	NBT	NBR	SBL	SBT
Lane Group Flow (vph)	105	682	39	398	113	14	19	17	145	46
v/c Ratio	0.50	0.51	0.33	0.59	0.24	0.06	0.03	0.03	0.61	0.05
Control Delay	57.8	40.7	43.3	32.5	1.2	36.1	14.9	0.1	44.1	6.8
Queue Delay	0.0	0.0	0.0	0.0	0.0	0.0	0.0	0.0	0.0	0.0
Total Delay	57.8	40.7	43.3	32.5	1.2	36.1	14.9	0.1	44.1	6.8
Queue Length 50th (ft)	56	129	19	96	0	3	2	0	68	1
Queue Length 95th (ft)	96	149	49	128	1	12	20	0	#139	24
Internal Link Dist (ft)		574		1412			192			168
Turn Bay Length (ft)	120		205					100		
Base Capacity (vph)	218	1647	119	1019	600	218	584	674	256	861
Starvation Cap Reductn	0	0	0	0	0	0	0	0	0	0
Spillback Cap Reductn	0	0	0	0	0	0	0	0	0	0
Storage Cap Reductn	0	0	0	0	0	0	0	0	0	0
Reduced v/c Ratio	0.48	0.41	0.33	0.39	0.19	0.06	0.03	0.03	0.57	0.05

Intersection Summary

95th percentile volume exceeds capacity, queue may be longer.
Queue shown is maximum after two cycles.

Queues
33: Gateway Drive & Cleveland Avenue

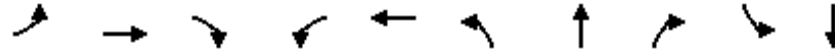

Lane Group	EBL	EBT	EBR	WBL	WBT	NBL	NBT	NBR	SBL	SBT
Lane Group Flow (vph)	4	732	155	227	886	146	53	183	67	100
v/c Ratio	0.02	0.64	0.24	0.52	0.66	0.34	0.08	0.27	0.42	0.09
Control Delay	24.8	35.7	8.0	43.8	29.5	38.2	23.8	5.5	46.5	23.8
Queue Delay	0.0	0.1	0.0	2.8	33.5	0.0	0.0	0.0	0.0	0.0
Total Delay	24.8	35.7	8.0	46.5	63.0	38.2	23.8	5.5	46.5	23.8
Queue Length 50th (ft)	2	134	25	60	208	39	20	0	36	20
Queue Length 95th (ft)	m6	159	53	74	220	68	54	51	77	44
Internal Link Dist (ft)		207			111		765			296
Turn Bay Length (ft)	110					245			45	
Base Capacity (vph)	161	1723	649	447	1426	425	667	672	181	1089
Starvation Cap Reductn	0	168	0	127	587	0	0	0	0	0
Spillback Cap Reductn	0	0	0	0	475	0	0	0	0	0
Storage Cap Reductn	0	0	0	0	0	0	0	0	0	0
Reduced v/c Ratio	0.02	0.47	0.24	0.71	1.06	0.34	0.08	0.27	0.37	0.09

Intersection Summary

m Volume for 95th percentile queue is metered by upstream signal.

Queues
34: Cleveland Avenue & County Club Drive



Lane Group	WBL	NBT	NBR	SBL	SBT
Lane Group Flow (vph)	453	743	238	103	702
v/c Ratio	0.69	0.30	0.15	0.22	0.20
Control Delay	38.3	2.0	0.2	6.6	4.8
Queue Delay	0.0	0.5	0.0	0.0	0.0
Total Delay	38.3	2.5	0.2	6.6	4.8
Queue Length 50th (ft)	121	12	0	17	41
Queue Length 95th (ft)	160	22	0	45	66
Internal Link Dist (ft)	239	111			159
Turn Bay Length (ft)					
Base Capacity (vph)	1261	2498	1568	465	3589
Starvation Cap Reductn	0	1206	0	0	0
Spillback Cap Reductn	8	0	0	0	835
Storage Cap Reductn	0	0	0	0	0
Reduced v/c Ratio	0.36	0.58	0.15	0.22	0.25
Intersection Summary					

Queues
36: Pine Street & Howard Road



Lane Group	EBL	EBT	WBL	WBT	NBL	NBT	NBR	SBT	SBR
Lane Group Flow (vph)	37	836	164	483	129	178	264	308	109
v/c Ratio	0.38	0.78	0.65	0.32	0.35	0.46	0.50	0.92	0.28
Control Delay	66.2	42.5	58.9	21.4	45.9	48.0	8.9	81.0	5.4
Queue Delay	0.0	0.0	0.0	0.0	0.0	0.0	0.0	0.0	0.0
Total Delay	66.2	42.5	58.9	21.4	45.9	48.0	8.9	81.0	5.4
Queue Length 50th (ft)	28	305	128	102	88	125	0	235	0
Queue Length 95th (ft)	65	345	#236	140	155	206	77	#398	31
Internal Link Dist (ft)		265		561		224		259	
Turn Bay Length (ft)	95		140		90				
Base Capacity (vph)	101	1387	252	1549	365	384	528	344	398
Starvation Cap Reductn	0	0	0	0	0	0	0	0	0
Spillback Cap Reductn	0	0	0	0	0	0	0	0	0
Storage Cap Reductn	0	0	0	0	0	0	0	0	0
Reduced v/c Ratio	0.37	0.60	0.65	0.31	0.35	0.46	0.50	0.90	0.27

Intersection Summary

95th percentile volume exceeds capacity, queue may be longer.
Queue shown is maximum after two cycles.

Queues

37: Olive Avenue/Q Street & Howard Road/Yosemite Avenue

Village D Specific Plan

Phase II NP - AM Peak Hour



Lane Group	EBL	EBT	EBR	WBL	WBT	NBL	NBT	NBR	SBL	SBT	SBR
Lane Group Flow (vph)	7	608	355	29	395	216	219	23	111	163	13
v/c Ratio	0.09	0.71	0.56	0.26	0.38	0.29	0.29	0.03	0.50	0.70	0.04
Control Delay	86.0	28.6	5.0	58.7	33.1	26.4	26.3	0.1	56.3	66.0	0.2
Queue Delay	0.0	0.0	0.0	0.0	0.0	0.0	0.0	0.0	0.0	0.0	0.0
Total Delay	86.0	28.6	5.0	58.7	33.1	26.4	26.3	0.1	56.3	66.0	0.2
Queue Length 50th (ft)	6	84	0	22	116	116	118	0	81	122	0
Queue Length 95th (ft)	m10	m170	m11	53	157	218	221	0	138	193	0
Internal Link Dist (ft)		561			230		220			195	
Turn Bay Length (ft)	40			80		130			50		50
Base Capacity (vph)	81	1013	690	272	1378	737	755	740	265	279	353
Starvation Cap Reductn	0	0	0	0	0	0	0	0	0	0	0
Spillback Cap Reductn	0	0	0	0	0	0	0	0	0	0	0
Storage Cap Reductn	0	0	0	0	0	0	0	0	0	0	0
Reduced v/c Ratio	0.09	0.60	0.51	0.11	0.29	0.29	0.29	0.03	0.42	0.58	0.04

Intersection Summary

m Volume for 95th percentile queue is metered by upstream signal.

Queues
39: 4th Street & Sunset Avenue



Lane Group	EBL	NBL	NBT	SBT	SBR
Lane Group Flow (vph)	453	37	360	479	304
v/c Ratio	0.71	0.28	0.14	0.40	0.23
Control Delay	40.5	44.4	4.4	3.7	0.4
Queue Delay	0.0	0.0	0.0	0.0	0.0
Total Delay	40.5	44.4	4.4	3.7	0.4
Queue Length 50th (ft)	122	20	30	29	0
Queue Length 95th (ft)	170	50	45	54	0
Internal Link Dist (ft)	7441		193	501	
Turn Bay Length (ft)	135				
Base Capacity (vph)	721	147	2542	1190	1354
Starvation Cap Reductn	0	0	0	0	0
Spillback Cap Reductn	0	0	0	0	0
Storage Cap Reductn	0	0	0	0	0
Reduced v/c Ratio	0.63	0.25	0.14	0.40	0.22
Intersection Summary					

Queues
41: I Street & 4th Street



Lane Group	EBL	EBT	WBL	WBT	NBL	NBT	NBR	SBL	SBT	SBR
Lane Group Flow (vph)	30	783	96	614	58	62	179	259	309	152
v/c Ratio	0.25	0.85	0.64	0.59	0.41	0.13	0.31	0.69	0.40	0.21
Control Delay	30.5	34.5	53.2	28.3	47.9	30.5	3.1	42.1	23.0	2.7
Queue Delay	0.0	0.0	0.0	0.0	0.0	0.0	0.0	0.0	0.0	0.0
Total Delay	30.5	34.5	53.2	28.3	47.9	30.5	3.1	42.1	23.0	2.7
Queue Length 50th (ft)	15	239	59	165	32	29	0	132	134	0
Queue Length 95th (ft)	m34	#316	m70	m188	70	64	24	213	211	27
Internal Link Dist (ft)		501		26		314			779	
Turn Bay Length (ft)	130				45		25	80		80
Base Capacity (vph)	127	946	155	1072	155	482	578	418	770	739
Starvation Cap Reductn	0	0	0	0	0	0	0	0	0	0
Spillback Cap Reductn	0	0	0	0	0	0	0	0	0	0
Storage Cap Reductn	0	0	0	0	0	0	0	0	0	0
Reduced v/c Ratio	0.24	0.83	0.62	0.57	0.37	0.13	0.31	0.62	0.40	0.21

Intersection Summary

95th percentile volume exceeds capacity, queue may be longer.

Queue shown is maximum after two cycles.

m Volume for 95th percentile queue is metered by upstream signal.

Queues
 16: Love's Truck Stop Driveway/Driveway & Avenue 17

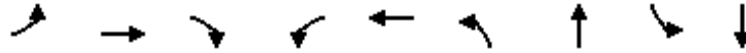

Lane Group	EBL	EBT	EBR	WBL	WBT	NBL	NBT	SBL	SBT
Lane Group Flow (vph)	604	735	153	35	860	174	34	303	564
v/c Ratio	1.55	0.38	0.17	0.38	1.43	1.23	0.07	1.39	0.87
Control Delay	292.5	17.5	4.0	66.6	233.0	194.4	0.3	240.6	29.6
Queue Delay	0.0	0.0	0.0	0.0	0.0	0.0	0.0	0.0	0.0
Total Delay	292.5	17.5	4.0	66.6	233.0	194.4	0.3	240.6	29.6
Queue Length 50th (ft)	~659	182	6	27	-899	~165	0	~313	143
Queue Length 95th (ft)	#883	230	41	62	#1148	#310	0	#492	#354
Internal Link Dist (ft)		423			402		160		227
Turn Bay Length (ft)	100		100	100					
Base Capacity (vph)	390	1910	917	96	603	142	465	218	647
Starvation Cap Reductn	0	0	0	0	0	0	0	0	0
Spillback Cap Reductn	0	0	0	0	0	0	0	0	0
Storage Cap Reductn	0	0	0	0	0	0	0	0	0
Reduced v/c Ratio	1.55	0.38	0.17	0.36	1.43	1.23	0.07	1.39	0.87

Intersection Summary

~ Volume exceeds capacity, queue is theoretically infinite.
 Queue shown is maximum after two cycles.

95th percentile volume exceeds capacity, queue may be longer.
 Queue shown is maximum after two cycles.

Queues
 23: Avenue 16/Ellis Street & Kennedy Street



Lane Group	WBL	WBR	NBT	SBL	SBT
Lane Group Flow (vph)	163	243	687	261	359
v/c Ratio	0.59	0.38	0.40	0.72	0.14
Control Delay	24.8	9.9	8.3	42.8	3.8
Queue Delay	0.0	0.0	0.0	0.0	0.0
Total Delay	24.8	9.9	8.3	42.8	3.8
Queue Length 50th (ft)	75	15	57	118	22
Queue Length 95th (ft)	126	43	101	#237	44
Internal Link Dist (ft)	782		506		440
Turn Bay Length (ft)	175			280	
Base Capacity (vph)	431	863	1734	364	2609
Starvation Cap Reductn	0	0	0	0	0
Spillback Cap Reductn	0	0	0	0	0
Storage Cap Reductn	0	0	0	0	0
Reduced v/c Ratio	0.38	0.28	0.40	0.72	0.14

Intersection Summary

95th percentile volume exceeds capacity, queue may be longer.
 Queue shown is maximum after two cycles.

Queues
24: Schnoor Avenue & Kennedy Street



Lane Group	EBL	EBT	WBL	WBT	NBL	NBT	SBL	SBT	SBR
Lane Group Flow (vph)	74	475	240	326	211	373	152	54	33
v/c Ratio	0.38	0.68	0.73	0.67	0.57	0.49	1.31	0.10	0.06
Control Delay	34.3	11.8	43.9	29.5	40.7	9.3	222.3	23.1	0.2
Queue Delay	0.0	0.0	0.0	0.0	0.0	0.0	0.0	0.0	0.0
Total Delay	34.3	11.8	43.9	29.5	40.7	9.3	222.3	23.1	0.2
Queue Length 50th (ft)	37	53	112	128	52	34	-99	19	0
Queue Length 95th (ft)	m68	61	#193	189	86	119	#212	50	0
Internal Link Dist (ft)		782		187		321		193	
Turn Bay Length (ft)	95		40		75		60		
Base Capacity (vph)	195	908	370	669	368	757	116	523	583
Starvation Cap Reductn	0	0	0	0	0	0	0	0	0
Spillback Cap Reductn	0	0	0	0	0	0	0	0	0
Storage Cap Reductn	0	0	0	0	0	0	0	0	0
Reduced v/c Ratio	0.38	0.52	0.65	0.49	0.57	0.49	1.31	0.10	0.06

Intersection Summary

- ~ Volume exceeds capacity, queue is theoretically infinite.
Queue shown is maximum after two cycles.
- # 95th percentile volume exceeds capacity, queue may be longer.
Queue shown is maximum after two cycles.
- m Volume for 95th percentile queue is metered by upstream signal.

Queues
29: Schnoor Avenue & Cleveland Avenue

Village D Specific Plan
Phase II NP - PM Peak Hour



Lane Group	EBL	EBT	EBR	WBL	WBT	WBR	NBL	NBT	NBR	SBL	SBT	SBR
Lane Group Flow (vph)	136	439	48	295	556	123	68	237	160	130	237	107
v/c Ratio	0.66	0.65	0.11	0.54	0.67	0.24	0.38	0.18	0.18	0.88	0.18	0.15
Control Delay	53.5	37.8	0.5	22.3	20.1	1.3	43.4	21.4	2.4	90.7	22.7	0.9
Queue Delay	0.0	0.0	0.0	0.0	0.0	0.0	0.0	0.0	0.0	0.0	0.0	0.0
Total Delay	53.5	37.8	0.5	22.3	20.1	1.3	43.4	21.4	2.4	90.7	22.7	0.9
Queue Length 50th (ft)	74	122	0	36	68	0	37	48	0	74	50	0
Queue Length 95th (ft)	#135	159	0	70	78	0	76	84	29	#179	90	5
Internal Link Dist (ft)		2178			574			393			326	
Turn Bay Length (ft)	120		60	220		95	75		75	105		65
Base Capacity (vph)	228	1294	680	570	1330	701	178	1312	915	148	1335	697
Starvation Cap Reductn	0	0	0	0	0	0	0	0	0	0	0	0
Spillback Cap Reductn	0	0	0	0	0	0	0	0	0	0	0	0
Storage Cap Reductn	0	0	0	0	0	0	0	0	0	0	0	0
Reduced v/c Ratio	0.60	0.34	0.07	0.52	0.42	0.18	0.38	0.18	0.17	0.88	0.18	0.15

Intersection Summary

95th percentile volume exceeds capacity, queue may be longer.
Queue shown is maximum after two cycles.

Queues
30: Fairgrounds & Cleveland Avenue



Lane Group	EBL	EBT	WBL	WBT	WBR	NBL	NBT	NBR	SBL	SBT
Lane Group Flow (vph)	105	670	180	676	178	103	85	78	316	160
v/c Ratio	0.51	0.49	0.79	0.68	0.31	0.42	0.19	0.14	1.09	0.24
Control Delay	38.7	14.7	53.1	18.6	5.5	45.6	18.7	0.5	116.8	8.4
Queue Delay	0.0	0.0	0.0	0.0	0.0	0.0	0.0	0.0	0.0	0.0
Total Delay	38.7	14.7	53.1	18.6	5.5	45.6	18.7	0.5	116.8	8.4
Queue Length 50th (ft)	63	132	87	158	13	29	21	0	~204	15
Queue Length 95th (ft)	m#142	m157	#199	182	35	55	63	0	#365	61
Internal Link Dist (ft)		574		1412			192			168
Turn Bay Length (ft)	120		205					100		
Base Capacity (vph)	205	1536	236	1330	696	249	440	550	290	677
Starvation Cap Reductn	0	0	0	0	0	0	0	0	0	0
Spillback Cap Reductn	0	0	0	0	0	0	0	0	0	0
Storage Cap Reductn	0	0	0	0	0	0	0	0	0	0
Reduced v/c Ratio	0.51	0.44	0.76	0.51	0.26	0.41	0.19	0.14	1.09	0.24

Intersection Summary

- ~ Volume exceeds capacity, queue is theoretically infinite.
Queue shown is maximum after two cycles.
- # 95th percentile volume exceeds capacity, queue may be longer.
Queue shown is maximum after two cycles.
- m Volume for 95th percentile queue is metered by upstream signal.

Queues
33: Gateway Drive & Cleveland Avenue

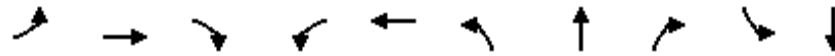

Lane Group	EBL	EBT	EBR	WBL	WBT	NBL	NBT	NBR	SBL	SBT
Lane Group Flow (vph)	17	953	290	227	1011	246	149	294	220	195
v/c Ratio	0.09	0.67	0.35	0.59	0.73	0.51	0.29	0.54	0.94	0.21
Control Delay	7.9	20.4	2.0	36.9	23.6	39.9	29.5	17.7	85.2	25.6
Queue Delay	0.0	24.6	0.1	2.1	50.2	0.0	0.0	0.2	0.0	0.0
Total Delay	7.9	45.1	2.1	39.0	73.7	39.9	29.5	17.9	85.2	25.6
Queue Length 50th (ft)	2	93	4	55	127	67	68	61	126	42
Queue Length 95th (ft)	m5	96	7	#96	303	105	127	151	#262	74
Internal Link Dist (ft)		207			111		765			296
Turn Bay Length (ft)	110					245			45	
Base Capacity (vph)	187	1762	826	385	1412	485	512	547	235	928
Starvation Cap Reductn	0	276	79	67	556	0	0	0	0	0
Spillback Cap Reductn	0	838	0	0	48	0	0	31	0	0
Storage Cap Reductn	0	0	0	0	0	0	0	0	0	0
Reduced v/c Ratio	0.09	1.03	0.39	0.71	1.18	0.51	0.29	0.57	0.94	0.21

Intersection Summary

95th percentile volume exceeds capacity, queue may be longer.

Queue shown is maximum after two cycles.

m Volume for 95th percentile queue is metered by upstream signal.

Queues
 34: Cleveland Avenue & County Club Drive



Lane Group	WBL	NBT	NBR	SBL	SBT
Lane Group Flow (vph)	450	918	534	129	813
v/c Ratio	0.68	0.36	0.34	0.34	0.22
Control Delay	38.2	17.3	1.4	8.7	4.9
Queue Delay	0.0	51.5	0.0	0.0	0.0
Total Delay	38.2	68.8	1.4	8.7	4.9
Queue Length 50th (ft)	120	209	22	23	49
Queue Length 95th (ft)	159	m246	m25	65	77
Internal Link Dist (ft)	239	111			159
Turn Bay Length (ft)					
Base Capacity (vph)	1376	2522	1563	380	3623
Starvation Cap Reductn	0	1738	0	0	0
Spillback Cap Reductn	16	0	0	0	727
Storage Cap Reductn	0	0	0	0	0
Reduced v/c Ratio	0.33	1.17	0.34	0.34	0.28

Intersection Summary

m Volume for 95th percentile queue is metered by upstream signal.

Queues
36: Pine Street & Howard Road



Lane Group	EBL	EBT	WBL	WBT	NBL	NBT	NBR	SBT	SBR
Lane Group Flow (vph)	95	698	111	547	154	187	172	180	129
v/c Ratio	0.37	0.76	0.63	0.70	0.31	0.36	0.30	0.64	0.33
Control Delay	40.3	34.7	67.2	32.7	29.8	30.3	5.7	45.8	4.0
Queue Delay	0.0	0.0	0.0	0.0	0.0	0.0	0.0	0.0	0.0
Total Delay	40.3	34.7	67.2	32.7	29.8	30.3	5.7	45.8	4.0
Queue Length 50th (ft)	48	183	56	91	72	88	0	97	0
Queue Length 95th (ft)	#104	236	#169	165	132	157	45	156	19
Internal Link Dist (ft)		265		561		224		259	
Turn Bay Length (ft)	95		140		90				
Base Capacity (vph)	256	1058	177	1091	500	526	572	370	462
Starvation Cap Reductn	0	0	0	0	0	0	0	0	0
Spillback Cap Reductn	0	0	0	0	0	0	0	0	0
Storage Cap Reductn	0	0	0	0	0	0	0	0	0
Reduced v/c Ratio	0.37	0.66	0.63	0.50	0.31	0.36	0.30	0.49	0.28

Intersection Summary

95th percentile volume exceeds capacity, queue may be longer.
Queue shown is maximum after two cycles.

Queues

37: Olive Avenue/Q Street & Howard Road/Yosemite Avenue

Village D Specific Plan

Phase II NP - PM Peak Hour



Lane Group	EBL	EBT	EBR	WBL	WBT	NBL	NBT	NBR	SBL	SBT	SBR
Lane Group Flow (vph)	8	488	272	14	406	207	215	14	18	62	2
v/c Ratio	0.07	0.65	0.50	0.11	0.54	0.23	0.23	0.01	0.11	0.36	0.01
Control Delay	43.6	48.3	24.8	40.8	33.1	15.6	15.6	0.0	37.6	43.3	0.0
Queue Delay	0.0	0.0	0.0	0.0	0.0	0.0	0.0	0.0	0.0	0.0	0.0
Total Delay	43.6	48.3	24.8	40.8	33.1	15.6	15.6	0.0	37.6	43.3	0.0
Queue Length 50th (ft)	5	152	95	8	107	60	63	0	10	34	0
Queue Length 95th (ft)	m9	205	163	26	139	161	166	0	29	71	0
Internal Link Dist (ft)		561			230		220			195	
Turn Bay Length (ft)	40			80		130			50		50
Base Capacity (vph)	118	797	562	357	1206	919	938	934	357	376	465
Starvation Cap Reductn	0	0	0	0	0	0	0	0	0	0	0
Spillback Cap Reductn	0	0	0	0	0	0	0	0	0	0	0
Storage Cap Reductn	0	0	0	0	0	0	0	0	0	0	0
Reduced v/c Ratio	0.07	0.61	0.48	0.04	0.34	0.23	0.23	0.01	0.05	0.16	0.00

Intersection Summary

m Volume for 95th percentile queue is metered by upstream signal.

Queues
39: 4th Street & Sunset Avenue



Lane Group	EBL	NBL	NBT	SBT	SBR
Lane Group Flow (vph)	267	15	354	412	404
v/c Ratio	0.58	0.09	0.13	0.32	0.30
Control Delay	44.4	39.1	3.1	3.4	0.7
Queue Delay	0.0	0.0	0.0	0.0	0.0
Total Delay	44.4	39.1	3.1	3.4	0.7
Queue Length 50th (ft)	81	9	22	39	0
Queue Length 95th (ft)	117	27	42	91	0
Internal Link Dist (ft)	7441		193	501	
Turn Bay Length (ft)	135				
Base Capacity (vph)	962	271	2727	1288	1401
Starvation Cap Reductn	0	0	0	0	0
Spillback Cap Reductn	0	0	0	0	0
Storage Cap Reductn	0	0	0	0	0
Reduced v/c Ratio	0.28	0.06	0.13	0.32	0.29
Intersection Summary					

Queues
41: I Street & 4th Street



Lane Group	EBL	EBT	WBL	WBT	NBL	NBT	NBR	SBL	SBT	SBR
Lane Group Flow (vph)	41	632	66	687	111	79	274	198	185	129
v/c Ratio	0.34	0.76	0.43	0.71	0.58	0.13	0.39	0.57	0.24	0.18
Control Delay	45.2	28.7	42.0	19.8	54.5	29.3	5.8	43.2	23.6	5.2
Queue Delay	0.0	0.0	0.0	0.2	0.0	0.0	0.0	0.0	0.0	0.0
Total Delay	45.2	28.7	42.0	20.0	54.5	29.3	5.8	43.2	23.6	5.2
Queue Length 50th (ft)	26	186	45	96	68	38	0	114	82	0
Queue Length 95th (ft)	62	227	m61	m113	123	80	63	184	145	40
Internal Link Dist (ft)		501		26		314			779	
Turn Bay Length (ft)	130				45		25	80		80
Base Capacity (vph)	126	955	172	1096	226	602	698	380	760	714
Starvation Cap Reductn	0	0	0	58	0	0	0	0	0	0
Spillback Cap Reductn	0	0	0	0	0	0	0	0	0	0
Storage Cap Reductn	0	0	0	0	0	0	0	0	0	0
Reduced v/c Ratio	0.33	0.66	0.38	0.66	0.49	0.13	0.39	0.52	0.24	0.18

Intersection Summary

m Volume for 95th percentile queue is metered by upstream signal.

Queues

16: Love's Truck Stop Driveway/Driveway & Avenue 17

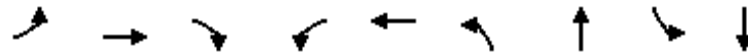

Lane Group	EBL	EBT	EBR	WBL	WBT	NBL	NBT	SBL	SBT
Lane Group Flow (vph)	176	691	143	49	1110	148	24	52	98
v/c Ratio	2.00	0.35	0.15	0.56	1.12	1.64	0.04	0.58	0.23
Control Delay	514.7	13.4	2.4	70.7	92.1	366.4	0.1	72.0	2.6
Queue Delay	0.0	0.0	0.0	0.0	0.0	0.0	0.0	0.0	0.0
Total Delay	514.7	13.4	2.4	70.7	92.1	366.4	0.1	72.0	2.6
Queue Length 50th (ft)	~176	127	0	31	-821	~137	0	33	0
Queue Length 95th (ft)	#309	166	27	#82	#1073	#261	0	#88	11
Internal Link Dist (ft)		311			402		160		226
Turn Bay Length (ft)	100		100	100					
Base Capacity (vph)	88	1960	940	88	991	90	550	90	425
Starvation Cap Reductn	0	0	0	0	0	0	0	0	0
Spillback Cap Reductn	0	0	0	0	0	0	0	0	0
Storage Cap Reductn	0	0	0	0	0	0	0	0	0
Reduced v/c Ratio	2.00	0.35	0.15	0.56	1.12	1.64	0.04	0.58	0.23

Intersection Summary

~ Volume exceeds capacity, queue is theoretically infinite.
 Queue shown is maximum after two cycles.

95th percentile volume exceeds capacity, queue may be longer.
 Queue shown is maximum after two cycles.

Queues
 23: Avenue 16/Ellis Street & Kennedy Street



Lane Group	WBL	WBR	NBT	SBL	SBT
Lane Group Flow (vph)	212	160	683	286	384
v/c Ratio	0.66	0.25	0.56	0.55	0.15
Control Delay	29.1	5.5	21.4	28.6	4.6
Queue Delay	0.0	0.0	0.0	0.0	0.0
Total Delay	29.1	5.5	21.4	28.6	4.6
Queue Length 50th (ft)	68	0	126	120	28
Queue Length 95th (ft)	118	m8	198	197	52
Internal Link Dist (ft)	782		506		440
Turn Bay Length (ft)	175			280	
Base Capacity (vph)	423	787	1228	519	2488
Starvation Cap Reductn	0	0	0	0	0
Spillback Cap Reductn	0	0	0	0	0
Storage Cap Reductn	0	0	0	0	0
Reduced v/c Ratio	0.50	0.20	0.56	0.55	0.15

Intersection Summary

m Volume for 95th percentile queue is metered by upstream signal.

Queues
24: Schnoor Avenue & Kennedy Street



Lane Group	EBL	EBT	WBL	WBT	NBL	NBT	SBL	SBT	SBR
Lane Group Flow (vph)	89	398	232	395	125	337	105	34	26
v/c Ratio	0.75	0.62	0.74	0.75	0.48	0.43	1.15	0.06	0.04
Control Delay	73.7	10.7	45.9	31.3	42.3	6.1	180.1	20.5	0.1
Queue Delay	0.0	0.0	0.0	0.0	0.0	0.0	0.0	0.0	0.0
Total Delay	73.7	10.7	45.9	31.3	42.3	6.1	180.1	20.5	0.1
Queue Length 50th (ft)	48	15	108	161	31	11	-63	11	0
Queue Length 95th (ft)	m#106	45	#185	228	58	78	#159	35	0
Internal Link Dist (ft)		782		187		321		193	
Turn Bay Length (ft)	95		40		75		60		
Base Capacity (vph)	119	882	354	657	258	791	91	547	590
Starvation Cap Reductn	0	0	0	0	0	0	0	0	0
Spillback Cap Reductn	0	0	0	0	0	0	0	0	0
Storage Cap Reductn	0	0	0	0	0	0	0	0	0
Reduced v/c Ratio	0.75	0.45	0.66	0.60	0.48	0.43	1.15	0.06	0.04

Intersection Summary

- ~ Volume exceeds capacity, queue is theoretically infinite.
Queue shown is maximum after two cycles.
- # 95th percentile volume exceeds capacity, queue may be longer.
Queue shown is maximum after two cycles.
- m Volume for 95th percentile queue is metered by upstream signal.

Queues
29: Schnoor Avenue & Cleveland Avenue

Village D Specific Plan
Phase II WP - AM Peak Hour



Lane Group	EBL	EBT	EBR	WBL	WBT	WBR	NBL	NBT	NBR	SBL	SBT	SBR
Lane Group Flow (vph)	145	1139	84	180	455	50	67	277	186	97	210	80
v/c Ratio	0.58	0.88	0.12	0.64	0.42	0.08	0.57	0.28	0.28	0.68	0.21	0.14
Control Delay	41.6	33.4	0.4	22.9	4.5	0.2	56.5	25.0	6.4	60.7	23.4	0.5
Queue Delay	0.0	0.0	0.0	0.0	0.0	0.0	0.0	0.0	0.0	0.0	0.0	0.0
Total Delay	41.6	33.4	0.4	22.9	4.5	0.2	56.5	25.0	6.4	60.7	23.4	0.5
Queue Length 50th (ft)	68	272	0	41	8	0	33	60	13	48	43	0
Queue Length 95th (ft)	122	#390	0	#79	19	m0	#88	93	54	#119	71	0
Internal Link Dist (ft)		2178			574			393			326	
Turn Bay Length (ft)	120		60	220		95	75		75	105		65
Base Capacity (vph)	299	1317	705	280	1071	614	118	984	657	144	1014	588
Starvation Cap Reductn	0	0	0	0	0	0	0	0	0	0	0	0
Spillback Cap Reductn	0	0	0	0	0	0	0	0	0	0	0	0
Storage Cap Reductn	0	0	0	0	0	0	0	0	0	0	0	0
Reduced v/c Ratio	0.48	0.86	0.12	0.64	0.42	0.08	0.57	0.28	0.28	0.67	0.21	0.14

Intersection Summary

- # 95th percentile volume exceeds capacity, queue may be longer.
Queue shown is maximum after two cycles.
- m Volume for 95th percentile queue is metered by upstream signal.

Queues
30: Fairgrounds & Cleveland Avenue



Lane Group	EBL	EBT	WBL	WBT	WBR	NBL	NBT	NBR	SBL	SBT
Lane Group Flow (vph)	105	1356	39	613	149	14	19	17	157	46
v/c Ratio	0.48	0.78	0.25	0.61	0.25	0.06	0.04	0.03	0.70	0.06
Control Delay	21.1	12.6	36.9	28.6	2.5	36.1	15.3	0.1	51.3	7.1
Queue Delay	0.0	0.0	0.0	0.0	0.0	0.0	0.0	0.0	0.0	0.0
Total Delay	21.1	12.6	36.9	28.6	2.5	36.1	15.3	0.1	51.3	7.1
Queue Length 50th (ft)	36	77	19	145	0	3	3	0	76	1
Queue Length 95th (ft)	m49	m#314	46	198	19	12	20	0	#156	24
Internal Link Dist (ft)		574		1412			192			168
Turn Bay Length (ft)	120		205					100		
Base Capacity (vph)	238	1744	251	1041	610	218	444	604	236	712
Starvation Cap Reductn	0	0	0	0	0	0	0	0	0	0
Spillback Cap Reductn	0	0	0	0	0	0	0	0	0	0
Storage Cap Reductn	0	0	0	0	0	0	0	0	0	0
Reduced v/c Ratio	0.44	0.78	0.16	0.59	0.24	0.06	0.04	0.03	0.67	0.06

Intersection Summary

95th percentile volume exceeds capacity, queue may be longer.

Queue shown is maximum after two cycles.

m Volume for 95th percentile queue is metered by upstream signal.

Queues
33: Gateway Drive & Cleveland Avenue

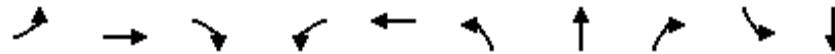

Lane Group	EBL	EBT	EBR	WBL	WBT	NBL	NBT	NBR	SBL	SBT
Lane Group Flow (vph)	4	963	299	227	981	192	53	183	67	100
v/c Ratio	0.02	0.72	0.38	0.52	0.67	0.45	0.09	0.29	0.42	0.10
Control Delay	22.5	26.6	5.8	37.8	22.1	40.0	25.4	5.8	46.5	25.5
Queue Delay	0.0	0.9	0.1	0.6	27.4	0.0	0.0	0.0	0.2	0.0
Total Delay	22.5	27.5	5.9	38.4	49.5	40.0	25.4	5.8	46.7	25.5
Queue Length 50th (ft)	1	167	15	54	171	52	22	0	36	21
Queue Length 95th (ft)	m3	247	55	86	236	86	54	51	77	44
Internal Link Dist (ft)		207			111		765			296
Turn Bay Length (ft)	110					245			45	
Base Capacity (vph)	220	1426	791	587	1463	425	602	625	181	964
Starvation Cap Reductn	0	219	64	130	521	0	0	0	0	0
Spillback Cap Reductn	0	82	0	0	102	0	0	14	6	0
Storage Cap Reductn	0	0	0	0	0	0	0	0	0	0
Reduced v/c Ratio	0.02	0.80	0.41	0.50	1.04	0.45	0.09	0.30	0.38	0.10

Intersection Summary

m Volume for 95th percentile queue is metered by upstream signal.

Queues
34: Cleveland Avenue & County Club Drive



Lane Group	WBL	NBT	NBR	SBL	SBT
Lane Group Flow (vph)	520	810	402	103	729
v/c Ratio	0.71	0.33	0.26	0.25	0.21
Control Delay	37.9	10.1	1.3	7.9	5.5
Queue Delay	0.0	1.6	0.0	0.0	0.1
Total Delay	37.9	11.7	1.3	7.9	5.5
Queue Length 50th (ft)	139	91	14	19	46
Queue Length 95th (ft)	179	143	40	51	74
Internal Link Dist (ft)	239	111			159
Turn Bay Length (ft)					
Base Capacity (vph)	1261	2428	1568	413	3489
Starvation Cap Reductn	0	1375	0	0	0
Spillback Cap Reductn	3	0	0	0	1028
Storage Cap Reductn	0	0	0	0	0
Reduced v/c Ratio	0.41	0.77	0.26	0.25	0.30
Intersection Summary					

Queues
36: Pine Street & Howard Road



Lane Group	EBL	EBT	WBL	WBT	NBL	NBT	NBR	SBT	SBR
Lane Group Flow (vph)	37	917	164	512	161	182	264	323	109
v/c Ratio	0.38	0.80	0.70	0.33	0.48	0.52	0.52	0.94	0.28
Control Delay	66.2	40.4	65.4	22.7	50.3	51.0	9.4	85.3	5.4
Queue Delay	0.0	0.0	0.0	0.0	0.0	0.0	0.0	0.0	0.0
Total Delay	66.2	40.4	65.4	22.7	50.3	51.0	9.4	85.3	5.4
Queue Length 50th (ft)	28	327	128	116	116	132	0	249	0
Queue Length 95th (ft)	65	368	#272	162	190	211	77	#427	31
Internal Link Dist (ft)		265		565		224		259	
Turn Bay Length (ft)	95		140		90				
Base Capacity (vph)	101	1372	233	1569	332	349	504	344	398
Starvation Cap Reductn	0	0	0	0	0	0	0	0	0
Spillback Cap Reductn	0	0	0	0	0	0	0	0	0
Storage Cap Reductn	0	0	0	0	0	0	0	0	0
Reduced v/c Ratio	0.37	0.67	0.70	0.33	0.48	0.52	0.52	0.94	0.27

Intersection Summary

95th percentile volume exceeds capacity, queue may be longer.
Queue shown is maximum after two cycles.

Queues

37: Olive Avenue/Q Street & Howard Road/Yosemite Avenue

Village D Specific Plan

Phase II WP - AM Peak Hour



Lane Group	EBL	EBT	EBR	WBL	WBT	NBL	NBT	NBR	SBL	SBT	SBR
Lane Group Flow (vph)	7	608	357	29	398	229	232	23	111	163	13
v/c Ratio	0.09	0.70	0.56	0.26	0.38	0.31	0.31	0.03	0.50	0.70	0.04
Control Delay	77.5	25.6	5.8	58.7	32.9	26.8	26.7	0.1	56.3	66.0	0.2
Queue Delay	0.0	0.0	0.0	0.0	0.0	0.0	0.0	0.0	0.0	0.0	0.0
Total Delay	77.5	25.6	5.8	58.7	32.9	26.8	26.7	0.1	56.3	66.0	0.2
Queue Length 50th (ft)	5	177	44	22	117	125	126	0	81	122	0
Queue Length 95th (ft)	m8	m258	m138	53	157	232	233	0	138	193	0
Internal Link Dist (ft)		565			230		220			195	
Turn Bay Length (ft)	40			80		130			50		50
Base Capacity (vph)	78	1025	695	265	1393	742	759	744	265	279	353
Starvation Cap Reductn	0	0	0	0	0	0	0	0	0	0	0
Spillback Cap Reductn	0	0	0	0	0	0	0	0	0	0	0
Storage Cap Reductn	0	0	0	0	0	0	0	0	0	0	0
Reduced v/c Ratio	0.09	0.59	0.51	0.11	0.29	0.31	0.31	0.03	0.42	0.58	0.04

Intersection Summary

m Volume for 95th percentile queue is metered by upstream signal.

Queues
39: 4th Street & Sunset Avenue



Lane Group	EBL	NBL	NBT	SBT	SBR
Lane Group Flow (vph)	453	37	382	545	308
v/c Ratio	0.71	0.15	0.15	0.51	0.25
Control Delay	40.5	32.3	4.4	9.1	0.6
Queue Delay	0.0	0.0	0.0	0.0	0.0
Total Delay	40.5	32.3	4.4	9.1	0.6
Queue Length 50th (ft)	122	17	32	78	0
Queue Length 95th (ft)	170	44	48	109	0
Internal Link Dist (ft)	7441		193	501	
Turn Bay Length (ft)	135				
Base Capacity (vph)	721	344	2542	1065	1272
Starvation Cap Reductn	0	0	0	0	0
Spillback Cap Reductn	0	0	0	0	0
Storage Cap Reductn	0	0	0	0	0
Reduced v/c Ratio	0.63	0.11	0.15	0.51	0.24
Intersection Summary					

Queues
41: I Street & 4th Street



Lane Group	EBL	EBT	WBL	WBT	NBL	NBT	NBR	SBL	SBT	SBR
Lane Group Flow (vph)	30	804	96	617	58	62	179	305	309	217
v/c Ratio	0.29	0.87	0.65	0.58	0.41	0.13	0.31	0.78	0.40	0.29
Control Delay	64.5	33.2	40.9	19.3	47.9	30.5	3.1	48.0	22.9	6.1
Queue Delay	0.0	0.0	0.0	0.0	0.0	0.0	0.0	0.0	0.0	0.0
Total Delay	64.5	33.2	40.9	19.3	47.9	30.5	3.1	48.0	22.9	6.1
Queue Length 50th (ft)	18	128	55	73	32	29	0	160	134	13
Queue Length 95th (ft)	m38	#174	m66	m85	70	64	24	#271	211	60
Internal Link Dist (ft)		501		26		314			779	
Turn Bay Length (ft)	130				45		25	80		80
Base Capacity (vph)	104	951	153	1117	155	472	570	422	776	744
Starvation Cap Reductn	0	0	0	0	0	0	0	0	0	0
Spillback Cap Reductn	0	0	0	0	0	0	0	0	0	0
Storage Cap Reductn	0	0	0	0	0	0	0	0	0	0
Reduced v/c Ratio	0.29	0.85	0.63	0.55	0.37	0.13	0.31	0.72	0.40	0.29

Intersection Summary

95th percentile volume exceeds capacity, queue may be longer.

Queue shown is maximum after two cycles.

m Volume for 95th percentile queue is metered by upstream signal.

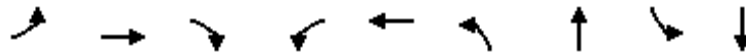

Lane Group	EBL	EBT	EBR	WBL	WBT	NBL	NBT	SBL	SBT
Lane Group Flow (vph)	604	924	153	35	1177	174	34	303	564
v/c Ratio	4.35	0.70	0.22	0.25	2.25	1.23	0.06	2.15	0.93
Control Delay	1534.2	23.2	3.4	32.6	590.0	183.6	0.2	561.2	40.2
Queue Delay	0.0	0.0	0.0	0.0	0.0	0.0	0.0	0.0	0.0
Total Delay	1534.2	23.2	3.4	32.6	590.0	183.6	0.2	561.2	40.2
Queue Length 50th (ft)	~446	138	0	13	~776	~86	0	~194	137
Queue Length 95th (ft)	#622	#292	28	38	#1003	#194	0	#330	#328
Internal Link Dist (ft)		423			402		160		227
Turn Bay Length (ft)	100		100	100					
Base Capacity (vph)	139	1323	705	138	522	141	600	141	605
Starvation Cap Reductn	0	0	0	0	0	0	0	0	0
Spillback Cap Reductn	0	0	0	0	0	0	0	0	0
Storage Cap Reductn	0	0	0	0	0	0	0	0	0
Reduced v/c Ratio	4.35	0.70	0.22	0.25	2.25	1.23	0.06	2.15	0.93

Intersection Summary

~ Volume exceeds capacity, queue is theoretically infinite.
 Queue shown is maximum after two cycles.

95th percentile volume exceeds capacity, queue may be longer.
 Queue shown is maximum after two cycles.

Queues
23: Avenue 16/Ellis Street & Kennedy Street

Village D Specific Plan
Phase II WP - PM Peak Hour



Lane Group	WBL	WBR	NBT	SBL	SBT
Lane Group Flow (vph)	165	243	742	261	468
v/c Ratio	0.59	0.38	0.42	0.74	0.18
Control Delay	25.6	10.4	8.8	45.3	4.0
Queue Delay	0.0	0.0	0.0	0.0	0.0
Total Delay	25.6	10.4	8.8	45.3	4.0
Queue Length 50th (ft)	79	21	68	118	31
Queue Length 95th (ft)	130	51	112	#258	57
Internal Link Dist (ft)	782		506		440
Turn Bay Length (ft)	175			280	
Base Capacity (vph)	409	831	1750	354	2604
Starvation Cap Reductn	0	0	0	0	0
Spillback Cap Reductn	0	0	0	0	0
Storage Cap Reductn	0	0	0	0	0
Reduced v/c Ratio	0.40	0.29	0.42	0.74	0.18

Intersection Summary

95th percentile volume exceeds capacity, queue may be longer.
Queue shown is maximum after two cycles.

Queues
24: Schnoor Avenue & Kennedy Street



Lane Group	EBL	EBT	WBL	WBT	NBL	NBT	SBL	SBT	SBR
Lane Group Flow (vph)	74	477	265	329	211	416	152	54	33
v/c Ratio	0.35	0.68	0.75	0.67	0.57	0.55	1.31	0.11	0.06
Control Delay	32.4	12.2	44.6	29.2	40.7	9.7	222.3	23.7	0.2
Queue Delay	0.0	0.0	0.0	0.0	0.0	0.0	0.0	0.0	0.0
Total Delay	32.4	12.2	44.6	29.2	40.7	9.7	222.3	23.7	0.2
Queue Length 50th (ft)	37	56	122	130	52	37	-99	20	0
Queue Length 95th (ft)	m68	62	#233	191	86	129	#212	50	0
Internal Link Dist (ft)		782		187		321		193	
Turn Bay Length (ft)	95		40		75		60		
Base Capacity (vph)	211	908	380	669	368	762	116	501	567
Starvation Cap Reductn	0	0	0	0	0	0	0	0	0
Spillback Cap Reductn	0	0	0	0	0	0	0	0	0
Storage Cap Reductn	0	0	0	0	0	0	0	0	0
Reduced v/c Ratio	0.35	0.53	0.70	0.49	0.57	0.55	1.31	0.11	0.06

Intersection Summary

- ~ Volume exceeds capacity, queue is theoretically infinite.
Queue shown is maximum after two cycles.
- # 95th percentile volume exceeds capacity, queue may be longer.
Queue shown is maximum after two cycles.
- m Volume for 95th percentile queue is metered by upstream signal.

Queues
29: Schnoor Avenue & Cleveland Avenue



Lane Group	EBL	EBT	EBR	WBL	WBT	WBR	NBL	NBT	NBR	SBL	SBT	SBR
Lane Group Flow (vph)	158	709	60	295	1128	123	97	254	160	130	245	145
v/c Ratio	0.73	0.71	0.11	0.41	0.87	0.18	0.81	0.30	0.21	0.88	0.28	0.28
Control Delay	58.5	32.9	0.4	12.9	11.2	0.4	86.9	30.4	5.3	90.7	28.7	3.7
Queue Delay	0.0	0.0	0.0	0.0	0.0	0.0	0.0	0.0	0.0	0.0	0.0	0.0
Total Delay	58.5	32.9	0.4	12.9	11.2	0.4	86.9	30.4	5.3	90.7	28.7	3.7
Queue Length 50th (ft)	87	191	0	44	54	1	56	64	9	74	60	0
Queue Length 95th (ft)	#174	225	0	m74	m61	m0	#148	99	48	#179	93	28
Internal Link Dist (ft)		2178			574			393			326	
Turn Bay Length (ft)	120		60	220		95	75		75	105		65
Base Capacity (vph)	228	1294	680	712	1330	701	120	837	771	148	887	524
Starvation Cap Reductn	0	0	0	0	0	0	0	0	0	0	0	0
Spillback Cap Reductn	0	0	0	0	0	0	0	0	0	0	0	0
Storage Cap Reductn	0	0	0	0	0	0	0	0	0	0	0	0
Reduced v/c Ratio	0.69	0.55	0.09	0.41	0.85	0.18	0.81	0.30	0.21	0.88	0.28	0.28

Intersection Summary

95th percentile volume exceeds capacity, queue may be longer.
Queue shown is maximum after two cycles.

m Volume for 95th percentile queue is metered by upstream signal.

Queues
30: Fairgrounds & Cleveland Avenue



Lane Group	EBL	EBT	WBL	WBT	WBR	NBL	NBT	NBR	SBL	SBT
Lane Group Flow (vph)	105	945	180	1260	194	103	85	78	348	160
v/c Ratio	0.81	0.61	0.79	0.98	0.28	0.42	0.23	0.16	1.20	0.26
Control Delay	66.2	10.6	54.9	30.2	2.4	45.6	19.4	0.7	153.7	8.7
Queue Delay	0.0	0.0	0.0	0.0	0.0	0.0	0.0	0.0	0.0	0.0
Total Delay	66.2	10.6	54.9	30.2	2.4	45.6	19.4	0.7	153.7	8.7
Queue Length 50th (ft)	63	55	95	287	15	29	22	0	~242	15
Queue Length 95th (ft)	m#143	m108	m128	#506	m18	55	63	0	#409	61
Internal Link Dist (ft)		574		1412			192			168
Turn Bay Length (ft)	120		205					100		
Base Capacity (vph)	129	1561	236	1290	689	249	374	498	290	614
Starvation Cap Reductn	0	0	0	0	0	0	0	0	0	0
Spillback Cap Reductn	0	0	0	0	0	0	0	0	0	0
Storage Cap Reductn	0	0	0	0	0	0	0	0	0	0
Reduced v/c Ratio	0.81	0.61	0.76	0.98	0.28	0.41	0.23	0.16	1.20	0.26

Intersection Summary

- ~ Volume exceeds capacity, queue is theoretically infinite.
Queue shown is maximum after two cycles.
- # 95th percentile volume exceeds capacity, queue may be longer.
Queue shown is maximum after two cycles.
- m Volume for 95th percentile queue is metered by upstream signal.

Queues
33: Gateway Drive & Cleveland Avenue

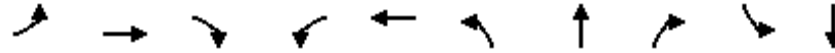

Lane Group	EBL	EBT	EBR	WBL	WBT	NBL	NBT	NBR	SBL	SBT
Lane Group Flow (vph)	17	1101	341	227	1252	362	149	294	220	195
v/c Ratio	0.09	0.70	0.39	0.65	0.85	0.75	0.31	0.58	0.94	0.23
Control Delay	7.1	12.4	1.5	48.4	30.1	47.8	30.8	19.7	85.2	26.7
Queue Delay	0.0	1.5	0.1	2.8	48.3	64.3	0.0	0.5	0.0	0.0
Total Delay	7.1	13.9	1.6	51.3	78.4	112.2	30.8	20.2	85.2	26.7
Queue Length 50th (ft)	2	61	3	68	237	103	72	69	126	44
Queue Length 95th (ft)	m4	103	5	#117	#477	#160	127	156	#262	74
Internal Link Dist (ft)		207			111		765			296
Turn Bay Length (ft)	110					245			45	
Base Capacity (vph)	183	1762	874	351	1469	485	474	511	235	857
Starvation Cap Reductn	0	333	96	54	484	0	0	0	0	0
Spillback Cap Reductn	0	439	0	0	167	309	0	41	0	1
Storage Cap Reductn	0	0	0	0	0	0	0	0	0	0
Reduced v/c Ratio	0.09	0.83	0.44	0.76	1.27	2.06	0.31	0.63	0.94	0.23

Intersection Summary

95th percentile volume exceeds capacity, queue may be longer.

Queue shown is maximum after two cycles.

m Volume for 95th percentile queue is metered by upstream signal.

Queues
34: Cleveland Avenue & County Club Drive



Lane Group	WBL	NBT	NBR	SBL	SBT
Lane Group Flow (vph)	626	953	644	129	877
v/c Ratio	0.74	0.41	0.41	0.40	0.26
Control Delay	36.3	13.8	1.9	13.1	7.0
Queue Delay	0.0	11.5	0.0	0.0	0.1
Total Delay	36.4	25.3	1.9	13.1	7.2
Queue Length 50th (ft)	168	150	19	30	66
Queue Length 95th (ft)	206	m205	m54	86	105
Internal Link Dist (ft)	239	111			159
Turn Bay Length (ft)					
Base Capacity (vph)	1378	2331	1563	322	3349
Starvation Cap Reductn	0	1358	0	0	0
Spillback Cap Reductn	52	0	0	0	1207
Storage Cap Reductn	0	0	0	0	0
Reduced v/c Ratio	0.47	0.98	0.41	0.40	0.41

Intersection Summary

m Volume for 95th percentile queue is metered by upstream signal.

Queues
36: Pine Street & Howard Road



Lane Group	EBL	EBT	WBL	WBT	NBL	NBT	NBR	SBT	SBR
Lane Group Flow (vph)	95	836	111	630	226	202	172	187	129
v/c Ratio	0.38	0.84	0.64	0.72	0.49	0.42	0.32	0.65	0.32
Control Delay	43.1	37.5	53.6	33.6	34.2	32.4	5.9	46.1	3.9
Queue Delay	0.0	0.0	0.0	0.0	0.0	0.0	0.0	0.0	0.0
Total Delay	43.1	37.5	53.6	33.6	34.2	32.4	5.9	46.1	3.9
Queue Length 50th (ft)	48	221	65	192	115	101	0	101	0
Queue Length 95th (ft)	#134	293	#154	197	189	168	45	162	19
Internal Link Dist (ft)		265		561		224		259	
Turn Bay Length (ft)	95		140		90				
Base Capacity (vph)	250	1056	174	1091	462	486	543	370	462
Starvation Cap Reductn	0	0	0	0	0	0	0	0	0
Spillback Cap Reductn	0	0	0	0	0	0	0	0	0
Storage Cap Reductn	0	0	0	0	0	0	0	0	0
Reduced v/c Ratio	0.38	0.79	0.64	0.58	0.49	0.42	0.32	0.51	0.28

Intersection Summary

95th percentile volume exceeds capacity, queue may be longer.
Queue shown is maximum after two cycles.

Queues

37: Olive Avenue/Q Street & Howard Road/Yosemite Avenue

Village D Specific Plan

Phase II WP - PM Peak Hour



Lane Group	EBL	EBT	EBR	WBL	WBT	NBL	NBT	NBR	SBL	SBT	SBR
Lane Group Flow (vph)	8	499	363	14	416	244	252	14	18	62	2
v/c Ratio	0.07	0.63	0.58	0.11	0.52	0.27	0.27	0.02	0.11	0.36	0.01
Control Delay	41.3	14.2	4.5	40.8	32.1	16.5	16.5	0.0	37.6	43.3	0.0
Queue Delay	0.0	0.0	0.0	0.0	0.0	0.0	0.0	0.0	0.0	0.0	0.0
Total Delay	41.3	14.2	4.5	40.8	32.1	16.5	16.5	0.0	37.6	43.3	0.0
Queue Length 50th (ft)	3	48	0	8	108	74	77	0	10	34	0
Queue Length 95th (ft)	m5	m92	m25	26	143	189	194	0	29	71	0
Internal Link Dist (ft)		561			230		220			195	
Turn Bay Length (ft)	40			80		130			50		50
Base Capacity (vph)	118	821	640	357	1226	908	924	927	357	376	465
Starvation Cap Reductn	0	0	0	0	0	0	0	0	0	0	0
Spillback Cap Reductn	0	0	0	0	0	0	0	0	0	0	0
Storage Cap Reductn	0	0	0	0	0	0	0	0	0	0	0
Reduced v/c Ratio	0.07	0.61	0.57	0.04	0.34	0.27	0.27	0.02	0.05	0.16	0.00

Intersection Summary

m Volume for 95th percentile queue is metered by upstream signal.

Queues
39: 4th Street & Sunset Avenue



Lane Group	EBL	NBL	NBT	SBT	SBR
Lane Group Flow (vph)	278	15	412	441	414
v/c Ratio	0.58	0.08	0.15	0.35	0.31
Control Delay	44.5	38.3	3.3	4.3	0.7
Queue Delay	0.0	0.0	0.0	0.0	0.0
Total Delay	44.5	38.3	3.3	4.3	0.7
Queue Length 50th (ft)	85	9	27	51	0
Queue Length 95th (ft)	121	27	49	106	0
Internal Link Dist (ft)	7441		193	501	
Turn Bay Length (ft)	135				
Base Capacity (vph)	962	292	2741	1274	1397
Starvation Cap Reductn	0	0	0	0	0
Spillback Cap Reductn	0	0	0	0	0
Storage Cap Reductn	0	0	0	0	0
Reduced v/c Ratio	0.29	0.05	0.15	0.35	0.30
Intersection Summary					

Queues
41: I Street & 4th Street



Lane Group	EBL	EBT	WBL	WBT	NBL	NBT	NBR	SBL	SBT	SBR
Lane Group Flow (vph)	41	701	66	697	111	79	274	217	185	159
v/c Ratio	0.33	0.80	0.45	0.70	0.58	0.13	0.40	0.63	0.25	0.22
Control Delay	44.6	30.6	42.5	19.2	54.5	29.8	6.7	45.3	24.1	4.9
Queue Delay	0.0	0.0	0.0	0.2	0.0	0.0	0.0	0.0	0.0	0.0
Total Delay	44.6	30.6	42.5	19.4	54.5	29.8	6.7	45.3	24.1	4.9
Queue Length 50th (ft)	26	202	45	98	68	39	5	127	84	0
Queue Length 95th (ft)	61	248	m57	m111	123	80	70	201	145	44
Internal Link Dist (ft)		501		26		314			779	
Turn Bay Length (ft)	130				45		25	80		80
Base Capacity (vph)	128	955	169	1109	226	586	679	380	744	719
Starvation Cap Reductn	0	0	0	63	0	0	0	0	0	0
Spillback Cap Reductn	0	0	0	0	0	0	0	0	0	0
Storage Cap Reductn	0	0	0	0	0	0	0	0	0	0
Reduced v/c Ratio	0.32	0.73	0.39	0.67	0.49	0.13	0.40	0.57	0.25	0.22

Intersection Summary

m Volume for 95th percentile queue is metered by upstream signal.

Queues

16: Love's Truck Stop Driveway/Driveway & Avenue 17

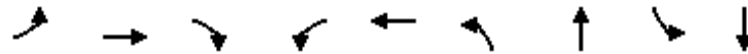

Lane Group	EBL	EBT	EBR	WBL	WBT	NBL	NBT	SBL	SBT
Lane Group Flow (vph)	176	432	143	49	1015	148	24	52	98
v/c Ratio	0.98	0.23	0.16	0.43	1.11	0.96	0.03	0.44	0.23
Control Delay	117.0	14.4	2.6	65.1	93.2	117.9	0.1	65.2	1.3
Queue Delay	0.0	0.0	0.0	0.0	0.0	0.0	0.0	0.0	0.0
Total Delay	117.0	14.4	2.6	65.1	93.2	117.9	0.1	65.2	1.3
Queue Length 50th (ft)	138	90	0	37	-898	116	0	39	0
Queue Length 95th (ft)	#284	122	31	78	#1155	#249	0	81	0
Internal Link Dist (ft)		311			402		160		226
Turn Bay Length (ft)	100		100	100					
Base Capacity (vph)	179	1884	905	129	917	154	691	133	425
Starvation Cap Reductn	0	0	0	0	0	0	0	0	0
Spillback Cap Reductn	0	0	0	0	0	0	0	0	0
Storage Cap Reductn	0	0	0	0	0	0	0	0	0
Reduced v/c Ratio	0.98	0.23	0.16	0.38	1.11	0.96	0.03	0.39	0.23

Intersection Summary

~ Volume exceeds capacity, queue is theoretically infinite.
 Queue shown is maximum after two cycles.

95th percentile volume exceeds capacity, queue may be longer.
 Queue shown is maximum after two cycles.

Queues
 23: Avenue 16/Ellis Street & Kennedy Street

Village D Specific Plan
 Phase III NP - AM Peak Hour



Lane Group	WBL	WBR	NBT	SBL	SBT
Lane Group Flow (vph)	263	183	669	296	402
v/c Ratio	0.74	0.26	0.57	0.57	0.17
Control Delay	33.9	5.6	21.0	29.1	5.2
Queue Delay	0.0	0.0	0.0	0.0	0.0
Total Delay	33.9	5.6	21.0	29.1	5.2
Queue Length 50th (ft)	89	0	119	125	33
Queue Length 95th (ft)	m142	m6	182	204	54
Internal Link Dist (ft)	782		506		440
Turn Bay Length (ft)	175			280	
Base Capacity (vph)	423	804	1167	519	2416
Starvation Cap Reductn	0	0	0	0	0
Spillback Cap Reductn	0	0	0	0	0
Storage Cap Reductn	0	0	0	0	0
Reduced v/c Ratio	0.62	0.23	0.57	0.57	0.17

Intersection Summary

m Volume for 95th percentile queue is metered by upstream signal.

Queues
24: Schnoor Avenue & Kennedy Street



Lane Group	EBL	EBT	WBL	WBT	NBL	NBT	SBL	SBT	SBR
Lane Group Flow (vph)	126	413	220	519	136	366	150	47	37
v/c Ratio	1.06	0.48	0.72	0.87	0.53	0.51	1.65	0.11	0.07
Control Delay	134.9	8.2	44.8	39.0	43.6	7.6	364.3	23.0	0.3
Queue Delay	0.0	0.0	0.0	0.0	0.0	0.0	0.0	0.0	0.0
Total Delay	134.9	8.2	44.8	39.0	43.6	7.6	364.3	23.0	0.3
Queue Length 50th (ft)	~72	28	103	206	34	19	~110	18	0
Queue Length 95th (ft)	m#170	49	173	#365	62	90	#223	44	0
Internal Link Dist (ft)		782		187		321		193	
Turn Bay Length (ft)	95		40		75		60		
Base Capacity (vph)	119	890	354	659	258	721	91	424	503
Starvation Cap Reductn	0	0	0	0	0	0	0	0	0
Spillback Cap Reductn	0	0	0	0	0	0	0	0	0
Storage Cap Reductn	0	0	0	0	0	0	0	0	0
Reduced v/c Ratio	1.06	0.46	0.62	0.79	0.53	0.51	1.65	0.11	0.07

Intersection Summary

~ Volume exceeds capacity, queue is theoretically infinite.
Queue shown is maximum after two cycles.

95th percentile volume exceeds capacity, queue may be longer.
Queue shown is maximum after two cycles.

m Volume for 95th percentile queue is metered by upstream signal.

Queues
29: Schnoor Avenue & Cleveland Avenue

Village D Specific Plan
Phase III NP - AM Peak Hour



Lane Group	EBL	EBT	EBR	WBL	WBT	WBR	NBL	NBT	NBR	SBL	SBT	SBR
Lane Group Flow (vph)	123	501	52	183	240	52	55	293	195	102	208	66
v/c Ratio	0.53	0.64	0.10	0.45	0.29	0.10	0.36	0.22	0.22	0.64	0.15	0.09
Control Delay	40.5	31.7	0.4	24.0	13.7	4.0	41.4	20.9	2.9	54.7	19.3	0.2
Queue Delay	0.0	0.0	0.0	0.0	0.0	0.0	0.0	0.0	0.0	0.0	0.0	0.0
Total Delay	40.5	31.7	0.4	24.0	13.7	4.0	41.4	20.9	2.9	54.7	19.3	0.2
Queue Length 50th (ft)	58	120	0	51	65	4	26	54	0	50	38	0
Queue Length 95th (ft)	106	153	0	84	101	23	#64	100	35	#116	71	0
Internal Link Dist (ft)		2178			574			393			326	
Turn Bay Length (ft)	120		60	220		95	75		75	105		65
Base Capacity (vph)	293	1292	694	407	984	579	154	1311	872	164	1393	731
Starvation Cap Reductn	0	0	0	0	0	0	0	0	0	0	0	0
Spillback Cap Reductn	0	0	0	0	0	0	0	0	0	0	0	0
Storage Cap Reductn	0	0	0	0	0	0	0	0	0	0	0	0
Reduced v/c Ratio	0.42	0.39	0.07	0.45	0.24	0.09	0.36	0.22	0.22	0.62	0.15	0.09

Intersection Summary

95th percentile volume exceeds capacity, queue may be longer.
Queue shown is maximum after two cycles.

Queues
30: Fairgrounds & Cleveland Avenue



Lane Group	EBL	EBT	WBL	WBT	WBR	NBL	NBT	NBR	SBL	SBT
Lane Group Flow (vph)	116	738	41	404	135	15	21	19	167	48
v/c Ratio	0.53	0.57	0.26	0.57	0.28	0.06	0.04	0.03	0.67	0.06
Control Delay	38.1	28.0	37.1	31.7	2.5	35.6	15.6	0.1	47.9	6.8
Queue Delay	0.0	0.0	0.0	0.0	0.0	0.0	0.0	0.0	0.0	0.0
Total Delay	38.1	28.0	37.1	31.7	2.5	35.6	15.6	0.1	47.9	6.8
Queue Length 50th (ft)	43	81	20	97	0	3	3	0	78	1
Queue Length 95th (ft)	m66	82	48	130	12	12	22	0	#170	25
Internal Link Dist (ft)		574		1412			192			168
Turn Bay Length (ft)	120		205					100		
Base Capacity (vph)	226	1418	227	1019	600	244	562	692	258	843
Starvation Cap Reductn	0	0	0	0	0	0	0	0	0	0
Spillback Cap Reductn	0	0	0	0	0	0	0	0	0	0
Storage Cap Reductn	0	0	0	0	0	0	0	0	0	0
Reduced v/c Ratio	0.51	0.52	0.18	0.40	0.23	0.06	0.04	0.03	0.65	0.06

Intersection Summary

95th percentile volume exceeds capacity, queue may be longer.

Queue shown is maximum after two cycles.

m Volume for 95th percentile queue is metered by upstream signal.

Queues
33: Gateway Drive & Cleveland Avenue

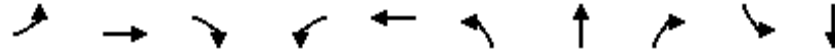

Lane Group	EBL	EBT	EBR	WBL	WBT	NBL	NBT	NBR	SBL	SBT
Lane Group Flow (vph)	4	814	158	258	941	149	54	213	73	101
v/c Ratio	0.02	0.66	0.23	0.58	0.66	0.35	0.09	0.32	0.45	0.10
Control Delay	15.5	19.6	2.5	44.0	27.3	38.3	25.2	5.6	47.2	25.1
Queue Delay	0.0	0.1	0.0	4.3	39.6	0.0	0.0	0.0	0.0	0.0
Total Delay	15.5	19.8	2.5	48.3	66.9	38.3	25.2	5.6	47.2	25.1
Queue Length 50th (ft)	1	86	0	62	195	40	22	0	40	21
Queue Length 95th (ft)	m4	114	17	93	245	69	54	54	83	45
Internal Link Dist (ft)		207			111		765			296
Turn Bay Length (ft)	110					245			45	
Base Capacity (vph)	162	1745	680	449	1477	425	621	658	182	1006
Starvation Cap Reductn	0	236	0	123	600	0	0	0	0	0
Spillback Cap Reductn	0	0	0	0	185	0	0	0	0	0
Storage Cap Reductn	0	0	0	0	0	0	0	0	0	0
Reduced v/c Ratio	0.02	0.54	0.23	0.79	1.07	0.35	0.09	0.32	0.40	0.10

Intersection Summary

m Volume for 95th percentile queue is metered by upstream signal.

Queues
 34: Cleveland Avenue & County Club Drive

Village D Specific Plan
 Phase III NP - AM Peak Hour



Lane Group	WBL	NBT	NBR	SBL	SBT
Lane Group Flow (vph)	520	850	250	113	732
v/c Ratio	0.72	0.35	0.16	0.29	0.21
Control Delay	37.7	3.4	0.2	8.5	5.5
Queue Delay	0.0	0.6	0.0	0.0	0.1
Total Delay	37.8	4.1	0.2	8.5	5.5
Queue Length 50th (ft)	138	18	0	21	46
Queue Length 95th (ft)	179	47	0	58	75
Internal Link Dist (ft)	239	111			159
Turn Bay Length (ft)					
Base Capacity (vph)	1260	2430	1568	393	3491
Starvation Cap Reductn	0	1111	0	0	0
Spillback Cap Reductn	65	0	0	0	1123
Storage Cap Reductn	0	0	0	0	0
Reduced v/c Ratio	0.44	0.64	0.16	0.29	0.31
Intersection Summary					

Queues
36: Pine Street & Howard Road



Lane Group	EBL	EBT	WBL	WBT	NBL	NBT	NBR	SBT	SBR
Lane Group Flow (vph)	38	852	177	485	132	186	275	323	111
v/c Ratio	0.39	0.79	0.65	0.31	0.40	0.53	0.54	0.94	0.28
Control Delay	66.7	42.3	58.3	21.1	47.9	51.2	9.4	85.3	5.7
Queue Delay	0.0	0.0	0.0	0.0	0.0	0.0	0.0	0.0	0.0
Total Delay	66.7	42.3	58.3	21.1	47.9	51.2	9.4	85.3	5.7
Queue Length 50th (ft)	29	311	139	103	92	134	0	249	0
Queue Length 95th (ft)	66	351	#268	142	158	215	79	#427	32
Internal Link Dist (ft)		265		561		224		259	
Turn Bay Length (ft)	95		140		90				
Base Capacity (vph)	101	1387	273	1576	331	348	512	344	398
Starvation Cap Reductn	0	0	0	0	0	0	0	0	0
Spillback Cap Reductn	0	0	0	0	0	0	0	0	0
Storage Cap Reductn	0	0	0	0	0	0	0	0	0
Reduced v/c Ratio	0.38	0.61	0.65	0.31	0.40	0.53	0.54	0.94	0.28

Intersection Summary

95th percentile volume exceeds capacity, queue may be longer.
Queue shown is maximum after two cycles.

Queues

37: Olive Avenue/Q Street & Howard Road/Yosemite Avenue

Village D Specific Plan

Phase III NP - AM Peak Hour



Lane Group	EBL	EBT	EBR	WBL	WBT	NBL	NBT	NBR	SBL	SBT	SBR
Lane Group Flow (vph)	7	617	365	30	400	219	226	23	113	165	14
v/c Ratio	0.09	0.71	0.56	0.27	0.38	0.30	0.30	0.03	0.51	0.71	0.04
Control Delay	86.0	29.3	5.2	58.9	32.6	27.0	26.9	0.1	56.5	66.3	0.2
Queue Delay	0.0	0.0	0.0	0.0	0.0	0.0	0.0	0.0	0.0	0.0	0.0
Total Delay	86.0	29.3	5.2	58.9	32.6	27.0	26.9	0.1	56.5	66.3	0.2
Queue Length 50th (ft)	6	91	0	23	117	120	124	0	82	123	0
Queue Length 95th (ft)	m9	m175	m12	53	157	224	229	0	140	195	0
Internal Link Dist (ft)		561			230		220			195	
Turn Bay Length (ft)	40			80		130			50		50
Base Capacity (vph)	78	1026	701	265	1393	729	746	733	265	279	353
Starvation Cap Reductn	0	0	0	0	0	0	0	0	0	0	0
Spillback Cap Reductn	0	0	0	0	0	0	0	0	0	0	0
Storage Cap Reductn	0	0	0	0	0	0	0	0	0	0	0
Reduced v/c Ratio	0.09	0.60	0.52	0.11	0.29	0.30	0.30	0.03	0.43	0.59	0.04

Intersection Summary

m Volume for 95th percentile queue is metered by upstream signal.

Queues
39: 4th Street & Sunset Avenue



Lane Group	EBL	NBL	NBT	SBT	SBR
Lane Group Flow (vph)	460	38	382	502	312
v/c Ratio	0.72	0.34	0.15	0.41	0.23
Control Delay	40.9	48.6	4.4	10.1	0.6
Queue Delay	0.0	0.0	0.0	0.0	0.0
Total Delay	40.9	48.6	4.4	10.1	0.6
Queue Length 50th (ft)	123	21	32	148	0
Queue Length 95th (ft)	173	53	47	221	9
Internal Link Dist (ft)	7441		193	501	
Turn Bay Length (ft)	135				
Base Capacity (vph)	705	113	2541	1211	1366
Starvation Cap Reductn	0	0	0	0	0
Spillback Cap Reductn	0	0	0	0	0
Storage Cap Reductn	0	0	0	0	0
Reduced v/c Ratio	0.65	0.34	0.15	0.41	0.23
Intersection Summary					

Queues
41: I Street & 4th Street



Lane Group	EBL	EBT	WBL	WBT	NBL	NBT	NBR	SBL	SBT	SBR
Lane Group Flow (vph)	32	800	97	639	59	63	183	274	312	162
v/c Ratio	0.29	0.87	0.62	0.60	0.44	0.13	0.32	0.74	0.41	0.22
Control Delay	47.1	42.3	49.6	27.5	50.2	30.6	3.3	45.5	23.1	3.2
Queue Delay	0.0	0.0	0.0	0.0	0.0	0.0	0.0	0.0	0.0	0.0
Total Delay	47.1	42.3	49.6	27.5	50.2	30.6	3.3	45.5	23.1	3.2
Queue Length 50th (ft)	18	223	59	163	33	30	0	143	136	0
Queue Length 95th (ft)	47	#318	m67	m177	72	64	26	228	213	32
Internal Link Dist (ft)		501		26		314			779	
Turn Bay Length (ft)	130				45		25	80		80
Base Capacity (vph)	113	950	165	1117	142	478	575	404	768	737
Starvation Cap Reductn	0	0	0	0	0	0	0	0	0	0
Spillback Cap Reductn	0	0	0	0	0	0	0	0	0	0
Storage Cap Reductn	0	0	0	0	0	0	0	0	0	0
Reduced v/c Ratio	0.28	0.84	0.59	0.57	0.42	0.13	0.32	0.68	0.41	0.22

Intersection Summary

95th percentile volume exceeds capacity, queue may be longer.

Queue shown is maximum after two cycles.

m Volume for 95th percentile queue is metered by upstream signal.

Queues
 16: Love's Truck Stop Driveway/Driveway & Avenue 17

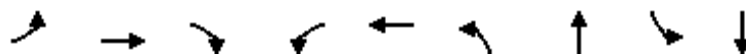

Lane Group	EBL	EBT	EBR	WBL	WBT	NBL	NBT	SBL	SBT
Lane Group Flow (vph)	604	790	153	35	920	174	34	303	564
v/c Ratio	1.55	0.41	0.16	0.38	1.49	1.37	0.07	1.49	0.88
Control Delay	292.5	17.3	3.8	66.6	258.0	250.0	0.3	283.1	31.4
Queue Delay	0.0	0.0	0.0	0.0	0.0	0.0	0.0	0.0	0.0
Total Delay	292.5	17.3	3.8	66.6	258.0	250.0	0.3	283.1	31.4
Queue Length 50th (ft)	~659	195	6	27	-985	~177	0	~325	152
Queue Length 95th (ft)	#883	246	40	62	#1237	#322	0	#504	#365
Internal Link Dist (ft)		423			402		160		227
Turn Bay Length (ft)	100		100	100					
Base Capacity (vph)	390	1939	929	96	619	127	454	203	640
Starvation Cap Reductn	0	0	0	0	0	0	0	0	0
Spillback Cap Reductn	0	0	0	0	0	0	0	0	0
Storage Cap Reductn	0	0	0	0	0	0	0	0	0
Reduced v/c Ratio	1.55	0.41	0.16	0.36	1.49	1.37	0.07	1.49	0.88

Intersection Summary

- ~ Volume exceeds capacity, queue is theoretically infinite.
 Queue shown is maximum after two cycles.
- # 95th percentile volume exceeds capacity, queue may be longer.
 Queue shown is maximum after two cycles.

Queues
 23: Avenue 16/Ellis Street & Kennedy Street

Village D Specific Plan
 Phase III NP - PM Peak Hour



Lane Group	WBL	WBR	NBT	SBL	SBT
Lane Group Flow (vph)	192	251	880	293	443
v/c Ratio	0.62	0.36	0.56	0.69	0.17
Control Delay	23.4	5.7	13.8	36.9	4.4
Queue Delay	0.0	0.0	0.0	0.0	0.0
Total Delay	23.4	5.7	13.8	36.9	4.4
Queue Length 50th (ft)	69	1	109	131	31
Queue Length 95th (ft)	126	25	191	212	60
Internal Link Dist (ft)	782		506		440
Turn Bay Length (ft)	175			280	
Base Capacity (vph)	564	1059	1570	423	2546
Starvation Cap Reductn	0	0	0	0	0
Spillback Cap Reductn	0	0	0	0	0
Storage Cap Reductn	0	0	0	0	0
Reduced v/c Ratio	0.34	0.24	0.56	0.69	0.17
Intersection Summary					

Queues
24: Schnoor Avenue & Kennedy Street



Lane Group	EBL	EBT	WBL	WBT	NBL	NBT	SBL	SBT	SBR
Lane Group Flow (vph)	107	566	265	411	215	443	216	73	46
v/c Ratio	0.53	0.72	0.72	0.79	0.58	0.67	1.86	0.16	0.09
Control Delay	43.7	15.5	41.8	33.4	41.1	18.5	444.8	25.2	0.3
Queue Delay	0.0	0.0	0.0	0.0	0.0	0.0	0.0	0.0	0.0
Total Delay	43.7	15.5	41.8	33.4	41.1	18.5	444.8	25.2	0.3
Queue Length 50th (ft)	55	58	119	161	53	95	~167	29	0
Queue Length 95th (ft)	m#133	118	#233	232	88	#211	#298	63	0
Internal Link Dist (ft)		782		187		321		193	
Turn Bay Length (ft)	95		40		75		60		
Base Capacity (vph)	203	919	378	672	368	660	116	446	527
Starvation Cap Reductn	0	0	0	0	0	0	0	0	0
Spillback Cap Reductn	0	0	0	0	0	0	0	0	0
Storage Cap Reductn	0	0	0	0	0	0	0	0	0
Reduced v/c Ratio	0.53	0.62	0.70	0.61	0.58	0.67	1.86	0.16	0.09

Intersection Summary

- ~ Volume exceeds capacity, queue is theoretically infinite.
Queue shown is maximum after two cycles.
- # 95th percentile volume exceeds capacity, queue may be longer.
Queue shown is maximum after two cycles.
- m Volume for 95th percentile queue is metered by upstream signal.

Queues
29: Schnoor Avenue & Cleveland Avenue

Village D Specific Plan
Phase III NP - PM Peak Hour



Lane Group	EBL	EBT	EBR	WBL	WBT	WBR	NBL	NBT	NBR	SBL	SBT	SBR
Lane Group Flow (vph)	148	461	52	306	616	131	75	253	164	138	256	123
v/c Ratio	0.80	0.66	0.12	0.54	0.68	0.24	0.43	0.20	0.19	0.82	0.20	0.18
Control Delay	70.4	37.6	0.5	21.9	18.9	1.1	45.7	22.8	2.5	76.7	23.0	1.9
Queue Delay	0.0	0.0	0.0	0.0	0.0	0.0	0.0	0.0	0.0	0.0	0.0	0.0
Total Delay	70.4	37.6	0.5	21.9	18.9	1.1	45.7	22.8	2.5	76.7	23.0	1.9
Queue Length 50th (ft)	84	127	0	38	76	0	41	52	0	78	53	0
Queue Length 95th (ft)	#184	166	0	71	72	0	84	93	30	#179	97	14
Internal Link Dist (ft)		2178			574			393			326	
Turn Bay Length (ft)	120		60	220		95	75		75	105		65
Base Capacity (vph)	188	1254	665	567	1370	717	176	1238	886	168	1310	687
Starvation Cap Reductn	0	0	0	0	0	0	0	0	0	0	0	0
Spillback Cap Reductn	0	0	0	0	0	0	0	0	0	0	0	0
Storage Cap Reductn	0	0	0	0	0	0	0	0	0	0	0	0
Reduced v/c Ratio	0.79	0.37	0.08	0.54	0.45	0.18	0.43	0.20	0.19	0.82	0.20	0.18

Intersection Summary

95th percentile volume exceeds capacity, queue may be longer.
Queue shown is maximum after two cycles.

Queues
30: Fairgrounds & Cleveland Avenue



Lane Group	EBL	EBT	WBL	WBT	WBR	NBL	NBT	NBR	SBL	SBT
Lane Group Flow (vph)	111	705	188	748	202	105	87	81	352	171
v/c Ratio	0.56	0.49	0.82	0.70	0.33	0.43	0.21	0.15	1.21	0.26
Control Delay	43.6	14.9	55.8	18.6	5.6	45.7	19.0	0.6	158.7	8.4
Queue Delay	0.0	0.0	0.0	0.0	0.0	0.0	0.0	0.0	0.0	0.0
Total Delay	43.6	14.9	55.8	18.6	5.6	45.7	19.0	0.6	158.7	8.4
Queue Length 50th (ft)	67	140	91	172	17	29	23	0	~247	16
Queue Length 95th (ft)	m#165	m168	#213	205	42	56	65	0	#414	62
Internal Link Dist (ft)		574		1412			192			168
Turn Bay Length (ft)	120		205					100		
Base Capacity (vph)	197	1536	236	1330	709	249	412	528	290	655
Starvation Cap Reductn	0	0	0	0	0	0	0	0	0	0
Spillback Cap Reductn	0	0	0	0	0	0	0	0	0	0
Storage Cap Reductn	0	0	0	0	0	0	0	0	0	0
Reduced v/c Ratio	0.56	0.46	0.80	0.56	0.28	0.42	0.21	0.15	1.21	0.26

Intersection Summary

- ~ Volume exceeds capacity, queue is theoretically infinite.
Queue shown is maximum after two cycles.
- # 95th percentile volume exceeds capacity, queue may be longer.
Queue shown is maximum after two cycles.
- m Volume for 95th percentile queue is metered by upstream signal.

Queues
33: Gateway Drive & Cleveland Avenue

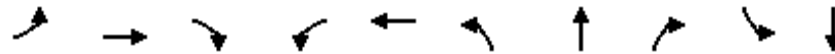

Lane Group	EBL	EBT	EBR	WBL	WBT	NBL	NBT	NBR	SBL	SBT
Lane Group Flow (vph)	18	1039	313	264	1114	252	164	329	248	216
v/c Ratio	0.10	0.68	0.37	0.68	0.76	0.52	0.35	0.65	1.06	0.25
Control Delay	7.7	15.2	1.7	41.8	23.7	40.2	31.3	24.0	114.0	27.3
Queue Delay	0.0	50.3	0.1	6.4	49.7	0.0	0.0	0.5	0.0	0.0
Total Delay	7.7	65.5	1.8	48.2	73.4	40.2	31.3	24.5	114.0	27.3
Queue Length 50th (ft)	3	86	5	62	136	69	80	94	~156	50
Queue Length 95th (ft)	m5	88	8	#130	382	107	138	191	#303	82
Internal Link Dist (ft)		207			111		765			296
Turn Bay Length (ft)	110					245			45	
Base Capacity (vph)	185	1762	840	391	1466	485	473	506	235	855
Starvation Cap Reductn	0	300	87	83	572	0	0	0	0	0
Spillback Cap Reductn	0	839	0	0	91	0	0	29	0	0
Storage Cap Reductn	0	0	0	0	0	0	0	0	0	0
Reduced v/c Ratio	0.10	1.13	0.42	0.86	1.25	0.52	0.35	0.69	1.06	0.25

Intersection Summary

- ~ Volume exceeds capacity, queue is theoretically infinite.
Queue shown is maximum after two cycles.
- # 95th percentile volume exceeds capacity, queue may be longer.
Queue shown is maximum after two cycles.
- m Volume for 95th percentile queue is metered by upstream signal.

Queues
34: Cleveland Avenue & County Club Drive



Lane Group	WBL	NBT	NBR	SBL	SBT
Lane Group Flow (vph)	488	1003	596	155	917
v/c Ratio	0.70	0.40	0.38	0.46	0.26
Control Delay	37.9	17.3	1.3	12.6	5.5
Queue Delay	0.1	51.6	0.0	0.0	0.0
Total Delay	38.0	69.0	1.3	12.6	5.5
Queue Length 50th (ft)	130	225	21	33	59
Queue Length 95th (ft)	170	m258	m21	100	93
Internal Link Dist (ft)	239	111			159
Turn Bay Length (ft)					
Base Capacity (vph)	1375	2481	1563	334	3566
Starvation Cap Reductn	0	1719	0	0	0
Spillback Cap Reductn	111	0	0	0	746
Storage Cap Reductn	0	0	0	0	0
Reduced v/c Ratio	0.39	1.32	0.38	0.46	0.33

Intersection Summary

m Volume for 95th percentile queue is metered by upstream signal.

Queues
36: Pine Street & Howard Road



Lane Group	EBL	EBT	WBL	WBT	NBL	NBT	NBR	SBT	SBR
Lane Group Flow (vph)	96	711	119	558	155	197	184	192	129
v/c Ratio	0.38	0.76	0.66	0.69	0.32	0.39	0.33	0.66	0.32
Control Delay	41.0	34.9	68.1	33.1	30.3	31.2	6.5	46.3	3.9
Queue Delay	0.0	0.0	0.0	0.0	0.0	0.0	0.0	0.0	0.0
Total Delay	41.0	34.9	68.1	33.1	30.3	31.2	6.5	46.3	3.9
Queue Length 50th (ft)	49	186	61	95	72	94	0	103	0
Queue Length 95th (ft)	#113	241	#183	169	134	165	52	165	19
Internal Link Dist (ft)		265		561		224		259	
Turn Bay Length (ft)	95		140		90				
Base Capacity (vph)	255	1058	180	1091	484	510	561	370	462
Starvation Cap Reductn	0	0	0	0	0	0	0	0	0
Spillback Cap Reductn	0	0	0	0	0	0	0	0	0
Storage Cap Reductn	0	0	0	0	0	0	0	0	0
Reduced v/c Ratio	0.38	0.67	0.66	0.51	0.32	0.39	0.33	0.52	0.28

Intersection Summary

95th percentile volume exceeds capacity, queue may be longer.
Queue shown is maximum after two cycles.

Queues

37: Olive Avenue/Q Street & Howard Road/Yosemite Avenue

Village D Specific Plan

Phase III NP - PM Peak Hour



Lane Group	EBL	EBT	EBR	WBL	WBT	NBL	NBT	NBR	SBL	SBT	SBR
Lane Group Flow (vph)	8	491	292	15	408	219	223	14	18	63	2
v/c Ratio	0.07	0.64	0.51	0.12	0.52	0.24	0.24	0.02	0.11	0.36	0.01
Control Delay	43.9	47.3	24.4	40.8	32.4	16.1	16.0	0.0	37.5	43.2	0.0
Queue Delay	0.0	0.0	0.0	0.0	0.0	0.0	0.0	0.0	0.0	0.0	0.0
Total Delay	43.9	47.3	24.4	40.8	32.4	16.1	16.0	0.0	37.5	43.2	0.0
Queue Length 50th (ft)	5	152	101	8	106	66	67	0	10	34	0
Queue Length 95th (ft)	m9	206	172	27	140	170	172	0	29	71	0
Internal Link Dist (ft)		561			230		220			195	
Turn Bay Length (ft)	40			80		130			50		50
Base Capacity (vph)	118	810	582	357	1226	907	926	925	357	376	465
Starvation Cap Reductn	0	0	0	0	0	0	0	0	0	0	0
Spillback Cap Reductn	0	0	0	0	0	0	0	0	0	0	0
Storage Cap Reductn	0	0	0	0	0	0	0	0	0	0	0
Reduced v/c Ratio	0.07	0.61	0.50	0.04	0.33	0.24	0.24	0.02	0.05	0.17	0.00

Intersection Summary

m Volume for 95th percentile queue is metered by upstream signal.

Queues
39: 4th Street & Sunset Avenue



Lane Group	EBL	NBL	NBT	SBT	SBR
Lane Group Flow (vph)	274	15	380	445	411
v/c Ratio	0.58	0.09	0.14	0.35	0.31
Control Delay	44.5	38.4	3.2	4.1	0.6
Queue Delay	0.0	0.0	0.0	0.0	0.0
Total Delay	44.5	38.4	3.2	4.1	0.6
Queue Length 50th (ft)	84	9	24	47	0
Queue Length 95th (ft)	119	27	45	105	0
Internal Link Dist (ft)	7441		193	501	
Turn Bay Length (ft)	135				
Base Capacity (vph)	962	289	2721	1277	1397
Starvation Cap Reductn	0	0	0	0	0
Spillback Cap Reductn	0	0	0	0	0
Storage Cap Reductn	0	0	0	0	0
Reduced v/c Ratio	0.28	0.05	0.14	0.35	0.29
Intersection Summary					

Queues
41: I Street & 4th Street



Lane Group	EBL	EBT	WBL	WBT	NBL	NBT	NBR	SBL	SBT	SBR
Lane Group Flow (vph)	46	659	67	707	114	82	278	210	188	143
v/c Ratio	0.38	0.77	0.45	0.71	0.59	0.14	0.40	0.61	0.25	0.20
Control Delay	47.1	28.9	42.4	19.6	55.0	29.6	6.2	44.3	23.8	5.0
Queue Delay	0.0	0.0	0.0	0.2	0.0	0.0	0.0	0.0	0.0	0.0
Total Delay	47.1	28.9	42.4	19.9	55.0	29.6	6.2	44.3	23.8	5.0
Queue Length 50th (ft)	29	192	46	101	70	40	2	122	85	0
Queue Length 95th (ft)	68	236	m58	m114	125	82	66	195	148	42
Internal Link Dist (ft)		501		26		314			779	
Turn Bay Length (ft)	130				45		25	80		80
Base Capacity (vph)	123	955	169	1102	226	593	691	380	751	715
Starvation Cap Reductn	0	0	0	66	0	0	0	0	0	0
Spillback Cap Reductn	0	0	0	0	0	0	0	0	0	0
Storage Cap Reductn	0	0	0	0	0	0	0	0	0	0
Reduced v/c Ratio	0.37	0.69	0.40	0.68	0.50	0.14	0.40	0.55	0.25	0.20

Intersection Summary

m Volume for 95th percentile queue is metered by upstream signal.

Queues
 16: Love's Truck Stop Driveway/Driveway & Avenue 17

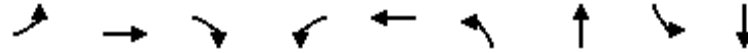

Lane Group	EBL	EBT	EBR	WBL	WBT	NBL	NBT	SBL	SBT
Lane Group Flow (vph)	176	890	143	49	1207	148	24	52	98
v/c Ratio	2.00	0.45	0.15	0.56	1.22	1.64	0.05	0.58	0.24
Control Delay	514.7	14.7	3.7	71.6	132.4	366.4	0.2	72.0	3.7
Queue Delay	0.0	0.0	0.0	0.0	0.0	0.0	0.0	0.0	0.0
Total Delay	514.7	14.7	3.7	71.6	132.4	366.4	0.2	72.0	3.7
Queue Length 50th (ft)	~176	176	7	31	-954	~137	0	33	0
Queue Length 95th (ft)	#309	225	36	#83	#1210	#261	0	#88	19
Internal Link Dist (ft)		311			402		160		226
Turn Bay Length (ft)	100		100	100					
Base Capacity (vph)	88	1960	929	87	990	90	496	90	412
Starvation Cap Reductn	0	0	0	0	0	0	0	0	0
Spillback Cap Reductn	0	0	0	0	0	0	0	0	0
Storage Cap Reductn	0	0	0	0	0	0	0	0	0
Reduced v/c Ratio	2.00	0.45	0.15	0.56	1.22	1.64	0.05	0.58	0.24

Intersection Summary

~ Volume exceeds capacity, queue is theoretically infinite.
 Queue shown is maximum after two cycles.

95th percentile volume exceeds capacity, queue may be longer.
 Queue shown is maximum after two cycles.

Queues
23: Avenue 16/Ellis Street & Kennedy Street



Lane Group	WBL	WBR	NBT	SBL	SBT
Lane Group Flow (vph)	283	183	921	296	453
v/c Ratio	0.78	0.25	0.78	0.57	0.19
Control Delay	35.2	5.5	26.2	29.1	5.4
Queue Delay	0.0	0.0	0.0	0.0	0.0
Total Delay	35.2	5.5	26.2	29.1	5.4
Queue Length 50th (ft)	93	0	183	125	40
Queue Length 95th (ft)	m150	m6	#294	204	61
Internal Link Dist (ft)	782		506		440
Turn Bay Length (ft)	175			280	
Base Capacity (vph)	423	804	1185	519	2395
Starvation Cap Reductn	0	0	0	0	0
Spillback Cap Reductn	0	0	0	0	0
Storage Cap Reductn	0	0	0	0	0
Reduced v/c Ratio	0.67	0.23	0.78	0.57	0.19

Intersection Summary

95th percentile volume exceeds capacity, queue may be longer.

Queue shown is maximum after two cycles.

m Volume for 95th percentile queue is metered by upstream signal.

Queues
24: Schnoor Avenue & Kennedy Street



Lane Group	EBL	EBT	WBL	WBT	NBL	NBT	SBL	SBT	SBR
Lane Group Flow (vph)	126	536	265	538	136	384	150	47	37
v/c Ratio	1.05	0.68	0.81	0.89	0.53	0.53	1.65	0.11	0.07
Control Delay	126.6	14.8	50.7	40.8	43.6	7.8	364.3	23.3	0.3
Queue Delay	0.0	0.0	0.0	0.0	0.0	0.0	0.0	0.0	0.0
Total Delay	126.6	14.8	50.7	40.8	43.6	7.8	364.3	23.3	0.3
Queue Length 50th (ft)	~63	76	125	216	34	19	~110	18	0
Queue Length 95th (ft)	m#136	m88	#236	#390	62	92	#223	44	0
Internal Link Dist (ft)		782		187		321		193	
Turn Bay Length (ft)	95		40		75		60		
Base Capacity (vph)	120	850	354	658	258	723	91	413	496
Starvation Cap Reductn	0	0	0	0	0	0	0	0	0
Spillback Cap Reductn	0	0	0	0	0	0	0	0	0
Storage Cap Reductn	0	0	0	0	0	0	0	0	0
Reduced v/c Ratio	1.05	0.63	0.75	0.82	0.53	0.53	1.65	0.11	0.07

Intersection Summary

- ~ Volume exceeds capacity, queue is theoretically infinite.
Queue shown is maximum after two cycles.
- # 95th percentile volume exceeds capacity, queue may be longer.
Queue shown is maximum after two cycles.
- m Volume for 95th percentile queue is metered by upstream signal.

Queues
29: Schnoor Avenue & Cleveland Avenue

Village D Specific Plan
Phase III WP - AM Peak Hour



Lane Group	EBL	EBT	EBR	WBL	WBT	WBR	NBL	NBT	NBR	SBL	SBT	SBR
Lane Group Flow (vph)	192	1238	89	183	541	52	67	298	195	102	223	100
v/c Ratio	0.71	0.94	0.13	0.66	0.52	0.09	0.58	0.31	0.30	0.70	0.22	0.17
Control Delay	47.2	39.7	0.4	22.2	4.7	0.2	57.5	25.3	6.9	62.3	23.6	0.6
Queue Delay	0.0	0.0	0.0	0.0	0.0	0.0	0.0	0.0	0.0	0.0	0.0	0.0
Total Delay	47.2	39.7	0.4	22.2	4.7	0.2	57.5	25.3	6.9	62.3	23.6	0.6
Queue Length 50th (ft)	91	308	0	36	12	0	33	64	16	51	46	0
Queue Length 95th (ft)	#170	#446	0	m48	18	m0	#88	100	58	#126	75	0
Internal Link Dist (ft)		2178			574			393			326	
Turn Bay Length (ft)	120		60	220		95	75		75	105		65
Base Capacity (vph)	299	1317	705	276	1045	604	116	965	648	146	1006	586
Starvation Cap Reductn	0	0	0	0	0	0	0	0	0	0	0	0
Spillback Cap Reductn	0	0	0	0	0	0	0	0	0	0	0	0
Storage Cap Reductn	0	0	0	0	0	0	0	0	0	0	0	0
Reduced v/c Ratio	0.64	0.94	0.13	0.66	0.52	0.09	0.58	0.31	0.30	0.70	0.22	0.17

Intersection Summary

95th percentile volume exceeds capacity, queue may be longer.

Queue shown is maximum after two cycles.

m Volume for 95th percentile queue is metered by upstream signal.

Queues
30: Fairgrounds & Cleveland Avenue



Lane Group	EBL	EBT	WBL	WBT	WBR	NBL	NBT	NBR	SBL	SBT
Lane Group Flow (vph)	116	1446	41	693	171	15	21	19	180	48
v/c Ratio	0.47	0.78	0.25	0.68	0.28	0.07	0.05	0.03	0.79	0.07
Control Delay	18.5	13.1	37.0	31.1	3.7	36.1	15.8	0.1	58.7	7.0
Queue Delay	0.0	0.0	0.0	0.0	0.0	0.0	0.0	0.0	0.0	0.0
Total Delay	18.5	13.1	37.0	31.1	3.7	36.1	15.8	0.1	58.7	7.0
Queue Length 50th (ft)	35	83	20	172	0	3	3	0	88	1
Queue Length 95th (ft)	m45	m#315	48	#254	32	12	22	0	#187	25
Internal Link Dist (ft)		574		1412			192			168
Turn Bay Length (ft)	120		205					100		
Base Capacity (vph)	276	1843	251	1016	600	218	411	575	236	681
Starvation Cap Reductn	0	0	0	0	0	0	0	0	0	0
Spillback Cap Reductn	0	0	0	0	0	0	0	0	0	0
Storage Cap Reductn	0	0	0	0	0	0	0	0	0	0
Reduced v/c Ratio	0.42	0.78	0.16	0.68	0.28	0.07	0.05	0.03	0.76	0.07

Intersection Summary

95th percentile volume exceeds capacity, queue may be longer.

Queue shown is maximum after two cycles.

m Volume for 95th percentile queue is metered by upstream signal.

Queues
33: Gateway Drive & Cleveland Avenue

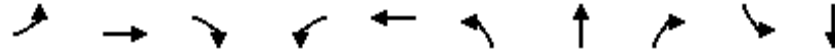

Lane Group	EBL	EBT	EBR	WBL	WBT	NBL	NBT	NBR	SBL	SBT
Lane Group Flow (vph)	4	1124	302	258	1079	201	54	213	73	101
v/c Ratio	0.02	0.81	0.37	0.56	0.70	0.47	0.10	0.34	0.44	0.11
Control Delay	21.5	28.4	5.2	36.5	21.0	40.3	26.6	6.0	46.0	26.2
Queue Delay	0.0	3.2	0.1	1.0	39.3	0.0	0.0	0.1	2.8	0.0
Total Delay	21.5	31.6	5.3	37.5	60.2	40.3	26.6	6.1	48.9	26.2
Queue Length 50th (ft)	1	228	21	57	182	55	23	0	40	22
Queue Length 95th (ft)	m3	273	43	90	254	89	55	55	81	45
Internal Link Dist (ft)		207			111		765			296
Turn Bay Length (ft)	110					245			45	
Base Capacity (vph)	222	1426	810	587	1532	429	564	618	202	896
Starvation Cap Reductn	0	205	70	146	528	0	0	0	0	0
Spillback Cap Reductn	0	64	0	0	168	0	0	41	64	0
Storage Cap Reductn	0	0	0	0	0	0	0	0	0	0
Reduced v/c Ratio	0.02	0.92	0.41	0.59	1.07	0.47	0.10	0.37	0.53	0.11

Intersection Summary

m Volume for 95th percentile queue is metered by upstream signal.

Queues
 34: Cleveland Avenue & County Club Drive



Lane Group	WBL	NBT	NBR	SBL	SBT
Lane Group Flow (vph)	625	926	483	113	765
v/c Ratio	0.75	0.40	0.31	0.34	0.23
Control Delay	36.6	12.1	1.8	11.4	6.8
Queue Delay	0.0	2.4	0.0	0.0	0.1
Total Delay	36.6	14.5	1.8	11.4	6.8
Queue Length 50th (ft)	167	113	26	25	56
Queue Length 95th (ft)	206	187	m44	71	90
Internal Link Dist (ft)	239	111			159
Turn Bay Length (ft)					
Base Capacity (vph)	1260	2316	1568	333	3328
Starvation Cap Reductn	0	1217	0	0	0
Spillback Cap Reductn	16	0	0	0	1044
Storage Cap Reductn	0	0	0	0	0
Reduced v/c Ratio	0.50	0.84	0.31	0.34	0.33

Intersection Summary

m Volume for 95th percentile queue is metered by upstream signal.

Queues
36: Pine Street & Howard Road



Lane Group	EBL	EBT	WBL	WBT	NBL	NBT	NBR	SBT	SBR
Lane Group Flow (vph)	38	1324	177	640	173	189	275	339	111
v/c Ratio	0.39	0.95	1.04	0.38	0.61	0.64	0.58	0.99	0.28
Control Delay	66.4	50.1	130.8	22.8	56.8	57.4	10.4	93.9	5.7
Queue Delay	0.0	0.0	0.0	0.0	0.0	0.0	0.0	0.0	0.0
Total Delay	66.4	50.1	130.8	22.8	56.8	57.4	10.4	93.9	5.7
Queue Length 50th (ft)	29	509	~153	166	126	138	0	264	0
Queue Length 95th (ft)	66	#666	#300	218	203	219	79	#456	32
Internal Link Dist (ft)		265		565		224		259	
Turn Bay Length (ft)	95		140		90				
Base Capacity (vph)	102	1391	170	1679	282	297	477	344	398
Starvation Cap Reductn	0	0	0	0	0	0	0	0	0
Spillback Cap Reductn	0	0	0	0	0	0	0	0	0
Storage Cap Reductn	0	0	0	0	0	0	0	0	0
Reduced v/c Ratio	0.37	0.95	1.04	0.38	0.61	0.64	0.58	0.99	0.28

Intersection Summary

- ~ Volume exceeds capacity, queue is theoretically infinite.
Queue shown is maximum after two cycles.
- # 95th percentile volume exceeds capacity, queue may be longer.
Queue shown is maximum after two cycles.

Queues

37: Olive Avenue/Q Street & Howard Road/Yosemite Avenue

Village D Specific Plan

Phase III WP - AM Peak Hour



Lane Group	EBL	EBT	EBR	WBL	WBT	NBL	NBT	NBR	SBL	SBT	SBR
Lane Group Flow (vph)	7	662	679	30	419	290	291	23	113	165	14
v/c Ratio	0.09	0.65	0.74	0.27	0.35	0.43	0.42	0.03	0.51	0.71	0.04
Control Delay	80.2	22.1	9.4	58.9	29.3	32.7	32.4	0.1	56.5	66.3	0.2
Queue Delay	0.0	0.0	2.6	0.0	0.0	0.0	0.0	0.0	0.0	0.0	0.0
Total Delay	80.2	22.1	12.0	58.9	29.3	32.7	32.4	0.1	56.5	66.3	0.2
Queue Length 50th (ft)	5	125	422	23	115	180	180	0	82	123	0
Queue Length 95th (ft)	m6	m174	m444	53	154	317	317	0	140	195	0
Internal Link Dist (ft)		565			230		220			195	
Turn Bay Length (ft)	40			80		130			50		50
Base Capacity (vph)	79	1092	941	265	1418	674	687	689	265	279	353
Starvation Cap Reductn	0	0	154	0	0	0	0	0	0	0	0
Spillback Cap Reductn	0	0	0	0	0	0	0	0	0	0	0
Storage Cap Reductn	0	0	0	0	0	0	0	0	0	0	0
Reduced v/c Ratio	0.09	0.61	0.86	0.11	0.30	0.43	0.42	0.03	0.43	0.59	0.04

Intersection Summary

m Volume for 95th percentile queue is metered by upstream signal.

Queues
39: 4th Street & Sunset Avenue



Lane Group	EBL	NBL	NBT	SBT	SBR
Lane Group Flow (vph)	474	38	403	567	322
v/c Ratio	0.73	0.14	0.16	0.54	0.26
Control Delay	41.1	31.5	4.5	9.9	0.6
Queue Delay	0.0	0.0	0.0	0.0	0.0
Total Delay	41.1	31.5	4.5	10.0	0.6
Queue Length 50th (ft)	127	18	35	82	0
Queue Length 95th (ft)	178	44	51	429	0
Internal Link Dist (ft)	7441		193	501	
Turn Bay Length (ft)	135				
Base Capacity (vph)	721	363	2530	1046	1264
Starvation Cap Reductn	0	0	0	16	0
Spillback Cap Reductn	0	0	0	0	0
Storage Cap Reductn	0	0	0	0	0
Reduced v/c Ratio	0.66	0.10	0.16	0.55	0.25
Intersection Summary					

Queues
41: I Street & 4th Street



Lane Group	EBL	EBT	WBL	WBT	NBL	NBT	NBR	SBL	SBT	SBR
Lane Group Flow (vph)	32	836	97	649	59	63	183	338	312	227
v/c Ratio	0.29	0.88	0.66	0.60	0.44	0.14	0.33	0.87	0.40	0.30
Control Delay	63.0	32.5	39.3	18.2	50.2	30.6	3.4	57.0	23.0	6.3
Queue Delay	0.0	0.0	0.0	0.0	0.0	0.0	0.0	0.0	0.0	0.0
Total Delay	63.0	32.5	39.3	18.2	50.2	30.6	3.4	57.0	23.0	6.3
Queue Length 50th (ft)	19	133	54	76	33	30	0	183	136	14
Queue Length 95th (ft)	m39	#185	m63	m85	72	64	26	#324	212	64
Internal Link Dist (ft)		501		26		314			779	
Turn Bay Length (ft)	130				45		25	80		80
Base Capacity (vph)	113	973	153	1117	142	460	562	409	773	745
Starvation Cap Reductn	0	0	0	0	0	0	0	0	0	0
Spillback Cap Reductn	0	0	0	0	0	0	0	0	0	0
Storage Cap Reductn	0	0	0	0	0	0	0	0	0	0
Reduced v/c Ratio	0.28	0.86	0.63	0.58	0.42	0.14	0.33	0.83	0.40	0.30

Intersection Summary

95th percentile volume exceeds capacity, queue may be longer.

Queue shown is maximum after two cycles.

m Volume for 95th percentile queue is metered by upstream signal.

Queues
 16: Love's Truck Stop Driveway/Driveway & Avenue 17

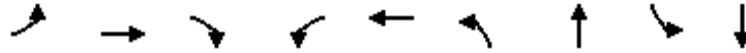

Lane Group	EBL	EBT	EBR	WBL	WBT	NBL	NBT	SBL	SBT
Lane Group Flow (vph)	604	1139	153	35	1454	174	34	303	564
v/c Ratio	4.35	0.86	0.22	0.25	2.76	1.23	0.06	2.15	0.94
Control Delay	1534.2	30.8	3.4	32.5	813.7	183.6	0.2	561.2	41.3
Queue Delay	0.0	0.0	0.0	0.0	0.0	0.0	0.0	0.0	0.0
Total Delay	1534.2	30.8	3.4	32.5	813.7	183.6	0.2	561.2	41.3
Queue Length 50th (ft)	~446	186	0	13	~1014	~86	0	~194	140
Queue Length 95th (ft)	#622	#394	28	38	#1254	#194	0	#330	#331
Internal Link Dist (ft)		423			402		160		227
Turn Bay Length (ft)	100		100	100					
Base Capacity (vph)	139	1323	705	139	527	141	596	141	602
Starvation Cap Reductn	0	0	0	0	0	0	0	0	0
Spillback Cap Reductn	0	0	0	0	0	0	0	0	0
Storage Cap Reductn	0	0	0	0	0	0	0	0	0
Reduced v/c Ratio	4.35	0.86	0.22	0.25	2.76	1.23	0.06	2.15	0.94

Intersection Summary

~ Volume exceeds capacity, queue is theoretically infinite.
 Queue shown is maximum after two cycles.

95th percentile volume exceeds capacity, queue may be longer.
 Queue shown is maximum after two cycles.

Queues
 23: Avenue 16/Ellis Street & Kennedy Street



Lane Group	WBL	WBR	NBT	SBL	SBT
Lane Group Flow (vph)	305	251	1000	293	570
v/c Ratio	0.81	0.32	0.65	0.79	0.24
Control Delay	31.5	5.0	15.7	45.7	5.5
Queue Delay	0.0	0.0	0.0	0.0	0.0
Total Delay	31.5	5.0	15.7	45.7	5.5
Queue Length 50th (ft)	110	0	150	135	53
Queue Length 95th (ft)	m#202	m12	221	#240	74
Internal Link Dist (ft)	782		506		440
Turn Bay Length (ft)	175			280	
Base Capacity (vph)	409	837	1547	413	2413
Starvation Cap Reductn	0	0	0	0	0
Spillback Cap Reductn	0	0	0	0	0
Storage Cap Reductn	0	0	0	0	0
Reduced v/c Ratio	0.75	0.30	0.65	0.71	0.24

Intersection Summary

95th percentile volume exceeds capacity, queue may be longer.

Queue shown is maximum after two cycles.

m Volume for 95th percentile queue is metered by upstream signal.

Queues
24: Schnoor Avenue & Kennedy Street



Lane Group	EBL	EBT	WBL	WBT	NBL	NBT	SBL	SBT	SBR
Lane Group Flow (vph)	107	612	289	522	215	485	216	73	46
v/c Ratio	0.68	0.77	0.73	0.86	0.58	0.76	1.86	0.18	0.09
Control Delay	52.6	19.0	42.1	38.5	41.1	21.7	444.8	25.9	0.4
Queue Delay	0.0	0.0	0.0	0.0	0.0	0.0	0.0	0.0	0.0
Total Delay	52.6	19.0	42.1	38.5	41.1	21.7	444.8	25.9	0.4
Queue Length 50th (ft)	56	88	134	213	53	106	~167	29	0
Queue Length 95th (ft)	m#115	139	#260	#365	88	#262	#298	63	0
Internal Link Dist (ft)		782		187		321		193	
Turn Bay Length (ft)	95		40		75		60		
Base Capacity (vph)	158	898	396	675	368	642	116	405	498
Starvation Cap Reductn	0	0	0	0	0	0	0	0	0
Spillback Cap Reductn	0	0	0	0	0	0	0	0	0
Storage Cap Reductn	0	0	0	0	0	0	0	0	0
Reduced v/c Ratio	0.68	0.68	0.73	0.77	0.58	0.76	1.86	0.18	0.09

Intersection Summary

- ~ Volume exceeds capacity, queue is theoretically infinite.
Queue shown is maximum after two cycles.
- # 95th percentile volume exceeds capacity, queue may be longer.
Queue shown is maximum after two cycles.
- m Volume for 95th percentile queue is metered by upstream signal.

Queues
29: Schnoor Avenue & Cleveland Avenue

Village D Specific Plan
Phase III WP - PM Peak Hour



Lane Group	EBL	EBT	EBR	WBL	WBT	WBR	NBL	NBT	NBR	SBL	SBT	SBR
Lane Group Flow (vph)	207	957	63	306	1394	131	104	269	164	138	264	208
v/c Ratio	0.91	0.80	0.10	0.54	1.05	0.19	0.77	0.35	0.24	0.93	0.33	0.41
Control Delay	80.8	32.5	0.3	13.5	33.3	0.1	76.8	31.4	6.3	101.8	30.6	7.0
Queue Delay	0.0	0.0	0.0	0.0	0.0	0.0	0.0	0.0	0.0	0.0	0.0	0.0
Total Delay	80.8	32.5	0.3	13.5	33.3	0.1	76.8	31.4	6.3	101.8	30.6	7.0
Queue Length 50th (ft)	118	246	0	65	-441	0	59	68	12	79	66	0
Queue Length 95th (ft)	#247	318	0	m61	m55	m0	#145	105	51	#191	102	55
Internal Link Dist (ft)		2178			574			393			326	
Turn Bay Length (ft)	120		60	220		95	75		75	105		65
Base Capacity (vph)	228	1294	680	567	1330	701	135	774	681	148	802	511
Starvation Cap Reductn	0	0	0	0	0	0	0	0	0	0	0	0
Spillback Cap Reductn	0	0	0	0	0	0	0	0	0	0	0	0
Storage Cap Reductn	0	0	0	0	0	0	0	0	0	0	0	0
Reduced v/c Ratio	0.91	0.74	0.09	0.54	1.05	0.19	0.77	0.35	0.24	0.93	0.33	0.41

Intersection Summary

- ~ Volume exceeds capacity, queue is theoretically infinite.
Queue shown is maximum after two cycles.
- # 95th percentile volume exceeds capacity, queue may be longer.
Queue shown is maximum after two cycles.
- m Volume for 95th percentile queue is metered by upstream signal.

Queues
30: Fairgrounds & Cleveland Avenue



Lane Group	EBL	EBT	WBL	WBT	WBR	NBL	NBT	NBR	SBL	SBT
Lane Group Flow (vph)	111	1208	188	1533	218	105	87	81	384	171
v/c Ratio	0.86	0.78	0.82	1.19	0.32	0.43	0.23	0.16	1.32	0.28
Control Delay	67.6	12.7	53.4	108.3	2.7	45.7	19.4	0.7	200.9	8.5
Queue Delay	0.0	0.0	0.0	0.0	0.0	0.0	0.0	0.0	0.0	0.0
Total Delay	67.6	12.7	53.4	108.3	2.7	45.7	19.4	0.7	200.9	8.5
Queue Length 50th (ft)	65	119	96	~548	15	29	23	0	~285	16
Queue Length 95th (ft)	m#106	m149	m115	m#663	m15	56	65	0	#458	62
Internal Link Dist (ft)		574		1412			192			168
Turn Bay Length (ft)	120		205					100		
Base Capacity (vph)	129	1555	236	1290	683	249	375	498	290	620
Starvation Cap Reductn	0	0	0	0	0	0	0	0	0	0
Spillback Cap Reductn	0	0	0	0	0	0	0	0	0	0
Storage Cap Reductn	0	0	0	0	0	0	0	0	0	0
Reduced v/c Ratio	0.86	0.78	0.80	1.19	0.32	0.42	0.23	0.16	1.32	0.28

Intersection Summary

- ~ Volume exceeds capacity, queue is theoretically infinite.
Queue shown is maximum after two cycles.
- # 95th percentile volume exceeds capacity, queue may be longer.
Queue shown is maximum after two cycles.
- m Volume for 95th percentile queue is metered by upstream signal.

Queues
33: Gateway Drive & Cleveland Avenue

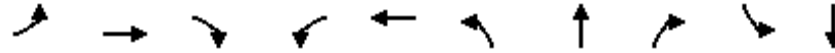

Lane Group	EBL	EBT	EBR	WBL	WBT	NBL	NBT	NBR	SBL	SBT
Lane Group Flow (vph)	18	1310	383	264	1499	384	164	329	248	216
v/c Ratio	0.10	0.76	0.43	0.80	0.97	0.79	0.38	0.70	1.06	0.27
Control Delay	6.8	16.3	2.9	56.5	43.3	50.7	32.5	27.1	114.0	28.1
Queue Delay	0.0	15.6	0.2	0.3	41.7	163.6	0.0	3.4	0.0	0.1
Total Delay	6.8	31.8	3.1	56.8	85.0	214.3	32.5	30.5	114.0	28.2
Queue Length 50th (ft)	2	85	5	79	287	110	80	98	~156	50
Queue Length 95th (ft)	m3	200	36	#140	#643	#176	138	#200	#303	82
Internal Link Dist (ft)		207			111		765			296
Turn Bay Length (ft)	110					245			45	
Base Capacity (vph)	182	1780	894	332	1538	485	436	473	235	788
Starvation Cap Reductn	0	372	114	3	373	0	0	0	0	0
Spillback Cap Reductn	0	484	0	0	175	472	0	75	0	127
Storage Cap Reductn	0	0	0	0	0	0	0	0	0	0
Reduced v/c Ratio	0.10	1.01	0.49	0.80	1.29	29.54	0.38	0.83	1.06	0.33

Intersection Summary

- ~ Volume exceeds capacity, queue is theoretically infinite.
Queue shown is maximum after two cycles.
- # 95th percentile volume exceeds capacity, queue may be longer.
Queue shown is maximum after two cycles.
- m Volume for 95th percentile queue is metered by upstream signal.

Queues
34: Cleveland Avenue & County Club Drive



Lane Group	WBL	NBT	NBR	SBL	SBT
Lane Group Flow (vph)	784	1060	805	155	1004
v/c Ratio	0.77	0.49	0.52	0.64	0.32
Control Delay	34.0	17.9	3.6	29.1	9.5
Queue Delay	0.1	50.4	0.0	0.0	0.2
Total Delay	34.1	68.3	3.6	29.1	9.7
Queue Length 50th (ft)	206	188	60	52	93
Queue Length 95th (ft)	244	m257	m165	#179	142
Internal Link Dist (ft)	239	111			159
Turn Bay Length (ft)					
Base Capacity (vph)	1379	2155	1563	242	3097
Starvation Cap Reductn	0	1219	0	0	0
Spillback Cap Reductn	79	0	0	0	1143
Storage Cap Reductn	0	0	0	0	0
Reduced v/c Ratio	0.60	1.13	0.52	0.64	0.51

Intersection Summary

95th percentile volume exceeds capacity, queue may be longer.

Queue shown is maximum after two cycles.

m Volume for 95th percentile queue is metered by upstream signal.

Queues
36: Pine Street & Howard Road



Lane Group	EBL	EBT	WBL	WBT	NBL	NBT	NBR	SBT	SBR
Lane Group Flow (vph)	96	1008	119	943	252	212	184	199	129
v/c Ratio	0.57	0.95	0.67	0.85	0.61	0.49	0.36	0.67	0.32
Control Delay	55.5	48.0	55.7	34.2	38.5	34.8	6.9	46.7	3.9
Queue Delay	0.0	0.0	0.0	0.0	0.0	0.0	0.0	0.0	0.0
Total Delay	55.5	48.0	55.7	34.2	38.5	34.8	6.9	46.7	3.9
Queue Length 50th (ft)	55	287	69	277	130	106	0	107	0
Queue Length 95th (ft)	#136	#421	#170	#311	211	176	52	171	19
Internal Link Dist (ft)		265		561		224		259	
Turn Bay Length (ft)	95		140		90				
Base Capacity (vph)	169	1066	178	1134	415	437	507	370	462
Starvation Cap Reductn	0	0	0	0	0	0	0	0	0
Spillback Cap Reductn	0	0	0	0	0	0	0	0	0
Storage Cap Reductn	0	0	0	0	0	0	0	0	0
Reduced v/c Ratio	0.57	0.95	0.67	0.83	0.61	0.49	0.36	0.54	0.28

Intersection Summary

95th percentile volume exceeds capacity, queue may be longer.
Queue shown is maximum after two cycles.

Queues

37: Olive Avenue/Q Street & Howard Road/Yosemite Avenue

Village D Specific Plan

Phase III WP - PM Peak Hour



Lane Group	EBL	EBT	EBR	WBL	WBT	NBL	NBT	NBR	SBL	SBT	SBR
Lane Group Flow (vph)	8	516	520	15	452	394	393	14	18	63	2
v/c Ratio	0.06	0.61	0.68	0.12	0.55	0.45	0.44	0.02	0.11	0.36	0.01
Control Delay	21.9	13.2	6.8	40.8	32.5	19.9	19.7	0.0	37.5	43.2	0.0
Queue Delay	0.0	0.0	0.0	0.0	0.0	0.0	0.0	0.0	0.0	0.0	0.0
Total Delay	21.9	13.2	6.8	40.8	32.5	19.9	19.7	0.0	37.5	43.2	0.0
Queue Length 50th (ft)	4	35	0	8	115	143	142	0	10	34	0
Queue Length 95th (ft)	m6	m72	m39	27	164	#329	320	0	29	71	0
Internal Link Dist (ft)		561			230		220			195	
Turn Bay Length (ft)	40			80		130			50		50
Base Capacity (vph)	133	866	775	357	1226	874	884	898	357	376	465
Starvation Cap Reductn	0	0	0	0	0	0	0	0	0	0	0
Spillback Cap Reductn	0	0	0	0	0	0	0	0	0	0	0
Storage Cap Reductn	0	0	0	0	0	0	0	0	0	0	0
Reduced v/c Ratio	0.06	0.60	0.67	0.04	0.37	0.45	0.44	0.02	0.05	0.17	0.00

Intersection Summary

95th percentile volume exceeds capacity, queue may be longer.

Queue shown is maximum after two cycles.

m Volume for 95th percentile queue is metered by upstream signal.

Queues
39: 4th Street & Sunset Avenue

Village D Specific Plan
 Phase III WP - PM Peak Hour



Lane Group	EBL	NBL	NBT	SBT	SBR
Lane Group Flow (vph)	288	15	438	474	429
v/c Ratio	0.58	0.07	0.16	0.39	0.32
Control Delay	43.6	34.0	3.5	5.9	0.7
Queue Delay	0.0	0.0	0.0	0.0	0.0
Total Delay	43.6	34.0	3.5	5.9	0.7
Queue Length 50th (ft)	87	9	31	57	0
Queue Length 95th (ft)	123	25	55	125	0
Internal Link Dist (ft)	7441		193	501	
Turn Bay Length (ft)	135				
Base Capacity (vph)	962	398	2720	1230	1385
Starvation Cap Reductn	0	0	0	0	0
Spillback Cap Reductn	0	0	0	0	0
Storage Cap Reductn	0	0	0	0	0
Reduced v/c Ratio	0.30	0.04	0.16	0.39	0.31
Intersection Summary					

Queues
41: I Street & 4th Street

Village D Specific Plan
 Phase III WP - PM Peak Hour



Lane Group	EBL	EBT	WBL	WBT	NBL	NBT	NBR	SBL	SBT	SBR
Lane Group Flow (vph)	46	731	67	726	114	82	278	236	188	173
v/c Ratio	0.37	0.82	0.45	0.71	0.59	0.14	0.42	0.68	0.26	0.24
Control Delay	46.4	31.5	41.9	19.6	55.0	30.2	8.2	47.7	24.5	4.8
Queue Delay	0.0	0.0	0.0	0.3	0.0	0.0	0.0	0.0	0.0	0.0
Total Delay	46.4	31.5	41.9	19.8	55.0	30.2	8.2	47.7	24.5	4.8
Queue Length 50th (ft)	29	210	46	110	70	41	15	139	87	0
Queue Length 95th (ft)	68	264	m55	m112	125	82	85	219	148	46
Internal Link Dist (ft)		501		26		314			779	
Turn Bay Length (ft)	130				45		25	80		80
Base Capacity (vph)	127	955	169	1121	226	572	659	380	730	717
Starvation Cap Reductn	0	0	0	73	0	0	0	0	0	0
Spillback Cap Reductn	0	0	0	0	0	0	0	0	0	0
Storage Cap Reductn	0	0	0	0	0	0	0	0	0	0
Reduced v/c Ratio	0.36	0.77	0.40	0.69	0.50	0.14	0.42	0.62	0.26	0.24

Intersection Summary

m Volume for 95th percentile queue is metered by upstream signal.

Queues

5: Road 23/SR-99 Southbound Off-Ramp & Avenue 18 1/2

Village D Specific Plan

Existing WP MIT - AM Peak Hour

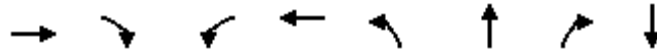

Lane Group	EBT	EBR	WBL	WBT	NBL	NBT	NBR	SBT
Lane Group Flow (vph)	347	89	45	308	152	410	410	398
v/c Ratio	0.96	0.14	0.49	0.55	0.52	0.52	0.52	0.43
Control Delay	70.6	3.4	46.2	18.7	35.9	2.5	2.4	22.4
Queue Delay	0.0	0.0	0.0	0.0	0.0	0.0	0.0	0.0
Total Delay	70.6	3.4	46.2	18.7	35.9	2.5	2.4	22.4
Queue Length 50th (ft)	171	2	16	158	69	0	0	73
Queue Length 95th (ft)	#323	21	m34	230	115	0	0	118
Internal Link Dist (ft)	230			210		324		245
Turn Bay Length (ft)		50					25	
Base Capacity (vph)	362	699	92	561	386	829	793	935
Starvation Cap Reductn	0	0	0	0	0	0	0	0
Spillback Cap Reductn	0	0	0	0	0	0	0	0
Storage Cap Reductn	0	0	0	0	0	0	0	0
Reduced v/c Ratio	0.96	0.13	0.49	0.55	0.39	0.49	0.52	0.43

Intersection Summary

95th percentile volume exceeds capacity, queue may be longer.

Queue shown is maximum after two cycles.

m Volume for 95th percentile queue is metered by upstream signal.

Queues
6: SR-99 Northbound Ramps & Avenue 18 1/2

Village D Specific Plan
Existing WP MIT - AM Peak Hour



Lane Group	EBL	EBT	WBT	NBT
Lane Group Flow (vph)	958	65	188	280
v/c Ratio	0.89	0.07	0.67	0.61
Control Delay	42.3	5.1	40.5	31.9
Queue Delay	0.0	0.0	0.0	0.0
Total Delay	42.3	5.1	40.5	31.9
Queue Length 50th (ft)	241	10	83	118
Queue Length 95th (ft)	m274	m14	128	#214
Internal Link Dist (ft)		549	786	644
Turn Bay Length (ft)	145			
Base Capacity (vph)	1128	1102	365	459
Starvation Cap Reductn	0	0	0	0
Spillback Cap Reductn	0	0	0	0
Storage Cap Reductn	0	0	0	0
Reduced v/c Ratio	0.85	0.06	0.52	0.61

Intersection Summary

95th percentile volume exceeds capacity, queue may be longer.

Queue shown is maximum after two cycles.

m Volume for 95th percentile queue is metered by upstream signal.

Queues
7: Road 23 & Avenue 17

Village D Specific Plan
Existing WP MIT - AM Peak Hour



Lane Group	EBL	EBT	WBL	WBT	NBL	NBT	NBR	SBL	SBT
Lane Group Flow (vph)	174	551	515	142	55	988	1059	16	481
v/c Ratio	0.67	0.87	0.49	0.12	0.40	0.81	0.92	0.18	0.50
Control Delay	51.8	52.5	38.6	36.9	43.1	35.0	21.8	50.7	32.7
Queue Delay	0.0	0.0	0.0	0.0	0.0	0.0	0.0	0.0	0.0
Total Delay	51.8	52.5	38.6	36.9	43.1	35.0	21.8	50.7	32.7
Queue Length 50th (ft)	99	180	165	36	37	300	407	10	137
Queue Length 95th (ft)	164	#266	228	m82	m38	m#383	m#552	32	191
Internal Link Dist (ft)		2671		6172		2520			336
Turn Bay Length (ft)	100		200		100		200	100	
Base Capacity (vph)	319	648	1047	1193	153	1224	1155	87	954
Starvation Cap Reductn	0	0	0	0	0	0	0	0	0
Spillback Cap Reductn	0	0	0	0	0	0	0	0	0
Storage Cap Reductn	0	0	0	0	0	0	0	0	0
Reduced v/c Ratio	0.55	0.85	0.49	0.12	0.36	0.81	0.92	0.18	0.50

Intersection Summary

95th percentile volume exceeds capacity, queue may be longer.

Queue shown is maximum after two cycles.

m Volume for 95th percentile queue is metered by upstream signal.

Queues
8: Road 23 & Avenue 16

Village D Specific Plan
Existing WP MIT - AM Peak Hour



Lane Group	EBL	EBT	EBR	WBL	WBT	WBR	NBL	NBT	NBR	SBL	SBT
Lane Group Flow (vph)	152	38	422	176	40	241	163	1107	53	63	791
v/c Ratio	0.65	0.10	0.90	0.76	0.11	0.52	0.57	0.69	0.07	0.32	0.55
Control Delay	54.0	31.6	42.3	63.1	32.6	12.9	50.1	29.4	3.7	28.4	35.4
Queue Delay	0.0	0.0	0.0	0.0	0.0	0.0	0.0	0.0	0.0	0.0	0.0
Total Delay	54.0	31.6	42.3	63.1	32.6	12.9	50.1	29.4	3.7	28.4	35.4
Queue Length 50th (ft)	93	20	138	109	20	25	47	399	2	22	275
Queue Length 95th (ft)	155	46	#290	#201	49	94	m80	457	m11	m32	338
Internal Link Dist (ft)		2685			1572			2602			2585
Turn Bay Length (ft)	100			100			200			200	
Base Capacity (vph)	284	442	531	250	410	499	289	1614	784	194	1427
Starvation Cap Reductn	0	0	0	0	0	0	0	0	0	0	0
Spillback Cap Reductn	0	0	0	0	0	0	0	0	0	0	0
Storage Cap Reductn	0	0	0	0	0	0	0	0	0	0	0
Reduced v/c Ratio	0.54	0.09	0.79	0.70	0.10	0.48	0.56	0.69	0.07	0.32	0.55

Intersection Summary

95th percentile volume exceeds capacity, queue may be longer.

Queue shown is maximum after two cycles.

m Volume for 95th percentile queue is metered by upstream signal.

Queues
9: Road 23 & Cleveland Avenue

Village D Specific Plan
Existing WP MIT - AM Peak Hour



Lane Group	EBL	EBT	EBR	WBL	WBT	WBR	NBL	NBT	NBR	SBL	SBT	SBR
Lane Group Flow (vph)	442	250	676	329	257	254	383	634	322	385	724	232
v/c Ratio	0.74	0.48	0.61	0.63	0.58	0.42	0.64	0.50	0.35	0.71	0.60	0.27
Control Delay	34.6	36.0	29.6	51.8	37.2	16.7	41.9	30.8	4.6	33.1	31.9	11.5
Queue Delay	0.0	0.0	0.0	0.0	0.0	0.0	0.0	0.0	0.0	0.0	0.0	0.0
Total Delay	34.6	36.0	29.6	51.8	37.2	16.7	41.9	30.8	4.6	33.1	31.9	11.5
Queue Length 50th (ft)	124	84	211	101	83	100	100	165	49	88	210	69
Queue Length 95th (ft)	159	121	273	150	101	141	155	265	81	m142	#334	m103
Internal Link Dist (ft)		2664			3869			1127			2602	
Turn Bay Length (ft)	200		200	200		200	200		200	200		200
Base Capacity (vph)	679	649	1203	676	646	608	713	1278	992	554	1215	901
Starvation Cap Reductn	0	0	0	0	0	0	0	0	0	0	0	0
Spillback Cap Reductn	0	0	0	0	0	0	0	0	0	0	0	0
Storage Cap Reductn	0	0	0	0	0	0	0	0	0	0	0	0
Reduced v/c Ratio	0.65	0.39	0.56	0.49	0.40	0.42	0.54	0.50	0.32	0.69	0.60	0.26

Intersection Summary

95th percentile volume exceeds capacity, queue may be longer.

Queue shown is maximum after two cycles.

m Volume for 95th percentile queue is metered by upstream signal.

Queues
10: Road 23 & Avenue 14 1/2

Village D Specific Plan
Existing WP MIT - AM Peak Hour



Lane Group	EBT	WBT	WBR	NBL	NBT	SBL	SBT
Lane Group Flow (vph)	6	23	214	4	692	254	1319
v/c Ratio	0.04	0.20	0.66	0.04	0.35	0.74	0.47
Control Delay	40.4	45.3	16.1	55.0	15.0	63.5	1.2
Queue Delay	0.0	0.0	0.0	0.0	0.0	0.0	0.0
Total Delay	40.4	45.3	16.1	55.0	15.0	63.5	1.2
Queue Length 50th (ft)	4	14	0	2	138	168	8
Queue Length 95th (ft)	15	35	53	m8	240	207	41
Internal Link Dist (ft)	377	475			2577		3397
Turn Bay Length (ft)			100	100		200	
Base Capacity (vph)	389	295	501	99	1998	499	2830
Starvation Cap Reductn	0	0	0	0	0	0	0
Spillback Cap Reductn	0	0	0	0	0	0	0
Storage Cap Reductn	0	0	0	0	0	0	0
Reduced v/c Ratio	0.02	0.08	0.43	0.04	0.35	0.51	0.47

Intersection Summary

m Volume for 95th percentile queue is metered by upstream signal.

Queues
11: Road 23 & Avenue 14

Village D Specific Plan
Existing WP MIT - AM Peak Hour



Lane Group	EBL	EBT	WBL	WBT	WBR	NBL	NBT	SBL	SBT	SBR
Lane Group Flow (vph)	111	215	25	232	437	32	244	905	401	189
v/c Ratio	0.66	0.45	0.25	0.78	0.27	0.31	0.32	0.86	0.21	0.20
Control Delay	62.9	33.8	51.6	57.7	1.5	52.9	33.2	31.8	17.4	8.0
Queue Delay	0.0	0.0	0.0	0.0	0.0	0.0	0.0	0.0	0.0	0.0
Total Delay	62.9	33.8	51.6	57.7	1.5	52.9	33.2	31.8	17.4	8.0
Queue Length 50th (ft)	69	101	16	140	0	20	70	254	101	30
Queue Length 95th (ft)	104	155	35	181	7	42	88	267	128	63
Internal Link Dist (ft)		1109		7848			463		2577	
Turn Bay Length (ft)	100		100		200	100		150		100
Base Capacity (vph)	180	477	100	337	1666	107	771	1109	1872	925
Starvation Cap Reductn	0	0	0	0	0	0	0	0	0	0
Spillback Cap Reductn	0	0	0	0	0	0	0	0	0	0
Storage Cap Reductn	0	0	0	0	0	0	0	0	0	0
Reduced v/c Ratio	0.62	0.45	0.25	0.69	0.26	0.30	0.32	0.82	0.21	0.20

Intersection Summary

Queues
13: Airport Drive/Golden State Boulevard & Avenue 17

Village D Specific Plan
Existing WP MIT - AM Peak Hour



Lane Group	EBL	EBT	EBR	WBL	WBT	WBR	NBL	NBT	NBR	SBL	SBT
Lane Group Flow (vph)	4	1259	264	140	525	93	110	27	70	97	25
v/c Ratio	0.04	0.88	0.33	0.74	0.28	0.11	0.71	0.06	0.14	0.66	0.07
Control Delay	37.8	32.1	5.2	85.2	15.4	5.1	68.7	32.8	0.6	65.0	29.1
Queue Delay	0.0	0.0	0.0	0.0	0.0	0.0	0.0	0.0	0.0	0.0	0.0
Total Delay	37.8	32.1	5.2	85.2	15.4	5.1	68.7	32.8	0.6	65.0	29.1
Queue Length 50th (ft)	0	379	25	96	67	8	69	14	0	60	11
Queue Length 95th (ft)	m3	m450	m31	#183	114	28	#148	37	0	#129	34
Internal Link Dist (ft)		188			379			370			222
Turn Bay Length (ft)	85			70		105	60		50	100	
Base Capacity (vph)	89	1447	804	199	1855	883	163	434	492	157	374
Starvation Cap Reductn	0	0	0	0	0	0	0	0	0	0	0
Spillback Cap Reductn	0	0	0	0	0	0	0	0	0	0	0
Storage Cap Reductn	0	0	0	0	0	0	0	0	0	0	0
Reduced v/c Ratio	0.04	0.87	0.33	0.70	0.28	0.11	0.67	0.06	0.14	0.62	0.07

Intersection Summary

95th percentile volume exceeds capacity, queue may be longer.

Queue shown is maximum after two cycles.

m Volume for 95th percentile queue is metered by upstream signal.

Queues
 14: Avenue 17 & SR-99 Southbound Off-Ramp

Village D Specific Plan
 Existing WP MIT - AM Peak Hour

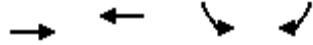

Lane Group	EBT	WBT	SBL	SBR
Lane Group Flow (vph)	1462	734	66	47
v/c Ratio	0.70	0.36	0.14	0.10
Control Delay	6.1	11.8	29.1	9.8
Queue Delay	0.0	0.0	0.0	0.0
Total Delay	6.2	11.8	29.1	9.8
Queue Length 50th (ft)	71	126	30	0
Queue Length 95th (ft)	52	141	70	28
Internal Link Dist (ft)	379	248	971	
Turn Bay Length (ft)				610
Base Capacity (vph)	2424	2377	480	461
Starvation Cap Reductn	42	0	0	0
Spillback Cap Reductn	0	0	0	0
Storage Cap Reductn	0	0	0	0
Reduced v/c Ratio	0.61	0.31	0.14	0.10
Intersection Summary				

Queues
15: SR-99 Northbound Ramps & Avenue 17

Village D Specific Plan
Existing WP MIT - AM Peak Hour

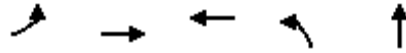

Lane Group	EBL	EBT	WBT	NBL	NBT
Lane Group Flow (vph)	57	605	998	181	182
v/c Ratio	0.38	0.35	0.76	0.26	0.26
Control Delay	52.1	24.5	20.5	23.8	23.8
Queue Delay	0.0	0.0	0.0	0.0	0.0
Total Delay	52.1	24.5	20.5	23.8	23.8
Queue Length 50th (ft)	40	130	131	81	82
Queue Length 95th (ft)	m0	134	m157	161	162
Internal Link Dist (ft)		518	493		633
Turn Bay Length (ft)	125				
Base Capacity (vph)	201	2225	1647	691	693
Starvation Cap Reductn	0	0	0	0	0
Spillback Cap Reductn	0	0	0	0	0
Storage Cap Reductn	0	0	0	0	0
Reduced v/c Ratio	0.28	0.27	0.61	0.26	0.26

Intersection Summary

m Volume for 95th percentile queue is metered by upstream signal.

Queues
17: Westberry Boulevard & Cleveland Avenue

Village D Specific Plan
Existing WP MIT - AM Peak Hour



Lane Group	EBL	EBT	WBL	WBT	NBL	NBT	NBR	SBL	SBT	SBR
Lane Group Flow (vph)	454	1149	24	489	31	42	69	17	23	169
v/c Ratio	0.84	0.66	0.24	0.75	0.28	0.06	0.11	0.17	0.04	0.27
Control Delay	44.5	5.8	51.3	46.0	51.9	28.9	0.3	49.1	30.9	6.7
Queue Delay	0.0	0.0	0.0	0.0	0.0	0.0	0.0	0.0	0.0	0.0
Total Delay	44.5	5.8	51.3	46.0	51.9	28.9	0.3	49.1	30.9	6.7
Queue Length 50th (ft)	183	47	15	153	19	17	0	10	11	0
Queue Length 95th (ft)	225	65	38	190	45	47	0	30	31	42
Internal Link Dist (ft)		630		1237		511			3065	
Turn Bay Length (ft)	110		165		65		50	100		50
Base Capacity (vph)	658	1835	100	710	109	652	654	101	604	621
Starvation Cap Reductn	0	0	0	0	0	0	0	0	0	0
Spillback Cap Reductn	0	0	0	0	0	0	0	0	0	0
Storage Cap Reductn	0	0	0	0	0	0	0	0	0	0
Reduced v/c Ratio	0.69	0.63	0.24	0.69	0.28	0.06	0.11	0.17	0.04	0.27

Intersection Summary

Queues
18: Westberry Boulevard & Sunset Avenue

Village D Specific Plan
Existing WP MIT - AM Peak Hour



Lane Group	EBL	EBT	WBL	WBT	NBL	NBT	NBR	SBL	SBT	SBR
Lane Group Flow (vph)	91	532	68	326	177	148	146	159	117	59
v/c Ratio	0.24	0.71	0.32	0.43	0.48	0.40	0.34	0.46	0.33	0.16
Control Delay	14.4	20.2	18.0	14.7	28.3	26.6	7.7	28.8	26.2	5.3
Queue Delay	0.0	0.0	0.0	0.0	0.0	0.0	0.0	0.0	0.0	0.0
Total Delay	14.4	20.2	18.0	14.7	28.3	26.6	7.7	28.8	26.2	5.3
Queue Length 50th (ft)	20	140	15	75	53	45	0	48	35	0
Queue Length 95th (ft)	40	187	36	112	99	81	19	92	68	7
Internal Link Dist (ft)		306		490		2579			413	
Turn Bay Length (ft)	90		90		130		50	135		50
Base Capacity (vph)	589	1153	331	1168	505	848	781	468	808	716
Starvation Cap Reductn	0	0	0	0	0	0	0	0	0	0
Spillback Cap Reductn	0	0	0	0	0	0	0	0	0	0
Storage Cap Reductn	0	0	0	0	0	0	0	0	0	0
Reduced v/c Ratio	0.15	0.46	0.21	0.28	0.35	0.17	0.19	0.34	0.14	0.08
Intersection Summary										

Queues
19: Westberry Boulevard & Avenue 14

Village D Specific Plan
Existing WP MIT - AM Peak Hour

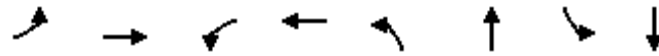

Lane Group	EBL	EBT	WBL	WBT	NBL	NBT	SBL	SBT
Lane Group Flow (vph)	117	913	13	563	95	70	188	152
v/c Ratio	0.45	0.60	0.08	0.56	0.38	0.29	0.56	0.34
Control Delay	32.1	15.6	30.5	20.8	30.5	21.2	31.5	14.9
Queue Delay	0.0	0.0	0.0	0.0	0.0	0.0	0.0	0.0
Total Delay	32.1	15.6	30.5	20.8	30.5	21.2	31.5	14.9
Queue Length 50th (ft)	40	117	5	92	33	15	64	21
Queue Length 95th (ft)	90	223	20	138	76	47	129	67
Internal Link Dist (ft)		7848		580		537		2579
Turn Bay Length (ft)	100		100		100		100	
Base Capacity (vph)	301	1704	159	1250	308	646	397	739
Starvation Cap Reductn	0	0	0	0	0	0	0	0
Spillback Cap Reductn	0	0	0	0	0	0	0	0
Storage Cap Reductn	0	0	0	0	0	0	0	0
Reduced v/c Ratio	0.39	0.54	0.08	0.45	0.31	0.11	0.47	0.21
Intersection Summary								

Queues
51: Project Driveway 1 & Avenue 17

Village D Specific Plan
Existing WP MIT - AM Peak Hour



Lane Group	EBT	WBL	WBT	NBL	NBR
Lane Group Flow (vph)	70	168	72	61	684
v/c Ratio	0.43	0.65	0.15	0.05	0.53
Control Delay	42.8	45.1	22.7	9.0	2.5
Queue Delay	0.0	0.0	0.0	0.0	0.0
Total Delay	42.8	45.1	22.7	9.0	2.5
Queue Length 50th (ft)	34	108	30	14	0
Queue Length 95th (ft)	76	167	67	36	50
Internal Link Dist (ft)	2580		2671	2061	
Turn Bay Length (ft)				50	
Base Capacity (vph)	329	345	791	1176	1290
Starvation Cap Reductn	0	0	0	0	0
Spillback Cap Reductn	0	0	0	0	0
Storage Cap Reductn	0	0	0	0	0
Reduced v/c Ratio	0.21	0.49	0.09	0.05	0.53
Intersection Summary					

Queues
53: Road 22 1/2 & Cleveland Avenue

Village D Specific Plan
Existing WP MIT - AM Peak Hour



Lane Group	EBL	EBT	WBL	WBT	WBR	NBL	NBT	SBL	SBT
Lane Group Flow (vph)	13	441	96	252	157	15	204	362	38
v/c Ratio	0.13	0.69	0.50	0.46	0.27	0.14	0.26	0.67	0.04
Control Delay	48.1	43.9	38.9	16.1	4.4	52.5	6.1	45.8	12.5
Queue Delay	0.0	0.0	0.0	0.0	0.0	0.0	0.0	0.0	0.0
Total Delay	48.1	43.9	38.9	16.1	4.4	52.5	6.1	45.8	12.5
Queue Length 50th (ft)	8	140	41	72	5	9	3	113	7
Queue Length 95th (ft)	28	181	90	221	32	m29	71	153	31
Internal Link Dist (ft)		2664		2664			1767		2623
Turn Bay Length (ft)	100		100			100		100	
Base Capacity (vph)	99	811	261	622	639	107	773	717	1025
Starvation Cap Reductn	0	0	0	0	0	0	0	0	0
Spillback Cap Reductn	0	0	0	0	0	0	0	0	0
Storage Cap Reductn	0	0	0	0	0	0	0	0	0
Reduced v/c Ratio	0.13	0.54	0.37	0.41	0.25	0.14	0.26	0.50	0.04

Intersection Summary

m Volume for 95th percentile queue is metered by upstream signal.

Queues
55: Road 23 & Project Driveway 3

Village D Specific Plan
Existing WP MIT - AM Peak Hour



Lane Group	EBL	EBR	NBL	NBT	SBT	SBR
Lane Group Flow (vph)	876	133	101	1348	688	362
v/c Ratio	0.97	0.13	0.68	0.94	0.70	0.52
Control Delay	49.6	5.5	48.7	42.0	32.3	13.5
Queue Delay	0.0	0.0	0.0	0.0	0.0	0.0
Total Delay	49.6	5.5	48.7	42.0	32.3	13.5
Queue Length 50th (ft)	514	22	64	473	246	130
Queue Length 95th (ft)	#794	44	m92	#591	m306	m217
Internal Link Dist (ft)	1503			2585	2520	
Turn Bay Length (ft)	50		50			
Base Capacity (vph)	911	1035	155	1439	982	699
Starvation Cap Reductn	0	0	0	0	0	0
Spillback Cap Reductn	0	0	0	0	0	0
Storage Cap Reductn	0	0	0	0	0	0
Reduced v/c Ratio	0.96	0.13	0.65	0.94	0.70	0.52

Intersection Summary

95th percentile volume exceeds capacity, queue may be longer.

Queue shown is maximum after two cycles.

m Volume for 95th percentile queue is metered by upstream signal.

Queues
56: Road 23 & Project Driveway 4

Village D Specific Plan
Existing WP MIT - AM Peak Hour



Lane Group	WBL	WBR	NBT	NBR	SBL	SBT
Lane Group Flow (vph)	115	584	757	149	457	1268
v/c Ratio	0.55	0.52	0.40	0.16	0.67	0.45
Control Delay	50.8	19.1	5.5	1.0	42.6	3.9
Queue Delay	0.0	0.0	0.0	0.0	0.0	0.0
Total Delay	50.8	19.1	5.5	1.0	42.6	3.9
Queue Length 50th (ft)	70	119	61	1	144	16
Queue Length 95th (ft)	121	146	71	5	185	221
Internal Link Dist (ft)	754		528			1127
Turn Bay Length (ft)	100				200	
Base Capacity (vph)	406	1249	1893	913	847	2807
Starvation Cap Reductn	0	0	0	0	0	0
Spillback Cap Reductn	0	0	0	0	0	0
Storage Cap Reductn	0	0	0	0	0	0
Reduced v/c Ratio	0.28	0.47	0.40	0.16	0.54	0.45
Intersection Summary						

Queues
57: Road 23 & Project Driveway 5

Village D Specific Plan
Existing WP MIT - AM Peak Hour



Lane Group	EBL	EBR	NBL	NBT	SBT
Lane Group Flow (vph)	127	160	72	785	1389
v/c Ratio	0.57	0.47	0.45	0.29	0.60
Control Delay	51.0	11.0	35.4	10.2	13.7
Queue Delay	0.0	0.0	0.0	0.0	0.1
Total Delay	51.0	11.0	35.4	10.2	13.8
Queue Length 50th (ft)	78	0	46	197	303
Queue Length 95th (ft)	130	55	68	261	455
Internal Link Dist (ft)	2646			3397	528
Turn Bay Length (ft)			50		
Base Capacity (vph)	337	432	186	2680	2327
Starvation Cap Reductn	0	0	0	0	173
Spillback Cap Reductn	0	0	0	0	0
Storage Cap Reductn	0	0	0	0	0
Reduced v/c Ratio	0.38	0.37	0.39	0.29	0.64
Intersection Summary					

Queues
58: Project Driveway 6 & Cleveland Avenue

Village D Specific Plan
Existing WP MIT - AM Peak Hour



Lane Group	EBT	WBL	WBT	NBL	NBR
Lane Group Flow (vph)	1305	167	503	212	317
v/c Ratio	0.84	0.68	0.23	0.41	0.46
Control Delay	23.9	77.7	2.1	33.2	6.4
Queue Delay	0.0	0.0	0.0	0.0	0.0
Total Delay	23.9	77.7	2.1	33.2	6.4
Queue Length 50th (ft)	412	113	14	113	3
Queue Length 95th (ft)	480	m171	15	188	71
Internal Link Dist (ft)	3869		3165	834	
Turn Bay Length (ft)		50		50	
Base Capacity (vph)	1618	294	2376	522	688
Starvation Cap Reductn	0	0	0	0	0
Spillback Cap Reductn	0	0	0	0	0
Storage Cap Reductn	0	0	0	0	0
Reduced v/c Ratio	0.81	0.57	0.21	0.41	0.46

Intersection Summary

m Volume for 95th percentile queue is metered by upstream signal.

Queues
21: Granada Drive & Cleveland Avenue

Village D Specific Plan
Existing WP MIT - AM Peak Hour



Lane Group	EBL	EBT	WBL	WBT	NBL	NBT	NBR	SBL	SBT	SBR
Lane Group Flow (vph)	19	1115	220	458	30	340	319	5	256	6
v/c Ratio	0.16	0.95	0.82	0.26	0.26	0.55	0.49	0.04	0.45	0.01
Control Delay	38.8	43.8	42.2	9.6	41.4	27.3	11.2	36.2	26.7	0.0
Queue Delay	0.0	0.0	0.0	0.0	0.0	0.0	0.0	0.0	0.0	0.0
Total Delay	38.8	43.8	42.2	9.6	41.4	27.3	11.2	36.2	26.7	0.0
Queue Length 50th (ft)	9	285	79	46	15	130	38	2	93	0
Queue Length 95th (ft)	28	#374	#194	145	38	226	106	12	170	0
Internal Link Dist (ft)		289		2178		418			382	
Turn Bay Length (ft)	90		125		50		50	50		50
Base Capacity (vph)	118	1179	270	1732	117	617	656	114	571	621
Starvation Cap Reductn	0	0	0	0	0	0	0	0	0	0
Spillback Cap Reductn	0	0	0	0	0	0	0	0	0	0
Storage Cap Reductn	0	0	0	0	0	0	0	0	0	0
Reduced v/c Ratio	0.16	0.95	0.81	0.26	0.26	0.55	0.49	0.04	0.45	0.01

Intersection Summary

95th percentile volume exceeds capacity, queue may be longer.
Queue shown is maximum after two cycles.

Queues
22: Granada Drive & Sunset Avenue

Village D Specific Plan
Existing WP MIT - AM Peak Hour



Lane Group	EBL	EBT	WBL	WBT	WBR	NBL	NBT	SBL	SBT
Lane Group Flow (vph)	72	451	30	154	79	57	281	155	388
v/c Ratio	0.33	0.75	0.20	0.32	0.14	0.34	0.64	0.56	0.54
Control Delay	34.3	29.4	36.7	23.9	0.5	38.7	30.3	38.1	21.9
Queue Delay	0.0	0.0	0.0	0.0	0.0	0.0	0.0	0.0	0.0
Total Delay	34.3	29.4	36.7	23.9	0.5	38.7	30.3	38.1	21.9
Queue Length 50th (ft)	25	130	11	53	0	20	92	53	120
Queue Length 95th (ft)	67	266	37	100	0	58	174	#130	222
Internal Link Dist (ft)		721		7441			203		209
Turn Bay Length (ft)	95		120		70	95		85	
Base Capacity (vph)	270	801	150	674	701	167	660	319	813
Starvation Cap Reductn	0	0	0	0	0	0	0	0	0
Spillback Cap Reductn	0	0	0	0	0	0	0	0	0
Storage Cap Reductn	0	0	0	0	0	0	0	0	0
Reduced v/c Ratio	0.27	0.56	0.20	0.23	0.11	0.34	0.43	0.49	0.48

Intersection Summary

95th percentile volume exceeds capacity, queue may be longer.
Queue shown is maximum after two cycles.

Queues
23: Avenue 16/Ellis Street & Kennedy Street

Village D Specific Plan
Existing WP MIT - AM Peak Hour



Lane Group	WBL	WBR	NBT	SBL	SBT
Lane Group Flow (vph)	138	123	619	284	280
v/c Ratio	0.55	0.25	0.43	0.54	0.11
Control Delay	25.6	7.7	12.4	28.3	3.4
Queue Delay	0.0	0.0	0.0	0.0	0.0
Total Delay	25.6	7.7	12.4	28.3	3.4
Queue Length 50th (ft)	70	0	68	118	16
Queue Length 95th (ft)	69	0	113	183	31
Internal Link Dist (ft)	782		506		440
Turn Bay Length (ft)	175			280	
Base Capacity (vph)	423	759	1434	524	2652
Starvation Cap Reductn	0	0	0	0	0
Spillback Cap Reductn	0	0	0	0	0
Storage Cap Reductn	0	0	0	0	0
Reduced v/c Ratio	0.33	0.16	0.43	0.54	0.11
Intersection Summary					

Queues
24: Schnoor Avenue & Kennedy Street

Village D Specific Plan
Existing WP MIT - AM Peak Hour



Lane Group	EBL	EBT	WBL	WBT	NBL	NBT	SBL	SBT	SBR
Lane Group Flow (vph)	16	493	167	168	105	248	16	7	4
v/c Ratio	0.13	0.70	0.61	0.25	0.41	0.28	0.18	0.01	0.01
Control Delay	40.8	18.1	40.6	17.0	40.5	4.2	39.9	20.8	0.0
Queue Delay	0.0	0.0	0.0	0.0	0.0	0.0	0.0	0.0	0.0
Total Delay	40.8	18.1	40.6	17.0	40.5	4.2	39.9	20.8	0.0
Queue Length 50th (ft)	8	42	78	51	26	1	8	2	0
Queue Length 95th (ft)	m15	76	133	100	50	55	27	12	0
Internal Link Dist (ft)		782		187		321		193	
Turn Bay Length (ft)	95		40		75		60		
Base Capacity (vph)	120	862	358	714	258	872	91	540	585
Starvation Cap Reductn	0	0	0	0	0	0	0	0	0
Spillback Cap Reductn	0	0	0	0	0	0	0	0	0
Storage Cap Reductn	0	0	0	0	0	0	0	0	0
Reduced v/c Ratio	0.13	0.57	0.47	0.24	0.41	0.28	0.18	0.01	0.01

Intersection Summary

m Volume for 95th percentile queue is metered by upstream signal.

Queues
29: Schnoor Avenue & Cleveland Avenue

Village D Specific Plan
Existing WP MIT - AM Peak Hour



Lane Group	EBL	EBT	EBR	WBL	WBT	WBR	NBL	NBT	NBR	SBL	SBT	SBR
Lane Group Flow (vph)	148	1098	73	177	535	47	67	237	170	87	187	99
v/c Ratio	0.59	0.85	0.11	0.63	0.50	0.08	0.57	0.24	0.26	0.61	0.18	0.17
Control Delay	20.1	21.6	0.9	21.5	4.4	0.2	56.5	24.5	5.6	54.8	23.1	0.6
Queue Delay	0.0	0.0	0.0	0.0	0.0	0.0	0.0	0.0	0.0	0.0	0.0	0.0
Total Delay	20.1	21.6	0.9	21.5	4.4	0.2	56.5	24.5	5.6	54.8	23.1	0.6
Queue Length 50th (ft)	46	292	0	38	15	0	33	50	8	43	38	0
Queue Length 95th (ft)	m59	m335	m2	m46	22	m0	#88	81	46	#104	64	0
Internal Link Dist (ft)		2178			574			393			326	
Turn Bay Length (ft)	120		60	220		95	75		75	105		65
Base Capacity (vph)	299	1317	705	280	1061	610	118	992	660	146	1032	596
Starvation Cap Reductn	0	0	0	0	0	0	0	0	0	0	0	0
Spillback Cap Reductn	0	0	0	0	0	0	0	0	0	0	0	0
Storage Cap Reductn	0	0	0	0	0	0	0	0	0	0	0	0
Reduced v/c Ratio	0.49	0.83	0.10	0.63	0.50	0.08	0.57	0.24	0.26	0.60	0.18	0.17

Intersection Summary

95th percentile volume exceeds capacity, queue may be longer.

Queue shown is maximum after two cycles.

m Volume for 95th percentile queue is metered by upstream signal.

Queues
30: Fairgrounds & Cleveland Avenue

Village D Specific Plan
Existing WP MIT - AM Peak Hour



Lane Group	EBL	EBT	WBL	WBT	WBR	NBL	NBT	NBR	SBL	SBT
Lane Group Flow (vph)	85	1277	34	673	105	14	15	15	114	45
v/c Ratio	0.43	0.77	0.22	0.69	0.18	0.06	0.03	0.02	0.55	0.06
Control Delay	19.2	13.8	36.7	30.4	0.7	36.1	16.4	0.1	43.2	7.2
Queue Delay	0.0	0.0	0.0	0.0	0.0	0.0	0.0	0.0	0.0	0.0
Total Delay	19.2	13.8	36.7	30.4	0.7	36.1	16.4	0.1	43.2	7.2
Queue Length 50th (ft)	29	41	16	158	0	3	2	0	54	1
Queue Length 95th (ft)	m39	#206	42	218	0	12	17	0	104	24
Internal Link Dist (ft)		574		1412			192			168
Turn Bay Length (ft)	120		205					100		
Base Capacity (vph)	232	1658	254	996	592	218	535	674	236	743
Starvation Cap Reductn	0	0	0	0	0	0	0	0	0	0
Spillback Cap Reductn	0	0	0	0	0	0	0	0	0	0
Storage Cap Reductn	0	0	0	0	0	0	0	0	0	0
Reduced v/c Ratio	0.37	0.77	0.13	0.68	0.18	0.06	0.03	0.02	0.48	0.06

Intersection Summary

95th percentile volume exceeds capacity, queue may be longer.

Queue shown is maximum after two cycles.

m Volume for 95th percentile queue is metered by upstream signal.

Queues
31: SR-99 Southbound Ramps & Cleveland Avenue

Village D Specific Plan
Existing WP MIT - AM Peak Hour



Lane Group	EBT	EBR	WBL	WBT	SBL	SBR
Lane Group Flow (vph)	760	832	360	1054	275	92
v/c Ratio	0.62	0.89	0.86	0.47	0.60	0.20
Control Delay	26.5	20.6	64.9	6.7	37.9	7.9
Queue Delay	0.0	0.0	0.0	0.1	0.0	0.0
Total Delay	26.5	20.6	64.9	6.9	37.9	7.9
Queue Length 50th (ft)	177	124	223	104	147	0
Queue Length 95th (ft)	224	#328	m#306	124	#245	35
Internal Link Dist (ft)	1412			372		
Turn Bay Length (ft)			115			140
Base Capacity (vph)	1336	966	454	2422	456	469
Starvation Cap Reductn	0	0	0	445	0	0
Spillback Cap Reductn	0	0	0	0	0	0
Storage Cap Reductn	0	0	0	0	0	0
Reduced v/c Ratio	0.57	0.86	0.79	0.53	0.60	0.20

Intersection Summary

95th percentile volume exceeds capacity, queue may be longer.

Queue shown is maximum after two cycles.

m Volume for 95th percentile queue is metered by upstream signal.

Queues
32: SR-99 Northbound Ramps & Cleveland Avenue

Village D Specific Plan
Existing WP MIT - AM Peak Hour



Lane Group	EBL	EBT	WBT	WBR	NBL	NBT	NBR
Lane Group Flow (vph)	68	1043	1046	146	236	237	300
v/c Ratio	0.40	0.59	0.78	0.23	0.36	0.37	0.45
Control Delay	39.2	23.1	13.2	3.5	24.1	24.1	17.5
Queue Delay	0.0	0.3	1.5	0.0	0.0	0.0	0.0
Total Delay	39.2	23.4	14.7	3.5	24.1	24.1	17.6
Queue Length 50th (ft)	39	201	72	0	106	106	84
Queue Length 95th (ft)	m67	217	120	m8	162	162	142
Internal Link Dist (ft)		372	207			441	
Turn Bay Length (ft)	90			50	145		325
Base Capacity (vph)	360	2044	1355	651	649	649	673
Starvation Cap Reductn	0	400	152	0	0	0	0
Spillback Cap Reductn	0	128	0	0	0	0	3
Storage Cap Reductn	0	0	0	0	0	0	0
Reduced v/c Ratio	0.19	0.63	0.87	0.22	0.36	0.37	0.45

Intersection Summary

m Volume for 95th percentile queue is metered by upstream signal.

Queues
33: Gateway Drive & Cleveland Avenue

Village D Specific Plan
Existing WP MIT - AM Peak Hour

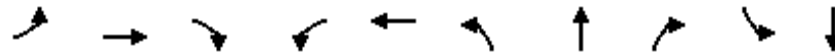

Lane Group	EBL	EBT	EBR	WBL	WBT	NBL	NBT	NBR	SBL	SBT
Lane Group Flow (vph)	5	994	337	190	1039	220	58	140	63	110
v/c Ratio	0.03	0.74	0.41	0.46	0.72	0.51	0.09	0.22	0.40	0.11
Control Delay	21.2	26.8	5.9	38.2	24.1	41.2	25.0	2.9	46.1	25.1
Queue Delay	0.0	1.2	0.1	0.3	32.9	0.0	0.0	0.0	0.0	0.0
Total Delay	21.2	27.9	6.0	38.5	57.0	41.2	25.0	2.9	46.1	25.1
Queue Length 50th (ft)	2	174	28	46	191	60	24	0	34	23
Queue Length 95th (ft)	m4	177	43	65	230	86	51	14	66	42
Internal Link Dist (ft)		207			111		765			296
Turn Bay Length (ft)	110					245			45	
Base Capacity (vph)	221	1426	818	587	1448	429	620	638	180	981
Starvation Cap Reductn	0	218	60	115	466	0	0	0	0	0
Spillback Cap Reductn	0	64	0	0	80	0	0	13	0	0
Storage Cap Reductn	0	0	0	0	0	0	0	0	0	0
Reduced v/c Ratio	0.02	0.82	0.44	0.40	1.06	0.51	0.09	0.22	0.35	0.11

Intersection Summary

m Volume for 95th percentile queue is metered by upstream signal.

Queues
34: Cleveland Avenue & County Club Drive

Village D Specific Plan
Existing WP MIT - AM Peak Hour



Lane Group	WBL	NBT	NBR	SBL	SBT
Lane Group Flow (vph)	470	672	494	92	752
v/c Ratio	0.69	0.26	0.31	0.18	0.21
Control Delay	38.5	10.1	3.1	6.2	5.0
Queue Delay	0.0	1.5	0.0	0.0	0.1
Total Delay	38.5	11.6	3.1	6.2	5.1
Queue Length 50th (ft)	127	79	63	15	45
Queue Length 95th (ft)	151	118	71	35	65
Internal Link Dist (ft)	239	111			159
Turn Bay Length (ft)					
Base Capacity (vph)	1264	2551	1615	515	3665
Starvation Cap Reductn	0	1637	0	0	0
Spillback Cap Reductn	1	0	0	0	1151
Storage Cap Reductn	0	0	0	0	0
Reduced v/c Ratio	0.37	0.74	0.31	0.18	0.30
Intersection Summary					

Queues
36: Pine Street & Howard Road

Village D Specific Plan
Existing WP MIT - AM Peak Hour



Lane Group	EBL	EBT	WBL	WBT	NBL	NBT	NBR	SBL	SBT	SBR
Lane Group Flow (vph)	39	1380	148	683	180	181	261	19	298	114
v/c Ratio	0.40	1.00	0.88	0.41	0.70	0.29	0.37	0.19	0.79	0.27
Control Delay	67.2	60.0	92.2	22.9	64.1	31.2	5.6	57.7	60.9	5.8
Queue Delay	0.0	0.0	0.0	0.0	0.0	0.0	0.0	0.0	0.0	0.0
Total Delay	67.2	60.0	92.2	22.9	64.1	31.2	5.6	57.7	60.9	5.8
Queue Length 50th (ft)	30	550	90	206	134	93	0	14	220	0
Queue Length 95th (ft)	63	#646	#218	331	201	166	50	37	#317	27
Internal Link Dist (ft)		265		565		224			259	
Turn Bay Length (ft)	95		140		90			115		
Base Capacity (vph)	101	1381	169	1669	256	633	697	260	379	424
Starvation Cap Reductn	0	0	0	0	0	0	0	0	0	0
Spillback Cap Reductn	0	0	0	0	0	0	5	0	0	0
Storage Cap Reductn	0	0	0	0	0	0	0	0	0	0
Reduced v/c Ratio	0.39	1.00	0.88	0.41	0.70	0.29	0.38	0.07	0.79	0.27

Intersection Summary

95th percentile volume exceeds capacity, queue may be longer.
Queue shown is maximum after two cycles.

Queues
37: Olive Avenue/Q Street & Howard Road/Yosemite Avenue

Village D Specific Plan
Existing WP MIT - AM Peak Hour



Lane Group	EBL	EBT	EBR	WBL	WBT	NBL	NBT	NBR	SBL	SBT	SBR
Lane Group Flow (vph)	8	776	796	35	490	334	339	27	132	196	16
v/c Ratio	0.11	0.68	0.78	0.30	0.37	0.56	0.55	0.04	0.55	0.78	0.05
Control Delay	53.5	27.9	18.2	59.4	27.0	39.0	38.9	0.1	57.1	70.7	0.2
Queue Delay	0.0	0.0	0.8	0.0	0.0	0.0	0.0	0.0	0.0	0.0	0.0
Total Delay	53.5	27.9	19.0	59.4	27.0	39.0	38.9	0.1	57.1	70.7	0.2
Queue Length 50th (ft)	5	320	387	26	124	242	245	0	95	146	0
Queue Length 95th (ft)	m8	320	348	49	145	290	294	0	131	186	0
Internal Link Dist (ft)		565			230		220			195	
Turn Bay Length (ft)	40			80		130			50		50
Base Capacity (vph)	76	1166	1023	265	1484	600	611	628	265	279	353
Starvation Cap Reductn	0	0	59	0	0	0	0	0	0	0	0
Spillback Cap Reductn	0	0	0	0	0	0	0	0	0	0	0
Storage Cap Reductn	0	0	0	0	0	0	0	0	0	0	0
Reduced v/c Ratio	0.11	0.67	0.83	0.13	0.33	0.56	0.55	0.04	0.50	0.70	0.05

Intersection Summary

m Volume for 95th percentile queue is metered by upstream signal.

Queues

38: I Street & 2nd Street/SR-99 Southbound Off-Ramp

Village D Specific Plan

Existing WP MIT - AM Peak Hour



Lane Group	EBT	WBT	WBR	NBL	NBT	SBT
Lane Group Flow (vph)	62	561	12	17	92	150
v/c Ratio	0.34	0.83	0.02	0.03	0.12	0.19
Control Delay	13.6	35.7	0.1	8.2	8.3	20.8
Queue Delay	0.0	0.0	0.0	0.0	0.0	0.0
Total Delay	13.6	35.7	0.1	8.2	8.3	20.8
Queue Length 50th (ft)	0	278	0	4	23	54
Queue Length 95th (ft)	30	352	0	m12	50	114
Internal Link Dist (ft)	129	218			779	118
Turn Bay Length (ft)			50	75		
Base Capacity (vph)	380	799	736	500	763	785
Starvation Cap Reductn	0	0	0	0	0	0
Spillback Cap Reductn	0	0	0	0	0	0
Storage Cap Reductn	0	0	0	0	0	0
Reduced v/c Ratio	0.16	0.70	0.02	0.03	0.12	0.19

Intersection Summary

m Volume for 95th percentile queue is metered by upstream signal.

Queues
39: 4th Street & Sunset Avenue

Village D Specific Plan
Existing WP MIT - AM Peak Hour



Lane Group	EBL	NBL	NBT	SBT	SBR
Lane Group Flow (vph)	452	34	338	500	300
v/c Ratio	0.69	0.25	0.13	0.42	0.23
Control Delay	39.5	43.7	4.5	4.0	0.5
Queue Delay	0.0	0.0	0.0	0.0	0.0
Total Delay	39.5	43.7	4.5	4.0	0.5
Queue Length 50th (ft)	121	19	27	121	0
Queue Length 95th (ft)	167	48	45	62	0
Internal Link Dist (ft)	7441		193	501	
Turn Bay Length (ft)	135				
Base Capacity (vph)	760	148	2528	1182	1360
Starvation Cap Reductn	0	0	0	0	0
Spillback Cap Reductn	0	0	0	0	0
Storage Cap Reductn	0	0	0	0	0
Reduced v/c Ratio	0.59	0.23	0.13	0.42	0.22
Intersection Summary					

Queues
41: I Street & 4th Street

Village D Specific Plan
Existing WP MIT - AM Peak Hour



Lane Group	EBL	EBT	WBL	WBT	NBL	NBT	NBR	SBL	SBT	SBR
Lane Group Flow (vph)	29	838	99	615	59	64	186	312	322	210
v/c Ratio	0.26	0.88	0.67	0.53	0.44	0.14	0.33	0.81	0.42	0.28
Control Delay	42.2	30.1	45.4	18.2	50.2	30.6	3.5	53.2	18.3	6.6
Queue Delay	0.0	0.0	0.0	0.0	0.0	0.0	0.0	0.0	0.0	0.0
Total Delay	42.2	30.1	45.4	18.2	50.2	30.6	3.5	53.2	18.3	6.6
Queue Length 50th (ft)	10	226	60	73	33	30	0	186	161	47
Queue Length 95th (ft)	m26	#272	m76	m90	69	62	22	#276	209	m54
Internal Link Dist (ft)		501		26		314			779	
Turn Bay Length (ft)	130				45		25	80		80
Base Capacity (vph)	113	973	153	1196	142	466	567	409	773	741
Starvation Cap Reductn	0	0	0	0	0	0	0	0	0	0
Spillback Cap Reductn	0	0	0	0	0	0	0	0	0	0
Storage Cap Reductn	0	0	0	0	0	0	0	0	0	0
Reduced v/c Ratio	0.26	0.86	0.65	0.51	0.42	0.14	0.33	0.76	0.42	0.28

Intersection Summary

95th percentile volume exceeds capacity, queue may be longer.

Queue shown is maximum after two cycles.

m Volume for 95th percentile queue is metered by upstream signal.

Queues
 43: SR-99 Northbound Off-Ramp/H Street & 4th Street

Village D Specific Plan
 Existing WP MIT - AM Peak Hour

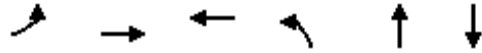

Lane Group	EBL	EBT	WBT	NBL	NBT	SBT
Lane Group Flow (vph)	271	612	630	278	255	72
v/c Ratio	0.86	0.40	0.90	0.71	0.48	0.17
Control Delay	46.0	7.8	51.5	44.6	9.5	2.0
Queue Delay	0.0	0.0	0.0	0.0	0.0	0.0
Total Delay	46.0	7.8	51.5	44.6	9.5	2.0
Queue Length 50th (ft)	166	69	179	149	13	0
Queue Length 95th (ft)	m#215	m86	#254	#240	67	5
Internal Link Dist (ft)		197	236		443	771
Turn Bay Length (ft)						
Base Capacity (vph)	327	1568	712	390	533	429
Starvation Cap Reductn	0	0	0	0	0	0
Spillback Cap Reductn	0	0	0	0	0	0
Storage Cap Reductn	0	0	0	0	0	0
Reduced v/c Ratio	0.83	0.39	0.88	0.71	0.48	0.17

Intersection Summary

95th percentile volume exceeds capacity, queue may be longer.

Queue shown is maximum after two cycles.

m Volume for 95th percentile queue is metered by upstream signal.

Queues
 45: Olive Avenue & SR-99 Southbound Off-Ramp

Village D Specific Plan
 Existing WP MIT - AM Peak Hour

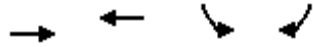

Lane Group	EBT	WBT	SBL	SBR
Lane Group Flow (vph)	799	519	537	105
v/c Ratio	0.70	0.66	0.48	0.10
Control Delay	31.7	35.7	8.9	3.4
Queue Delay	0.4	56.1	0.1	0.0
Total Delay	32.1	91.7	9.0	3.4
Queue Length 50th (ft)	131	141	123	9
Queue Length 95th (ft)	172	195	194	26
Internal Link Dist (ft)	103	112	135	
Turn Bay Length (ft)				
Base Capacity (vph)	1227	846	1112	1011
Starvation Cap Reductn	0	459	0	0
Spillback Cap Reductn	108	0	53	0
Storage Cap Reductn	0	0	0	0
Reduced v/c Ratio	0.71	1.34	0.51	0.10
Intersection Summary				

Queues
46: Madera Avenue & SR-99 Northbound Ramps

Village D Specific Plan
Existing WP MIT - AM Peak Hour



Lane Group	WBL	WBT	WBR	NBL	NBT	SBT
Lane Group Flow (vph)	111	113	82	436	537	805
v/c Ratio	0.49	0.50	0.29	0.60	0.21	0.50
Control Delay	38.6	38.8	10.1	28.4	2.9	15.3
Queue Delay	0.0	0.0	0.0	0.0	0.0	0.0
Total Delay	38.6	38.8	10.1	28.4	2.9	15.3
Queue Length 50th (ft)	54	55	0	87	23	127
Queue Length 95th (ft)	98	101	35	m117	m36	202
Internal Link Dist (ft)		337			388	217
Turn Bay Length (ft)	140			205		
Base Capacity (vph)	381	382	416	729	2581	1598
Starvation Cap Reductn	0	0	0	0	0	0
Spillback Cap Reductn	0	0	0	0	0	0
Storage Cap Reductn	0	0	0	0	0	0
Reduced v/c Ratio	0.29	0.30	0.20	0.60	0.21	0.50

Intersection Summary

m Volume for 95th percentile queue is metered by upstream signal.

Queues

47: Madera Avenue & Olive Avenue/SR-99 Southbound On-Ramp

Village D Specific Plan

Existing WP MIT - AM Peak Hour



Lane Group	EBL	EBT	EBR	NBL	NBT	SBL	SBT
Lane Group Flow (vph)	376	428	517	134	564	88	725
v/c Ratio	0.87	0.94	0.61	0.37	0.35	0.48	0.44
Control Delay	37.8	48.6	4.8	35.1	14.1	54.6	2.4
Queue Delay	5.0	3.9	0.8	0.0	0.0	0.0	0.3
Total Delay	42.8	52.5	5.6	35.1	14.1	54.6	2.7
Queue Length 50th (ft)	90	103	20	32	91	49	5
Queue Length 95th (ft)	#344	#397	43	56	132	96	33
Internal Link Dist (ft)		112			323		388
Turn Bay Length (ft)				120		90	
Base Capacity (vph)	434	455	946	634	1629	214	1647
Starvation Cap Reductn	28	12	187	0	0	0	0
Spillback Cap Reductn	0	0	0	0	0	0	404
Storage Cap Reductn	0	0	0	0	0	0	0
Reduced v/c Ratio	0.93	0.97	0.68	0.21	0.35	0.41	0.58

Intersection Summary

95th percentile volume exceeds capacity, queue may be longer.
 Queue shown is maximum after two cycles.

Queues
49: Yosemite Avenue & Cleveland Avenue/Tozer Street

Village D Specific Plan
Existing WP MIT - AM Peak Hour



Lane Group	EBL	EBT	WBL	WBT	WBR	NBL	NBT	NBR	SBL	SBT	SBR
Lane Group Flow (vph)	337	938	131	354	49	156	125	88	71	273	255
v/c Ratio	0.87	0.75	0.76	0.42	0.10	0.83	0.28	0.17	0.41	0.70	0.35
Control Delay	56.2	25.7	66.3	28.9	0.4	73.5	28.3	0.7	43.2	40.1	9.1
Queue Delay	0.0	0.0	0.0	0.0	0.0	0.0	0.0	0.0	0.0	0.0	0.0
Total Delay	56.2	25.7	66.3	28.9	0.4	73.5	28.3	0.7	43.2	40.1	9.1
Queue Length 50th (ft)	166	196	66	80	0	79	54	0	34	130	45
Queue Length 95th (ft)	#312	274	#155	123	0	#183	94	0	74	191	79
Internal Link Dist (ft)		318		397			415			443	
Turn Bay Length (ft)	210		150		50	240			150		100
Base Capacity (vph)	389	1254	172	841	470	187	563	597	201	582	730
Starvation Cap Reductn	0	0	0	0	0	0	0	0	0	0	0
Spillback Cap Reductn	0	0	0	0	0	0	0	0	0	0	0
Storage Cap Reductn	0	0	0	0	0	0	0	0	0	0	0
Reduced v/c Ratio	0.87	0.75	0.76	0.42	0.10	0.83	0.22	0.15	0.35	0.47	0.35

Intersection Summary

95th percentile volume exceeds capacity, queue may be longer.
Queue shown is maximum after two cycles.

Queues

5: Road 23/SR-99 Southbound Off-Ramp & Avenue 18 1/2

Village D Specific Plan

Existing WP MIT - PM Peak Hour

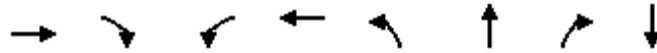

Lane Group	EBT	EBR	WBL	WBT	NBL	NBT	NBR	SBT
Lane Group Flow (vph)	404	314	41	203	95	203	203	842
v/c Ratio	0.94	0.51	0.51	0.38	0.42	0.27	0.27	0.72
Control Delay	65.7	13.8	51.5	26.8	40.3	0.9	0.9	30.4
Queue Delay	0.0	0.0	0.0	0.0	0.0	0.0	0.0	0.0
Total Delay	65.7	13.8	51.5	26.8	40.3	0.9	0.9	30.4
Queue Length 50th (ft)	224	76	24	111	51	0	0	209
Queue Length 95th (ft)	#400	125	#68	184	90	0	0	#350
Internal Link Dist (ft)	230			210		324		245
Turn Bay Length (ft)		50					25	
Base Capacity (vph)	435	702	81	540	347	802	752	1164
Starvation Cap Reductn	0	0	0	0	0	0	0	0
Spillback Cap Reductn	0	0	0	0	0	0	0	0
Storage Cap Reductn	0	0	0	0	0	0	0	0
Reduced v/c Ratio	0.93	0.45	0.51	0.38	0.27	0.25	0.27	0.72

Intersection Summary

95th percentile volume exceeds capacity, queue may be longer.
 Queue shown is maximum after two cycles.

Queues
6: SR-99 Northbound Ramps & Avenue 18 1/2

Village D Specific Plan
Existing WP MIT - PM Peak Hour



Lane Group	EBL	EBT	WBT	NBT
Lane Group Flow (vph)	520	88	99	197
v/c Ratio	0.73	0.14	0.50	0.25
Control Delay	51.0	20.1	42.5	14.9
Queue Delay	0.0	0.0	0.0	0.0
Total Delay	51.0	20.1	42.5	14.9
Queue Length 50th (ft)	155	33	49	60
Queue Length 95th (ft)	m184	m31	95	127
Internal Link Dist (ft)		549	786	644
Turn Bay Length (ft)	145			
Base Capacity (vph)	990	1006	366	783
Starvation Cap Reductn	0	0	0	0
Spillback Cap Reductn	0	0	0	0
Storage Cap Reductn	0	0	0	0
Reduced v/c Ratio	0.53	0.09	0.27	0.25

Intersection Summary

m Volume for 95th percentile queue is metered by upstream signal.

Queues
7: Road 23 & Avenue 17

Village D Specific Plan
Existing WP MIT - PM Peak Hour



Lane Group	EBL	EBT	WBL	WBT	NBL	NBT	NBR	SBL	SBT
Lane Group Flow (vph)	90	343	1051	518	38	583	697	66	1255
v/c Ratio	0.57	0.72	1.00	0.42	0.26	0.45	0.60	0.51	0.89
Control Delay	60.1	53.6	69.4	31.3	33.6	39.2	3.9	67.2	43.2
Queue Delay	0.0	0.0	0.0	0.0	0.0	0.0	0.0	0.0	0.0
Total Delay	60.1	53.6	69.4	31.3	33.6	39.2	3.9	67.2	43.2
Queue Length 50th (ft)	69	131	419	160	15	189	130	50	~510
Queue Length 95th (ft)	108	185	#567	210	m42	m250	m8	97	#671
Internal Link Dist (ft)		2671		6172		2520			336
Turn Bay Length (ft)	100		200		100		200	100	
Base Capacity (vph)	187	537	1053	1245	147	1292	1167	146	1410
Starvation Cap Reductn	0	0	0	0	0	0	0	0	0
Spillback Cap Reductn	0	0	0	0	0	0	0	0	0
Storage Cap Reductn	0	0	0	0	0	0	0	0	0
Reduced v/c Ratio	0.48	0.64	1.00	0.42	0.26	0.45	0.60	0.45	0.89

Intersection Summary

- ~ Volume exceeds capacity, queue is theoretically infinite.
Queue shown is maximum after two cycles.
- # 95th percentile volume exceeds capacity, queue may be longer.
Queue shown is maximum after two cycles.
- m Volume for 95th percentile queue is metered by upstream signal.

Queues
8: Road 23 & Avenue 16

Village D Specific Plan
Existing WP MIT - PM Peak Hour



Lane Group	EBL	EBT	EBR	WBL	WBT	WBR	NBL	NBT	NBR	SBL	SBT
Lane Group Flow (vph)	141	26	263	98	27	115	406	1128	180	234	1651
v/c Ratio	0.87	0.15	0.75	0.70	0.18	0.49	0.76	0.55	0.18	0.63	0.90
Control Delay	96.2	49.6	24.0	78.8	51.4	15.8	48.6	23.6	6.8	43.8	50.4
Queue Delay	0.0	0.0	0.0	0.0	0.0	0.0	0.0	0.0	0.0	0.0	0.0
Total Delay	96.2	49.6	24.0	78.8	51.4	15.8	48.6	23.6	6.8	43.8	50.4
Queue Length 50th (ft)	110	19	29	75	20	0	141	328	13	80	712
Queue Length 95th (ft)	#227	45	112	#151	47	54	m#210	m454	m69	m96	#845
Internal Link Dist (ft)		2685			1572			2602			2585
Turn Bay Length (ft)	100			100			200			200	
Base Capacity (vph)	163	299	442	148	285	340	534	2039	989	405	1844
Starvation Cap Reductn	0	0	0	0	0	0	0	0	0	0	0
Spillback Cap Reductn	0	0	0	0	0	0	0	0	0	0	0
Storage Cap Reductn	0	0	0	0	0	0	0	0	0	0	0
Reduced v/c Ratio	0.87	0.09	0.60	0.66	0.09	0.34	0.76	0.55	0.18	0.58	0.90

Intersection Summary

95th percentile volume exceeds capacity, queue may be longer.

Queue shown is maximum after two cycles.

m Volume for 95th percentile queue is metered by upstream signal.

Queues
9: Road 23 & Cleveland Avenue

Village D Specific Plan
Existing WP MIT - PM Peak Hour



Lane Group	EBL	EBT	EBR	WBL	WBT	WBR	NBL	NBT	NBR	SBL	SBT	SBR
Lane Group Flow (vph)	513	540	847	269	531	385	1041	991	308	323	990	654
v/c Ratio	1.03	0.78	0.57	0.77	0.98	0.62	1.08	0.66	0.33	0.68	1.00	0.83
Control Delay	92.5	57.3	26.1	57.6	78.3	37.7	83.2	42.2	15.0	43.2	68.9	49.7
Queue Delay	0.0	0.0	0.0	0.0	0.0	0.0	0.0	0.0	0.0	0.0	0.0	0.0
Total Delay	92.5	57.3	26.1	57.6	78.3	37.7	83.2	42.2	15.0	43.2	68.9	49.7
Queue Length 50th (ft)	~222	223	248	106	221	242	~473	374	114	111	429	487
Queue Length 95th (ft)	#327	285	348	#163	#336	335	m#521	m411	m137	m126	m#538	m573
Internal Link Dist (ft)		2664			3869			1127			2602	
Turn Bay Length (ft)	200		200	200		200	200		200	200		200
Base Capacity (vph)	499	694	1474	358	541	663	967	1501	937	586	994	784
Starvation Cap Reductn	0	0	0	0	0	0	0	0	0	0	0	0
Spillback Cap Reductn	0	0	0	0	0	0	0	0	0	0	0	0
Storage Cap Reductn	0	0	0	0	0	0	0	0	0	0	0	0
Reduced v/c Ratio	1.03	0.78	0.57	0.75	0.98	0.58	1.08	0.66	0.33	0.55	1.00	0.83

Intersection Summary

- ~ Volume exceeds capacity, queue is theoretically infinite.
Queue shown is maximum after two cycles.
- # 95th percentile volume exceeds capacity, queue may be longer.
Queue shown is maximum after two cycles.
- m Volume for 95th percentile queue is metered by upstream signal.

Queues
10: Road 23 & Avenue 14 1/2

Village D Specific Plan
Existing WP MIT - PM Peak Hour



Lane Group	EBT	WBT	WBR	NBL	NBT	SBL	SBT
Lane Group Flow (vph)	6	8	341	2	1429	343	1049
v/c Ratio	0.05	0.07	0.78	0.02	0.68	0.85	0.36
Control Delay	37.2	48.6	18.2	61.5	18.1	48.8	3.7
Queue Delay	0.0	0.0	0.0	0.0	0.0	0.0	0.0
Total Delay	37.2	48.6	18.2	61.5	18.1	48.8	3.7
Queue Length 50th (ft)	2	6	0	2	383	178	1
Queue Length 95th (ft)	15	20	77	m4	584	297	310
Internal Link Dist (ft)	377	475			2577		3397
Turn Bay Length (ft)			100	100		200	
Base Capacity (vph)	265	250	537	82	2087	454	2947
Starvation Cap Reductn	0	0	0	0	0	0	0
Spillback Cap Reductn	0	0	0	0	0	0	0
Storage Cap Reductn	0	0	0	0	0	0	0
Reduced v/c Ratio	0.02	0.03	0.64	0.02	0.68	0.76	0.36

Intersection Summary

m Volume for 95th percentile queue is metered by upstream signal.

Queues
11: Road 23 & Avenue 14

Village D Specific Plan
Existing WP MIT - PM Peak Hour



Lane Group	EBL	EBT	WBL	WBT	WBR	NBL	NBT	SBL	SBT	SBR
Lane Group Flow (vph)	148	130	12	38	820	15	381	577	306	91
v/c Ratio	0.66	0.44	0.15	0.31	0.72	0.16	0.24	0.72	0.13	0.08
Control Delay	63.5	42.5	59.3	59.2	20.1	57.1	24.0	40.3	17.7	9.4
Queue Delay	0.0	0.0	0.0	0.0	0.0	0.0	0.0	0.0	0.0	0.0
Total Delay	63.5	42.5	59.3	59.2	20.1	57.1	24.0	40.3	17.7	9.4
Queue Length 50th (ft)	111	73	9	29	152	11	97	215	46	5
Queue Length 95th (ft)	173	134	30	64	197	34	168	294	178	75
Internal Link Dist (ft)		1109		7848			463		2577	
Turn Bay Length (ft)	100		100		200	100		150		100
Base Capacity (vph)	322	524	81	289	1272	101	1560	984	2406	1119
Starvation Cap Reductn	0	0	0	0	0	0	0	0	0	0
Spillback Cap Reductn	0	0	0	0	0	0	0	0	0	0
Storage Cap Reductn	0	0	0	0	0	0	0	0	0	0
Reduced v/c Ratio	0.46	0.25	0.15	0.13	0.64	0.15	0.24	0.59	0.13	0.08

Intersection Summary

Queues
13: Airport Drive/Golden State Boulevard & Avenue 17

Village D Specific Plan
Existing WP MIT - PM Peak Hour



Lane Group	EBL	EBT	EBR	WBL	WBT	WBR	NBL	NBT	NBR	SBL	SBT
Lane Group Flow (vph)	8	913	172	91	1279	96	274	30	171	135	36
v/c Ratio	0.09	0.73	0.26	0.65	0.83	0.13	0.85	0.06	0.30	0.62	0.09
Control Delay	47.7	32.5	4.5	79.5	18.5	1.6	63.8	30.0	6.6	53.8	28.3
Queue Delay	0.0	0.0	0.0	0.0	0.4	0.0	0.0	0.0	0.0	0.0	0.0
Total Delay	47.7	32.5	4.5	79.5	19.0	1.6	63.8	30.0	6.6	53.8	28.3
Queue Length 50th (ft)	5	267	0	63	108	0	166	14	0	82	15
Queue Length 95th (ft)	20	325	41	m#115	#297	m9	#301	39	51	140	42
Internal Link Dist (ft)		188			379			370			222
Turn Bay Length (ft)	85			70		105	60		50	100	
Base Capacity (vph)	89	1308	694	146	1559	762	336	538	578	268	417
Starvation Cap Reductn	0	0	0	0	57	0	0	0	0	0	0
Spillback Cap Reductn	0	0	0	0	0	0	0	0	0	0	0
Storage Cap Reductn	0	0	0	0	0	0	0	0	0	0	0
Reduced v/c Ratio	0.09	0.70	0.25	0.62	0.85	0.13	0.82	0.06	0.30	0.50	0.09

Intersection Summary

95th percentile volume exceeds capacity, queue may be longer.

Queue shown is maximum after two cycles.

m Volume for 95th percentile queue is metered by upstream signal.

Queues
 14: Avenue 17 & SR-99 Southbound Off-Ramp

Village D Specific Plan
 Existing WP MIT - PM Peak Hour

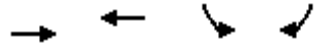

Lane Group	EBT	WBT	SBL	SBR
Lane Group Flow (vph)	1187	1367	166	47
v/c Ratio	0.62	0.70	0.26	0.08
Control Delay	7.5	27.6	26.2	8.4
Queue Delay	0.1	0.0	0.0	0.0
Total Delay	7.6	27.7	26.2	8.4
Queue Length 50th (ft)	75	422	74	0
Queue Length 95th (ft)	70	425	145	28
Internal Link Dist (ft)	379	248	971	
Turn Bay Length (ft)				610
Base Capacity (vph)	2318	2340	629	592
Starvation Cap Reductn	189	0	0	0
Spillback Cap Reductn	0	65	0	0
Storage Cap Reductn	0	0	0	0
Reduced v/c Ratio	0.56	0.60	0.26	0.08
Intersection Summary				

Queues
15: SR-99 Northbound Ramps & Avenue 17

Village D Specific Plan
Existing WP MIT - PM Peak Hour

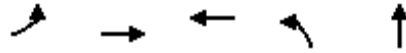

Lane Group	EBL	EBT	WBT	NBL	NBT
Lane Group Flow (vph)	67	747	870	356	357
v/c Ratio	0.44	0.49	0.78	0.44	0.44
Control Delay	65.0	12.7	35.6	21.6	21.6
Queue Delay	0.0	0.0	0.0	0.0	0.0
Total Delay	65.0	12.7	35.6	21.6	21.6
Queue Length 50th (ft)	44	66	257	161	161
Queue Length 95th (ft)	m84	90	310	272	273
Internal Link Dist (ft)		518	381		633
Turn Bay Length (ft)	125				
Base Capacity (vph)	185	1822	1282	816	818
Starvation Cap Reductn	0	0	0	0	0
Spillback Cap Reductn	0	0	0	0	0
Storage Cap Reductn	0	0	0	0	0
Reduced v/c Ratio	0.36	0.41	0.68	0.44	0.44

Intersection Summary

m Volume for 95th percentile queue is metered by upstream signal.

Queues
17: Westberry Boulevard & Cleveland Avenue

Village D Specific Plan
Existing WP MIT - PM Peak Hour



Lane Group	EBL	EBT	WBL	WBT	NBL	NBT	NBR	SBL	SBT	SBR
Lane Group Flow (vph)	262	916	32	1236	55	10	40	15	26	439
v/c Ratio	0.86	0.49	0.30	0.94	0.56	0.02	0.07	0.16	0.05	0.70
Control Delay	67.9	17.5	52.7	45.5	67.6	29.0	0.2	49.8	31.0	18.6
Queue Delay	0.0	0.0	0.0	0.0	0.0	0.0	0.0	0.0	0.0	0.0
Total Delay	67.9	17.5	52.7	45.5	67.6	29.0	0.2	49.8	31.0	18.6
Queue Length 50th (ft)	163	205	20	395	35	4	0	9	13	81
Queue Length 95th (ft)	#262	238	47	#451	#78	17	0	29	33	167
Internal Link Dist (ft)		674		1237		511			3065	
Turn Bay Length (ft)	110		165		65		50	100		50
Base Capacity (vph)	315	1851	108	1315	99	558	590	92	478	627
Starvation Cap Reductn	0	0	0	0	0	0	0	0	0	0
Spillback Cap Reductn	0	0	0	0	0	0	0	0	0	0
Storage Cap Reductn	0	0	0	0	0	0	0	0	0	0
Reduced v/c Ratio	0.83	0.49	0.30	0.94	0.56	0.02	0.07	0.16	0.05	0.70

Intersection Summary

95th percentile volume exceeds capacity, queue may be longer.
Queue shown is maximum after two cycles.

Queues
18: Westberry Boulevard & Sunset Avenue

Village D Specific Plan
Existing WP MIT - PM Peak Hour



Lane Group	EBL	EBT	WBL	WBT	NBL	NBT	NBR	SBL	SBT	SBR
Lane Group Flow (vph)	42	209	67	213	70	113	57	17	99	54
v/c Ratio	0.11	0.34	0.17	0.34	0.16	0.13	0.07	0.04	0.13	0.07
Control Delay	11.3	11.1	11.7	11.9	14.4	9.9	2.9	15.9	13.3	0.2
Queue Delay	0.0	0.0	0.0	0.0	0.0	0.0	0.0	0.0	0.0	0.0
Total Delay	11.3	11.1	11.7	11.9	14.4	9.9	2.9	15.9	13.3	0.2
Queue Length 50th (ft)	3	15	5	17	7	10	0	2	9	0
Queue Length 95th (ft)	26	83	36	88	43	55	14	17	54	0
Internal Link Dist (ft)		306		490		2579			413	
Turn Bay Length (ft)	90		90		130		50	135		50
Base Capacity (vph)	997	1529	1000	1577	960	1698	1452	496	1570	1359
Starvation Cap Reductn	0	0	0	0	0	0	0	0	0	0
Spillback Cap Reductn	0	0	0	0	0	0	0	0	0	0
Storage Cap Reductn	0	0	0	0	0	0	0	0	0	0
Reduced v/c Ratio	0.04	0.14	0.07	0.14	0.07	0.07	0.04	0.03	0.06	0.04

Intersection Summary

Queues
19: Westberry Boulevard & Avenue 14

Village D Specific Plan
Existing WP MIT - PM Peak Hour

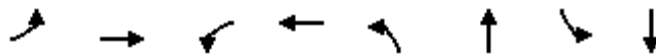

Lane Group	EBL	EBT	WBL	WBT	NBL	NBT	SBL	SBT
Lane Group Flow (vph)	76	802	25	948	60	64	99	137
v/c Ratio	0.32	0.47	0.13	0.69	0.27	0.24	0.38	0.34
Control Delay	32.4	12.7	31.5	19.1	32.1	23.6	32.6	14.4
Queue Delay	0.0	0.0	0.0	0.0	0.0	0.0	0.0	0.0
Total Delay	32.4	12.7	31.5	19.1	32.1	23.6	32.6	14.4
Queue Length 50th (ft)	29	85	10	161	23	18	38	17
Queue Length 95th (ft)	69	181	32	235	58	50	84	63
Internal Link Dist (ft)		7848		580		537		2579
Turn Bay Length (ft)	100		100		100		100	
Base Capacity (vph)	267	2093	192	1840	245	709	302	765
Starvation Cap Reductn	0	0	0	0	0	0	0	0
Spillback Cap Reductn	0	0	0	0	0	0	0	0
Storage Cap Reductn	0	0	0	0	0	0	0	0
Reduced v/c Ratio	0.28	0.38	0.13	0.52	0.24	0.09	0.33	0.18
Intersection Summary								

Queues
51: Project Driveway 1 & Avenue 17

Village D Specific Plan
Existing WP MIT - PM Peak Hour



Lane Group	EBT	WBL	WBT	NBL	NBR
Lane Group Flow (vph)	162	682	53	25	328
v/c Ratio	0.70	0.84	0.05	0.04	0.45
Control Delay	60.1	40.5	12.5	35.0	6.3
Queue Delay	0.0	0.0	0.0	0.0	0.0
Total Delay	60.1	40.5	12.5	35.0	6.3
Queue Length 50th (ft)	108	489	26	14	0
Queue Length 95th (ft)	177	m580	m48	41	79
Internal Link Dist (ft)	2580		2671	2061	
Turn Bay Length (ft)				50	
Base Capacity (vph)	293	955	1369	574	737
Starvation Cap Reductn	0	0	0	0	0
Spillback Cap Reductn	0	0	0	0	0
Storage Cap Reductn	0	0	0	0	0
Reduced v/c Ratio	0.55	0.71	0.04	0.04	0.45

Intersection Summary

m Volume for 95th percentile queue is metered by upstream signal.

Queues
53: Road 22 1/2 & Cleveland Avenue

Village D Specific Plan
Existing WP MIT - PM Peak Hour



Lane Group	EBL	EBT	WBL	WBT	WBR	NBL	NBT	SBL	SBT
Lane Group Flow (vph)	9	470	123	570	488	15	99	359	42
v/c Ratio	0.11	0.53	0.63	0.80	0.54	0.17	0.15	0.72	0.05
Control Delay	58.0	40.1	52.1	28.6	3.3	55.1	12.2	57.2	19.3
Queue Delay	0.0	0.0	0.0	0.0	0.0	0.0	0.0	0.0	0.0
Total Delay	58.0	40.1	52.1	28.6	3.3	55.1	12.2	57.2	19.3
Queue Length 50th (ft)	7	168	84	392	33	9	19	138	12
Queue Length 95th (ft)	25	184	m81	m422	m49	m30	70	185	46
Internal Link Dist (ft)		2664		2664			1767		2623
Turn Bay Length (ft)	100		100			100		100	
Base Capacity (vph)	82	1304	248	862	999	90	642	598	916
Starvation Cap Reductn	0	0	0	0	0	0	0	0	0
Spillback Cap Reductn	0	0	0	0	0	0	0	0	0
Storage Cap Reductn	0	0	0	0	0	0	0	0	0
Reduced v/c Ratio	0.11	0.36	0.50	0.66	0.49	0.17	0.15	0.60	0.05

Intersection Summary

m Volume for 95th percentile queue is metered by upstream signal.

Queues
55: Road 23 & Project Driveway 3

Village D Specific Plan
Existing WP MIT - PM Peak Hour



Lane Group	EBL	EBR	NBL	NBT	SBT	SBR
Lane Group Flow (vph)	320	229	248	1197	1678	686
v/c Ratio	0.90	0.36	0.89	0.46	0.88	0.62
Control Delay	76.0	25.8	71.4	13.8	35.3	11.8
Queue Delay	0.0	0.0	0.0	0.0	0.0	0.0
Total Delay	76.0	25.8	71.4	13.8	35.3	11.8
Queue Length 50th (ft)	242	114	176	189	664	277
Queue Length 95th (ft)	#401	180	m#322	476	m702	m112
Internal Link Dist (ft)	1503			2585	2520	
Turn Bay Length (ft)	50		50			
Base Capacity (vph)	368	648	290	2603	1909	1103
Starvation Cap Reductn	0	0	0	0	0	0
Spillback Cap Reductn	0	0	0	0	0	0
Storage Cap Reductn	0	0	0	0	0	0
Reduced v/c Ratio	0.87	0.35	0.86	0.46	0.88	0.62

Intersection Summary

95th percentile volume exceeds capacity, queue may be longer.

Queue shown is maximum after two cycles.

m Volume for 95th percentile queue is metered by upstream signal.

Queues
56: Road 23 & Project Driveway 4

Village D Specific Plan
Existing WP MIT - PM Peak Hour



Lane Group	WBL	WBR	NBT	NBR	SBL	SBT
Lane Group Flow (vph)	402	967	1349	371	1062	1058
v/c Ratio	1.05	0.62	1.00	0.48	1.05	0.42
Control Delay	105.4	20.6	48.5	5.8	74.1	10.3
Queue Delay	0.0	0.0	3.7	0.0	0.0	0.0
Total Delay	105.4	20.6	52.2	5.8	74.1	10.3
Queue Length 50th (ft)	~339	276	585	45	-473	202
Queue Length 95th (ft)	#537	350	#693	27	m#534	m214
Internal Link Dist (ft)	754		528			1127
Turn Bay Length (ft)	100				200	
Base Capacity (vph)	383	1557	1355	778	1015	2521
Starvation Cap Reductn	0	0	20	0	0	0
Spillback Cap Reductn	0	0	0	0	0	0
Storage Cap Reductn	0	0	0	0	0	0
Reduced v/c Ratio	1.05	0.62	1.01	0.48	1.05	0.42

Intersection Summary

- ~ Volume exceeds capacity, queue is theoretically infinite.
Queue shown is maximum after two cycles.
- # 95th percentile volume exceeds capacity, queue may be longer.
Queue shown is maximum after two cycles.
- m Volume for 95th percentile queue is metered by upstream signal.

Queues
57: Road 23 & Project Driveway 5

Village D Specific Plan
Existing WP MIT - PM Peak Hour



Lane Group	EBL	EBR	NBL	NBT	SBT
Lane Group Flow (vph)	78	45	102	1643	1457
v/c Ratio	0.49	0.25	0.57	0.53	0.58
Control Delay	62.1	17.3	51.4	11.9	16.8
Queue Delay	0.0	0.0	0.0	0.1	0.2
Total Delay	62.1	17.3	51.4	12.0	17.0
Queue Length 50th (ft)	59	0	75	516	115
Queue Length 95th (ft)	106	36	m97	722	m123
Internal Link Dist (ft)	2646			3397	528
Turn Bay Length (ft)			50		
Base Capacity (vph)	278	287	234	3084	2513
Starvation Cap Reductn	0	0	0	0	373
Spillback Cap Reductn	0	0	0	287	0
Storage Cap Reductn	0	0	0	0	0
Reduced v/c Ratio	0.28	0.16	0.44	0.59	0.68

Intersection Summary

m Volume for 95th percentile queue is metered by upstream signal.

Queues
58: Project Driveway 6 & Cleveland Avenue

Village D Specific Plan
Existing WP MIT - PM Peak Hour



Lane Group	EBT	WBL	WBT	NBL	NBR
Lane Group Flow (vph)	1094	361	1360	71	264
v/c Ratio	0.84	0.83	0.58	0.14	0.42
Control Delay	39.6	58.5	12.4	38.4	7.2
Queue Delay	0.0	0.0	0.0	0.0	0.0
Total Delay	39.6	58.5	12.4	38.4	7.2
Queue Length 50th (ft)	468	265	271	43	0
Queue Length 95th (ft)	541	349	242	91	73
Internal Link Dist (ft)	3869		3121	834	
Turn Bay Length (ft)		50		50	
Base Capacity (vph)	1404	555	2674	494	633
Starvation Cap Reductn	0	0	0	0	0
Spillback Cap Reductn	0	0	0	0	0
Storage Cap Reductn	0	0	0	0	0
Reduced v/c Ratio	0.78	0.65	0.51	0.14	0.42
Intersection Summary					

Queues
21: Granada Drive & Cleveland Avenue

Village D Specific Plan
Existing WP MIT - PM Peak Hour



Lane Group	EBL	EBT	WBL	WBT	NBL	NBT	NBR	SBL	SBT	SBR
Lane Group Flow (vph)	14	745	340	1085	30	203	244	20	248	22
v/c Ratio	0.12	0.82	0.81	0.59	0.26	0.33	0.38	0.18	0.44	0.04
Control Delay	42.4	40.6	58.6	9.3	46.4	28.0	10.0	44.3	31.5	0.1
Queue Delay	0.0	0.0	0.0	0.0	0.0	0.0	0.0	0.0	0.0	0.0
Total Delay	42.4	40.6	58.6	9.3	46.4	28.0	10.0	44.3	31.5	0.1
Queue Length 50th (ft)	8	200	201	47	16	87	22	11	131	0
Queue Length 95th (ft)	27	#298	m200	m51	45	166	91	34	202	0
Internal Link Dist (ft)		289		2178		418			382	
Turn Bay Length (ft)	90		125		50		50	50		50
Base Capacity (vph)	115	929	477	1864	114	620	647	111	586	623
Starvation Cap Reductn	0	0	0	0	0	0	0	0	0	0
Spillback Cap Reductn	0	0	0	0	0	0	0	0	0	0
Storage Cap Reductn	0	0	0	0	0	0	0	0	0	0
Reduced v/c Ratio	0.12	0.80	0.71	0.58	0.26	0.33	0.38	0.18	0.42	0.04

Intersection Summary

95th percentile volume exceeds capacity, queue may be longer.

Queue shown is maximum after two cycles.

m Volume for 95th percentile queue is metered by upstream signal.

Queues
22: Granada Drive & Sunset Avenue

Village D Specific Plan
Existing WP MIT - PM Peak Hour



Lane Group	EBL	EBT	WBL	WBT	WBR	NBL	NBT	SBL	SBT
Lane Group Flow (vph)	30	217	58	232	116	49	327	82	349
v/c Ratio	0.13	0.46	0.22	0.41	0.21	0.19	0.56	0.27	0.56
Control Delay	32.5	24.2	31.3	21.7	4.1	31.6	22.1	29.5	20.4
Queue Delay	0.0	0.0	0.0	0.0	0.0	0.0	0.0	0.0	0.0
Total Delay	32.5	24.2	31.3	21.7	4.1	31.6	22.1	29.5	20.4
Queue Length 50th (ft)	11	69	20	58	0	17	105	28	109
Queue Length 95th (ft)	40	153	63	163	27	56	203	80	206
Internal Link Dist (ft)		721		7441			203		209
Turn Bay Length (ft)	95		120		70	95		85	
Base Capacity (vph)	239	830	299	932	844	279	1141	408	1228
Starvation Cap Reductn	0	0	0	0	0	0	0	0	0
Spillback Cap Reductn	0	0	0	0	0	0	0	0	0
Storage Cap Reductn	0	0	0	0	0	0	0	0	0
Reduced v/c Ratio	0.13	0.26	0.19	0.25	0.14	0.18	0.29	0.20	0.28

Intersection Summary

Queues
23: Avenue 16/Ellis Street & Kennedy Street

Village D Specific Plan
Existing WP MIT - PM Peak Hour



Lane Group	WBL	WBR	NBT	SBL	SBT
Lane Group Flow (vph)	222	234	430	201	322
v/c Ratio	0.68	0.33	0.25	0.72	0.13
Control Delay	27.2	9.9	7.5	47.7	4.4
Queue Delay	0.0	0.0	0.0	0.0	0.0
Total Delay	27.2	9.9	7.5	47.7	4.4
Queue Length 50th (ft)	113	23	35	94	23
Queue Length 95th (ft)	187	55	64	#190	42
Internal Link Dist (ft)	782		506		440
Turn Bay Length (ft)	175			280	
Base Capacity (vph)	409	824	1736	296	2539
Starvation Cap Reductn	0	0	0	0	0
Spillback Cap Reductn	0	0	0	0	0
Storage Cap Reductn	0	0	0	0	0
Reduced v/c Ratio	0.54	0.28	0.25	0.68	0.13

Intersection Summary

95th percentile volume exceeds capacity, queue may be longer.
Queue shown is maximum after two cycles.

Queues
24: Schnoor Avenue & Kennedy Street

Village D Specific Plan
Existing WP MIT - PM Peak Hour



Lane Group	EBL	EBT	WBL	WBT	NBL	NBT	SBL	SBT	SBR
Lane Group Flow (vph)	10	339	215	269	204	277	24	15	9
v/c Ratio	0.07	0.62	0.66	0.45	0.57	0.31	0.21	0.03	0.01
Control Delay	26.8	10.3	39.6	23.5	40.9	4.7	39.5	21.2	0.0
Queue Delay	0.0	0.0	0.0	0.0	0.0	0.0	0.0	0.0	0.0
Total Delay	26.8	10.3	39.6	23.5	40.9	4.7	39.5	21.2	0.0
Queue Length 50th (ft)	5	44	101	96	51	3	12	5	0
Queue Length 95th (ft)	m14	31	157	181	84	61	35	21	0
Internal Link Dist (ft)		782		187		321		193	
Turn Bay Length (ft)	95		40		75		60		
Base Capacity (vph)	153	862	383	699	368	889	116	586	628
Starvation Cap Reductn	0	0	0	0	0	0	0	0	0
Spillback Cap Reductn	0	0	0	0	0	0	0	0	0
Storage Cap Reductn	0	0	0	0	0	0	0	0	0
Reduced v/c Ratio	0.07	0.39	0.56	0.38	0.55	0.31	0.21	0.03	0.01

Intersection Summary

m Volume for 95th percentile queue is metered by upstream signal.

Queues
29: Schnoor Avenue & Cleveland Avenue

Village D Specific Plan
Existing WP MIT - PM Peak Hour



Lane Group	EBL	EBT	EBR	WBL	WBT	WBR	NBL	NBT	NBR	SBL	SBT	SBR
Lane Group Flow (vph)	170	891	54	272	1210	106	82	223	153	113	209	162
v/c Ratio	0.78	0.77	0.09	0.47	0.92	0.15	0.62	0.28	0.22	0.76	0.23	0.30
Control Delay	64.2	48.4	3.9	14.2	12.1	0.2	61.7	30.3	5.6	72.9	28.7	5.1
Queue Delay	0.0	0.0	0.0	0.0	0.0	0.0	0.0	0.0	0.0	0.0	0.0	0.0
Total Delay	64.2	48.4	3.9	14.2	12.1	0.2	61.7	30.3	5.6	72.9	28.7	5.1
Queue Length 50th (ft)	103	278	0	51	54	0	46	56	8	64	51	0
Queue Length 95th (ft)	m#150	344	m7	m62	m58	m0	#108	88	46	#152	82	39
Internal Link Dist (ft)		2178			574			393			326	
Turn Bay Length (ft)	120		60	220		95	75		75	105		65
Base Capacity (vph)	228	1294	680	579	1330	701	135	800	696	148	918	536
Starvation Cap Reductn	0	0	0	0	0	0	0	0	0	0	0	0
Spillback Cap Reductn	0	0	0	0	0	0	0	0	0	0	0	0
Storage Cap Reductn	0	0	0	0	0	0	0	0	0	0	0	0
Reduced v/c Ratio	0.75	0.69	0.08	0.47	0.91	0.15	0.61	0.28	0.22	0.76	0.23	0.30

Intersection Summary

- # 95th percentile volume exceeds capacity, queue may be longer.
Queue shown is maximum after two cycles.
- m Volume for 95th percentile queue is metered by upstream signal.

Queues
30: Fairgrounds & Cleveland Avenue

Village D Specific Plan
Existing WP MIT - PM Peak Hour



Lane Group	EBL	EBT	WBL	WBT	WBR	NBL	NBT	NBR	SBL	SBT
Lane Group Flow (vph)	94	1102	163	1314	145	100	81	73	276	139
v/c Ratio	0.73	0.70	0.73	1.02	0.21	0.41	0.22	0.15	0.95	0.23
Control Delay	49.9	9.8	51.1	40.1	1.8	45.3	19.5	0.6	81.5	9.2
Queue Delay	0.0	0.0	0.0	0.0	0.0	0.0	0.0	0.0	0.0	0.0
Total Delay	49.9	9.8	51.1	40.1	1.8	45.3	19.5	0.6	81.5	9.2
Queue Length 50th (ft)	57	71	86	~336	8	28	21	0	157	15
Queue Length 95th (ft)	m#92	106	m113	#541	m10	54	62	0	#309	58
Internal Link Dist (ft)		574		1412			192			168
Turn Bay Length (ft)	120		205					100		
Base Capacity (vph)	129	1574	236	1290	681	249	373	498	290	603
Starvation Cap Reductn	0	0	0	0	0	0	0	0	0	0
Spillback Cap Reductn	0	0	0	0	0	0	0	0	0	0
Storage Cap Reductn	0	0	0	0	0	0	0	0	0	0
Reduced v/c Ratio	0.73	0.70	0.69	1.02	0.21	0.40	0.22	0.15	0.95	0.23

Intersection Summary

- ~ Volume exceeds capacity, queue is theoretically infinite.
Queue shown is maximum after two cycles.
- # 95th percentile volume exceeds capacity, queue may be longer.
Queue shown is maximum after two cycles.
- m Volume for 95th percentile queue is metered by upstream signal.

Queues
 31: SR-99 Southbound Ramps & Cleveland Avenue

Village D Specific Plan
 Existing WP MIT - PM Peak Hour



Lane Group	EBT	EBR	WBL	WBT	SBL	SBR
Lane Group Flow (vph)	975	586	199	1842	219	95
v/c Ratio	0.71	0.61	0.52	0.79	0.49	0.21
Control Delay	11.7	4.4	28.9	8.3	33.9	11.3
Queue Delay	0.1	0.0	0.0	3.4	0.0	0.0
Total Delay	11.8	4.4	28.9	11.7	33.9	11.3
Queue Length 50th (ft)	96	26	104	242	109	10
Queue Length 95th (ft)	m116	m36	m135	m190	181	48
Internal Link Dist (ft)	1412			372		
Turn Bay Length (ft)			115			140
Base Capacity (vph)	1449	986	386	2386	443	444
Starvation Cap Reductn	0	0	0	439	0	0
Spillback Cap Reductn	38	0	0	0	0	0
Storage Cap Reductn	0	0	0	0	0	0
Reduced v/c Ratio	0.69	0.59	0.52	0.95	0.49	0.21

Intersection Summary

m Volume for 95th percentile queue is metered by upstream signal.

Queues
32: SR-99 Northbound Ramps & Cleveland Avenue

Village D Specific Plan
Existing WP MIT - PM Peak Hour



Lane Group	EBL	EBT	WBT	WBR	NBL	NBT	NBR
Lane Group Flow (vph)	107	1112	1200	249	442	447	279
v/c Ratio	0.51	0.66	1.02	0.45	0.61	0.61	0.39
Control Delay	36.5	9.3	53.8	15.7	26.1	26.3	16.2
Queue Delay	0.0	0.8	29.0	1.1	0.0	0.0	0.0
Total Delay	36.5	10.0	82.8	16.8	26.1	26.3	16.2
Queue Length 50th (ft)	66	162	~302	43	208	211	79
Queue Length 95th (ft)	m103	193	#500	m66	345	348	157
Internal Link Dist (ft)		372	207			441	
Turn Bay Length (ft)	90			50	145		325
Base Capacity (vph)	287	1925	1171	555	728	730	717
Starvation Cap Reductn	0	462	148	135	0	0	0
Spillback Cap Reductn	0	0	15	0	0	0	0
Storage Cap Reductn	0	0	0	0	0	0	0
Reduced v/c Ratio	0.37	0.76	1.17	0.59	0.61	0.61	0.39

Intersection Summary

- ~ Volume exceeds capacity, queue is theoretically infinite.
Queue shown is maximum after two cycles.
- # 95th percentile volume exceeds capacity, queue may be longer.
Queue shown is maximum after two cycles.
- m Volume for 95th percentile queue is metered by upstream signal.

Queues
33: Gateway Drive & Cleveland Avenue

Village D Specific Plan
Existing WP MIT - PM Peak Hour

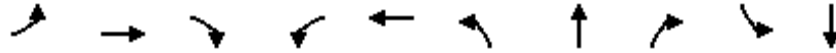

Lane Group	EBL	EBT	EBR	WBL	WBT	NBL	NBT	NBR	SBL	SBT
Lane Group Flow (vph)	15	1051	316	153	1192	364	119	223	165	155
v/c Ratio	0.08	0.68	0.36	0.47	0.80	0.77	0.23	0.40	0.72	0.17
Control Delay	6.3	13.3	1.3	38.9	24.4	49.6	28.8	10.1	56.6	24.2
Queue Delay	0.0	0.6	0.1	0.3	47.1	62.1	0.0	0.2	0.0	0.0
Total Delay	6.3	14.0	1.4	39.2	71.6	111.7	28.8	10.3	56.6	24.2
Queue Length 50th (ft)	2	58	1	38	191	104	54	19	91	31
Queue Length 95th (ft)	m3	84	2	72	#327	#162	104	82	#181	60
Internal Link Dist (ft)		207			111		765			296
Turn Bay Length (ft)	110					245			45	
Base Capacity (vph)	184	1780	872	340	1498	485	514	561	235	931
Starvation Cap Reductn	0	316	98	21	411	0	0	0	0	0
Spillback Cap Reductn	0	361	0	0	167	284	0	53	0	1
Storage Cap Reductn	0	0	0	0	0	0	0	0	0	0
Reduced v/c Ratio	0.08	0.74	0.41	0.48	1.10	1.81	0.23	0.44	0.70	0.17

Intersection Summary

95th percentile volume exceeds capacity, queue may be longer.

Queue shown is maximum after two cycles.

m Volume for 95th percentile queue is metered by upstream signal.

Queues
34: Cleveland Avenue & County Club Drive

Village D Specific Plan
Existing WP MIT - PM Peak Hour



Lane Group	WBL	NBT	NBR	SBL	SBT
Lane Group Flow (vph)	667	803	620	79	693
v/c Ratio	0.75	0.34	0.39	0.20	0.21
Control Delay	35.7	14.7	2.3	9.5	7.2
Queue Delay	0.0	3.6	0.0	0.0	0.1
Total Delay	35.7	18.3	2.3	9.5	7.3
Queue Length 50th (ft)	179	133	20	16	52
Queue Length 95th (ft)	217	189	80	46	84
Internal Link Dist (ft)	239	111			159
Turn Bay Length (ft)					
Base Capacity (vph)	1380	2328	1594	387	3345
Starvation Cap Reductn	0	1405	0	0	0
Spillback Cap Reductn	5	0	0	0	1109
Storage Cap Reductn	0	0	0	0	0
Reduced v/c Ratio	0.49	0.87	0.39	0.20	0.31
Intersection Summary					

Queues
36: Pine Street & Howard Road

Village D Specific Plan
Existing WP MIT - PM Peak Hour



Lane Group	EBL	EBT	WBL	WBT	NBL	NBT	NBR	SBL	SBT	SBR
Lane Group Flow (vph)	91	968	92	911	249	182	148	16	147	128
v/c Ratio	0.68	0.92	0.71	0.85	0.61	0.21	0.18	0.13	0.36	0.26
Control Delay	66.7	44.7	70.5	34.8	40.2	17.0	2.4	40.9	32.6	2.9
Queue Delay	0.0	0.0	0.0	0.0	0.0	0.0	0.0	0.0	0.0	0.0
Total Delay	66.7	44.7	70.5	34.8	40.2	17.0	2.4	40.9	32.6	2.9
Queue Length 50th (ft)	51	271	53	236	132	58	0	9	71	0
Queue Length 95th (ft)	#123	#394	#135	#331	#230	128	26	28	126	18
Internal Link Dist (ft)		265		561		224			259	
Turn Bay Length (ft)	95		140		90			115		
Base Capacity (vph)	135	1058	129	1076	407	887	840	354	411	491
Starvation Cap Reductn	0	0	0	0	0	0	0	0	0	0
Spillback Cap Reductn	0	0	0	0	0	0	0	0	0	0
Storage Cap Reductn	0	0	0	0	0	0	0	0	0	0
Reduced v/c Ratio	0.67	0.91	0.71	0.85	0.61	0.21	0.18	0.05	0.36	0.26

Intersection Summary

95th percentile volume exceeds capacity, queue may be longer.
Queue shown is maximum after two cycles.

Queues
37: Olive Avenue/Q Street & Howard Road/Yosemite Avenue

Village D Specific Plan
Existing WP MIT - PM Peak Hour



Lane Group	EBL	EBT	EBR	WBL	WBT	NBL	NBT	NBR	SBL	SBT	SBR
Lane Group Flow (vph)	8	528	477	14	467	379	382	14	18	63	2
v/c Ratio	0.06	0.62	0.65	0.11	0.56	0.43	0.43	0.02	0.11	0.36	0.01
Control Delay	41.4	25.7	16.5	40.8	32.6	19.3	19.2	0.0	37.4	43.2	0.0
Queue Delay	0.0	0.0	0.0	0.0	0.0	0.0	0.0	0.0	0.0	0.0	0.0
Total Delay	41.4	25.7	16.5	40.8	32.6	19.3	19.2	0.0	37.4	43.2	0.0
Queue Length 50th (ft)	5	167	182	8	120	135	136	0	10	34	0
Queue Length 95th (ft)	m8	m184	m205	26	163	296	297	0	29	69	0
Internal Link Dist (ft)		561			230		220			195	
Turn Bay Length (ft)	40			80		130			50		50
Base Capacity (vph)	287	865	743	357	895	883	893	879	357	376	421
Starvation Cap Reductn	0	0	0	0	0	0	0	0	0	0	0
Spillback Cap Reductn	0	0	0	0	0	0	0	0	0	0	0
Storage Cap Reductn	0	0	0	0	0	0	0	0	0	0	0
Reduced v/c Ratio	0.03	0.61	0.64	0.04	0.52	0.43	0.43	0.02	0.05	0.17	0.00

Intersection Summary

m Volume for 95th percentile queue is metered by upstream signal.

Queues

38: I Street & 2nd Street/SR-99 Southbound Off-Ramp



Lane Group	EBT	WBT	WBR	NBL	NBT	SBT
Lane Group Flow (vph)	33	303	4	43	144	114
v/c Ratio	0.06	0.75	0.01	0.05	0.12	0.10
Control Delay	0.2	47.1	0.0	2.1	2.1	10.3
Queue Delay	0.0	0.0	0.0	0.0	0.0	0.0
Total Delay	0.2	47.1	0.0	2.1	2.1	10.3
Queue Length 50th (ft)	0	181	0	1	5	30
Queue Length 95th (ft)	0	249	0	m5	m16	66
Internal Link Dist (ft)	129	218			779	118
Turn Bay Length (ft)			50	75		
Base Capacity (vph)	721	719	679	806	1182	1182
Starvation Cap Reductn	0	0	0	0	0	0
Spillback Cap Reductn	0	0	0	0	0	0
Storage Cap Reductn	0	0	0	0	0	0
Reduced v/c Ratio	0.05	0.42	0.01	0.05	0.12	0.10

Intersection Summary

m Volume for 95th percentile queue is metered by upstream signal.

Queues
39: 4th Street & Sunset Avenue

Village D Specific Plan
Existing WP MIT - PM Peak Hour



Lane Group	EBL	NBL	NBT	SBT	SBR
Lane Group Flow (vph)	279	15	372	389	424
v/c Ratio	0.58	0.12	0.14	0.29	0.31
Control Delay	44.1	44.2	3.3	2.1	0.7
Queue Delay	0.0	0.0	0.0	0.0	0.0
Total Delay	44.1	44.2	3.3	2.1	0.7
Queue Length 50th (ft)	86	9	24	29	0
Queue Length 95th (ft)	118	28	45	62	1
Internal Link Dist (ft)	7441		193	501	
Turn Bay Length (ft)	135				
Base Capacity (vph)	962	168	2734	1334	1443
Starvation Cap Reductn	0	0	0	0	0
Spillback Cap Reductn	0	0	0	0	0
Storage Cap Reductn	0	0	0	0	0
Reduced v/c Ratio	0.29	0.09	0.14	0.29	0.29
Intersection Summary					

Queues
41: I Street & 4th Street

Village D Specific Plan
 Existing WP MIT - PM Peak Hour



Lane Group	EBL	EBT	WBL	WBT	NBL	NBT	NBR	SBL	SBT	SBR
Lane Group Flow (vph)	35	672	66	689	108	76	274	206	183	135
v/c Ratio	0.28	0.78	0.45	0.70	0.57	0.13	0.39	0.60	0.24	0.19
Control Delay	42.5	29.8	43.5	20.0	54.1	29.5	5.8	56.2	24.4	11.0
Queue Delay	0.0	0.0	0.0	0.2	0.0	0.0	0.0	0.0	0.0	0.0
Total Delay	42.5	29.8	43.5	20.2	54.1	29.5	5.8	56.2	24.4	11.0
Queue Length 50th (ft)	22	196	45	97	66	37	0	134	109	30
Queue Length 95th (ft)	55	237	m64	m113	119	76	61	206	175	69
Internal Link Dist (ft)		501		26		314			779	
Turn Bay Length (ft)	130				45		25	80		80
Base Capacity (vph)	129	955	169	1103	226	596	694	380	754	712
Starvation Cap Reductn	0	0	0	59	0	0	0	0	0	0
Spillback Cap Reductn	0	0	0	0	0	0	0	0	0	0
Storage Cap Reductn	0	0	0	0	0	0	0	0	0	0
Reduced v/c Ratio	0.27	0.70	0.39	0.66	0.48	0.13	0.39	0.54	0.24	0.19

Intersection Summary

m Volume for 95th percentile queue is metered by upstream signal.

Queues
43: SR-99 Northbound Off-Ramp/H Street & 4th Street

Village D Specific Plan
Existing WP MIT - PM Peak Hour

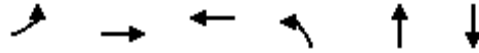

Lane Group	EBL	EBT	WBT	NBL	NBT	SBT
Lane Group Flow (vph)	269	464	701	254	173	91
v/c Ratio	0.84	0.29	0.87	0.62	0.35	0.23
Control Delay	45.9	7.0	47.9	42.9	9.8	5.5
Queue Delay	0.0	0.0	0.0	0.0	0.0	0.0
Total Delay	45.9	7.0	47.9	42.9	9.8	5.5
Queue Length 50th (ft)	180	51	215	150	10	0
Queue Length 95th (ft)	m#293	66	#307	237	66	28
Internal Link Dist (ft)		197	236		443	771
Turn Bay Length (ft)						
Base Capacity (vph)	348	1697	831	412	489	394
Starvation Cap Reductn	0	0	0	0	0	0
Spillback Cap Reductn	0	0	0	0	0	0
Storage Cap Reductn	0	0	0	0	0	0
Reduced v/c Ratio	0.77	0.27	0.84	0.62	0.35	0.23

Intersection Summary

95th percentile volume exceeds capacity, queue may be longer.

Queue shown is maximum after two cycles.

m Volume for 95th percentile queue is metered by upstream signal.

Queues
45: Olive Avenue & SR-99 Southbound Off-Ramp

Village D Specific Plan
Existing WP MIT - PM Peak Hour

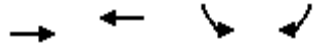

Lane Group	EBT	WBT	SBL	SBR
Lane Group Flow (vph)	716	679	348	68
v/c Ratio	0.60	0.81	0.30	0.07
Control Delay	32.7	50.6	7.4	4.0
Queue Delay	0.3	55.8	0.0	0.0
Total Delay	33.0	106.4	7.4	4.0
Queue Length 50th (ft)	130	222	77	7
Queue Length 95th (ft)	169	280	120	21
Internal Link Dist (ft)	103	112	135	
Turn Bay Length (ft)				
Base Capacity (vph)	1284	893	1166	1040
Starvation Cap Reductn	0	529	0	0
Spillback Cap Reductn	154	0	1	0
Storage Cap Reductn	0	0	0	0
Reduced v/c Ratio	0.63	1.87	0.30	0.07
Intersection Summary				

Queues
46: Madera Avenue & SR-99 Northbound Ramps

Village D Specific Plan
Existing WP MIT - PM Peak Hour



Lane Group	WBL	WBT	WBR	NBL	NBT	SBT
Lane Group Flow (vph)	184	186	35	554	644	945
v/c Ratio	0.66	0.67	0.11	0.64	0.24	0.62
Control Delay	46.5	46.8	2.2	40.0	6.7	20.9
Queue Delay	0.0	0.0	0.0	0.0	0.0	0.0
Total Delay	46.5	46.8	2.2	40.0	6.7	20.9
Queue Length 50th (ft)	104	105	0	161	71	196
Queue Length 95th (ft)	169	170	6	m204	m87	283
Internal Link Dist (ft)		337			388	217
Turn Bay Length (ft)	140			205		
Base Capacity (vph)	350	351	384	866	2631	1513
Starvation Cap Reductn	0	0	0	0	0	0
Spillback Cap Reductn	0	0	0	0	0	0
Storage Cap Reductn	0	0	0	0	0	0
Reduced v/c Ratio	0.53	0.53	0.09	0.64	0.24	0.62

Intersection Summary

m Volume for 95th percentile queue is metered by upstream signal.

Queues

47: Madera Avenue & Olive Avenue/SR-99 Southbound On-Ramp



Lane Group	EBL	EBT	EBR	NBL	NBT	SBL	SBT
Lane Group Flow (vph)	314	321	407	157	752	134	851
v/c Ratio	0.93	0.91	0.57	0.73	0.40	0.68	0.40
Control Delay	55.1	51.8	5.2	62.0	13.1	60.0	1.9
Queue Delay	4.2	4.1	0.2	0.0	0.0	0.0	0.7
Total Delay	59.3	55.9	5.3	62.0	13.1	60.0	2.7
Queue Length 50th (ft)	193	196	0	46	126	62	14
Queue Length 95th (ft)	#355	#356	7	#94	167	m#131	6
Internal Link Dist (ft)		112			323		388
Turn Bay Length (ft)				120		90	
Base Capacity (vph)	342	355	712	216	1889	208	2110
Starvation Cap Reductn	11	13	30	0	0	0	0
Spillback Cap Reductn	0	0	0	0	0	0	858
Storage Cap Reductn	0	0	0	0	0	0	0
Reduced v/c Ratio	0.95	0.94	0.60	0.73	0.40	0.64	0.68

Intersection Summary

95th percentile volume exceeds capacity, queue may be longer.

Queue shown is maximum after two cycles.

m Volume for 95th percentile queue is metered by upstream signal.

Queues
49: Yosemite Avenue & Cleveland Avenue/Tozer Street

Village D Specific Plan
Existing WP MIT - PM Peak Hour



Lane Group	EBL	EBT	WBL	WBT	WBR	NBL	NBT	NBR	SBL	SBT	SBR
Lane Group Flow (vph)	279	667	52	513	38	332	308	103	73	182	359
v/c Ratio	0.84	0.49	0.44	0.63	0.07	0.85	0.54	0.17	0.43	0.62	0.58
Control Delay	58.7	20.3	52.1	34.9	0.3	54.2	29.9	1.5	45.6	43.3	17.2
Queue Delay	0.0	0.0	0.0	0.0	0.0	0.0	0.0	0.0	0.0	0.0	0.0
Total Delay	58.7	20.3	52.1	34.9	0.3	54.2	29.9	1.5	45.6	43.3	17.2
Queue Length 50th (ft)	147	133	28	132	0	173	144	0	38	93	95
Queue Length 95th (ft)	#305	205	#67	200	0	#345	228	9	83	158	172
Internal Link Dist (ft)		318		397			415			443	
Turn Bay Length (ft)	210		150		50	240			150		100
Base Capacity (vph)	331	1358	119	809	518	392	798	772	199	595	615
Starvation Cap Reductn	0	0	0	0	0	0	0	0	0	0	0
Spillback Cap Reductn	0	0	0	0	0	0	0	0	0	0	0
Storage Cap Reductn	0	0	0	0	0	0	0	0	0	0	0
Reduced v/c Ratio	0.84	0.49	0.44	0.63	0.07	0.85	0.39	0.13	0.37	0.31	0.58

Intersection Summary

95th percentile volume exceeds capacity, queue may be longer.
Queue shown is maximum after two cycles.

Queues

5: Road 23/SR-99 Southbound Off-Ramp & Avenue 18 1/2

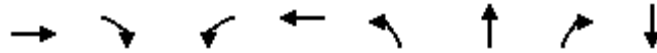

Lane Group	EBT	EBR	WBL	WBT	NBL	NBT	NBR	SBT
Lane Group Flow (vph)	338	63	47	300	83	184	184	230
v/c Ratio	0.95	0.09	0.52	0.54	0.21	0.23	0.22	0.34
Control Delay	70.3	1.8	49.9	38.0	26.1	0.6	0.6	16.9
Queue Delay	0.0	0.0	0.0	0.0	0.0	0.0	0.0	0.0
Total Delay	70.3	1.8	49.9	38.0	26.1	0.6	0.6	16.9
Queue Length 50th (ft)	167	0	25	166	33	0	0	30
Queue Length 95th (ft)	#327	12	m#66	245	70	0	0	60
Internal Link Dist (ft)	230			210		324		245
Turn Bay Length (ft)		50					25	
Base Capacity (vph)	354	700	91	552	393	815	820	685
Starvation Cap Reductn	0	0	0	0	0	0	0	0
Spillback Cap Reductn	0	0	0	0	0	0	0	0
Storage Cap Reductn	0	0	0	0	0	0	0	0
Reduced v/c Ratio	0.95	0.09	0.52	0.54	0.21	0.23	0.22	0.34

Intersection Summary

95th percentile volume exceeds capacity, queue may be longer.

Queue shown is maximum after two cycles.

m Volume for 95th percentile queue is metered by upstream signal.

Queues
6: SR-99 Northbound Ramps & Avenue 18 1/2

Village D Specific Plan
Phase I WP MIT - AM Peak Hour



Lane Group	EBL	EBT	WBT	NBT
Lane Group Flow (vph)	447	62	183	257
v/c Ratio	0.72	0.09	0.66	0.41
Control Delay	37.3	19.7	39.7	18.9
Queue Delay	0.0	0.0	0.0	0.0
Total Delay	37.3	19.7	39.7	18.9
Queue Length 50th (ft)	117	25	81	82
Queue Length 95th (ft)	m142	m39	137	168
Internal Link Dist (ft)		549	786	644
Turn Bay Length (ft)	145			
Base Capacity (vph)	723	855	372	632
Starvation Cap Reductn	0	0	0	0
Spillback Cap Reductn	0	0	0	0
Storage Cap Reductn	0	0	0	0
Reduced v/c Ratio	0.62	0.07	0.49	0.41

Intersection Summary

m Volume for 95th percentile queue is metered by upstream signal.

Queues
7: Road 23 & Avenue 17

Village D Specific Plan
Phase I WP MIT - AM Peak Hour



Lane Group	EBL	EBT	WBL	WBT	NBL	NBT	NBR	SBL	SBT
Lane Group Flow (vph)	2	50	92	25	46	473	130	16	217
v/c Ratio	0.02	0.39	0.57	0.09	0.38	0.38	0.12	0.18	0.20
Control Delay	55.0	43.5	64.1	36.5	61.0	11.5	2.1	57.8	12.1
Queue Delay	0.0	0.0	0.0	0.0	0.0	0.0	0.0	0.0	0.0
Total Delay	55.0	43.5	64.1	36.5	61.0	11.5	2.1	57.8	12.1
Queue Length 50th (ft)	2	22	69	14	35	122	0	12	70
Queue Length 95th (ft)	11	62	120	40	72	309	26	35	141
Internal Link Dist (ft)		2671		6172		2520			336
Turn Bay Length (ft)	100		100		100		100	100	
Base Capacity (vph)	121	335	323	527	234	1244	1100	153	1082
Starvation Cap Reductn	0	0	0	0	0	0	0	0	0
Spillback Cap Reductn	0	0	0	0	0	0	0	0	0
Storage Cap Reductn	0	0	0	0	0	0	0	0	0
Reduced v/c Ratio	0.02	0.15	0.28	0.05	0.20	0.38	0.12	0.10	0.20

Intersection Summary

Queues
13: Airport Drive/Golden State Boulevard & Avenue 17

Village D Specific Plan
Phase I WP MIT - AM Peak Hour



Lane Group	EBL	EBT	EBR	WBL	WBT	WBR	NBL	NBT	NBR	SBL	SBT
Lane Group Flow (vph)	4	140	21	204	109	167	18	60	116	146	38
v/c Ratio	0.04	0.54	0.05	0.68	0.17	0.26	0.14	0.10	0.19	0.42	0.05
Control Delay	36.2	39.1	0.3	52.5	36.9	23.0	36.6	22.7	0.8	36.9	15.5
Queue Delay	0.0	0.0	0.0	0.0	0.0	0.0	0.0	0.0	0.0	0.0	0.0
Total Delay	36.2	39.1	0.3	52.5	36.9	23.0	36.6	22.7	0.8	36.9	15.5
Queue Length 50th (ft)	2	66	0	111	56	63	9	20	0	35	8
Queue Length 95th (ft)	11	114	0	178	88	86	28	55	3	62	36
Internal Link Dist (ft)		188			379			370			222
Turn Bay Length (ft)	85			70		105	60		50	100	
Base Capacity (vph)	106	403	501	382	704	698	125	576	624	355	820
Starvation Cap Reductn	0	0	0	0	0	0	0	0	0	0	0
Spillback Cap Reductn	0	0	0	0	0	0	0	0	0	0	0
Storage Cap Reductn	0	0	0	0	0	0	0	0	0	0	0
Reduced v/c Ratio	0.04	0.35	0.04	0.53	0.15	0.24	0.14	0.10	0.19	0.41	0.05

Intersection Summary

Queues
 14: Avenue 17 & SR-99 Southbound Off-Ramp

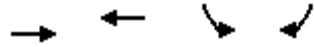

Lane Group	EBT	WBT	SBL	SBR
Lane Group Flow (vph)	405	402	273	82
v/c Ratio	0.64	0.63	0.24	0.08
Control Delay	33.9	39.8	5.7	1.6
Queue Delay	0.0	0.0	0.0	0.0
Total Delay	33.9	39.8	5.7	1.6
Queue Length 50th (ft)	71	101	41	0
Queue Length 95th (ft)	100	m122	88	14
Internal Link Dist (ft)	379	248	971	
Turn Bay Length (ft)				610
Base Capacity (vph)	1128	1138	1148	1052
Starvation Cap Reductn	0	0	0	0
Spillback Cap Reductn	0	0	0	0
Storage Cap Reductn	0	0	0	0
Reduced v/c Ratio	0.36	0.35	0.24	0.08

Intersection Summary

m Volume for 95th percentile queue is metered by upstream signal.

Queues
15: SR-99 Northbound Ramps & Avenue 17

Village D Specific Plan
Phase I WP MIT - AM Peak Hour

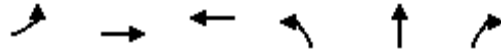

Lane Group	EBL	EBT	WBT	NBL	NBT	NBR
Lane Group Flow (vph)	90	467	1244	87	86	261
v/c Ratio	0.48	0.23	0.80	0.18	0.17	0.40
Control Delay	38.3	13.4	28.1	25.2	25.3	5.7
Queue Delay	0.0	0.0	0.0	0.0	0.0	0.0
Total Delay	38.3	13.4	28.1	25.2	25.3	5.7
Queue Length 50th (ft)	47	57	136	36	36	0
Queue Length 95th (ft)	94	97	200	76	75	56
Internal Link Dist (ft)		518	493		633	
Turn Bay Length (ft)	125					50
Base Capacity (vph)	217	2238	1638	494	495	646
Starvation Cap Reductn	0	0	0	0	0	0
Spillback Cap Reductn	0	0	0	0	0	0
Storage Cap Reductn	0	0	0	0	0	0
Reduced v/c Ratio	0.41	0.21	0.76	0.18	0.17	0.40
Intersection Summary						

Queues
 16: Love's Truck Stop Driveway/Driveway & Avenue 17

Village D Specific Plan
 Phase I WP MIT - AM Peak Hour

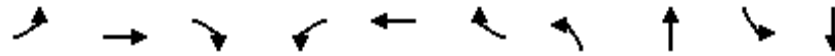

Lane Group	EBL	EBT	EBR	WBL	WBT	WBR	NBL	NBT	SBL	SBT
Lane Group Flow (vph)	176	404	143	49	933	61	148	24	52	98
v/c Ratio	0.51	0.24	0.22	0.36	0.72	0.11	0.60	0.03	0.37	0.15
Control Delay	42.9	14.3	2.4	42.4	30.7	0.4	42.4	0.0	42.5	0.5
Queue Delay	0.0	0.0	0.0	0.0	0.0	0.0	0.0	0.0	0.0	0.0
Total Delay	42.9	14.3	2.4	42.4	30.7	0.4	42.4	0.0	42.5	0.5
Queue Length 50th (ft)	47	46	0	24	153	0	70	0	25	0
Queue Length 95th (ft)	73	62	5	57	197	0	125	0	60	0
Internal Link Dist (ft)		311			402			160		226
Turn Bay Length (ft)	200		100	100		100				
Base Capacity (vph)	364	1686	662	142	1353	571	293	879	146	651
Starvation Cap Reductn	0	0	0	0	0	0	0	0	0	0
Spillback Cap Reductn	0	0	0	0	0	0	0	0	0	0
Storage Cap Reductn	0	0	0	0	0	0	0	0	0	0
Reduced v/c Ratio	0.48	0.24	0.22	0.35	0.69	0.11	0.51	0.03	0.36	0.15

Intersection Summary

Queues
17: Westberry Boulevard & Cleveland Avenue

Village D Specific Plan
Phase I WP MIT - AM Peak Hour



Lane Group	EBL	EBT	WBL	WBT	NBL	NBT	NBR	SBL	SBT	SBR
Lane Group Flow (vph)	276	941	29	335	41	111	107	15	42	115
v/c Ratio	0.74	0.68	0.24	0.55	0.30	0.14	0.13	0.12	0.06	0.16
Control Delay	42.2	23.0	40.3	32.6	41.2	18.4	0.3	37.6	22.4	0.6
Queue Delay	0.0	0.0	0.0	0.0	0.0	0.0	0.0	0.0	0.0	0.0
Total Delay	42.2	23.0	40.3	32.6	41.2	18.4	0.3	37.6	22.4	0.6
Queue Length 50th (ft)	128	182	14	81	20	31	0	7	15	0
Queue Length 95th (ft)	203	258	39	113	51	87	0	26	42	2
Internal Link Dist (ft)		630		1237		511			3065	
Turn Bay Length (ft)	110		165		65		50	100		50
Base Capacity (vph)	439	1454	122	802	136	816	801	124	709	722
Starvation Cap Reductn	0	0	0	0	0	0	0	0	0	0
Spillback Cap Reductn	0	0	0	0	0	0	0	0	0	0
Storage Cap Reductn	0	0	0	0	0	0	0	0	0	0
Reduced v/c Ratio	0.63	0.65	0.24	0.42	0.30	0.14	0.13	0.12	0.06	0.16
Intersection Summary										

Queues
56: Road 23 & Project Driveway 4

Village D Specific Plan
Phase I WP MIT - AM Peak Hour



Lane Group	WBL	WBR	NBT	SBL	SBT
Lane Group Flow (vph)	87	286	467	143	439
v/c Ratio	0.41	0.65	0.50	0.57	0.32
Control Delay	37.5	11.6	13.8	39.8	3.9
Queue Delay	0.0	0.0	0.0	0.0	0.0
Total Delay	37.5	11.6	13.8	39.8	3.9
Queue Length 50th (ft)	41	0	121	67	50
Queue Length 95th (ft)	79	64	259	116	107
Internal Link Dist (ft)	754		528		1127
Turn Bay Length (ft)	50			50	
Base Capacity (vph)	412	590	942	304	1366
Starvation Cap Reductn	0	0	0	0	0
Spillback Cap Reductn	0	0	0	0	0
Storage Cap Reductn	0	0	0	0	0
Reduced v/c Ratio	0.21	0.48	0.50	0.47	0.32
Intersection Summary					

Queues
58: Project Driveway 6 & Cleveland Avenue

Village D Specific Plan
Phase I WP MIT - AM Peak Hour



Lane Group	EBT	WBL	WBT	NBL	NBR
Lane Group Flow (vph)	1060	167	355	225	317
v/c Ratio	0.96	0.85	0.26	0.67	0.60
Control Delay	43.1	87.8	5.5	56.8	12.8
Queue Delay	0.0	0.0	0.0	0.0	0.0
Total Delay	43.1	87.8	5.5	56.8	12.8
Queue Length 50th (ft)	723	129	74	165	23
Queue Length 95th (ft)	#1069	#249	108	#254	113
Internal Link Dist (ft)	3869		3165	834	
Turn Bay Length (ft)		50		50	
Base Capacity (vph)	1110	201	1402	335	529
Starvation Cap Reductn	0	0	0	0	0
Spillback Cap Reductn	0	0	0	0	0
Storage Cap Reductn	0	0	0	0	0
Reduced v/c Ratio	0.95	0.83	0.25	0.67	0.60

Intersection Summary

95th percentile volume exceeds capacity, queue may be longer.
Queue shown is maximum after two cycles.

Queues
21: Granada Drive & Cleveland Avenue

Village D Specific Plan
Phase I WP MIT - AM Peak Hour



Lane Group	EBL	EBT	WBL	WBT	NBL	NBT	NBR	SBL	SBT	SBR
Lane Group Flow (vph)	24	973	204	329	27	367	321	8	259	5
v/c Ratio	0.20	0.93	0.82	0.21	0.23	0.52	0.45	0.07	0.39	0.01
Control Delay	39.7	43.4	45.6	11.7	40.7	24.0	9.9	36.7	23.5	0.0
Queue Delay	0.0	0.0	0.0	0.0	0.0	0.0	0.0	0.0	0.0	0.0
Total Delay	39.7	43.4	45.6	11.7	40.7	24.0	9.9	36.7	23.5	0.0
Queue Length 50th (ft)	12	246	96	43	13	134	37	4	89	0
Queue Length 95th (ft)	35	#368	#210	116	38	259	122	17	179	0
Internal Link Dist (ft)		289		2178		418			382	
Turn Bay Length (ft)	90		125		50		50	50		50
Base Capacity (vph)	118	1051	254	1555	117	707	721	114	661	687
Starvation Cap Reductn	0	0	0	0	0	0	0	0	0	0
Spillback Cap Reductn	0	0	0	0	0	0	0	0	0	0
Storage Cap Reductn	0	0	0	0	0	0	0	0	0	0
Reduced v/c Ratio	0.20	0.93	0.80	0.21	0.23	0.52	0.45	0.07	0.39	0.01

Intersection Summary

95th percentile volume exceeds capacity, queue may be longer.
Queue shown is maximum after two cycles.

Queues
 23: Avenue 16/Ellis Street & Kennedy Street

Village D Specific Plan
 Phase I WP MIT - AM Peak Hour



Lane Group	WBL	WBR	NBT	SBL	SBT
Lane Group Flow (vph)	161	138	570	275	321
v/c Ratio	0.59	0.25	0.43	0.53	0.12
Control Delay	23.8	6.0	18.0	28.1	3.8
Queue Delay	0.0	0.0	0.0	0.0	0.0
Total Delay	23.8	6.0	18.0	28.1	3.8
Queue Length 50th (ft)	47	0	94	114	20
Queue Length 95th (ft)	81	1	153	188	40
Internal Link Dist (ft)	782		506		440
Turn Bay Length (ft)	175			280	
Base Capacity (vph)	423	770	1313	519	2580
Starvation Cap Reductn	0	0	0	0	0
Spillback Cap Reductn	0	0	0	0	0
Storage Cap Reductn	0	0	0	0	0
Reduced v/c Ratio	0.38	0.18	0.43	0.53	0.12
Intersection Summary					

Queues
24: Schnoor Avenue & Kennedy Street

Village D Specific Plan
Phase I WP MIT - AM Peak Hour



Lane Group	EBL	EBT	WBL	WBT	NBL	NBT	SBL	SBT	SBR
Lane Group Flow (vph)	53	381	153	271	115	275	61	20	15
v/c Ratio	0.45	0.65	0.58	0.56	0.45	0.32	0.67	0.03	0.02
Control Delay	52.2	14.2	40.0	26.3	41.3	4.8	72.5	17.9	0.1
Queue Delay	0.0	0.0	0.0	0.0	0.0	0.0	0.0	0.0	0.0
Total Delay	52.2	14.2	40.0	26.3	41.3	4.8	72.5	17.9	0.1
Queue Length 50th (ft)	28	10	72	109	28	6	30	6	0
Queue Length 95th (ft)	m53	36	122	159	54	61	#91	23	0
Internal Link Dist (ft)		782		187		321		193	
Turn Bay Length (ft)	95		40		75		60		
Base Capacity (vph)	119	879	354	656	258	855	91	613	637
Starvation Cap Reductn	0	0	0	0	0	0	0	0	0
Spillback Cap Reductn	0	0	0	0	0	0	0	0	0
Storage Cap Reductn	0	0	0	0	0	0	0	0	0
Reduced v/c Ratio	0.45	0.43	0.43	0.41	0.45	0.32	0.67	0.03	0.02

Intersection Summary

95th percentile volume exceeds capacity, queue may be longer.

Queue shown is maximum after two cycles.

m Volume for 95th percentile queue is metered by upstream signal.

Queues
 25: Kennedy Street/Gateway Drive & SR-99 Southbound Ramps

Village D Specific Plan
 Phase I WP MIT - AM Peak Hour



Lane Group	EBL	EBT	WBT	SBL	SBR
Lane Group Flow (vph)	273	255	311	71	121
v/c Ratio	0.88	0.28	0.70	0.12	0.12
Control Delay	56.8	9.1	29.2	15.4	1.9
Queue Delay	0.0	0.0	0.0	0.0	0.0
Total Delay	56.8	9.1	29.2	15.4	1.9
Queue Length 50th (ft)	98	48	100	17	0
Queue Length 95th (ft)	#219	77	165	44	18
Internal Link Dist (ft)		189	811	461	
Turn Bay Length (ft)	140				335
Base Capacity (vph)	309	1024	538	613	984
Starvation Cap Reductn	0	0	0	0	0
Spillback Cap Reductn	0	0	0	0	0
Storage Cap Reductn	0	0	0	0	0
Reduced v/c Ratio	0.88	0.25	0.58	0.12	0.12

Intersection Summary

95th percentile volume exceeds capacity, queue may be longer.
 Queue shown is maximum after two cycles.

Queues
29: Schnoor Avenue & Cleveland Avenue

Village D Specific Plan
Phase I WP MIT - AM Peak Hour



Lane Group	EBL	EBT	EBR	WBL	WBT	WBR	NBL	NBT	NBR	SBL	SBT	SBR
Lane Group Flow (vph)	129	1089	77	177	452	49	66	251	177	91	183	80
v/c Ratio	0.54	0.85	0.11	0.63	0.38	0.07	0.56	0.25	0.27	0.64	0.18	0.14
Control Delay	20.3	20.8	0.9	22.2	3.5	0.2	55.9	24.6	6.0	57.5	23.1	0.5
Queue Delay	0.0	0.0	0.0	0.0	0.0	0.0	0.0	0.0	0.0	0.0	0.0	0.0
Total Delay	20.3	20.8	0.9	22.2	3.5	0.2	55.9	24.6	6.0	57.5	23.1	0.5
Queue Length 50th (ft)	39	286	1	40	7	0	33	53	11	45	37	0
Queue Length 95th (ft)	m50	m336	m3	#66	19	m0	#87	85	50	#110	63	0
Internal Link Dist (ft)		2178			574			393			326	
Turn Bay Length (ft)	120		60	220		95	75		75	105		65
Base Capacity (vph)	299	1317	705	280	1182	656	118	994	661	144	1024	592
Starvation Cap Reductn	0	0	0	0	0	0	0	0	0	0	0	0
Spillback Cap Reductn	0	0	0	0	0	0	0	0	0	0	0	0
Storage Cap Reductn	0	0	0	0	0	0	0	0	0	0	0	0
Reduced v/c Ratio	0.43	0.83	0.11	0.63	0.38	0.07	0.56	0.25	0.27	0.63	0.18	0.14

Intersection Summary

95th percentile volume exceeds capacity, queue may be longer.

Queue shown is maximum after two cycles.

m Volume for 95th percentile queue is metered by upstream signal.

Queues
30: Fairgrounds & Cleveland Avenue

Village D Specific Plan
Phase I WP MIT - AM Peak Hour



Lane Group	EBL	EBT	WBL	WBT	WBR	NBL	NBT	NBR	SBL	SBT
Lane Group Flow (vph)	96	1300	36	606	91	14	18	16	123	46
v/c Ratio	0.46	0.78	0.23	0.63	0.16	0.06	0.03	0.02	0.58	0.06
Control Delay	20.9	14.5	36.8	29.5	0.6	36.1	15.7	0.1	44.6	7.1
Queue Delay	0.0	0.0	0.0	0.0	0.0	0.0	0.0	0.0	0.0	0.0
Total Delay	20.9	14.5	36.8	29.5	0.6	36.1	15.7	0.1	44.6	7.1
Queue Length 50th (ft)	32	48	17	143	0	3	3	0	58	1
Queue Length 95th (ft)	m47	#295	44	195	0	12	20	0	111	24
Internal Link Dist (ft)		574		1412			192			168
Turn Bay Length (ft)	120		205					100		
Base Capacity (vph)	236	1659	251	999	593	218	531	671	236	740
Starvation Cap Reductn	0	0	0	0	0	0	0	0	0	0
Spillback Cap Reductn	0	0	0	0	0	0	0	0	0	0
Storage Cap Reductn	0	0	0	0	0	0	0	0	0	0
Reduced v/c Ratio	0.41	0.78	0.14	0.61	0.15	0.06	0.03	0.02	0.52	0.06

Intersection Summary

95th percentile volume exceeds capacity, queue may be longer.

Queue shown is maximum after two cycles.

m Volume for 95th percentile queue is metered by upstream signal.

Queues
31: SR-99 Southbound Ramps & Cleveland Avenue

Village D Specific Plan
Phase I WP MIT - AM Peak Hour



Lane Group	EBT	EBR	WBL	WBT	SBL	SBR
Lane Group Flow (vph)	718	836	368	945	71	59
v/c Ratio	0.53	0.90	0.87	0.41	0.17	0.14
Control Delay	29.4	25.4	64.9	9.8	41.9	12.0
Queue Delay	0.0	0.0	1.5	0.6	0.0	0.0
Total Delay	29.4	25.4	66.3	10.4	41.9	12.0
Queue Length 50th (ft)	208	245	270	132	46	0
Queue Length 95th (ft)	248	451	#403	132	95	38
Internal Link Dist (ft)	1412			372		
Turn Bay Length (ft)			115			140
Base Capacity (vph)	1607	1004	474	2672	415	409
Starvation Cap Reductn	0	0	27	1221	0	0
Spillback Cap Reductn	0	0	0	0	0	0
Storage Cap Reductn	0	0	0	0	0	0
Reduced v/c Ratio	0.45	0.83	0.82	0.65	0.17	0.14

Intersection Summary

95th percentile volume exceeds capacity, queue may be longer.
Queue shown is maximum after two cycles.

Queues
32: SR-99 Northbound Ramps & Cleveland Avenue

Village D Specific Plan
Phase I WP MIT - AM Peak Hour



Lane Group	EBL	EBT	WBT	WBR	NBL	NBT	NBR
Lane Group Flow (vph)	57	734	910	85	202	203	317
v/c Ratio	0.35	0.46	0.76	0.15	0.28	0.28	0.40
Control Delay	43.6	16.6	15.7	2.0	20.7	20.7	9.3
Queue Delay	0.0	0.0	0.6	0.0	0.0	0.0	0.0
Total Delay	43.6	16.6	16.4	2.0	20.7	20.7	9.3
Queue Length 50th (ft)	31	137	104	0	78	78	37
Queue Length 95th (ft)	66	143	77	m2	157	158	120
Internal Link Dist (ft)		372	207			441	
Turn Bay Length (ft)	90			50	145		325
Base Capacity (vph)	356	2024	1250	606	722	722	798
Starvation Cap Reductn	0	0	105	0	0	0	0
Spillback Cap Reductn	0	0	0	0	0	0	0
Storage Cap Reductn	0	0	0	0	0	0	0
Reduced v/c Ratio	0.16	0.36	0.79	0.14	0.28	0.28	0.40

Intersection Summary

m Volume for 95th percentile queue is metered by upstream signal.

Queues
33: Gateway Drive & Cleveland Avenue

Village D Specific Plan
Phase I WP MIT - AM Peak Hour

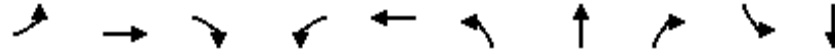

Lane Group	EBL	EBT	EBR	WBL	WBT	NBL	NBT	NBR	SBL	SBT
Lane Group Flow (vph)	4	779	261	198	885	177	52	153	61	97
v/c Ratio	0.02	0.66	0.36	0.48	0.66	0.42	0.08	0.23	0.39	0.09
Control Delay	18.8	23.4	2.0	38.3	24.6	39.3	23.6	3.7	45.8	23.8
Queue Delay	0.0	0.3	0.1	0.4	23.7	0.0	0.0	0.0	0.0	0.0
Total Delay	18.8	23.7	2.1	38.7	48.3	39.3	23.6	3.7	45.8	23.8
Queue Length 50th (ft)	1	84	0	42	162	48	20	0	33	19
Queue Length 95th (ft)	m3	141	11	79	224	80	53	33	72	43
Internal Link Dist (ft)		207			111		765			296
Turn Bay Length (ft)	110					245			45	
Base Capacity (vph)	217	1426	730	587	1371	425	670	674	179	1087
Starvation Cap Reductn	0	181	46	118	510	0	0	0	0	0
Spillback Cap Reductn	0	0	0	0	110	0	0	2	0	0
Storage Cap Reductn	0	0	0	0	0	0	0	0	0	0
Reduced v/c Ratio	0.02	0.63	0.38	0.42	1.03	0.42	0.08	0.23	0.34	0.09

Intersection Summary

m Volume for 95th percentile queue is metered by upstream signal.

Queues
 34: Cleveland Avenue & County Club Drive

Village D Specific Plan
 Phase I WP MIT - AM Peak Hour



Lane Group	WBL	NBT	NBR	SBL	SBT
Lane Group Flow (vph)	427	674	318	92	689
v/c Ratio	0.67	0.27	0.20	0.18	0.19
Control Delay	38.7	6.2	0.8	5.8	4.5
Queue Delay	0.0	1.0	0.0	0.0	0.0
Total Delay	38.7	7.2	0.8	5.8	4.6
Queue Length 50th (ft)	114	48	5	14	39
Queue Length 95th (ft)	154	97	24	38	63
Internal Link Dist (ft)	239	111			159
Turn Bay Length (ft)					
Base Capacity (vph)	1262	2523	1568	511	3625
Starvation Cap Reductn	0	1512	0	0	0
Spillback Cap Reductn	1	0	0	0	985
Storage Cap Reductn	0	0	0	0	0
Reduced v/c Ratio	0.34	0.67	0.20	0.18	0.26
Intersection Summary					

Queues
36: Pine Street & Howard Road

Village D Specific Plan
Phase I WP MIT - AM Peak Hour



Lane Group	EBL	EBT	WBL	WBT	NBL	NBT	NBR	SBT	SBR
Lane Group Flow (vph)	37	879	150	509	150	172	252	292	108
v/c Ratio	0.37	0.79	0.66	0.34	0.40	0.44	0.48	0.89	0.28
Control Delay	65.5	41.3	63.7	25.0	46.8	47.3	8.8	76.8	5.4
Queue Delay	0.0	0.0	0.0	0.0	0.0	0.0	0.0	0.0	0.0
Total Delay	65.5	41.3	63.7	25.0	46.8	47.3	8.8	76.8	5.4
Queue Length 50th (ft)	28	317	118	118	104	120	0	221	0
Queue Length 95th (ft)	65	356	#227	160	177	200	76	#371	30
Internal Link Dist (ft)		265		565		224		259	
Turn Bay Length (ft)	95		140		90				
Base Capacity (vph)	104	1399	227	1553	371	391	523	341	396
Starvation Cap Reductn	0	0	0	0	0	0	0	0	0
Spillback Cap Reductn	0	0	0	0	0	0	0	0	0
Storage Cap Reductn	0	0	0	0	0	0	0	0	0
Reduced v/c Ratio	0.36	0.63	0.66	0.33	0.40	0.44	0.48	0.86	0.27

Intersection Summary

95th percentile volume exceeds capacity, queue may be longer.
Queue shown is maximum after two cycles.

Queues

37: Olive Avenue/Q Street & Howard Road/Yosemite Avenue

Village D Specific Plan

Phase I WP MIT - AM Peak Hour



Lane Group	EBL	EBT	EBR	WBL	WBT	NBL	NBT	NBR	SBL	SBT	SBR
Lane Group Flow (vph)	7	598	346	29	391	222	227	22	110	162	13
v/c Ratio	0.09	0.70	0.55	0.26	0.38	0.30	0.30	0.03	0.50	0.70	0.04
Control Delay	77.7	23.8	6.0	58.7	33.2	26.3	26.2	0.1	56.2	65.8	0.2
Queue Delay	0.0	0.0	0.0	0.0	0.0	0.0	0.0	0.0	0.0	0.0	0.0
Total Delay	77.7	23.8	6.0	58.7	33.2	26.3	26.2	0.1	56.2	65.8	0.2
Queue Length 50th (ft)	5	181	49	22	115	120	123	0	80	121	0
Queue Length 95th (ft)	m9	m270	m165	53	155	224	228	0	137	192	0
Internal Link Dist (ft)		565			230		220			195	
Turn Bay Length (ft)	40			80		130			50		50
Base Capacity (vph)	78	1023	686	265	1393	748	766	750	265	279	353
Starvation Cap Reductn	0	0	0	0	0	0	0	0	0	0	0
Spillback Cap Reductn	0	0	0	0	0	0	0	0	0	0	0
Storage Cap Reductn	0	0	0	0	0	0	0	0	0	0	0
Reduced v/c Ratio	0.09	0.58	0.50	0.11	0.28	0.30	0.30	0.03	0.42	0.58	0.04

Intersection Summary

m Volume for 95th percentile queue is metered by upstream signal.

Queues
39: 4th Street & Sunset Avenue

Village D Specific Plan
Phase I WP MIT - AM Peak Hour



Lane Group	EBL	NBL	NBT	SBT	SBR
Lane Group Flow (vph)	445	35	343	477	301
v/c Ratio	0.70	0.26	0.13	0.40	0.23
Control Delay	40.3	44.1	4.3	5.0	0.6
Queue Delay	0.0	0.0	0.0	0.0	0.0
Total Delay	40.3	44.1	4.3	5.0	0.6
Queue Length 50th (ft)	120	19	28	131	0
Queue Length 95th (ft)	167	49	44	69	0
Internal Link Dist (ft)	7441		193	501	
Turn Bay Length (ft)	135				
Base Capacity (vph)	721	147	2546	1192	1355
Starvation Cap Reductn	0	0	0	0	0
Spillback Cap Reductn	0	0	0	0	0
Storage Cap Reductn	0	0	0	0	0
Reduced v/c Ratio	0.62	0.24	0.13	0.40	0.22
Intersection Summary					

Queues
41: I Street & 4th Street



Lane Group	EBL	EBT	WBL	WBT	NBL	NBT	NBR	SBL	SBT	SBR
Lane Group Flow (vph)	28	771	93	594	57	61	177	242	304	161
v/c Ratio	0.25	0.86	0.57	0.52	0.42	0.12	0.30	0.66	0.39	0.22
Control Delay	44.5	28.7	36.5	19.0	49.0	30.4	3.0	41.1	22.8	3.2
Queue Delay	0.0	0.0	0.0	0.0	0.0	0.0	0.0	0.0	0.0	0.0
Total Delay	44.5	28.7	36.5	19.0	49.0	30.4	3.0	41.1	22.8	3.2
Queue Length 50th (ft)	10	205	54	67	31	29	0	123	132	0
Queue Length 95th (ft)	m26	#283	m67	m86	70	63	23	201	207	31
Internal Link Dist (ft)		501		26		314			779	
Turn Bay Length (ft)	130				45		25	80		80
Base Capacity (vph)	110	921	177	1189	146	488	582	408	774	741
Starvation Cap Reductn	0	0	0	0	0	0	0	0	0	0
Spillback Cap Reductn	0	0	0	0	0	0	0	0	0	0
Storage Cap Reductn	0	0	0	0	0	0	0	0	0	0
Reduced v/c Ratio	0.25	0.84	0.53	0.50	0.39	0.13	0.30	0.59	0.39	0.22

Intersection Summary

95th percentile volume exceeds capacity, queue may be longer.

Queue shown is maximum after two cycles.

m Volume for 95th percentile queue is metered by upstream signal.

Queues
 43: SR-99 Northbound Off-Ramp/H Street & 4th Street

Village D Specific Plan
 Phase I WP MIT - AM Peak Hour

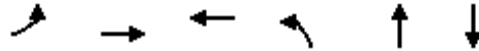

Lane Group	EBL	EBT	WBT	NBL	NBT	SBT
Lane Group Flow (vph)	255	499	606	275	258	79
v/c Ratio	0.83	0.33	0.88	0.69	0.48	0.18
Control Delay	43.3	6.9	49.6	43.2	9.5	2.7
Queue Delay	0.0	0.0	0.0	0.0	0.0	0.0
Total Delay	43.3	6.9	49.6	43.2	9.5	2.7
Queue Length 50th (ft)	156	49	172	147	14	0
Queue Length 95th (ft)	m#212	m64	#263	#258	79	13
Internal Link Dist (ft)		197	236		443	771
Turn Bay Length (ft)						
Base Capacity (vph)	324	1553	706	399	540	429
Starvation Cap Reductn	0	0	0	0	0	0
Spillback Cap Reductn	0	0	0	0	0	0
Storage Cap Reductn	0	0	0	0	0	0
Reduced v/c Ratio	0.79	0.32	0.86	0.69	0.48	0.18

Intersection Summary

95th percentile volume exceeds capacity, queue may be longer.

Queue shown is maximum after two cycles.

m Volume for 95th percentile queue is metered by upstream signal.

Queues
 45: Olive Avenue & SR-99 Southbound Off-Ramp

Village D Specific Plan
 Phase I WP MIT - AM Peak Hour

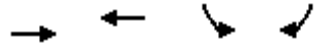

Lane Group	EBT	WBT	SBL	SBR
Lane Group Flow (vph)	562	488	567	113
v/c Ratio	0.55	0.69	0.50	0.11
Control Delay	30.2	38.8	8.6	3.1
Queue Delay	0.1	55.0	0.1	0.0
Total Delay	30.3	93.8	8.6	3.1
Queue Length 50th (ft)	91	136	121	8
Queue Length 95th (ft)	121	187	211	26
Internal Link Dist (ft)	103	112	135	
Turn Bay Length (ft)				
Base Capacity (vph)	1204	838	1137	1036
Starvation Cap Reductn	0	397	0	0
Spillback Cap Reductn	110	0	41	0
Storage Cap Reductn	0	0	0	0
Reduced v/c Ratio	0.51	1.11	0.52	0.11
Intersection Summary				

Queues
46: Madera Avenue & SR-99 Northbound Ramps

Village D Specific Plan
Phase I WP MIT - AM Peak Hour



Lane Group	WBL	WBT	WBR	NBL	NBT	SBT
Lane Group Flow (vph)	96	98	93	520	477	873
v/c Ratio	0.46	0.47	0.34	0.72	0.18	0.54
Control Delay	38.4	38.7	10.5	30.4	2.3	15.4
Queue Delay	0.0	0.0	0.0	0.0	0.0	0.0
Total Delay	38.4	38.7	10.5	30.4	2.3	15.4
Queue Length 50th (ft)	47	48	0	101	11	139
Queue Length 95th (ft)	89	90	37	160	33	218
Internal Link Dist (ft)		337			388	217
Turn Bay Length (ft)	140			205		
Base Capacity (vph)	377	378	421	722	2585	1624
Starvation Cap Reductn	0	0	0	0	0	0
Spillback Cap Reductn	0	0	0	0	0	0
Storage Cap Reductn	0	0	0	0	0	0
Reduced v/c Ratio	0.25	0.26	0.22	0.72	0.18	0.54
Intersection Summary						

Queues

47: Madera Avenue & Olive Avenue/SR-99 Southbound On-Ramp



Lane Group	EBL	EBT	EBR	NBL	NBT	SBL	SBT
Lane Group Flow (vph)	287	301	527	149	623	89	735
v/c Ratio	0.79	0.80	0.68	0.38	0.36	0.48	0.43
Control Delay	37.3	37.4	8.6	34.1	13.2	53.3	3.2
Queue Delay	3.5	3.5	2.0	0.0	0.0	0.0	0.3
Total Delay	40.7	41.0	10.6	34.1	13.2	53.3	3.5
Queue Length 50th (ft)	84	88	23	36	101	49	9
Queue Length 95th (ft)	#255	#266	230	59	144	m93	37
Internal Link Dist (ft)		112			323		388
Turn Bay Length (ft)				120		90	
Base Capacity (vph)	406	421	862	628	1738	214	1703
Starvation Cap Reductn	57	58	195	0	0	0	0
Spillback Cap Reductn	0	0	0	0	0	0	397
Storage Cap Reductn	0	0	0	0	0	0	0
Reduced v/c Ratio	0.82	0.83	0.79	0.24	0.36	0.42	0.56

Intersection Summary

95th percentile volume exceeds capacity, queue may be longer.

Queue shown is maximum after two cycles.

m Volume for 95th percentile queue is metered by upstream signal.

Queues
49: Yosemite Avenue & Cleveland Avenue/Tozer Street

Village D Specific Plan
Phase I WP MIT - AM Peak Hour



Lane Group	EBL	EBT	WBL	WBT	WBR	NBL	NBT	NBR	SBL	SBT	SBR
Lane Group Flow (vph)	270	839	122	336	51	146	126	82	72	264	228
v/c Ratio	0.78	0.66	0.71	0.36	0.10	0.78	0.28	0.16	0.42	0.69	0.33
Control Delay	47.6	22.6	60.7	27.2	0.4	65.3	28.6	0.7	43.0	40.0	7.9
Queue Delay	0.0	0.0	0.0	0.0	0.0	0.0	0.0	0.0	0.0	0.0	0.0
Total Delay	47.6	22.6	60.7	27.2	0.4	65.3	28.6	0.7	43.0	40.0	7.9
Queue Length 50th (ft)	126	162	61	75	0	73	55	0	35	125	33
Queue Length 95th (ft)	#255	256	#157	125	0	#186	103	0	80	202	72
Internal Link Dist (ft)		318		397			415			443	
Turn Bay Length (ft)	210		150		50	240			150		
Base Capacity (vph)	391	1264	173	927	499	188	567	600	203	586	733
Starvation Cap Reductn	0	0	0	0	0	0	0	0	0	0	0
Spillback Cap Reductn	0	0	0	0	0	0	0	0	0	0	0
Storage Cap Reductn	0	0	0	0	0	0	0	0	0	0	0
Reduced v/c Ratio	0.69	0.66	0.71	0.36	0.10	0.78	0.22	0.14	0.35	0.45	0.31

Intersection Summary

95th percentile volume exceeds capacity, queue may be longer.
Queue shown is maximum after two cycles.

Queues

5: Road 23/SR-99 Southbound Off-Ramp & Avenue 18 1/2

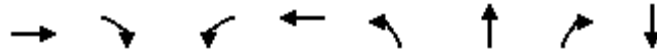

Lane Group	EBT	EBR	WBL	WBT	NBL	NBT	NBR	SBT
Lane Group Flow (vph)	413	246	48	209	55	110	109	465
v/c Ratio	0.96	0.32	0.56	0.39	0.14	0.14	0.14	0.64
Control Delay	65.6	5.0	58.2	31.5	25.8	0.4	0.4	28.7
Queue Delay	0.0	0.0	0.0	0.0	0.0	0.0	0.0	0.0
Total Delay	65.6	5.0	58.2	31.5	25.8	0.4	0.4	28.7
Queue Length 50th (ft)	206	20	25	90	22	0	0	95
Queue Length 95th (ft)	#387	56	#75	184	51	0	0	145
Internal Link Dist (ft)	230			210		324		245
Turn Bay Length (ft)		50					25	
Base Capacity (vph)	432	765	86	551	398	781	786	722
Starvation Cap Reductn	0	0	0	0	0	0	0	0
Spillback Cap Reductn	0	0	0	0	0	0	0	0
Storage Cap Reductn	0	0	0	0	0	0	0	0
Reduced v/c Ratio	0.96	0.32	0.56	0.38	0.14	0.14	0.14	0.64

Intersection Summary

95th percentile volume exceeds capacity, queue may be longer.
 Queue shown is maximum after two cycles.

Queues
6: SR-99 Northbound Ramps & Avenue 18 1/2

Village D Specific Plan
Phase I WP MIT - PM Peak Hour



Lane Group	EBL	EBT	WBT	NBT
Lane Group Flow (vph)	320	103	109	203
v/c Ratio	0.62	0.19	0.50	0.25
Control Delay	36.7	25.4	36.4	12.5
Queue Delay	0.0	0.0	0.0	0.0
Total Delay	36.7	25.4	36.4	12.5
Queue Length 50th (ft)	86	49	46	51
Queue Length 95th (ft)	m102	m63	90	114
Internal Link Dist (ft)		549	786	644
Turn Bay Length (ft)	145			
Base Capacity (vph)	704	877	413	819
Starvation Cap Reductn	0	0	0	0
Spillback Cap Reductn	0	0	0	0
Storage Cap Reductn	0	0	0	0
Reduced v/c Ratio	0.45	0.12	0.26	0.25

Intersection Summary

m Volume for 95th percentile queue is metered by upstream signal.

Queues
7: Road 23 & Avenue 17

Village D Specific Plan
Phase I WP MIT - PM Peak Hour



Lane Group	EBL	EBT	WBL	WBT	NBL	NBT	NBR	SBL	SBT	SBR
Lane Group Flow (vph)	1	96	141	34	18	251	146	67	536	2
v/c Ratio	0.01	0.55	0.64	0.08	0.18	0.24	0.15	0.47	0.46	0.00
Control Delay	55.0	48.3	63.0	27.0	57.4	16.1	1.8	62.1	15.7	0.0
Queue Delay	0.0	0.0	0.0	0.0	0.0	0.0	0.0	0.0	0.0	0.0
Total Delay	55.0	48.3	63.0	27.0	57.4	16.1	1.8	62.1	15.7	0.0
Queue Length 50th (ft)	1	50	105	14	14	95	0	50	171	0
Queue Length 95th (ft)	7	103	166	42	38	186	23	95	412	0
Internal Link Dist (ft)		2671		6172		2520			336	
Turn Bay Length (ft)	100		100		100		100	100		100
Base Capacity (vph)	110	364	390	637	138	1063	978	238	1164	1039
Starvation Cap Reductn	0	0	0	0	0	0	0	0	0	0
Spillback Cap Reductn	0	0	0	0	0	0	0	0	0	0
Storage Cap Reductn	0	0	0	0	0	0	0	0	0	0
Reduced v/c Ratio	0.01	0.26	0.36	0.05	0.13	0.24	0.15	0.28	0.46	0.00

Intersection Summary

Queues
13: Airport Drive/Golden State Boulevard & Avenue 17

Village D Specific Plan
Phase I WP MIT - PM Peak Hour



Lane Group	EBL	EBT	EBR	WBL	WBT	WBR	NBL	NBT	NBR	SBL	SBT
Lane Group Flow (vph)	10	333	29	154	190	179	23	58	263	252	67
v/c Ratio	0.09	0.78	0.06	0.67	0.26	0.25	0.19	0.11	0.41	0.62	0.09
Control Delay	37.3	41.8	0.2	53.1	36.5	20.8	38.9	24.0	5.7	40.5	16.6
Queue Delay	0.0	0.0	0.0	0.0	0.0	0.0	0.0	0.0	0.0	0.0	0.0
Total Delay	37.3	41.8	0.2	53.1	36.5	20.8	38.9	24.0	5.7	40.5	16.6
Queue Length 50th (ft)	5	154	0	84	100	52	11	22	0	61	16
Queue Length 95th (ft)	20	236	0	#149	146	96	34	52	56	100	50
Internal Link Dist (ft)		188			379			370			222
Turn Bay Length (ft)	85			70		105	60		50	100	
Base Capacity (vph)	110	500	575	251	739	736	122	532	637	420	765
Starvation Cap Reductn	0	0	0	0	0	0	0	0	0	0	0
Spillback Cap Reductn	0	0	0	0	0	0	0	0	0	0	0
Storage Cap Reductn	0	0	0	0	0	0	0	0	0	0	0
Reduced v/c Ratio	0.09	0.67	0.05	0.61	0.26	0.24	0.19	0.11	0.41	0.60	0.09

Intersection Summary

95th percentile volume exceeds capacity, queue may be longer.
Queue shown is maximum after two cycles.

Queues
14: Avenue 17 & SR-99 Southbound Off-Ramp

Village D Specific Plan
Phase I WP MIT - PM Peak Hour

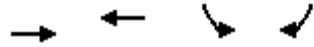

Lane Group	EBT	WBT	SBL	SBR
Lane Group Flow (vph)	852	458	454	64
v/c Ratio	0.79	0.43	0.44	0.07
Control Delay	27.5	32.5	11.7	2.6
Queue Delay	0.0	0.0	0.0	0.0
Total Delay	27.5	32.5	11.7	2.6
Queue Length 50th (ft)	139	92	125	0
Queue Length 95th (ft)	246	m99	196	16
Internal Link Dist (ft)	379	248	971	
Turn Bay Length (ft)				610
Base Capacity (vph)	1161	1138	1026	944
Starvation Cap Reductn	0	0	0	0
Spillback Cap Reductn	0	0	0	0
Storage Cap Reductn	0	0	0	0
Reduced v/c Ratio	0.73	0.40	0.44	0.07

Intersection Summary

m Volume for 95th percentile queue is metered by upstream signal.

Queues
15: SR-99 Northbound Ramps & Avenue 17

Village D Specific Plan
Phase I WP MIT - PM Peak Hour

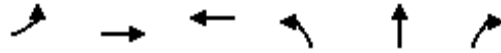

Lane Group	EBL	EBT	WBT	NBL	NBT	NBR
Lane Group Flow (vph)	108	905	1383	61	61	557
v/c Ratio	0.76	0.48	0.98	0.10	0.10	0.88
Control Delay	59.1	21.0	43.8	18.2	18.2	37.3
Queue Delay	0.0	0.0	0.0	0.0	0.0	0.0
Total Delay	59.1	21.0	43.8	18.2	18.2	37.3
Queue Length 50th (ft)	56	188	337	21	21	209
Queue Length 95th (ft)	m#100	252	#497	48	48	#403
Internal Link Dist (ft)		518	381		633	
Turn Bay Length (ft)	125					50
Base Capacity (vph)	143	1897	1411	590	592	631
Starvation Cap Reductn	0	0	0	0	0	0
Spillback Cap Reductn	0	0	0	0	0	0
Storage Cap Reductn	0	0	0	0	0	0
Reduced v/c Ratio	0.76	0.48	0.98	0.10	0.10	0.88

Intersection Summary

95th percentile volume exceeds capacity, queue may be longer.

Queue shown is maximum after two cycles.

m Volume for 95th percentile queue is metered by upstream signal.

Queues
16: Love's Truck Stop Driveway/Driveway & Avenue 17

Village D Specific Plan
Phase I WP MIT - PM Peak Hour

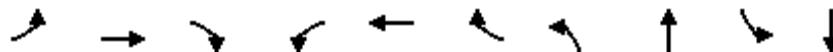

Lane Group	EBL	EBT	EBR	WBL	WBT	WBR	NBL	NBT	SBL	SBT
Lane Group Flow (vph)	604	747	153	35	684	205	174	34	303	564
v/c Ratio	0.90	0.40	0.22	0.30	0.70	0.42	0.83	0.06	0.88	0.75
Control Delay	54.3	22.7	3.0	47.1	38.3	5.6	70.4	0.2	63.5	16.3
Queue Delay	0.0	0.0	0.0	0.0	0.0	0.0	0.0	0.0	0.0	0.0
Total Delay	54.3	22.7	3.0	47.1	38.3	5.6	70.4	0.2	63.5	16.3
Queue Length 50th (ft)	174	121	0	19	132	0	98	0	168	86
Queue Length 95th (ft)	#269	157	29	50	173	40	#209	0	#311	225
Internal Link Dist (ft)		423			402			160		227
Turn Bay Length (ft)	200		100	100		100				
Base Capacity (vph)	674	1868	697	118	1017	505	212	547	353	753
Starvation Cap Reductn	0	0	0	0	0	0	0	0	0	0
Spillback Cap Reductn	0	0	0	0	0	0	0	0	0	0
Storage Cap Reductn	0	0	0	0	0	0	0	0	0	0
Reduced v/c Ratio	0.90	0.40	0.22	0.30	0.67	0.41	0.82	0.06	0.86	0.75

Intersection Summary

95th percentile volume exceeds capacity, queue may be longer.
Queue shown is maximum after two cycles.

Queues
17: Westberry Boulevard & Cleveland Avenue

Village D Specific Plan
Phase I WP MIT - PM Peak Hour



Lane Group	EBL	EBT	WBL	WBT	NBL	NBT	NBR	SBL	SBT	SBR
Lane Group Flow (vph)	163	541	71	843	55	26	68	20	86	254
v/c Ratio	0.65	0.43	0.41	0.83	0.43	0.04	0.10	0.17	0.14	0.36
Control Delay	45.0	21.1	40.9	34.9	46.2	20.9	0.3	38.9	22.8	5.1
Queue Delay	0.0	0.0	0.0	0.0	0.0	0.0	0.0	0.0	0.0	0.0
Total Delay	45.0	21.1	40.9	34.9	46.2	20.9	0.3	38.9	22.8	5.1
Queue Length 50th (ft)	77	105	34	202	27	8	0	10	34	0
Queue Length 95th (ft)	138	150	73	272	63	28	0	31	69	54
Internal Link Dist (ft)		674		1237		511			3065	
Turn Bay Length (ft)	110		165		65		50	100		50
Base Capacity (vph)	282	1262	196	1059	129	687	675	119	635	709
Starvation Cap Reductn	0	0	0	0	0	0	0	0	0	0
Spillback Cap Reductn	0	0	0	0	0	0	0	0	0	0
Storage Cap Reductn	0	0	0	0	0	0	0	0	0	0
Reduced v/c Ratio	0.58	0.43	0.36	0.80	0.43	0.04	0.10	0.17	0.14	0.36

Intersection Summary

Queues
56: Road 23 & Project Driveway 4



Lane Group	WBL	WBR	NBT	SBL	SBT
Lane Group Flow (vph)	359	232	777	328	423
v/c Ratio	0.90	0.43	1.03	0.97	0.35
Control Delay	57.3	6.6	65.7	77.1	6.9
Queue Delay	0.0	0.0	0.0	0.0	0.0
Total Delay	57.3	6.6	65.7	77.1	6.9
Queue Length 50th (ft)	173	0	~406	~166	82
Queue Length 95th (ft)	#322	54	#622	#329	127
Internal Link Dist (ft)	754		528		1127
Turn Bay Length (ft)	50			50	
Base Capacity (vph)	412	548	752	338	1215
Starvation Cap Reductn	0	0	0	0	0
Spillback Cap Reductn	0	0	0	0	0
Storage Cap Reductn	0	0	0	0	0
Reduced v/c Ratio	0.87	0.42	1.03	0.97	0.35

Intersection Summary

- ~ Volume exceeds capacity, queue is theoretically infinite.
Queue shown is maximum after two cycles.
- # 95th percentile volume exceeds capacity, queue may be longer.
Queue shown is maximum after two cycles.

Queues
58: Project Driveway 6 & Cleveland Avenue

Village D Specific Plan
Phase I WP MIT - PM Peak Hour



Lane Group	EBT	WBL	WBT	NBL	NBR
Lane Group Flow (vph)	687	361	865	85	264
v/c Ratio	0.96	0.91	0.69	0.20	0.45
Control Delay	51.7	62.2	13.0	29.6	6.6
Queue Delay	0.0	0.0	0.0	0.0	0.0
Total Delay	51.7	62.2	13.0	29.6	6.6
Queue Length 50th (ft)	359	199	260	39	0
Queue Length 95th (ft)	#592	#356	387	79	60
Internal Link Dist (ft)	3869		3121	834	
Turn Bay Length (ft)		50		50	
Base Capacity (vph)	730	411	1277	435	589
Starvation Cap Reductn	0	0	0	0	0
Spillback Cap Reductn	0	0	0	0	0
Storage Cap Reductn	0	0	0	0	0
Reduced v/c Ratio	0.94	0.88	0.68	0.20	0.45

Intersection Summary

95th percentile volume exceeds capacity, queue may be longer.
Queue shown is maximum after two cycles.

Queues
21: Granada Drive & Cleveland Avenue

Village D Specific Plan
Phase I WP MIT - PM Peak Hour



Lane Group	EBL	EBT	WBL	WBT	NBL	NBT	NBR	SBL	SBT	SBR
Lane Group Flow (vph)	19	497	362	887	30	231	246	36	291	35
v/c Ratio	0.17	0.70	0.85	0.56	0.24	0.38	0.38	0.29	0.44	0.05
Control Delay	39.2	34.8	48.2	18.0	40.6	26.4	8.3	41.9	25.7	0.2
Queue Delay	0.0	0.0	0.0	0.0	0.0	0.0	0.0	0.0	0.0	0.0
Total Delay	39.2	34.8	48.2	18.0	40.6	26.4	8.3	41.9	25.7	0.2
Queue Length 50th (ft)	9	118	168	137	14	102	16	17	107	0
Queue Length 95th (ft)	30	166	#300	231	41	171	76	47	215	0
Internal Link Dist (ft)		289		2178		418			382	
Turn Bay Length (ft)	90		125		50		50	50		50
Base Capacity (vph)	112	810	462	1616	124	611	652	124	661	696
Starvation Cap Reductn	0	0	0	0	0	0	0	0	0	0
Spillback Cap Reductn	0	0	0	0	0	0	0	0	0	0
Storage Cap Reductn	0	0	0	0	0	0	0	0	0	0
Reduced v/c Ratio	0.17	0.61	0.78	0.55	0.24	0.38	0.38	0.29	0.44	0.05

Intersection Summary

95th percentile volume exceeds capacity, queue may be longer.
Queue shown is maximum after two cycles.

Queues
 23: Avenue 16/Ellis Street & Kennedy Street



Lane Group	WBL	WBR	NBT	SBL	SBT
Lane Group Flow (vph)	134	237	548	229	384
v/c Ratio	0.54	0.40	0.31	0.66	0.14
Control Delay	26.5	12.8	7.6	40.9	3.4
Queue Delay	0.0	0.0	0.0	0.0	0.0
Total Delay	26.5	12.8	7.6	40.9	3.4
Queue Length 50th (ft)	67	39	46	103	22
Queue Length 95th (ft)	118	71	77	#219	43
Internal Link Dist (ft)	782		506		440
Turn Bay Length (ft)	175			280	
Base Capacity (vph)	409	826	1771	349	2667
Starvation Cap Reductn	0	0	0	0	0
Spillback Cap Reductn	0	0	0	0	0
Storage Cap Reductn	0	0	0	0	0
Reduced v/c Ratio	0.33	0.29	0.31	0.66	0.14

Intersection Summary

95th percentile volume exceeds capacity, queue may be longer.
 Queue shown is maximum after two cycles.

Queues
24: Schnoor Avenue & Kennedy Street

Village D Specific Plan
Phase I WP MIT - PM Peak Hour



Lane Group	EBL	EBT	WBL	WBT	NBL	NBT	SBL	SBT	SBR
Lane Group Flow (vph)	43	385	215	243	207	303	88	34	21
v/c Ratio	0.21	0.65	0.67	0.53	0.58	0.37	0.76	0.06	0.03
Control Delay	28.5	11.8	27.8	19.2	41.1	6.1	76.1	21.3	0.1
Queue Delay	0.0	0.0	0.0	0.0	0.0	0.0	0.0	0.0	0.0
Total Delay	28.5	11.8	27.8	19.2	41.1	6.1	76.1	21.3	0.1
Queue Length 50th (ft)	22	47	107	42	51	12	44	11	0
Queue Length 95th (ft)	m43	41	173	100	85	77	#121	36	0
Internal Link Dist (ft)		782		187		321		193	
Turn Bay Length (ft)	95		40		75		60		
Base Capacity (vph)	205	882	375	668	368	821	116	577	622
Starvation Cap Reductn	0	0	0	0	0	0	0	0	0
Spillback Cap Reductn	0	0	0	0	0	0	0	0	0
Storage Cap Reductn	0	0	0	0	0	0	0	0	0
Reduced v/c Ratio	0.21	0.44	0.57	0.36	0.56	0.37	0.76	0.06	0.03

Intersection Summary

95th percentile volume exceeds capacity, queue may be longer.

Queue shown is maximum after two cycles.

m Volume for 95th percentile queue is metered by upstream signal.

Queues
 25: Kennedy Street/Gateway Drive & SR-99 Southbound Ramps

Village D Specific Plan
 Phase I WP MIT - PM Peak Hour

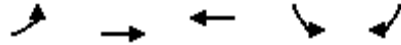

Lane Group	EBL	EBT	WBT	SBL	SBR
Lane Group Flow (vph)	199	393	340	142	196
v/c Ratio	0.65	0.44	0.73	0.20	0.19
Control Delay	42.9	14.2	36.7	19.7	1.8
Queue Delay	0.0	0.0	0.0	0.0	0.0
Total Delay	42.9	14.2	36.7	19.7	1.8
Queue Length 50th (ft)	99	120	156	45	0
Queue Length 95th (ft)	m135	m62	217	106	27
Internal Link Dist (ft)		189	811	461	
Turn Bay Length (ft)	140				335
Base Capacity (vph)	405	1164	633	701	1134
Starvation Cap Reductn	0	0	0	0	0
Spillback Cap Reductn	0	0	0	0	0
Storage Cap Reductn	0	0	0	0	0
Reduced v/c Ratio	0.49	0.34	0.54	0.20	0.17

Intersection Summary

m Volume for 95th percentile queue is metered by upstream signal.

Queues
29: Schnoor Avenue & Cleveland Avenue

Village D Specific Plan
Phase I WP MIT - PM Peak Hour



Lane Group	EBL	EBT	EBR	WBL	WBT	WBR	NBL	NBT	NBR	SBL	SBT	SBR
Lane Group Flow (vph)	145	687	57	284	1066	114	90	222	157	122	220	130
v/c Ratio	0.69	0.71	0.10	0.40	0.83	0.17	0.73	0.26	0.20	0.82	0.24	0.24
Control Delay	55.4	33.3	0.4	13.0	10.5	0.4	76.4	29.6	5.1	81.4	28.2	2.7
Queue Delay	0.0	0.0	0.0	0.0	0.0	0.0	0.0	0.0	0.0	0.0	0.0	0.0
Total Delay	55.4	33.3	0.4	13.0	10.5	0.4	76.4	29.6	5.1	81.4	28.2	2.7
Queue Length 50th (ft)	80	185	0	43	52	1	52	55	8	70	53	0
Queue Length 95th (ft)	#154	219	0	m74	m62	m1	#138	88	46	#166	85	19
Internal Link Dist (ft)		2178			574			393			326	
Turn Bay Length (ft)	120		60	220		95	75		75	105		65
Base Capacity (vph)	228	1294	680	707	1330	701	123	860	775	148	912	534
Starvation Cap Reductn	0	0	0	0	0	0	0	0	0	0	0	0
Spillback Cap Reductn	0	0	0	0	0	0	0	0	0	0	0	0
Storage Cap Reductn	0	0	0	0	0	0	0	0	0	0	0	0
Reduced v/c Ratio	0.64	0.53	0.08	0.40	0.80	0.16	0.73	0.26	0.20	0.82	0.24	0.24

Intersection Summary

95th percentile volume exceeds capacity, queue may be longer.

Queue shown is maximum after two cycles.

m Volume for 95th percentile queue is metered by upstream signal.

Queues
30: Fairgrounds & Cleveland Avenue

Village D Specific Plan
Phase I WP MIT - PM Peak Hour



Lane Group	EBL	EBT	WBL	WBT	WBR	NBL	NBT	NBR	SBL	SBT
Lane Group Flow (vph)	99	911	172	1186	154	102	83	76	279	150
v/c Ratio	0.76	0.58	0.76	0.92	0.23	0.42	0.19	0.14	1.21	0.25
Control Delay	58.3	10.1	53.5	21.5	2.1	45.5	17.6	0.5	165.3	9.0
Queue Delay	0.0	0.0	0.0	0.0	0.0	0.0	0.0	0.0	0.0	0.0
Total Delay	58.3	10.1	53.5	21.5	2.1	45.5	17.6	0.5	165.3	9.0
Queue Length 50th (ft)	59	51	94	243	11	29	21	0	~196	15
Queue Length 95th (ft)	m#134	98	m126	#457	m15	54	60	0	#350	59
Internal Link Dist (ft)		574		1412			192			168
Turn Bay Length (ft)	120		205					100		
Base Capacity (vph)	131	1565	236	1290	681	249	428	541	230	609
Starvation Cap Reductn	0	0	0	0	0	0	0	0	0	0
Spillback Cap Reductn	0	0	0	0	0	0	0	0	0	0
Storage Cap Reductn	0	0	0	0	0	0	0	0	0	0
Reduced v/c Ratio	0.76	0.58	0.73	0.92	0.23	0.41	0.19	0.14	1.21	0.25

Intersection Summary

- ~ Volume exceeds capacity, queue is theoretically infinite.
Queue shown is maximum after two cycles.
- # 95th percentile volume exceeds capacity, queue may be longer.
Queue shown is maximum after two cycles.
- m Volume for 95th percentile queue is metered by upstream signal.

Queues
31: SR-99 Southbound Ramps & Cleveland Avenue

Village D Specific Plan
Phase I WP MIT - PM Peak Hour



Lane Group	EBT	EBR	WBL	WBT	SBL	SBR
Lane Group Flow (vph)	874	510	264	1756	156	82
v/c Ratio	0.68	0.57	0.66	0.77	0.34	0.18
Control Delay	12.1	4.1	32.4	8.4	30.3	9.5
Queue Delay	0.0	0.0	0.0	1.8	0.0	0.0
Total Delay	12.1	4.1	32.4	10.2	30.3	9.5
Queue Length 50th (ft)	102	21	141	230	73	4
Queue Length 95th (ft)	m117	m37	m194	m209	131	39
Internal Link Dist (ft)	1412			372		
Turn Bay Length (ft)			115			140
Base Capacity (vph)	1449	941	401	2386	462	460
Starvation Cap Reductn	0	0	0	442	0	0
Spillback Cap Reductn	19	0	0	0	0	0
Storage Cap Reductn	0	0	0	0	0	0
Reduced v/c Ratio	0.61	0.54	0.66	0.90	0.34	0.18

Intersection Summary

m Volume for 95th percentile queue is metered by upstream signal.

Queues
32: SR-99 Northbound Ramps & Cleveland Avenue

Village D Specific Plan
Phase I WP MIT - PM Peak Hour



Lane Group	EBL	EBT	WBT	WBR	NBL	NBT	NBR
Lane Group Flow (vph)	78	974	1180	69	442	447	308
v/c Ratio	0.43	0.60	1.01	0.12	0.59	0.59	0.41
Control Delay	35.6	7.9	48.5	4.8	24.6	24.7	14.6
Queue Delay	0.0	0.4	33.8	0.0	0.0	0.0	0.0
Total Delay	35.6	8.3	82.2	4.8	24.6	24.7	14.6
Queue Length 50th (ft)	49	51	~221	3	202	205	79
Queue Length 95th (ft)	m83	101	#487	m10	333	337	160
Internal Link Dist (ft)		372	207			441	
Turn Bay Length (ft)	90			50	145		325
Base Capacity (vph)	287	1925	1171	555	750	752	751
Starvation Cap Reductn	0	449	115	0	0	0	0
Spillback Cap Reductn	0	0	2	0	0	0	0
Storage Cap Reductn	0	0	0	0	0	0	0
Reduced v/c Ratio	0.27	0.66	1.12	0.12	0.59	0.59	0.41

Intersection Summary

- ~ Volume exceeds capacity, queue is theoretically infinite.
Queue shown is maximum after two cycles.
- # 95th percentile volume exceeds capacity, queue may be longer.
Queue shown is maximum after two cycles.
- m Volume for 95th percentile queue is metered by upstream signal.

Queues
33: Gateway Drive & Cleveland Avenue

Village D Specific Plan
Phase I WP MIT - PM Peak Hour

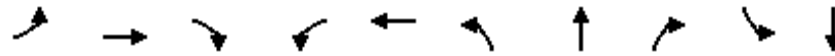

Lane Group	EBL	EBT	EBR	WBL	WBT	NBL	NBT	NBR	SBL	SBT
Lane Group Flow (vph)	16	961	303	190	1055	321	134	259	193	175
v/c Ratio	0.09	0.67	0.36	0.53	0.73	0.68	0.25	0.46	0.84	0.18
Control Delay	7.2	12.6	1.3	43.9	24.1	44.8	28.7	13.7	69.2	24.6
Queue Delay	0.0	0.5	0.1	0.9	35.8	60.7	0.0	0.1	0.0	0.0
Total Delay	7.2	13.1	1.4	44.8	59.9	105.5	28.7	13.8	69.2	24.6
Queue Length 50th (ft)	2	57	1	52	194	90	60	39	108	36
Queue Length 95th (ft)	m4	65	5	94	277	134	116	115	#223	67
Internal Link Dist (ft)		207			111		765			296
Turn Bay Length (ft)	110					245			45	
Base Capacity (vph)	186	1762	836	364	1473	485	530	567	235	959
Starvation Cap Reductn	0	271	75	48	483	0	0	0	0	0
Spillback Cap Reductn	0	381	0	0	167	247	0	28	0	1
Storage Cap Reductn	0	0	0	0	0	0	0	0	0	0
Reduced v/c Ratio	0.09	0.70	0.40	0.60	1.07	1.35	0.25	0.48	0.82	0.18

Intersection Summary

95th percentile volume exceeds capacity, queue may be longer.

Queue shown is maximum after two cycles.

m Volume for 95th percentile queue is metered by upstream signal.

Queues
34: Cleveland Avenue & County Club Drive

Village D Specific Plan
Phase I WP MIT - PM Peak Hour



Lane Group	WBL	NBT	NBR	SBL	SBT
Lane Group Flow (vph)	517	854	543	104	748
v/c Ratio	0.71	0.35	0.35	0.26	0.21
Control Delay	37.9	11.4	1.3	8.2	5.5
Queue Delay	0.0	2.8	0.0	0.0	0.1
Total Delay	37.9	14.2	1.3	8.2	5.6
Queue Length 50th (ft)	139	125	12	19	48
Queue Length 95th (ft)	179	170	m22	52	76
Internal Link Dist (ft)	239	111			159
Turn Bay Length (ft)					
Base Capacity (vph)	1376	2449	1563	393	3519
Starvation Cap Reductn	0	1444	0	0	0
Spillback Cap Reductn	17	0	0	0	1098
Storage Cap Reductn	0	0	0	0	0
Reduced v/c Ratio	0.38	0.85	0.35	0.26	0.31

Intersection Summary

m Volume for 95th percentile queue is metered by upstream signal.

Queues
36: Pine Street & Howard Road

Village D Specific Plan
Phase I WP MIT - PM Peak Hour



Lane Group	EBL	EBT	WBL	WBT	NBL	NBT	NBR	SBT	SBR
Lane Group Flow (vph)	92	815	101	619	210	176	160	169	128
v/c Ratio	0.41	0.82	0.58	0.62	0.44	0.35	0.29	0.62	0.33
Control Delay	43.8	36.7	49.8	30.4	32.7	31.0	4.9	45.2	4.0
Queue Delay	0.0	0.0	0.0	0.0	0.0	0.0	0.0	0.0	0.0
Total Delay	43.8	36.7	49.8	30.4	32.7	31.0	4.9	45.2	4.0
Queue Length 50th (ft)	45	213	59	188	106	86	0	91	0
Queue Length 95th (ft)	#130	284	#139	198	177	148	38	147	18
Internal Link Dist (ft)		265		561		224		259	
Turn Bay Length (ft)	95		140		90				
Base Capacity (vph)	226	1056	173	1134	480	505	557	370	462
Starvation Cap Reductn	0	0	0	0	0	0	0	0	0
Spillback Cap Reductn	0	0	0	0	0	0	0	0	0
Storage Cap Reductn	0	0	0	0	0	0	0	0	0
Reduced v/c Ratio	0.41	0.77	0.58	0.55	0.44	0.35	0.29	0.46	0.28

Intersection Summary

95th percentile volume exceeds capacity, queue may be longer.
Queue shown is maximum after two cycles.

Queues

37: Olive Avenue/Q Street & Howard Road/Yosemite Avenue

Village D Specific Plan

Phase I WP MIT - PM Peak Hour



Lane Group	EBL	EBT	EBR	WBL	WBT	NBL	NBT	NBR	SBL	SBT	SBR
Lane Group Flow (vph)	8	495	341	14	414	237	240	13	17	61	2
v/c Ratio	0.07	0.63	0.56	0.11	0.52	0.26	0.26	0.01	0.10	0.35	0.01
Control Delay	40.9	13.4	4.6	40.8	32.3	16.3	16.2	0.0	37.5	43.2	0.0
Queue Delay	0.0	0.0	0.0	0.0	0.0	0.0	0.0	0.0	0.0	0.0	0.0
Total Delay	40.9	13.4	4.6	40.8	32.3	16.3	16.2	0.0	37.5	43.2	0.0
Queue Length 50th (ft)	3	46	0	8	107	72	73	0	9	33	0
Queue Length 95th (ft)	m5	m91	m24	26	142	183	185	0	28	69	0
Internal Link Dist (ft)		561			230		220			195	
Turn Bay Length (ft)	40			80		130			50		50
Base Capacity (vph)	118	813	621	357	1227	904	920	922	357	376	465
Starvation Cap Reductn	0	0	0	0	0	0	0	0	0	0	0
Spillback Cap Reductn	0	0	0	0	0	0	0	0	0	0	0
Storage Cap Reductn	0	0	0	0	0	0	0	0	0	0	0
Reduced v/c Ratio	0.07	0.61	0.55	0.04	0.34	0.26	0.26	0.01	0.05	0.16	0.00

Intersection Summary

m Volume for 95th percentile queue is metered by upstream signal.

Queues
39: 4th Street & Sunset Avenue

Village D Specific Plan
Phase I WP MIT - PM Peak Hour



Lane Group	EBL	NBL	NBT	SBT	SBR
Lane Group Flow (vph)	274	14	343	386	408
v/c Ratio	0.58	0.12	0.13	0.28	0.29
Control Delay	44.6	45.1	3.2	2.3	0.7
Queue Delay	0.0	0.0	0.0	0.0	0.0
Total Delay	44.6	45.1	3.2	2.3	0.7
Queue Length 50th (ft)	84	9	22	36	0
Queue Length 95th (ft)	119	28	41	71	3
Internal Link Dist (ft)	7441		193	501	
Turn Bay Length (ft)	135				
Base Capacity (vph)	962	166	2719	1379	1459
Starvation Cap Reductn	0	0	0	0	0
Spillback Cap Reductn	0	0	0	0	0
Storage Cap Reductn	0	0	0	0	0
Reduced v/c Ratio	0.28	0.08	0.13	0.28	0.28
Intersection Summary					

Queues
41: I Street & 4th Street

Village D Specific Plan
Phase I WP MIT - PM Peak Hour



Lane Group	EBL	EBT	WBL	WBT	NBL	NBT	NBR	SBL	SBT	SBR
Lane Group Flow (vph)	38	631	65	679	108	76	270	185	180	122
v/c Ratio	0.31	0.76	0.43	0.70	0.57	0.13	0.39	0.54	0.24	0.17
Control Delay	43.7	28.7	42.1	19.5	54.1	29.2	5.8	42.1	23.4	5.3
Queue Delay	0.0	0.0	0.0	0.2	0.0	0.0	0.0	0.0	0.0	0.0
Total Delay	43.7	28.7	42.1	19.7	54.1	29.2	5.8	42.1	23.4	5.3
Queue Length 50th (ft)	25	187	44	93	66	36	0	106	79	0
Queue Length 95th (ft)	59	227	m62	m111	120	78	63	172	142	39
Internal Link Dist (ft)		501		26		314			779	
Turn Bay Length (ft)	130				45		25	80		80
Base Capacity (vph)	126	954	171	1096	226	606	698	380	763	712
Starvation Cap Reductn	0	0	0	54	0	0	0	0	0	0
Spillback Cap Reductn	0	0	0	0	0	0	0	0	0	0
Storage Cap Reductn	0	0	0	0	0	0	0	0	0	0
Reduced v/c Ratio	0.30	0.66	0.38	0.65	0.48	0.13	0.39	0.49	0.24	0.17

Intersection Summary

m Volume for 95th percentile queue is metered by upstream signal.

Queues
43: SR-99 Northbound Off-Ramp/H Street & 4th Street

Village D Specific Plan
Phase I WP MIT - PM Peak Hour

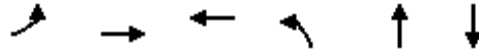

Lane Group	EBL	EBT	WBT	NBL	NBT	SBT
Lane Group Flow (vph)	253	438	686	270	204	107
v/c Ratio	0.80	0.27	0.85	0.64	0.40	0.27
Control Delay	43.5	7.1	47.3	43.6	10.2	8.0
Queue Delay	0.0	0.0	0.0	0.0	0.0	0.0
Total Delay	43.5	7.1	47.3	43.6	10.2	8.0
Queue Length 50th (ft)	170	48	212	161	14	0
Queue Length 95th (ft)	#269	65	#299	#269	76	40
Internal Link Dist (ft)		197	236		443	771
Turn Bay Length (ft)						
Base Capacity (vph)	348	1697	830	422	516	395
Starvation Cap Reductn	0	0	0	0	0	0
Spillback Cap Reductn	0	0	0	0	0	0
Storage Cap Reductn	0	0	0	0	0	0
Reduced v/c Ratio	0.73	0.26	0.83	0.64	0.40	0.27

Intersection Summary

95th percentile volume exceeds capacity, queue may be longer.
Queue shown is maximum after two cycles.

Queues
 45: Olive Avenue & SR-99 Southbound Off-Ramp

Village D Specific Plan
 Phase I WP MIT - PM Peak Hour

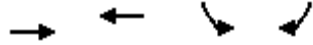

Lane Group	EBT	WBT	SBL	SBR
Lane Group Flow (vph)	663	503	431	81
v/c Ratio	0.65	0.70	0.36	0.07
Control Delay	35.8	48.3	6.8	2.1
Queue Delay	0.3	55.5	0.0	0.0
Total Delay	36.1	103.8	6.8	2.1
Queue Length 50th (ft)	126	164	86	3
Queue Length 95th (ft)	158	216	149	17
Internal Link Dist (ft)	103	112	135	
Turn Bay Length (ft)				
Base Capacity (vph)	1226	853	1214	1092
Starvation Cap Reductn	0	437	0	0
Spillback Cap Reductn	140	0	27	0
Storage Cap Reductn	0	0	0	0
Reduced v/c Ratio	0.61	1.21	0.36	0.07
Intersection Summary				

Queues
46: Madera Avenue & SR-99 Northbound Ramps

Village D Specific Plan
Phase I WP MIT - PM Peak Hour



Lane Group	WBL	WBT	WBR	NBL	NBT	SBT
Lane Group Flow (vph)	116	118	36	633	670	893
v/c Ratio	0.53	0.53	0.13	0.74	0.25	0.55
Control Delay	44.4	44.7	2.9	41.6	5.4	18.1
Queue Delay	0.0	0.0	0.0	0.0	0.0	0.0
Total Delay	44.4	44.7	2.9	41.6	5.4	18.1
Queue Length 50th (ft)	66	67	0	188	68	171
Queue Length 95th (ft)	114	115	7	m240	m85	257
Internal Link Dist (ft)		337			388	217
Turn Bay Length (ft)	140			205		
Base Capacity (vph)	350	351	384	858	2724	1626
Starvation Cap Reductn	0	0	0	0	0	0
Spillback Cap Reductn	0	0	0	0	0	0
Storage Cap Reductn	0	0	0	0	0	0
Reduced v/c Ratio	0.33	0.34	0.09	0.74	0.25	0.55

Intersection Summary

m Volume for 95th percentile queue is metered by upstream signal.

Queues

47: Madera Avenue & Olive Avenue/SR-99 Southbound On-Ramp



Lane Group	EBL	EBT	EBR	NBL	NBT	SBL	SBT
Lane Group Flow (vph)	299	309	462	148	862	136	729
v/c Ratio	0.90	0.90	0.60	0.43	0.45	0.69	0.37
Control Delay	52.4	51.9	5.1	41.7	13.7	62.2	2.3
Queue Delay	9.0	9.6	0.2	0.0	0.0	0.0	0.4
Total Delay	61.5	61.4	5.3	41.7	13.7	62.2	2.7
Queue Length 50th (ft)	144	151	0	41	151	64	0
Queue Length 95th (ft)	#334	#343	213	70	197	#144	46
Internal Link Dist (ft)		112			323		388
Turn Bay Length (ft)				120		90	
Base Capacity (vph)	342	353	783	400	1900	208	1980
Starvation Cap Reductn	28	30	48	0	0	0	0
Spillback Cap Reductn	0	0	0	0	0	0	714
Storage Cap Reductn	0	0	0	0	0	0	0
Reduced v/c Ratio	0.95	0.96	0.63	0.37	0.45	0.65	0.58

Intersection Summary

95th percentile volume exceeds capacity, queue may be longer.
 Queue shown is maximum after two cycles.

Queues
49: Yosemite Avenue & Cleveland Avenue/Tozer Street

Village D Specific Plan
Phase I WP MIT - PM Peak Hour



Lane Group	EBL	EBT	WBL	WBT	WBR	NBL	NBT	NBR	SBL	SBT	SBR
Lane Group Flow (vph)	263	680	53	504	43	337	324	105	78	189	310
v/c Ratio	0.81	0.54	0.45	0.62	0.08	0.86	0.56	0.17	0.46	0.63	0.50
Control Delay	55.6	22.1	52.7	34.8	0.3	55.9	30.3	1.6	46.5	43.4	14.5
Queue Delay	0.0	0.0	0.0	0.0	0.0	0.0	0.0	0.0	0.0	0.0	0.0
Total Delay	55.6	22.1	52.7	34.8	0.3	55.9	30.3	1.6	46.5	43.4	14.5
Queue Length 50th (ft)	138	138	28	130	0	177	154	0	40	97	72
Queue Length 95th (ft)	#285	213	#73	198	0	#355	241	10	88	163	138
Internal Link Dist (ft)		318		397			415			443	
Turn Bay Length (ft)	210		150		50	240			150		
Base Capacity (vph)	331	1269	119	809	518	392	798	772	199	595	621
Starvation Cap Reductn	0	0	0	0	0	0	0	0	0	0	0
Spillback Cap Reductn	0	0	0	0	0	0	0	0	0	0	0
Storage Cap Reductn	0	0	0	0	0	0	0	0	0	0	0
Reduced v/c Ratio	0.79	0.54	0.45	0.62	0.08	0.86	0.41	0.14	0.39	0.32	0.50

Intersection Summary

95th percentile volume exceeds capacity, queue may be longer.
Queue shown is maximum after two cycles.

Queues

5: Road 23/SR-99 Southbound Off-Ramp & Avenue 18 1/2

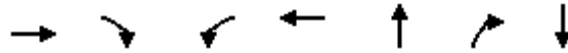

Lane Group	EBT	EBR	WBL	WBT	NBT	NBR	SBT
Lane Group Flow (vph)	345	79	51	305	129	599	318
v/c Ratio	0.68	0.12	0.41	0.32	0.28	0.66	0.45
Control Delay	37.0	2.9	38.3	34.2	26.1	5.2	22.6
Queue Delay	0.0	0.0	0.0	0.0	0.0	0.0	0.0
Total Delay	37.0	2.9	38.3	34.2	26.1	5.2	22.6
Queue Length 50th (ft)	84	0	28	88	51	3	54
Queue Length 95th (ft)	123	19	m60	130	102	34	93
Internal Link Dist (ft)	230			210	324		245
Turn Bay Length (ft)		50	100			25	
Base Capacity (vph)	620	679	134	1074	468	916	713
Starvation Cap Reductn	0	0	0	0	0	0	0
Spillback Cap Reductn	0	0	0	0	0	0	0
Storage Cap Reductn	0	0	0	0	0	0	0
Reduced v/c Ratio	0.56	0.12	0.38	0.28	0.28	0.65	0.45

Intersection Summary

m Volume for 95th percentile queue is metered by upstream signal.

Queues
6: SR-99 Northbound Ramps & Avenue 18 1/2

Village D Specific Plan
Phase II WP MIT - AM Peak Hour

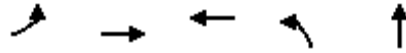

Lane Group	EBL	EBT	WBT	NBL	NBT
Lane Group Flow (vph)	674	66	197	234	28
v/c Ratio	0.80	0.08	0.69	0.44	0.06
Control Delay	35.8	14.3	41.0	23.8	8.8
Queue Delay	0.0	0.0	0.0	0.0	0.0
Total Delay	35.8	14.3	41.0	23.8	8.8
Queue Length 50th (ft)	172	23	87	87	0
Queue Length 95th (ft)	231	m34	148	170	18
Internal Link Dist (ft)		549	786		644
Turn Bay Length (ft)	145				
Base Capacity (vph)	949	987	362	536	499
Starvation Cap Reductn	0	0	0	0	0
Spillback Cap Reductn	0	0	0	0	0
Storage Cap Reductn	0	0	0	0	0
Reduced v/c Ratio	0.71	0.07	0.54	0.44	0.06

Intersection Summary

m Volume for 95th percentile queue is metered by upstream signal.

Queues
7: Road 23 & Avenue 17

Village D Specific Plan
Phase II WP MIT - AM Peak Hour



Lane Group	EBL	EBT	WBL	WBT	NBL	NBT	NBR	SBL	SBT	SBR
Lane Group Flow (vph)	175	586	402	145	80	698	779	17	316	46
v/c Ratio	0.71	0.86	0.81	0.21	0.54	0.38	0.73	0.23	0.21	0.06
Control Delay	65.2	60.2	63.1	40.9	65.7	19.1	11.7	63.2	22.3	0.2
Queue Delay	0.0	0.0	0.0	0.0	0.0	0.0	0.0	0.0	0.0	0.0
Total Delay	65.2	60.2	63.1	40.9	65.7	19.1	11.7	63.2	22.3	0.2
Queue Length 50th (ft)	131	228	155	48	60	157	122	13	82	0
Queue Length 95th (ft)	202	#312	#212	81	112	239	340	38	118	0
Internal Link Dist (ft)		2671		6172		2520			336	
Turn Bay Length (ft)	100		100		100		100	100		100
Base Capacity (vph)	308	703	524	695	178	1824	1072	74	1499	745
Starvation Cap Reductn	0	0	0	0	0	0	0	0	0	0
Spillback Cap Reductn	0	0	0	0	0	0	0	0	0	0
Storage Cap Reductn	0	0	0	0	0	0	0	0	0	0
Reduced v/c Ratio	0.57	0.83	0.77	0.21	0.45	0.38	0.73	0.23	0.21	0.06

Intersection Summary

95th percentile volume exceeds capacity, queue may be longer.
Queue shown is maximum after two cycles.

Queues
8: Road 23 & Avenue 16

Village D Specific Plan
Phase II WP MIT - AM Peak Hour



Lane Group	EBL	EBT	WBL	WBT	NBL	NBT	NBR	SBL	SBT	SBR
Lane Group Flow (vph)	54	371	149	352	172	795	25	127	752	57
v/c Ratio	0.38	0.82	0.72	0.60	0.69	0.60	0.03	0.63	0.61	0.07
Control Delay	42.9	26.6	54.7	9.9	48.4	23.6	0.0	48.5	25.5	2.1
Queue Delay	0.0	0.0	0.0	0.0	0.0	0.0	0.0	0.0	0.0	0.0
Total Delay	42.9	26.6	54.7	9.9	48.4	23.6	0.0	48.5	25.5	2.1
Queue Length 50th (ft)	26	60	73	21	80	173	0	60	169	0
Queue Length 95th (ft)	61	150	#156	89	#171	249	0	#136	245	13
Internal Link Dist (ft)		2685		1572		2602			2585	
Turn Bay Length (ft)	50		50		50		100	50		100
Base Capacity (vph)	147	548	216	653	262	1322	898	211	1224	804
Starvation Cap Reductn	0	0	0	0	0	0	0	0	0	0
Spillback Cap Reductn	0	0	0	0	0	0	0	0	0	0
Storage Cap Reductn	0	0	0	0	0	0	0	0	0	0
Reduced v/c Ratio	0.37	0.68	0.69	0.54	0.66	0.60	0.03	0.60	0.61	0.07

Intersection Summary

95th percentile volume exceeds capacity, queue may be longer.
Queue shown is maximum after two cycles.

Queues
9: Road 23 & Cleveland Avenue

Village D Specific Plan
Phase II WP MIT - AM Peak Hour



Lane Group	EBT	WBL	WBT	NBL	NBT	NBR	SBL	SBT
Lane Group Flow (vph)	31	338	376	10	740	327	325	845
v/c Ratio	0.22	0.99	0.54	0.09	0.71	0.33	0.69	0.41
Control Delay	32.8	85.9	6.5	40.4	35.4	2.7	37.5	12.2
Queue Delay	0.0	0.0	0.0	0.0	0.0	0.0	0.0	0.0
Total Delay	32.8	85.9	6.5	40.4	35.4	2.7	37.5	12.2
Queue Length 50th (ft)	11	194	8	6	210	0	164	128
Queue Length 95th (ft)	38	#366	69	21	#346	45	253	245
Internal Link Dist (ft)	2664		3869		1127			2602
Turn Bay Length (ft)		50		50		200	50	
Base Capacity (vph)	369	340	774	117	1036	985	470	2048
Starvation Cap Reductn	0	0	0	0	0	0	0	0
Spillback Cap Reductn	0	0	0	0	0	0	0	0
Storage Cap Reductn	0	0	0	0	0	0	0	0
Reduced v/c Ratio	0.08	0.99	0.49	0.09	0.71	0.33	0.69	0.41

Intersection Summary

95th percentile volume exceeds capacity, queue may be longer.
Queue shown is maximum after two cycles.

Queues
10: Road 23 & Avenue 14 1/2



Lane Group	EBT	WBT	NBL	NBT	SBL	SBT
Lane Group Flow (vph)	5	174	4	456	133	682
v/c Ratio	0.03	0.59	0.03	0.24	0.55	0.27
Control Delay	30.6	16.6	35.0	9.3	39.5	4.1
Queue Delay	0.0	0.0	0.0	0.0	0.0	0.0
Total Delay	30.6	16.6	35.0	9.3	39.5	4.1
Queue Length 50th (ft)	2	10	2	49	63	30
Queue Length 95th (ft)	12	63	11	101	109	113
Internal Link Dist (ft)	377	475		2577		3397
Turn Bay Length (ft)			200		200	
Base Capacity (vph)	534	563	133	1931	390	2573
Starvation Cap Reductn	0	0	0	0	0	0
Spillback Cap Reductn	0	0	0	0	0	0
Storage Cap Reductn	0	0	0	0	0	0
Reduced v/c Ratio	0.01	0.31	0.03	0.24	0.34	0.27
Intersection Summary						

Queues
13: Airport Drive/Golden State Boulevard & Avenue 17

Village D Specific Plan
Phase II WP MIT - AM Peak Hour



Lane Group	EBL	EBT	EBR	WBL	WBT	WBR	NBL	NBT	NBR	SBL	SBT
Lane Group Flow (vph)	5	1117	159	266	472	239	71	91	157	190	50
v/c Ratio	0.05	0.92	0.24	0.87	0.25	0.25	0.70	0.16	0.27	0.33	0.12
Control Delay	41.4	42.2	3.4	64.9	11.7	2.5	76.7	22.4	5.1	31.2	27.6
Queue Delay	0.0	0.0	0.0	0.0	0.0	0.0	0.0	0.0	0.0	0.0	0.0
Total Delay	41.4	42.2	3.4	64.9	11.7	2.5	76.7	22.4	5.1	31.2	27.6
Queue Length 50th (ft)	3	317	0	148	65	0	40	36	0	47	21
Queue Length 95th (ft)	14	#448	31	#280	117	38	#112	72	41	79	52
Internal Link Dist (ft)		188			379			370			222
Turn Bay Length (ft)	85			70		105	60		50	100	
Base Capacity (vph)	99	1213	663	315	1875	947	102	570	589	577	423
Starvation Cap Reductn	0	0	0	0	0	0	0	0	0	0	0
Spillback Cap Reductn	0	0	0	0	0	0	0	0	0	0	0
Storage Cap Reductn	0	0	0	0	0	0	0	0	0	0	0
Reduced v/c Ratio	0.05	0.92	0.24	0.84	0.25	0.25	0.70	0.16	0.27	0.33	0.12

Intersection Summary

95th percentile volume exceeds capacity, queue may be longer.
Queue shown is maximum after two cycles.

Queues
 14: Avenue 17 & SR-99 Southbound Off-Ramp

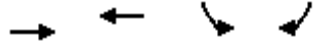

Lane Group	EBT	WBT	SBL	SBR
Lane Group Flow (vph)	1466	861	299	117
v/c Ratio	0.67	0.40	0.41	0.17
Control Delay	19.3	18.7	18.1	5.0
Queue Delay	0.0	0.0	0.0	0.0
Total Delay	19.3	18.7	18.1	5.0
Queue Length 50th (ft)	199	126	100	4
Queue Length 95th (ft)	232	m147	174	34
Internal Link Dist (ft)	379	248	971	
Turn Bay Length (ft)				610
Base Capacity (vph)	2400	2377	730	709
Starvation Cap Reductn	0	0	0	0
Spillback Cap Reductn	0	0	0	0
Storage Cap Reductn	0	0	0	0
Reduced v/c Ratio	0.61	0.36	0.41	0.17

Intersection Summary

m Volume for 95th percentile queue is metered by upstream signal.

Queues
15: SR-99 Northbound Ramps & Avenue 17

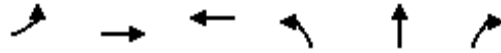

Lane Group	EBL	EBT	WBT	NBL	NBT	NBR
Lane Group Flow (vph)	124	759	1373	258	261	261
v/c Ratio	0.64	0.38	0.89	0.51	0.51	0.43
Control Delay	47.9	11.3	32.5	28.8	28.9	10.6
Queue Delay	0.0	0.0	0.0	0.0	0.0	0.0
Total Delay	47.9	11.3	32.5	28.8	28.9	10.6
Queue Length 50th (ft)	65	63	181	117	118	30
Queue Length 95th (ft)	m108	107	#266	198	200	93
Internal Link Dist (ft)		518	493		633	
Turn Bay Length (ft)	125					50
Base Capacity (vph)	206	2156	1560	507	508	604
Starvation Cap Reductn	0	0	0	0	0	0
Spillback Cap Reductn	0	0	0	0	0	0
Storage Cap Reductn	0	0	0	0	0	0
Reduced v/c Ratio	0.60	0.35	0.88	0.51	0.51	0.43

Intersection Summary

95th percentile volume exceeds capacity, queue may be longer.

Queue shown is maximum after two cycles.

m Volume for 95th percentile queue is metered by upstream signal.

Queues
 16: Love's Truck Stop Driveway/Driveway & Avenue 17

Village D Specific Plan
 Phase II WP MIT - AM Peak Hour

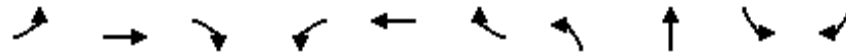

Lane Group	EBL	EBT	EBR	WBL	WBT	WBR	NBL	NBT	SBL	SBR
Lane Group Flow (vph)	176	691	143	49	1049	61	148	24	52	98
v/c Ratio	0.48	0.36	0.21	0.35	0.69	0.11	0.76	0.03	0.37	0.13
Control Delay	35.9	17.6	6.8	42.3	27.2	0.4	61.2	0.1	42.5	5.4
Queue Delay	0.0	0.0	0.0	0.0	0.0	0.0	0.0	0.0	0.0	0.0
Total Delay	35.9	17.6	6.8	42.3	27.2	0.4	61.2	0.1	42.5	5.4
Queue Length 50th (ft)	45	93	16	24	161	0	74	0	25	5
Queue Length 95th (ft)	73	107	30	57	206	0	#174	0	60	32
Internal Link Dist (ft)		311			402			160		
Turn Bay Length (ft)	200		100	100		100				
Base Capacity (vph)	399	1934	690	143	1646	609	196	761	146	744
Starvation Cap Reductn	0	0	0	0	0	0	0	0	0	0
Spillback Cap Reductn	0	0	0	0	0	0	0	0	0	0
Storage Cap Reductn	0	0	0	0	0	0	0	0	0	0
Reduced v/c Ratio	0.44	0.36	0.21	0.34	0.64	0.10	0.76	0.03	0.36	0.13

Intersection Summary

95th percentile volume exceeds capacity, queue may be longer.
 Queue shown is maximum after two cycles.

Queues
17: Westberry Boulevard & Cleveland Avenue

Village D Specific Plan
Phase II WP MIT - AM Peak Hour



Lane Group	EBL	EBT	WBL	WBT	NBL	NBT	NBR	SBL	SBT	SBR
Lane Group Flow (vph)	279	951	37	336	55	187	152	15	65	116
v/c Ratio	0.75	0.72	0.29	0.51	0.39	0.24	0.19	0.12	0.10	0.17
Control Delay	42.5	24.6	41.1	31.0	44.0	19.6	2.2	37.8	23.2	0.7
Queue Delay	0.0	0.0	0.0	0.0	0.0	0.0	0.0	0.0	0.0	0.0
Total Delay	42.5	24.6	41.1	31.0	44.0	19.6	2.2	37.8	23.2	0.7
Queue Length 50th (ft)	130	209	18	75	26	61	0	7	26	0
Queue Length 95th (ft)	205	263	47	113	63	137	21	26	57	3
Internal Link Dist (ft)		630		1237		511			3065	
Turn Bay Length (ft)	110		165		65		50	100		50
Base Capacity (vph)	439	1414	131	802	140	790	782	122	681	702
Starvation Cap Reductn	0	0	0	0	0	0	0	0	0	0
Spillback Cap Reductn	0	0	0	0	0	0	0	0	0	0
Storage Cap Reductn	0	0	0	0	0	0	0	0	0	0
Reduced v/c Ratio	0.64	0.67	0.28	0.42	0.39	0.24	0.19	0.12	0.10	0.17

Intersection Summary

Queues
51: Project Driveway 1 & Avenue 17

Village D Specific Plan
Phase II WP MIT - AM Peak Hour

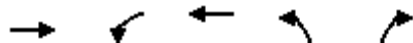

Lane Group	EBT	WBL	WBT	NBL	NBR
Lane Group Flow (vph)	89	189	78	61	702
v/c Ratio	0.44	0.66	0.14	0.06	0.57
Control Delay	34.2	42.4	17.4	10.2	3.1
Queue Delay	0.0	0.0	0.0	0.0	0.0
Total Delay	34.2	42.4	17.4	10.2	3.1
Queue Length 50th (ft)	35	89	27	13	0
Queue Length 95th (ft)	75	151	50	35	54
Internal Link Dist (ft)	2580		2671	2061	
Turn Bay Length (ft)		50		50	
Base Capacity (vph)	396	342	884	1050	1233
Starvation Cap Reductn	0	0	0	0	0
Spillback Cap Reductn	0	0	0	0	0
Storage Cap Reductn	0	0	0	0	0
Reduced v/c Ratio	0.22	0.55	0.09	0.06	0.57
Intersection Summary					

Queues
55: Road 23 & Project Driveway 3

Village D Specific Plan
Phase II WP MIT - AM Peak Hour



Lane Group	EBL	EBR	NBL	NBT	SBT	SBR
Lane Group Flow (vph)	891	285	249	858	615	378
v/c Ratio	1.00	0.30	0.97	0.62	0.88	0.69
Control Delay	54.3	2.7	89.2	23.6	50.3	15.8
Queue Delay	0.0	0.0	0.0	0.0	0.0	0.0
Total Delay	54.3	2.7	89.2	23.6	50.3	15.8
Queue Length 50th (ft)	483	2	143	198	180	40
Queue Length 95th (ft)	#760	41	#291	261	#274	139
Internal Link Dist (ft)	1503			2585	2520	
Turn Bay Length (ft)	50		50			100
Base Capacity (vph)	892	939	257	1394	700	546
Starvation Cap Reductn	0	0	0	0	0	0
Spillback Cap Reductn	0	0	0	0	0	0
Storage Cap Reductn	0	0	0	0	0	0
Reduced v/c Ratio	1.00	0.30	0.97	0.62	0.88	0.69

Intersection Summary

95th percentile volume exceeds capacity, queue may be longer.
Queue shown is maximum after two cycles.

Queues
56: Road 23 & Project Driveway 4

Village D Specific Plan
Phase II WP MIT - AM Peak Hour



Lane Group	WBL	WBR	NBT	NBR	SBL	SBT
Lane Group Flow (vph)	87	592	430	120	465	655
v/c Ratio	0.50	0.73	0.15	0.13	0.75	0.16
Control Delay	60.5	9.8	11.3	2.7	54.3	2.3
Queue Delay	0.0	0.0	0.0	0.0	0.0	0.0
Total Delay	60.5	9.8	11.3	2.7	54.3	2.3
Queue Length 50th (ft)	65	0	49	0	177	27
Queue Length 95th (ft)	114	55	82	29	223	46
Internal Link Dist (ft)	754		528			1127
Turn Bay Length (ft)	200			200	200	
Base Capacity (vph)	579	1313	2892	947	1052	4133
Starvation Cap Reductn	0	0	0	0	0	0
Spillback Cap Reductn	0	0	0	0	0	0
Storage Cap Reductn	0	0	0	0	0	0
Reduced v/c Ratio	0.15	0.45	0.15	0.13	0.44	0.16
Intersection Summary						

Queues
58: Project Driveway 6 & Cleveland Avenue



Lane Group	EBT	WBL	WBT	NBL	NBR
Lane Group Flow (vph)	1071	167	351	216	317
v/c Ratio	1.02	0.89	0.26	0.62	0.60
Control Delay	55.1	88.6	5.6	45.4	13.2
Queue Delay	0.0	0.0	0.0	0.0	0.0
Total Delay	55.1	88.6	5.6	45.4	13.2
Queue Length 50th (ft)	~681	107	68	127	29
Queue Length 95th (ft)	#975	#230	102	205	114
Internal Link Dist (ft)	3869		3165	834	
Turn Bay Length (ft)		50		50	
Base Capacity (vph)	1053	187	1344	351	526
Starvation Cap Reductn	0	0	0	0	0
Spillback Cap Reductn	0	0	0	0	0
Storage Cap Reductn	0	0	0	0	0
Reduced v/c Ratio	1.02	0.89	0.26	0.62	0.60

Intersection Summary

- ~ Volume exceeds capacity, queue is theoretically infinite.
Queue shown is maximum after two cycles.
- # 95th percentile volume exceeds capacity, queue may be longer.
Queue shown is maximum after two cycles.

Queues
21: Granada Drive & Cleveland Avenue

Village D Specific Plan
Phase II WP MIT - AM Peak Hour



Lane Group	EBL	EBT	WBL	WBT	NBL	NBT	NBR	SBL	SBT	SBR
Lane Group Flow (vph)	32	1009	208	339	28	425	351	12	284	5
v/c Ratio	0.28	0.93	0.82	0.22	0.25	0.59	0.49	0.12	0.42	0.01
Control Delay	46.7	46.2	63.1	16.9	46.0	27.9	13.4	43.2	26.0	0.0
Queue Delay	0.0	0.0	0.0	0.0	0.0	0.0	0.0	0.0	0.0	0.0
Total Delay	46.7	46.2	63.1	16.9	46.0	27.9	13.4	43.2	26.0	0.0
Queue Length 50th (ft)	18	290	115	64	16	185	64	7	113	0
Queue Length 95th (ft)	47	#416	#226	96	43	#359	169	24	215	0
Internal Link Dist (ft)		289		2178		418			382	
Turn Bay Length (ft)	90		125		50		50	50		50
Base Capacity (vph)	115	1088	265	1507	112	722	718	102	677	684
Starvation Cap Reductn	0	0	0	0	0	0	0	0	0	0
Spillback Cap Reductn	0	0	0	0	0	0	0	0	0	0
Storage Cap Reductn	0	0	0	0	0	0	0	0	0	0
Reduced v/c Ratio	0.28	0.93	0.78	0.22	0.25	0.59	0.49	0.12	0.42	0.01

Intersection Summary

95th percentile volume exceeds capacity, queue may be longer.
Queue shown is maximum after two cycles.

Queues
22: Granada Drive & Sunset Avenue

Village D Specific Plan
Phase II WP MIT - AM Peak Hour



Lane Group	EBL	EBT	WBL	WBT	WBR	NBL	NBT	SBL	SBT
Lane Group Flow (vph)	71	369	28	120	72	52	290	142	364
v/c Ratio	0.52	0.76	0.21	0.33	0.16	0.33	0.46	0.61	0.44
Control Delay	44.2	32.5	32.3	23.8	0.8	34.1	20.8	44.1	17.7
Queue Delay	0.0	0.0	0.0	0.0	0.0	0.0	0.0	0.0	0.0
Total Delay	44.2	32.5	32.3	23.8	0.8	34.1	20.8	44.1	17.7
Queue Length 50th (ft)	28	120	11	44	0	19	89	51	102
Queue Length 95th (ft)	#75	#237	33	75	0	51	166	#150	206
Internal Link Dist (ft)		721		7441			203		209
Turn Bay Length (ft)	95		120		70	95		85	
Base Capacity (vph)	136	520	131	496	549	158	634	232	822
Starvation Cap Reductn	0	0	0	0	0	0	0	0	0
Spillback Cap Reductn	0	0	0	0	0	0	0	0	0
Storage Cap Reductn	0	0	0	0	0	0	0	0	0
Reduced v/c Ratio	0.52	0.71	0.21	0.24	0.13	0.33	0.46	0.61	0.44

Intersection Summary

95th percentile volume exceeds capacity, queue may be longer.
Queue shown is maximum after two cycles.

Queues
23: Avenue 16/Ellis Street & Kennedy Street

Village D Specific Plan
Phase II WP MIT - AM Peak Hour



Lane Group	WBL	WBR	NBT	SBL	SBT
Lane Group Flow (vph)	212	160	683	286	384
v/c Ratio	0.66	0.25	0.56	0.55	0.15
Control Delay	28.9	5.4	21.4	28.6	4.6
Queue Delay	0.0	0.0	0.0	0.0	0.0
Total Delay	28.9	5.4	21.4	28.6	4.6
Queue Length 50th (ft)	68	0	126	120	28
Queue Length 95th (ft)	118	m0	198	197	52
Internal Link Dist (ft)	782		506		440
Turn Bay Length (ft)	175			280	
Base Capacity (vph)	423	787	1228	519	2488
Starvation Cap Reductn	0	0	0	0	0
Spillback Cap Reductn	0	0	0	0	0
Storage Cap Reductn	0	0	0	0	0
Reduced v/c Ratio	0.50	0.20	0.56	0.55	0.15

Intersection Summary

m Volume for 95th percentile queue is metered by upstream signal.

Queues
24: Schnoor Avenue & Kennedy Street

Village D Specific Plan
Phase II WP MIT - AM Peak Hour



Lane Group	EBL	EBT	WBL	WBT	NBL	NBT	SBL	SBT	SBR
Lane Group Flow (vph)	89	398	232	395	125	337	105	34	26
v/c Ratio	0.75	0.62	0.74	0.75	0.48	0.43	1.15	0.06	0.04
Control Delay	73.7	10.7	52.1	46.5	42.3	6.1	180.1	20.5	0.1
Queue Delay	0.0	0.0	0.0	0.0	0.0	0.0	0.0	0.0	0.0
Total Delay	73.7	10.7	52.1	46.5	42.3	6.1	180.1	20.5	0.1
Queue Length 50th (ft)	48	15	123	190	31	11	-63	11	0
Queue Length 95th (ft)	m#106	45	m177	m218	58	78	#159	35	0
Internal Link Dist (ft)		782		187		321		193	
Turn Bay Length (ft)	95		40		75		60		
Base Capacity (vph)	119	882	354	657	258	791	91	547	590
Starvation Cap Reductn	0	0	0	0	0	0	0	0	0
Spillback Cap Reductn	0	0	0	0	0	0	0	0	0
Storage Cap Reductn	0	0	0	0	0	0	0	0	0
Reduced v/c Ratio	0.75	0.45	0.66	0.60	0.48	0.43	1.15	0.06	0.04

Intersection Summary

- ~ Volume exceeds capacity, queue is theoretically infinite.
Queue shown is maximum after two cycles.
- # 95th percentile volume exceeds capacity, queue may be longer.
Queue shown is maximum after two cycles.
- m Volume for 95th percentile queue is metered by upstream signal.

Queues
 25: Kennedy Street/Gateway Drive & SR-99 Southbound Ramps

Village D Specific Plan
 Phase II WP MIT - AM Peak Hour



Lane Group	EBL	EBT	WBT	SBL	SBR
Lane Group Flow (vph)	343	282	438	72	174
v/c Ratio	0.81	0.26	0.84	0.14	0.17
Control Delay	41.3	6.4	41.6	24.6	1.9
Queue Delay	0.0	0.0	0.0	0.0	0.0
Total Delay	41.3	6.4	41.6	24.6	1.9
Queue Length 50th (ft)	136	35	198	28	0
Queue Length 95th (ft)	m246	m68	#306	63	25
Internal Link Dist (ft)		189	811	461	
Turn Bay Length (ft)	140				335
Base Capacity (vph)	475	1222	593	526	1046
Starvation Cap Reductn	0	0	0	0	0
Spillback Cap Reductn	0	0	0	0	0
Storage Cap Reductn	0	0	0	0	0
Reduced v/c Ratio	0.72	0.23	0.74	0.14	0.17

Intersection Summary

95th percentile volume exceeds capacity, queue may be longer.

Queue shown is maximum after two cycles.

m Volume for 95th percentile queue is metered by upstream signal.

Queues
29: Schnoor Avenue & Cleveland Avenue

Village D Specific Plan
Phase II WP MIT - AM Peak Hour



Lane Group	EBL	EBT	EBR	WBL	WBT	WBR	NBL	NBT	NBR	SBL	SBT	SBR
Lane Group Flow (vph)	145	1139	84	180	455	50	67	277	186	97	210	80
v/c Ratio	0.58	0.88	0.12	0.64	0.42	0.08	0.57	0.28	0.28	0.68	0.21	0.14
Control Delay	41.6	33.4	0.4	22.9	4.5	0.2	56.5	25.0	6.4	60.7	23.4	0.5
Queue Delay	0.0	0.0	0.0	0.0	0.0	0.0	0.0	0.0	0.0	0.0	0.0	0.0
Total Delay	41.6	33.4	0.4	22.9	4.5	0.2	56.5	25.0	6.4	60.7	23.4	0.5
Queue Length 50th (ft)	68	272	0	41	8	0	33	60	13	48	43	0
Queue Length 95th (ft)	122	#390	0	#79	19	m0	#88	93	54	#119	71	0
Internal Link Dist (ft)		2178			574			393			326	
Turn Bay Length (ft)	120		60	220		95	75		75	105		65
Base Capacity (vph)	299	1317	705	280	1071	614	118	984	657	144	1014	588
Starvation Cap Reductn	0	0	0	0	0	0	0	0	0	0	0	0
Spillback Cap Reductn	0	0	0	0	0	0	0	0	0	0	0	0
Storage Cap Reductn	0	0	0	0	0	0	0	0	0	0	0	0
Reduced v/c Ratio	0.48	0.86	0.12	0.64	0.42	0.08	0.57	0.28	0.28	0.67	0.21	0.14

Intersection Summary

- # 95th percentile volume exceeds capacity, queue may be longer.
Queue shown is maximum after two cycles.
- m Volume for 95th percentile queue is metered by upstream signal.

Queues
30: Fairgrounds & Cleveland Avenue

Village D Specific Plan
Phase II WP MIT - AM Peak Hour



Lane Group	EBL	EBT	WBL	WBT	WBR	NBL	NBT	NBR	SBL	SBT
Lane Group Flow (vph)	105	1356	39	613	149	14	19	17	157	46
v/c Ratio	0.48	0.78	0.25	0.61	0.25	0.06	0.04	0.03	0.70	0.06
Control Delay	21.1	12.6	36.9	28.6	2.5	36.1	15.3	0.1	51.3	7.1
Queue Delay	0.0	0.0	0.0	0.0	0.0	0.0	0.0	0.0	0.0	0.0
Total Delay	21.1	12.6	36.9	28.6	2.5	36.1	15.3	0.1	51.3	7.1
Queue Length 50th (ft)	36	77	19	145	0	3	3	0	76	1
Queue Length 95th (ft)	m49	m#314	46	198	19	12	20	0	#156	24
Internal Link Dist (ft)		574		1412			192			168
Turn Bay Length (ft)	120		205					100		
Base Capacity (vph)	238	1744	251	1041	610	218	444	604	236	712
Starvation Cap Reductn	0	0	0	0	0	0	0	0	0	0
Spillback Cap Reductn	0	0	0	0	0	0	0	0	0	0
Storage Cap Reductn	0	0	0	0	0	0	0	0	0	0
Reduced v/c Ratio	0.44	0.78	0.16	0.59	0.24	0.06	0.04	0.03	0.67	0.06

Intersection Summary

95th percentile volume exceeds capacity, queue may be longer.

Queue shown is maximum after two cycles.

m Volume for 95th percentile queue is metered by upstream signal.

Queues
31: SR-99 Southbound Ramps & Cleveland Avenue

Village D Specific Plan
Phase II WP MIT - AM Peak Hour



Lane Group	EBT	EBR	WBL	WBT	SBL	SBR
Lane Group Flow (vph)	762	887	396	962	217	104
v/c Ratio	0.57	0.95	0.90	0.40	0.55	0.25
Control Delay	26.0	30.6	61.0	7.5	42.2	8.6
Queue Delay	0.0	0.0	0.0	0.6	0.0	0.0
Total Delay	26.0	30.6	61.0	8.1	42.2	8.6
Queue Length 50th (ft)	190	236	240	108	129	0
Queue Length 95th (ft)	248	#552	#401	139	209	44
Internal Link Dist (ft)	1412			372		
Turn Bay Length (ft)			115			140
Base Capacity (vph)	1426	964	464	2506	391	424
Starvation Cap Reductn	0	0	0	1052	0	0
Spillback Cap Reductn	0	0	0	0	0	0
Storage Cap Reductn	0	0	0	0	0	0
Reduced v/c Ratio	0.53	0.92	0.85	0.66	0.55	0.25

Intersection Summary

95th percentile volume exceeds capacity, queue may be longer.
Queue shown is maximum after two cycles.

Queues
32: SR-99 Northbound Ramps & Cleveland Avenue

Village D Specific Plan
Phase II WP MIT - AM Peak Hour



Lane Group	EBL	EBT	WBT	WBR	NBL	NBT	NBR
Lane Group Flow (vph)	80	900	938	160	213	213	370
v/c Ratio	0.43	0.53	0.76	0.27	0.31	0.31	0.51
Control Delay	44.3	16.6	15.5	3.7	22.4	22.4	16.8
Queue Delay	0.0	0.3	1.2	0.0	0.0	0.0	0.0
Total Delay	44.3	16.9	16.7	3.7	22.4	22.4	16.8
Queue Length 50th (ft)	43	164	121	0	89	89	96
Queue Length 95th (ft)	84	182	104	m7	166	166	204
Internal Link Dist (ft)		372	207			441	
Turn Bay Length (ft)	90			50	145		325
Base Capacity (vph)	379	2044	1264	612	684	684	728
Starvation Cap Reductn	0	558	146	0	0	0	0
Spillback Cap Reductn	0	52	0	0	0	0	2
Storage Cap Reductn	0	0	0	0	0	0	0
Reduced v/c Ratio	0.21	0.61	0.84	0.26	0.31	0.31	0.51

Intersection Summary

m Volume for 95th percentile queue is metered by upstream signal.

Queues
33: Gateway Drive & Cleveland Avenue

Village D Specific Plan
Phase II WP MIT - AM Peak Hour

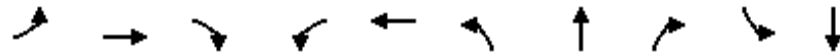

Lane Group	EBL	EBT	EBR	WBL	WBT	NBL	NBT	NBR	SBL	SBT
Lane Group Flow (vph)	4	963	299	227	981	192	53	183	67	100
v/c Ratio	0.02	0.72	0.38	0.52	0.67	0.45	0.09	0.29	0.42	0.10
Control Delay	18.2	23.5	1.6	37.8	22.1	40.0	25.4	5.8	46.5	25.5
Queue Delay	0.0	0.9	0.1	0.6	27.4	0.0	0.0	0.0	0.2	0.0
Total Delay	18.2	24.5	1.7	38.4	49.5	40.0	25.4	5.8	46.7	25.5
Queue Length 50th (ft)	1	128	2	54	171	52	22	0	36	21
Queue Length 95th (ft)	m2	191	6	86	236	86	54	51	77	44
Internal Link Dist (ft)		207			111		765			296
Turn Bay Length (ft)	110					245			45	
Base Capacity (vph)	220	1426	791	587	1463	425	602	625	181	964
Starvation Cap Reductn	0	219	64	130	521	0	0	0	0	0
Spillback Cap Reductn	0	82	0	0	102	0	0	14	6	0
Storage Cap Reductn	0	0	0	0	0	0	0	0	0	0
Reduced v/c Ratio	0.02	0.80	0.41	0.50	1.04	0.45	0.09	0.30	0.38	0.10

Intersection Summary

m Volume for 95th percentile queue is metered by upstream signal.

Queues
 34: Cleveland Avenue & County Club Drive



Lane Group	WBL	NBT	NBR	SBL	SBT
Lane Group Flow (vph)	520	810	402	103	729
v/c Ratio	0.71	0.33	0.26	0.25	0.21
Control Delay	37.9	9.9	1.3	7.9	5.5
Queue Delay	0.0	1.6	0.0	0.0	0.1
Total Delay	37.9	11.5	1.3	7.9	5.5
Queue Length 50th (ft)	139	91	12	19	46
Queue Length 95th (ft)	179	143	38	51	74
Internal Link Dist (ft)	239	111			159
Turn Bay Length (ft)					
Base Capacity (vph)	1261	2428	1568	413	3489
Starvation Cap Reductn	0	1375	0	0	0
Spillback Cap Reductn	3	0	0	0	1028
Storage Cap Reductn	0	0	0	0	0
Reduced v/c Ratio	0.41	0.77	0.26	0.25	0.30
Intersection Summary					

Queues
36: Pine Street & Howard Road

Village D Specific Plan
Phase II WP MIT - AM Peak Hour



Lane Group	EBL	EBT	WBL	WBT	NBL	NBT	NBR	SBT	SBR
Lane Group Flow (vph)	37	917	164	512	161	182	264	323	109
v/c Ratio	0.38	0.80	0.70	0.33	0.48	0.52	0.52	0.94	0.28
Control Delay	66.2	40.4	65.4	22.7	50.3	51.0	9.4	85.3	5.4
Queue Delay	0.0	0.0	0.0	0.0	0.0	0.0	0.0	0.0	0.0
Total Delay	66.2	40.4	65.4	22.7	50.3	51.0	9.4	85.3	5.4
Queue Length 50th (ft)	28	327	128	116	116	132	0	249	0
Queue Length 95th (ft)	65	368	#272	162	190	211	77	#427	31
Internal Link Dist (ft)		265		565		224		259	
Turn Bay Length (ft)	95		140		90				
Base Capacity (vph)	101	1372	233	1569	332	349	504	344	398
Starvation Cap Reductn	0	0	0	0	0	0	0	0	0
Spillback Cap Reductn	0	0	0	0	0	0	0	0	0
Storage Cap Reductn	0	0	0	0	0	0	0	0	0
Reduced v/c Ratio	0.37	0.67	0.70	0.33	0.48	0.52	0.52	0.94	0.27

Intersection Summary

95th percentile volume exceeds capacity, queue may be longer.
Queue shown is maximum after two cycles.

Queues
37: Olive Avenue/Q Street & Howard Road/Yosemite Avenue

Village D Specific Plan
Phase II WP MIT - AM Peak Hour



Lane Group	EBL	EBT	EBR	WBL	WBT	NBL	NBT	NBR	SBL	SBT	SBR
Lane Group Flow (vph)	7	608	357	29	398	229	232	23	111	163	13
v/c Ratio	0.09	0.70	0.56	0.26	0.38	0.31	0.31	0.03	0.50	0.70	0.04
Control Delay	77.5	25.6	5.8	58.7	32.9	26.8	26.7	0.1	56.3	66.0	0.2
Queue Delay	0.0	0.0	0.0	0.0	0.0	0.0	0.0	0.0	0.0	0.0	0.0
Total Delay	77.5	25.6	5.8	58.7	32.9	26.8	26.7	0.1	56.3	66.0	0.2
Queue Length 50th (ft)	5	177	44	22	117	125	126	0	81	122	0
Queue Length 95th (ft)	m8	m258	m138	53	157	232	233	0	138	193	0
Internal Link Dist (ft)		565			230		220			195	
Turn Bay Length (ft)	40			80		130			50		50
Base Capacity (vph)	78	1025	695	265	1393	742	759	744	265	279	353
Starvation Cap Reductn	0	0	0	0	0	0	0	0	0	0	0
Spillback Cap Reductn	0	0	0	0	0	0	0	0	0	0	0
Storage Cap Reductn	0	0	0	0	0	0	0	0	0	0	0
Reduced v/c Ratio	0.09	0.59	0.51	0.11	0.29	0.31	0.31	0.03	0.42	0.58	0.04

Intersection Summary

m Volume for 95th percentile queue is metered by upstream signal.

Queues

38: I Street & 2nd Street/SR-99 Southbound Off-Ramp



Lane Group	EBT	WBT	WBR	NBL	NBT	SBT
Lane Group Flow (vph)	70	558	12	23	95	164
v/c Ratio	0.56	0.82	0.02	0.05	0.13	0.23
Control Delay	24.5	32.4	0.1	21.6	21.2	21.3
Queue Delay	0.0	0.0	0.0	0.0	0.0	0.0
Total Delay	24.5	32.4	0.1	21.6	21.2	21.3
Queue Length 50th (ft)	0	242	0	7	31	55
Queue Length 95th (ft)	33	316	0	28	79	125
Internal Link Dist (ft)	129	218			779	118
Turn Bay Length (ft)			50	75		
Base Capacity (vph)	196	724	679	453	705	725
Starvation Cap Reductn	0	0	0	0	0	0
Spillback Cap Reductn	0	0	0	0	0	0
Storage Cap Reductn	0	0	0	0	0	0
Reduced v/c Ratio	0.36	0.77	0.02	0.05	0.13	0.23

Intersection Summary

Queues
39: 4th Street & Sunset Avenue



Lane Group	EBL	NBL	NBT	SBT	SBR
Lane Group Flow (vph)	453	37	382	545	308
v/c Ratio	0.71	0.45	0.15	0.45	0.23
Control Delay	40.5	63.9	4.4	5.6	0.5
Queue Delay	0.0	0.0	0.0	0.0	0.0
Total Delay	40.5	63.9	4.4	5.6	0.5
Queue Length 50th (ft)	122	21	32	60	0
Queue Length 95th (ft)	170	#78	48	70	0
Internal Link Dist (ft)	7441		193	501	
Turn Bay Length (ft)	135				
Base Capacity (vph)	721	82	2542	1203	1346
Starvation Cap Reductn	0	0	0	0	0
Spillback Cap Reductn	0	0	0	0	0
Storage Cap Reductn	0	0	0	0	0
Reduced v/c Ratio	0.63	0.45	0.15	0.45	0.23

Intersection Summary

95th percentile volume exceeds capacity, queue may be longer.
Queue shown is maximum after two cycles.

Queues
41: I Street & 4th Street



Lane Group	EBL	EBT	WBL	WBT	NBL	NBT	NBR	SBL	SBT	SBR
Lane Group Flow (vph)	30	804	96	617	58	62	179	305	309	217
v/c Ratio	0.29	0.87	0.65	0.58	0.41	0.13	0.31	0.78	0.40	0.29
Control Delay	58.9	34.0	40.9	19.3	47.9	30.5	3.1	48.0	22.9	6.1
Queue Delay	0.0	0.0	0.0	0.0	0.0	0.0	0.0	0.0	0.0	0.0
Total Delay	58.9	34.0	40.9	19.3	47.9	30.5	3.1	48.0	22.9	6.1
Queue Length 50th (ft)	16	240	55	73	32	29	0	160	134	13
Queue Length 95th (ft)	m35	#336	m66	m85	70	64	24	#271	211	60
Internal Link Dist (ft)		501		26		314			779	
Turn Bay Length (ft)	130				45		25	80		80
Base Capacity (vph)	104	951	153	1117	155	472	570	422	776	744
Starvation Cap Reductn	0	0	0	0	0	0	0	0	0	0
Spillback Cap Reductn	0	0	0	0	0	0	0	0	0	0
Storage Cap Reductn	0	0	0	0	0	0	0	0	0	0
Reduced v/c Ratio	0.29	0.85	0.63	0.55	0.37	0.13	0.31	0.72	0.40	0.29

Intersection Summary

95th percentile volume exceeds capacity, queue may be longer.

Queue shown is maximum after two cycles.

m Volume for 95th percentile queue is metered by upstream signal.

Queues
43: SR-99 Northbound Off-Ramp/H Street & 4th Street

Village D Specific Plan
Phase II WP MIT - AM Peak Hour

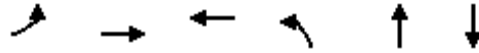

Lane Group	EBL	EBT	WBT	NBL	NBT	SBT
Lane Group Flow (vph)	291	552	668	290	279	90
v/c Ratio	0.91	0.35	0.95	0.77	0.52	0.21
Control Delay	51.2	6.9	58.8	48.5	10.0	3.7
Queue Delay	0.0	0.0	0.0	0.0	0.0	0.0
Total Delay	51.2	6.9	58.8	48.5	10.0	3.7
Queue Length 50th (ft)	180	60	193	157	16	0
Queue Length 95th (ft)	m#257	m74	#305	#279	85	20
Internal Link Dist (ft)		197	236		443	771
Turn Bay Length (ft)						
Base Capacity (vph)	327	1568	705	379	538	429
Starvation Cap Reductn	0	0	0	0	0	0
Spillback Cap Reductn	0	0	0	0	0	0
Storage Cap Reductn	0	0	0	0	0	0
Reduced v/c Ratio	0.89	0.35	0.95	0.77	0.52	0.21

Intersection Summary

95th percentile volume exceeds capacity, queue may be longer.

Queue shown is maximum after two cycles.

m Volume for 95th percentile queue is metered by upstream signal.

Queues
 45: Olive Avenue & SR-99 Southbound Off-Ramp

Village D Specific Plan
 Phase II WP MIT - AM Peak Hour

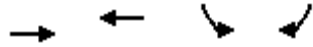

Lane Group	EBT	WBT	SBL	SBR
Lane Group Flow (vph)	586	544	827	120
v/c Ratio	0.54	0.72	0.74	0.12
Control Delay	29.0	40.6	15.0	3.8
Queue Delay	0.0	55.1	0.9	0.0
Total Delay	29.1	95.7	15.9	3.8
Queue Length 50th (ft)	93	154	246	11
Queue Length 95th (ft)	123	206	439	31
Internal Link Dist (ft)	103	112	135	
Turn Bay Length (ft)				
Base Capacity (vph)	1265	880	1113	1012
Starvation Cap Reductn	0	449	0	0
Spillback Cap Reductn	39	0	97	0
Storage Cap Reductn	0	0	0	0
Reduced v/c Ratio	0.48	1.26	0.81	0.12
Intersection Summary				

Queues
46: Madera Avenue & SR-99 Northbound Ramps



Lane Group	WBL	WBT	WBR	NBL	NBT	SBT
Lane Group Flow (vph)	112	114	104	655	540	990
v/c Ratio	0.50	0.50	0.35	0.91	0.21	0.62
Control Delay	38.6	38.8	9.8	41.6	1.5	17.1
Queue Delay	0.0	0.0	0.0	0.0	0.0	0.0
Total Delay	38.6	38.8	9.8	41.6	1.5	17.1
Queue Length 50th (ft)	55	56	0	145	2	168
Queue Length 95th (ft)	100	101	39	#260	22	264
Internal Link Dist (ft)		337			388	217
Turn Bay Length (ft)	140			205		
Base Capacity (vph)	377	378	430	722	2552	1591
Starvation Cap Reductn	0	0	0	0	0	0
Spillback Cap Reductn	0	0	0	0	0	0
Storage Cap Reductn	0	0	0	0	0	0
Reduced v/c Ratio	0.30	0.30	0.24	0.91	0.21	0.62

Intersection Summary

95th percentile volume exceeds capacity, queue may be longer.
Queue shown is maximum after two cycles.

Queues

47: Madera Avenue & Olive Avenue/SR-99 Southbound On-Ramp



Lane Group	EBL	EBT	EBR	NBL	NBT	SBL	SBT
Lane Group Flow (vph)	333	345	720	182	733	92	815
v/c Ratio	0.75	0.75	0.83	0.29	0.46	0.49	0.61
Control Delay	29.0	28.9	18.5	28.7	17.3	51.1	12.1
Queue Delay	1.7	1.7	40.7	0.0	0.0	0.0	1.8
Total Delay	30.7	30.6	59.2	28.7	17.3	51.1	13.9
Queue Length 50th (ft)	116	121	261	38	135	51	24
Queue Length 95th (ft)	m161	m168	393	68	204	m86	162
Internal Link Dist (ft)		112			323		388
Turn Bay Length (ft)				120		90	
Base Capacity (vph)	540	558	882	659	1592	214	1331
Starvation Cap Reductn	89	94	213	0	0	0	0
Spillback Cap Reductn	0	0	0	0	0	0	341
Storage Cap Reductn	0	0	0	0	0	0	0
Reduced v/c Ratio	0.74	0.74	1.08	0.28	0.46	0.43	0.82

Intersection Summary

m Volume for 95th percentile queue is metered by upstream signal.

Queues
49: Yosemite Avenue & Cleveland Avenue/Tozer Street

Village D Specific Plan
Phase II WP MIT - AM Peak Hour



Lane Group	EBL	EBT	WBL	WBT	WBR	NBL	NBT	NBR	SBL	SBT	SBR
Lane Group Flow (vph)	309	860	124	363	59	150	137	84	79	278	260
v/c Ratio	0.84	0.69	0.73	0.42	0.12	0.81	0.30	0.16	0.45	0.71	0.36
Control Delay	52.8	23.6	62.6	28.7	0.5	69.4	28.6	0.7	44.5	40.3	9.3
Queue Delay	0.0	0.0	0.0	0.0	0.0	0.0	0.0	0.0	0.0	0.0	0.0
Total Delay	52.8	23.6	62.6	28.7	0.5	69.4	28.6	0.7	44.5	40.3	9.3
Queue Length 50th (ft)	150	171	63	83	0	76	60	0	38	133	46
Queue Length 95th (ft)	#314	270	#163	137	0	#194	110	0	87	212	91
Internal Link Dist (ft)		318		397			415			443	
Turn Bay Length (ft)	210		150		50	240			150		
Base Capacity (vph)	388	1253	172	872	480	186	562	596	201	581	732
Starvation Cap Reductn	0	0	0	0	0	0	0	0	0	0	0
Spillback Cap Reductn	0	0	0	0	0	0	0	0	0	0	0
Storage Cap Reductn	0	0	0	0	0	0	0	0	0	0	0
Reduced v/c Ratio	0.80	0.69	0.72	0.42	0.12	0.81	0.24	0.14	0.39	0.48	0.36

Intersection Summary

95th percentile volume exceeds capacity, queue may be longer.
Queue shown is maximum after two cycles.

Queues

5: Road 23/SR-99 Southbound Off-Ramp & Avenue 18 1/2

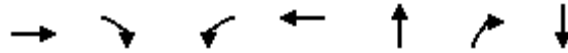

Lane Group	EBT	EBR	WBL	WBT	NBT	NBR	SBT
Lane Group Flow (vph)	422	290	55	214	81	348	683
v/c Ratio	0.71	0.41	0.58	0.24	0.17	0.46	0.91
Control Delay	36.7	7.8	61.4	31.7	24.2	3.3	46.8
Queue Delay	0.0	0.0	0.0	0.0	0.0	0.0	0.0
Total Delay	36.7	7.8	61.4	31.7	24.2	3.3	46.8
Queue Length 50th (ft)	103	40	30	53	31	0	167
Queue Length 95th (ft)	147	88	#84	98	67	25	#271
Internal Link Dist (ft)	230			210	324		245
Turn Bay Length (ft)		50				25	
Base Capacity (vph)	688	714	95	971	480	762	751
Starvation Cap Reductn	0	0	0	0	0	0	0
Spillback Cap Reductn	0	0	0	0	0	0	0
Storage Cap Reductn	0	0	0	0	0	0	0
Reduced v/c Ratio	0.61	0.41	0.58	0.22	0.17	0.46	0.91

Intersection Summary

95th percentile volume exceeds capacity, queue may be longer.
 Queue shown is maximum after two cycles.

Queues
6: SR-99 Northbound Ramps & Avenue 18 1/2

Village D Specific Plan
Phase II WP MIT - PM Peak Hour

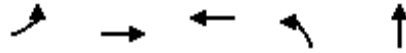

Lane Group	EBL	EBT	WBT	NBL	NBT
Lane Group Flow (vph)	443	120	121	207	3
v/c Ratio	0.69	0.19	0.53	0.22	0.00
Control Delay	35.6	21.8	36.7	14.2	14.0
Queue Delay	0.0	0.0	0.0	0.0	0.0
Total Delay	35.6	21.8	36.7	14.2	14.0
Queue Length 50th (ft)	118	52	51	56	1
Queue Length 95th (ft)	m161	m88	96	122	6
Internal Link Dist (ft)		549	786		644
Turn Bay Length (ft)	145				
Base Capacity (vph)	871	977	412	934	983
Starvation Cap Reductn	0	0	0	0	0
Spillback Cap Reductn	0	0	0	0	0
Storage Cap Reductn	0	0	0	0	0
Reduced v/c Ratio	0.51	0.12	0.29	0.22	0.00

Intersection Summary

m Volume for 95th percentile queue is metered by upstream signal.

Queues
7: Road 23 & Avenue 17

Village D Specific Plan
Phase II WP MIT - PM Peak Hour



Lane Group	EBL	EBT	WBL	WBT	NBL	NBT	NBR	SBL	SBT	SBR
Lane Group Flow (vph)	90	400	702	526	92	345	461	68	718	180
v/c Ratio	0.57	0.75	0.83	0.49	0.57	0.24	0.50	0.50	0.55	0.27
Control Delay	66.4	53.1	52.3	35.7	87.4	16.2	3.4	65.7	33.4	10.2
Queue Delay	0.0	0.0	0.0	0.0	0.0	0.0	0.0	0.0	0.0	0.0
Total Delay	66.4	53.1	52.3	35.7	87.4	16.2	3.4	65.7	33.4	10.2
Queue Length 50th (ft)	68	140	266	175	0	30	0	51	233	22
Queue Length 95th (ft)	122	192	321	214	m123	91	55	99	328	82
Internal Link Dist (ft)		2671		6172		2520			336	
Turn Bay Length (ft)	100		100		100		100	100		100
Base Capacity (vph)	187	608	977	1230	191	1433	915	154	1309	671
Starvation Cap Reductn	0	0	0	0	0	0	0	0	0	0
Spillback Cap Reductn	0	0	0	0	0	0	0	0	0	0
Storage Cap Reductn	0	0	0	0	0	0	0	0	0	0
Reduced v/c Ratio	0.48	0.66	0.72	0.43	0.48	0.24	0.50	0.44	0.55	0.27

Intersection Summary

m Volume for 95th percentile queue is metered by upstream signal.

Queues
8: Road 23 & Avenue 16

Village D Specific Plan
Phase II WP MIT - PM Peak Hour



Lane Group	EBL	EBT	WBL	WBT	NBL	NBT	NBR	SBL	SBT
Lane Group Flow (vph)	109	294	51	271	298	1024	133	334	1254
v/c Ratio	0.69	0.74	0.54	0.84	0.86	0.68	0.15	0.87	0.80
Control Delay	75.0	32.5	76.4	47.7	69.7	32.5	4.5	62.6	49.6
Queue Delay	0.0	0.0	0.0	0.0	0.0	0.0	0.0	0.0	0.0
Total Delay	75.0	32.5	76.4	47.7	69.7	32.5	4.5	62.6	49.6
Queue Length 50th (ft)	83	96	39	103	219	355	4	276	530
Queue Length 95th (ft)	#157	192	#89	#203	#353	454	40	#393	#638
Internal Link Dist (ft)		2685		1572		2602			2585
Turn Bay Length (ft)	50		50		50		200	50	
Base Capacity (vph)	171	453	97	373	379	1512	882	420	1559
Starvation Cap Reductn	0	0	0	0	0	0	0	0	0
Spillback Cap Reductn	0	0	0	0	0	0	0	0	0
Storage Cap Reductn	0	0	0	0	0	0	0	0	0
Reduced v/c Ratio	0.64	0.65	0.53	0.73	0.79	0.68	0.15	0.80	0.80

Intersection Summary

95th percentile volume exceeds capacity, queue may be longer.
Queue shown is maximum after two cycles.

Queues
9: Road 23 & Cleveland Avenue

Village D Specific Plan
Phase II WP MIT - PM Peak Hour



Lane Group	EBL	EBT	WBL	WBT	NBL	NBT	NBR	SBL	SBT	SBR
Lane Group Flow (vph)	1	42	267	323	14	1125	322	300	1104	1
v/c Ratio	0.01	0.30	0.99	0.56	0.12	0.80	0.30	0.69	0.47	0.00
Control Delay	46.0	36.5	95.0	9.6	46.0	34.6	2.3	43.4	11.2	0.0
Queue Delay	0.0	0.0	0.0	0.0	0.0	0.0	0.0	0.0	0.0	0.0
Total Delay	46.0	36.5	95.0	9.6	46.0	34.6	2.3	43.4	11.2	0.0
Queue Length 50th (ft)	1	17	172	13	9	355	0	173	173	0
Queue Length 95th (ft)	6	49	#332	93	28	#522	41	265	331	0
Internal Link Dist (ft)		2664		3869		1127			2602	
Turn Bay Length (ft)	50		50		50		200	50		200
Base Capacity (vph)	90	335	271	670	114	1400	1073	433	2325	1219
Starvation Cap Reductn	0	0	0	0	0	0	0	0	0	0
Spillback Cap Reductn	0	0	0	0	0	0	0	0	0	0
Storage Cap Reductn	0	0	0	0	0	0	0	0	0	0
Reduced v/c Ratio	0.01	0.13	0.99	0.48	0.12	0.80	0.30	0.69	0.47	0.00

Intersection Summary

95th percentile volume exceeds capacity, queue may be longer.
Queue shown is maximum after two cycles.

Queues
10: Road 23 & Avenue 14 1/2

Village D Specific Plan
Phase II WP MIT - PM Peak Hour



Lane Group	EBT	WBT	NBL	NBT	SBL	SBT
Lane Group Flow (vph)	6	165	2	790	190	614
v/c Ratio	0.04	0.56	0.02	0.40	0.63	0.23
Control Delay	25.7	14.6	34.5	11.6	39.4	3.7
Queue Delay	0.0	0.0	0.0	0.0	0.0	0.0
Total Delay	25.7	14.6	34.5	11.6	39.4	3.7
Queue Length 50th (ft)	1	4	1	101	89	24
Queue Length 95th (ft)	12	56	8	192	143	95
Internal Link Dist (ft)	377	475		2577		3397
Turn Bay Length (ft)			200		200	
Base Capacity (vph)	356	500	124	1985	390	2696
Starvation Cap Reductn	0	0	0	0	0	0
Spillback Cap Reductn	0	0	0	0	0	0
Storage Cap Reductn	0	0	0	0	0	0
Reduced v/c Ratio	0.02	0.33	0.02	0.40	0.49	0.23
Intersection Summary						

Queues
13: Airport Drive/Golden State Boulevard & Avenue 17

Village D Specific Plan
Phase II WP MIT - PM Peak Hour



Lane Group	EBL	EBT	EBR	WBL	WBT	WBR	NBL	NBT	NBR	SBL	SBT
Lane Group Flow (vph)	11	792	99	195	1083	250	153	86	332	355	96
v/c Ratio	0.10	0.86	0.18	0.79	0.71	0.32	0.72	0.19	0.60	0.80	0.20
Control Delay	37.5	39.6	0.7	60.8	33.1	18.1	54.5	25.7	14.8	49.0	23.5
Queue Delay	0.0	0.0	0.0	0.0	0.0	0.0	0.0	0.0	0.0	0.0	0.0
Total Delay	37.5	39.6	0.7	60.8	33.1	18.1	54.5	25.7	14.8	49.0	23.5
Queue Length 50th (ft)	5	196	0	108	207	57	74	34	47	90	35
Queue Length 95th (ft)	21	#291	0	m#178	#297	m110	#158	71	131	#154	74
Internal Link Dist (ft)		188			379			370			222
Turn Bay Length (ft)	85			70		105	60		50		
Base Capacity (vph)	111	938	570	256	1529	773	221	459	554	446	474
Starvation Cap Reductn	0	0	0	0	0	0	0	0	0	0	0
Spillback Cap Reductn	0	0	0	0	0	0	0	0	0	0	0
Storage Cap Reductn	0	0	0	0	0	0	0	0	0	0	0
Reduced v/c Ratio	0.10	0.84	0.17	0.76	0.71	0.32	0.69	0.19	0.60	0.80	0.20

Intersection Summary

95th percentile volume exceeds capacity, queue may be longer.

Queue shown is maximum after two cycles.

m Volume for 95th percentile queue is metered by upstream signal.

Queues
 14: Avenue 17 & SR-99 Southbound Off-Ramp

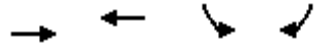

Lane Group	EBT	WBT	SBL	SBR
Lane Group Flow (vph)	1483	1443	473	83
v/c Ratio	0.73	0.70	0.55	0.11
Control Delay	18.3	21.9	18.1	11.1
Queue Delay	0.0	0.0	0.0	0.0
Total Delay	18.3	21.9	18.1	11.1
Queue Length 50th (ft)	123	207	163	19
Queue Length 95th (ft)	149	257	255	44
Internal Link Dist (ft)	379	248	971	
Turn Bay Length (ft)				610
Base Capacity (vph)	2108	2129	856	771
Starvation Cap Reductn	0	0	0	0
Spillback Cap Reductn	0	0	0	0
Storage Cap Reductn	0	0	0	0
Reduced v/c Ratio	0.70	0.68	0.55	0.11
Intersection Summary				

Queues
15: SR-99 Northbound Ramps & Avenue 17

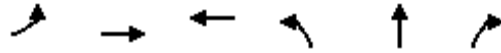

Lane Group	EBL	EBT	WBT	NBL	NBT	NBR
Lane Group Flow (vph)	148	1081	1668	407	410	557
v/c Ratio	0.90	0.52	1.04	0.75	0.75	0.96
Control Delay	95.1	13.0	61.9	40.7	40.8	58.6
Queue Delay	0.0	0.0	0.0	0.0	0.0	0.0
Total Delay	95.1	13.0	61.9	40.7	40.8	58.6
Queue Length 50th (ft)	95	197	~602	243	245	298
Queue Length 95th (ft)	#212	250	#742	#365	#371	#521
Internal Link Dist (ft)		518	381		633	
Turn Bay Length (ft)	125					50
Base Capacity (vph)	164	2098	1599	543	545	578
Starvation Cap Reductn	0	0	0	0	0	0
Spillback Cap Reductn	0	0	0	0	0	0
Storage Cap Reductn	0	0	0	0	0	0
Reduced v/c Ratio	0.90	0.52	1.04	0.75	0.75	0.96

Intersection Summary

- ~ Volume exceeds capacity, queue is theoretically infinite.
Queue shown is maximum after two cycles.
- # 95th percentile volume exceeds capacity, queue may be longer.
Queue shown is maximum after two cycles.

Queues
 16: Love's Truck Stop Driveway/Driveway & Avenue 17

Village D Specific Plan
 Phase II WP MIT - PM Peak Hour

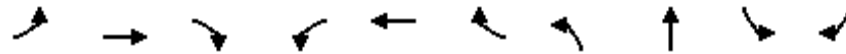

Lane Group	EBL	EBT	EBR	WBL	WBT	WBR	NBL	NBT	SBL	SBR
Lane Group Flow (vph)	604	924	153	35	972	205	174	34	303	564
v/c Ratio	0.90	0.47	0.22	0.30	0.93	0.44	0.65	0.07	0.92	0.65
Control Delay	53.3	23.0	6.1	47.1	51.4	9.9	47.8	0.3	71.3	16.9
Queue Delay	0.0	0.0	0.0	0.0	0.0	0.0	0.0	0.0	0.0	0.0
Total Delay	53.3	23.0	6.1	47.1	51.4	9.9	47.8	0.3	71.3	16.9
Queue Length 50th (ft)	174	154	7	19	200	11	94	0	171	170
Queue Length 95th (ft)	#269	195	48	50	#281	69	156	0	#323	302
Internal Link Dist (ft)		423			402			160		
Turn Bay Length (ft)	200		100	100		100				
Base Capacity (vph)	674	1952	691	118	1045	469	322	501	330	874
Starvation Cap Reductn	0	0	0	0	0	0	0	0	0	0
Spillback Cap Reductn	0	0	0	0	0	0	0	0	0	0
Storage Cap Reductn	0	0	0	0	0	0	0	0	0	0
Reduced v/c Ratio	0.90	0.47	0.22	0.30	0.93	0.44	0.54	0.07	0.92	0.65

Intersection Summary

95th percentile volume exceeds capacity, queue may be longer.
 Queue shown is maximum after two cycles.

Queues
17: Westberry Boulevard & Cleveland Avenue

Village D Specific Plan
Phase II WP MIT - PM Peak Hour



Lane Group	EBL	EBT	WBL	WBT	NBL	NBT	NBR	SBL	SBT	SBR
Lane Group Flow (vph)	174	553	112	862	62	47	100	24	153	260
v/c Ratio	0.68	0.46	0.54	0.84	0.47	0.07	0.15	0.20	0.27	0.39
Control Delay	46.6	22.2	42.9	35.6	48.7	21.1	2.4	39.4	25.0	5.4
Queue Delay	0.0	0.0	0.0	0.0	0.0	0.0	0.0	0.0	0.0	0.0
Total Delay	46.6	22.2	42.9	35.6	48.7	21.1	2.4	39.4	25.0	5.4
Queue Length 50th (ft)	82	112	53	208	31	15	0	12	62	0
Queue Length 95th (ft)	#150	160	102	#283	#76	44	18	35	112	54
Internal Link Dist (ft)		674		1237		511			3065	
Turn Bay Length (ft)	110		165		65		50	100		50
Base Capacity (vph)	282	1208	236	1057	131	676	667	122	572	668
Starvation Cap Reductn	0	0	0	0	0	0	0	0	0	0
Spillback Cap Reductn	0	0	0	0	0	0	0	0	0	0
Storage Cap Reductn	0	0	0	0	0	0	0	0	0	0
Reduced v/c Ratio	0.62	0.46	0.47	0.82	0.47	0.07	0.15	0.20	0.27	0.39

Intersection Summary

95th percentile volume exceeds capacity, queue may be longer.
Queue shown is maximum after two cycles.

Queues
51: Project Driveway 1 & Avenue 17

Village D Specific Plan
Phase II WP MIT - PM Peak Hour



Lane Group	EBT	WBL	WBT	NBL	NBR
Lane Group Flow (vph)	180	716	72	25	363
v/c Ratio	0.64	0.93	0.06	0.05	0.51
Control Delay	41.9	43.9	5.4	28.1	6.4
Queue Delay	0.0	0.0	0.0	0.0	0.0
Total Delay	41.9	43.9	5.4	28.1	6.4
Queue Length 50th (ft)	86	359	13	11	0
Queue Length 95th (ft)	145	#584	23	33	73
Internal Link Dist (ft)	2580		2671	2061	
Turn Bay Length (ft)		50		50	
Base Capacity (vph)	377	812	1330	497	708
Starvation Cap Reductn	0	0	0	0	0
Spillback Cap Reductn	0	0	0	0	0
Storage Cap Reductn	0	0	0	0	0
Reduced v/c Ratio	0.48	0.88	0.05	0.05	0.51

Intersection Summary

95th percentile volume exceeds capacity, queue may be longer.
Queue shown is maximum after two cycles.

Queues
55: Road 23 & Project Driveway 3

Village D Specific Plan
Phase II WP MIT - PM Peak Hour



Lane Group	EBL	EBR	NBL	NBT	SBT	SBR
Lane Group Flow (vph)	351	449	468	889	1139	717
v/c Ratio	0.72	0.58	0.89	0.32	0.50	0.75
Control Delay	57.8	24.1	43.0	8.6	31.4	25.9
Queue Delay	0.0	0.0	0.0	0.0	0.0	0.0
Total Delay	57.8	24.1	43.0	8.6	31.4	25.9
Queue Length 50th (ft)	135	220	351	270	316	375
Queue Length 95th (ft)	182	305	#508	265	365	526
Internal Link Dist (ft)	1503			2585	2520	
Turn Bay Length (ft)	50		50			100
Base Capacity (vph)	569	817	569	2778	2295	951
Starvation Cap Reductn	0	0	0	0	0	0
Spillback Cap Reductn	0	0	0	0	0	0
Storage Cap Reductn	0	0	0	0	0	0
Reduced v/c Ratio	0.62	0.55	0.82	0.32	0.50	0.75

Intersection Summary

95th percentile volume exceeds capacity, queue may be longer.
Queue shown is maximum after two cycles.

Queues
56: Road 23 & Project Driveway 4

Village D Specific Plan
Phase II WP MIT - PM Peak Hour



Lane Group	WBL	WBR	NBT	NBR	SBL	SBT
Lane Group Flow (vph)	359	858	664	327	951	523
v/c Ratio	0.79	0.63	0.43	0.46	0.85	0.15
Control Delay	54.3	4.4	36.1	6.5	45.6	7.9
Queue Delay	0.0	0.0	0.0	0.0	0.0	0.0
Total Delay	54.3	4.4	36.1	6.5	45.6	7.9
Queue Length 50th (ft)	257	0	152	0	351	51
Queue Length 95th (ft)	349	49	216	79	406	75
Internal Link Dist (ft)	754		528			1127
Turn Bay Length (ft)	200			200	200	
Base Capacity (vph)	549	1461	1558	711	1273	3421
Starvation Cap Reductn	0	0	0	0	0	0
Spillback Cap Reductn	0	0	0	0	0	0
Storage Cap Reductn	0	0	0	0	0	0
Reduced v/c Ratio	0.65	0.59	0.43	0.46	0.75	0.15
Intersection Summary						

Queues
58: Project Driveway 6 & Cleveland Avenue

Village D Specific Plan
Phase II WP MIT - PM Peak Hour



Lane Group	EBT	WBL	WBT	NBL	NBR
Lane Group Flow (vph)	661	361	866	75	264
v/c Ratio	0.93	0.88	0.69	0.17	0.45
Control Delay	48.2	57.2	12.8	30.1	6.7
Queue Delay	0.0	0.0	0.0	0.0	0.0
Total Delay	48.2	57.2	12.8	30.1	6.7
Queue Length 50th (ft)	337	196	249	35	0
Queue Length 95th (ft)	#557	#343	371	73	61
Internal Link Dist (ft)	3869		3121	834	
Turn Bay Length (ft)		50		50	
Base Capacity (vph)	730	431	1298	435	589
Starvation Cap Reductn	0	0	0	0	0
Spillback Cap Reductn	0	0	0	0	0
Storage Cap Reductn	0	0	0	0	0
Reduced v/c Ratio	0.91	0.84	0.67	0.17	0.45

Intersection Summary

95th percentile volume exceeds capacity, queue may be longer.
Queue shown is maximum after two cycles.

Queues
21: Granada Drive & Cleveland Avenue

Village D Specific Plan
Phase II WP MIT - PM Peak Hour



Lane Group	EBL	EBT	WBL	WBT	NBL	NBT	NBR	SBL	SBT	SBR
Lane Group Flow (vph)	26	521	382	952	30	263	249	52	339	49
v/c Ratio	0.22	0.72	0.87	0.59	0.25	0.44	0.39	0.42	0.53	0.07
Control Delay	40.0	35.2	51.3	18.3	40.9	27.7	8.6	46.7	28.4	0.2
Queue Delay	0.0	0.0	0.0	0.0	0.0	0.0	0.0	0.0	0.0	0.0
Total Delay	40.0	35.2	51.3	18.3	40.9	27.7	8.6	46.7	28.4	0.2
Queue Length 50th (ft)	13	124	181	148	14	118	18	26	130	0
Queue Length 95th (ft)	37	175	#326	256	41	194	78	#66	#283	0
Internal Link Dist (ft)		289		2178		418			382	
Turn Bay Length (ft)	90		125		50		50	50		50
Base Capacity (vph)	119	810	457	1612	121	592	638	124	640	680
Starvation Cap Reductn	0	0	0	0	0	0	0	0	0	0
Spillback Cap Reductn	0	0	0	0	0	0	0	0	0	0
Storage Cap Reductn	0	0	0	0	0	0	0	0	0	0
Reduced v/c Ratio	0.22	0.64	0.84	0.59	0.25	0.44	0.39	0.42	0.53	0.07

Intersection Summary

95th percentile volume exceeds capacity, queue may be longer.
Queue shown is maximum after two cycles.

Queues
22: Granada Drive & Sunset Avenue

Village D Specific Plan
Phase II WP MIT - PM Peak Hour



Lane Group	EBL	EBT	WBL	WBT	WBR	NBL	NBT	SBL	SBT
Lane Group Flow (vph)	33	189	60	186	120	55	347	87	402
v/c Ratio	0.24	0.55	0.43	0.47	0.26	0.30	0.43	0.41	0.45
Control Delay	32.8	26.9	38.9	25.8	2.8	31.2	18.5	32.6	18.0
Queue Delay	0.0	0.0	0.0	0.0	0.0	0.0	0.0	0.0	0.0
Total Delay	32.8	26.9	38.9	25.8	2.8	31.2	18.5	32.6	18.0
Queue Length 50th (ft)	13	61	23	55	0	20	105	32	124
Queue Length 95th (ft)	37	106	#58	112	16	52	200	72	#260
Internal Link Dist (ft)		721		7441			203		209
Turn Bay Length (ft)	95		120		70	95		85	
Base Capacity (vph)	137	519	138	542	575	186	810	213	900
Starvation Cap Reductn	0	0	0	0	0	0	0	0	0
Spillback Cap Reductn	0	0	0	0	0	0	0	0	0
Storage Cap Reductn	0	0	0	0	0	0	0	0	0
Reduced v/c Ratio	0.24	0.36	0.43	0.34	0.21	0.30	0.43	0.41	0.45

Intersection Summary

95th percentile volume exceeds capacity, queue may be longer.
Queue shown is maximum after two cycles.

Queues
23: Avenue 16/Ellis Street & Kennedy Street

Village D Specific Plan
Phase II WP MIT - PM Peak Hour



Lane Group	WBL	WBR	NBT	SBL	SBT
Lane Group Flow (vph)	165	243	742	261	468
v/c Ratio	0.59	0.38	0.42	0.74	0.18
Control Delay	25.1	10.2	8.8	45.3	4.0
Queue Delay	0.0	0.0	0.0	0.0	0.0
Total Delay	25.1	10.2	8.8	45.3	4.0
Queue Length 50th (ft)	75	2	68	118	31
Queue Length 95th (ft)	128	50	112	#258	57
Internal Link Dist (ft)	782		506		440
Turn Bay Length (ft)	175			280	
Base Capacity (vph)	409	831	1750	354	2604
Starvation Cap Reductn	0	0	0	0	0
Spillback Cap Reductn	0	0	0	0	0
Storage Cap Reductn	0	0	0	0	0
Reduced v/c Ratio	0.40	0.29	0.42	0.74	0.18

Intersection Summary

95th percentile volume exceeds capacity, queue may be longer.
Queue shown is maximum after two cycles.

Queues
24: Schnoor Avenue & Kennedy Street

Village D Specific Plan
Phase II WP MIT - PM Peak Hour



Lane Group	EBL	EBT	WBL	WBT	NBL	NBT	SBL	SBT	SBR
Lane Group Flow (vph)	74	477	265	329	211	416	152	54	33
v/c Ratio	0.35	0.68	0.75	0.67	0.57	0.55	1.31	0.11	0.06
Control Delay	32.4	12.2	31.9	22.1	40.7	9.7	222.3	23.7	0.2
Queue Delay	0.0	0.0	0.0	0.0	0.0	0.0	0.0	0.0	0.0
Total Delay	32.4	12.2	31.9	22.1	40.7	9.7	222.3	23.7	0.2
Queue Length 50th (ft)	37	56	119	70	52	37	-99	20	0
Queue Length 95th (ft)	m68	62	m#236	110	86	129	#212	50	0
Internal Link Dist (ft)		782		187		321		193	
Turn Bay Length (ft)	95		40		75		60		
Base Capacity (vph)	211	908	380	669	368	762	116	501	567
Starvation Cap Reductn	0	0	0	0	0	0	0	0	0
Spillback Cap Reductn	0	0	0	0	0	0	0	0	0
Storage Cap Reductn	0	0	0	0	0	0	0	0	0
Reduced v/c Ratio	0.35	0.53	0.70	0.49	0.57	0.55	1.31	0.11	0.06

Intersection Summary

- ~ Volume exceeds capacity, queue is theoretically infinite.
Queue shown is maximum after two cycles.
- # 95th percentile volume exceeds capacity, queue may be longer.
Queue shown is maximum after two cycles.
- m Volume for 95th percentile queue is metered by upstream signal.

Queues

25: Kennedy Street/Gateway Drive & SR-99 Southbound Ramps



Lane Group	EBL	EBT	WBT	SBL	SBR
Lane Group Flow (vph)	288	490	428	147	247
v/c Ratio	0.77	0.47	0.81	0.25	0.24
Control Delay	44.7	9.0	38.4	23.9	2.6
Queue Delay	0.0	0.0	0.0	0.0	0.0
Total Delay	44.7	9.0	38.4	23.9	2.6
Queue Length 50th (ft)	145	69	195	55	6
Queue Length 95th (ft)	m173	m59	280	112	38
Internal Link Dist (ft)		189	811	461	
Turn Bay Length (ft)	140				335
Base Capacity (vph)	431	1199	633	582	1070
Starvation Cap Reductn	0	0	0	0	0
Spillback Cap Reductn	0	0	0	0	0
Storage Cap Reductn	0	0	0	0	0
Reduced v/c Ratio	0.67	0.41	0.68	0.25	0.23

Intersection Summary

m Volume for 95th percentile queue is metered by upstream signal.

Queues
29: Schnoor Avenue & Cleveland Avenue

Village D Specific Plan
Phase II WP MIT - PM Peak Hour



Lane Group	EBL	EBT	EBR	WBL	WBT	WBR	NBL	NBT	NBR	SBL	SBT	SBR
Lane Group Flow (vph)	158	709	60	295	1128	123	97	254	160	130	245	145
v/c Ratio	0.73	0.71	0.11	0.41	0.87	0.18	0.81	0.30	0.21	0.88	0.28	0.28
Control Delay	58.5	32.9	0.4	12.9	11.2	0.4	86.9	30.4	5.3	90.7	28.7	3.7
Queue Delay	0.0	0.0	0.0	0.0	0.0	0.0	0.0	0.0	0.0	0.0	0.0	0.0
Total Delay	58.5	32.9	0.4	12.9	11.2	0.4	86.9	30.4	5.3	90.7	28.7	3.7
Queue Length 50th (ft)	87	191	0	44	54	1	56	64	9	74	60	0
Queue Length 95th (ft)	#174	225	0	m74	m61	m0	#148	99	48	#179	93	28
Internal Link Dist (ft)		2178			574			393			326	
Turn Bay Length (ft)	120		60	220		95	75		75	105		65
Base Capacity (vph)	228	1294	680	712	1330	701	120	837	771	148	887	524
Starvation Cap Reductn	0	0	0	0	0	0	0	0	0	0	0	0
Spillback Cap Reductn	0	0	0	0	0	0	0	0	0	0	0	0
Storage Cap Reductn	0	0	0	0	0	0	0	0	0	0	0	0
Reduced v/c Ratio	0.69	0.55	0.09	0.41	0.85	0.18	0.81	0.30	0.21	0.88	0.28	0.28

Intersection Summary

- # 95th percentile volume exceeds capacity, queue may be longer.
Queue shown is maximum after two cycles.
- m Volume for 95th percentile queue is metered by upstream signal.

Queues
30: Fairgrounds & Cleveland Avenue

Village D Specific Plan
Phase II WP MIT - PM Peak Hour



Lane Group	EBL	EBT	WBL	WBT	WBR	NBL	NBT	NBR	SBL	SBT
Lane Group Flow (vph)	105	945	180	1260	194	103	85	78	348	160
v/c Ratio	0.81	0.61	0.79	0.98	0.28	0.42	0.23	0.16	1.20	0.26
Control Delay	66.2	10.6	54.9	30.2	2.4	45.6	19.4	0.7	153.7	8.7
Queue Delay	0.0	0.0	0.0	0.0	0.0	0.0	0.0	0.0	0.0	0.0
Total Delay	66.2	10.6	54.9	30.2	2.4	45.6	19.4	0.7	153.7	8.7
Queue Length 50th (ft)	63	55	95	287	15	29	22	0	~242	15
Queue Length 95th (ft)	m#143	m108	m128	#506	m18	55	63	0	#409	61
Internal Link Dist (ft)		574		1412			192			168
Turn Bay Length (ft)	120		205					100		
Base Capacity (vph)	129	1561	236	1290	689	249	374	498	290	614
Starvation Cap Reductn	0	0	0	0	0	0	0	0	0	0
Spillback Cap Reductn	0	0	0	0	0	0	0	0	0	0
Storage Cap Reductn	0	0	0	0	0	0	0	0	0	0
Reduced v/c Ratio	0.81	0.61	0.76	0.98	0.28	0.41	0.23	0.16	1.20	0.26

Intersection Summary

- ~ Volume exceeds capacity, queue is theoretically infinite.
Queue shown is maximum after two cycles.
- # 95th percentile volume exceeds capacity, queue may be longer.
Queue shown is maximum after two cycles.
- m Volume for 95th percentile queue is metered by upstream signal.

Queues
31: SR-99 Southbound Ramps & Cleveland Avenue

Village D Specific Plan
Phase II WP MIT - PM Peak Hour



Lane Group	EBT	EBR	WBL	WBT	SBL	SBR
Lane Group Flow (vph)	953	538	328	1857	251	100
v/c Ratio	0.71	0.58	0.85	0.80	0.55	0.22
Control Delay	12.7	4.2	40.7	8.3	35.2	11.9
Queue Delay	0.2	0.0	0.0	6.5	0.0	0.0
Total Delay	12.9	4.2	40.7	14.7	35.2	11.9
Queue Length 50th (ft)	117	27	203	252	127	12
Queue Length 95th (ft)	m135	m46	m#236	m194	206	52
Internal Link Dist (ft)	1412			372		
Turn Bay Length (ft)			115			140
Base Capacity (vph)	1449	957	385	2386	453	453
Starvation Cap Reductn	0	0	0	487	0	0
Spillback Cap Reductn	78	0	0	0	0	0
Storage Cap Reductn	0	0	0	0	0	0
Reduced v/c Ratio	0.70	0.56	0.85	0.98	0.55	0.22

Intersection Summary

95th percentile volume exceeds capacity, queue may be longer.

Queue shown is maximum after two cycles.

m Volume for 95th percentile queue is metered by upstream signal.

Queues
32: SR-99 Northbound Ramps & Cleveland Avenue

Village D Specific Plan
Phase II WP MIT - PM Peak Hour



Lane Group	EBL	EBT	WBT	WBR	NBL	NBT	NBR
Lane Group Flow (vph)	113	1114	1263	198	486	493	338
v/c Ratio	0.53	0.66	1.08	0.36	0.66	0.67	0.47
Control Delay	38.9	11.1	70.1	13.2	28.2	28.5	18.4
Queue Delay	0.0	0.8	9.4	0.7	0.0	0.0	0.0
Total Delay	38.9	11.9	79.5	13.9	28.2	28.5	18.4
Queue Length 50th (ft)	70	190	~408	22	237	242	108
Queue Length 95th (ft)	m111	297	#541	m39	#421	#429	201
Internal Link Dist (ft)		372	207			441	
Turn Bay Length (ft)	90			50	145		325
Base Capacity (vph)	287	1925	1171	555	731	734	721
Starvation Cap Reductn	0	472	149	151	0	0	0
Spillback Cap Reductn	0	0	23	0	0	0	0
Storage Cap Reductn	0	0	0	0	0	0	0
Reduced v/c Ratio	0.39	0.77	1.24	0.49	0.66	0.67	0.47

Intersection Summary

- ~ Volume exceeds capacity, queue is theoretically infinite.
Queue shown is maximum after two cycles.
- # 95th percentile volume exceeds capacity, queue may be longer.
Queue shown is maximum after two cycles.
- m Volume for 95th percentile queue is metered by upstream signal.

Queues
33: Gateway Drive & Cleveland Avenue

Village D Specific Plan
Phase II WP MIT - PM Peak Hour

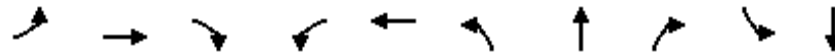

Lane Group	EBL	EBT	EBR	WBL	WBT	NBL	NBT	NBR	SBL	SBT
Lane Group Flow (vph)	17	1101	341	227	1252	362	149	294	220	195
v/c Ratio	0.09	0.70	0.39	0.65	0.85	0.75	0.31	0.58	0.94	0.23
Control Delay	7.1	12.4	1.5	48.4	30.1	47.8	30.8	19.7	85.2	26.7
Queue Delay	0.0	1.5	0.1	2.8	48.3	64.3	0.0	0.5	0.0	0.0
Total Delay	7.1	13.9	1.6	51.3	78.4	112.2	30.8	20.2	85.2	26.7
Queue Length 50th (ft)	2	61	3	68	237	103	72	69	126	44
Queue Length 95th (ft)	m4	103	5	#117	#477	#160	127	156	#262	74
Internal Link Dist (ft)		207			111		765			296
Turn Bay Length (ft)	110					245			45	
Base Capacity (vph)	183	1762	874	351	1469	485	474	511	235	857
Starvation Cap Reductn	0	333	96	54	484	0	0	0	0	0
Spillback Cap Reductn	0	439	0	0	167	309	0	41	0	1
Storage Cap Reductn	0	0	0	0	0	0	0	0	0	0
Reduced v/c Ratio	0.09	0.83	0.44	0.76	1.27	2.06	0.31	0.63	0.94	0.23

Intersection Summary

95th percentile volume exceeds capacity, queue may be longer.

Queue shown is maximum after two cycles.

m Volume for 95th percentile queue is metered by upstream signal.

Queues
34: Cleveland Avenue & County Club Drive

Village D Specific Plan
Phase II WP MIT - PM Peak Hour



Lane Group	WBL	NBT	NBR	SBL	SBT
Lane Group Flow (vph)	626	953	644	129	877
v/c Ratio	0.74	0.41	0.41	0.40	0.26
Control Delay	36.3	13.8	1.9	13.1	7.0
Queue Delay	0.0	11.5	0.0	0.0	0.1
Total Delay	36.4	25.3	1.9	13.1	7.2
Queue Length 50th (ft)	168	150	19	30	66
Queue Length 95th (ft)	206	m205	m54	86	105
Internal Link Dist (ft)	239	111			159
Turn Bay Length (ft)					
Base Capacity (vph)	1378	2331	1563	322	3349
Starvation Cap Reductn	0	1358	0	0	0
Spillback Cap Reductn	52	0	0	0	1207
Storage Cap Reductn	0	0	0	0	0
Reduced v/c Ratio	0.47	0.98	0.41	0.40	0.41

Intersection Summary

m Volume for 95th percentile queue is metered by upstream signal.

Queues
36: Pine Street & Howard Road

Village D Specific Plan
Phase II WP MIT - PM Peak Hour



Lane Group	EBL	EBT	WBL	WBT	NBL	NBT	NBR	SBT	SBR
Lane Group Flow (vph)	95	836	111	630	226	202	172	187	129
v/c Ratio	0.38	0.84	0.64	0.72	0.49	0.42	0.32	0.65	0.32
Control Delay	43.1	37.5	53.6	33.6	34.2	32.4	5.9	46.1	3.9
Queue Delay	0.0	0.0	0.0	0.0	0.0	0.0	0.0	0.0	0.0
Total Delay	43.1	37.5	53.6	33.6	34.2	32.4	5.9	46.1	3.9
Queue Length 50th (ft)	48	221	65	192	115	101	0	101	0
Queue Length 95th (ft)	#134	293	#154	197	189	168	45	162	19
Internal Link Dist (ft)		265		561		224		259	
Turn Bay Length (ft)	95		140		90				
Base Capacity (vph)	250	1056	174	1091	462	486	543	370	462
Starvation Cap Reductn	0	0	0	0	0	0	0	0	0
Spillback Cap Reductn	0	0	0	0	0	0	0	0	0
Storage Cap Reductn	0	0	0	0	0	0	0	0	0
Reduced v/c Ratio	0.38	0.79	0.64	0.58	0.49	0.42	0.32	0.51	0.28

Intersection Summary

95th percentile volume exceeds capacity, queue may be longer.
Queue shown is maximum after two cycles.

Queues

37: Olive Avenue/Q Street & Howard Road/Yosemite Avenue

Village D Specific Plan

Phase II WP MIT - PM Peak Hour



Lane Group	EBL	EBT	EBR	WBL	WBT	NBL	NBT	NBR	SBL	SBT	SBR
Lane Group Flow (vph)	8	499	363	14	416	244	252	14	18	62	2
v/c Ratio	0.07	0.63	0.58	0.11	0.52	0.27	0.27	0.02	0.11	0.36	0.01
Control Delay	41.3	14.2	4.5	40.8	32.1	16.5	16.5	0.0	37.6	43.3	0.0
Queue Delay	0.0	0.0	0.0	0.0	0.0	0.0	0.0	0.0	0.0	0.0	0.0
Total Delay	41.3	14.2	4.5	40.8	32.1	16.5	16.5	0.0	37.6	43.3	0.0
Queue Length 50th (ft)	3	48	0	8	108	74	77	0	10	34	0
Queue Length 95th (ft)	m5	m92	m25	26	143	189	194	0	29	71	0
Internal Link Dist (ft)		561			230		220			195	
Turn Bay Length (ft)	40			80		130			50		50
Base Capacity (vph)	118	821	640	357	1226	908	924	927	357	376	465
Starvation Cap Reductn	0	0	0	0	0	0	0	0	0	0	0
Spillback Cap Reductn	0	0	0	0	0	0	0	0	0	0	0
Storage Cap Reductn	0	0	0	0	0	0	0	0	0	0	0
Reduced v/c Ratio	0.07	0.61	0.57	0.04	0.34	0.27	0.27	0.02	0.05	0.16	0.00

Intersection Summary

m Volume for 95th percentile queue is metered by upstream signal.

Queues

38: I Street & 2nd Street/SR-99 Southbound Off-Ramp



Lane Group	EBT	WBT	WBR	NBL	NBT	SBT
Lane Group Flow (vph)	41	341	5	51	157	121
v/c Ratio	0.08	0.74	0.01	0.07	0.15	0.11
Control Delay	0.3	37.0	0.0	12.4	11.9	11.9
Queue Delay	0.0	0.0	0.0	0.0	0.0	0.0
Total Delay	0.3	37.0	0.0	12.4	11.9	11.9
Queue Length 50th (ft)	0	157	0	12	40	30
Queue Length 95th (ft)	0	218	0	36	88	70
Internal Link Dist (ft)	129	218			779	118
Turn Bay Length (ft)			50	75		
Base Capacity (vph)	709	611	598	714	1053	1053
Starvation Cap Reductn	0	0	0	0	0	0
Spillback Cap Reductn	0	0	0	0	0	0
Storage Cap Reductn	0	0	0	0	0	0
Reduced v/c Ratio	0.06	0.56	0.01	0.07	0.15	0.11

Intersection Summary

Queues
39: 4th Street & Sunset Avenue

Village D Specific Plan
Phase II WP MIT - PM Peak Hour



Lane Group	EBL	NBL	NBT	SBT	SBR
Lane Group Flow (vph)	278	15	412	441	414
v/c Ratio	0.58	0.08	0.15	0.35	0.31
Control Delay	44.5	38.3	3.3	4.3	0.7
Queue Delay	0.0	0.0	0.0	0.0	0.0
Total Delay	44.5	38.3	3.3	4.3	0.7
Queue Length 50th (ft)	85	9	27	51	0
Queue Length 95th (ft)	121	27	49	106	0
Internal Link Dist (ft)	7441		193	501	
Turn Bay Length (ft)	135				
Base Capacity (vph)	962	292	2741	1274	1397
Starvation Cap Reductn	0	0	0	0	0
Spillback Cap Reductn	0	0	0	0	0
Storage Cap Reductn	0	0	0	0	0
Reduced v/c Ratio	0.29	0.05	0.15	0.35	0.30
Intersection Summary					

Queues
41: I Street & 4th Street



Lane Group	EBL	EBT	WBL	WBT	NBL	NBT	NBR	SBL	SBT	SBR
Lane Group Flow (vph)	41	701	66	697	111	79	274	217	185	159
v/c Ratio	0.33	0.80	0.45	0.70	0.58	0.13	0.40	0.63	0.25	0.22
Control Delay	44.6	30.6	42.5	19.2	54.5	29.8	6.7	45.3	24.1	4.9
Queue Delay	0.0	0.0	0.0	0.2	0.0	0.0	0.0	0.0	0.0	0.0
Total Delay	44.6	30.6	42.5	19.4	54.5	29.8	6.7	45.3	24.1	4.9
Queue Length 50th (ft)	26	202	45	98	68	39	5	127	84	0
Queue Length 95th (ft)	61	248	m57	m111	123	80	70	201	145	44
Internal Link Dist (ft)		501		26		314			779	
Turn Bay Length (ft)	130				45		25	80		80
Base Capacity (vph)	128	955	169	1109	226	586	679	380	744	719
Starvation Cap Reductn	0	0	0	63	0	0	0	0	0	0
Spillback Cap Reductn	0	0	0	0	0	0	0	0	0	0
Storage Cap Reductn	0	0	0	0	0	0	0	0	0	0
Reduced v/c Ratio	0.32	0.73	0.39	0.67	0.49	0.13	0.40	0.57	0.25	0.22

Intersection Summary

m Volume for 95th percentile queue is metered by upstream signal.

Queues
43: SR-99 Northbound Off-Ramp/H Street & 4th Street

Village D Specific Plan
Phase II WP MIT - PM Peak Hour

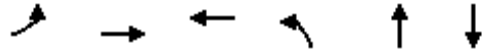

Lane Group	EBL	EBT	WBT	NBL	NBT	SBT
Lane Group Flow (vph)	319	460	780	287	234	119
v/c Ratio	0.93	0.27	0.94	0.76	0.47	0.30
Control Delay	57.7	6.4	55.2	51.3	11.0	9.7
Queue Delay	0.0	0.0	0.0	0.0	0.0	0.0
Total Delay	57.7	6.4	55.2	51.3	11.0	9.7
Queue Length 50th (ft)	218	48	245	174	18	2
Queue Length 95th (ft)	m#367	63	#364	#295	85	50
Internal Link Dist (ft)		197	236		443	771
Turn Bay Length (ft)						
Base Capacity (vph)	348	1697	834	379	500	395
Starvation Cap Reductn	0	0	0	0	0	0
Spillback Cap Reductn	0	0	0	0	0	0
Storage Cap Reductn	0	0	0	0	0	0
Reduced v/c Ratio	0.92	0.27	0.94	0.76	0.47	0.30

Intersection Summary

95th percentile volume exceeds capacity, queue may be longer.

Queue shown is maximum after two cycles.

m Volume for 95th percentile queue is metered by upstream signal.

Queues
 45: Olive Avenue & SR-99 Southbound Off-Ramp

Village D Specific Plan
 Phase II WP MIT - PM Peak Hour

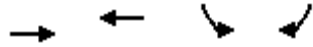

Lane Group	EBT	WBT	SBL	SBR
Lane Group Flow (vph)	711	541	642	95
v/c Ratio	0.71	0.78	0.52	0.09
Control Delay	38.3	54.9	8.3	3.3
Queue Delay	0.0	56.5	0.2	0.0
Total Delay	38.3	111.4	8.4	3.3
Queue Length 50th (ft)	137	176	152	10
Queue Length 95th (ft)	179	231	230	24
Internal Link Dist (ft)	103	112	135	
Turn Bay Length (ft)				
Base Capacity (vph)	1055	734	1225	1092
Starvation Cap Reductn	0	396	0	0
Spillback Cap Reductn	3	0	110	0
Storage Cap Reductn	0	0	0	0
Reduced v/c Ratio	0.68	1.60	0.58	0.09
Intersection Summary				

Queues
46: Madera Avenue & SR-99 Northbound Ramps

Village D Specific Plan
Phase II WP MIT - PM Peak Hour



Lane Group	WBL	WBT	WBR	NBL	NBT	SBT
Lane Group Flow (vph)	123	124	36	860	776	978
v/c Ratio	0.55	0.55	0.13	0.99	0.28	0.61
Control Delay	44.7	44.8	2.8	58.5	3.6	19.2
Queue Delay	0.0	0.0	0.0	0.0	0.0	0.0
Total Delay	44.7	44.8	2.8	58.5	3.6	19.2
Queue Length 50th (ft)	70	70	0	245	52	194
Queue Length 95th (ft)	118	121	7	#379	73	291
Internal Link Dist (ft)		337			388	217
Turn Bay Length (ft)	140			205		
Base Capacity (vph)	350	351	384	866	2740	1615
Starvation Cap Reductn	0	0	0	0	0	0
Spillback Cap Reductn	0	0	0	0	0	0
Storage Cap Reductn	0	0	0	0	0	0
Reduced v/c Ratio	0.35	0.35	0.09	0.99	0.28	0.61

Intersection Summary

95th percentile volume exceeds capacity, queue may be longer.
Queue shown is maximum after two cycles.

Queues

47: Madera Avenue & Olive Avenue/SR-99 Southbound On-Ramp



Lane Group	EBL	EBT	EBR	NBL	NBT	SBL	SBT
Lane Group Flow (vph)	348	362	615	180	1108	138	778
v/c Ratio	0.84	0.84	0.81	0.50	0.64	0.70	0.43
Control Delay	36.1	36.3	13.4	42.6	19.9	62.5	2.6
Queue Delay	4.1	4.3	0.4	0.0	0.0	0.0	0.8
Total Delay	40.3	40.6	13.8	42.6	19.9	62.5	3.3
Queue Length 50th (ft)	110	115	62	50	250	65	5
Queue Length 95th (ft)	#306	#316	88	82	322	m#144	55
Internal Link Dist (ft)		112			323		388
Turn Bay Length (ft)				120		90	
Base Capacity (vph)	453	467	776	400	1723	208	1802
Starvation Cap Reductn	53	54	19	0	0	0	0
Spillback Cap Reductn	0	0	0	0	0	0	662
Storage Cap Reductn	0	0	0	0	0	0	0
Reduced v/c Ratio	0.87	0.88	0.81	0.45	0.64	0.66	0.68

Intersection Summary

95th percentile volume exceeds capacity, queue may be longer.

Queue shown is maximum after two cycles.

m Volume for 95th percentile queue is metered by upstream signal.

Queues
49: Yosemite Avenue & Cleveland Avenue/Tozer Street

Village D Specific Plan
Phase II WP MIT - PM Peak Hour



Lane Group	EBL	EBT	WBL	WBT	WBR	NBL	NBT	NBR	SBL	SBT	SBR
Lane Group Flow (vph)	296	708	55	535	48	342	341	107	85	197	340
v/c Ratio	0.91	0.56	0.47	0.67	0.09	0.87	0.58	0.17	0.49	0.64	0.54
Control Delay	68.1	23.0	54.3	36.3	0.4	57.9	30.8	1.6	47.9	43.5	15.8
Queue Delay	0.0	0.0	0.0	0.0	0.0	0.0	0.0	0.0	0.0	0.0	0.0
Total Delay	68.1	23.0	54.3	36.3	0.4	57.9	30.8	1.6	47.9	43.5	15.8
Queue Length 50th (ft)	160	148	30	141	0	181	165	0	44	102	85
Queue Length 95th (ft)	#337	230	#78	213	0	#366	254	11	95	169	158
Internal Link Dist (ft)		318		397			415			443	
Turn Bay Length (ft)	210		150		50	240			150		
Base Capacity (vph)	327	1267	118	801	515	392	798	773	197	589	624
Starvation Cap Reductn	0	0	0	0	0	0	0	0	0	0	0
Spillback Cap Reductn	0	0	0	0	0	0	0	0	0	0	0
Storage Cap Reductn	0	0	0	0	0	0	0	0	0	0	0
Reduced v/c Ratio	0.91	0.56	0.47	0.67	0.09	0.87	0.43	0.14	0.43	0.33	0.54

Intersection Summary

95th percentile volume exceeds capacity, queue may be longer.
Queue shown is maximum after two cycles.

Queues

5: Road 23/SR-99 Southbound Off-Ramp & Avenue 18 1/2

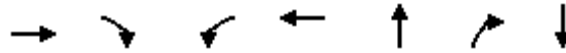

Lane Group	EBT	EBR	WBL	WBT	NBT	NBR	SBT
Lane Group Flow (vph)	351	90	54	311	486	465	394
v/c Ratio	0.73	0.11	0.45	0.37	0.68	0.48	0.80
Control Delay	56.0	2.3	48.6	42.9	29.1	2.5	58.8
Queue Delay	0.0	0.0	0.0	0.0	0.0	0.0	0.0
Total Delay	56.0	2.3	48.6	42.9	29.1	2.5	58.8
Queue Length 50th (ft)	136	1	42	131	251	0	145
Queue Length 95th (ft)	178	21	86	183	#503	30	#219
Internal Link Dist (ft)	230			210	324		245
Turn Bay Length (ft)		50	100				
Base Capacity (vph)	815	831	328	1611	711	1120	490
Starvation Cap Reductn	0	0	0	0	0	0	0
Spillback Cap Reductn	0	0	0	0	0	0	0
Storage Cap Reductn	0	0	0	0	0	0	0
Reduced v/c Ratio	0.43	0.11	0.16	0.19	0.68	0.42	0.80

Intersection Summary

95th percentile volume exceeds capacity, queue may be longer.
 Queue shown is maximum after two cycles.

Queues
6: SR-99 Northbound Ramps & Avenue 18 1/2

Village D Specific Plan
Phase III WP MIT - AM Peak Hour

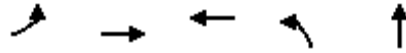

Lane Group	EBL	EBT	WBT	NBL	NBT
Lane Group Flow (vph)	876	70	211	235	31
v/c Ratio	0.84	0.04	0.62	0.37	0.05
Control Delay	60.3	15.1	54.2	26.5	8.9
Queue Delay	0.0	0.0	0.0	0.0	0.0
Total Delay	60.3	15.1	54.2	26.5	8.9
Queue Length 50th (ft)	350	13	75	119	0
Queue Length 95th (ft)	395	m23	113	220	22
Internal Link Dist (ft)		549	786		644
Turn Bay Length (ft)	145				
Base Capacity (vph)	1286	1955	473	627	581
Starvation Cap Reductn	0	0	0	0	0
Spillback Cap Reductn	0	0	0	0	0
Storage Cap Reductn	0	0	0	0	0
Reduced v/c Ratio	0.68	0.04	0.45	0.37	0.05

Intersection Summary

m Volume for 95th percentile queue is metered by upstream signal.

Queues
7: Road 23 & Avenue 17



Lane Group	EBL	EBT	WBL	WBT	NBL	NBT	NBR	SBL	SBT	SBR
Lane Group Flow (vph)	176	567	518	146	57	997	1061	17	440	46
v/c Ratio	0.68	0.89	0.50	0.12	0.41	0.82	0.92	0.20	0.46	0.08
Control Delay	53.5	57.2	37.5	38.4	60.3	39.6	24.9	51.1	32.9	0.3
Queue Delay	0.0	0.0	0.0	0.0	0.0	0.0	0.0	0.0	0.0	0.0
Total Delay	53.5	57.2	37.5	38.4	60.3	39.6	24.9	51.1	32.9	0.3
Queue Length 50th (ft)	107	185	155	41	39	245	149	11	127	0
Queue Length 95th (ft)	172	#278	m227	m79	m74	#472	#326	33	177	0
Internal Link Dist (ft)		2671		6172		2520			336	
Turn Bay Length (ft)	100		200		100			100		100
Base Capacity (vph)	321	648	1037	1183	155	1219	1151	87	952	544
Starvation Cap Reductn	0	0	0	0	0	0	0	0	0	0
Spillback Cap Reductn	0	0	0	0	0	0	0	0	0	0
Storage Cap Reductn	0	0	0	0	0	0	0	0	0	0
Reduced v/c Ratio	0.55	0.88	0.50	0.12	0.37	0.82	0.92	0.20	0.46	0.08

Intersection Summary

95th percentile volume exceeds capacity, queue may be longer.

Queue shown is maximum after two cycles.

m Volume for 95th percentile queue is metered by upstream signal.

Queues
8: Road 23 & Avenue 16

Village D Specific Plan
Phase III WP MIT - AM Peak Hour



Lane Group	EBL	EBT	EBR	WBL	WBT	WBR	NBL	NBT	NBR	SBL	SBT	SBR
Lane Group Flow (vph)	159	70	449	176	40	241	182	1191	53	63	909	72
v/c Ratio	0.67	0.17	0.88	0.72	0.09	0.45	0.59	0.57	0.07	0.32	0.51	0.11
Control Delay	44.1	24.3	35.9	57.9	28.2	8.5	48.3	26.2	4.0	32.3	38.5	16.1
Queue Delay	0.0	0.0	0.0	0.0	0.0	0.0	0.0	0.0	0.0	0.0	0.0	0.0
Total Delay	44.1	24.3	35.9	57.9	28.2	8.5	48.3	26.2	4.0	32.3	38.5	16.1
Queue Length 50th (ft)	98	39	180	107	20	12	56	246	2	21	223	19
Queue Length 95th (ft)	137	m68	302	178	44	70	m89	319	m13	43	270	61
Internal Link Dist (ft)		2685			1572			2602			2585	
Turn Bay Length (ft)	100			100			200		100	200		100
Base Capacity (vph)	290	544	602	279	539	613	311	2077	713	199	1789	630
Starvation Cap Reductn	0	0	0	0	0	0	0	0	0	0	0	0
Spillback Cap Reductn	0	0	0	0	0	0	0	0	0	0	0	0
Storage Cap Reductn	0	0	0	0	0	0	0	0	0	0	0	0
Reduced v/c Ratio	0.55	0.13	0.75	0.63	0.07	0.39	0.59	0.57	0.07	0.32	0.51	0.11

Intersection Summary

m Volume for 95th percentile queue is metered by upstream signal.

Queues
9: Road 23 & Cleveland Avenue

Village D Specific Plan
Phase III WP MIT - AM Peak Hour



Lane Group	EBL	EBT	EBR	WBL	WBT	WBR	NBL	NBT	NBR	SBL	SBT	SBR
Lane Group Flow (vph)	442	250	676	353	257	428	383	740	341	464	838	232
v/c Ratio	0.74	0.38	0.63	0.70	0.49	0.71	0.64	0.44	0.22	0.68	0.47	0.15
Control Delay	35.2	36.0	32.1	42.4	43.2	31.0	39.8	31.7	3.7	29.4	27.7	9.7
Queue Delay	0.0	0.0	0.0	0.0	0.0	0.0	0.0	0.0	0.0	0.0	0.0	0.0
Total Delay	35.2	36.0	32.1	42.4	43.2	31.0	39.8	31.7	3.7	29.4	27.7	9.7
Queue Length 50th (ft)	143	59	211	114	59	217	99	143	16	117	164	34
Queue Length 95th (ft)	158	83	272	159	86	284	155	195	26	159	239	m61
Internal Link Dist (ft)		2664			3869			1127			2602	
Turn Bay Length (ft)	200		200	200		200	200		200	200		200
Base Capacity (vph)	682	1084	1120	569	915	652	659	1684	1618	786	1788	1580
Starvation Cap Reductn	0	0	0	0	0	0	0	0	0	0	0	0
Spillback Cap Reductn	0	0	0	0	0	0	0	0	0	0	0	0
Storage Cap Reductn	0	0	0	0	0	0	0	0	0	0	0	0
Reduced v/c Ratio	0.65	0.23	0.60	0.62	0.28	0.66	0.58	0.44	0.21	0.59	0.47	0.15

Intersection Summary

m Volume for 95th percentile queue is metered by upstream signal.

Queues
10: Road 23 & Avenue 14 1/2



Lane Group	EBT	WBT	WBR	NBL	NBT	SBL	SBT
Lane Group Flow (vph)	5	23	234	4	734	255	1342
v/c Ratio	0.03	0.20	0.68	0.04	0.37	0.74	0.48
Control Delay	40.0	45.0	16.0	45.0	13.1	63.2	0.8
Queue Delay	0.0	0.0	0.0	0.0	0.0	0.0	0.0
Total Delay	40.0	45.0	16.0	45.0	13.1	63.2	0.8
Queue Length 50th (ft)	3	14	0	2	117	171	3
Queue Length 95th (ft)	14	37	68	14	215	m219	22
Internal Link Dist (ft)	377	475			2577		3397
Turn Bay Length (ft)			100	100		200	
Base Capacity (vph)	389	292	517	98	1969	494	2798
Starvation Cap Reductn	0	0	0	0	0	0	0
Spillback Cap Reductn	0	0	0	0	0	0	0
Storage Cap Reductn	0	0	0	0	0	0	0
Reduced v/c Ratio	0.01	0.08	0.45	0.04	0.37	0.52	0.48

Intersection Summary

m Volume for 95th percentile queue is metered by upstream signal.

Queues
11: Road 23 & Avenue 14



Lane Group	EBL	EBT	WBL	WBT	WBR	NBL	NBT	SBL	SBT	SBR
Lane Group Flow (vph)	116	230	22	201	389	59	245	772	396	195
v/c Ratio	0.70	0.43	0.17	0.59	0.24	0.36	0.51	0.81	0.28	0.26
Control Delay	56.3	21.9	35.2	32.8	1.4	36.6	29.9	31.8	16.2	4.1
Queue Delay	0.0	0.0	0.0	0.0	0.0	0.0	0.0	0.0	0.0	0.0
Total Delay	56.3	21.9	35.2	32.8	1.4	36.6	29.9	31.8	16.2	4.1
Queue Length 50th (ft)	47	61	9	76	0	23	47	148	63	0
Queue Length 95th (ft)	#142	150	32	144	19	62	87	#286	108	41
Internal Link Dist (ft)		1109		7848			463		2577	
Turn Bay Length (ft)	100		100		200	100		150		100
Base Capacity (vph)	166	551	130	495	1667	180	829	979	1584	815
Starvation Cap Reductn	0	0	0	0	0	0	0	0	0	0
Spillback Cap Reductn	0	0	0	0	0	0	0	0	0	0
Storage Cap Reductn	0	0	0	0	0	0	0	0	0	0
Reduced v/c Ratio	0.70	0.42	0.17	0.41	0.23	0.33	0.30	0.79	0.25	0.24

Intersection Summary

95th percentile volume exceeds capacity, queue may be longer.
Queue shown is maximum after two cycles.

Queues
13: Airport Drive/Golden State Boulevard & Avenue 17



Lane Group	EBL	EBT	EBR	WBL	WBT	WBR	NBL	NBT	NBR	SBL	SBT
Lane Group Flow (vph)	5	1279	262	328	547	311	110	124	196	235	63
v/c Ratio	0.06	1.01	0.36	0.98	0.28	0.31	0.87	0.38	0.29	0.93	0.19
Control Delay	37.4	54.1	7.1	107.4	8.6	3.0	99.3	39.2	13.5	88.0	34.0
Queue Delay	0.0	0.0	0.0	0.0	0.0	0.0	0.0	0.0	0.0	0.0	0.0
Total Delay	37.4	54.1	7.1	107.4	8.6	3.0	99.3	39.2	13.5	88.0	34.0
Queue Length 50th (ft)	3	-463	30	220	48	8	71	70	51	78	32
Queue Length 95th (ft)	m3	m#548	m35	#392	89	43	#173	125	102	#151	69
Internal Link Dist (ft)		188			379			370			222
Turn Bay Length (ft)	85			70			60		50	100	
Base Capacity (vph)	89	1268	721	335	1980	1018	126	329	669	253	335
Starvation Cap Reductn	0	0	0	0	0	0	0	0	0	0	0
Spillback Cap Reductn	0	0	0	0	0	0	0	0	0	0	0
Storage Cap Reductn	0	0	0	0	0	0	0	0	0	0	0
Reduced v/c Ratio	0.06	1.01	0.36	0.98	0.28	0.31	0.87	0.38	0.29	0.93	0.19

Intersection Summary

- ~ Volume exceeds capacity, queue is theoretically infinite.
Queue shown is maximum after two cycles.
- # 95th percentile volume exceeds capacity, queue may be longer.
Queue shown is maximum after two cycles.
- m Volume for 95th percentile queue is metered by upstream signal.

Queues
 14: Avenue 17 & SR-99 Southbound Off-Ramp

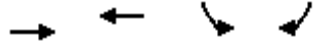

Lane Group	EBT	WBT	SBL	SBR
Lane Group Flow (vph)	1711	1032	324	153
v/c Ratio	0.64	0.39	0.28	0.25
Control Delay	14.5	24.3	24.3	8.0
Queue Delay	0.1	0.0	0.0	0.0
Total Delay	14.6	24.3	24.3	8.0
Queue Length 50th (ft)	169	192	73	10
Queue Length 95th (ft)	m97	193	124	60
Internal Link Dist (ft)	379	248	971	
Turn Bay Length (ft)				610
Base Capacity (vph)	3167	3136	1176	622
Starvation Cap Reductn	357	0	0	0
Spillback Cap Reductn	0	0	0	0
Storage Cap Reductn	0	0	0	0
Reduced v/c Ratio	0.61	0.33	0.28	0.25

Intersection Summary
 m Volume for 95th percentile queue is metered by upstream signal.

Queues
15: SR-99 Northbound Ramps & Avenue 17



Lane Group	EBL	EBT	WBT	WBR	NBL	NBT	NBR
Lane Group Flow (vph)	158	962	1208	275	296	301	261
v/c Ratio	0.65	0.37	0.70	0.43	0.47	0.48	0.23
Control Delay	62.8	16.8	22.8	6.3	27.9	28.1	11.1
Queue Delay	0.0	0.0	0.0	0.0	0.0	0.0	0.0
Total Delay	62.8	16.8	22.8	6.3	27.9	28.1	11.1
Queue Length 50th (ft)	108	91	241	5	156	160	29
Queue Length 95th (ft)	163	143	m284	m24	249	253	61
Internal Link Dist (ft)		518	493			633	
Turn Bay Length (ft)	125			85			50
Base Capacity (vph)	321	2868	1804	658	628	630	1128
Starvation Cap Reductn	0	0	0	0	0	0	0
Spillback Cap Reductn	0	0	0	0	0	0	0
Storage Cap Reductn	0	0	0	0	0	0	0
Reduced v/c Ratio	0.49	0.34	0.67	0.42	0.47	0.48	0.23

Intersection Summary

m Volume for 95th percentile queue is metered by upstream signal.

Queues
 16: Love's Truck Stop Driveway/Driveway & Avenue 17

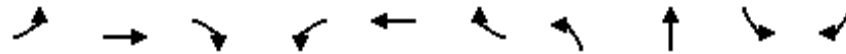

Lane Group	EBL	EBT	EBR	WBL	WBT	WBR	NBL	NBT	SBL	SBR
Lane Group Flow (vph)	176	890	143	49	1146	61	148	24	52	98
v/c Ratio	1.03	0.32	0.15	0.56	0.42	0.07	1.64	0.05	0.58	0.20
Control Delay	120.8	9.3	2.5	71.6	14.6	0.4	366.4	0.2	72.0	12.5
Queue Delay	0.0	0.0	0.0	0.0	0.0	0.0	0.0	0.0	0.0	0.0
Total Delay	120.8	9.3	2.5	71.6	14.6	0.4	366.4	0.2	72.0	12.5
Queue Length 50th (ft)	~64	91	5	31	152	0	~137	0	33	15
Queue Length 95th (ft)	#130	104	17	#83	186	3	#261	0	#88	55
Internal Link Dist (ft)		311			402			160		
Turn Bay Length (ft)	200		100	100		100				
Base Capacity (vph)	171	2817	940	87	2720	900	90	496	90	499
Starvation Cap Reductn	0	0	0	0	0	0	0	0	0	0
Spillback Cap Reductn	0	0	0	0	0	0	0	0	0	0
Storage Cap Reductn	0	0	0	0	0	0	0	0	0	0
Reduced v/c Ratio	1.03	0.32	0.15	0.56	0.42	0.07	1.64	0.05	0.58	0.20

Intersection Summary

- ~ Volume exceeds capacity, queue is theoretically infinite.
 Queue shown is maximum after two cycles.
- # 95th percentile volume exceeds capacity, queue may be longer.
 Queue shown is maximum after two cycles.

Queues
17: Westberry Boulevard & Cleveland Avenue

Village D Specific Plan
Phase III WP MIT - AM Peak Hour



Lane Group	EBL	EBT	EBR	WBL	WBT	NBL	NBT	NBR	SBL	SBT	SBR
Lane Group Flow (vph)	420	979	89	45	446	68	261	197	16	87	153
v/c Ratio	0.93	0.65	0.12	0.33	0.65	0.50	0.38	0.28	0.13	0.16	0.26
Control Delay	58.6	21.3	1.2	42.1	34.1	50.9	22.9	4.6	37.9	25.5	2.8
Queue Delay	0.0	0.0	0.0	0.0	0.0	0.0	0.0	0.0	0.0	0.0	0.0
Total Delay	58.6	21.3	1.2	42.1	34.1	50.9	22.9	4.6	37.9	25.5	2.8
Queue Length 50th (ft)	203	214	0	22	106	33	93	0	8	35	0
Queue Length 95th (ft)	#369	271	9	54	150	#91	192	46	27	72	22
Internal Link Dist (ft)		630			1237		511			3065	
Turn Bay Length (ft)	110			165		65		50	100		50
Base Capacity (vph)	462	1530	750	138	802	135	692	711	122	536	596
Starvation Cap Reductn	0	0	0	0	0	0	0	0	0	0	0
Spillback Cap Reductn	0	0	0	0	0	0	0	0	0	0	0
Storage Cap Reductn	0	0	0	0	0	0	0	0	0	0	0
Reduced v/c Ratio	0.91	0.64	0.12	0.33	0.56	0.50	0.38	0.28	0.13	0.16	0.26

Intersection Summary

95th percentile volume exceeds capacity, queue may be longer.
Queue shown is maximum after two cycles.

Queues
18: Westberry Boulevard & Sunset Avenue

Village D Specific Plan
Phase III WP MIT - AM Peak Hour



Lane Group	EBL	EBT	WBL	WBT	NBL	NBT	NBR	SBL	SBT	SBR
Lane Group Flow (vph)	83	425	65	263	138	229	135	143	160	46
v/c Ratio	0.23	0.65	0.28	0.40	0.40	0.49	0.29	0.41	0.34	0.10
Control Delay	16.3	20.6	18.8	16.3	27.9	24.7	8.9	27.9	22.5	2.5
Queue Delay	0.0	0.0	0.0	0.0	0.0	0.0	0.0	0.0	0.0	0.0
Total Delay	16.3	20.6	18.8	16.3	27.9	24.7	8.9	27.9	22.5	2.5
Queue Length 50th (ft)	19	107	15	60	40	65	6	41	43	0
Queue Length 95th (ft)	57	241	52	143	113	158	50	117	113	10
Internal Link Dist (ft)		306		490		2579			413	
Turn Bay Length (ft)	90		90		130		50	135		50
Base Capacity (vph)	639	1123	401	1126	521	915	813	521	915	799
Starvation Cap Reductn	0	0	0	0	0	0	0	0	0	0
Spillback Cap Reductn	0	0	0	0	0	0	0	0	0	0
Storage Cap Reductn	0	0	0	0	0	0	0	0	0	0
Reduced v/c Ratio	0.13	0.38	0.16	0.23	0.26	0.25	0.17	0.27	0.17	0.06
Intersection Summary										

Queues
19: Westberry Boulevard & Avenue 14



Lane Group	EBL	EBT	WBL	WBT	WBR	NBL	NBT	SBL	SBT
Lane Group Flow (vph)	123	866	13	433	145	93	85	336	189
v/c Ratio	0.59	0.65	0.09	0.58	0.30	0.40	0.35	0.74	0.34
Control Delay	41.9	20.3	31.3	25.6	3.0	32.1	23.8	34.9	13.4
Queue Delay	0.0	0.0	0.0	0.0	0.0	0.0	0.0	0.0	0.0
Total Delay	41.9	20.3	31.3	25.6	3.0	32.1	23.8	34.9	13.4
Queue Length 50th (ft)	46	131	5	78	0	33	21	117	29
Queue Length 95th (ft)	#124	#282	21	126	17	79	60	#265	84
Internal Link Dist (ft)		7848		580			537		2579
Turn Bay Length (ft)	100		100		100	100		100	
Base Capacity (vph)	213	1340	139	1004	583	278	600	478	794
Starvation Cap Reductn	0	0	0	0	0	0	0	0	0
Spillback Cap Reductn	0	0	0	0	0	0	0	0	0
Storage Cap Reductn	0	0	0	0	0	0	0	0	0
Reduced v/c Ratio	0.58	0.65	0.09	0.43	0.25	0.33	0.14	0.70	0.24

Intersection Summary

95th percentile volume exceeds capacity, queue may be longer.
Queue shown is maximum after two cycles.

Queues
20: Westberry Boulevard & Avenue 16



Lane Group	WBL	WBR	NBT	NBR	SBL	SBT
Lane Group Flow (vph)	157	255	229	592	109	70
v/c Ratio	0.40	0.31	0.35	0.66	0.33	0.07
Control Delay	20.4	1.0	13.1	6.4	22.0	4.1
Queue Delay	0.0	0.0	0.0	0.0	0.0	0.0
Total Delay	20.4	1.0	13.1	6.4	22.0	4.1
Queue Length 50th (ft)	34	0	45	14	24	6
Queue Length 95th (ft)	93	0	86	67	73	17
Internal Link Dist (ft)			3065			465
Turn Bay Length (ft)	100	50		50	100	
Base Capacity (vph)	472	1171	1241	1234	347	1371
Starvation Cap Reductn	0	0	0	0	0	0
Spillback Cap Reductn	0	0	0	0	0	0
Storage Cap Reductn	0	0	0	0	0	0
Reduced v/c Ratio	0.33	0.22	0.18	0.48	0.31	0.05
Intersection Summary						

Queues
51: Project Driveway 1 & Avenue 17

Village D Specific Plan
Phase III WP MIT - AM Peak Hour



Lane Group	EBT	WBL	WBT	NBL	NBR
Lane Group Flow (vph)	91	168	77	61	684
v/c Ratio	0.45	0.62	0.14	0.06	0.56
Control Delay	34.7	41.4	17.7	10.0	3.0
Queue Delay	0.0	0.0	0.0	0.0	0.0
Total Delay	34.7	41.4	17.7	10.0	3.0
Queue Length 50th (ft)	37	79	27	13	0
Queue Length 95th (ft)	77	136	49	35	54
Internal Link Dist (ft)	2580		2671	2061	
Turn Bay Length (ft)				50	
Base Capacity (vph)	394	336	880	1063	1232
Starvation Cap Reductn	0	0	0	0	0
Spillback Cap Reductn	0	0	0	0	0
Storage Cap Reductn	0	0	0	0	0
Reduced v/c Ratio	0.23	0.50	0.09	0.06	0.56
Intersection Summary					

Queues
52: Road 22 1/2/Project Driveway 2 & Avenue 16

Village D Specific Plan
Phase III WP MIT - AM Peak Hour



Lane Group	EBT	WBL	WBT	WBR	NBL	NBT	NBR	SBL	SBT
Lane Group Flow (vph)	76	96	38	121	17	142	348	257	137
v/c Ratio	0.46	0.53	0.09	0.25	0.14	0.17	0.38	0.74	0.11
Control Delay	49.0	67.3	10.3	2.3	54.4	16.3	1.9	50.2	10.6
Queue Delay	0.0	0.0	0.0	0.0	0.0	0.0	0.0	0.0	0.0
Total Delay	49.0	67.3	10.3	2.3	54.4	16.3	1.9	50.2	10.6
Queue Length 50th (ft)	45	63	6	0	11	41	0	155	29
Queue Length 95th (ft)	87	m114	m14	0	34	105	20	224	83
Internal Link Dist (ft)	2656		2685			2623			2019
Turn Bay Length (ft)		100			100		100	100	
Base Capacity (vph)	316	221	509	551	118	854	917	447	1215
Starvation Cap Reductn	0	0	0	0	0	0	0	0	0
Spillback Cap Reductn	0	0	0	0	0	0	0	0	0
Storage Cap Reductn	0	0	0	0	0	0	0	0	0
Reduced v/c Ratio	0.24	0.43	0.07	0.22	0.14	0.17	0.38	0.57	0.11

Intersection Summary

m Volume for 95th percentile queue is metered by upstream signal.

Queues
53: Road 22 1/2 & Cleveland Avenue

Village D Specific Plan
Phase III WP MIT - AM Peak Hour



Lane Group	EBL	EBT	WBL	WBT	WBR	NBL	NBT	SBL	SBT
Lane Group Flow (vph)	13	441	96	252	157	15	204	362	38
v/c Ratio	0.14	0.68	0.53	0.25	0.18	0.13	0.26	0.66	0.04
Control Delay	49.0	43.3	45.1	10.3	3.6	49.3	6.2	49.8	12.1
Queue Delay	0.0	0.0	0.0	0.0	0.0	0.0	0.0	0.0	0.0
Total Delay	49.0	43.3	45.1	10.3	3.6	49.3	6.2	49.8	12.1
Queue Length 50th (ft)	8	139	43	35	0	9	3	118	7
Queue Length 95th (ft)	28	179	m99	63	15	m28	m63	159	m28
Internal Link Dist (ft)		948		2664			1767		2623
Turn Bay Length (ft)	100		100			100		100	
Base Capacity (vph)	92	1235	214	1483	892	116	776	616	1022
Starvation Cap Reductn	0	0	0	0	0	0	0	0	0
Spillback Cap Reductn	0	0	0	0	0	0	0	0	0
Storage Cap Reductn	0	0	0	0	0	0	0	0	0
Reduced v/c Ratio	0.14	0.36	0.45	0.17	0.18	0.13	0.26	0.59	0.04

Intersection Summary

m Volume for 95th percentile queue is metered by upstream signal.

Queues
55: Road 23 & Project Driveway 3

Village D Specific Plan
Phase III WP MIT - AM Peak Hour



Lane Group	EBL	EBR	NBL	NBT	SBT	SBR
Lane Group Flow (vph)	876	133	101	1422	867	362
v/c Ratio	0.80	0.17	0.53	0.48	0.40	0.43
Control Delay	37.4	10.3	34.1	16.7	19.3	10.5
Queue Delay	0.0	0.0	0.0	0.0	0.0	0.0
Total Delay	37.4	10.3	34.1	16.7	19.3	10.5
Queue Length 50th (ft)	261	35	61	300	153	55
Queue Length 95th (ft)	303	54	m111	361	m250	m216
Internal Link Dist (ft)	1503			2585	2520	
Turn Bay Length (ft)	200		50			100
Base Capacity (vph)	1348	829	254	2983	2164	845
Starvation Cap Reductn	0	0	0	0	0	0
Spillback Cap Reductn	0	0	0	0	0	0
Storage Cap Reductn	0	0	0	0	0	0
Reduced v/c Ratio	0.65	0.16	0.40	0.48	0.40	0.43

Intersection Summary

m Volume for 95th percentile queue is metered by upstream signal.

Queues
56: Road 23 & Project Driveway 4

Village D Specific Plan
Phase III WP MIT - AM Peak Hour



Lane Group	WBL	WBR	NBT	NBR	SBL	SBT
Lane Group Flow (vph)	115	584	771	149	457	1279
v/c Ratio	0.55	0.54	0.29	0.16	0.67	0.32
Control Delay	50.7	22.8	4.3	0.7	43.0	2.9
Queue Delay	0.0	0.0	0.0	0.0	0.0	0.0
Total Delay	50.7	22.8	4.3	0.7	43.0	2.9
Queue Length 50th (ft)	70	142	20	0	148	17
Queue Length 95th (ft)	121	165	59	5	190	141
Internal Link Dist (ft)	754		528			1127
Turn Bay Length (ft)	200			200	200	
Base Capacity (vph)	478	1286	2690	905	944	4032
Starvation Cap Reductn	0	0	0	0	0	0
Spillback Cap Reductn	0	0	0	0	0	50
Storage Cap Reductn	0	0	0	0	0	0
Reduced v/c Ratio	0.24	0.45	0.29	0.16	0.48	0.32
Intersection Summary						

Queues
57: Road 23 & Project Driveway 5

Village D Specific Plan
Phase III WP MIT - AM Peak Hour



Lane Group	EBL	EBR	NBL	NBT	SBT
Lane Group Flow (vph)	127	160	72	799	2226
v/c Ratio	0.57	0.47	0.46	0.21	0.69
Control Delay	51.0	11.0	41.3	6.7	14.1
Queue Delay	0.0	0.0	0.0	0.0	0.3
Total Delay	51.0	11.0	41.3	6.7	14.4
Queue Length 50th (ft)	78	0	44	106	298
Queue Length 95th (ft)	130	55	73	131	462
Internal Link Dist (ft)	2646			3397	528
Turn Bay Length (ft)			50		
Base Capacity (vph)	330	426	185	3850	3205
Starvation Cap Reductn	0	0	0	0	352
Spillback Cap Reductn	0	0	0	0	0
Storage Cap Reductn	0	0	0	0	0
Reduced v/c Ratio	0.38	0.38	0.39	0.21	0.78
Intersection Summary					

Queues
58: Project Driveway 6 & Cleveland Avenue

Village D Specific Plan
Phase III WP MIT - AM Peak Hour

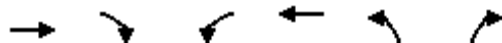

Lane Group	EBT	EBR	WBL	WBT	NBL	NBR
Lane Group Flow (vph)	1224	84	167	508	212	317
v/c Ratio	0.70	0.14	0.64	0.19	0.31	0.39
Control Delay	21.9	4.9	51.2	11.7	26.0	4.8
Queue Delay	0.0	0.0	0.0	0.0	0.0	0.0
Total Delay	21.9	4.9	51.2	11.7	26.0	4.8
Queue Length 50th (ft)	276	1	102	57	95	0
Queue Length 95th (ft)	315	m28	161	60	177	63
Internal Link Dist (ft)	3869			3165	834	
Turn Bay Length (ft)		100	100		100	
Base Capacity (vph)	1943	638	366	3210	682	807
Starvation Cap Reductn	0	0	0	0	0	0
Spillback Cap Reductn	0	0	0	0	0	0
Storage Cap Reductn	0	0	0	0	0	0
Reduced v/c Ratio	0.63	0.13	0.46	0.16	0.31	0.39

Intersection Summary

m Volume for 95th percentile queue is metered by upstream signal.

Queues
23: Avenue 16/Ellis Street & Kennedy Street

Village D Specific Plan
Phase III WP MIT - AM Peak Hour



Lane Group	WBL	WBR	NBT	SBL	SBT
Lane Group Flow (vph)	283	183	921	296	453
v/c Ratio	0.78	0.25	0.78	0.57	0.19
Control Delay	44.4	5.1	26.2	29.1	5.4
Queue Delay	0.0	0.0	0.0	0.0	0.0
Total Delay	44.4	5.1	26.2	29.1	5.4
Queue Length 50th (ft)	131	0	183	125	40
Queue Length 95th (ft)	211	26	#294	204	61
Internal Link Dist (ft)	782		506		440
Turn Bay Length (ft)	175			280	
Base Capacity (vph)	423	804	1185	519	2395
Starvation Cap Reductn	0	0	0	0	0
Spillback Cap Reductn	0	0	0	0	0
Storage Cap Reductn	0	0	0	0	0
Reduced v/c Ratio	0.67	0.23	0.78	0.57	0.19

Intersection Summary

95th percentile volume exceeds capacity, queue may be longer.
Queue shown is maximum after two cycles.

Queues
24: Schnoor Avenue & Kennedy Street



Lane Group	EBL	EBT	WBL	WBT	NBL	NBT	SBL	SBT	SBR
Lane Group Flow (vph)	126	536	265	538	136	384	150	47	37
v/c Ratio	0.71	0.77	0.61	0.89	0.49	0.55	0.64	0.10	0.08
Control Delay	73.3	46.6	54.5	58.2	59.4	14.8	65.8	32.7	0.3
Queue Delay	0.0	0.3	0.0	0.6	0.0	0.0	0.0	0.0	0.0
Total Delay	73.3	46.8	54.5	58.8	59.4	14.8	65.8	32.7	0.3
Queue Length 50th (ft)	95	180	153	292	53	70	57	26	0
Queue Length 95th (ft)	#170	227	m190	m352	86	182	94	60	0
Internal Link Dist (ft)		782		187		321		193	
Turn Bay Length (ft)	95		40		75		60		
Base Capacity (vph)	197	886	452	678	277	696	249	456	479
Starvation Cap Reductn	0	0	0	20	0	0	0	0	0
Spillback Cap Reductn	0	58	0	0	0	4	0	0	0
Storage Cap Reductn	0	0	0	0	0	0	0	0	0
Reduced v/c Ratio	0.64	0.65	0.59	0.82	0.49	0.55	0.60	0.10	0.08

Intersection Summary

95th percentile volume exceeds capacity, queue may be longer.

Queue shown is maximum after two cycles.

m Volume for 95th percentile queue is metered by upstream signal.

Queues
 25: Kennedy Street/Gateway Drive & SR-99 Southbound Ramps

Village D Specific Plan
 Phase III WP MIT - AM Peak Hour



Lane Group	EBL	EBT	WBT	SBL	SBR
Lane Group Flow (vph)	535	290	580	73	183
v/c Ratio	0.92	0.22	0.91	0.20	0.19
Control Delay	44.6	8.3	57.1	45.2	3.9
Queue Delay	0.7	0.0	0.8	0.0	0.0
Total Delay	45.3	8.3	57.9	45.2	3.9
Queue Length 50th (ft)	255	69	409	50	12
Queue Length 95th (ft)	#553	123	#608	97	47
Internal Link Dist (ft)		189	811	461	
Turn Bay Length (ft)	140				335
Base Capacity (vph)	626	1436	679	357	993
Starvation Cap Reductn	12	0	0	0	0
Spillback Cap Reductn	0	0	15	0	1
Storage Cap Reductn	0	0	0	0	0
Reduced v/c Ratio	0.87	0.20	0.87	0.20	0.18

Intersection Summary

95th percentile volume exceeds capacity, queue may be longer.
 Queue shown is maximum after two cycles.

Queues

5: Road 23/SR-99 Southbound Off-Ramp & Avenue 18 1/2

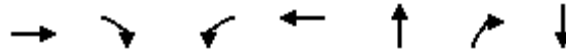

Lane Group	EBT	EBR	WBL	WBT	NBT	NBR	SBT
Lane Group Flow (vph)	431	327	62	219	313	299	904
v/c Ratio	0.76	0.45	0.50	0.25	0.67	0.43	0.89
Control Delay	55.3	9.3	76.1	38.9	37.0	3.7	50.3
Queue Delay	0.0	0.0	0.0	0.0	0.0	0.0	0.0
Total Delay	55.3	9.3	76.1	38.9	37.0	3.7	50.3
Queue Length 50th (ft)	168	48	52	68	160	0	344
Queue Length 95th (ft)	214	128	100	96	#358	35	#460
Internal Link Dist (ft)	230			210	324		245
Turn Bay Length (ft)		50	100				
Base Capacity (vph)	661	728	202	1099	468	768	1019
Starvation Cap Reductn	0	0	0	0	0	0	0
Spillback Cap Reductn	0	0	0	0	0	0	0
Storage Cap Reductn	0	0	0	0	0	0	0
Reduced v/c Ratio	0.65	0.45	0.31	0.20	0.67	0.39	0.89

Intersection Summary

95th percentile volume exceeds capacity, queue may be longer.
 Queue shown is maximum after two cycles.

Queues
6: SR-99 Northbound Ramps & Avenue 18 1/2

Village D Specific Plan
Phase III WP MIT - PM Peak Hour

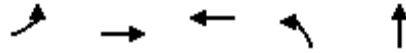

Lane Group	EBL	EBT	WBT	NBL	NBT
Lane Group Flow (vph)	589	135	132	213	3
v/c Ratio	0.79	0.12	0.49	0.26	0.00
Control Delay	58.4	37.2	50.7	15.5	14.3
Queue Delay	0.0	0.0	0.0	0.0	0.0
Total Delay	58.4	37.2	50.7	15.5	14.3
Queue Length 50th (ft)	239	48	44	79	1
Queue Length 95th (ft)	m295	m72	76	152	7
Internal Link Dist (ft)		549	786		644
Turn Bay Length (ft)	145				
Base Capacity (vph)	1143	1856	551	831	874
Starvation Cap Reductn	0	0	0	0	0
Spillback Cap Reductn	0	0	0	0	0
Storage Cap Reductn	0	0	0	0	0
Reduced v/c Ratio	0.52	0.07	0.24	0.26	0.00

Intersection Summary

m Volume for 95th percentile queue is metered by upstream signal.

Queues
7: Road 23 & Avenue 17



Lane Group	EBL	EBT	WBL	WBT	NBL	NBT	NBR	SBL	SBT	SBR
Lane Group Flow (vph)	90	350	1052	529	41	591	702	70	1078	180
v/c Ratio	0.57	0.69	0.99	0.41	0.39	0.47	0.61	0.53	0.84	0.27
Control Delay	66.4	53.4	66.6	30.0	76.2	28.0	10.0	68.0	43.5	10.0
Queue Delay	0.0	0.0	0.0	0.0	0.0	0.0	0.0	0.0	0.0	0.0
Total Delay	66.4	53.4	66.6	30.0	76.2	28.0	10.0	68.0	43.5	10.0
Queue Length 50th (ft)	68	130	417	163	26	171	452	52	416	23
Queue Length 95th (ft)	122	173	#562	201	m#66	231	247	#116	#574	79
Internal Link Dist (ft)		2671		6172		2520			336	
Turn Bay Length (ft)	100		200		100			100		100
Base Capacity (vph)	187	668	1065	1392	106	1246	1154	135	1283	661
Starvation Cap Reductn	0	0	0	0	0	0	0	0	0	0
Spillback Cap Reductn	0	0	0	0	0	0	0	0	0	0
Storage Cap Reductn	0	0	0	0	0	0	0	0	0	0
Reduced v/c Ratio	0.48	0.52	0.99	0.38	0.39	0.47	0.61	0.52	0.84	0.27

Intersection Summary

95th percentile volume exceeds capacity, queue may be longer.

Queue shown is maximum after two cycles.

m Volume for 95th percentile queue is metered by upstream signal.

Queues
8: Road 23 & Avenue 16

Village D Specific Plan
Phase III WP MIT - PM Peak Hour



Lane Group	EBL	EBT	EBR	WBL	WBT	WBR	NBL	NBT	NBR	SBL	SBT	SBR
Lane Group Flow (vph)	164	26	265	98	27	115	414	1274	180	234	1518	240
v/c Ratio	0.71	0.14	0.67	0.59	0.23	0.44	0.74	0.45	0.19	0.61	0.60	0.27
Control Delay	51.1	41.6	28.7	66.9	57.7	6.3	50.7	26.8	14.2	35.8	39.5	20.6
Queue Delay	0.0	0.0	0.0	0.0	0.0	0.0	0.0	0.0	0.0	0.0	0.0	0.0
Total Delay	51.1	41.6	28.7	66.9	57.7	6.3	50.7	26.8	14.2	35.8	39.5	20.6
Queue Length 50th (ft)	134	21	109	74	20	0	151	280	36	80	436	111
Queue Length 95th (ft)	190	m37	169	130	50	10	m173	m386	m110	107	505	185
Internal Link Dist (ft)		2685			1572			2602			2585	
Turn Bay Length (ft)	100			100			200		100	200		100
Base Capacity (vph)	275	366	525	195	282	390	618	2813	937	421	2531	876
Starvation Cap Reductn	0	0	0	0	0	0	0	0	0	0	0	0
Spillback Cap Reductn	0	0	0	0	0	0	0	0	0	0	0	0
Storage Cap Reductn	0	0	0	0	0	0	0	0	0	0	0	0
Reduced v/c Ratio	0.60	0.07	0.50	0.50	0.10	0.29	0.67	0.45	0.19	0.56	0.60	0.27

Intersection Summary

m Volume for 95th percentile queue is metered by upstream signal.

Queues
9: Road 23 & Cleveland Avenue

Village D Specific Plan
Phase III WP MIT - PM Peak Hour



Lane Group	EBL	EBT	EBR	WBL	WBT	WBR	NBL	NBT	NBR	SBL	SBT	SBR
Lane Group Flow (vph)	513	540	847	281	531	417	1041	1057	341	359	1002	654
v/c Ratio	0.95	0.60	0.54	0.63	0.70	0.69	0.93	0.52	0.37	0.68	0.88	0.54
Control Delay	71.1	50.7	24.7	42.3	44.2	41.9	50.2	47.6	17.7	34.1	64.7	44.0
Queue Delay	0.0	0.0	0.0	0.0	0.0	0.0	0.0	0.0	0.0	0.0	0.0	0.0
Total Delay	71.1	50.7	24.7	42.3	44.2	41.9	50.2	47.6	17.7	34.1	64.7	44.0
Queue Length 50th (ft)	211	152	228	109	150	304	431	293	135	150	304	259
Queue Length 95th (ft)	#317	195	338	148	183	389	m#542	m346	m161	145	#366	343
Internal Link Dist (ft)		2664			3869			1127			2602	
Turn Bay Length (ft)	200		200	200		200	200		200	200		200
Base Capacity (vph)	542	904	1567	598	860	685	1125	2027	990	700	1138	1216
Starvation Cap Reductn	0	0	0	0	0	0	0	0	0	0	0	0
Spillback Cap Reductn	0	0	0	0	0	0	0	0	0	0	0	0
Storage Cap Reductn	0	0	0	0	0	0	0	0	0	0	0	0
Reduced v/c Ratio	0.95	0.60	0.54	0.47	0.62	0.61	0.93	0.52	0.34	0.51	0.88	0.54

Intersection Summary

95th percentile volume exceeds capacity, queue may be longer.

Queue shown is maximum after two cycles.

m Volume for 95th percentile queue is metered by upstream signal.

Queues
10: Road 23 & Avenue 14 1/2

Village D Specific Plan
Phase III WP MIT - PM Peak Hour



Lane Group	EBT	WBT	WBR	NBL	NBT	SBL	SBT
Lane Group Flow (vph)	6	10	335	2	1474	336	1021
v/c Ratio	0.05	0.08	0.78	0.02	0.71	0.85	0.35
Control Delay	37.3	49.3	18.2	55.5	21.6	51.4	9.5
Queue Delay	0.0	0.0	0.0	0.0	0.0	0.0	0.0
Total Delay	37.3	49.3	18.2	55.5	21.6	51.4	9.5
Queue Length 50th (ft)	2	8	0	2	386	274	300
Queue Length 95th (ft)	15	23	87	11	618	#378	396
Internal Link Dist (ft)	377	475			2577		3397
Turn Bay Length (ft)			100	100		200	
Base Capacity (vph)	265	244	532	81	2081	442	2946
Starvation Cap Reductn	0	0	0	0	0	0	0
Spillback Cap Reductn	0	0	0	0	0	0	0
Storage Cap Reductn	0	0	0	0	0	0	0
Reduced v/c Ratio	0.02	0.04	0.63	0.02	0.71	0.76	0.35

Intersection Summary

95th percentile volume exceeds capacity, queue may be longer.
Queue shown is maximum after two cycles.

Queues
11: Road 23 & Avenue 14

Village D Specific Plan
Phase III WP MIT - PM Peak Hour



Lane Group	EBL	EBT	WBL	WBT	WBR	NBL	NBT	SBL	SBT	SBR
Lane Group Flow (vph)	198	136	13	40	838	16	417	579	309	107
v/c Ratio	0.61	0.32	0.08	0.17	0.76	0.10	0.54	0.65	0.16	0.11
Control Delay	34.8	18.6	29.5	27.2	17.1	29.9	22.4	25.2	8.8	0.2
Queue Delay	0.0	0.0	0.0	0.0	0.0	0.0	0.0	0.0	0.0	0.0
Total Delay	34.8	18.6	29.5	27.2	17.1	29.9	22.4	25.2	8.8	0.2
Queue Length 50th (ft)	54	29	4	11	98	5	55	76	16	0
Queue Length 95th (ft)	#182	87	21	42	181	24	118	#197	71	0
Internal Link Dist (ft)		1109		7848			463		2577	
Turn Bay Length (ft)	100		100		200	100		150		100
Base Capacity (vph)	329	756	164	623	1114	159	1201	913	1949	963
Starvation Cap Reductn	0	0	0	0	0	0	0	0	0	0
Spillback Cap Reductn	0	0	0	0	0	0	0	0	0	0
Storage Cap Reductn	0	0	0	0	0	0	0	0	0	0
Reduced v/c Ratio	0.60	0.18	0.08	0.06	0.75	0.10	0.35	0.63	0.16	0.11

Intersection Summary

95th percentile volume exceeds capacity, queue may be longer.
Queue shown is maximum after two cycles.

Queues
13: Airport Drive/Golden State Boulevard & Avenue 17

Village D Specific Plan
Phase III WP MIT - PM Peak Hour



Lane Group	EBL	EBT	EBR	WBL	WBT	WBR	NBL	NBT	NBR	SBL	SBT
Lane Group Flow (vph)	13	953	174	235	1301	320	270	114	401	459	127
v/c Ratio	0.15	0.92	0.30	0.88	0.79	0.36	0.90	0.29	0.59	0.83	0.33
Control Delay	49.3	49.5	5.7	89.5	13.7	2.8	74.1	35.7	23.2	54.3	35.7
Queue Delay	0.0	0.0	0.0	0.0	0.0	0.0	0.0	0.0	0.0	0.0	0.0
Total Delay	49.3	49.5	5.7	89.5	13.7	2.8	74.1	35.7	23.2	54.3	35.7
Queue Length 50th (ft)	8	308	0	163	108	9	170	62	164	146	67
Queue Length 95th (ft)	28	#431	48	#290	#529	37	#314	112	264	#218	122
Internal Link Dist (ft)		188			379			370			222
Turn Bay Length (ft)	85			70			60		50	100	
Base Capacity (vph)	89	1036	587	274	1652	901	306	398	690	571	382
Starvation Cap Reductn	0	0	0	0	0	0	0	0	0	0	0
Spillback Cap Reductn	0	0	0	0	0	0	0	0	0	0	0
Storage Cap Reductn	0	0	0	0	0	0	0	0	0	0	0
Reduced v/c Ratio	0.15	0.92	0.30	0.86	0.79	0.36	0.88	0.29	0.58	0.80	0.33

Intersection Summary

95th percentile volume exceeds capacity, queue may be longer.
Queue shown is maximum after two cycles.

Queues
 14: Avenue 17 & SR-99 Southbound Off-Ramp

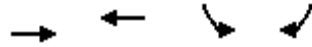

Lane Group	EBT	WBT	SBL	SBR
Lane Group Flow (vph)	1813	1755	491	100
v/c Ratio	0.66	0.64	0.39	0.17
Control Delay	14.2	26.4	25.8	19.8
Queue Delay	0.3	0.0	0.0	0.0
Total Delay	14.5	26.5	25.8	19.8
Queue Length 50th (ft)	189	358	119	34
Queue Length 95th (ft)	m170	364	178	78
Internal Link Dist (ft)	379	248	971	
Turn Bay Length (ft)				610
Base Capacity (vph)	3076	3076	1248	589
Starvation Cap Reductn	552	0	0	0
Spillback Cap Reductn	0	51	0	0
Storage Cap Reductn	0	0	0	0
Reduced v/c Ratio	0.72	0.58	0.39	0.17

Intersection Summary

m Volume for 95th percentile queue is metered by upstream signal.

Queues
15: SR-99 Northbound Ramps & Avenue 17

Village D Specific Plan
Phase III WP MIT - PM Peak Hour



Lane Group	EBL	EBT	WBT	WBR	NBL	NBT	NBR
Lane Group Flow (vph)	189	1295	1573	369	432	436	557
v/c Ratio	0.76	0.46	0.84	0.54	0.72	0.72	0.53
Control Delay	72.3	10.8	17.5	6.2	35.7	35.9	23.5
Queue Delay	0.0	0.0	0.0	0.0	0.0	0.0	0.0
Total Delay	72.3	10.8	17.5	6.2	35.7	35.9	23.5
Queue Length 50th (ft)	129	111	145	27	248	251	134
Queue Length 95th (ft)	#215	161	164	m42	371	375	191
Internal Link Dist (ft)		518	381			633	
Turn Bay Length (ft)	125			85			50
Base Capacity (vph)	274	2822	1870	681	604	606	1055
Starvation Cap Reductn	0	0	0	0	0	0	0
Spillback Cap Reductn	0	0	0	0	0	0	0
Storage Cap Reductn	0	0	0	0	0	0	0
Reduced v/c Ratio	0.69	0.46	0.84	0.54	0.72	0.72	0.53

Intersection Summary

95th percentile volume exceeds capacity, queue may be longer.

Queue shown is maximum after two cycles.

m Volume for 95th percentile queue is metered by upstream signal.

Queues
 16: Love's Truck Stop Driveway/Driveway & Avenue 17

Village D Specific Plan
 Phase III WP MIT - PM Peak Hour

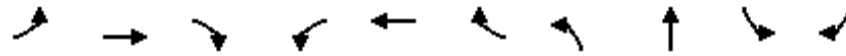

Lane Group	EBL	EBT	EBR	WBL	WBT	WBR	NBL	NBT	SBL	SBR
Lane Group Flow (vph)	604	1139	153	35	1249	205	174	34	303	564
v/c Ratio	0.97	0.51	0.19	0.32	0.88	0.35	0.89	0.07	0.97	0.70
Control Delay	68.5	23.2	4.1	53.3	43.6	5.4	86.0	0.3	86.8	23.3
Queue Delay	0.0	0.0	0.0	0.0	0.0	0.0	0.0	0.0	0.0	0.0
Total Delay	68.5	23.2	4.1	53.3	43.6	5.4	86.0	0.3	86.8	23.3
Queue Length 50th (ft)	209	204	5	22	279	0	111	0	194	240
Queue Length 95th (ft)	#311	234	23	54	#346	48	#234	0	#363	370
Internal Link Dist (ft)		423			402			160		
Turn Bay Length (ft)	200		100	100		100				
Base Capacity (vph)	620	2233	788	110	1412	594	196	483	312	810
Starvation Cap Reductn	0	0	0	0	0	0	0	0	0	0
Spillback Cap Reductn	0	0	0	0	0	0	0	0	0	0
Storage Cap Reductn	0	0	0	0	0	0	0	0	0	0
Reduced v/c Ratio	0.97	0.51	0.19	0.32	0.88	0.35	0.89	0.07	0.97	0.70

Intersection Summary

95th percentile volume exceeds capacity, queue may be longer.
 Queue shown is maximum after two cycles.

Queues
17: Westberry Boulevard & Cleveland Avenue



Lane Group	EBL	EBT	EBR	WBL	WBT	NBL	NBT	NBR	SBL	SBT	SBR
Lane Group Flow (vph)	272	814	58	153	1189	67	66	132	29	217	417
v/c Ratio	0.89	0.60	0.09	0.62	0.97	0.63	0.12	0.23	0.28	0.45	0.66
Control Delay	68.9	25.6	0.3	47.6	48.9	68.6	26.1	6.5	48.1	33.1	15.1
Queue Delay	0.0	0.0	0.0	0.0	0.0	0.0	0.0	0.0	0.0	0.0	0.0
Total Delay	68.9	25.6	0.3	47.6	48.9	68.6	26.1	6.5	48.1	33.1	15.1
Queue Length 50th (ft)	152	195	0	83	346	38	25	0	16	108	56
Queue Length 95th (ft)	#292	267	0	142	#494	#100	64	44	44	178	162
Internal Link Dist (ft)		674			1237		511			3065	
Turn Bay Length (ft)	110			165		65		50	100		50
Base Capacity (vph)	310	1352	667	298	1231	106	562	571	102	478	630
Starvation Cap Reductn	0	0	0	0	0	0	0	0	0	0	0
Spillback Cap Reductn	0	0	0	0	0	0	0	0	0	0	0
Storage Cap Reductn	0	0	0	0	0	0	0	0	0	0	0
Reduced v/c Ratio	0.88	0.60	0.09	0.51	0.97	0.63	0.12	0.23	0.28	0.45	0.66

Intersection Summary

95th percentile volume exceeds capacity, queue may be longer.
Queue shown is maximum after two cycles.

Queues
18: Westberry Boulevard & Sunset Avenue

Village D Specific Plan
Phase III WP MIT - PM Peak Hour



Lane Group	EBL	EBT	WBL	WBT	NBL	NBT	NBR	SBL	SBT	SBR
Lane Group Flow (vph)	44	216	80	222	75	202	64	25	220	61
v/c Ratio	0.13	0.38	0.22	0.39	0.19	0.19	0.07	0.07	0.27	0.08
Control Delay	14.7	14.7	15.7	15.6	18.6	9.3	2.9	20.1	14.6	0.2
Queue Delay	0.0	0.0	0.0	0.0	0.0	0.0	0.0	0.0	0.0	0.0
Total Delay	14.7	14.7	15.7	15.6	18.6	9.3	2.9	20.1	14.6	0.2
Queue Length 50th (ft)	8	38	15	42	15	21	0	5	43	0
Queue Length 95th (ft)	32	103	50	110	54	95	16	26	112	1
Internal Link Dist (ft)		306		490		2579			413	
Turn Bay Length (ft)	90		90		130		50	135		50
Base Capacity (vph)	800	1265	819	1301	780	1564	1344	490	1444	1261
Starvation Cap Reductn	0	0	0	0	0	0	0	0	0	0
Spillback Cap Reductn	0	0	0	0	0	0	0	0	0	0
Storage Cap Reductn	0	0	0	0	0	0	0	0	0	0
Reduced v/c Ratio	0.06	0.17	0.10	0.17	0.10	0.13	0.05	0.05	0.15	0.05
Intersection Summary										

Queues
19: Westberry Boulevard & Avenue 14



Lane Group	EBL	EBT	WBL	WBT	WBR	NBL	NBT	SBL	SBT
Lane Group Flow (vph)	96	792	25	783	261	59	76	164	158
v/c Ratio	0.41	0.51	0.15	0.63	0.39	0.27	0.28	0.50	0.34
Control Delay	34.4	15.0	32.0	20.8	7.0	32.1	24.7	31.8	13.3
Queue Delay	0.0	0.0	0.0	0.0	0.0	0.0	0.0	0.0	0.0
Total Delay	34.4	15.0	32.0	20.8	7.0	32.1	24.7	31.8	13.3
Queue Length 50th (ft)	38	96	10	141	16	23	22	62	22
Queue Length 95th (ft)	#85	201	32	212	68	58	58	123	68
Internal Link Dist (ft)		7848		580			537		2579
Turn Bay Length (ft)	100		100		100	100		100	
Base Capacity (vph)	253	1842	172	1522	778	236	733	400	889
Starvation Cap Reductn	0	0	0	0	0	0	0	0	0
Spillback Cap Reductn	0	0	0	0	0	0	0	0	0
Storage Cap Reductn	0	0	0	0	0	0	0	0	0
Reduced v/c Ratio	0.38	0.43	0.15	0.51	0.34	0.25	0.10	0.41	0.18

Intersection Summary

95th percentile volume exceeds capacity, queue may be longer.
Queue shown is maximum after two cycles.

Queues
20: Westberry Boulevard & Avenue 16

Village D Specific Plan
Phase III WP MIT - PM Peak Hour



Lane Group	WBL	WBR	NBT	NBR	SBL	SBT
Lane Group Flow (vph)	496	149	105	291	251	199
v/c Ratio	0.79	0.14	0.31	0.55	0.77	0.23
Control Delay	26.6	0.3	19.2	7.2	38.6	8.4
Queue Delay	0.0	0.0	0.0	0.0	0.0	0.0
Total Delay	26.6	0.3	19.2	7.2	38.6	8.4
Queue Length 50th (ft)	114	0	25	0	64	30
Queue Length 95th (ft)	#277	0	57	47	#174	59
Internal Link Dist (ft)			3065			465
Turn Bay Length (ft)	100	50		50	100	
Base Capacity (vph)	630	1275	771	828	328	931
Starvation Cap Reductn	0	0	0	0	0	0
Spillback Cap Reductn	0	0	0	0	0	0
Storage Cap Reductn	0	0	0	0	0	0
Reduced v/c Ratio	0.79	0.12	0.14	0.35	0.77	0.21

Intersection Summary

95th percentile volume exceeds capacity, queue may be longer.
Queue shown is maximum after two cycles.

Queues
51: Project Driveway 1 & Avenue 17



Lane Group	EBT	WBL	WBT	NBL	NBR
Lane Group Flow (vph)	176	682	68	25	328
v/c Ratio	0.60	0.99	0.06	0.05	0.46
Control Delay	35.2	59.2	6.3	22.5	5.5
Queue Delay	0.0	0.0	0.0	0.0	0.0
Total Delay	35.2	59.2	6.3	22.5	5.5
Queue Length 50th (ft)	71	331	13	9	0
Queue Length 95th (ft)	124	#559	24	29	62
Internal Link Dist (ft)	2580		2671	2061	
Turn Bay Length (ft)				50	
Base Capacity (vph)	422	688	1258	540	713
Starvation Cap Reductn	0	0	0	0	0
Spillback Cap Reductn	0	0	0	0	0
Storage Cap Reductn	0	0	0	0	0
Reduced v/c Ratio	0.42	0.99	0.05	0.05	0.46

Intersection Summary

95th percentile volume exceeds capacity, queue may be longer.
Queue shown is maximum after two cycles.

Queues
52: Road 22 1/2/Project Driveway 2 & Avenue 16

Village D Specific Plan
Phase III WP MIT - PM Peak Hour



Lane Group	EBT	WBL	WBT	WBR	NBL	NBT	NBR	SBL	SBT
Lane Group Flow (vph)	236	322	16	245	7	193	161	154	195
v/c Ratio	0.78	0.81	0.02	0.29	0.08	0.31	0.25	0.69	0.22
Control Delay	64.3	35.8	1.7	1.8	63.5	26.8	4.4	65.6	23.0
Queue Delay	0.0	0.0	0.0	0.0	0.0	0.0	0.0	0.0	0.0
Total Delay	64.3	35.8	1.7	1.8	63.5	26.8	4.4	65.6	23.0
Queue Length 50th (ft)	173	222	2	0	5	112	21	115	85
Queue Length 95th (ft)	253	329	m2	0	m11	215	69	183	183
Internal Link Dist (ft)	2656		2685			2623			2019
Turn Bay Length (ft)		100			100		100	100	
Base Capacity (vph)	378	503	920	908	85	622	648	278	899
Starvation Cap Reductn	0	0	0	0	0	0	0	0	0
Spillback Cap Reductn	0	0	0	0	0	0	0	0	0
Storage Cap Reductn	0	0	0	0	0	0	0	0	0
Reduced v/c Ratio	0.62	0.64	0.02	0.27	0.08	0.31	0.25	0.55	0.22

Intersection Summary

m Volume for 95th percentile queue is metered by upstream signal.

Queues
53: Road 22 1/2 & Cleveland Avenue

Village D Specific Plan
Phase III WP MIT - PM Peak Hour



Lane Group	EBL	EBT	WBL	WBT	WBR	NBL	NBT	SBL	SBT
Lane Group Flow (vph)	9	470	123	570	488	15	99	359	42
v/c Ratio	0.11	0.72	0.63	0.51	0.46	0.15	0.13	0.67	0.04
Control Delay	58.0	52.1	57.1	28.1	4.7	57.6	8.7	66.8	10.9
Queue Delay	0.0	0.0	0.0	0.0	0.0	0.0	0.0	0.0	0.0
Total Delay	58.0	52.1	57.1	28.1	4.7	57.6	8.7	66.8	10.9
Queue Length 50th (ft)	7	180	85	166	49	10	15	150	8
Queue Length 95th (ft)	25	226	m116	m222	m91	m27	56	150	m20
Internal Link Dist (ft)		1112		2664			1767		2623
Turn Bay Length (ft)	100		100			100		100	
Base Capacity (vph)	82	1334	248	1669	1071	98	735	596	1029
Starvation Cap Reductn	0	0	0	0	0	0	0	0	0
Spillback Cap Reductn	0	0	0	0	0	0	0	0	0
Storage Cap Reductn	0	0	0	0	0	0	0	0	0
Reduced v/c Ratio	0.11	0.35	0.50	0.34	0.46	0.15	0.13	0.60	0.04

Intersection Summary

m Volume for 95th percentile queue is metered by upstream signal.

Queues
55: Road 23 & Project Driveway 3

Village D Specific Plan
Phase III WP MIT - PM Peak Hour



Lane Group	EBL	EBR	NBL	NBT	SBT	SBR
Lane Group Flow (vph)	320	229	248	1364	1834	686
v/c Ratio	0.70	0.40	0.78	0.34	0.63	0.66
Control Delay	58.1	29.6	58.7	7.0	27.4	20.9
Queue Delay	0.0	0.0	0.0	0.0	0.0	0.0
Total Delay	58.1	29.6	58.7	7.0	27.4	20.9
Queue Length 50th (ft)	123	127	189	72	481	211
Queue Length 95th (ft)	169	180	280	258	m543	m407
Internal Link Dist (ft)	1503			2585	2520	
Turn Bay Length (ft)	200		50			100
Base Capacity (vph)	528	640	398	4036	2934	1046
Starvation Cap Reductn	0	0	0	0	0	0
Spillback Cap Reductn	0	0	0	0	0	0
Storage Cap Reductn	0	0	0	0	0	0
Reduced v/c Ratio	0.61	0.36	0.62	0.34	0.63	0.66

Intersection Summary

m Volume for 95th percentile queue is metered by upstream signal.

Queues
56: Road 23 & Project Driveway 4

Village D Specific Plan
Phase III WP MIT - PM Peak Hour



Lane Group	WBL	WBR	NBT	NBR	SBL	SBT
Lane Group Flow (vph)	402	967	1448	371	1062	1102
v/c Ratio	0.93	0.56	0.89	0.54	0.94	0.32
Control Delay	75.0	15.5	30.9	8.5	52.7	12.4
Queue Delay	0.0	0.0	0.0	0.0	0.0	0.0
Total Delay	75.0	15.5	30.9	8.5	52.7	12.4
Queue Length 50th (ft)	304	233	422	166	448	157
Queue Length 95th (ft)	#489	295	#494	133	m#539	m169
Internal Link Dist (ft)	754		528			1127
Turn Bay Length (ft)	200			200	200	
Base Capacity (vph)	443	1722	1624	692	1132	3490
Starvation Cap Reductn	0	0	0	0	0	0
Spillback Cap Reductn	0	0	0	0	0	0
Storage Cap Reductn	0	0	0	0	0	0
Reduced v/c Ratio	0.91	0.56	0.89	0.54	0.94	0.32

Intersection Summary

95th percentile volume exceeds capacity, queue may be longer.

Queue shown is maximum after two cycles.

m Volume for 95th percentile queue is metered by upstream signal.

Queues
57: Road 23 & Project Driveway 5

Village D Specific Plan
Phase III WP MIT - PM Peak Hour



Lane Group	EBL	EBR	NBL	NBT	SBT
Lane Group Flow (vph)	142	67	102	1686	1513
v/c Ratio	0.64	0.26	0.57	0.41	0.45
Control Delay	62.9	13.0	54.2	8.3	17.5
Queue Delay	0.0	0.0	0.0	0.0	0.0
Total Delay	62.9	13.0	54.2	8.3	17.5
Queue Length 50th (ft)	106	0	66	354	86
Queue Length 95th (ft)	167	41	m95	221	m378
Internal Link Dist (ft)	2646			3397	528
Turn Bay Length (ft)			50		
Base Capacity (vph)	368	383	272	4079	3329
Starvation Cap Reductn	0	0	0	0	0
Spillback Cap Reductn	0	0	0	0	0
Storage Cap Reductn	0	0	0	0	0
Reduced v/c Ratio	0.39	0.17	0.38	0.41	0.45

Intersection Summary

m Volume for 95th percentile queue is metered by upstream signal.

Queues
58: Project Driveway 6 & Cleveland Avenue

Village D Specific Plan
Phase III WP MIT - PM Peak Hour



Lane Group	EBT	EBR	WBL	WBT	NBL	NBR
Lane Group Flow (vph)	946	158	361	1363	71	264
v/c Ratio	0.69	0.32	0.81	0.48	0.11	0.34
Control Delay	41.3	21.0	56.5	16.6	29.8	5.5
Queue Delay	0.0	0.0	0.0	0.0	0.0	0.0
Total Delay	41.3	21.0	56.5	16.6	29.8	5.5
Queue Length 50th (ft)	284	71	264	224	36	0
Queue Length 95th (ft)	330	123	343	175	84	66
Internal Link Dist (ft)	3869			3121	834	
Turn Bay Length (ft)		100	100		100	
Base Capacity (vph)	1552	550	654	3609	675	769
Starvation Cap Reductn	0	0	0	0	0	0
Spillback Cap Reductn	0	0	0	0	0	0
Storage Cap Reductn	0	0	0	0	0	0
Reduced v/c Ratio	0.61	0.29	0.55	0.38	0.11	0.34
Intersection Summary						

Queues
21: Granada Drive & Cleveland Avenue

Village D Specific Plan
Phase III WP MIT - PM Peak Hour



Lane Group	EBL	EBT	WBL	WBT	WBR	NBL	NBT	NBR	SBL	SBT	SBR
Lane Group Flow (vph)	31	815	403	1198	77	31	293	251	68	385	62
v/c Ratio	0.30	0.94	0.92	0.71	0.09	0.30	0.57	0.44	0.57	0.67	0.10
Control Delay	48.8	53.2	60.0	6.0	0.1	48.9	34.7	11.8	59.7	36.2	0.3
Queue Delay	0.0	0.0	0.0	0.0	0.0	0.0	0.0	0.0	0.0	0.0	0.0
Total Delay	48.8	53.2	60.0	6.0	0.1	48.9	34.7	11.8	59.7	36.2	0.3
Queue Length 50th (ft)	17	240	205	55	0	17	149	31	38	205	0
Queue Length 95th (ft)	46	#360	m212	m63	m0	46	235	99	#93	#343	0
Internal Link Dist (ft)		289		2178			418			382	
Turn Bay Length (ft)	90		125			50		50	50		50
Base Capacity (vph)	102	870	451	1698	811	102	515	565	122	574	615
Starvation Cap Reductn	0	0	0	0	0	0	0	0	0	0	0
Spillback Cap Reductn	0	0	0	0	0	0	0	0	0	0	0
Storage Cap Reductn	0	0	0	0	0	0	0	0	0	0	0
Reduced v/c Ratio	0.30	0.94	0.89	0.71	0.09	0.30	0.57	0.44	0.56	0.67	0.10

Intersection Summary

95th percentile volume exceeds capacity, queue may be longer.

Queue shown is maximum after two cycles.

m Volume for 95th percentile queue is metered by upstream signal.

Queues
22: Granada Drive & Sunset Avenue

Village D Specific Plan
Phase III WP MIT - PM Peak Hour



Lane Group	EBL	EBT	WBL	WBT	WBR	NBL	NBT	SBL	SBT
Lane Group Flow (vph)	34	227	61	237	122	57	358	90	429
v/c Ratio	0.24	0.58	0.43	0.53	0.24	0.32	0.46	0.46	0.50
Control Delay	32.2	26.6	38.2	25.5	2.5	32.0	19.5	37.7	20.3
Queue Delay	0.0	0.0	0.0	0.0	0.0	0.0	0.0	0.0	0.0
Total Delay	32.2	26.6	38.2	25.5	2.5	32.0	19.5	37.7	20.3
Queue Length 50th (ft)	13	75	23	68	0	21	114	32	140
Queue Length 95th (ft)	37	122	56	134	15	54	#208	#97	#295
Internal Link Dist (ft)		721		7441			203		209
Turn Bay Length (ft)	95		120		70	95		85	
Base Capacity (vph)	141	532	141	558	588	179	775	196	857
Starvation Cap Reductn	0	0	0	0	0	0	0	0	0
Spillback Cap Reductn	0	0	0	0	0	0	0	0	0
Storage Cap Reductn	0	0	0	0	0	0	0	0	0
Reduced v/c Ratio	0.24	0.43	0.43	0.42	0.21	0.32	0.46	0.46	0.50

Intersection Summary

95th percentile volume exceeds capacity, queue may be longer.
Queue shown is maximum after two cycles.

Queues
23: Avenue 16/Ellis Street & Kennedy Street

Village D Specific Plan
Phase III WP MIT - PM Peak Hour



Lane Group	WBL	WBR	NBT	SBL	SBT
Lane Group Flow (vph)	305	251	1000	293	570
v/c Ratio	0.81	0.32	0.65	0.79	0.24
Control Delay	33.8	5.1	15.7	45.7	5.5
Queue Delay	0.0	0.0	0.0	0.0	0.0
Total Delay	33.8	5.1	15.7	45.7	5.5
Queue Length 50th (ft)	125	0	150	135	53
Queue Length 95th (ft)	m#202	m12	221	#240	74
Internal Link Dist (ft)	782		506		440
Turn Bay Length (ft)	175			280	
Base Capacity (vph)	409	837	1547	413	2413
Starvation Cap Reductn	0	0	0	0	0
Spillback Cap Reductn	0	0	0	0	0
Storage Cap Reductn	0	0	0	0	0
Reduced v/c Ratio	0.75	0.30	0.65	0.71	0.24

Intersection Summary

95th percentile volume exceeds capacity, queue may be longer.

Queue shown is maximum after two cycles.

m Volume for 95th percentile queue is metered by upstream signal.

Queues
24: Schnoor Avenue & Kennedy Street

Village D Specific Plan
Phase III WP MIT - PM Peak Hour



Lane Group	EBL	EBT	WBL	WBT	NBL	NBT	SBL	SBT	SBR
Lane Group Flow (vph)	107	612	289	522	215	485	216	73	46
v/c Ratio	0.68	0.77	0.73	0.86	0.58	0.76	0.96	0.18	0.09
Control Delay	52.6	19.0	28.5	26.8	41.1	21.7	89.4	25.9	0.4
Queue Delay	0.0	0.0	0.0	0.0	0.0	0.0	0.0	0.0	0.0
Total Delay	52.6	19.0	28.5	26.8	41.1	21.7	89.4	25.9	0.4
Queue Length 50th (ft)	56	88	119	103	53	106	56	29	0
Queue Length 95th (ft)	m#115	139	m164	m127	88	#262	#123	63	0
Internal Link Dist (ft)		782		187		321		193	
Turn Bay Length (ft)	95		40		75		60		
Base Capacity (vph)	158	898	396	675	368	642	226	405	498
Starvation Cap Reductn	0	0	0	0	0	0	0	0	0
Spillback Cap Reductn	0	0	0	0	0	0	0	0	0
Storage Cap Reductn	0	0	0	0	0	0	0	0	0
Reduced v/c Ratio	0.68	0.68	0.73	0.77	0.58	0.76	0.96	0.18	0.09

Intersection Summary

95th percentile volume exceeds capacity, queue may be longer.

Queue shown is maximum after two cycles.

m Volume for 95th percentile queue is metered by upstream signal.

Queues

25: Kennedy Street/Gateway Drive & SR-99 Southbound Ramps



Lane Group	EBL	EBT	WBT	SBL	SBR
Lane Group Flow (vph)	421	543	604	150	271
v/c Ratio	0.94	0.45	0.96	0.36	0.30
Control Delay	57.4	4.2	54.2	28.8	6.8
Queue Delay	0.0	0.0	0.0	0.0	0.0
Total Delay	57.4	4.2	54.2	28.8	6.8
Queue Length 50th (ft)	199	45	289	63	39
Queue Length 95th (ft)	m#333	m68	#495	116	80
Internal Link Dist (ft)		189	811	461	
Turn Bay Length (ft)	140				335
Base Capacity (vph)	453	1222	639	415	910
Starvation Cap Reductn	0	0	0	0	0
Spillback Cap Reductn	0	0	0	0	0
Storage Cap Reductn	0	0	0	0	0
Reduced v/c Ratio	0.93	0.44	0.95	0.36	0.30

Intersection Summary

95th percentile volume exceeds capacity, queue may be longer.

Queue shown is maximum after two cycles.

m Volume for 95th percentile queue is metered by upstream signal.

Queues
29: Schnoor Avenue & Cleveland Avenue



Lane Group	EBL	EBT	EBR	WBL	WBT	WBR	NBL	NBT	NBR	SBL	SBT	SBR
Lane Group Flow (vph)	207	957	63	306	1394	131	104	269	164	138	264	208
v/c Ratio	0.91	0.80	0.10	0.54	1.05	0.19	0.77	0.35	0.24	0.93	0.33	0.41
Control Delay	73.4	47.5	5.3	15.8	42.0	0.3	76.8	31.4	6.3	101.8	30.6	7.0
Queue Delay	0.0	0.0	0.0	0.0	0.0	0.0	0.0	0.0	0.0	0.0	0.0	0.0
Total Delay	73.4	47.5	5.3	15.8	42.0	0.3	76.8	31.4	6.3	101.8	30.6	7.0
Queue Length 50th (ft)	126	301	1	69	-456	0	59	68	12	79	66	0
Queue Length 95th (ft)	m#178	m341	m8	m76	m#499	m0	#145	105	51	#191	102	55
Internal Link Dist (ft)		2178			574			393			326	
Turn Bay Length (ft)	120		60	220		95	75		75	105		65
Base Capacity (vph)	228	1294	680	567	1330	701	135	774	681	148	802	511
Starvation Cap Reductn	0	0	0	0	0	0	0	0	0	0	0	0
Spillback Cap Reductn	0	0	0	0	0	0	0	0	0	0	0	0
Storage Cap Reductn	0	0	0	0	0	0	0	0	0	0	0	0
Reduced v/c Ratio	0.91	0.74	0.09	0.54	1.05	0.19	0.77	0.35	0.24	0.93	0.33	0.41

Intersection Summary

- ~ Volume exceeds capacity, queue is theoretically infinite.
Queue shown is maximum after two cycles.
- # 95th percentile volume exceeds capacity, queue may be longer.
Queue shown is maximum after two cycles.
- m Volume for 95th percentile queue is metered by upstream signal.

Queues
30: Fairgrounds & Cleveland Avenue

Village D Specific Plan
Phase III WP MIT - PM Peak Hour



Lane Group	EBL	EBT	WBL	WBT	NBL	NBT	NBR	SBL	SBT
Lane Group Flow (vph)	111	1208	188	1751	105	87	81	384	171
v/c Ratio	0.86	0.78	0.82	0.95	0.43	0.23	0.16	1.32	0.28
Control Delay	66.9	11.9	53.4	23.3	45.7	19.4	0.7	200.9	8.5
Queue Delay	0.0	0.0	0.0	0.0	0.0	0.0	0.0	0.0	0.0
Total Delay	66.9	11.9	53.4	23.3	45.7	19.4	0.7	200.9	8.5
Queue Length 50th (ft)	66	107	96	269	29	23	0	~285	16
Queue Length 95th (ft)	m#105	m140	m115	m#438	56	65	0	#458	62
Internal Link Dist (ft)		574		1412		192			168
Turn Bay Length (ft)	120		205				100		
Base Capacity (vph)	129	1555	236	1835	249	375	498	290	620
Starvation Cap Reductn	0	0	0	0	0	0	0	0	0
Spillback Cap Reductn	0	0	0	0	0	0	0	0	0
Storage Cap Reductn	0	0	0	0	0	0	0	0	0
Reduced v/c Ratio	0.86	0.78	0.80	0.95	0.42	0.23	0.16	1.32	0.28

Intersection Summary

- ~ Volume exceeds capacity, queue is theoretically infinite.
Queue shown is maximum after two cycles.
- # 95th percentile volume exceeds capacity, queue may be longer.
Queue shown is maximum after two cycles.
- m Volume for 95th percentile queue is metered by upstream signal.

Queues
31: SR-99 Southbound Ramps & Cleveland Avenue

Village D Specific Plan
Phase III WP MIT - PM Peak Hour



Lane Group	EBT	EBR	WBL	WBT	SBL	SBR
Lane Group Flow (vph)	1114	669	393	2145	299	103
v/c Ratio	0.79	0.67	1.02	0.90	0.72	0.24
Control Delay	11.9	5.3	51.4	9.3	42.4	12.4
Queue Delay	2.6	0.0	0.0	46.0	0.0	0.0
Total Delay	14.5	5.3	51.4	55.3	42.4	12.4
Queue Length 50th (ft)	122	33	~259	311	157	13
Queue Length 95th (ft)	m144	m47	m#260	m265	#265	54
Internal Link Dist (ft)	1412			372		
Turn Bay Length (ft)			115			140
Base Capacity (vph)	1449	1010	387	2386	418	423
Starvation Cap Reductn	0	0	0	492	0	0
Spillback Cap Reductn	217	0	0	0	0	0
Storage Cap Reductn	0	0	0	0	0	0
Reduced v/c Ratio	0.90	0.66	1.02	1.13	0.72	0.24

Intersection Summary

- ~ Volume exceeds capacity, queue is theoretically infinite.
Queue shown is maximum after two cycles.
- # 95th percentile volume exceeds capacity, queue may be longer.
Queue shown is maximum after two cycles.
- m Volume for 95th percentile queue is metered by upstream signal.

Queues
32: SR-99 Northbound Ramps & Cleveland Avenue

Village D Specific Plan
Phase III WP MIT - PM Peak Hour



Lane Group	EBL	EBT	WBT	WBR	NBL	NBT	NBR
Lane Group Flow (vph)	116	1325	1452	253	573	580	367
v/c Ratio	0.53	0.76	1.19	0.44	0.82	0.83	0.53
Control Delay	36.0	12.1	114.5	16.2	37.2	37.8	20.3
Queue Delay	0.0	2.9	0.6	1.0	0.0	0.0	0.0
Total Delay	36.0	15.0	115.0	17.3	37.2	37.8	20.3
Queue Length 50th (ft)	72	249	~534	52	304	309	124
Queue Length 95th (ft)	m97	418	m#579	m51	#545	#553	226
Internal Link Dist (ft)		372	207			441	
Turn Bay Length (ft)	90			50	145		325
Base Capacity (vph)	287	1925	1223	576	696	697	688
Starvation Cap Reductn	0	471	151	145	0	0	0
Spillback Cap Reductn	0	61	106	0	0	0	1
Storage Cap Reductn	0	0	0	0	0	0	0
Reduced v/c Ratio	0.40	0.91	1.35	0.59	0.82	0.83	0.53

Intersection Summary

- ~ Volume exceeds capacity, queue is theoretically infinite.
Queue shown is maximum after two cycles.
- # 95th percentile volume exceeds capacity, queue may be longer.
Queue shown is maximum after two cycles.
- m Volume for 95th percentile queue is metered by upstream signal.

Queues
33: Gateway Drive & Cleveland Avenue

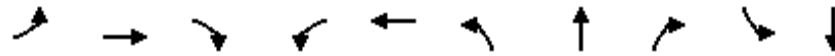

Lane Group	EBL	EBT	EBR	WBL	WBT	NBL	NBT	NBR	SBL	SBT
Lane Group Flow (vph)	18	1310	383	264	1499	384	164	329	248	216
v/c Ratio	0.10	0.76	0.43	0.80	0.97	0.79	0.38	0.70	1.06	0.27
Control Delay	6.8	16.3	2.9	56.5	43.3	50.7	32.5	27.1	114.0	28.1
Queue Delay	0.0	15.6	0.2	0.3	41.7	163.6	0.0	3.4	0.0	0.1
Total Delay	6.8	31.8	3.1	56.8	85.0	214.3	32.5	30.5	114.0	28.2
Queue Length 50th (ft)	2	85	5	79	287	110	80	98	~156	50
Queue Length 95th (ft)	m3	200	36	#140	#643	#176	138	#200	#303	82
Internal Link Dist (ft)		207			111		765			296
Turn Bay Length (ft)	110					245			45	
Base Capacity (vph)	182	1780	894	332	1538	485	436	473	235	788
Starvation Cap Reductn	0	372	114	3	373	0	0	0	0	0
Spillback Cap Reductn	0	484	0	0	175	472	0	75	0	127
Storage Cap Reductn	0	0	0	0	0	0	0	0	0	0
Reduced v/c Ratio	0.10	1.01	0.49	0.80	1.29	29.54	0.38	0.83	1.06	0.33

Intersection Summary

- ~ Volume exceeds capacity, queue is theoretically infinite.
Queue shown is maximum after two cycles.
- # 95th percentile volume exceeds capacity, queue may be longer.
Queue shown is maximum after two cycles.
- m Volume for 95th percentile queue is metered by upstream signal.

Queues
34: Cleveland Avenue & County Club Drive



Lane Group	WBL	NBT	NBR	SBL	SBT
Lane Group Flow (vph)	784	1060	805	155	1004
v/c Ratio	0.77	0.49	0.52	0.64	0.32
Control Delay	34.0	17.9	3.6	29.1	9.5
Queue Delay	0.1	50.4	0.0	0.0	0.2
Total Delay	34.1	68.3	3.6	29.1	9.7
Queue Length 50th (ft)	206	188	60	52	93
Queue Length 95th (ft)	244	m257	m165	#179	142
Internal Link Dist (ft)	239	111			159
Turn Bay Length (ft)					
Base Capacity (vph)	1379	2155	1563	242	3097
Starvation Cap Reductn	0	1219	0	0	0
Spillback Cap Reductn	79	0	0	0	1143
Storage Cap Reductn	0	0	0	0	0
Reduced v/c Ratio	0.60	1.13	0.52	0.64	0.51

Intersection Summary

95th percentile volume exceeds capacity, queue may be longer.

Queue shown is maximum after two cycles.

m Volume for 95th percentile queue is metered by upstream signal.

Queues
36: Pine Street & Howard Road

Village D Specific Plan
Phase III WP MIT - PM Peak Hour



Lane Group	EBL	EBT	WBL	WBT	NBL	NBT	NBR	SBL	SBT	SBR
Lane Group Flow (vph)	96	1008	119	943	252	212	184	19	180	129
v/c Ratio	0.71	0.95	0.80	0.78	0.71	0.28	0.25	0.15	0.46	0.27
Control Delay	69.6	49.4	78.0	30.3	45.7	20.8	4.5	41.2	35.4	3.1
Queue Delay	0.0	0.0	0.0	0.0	0.0	0.0	0.0	0.0	0.0	0.0
Total Delay	69.6	49.4	78.0	30.3	45.7	20.8	4.5	41.2	35.4	3.1
Queue Length 50th (ft)	54	287	69	221	134	71	0	10	90	0
Queue Length 95th (ft)	#132	#421	#169	#338	#235	152	45	32	154	19
Internal Link Dist (ft)		265		561		224			259	
Turn Bay Length (ft)	95		140		90			115		115
Base Capacity (vph)	135	1058	148	1205	357	766	751	354	393	477
Starvation Cap Reductn	0	0	0	0	0	0	0	0	0	0
Spillback Cap Reductn	0	0	0	0	0	0	0	0	0	0
Storage Cap Reductn	0	0	0	0	0	0	0	0	0	0
Reduced v/c Ratio	0.71	0.95	0.80	0.78	0.71	0.28	0.25	0.05	0.46	0.27

Intersection Summary

95th percentile volume exceeds capacity, queue may be longer.
Queue shown is maximum after two cycles.

Queues

37: Olive Avenue/Q Street & Howard Road/Yosemite Avenue

Village D Specific Plan

Phase III WP MIT - PM Peak Hour



Lane Group	EBL	EBT	EBR	WBL	WBT	NBL	NBT	NBR	SBL	SBT	SBR
Lane Group Flow (vph)	8	516	520	15	452	394	393	14	18	63	2
v/c Ratio	0.06	0.61	0.68	0.12	0.55	0.45	0.44	0.02	0.11	0.36	0.01
Control Delay	39.6	23.6	16.1	40.8	32.5	19.9	19.7	0.0	37.5	43.2	0.0
Queue Delay	0.0	0.0	0.0	0.0	0.0	0.0	0.0	0.0	0.0	0.0	0.0
Total Delay	39.6	23.6	16.1	40.8	32.5	19.9	19.7	0.0	37.5	43.2	0.0
Queue Length 50th (ft)	5	164	196	8	115	143	142	0	10	34	0
Queue Length 95th (ft)	m9	m172	m210	27	164	#329	320	0	29	71	0
Internal Link Dist (ft)		561			230		220			195	
Turn Bay Length (ft)	40			80		130			50		50
Base Capacity (vph)	133	866	775	357	1226	874	884	898	357	376	465
Starvation Cap Reductn	0	0	0	0	0	0	0	0	0	0	0
Spillback Cap Reductn	0	0	0	0	0	0	0	0	0	0	0
Storage Cap Reductn	0	0	0	0	0	0	0	0	0	0	0
Reduced v/c Ratio	0.06	0.60	0.67	0.04	0.37	0.45	0.44	0.02	0.05	0.17	0.00

Intersection Summary

95th percentile volume exceeds capacity, queue may be longer.

Queue shown is maximum after two cycles.

m Volume for 95th percentile queue is metered by upstream signal.

Queues

38: I Street & 2nd Street/SR-99 Southbound Off-Ramp



Lane Group	EBT	WBT	WBR	NBL	NBT	SBT
Lane Group Flow (vph)	45	369	5	55	163	124
v/c Ratio	0.09	0.78	0.01	0.07	0.15	0.11
Control Delay	0.3	44.6	0.0	2.9	2.9	12.5
Queue Delay	0.0	0.0	0.0	0.0	0.0	0.0
Total Delay	0.3	44.6	0.0	2.9	2.9	12.5
Queue Length 50th (ft)	0	217	0	2	6	37
Queue Length 95th (ft)	0	284	0	m10	m29	80
Internal Link Dist (ft)	129	218			779	118
Turn Bay Length (ft)			50	75		
Base Capacity (vph)	676	755	710	746	1105	1105
Starvation Cap Reductn	0	0	0	0	0	0
Spillback Cap Reductn	0	0	0	0	0	0
Storage Cap Reductn	0	0	0	0	0	0
Reduced v/c Ratio	0.07	0.49	0.01	0.07	0.15	0.11

Intersection Summary

m Volume for 95th percentile queue is metered by upstream signal.

Queues
39: 4th Street & Sunset Avenue

Village D Specific Plan
Phase III WP MIT - PM Peak Hour



Lane Group	EBL	NBL	NBT	SBT	SBR
Lane Group Flow (vph)	288	15	438	474	429
v/c Ratio	0.58	0.07	0.16	0.39	0.32
Control Delay	43.6	34.0	3.5	6.5	0.8
Queue Delay	0.0	0.0	0.0	0.0	0.0
Total Delay	43.6	34.0	3.5	6.5	0.8
Queue Length 50th (ft)	87	9	31	48	0
Queue Length 95th (ft)	123	25	55	137	7
Internal Link Dist (ft)	7441		193	501	
Turn Bay Length (ft)	135				
Base Capacity (vph)	962	398	2720	1230	1385
Starvation Cap Reductn	0	0	0	0	0
Spillback Cap Reductn	0	0	0	0	0
Storage Cap Reductn	0	0	0	0	0
Reduced v/c Ratio	0.30	0.04	0.16	0.39	0.31
Intersection Summary					

Queues
41: I Street & 4th Street



Lane Group	EBL	EBT	WBL	WBT	NBL	NBT	NBR	SBL	SBT	SBR
Lane Group Flow (vph)	46	731	67	726	114	82	278	236	188	173
v/c Ratio	0.37	0.82	0.45	0.71	0.59	0.14	0.42	0.68	0.26	0.24
Control Delay	46.4	31.5	41.9	19.6	55.0	30.2	8.2	60.9	25.9	12.0
Queue Delay	0.0	0.0	0.0	0.3	0.0	0.0	0.0	0.0	0.0	0.0
Total Delay	46.4	31.5	41.9	19.8	55.0	30.2	8.2	60.9	25.9	12.0
Queue Length 50th (ft)	29	210	46	110	70	41	15	155	114	42
Queue Length 95th (ft)	68	264	m55	m112	125	82	85	234	176	85
Internal Link Dist (ft)		501		26		314			779	
Turn Bay Length (ft)	130				45		25	80		80
Base Capacity (vph)	127	955	169	1121	226	572	659	380	730	717
Starvation Cap Reductn	0	0	0	73	0	0	0	0	0	0
Spillback Cap Reductn	0	0	0	0	0	0	0	0	0	0
Storage Cap Reductn	0	0	0	0	0	0	0	0	0	0
Reduced v/c Ratio	0.36	0.77	0.40	0.69	0.50	0.14	0.42	0.62	0.26	0.24

Intersection Summary

m Volume for 95th percentile queue is metered by upstream signal.

Queues
43: SR-99 Northbound Off-Ramp/H Street & 4th Street

Village D Specific Plan
Phase III WP MIT - PM Peak Hour

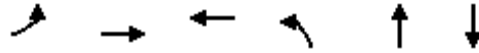

Lane Group	EBL	EBT	WBT	NBL	NBT	SBT
Lane Group Flow (vph)	345	472	855	303	264	134
v/c Ratio	0.99	0.28	1.02	0.81	0.51	0.34
Control Delay	70.4	6.5	73.0	55.6	11.6	12.0
Queue Delay	0.0	0.0	0.0	0.0	0.0	0.0
Total Delay	70.4	6.5	73.0	55.6	11.6	12.0
Queue Length 50th (ft)	237	50	-291	185	22	10
Queue Length 95th (ft)	m#398	m63	#416	#321	95	61
Internal Link Dist (ft)		197	236		443	771
Turn Bay Length (ft)						
Base Capacity (vph)	348	1697	837	375	515	395
Starvation Cap Reductn	0	0	0	0	0	0
Spillback Cap Reductn	0	0	0	0	0	0
Storage Cap Reductn	0	0	0	0	0	0
Reduced v/c Ratio	0.99	0.28	1.02	0.81	0.51	0.34

Intersection Summary

- ~ Volume exceeds capacity, queue is theoretically infinite.
Queue shown is maximum after two cycles.
- # 95th percentile volume exceeds capacity, queue may be longer.
Queue shown is maximum after two cycles.
- m Volume for 95th percentile queue is metered by upstream signal.

Queues
45: Olive Avenue & SR-99 Southbound Off-Ramp

Village D Specific Plan
Phase III WP MIT - PM Peak Hour

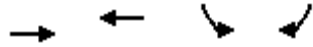

Lane Group	EBT	WBT	SBL	SBR
Lane Group Flow (vph)	856	793	817	107
v/c Ratio	0.65	0.87	0.73	0.11
Control Delay	32.6	53.9	15.8	5.6
Queue Delay	0.0	54.9	2.2	0.0
Total Delay	32.6	108.8	18.0	5.6
Queue Length 50th (ft)	158	254	284	18
Queue Length 95th (ft)	201	#333	438	37
Internal Link Dist (ft)	103	112	135	
Turn Bay Length (ft)				
Base Capacity (vph)	1341	933	1120	995
Starvation Cap Reductn	0	578	0	0
Spillback Cap Reductn	0	0	175	0
Storage Cap Reductn	0	0	0	0
Reduced v/c Ratio	0.64	2.23	0.86	0.11

Intersection Summary

95th percentile volume exceeds capacity, queue may be longer.
Queue shown is maximum after two cycles.

Queues
46: Madera Avenue & SR-99 Northbound Ramps



Lane Group	WBL	WBT	WBR	NBL	NBT	SBT
Lane Group Flow (vph)	203	205	37	1029	890	1062
v/c Ratio	0.70	0.71	0.11	1.20	0.34	0.71
Control Delay	48.2	48.4	2.6	125.5	2.6	23.8
Queue Delay	0.0	0.0	0.0	0.0	0.3	0.0
Total Delay	48.2	48.4	2.6	125.5	2.8	23.8
Queue Length 50th (ft)	114	115	0	~374	34	243
Queue Length 95th (ft)	185	187	8	m#450	m46	337
Internal Link Dist (ft)		337			388	217
Turn Bay Length (ft)	140			205		
Base Capacity (vph)	350	351	384	858	2581	1490
Starvation Cap Reductn	0	0	0	0	912	0
Spillback Cap Reductn	0	0	0	0	0	0
Storage Cap Reductn	0	0	0	0	0	0
Reduced v/c Ratio	0.58	0.58	0.10	1.20	0.53	0.71

Intersection Summary

- ~ Volume exceeds capacity, queue is theoretically infinite.
Queue shown is maximum after two cycles.
- # 95th percentile volume exceeds capacity, queue may be longer.
Queue shown is maximum after two cycles.
- m Volume for 95th percentile queue is metered by upstream signal.

Queues

47: Madera Avenue & Olive Avenue/SR-99 Southbound On-Ramp



Lane Group	EBL	EBT	EBR	NBL	NBT	SBL	SBT
Lane Group Flow (vph)	431	440	767	253	1299	141	998
v/c Ratio	0.78	0.77	0.94	0.55	0.93	0.66	0.68
Control Delay	25.8	25.1	29.0	41.5	41.1	61.5	10.4
Queue Delay	4.4	4.4	44.2	0.3	0.0	0.0	50.2
Total Delay	30.2	29.5	73.2	41.8	41.1	61.5	60.6
Queue Length 50th (ft)	143	146	142	68	-391	77	95
Queue Length 95th (ft)	189	192	#567	111	#588	m#116	187
Internal Link Dist (ft)		112			323		388
Turn Bay Length (ft)				120		90	
Base Capacity (vph)	675	699	814	461	1399	223	1462
Starvation Cap Reductn	171	184	125	0	0	0	103
Spillback Cap Reductn	0	0	0	25	0	0	584
Storage Cap Reductn	0	0	0	0	0	0	0
Reduced v/c Ratio	0.86	0.85	1.11	0.58	0.93	0.63	1.14

Intersection Summary

- ~ Volume exceeds capacity, queue is theoretically infinite.
Queue shown is maximum after two cycles.
- # 95th percentile volume exceeds capacity, queue may be longer.
Queue shown is maximum after two cycles.
- m Volume for 95th percentile queue is metered by upstream signal.

Queues
49: Yosemite Avenue & Cleveland Avenue/Tozer Street

Village D Specific Plan
Phase III WP MIT - PM Peak Hour



Lane Group	EBL	EBT	WBL	WBT	WBR	NBL	NBT	NBR	SBL	SBT	SBR
Lane Group Flow (vph)	348	741	57	570	53	348	358	109	90	204	392
v/c Ratio	0.90	0.56	0.40	0.72	0.10	0.90	0.61	0.18	0.62	0.71	0.60
Control Delay	65.5	24.4	51.6	41.2	0.4	65.5	33.9	1.8	63.2	52.6	18.7
Queue Delay	0.0	0.0	0.0	0.0	0.0	0.0	0.0	0.0	0.0	0.0	0.0
Total Delay	65.5	24.4	51.6	41.2	0.4	65.5	33.9	1.8	63.2	52.6	18.7
Queue Length 50th (ft)	212	179	34	175	0	212	193	0	55	121	122
Queue Length 95th (ft)	#385	251	76	242	0	#385	290	12	#125	197	208
Internal Link Dist (ft)		318		397			415			443	
Turn Bay Length (ft)	210		150		50	240			150		
Base Capacity (vph)	399	1320	162	796	513	399	616	633	152	351	668
Starvation Cap Reductn	0	0	0	0	0	0	0	0	0	0	0
Spillback Cap Reductn	0	0	0	0	0	0	0	0	0	0	0
Storage Cap Reductn	0	0	0	0	0	0	0	0	0	0	0
Reduced v/c Ratio	0.87	0.56	0.35	0.72	0.10	0.87	0.58	0.17	0.59	0.58	0.59

Intersection Summary

95th percentile volume exceeds capacity, queue may be longer.
Queue shown is maximum after two cycles.

APPENDIX G:

SIGNAL WARRANT ANALYSIS WORKSHEETS

WARRANT 3, PEAK HOUR

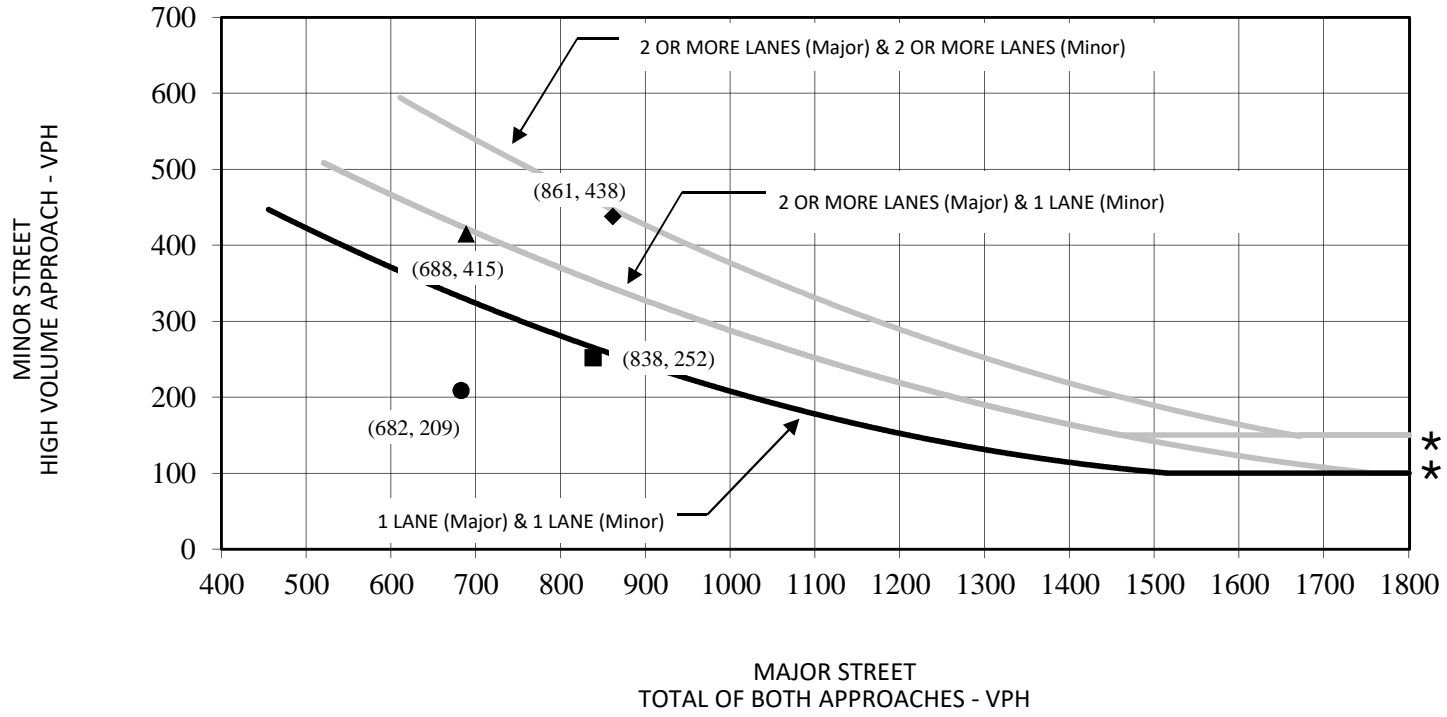

★ 150 VPH applies as the lower threshold volume for a minor street approach with two or more lanes and 100 VPH applies as the lower threshold volume for a minor street approaching with one lane.



FIGURE G-1

- No Project AM Peak Hour
- ▲ With Project AM Peak Hour
- No Project PM Peak Hour
- ◆ With Project PM Peak Hour

Village D Specific Plan
Traffic Impact Analysis

Phase I Peak Hour Warrant: SR-99 Southbound Ramps – Road 23/Avenue 18 ½

SOURCE: MANUAL ON UNIFORM TRAFFIC CONTROL DEVICES, FIGURE 4C-3

R:\CMD1801 Village D\Traffic\Signal Warrant\SW_INT 5_PHI.xlsx (2/18/2020)

WARRANT 3, PEAK HOUR

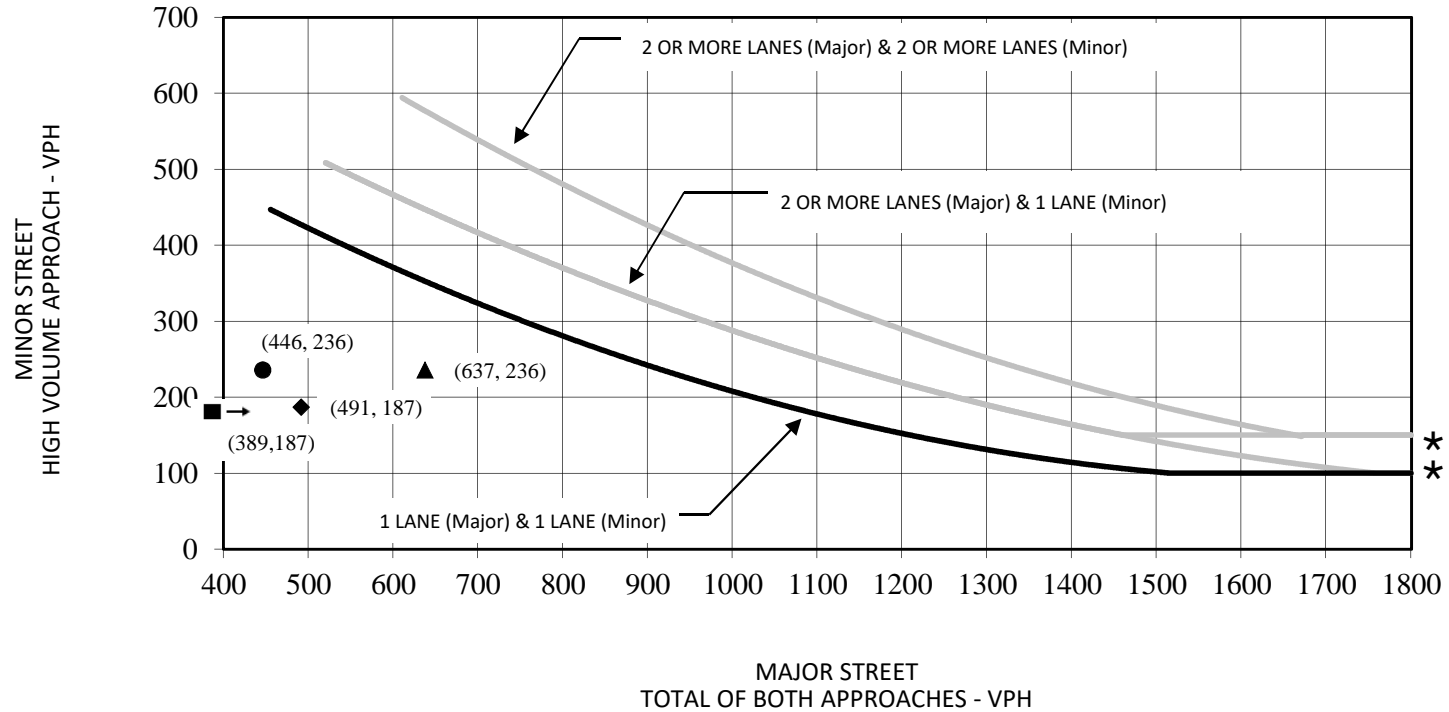

★ 150 VPH applies as the lower threshold volume for a minor street approach with two or more lanes and 100 VPH applies as the lower threshold volume for a minor street approaching with one lane.



FIGURE G-2A

- No Project AM Peak Hour
- ▲ With Project AM Peak Hour
- No Project PM Peak Hour
- ◆ With Project PM Peak Hour

Village D Specific Plan
Traffic Impact Analysis

Phase I Peak Hour Warrant: SR-99 Northbound Ramps/Avenue 18 ½

WARRANT 3, PEAK HOUR

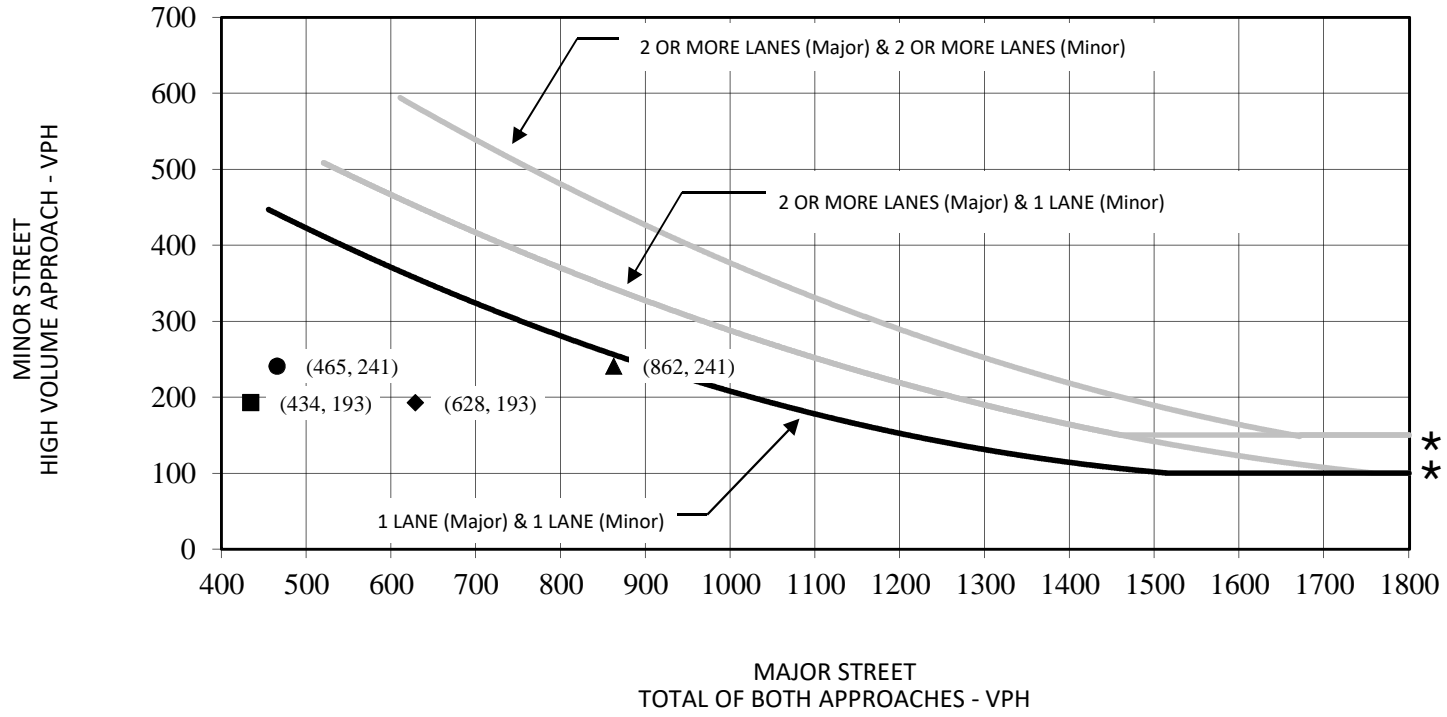

★ 150 VPH applies as the lower threshold volume for a minor street approach with two or more lanes and 100 VPH applies as the lower threshold volume for a minor street approaching with one lane.



FIGURE G-2B

- No Project AM Peak Hour
- ▲ With Project AM Peak Hour
- No Project PM Peak Hour
- ◆ With Project PM Peak Hour

Village D Specific Plan
Traffic Impact Analysis

Phase II Peak Hour Warrant: SR-99 Northbound Ramps/Avenue 18 ½

WARRANT 3, PEAK HOUR

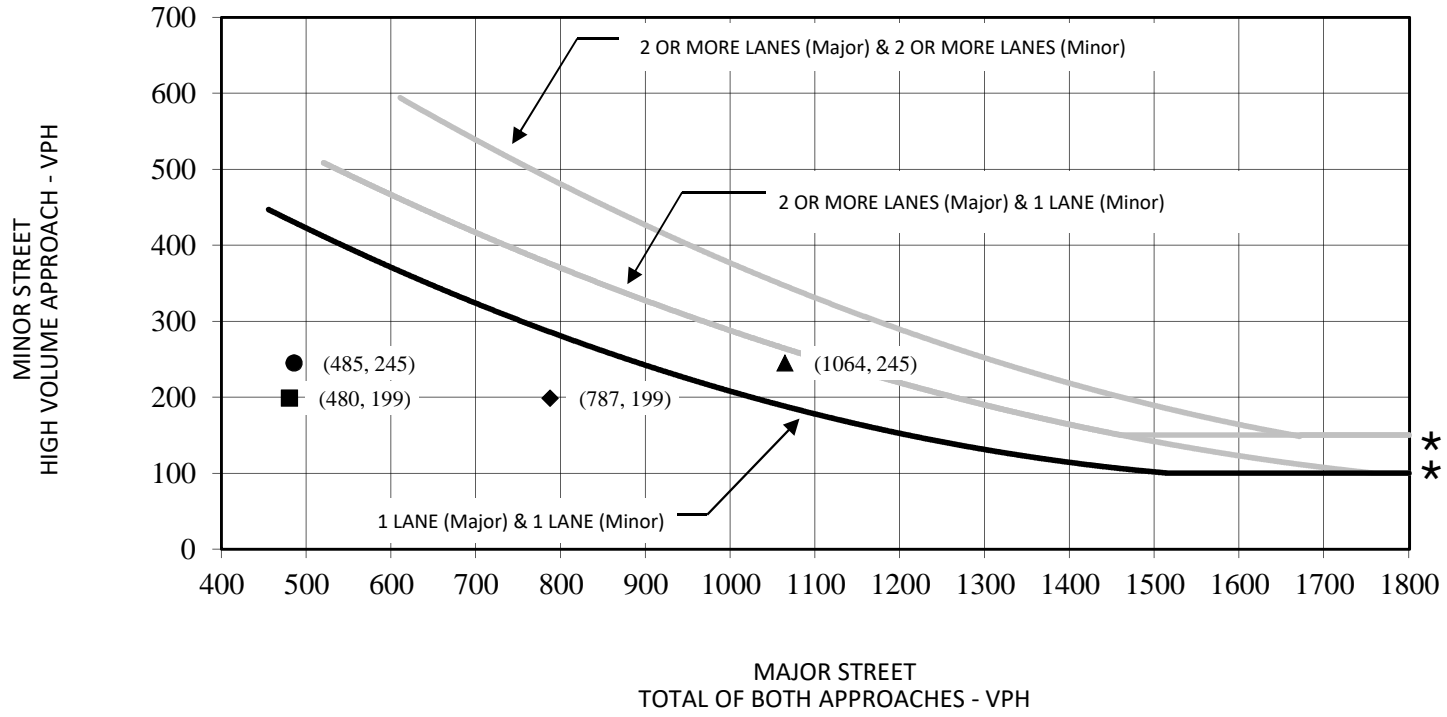

★ 150 VPH applies as the lower threshold volume for a minor street approach with two or more lanes and 100 VPH applies as the lower threshold volume for a minor street approaching with one lane.



FIGURE G-2C

- No Project AM Peak Hour
- ▲ With Project AM Peak Hour
- No Project PM Peak Hour
- ◆ With Project PM Peak Hour

Village D Specific Plan
Traffic Impact Analysis

Phase III Peak Hour Warrant: SR-99 Northbound Ramps/Avenue 18 ½

WARRANT 3, PEAK HOUR

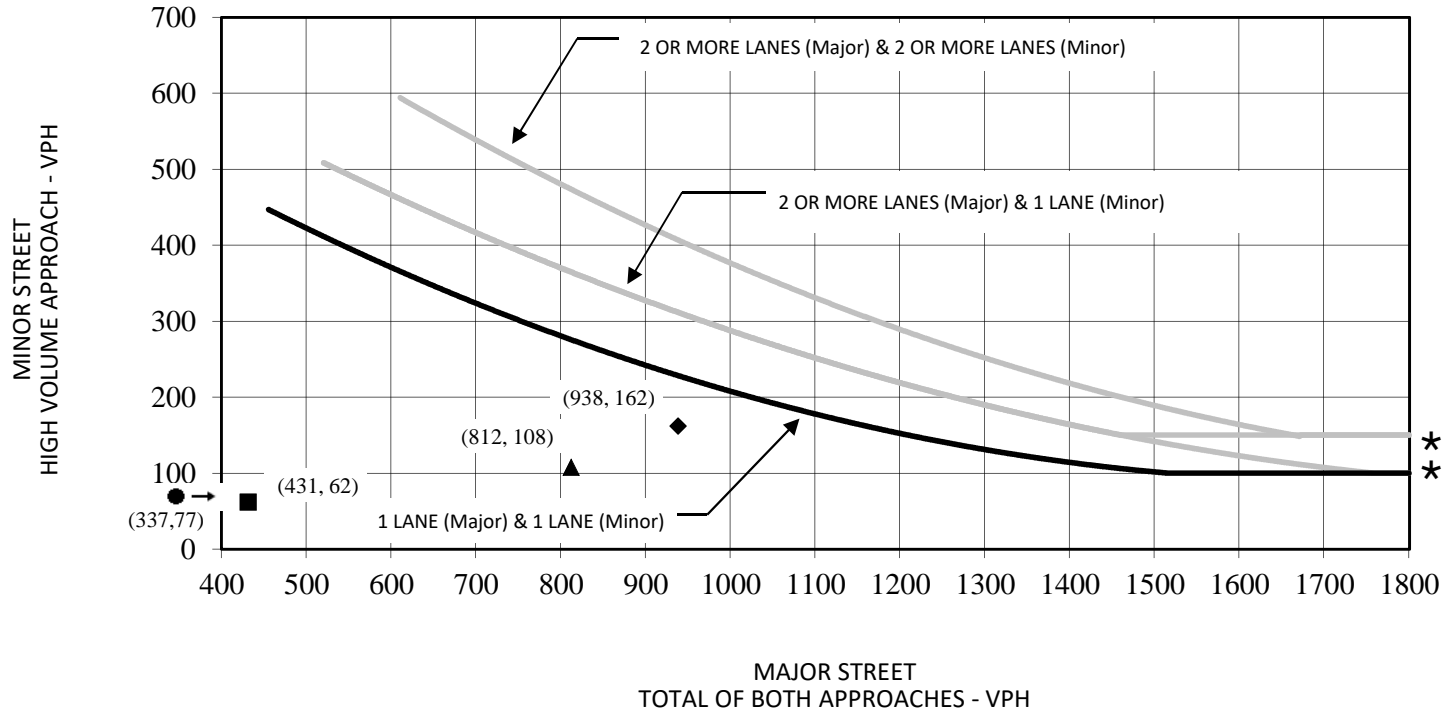

★ 150 VPH applies as the lower threshold volume for a minor street approach with two or more lanes and 100 VPH applies as the lower threshold volume for a minor street approaching with one lane.



FIGURE G-3A

- No Project AM Peak Hour
- ▲ With Project AM Peak Hour
- No Project PM Peak Hour
- ◆ With Project PM Peak Hour

Village D Specific Plan
Traffic Impact Analysis

Phase I Peak Hour Warrant: Road 23/Avenue 17

SOURCE: MANUAL ON UNIFORM TRAFFIC CONTROL DEVICES, FIGURE 4C-3

R:\CMD1801 Village D\Traffic\Signal Warrant\SW_INT 7_PHI.xlsx (2/18/2020)

WARRANT 3, PEAK HOUR

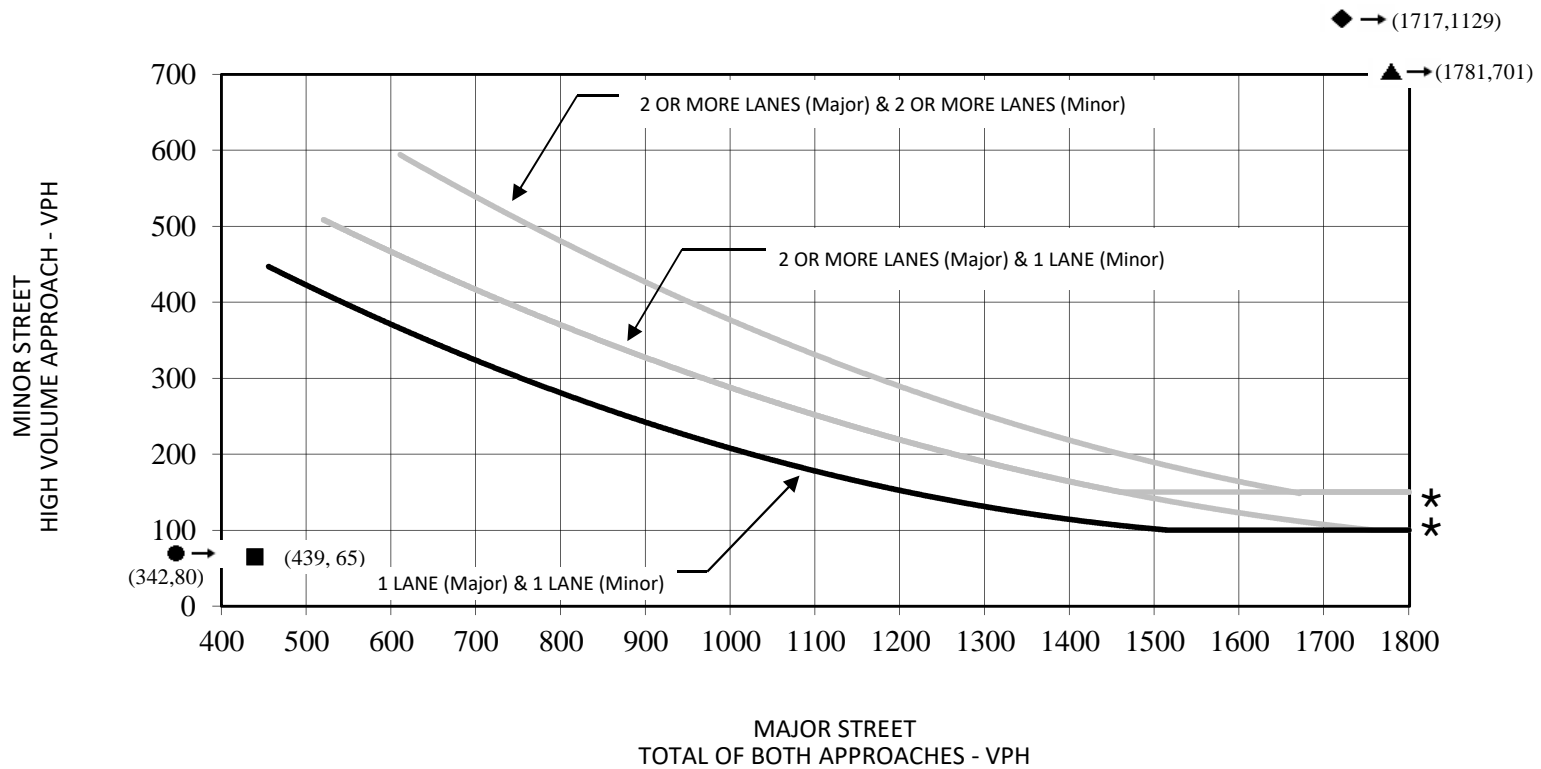

★ 150 VPH applies as the lower threshold volume for a minor street approach with two or more lanes and 100 VPH applies as the lower threshold volume for a minor street approaching with one lane.



FIGURE G-3B

- No Project AM Peak Hour
- ▲ With Project AM Peak Hour
- No Project PM Peak Hour
- ◆ With Project PM Peak Hour

Village D Specific Plan
Traffic Impact Analysis

Phase II Peak Hour Warrant: Road 23/Avenue 17

WARRANT 3, PEAK HOUR

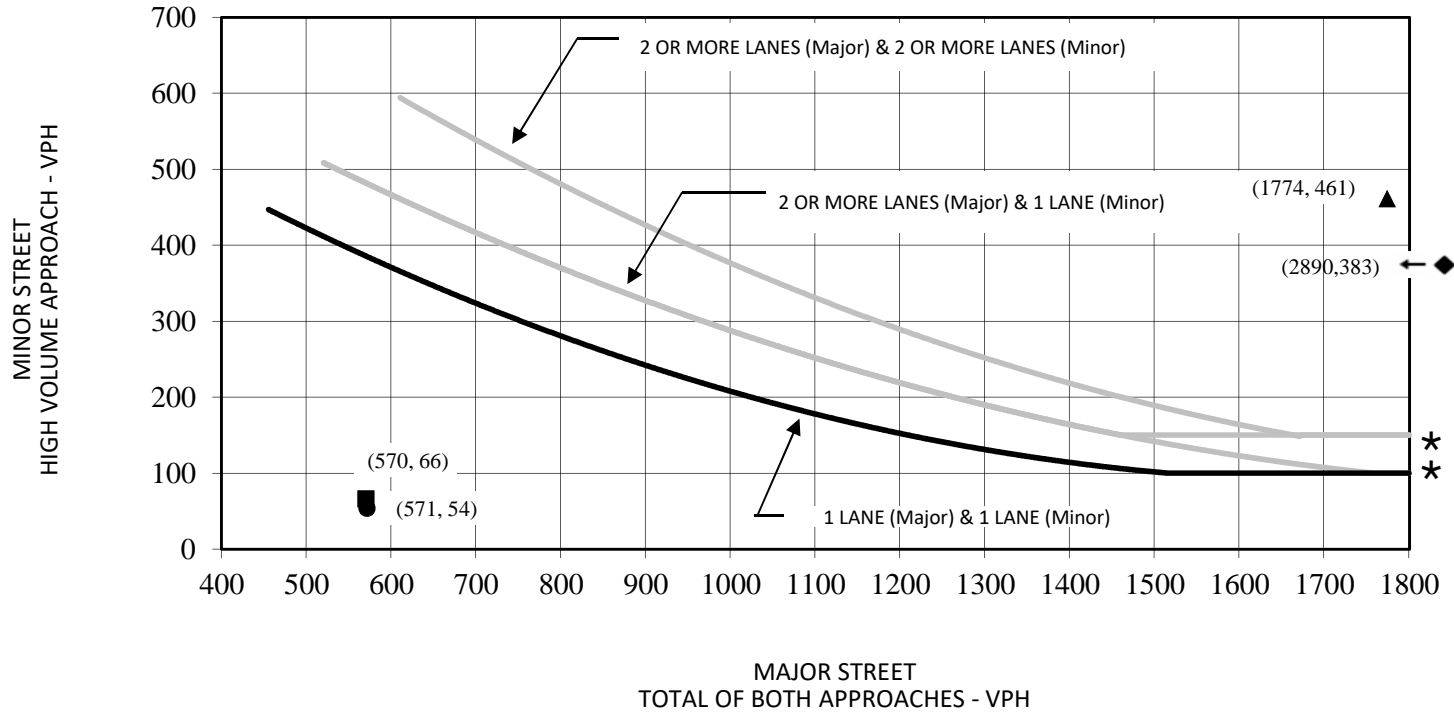

★ 150 VPH applies as the lower threshold volume for a minor street approach with two or more lanes and 100 VPH applies as the lower threshold volume for a minor street approaching with one lane.



FIGURE G-4

- No Project AM Peak Hour
- ▲ With Project AM Peak Hour
- No Project PM Peak Hour
- ◆ With Project PM Peak Hour

Village D Specific Plan
Traffic Impact Analysis

Phase II Peak Hour Warrant: Road 23/Avenue 16

WARRANT 3, PEAK HOUR

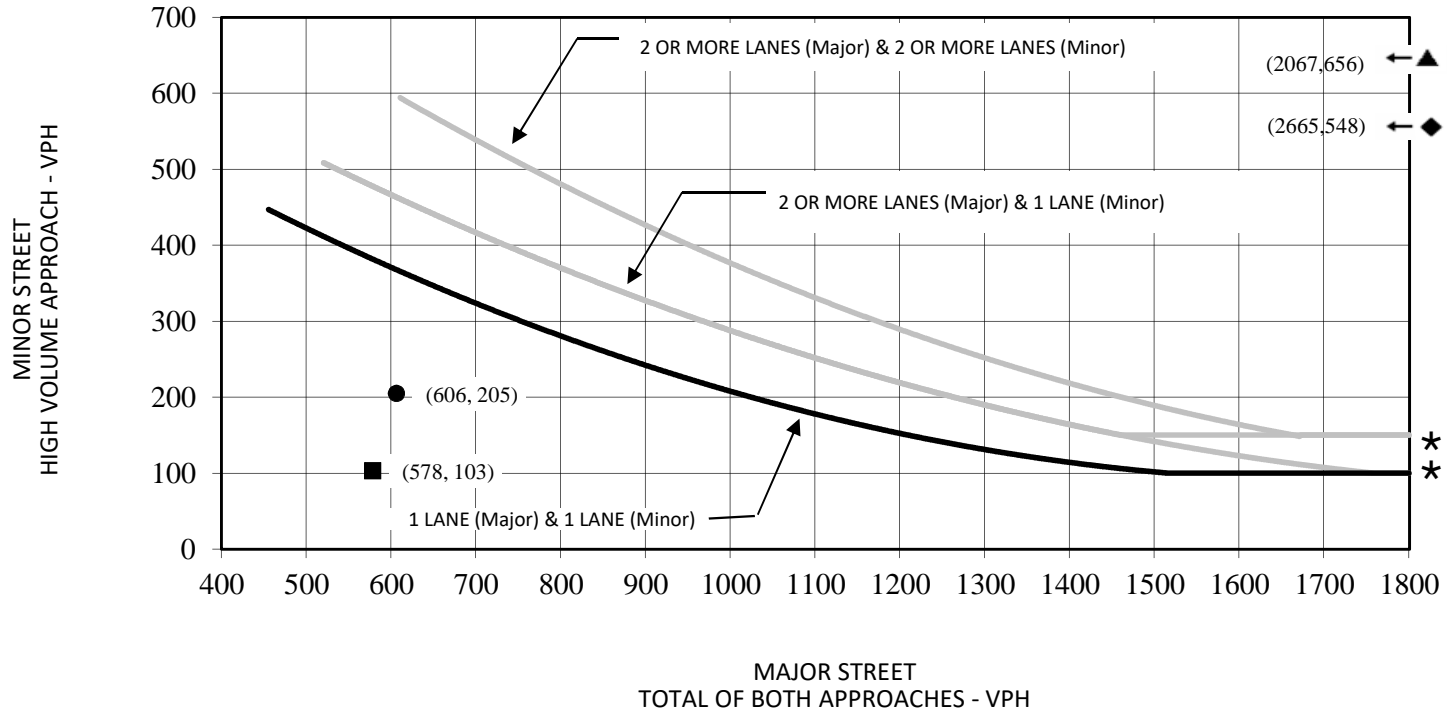

★ 150 VPH applies as the lower threshold volume for a minor street approach with two or more lanes and 100 VPH applies as the lower threshold volume for a minor street approaching with one lane.



FIGURE G-5

- No Project AM Peak Hour
- ▲ With Project AM Peak Hour
- No Project PM Peak Hour
- ◆ With Project PM Peak Hour

Village D Specific Plan
Traffic Impact Analysis

Phase II Peak Hour Warrant: Road 23/Cleveland Avenue

WARRANT 3, PEAK HOUR

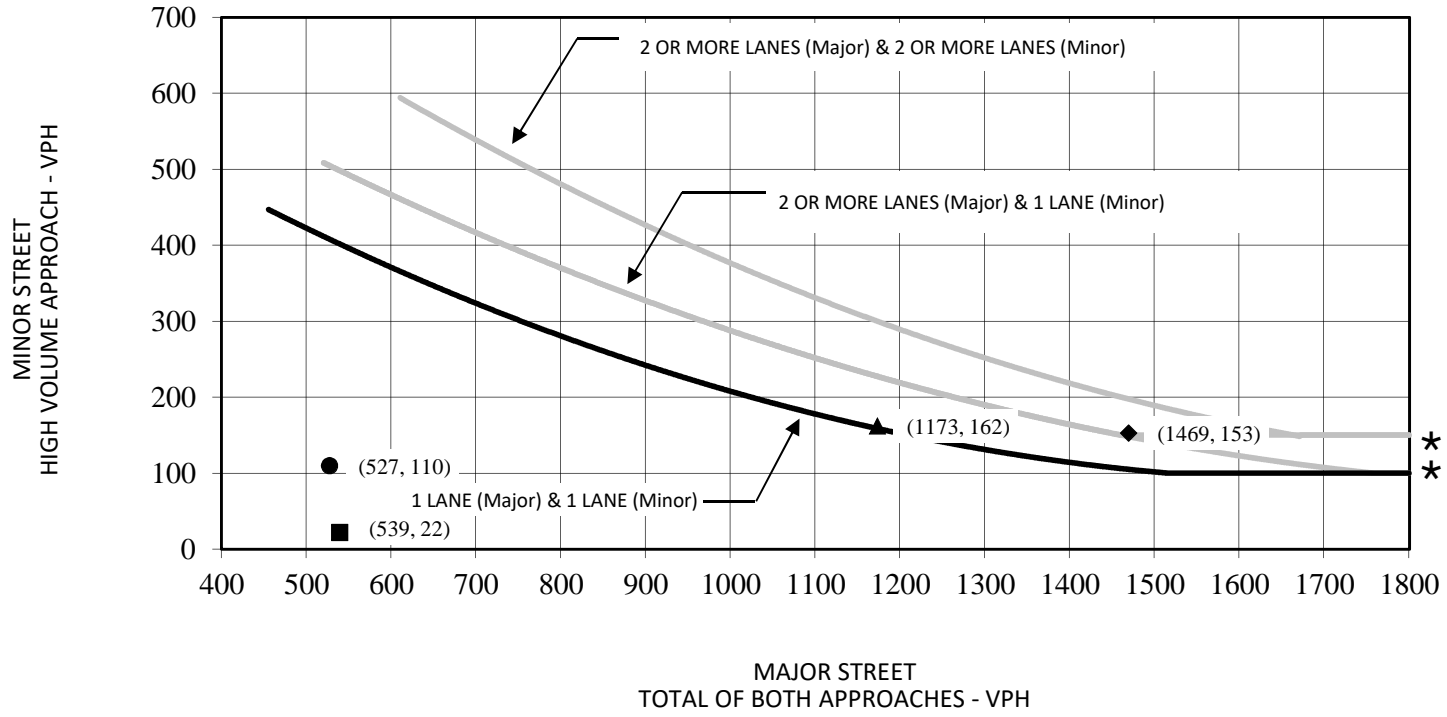

★ 150 VPH applies as the lower threshold volume for a minor street approach with two or more lanes and 100 VPH applies as the lower threshold volume for a minor street approaching with one lane.



FIGURE G-6

- No Project AM Peak Hour
- ▲ With Project AM Peak Hour
- No Project PM Peak Hour
- ◆ With Project PM Peak Hour

Village D Specific Plan
Traffic Impact Analysis

Phase II Peak Hour Warrant: Road 23/Avenue 14 ½

SOURCE: MANUAL ON UNIFORM TRAFFIC CONTROL DEVICES, FIGURE 4C-3

R:\CMD1801 Village D\Traffic\Signal Warrant\SW_INT 10_PHII.xlsx (2/18/2020)

WARRANT 3, PEAK HOUR

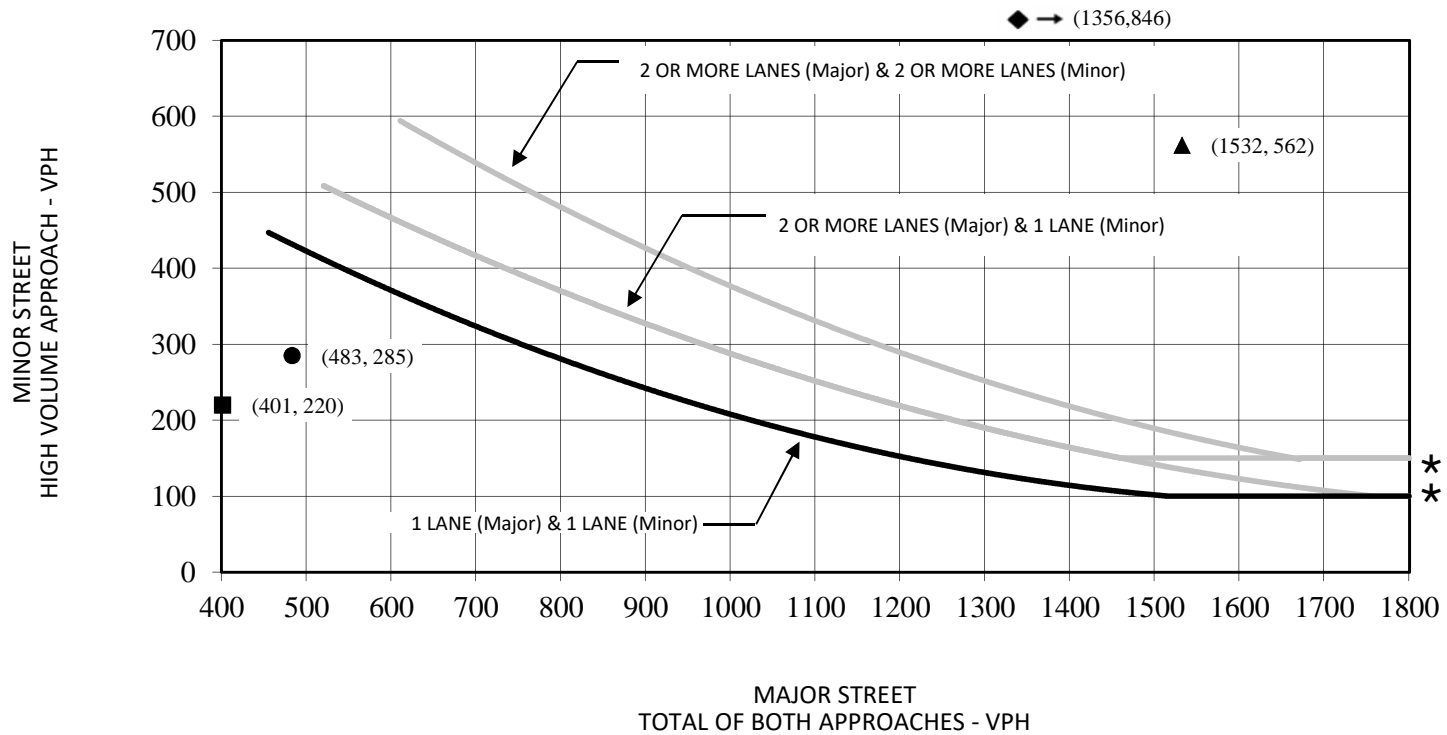

★ 150 VPH applies as the lower threshold volume for a minor street approach with two or more lanes and 100 VPH applies as the lower threshold volume for a minor street approaching with one lane.



FIGURE G-7

- No Project AM Peak Hour
- ▲ With Project AM Peak Hour
- No Project PM Peak Hour
- ◆ With Project PM Peak Hour

Village D Specific Plan
Traffic Impact Analysis

Phase III Peak Hour Warrant: Road 23/Avenue 14

WARRANT 3, PEAK HOUR

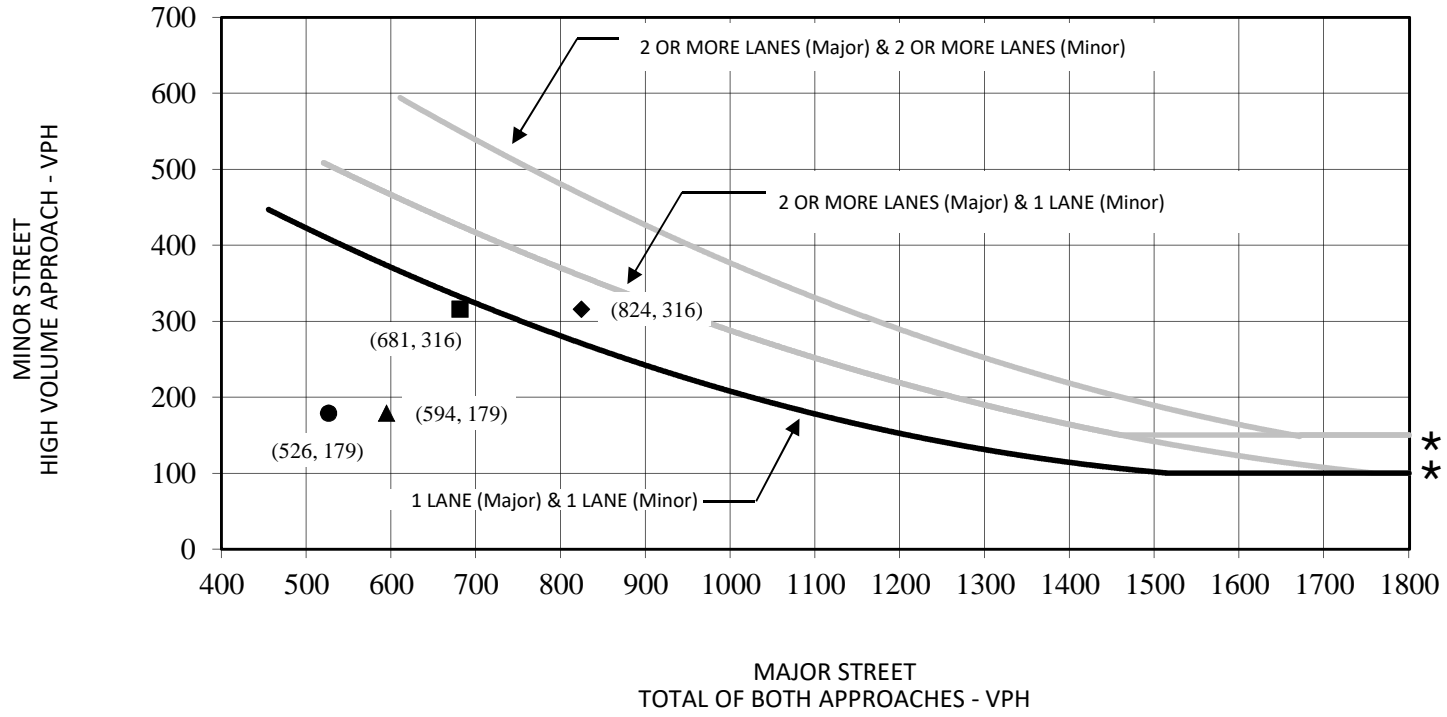

★ 150 VPH applies as the lower threshold volume for a minor street approach with two or more lanes and 100 VPH applies as the lower threshold volume for a minor street approaching with one lane.



FIGURE G-8

- No Project AM Peak Hour
- ▲ With Project AM Peak Hour
- No Project PM Peak Hour
- ◆ With Project PM Peak Hour

Village D Specific Plan
Traffic Impact Analysis

Phase I Peak Hour Warrant: Golden State Boulevard – Airport Drive/Avenue 17

SOURCE: MANUAL ON UNIFORM TRAFFIC CONTROL DEVICES, FIGURE 4C-3

R:\CMD1801 Village D\Traffic\Signal Warrant\SW_INT 13_PHI.xlsx (2/18/2020)

WARRANT 3, PEAK HOUR

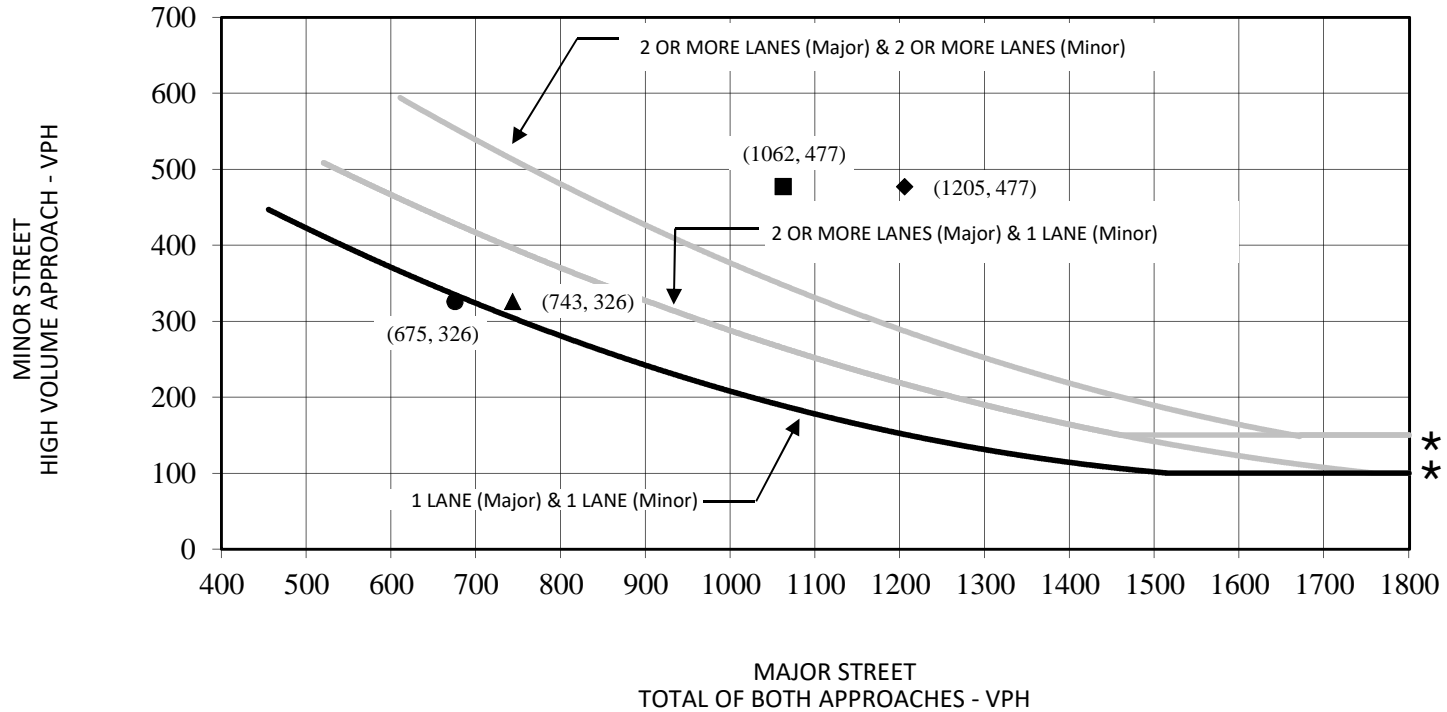

★ 150 VPH applies as the lower threshold volume for a minor street approach with two or more lanes and 100 VPH applies as the lower threshold volume for a minor street approaching with one lane.



FIGURE G-9

- No Project AM Peak Hour
- ▲ With Project AM Peak Hour
- No Project PM Peak Hour
- ◆ With Project PM Peak Hour

Village D Specific Plan
Traffic Impact Analysis

Phase I Peak Hour Warrant: SR-99 Southbound Ramps/Avenue 17

WARRANT 3, PEAK HOUR

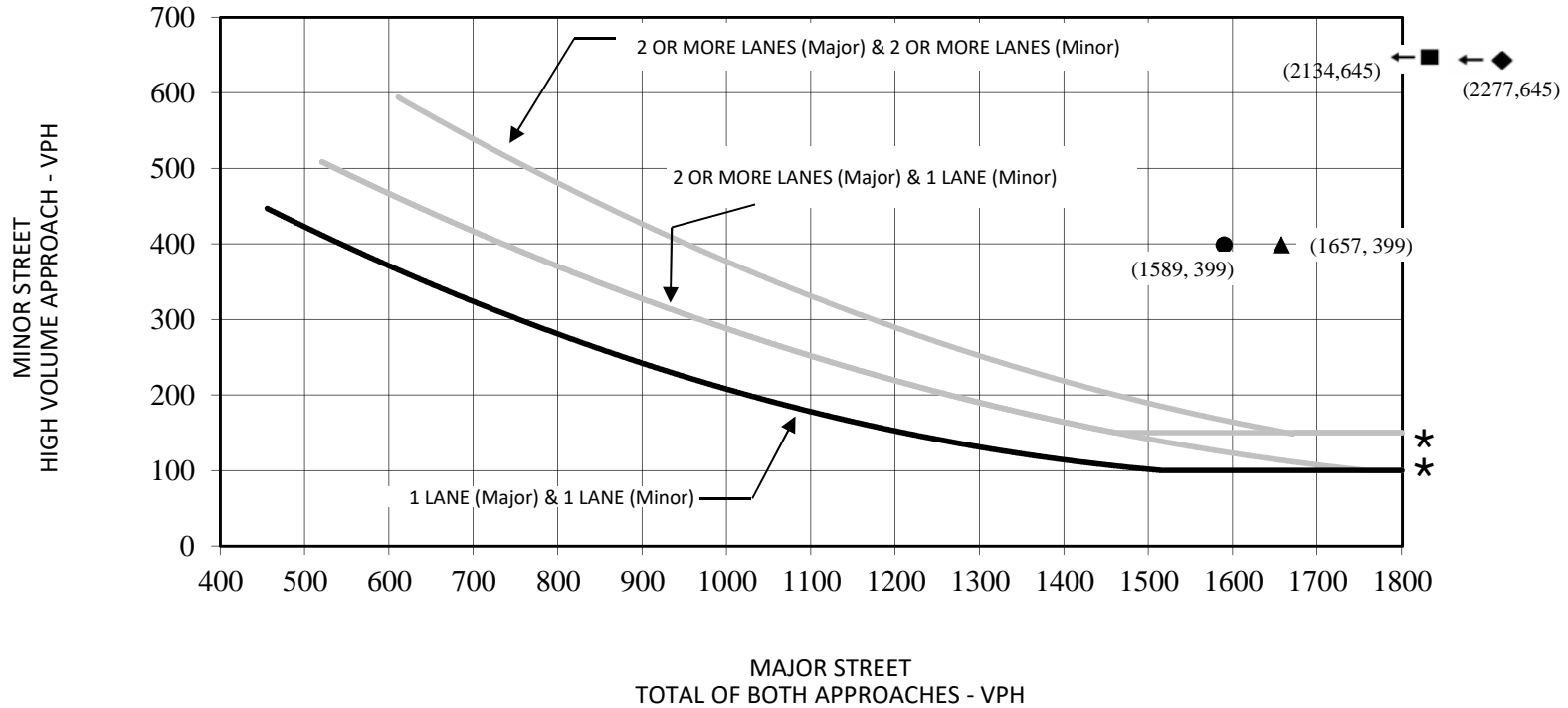

★ 150 VPH applies as the lower threshold volume for a minor street approach with two or more lanes and 100 VPH applies as the lower threshold volume for a minor street approaching with one lane.



FIGURE G-10

- No Project AM Peak Hour
- ▲ With Project AM Peak Hour
- No Project PM Peak Hour
- ◆ With Project PM Peak Hour

Village D Specific Plan
Traffic Impact Analysis

Phase I Peak Hour Warrant: SR-99 Northbound Ramps/Avenue 17

WARRANT 3, PEAK HOUR

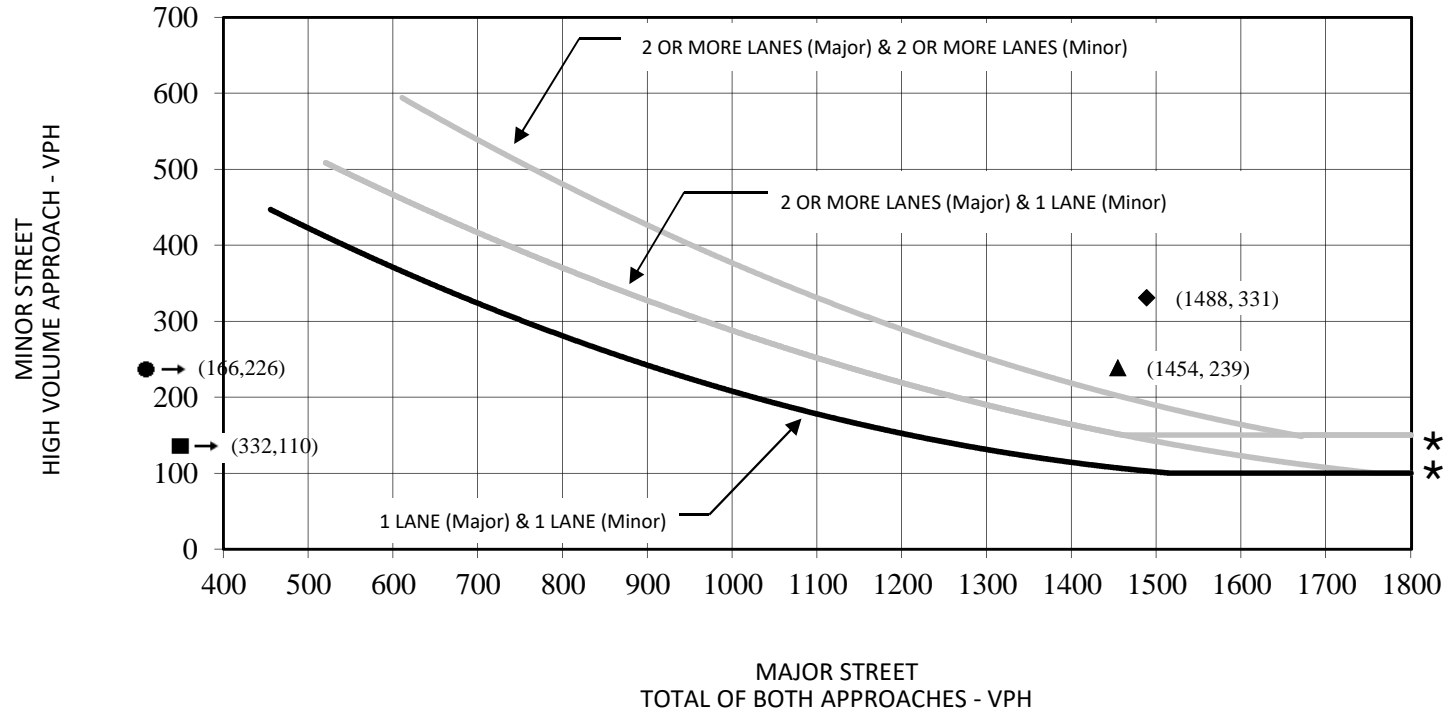

★ 150 VPH applies as the lower threshold volume for a minor street approach with two or more lanes and 100 VPH applies as the lower threshold volume for a minor street approaching with one lane.



FIGURE G-11

- No Project AM Peak Hour
- ▲ With Project AM Peak Hour
- No Project PM Peak Hour
- ◆ With Project PM Peak Hour

Village D Specific Plan
Traffic Impact Analysis

Phase I Peak Hour Warrant: Westberry Boulevard/Cleveland Avenue

WARRANT 3, PEAK HOUR

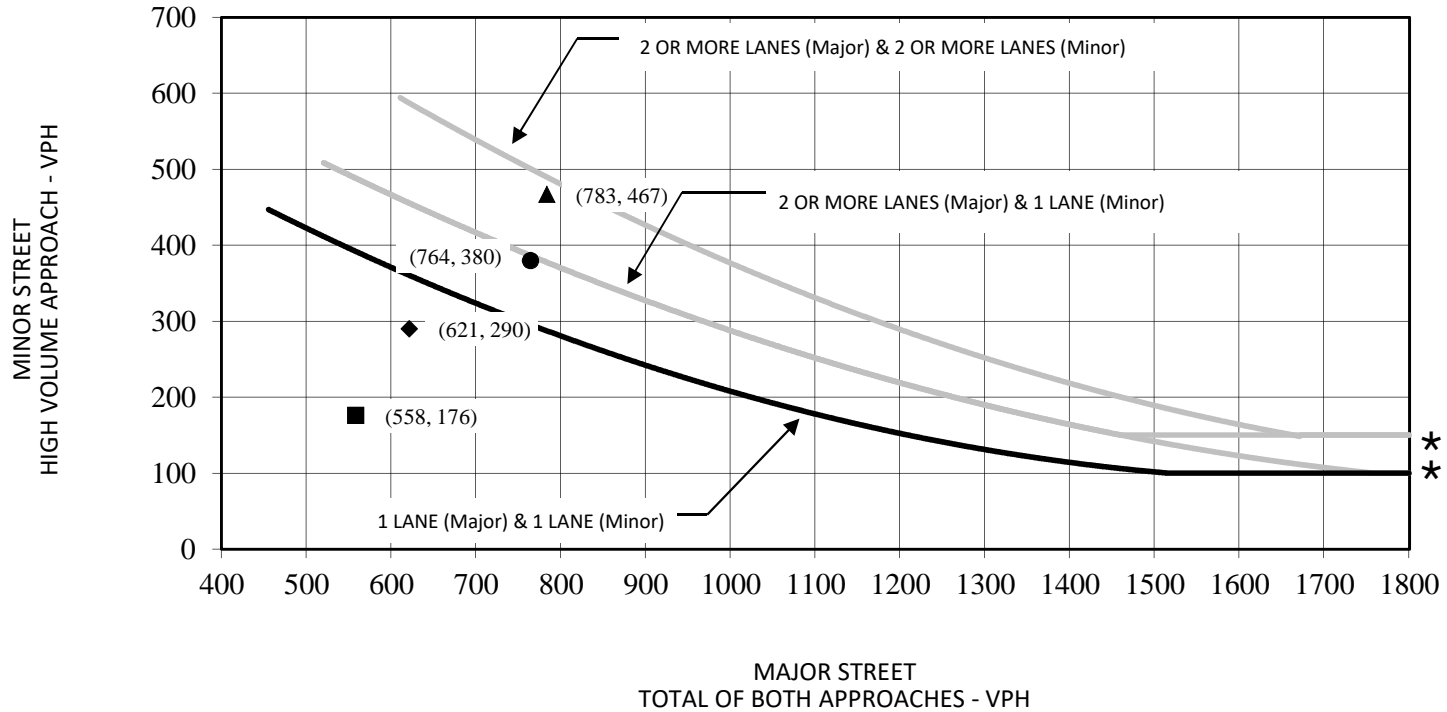

★ 150 VPH applies as the lower threshold volume for a minor street approach with two or more lanes and 100 VPH applies as the lower threshold volume for a minor street approaching with one lane.



FIGURE G-12

- No Project AM Peak Hour
- ▲ With Project AM Peak Hour
- No Project PM Peak Hour
- ◆ With Project PM Peak Hour

Village D Specific Plan
Traffic Impact Analysis

Phase III Peak Hour Warrant: Westberry Boulevard/Sunset Avenue

WARRANT 3, PEAK HOUR

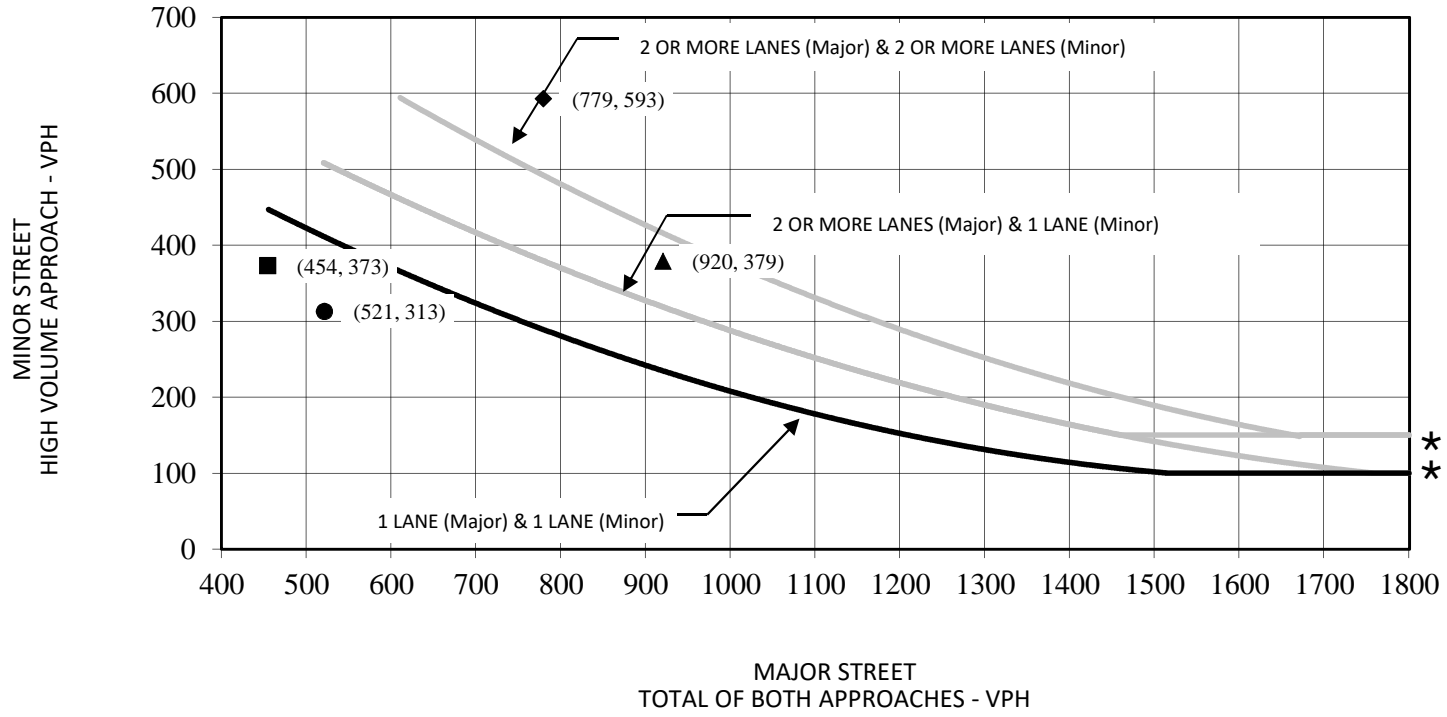

★ 150 VPH applies as the lower threshold volume for a minor street approach with two or more lanes and 100 VPH applies as the lower threshold volume for a minor street approaching with one lane.



FIGURE G-13

- No Project AM Peak Hour
- ▲ With Project AM Peak Hour
- No Project PM Peak Hour
- ◆ With Project PM Peak Hour

Village D Specific Plan
Traffic Impact Analysis

Phase III Peak Hour Warrant: Westberry Boulevard/Avenue 16

WARRANT 3, PEAK HOUR

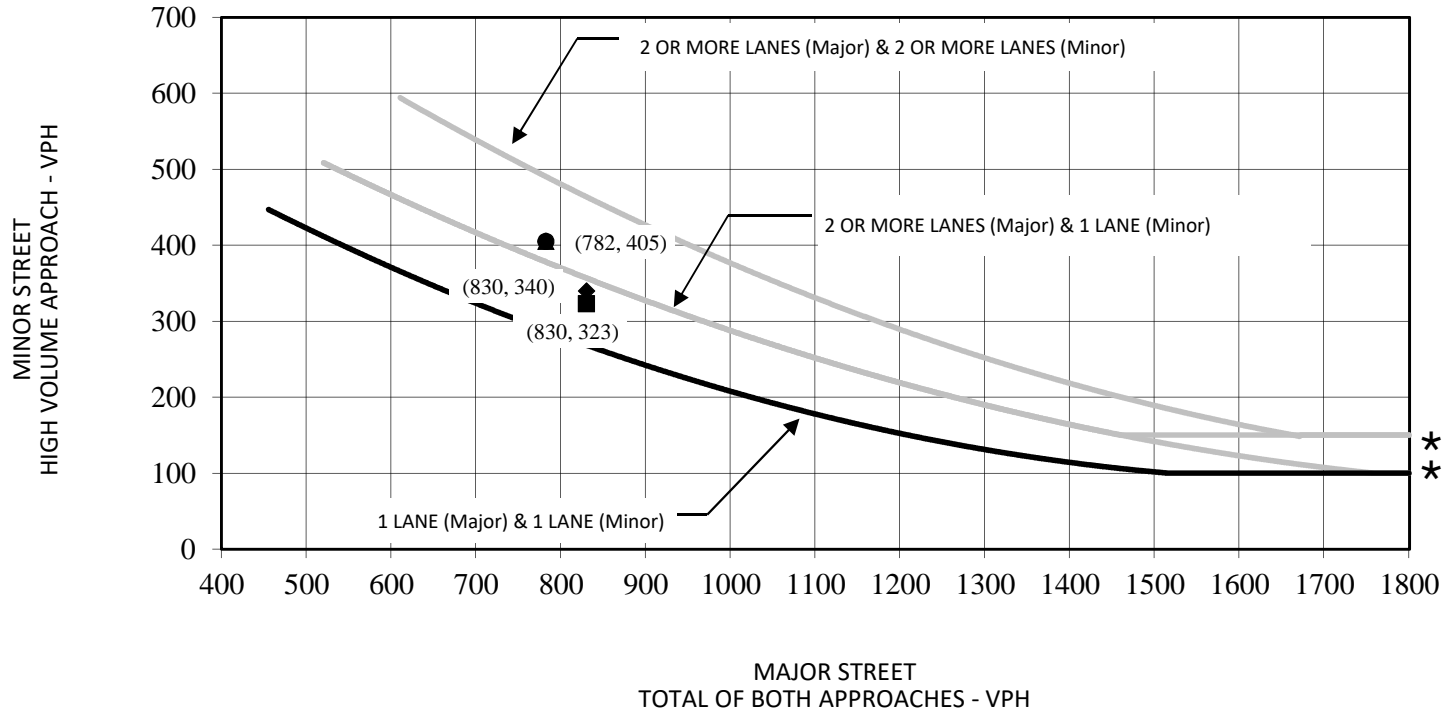

★ 150 VPH applies as the lower threshold volume for a minor street approach with two or more lanes and 100 VPH applies as the lower threshold volume for a minor street approaching with one lane.



FIGURE G-14

- No Project AM Peak Hour
- ▲ With Project AM Peak Hour
- No Project PM Peak Hour
- ◆ With Project PM Peak Hour

Village D Specific Plan
Traffic Impact Analysis

Phase II Peak Hour Warrant: Granada Drive/Sunset Avenue

SOURCE: MANUAL ON UNIFORM TRAFFIC CONTROL DEVICES, FIGURE 4C-3

R:\CMD1801 Village D\Traffic\Signal Warrant\SW_INT 22_PHI.xlsx (2/18/2020)

WARRANT 3, PEAK HOUR

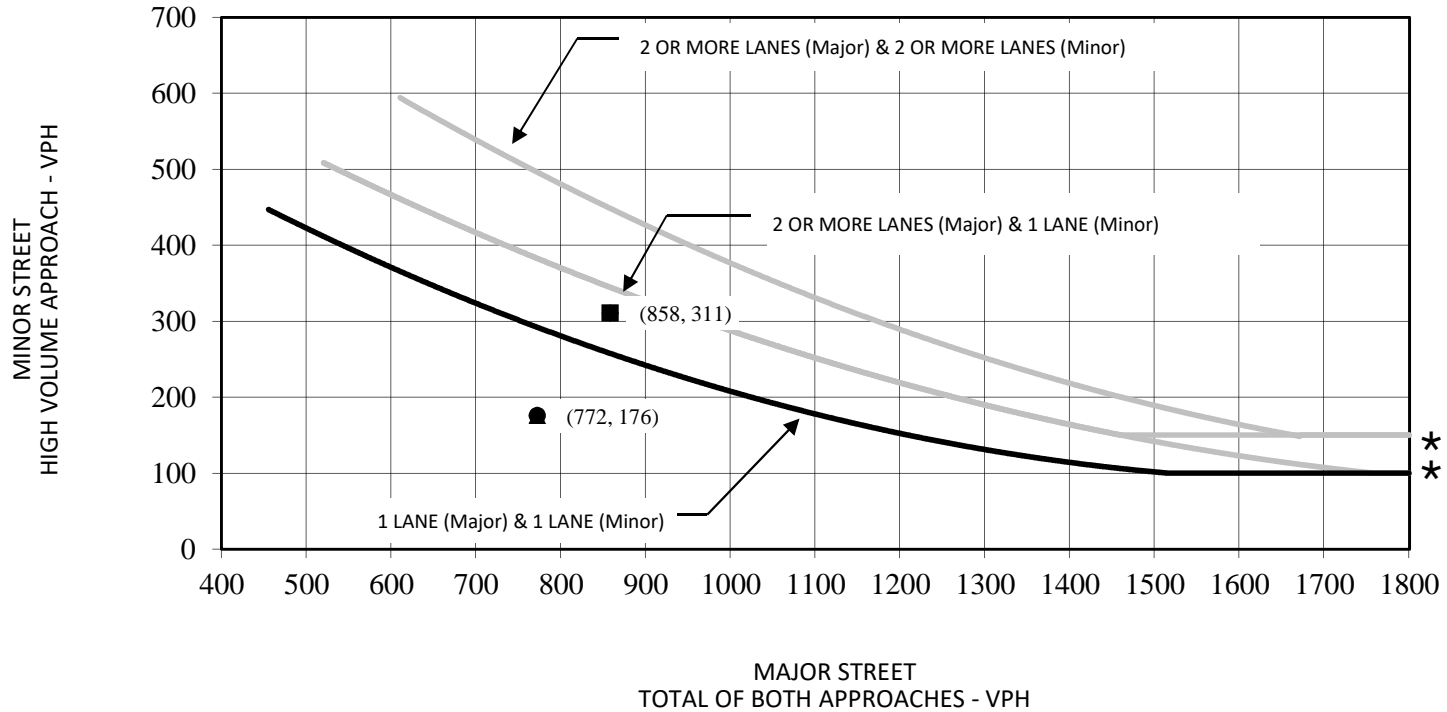

* 150 VPH applies as the lower threshold volume for a minor street approach with two or more lanes and 100 VPH applies as the lower threshold volume for a minor street approaching with one lane.



FIGURE G-15

- No Project AM Peak Hour
- With Project AM Peak Hour
- No Project PM Peak Hour
- With Project PM Peak Hour

*Village D Specific Plan
Traffic Impact Analysis*

Phase I Peak Hour Warrant: SR-99 Southbound Ramps/Kennedy Street - Gateway Drive



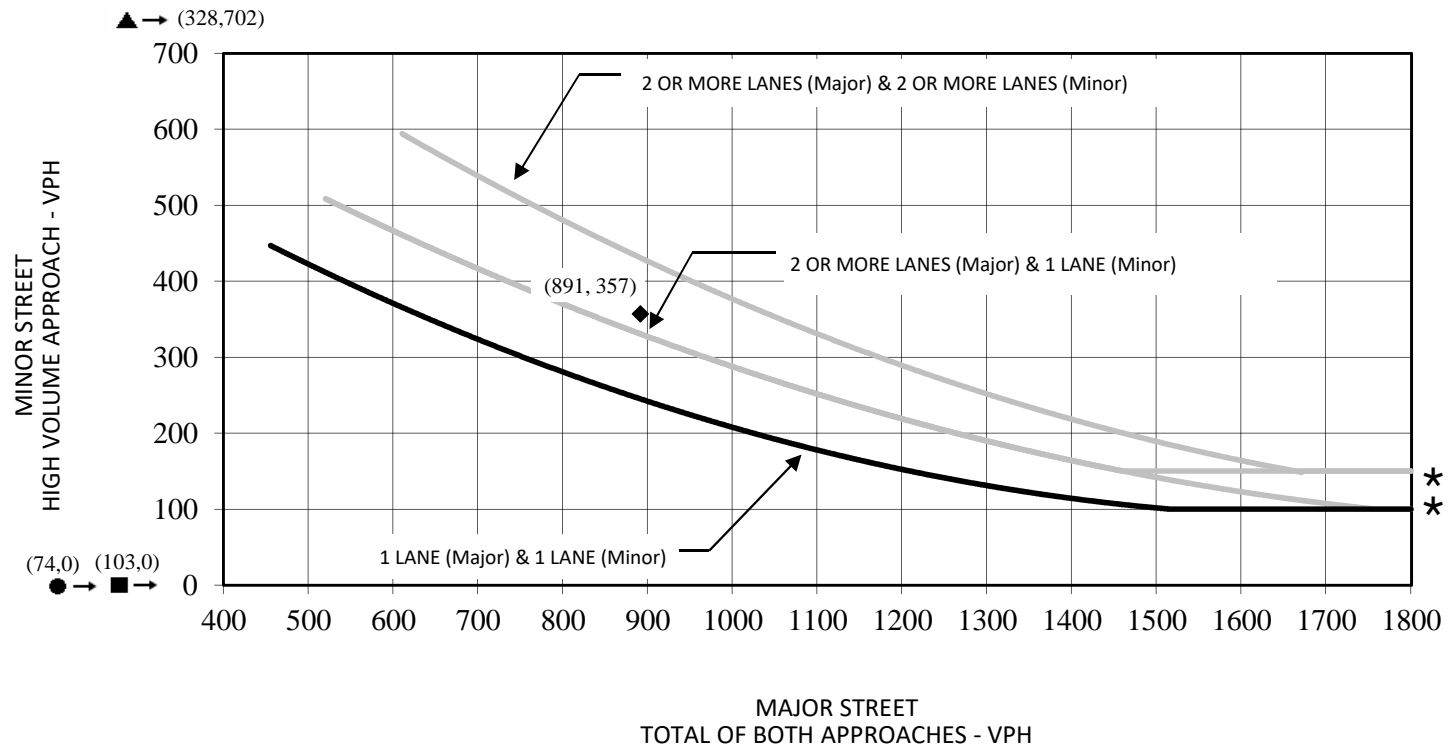

WARRANT 3, PEAK HOUR



* 150 VPH applies as the lower threshold volume for a minor street approach with two or more lanes and 100 VPH applies as the lower threshold volume for a minor street approaching with one lane.



FIGURE G-16

-  No Project AM Peak Hour
-  With Project AM Peak Hour
-  No Project PM Peak Hour
-  With Project PM Peak Hour

Village D Specific Plan
Traffic Impact Analysis

Phase II Peak Hour Warrant: Project Driveway 1/Avenue 17

WARRANT 3, PEAK HOUR

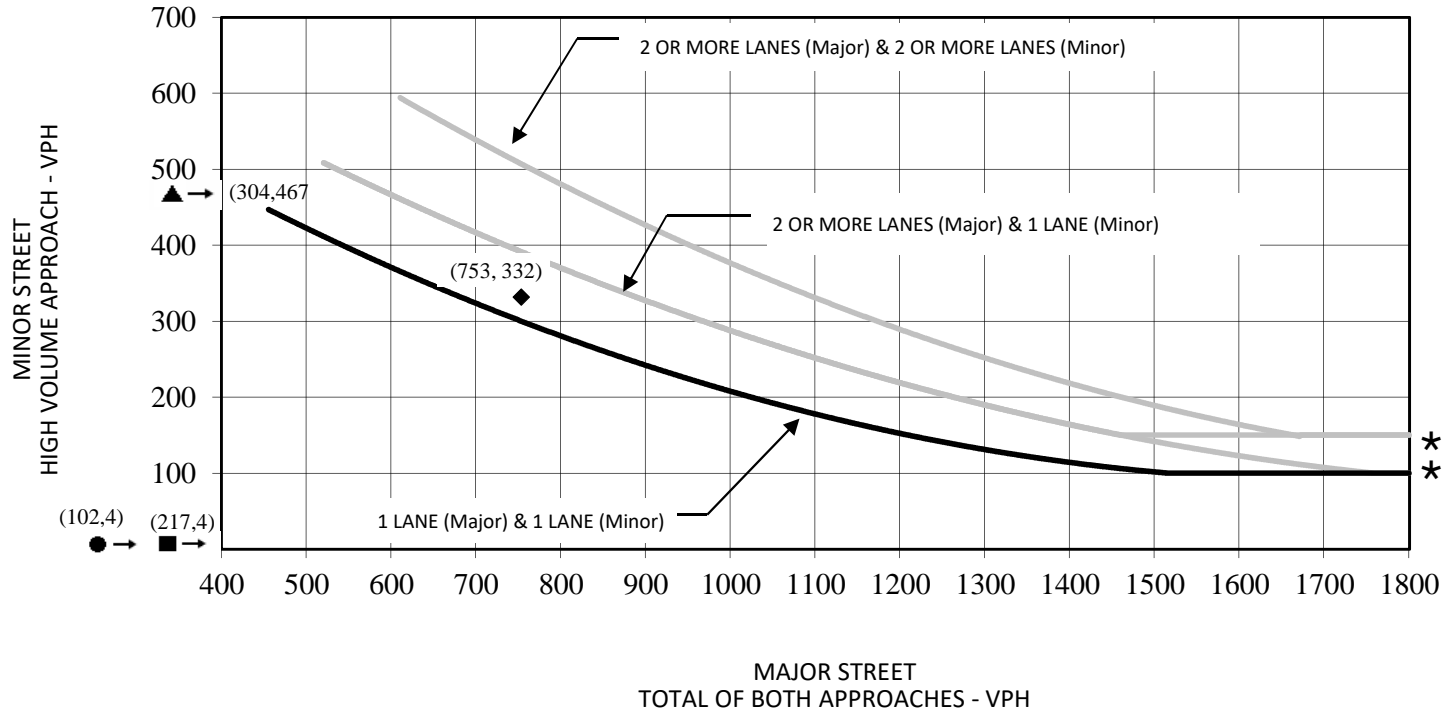

★ 150 VPH applies as the lower threshold volume for a minor street approach with two or more lanes and 100 VPH applies as the lower threshold volume for a minor street approaching with one lane.



FIGURE G-17

- No Project AM Peak Hour
- ▲ With Project AM Peak Hour
- No Project PM Peak Hour
- ◆ With Project PM Peak Hour

Village D Specific Plan
Traffic Impact Analysis

Phase III Peak Hour Warrant: Road 22 ½ - Project Driveway 2/Avenue 16

WARRANT 3, PEAK HOUR

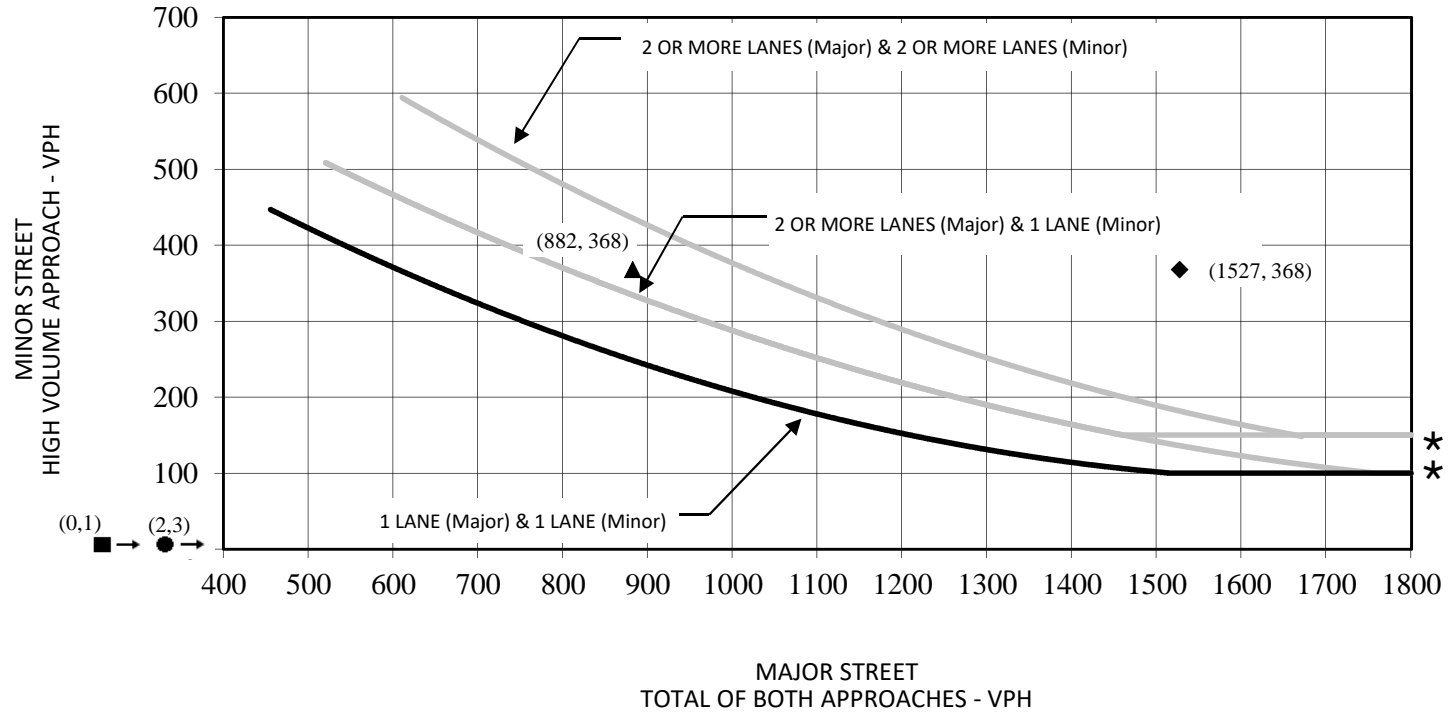

* 150 VPH applies as the lower threshold volume for a minor street approach with two or more lanes and 100 VPH applies as the lower threshold volume for a minor street approaching with one lane.

LSA

FIGURE G-18

- No Project AM Peak Hour
- ▲ With Project AM Peak Hour
- No Project PM Peak Hour
- ◆ With Project PM Peak Hour

Village D Specific Plan
Traffic Impact Analysis

Phase III Peak Hour Warrant: Road 22 ½/Cleveland Avenue

WARRANT 3, PEAK HOUR

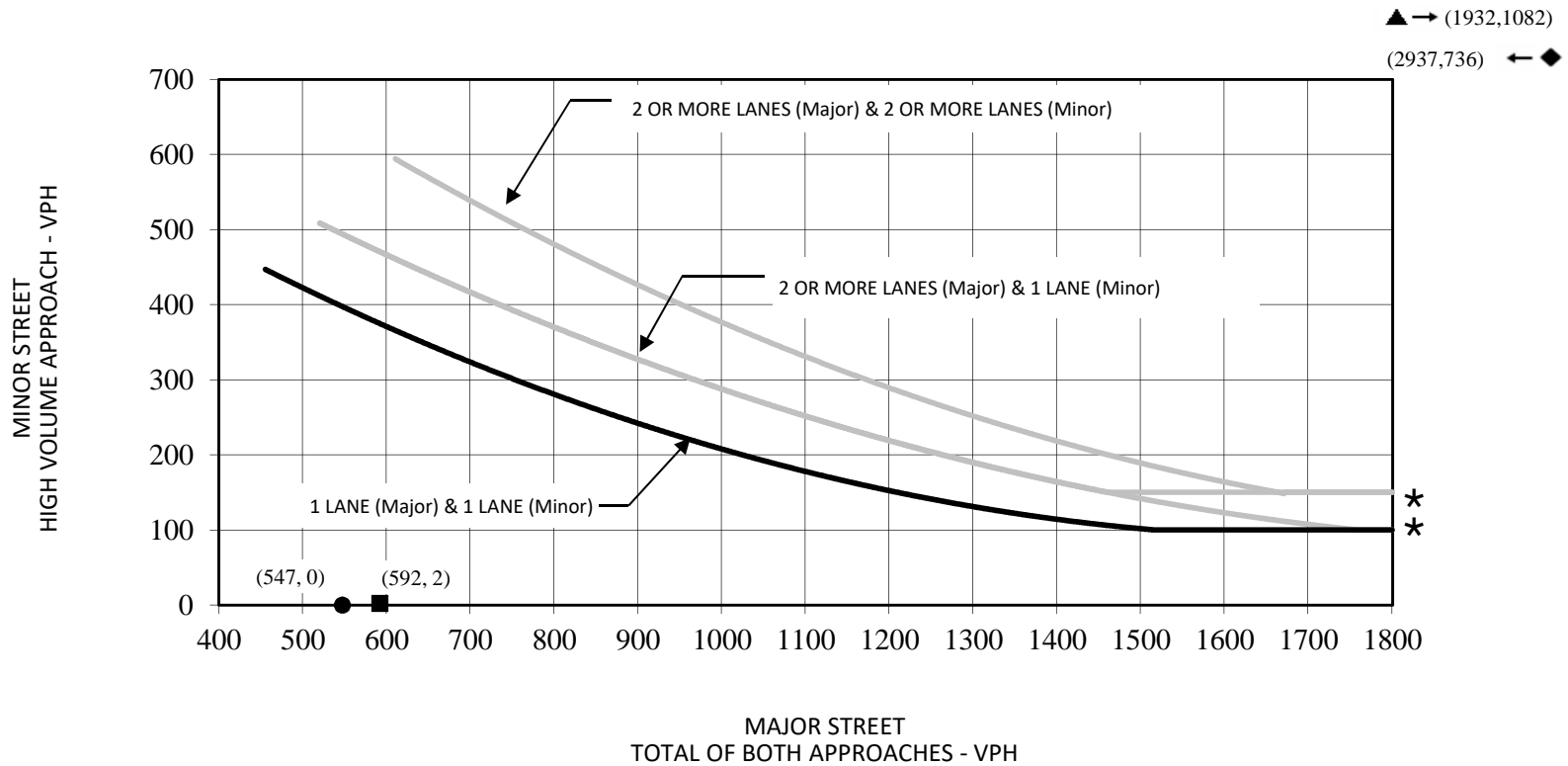

* 150 VPH applies as the lower threshold volume for a minor street approach with two or more lanes and 100 VPH applies as the lower threshold volume for a minor street approaching with one lane.



FIGURE G-19

- No Project AM Peak Hour
- ▲ With Project AM Peak Hour
- No Project PM Peak Hour
- ◆ With Project PM Peak Hour

Village D Specific Plan
Traffic Impact Analysis

Phase II Peak Hour Warrant: Road 23/Project Driveway 3

WARRANT 3, PEAK HOUR

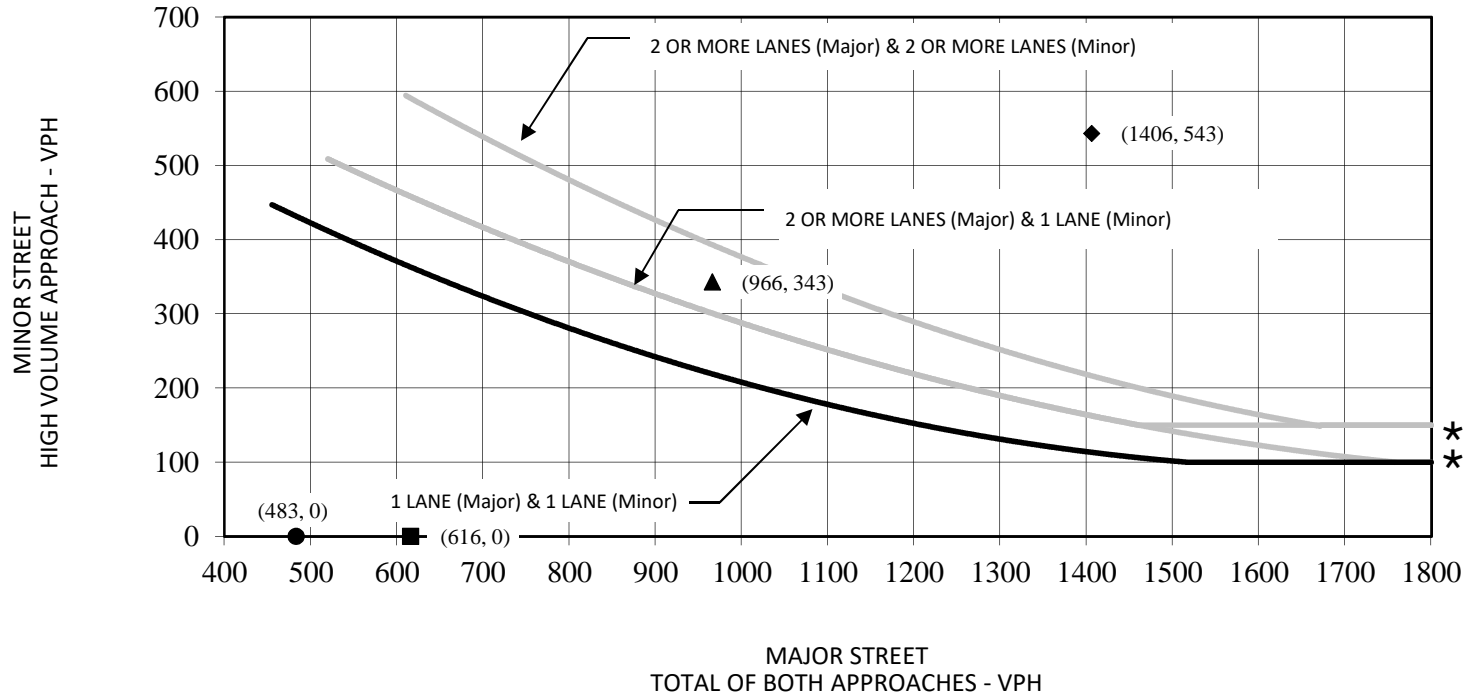

★ 150 VPH applies as the lower threshold volume for a minor street approach with two or more lanes and 100 VPH applies as the lower threshold volume for a minor street approaching with one lane.



FIGURE G-20

- No Project AM Peak Hour
- ▲ With Project AM Peak Hour
- No Project PM Peak Hour
- ◆ With Project PM Peak Hour

Village D Specific Plan
Traffic Impact Analysis

Phase I Peak Hour Warrant: Road 23/Project Driveway 4

SOURCE: MANUAL ON UNIFORM TRAFFIC CONTROL DEVICES, FIGURE 4C-3

WARRANT 3, PEAK HOUR

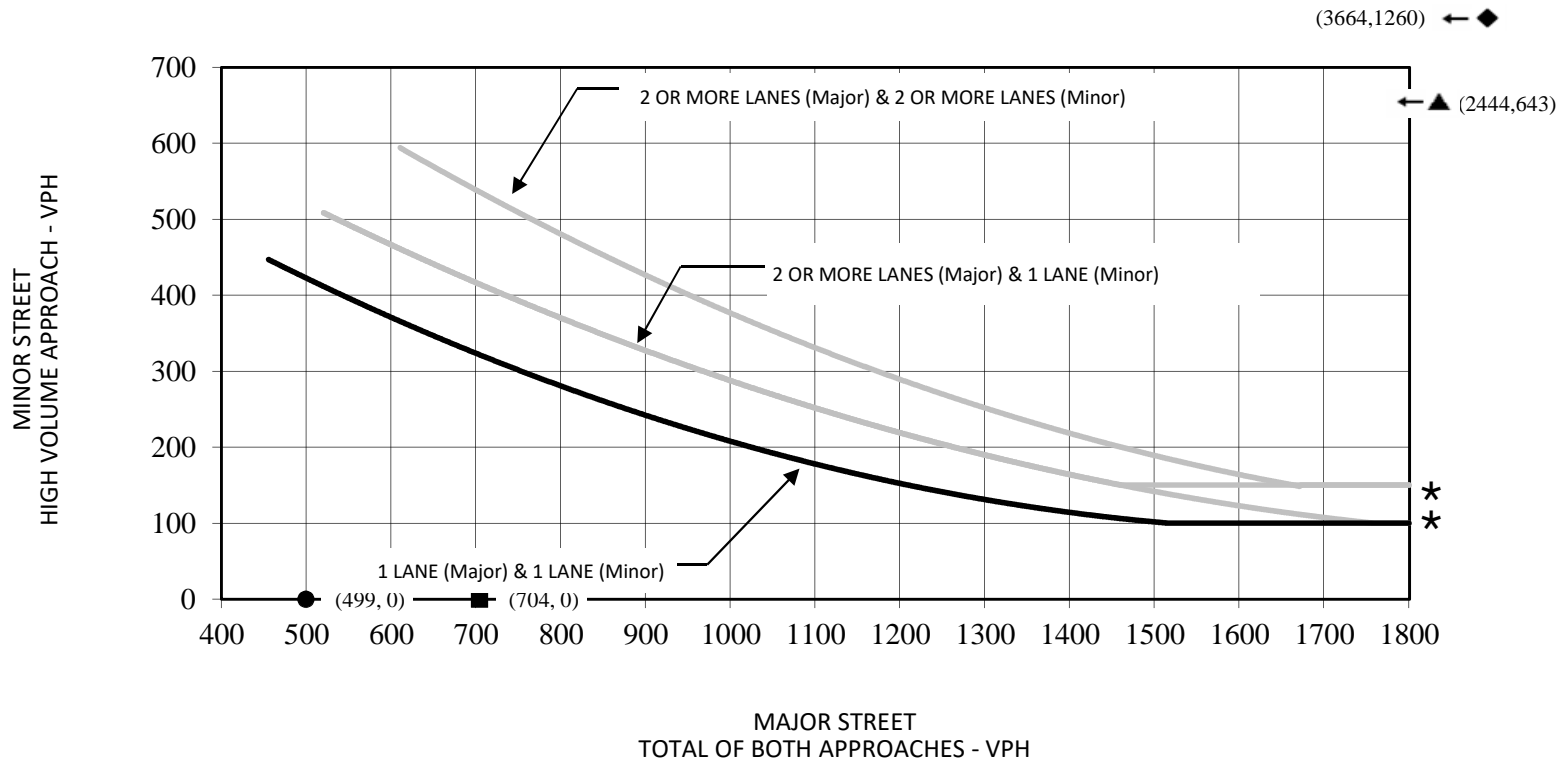

* 150 VPH applies as the lower threshold volume for a minor street approach with two or more lanes and 100 VPH applies as the lower threshold volume for a minor street approaching with one lane.



FIGURE G-21

- No Project AM Peak Hour
- No Project PM Peak Hour
- With Project AM Peak Hour
- With Project PM Peak Hour

Village D Specific Plan
Traffic Impact Analysis

Phase III Peak Hour Warrant: Road 23/Project Driveway 5

WARRANT 3, PEAK HOUR

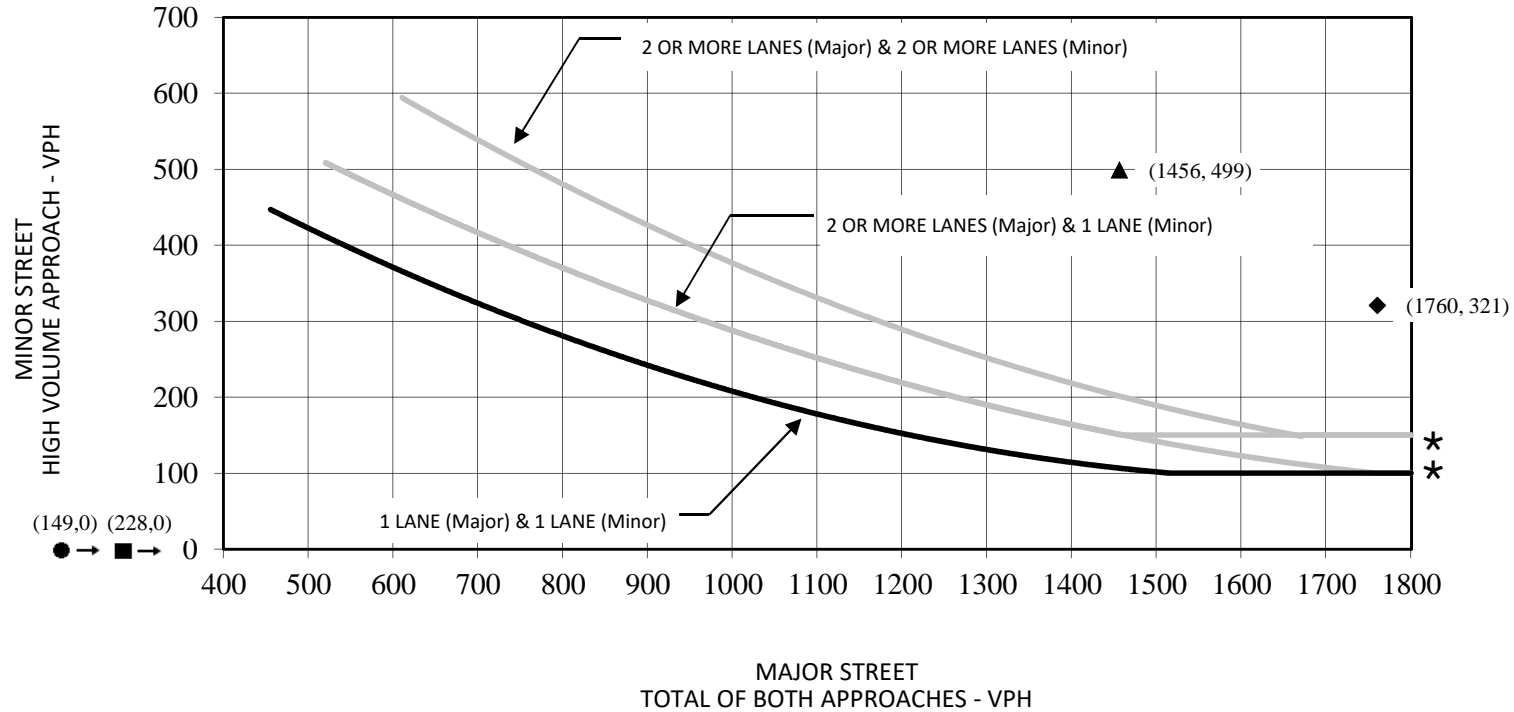

★ 150 VPH applies as the lower threshold volume for a minor street approach with two or more lanes and 100 VPH applies as the lower threshold volume for a minor street approaching with one lane.



FIGURE G-22

- No Project AM Peak Hour
- ▲ With Project AM Peak Hour
- No Project PM Peak Hour
- ◆ With Project PM Peak Hour

Village D Specific Plan
Traffic Impact Analysis

Phase I Peak Hour Warrant: Project Driveway 6/Cleveland Avenue

APPENDIX H:

VMT CALCULATION WORKSHEETS

Appendix H

Village D Specific Plan VMT Calculation Worksheet

Residential VMT Calculation

Region	Total Homebased VMT	Total Population	VMT/Capita
2018 Entire Modeling Area (No Project)	2,096,401	142,685	14.69
2018 Madera City	623,208	52,674	11.83
2042 Project Only	357,603	32,403	11.04
2042 Madera City	759,534	70,255	10.81
2042 Entire Modeling Area (No Project)	2,588,030	192,670	13.43
2042 Entire Modeling Area (Including Project)	2,945,634	225,073	13.09

Existing (2019) Entire Modeling Area (No Project) VMT/Capita (Interpolation) **14.64**
 2042 Project VMT/Capita **11.04**
 Percentage Difference between project VMT/Capita (2042) and Existing (2019) Regional VMT/Capita **-24.6%**

Non-Residential VMT Calculation

Region	Total Homebased Work VMT	Total Employment	VMT/Employee
2018 Entire Modeling Area (No Project)	1,192,342	47,700	25.00
2018 Madera City	274,895	14,982	18.35
2042 Project Only	83,353	5,198	16.04
2042 Madera City	360,920	22,185	16.27
2042 Entire Modeling Area (No Project)	1,488,604	64,454	23.10
2042 Entire Modeling Area (Including Project)	1,571,957	69,652	22.57

Existing (2019) Entire Modeling Area (No Project) VMT/Employee (Interpolation) **24.92**
 2042 Project VMT/Employee **16.04**
 Percentage Difference Between Project VMT/Employee (2042) and Existing (2019) Regional VMT/Employee **-35.6%**

Service Population VMT Calculation

Region	Total VMT	Total Service Population	VMT/Service Population
2018 Entire Modeling Area (No Project)	4,431,162	190,375	23.28
2018 Madera City	1,373,131	67,656	20.30
2042 Project Only	696,447	37,601	18.52
2042 Madera City	1,740,847	92,440	18.83
2042 Entire Modeling Area (No Project)	5,405,361	257,124	21.02
2042 Entire Modeling Area (Including Project)	5,820,513	294,725	19.75

Existing (2019) Entire Modeling Area (No Project) VMT/Service Population (Interpolation) **23.18**
 2042 Project VMT/Service Population **18.52**
 Percentage Difference Between Project VMT/Service Population (2042) and Existing Regional VMT/Service Population **-20.1%**

This page intentionally left blank