

***Pepper Canyon Ancillary Site Work Project  
UC San Diego Project/Job Number: 963540/5434***

**Addendum No. 8 to Program Environmental Impact Report for the  
2018 La Jolla Campus Long Range Development Plan**

Prepared by:

**DUDEK  
605 3RD STREET ENCINITAS, CALIFORNIA  
605 3<sup>RD</sup> STREET  
ENCINITAS, CALIFORNIA 92024**

Prepared for:

**CAMPUS PLANNING OFFICE  
UNIVERSITY OF CALIFORNIA, SAN DIEGO  
9500 GILMAN DRIVE, MC 0074  
LA JOLLA, CALIFORNIA 92093-0074**

*May 2021*



# TABLE OF CONTENTS

<u>Section</u>	<u>Page</u>
<b>1 INTRODUCTION .....</b>	<b>1-1</b>
1.1 Project Summary.....	1-1
1.2 Purpose of Consistency Review .....	1-2
1.3 CEQA Determination .....	1-3
<b>2 PROJECT DESCRIPTION.....</b>	<b>2-1</b>
2.1 Regional Location and Setting .....	2-1
2.2 Project Site and Setting.....	2-1
2.3 Project Background .....	2-9
2.4 Project Objectives .....	2-9
2.5 Project Features.....	2-10
2.5.1 Project Components .....	2-10
2.5.2 Landscape Improvements.....	2-11
2.5.3 Hardscape Improvements.....	2-13
2.5.4 Regional Storm Water Quality Basin.....	2-17
2.5.5 Utility and Service Systems .....	2-21
2.5.6 Project Construction .....	2-22
2.5.7 Sustainability Features .....	2-23
2.6 Project Approval/Schedule.....	2-25
<b>3 CONSISTENCY WITH 2018 LRDP .....</b>	<b>3-1</b>
3.1 2018 LRDP Objectives .....	3-1
3.2 2018 LRDP Campus Population.....	3-4
3.3 2018 LRDP Land USE.....	3-4
3.4 2018 LRDP Development Space .....	3-5
<b>4 CONSISTENCY WITH 2018 LRDP EIR.....</b>	<b>4-1</b>
4.1 Evaluation of Project Environmental Impacts .....	4-1
4.1.1 Aesthetics .....	4-3
4.1.2 Air Quality .....	4-5
4.1.3 Biological Resources .....	4-8
4.1.4 Cultural and Tribal Cultural Resources.....	4-17
4.1.5 Energy.....	4-22
4.1.6 Geology and Soils.....	4-23
4.1.7 Greenhouse Gas Emissions .....	4-26
4.1.8 Hazards and Hazardous Materials .....	4-28
4.1.9 Hydrology and Water Quality .....	4-32
4.1.10 Land Use and Planning.....	4-37
4.1.11 Noise.....	4-38
4.1.12 Population and Housing.....	4-40
4.1.13 Public Services.....	4-41
4.1.14 Recreation .....	4-42
4.1.15 Transportation and Circulation .....	4-44
4.1.16 Utilities and Service Systems .....	4-46
4.1.17 Wildfire.....	4-50
4.1.16 Mandatory Findings of Significance.....	4-53
<b>5 APPLICABLE MITIGATION MEASURES.....</b>	<b>5-1</b>
<b>6 REFERENCES .....</b>	<b>6-1</b>

**List of Figures**

1 Regional Map..... 2-3  
 2 Project Vicinity..... 2-5  
 3 Site Boundary Map ..... 2-7  
 4 Proposed Trail Diagram..... 2-14  
 5 Location of Regional Storm Water Quality Basin ..... 2-19  
 6 Biological Resources..... 4-13

**List of Tables**

2-1 Project Components ..... 2-10  
 3-1 Total Campus Population Growth Projections..... 3-4  
 3-2 Total Campus Space Projections ..... 3-6  
 4-1 Vegetation Communities and Land Covers on the Project Site ..... 4-11  
 4-2 Jurisdictional Aquatic Resources on the Project Site ..... 4-11

**List of Appendices**

Appendix A – Aquatic Resources Delineation Report for the Pepper Canyon Basin (May 2021)  
 Appendix B – Drainage Study for UCSD Pepper Canyon Ancillary Site Work (April 2021)  
 Appendix C – Post-Construction Stormwater Management Checklist – Pepper Canyon Ancillary Site  
 Work Project (February 2021)

# 1 INTRODUCTION

## 1.1 PROJECT SUMMARY

The Pepper Canyon Ancillary Site Work Project (Project) is addressed in this Addendum for consistency with the 2018 Long Range Development Plan (LRDP) for the University of California (UC) San Diego La Jolla Campus and the certified Program Environmental Impact Report (EIR) assessing the environmental impacts of implementing the plan (SCH No. 2016111019).

**Project name:** Pepper Canyon Ancillary Site Work Project

**Project location:** University of California, San Diego

**Lead agency's name and address:** The Regents of the University of California  
1111 Franklin Street  
Oakland, CA 94607

**Contact person:** Lauren Kahal Livers, Senior Planner  
UC San Diego Campus Planning Office

**Project sponsor's name and address:** UC San Diego  
9500 Gilman Drive, MC 0074  
La Jolla, California 92093-0074

**Location of administrative record:** UC San Diego Campus Planning Office  
10280 North Torrey Pines Road, Suite 460  
La Jolla, CA 92093

**Previously Certified 2018 LRDP Program EIR:** The 2018 LRDP is a comprehensive land use plan that guides physical development on campus to accommodate projected enrollment increases and new program initiatives. The 2018 LRDP and its EIR are available at the following locations:

- UC San Diego Campus Planning Office in Torrey Pines Center South, Suite 460, 10280 North Torrey Pines Road, La Jolla, CA.
- Online at: <http://lrdp.ucsd.edu/campus/review/final.html>

## 1.2 PURPOSE OF CONSISTENCY REVIEW

This document provides a project-level review of whether the Pepper Canyon Ancillary Site Work Project (Project) is consistent with the scope of activities identified in the 2018 LRDP and covered in the environmental impact evaluation in the 2018 LRDP EIR. This document will also serve as the Project-specific Addendum to the 2018 LRDP Program EIR, as described in the California Environmental Quality Act (CEQA) determination below.

The 2018 LRDP is a comprehensive land use plan that guides physical development on campus to accommodate projected enrollment increases and expanded and new program initiatives (UC San Diego 2018a). The 2018 LRDP EIR was prepared in accordance with Section 15168 of the California Environmental Quality Act (CEQA) Guidelines and California Public Resources Code, Section 21094, and analyzed the environmental impacts of the 2018 LRDP (UC San Diego 2018b). The 2018 LRDP EIR (Volume I) analyzes full implementation of uses and physical development proposed under the 2018 LRDP and identifies measures to mitigate the significant adverse program-level and cumulative impacts associated with that growth.

This Addendum documents whether the site-specific development proposed by the Project is consistent with the objectives, land use plans and development and population forecasts contained in the 2018 LRDP and is covered by the 2018 LRDP EIR pursuant to Section 15168(c) of the CEQA Guidelines, which states, “subsequent activities in the program must be examined in the light of the program EIR to determine whether an additional environmental document must be prepared.” Pursuant to Section 15168(c)(4), an agency should use “...a written checklist or similar device to document the evaluation of the site and the activity to determine whether the environmental effects of the operation were covered in the program EIR.” This Addendum also documents that none of the conditions described in CEQA Guidelines Section 15162 calling for the preparation of a subsequent EIR have occurred and an addendum to the 2018 LRDP EIR may be prepared (14 CCR 15164).

### 1.3 CEQA DETERMINATION

UC San Diego previously prepared the 2018 LRDP EIR and on the basis of this evaluation and pursuant to the State CEQA Guidelines:

- I find that the Project **WOULD NOT** have new significant effects on the environment have occurred with respect to the circumstances under which the Project will be undertaken, and no new information of substantial importance to the Project has been identified. However, minor technical changes or additions are necessary, and in accordance with §15164 of the State CEQA Guidelines, an **ADDENDUM** has been prepared.
  
- I find that although the Project **WOULD** have one or more new significant effects on the environment, there will not be a significant effect in this case because new project-specific mitigation measures have been identified that would reduce the effects to a less than significant level. In accordance with §15162 of the State CEQA Guidelines, a **TIERED MITIGATED NEGATIVE DECLARATION** has been prepared.
  
- I find that the Project **MAY** have a new significant effect on the environment that was not adequately addressed in the previous EIR or a significant effect previously examined will be substantially more severe than shown in the previous EIR, and there may not be feasible mitigation which would reduce the new significant effect to a less than significant level. In accordance with §15162 of the State CEQA Guidelines, a **TIERED ENVIRONMENTAL IMPACT REPORT** is required.

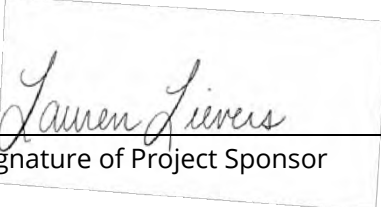

Signature of Project Sponsor

May 18, 2021

Date

This page intentionally left blank.



## 2 PROJECT DESCRIPTION

### 2.1 REGIONAL LOCATION AND SETTING

The UC San Diego La Jolla campus is located adjacent to the communities of La Jolla and University City, within the northwest portion of the City of San Diego (see Figure 2-1 of the 2018 LRDP Program EIR). UC San Diego's campus is generally composed of three distinct, but contiguous, geographical areas: the Scripps Institution of Oceanography (SIO) portion of the campus (178.7 acres), the western area of the campus (West Campus, 634.8 acres), and the eastern area of the campus (East Campus, 265.7 acres). The East and West Campuses are bisected by Interstate 5 [I-5]. The La Jolla del Sol housing complex (12 acres) is located southeast of these larger geographical areas and not contiguous to the campus.

Refer to Section 2.2 of the 2018 LRDP EIR for additional description on each of the campus areas. Also included in the 2018 LRDP are the beach properties, consisting of the Audrey Geisel House and an adjacent coastal canyon and beachfront parcel (25.8 acres), and the Torrey Pines Gliderport, Torrey Pines Center and Torrey Pines Court (41.0 acres). The 2018 LRDP addresses campus properties that encompass a total of 1,158 acres in La Jolla, California (see Figure 2-2 of the 2018 LRDP EIR).

### 2.2 PROJECT SITE AND SETTING

The proposed Project would be located on the West Campus, which is situated between Genesee Avenue to the north, La Jolla Village Drive to the south, North Torrey Pines Road to the west, and I-5 to the east (see Figure 1, Regional Map, and Figure 2, Project Vicinity). The West Campus is the largest and most developed of the three areas of the La Jolla Campus with approximately 11 million gross square feet (GSF) of total building space on approximately 635 acres of land. Seven undergraduate colleges and four professional schools are located on this portion of the campus. In addition to academic instruction and research facilities, the West Campus includes libraries; theaters; and student activity, administrative, sports/recreational, housing, dining, a central utilities plant, a satellite utility plant, campus services, and parking facilities (UC San Diego 2018a).

The Project site is located within the Pepper Canyon Neighborhood on the eastern edge of West Campus (see Figure 2-6 of the 2018 LRDP Program EIR). The Project site is located on a total of approximately 2.35 acres within a small canyon ("Pepper Canyon"), bound by the future Rupertus Walk to the north, The Village at Pepper Canyon East and Matthews

Apartments to the east, Gilman Drive to the south, and The Village at Pepper Canyon West to the west. (Note The Village at Pepper Canyon West was previously known as Sixth College Residence Halls, which relocated to North Torrey Pines Living and Learning Neighborhood). An elevated Light Rail Transit (LRT) guideway travels over the canyon, with the UC San Diego Central Campus Trolley Station (“Central Campus Trolley Station”) located at the northern edge of the canyon. The land use designation for the Project site in the 2018 LRDP is the Urban Forest category of Open Space Preserve, with surrounding land uses including Academic Mixed-Use to the west (The Village at Pepper Canyon West), Academic to the north and south (Structural and Materials Engineering Building and Biomedical Sciences Buildings) and Housing to the east (Matthews Apartments and The Village at Pepper Canyon East) (see Figure 3.5: LRDP Land Use Plan in the 2018 LRDP; UC San Diego 2018a).

The Project site is located within a construction zone associated with the San Diego County Association of Governments (SANDAG) Mid-Coast Corridor Transit Project which is currently constructing the LRT line and Central Campus Trolley Station and will enter the testing phase summer 2021, with operation expected in late 2021. The LRT line and station are elevated over the proposed Project site and are supported by several large columns, one of which is located within the limits of the proposed Project. The proposed Project is designed to be integrated with the adjacent projects’ post-construction conditions, including the future level of grade and utilities connections.

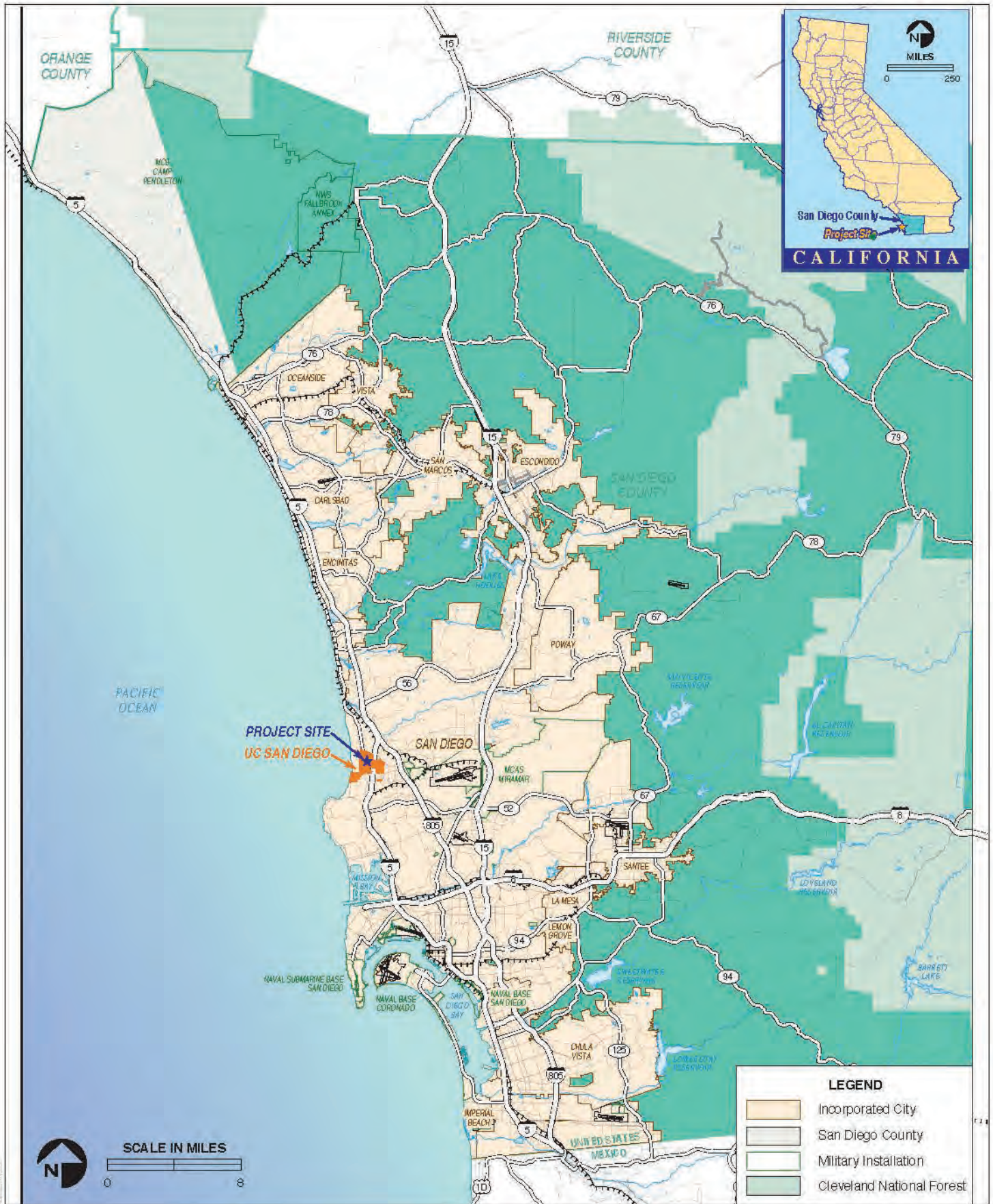

SOURCE: UCSD 2018

**FIGURE 1**

**Regional Map**

Pepper Canyon Ancillary Site Work Project

This page intentionally left blank.

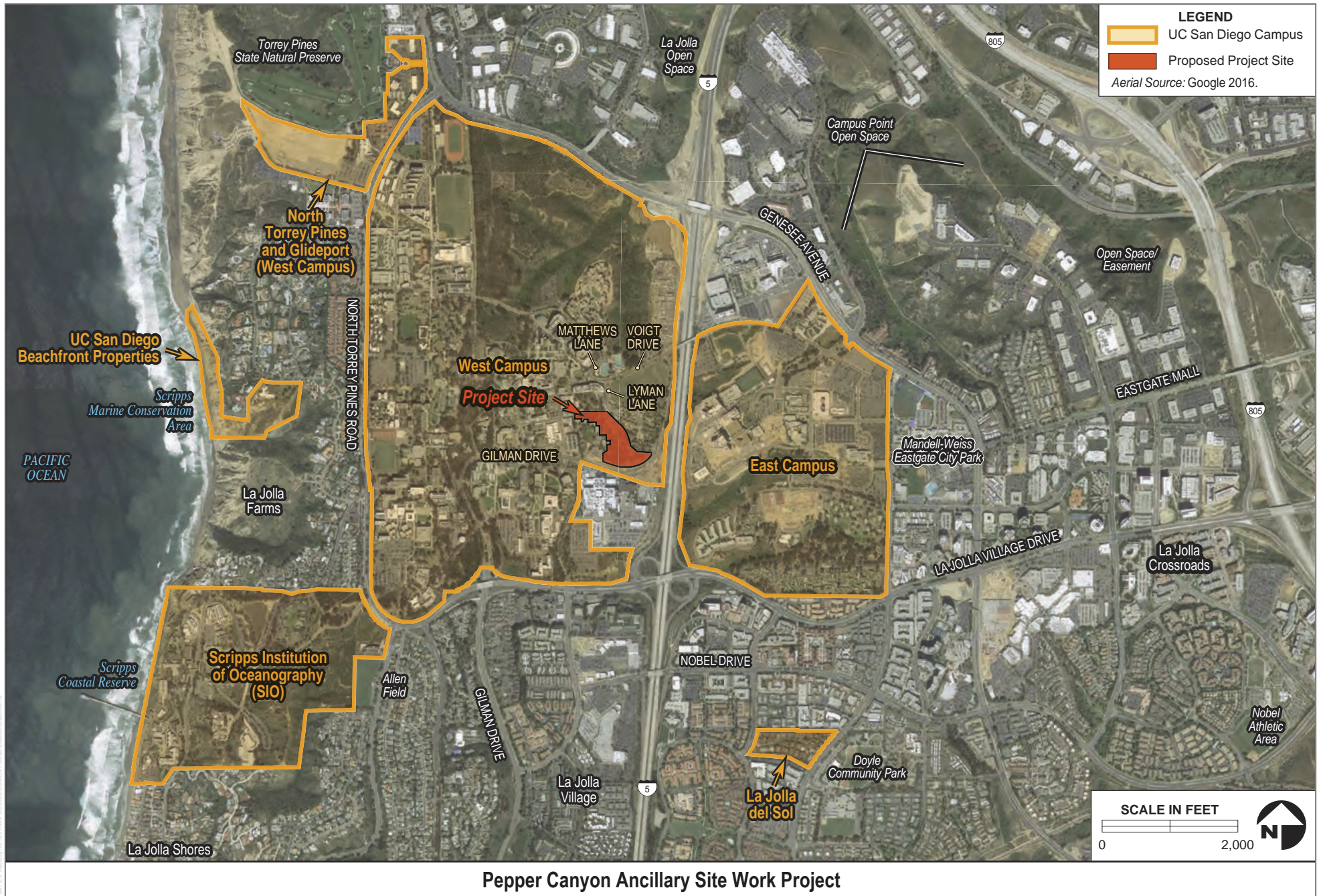

Pepper Canyon Ancillary Site Work Project

**FIGURE 2**  
Project Vicinity

Pepper Canyon Ancillary Site Work Project

This page intentionally left blank.

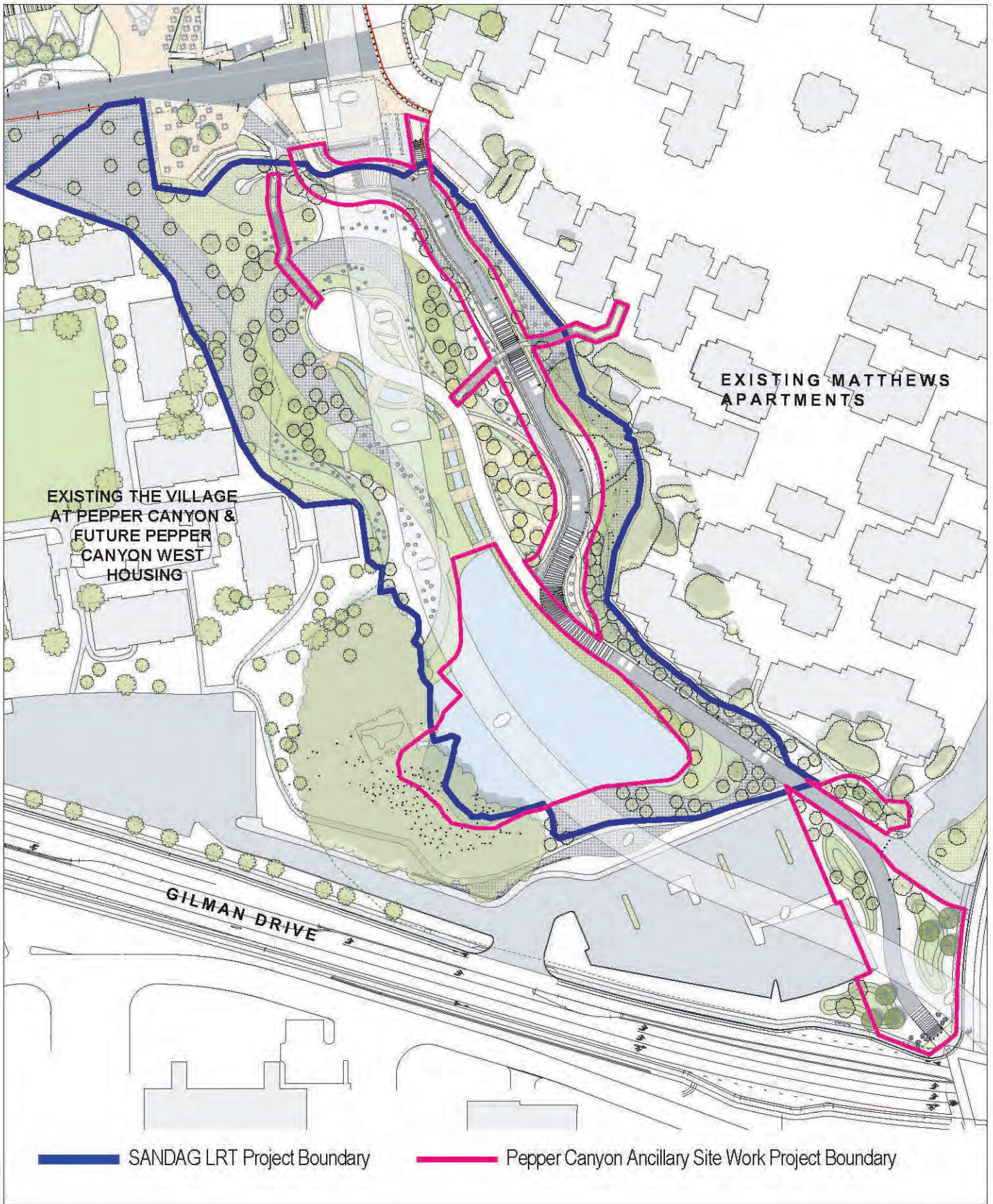

SOURCE: UCSD 2021

FIGURE 3

Site Boundary Map

Pepper Canyon Ancillary Site Work Project

This page intentionally left blank.



## 2.3 PROJECT BACKGROUND

Pepper Canyon was completely altered during construction of the LRT line and associated Central Campus Station and requires re-grading and re-vegetation. While the majority of this restoration work is being completed by SANDAG as part of the Mid-Coast Corridor Transit Project, the proposed Project would include additional improvements in portions of the canyon. The canyon is also a site identified for a regional stormwater facility planned for by the 2018 LRDP. Therefore, the proposed Project would include the installation of landscape improvements, hardscape improvements, and a Regional Storm Water Quality Basin within an approximately 2.35-acre area of the canyon below the Central Campus Trolley Station LRT line.

Pepper Canyon is classified as the 'Urban Forest' designation of the Open Space Preserve land use category and has a series of special features that distinguish it from other Open Space Preserve areas. First, it is unique by its association with the new Central Campus Trolley Station and surrounding transit-oriented development and would provide a gateway function for those arriving on campus via light rail. Second, it would function as the central open space for the existing housing facilities to the east and the west of the Canyon and would integrate these two areas. Third, it would function as a corridor for major bicycle and pedestrian routes and would be a destination for recreation and respite from busy campus life.

A small off-site riparian area is located within the southwest area of the canyon; however, is not within the proposed Project limits and would not be impacted by the proposed Project.

## 2.4 PROJECT OBJECTIVES

UC San Diego has identified the following objectives for the proposed Project:

- Improve a portion of the disturbed canyon consistent with the Urban Forest designation of the Open Space Preserve as an important visual and physical center to the Pepper Canyon Neighborhood.
- Integrate the open space with the Pepper Canyon Light Rail Transit Station and surrounding academic and housing land uses by establishing a multi-modal path that is consistent with the "Urban Forest" designation.
- Provide a Regional Storm Water Quality Basin that will mitigate peak flow runoff from and provide water quality treatment for surrounding existing and planned development.

- Implement Low Impact Development (LID) opportunities with respect to storm water management, landscape, planting, and hardscape design.

These objectives are consistent with the overall objectives of the 2018 LRDP (see Section 2.3 of the 2018 LRDP Program EIR), as described in Section 3.1 of this Addendum.

## 2.5 PROJECT FEATURES

### 2.5.1 Project Components

The Project proposes improvements within Pepper Canyon, which is a small canyon designated as the Urban Forest category of the Open Space Preserve, surrounded by existing development and an approximately 63-acre drainage tributary area. The proposed Project involves landscape improvements, hardscape improvements (including the East Rim Multimodal Path), and a Regional Storm Water Quality Basin which are described in more detail in the following subsections.

Table 2-1 lists the areas within each project component and the associated acreage and/or square feet within the overall 2.35-acre Project site, and Figure 3, Site Boundary Map, depicts the site boundary for each component of the Project. The components are described in detail in the following subsections.

**Table 2-1  
Project Components**

<b>Project Component</b>	<b>Approximate Area</b>
East Rim Multimodal Path	783 linear feet long
Urban Forest Open Space Preserve Area	2.35 acres
Regional Storm Water Quality Basin	34,000 square feet

## 2.5.2 Landscape Improvements

Pepper Canyon was completely altered during construction of the LRT line and associated Central Campus Trolley Station and requires complete re-vegetation. The revegetation is planned to be installed in phases with the majority currently being installed by SANDAG as part of the Mid-Coast Corridor Transit Project and a portion installed during the proposed Project. The landscape improvements that would be installed during the proposed Project would only include those areas of the canyon directly impacted by the construction of the East Rim Multimodal Path and around the Regional Storm Water Quality Basin. See Figure 3 for the limits of work for the path.

The tree and understory planting palette for Pepper Canyon would be focused on native and/or climate adaptive, non-invasive ornamental species. A 50-foot setback from the rail line would prevent trees from being planted in the center of Pepper Canyon but would allow for trees to be planted further away. The slopes of the canyon within the Project limits would be planted with species that provide good coverage and deep rooting to support other measures for stabilization and erosion control. The existing off-site riparian area in the canyon bottom would remain in its undisturbed, natural state).

Less flammable plant and tree species would be selected as required by the UC San Diego Fire Marshall. All LRT clearances and easements would be addressed per agreements negotiated with the City of San Diego and MTS. All new landscape planting would be kept at heights less than 3-feet per San Diego Fire Department requirements and dense zones of trees would be avoided to ensure good visibility. Per the Campus Fire Marshall, landscaping in the Pepper Canyon Urban Forest Open Space Preserve would comply with strict control over flammable plant and tree species. These policies would not apply to the existing wetland vegetation in the canyon, which would be protected. The Urban Forest area would also require irrigation and maintenance of plant species as “low ground mounds,” and the area would be maintained on an annual or as-needed basis to remove dead, dying or diseased materials from the vegetation. Adherence to these conditions would help to convert the area from its currently designated ‘Very High Fire Hazard Severity Zone’ (VHFHSZ) to an ‘urban park’ like environment.

The tree, groundcover, and basin planting palettes that would be included are pictured below.

GROUNDCOVERS



**Acacia redodens 'Low Boy'**  
*Prostrate Acacia*  
Height: 1'-2' Spread: 10'-15'  
Water: Low  
Light: Full



**Arctostaphylos 'Pacific Mist'**  
*Manzanita*  
Height: 2'-3' Spread: 6'-15'  
Water: Low  
Light: Full  
*\*Cannot be planted within 20' of occupiable building.*



**Native Mow Free Sod**  
*Festuca idahoensis,*  
*Festuca rubra,*  
*Festuca occidentalis*  
Height-Spread: Varies  
Water: Low  
Light: Full, Partial

PLANTING PALETTE - ACCENT PLANTS



**Agave 'Blue Flame'**  
*Blue Flame' Agave*  
Height: 2'-3' Spread: 3'-4'  
Water: Low  
Light: Full



**Agave weberi**  
*Weber Agave*  
Height: 4'-5' Spread: 6'-8'  
Water: Low  
Light: Full



**Yucca schidigera**  
*Mojave Yucca*  
Height: 2'-16' Spread: 2'-3'  
Water: Minimal  
Light: Full

CANYON PALETTE - TREES



**Lophostemon confertus**  
*Brisbane Box*  
Height: 40'-60' Mature Spread: 15'-25'  
Water: Moderate  
Light: Full



**Quercus lobata**  
*Valley Oak*  
Height: 40'-80' Mature Spread: 30'-50'  
Water: Low  
Light: Full



**Platanus racemosa**  
*California/Mexican Sycamore*  
Height: 40-80' Mature Spread: 30'-50'  
Water: Moderate  
Light: Sun or Shade



**Pinus torreyana**  
*Torrey Pine*  
Height: 25'-60' Mature Spread: 25'-50'  
Water: Minimal  
Light: Full



**Arbutus 'Marina'**  
*Marina Arbutus*  
Height: 40'-50' Mature Spread: 25'-40'  
Water: Minimal  
Light: Full

### 2.5.3 Hardscape Improvements

Pepper Canyon provides a series of benefits for the adjacent communities, but its steep canyon slopes and significant elevation changes also make it a barrier by preventing easy access across the canyon. The proposed Project would address access and security concerns in the Pepper Canyon Urban Forest Open Space Preserve by providing the East Rim Multimodal Path that has been designed to provide easy access, visibility, and lighting.

The East Rim Multimodal Trail would be a 16-foot-wide multimodal asphalt pathway along the eastern rim of the canyon to accommodate pedestrians and micromobility (bicycle, skateboards, scooters, etc.) travelers from the Central Campus Trolley Station to the corner of Gilman Drive and Gilman North Drive, where travelers can transition to sidewalks and bicycle lanes. Lighting of the trail would be designed and installed in accordance with the UC San Diego Outdoor Lighting Policy and kept to the minimum illumination necessary for public safety.

Retaining walls would be required in two areas on the west side of the pathway due to the slope. Rustic trails would provide additional access to the Canyon. The path would be flanked by a 1.5-foot concrete strip, a 3-foot swale and planting on the east side and 1.5-feet of gravel and 3-feet of planting on the west side. The 3-foot swale on the east side of the path would provide storm water control.

Rustic trail steps would also be installed to provide additional access. The steps would be around 5-feet-wide and would be composed of durable lumber risers with decomposed granite fill in between per County Trail Standards. The rustic trail steps would tier off the multimodal path to provide pedestrian access to the bottom of the canyon. Steps would be installed in two separate locations along this trail where the slope is steep.

An existing asphalt trail that travels from the existing Matthews Apartments to the Village at Pepper Canyon West surface parking lot (P406) would remain in place and is not within the scope of the proposed Project. Figure 4 shows the proposed and existing trail.

This page intentionally left blank.

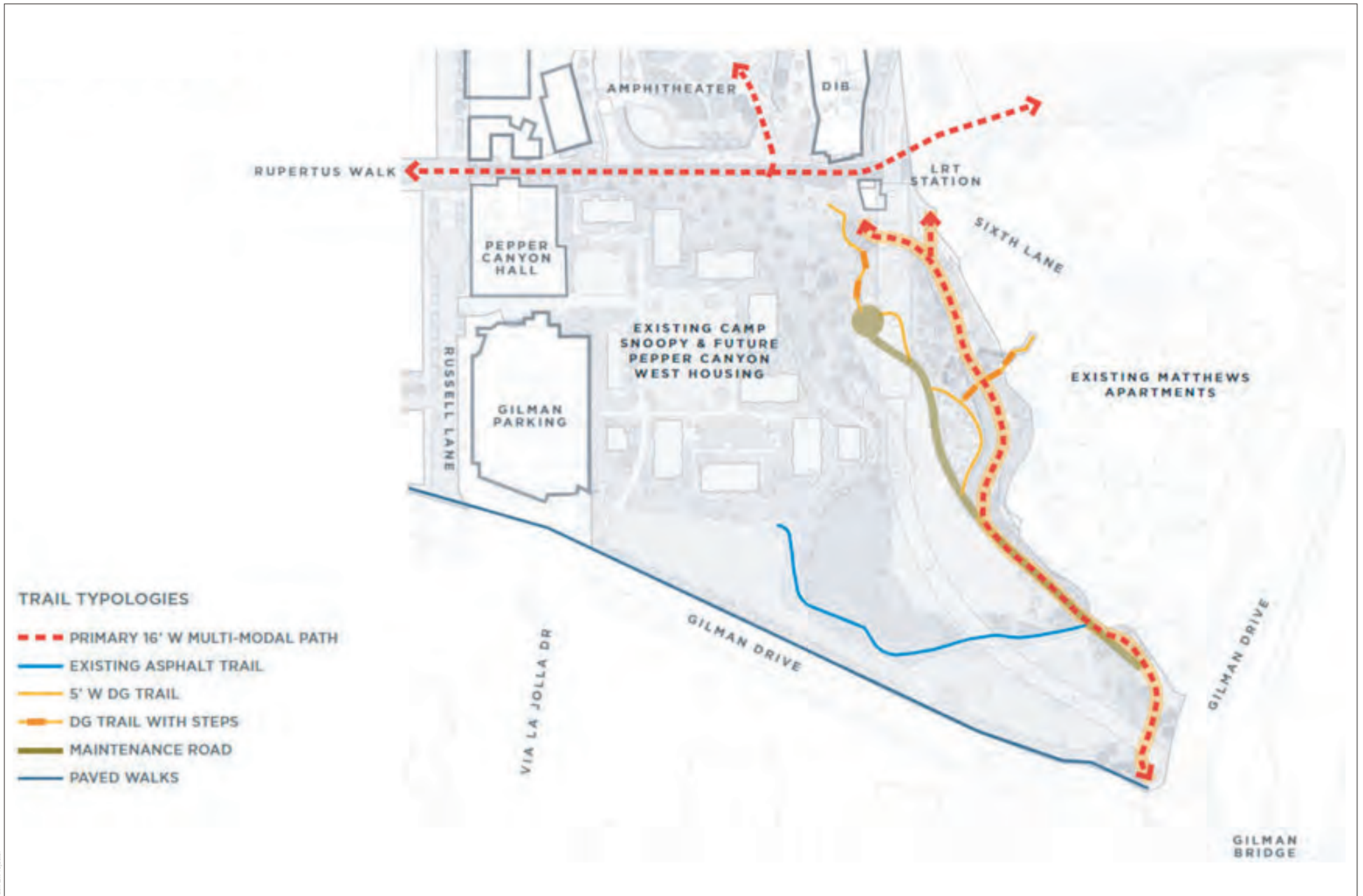

SOURCE: UCSD 2018

FIGURE 4

Proposed Trail Diagram

Pepper Canyon Ancillary Site Work Project

This page intentionally left blank.



## 2.5.4 Regional Storm Water Quality Basin

### Existing Conditions

A series of existing small area drains flow into Pepper Canyon. The larger drainage system flows to the south under the existing parking lot and ultimately conveys flows into the Pepper Canyon Urban Forest Open Space Preserve. This southerly storm drain system also receives secondary flows from the west, near the Gilman Parking Structure. The storm drain system currently outfalls to an existing concrete headwall near a protected off-site riparian area. Two additional storm drain lines (30-inch and 42-inch) convey off-site drainage under the existing parking lot and ultimately discharge to the concrete headwall near the protected off-site riparian area.

Following construction activity in the area by SANDAG, several concrete check dams and a concrete swale were installed beneath the path of the LRT (see below), these features would remain protected in place.

EXISTING CONDITIONS



### Proposed Regional Storm Water Quality Basin

The Project proposes the development of an approximately 34,000 square foot Regional Storm Water Quality Basin in the southerly portion of the Pepper Canyon Urban Forest Open Space Preserve as depicted in Figure 5, Regional Storm Water Quality Basin. The

proposed improvements within the Regional Storm Water Quality Basin include grading and installation of rock, soil media, perforated sub-drains and a riser for regional flow control. The Regional Storm Water Quality Basin would be designed to handle storm water inflows from existing and on-going development projects within the tributary watershed, including the following: The Design and Innovation Center, Pepper Canyon Amphitheater, Mid Coast Trolley, and The Village at Pepper Canyon West (formerly named the Sixth College Residence Hall). The basin would also be sized to accommodate future inflows from other planned development in the area, as called for by the 2018 LRDP.

An existing drainage area and environmentally sensitive off-site riparian area are located within the southwest portions of Pepper Canyon. The proposed Project grading has been designed around the limits of the off-site riparian area located adjacent and to the southwest of the proposed Project limits. The Project would not disturb the off-site riparian area. Photos 1 and 2 show the approximate limits of this area and adjacent storm drain headwall.



Photo 1



Photo 2

Approximate limits and location of storm drain headwall within the open off-site riparian area (looking northeast along Space Preserve/bottom of canyon off-site riparian area in south end of Pepper Canyon).



SOURCE: UCSD 2018

**DUDEK**

**FIGURE 5**  
Location of Regional Water Quality Basin Pepper Canyon Ancillary Site Work Project

Pepper Canyon Ancillary Site Work Project

This page intentionally left blank.

The drainage channel area (located east of the off-site riparian area) has been previously disturbed via the SANDAG Mid-Coast Corridor Transit Project. SANDAG is currently completing construction of the Mid-Coast Corridor Transit Project that spans overtop the proposed Regional Storm Water Quality Basin and will complete testing and open for operation in late 2021. One of the support columns is located within the Regional Storm Water Quality Basin. SANDAG constructed a Post-Construction Best Management Practice (BMP) adjacent to the proposed Project site that will remain in place. The BMP includes a vegetated swale which would be protected in place during construction of the proposed Project and would continue to provide conveyance under post-construction conditions. SANDAG also constructed a series of concrete cut-off walls within the vegetated swale. These walls would be protected during development of the proposed Project to the extent possible.

### 2.5.5 Utility and Service Systems

The Project would not require connection to the campus's domestic water system as it would not utilize potable water for irrigation nor would it require any change to fire water service as an existing fire hydrant serves the site. Utilities that would serve the Project include reclaimed water and power, which are discussed further below.

#### **Reclaimed Water Infrastructure**

An existing 12-inch PVC reclaimed water line loop runs through the Proposed Project site. The 12-inch line connects to the reclaimed water system in Gilman Drive and continues north, parallel to the existing Gilman Parking Structure. Once the line reaches Russell Way, the system travels directly east through The Village at Pepper Canyon West housing and continues east through the Pepper Canyon Open Space Preserve. The existing reclaimed water line is part of the larger infrastructure system that serves the overall campus. This system would be used during construction activities. No major upgrades are required to the existing reclaimed water infrastructure to serve the Project.

#### **Power**

Electrical power would be supplied to the proposed Project during construction via the existing UC San Diego power grid, which provides 100% clean energy via the UC Regents Energy Services Unit Direct Access Program. Based on review of the Master Utility Plan (MUP) prepared for the 2018 LRDP there is sufficient capacity within the existing utility systems to support construction of the proposed Project and no major utility upgrades would be required.

## 2.5.6 Project Construction

The approximately 2.35-acre Project site is within the interior of the campus. Construction of the East Rim Multimodal Path, the Regional Storm Water Quality Basin and the other associated improvements within Pepper Canyon are anticipated to take up to 6 months to complete. Construction activities are anticipated to begin in July 2021 and end by December 2021. Construction activities would typically occur Monday through Friday, between the hours of 7:00 a.m. and 7:00 p.m. Limited nighttime construction may occur in order to eliminate daytime conflicts or other necessary reasons, with approval from the appropriate campus stakeholders. For public safety reasons, during the 6-month construction period, the public would not have access to the Project site or any area within the Project's construction limits. A construction management plan would outline how the site would be accessed and managed during the construction period, including the notifications and signage to be employed.

Figure 3, Site Boundary Map, depicts the construction limits and locations for site ingress and egress. Contractor trailers would be located immediately south of the Project site in the construction staging area. This approximately 2.35-acre area would be dedicated as a construction zone associated with the proposed Project. Following the completion of construction activities, this area would be returned to preexisting condition (i.e., paved parking lot).

### **Site Grading**

#### ***Existing Conditions***

Grading operations from the Central Campus Trolley Station have concluded within the Pepper Canyon Urban Forest Open Space Preserve area. SANDAG will return the site to the conditions prescribed by the approved SANDAG Mid-Coast Corridor Transit Project Grading and Drainage Plans (Contract number 5008600.4) prior to returning the site to UC San Diego in September 2021. SANDAG will be responsible for revegetating the area of the canyon depicted as "SANDAG LRT Project Boundary" in Figure 3, excluding the portion of the canyon within the Pepper Canyon Ancillary Site Work Project Boundary, which would be vegetated by the University as part of the proposed Project.

### **Landscape & Hardscape Improvements.**

#### ***Proposed Grading***

The proposed project would export approximately 5,000 cubic yards of fill to create the lower retention basin. All major slopes within the canyon would remain.

### **Construction Access**

Due to the current road layout, it is anticipated that access to the construction site would be primarily from the south off Gilman Drive.

### **Construction Phasing**

Construction would take place in phases including the following:

- Grading
- Construction of the East Rim Multimodal Path
- Installation of Regional Storm Water Quality Basin
- Landscape/Hardscape

Full site preparation and construction is anticipated to take up to 6 months.

The proposed Project would comply with the National Pollutant Discharge Elimination System (NPDES) General Permit for Storm Water Discharges Associated with Construction and Land Disturbance Activity (General Permit). Division II of the guidelines also requires storm water BMPs to be implemented in accordance with UC San Diego's NPDES Phase II Small MS4 General Permit (2013 0001-DWQ) and/or Storm Water Management Program. As part of the General Permit, campus construction projects managed by outside contractors and disturbing more than 1 acre must implement Storm Water Pollution Prevention Plans (SWPPPs), which specify BMPs to reduce the contribution of sediments, spilled and leaked liquids from construction equipment, and other construction-related pollutants to storm water runoff.

As discussed above, the Project would inherit an existing post-construction BMP adjacent to the Project site within the Pepper Canyon area, as constructed by SANDAG. The BMP would include a vegetated swale that would be protected in place during construction and would continue to provide conveyance under post-construction conditions, to the maximum extent possible. A series of concrete cut-off walls have also been constructed within the vegetated swale by SANDAG. These walls would also be protected during development of the proposed Project.

## **2.5.7 Sustainability Features**

The UC Sustainable Practices Policy covers nine areas of sustainable practices: green building, clean energy, climate protection, sustainable transportation, sustainable operations, recycling and waste management, environmentally preferable purchasing,

sustainable foodservices, and sustainable water systems. The UC Sustainable Practices Policy establishes guidelines and includes climate change goals for all of the campus.

Though the proposed Project does not include development of any buildings, it would embody UC San Diego's commitment to sustainable design, sustainable construction practices, and sustainable living. Sustainable strategies have been organized around three primary focus areas, described below.

- 2.5.7.1 **Location and Transportation:** The Project's proximity to the new Central Campus Trolley Station and provision of a multimodal path benefits the campus' transportation demand management program by providing additional bike and pedestrian connectivity. Landscape and lighting improvements included with the proposed Project will benefit the transit riders' experience.
- 2.5.7.2 **Site and Landscape:** The proposed Project's landscape program restores a portion of the canyon directly surrounding the proposed East Rim Multimodal Path and Regional Storm Water Quality Basin. This area would be landscaped with native and drought-tolerant plant species that would be low-water use and provide for storm water infiltration, and would be low-flammable species.
- 2.5.7.3 **Water:** Outdoor water use would be reduced through the selection of native and adapted plant species that are low-water use. In addition, where irrigation is required, water would be provided via the campus recycled water loop.



## 2.6 PROJECT APPROVAL/SCHEDULE

The proposed Project is anticipated to be constructed by December 2021. As a public agency principally responsible for approving or carrying out the proposed Project, the University of California is considered the Lead Agency under CEQA. The Addendum for this proposed Project will be considered by The Regents or their delegate and the Project may be approved at The Regents or their delegate's discretion and only if The Regents or their delegates determine that such approval complies with CEQA.

The Project would require a Section 1602 Streambed Alteration Agreement from the California Department of Fish and Wildlife (CDFW) prior to altering the unvegetated stream channel in Pepper Canyon to install the proposed Regional Storm Water Quality Basin, and may require a Section 404 Nationwide Permit verification from the U.S. Army Corps of Engineers (USACE) and a Section 401 Water Quality Certification from the Regional Water Quality Control Board (RWQCB) if the unvegetated stream channel is determined to be under federal jurisdiction as waters of the U.S. If it is determined the unvegetated stream channel in Pepper Canyon is not under federal jurisdiction, the Project would also require a Waste Discharge Requirement permit from RWQCB. All necessary permits and required mitigation would be secured in accordance with the jurisdictional agencies' requirements prior to any disturbance to the unvegetated stream channel.

This page intentionally left blank.

### **3 CONSISTENCY WITH 2018 LRDP**

To determine whether the Project is covered by the 2018 LRDP and 2018 LRDP EIR, the following questions must be answered:

- Are the objectives of the Project consistent with the objectives adopted for the 2018 LRDP?
- Are the changes to campus population associated with the Project included within the scope of the 2018 LRDP's population projections?
- Is the proposed location of the Project in an area designated for this type of use in the 2018 LRDP?
- Is the Project included in the amount of the development projected in the 2018 LRDP?
- Are the Project activities within the scope of the environmental analysis in the 2018 LRDP EIR?
- Have the conditions described in the CEQA Guidelines Section 15162 calling for the preparation of a subsequent EIR occurred?

Sections 3.1 through 3.4 document the Project's consistency with the objectives, population projections, land use designations, and development projections contained in the 2018 LRDP.

Section 4 contains a detailed examination of environmental topics with the potential for significant impacts addressed in the 2018 LRDP EIR and documents whether or not the Project is consistent with and within the scope of the environmental impact analysis of the 2018 LRDP EIR.

#### **3.1 2018 LRDP OBJECTIVES**

Key objectives of the 2018 LRDP, as outlined in the plan, include accommodate projected growth by expanding both academic and non-academic programs in support of the UC mission; establish two new undergraduate colleges; locate buildings in accordance with the established character, scale and design; co-locate and strengthen campus programs; activate and enliven the campus through mixed- use and transit-oriented development;

redevelop the University Center into a town center; expand multimodal connections and trip reduction programs; implement sustainable development practices; and be responsible stewards for the campus open space systems. The Project would support the following 2018 LRDP objectives:

5. Activate and enliven the campus through strategic mixed-use and transit-oriented development, improved public spaces, expanded campus services, and additional on campus housing to facilitate a living-learning campus environment;
10. Expand multi-modal connections and Transportation Demand Management (TDM) programs to optimize trip reduction benefits of the light rail transit system, reduce automobile commuting, and coordinate with regional transportation programs;
11. Minimize environmental impacts through sustainable development practices related to campus planning, building siting, design, construction and operations; and
12. Recognize the importance of campus open spaces that form a balance with the built environment and continue to be responsible stewards of campus natural and biological resources.

#### **Project's Consistency with LRDP Objective No. 5 - Enliven the Campus through Mixed-Use and Transit-Oriented Development**

The Project site is located in close proximity to future transit and multimodal facilities, including the Mid-Coast Corridor Transit Project and the associated Central Campus Trolley Station and nearby pedestrian and bicycle connections. Further, the Project is located in close proximity to the future Rupertus Walk Extension, which would be the primary pedestrian and bicyclist connection from the Central Campus Trolley Station to the West Campus. The future Rupertus Walk would connect with the East Rim Multimodal Path component of the Project, facilitating a pedestrian and bicycle connection across West Campus and even to the East Campus via the pedestrian and bicycle path along Gilman Bridge. The proposed Project would also improve the transit rider and pedestrian experience through landscape improvements and security lighting. As such, the proposed Project would be consistent with the mixed-use and transit-oriented development objective of the 2018 LRDP EIR.

#### **Project's Consistency with LRDP Objective No. 10 - Expand Multi-Modal Connections**

The Project would expand multimodal connections and by redeveloping approximately 2.35 acres at the center of campus adjacent to the Mid-Coast Corridor Transit Project and the associated Central Campus Trolley Station that is scheduled to open in late 2021.

Further, the Project is located to the immediate south of the future Rupertus Walk Extension, which would be the primary pedestrian and bicyclist connection from the Pepper Canyon Station to the West Campus. The East Rim Multimodal Path would provide a connection for pedestrians and bicyclists between Rupertus Walk Extension and Gilman Drive. The future Rupertus Walk would connect with the northern portion of path, facilitating a pedestrian and bicycle connection. The East Rim Multimodal Path also benefits the East Campus by facilitating a connection to the pedestrian and bicycle path along Gilman Bridge. Thus, the Project is consistent with the objective of the 2018 LRDP EIR to expand multimodal connections.

### **Project's Consistency with LRDP Objective No. 11 - Implement Sustainable Development Practices**

The Project would implement sustainability features in line with UC San Diego's commitment to sustainable design, sustainable construction practices, and sustainable living. As discussed earlier, the Project's proximity to the Central Campus Trolley Station and the proposed pedestrian and bicyclist path would encourage alternative modes of transportation that decrease reliance on fossil-fuel burning vehicles. Project areas would be planted with drought tolerant native plants that would also provide for storm water infiltration. Recycled materials would be utilized where possible and materials would be recycled in accordance with local policies. These conscious decisions to implement sustainable development practices would minimize environmental impacts and therefore would be consistent with the sustainability objective of the 2018 LRDP EIR.

### **Project's Consistency with LRDP Objective No. 12 - Recognize the Importance of Campus Open Spaces that Form a Balance with the Built Environment**

Pepper Canyon is designated as the Urban Forest category of the campus' Open Space Preserve and provides visual and natural relief from the surrounding campus development. The canyon was completely altered during construction of the LRT line and associated Central Campus Trolley Station. The alteration required the canyon to be re-graded by SANDAG and will require the complete re-vegetation of the canyon by SANDAG and UC San Diego. The Project includes the installation of landscape improvements, hardscape improvements, and a Regional Storm Water Quality Basin in an approximately 2.35-acre area of the canyon below the Central Campus Trolley Station LRT line that would improve the overall quality of this portion of the campus's Open Space Preserve. Therefore, this component would be consistent with Objective No. 12 of the 2018 LRDP.

## 3.2 2018 LRDP CAMPUS POPULATION

The 2018 LRDP anticipates that the total campus population would grow by 16,750 people over the 2018 LRDP planning period, resulting in a total population of 65,600 by 2035 (Table 3-1). The proposed project would not result in new campus populations related to student enrollment and/or faculty/staff because the project would serve existing populations already coming to campus and would not contribute to an increase in the campus student enrollment. The Project also does not include development of a habitable building. Therefore, it has been determined that the project is consistent with the campus population projections contained in the 2018 LRDP.

**Table 3-1  
Total Campus Population Growth Projections**

<b>Category</b>	<b>Fall 2015 (Baseline)<sup>1</sup></b>	<b>Fall 2020 (Actual)<sup>2</sup></b>	<b>Fall 2035 (Projected)<sup>1</sup></b>
Students	32,850	39,575	42,400
Faculty	1,300	1,725	2,200
Staff	14,700	18,050	21,000
<b>Total Population</b>	<b>48,850</b>	<b>59,350</b>	<b>65,600</b>

<sup>1</sup> UC San Diego 2018a

<sup>2</sup> See Links Below

University of California Infocenter – Fall Enrollment at a Glance.  
Available at: <https://www.universityofcalifornia.edu/infocenter/fall-enrollment-glance> University of California Infocenter – UC Employee Headcount.

Available at: <https://www.universityofcalifornia.edu/infocenter/employee-fte>

Implementation of the 2018 LRDP would result in direct population growth on the campus because it assumes an increase in the number of students, faculty, researchers and staff over time.

The Project would not include building space. It would provide landscape, storm water, and multimodal pathway improvements within an existing open space, which would not induce or inhibit population growth. Therefore, it has been determined that the Project is in line with the population projections contained in the 2018 LRDP EIR.

## 3.3 2018 LRDP LAND USE

The Land Use Plan of the 2018 LRDP describes functional land use categories that reflect those activities that would be predominant in any given area of campus (Figure 2-3 in the

2018 LRDP EIR). Predominant uses are the primary programs, facilities, and activities in a general geographic area. Other support or ancillary uses are allowable within any given area defined by a predominant use.

The proposed Project site is designated as the Urban Forest within the Open Space Preserve land use category. The Open Space Preserve designation denotes open space areas that have ecological or aesthetic value and are subject to special constraints on development; e.g., slopes, canyons and bluffs. The Urban Forest designation includes the large stands of eucalyptus trees within Pepper Canyon. In these areas, the University is seeking to introduce a diversity of tree species and replenish the Urban Forest to enhance the integrity of this open space. The designation also allows for the development of suitable bicycle and pedestrian paths and other infrastructure within the Urban Forest. Pepper Canyon was almost completely altered during construction of the LRT line and associated Central Campus Trolley Station and required re-grading and complete re-vegetation by SANDAG and UC San Diego. The proposed Project includes the installation of landscape improvements, hardscape improvements, and a Regional Storm Water Quality Basin in an approximately 2.35-acre area of the canyon below the above-grade Central Campus Trolley Station line. The landscape improvements included in this component include the installation of native and/or climate adaptive, non-invasive ornamental species. The hardscape improvements included in this component would include the installation of the multimodal path and meandering rustic paths. The multimodal path would be open to pedestrians and bicycles and other micromobility modes. With the installation of these improvements, this area would continue to function as the central open space for the existing student housing to the east and west of the canyon. Therefore, the Project would be consistent with the Urban Forest Open Space Preserve designation, and it has been determined that the components of the Project are consistent with the land use categories in the 2018 LRDP.

### 3.4 2018 LRDP DEVELOPMENT SPACE

The 2018 LRDP provides capacity for approximately 9 million GSF of additional building space for academic, clinical, housing, administrative, and service programs. This project does not propose the construction of new buildings. Thus, the Project would not increase the total building space within the West Campus. Based on this data, it has been determined that the proposed Project would not exceed building space projections contemplated in the 2018 LRDP and is consistent with the plan.

**Table 3-2  
Total Campus Space Projections**

<b>Campus Location</b>	<b>Fall 2015 GSF (Baseline)<sup>1</sup></b>	<b>Spring 2021 GSF (Actual)<sup>2</sup></b>	<b>Fall 2035 GSF (Projected)<sup>1</sup></b>
West Campus	11,099,000	12,286,265	16,046,000
East Campus	3,075,300	5,011,900	9,358,300
Scripps Institution of Oceanography	1,018,000	1,018,000	2,011,000
Nearby Properties	471,000	471,000	471,000
<b>Total Space</b>	<b>15,663,300</b>	<b>18,787,165</b>	<b>27,886,300</b>

Sources:

<sup>1</sup> UC San Diego 2018a

<sup>2</sup> UC San Diego 2021, includes all building space on campus as of spring 2021 (not including buildings under construction).



## 4 CONSISTENCY WITH 2018 LRDP EIR

The evaluation contained in this consistency review was conducted in accordance with Sections 15152 and 15183.5(a) of the CEQA Guidelines which allow for tiered CEQA review provided the Project's effects have been addressed in a prior (or earlier) programmatic analysis. The 2018 LRDP EIR comprehensively addressed the potential environmental effects of campus growth and development due to implementation of future projects and activities proposed under the 2018 LRDP EIR. The Governor's Office of Planning and Research (OPR) proposed amendments and additions to Appendix G of the CEQA Guidelines which were finalized by the Natural Resources Agency in 2018 for use beginning in January 2019. This Addendum reflects the most recent questions as they appear in Appendix G of the CEQA Guidelines.

### 4.1 EVALUATION OF PROJECT ENVIRONMENTAL IMPACTS

#### **Checklist Explanation**

On the basis of the tiering and subsequent review concepts identified in the CEQA Guidelines, the University has defined the following column headings in this Addendum. Both headings rely on the relevant analyses in the 2018 LRDP EIR:

Impacts Adequately Examined in the 2018 LRDP EIR: This column is checked where the potential impacts of the Project were adequately examined in the certified 2018 LRDP EIR. Where applicable, mitigation measures identified in the 2018 LRDP EIR would mitigate the impacts of the Project. All applicable mitigation measures from the 2018 LRDP are incorporated into the Project as noted in Section 5 of this Addendum. The Project is consistent with the analysis evaluated in the 2018 LRDP EIR.

Impacts Not Examined in the 2018 LRDP EIR: If a column is checked in this section, this indicates potential effects of the Project were not adequately evaluated in the certified 2018 LRDP EIR. However, as described in the supporting text, the potential effects of the Project could result in: a) no impact in the category, b) less-than- significant impact in the category, or c) new potentially significant impact. In the instance that a) or b) is checked, no additional CEQA documentation would be necessary. In the instance that c) is checked, additional CEQA documentation would be necessary to further address the issue. All applicable mitigation measures (LRDP Program and/or project-specific) would be incorporated into the Project as noted in Section 5 of this Addendum.

## Environmental Topics Addressed

The following environmental resources, if checked below, would be potentially affected by this Project and would involve at least one significant impact that substantially exceeds or is otherwise outside the scope of activities evaluated for potential environmental effects in the 2018 LRDP EIR, as discussed below in Sections 4.1.1 through 4.1.18 of the Addendum. Agriculture and Forestry and Mineral Resources are discussed in Section 4.1 of the 2018 LRDP EIR under Effects Not Found to be Significant. As noted in those discussions, no potential for significant impacts to those topics would occur due to the lack of such resources on the UC San Diego campus. As such, those topics are not discussed in this Addendum.

If "None" is checked below, this Project is deemed entirely consistent with and covered by the environmental analysis contained in the 2018 LRDP EIR.

- |   |  |   |
|---|--|---|
| <input type="checkbox"/> Aesthetics                             | <input type="checkbox"/> Air Quality                     | <input type="checkbox"/> Biological Resources               |
| <input type="checkbox"/> Cultural and Tribal Cultural Resources | <input type="checkbox"/> Energy                          | <input type="checkbox"/> Geology and Soils                  |
| <input type="checkbox"/> Greenhouse Gas Emissions               | <input type="checkbox"/> Hazards and Hazardous Materials | <input type="checkbox"/> Hydrology and Water Quality        |
| <input type="checkbox"/> Land Use and Planning                  | <input type="checkbox"/> Noise                           | <input type="checkbox"/> Population and Housing             |
| <input type="checkbox"/> Public Services                        | <input type="checkbox"/> Recreation                      | <input type="checkbox"/> Transportation/<br>Circulation     |
| <input type="checkbox"/> Utilities and Service Systems          | <input type="checkbox"/> Wildfire                        | <input type="checkbox"/> Mandatory Findings of Significance |
| <input checked="" type="checkbox"/> None                        |  |   |

### 4.1.1 Aesthetics

Section 3.1 of the 2018 LRDP EIR evaluates the impacts of campus growth under the 2018 LRDP on aesthetics. The 2018 LRDP EIR concludes that implementation of future projects under the plan would result in potentially significant impacts to scenic vistas, visual character or quality and light or glare (Sections 3.1.3.1 through 3.1.3.3). No potential for significant impacts to scenic resources within the viewshed of the state scenic highway is identified (Section 3.1.5 of the 2018 LRDP EIR). Mitigation Measures (MM) Aes-1 (scenic vistas) and Aes-2A and Aes-2B (visual character/quality) and Aes-3 (night lighting) are identified in the mitigation framework of the 2018 LRDP EIR for projects that would contribute to these impacts. Implementation of the measures would reduce the future aesthetics impacts to less than significant levels, consistent with the 2018 LRDP.

AESTHETICS	Impact Examined in 2018 LRDP EIR	Impact Not Examined in 2018 LRDP EIR		
		No Impact	Less-than-Significant Impact	Potentially Significant Impact
Would the Project...				
a) Have a substantial adverse effect on a scenic vista?	<input checked="" type="checkbox"/>	<input type="checkbox"/>	<input type="checkbox"/>	<input type="checkbox"/>
b) Substantially damage scenic resources, including, but not limited to, trees, rock outcroppings, and historic buildings within a state scenic highway?	<input checked="" type="checkbox"/>	<input type="checkbox"/>	<input type="checkbox"/>	<input type="checkbox"/>
c) In non-urbanized areas, substantially degrade the existing visual character or quality of public views of the site and its surroundings? (Public views are those that are experienced from publicly accessible vantage point). If the project is in an urbanized area, would the project conflict with applicable zoning and other regulations governing scenic quality?	<input checked="" type="checkbox"/>	<input type="checkbox"/>	<input type="checkbox"/>	<input type="checkbox"/>
d) Create a new source of substantial light or glare which would adversely affect day or nighttime views in the area?	<input checked="" type="checkbox"/>	<input type="checkbox"/>	<input type="checkbox"/>	<input type="checkbox"/>

a) As shown in Figure 3.1-2 of the 2018 LRDP Program EIR, the Project site is not located within a designated Visual Sensitive Zone (VSZ) or a Perimeter Development Zone (PDZ). Further, the Project site is not located near any of the Key Vantage Points (KVPs) identified in the 2018 LRDP Program EIR. As described in Section 2.2, Project Site and Setting, the Project site is currently located within approximately

2.35 acres of Pepper Canyon, which has been disturbed by development of the Mid-Coast Corridor Transit Project; thus, the site is on previously disturbed/developed land. Although the visual character of the Project site would change upon completion of the Project, it would benefit aesthetics of the Project area as it would install landscape improvements in a disturbed area. The Project would not have the potential for a significant impact to views because it is not located at a scenic vista location. Additionally, the majority of the Project is located within the Pepper Canyon, therefore not visible from many surrounding views due to depressed topography. Therefore, the Project would result in less than significant impacts consistent with the scenic vistas/views analysis evaluated in the 2018 LRDP EIR.

- b) Caltrans identifies the segment of I-5 from the Orange County border south to the Coronado Bridge as an eligible state scenic highway (Caltrans 2020). Although the segment of I-5 directly west of the project site is not officially designated as scenic, implementation of the Project would not result in substantial damage to scenic resources as it would not impede any views from the I-5 and would be installing landscape and hardscape improvements within a disturbed canyon. Therefore, the Project would result in less than significant impacts consistent with the scenic resources analysis evaluated in the 2018 LRDP EIR.
- c) As previously described in item a, the Project site is not located within a designated VSZ or a PDZ. Additionally, the Project site is not located near any of the KVPs identified in the 2018 LRDP Program EIR. The Project would not have the potential for a significant impact to visual character due to its absence from those designated views on campus (refer to Figure 3.1.2 in the 2018 LRDP EIR).

The Project site is located on West Campus and currently exists as Pepper Canyon Open Space Preserve. Section 3.1.1.1, Campus Visual Character, of the 2018 LRDP Program EIR describes the Open Space Preserve as providing an integrated system of open spaces that contributes significantly to the campus' identity and character. According to Section 2.5.2, the Project would construct the East Rim Multimodal Path and the Regional Storm Water Quality Basin. The proposed Project would remain consistent with the existing visual character comprised of Urban Forest Open Space Preserve and is consistent with the visual landscape and character of the surrounding development at the Project site.

The project is located in an urbanized area and would be consistent with the land use designation of the site, Open Space Preserve. Therefore, the project would be consistent with the visual character and quality analysis evaluated in the 2018 LRDP

EIR and would not result in new significant environmental effects or a substantial increase in the severity of previously identified significant effects regarding conflicts with applicable zoning or other regulations governing scenic quality.

- d) As with all projects at UC San Diego, the Project has been designed to comply with the UC San Diego Design Guidelines, which includes an Outdoor Lighting Policy. Compliance with these policies would require all glare from lighting would be minimized to not produce glare. All light fixtures utilized on the Project site would be downcast and would minimize light pollution or spill over, and would be the minimum necessary for pedestrian safety. Further, the Project does not include any parking areas or roads intended for high traffic usage that would result in vehicle headlights affecting nighttime views. Therefore, the Project would result in less than significant impacts consistent with the light and glare analysis evaluated in the 2018 LRDP EIR.

#### 4.1.2 Air Quality

Section 3.2 of the 2018 LRDP EIR addresses the air quality effects of campus growth under the 2018 LRDP and concludes that its implementation would result in potentially significant impacts from construction and operational activities that could lead to a violation of air quality standards or contribute substantially to an existing or projected air quality violation (Section 3.2.3.2). Cumulatively significant impacts were identified due to a considerable net increase in criteria pollutants in a region that is in non-attainment (Section 3.2.3.3).

Potentially significant construction-related emissions would cause exposure of sensitive receptors to toxic air contaminant (TAC) emissions (Section 3.2.3.5). Less than significant impacts were identified related to consistency with the Regional Air Quality Strategy (RAQS) and State Implementation Plan (SIP) and due to carbon monoxide hot spots (Sections 3.2.3.1 and 3.2.3.4). No potential for significant odors impacts was identified (Section 3.2.5).

MM AQ-2A (fugitive dust emissions) and AQ-2B (off-road construction emissions) are required for projects that would contribute to these impacts. However, the 2018 LRDP EIR acknowledges that not all projects under the plan can feasibly implement MM AQ-2B and certain projects would contribute to significant and unavoidable impacts related to criteria pollutants and TACs.

AIR QUALITY	Impact Examined in 2018 LRDP EIR	Impact Not Examined in 2018 LRDP EIR		
		No Impact	Less-than-Significant Impact	Potentially Significant Impact
Would the Project...				
a) Conflict with or obstruct implementation of the applicable air quality plan?	<input checked="" type="checkbox"/>	<input type="checkbox"/>	<input type="checkbox"/>	<input type="checkbox"/>
b) Result in a cumulatively considerable net increase of any criteria pollutant for which the project region is in non-attainment under an applicable federal or state ambient air quality standard?	<input checked="" type="checkbox"/>	<input type="checkbox"/>	<input type="checkbox"/>	<input type="checkbox"/>
c) Expose sensitive receptors to substantial pollutant concentrations?	<input checked="" type="checkbox"/>	<input type="checkbox"/>	<input type="checkbox"/>	<input type="checkbox"/>
d) Result in other emissions (such as those leading to odors) affecting a substantial number of people?	<input checked="" type="checkbox"/>	<input type="checkbox"/>	<input type="checkbox"/>	<input type="checkbox"/>
a) The 2018 LRDP incorporates development strategies identified in the <i>SANDAG Regional Transportation Plan and Sustainable Communities Strategy (October 2011)</i> by integrating land use, housing, and transportation planning, which is consistent with the goals developed by SANDAG and the University land use assumed in the Regional Air Quality Strategy. Projects that propose development that is consistent with the growth anticipated by local plans are considered consistent with the Regional Air Quality Strategy. The project is consistent with the land use designation/development identified for the site in the 2018 LRDP, as described in Section 3, <i>Consistency with the 2018 LRDP</i> , of this Addendum. Therefore, the project is consistent with the air quality analysis evaluated in the 2018 LRDP EIR and would not result in new significant environmental effects or a substantial increase in the severity of previously identified significant effects regarding applicable air quality plans.				
b) The proposed Project includes a multi-modal trail for pedestrians and bicyclists, a Storm Water Quality Basin, and revegetation of the canyon. Minimal operational emissions are anticipated and such emissions would be consistent with typical operations described in the 2018 LRDP EIR. Implementation the Project would contribute to a cumulatively considerable net increase of criteria pollutants for which the region is in non-attainment under an applicable federal or state ambient air quality standard. MMs AQ-2A (fugitive dust emissions) and AQ-2B (off-road construction emissions) would be incorporated into construction specifications to minimize this impact. With these measures in place, the Project would result in less than significant impacts. However, the feasibility of implementing MM AQ-2B is not				

assured. Therefore, implementation of the Project would contribute to a cumulatively considerable net increase of criteria pollutants for which the region is non-attainment. The Project is consistent with the air quality analysis evaluated in the 2018 LRDP EIR.

- c) The Project would not induce vehicular traffic; rather, it would encourage pedestrian and micromobility travel and transit use. Therefore, operation of the Project would not expose sensitive receptors to substantial pollutant concentrations caused by localized CO impacts. The Project would result in less than significant impacts and is consistent with the air quality analysis evaluated in the 2018 LRDP EIR.

TAC emissions would be associated with Project-related construction and operations due to diesel PM emissions from construction equipment and motor vehicles. As described in Section 3.2.3.5 of the 2018 LRDP EIR, campus growth, including the Project, would not exceed the risk threshold for on-campus residents and workers; however, the potential to exceed the thresholds for cancer risks for off-campus residents and workers and off-campus and on-campus sensitive receptors of a programmatic level would exist. Because construction of the Project, as well as traffic generated during its operations, would contribute TAC emissions, MM AQ-2B would be incorporated into construction specifications to minimize this impact. However, the feasibility of implementing MM AQ-2B is not assured and the Project would contribute to the significant and unavoidable air quality (TAC) impacts associated with implementing the 2018 LRDP, consistent with the air quality analysis evaluated in the 2018 LRDP EIR.

- d) Potential sources that may emit odors during construction of the project would include exhaust from diesel construction equipment. However, because of the temporary nature of these emissions and the highly diffusive properties of diesel exhaust, odors from construction equipment would not affect a substantial amount of people. The project would use typical construction techniques, and the odors from off-road equipment and on-road vehicles would be typical of most construction sites and temporary in nature. In addition, Project operation would not produce new sources of odor or other pollutants that would adversely affect a substantial number of people as the Project consists of landscape and hardscape improvements and a stormwater facility. Therefore, the project would result in less than significant impacts and is consistent with the air quality analysis evaluated in the 2018 LRDP EIR.

### 4.1.3 Biological Resources

Section 3.5 of the 2018 LRDP EIR addresses the effects of campus growth under the 2018 LRDP on biological resources and concludes that its implementation would result in potentially significant impacts to sensitive biological resources, including candidate, sensitive, or special-status plant species (Section 3.3.3.1); sensitive animal species (Section 3.3.3.2); sensitive vegetation communities (Section 3.3.3.3) and federally protected off-site riparian area (Section 3.3.3.4). It also concluded that there was no potential for significant impacts to wildlife corridors or linkages and that it was not in conflict with local policies or ordinances, including any adopted habitat conservation plans (Section 3.3.5).

The mitigation framework addresses all of the potentially significant impacts identified in Section 3.3.3 of the 2018 LRDP EIR. If an LRDP project would impact sensitive plants, the site would be surveyed for sensitive plants in accordance with MM Bio-1A and, if applicable, San Diego barrel cactus would be relocated in accordance with MM Bio-1B. For impacts to sensitive animal species, surveys for the species, construction noise attenuation, and agency consultation are required by MMs Bio-2A, 2B, and 2C; avian nest surveys and avoidance measures are required by MMs Bio-2D and 2E. MMs Bio-3A and 3B require project-level surveys for sensitive vegetation communities, while avoidance and compensatory mitigation is required by MMs Bio-3C and Bio-3D. Indirect construction impacts are addressed through the implementation of MMs Bio-3E and Bio-3F, and indirect operational impacts require compliance with MMs Bio-3G through Bio-3M. Implementation of these measures would reduce future project-level impacts to less than significant levels.

BIOLOGICAL RESOURCES	Impact Examined in 2018 LRDP EIR	Impact Not Examined in 2018 LRDP EIR		
		No Impact	Less-than-Significant Impact	Potentially Significant Impact
Would the Project...				
a) Have a substantial adverse effect, either directly or through habitat modifications, on any species identified as a candidate, sensitive, or special status species in local or regional plans, policies, or regulations, or by the California Department of Fish and Wildlife or U.S. Fish and Wildlife Service?	<input checked="" type="checkbox"/>	<input type="checkbox"/>	<input type="checkbox"/>	<input type="checkbox"/>
b) Have a substantial adverse effect on any riparian habitat or other sensitive natural community identified in local or regional plans, policies, regulations or by the California Department of Fish and Wildlife or US Fish and Wildlife Service?	<input checked="" type="checkbox"/>	<input type="checkbox"/>	<input type="checkbox"/>	<input type="checkbox"/>



BIOLOGICAL RESOURCES	Impact Examined in 2018 LRDP EIR	Impact Not Examined in 2018 LRDP EIR		
		No Impact	Less-than-Significant Impact	Potentially Significant Impact
Would the Project...				
c) Have a substantial adverse effect on state or federally protected wetlands as defined by Section 404 of the Clean Water Act (including, but not limited to, marsh, vernal pool, coastal, etc.) through direct removal, filling, hydrological interruption, or other means?	<input checked="" type="checkbox"/>	<input type="checkbox"/>	<input type="checkbox"/>	<input type="checkbox"/>
d) Interfere substantially with the movement of any native resident or migratory fish or wildlife species or with established native resident or migratory wildlife corridors, or impede the use of native wildlife nursery sites?	<input checked="" type="checkbox"/>	<input type="checkbox"/>	<input type="checkbox"/>	<input type="checkbox"/>
e) Conflict with any local policies or ordinances protecting biological resources, such as a tree preservation policy or ordinance?	<input checked="" type="checkbox"/>	<input type="checkbox"/>	<input type="checkbox"/>	<input type="checkbox"/>
f) Conflict with the provisions of an adopted Habitat Conservation Plan, Natural Community Conservation Plan, or other approved local, regional, or state habitat conservation plan?	<input checked="" type="checkbox"/>	<input type="checkbox"/>	<input type="checkbox"/>	<input type="checkbox"/>

a) The approximately 2.35-acre Project site includes primarily undeveloped areas within the Urban Forest category of the Open Space Preserve. The 2018 LRDP EIR describes the Pepper Canyon area as containing the following habitat types: herbaceous off-site riparian area, eucalyptus woodland, Diegan coastal sage scrub (including disturbed variety), non- native grassland, and disturbed habitat (Figure 3.3-2 in the 2018 LRDP EIR). However, the construction of SANDAG’s Mid-Coast Corridor Transit Project and the associated Central Campus Trolley Station has substantially altered or removed the majority of the habitat within the undeveloped portions of the Project site. Based on an updated vegetation survey of the Project site conducted in October 2019 and March 2021, two small areas of eucalyptus woodland remain in the southwest corner of the Project site (see Figure 6). The remaining areas on the Project site consist of urban/developed land and disturbed habitat. Eucalyptus woodlands are a non-native vegetation community and do not support habitat for special- status species that are known or have the potential to occur on UC San Diego.

Although suitable habitat for sensitive species is not present, implementation of the Project has the potential to impact nesting birds (including raptors) through direct removal of nesting habitat and through indirect disturbance to nesting birds from construction during the breeding season.

To avoid significant impacts to nesting birds (including raptors), avian nest surveys and avoidance would be implemented in accordance with MM-Bio-2D and MM-Bio-2E. Compliance with the 2018 LRDP EIR mitigation framework would ensure the Project would reduce its potentially sensitive species impacts to less than significant levels and is consistent with the sensitive species analysis evaluated in the 2018 LRDP EIR.

b, c) The proposed Project site is adjacent to vegetation mapped as potential wetlands and contains an unvegetated natural drainage course. As such and in accordance with MM Bio-4A from the 2018 LRDP EIR, on March 25, 2021, Dudek biologists conducted an Aquatic Resources Jurisdictional Delineation in the Pepper Canyon Urban Forest (see Appendix A). The aquatic resources delineation was performed in accordance with the 1987 U.S. Army Corps of Engineers Wetlands Delineation Manual (USACE 1987) and the Regional Supplement to the Corps of Engineers Wetland Delineation Manual: Arid West Region (USACE 2008a). A Field Guide to the Identification of the Ordinary High Water Mark (OHWM) in the Arid West Region of the Western United States: A Delineation Manual (USACE 2008b), the Updated Datasheet for the Identification of the Ordinary High Water Mark (OHWM) in the Arid West Region of the Western United States (USACE 2010), and the Field Form for the beta Arid Streamflow Duration Assessment Method (USACE 2021) were used to determine the extent of non-wetland waters. Pursuant to the federal Clean Water Act (USACE and EPA 2008), USACE wetlands included areas supporting all three wetlands criteria described in the 1987 USACE Manual: hydric soils, hydrology, and hydrophytic vegetation. Non-wetland waters included channels that display evidence of an ordinary high-water mark (OHWM), but do not meet the three-parameter criteria for a wetland. Streambeds under the jurisdiction of the California Department of Fish and Wildlife (CDFW) were mapped based on the presence of a defined bed and bank, and riparian areas under CDFW jurisdiction were mapped to the limits of hydrophytic vegetation associated with a streambank. The delineation defined areas under CDFW jurisdiction pursuant to Sections 1600–1603 of the California Fish and Game Code; USACE jurisdiction pursuant to Section 404 of the federal Clean Water Act; and Regional Water Quality Control Board jurisdiction

pursuant to Clean Water Act Section 401 and the Porter–Cologne Water Quality Control Act.

An updated vegetation survey was also completed at the same time to document the alteration of vegetation communities mapped in the 2018 LRDP EIR by the ongoing construction of the Mid-Coast Corridor Transit Project. Vegetation communities were mapped in the field directly onto a 100-foot-scale (1 inch = 100 feet), aerial photograph–based field map with an overlay of the Project survey area. The results of the Aquatic Resources Delineation Report for the Pepper Canyon Basin and vegetation survey are shown in Figure 6. The acreages of the jurisdictional aquatic resources and updated vegetation communities and land covers are listed in Tables 4-1 and 4-2, respectively.

**Table 4-1  
Vegetation Communities and Land Covers on the Project Site**

Vegetation Community/Land Cover	Acres
Urban/developed land	0.75
Disturbed	1.17
Eucalyptus woodlands	0.42
<b>Total</b>	<b>2.35</b>

**Table 4-2  
Jurisdictional Aquatic Resources on the Project Site**

Aquatic Resource	USACE/RWQCB Jurisdiction	CDFW Jurisdiction	Acres
Unvegetated stream channel	Non-wetland waters of the United States	Streambed	< 0.01
<b>Total</b>			<b>&lt; 0.01</b>

This page intentionally left blank.



SOURCE: SANDAG 2017

**FIGURE 6**

**Biological Resources**

Pepper Canyon Ancillary Site Work Project

This page intentionally left blank.

## **Jurisdictional Aquatic Resources**

Aquatic resources on the Project site are associated with runoff that drains from two storm drains located at a single headwall in the southwest corner of Pepper Canyon (see Figure 5). Runoff from the storm drains is conveyed approximately 220 feet westward across the southern portion of canyon where it enters an existing concrete storm drain box. The upper portion of the drainage consists of southern willow scrub under USACE and RWQCB jurisdiction as wetlands, and under CDFW jurisdiction as riparian habitat located off-site to the southwest. Southern willow scrub areas that lack indicators of wetlands hydrology or soil do not meet the three-parameter definition for wetlands under USACE jurisdiction and are under CDFW jurisdiction only, based on the presence of hydrophytic vegetation in association with the streambank. The lower portion of the drainage is within the Project site and within the active construction area for the Mid-Coast Corridor Transit Project and currently exists in a temporary disturbed condition as authorized under the terms and conditions of permits issued to SANDAG by USACE, CDFW and RWQCB. The approximately 160-foot-long drainage channel currently consists of a 2-foot-wide graded earthen channel, lined with engineering fabric and riprap. Despite its current disturbed condition, the existing drainage channel is considered an ephemeral unvegetated stream channel under CDFW jurisdiction and may also be a non-wetland waters under USACE and RWQCB jurisdiction, subject to an approved jurisdictional determination by USACE.

## **Vegetation Communities**

The only remaining vegetation communities in the undeveloped areas of the Project site include eucalyptus woodland in the southern end of Pepper Canyon. The remaining undeveloped areas in the Project site have been graded and continue to be disturbed by ongoing construction and will be restored by SANDAG as part of the Mid-Coast Corridor Transit Project.

## **Impacts**

In accordance with MM Bio-3B from the 2018 LRDP EIR, site plans were designed to avoid or minimize impacts to sensitive vegetation communities, to the extent feasible. As described in Section 2.5.4 of this Addendum, the existing off-site wetlands (southern willow scrub) would be protected and is located outside of the proposed Project. To the east of the existing wetlands, grading for the proposed Regional Storm Water Quality Basin was designed to accommodate a minimum 10-

foot-wide disturbance buffer. Potential indirect impacts to the existing wetlands are consistent with the indirect impacts disclosed in Section 3.3.3.3 of the 2018 LRDP EIR including water quality, fugitive dust, invasive species, edge effects/human activity, noise, lighting, and inadvertent encroachments.

Implementation of MM Bio-3E, MM-Bio-3F, MM-Bio-3G, MM-Bio-3H, MM-Bio- 3I, MM-Bio-3K, and MM-Bio-3M would ensure the Project would reduce its potentially significant indirect impacts on sensitive vegetation communities to less than significant levels and is consistent with the biological resources analysis evaluated in the 2018 LRDP EIR.

Potential indirect impacts from roadkill, non-native insects and brush management are not expected to occur or would be very limited. No new roads are proposed in the vicinity of the existing wetlands such that vehicle-related wildlife mortality would not be significant. Because the existing wetlands are already situated in a relatively urbanized setting, the potential for the Project to result in indirect impacts from non-native insects such as Argentine ants (*Linepithema humile*), red imported fire ants (*Solenopsis invicta*), and/or invasive shot hole borers (SHBs, [*Euwallacea* sp.]) would largely be the same as under current conditions. Adherence to MM-BIO-3I and MM-BIO-3G in the mitigation framework would address these impacts. Lastly, while planted areas of the Pepper Canyon Urban Forest Open Space Preserve would be subject to the vegetation management policies and requirements of the San Diego Fire Department, these policies would not apply to the existing wetland vegetation in the canyon, which would be protected.

While direct and indirect impacts to the existing wetlands in the Project site are being avoided and/or minimized to less than significant levels consistent with the 2018 LRDP EIR mitigation framework, construction of the proposed Regional Storm Water Quality Basin described in Section 2.5.4 would result in direct impacts to all or a portion of the unvegetated stream channel. While not considered wetland habitat, as a stream channel under CDFW jurisdiction, and potentially under USACE and RWQCB jurisdiction as non-wetland waters of the United States, impacts to less than 0.01 acres of unvegetated stream channel would require the necessary permits from USACE, RWQCB, and CDFW.

UC San Diego is currently coordinating with the USACE, RWQCB and CDFW regarding Project permitting requirements. The stream channel would not be impacted until the necessary permits are obtained, and any requirements or conditions of the permits would be adhered to. It is anticipated that purchasing mitigation credits for



impacts to unvegetated stream channel at a minimum 1:1 ratio would be required by the permitting agencies to ensure no net loss.

Compliance with the 2018 LRDP EIR mitigation framework identified in Section 5 of this Addendum would ensure the Project would reduce its potentially significant wetland impacts to less than significant levels and is consistent with the biological resources analysis evaluated in the 2018 LRDP EIR.

- d) Development of the Project would not preclude wildlife movement or impact wildlife corridors or linkages as none exist on the campus. Therefore, the Project is consistent with the biological resources analysis evaluated in the 2018 LRDP EIR.
- e) UC San Diego is a part of the UC, a constitutionally created unit of the State of California. As a state entity, UC is not subject to municipal plans, policies, and regulations, such as County and City General Plans or local ordinances. Thus, the Project would not result in any conflicts with any local policies protecting biological resources and is consistent with the biological resources analysis evaluated in the 2018 LRDP EIR.

The Project would not directly or indirectly affect resources preserved by the City of San Diego as part of its Multiple Species Conservation Plan (MSCP). Therefore, no inconsistencies are anticipated to the City's MSCP or the NCCP Program and is consistent with the biological resources analysis evaluated in the 2018 LRDP EIR.

#### 4.1.4 Cultural and Tribal Cultural Resources

Section 3.4 of the 2018 LRDP EIR addresses the effects of campus growth under the 2018 LRDP on archaeological and historical resources, including tribal cultural resources, and concludes that its implementation would result in potentially significant impacts due to potential alterations of historical (built environment) resources that would cause a substantial adverse change in their significance (Section 3.4.3.1); land disturbance of recorded archaeological resources and unrecorded subsurface archaeological resources (Section 3.4.3.2); disturbance of geological formations containing paleontological (fossil) resources (Section 3.4.3.3); disturbance of human remains and of potential human remains in unrecorded subsurface sites (Section 3.4.3.4); and disturbance of tribal cultural resources (TCRs) (Section 3.4.3.5).

The mitigation framework addresses all of the potentially significant impacts identified in Section 3.4.3 of the 2018 LRDP EIR. For impacts to historical resources, MM Cul-1A requires an analysis of historical resources and avoidance through compliance with the Secretary of

the Interior's Standards for Rehabilitation; project redesign is required in accordance with MM Cul-1B; preparation of documentation is required by MM Cul-1C; and feasible relocation of historical resources through compliance with MM Cul-1D. Supplemental measures are also required for certain projects as described in MM Cul-1E through Cul-1G. Demolition would be considered a significant and unavoidable impact of the 2018 LRDP implementation.

The mitigation framework requires the identification of archaeological resources in the Area of Potential Effects (APE) and evaluation in accordance with MM Cul-2A; avoidance of impacted resources per MM Cul-2B; documentation and treatment is required by MM Cul-2C; unknown resources, including human remains, are treated in accordance with MM Cul-2D; and construction monitoring to comply with MM Cul- 2E. Compliance with California Health and Safety Code Sections 7050.5 and 7052 and PRC Section 5097.98 is required for inadvertent discoveries of human remains, as noted in MM Cul-2E. Implementation of these measures would reduce future project-level impacts to archaeological resources, including human remains, to less than significant levels.

Paleontological monitoring is required in formations of high sensitivity; identification and evaluation; avoidance; documentation and treatment; construction monitoring in accordance with MM Cul-3. Implementation of this measure would reduce future project-level impacts to less than significant levels.

If campus development would affect TCRs, UC San Diego would initiate tribal consultation and identify feasible avoidance and minimization measures in accordance with MM Cul-5A. If avoidance is not feasible, TCRs would be treated through construction monitoring in accordance with MM Cul-5B; any cultural materials would be returned to the tribe per MM Cul-5C. Implementation of these measures would reduce future project-level impacts to TCRs to less than significant levels.

Would the Project...	Impact Examined in 2018 LRDP EIR	Impact Not Examined in 2018 LRDP EIR		
		No Impact	Less-than-Significant Impact	Potentially Significant Impact
a) Cause a substantial adverse change in the significance of a historical resource pursuant to Section 15064.5?	<input checked="" type="checkbox"/>	<input type="checkbox"/>	<input type="checkbox"/>	<input type="checkbox"/>
b) Cause a substantial adverse change in the significance of an archaeological resource pursuant to Section 15064.5?	<input checked="" type="checkbox"/>	<input type="checkbox"/>	<input type="checkbox"/>	<input type="checkbox"/>

Would the Project...	Impact Examined in 2018 LRDP EIR	Impact Not Examined in 2018 LRDP EIR		
		No Impact	Less-than-Significant Impact	Potentially Significant Impact
c) Disturb any human remains, including those interred outside of formal cemeteries?	<input checked="" type="checkbox"/>	<input type="checkbox"/>	<input type="checkbox"/>	<input type="checkbox"/>
d) Cause a substantial adverse change in the significance of a Tribal Cultural Resource as defined in Public Resources Code § 21074 as either a site, feature, place, cultural landscape that is geographically defined in terms of the size and scope of the landscape, sacred place, or object with cultural value to a California Native American tribe, and that is:				
1) Listed or eligible for listing in the California Register of Historical Resources, or in a local register of historical resources as defined in Public Resources Code section 5020.1(k), or	<input checked="" type="checkbox"/>	<input type="checkbox"/>	<input type="checkbox"/>	<input type="checkbox"/>
2) A resource determined by the lead agency, in its discretion and supported by substantial evidence, to be significant pursuant to criteria set forth in subdivision (c) of Public Resources Code Section 5024.1. In applying the criteria set forth in subdivision (c) of Public Resource Code Section 5024.1, the lead agency shall consider the significance of the resource to a California Native American tribe.				

a) Based on the inventory and analysis contained in the Historic Resources Report prepared for the 2018 LRDP EIR (ARG 2018), the Project site does not contain structures or facilities that are eligible for the National Register of Historic Places (NRHP) or the California Register of Historic Resources (CRHR); therefore, no historical properties exist onsite, and the Project would not have the potential to cause changes to the significance of historic resources due to modifications.

b, c) SANDAG will finalize construction of the Mid-Coast Trolley Project that spans overtop the proposed Regional Storm Water Quality Basin by June 2021. Construction of these facilities required significant grading and excavation in the Pepper Canyon Urban Forest area. Based on a review of the proposed Project's Area of Potential Effects in accordance with MM Cul-2A and the inventory and analysis contained in the Archaeological Resources Report prepared for the 2018 LRDP EIR

(AECOM 2018), the Project site contains two identified historic archaeological resources.

Site P-37-032491 is a historic archeological resource that is a rectangular concrete foundation possibly associated with the former Camp Calvin B. Matthews, a Marine Corps rifle range. The concrete pad measures 55 feet long by 31 feet wide, and walls are present along the north and west edges of the resource. The original purpose of the structure is not clear but may be storage related. No artifacts were observed within or adjacent to the foundations. Research and field survey results indicate that this resource is more than 45 years old and possibly built in the 1950s. However, this site is not eligible for the NRHP or the CRHR because the foundation does not retain integrity of design, materials, workmanship, or feeling of when it was constructed.

Site P-37-032492/CA-SDI-20616 is a historic archeological resource that is composed of concrete culvert that is also possibly associated with Camp Calvin B. Matthews. The remains include two wood-formed concrete walls, a concrete base, a metal pipe railing, and a rubble pile of concrete chunks. The south concrete wall measures 14.5 feet long, 8 inches wide, and 82 inches tall and contains the culvert opening. The culvert opening is all concrete, measures 24 inches diameter, and has a modern plastic pipe cemented into it. The east concrete wall measures 12.5 feet long, 6 inches wide, and 65 inches tall. The concrete base joins the two walls, although it is mainly covered with the concrete rubble. The concrete rubble extends approximately 40 feet north of the culvert opening and may be an attempt to fill the former drainage channel. No artifacts were observed on or adjacent to the site.

Neither of these resources are considered significant archaeological resources, and the Archaeological Resources Report for the 2018 LRDP (AECOM 2018) concluded no further testing was required at these locations. MM CUL-2D requires archaeological monitoring for unknown resources within areas of natural deposition on the West Campus; however, Pepper Canyon has been disturbed and graded by the Mid-Coast Corridor Transit Project and no further excavation would be conducted as part of the proposed project. Therefore, no monitoring is required. Implementation of the Project would result in less than significant impacts, consistent with the cultural resources analysis evaluated in the 2018 LRDP EIR.

- d) Assembly Bill 52 (AB 52) requires that CEQA lead agencies consult with California Native American tribes that have requested such consultation, at initiation of the CEQA process, to identify and evaluate the significance of TCRs. The process for

identification of TCRs on the UC San Diego campus consisted of the formal consultation process mandated by AB 52, as well as a Native American consultation and outreach program conducted for the 2018 LRDP EIR.

In January 2016, UC San Diego proactively contacted California Native American tribes traditionally and culturally affiliated with the San Diego region to solicit their interest in being notified of proposed campus development projects as part of the planning process pursuant to AB 52. UC San Diego did not receive any responses as a result of this outreach attempt. However, UC San Diego was contacted independently by the San Luis Rey Band of Mission Indians, who expressed interest in receiving formal notifications of proposed projects on campus. Accordingly, UC San Diego has been sending out formal consultation request letters to the San Luis Rey Band of Mission Indians on a project-by-project basis. Such a letter describing the 2018 LRDP and requesting a consultation was sent to the San Luis Rey Band of Mission Indians on December 9, 2016. Because no response was received within the requested 30 days, UC San Diego assumed that consultation was declined.

The 2018 LRDP EIR Notice of Preparation (NOP) dated November 3, 2016, was also sent to 13 Native American tribes and the Native American Heritage Commission (NAHC) notifying them of the preparation of the 2018 LRDP EIR and soliciting input from them regarding potential environmental issues associated with implementing the 2018 LRDP. Although an NOP response letter was received from the NAHC, no response letters were received from the notified tribes (refer to Appendix A to the 2018 LRDP EIR).

In February 2017, a Sacred Lands File (SLF) search was requested from the NAHC as part of the 2018 LRDP EIR preparation (see Appendix D to the 2018 LRDP EIR). The NAHC responded that sites had been identified within the project area and recommended contacting the Lipay Nation of Santa Ysabel for more information. Campus representatives then contacted the tribe, which indicated there are several sites in the vicinity of UC San Diego that are considered sacred due to the known presence of human remains. Because the Project is consistent with the 2018 LRDP and is not located on or near the TCRs identified on campus through these prior consultation and communication efforts, no potential for impacts to TCRs would likely occur. Therefore, the Project is consistent with the tribal cultural resources analysis evaluated in the 2018 LRDP EIR.

## 4.1.5 Energy

Since the 2018 LRDP EIR was certified, the CEQA Guidelines were amended in December 2018 to provide new requirements to address a project's impacts on energy. A new section has been added to Appendix G of the CEQA Guidelines to address the need to evaluate energy impacts.

ENERGY	Impact Examined in 2018 LRDP EIR	Impact Not Examined in 2018 LRDP EIR		
		No Impact	Less-than-Significant Impact	Potentially Significant Impact
Would the Project...				
a) Result in potentially significant environmental impact due to wasteful, inefficient, or unnecessary consumption of energy resources, during project construction or operation?	<input checked="" type="checkbox"/>	<input type="checkbox"/>	<input type="checkbox"/>	<input type="checkbox"/>
b) Conflict with or obstruct a state or local plan for renewable energy or energy efficiency?	<input checked="" type="checkbox"/>	<input type="checkbox"/>	<input type="checkbox"/>	<input type="checkbox"/>

a) During construction, the Project would result in an increase in energy consumption through the combustion of fossil fuels in construction vehicles, worker commute vehicles, and construction equipment. The Project would consume minimal energy following construction, and energy use would be limited to lighting and landscape maintenance equipment. However, the Project would comply with the energy conservation strategies expressed in the UC Sustainable Practices Policy. The Project lighting would use electricity purchased from the UC Energy Services Unit Direct Access Program (100 percent renewable). The Project would also benefit the campus's transportation demand management program and encourage alternative transportation use by facilitating a pedestrian and micromobility connection in the vicinity of the new Central Campus Trolley Station. As noted under the VMT discussion above under item g of the Transportation/Traffic discussion, the campus as a whole, including the Project would produce a VMT that would be measurably lower than the regional and City averages, thus reducing energy usage associated with vehicle trips. The Project would not result in wasteful, inefficient, or unnecessary use of energy and is consistent with the energy analysis evaluated in the 2018 LRDP EIR.

b) Construction of the Project would implement sustainability measures identified in Section 2.5.7 of this Addendum. Conformance with the UC Sustainable Practices

Policy and other UC requirements related to energy reduction and carbon-free energy use would ensure that the project would not conflict with or obstruct a state or local plan for renewable energy or energy efficiency. Therefore, the project would not result in any new significant environmental effects or a substantial increase in the severity of previously identified significant effects regarding conflict with energy plan or policy.

#### 4.1.6 Geology and Soils

Section 3.5 of the 2018 LRDP EIR addresses the geology and soils effects of campus growth under the 2018 LRDP and concludes that implementation of future projects under the plan that comply with the applicable regulations related to geologic and soils hazards and result in less than significant impacts related to exposure to seismic-related hazards (Section 3.5.3.1), soil erosion and topsoil loss associated with ground disturbance (Section 3.5.3.2); unstable geologic or soil conditions (Section 3.5.3.3), and expansive soils (Section 3.5.3.4). The analysis determined there is no potential for a significant geology or soils impact related to use of septic tanks or alternative wastewater disposal systems (Section 3.5.5). No geology and soils mitigation is required in the 2018 LRDP EIR.

Section 3.4 of the 2018 LRDP EIR addresses the effects of campus growth under the 2018 LRDP on paleontological resources and concludes that its implementation would result in potentially significant impacts to disturbance of geological formations containing paleontological (fossil) resources (Section 3.4.3.3). Paleontological monitoring is required in formations of high sensitivity; identification and evaluation; avoidance; documentation and treatment; and construction monitoring in accordance with MM Cul-3. Implementation of this measure would reduce future project-level impacts to less than significant levels.

GEOLOGY AND SOILS	Impact Examined in 2018 LRDP EIR	Impact Not Examined in 2018 LRDP EIR		
		No Impact	Less-than-Significant Impact	Potentially Significant Impact
Would the Project...				
a) Expose people or structures to potential substantial adverse effects, including the risk of loss, injury, or death involving:				
i) Rupture of a known earthquake fault, as delineated on the most recent Alquist-Priolo Earthquake Fault Zoning Map issued by the State Geologist for the area or based on other substantial evidence of a known fault? Refer to Division of Mines and Geology Special Publication 42.	<input checked="" type="checkbox"/>	<input type="checkbox"/>	<input type="checkbox"/>	<input type="checkbox"/>
ii) Strong seismic ground shaking?	<input checked="" type="checkbox"/>	<input type="checkbox"/>	<input type="checkbox"/>	<input type="checkbox"/>
iii) Seismic-related ground failure, including liquefaction?	<input checked="" type="checkbox"/>	<input type="checkbox"/>	<input type="checkbox"/>	<input type="checkbox"/>
iv) Landslides?	<input checked="" type="checkbox"/>	<input type="checkbox"/>	<input type="checkbox"/>	<input type="checkbox"/>
b) Result in substantial soil erosion or the loss of topsoil?	<input checked="" type="checkbox"/>	<input type="checkbox"/>	<input type="checkbox"/>	<input type="checkbox"/>
c) Be located on a geologic unit or soil that is unstable, or that would become unstable as a result of the project, and potentially result in on- or off-site landslide, lateral spreading, subsidence, liquefaction or collapse?	<input checked="" type="checkbox"/>	<input type="checkbox"/>	<input type="checkbox"/>	<input type="checkbox"/>
d) Be located on expansive soil, as defined in Table 18-1-B of the Uniform Building Code (1994), creating substantial risks to life or property?	<input checked="" type="checkbox"/>	<input type="checkbox"/>	<input type="checkbox"/>	<input type="checkbox"/>
e) Have soils incapable of adequately supporting the use of septic tanks or alternative wastewater disposal systems where sewers are not available for the disposal of wastewater?	<input checked="" type="checkbox"/>	<input type="checkbox"/>	<input type="checkbox"/>	<input type="checkbox"/>
f) Directly or indirectly destroy a unique paleontological resource or site or unique geologic feature?	<input checked="" type="checkbox"/>	<input type="checkbox"/>	<input type="checkbox"/>	<input type="checkbox"/>

- a) Although the campus contains seismic hazards, implementation of the Project would not result in significant impacts because the UC San Diego campus and the surrounding area are not located within an Alquist-Priolo Earthquake Fault Zone. The Project site would not be subject to surface fault rupture but could be subject to a severe level of seismic ground shaking. In addition, portions of the campus could



be subject to earthquake-induced landslides.

Based on the analysis contained in the 2018 LRDP Program EIR, the potential for seismic-related liquefaction is considered very low on campus due to the types of soils and depths to groundwater. Additionally, based on referenced geologic maps, literature, topographic maps, and stereoscopic aerial photographs, no landslides or indications of deep-seated landsliding were noted underlying the Project site. However, the Project site is mapped within a marginally susceptible landslide area. Thus, any potential for seismic hazards and the Project is consistent with the geology and soils analysis evaluated in the 2018 LRDP EIR.

- b) Similar to other campus development, the Project would comply with the UC San Diego Design Guidelines, which include the incorporation of low impact development (LID) and erosion and sediment control best management practices (BMPs), and UC San Diego's Storm Water Management Program and other regulatory requirements, as needed to minimize erosion and topsoil loss. Specifically, the Project would comply with relevant National Pollutant Discharge Elimination System (NPDES) permits, including the General Permit for Storm Water Discharges Associated with Construction Activity (General Construction Permit) and the General Permit for Storm Water Discharges from Small Municipal Separate Storm Sewer Systems (Phase II Small MS4 Permit), which require soil erosion control measures. Project compliance with these regulations during construction and operation would provide adequate protection against soil erosion during and after site construction. Therefore, the Project is consistent with the geology and soils analysis evaluated in the 2018 LRDP EIR.
- c) The potential for large-scale slope instabilities at the Project site is low. The Project site is mapped within a marginally susceptible landslide area. As discussed earlier, the Project would be required to comply with the CBC and the University of California Seismic Safety Policy, which would address unstable soil and slope conditions, if needed. Project compliance with these regulations during construction and operation would provide adequate protection against impacts. The Project is consistent with the geology and soils analysis evaluated in the 2018 LRDP EIR.
- d) Based on the Natural Resources Conservation Service's (NRCS) Websoil Survey, the Project site is comprised of approximately 0.8% Altamont clay (AtE2) soil type D, 19.9% Chesterton fine sandy loam (CfB) soil type D, Chesterton-urban land complex (CgC) soil type D, Huerhuero-Urban land complex (HuE) soil type D, and Salinas clay

loam (SbC) soil type C (Appendix B – Drainage Study for UCSD Pepper Canyon Ancillary Site Work). These soils exhibit a low expansion index. The Project would be required to comply with the CBC and the University of California Seismic Safety Policy. Project compliance with these regulations during construction and operation would provide adequate protection against impacts. The Project is consistent with the geology and soils analysis evaluated in the 2018 LRDP EIR.

- e) UC San Diego is provided sanitary sewer service by the City of San Diego and no septic tanks or alternative wastewater systems are used or anticipated to be associated with the implementation of the 2018 LRDP, including the Project. The Project is consistent with the geology and soils analysis evaluated in the 2018 LRDP EIR.
- f) The Project site has been previously graded by SANDAG as part of the Mid-Coast Corridor Transit Project and will be returned to UC San Diego in June 2021; however, based on the mapping and analysis contained in the 2018 LRDP EIR, the Project site is located within an area of high potential for paleontological resources. Figure 3.4-2, Highly Sensitive Geologic Formations to be Monitored for Paleontological Resources, of the 2018 LRDP EIR indicates that portions of the Project site could potentially have “undifferentiated Eocene sedimentary deposits including Ardath Shale and Scripps Formation.” Thus, there could be potential impacts to unique paleontological resources. The Project proposes to export approximately 5,000 cubic yards of fill to create the lower retention basin of the Regional Storm Water Quality Basin, at anticipated depths of up to 11 feet. Other minor grading improvements would also be required within the previously disturbed area of the drainage channel where grades will be slightly modified to allow water to flow unobstructed into the Regional Storm Water Quality Basin. While the basin construction requires excavation depths of up to 11 feet, the overall excavation at depths 10 feet or greater is anticipated to be significantly less than the 1,000 cubic yards within highly sensitive geologic formations. Therefore, implementation of the Project would not cause impacts to unique paleontological resources and is consistent with the cultural resources analysis evaluated in the 2018 LRDP EIR.

#### 4.1.7 Greenhouse Gas Emissions

Section 3.6 of the 2018 LRDP EIR addresses potential impacts from greenhouse gas (GHG) emissions and climate change and determines that implementation of the 2018 LRDP would generate GHG emissions that may have a potentially significant cumulative impact

on the environment during construction and operation (Section 3.6.3.1) even with the implementation of GHG Reduction Actions contained in the 2018 LRDP and described in Section 3.6.3.1 of the 2018 LRDP EIR. Despite the projected increase in GHG emissions over time, the campus would not conflict with UC policies and plans adopted for the purposes of reducing GHG emissions which are consistent with GHG reduction targets contained in Assembly Bill (AB) 32 and Senate Bill (SB 32) (Section 3.6.3.2).

Implementation of programmatic measures identified in the 2018 LRDP EIR mitigation framework require the campus to decarbonize the cogeneration plant after 2032 (MM GHG-1A), to install electric charging stations across the campus (MM GHG-1B), and to conduct annual inventory updates and determine the need for and purchase of carbon credit purchases (MM GHG-1C) would reduce campus-wide contributions to cumulative GHG emissions (and related climate change impacts) to less than significance. No project-level mitigation measures are required for cumulative GHG emissions impacts.

Would the Project...	Impact Examined in 2018 LRDP EIR	Impact Not Examined in 2018 LRDP EIR		
		No Impact	Less-than-Significant Impact	Potentially Significant Impact
a) Generate greenhouse gas emissions, either directly or indirectly, that may have a significant impact on the environment?	<input checked="" type="checkbox"/>	<input type="checkbox"/>	<input type="checkbox"/>	<input type="checkbox"/>
b) Conflict with an applicable plan, policy, or regulation adopted for the purpose or reducing the emissions of greenhouse gases?	<input checked="" type="checkbox"/>	<input type="checkbox"/>	<input type="checkbox"/>	<input type="checkbox"/>

- a) Construction of the Project would result in GHG emissions from site preparation, construction vehicle trips, and construction equipment. Although the Project would result in GHG emissions, through the initiatives to reduce campus wide GHG emissions, Project emissions would be reduced or offset over time. In addition, as part of the overall campus, the Project's emissions would be included in the annual GHG inventory as part of the campus' implementation of the programmatic MM GHG-1C. It is also important to note that the Project would encourage use of alternative modes of transportation, which reduce GHG emissions from vehicular transportation, by providing a micromobility path in the vicinity of the Central Campus Trolley Station. The Project is consistent with the GHG analysis evaluated in the 2018 LRDP EIR.
- b) The 2018 LRDP contains several GHG Reduction Actions focused as minimizing and reducing future GHG emissions across the campus. Implementation of those

strategies would support the University's efforts in reaching the UC Sustainable Practices Policy target of climate neutrality for Scope 1 and 2 emissions by 2025 and climate neutrality for Scope 3 emissions by 2050, which are in line with the UC Carbon Neutrality Initiative and the UC San Diego Climate Action Plan. The Project would not conflict with UC Sustainable Practices Policy. Consistent with the overall 2018 LRDP, the Project would not conflict with an applicable plan, policy, or regulation adopted for the purpose or reducing the emissions of GHGs and is consistent with the GHG analysis evaluated in the 2018 LRDP EIR.

#### 4.1.8 Hazards and Hazardous Materials

Section 3.7 of the 2018 LRDP EIR addresses the hazards and hazardous materials effects of campus growth and determined that implementation of the 2018 LRDP would not result in a potentially significant impact related to the transport, use, and disposal of hazardous materials (Section 3.7.3.1 and 3.7.3.2); or pose a health risk to occupants of the school or the campus community (Section 3.7.3.3). The potential for significant hazards related to listed hazardous materials sites on the UC San Diego campus would exist due to the unknown potential for munitions debris or munitions and explosives of concern (MEC) associated with historical military training (Section 3.7.3.4). Aircraft operations and activities would not pose significant safety hazards (Section 3.7.3.5). Construction-related road closures or detours on the campus could impair or intervene with emergency response and result in potentially significant impacts (Section 3.7.3.6). Based on the analysis of wildfire hazards on campus, there would be less than significant potential for large-scale wildland fires (Section 3.7.3.7).

The 2018 LRDP EIR mitigation framework requires the assessment of hazardous materials contamination on the Project site and removal or remediation if a public health risk is identified (MM Haz-4A and -4B). MM Haz-4C requires construction activities to be halted if unknown contamination is encountered and implementation of remedial activities. Implementation of these measures during project-level planning and construction would reduce potential hazards from past contamination to less than significant levels. Compliance with MM Haz-6 would require contractors to notify Campus Fire Marshall and the campus community of any required road closures to reduce emergency access/response impacts to less than significant levels.

HAZARDS AND HAZARDOUS MATERIALS	Impact Examined in 2018 LRDP EIR	Impact Not Examined in 2018 LRDP EIR		
		No Impact	Less-than-Significant Impact	Potentially Significant Impact
Would the Project...				
a) Create a significant hazard to the public or the environment through the routine transport, use, or disposal of hazardous materials?	<input checked="" type="checkbox"/>	<input type="checkbox"/>	<input type="checkbox"/>	<input type="checkbox"/>
b) Create a significant hazard to the public or the environment through reasonably foreseeable upset and accident conditions involving the release of hazardous materials into the environment?	<input checked="" type="checkbox"/>	<input type="checkbox"/>	<input type="checkbox"/>	<input type="checkbox"/>
c) Emit hazardous emissions or handle hazardous or acutely hazardous materials, substances, or waste within one-quarter mile of an existing or proposed school?	<input checked="" type="checkbox"/>	<input type="checkbox"/>	<input type="checkbox"/>	<input type="checkbox"/>
d) Be located on a site which is included on a list of hazardous materials sites compiled pursuant to Government Code Section 65962.5 and, as a result, would it create a significant hazard to the public or the environment?	<input checked="" type="checkbox"/>	<input type="checkbox"/>	<input type="checkbox"/>	<input type="checkbox"/>
e) For a project located within an airport land use plan or, where such a plan has not been adopted, within two miles of a public airport or public use airport, would the project result in a safety hazard for people residing or working in the project area?	<input checked="" type="checkbox"/>	<input type="checkbox"/>	<input type="checkbox"/>	<input type="checkbox"/>
f) Impair implementation of or physically interfere with an adopted emergency response plan or emergency evacuation plan?	<input checked="" type="checkbox"/>	<input type="checkbox"/>	<input type="checkbox"/>	<input type="checkbox"/>
g) Expose people or structures, either directly or indirectly, to a significant risk of loss, injury or death involving wildland fires?	<input checked="" type="checkbox"/>	<input type="checkbox"/>	<input type="checkbox"/>	<input type="checkbox"/>

a, b) The Pepper Canyon Urban Forest Open Space Preserve was graded by SANDAG as part of the Mid-Coast Corridor Transit Project and will be returned to UC San Diego in June 2021. MM-HAZ-4A, MM-HAZ-4B and MM-HAZ-4C of the 2018 LRDP EIR was implemented during SANDAG's construction of the Mid-Coast Corridor Transit Project; therefore, materials generated from excavations within these areas were subject to on-site testing and evaluation in accordance with UC San Diego's Environmental Health and

Safety (EH&S) Guidelines. Thus, SANDAG complied with the LRDP mitigation framework during the initial excavation of the site.

The Project proposes to export approximately 5,000 cubic yards of fill to create the lower retention basin of the Regional Storm Water Quality Basin. By implementing MM-HAZ-4A, MM-HAZ-4B and MM-HAZ-4C of the 2018 LRDP EIR, materials exported from grading within this area would be subject to on-site testing and evaluation in accordance with UC San Diego's Environmental Health and Safety (EH&S) Guidelines. In addition, in the event that hazardous materials not identified in consultation with EH&S, or undocumented areas of contamination are encountered during the Project construction, work would be discontinued until appropriate health and safety procedures are implemented. Therefore, compliance with the 2018 LRDP mitigation framework, adherence to UC San Diego's EH&S Guidelines and existing regulations, and compliance with campus safety standards mandated by applicable federal, state, University, and local laws and regulations, would minimize the risks resulting from the routine transportation, use, storage, or disposal of hazardous materials or hazardous wastes and from accidental releases during Project construction. The Project is consistent with the hazards and hazardous materials analysis evaluated in the 2018 LRDP EIR.

- c) The Project would potentially transport hazardous materials during the Project grading phases of construction. However, as discussed in Items a and b above, SANDAG complied the 2018 LRDP mitigation framework and the UC San Diego's EH&S Guidelines. The proposed Project would also comply with MM-HAZ-4A and MM-HAZ-4B of the 2018 LRDP EIR, EH&S Guidelines and with federal and state regulations pertaining to hazardous wastes. Thus, impacts would be less than significant. There are also existing campus programs, practices, and procedures that would ensure that risks associated with hazardous emissions or materials to existing or proposed primary or secondary schools located within one-quarter mile from the campus would remain less than significant through proper handling procedures, disposal practices, and/or cleanup procedures. The Project is consistent with the hazards and hazardous materials analysis evaluated in the 2018 LRDP EIR.
- d) The Project site is not located on a contaminated site pursuant to Government Code Section 65962.5 (2018 LRDP EIR Impact 3.9-2). The Project would not disturb known contamination sites associated with the former Camp Matthews training activities. The Project is consistent with the hazards and hazardous materials analysis evaluated in the 2018 LRDP EIR.

- e) UC San Diego is not located within any Aircraft Potential Zones (APZs) for MCAS Miramar and, thus, implementation of the Project would not result in a significant aircraft safety hazard. With regard to the Torrey Pines Gliderport, its short-term use is not a safety hazard to the campus and surrounding area because the gliders do not take-off or land over UC San Diego structures. The Project is consistent with the hazards and hazardous materials analysis evaluated in the 2018 LRDP EIR.
- f) Project construction would not require the temporary closure of the existing campus roadway network and would not interfere with response times of emergency vehicles during its operation. As required by MM Haz-6, UC San Diego would require the construction contractor to notify the campus Fire Marshall and community to prevent conflicts with emergency access or evacuation routes during construction. Compliance with the 2018 LRDP EIR mitigation framework would ensure the Project would reduce its potentially significant impacts to less than significant levels and is consistent with the hazards and hazardous materials analysis evaluated in the 2018 LRDP EIR.
- g) The proposed Project is located in a portion of the campus identified as a Very High Fire Hazard Severity Zone (VHFHSZ) as designated by the City of San Diego Fire-Rescue Department (SDFR) in 2009 (City of San Diego 2009). Pepper Canyon is classified as the 'Urban Forest' designation of the Campus Open Space Preserve land use category. Multiple Project design features relevant to fire safety, as discussed in Section 2.5.2, would be implemented to minimize the potential for wildfire hazards. UC San Diego would continue to implement brush management around buildings that are adjacent to undeveloped areas of the campus, would equip all new on-campus academic, residential, medical, research, and support facilities with emergency fire sprinkler systems and would continue to retrofit existing buildings with fire sprinklers, in accordance with the CBC. The UC San Diego Fire Marshal is responsible for ensuring that adequate access is maintained on campus at all times and would continue to meet regularly with the City of San Diego Deputy Fire Chief to maintain a site plan/access plan that would adequately serve the campus.

The tree and understory planting palette for the Pepper Canyon Urban Forest Open Space Preserve would be focused on native and/or climate adaptive, non-invasive ornamental species. A 50- foot setback from the rail line would prevent trees from being planted in the center of Pepper Canyon, but would allow for trees to be planted further away. Security concerns in the Pepper Canyon Urban Forest Open

Space Preserve with respect to vegetation would be addressed by keeping planting heights less than 3-feet per San Diego Fire Department standards and by avoiding dense zones of trees to ensure good visibility. Per the Campus Fire Marshall, landscaping in the Pepper Canyon Urban Forest Open Space Preserve would comply with strict control over flammable plant and tree species. The Urban Forest Open Space Preserve Area would also require irrigation and maintenance of plant species as “low ground mounds,” and the area would be maintained on an annual or as-needed basis to remove dead, dying or diseased materials from the vegetation. Adherence to these conditions would minimize wildfire hazards. The Project would result in less than significant wildfire impacts and is consistent with the hazards and hazardous materials analysis evaluated in the 2018 LRDP EIR.

#### 4.1.9 Hydrology and Water Quality

Section 3.8 of the 2018 LRDP EIR addresses the hydrology and water quality effects of campus growth under the 2018 LRDP and determined it would result in less than significant impacts related to the alteration of drainage patterns and potential water quality effects due to Project compliance with applicable policies and regulations (i.e., UC San Diego’s Design Guidelines, Sustainability Policies, Phase II Small MS4 Permit and additional Storm Water Management Program requirements [Sections and 3.8.3.2]). No potential for seiches exists on campus, while less than significant risk associated with tsunamis would occur (Section 3.8.3.3). No potential exists for significant impacts related to the depletion of groundwater supplies and flooding (Section 3.8.5). The following analysis is based on a Drainage Study that was prepared by Michael Baker International in April 2021, herein included as Appendix B to this Addendum, Drainage Study for UCSD Pepper Canyon Ancillary Site Work.

No mitigation is required for hydrology and water quality impacts as described in the 2018 LRDP EIR.

HYDROLOGY AND WATER QUALITY	Impact Examined in 2018 LRDP EIR	Impact Not Examined in 2018 LRDP EIR		
		No Impact	Less-than-Significant Impact	Potentially Significant Impact
Would the Project...				
a) Violate any water quality standards or waste discharge requirements, or otherwise substantially degrade water quality?	<input checked="" type="checkbox"/>	<input type="checkbox"/>	<input type="checkbox"/>	<input type="checkbox"/>
b) Substantially deplete groundwater supplies or interfere substantially with groundwater recharge such that the project may impede	<input checked="" type="checkbox"/>	<input type="checkbox"/>	<input type="checkbox"/>	<input type="checkbox"/>



HYDROLOGY AND WATER QUALITY	Impact Examined in 2018 LRDP EIR	Impact Not Examined in 2018 LRDP EIR		
		No Impact	Less-than-Significant Impact	Potentially Significant Impact
Would the Project... sustainable groundwater management of the basin?				
c) Substantially alter the existing drainage pattern of the site or area, including through the alteration of the course of a stream or river, in a manner which would: (i) result in substantial erosion or siltation on- or off-site? (ii) substantially increase the rate or amount of surface runoff in a manner which would result in flooding on- or offsite; (iii) create or contribute runoff water which would exceed the capacity of existing or planned storm water drainage systems or provide substantial additional sources of polluted runoff; or (iv) impede or redirect flood flows?	<input checked="" type="checkbox"/>	<input type="checkbox"/>	<input type="checkbox"/>	<input type="checkbox"/>
d) In flood hazard, tsunami, or seiche zones, risk release of pollutants due to project inundation?	<input checked="" type="checkbox"/>	<input type="checkbox"/>	<input type="checkbox"/>	<input type="checkbox"/>
e) Conflict with or obstruct implementation of a water quality control plan or sustainable groundwater management plan?	<input checked="" type="checkbox"/>	<input type="checkbox"/>	<input type="checkbox"/>	<input type="checkbox"/>
i) Expose people or structures to a significant risk of loss, injury or death involving flooding, including flooding as a result of the failure of a levee or dam?	<input checked="" type="checkbox"/>	<input type="checkbox"/>	<input type="checkbox"/>	<input type="checkbox"/>
j) Inundation by seiche, tsunami, or mudflow?	<input checked="" type="checkbox"/>	<input type="checkbox"/>	<input type="checkbox"/>	<input type="checkbox"/>

a, c) Construction of the Project would not contribute substantial loads of sediment or other pollutants to storm water runoff due to compliance with the NPDES state-wide General Permit for Storm Water Discharges Associated with Construction and Land Disturbance Activity (General Permit). As part of the General Permit, campus construction projects managed by outside contractors and disturbing over one acre (including the Project) must implement Storm Water Pollution Prevention Plans (SWPPPs), which specify BMPs to reduce the contribution of sediments, spilled and leaked liquids from construction equipment, and other construction-related pollutants to storm water runoff. The Project's SWPPP includes the following erosion

control BMPs: scheduling to limit exposure of disturbed soil to wind, rain, and stormwater; preserving existing vegetation, use of soil binders, geotextiles, and mats earth dikes and drainage swales; velocity dissipation devices; and non-vegetative stabilization; as well as the following sediment control BMPs: silt fencing, check dams, fiber rolls, gravel bag berm, street sweeping and vacuuming, and storm drain inlet protection. All BMPs would be appropriately monitored and maintained by a Qualified SWPPP Practitioner per conditions of the SWPPP. Wind erosion control BMPs to prevent discharge from dust control activities and waste management and pollution controls would also be employed. Compliance with the regulations would provide adequate protection from storm water contamination and water quality protection from construction activities on campus.

Post-construction, the Project would result in approximately 3,050 sf of newly constructed impervious surfaces from the proposed improvements, which would result in new sources of stormwater runoff and contamination, as well as risk of flooding and sedimentation (see Appendix C - Post-Construction Stormwater Management Checklist Pepper Canyon Ancillary Site Work Project. However, development of the proposed Project would produce changes to site-specific storm water infrastructure. Section 2.5.4 of this Addendum describes the existing storm drain conditions that would serve the Project site. A series of existing small area drains serve the northerly portion of the Project site and ultimately flow into the canyon. These small area drains flow into the canyon as well. This storm drain system also receives secondary flows from the west. Storm drain lines (30-inch and 18-inch), which convey off-site drainage under the existing parking lot and ultimately discharge to the concrete headwall near the protected wetlands.

Post-construction, the Project would result in new impervious surfaces (3,050 sf from installation of the East Rim Multimodal Path) which could result in new sources of storm water runoff and contamination but would be addressed as described below. Campus development, including the Project, is covered under the Phase II Small MS4 Permit, which requires management of long-term storm water discharges and implementation of pollution protection measures. These management practices are enforced under the campus storm water management program and ensure long-term protection related to storm water pollution. In addition, as described in Section 2.5.4, SANDAG is currently completing construction of the Mid-Coast Trolley Project and continues to implement BMPs and minor surface improvements near the Wetland and Drainage Channel. The proposed project will inherit a post-construction BMP within the overall project area, as

constructed by SANDAG. This includes several concrete check dams and a vegetated swale with concrete cut-off walls. These features would be protected in place during the proposed project's construction and would continue to provide conveyance under post-construction conditions.

The proposed Project would be designed to comply with the UC San Diego's Storm Water Management Plan. Low Impact Development (LID) features (e.g., concrete swales, permeable pavements, etc.) would be utilized in the proposed Project design where feasible to effectively address storm water runoff. In addition, the East Rim Multimodal Path would be flanked by a 3-foot swale on the east side of the path that would provide storm water control. Storm drain infrastructure within the Project site drains would ultimately tie into the existing storm drain mains as constructed within the Pepper Canyon Open Space Preserve.

The proposed Project would not result in substantial alteration to the existing drainage pattern across the site. To the extent feasible, historic flow patterns would be adhered to for the proposed design. The proposed Project also includes the installation of an approximately 34,000-square-foot Regional Storm Water Quality Basin in the southerly portion of the Pepper Canyon, Urban Forest Open Space preserve as depicted in Figure 6, Regional Storm Water Quality Basin. Upon completion of the Project, runoff will discharge into the Regional Storm Water Quality Basin as concentrated flow. No new discharge locations are proposed, and all existing discharge locations are adequately protected against erosion under present day conditions. Water quality for the future housing site at Village at Pepper Canyon West is anticipated to be addressed by the Regional Storm Water Quality Basin that is proposed within the Open Space Preserve. In addition, runoff from the Pepper Canyon Open Space Preserve and adjacent development within UC San Diego will be captured and treated within the Regional Storm Water Quality Basin.

Upon implementation of the Project, the peak flow rates leaving the Pepper Canyon under 10-year and 100-year conditions would decrease because of the improvements associated with the Regional Storm Water Quality Basin. The proposed Project's Drainage Study (Appendix B) found a reduction in both 10- and 100-year events. Runoff from the East Rim Multimodal Path would be captured and discharged into the Regional Storm Water Quality Basin where a riser and outlet structures would mitigate the peak flow and velocity before discharging to the existing storm drain system. Also, existing flows downstream from the vegetated swale and wetland area would be unaffected by the Regional Storm Water Quality Basin, and the potential for downstream erosion was also shown to be unaffected by the proposed

improvements. Thus, proposed improvements result in a reduction in total peak flow as compared to existing conditions. As such, the off-site open channel is expected to function better in the proposed condition, as compared to existing, based on a reduction in peak flow.

The Project would also be required to comply with UC San Diego Design Guidelines and Storm Water Management Program and other regulatory requirements related to storm water runoff. These include compliance with the National Pollutant Discharge Elimination System (NPDES) General Permit for Storm Water Discharges Associated with Construction and Land Disturbance Activity (General Permit). Division II of guidelines would also require storm water BMPs to be implemented in accordance with UC San Diego's NPDES Phase II Small MS4 General Plan (2013-0001-DWQ) and/or Storm Water Management Program (Section 2.5.6). Water quality impacts related to storm water runoff are evaluated under items a, f), above. The Project would result in less than significant impacts and be consistent with the hydrology/water quality analysis evaluated in the 2018 LRDP EIR.

Therefore, the Project would result in less than significant water quality impacts and is consistent with the hydrology/water quality analysis evaluated in the 2018 LRDP EIR.

- b) No removal of groundwater is proposed, as the Project similar to the rest of campus would use potable and recycled water supplied by the City of San Diego Public Utilities Department via existing and future lines on UC San Diego's campus. The Project would not result in impacts to groundwater resources and is consistent with the hydrology/water quality analysis evaluated in the 2018 LRDP EIR.
- d) The entire UC San Diego campus is outside of the 100-year and 500-year flood hazard areas or any County-identified flood hazard areas. In addition, the Project site is not within an area that contains risk from seiches because this phenomenon is typically associated with land-locked bodies of water. The Project is also not within SIO and therefore not at risk for inundation by tsunamis. Thus, the Project would not result in significant impacts related to potential pollutant release during floods, tsunamis, and seiches. The Project is consistent with the hydrology/water quality analysis evaluated in the 2018 LRDP EIR.
- e) Construction activities could result in short-term water quality impacts from uncontrolled sediment and pollutants in storm water runoff that could conflict with the policies of the applicable Basin Plan, but would be addressed with appropriate construction BMPs as required by UC San Diego requirements for all construction

projects. Operation of the project would result in net benefit to long-term water quality as it provides an approximately 34,000 square foot Regional Water Quality Basin. With the incorporation of the proposed site design, source control, and treatment control BMPs and the continued implementation of UC San Diego Design Guidelines, and other regulatory requirements, water quality impacts associated with changes in storm water runoff would be minimized and would not conflict with or obstruct implementation of the Basin Plan. In addition, the project is not in an area governed by a sustainable groundwater management plan. Therefore, impacts would be less than significant, and the project is consistent with the hydrology and water quality analysis evaluated in the 2018 LRDP EIR.

#### 4.1.10 Land Use and Planning

Section 3.9 of the 2018 LRDP EIR addresses the land use and planning effects of campus growth under the 2018 LRDP and determined that its implementation would not result in inconsistencies with applicable land use plans, policies, and regulation (Section 3.9.3.1). In addition, as noted in Section 3.9.5 of the 2018 LRDP EIR, there is no potential for significant impacts related to physically dividing an established community or conflict with a Habitat Conservation Plan or Natural Community Conservation Plan (NCCP) Program.

No mitigation is required for land use and planning impacts as described in the 2018 LRDP EIR.

LAND USE AND PLANNING Would the Project...	Impact Examined in 2018 LRDP EIR	Impact Not Examined in 2018 LRDP EIR		
		No Impact	Less-than-Significant Impact	Potentially Significant Impact
a) Physically divide an established community?	<input checked="" type="checkbox"/>	<input type="checkbox"/>	<input type="checkbox"/>	<input type="checkbox"/>
b) Cause a significant environmental impact due to a conflict with any land use plan, policy, or regulation adopted for the purpose of avoiding or mitigating an environmental effect?	<input checked="" type="checkbox"/>	<input type="checkbox"/>	<input type="checkbox"/>	<input type="checkbox"/>

- a) The Project does not involve any development outside of established campus properties or boundaries, and no incursion into, or division of, the surrounding residential communities would occur. The Project would also include the development of the paved East Rim Multimodal Path that would strengthen

connectivity within campus areas. The East Rim Multimodal Path would run along Pepper Canyon, and would provide the main pedestrian and bicycle connector between the future Rupertus Walk and Gilman Drive. The Project would not result in an impact and is consistent with the land use analysis evaluated in the 2018 LRDP EIR.

- b) As described in Section 3 of this document, the Project is consistent with the objectives, population forecasts and building space projections in the 2018 LRDP, which is the applicable land use plan for the UC San Diego campus. The Project would not result in an impact and is consistent with the land use analysis evaluated in the 2018 LRDP EIR.

#### 4.1.11 Noise

Section 3.10 of the 2018 LRDP EIR addresses the noise effects of campus growth under the 2018 LRDP and concludes there is the potential for significant impacts due to noise-sensitive land uses being exposed to noise levels in excess of applicable standards (Section 3.10.3.1); exposure of vibration sensitive land uses to or the generation of excessive groundborne vibration or groundborne noise levels (Section 3.10.3.2); permanent increases in ambient noise levels (Section 3.10.3.3); and temporary increases in ambient noise levels (Section 3.10.3.4). No potential for significant impacts from noise produced by a private, public or public use airport (Section 3.10.5).

The mitigation framework in the 2018 LRDP addresses these potentially significant impacts by evaluating whether screening distances can be observed to avoid the impact; requiring site-specific studies based on the type of noise source; and integrating source-specific controls into project designs to reduce noise levels at sensitive land uses as required by MM Noi-1A through Noi-1F. MM Noi-2A requires new vibration sensitive uses near the trolley to prepare a vibration mitigation program to identify controls to reduce vibration effects and the incorporation of those controls into the project designs. Certain construction projects are required to prepare and implement a construction vibration program to comply with MM Noi-2B. Implementation of these measures would reduce future project-level impacts from noise and vibration to less than significant levels.

NOISE	Impact Examined in 2018 LRDP EIR	Impact Not Examined in 2018 LRDP EIR		
		No Impact	Less-than-Significant Impact	Potentially Significant Impact
Would the Project...				
a) Generation of a substantial temporary or permanent increase in ambient noise levels in excess of standards established in the local general plan or noise ordinance, or applicable standards of other agencies?	<input checked="" type="checkbox"/>	<input type="checkbox"/>	<input type="checkbox"/>	<input type="checkbox"/>
b) Generation of excessive groundborne vibration or groundborne noise levels?	<input checked="" type="checkbox"/>	<input type="checkbox"/>	<input type="checkbox"/>	<input type="checkbox"/>
c) For a project located within the vicinity of a private airstrip or within an airport land use plan or, where such a plan has not been adopted, within two miles of a public airport or public use airport, would the project expose people residing or working in the project area to excessive noise levels?	<input checked="" type="checkbox"/>	<input type="checkbox"/>	<input type="checkbox"/>	<input type="checkbox"/>

- a) The Project site is located beneath the Mid-Coast Corridor Transit Project and the associated Central Campus Trolley Station, which generate noise. The Project involves construction of stormwater and pedestrian circulation infrastructure and therefore would not contribute to projected increases in traffic noise along local roadways and would not introduce other noise-generating uses in the Project site.

The Project would involve construction activities that would require the use of construction equipment within 150 feet of existing residences to the east of the Project site. Construction would typically occur between 7:00 a.m. and 7:00 p.m. from Monday to Sunday, with limited nighttime construction to be approved by appropriate campus stakeholders, when found to be absolutely necessary or to reduce impacts on campus operations (Section 2.5.6). The Project would comply with MM Noi-1F of the 2018 LRDP EIR, which requires the integration of construction noise mitigation recommendations into the contractor specifications and its implementation during construction.

Therefore, less than significant noise impacts following mitigation would occur due to Project implementation and the Project is consistent with the noise analysis evaluated in the 2018 LRDP EIR.

- b) The Project site is located beneath the Mid-Coast Corridor Transit Project and the associated Central Campus Trolley Station, which generate vibration that would be

perceived by adjacent areas; however, the proposed Project would not introduce a vibration-sensitive receptor in proximity to the Mid-Coast Trolley route. In addition, proposed construction activities would not involve heavy earth-moving equipment or impact-type pile driving within the applicable vibration screening distance to nearby sensitive receptors (as noted in Table 3.10-16 of the 2018 LRDP EIR). No potential for significant vibration impacts would occur as a result of Project implementation and the Project is consistent with the vibration analysis evaluated in the 2018 LRDP EIR

Project is consistent with the noise analysis evaluated in the 2018 LRDP EIR.

- c) Because there are no private airstrips within two miles of the UC San Diego campus and the campus is not located within the 60 dBA CNEL contour of any airport, including MCAS Miramar and the Medical Center heliport operations; there is no potential for significant noise impacts from aircraft operations in the Project area. Therefore, the Project is consistent with the noise analysis evaluated in the 2018 LRDP EIR.

#### 4.1.12 Population and Housing

Section 3.11 of the 2018 LRDP EIR addresses the population and housing effects of implementing the 2018 LRDP and concludes that plan implementation would result in the direct inducement of substantial population growth in the area (Section 3.11.3.1). However, the 2018 LRDP would not result in indirect inducement of substantial population growth due to the extension of roads or other infrastructure (Section 3.11.3.1). Less than significant impacts are identified for the temporary displacement of existing on-campus housing and people (Section 3.11.3.2). No feasible mitigation is available for direct inducement of substantial population growth in the area; therefore, the population-related impacts of the campus growth are unavoidable.



POPULATION AND HOUSING	Impact Examined in 2018 LRDP EIR	Impact Not Examined in 2018 LRDP EIR		
		No Impact	Less-than-Significant Impact	Potentially Significant Impact
Would the Project...				
a) Induce substantial population growth in an area, either directly (for example, by proposing new homes and businesses) or indirectly (for example, through extension of roads or other infrastructure)?	<input checked="" type="checkbox"/>	<input type="checkbox"/>	<input type="checkbox"/>	<input type="checkbox"/>
b) Displace substantial numbers of existing people or housing, necessitating the construction of replacement housing elsewhere?	<input checked="" type="checkbox"/>	<input type="checkbox"/>	<input type="checkbox"/>	<input type="checkbox"/>

- a) As described in Section 2, Project Description, of this Addendum, the Project would construct an East Rim Multimodal Path and a Regional Storm Water Quality Basin. These facilities would not contribute to direct population growth in the region beyond what was anticipated in the 2018 LRDP population projections. No new roads would be extended into undeveloped areas as part of the Project and the storm water upgrades would be sized to accommodate projected campus growth as noted in Section 2, Project Description, of this Addendum. Therefore, the Project is consistent with the population and housing analysis evaluated in the 2018 LRDP EIR.
- b) As described in Section 2, Project Description, of this Addendum, the Project would construct an East Rim Multimodal Path and a Regional Storm Water Quality Basin. The Project would not temporarily displace a substantial number of people on the campus or create a demand for new housing that cannot be accommodated locally. Therefore, no potential for an impact would occur, consistent with the population and housing analysis evaluated in the 2018 LRDP EIR.

#### 4.1.13 Public Services

Section 3.12 of the 2018 LRDP EIR addresses the physical effects of providing public services to meet the needs of the campus growth under the 2018 LRDP and determines that less than significant environmental impacts would occur due to the need for additional fire protection facilities (Section 3.12.3.1), police protection facilities (Section 3.12.3.2), and public school facilities (Section 3.12.3.3). No mitigation is required for public services impacts as described in the 2018 LRDP EIR.

PUBLIC SERVICES	Impact Examined in 2018 LRDP EIR	Impact Not Examined in 2018 LRDP EIR		
		No Impact	Less-than-Significant Impact	Potentially Significant Impact
Would the Project...				
a) Would the project result in substantial adverse physical impacts associated with the provision of new or physically altered governmental facilities, need for new or physically altered governmental facilities, the construction of which could cause significant environmental impacts, in order to maintain acceptable service ratios, response times or other performance objectives for any of the public services:				
i) Fire protection?	<input checked="" type="checkbox"/>	<input type="checkbox"/>	<input type="checkbox"/>	<input type="checkbox"/>
ii) Police protection?	<input checked="" type="checkbox"/>	<input type="checkbox"/>	<input type="checkbox"/>	<input type="checkbox"/>
iii) Schools?	<input checked="" type="checkbox"/>	<input type="checkbox"/>	<input type="checkbox"/>	<input type="checkbox"/>

a) Implementation of the Project would not contribute to the overall need for new fire protection, police protection and school facilities in the University area as it is installing stormwater infrastructure and a multimodal connection, which would not induce population growth. Implementation of the overall 2018 LRDP would contribute to such need, but not at a level that would require new facilities beyond those that exist or are already planned by the various service providers nor would any new facilities result in a significant physical impact to the environment. It is also important to note that the City of San Diego has constructed a new fire station at the northwest corner of the West Campus, which would serve the campus and surrounding communities. Therefore, the Project is consistent with the public services analysis evaluated in the 2018 LRDP EIR.

#### 4.1.14 Recreation

Section 3.13 of the 2018 LRDP EIR addresses the environmental effects associated with modifying recreational facilities to meet the needs of campus growth under the 2018 LRDP and concludes that despite the increase in usage of on- and off-campus recreational facilities, less than significant impacts would occur (Section 3.13.3.1). Any construction and expansion of recreational facilities would be addressed through compliance with the 2018 LRDP EIR mitigation framework and less than significant impacts would occur (Section 3.13.3.2). No mitigation is required for recreation impacts as described in the 2018 LRDP EIR.

RECREATION	Impact Examined in 2018 LRDP EIR	Impact Not Examined in 2018 LRDP EIR		
		No Impact	Less-than-Significant Impact	Potentially Significant Impact
Would the Project...				
a) Would the project increase the use of existing neighborhood and regional parks or other recreational facilities such that substantial physical deterioration of the facility would occur or be accelerated?	<input checked="" type="checkbox"/>	<input type="checkbox"/>	<input type="checkbox"/>	<input type="checkbox"/>
b) Does the project include recreational facilities or require the construction or expansion of recreational facilities which might have an adverse physical effect on the environment?	<input checked="" type="checkbox"/>	<input type="checkbox"/>	<input type="checkbox"/>	<input type="checkbox"/>

a) The proposed Project would not contribute to increased demands for recreation facilities on and off campus. The 2018 LRDP anticipates the need for new recreation facilities and the campus would continue to manage and maintain its existing recreation facilities. The City of San Diego would continue to expand and maintain its off-campus recreation facilities in response to its own population growth. The proposed improvements include increased opportunities for passive recreation such as the East Rim Multimodal Path that could be used for walking, running and cycling. Substantial physical deterioration in recreation facilities is, therefore, not expected to occur as a result of the Project. Therefore, the Project is consistent with the public services analysis evaluated in the 2018 LRDP EIR.

b) The Project would provide the East Rim Multimodal Path and would improve Pepper Canyon, which is designated as the Urban Forest category of the campus' Open Space Preserve. These outdoor recreational facilities would provide public spaces suitable for walking, running, cycling, studying and other open space passive recreational opportunities. Additionally, these amenities would provide an important visual and physical center to the Pepper Canyon Neighborhood that would provide quiet spaces to enjoy and study. Access to the Urban Forest Open Space Preserve Area would be provided by rustic trail steps and the path would run through the area that would be suitable for walking and running.

The construction of these recreational facilities would not have an adverse physical effect on the environment that have not been addressed in the 2018 LRDP EIR and this Addendum. The environmental impacts associated with the development of new campus recreational facilities would be less than significant or would be mitigated to below a level of significance through the application of the mitigation

framework in the 2018 LRDP EIR. Therefore, the Project is consistent with the recreation analysis evaluated in the 2018 LRDP EIR.

#### 4.1.15 Transportation and Circulation

Section 3.14 of the 2018 LRDP EIR addresses the transportation and traffic effects of campus growth under the 2018 LRDP and concludes that traffic associated with plan implementation would result in cumulatively significant impacts due to exceedances of level of service (LOS) criteria in the Near-Term (Year 2025) and Long-Term (Year 2035) Scenarios for intersections, street segments, freeway mainline segments, and freeway ramp meters in the area (Section 3.14.3.1).

However, implementation of the 2018 LRDP would not cause substantial additional vehicle miles traveled (VMT) to exceed the regional averages for applicable campus land uses therefore less than significant VMT impacts are identified (Section 3.14.3.2). In addition, implementation of the 2018 LRDP would not conflict with applicable policies, plans, or programs regarding safety or performance of public transit, bicycle, or pedestrian facilities and its impact would be less than significant (Section 3.14.3.3). There is no potential for significant impacts to air traffic patterns, conflicts with a congestion management plan, safety hazards due to a design feature or incompatible uses, or inadequate emergency access (Section 3.14.5).

The 2018 LRDP mitigation framework includes programmatic mitigation to reduce or minimize the LOS impacts of plan implementation, as described in Section of the 2018 LRDP EIR. Specifically, the campus would implement MM Tra-1A-OPT2 by funding and installing the needed improvements at a subset of impacted intersections, and freeway ramp meters in phases over the next five years. UC San Diego would work with the City of San Diego and Caltrans to obtain the appropriate agreements and permits. Despite these improvements, impacts would be cumulatively significant and unavoidable as described in Section 3.14.3.1 of the 2018 LRDP EIR. No project-level mitigation measures are required for cumulative traffic impacts.

On September 27, 2013, SB 743 was signed into law, which created a process to change the way that transportation impacts are analyzed under CEQA. SB 743 required the California Governor's Office of Planning and Research to amend the CEQA Guidelines to provide an alternative to LOS for evaluating transportation impacts. The transportation impact assessment updates to the CEQA Guidelines required under SB 743 were approved on December 28, 2018, and were required to be implemented statewide by July 1, 2020. Under the new (i.e., current) CEQA transportation guidelines, LOS, or vehicle delay, is no longer

considered an environmental impact under CEQA; and, VMT has been adopted as the most appropriate measure of transportation impacts under CEQA. Therefore, this Addendum addresses the Project’s consistency with the Program EIR’s VMT analysis.

<b>TRANSPORTATION/CIRCULATION</b>	Impact Examined in 2018 LRDP EIR	Impact Not Examined in 2018 LRDP EIR		
		No Impact	Less-than-Significant Impact	Potentially Significant Impact
Would the Project...				
a) Conflict with an applicable plan, ordinance, or addressing the circulation system, including transit, roadway, bicycle and pedestrian facilities?	<input checked="" type="checkbox"/>	<input type="checkbox"/>	<input type="checkbox"/>	<input type="checkbox"/>
b) Would the project conflict or be inconsistent with CEQA Guidelines section 15064.3, subdivision (b)?	<input checked="" type="checkbox"/>	<input type="checkbox"/>	<input type="checkbox"/>	<input type="checkbox"/>
d) Substantially increase hazards due to a design feature (e.g., sharp curves or dangerous intersections) or incompatible uses (e.g., farm equipment)?	<input checked="" type="checkbox"/>	<input type="checkbox"/>	<input type="checkbox"/>	<input type="checkbox"/>
e) Result in inadequate emergency access?	<input checked="" type="checkbox"/>	<input type="checkbox"/>	<input type="checkbox"/>	<input type="checkbox"/>

a) Implementation of the Project would not conflict with applicable policies, plans, or programs regarding safety or performance of public transit, roadway, bicycle, or pedestrian facilities. As noted in Section 3.14.3.2 of the 2018 LRDP EIR, UC San Diego continues to look for opportunities to close gaps in the bicycle/pedestrian network in and adjacent to campus and improve last mile connections to campus trolley stations, whenever feasible. The proposed Project directly addresses this by providing a multimodal connection in the immediate vicinity of the Central Campus Trolley Station. The path would provide a connection to Rupertus Walk, which is the primary pedestrian path for LRT riders to access the West Campus, and also to the Gilman Bridge pedestrian and bicycle path, facilitating pedestrian and micromobility access between the West and East Campuses. Because the Project encourages alternative transportation and benefits the campus’s transportation demand management project, less than significant impacts would occur and the Project is consistent with the transportation analysis evaluated in the 2018 LRDP EIR. The San Diego region, which includes UC San Diego, elected to be exempt from the state-mandated congestion management plan (CMP) in October of 2009.

- b) CEQA Guidelines section 15064.3 pertains to impacts associated with vehicle miles traveled (VMT). As part of the 2018 LRDP EIR, a six-tier analysis of VMT impacts was conducted in accordance with the concepts expressed in Senate Bill (SB) 743. As shown in that comprehensive analysis, the 2018 LRDP VMT per resident, VMT per employee, and VMT per capita would be measurably lower than the regional and City averages. In addition, the campus transportation demand management (TDM) program combined with its location within a transit priority area (TPA) would lower auto dependency and VMT over time. The Project is adjacent to the Central Campus Trolley Station, which once in operation, would facilitate vehicular trip reduction. The Project would encourage use of the LRT line by improving a portion of the area surrounding the station and providing a multimodal pathway with the East Rim Multimodal Path that increases the overall accessibility of the Central Campus Trolley Station. Therefore, less than significant impacts would occur and the Project is consistent with the transportation analysis evaluated in the 2018 LRDP EIR.
- c) The Project would not change the off-site circulation system such that hazards would be increased, and would include a number of amenities that would improve the on-campus circulation system as described above for question a). The Project would also not substantially increase hazards due to design features or incompatible uses. Therefore, no impacts would occur and the Project is consistent with the transportation analysis evaluated in the 2018 LRDP EIR.
- d) The Project would not require an amendment to the campus's emergency access route map, as necessary, to ensure that adequate fire protection and emergency access is maintained on campus at all times. Therefore, no impacts would occur and the Project is consistent with the transportation analysis evaluated in the 2018 LRDP EIR.

#### 4.1.16 Utilities, Service Systems and Energy

Section 3.15 of the 2018 LRDP EIR addresses the physical effects of expanding the utility infrastructure and the energy demands associated with campus growth under the 2018 LRDP and concludes that less than significant impacts would occur related to wastewater treatment capacity (Section 3.15.3.1); new and expanded water and wastewater infrastructure (Section 3.15.3.2); new or expanded storm water drainage facilities (Section 3.15.3.3), water supply availability (Section 3.15.3.4); compliance with statutes and regulations related to solid waste management (Section 3.15.3.5); and energy usage (Section 3.15.3.6). The 2018 LRDP EIR further determines there is no potential for significant

impacts related to solid waste disposal needs or the capacity of local infrastructure to impact the provision of solid waste services or impair the attainment of solid waste reduction goals. No mitigation is required for utilities, service systems or energy impacts as described in the 2018 LRDP EIR.

UTILITIES AND SERVICE SYSTEMS	Impact Examined in 2018 LRDP EIR	Impact Not Examined in 2018 LRDP EIR		
		No Impact	Less-than-Significant Impact	Potentially Significant Impact
Would the Project...				
a) Require or result in the relocation or construction of new or expanded water, wastewater treatment or storm water drainage, electric power, natural gas, or telecommunications facilities or expansion of existing facilities, the construction or relocation of which could cause significant environmental effects?	<input checked="" type="checkbox"/>	<input type="checkbox"/>	<input type="checkbox"/>	<input type="checkbox"/>
b) Have sufficient water supplies available to serve the project and reasonably foreseeable future development during normal, dry, and multiple dry years?	<input checked="" type="checkbox"/>	<input type="checkbox"/>	<input type="checkbox"/>	<input type="checkbox"/>
c) Result in a determination by the wastewater treatment provider which serves or may serve the project that it has adequate capacity to serve the project's projected demand in addition to the providers existing commitments?	<input checked="" type="checkbox"/>	<input type="checkbox"/>	<input type="checkbox"/>	<input type="checkbox"/>
d) Generate solid waste in excess of State or local standards or the capacity of local infrastructure or negatively impact the provision of solid waste services or impair the attainment of solid waste reduction goals?	<input checked="" type="checkbox"/>	<input type="checkbox"/>	<input type="checkbox"/>	<input type="checkbox"/>
e) Comply with federal, state, and local statutes and regulations related to solid waste?	<input checked="" type="checkbox"/>	<input type="checkbox"/>	<input type="checkbox"/>	<input type="checkbox"/>

a) During the project planning and design phase for the Project, UC San Diego Campus Planning, Capital Program Management (CPM), and Design and Development Services (DDS) staff conducted a review of the Project's utility needs to verify that adequate infrastructure would be available to serve its storm water, energy, and recycled water needs. The Project does not require connection to domestic water or wastewater facilities. Additionally, as part of the site evaluation process and/or site feasibility study, the Campus Planner also consulted the Master Infrastructure Plan

(MIP) and CPM/DDS engineers to identify any capacity constraints and determine whether system improvements would be required to support the Project. The Project would require minimal water which would be provided via the campus's recycled water loop. No wastewater would be generated by the Project, nor would it need any telecommunication connections.

According to the 2018 LRDP EIR, incorporation of Low Impact Design (LID) standards for storm water treatment and retention would comply with the 2018 LRDP's standard for all projects that create or replace impervious surfaces to avoid flooding during storms. An objective of the Project is to implement LID opportunities with respect to storm water management, landscape, planting, and hardscape design. This objective is achieved through the installation of landscaping, hardscaping, and storm water facilities in Pepper Canyon Urban Forest.

The existing storm water facilities in Pepper Canyon Urban Forest Open Space Preserve Bare described in Section 2.5.4 of this Addendum.

The proposed 34,000 square foot Regional Storm Water Quality Basin would be installed in the southerly portion of the Pepper Canyon Urban Forest Open Space preserve (Section 2.5.4), and a network of proposed storm drain infrastructure would support the Project site. This would include connections to existing storm drain infrastructure that would ultimately tie into the existing storm drain mains as constructed within the Pepper Canyon Open Space Preserve. The proposed project would protect in place the concrete check dams and a vegetated swale with concrete cut-off walls that have recently been constructed by SANDAG. These features would continue to provide conveyance under post-construction conditions. In addition, the East Rim Multimodal Path would be flanked by a 3-foot swale on the east side of the path that would provide storm water control. To the extent possible, historic flow patterns would be adhered to for the proposed design.

Therefore, less than significant impacts would occur and the Project is consistent with the utilities and service systems analysis evaluated in the 2018 LRDP EIR.

- b) Implementation of the Project would not increase potable water usage on the campus beyond levels anticipated in the City's Water Supply Assessment Report prepared for the 2018 LRDP. Additionally, the Project would implement water-use reduction sustainability features that would comply with the UC Sustainable Practices Policy. One of these policies include the use of water efficient fixtures and drought tolerant landscaping in accordance with the water conservation goals of the



UC Sustainable Practices Policy and Water Action Plan (Section 2.5.7). Outdoor water use would be reduced through the selection drought tolerant native and adapted plant species. Areas where irrigation is required, water will be provided via the campus recycled water loop. Therefore, less than significant impacts would occur and the Project is consistent with the utilities and service systems analysis evaluated in the 2018 LRDP EIR.

- c) Implementation of the Project would not increase the amount of on-campus building space or the on-campus residential population. No physical expansion of the Point Loma Wastewater Treatment Plant capacity would be required to serve the proposed Project. Therefore, less than significant impacts would occur and the Project is consistent with the utilities and service systems analysis evaluated in the 2018 LRDP EIR.
- d) Implementation of the 2018 LRDP would not result in inadequate capacity of solid waste facilities in the region such that construction of a new landfill or expansion of an existing landfill would be necessary. Still, Project implementation would require demolition, and grading activities that would produce excavated soils, green waste, asphalt/concrete, and other construction and demolition waste. Demolition materials would be recycled in accordance with local policies. Operations of the Project would contribute additional non-recyclable/non-reusable waste which would be deposited at Miramar Landfill, after accounting for waste reduction and diversion. However, the Project would comply with applicable waste reduction and diversion programs as part of the campus-wide effort to meet the UC Sustainable Practices Policy's zero waste goal by 2020.

Therefore, the Project would minimize its waste disposal needs and assist the state and local agencies in achieving their applicable solid waste management and diversion goals, resulting in less than significant impacts. The Project is consistent with the utilities and service systems analysis evaluated in the 2018 LRDP EIR.

- e) Project implementation would require activities that would produce excavated soils, green waste, and other construction waste. Operations of the Project would contribute very small amounts of non-recyclable/non-reusable waste as the Project would install infrastructure and no habitable structure. Any waste would be deposited at Miramar Landfill, after accounting for waste reduction and diversion per UC San Diego procedures. However, the Project would comply with applicable waste reduction and diversion programs as part of the campus-wide effort to meet the UC Sustainable Practices Policy's zero waste goal by 2020 where applicable (for

example, recycling bins may be provided along the East Rim Multimodal Path). Therefore, the Project would minimize its waste disposal needs and assist the state and local agencies in achieving their applicable solid waste management and diversion goals, resulting in less than significant impacts. The Project is consistent with the utilities and service systems analysis evaluated in the 2018 LRDP EIR.

#### 4.1.17 Wildfire

Since the 2018 LRDP EIR was certified, the CEQA Guidelines were amended to provide new requirements to address a project's impacts on wildfire hazards. This section of this Addendum addresses those new questions, which were not explicitly addressed in the 2018 LRDP EIR. Relevant information provided in the 2018 LRDP EIR along with new project-specific information is relied upon to make new impact determinations.

WILDFIRE	Impact Examined in 2018 LRDP EIR	Impact Not Examined in 2018 LRDP EIR		
		No Impact	Less-than-Significant Impact	Potentially Significant Impact
Would the Project...				
a) Substantially impair an adopted emergency response plan or emergency evacuation plan?	<input type="checkbox"/>	<input type="checkbox"/>	<input checked="" type="checkbox"/>	<input type="checkbox"/>
b) Due to slope, prevailing winds, and other factors, exacerbate wildfire risks, and thereby expose project occupants to pollutant concentrations from a wildfire or the uncontrolled spread of a wildfire?	<input type="checkbox"/>	<input type="checkbox"/>	<input checked="" type="checkbox"/>	<input type="checkbox"/>
c) Require the installation or maintenance of associated infrastructure (such as roads, fuel breaks, emergency water sources, power lines or other utilities) that may exacerbate fire risk or that may result in temporary or ongoing impacts to the environment?	<input type="checkbox"/>	<input type="checkbox"/>	<input checked="" type="checkbox"/>	<input type="checkbox"/>
d) Expose people or structures to significant risks, including downslope or downstream flooding or landslides, as a result of runoff, post-fire slope instability, or drainage changes?	<input type="checkbox"/>	<input type="checkbox"/>	<input checked="" type="checkbox"/>	<input type="checkbox"/>

- a) UC San Diego has an Emergency Operations Plan that addresses planned responses instructions and procedures to various levels of human-made or natural emergency situations for all campus staff, students, and visitors. It provides information for building evacuation, emergency supplies, and related emergency contacts and information sources. Multiple emergency response regions are provided throughout the campus equipped to provide necessary supplies and trained personnel in the event of an emergency. The Project would not result in roadway closures or other

obstructions to emergency operations. If unanticipated closure of any lane or roadway are necessary, as required by Mitigation Measure Haz-6, UC San Diego would require the construction contractor to notify the Campus Fire Marshal and community to prevent conflicts with emergency access or evacuation routes during construction. Implementation of Mitigation Measure Haz-6, which requires the notification of the Campus Fire Marshal and campus community at large prior to the start of construction, would reduce impacts to less than significant levels. Therefore, the Project would not result in any new significant environmental effects.

- b) Equipment used for construction, landscaping, and maintenance could exacerbate wildfire risk and expose project occupants to wildfire pollutants. Consistent with the 2018 LRDP, the project would be reviewed by the Campus Fire Marshal to ensure that adequate fire protection and emergency access is maintained on campus at all times. Less flammable plant and tree species would be selected as required by the UC San Diego Fire Marshall. All LRT clearances and easements would be addressed per agreements negotiated with the City of San Diego and MTS. All new landscape planting would be kept at heights less than 3-feet per San Diego Fire Department requirements and dense zones of trees would be avoided to ensure good visibility. Per the Campus Fire Marshall, landscaping in the Pepper Canyon Urban Forest Open Space Preserve would comply with strict control over flammable plant and tree species. These policies would not apply to the existing wetland vegetation in the canyon, which would be protected. The Urban Forest area would also require irrigation and maintenance of plant species as "low ground mounds," and the area would be maintained on an annual or as-needed basis to remove dead, dying or diseased materials from the vegetation. Implementation of these fire protection measures, fuel management regulations, and compliance with associated regulations would ensure impacts to project occupants due to wildfire pollutants under the proposed project would be less than significant. Therefore, the project would not result in any new significant environmental effects regarding exposure of project occupants to pollutant concentrations from a wildfire.
- c) The Project would not include the installation of roads, fuel breaks, emergency water sources, or power lines. The Project would install stormwater and multimodal infrastructure within an existing canyon and would not exacerbate fire risk due to its location within the campus where fire protection measures including fuel management zones and building review by the Campus Fire Marshal exist. Any temporary or ongoing impacts to the environment resulting from the installation and maintenance of infrastructure is part of ongoing operations and projected future development of the campus and therefore evaluated under the 2018 LRDP EIR. Therefore, the project would

not result in any new significant environmental effects regarding installation or maintenance of associated infrastructure.

- d) In the event that the steep slopes near the project are burned, unstable soils could occur due to the lack of vegetation to anchor the hillside. UC San Diego would implement BMPs to stabilize slopes and prevent sediment movement exposure to off-site adjacent occupants. These BMPs would include the placement of fiber rolls, straw wattles, or sandbags on the affected slopes, as well as erosion control mats, to stabilize and protect the burned areas. The Project would install a Regional Storm Water Quality Basin that would better address stormwater flow from existing and planned development from the existing condition. See Section 4.1.9, Hydrology and Water Quality, for a discussion of the Project's stormwater management. The Project also would install vegetation along the eastern slope of the canyon on either side of the East Rim Multimodal Path, including a vegetated swale to address flows. Therefore, the possibility of flooding or landslides as a result of running water down the slope would be greatly lessened. In addition, the project would result in the redevelopment of a disturbed area and add additional fire protection measures, resulting in a less than significant impact. Therefore, the project would not result in any new significant environmental effects regarding downstream or down slope flooding.

### 4.1.18 Mandatory Findings of Significance

	Impact Examined in 2018 LRDP EIR	Impact Not Examined in 2018 LRDP EIR		
		No Impact	Less-than-Significant Impact	Potentially Significant Impact
a) Does the project have the potential to substantially degrade the quality of the environment, substantially reduce the habitat of a fish or wildlife species, cause a fish or wildlife population to drop below self-sustaining levels, threaten to eliminate a plant or animal community, substantially reduce the number or restrict the range of a rare or endangered plant or animal or eliminate important examples of the major periods of California history or prehistory?	<input checked="" type="checkbox"/>	<input type="checkbox"/>	<input type="checkbox"/>	<input type="checkbox"/>
b) Does the project have impacts that are individually limited, but cumulatively considerable? (“Cumulatively considerable” means that the incremental effects of a project are considerable when viewed in connection with the effects of past projects, the effects of other current projects, and the effects of probable future projects)?	<input checked="" type="checkbox"/>	<input type="checkbox"/>	<input type="checkbox"/>	<input type="checkbox"/>
c) Does the project have environmental effects that will cause substantial adverse effects on human beings, either directly or indirectly?	<input checked="" type="checkbox"/>	<input type="checkbox"/>	<input type="checkbox"/>	<input type="checkbox"/>

a) All applicable mitigation measures identified in the 2018 LRDP EIR to avoid and reduce impacts are integrated into the proposed Project and with the integration of these measures, the Project would not substantially degrade the quality of the environment.

As described in Section 4.1.3, Biological Resources, of this Addendum, the Project site is developed and mostly devoid of sensitive biological resources, except potential nest trees for special-status birds and jurisdictional wetlands. The Project would not significantly affect fish or wildlife habitat or species with compliance with the 2018 LRDP EIR mitigation framework. The implementation of biological resources mitigation measures and the project design would reduce or avoid the Project’s potentially significant impacts on sensitive vegetation communities

(wetlands) and nesting special-status birds to less than significant levels and is consistent with the biological resources analysis evaluated in the 2018 LRDP EIR.

As described in Section 4.1.4, Cultural and Tribal Cultural Resources, based on the inventory and analysis contained in the Historic Resources Report prepared for the 2018 LRDP EIR (ARG 2018), no historic structures exist on site. Based on the Archaeological Resources Report for the 2018 LRDP (AECOM 2018), two previous historic archaeological resources have been identified within the Project site. However, these resources were determined not to be of significance and testing has shown that no further work at the sites is required. Additionally, since recordation, these sites have likely been displaced or destroyed during the construction of the LRT station for the Mid-Coast Corridor Transit. The Project site is not within an area of archaeological or tribal cultural sensitivity. Therefore, the Project would not eliminate any examples of the major periods of California history or prehistory.

- b) The 2018 LRDP EIR identified significant and unavoidable cumulative impacts to air quality (construction, operational and toxic air contaminant emissions) population and housing (physical effects of population growth), transportation/traffic (levels of service) and growth inducement (regional growth). As part of the 2018 LRDP EIR development program, the Project would contribute to some (air quality) of these significant and unavoidable impacts as described in this Addendum. However, the Project is within the scope of campus development and population evaluated in the 2018 LRDP EIR as noted in Section 3 of this document.

These impacts were also addressed in the Findings and Statement of Overriding Considerations adopted by The Regents in connection with its approval of the 2018 LRDP. No conditions have changed, and no new information has become available since certification of the 2018 LRDP EIR that would alter this previous analysis. No additional mitigation is available to reduce the Project's contribution to these previously identified impacts.

- c) As described above, the Project would incrementally contribute to cumulative air quality impacts (toxic air contaminants) that were identified as significant and unavoidable as well as cumulatively considerable in the 2018 LRDP EIR. The Project's construction and operation emissions are within the scope of impacts examined in the 2018 LRDP EIR. These impacts were also addressed in the Findings and Statement of Overriding Considerations adopted by The Regents in connection with its approval of the 2018 LRDP.

Effects of the Project would not result in substantial adverse effects on human beings beyond those analyzed in the 2018 LRDP EIR. No conditions have changed, and no new information has become available since certification of the 2018 LRDP EIR that would alter this analysis. No additional mitigation is available to reduce the Project's contribution these impacts. Other impacts with the potential to affect human beings were determined to be Less Than Significant.

This page intentionally left blank.



## 5 APPLICABLE MITIGATION MEASURES

The following mitigation measures from the certified 2018 LRDP EIR Mitigation Monitoring and Reporting Program (MMRP) would be applicable to the impacts associated with the Project. No new significant impacts or increased severity in impacts that were not analyzed in the 2018 LRDP EIR have been identified; therefore, no additional project-specific mitigation is required.

### **Air Quality**

**AQ-2A:** Implement Measures to Control PM Emissions Generated by Construction Activities. UC San Diego shall require by contract specification that contractors implement the following measures during all phases of construction of individual projects developed under the proposed 2018 LRDP:

- Water the grading areas a minimum of twice daily to minimize fugitive dust;
- Stabilize graded areas as quickly as possible to minimize fugitive dust;
- Apply chemical stabilizer or pave the last 100 feet of internal travel path within the construction site prior to public road entry;
- Install wheel washers adjacent to a paved apron prior to vehicle entry on public roads;
- Remove any visible track-out into traveled public streets via regular street sweeping;
- Wet wash the construction access point at the end of each workday if any vehicle travel on unpaved surfaces has occurred;
- Provide sufficient perimeter erosion control to prevent washout of silty material onto public roads;
- Cover haul trucks or maintain at least 12 inches of freeboard to reduce blow-off during hauling;
- Suspend all soil disturbance and travel on unpaved surfaces if winds exceed 25 mph;
- Cover/water on-site stockpiles of excavated material;
- Enforce a 15-mph speed limit on unpaved surfaces;
- On dry days, dirt and debris spilled onto paved surfaces shall be swept up immediately to reduce re-suspension of particulate matter caused by vehicle movement. Approach routes to construction sites shall be cleaned daily of construction-related dirt in dry weather;
- Disturbed areas shall be hydroseeded, landscaped, or developed as quickly as possible to reduce dust generation; and

- Limit the daily grading volumes/area to extent feasible.

**AQ-2B:** Minimize Off-Road Construction Equipment Emissions. UC San Diego shall require by contract specification that the construction contractor use off-road construction diesel engines that meet, at a minimum, the Tier 4 interim California Emissions Standards, unless such an engine is not available for a particular item of equipment. Tier 3 engines will be allowed on a project-by-project basis when the contractor has documented that no Tier 4 interim equipment or emissions equivalent retrofit equipment is available or feasible for the project.

### **Biological Resources**

**Bio-2D:** If project construction is scheduled to commence during the raptor nesting season (generally January 15 through July 31), pre-construction surveys for raptor nests shall be performed by a qualified biologist within 500 feet of project construction activities no more than seven days prior to the initiation of construction. Construction activities within 500 feet of an identified active raptor nest shall not commence during the breeding season until a qualified biologist determines that the nest is no longer active and any young birds in the area have adequately fledged and are no longer reliant on the nest. Trees with inactive nests can be removed outside the breeding season without causing an impact.

**Bio-2E:** No grubbing, trimming, or clearing of vegetation (including brush management) from project sites shall occur during the general avian breeding season (February 15 through August 31). If grubbing, trimming, or clearing cannot feasibly occur outside of the general avian breeding season, a qualified biologist shall perform a pre-construction nesting bird survey no more than seven days prior to the commencement of vegetation clearing or grubbing to determine if active bird nests are present in the affected areas. Should an active migratory bird nest be located, the project biologist shall direct vegetation clearing away from the nest until it has been determined by the project biologist that the young have fledged, or the nest has failed. If there are no nesting birds (includes nest building or other breeding/nesting behavior) within the survey area, clearing, grubbing, and grading shall be allowed to proceed.

**Bio-3B:** During the project planning phase, site plans shall be designed to minimize impacts to sensitive vegetation communities, to the extent feasible. Such minimization efforts include the following:

- i. Use of retaining walls to minimize grading impacts, to the extent that this is possible from an engineering and visual impact standpoint.

- ii. Locations, widths, design features, and construction methods of any new trails or overlook areas shall carefully consider how to avoid and minimize impacts to sensitive vegetation communities (e.g., routing trails along canyon rims rather than through canyons, cantilevered overlook platforms, using bridges to avoid wetland vegetation communities, clearing trails by hand).
- iii. To the extent practicable, a 50-foot-wide buffer shall be provided between permanent development and wetland vegetation.

**Bio-3E:** Prior to construction, a pre-construction meeting shall be held between the Project Manager, qualified Biologist, Environmental Planner, and construction crews to ensure crews are informed of the sensitivity of habitats in the Open Space Preserve and adjacent undeveloped lands.

- i. Prior to commencement of clearing or grading activities, fencing (e.g., silt fencing, orange construction fencing, and/or chain-link fencing as determined by campus planning) shall be installed around the approved limits of disturbance to prevent errant disturbance of sensitive biological resources by construction vehicles or personnel. Installation of fencing to demarcate the approved limits of disturbance shall be verified by the project biologist prior to initiation of clearing or grading activities. All movement of construction contractors, including ingress and egress of equipment and personnel, shall be limited to designated construction zones. This fencing shall be removed upon completion of all construction activities.
- ii. No temporary storage or stockpiling of construction materials shall be allowed within the Ecological Reserve or Restoration Lands, and all staging areas for equipment and materials shall be located at least 50 feet from the edge of these areas. This prohibition shall not be applied to facilities that are planned to traverse Ecological Reserve or Restoration Lands (e.g., trails and utilities). Staging areas and construction sites in proximity to the Ecological Reserve or Restoration Lands shall be kept free of trash, refuse, and other waste; no waste dirt, rubble, or trash shall be deposited in these areas.
- iii. Equipment to extinguish small brush fires (e.g., from trucks or other vehicles) shall be present on site during all phases of project construction activities, along with personnel trained in the use of such equipment. Smoking shall be prohibited in construction areas adjacent to flammable vegetation.
- iv. Temporary night lighting shall not be used during construction unless determined to be absolutely necessary. If night lighting is necessary, lights shall be directed away

from sensitive vegetation communities and shielded to minimize temporary lighting of the surrounding habitat.

**Bio-3F:** During project construction, a biological monitor shall visit the site weekly during site preparation and rough grading activities, and monthly following completion of rough grading, until construction is completed. During site visits, the monitor shall be responsible for ensuring that the construction activities and staging areas are restricted to the approved limits of work, and protective fencing is adequately maintained. The monitor shall be responsible for ensuring that the contractor adheres to the other provisions described above. The monitor, in cooperation with the on-site construction manager, shall have the authority to halt construction activities in the event that these provisions are not met. Monitors shall submit regular reports to the UC San Diego Campus Planning Office during construction documenting the implementation of construction measures Bio-3E.

**Bio-3G:** The following best management practices shall be implemented for each project that would remove or install tree species on UC San Diego that may be used as host trees by SHBs

- i. Trees to be planted on UC San Diego shall be obtained from a reliable source and be free of sign of SHB infestation.
- ii. An education program for on-site workers responsible for tree installation shall be implemented. The program shall describe the signs of SHB infestation (e.g., sugary exudate on trunks or branches, and SHB entry/exit holes [approximately the size of the tip of a ballpoint pen]).
- iii. Sign of SHB infestation shall be reported to CDFW and UC Riverside's Eskalen Lab ([www.eskalenlab.ucr.edu](http://www.eskalenlab.ucr.edu)) by the UC San Diego Project Manager and/or the project biologist.
- iv. Trees with sign of SHB infestation shall be pruned or removed, as appropriate, and potential host materials shall be chipped to less than one inch prior to composting on site or transfer to a landfill.
- v. Equipment that is used to prune or remove SHB-infected trees shall be disinfected prior to additional use.
- vi. Biologists monitoring mitigation sites shall be knowledgeable regarding sign of SHB infestation.

**Bio-3H:** Areas selectively thinned for brush management shall be monitored by a qualified biologist for establishment of invasive plant species pursuant to the HMP.

**Bio-3I:** Landscaping adjacent to the Open Space Preserve shall comply with the following requirements to prevent the introduction of invasive species:

- i. Appropriate landscaping shall be selected based on the vegetation communities within the portion of the Open Space Preserve adjacent to the project. In areas supporting native (or disturbed native) vegetation communities, revegetation of impacted slopes shall be with appropriate native plant materials. In particular, where the Open Space Preserve is disturbed by construction of the Campus Meander, installation of native plants such as lemonadeberry, toyon, deerweed (*Acmispon glaber*), monkey flower (*Diplacus aurantiacus*), and sages (*Salvia* spp.) are recommended to make the Open Space Preserve more impenetrable to people while reinforcing the boundaries and edges of the Campus Meander (The Harrison Studio 1997).
- ii. Only non-invasive plant species shall be included in the landscape plans for projects (species not listed on the California Invasive Plant Inventory prepared by the Cal-IPC [2006]). A qualified landscape architect and/or qualified biologist shall review landscape plant palettes prior to implementation to ensure that no invasive species are included.
- iii. Any planting stock brought onto a project site adjacent to the Open Space Preserve for landscaping or habitat restoration shall be inspected to ensure it is free of pest species that could invade natural areas, including but not limited to Argentine ants and South American fire ants. Inspections of planting stock for habitat restoration shall be by a qualified biologist, and inspections of planting stock for landscaping shall be the responsibility of qualified UC San Diego Project Manager or their designated assignee. Any planting stock found to be infested with such pests shall be quarantined, treated, or disposed of according to best management practices by qualified personnel, in a manner that precludes invasions into natural habitats.

**Bio-3K:** The following best management practices shall be implemented by the campus along areas that interface with the Open Space Preserve to address runoff/water quality impacts from landscaping:

- i. Integrated Pest Management principles (University of California Integrated Pest Management Program) shall be implemented to the extent practicable for areas in and adjacent to the Open Space Preserve for chemical pesticides, herbicides, and fertilizers. Examples of such measures may include, but are not limited to, alternative weed/pest control measures (e.g., removal by hand) and proper application techniques (e.g., conformance to manufacturer specifications and legal requirements).

- ii. Irrigation for project landscaping shall be minimized and controlled in areas in and adjacent to the Open Space Preserve through efforts such as designing irrigation systems to match landscaping water needs, using sensor devices to prevent irrigation during and after precipitation, and using automatic flow reducers/shut-off valves that are triggered by a decrease in water pressure from broken sprinkler heads or pipes.

**Bio-3M:** Maintenance of storm water facilities shall be conducted in a manner to minimize impacts to adjacent sensitive habitats. Maintenance will be overseen by a qualified biologist and occur outside the general bird breeding season which extends from February 15 through August 31.

**Bio-4A:** During the project planning process, if a project has vegetation mapped as potential wetlands or the project site contains or is located immediately adjacent to a natural drainage course, a qualified biologist shall conduct a jurisdictional delineation. The jurisdictional delineation shall use current regulatory guidance to identify the presence of potential regulated waters and wetlands in the project vicinity. If there is potential for the project to adversely affect wetlands or waters, impacts shall be avoided and minimized during project design process, to the extent practicable, and unavoidable impacts shall be mitigated through implementation of mitigation measure Bio-3D, and conformance with applicable wetland permit conditions.

*Note: Mitigation Measure Bio-4A has been completed and the Project would not adversely affect the adjacent wetland. The applicable permits for impacts to the nonvegetated channel are underway and the appropriate mitigation to be determined by the regulatory agencies would be secured prior to any impact occurring to the channel.*

### **Cultural and Tribal Cultural Resources**

Cul-2A: Evaluation. As early as possible in the project planning process, UC San Diego shall define the project's Area of Potential Effects (APE) for archaeological resources based on the extent of ground disturbance and site modification anticipated for the project. If, based on the APE, it is determined that the project may affect a recorded significant or potentially significant archaeological resource, then UC San Diego shall implement the measures listed below. When determining if a project may affect a recorded archaeological resource that has undefined boundaries, a buffer of appropriate size for the resource shall be considered.

- i. If the resource or a portion thereof has been determined to be significant, UC San Diego shall implement mitigation measure Cul-2B.;

- ii. If a determination has not been made regarding the resource's significance (or a portion thereof), the locus shall be evaluated by a qualified UC San Diego-retained archaeologist through testing and other appropriate means, who will determine if it qualifies as a unique archaeological resource under the criteria of CEQA Guidelines Section 15064.5. This evaluation shall also determine the extent of the resource, if not already established. The qualified archaeologist shall be responsible for submitting appropriate records to the SCIC at San Diego State University and the San Diego Museum of Man.

*Note: Mitigation Measure Cul-2A has been completed; there are no potentially significant resources within the APE. The site has been completely graded by the Mid-Coast Corridor Transit Project. Items i) and ii) are not required.*

### **Hazards and Hazardous Materials**

**Haz-4A:** During project planning, EH&S shall be consulted in order to identify if any past contamination, USTs, ASTs, or other contamination could potentially occur in areas to be impacted. EH&S will consider the cases on file at the County of San Diego DEH and information on historical uses in the area to be impacted such as old maps and photos. If EH&S determines that there is limited potential for contamination to occur on site, no additional mitigation is necessary. If it is determined that contamination has potential to exist on a project site, Mitigation Measure Haz-4B shall be implemented.

**Haz-4B:** If contamination exists on a proposed project site and if it poses a risk to human health or the environment, actions shall be taken prior to any construction, pursuant to applicable regulations, to remove or otherwise remediate the contamination through appropriate measures such as natural attenuation, active remediation, and engineering controls. Assessment and remediation activities shall incorporate the following conditions:

- i. All assessment and remediation activities shall be conducted in accordance with a work plan that is approved by the regulatory agency having oversight of the activities.
- ii. It may be necessary to excavate existing soil within the project site, or to bring fill soils into the site from off-site locations. At sites that have been identified as being contaminated or where soil contamination is suspected, appropriate sampling and classification are required prior to disposal of excavated soil. Contaminated soil shall be properly disposed of at an approved off-site facility. Fill soils also shall be sampled to ensure that imported soil parameters are within acceptable levels.
- iii. Caution shall be taken during excavation activities near existing groundwater monitoring wells, so that they are not damaged. Existing groundwater monitoring

wells may have to be abandoned and reinstalled if they are located in an area that is undergoing redevelopment.

**Haz-4C:** In the event that USTs, not identified in consultation with EH&S, or undocumented areas of contamination are encountered during construction or redevelopment activities, work shall be discontinued until appropriate health and safety procedures are implemented. Either the County of San Diego DEH or the San Diego RWQCB, depending on the nature of the contamination, must be notified regarding the contamination. Each agency and program within the respective agency has its own mechanism for initiating an investigation. The appropriate program (e.g., the DEH Local Oversight Program for tank release cases, the County of San Diego DEH Voluntary Assistance Program for non-tank release cases, the RWQCB for non-tank cases involving groundwater contamination) will be selected based on the nature of the contamination identified. The contamination remediation and removal activities will be conducted in accordance with pertinent regulatory guidelines, under the oversight of the appropriate regulatory agency.

**Haz-6:** In the event that the construction of a project requires a lane or roadway closure on campus, prior to construction the contractor and/or Project Manager shall ensure that the UC San Diego Fire Marshal and campus community at large are notified. If determined necessary by the UC San Diego Fire Marshal, local emergency services will be notified by the Fire Marshal of the closure.

## **Noise**

**Noi-1F:** If project construction activities resulting from implementation of the 2018 LRDP are proposed less than 150 feet of NSLU, or may involve the use of vibratory or impact-type pile drivers, impact-type equipment (including but not limited to: clam shovels, hydra break rams, hoe rams, and jackhammers), concrete saws, pavement scarifiers, sand blasters, or vibrating hoppers, mitigation shall be integrated into the project's construction specifications to minimize temporary noise caused by construction activities to less than significant levels:

- i. Require the construction contractor to work with proper administrative controls on equipment operation periods so as not to exceed a 12-hour average sound level of 75 dBA  $L_{eq}$  at any NSLU between 7:00 a.m. and 7:00 p.m. Monday through Saturday.
- ii. p.m. Monday through Saturday.
- iii. Outfit construction equipment with properly maintained, manufacturer-approved or recommended sound abatement means on air intakes, combustion exhausts, heat dissipation vents, and the interior surfaces of engine hoods and power train enclosures.



- iv. Locate (to the extent practical) steady-state, continuously operating stationary construction equipment such as generators, pumps, and air compressors at least 150 feet from nearby NSLUs. If this screening distance cannot be achieved in the field, consider deployment of temporary noise walls or acoustical blankets/curtains that would block direct sound paths between the operating equipment and the receptor(s) of concern.
- v. Position (to the extent practical) construction laydown and vehicle staging areas as far from NSLUs as feasible.
- vi. Inform, whenever possible and preferably with at least a two week advanced notice, all neighboring NSLUs expected to be exposed to elevated noise levels that a construction project would commence.
- vii. Where NSLU are expected to be less than 100 feet away, schedule anticipated loud construction activities, which could involve impact-type equipment and processes such as pile driving, jackhammering, pavement breaking, compactors, etc., to not coincide with any finals week of classes and recognized holidays. Adjust hours or days of the construction activity to occur before or after these noise-sensitive periods of the UC San Diego academic year.

This page intentionally left blank.

## 6 REFERENCES

The primary sources of information for the project-level Addendum are the 2018 LRDP and its EIR, including all relevant technical studies and references noted in those documents, which are incorporated by reference herein. Additional project-specific information has been added to supplement the information in those primary references.

AECOM. 2018. UC San Diego Long Range Development Plan Noise Technical Report. July.

ARG. 2018. UC San Diego 2018 Long Range Development Plan Historic Resources Survey Report. October.

City of San Diego. 2009. City of San Diego Fire Hazard Severity Zone GIS Data. Downloaded from San Diego Geographic Information Source Regional Data Warehouse January 11, 2020.

Michael Baker International. 2021. Drainage Study for UCSD Pepper Canyon Ancillary Site Work. April.

San Diego County Association of Governments (SANDAG). 2019. Mid-Coast Trolley. Accessed on December 2019. Available at <https://www.sandag.org/index.asp?fuseaction=projects.detail&projectid=250>.

SANDAG. 2014. Mid-Coast Corridor Transit Project Final Impact Report. Accessed on: December 11, 2019. Available at: <https://www.sandag.org/index.asp?projectid=434&fuseaction=projects.detail>.

USACE (U.S. Army Corps of Engineers). 1987. U.S. Army Corps of Engineers Wetlands Delineation Manual.

USACE. 2008a. Regional Supplement to the Corps of Engineers Wetland Delineation Manual: Arid West Region

USACE. 2008b. Field Guide to the Identification of the Ordinary High Water Mark (OHWM) in the Arid West Region of the Western United States: A Delineation Manual

USACE 2010. Updated Datasheet for the Identification of the Ordinary High Water Mark (OHWM) in the Arid West Region of the Western United States.

USACE and EPA (U.S. Environmental Protection Agency). 2008.

University of California, Office of the President. 2018. UC Sustainable Practices Policy.

Accessed on: 11 November 2019. Available at: <https://www.ucop.edu/sustainability/policy-areas/index.html>

University of California, San Diego (UC San Diego). 2018a. 2018 Long Range Development Plan. November.

UC San Diego. 2018b. 2018 Long Range Development Plan Environmental Impact Report (EIR). November.

# **APPENDIX A**

## *Aquatic Resources Delineation Report for the Pepper Canyon Basin*



## MEMORANDUM

---

**To:** Chris Allen, U.S. Army Corps of Engineers  
**From:** Kamarul Muri, Dudek  
**Subject:** Aquatic Resources Delineation Report for the Pepper Canyon Basin  
**Date:** May 4, 2021  
**cc:** Lauren Lievers, UC San Diego  
**Attachment(s):** A: Interim Approved Jurisdictional Determination Form  
B: Figures  
C: Delineation Forms  
D: Review Area Photos  
E: Antecedent Precipitation Tool  
F: Digital Data (provided via email)

---

This Aquatic Resources Delineation Report is being provided to the U.S. Army Corps of Engineers (USACE) in accordance with the Minimum Standards for Acceptance of Aquatic Resources Delineation Reports. This report and supporting attachment provide the 20 items listed in the Minimum Standards for Acceptance of Aquatic Resources Delineation Reports.

### Item 1: Request for a Jurisdictional Determination

Attachment A contains Appendix 1 of Regulatory Guidance Letter (RGL) 16-1, Request for Corps Jurisdictional Determination.

### Item 2: Contact Information

<b>Applicant:</b>	UC San Diego	<b>Agent:</b>	Dudek
<b>Contact Name:</b>	Lauren Lievers	<b>Contact Name:</b>	Kamarul Muri
<b>Address:</b>	9500 Gilman Drive, MC 0074 La Jolla, California 92093-0074	<b>Address:</b>	605 Third Street Encinitas, California 92024
<b>Phone:</b>	949.939.3076	<b>Phone:</b>	760.479.4292
<b>Fax:</b>	—	<b>Fax:</b>	760.632.0164
<b>Email:</b>	llievers@ucsd.edu	<b>Email:</b>	kmuri@dudek.com

### Item 3: Site Access

The Project applicant or agent will accompany USACE staff to the review area if site visits are deemed necessary.

## Item 4: Directions to the Review Area

The review area is located on the UC San Diego campus in La Jolla. From the north or south: take Interstate 5 (I-5) and exit west onto La Jolla Village Drive. Turn north on Village La Jolla Drive and then turn east on Gilman Drive. The review area is located just below, and to the east of, the first parking lot on Gilman Drive (Attachment B, Figures 1 and 2).

## Item 5: Jurisdictional Delineation Methods

The USACE wetlands delineation was performed in accordance with the 1987 U.S. Army Corps of Engineers Wetlands Delineation Manual (USACE 1987) and the Regional Supplement to the Corps of Engineers Wetland Delineation Manual: Arid West Region (USACE 2008a). A Field Guide to the Identification of the Ordinary High Water Mark (OHWM) in the Arid West Region of the Western United States: A Delineation Manual (USACE 2008b) and the Updated Datasheet for the Identification of the Ordinary High Water Mark (OHWM) in the Arid West Region of the Western United States (USACE 2010) were used to determine the extent of non-wetland waters. Pursuant to the federal Clean Water Act (USACE and EPA 2008), USACE wetlands included areas supporting all three wetlands criteria described in the 1987 USACE Manual: hydric soils, hydrology, and hydrophytic vegetation. Non-wetland waters included channels that display evidence of an OHWM, but do not meet the three-parameter criteria for a wetland.

## Item 6: Aquatic Resources Narrative

The Project site contains one non-wetland water (NWW-1) totaling 0.005 acres and 104 linear feet (Figure 3 of Attachment B). An OHWM datasheet was recorded at the non-wetland water to determine the status of OHWM indicators within that feature. Due to the presence of herbaceous wetland plant species, a wetland determination data form was also completed. In addition, the Project site was evaluated using the Beta Streamflow Duration Assessment Method for the Arid West. All forms utilized during the delineation are provided in Attachment C. Photos of the feature identified in Figure 3 (NWW-1) are provided in Attachment D, Review Area Photos. A discussion of the feature evaluated within the Review Area is provided as follows. Note that just upstream of the non-wetland water is a stand of willows that is located outside of the review area.

### **NWW-1: Unvegetated Channel (OHWM1)**

NWW-1 is located within the Mid-Coast Corridor Transit Project temporary disturbance footprint. This channel was included in the delineation and subsequent verification for this project (SPL-2010-00628-MG). Under the USACE permit for the Mid-Coast project, the channel was identified as a temporary impact, which would be restored following project construction. In its pre-project condition, the channel was devoid of vegetation and conveyed flow from an upstream storm drain headwall to a box inlet (see photos 1 through 3 in Attachment D). In 2018 the channel was considered ephemeral in nature as it conveyed flows only during storms. The channel has since been realigned to accommodate construction within the area. The non-native vegetation surrounding the channel has been removed, and the slopes adjacent to the channel have been contoured to support the trolley pillars (see photo 6 in Attachment D). A new channel has been created from the edge of the southern willow scrubs to the box inlet. The temporary channel is lined with engineering fabric and riprap (see photos 4 and 5 in Attachment D).



The channel supports sparse herbaceous hydrophytic vegetation around the edges of the riprap and where there is space between the rocks. In this area sediment has accumulated allowing for this growth (see photo 5 in Attachment D). The previous delineation did not detect herbaceous hydrophytic vegetation within the channel. The riprap within the channel is approximately 1 to 2 feet deep and 3 to 4 feet wide. A soil sample was not taken from the site because of the riprap; however, given the recent construction of the temporary channel, it is unlikely that hydric soils have developed within the channel. Water was observed flowing within the channel during a site visit to the area during a significant storm event on March 15, 2021. Water was not observed the following week during the updated delineation on March 25, 2021.

The Beta Streamflow Duration Assessment Method for the Arid West was utilized to determine the flow regime of NWW-1, but the classification flow chart indicates more information is needed to make a determination. Historical data available for the drainage—i.e., the limited size of the channel and the lack of hydrophytic vegetation or other indications of intermittent flow, the lack of changes to upstream drainage conditions that could affect flow conditions within the channel, and current observations that no flows or water were present within the channel 10 days following a significant rain event when the channel was observed to be flowing with 1 to 2 feet of water—suggest that the streamflow in the channel remains ephemeral as originally observed prior to the current construction disturbance.

## Item 7: Delineation Maps

All maps of delineated resources are provided in Attachment B.

## Item 8: Dates of Field Work

A jurisdictional delineation within the review area was conducted in in March 2021 by Dudek Biologist Kamarul Muri (Table 3).

**Table 3. Schedule of the Jurisdictional Delineation Conducted for the Lake San Marcos Site**

Date	Hours	Personnel	Conditions
3/25/21	1000–1130	K. Muri	60 °F–62 °F; 0%–50% cloud cover; 0–8 mph wind

## Item 9: Table of Aquatic Resources

Table 4 includes a description of NWW-1 identified within the review area, its Cowardin type, any OHWM indicators present, the location, and the updated acreage/linear feet. Channel widths are provided on the figures (see Attachment B).

**Table 4. Aquatic Resource Summary**

Feature Name	Cowardin	OHWM Indicators	Location (Latitude/ Longitude)	Acreage/ Linear Feet
<b>Non-Wetland Waters</b>				
NWW-1	None listed	Bed and bank	32.877297—, 117.231459	0.005/104
<b>Grand Total<sup>a</sup></b>				<b>0.005/104</b>

**Source:** Cowardin et al. 1979.

**Notes:** OHWM = ordinary high water mark.

<sup>a</sup> Total may not sum due to rounding.

## Item 10: Review Area Description

The review area consists of a discrete portion of Pepper Canyon where a water quality basin is proposed. This area was previously delineated and permitted in association with the Mid-Coast Corridor Transit Project (SPL-2010-00628-MG) with authorization for temporary impacts to less than 0.01 acres of non-wetland waters. As part of the ongoing construction for the Mid-Coast Corridor Transit Project in the area, the original channel was realigned and lined with fabric and riprap in 2018 to drain directly into an existing concrete storm drain box in the bottom of the canyon. The channel is still in its re-aligned form but is scheduled to be restored to pre-construction contours as an unlined earthen channel upon completion of the Mid-Coast project in Summer 2021. UC San Diego is proposing to construct an approximately 40,000-square-foot regional water quality control basin at this location, which would permanently impact the existing temporary channel as well as the location of the original pre-disturbance channel alignment. Given the recent regulatory changes under the Navigable Waters Protection Rule excluding ephemeral waters from USACE jurisdiction, UC San Diego is requesting a jurisdictional determination to evaluate if this channel, either in its previous form or the current condition, would be regulated by the USACE.

## Item 11: Hydrology

The review area and associated non-wetland water are located in the northwestern portion of the Miramar Reservoir Hydrologic Area of the Peñasquitos Hydrologic Unit in San Diego County (Attachment B, Figure 4).

The Antecedent Precipitation Tool (APT) table is provided in Attachment E. The result of the APT are that normal conditions existed at the time of the delineation.

## Item 12: Remote Sensing

Remote sensing was not used for the delineation.

## Item 13: Soils

According to the Web Soil Survey (USDA 2019a), Salinas clay loam, 2 to 9 percent slopes, is the only soil type within the review area (Figure 5, Soils, in Attachment B). Salinas clay loam, 2 to 9 percent slopes is not a hydric soil (USDA 2019b).

## Item 14: Site Location Maps

All maps are provided in Attachment B.

## Item 15: Aquatic Features Spreadsheet

A copy of the ORM Bulk Upload Aquatic Resources or Consolidated Excel spreadsheet is not submitted with this memo because Table 4 provides all the information requested.

## Item 16: Delineation Maps

All maps are provided in Attachment B.

## Item 17: Photographs

Photos of the review area are provided in Attachment D.

## Item 18: Data Forms

The completed wetland determination data form, OHWM datasheet and the stream duration assessment form are provided in Attachment C.

## Item 19: Methods

Jurisdictional boundaries were mapped in the field using ESRI Collector on a mobile device paired with a Trimble R1 external Bluetooth GPS receiver with submeter accuracy. The delineation defined areas under the jurisdiction of the California Department of Fish and Wildlife, pursuant to Sections 1600–1603 of the California Fish and Game Code; USACE, pursuant to Section 404 of the federal Clean Water Act (see Item 5); and the Regional Water Quality Control Board, pursuant to Clean Water Act Section 401 and the Porter–Cologne Water Quality Control Act.

## Item 20: Digital Data

Geographic information system data is provided as Attachment F (electronic).

## References

- Cowardin, L.M., V. Carter, F.C. Golet, and E.T. LaRoe. 1979. *Classification of Wetlands and Deepwater Habitats of the United States*. FWS/OBS-79/31. Prepared for U.S. Fish and Wildlife Service. December 1979. Reprinted 1992. <http://www.fws.gov/wetlands/documents/classification-of-wetlands-and-deepwater-habitats-of-the-united-states.pdf>.
- USACE (U.S. Army Corps of Engineers). 1987. *Corps of Engineers Wetlands Delineation Manual*. Online ed. Environmental Laboratory, Wetlands Research Program Technical Report Y-87-1. Vicksburg, Mississippi: U.S. Army Engineer Waterways Experiment Station. January 1987.
- USACE. 2008a. *Regional Supplement to the Corps of Engineers Wetland Delineation Manual: Arid West Region (Version 2.0)*. Environmental Laboratory, ERDC/EL TR-08-28. Vicksburg, Mississippi: U.S. Army Engineer Research and Development Center. September 2008.
- USACE. 2008b. *A Field Guide to the Identification of the Ordinary High Water Mark (OHWM) in the Arid West Region of the Western United States: A Delineation Manual*. ERDC/CRREL TR-08-12. Prepared by R.W. Lichvar and S.M. McColley. Hanover, New Hampshire: U.S. Army Engineer Research and Development Center, Cold Regions Research and Engineering Laboratory. August 2008.
- USACE. 2010. *Updated Datasheet for the Identification of the Ordinary High Water Mark (OHWM) in the Arid West Region of the Western United States*. Wetland Regulatory Assistance Program, ERDC/CRREL TN-10-1. Prepared by K.E. Curtis and R.W. Lichvar. Hanover, New Hampshire: U.S. Army Corps of Engineers Research and Development Center, Cold Regions Research and Engineering Laboratory. July 2010.
- USACE and EPA (U.S. Army Corps of Engineers and U.S. Environmental Protection Agency). 2008. *Clean Water Act Jurisdiction Following the U.S. Supreme Court's Decision in Rapanos v. United States & Carabell v. United States*. December 2, 2008. [https://www.epa.gov/sites/production/files/2016-02/documents/cwa\\_jurisdiction\\_following\\_rapanos120208.pdf](https://www.epa.gov/sites/production/files/2016-02/documents/cwa_jurisdiction_following_rapanos120208.pdf).
- USDA (U.S. Department of Agriculture). 2019a. Web Soil Survey. USDA Natural Resources Conservation Service, Soil Survey Staff. Accessed September 2019. <http://websoilsurvey.nrcs.usda.gov/>.
- USDA. 2019b. "State Soil Data Access (SDA) Hydric Soils List." Accessed September 2019. [https://www.nrcs.usda.gov/Internet/FSE\\_DOCUMENTS/nrcseprd1389479.html#reportref](https://www.nrcs.usda.gov/Internet/FSE_DOCUMENTS/nrcseprd1389479.html#reportref).



# Attachment A

---

Interim Approved Jurisdictional Determination Form





**U.S. ARMY CORPS OF ENGINEERS  
REGULATORY PROGRAM  
APPROVED JURISDICTIONAL DETERMINATION FORM (INTERIM)  
NAVIGABLE WATERS PROTECTION RULE**

**I. ADMINISTRATIVE INFORMATION**

Completion Date of Approved Jurisdictional Determination (AJD): [Inter](#)

ORM Number: Not yet assigned

Associated JDs: [SPL-2010-00628-MG](#)

Review Area Location<sup>1</sup>: State/Territory: [CA](#) City: [La Jolla](#) County/Parish/Borough: [San Diego County](#)

Center Coordinates of Review Area: Latitude [32.877297](#) Longitude [-117.231459](#)

**II. FINDINGS**

**A. Summary:** Check all that apply. At least one box from the following list **MUST** be selected. Complete the corresponding sections/tables and summarize data sources.

- The review area is comprised entirely of dry land (i.e., there are no waters or water features, including wetlands, of any kind in the entire review area). Rationale: [N/A or describe rationale](#).
- There are “navigable waters of the United States” within Rivers and Harbors Act jurisdiction within the review area (complete table in Section II.B).
- There are “waters of the United States” within Clean Water Act jurisdiction within the review area (complete appropriate tables in Section II.C).
- There are waters or water features excluded from Clean Water Act jurisdiction within the review area (complete table in Section II.D).

**B. Rivers and Harbors Act of 1899 Section 10 (§ 10)<sup>2</sup>**

§ 10 Name	§ 10 Size	§ 10 Criteria	Rationale for § 10 Determination
<a href="#">N/A.</a>	<a href="#">N/A.</a>	<a href="#">N/A.</a>	<a href="#">N/A.</a>

**C. Clean Water Act Section 404**

Territorial Seas and Traditional Navigable Waters ((a)(1) waters): <sup>3</sup>			
(a)(1) Name	(a)(1) Size	(a)(1) Criteria	Rationale for (a)(1) Determination
<a href="#">N/A.</a>	<a href="#">N/A.</a>	<a href="#">N/A.</a>	<a href="#">N/A.</a>

Tributaries ((a)(2) waters):			
(a)(2) Name	(a)(2) Size	(a)(2) Criteria	Rationale for (a)(2) Determination
<a href="#">N/A.</a>	<a href="#">N/A.</a>	<a href="#">N/A.</a>	<a href="#">N/A.</a>

Lakes and ponds, and impoundments of jurisdictional waters ((a)(3) waters):			
(a)(3) Name	(a)(3) Size	(a)(3) Criteria	Rationale for (a)(3) Determination
<a href="#">N/A.</a>	<a href="#">N/A.</a>	<a href="#">N/A.</a>	<a href="#">N/A.</a>

Adjacent wetlands ((a)(4) waters):			
(a)(4) Name	(a)(4) Size	(a)(4) Criteria	Rationale for (a)(4) Determination
<a href="#">N/A.</a>	<a href="#">N/A.</a>	<a href="#">N/A.</a>	<a href="#">N/A.</a>

<sup>1</sup> Map(s)/figure(s) are attached to the AJD provided to the requestor.

<sup>2</sup> If the navigable water is not subject to the ebb and flow of the tide or included on the District's list of Rivers and Harbors Act Section 10 navigable waters list, do NOT use this document to make the determination. The District must continue to follow the procedure outlined in 33 CFR part 329.14 to make a Rivers and Harbors Act Section 10 navigability determination.

<sup>3</sup> A stand-alone TNW determination is completed independently of a request for an AJD. A stand-alone TNW determination is conducted for a specific segment of river or stream or other type of waterbody, such as a lake, where upstream or downstream limits or lake borders are established. A stand-alone TNW determination should be completed following applicable guidance and should NOT be documented on the AJD Form.



**U.S. ARMY CORPS OF ENGINEERS  
REGULATORY PROGRAM  
APPROVED JURISDICTIONAL DETERMINATION FORM (INTERIM)  
NAVIGABLE WATERS PROTECTION RULE**

**D. Excluded Waters or Features**

Excluded waters ((b)(1) – (b)(12)): <sup>4</sup>			
Exclusion Name	Exclusion Size	Exclusion <sup>5</sup>	Rationale for Exclusion Determination
Unnamed tributary to Rose Creek	0.01 acre(s)	(b)(3) Ephemeral feature, including an ephemeral stream, swale, gully, rill, or pool.	The feature in question is ephemeral in nature in that it only provides surface water flow in direct response to precipitation (e.g., rain or snow fall) and is not reliant on groundwater as a source of hydrology. Further, the feature is an excavated channel lined with fabric and rock. Herbaceous vegetation generally confined to edges where minimal sediment has accumulated, and space is available between rocks (1-2+ feet in size).

**III. SUPPORTING INFORMATION**

**A. Select/enter all resources** that were used to aid in this determination and attach data/maps to this document and/or references/citations in the administrative record, as appropriate.

- Information submitted by, or on behalf of, the applicant/consultant: [Aquatic Resources Delineation Report for the Pepper Canyon Basin April, 2021](#)

This information is sufficient for purposes of this AJD.

Rationale: : [The jurisdictional delineation was conducted by Dudek and was submitted with supporting information sufficient for review.](#)

- Data sheets prepared by the Corps: [Title\(s\) and/or date\(s\)](#).
- Photographs: [Aerial: See Attachment B](#)
- Corps site visit(s) conducted on: [Date\(s\)](#).
- Previous Jurisdictional Determinations (AJDs or PJDs): [SPL-2010-00628-MG](#)
- Antecedent Precipitation Tool: [provide detailed discussion in Section III.B.](#)
- USDA NRCS Soil Survey: [Figure 3, Soils](#)
- USFWS NWI maps: [Figure 4, Hydrology](#)
- USGS topographic maps: [Figure 2, USGS Topography](#)

**Other data sources used to aid in this determination:**

Data Source (select)	Name and/or date and other relevant information
<a href="#">USGS Sources</a>	N/A
<a href="#">USDA Sources</a>	N/A.
<a href="#">NOAA Sources</a>	N/A.
<a href="#">USACE Sources</a>	1. <a href="#">National Wetland Plant List Version 3.4., November 5, 2020</a>  2. <a href="#">A Field Guide to the Identification of the Ordinary High Water Mark (OHWM) in the Arid West Region of the Western United States. Cold Regions Research and Engineering Laboratory ERD/CRREL TR-08-12. August 2008.</a>
<a href="#">State/Local/Tribal Sources</a>	N/A.

<sup>4</sup> Some excluded waters, such as (b)(2) and (b)(4), may not be specifically identified on the AJD form unless a requestor specifically asks a Corps district to do so. Corps districts may, in case-by-case instances, choose to identify some or all of these waters within the review area.

<sup>5</sup> Because of the broad nature of the (b)(1) exclusion and in an effort to collect data on specific types of waters that would be covered by the (b)(1) exclusion, four sub-categories of (b)(1) exclusions were administratively created for the purposes of the AJD Form. These four sub-categories are not new exclusions, but are simply administrative distinctions and remain (b)(1) exclusions as defined by the NWPR.





**U.S. ARMY CORPS OF ENGINEERS  
REGULATORY PROGRAM  
APPROVED JURISDICTIONAL DETERMINATION FORM (INTERIM)  
NAVIGABLE WATERS PROTECTION RULE**

Data Source (select)	Name and/or date and other relevant information
<a href="#">Other Sources</a>	<a href="#">N/A.</a>

**B. Typical year assessment(s):** [N/A](#)

**C. Additional comments to support AJD:** [See the Aquatic Resources Delineation Report for the Pepper Canyon Basin](#)





# Attachment B

---

Figures



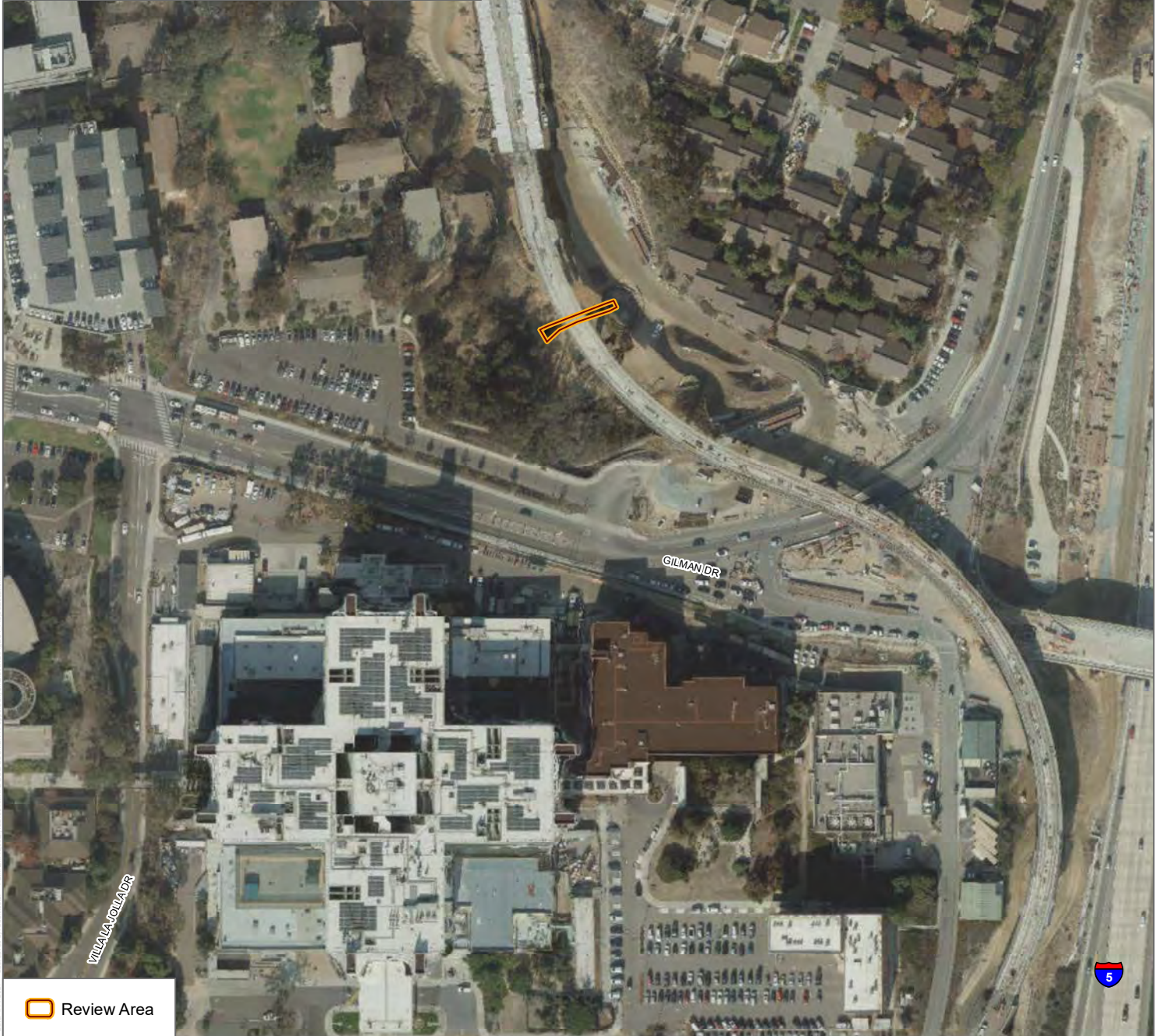

SOURCE: SANGIS 2017  
 Coordinate System: State Plane Zone 6, NAD 1983, Units U.S. Feet  
 Vertical Datum: NAVD88, U.S. Feet  
 Created: April 8, 2021



0 100 200 Feet  
 1 inch = 200 feet

**FIGURE 1**

**Review Area Location**



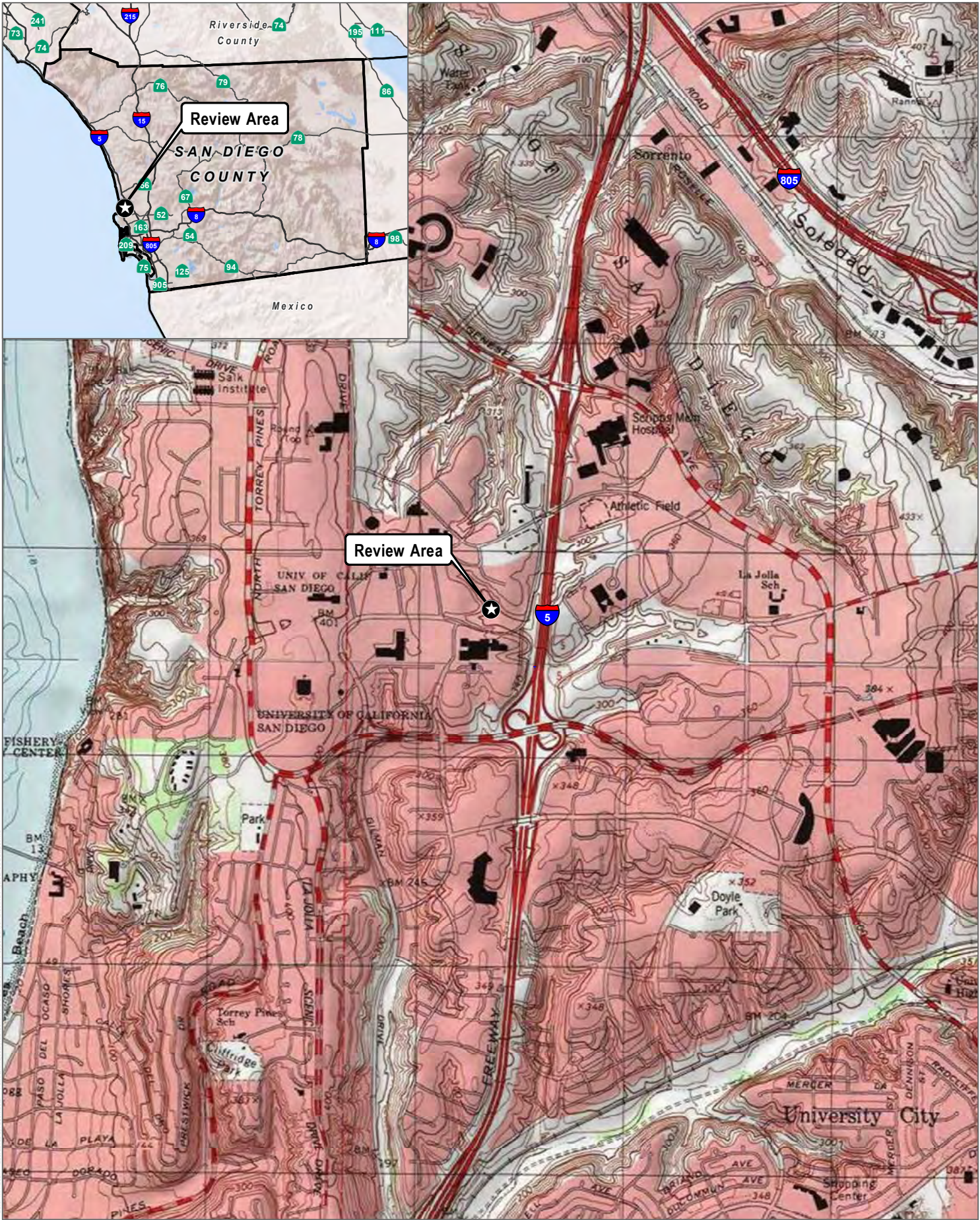

SOURCE: USGS 7.5-Minute Del Mar Quadrangle  
 Coordinate System: State Plane Zone 6, NAD 1983, Units U.S. Feet  
 Vertical Datum: NAVD88, U.S. Feet  
 Created: April 8, 2021

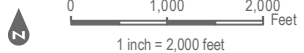

**FIGURE 2**  
 USGS Topography







Review Area  
 OHWM Cross-section  
● Sampling Point (PCASW DS1)  
⊕ Control Points  
**Aquatic Resources Delineation**  
 Non-wetland Waters/Streambed (NWW-1)

SOURCE: ESRI 2019  
 Coordinate System: State Plane Zone 6, NAD 1983, Units U.S. Feet  
 Vertical Datum: NAVD88, U.S. Feet  
 Created: April 8, 2021

**DUDEK**   
 1 inch = 50 feet

**FIGURE 3**

**Aquatic Resources Delineation**

Aquatic Resources Delineation Report for the Pepper Canyon Ancillary Site Work Project



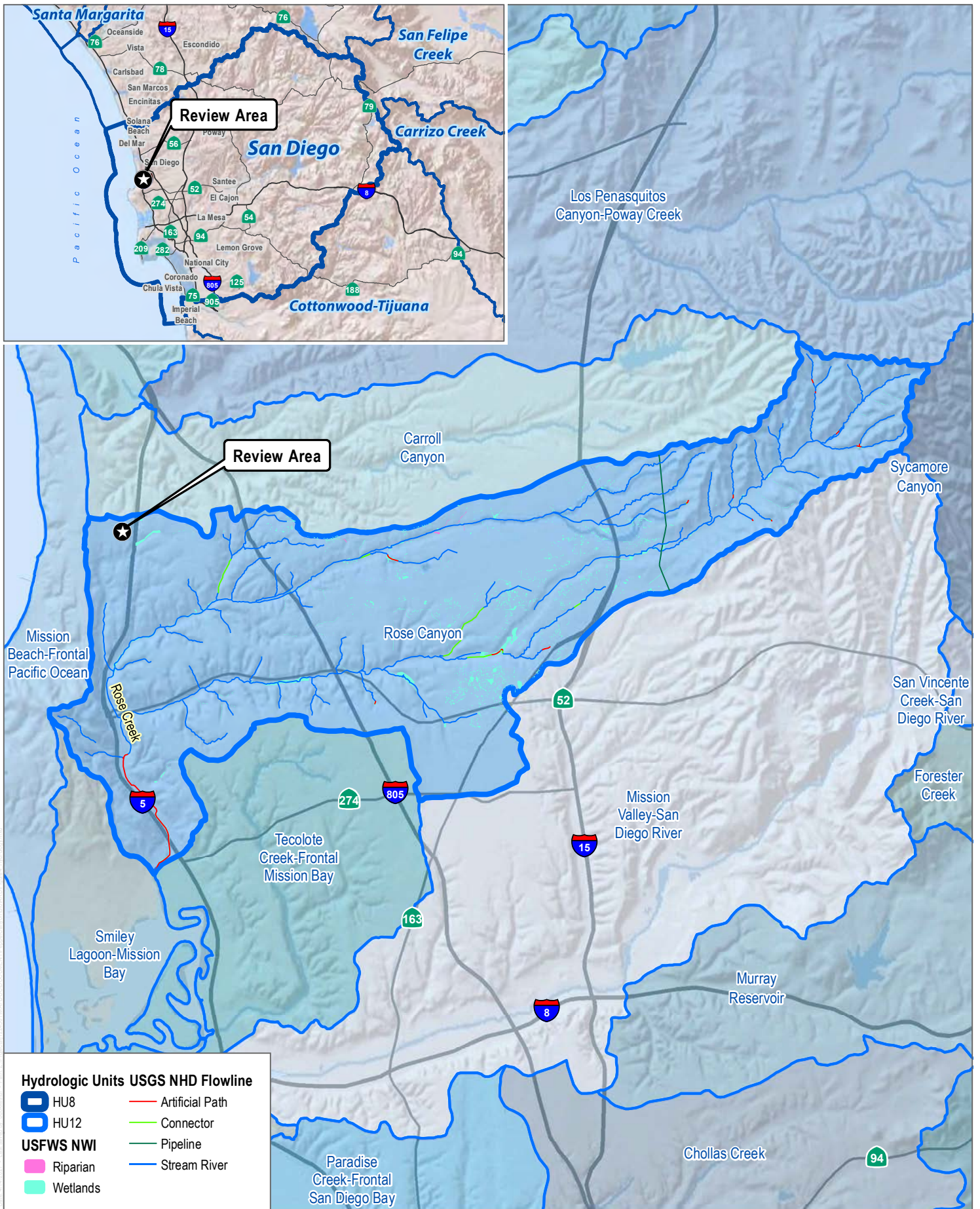

SOURCE: SANGIS 2017; California Dept. of Water Resources 2019; USGS 2018; USFWS 2019  
 Coordinate System: State Plane Zone 6, NAD 1983, Units U.S. Feet  
 Vertical Datum: NAVD88, U.S. Feet  
 Created: October 8, 2019

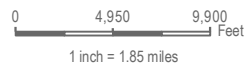

**FIGURE 4**

**Hydrology**

Aquatic Resources Delineation Report for the Lake San Marcos Aeration Project





 Review Area

**Soils**

 SbC - Salinas clay loam, 2 to 9 percent slopes

SOURCE: ESRI 2018, USDA 2019  
 Coordinate System: State Plane Zone 6, NAD 1983, Units U.S. Feet  
 Vertical Datum: NAVD88, U.S. Feet  
 Created: April 8, 2021

**DUDEK**

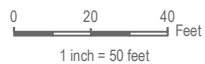

**FIGURE 5**  
**Soils**





# Attachment C

---

Delineation Forms and Summary Table





## Arid West Ephemeral and Intermittent Streams OHWM Datasheet

<b>Project:</b> UCSD Pepper Canyon Ancillary Site Work Project <b>Project Number:</b> <b>Stream:</b> Unnamed drainage <b>Investigator(s):</b> Kamarul Muri	<b>Date:</b> 3/25/21 <b>Town:</b> San Diego <b>Photo begin file#:</b>	<b>Time:</b> <b>State:</b> CA <b>Photo end file#:</b>
---	---	---

Y <input type="checkbox"/> / N <input checked="" type="checkbox"/> Do normal circumstances exist on the site?  Y <input type="checkbox"/> / N <input checked="" type="checkbox"/> Is the site significantly disturbed?	<b>Location Details:</b>  <b>Projection:</b> <span style="float: right;"><b>Datum:</b></span> <b>Coordinates:</b>
--	--

**Potential anthropogenic influences on the channel system:**

Existing channel is in disturbed state within Mid-Coast Corridor Transit Project temporary construction disturbance footprint in accordance with NWP verification dated 2/16/18 (SPL-2010-00628-MG)

**Brief site description:**

Drainage channel is located within active construction area for Mid-Coast Corridor Transit Project and is lined with engineering fabric and riprap

**Checklist of resources (if available):**

<input type="checkbox"/> Aerial photography	<input type="checkbox"/> Stream gage data
Dates:	Gage number:
<input checked="" type="checkbox"/> Topographic maps	Period of record:
<input type="checkbox"/> Geologic maps	<input type="checkbox"/> History of recent effective discharges
<input checked="" type="checkbox"/> Vegetation maps	<input type="checkbox"/> Results of flood frequency analysis
<input checked="" type="checkbox"/> Soils maps	<input type="checkbox"/> Most recent shift-adjusted rating
<input type="checkbox"/> Rainfall/precipitation maps	<input type="checkbox"/> Gage heights for 2-, 5-, 10-, and 25-year events and the most recent event exceeding a 5-year event
<input checked="" type="checkbox"/> Existing delineation(s) for site	
<input checked="" type="checkbox"/> Global positioning system (GPS)	
<input type="checkbox"/> Other studies	

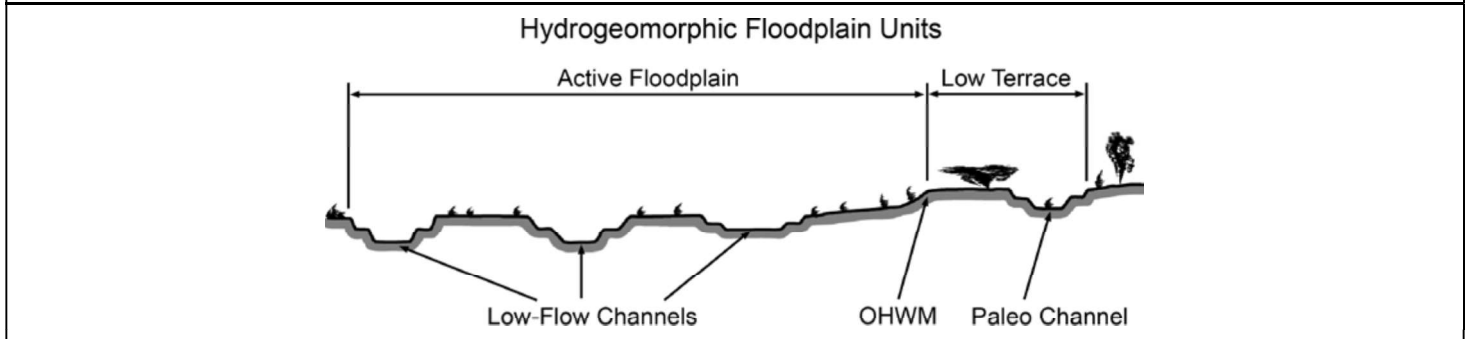

- Procedure for identifying and characterizing the floodplain units to assist in identifying the OHWM:**
1. Walk the channel and floodplain within the study area to get an impression of the geomorphology and vegetation present at the site.
  2. Select a representative cross section across the channel. Draw the cross section and label the floodplain units.
  3. Determine a point on the cross section that is characteristic of one of the hydrogeomorphic floodplain units.
    - a) Record the floodplain unit and GPS position.
    - b) Describe the sediment texture (using the Wentworth class size) and the vegetation characteristics of the floodplain unit.
    - c) Identify any indicators present at the location.
  4. Repeat for other points in different hydrogeomorphic floodplain units across the cross section.
  5. Identify the OHWM and record the indicators. Record the OHWM position via:
 

<input type="checkbox"/> Mapping on aerial photograph	<input checked="" type="checkbox"/> GPS
<input type="checkbox"/> Digitized on computer	<input type="checkbox"/> Other:

Project ID:

Cross section ID:

Date:

Time:

**Cross section drawing:**

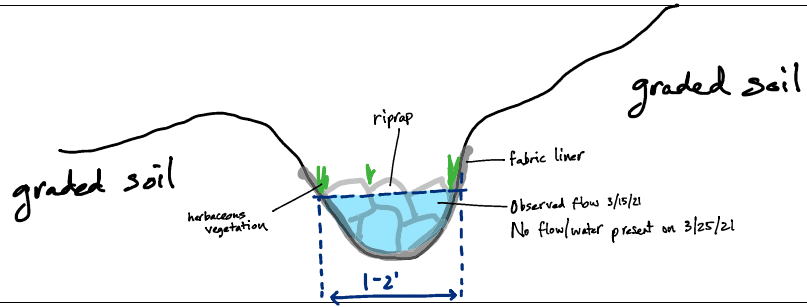

**OHWM**

GPS point: ohwm1

**Indicators:**

- |   |   |
|---|---|
| <input type="checkbox"/> Change in average sediment texture | <input checked="" type="checkbox"/> Break in bank slope |
| <input type="checkbox"/> Change in vegetation species       | <input checked="" type="checkbox"/> Other: _____        |
| <input type="checkbox"/> Change in vegetation cover         | <input type="checkbox"/> Other: _____                   |

**Comments:**

Observed flow conditions during 3/15/21 precipitation event.

**Floodplain unit:**     Low-Flow Channel     Active Floodplain     Low Terrace

GPS point: \_\_\_\_\_

**Characteristics of the floodplain unit:**

Average sediment texture: N/A

Total veg cover: <2 %    Tree: 0 %    Shrub: 0 %    Herb: <2 %

Community successional stage:

- |  |  |
|--|--|
| <input type="checkbox"/> NA  | <input type="checkbox"/> Mid (herbaceous, shrubs, saplings)      |
| <input checked="" type="checkbox"/> Early (herbaceous & seedlings) | <input type="checkbox"/> Late (herbaceous, shrubs, mature trees) |

**Indicators:**

- |  |   |
|--|---|
| <input type="checkbox"/> Mudcracks                           | <input type="checkbox"/> Soil development |
| <input type="checkbox"/> Ripples                             | <input type="checkbox"/> Surface relief   |
| <input type="checkbox"/> Drift and/or debris                 | <input type="checkbox"/> Other: _____     |
| <input checked="" type="checkbox"/> Presence of bed and bank | <input type="checkbox"/> Other: _____     |
| <input type="checkbox"/> Benches                             | <input type="checkbox"/> Other: _____     |

**Comments:**

**WETLAND DETERMINATION DATA FORM – Arid West Region**

Project/Site: UCSD PCASW City/County: San Diego Sampling Date: 2021-03-25  
 Applicant/Owner: UC San Diego State: California Sampling Point: PCASW DS1  
 Investigator(s): Kamarul Muri Section, Township, Range: \_\_\_\_\_  
 Landform (hillslope, terrace, etc.): Ditch Local relief (concave, convex, none): Concave Slope (%): \_\_\_\_\_  
 Subregion (LRR): C 19 Lat: 32.8768005 Long: -117.2317001 Datum: WGS 84  
 Soil Map Unit Name: SbC NWI classification: None

Are climatic / hydrologic conditions on the site typical for this time of year? Yes  No \_\_\_\_\_ (If no, explain in Remarks.)  
 Are Vegetation , Soil , or Hydrology \_\_\_\_\_ significantly disturbed? Are "Normal Circumstances" present? Yes \_\_\_\_\_ No   
 Are Vegetation , Soil , or Hydrology \_\_\_\_\_ naturally problematic? (If needed, explain any answers in Remarks.)

**SUMMARY OF FINDINGS – Attach site map showing sampling point locations, transects, important features, etc.**

Hydrophytic Vegetation Present? Yes _____ No <input checked="" type="checkbox"/> Hydric Soil Present? Yes _____ No <input checked="" type="checkbox"/> Wetland Hydrology Present? Yes <input checked="" type="checkbox"/> No _____	<b>Is the Sampled Area within a Wetland?</b> Yes _____ No <input checked="" type="checkbox"/>
Remarks: <p><b>Sampling point is within existing disturbed channel in active construction area. Channel is excavated and lined with engineering fabric and riprap rock to convey runoff across disturbed construction site.</b></p>	

**VEGETATION – Use scientific names of plants.**

Tree Stratum (Plot size: <u>30 ft r</u> )	Absolute % Cover	Dominant Species?	Indicator Status	
1. _____	_____	_____	_____	
2. _____	_____	_____	_____	
3. _____	_____	_____	_____	
4. _____	_____	_____	_____	
_____ = Total Cover				
Sapling/Shrub Stratum (Plot size: <u>5 ft r</u> )	Absolute % Cover	Dominant Species?	Indicator Status	
1. _____	_____	_____	_____	
2. _____	_____	_____	_____	
3. _____	_____	_____	_____	
4. _____	_____	_____	_____	
5. _____	_____	_____	_____	
_____ = Total Cover				
Herb Stratum (Plot size: <u>5 ft r</u> )	Absolute % Cover	Dominant Species?	Indicator Status	
1. <u>Cyperus eragrostis</u>	<u>15</u>	<input checked="" type="checkbox"/>	<u>FACW</u>	
2. <u>Epilobium ciliatum</u>	<u>2</u>		<u>FACW</u>	
3. <u>Sonchus asper</u>	<u>1</u>		<u>FAC</u>	
4. _____	_____	_____	_____	
5. _____	_____	_____	_____	
6. _____	_____	_____	_____	
7. _____	_____	_____	_____	
8. _____	_____	_____	_____	
<u>18%</u> = Total Cover				
Woody Vine Stratum (Plot size: <u>30 ft r</u> )	Absolute % Cover	Dominant Species?	Indicator Status	
1. _____	_____	_____	_____	
2. _____	_____	_____	_____	
_____ = Total Cover				
% Bare Ground in Herb Stratum _____ % Cover of Biotic Crust _____				

**Dominance Test worksheet:**  
 Number of Dominant Species That Are OBL, FACW, or FAC: 1 (A)  
 Total Number of Dominant Species Across All Strata: 1 (B)  
 Percent of Dominant Species That Are OBL, FACW, or FAC: 100 (A/B)

**Prevalence Index worksheet:**  
 Total % Cover of: \_\_\_\_\_ Multiply by: \_\_\_\_\_  
 OBL species 0 x 1 = 0  
 FACW species 17 x 2 = 34  
 FAC species 1 x 3 = 3  
 FACU species 0 x 4 = 0  
 UPL species 0 x 5 = 0  
 Column Totals: 18 (A) 37 (B)  
 Prevalence Index = B/A = 2.06

**Hydrophytic Vegetation Indicators:**  
 Dominance Test is >50%  
 Prevalence Index is ≤3.0<sup>1</sup>  
 \_\_\_ Morphological Adaptations<sup>1</sup> (Provide supporting data in Remarks or on a separate sheet)  
 Problematic Hydrophytic Vegetation<sup>1</sup> (Explain)

<sup>1</sup>Indicators of hydric soil and wetland hydrology must be present, unless disturbed or problematic.

**Hydrophytic Vegetation Present?** Yes \_\_\_\_\_ No

Remarks:  
**Excavated channel is lined with fabric and rock. Herbaceous vegetation generally confined to edges where minimal sediment has accumulated and space is available between rocks (1-2+ feet in size).**

**SOIL**

Sampling Point: PCASW DS1

**Profile Description: (Describe to the depth needed to document the indicator or confirm the absence of indicators.)**

Depth (inches)	Matrix		Redox Features				Texture	Remarks
	Color (moist)	%	Color (moist)	%	Type <sup>1</sup>	Loc <sup>2</sup>		
-								
-								
-								
-								
-								
-								
-								
-								
-								

<sup>1</sup>Type: C=Concentration, D=Depletion, RM=Reduced Matrix, CS=Covered or Coated Sand Grains.      <sup>2</sup>Location: PL=Pore Lining, M=Matrix.

**Hydric Soil Indicators: (Applicable to all LRRs, unless otherwise noted.)**

- Histosol (A1)
- Histic Epipedon (A2)
- Black Histic (A3)
- Hydrogen Sulfide (A4)
- Stratified Layers (A5) **(LRR C)**
- 1 cm Muck (A9) **(LRR D)**
- Depleted Below Dark Surface (A11)
- Thick Dark Surface (A12)
- Sandy Mucky Mineral (S1)
- Sandy Gleyed Matrix (S4)

- Sandy Redox (S5)
- Stripped Matrix (S6)
- Loamy Mucky Mineral (F1)
- Loamy Gleyed Matrix (F2)
- Depleted Matrix (F3)
- Redox Dark Surface (F6)
- Depleted Dark Surface (F7)
- Redox Depressions (F8)
- Vernal Pools (F9)

**Indicators for Problematic Hydric Soils<sup>3</sup>:**

- 1 cm Muck (A9) **(LRR C)**
- 2 cm Muck (A10) **(LRR B)**
- Reduced Vertic (F18)
- Red Parent Material (TF2)
- Other (Explain in Remarks)

<sup>3</sup>Indicators of hydrophytic vegetation and wetland hydrology must be present, unless disturbed or problematic.

**Restrictive Layer (if present):**

Type: \_\_\_\_\_  
Depth (inches): \_\_\_\_\_

**Hydric Soil Present?** Yes \_\_\_\_\_ No

Remarks:

Unable to examine soil because of rock in channel.

**HYDROLOGY**

**Wetland Hydrology Indicators:**

Primary Indicators (minimum of one required; check all that apply)

- Surface Water (A1)
- High Water Table (A2)
- Saturation (A3)
- Water Marks (B1) **(Nonriverine)**
- Sediment Deposits (B2) **(Nonriverine)**
- Drift Deposits (B3) **(Nonriverine)**
- Surface Soil Cracks (B6)
- Inundation Visible on Aerial Imagery (B7)
- Water-Stained Leaves (B9)

- Salt Crust (B11)
- Biotic Crust (B12)
- Aquatic Invertebrates (B13)
- Hydrogen Sulfide Odor (C1)
- Oxidized Rhizospheres along Living Roots (C3)
- Presence of Reduced Iron (C4)
- Recent Iron Reduction in Tilled Soils (C6)
- Thin Muck Surface (C7)
- Other (Explain in Remarks)

Secondary Indicators (2 or more required)

- Water Marks (B1) **(Riverine)**
- Sediment Deposits (B2) **(Riverine)**
- Drift Deposits (B3) **(Riverine)**
- Drainage Patterns (B10)
- Dry-Season Water Table (C2)
- Crayfish Burrows (C8)
- Saturation Visible on Aerial Imagery (C9)
- Shallow Aquitard (D3)
- FAC-Neutral Test (D5)

**Field Observations:**

Surface Water Present? Yes \_\_\_\_\_ No  Depth (inches): \_\_\_\_\_  
 Water Table Present? Yes \_\_\_\_\_ No  Depth (inches): \_\_\_\_\_  
 Saturation Present? (includes capillary fringe) Yes \_\_\_\_\_ No  Depth (inches): \_\_\_\_\_

**Wetland Hydrology Present?** Yes  No \_\_\_\_\_

Describe Recorded Data (stream gauge, monitoring well, aerial photos, previous inspections), if available:

Remarks:

No water present in channel at time of delineation on March 25, 2021; ordinary high water mark mapped based on flow in channel observed during rainfall event on March 15, 2021.

# Beta Arid West Streamflow Duration Assessment Method

## General site information

Project name or number: Pepper Canyon Basin		
Site code or identifier:	Assessor(s): Kam Muri	
Waterway name: NWW-1	Visit date: 3-25-21	
Current weather conditions (check one) <input type="checkbox"/> Storm/heavy rain <input type="checkbox"/> Steady rain <input type="checkbox"/> Intermittent rain <input type="checkbox"/> Snowing <input type="checkbox"/> Cloudy (___ % cover) <input checked="" type="checkbox"/> Clear/Sunny	Notes on current or recent weather conditions (e.g., precipitation in previous week):	Coordinates at downstream end (decimal degrees): Lat (N): 32.877297  Long (W): -117.231459  Datum:
Surrounding land-use within 100 m (check one or two): <input type="checkbox"/> Urban/industrial/residential <input type="checkbox"/> Agricultural (farmland, crops, vineyards, pasture) <input checked="" type="checkbox"/> Developed open-space (e.g., golf course) <input type="checkbox"/> Forested <input type="checkbox"/> Other natural <input type="checkbox"/> Other: _____	Describe reach boundaries: NWW-1 is located within the Mid-Coast Corridor Transit Project temporary disturbance footprint. The channel has since been realigned to accommodate construction within the area. The non-native vegetation surrounding the channel has been removed and the slopes adjacent to the channel have been contoured to support the trolley pillars.	
Mean channel width (m) 0.5	Reach length (m): 40x width; min 40 m; max 200 m. 32	Enter photo ID, or check if completed Top down: _____ Mid down: _____ Mid up: _____ Bottom up: _____
Disturbed or difficult conditions (check all that apply): <input type="checkbox"/> Recent flood or debris flow <input checked="" type="checkbox"/> Stream modifications (e.g., channelization) <input type="checkbox"/> Diversions <input type="checkbox"/> Discharges <input type="checkbox"/> Drought <input checked="" type="checkbox"/> Vegetation removal/limitations <input checked="" type="checkbox"/> Other (explain in notes) <input type="checkbox"/> None	Notes on disturbances or difficult site conditions: Sampling point is within existing disturbed channel in active construction area. NWW-1 is excavated and lined with engineering fabric and riprap rock to convey runoff across disturbed construction site.	
Observed hydrology: ___ 0 ___ % of reach with surface flow ___ 0 ___ % of reach with sub-surface or surface flow ___ 0 ___ # of isolated pools	Comments on observed hydrology:	

## Site sketch:

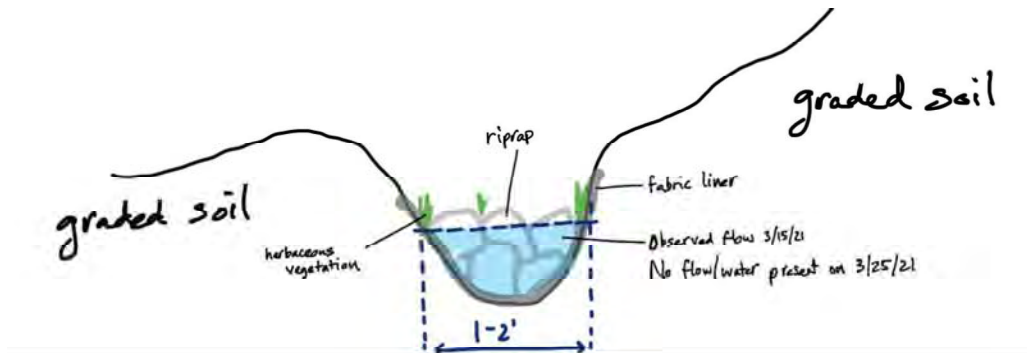

### 1. Hydrophytic plant species



Record up to 5 hydrophytic plant species (FACW or OBL in the **Arid West** regional wetland plant list) within the assessment area: **within the channel or up to one half-channel width**. Explain in notes if species has an odd distribution (e.g., covers less than 2% of assessment area, long-lived species solely represented by seedlings, or long-lived species solely represented by specimens in decline), or if there is uncertainty about the identification. Enter photo ID, or check if photo is taken.

Check if applicable:       No vegetation in assessment area       No hydrophytes in assessment area

Species	Odd distribution?	Notes	Photo ID
<b>Cyperus eragrostis</b>	yes	Excavated channel is lined with fabric and rock. Herbaceous vegetation generally confined to edges where minimal sediment has accumulated and space is available between rocks (1-2+ feet in size).	
<b>Epilobium ciliatum</b>	yes	same	

Notes on hydrophytic vegetation:

### 2 and 3. Aquatic invertebrates

<p><b>2. How many aquatic invertebrates are quantified in a 15-minute search?</b></p> <p>Number of individuals quantified:    <input checked="" type="checkbox"/> None              <input type="checkbox"/> 1 to 19              <input type="checkbox"/> 20 +</p> <p>(Do not count mosquitos)</p> <p>Photo ID: _____</p>	<p><b>3. Is there evidence of aquatic stages of EPT (Ephemeroptera, Plecoptera and Trichoptera)?</b></p> <p style="text-align: center;">Yes / <del>No</del></p> <div style="display: flex; justify-content: space-around; align-items: center;"> <div style="text-align: center;">  <p>Ephemeroptera larva Image credit: <a href="#">Dieter Tracey</a></p> </div> <div style="text-align: center;">  <p>Plecoptera larva <a href="#">Tracey Saxby</a></p> </div> <div style="text-align: center;">  <p>Trichoptera larva <a href="#">Tracey Saxby</a></p> </div> </div>
--	---

Notes on aquatic invertebrates:

### 4. Algal Cover

<p><b>Are algae found on the streambed?</b></p> <p><input type="checkbox"/> Check if <u>all</u> observed algae appear to be deposited from an upstream source.</p>	<p><input checked="" type="checkbox"/> Not detected  <input type="checkbox"/> Yes, &lt; 10% cover  <input type="checkbox"/> Yes, ≥ 10% (check Yes in single indicator below)</p>	<p>Notes on algae cover:</p>	<p>Photo ID:</p>
--	--	------------------------------	------------------

### 5. Are single indicators observed?

Indicator	Present	Notes	Photo ID
Fish	<input type="checkbox"/> Yes <input checked="" type="checkbox"/> No, no fish <input type="checkbox"/> No, only non-native mosquitofish		
Algae cover $\geq$ 10%	<input type="checkbox"/> Yes <input checked="" type="checkbox"/> No		

**Supplemental information** E.g., aquatic or semi-aquatic amphibians, snakes, or turtles; iron-oxidizing bacteria and fungi; etc.

### Photo log

Indicate if any other photos taken during the assessment

Photo ID	Description
	Provided as Attachment D

**Additional notes about the assessment:**

**Classification:** Need more information

1. Hydrophytic plant species	2. Aquatic invertebrates	3. EPT taxa	4. Algae	5. Single indicators • fish present • algae cover $\geq$ 10%	Classification	
None	None	Absent	Absent	Absent	Ephemeral	
			Present	Present	At least intermittent	
	Few (1-19)	Absent	Absent	Absent	Need more information	
			Present	Present	At least intermittent	
		Present	Absent	Absent	Need more information	
			Present	Present	At least intermittent	
	Many (20+)	Absent	Absent	Absent	Need more information	
			Present	Present	At least intermittent	
		Present	Absent	Absent	Need more information	
			Present	Present	At least intermittent	
	Few (1-2)	None	Absent	Absent	Absent	Need more information
				Present	Present	At least intermittent
Few (1-19)		Absent	Absent		Intermittent	
			Present		At least intermittent	
		Present	Absent		At least intermittent	
			Present		Intermittent	
Many (20+)		Absent	Absent		Intermittent	
			Present		At least intermittent	
		Present	Absent		At least intermittent	
			Present		Intermittent	
Many (3+)	None	Absent	Absent	Absent	Need more information	
			Present	Present	At least intermittent	
			Present		At least intermittent	
	Few (1-19)	Absent			At least intermittent	
			Present		Perennial	
	Many (20+)	Absent			At least intermittent	
			Present		Perennial	
		Present			Perennial	

Shading provided to enhance readability by increasing the contrast between neighboring cells; empty cells indicate the classification will not change with additional information however it is recommended that all five indicators be measured and recorded during every assessment.





# Attachment D

---

Review Area Photos



APPENDIX D  
REVIEW AREA PHOTOS



Photo 1: Stream channel prior to impacts from the Mid-Coast Corridor Transit Project.



Photo 2: Stream channel prior to impacts from the Mid-Coast Corridor Transit Project.



Photo 3: Stream channel prior to impacts from the Mid-Coast Corridor Transit Project.



Photo 4: Current condition of NWW-1.



Photo 5: Current condition of NWW-1.



Photo 6: Current condition of NWW-1.



# Attachment E

---

Antecedent Precipitation Tool



# Antecedent Precipitation vs Normal Range based on NOAA's Daily Global Historical Climatology Network

Rainfall (Inches)

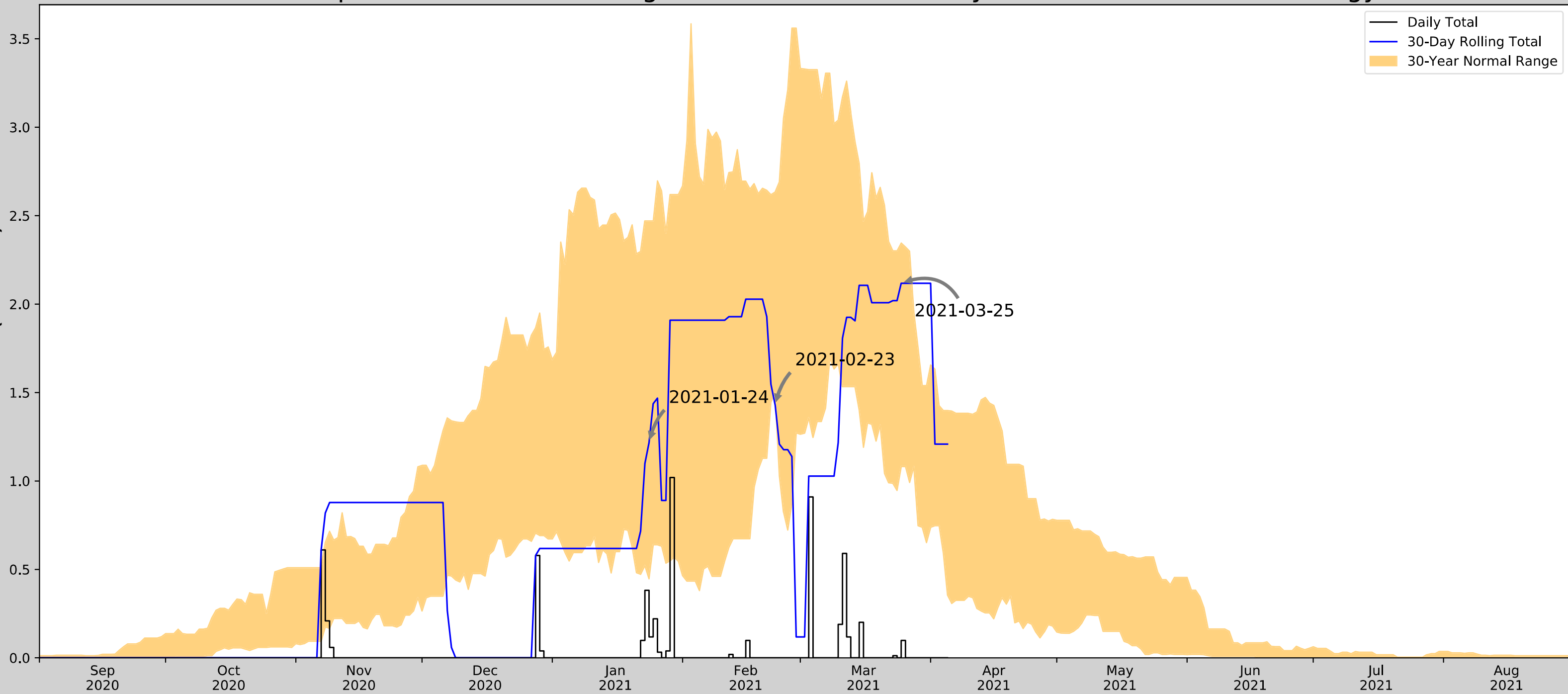

Coordinates	32.877297, -117.231459
Observation Date	2021-03-25
Elevation (ft)	295.05
Drought Index (PDSI)	Severe drought (2021-02)
WebWIMP H <sub>2</sub> O Balance	Wet Season

30 Days Ending	30 <sup>th</sup> %ile (in)	70 <sup>th</sup> %ile (in)	Observed (in)	Wetness Condition	Condition Value	Month Weight	Product
2021-03-25	1.08189	2.345276	2.11811	Normal	2	3	6
2021-02-23	1.498032	2.633071	1.429134	Dry	1	2	2
2021-01-24	0.44685	2.470473	1.216535	Normal	2	1	2
Result							Normal Conditions - 10

Weather Station Name	Coordinates	Elevation (ft)	Distance (mi)	Elevation Δ	Weighted Δ	Days (Normal)	Days (Antecedent)
SAN DIEGO MONTGOMERY FLD	32.8158, -117.1394	416.995	6.827	121.945	3.905	8206	90
LA JOLLA 2.2 NE	32.8705, -117.2477	371.063	1.053	76.013	0.554	2	0
SAN DIEGO 9.5 NNW	32.8428, -117.2208	284.121	2.462	10.929	1.135	5	0
SAN DIEGO 3.2 WNW	32.8353, -117.1859	374.016	3.926	78.966	2.077	3	0
SAN DIEGO MIRAMAR NAS	32.8667, -117.1333	477.034	5.743	181.984	3.63	3134	0
SAN DIEGO LINDBERGH FLD	32.7336, -117.1831	15.092	10.318	279.958	7.532	3	0

Figure and tables made by the  
**Antecedent Precipitation Tool**  
Version 1.0

Written by Jason Deters  
U.S. Army Corps of Engineers







# Attachment F

---

Digital Data (provided via email)



# **APPENDIX B**

*Drainage Study for UCSD  
Pepper Canyon Ancillary Site Work*



# **Drainage Study for UCSD Pepper Canyon Ancillary Site Work**

## **Prepared For:**

University of California, San Diego  
San Diego, CA 92093

**UCSD Project #5434**

## **Project Location:**

Gilman Drive & Villa La Jolla Drive  
San Diego, CA 92093  
City of San Diego, County of San Diego, CA

## **Prepared By:**

**Michael Baker**

**I N T E R N A T I O N A L**  
5050 Avenida Encinas Ste 260  
Carlsbad, CA 92008  
(760) 603-6263  
Stefani Bell, PE, CFM, QSD

**Michael Baker JN:**  
174027

**Prepared:**  
February 2020  
REV. April 202  
REV. May 2020  
REV. March 2021  
REV. April 2021

## **Table of Contents**

<b>SECTION 1 PROJECT INFORMATION.....</b>	<b>3</b>
1.1    PROJECT DESCRIPTION .....	3
1.2    PROJECT FEATURES .....	3
1.3    SCOPE OF REPORT.....	4
1.4    STUDY OBJECTIVES .....	5
<b>SECTION 2 METHODOLOGY .....</b>	<b>5</b>
2.1    EXISTING CONDITIONS .....	5
2.2    PROPOSED CONDITIONS .....	7
2.3    HYDROLOGY.....	8
2.4    HYDRAULICS .....	9
<b>SECTION 3 RESULTS .....</b>	<b>9</b>
3.1    HYDROLOGY.....	9
3.2    HYDRAULICS .....	10
<b>SECTION 4 CONCLUSIONS.....</b>	<b>12</b>
<b>SECTION 5 CEQA THRESHOLDS OF SIGNIFICANCE .....</b>	<b>13</b>
<b>SECTION 6 DECLARATION OF RESPONSIBLE CHARGE .....</b>	<b>16</b>
<b>SECTION 7 BIBLIOGRAPHY .....</b>	<b>17</b>

## **List of Figures**

FIGURE 1. FEMA FIRMETTE FOR PROJECT AREA .....	4
FIGURE 2. LONGITUDINAL CRACKING IN 30” RCP. THIS PIPE IS DOWNSTREAM OF THE 24” HDPE PER THE OPERATOR’S VERBAL COMMENTS AND SURVEY REPORTS, INCLUDED IN APPENDIX G. ....	6
FIGURE 3. CLOGGED 48” RCP DATED 2013.....	7
FIGURE 4. UNCLOGGED 48” RCP DATED 2020 .....	7

## **List of Tables**

TABLE 3-1 – OSP REGIONAL BASIN HYDROLOGIC SUMMARY: TOTAL INFLOW.....	9
TABLE 3-2 – EAST RIM TRAIL HYDROLOGY SUMMARY .....	10
TABLE 3-3 – OSP REGIONAL BASIN HYDROLOGIC SUMMARY: TOTAL DISCHARGE .....	11
TABLE 3-4 – OSP REGIONAL BASIN HYDROLOGIC SUMMARY: ATTENUATION RESULTS.....	11
TABLE 3-5 – EAST RIM TRAIL DESIGN RESULTS .....	11

## **List of Appendices**

APPENDIX A – SITE INFORMATION

APPENDIX B – EXISTING HYDROLOGY

APPENDIX C – PROPOSED HYDROLOGY

APPENDIX D – HYDRAULICS

APPENDIX E – EXCERPTS FROM MICHAEL BAKER INTERNATIONAL'S GRADING PLAN

APPENDIX F – EXCERPTS FROM AFFORDABLE PIPELINE SERVICE 2013 & 2020 STORM DRAIN SURVEY

## **Section 1    Project Information**

### **1.1    Project Description**

The UCSD Pepper Canyon Ancillary Site Work (PCASW) project is comprised of two separate, yet connected projects located within the Open Space Preserve (OSP). This large canyon-like depression is surrounded by existing development and has an approximately 62-acre tributary area. Proposed projects within the OSP include the East Rim Trail and the Regional Water Quality Basin. The purpose of the regional basin is to provide water quality treatment and runoff storage for future improvements within the drainage area, which may eventually include Triton Pavilion, Design and Innovation Center, Pepper Canyon Amphitheater, Mid Coast Trolley, Village at Pepper Canyon West, and the Pepper Canyon Open Space Preserve (this project). Proposed improvements within the regional basin, herein “Open Space Preserve (OSP),” include grading and installation of rock, soil media, perforated sub-drains and a riser for regional flow control. These improvements are located downstream from existing storm drain infrastructure as recently completed per the SANDAG/MCTC Light Rail Project. The East Rim Trail improvements include a multi-modal trail project that will demolish the existing brow ditch and create a paved path connecting northern and southern ends of the preserve.

### **1.2    Project Features**

Based on the Natural Resources Conservation Service’s (NRCS) Websoil Survey, the OSP regional basin project site is comprised of approximately 0.8% Altamont clay (AtE2) soil type D, 19.9% Chesterton fine sandy loam (CfB) soil type D, Chesterton-urban land complex (CgC) soil type D, Huerhuero-Urban land complex (HuE) soil type D, and Salinas clay loam (SbC) soil type C.

The Federal Emergency Management Agency (FEMA) has not mapped a Special Flood Hazard Area (SFHA) within the project site vicinity nor the OSP regional basin. Both areas lie within un-shaded Zone X, which correlates with areas determined to be outside the 500-year floodplain. See Figure 1 for the FIRMette depicting the SFHA in the project area.



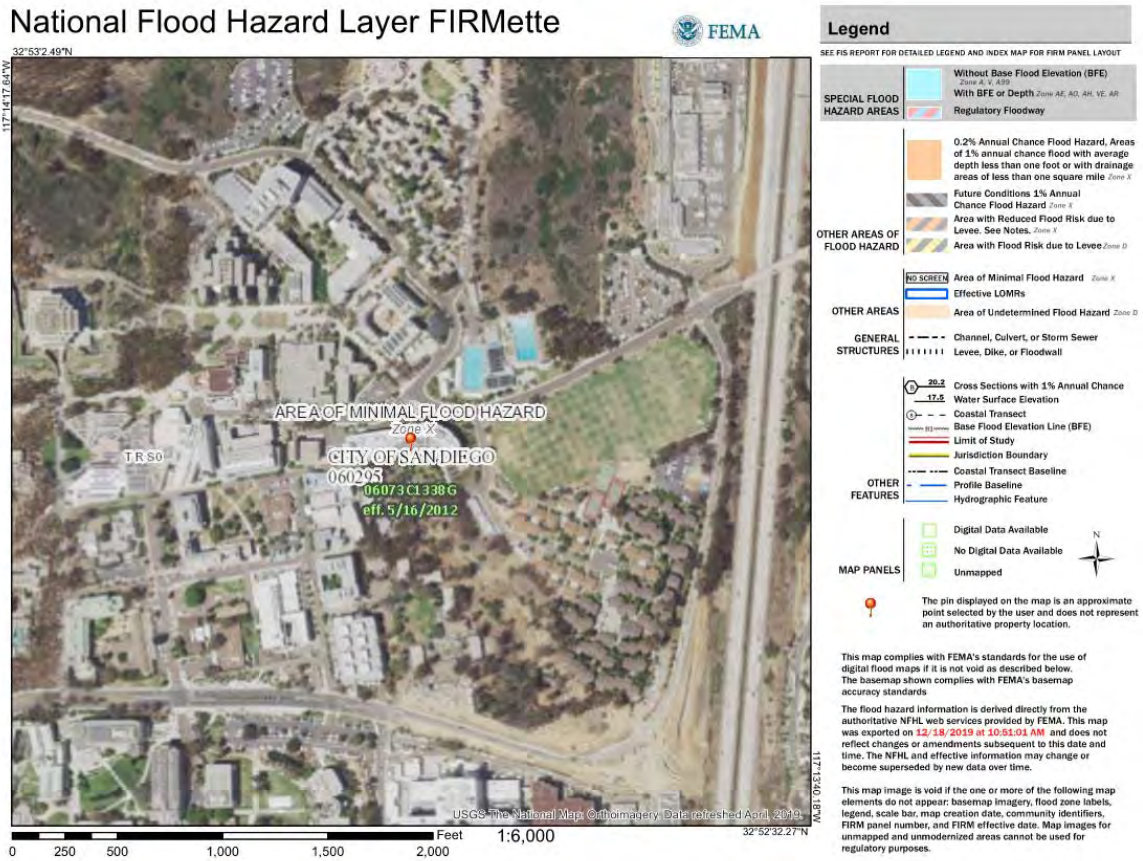

Figure 1. FEMA FIRMette for Project Area

An existing wetland was identified in the southwest corner of the OSP. Development and/or any ground disturbance must be avoided within this area or the setback, which have been delineated on the exhibits included herein. See Appendix A for an exhibit of the wetland delineation.

SANDAG is finalizing construction of the Mid-Coast Trolley, which spans above the OSP regional basin. One of the support columns has been located within the OSP and is identified on the exhibits herein. Flood level calculations were prepared and coordinated with the SANDAG team that identify water levels adjacent to the support column. Additionally, this project will inherit a post-construction vegetated swale BMP within the OSP, as left by SANDAG. The BMP will be protected in place during construction and will continue to provide conveyance under post-construction conditions.

### 1.3 Scope of Report

The scope of this report includes project site analysis of the 10-year and 100-year peak flows under existing and proposed conditions. Calculations include tributary watershed analysis for the existing stormwater system on UCSD campus draining to the OSP. Project site analysis also includes sizing for new storm drain infrastructure related to the OSP basin riser and outlet piping, and drainage design for the East Rim Trail. The analysis ends at the outlet of the OSP basin,

although the final discharge location is a 48" RCP outlet to a concrete-lined channel in the Caltrans Right-of-Way. Preliminary evaluation of the existing UCSD storm drain system at that location shows additional tie-ins from drainage areas not included for analysis in the scope of this report. Therefore, this report will only address the flows contributing to that drain system as a result of the OSP project.

Additional work areas include access road replacement and grading improvements for an access road between the OSP drainage basin and Interstate 5. However, according to the existing and proposed topography, this surface area does not sheet flow to the OSP basin thus was excluded from this analysis. Surface flow from this area is collected in a pipe network that flows directly into the existing 48-inch connection that discharges to the Caltrans channel. For stormwater quality treatment measures of this proposed access road, refer to the Storm Water Quality Management Plan (SWQMP). Refer to Section 3 for methodology and the appendices for exhibits.

This report does not address temporary Best Management Practices (BMPs) required during construction. Refer to the project Storm Water Pollution Prevention Plan (SWPPP) for this information. Water quality performance is addressed in the SWQMP sheets included in the Construction Documents.

UCSD is listed as a non-traditional Permittee of the Phase II Small MS4 General Permit, Order No. 2013-0001-DWQ NPDES No. CA2000004. To comply with Section F of the General Permit, *Non-Traditional Small MS4 Permittee Provisions*, UCSD has developed programs designed to reduce storm water pollution and protect water quality. Proposed drainage and stormwater quality treatment measures will adhere to UCSD MS4 permit guidelines.

## **1.4 Study Objectives**

The specific objectives of this study are as follows:

- Quantify the OSP regional basin 10-year and 100-year peak flow discharge rates under existing and proposed conditions
- Document the 10-year and 100-year water surface elevations within the OSP regional basin
- Demonstrate the proposed improvements will not increase the potential for erosion on the project site or downstream area, nor contribute to any adverse impacts associated with storm water runoff.

## **Section 2 Methodology**

### **2.1 Existing Conditions**

A portion of the SANDAG Mid-Coast Trolley project is elevated over the OSP and is supported by a large bent column within the OSP area. The OSP receives storm runoff from a portion of the

main campus and the surrounding adjacent areas, as shown on the exhibits in Appendix B. Storm water is ultimately discharged from the OSP to a concrete-lined channel in the Caltrans Right-of-Way via two existing Type F inlets:

1. The first Type F inlet is 4' x 4' and located in a small depression in the middle of the canyon. This inlet is connected to a second Type F inlet to the south by a 24" HDPE that transitions to a 30" RCP. A storm drain inspection performed by Affordable Pipeline Services in 2013 identified structural damage to the 30" RCP, shown in Figure 2 below. Survey data from the inspection is included in Appendix G. This damage is not anticipated to impact conveyance capacity; however, the proposed improvements will include removal and replacement.
2. The second Type F inlet is 5' x 5' and has openings roughly 1.5' above the opening of the first Type F inlet. These two inlets ultimately discharge the OSP area to the south through a 42" RCP that transitions to a 48" RCP before reaching the Caltrans channel, adjacent to Interstate 5.



3.

**Figure 2. Longitudinal cracking in 30" RCP. This pipe is downstream of the 24" HDPE per the operator's verbal comments and survey reports, included in Appendix G.**

The 2013 CCTV identified this 48-inch RCP as partially clogged with sediment, shown in Figure 3 below., however, a new CCTV study was conducted in March 2020 that showed the pipe had been recently cleaned, thus calculations do not include obstruction. Figure 4 shows the cleaned pipe as of March 2020.

In this section, the report should discuss the "existing" condition of the surrounding developments that are tributary to the regional basin. Keep in mind that this "regional basin" is going to be built so that it detains the increased runoff from those developments. So the "existing condition" should reflect a condition prior to DIB and Amphitheater.

Also, include a calc and assumption for all the C values used.



**Figure 3. Clogged 48" RCP dated 2013**



**Figure 4. Unclogged 48" RCP dated 2020**

The wetland and development setback are shown on the exhibits in Appendix E and will be protected. Existing impervious area consists of a portion of the suspended Mid-Coast Trolley area and a parking lot that also drain to the OSP.

During the preparation of this report, SANDAG construction activities continued within the OSP work limits. Although as-built plans have not been received by SANDAG, this report and associated calculations are based on completed infrastructure per the SANDAG Light Rail improvement plans.

## **2.2 Proposed Conditions**

### ***OSP Regional Basin***

Proposed improvements associated with the PCASW project include a 16' wide multi-modal trail with drainage channel, and a graded and lined biofiltration basin within the OSP. The biofiltration basin will feature 18" of engineered soil media over 24" of gravel and liner. A network of 8" perforated PVC pipe will be located 3" above the bottom of the gravel layer and will connect to a newly proposed riser structure. Storm water will be allowed to pond 12" prior to discharge through the new riser. The two existing Type-F inlets will be removed and replaced with two new outlet structures sized to mitigate flow from the tributary areas. New 42" storm drain is proposed in-place of the existing 24", 30" and 42" RCP and is shown on the proposed work map

found in Appendix C, and a detail of the bioretention can be found in Appendix E. The 42" outlet will tie-in to the existing 42" pipe before transitioning to the newly cleared 48" RCP.

### ***East Rim Trail***

The East Rim Trail is approximately 650' long, 16' wide, and up to 15% grade in the most extreme cases. The trail will drain to a concrete-lined V-ditch that has been sized for 100-year storm runoff from the path as well as run-on from adjacent improvements and the uphill buildings to the east. The western side of the trail is bounded by a retaining wall. The trail contributes approximately 9,700 sf of new impervious area.

The proposed V-ditch shall contain 1.5:1 side slope and have a top width of 3'. The concrete lining shall have a minimum thickness of 6" for flow velocities less than 30 fps (City of San Diego, 2017). The V-ditch will connect downstream to a 24" High Density Poly-Ethylene (HDPE) pipe at 3% slope (most downstream connection) that outlets to the OSP Regional Basin. SDRSD D-34 headwalls should be installed at upstream and downstream ends to prevent erosion and scour from the abrupt change in flow direction. The hydraulic analysis results are shown in Section 3.2 Design calculations for the ditch are included in Appendix D.

## **2.3 Hydrology**

Advanced Engineering Solutions (AES – HydroWIN 2013) was used to model the hydrologic characteristics of the project site and off-site tributary area under pre and post development conditions. This software utilizes the Rational Method and conforms to the hydrologic methodologies outlined in the San Diego County Hydrology Manual (SDCHM, June 2003). The Rational Method is a physically based model that calculates peak flow rates (Q) as a function of runoff coefficients (C), rainfall intensities (I), and drainage areas (A):

$$Q = C * I * A$$

Weighted runoff coefficients (c) have been established using regional guidance for impervious and pervious area. Refer to the existing and proposed condition hydrologic work maps in Appendices B and C, respectively.

Time of concentration and rainfall intensities were developed internally within the AES software. The 'San Diego' AES module was used for this analysis and conforms to the methodologies described in the SDCHM (June 2003). This software is accepted by both the City and County of San Diego. Refer to Appendices B and C for existing and proposed condition calculations, respectively.

Area delineations were developed using project specific 1-foot contour topography.

AES flows confluence where the tributaries all discharge to the OSP basin. Appendix B contains the Existing Conditions Hydrology exhibit and displays the drainage area boundaries and existing curb-and-gutter and storm drain system. The AES calculations are also included for time of concentration, drainage area, rainfall intensity, and peak flow calculations. The proposed condition included the improvements in the OSP drainage basin, which includes the East Rim Trail.

The Proposed Conditions Hydrology exhibit is included in Appendix C, with the supporting AES calculations.

## 2.4 Hydraulics

Existing and proposed peak flows from combined tributary areas were used to develop hydrographs for routing calculations through the existing and proposed OSP basin configurations. Hydrographs for the 10-year and 100-year peak flows were generated using RayHydro software (Rick Engineering Company), and routed using Autodesk Hydraflow Hydrographs extension. Hydraflow relies on user input contours and elevations to calculate the volume of the basin at various stages. The outlet control structures provide weir and orifice outflows based on user-specified design. The inflow hydrographs are routed using stage-storage calculations to determine the peak flow (and associated hydrograph) of the mitigated condition. Existing and proposed hydraulic routing calculations are provided in Appendix D.

Bentley’s Flow Master was used to analyze pipe flow capacity based on normal depth for the proposed storm drain infrastructure in the OSP. Flow Master uses Manning’s equation with user supplied pipe information (diameter, n value, slope, and Q) to determine normal depth within the proposed pipes. Given this software does not account for hydraulic losses associated with manholes and pipe angles, pipe capacity has not been maxed out; rather, limited to 75% full based on 100-year peak flow.

## Section 3 Results

### 3.1 Hydrology

Table 3-1 below summarizes peak flow discharge into the OSP regional basin. These peak flows are derived from the AES hydrologic analyses and do not account for attenuation provided by the OSP Regional Basin, rather, are before the flows have reached the OSP basin.

**Table 3-1 – OSP Regional Basin Hydrologic Summary: Total Inflow**

Node	Area	EX. Q <sub>10</sub>	PR. Q <sub>10</sub>	EX. Q <sub>100</sub>	PR. Q <sub>100</sub>
	(ac)	(cfs)	(cfs)	(cfs)	(cfs)
<b><i>Southerly OSP Tributary Area</i></b>					
1000	31.2	69.4	69.4	108.2	108.2
<b><i>Northerly OSP Tributary Area</i></b>					
3000	25.3	53.67	53.67	83.51	83.51
<b><i>Confluence Nodes 1000 and 3000</i></b>					
Total QSP Basin Inflow	63.5	129.82	130.14	202.58	203.8

Node 1000 is located at the southwesterly corner of the OSP regional basin. On-site sub-basin 300 is included within this analysis. Discharge into the OSP regional basin is 108.2 cfs during the 100-year, proposed storm event, at this location.

Node 3000 is located at the northerly end of the OSP regional basin. On-site sub-basins 100 and 200 are included within this analysis. Discharge into the OSP regional basin is 83.51 cfs during the 100-year, proposed storm event, at this location.

Hydrologic results for Nodes 1000 and 3000 have been confluent within AES using respective times of concentration. As such, the total OSP inflow during 100-year, proposed condition, is 203.8 cfs. Adding peak flow at Nodes 1000 and 3000, to derive total basin inflow, does not account for the differing times of concentration and thus has been intentionally calculated as a confluence.

Based on the project site’s location within the OSP’s total tributary area, proposed improvements associated with the Ancillary Site Work do not have a significant impact on total inflow into the OSP. When considering the total confluence of all OSP Regional Basin inflow, the proposed improvements result in slight increases in both events due to the small increase in runoff coefficient from the proposed trail. These results highlight the impact differing times of concentration, routing, and storm intensity can have on peak flow. Refer to Section 3.2 for total OSP regional basin discharge, which is a function of basin volume, hydrologic routing, and the hydraulic performance of the existing and proposed outlet structures.

Hydrologic calculations for the East Rim Trail drainage area are shown below.

**Table 3-2 – East Rim Trail Hydrology Summary**

Design Event	C	A	P6	I	Q
		(ac)	(in)	(in/hr)	(cfs)
10-Year	0.4	1.03	1.5	1.98	0.81
100-Year	0.4	1.03	2.25	2.98	1.22

### 3.2 Hydraulics

The table below summarizes peak flow discharge from the OSP regional basin. Peak flow discharge has been determined by routing hydrographs through the OSP under existing and proposed conditions. Velocity calculations were determined for the 42” RCP outlet pipe using Flowmaster.

**Table 3-3 – OSP Regional Basin Hydrologic Summary: Total Discharge**

ID	Outlet Type	A	Q <sub>10</sub>	Q <sub>100</sub>	V <sub>10</sub>	V <sub>100</sub>
		(ac)	(cfs)	(cfs)	(fps)	(fps)
Existing Condition	42" RCP	63.5	69.86	92.58	11.29	11.86
Proposed Condition	42" RCP	63.5	51.74	75.71	10.53	11.48
Delta		0	-18.12	-16.87	-0.76	-0.38

Ponding depths, drawdown time, and attenuated volumes are tabulated below.

**Table 3-4 – OSP Regional Basin Hydrologic Summary: Attenuation Results**

ID	Outlet Type	10-YR WSE (ft)	100-YR WSE (ft)	100 -YR Drawdown Time (Hours)	100-YR Volume Attenuated (cuft)
Existing Condition	42" RCP	292.25	293.35	6.30	381,157
Proposed Condition	42" RCP	292.17	293.29	7.3	362,574
Delta		-0.08	-0.06	+1.0	-18,583

The OSP regional basin has been designed with two riser structures to reduce 100-year peak flow by 18 cfs, which can be applied to the on-going and future projects within the OSP tributary area. Refer to Appendix D for calculations and exhibits. A Biofiltration basin detail is included in Appendix E.

Design calculations for the East Rim Trail drainage system are summarized in Table 3-5. The trail was designed to drain the 100-year event with the appropriate capacity, freeboard, and velocity constraints.

**Table 3-5 – East Rim Trail Design Results**

ID	Normal Depth (ft)	Design Depth (ft)	Freeboard (ft)	Avg. Longitudinal Slope (%)	Maximum Velocity (fps)
Concrete V-Ditch	0.32	1.0	0.68	7.5	10.2
Inlet/Pipe System	0.19	2.0	0.81	6.4	7.8

Normal depth during the 100-year event is 0.28' and the maximum velocity is 10.2 fps. Required freeboard for concrete-lined channels conveying less than 10 cfs shall be 0.5' (City of San Diego, 2017). The flow regime calculated for the ditch is supercritical. Hydraulic jumps are likely to occur and will be mitigated by the stability of the 6" of concrete lining and extra freeboard.



The proposed inlet is a 36" x 36" grate, which can convey flow rates up to 12.1 cfs. The inlet has more than the required 1.22 cfs of capacity to capture flows from the concrete ditch and convey them underground. The 24" HDPE system outlets to the OSP. The County of San Diego recommends a riprap apron for exit velocities of 6 fps or greater, thus, a 4' wide x 10' long riprap pad is included in the design, per the San Diego County Hydraulic Design Manual, Standard Rock Riprap Apron Layout.

Other locations where runoff flows into the OSP basin are the outlet of the existing wetland and the outlet of the swale left by SANDAG. Typically, energy dissipation measures are designed based on the discharge velocity of the outfall. The flow rate entering the wetland was calculated at 108.22 cfs. This flow is slowed significantly by entering the vegetated channel and large cross-section area provided by the wetland. Thus, velocity exiting the wetland was calculated as 3.5 fps, which is less than the 6.0 fps required by Table 7-1 for riprap aprons at storm drain outlets. However, a 10' wide by 30' long apron was included in the design to provide stability at the flow transition from the existing wetland to the side slopes of the OSP basin, until vegetation is adequately established. Velocity calculations are included in Appendix D.

The 83.98 cfs that enters the OSP via the SANDAG channel is controlled by several drop structures. The existing 1300 sf riprap pad at the bottom of this channel will be replaced by a 30' wide by 10' long ¼ ton backing riprap pad 2.7 ft deep. The riprap will be stabilized by a retention wall to prevent rock from slipping into the OSP basin.

## Section 4 Conclusions

This report documents that the study objectives have been met, and the following can be concluded:

- A reduction in peak flow, under 10-year and 100-year conditions, as a result of the proposed improvements associated with the PCASW project at the OSP regional basin
- The existing and proposed 10- and 100-year WSEs in the basin have been determined
- The potential for downstream erosion was shown to be unaffected by the proposed OSP or associated site work through velocity calculations, which show a reduction in both 10- and 100-year events. Runoff from the East Rim Trail is captured and discharged into the OSP, where the riser and outlet structures mitigate the peak flow and velocity before discharging to the existing storm drain system.

Existing flows from the vegetated swale and the wetland area are unaffected by the OSP downstream. Existing storm drain infrastructure within the OSP will be replaced with new 42" RCP and perforated sub-drains. Ultimately, the OSP discharges to an open channel immediately adjacent to I-5 via an existing 48" RCP that will remain. Proposed improvements do not include changes or improvements at the 48" outfall. Additionally, proposed improvements result in a

reduction in total peak flow, as compared to existing conditions. As such, the off-site open channel is expected to function better in the proposed condition, as compared to existing, based on a reduction in peak flow.

The existing wetland area (within the OSP area) has been identified and shown on the exhibits included in Appendix A. This area has not been mapped by the USACE as a navigable waterway and does not require a FEMA Letter or Map Revision. Additionally, no 1600 streambed alteration permit or CWA Section 401 permit is required based on the location of the project.

## **Section 5 CEQA Thresholds of Significance**

- 1. Will the project substantially alter the existing drainage pattern of the site or area, including through the alteration of the course of a stream or river, in a manner which would result in substantial erosion or siltation on- or off-site?**

The proposed project will not result in a substantial alteration to the existing drainage pattern across the site. Upon completion of the project, runoff will continue to discharge easterly into the Open Space Preserve (OSP) Regional Basin, as it does under existing conditions, as concentrated flow. No new discharge locations are proposed, and all existing discharge locations are adequately protected against erosion under present day conditions.

- 2. Will the project increase water surface elevation in a watercourse within a watershed equal to or greater than 1 square mile, by 1 foot or more in height and in the case of the San Luis Rey River, San Dieguito River, San Diego River, Sweetwater River and Otay River, 2/10 of a foot or more?**

No watercourses are presumed to be affected as the ultimate discharge location is an existing concrete channel that outlets to the Pacific Ocean. The reduction in flow and velocity provided by the OSP are more likely to reduce the water surface elevations within this channel. Within the OSP, the 100-year depth will be reduced, compared to pre-development conditions, through proposed grading and a hydraulically improved outlet structure.

- 3. Will the project result in increased velocities and peak flow rates exiting the project site that could cause flooding downstream or exceed the storm water drainage system capacity serving the site?**

The project will not increase peak flow rates or velocities leaving the OSP Regional Basin. The project will not cause flooding downstream, nor will it hydraulically impact on-site or downstream storm water infrastructure.

- 4. Will the project result in placing housing, habitable structures, or unanchored impediments to flow in a 100-year floodplain area or other special flood hazard area, as shown on a FIRM, a County Flood Plain Map or County Alluvial Fan Map,**

**which would subsequently endanger health, safety and property due to flooding?**

The project will not result in placing any habitable structures within a 100-year floodplain or any other Special Flood Hazard Area (SFHA).

- 5. Will the project place structures within a 100-year flood hazard or alter the floodway in a manner that would redirect or impede flow resulting in any of the following:**
  - a. Alter the line of inundation resulting in the placement of other housing in a 100 year flood hazard**
  - b. Increase water surface elevation in a watercourse with a watershed equal to or greater than 1 square mile by 1 foot or more in height and in the case of the San Luis Rey River, San Dieguito River, San Diego River, Sweetwater River and Otay River, 2/10 of a foot or more?**

The proposed project does not include fill, grading, or any other work within a mapped Regulatory Floodplain or Floodway. The project will not place any structures within a 100-year floodplain.

- 6. Will the project substantially deplete groundwater supplies or interfere substantially with groundwater recharge such that there would be a net deficit in aquifer volume or a lowering of the local groundwater table level (e.g., the production rate of pre-existing nearby wells would drop to a level which would not support existing land uses or planned uses for which permits have been granted)?**

The proposed project will not deplete groundwater supplies or interfere with aquifers.

- 7. Will the project substantially alter the existing drainage pattern of the site or area, including through the alteration of the course of a stream or river, or substantially increase the rate or amount of surface runoff in a manner which would result in flooding on- or off-site?**

The proposed project will not result in a substantial alteration to the existing drainage pattern across the site. Upon completion of the project, runoff will continue to discharge easterly into the Open Space Preserve (OSP) Regional Basin, as it does under existing conditions, as concentrated flow. No new discharge locations are proposed, and all existing discharge locations are adequately protected against erosion under present day conditions.

- 8. Will the project create or contribute runoff water which would exceed the capacity of existing or planned stormwater drainage systems or provide substantial additional sources of polluted runoff?**

The project will not increase peak flow rates leaving the OSP Regional Basin. The project will not cause flooding downstream, nor will it hydraulically impact on-site or downstream storm water infrastructure.

**9. Will the project expose people or structures to a significant risk of loss, injury or death involving flooding, including flooding as a result of the failure of a levee or dam?**

No levees or dams are located within the project area or surrounding area.

**10. Will the project cause inundation by seiche, tsunami, or mudflow?**

Based on project location it is unlikely that the project is subject to inundation by seiche, tsunami or mudflow.

## Section 6 Declaration of Responsible Charge

I, hereby declare that I am the Civil Engineer of work for this project, that I have exercised responsible charge over the design of the project as defined in Section 6703 of the Business and Professions Code, and that the design is consistent with current design.

I understand that the check of project drawings and specifications by UCSD is confined to a review only and does not relieve me, as Engineer of Work, of my responsibilities for the project design.



4/28/2021



---

Stefani Bell RCE 88581

---

Date

## **Section 7    Bibliography**

City of San Diego. (January 2017). *Drainage Design Manual*. San Diego.

City of San Diego. (January 2018). *Storm Water Standards*. San Diego.

County of San Diego (June 2003) *Hydrology Manual*. San Diego.

County of San Diego (September 2014) *Hydraulic Design Manual*. San Diego.

FEMA. (1997). *Flood Insurance Rate Map*. San Diego.

Soil Survey Staff, N. R. (2018, September 24). *Web Soil Survey*. Retrieved from Web Soil Survey:  
<https://websoilsurvey.sc.egov.usda.gov/>

Moffatt & Nichol. (2016) *Final Drainage Study for Pepper Canyon Basin*

## Appendix A – Site Information

*Vicinity Map*

*Rainfall Isopluvials*

*FEMA FIRM*

*NRCS WebSoil Survey*

*Wetland Delineation*



## *VICINITY MAP*

NO SCALE



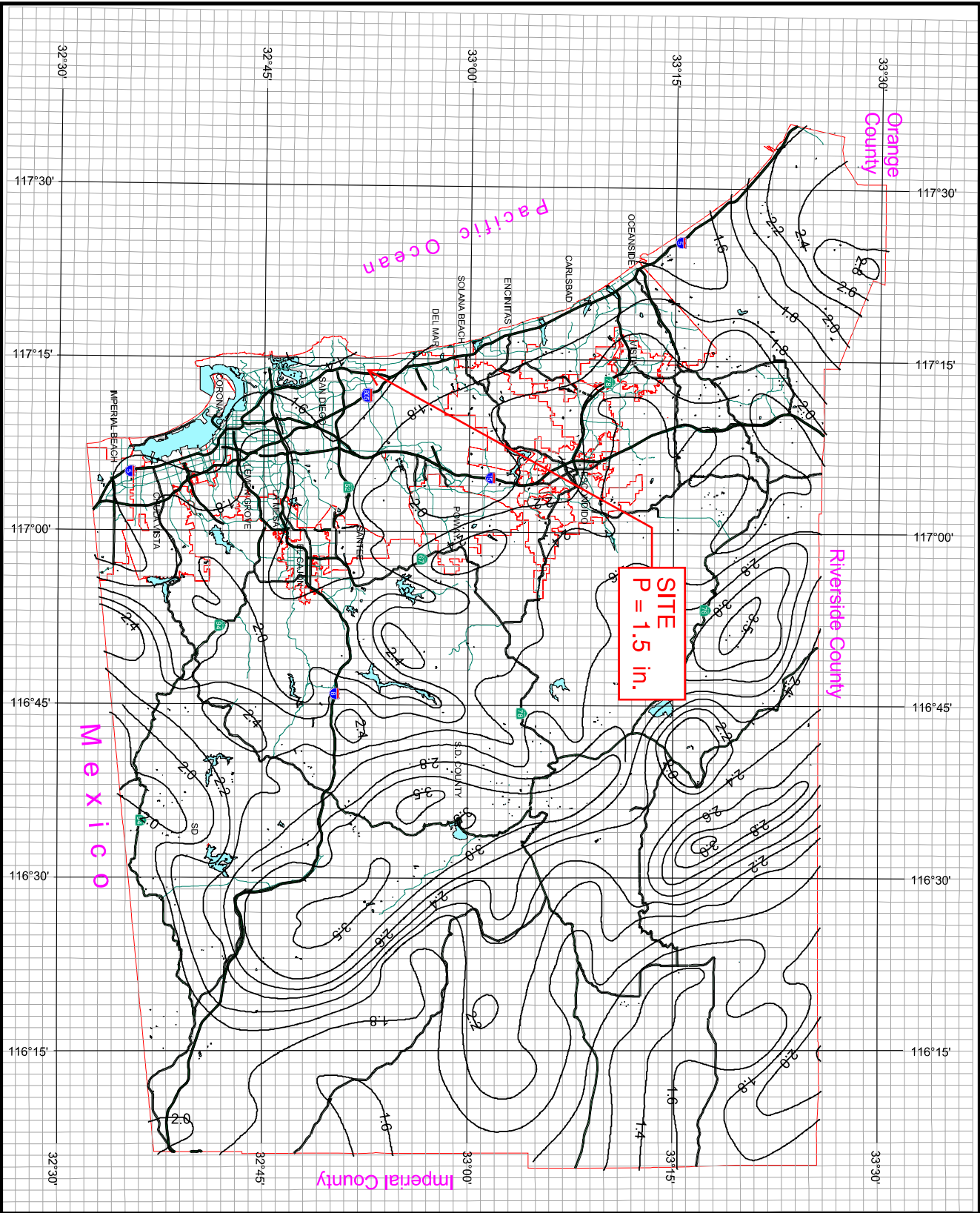

# County of San Diego Hydrology Manual



## Rainfall Isoplethals

### 10 Year Rainfall Event - 6 Hours

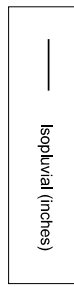



Department of Public Works  
Geospatial Information Services



SanGIS  
We Have Your Back!

THIS MAP IS PROVIDED WITHOUT WARRANTY OF ANY KIND, EITHER EXPRESS OR IMPLIED, AND FITNESS FOR A PARTICULAR PURPOSE. Copyright © SanGIS. All Rights Reserved. This product may contain information from the SANDAG Regional Information System (RIS) or other sources. All rights reserved. This product may contain information which has been reproduced with permission granted by Thomas Brothers Maps.





# County of San Diego Hydrology Manual

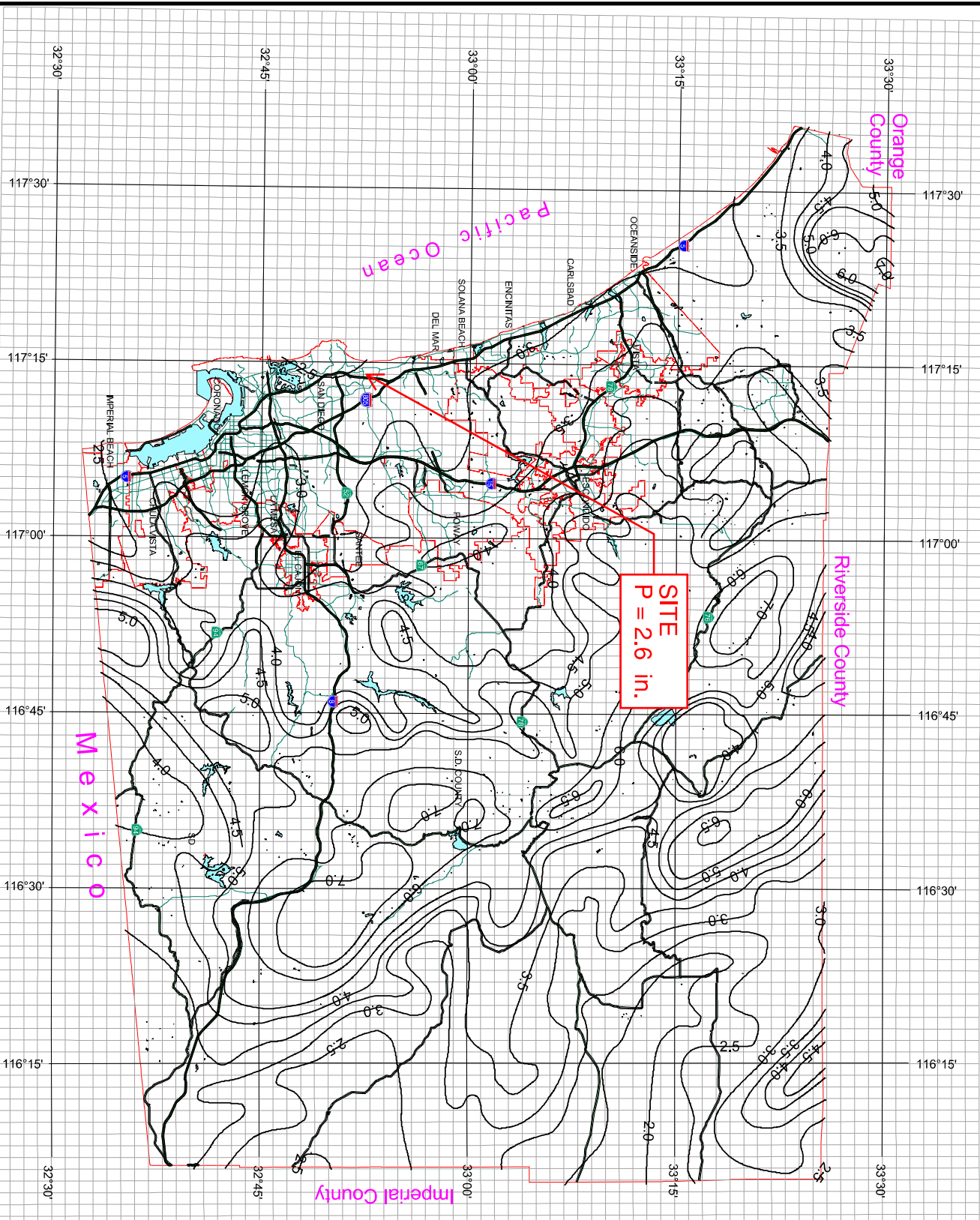

## Rainfall Isoplethals

10 Year Rainfall Event - 24 Hours



SanGIS  
We Have You Covered!

3 0 3 Miles

THIS MAP IS PROVIDED WITHOUT WARRANTY OF ANY KIND, EITHER EXPRESS OR IMPLIED, AND FITNESS FOR A PARTICULAR PURPOSE. Copyright SanGIS, All Rights Reserved. This product may contain information from the SANDAG Regional Information System. It is reproduced with the permission of SANDAG. This product may contain information which has been reproduced with permission granted by Thomas Brothers Maps.

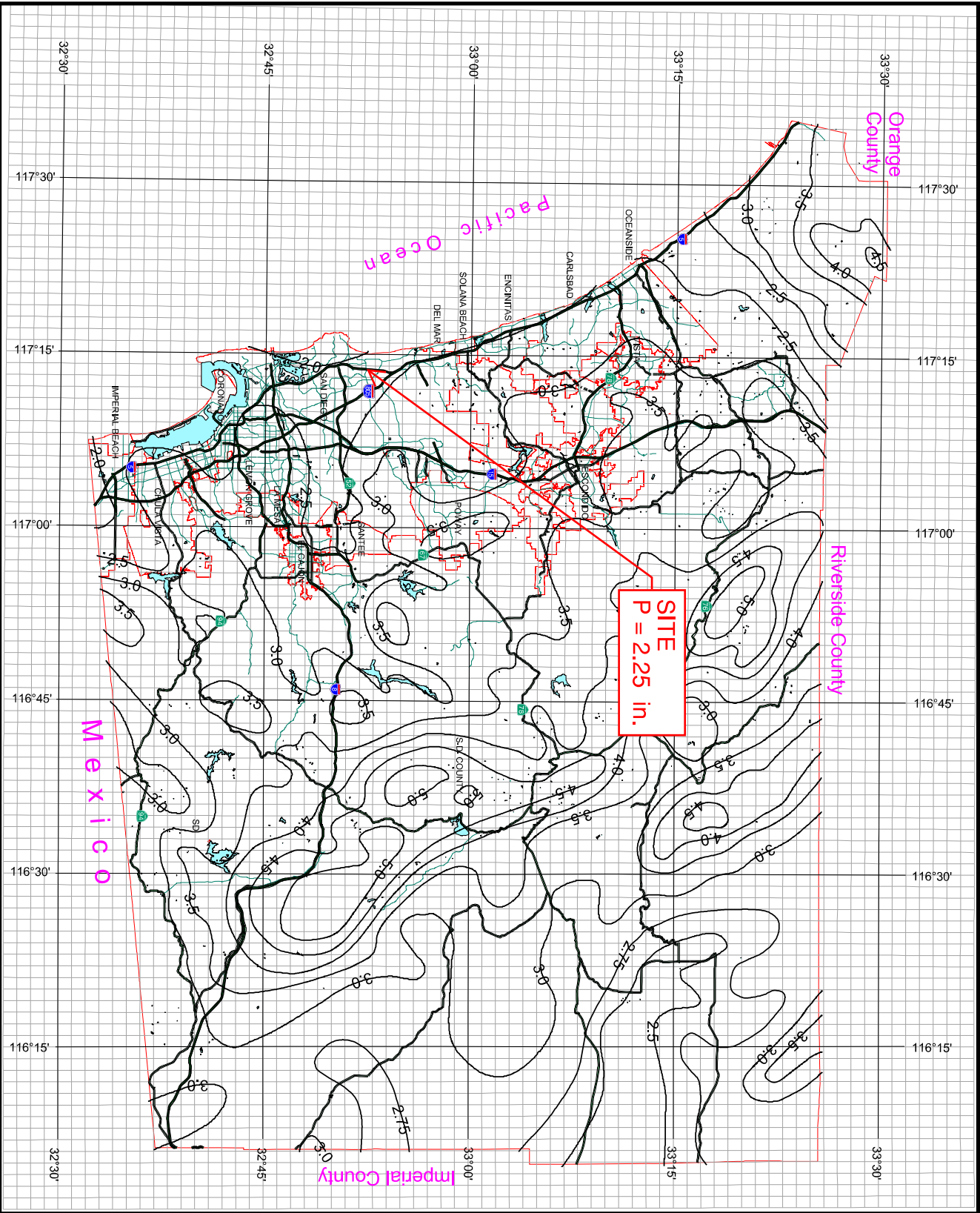

# County of San Diego Hydrology Manual



## Rainfall Isoplethals

### 100 Year Rainfall Event - 6 Hours

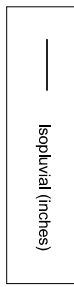

Department of Public Works  
Geographic Information Systems

We Have San Diego Covered!

THIS MAP IS PROVIDED WITHOUT WARRANTY OF ANY KIND, EITHER EXPRESS OR IMPLIED, INCLUDING MERCHANTABILITY AND FITNESS FOR A PARTICULAR PURPOSE. THE USER ASSUMES ALL LIABILITY FOR ANY DAMAGE, INCLUDING REPUTATIONAL DAMAGE, ARISING FROM ANY USE OF THIS INFORMATION. THE PRODUCT MAY CONTAIN INFORMATION FROM THE SANDAG Regional Information System (RIS) and is a Trade Dress of SANDAG. All rights reserved. This product may contain information that has been reproduced with permission granted by Thomas Brothers Maps.

3 0 3 Miles

# County of San Diego Hydrology Manual



## Rainfall Isoplethals

100 Year Rainfall Event - 24 Hours



SanGIS  
We Have Your Back!

3 0 3 Miles

THIS MAP IS PROVIDED WITHOUT WARRANTY OF ANY KIND, EITHER EXPRESS OR IMPLIED, AND FITNESS FOR A PARTICULAR PURPOSE. Copyright SanGIS. All Rights Reserved. This product may contain information from the SANDAG Regional Water Information System (RWIS) or other sources. All rights reserved. This product may contain information which has been reproduced with permission granted by Thomas Brothers Maps.

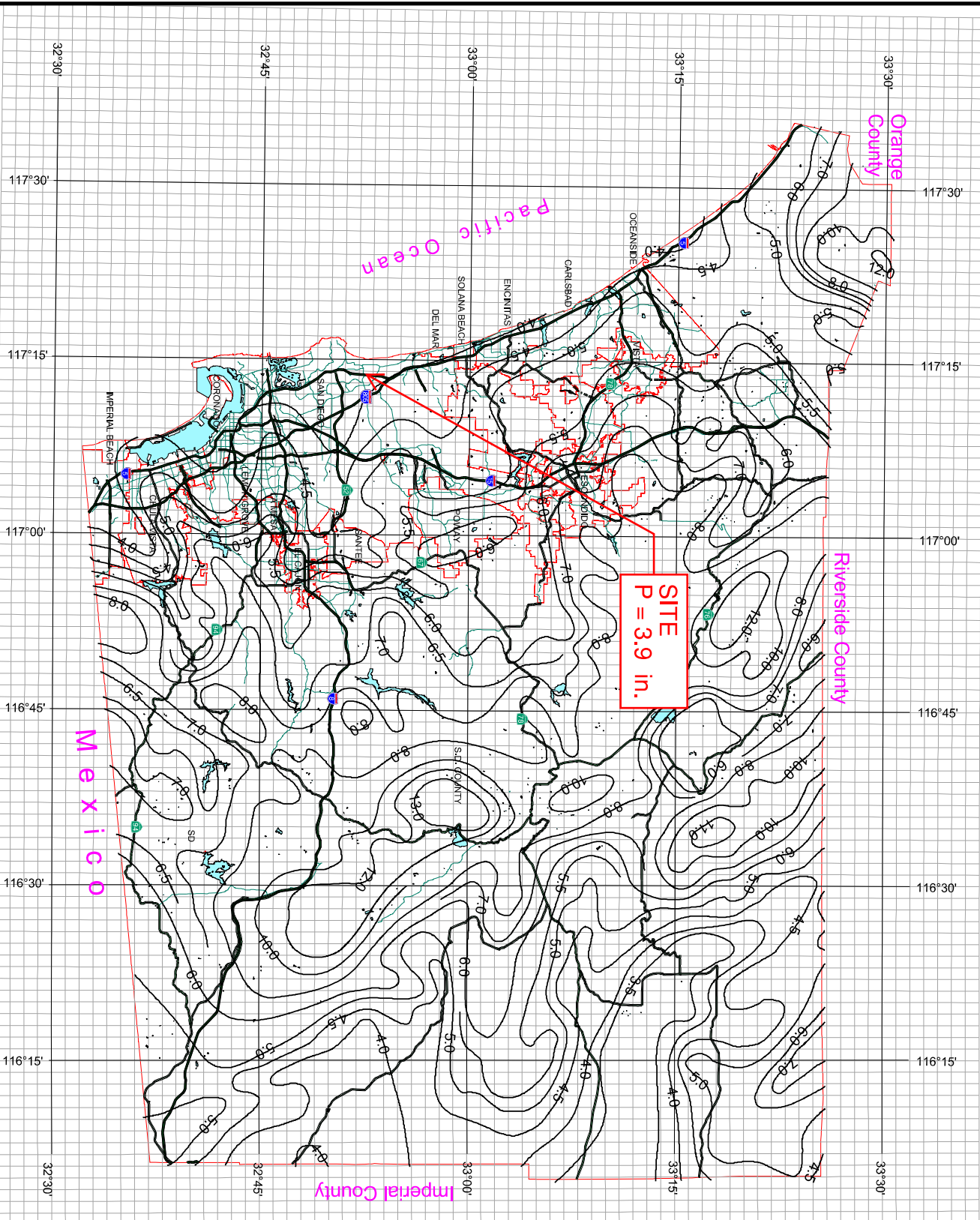







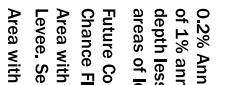
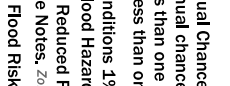
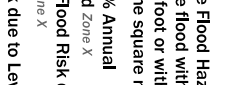

## Legend

SEE FIS REPORT FOR DETAILED LEGEND AND INDEX MAP FOR FIRM PANEL LAYOUT

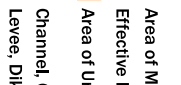
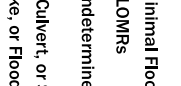
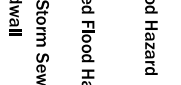
<b>SPECIAL FLOOD HAZARD AREAS</b>		Without Base Flood Elevation (BFE) Zone A, V, A99
		With BFE or Depth Zone AE, AO, AH, VE, AR Regulatory Floodway

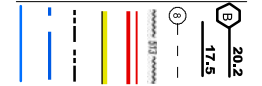
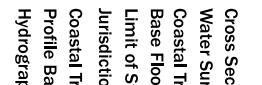
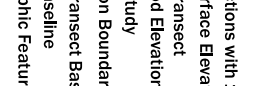
<b>OTHER AREAS OF FLOOD HAZARD</b>		0.2% Annual Chance Flood Hazard, Areas of 1% annual chance Flood with average depth less than one foot or with drainage areas of less than one square mile Zone X
		Future Conditions 1% Annual Chance Flood Hazard Zone X
		Area with Reduced Flood Risk due to Levee, See Notes, Zone X
		Area with Flood Risk due to Levee Zone D

<b>OTHER AREAS</b>		Area of Minimal Flood Hazard Zone X
		Area of Undetermined Flood Hazard Zone D
<b>GENERAL STRUCTURES</b>		Channel, Culvert, or Storm Sewer
		Levee, Dike, or Floodwall

<b>OTHER FEATURES</b>		20.2 Cross Sections with 1% Annual Chance Water Surface Elevation
		17.5 Coastal Transect
		Base Flood Elevation Line (BFE)
		Limit of Study
		Jurisdiction Boundary
		Coastal Transect Baseline
		Profile Baseline
		Hydrographic Feature

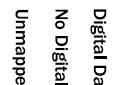
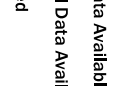
<b>MAP PANELS</b>		Digital Data Available
		No Digital Data Available
		Unmapped

 The pin displayed on the map is an approximate point selected by the user and does not represent an authoritative property location.

This map complies with FEMA's standards for the use of digital flood maps if it is not void as described below. The basemap shown complies with FEMA's basemap accuracy standards

The flood hazard information is derived directly from the authoritative NFHL web services provided by FEMA. This map was exported on **12/18/2019 at 10:51:01 AM** and does not reflect changes or amendments subsequent to this date and time. The NFHL and effective information may change or become superseded by new data over time.

This map image is void if the one or more of the following map elements do not appear: basemap imagery, flood zone labels, legend, scale bar, map creation date, community identifiers, FRM panel number, and FIRM effective date. Map images for unmapped and undetermined areas cannot be used for regulatory purposes.

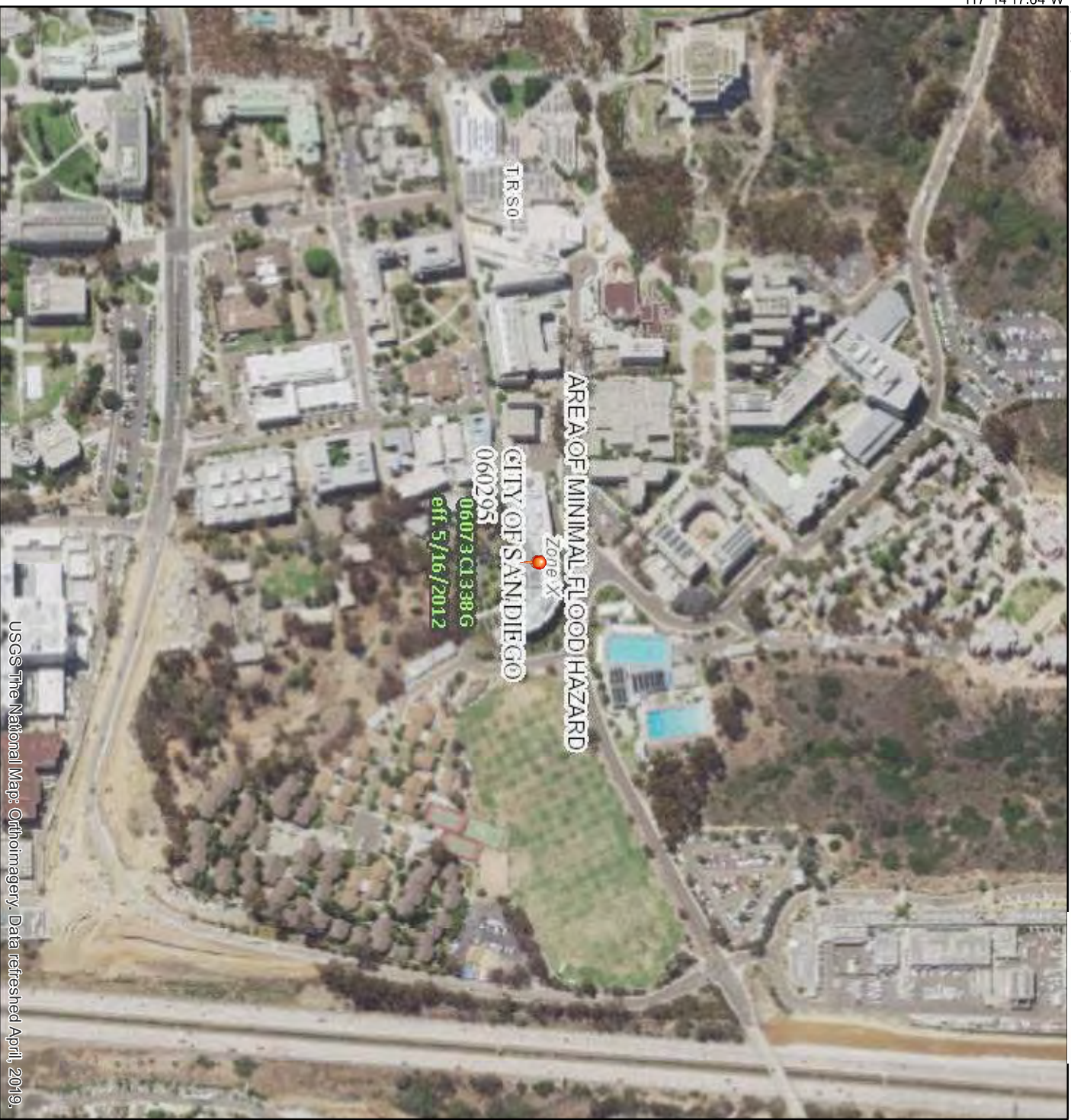

USGS The National Map: Orthoimagery. Data refreshed April, 2019. 117°13'40.18"W 32°52'32.27"N

Hydrologic Soil Group—San Diego County Area, California

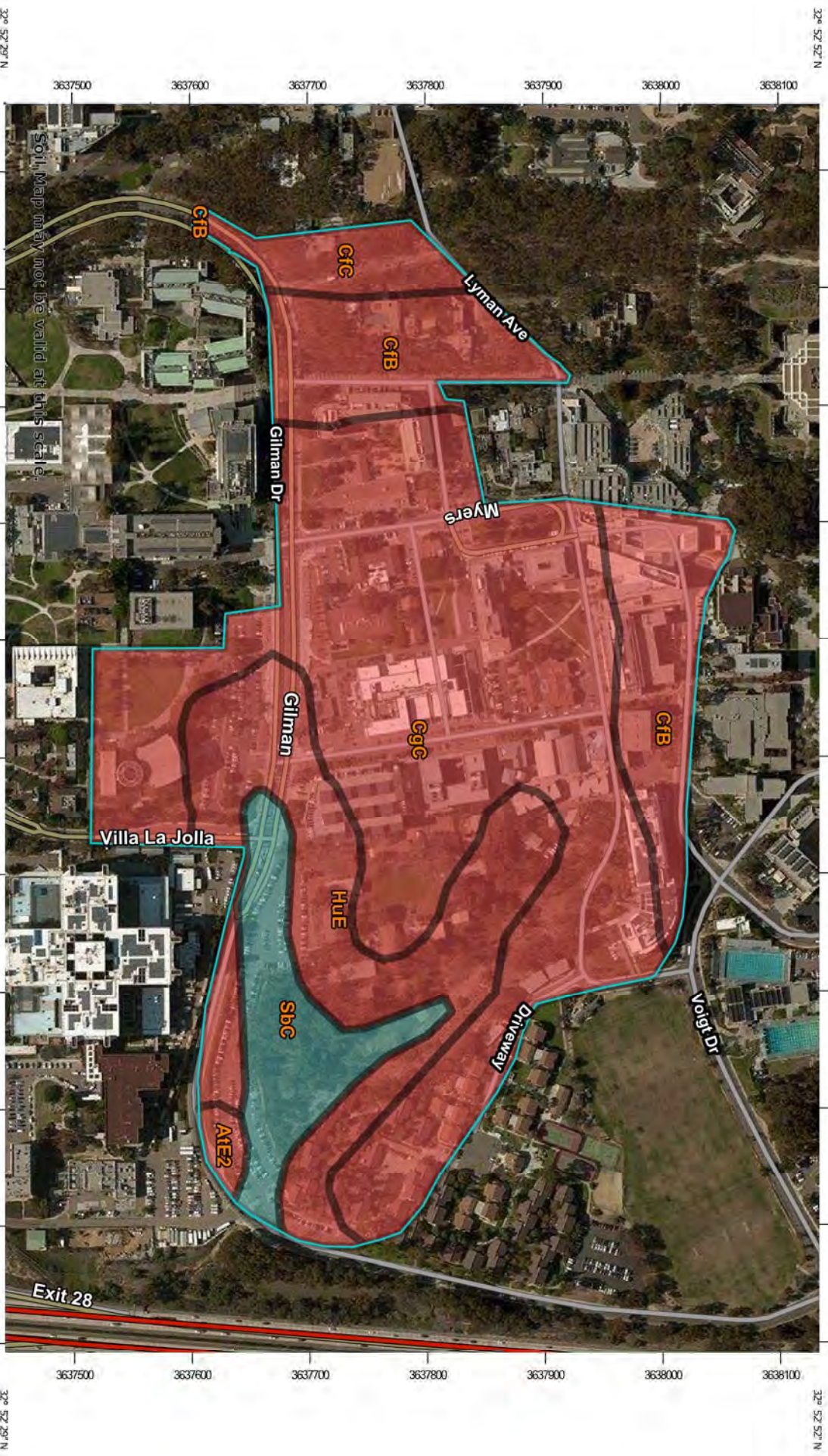

32° 52' 29" N  
117° 14' 24" W  
477800 477700 477800 477900 478000 478100 478200 478300 478400 478500 478600  
3637500 3637600 3637700 3637800 3637900 3638000 3638100  
32° 52' 29" N  
117° 13' 43" W  
478600 478500 478400 478300 478200 478100 478000 477900 477800 477700 477600 477500

Map Scale: 1:4,880 if printed on A landscape (11" x 8.5") sheet.  
0 50 100 200 300  
Meters  
0 200 400 800 1200  
Feet  
Map projection: Web Mercator Corner coordinates: WGS84 Edge tics: UTM Zone 11N WGS84

## MAP LEGEND

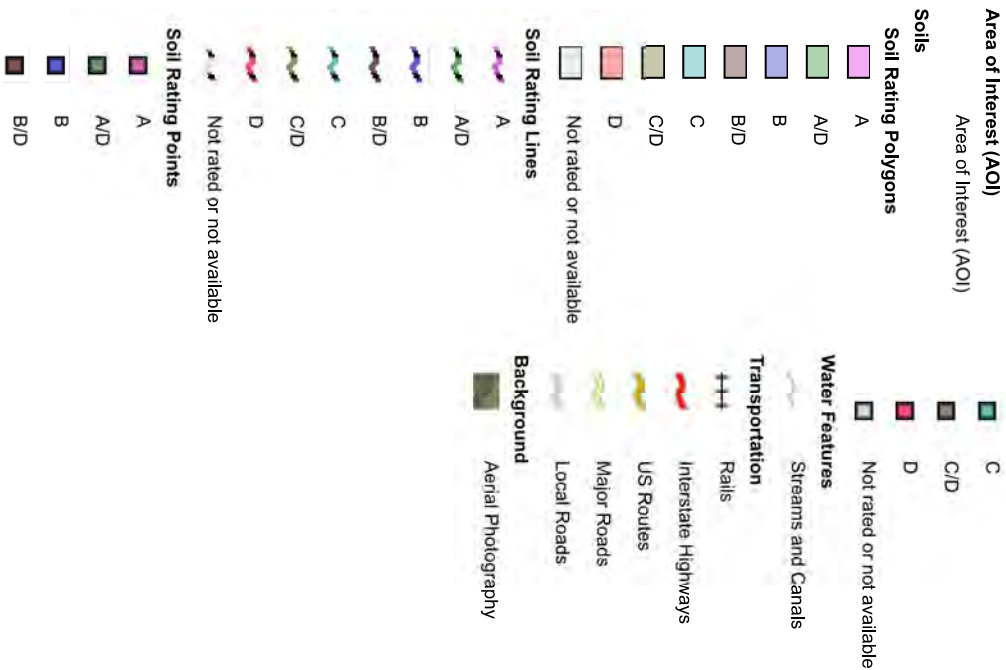

## MAP INFORMATION

The soil surveys that comprise your AOI were mapped at 1:24,000.

Warning: Soil Map may not be valid at this scale.

Enlargement of maps beyond the scale of mapping can cause misunderstanding of the detail of mapping and accuracy of soil line placement. The maps do not show the small areas of contrasting soils that could have been shown at a more detailed scale.

Please rely on the bar scale on each map sheet for map measurements.

Source of Map: Natural Resources Conservation Service

Web Soil Survey URL:

Coordinate System: Web Mercator (EPSG:3857)

Maps from the Web Soil Survey are based on the Web Mercator projection, which preserves direction and shape but distorts distance and area. A projection that preserves area, such as the Albers equal-area conic projection, should be used if more accurate calculations of distance or area are required.

This product is generated from the USDA-NRCS certified data as of the version date(s) listed below.

Soil Survey Area: San Diego County Area, California  
 Survey Area Data: Version 14, Sep 16, 2019

Soil map units are labeled (as space allows) for map scales 1:50,000 or larger.

Date(s) aerial images were photographed: Dec 7, 2014—Jan 4, 2015

The orthophoto or other base map on which the soil lines were compiled and digitized probably differs from the background imagery displayed on these maps. As a result, some minor shifting of map unit boundaries may be evident.

## Hydrologic Soil Group

Map unit symbol	Map unit name	Rating	Acres in AOI	Percent of AOI
AtE2	Altamont clay, 15 to 30 percent slopes, eroded	D	0.6	0.8%
CfB	Chesterton fine sandy loam, 2 to 5 percent slopes	D	10.9	16.1%
CfC	Chesterton fine sandy loam, 5 to 9 percent slopes	D	2.5	3.8%
CgC	Chesterton-Urban land complex, 2 to 9 percent slopes	D	35.0	51.8%
HuE	Huerhuero-Urban land complex, 9 to 30 percent slopes	D	13.2	19.5%
SbC	Salinas clay loam, 2 to 9 percent slopes	C	5.4	8.0%
<b>Totals for Area of Interest</b>			<b>67.5</b>	<b>100.0%</b>



## Description

Hydrologic soil groups are based on estimates of runoff potential. Soils are assigned to one of four groups according to the rate of water infiltration when the soils are not protected by vegetation, are thoroughly wet, and receive precipitation from long-duration storms.

The soils in the United States are assigned to four groups (A, B, C, and D) and three dual classes (A/D, B/D, and C/D). The groups are defined as follows:

Group A. Soils having a high infiltration rate (low runoff potential) when thoroughly wet. These consist mainly of deep, well drained to excessively drained sands or gravelly sands. These soils have a high rate of water transmission.

Group B. Soils having a moderate infiltration rate when thoroughly wet. These consist chiefly of moderately deep or deep, moderately well drained or well drained soils that have moderately fine texture to moderately coarse texture. These soils have a moderate rate of water transmission.

Group C. Soils having a slow infiltration rate when thoroughly wet. These consist chiefly of soils having a layer that impedes the downward movement of water or soils of moderately fine texture or fine texture. These soils have a slow rate of water transmission.

Group D. Soils having a very slow infiltration rate (high runoff potential) when thoroughly wet. These consist chiefly of clays that have a high shrink-swell potential, soils that have a high water table, soils that have a claypan or clay layer at or near the surface, and soils that are shallow over nearly impervious material. These soils have a very slow rate of water transmission.

If a soil is assigned to a dual hydrologic group (A/D, B/D, or C/D), the first letter is for drained areas and the second is for undrained areas. Only the soils that in their natural condition are in group D are assigned to dual classes.

## Rating Options

*Aggregation Method:* Dominant Condition

*Component Percent Cutoff:* None Specified

*Tie-break Rule:* Higher

174027 - UCSD PEPPER CANYON "SUPPLEMENTAL TOPO"

BASIS OF COORDINATES & BEARINGS

THE COORDINATES AND BEARINGS SHOWN HEREON ARE BASED UPON THE CALIFORNIA COORDINATE SYSTEM OF 1983, COSEB, ZONE 6, (EPOCH 1991.35). SAID COORDINATES AND BEARINGS ARE BASED LOCALLY UPON FIELD-OBSERVED TIES TO THE FOLLOWING CONTROL STATIONS FOR UCSD SURVEY CONTROL.

STATION	NORTHING (F.L.) GRID	EASTING (F.L.) GRID
9022	1900211.775	6295401.991
9022	1900293.789	6295927.273

THE BASIS OF BEARINGS IS THE CALCULATED BEARING BETWEEN SAID CONTROL STATIONS 1622 & 9062, I. E. N<sup>0</sup>41.36"

STATION	NORTHING (F.L.) GRID	EASTING (F.L.) GRID
102	1900057.347	6260774.706

BENCHMARK

THE BASIS OF ELEVATIONS FOR THIS SURVEY IS THE NATIONAL GEODETIC VERTICAL DATUM OF 1929 (NGVD29). PERIODIC SURVEY CONTROL STATION #1029922 ELEVATION: 348.54 (NGVD29)

DATE OF SURVEY

OCTOBER 28, 2019

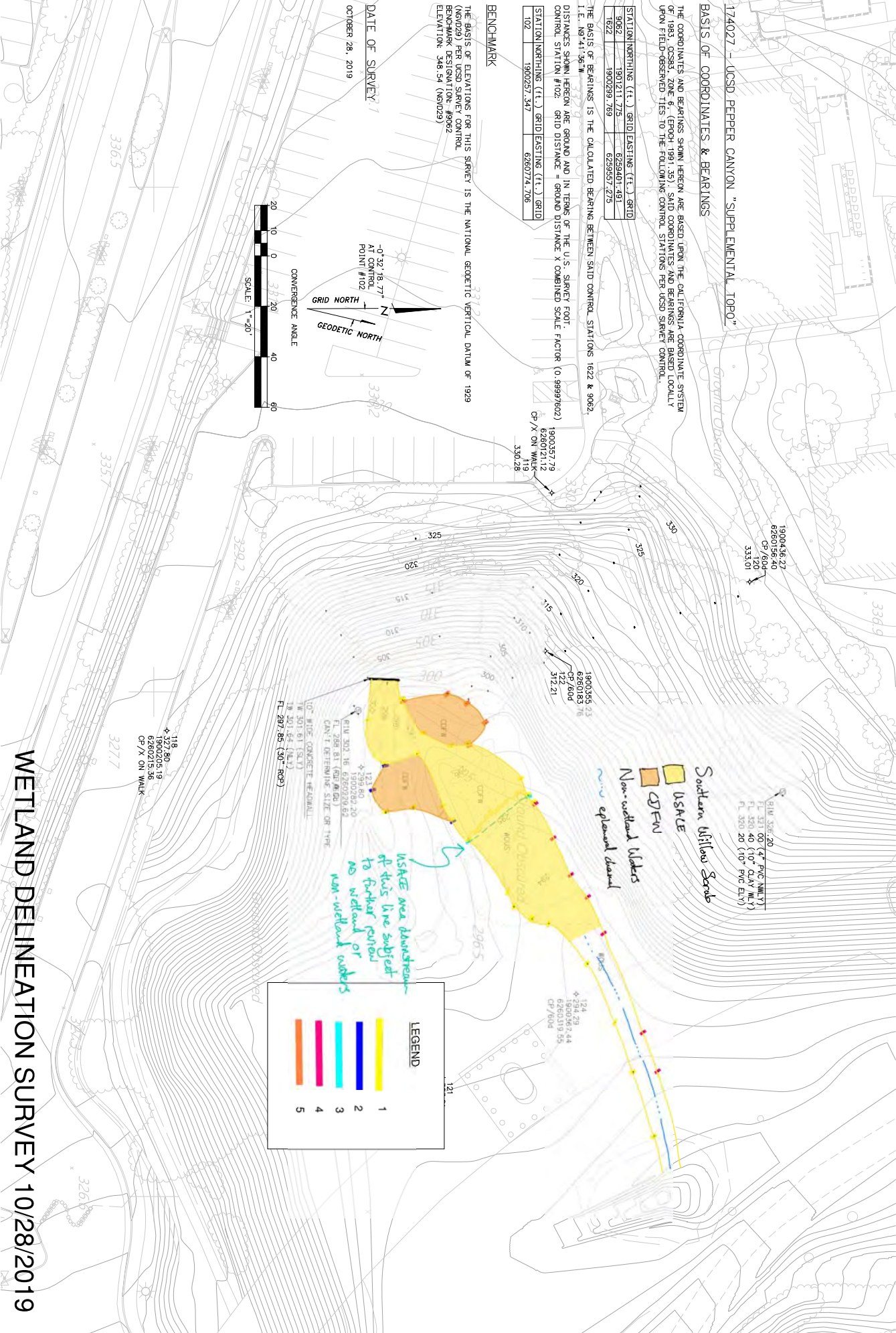
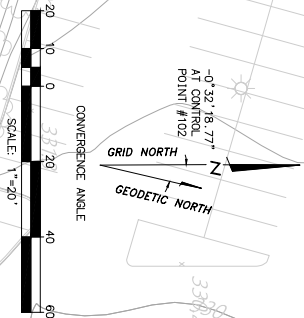

WETLAND DELINEATION SURVEY 10/28/2019

# Appendix B – Existing Hydrology

*On-Site Hydrologic Work Map  
AES Output*

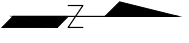
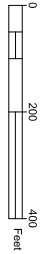
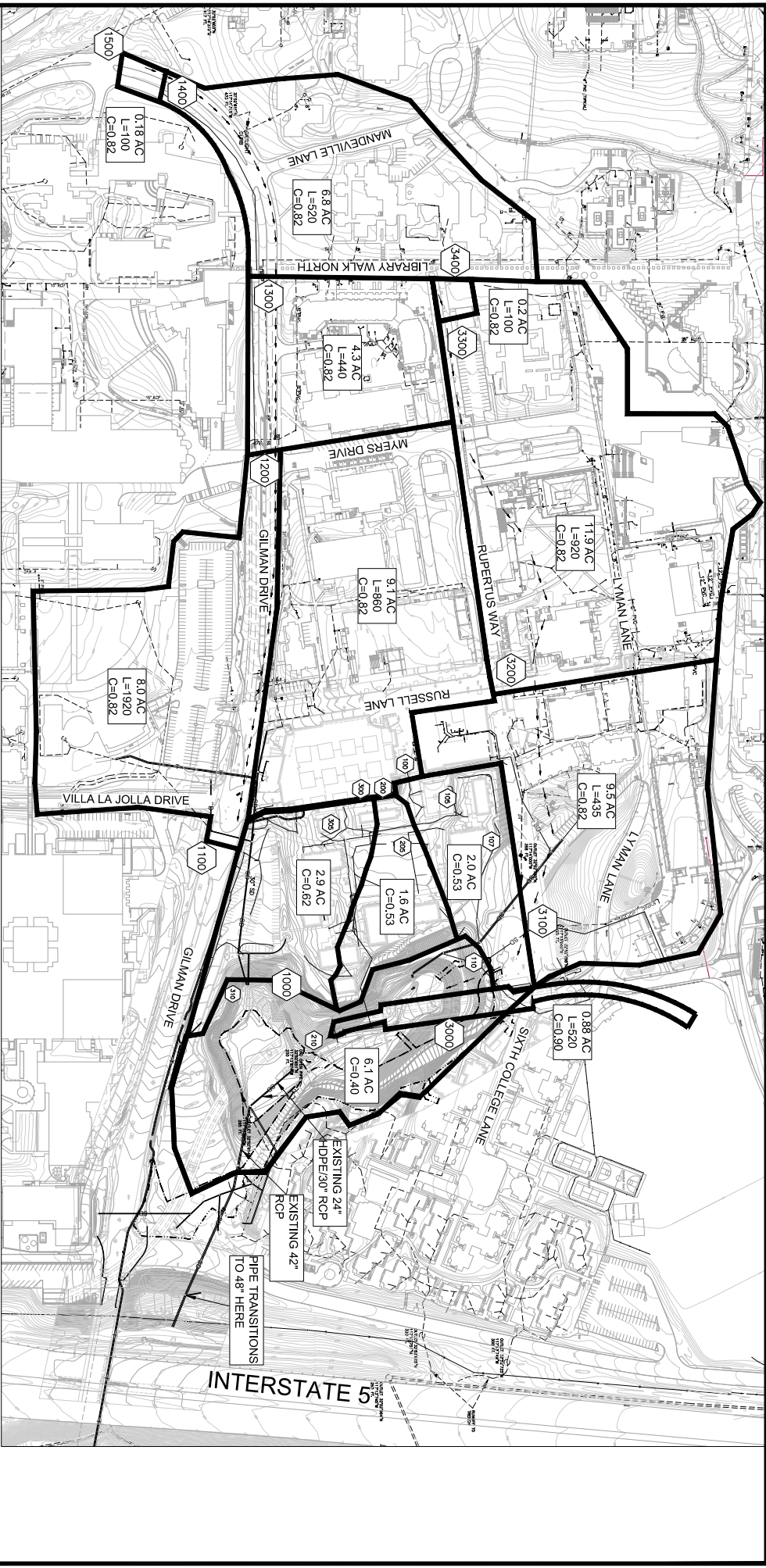

- LEGEND**
- DRAINAGE BOUNDARY
  - SUBAREA BOUNDARY
  - FLOW PATH
  - RUN-OFF COEFFICIENT
  - AREA (ACRES)
  - HYDROLOGY NODE
  - NODE ELEVATION

EXISTING WETLAND

**PEPPER CANYON REGIONAL BASIN  
EXISTING WATERSHED HYDROLOGY**

**Michael Baker  
INTERNATIONAL**  
10000 Rockledge Drive, Suite 200  
Boulder, CO 80501  
Phone: (303) 440-4000 • BAKERINTL.COM

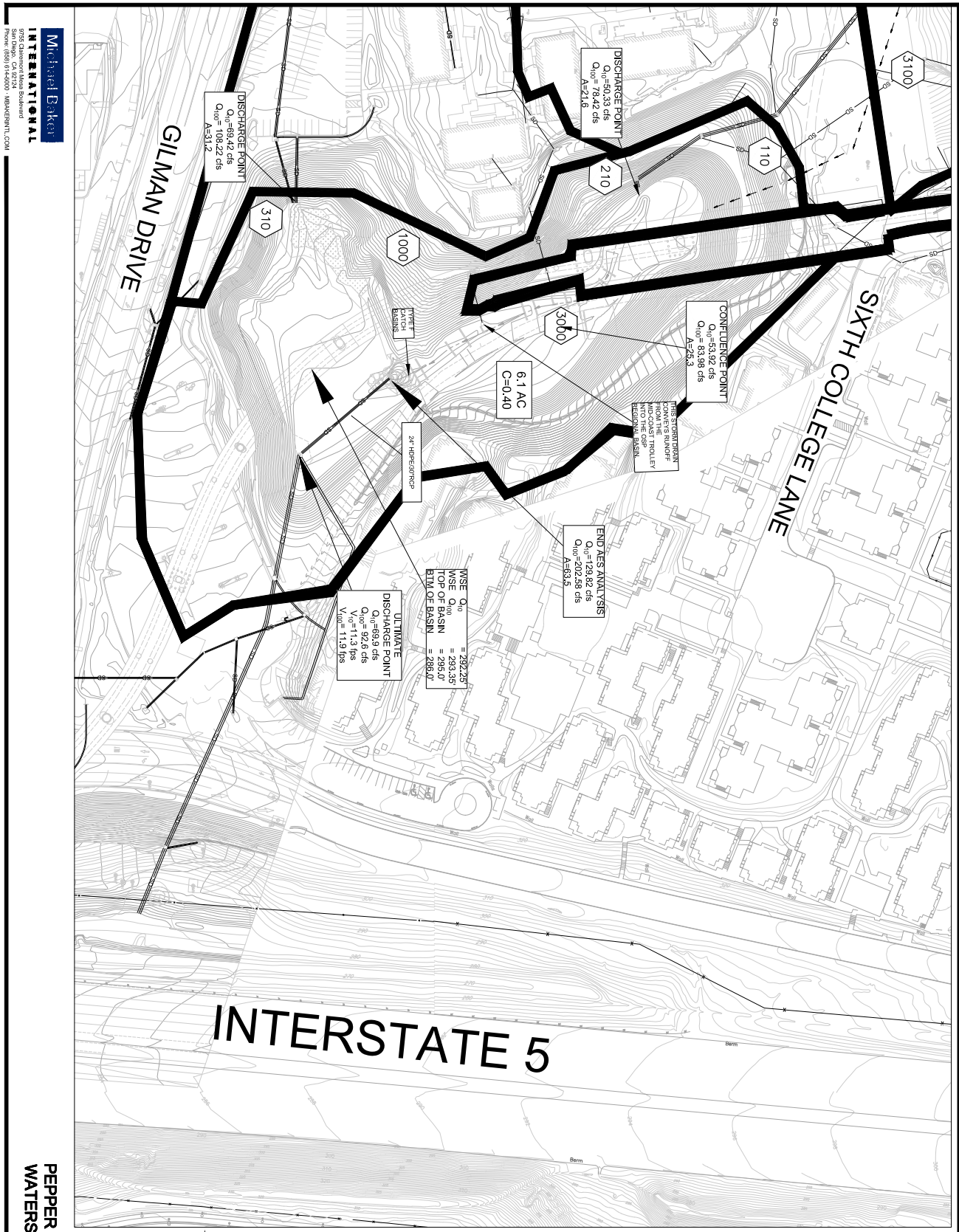

**LEGEND**

- DRAINAGE BOUNDARY
- - - SUBAREA BOUNDARY
- FLOW PATH
- - - RUN-OFF COEFFICIENT
- AREA (ACRES)
- HYDROLOGY NODE
- NODE ELEVATION
- MAPPED SENSITIVE WETLAND

SCALE 1"=50'

**Michael Baker INTERNATIONAL**  
 10000 Westpark Drive  
 San Diego, CA 92124  
 Phone: (619) 614-4000 • MBK@BENTLEY.COM

**PEPPER CANYON REGIONAL BASIN  
 WATERSHED HYDROLOGY EXISTING**

# 10-YR Existing

\*\*\*\*\*

RATIONAL METHOD HYDROLOGY COMPUTER PROGRAM PACKAGE  
Reference: SAN DIEGO COUNTY FLOOD CONTROL DISTRICT  
2003,1985,1981 HYDROLOGY MANUAL  
(c) Copyright 1982-2016 Advanced Engineering Software (aes)  
Ver. 23.0 Release Date: 07/01/2016 License ID 1264

Analysis prepared by:

\*\*\*\*\* DESCRIPTION OF STUDY \*\*\*\*\*

- \* Regional Basin \*
- \* Existing Condition \*
- \* 10 Year \*

\*\*\*\*\*

FILE NAME: C:\10EX\RBEX10.DAT  
TIME/DATE OF STUDY: 13:23 04/23/2021

-----  
USER SPECIFIED HYDROLOGY AND HYDRAULIC MODEL INFORMATION:  
-----

2003 SAN DIEGO MANUAL CRITERIA

USER SPECIFIED STORM EVENT(YEAR) = 10.00  
6-HOUR DURATION PRECIPITATION (INCHES) = 1.500  
SPECIFIED MINIMUM PIPE SIZE(INCH) = 18.00  
SPECIFIED PERCENT OF GRADIENTS(DECIMAL) TO USE FOR FRICTION SLOPE = 0.95  
SAN DIEGO HYDROLOGY MANUAL "C"-VALUES USED FOR RATIONAL METHOD  
NOTE: USE MODIFIED RATIONAL METHOD PROCEDURES FOR CONFLUENCE ANALYSIS

\*USER-DEFINED STREET-SECTIONS FOR COUPLED PIPEFLOW AND STREETFLOW MODEL\*

NO.	HALF- WIDTH (FT)	CROWN TO CROSSFALL (FT)	STREET-CROSSFALL: IN- / OUT- / PARK- SIDE / SIDE / WAY	CURB HEIGHT (FT)	GUTTER-GEOMETRIES: WIDTH LIP HIKE (FT) (FT) (FT)	MANNING FACTOR (n)
1	30.0	20.0	0.018/0.018/0.020	0.67	2.00 0.0313 0.167	0.0150

GLOBAL STREET FLOW-DEPTH CONSTRAINTS:

1. Relative Flow-Depth = 0.00 FEET  
as (Maximum Allowable Street Flow Depth) - (Top-of-Curb)
2. (Depth)\*(Velocity) Constraint = 6.0 (FT\*FT/S)

\*SIZE PIPE WITH A FLOW CAPACITY GREATER THAN  
OR EQUAL TO THE UPSTREAM TRIBUTARY PIPE.\*

+-----+

| Begin Southerly Off-Site analysis  
| Tributary Area to OSP Regional Basin  
|

+-----+

\*\*\*\*\*

FLOW PROCESS FROM NODE 1500.00 TO NODE 1400.00 IS CODE = 21

-----

>>>>RATIONAL METHOD INITIAL SUBAREA ANALYSIS<<<<<

=====

\*USER SPECIFIED(SUBAREA):

USER-SPECIFIED RUNOFF COEFFICIENT = .8200

S.C.S. CURVE NUMBER (AMC II) = 0

INITIAL SUBAREA FLOW-LENGTH(FEET) = 100.00

UPSTREAM ELEVATION(FEET) = 388.00

DOWNSTREAM ELEVATION(FEET) = 386.00

ELEVATION DIFFERENCE(FEET) = 2.00

SUBAREA OVERLAND TIME OF FLOW(MIN.) = 3.464

WARNING: INITIAL SUBAREA FLOW PATH LENGTH IS GREATER THAN

THE MAXIMUM OVERLAND FLOW LENGTH = 75.00

(Reference: Table 3-1B of Hydrology Manual)

THE MAXIMUM OVERLAND FLOW LENGTH IS USED IN Tc CALCULATION!

10 YEAR RAINFALL INTENSITY(INCH/HOUR) = 3.952

NOTE: RAINFALL INTENSITY IS BASED ON Tc = 5-MINUTE.

SUBAREA RUNOFF(CFS) = 0.58

TOTAL AREA(ACRES) = 0.18 TOTAL RUNOFF(CFS) = 0.58

\*\*\*\*\*

FLOW PROCESS FROM NODE 1400.00 TO NODE 1300.00 IS CODE = 62

-----

>>>>COMPUTE STREET FLOW TRAVEL TIME THRU SUBAREA<<<<<

>>>>(STREET TABLE SECTION # 1 USED)<<<<<

=====

UPSTREAM ELEVATION(FEET) = 386.00 DOWNSTREAM ELEVATION(FEET) = 376.00

STREET LENGTH(FEET) = 520.00 CURB HEIGHT(INCHES) = 8.0

STREET HALFWIDTH(FEET) = 30.00

DISTANCE FROM CROWN TO CROSSFALL GRADEBREAK(FEET) = 20.00

INSIDE STREET CROSSFALL(DECIMAL) = 0.018

OUTSIDE STREET CROSSFALL(DECIMAL) = 0.018

SPECIFIED NUMBER OF HALFSTREETS CARRYING RUNOFF = 2

STREET PARKWAY CROSSFALL(DECIMAL) = 0.020

Manning's FRICTION FACTOR for Streetflow Section(curbs-to-curbs) = 0.0150

Manning's FRICTION FACTOR for Back-of-Walk Flow Section = 0.0200

\*\*TRAVEL TIME COMPUTED USING ESTIMATED FLOW(CFS) = 10.40

STREETFLOW MODEL RESULTS USING ESTIMATED FLOW:

STREET FLOW DEPTH(FEET) = 0.38

HALFSTREET FLOOD WIDTH(FEET) = 12.30

AVERAGE FLOW VELOCITY(FEET/SEC.) = 3.36  
PRODUCT OF DEPTH&VELOCITY(FT\*FT/SEC.) = 1.29  
STREET FLOW TRAVEL TIME(MIN.) = 2.58 Tc(MIN.) = 6.04  
10 YEAR RAINFALL INTENSITY(INCH/HOUR) = 3.498

\*USER SPECIFIED(SUBAREA):

USER-SPECIFIED RUNOFF COEFFICIENT = .8200  
S.C.S. CURVE NUMBER (AMC II) = 0  
AREA-AVERAGE RUNOFF COEFFICIENT = 0.820  
SUBAREA AREA(ACRES) = 6.80 SUBAREA RUNOFF(CFS) = 19.50  
TOTAL AREA(ACRES) = 7.0 PEAK FLOW RATE(CFS) = 20.02

END OF SUBAREA STREET FLOW HYDRAULICS:

DEPTH(FEET) = 0.45 HALFSTREET FLOOD WIDTH(FEET) = 16.29  
FLOW VELOCITY(FEET/SEC.) = 3.91 DEPTH\*VELOCITY(FT\*FT/SEC.) = 1.77  
LONGEST FLOWPATH FROM NODE 1500.00 TO NODE 1300.00 = 620.00 FEET.

\*\*\*\*\*

FLOW PROCESS FROM NODE 1300.00 TO NODE 1200.00 IS CODE = 62

-----  
>>>>COMPUTE STREET FLOW TRAVEL TIME THRU SUBAREA<<<<<

>>>>(STREET TABLE SECTION # 1 USED)<<<<<

=====

UPSTREAM ELEVATION(FEET) = 376.00 DOWNSTREAM ELEVATION(FEET) = 362.00  
STREET LENGTH(FEET) = 440.00 CURB HEIGHT(INCHES) = 8.0  
STREET HALFWIDTH(FEET) = 30.00

DISTANCE FROM CROWN TO CROSSFALL GRADEBREAK(FEET) = 20.00

INSIDE STREET CROSSFALL(DECIMAL) = 0.018

OUTSIDE STREET CROSSFALL(DECIMAL) = 0.018

SPECIFIED NUMBER OF HALFSTREETS CARRYING RUNOFF = 2

STREET PARKWAY CROSSFALL(DECIMAL) = 0.020

Manning's FRICTION FACTOR for Streetflow Section(curbs-to-curbs) = 0.0150

Manning's FRICTION FACTOR for Back-of-Walk Flow Section = 0.0200

\*\*TRAVEL TIME COMPUTED USING ESTIMATED FLOW(CFS) = 25.39

STREETFLOW MODEL RESULTS USING ESTIMATED FLOW:

STREET FLOW DEPTH(FEET) = 0.45

HALFSTREET FLOOD WIDTH(FEET) = 16.13

AVERAGE FLOW VELOCITY(FEET/SEC.) = 5.04

PRODUCT OF DEPTH&VELOCITY(FT\*FT/SEC.) = 2.27

STREET FLOW TRAVEL TIME(MIN.) = 1.45 Tc(MIN.) = 7.50

10 YEAR RAINFALL INTENSITY(INCH/HOUR) = 3.044

\*USER SPECIFIED(SUBAREA):

USER-SPECIFIED RUNOFF COEFFICIENT = .8200

S.C.S. CURVE NUMBER (AMC II) = 0

AREA-AVERAGE RUNOFF COEFFICIENT = 0.820

SUBAREA AREA(ACRES) = 4.30 SUBAREA RUNOFF(CFS) = 10.73

TOTAL AREA(ACRES) = 11.3 PEAK FLOW RATE(CFS) = 28.15



END OF SUBAREA STREET FLOW HYDRAULICS:

DEPTH(FEET) = 0.46 HALFSTREET FLOOD WIDTH(FEET) = 16.84  
FLOW VELOCITY(FEET/SEC.) = 5.17 DEPTH\*VELOCITY(FT\*FT/SEC.) = 2.39  
LONGEST FLOWPATH FROM NODE 1500.00 TO NODE 1200.00 = 1060.00 FEET.

\*\*\*\*\*

FLOW PROCESS FROM NODE 1200.00 TO NODE 1100.00 IS CODE = 41

-----  
>>>>COMPUTE PIPE-FLOW TRAVEL TIME THRU SUBAREA<<<<<  
>>>>USING USER-SPECIFIED PIPESIZE (EXISTING ELEMENT)<<<<<

=====

ELEVATION DATA: UPSTREAM(FEET) = 362.00 DOWNSTREAM(FEET) = 339.00  
FLOW LENGTH(FEET) = 860.00 MANNING'S N = 0.013  
DEPTH OF FLOW IN 30.0 INCH PIPE IS 13.8 INCHES  
PIPE-FLOW VELOCITY(FEET/SEC.) = 12.82  
GIVEN PIPE DIAMETER(INCH) = 30.00 NUMBER OF PIPES = 1  
PIPE-FLOW(CFS) = 28.15  
PIPE TRAVEL TIME(MIN.) = 1.12 Tc(MIN.) = 8.61  
LONGEST FLOWPATH FROM NODE 1500.00 TO NODE 1100.00 = 1920.00 FEET.

\*\*\*\*\*

FLOW PROCESS FROM NODE 1100.00 TO NODE 1100.00 IS CODE = 81

-----  
>>>>ADDITION OF SUBAREA TO MAINLINE PEAK FLOW<<<<<

=====

10 YEAR RAINFALL INTENSITY(INCH/HOUR) = 2.783  
\*USER SPECIFIED(SUBAREA):  
USER-SPECIFIED RUNOFF COEFFICIENT = .8200  
S.C.S. CURVE NUMBER (AMC II) = 0  
AREA-AVERAGE RUNOFF COEFFICIENT = 0.8200  
SUBAREA AREA(ACRES) = 8.00 SUBAREA RUNOFF(CFS) = 18.25  
TOTAL AREA(ACRES) = 19.3 TOTAL RUNOFF(CFS) = 43.99  
TC(MIN.) = 8.61

\*\*\*\*\*

FLOW PROCESS FROM NODE 1105.00 TO NODE 1100.00 IS CODE = 81

-----  
>>>>ADDITION OF SUBAREA TO MAINLINE PEAK FLOW<<<<<

=====

10 YEAR RAINFALL INTENSITY(INCH/HOUR) = 2.783  
\*USER SPECIFIED(SUBAREA):  
USER-SPECIFIED RUNOFF COEFFICIENT = .8200  
S.C.S. CURVE NUMBER (AMC II) = 0  
AREA-AVERAGE RUNOFF COEFFICIENT = 0.8200  
SUBAREA AREA(ACRES) = 9.10 SUBAREA RUNOFF(CFS) = 20.76  
TOTAL AREA(ACRES) = 28.4 TOTAL RUNOFF(CFS) = 64.76  
TC(MIN.) = 8.61

\*\*\*\*\*

FLOW PROCESS FROM NODE 1100.00 TO NODE 1000.00 IS CODE = 41

-----  
>>>>COMPUTE PIPE-FLOW TRAVEL TIME THRU SUBAREA<<<<<  
>>>>USING USER-SPECIFIED PIPESIZE (EXISTING ELEMENT)<<<<<

=====

ELEVATION DATA: UPSTREAM(FEET) =	339.00	DOWNSTREAM(FEET) =	336.00
FLOW LENGTH(FEET) =	420.00	MANNING'S N =	0.013
DEPTH OF FLOW IN	42.0 INCH PIPE IS	27.9 INCHES	
PIPE-FLOW VELOCITY(FEET/SEC.) =	9.53		
GIVEN PIPE DIAMETER(INCH) =	42.00	NUMBER OF PIPES =	1
PIPE-FLOW(CFS) =	64.76		
PIPE TRAVEL TIME(MIN.) =	0.73	Tc(MIN.) =	9.35
LONGEST FLOWPATH FROM NODE	1500.00	TO NODE	1000.00 = 2340.00 FEET.

\*\*\*\*\*  
FLOW PROCESS FROM NODE 1000.00 TO NODE 1000.00 IS CODE = 1

-----  
>>>>DESIGNATE INDEPENDENT STREAM FOR CONFLUENCE<<<<<

=====

TOTAL NUMBER OF STREAMS =	2
CONFLUENCE VALUES USED FOR INDEPENDENT STREAM 1 ARE:	
TIME OF CONCENTRATION(MIN.) =	9.35
RAINFALL INTENSITY(INCH/HR) =	2.64
TOTAL STREAM AREA(ACRES) =	28.38
PEAK FLOW RATE(CFS) AT CONFLUENCE =	64.76

+-----+  
| Confluence ON-Site with Off-site |  
| Refer to On-site AES at Node 310 (existing condition) |  
+-----+

\*\*\*\*\*  
FLOW PROCESS FROM NODE 310.00 TO NODE 1000.00 IS CODE = 7

-----  
>>>>USER SPECIFIED HYDROLOGY INFORMATION AT NODE<<<<<

=====

USER-SPECIFIED VALUES ARE AS FOLLOWS:			
TC(MIN) =	8.24	RAIN INTENSITY(INCH/HOUR) =	2.86
TOTAL AREA(ACRES) =	2.85	TOTAL RUNOFF(CFS) =	5.06

\*\*\*\*\*  
FLOW PROCESS FROM NODE 1000.00 TO NODE 1000.00 IS CODE = 1

-----  
>>>>DESIGNATE INDEPENDENT STREAM FOR CONFLUENCE<<<<<  
>>>>AND COMPUTE VARIOUS CONFLUENCED STREAM VALUES<<<<<

=====

TOTAL NUMBER OF STREAMS =	2
CONFLUENCE VALUES USED FOR INDEPENDENT STREAM 2 ARE:	
TIME OF CONCENTRATION(MIN.) =	8.24
RAINFALL INTENSITY(INCH/HR) =	2.86

TOTAL STREAM AREA(ACRES) = 2.85  
PEAK FLOW RATE(CFS) AT CONFLUENCE = 5.06

\*\* CONFLUENCE DATA \*\*

STREAM NUMBER	RUNOFF (CFS)	Tc (MIN.)	INTENSITY (INCH/HOUR)	AREA (ACRE)
1	64.76	9.35	2.640	28.38
2	5.06	8.24	2.863	2.85

RAINFALL INTENSITY AND TIME OF CONCENTRATION RATIO  
CONFLUENCE FORMULA USED FOR 2 STREAMS.

\*\* PEAK FLOW RATE TABLE \*\*

STREAM NUMBER	RUNOFF (CFS)	Tc (MIN.)	INTENSITY (INCH/HOUR)
1	62.13	8.24	2.863
2	69.42	9.35	2.640

COMPUTED CONFLUENCE ESTIMATES ARE AS FOLLOWS:

PEAK FLOW RATE(CFS) = 69.42 Tc(MIN.) = 9.35  
TOTAL AREA(ACRES) = 31.2  
LONGEST FLOWPATH FROM NODE 1500.00 TO NODE 1000.00 = 2340.00 FEET.

\*\*\*\*\*

FLOW PROCESS FROM NODE 1000.00 TO NODE 1000.00 IS CODE = 10

>>>>MAIN-STREAM MEMORY COPIED ONTO MEMORY BANK # 1 <<<<<

\*\*\*\*\*

FLOW PROCESS FROM NODE 1000.00 TO NODE 1000.00 IS CODE = 13

>>>>CLEAR THE MAIN-STREAM MEMORY<<<<<

```
+-----+
| Begin Northerly Off-Site Analysis |
| Tributary Area to OSP Regional Basin |
+-----+
```

\*\*\*\*\*

FLOW PROCESS FROM NODE 3400.00 TO NODE 3300.00 IS CODE = 21

>>>>RATIONAL METHOD INITIAL SUBAREA ANALYSIS<<<<<

\*USER SPECIFIED(SUBAREA):  
USER-SPECIFIED RUNOFF COEFFICIENT = .8200  
S.C.S. CURVE NUMBER (AMC II) = 0  
INITIAL SUBAREA FLOW-LENGTH(FEET) = 100.00

UPSTREAM ELEVATION(FEET) = 376.00  
DOWNSTREAM ELEVATION(FEET) = 372.00  
ELEVATION DIFFERENCE(FEET) = 4.00  
SUBAREA OVERLAND TIME OF FLOW(MIN.) = 3.012  
WARNING: INITIAL SUBAREA FLOW PATH LENGTH IS GREATER THAN  
THE MAXIMUM OVERLAND FLOW LENGTH = 90.00  
(Reference: Table 3-1B of Hydrology Manual)  
THE MAXIMUM OVERLAND FLOW LENGTH IS USED IN Tc CALCULATION!  
10 YEAR RAINFALL INTENSITY(INCH/HOUR) = 3.952  
NOTE: RAINFALL INTENSITY IS BASED ON Tc = 5-MINUTE.  
SUBAREA RUNOFF(CFS) = 0.65  
TOTAL AREA(ACRES) = 0.20 TOTAL RUNOFF(CFS) = 0.65

\*\*\*\*\*

FLOW PROCESS FROM NODE 3300.00 TO NODE 3200.00 IS CODE = 62

-----  
>>>>>COMPUTE STREET FLOW TRAVEL TIME THRU SUBAREA<<<<<<  
>>>>>(STREET TABLE SECTION # 1 USED)<<<<<<  
=====

UPSTREAM ELEVATION(FEET) = 372.00 DOWNSTREAM ELEVATION(FEET) = 351.00  
STREET LENGTH(FEET) = 920.00 CURB HEIGHT(INCHES) = 8.0  
STREET HALFWIDTH(FEET) = 30.00

DISTANCE FROM CROWN TO CROSSFALL GRADEBREAK(FEET) = 20.00  
INSIDE STREET CROSSFALL(DECIMAL) = 0.018  
OUTSIDE STREET CROSSFALL(DECIMAL) = 0.018

SPECIFIED NUMBER OF HALFSTREETS CARRYING RUNOFF = 1  
STREET PARKWAY CROSSFALL(DECIMAL) = 0.020  
Manning's FRICTION FACTOR for Streetflow Section(curbs-to-curbs) = 0.0150  
Manning's FRICTION FACTOR for Back-of-Walk Flow Section = 0.0200

\*\*TRAVEL TIME COMPUTED USING ESTIMATED FLOW(CFS) = 17.58  
STREETFLOW MODEL RESULTS USING ESTIMATED FLOW:  
STREET FLOW DEPTH(FEET) = 0.51  
HALFSTREET FLOOD WIDTH(FEET) = 19.73  
AVERAGE FLOW VELOCITY(FEET/SEC.) = 4.79  
PRODUCT OF DEPTH&VELOCITY(FT\*FT/SEC.) = 2.47  
STREET FLOW TRAVEL TIME(MIN.) = 3.20 Tc(MIN.) = 6.21  
10 YEAR RAINFALL INTENSITY(INCH/HOUR) = 3.436

\*USER SPECIFIED(SUBAREA):  
USER-SPECIFIED RUNOFF COEFFICIENT = .8200  
S.C.S. CURVE NUMBER (AMC II) = 0  
AREA-AVERAGE RUNOFF COEFFICIENT = 0.820  
SUBAREA AREA(ACRES) = 11.90 SUBAREA RUNOFF(CFS) = 33.53  
TOTAL AREA(ACRES) = 12.1 PEAK FLOW RATE(CFS) = 34.09

END OF SUBAREA STREET FLOW HYDRAULICS:  
DEPTH(FEET) = 0.62 HALFSTREET FLOOD WIDTH(FEET) = 25.66  
FLOW VELOCITY(FEET/SEC.) = 5.61 DEPTH\*VELOCITY(FT\*FT/SEC.) = 3.48

LONGEST FLOWPATH FROM NODE 3400.00 TO NODE 3200.00 = 1020.00 FEET.

\*\*\*\*\*

FLOW PROCESS FROM NODE 3200.00 TO NODE 3100.00 IS CODE = 62

-----  
>>>>COMPUTE STREET FLOW TRAVEL TIME THRU SUBAREA<<<<<

>>>>(STREET TABLE SECTION # 1 USED)<<<<<

=====

UPSTREAM ELEVATION(FEET) = 351.00 DOWNSTREAM ELEVATION(FEET) = 348.00  
STREET LENGTH(FEET) = 435.00 CURB HEIGHT(INCHES) = 8.0  
STREET HALFWIDTH(FEET) = 30.00

DISTANCE FROM CROWN TO CROSSFALL GRADEBREAK(FEET) = 20.00  
INSIDE STREET CROSSFALL(DECIMAL) = 0.018  
OUTSIDE STREET CROSSFALL(DECIMAL) = 0.018

SPECIFIED NUMBER OF HALFSTREETS CARRYING RUNOFF = 1  
STREET PARKWAY CROSSFALL(DECIMAL) = 0.020  
Manning's FRICTION FACTOR for Streetflow Section(curbs-to-curbs) = 0.0150  
Manning's FRICTION FACTOR for Back-of-Walk Flow Section = 0.0200

\*\*TRAVEL TIME COMPUTED USING ESTIMATED FLOW(CFS) = 45.16

\*\*\*STREET FLOW SPLITS OVER STREET-CROWN\*\*\*

FULL DEPTH(FEET) = 0.70 FLOOD WIDTH(FEET) = 31.58

FULL HALF-STREET VELOCITY(FEET/SEC.) = 3.41

SPLIT DEPTH(FEET) = 0.60 SPLIT FLOOD WIDTH(FEET) = 24.65

SPLIT FLOW(CFS) = 17.00 SPLIT VELOCITY(FEET/SEC.) = 3.03

STREETFLOW MODEL RESULTS USING ESTIMATED FLOW:

STREET FLOW DEPTH(FEET) = 0.70

HALFSTREET FLOOD WIDTH(FEET) = 31.58

AVERAGE FLOW VELOCITY(FEET/SEC.) = 3.41

PRODUCT OF DEPTH&VELOCITY(FT\*FT/SEC.) = 2.38

STREET FLOW TRAVEL TIME(MIN.) = 2.13 Tc(MIN.) = 8.34

10 YEAR RAINFALL INTENSITY(INCH/HOUR) = 2.842

\*USER SPECIFIED(SUBAREA):

USER-SPECIFIED RUNOFF COEFFICIENT = .8200

S.C.S. CURVE NUMBER (AMC II) = 0

AREA-AVERAGE RUNOFF COEFFICIENT = 0.820

SUBAREA AREA(ACRES) = 9.50 SUBAREA RUNOFF(CFS) = 22.14

TOTAL AREA(ACRES) = 21.6 PEAK FLOW RATE(CFS) = 50.33

END OF SUBAREA STREET FLOW HYDRAULICS:

DEPTH(FEET) = 0.70 HALFSTREET FLOOD WIDTH(FEET) = 31.58

FLOW VELOCITY(FEET/SEC.) = 3.41 DEPTH\*VELOCITY(FT\*FT/SEC.) = 2.38

\*NOTE: INITIAL SUBAREA NOMOGRAPH WITH SUBAREA PARAMETERS,

AND L = 435.0 FT WITH ELEVATION-DROP = 3.0 FT, IS 30.8 CFS,

WHICH EXCEEDS THE TOP-OF-CURB STREET CAPACITY AT NODE 3100.00

LONGEST FLOWPATH FROM NODE 3400.00 TO NODE 3100.00 = 1455.00 FEET.

\*\*\*\*\*

FLOW PROCESS FROM NODE 3100.00 TO NODE 3000.00 IS CODE = 41

-----  
>>>>COMPUTE PIPE-FLOW TRAVEL TIME THRU SUBAREA<<<<<  
>>>>USING USER-SPECIFIED PIPESIZE (EXISTING ELEMENT)<<<<<

=====

ELEVATION DATA: UPSTREAM(FEET) = 348.00 DOWNSTREAM(FEET) = 301.00  
FLOW LENGTH(FEET) = 316.00 MANNING'S N = 0.013  
DEPTH OF FLOW IN 42.0 INCH PIPE IS 10.3 INCHES  
PIPE-FLOW VELOCITY(FEET/SEC.) = 27.31  
GIVEN PIPE DIAMETER(INCH) = 42.00 NUMBER OF PIPES = 1  
PIPE-FLOW(CFS) = 50.33  
PIPE TRAVEL TIME(MIN.) = 0.19 Tc(MIN.) = 8.53  
LONGEST FLOWPATH FROM NODE 3400.00 TO NODE 3000.00 = 1771.00 FEET.

\*\*\*\*\*

FLOW PROCESS FROM NODE 3000.00 TO NODE 3000.00 IS CODE = 1

-----  
>>>>DESIGNATE INDEPENDENT STREAM FOR CONFLUENCE<<<<<

=====

TOTAL NUMBER OF STREAMS = 3  
CONFLUENCE VALUES USED FOR INDEPENDENT STREAM 1 ARE:  
TIME OF CONCENTRATION(MIN.) = 8.53  
RAINFALL INTENSITY(INCH/HR) = 2.80  
TOTAL STREAM AREA(ACRES) = 21.60  
PEAK FLOW RATE(CFS) AT CONFLUENCE = 50.33

+-----+  
| Confluence ON-Site with Off-Site |  
| Refer to On-Site AES at Node 110 |  
+-----+

\*\*\*\*\*

FLOW PROCESS FROM NODE 110.00 TO NODE 3000.00 IS CODE = 7

-----  
>>>>USER SPECIFIED HYDROLOGY INFORMATION AT NODE<<<<<

=====

USER-SPECIFIED VALUES ARE AS FOLLOWS:  
TC(MIN) = 9.96 RAIN INTENSITY(INCH/HOUR) = 2.53  
TOTAL AREA(ACRES) = 2.13 TOTAL RUNOFF(CFS) = 2.86

\*\*\*\*\*

FLOW PROCESS FROM NODE 3000.00 TO NODE 3000.00 IS CODE = 1

-----  
>>>>DESIGNATE INDEPENDENT STREAM FOR CONFLUENCE<<<<<

=====

TOTAL NUMBER OF STREAMS = 3  
CONFLUENCE VALUES USED FOR INDEPENDENT STREAM 2 ARE:  
TIME OF CONCENTRATION(MIN.) = 9.96  
RAINFALL INTENSITY(INCH/HR) = 2.53

TOTAL STREAM AREA(ACRES) = 2.13  
PEAK FLOW RATE(CFS) AT CONFLUENCE = 2.86

```
+-----+
| Confluence ON-Site with Off-site
| Refer to On-Site AES at Node 210 (existing condition)
|-----+
```

\*\*\*\*\*  
FLOW PROCESS FROM NODE 210.00 TO NODE 3000.00 IS CODE = 7

>>>>USER SPECIFIED HYDROLOGY INFORMATION AT NODE<<<<<

=====

USER-SPECIFIED VALUES ARE AS FOLLOWS:

TC(MIN) = 13.14 RAIN INTENSITY(INCH/HOUR) = 2.12  
TOTAL AREA(ACRES) = 1.56 TOTAL RUNOFF(CFS) = 1.75

\*\*\*\*\*  
FLOW PROCESS FROM NODE 3000.00 TO NODE 3000.00 IS CODE = 1

>>>>DESIGNATE INDEPENDENT STREAM FOR CONFLUENCE<<<<<  
>>>>AND COMPUTE VARIOUS CONFLUENCED STREAM VALUES<<<<<

=====

TOTAL NUMBER OF STREAMS = 3  
CONFLUENCE VALUES USED FOR INDEPENDENT STREAM 3 ARE:  
TIME OF CONCENTRATION(MIN.) = 13.14  
RAINFALL INTENSITY(INCH/HR) = 2.12  
TOTAL STREAM AREA(ACRES) = 1.56  
PEAK FLOW RATE(CFS) AT CONFLUENCE = 1.75

\*\* CONFLUENCE DATA \*\*

STREAM NUMBER	RUNOFF (CFS)	Tc (MIN.)	INTENSITY (INCH/HOUR)	AREA (ACRE)
1	50.33	8.53	2.800	21.60
2	2.86	9.96	2.534	2.13
3	1.75	13.14	2.119	1.56

RAINFALL INTENSITY AND TIME OF CONCENTRATION RATIO  
CONFLUENCE FORMULA USED FOR 3 STREAMS.

\*\* PEAK FLOW RATE TABLE \*\*

STREAM NUMBER	RUNOFF (CFS)	Tc (MIN.)	INTENSITY (INCH/HOUR)
1	53.92	8.53	2.800
2	49.73	9.96	2.534
3	42.23	13.14	2.119

COMPUTED CONFLUENCE ESTIMATES ARE AS FOLLOWS:

PEAK FLOW RATE(CFS) = 53.92 Tc(MIN.) = 8.53

TOTAL AREA(ACRES) = 25.3  
LONGEST FLOWPATH FROM NODE 3400.00 TO NODE 3000.00 = 1771.00 FEET.

```
+-----+
| Add Area from New Mid-Coast Trolley
| A = 0.88
|-----+
```

\*\*\*\*\*  
FLOW PROCESS FROM NODE 3000.00 TO NODE 3000.00 IS CODE = 81

>>>>ADDITION OF SUBAREA TO MAINLINE PEAK FLOW<<<<<

```
=====
10 YEAR RAINFALL INTENSITY(INCH/HOUR) = 2.800
*USER SPECIFIED(SUBAREA):
USER-SPECIFIED RUNOFF COEFFICIENT = .9000
S.C.S. CURVE NUMBER (AMC II) = 0
AREA-AVERAGE RUNOFF COEFFICIENT = 0.7818
SUBAREA AREA(ACRES) = 0.88 SUBAREA RUNOFF(CFS) = 2.22
TOTAL AREA(ACRES) = 26.2 TOTAL RUNOFF(CFS) = 57.29
TC(MIN.) = 8.53
```

```
+-----+
| Add area: OSP Regional Basin
|-----+
```

\*\*\*\*\*  
FLOW PROCESS FROM NODE 3000.00 TO NODE 3000.00 IS CODE = 81

>>>>ADDITION OF SUBAREA TO MAINLINE PEAK FLOW<<<<<

```
=====
10 YEAR RAINFALL INTENSITY(INCH/HOUR) = 2.800
*USER SPECIFIED(SUBAREA):
USER-SPECIFIED RUNOFF COEFFICIENT = .4000
S.C.S. CURVE NUMBER (AMC II) = 0
AREA-AVERAGE RUNOFF COEFFICIENT = 0.7100
SUBAREA AREA(ACRES) = 6.06 SUBAREA RUNOFF(CFS) = 6.79
TOTAL AREA(ACRES) = 32.2 TOTAL RUNOFF(CFS) = 64.07
TC(MIN.) = 8.53
```

\*\*\*\*\*  
FLOW PROCESS FROM NODE 3000.00 TO NODE 1000.00 IS CODE = 11

>>>>CONFLUENCE MEMORY BANK # 1 WITH THE MAIN-STREAM MEMORY<<<<<

=====  
\*\* MAIN STREAM CONFLUENCE DATA \*\*



STREAM NUMBER	RUNOFF (CFS)	Tc (MIN.)	INTENSITY (INCH/HOUR)	AREA (ACRE)
1	64.07	8.53	2.800	32.23

LONGEST FLOWPATH FROM NODE 3400.00 TO NODE 1000.00 = 1771.00 FEET.

\*\* MEMORY BANK # 1 CONFLUENCE DATA \*\*

STREAM NUMBER	RUNOFF (CFS)	Tc (MIN.)	INTENSITY (INCH/HOUR)	AREA (ACRE)
1	69.42	9.35	2.640	31.23

LONGEST FLOWPATH FROM NODE 1500.00 TO NODE 1000.00 = 2340.00 FEET.

\*\* PEAK FLOW RATE TABLE \*\*

STREAM NUMBER	RUNOFF (CFS)	Tc (MIN.)	INTENSITY (INCH/HOUR)
1	127.42	8.53	2.800
2	129.82	9.35	2.640

COMPUTED CONFLUENCE ESTIMATES ARE AS FOLLOWS:

PEAK FLOW RATE(CFS) = 129.82 Tc(MIN.) = 9.35  
TOTAL AREA(ACRES) = 63.5

=====

END OF STUDY SUMMARY:

TOTAL AREA(ACRES) = 63.5 TC(MIN.) = 9.35  
PEAK FLOW RATE(CFS) = 129.82

=====

=====

END OF RATIONAL METHOD ANALYSIS

=====



# 100-YR Existing

\*\*\*\*\*

RATIONAL METHOD HYDROLOGY COMPUTER PROGRAM PACKAGE  
Reference: SAN DIEGO COUNTY FLOOD CONTROL DISTRICT  
2003,1985,1981 HYDROLOGY MANUAL  
(c) Copyright 1982-2016 Advanced Engineering Software (aes)  
Ver. 23.0 Release Date: 07/01/2016 License ID 1264

Analysis prepared by:

\*\*\*\*\* DESCRIPTION OF STUDY \*\*\*\*\*

- \* Regional Basin \*
- \* Existing Condition \*
- \* 100 Year \*

\*\*\*\*\*

FILE NAME: C:\100EX\RBEX100.DAT  
TIME/DATE OF STUDY: 13:24 04/23/2021

-----  
USER SPECIFIED HYDROLOGY AND HYDRAULIC MODEL INFORMATION:  
-----

2003 SAN DIEGO MANUAL CRITERIA

USER SPECIFIED STORM EVENT(YEAR) = 100.00  
6-HOUR DURATION PRECIPITATION (INCHES) = 2.250  
SPECIFIED MINIMUM PIPE SIZE(INCH) = 18.00  
SPECIFIED PERCENT OF GRADIENTS(DECIMAL) TO USE FOR FRICTION SLOPE = 0.95  
SAN DIEGO HYDROLOGY MANUAL "C"-VALUES USED FOR RATIONAL METHOD  
NOTE: USE MODIFIED RATIONAL METHOD PROCEDURES FOR CONFLUENCE ANALYSIS

\*USER-DEFINED STREET-SECTIONS FOR COUPLED PIPEFLOW AND STREETFLOW MODEL\*

NO.	HALF- WIDTH (FT)	CROWN TO CROSSFALL (FT)	STREET-CROSSFALL: IN- / OUT- / PARK- SIDE / SIDE / WAY	CURB HEIGHT (FT)	GUTTER-GEOMETRIES: WIDTH LIP HIKE (FT) (FT) (FT)	MANNING FACTOR (n)
1	30.0	20.0	0.018/0.018/0.020	0.67	2.00 0.0313 0.167	0.0150

GLOBAL STREET FLOW-DEPTH CONSTRAINTS:

1. Relative Flow-Depth = 0.00 FEET  
as (Maximum Allowable Street Flow Depth) - (Top-of-Curb)
2. (Depth)\*(Velocity) Constraint = 6.0 (FT\*FT/S)

\*SIZE PIPE WITH A FLOW CAPACITY GREATER THAN  
OR EQUAL TO THE UPSTREAM TRIBUTARY PIPE.\*

+-----+

| Begin Southerly Off-Site analysis  
| Tributary Area to OSP Regional Basin  
|

+-----+

\*\*\*\*\*

FLOW PROCESS FROM NODE 1500.00 TO NODE 1400.00 IS CODE = 21

-----

>>>>RATIONAL METHOD INITIAL SUBAREA ANALYSIS<<<<<

=====

\*USER SPECIFIED(SUBAREA):

USER-SPECIFIED RUNOFF COEFFICIENT = .8200

S.C.S. CURVE NUMBER (AMC II) = 0

INITIAL SUBAREA FLOW-LENGTH(FEET) = 100.00

UPSTREAM ELEVATION(FEET) = 388.00

DOWNSTREAM ELEVATION(FEET) = 386.00

ELEVATION DIFFERENCE(FEET) = 2.00

SUBAREA OVERLAND TIME OF FLOW(MIN.) = 3.464

WARNING: INITIAL SUBAREA FLOW PATH LENGTH IS GREATER THAN

THE MAXIMUM OVERLAND FLOW LENGTH = 75.00

(Reference: Table 3-1B of Hydrology Manual)

THE MAXIMUM OVERLAND FLOW LENGTH IS USED IN Tc CALCULATION!

100 YEAR RAINFALL INTENSITY(INCH/HOUR) = 5.928

NOTE: RAINFALL INTENSITY IS BASED ON Tc = 5-MINUTE.

SUBAREA RUNOFF(CFS) = 0.87

TOTAL AREA(ACRES) = 0.18 TOTAL RUNOFF(CFS) = 0.87

\*\*\*\*\*

FLOW PROCESS FROM NODE 1400.00 TO NODE 1300.00 IS CODE = 62

-----

>>>>COMPUTE STREET FLOW TRAVEL TIME THRU SUBAREA<<<<<

>>>>(STREET TABLE SECTION # 1 USED)<<<<<

=====

UPSTREAM ELEVATION(FEET) = 386.00 DOWNSTREAM ELEVATION(FEET) = 376.00

STREET LENGTH(FEET) = 520.00 CURB HEIGHT(INCHES) = 8.0

STREET HALFWIDTH(FEET) = 30.00

DISTANCE FROM CROWN TO CROSSFALL GRADEBREAK(FEET) = 20.00

INSIDE STREET CROSSFALL(DECIMAL) = 0.018

OUTSIDE STREET CROSSFALL(DECIMAL) = 0.018

SPECIFIED NUMBER OF HALFSTREETS CARRYING RUNOFF = 2

STREET PARKWAY CROSSFALL(DECIMAL) = 0.020

Manning's FRICTION FACTOR for Streetflow Section(curbs-to-curbs) = 0.0150

Manning's FRICTION FACTOR for Back-of-Walk Flow Section = 0.0200

\*\*TRAVEL TIME COMPUTED USING ESTIMATED FLOW(CFS) = 15.97

STREETFLOW MODEL RESULTS USING ESTIMATED FLOW:

STREET FLOW DEPTH(FEET) = 0.43

HALFSTREET FLOOD WIDTH(FEET) = 14.80

AVERAGE FLOW VELOCITY(FEET/SEC.) = 3.71  
PRODUCT OF DEPTH&VELOCITY(FT\*FT/SEC.) = 1.59  
STREET FLOW TRAVEL TIME(MIN.) = 2.33 Tc(MIN.) = 5.80  
100 YEAR RAINFALL INTENSITY(INCH/HOUR) = 5.388

\*USER SPECIFIED(SUBAREA):

USER-SPECIFIED RUNOFF COEFFICIENT = .8200  
S.C.S. CURVE NUMBER (AMC II) = 0  
AREA-AVERAGE RUNOFF COEFFICIENT = 0.820  
SUBAREA AREA(ACRES) = 6.80 SUBAREA RUNOFF(CFS) = 30.04  
TOTAL AREA(ACRES) = 7.0 PEAK FLOW RATE(CFS) = 30.84

END OF SUBAREA STREET FLOW HYDRAULICS:

DEPTH(FEET) = 0.51 HALFSTREET FLOOD WIDTH(FEET) = 19.41  
FLOW VELOCITY(FEET/SEC.) = 4.33 DEPTH\*VELOCITY(FT\*FT/SEC.) = 2.21  
LONGEST FLOWPATH FROM NODE 1500.00 TO NODE 1300.00 = 620.00 FEET.

\*\*\*\*\*

FLOW PROCESS FROM NODE 1300.00 TO NODE 1200.00 IS CODE = 62

-----  
>>>>COMPUTE STREET FLOW TRAVEL TIME THRU SUBAREA<<<<<

>>>>(STREET TABLE SECTION # 1 USED)<<<<<

=====

UPSTREAM ELEVATION(FEET) = 376.00 DOWNSTREAM ELEVATION(FEET) = 362.00  
STREET LENGTH(FEET) = 440.00 CURB HEIGHT(INCHES) = 8.0  
STREET HALFWIDTH(FEET) = 30.00

DISTANCE FROM CROWN TO CROSSFALL GRADEBREAK(FEET) = 20.00  
INSIDE STREET CROSSFALL(DECIMAL) = 0.018  
OUTSIDE STREET CROSSFALL(DECIMAL) = 0.018

SPECIFIED NUMBER OF HALFSTREETS CARRYING RUNOFF = 2  
STREET PARKWAY CROSSFALL(DECIMAL) = 0.020  
Manning's FRICTION FACTOR for Streetflow Section(curbs-to-curbs) = 0.0150  
Manning's FRICTION FACTOR for Back-of-Walk Flow Section = 0.0200

\*\*TRAVEL TIME COMPUTED USING ESTIMATED FLOW(CFS) = 39.17

STREETFLOW MODEL RESULTS USING ESTIMATED FLOW:

STREET FLOW DEPTH(FEET) = 0.51  
HALFSTREET FLOOD WIDTH(FEET) = 19.26  
AVERAGE FLOW VELOCITY(FEET/SEC.) = 5.59  
PRODUCT OF DEPTH&VELOCITY(FT\*FT/SEC.) = 2.83  
STREET FLOW TRAVEL TIME(MIN.) = 1.31 Tc(MIN.) = 7.11  
100 YEAR RAINFALL INTENSITY(INCH/HOUR) = 4.723

\*USER SPECIFIED(SUBAREA):

USER-SPECIFIED RUNOFF COEFFICIENT = .8200  
S.C.S. CURVE NUMBER (AMC II) = 0  
AREA-AVERAGE RUNOFF COEFFICIENT = 0.820  
SUBAREA AREA(ACRES) = 4.30 SUBAREA RUNOFF(CFS) = 16.65  
TOTAL AREA(ACRES) = 11.3 PEAK FLOW RATE(CFS) = 43.69

END OF SUBAREA STREET FLOW HYDRAULICS:

DEPTH(FEET) = 0.52 HALFSTREET FLOOD WIDTH(FEET) = 20.12  
FLOW VELOCITY(FEET/SEC.) = 5.74 DEPTH\*VELOCITY(FT\*FT/SEC.) = 2.99  
LONGEST FLOWPATH FROM NODE 1500.00 TO NODE 1200.00 = 1060.00 FEET.

\*\*\*\*\*

FLOW PROCESS FROM NODE 1200.00 TO NODE 1100.00 IS CODE = 41

-----  
>>>>COMPUTE PIPE-FLOW TRAVEL TIME THRU SUBAREA<<<<<  
>>>>USING USER-SPECIFIED PIPESIZE (EXISTING ELEMENT)<<<<<

=====

ELEVATION DATA: UPSTREAM(FEET) = 362.00 DOWNSTREAM(FEET) = 339.00  
FLOW LENGTH(FEET) = 860.00 MANNING'S N = 0.013  
DEPTH OF FLOW IN 30.0 INCH PIPE IS 17.9 INCHES  
PIPE-FLOW VELOCITY(FEET/SEC.) = 14.27  
GIVEN PIPE DIAMETER(INCH) = 30.00 NUMBER OF PIPES = 1  
PIPE-FLOW(CFS) = 43.69  
PIPE TRAVEL TIME(MIN.) = 1.00 Tc(MIN.) = 8.12  
LONGEST FLOWPATH FROM NODE 1500.00 TO NODE 1100.00 = 1920.00 FEET.

\*\*\*\*\*

FLOW PROCESS FROM NODE 1100.00 TO NODE 1100.00 IS CODE = 81

-----  
>>>>ADDITION OF SUBAREA TO MAINLINE PEAK FLOW<<<<<

=====

100 YEAR RAINFALL INTENSITY(INCH/HOUR) = 4.337  
\*USER SPECIFIED(SUBAREA):  
USER-SPECIFIED RUNOFF COEFFICIENT = .8200  
S.C.S. CURVE NUMBER (AMC II) = 0  
AREA-AVERAGE RUNOFF COEFFICIENT = 0.8200  
SUBAREA AREA(ACRES) = 8.00 SUBAREA RUNOFF(CFS) = 28.45  
TOTAL AREA(ACRES) = 19.3 TOTAL RUNOFF(CFS) = 68.57  
TC(MIN.) = 8.12

\*\*\*\*\*

FLOW PROCESS FROM NODE 1105.00 TO NODE 1100.00 IS CODE = 81

-----  
>>>>ADDITION OF SUBAREA TO MAINLINE PEAK FLOW<<<<<

=====

100 YEAR RAINFALL INTENSITY(INCH/HOUR) = 4.337  
\*USER SPECIFIED(SUBAREA):  
USER-SPECIFIED RUNOFF COEFFICIENT = .8200  
S.C.S. CURVE NUMBER (AMC II) = 0  
AREA-AVERAGE RUNOFF COEFFICIENT = 0.8200  
SUBAREA AREA(ACRES) = 9.10 SUBAREA RUNOFF(CFS) = 32.37  
TOTAL AREA(ACRES) = 28.4 TOTAL RUNOFF(CFS) = 100.94  
TC(MIN.) = 8.12

\*\*\*\*\*

FLOW PROCESS FROM NODE 1100.00 TO NODE 1000.00 IS CODE = 41

-----  
>>>>COMPUTE PIPE-FLOW TRAVEL TIME THRU SUBAREA<<<<<  
>>>>USING USER-SPECIFIED PIPESIZE (EXISTING ELEMENT)<<<<<

=====

ELEVATION DATA: UPSTREAM(FEET) = 339.00 DOWNSTREAM(FEET) = 336.00  
FLOW LENGTH(FEET) = 420.00 MANNING'S N = 0.013  
ASSUME FULL-FLOWING PIPELINE  
PIPE-FLOW VELOCITY(FEET/SEC.) = 10.49  
PIPE FLOW VELOCITY = (TOTAL FLOW)/(PIPE CROSS SECTION AREA)  
GIVEN PIPE DIAMETER(INCH) = 42.00 NUMBER OF PIPES = 1  
PIPE-FLOW(CFS) = 100.94  
PIPE TRAVEL TIME(MIN.) = 0.67 Tc(MIN.) = 8.78  
LONGEST FLOWPATH FROM NODE 1500.00 TO NODE 1000.00 = 2340.00 FEET.

\*\*\*\*\*

FLOW PROCESS FROM NODE 1000.00 TO NODE 1000.00 IS CODE = 1

-----  
>>>>DESIGNATE INDEPENDENT STREAM FOR CONFLUENCE<<<<<

=====

TOTAL NUMBER OF STREAMS = 2  
CONFLUENCE VALUES USED FOR INDEPENDENT STREAM 1 ARE:  
TIME OF CONCENTRATION(MIN.) = 8.78  
RAINFALL INTENSITY(INCH/HR) = 4.12  
TOTAL STREAM AREA(ACRES) = 28.38  
PEAK FLOW RATE(CFS) AT CONFLUENCE = 100.94

+-----+  
| Confluence ON-Site with Off-site |  
| Refer to On-site AES at Node 310 (existing condition) |  
+-----+

\*\*\*\*\*

FLOW PROCESS FROM NODE 310.00 TO NODE 1000.00 IS CODE = 7

-----  
>>>>USER SPECIFIED HYDROLOGY INFORMATION AT NODE<<<<<

=====

USER-SPECIFIED VALUES ARE AS FOLLOWS:  
TC(MIN) = 7.76 RAIN INTENSITY(INCH/HOUR) = 4.46  
TOTAL AREA(ACRES) = 2.85 TOTAL RUNOFF(CFS) = 7.89

\*\*\*\*\*

FLOW PROCESS FROM NODE 1000.00 TO NODE 1000.00 IS CODE = 1

-----  
>>>>DESIGNATE INDEPENDENT STREAM FOR CONFLUENCE<<<<<  
>>>>AND COMPUTE VARIOUS CONFLUENCED STREAM VALUES<<<<<

=====

TOTAL NUMBER OF STREAMS = 2  
CONFLUENCE VALUES USED FOR INDEPENDENT STREAM 2 ARE:  
TIME OF CONCENTRATION(MIN.) = 7.76

RAINFALL INTENSITY(INCH/HR) = 4.46  
 TOTAL STREAM AREA(ACRES) = 2.85  
 PEAK FLOW RATE(CFS) AT CONFLUENCE = 7.89

\*\* CONFLUENCE DATA \*\*

STREAM NUMBER	RUNOFF (CFS)	Tc (MIN.)	INTENSITY (INCH/HOUR)	AREA (ACRE)
1	100.94	8.78	4.122	28.38
2	7.89	7.76	4.465	2.85

RAINFALL INTENSITY AND TIME OF CONCENTRATION RATIO  
 CONFLUENCE FORMULA USED FOR 2 STREAMS.

\*\* PEAK FLOW RATE TABLE \*\*

STREAM NUMBER	RUNOFF (CFS)	Tc (MIN.)	INTENSITY (INCH/HOUR)
1	97.07	7.76	4.465
2	108.22	8.78	4.122

COMPUTED CONFLUENCE ESTIMATES ARE AS FOLLOWS:

PEAK FLOW RATE(CFS) = 108.22 Tc(MIN.) = 8.78  
 TOTAL AREA(ACRES) = 31.2  
 LONGEST FLOWPATH FROM NODE 1500.00 TO NODE 1000.00 = 2340.00 FEET.

\*\*\*\*\*  
 FLOW PROCESS FROM NODE 1000.00 TO NODE 1000.00 IS CODE = 10

-----  
 >>>>MAIN-STREAM MEMORY COPIED ONTO MEMORY BANK # 1 <<<<<  
 =====

\*\*\*\*\*  
 FLOW PROCESS FROM NODE 1000.00 TO NODE 1000.00 IS CODE = 13

-----  
 >>>>CLEAR THE MAIN-STREAM MEMORY<<<<<  
 =====

+-----+  
 | Begin Northerly Off-Site Analysis |  
 | Tributary Area to OSP Regional Basin |  
 | |  
 +-----+

\*\*\*\*\*  
 FLOW PROCESS FROM NODE 3400.00 TO NODE 3300.00 IS CODE = 21

-----  
 >>>>RATIONAL METHOD INITIAL SUBAREA ANALYSIS<<<<<  
 =====

\*USER SPECIFIED(SUBAREA):  
 USER-SPECIFIED RUNOFF COEFFICIENT = .8200  
 S.C.S. CURVE NUMBER (AMC II) = 0

INITIAL SUBAREA FLOW-LENGTH(FEET) = 100.00  
UPSTREAM ELEVATION(FEET) = 376.00  
DOWNSTREAM ELEVATION(FEET) = 372.00  
ELEVATION DIFFERENCE(FEET) = 4.00  
SUBAREA OVERLAND TIME OF FLOW(MIN.) = 3.012  
WARNING: INITIAL SUBAREA FLOW PATH LENGTH IS GREATER THAN  
THE MAXIMUM OVERLAND FLOW LENGTH = 90.00  
(Reference: Table 3-1B of Hydrology Manual)  
THE MAXIMUM OVERLAND FLOW LENGTH IS USED IN Tc CALCULATION!  
100 YEAR RAINFALL INTENSITY(INCH/HOUR) = 5.928  
NOTE: RAINFALL INTENSITY IS BASED ON Tc = 5-MINUTE.  
SUBAREA RUNOFF(CFS) = 0.97  
TOTAL AREA(ACRES) = 0.20 TOTAL RUNOFF(CFS) = 0.97

\*\*\*\*\*

FLOW PROCESS FROM NODE 3300.00 TO NODE 3200.00 IS CODE = 62

-----  
>>>>COMPUTE STREET FLOW TRAVEL TIME THRU SUBAREA<<<<<  
>>>>(STREET TABLE SECTION # 1 USED)<<<<<

=====

UPSTREAM ELEVATION(FEET) = 372.00 DOWNSTREAM ELEVATION(FEET) = 351.00  
STREET LENGTH(FEET) = 920.00 CURB HEIGHT(INCHES) = 8.0  
STREET HALFWIDTH(FEET) = 30.00

DISTANCE FROM CROWN TO CROSSFALL GRADEBREAK(FEET) = 20.00  
INSIDE STREET CROSSFALL(DECIMAL) = 0.018  
OUTSIDE STREET CROSSFALL(DECIMAL) = 0.018

SPECIFIED NUMBER OF HALFSTREETS CARRYING RUNOFF = 1  
STREET PARKWAY CROSSFALL(DECIMAL) = 0.020  
Manning's FRICTION FACTOR for Streetflow Section(curbs-to-curbs) = 0.0150  
Manning's FRICTION FACTOR for Back-of-Walk Flow Section = 0.0200

\*\*TRAVEL TIME COMPUTED USING ESTIMATED FLOW(CFS) = 27.18  
STREETFLOW MODEL RESULTS USING ESTIMATED FLOW:  
STREET FLOW DEPTH(FEET) = 0.58  
HALFSTREET FLOOD WIDTH(FEET) = 23.48  
AVERAGE FLOW VELOCITY(FEET/SEC.) = 5.31  
PRODUCT OF DEPTH&VELOCITY(FT\*FT/SEC.) = 3.09  
STREET FLOW TRAVEL TIME(MIN.) = 2.89 Tc(MIN.) = 5.90  
100 YEAR RAINFALL INTENSITY(INCH/HOUR) = 5.329  
\*USER SPECIFIED(SUBAREA):  
USER-SPECIFIED RUNOFF COEFFICIENT = .8200  
S.C.S. CURVE NUMBER (AMC II) = 0  
AREA-AVERAGE RUNOFF COEFFICIENT = 0.820  
SUBAREA AREA(ACRES) = 11.90 SUBAREA RUNOFF(CFS) = 52.00  
TOTAL AREA(ACRES) = 12.1 PEAK FLOW RATE(CFS) = 52.88

END OF SUBAREA STREET FLOW HYDRAULICS:  
DEPTH(FEET) = 0.70 HALFSTREET FLOOD WIDTH(FEET) = 31.58



FLOW VELOCITY(FEET/SEC.) = 6.20 DEPTH\*VELOCITY(FT\*FT/SEC.) = 4.33  
\*NOTE: INITIAL SUBAREA NOMOGRAPH WITH SUBAREA PARAMETERS,  
AND L = 920.0 FT WITH ELEVATION-DROP = 21.0 FT, IS 57.8 CFS,  
WHICH EXCEEDS THE TOP-OF-CURB STREET CAPACITY AT NODE 3200.00  
LONGEST FLOWPATH FROM NODE 3400.00 TO NODE 3200.00 = 1020.00 FEET.

\*\*\*\*\*

FLOW PROCESS FROM NODE 3200.00 TO NODE 3100.00 IS CODE = 62

-----  
>>>>COMPUTE STREET FLOW TRAVEL TIME THRU SUBAREA<<<<<

>>>>(STREET TABLE SECTION # 1 USED)<<<<<

=====

UPSTREAM ELEVATION(FEET) = 351.00 DOWNSTREAM ELEVATION(FEET) = 348.00  
STREET LENGTH(FEET) = 435.00 CURB HEIGHT(INCHES) = 8.0  
STREET HALFWIDTH(FEET) = 30.00

DISTANCE FROM CROWN TO CROSSFALL GRADEBREAK(FEET) = 20.00  
INSIDE STREET CROSSFALL(DECIMAL) = 0.018  
OUTSIDE STREET CROSSFALL(DECIMAL) = 0.018

SPECIFIED NUMBER OF HALFSTREETS CARRYING RUNOFF = 1  
STREET PARKWAY CROSSFALL(DECIMAL) = 0.020  
Manning's FRICTION FACTOR for Streetflow Section(curbs-to-curbs) = 0.0150  
Manning's FRICTION FACTOR for Back-of-Walk Flow Section = 0.0200

\*\*TRAVEL TIME COMPUTED USING ESTIMATED FLOW(CFS) = 70.17

\*\*\*STREET FLOWING FULL\*\*\*

STREETFLOW MODEL RESULTS USING ESTIMATED FLOW:

STREET FLOW DEPTH(FEET) = 0.74

HALFSTREET FLOOD WIDTH(FEET) = 33.51

AVERAGE FLOW VELOCITY(FEET/SEC.) = 3.69

PRODUCT OF DEPTH&VELOCITY(FT\*FT/SEC.) = 2.72

STREET FLOW TRAVEL TIME(MIN.) = 1.96 Tc(MIN.) = 7.86

100 YEAR RAINFALL INTENSITY(INCH/HOUR) = 4.427

\*USER SPECIFIED(SUBAREA):

USER-SPECIFIED RUNOFF COEFFICIENT = .8200

S.C.S. CURVE NUMBER (AMC II) = 0

AREA-AVERAGE RUNOFF COEFFICIENT = 0.820

SUBAREA AREA(ACRES) = 9.50 SUBAREA RUNOFF(CFS) = 34.49

TOTAL AREA(ACRES) = 21.6 PEAK FLOW RATE(CFS) = 78.42

END OF SUBAREA STREET FLOW HYDRAULICS:

DEPTH(FEET) = 0.76 HALFSTREET FLOOD WIDTH(FEET) = 34.54

FLOW VELOCITY(FEET/SEC.) = 3.84 DEPTH\*VELOCITY(FT\*FT/SEC.) = 2.91

\*NOTE: INITIAL SUBAREA NOMOGRAPH WITH SUBAREA PARAMETERS,

AND L = 435.0 FT WITH ELEVATION-DROP = 3.0 FT, IS 46.2 CFS,

WHICH EXCEEDS THE TOP-OF-CURB STREET CAPACITY AT NODE 3100.00

LONGEST FLOWPATH FROM NODE 3400.00 TO NODE 3100.00 = 1455.00 FEET.

\*\*\*\*\*

FLOW PROCESS FROM NODE 3100.00 TO NODE 3000.00 IS CODE = 41

-----  
>>>>COMPUTE PIPE-FLOW TRAVEL TIME THRU SUBAREA<<<<<  
>>>>USING USER-SPECIFIED PIPESIZE (EXISTING ELEMENT)<<<<<

=====

ELEVATION DATA: UPSTREAM(FEET) = 348.00 DOWNSTREAM(FEET) = 301.00  
FLOW LENGTH(FEET) = 316.00 MANNING'S N = 0.013  
DEPTH OF FLOW IN 42.0 INCH PIPE IS 13.0 INCHES  
PIPE-FLOW VELOCITY(FEET/SEC.) = 31.01  
GIVEN PIPE DIAMETER(INCH) = 42.00 NUMBER OF PIPES = 1  
PIPE-FLOW(CFS) = 78.42  
PIPE TRAVEL TIME(MIN.) = 0.17 Tc(MIN.) = 8.03  
LONGEST FLOWPATH FROM NODE 3400.00 TO NODE 3000.00 = 1771.00 FEET.

\*\*\*\*\*

FLOW PROCESS FROM NODE 3000.00 TO NODE 3000.00 IS CODE = 1

-----  
>>>>DESIGNATE INDEPENDENT STREAM FOR CONFLUENCE<<<<<

=====

TOTAL NUMBER OF STREAMS = 3  
CONFLUENCE VALUES USED FOR INDEPENDENT STREAM 1 ARE:  
TIME OF CONCENTRATION(MIN.) = 8.03  
RAINFALL INTENSITY(INCH/HR) = 4.37  
TOTAL STREAM AREA(ACRES) = 21.60  
PEAK FLOW RATE(CFS) AT CONFLUENCE = 78.42

+-----+  
| Confluence ON-Site with Off-Site |  
| Refer to On-Site AES at Node 110 |  
+-----+

\*\*\*\*\*

FLOW PROCESS FROM NODE 110.00 TO NODE 3000.00 IS CODE = 7

-----  
>>>>USER SPECIFIED HYDROLOGY INFORMATION AT NODE<<<<<

=====

USER-SPECIFIED VALUES ARE AS FOLLOWS:  
TC(MIN) = 9.71 RAIN INTENSITY(INCH/HOUR) = 3.86  
TOTAL AREA(ACRES) = 2.13 TOTAL RUNOFF(CFS) = 4.40

\*\*\*\*\*

FLOW PROCESS FROM NODE 3000.00 TO NODE 3000.00 IS CODE = 1

-----  
>>>>DESIGNATE INDEPENDENT STREAM FOR CONFLUENCE<<<<<

=====

TOTAL NUMBER OF STREAMS = 3  
CONFLUENCE VALUES USED FOR INDEPENDENT STREAM 2 ARE:  
TIME OF CONCENTRATION(MIN.) = 9.71  
RAINFALL INTENSITY(INCH/HR) = 3.86

TOTAL STREAM AREA(ACRES) = 2.13  
PEAK FLOW RATE(CFS) AT CONFLUENCE = 4.40

```
+-----+
| Confluence ON-Site with Off-site
| Refer to On-Site AES at Node 210 (existing condition)
|-----+
```

\*\*\*\*\*  
FLOW PROCESS FROM NODE 210.00 TO NODE 3000.00 IS CODE = 7

>>>>USER SPECIFIED HYDROLOGY INFORMATION AT NODE<<<<<

=====

USER-SPECIFIED VALUES ARE AS FOLLOWS:  
TC(MIN) = 11.75 RAIN INTENSITY(INCH/HOUR) = 3.42  
TOTAL AREA(ACRES) = 1.56 TOTAL RUNOFF(CFS) = 2.82

\*\*\*\*\*  
FLOW PROCESS FROM NODE 3000.00 TO NODE 3000.00 IS CODE = 1

>>>>DESIGNATE INDEPENDENT STREAM FOR CONFLUENCE<<<<<  
>>>>AND COMPUTE VARIOUS CONFLUENCED STREAM VALUES<<<<<

=====

TOTAL NUMBER OF STREAMS = 3  
CONFLUENCE VALUES USED FOR INDEPENDENT STREAM 3 ARE:  
TIME OF CONCENTRATION(MIN.) = 11.75  
RAINFALL INTENSITY(INCH/HR) = 3.42  
TOTAL STREAM AREA(ACRES) = 1.56  
PEAK FLOW RATE(CFS) AT CONFLUENCE = 2.82

\*\* CONFLUENCE DATA \*\*

STREAM NUMBER	RUNOFF (CFS)	Tc (MIN.)	INTENSITY (INCH/HOUR)	AREA (ACRE)
1	78.42	8.03	4.367	21.60
2	4.40	9.71	3.864	2.13
3	2.82	11.75	3.416	1.56

RAINFALL INTENSITY AND TIME OF CONCENTRATION RATIO  
CONFLUENCE FORMULA USED FOR 3 STREAMS.

\*\* PEAK FLOW RATE TABLE \*\*

STREAM NUMBER	RUNOFF (CFS)	Tc (MIN.)	INTENSITY (INCH/HOUR)
1	83.98	8.03	4.367
2	76.11	9.71	3.864
3	68.06	11.75	3.416

COMPUTED CONFLUENCE ESTIMATES ARE AS FOLLOWS:  
PEAK FLOW RATE(CFS) = 83.98 Tc(MIN.) = 8.03

TOTAL AREA(ACRES) = 25.3  
LONGEST FLOWPATH FROM NODE 3400.00 TO NODE 3000.00 = 1771.00 FEET.

```
+-----+
| Add Area from New Mid-Coast Trolley
| A = 0.88
|-----+
```

\*\*\*\*\*  
FLOW PROCESS FROM NODE 3000.00 TO NODE 3000.00 IS CODE = 81

>>>>ADDITION OF SUBAREA TO MAINLINE PEAK FLOW<<<<<

```
=====
100 YEAR RAINFALL INTENSITY(INCH/HOUR) = 4.367
*USER SPECIFIED(SUBAREA):
USER-SPECIFIED RUNOFF COEFFICIENT = .9000
S.C.S. CURVE NUMBER (AMC II) = 0
AREA-AVERAGE RUNOFF COEFFICIENT = 0.7821
SUBAREA AREA(ACRES) = 0.88 SUBAREA RUNOFF(CFS) = 3.46
TOTAL AREA(ACRES) = 26.2 TOTAL RUNOFF(CFS) = 89.38
TC(MIN.) = 8.03
```

```
+-----+
| Add area: OSP Regional Basin
|-----+
```

\*\*\*\*\*  
FLOW PROCESS FROM NODE 3000.00 TO NODE 3000.00 IS CODE = 81

>>>>ADDITION OF SUBAREA TO MAINLINE PEAK FLOW<<<<<

```
=====
100 YEAR RAINFALL INTENSITY(INCH/HOUR) = 4.367
*USER SPECIFIED(SUBAREA):
USER-SPECIFIED RUNOFF COEFFICIENT = .4000
S.C.S. CURVE NUMBER (AMC II) = 0
AREA-AVERAGE RUNOFF COEFFICIENT = 0.7103
SUBAREA AREA(ACRES) = 6.06 SUBAREA RUNOFF(CFS) = 10.58
TOTAL AREA(ACRES) = 32.2 TOTAL RUNOFF(CFS) = 99.96
TC(MIN.) = 8.03
```

\*\*\*\*\*  
FLOW PROCESS FROM NODE 3000.00 TO NODE 1000.00 IS CODE = 11

>>>>CONFLUENCE MEMORY BANK # 1 WITH THE MAIN-STREAM MEMORY<<<<<

=====  
\*\* MAIN STREAM CONFLUENCE DATA \*\*

STREAM NUMBER	RUNOFF (CFS)	Tc (MIN.)	INTENSITY (INCH/HOUR)	AREA (ACRE)
1	99.96	8.03	4.367	32.23

LONGEST FLOWPATH FROM NODE 3400.00 TO NODE 1000.00 = 1771.00 FEET.

\*\* MEMORY BANK # 1 CONFLUENCE DATA \*\*

STREAM NUMBER	RUNOFF (CFS)	Tc (MIN.)	INTENSITY (INCH/HOUR)	AREA (ACRE)
1	108.22	8.78	4.122	31.23

LONGEST FLOWPATH FROM NODE 1500.00 TO NODE 1000.00 = 2340.00 FEET.

\*\* PEAK FLOW RATE TABLE \*\*

STREAM NUMBER	RUNOFF (CFS)	Tc (MIN.)	INTENSITY (INCH/HOUR)
1	198.92	8.03	4.367
2	202.58	8.78	4.122

COMPUTED CONFLUENCE ESTIMATES ARE AS FOLLOWS:

PEAK FLOW RATE(CFS) = 202.58 Tc(MIN.) = 8.78  
TOTAL AREA(ACRES) = 63.5

=====

END OF STUDY SUMMARY:

TOTAL AREA(ACRES) = 63.5 TC(MIN.) = 8.78  
PEAK FLOW RATE(CFS) = 202.58

=====

=====

END OF RATIONAL METHOD ANALYSIS



# Appendix C – Proposed Hydrology

*On-Site Hydrologic Work Map  
AES Output*

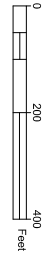
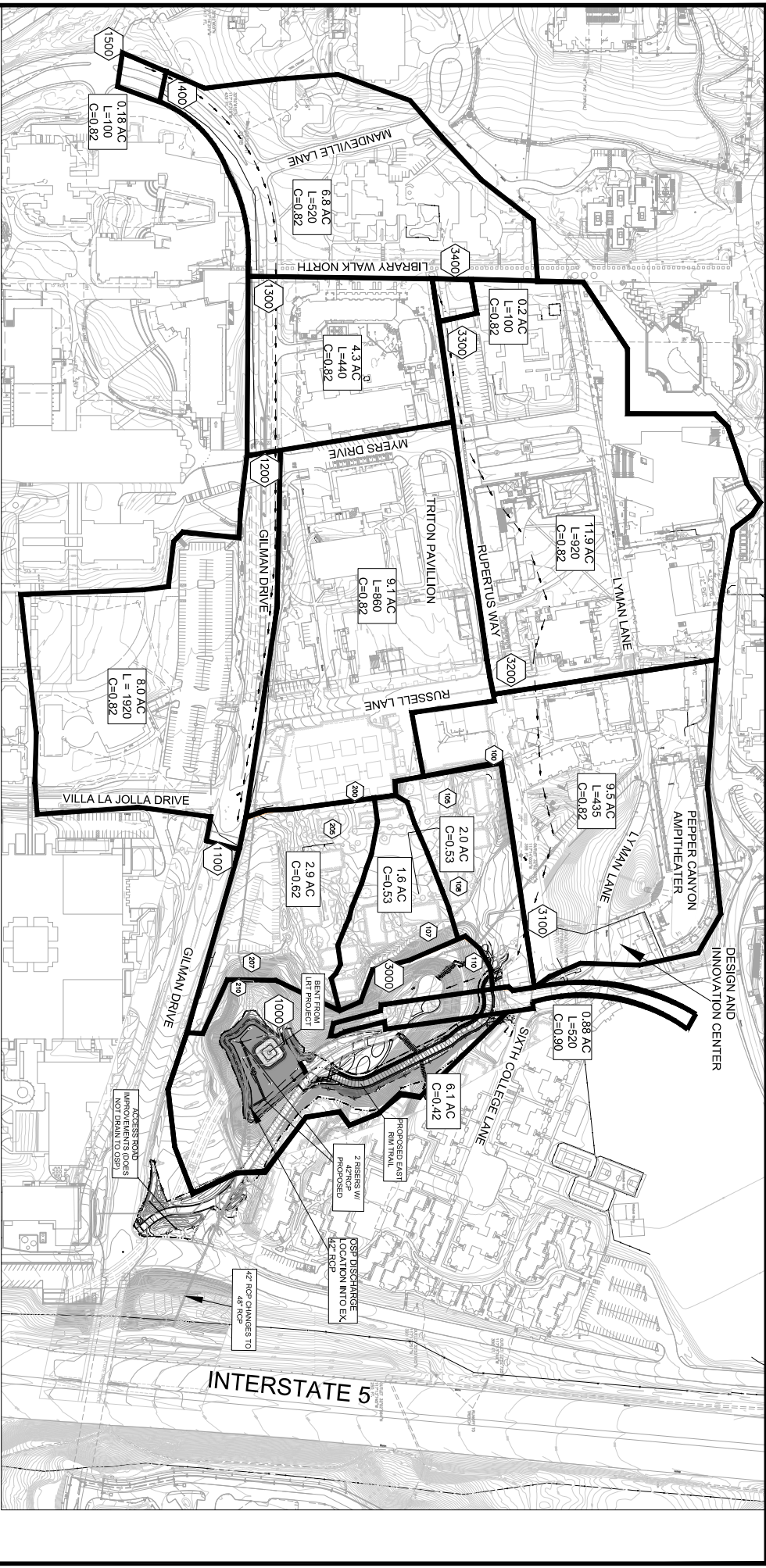

- LEGEND**
- DRAINAGE BOUNDARY
  - SUBAREA BOUNDARY
  - FLOW PATH
  - C=0.00 RUN-OFF COEFFICIENT
  - A=0.00 AREA (ACRES)
  - HYDROLOGY NODE
  - NODE ELEVATION

- PROPOSED**
- EXISTING WETLAND
  - PROPOSED BASIN

**PROPOSED  
PEPPER CANYON REGIONAL BASIN  
WATERSHED HYDROLOGY**

**Michael Baker  
INTERNATIONAL**  
10000  
San Diego, CA 92124  
Phone: (619) 441-4000 • MBI@MBAKERINTL.COM

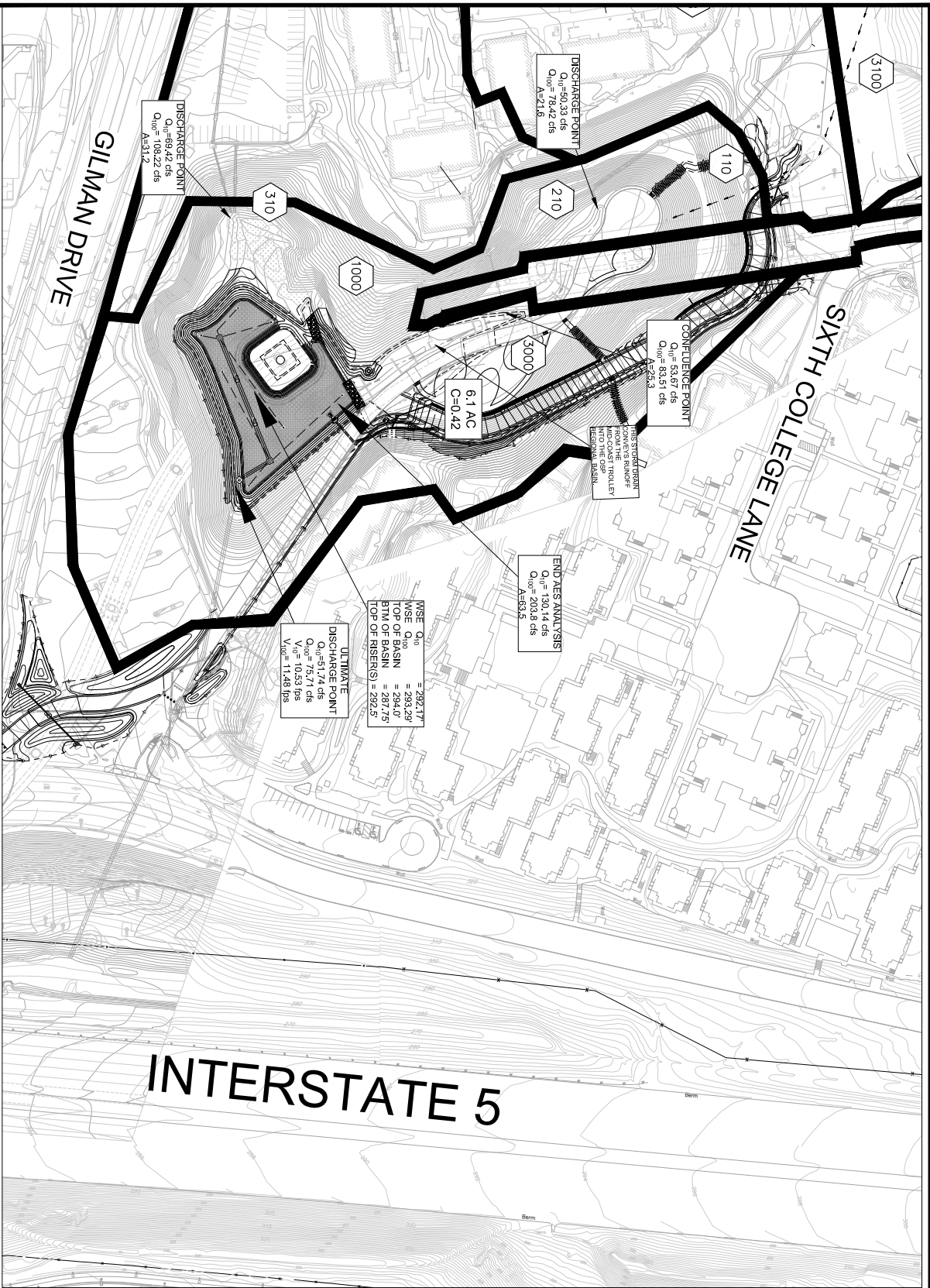

**Michael Baker INTERNATIONAL**  
 10000 Boulevard  
 San Diego, CA 92124  
 Phone: (619) 614-4000 • MBAKERINTL.COM

**PEPPER CANYON REGIONAL BASIN  
 WATERSHED HYDROLOGY PROPOSED**

- LEGEND**
- DRAINAGE BOUNDARY
  - - - SUBAREA BOUNDARY
  - FLOW PATH
  - - - RUN-OFF COEFFICIENT AREA (ACRES)
  - HYDROLOGY NODE
  - 442 NODE ELEVATION
  - ◻ MAPPED SENSITIVE WETLAND
  - ◻ PROPOSED BASIN





# 10-YR Proposed

\*\*\*\*\*

RATIONAL METHOD HYDROLOGY COMPUTER PROGRAM PACKAGE  
Reference: SAN DIEGO COUNTY FLOOD CONTROL DISTRICT  
2003,1985,1981 HYDROLOGY MANUAL  
(c) Copyright 1982-2016 Advanced Engineering Software (aes)  
Ver. 23.0 Release Date: 07/01/2016 License ID 1264

Analysis prepared by:

\*\*\*\*\* DESCRIPTION OF STUDY \*\*\*\*\*

- \* Regional Basin \*
- \* Proposed Condition \*
- \* 10 Year \*

\*\*\*\*\*

FILE NAME: C:\10PR\RBPR10.DAT  
TIME/DATE OF STUDY: 14:34 04/23/2021

-----  
USER SPECIFIED HYDROLOGY AND HYDRAULIC MODEL INFORMATION:  
-----

2003 SAN DIEGO MANUAL CRITERIA

USER SPECIFIED STORM EVENT(YEAR) = 10.00  
6-HOUR DURATION PRECIPITATION (INCHES) = 1.500  
SPECIFIED MINIMUM PIPE SIZE(INCH) = 18.00  
SPECIFIED PERCENT OF GRADIENTS(DECIMAL) TO USE FOR FRICTION SLOPE = 0.95  
SAN DIEGO HYDROLOGY MANUAL "C"-VALUES USED FOR RATIONAL METHOD  
NOTE: USE MODIFIED RATIONAL METHOD PROCEDURES FOR CONFLUENCE ANALYSIS

\*USER-DEFINED STREET-SECTIONS FOR COUPLED PIPEFLOW AND STREETFLOW MODEL\*

NO.	HALF- WIDTH (FT)	CROWN TO CROSSFALL (FT)	STREET-CROSSFALL: IN- / OUT- / PARK- SIDE / SIDE / WAY	CURB HEIGHT (FT)	GUTTER-GEOMETRIES: WIDTH LIP HIKE (FT) (FT) (FT)	MANNING FACTOR (n)
1	30.0	20.0	0.018/0.018/0.020	0.67	2.00 0.0313 0.167	0.0150

GLOBAL STREET FLOW-DEPTH CONSTRAINTS:

1. Relative Flow-Depth = 0.00 FEET  
as (Maximum Allowable Street Flow Depth) - (Top-of-Curb)
2. (Depth)\*(Velocity) Constraint = 6.0 (FT\*FT/S)

\*SIZE PIPE WITH A FLOW CAPACITY GREATER THAN  
OR EQUAL TO THE UPSTREAM TRIBUTARY PIPE.\*

+-----+

| Begin Southerly Off-Site analysis  
| Tributary Area to OSP Regional Basin  
|

+-----+

\*\*\*\*\*

FLOW PROCESS FROM NODE 1500.00 TO NODE 1400.00 IS CODE = 21

-----

>>>>RATIONAL METHOD INITIAL SUBAREA ANALYSIS<<<<<

=====

\*USER SPECIFIED(SUBAREA):

USER-SPECIFIED RUNOFF COEFFICIENT = .8200

S.C.S. CURVE NUMBER (AMC II) = 0

INITIAL SUBAREA FLOW-LENGTH(FEET) = 100.00

UPSTREAM ELEVATION(FEET) = 388.00

DOWNSTREAM ELEVATION(FEET) = 386.00

ELEVATION DIFFERENCE(FEET) = 2.00

SUBAREA OVERLAND TIME OF FLOW(MIN.) = 3.464

WARNING: INITIAL SUBAREA FLOW PATH LENGTH IS GREATER THAN

THE MAXIMUM OVERLAND FLOW LENGTH = 75.00

(Reference: Table 3-1B of Hydrology Manual)

THE MAXIMUM OVERLAND FLOW LENGTH IS USED IN T<sub>c</sub> CALCULATION!

10 YEAR RAINFALL INTENSITY(INCH/HOUR) = 3.952

NOTE: RAINFALL INTENSITY IS BASED ON T<sub>c</sub> = 5-MINUTE.

SUBAREA RUNOFF(CFS) = 0.58

TOTAL AREA(ACRES) = 0.18 TOTAL RUNOFF(CFS) = 0.58

\*\*\*\*\*

FLOW PROCESS FROM NODE 1400.00 TO NODE 1300.00 IS CODE = 62

-----

>>>>COMPUTE STREET FLOW TRAVEL TIME THRU SUBAREA<<<<<

>>>>(STREET TABLE SECTION # 1 USED)<<<<<

=====

UPSTREAM ELEVATION(FEET) = 386.00 DOWNSTREAM ELEVATION(FEET) = 376.00

STREET LENGTH(FEET) = 520.00 CURB HEIGHT(INCHES) = 8.0

STREET HALFWIDTH(FEET) = 30.00

DISTANCE FROM CROWN TO CROSSFALL GRADEBREAK(FEET) = 20.00

INSIDE STREET CROSSFALL(DECIMAL) = 0.018

OUTSIDE STREET CROSSFALL(DECIMAL) = 0.018

SPECIFIED NUMBER OF HALFSTREETS CARRYING RUNOFF = 2

STREET PARKWAY CROSSFALL(DECIMAL) = 0.020

Manning's FRICTION FACTOR for Streetflow Section(curbs-to-curbs) = 0.0150

Manning's FRICTION FACTOR for Back-of-Walk Flow Section = 0.0200

\*\*TRAVEL TIME COMPUTED USING ESTIMATED FLOW(CFS) = 10.40

STREETFLOW MODEL RESULTS USING ESTIMATED FLOW:

STREET FLOW DEPTH(FEET) = 0.38

HALFSTREET FLOOD WIDTH(FEET) = 12.30

AVERAGE FLOW VELOCITY(FEET/SEC.) = 3.36  
PRODUCT OF DEPTH&VELOCITY(FT\*FT/SEC.) = 1.29  
STREET FLOW TRAVEL TIME(MIN.) = 2.58 Tc(MIN.) = 6.04  
10 YEAR RAINFALL INTENSITY(INCH/HOUR) = 3.498

\*USER SPECIFIED(SUBAREA):

USER-SPECIFIED RUNOFF COEFFICIENT = .8200  
S.C.S. CURVE NUMBER (AMC II) = 0  
AREA-AVERAGE RUNOFF COEFFICIENT = 0.820  
SUBAREA AREA(ACRES) = 6.80 SUBAREA RUNOFF(CFS) = 19.50  
TOTAL AREA(ACRES) = 7.0 PEAK FLOW RATE(CFS) = 20.02

END OF SUBAREA STREET FLOW HYDRAULICS:

DEPTH(FEET) = 0.45 HALFSTREET FLOOD WIDTH(FEET) = 16.29  
FLOW VELOCITY(FEET/SEC.) = 3.91 DEPTH\*VELOCITY(FT\*FT/SEC.) = 1.77  
LONGEST FLOWPATH FROM NODE 1500.00 TO NODE 1300.00 = 620.00 FEET.

\*\*\*\*\*

FLOW PROCESS FROM NODE 1300.00 TO NODE 1200.00 IS CODE = 62

-----  
>>>>COMPUTE STREET FLOW TRAVEL TIME THRU SUBAREA<<<<<

>>>>(STREET TABLE SECTION # 1 USED)<<<<<

=====

UPSTREAM ELEVATION(FEET) = 376.00 DOWNSTREAM ELEVATION(FEET) = 362.00  
STREET LENGTH(FEET) = 440.00 CURB HEIGHT(INCHES) = 8.0  
STREET HALFWIDTH(FEET) = 30.00

DISTANCE FROM CROWN TO CROSSFALL GRADEBREAK(FEET) = 20.00  
INSIDE STREET CROSSFALL(DECIMAL) = 0.018  
OUTSIDE STREET CROSSFALL(DECIMAL) = 0.018

SPECIFIED NUMBER OF HALFSTREETS CARRYING RUNOFF = 2  
STREET PARKWAY CROSSFALL(DECIMAL) = 0.020  
Manning's FRICTION FACTOR for Streetflow Section(curbs-to-curbs) = 0.0150  
Manning's FRICTION FACTOR for Back-of-Walk Flow Section = 0.0200

\*\*TRAVEL TIME COMPUTED USING ESTIMATED FLOW(CFS) = 25.39

STREETFLOW MODEL RESULTS USING ESTIMATED FLOW:

STREET FLOW DEPTH(FEET) = 0.45  
HALFSTREET FLOOD WIDTH(FEET) = 16.13  
AVERAGE FLOW VELOCITY(FEET/SEC.) = 5.04  
PRODUCT OF DEPTH&VELOCITY(FT\*FT/SEC.) = 2.27  
STREET FLOW TRAVEL TIME(MIN.) = 1.45 Tc(MIN.) = 7.50  
10 YEAR RAINFALL INTENSITY(INCH/HOUR) = 3.044

\*USER SPECIFIED(SUBAREA):

USER-SPECIFIED RUNOFF COEFFICIENT = .8200  
S.C.S. CURVE NUMBER (AMC II) = 0  
AREA-AVERAGE RUNOFF COEFFICIENT = 0.820  
SUBAREA AREA(ACRES) = 4.30 SUBAREA RUNOFF(CFS) = 10.73  
TOTAL AREA(ACRES) = 11.3 PEAK FLOW RATE(CFS) = 28.15

END OF SUBAREA STREET FLOW HYDRAULICS:

DEPTH(FEET) = 0.46 HALFSTREET FLOOD WIDTH(FEET) = 16.84  
FLOW VELOCITY(FEET/SEC.) = 5.17 DEPTH\*VELOCITY(FT\*FT/SEC.) = 2.39  
LONGEST FLOWPATH FROM NODE 1500.00 TO NODE 1200.00 = 1060.00 FEET.

\*\*\*\*\*

FLOW PROCESS FROM NODE 1200.00 TO NODE 1100.00 IS CODE = 41

-----  
>>>>COMPUTE PIPE-FLOW TRAVEL TIME THRU SUBAREA<<<<<  
>>>>USING USER-SPECIFIED PIPESIZE (EXISTING ELEMENT)<<<<<

=====

ELEVATION DATA: UPSTREAM(FEET) = 362.00 DOWNSTREAM(FEET) = 339.00  
FLOW LENGTH(FEET) = 860.00 MANNING'S N = 0.013  
DEPTH OF FLOW IN 30.0 INCH PIPE IS 13.8 INCHES  
PIPE-FLOW VELOCITY(FEET/SEC.) = 12.82  
GIVEN PIPE DIAMETER(INCH) = 30.00 NUMBER OF PIPES = 1  
PIPE-FLOW(CFS) = 28.15  
PIPE TRAVEL TIME(MIN.) = 1.12 Tc(MIN.) = 8.61  
LONGEST FLOWPATH FROM NODE 1500.00 TO NODE 1100.00 = 1920.00 FEET.

\*\*\*\*\*

FLOW PROCESS FROM NODE 1100.00 TO NODE 1100.00 IS CODE = 81

-----  
>>>>ADDITION OF SUBAREA TO MAINLINE PEAK FLOW<<<<<

=====

10 YEAR RAINFALL INTENSITY(INCH/HOUR) = 2.783  
\*USER SPECIFIED(SUBAREA):  
USER-SPECIFIED RUNOFF COEFFICIENT = .8200  
S.C.S. CURVE NUMBER (AMC II) = 0  
AREA-AVERAGE RUNOFF COEFFICIENT = 0.8200  
SUBAREA AREA(ACRES) = 8.00 SUBAREA RUNOFF(CFS) = 18.25  
TOTAL AREA(ACRES) = 19.3 TOTAL RUNOFF(CFS) = 43.99  
TC(MIN.) = 8.61

\*\*\*\*\*

FLOW PROCESS FROM NODE 1105.00 TO NODE 1100.00 IS CODE = 81

-----  
>>>>ADDITION OF SUBAREA TO MAINLINE PEAK FLOW<<<<<

=====

10 YEAR RAINFALL INTENSITY(INCH/HOUR) = 2.783  
\*USER SPECIFIED(SUBAREA):  
USER-SPECIFIED RUNOFF COEFFICIENT = .8200  
S.C.S. CURVE NUMBER (AMC II) = 0  
AREA-AVERAGE RUNOFF COEFFICIENT = 0.8200  
SUBAREA AREA(ACRES) = 9.10 SUBAREA RUNOFF(CFS) = 20.76  
TOTAL AREA(ACRES) = 28.4 TOTAL RUNOFF(CFS) = 64.76  
TC(MIN.) = 8.61

\*\*\*\*\*

FLOW PROCESS FROM NODE 1100.00 TO NODE 1000.00 IS CODE = 41

-----  
>>>>COMPUTE PIPE-FLOW TRAVEL TIME THRU SUBAREA<<<<<  
>>>>USING USER-SPECIFIED PIPESIZE (EXISTING ELEMENT)<<<<<

=====

ELEVATION DATA: UPSTREAM(FEET) =	339.00	DOWNSTREAM(FEET) =	336.00
FLOW LENGTH(FEET) =	420.00	MANNING'S N =	0.013
DEPTH OF FLOW IN	42.0 INCH PIPE IS	27.9 INCHES	
PIPE-FLOW VELOCITY(FEET/SEC.) =	9.53		
GIVEN PIPE DIAMETER(INCH) =	42.00	NUMBER OF PIPES =	1
PIPE-FLOW(CFS) =	64.76		
PIPE TRAVEL TIME(MIN.) =	0.73	Tc(MIN.) =	9.35
LONGEST FLOWPATH FROM NODE	1500.00	TO NODE	1000.00 =
			2340.00 FEET.

\*\*\*\*\*  
FLOW PROCESS FROM NODE 1000.00 TO NODE 1000.00 IS CODE = 1

-----  
>>>>DESIGNATE INDEPENDENT STREAM FOR CONFLUENCE<<<<<

=====

TOTAL NUMBER OF STREAMS =	2
CONFLUENCE VALUES USED FOR INDEPENDENT STREAM 1 ARE:	
TIME OF CONCENTRATION(MIN.) =	9.35
RAINFALL INTENSITY(INCH/HR) =	2.64
TOTAL STREAM AREA(ACRES) =	28.38
PEAK FLOW RATE(CFS) AT CONFLUENCE =	64.76

+-----+  
| Confluence ON-Site with Off-site  
| Refer to On-site AES at Node 310  
|-----+  
+

\*\*\*\*\*  
FLOW PROCESS FROM NODE 310.00 TO NODE 1000.00 IS CODE = 7

-----  
>>>>USER SPECIFIED HYDROLOGY INFORMATION AT NODE<<<<<

=====

USER-SPECIFIED VALUES ARE AS FOLLOWS:			
TC(MIN) =	8.24	RAIN INTENSITY(INCH/HOUR) =	2.86
TOTAL AREA(ACRES) =	2.85	TOTAL RUNOFF(CFS) =	5.06

\*\*\*\*\*  
FLOW PROCESS FROM NODE 1000.00 TO NODE 1000.00 IS CODE = 1

-----  
>>>>DESIGNATE INDEPENDENT STREAM FOR CONFLUENCE<<<<<  
>>>>AND COMPUTE VARIOUS CONFLUENCED STREAM VALUES<<<<<

=====

TOTAL NUMBER OF STREAMS =	2
CONFLUENCE VALUES USED FOR INDEPENDENT STREAM 2 ARE:	
TIME OF CONCENTRATION(MIN.) =	8.24
RAINFALL INTENSITY(INCH/HR) =	2.86

TOTAL STREAM AREA(ACRES) = 2.85  
PEAK FLOW RATE(CFS) AT CONFLUENCE = 5.06

\*\* CONFLUENCE DATA \*\*

STREAM NUMBER	RUNOFF (CFS)	Tc (MIN.)	INTENSITY (INCH/HOUR)	AREA (ACRE)
1	64.76	9.35	2.640	28.38
2	5.06	8.24	2.863	2.85

RAINFALL INTENSITY AND TIME OF CONCENTRATION RATIO  
CONFLUENCE FORMULA USED FOR 2 STREAMS.

\*\* PEAK FLOW RATE TABLE \*\*

STREAM NUMBER	RUNOFF (CFS)	Tc (MIN.)	INTENSITY (INCH/HOUR)
1	62.13	8.24	2.863
2	69.42	9.35	2.640

COMPUTED CONFLUENCE ESTIMATES ARE AS FOLLOWS:

PEAK FLOW RATE(CFS) = 69.42 Tc(MIN.) = 9.35  
TOTAL AREA(ACRES) = 31.2  
LONGEST FLOWPATH FROM NODE 1500.00 TO NODE 1000.00 = 2340.00 FEET.

\*\*\*\*\*

FLOW PROCESS FROM NODE 1000.00 TO NODE 1000.00 IS CODE = 10

>>>>MAIN-STREAM MEMORY COPIED ONTO MEMORY BANK # 1 <<<<<

\*\*\*\*\*

FLOW PROCESS FROM NODE 1000.00 TO NODE 1000.00 IS CODE = 13

>>>>CLEAR THE MAIN-STREAM MEMORY<<<<<

```
+-----+
| Begin Northerly Off-Site Analysis |
| Tributary Area to OSP Regional Basin |
+-----+
```

\*\*\*\*\*

FLOW PROCESS FROM NODE 3400.00 TO NODE 3300.00 IS CODE = 21

>>>>RATIONAL METHOD INITIAL SUBAREA ANALYSIS<<<<<

\*USER SPECIFIED(SUBAREA):  
USER-SPECIFIED RUNOFF COEFFICIENT = .8200  
S.C.S. CURVE NUMBER (AMC II) = 0  
INITIAL SUBAREA FLOW-LENGTH(FEET) = 100.00

UPSTREAM ELEVATION(FEET) = 376.00  
DOWNSTREAM ELEVATION(FEET) = 372.00  
ELEVATION DIFFERENCE(FEET) = 4.00  
SUBAREA OVERLAND TIME OF FLOW(MIN.) = 3.012  
WARNING: INITIAL SUBAREA FLOW PATH LENGTH IS GREATER THAN  
THE MAXIMUM OVERLAND FLOW LENGTH = 90.00  
(Reference: Table 3-1B of Hydrology Manual)  
THE MAXIMUM OVERLAND FLOW LENGTH IS USED IN Tc CALCULATION!  
10 YEAR RAINFALL INTENSITY(INCH/HOUR) = 3.952  
NOTE: RAINFALL INTENSITY IS BASED ON Tc = 5-MINUTE.  
SUBAREA RUNOFF(CFS) = 0.65  
TOTAL AREA(ACRES) = 0.20 TOTAL RUNOFF(CFS) = 0.65

\*\*\*\*\*

FLOW PROCESS FROM NODE 3300.00 TO NODE 3200.00 IS CODE = 62

-----  
>>>>COMPUTE STREET FLOW TRAVEL TIME THRU SUBAREA<<<<<  
>>>>(STREET TABLE SECTION # 1 USED)<<<<<

=====

UPSTREAM ELEVATION(FEET) = 372.00 DOWNSTREAM ELEVATION(FEET) = 351.00  
STREET LENGTH(FEET) = 920.00 CURB HEIGHT(INCHES) = 8.0  
STREET HALFWIDTH(FEET) = 30.00

DISTANCE FROM CROWN TO CROSSFALL GRADEBREAK(FEET) = 20.00  
INSIDE STREET CROSSFALL(DECIMAL) = 0.018  
OUTSIDE STREET CROSSFALL(DECIMAL) = 0.018

SPECIFIED NUMBER OF HALFSTREETS CARRYING RUNOFF = 1  
STREET PARKWAY CROSSFALL(DECIMAL) = 0.020  
Manning's FRICTION FACTOR for Streetflow Section(curbs-to-curbs) = 0.0150  
Manning's FRICTION FACTOR for Back-of-Walk Flow Section = 0.0200

\*\*TRAVEL TIME COMPUTED USING ESTIMATED FLOW(CFS) = 16.06  
STREETFLOW MODEL RESULTS USING ESTIMATED FLOW:  
STREET FLOW DEPTH(FEET) = 0.50  
HALFSTREET FLOOD WIDTH(FEET) = 19.02  
AVERAGE FLOW VELOCITY(FEET/SEC.) = 4.69  
PRODUCT OF DEPTH&VELOCITY(FT\*FT/SEC.) = 2.35  
STREET FLOW TRAVEL TIME(MIN.) = 3.27 Tc(MIN.) = 6.28  
10 YEAR RAINFALL INTENSITY(INCH/HOUR) = 3.411

\*USER SPECIFIED(SUBAREA):  
USER-SPECIFIED RUNOFF COEFFICIENT = .8200  
S.C.S. CURVE NUMBER (AMC II) = 0  
AREA-AVERAGE RUNOFF COEFFICIENT = 0.820  
SUBAREA AREA(ACRES) = 10.90 SUBAREA RUNOFF(CFS) = 30.48  
TOTAL AREA(ACRES) = 11.1 PEAK FLOW RATE(CFS) = 31.04

END OF SUBAREA STREET FLOW HYDRAULICS:  
DEPTH(FEET) = 0.60 HALFSTREET FLOOD WIDTH(FEET) = 24.73  
FLOW VELOCITY(FEET/SEC.) = 5.49 DEPTH\*VELOCITY(FT\*FT/SEC.) = 3.32

LONGEST FLOWPATH FROM NODE 3400.00 TO NODE 3200.00 = 1020.00 FEET.

\*\*\*\*\*

FLOW PROCESS FROM NODE 3200.00 TO NODE 3100.00 IS CODE = 62

-----  
>>>>COMPUTE STREET FLOW TRAVEL TIME THRU SUBAREA<<<<<

>>>>(STREET TABLE SECTION # 1 USED)<<<<<

=====

UPSTREAM ELEVATION(FEET) = 351.00 DOWNSTREAM ELEVATION(FEET) = 348.00  
STREET LENGTH(FEET) = 435.00 CURB HEIGHT(INCHES) = 8.0  
STREET HALFWIDTH(FEET) = 30.00

DISTANCE FROM CROWN TO CROSSFALL GRADEBREAK(FEET) = 20.00  
INSIDE STREET CROSSFALL(DECIMAL) = 0.018  
OUTSIDE STREET CROSSFALL(DECIMAL) = 0.018

SPECIFIED NUMBER OF HALFSTREETS CARRYING RUNOFF = 1  
STREET PARKWAY CROSSFALL(DECIMAL) = 0.020  
Manning's FRICTION FACTOR for Streetflow Section(curbs-to-curbs) = 0.0150  
Manning's FRICTION FACTOR for Back-of-Walk Flow Section = 0.0200

\*\*TRAVEL TIME COMPUTED USING ESTIMATED FLOW(CFS) = 43.21

\*\*\*STREET FLOW SPLITS OVER STREET-CROWN\*\*\*

FULL DEPTH(FEET) = 0.70 FLOOD WIDTH(FEET) = 31.58

FULL HALF-STREET VELOCITY(FEET/SEC.) = 3.41

SPLIT DEPTH(FEET) = 0.58 SPLIT FLOOD WIDTH(FEET) = 23.55

SPLIT FLOW(CFS) = 15.05 SPLIT VELOCITY(FEET/SEC.) = 2.92

STREETFLOW MODEL RESULTS USING ESTIMATED FLOW:

STREET FLOW DEPTH(FEET) = 0.70

HALFSTREET FLOOD WIDTH(FEET) = 31.58

AVERAGE FLOW VELOCITY(FEET/SEC.) = 3.41

PRODUCT OF DEPTH&VELOCITY(FT\*FT/SEC.) = 2.38

STREET FLOW TRAVEL TIME(MIN.) = 2.13 Tc(MIN.) = 8.41

10 YEAR RAINFALL INTENSITY(INCH/HOUR) = 2.826

\*USER SPECIFIED(SUBAREA):

USER-SPECIFIED RUNOFF COEFFICIENT = .8200

S.C.S. CURVE NUMBER (AMC II) = 0

AREA-AVERAGE RUNOFF COEFFICIENT = 0.820

SUBAREA AREA(ACRES) = 10.50 SUBAREA RUNOFF(CFS) = 24.33

TOTAL AREA(ACRES) = 21.6 PEAK FLOW RATE(CFS) = 50.06

END OF SUBAREA STREET FLOW HYDRAULICS:

DEPTH(FEET) = 0.70 HALFSTREET FLOOD WIDTH(FEET) = 31.58

FLOW VELOCITY(FEET/SEC.) = 3.41 DEPTH\*VELOCITY(FT\*FT/SEC.) = 2.38

\*NOTE: INITIAL SUBAREA NOMOGRAPH WITH SUBAREA PARAMETERS,

AND L = 435.0 FT WITH ELEVATION-DROP = 3.0 FT, IS 34.0 CFS,

WHICH EXCEEDS THE TOP-OF-CURB STREET CAPACITY AT NODE 3100.00

LONGEST FLOWPATH FROM NODE 3400.00 TO NODE 3100.00 = 1455.00 FEET.

\*\*\*\*\*



FLOW PROCESS FROM NODE 3100.00 TO NODE 3000.00 IS CODE = 41

-----  
>>>>COMPUTE PIPE-FLOW TRAVEL TIME THRU SUBAREA<<<<<  
>>>>USING USER-SPECIFIED PIPESIZE (EXISTING ELEMENT)<<<<<

=====

ELEVATION DATA: UPSTREAM(FEET) = 348.00 DOWNSTREAM(FEET) = 301.00  
FLOW LENGTH(FEET) = 316.00 MANNING'S N = 0.013  
DEPTH OF FLOW IN 42.0 INCH PIPE IS 10.3 INCHES  
PIPE-FLOW VELOCITY(FEET/SEC.) = 27.27  
GIVEN PIPE DIAMETER(INCH) = 42.00 NUMBER OF PIPES = 1  
PIPE-FLOW(CFS) = 50.06  
PIPE TRAVEL TIME(MIN.) = 0.19 Tc(MIN.) = 8.60  
LONGEST FLOWPATH FROM NODE 3400.00 TO NODE 3000.00 = 1771.00 FEET.

\*\*\*\*\*

FLOW PROCESS FROM NODE 3000.00 TO NODE 3000.00 IS CODE = 1

-----  
>>>>DESIGNATE INDEPENDENT STREAM FOR CONFLUENCE<<<<<

=====

TOTAL NUMBER OF STREAMS = 3  
CONFLUENCE VALUES USED FOR INDEPENDENT STREAM 1 ARE:  
TIME OF CONCENTRATION(MIN.) = 8.60  
RAINFALL INTENSITY(INCH/HR) = 2.79  
TOTAL STREAM AREA(ACRES) = 21.60  
PEAK FLOW RATE(CFS) AT CONFLUENCE = 50.06

+-----+  
| Confluence ON-Site with Off-Site |  
| Refer to On-Site AES at Node 110 |  
+-----+

\*\*\*\*\*

FLOW PROCESS FROM NODE 110.00 TO NODE 3000.00 IS CODE = 7

-----  
>>>>USER SPECIFIED HYDROLOGY INFORMATION AT NODE<<<<<

=====

USER-SPECIFIED VALUES ARE AS FOLLOWS:  
TC(MIN) = 9.96 RAIN INTENSITY(INCH/HOUR) = 2.53  
TOTAL AREA(ACRES) = 2.13 TOTAL RUNOFF(CFS) = 2.86

\*\*\*\*\*

FLOW PROCESS FROM NODE 3000.00 TO NODE 3000.00 IS CODE = 1

-----  
>>>>DESIGNATE INDEPENDENT STREAM FOR CONFLUENCE<<<<<

=====

TOTAL NUMBER OF STREAMS = 3  
CONFLUENCE VALUES USED FOR INDEPENDENT STREAM 2 ARE:  
TIME OF CONCENTRATION(MIN.) = 9.96  
RAINFALL INTENSITY(INCH/HR) = 2.53

TOTAL STREAM AREA(ACRES) = 2.13  
PEAK FLOW RATE(CFS) AT CONFLUENCE = 2.86

```
+-----+
| Confluence ON-Site with Off-site
| Refer to On-site AES at Node 210
|-----+
```

\*\*\*\*\*  
FLOW PROCESS FROM NODE 210.00 TO NODE 3000.00 IS CODE = 7

>>>>USER SPECIFIED HYDROLOGY INFORMATION AT NODE<<<<<

=====

USER-SPECIFIED VALUES ARE AS FOLLOWS:

TC(MIN) = 13.14 RAIN INTENSITY(INCH/HOUR) = 2.12  
TOTAL AREA(ACRES) = 1.56 TOTAL RUNOFF(CFS) = 1.75

\*\*\*\*\*  
FLOW PROCESS FROM NODE 3000.00 TO NODE 3000.00 IS CODE = 1

>>>>DESIGNATE INDEPENDENT STREAM FOR CONFLUENCE<<<<<  
>>>>AND COMPUTE VARIOUS CONFLUENCED STREAM VALUES<<<<<

=====

TOTAL NUMBER OF STREAMS = 3  
CONFLUENCE VALUES USED FOR INDEPENDENT STREAM 3 ARE:  
TIME OF CONCENTRATION(MIN.) = 13.14  
RAINFALL INTENSITY(INCH/HR) = 2.12  
TOTAL STREAM AREA(ACRES) = 1.56  
PEAK FLOW RATE(CFS) AT CONFLUENCE = 1.75

\*\* CONFLUENCE DATA \*\*

STREAM NUMBER	RUNOFF (CFS)	Tc (MIN.)	INTENSITY (INCH/HOUR)	AREA (ACRE)
1	50.06	8.60	2.785	21.60
2	2.86	9.96	2.534	2.13
3	1.75	13.14	2.119	1.56

RAINFALL INTENSITY AND TIME OF CONCENTRATION RATIO  
CONFLUENCE FORMULA USED FOR 3 STREAMS.

\*\* PEAK FLOW RATE TABLE \*\*

STREAM NUMBER	RUNOFF (CFS)	Tc (MIN.)	INTENSITY (INCH/HOUR)
1	53.67	8.60	2.785
2	49.73	9.96	2.534
3	42.23	13.14	2.119

COMPUTED CONFLUENCE ESTIMATES ARE AS FOLLOWS:

PEAK FLOW RATE(CFS) = 53.67 Tc(MIN.) = 8.60

TOTAL AREA(ACRES) = 25.3  
LONGEST FLOWPATH FROM NODE 3400.00 TO NODE 3000.00 = 1771.00 FEET.

```
+-----+
| Add Area from New Mid-Coast Trolley
| A = 0.88
|-----+
```

\*\*\*\*\*  
FLOW PROCESS FROM NODE 3000.00 TO NODE 3000.00 IS CODE = 81

>>>>ADDITION OF SUBAREA TO MAINLINE PEAK FLOW<<<<<

```
=====
10 YEAR RAINFALL INTENSITY(INCH/HOUR) = 2.785
*USER SPECIFIED(SUBAREA):
USER-SPECIFIED RUNOFF COEFFICIENT = .9000
S.C.S. CURVE NUMBER (AMC II) = 0
AREA-AVERAGE RUNOFF COEFFICIENT = 0.7818
SUBAREA AREA(ACRES) = 0.88 SUBAREA RUNOFF(CFS) = 2.21
TOTAL AREA(ACRES) = 26.2 TOTAL RUNOFF(CFS) = 56.98
TC(MIN.) = 8.60
```

```
+-----+
| Add area: OSP Regional Basin
|-----+
```

\*\*\*\*\*  
FLOW PROCESS FROM NODE 3000.00 TO NODE 3000.00 IS CODE = 81

>>>>ADDITION OF SUBAREA TO MAINLINE PEAK FLOW<<<<<

```
=====
10 YEAR RAINFALL INTENSITY(INCH/HOUR) = 2.785
*USER SPECIFIED(SUBAREA):
USER-SPECIFIED RUNOFF COEFFICIENT = .4200
S.C.S. CURVE NUMBER (AMC II) = 0
AREA-AVERAGE RUNOFF COEFFICIENT = 0.7137
SUBAREA AREA(ACRES) = 6.06 SUBAREA RUNOFF(CFS) = 7.09
TOTAL AREA(ACRES) = 32.2 TOTAL RUNOFF(CFS) = 64.07
TC(MIN.) = 8.60
```

\*\*\*\*\*  
FLOW PROCESS FROM NODE 3000.00 TO NODE 1000.00 IS CODE = 11

>>>>CONFLUENCE MEMORY BANK # 1 WITH THE MAIN-STREAM MEMORY<<<<<

=====  
\*\* MAIN STREAM CONFLUENCE DATA \*\*

STREAM NUMBER	RUNOFF (CFS)	Tc (MIN.)	INTENSITY (INCH/HOUR)	AREA (ACRE)
1	64.07	8.60	2.785	32.23

LONGEST FLOWPATH FROM NODE 3400.00 TO NODE 1000.00 = 1771.00 FEET.

\*\* MEMORY BANK # 1 CONFLUENCE DATA \*\*

STREAM NUMBER	RUNOFF (CFS)	Tc (MIN.)	INTENSITY (INCH/HOUR)	AREA (ACRE)
1	69.42	9.35	2.640	31.23

LONGEST FLOWPATH FROM NODE 1500.00 TO NODE 1000.00 = 2340.00 FEET.

\*\* PEAK FLOW RATE TABLE \*\*

STREAM NUMBER	RUNOFF (CFS)	Tc (MIN.)	INTENSITY (INCH/HOUR)
1	127.94	8.60	2.785
2	130.14	9.35	2.640

COMPUTED CONFLUENCE ESTIMATES ARE AS FOLLOWS:

PEAK FLOW RATE(CFS) = 130.14 Tc(MIN.) = 9.35  
TOTAL AREA(ACRES) = 63.5

=====

END OF STUDY SUMMARY:

TOTAL AREA(ACRES) = 63.5 TC(MIN.) = 9.35  
PEAK FLOW RATE(CFS) = 130.14

=====

=====

END OF RATIONAL METHOD ANALYSIS



# 100-YR Proposed

\*\*\*\*\*

RATIONAL METHOD HYDROLOGY COMPUTER PROGRAM PACKAGE  
Reference: SAN DIEGO COUNTY FLOOD CONTROL DISTRICT  
2003,1985,1981 HYDROLOGY MANUAL  
(c) Copyright 1982-2016 Advanced Engineering Software (aes)  
Ver. 23.0 Release Date: 07/01/2016 License ID 1264

Analysis prepared by:

\*\*\*\*\* DESCRIPTION OF STUDY \*\*\*\*\*

\* Regional Basin \*  
\* Proposed Condition \*  
\* 100 Year \*  
\*\*\*\*\*

FILE NAME: C:\100PR\RBPR100.DAT  
TIME/DATE OF STUDY: 14:28 04/23/2021

-----  
USER SPECIFIED HYDROLOGY AND HYDRAULIC MODEL INFORMATION:  
-----

2003 SAN DIEGO MANUAL CRITERIA

USER SPECIFIED STORM EVENT(YEAR) = 100.00  
6-HOUR DURATION PRECIPITATION (INCHES) = 2.250  
SPECIFIED MINIMUM PIPE SIZE(INCH) = 18.00  
SPECIFIED PERCENT OF GRADIENTS(DECIMAL) TO USE FOR FRICTION SLOPE = 0.95  
SAN DIEGO HYDROLOGY MANUAL "C"-VALUES USED FOR RATIONAL METHOD  
NOTE: USE MODIFIED RATIONAL METHOD PROCEDURES FOR CONFLUENCE ANALYSIS

\*USER-DEFINED STREET-SECTIONS FOR COUPLED PIPEFLOW AND STREETFLOW MODEL\*

NO.	HALF- WIDTH (FT)	CROWN TO CROSSFALL (FT)	STREET-CROSSFALL: IN- / OUT-/ SIDE / SIDE/ WAY	CURB HEIGHT (FT)	GUTTER-GEOMETRIES: WIDTH LIP (FT) (FT)	HIKE (FT)	MANNING FACTOR (n)
1	30.0	20.0	0.018/0.018/0.020	0.67	2.00 0.0313	0.167	0.0150

GLOBAL STREET FLOW-DEPTH CONSTRAINTS:

1. Relative Flow-Depth = 0.00 FEET  
as (Maximum Allowable Street Flow Depth) - (Top-of-Curb)
2. (Depth)\*(Velocity) Constraint = 6.0 (FT\*FT/S)

\*SIZE PIPE WITH A FLOW CAPACITY GREATER THAN  
OR EQUAL TO THE UPSTREAM TRIBUTARY PIPE.\*

-----+

| Begin Southerly Off-Site analysis  
| Tributary Area to OSP Regional Basin  
|

+-----+

\*\*\*\*\*

FLOW PROCESS FROM NODE 1500.00 TO NODE 1400.00 IS CODE = 21

-----

>>>>RATIONAL METHOD INITIAL SUBAREA ANALYSIS<<<<<

=====

\*USER SPECIFIED(SUBAREA):

USER-SPECIFIED RUNOFF COEFFICIENT = .8200

S.C.S. CURVE NUMBER (AMC II) = 0

INITIAL SUBAREA FLOW-LENGTH(FEET) = 100.00

UPSTREAM ELEVATION(FEET) = 388.00

DOWNSTREAM ELEVATION(FEET) = 386.00

ELEVATION DIFFERENCE(FEET) = 2.00

SUBAREA OVERLAND TIME OF FLOW(MIN.) = 3.464

WARNING: INITIAL SUBAREA FLOW PATH LENGTH IS GREATER THAN

THE MAXIMUM OVERLAND FLOW LENGTH = 75.00

(Reference: Table 3-1B of Hydrology Manual)

THE MAXIMUM OVERLAND FLOW LENGTH IS USED IN Tc CALCULATION!

100 YEAR RAINFALL INTENSITY(INCH/HOUR) = 5.928

NOTE: RAINFALL INTENSITY IS BASED ON Tc = 5-MINUTE.

SUBAREA RUNOFF(CFS) = 0.87

TOTAL AREA(ACRES) = 0.18 TOTAL RUNOFF(CFS) = 0.87

\*\*\*\*\*

FLOW PROCESS FROM NODE 1400.00 TO NODE 1300.00 IS CODE = 62

-----

>>>>COMPUTE STREET FLOW TRAVEL TIME THRU SUBAREA<<<<<

>>>>(STREET TABLE SECTION # 1 USED)<<<<<

=====

UPSTREAM ELEVATION(FEET) = 386.00 DOWNSTREAM ELEVATION(FEET) = 376.00

STREET LENGTH(FEET) = 520.00 CURB HEIGHT(INCHES) = 8.0

STREET HALFWIDTH(FEET) = 30.00

DISTANCE FROM CROWN TO CROSSFALL GRADEBREAK(FEET) = 20.00

INSIDE STREET CROSSFALL(DECIMAL) = 0.018

OUTSIDE STREET CROSSFALL(DECIMAL) = 0.018

SPECIFIED NUMBER OF HALFSTREETS CARRYING RUNOFF = 2

STREET PARKWAY CROSSFALL(DECIMAL) = 0.020

Manning's FRICTION FACTOR for Streetflow Section(curbs-to-curbs) = 0.0150

Manning's FRICTION FACTOR for Back-of-Walk Flow Section = 0.0200

\*\*TRAVEL TIME COMPUTED USING ESTIMATED FLOW(CFS) = 15.97

STREETFLOW MODEL RESULTS USING ESTIMATED FLOW:

STREET FLOW DEPTH(FEET) = 0.43

HALFSTREET FLOOD WIDTH(FEET) = 14.80

AVERAGE FLOW VELOCITY(FEET/SEC.) = 3.71  
PRODUCT OF DEPTH&VELOCITY(FT\*FT/SEC.) = 1.59  
STREET FLOW TRAVEL TIME(MIN.) = 2.33 Tc(MIN.) = 5.80  
100 YEAR RAINFALL INTENSITY(INCH/HOUR) = 5.388

\*USER SPECIFIED(SUBAREA):

USER-SPECIFIED RUNOFF COEFFICIENT = .8200  
S.C.S. CURVE NUMBER (AMC II) = 0  
AREA-AVERAGE RUNOFF COEFFICIENT = 0.820  
SUBAREA AREA(ACRES) = 6.80 SUBAREA RUNOFF(CFS) = 30.04  
TOTAL AREA(ACRES) = 7.0 PEAK FLOW RATE(CFS) = 30.84

END OF SUBAREA STREET FLOW HYDRAULICS:

DEPTH(FEET) = 0.51 HALFSTREET FLOOD WIDTH(FEET) = 19.41  
FLOW VELOCITY(FEET/SEC.) = 4.33 DEPTH\*VELOCITY(FT\*FT/SEC.) = 2.21  
LONGEST FLOWPATH FROM NODE 1500.00 TO NODE 1300.00 = 620.00 FEET.

\*\*\*\*\*

FLOW PROCESS FROM NODE 1300.00 TO NODE 1200.00 IS CODE = 62

-----  
>>>>COMPUTE STREET FLOW TRAVEL TIME THRU SUBAREA<<<<<

>>>>(STREET TABLE SECTION # 1 USED)<<<<<

=====

UPSTREAM ELEVATION(FEET) = 376.00 DOWNSTREAM ELEVATION(FEET) = 362.00  
STREET LENGTH(FEET) = 440.00 CURB HEIGHT(INCHES) = 8.0  
STREET HALFWIDTH(FEET) = 30.00

DISTANCE FROM CROWN TO CROSSFALL GRADEBREAK(FEET) = 20.00

INSIDE STREET CROSSFALL(DECIMAL) = 0.018

OUTSIDE STREET CROSSFALL(DECIMAL) = 0.018

SPECIFIED NUMBER OF HALFSTREETS CARRYING RUNOFF = 2

STREET PARKWAY CROSSFALL(DECIMAL) = 0.020

Manning's FRICTION FACTOR for Streetflow Section(curbs-to-curbs) = 0.0150

Manning's FRICTION FACTOR for Back-of-Walk Flow Section = 0.0200

\*\*TRAVEL TIME COMPUTED USING ESTIMATED FLOW(CFS) = 39.17

STREETFLOW MODEL RESULTS USING ESTIMATED FLOW:

STREET FLOW DEPTH(FEET) = 0.51

HALFSTREET FLOOD WIDTH(FEET) = 19.26

AVERAGE FLOW VELOCITY(FEET/SEC.) = 5.59

PRODUCT OF DEPTH&VELOCITY(FT\*FT/SEC.) = 2.83

STREET FLOW TRAVEL TIME(MIN.) = 1.31 Tc(MIN.) = 7.11

100 YEAR RAINFALL INTENSITY(INCH/HOUR) = 4.723

\*USER SPECIFIED(SUBAREA):

USER-SPECIFIED RUNOFF COEFFICIENT = .8200

S.C.S. CURVE NUMBER (AMC II) = 0

AREA-AVERAGE RUNOFF COEFFICIENT = 0.820

SUBAREA AREA(ACRES) = 4.30 SUBAREA RUNOFF(CFS) = 16.65

TOTAL AREA(ACRES) = 11.3 PEAK FLOW RATE(CFS) = 43.69

END OF SUBAREA STREET FLOW HYDRAULICS:

DEPTH(FEET) = 0.52 HALFSTREET FLOOD WIDTH(FEET) = 20.12  
FLOW VELOCITY(FEET/SEC.) = 5.74 DEPTH\*VELOCITY(FT\*FT/SEC.) = 2.99  
LONGEST FLOWPATH FROM NODE 1500.00 TO NODE 1200.00 = 1060.00 FEET.

\*\*\*\*\*

FLOW PROCESS FROM NODE 1200.00 TO NODE 1100.00 IS CODE = 41

-----  
>>>>COMPUTE PIPE-FLOW TRAVEL TIME THRU SUBAREA<<<<<  
>>>>USING USER-SPECIFIED PIPESIZE (EXISTING ELEMENT)<<<<<

=====

ELEVATION DATA: UPSTREAM(FEET) = 362.00 DOWNSTREAM(FEET) = 339.00  
FLOW LENGTH(FEET) = 860.00 MANNING'S N = 0.013  
DEPTH OF FLOW IN 30.0 INCH PIPE IS 17.9 INCHES  
PIPE-FLOW VELOCITY(FEET/SEC.) = 14.27  
GIVEN PIPE DIAMETER(INCH) = 30.00 NUMBER OF PIPES = 1  
PIPE-FLOW(CFS) = 43.69  
PIPE TRAVEL TIME(MIN.) = 1.00 Tc(MIN.) = 8.12  
LONGEST FLOWPATH FROM NODE 1500.00 TO NODE 1100.00 = 1920.00 FEET.

\*\*\*\*\*

FLOW PROCESS FROM NODE 1100.00 TO NODE 1100.00 IS CODE = 81

-----  
>>>>ADDITION OF SUBAREA TO MAINLINE PEAK FLOW<<<<<

=====

100 YEAR RAINFALL INTENSITY(INCH/HOUR) = 4.337  
\*USER SPECIFIED(SUBAREA):  
USER-SPECIFIED RUNOFF COEFFICIENT = .8200  
S.C.S. CURVE NUMBER (AMC II) = 0  
AREA-AVERAGE RUNOFF COEFFICIENT = 0.8200  
SUBAREA AREA(ACRES) = 8.00 SUBAREA RUNOFF(CFS) = 28.45  
TOTAL AREA(ACRES) = 19.3 TOTAL RUNOFF(CFS) = 68.57  
TC(MIN.) = 8.12

\*\*\*\*\*

FLOW PROCESS FROM NODE 1105.00 TO NODE 1100.00 IS CODE = 81

-----  
>>>>ADDITION OF SUBAREA TO MAINLINE PEAK FLOW<<<<<

=====

100 YEAR RAINFALL INTENSITY(INCH/HOUR) = 4.337  
\*USER SPECIFIED(SUBAREA):  
USER-SPECIFIED RUNOFF COEFFICIENT = .8200  
S.C.S. CURVE NUMBER (AMC II) = 0  
AREA-AVERAGE RUNOFF COEFFICIENT = 0.8200  
SUBAREA AREA(ACRES) = 9.10 SUBAREA RUNOFF(CFS) = 32.37  
TOTAL AREA(ACRES) = 28.4 TOTAL RUNOFF(CFS) = 100.94  
TC(MIN.) = 8.12

\*\*\*\*\*

FLOW PROCESS FROM NODE 1100.00 TO NODE 1000.00 IS CODE = 41



-----  
>>>>COMPUTE PIPE-FLOW TRAVEL TIME THRU SUBAREA<<<<<  
>>>>USING USER-SPECIFIED PIPESIZE (EXISTING ELEMENT)<<<<<

=====

ELEVATION DATA: UPSTREAM(FEET) = 339.00 DOWNSTREAM(FEET) = 336.00  
FLOW LENGTH(FEET) = 420.00 MANNING'S N = 0.013  
ASSUME FULL-FLOWING PIPELINE  
PIPE-FLOW VELOCITY(FEET/SEC.) = 10.49  
PIPE FLOW VELOCITY = (TOTAL FLOW)/(PIPE CROSS SECTION AREA)  
GIVEN PIPE DIAMETER(INCH) = 42.00 NUMBER OF PIPES = 1  
PIPE-FLOW(CFS) = 100.94  
PIPE TRAVEL TIME(MIN.) = 0.67 Tc(MIN.) = 8.78  
LONGEST FLOWPATH FROM NODE 1500.00 TO NODE 1000.00 = 2340.00 FEET.

\*\*\*\*\*  
FLOW PROCESS FROM NODE 1000.00 TO NODE 1000.00 IS CODE = 1

-----  
>>>>DESIGNATE INDEPENDENT STREAM FOR CONFLUENCE<<<<<

=====

TOTAL NUMBER OF STREAMS = 2  
CONFLUENCE VALUES USED FOR INDEPENDENT STREAM 1 ARE:  
TIME OF CONCENTRATION(MIN.) = 8.78  
RAINFALL INTENSITY(INCH/HR) = 4.12  
TOTAL STREAM AREA(ACRES) = 28.38  
PEAK FLOW RATE(CFS) AT CONFLUENCE = 100.94

+-----+  
| Confluence ON-Site with Off-site |  
| Refer to On-site AES at Node 310 |  
+-----+

\*\*\*\*\*  
FLOW PROCESS FROM NODE 310.00 TO NODE 1000.00 IS CODE = 7

-----  
>>>>USER SPECIFIED HYDROLOGY INFORMATION AT NODE<<<<<

=====

USER-SPECIFIED VALUES ARE AS FOLLOWS:  
TC(MIN) = 7.76 RAIN INTENSITY(INCH/HOUR) = 4.46  
TOTAL AREA(ACRES) = 2.85 TOTAL RUNOFF(CFS) = 7.89

\*\*\*\*\*  
FLOW PROCESS FROM NODE 1000.00 TO NODE 1000.00 IS CODE = 1

-----  
>>>>DESIGNATE INDEPENDENT STREAM FOR CONFLUENCE<<<<<  
>>>>AND COMPUTE VARIOUS CONFLUENCED STREAM VALUES<<<<<

=====

TOTAL NUMBER OF STREAMS = 2  
CONFLUENCE VALUES USED FOR INDEPENDENT STREAM 2 ARE:  
TIME OF CONCENTRATION(MIN.) = 7.76

RAINFALL INTENSITY(INCH/HR) = 4.46  
 TOTAL STREAM AREA(ACRES) = 2.85  
 PEAK FLOW RATE(CFS) AT CONFLUENCE = 7.89

\*\* CONFLUENCE DATA \*\*

STREAM NUMBER	RUNOFF (CFS)	Tc (MIN.)	INTENSITY (INCH/HOUR)	AREA (ACRE)
1	100.94	8.78	4.122	28.38
2	7.89	7.76	4.465	2.85

RAINFALL INTENSITY AND TIME OF CONCENTRATION RATIO  
 CONFLUENCE FORMULA USED FOR 2 STREAMS.

\*\* PEAK FLOW RATE TABLE \*\*

STREAM NUMBER	RUNOFF (CFS)	Tc (MIN.)	INTENSITY (INCH/HOUR)
1	97.07	7.76	4.465
2	108.22	8.78	4.122

COMPUTED CONFLUENCE ESTIMATES ARE AS FOLLOWS:

PEAK FLOW RATE(CFS) = 108.22 Tc(MIN.) = 8.78  
 TOTAL AREA(ACRES) = 31.2  
 LONGEST FLOWPATH FROM NODE 1500.00 TO NODE 1000.00 = 2340.00 FEET.

\*\*\*\*\*  
 FLOW PROCESS FROM NODE 1000.00 TO NODE 1000.00 IS CODE = 10

-----  
 >>>>MAIN-STREAM MEMORY COPIED ONTO MEMORY BANK # 1 <<<<<  
 =====

\*\*\*\*\*  
 FLOW PROCESS FROM NODE 1000.00 TO NODE 1000.00 IS CODE = 13

-----  
 >>>>CLEAR THE MAIN-STREAM MEMORY<<<<<  
 =====

+-----+  
 | Begin Northerly Off-Site Analysis |  
 | Tributary Area to OSP Regional Basin |  
 | |  
 +-----+

\*\*\*\*\*  
 FLOW PROCESS FROM NODE 3400.00 TO NODE 3300.00 IS CODE = 21

-----  
 >>>>RATIONAL METHOD INITIAL SUBAREA ANALYSIS<<<<<  
 =====

\*USER SPECIFIED(SUBAREA):  
 USER-SPECIFIED RUNOFF COEFFICIENT = .8200  
 S.C.S. CURVE NUMBER (AMC II) = 0

INITIAL SUBAREA FLOW-LENGTH(FEET) = 100.00  
 UPSTREAM ELEVATION(FEET) = 376.00  
 DOWNSTREAM ELEVATION(FEET) = 372.00  
 ELEVATION DIFFERENCE(FEET) = 4.00  
 SUBAREA OVERLAND TIME OF FLOW(MIN.) = 3.012  
 WARNING: INITIAL SUBAREA FLOW PATH LENGTH IS GREATER THAN  
           THE MAXIMUM OVERLAND FLOW LENGTH = 90.00  
           (Reference: Table 3-1B of Hydrology Manual)  
           THE MAXIMUM OVERLAND FLOW LENGTH IS USED IN Tc CALCULATION!  
 100 YEAR RAINFALL INTENSITY(INCH/HOUR) = 5.928  
 NOTE: RAINFALL INTENSITY IS BASED ON Tc = 5-MINUTE.  
 SUBAREA RUNOFF(CFS) = 0.97  
 TOTAL AREA(ACRES) = 0.20    TOTAL RUNOFF(CFS) = 0.97

\*\*\*\*\*

FLOW PROCESS FROM NODE 3300.00 TO NODE 3200.00 IS CODE = 62

>>>>COMPUTE STREET FLOW TRAVEL TIME THRU SUBAREA<<<<<  
 >>>>(STREET TABLE SECTION # 1 USED)<<<<<

UPSTREAM ELEVATION(FEET) = 372.00    DOWNSTREAM ELEVATION(FEET) = 351.00  
 STREET LENGTH(FEET) = 920.00    CURB HEIGHT(INCHES) = 8.0  
 STREET HALFWIDTH(FEET) = 30.00

DISTANCE FROM CROWN TO CROSSFALL GRADEBREAK(FEET) = 20.00  
 INSIDE STREET CROSSFALL(DECIMAL) = 0.018  
 OUTSIDE STREET CROSSFALL(DECIMAL) = 0.018

SPECIFIED NUMBER OF HALFSTREETS CARRYING RUNOFF = 1  
 STREET PARKWAY CROSSFALL(DECIMAL) = 0.020  
 Manning's FRICTION FACTOR for Streetflow Section(curbs-to-curbs) = 0.0150  
 Manning's FRICTION FACTOR for Back-of-Walk Flow Section = 0.0200

\*\*TRAVEL TIME COMPUTED USING ESTIMATED FLOW(CFS) = 24.82  
 STREETFLOW MODEL RESULTS USING ESTIMATED FLOW:  
 STREET FLOW DEPTH(FEET) = 0.57  
 HALFSTREET FLOOD WIDTH(FEET) = 22.62  
 AVERAGE FLOW VELOCITY(FEET/SEC.) = 5.21  
 PRODUCT OF DEPTH&VELOCITY(FT\*FT/SEC.) = 2.95  
 STREET FLOW TRAVEL TIME(MIN.) = 2.94    Tc(MIN.) = 5.95  
 100 YEAR RAINFALL INTENSITY(INCH/HOUR) = 5.297

\*USER SPECIFIED(SUBAREA):  
 USER-SPECIFIED RUNOFF COEFFICIENT = .8200  
 S.C.S. CURVE NUMBER (AMC II) = 0  
 AREA-AVERAGE RUNOFF COEFFICIENT = 0.820  
 SUBAREA AREA(ACRES) = 10.90    SUBAREA RUNOFF(CFS) = 47.34  
 TOTAL AREA(ACRES) = 11.1    PEAK FLOW RATE(CFS) = 48.21

END OF SUBAREA STREET FLOW HYDRAULICS:  
 DEPTH(FEET) = 0.69    HALFSTREET FLOOD WIDTH(FEET) = 30.33

FLOW VELOCITY(FEET/SEC.) = 6.11 DEPTH\*VELOCITY(FT\*FT/SEC.) = 4.20  
\*NOTE: INITIAL SUBAREA NOMOGRAPH WITH SUBAREA PARAMETERS,  
AND L = 920.0 FT WITH ELEVATION-DROP = 21.0 FT, IS 53.0 CFS,  
WHICH EXCEEDS THE TOP-OF-CURB STREET CAPACITY AT NODE 3200.00  
LONGEST FLOWPATH FROM NODE 3400.00 TO NODE 3200.00 = 1020.00 FEET.

\*\*\*\*\*

FLOW PROCESS FROM NODE 3200.00 TO NODE 3100.00 IS CODE = 62

-----  
>>>>COMPUTE STREET FLOW TRAVEL TIME THRU SUBAREA<<<<<

>>>>(STREET TABLE SECTION # 1 USED)<<<<<

=====

UPSTREAM ELEVATION(FEET) = 351.00 DOWNSTREAM ELEVATION(FEET) = 348.00  
STREET LENGTH(FEET) = 435.00 CURB HEIGHT(INCHES) = 8.0  
STREET HALFWIDTH(FEET) = 30.00

DISTANCE FROM CROWN TO CROSSFALL GRADEBREAK(FEET) = 20.00  
INSIDE STREET CROSSFALL(DECIMAL) = 0.018  
OUTSIDE STREET CROSSFALL(DECIMAL) = 0.018

SPECIFIED NUMBER OF HALFSTREETS CARRYING RUNOFF = 1  
STREET PARKWAY CROSSFALL(DECIMAL) = 0.020  
Manning's FRICTION FACTOR for Streetflow Section(curbs-to-curbs) = 0.0150  
Manning's FRICTION FACTOR for Back-of-Walk Flow Section = 0.0200

\*\*TRAVEL TIME COMPUTED USING ESTIMATED FLOW(CFS) = 67.19

\*\*\*STREET FLOWING FULL\*\*\*

STREETFLOW MODEL RESULTS USING ESTIMATED FLOW:  
STREET FLOW DEPTH(FEET) = 0.73  
HALFSTREET FLOOD WIDTH(FEET) = 33.08  
AVERAGE FLOW VELOCITY(FEET/SEC.) = 3.64  
PRODUCT OF DEPTH&VELOCITY(FT\*FT/SEC.) = 2.65  
STREET FLOW TRAVEL TIME(MIN.) = 1.99 Tc(MIN.) = 7.94  
100 YEAR RAINFALL INTENSITY(INCH/HOUR) = 4.398

\*USER SPECIFIED(SUBAREA):

USER-SPECIFIED RUNOFF COEFFICIENT = .8200  
S.C.S. CURVE NUMBER (AMC II) = 0  
AREA-AVERAGE RUNOFF COEFFICIENT = 0.820  
SUBAREA AREA(ACRES) = 10.50 SUBAREA RUNOFF(CFS) = 37.86  
TOTAL AREA(ACRES) = 21.6 PEAK FLOW RATE(CFS) = 77.89

END OF SUBAREA STREET FLOW HYDRAULICS:

DEPTH(FEET) = 0.76 HALFSTREET FLOOD WIDTH(FEET) = 34.48  
FLOW VELOCITY(FEET/SEC.) = 3.83 DEPTH\*VELOCITY(FT\*FT/SEC.) = 2.90

\*NOTE: INITIAL SUBAREA NOMOGRAPH WITH SUBAREA PARAMETERS,  
AND L = 435.0 FT WITH ELEVATION-DROP = 3.0 FT, IS 51.0 CFS,  
WHICH EXCEEDS THE TOP-OF-CURB STREET CAPACITY AT NODE 3100.00  
LONGEST FLOWPATH FROM NODE 3400.00 TO NODE 3100.00 = 1455.00 FEET.

\*\*\*\*\*

FLOW PROCESS FROM NODE 3100.00 TO NODE 3000.00 IS CODE = 41

>>>>COMPUTE PIPE-FLOW TRAVEL TIME THRU SUBAREA<<<<<  
>>>>USING USER-SPECIFIED PIPESIZE (EXISTING ELEMENT)<<<<<

ELEVATION DATA: UPSTREAM(FEET) = 348.00 DOWNSTREAM(FEET) = 301.00  
FLOW LENGTH(FEET) = 316.00 MANNING'S N = 0.013  
DEPTH OF FLOW IN 42.0 INCH PIPE IS 12.9 INCHES  
PIPE-FLOW VELOCITY(FEET/SEC.) = 30.95  
GIVEN PIPE DIAMETER(INCH) = 42.00 NUMBER OF PIPES = 1  
PIPE-FLOW(CFS) = 77.89  
PIPE TRAVEL TIME(MIN.) = 0.17 Tc(MIN.) = 8.11  
LONGEST FLOWPATH FROM NODE 3400.00 TO NODE 3000.00 = 1771.00 FEET.

\*\*\*\*\*

FLOW PROCESS FROM NODE 3000.00 TO NODE 3000.00 IS CODE = 1

>>>>DESIGNATE INDEPENDENT STREAM FOR CONFLUENCE<<<<<

TOTAL NUMBER OF STREAMS = 3  
CONFLUENCE VALUES USED FOR INDEPENDENT STREAM 1 ARE:  
TIME OF CONCENTRATION(MIN.) = 8.11  
RAINFALL INTENSITY(INCH/HR) = 4.34  
TOTAL STREAM AREA(ACRES) = 21.60  
PEAK FLOW RATE(CFS) AT CONFLUENCE = 77.89

+-----+  
| Confluence ON-Site with Off-Site |  
| Refer to On-Site AES at Node 110 |  
+-----+

\*\*\*\*\*

FLOW PROCESS FROM NODE 110.00 TO NODE 3000.00 IS CODE = 7

>>>>USER SPECIFIED HYDROLOGY INFORMATION AT NODE<<<<<

USER-SPECIFIED VALUES ARE AS FOLLOWS:  
TC(MIN) = 9.71 RAIN INTENSITY(INCH/HOUR) = 3.86  
TOTAL AREA(ACRES) = 2.13 TOTAL RUNOFF(CFS) = 4.40

\*\*\*\*\*

FLOW PROCESS FROM NODE 3000.00 TO NODE 3000.00 IS CODE = 1

>>>>DESIGNATE INDEPENDENT STREAM FOR CONFLUENCE<<<<<

TOTAL NUMBER OF STREAMS = 3  
CONFLUENCE VALUES USED FOR INDEPENDENT STREAM 2 ARE:  
TIME OF CONCENTRATION(MIN.) = 9.71  
RAINFALL INTENSITY(INCH/HR) = 3.86

TOTAL STREAM AREA(ACRES) = 2.13  
PEAK FLOW RATE(CFS) AT CONFLUENCE = 4.40

```
+-----+
| Confluence ON-Site with Off-site
| Refer to On-site AES at Node 210
|
+-----+
```

\*\*\*\*\*  
FLOW PROCESS FROM NODE 210.00 TO NODE 3000.00 IS CODE = 7

>>>>USER SPECIFIED HYDROLOGY INFORMATION AT NODE<<<<<

=====

USER-SPECIFIED VALUES ARE AS FOLLOWS:

TC(MIN) = 11.75 RAIN INTENSITY(INCH/HOUR) = 3.42  
TOTAL AREA(ACRES) = 1.56 TOTAL RUNOFF(CFS) = 2.82

\*\*\*\*\*  
FLOW PROCESS FROM NODE 3000.00 TO NODE 3000.00 IS CODE = 1

>>>>DESIGNATE INDEPENDENT STREAM FOR CONFLUENCE<<<<<  
>>>>AND COMPUTE VARIOUS CONFLUENCED STREAM VALUES<<<<<

=====

TOTAL NUMBER OF STREAMS = 3  
CONFLUENCE VALUES USED FOR INDEPENDENT STREAM 3 ARE:  
TIME OF CONCENTRATION(MIN.) = 11.75  
RAINFALL INTENSITY(INCH/HR) = 3.42  
TOTAL STREAM AREA(ACRES) = 1.56  
PEAK FLOW RATE(CFS) AT CONFLUENCE = 2.82

\*\* CONFLUENCE DATA \*\*

STREAM NUMBER	RUNOFF (CFS)	Tc (MIN.)	INTENSITY (INCH/HOUR)	AREA (ACRE)
1	77.89	8.11	4.338	21.60
2	4.40	9.71	3.864	2.13
3	2.82	11.75	3.416	1.56

RAINFALL INTENSITY AND TIME OF CONCENTRATION RATIO  
CONFLUENCE FORMULA USED FOR 3 STREAMS.

\*\* PEAK FLOW RATE TABLE \*\*

STREAM NUMBER	RUNOFF (CFS)	Tc (MIN.)	INTENSITY (INCH/HOUR)
1	83.51	8.11	4.338
2	76.11	9.71	3.864
3	68.06	11.75	3.416

COMPUTED CONFLUENCE ESTIMATES ARE AS FOLLOWS:

PEAK FLOW RATE(CFS) = 83.51 Tc(MIN.) = 8.11

TOTAL AREA(ACRES) = 25.3  
LONGEST FLOWPATH FROM NODE 3400.00 TO NODE 3000.00 = 1771.00 FEET.

```
+-----+
| Add Area from New Mid-Coast Trolley
| A = 0.88
|-----+
```

\*\*\*\*\*  
FLOW PROCESS FROM NODE 3000.00 TO NODE 3000.00 IS CODE = 81

>>>>ADDITION OF SUBAREA TO MAINLINE PEAK FLOW<<<<<

```
=====
100 YEAR RAINFALL INTENSITY(INCH/HOUR) = 4.338
*USER SPECIFIED(SUBAREA):
USER-SPECIFIED RUNOFF COEFFICIENT = .9000
S.C.S. CURVE NUMBER (AMC II) = 0
AREA-AVERAGE RUNOFF COEFFICIENT = 0.7821
SUBAREA AREA(ACRES) = 0.88 SUBAREA RUNOFF(CFS) = 3.44
TOTAL AREA(ACRES) = 26.2 TOTAL RUNOFF(CFS) = 88.79
TC(MIN.) = 8.11
```

```
+-----+
| Add area: OSP Regional Basin
|-----+
```

\*\*\*\*\*  
FLOW PROCESS FROM NODE 3000.00 TO NODE 3000.00 IS CODE = 81

>>>>ADDITION OF SUBAREA TO MAINLINE PEAK FLOW<<<<<

```
=====
100 YEAR RAINFALL INTENSITY(INCH/HOUR) = 4.338
*USER SPECIFIED(SUBAREA):
USER-SPECIFIED RUNOFF COEFFICIENT = .4200
S.C.S. CURVE NUMBER (AMC II) = 0
AREA-AVERAGE RUNOFF COEFFICIENT = 0.7140
SUBAREA AREA(ACRES) = 6.06 SUBAREA RUNOFF(CFS) = 11.04
TOTAL AREA(ACRES) = 32.2 TOTAL RUNOFF(CFS) = 99.83
TC(MIN.) = 8.11
```

\*\*\*\*\*  
FLOW PROCESS FROM NODE 3000.00 TO NODE 1000.00 IS CODE = 11

>>>>CONFLUENCE MEMORY BANK # 1 WITH THE MAIN-STREAM MEMORY<<<<<

\*\*\*\*\*  
\*\* MAIN STREAM CONFLUENCE DATA \*\*

STREAM NUMBER	RUNOFF (CFS)	Tc (MIN.)	INTENSITY (INCH/HOUR)	AREA (ACRE)
1	99.83	8.11	4.338	32.23

LONGEST FLOWPATH FROM NODE 3400.00 TO NODE 1000.00 = 1771.00 FEET.

\*\* MEMORY BANK # 1 CONFLUENCE DATA \*\*

STREAM NUMBER	RUNOFF (CFS)	Tc (MIN.)	INTENSITY (INCH/HOUR)	AREA (ACRE)
1	108.22	8.78	4.122	31.23

LONGEST FLOWPATH FROM NODE 1500.00 TO NODE 1000.00 = 2340.00 FEET.

\*\* PEAK FLOW RATE TABLE \*\*

STREAM NUMBER	RUNOFF (CFS)	Tc (MIN.)	INTENSITY (INCH/HOUR)
1	199.81	8.11	4.338
2	203.08	8.78	4.122

COMPUTED CONFLUENCE ESTIMATES ARE AS FOLLOWS:

PEAK FLOW RATE(CFS) = 203.08 Tc(MIN.) = 8.78  
 TOTAL AREA(ACRES) = 63.5

=====

END OF STUDY SUMMARY:

TOTAL AREA(ACRES) = 63.5 TC(MIN.) = 8.78  
 PEAK FLOW RATE(CFS) = 203.08

=====

=====

END OF RATIONAL METHOD ANALYSIS





# Appendix D – Hydraulics

*RickHydro Inflow Hydrographs – Existing & Proposed*  
*Hydraflow Hydrographs Pond Reports – Existing & Proposed*  
*East Rim Trail Calculations*

RUN DATE 4/23/2021  
HYDROGRAPH FILE NAME Text1  
TIME OF CONCENTRATION 9 MIN.  
6 HOUR RAINFALL 1.5 INCHES  
BASIN AREA 63.5 ACRES  
RUNOFF COEFFICIENT 0.75  
PEAK DISCHARGE 129.82 CFS

# 10-YR Existing

TIME (MIN) = 0	DISCHARGE (CFS) = 0
TIME (MIN) = 9	DISCHARGE (CFS) = 0
TIME (MIN) = 18	DISCHARGE (CFS) = 4.3
TIME (MIN) = 27	DISCHARGE (CFS) = 4.4
TIME (MIN) = 36	DISCHARGE (CFS) = 4.6
TIME (MIN) = 45	DISCHARGE (CFS) = 4.7
TIME (MIN) = 54	DISCHARGE (CFS) = 4.8
TIME (MIN) = 63	DISCHARGE (CFS) = 4.9
TIME (MIN) = 72	DISCHARGE (CFS) = 5.2
TIME (MIN) = 81	DISCHARGE (CFS) = 5.3
TIME (MIN) = 90	DISCHARGE (CFS) = 5.5
TIME (MIN) = 99	DISCHARGE (CFS) = 5.7
TIME (MIN) = 108	DISCHARGE (CFS) = 6
TIME (MIN) = 117	DISCHARGE (CFS) = 6.1
TIME (MIN) = 126	DISCHARGE (CFS) = 6.5
TIME (MIN) = 135	DISCHARGE (CFS) = 6.7
TIME (MIN) = 144	DISCHARGE (CFS) = 7.2
TIME (MIN) = 153	DISCHARGE (CFS) = 7.5
TIME (MIN) = 162	DISCHARGE (CFS) = 8.2
TIME (MIN) = 171	DISCHARGE (CFS) = 8.5
TIME (MIN) = 180	DISCHARGE (CFS) = 9.5
TIME (MIN) = 189	DISCHARGE (CFS) = 10
TIME (MIN) = 198	DISCHARGE (CFS) = 11.5
TIME (MIN) = 207	DISCHARGE (CFS) = 12.5
TIME (MIN) = 216	DISCHARGE (CFS) = 15.3
TIME (MIN) = 225	DISCHARGE (CFS) = 17.4
TIME (MIN) = 234	DISCHARGE (CFS) = 25.5
TIME (MIN) = 243	DISCHARGE (CFS) = 35
TIME (MIN) = 252	DISCHARGE (CFS) = 129.82
TIME (MIN) = 261	DISCHARGE (CFS) = 20.5
TIME (MIN) = 270	DISCHARGE (CFS) = 13.7
TIME (MIN) = 279	DISCHARGE (CFS) = 10.7
TIME (MIN) = 288	DISCHARGE (CFS) = 9
TIME (MIN) = 297	DISCHARGE (CFS) = 7.8
TIME (MIN) = 306	DISCHARGE (CFS) = 7
TIME (MIN) = 315	DISCHARGE (CFS) = 6.3
TIME (MIN) = 324	DISCHARGE (CFS) = 5.8
TIME (MIN) = 333	DISCHARGE (CFS) = 5.4
TIME (MIN) = 342	DISCHARGE (CFS) = 5
TIME (MIN) = 351	DISCHARGE (CFS) = 4.7
TIME (MIN) = 360	DISCHARGE (CFS) = 4.5
TIME (MIN) = 369	DISCHARGE (CFS) = 0

RUN DATE 4/23/2021  
HYDROGRAPH FILE NAME Text1  
TIME OF CONCENTRATION 9 MIN.  
6 HOUR RAINFALL 2.25 INCHES  
BASIN AREA 63.5 ACRES  
RUNOFF COEFFICIENT 0.75  
PEAK DISCHARGE 202.58 CFS

# 100-YR Existing

TIME (MIN) = 0	DISCHARGE (CFS) = 0
TIME (MIN) = 9	DISCHARGE (CFS) = 0
TIME (MIN) = 18	DISCHARGE (CFS) = 6.5
TIME (MIN) = 27	DISCHARGE (CFS) = 6.6
TIME (MIN) = 36	DISCHARGE (CFS) = 6.9
TIME (MIN) = 45	DISCHARGE (CFS) = 7
TIME (MIN) = 54	DISCHARGE (CFS) = 7.3
TIME (MIN) = 63	DISCHARGE (CFS) = 7.4
TIME (MIN) = 72	DISCHARGE (CFS) = 7.7
TIME (MIN) = 81	DISCHARGE (CFS) = 7.9
TIME (MIN) = 90	DISCHARGE (CFS) = 8.3
TIME (MIN) = 99	DISCHARGE (CFS) = 8.5
TIME (MIN) = 108	DISCHARGE (CFS) = 9
TIME (MIN) = 117	DISCHARGE (CFS) = 9.2
TIME (MIN) = 126	DISCHARGE (CFS) = 9.8
TIME (MIN) = 135	DISCHARGE (CFS) = 10.1
TIME (MIN) = 144	DISCHARGE (CFS) = 10.8
TIME (MIN) = 153	DISCHARGE (CFS) = 11.2
TIME (MIN) = 162	DISCHARGE (CFS) = 12.2
TIME (MIN) = 171	DISCHARGE (CFS) = 12.8
TIME (MIN) = 180	DISCHARGE (CFS) = 14.2
TIME (MIN) = 189	DISCHARGE (CFS) = 15.1
TIME (MIN) = 198	DISCHARGE (CFS) = 17.3
TIME (MIN) = 207	DISCHARGE (CFS) = 18.7
TIME (MIN) = 216	DISCHARGE (CFS) = 22.9
TIME (MIN) = 225	DISCHARGE (CFS) = 26.1
TIME (MIN) = 234	DISCHARGE (CFS) = 38.3
TIME (MIN) = 243	DISCHARGE (CFS) = 44.6
TIME (MIN) = 252	DISCHARGE (CFS) = 202.58
TIME (MIN) = 261	DISCHARGE (CFS) = 30.7
TIME (MIN) = 270	DISCHARGE (CFS) = 20.5
TIME (MIN) = 279	DISCHARGE (CFS) = 16.1
TIME (MIN) = 288	DISCHARGE (CFS) = 13.5
TIME (MIN) = 297	DISCHARGE (CFS) = 11.7
TIME (MIN) = 306	DISCHARGE (CFS) = 10.4
TIME (MIN) = 315	DISCHARGE (CFS) = 9.5
TIME (MIN) = 324	DISCHARGE (CFS) = 8.7
TIME (MIN) = 333	DISCHARGE (CFS) = 8.1
TIME (MIN) = 342	DISCHARGE (CFS) = 7.6
TIME (MIN) = 351	DISCHARGE (CFS) = 7.1
TIME (MIN) = 360	DISCHARGE (CFS) = 6.7
TIME (MIN) = 369	DISCHARGE (CFS) = 0

RUN DATE 4/23/2021  
HYDROGRAPH FILE NAME Text1  
TIME OF CONCENTRATION 9 MIN.  
6 HOUR RAINFALL 1.5 INCHES  
BASIN AREA 63.5 ACRES  
RUNOFF COEFFICIENT 0.75  
PEAK DISCHARGE 130.14 CFS

# 10-YR Proposed

TIME (MIN) = 0	DISCHARGE (CFS) = 0
TIME (MIN) = 9	DISCHARGE (CFS) = 0
TIME (MIN) = 18	DISCHARGE (CFS) = 4.3
TIME (MIN) = 27	DISCHARGE (CFS) = 4.4
TIME (MIN) = 36	DISCHARGE (CFS) = 4.6
TIME (MIN) = 45	DISCHARGE (CFS) = 4.7
TIME (MIN) = 54	DISCHARGE (CFS) = 4.8
TIME (MIN) = 63	DISCHARGE (CFS) = 4.9
TIME (MIN) = 72	DISCHARGE (CFS) = 5.2
TIME (MIN) = 81	DISCHARGE (CFS) = 5.3
TIME (MIN) = 90	DISCHARGE (CFS) = 5.5
TIME (MIN) = 99	DISCHARGE (CFS) = 5.7
TIME (MIN) = 108	DISCHARGE (CFS) = 6
TIME (MIN) = 117	DISCHARGE (CFS) = 6.1
TIME (MIN) = 126	DISCHARGE (CFS) = 6.5
TIME (MIN) = 135	DISCHARGE (CFS) = 6.7
TIME (MIN) = 144	DISCHARGE (CFS) = 7.2
TIME (MIN) = 153	DISCHARGE (CFS) = 7.5
TIME (MIN) = 162	DISCHARGE (CFS) = 8.2
TIME (MIN) = 171	DISCHARGE (CFS) = 8.5
TIME (MIN) = 180	DISCHARGE (CFS) = 9.5
TIME (MIN) = 189	DISCHARGE (CFS) = 10
TIME (MIN) = 198	DISCHARGE (CFS) = 11.5
TIME (MIN) = 207	DISCHARGE (CFS) = 12.5
TIME (MIN) = 216	DISCHARGE (CFS) = 15.3
TIME (MIN) = 225	DISCHARGE (CFS) = 17.4
TIME (MIN) = 234	DISCHARGE (CFS) = 25.5
TIME (MIN) = 243	DISCHARGE (CFS) = 34.6
TIME (MIN) = 252	DISCHARGE (CFS) = 130.14
TIME (MIN) = 261	DISCHARGE (CFS) = 20.5
TIME (MIN) = 270	DISCHARGE (CFS) = 13.7
TIME (MIN) = 279	DISCHARGE (CFS) = 10.7
TIME (MIN) = 288	DISCHARGE (CFS) = 9
TIME (MIN) = 297	DISCHARGE (CFS) = 7.8
TIME (MIN) = 306	DISCHARGE (CFS) = 7
TIME (MIN) = 315	DISCHARGE (CFS) = 6.3
TIME (MIN) = 324	DISCHARGE (CFS) = 5.8
TIME (MIN) = 333	DISCHARGE (CFS) = 5.4
TIME (MIN) = 342	DISCHARGE (CFS) = 5
TIME (MIN) = 351	DISCHARGE (CFS) = 4.7
TIME (MIN) = 360	DISCHARGE (CFS) = 4.5
TIME (MIN) = 369	DISCHARGE (CFS) = 0

RUN DATE 4/23/2021  
HYDROGRAPH FILE NAME Text1  
TIME OF CONCENTRATION 9 MIN.  
6 HOUR RAINFALL 2.25 INCHES  
BASIN AREA 63.5 ACRES  
RUNOFF COEFFICIENT 0.75  
PEAK DISCHARGE 203.08 CFS

# 100-YR Proposed

TIME (MIN) = 0	DISCHARGE (CFS) = 0
TIME (MIN) = 9	DISCHARGE (CFS) = 0
TIME (MIN) = 18	DISCHARGE (CFS) = 6.5
TIME (MIN) = 27	DISCHARGE (CFS) = 6.6
TIME (MIN) = 36	DISCHARGE (CFS) = 6.9
TIME (MIN) = 45	DISCHARGE (CFS) = 7
TIME (MIN) = 54	DISCHARGE (CFS) = 7.3
TIME (MIN) = 63	DISCHARGE (CFS) = 7.4
TIME (MIN) = 72	DISCHARGE (CFS) = 7.7
TIME (MIN) = 81	DISCHARGE (CFS) = 7.9
TIME (MIN) = 90	DISCHARGE (CFS) = 8.3
TIME (MIN) = 99	DISCHARGE (CFS) = 8.5
TIME (MIN) = 108	DISCHARGE (CFS) = 9
TIME (MIN) = 117	DISCHARGE (CFS) = 9.2
TIME (MIN) = 126	DISCHARGE (CFS) = 9.8
TIME (MIN) = 135	DISCHARGE (CFS) = 10.1
TIME (MIN) = 144	DISCHARGE (CFS) = 10.8
TIME (MIN) = 153	DISCHARGE (CFS) = 11.2
TIME (MIN) = 162	DISCHARGE (CFS) = 12.2
TIME (MIN) = 171	DISCHARGE (CFS) = 12.8
TIME (MIN) = 180	DISCHARGE (CFS) = 14.2
TIME (MIN) = 189	DISCHARGE (CFS) = 15.1
TIME (MIN) = 198	DISCHARGE (CFS) = 17.3
TIME (MIN) = 207	DISCHARGE (CFS) = 18.7
TIME (MIN) = 216	DISCHARGE (CFS) = 22.9
TIME (MIN) = 225	DISCHARGE (CFS) = 26.1
TIME (MIN) = 234	DISCHARGE (CFS) = 38.3
TIME (MIN) = 243	DISCHARGE (CFS) = 44.1
TIME (MIN) = 252	DISCHARGE (CFS) = 203.08
TIME (MIN) = 261	DISCHARGE (CFS) = 30.7
TIME (MIN) = 270	DISCHARGE (CFS) = 20.5
TIME (MIN) = 279	DISCHARGE (CFS) = 16.1
TIME (MIN) = 288	DISCHARGE (CFS) = 13.5
TIME (MIN) = 297	DISCHARGE (CFS) = 11.7
TIME (MIN) = 306	DISCHARGE (CFS) = 10.4
TIME (MIN) = 315	DISCHARGE (CFS) = 9.5
TIME (MIN) = 324	DISCHARGE (CFS) = 8.7
TIME (MIN) = 333	DISCHARGE (CFS) = 8.1
TIME (MIN) = 342	DISCHARGE (CFS) = 7.6
TIME (MIN) = 351	DISCHARGE (CFS) = 7.1
TIME (MIN) = 360	DISCHARGE (CFS) = 6.7
TIME (MIN) = 369	DISCHARGE (CFS) = 0

# Hydrograph Summary Report

Hydraflow Hydrographs Extension for Autodesk® Civil 3D® by Autodesk, Inc. v2020

Hyd. No.	Hydrograph type (origin)	Peak flow (cfs)	Time interval (min)	Time to Peak (min)	Hyd. volume (cuft)	Inflow hyd(s)	Maximum elevation (ft)	Total strge used (cuft)	Hydrograph Description
2	Manual	129.82	9	252	255,431	-----	-----	-----	Existing Inflow
3	Manual	130.14	9	252	255,334	-----	-----	-----	Proposed inflow
4	Reservoir	69.86	9	261	253,353	2	292.25	30,742	Existing Outflow
5	Reservoir	51.74	9	261	234,734	3	292.17	90,244	Proposed Outflow

# Hydrograph Report

Hydraflow Hydrographs Extension for Autodesk® Civil 3D® by Autodesk, Inc. v2020

Friday, 04 / 23 / 2021

## Hyd. No. 4

### Existing Outflow

Hydrograph type	= Reservoir	Peak discharge	= 69.86 cfs
Storm frequency	= 10 yrs	Time to peak	= 4.35 hrs
Time interval	= 9 min	Hyd. volume	= 253,353 cuft
Inflow hyd. No.	= 2 - Existing Inflow	Max. Elevation	= 292.25 ft
Reservoir name	= Regional Basin Existing	Max. Storage	= 30,742 cuft

Storage Indication method used.

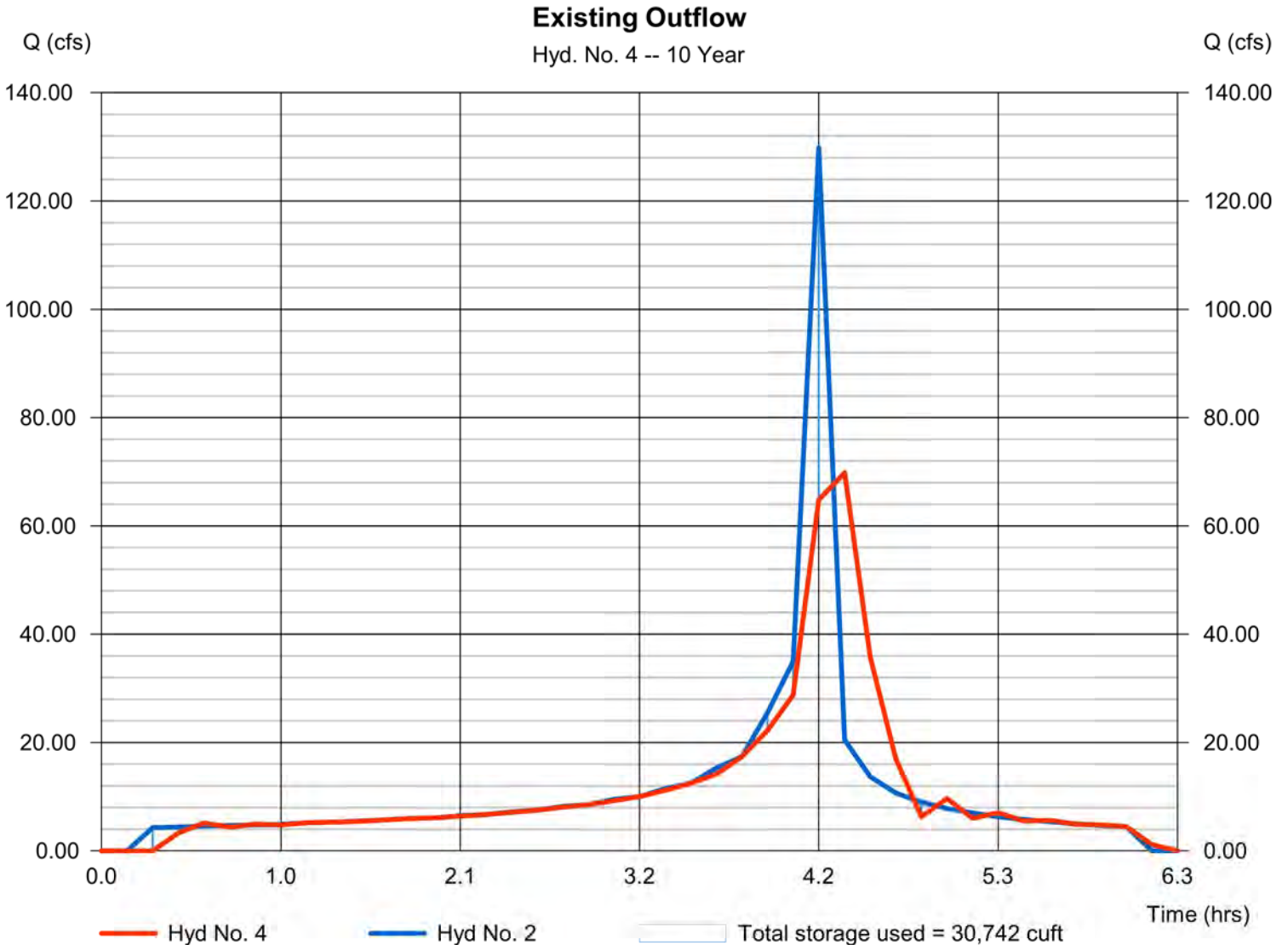

## Pond No. 2 - Regional Basin Existing

### Pond Data

Contours -User-defined contour areas. Average end area method used for volume calculation. Beginning Elevation = 286.00 ft

### Stage / Storage Table

Stage (ft)	Elevation (ft)	Contour area (sqft)	Incr. Storage (cuft)	Total storage (cuft)
0.00	286.00	232	0	0
1.00	287.00	408	320	320
2.00	288.00	673	541	861
3.00	289.00	1,456	1,065	1,925
4.00	290.00	3,136	2,296	4,221
5.00	291.00	8,752	5,944	10,165
6.00	292.00	19,909	14,331	24,496
7.00	293.00	29,765	24,837	49,333
8.00	294.00	39,512	34,639	83,971
9.00	295.00	49,506	44,509	128,480

### Culvert / Orifice Structures

	[A]	[B]	[C]	[PrfRsr]
Rise (in)	= 42.00	6.50	6.50	0.00
Span (in)	= 42.00	36.00	48.00	0.00
No. Barrels	= 1	4	4	0
Invert El. (ft)	= 286.00	289.11	291.42	0.00
Length (ft)	= 10.00	0.00	0.00	0.00
Slope (%)	= 0.50	0.00	0.00	n/a
N-Value	= .013	.013	.013	n/a
Orifice Coeff.	= 0.60	0.60	0.60	0.60
Multi-Stage	= n/a	Yes	Yes	No

### Weir Structures

	[A]	[B]	[C]	[D]
Crest Len (ft)	Inactive	Inactive	0.00	0.00
Crest El. (ft)	= 0.00	0.00	0.00	0.00
Weir Coeff.	= 3.33	3.33	3.33	3.33
Weir Type	= ---	Rect	---	---
Multi-Stage	= Yes	No	No	No
Exfil.(in/hr)	= 0.000 (by Wet area)			
TW Elev. (ft)	= 0.00			

Note: Culvert/Orifice outflows are analyzed under inlet (ic) and outlet (oc) control. Weir risers checked for orifice conditions (ic) and submergence (s).

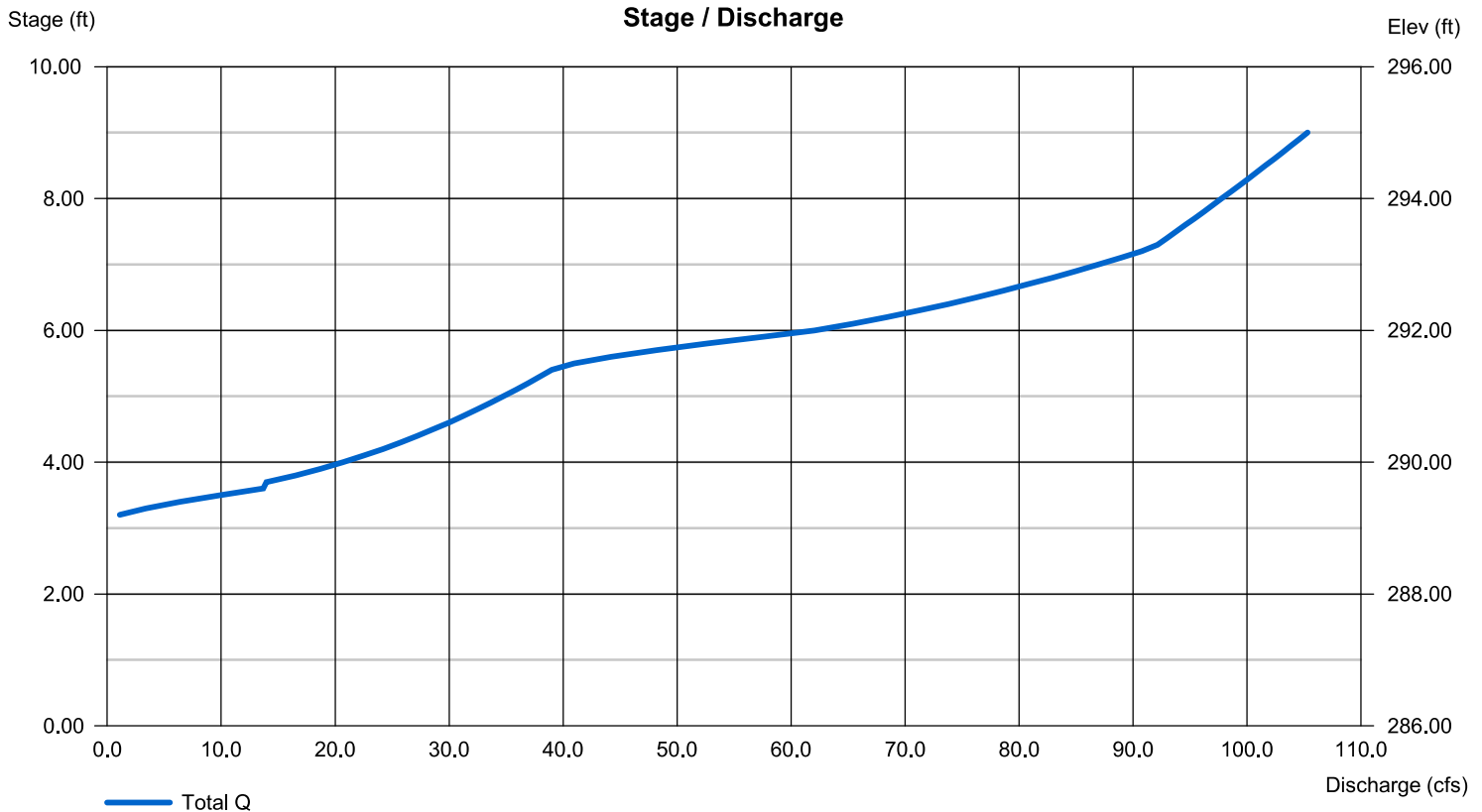



# Hydrograph Summary Report

Hydraflow Hydrographs Extension for Autodesk® Civil 3D® by Autodesk, Inc. v2020

Hyd. No.	Hydrograph type (origin)	Peak flow (cfs)	Time interval (min)	Time to Peak (min)	Hyd. volume (cuft)	Inflow hyd(s)	Maximum elevation (ft)	Total strge used (cuft)	Hydrograph Description
2	Manual	202.58	9	252	383,173	-----	-----	-----	Existing Inflow
3	Manual	203.08	9	252	383,173	-----	-----	-----	Proposed inflow
4	Reservoir	92.58	9	261	381,157	2	293.35	61,545	Existing Outflow
5	Reservoir	75.71	9	261	362,574	3	293.29	129,695	Proposed Outflow

# Hydrograph Report

Hydraflow Hydrographs Extension for Autodesk® Civil 3D® by Autodesk, Inc. v2020

Friday, 04 / 23 / 2021

## Hyd. No. 4

### Existing Outflow

Hydrograph type	= Reservoir	Peak discharge	= 92.58 cfs
Storm frequency	= 100 yrs	Time to peak	= 4.35 hrs
Time interval	= 9 min	Hyd. volume	= 381,157 cuft
Inflow hyd. No.	= 2 - Existing Inflow	Max. Elevation	= 293.35 ft
Reservoir name	= Regional Basin Existing	Max. Storage	= 61,545 cuft

Storage Indication method used.

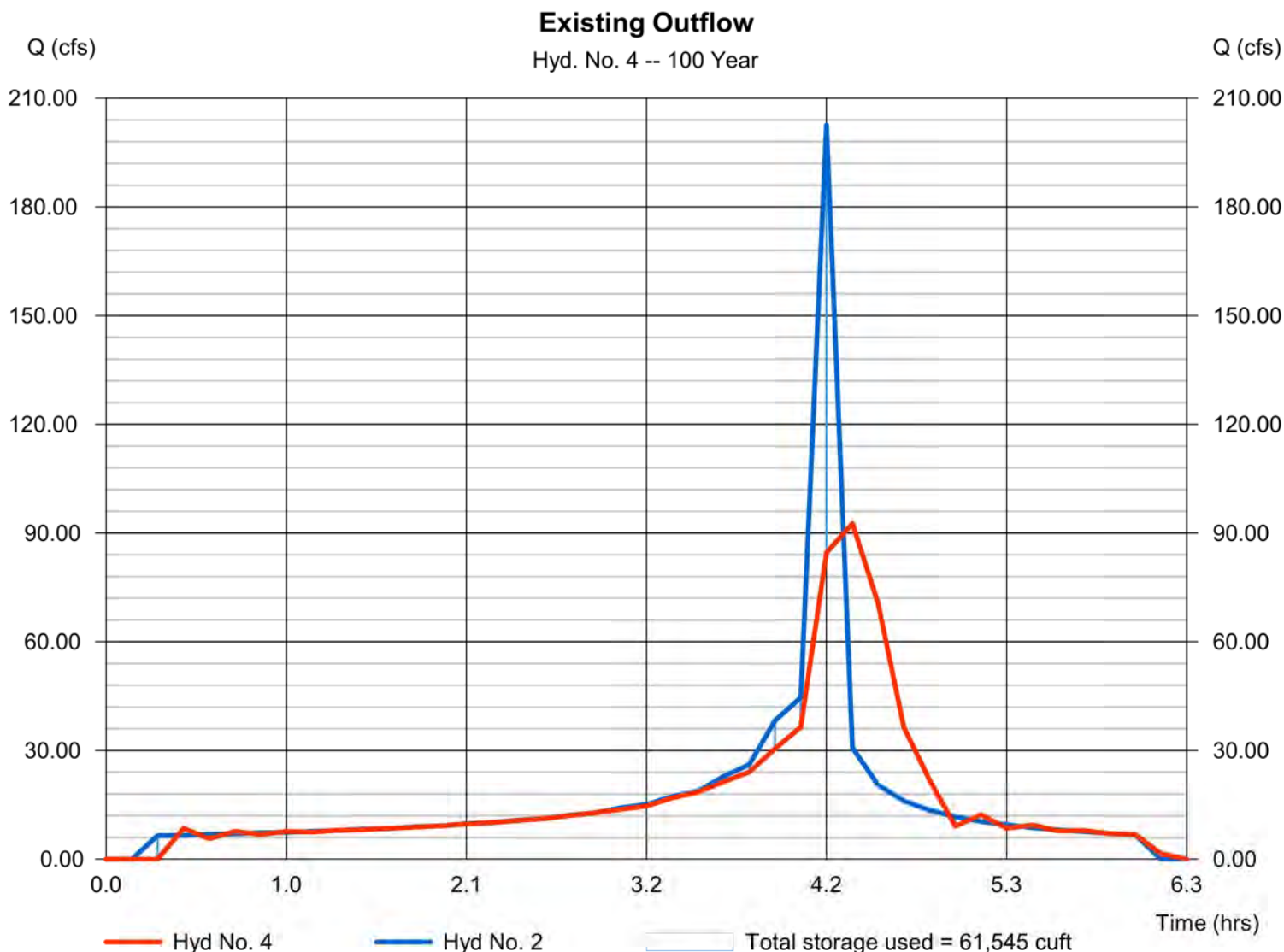

# Hydrograph Summary Report

Hydraflow Hydrographs Extension for Autodesk® Civil 3D® by Autodesk, Inc. v2020

Hyd. No.	Hydrograph type (origin)	Peak flow (cfs)	Time interval (min)	Time to Peak (min)	Hyd. volume (cuft)	Inflow hyd(s)	Maximum elevation (ft)	Total strge used (cuft)	Hydrograph Description
2	Manual	129.82	9	252	255,431	-----	-----	-----	Existing Inflow
3	Manual	130.14	9	252	255,334	-----	-----	-----	Proposed inflow
4	Reservoir	69.86	9	261	253,353	2	292.25	30,742	Existing Outflow
5	Reservoir	51.74	9	261	234,734	3	292.17	90,244	Proposed Outflow

# Hydrograph Report

Hydraflow Hydrographs Extension for Autodesk® Civil 3D® by Autodesk, Inc. v2020

Friday, 04 / 23 / 2021

## Hyd. No. 5

### Proposed Outflow

Hydrograph type	= Reservoir	Peak discharge	= 51.74 cfs
Storm frequency	= 10 yrs	Time to peak	= 4.35 hrs
Time interval	= 9 min	Hyd. volume	= 234,734 cuft
Inflow hyd. No.	= 3 - Proposed inflow	Max. Elevation	= 292.17 ft
Reservoir name	= Regional Basin Proposed 18 2	Max. Storage	= 90,244 cuft

Storage Indication method used.

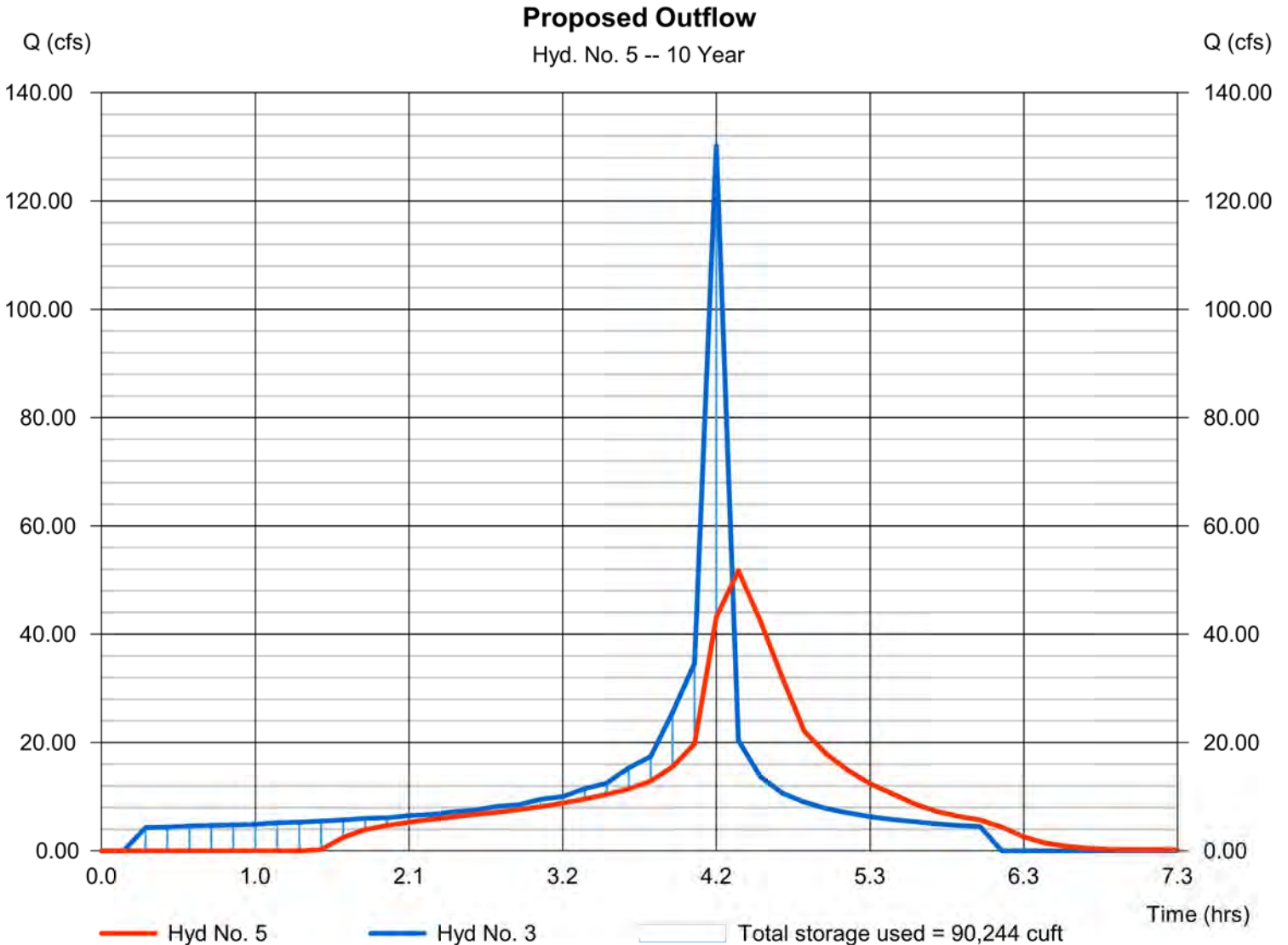

## Pond No. 3 - Regional Basin Proposed 18 24

### Pond Data

Contours -User-defined contour areas. Average end area method used for volume calculation. Beginning Elevation = 287.75 ft

### Stage / Storage Table

Stage (ft)	Elevation (ft)	Contour area (sqft)	Incr. Storage (cuft)	Total storage (cuft)
0.00	287.75	13,337	0	0
0.25	288.00	13,924	3,408	3,408
1.25	289.00	14,058	13,991	17,399
2.25	290.00	17,883	15,970	33,369
3.25	291.00	26,400	22,142	55,511
4.25	292.00	31,675	29,038	84,548
5.25	293.00	36,120	33,897	118,446
6.25	294.00	41,881	39,000	157,446

### Culvert / Orifice Structures

	[A]	[B]	[C]	[PrfRsr]
Rise (in)	= 42.00	8.00	8.00	0.00
Span (in)	= 42.00	8.00	8.00	0.00
No. Barrels	= 1	24	24	0
Invert El. (ft)	= 288.76	289.25	290.75	0.00
Length (ft)	= 690.00	0.00	0.00	0.00
Slope (%)	= 1.00	0.00	0.00	n/a
N-Value	= .013	.013	.013	n/a
Orifice Coeff.	= 0.60	0.60	0.60	0.60
Multi-Stage	= n/a	Yes	Yes	No

### Weir Structures

	[A]	[B]	[C]	[D]
Crest Len (ft)	= 40.00	0.00	0.00	0.00
Crest El. (ft)	= 292.50	0.00	0.00	0.00
Weir Coeff.	= 3.33	3.33	3.33	3.33
Weir Type	= 1	---	---	---
Multi-Stage	= Yes	No	No	No
Exfil.(in/hr)	= 0.000 (by Wet area)			
TW Elev. (ft)	= 0.00			

Note: Culvert/Orifice outflows are analyzed under inlet (ic) and outlet (oc) control. Weir risers checked for orifice conditions (ic) and submergence (s).

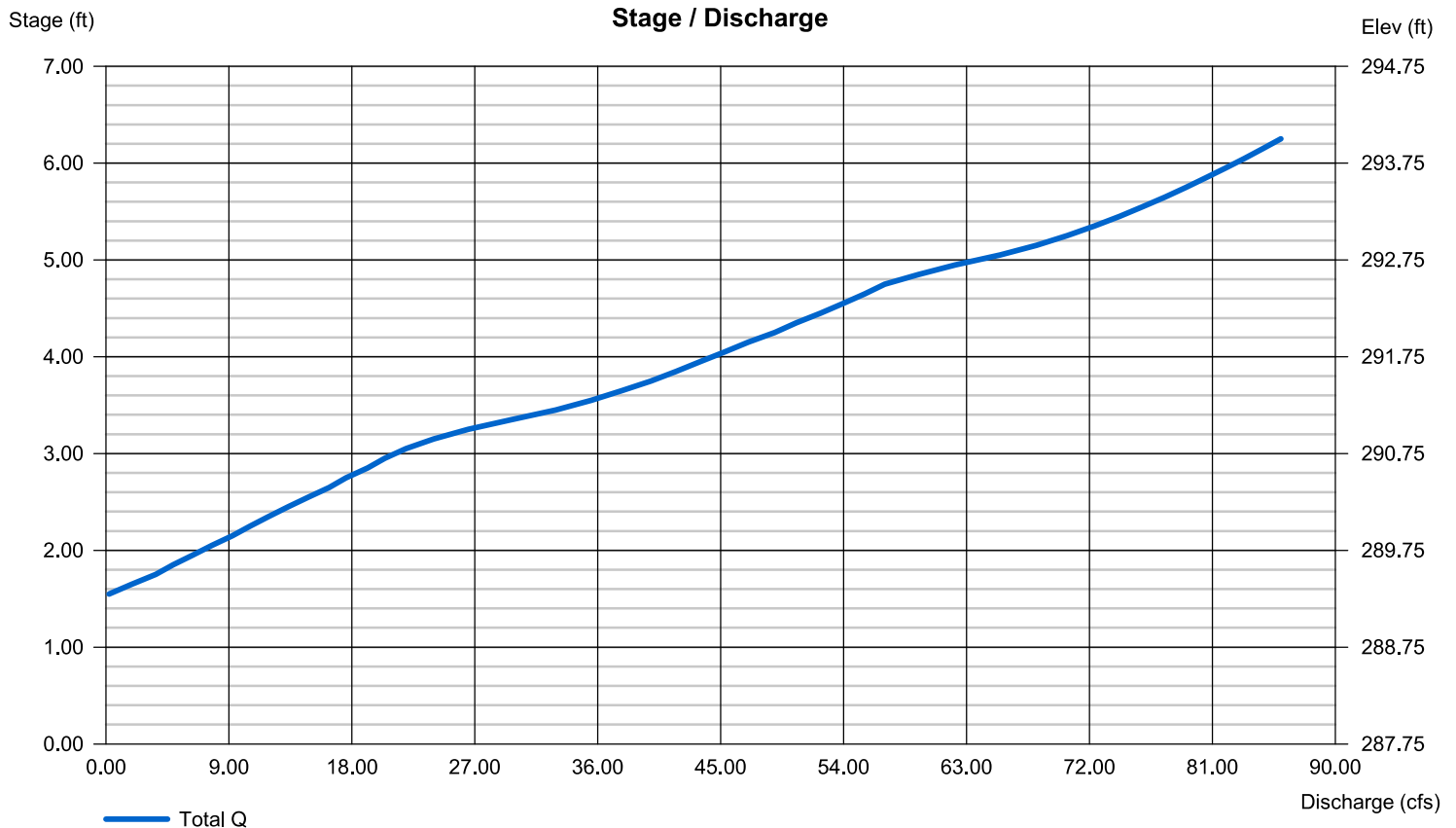

# Hydrograph Summary Report

Hydraflow Hydrographs Extension for Autodesk® Civil 3D® by Autodesk, Inc. v2020

Hyd. No.	Hydrograph type (origin)	Peak flow (cfs)	Time interval (min)	Time to Peak (min)	Hyd. volume (cuft)	Inflow hyd(s)	Maximum elevation (ft)	Total strge used (cuft)	Hydrograph Description
2	Manual	202.58	9	252	383,173	-----	-----	-----	Existing Inflow
3	Manual	203.08	9	252	383,173	-----	-----	-----	Proposed inflow
4	Reservoir	92.58	9	261	381,157	2	293.35	61,545	Existing Outflow
5	Reservoir	75.71	9	261	362,574	3	293.29	129,695	Proposed Outflow

# Hydrograph Report

Hydraflow Hydrographs Extension for Autodesk® Civil 3D® by Autodesk, Inc. v2020

Friday, 04 / 23 / 2021

## Hyd. No. 5

### Proposed Outflow

Hydrograph type	= Reservoir	Peak discharge	= 75.71 cfs
Storm frequency	= 100 yrs	Time to peak	= 4.35 hrs
Time interval	= 9 min	Hyd. volume	= 362,574 cuft
Inflow hyd. No.	= 3 - Proposed inflow	Max. Elevation	= 293.29 ft
Reservoir name	= Regional Basin Proposed 18 2	Max. Storage	= 129,695 cuft

Storage Indication method used.

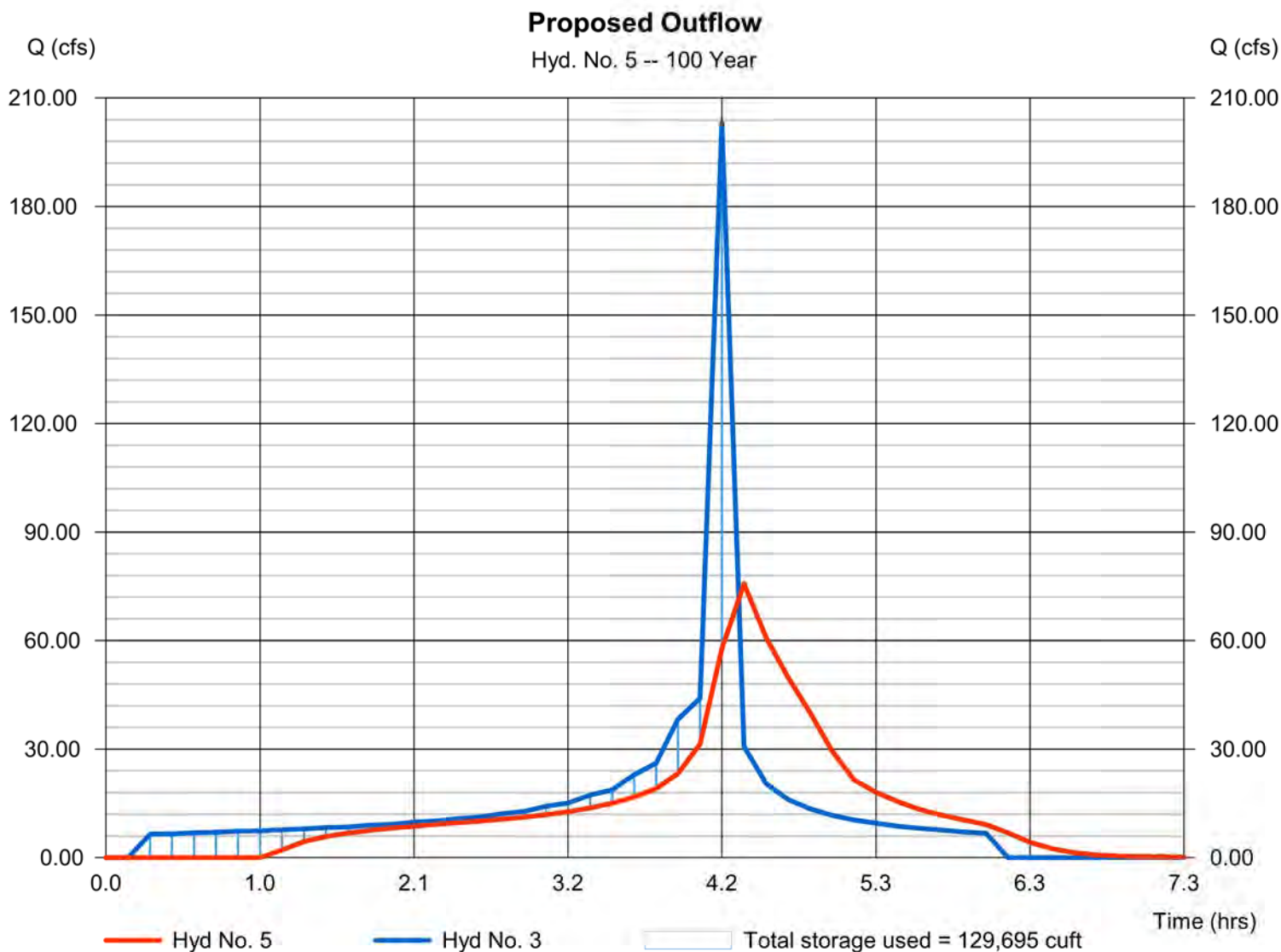

---

## Worksheet for EX 10 YR

---

### Project Description

Friction Method	Manning Formula
Solve For	Normal Depth

### Input Data

Roughness Coefficient	0.013	
Channel Slope	0.01000	ft/ft
Diameter	3.50	ft
Discharge	69.86	ft <sup>3</sup> /s

### Results

Normal Depth	2.15	ft
Flow Area	6.19	ft <sup>2</sup>
Wetted Perimeter	6.30	ft
Hydraulic Radius	0.98	ft
Top Width	3.41	ft
Critical Depth	2.62	ft
Percent Full	61.3	%
Critical Slope	0.00583	ft/ft
Velocity	11.29	ft/s
Velocity Head	1.98	ft
Specific Energy	4.13	ft
Froude Number	1.48	
Maximum Discharge	108.22	ft <sup>3</sup> /s
Discharge Full	100.60	ft <sup>3</sup> /s
Slope Full	0.00482	ft/ft
Flow Type	SuperCritical	

### GVF Input Data

Downstream Depth	0.00	ft
Length	0.00	ft
Number Of Steps	0	

### GVF Output Data

Upstream Depth	0.00	ft
Profile Description		
Profile Headloss	0.00	ft
Average End Depth Over Rise	0.00	%
Normal Depth Over Rise	61.32	%
Downstream Velocity	Infinity	ft/s



---

## Worksheet for EX 10 YR

---

### GVF Output Data

Upstream Velocity	Infinity	ft/s
Normal Depth	2.15	ft
Critical Depth	2.62	ft
Channel Slope	0.01000	ft/ft
Critical Slope	0.00583	ft/ft

---

## Worksheet for EX 100 YR

---

### Project Description

Friction Method	Manning Formula
Solve For	Normal Depth

### Input Data

Roughness Coefficient	0.013	
Channel Slope	0.01000	ft/ft
Diameter	3.50	ft
Discharge	92.58	ft <sup>3</sup> /s

### Results

Normal Depth	2.65	ft
Flow Area	7.80	ft <sup>2</sup>
Wetted Perimeter	7.38	ft
Hydraulic Radius	1.06	ft
Top Width	3.01	ft
Critical Depth	2.98	ft
Percent Full	75.6	%
Critical Slope	0.00796	ft/ft
Velocity	11.86	ft/s
Velocity Head	2.19	ft
Specific Energy	4.83	ft
Froude Number	1.30	
Maximum Discharge	108.22	ft <sup>3</sup> /s
Discharge Full	100.60	ft <sup>3</sup> /s
Slope Full	0.00847	ft/ft
Flow Type	SuperCritical	

### GVF Input Data

Downstream Depth	0.00	ft
Length	0.00	ft
Number Of Steps	0	

### GVF Output Data

Upstream Depth	0.00	ft
Profile Description		
Profile Headloss	0.00	ft
Average End Depth Over Rise	0.00	%
Normal Depth Over Rise	75.60	%
Downstream Velocity	Infinity	ft/s

---

## Worksheet for EX 100 YR

---

### GVF Output Data

Upstream Velocity	Infinity	ft/s
Normal Depth	2.65	ft
Critical Depth	2.98	ft
Channel Slope	0.01000	ft/ft
Critical Slope	0.00796	ft/ft

---

## Worksheet for PR 10 YR

---

### Project Description

Friction Method	Manning Formula
Solve For	Normal Depth

### Input Data

Roughness Coefficient	0.013	
Channel Slope	0.01000	ft/ft
Diameter	3.50	ft
Discharge	51.74	ft <sup>3</sup> /s

### Results

Normal Depth	1.78	ft
Flow Area	4.91	ft <sup>2</sup>
Wetted Perimeter	5.56	ft
Hydraulic Radius	0.88	ft
Top Width	3.50	ft
Critical Depth	2.25	ft
Percent Full	50.8	%
Critical Slope	0.00478	ft/ft
Velocity	10.53	ft/s
Velocity Head	1.72	ft
Specific Energy	3.50	ft
Froude Number	1.57	
Maximum Discharge	108.22	ft <sup>3</sup> /s
Discharge Full	100.60	ft <sup>3</sup> /s
Slope Full	0.00264	ft/ft
Flow Type	SuperCritical	

### GVF Input Data

Downstream Depth	0.00	ft
Length	0.00	ft
Number Of Steps	0	

### GVF Output Data

Upstream Depth	0.00	ft
Profile Description		
Profile Headloss	0.00	ft
Average End Depth Over Rise	0.00	%
Normal Depth Over Rise	50.85	%
Downstream Velocity	Infinity	ft/s

---

## Worksheet for PR 10 YR

---

### GVF Output Data

Upstream Velocity	Infinity	ft/s
Normal Depth	1.78	ft
Critical Depth	2.25	ft
Channel Slope	0.01000	ft/ft
Critical Slope	0.00478	ft/ft

---

## Worksheet for PR 100 YR

---

### Project Description

Friction Method                      Manning Formula  
Solve For                                Normal Depth

### Input Data

Roughness Coefficient	0.013	
Channel Slope	0.01000	ft/ft
Diameter	3.50	ft
Discharge	75.71	ft <sup>3</sup> /s

### Results

Normal Depth	2.27	ft
Flow Area	6.59	ft <sup>2</sup>
Wetted Perimeter	6.55	ft
Hydraulic Radius	1.01	ft
Top Width	3.34	ft
Critical Depth	2.72	ft
Percent Full	64.8	%
Critical Slope	0.00627	ft/ft
<b>Velocity</b>	<b>11.48</b>	<b>ft/s</b>
Velocity Head	2.05	ft
Specific Energy	4.32	ft
Froude Number	1.44	
Maximum Discharge	108.22	ft <sup>3</sup> /s
Discharge Full	100.60	ft <sup>3</sup> /s
Slope Full	0.00566	ft/ft
Flow Type	SuperCritical	

### GVF Input Data

Downstream Depth	0.00	ft
Length	0.00	ft
Number Of Steps	0	

### GVF Output Data

Upstream Depth	0.00	ft
Profile Description		
Profile Headloss	0.00	ft
Average End Depth Over Rise	0.00	%
Normal Depth Over Rise	64.77	%
Downstream Velocity	Infinity	ft/s

---

## Worksheet for PR 100 YR

---

### GVF Output Data

Upstream Velocity	Infinity	ft/s
Normal Depth	2.27	ft
Critical Depth	2.72	ft
Channel Slope	0.01000	ft/ft
Critical Slope	0.00627	ft/ft

---

## Worksheet for V-Ditch

---

### Project Description

Friction Method	Manning Formula
Solve For	Normal Depth

### Input Data

Roughness Coefficient	0.013	
Channel Slope	0.07500	ft/ft
Left Side Slope	1.50	ft/ft (H:V)
Right Side Slope	1.50	ft/ft (H:V)
Discharge	1.22	ft <sup>3</sup> /s

### Results

Normal Depth	0.32	ft
Flow Area	0.15	ft <sup>2</sup>
Wetted Perimeter	1.14	ft
Hydraulic Radius	0.13	ft
Top Width	0.95	ft
Critical Depth	0.53	ft
Critical Slope	0.00491	ft/ft
Velocity	8.11	ft/s
Velocity Head	1.02	ft
Specific Energy	1.34	ft
Froude Number	3.59	
Flow Type	Supercritical	

### GVF Input Data

Downstream Depth	0.00	ft
Length	0.00	ft
Number Of Steps	0	

### GVF Output Data

Upstream Depth	0.00	ft
Profile Description		
Profile Headloss	0.00	ft
Downstream Velocity	Infinity	ft/s
Upstream Velocity	Infinity	ft/s
Normal Depth	0.32	ft
Critical Depth	0.53	ft
Channel Slope	0.07500	ft/ft
Critical Slope	0.00491	ft/ft



Inlet Capacities			
City DDM Equation 3-10,3-12 Grated Inlets in Sag			
<b>36"x36" Catch Basin</b>			
Weir Flow			
$Q=C_w * P * d^{2/3} * C_L$	Cw = 3	Weir Coefficient	
	P = 12	Inlet Perimeter	
	d = 1	Available Ponding Depth	
	C <sub>L</sub> = 0.5	Clogging Factor	
Q= 18.0	cfs		
<b>36"x36" Catch Basin</b>			
Orifice Flow			
$Q=C_o * A * (2gd)^{1/2} * C_L$	Co = 0.67	Orifice Coefficient	
	A = 4.5	Inlet Area	
	d = 1	Available Ponding Depth	
	C <sub>L</sub> = 0.5	Clogging Factor	
Q= 12.1	cfs		

Inlet Capacities			
City DDM Equation 3-12 Grated Inlets in Sag (Orifice Condition)			
<b>18"x18" Catch Basin</b>			
Weir Flow			
$Q=C_w * P * d^{2/3} * C_L$	Cw = 3	Weir Coefficient	
	P = 6	Inlet Perimeter	
	d = 1	Available Ponding Depth	
	C <sub>L</sub> = 0.5	Clogging Factor	
Q= 9.0	cfs		
<b>18"x18" Catch Basin</b>			
Orifice Flow			
$Q=C_o * A * (2gd)^{1/2} * C_L$	Co = 0.67	Weir Coefficient	
	A = 2.25	Inlet Area	
	d = 1	Available Ponding Depth	
	C <sub>L</sub> = 0.5	Clogging Factor	
Q= 6.0	cfs		

Inlet Capacities			
City DDM Equation 3-12 Grated Inlets in Sag (Orifice Condition)			
<b>12"x12" Catch Basin</b>			
Weir Flow			
$Q=C_w * P * d^{2/3} * C_L$	Cw = 3	Weir Coefficient	
	P = 4	Inlet Perimeter	
	d = 0.5	Available Ponding Depth	
	C <sub>L</sub> = 0.5	Clogging Factor	
Q= 2.1	cfs		
<b>12"x12" Catch Basin</b>			
Orifice Flow			
$Q=C_o * A * (2gd)^{1/2} * C_L$	Co = 0.67	Weir Coefficient	
	A = 1	Inlet Area	
	d = 0.5	Available Ponding Depth	
	C <sub>L</sub> = 0.5	Clogging Factor	
Q= 1.9	cfs		

---

## Worksheet for 24 inch HDPE

---

### Project Description

Friction Method	Manning Formula
Solve For	Normal Depth

### Input Data

Roughness Coefficient	0.012	
Channel Slope	0.06400	ft/ft
Diameter	2.00	ft
Discharge	1.22	ft <sup>3</sup> /s

### Results

Normal Depth	0.19	ft
Flow Area	0.16	ft <sup>2</sup>
Wetted Perimeter	1.27	ft
Hydraulic Radius	0.12	ft
Top Width	1.19	ft
Critical Depth	0.38	ft
Percent Full	9.7	%
Critical Slope	0.00393	ft/ft
Velocity	7.78	ft/s
Velocity Head	0.94	ft
Specific Energy	1.13	ft
Froude Number	3.77	
Maximum Discharge	66.69	ft <sup>3</sup> /s
Discharge Full	62.00	ft <sup>3</sup> /s
Slope Full	0.00002	ft/ft
Flow Type	SuperCritical	

### GVF Input Data

Downstream Depth	0.00	ft
Length	0.00	ft
Number Of Steps	0	

### GVF Output Data

Upstream Depth	0.00	ft
Profile Description		
Profile Headloss	0.00	ft
Average End Depth Over Rise	0.00	%
Normal Depth Over Rise	9.72	%
Downstream Velocity	Infinity	ft/s

---

## Worksheet for 24 inch HDPE

---

### GVF Output Data

Upstream Velocity	Infinity	ft/s
Normal Depth	0.19	ft
Critical Depth	0.38	ft
Channel Slope	0.06400	ft/ft
Critical Slope	0.00393	ft/ft

---

## Worksheet for Wetland Channel

---

### Project Description

Friction Method	Manning Formula
Solve For	Normal Depth

### Input Data

Roughness Coefficient	0.150	
Channel Slope	0.07300	ft/ft
Left Side Slope	2.50	ft/ft (H:V)
Right Side Slope	2.50	ft/ft (H:V)
Bottom Width	10.00	ft
Discharge	108.22	ft <sup>3</sup> /s

### Results

Normal Depth	2.06	ft
Flow Area	31.16	ft <sup>2</sup>
Wetted Perimeter	21.08	ft
Hydraulic Radius	1.48	ft
Top Width	20.29	ft
Critical Depth	1.36	ft
Critical Slope	0.33216	ft/ft
Velocity	3.47	ft/s
Velocity Head	0.19	ft
Specific Energy	2.25	ft
Froude Number	0.49	
Flow Type	Subcritical	

### GVF Input Data

Downstream Depth	0.00	ft
Length	0.00	ft
Number Of Steps	0	

### GVF Output Data

Upstream Depth	0.00	ft
Profile Description		
Profile Headloss	0.00	ft
Downstream Velocity	Infinity	ft/s
Upstream Velocity	Infinity	ft/s
Normal Depth	2.06	ft
Critical Depth	1.36	ft
Channel Slope	0.07300	ft/ft

---

## Worksheet for Wetland Channel

---

### GVF Output Data

Critical Slope 0.33216 ft/ft

Figure 7-1

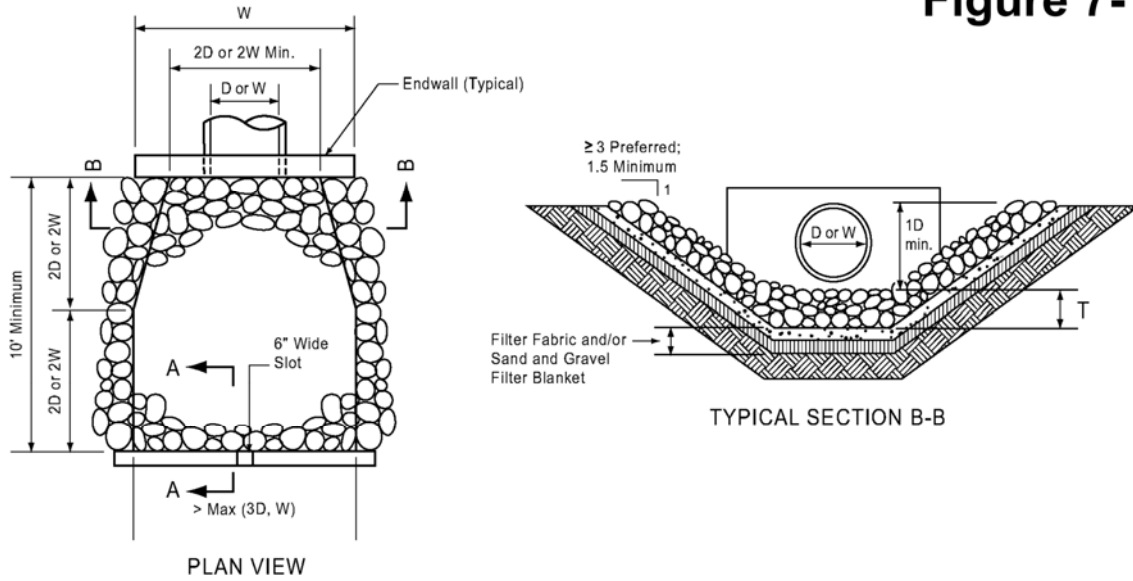
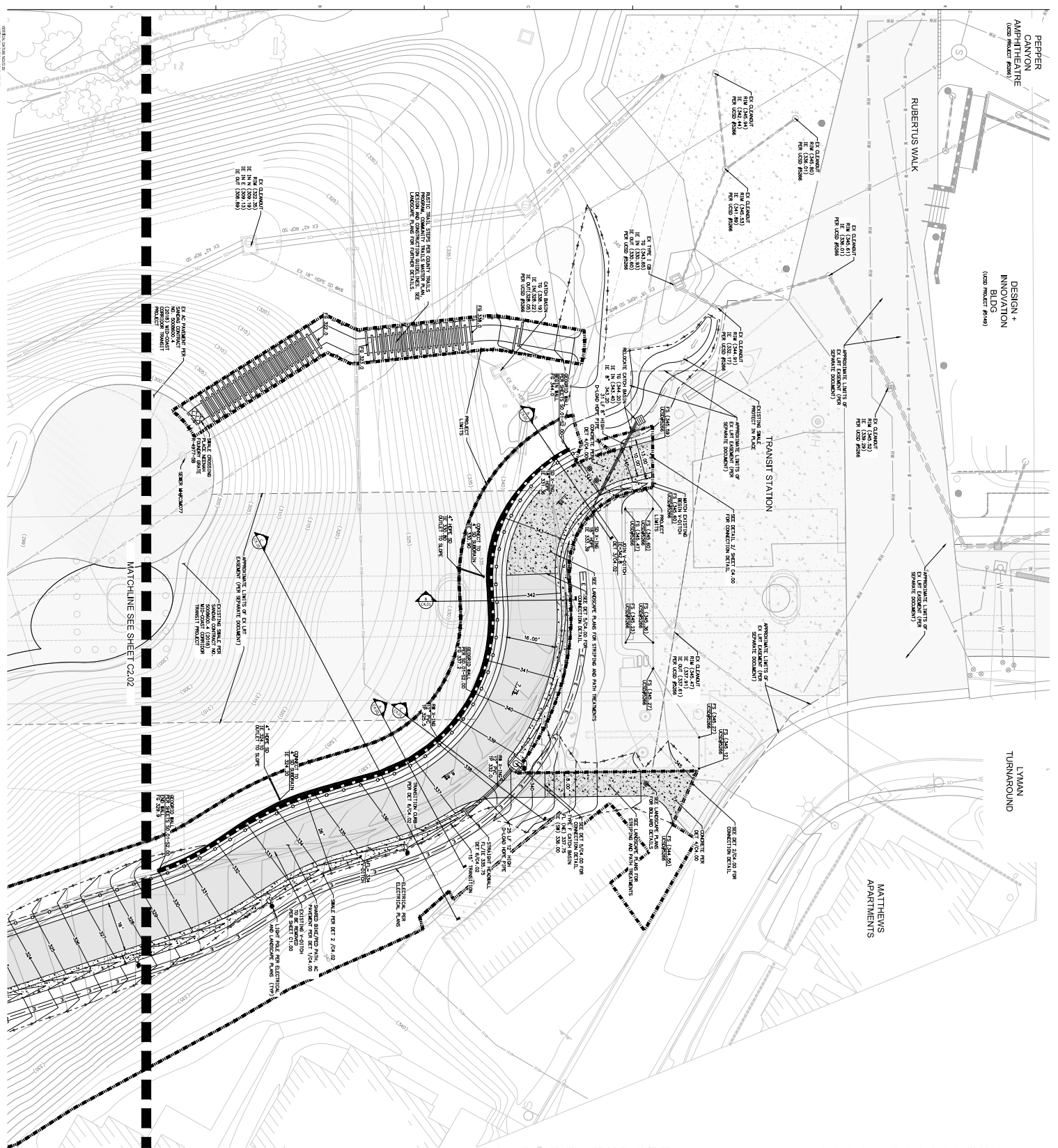

Figure 7-1 San Diego Regional Standard Rock Riprap Apron Layout

Appendix E – Excerpts from Michael Baker  
International's Grading Plan



MATCHLINE SEE SHEET C2.02

**LEGEND**

- EXISTING BUILDING
- EXISTING 8'W AP
- EXISTING STRUCTURE
- EXISTING LIGHT FIXTURE (OPTICAL)
- APPROXIMATE PROJECT LIMITS
- EXISTING WALK
- EXISTING RECYCLED WATER
- EXISTING STORM DRAIN
- EXISTING STORM INFLOW
- EXISTING STREET LIGHT FIXTURE
- EXISTING GAS
- EXISTING TELECOM
- EXISTING ELECTRIC
- EXISTING SEWER
- EXISTING WATER
- EXISTING FIRE HYDRANT
- EXISTING STORM BASIN
- EXISTING SWALE
- EXISTING FIRE HYDRANT
- EXISTING STORM DRAIN
- EXISTING STORM INFLOW
- EXISTING STREET LIGHT FIXTURE

- NOTES:**
- EXISTING UTILITIES SHOWN ARE BASED ON RECORD DRAWINGS. CONTRACTOR TO VERIFY ALL UTILITIES PRIOR TO CONSTRUCTION.
  - RECORDING PLAN OF RECORD DRAWINGS TO BE PROVIDED TO THE CITY ENGINEER FOR REVIEW AND APPROVAL.
  - SEE LANDSCAPE PLANS FOR PLANTING.



**Perkins & Will**  
 1000 17th Street, Suite 3000  
 San Diego, CA 92101  
 619.594.3800  
 www.perkinswill.com

**Clare**  
 1000 17th Street, Suite 3000  
 San Diego, CA 92101  
 619.594.3800  
 www.clare.com

**5434: UCSD PEPPER CANYON ANCILLARY SITE WORK**  
 University of California San Diego Campus  
 La Jolla, California 92037

**95% CONSTRUCTION DOCUMENTS**  
 April 30, 2021



NO.	DATE	DESCRIPTION	BY	CHECKED
1	04/29/21	ISSUED FOR PERMITS	KW	MS
2	04/29/21	ISSUED FOR PERMITS	KW	MS
3	04/29/21	ISSUED FOR PERMITS	KW	MS
4	04/29/21	ISSUED FOR PERMITS	KW	MS
5	04/29/21	ISSUED FOR PERMITS	KW	MS

**Civil - GRADING PLAN**  
 SHEET NUMBER  
**C2.01**





### RIP RAP NOTES:

1. PLACE 24 IN THICKNESS 2.5% OF EXISTING IN ROW WITH IN-TYPE OR CONCRETE WITH 3% SLOPE OVER TO 3" INTO SOIL UNDER SOLE OR STRIP AREA. MINIMUM IS 2.0'.
2. PLACE NEW 24 IN THICKNESS 2.5% OF EXISTING IN ROW WITH IN-TYPE OR CONCRETE WITH 3% SLOPE OVER TO 3" INTO SOIL UNDER SOLE OR STRIP AREA. MINIMUM IS 2.0'.

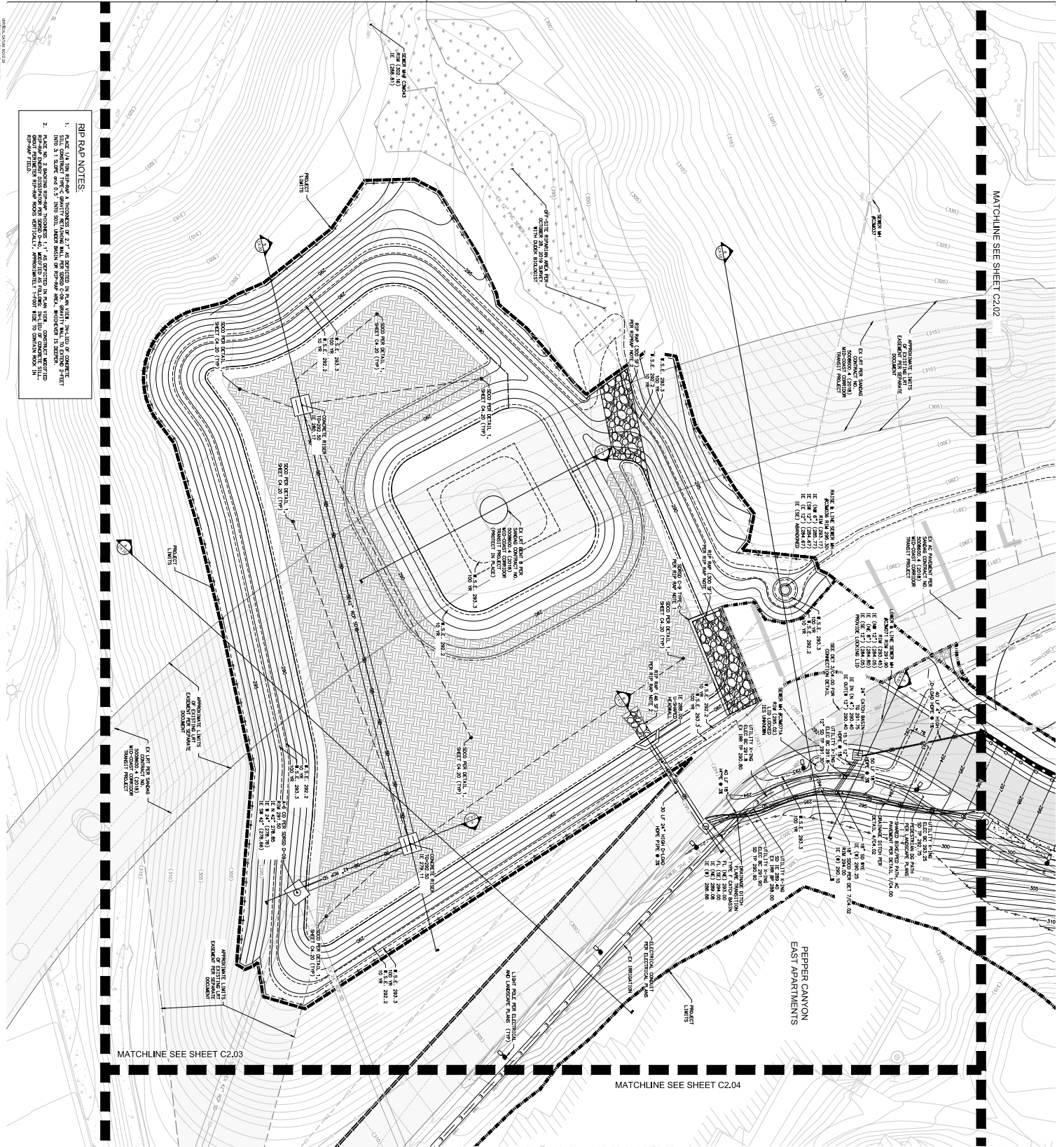

### LEGEND

- [Symbol] EXISTING BUILDING
- [Symbol] EXISTING 6" PIPE
- [Symbol] EXISTING 12" PIPE
- [Symbol] EXISTING 24" PIPE
- [Symbol] EXISTING 36" PIPE
- [Symbol] EXISTING 48" PIPE
- [Symbol] EXISTING 60" PIPE
- [Symbol] EXISTING 72" PIPE
- [Symbol] EXISTING 84" PIPE
- [Symbol] EXISTING 96" PIPE
- [Symbol] EXISTING 108" PIPE
- [Symbol] EXISTING 120" PIPE
- [Symbol] EXISTING 132" PIPE
- [Symbol] EXISTING 144" PIPE
- [Symbol] EXISTING 156" PIPE
- [Symbol] EXISTING 168" PIPE
- [Symbol] EXISTING 180" PIPE
- [Symbol] EXISTING 192" PIPE
- [Symbol] EXISTING 204" PIPE
- [Symbol] EXISTING 216" PIPE
- [Symbol] EXISTING 228" PIPE
- [Symbol] EXISTING 240" PIPE
- [Symbol] EXISTING 252" PIPE
- [Symbol] EXISTING 264" PIPE
- [Symbol] EXISTING 276" PIPE
- [Symbol] EXISTING 288" PIPE
- [Symbol] EXISTING 300" PIPE
- [Symbol] EXISTING 312" PIPE
- [Symbol] EXISTING 324" PIPE
- [Symbol] EXISTING 336" PIPE
- [Symbol] EXISTING 348" PIPE
- [Symbol] EXISTING 360" PIPE
- [Symbol] EXISTING 372" PIPE
- [Symbol] EXISTING 384" PIPE
- [Symbol] EXISTING 396" PIPE
- [Symbol] EXISTING 408" PIPE
- [Symbol] EXISTING 420" PIPE
- [Symbol] EXISTING 432" PIPE
- [Symbol] EXISTING 444" PIPE
- [Symbol] EXISTING 456" PIPE
- [Symbol] EXISTING 468" PIPE
- [Symbol] EXISTING 480" PIPE
- [Symbol] EXISTING 492" PIPE
- [Symbol] EXISTING 504" PIPE
- [Symbol] EXISTING 516" PIPE
- [Symbol] EXISTING 528" PIPE
- [Symbol] EXISTING 540" PIPE
- [Symbol] EXISTING 552" PIPE
- [Symbol] EXISTING 564" PIPE
- [Symbol] EXISTING 576" PIPE
- [Symbol] EXISTING 588" PIPE
- [Symbol] EXISTING 600" PIPE
- [Symbol] EXISTING 612" PIPE
- [Symbol] EXISTING 624" PIPE
- [Symbol] EXISTING 636" PIPE
- [Symbol] EXISTING 648" PIPE
- [Symbol] EXISTING 660" PIPE
- [Symbol] EXISTING 672" PIPE
- [Symbol] EXISTING 684" PIPE
- [Symbol] EXISTING 696" PIPE
- [Symbol] EXISTING 708" PIPE
- [Symbol] EXISTING 720" PIPE
- [Symbol] EXISTING 732" PIPE
- [Symbol] EXISTING 744" PIPE
- [Symbol] EXISTING 756" PIPE
- [Symbol] EXISTING 768" PIPE
- [Symbol] EXISTING 780" PIPE
- [Symbol] EXISTING 792" PIPE
- [Symbol] EXISTING 804" PIPE
- [Symbol] EXISTING 816" PIPE
- [Symbol] EXISTING 828" PIPE
- [Symbol] EXISTING 840" PIPE
- [Symbol] EXISTING 852" PIPE
- [Symbol] EXISTING 864" PIPE
- [Symbol] EXISTING 876" PIPE
- [Symbol] EXISTING 888" PIPE
- [Symbol] EXISTING 900" PIPE
- [Symbol] EXISTING 912" PIPE
- [Symbol] EXISTING 924" PIPE
- [Symbol] EXISTING 936" PIPE
- [Symbol] EXISTING 948" PIPE
- [Symbol] EXISTING 960" PIPE
- [Symbol] EXISTING 972" PIPE
- [Symbol] EXISTING 984" PIPE
- [Symbol] EXISTING 996" PIPE
- [Symbol] EXISTING 1008" PIPE
- [Symbol] EXISTING 1020" PIPE
- [Symbol] EXISTING 1032" PIPE
- [Symbol] EXISTING 1044" PIPE
- [Symbol] EXISTING 1056" PIPE
- [Symbol] EXISTING 1068" PIPE
- [Symbol] EXISTING 1080" PIPE
- [Symbol] EXISTING 1092" PIPE
- [Symbol] EXISTING 1104" PIPE
- [Symbol] EXISTING 1116" PIPE
- [Symbol] EXISTING 1128" PIPE
- [Symbol] EXISTING 1140" PIPE
- [Symbol] EXISTING 1152" PIPE
- [Symbol] EXISTING 1164" PIPE
- [Symbol] EXISTING 1176" PIPE
- [Symbol] EXISTING 1188" PIPE
- [Symbol] EXISTING 1200" PIPE
- [Symbol] EXISTING 1212" PIPE
- [Symbol] EXISTING 1224" PIPE
- [Symbol] EXISTING 1236" PIPE
- [Symbol] EXISTING 1248" PIPE
- [Symbol] EXISTING 1260" PIPE
- [Symbol] EXISTING 1272" PIPE
- [Symbol] EXISTING 1284" PIPE
- [Symbol] EXISTING 1296" PIPE
- [Symbol] EXISTING 1308" PIPE
- [Symbol] EXISTING 1320" PIPE
- [Symbol] EXISTING 1332" PIPE
- [Symbol] EXISTING 1344" PIPE
- [Symbol] EXISTING 1356" PIPE
- [Symbol] EXISTING 1368" PIPE
- [Symbol] EXISTING 1380" PIPE
- [Symbol] EXISTING 1392" PIPE
- [Symbol] EXISTING 1404" PIPE
- [Symbol] EXISTING 1416" PIPE
- [Symbol] EXISTING 1428" PIPE
- [Symbol] EXISTING 1440" PIPE
- [Symbol] EXISTING 1452" PIPE
- [Symbol] EXISTING 1464" PIPE
- [Symbol] EXISTING 1476" PIPE
- [Symbol] EXISTING 1488" PIPE
- [Symbol] EXISTING 1500" PIPE
- [Symbol] EXISTING 1512" PIPE
- [Symbol] EXISTING 1524" PIPE
- [Symbol] EXISTING 1536" PIPE
- [Symbol] EXISTING 1548" PIPE
- [Symbol] EXISTING 1560" PIPE
- [Symbol] EXISTING 1572" PIPE
- [Symbol] EXISTING 1584" PIPE
- [Symbol] EXISTING 1596" PIPE
- [Symbol] EXISTING 1608" PIPE
- [Symbol] EXISTING 1620" PIPE
- [Symbol] EXISTING 1632" PIPE
- [Symbol] EXISTING 1644" PIPE
- [Symbol] EXISTING 1656" PIPE
- [Symbol] EXISTING 1668" PIPE
- [Symbol] EXISTING 1680" PIPE
- [Symbol] EXISTING 1692" PIPE
- [Symbol] EXISTING 1704" PIPE
- [Symbol] EXISTING 1716" PIPE
- [Symbol] EXISTING 1728" PIPE
- [Symbol] EXISTING 1740" PIPE
- [Symbol] EXISTING 1752" PIPE
- [Symbol] EXISTING 1764" PIPE
- [Symbol] EXISTING 1776" PIPE
- [Symbol] EXISTING 1788" PIPE
- [Symbol] EXISTING 1800" PIPE
- [Symbol] EXISTING 1812" PIPE
- [Symbol] EXISTING 1824" PIPE
- [Symbol] EXISTING 1836" PIPE
- [Symbol] EXISTING 1848" PIPE
- [Symbol] EXISTING 1860" PIPE
- [Symbol] EXISTING 1872" PIPE
- [Symbol] EXISTING 1884" PIPE
- [Symbol] EXISTING 1896" PIPE
- [Symbol] EXISTING 1908" PIPE
- [Symbol] EXISTING 1920" PIPE
- [Symbol] EXISTING 1932" PIPE
- [Symbol] EXISTING 1944" PIPE
- [Symbol] EXISTING 1956" PIPE
- [Symbol] EXISTING 1968" PIPE
- [Symbol] EXISTING 1980" PIPE
- [Symbol] EXISTING 1992" PIPE
- [Symbol] EXISTING 2004" PIPE
- [Symbol] EXISTING 2016" PIPE
- [Symbol] EXISTING 2028" PIPE
- [Symbol] EXISTING 2040" PIPE
- [Symbol] EXISTING 2052" PIPE
- [Symbol] EXISTING 2064" PIPE
- [Symbol] EXISTING 2076" PIPE
- [Symbol] EXISTING 2088" PIPE
- [Symbol] EXISTING 2100" PIPE
- [Symbol] EXISTING 2112" PIPE
- [Symbol] EXISTING 2124" PIPE
- [Symbol] EXISTING 2136" PIPE
- [Symbol] EXISTING 2148" PIPE
- [Symbol] EXISTING 2160" PIPE
- [Symbol] EXISTING 2172" PIPE
- [Symbol] EXISTING 2184" PIPE
- [Symbol] EXISTING 2196" PIPE
- [Symbol] EXISTING 2208" PIPE
- [Symbol] EXISTING 2220" PIPE
- [Symbol] EXISTING 2232" PIPE
- [Symbol] EXISTING 2244" PIPE
- [Symbol] EXISTING 2256" PIPE
- [Symbol] EXISTING 2268" PIPE
- [Symbol] EXISTING 2280" PIPE
- [Symbol] EXISTING 2292" PIPE
- [Symbol] EXISTING 2304" PIPE
- [Symbol] EXISTING 2316" PIPE
- [Symbol] EXISTING 2328" PIPE
- [Symbol] EXISTING 2340" PIPE
- [Symbol] EXISTING 2352" PIPE
- [Symbol] EXISTING 2364" PIPE
- [Symbol] EXISTING 2376" PIPE
- [Symbol] EXISTING 2388" PIPE
- [Symbol] EXISTING 2400" PIPE
- [Symbol] EXISTING 2412" PIPE
- [Symbol] EXISTING 2424" PIPE
- [Symbol] EXISTING 2436" PIPE
- [Symbol] EXISTING 2448" PIPE
- [Symbol] EXISTING 2460" PIPE
- [Symbol] EXISTING 2472" PIPE
- [Symbol] EXISTING 2484" PIPE
- [Symbol] EXISTING 2496" PIPE
- [Symbol] EXISTING 2508" PIPE
- [Symbol] EXISTING 2520" PIPE
- [Symbol] EXISTING 2532" PIPE
- [Symbol] EXISTING 2544" PIPE
- [Symbol] EXISTING 2556" PIPE
- [Symbol] EXISTING 2568" PIPE
- [Symbol] EXISTING 2580" PIPE
- [Symbol] EXISTING 2592" PIPE
- [Symbol] EXISTING 2604" PIPE
- [Symbol] EXISTING 2616" PIPE
- [Symbol] EXISTING 2628" PIPE
- [Symbol] EXISTING 2640" PIPE
- [Symbol] EXISTING 2652" PIPE
- [Symbol] EXISTING 2664" PIPE
- [Symbol] EXISTING 2676" PIPE
- [Symbol] EXISTING 2688" PIPE
- [Symbol] EXISTING 2700" PIPE
- [Symbol] EXISTING 2712" PIPE
- [Symbol] EXISTING 2724" PIPE
- [Symbol] EXISTING 2736" PIPE
- [Symbol] EXISTING 2748" PIPE
- [Symbol] EXISTING 2760" PIPE
- [Symbol] EXISTING 2772" PIPE
- [Symbol] EXISTING 2784" PIPE
- [Symbol] EXISTING 2796" PIPE
- [Symbol] EXISTING 2808" PIPE
- [Symbol] EXISTING 2820" PIPE
- [Symbol] EXISTING 2832" PIPE
- [Symbol] EXISTING 2844" PIPE
- [Symbol] EXISTING 2856" PIPE
- [Symbol] EXISTING 2868" PIPE
- [Symbol] EXISTING 2880" PIPE
- [Symbol] EXISTING 2892" PIPE
- [Symbol] EXISTING 2904" PIPE
- [Symbol] EXISTING 2916" PIPE
- [Symbol] EXISTING 2928" PIPE
- [Symbol] EXISTING 2940" PIPE
- [Symbol] EXISTING 2952" PIPE
- [Symbol] EXISTING 2964" PIPE
- [Symbol] EXISTING 2976" PIPE
- [Symbol] EXISTING 2988" PIPE
- [Symbol] EXISTING 3000" PIPE

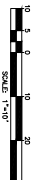

### NOTES:

1. EXISTING UTILITIES SHOWN ARE BASED ON RECORD DRAWINGS AND FIELD SURVEY DATA. VERIFY ALL UTILITIES PRIOR TO CONSTRUCTION.
2. GEOTECHNICAL DATA FROM RECORD DRAWINGS SHALL BE USED UNLESS OTHERWISE NOTED.
3. SEE LANDSCAPE PLANS FOR PLANTING SPECIFICATIONS AND MATERIALS.

Civil - GRADING PLAN  
SHEET NUMBER  
C2.03

Perkins&Will  
5434 UCSD  
PEPPER  
CANYON  
ANGILARY  
SITE WORK

CLARK  
18817 Moorpark Street  
Torrance, CA 90504  
Tel: 310.251.2252  
Fax: 310.251.2253  
www.clark-engineers.com

5434 UCSD  
PEPPER  
CANYON  
ANGILARY  
SITE WORK  
San Diego Campus  
La Jolla, California 92037



REGISTERED STAMP  
DATE: 4/29/2021  
PROJECT: 5434 UCSD PEPPER CANYON ANGILARY SITE WORK  
SHEET: C2.03

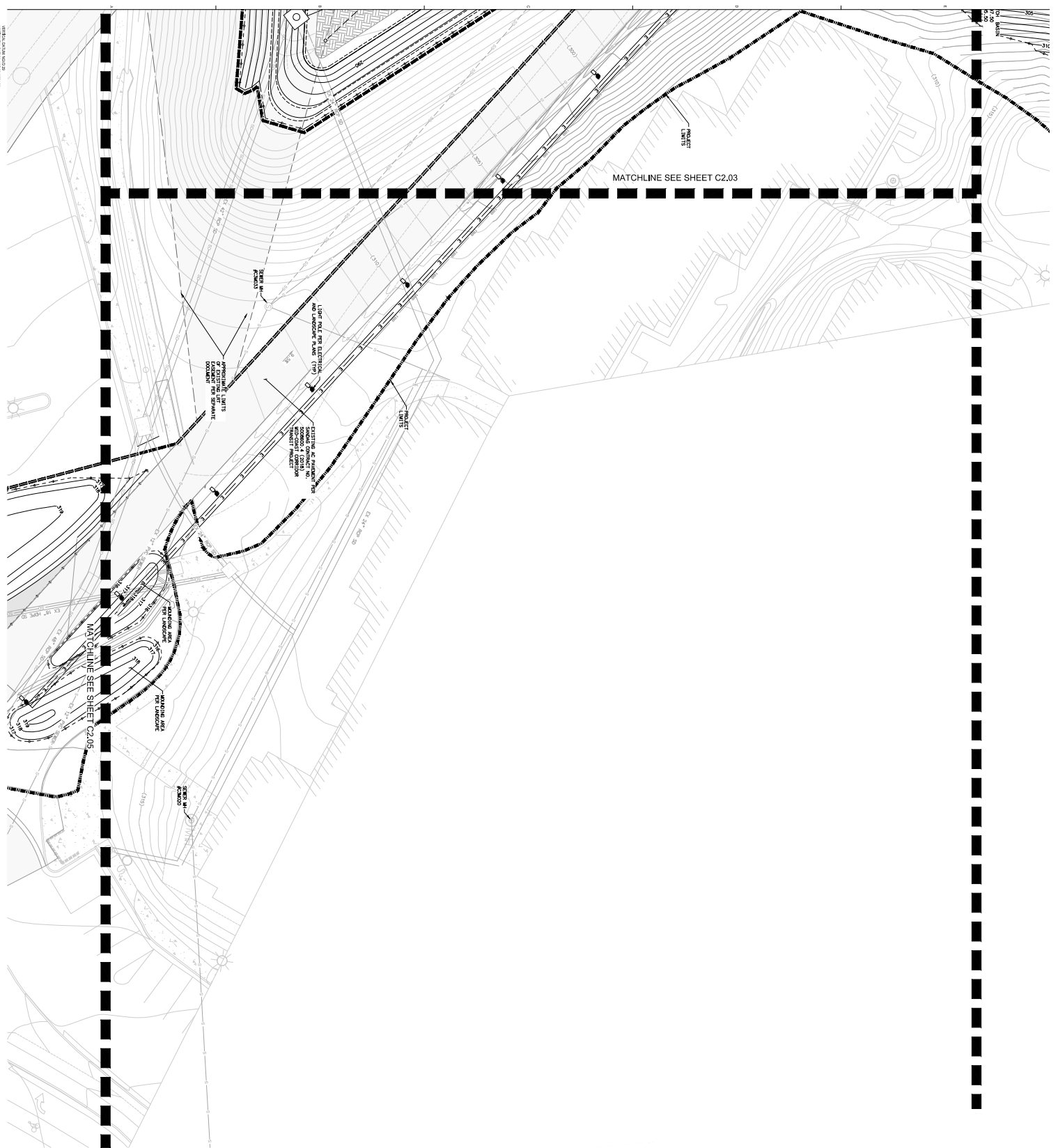

MATCHLINE SEE SHEET C2.03

MATCHLINE SEE SHEET C2.05

**LEGEND**

- EXISTING BUILDING
- EXISTING 6\"/>

**NOTES:**

1. EXISTING UTILITIES SHOWN ARE BASED ON RECORD DRAWINGS AND FIELD SURVEY. INVESTIGATE AND VERIFY ALL UTILITIES PRIOR TO CONSTRUCTION.
2. GEOTECHNICAL, LIMIT OF RECORD IS SHOWN FOR INFORMATION ONLY. CONSULT GEOTECHNICAL ENGINEER FOR DESIGN CONSTRUCTION.
3. SEE LANDSCAPE PLANS FOR PLANTING, FINISH, AND SITE DETAILS.

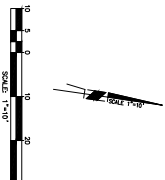

REGISTRATION STAMP

DATE: \_\_\_\_\_

PROJECT: \_\_\_\_\_

SCALE: \_\_\_\_\_

BY: \_\_\_\_\_

CHECKED BY: \_\_\_\_\_



**BASIN SPECIFICATIONS**

REGIONAL	ROCK/CONCRETE THICKNESS (IN)	SOIL THICKNESS (IN)	GRAVEL THICKNESS (IN)	PERFORATED PIPE, 12" DIA. (IN)	EL. BOTTOM (IN)
3	18	18	24	3"	7"

**BASIN SPECIFICATIONS**

- CONCRETE SHALL BE 4000 PSI STRENGTH CONCRETE WITH A MIN. 4% AIR ENTRAINMENT. ALL CONCRETE SHALL BE CAST IN PLACE AND CURED PROPERLY. ALL CONCRETE SHALL BE FINISHED TO A SMOOTH SURFACE. ALL CONCRETE SHALL BE FINISHED TO A SMOOTH SURFACE. ALL CONCRETE SHALL BE FINISHED TO A SMOOTH SURFACE.

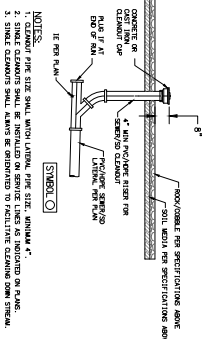
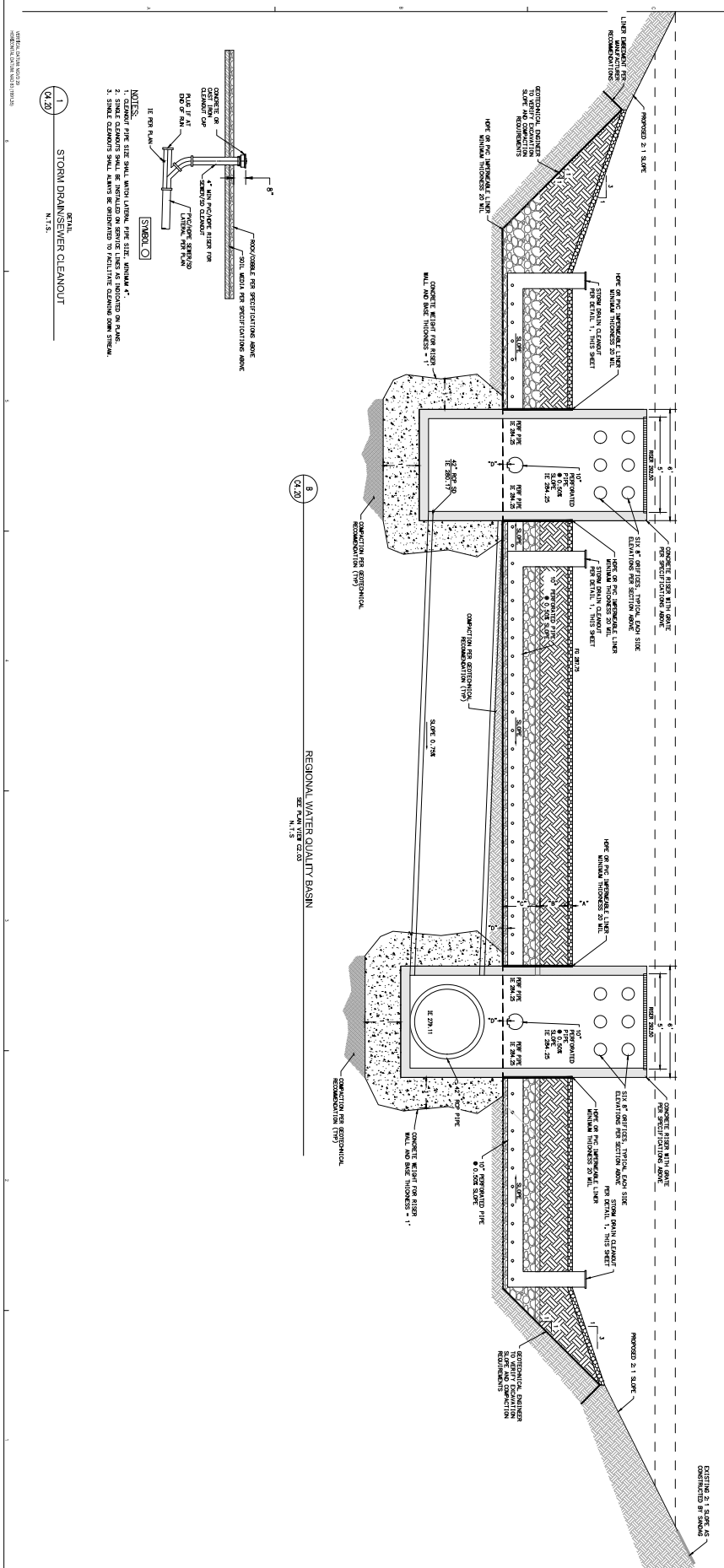
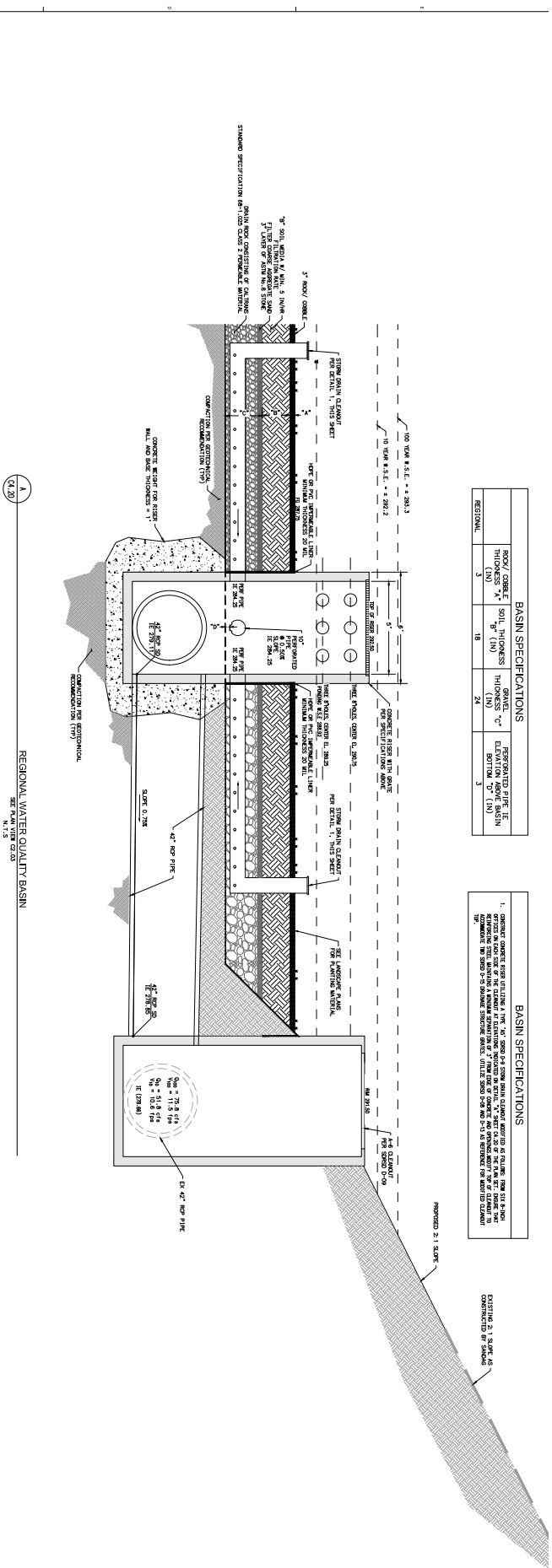

- NOTES:**
- ALL CONCRETE SHALL BE 4000 PSI STRENGTH CONCRETE WITH A MIN. 4% AIR ENTRAINMENT.
  - ALL CONCRETE SHALL BE CAST IN PLACE AND CURED PROPERLY.
  - ALL CONCRETE SHALL BE FINISHED TO A SMOOTH SURFACE.

1  
C420  
STORM DRAIN/SEWER CLEANOUT  
N.T.S.

8  
C420  
REGIONAL WATER QUALITY BASIN  
SEE PLAN VIEW C230  
N.T.S.

1  
C420  
REGIONAL WATER QUALITY BASIN  
SEE PLAN VIEW C230  
N.T.S.

**Perkins & Will**  
1000 Wilshire Blvd  
Suite 3000  
Los Angeles, CA 90017  
Tel: 213.709.7000  
Fax: 213.709.7001  
www.perkinswill.com

**CLARK**  
2021  
2020  
2019  
2018  
2017  
2016  
2015  
2014  
2013  
2012  
2011  
2010  
2009  
2008  
2007  
2006  
2005  
2004  
2003  
2002  
2001  
2000  
1999  
1998  
1997  
1996  
1995  
1994  
1993  
1992  
1991  
1990  
1989  
1988  
1987  
1986  
1985  
1984  
1983  
1982  
1981  
1980

**Michael Baker**  
1800 S. Bascom Avenue  
Suite 100  
San Jose, CA 95128  
Tel: 408.951.1000  
Fax: 408.951.1001  
www.michaelbaker.com

**5434: UCSD  
PEPPER  
CANYON  
ANCLILARY  
SITE WORK**  
University of California  
San Diego Campus  
La Jolla, California 92037

95%  
CONSTRUCTION  
DOCUMENTS  
April 30, 2021



REGISTRATION STAMP  
CNS STAMP

**REVISIONS**

NO.	DATE	DESCRIPTION
1		
2		
3		
4		

**PROJECT INFORMATION**

PROJECT: 5434: UCSD PEPPER CANYON ANCLILARY SITE WORK  
SHEET NUMBER: C420  
DATE: 4/29/2021

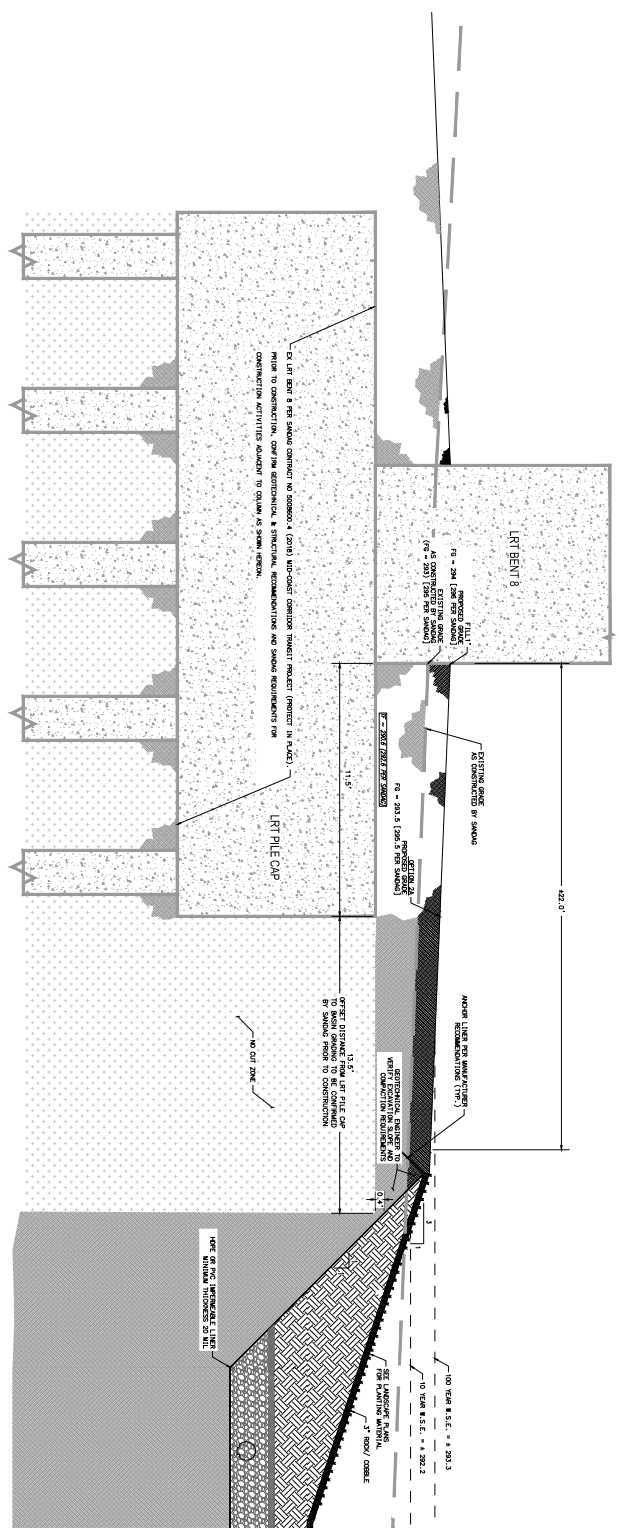

1  
C4.21  
REGIONAL WATER QUALITY BASIN  
N.T.S.

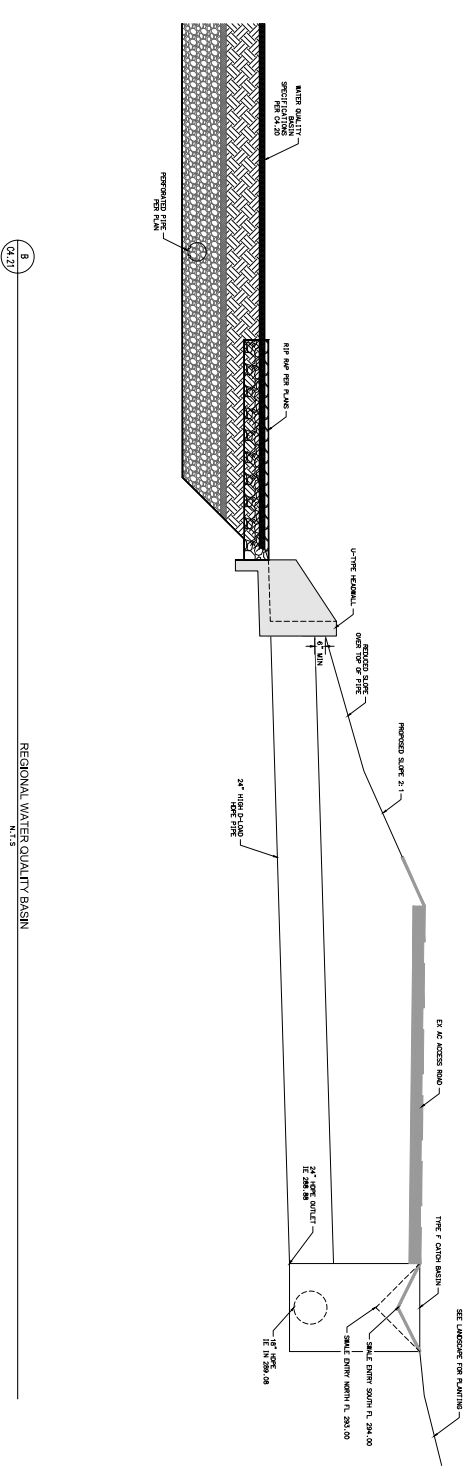

8  
C4.21  
REGIONAL WATER QUALITY BASIN  
N.T.S.

Appendix F – Excerpts from Affordable Pipeline  
Service 2013 & 2020 Storm Drain Survey

**Pipe Graphic Report of PLR A X for UCSD**

<b>Work Order</b>	<b>Contract</b>	<b>Video</b>	<b>Setup</b> 1
<b>Facility</b>	<b>Operator</b> CK	<b>Van Ref</b> 10	<b>Surveyed On</b> 03/01/2013
<b>Street Name</b>	Pepper Canyon	<b>City</b>	UCSD
<b>Location type</b>	Private - with easement		
<b>Surface</b>	Landscaping, Light shrubs, Garden		
<b>Survey purpose</b>	<b>Weather</b> Dry		
<b>Pipe Use</b> Storm	<b>Schedule length</b> 140.5 Ft	<b>From</b> B	<b>Depth</b> Ft
<b>Shape</b> Circular	<b>Size</b> 30 <b>by</b> ins	<b>To</b> A	<b>Depth</b> Ft
<b>Material</b> Reinforced Concrete Pipe	<b>Joint spacing</b> Ft	<b>Direction</b> Upstream	
<b>Lining</b>	<b>Year laid</b>	<b>Pre-clean</b>	<b>Last cleaned</b>
<b>General note</b>	<span style="color: blue;">Structural</span> <span style="color: red;">Service</span> <span style="color: purple;">Constructional</span>		
<b>Location note</b>	<span style="color: orange;">Miscellaneous</span> <span style="color: teal;">Hydraulic</span>		

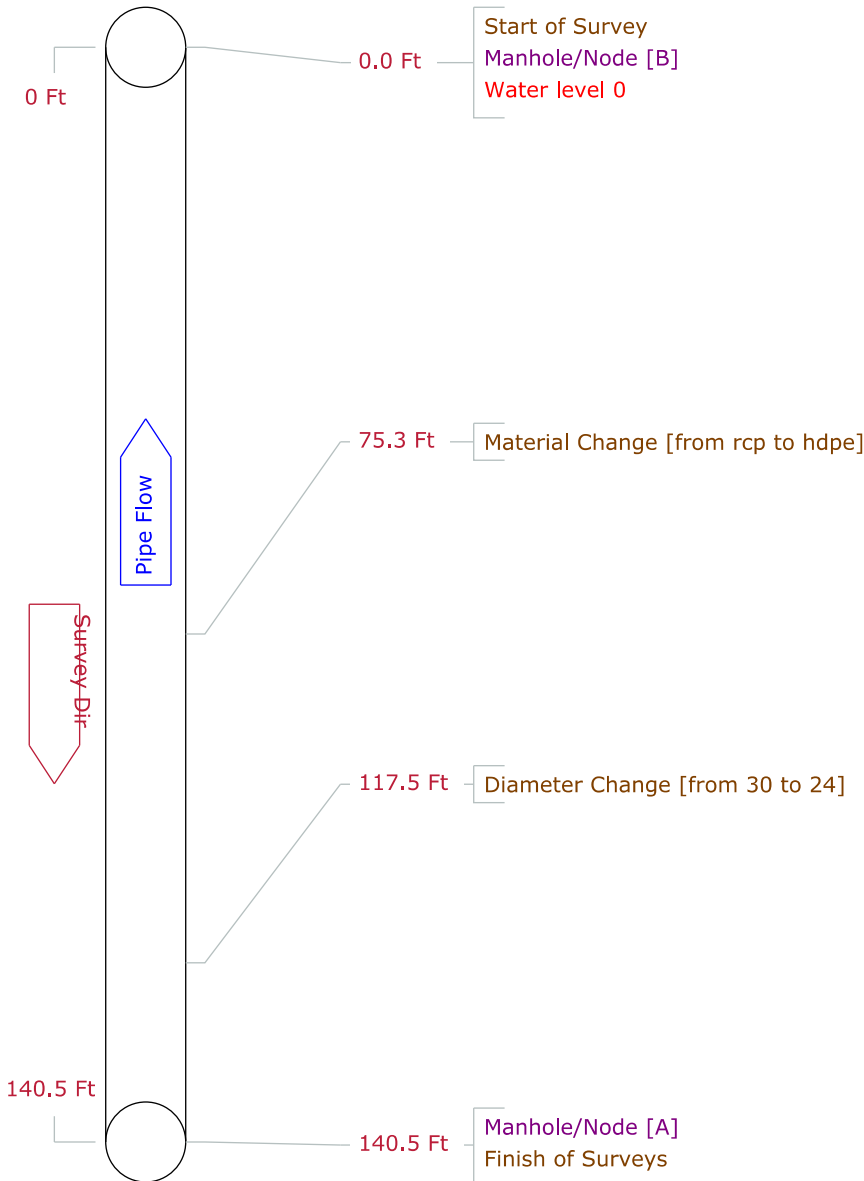

**Affordable Pipeline Services**  
**Phone: 858-689-4000**  
**Fax: 858-689-4035**



Tabular Report of PLR A X for UCSD

<b>Work Order</b> Facility	<b>Contract</b> Operator CK	<b>Video</b> Van Ref 10	<b>Setup 1</b> Surveyed On 03/01/2013
<b>Street Name</b> Pepper Canyon		<b>City</b> UCSD	
<b>Location type</b> Private - with easement			
<b>Surface</b> Landscaping, Light shrubs, Garden			
<b>Survey purpose</b>		<b>Weather</b> Dry	
<b>Pipe Use</b> Storm	<b>Sched length</b> 140.5 Ft	<b>From B</b>	<b>Depth</b> Ft
<b>Shape</b> Circular	<b>Size</b> 30 by ins	<b>To A</b>	<b>Depth</b> Ft
<b>Material</b> Reinforced Concrete Pipe	<b>Joint Spacing</b> Ft	<b>Direction</b> Up	
<b>Lining</b>	<b>Year laid</b>	<b>Pre-clean</b>	<b>Last Cleaned</b>
<b>General note</b>		Structural	Service
<b>Location note</b>		Miscellaneous	Constructional
		Hydraulic	

Video	Count	CD	Code	Sev	Fr	To	Value	Remarks
	0.0		ST					Start of Survey
	0.0		MH					B
	0.0		WL				0	
	75.3		MC					from rcp to hdpe
	117.5		DC					from 30 to 24
	140.5		MH					A
	140.5		FH					Finish of Surveys

140.5 Ft Total Length Surveyed

<b>Scores</b>	<b>Structural:</b>	<b>Total</b> 0	<b>Mean Defect</b> 0	<b>Peak</b> 0	<b>Mean Pipe</b> 0
	<b>Service:</b>	<b>Total</b> 0	<b>Mean Defect</b> 0	<b>Peak</b> 0	<b>Mean Pipe</b> 0



**AFFORDABLE**  
PIPELINE SERVICES  
A DIVISION OF AFFORDABLE DESIGN SERVICE, INC.

**Affordable Pipeline Services**  
Phone: 858-689-4000  
Fax: 858-689-4035

**Pipe Graphic Report of PLR B X for UCSD**

<b>Work Order</b>	<b>Contract</b>	<b>Video</b>	<b>Setup</b> 2
<b>Facility</b>	<b>Operator</b> CK	<b>Van Ref</b> 10	<b>Surveyed On</b> 03/01/2013
<b>Street Name</b>	Pepper Canyon	<b>City</b>	UCSD
<b>Location type</b>	Private - with easement		
<b>Surface</b>	Landscaping, Light shrubs, Garden		
<b>Survey purpose</b>	<b>Weather</b> Dry		
<b>Pipe Use</b> Storm	<b>Schedule length</b> 196.9 Ft	<b>From</b> B	<b>Depth</b> Ft
<b>Shape</b> Circular	<b>Size</b> 48 <b>by</b> ins	<b>To</b> C	<b>Depth</b> Ft
<b>Material</b> Reinforced Concrete Pipe	<b>Joint spacing</b> Ft	<b>Direction</b> Downstream	
<b>Lining</b>	<b>Year laid</b>	<b>Pre-clean</b>	<b>Last cleaned</b>
<b>General note</b>	<span style="color: blue;">Structural</span> <span style="color: red;">Service</span> <span style="color: purple;">Constructional</span>		
<b>Location note</b>	<span style="color: orange;">Miscellaneous</span> <span style="color: teal;">Hydraulic</span>		

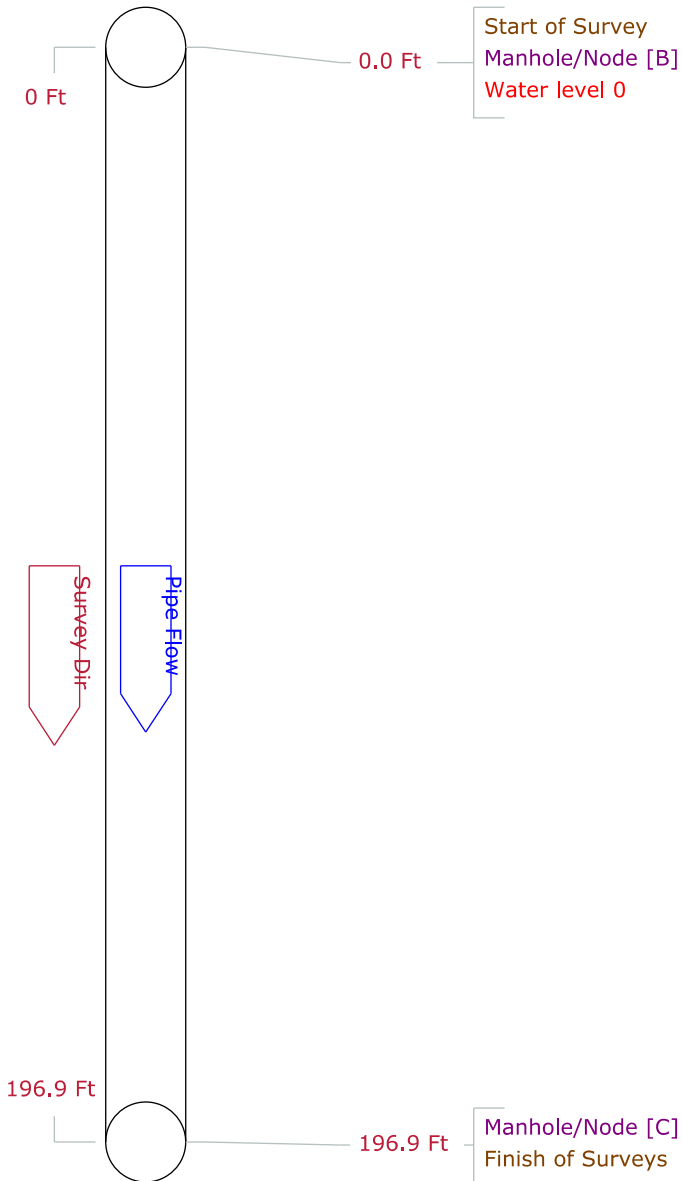

**Affordable Pipeline Services**  
**Phone: 858-689-4000**  
**Fax: 858-689-4035**

Tabular Report of PLR B X for UCSD

<b>Work Order</b> Facility	<b>Contract</b> Operator CK	<b>Video</b> Van Ref 10	<b>Setup 2</b> Surveyed On 03/01/2013
<b>Street Name</b> Pepper Canyon		<b>City</b> UCSD	
<b>Location type</b> Private - with easement			
<b>Surface</b> Landscaping, Light shrubs, Garden			
<b>Survey purpose</b>		<b>Weather</b> Dry	
<b>Pipe Use</b> Storm	<b>Sched length</b> 196.9 Ft	<b>From B</b>	<b>Depth</b> Ft
<b>Shape</b> Circular	<b>Size</b> 48 by ins	<b>To C</b>	<b>Depth</b> Ft
<b>Material</b> Reinforced Concrete Pipe	<b>Joint Spacing</b> Ft	<b>Direction</b> Down	
<b>Lining</b>	<b>Year laid</b>	<b>Pre-clean</b>	<b>Last Cleaned</b>
<b>General note</b>		Structural	Service
<b>Location note</b>		Miscellaneous	Constructional
		Hydraulic	

Video	Count	CD	Code	Sev	Fr	To	Value	Remarks
	0.0		ST Start of Survey					
	0.0		MH Manhole/Node					B
	0.0		WL Water level				0	
	196.9		MH Manhole/Node					C
	196.9		FH Finish of Surveys					

196.9 Ft Total Length Surveyed

<b>Scores</b>	<b>Structural:</b>	<b>Total</b> 0	<b>Mean Defect</b> 0	<b>Peak</b> 0	<b>Mean Pipe</b> 0
	<b>Service:</b>	<b>Total</b> 0	<b>Mean Defect</b> 0	<b>Peak</b> 0	<b>Mean Pipe</b> 0



**AFFORDABLE**  
PIPELINE SERVICES  
A DIVISION OF AFFORDABLE DESIGN SERVICE, INC.

**Affordable Pipeline Services**  
Phone: 858-689-4000  
Fax: 858-689-4035

Pipe Graphic Report of PLR C X for UCSD

<b>Work Order</b>	<b>Contract</b>	<b>Video</b>	<b>Setup</b> 3
<b>Facility</b>	<b>Operator</b> CK	<b>Van Ref</b> 10	<b>Surveyed On</b> 03/01/2013
<b>Street Name</b>	Pepper Canyon	<b>City</b>	UCSD
<b>Location type</b>	Private - with easement		
<b>Surface</b>	Landscaping, Light shrubs, Garden		
<b>Survey purpose</b>	<b>Weather</b> Dry		
<b>Pipe Use</b> Storm	<b>Schedule length</b>	Ft	<b>From</b> C <b>Depth</b> Ft
<b>Shape</b> Circular	<b>Size</b> 48 <b>by</b> ins		<b>To</b> D <b>Depth</b> Ft
<b>Material</b> Reinforced Concrete Pipe	<b>Joint spacing</b>	Ft	<b>Direction</b> Downstream
<b>Lining</b>	<b>Year laid</b>		<b>Pre-clean</b> <b>Last cleaned</b>
<b>General note</b>	Structural Service Constructional		
<b>Location note</b>	Miscellaneous Hydraulic		

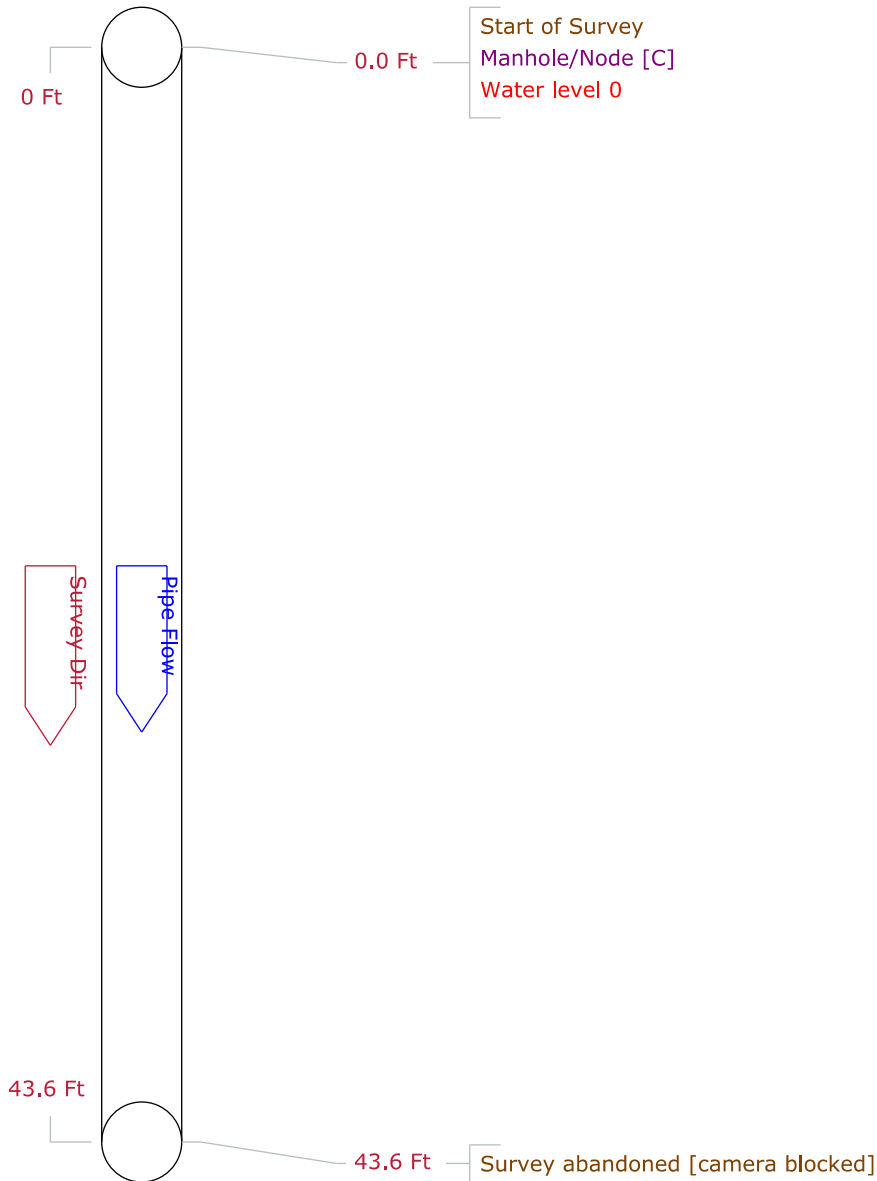

**Affordable Pipeline Services**  
**Phone: 858-689-4000**  
**Fax: 858-689-4035**

Tabular Report of PLR C X for UCSD

<b>Work Order</b> Facility	<b>Contract</b> Operator CK	<b>Video</b> Van Ref 10	<b>Setup 3</b> Surveyed On 03/01/2013
<b>Street Name</b> Pepper Canyon		<b>City</b> UCSD	
<b>Location type</b> Private - with easement			
<b>Surface</b> Landscaping, Light shrubs, Garden			
<b>Survey purpose</b>		<b>Weather</b> Dry	
<b>Pipe Use</b> Storm	<b>Sched length</b>	<b>Ft</b>	<b>From C</b>
<b>Shape</b> Circular	<b>Size 48 by</b>	<b>ins</b>	<b>To D</b>
<b>Material</b> Reinforced Concrete Pipe	<b>Joint Spacing</b>	<b>Ft</b>	<b>Direction</b> Down
<b>Lining</b>	<b>Year laid</b>		<b>Pre-clean</b> <b>Last Cleaned</b>
<b>General note</b>			Structural      Service      Constructional
<b>Location note</b>			Miscellaneous      Hydraulic

Video	Count	CD	Code	Sev	Fr	To	Value	Remarks
	0.0		ST Start of Survey					
	0.0		MH Manhole/Node					C
	0.0		WL Water level				0	
	43.6		SA Survey abandoned					camera blocked

43.6 Ft Total Length Surveyed

Scores

<b>Structural:</b>	<b>Total</b> 0	<b>Mean Defect</b> 0	<b>Peak</b> 0	<b>Mean Pipe</b> 0
<b>Service:</b>	<b>Total</b> 0	<b>Mean Defect</b> 0	<b>Peak</b> 0	<b>Mean Pipe</b> 0



**AFFORDABLE**  
PIPELINE SERVICES  
A DIVISION OF AFFORDABLE DESIGN SERVICES, INC.

**Affordable Pipeline Services**  
Phone: 858-689-4000  
Fax: 858-689-4035

**Pipe Graphic Report of PLR**      C      X      for UCSD

<b>Work Order</b>	<b>Contract</b>		<b>Video</b>		<b>Setup</b>	4	
<b>Facility</b>	<b>Operator</b>	CK	<b>Van Ref</b>	10	<b>Surveyed On</b>	05/28/2013	
<b>Street Name</b>	Pepper Canyon		<b>City</b>	UCSD			
<b>Location type</b>	Private - with easement						
<b>Surface</b>							
<b>Survey purpose</b>			<b>Weather</b>	Dry			
<b>Pipe Use</b>	Storm	<b>Schedule length</b>	327.1 Ft	<b>From</b>	C	<b>Depth</b>	F
<b>Shape</b>	Circular	<b>Size</b>	48 by ins	<b>To</b>	D	<b>Depth</b>	t
<b>Material</b>			<b>Joint spacing</b>	Ft	<b>Direction</b>	Downstream	
<b>Lining</b>			<b>Year laid</b>			<b>Pre-clean</b>	<b>Last cleaned</b>
<b>General note</b>					Structural	Service	Constructional
<b>Location note</b>					Miscellaneous	Hydraulic	

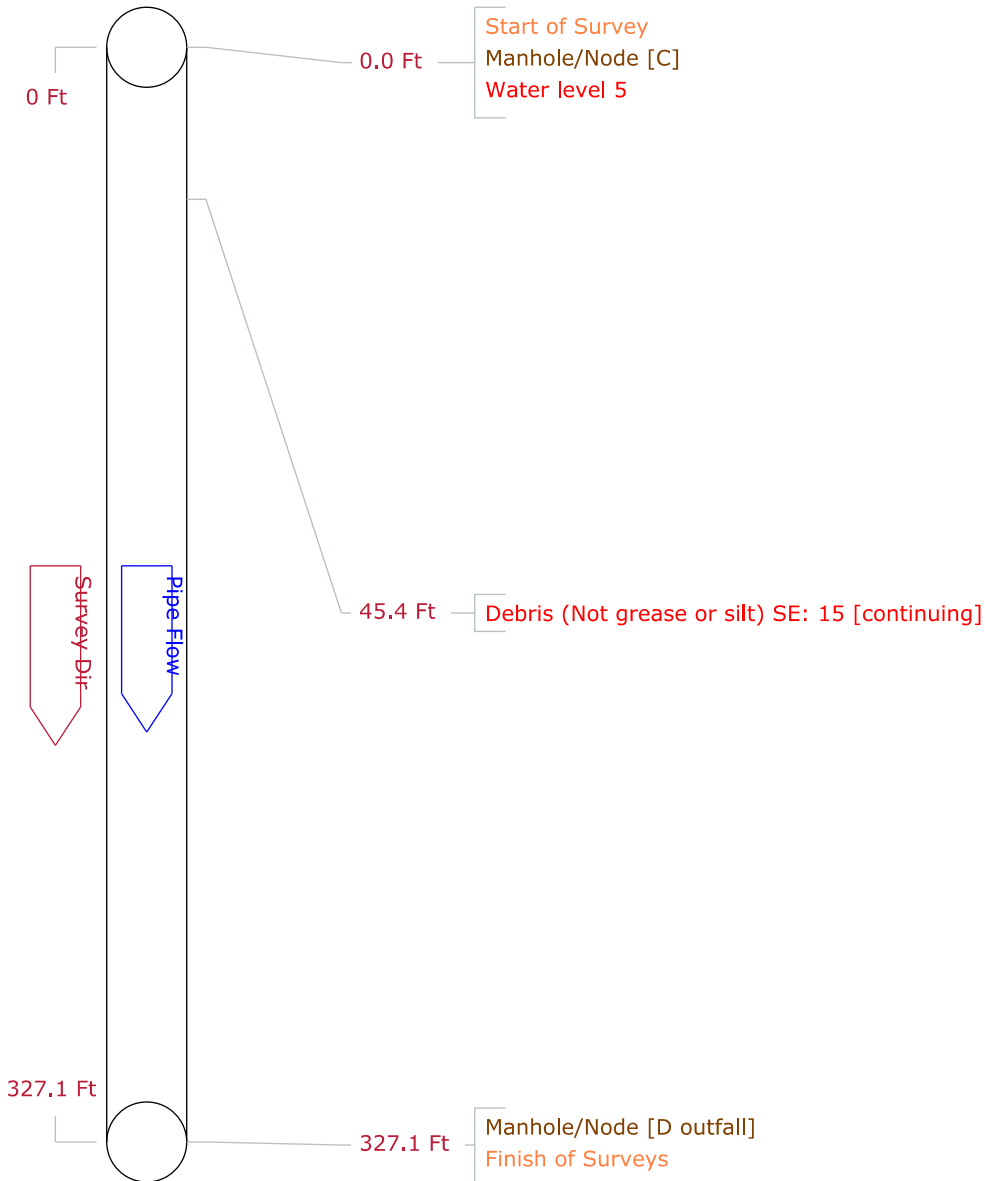

**Affordable Pipeline Services**  
**Phone: 858-689-4000**  
**Fax: 858-689-4035**

**Tabular Report of PLR C X for UCSD**

<b>Work Order</b>	<b>Contract</b>		<b>Video</b>		<b>Setup 4</b>	
<b>Facility</b>	<b>Operator</b> CK		<b>Van Ref</b> 10		<b>Surveyed On</b> 05/28/2013	
<b>Street Name</b>	Pepper Canyon		<b>City</b> UCSD			
<b>Location type</b>	Private - with easement					
<b>Surface</b>	LAND					
<b>Survey purpose</b>			<b>Weather</b>		Dry	
<b>Pipe Use</b>	Storm		<b>Sched length</b>	327.1	<b>Ft</b>	
<b>Shape</b>	Circular		<b>Size</b>	48	<b>by</b>	ins
<b>Material</b>	RCP		<b>Joint Spacing</b>		<b>Ft</b>	
<b>Lining</b>			<b>Year laid</b>			
<b>General note</b>			<b>From</b>	C	<b>Depth</b>	<b>Ft</b>
<b>Location note</b>			<b>To</b>	D	<b>Depth</b>	<b>Ft</b>
			<b>Direction</b>	Down		
			<b>Pre-clean</b>	<b>Last Cleaned</b>		
			<b>Structural</b>	<b>Service</b>	<b>Constructional</b>	
			<b>Miscellaneous</b>	<b>Hydraulic</b>		

Video	Count	CD	Code	Sev	Fr	To	Value	Remarks
	0.0		ST Start of Survey					
	0.0		MH Manhole/Node					C
	0.0		WL Water level				5	
	45.4		DE Debris (Not grease or silt)	L				continuing
	327.1		MH Manhole/Node					D outfall
	327.1		FH Finish of Surveys					

327.1 Ft Total Length Surveyed

<b>Scores</b>	<b>Structural:</b>	<b>Total</b>	<b>Mean Defect</b>	<b>Peak</b>	<b>Mean Pipe</b>
	<b>Service:</b>	<b>Total</b>	<b>Mean Defect</b>	<b>Peak</b>	<b>Mean Pipe</b>



**AFFORDABLE PIPELINE SERVICES**  
A DIVISION OF AFFORDABLE DESIGN SERVICES, INC.

**Affordable Pipeline Services**  
Phone: 858-689-4000  
Fax: 858-689-4035

**Pipe Graphic Report of PLR**      4H0062      X      for UCSD

<b>Work Order</b>	SD02687	<b>Contract</b>		<b>Video</b>		<b>Setup</b>	10
<b>Facility</b>	SD02687	<b>Operator</b>	C.Kintz	<b>Van Ref</b>	16	<b>Surveyed On</b>	03/16/2020
<b>Street Name</b>	Gilman Dr		<b>City</b>	UCSD			
<b>Location type</b>							
<b>Surface</b>							
<b>Survey purpose</b>				<b>Weather</b>	Dry		
<b>Pipe Use</b>	Storm	<b>Schedule length</b>	108.3 Ft	<b>From</b>	4H0062	<b>Depth</b>	F t
<b>Shape</b>	Circular	<b>Size</b>	48 by ins	<b>To</b>	4H0001	<b>Depth</b>	
<b>Material</b>				<b>Joint spacing</b>	Ft	<b>Direction</b>	Downstream
<b>Lining</b>				<b>Year laid</b>			
<b>General note</b>	Easement from Pepper Canyon			<b>Pre-clean</b>	<b>Last cleaned</b>		
<b>Location note</b>				Structural	Service	Constructional	
				Miscellaneous	Hydraulic		

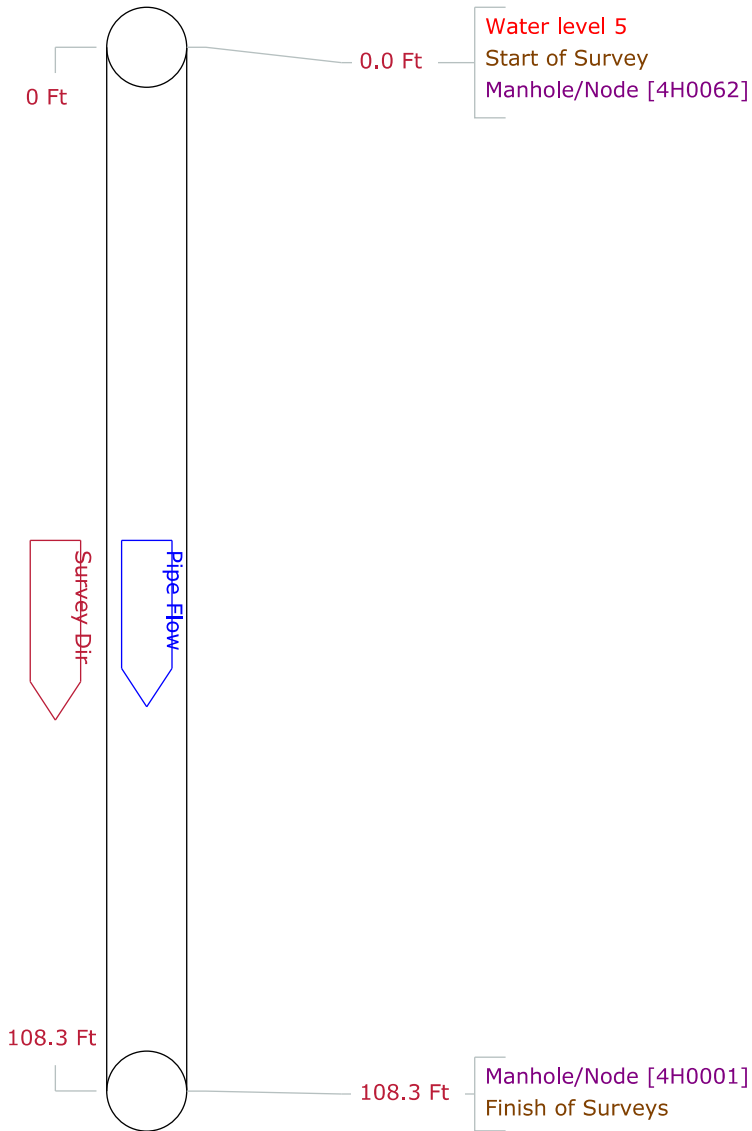



<b>Tabular Report of PLR</b>		4H0062	X			<b>for UCSD</b>	
<b>Work Order</b>	SD02687	<b>Contract</b>		<b>Video</b>		<b>Setup 10</b>	
<b>Facility</b>	SD02687	<b>Operator</b> C.Kintz		<b>Van Ref</b> 16		<b>Surveyed On</b> 03/16/2020	
<b>Street Name</b>	Gilman Dr			<b>City</b> UCSD			
<b>Location type</b>							
<b>Surface</b>							
<b>Survey purpose</b>				<b>Weather</b>	Dry		
<b>From</b>	4H0062			<b>Depth</b>	<b>Ft</b>	<b>Direction</b> Down	
<b>To</b>	4H0001			<b>Depth</b>	<b>Ft</b>	<b>Year laid</b>	
	<b>Sched length</b>	108.3 <b>Ft</b>	<b>Size</b>	48 <b>by</b>	<b>ins</b>	<b>Joint Spacing</b>	<b>Ft</b>
	<b>Pipe Use</b>	Storm		<b>Shape</b>	Circular		<b>Pre-clean</b>
	<b>Material</b>	CC-RF		<b>Lining</b>	<b>Last Cleaned</b>		
<b>General note</b>	Easement from Pepper Canyon			<b>Structural</b>	<b>Service</b>	<b>Constructional</b>	
<b>Location note</b>				<b>Miscellaneous</b>	<b>Hydraulic</b>		

Video	Count	CD	Code	Sev	Fr	To	Value	Remarks
	0.0		WL Water level				5	
	0.0		ST Start of Survey					
	0.0		MH Manhole/Node					4H0062
	108.3		MH Manhole/Node					4H0001
	108.3		FH Finish of Surveys					

108.3 Ft **Total Length Surveyed**

<b>Scores</b>	<b>Structural:</b>	<b>Total</b>	<b>Mean Defect</b>	<b>Peak</b>	<b>Mean Pipe</b>
	<b>Service:</b>	<b>Total</b>	<b>Mean Defect</b>	<b>Peak</b>	<b>Mean Pipe</b>

**Pipe Graphic Report of PLR**      4H0091      X      for UCSD

<b>Work Order</b>	SD03239	<b>Contract</b>		<b>Video</b>		<b>Setup</b>	11
<b>Facility</b>	SD03239	<b>Operator</b>	C.Kintz	<b>Van Ref</b>	16	<b>Surveyed On</b>	03/16/2020
<b>Street Name</b>	Gilman Dr		<b>City</b>	UCSD			
<b>Location type</b>							
<b>Surface</b>							
<b>Survey purpose</b>				<b>Weather</b>	Dry		
<b>Pipe Use</b>	Storm	<b>Schedule length</b>	281.7 Ft	<b>From</b>	4H0062	<b>Depth</b>	F f t
<b>Shape</b>	Circular	<b>Size</b>	42 by ins	<b>To</b>	4H0091	<b>Depth</b>	
<b>Material</b>		<b>Joint spacing</b>	Ft	<b>Direction</b>	Upstream		
<b>Lining</b>		<b>Year laid</b>		<b>Pre-clean</b>	<b>Last cleaned</b>		
<b>General note</b>	Easement from Pepper Canyon			<b>Structural</b>	<b>Service</b>	<b>Constructional</b>	
<b>Location note</b>				<b>Miscellaneous</b>	<b>Hydraulic</b>		

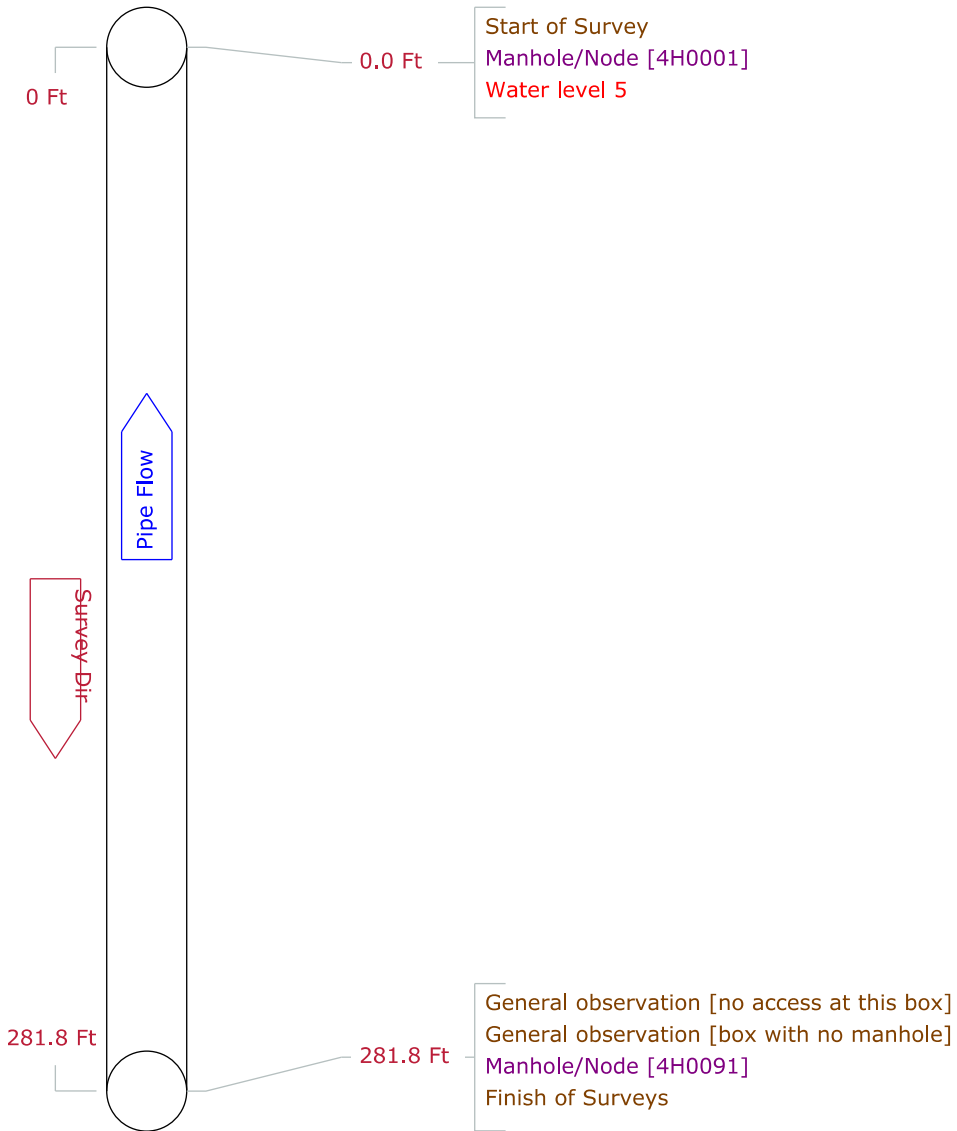

<b>Tabular Report of PLR</b>		4H0091	X			<b>for UCSD</b>	
<b>Work Order</b>	SD03239	<b>Contract</b>		<b>Video</b>		<b>Setup 11</b>	
<b>Facility</b>	SD03239	<b>Operator</b> C.Kintz		<b>Van Ref</b> 16		<b>Surveyed On</b> 03/16/2020	
<b>Street Name</b>	Gilman Dr			<b>City</b> UCSD			
<b>Location type</b>							
<b>Surface</b>							
<b>Survey purpose</b>				<b>Weather</b>	Dry		
<b>From</b>	4H0062			<b>Depth</b>	<b>Ft</b>	<b>Direction</b> Up	
<b>To</b>	4H0091			<b>Depth</b>	<b>Ft</b>	<b>Year laid</b>	
	<b>Sched length</b> 281.7 <b>Ft</b>	<b>Size</b>	42 <b>by</b>	<b>ins</b>	<b>Joint Spacing</b>	<b>Ft</b>	
	<b>Pipe Use</b> Storm			<b>Shape</b>	Circular		<b>Pre-clean</b>
	<b>Material</b> CC-RF			<b>Lining</b>	<b>Last Cleaned</b>		
<b>General note</b>	Easement from Pepper Canyon			<b>Structural</b>		<b>Service</b>	<b>Constructional</b>
<b>Location note</b>				<b>Miscellaneous</b>		<b>Hydraulic</b>	

Video	Count	CD	Code	Sev	Fr	To	Value	Remarks
	0.0		ST Start of Survey					
	0.0		MH Manhole/Node					4H0001
	0.0		WL Water level				5	
	281.8		GO General observation					no access at this box
	281.8		GO General observation					box with no manhole
	281.8		MH Manhole/Node					4H0091
	281.8		FH Finish of Surveys					

281.8 Ft **Total Length Surveyed**

<b>Scores</b>	<b>Structural:</b>	<b>Total</b>	<b>Mean Defect</b>	<b>Peak</b>	<b>Mean Pipe</b>
	<b>Service:</b>	<b>Total</b>	<b>Mean Defect</b>	<b>Peak</b>	<b>Mean Pipe</b>

**Pipe Graphic Report of PLR**      4H0003      X      for UCSD

<b>Work Order</b>	SD03240	<b>Contract</b>		<b>Video</b>		<b>Setup</b>	12
<b>Facility</b>	SD03240	<b>Operator</b>	C.Kintz	<b>Van Ref</b>	16	<b>Surveyed On</b>	03/16/2020
<b>Street Name</b>	Gilman Dr		<b>City</b>	UCSD			
<b>Location type</b>							
<b>Surface</b>							
<b>Survey purpose</b>				<b>Weather</b>	Dry		
<b>Pipe Use</b>	Storm	<b>Schedule length</b>	201.9 Ft	<b>From</b>	4H0091	<b>Depth</b>	F
<b>Shape</b>	Circular	<b>Size</b>	42 by ins	<b>To</b>	4H0003	<b>Depth</b>	F
<b>Material</b>		<b>Joint spacing</b>	Ft	<b>Direction</b>	Upstream		
<b>Lining</b>		<b>Year laid</b>		<b>Pre-clean</b>		<b>Last cleaned</b>	
<b>General note</b>	Easement from Pepper Canyon			<b>Structural</b>	<b>Service</b>	<b>Constructional</b>	
<b>Location note</b>				<b>Miscellaneous</b>	<b>Hydraulic</b>		

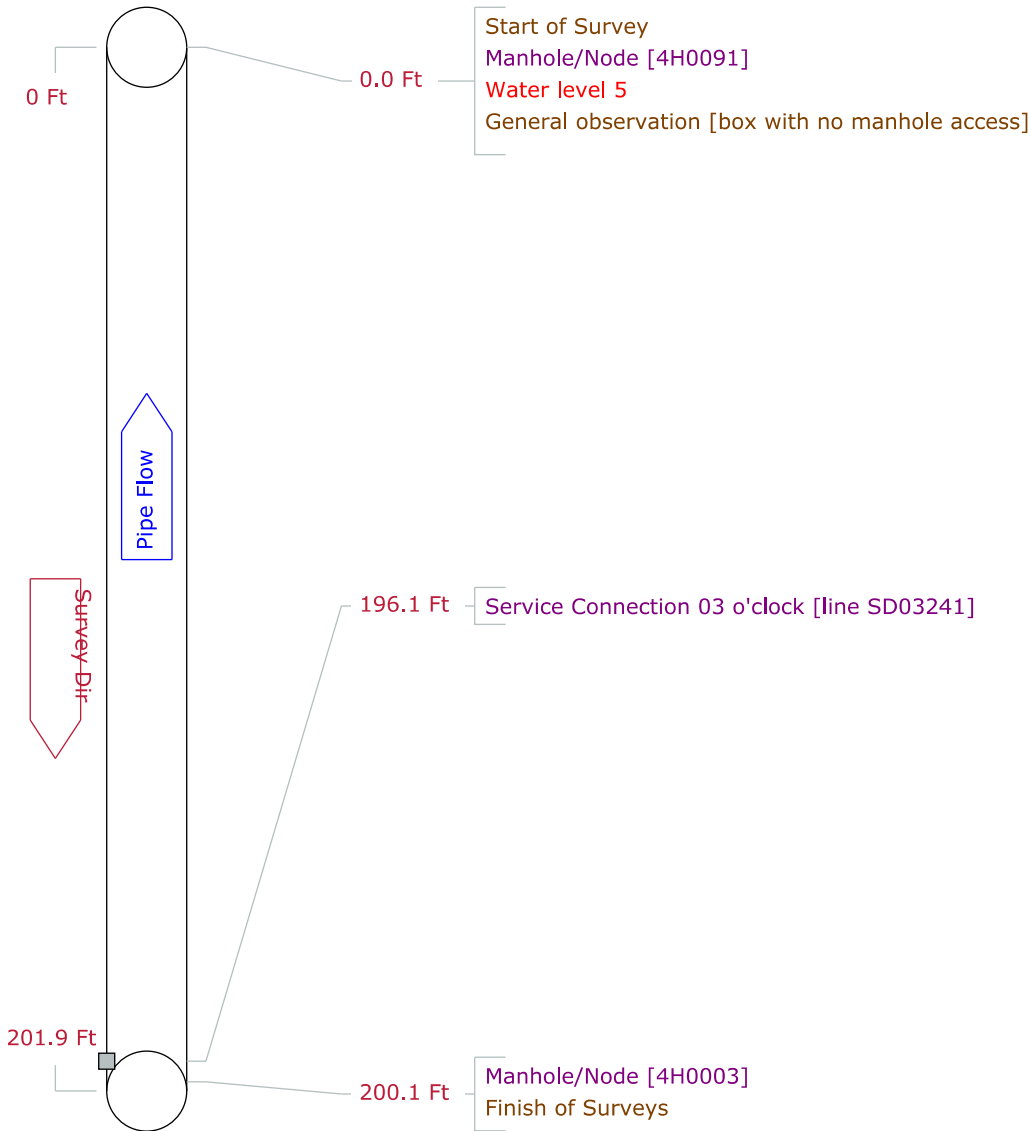

<b>Tabular Report of PLR</b>		4H0003	X			<b>for UCSD</b>	
<b>Work Order</b>	SD03240	<b>Contract</b>		<b>Video</b>		<b>Setup 12</b>	
<b>Facility</b>	SD03240	<b>Operator</b> C.Kintz		<b>Van Ref</b> 16		<b>Surveyed On</b> 03/16/2020	
<b>Street Name</b>	Gilman Dr			<b>City</b> UCSD			
<b>Location type</b>							
<b>Surface</b>							
<b>Survey purpose</b>				<b>Weather</b>	Dry		
<b>From</b>	4H0091			<b>Depth</b>	Ft	<b>Direction</b> Up	
<b>To</b>	4H0003			<b>Depth</b>	Ft	<b>Year laid</b>	
	<b>Sched length</b>	201.9	<b>Ft</b>	<b>Size</b>	42	<b>by</b>	<b>ins</b>
	<b>Joint Spacing</b>				<b>Ft</b>		
	<b>Pipe Use</b>	Storm			<b>Shape</b>	Circular	
	<b>Material</b>	CC-RF			<b>Lining</b>		
<b>General note</b>	Easement from Pepper Canyon			<b>Structural</b>	<b>Service</b>	<b>Constructional</b>	
<b>Location note</b>				<b>Miscellaneous</b>	<b>Hydraulic</b>		

Video	Count	CD	Code	Sev	Fr	To	Value	Remarks
	0.0		ST Start of Survey					
	0.0		MH Manhole/Node					4H0091
	0.0		WL Water level				5	
	0.0		GO General observation					box with no manhole access
	196.1		CN Service Connection		03			line SD03241
	200.1		MH Manhole/Node					4H0003
	200.1		FH Finish of Surveys					

200.1 Ft **Total Length Surveyed**

<b>Scores</b>	<b>Structural:</b>	<b>Total</b>	<b>Mean Defect</b>	<b>Peak</b>	<b>Mean Pipe</b>
	<b>Service:</b>	<b>Total</b>	<b>Mean Defect</b>	<b>Peak</b>	<b>Mean Pipe</b>



**APPENDIX C**  
*Post Construction*  
*Stormwater Management Checklist*





## Post-Construction Stormwater Management Checklist\* (5,000 SF or Greater)

**Applicability:** Required for projects that create and/or replace 5,000 square feet or greater of impervious surface (i.e. asphalt roads, concrete structures, building area, sidewalks, etc.). Impervious surfaces are those that water cannot infiltrate/soak into.

*To ensure that required site design measures are implemented in accordance with UC San Diego's Phase II Small MS4 General Permit 2013-0001-DWQ, submit working versions of this checklist (electronic or hard copy) to the UC San Diego Project Manager, to Environmental Planning, and to the FD&C Civil Engineering Group for review during the following project design phases (as applicable):*

- |                            |   |
|----------------------------|---|
| 1. Conceptual Design Phase | 4. 100% Construction Drawings                                     |
| 2. 100% Schematic Design   | 5. At Project Close-out (final and complete version of checklist) |
| 3. Design Development      | (also submit final and complete version of checklist to EH&S)     |

**Is Project Exempt?**  Yes  No

**Exemptions:** The following projects are exempt from the Phase II Small MS4 permit storm water site design measures and low impact design requirements:

- 1. Regulated projects that have been designed, approved, and funded prior to July 1, 2014.
- 2. Interior remodels.
- 3. Linear underground/overhead projects (LUPs) that have less than 5,000 square feet of newly constructed contiguous impervious surface.
- 4. Routine maintenance or repair projects such as:
  - a. Maintenance, repair, and replacement work on existing underground utilities such as sanitary sewer lines or other utilities.
  - b. Exterior wall surface replacement.
  - c. Roof replacement.
  - d. Pavement or asphalt resurfacing within the existing footprint.
  - e. Sidewalk replacement within an existing footprint to replace concrete that is causing a trip hazard.
  - f. routine replacement/repair of damaged pavement/asphalt such as pothole repair.
- 5. Bicycle lanes or pedestrian ramps on existing roads or sidewalks within existing footprint (e.g., no new impervious area).
- 6. Sidewalks built as a part of new streets or roads and built to direct storm water runoff to adjacent vegetated areas.
- 7. Bicycle lanes that are built as part of new streets or roads that direct storm water runoff to adjacent vegetated areas.
- 8. Impervious trails build to direct storm water runoff to adjacent vegetated areas, or other non-erodible permeable areas.
- 9. Sidewalks, bicycle lanes or trails constructed with permeable surfaces.

**\*NOTE: If the project meets the exemption requirements, applicable portions of the checklist must still be completed.**

<b>Project Name:</b> UCSD Pepper Canyon Ancillary Site Work	<b>Project #:</b> 5265
--	---------------------------

<b>Street Address:</b> Gilman Drive & Villa La Jolla Drive, San Diego, CA 92039	<b>Cross Streets:</b> Gilman Drive & Villa La Jolla Drive
--	--

**Project Watershed (circle):** See Attached Map if unsure which watershed your project lies within.

Scripps     
  Miramar Reservoir     
  **Miramar**     
  Other: \_\_\_\_\_

## Post-Construction Stormwater Management Checklist\* (5,000 SF or Greater)

**Project Type:**      New Development      Re-Development      Road      Landscaping  
**(Circle)**                      Retrofit                      Utility                      Other: \_\_\_\_\_

**Description of Project:**

The UCSD Pepper Canyon Ancillary Site Work (PCASW) project is comprised of two separate, yet connected projects located within the Open Space Preserve (OSP). This large canyon-like depression is surrounded by existing development and has an approximately 62-acre tributary area. Proposed projects within the OSP include the East Rim Trail and the Regional Water Quality Basin. The purpose of the basin is to provide water quality treatment and runoff storage for future improvements within the drainage area, which may eventually include Triton Pavilion, Design and Innovation Center, Pepper Canyon Amphitheater, Mid Coast Trolley, Village at Pepper Canyon West, and the Pepper Canyon Open Space Preserve (this project)

The regional basin will treat all of the impervious area from the projects listed above based on the Design Storm option of the California Phase II LID Sizing Tool - v1.2.

The OSP regional basin and proposed riser structure will reduce 10-year and 100-year peak flow as compared to the existing condition. Attenuated flow will discharge from the OSP basin via a proposed 48" pipe. Full peak flow calculations can be found in the Hydrology & Hydraulic study prepared by Michael Baker International dated April 2021.

**Total Project Area (in square feet):**

Pre-Project Impervious Area: 781,901 SF      New Impervious: 3,050 SF      Post Project Impervious: 784,951 SF

Does the project result in an increase of more than 50% of the existing impervious surface?\*       Yes       No

\*If **YES** then runoff from the entire project site including all existing, new, and/or replaced impervious surface must be included in the storm water treatment and design calculations. If **NO** then only runoff from the new and/or replaced impervious surface must be included in the storm water treatment and design calculations.

## Post-Construction Stormwater Management Checklist\* (5,000 SF or Greater)

**PART A - SITE DESIGN MEASURES:** Which site design measures have been implemented to reduce project site runoff? Applicant must select one or more of the following options below (check all that apply). In addition, The State Water Board's California Phase II LID Sizing Tool (or equivalent) must be used to quantify the runoff reduction resulting from implementation of any site design measures specified below and attach the calculations to this checklist. If post-construction water balance cannot be achieved with site design measures only, then additional storm water treatment BMPs must be designed for the project as described in PART B below. An electronic copy of the LID Sizing Tool is available at: <http://owp-web1.saclink.csus.edu/LIDTool/Start.aspx> or on the UC San Diego Storm Water Management Program website: <http://stormwater.ucsd.edu>

**Stream Setbacks and Buffers**

(A vegetated area including trees, shrubs, and herbaceous vegetation, that exists or is established to protect a stream system, lake reservoir, or coastal estuarine area)

**Soil Quality Improvement and Maintenance**

(improvements and maintenance through soil amendments and creation of microbial community)

**Tree Planting and Preservation**

(planting and preservation of healthy established trees that include both evergreens and deciduous, as applicable)

**Rooftop and Impervious Area Disconnection**

(Rerouting of rooftop drainage pipes to drain rainwater to rain barrels, cisterns, or permeable areas instead of to the storm water system)

**Porous Pavement**

(Pavement that allows runoff to pass through it, thereby reducing the runoff from a site and surrounding areas and filtering pollutants)

**Green Roofs**

(a vegetative layer grown on a roof (rooftop garden))

**Vegetated Swales**

(A vegetated, open-channel management practice designed specifically to treat and attenuate storm water runoff)

**Rain Barrels and Cisterns**

(system that collects and stores storm water runoff from a roof or other impervious surface)

Description of Site Design Measures Implemented for Project:

Although the project will feature buffers, tree planting and preservation, impervious area disconnection, and swales, the entirety of the WQ and flow control requirements will be handled by the biofiltration basin. Therefore, the volume and square footage of project area treated by soil amendments has not been quantified.

Volume of runoff that will be treated:

Size of area that will drain to BMP:

Pollutants that will be captured or treated by BMP (check all that apply):

Non-storm water discharges (e.g. irrigation runoff)     Trash/Litter     Sediment     Petroleum Hydrocarbons     Other:

## Post-Construction Stormwater Management Checklist\* (5,000 SF or Greater)

**PART B - SOURCE CONTROL MEASURES:** Projects that will create and/or replace 5,000 square feet or more of impervious surface must implement standard permanent and/or operational source control measures for pollutant generating activities and sources associated with the end use of the project site. This requires an evaluation of the equipment and activities that will be located or implemented at the project site after construction. Source control measures for the following pollutant generating activities shall be designed consistent with recommendations from the CASQA Stormwater BMP Handbook for New Development and Redevelopment (<https://www.casqa.org/resources/bmp-handbooks/new-development-redevelopment-bmp-handbook>). Please check all pollutant generating activities or sources that apply to this project below.

- |   |  |
|---|--|
| <input type="checkbox"/> Accidental spills or leaks<br><input type="checkbox"/> Interior floor drains<br><input type="checkbox"/> Parking/Storage area maintenance<br><input type="checkbox"/> Indoor and structural pest control<br><input checked="" type="checkbox"/> Landscape/outdoor pesticide use<br><input type="checkbox"/> Pools, spas, ponds, decorative fountains, and other water features<br><input checked="" type="checkbox"/> Outdoor storage of equipment or materials<br><input type="checkbox"/> Vehicle and equipment repair and maintenance<br><input type="checkbox"/> Drain or wash water from boiler drain lines, condensate drain lines, rooftop equipment, drainage sumps, and other sources | <input type="checkbox"/> Fire sprinkler test water<br><input type="checkbox"/> Loading docks<br><input type="checkbox"/> Vehicle and equipment cleaning<br><input type="checkbox"/> Fuel dispensing areas<br><input type="checkbox"/> Storage and handling of solid waste<br><input type="checkbox"/> Restaurants, grocery stores, and other food service operations<br><input type="checkbox"/> Unauthorized non-storm water discharges<br><input checked="" type="checkbox"/> Building and grounds maintenance |
|---|--|

Describe the source control BMPs that will be implemented for the project for all pollutant generating activities checked above:

The project will prevent illicit discharges into the MS4 through a combination of source control BMPs. Storm drain stamps will be provided at each inlet. Each inlet will also be located or will drain to a water quality basin before discharging the project area. Outdoor storage areas will be covered.

## Post-Construction Stormwater Management Checklist\* (5,000 SF or Greater)

**PART C - STORM WATER TREATMENT/BASELINE HYDROMODIFICATION MEASURES:** Only required if site design measures listed above cannot fully meet Permit requirements (i.e.. Calculations on California Phase II LID Sizing Tool show that post-construction water balance is not achieved ). All stormwater treatment BMPs shall be designed based on the flow-based or volume-based criteria specified in Section F.5.g.2.b (Numeric Sizing Criteria) of the Permit. Treatment BMPs must be designed for each Drainage Management Area (DMA). Bioretention facilities are preferred for treatment but alternative treatment BMPs can be used if the proper documentation and supporting calculations are provided and attached to this checklist. If Alternative BMPs are selected then all sizing and calculations should be prepared by a Registered Civil Engineer.

### STEP 1: Calculating What is Required for Treatment BMPs:

If you have a concept plan or design drawings for the proposed project which clearly define impervious and pervious areas you will be able to calculate the amount of area, volume, or flow that is required to be treated by stormwater treatment/hydromodification measures. If your project has more than one discharge point then you will need to divide your project into individual drainage management areas (DMA's) and calculate the required treatment for each DMA. If Bioretention is specified as the treatment control BMP of choice then skip to the Step 2 below for sizing BMPs. If alternative BMPs (BMPs other than bioretention) are utilized then depending on the type of BMP that will be designated for each DMA either volume-based or flow-based calculations should be performed to determine the required treatment volumes or rates. These calculations should be performed by a Registered Civil Engineer. The following sizing criteria should be used when determining volumes and rates for BMPs:

#### Volume-Based BMP Sizing Criteria:

a) The maximized stormwater capture volume for the tributary are based on historical rainfall records and determined in accordance with Urban Runoff Quality Management, WEF Manual of Practice No. 23/ASCE Manual of Practice No. 87 (1998), pages 175-178 (the 85th percentile, 24-hour storm event) **OR:** b.) The volume of annual runoff required to achieve 80 percent or more capture, determined in accordance with CASQA's Stormwater BMP Handbook for New and Redevelopment (2003) using local rainfall.

#### Flow-Based BMP Sizing Criteria:

a) The flow of runoff produced from a rain event equal to at least 0.2 inches per hour intensity **OR:** b) The flow of runoff produced from a rain event equivalent to at least 2 times the 85th percentile hourly rainfall intensity as determined from local rainfall records.

**The California Phase II LID Sizing Tool or equivalent should be used to verify selected site design measures and LID for each drainage area meet permit requirements.**

**The LID Sizing Tool is available at: <http://owp-web1.saclink.csus.edu/LIDTool/Start.aspx>**

Treatment Rate or Volume Required for Project:  
(If multiple DMA's please attach additional calculations to this checklist )

13,000 SF

# Post-Construction Stormwater Management Checklist\* (5,000 SF or Greater)

## STEP 2: Selecting Treatment/Hydromodification BMPs

### Bioretention Facilities or Flow-Through Planters (Suggested BMP by Permit)

- Vegetated areas that can be designed as swales, basins, or flow-through planters. Bioretention facilities should be sized based on 4% of the total impervious tributary area to the bioretention facility and in accordance with the typical section below:

#### Permit-Prescribed Bioretention Vertical Profile

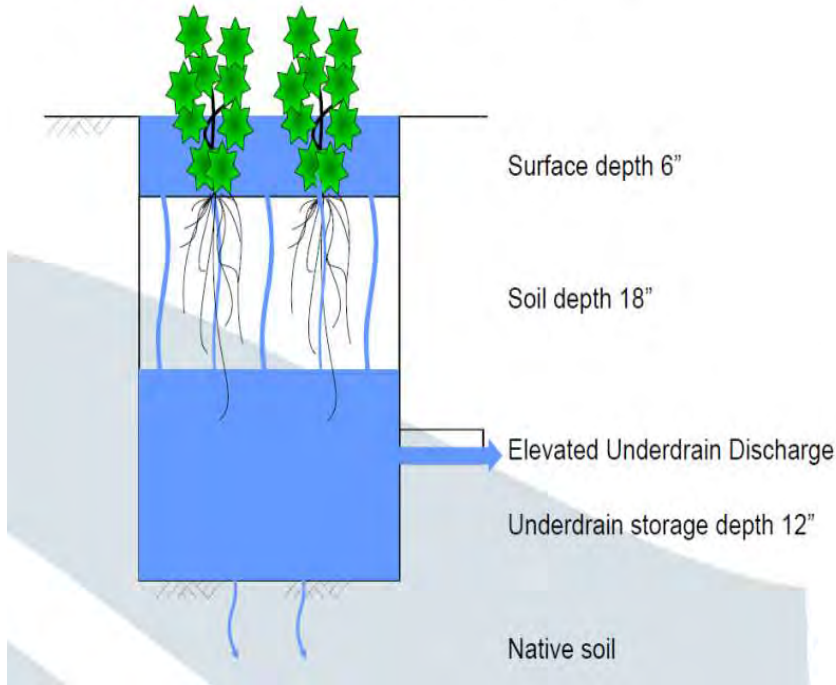

#### Additional Design Requirements for Bioretention:

- Bioretention facilities located in areas with highly infiltrative soils or high groundwater tables may omit the underdrain.
  - The 18" Soil layer (Planting layer) shall be comprised of blended biofiltration soil media (BSM) consisting of 60% to 80% by volume sand, up to 20% by volume topsoil, and up to 20% by volume compost. Sand, topsoil, and compost used in BSM shall conform to requirements listed in Sections 803-3, 803-4, and 803-5 of the 2019 County of San Diego BMP Design Manual.
  - The 12" Storage layer shall be comprised of gravel and underdrain shall be placed near the top of this layer.
  - Liners shall be used for Type D Soil areas and liners or other barriers shall be used if there is a structure or other geotechnical hazard located within 10 feet of facility.
  - The appropriate plant palette should be selected based on the soil type and be drought tolerant/low water.
- NOTE:** Please refer to the 2019 County of San Diego BMP Design Manual and to the County of San Diego LID Handbook for guidance.

Total Bioretention Area Required (based on 4% of impervious area) 13,000 ft<sup>2</sup>

Total Bioretention Area Provided: 13,337 ft<sup>2</sup>

If the Total Bioretention Area is less than the area required please explain why in the space below:

### Other BMPs as listed below (check all that apply)

- Extended Detention Basin
- Infiltration Basin or Infiltration Trench
- High-Rate Biofilters (e.g. Tree wells or other) <sup>(1)</sup>
- High-Rate Media Filter (e.g. Vault unit with replaceable cartridges) <sup>(1)</sup>
- Other equally effective as bioretention BMP \_\_\_\_\_

*(1) High-rate Biofilters or Media Filters are only allowed if bioretention or equivalent facility is proven to be infeasible for the project and if the following conditions apply: 1) project is creating or replacing an acre or less and is located in an area that has at least 85% of the site covered by permanent structures; 2) The proposed facility is receiving runoff solely from existing (pre-project) impervious areas.*

## Post-Construction Stormwater Management Checklist\* (5,000 SF or Greater)

Please attached the completed California Phase II LID Sizing Tool worksheets or equivalent for all Site Design Measures for each drainage area (Part A). The LID Sizing Tool is available at: <http://owp-web1.saclink.csus.edu/LIDTool/Start.aspx>

Attached       If not attached, how were the calculations submitted to UC San Diego?

Has all documentation for any source control measure that will be implemented on project been attached to this checklist (e.g.. CASQA Fact Sheets)?

Yes       No

Have all calculations for design of Storm water Treatment Facilities (bioretention facilities, etc.) been performed and attached to this report?

Yes       No

### PART D - RUNOFF CONTROL

Does the project increase storm water runoff for the 10 year 6 hour storm per discharge point? (Yes or No): YES

If YES, describe the mitigation measures that will be implemented to reduce runoff from pre-development to post-development per discharge point:

In order to reduce the peak flow from the canyon the existing Type F inlets will be demolished and replaced by a biofiltration basin. The sub-grade storage volume, perforated pipes, and ponding depth provided by the new basin will reduce the peak flow in the proposed condition as compared to the existing condition. See the project Hydrologic and Hydraulic Study for a full discussion of the peak flow calculations.

### PART E - POST- CONSTRUCTION BMP FOLLOW-UP (to be completed after construction)

Where was the post-construction storm water treatment system installed (Circle all that apply):      Onsite      Joint storm water treatment facility      Offsite

O&M Responsibility of the Site Design and Treatment BMPs for the life of the project:

HDH       FM       Contractor      Other: \_\_\_\_\_

BMP O&M procedures/guidance provided to UC San Diego?       Yes       No

Date of Installation:

Date of post-construction inspection:      Inspected by:

Proper Installation?       Yes       No      Corrective actions needed:

# California Phase II LID Sizing Tool - v1.2

## Step 8 - Summary

Project name UCSD Pepper Canyon Ancillary Site Work  
 Climate station SAN DIEGO WSO AP  
 Saturated hydraulic conductivity 0.01 in/hr  
 Design Storm 0.52 inches

Method	LID BMP Types	Area Needed (acres)	Area Available (acres)	Percent Accomplished	Volume Evaporated (acre-ft/year)	Volume Infiltrated (acre-ft/year)	Volume of Passing Through the Underdrain (acre-ft/year)	Volume Untreated (acre-ft/year)
Design Storm	<a href="#">Bioretention Cell - 18" Soil - 24" Gravel Storage</a>	0.012	0.3	2500.00	-	-	-	-
	<b>Total LID BMP Area</b>		0.3	2500.00	-	-	-	-
	<b>Total Impervious Area</b>		0.5	0.00	-	-	-	-
	<b>Totals</b>		0.80	2500.00	-	-	-	-



Instructions +

Background +

CA Phase II LID Sizing Tool Methods +

Special Notes Regarding the Tables +



# Site Design & Landscape Planning SD-10



## Design Objectives

- Maximize Infiltration
- Provide Retention
- Slow Runoff
- Minimize Impervious Land Coverage
- Prohibit Dumping of Improper Materials
- Contain Pollutants
- Collect and Convey

## Description

Each project site possesses unique topographic, hydrologic, and vegetative features, some of which are more suitable for development than others. Integrating and incorporating appropriate landscape planning methodologies into the project design is the most effective action that can be done to minimize surface and groundwater contamination from stormwater.

## Approach

Landscape planning should couple consideration of land suitability for urban uses with consideration of community goals and projected growth. Project plan designs should conserve natural areas to the extent possible, maximize natural water storage and infiltration opportunities, and protect slopes and channels.

## Suitable Applications

Appropriate applications include residential, commercial and industrial areas planned for development or redevelopment.

## Design Considerations

Design requirements for site design and landscapes planning should conform to applicable standards and specifications of agencies with jurisdiction and be consistent with applicable General Plan and Local Area Plan policies.



# **SD-10 Site Design & Landscape Planning**

## ***Designing New Installations***

Begin the development of a plan for the landscape unit with attention to the following general principles:

- Formulate the plan on the basis of clearly articulated community goals. Carefully identify conflicts and choices between retaining and protecting desired resources and community growth.
- Map and assess land suitability for urban uses. Include the following landscape features in the assessment: wooded land, open unwooded land, steep slopes, erosion-prone soils, foundation suitability, soil suitability for waste disposal, aquifers, aquifer recharge areas, wetlands, floodplains, surface waters, agricultural lands, and various categories of urban land use. When appropriate, the assessment can highlight outstanding local or regional resources that the community determines should be protected (e.g., a scenic area, recreational area, threatened species habitat, farmland, fish run). Mapping and assessment should recognize not only these resources but also additional areas needed for their sustenance.

Project plan designs should conserve natural areas to the extent possible, maximize natural water storage and infiltration opportunities, and protect slopes and channels.

## ***Conserve Natural Areas during Landscape Planning***

If applicable, the following items are required and must be implemented in the site layout during the subdivision design and approval process, consistent with applicable General Plan and Local Area Plan policies:

- Cluster development on least-sensitive portions of a site while leaving the remaining land in a natural undisturbed condition.
- Limit clearing and grading of native vegetation at a site to the minimum amount needed to build lots, allow access, and provide fire protection.
- Maximize trees and other vegetation at each site by planting additional vegetation, clustering tree areas, and promoting the use of native and/or drought tolerant plants.
- Promote natural vegetation by using parking lot islands and other landscaped areas.
- Preserve riparian areas and wetlands.

## ***Maximize Natural Water Storage and Infiltration Opportunities Within the Landscape Unit***

- Promote the conservation of forest cover. Building on land that is already deforested affects basin hydrology to a lesser extent than converting forested land. Loss of forest cover reduces interception storage, detention in the organic forest floor layer, and water losses by evapotranspiration, resulting in large peak runoff increases and either their negative effects or the expense of countering them with structural solutions.
- Maintain natural storage reservoirs and drainage corridors, including depressions, areas of permeable soils, swales, and intermittent streams. Develop and implement policies and

# Site Design & Landscape Planning SD-10

---

regulations to discourage the clearing, filling, and channelization of these features. Utilize them in drainage networks in preference to pipes, culverts, and engineered ditches.

- Evaluating infiltration opportunities by referring to the stormwater management manual for the jurisdiction and pay particular attention to the selection criteria for avoiding groundwater contamination, poor soils, and hydrogeological conditions that cause these facilities to fail. If necessary, locate developments with large amounts of impervious surfaces or a potential to produce relatively contaminated runoff away from groundwater recharge areas.

## *Protection of Slopes and Channels during Landscape Design*

- Convey runoff safely from the tops of slopes.
- Avoid disturbing steep or unstable slopes.
- Avoid disturbing natural channels.
- Stabilize disturbed slopes as quickly as possible.
- Vegetate slopes with native or drought tolerant vegetation.
- Control and treat flows in landscaping and/or other controls prior to reaching existing natural drainage systems.
- Stabilize temporary and permanent channel crossings as quickly as possible, and ensure that increases in run-off velocity and frequency caused by the project do not erode the channel.
- Install energy dissipaters, such as riprap, at the outlets of new storm drains, culverts, conduits, or channels that enter unlined channels in accordance with applicable specifications to minimize erosion. Energy dissipaters shall be installed in such a way as to minimize impacts to receiving waters.
- Line on-site conveyance channels where appropriate, to reduce erosion caused by increased flow velocity due to increases in tributary impervious area. The first choice for linings should be grass or some other vegetative surface, since these materials not only reduce runoff velocities, but also provide water quality benefits from filtration and infiltration. If velocities in the channel are high enough to erode grass or other vegetative linings, riprap, concrete, soil cement, or geo-grid stabilization are other alternatives.
- Consider other design principles that are comparable and equally effective.

## ***Redeveloping Existing Installations***

Various jurisdictional stormwater management and mitigation plans (SUSMP, WQMP, etc.) define “redevelopment” in terms of amounts of additional impervious area, increases in gross floor area and/or exterior construction, and land disturbing activities with structural or impervious surfaces. The definition of “redevelopment” must be consulted to determine whether or not the requirements for new development apply to areas intended for redevelopment. If the definition applies, the steps outlined under “designing new installations” above should be followed.

# **SD-10 Site Design & Landscape Planning**

Redevelopment may present significant opportunity to add features which had not previously been implemented. Examples include incorporation of depressions, areas of permeable soils, and swales in newly redeveloped areas. While some site constraints may exist due to the status of already existing infrastructure, opportunities should not be missed to maximize infiltration, slow runoff, reduce impervious areas, disconnect directly connected impervious areas.

## **Other Resources**

A Manual for the Standard Urban Stormwater Mitigation Plan (SUSMP), Los Angeles County Department of Public Works, May 2002.

Stormwater Management Manual for Western Washington, Washington State Department of Ecology, August 2001.

Model Standard Urban Storm Water Mitigation Plan (SUSMP) for San Diego County, Port of San Diego, and Cities in San Diego County, February 14, 2002.

Model Water Quality Management Plan (WQMP) for County of Orange, Orange County Flood Control District, and the Incorporated Cities of Orange County, Draft February 2003.

Ventura Countywide Technical Guidance Manual for Stormwater Quality Control Measures, July 2002.



## Design Objectives

- Maximize Infiltration
- Provide Retention
- Slow Runoff
- Minimize Impervious Land Coverage
- Prohibit Dumping of Improper Materials
- Contain Pollutants
- Collect and Convey

## Description

Waste materials dumped into storm drain inlets can have severe impacts on receiving and ground waters. Posting notices regarding discharge prohibitions at storm drain inlets can prevent waste dumping. Storm drain signs and stencils are highly visible source controls that are typically placed directly adjacent to storm drain inlets.

## Approach

The stencil or affixed sign contains a brief statement that prohibits dumping of improper materials into the urban runoff conveyance system. Storm drain messages have become a popular method of alerting the public about the effects of and the prohibitions against waste disposal.

## Suitable Applications

Stencils and signs alert the public to the destination of pollutants discharged to the storm drain. Signs are appropriate in residential, commercial, and industrial areas, as well as any other area where contributions or dumping to storm drains is likely.

## Design Considerations

Storm drain message markers or placards are recommended at all storm drain inlets within the boundary of a development project. The marker should be placed in clear sight facing toward anyone approaching the inlet from either side. All storm drain inlet locations should be identified on the development site map.

## Designing New Installations

The following methods should be considered for inclusion in the project design and show on project plans:

- Provide stenciling or labeling of all storm drain inlets and catch basins, constructed or modified, within the project area with prohibitive language. Examples include “NO DUMPING



- DRAINS TO OCEAN” and/or other graphical icons to discourage illegal dumping.
- Post signs with prohibitive language and/or graphical icons, which prohibit illegal dumping at public access points along channels and creeks within the project area.

Note - Some local agencies have approved specific signage and/or storm drain message placards for use. Consult local agency stormwater staff to determine specific requirements for placard types and methods of application.

### ***Redeveloping Existing Installations***

Various jurisdictional stormwater management and mitigation plans (SUSMP, WQMP, etc.) define “redevelopment” in terms of amounts of additional impervious area, increases in gross floor area and/or exterior construction, and land disturbing activities with structural or impervious surfaces. If the project meets the definition of “redevelopment”, then the requirements stated under “designing new installations” above should be included in all project design plans.

### **Additional Information**

#### ***Maintenance Considerations***

- Legibility of markers and signs should be maintained. If required by the agency with jurisdiction over the project, the owner/operator or homeowner’s association should enter into a maintenance agreement with the agency or record a deed restriction upon the property title to maintain the legibility of placards or signs.

#### ***Placement***

- Signage on top of curbs tends to weather and fade.
- Signage on face of curbs tends to be worn by contact with vehicle tires and sweeper brooms.

### **Supplemental Information**

#### ***Examples***

- Most MS4 programs have storm drain signage programs. Some MS4 programs will provide stencils, or arrange for volunteers to stencil storm drains as part of their outreach program.

### **Other Resources**

A Manual for the Standard Urban Stormwater Mitigation Plan (SUSMP), Los Angeles County Department of Public Works, May 2002.

Model Standard Urban Storm Water Mitigation Plan (SUSMP) for San Diego County, Port of San Diego, and Cities in San Diego County, February 14, 2002.

Model Water Quality Management Plan (WQMP) for County of Orange, Orange County Flood Control District, and the Incorporated Cities of Orange County, Draft February 2003.

Ventura Countywide Technical Guidance Manual for Stormwater Quality Control Measures, July 2002.







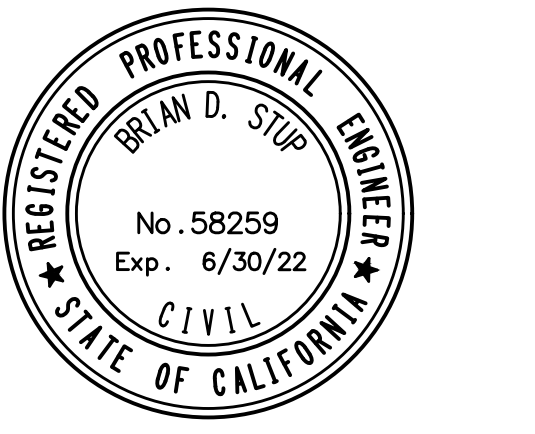
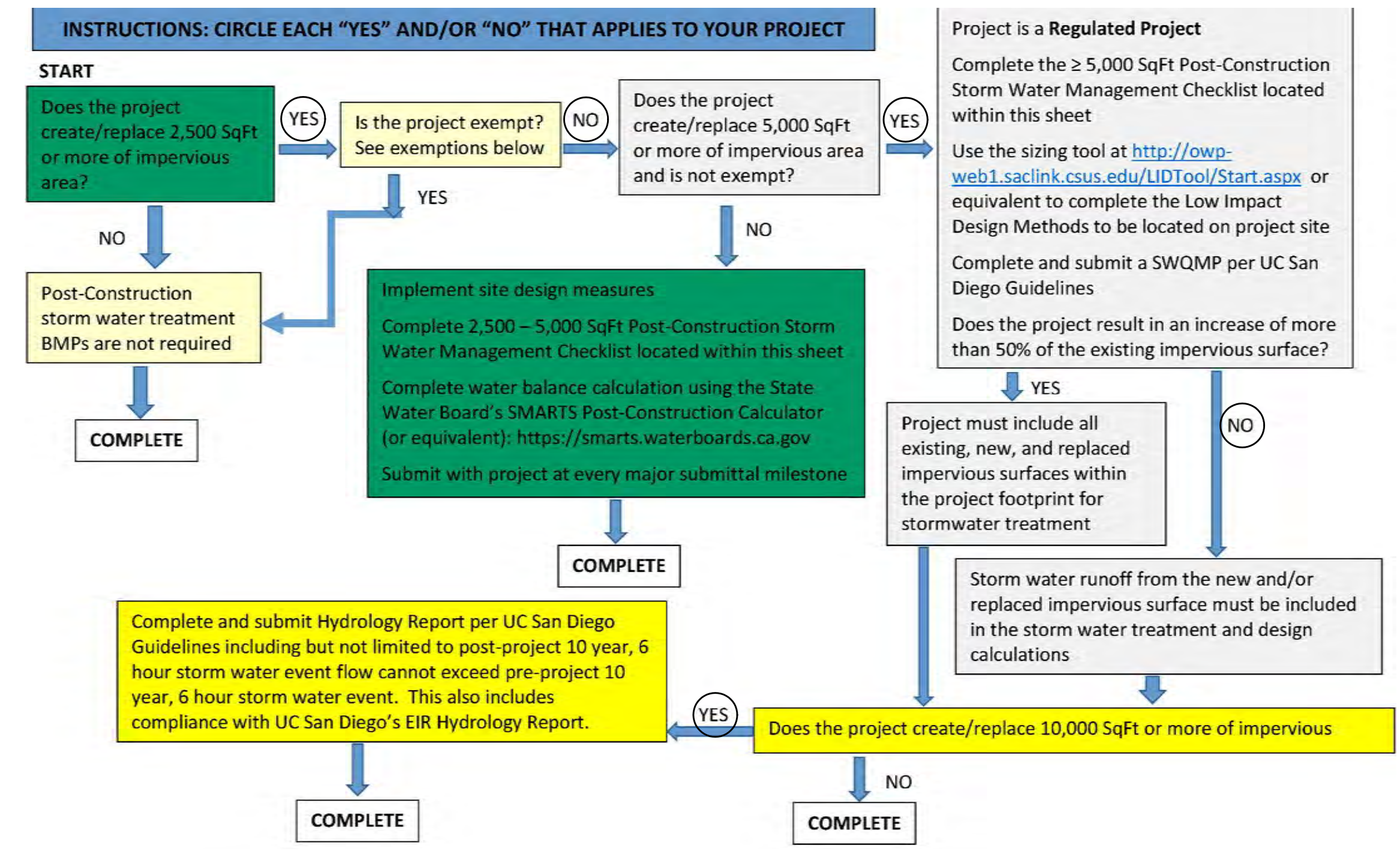

Table with 3 columns: Description, Issue, Date. Includes rows for Drawn, Checked, and Approved with dates and initials.

CIVIL - GENERAL NOTES



- IS YOUR PROJECT EXEMPT?  
YOU ARE EXEMPT IF YOU MEET ONE OR MORE OF THE FOLLOWING CONDITIONS:
- 1. REGULATED PROJECTS THAT HAVE BEEN DESIGNED, APPROVED, AND FUNDED PRIOR TO JULY 1, 2014
  - 2. INTERIOR REMODELS
  - 3. LINEAR UNDERGROUND/OVERHEAD PROJECTS (LUPs) THAT HAVE LESS THAN 5,000 SQUARE FEET OF NEWLY CONSTRUCTED CONTIGUOUS IMPERVIOUS SURFACE
  - 4. ROUTINE MAINTENANCE OR REPAIR PROJECT SUCH AS:  
A. MAINTENANCE, REPAIR, AND REPLACEMENT WORK ON EXISTING UNDERGROUND UTILITIES SUCH AS SANITARY SEWER LINES OR OTHER UTILITIES  
B. EXTERIOR ALL SURFACE REPLACEMENT  
C. ROOF REPLACEMENT  
D. PAVEMENT OR ASPHALT RESURFACING WITH EXISTING FOOTPRINT  
E. SIDEWALK REPLACEMENT WITHIN AN EXISTING FOOTPRINT TO REPLACE CONCRETE THAT IS CAUSING A TRIP HAZARD  
F. ROUTINE REPLACEMENT/REPAIR OF DAMAGED PAVEMENT/ASPHALT SUCH AS POTHOLE REPAIR
  - 5. BICYCLE LANES OR PEDESTRIAN RAMPS ON EXISTING ROADS OR SIDEWALKS WITHIN EXISTING FOOTPRINT (E.G., NO NEW IMPERVIOUS AREA)
  - 6. SIDEWALKS BUILT AS A PART OF NEW STREETS OR ROADS AND BUILT TO DIRECT STORM WATER RUNOFF TO ADJACENT VEGETATED AREAS
  - 7. BICYCLE LANES THAT ARE BUILT AS A PART OF NEW STREETS OR ROADS THAT DIRECT STORM WATER RUNOFF TO ADJACENT VEGETATED AREAS
  - 8. IMPERVIOUS TRAILS BUILT TO DIRECT STORM WATER RUNOFF TO ADJACENT VEGETATED AREAS, OR OTHER NON-ERODIBLE PERMEABLE AREAS
  - 9. SIDEWALKS, BICYCLE LANES OR TRAILS CONSTRUCTED WITH PERMEABLE SURFACES

NOTE: IF THE PROJECT MEETS THE EXEMPTION REQUIREMENTS, APPLICABLE PORTIONS OF THE CHECKLIST MUST STILL BE COMPLETED.  
POST-CONSTRUCTION STORMWATER MANAGEMENT  
PHASE II SHALL MEET GENERAL PERMIT SECTION F REQUIRES UCSD TO COMPLY WITH ITS POST CONSTRUCTION STORM WATER MANAGEMENT PROGRAM STRUCTURED AS FOLLOWS:  
1. PROJECTS THAT CREATE AND/OR REPLACE LESS THAN 2,500 SQUARE FEET OF IMPERVIOUS SURFACE - EXEMPT FROM POST CONSTRUCTION STORM WATER MANAGEMENT REQUIREMENTS.  
2. PROJECTS THAT CREATE AND/OR REPLACE BETWEEN 2,500 SQUARE FEET AND 5,000 SQUARE FEET OF IMPERVIOUS SURFACE 'SMALL PROJECTS':  
a. IMPLEMENT SITE DESIGN MEASURES - USE STATE WATER BOARD SMARTS POST-CONSTRUCTION CALCULATOR  
b. IF UNABLE TO MEET THE CRITERIA ON THE CALCULATOR, IMPLEMENT STORM WATER TREATMENT MEASURES USING NUMERIC SIZING CRITERIA SPECIFIED IN SECTION F.5.G.2.B. TO TREAT RUNOFF FROM REMAINING IMPERVIOUS DMAS  
3. PROJECTS THAT CREATE AND/OR REPLACE 5,000 SQUARE FEET OR MORE OF IMPERVIOUS SURFACE - REGULATED PROJECTS:  
a. IMPLEMENT LOW IMPACT DEVELOPMENT (LID) DESIGN STANDARDS, WHICH INCLUDES:  
i. SOURCE CONTROL MEASURES  
ii. SITE DESIGN MEASURES USING THE STATE'S POST-CONSTRUCTION WATER BALANCE CALCULATOR  
iii. STORM WATER TREATMENT BMPs TO TREAT RUNOFF FROM THE REMAINING IMPERVIOUS DMAS AFTER IMPLEMENTATION OF SITE DESIGN MEASURES USING DESIGN PARAMETERS SPECIFIED IN SECTION F.5.G.2.D

PROJECT INFORMATION  
PROJECT TYPE:  NEW DEVELOPMENT  RE-DEVELOPMENT  ROAD  LANDSCAPING  RETROFIT  UTILITIES  OTHER  
PROJECT AREAS  
TOTAL PROJECT AREA 1,234,054 SF  
PRE IMPERVIOUS 281,901 SF  
POST IMPERVIOUS 284,951 SF  
NEW IMPERVIOUS 3,050 SF  
REPLACED IMPERVIOUS 221,354 SF  
(INSTRUCTION)  
PROJECT EXEMPTION: IF ANY OF THE FOLLOWING CONDITIONS APPLY, THE PROJECT IS EXEMPT FROM SITE DESIGN BMP REQUIREMENTS. COMPLETE THE TABLE BELOW AND PASTE ON THE TITLE SHEET.  
IS THE PROJECT EXEMPT?  YES  NO  
1. PROJECT COMPLETED BEFORE JULY 1, 2014?  YES  NO  
2. REGULATED PROJECTS THAT HAVE BEEN DESIGNED, APPROVED, AND FUNDED PRIOR TO JULY 1, 2014?  YES  NO  
3. INTERIOR REMODELS?  YES  NO  
4. ROUTINE MAINTENANCE OR REPAIR PROJECTS SUCH AS:  YES  NO  
a. MAINTENANCE, REPAIR, AND REPLACEMENT WORK ON EXISTING UNDERGROUND UTILITIES SUCH AS SANITARY SEWER LINES OR OTHER UTILITIES?  YES  NO  
b. EXTERIOR WALL SURFACE REPLACEMENT?  YES  NO  
c. ROOF REPLACEMENT?  YES  NO  
d. PAVEMENT OR ASPHALT RESURFACING WITHIN THE EXISTING FOOTPRINT?  YES  NO  
e. SIDEWALK REPLACEMENT WITHIN AN EXISTING FOOTPRINT TO REPLACE CONCRETE THAT IS CAUSING A TRIP HAZARD?  YES  NO  
f. ROUTINE REPLACEMENT/REPAIR OF DAMAGED PAVEMENT/ASPHALT SUCH AS POTHOLE REPAIR?  YES  NO  
5. BICYCLE LANES OR PEDESTRIAN RAMPS ON EXISTING ROADS OR SIDEWALKS WITHIN EXISTING FOOTPRINT (E.G., NO NEW IMPERVIOUS AREA)?  YES  NO  
6. SIDEWALKS BUILT AS A PART OF NEW STREETS OR ROADS AND BUILT TO DIRECT STORM WATER RUNOFF TO ADJACENT VEGETATED AREAS?  YES  NO  
7. BICYCLE LANES THAT ARE BUILT AS A PART OF NEW STREETS OR ROADS THAT DIRECT STORM WATER RUNOFF TO ADJACENT VEGETATED AREAS?  YES  NO  
8. IMPERVIOUS TRAILS BUILT TO DIRECT STORM WATER RUNOFF TO ADJACENT VEGETATED AREAS, OR OTHER NON-ERODIBLE PERMEABLE AREAS?  YES  NO  
9. SIDEWALKS, BICYCLE LANES OR TRAILS CONSTRUCTED WITH PERMEABLE SURFACES?  YES  NO

(INSTRUCTIONS)  
1. IF THE PROJECT CREATES AND/OR REPLACE BETWEEN 2,500 SQUARE FEET AND 5,000 SQUARE FEET, COMPLETE THE TABLE BELOW AND REMOVE TABLE FOR 5,000 SQUARE FEET OR GREATER.  
2. USE THE EXCEL FILE FOR THE STATE WATER RESOURCES CONTROL BOARD'S POST-CONSTRUCTION WATER BALANCE CALCULATOR AND INCLUDE IT IN THE DESIGN SUBMITTALS.  
3. IF BMPs 5, 6, 7, AND 8 BELOW ARE PROPOSED IN THE DESIGN PLANS, COMPLETE BMP TREATMENT DATA TABLE PROVIDED IN THE CAD TEMPLATE. LIST ALL BMPs INDIVIDUALLY AND PROVIDE THEIR TREATMENT DATA. EACH INDIVIDUAL BMP SHALL HAVE ITS OWN BMP ID THAT MATCHES IN THE DESIGN PLANS.

PROJECT THAT CREATE AND/OR REPLACE BETWEEN 2,500 SQUARE FEET TO 5,000 SQUARE FEET

SITE DESIGN BMPs - USE THE EXCEL FILE FOR THE STATE WATER BOARD'S POST-CONSTRUCTION CALCULATOR AND INCLUDE IN THE DESIGN SUBMITTALS/APPLICATED.  
1. STREAM SETBACKS AND BUFFERS  
(A VEGETATED AREA INCLUDING TREES, SHRUBS, AND HERBACEOUS VEGETATION, THAT EXISTS OR IS ESTABLISHED TO PROTECT A STREAM SYSTEM, LAKE RESERVOIR, OR COASTAL ESTUARINE AREA)  YES  NO  
2. SOIL QUALITY IMPROVEMENT AND MAINTENANCE  
(IMPROVEMENTS AND MAINTENANCE THROUGH SOIL AMENDMENTS AND CREATION OF MICROBIAL COMMUNITY)  YES  NO  
3. TREE PLANTING AND PRESERVATION  
(PLANTING AND PRESERVATION OF HEALTHY ESTABLISHED TREES THAT INCLUDE BOTH EVERGREENS AND DECIDUOUS, AS APPLICABLE)  YES  NO  
4. ROOFTOP AND IMPERVIOUS AREA DISCONNECTION  
(REROUTING OF ROOFTOP DRAINAGE PIPES TO DRAIN RAINWATER TO RAIN BARRELS, CISTERNS, OR PERMEABLE AREAS INSTEAD OF TO THE STORM WATER SYSTEM)  YES  NO  
5. POROUS PAVEMENT  
(PAVEMENT THAT ALLOWS TO PASS THROUGH IT, THEREBY REDUCING THE RUNOFF FROM A SITE AND SURROUNDING AREAS AND FILTERING POLLUTANTS)  YES  NO  
6. GREEN ROOFS  
(A VEGETATIVE LAYER GROWN ON A ROOF - ROOFTOP GARDEN)  YES  NO  
7. VEGETATED SWALES  
(A VEGETATED, OPEN-CHANNEL MANAGEMENT PRACTICE DESIGNED SPECIFICALLY TO TREAT AND ATTENUATE STORM WATER RUNOFF)  YES  NO  
8. RAIN BARRELS AND CISTERNS  
(SYSTEM THAT COLLECTS AND STORES STORM WATER RUNOFF FROM A ROOF OR OTHER IMPERVIOUS SURFACE)  YES  NO  
9. DOES THE POST-CONSTRUCTION WATER BALANCE CALCULATOR SHOW THAT ITS MINIMUM REQUIREMENTS HAVE BEEN MET?  YES  NO

BMP TREATMENT DATA TABLE (TABLE X)  
TYPE OF BMP:  TARGET STORM EVENT/TREATMENT AREA (SF) TREATMENT FLOW (CFS) OR VOLUME (CUMULATED POLLUTANTS)

Table titled 'BMP TREATMENT TABLE (APPLIES TO BOTH 2,500 TO 5,000 SQUARE FEET AND 5,000 SQUARE FEET AND UP)'. Columns include TYPE OF BMP, BMP ID, TARGET STORM EVENT, TREATMENT AREA (SF), TREATMENT FLOW (CFS) OR VOLUME (SF), and TARGETED POLLUTANTS. Row 1: BIoretention, BRT-1, 100-YR, 13,000, 13,000.

BIOFILTRATION INSPECTION SCHEDULE NOTES

- CONTRACTOR MUST CONTACT ENGINEER FOR INSPECTION(\*) OF BMPs AT THE FOLLOWING STAGES OF CONSTRUCTION:  
- PRIOR TO START OF CONSTRUCTION OF BIOFILTRATION AREA  
- PRIOR TO CONSTRUCTION OF OUTLET STRUCTURES  
- AFTER GRADING OF BASIN AREA  
- AFTER PLACEMENT OF IMPERVIOUS LINER  
- AFTER PLACEMENT OF SUB-DRAIN  
- AFTER THE PLACEMENT OF GRAVEL DRAINAGE LAYER  
- AFTER PLACEMENT OF TREATMENT SOIL  
- AFTER IRRIGATION AND LANDSCAPE ACTIVITIES  
(\* SURVEY STAKES SHALL BE AVAILABLE FOR EACH INSPECTION)

(INSTRUCTIONS)  
1. IF THE PROJECT CREATES AND/OR REPLACE 5,000 SQUARE FEET OR GREATER OF IMPERVIOUS SURFACE, COMPLETE THE TABLES BELOW AND REMOVE TABLE FOR 2,500 TO 5,000 SQUARE FEET.  
2. USE CALIFORNIA PHASE II LID SIZING TOOL (<https://online.sanlak.usdrc.edu/lidtool/start.aspx>) TO SIZE ALL LID BMPs. OUTPUT OF THE SIZING SHALL BE INCLUDED IN YOUR SHOP.  
3. ALL SIZED BMPs TO BE INCLUDED IN BMP TREATMENT DATA TABLE PROVIDED IN THE CAD TEMPLATE. LIST ALL BMPs INDIVIDUALLY AND PROVIDE THEIR TREATMENT DATA. INDIVIDUAL BMP SHALL HAVE ITS OWN BMP ID THAT MATCHES IN THE DESIGN PLANS.

PROJECT THAT CREATE AND/OR REPLACE 5,000 SQUARE FEET OR GREATER OF IMPERVIOUS SURFACE

SOURCE CONTROL BMPs - REFER TO CASQA STORMWATER BMP HANDBOOK FOR NEW DEVELOPMENT AND REDEVELOPMENT APPLIED?  
1. ACCIDENTAL SPILLS OR LEAKS  YES  NO  
2. INTERIOR FLOOR DRAINS  YES  NO  
3. PARKING/STORAGE AREA MAINTENANCE  YES  NO  
4. INDOOR AND STRUCTURAL PEST CONTROL  YES  NO  
5. LANDSCAPE/OUTDOOR PESTICIDE USE  YES  NO  
6. POOLS, SPAS, PONDS, DECORATIVE FOUNTAINS, AND OTHER WATER FEATURES  YES  NO  
7. OUTDOOR STORAGE OF EQUIPMENT OR MATERIALS  YES  NO  
8. VEHICLE AD EQUIPMENT REPAIR AND MAINTENANCE  YES  NO  
9. DRAIN OR WASH FROM BOILER DRAIN LINES, CONDENSATE DRAIN LINES, ROOFTOP EQUIPMENT, DRAINAGE SUMPS, AND OTHER SOURCES  YES  NO  
10. FIRE SPRINKLER TEST WATER  YES  NO  
11. LOADING DOCKS  YES  NO  
12. VEHICLE AND EQUIPMENT CLEANING  YES  NO  
13. FUEL DISPENSING AREAS  YES  NO  
14. STORAGE AND HANDLING OF SOLID WASTE  YES  NO  
15. RESTAURANTS, GROCERY STORES, AND OTHER FOOD SERVICE OPERATIONS  YES  NO  
16. UNAUTHORIZED NON-STORM WATER DISCHARGES  YES  NO  
17. BUILDING AND GROUNDS MAINTENANCE  YES  NO  
DESCRIPTION OF ALL SOURCE CONTROL BMPs IMPLEMENTED FOR PROJECT

SITE DESIGN BMPs - USE CALIFORNIA PHASE II LID SIZING TOOL (<https://online.sanlak.usdrc.edu/lidtool/start.aspx>) APPLIED?  
1. STREAM SETBACKS AND BUFFERS (A VEGETATED AREA INCLUDING TREES, SHRUBS, AND HERBACEOUS VEGETATION, THAT EXISTS OR IS ESTABLISHED TO PROTECT A STREAM SYSTEM, LAKE RESERVOIR, OR COASTAL ESTUARINE AREA)  YES  NO  
2. SOIL QUALITY IMPROVEMENT AND MAINTENANCE (IMPROVEMENTS AND MAINTENANCE THROUGH SOIL AMENDMENTS AND CREATION OF MICROBIAL COMMUNITY)  YES  NO  
3. TREE PLANTING AND PRESERVATION (PLANTING AND PRESERVATION OF HEALTHY ESTABLISHED TREES THAT INCLUDE BOTH EVERGREENS AND DECIDUOUS, AS APPLICABLE)  YES  NO  
4. ROOFTOP AND IMPERVIOUS AREA DISCONNECTION (REROUTING OF ROOFTOP DRAINAGE PIPES TO DRAIN RAINWATER TO RAIN BARRELS, CISTERNS, OR PERMEABLE AREAS INSTEAD OF TO THE STORM WATER SYSTEM)  YES  NO  
5. POROUS PAVEMENT (PAVEMENT THAT ALLOWS TO PASS THROUGH IT, THEREBY REDUCING THE RUNOFF FROM A SITE AND SURROUNDING AREAS AND FILTERING POLLUTANTS)  YES  NO  
6. GREEN ROOFS (A VEGETATIVE LAYER GROWN ON A ROOF - ROOFTOP GARDEN)  YES  NO  
7. VEGETATED SWALES (A VEGETATED, OPEN-CHANNEL MANAGEMENT PRACTICE DESIGNED SPECIFICALLY TO TREAT AND ATTENUATE STORM WATER RUNOFF)  YES  NO  
8. RAIN BARRELS AND CISTERNS (SYSTEM THAT COLLECTS AND STORES STORM WATER RUNOFF FROM A ROOF OR OTHER IMPERVIOUS SURFACE)  YES  NO

FOR BMP 5, 6, 7, AND 8: DOES THE CALIFORNIA PHASE II LID SIZING TOOL SHOW THAT ITS TREATMENT REQUIREMENTS HAVE BEEN MET?  YES  NO  
IF ANSWERED NO ABOVE, HAS THE PROJECT INCLUDED BIORETENTION FACILITIES?  YES  NO  
TREATMENT BMPs - DESIGNATED PER NUMERIC SIZING CRITERIA (FLOW-BASED OR VOLUME-BASED) SPECIFIED IN SECTION F.5.G.2.B OF THE PERMIT APPLIED?  
-PROPOSED FACILITIES HAVE MAXIMUM SURFACE LOADING RATE OF 5 INCHES PER HOUR  YES  NO  
-A SIZING FACTOR OF 4% OF TRIBUTARY IMPERVIOUS AREA IS USED  YES  NO  
-MINIMUM SURFACE RESERVOIR VOLUME IS EQUAL TO SURFACE AREA TIMES A DEPTH OF 6 INCHES  YES  NO  
-MINIMUM PLANTING MEDIUM DEPTH IS 18 INCHES  YES  NO  
-PLANTING MEDIUM SUSTAINS A MINIMUM INFILTRATION RATE OF 5 INCHES PER HOUR  YES  NO  
-PLANTING MEDIUM COMPOSITION COMPLES TO 2019 COUNTY OF SAN DIEGO BMP DESIGN MANUAL (APPENDIX F)  YES  NO  
-VEGETATED SWALES (A VEGETATED, OPEN-CHANNEL MANAGEMENT PRACTICE DESIGNED SPECIFICALLY TO TREAT AND ATTENUATE STORM WATER RUNOFF)  YES  NO  
-RAIN BARRELS AND CISTERNS (SYSTEM THAT COLLECTS AND STORES STORM WATER RUNOFF FROM A ROOF OR OTHER IMPERVIOUS SURFACE)  YES  NO  
TOTAL TREATMENT AREA REQUIRED FOR PROJECT (% OF TRIBUTARY IMPERVIOUS AREA FROM REMAINING DMAS AFTER IMPLEMENTING SITE DESIGN BMPs):  1,000 SF DO ALL DESIGN CALCULATIONS AND INCLUDED IN THE STORM WATER QUALITY MANAGEMENT PLAN (SWQMP)?  YES  NO

Table titled 'POST-CONSTRUCTION BMP DETAILS'. Columns include OWN RESPONSIBLE PARTY, TYPE OF BMP, LOCATION, AREA MAINTAINED, TREATED STORM, PROPOSED FLOW, POLLUTANTS TREATED, and TREATMENT DESCRIPTION/DETAILS. Row 1: UC SAN DIEGO, BIoretention, 13,000 SF, 13,000 SF, 13,000 SF, TSS, SS, Sediment, Carbon.

POST-CONSTRUCTION BMP COMMISSIONING  
TO ENSURE THAT THE INSTALLED STORM WATER TREATMENT SYSTEMS ARE FUNCTIONING IN ACCORDANCE WITH DESIGN SPECIFICATIONS, THEY MUST BE TESTED PRIOR TO PROJECT CLOSE-OUT. FOR EXAMPLE, TEST INFILTRATION OF BIORETENTION SYSTEMS USING THE DOUBLE-RINGS INFILTRMETER METHOD OR THE CASD BORHOLE METHOD. INSPECT AND TEST MANUFACTURER BMPs (E.G., DRY WELLS, MODULAR WETLANDS, ETC.) IN ACCORDANCE WITH MANUFACTURER SUGGESTED METHODS TO CONFIRM THEY ARE OPERATING CORRECTLY AND DO NOT HAVE CRACKS/LEAKS, MISSING PARTS, ETC.

Table with 5 columns: TYPE OF BMP, LOCATION, TESTING METHOD USED, DATE OF TEST, PASS OR FAIL? All cells are currently empty.

5434: UCSD  
PEPPER  
CANYON  
ANCILLARY  
SITE WORK  
University of California  
San Diego Campus  
La Jolla, California 92037

95%  
CONSTRUCTION  
DOCUMENTS  
April 30, 2021



REGISTRATION STAMP



CFM STAMP

KEYPLAN

Issue	Issue	Date
Job Number	161911000	
Drawn		Author
Checked		Checked
Approved		Approved

TITLE

CIVIL - GENERAL NOTES

SHEET NUMBER

C0.04

STANDARD ENVIRONMENTAL/MITIGATION REQUIREMENTS:

- ENVIRONMENTAL REQUIREMENTS FOR CAD PLAN TEMPLATE (FOR CONSTRUCTION CONTRACTORS)
- COORDINATE THE SELECTION OF EXTERIOR CONSTRUCTION STAGING/LAYDOWN AREAS WITH CAMPUS PLANNING.
  - COORDINATE POST-CONSTRUCTION LANDSCAPING AND/OR RE-VEGETATION REQUIREMENTS WITH CAMPUS PLANNING.
    - THE FOLLOWING PM EMISSIONS CONTROLS SHALL BE IMPLEMENTED:
      - WATER THE GRADING AREAS A MINIMUM OF TWICE DAILY TO MINIMIZE FUGITIVE DUST;
      - STABILIZE GRADED AREAS AS QUICKLY AS POSSIBLE TO MINIMIZE FUGITIVE DUST;
      - APPLY CHEMICAL STABILIZER OR PAVE THE LAST 100 FEET OF INTERNAL TRAVEL PATH WITHIN THE CONSTRUCTION SITE PRIOR TO PUBLIC ROAD ENTRY;
      - INSTALL WHEEL WASHERS ADJACENT TO A PAVED APRON PRIOR TO VEHICLE ENTRY ON PUBLIC ROADS;
      - REMOVE ANY VISIBLE TRACK-OUT INTO TRAVELED PUBLIC STREETS VIA REGULAR STREET SWEEPING;
      - WET WASH THE CONSTRUCTION ACCESS POINT AT THE END OF EACH WORKDAY IF ANY VEHICLE TRAVEL ON UNPAVED SURFACES HAS OCCURRED;
      - PROVIDE SUFFICIENT PERIMETER EROSION CONTROL TO PREVENT WASHOUT OF SILTY MATERIAL ONTO PUBLIC ROADS;
      - COVER HAIL TRUCKS OR MAINTAIN AT LEAST 12 INCHES OF FREEBOARD TO REDUCE BLOW-OFF DURING HAILINGS;
      - SUSPEND ALL SOIL DISTURBANCE AND TRAVEL ON UNPAVED SURFACES IF WINDS EXCEED 25 MPH;
      - COVER/WATER ON-SITE STOCKPILES OF EXCAVATED MATERIAL;
      - ENFORCE A 15-MPH SPEED LIMIT ON UNPAVED SURFACES;
      - ON DRY DAYS, DIRT AND DEBRIS SPILLED ONTO PAVED SURFACES SHALL BE SWEEPED UP IMMEDIATELY TO REDUCE RE-SUSPENSION OF PARTICULATE MATTER CAUSED BY VEHICLE MOVEMENT. APPROACH ROUTES TO CONSTRUCTION SITES SHALL BE CLEANED DAILY OF CONSTRUCTION-RELATED DIRT IN DRY WEATHER;
      - DISTURBED AREAS SHALL BE HYDROSEEDDED, LANDSCAPED, OR DEVELOPED AS QUICKLY AS POSSIBLE TO REDUCE DUST GENERATION; AND
      - LIMIT THE DAILY GRADING VOLUMES/AREA TO EXTENT FEASIBLE.
  - OFF-ROAD CONSTRUCTION DIESEL ENGINES THAT MEET, AT A MINIMUM, THE TIER 4 INTERIM CALIFORNIA EMISSIONS STANDARDS SHALL BE UTILIZED, UNLESS SUCH AN ENGINE IS NOT AVAILABLE FOR A PARTICULAR ITEM OF EQUIPMENT. TIER 3 ENGINES WILL BE ALLOWED WHEN THE CONTRACTOR HAS PROVIDED CAMPUS PLANNING WITH DOCUMENTATION THAT NO TIER 4 INTERIM EQUIPMENT OR EMISSIONS EQUIVALENT RETROFIT EQUIPMENT IS AVAILABLE OR FEASIBLE FOR THE PROJECT.
    - TREE REMOVAL SHALL OCCUR OUTSIDE OF THE RAPTOR NESTING SEASON (GENERALLY JANUARY 15 THROUGH JULY 31). IF TREE REMOVAL WERE TO OCCUR DURING THE NESTING SEASON, A PRE-CONSTRUCTION SURVEY FOR RAPTOR NEST SHALL BE PERFORMED BY A BIOLOGIST WITHIN 500 FEET OF PROJECT CONSTRUCTION ACTIVITIES NO MORE THAN SEVEN DAYS PRIOR TO THE INITIATION OF CONSTRUCTION. CONSTRUCTION ACTIVITIES WITHIN 500 FEET OF AN IDENTIFIED ACTIVE RAPTOR NEST SHALL NOT COMMENCE DURING THE BREEDING SEASON UNTIL A QUALIFIED BIOLOGIST DETERMINES THAT THE NEST IS NO LONGER ACTIVE AND ANY YOUNG BIRDS IN THE AREA HAVE ADEQUATELY FLEDGED AND ARE NO LONGER RELIANT ON THE NEST. TREES WITH INACTIVE NESTS CAN BE REMOVED OUTSIDE THE BREEDING SEASON WITHOUT CAUSING AN IMPACT.
  - NO GRUBBING, TRIMMING, OR CLEARING OF VEGETATION (INCLUDING BRUSH MANAGEMENT) FROM PROJECT SITES SHALL OCCUR DURING THE GENERAL AVIAN BREEDING SEASON (FEBRUARY 15 THROUGH AUGUST 31). IF CANNOT FEASIBLY OCCUR OUTSIDE OF THE AVIAN BREEDING SEASON, A BIOLOGIST SHALL PERFORM A PRE-CONSTRUCTION NESTING BIRD SURVEY NO MORE THAN SEVEN DAYS PRIOR TO THE CLEARING/GRUBBING ACTIVITIES. THE BIOLOGIST SHALL DIRECT VEGETATION CLEARING AWAY FROM ANY ACTIVE NESTS UNTIL THE BIOLOGIST CONFIRMS THE NEST IS NO LONGER ACTIVE. IF THERE ARE NO NESTING BIRDS WITHIN THE SURVEY AREA, CLEARING, GRUBBING, AND GRADING SHALL BE ALLOWED TO PROCEED.
    - For projects adjacent to the Open Space Preserve or other undeveloped lands:
      - PRIOR TO COMMENCEMENT OF CLEARING OR GRADING ACTIVITIES, FENCING (E.G., SILT FENCING, ORANGE CONSTRUCTION FENCING, AND/OR CHAIN-LINK FENCING, AS DETERMINED BY CAMPUS PLANNING) SHALL BE INSTALLED AROUND THE APPROVED PROJECT LIMITS. A BIOLOGICAL MONITOR, PROVIDED BY CAMPUS PLANNING, SHALL REVIEW FENCING PLANS AND MONITOR THE INSTALLATION OF FENCING. ALL MOVEMENT OF CONSTRUCTION CONTRACTORS, INCLUDING INGRESS AND EGRESS OF EQUIPMENT AND PERSONNEL, SHALL BE LIMITED TO DESIGNATED CONSTRUCTION ZONES. THE CONTRACTOR SHALL REMOVE FENCING UPON COMPLETION OF ALL CONSTRUCTION ACTIVITIES.
      - NO TEMPORARY STORAGE OR STOCKPILING OF CONSTRUCTION MATERIALS SHALL BE ALLOWED WITHIN THE ECOLOGICAL RESERVE OR RESTORATION LANDS CATEGORIES OF THE OPEN SPACE PRESERVE, AND ALL STAGING AREAS FOR EQUIPMENT AND MATERIALS SHALL BE LOCATED AT LEAST 50 FEET FROM THE EDGE OF THESE AREAS. STAGING AREAS AND CONSTRUCTION SITES IN PROXIMITY TO THE ECOLOGICAL RESERVE OR RESTORATION LANDS SHALL BE KEPT FREE OF TRASH, REFUSE, AND OTHER WASTE. NO WASTE DIRT, RUBBLE, OR TRASH SHALL BE DEPOSITED IN THESE AREAS.
      - EQUIPMENT TO EXTINGUISH SMALL BRUSH FIRES (E.G., FROM TRUCKS OR OTHER VEHICLES) SHALL BE PRESENT ON SITE DURING ALL PHASES OF PROJECT CONSTRUCTION ACTIVITIES, ALONG WITH PERSONNEL TRAINED IN THE USE OF SUCH EQUIPMENT. SMOKING SHALL BE PROHIBITED IN CONSTRUCTION AREAS ADJACENT TO FLAMMABLE VEGETATION.
      - TEMPORARY NIGHT LIGHTING SHALL NOT BE USED DURING CONSTRUCTION UNLESS DETERMINED TO BE ABSOLUTELY NECESSARY. IF NIGHT LIGHTING IS NECESSARY, LIGHTS SHALL BE DIRECTED AWAY FROM SENSITIVE VEGETATION COMMUNITIES AND SHIELDED TO MINIMIZE TEMPORARY LIGHTING OF THE SURROUNDING HABITAT.
      - A BIOLOGICAL MONITOR, PROVIDED BY CAMPUS PLANNING, SHALL ATTEND A PRE-CONSTRUCTION MEETING WITH THE CONSTRUCTION CONTRACTOR DURING PROJECT CONSTRUCTION (INCLUDING SITE PREPARATION). THE BIOLOGICAL MONITOR SHALL VISIT THE SITE REGULARLY UNTIL CONSTRUCTION IS COMPLETE. IN COOPERATION WITH THE ON-SITE CONSTRUCTION MANAGER, THE BIOLOGICAL MONITOR SHALL HAVE THE AUTHORITY TO TEMPORARILY HALT CONSTRUCTION ACTIVITIES.
  - TREES REMOVED FROM THE HISTORIC GROVE SHOULD BE REPLACED AT A RATIO OF 2:1 (TWO NEW TREES FOR EVERY ONE TREE REMOVED). TREES REMOVED FROM THE URBAN FOREST SHALL BE REPLACED AT A RATIO OF 1:1 (ONE NEW TREE OR EVERY ONE TREE REMOVED). TREE PLACEMENT SHALL BE COORDINATED WITH CAMPUS PLANNING AND SHALL BE INSTALLED WITH THE APPROPRIATE IRRIGATION IMPROVEMENTS.
  - CONSTRUCTION WITHIN CULTURALLY SENSITIVE AREAS SHALL BE MONITORED BY AN ARCHAEOLOGIST, PROVIDED BY CAMPUS PLANNING. THE ARCHAEOLOGIST SHALL ATTEND A PRE-CONSTRUCTION MEETING WITH THE GRADING/CONSTRUCTION CONTRACTOR AND SHALL HAVE THE AUTHORITY TO TEMPORARILY HALT AND DIVERT WORK.
  - GRADING AND EXCAVATION EXCATING TO 1,000 CUBIC YARDS OR MORE AT DEPTHS OF 10 FEET OR GREATER WITHIN HIGHLY SENSITIVE GEOLOGIC FORMATIONS SHALL BE MONITORED BY A PALEONTOLOGIST, PROVIDED BY CAMPUS PLANNING. THE PALEONTOLOGIST SHALL ATTEND A PRE-CONSTRUCTION MEETING WITH THE GRADING/EXCAVATION CONTRACTOR AND SHALL HAVE THE AUTHORITY TO TEMPORARILY HALT AND DIVERT WORK.
  - IF CONSTRUCTION ACTIVITIES ARE WITHIN 150 FEET OF A NOISE-SENSITIVE LAND USE (NSLU), OR MAY INVOLVE THE USE OF VIBRATORY OR IMPACT-TYPE PILE DRIVERS, IMPACT-TYPE EQUIPMENT (INCLUDING BUT NOT LIMITED TO: CLAM SHOVELS, HYDRA BREAK RAMS, HEE RAMS, AND JACKHAMMERS), CONCRETE SAWS, PAVEMENT SCARIFIERS, SAND BLASTERS, OR VIBRATING HOPPERS, THE FOLLOWING SHALL BE IMPLEMENTED:
    - CONSTRUCTION EQUIPMENT OPERATION SHALL NOT TO EXCEED A 12-HOUR AVERAGE SOUND LEVEL OF 75 DBA LEQ AT ANY NSLU BETWEEN 7:00 A.M. AND 7:00 P.M. MONDAY THROUGH SATURDAY.
    - OUTFIT CONSTRUCTION EQUIPMENT WITH PROPERLY MAINTAINED, MANUFACTURER-APPROVED OR RECOMMENDED SOUND ABATEMENT MEANS ON AIR INTAKES, COMBUSTION EXHAUSTS, HEAT DISSIPATION VENTS, AND THE INTERIOR SURFACES OF ENGINE HOODS AND POWER TRAIN ENCLOSURES.
    - LOCATE (TO THE EXTENT PRACTICAL) STEADY-STATE, CONTINUOUSLY OPERATING STATIONARY CONSTRUCTION EQUIPMENT SUCH AS GENERATORS, PUMPS, AND AIR COMPRESSORS AT LEAST 150 FEET FROM NEARBY NSLUS. IF THIS SCREENING DISTANCE CANNOT BE ACHIEVED IN THE FIELD, CONSIDER DEPLOYMENT OF TEMPORARY NOISE WALLS OR ACOUSTICAL BLANKETS/CURTAINS THAT WOULD BLOCK DIRECT SOUND PATHS BETWEEN THE OPERATING EQUIPMENT AND THE RECEPTOR(S) OF CONCERN.
    - POSITION (TO THE EXTENT PRACTICAL) CONSTRUCTION LAYDOWN AND VEHICLE STAGING AREAS AS FAR FROM NSLUS AS FEASIBLE.
    - NFIRM, WHENEVER POSSIBLE AND PREFERABLY WITH AT LEAST A TWO WEEK ADVANCED NOTICE, ALL NEIGHBORING NSLUS EXPECTED TO BE EXPOSED TO ELEVATED NOISE LEVELS THAT A CONSTRUCTION PROJECT WOULD COMMENCE.
    - WHERE NSLU ARE EXPECTED TO BE LESS THAN 100 FEET AWAY, SCHEDULE ANTICIPATED LOUD CONSTRUCTION ACTIVITIES, WHICH COULD INVOLVE IMPACT-TYPE EQUIPMENT AND PROCESSES SUCH AS PILE DRIVING, JACKHAMMERING, PAVEMENT BREAKING, COMPACTORS, ETC., TO NOT COINCIDE WITH ANY FINALS WEEK OF CLASSES AND RECOGNIZED HOLIDAYS. ADJUST HOURS OR DAYS OF THE CONSTRUCTION ACTIVITY TO OCCUR BEFORE OR AFTER THESE NOISE-SENSITIVE PERIODS OF THE UC SAN DIEGO ACADEMIC YEAR.
    - PRIOR TO THE COMMENCEMENT OF CONSTRUCTION OF PROJECTS THAT INVOLVE HEAVY EARTH-MOVING EQUIPMENT OR IMPACT-TYPE PILE, CONFIRM WITH CAMPUS PLANNING IF A CONSTRUCTION VIBRATION MITIGATION PROGRAM IS REQUIRED.
  - COORDINATE WITH CAMPUS PLANNING TO DETERMINE ANY ADDITIONAL PROJECT-SPECIFIC MITIGATION MEASURES.

SPECIAL ENVIRONMENTAL MITIGATION PROVISIONS

YOUR PROJECT MAY BE SUBJECT TO SPECIAL ENVIRONMENTAL MITIGATION MEASURES. PLEASE SEE ENVIRONMENTAL PLANNING

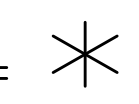

C:\USERS\PUBLIC\MBPW\210\41855519\5434\_C004\_P045M\_DRAWING - JONES, CHRISTIAN 4/28/2021 3:09 PM



REGISTRATION STAMP

CFM STAMP

KEYPLAN

Drawn	18/01/2020	Author
Checked		Checker
Approved		Approver

TITLE  
CIVIL - EXISTING  
CONDITIONS AND  
DEMOLITION

SHEET NUMBER

C1.00

LEGEND

- EXISTING BUILDING
- EXISTING RIP RAP
- EXISTING STOCKPILE
- EXISTING LRT EASEMENT (APPROX)

- APPROXIMATE PROJECT LIMITS
- EXISTING WATER
- EXISTING RECLAIMED WATER
- EXISTING SEWER
- EXISTING ABANDONED SEWER
- EXISTING STORM DRAIN
- EXISTING IRRIGATION
- EXISTING STREET LIGHT CONDUIT
- EXISTING GAS
- EXISTING TELECOM
- EXISTING ELECTRIC
- EXISTING SWALE
- EXISTING WALL
- EXISTING FIRE HYDRANT
- EXISTING CATCH BASIN
- EXISTING MANHOLE
- EXISTING VALVE
- EXISTING LIGHT POLE
- EXISTING TREE
- EXISTING SPOT ELEVATION
- PROPOSED SPOT ELEVATION

- PROPOSED AC PAVEMENT
- PROPOSED CONC PAVEMENT
- TRAIL/PATH
- PROPOSED CONCRETE SWALE
- RIP RAP ENERGY DISSIPATOR
- PROPOSED WOB TREATMENT AREA
- RUSTIC TRAIL STEPS
- PROPOSED STORM DRAIN MATERIAL
- PROPOSED ELECTRICAL & COMM CONDUIT
- PROPOSED GEOTRID WALL
- FALL PROTECTION
- WOB LINER
- PROPOSED PERFORATED PIPE
- PROPOSED MAJOR CONTOUR
- PROPOSED MINOR CONTOUR
- PROPOSED CATCH BASIN
- PROPOSED CONCRETE RISER
- TYPE F CATCH BASIN
- TYPE A CLEAN OUT
- PROPOSED STORM DRAIN CLEANOUT
- PROPOSED BOLLARD
- STRAIGHT HEADWALL
- U-SHAPED HEADWALL

DEMOLITION LEGEND

- EXISTING ITEM TO BE REMOVED

NOTES:

- EXISTING UTILITIES SHOWN ARE BASED ON AS-BUILT AND TOPOGRAPHIC SURVEY INFORMATION. CONTRACTOR TO FIELD VERIFY ALL UTILITIES PRIOR TO DEMOLITION.
- DEMOLITION OF IRRIGATION LINES TO BE COORDINATED WITH OJB LANDSCAPE ARCHITECTURE PRIOR TO DEMOLITION.
- EXISTING CONDITIONS (AS SHOWN HEREON) FOR THE SANDAG CONTRACT NO. 5008600.4 (2018) ARE SHOWN PER THE DEVELOPED CONDITION.
- EXISTING CONDITIONS (AS SHOWN HEREON) FOR THE OPEN SPACE PRESERVE, ARE BASED ON THE AERIAL TOPOGRAPHY SURVEY DATED JULY 26, 2019 (PREPARED BY AEROTECH MAPPING, INC.). PRIOR TO CONSTRUCTION, AS-BUILT FILES WILL BE PROVIDED BY SANDAG, AND INCORPORATED INTO THE FINAL DESIGN DOCUMENTS.
- THIS PLAN ASSUMES THAT ALL GRADING, INFRASTRUCTURE, AND EROSION CONTROL MEASURES (BMPs) HAVE BEEN INSTALLED (AND REMAIN IN PLACE) PER THE SANDAG CONTRACT NO. 5008600.4 (2018).

DEMOLITION NOTES

- REMOVE EXISTING CONCRETE
- REMOVE EXISTING RIP RAP
- REMOVE EXISTING STORM DRAIN LINE
- REMOVE 5' OF EXISTING SHADE STRUCTURE
- REMOVE EXISTING V-DITCH
- REMOVE EXISTING INLET
- REMOVE EXISTING ASPHALT
- REMOVE EXISTING CURB

PROTECTION NOTES

- PROTECT IN PLACE EXISTING WATER LINE
- PROTECT IN PLACE EXISTING SEWER LINE
- PROTECT IN PLACE EXISTING STORM DRAIN LINE
- PROTECT IN PLACE EXISTING RECLAIMED WATER LINE
- PROTECT IN PLACE EXISTING ELECTRICAL CONDUIT
- PROTECT IN PLACE EXISTING TELECOM CONDUIT
- PROTECT IN PLACE EXISTING STREET LIGHT CONDUIT
- PROTECT IN PLACE EXISTING MANHOLE
- PROTECT IN PLACE EXISTING WATER APPURTENANCES
- PROTECT IN PLACE EXISTING FIRE WATER APPURTENANCES
- PROTECT IN PLACE EXISTING WETLAND (ENCROACHMENTS OF ANY TYPE SHALL NOT OCCUR WITHIN WETLANDS LIMITS)
- PROTECT IN PLACE EXISTING COLUMN
- PROTECT IN PLACE EXISTING HEADWALL
- PROTECT IN PLACE EXISTING AC
- PROTECT IN PLACE EXISTING LIGHT POLE
- PROTECT IN PLACE EXISTING INLET
- PROTECT IN PLACE EXISTING CONCRETE PATH
- PROTECT IN PLACE EXISTING RETAINING WALL
- PROTECT IN PLACE EXISTING SO CLEANOUT
- PROTECT IN PLACE EXISTING V-DITCH
- PROTECT IN PLACE EXISTING CONCRETE DROP STRUCTURE PER SANDAG/MCTC

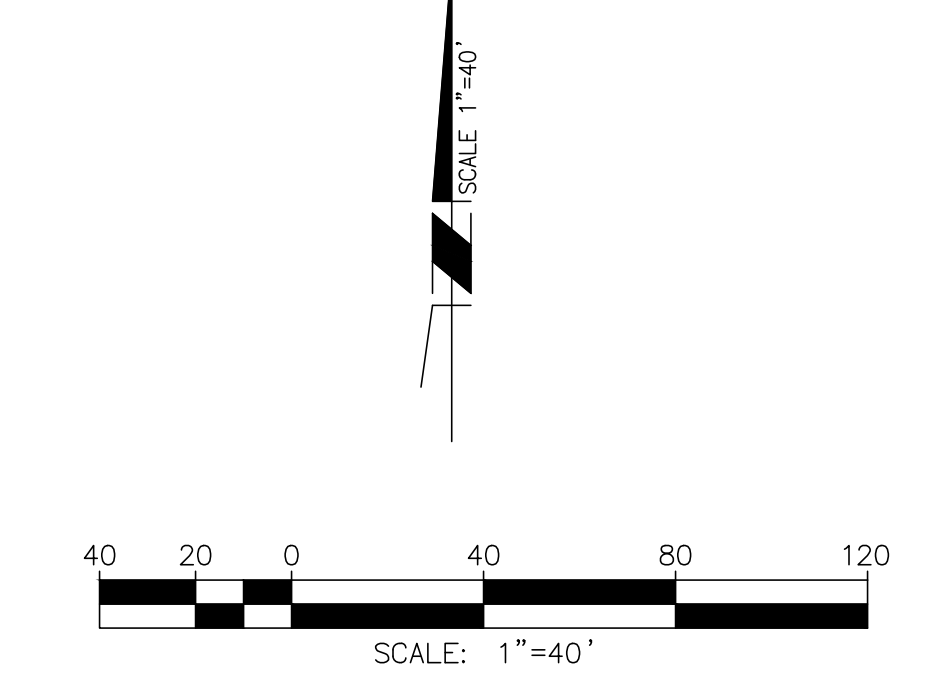
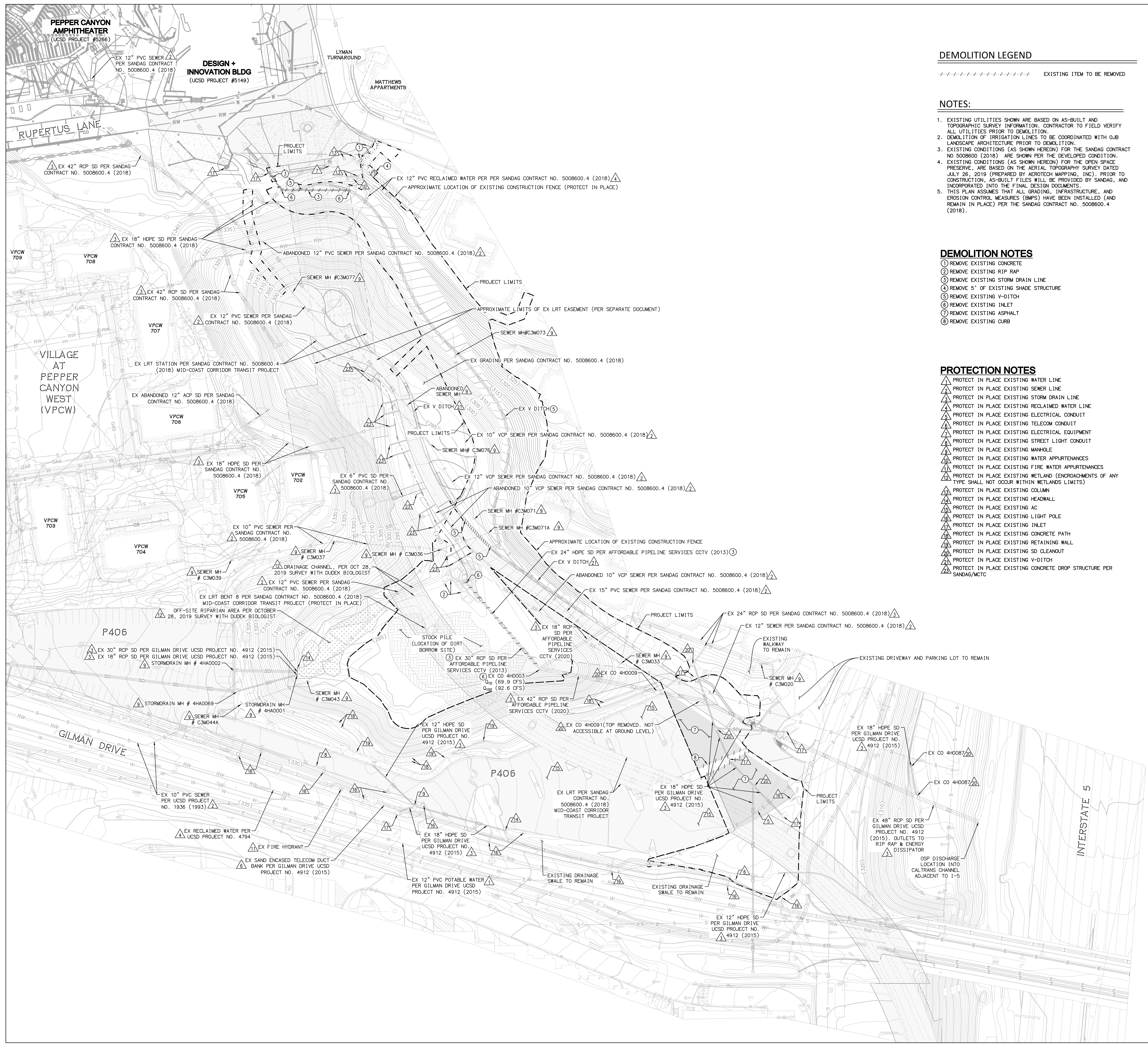



**LEGEND**

- EXISTING BUILDING
- EXISTING RIP RAP
- EXISTING STOCKPILE
- EXISTING LRT EASEMENT (APPROX)
- APPROXIMATE PROJECT LIMITS
- EXISTING WATER
- EXISTING RECLAIMED WATER
- EXISTING SEWER
- EXISTING ABANDONED SEWER
- EXISTING STORM DRAIN
- EXISTING IRRIGATION
- EXISTING STREET LIGHT CONDUIT
- EXISTING GAS
- EXISTING TELECOM
- EXISTING ELECTRIC
- EXISTING SWALE
- EXISTING WALL
- EXISTING FIRE HYDRANT
- EXISTING CATCH BASIN
- EXISTING MANHOLE
- EXISTING VALVE
- EXISTING LIGHT POLE
- EXISTING TREE
- EXISTING SPOT ELEVATION
- PROPOSED SPOT ELEVATION
- PROPOSED AC PAVEMENT
- PROPOSED CONCRETE PAVEMENT
- TRAIL/PATH FOR LANDSCAPE PLANS
- PROPOSED CONCRETE SWALE
- RIP RAP ENERGY DISSIPATER
- PROPOSED WOB TREATMENT AREA
- RUSTIC TRAIL STEPS FOR LANDSCAPE PLANS
- PROPOSED STORM DRAIN MATERIAL
- PROPOSED ELECTRICAL & COMM CONDUIT
- PROPOSED GEORGRID WALL
- FALL PROTECTION FOR LANDSCAPE PLANS
- WOB LINER FOR DETAIL A/C4.20
- PROPOSED PERFORATED PIPE MATERIAL
- PROPOSED MINOR CONTOUR
- PROPOSED CATCH BASIN
- PROPOSED CONCRETE RISER
- TYPE F CATCH BASIN
- TYPE A CLEAN OUT
- PROPOSED STORM DRAIN CLEANOUT
- PROPOSED BOLLARD FOR LANDSCAPE PLANS
- STRAIGHT HEADWALL
- U-SHAPED HEADWALL

**NOTES:**

1. EXISTING UTILITIES SHOWN ARE BASED OFF OF AS-BUILT AND TOPOGRAPHIC SURVEY INFORMATION. CONTRACTOR TO FIELD VERIFY ALL UTILITIES PRIOR TO DEMOLITION.
2. GEOTECHNICAL FIRM OF RECORD TO PERFORM INFILTRATION TESTING DURING CONSTRUCTION.
3. SEE LANDSCAPE PLANS FOR PLANTING, HARDSCAPE MATERIALS/FINISHES, BIKE PATH, AND STEP DETAILS.

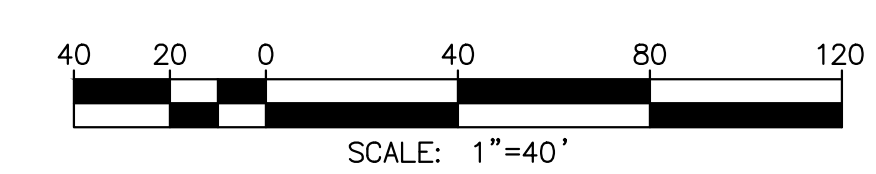
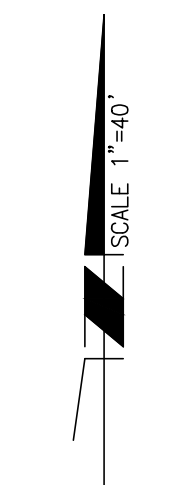

1301 Fifth Avenue  
Suite 2300  
Seattle, WA 98101  
1.206.398.0000  
1.206.441.4881  
www.perkinswill.com



525 B St  
Suite 250  
San Diego, CA 92101  
1.619.578.2600



9755 Cassmont Mesa Blvd  
San Diego, CA 92124  
Phone: (619) 614-6000  
MB@MBAKERTL.COM

**5434: UCSD PEPPER CANYON ANCILLARY SITE WORK**  
University of California  
San Diego Campus  
La Jolla, California 92037

**95% CONSTRUCTION DOCUMENTS**  
April 30, 2021



REGISTRATION STAMP



CFM STAMP

KEYPLAN

Drawn	Checked	Approved

**CIVIL - GRADING PLAN KEY MAP & NOTES**

SHEET NUMBER

**C2.00**



**LEGEND**

[Symbol]	EXISTING BUILDING
[Symbol]	EXISTING RIP RAP
[Symbol]	EXISTING STOCKPILE
[Symbol]	EXISTING LRT EASEMENT (APPROX)
[Symbol]	APPROXIMATE PROJECT LIMITS
[Symbol]	EXISTING WATER
[Symbol]	EXISTING RECLAIMED WATER
[Symbol]	EXISTING SEWER
[Symbol]	EXISTING ABANDONED SEWER
[Symbol]	EXISTING STORM DRAIN
[Symbol]	EXISTING IRRIGATION
[Symbol]	EXISTING STREET LIGHT CONDUIT
[Symbol]	EXISTING GAS
[Symbol]	EXISTING TELECOM
[Symbol]	EXISTING ELECTRIC
[Symbol]	EXISTING SWALE
[Symbol]	EXISTING WALL
[Symbol]	EXISTING FIRE HYDRANT
[Symbol]	EXISTING CATCH BASIN
[Symbol]	EXISTING MANHOLE
[Symbol]	EXISTING VALVE
[Symbol]	EXISTING LIGHT POLE
[Symbol]	EXISTING TREE
[Symbol]	EXISTING SPOT ELEVATION
[Symbol]	PROPOSED SPOT ELEVATION
[Symbol]	PROPOSED AC PAVEMENT DET 1/4 C.00
[Symbol]	PROPOSED CONC PAVEMENT DET 4/4 C.00
[Symbol]	TRAIL/PATH PER LANDSCAPE PLANS
[Symbol]	PROPOSED CONCRETE SWALE DET 2/4 C.02
[Symbol]	RIP RAP ENERGY DISSIPATOR SDRSD D-40
[Symbol]	PROPOSED MOB TREATMENT AREA DET A/4 C.20
[Symbol]	RUSTIC TRAIL STEPS PER LANDSCAPE PLANS
[Symbol]	PROPOSED STORM DRAIN MATERIAL PER DET 2/4 C.02
[Symbol]	PROPOSED ELECTRICAL & COMM CONDUIT PER ELECTRICAL
[Symbol]	PROPOSED GEORGRID WALL PER SHEETS S0.01-S2.00
[Symbol]	FALL PROTECTION PER LANDSCAPE PLANS
[Symbol]	MOB LINER PER DETAIL A/4 C.20
[Symbol]	PROPOSED PERFORATED PIPE MATERIAL PER PLAN
[Symbol]	PROPOSED MAJOR CONTOUR
[Symbol]	PROPOSED MINOR CONTOUR
[Symbol]	PROPOSED CATCH BASIN DET 1/4 C.02
[Symbol]	PROPOSED CONCRETE RISER DET A/4 C.20
[Symbol]	TYPE F CATCH BASIN SDRSD D-07
[Symbol]	TYPE A CLEAN OUT SDRSD D-09
[Symbol]	PROPOSED STORM DRAIN CLEANOUT DET 5/4 C.02 OR DET 1/4 C.20
[Symbol]	PROPOSED BOLLARD PER LANDSCAPE PLANS
[Symbol]	STRAIGHT HEADWALL SDRSD D-32
[Symbol]	U-SHAPED HEADWALL SDRSD D-34

- NOTES:**
- EXISTING UTILITIES SHOWN ARE BASED OFF OF AS-BUILT AND TOPOGRAPHIC SURVEY INFORMATION. CONTRACTOR TO FIELD VERIFY ALL UTILITIES PRIOR TO DEMOLITION.
  - GEOTECHNICAL FIRM OF RECORD TO PERFORM INFILTRATION TESTING DURING CONSTRUCTION.
  - SEE LANDSCAPE PLANS FOR PLANTING, HARDSCAPE MATERIALS/FINISHES, BIKE PATH, AND STEP DETAILS.

**Perkins & Will**  
 1301 Fifth Avenue  
 Suite 2300  
 Seattle, WA 98101  
 1206.38.6000  
 1206.441.4881  
 www.perkinswill.com

**CLARK**  
 CONSULTING  
 525 B St  
 Suite 250  
 San Diego, CA 92101  
 619.578.2600

**Michael Baker**  
 INTERNATIONAL  
 9755 Casson Road Blvd  
 San Diego, CA 92124  
 Phone: (619) 614-6000  
 MB@MBAKERTL.COM

**95%  
 CONSTRUCTION  
 DOCUMENTS**  
 April 30, 2021



REGISTRATION STAMP

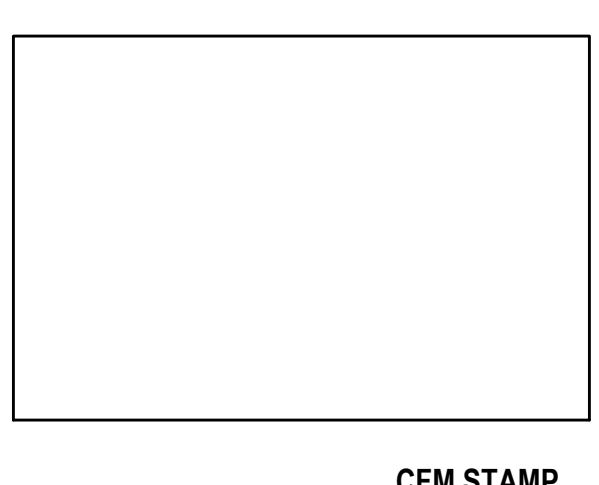

CFM STAMP

KEYPLAN

Drawn	16/9/11/00	Author
Checked		Checker
Approved		Approver

CIVIL - GRADING PLAN

SHEET NUMBER

**C2.02**

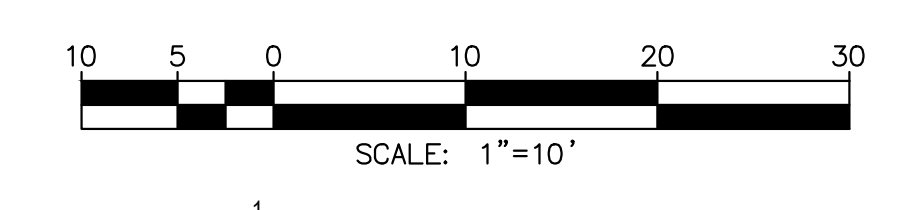

C:\USERS\PUBLIC\BRIAN.D\PROJECTS\19\0414\_C201\_PCS\SM\_CR.DWG JONES, CHRISTIAN 4/28/2021 9:11 PM

VERTICAL DATUM: NAVD 83  
 HORIZONTAL DATUM: NAD 83 (1991.35)

Copyright © 2020 Perkins and Will

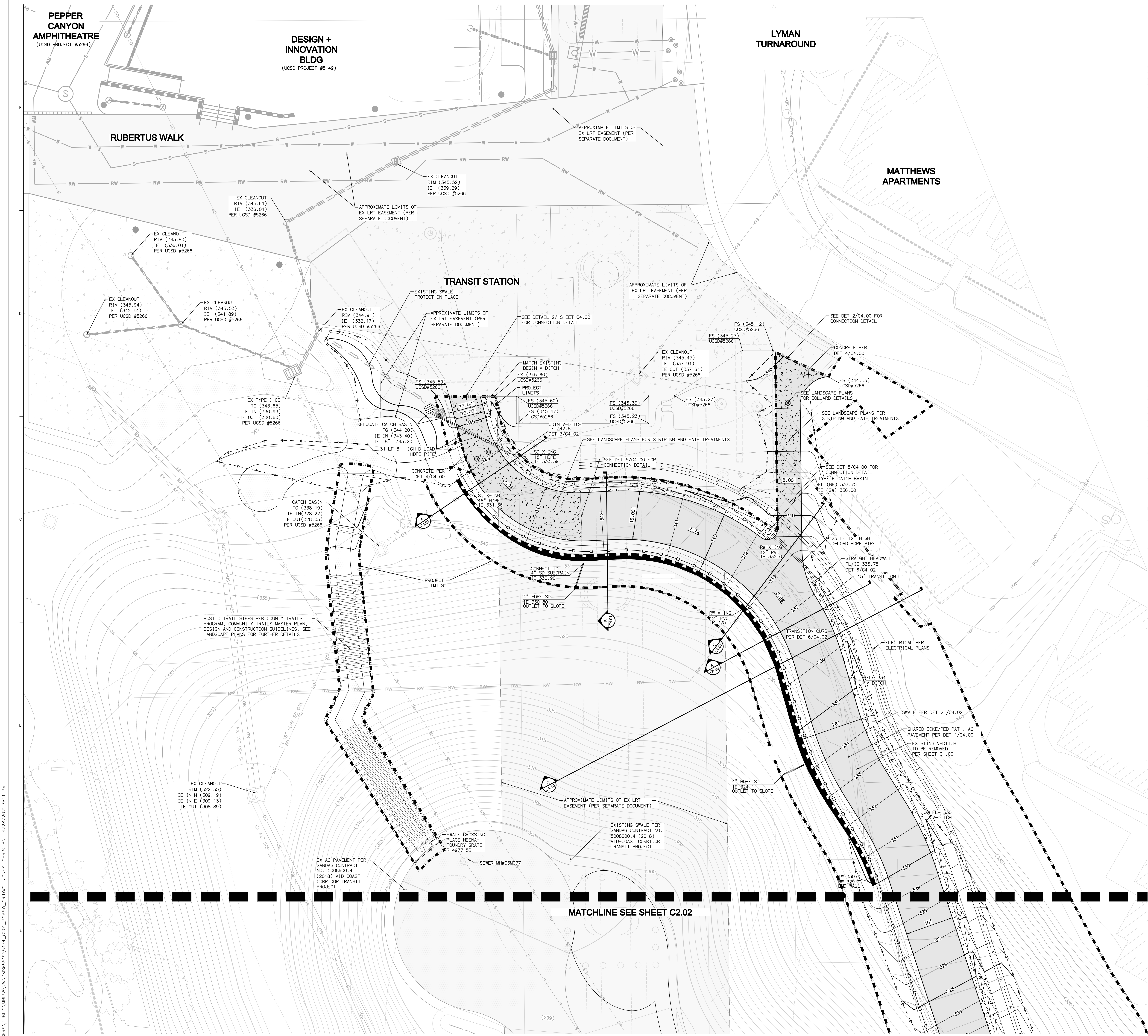

**LEGEND**

- EXISTING BUILDING
- EXISTING RIP RAP
- EXISTING STOCKPILE
- EXISTING LRT EASEMENT (APPROX)
- APPROXIMATE PROJECT LIMITS
- EXISTING WATER
- EXISTING RECLAIMED WATER
- EXISTING SEWER
- EXISTING ABANDONED SEWER
- EXISTING STORM DRAIN
- EXISTING IRRIGATION
- EXISTING STREET LIGHT CONDUIT
- EXISTING GAS
- EXISTING TELECOM
- EXISTING ELECTRIC
- EXISTING SWALE
- EXISTING WALL
- EXISTING FIRE HYDRANT
- EXISTING CATCH BASIN
- EXISTING MANHOLE
- EXISTING VALVE
- EXISTING LIGHT POLE
- EXISTING TREE
- EXISTING SPOT ELEVATION
- PROPOSED SPOT ELEVATION
- PROPOSED AC PAVEMENT
- PROPOSED CONCRETE PAVEMENT
- TRAIL/PATH PER LANDSCAPE PLANS
- PROPOSED CONCRETE SWALE
- RIP RAP ENERGY DISSIPATOR
- PROPOSED MOB TREATMENT AREA
- RUSTIC TRAIL STEPS PER LANDSCAPE PLANS
- PROPOSED STORM DRAIN MATERIAL PER DET 2/C4.02
- PROPOSED ELECTRICAL & COMM CONDUIT PER ELECTRICAL
- PROPOSED GEOTRID WALL PER SHEETS S0.01-S2.00
- FALL PROTECTION PER LANDSCAPE PLANS
- MOB LINER PER DETAIL A/C4.20
- PROPOSED PERFORATED PIPE MATERIAL PER PLAN
- PROPOSED MAJOR CONTOUR
- PROPOSED MINOR CONTOUR
- PROPOSED CATCH BASIN
- PROPOSED CONCRETE RISER
- TYPE F CATCH BASIN
- TYPE A CLEAN OUT
- PROPOSED STORM DRAIN CLEANOUT
- PROPOSED BOLLARD PER LANDSCAPE PLANS
- STRAIGHT HEADWALL
- U-SHAPED HEADWALL

- NOTES:**
- EXISTING UTILITIES SHOWN ARE BASED OFF OF AS-BUILT AND TOPOGRAPHIC SURVEY INFORMATION. CONTRACTOR TO FIELD VERIFY ALL UTILITIES PRIOR TO DEMOLITION.
  - GEOTECHNICAL FIRM OF RECORD TO PERFORM INFILTRATION TESTING DURING CONSTRUCTION.
  - SEE LANDSCAPE PLANS FOR PLANTING, HARDSCAPE MATERIALS/FINISHES, BIKE

**Perkins&Will**  
 1301 Fifth Avenue  
 Suite 2900  
 Seattle, WA 98101  
 206.398.6000  
 206.441.4881  
 www.perkinswill.com

**CLARK CONSULTING**  
 525 B St  
 Suite 250  
 San Diego, CA 92101  
 619.578.2600

**Michael Baker INTERNATIONAL**  
 9755 Casson Road Blvd  
 San Diego, CA 92124  
 Phone: (619) 614-5000  
 MBINTERNATIONAL.COM

**5434: UCSD PEPPER CANYON ANCILLARY SITE WORK**  
 University of California  
 San Diego Campus  
 La Jolla, California 92037

**95% CONSTRUCTION DOCUMENTS**  
 April 30, 2021

**REGISTRATION STAMP**

Professional Engineer  
 Brian D. Stipe  
 No. 58259  
 Exp. 6/30/22  
 CIVIL  
 STATE OF CALIFORNIA

**CFM STAMP**

**KEYPLAN**

DATE	ISSUE	BY
10/11/20	10/11/20	Author
		Checker
		Approver

TITLE

**CIVIL - GRADING PLAN**

SHEET NUMBER

**C2.01**

Copyright © 2020 Perkins and Will

C:\USERS\PUBLIC\BRIAN.D.STIPE\5434\_C201\_PCS\DWG\_05.DWG JONES, CHRISTIAN 4/28/2021 9:11 PM

VERTICAL DATUM: NAVD 83  
 HORIZONTAL DATUM: NAD 83 (1983)

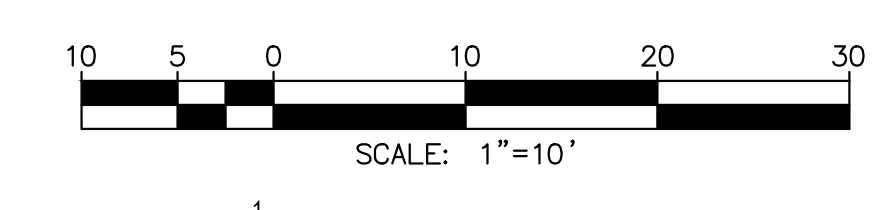



REGISTRATION STAMP



CFM STAMP

KEYPLAN

Drawn	Issue	Date
		10/19/2020

CIVIL - GRADING PLAN

SHEET NUMBER

C2.03

LEGEND

- EXISTING BUILDING
- EXISTING RIP RAP
- EXISTING STOCKPILE
- EXISTING LRT EASEMENT (APPROX)
- APPROXIMATE PROJECT LIMITS
- EXISTING WATER
- EXISTING RECLAIMED WATER
- EXISTING SEWER
- EXISTING ABANDONED SEWER
- EXISTING STORM DRAIN
- EXISTING IRRIGATION
- EXISTING STREET LIGHT CONDUIT
- EXISTING GAS
- EXISTING TELECOM
- EXISTING ELECTRIC
- EXISTING SWALE
- EXISTING WALL
- EXISTING FIRE HYDRANT
- EXISTING CATCH BASIN
- EXISTING MANHOLE
- EXISTING VALVE
- EXISTING LIGHT POLE
- EXISTING TREE
- EXISTING SPOT ELEVATION
- PROPOSED SPOT ELEVATION
- PROPOSED AC PAVEMENT DET 1/4.00
- PROPOSED CONCRETE PAVEMENT DET 4/4.00
- TRAIL/PATH PER LANDSCAPE PLANS
- PROPOSED CONCRETE SWALE DET 2/0.4.02
- RIP RAP ENERGY DISSIPATOR SORS D-40
- PROPOSED MOB TREATMENT AREA DET A/4.20
- RUSTIC TRAIL STEPS PER LANDSCAPE PLANS
- PROPOSED STORM DRAIN MATERIAL PER DET 2/4.02
- PROPOSED ELECTRICAL & COMM CONDUIT PER ELECTRICAL
- PROPOSED GEGRID WALL PER SHEETS S0.01-S2.00
- FALL PROTECTION PER LANDSCAPE PLANS
- MOB LINER PER DETAIL A/4.20
- PROPOSED PERFORATED PIPE MATERIAL PER PLAN
- PROPOSED MAJOR CONTOUR
- PROPOSED MINOR CONTOUR
- PROPOSED CATCH BASIN DET 1/4.02
- PROPOSED CONCRETE RISER DET A/4.20
- TYPE F CATCH BASIN SORS D-07
- TYPE A CLEAN OUT SORS D-09
- PROPOSED STORM DRAIN CLEANOUT DET 5/4.02 OR DET 1/4.20
- PROPOSED BOLLARD PER LANDSCAPE PLANS
- STRAIGHT HEADWALL SORS D-32
- U-SHAPED HEADWALL SORS D-34

NOTES:

1. EXISTING UTILITIES SHOWN ARE BASED OFF OF AS-BUILT AND TOPOGRAPHIC SURVEY INFORMATION. CONTRACTOR TO FIELD VERIFY ALL UTILITIES PRIOR TO DEMOLITION.
2. GEOTECHNICAL FIRM OF RECORD TO PERFORM INFILTRATION TESTING DURING CONSTRUCTION.
3. SEE LANDSCAPE PLANS FOR PLANTING, HARDSCAPE MATERIALS, FINISHES, BIKE PATH, AND STEP DETAILS.

**RIP RAP NOTES:**

1. PLACE "1/4" TON RIP RAP A THICKNESS OF 2.3' AS DEPICTED IN PLAN VIEW. IN-LIEU OF CONCRETE SILL, CONSTRUCT TYPE-C GRAVITY RETAINING WALL PER SORS C-09. GRAVITY WALL TO EXTEND 2-FEET INTO 3:1 SLOPE AND 0.5' INTO SOIL UNDER BASIN OR RIP-RAP AREA, WHICHEVER IS DEEPER.
2. CONSTRUCT MODIFIED RIP-RAP ENERGY DISSIPATOR PER SORS D-40, MODIFIED AS FOLLOWS: REMOVE 10-FOOT MINIMUM LENGTH REQUIREMENT FROM STANDARD DRAWING. IN-LIEU OF CONCRETE SILL, GROUT PERIMETER RIP-RAP ROCKS VERTICALLY, APPROXIMATELY 1-FOOT WIDE TO CONTAIN ROCK IN RIP-RAP FIELD.

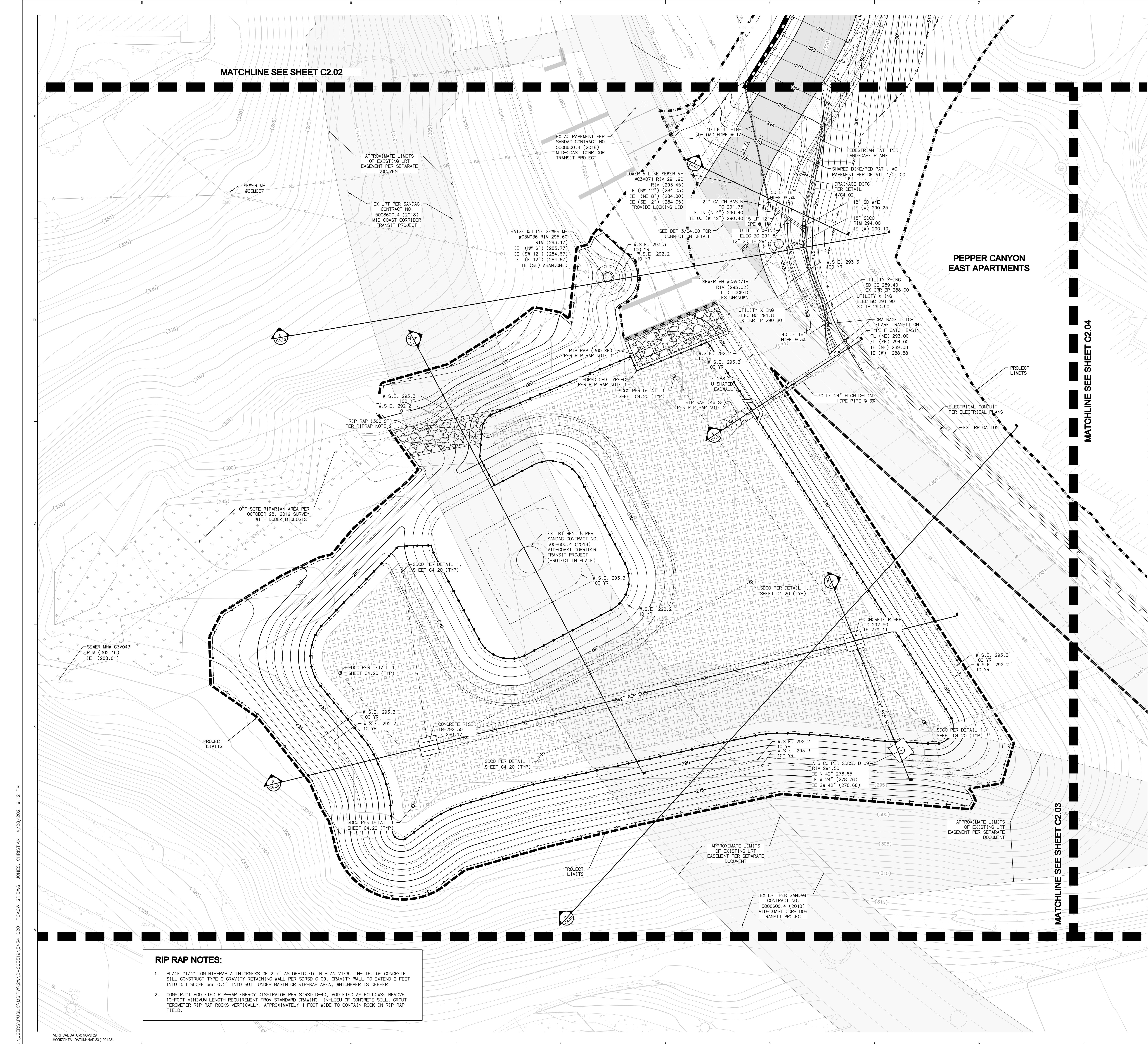

C:\USERS\PUBLIC\MPR\WORK\2020\555519\5434\_C201\_PC\AS\GR.DWG JONES, CHRISTIAN 4/28/2021 9:12 PM

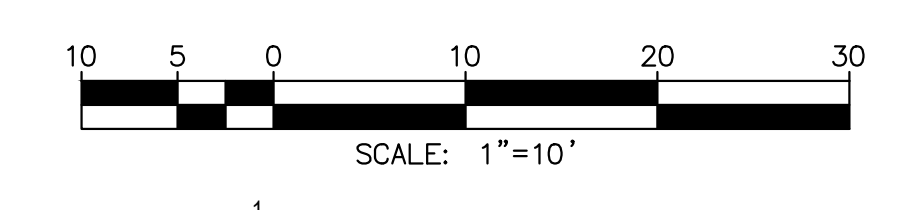

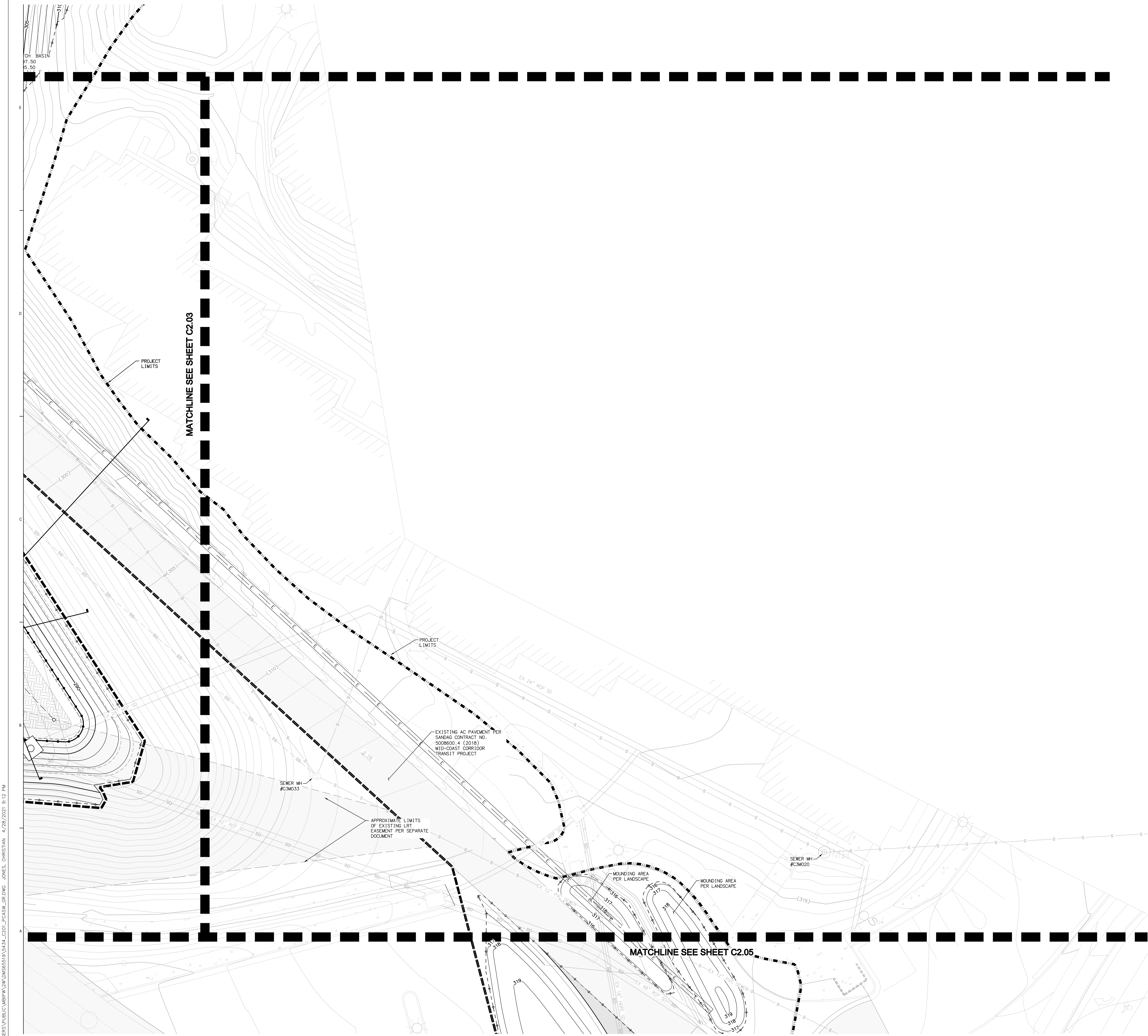

**LEGEND**

	EXISTING BUILDING
	EXISTING RIP RAP
	EXISTING STOCKPILE
	EXISTING LRT EASEMENT (APPROX)
	APPROXIMATE PROJECT LIMITS
	EXISTING WATER
	EXISTING RECLAIMED WATER
	EXISTING SEWER
	EXISTING ABANDONED SEWER
	EXISTING STORM DRAIN
	EXISTING IRRIGATION
	EXISTING STREET LIGHT CONDUIT
	EXISTING GAS
	EXISTING TELECOM
	EXISTING ELECTRIC
	EXISTING SWALE
	EXISTING WALL
	EXISTING FIRE HYDRANT
	EXISTING CATCH BASIN
	EXISTING MANHOLE
	EXISTING VALVE
	EXISTING LIGHT POLE
	EXISTING TREE
	EXISTING SPOT ELEVATION
	PROPOSED SPOT ELEVATION
	PROPOSED AC PAVEMENT DET 1/04.00
	PROPOSED CONC PAVEMENT DET 4/04.00
	TRAIL/PATH PER LANDSCAPE PLANS
	PROPOSED CONCRETE SWALE DET 2/04.02
	RIP RAP ENERGY DISSIPATER SORS D-40
	PROPOSED WOB TREATMENT AREA DET A/04.20
	RUSTIC TRAIL STEPS PER LANDSCAPE PLANS
	PROPOSED STORM DRAIN MATERIAL PER DET 2/04.02
	PROPOSED ELECTRICAL & COMM CONDUIT PER ELECTRICAL
	PROPOSED GEORGRID WALL PER SHEETS S0.01-S2.00
	FALL PROTECTION PER LANDSCAPE PLANS
	WOB LINER PER DETAIL A/04.20
	PROPOSED PERFORATED PIPE MATERIAL PER PLAN
	PROPOSED MAJOR CONTOUR
	PROPOSED MINOR CONTOUR
	PROPOSED CATCH BASIN DET 1/04.02
	PROPOSED CONCRETE RISER DET A/04.20
	TYPE F CATCH BASIN SORS D-07
	TYPE A CLEAN OUT SORS D-09
	PROPOSED STORM DRAIN CLEANOUT DET 5/04.02 OR DET 1/04.20
	PROPOSED BOLLARD PER LANDSCAPE PLANS
	STRAIGHT HEADWALL SORS D-32
	U-SHAPED HEADWALL SORS D-34

- NOTES:**
- EXISTING UTILITIES SHOWN ARE BASED OFF OF AS-BUILT AND TOPOGRAPHIC SURVEY INFORMATION. CONTRACTOR TO FIELD VERIFY ALL UTILITIES PRIOR TO DEMOLITION.
  - GEOTECHNICAL FIRM OF RECORD TO PERFORM INFILTRATION TESTING DURING CONSTRUCTION.
  - SEE LANDSCAPE PLANS FOR PLANTING, HARDSCAPE MATERIALS/FINISHES, BIKE PATH, AND STEP DETAILS.

**Perkins & Will**  
 1301 Fifth Avenue  
 Suite 2300  
 Seattle, WA 98101  
 1.206.399.6000  
 1.206.441.4881  
 www.perkinswill.com

**CLARK**  
 CONSULTING  
 525 B St  
 Suite 250  
 San Diego, CA 92101  
 619.578.2650

**Michael Baker**  
 INTERNATIONAL  
 9755 Casserone Mesa Blvd  
 San Diego, CA 92124  
 Phone: (858) 614-5000  
 MB@MBAINTL.COM

**95%  
 CONSTRUCTION  
 DOCUMENTS**  
 April 30, 2021



REGISTRATION STAMP

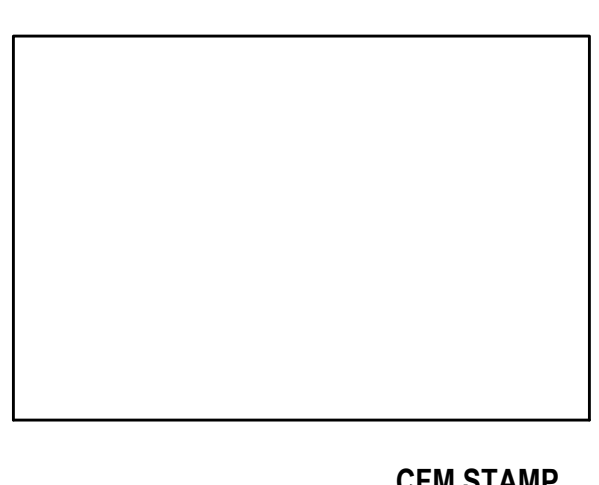

CFM STAMP



KEYPLAN

DATE	ISSUE	BY
10/19/2020	10/19/2020	Author
		Checker
		Approver

TITLE

CIVIL - GRADING PLAN

SHEET NUMBER

**C2.04**

Copyright © 2020 Perkins and Will

C:\USERS\PUBLIC\BRIAN.D.STUPP\20\04555519\04514\_C201\_PCAS\DWG\_C201\_PCAS\DWG\_C201\_PCAS.DWG JONES, CHRISTIAN 4/28/2021 9:12 PM

VERTICAL DATUM: NAVD 83  
 HORIZONTAL DATUM: NAD 83 (1991.35)

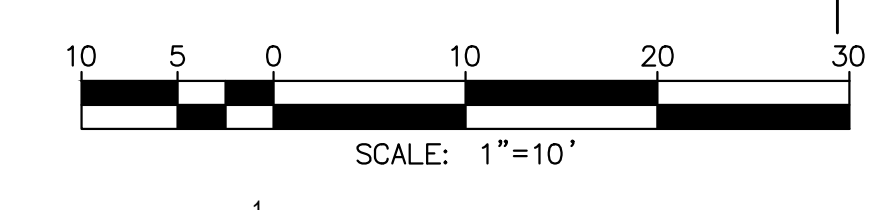





**LEGEND**

	EXISTING BUILDING
	EXISTING RIP RAP
	EXISTING STOCKPILE
	EXISTING LRT EASEMENT (APPROX)
	APPROXIMATE PROJECT LIMITS
	EXISTING WATER
	EXISTING RECLAIMED WATER
	EXISTING SEWER
	EXISTING ABANDONED SEWER
	EXISTING STORM DRAIN
	EXISTING IRRIGATION
	EXISTING STREET LIGHT CONDUIT
	EXISTING GAS
	EXISTING TELECOM
	EXISTING ELECTRIC
	EXISTING SWALE
	EXISTING WALL
	EXISTING FIRE HYDRANT
	EXISTING CATCH BASIN
	EXISTING MANHOLE
	EXISTING VALVE
	EXISTING LIGHT POLE
	EXISTING TREE
	EXISTING SPOT ELEVATION
	PROPOSED SPOT ELEVATION
	PROPOSED AC PAVEMENT DET 1/04.00
	PROPOSED CONC PAVEMENT DET 4/04.00
	TRAIL/PATH PER LANDSCAPE PLANS
	PROPOSED CONCRETE SWALE DET 2/04.02
	RIP RAP ENERGY DISSIPATER SDRSD D-40
	PROPOSED MOB TREATMENT AREA DET A/04.20
	RUSTIC TRAIL STEPS PER LANDSCAPE PLANS
	PROPOSED STORM DRAIN MATERIAL PER DET 2/04.02
	PROPOSED ELECTRICAL & COMM CONDUIT PER ELECTRICAL
	PROPOSED GEORID WALL PER SHEETS S0.01-S2.00
	FALL PROTECTION PER LANDSCAPE PLANS
	MOB LINER PER DETAIL A/04.20
	PROPOSED PERFORATED PIPE MATERIAL PER PLAN
	340 PROPOSED MAJOR CONTOUR
	339 PROPOSED MINOR CONTOUR
	PROPOSED CATCH BASIN DET 1/04.02
	PROPOSED CONCRETE RISER DET A/04.20
	TYPE F CATCH BASIN SDRSD D-07
	TYPE A CLEAN OUT SDRSD D-09
	PROPOSED STORM DRAIN CLEANOUT DET 5/04.02 OR DET 1/04.20
	PROPOSED BOLLARD PER LANDSCAPE PLANS
	STRAIGHT HEADWALL SDRSD D-32
	U-SHAPED HEADWALL SDRSD D-34

- NOTES:**
- EXISTING UTILITIES SHOWN ARE BASED OFF OF AS-BUILT AND TOPOGRAPHIC SURVEY INFORMATION. CONTRACTOR TO FIELD VERIFY ALL UTILITIES PRIOR TO DEMOLITION.
  - GEOTECHNICAL FIRM OF RECORD TO PERFORM INFILTRATION TESTING DURING CONSTRUCTION.
  - SEE LANDSCAPE PLANS FOR PLANTING, HARDSCAPE MATERIALS/FINISHES, BIKE PATH, AND STEP DETAILS.

**NOTES:**

- EXISTING UTILITIES SHOWN ARE BASED OFF OF AS-BUILT AND TOPOGRAPHIC SURVEY INFORMATION. CONTRACTOR TO FIELD VERIFY ALL UTILITIES PRIOR TO DEMOLITION.
- GEOTECHNICAL FIRM OF RECORD TO PERFORM INFILTRATION TESTING DURING CONSTRUCTION.
- SEE LANDSCAPE PLANS FOR PLANTING, HARDSCAPE MATERIALS/FINISHES, BIKE PATH, AND STEP DETAILS.

VERTICAL DATUM: NAVD 83  
HORIZONTAL DATUM: NAD 83 (1991.35)

SCALE: 1"=10'

10 5 0 10 20 30

**Perkins & Will**

1301 Fifth Avenue  
Suite 2300  
Seattle, WA 98101  
1206.38.6000  
1206.441.4881  
www.perkinswill.com

**CLARK**  
CONSTRUCTION

525 B St  
Suite 250  
San Diego, CA 92101  
1619.578.2600

**Michael Baker**  
INTERNATIONAL

9750 Cassman Mesa Blvd  
San Diego, CA 92124  
Phone: (619) 614-6000  
MB@PERKINSWILL.COM

**5434: UCSD  
PEPPER  
CANYON  
ANCILLARY  
SITE WORK**

University of California  
San Diego Campus  
La Jolla, California 92037

**95%  
CONSTRUCTION  
DOCUMENTS**

April 30, 2021



REGISTRATION STAMP

CFM STAMP

KEYPLAN

Drawn	Checked	Approved

TITLE

CIVIL - GRADING PLAN

SHEET NUMBER

**C2.05**

Copyright © 2020 Perkins and Will

C:\USERS\PUBLIC\MBRW\21\04555519\5414\_C201\_P04555519.DWG JONES, CHRISTIAN 4/28/2021 9:12 PM

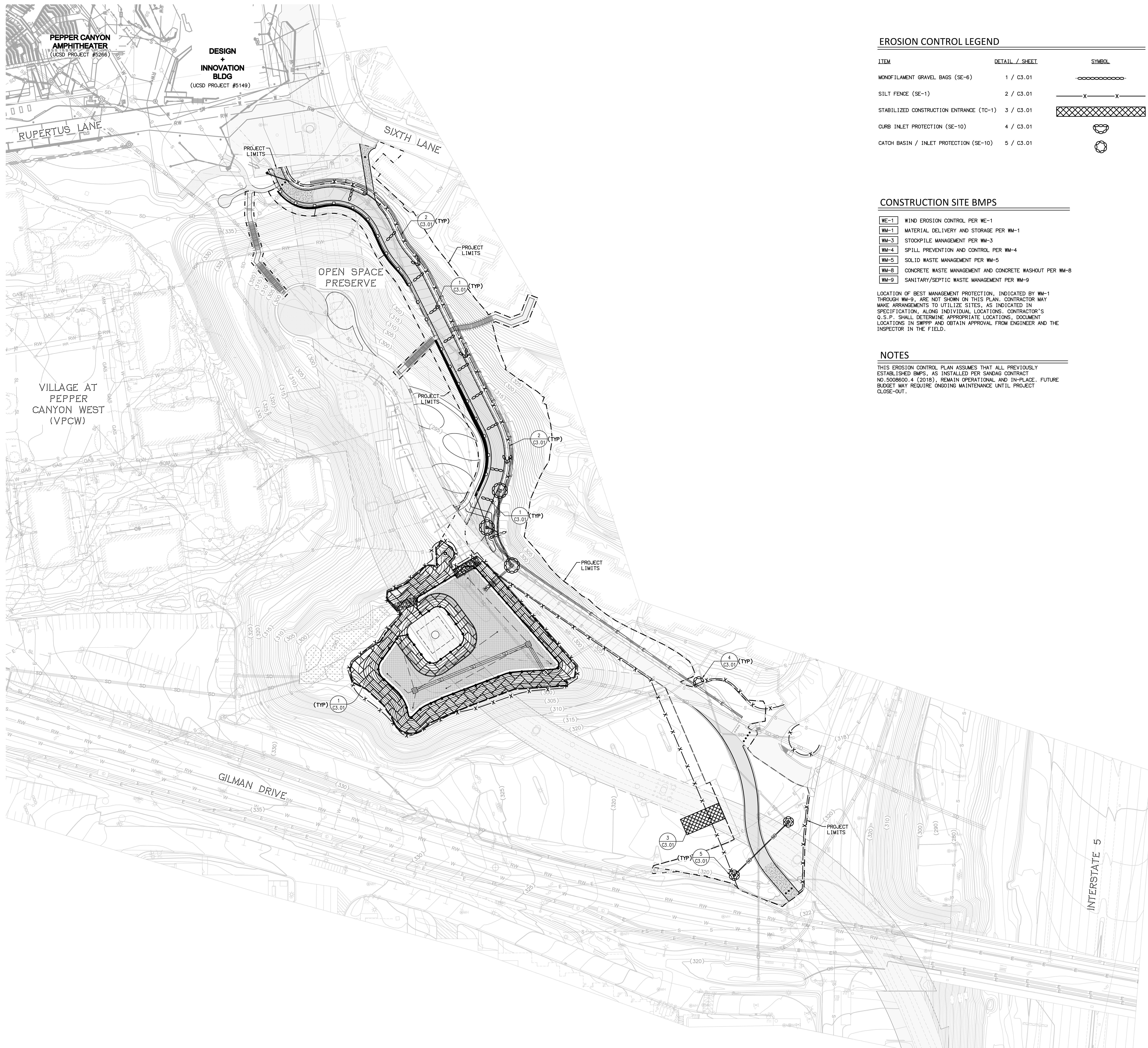

**LEGEND**

- EXISTING BUILDING
- EXISTING RIP RAP
- EXISTING STOCKPILE
- EXISTING LRT EASEMENT (APPROX)
- APPROXIMATE PROJECT LIMITS
- EXISTING WATER
- EXISTING RECLAIMED WATER
- EXISTING SEWER
- EXISTING ABANDONED SEWER
- EXISTING STORM DRAIN
- EXISTING IRRIGATION
- EXISTING STREET LIGHT CONDUIT
- EXISTING GAS
- EXISTING TELECOM
- EXISTING ELECTRIC
- EXISTING SWALE
- EXISTING WALL
- EXISTING FIRE HYDRANT
- EXISTING CATCH BASIN
- EXISTING MANHOLE
- EXISTING VALVE
- EXISTING LIGHT POLE
- EXISTING TREE
- EXISTING SPOT ELEVATION
- PROPOSED SPOT ELEVATION
- PROPOSED AC PAVEMENT
- PROPOSED CONIC PAVEMENT
- PROPOSED TRAIL/PATH PER LANDSCAPE PLANS
- PROPOSED CONCRETE SWALE
- RIP RAP ENERGY DISSIPATER
- PROPOSED MOB TREATMENT AREA
- RUSTIC TRAIL STEPS PER LANDSCAPE PLANS
- PROPOSED STORM DRAIN MATERIAL PER DET 2/C4.02
- PROPOSED ELECTRICAL & COMM CONDUIT PER ELECTRICAL
- PROPOSED GEORGRID WALL PER SHEETS S0.01-S2.00
- FALL PROTECTION PER LANDSCAPE PLANS
- MOB LINER PER DETAIL A/C4.20
- PROPOSED PERFORATED PIPE MATERIAL PER PLAN
- PROPOSED MAJOR CONTOUR
- PROPOSED MINOR CONTOUR
- PROPOSED CATCH BASIN
- PROPOSED CONCRETE RISER
- TYPE F CATCH BASIN
- TYPE A CLEAN OUT
- PROPOSED STORM DRAIN CLEANOUT
- PROPOSED BOLLARD PER LANDSCAPE PLANS
- STRAIGHT HEADWALL
- U-SHAPED HEADWALL

**EROSION CONTROL LEGEND**

ITEM	DETAIL / SHEET	SYMBOL
MONOFILAMENT GRAVEL BAGS (SE-6)	1 / C3.01	[Symbol]
SILT FENCE (SE-1)	2 / C3.01	[Symbol]
STABILIZED CONSTRUCTION ENTRANCE (TC-1)	3 / C3.01	[Symbol]
CURB INLET PROTECTION (SE-10)	4 / C3.01	[Symbol]
CATCH BASIN / INLET PROTECTION (SE-10)	5 / C3.01	[Symbol]

**CONSTRUCTION SITE BMPS**

- WE-1 WIND EROSION CONTROL PER WE-1
- WM-1 MATERIAL DELIVERY AND STORAGE PER WM-1
- WM-3 STOCKPILE MANAGEMENT PER WM-3
- WM-4 SPILL PREVENTION AND CONTROL PER WM-4
- WM-5 SOLID WASTE MANAGEMENT PER WM-5
- WM-8 CONCRETE WASTE MANAGEMENT AND CONCRETE WASHOUT PER WM-8
- WM-9 SANITARY/SEPTIC WASTE MANAGEMENT PER WM-9

LOCATION OF BEST MANAGEMENT PROTECTION, INDICATED BY WM-1 THROUGH WM-9, ARE NOT SHOWN ON THIS PLAN. CONTRACTOR MAY MAKE ARRANGEMENTS TO UTILIZE SITES, AS INDICATED IN SPECIFICATION, ALONG INDIVIDUAL LOCATIONS. CONTRACTOR'S O.S.P. SHALL DETERMINE APPROPRIATE LOCATIONS, DOCUMENT LOCATIONS IN SWPPP AND OBTAIN APPROVAL FROM ENGINEER AND THE INSPECTOR IN THE FIELD.

**NOTES**

THIS EROSION CONTROL PLAN ASSUMES THAT ALL PREVIOUSLY ESTABLISHED BMPS, AS INSTALLED PER SANDING CONTRACT NO. 5008600.4 (2018), REMAIN OPERATIONAL AND IN-PLACE. FUTURE BUDGET MAY REQUIRE ONGOING MAINTENANCE UNTIL PROJECT CLOSE-OUT.

**NOTES:**

- EXISTING UTILITIES SHOWN ARE BASED OFF OF AS-BUILT AND TOPOGRAPHIC SURVEY INFORMATION. CONTRACTOR TO FIELD VERIFY ALL UTILITIES PRIOR TO DEMOLITION.
- GEOTECHNICAL FIRM OF RECORD TO PERFORM INFILTRATION TESTING DURING CONSTRUCTION.
- SEE LANDSCAPE PLANS FOR PLANTING, HARDSCAPE MATERIALS/FINISHES, BIKE PATH, AND STEP DETAILS.

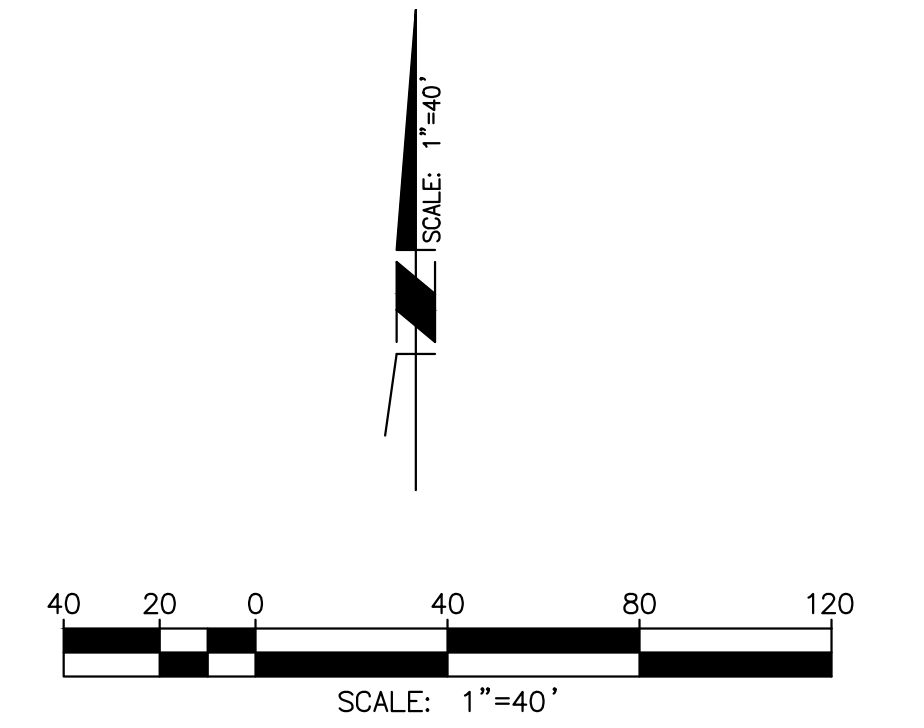

**Perkins & Will**  
 1301 Fifth Avenue  
 Suite 2300  
 Seattle, WA 98101  
 1206.381.6000  
 1206.441.4881  
 www.perkinswill.com

**CLARK**  
 CONSULTING  
 525 B St  
 Suite 250  
 San Diego, CA 92101  
 619.578.2600

**Michael Baker**  
 INTERNATIONAL  
 9755 Cassaron Mesa Blvd  
 San Diego, CA 92124  
 Phone: (619) 614-6000  
 MBK@MBAI.COM

**5434: UCSD PEPPER CANYON ANCILLARY SITE WORK**  
 University of California  
 San Diego Campus  
 La Jolla, California 92037

**95% CONSTRUCTION DOCUMENTS**  
 April 30, 2021

REGISTRATION STAMP

CFM STAMP

KEYPLAN

DATE	ISSUE	DATE
Job Number	161911000	Author
Drawn		Checked
Checked		Approved
Approved		TITLE

**CIVIL - EROSION CONTROL PLAN**  
 SHEET NUMBER  
**C3.00**

C:\USERS\PUBLIC\BRIAN.D.STUPP\20\161911000\5434\_C300\_PCASM\_EC.CWG JONES, CHRISTIAN 4/28/2021 9:13 PM

### TIME OF INSTALLATION:

IT IS THE INTENT THAT THE HYDROSEED MIX BE APPLIED NO SOONER THAN JUST BEFORE THE FIRST RAIN, IN NOVEMBER, AND NO LATER THAN JUST AFTER THE SECOND RAIN AFTER THE FIRST RAIN IN NOVEMBER.

### EROSION CONTROL:

PROVIDE ONE ROW OF GRAVEL BAGS OR STRAW ROLL AT THE BASE OF ALL HYDRO-SEEDED SLOPES AND DOWN SLOPE LIMITS OF GRADING.

### EROSION AND SEDIMENT CONTROL NOTES:

TEMPORARY EROSION/SEDIMENT CONTROL, PRIOR TO COMPLETION OF FINAL IMPROVEMENTS, SHALL BE PERFORMED BY THE CONTRACTOR OR QUALIFIED PERSON AS INDICATED BELOW:

- ALL REQUIREMENTS OF THE CITY OF SAN DIEGO "LAND DEVELOPMENT MANUAL, STORM WATER STANDARDS" MUST BE INCORPORATED INTO THE DESIGN AND CONSTRUCTION OF THE PROPOSED GRADING/IMPROVEMENTS CONSISTENT WITH THE APPROVED STORM WATER POLLUTION PREVENTION PLAN (SWPPP) AND/OR WATER POLLUTION CONTROL PLAN (WPCP) FOR CONSTRUCTION LEVEL BMP'S AND FOR PERMANENT POST CONSTRUCTION TREATMENT CONTROL PERMANENT BMP'S, THE WATER QUALITY TECHNICAL REPORT (WQTR) IF APPLICABLE.
- FOR STORM DRAIN INLETS, PROVIDE A GRAVEL BAG SILT BASIN IMMEDIATELY UPSTREAM OF INLET AS INDICATED ON DETAILS.
- FOR INLETS LOCATED AT SUMPS ADJACENT TO TOP OF SLOPES, THE CONTRACTOR SHALL ENSURE THAT WATER DRAINING TO THE SUMP IS DIRECTED INTO THE INLET AND THAT A MINIMUM OF 1.00' FREEBOARD EXISTS AND IS MAINTAINED ABOVE THE TOP OF THE INLET. IF FREEBOARD IS NOT PROVIDED BY GRADING SHOWN ON THESE PLANS, THE CONTRACTOR SHALL PROVIDE IT VIA TEMPORARY MEASURES, I. E. GRAVEL BAGS OR DIKES.
- THE CONTRACTOR OR QUALIFIED PERSON SHALL BE RESPONSIBLE FOR CLEANUP OF SILT AND MUD ON ADJACENT STREET(S) AND STORM DRAIN SYSTEM DUE TO CONSTRUCTION ACTIVITY.
- THE CONTRACTOR OR QUALIFIED PERSON SHALL CHECK AND MAINTAIN ALL LINED AND UNLINED DITCHES AFTER EACH RAINFALL.
- CONTRACTOR SHALL PLACE BMP'S TO PROTECT THE WETLAND, SUCH THAT NO SEDIMENT IS ALLOWED TO FLOW INTO THE WETLAND BOUNDARIES. IF SILT/ DEBRIS ERRANTLY ENTERS THE WETLAND, THE CONTRACTOR WILL NEED TO REMOVE THE SILT/DEBRIS BY HAND UNDER THE SUPERVISION OF A BIOLOGICAL MONITOR.
- THE CONTRACTOR SHALL REMOVE SILT AND DEBRIS AFTER EACH MAJOR RAINFALL.
- EQUIPMENT AND WORKERS FOR EMERGENCY WORK SHALL BE MADE AVAILABLE AT ALL TIMES DURING THE RAINY SEASON. ALL NECESSARY MATERIALS SHALL BE STOCKPILED ON SITE AT CONVENIENT LOCATIONS TO FACILITATE RAPID CONSTRUCTION OF TEMPORARY DEVICES WHEN RAIN IS IMMINENT.
- THE CONTRACTOR SHALL RESTORE ALL EROSION/SEDIMENT CONTROL DEVICES TO WORKING ORDER TO THE SATISFACTION OF THE CITY ENGINEER OR RESIDENT ENGINEER AFTER EACH RUN-OFF PRODUCING RAINFALL.
- THE CONTRACTOR SHALL INSTALL ADDITIONAL EROSION/SEDIMENT CONTROL MEASURES AS MAY BE REQUIRED BY THE RESIDENT ENGINEER DUE TO UNCOMPLETED GRADING OPERATIONS OR UNFORESEEN CIRCUMSTANCES, WHICH MAY ARISE.
- THE CONTRACTOR SHALL BE RESPONSIBLE AND SHALL TAKE NECESSARY PRECAUTIONS TO PREVENT PUBLIC TRESPASS ONTO AREAS WHERE IMPOUNDED WATERS CREATE A HAZARDOUS CONDITION.
- ALL EROSION/SEDIMENT CONTROL MEASURES PROVIDED PER THE APPROVED GRADING PLAN SHALL BE INCORPORATED HEREOF. ALL EROSION/SEDIMENT CONTROL FOR INTERIM CONDITIONS SHALL BE COMPLETED IN ACCORDANCE WITH THE PROJECT SPECIFICATIONS AND UCSD GUIDELINES AND IS SUBJECT TO REVIEW BY THE IOR AND CONSULTANTS WORKING ON BEHALF OF THE UNIVERSITY.
- GRADED AREAS AROUND THE PROJECT PERIMETER MUST DRAIN AWAY FROM THE FACE OF THE SLOPE AT THE COMPLETION OF EACH WORKING DAY.
- ALL REMOVABLE PROTECTIVE DEVICES SHOWN SHALL BE IN PLACE AT THE END OF EACH WORKING DAY WHEN RAIN IS IMMINENT.
- THE CONTRACTOR SHALL ONLY GRADE THE AREAS FOR WHICH THE CONTRACTOR OR QUALIFIED PERSON CAN PROVIDE EROSION/SEDIMENT CONTROL MEASURES. THIS NOTE ALSO APPLIES TO CLEARING AND GRUBBING AREAS.
- THE CONTRACTOR SHALL ARRANGE FOR WEEKLY MEETINGS DURING OCTOBER 1ST TO APRIL 30TH FOR PROJECT TEAM (GENERAL CONTRACTOR, UCSD, IOR AND UCSD SWPPP CONSULTANT AND EROSION CONTROL SUBCONTRACTOR IF ANY, ENGINEER OF WORK, OWNER/DEVELOPER AND THE RESIDENT ENGINEER) TO EVALUATE THE ADEQUACY OF THE EROSION/SEDIMENT CONTROL MEASURES AND OTHER RELATED CONSTRUCTION ACTIVITIES.

### HYDROSEEDING NOTES FOR SLOPE AREAS:

WITHIN 48 HOURS OF SLOPE COMPACTION, THE FOLLOWING SHALL BE APPLIED:

#### SEED

SEED SHALL BE DELIVERED TO THE SITE IN SEALED CONTAINERS. EACH CONTAINER SHALL HAVE AN ATTACHED SEED LABEL WHICH PROVIDES THE NET WEIGHT AND GENUS/SPECIES OF THE SEED, THE PERCENT PURITY, GERMINATION, INERT AND WEED SEED. THE WEED SEED SHALL NOT EXCEED 1% PERCENT. SEED TESTS FOR EACH OF THE SEEDS USED ON THE PROJECT SHALL BE MADE AVAILABLE TO THE OWNER'S REPRESENTATIVE UPON DEMAND. ANY WET, MOLDY, SPROUTED, OR OTHERWISE CONTAMINATED SEED SHALL NOT BE ACCEPTED. THE OWNER'S REPRESENTATIVE MAY PULL SAMPLES FROM EACH OF THE BAGS OF SEED FOR TESTING PURPOSES. NO CHANGES TO THE SEED MIX OR SUBSTITUTIONS MAY BE MADE WITHOUT FIRST SUBMITTING SUCH A REQUEST, IN WRITING, TO THE OWNER'S REPRESENTATIVE.

A SIGNED LETTER OF CONFORMANCE SHALL BE PROVIDED FROM THE SEED VENDOR CERTIFYING THAT EACH CONTAINER OF SEED DELIVERED IS FULLY LABELED IN ACCORDANCE WITH THE CALIFORNIA STATE AGRICULTURAL CODE AND MEETS SPECIFICATIONS. SEED MIX TO BE NON-INVASIVE SPECIES ONLY.

#### STORMWATER AND EROSION CONTROL FIBER ROLLS

STORMWATER AND EROSION CONTROL FIBER ROLLS SHALL BE USED ON ALL SLOPE AREAS THAT ARE 4:1 GRADIENT AND STEEPER FOR SOIL STABILIZATION. SEE SPECIFICATIONS FOR INSTALLATION.

#### HYDROSEEDING

THE COMBINATION OF SEED, MECHANICALLY BONDED FIBER MATRIX, FERTILIZER, AND WATER SHALL BE ADDED TO THE HYDROSEEDING MACHINE ON-SITE, IN THE PRESENCE OF THE OWNER'S REPRESENTATIVE. THE WATER AND MECHANICALLY BONDED FIBER MATRIX SHALL BE ADDED FIRST AND MIXED HOMogeneously UNTIL ALL PRODUCTS ARE VISIBLY MIXED WELL. ONCE PRODUCT IS WELL BLENDED, SEED AND FERTILIZER SHALL BE ADDED AND MIXED UNTIL THE SEED AND FERTILIZER ARE VISIBLE THROUGHOUT THE SLURRY. ONCE THE SEED AND FERTILIZER IS ADDED, THE AGITATION OF THE SLURRY SHOULD BE MINIMAL, SO AS NOT TO DAMAGE THE SEEDS. THE MATERIAL SHOULD THEN BE SPRAYED ONTO THE DESIGNATED PLANTING AREAS, AND CARE SHOULD BE TAKEN TO CLEAN UP ANY OVERSPRAY OR SPILLAGE.

#### INTERIM BINDER NOTE

GRADED, DISTURBED, OR ERODED AREAS TO BE TREATED WITH NON-IRRIGATED HYDROSEED MIX SHALL RECEIVE AN INTERIM BINDER/TACKIFIER AS NEEDED BETWEEN APRIL 2ND AND AUGUST 31ST FOR DUST-EROSION CONTROL WITH SUBSEQUENT APPLICATION OF HYDROSEED MIX DURING THE RAINY SEASON BETWEEN OCTOBER 1ST AND APRIL 1ST.

### MECHANICALLY BONDED FIBER MATRIX (3600LBS.ACRE)

THE MECHANICALLY BONDED FIBER MATRIX SHALL BE COMPOSED OF WOOD FIBER, CRIMPED POLYESTER FIBERS, POLYSACCHARIDE CROSSLINKED HYDRO-COLLOID POLYMER TACKIFIER, AND CONTAIN NO GERMINATION-INHIBITING OR GROWTH-INHIBITING FACTORS. THE MECHANICALLY BONDED FIBER MATRIX SHALL HAVE A TEMPORARY GREEN DYE AND SHALL NOT HAVE ANY ADVERSE EFFECTS OR BE INJURIOUS TO PLANTS OR ANIMALS. A CERTIFICATE OF COMPLIANCE SHALL BE PROVIDED BY THE PRODUCT MANUFACTURER TO CERTIFY COMPLIANCE WITH THE SPECIFICATIONS.

### AMENDMENTS

ANY SPECIFIED SOIL AMENDMENTS MUST BE APPLIED PRIOR TO THE HYDROSEEDING APPLICATION. IF THE AMENDMENT IS TO BE INCORPORATED INTO THE SEEDBED, IT MUST BE DONE IN SUCH A MANNER TO DISPERSE THE AMENDMENT EVENLY THROUGHOUT THE PLANTING AREA. ALL SOIL AMENDMENTS MUST BE APPLIED AT THE RATES SHOWN IN THE SPECIFICATIONS, AND AS SPECIFIED ON THE SOILS ANALYSIS REPORT(S). ANY DEVIATIONS FROM THESE NEEDS TO BE APPROVED BY THE OWNER'S REPRESENTATIVE IN WRITING PRIOR TO MAKING ANY SUCH CHANGES.

### PLANTING LEGEND FOR TEMPORARY EROSION CONTROL

HYDROSEED SLURRY COMPONENT FOR AREAS WITH ALL GRADIENTS

	COMMON NAME	BULK #'S
FIBER MULCH:	COMBED FIBERS 1000	1500 LBS/ACRE
BINDER/TACKIFIER:	ECOLOGY CONTROLS	150 LBS/ACRE
COMPOST:	HYDROPOST (PREMIUM)	1000 LBS/ACRE
SEED:	FESTUCA RUBRA 'MOLATE'	25 LBS/ACRE (85 PLS)
	KOeleria MACRANTHA	5 LBS/ACRE (85 PLS)
	STIPA POLYCHA	20 LBS/ACRE (85 PLS)
	STIPA CERNUA	10 LBS/ACRE (85 PLS)
FERTILIZER/AMENDMENTS:	BIOGOL MIX 7-2-3 MYCORRHIZAL INOCULUM	1000 LBS/ACRE 60 LBS/ACRE

#### NOTES:

1. ALL SLOPE AREAS THAT ARE 4:1 GRADIENT AND STEEPER THAT RECEIVE HYDROSEED MIX SHALL ALSO RECEIVE STORMWATER AND EROSION CONTROL FIBER ROLLS. SEE SPECIFICATIONS FOR INSTALLATION.

### HYDROSEED NOTES

- SEED MIXES SHALL BE SPECIFIED BY THE PURE LIVE SEED OF EACH SPECIES.
- FIBER MULCH SHALL BE APPLIED AT A MINIMUM RATE OF 2,000 POUNDS PER ACRE EXCEPT WHEN USED IN CONJUNCTION WITH STRAW MULCH, WHEN IT SHALL BE APPLIED AT A MINIMUM RATE OF 400 POUNDS PER ACRE.
- A WETTING AGENT CONSISTING OF 95 PERCENT ALKYL POLYETHYLENE GLYCOL SHALL BE APPLIED AS PER MANUFACTURERS' RECOMMENDATIONS.
- EQUIPMENT USED FOR THE APPLICATION OF SLURRY SHALL HAVE A BUILD-IN AGITATION SYSTEM TO SUSPEND AND HOMOGENEOUSLY MIX THE SLURRY. THE SLURRY MIX SHALL BE DIED GREEN. THE EQUIPMENT MUST HAVE A PUMP CAPABLE OF APPLYING SLURRY UNIFORMLY.

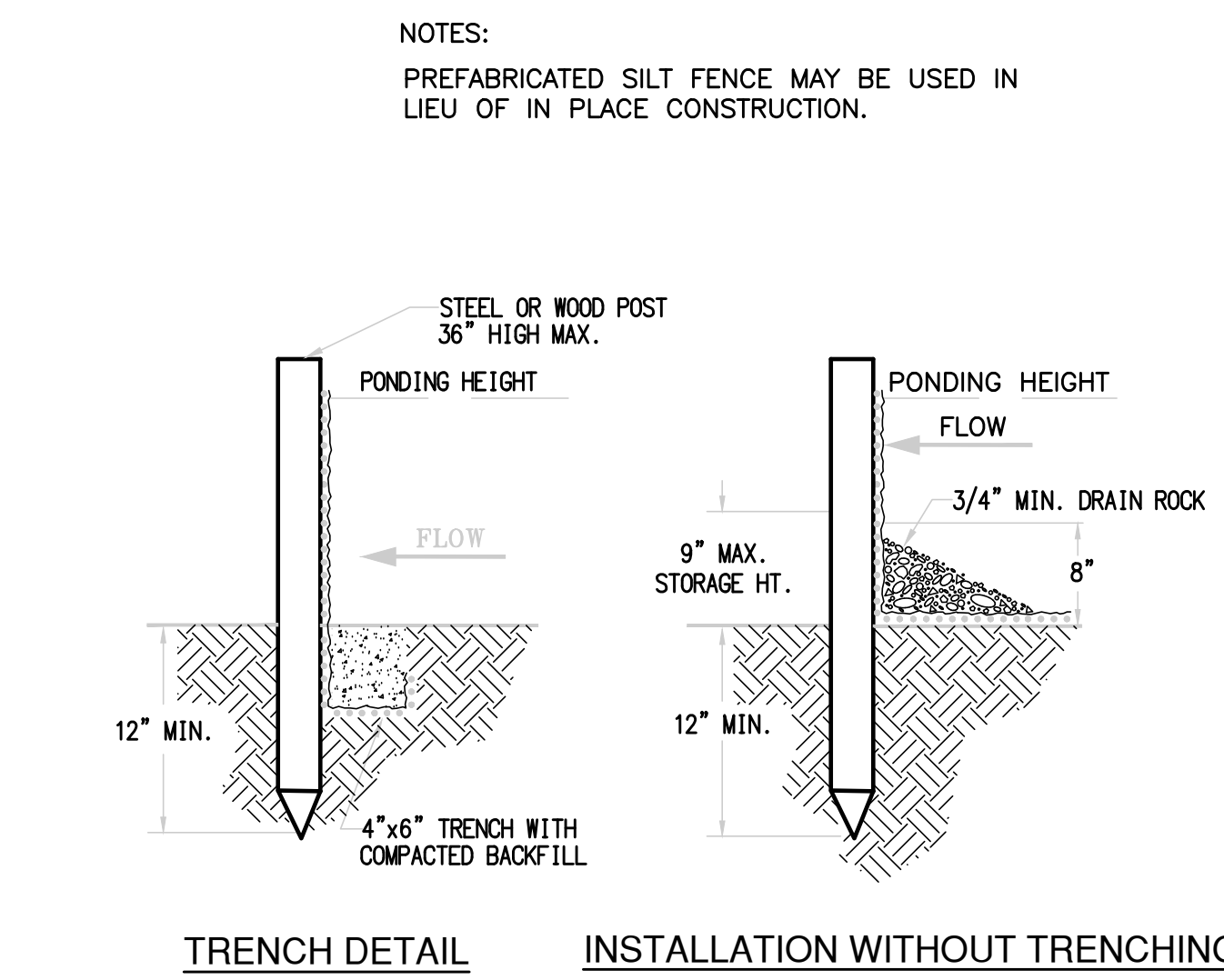
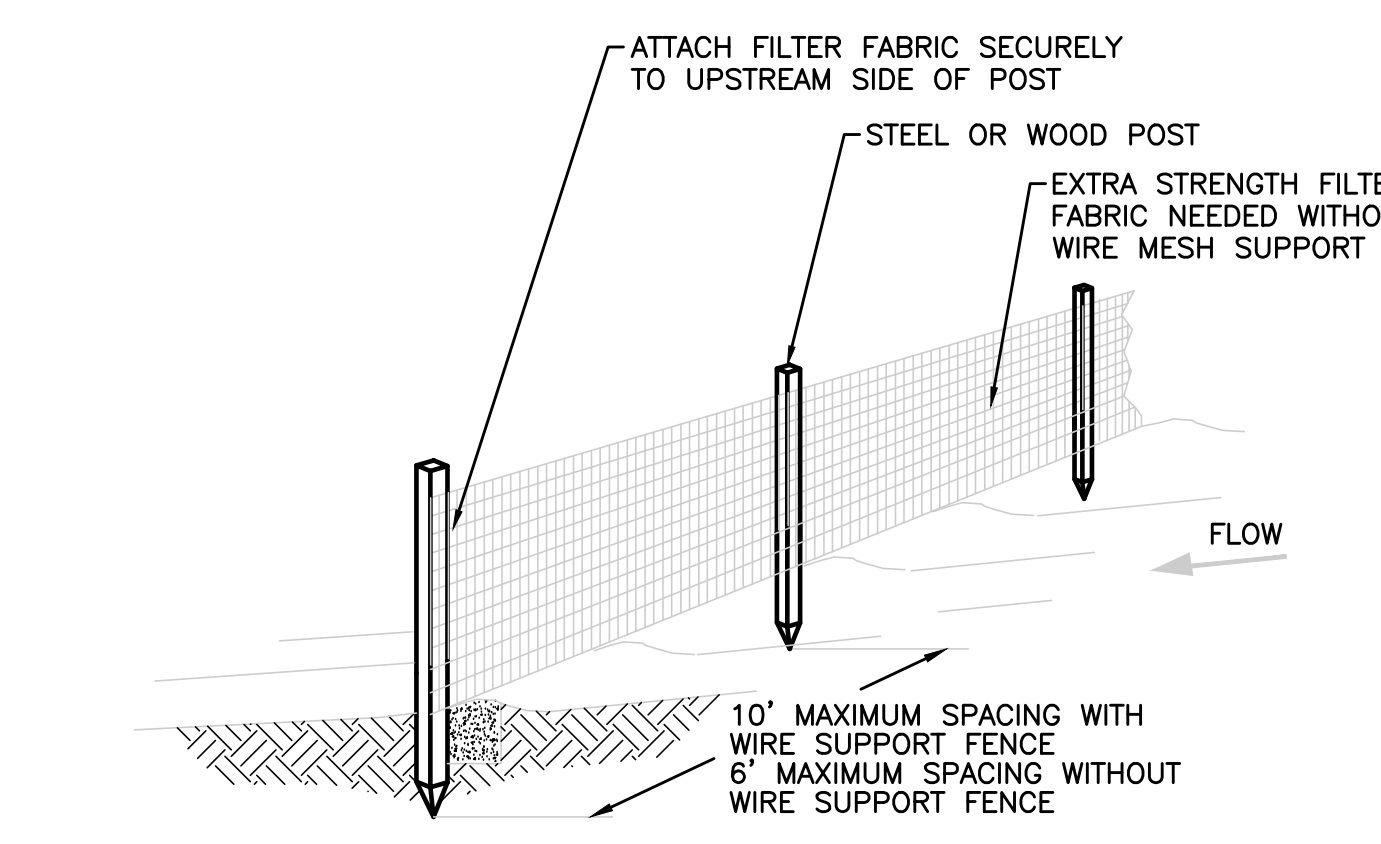

- NOTES:
- SILT FENCE SHALL BE PLACED ON SLOPE CONTOURS TO MAXIMIZE PONDIING EFFICIENCY.
  - INSPECT AND REPAIR FENCE AFTER EACH STORM EVENT AND REMOVE SEDIMENT WHEN NECESSARY. 9" MAXIMUM RECOMMENDED STORAGE HEIGHT.
  - REMOVED SEDIMENT SHALL BE DEPOSITED TO AN AREA THAT WILL NOT CONTRIBUTE SEDIMENT OFF-SITE AND CAN BE PERMANENTLY STABILIZED.

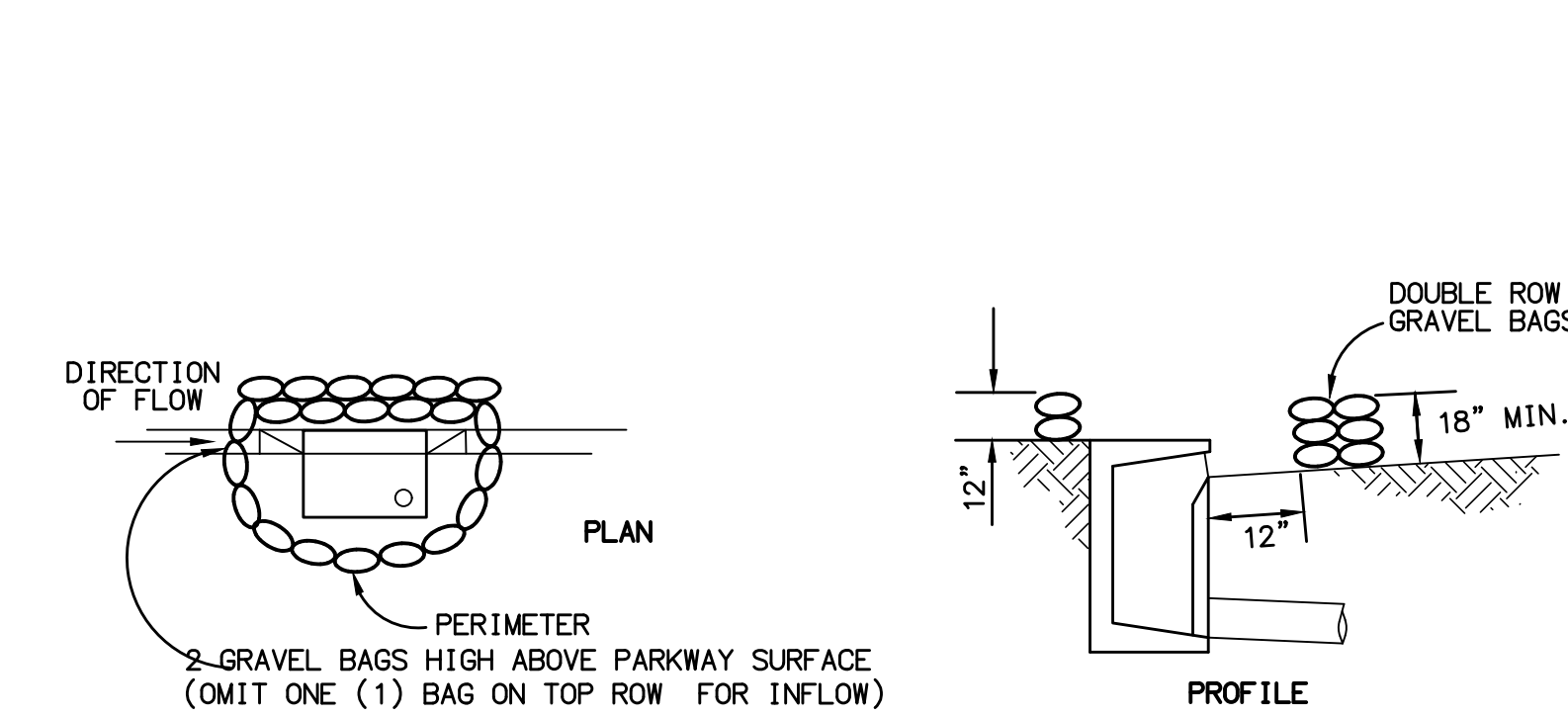
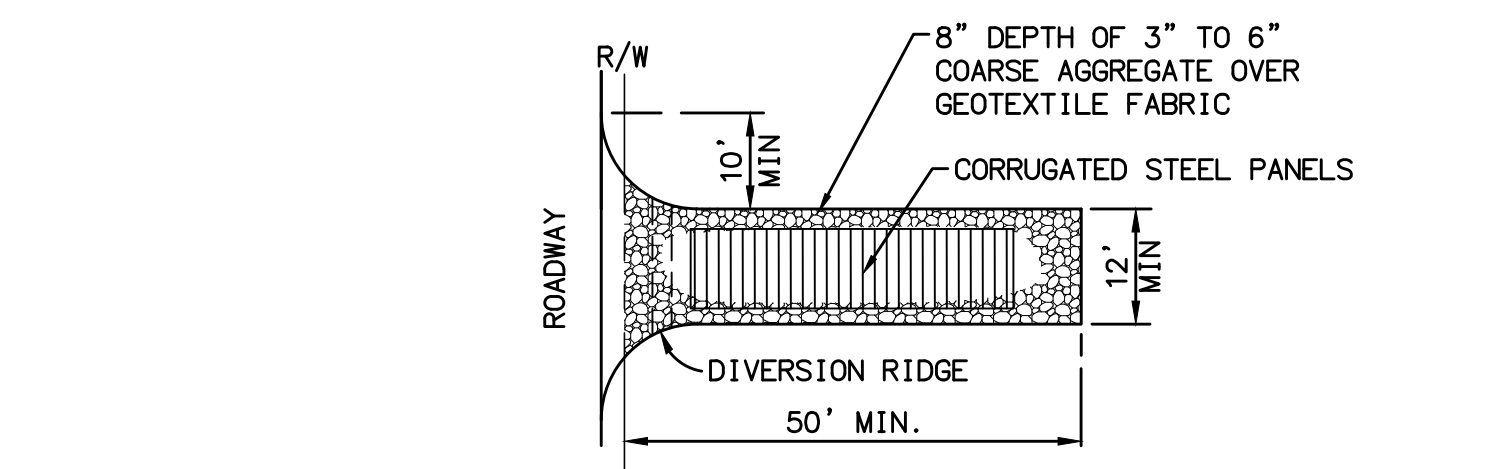

- NOTES:
- GRAVEL BAGS (OF BURLAP FABRIC) ARE FILLED WITH GRAVEL, LAYERED AND PACKED TIGHTLY.
  - INSPECT BARRIERS AND REMOVE SEDIMENT AFTER EACH STORM EVENT. SEDIMENT AND GRAVEL MUST BE REMOVED FROM THE TRAVELED WAY IMMEDIATELY.

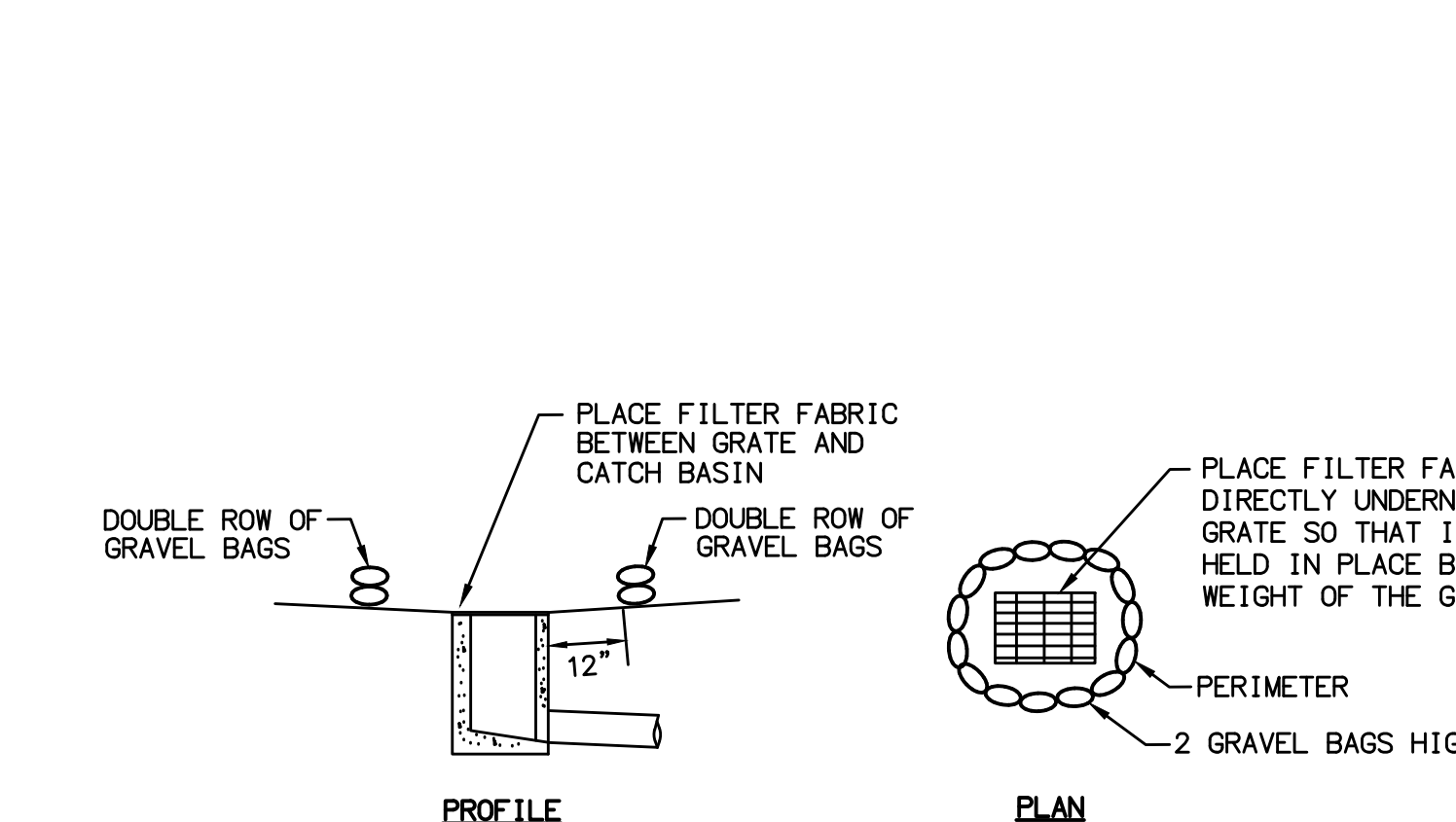

- NOTES:
- GRAVEL BAGS MONOFILAMENT ARE FILLED WITH GRAVEL, LAYERED AND PACKED TIGHTLY.
  - INSPECT BARRIERS AND REMOVE SEDIMENT AFTER EACH STORM EVENT. SEDIMENT AND GRAVEL MUST BE REMOVED FROM THE TRAVELED WAY IMMEDIATELY.



REGISTRATION STAMP

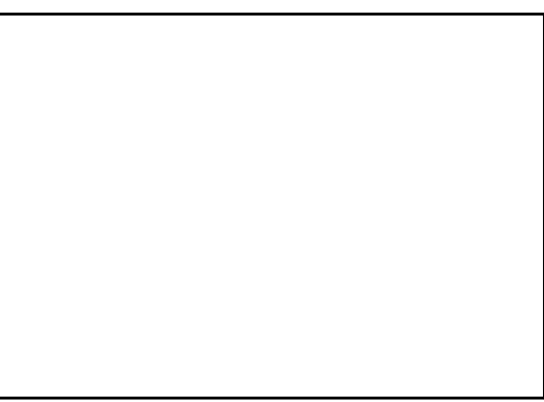

CFM STAMP

KEYPLAN

Issue	Date	By
Drawn	10/11/2020	Author
Checked		Checked
Approved		Approved

**5434: UCSD  
PEPPER  
CANYON  
ANCILLARY  
SITE WORK**  
University of California  
San Diego Campus  
La Jolla, California 92037

**95%  
CONSTRUCTION  
DOCUMENTS**  
April 30, 2021



REGISTRATION STAMP

CFM STAMP

KEYPLAN

BOOK	ISSUE	DATE
	1	10/11/2020
Drawn		Author
Checked		Checker
Approved		Approver

**CIVIL - MULTI-MODAL  
PATH & PAVEMENT  
SECTIONS**

SHEET NUMBER

**C4.00**

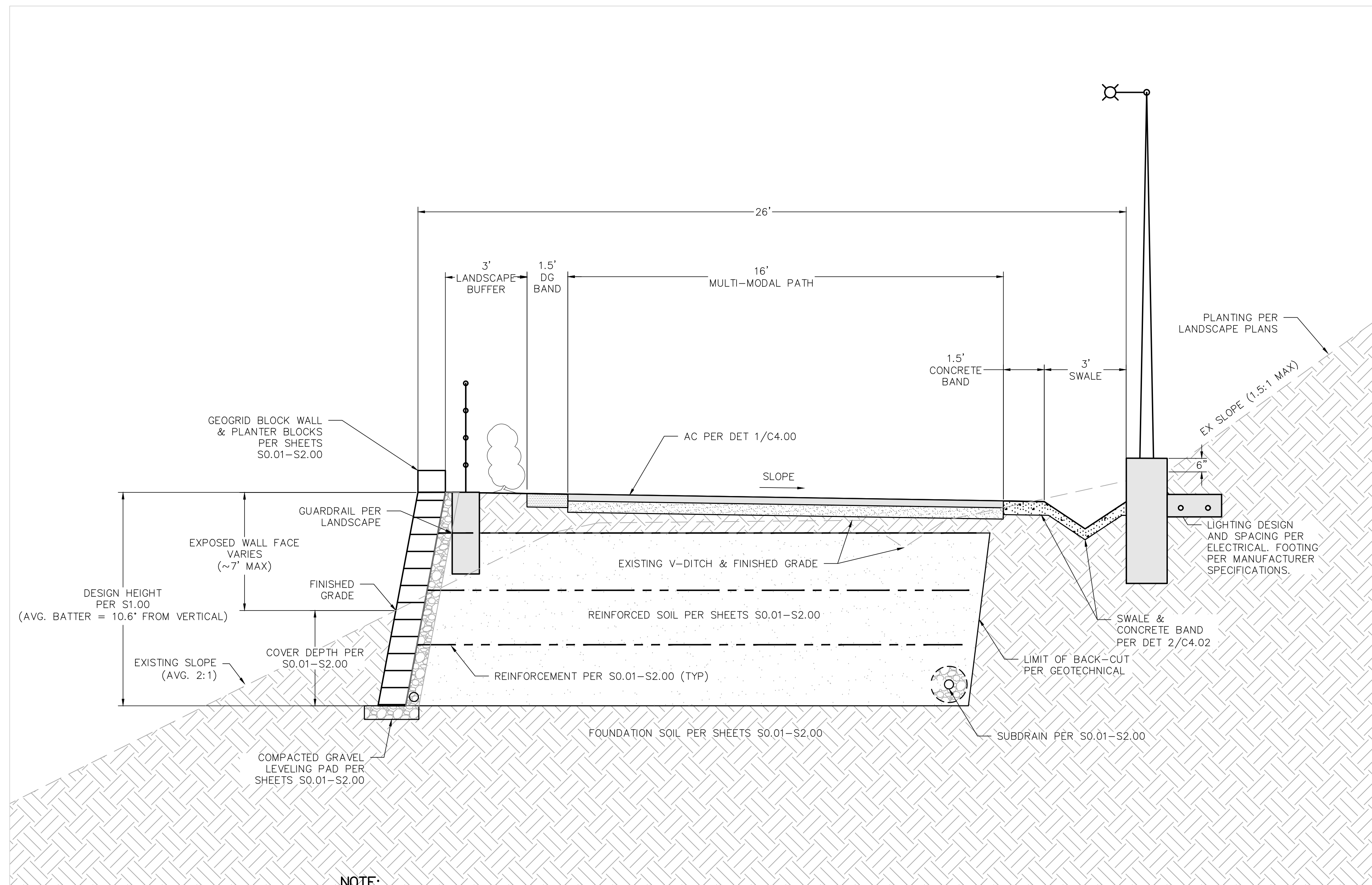

**NOTE:**  
ALL DETAILS FOR GEGRID WALL AND GEGRID FABRIC SHOWN HEREON ARE FOR GRAPHICAL PURPOSES ONLY. SEE SHEETS S0.01-S2.00 FOR GEGRID WALL DESIGN. FINAL DESIGN TO PREPARED PER MANUFACTURER RECOMMENDATIONS AND GEOTECHNICAL AND STRUCTURAL REVIEW (PER OTHERS).

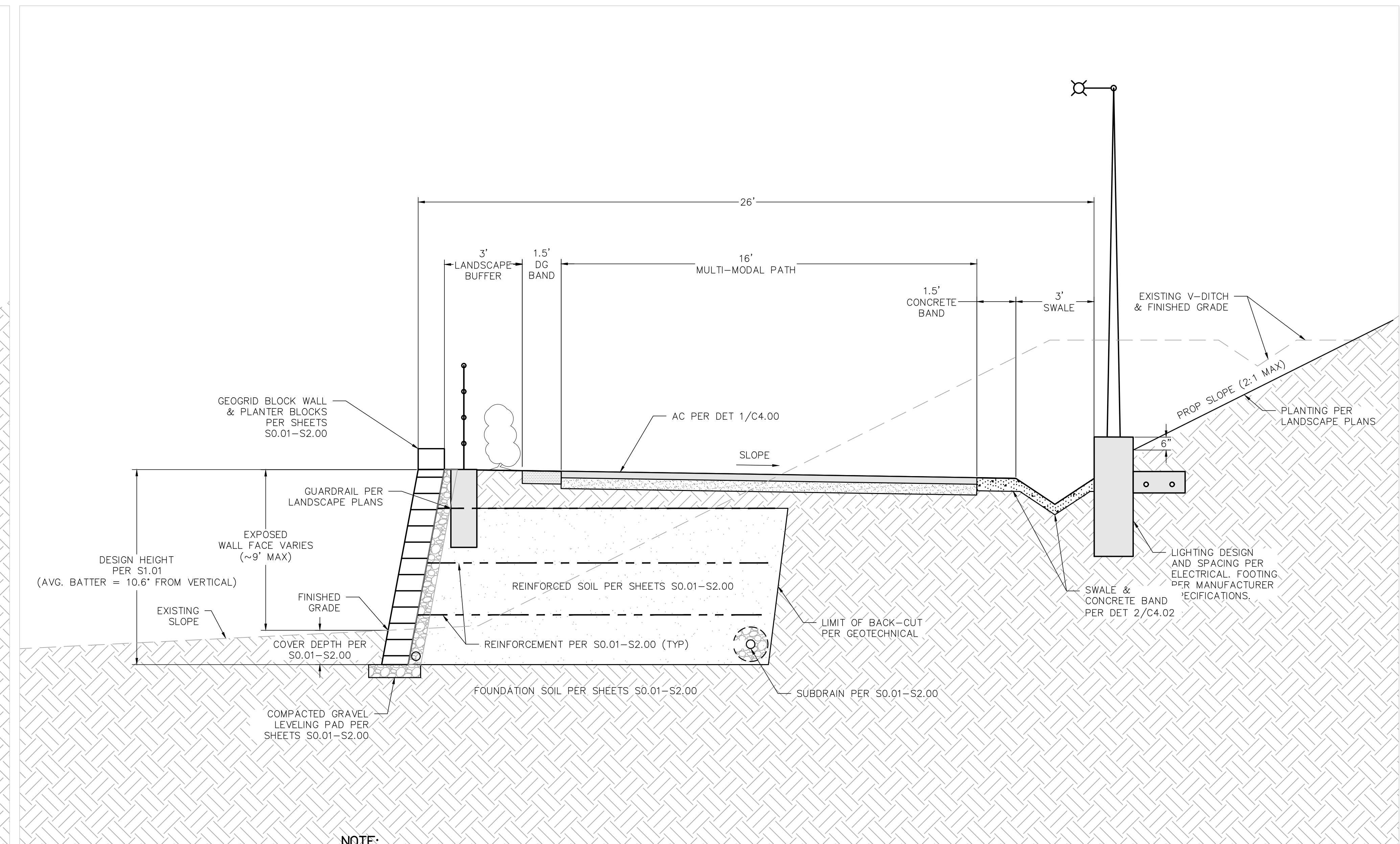

**NOTE:**  
ALL DETAILS FOR GEGRID WALL AND GEGRID FABRIC SHOWN HEREON ARE FOR GRAPHICAL PURPOSES ONLY. SEE SHEETS S0.01-S2.00 FOR GEGRID WALL DESIGN. FINAL DESIGN TO PREPARED PER MANUFACTURER RECOMMENDATIONS AND GEOTECHNICAL AND STRUCTURAL REVIEW (PER OTHERS).

**A**  
C4.00  
**MULTI-MODAL PATH TYPICAL SECTION (NORTH)**  
N.T.S.

**B**  
C4.00  
**MULTI-MODAL PATH TYPICAL SECTION (SOUTH)**  
N.T.S.

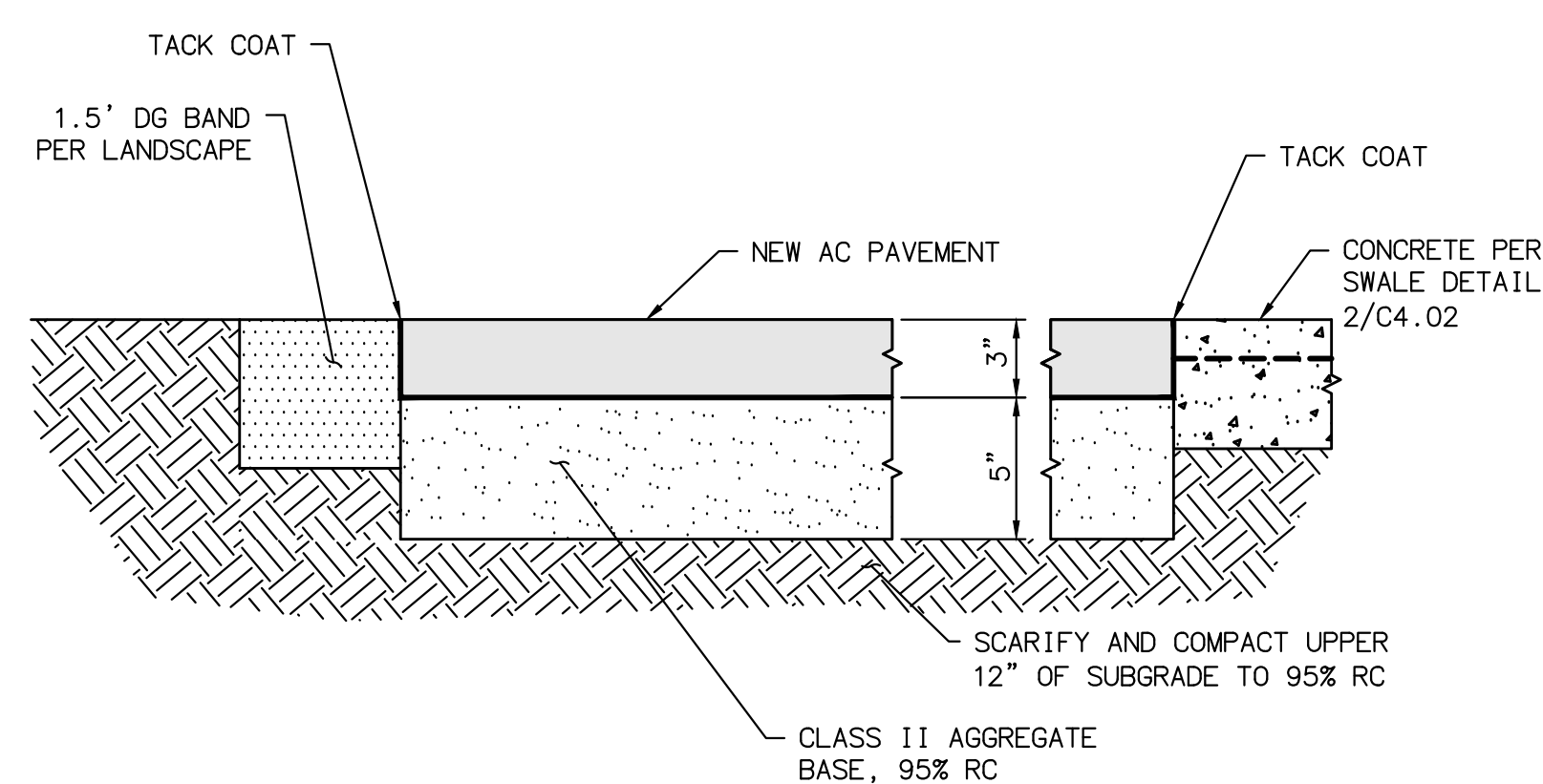

**NOTE:**  
1. SECTIONS TO BE CONSTRUCTED PER GEOTECHNICAL EVALUATION.

**1**  
C4.00  
**AC PAVEMENT (MULTI-MODAL PATH)**  
N.T.S.

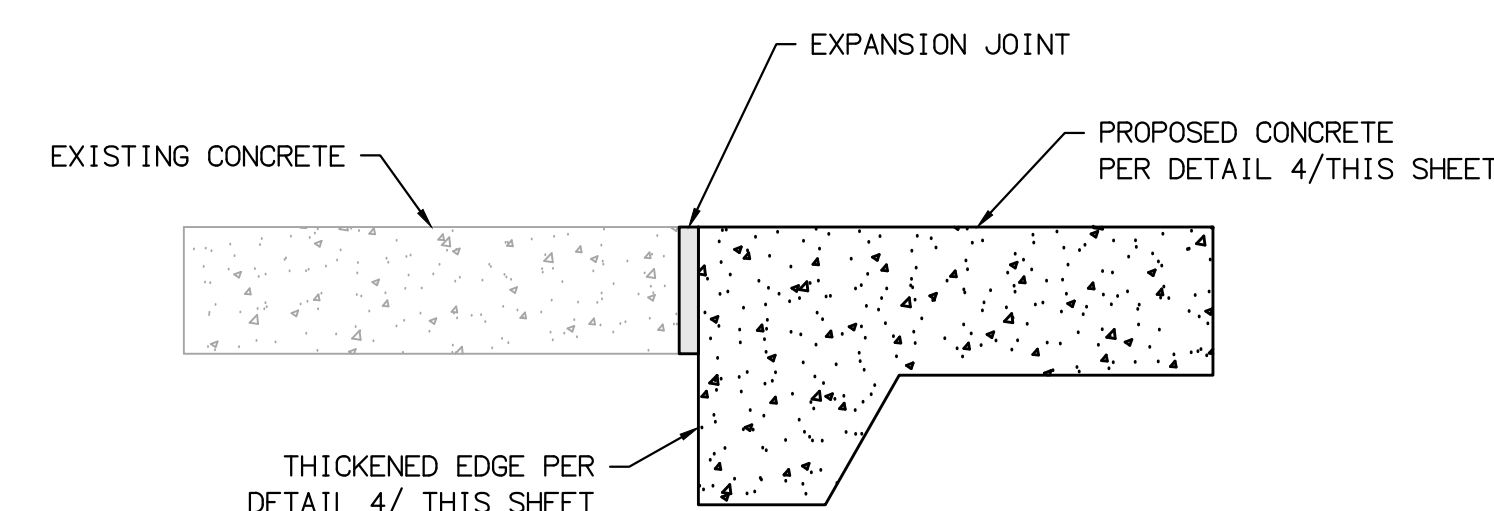

**2**  
C4.00  
**CONCRETE TO EXISTING CONCRETE CONNECTION**  
N.T.S.

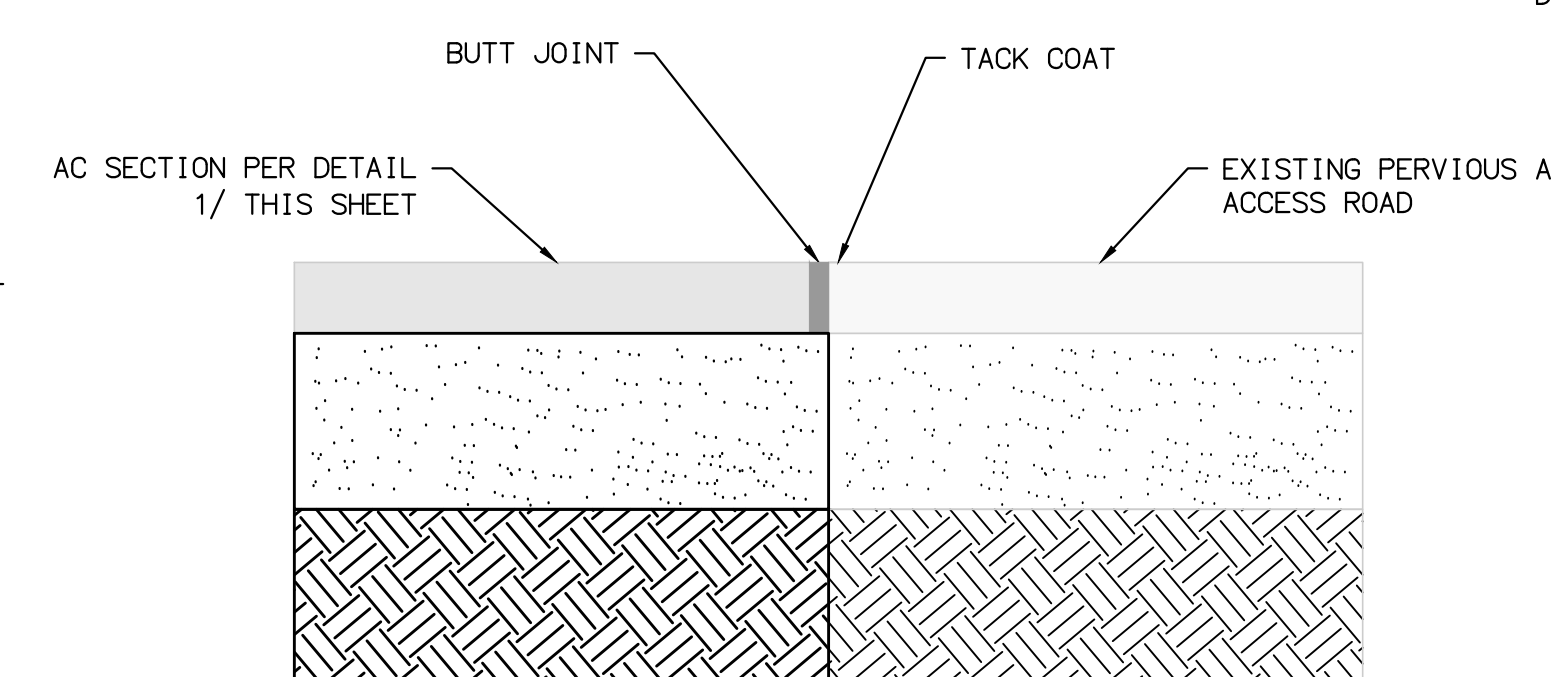

**3**  
C4.00  
**ASPHALT TO EXISTING ASPHALT CONNECTION**  
N.T.S.

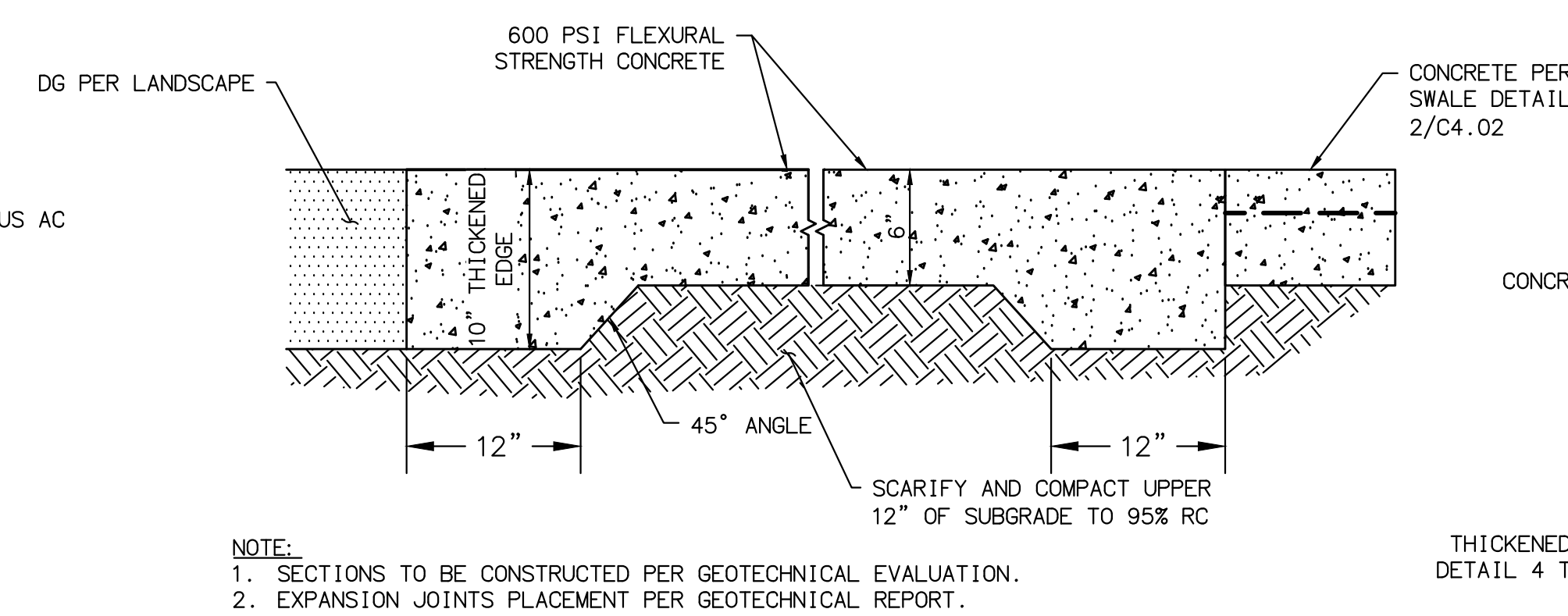

**NOTE:**  
1. SECTIONS TO BE CONSTRUCTED PER GEOTECHNICAL EVALUATION.  
2. EXPANSION JOINTS PLACEMENT PER GEOTECHNICAL REPORT.

**4**  
C4.00  
**CONCRETE DETAIL**  
N.T.S.

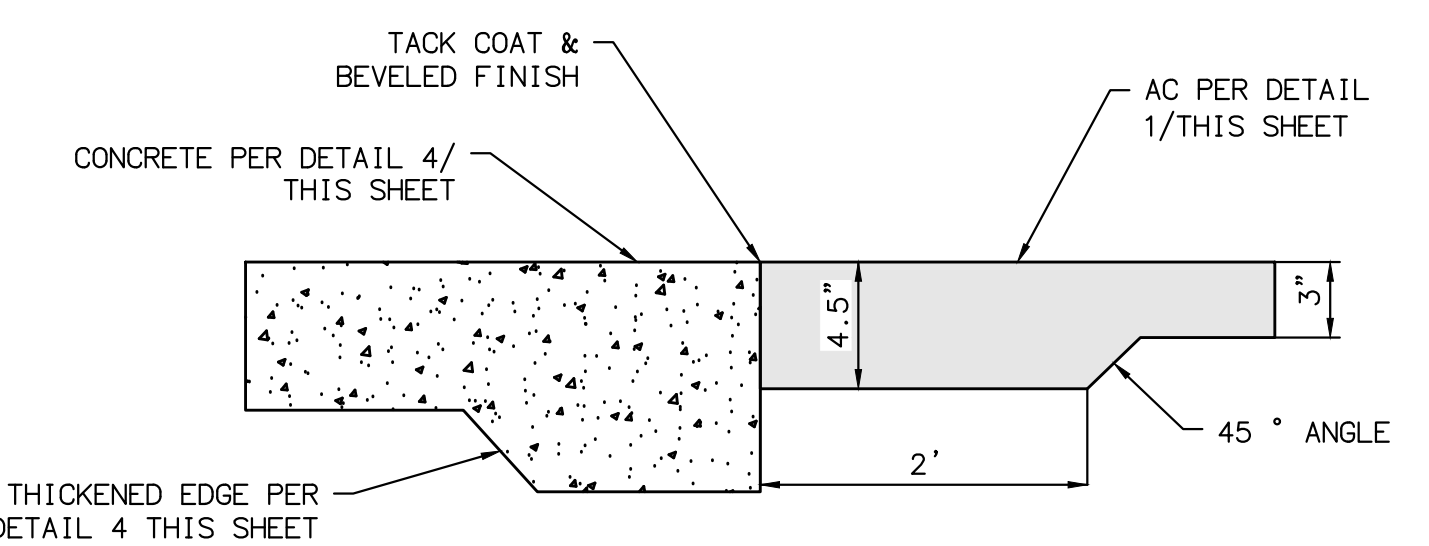

**5**  
C4.00  
**CONCRETE TO AC PAVEMENT CONNECTION**  
N.T.S.

**5434: UCSD  
PEPPER  
CANYON  
ANCILLARY  
SITE WORK**  
University of California  
San Diego Campus  
La Jolla, California 92037

**95%  
CONSTRUCTION  
DOCUMENTS**  
April 30, 2021



REGISTRATION STAMP

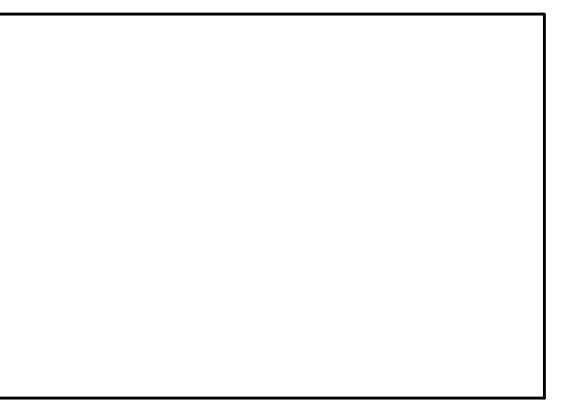

CFM STAMP

KEYPLAN

DATE	ISSUE	BY
10/11/2020	Author	
	Checked	
	Approved	

**CIVIL - MULTI-MODAL  
PATH SECTIONS**

SHEET NUMBER

**C4.01**

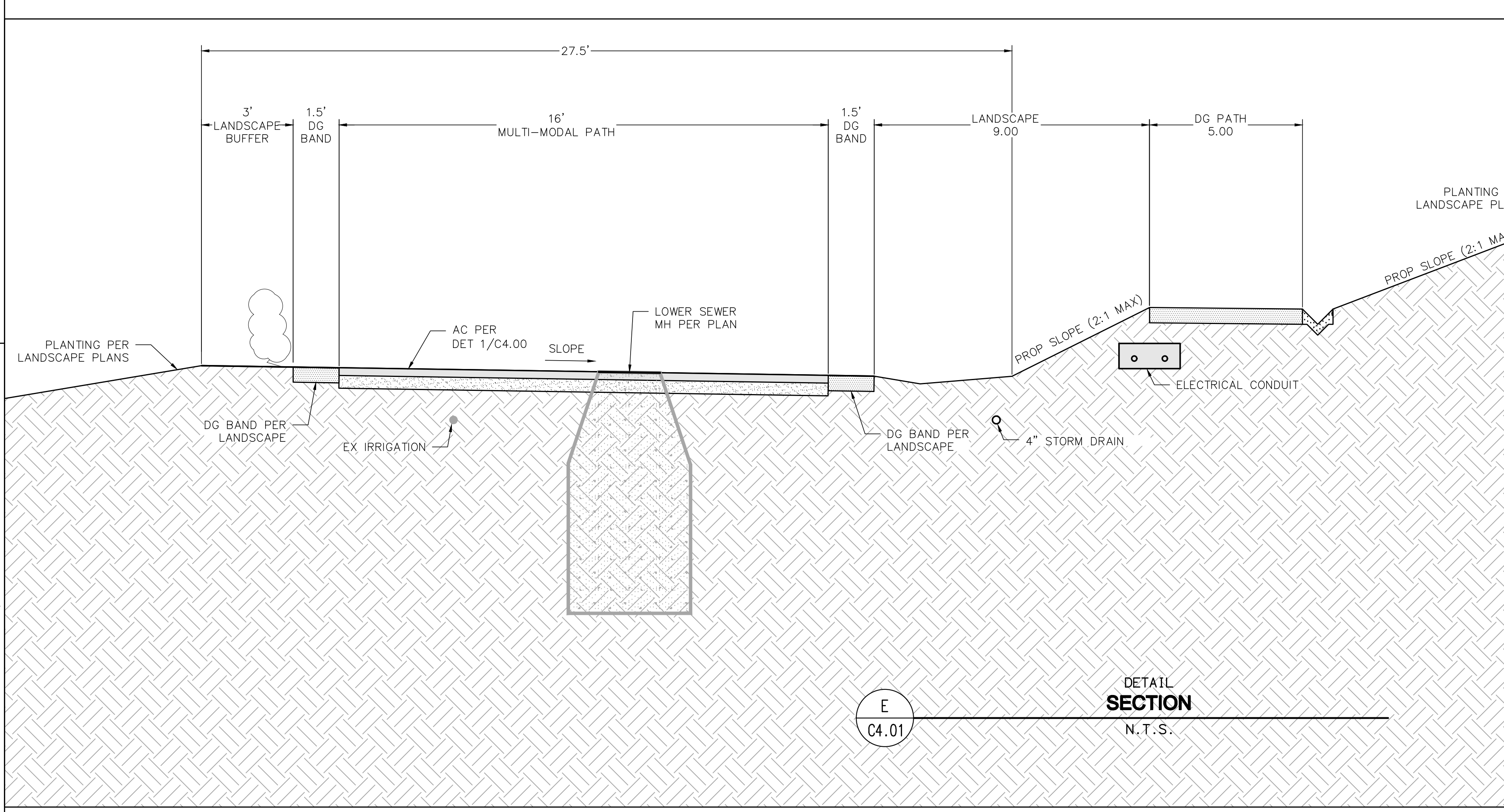
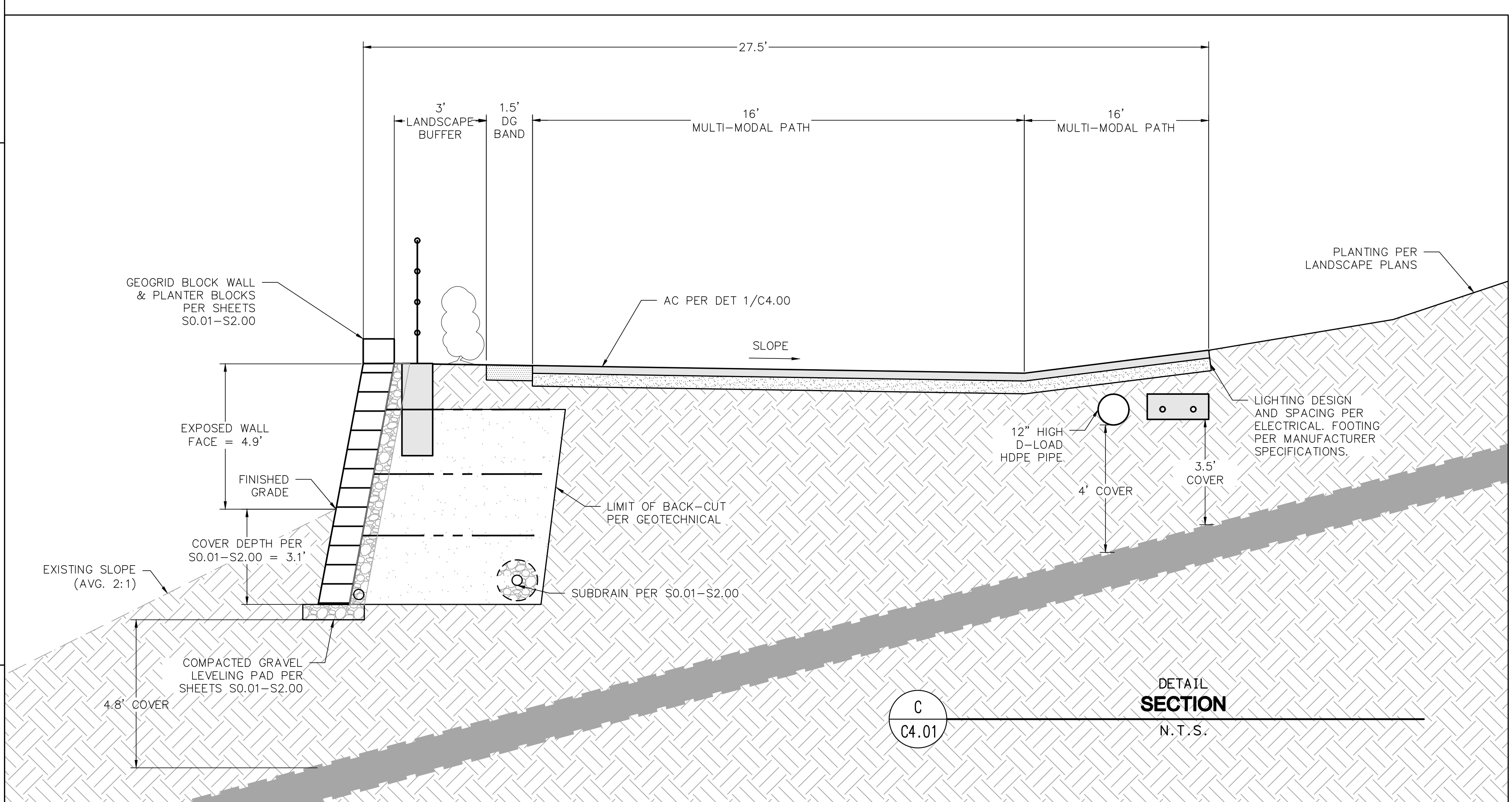
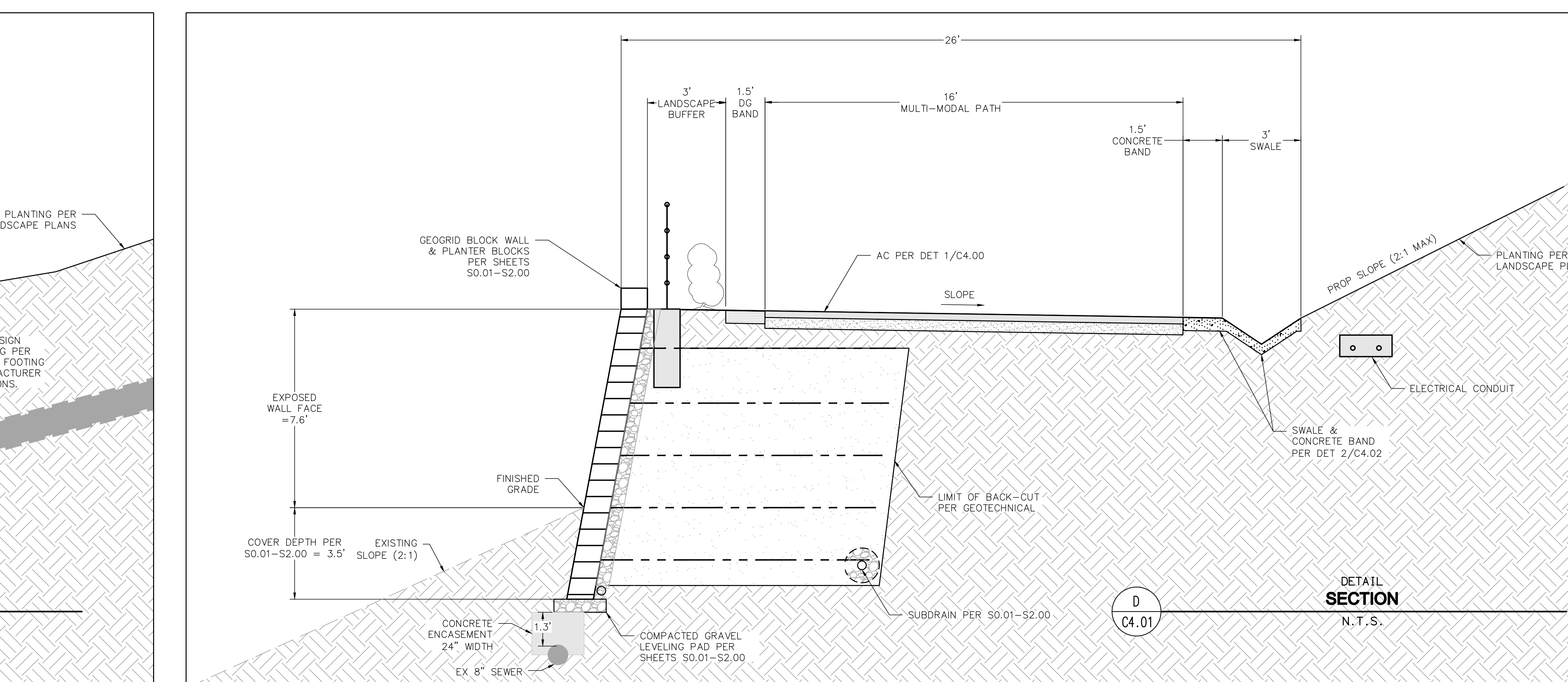
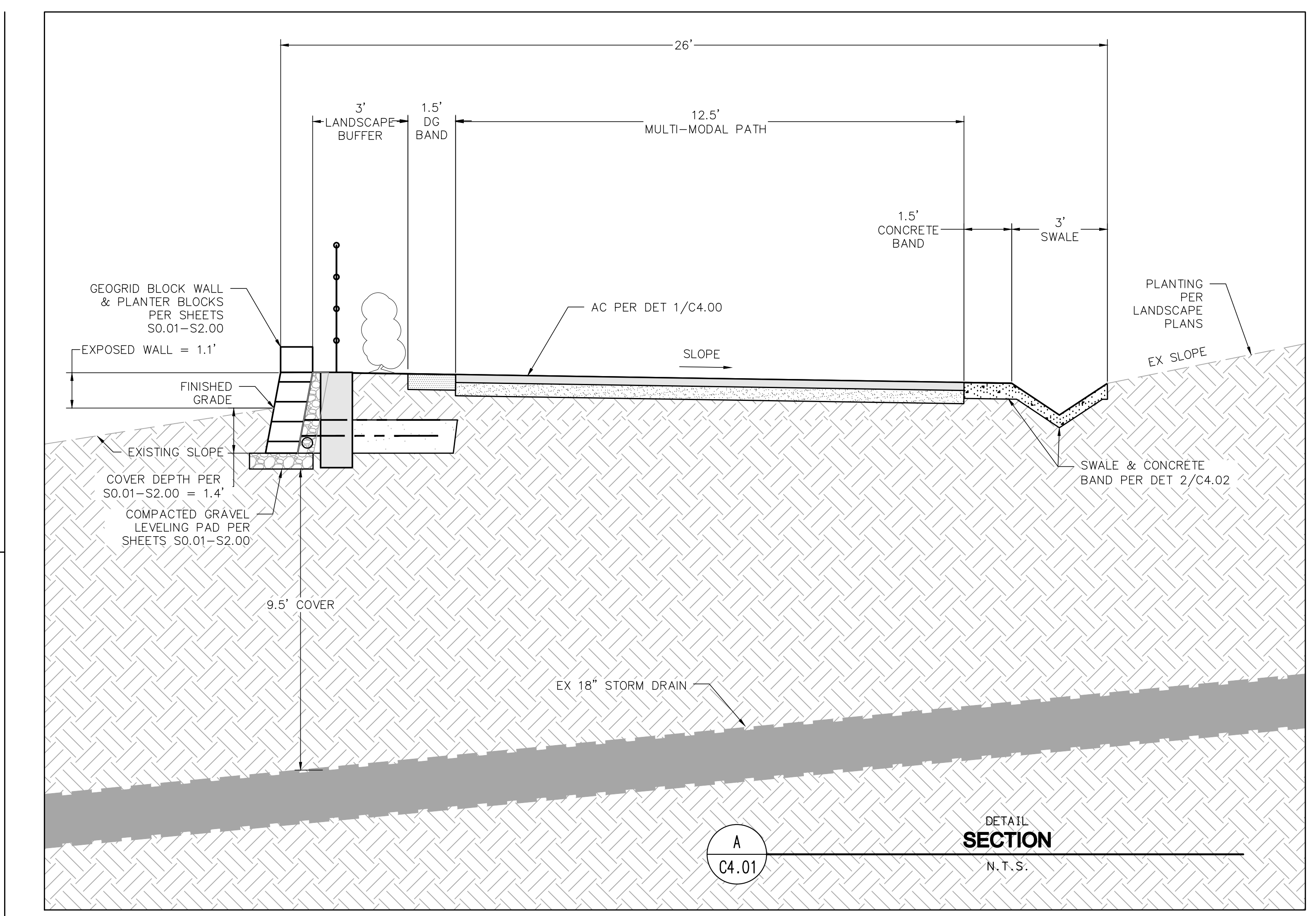
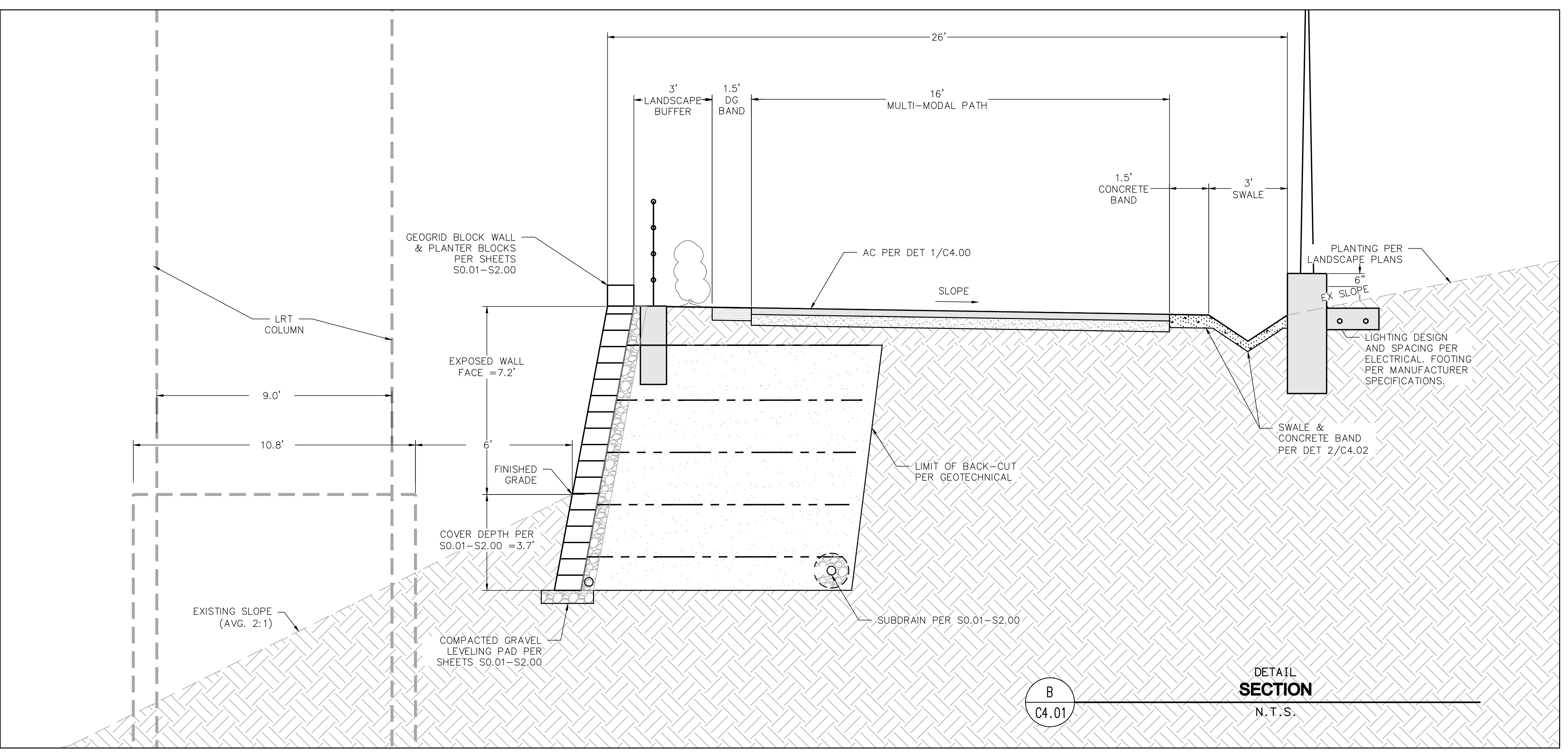

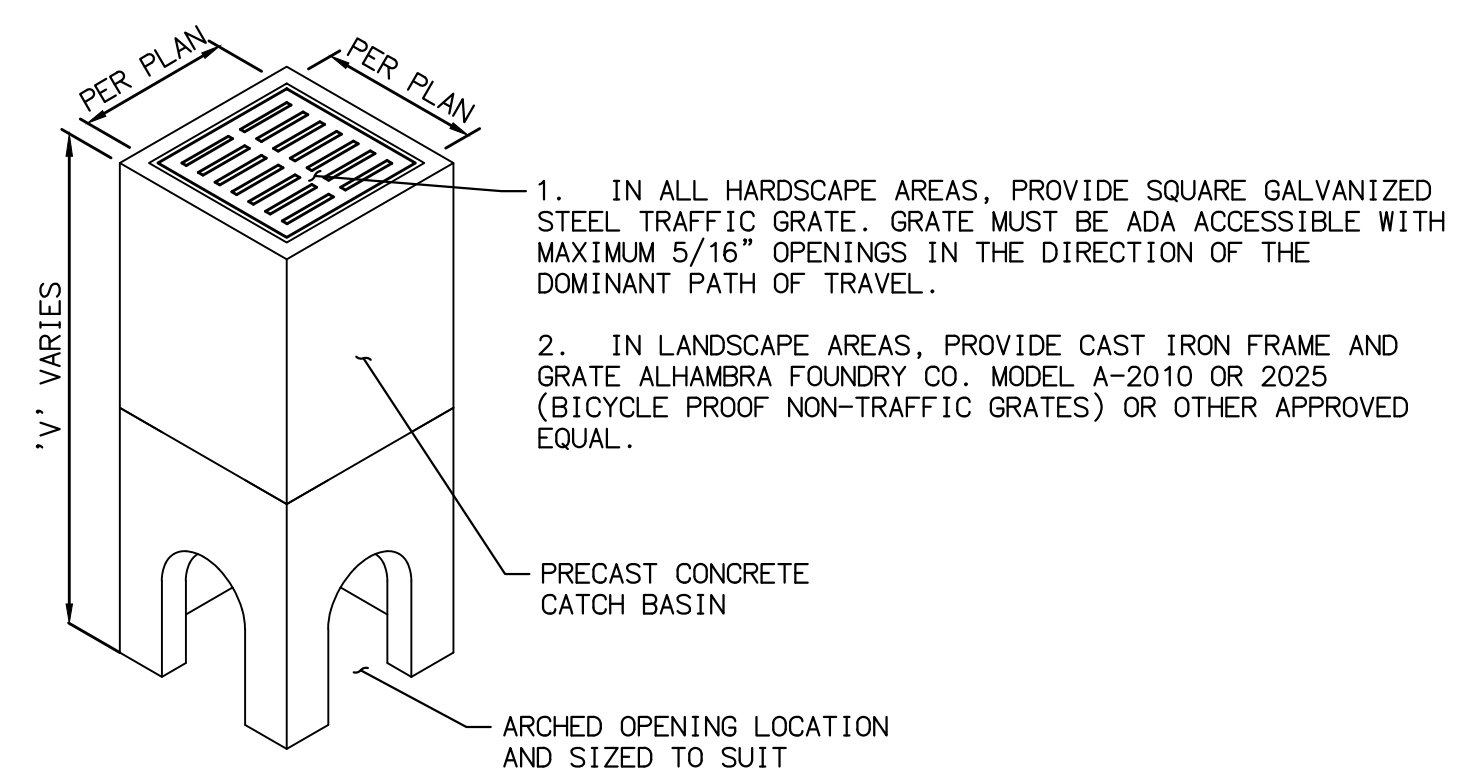

- NOTES:**
1. IN ALL HARDSCAPE AREAS, PROVIDE SQUARE GALVANIZED STEEL TRAFFIC GRATE. GRATE MUST BE ADA ACCESSIBLE WITH MAXIMUM 5/16" OPENINGS IN THE DIRECTION OF THE DOMINANT PATH OF TRAVEL.
  2. IN LANDSCAPE AREAS, PROVIDE CAST IRON FRAME AND GRATE ALHAMBRA FOUNDRY CO. MODEL A-2010 OR 2025 (61CYCLE PROOF NON-TRAFFIC GRATES) OR OTHER APPROVED EQUAL.
- PRECAST CONCRETE CATCH BASIN  
ARCHED OPENING LOCATION AND SIZED TO SUIT

1  
C4.02  
DETAIL  
**PRECAST CONCRETE CATCH BASIN 1**  
N.T.S.

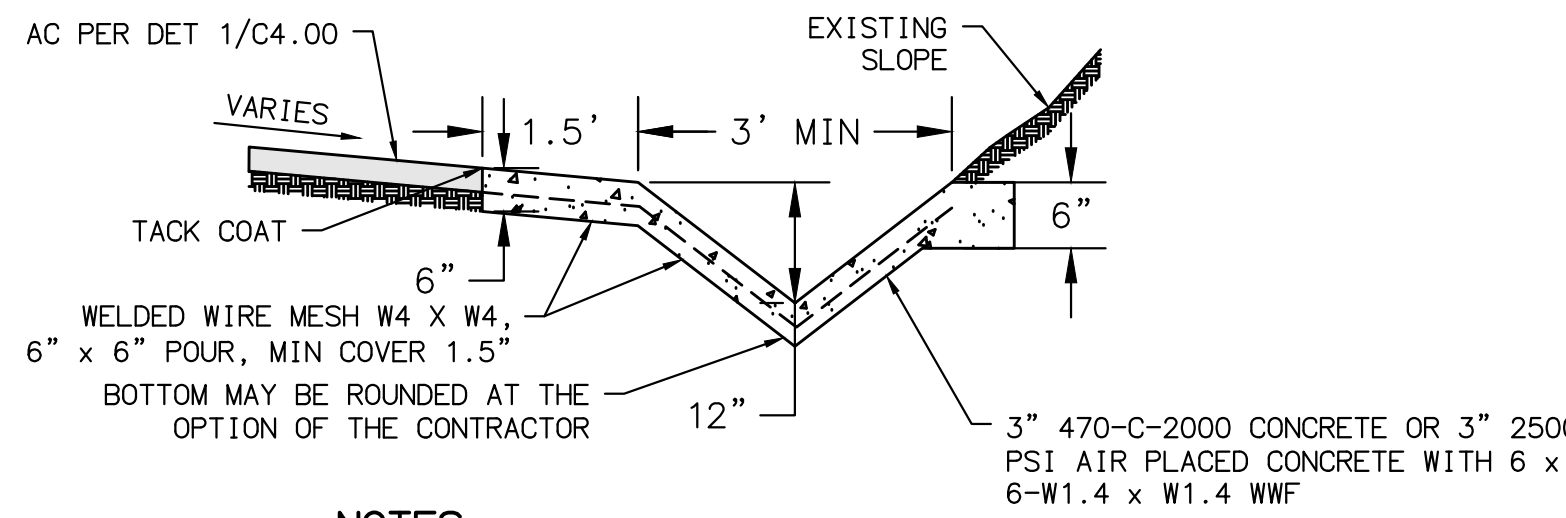

- NOTES:**
1. LONGITUDINAL SLOPE OF LINED DITCH SHALL BE 2% MINIMUM.
  2. USE A 6" THICKENED EDGE ON BOTH SIDES OF THE DRAINAGE DITCH WHEN THE DITCH IS BUILT DOWN A GRADED SLOPE.
  3. SEE LANDSCAPE PLANS FOR COLOR DETAILS.

2  
C4.02  
DETAIL  
**TYPICAL SWALE DETAIL - MULTI-MODAL PATH**  
N.T.S.

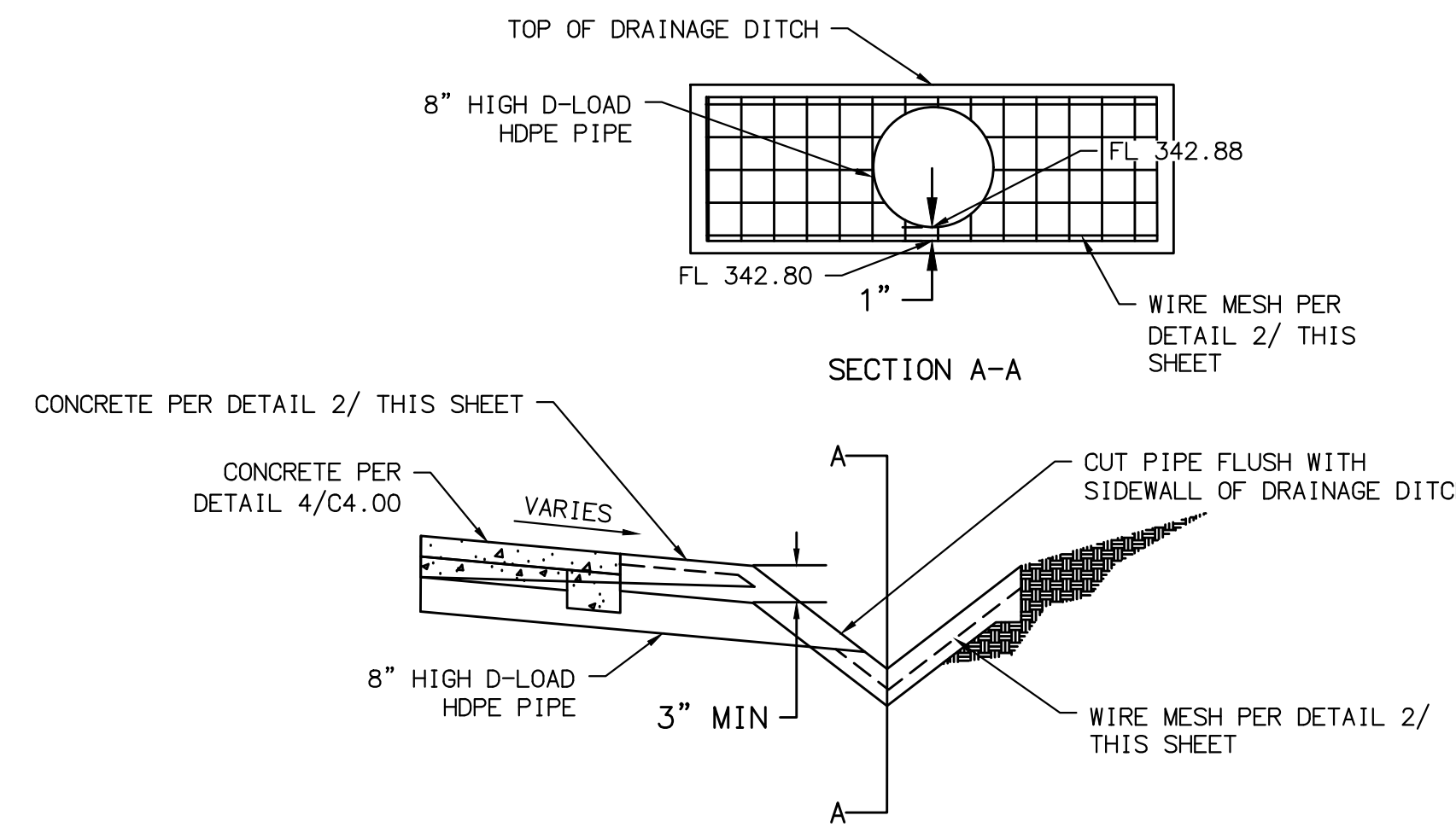

3  
C4.02  
DETAIL  
**PIPE TO SWALE CONNECTION DETAIL**  
N.T.S.

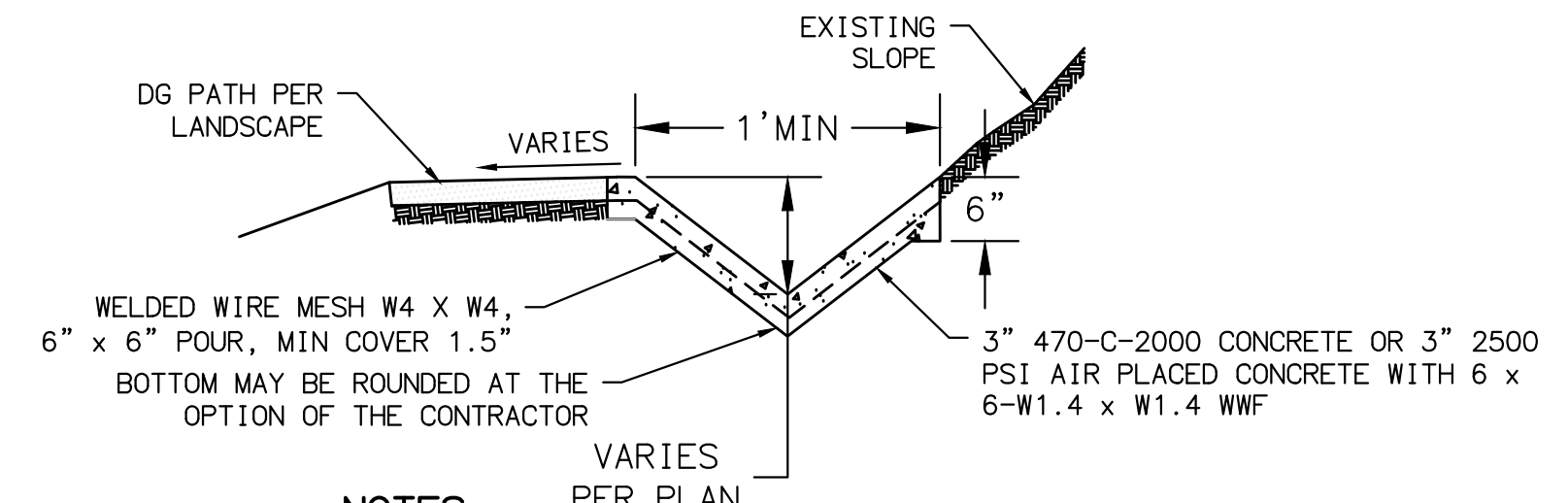

- NOTES:**
1. LONGITUDINAL SLOPE OF LINED DITCH SHALL BE 1.5% MINIMUM.
  2. USE A 6" THICKENED EDGE ON BOTH SIDES OF THE DRAINAGE DITCH WHEN THE DITCH IS BUILT DOWN A GRADED SLOPE.
  3. SEE LANDSCAPE PLANS FOR COLOR DETAILS.

4  
C4.02  
DETAIL  
**SWALE DETAIL**  
N.T.S.

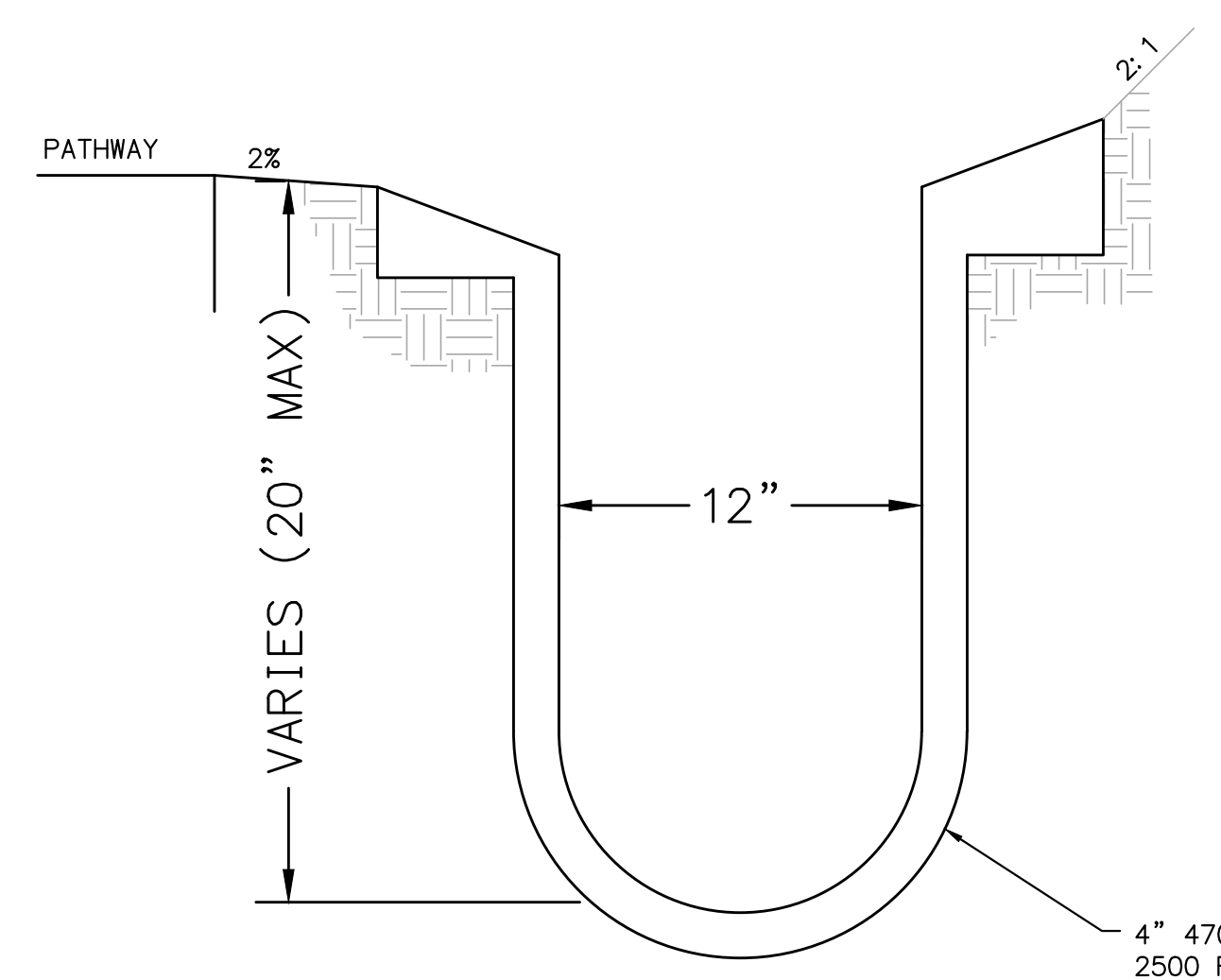

- NOTES:**
1. CONTRACTOR SHALL PROVIDE A 15 FOOT TRANSITION FROM MODIFIED TYPE B DRAINAGE DITCH TO DETAIL 5/ THIS SHEET

5  
C4.02  
DETAIL  
**MODIFIED TYPE 'B' DRAINAGE DITCH PER SDRSD D-75**  
N.T.S.

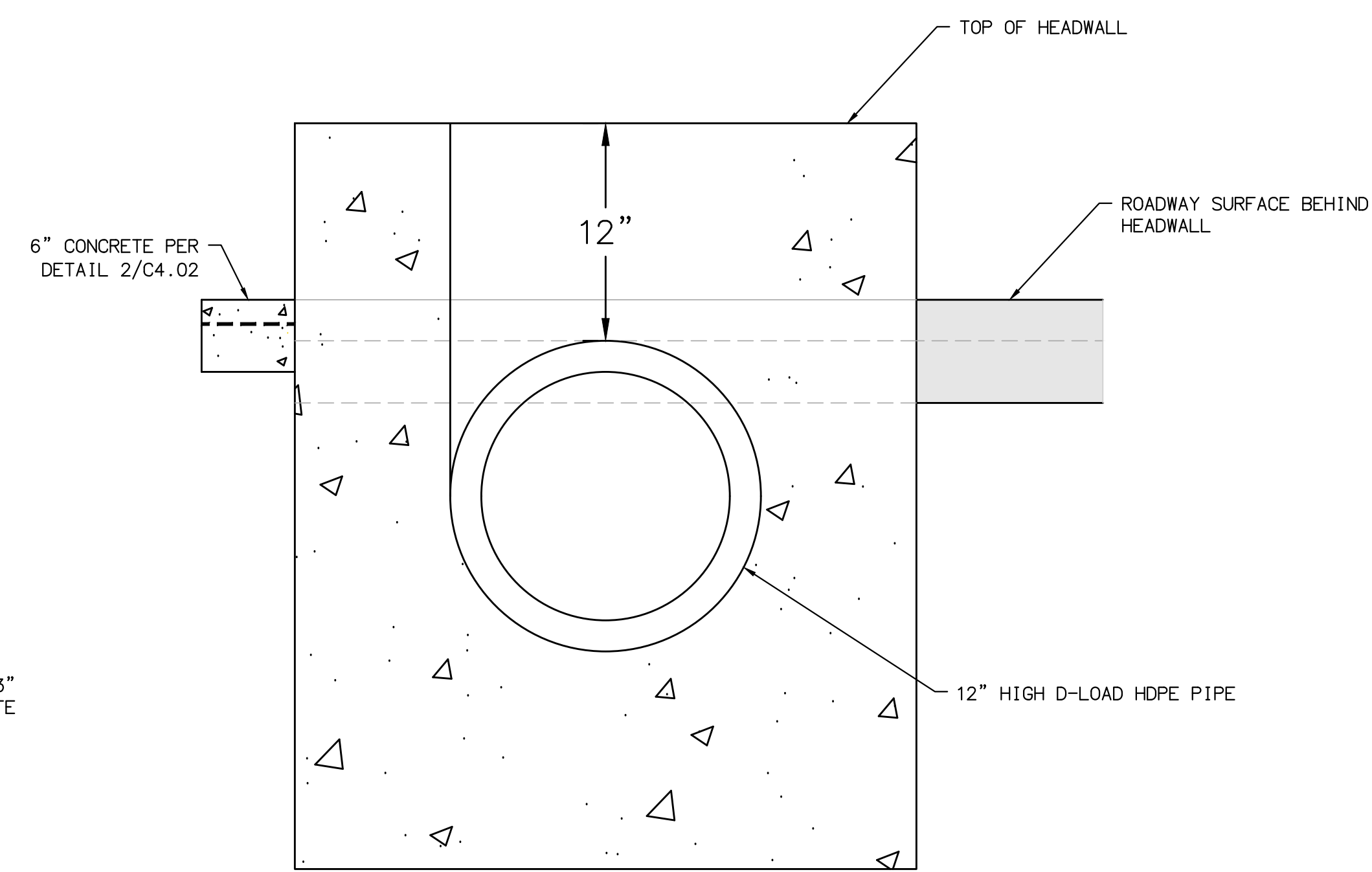

6  
C4.02  
DETAIL  
**MODIFIED TYPE 'U' HEADWALL PER SDRSD D-34**  
N.T.S.

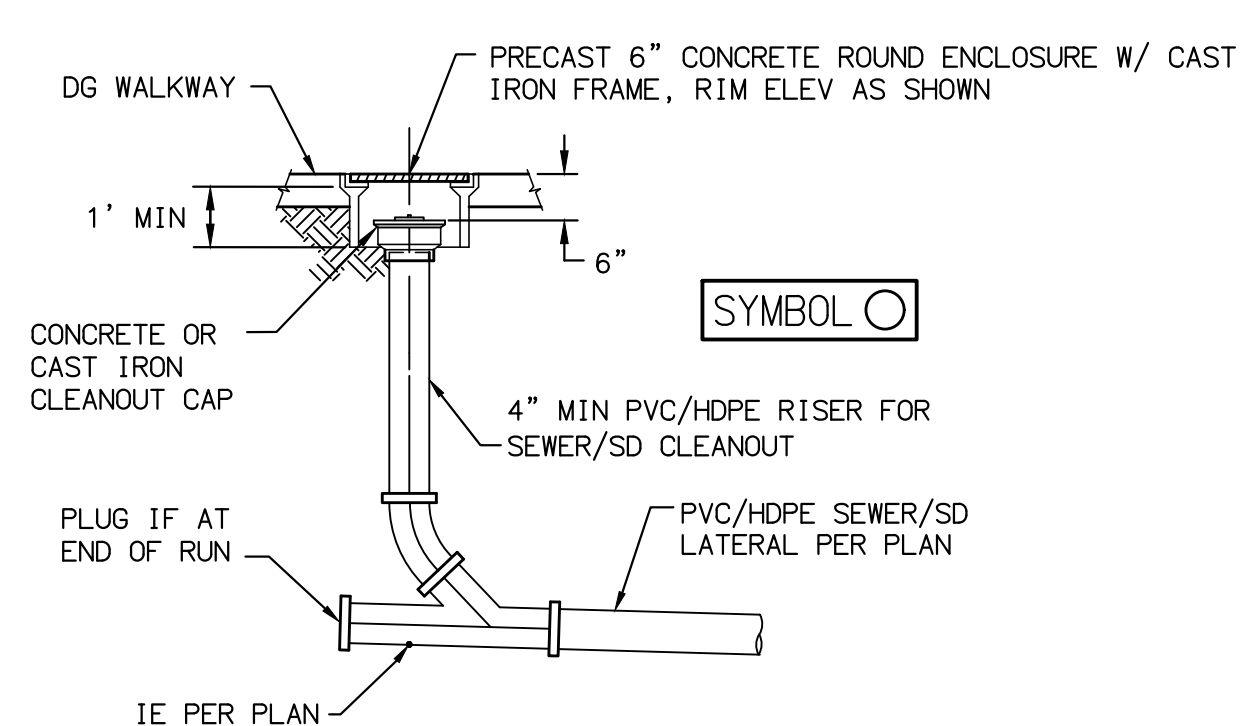

- NOTES:**
1. CLEANOUT PIPE SIZE SHALL MATCH LATERAL PIPE SIZE, MINIMUM 4".
  2. SINGLE CLEANOUTS SHALL BE INSTALLED ON SERVICE LINES AS INDICATED ON PLANS.

7  
C4.02  
DETAIL  
**STORM DRAIN/SEWER CLEANOUT**  
N.T.S.

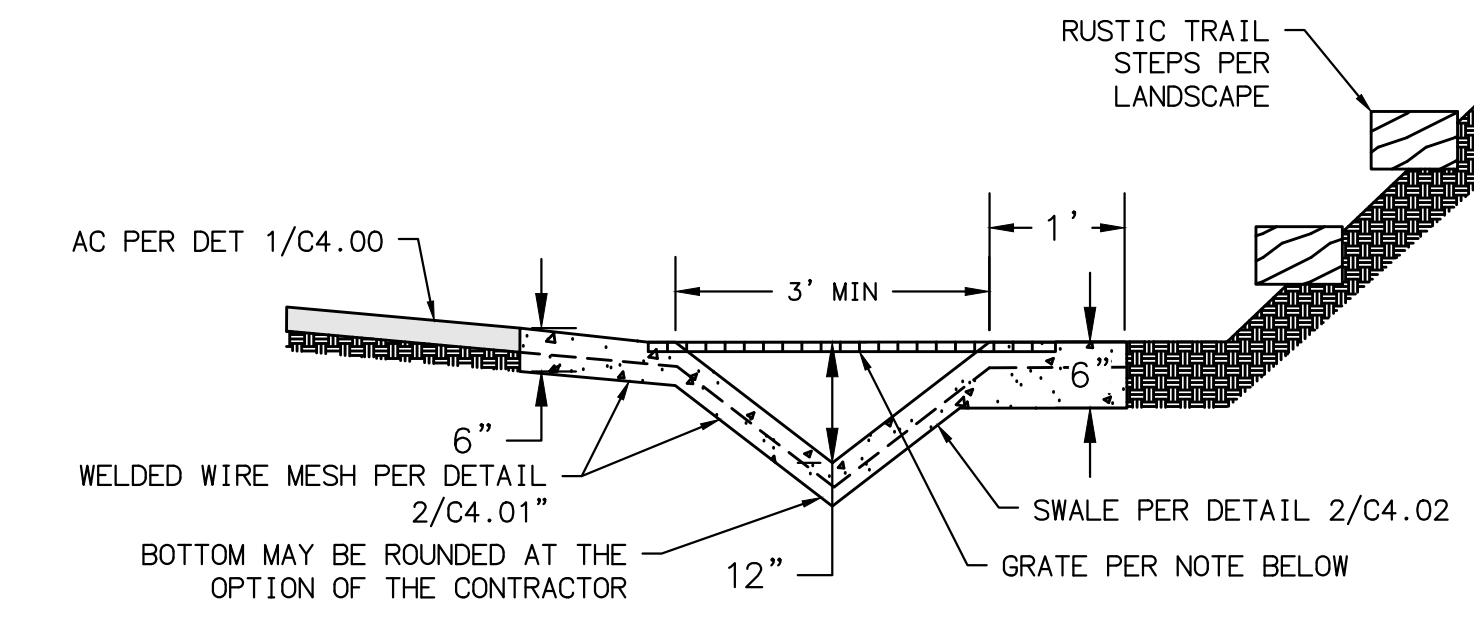

- NOTES:**
1. GRATE SHALL BE NEEHAH FOUNDRY R-4977-4B OR EQUIVALENT. PLACE TWO GRATES ADJACENT TO ONE ANOTHER TO CREATE 4' MIN WIDE CROSSING OVER SWALE.

8  
C4.02  
DETAIL  
**SWALE CROSSING DETAIL**  
N.T.S.



REGISTRATION STAMP



CFM STAMP

KEYPLAN

Issue	Issue	Date
Job Number	181911000	
Drawn	Author	
Checked	Checker	
Approved	Approver	

**CIVIL - STORM WATER  
DETAILS**

SHEET NUMBER

**C4.02**

**5434: UCSD  
PEPPER  
CANYON  
ANCILLARY  
SITE WORK**  
University of California  
San Diego Campus  
La Jolla, California 92037

**95%  
CONSTRUCTION  
DOCUMENTS**  
April 30, 2021



REGISTRATION STAMP

CFM STAMP

KEYPLAN

DATE	ISSUE	BY
10/19/2020	10/19/2020	Author
		Checked
		Approved

TITLE

**CIVIL - CROSS SECTIONS**

SHEET NUMBER

**C4.10**

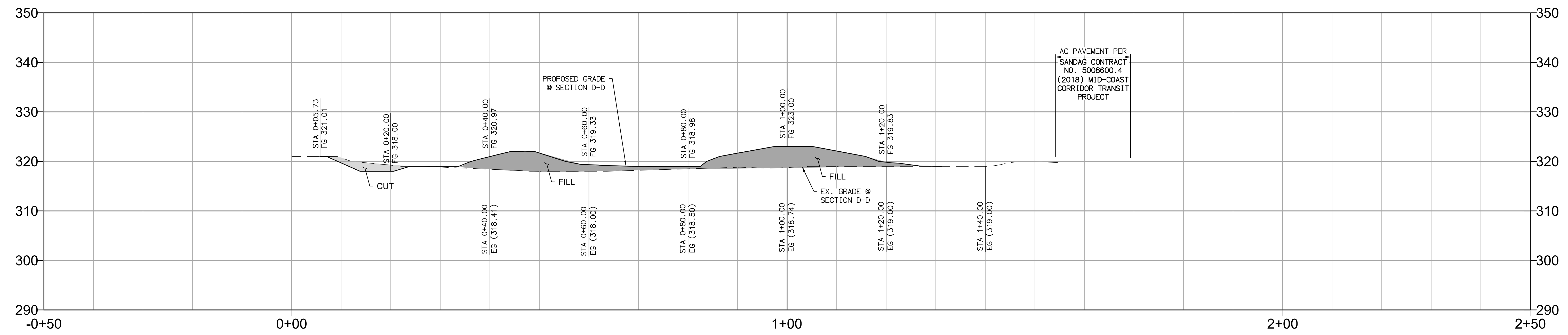

**D**  
C4.10  
**SOUTH SECTION**  
SCALE: HORIZ. 1"=10'  
VERT. 1"=10'

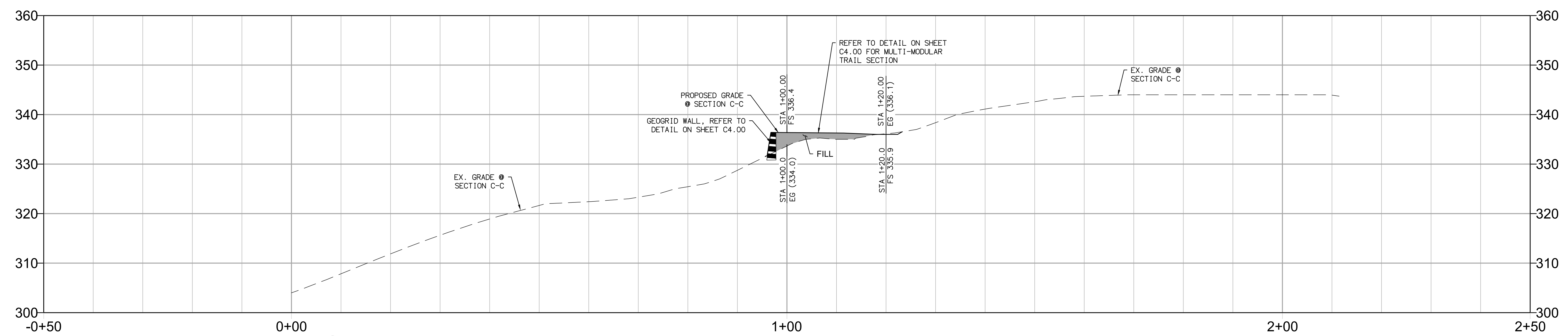

**C**  
C4.10  
**NORTH SECTION**  
SCALE: HORIZ. 1"=10'  
VERT. 1"=10'

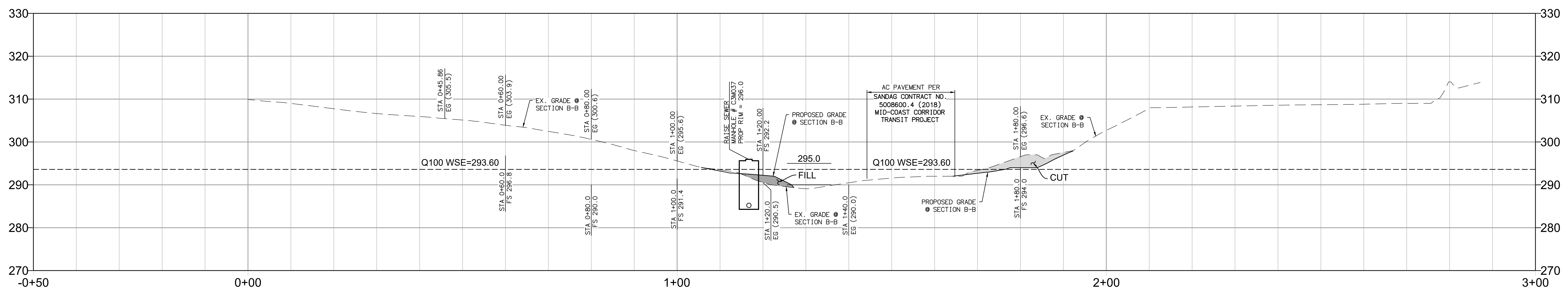

**B**  
C4.10  
**MIDDLE SECTION**  
SEE PLAN VIEW C2.03  
SCALE: HORIZ. 1"=10'  
VERT. 1"=10'

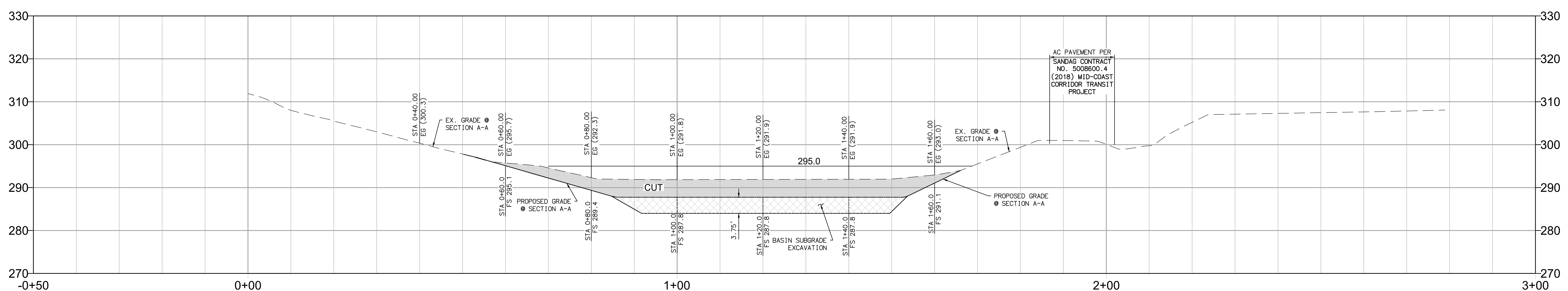

**A**  
C4.10  
**MIDDLE (BASIN) SECTION**  
SEE PLAN VIEW C2.03  
SCALE: HORIZ. 1"=10'  
VERT. 1"=10'

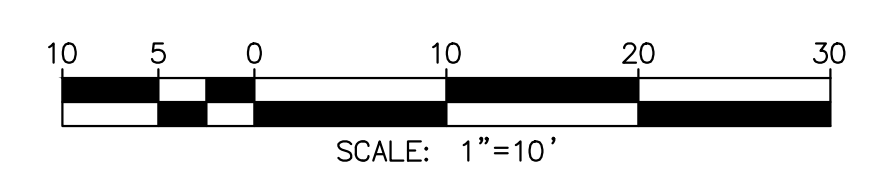

SCALE: 1"=10'

C:\USERS\PUBLIC\MPR\21\04555519\5434\_C4.10\_PCASW\_DT.DWG JONES, CHRISTIAN 4/28/2021 9:13 PM

**5434: UCSD  
PEPPER  
CANYON  
ANCILLARY  
SITE WORK**  
University of California  
San Diego Campus  
La Jolla, California 92037

**95%  
CONSTRUCTION  
DOCUMENTS**  
April 30, 2021



REGISTRATION STAMP



CFM STAMP

KEYPLAN

DATE	ISSUE	BY
10/31/2020	10/31/2020	Author
		Checked
		Approved

TITLE  
**CIVIL - WATER QUALITY  
BASIN SECTION &  
DETAILS**

SHEET NUMBER

**C4.20**

BASIN SPECIFICATIONS				
	ROCK/ COBBLE THICKNESS "A" (IN)	SOIL THICKNESS "B" (IN)	GRAVEL THICKNESS "C" (IN)	PERFORATED PIPE IE ELEVATION ABOVE BASIN BOTTOM "D" (IN)
REGIONAL	3	18	24	3

BASIN SPECIFICATIONS
1. CONSTRUCT CONCRETE RISER UTILIZING A TYPE "AS" SORSO D-9 STORM DRAIN CLEANOUT MODIFIED AS FOLLOWS: FROM SIX 8-INCH ORIFICES ON EACH SIDE OF THE CLEANOUT AT ELEVATIONS INDICATED ON DETAIL "A" SHEET C4.20 OF THE PLAN SET. ENSURE THAT REINFORCING STEEL MAINTAINS A MINIMUM SEPARATION OF 3" FROM EDGE OF CONCRETE AND OPENINGS. MODIFY TOP OF CLEANOUT TO ACCOMMODATE TWO SORSO D-15 DRAINAGE STRUCTURE GRATES. UTILIZE SORSO D-06 AND D-13 AS REFERENCE FOR MODIFIED CLEANOUT TOP.

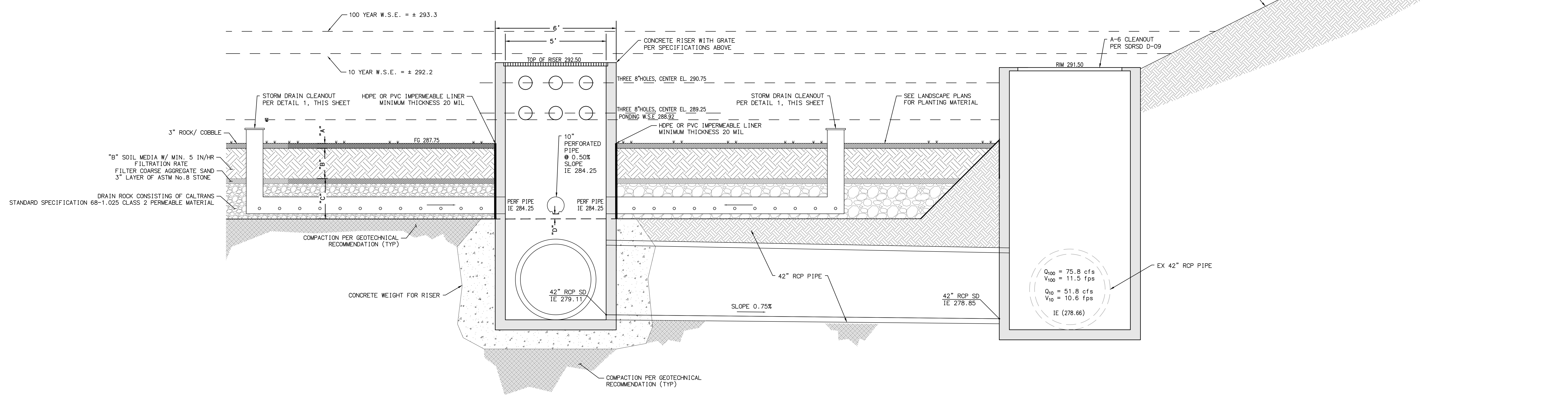

**A**  
REGIONAL WATER QUALITY BASIN  
SEE PLAN VIEW C2.03  
N.T.S.

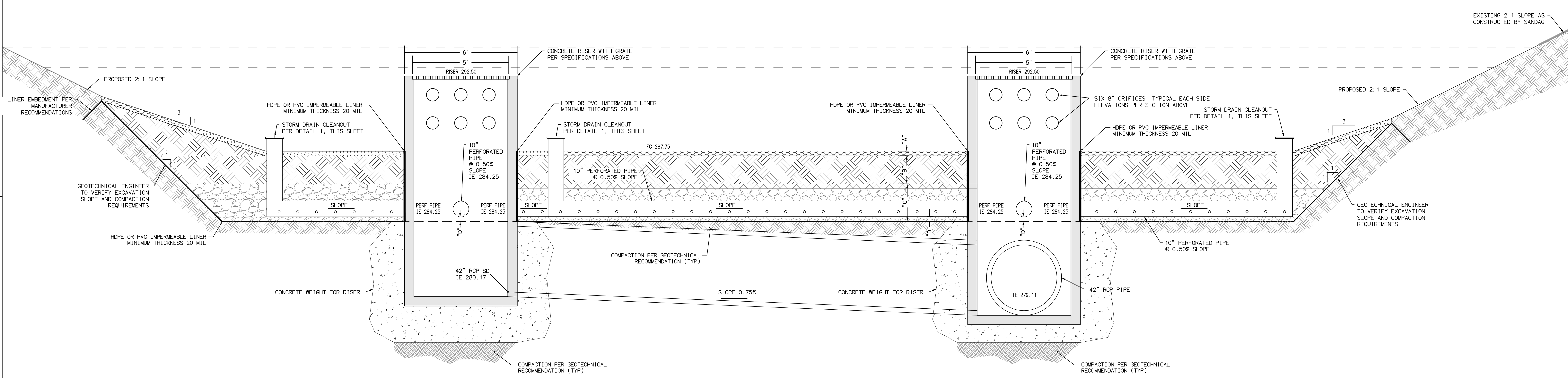

**B**  
REGIONAL WATER QUALITY BASIN  
SEE PLAN VIEW C2.03  
N.T.S.

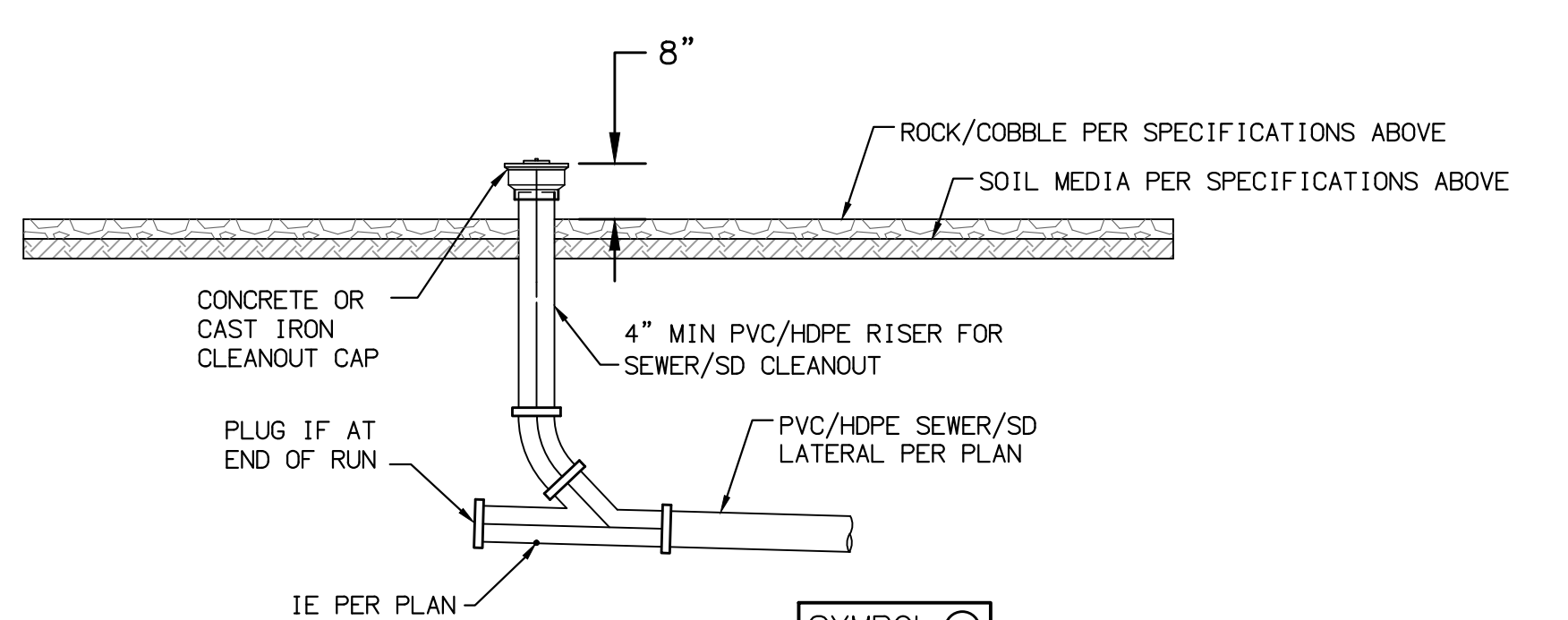

**NOTES:**  
1. CLEANOUT PIPE SIZE SHALL MATCH LATERAL PIPE SIZE, MINIMUM 4".  
2. SINGLE CLEANOUTS SHALL BE INSTALLED ON SERVICE LINES AS INDICATED ON PLANS.  
3. SINGLE CLEANOUTS SHALL ALWAYS BE ORIENTATED TO FACILITATE CLEANING DOWN STREAM.

**1**  
STORM DRAIN/SEWER CLEANOUT  
N.T.S.

C:\USERS\PUBLIC\MPR\A\2\A\0555519\5434\_C420\_PC\ASIN\_D1\_IN\BIDDING\_JONES CHRISTIAN 4/28/2021 9:14 PM





REGISTRATION STAMP



CFM STAMP

KEYPLAN

DATE	ISSUE	BY
10/11/2020	Author	
	Checked	
	Approved	

TITLE  
**CIVIL - WATER QUALITY  
BASIN SECTION &  
DETAILS**

SHEET NUMBER

**C4.21**

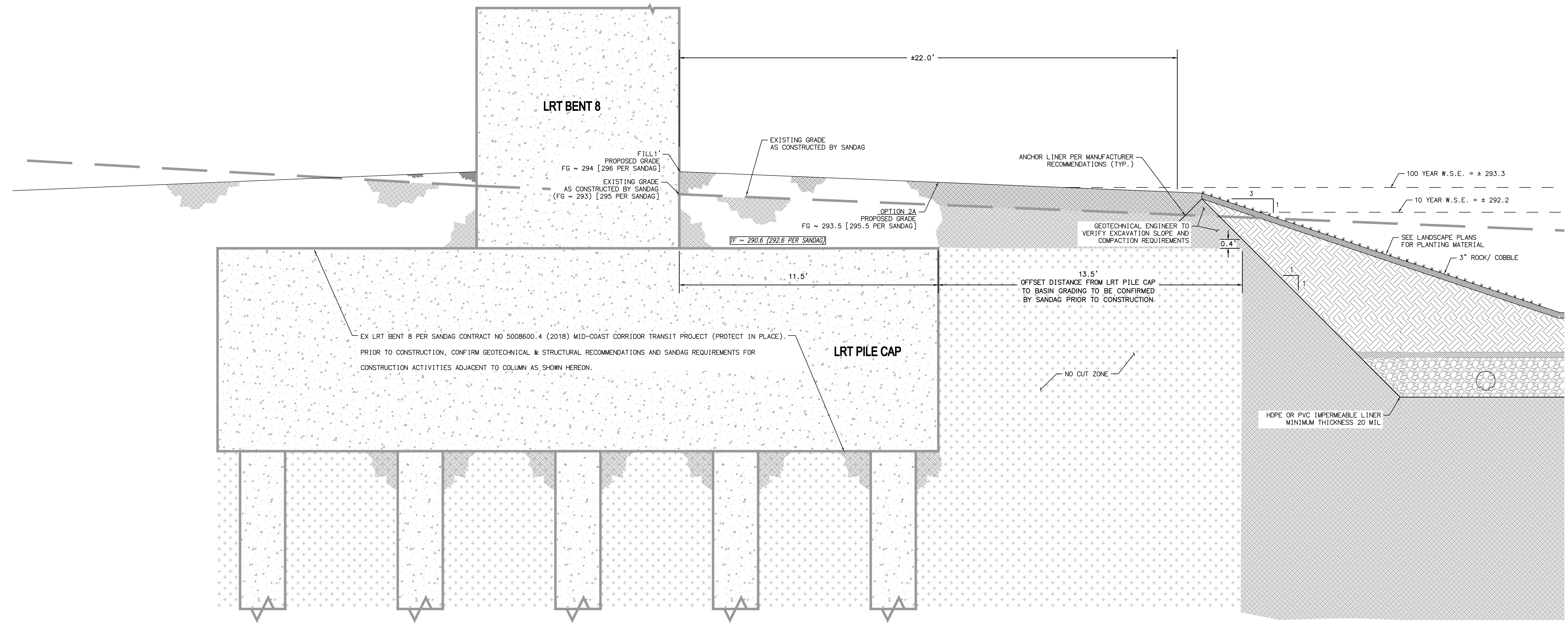

A  
C4.21

**REGIONAL WATER QUALITY BASIN**  
N.T.S

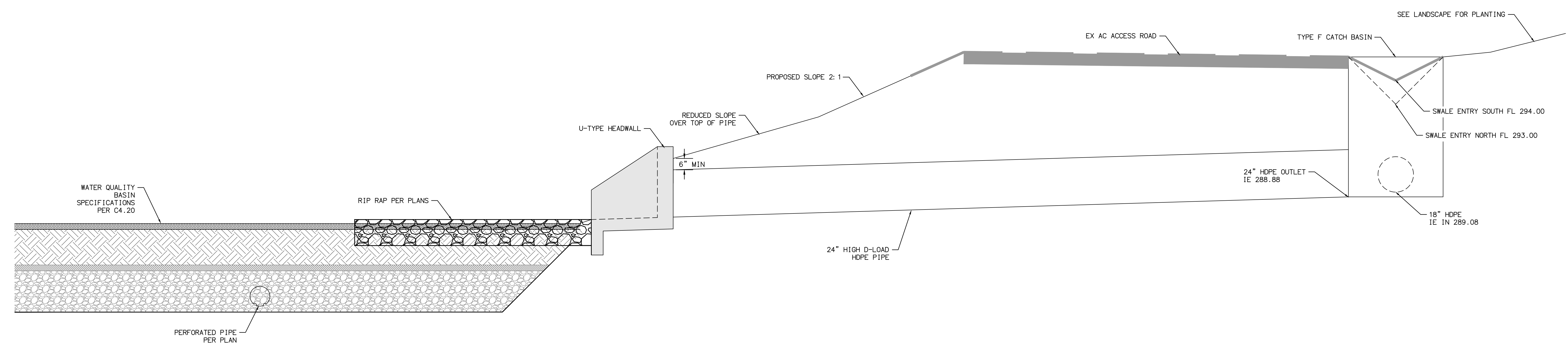

B  
C4.21

**REGIONAL WATER QUALITY BASIN**  
N.T.S

C:\USERS\PUBLIC\MPR\21\04555519\5434\_C420\_PCASIN\_DT\_INCBUILDING\_JONES CHRISTIAN 4/28/2021 9:14 PM

